

Analysis on the Present Condition

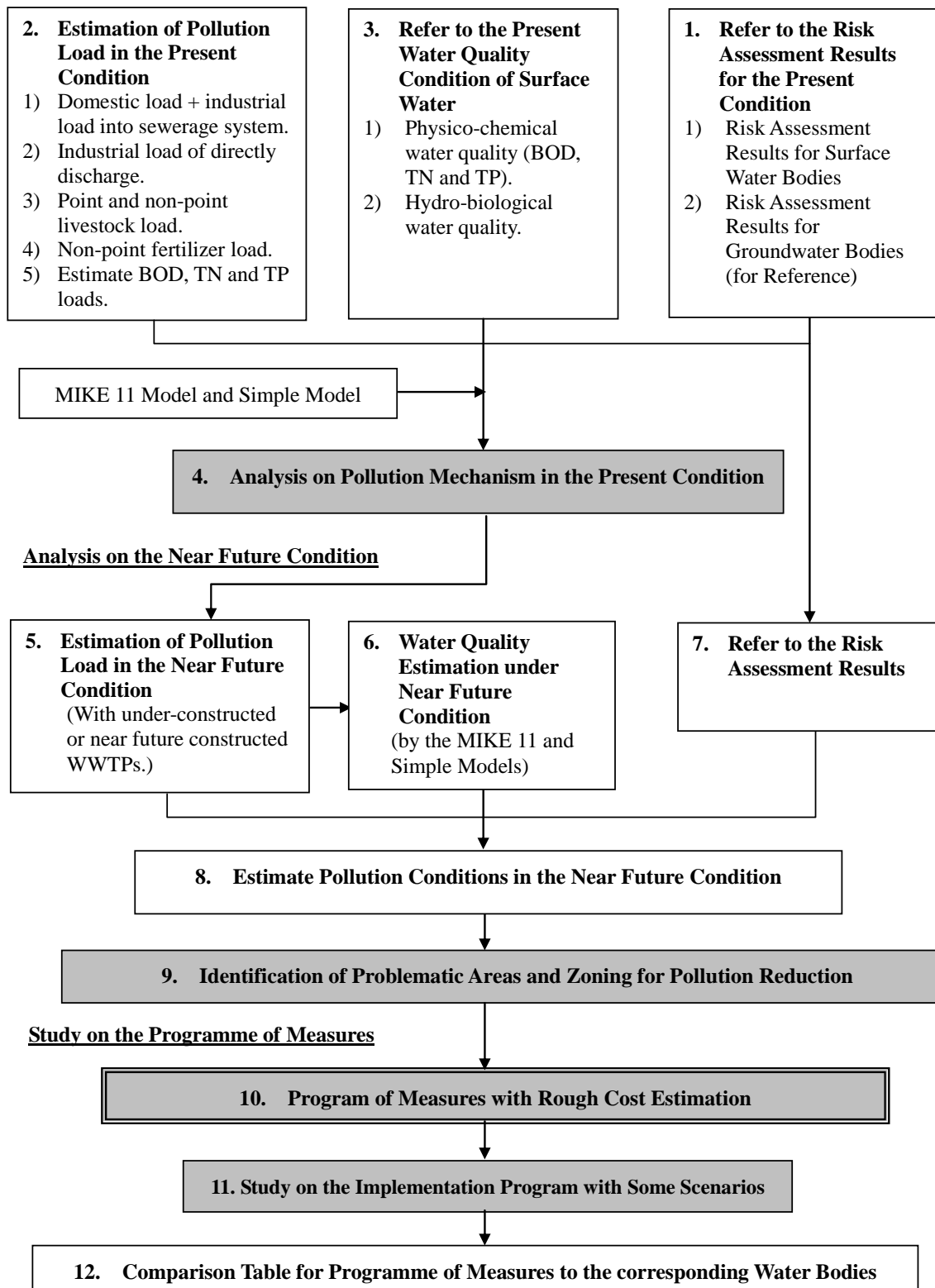

Figure C.4.1 Study Flow on the Programme of Measures for Water Quality Management

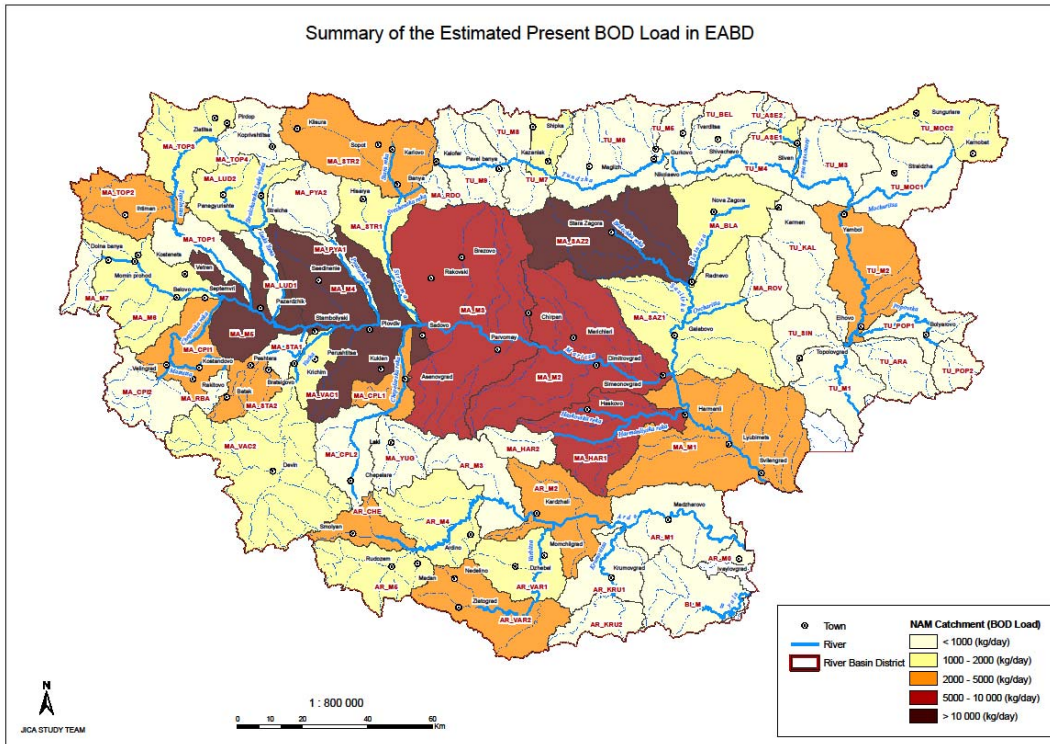

Figure C.4.2 Present BOD Load in EABD

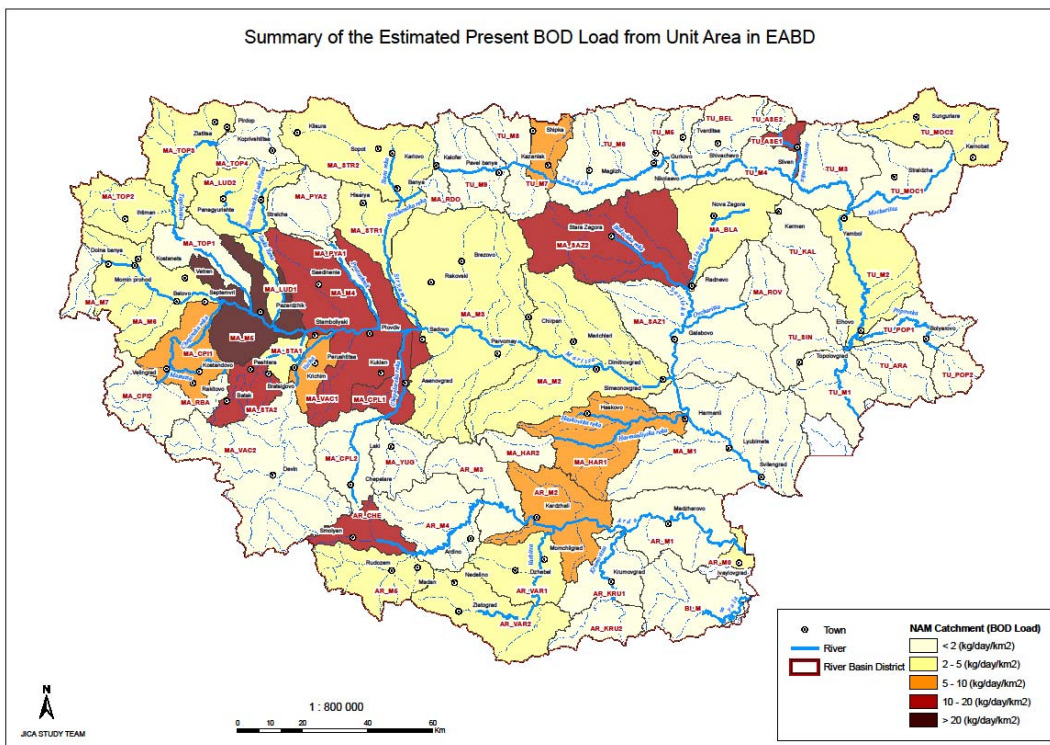

Figure C.4.3 Present BOD Load from Unit Area in EABD

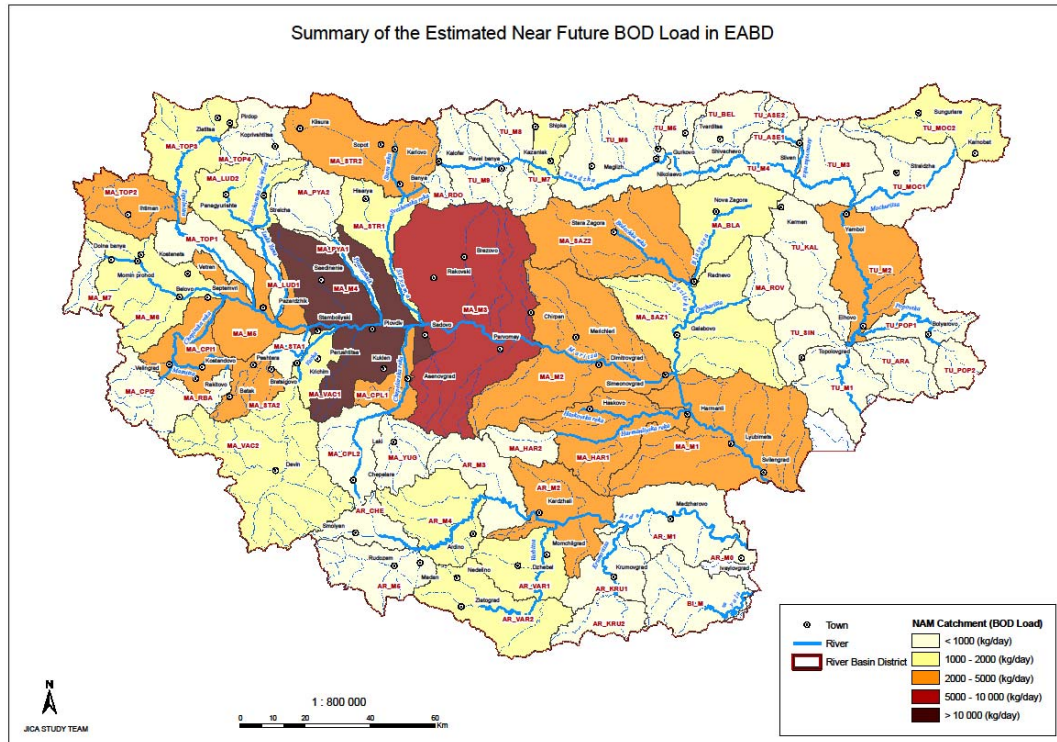

Figure C.4.4 Near Future BOD Load in EABD (with under-constructed and tendering WWTPs)

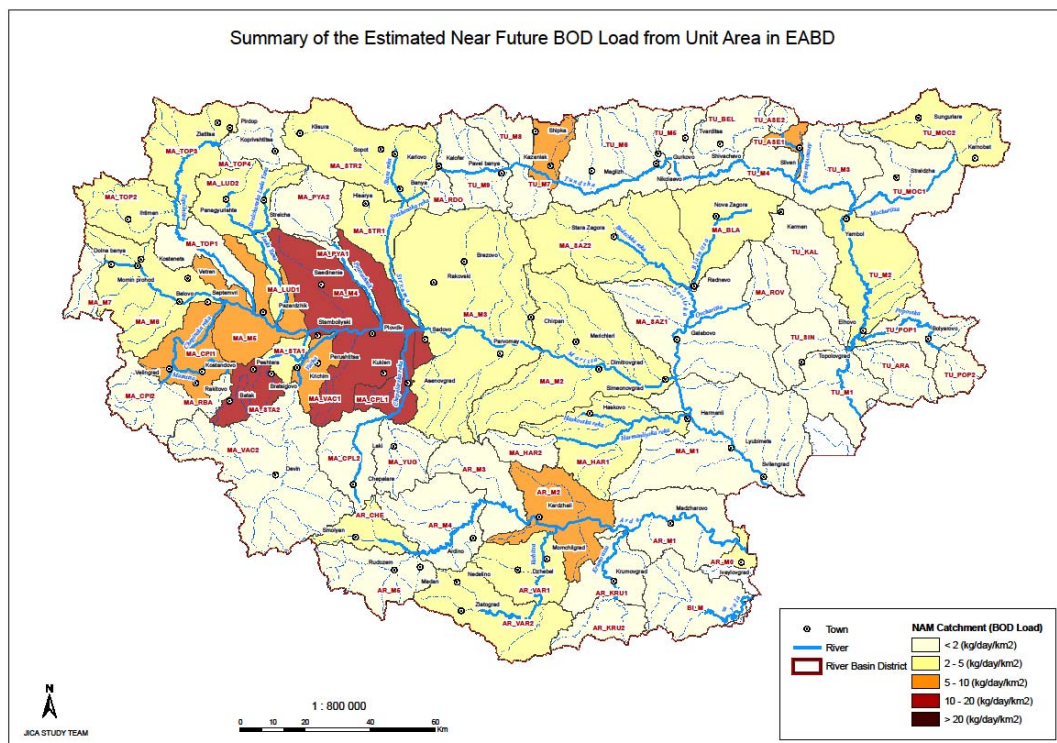

Figure C.4.5 Near Future BOD Load from Unit Area in EABD (with under-constructed and tendering WWTPs)

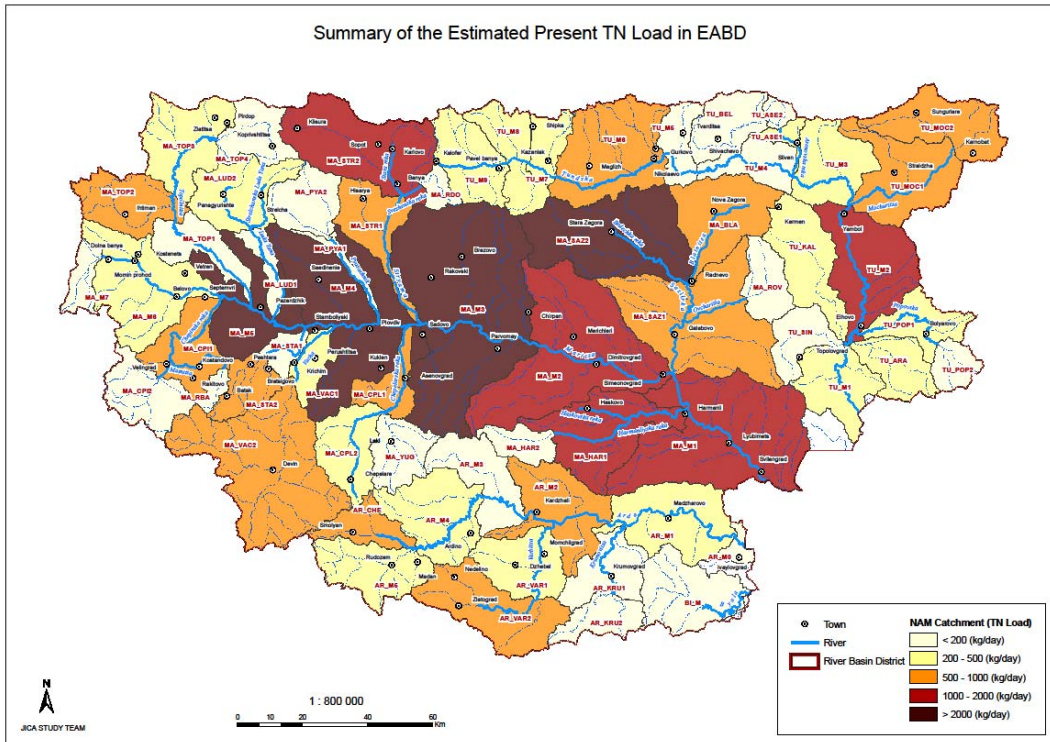

Figure C.4.6 Present TN Load in EABD

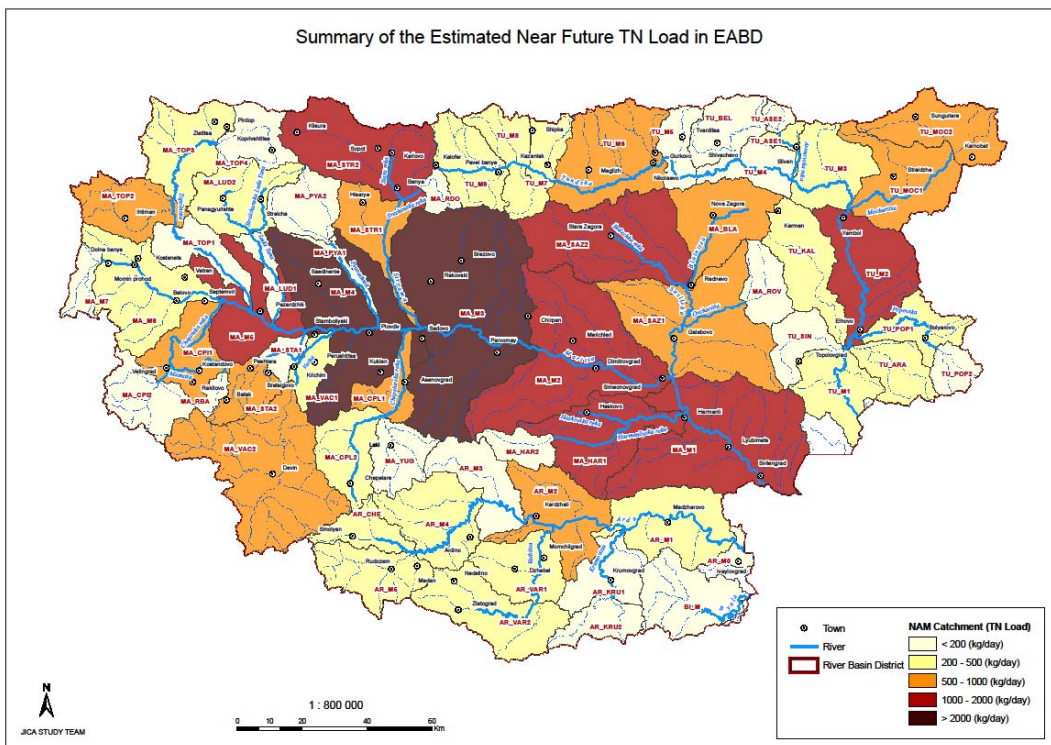

Figure C.4.7 Near Future TN Load in EABD

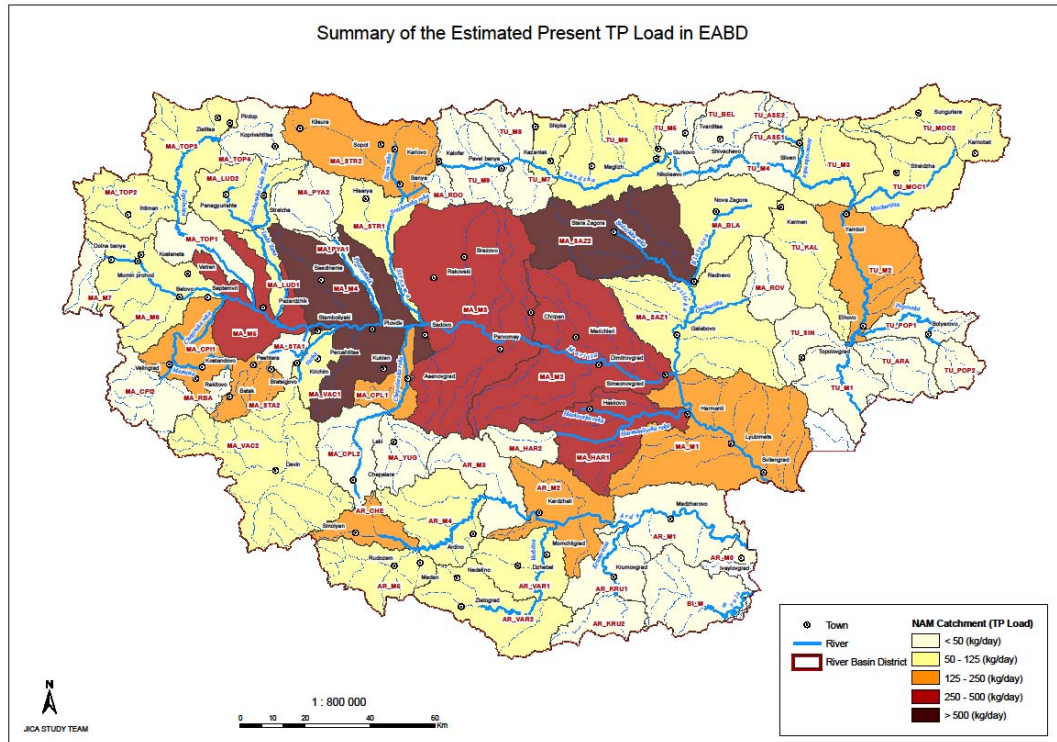

Figure C.4.8 Present TP Load in EABD

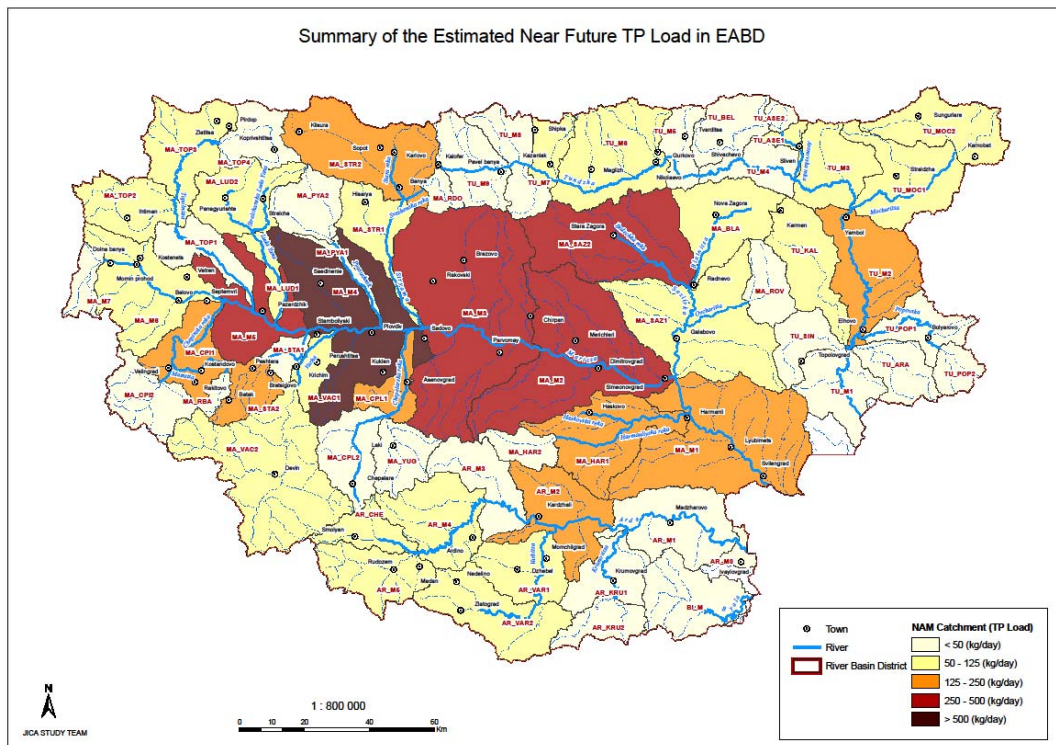

Figure C.4.9 Near Future TP Load in EABD

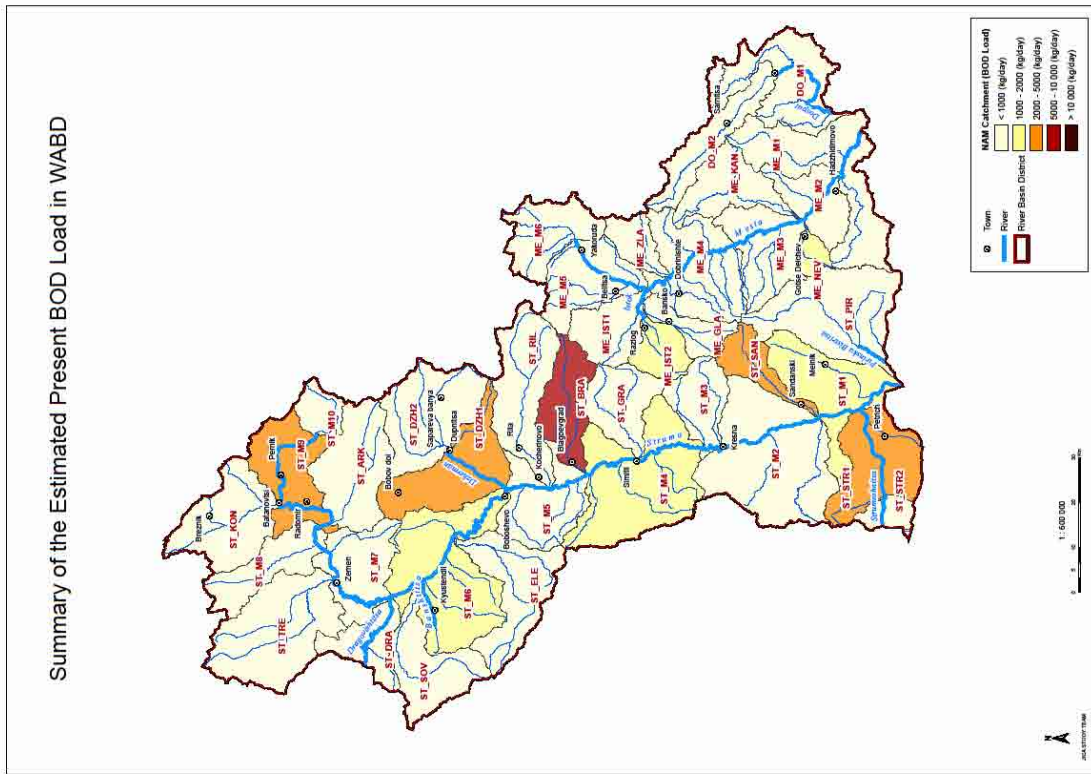

Figure C.4.10 Present BOD Loads in WABD

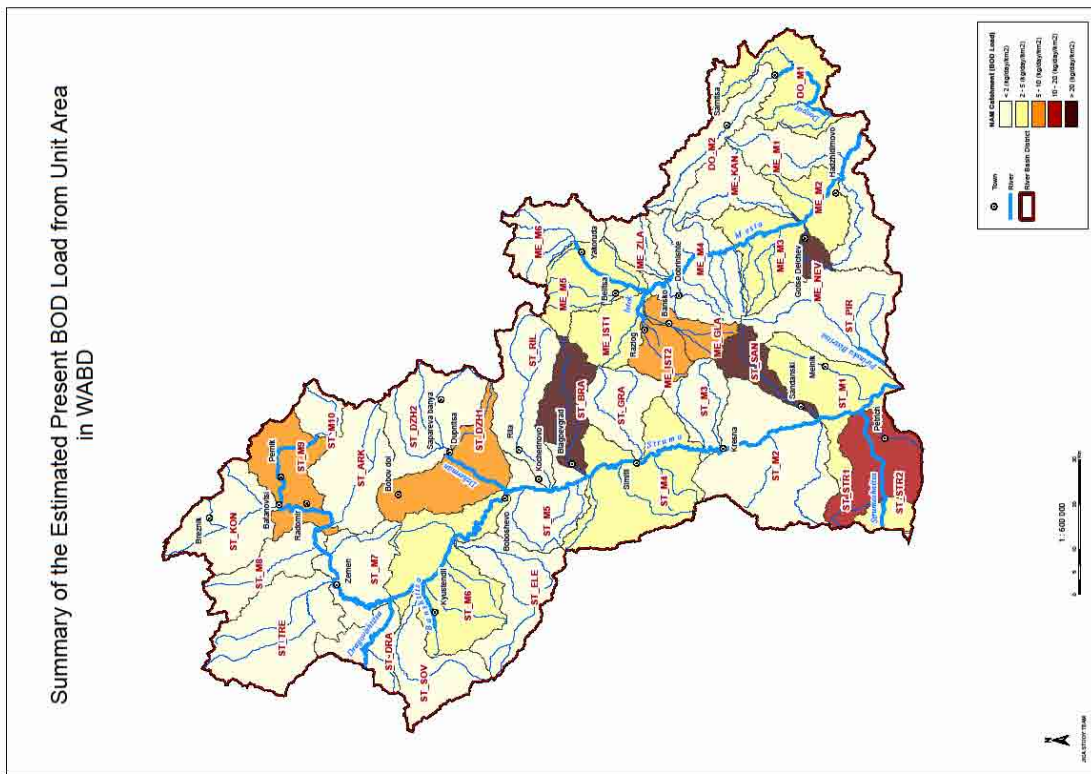

Figure C.4.11 Present BOD Loads from Unit Area in WABD

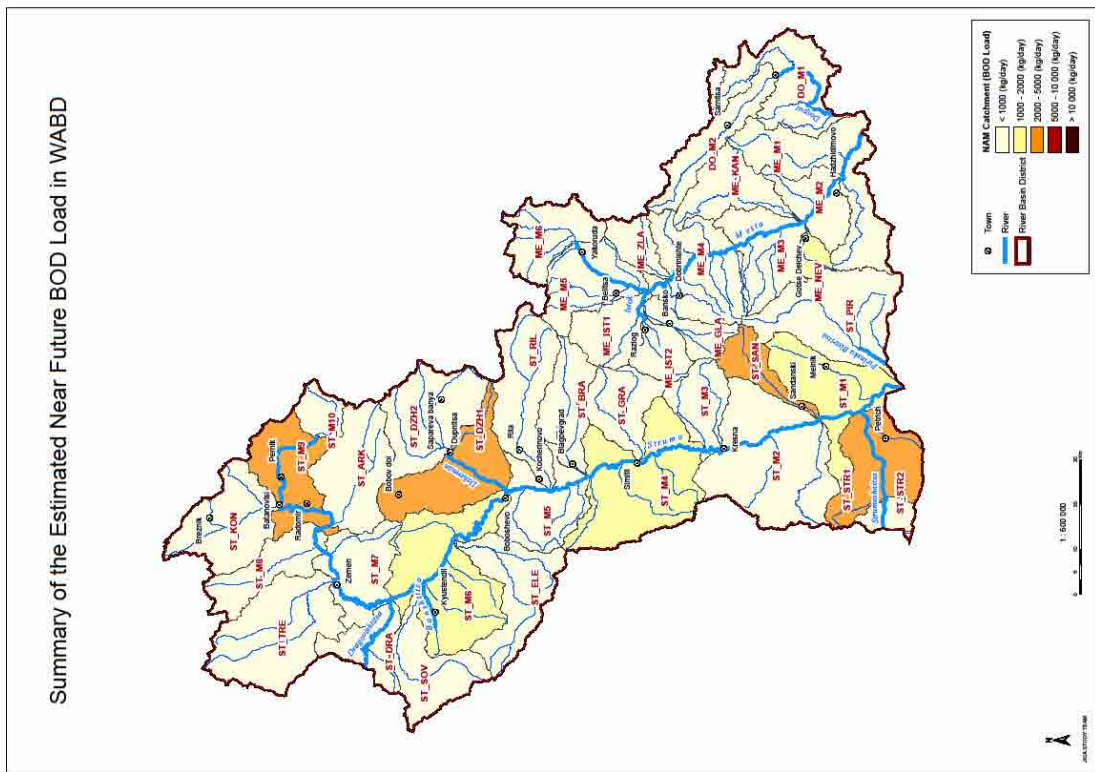

Figure C.4.12 Near Future BOD Loads in WABD with Under-constructed and Tendering WWTPs

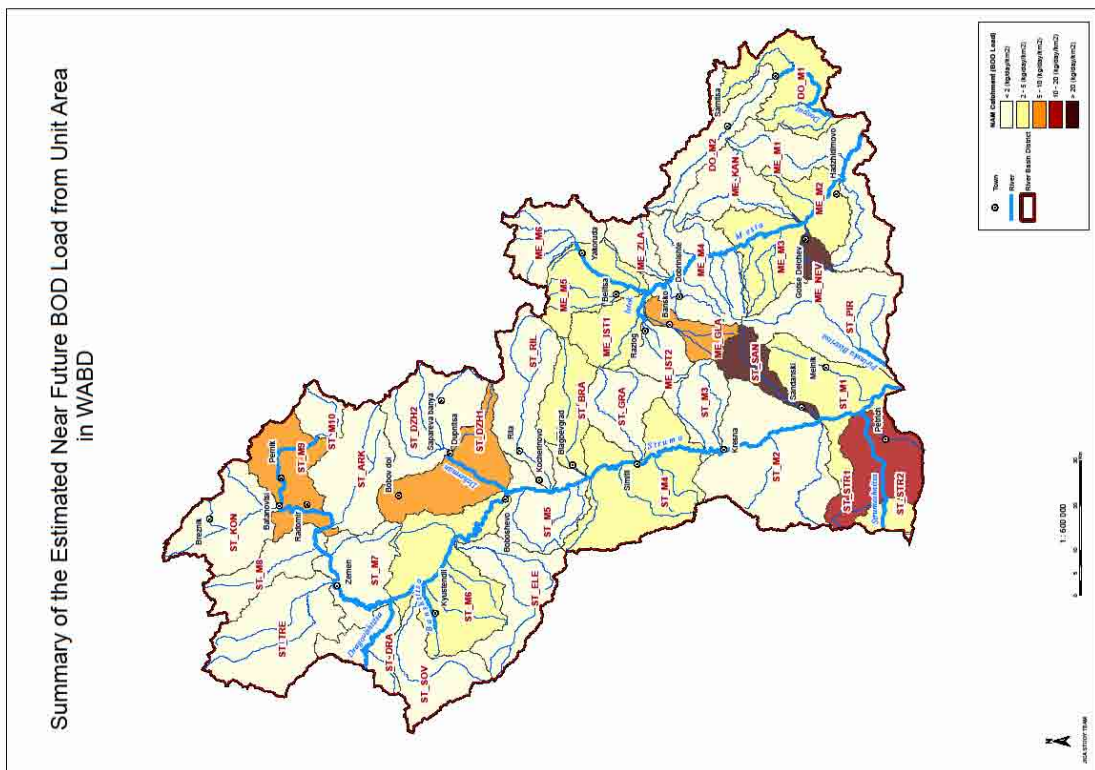

Figure C.4.13 Near Future BOD Loads from Unit Area in WABD

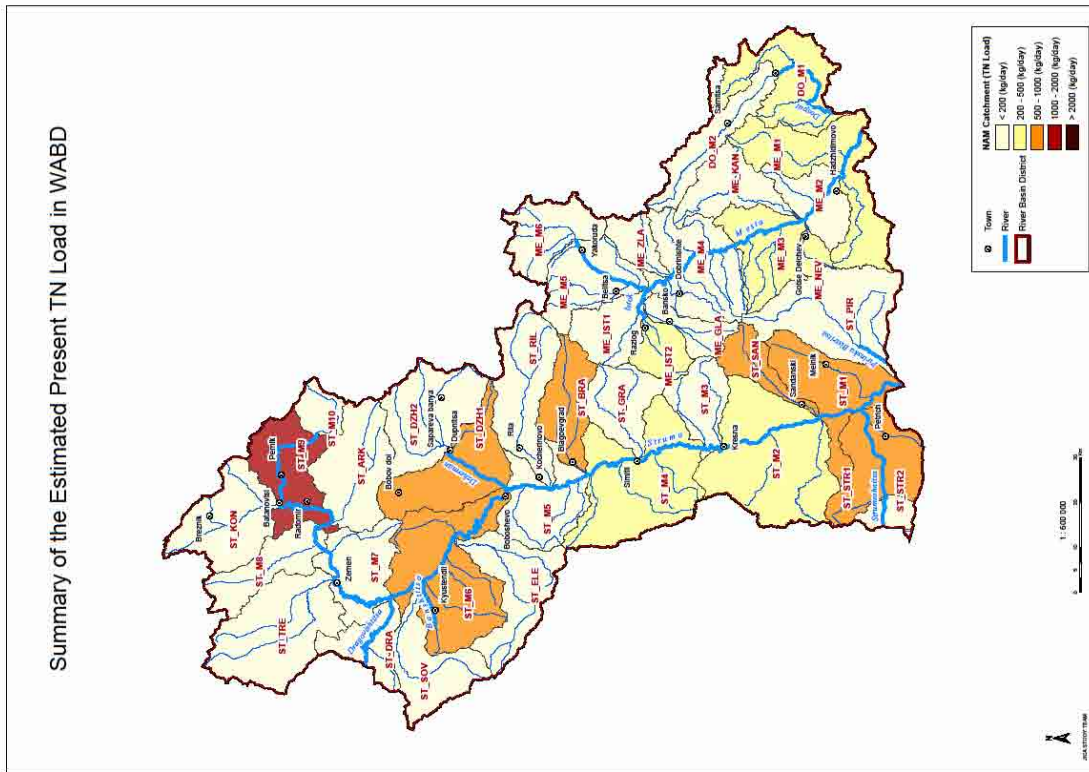

Figure C.4.14 Present TN Loads in WABD

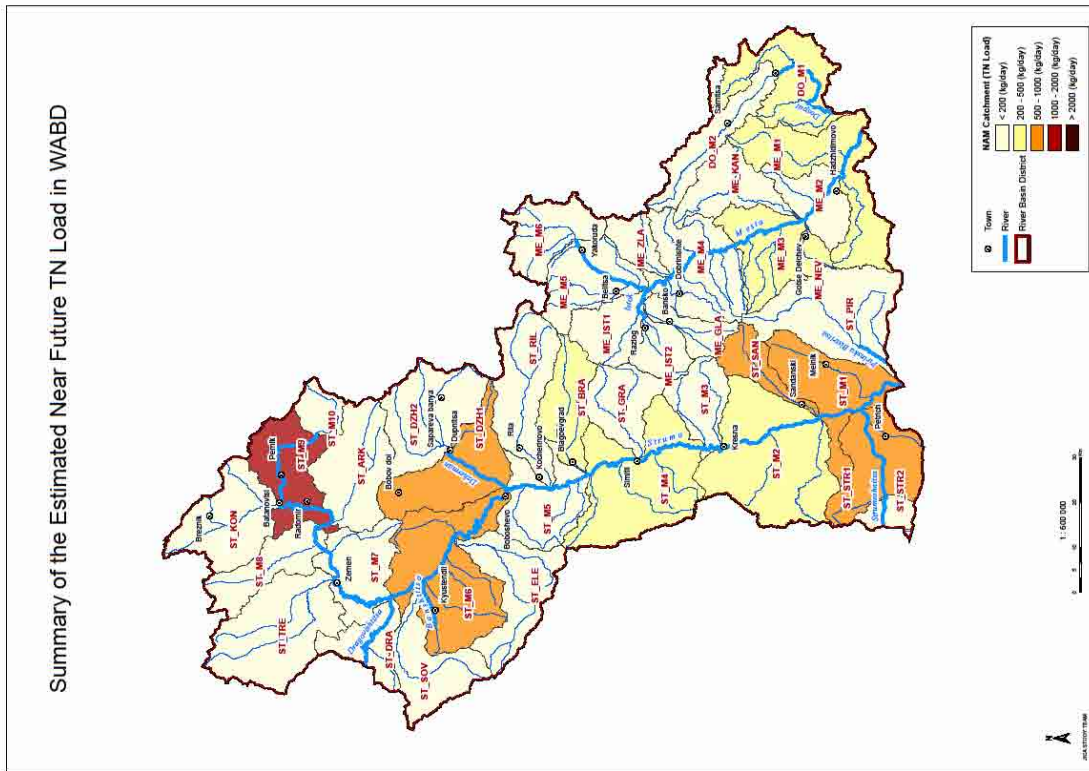

Figure C.4.15 Near Future TN Loads in WABD

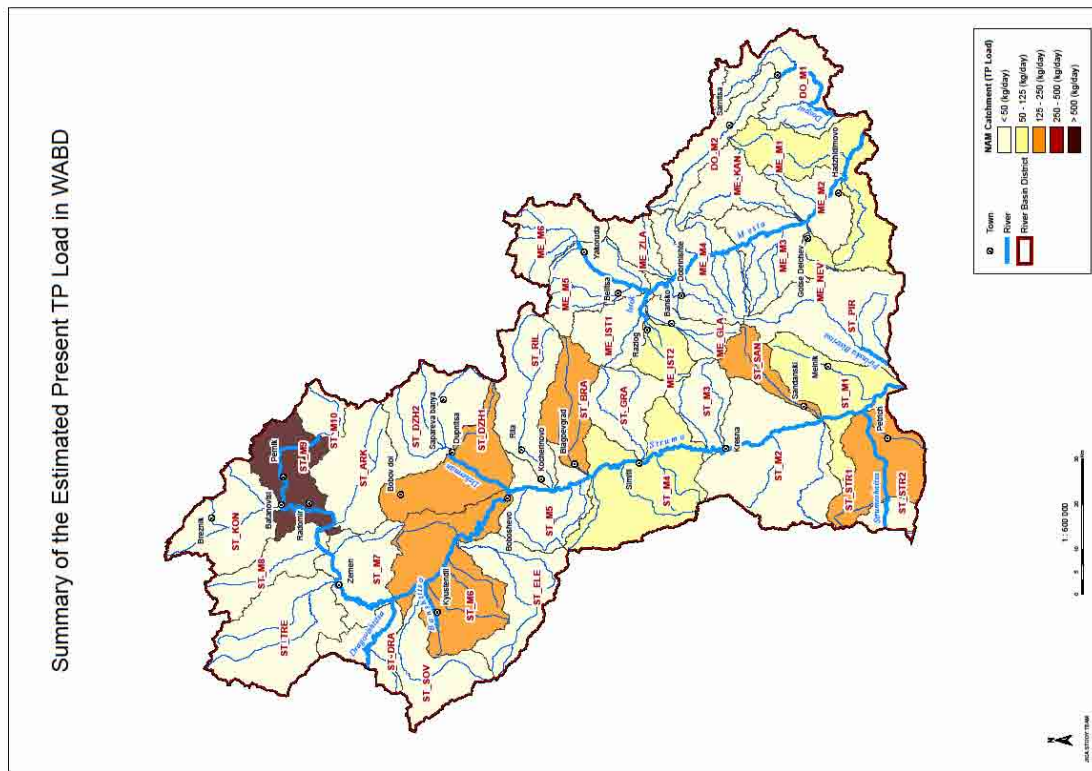

Figure C.4.16 Present TP Loads in WABD

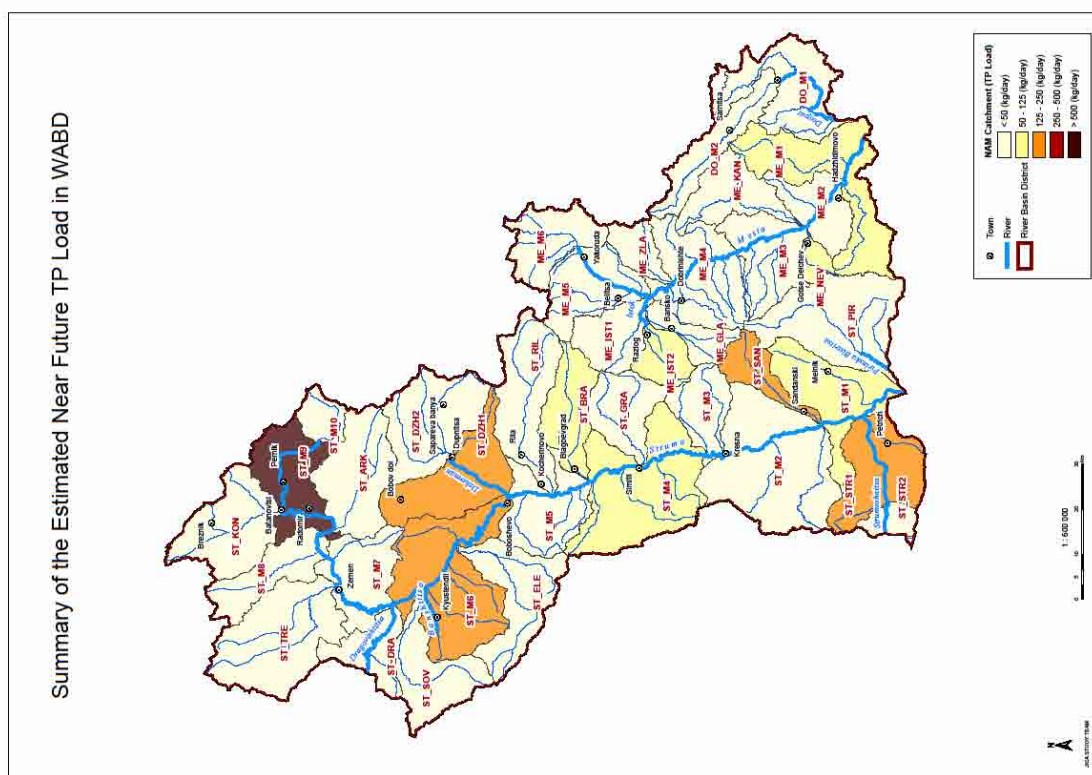

Figure C.4.17 Near Future TP Loads in WABD

Fig. A.3. 17 EABD: Co-relation between Present Catchment BOD Load and River BOD Load

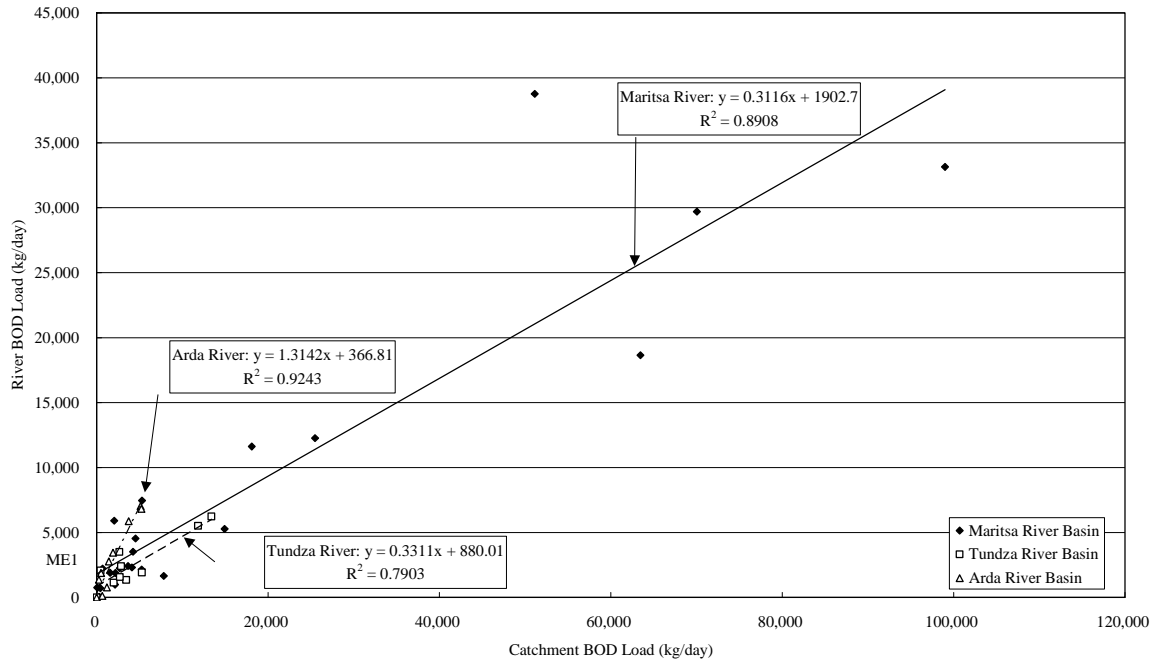

Figure C.4.18 EABD: Co-relation between Present Catchment BOD Load and River BOD Load

Table A.3-18 WABD: Co-relation between Present Catchment BOD Load and River BOD Load

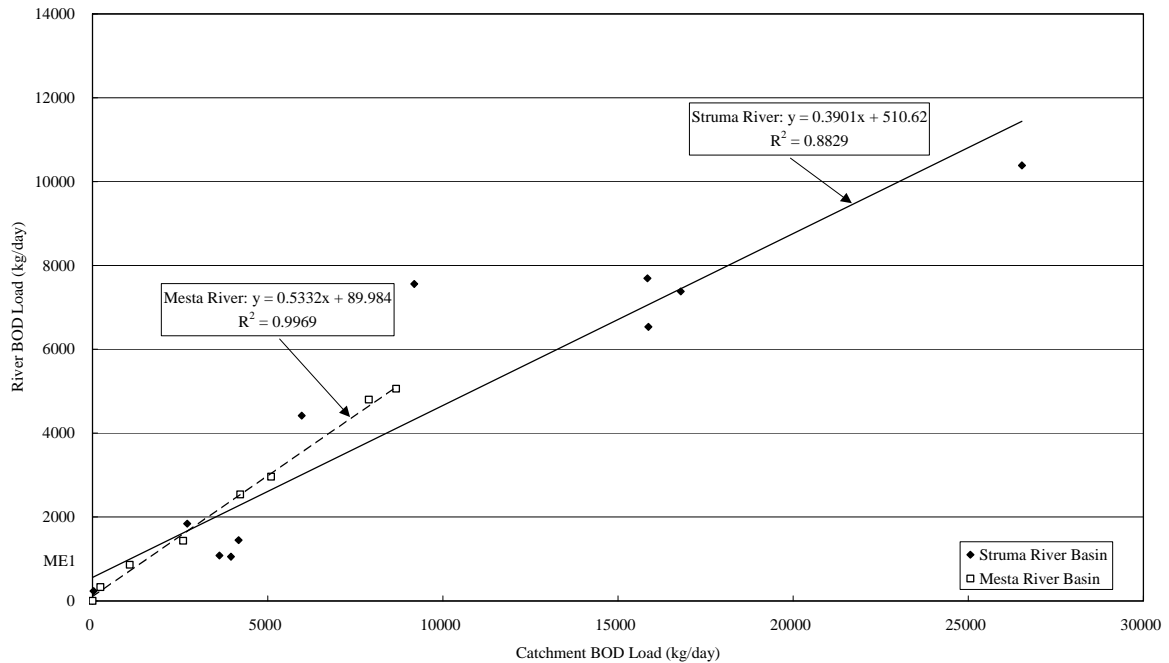

Figure C.4.19 WABD: Co-relation between Present Catchment BOD Load and River BOD Load

EABD Proposed Priority Towns for Wastewater Treatment and Improvement of Sewerage Networks

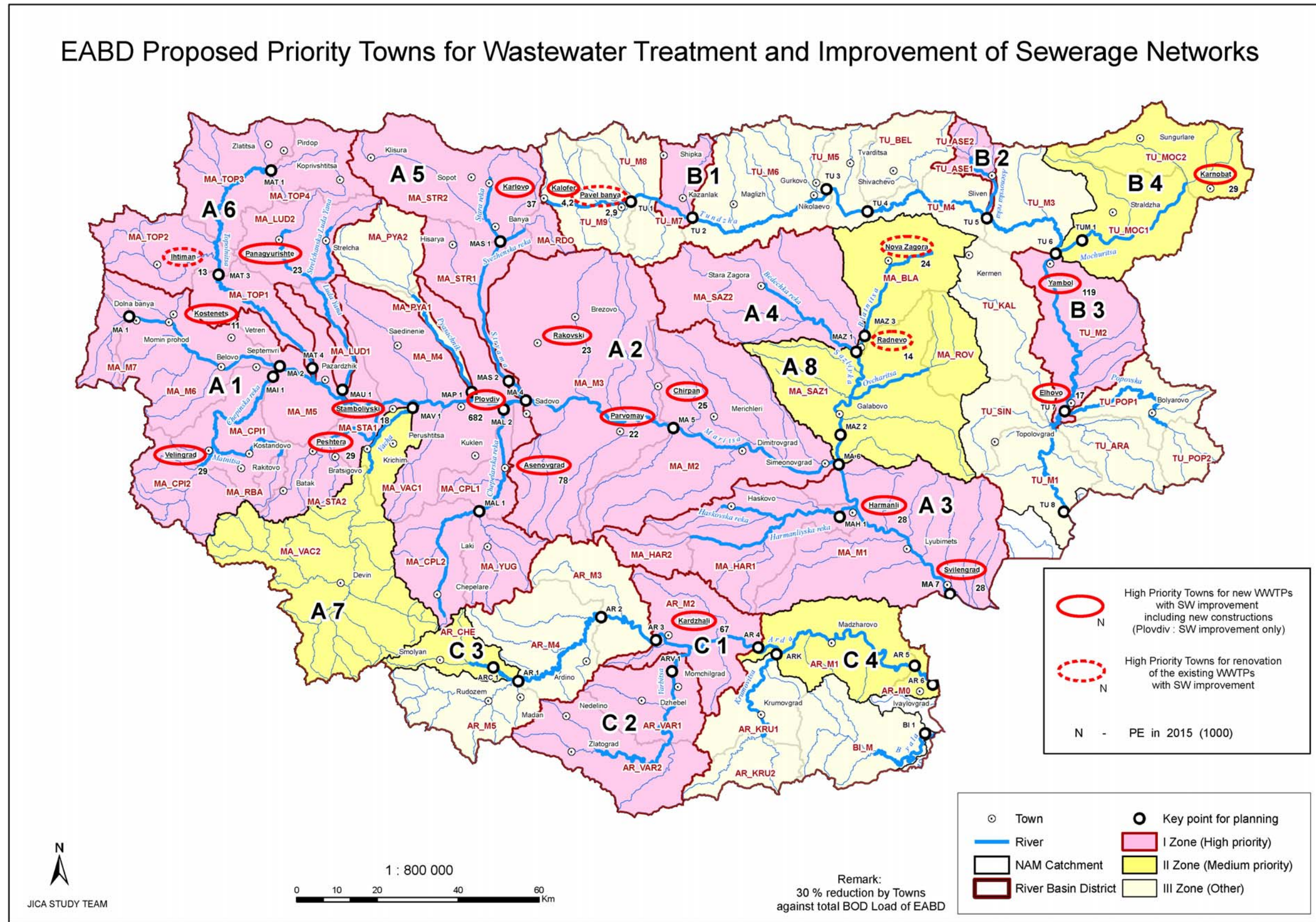

Figure C.4.20 Proposed High Priority Towns for Wastewater Treatment and Improvement of Sewerage Networks in EABD

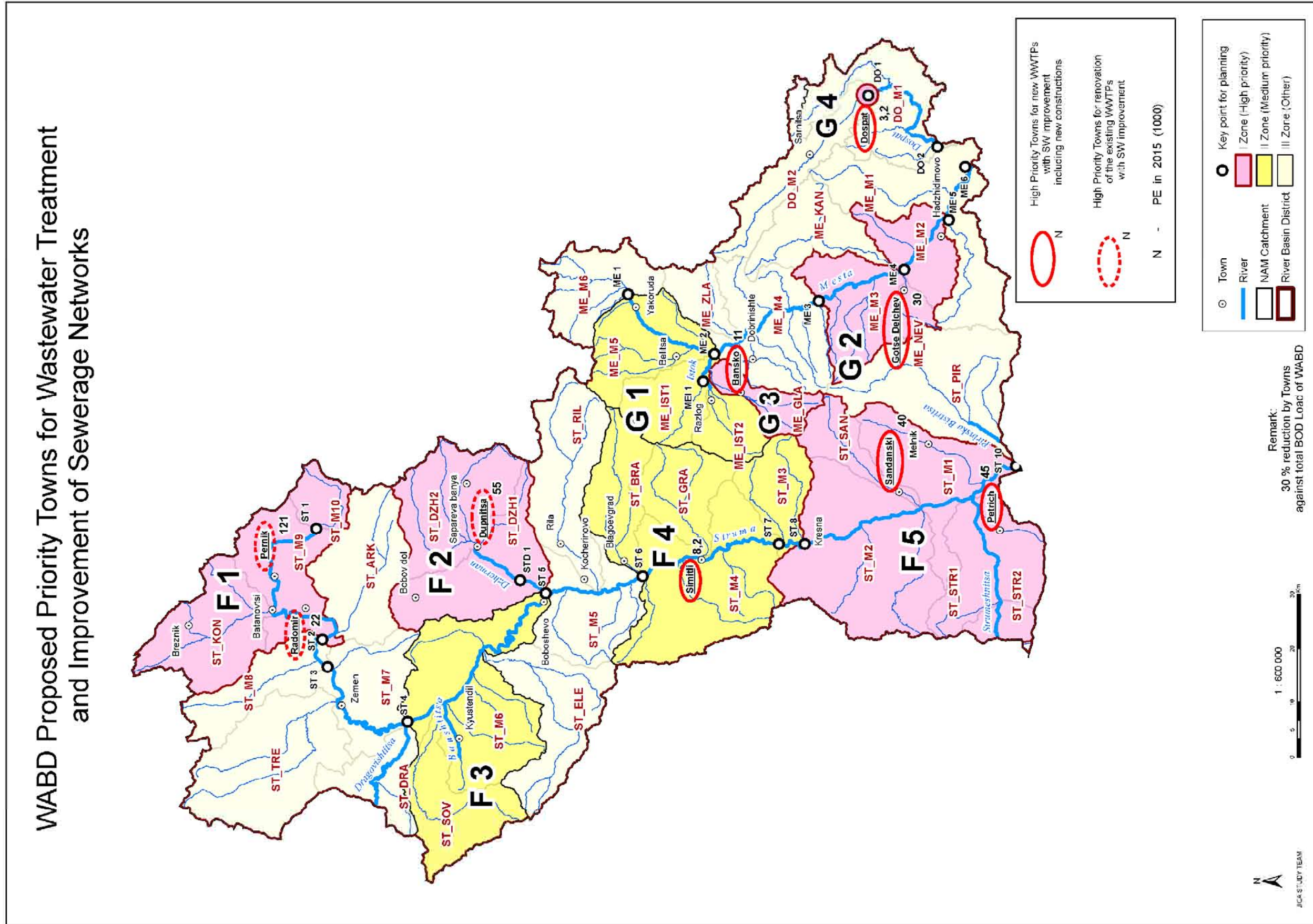

Figure C.4.21 Proposed High Priority Towns for Wastewater Treatment and Improvement of Sewerage Networks in EABD

EABD Proposed Priority Towns for Wastewater Treatment and Improvement of Sewerage Networks

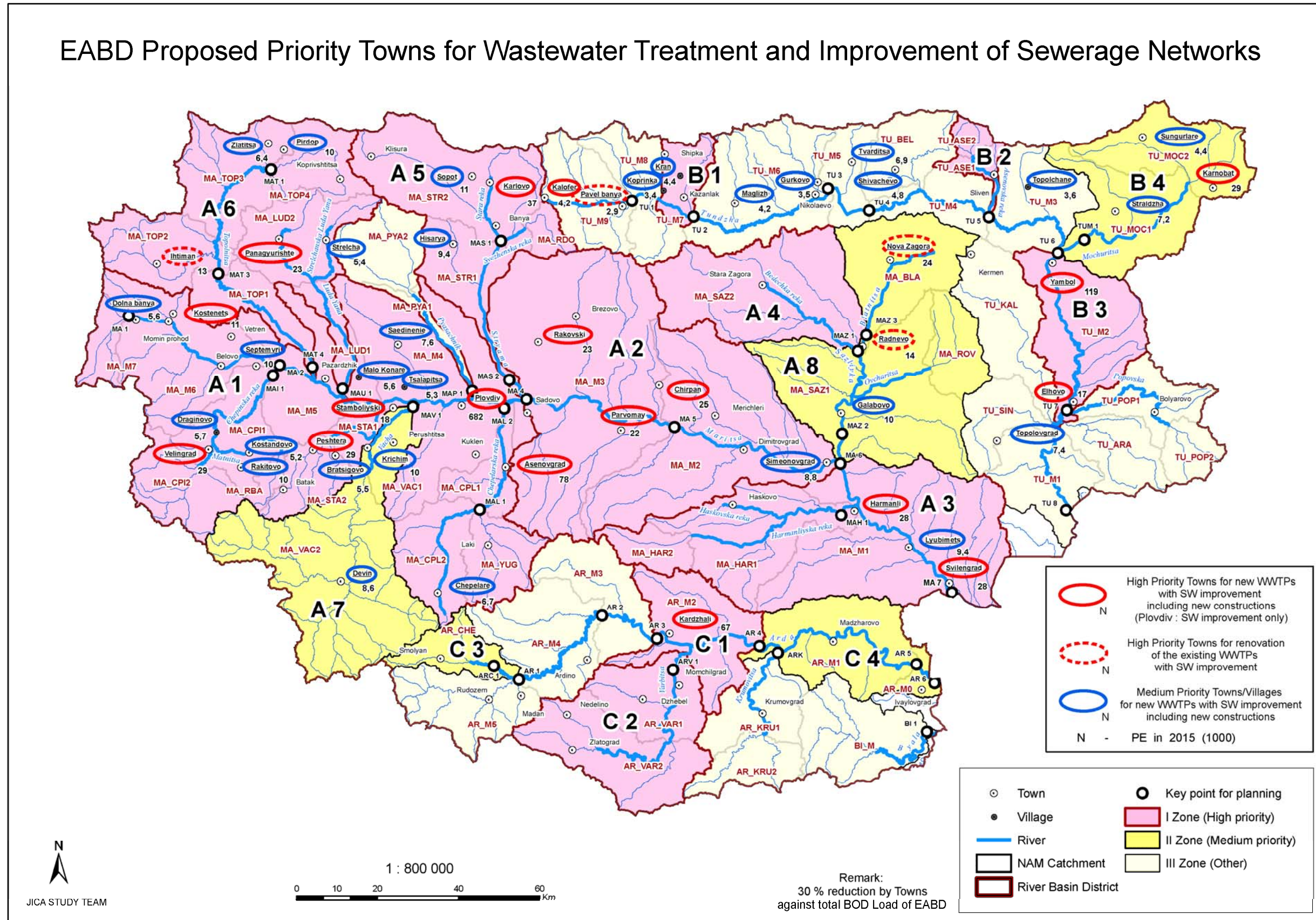

Figure C.4.22 Proposed High and Medium Priority Towns for Wastewater Treatment and Improvement of Sewerage Networks in EABD

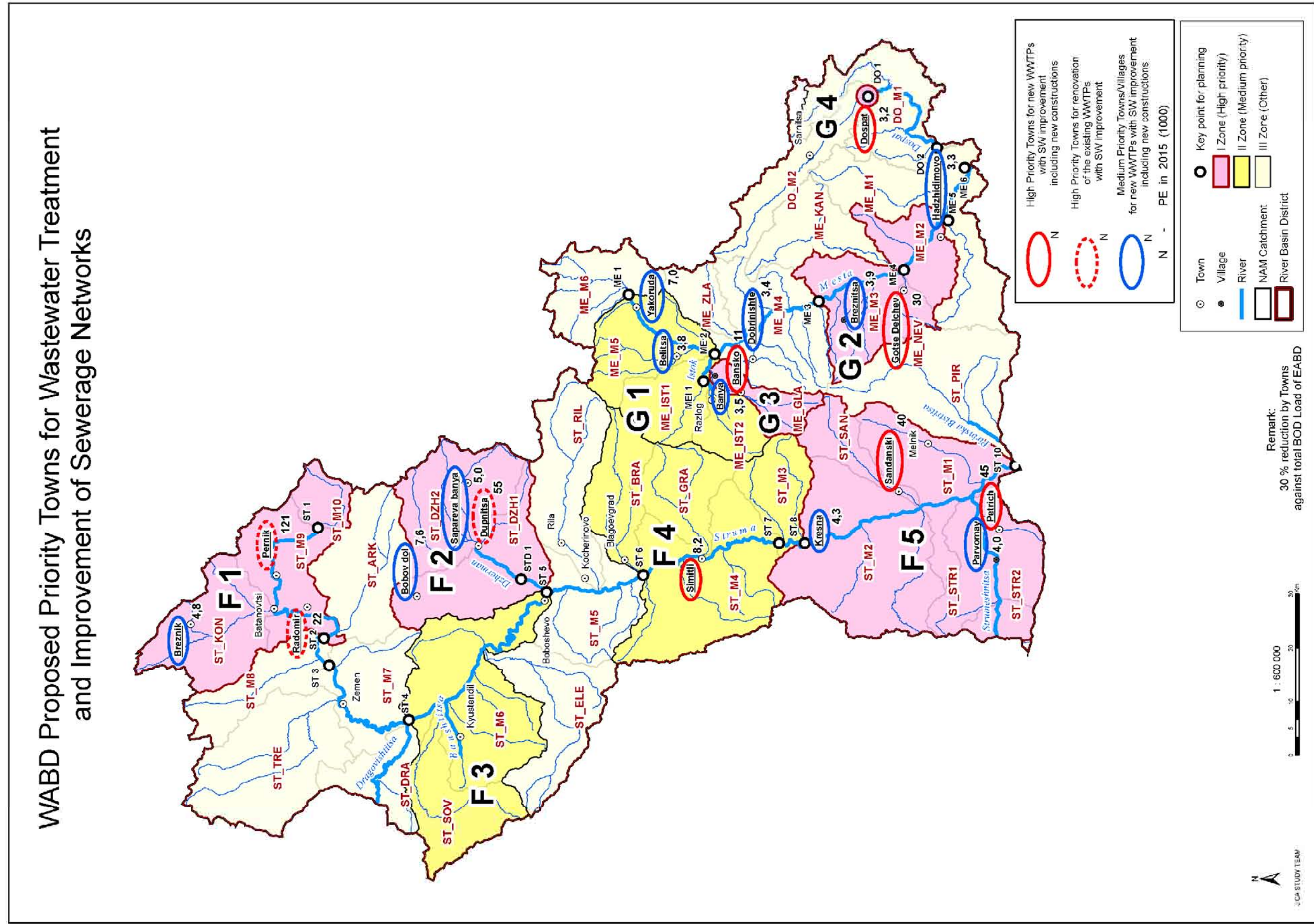

Figure C.4.23 Proposed High and Medium Priority Towns for Wastewater Treatment and Improvement of Sewerage Networks in EABD

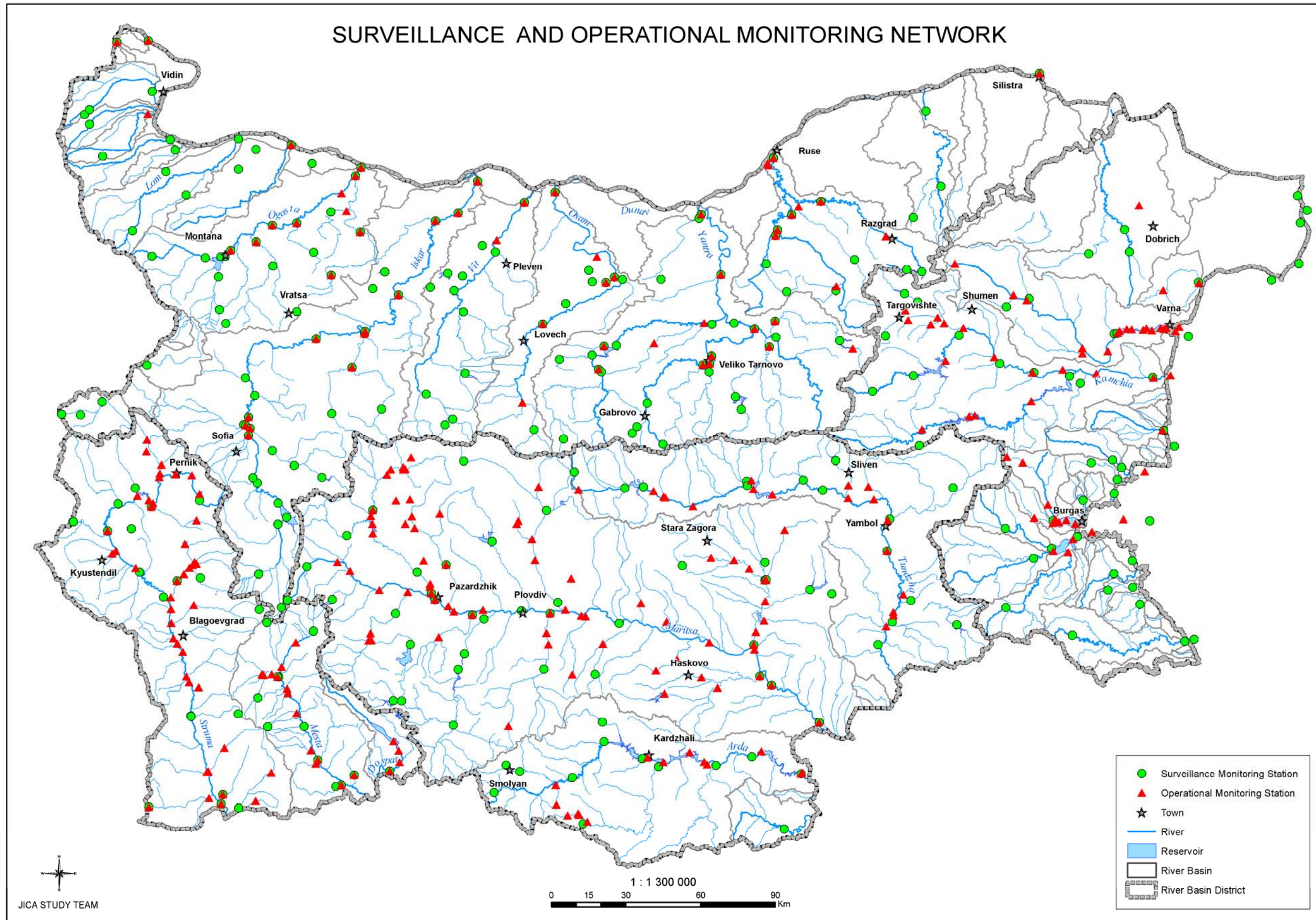

Figure C.4.25 Surveillance and Operational Monitoring Network

Proposed Key and Important Monitoring Zones in EABD and WABD

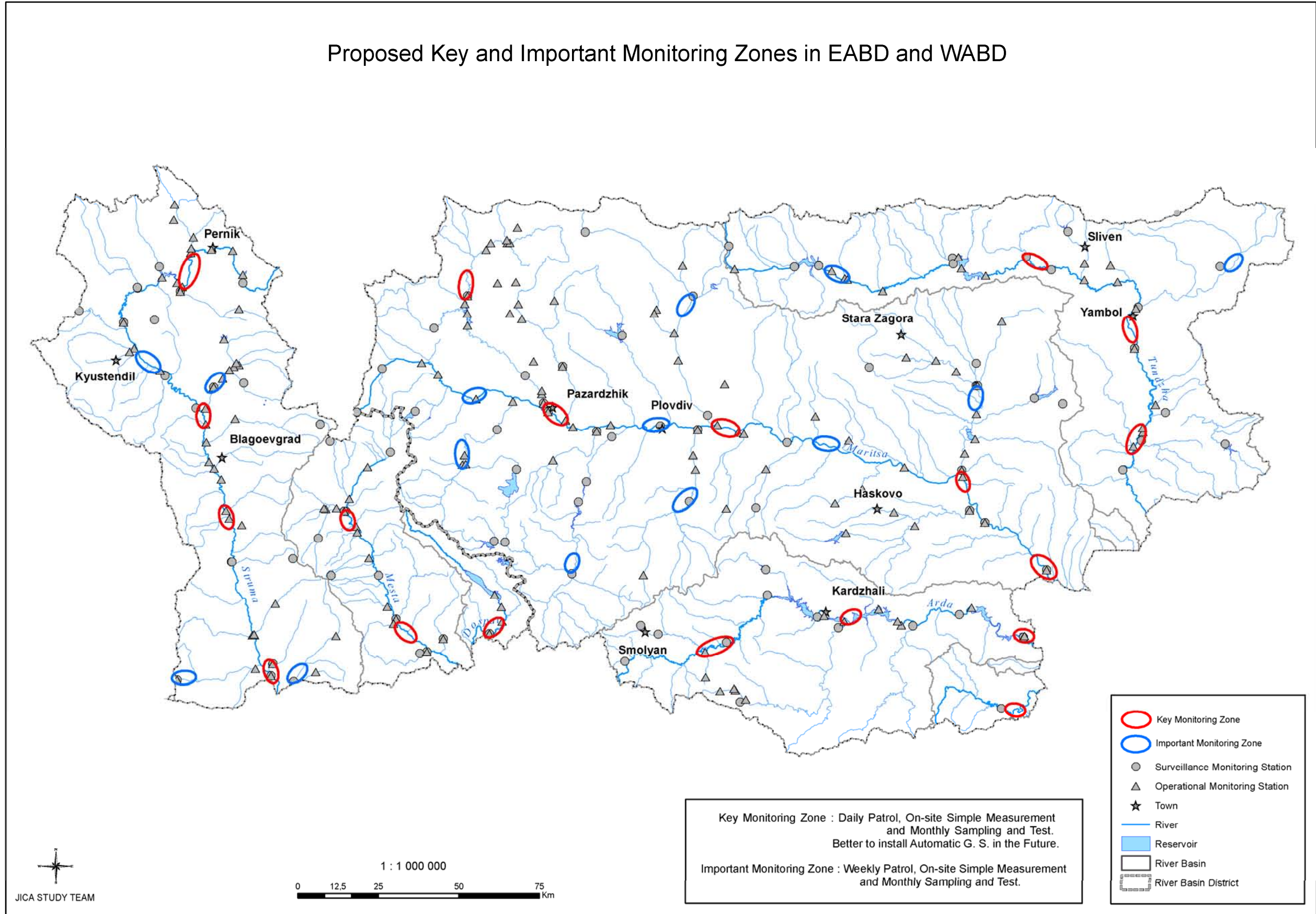

Figure C.4.26 Proposed Key and Important Monitoring Zones in EABD and WABD

Annex C.1

List

of

**Major Industries and Livestock farms
in Bulgaria based on NSI's Data**

Annex C.1.1 Main Industries and Animal Breeding Farms in DRBD

ID acc. to the NCIA*	Name	Region	Municipality	Settlement	Group acc. to the prod. - 2005
A 01.2 Animal Breeding					
01.21 Breeding of cattle					
1	"AGROHOLDING LOVIKO" JSCo	Gabrovo	Sevlievo	Sevlievo	2
2	"SORTOVI SEMENA ELIT-2001" Ltd.	Veliko Tarnovo	Svishtov	Svishtov	2
3	"TUS" Ltd.	Targovishte	Omurtag	Kamburovo village	1
4	FARMING COOPERATION "DAMYANOVO"	Gabrovo	Sevlievo	Damyanovo village	1
5	FARMING COOPERATION "ROSITSA"	Gabrovo	Sevlievo	Sevlievo	1
6	"ALEKSIYA 2002" PLC	Vratsa	Vratsa	Vratsa	1
7	"BOILA AGRO" PLC	Montana	Montana	Montana	1
8	"SIMA-NUKLEUS" PLC	Pleven	Pleven	Pleven	1
9	"CHEMERNIK" PLC	Sofia	Sofia	Sofia	1
10	"CHEH&P" PLC	Veliko Tarnovo	Veliko Tarnovo	Veliko Tarnovo	1
11	FARMING COOPERATION "SAGLASIE"	Veliko Tarnovo	Svishtov	Dragomirovo village	1
01.23 Breeding of pigs					
1	"AGROSPEKTAR INVEST" JSCo	Sofia	Sofia	Sofia	5
2	"BRATYA TOMOVI" JSCo	Targovishte	Popovo	Popovo	2
3	"KREMONINI" JSCo	Sofia	Sofia	Sofia	4
4	"SVINEKOMPLEKS BRASHLYAN" JSCo	Ruse	Slivo Pole	Brashlen village	7
5	"SVINEKOMPLEKS NIKOLOVO" JSCo	Ruse	Ruse	Nikolovo village	7
6	"SVINEKOMPLEKS SAMUIL" JSCo	Ruse	Slivo Pole	Brashlen village	7
7	"SVINEKOMPLEKS GOLYAMO VRANOVO" JSCo	Ruse	Slivo Pole	Golyamo Vranovo village	9
8	"AGRO-2000" Ltd.	Veliko Tarnovo	Strazhitsa	Strazhitsa	3
9	"ADAN-N" Ltd.	Vidin	Vidin	Vidin	1
10	"VALDINI TREYDING" Ltd.	Sofia	Sofia	Sofia	5
11	"PLANETA" Ltd.	Veliko Tarnovo	Gorna Oryahovitsa	Pisarevo village	2
12	"BELSUIN" PLC	Sofia	Sofia	Sofia	6
13	"BILYANA" PLC	Veliko Tarnovo	Svishtov	Balgarsko Slivovo village	3
14	"GERAN 99" PLC	Veliko Tarnovo	Veliko Tarnovo	Veliko Tarnovo	3
15	"RONEKS 2000" PLC	Sofia	Sofia	Sofia	6
16	"SVINEKOMPLEKS-STAMBOLOVO" PLC	Veliko Tarnovo	Pavlikeni	Stambolovo village	4
17	"SVINEKOMPLEKS-YUDELNIK" PLC	Ruse	Slivo Pole	Yudelnik village	4
18	"SILISTRA-HIBRID" PLC	Sofia	Sofia	Sofia	2
19	"TROYAINVEST" PLC	Lovech	Troyan	Troyan	3
20	"TROYAMEKS" PLC	Lovech	Troyan	Dalbok Dol village	7
01.24 Poultry breeding					
1	"BULAGRO" JSCo	Sofia	Kostinbrod	Kostinbrod	2
2	"DZHIEV" JSCo	Sofia	Kostinbrod	Kostinbrod	7
3	"OVOBIZNES" JSCo	Pleven	Pleven	Bohot village	1
4	"SIKONKO AGROTEHNIK" JSCo	Veliko Tarnovo	Polski Trambesh	Polski Trambesh	1
5	"SLAVYANA" JSCo	Pleven	Pleven	Pleven	5
6	"YAITSA I PTITSI" JSCo	Vratsa	Miziya	Miziya	5
7	"AVIS" Ltd.	Razgrad	Zavet	Zavet	2
8	"VEKTOR 91" Ltd.	Sofia	Sofia	Sofia	1
9	"EMBRIO" Ltd.	Vratsa	Byala Slatina	Byala Slatina	1
10	"PEGEMEKs TREYD" Ltd.	Lovech	Lovech	Lovech	2
11	"PILIGRIM 67" Ltd.	Pleven	Dolna Mitropoliya	Dolna Mitropoliya	2
12	"PRO AGRO 2000" Ltd.	Sofia	Sofia	Sofia	7
13	"AMON-RA" PLC	Silistra	Tutrakan	Tutrakan	7
14	"VATO" PLC	Ruse	Ruse	Chrvena Voda village	2
15	"GALUS KAMPANI" PLC	Sofia	Kostinbrod	Kostinbrod	2
16	"DITRONIKS" PLC	Pleven	Pleven	Pleven	1
17	"IGAL" PLC	Montana	Montana	Montana	1
18	"INOT AGRO" PLC	Lovech	Apriltsi	Apriltsi	1
19	"KENTAVAR" PLC	Veliko Tarnovo	Pavlikeni	Pavlikeni	2
20	"KOKO TREYD" PLC	Sofia	Sofia	Sofia	1
21	"MAR-KRAFT" PLC	Sofia	Sofia	Sofia	3
22	"NEDIFUUD" PLC	Silistra	Tutrakan	Tutrakan	3
23	"PLAMEN-EN" PLC	Ruse	Ivanovo	Krasen village	1
24	"POLTRI" PLC	Lovech	Lovech	Lovech	1
25	"TELEKOM" PLC	Sofia	Sofia	Podgumer village	1
26	"HAYPRO BULGARIA" PLC	Veliko Tarnovo	Pavlikeni	Pavlikeni	7
27	"YAYTSA I PTITSI-LOMTSI" PLC	Targovishte	Popovo	Lomtsi village	2
01.25. Other animals breeding					
1	"SIZIF" JSCo	Sofia	Sofia	Sofia	3
2	"NATURA VITA" Ltd.	Sofia	Sofia	Sofia	2
3	"GERADA-GM" PLC	Sofia	Sofia	Sofia	4

ID acc. to the NCIA*	Name	Region	Municipality	Settlement	Group acc. to the prod. - 2005
----------------------	------	--------	--------------	------------	--------------------------------

B 05. Fishery					
05.02 Fish breeding					
1	"RIBOVADSTVO" JSCo	Ruse	Ruse	Ruse	1
2	"STOYCHEV-2002" Ltd.	Veliko Tarnovo	Svishtov	Svishtov	NA
3	"BULRIB RIBARITSA" PLC	Lovech	Teteven	Ribaritsa village	1
4	"RIBENA" "TUNDZHA-73" PLC	Lovech	Teteven	Teteven	1
CA 10. Coal Mining					
10.20 Brown and Lignite coals production					
1	"MINA CHUKUROVO" JSCo	Sofia	Sofia	Sofia	7
2	"MINA CHERNO MORE-BURGAS" PJSCo	Sofia	Sofia	Sofia	9
CA 11. Crude Oils and Natural Gas Production					
11.10 Crude petroleum and natural gas production					
1	"PROUCHVANE I DOBIV NA NEFT I GAZ" JSCo	Sofia	Sofia	Sofia	9
11.20 Services connected with crude petroleum and natural gas production					
1	"PETRO- GAZ-ANTIKA" PLC	Montana	Montana	Montana	1
CB 14. Non - metal Resources Extraction					
14.11 Decorative stone materials production					
1	"MONOLIT" JSCo	Sofia	Sofia	Sofia	6
14.21 Breaking stone, gravel and sand production					
1	"MDZ-BALSHA" JSCo	Sofia	Sofia	Balsha village	7
2	"SKALNI MATERIALI" JSCo	Ruse	Ruse	Ruse	4
3	"POLARIS-8" PLC	Silistra	Silistra	Silistra	6
14.22 Clay and Kaolin					
1	"KAOLIN" JSCo	Ruse	Vetovo	Senovo	10
14.30 Mineral products for chemistry and fertilizers production					
1	"KREMIKOVTSI-RUDODOBIV" JSCo	Sofia	Sofia	Sofia	9
DA 15. Food & Beverages Production					
15.11 Meat production					
1	"MESOKOMBINAT-RAZGRAD" JSCo	Razgrad	Razgrad	Razgrad	9
2	"MESOKOMBINAT-SVISHTOV" Ltd.	Veliko Tarnovo	Svishtov	Svishtov	5
3	"ISMETSHABANOV-OLIMP-131" ST	Targovishte	Omurtag	Omurtag	8
4	"AVA" PLC	Sofia	Sofia	Sofia	6
5	"MEKOM" PLC	Sofia	Sofia	Sofia	4
6	"MMM IMPORT-EKSPORT" PLC	Montana	Montana	Montana	1
15.12 Meat production from poultry					
1	"ZORNITSA-KESAREVO" JSCo	Veliko Tarnovo	Strazhitsa	Kesarevo village	3
2	"AVIS"	Lovech	Lovech	Yoglav village	9
3	"GALUS -2004" Ltd.	Sofia	Sofia	Sofia	8
4	"DENIZ 2001" Ltd.	Sofia	Sofia	Sofia	5
5	"DZHIEV-K" Ltd.	Sofia	Kostinbrod	Kostinbrod	8
6	"KP PTITSEKLANITSA" Ltd.	Pleven	Pleven	Pleven	2
7	"PILKO" Ltd.	Razgrad	Razgrad	Razgrad	10
8	"SVS-98" Ltd.	Sofia	Sofia	Sofia	8
9	"PIMENS" PLC	Veliko Tarnovo	Strazhitsa	Strazhitsa	4
10	"POLO KOMERS" PLC	Sofia	Sofia	Sofia	8
15.13 Meat products					
1	"MEKOM" JSCo	Sofia	Sofia	Sofia	8
2	"MESOKOMBINAT-LOVECH" JSCo	Lovech	Lovech	Lovech	10
3	"MESOKOMBINAT RUSE" JSCo	Ruse	Ruse	Ruse	7
4	"NIKAS BULGARIA" JSCo	Sofia	Botevgrad	Botevgrad	9
5	"DEISLAVA KOMERS" Ltd.	Sofia	Sofia	Sofia	3
6	"LALOV I VACHEV" Ltd.	Vratsa	Vratsa	Vratsa	7
7	"SOLARIS-AS" Ltd.	Sofia	Sofia	Sofia	7
8	"KOKO-DIMITAR PACHEDZHIEV" ST	Sofia	Sofia	Sofia	3
9	KOOPERATSIYA "DOVERIE"	Lovech	Ugarchin	Lesidren village	5
10	"BRAVO" PLC	Sofia	Sofia	Sofia	9
11	"BARGAR" PLC	Sofia	Sofia	Sofia	3
12	"ELIT MES MINEV-RODOPA-V.T." PLC	Veliko Tarnovo	Veliko Tarnovo	Veliko Tarnovo	7
13	"KOMPAS" PLC	Montana	Berkovitsa	Komarevo village	6
14	"MESOTSENTRALA-MONTANA" PLC	Montana	Montana	Montana	8
15	"NADEZHDA-M-OOD" PLC	Ruse	Byala	Byala	5
16	"ORHANIE 1" PLC	Sofia	Botevgrad	Botevgrad	5
17	"TANDEM-V" PLC	Sofia	Sofia	Sofia	9
18	"CHEH-YOSIF NOVOSAD" PLC	Veliko Tarnovo	Veliko Tarnovo	Veliko Tarnovo	7
15.20 Manufacturing and canning fish					
1	"P.A.L.-BG" Ltd.	Sofia	Sofia	Sofia	6
15.31 Manufacturing and canning potatoes					
1	"ROYAL PATEYTOS" JSCo	Sofia	Samokov	Belchin village	6

ID acc. to the NCIA*	Name	Region	Municipality	Settlement	Group acc. to the prod. - 2005
15.32	Fruit and vegetable juices				
1	"BOVIS" JSCo	Sofia	Botevgrad	Trudovets village	8
2	"FLORINA-BALGARIYA" JSCo.	Sofia	Sofia	Sofia	9
3	"TIMBARK BALGARIYA" Ltd.	Lovech	Lovech	Kazachevo	1
15.33	Manufacturing and canning fruits and vegetables				
1	"DOMAT" JSCo.	Veliko Tarnovo	Lyaskovets	Dzhulyunitsa village	6
2	"KRASEN-AD" JSCo.	Ruse	Ivanovo	Krasen village	3
3	"LAYNS HOLDING" JSCo.	Pleven	Pleven	Pleven	7
4	"MELTA 90" JSCo.	Sofia	Sofia	Sofia	1
5	"VEGA STAR" Ltd.	Vratsa	Byala Slatina	Byala Slatina	4
6	"KENAR" Ltd.	Sofia	Sofia	Sofia	9
7	"LETNITSA" Ltd.	Lovech	Letnitsa	Letnitsa	4
8	"DETELINA-VINCHEVA-NADEZHDA VINCHEVA" ST	Gabrovo	Sevlievo	Sevlievo	4
9	"KUMINYANO FRUT OOD" PLC	Sofia	Etropole	Etropole	9
10	"MERLINI- DANIMOND" PLC	Sofia	Sofia	Sofia	7
15.41	Crude oils and fats				
1	"ZVEZDA" JSCo	Pleven	Dolna Mitropoliya	Dolna Mitropoliya	8
15.42	Refined oils and fats production				
1	"OLIVA" JSCo	Pleven	Knezha	Knezha	4
2	"ROSA" JSCo	Targovishte	Popovo	Popovo	9
3	"SLANCHEVI LACHI BULGARIA" PJSCo	Sofia	Sofia	Sofia	8
15.51	Milk production and dairy products				
1	"S I S-7" Ltd.	Sofia	Sofia	Sofia	4
2	"DANON SERDIKA" JSCo	Sofia	Sofia	Sofia	10
3	"SIRMA PRISTA" JSCo	Veliko Tarnovo	Veliko Tarnovo	Veliko Tarnovo	5
4	"EM DZHEY DERIZ" Ltd.	Sofia	Sofia	Sofia	5
5	"ZOROV-91-DIMITAR ZOROV" ST	Vratsa	Vratsa	Vratsa	7
6	"BI. SI. SI. HANDEL" PLC	Veliko Tarnovo	Veliko Tarnovo	Veliko Tarnovo	6
7	"BULDEKS" PLC	Silistra	Silistra	Silistra	2
8	"ZHOSI-OOD" PLC	Sofia	Sofia	Sofia	6
9	"MEGLE-EM. DZHEY" PLC	Sofia	Sofia	Sofia	9
10	"MILKIEKS" PLC	Gabrovo	Gabrovo	Gabrovo	6
11	"VOYNOV I SIE" PS	Montana	Montana	Montana	3
15.52	Ice-cream production				
1	"DARKO" JSCo	Sofia	Sofia	Sofia	7
2	"DELTA-BULGARIA" JSCo	Sofia	Sofia	Sofia	9
3	"FENIKS 22" JSCo	Sofia	Sofia	Sofia	1
15.61	Grain mill products				
1	"ZARNENI HRANI VIDIN 99" JSCo	Vidin	Vidin	Vidin	3
2	"KRISTERA" JSCo	Targovishte	Popovo	Popovo	6
3	"SOFIYA MEL" JSCo	Sofia	Sofia	Sofia	10
4	"ROKA-SO" PLC	Razgrad	Razgrad	Razgrad	4
5	"TEHRA" PLC	Sofia	Sofia	Sofia	4
6	"TOPAZ MEL" PLC	Sofia	Sofia	Sofia	9
15.62	Starch and starch products				
1	"AMILUM-BULGARIA" PJSCo	Razgrad	Razgrad	Razgrad	10
15.71	Forage production				
1	"BONMIKS" Ltd.	Lovech	Lovech	Lovech	7

ID acc. to the NCIA*	Name	Region	Municipality	Settlement	Group acc. to the prod. - 2005
----------------------	------	--------	--------------	------------	--------------------------------

15.81	Bread and sweets production				
1	"MLIN-97" JSCo	Razgrad	Razgrad	Razgrad	7
2	"PEN D'OR" JSCo	Sofia	Sofia	Sofia	6
3	"HLEBNI IZDELIYA-BOTUNETS" JSCo	Sofia	Sofia	Sofia	6
4	"HLEBNI IZDELIYA-VAZRAZHDA NE" JSCo	Sofia	Sofia	Sofia	2
5	"HLEBNI IZDELIYA-KNYAZHEVO" JSCo	Sofia	Sofia	Sofia	4
6	"HLEBNI IZDELIYA-LOZENETS" JSCo	Sofia	Sofia	Sofia	9
7	"HLEBNI IZDELIYA-LYULIN" JSCo	Sofia	Sofia	Sofia	4
8	"HLEBNI IZDELIYA-PODUENE" JSCo	Sofia	Sofia	Sofia	4
9	"CHIPITA BULGARIA" JSCo	Sofia	Sofia	Kazichene village	10
10	"PROFEKS HLYAB-S" PJSCo	Sofia	Samokov	Samokov	2
11	"SLAVYANKA" PJSCo	Veliko Tarnovo	Gorna Oryahovitsa	Gorna Oryahovitsa	2
12	"CHIPITA FUUDS BULGARIA" PJSCo	Sofia	Elin Pelin	Elin Pelin	9
13	"HLEBOPROIZVODSTVO I SLADKARSTVO" Ltd.	Lovech	Troyan	Troyan	3
14	"HLYAB I HLEBNI IZDELIYA-EOOD" Ltd.	Ruse	Ruse	Ruse	4
15	"BOZHANKA MAKAVEEVA" ST	Veliko Tarnovo	Gorna Oryahovitsa	Gorna Oryahovitsa	3
16	"VALKA-VALERI KRASTEV" ST	Montana	Montana	Montana	2
17	"OGNYAN TODOROV-ZGORIGRAD" ST	Vratsa	Vratsa	Zgorigrad village	1
18	"DZHI VI EL-SLATINA" PLC	Sofia	Sofia	Sofia	4
19	"ELIAZ" PLC	Sofia	Sofia	Sofia	5
20	"LID-KOMERS" PLC	Sofia	Sofia	Sofia	1
21	"NILANA" PLC	Sofia	Sofia	Sofia	7
22	"PROFEKS HLYAB" PLC	Sofia	Botevgrad	Botevgrad	4
23	"SAP" PLC	Sofia	Sofia	Sofia	2
24	"STILL-MS" PLC	Gabrovo	Tryavna	Tryavna	2
25	"UNIPEK" PLC	Sofia	Sofia	Sofia	3
26	"HLEBOZAVOD" PLC	Gabrovo	Gabrovo	Gabrovo	6
27	"MOLTEN HRISTOV I S-IE" PS	Sofia	Botevgrad	Botevgrad	3
15.82	Chip's biscuits, biscuits and dry sweets production				
1	"INTERNAK BULGARIA" Ltd.	Sofia	Sofia	Sofia	9
2	"LACHITA" Ltd.	Veliko Tarnovo	Veliko Tarnovo	Veliko Tarnovo	6
3	KOOPERATSIYA "HRISTO NIKOV"	Sofia	Sofia	Sofia	7
4	"VELIKOVI-OOD" PLC	Ruse	Dve Mogili	Dve Mogili	5
5	"DEN I NOSHT" PLC	Veliko Tarnovo	Gorna Oryahovitsa	Gorna Oryahovitsa	9
6	"MUUN LAYT- D. SH. D." PLC	Sofia	Sofia	Sofia	3
7	"PRESTIZH-96" PLC	Veliko Tarnovo	Veliko Tarnovo	Veliko Tarnovo	9
15.83	Shugar production				
1	"ZAHAR-BIO" JSCo	Ruse	Ruse	Ruse	10
2	"ZAHARNI ZAVODI" JSCo	Veliko Tarnovo	Gorna Oryahovitsa	Gorna Oryahovitsa	10
15.84	Cocoa and chocolate production				
1	"KRAFT FUUDS" JSCo	Sofia	Svoge	Svoge	10
2	"MELBON" JSCo	Sofia	Sofia	Sofia	6
3	"NESTLE BULGARIA" JSCo	Sofia	Sofia	Sofia	10
4	"ANIMEKS 98" Ltd.	Sofia	Sofia	Sofia	4
5	"BALGARSKA ZAHAR 2002" PLC	Pleven	Dolna Mitropoliya	Dolna Mitropoliya	4
6	"MILMEKS" PLC	Sofia	Sofia	Sofia	3
7	"SIGMA BIO" PLC	Sofia	Sofia	Sofia	4
8	"HOUK-MAVROV, PETROV I VLADOV" PLC	Sofia	Sofia	Sofia	3
15.86	Manufacturing of coffee and tea				
1	"BALKAM" JSCo	Sofia	Sofia	Sofia	9
2	"BIOPROGRAMA" Ltd.	Sofia	Sofia	Dobroslavtsi village	5
3	"SPETEMA-KAFE" PLC	Sofia	Sofia	Sofia	5
15.87	Food seasoning and sauces production				
1	"KONSUL" PLC	Sofia	Sofia	Sofia	8
2	"OLINEZA" PLC	Sofia	Sofia	Sofia	8
3	"MERKURIY-PRODANOVI, PENEVI I SIE" PS	Gabrovo	Gabrovo	Gabrovo	7
15.88	Finished products, including baby foods and dietetic foods				
1	"SLANCHO" JSCo	Veliko Tarnovo	Svishtov	Svishtov	4
15.89	Other food products				
1	"BALGARSKI HLYAB" JSCo	Gabrovo	Gabrovo	Gabrovo	4
2	"EUROSTOK" Ltd.	Sofia	Sofia	Sofia	9
3	"KENDI" PLC	Sofia	Sofia	Sofia	9
15.91	Spirits production				
1	"SIS-INDUSTRIYS" PLC	Sofia	Sofia	Sofia	10

ID acc. to the NCIA*	Name	Region	Municipality	Settlement	Group acc. to the prod. - 2005
15.93	Vine production				
1	"VINAL" JSCo	Lovech	Lovech	Lovech	5
2	"VINPROM -SVISHTOV" JSCo	Veliko Tarnovo	Svishtov	Svishtov	5
3	"DOMEYN BOYAR" JSCo	Sofia	Sofia	Sofia	9
4	"NOVA INDUSTRIALNA KOMPANIYA" JSCo	Sofia	Sofia	Sofia	6
5	"HEBROS-VINPROM" JSCo	Sofia	Sofia	Sofia	7
6	"LOVIKO LOZARI" PJSCo	Veliko Tarnovo	Suhindol	Suhindol	7
7	"VINPROM- RUSE-EOOD" Ltd.	Ruse	Ruse	Ruse	8
8	"IVENA COMERS-VALENTIN SHOTEV" ST	Sofia	Sofia	Sofia	9
9	"VINARNA SLANCHEVA DOLINA" PLC	Sofia	Sofia	Sofia	6
15.96	Beverages production				
1	"BOLYARKA VT" JSCo	Veliko Tarnovo	Veliko Tarnovo	Veliko Tarnovo	9
2	"KARLSBERG BULGARIA" JSCo	Sofia	Sofia	Sofia	10
3	"LOMSKO PIVO" JSCo	Montana	Lom	Lom	6
15.98	Mineral water and soft drinks				
1	"AGRIMA" JSCo	Sofia	Sofia	Sofia	10
2	"KOKA -KOLABHELENIK BOTALING COMPANI" JSCo	Sofia	Kostinbrod	Kostinbrod	10
3	BUTILIRASHTA KOMPANIYA "MINERALNI VODI-BAN"	Sofia	Sofia	Sofia	9
4	"BULMINVEKS-GB" Ltd.	Sofia	Sofia	Sofia	6
5	"BUTILIRASHTA KOMPANIYA-GORNA BANYA" PLC	Sofia	Sofia	Sofia	9
6	TPK "BUTILIRASHTA KOMPANIYA HISAR"	Sofia	Sofia	Sofia	4
DA 16.	Tobacco production				
16.00	Tobacco substitutes production				
1	"SOKOTAB BULGARIA" Ltd.	Sofia	Sofia	Sofia	10
DB 18.3.	Processing of Leather and products thereof				
18.30	Hides and articles thereof				
1	"STRASHIMIR BARDAROV-SASHA-IMPEKS" ST	Ruse	Ruse	Ruse	2
2	"MILVENA" PLC	Sofia	Sofia	Sofia	1
DC 19.1	Production of Leather				
19.10	Leather production				
1	"VELUR" JSCo	Lovech	Lovech	Lovech	3
2	"DELFI PRIM" JSCo	Sofia	Sofia	Sofia	6
3	"FULMAKS-21" JSCo	Gabrovo	Gabrovo	Gabrovo	1
4	"EVROLEDAR" PJSCo	Sofia	Etropole	Etropole	4
DE 21	Production of Pulp, Paper, Carboard and Products made of Paper and Cardboard				
21.11	Wood production				
1	"SVILOTSEL" PJSCo	Veliko Tarnovo	Svishtov	Svishtov	NA
21.12	Paper and paperboard production				
1	"MAYR-MELNHOF-NIKOPOL" JSCo	Pleven	Nikopol	Nikopol	10
21.21	Packing of paper and paperboard production				
1	"VELPA-91" JSCo	Veliko Tarnovo	Strazhitsa	Strazhitsa	8
2	"VITAVEL" CJSCo	Lovech	Lukovit	Lukovit	8
3	"GRAFOBAL BULGARIA" JSCo	Sofia	Svoge	Svoge	7
4	"UNIPAK" JSCo	Veliko Tarnovo	Pavlikeni	Pavlikeni	8
5	"STEMI" Ltd.	Razgrad	Razgrad	Getsovo village	5
21.22	Toilet articles of paper and paperboard				
1	"PALOMITA" PJSCo	Sofia	Sofia	Sofia	4
21.23	Office articles of paper and paperboard				
1	"SIDZHEST" PLC	Sofia	Sofia	Sofia	5
DF 23	Production of Coke, Refind Petrol Products and Nuclear Fuel				
23.20	Refined petroleum production				
1	"VERILA 1998 AD" JSCo	Sofia	Elin Pelin	Ravno Pole village	5
2	"PRISTA OIL" JSCo	Sofia	Sofia	Sofia	10
3	"BALGARSKA PETROLNA RAFINERIYA" Ltd.	Sofia	Sofia	Sofia	8
4	"LUBRIKA-OOD" PLC	Ruse	Ruse	Ruse	8
5	"POLISAN-OOD" PLC	Ruse	Ruse	Ruse	6
DG 24	Production of Chemical Substances				
24.30	Paints, varnishes and similsr products				
1	"LAKPROM" JSCo	Sofia	Sofia	Svetovrachane village	9
2	"ORGAHIM"-AD" JSCo	Ruse	Ruse	Ruse	10
3	"EKON-91-OOD" JSCo	Ruse	Ruse	Ruse	10
24.41	Medical substances				
1	"BALKANFARMA-RAZGRAD" JSCo	Razgrad	Razgrad	Razgrad	10
24.42	Medical goods and medicaments				
1	"BALKANFARMA-TROYAN" JSCo	Lovech	Troyan	Troyan	10
2	"MEDIKA" JSCo	Sofia	Sofia	Sofia	8
3	"SOFARMA" JSCo	Sofia	Sofia	Sofia	10
4	"UNIFARM" JSCo	Sofia	Sofia	Sofia	8
5	"FARMATSEVTICHNI ZAVODI MILVE" JSCo	Vratsa	Byala Slatina	Byala Slatina	5
6	"BUL BIO-NTSZPB" Ltd.	Sofia	Sofia	Sofia	7

ID acc. to the NCIA*	Name	Region	Municipality	Settlement	Group acc. to the prod. - 2005
24.52	Parfumery and toilet goods				
1	"AROMA" JSCo	Sofia	Sofia	Sofia	10
2	"STS HOLDING GRUP" PLC	Gabrovo	Gabrovo	Gabrovo	8
24.61	Ammunitions production				
1	"DUNARIT-AD" JSCo	Ruse	Ruse	Ruse	9
24.64	Photographic chemical materials				
1	"POLIHROM-POAP" JSCo	Sofia	Sofia	Sofia	10
24.70	Artificial and synthetic fibres production				
1	"SVILOZA-ZIK" JSCo	Veliko Tarnovo	Svishtov	Svishtov	10
DH 25	Production of Rubber and Plastic Products				
25.11	Tyres Production				
1	"VIDAHIM" JSCo	Vidin	Vidin	Vidin	10
2	"DINAMIK EM 2" JSCo	Sofia	Sofia	Sofia	5
25.13	Rubber and articles thereof				
1	"ELASTIK" JSCo	Sofia	Sofia	Svetovrachane village	5
2	"ZEBRA" JSCo	Sofia	Sofia	Novi Iskar	8
3	"KAUMET" JSCo	Silistra	Silistra	Aydemir village	3
4	"KAUCHUK" JSCo	Sofia	Sofia	Sofia	9
5	"KULA RING" JSCo	Vidin	Kula	Kula	6
6	"SIZAS-ZEBRA BULGARIA" JSCo	Sofia	Sofia	Sofia	6
7	"KRAYBURG BULGARIA" Ltd.	Sofia	Sofia	Sofia	8
25.21	Plastics and articles thereof				
1	"AUTOBAR PAKIDZHING BALKAN" JSCo	Sofia	Sofia	Sofia	9
2	"KAPITAN DYADO NIKOLA" JSCo	Gabrovo	Gabrovo	Gabrovo	10
3	"KOLTEKS" Ltd.	Gabrovo	Gabrovo	Gabrovo	4
4	"ORGANIKA BULGARIA-EOOD" Ltd.	Ruse	Dve Mogili	Batishnitsa village	6
25.22	Plastic packages production				
1	"PLASTIMO" JSCo	Sofia	Samokov	Samokov	6
2	"TRYIS IPOMA" JSCo	Sofia	Sofia	Sofia	8
3	"FABRIKA MEDIKET" JSCo	Sofia	Etropole	Etropole	6
4	"ANAKONDA" Ltd.	Pleven	Pleven	Pleven	7
5	"RODINA 75-1" Ltd.	Sofia	Botevgrad	Botevgrad	1
6	"ALFRIDA-PEYO PEEV" ST	Gabrovo	Gabrovo	Gabrovo	3
7	"EKOPLAST 99" PLC	Sofia	Sofia	Sofia	4
8	"EKSTRAPAK" PLC	Veliko Tarnovo	Veliko Tarnovo	Veliko Tarnovo	9
9	"MEGAPORT" PLC	Veliko Tarnovo	Veliko Tarnovo	Veliko Tarnovo	9
10	"NACHEV" PLC	Sofia	Botevgrad	Botevgrad	5
11	"PLASTOBAG" PLC	Sofia	Sofia	Sofia	2
12	"PLASTFORM" PLC	Gabrovo	Gabrovo	Gabrovo	6
13	"STS PAK HOLDING" PLC	Gabrovo	Gabrovo	Gabrovo	6
14	"TERAHIM 97" PLC	Gabrovo	Gabrovo	Gabrovo	9
25.23	Plastic articles for construction				
1	"ROLPLAST" Ltd.	Sofia	Sofia	Sofia	8
2	"MULTITEH" PLC	Sofia	Sofia	Sofia	6
25.24	Other plastic articles				
1	"LOTUS-94" Ltd.	Sofia	Sofia	Sofia	6
2	"RUVITEKS-EOOD" Ltd.	Ruse	Ruse	Ruse	4
3	"HAMBERGER BULGARIA" Ltd.	Gabrovo	Sevlievo	Sevlievo	9
4	"AGNESIKA PLAST" PLC	Sofia	Sofia	Sofia	6
5	"SOF POLIMER INDUSTRI" PLC	Sofia	Sofia	Sofia	4
6	TPK "HEMUS"	Sofia	Sofia	Sofia	1
DI 26	Production of Other Products Made of Non-mineral Resources				
26.12	Flat glass treatment				
1	"KRISTIAN-NEYKO-90" Ltd.	Sofia	Sofia	Sofia	4
26.13	Glassware production				
1	"DRUZHBA STAKLARSKI ZAVODI" JSCo	Sofia	Sofia	Sofia	10
2	"RUBIN" JSCo	Pleven	Pleven	Pleven	10
3	"INTERIOR GLAS" PLC	Veliko Tarnovo	Elena	Elena	7
4	"MERA GLAS" PLC	Lovech	Troyan	Troyan	4
26.21	Household and decoration porcelain and other ceramic articles				
1	"AKSIS HOLD" PLC	Sofia	Sofia	Sofia	3
26.22	Ceramic products				
1	"IDEAL STANDART BULGARIA" JSCo	Gabrovo	Sevlievo	Sevlievo	10
26.26	Fireproof ceramic products				
1	"TRUD-AD" JSCo	Ruse	Ruse	Ruse	6
2	"SHAMOT-AD" JSCo	Sofia	Elin Pelin	Elin Pelin	7
3	"TEHKERAMIK-M" PLC	Vratsa	Mezdra	Mezdra	4

ID acc. to the NCIA*	Name	Region	Municipality	Settlement	Group acc. to the prod. - 2005
----------------------	------	--------	--------------	------------	--------------------------------

26.30	Glazed tile production				
1	"KERAMIKS" JSCo	Sofia	Sofia	Sofia	5
2	"HAN ASPARUH" JSCo	Razgrad	Isperih	Isperih	10
3	"HAN OMURTAG" JSCo	Sofia	Sofia	Sofia	9
26.40	Bricks, tiles and other construction articles				
1	"KERAMINZHENERING" JSCo	Sofia	Sofia	Sofia	8
2	"TERA" JSCo	Pleven	Cherven Bryag	Cherven Bryag	2
3	"STROYKERAMIKA" PLC	Montana	Montana	Montana	4
26.51	Cement production				
1	"ZLATNA PANEGA TSEMENT" JSCo	Lovech	Yablanitsa	Zlatna Panega	10
2	"PLEVENSKI TSEMENT" JSCo	Pleven	Pleven	Pleven	10
3	"HOLSIM BULGARIA" JSCo	Vratsa	Vratsa	Beli Izvor village	10
26.52	Quicklime production				
1	"OGNYANOVO-K" JSCo	Sofia	Sofia	Sofia	8
26.53	Gypsum production				
1	"GIPS" JSCo	Vidin	Vidin	Koshava village	9
26.61	Concrete construction products				
1	"ZSK-KREMIKOVTSI" JSCo	Sofia	Sofia	Sofia	7
2	"ZAVOD ZA SROMANOBETONOVI KONSTRUKCII" Ltd	Sofia	Sofia	Sofia	3
3	"KSELA BULGARIA" Ltd.	Sofia	Sofia	Sofia	10
26.62	Gypsum products for construction purposes production				
1	"KNAUF" Ltd.	Sofia	Sofia	Sofia	9
26.63	Ready concrete mixtures production				
1	"SOFSTROY" JSCo	Sofia	Sofia	Sofia	9
2	RDP-SOFIA" Ltd.	Sofia	Sofia	Sofia	8
26.70	Cutting, profiling and processing of construction and decoration rock materials				
1	"MRAMOR-BERKSTON" JSCo	Montana	Berkovitsa	Berkovitsa	6
2	"HEMUS-M" JSCo	Vratsa	Mezdra	Mezdra	6
26.81	Abrasive products production				
1	"ZAI" JSCo	Montana	Berkovitsa	Berkovitsa	5
26.82	Products made of other non-metal minerals, not classified elsewhere production				
1	"BORO-BOGOMIL DACHEV" ST	Sofia	Sofia	Sofia	9
DJ 27	Production & Molding of Metals				
27.10	Production of Cast Iron, Steel and Ferro-alloys				
1	"KREMIKOVTSI" JSCo	Sofia	Sofia	Sofia	10
2	"PROMET STIL" JSCo	Sofia	Sofia	Sofia	10
3	"FEROSPLAVEN ZAVOD" Ltd.	Sofia	Elin Pelin	Ognyanovo village	4
27.21	Cast Iron Pipes Production				
1	"BERG MONTANA FITINGI" JSCo	Montana	Montana	Montana	9
2	"TSENTROMED" JSCo	Vratsa	Vratsa	Vratsa	7
27.22	Steel Pipes Production				
1	"KRAMS-AD" JSCo	Ruse	Ivanovo	Ivanovo village	3
2	"PRETSIZ INTER-HOLDING-AD" JSCo	Ruse	Ivanovo	Ivanovo village	10
27.34	Wire extention				
1	"ZHITI" JSCo	Ruse	Ruse	Ruse	10
2	"METIZI" JSCo	Vratsa	Roman	Roman	8
3	"CHUGUNENA ARMATURA BULGARIA" JSCo	Vratsa	Vratsa	Vratsa	4
27.42	Aluminium and alloys production				
1	"PRETSIZ INTER ALUMINIUM-AD" JSCo	Ruse	Ivanovo	Ivanovo village	2
27.44	Copper and alloys production				
2	"SOFIA MED" JSCo	Sofia	Sofia	Sofia	10
27.52	Steel Foundry				
1	"METAKOM-SLZ" JSCo	Pleven	Pleven	Pleven	7
2	"METALIK-BISIPI" Ltd.	Gabrovo	Gabrovo	Gabene village	4
27.53	Light metals Foundry				
1	"ALUKOM" JSCo	Pleven	Pleven	Pleven	6

ID acc. to the NCIA*	Name	Region	Municipality	Settlement	Group acc. to the prod. - 2005
----------------------	------	--------	--------------	------------	--------------------------------

DJ 28 Production of Products Made of Metals, Except for Mashinery and Equipment					
28.11 Metal constructions and parts to them production					
1	"BALKAN" JSCo	Montana	Montana	Montana	7
2	"ENERGOMONTAZHKOMPLEKS" JSCo	Pleven	Belene	Belene	6
3	"METALIK STORY" JSCo	Sofia	Bozhurishte	Bozhurishte	1
4	"MONTEL" JSCo	Sofia	Sofia	Sofia	5
5	"RMO-METALURGREMONT" JSCo	Sofia	Sofia	Sofia	4
6	"HIDKOM" JSCo	Vratsa	Oryahovo	Oryahovo	4
7	"NIKI-OOD" Ltd.	Sofia	Pravets	Pravets	3
8	"SEMKOV-2001" Ltd.	Vratsa	Vratsa	Beli Izvor village	2
9	"HRAMAR" Ltd.	Sofia	Sofia	Sofia	6
10	"ENERGOSERVIZ INZHENERING" PLC	Sofia	Sofia	Sofia	4
11	"M. V. LOMONOSOV" PLC	Pleven	Pleven	Pleven	5
12	"METATRON-MT" PLC	Sofia	Sofia	Sofia	7
28.12 Metal joinery production for construction purposes					
1	"KASTEL" JSCo	Montana	Berkovitsa	Berkovitsa	6
2	"STILMET" JSCo	Sofia	Sofia	Sofia	10
3	"PRETSIZ-AL-EOOD" Ltd.	Ruse	Ruse	Ruse	6
4	"TAL INGENERING" Ltd.	Sofia	Sofia	Sofia	6
5	"KAMAKS" PLC	Lovech	Teteven	Teteven	3
6	"KARAD-24" PLC	Sofia	Sofia	Sofia	3
7	"TRANSPROGRES-68" PLC	Sofia	Sofia	Sofia	3
8	"CHEH-PLAST" PLC	Vratsa	Vratsa	Vratsa	3
9	"YUVENTA-3" PLC	Sofia	Sofia	Sofia	7
28.21 Cisterns, reservoirs and metal containers					
1	"VRZ VOLA" JSCo	Vratsa	Vratsa	Vratsa	5
2	"MSM GAZ" PLC	Veliko Tarnovo	Veliko Tarnovo	Veliko Tarnovo	2
3	"RMZ VRATSATA" PLC	Vratsa	Vratsa	Vratsa	2
28.22 Steam-boilers and radiators production					
1	"KORADO BULGARIA" JSCo	Veliko Tarnovo	Strazhitsa	Strazhitsa	8
2	"ENERGOREMONT-RUSE-AD" PJSCo	Ruse	Ruse	Ruse	3
3	"DYAVACH" Ltd.	Sofia	Sofia	Sofia	2
28.30 Steam-boilers production					
1	"KOTLOSTROENE" JSCo	Sofia	Sofia	Sofia	4
2	"METALINZHENERING" Ltd.	Vratsa	Vratsa	Vratsa	4
28.40 Forging, stamping, stretching of metals, dust metalurgy					
1	"KPZ" JSCo	Gabrovo	Dryanovo	Tsareva Livada village	1
28.51 Surface treatment and coating of metals					
1	"DARIMEKS-DORA HRISTOVA"	Montana	Montana	Montana	1
2	"PRETSIZ- INTER 97-OOD"	Ruse	Ivanovo	Ivanovo village	2
28.52 Metal mechanical treatment					
1	"MZ BREZOVO" JSCo	Sofia	Sofia	Sofia	1
2	"TM-TEHNOLODZHI-AD" JSCo	Ruse	Ruse	Ruse	4
3	"BARDI" Ltd.	Sofia	Sofia	Sofia	2
4	"METMASTER" Ltd.	Vratsa	Vratsa	Vratsa	1
5	"OK OLIMP" Ltd.	Targovishte	Omurtag	Omurtag	1
6	"PLANZEE MB" Ltd.	Gabrovo	Gabrovo	Gabrovo	4
7	"ZGPU GRUP" PLC	Gabrovo	Gabrovo	Gabrovo	1
8	"SAMART-58" PLC	Sofia	Sofia	Sofia	5
28.61 Kitchen utensils and knives production					
1	"NOZHAROV" JSCo	Gabrovo	Gabrovo	Gabrovo	2
2	"NOZHARSKA FABRIKA-TERNA 1923" JSCo	Veliko Tarnovo	Veliko Tarnovo	Veliko Tarnovo	3
28.62 Hand-use devices and instruments production					
1	"TSERATITSIT BULGARIA" JSCo	Gabrovo	Gabrovo	Gabrovo	10
2	"REZBONAREZNI INSTRUMENTI GABROVO" Ltd.	Gabrovo	Gabrovo	Gabrovo	9
3	"INTERNATIONAL DAYMOND TEKNOLODZHI BG" PL	Sofia	Sofia	Sofia	4
28.72 Light metal packaging production					
1	"POLIGRAFICHESKI IZDELIA VARHU METALNINLIST	Sofia	Sofia	Sofia	3
2	"PRISOE" JSCo	Veliko Tarnovo	Veliko Tarnovo	Prisovo village	3
3	"SARTEN BULGARIA" PLC	Pleven	Pleven	Pleven	9
28.73 Wire articles production					
1	"RITI" JSCo	Veliko Tarnovo	Suhindol	Suhindol	3
2	"STAL-20" Ltd.	Vratsa	Roman	Roman	2
3	"VTPG-STROYMAKS" PLC	Veliko Tarnovo	Veliko Tarnovo	Veliko Tarnovo	5
28.74 Attachment elements, chains and springs production					
1	"RUBOLT-AD" JSCo	Ruse	Ruse	Ruse	3
2	"VIDIRA-PETAR PETROV" ST	Sofia	Sofia	Sofia	4

ID acc. to the NCIA*	Name	Region	Municipality	Settlement	Group acc. to the prod. - 2005
28.75	Other metal articles not classified elsewhere				
1	"ANALITIK" JSCo	Montana	Montana	Montana	5
2	"HROM" JSCo	Silistra	Silistra	Silistra	6
3	"DUNAV LIZING" PJSCo	Veliko Tarnovo	Veliko Tarnovo	Veliko Tarnovo	3
4	"BEZKONTAKTNI MULTIPLEKSORNI VERIGI" Ltd.	Sofia	Sofia	Sofia	9
5	"ISTRA EOOD" Ltd.	Sofia	Svoge	Svoge	6
6	"KAOMET" Ltd.	Sofia	Sofia	Sofia	2
7	"TRAFIK PATNA SIGNALIZATSIIYA" Ltd.	Sofia	Sofia	Sofia	6
8	"OMEGA" PLC	Sofia	Sofia	Sofia	10
9	"PALEMONT" PLC	Sofia	Sofia	Sofia	2
10	"SOLID-55" PLC	Sofia	Sofia	Sofia	5
11	"TANGRA-AB" PLC	Sofia	Sofia	Sofia	8
12	"PROMEKS-SHTARBEVI ISIE" PS	Sofia	Sofia	Sofia	3
DK 29	Production of Machinery, Equipment and Household Appliances				
29.11	Turbines and motors production, excluding aviation, auto and motorcycling				
1	"VAP HIDRO"	Pleven	Pleven	Pleven	7
29.12	Pumps and Compressors Production				
1	"VIPOM" JSCo	Vidin	Vidin	Vidin	6
2	"GARANT" JSCo	Vratsa	Byala Slatina	Byala Slatina	6
3	"PETROL TEHNIKA" Ltd.	Sofia	Sofia	Sofia	7
29.13	Reinforcement articles production				
1	"IDEAL STANDART-VIDIMA" JSCo	Gabrovo	Sevlievo	Sevlievo	10
2	"SAKAR-ISTRA" JSCo	Sofia	Svoge	Svidnya village	2
3	"DINAMO" PLC	Gabrovo	Sevlievo	Sevlievo	4
4	"SIBI" PLC	Gabrovo	Sevlievo	Sevlievo	6
29.14	Bearings, gears and connectors production				
1	"MODUL-AD" JSCo	Ruse	Byala	Byala	6
2	"SKF BERINGS BULGARIA" PJSCo	Sofia	Sofia	Sofia	9
29.22	Lifting-transport machines and lifts including				
1	"BALKAN" JSCo	Lovech	Lovech	Lovech	7
2	"BETA INDUSTRIIS KAMPANI" JSCo	Sofia	Sofia	Sofia	3
3	"VS-METAL KAMPANI" JSCo	Lovech	Lukovit	Lukovit	2
4	"ISKRA-SILATRONIK" JSCo	Sofia	Sofia	Sofia	4
5	"MIR 8" JSCo	Montana	Montana	Montana	5
6	"PODEMKRAN" JSCo	Gabrovo	Gabrovo	Gabrovo	8
7	"BALKANSKO EHO" Ltd.	Gabrovo	Sevlievo	Kravenik village	6
8	"PARFINGER PRODUKTSIONSTEHNIK BG" Ltd.	Pleven	Cherven Bryag	Cherven Bryag	10
9	"IZAMET 1991" PLC	Sofia	Sofia	Sofia	9
29.24	Other machines with common designation production				
1	"A. L. FILTAR" PLC	Ruse	Ruse	Ruse	7
29.32	Other mashines for agriculture and forestry production				
1	"SPARKI-AD" JSCo	Ruse	Ruse	Ruse	9
29.41	Portable hand instruments with inbuilt motors production				
1	"SPARKI-ELTOS" JSCo	Lovech	Lovech	Lovech	10
2	"OKTO-7-TSOLEV I SIE" PS	Sofia	Botrevgrad	Botrevgrad	4
29.42	Metal processing mashines production				
1	"ZMM" JSCo	Sofia	Sofia	Sofia	5
2	"ZMM-VRATSA" JSCo	Vratsa	Vratsa	Vratsa	4
3	"MASHSTROY" JSCo	Lovech	Troyan	Troyan	9
4	"SILOMA" JSCo	Silistra	Silistra	Silistra	6
5	"VAPRES" PLC	Pleven	Pleven	Pleven	7
29.43	Other processing mashines production				
1	"ZMM-STOMANA-AD" JSCo	Silistra	Silistra	Silistra	8
2	"VSK KENTAVAR-IZ DINAMIKA" Ltd.	Gabrovo	Dryanovo	Dryanovo	6
29.51	Mashines and equipment for metalurgy and foundry production				
1	"ILINDEN" Ltd.	Pleven	Pleven	Pleven	7
29.52	Mashines for construction and extraction production				
1	"PATNOSTROITELNA TEHNIKA" PJSCo	Sofia	Sofia	Sofia	8
2	"ATLAS KOPKO LIFTAN-EOOD" Ltd.	Ruse	Ruse	Ruse	8
3	"KERATEH INZHENERING" PLC	Razgrad	Isperih	Isperih	3
29.56	Other special destination machines production				
1	"ORIGINAL" JSCo	Gabrovo	Sevlievo	Sevlievo	5
2	"ATOMENERGOREMONT" PJSCo	Vratsa	Kozloduy	Kozloduy	9

ID acc. to the NCIA*	Name	Region	Municipality	Settlement	Group acc. to the prod. - 2005
29.60	Armaments and ammunitions production				
1	"ARKUS" JSCo	Veliko Tarnovo	Lyaskovets	Lyaskovets	10
2	"BITOVA ELEKTRONIKA" JSCo	Veliko Tarnovo	Veliko Tarnovo	Veliko Tarnovo	4
3	"IMPULS" JSCo	Gabrovo	Gabrovo	Gabrovo	7
4	"SAMEL-90" JSCo	Sofia	Samokov	Samokov	10
5	"TEREM-GEN. VLADIMIR ZAIMOV" Ltd.	Sofia	Bozhurishte	Bozhurishte	2
6	"TEREM-IVAYLO" Ltd.	Veliko Tarnovo	Veliko Tarnovo	Veliko Tarnovo	5
7	"TREMA GRUP" Ltd.	Gabrovo	Tryavna	Tryavna	1
29.71	Electrical domestic appliances production				
1	"SKLADOVA TEHNIKA" JSCo	Veliko Tarnovo	Veliko Tarnovo	Veliko Tarnovo	9
29.72	Non-electrical domestic appliances production				
1	"PRITI 95"	Veliko Tarnovo	Lyaskovets	Lyaskovets	7
DL 31	Production of Electric Mashines & Devices which are not listed elsewhere				
31.10	Electromotors, electrical generators and transformers production				
1	"AROS KUOLITI MANIT" JSCo	Sofia	Sofia	Sofia	5
2	"ELEKTROSTART" JSCo	Montana	Varshets	Varshets	9
3	"ELMA" JSCo	Lovech	Troyan	Troyan	9
4	"ELMOT" JSCo	Sofia	Sofia	Sofia	9
5	"ELPROM EMS" JSCo	Sofia	Sofia	Sofia	9
6	"ELPROM ZEM" JSCo	Sofia	Sofia	Sofia	7
7	"HYUNDAI HEVI INDUSTRIJSKI KO BG" JSCo	Sofia	Sofia	Sofia	10
8	"TSENTRALNA ENERGOREMONTNA BAZA" JSCo	Sofia	Sofia	Sofia	6
31.20	Electro-distribution and control equipment production				
1	"ABB AVANGARD" JSCo	Gabrovo	Sevlievo	Sevlievo	8
2	"ELPROM-ELIN" JSCo	Razgrad	Kubrat	Kubrat	4
3	"NAYDEN KIROV-AD" JSCo	Ruse	Ruse	Ruse	6
4	"MIKROAK EOOD" Ltd.	Sofia	Botevgrad	Botevgrad	7
5	"FESTO PROIZVODSTVO" Ltd.	Sofia	Sofia	Sofia	9
31.30	Isolated conductors and cables production				
1	"EMKA" JSCo	Gabrovo	Sevlievo	Sevlievo	10
31.40	Electrical accumulators, batteries and primary elements production				
1	"MONBAT" JSCo	Sofia	Sofia	Sofia	10
31.50	Illuminators and lamps production				
1	"MAUS-PS" Ltd.	Sofia	Sofia	Sofia	7
31.61	Electrical appliances for motors and vehicles production				
1	"EPIK ELEKTRONIK ASEMBLI EOOD" Ltd.	Sofia	Botevgrad	Botevgrad	10
31.62	Other electrical appliances production				
1	"AYHHOF KOMPONENTS BG" Ltd.	Vidin	Vidin	Vidin	3
DM 34	Production of Cars, Trailers and Semi-Trailers				
34.10	Autos and vehicle motors production				
1	"KENTA" JSCo	Targovishte	Omurtag	Omurtag	3
34.30	Production of parts and accessories for autos and motors				
1	"BALKANKAR-ZARYA" JSCo	Veliko Tarnovo	Pavlikeni	Pavlikeni	5
2	"DRUZHBA" JSCo	Razgrad	Razgrad	Razgrad	7
3	"USPEH-SSB HOLDING" Ltd.	Sofia	Sofia	Sofia	6
DM 35	Production of Means of Transportation, Excluding Cars				
35.11	Floating vessels construction and repair				
1	"RUSENSKA KORABOSTROITELNITSA-AD" JSCo	Ruse	Ruse	Ruse	10
35.20	Locomotives, motor carriages and waggons production				
1	"VAGONO-REMONTEN ZAVOD-LEVSKI" JSCo	Pleven	Levski	Levski	4
2	"TRAKTSIYA" JSCo	Razgrad	Samuil	Samuil village	9
3	"TRAMKAR" PJSCo	Sofia	Sofia	Sofia	5
4	"VAGONEN ZAVOD-INTERKOM" PLC	Gabrovo	Dryanovo	Dryanovo	3

ID acc. to the NCIA*	Name	Region	Municipality	Settlement	Group acc. to the prod. - 2005
----------------------	------	--------	--------------	------------	--------------------------------

E 40 Production and Distribution of Electricity, Gas Fuel and Heat Energy					
40.11 Electricity Production					
1	"TETS SVILOZA" JSCo	Sofia	Sofia	Sofia	9
2	"AETS KOZLODUY" PJSCo	Vratsa	Kozloduy	Kozloduy	10
3	"NATSIONALNA ELEKTRICHESKA KOMPANIYA" PJSCo	Sofia	Sofia	Sofia	10
40.30 Production and Distribution of Heat Energy					
1	"TOPLOFIKATSIYA SOFIA" JSCo	Sofia	Sofia	Sofia	10
2	"TOPLOFIKATSIYA-PLEVEN" PJSCo	Pleven	Pleven	Pleven	9
3	"TOPLOFIKATSIYA-VRATSA" PJSCo	Vratsa	Vratsa	Vratsa	8
4	"TOPLOFIKATSIYA-RUSE-EAD" PJSCo	Ruse	Ruse	Ruse	10
5	"KAMIBO" Ltd.	Sofia	Sofia	Sofia	7
E 41 Collection, Treatment and Distribution of Water					
41.00 Collection, Treatment and Distribution of Water					
1	"SOFIYSKA VODA" JSCo	Sofia	Sofia	Sofia	10
2	"VODOSNABDYAVANE I KANALIZATSIYA" Ltd.	Sofia	Sofia	Sofia	7
3	"VODOSNABDYAVANE I KANALIZATSIYA" Ltd.	Pleven	Pleven	Pleven	9
4	"VODOSNABDYAVANE I KANALIZATSIYA YOVKOVI	Veliko Tarnovo	Veliko Tarnovo	Veliko Tarnovo	9
5	"VODOSNABDYAVANE I KANALIZATSIYA" PLC	Vratsa	Vratsa	Vratsa	8

Data Source: NSI

NCIA* *National Classification of Economic Activities*

Groups according to the production - year 2005:

- 1 - from 10000 to 350000 Euro
- 2 - from 350001 to 650000 Euro
- 3 - from 650001 to 1000000 Euro
- 4 - from 1000001 to 1500000 Euro
- 5 - from 1500001 to 2000000 Euro
- 6 - from 2000001 to 3000000 Euro
- 7 - from 3000001 to 4500000 Euro
- 8 - from 4500001 to 6500000 Euro
- 9 - from 6500001 to 12500000 Euro
- 10 - over 12500000 Euro

Annex C.1.2 Main Industries and Animal Breeding Farms in BSBD

ID acc. to the NCIA*	Name	Region	Municipality	Settlement	Group acc. to the prod. - 2005
A 01.2 Animal Breeding					
01.21 Breeding of cattle					
1	"GETS-GI-AGRO" Ltd.	Burgas	Sredets	Zagortsi village	1
2	"LEVAL" Ltd.	Dobrich	Dobrich	Dobrich	1
3	"STOZHER 2005" Ltd.	Dobrich	Dobrich	Stozher village	1
4	FARMING COOPERATION "ZLATEN KLAS"	Burgas	Burgas	Rudnik village	1
5	FARMING COOPERATION "TRUD"	Varna	Vetrino	Belogradets village	1
6	"ZARA" PLC	Dobrich	Tervel	Tervel	1
01.22 Breeding of horses, donkeys, mules					
1	"SIRENA" Ltd.	Shumen	Shumen	Shumen	1
01.23 Breeding of pigs					
1	"MANEKS SAN" JSCo	Varna	Aksakovo	Slanchevo village	7
2	"SVINEKOMPLEKS BRESTAK" JSCo	Shumen	Shumen	Shumen	1
3	"HIBRIDEN TSEHTAR" JSCo	Shumen	Shumen	Shumen	7
4	"TETRAHIB" PJSCo	Shumen	Shumen	Shumen	1
5	"FAVORIT-97" Ltd.	Shumen	Shumen	Shumen	2
6	"BRADARS KOMERS" HIBRIDNO ZHIVOTNOVADSTVO	Shumen	Shumen	Shumen	8
01.24 Poultry breeding					
1	"AVES-94" JSCo	Burgas	Kameno	Cherni Vrah village	7
2	"KAMCHIYA" JSCo	Shumen	Shumen	Shumen	9
3	"SLANCHEVO" JSCo	Varna	Aksakovo	Slanchevo village	1
4	"YAITSA I PTITSI-ZORA" JSCo	Dobrich	Dobrich	Donchevo village	9
5	"HIBRIDEN TSENTAR-ZLATIYA" PJSCo	Dobrich	Dobrich	Zlatiya village	4
6	"PTITSEKOM" Ltd.	Varna	Varna	Varna	5
7	"AERKOK" PLC	Shumen	Shumen	Shumen	2
8	"DAN-2000" PLC	Varna	Varna	Varna	2
9	"POMORIE CHIKAN CAMPANI" PLC	Burgas	Pomorie	Pomorie	1
10	"TOP-94" PLC	Dobrich	Dobrich	Dobrich	2
11	"KVINS-ARGO I SIE" PS	Razgrad	Loznitsa	Loznitsa	1
01.25. Other animals breeding					
1	"BILAYN" JSCo	Targovishte	Targovishte	Alvanovo village	2
B 05. Fishery					
05.01 Fishing					
1	"ASO" PLC	Burgas	Nesebar	Nesebar	1
2	"DALBOKA" PLC	Dobrich	Kavarna	Kavarna	1
3	"DING-PAVLOVI I SIE" PS	Burgas	Sozopol	Sozopol	3
05.02 Fish breeding					
1	"SLADKOVODNO RIBOVADSTVO" JSCo	Burgas	Burgas	Burgas	1
CA 11. Crude Oils and Natural Gas Production					
11.10 Crude petroleum and natural gas production					
1	"PETREKO BULGARIA" Ltd.	Varna	Varna	Varna	9
CB 14. Non - metal Resources Extraction					
14.21 Breaking stone, gravel and sand production					
1	"ANDELA" JSCo	Burgas	Burgas	Burgas	9
2	"ESKANA" JSCo	Varna	Varna	Varna	9
DA 15. Food & Beverages Production					
15.12 Meat production from poultry					
1	"AROPLASMENT-92-V" JSCo	Varna	Varna	Varna	6
2	"PTITSEKLANITSA" JSCo	Dobrich	Dobrich	Dobrich	9
15.13 Meat products					
1	"EMIL ILIEV" Ltd.	Varna	Varna	Varna	8
2	"IVET" Ltd.	Shumen	Shumen	Shumen	6
3	"EMDI-EMIL DIMITROV" ST	Varna	Varna	Varna	6
4	"KARTEL-VALENTIN YANEV" ST	Varna	Varna	Varna	6
15.20 Manufacturing and canning fish					
1	"CHERNOMORSKI RIBOLOV BURGAS" JSCo	Burgas	Burgas	Burgas	4
2	"ELEKTA-EOOD" Ltd.	Varna	Varna	Varna	5
3	"DIAVENA" PLC	Shumen	Shumen	Shumen	6
4	"SEVER EKSPORT" PLC	Varna	Varna	Varna	5
15.33 Manufacturing and canning fruits and vegetables					
1	"SOLVEKS-MIRA-FRUKT" JSCo.	Shumen	Novi Pazar	Novi Pazar	4
2	"FRUKTO SLIVEN" JSCo.	Varna	Varna	Varna	5
3	"DENITO" PLC	Burgas	Burgas	Burgas	7
4	"EKO STANDART" PLC	Shumen	Shumen	Shumen	1
15.42 Refined oils and fats production					
1	"KALIAKRA" JSCo	Dobrich	Dobrich	Dobrich	10
2	"KLAS-OLIO" PLC	Dobrich	Dobrich	Karapelit village	8
3	"PLISKA" PLC	Shumen	Shumen	Shumen	7

ID acc. to the NCIA*	Name	Region	Municipality	Settlement	Group acc. to the prod. - 2005
----------------------	------	--------	--------------	------------	--------------------------------

15.51	Milk production and dairy products				
1	"SERDIKA-90" JSCo	Dobrich	Dobrich	Dobrich	8
2	"MIZIYA MILK" PLC	Targovishte	Targovishte	Targovishte	6
3	"STARS KAMPANI" PLC	Shumen	Shumen	Shumen	5
15.61	Grain mill products				
1	"MELNITSA VARNA 2006" PLC	Varna	Varna	Varna	4
15.71	Forage production				
1	"GALISMAN" JSCo	Shumen	Novi Pazar	Enevo village	7
15.81	Bread and sweets production				
1	"DOBRUDZHANSKI HLYAB" JSCo	Dobrich	Dobrich	Dobrich	9
2	"HLEBOZAVOD KORN" JSCo	Shumen	Shumen	Shumen	5
3	"DZGEYELPI" Ltd.	Burgas	Burgas	Burgas	5
4	"HLEBNI I SLADKARSKI IZDELIYA" Ltd.	Varna	Varna	Varna	1
5	"HLYAB I HLEBNI IZDELIYA" Ltd.	Burgas	Burgas	Burgas	4
6	"SLADKAR-2000" PLC	Burgas	Burgas	Burgas	2
7	"HLEBOZAVOD VARNA 1" PLC	Varna	Varna	Varna	4
8	"HLEBOPROIZVODSTVO ISLADKARSTVO" PLC	Targovishte	Targovishte	Targovishte	3
15.82	Chip's biscuits, biscuits and dry sweets production				
1	"ITAL FUUD INDUSTRI" JSCo	Shumen	Shumen	Shumen	3
2	"POBEDA" JSCo	Burgas	Burgas	Burgas	9
3	"NISAI-SASHKO IVANOV" ST	Varna	Varna	Varna	2
4	"ZAHARNI IZDELIYA-VARNA" PLC	Varna	Varna	Varna	7
15.83	Shugar production				
1	"BURGASKI ZAHAREN ZAVOD" PJSCo	Burgas	Burgas	Burgas	10
2	"DEVNENSKI ZAHAREN ZAVOD" Ltd.	Varna	Devnya	Devnya	10
15.84	Cocoa and chocolate production				
1	"CITRON" PLC	Shumen	Shumen	Shumen	2
15.85	Macaroni, noodles and couscous production				
1	"SAVIMEKS" Ltd.	Dobrich	Dobrich	Dobrich	7
15.91	Spirits production				
1	"VINEKS PRES LAV" JSCo	Shumen	Veliki Preslav	Veliki Preslav	8
15.93	Vine production				
1	"VINKOM" JSCo	Burgas	Pomorie	Pomorie	9
2	"LVK-VINPROM" JSCo	Targovishte	Targovishte	Targovishte	10
3	"CHERNOMORSKO ZLATO" JSCo	Burgas	Pomorie	Pomorie	9
4	VINARSKA IZBA "HAN KRUM"	Shumen	Veliki Preslav	Han Krum village	6
15.96	Beverages production				
1	"EVRO DRINKS" JSCo	Varna	Varna	Varna	7
DB 18.3	Processing of Leather and products thereof				
18.30	Hides and articles thereof				
1	"SVOBODA" JSCo	Dobrich	Dobrich	Dobrich	1
DE 21	Production of Pulp, Paper, Carboard and Products made of Paper and Cardboard				
21.21	Packing of paper and paperboard production				
1	"CHAYKA" JSCo	Varna	Varna	Varna	7
21.25	Other articles of paper and paperboard				
1	"AREON" Ltd.	Varna	Varna	Varna	3
DF 23	Production of Coke, Refind Petrol Products and Nuclear Fuel				
23.20	Refined petroleum production				
1	"LUKOYL NEFTOHIM BURGAS" JSCo	Burgas	Burgas	Burgas	10
DG 24	Production of Chemical Substances				
24.13	Base non organic chemical products				
1	"POLIMERI" JSCo	Varna	Devnya	Devnya	10
2	"SOLVEY SODI" JSCo	Varna	Devnya	Devnya	10
24.15	Fertilizers and nitrogent compounds production				
1	"AGROPOLIHIM-AD" JSCo	Varna	Devnya	Devnya	10
24.51	Soap and cleaning goods production				
1	"FIKOSOTA SINTEZ" PLC	Shumen	Shumen	Shumen	10
2	"HAYAT BULGARIA KAMPANI" PLC	Varna	Varna	Varna	9
24.52	Parfumery and toilet goods				
1	"FRESH AP COZMETIKS" PLC	Varna	Varna	Varna	7

ID acc. to the NCIA*	Name	Region	Municipality	Settlement	Group acc. to the prod. - 2005
----------------------	------	--------	--------------	------------	--------------------------------

DH 25 Production of Rubber and Plastic Products					
25.21 Plastics and articles thereof					
1	"KUIIN DIS" Ltd.	Burgas	Burgas	Burgas	8
2	"BULMAT" PLC	Dobrich	Dobrich	Dobrich	9
3	"FAMTEKS-T" PLC	Varna	Aksakovo	Aksakovo	8
25.22 Plastic packages production					
1	"PLASTMASOVI IZDELIYA" JSCo	Burgas	Sredets	Sredets	9
2	"FENIKS-PLASTIK" Ltd.	Targovishte	Targovishte	Targovishte	3
3	"ALUAKS" PLC	Shumen	Shumen	Shumen	4
4	"DANEV-ADVA-PAK" PLC	Burgas	Burgas	Burgas	5
25.23 Plastic articles for construction					
1	"SANIPLAST" JSCo	Shumen	Veliki Preslav	Veliki Preslav	5
2	"LOREKS" Ltd.	Shumen	Shumen	Shumen	4
DJ 26 Production of Other Products Made of Non-mineral Resources					
26.12 Flat glass treatment					
1	"TRAKIYA GLAS BULGRIA" PJSCo	Targovishte	Targovishte	Targovishte	9
26.13 Glassware production					
1	"NOVO STAKLO"	Shumen	Novi Pazar	Novi Pazar	7
2	"LEBED GLAS" Ltd.	Shumen	Novi Pazar	Novi Pazar	3
3	"INHOM" PLC	Varna	Beloslav	Beloslav	3
26.22 Ceramic products					
1	"ROKA BULGARIA" JSCo	Shumen	Kaspichan	Kaspichan	9
26.40 Bricks, tiles and other construction articles					
1	"KERAMAT" JSCo	Shumen	Kaspichan	Kaspichan	6
2	"KERAMIKA BURGAS" JSCo	Burgas	Burgas	Burgas	6
3	"KERAMIK-GT" JSCo	Dobrich	General Toshevo	General Toshevo	6
26.51 Cement production					
1	"DEVNYA TSEMENT" JSCo	Varna	Devnya	Devnya	10
26.61 Concrete construction products					
1	"ZSK "LOZOVO" JSCo	Burgas	Burgas	Burgas	7
26.63 Ready concrete mixtures production					
1	"ZSK-DEVNYA" JSCo	Varna	Devnya	Devnya	9
2	"PROIZVODSTVENO TEHNICHESKA BAZA" JSCo	Burgas	Burgas	Burgas	8
3	"HIT-A" JSCo	Burgas	Nesebar	Nesebar	7
4	"MIG-MARKET" PLC	Varna	Varna	Varna	7
DJ 27 Production & Molding of Metals					
27.42 Aluminium and alloys production					
1	"ALKOMET" JSCo	Shumen	Shumen	Shumen	10
DJ 28 Production of Products Made of Metals, Except for Machinery and Equipment					
28.11 Metal constructions and parts to them production					
1	"BITOVA TEHNIKA" JSCo	Dobrich	Dobrich	Dobrich	1
2	"PRODZHEKO BULGARIA" JSCo	Varna	Varna	Varna	6
3	"METALNI PANELI IKONSTRUKTSII-AD-BURGAS"	Burgas	Burgas	Burgas	4
28.12 Metal joinery production for construction purposes					
1	"IVAN ZHELJAZKOV-IVANEKS" ST	Dobrich	Kavarna	Kavarna	7
2	"DRIYM" PLC	Varna	Varna	Varna	3
3	"ELAN" PLC	Burgas	Burgas	Burgas	3
28.21 Cisterns, reservoirs and metal containers					
1	"STROITELSTVO I REMONT" JSCo	Varna	Devnya	Devnya	2
28.22 Steam-boilers and radiators production					
1	"PROMISHLENA ENERGETIKA-VARNA" JSCo	Varna	Varna	Varna	3
2	"EKOTERMAL" PLC	Burgas	Burgas	Burgas	3
28.40 Forging, stamping, stretching of metals, dust metalurgy					
1	"MADARA-KOV" PLC	Shumen	Shumen	Shumen	3
28.52 Metal mechanical treatment					
1	"BIOEKO" JSCo	Varna	Varna	Varna	2
2	"ZUESTO" JSCo	Varna	Varna	Varna	2
3	"MEHANICHEN ZAVOD-BALKANI" JSCo	Burgas	Burgas	Burgas	4
4	"INHOM-98" PLC	Varna	Aksakovo	Aksakovo	4
5	"MADARA-ZKV" PLC	Shumen	Shumen	Shumen	3
28.63 Construction and furniture casing production					
1	"METAL" JSCo	Varna	Varna	Varna	7
2	"OBKOV" JSCo	Varna	Dalgopol	Dalgopol	1
3	"MAUER LOKING SISTEMS" PLC	Varna	Varna	Varna	6
28.72 Light metal packaging production					
1	"FMA" JSCo	Targovishte	Targovishte	Targovishte	7
2	"KONTAKS" PLC	Shumen	Novi Pazar	Novi Pazar	5
3	"HERTI" PLC	Shumen	Shumen	Shumen	9

ID acc. to the NCIA*	Name	Region	Municipality	Settlement	Group acc. to the prod. - 2005
----------------------	------	--------	--------------	------------	--------------------------------

28.73	Wire articles production				
1	"METALNI IZDELIYA" JSCo	Burgas	Burgas	Burgas	8
28.75	Other metal articles not classified elsewhere				
1	"METAL" JSCo	Shumen	Shumen	Shumen	4
2	"MADARA-INSTRUMENT" PLC	Shumen	Shumen	Shumen	2
3	"MAKET" PLC	Shumen	Shumen	Shumen	4
DK 29	Production of Mashinery, Equipment and Household Appliances				
29.11	Turbines and motors production, excluding aviation, auto and motorcycling				
1	"VAMO" JSCo	Varna	Varna	Varna	8
2	"ENERGOREMONT-VARNA" PJSCo	Varna	Beloslav	Ezerovo village	6
29.22	Lifting-transport machines and lifts including				
1	"MAYAK-KM" JSCo	Shumen	Novi Pazar	Novi Pazar	3
29.24	Other machines with common designation production				
1	"SPARTAK" JSCo	Burgas	Burgas	Burgas	6
29.56	Other special destination machines production				
1	"KFK" JSCo	Varna	Varna	Varna	6
2	"RIMAKEM" Ltd.	Varna	Devnya	Devnya	4
29.60	Armaments and ammunitions production				
1	"TEREM-HAN KRUM" Ltd.	Targovishte	Targovishte	Targovishte	7
29.71	Electrical domestic appliances production				
1	"ELDOMINVEST" PLC	Varna	Varna	Varna	10
2	"FIKOSOTA" PLC	Shumen	Shumen	Shumen	10
DL 31	Production of Electric Mashines & Devices which are not listed elsewhere				
31.30	Islated conductors and cabels production				
1	"ELKABEL" JSCo	Burgas	Burgas	Burgas	10
31.40	Electrical accumulators, batteries and primary ellements production				
1	"ENERGIYA" JSCo	Targovishte	Targovishte	Targovishte	9
DM 34	Production of Cars, Trailers and Semi-Trailers				
34.30	Production of parts and accessories for autos and motors				
1	"MADARA-AVTOMOST" PLC	Shumen	Shumen	Shumen	3
DM 35	Production of Means of Transportation, Excluding Cars				
35.11	Floating vessels construction and repair				
1	"BULYARD KORABOSTROITELNA INDUSTRIYA" JSCo	Varna	Varna	Varna	10
2	"BURGASKI KORABOSTROITELNITSI" JSCo	Burgas	Burgas	Burgas	9
3	"KORABNO MASHINOSTROENE" JSCo	Varna	Varna	Varna	7
4	"KORABOREMONTEN ZAVOD ODESOS" JSCo	Varna	Varna	Varna	10
5	"MTG-DELFIN" JSCo	Varna	Varna	Varna	9
6	"TEREM-KRZ FLOTSKI ARSENAL-VARNA" Ltd.	Varna	Varna	Varna	8
35.20	Locomotives, motor carriages and waggons production				
1	"TRANSVAGON" JSCo	Burgas	Burgas	Burgas	9
E 40	Production and Distribution of Electricity, Gas Fuel and Heat Energy				
40.11	Electricity Production				
1	"TETS VARNA" PJSCo	Varna	Beloslav	Ezerovo village	10
40.30	Production and Distribution of Heat Energy				
1	"DEVEN" JSCo	Varna	Devnya	Devnya	10
E 41	Collection, Teatment and Distribution of Water				
41.00	Collection, Teatment and Distribution of Water				
1	"VODOSNABDYAVANE I KANALIZATSIYA" PJSCo	Burgas	Burgas	Burgas	10
2	"VODOSNABDYAVANE I KANALIZATSIYA" Ltd.	Dobrich	Dobrich	Dobrich	9
3	"VODOSNABDYAVANE I KANALIZATSIYA" PLC	Varna	Varna	Varna	10

Data Source: NSI

NCIA* National Casification of Iconomic Activities
Groups according to the production - year 2005:

- 1 - from 10000 to 350000 Euro
- 2 - from 350001 to 650000 Euro
- 3 - from 650001 to 1000000 Euro
- 4 - from 1000001 to 1500000 Euro
- 5 - from 1500001 to 2000000 Euro
- 6 - from 2000001 to 3000000 Euro
- 7 - from 3000001 to 4500000 Euro
- 8 - from 4500001 to 6500000 Euro
- 9 - from 6500001 to 12500000 Euro
- 10 - over 12500000 Euro

Annex C.1.3 Main Industries and Animal Breeding Farms in EABD

ID acc. to the NCIA *	Name	Region	Municipality	Settlement	Group acc. to the prod. - 2005
A 01.2 Animal Breeding					
01.21 Breeding of cattle					
1	"FERMA SEZONI" JSCo	Stara Zagora	Stara Zagora	Stara Zagora	1
2	"DRAGANOV 97" Ltd.	Plovdiv	Hisarya	Hisarya	1
3	"MCD 02" Ltd.	Sliven	Sliven	Samuilovo village	1
4	LIVESTOCK COOPERATION "GENDOV"	Plovdiv	Rakovski	Rakovski	1
5	FARMING COOPERATION "ECO-ASORTI-G 5"	Sliven	Sliven	Mechkarevo village	3
6	FARMING COOPERATION "MARITSA-95"	Pazardzhik	Pazardzhik	Pazardzhik	1
7	FARMING COOPERATION "TULOVO"	Stara Zagora	Maglizh	Tulovo village	1
8	FARMING COOPERATION "NAPREDAK"	Yambol	Tundzha	Roza village	2
9	"AGROYOKON-92" PLC	Plovdiv	Rakovski	Rakovski	5
10	"AGROFARMA" PLC	Sliven	Sliven	Sliven	1
11	"ASENITSA-96" PLC	Plovdiv	Plovdiv	Plovdiv	3
12	"ELIT 95" PLC	Plovdiv	Parvomay	Dalbok Izvor village	5
13	"KOSMO" PLC	Plovdiv	Plovdiv	Plovdiv	2
14	"MBM-2001" PLC	Plovdiv	Parvomay	Dalbok Izvor village	1
15	"POSTT" PLC	Sliven	Sliven	Sliven	1
01.23 Breeding of pigs					
1	"REPRODUKTOR PO SVINEVADSTVO" JSCo	Yambol	Tundzha	Kalchevo village	6
2	"SVIKOM" JSCo	Pazardzhik	Pazardzhik	Pazardzhik	2
3	"SVINEKOMPLEKS PASTREN" JSCo	Stara Zagora	Stara Zagora	Stara Zagora	1
4	"STOMAR INVEST" JSCo	Plovdiv	Plovdiv	Plovdiv	2
5	"FANTASTIKA" JSCo	Plovdiv	Rakovski	Belozem village	2
6	"BRATYA KARTEVI" Ltd.	Plovdiv	Maritsa	Radinovo village	2
7	"ROUZ TREYDING" Ltd.	Stara Zagora	Pavel Banya	Pavel Banya	1
8	"SVIKOM" Ltd.	Sliven	Sliven	Sliven	1
9	"AGRO-SLAVYANIN" PLC	Stara Zagora	Stara Zagora	Stara Zagora	3
10	"SVINEKOMPLEKS ZIMEN" JSCo	Burgas	Karnobat	Zimen village	5
11	"SVINEKOMPLEKS KRUMOVO GRADISHTE" JSCo	Burgas	Karnobat	Krumovo Gradishte village	5
12	"AYAKS-95" PLC	Haskovo	Dimitrovgrad	Dimitrovgrad	6
13	"MOLLOVA KURIYA" PLC	Sliven	Nova Zagora	Nova Zagora	1
14	"AGROMAKS" COOPERATION	Haskovo	Haskovo	Haskovo	1
01.24 Poultry breeding					
1	"KALAMITSA" JSCo	Plovdiv	Rodopi	Tsalapitsa village	4
2	"YAITSEPROM" JSCo	Kardzhali	Kardzhali	Kardzhali	1
3	"BIZNESGRUP" Ltd.	Yambol	Yambol	Yambol	3
4	"BOVANS-BULGARIA" Ltd.	Stara Zagora	Stara Zagora	Stara Zagora	1
5	"BULEV" Ltd.	Plovdiv	Parvomay	Parvomay	4
6	"MINA" Ltd.	Stara Zagora	Stara Zagora	Stara Zagora	3
7	"SIG" Ltd.	Haskovo	Haskovo	Haskovo	2
8	"TER-M" Ltd.	Plovdiv	Plovdiv	Plovdiv	4
9	"TONIVET EKO-27" Ltd.	Plovdiv	Plovdiv	Plovdiv	3
10	"HERON" Ltd.	Plovdiv	Rakovski	Rakovski	2
11	"GRADUS-7" PLC	Stara Zagora	Stara Zagora	Stara Zagora	6
12	"DANIK" PLC	Plovdiv	Sadovo	Popovitsa village	2
13	"ZHYULIV" PLC	Stara Zagora	Stara Zagora	Stara Zagora	6
14	"ILMA-IL" PLC	Pazardzhik	Pazardzhik	Pazardzhik	1
15	"KOKOIMPEKS" PLC	Smolyan	Smolyan	Smolyan	4
16	"MIZ" PLC	Plovdiv	Rakovski	Rakovski	3
17	"MILENIUM 2000" PLC	Stara Zagora	Stara Zagora	Stara Zagora	6
18	"FURAZHI-2000" PLC	Kardzhali	Kardzhali	Kardzhali	4
19	"HELIKS" PLC	Haskovo	Haskovo	Haskovo	3
20	"HRISTO HRISTOV-BAZA LOMTSI" PLC	Sliven	Sliven	Sliven	1
21	"AVITA-VA-TENEVI" PS	Stara Zagora	Stara Zagora	Stara Zagora	1
01.25 Other animals breeding					
1	"APITREYD" Ltd.	Plovdiv	Plovdiv	Plovdiv	1
2	"LULCHEV" Ltd.	Plovdiv	Plovdiv	Plovdiv	1
3	"APETIT" PLC	Stara Zagora	Stara Zagora	Stara Zagora	4

ID acc. to the NCIA*	Name	Region	Municipality	Settlement	Group acc. to the prod. - 2005
B 05. Fishery					
05.02 Fish breeding					
1	"DIANA FISH 13" Ltd.	Yambol	Tundzha	Kukorevo village	1
2	"ESETRA- COMERS" Ltd.	Plovdiv	Sadovo	Bolyartsi village	2
3	"INKOM 96" Ltd.	Yambol	Yambol	Yambol	1
4	"SALVELINUS" Ltd.	Smolyan	Dospat	Dospat	1
5	"SALVELINUS-REYA FISH KD"	Smolyan	Dospat	Dospat	1
6	"NAUCHNO ZVENO NA IRA-PLOVDIV"	Plovdiv	Plovdiv	Plovdiv	NA
7	"TUNDZHA-73"	Stara Zagora	Nikolaevo	Nikolaevo	1
CA 10. Coal Mining					
10.20 Brown and Lignite coals production					
1	"MINI MARITSA- IZTOK" PJSCo	Stara Zagora	Radnevo	Radnevo	10
CB 13. Metal Ore Production					
13.20 Non - ferrous ores production					
1	"ASAREL-MEDET" JSCo	Pazardzhik	Panagyurishte	Panagyurishte	10
2	"ELATSITE -MED" JSCo	Sofia	Mirkovo	Mirkovo village	10
3	"CHELOPECH MAYNING" PJSCo	Sofia	Chelopech	Chelopech village	10
4	"GORUBSO-KARDZHALI" JSCo	Kardzhali	Kardzhali	Kardzhali	9
5	"GORUBSO-MADAN" JSCo	Kardzhali	Kardzhali	Kardzhali	8
CB 14. Non - metal Resources Extraction					
14.12 Limestone, gypsum, chalk and dolomite production					
1	"BULGARMIN INZHENERING" JSCo	Pazardzhik	Panagyurishte	Panagyurishte	4
14.21 Breaking stone, gravel and sand production					
1	"INMAT" PLC	Stara Zagora	Radnevo	Radnevo	9
14.22 Clay and Kaolin					
1	"ES AND BI INDUSTRIAL MINERALS" JSCo	Kardzhali	Kardzhali	Kardzhali	9
DA 15. Food & Beverages Production					
15.11 Meat production					
1	"BRATYA KARTEVI" PLC	Plovdiv	Maritsa	Radinovo village	6
15.12 Meat production from poultry					
1	"BREZOVO" JSCo	Plovdiv	Brezovo	Brezovo	10
2	"ALIANS-AGRIKOL-ALAG" PLC	Yambol	Tundzha	Okop village	9
3	"GRADUS-1" PLC	Pazardzhik	Panagyurishte	Panagyurishte	10
15.13 Meat products					
1	"DIL TUR-PLOVDIV" JSCo	Plovdiv	Plovdiv	Plovdiv	10
2	"EKARISAZH-ZAGORE" JSCo	Stara Zagora	Stara Zagora	Stara Zagora	5
3	"KEN" JSCo	Stara Zagora	Stara Zagora	Stara Zagora	9
4	"MESOKOMBINAT-KARLOVO" JSCo	Plovdiv	Karlovo	Karlovo	8
5	"DIMITAR MADZHAROV-2" Ltd.	Plovdiv	Plovdiv	Plovdiv	9
6	"EKO MES" Ltd.	Pazardzhik	Pazardzhik	Velichkovo village	3
7	"DELIKATES-2" PLC	Plovdiv	Kaloyanovo	Zhitnitsa village	7
8	"EROPIMEL" PLC	Haskovo	Dimitrovgrad	Dimitrovgrad	4
9	"ORION 2001" PLC	Pazardzhik	Pazardzhik	Pazardzhik	6
10	"PTITSEKLANITSA -CHUBRA" PLC	Yambol	Yambol	Yambol	8
15.33 Manufacturing and canning fruits and vegetables					
1	"FILIKON-97" JSCo.	Plovdiv	Plovdiv	Plovdiv	8
2	"HLADILNIK-KOSTENETS" JSCo.	Sofia	Kostenets	Kostenets	1
3	"YUGOPLOD" JSCo.	Haskovo	Haskovo	Haskovo	6
4	"AGRI BULGARIYA" Ltd.	Plovdiv	Maritsa	Radinovo village	9
5	"YOKA" Ltd.	Plovdiv	Stamboliyski	Kurtovo Konare village	4
6	"PALIRRIYA-BULGARIA" Ltd.	Sliven	Nova Zagora	Nova Zagora	8
7	"GRIVAS" PLC	Sliven	Sliven	Sliven	7
8	"DERONI" PLC	Haskovo	Haskovo	Haskovo	7
9	"DIONI" PLC	Stara Zagora	Stara Zagora	Stara Zagora	7
10	"EFEB" PLC	Yambol	Yambol	Yambol	5
11	"KONEKS- TIVA" PLC	Stara Zagora	Bratya Daskalovi	Orizovo village	8
15.42 Refined oils and fats production					
1	"BISER OLIVA" JSCo	Stara Zagora	Stara Zagora	Stara Zagora	9
2	"ZLATNA TRAKIYA" JSCo	Kardzhali	Kardzhali	Kardzhali	7
3	"PAPAS-OLIO" JSCo	Yambol	Yambol	Yambol	10
4	"UNIBEL" JSCo	Plovdiv	Plovdiv	Plovdiv	8
15.51 Milk production and dairy products					
1	"LAKRIMA" JSCo	Pazardzhik	Pazardzhik	Pazardzhik	4
2	"OBEDINENA MLECHNA KOMPANIYA" JSCo	Plovdiv	Plovdiv	Plovdiv	10
3	"TIRBUL" PJSCo	Sliven	Sliven	Sliven	10
4	"VITELA NET" Ltd.	Stara Zagora	Stara Zagora	Stara Zagora	1
5	"FILIPOLIS-RK" PLC	Plovdiv	Plovdiv	Plovdiv	8
15.52 Aice-cream production					
1	"KARIL I TANYA" PLC	Yambol	Yambol	Yambol	6

ID acc. to the NCIA*	Name	Region	Municipality	Settlement	Group acc. to the prod. - 2005
15.61	Grain mill products				
1	"ZARNENI HRANI" JSCo	Haskovo	Haskovo	Haskovo	7
2	KOOPERATSIYA "SIMID 1000" PLC	Plovdiv	Plovdiv	Plovdiv	9
3	"MELNITSA SLIVEN- 2003" PLC	Sliven	Sliven	Sliven	7
15.71	Forage production				
1	"HRANSERVIZINZHENERING" JSCo	Stara Zagora	Stara Zagora	Stara Zagora	3
15.81	Bread and sweets production				
1	"BELLA BULGARIA" JSCo	Plovdiv	Plovdiv	Plovdiv	9
2	"ZARYA-2000" JSCo	Pazardzhik	Septemvri	Septemvri	3
3	"HLEBMASH KOMERS-95" JSCo	Pazardzhik	Pazardzhik	Pazardzhik	5
4	"HLEBOZAVOD-AD" JSCo	Haskovo	Haskovo	Haskovo	5
5	"BORSA" Ltd.	Pazardzhik	Septemvri	Septemvri	2
6	"MIO" Ltd.	Pazardzhik	Pazardzhik	Pazardzhik	5
7	"PETAR I PETAR" Ltd.	Plovdiv	Karlovo	Karlovo	1
8	"SIMID AGRO" Ltd.	Plovdiv	Plovdiv	Plovdiv	7
9	"HLEBOZAVOD TIMS" Ltd.	Haskovo	Haskovo	Haskovo	3
10	"HLEBOPROIZVODSTVO I SLADKARSTVO-VELINGRA	Pazardzhik	Velingrad	Velingrad	4
11	"HLYAB I HLEBNI IZDELIYA" Ltd.	Yambol	Elhovo	Elhovo	2
12	"AGI-1" PLC	Plovdiv	Plovdiv	Plovdiv	1
13	"DEMETRA-S" PLC	Sliven	Sliven	Sliven	6
14	"KEDAR-1994-R" PLC	Plovdiv	Plovdiv	Plovdiv	3
15	"M K B" PLC	Plovdiv	Plovdiv	Plovdiv	5
16	"MARITSA" PLC	Haskovo	Dimitrovgrad	Dimitrovgrad	2
17	"PI-MI" PLC	Plovdiv	Saedinenie	Saedinenie	2
18	"FEDON" PLC	Pazardzhik	Pazardzhik	Pazardzhik	4
19	"HLEBOPROIZVODSTVO" PLC	Stara Zagora	Stara Zagora	Stara Zagora	4
20	"HLYAB I HLEBNI IZDELIYA" PLC	Stara Zagora	Kazanlak	Kazanlak	3
21	"TSEPERERA 98" PLC	Stara Zagora	Stara Zagora	Stara Zagora	3
22	"YAMBOL HLYAB" PLC	Yambol	Yambol	Yambol	4
23	"ZHAK-03-ZHULEV S-IE" PS	Plovdiv	Plovdiv	Plovdiv	3
15.82	Chip's biscuits, biscuits and dry sweets production				
1	"NASLADA" JSCo	Stara Zagora	Stara Zagora	Stara Zagora	2
2	"GEORGI ATANASOV-96" ST	Plovdiv	Plovdiv	Plovdiv	2
3	"VIP SIMERS GRUP" PLC	Plovdiv	Plovdiv	Plovdiv	5
4	"MEDOVINA" PLC	Plovdiv	Rakovski	Rakovski	2
5	"SHOKOLINA" PLC	Plovdiv	Hisarya	Hisarya	5
6	"GALATEYA-2000-BYALKOVA I SIE" PS	Plovdiv	Plovdiv	Plovdiv	3
15.84	Cocoa and chocolate production				
1	"ZAHAREN KOMBINAT-KRISTAL" JSCo	Plovdiv	Plovdiv	Plovdiv	9
2	"HRANITELNO VKUSOV KOMBINAT" JSCo	Yambol	Yambol	Yambol	3
3	"KREEM LAYN BULGARIA" Ltd.	Pazardzhik	Pazardzhik	Pazardzhik	8
4	"MOTO BOYS" PLC	Plovdiv	Plovdiv	Plovdiv	6
5	"SHOKO TIM" PLC	Stara Zagora	Stara Zagora	Stara Zagora	5
15.87	Food seasoning and sauces production				
1	"RUBIKON" Ltd.	Plovdiv	Rakovski	Rakovski	3
15.91	Spirits production				
1	"VINPROM PESHTERA" JSCo	Plovdiv	Plovdiv	Plovdiv	10
2	"RIKOM" Ltd.	Plovdiv	Brezovo	Brezovo	5
15.92	Ethyl alcohol production				
1	"VIN. S. INDUSTRIYS" PLC	Burgas	Karnobat	Tserkovski village	9
15.93	Vine production				
1	"VINARSKA IZBA PALDIN" JSCo	Plovdiv	Perushitsa	Perushitsa	3
2	"VINARSKA KASHTA-SAKAR" JSCo	Haskovo	Lyubimets	Lyubimets	7
3	"VINEKS SLAVYANTSI" JSCo	Burgas	Sungurlare	Slavyantsi village	9
4	"VINZAVOD" JSCo	Plovdiv	Asenovgrad	Asenovgrad	7
5	"VINI" JSCo	Sliven	Sliven	Sliven	9
6	"VINTEHPROM" JSCo	Pazardzhik	Pazardzhik	Pazardzhik	5
7	"VINARSKA IZBA "ROZOVA DOLINA"	Plovdiv	Karlovo	Karlovo	1
8	"VINPROM PLEVEN" PJSCo	Plovdiv	Plovdiv	Plovdiv	4
9	"VINPROM YAMBOL" PJSCo	Yambol	Yambol	Yambol	6
10	"DOMEYN MENADA" Ltd.	Stara Zagora	Stara Zagora	Stara Zagora	10
11	"SANDAYL VINERI" Ltd.	Yambol	Yambol	Yambol	6
12	"NOVIKO-NORD" PLC	Stara Zagora	Chirpan	Chirpan	3
15.96	Beverages production				
1	"ZAGORKA" JSCo	Stara Zagora	Stara Zagora	Stara Zagora	10
2	"KAMENITSA" JSCo	Plovdiv	Plovdiv	Plovdiv	10
15.98	Mineral water and soft drinks				
1	"DEVIN" PJSCo	Smolyan	Devin	Devin	9
2	"NOVA TREYD" Ltd.	Plovdiv	Saedinenie	Saedinenie	6
3	"RADULOV" Ltd.	Stara Zagora	Stara Zagora	Stara Zagora	5

ID acc. to the NCIA*	Name	Region	Municipality	Settlement	Group acc. to the prod. - 2005
DA 16. Tobacco production					
16.00 Tobacco substitutes production					
1	"PLOVDIV-BT" JSCo	Plovdiv	Plovdiv	Plovdiv	10
2	"SLANTSE STARA ZAGORA-BT" JSCo	Stara Zagora	Stara Zagora	Stara Zagora	10
3	"ALAYANS UAN TABAKO BULGARIA" Ltd.	Haskovo	Haskovo	Haskovo	10
DB 18.3. Processing of Leather and products thereof					
18.30 Hides and articles thereof					
1	"PULPUDEVA" JSCo	Plovdiv	Plovdiv	Plovdiv	2
2	"TANIST" Ltd.	Plovdiv	Plovdiv	Plovdiv	2
DC 19.1 Production of Leather					
19.10 Leather production					
1	"EVROMIG" PLC	Stara Zagora	Stara Zagora	Stara Zagora	
DE 21 Production of Pulp, Paper, Carboard and Products made of Paper and Cardboard					
21.12 Paper and paperboard production					
1	"DUOPAK-TRAKIYA PAPIR" JSCo	Pazardzhik	Pazardzhik	Pazardzhik	10
2	"KOSTENETS-HHI" JSCo	Sofia	Kostenets	Kostenets	9
3	"MONDI PEKIDZHING STAMBOLYSKI" PJSCo	Plovdiv	Stamboliyski	Stamboliyski	10
21.21 Packing of paper and paperboard production					
1	"DUNAPAK-RODINA" JSCo	Plovdiv	Plovdiv	Plovdiv	9
2	"KAM-919" Ltd.	Plovdiv	Plovdiv	Plovdiv	7
3	"SAKSES BI DZHI" Ltd.	Haskovo	Ivaylovgrad	Ivaylovgrad	3
4	"TEMPODEM" Ltd.	Plovdiv	Maritsa	Trud village	7
5	KOOPERATSIYA "DENITSA KT"	Plovdiv	Plovdiv	Plovdiv	2
6	"FORT" PLC	Plovdiv	Plovdiv	Plovdiv	6
21.22 Toilet articles of paper and paperboard					
1	"ZAVOD ZA HARTIYA - BELOVO" JSCo	Pazardzhik	Belovo	Belovo	10
DF 23 Production of Coke, Refind Petrol Products and Nuclear Fuel					
23.20 Refined petroleum production					
1	"INSA" Ltd.	Plovdiv	Rakovski	Rakovski	8
DG 24 Production of Chemical Substances					
24.13 Base non organic chemical products					
1	"KALTSIT" JSCo	Plovdiv	Asenovgrad	Asenovgrad	9
24.15 Fertilizers and nitrogent compounds production					
1	"NEOHIM" JSCo	Haskovo	Dimitrovgrad	Dimitrovgrad	10
24.20 Pesticides and other agrochemicals					
1	"AGRIYA" JSCo	Plovdiv	Plovdiv	Plovdiv	8
24.41 Medical substances					
1	"BIOVET" JSCo	Pazardzhik	Peshtera	Peshtera	10
24.42 Medical goods and medicaments					
1	"BALGARSKA ROZA-SEVTOPOLIS" JSCo	Stara Zagora	Kazanlak	Kazanlak	8
24.52 Parfumery and toilet goods					
1	"ALEN MAK" JSCo	Plovdiv	Plovdiv	Plovdiv	9
2	"RUBELLA BYUTI" JSCo	Smolyan	Rudozem	Rudozem	9
3	"ROZAIMPEKS" PLC	Plovdiv	Plovdiv	Plovdiv	9
4	"SOLVEKS-KOZMETICHNI PRODUKTI" PLC	Plovdiv	Plovdiv	Plovdiv	7
24.70 Artificial and synthetic fibres production					
1	"YAMBOLEN" JSCo	Yambol	Yambol	Yambol	5
DH 25 Production of Rubber and Plastic Products					
25.13 Rubber and articles thereof					
1	"ZAVOD ZA KAUCHUKOVI UPLATNITELI" JSCo	Stara Zagora	Stara Zagora	Gorno Botevo village	3
25.21 Plastics and articles thereof					
1	"ASENOVA KREPOST" JSCo	Plovdiv	Asenovgrad	Asenovgrad	10
2	"HIMIK" JSCo	Plovdiv	Asenovgrad	Asenovgrad	5
3	"VIOMEL" Ltd.	Sofia	Kostenets	Kostenets	3
4	"ATE PLAST" PLC	Stara Zagora	Stara Zagora	Stara Zagora	8
5	"PANHIM" PLC	Stara Zagora	Stara Zagora	Stara Zagora	9
6	"FILPLAST" PLC	Plovdiv	Plovdiv	Plovdiv	2
7	"HIK-91-PATSEV SIE" PS	Plovdiv	Sadovo	Sadovo	9
25.22 Plastic packages production					
1	"EKOPLAST 2002" JSCo	Yambol	Yambol	Yambol	4
2	"GOTMAR" Ltd.	Plovdiv	Saedinenie	Saedinenie	10
3	"ITD" Ltd.	Plovdiv	Saedinenie	Saedinenie	9
4	"ZORNITSA-ILIYA RADEV" ST	Pazardzhik	Pazardzhik	Pazardzhik	5
5	"DANIK" PLC	Stara Zagora	Kazanlak	Kazanlak	7
6	PK ZA INVALIDI "RAYNA KNYAGINYA"	Pazardzhik	Panagyurishte	Panagyurishte	2
7	"ENKO-NEDEV-S-IE" PS	Plovdiv	Plovdiv	Plovdiv	3
25.23 Plastic articles for construction					
1	"TEOLINO PLAST" Ltd.	Plovdiv	Plovdiv	Plovdiv	4
2	"FORMATIK" Ltd.	Sofia	Ihtiman	Ihtiman	6
3	"IVAL" PLC	Plovdiv	Plovdiv	Plovdiv	4

ID acc. to the NCIA*	Name	Region	Municipality	Settlement	Group acc. to the prod. - 2005
25.24	Other plastic articles				
1	"BUNAY" JSCo	Pazardzhik	Panagyurishte	Panagyurishte	7
2	"AREKSIM" Ltd.	Plovdiv	Plovdiv	Plovdiv	7
3	"DIKO-IVAN DIKOLAKOV" Ltd.	Plovdiv	Plovdiv	Plovdiv	2
4	"MAGNETIK MEDIYA PLASTIK" PLC	Pazardzhik	Pazardzhik	Dragor village	1
DI 26	Production of Other Products Made of Non-mineral Resources				
26.40	Bricks, tiles and other construction articles				
1	"KERAMIK INVEST" JSCo	Sliven	Sliven	Sliven	4
26.51	Cement production				
1	"VULKAN" JSCo	Haskovo	Dimitrovgrad	Dimitrovgrad	10
26.61	Concrete construction products				
1	"ZSK "BORUY" JSCo	Stara Zagora	Stara Zagora	Stara Zagora	7
2	"SBKI" JSCo	Plovdiv	Plovdiv	Plovdiv	6
3	"SIMAT" JSCo	Haskovo	Dimitrovgrad	Dimitrovgrad	5
4	"ZAVOD ZA BETONOVI ELEMENTI" PLC	Plovdiv	Rakovski	Stryama village	6
26.63	Ready concrete mixtures production				
1	"STROYKOMBINAT-M" JSCo	Stara Zagora	Stara Zagora	Stara Zagora	7
2	"TMSI" Ltd.	Smolyan	Smolyan	Smolyan	6
26.82	Products made of other non-metal minerals, not classified elsewhere production				
1	"TEHNOSTROY-INZHENERING 99" JSCo	Yambol	Yambol	Yambol	7
DJ 27	Production & Molding of Metals				
27.44	Copper and alloys production				
1	"KUMERIO MED" JSCo	Sofia	Pirdop	Pirdop	10
27.43	Lead, zinc, tin and alloys production				
1	"KTSM" JSCo	Plovdiv	Plovdiv	Plovdiv	10
2	"OTSK" JSCo	Kardzhali	Kardzhali	Kardzhali	10
27.51	Cast Iron Foundry				
1	"BAMEKS" JSCo	Plovdiv	Karlovo	Karlovo	7
2	"PROGRES" JSCo	Stara Zagora	Stara Zagora	Stara Zagora	9
3	"CHUGUNOLEENE INVEST 97" JSCo	Plovdiv	Parvomay	Parvomay	7
4	"CHUGUNOLEENE" JSCo	Sofia	Ihtiman	Ihtiman	10
DJ 28	Production of Products Made of Metals, Except for Machinery and Equipment				
28.11	Metal constructions and parts to them production				
1	"VAZHOD I" JSCo	Plovdiv	Plovdiv	Plovdiv	3
2	"KOFRAZHNA TEHNIKA" JSCo	Plovdiv	Plovdiv	Plovdiv	7
3	"METALIK" JSCo	Stara Zagora	Stara Zagora	Stara Zagora	8
4	"MODUS" JSCo	Haskovo	Haskovo	Haskovo	3
5	"NIPI-M" JSCo	Stara Zagora	Stara Zagora	Stara Zagora	2
6	"PLOVDIVSTROYRESURS" JSCo	Plovdiv	Plovdiv	Plovdiv	5
7	"PODEMSTROYMASH" JSCo	Pazardzhik	Pazardzhik	Pazardzhik	6
8	"SIGN" Ltd.	Kardzhali	Kardzhali	Kardzhali	4
9	"TURISTSTROY-TSARATSOVO" Ltd.	Plovdiv	Maritsa	Tsaratsovo village	3
10	"DECHKO KOLEV-IDA" ST	Stara Zagora	Stara Zagora	Stara Zagora	8
11	"DZHI-ES-DZHI-DZHAMBAZOV"	Plovdiv	Plovdiv	Plovdiv	2
12	"CHAHOV" PLC	Stara Zagora	Stara Zagora	Bogomilovo village	6
28.12	Metal joinery production for construction purposes				
1	"NIKOLAY YANKOV-VILLAN" ST	Stara Zagora	Stara Zagora	Stara Zagora	3
28.21	Cisterns, reservoirs and metal containers				
1	"BIOMASHINOSTROENE" JSCo	Plovdiv	Plovdiv	Plovdiv	7
2	"TERMOTEHNIKA" JSCo	Plovdiv	Plovdiv	Plovdiv	3
3	"HIMMASH" JSCo	Haskovo	Haskovo	Haskovo	5
4	"PIM" PLC	Haskovo	Haskovo	Haskovo	9
5	"STIMEKS" PLC	Haskovo	Haskovo	Haskovo	4
28.22	Steam-boilers and radiators production				
1	KD "PROMISHLENA ENERGETIKA-97"	Pazardzhik	Pazardzhik	Pazardzhik	2
28.30	Steam-boilers production				
1	"PROMISHLENA ENERGETIKA" JSCo	Yambol	Yambol	Yambol	4
2	"VALIS" Ltd.	Stara Zagora	Stara Zagora	Stara Zagora	2
3	"PETKO PETKOV-24" Ltd.	Stara Zagora	Stara Zagora	Stara Zagora	3
4	"TOPLOMONTAZH-INZHENERING" Ltd.	Stara Zagora	Stara Zagora	Stara Zagora	1
5	"ENERGOTRANS 2002" PLC	Stara Zagora	Stara Zagora	Stara Zagora	4
28.40	Forging, stamping, stretching of metals, dust metalurgy				
1	"ZMM-ZLATOGRAĐ" JSCo	Smolyan	Zlatograd	Zlatograd	2
2	"METALURGREMONT 21" JSCo	Plovdiv	Plovdiv	Plovdiv	2
3	"PRESKOV" JSCo	Stara Zagora	Stara Zagora	Stara Zagora	7
28.51	Surface treatment and coating of metals				
1	"EVERT-LAK" Ltd.	Pazardzhik	Strelcha	Strelcha	1
2	"OLOPLAST OOD" PLC	Sofia	Pirdop	Pirdop	3

ID acc. to the NCIA*	Name	Region	Municipality	Settlement	Group acc. to the prod. - 2005
28.52	Metal mechanical treatment				
1	"HOUALD INDUSTRIAL SYSTEMS" PJSCo	Plovdiv	Maritsa	Voyvodino village	4
2	"AS-INZHENERING" Ltd.	Yambol	Yambol		3
3	"ASTROIDA-OOD" PLC	Pazardzhik	Panagyurishte	Panagyurishte	2
4	"ENERKOM" PLC	Plovdiv	Plovdiv	Plovdiv	2
5	"MAGNETIK MEDIYA MEHANIKS" PLC	Pazardzhik	Pazardzhik	Dragor village	4
6	"OPTOMEHANIKA" PLC	Pazardzhik	Panagyurishte	Panagyurishte	2
7	"STRATUS" PLC	Plovdiv	Plovdiv	Plovdiv	6
28.62	Hand-use devices and instruments production				
1	"HISAR" JSCo	Plovdiv	Hisarya	Hisarya	2
2	"SUPERABRAZIV" Ltd.	Stara Zagora	Kazanlak	Kran village	5
3	"MITKO TANEV KOMERSIAL"	Plovdiv	Plovdiv	Plovdiv	2
4	"ZMM" PLC	Smolyan	Smolyan	Smolyan	2
5	"INSTRUMENTALEN ZAVOD" PLC	Pazardzhik	Pazardzhik	Pazardzhik	2
28.63	Construction and furniture casing production				
1	"SONIKO" PLC	Plovdiv	Plovdiv	Plovdiv	4
28.72	Light metal packaging production				
1	"GUDEKS" JSCo	Plovdiv	Plovdiv	Plovdiv	7
2	"CHIKO" JSCo	Pazardzhik	Peshtera	Peshtera	1
3	"ARTGLAS" Ltd.	Plovdiv	Plovdiv	Plovdiv	2
4	"BULMETAL" PLC	Stara Zagora	Gurkovo	Gurkovo	8
5	"HEROS" PLC	Plovdiv	Plovdiv	Plovdiv	5
28.73	Wire articles production				
1	"FERAL I KO" JSCo	Plovdiv	Plovdiv	Plovdiv	4
2	"ELEKTRODI" JSCo	Sofia	Ihtiman	Ihtiman	7
3	"KALIBROVANI STOMANI" JSCo	Yambol	Yambol	Yambol	4
28.74	Attachment elements, chains and springs production				
1	"ZAVOD ZA PRUZHINI" JSCo	Stara Zagora	Kazanlak	Kazanlak	7
2	"KREPEZHNI IZDELIYA" JSCo	Plovdiv	Plovdiv	Plovdiv	7
28.75	Other metal articles not classified elsewhere				
1	"EAZ-99" JSCo	Plovdiv	Perushitsa	Perushitsa	1
2	"TOMIKA-METAL" JSCo	Plovdiv	Plovdiv	Plovdiv	6
3	"ALAEEDIN-INVESTMENT" Ltd.	Stara Zagora	Stara Zagora	Stara Zagora	6
4	"ELDIKS" Ltd.	Stara Zagora	Stara Zagora	Stara Zagora	2
5	"KARAT-PERFEKT" Ltd.	Plovdiv	Plovdiv	Plovdiv	2
6	"METAL IN" Ltd.	Plovdiv	Plovdiv	Plovdiv	3
7	"MONI MG" Ltd.	Plovdiv	Plovdiv	Plovdiv	5
8	"TIKE-MM" Ltd.	Plovdiv	Plovdiv	Plovdiv	3
9	"YUPITER-METAL" Ltd.	Plovdiv	Plovdiv	Plovdiv	4
10	"YUPITER 05" Ltd.	Plovdiv	Plovdiv	Plovdiv	7
11	"IDEAL FORMA" PLC	Stara Zagora	Kazanlak	Kazanlak	3
12	"OPTOFORM" PLC	Pazardzhik	Panagyurishte	Panagyurishte	2
13	"PROGRES-93" PLC	Haskovo	Haskovo	Haskovo	1
14	TPK "IVAN CHOLEV"	Sofia	Kostenets	Kostenets village	1
DK 29	Production of Machinery, Equipment and Household Appliances				
29.11	Turbines and motors production, excluding aviation, auto and motorcycling				
1	"ENERGOREMONT-GALABOVO" JSCo	Stara Zagora	Galabovo	Galabovo	9
2	"ATOMENERGOREMONT GALABOVO" Ltd.	Stara Zagora	Galabovo	Galabovo	7
29.12	Pumps and Compressors Production				
1	"BADESHTNOST" JSCo	Stara Zagora	Chirpan	Chirpan	8
2	"INDUSTRIALTEHNIK" JSCo	Stara Zagora	Kazanlak	Kazanlak	4
3	"KAPRONI" JSCo	Stara Zagora	Kazanlak	Kazanlak	9
4	KALVACHA INZHENERING" JSCo	Stara Zagora	Stara Zagora	Stara Zagora	6
5	"M+S HIDRAVLIK" JSCo	Stara Zagora	Kazanlak	Kazanlak	10
6	"PNEVMATIKA-SERTA" JSCo	Kardzhali	Kardzhali	Kardzhali	8
7	"HIDRAVLICHNI ELEMENTI ISISTEMI" JSCo	Yambol	Yambol	Yambol	10
8	"HIDROSISTEM" Ltd.	Yambol	Yambol	Yambol	4
9	"DZHEBEL-96" PLC	Kardzhali	Dzhebel	Dzhebel	6
29.14	Bearings, gears and connectors production				
1	"ZMM-NOVA ZAGORA" JSCo	Sliven	Nova Zagora	Nova Zagora	5
29.22	Lifting-transport machines and lifts including				
1	"BALKANKAR-REKORD" JSCo	Plovdiv	Plovdiv	Plovdiv	9
2	"BALKANKAR-RUEN" JSCo	Plovdiv	Asenovgrad	Asenovgrad	5
3	"BALKANKAR-SREDETS" JSCo	Pazardzhik	Pazardzhik	Pazardzhik	4
4	"MV YANTRA" JSCo	Plovdiv	Plovdiv	Plovdiv	3
29.23	Industrial refrigerating and ventilating equipment production				
1	"ATARO KLIMA" Ltd.	Plovdiv	Plovdiv	Plovdiv	9
29.24	Other machines with common designation production				
1	"MEHANOSERVIZ KTSM" Ltd.	Plovdiv	Plovdiv	Plovdiv	4
29.31	Tractors for agriculture and forestry production				
1	"AGROTEHNIKA" JSCo	Plovdiv	Karlovo	Karlovo	1

ID acc. to the NCIA*	Name	Region	Municipality	Settlement	Group acc. to the prod. - 2005
29.32	Other mashines for agriculture and forestry production				
1	"FIN THE MASH" JSCo	Plovdiv	Plovdiv	Plovdiv	8
29.42	Metal processing mashines production				
1	"ZMM-POBEDA" JSCo	Sliven	Sliven	Sliven	4
2	"ZMM-SLIVEN" JSCo	Sliven	Sliven	Sliven	9
29.52	Mashines for construction and extraction production				
1	"MONEK-YUG-AD" JSCo	Kardzhali	Kardzhali	Kardzhali	6
2	"REMOTEKS-RADNEVO" PJSCo	Stara Zagora	Radnevo	Radnevo	10
29.53	Mashines and equipment for processing of foods, beverages and tobacco production				
1	"RODINA-HASKOVO" JSCo	Haskovo	Haskovo	Haskovo	7
2	"HRANINVEST-HRANMASHKOMPLEKT" JSCo	Stara Zagora	Stara Zagora	Stara Zagora	10
3	"AYGER INGZHENERING" PLC	Plovdiv	Plovdiv	Plovdiv	6
29.56	Other special destination machines production				
1	"FORMOPLAST" JSCo	Kardzhali	Kardzhali	Kardzhali	3
29.60	Armaments and ammunitions production				
1	"ARSENAL" JSCo	Stara Zagora	Kazanlak	Kazanlak	10
2	"VAZOVSKI MASHINOSTROITELNI ZAVODI" PJSCo	Plovdiv	Sopot	Sopot	10
3	"TEREM-GEORGI" Ltd.	Plovdiv	Plovdiv	Plovdiv	3
29.71	Electrical domestic appliances production				
1	"DZU" JSCo	Stara Zagora	Stara Zagora	Stara Zagora	8
2	"LIBHER-HAUSGERETE MARITSA" Ltd.	Plovdiv	Maritsa	Maritsa	10
DL 31	Production of Electric Mashines & Devices which are not listed elsewhere				
31.10	Electromotors, electrical generators and transformers production				
1	"ELPROM-HARMANLI" JSCo	Haskovo	Harmanli	Harmanli	7
31.20	Electro-distribution and control equipment production				
1	"EAZ" JSCo	Plovdiv	Plovdiv	Plovdiv	4
2	"MINIPULS" PLC	Plovdiv	Plovdiv	Plovdiv	4
31.30	Isolated conductors and cables production				
1	"GAMAKABEL" JSCo	Smolyan	Smolyan	Smolyan	10
2	"SE BORDNETSE-BG" Ltd.	Burgas	Karnobat	Karnobat	9
31.40	Electrical accumulators, batteries and primary elements production				
1	"ELHIM-ISKRA" JSCo	Pazardzhik	Pazardzhik	Pazardzhik	9
31.61	Electrical appliances for motors and vehicles production				
1	"DINAMO" JSCo	Stara Zagora	Stara Zagora	Stara Zagora	7
2	"ELPROM-ELHOVO" JSCo	Yambol	Elhovo	Elhovo	6
3	"ARKOMAT-BULGARIA" Ltd.	Stara Zagora	Kazanlak	Kazanlak	5
4	"ATES" Ltd.	Stara Zagora	Kazanlak	Kazanlak	5
DM 34	Production of Cars, Trailers and Semi-Trailers				
34.30	Production of parts and accessories for autos and motors				
1	"AVTOREMONTNI ZAVODI" JSCo	Plovdiv	Parvomay	Parvomay	2
DM 35	Production of Means of Transportation, Excluding Cars				
35.20	Locomotives, motor carriages and waggons production				
1	"VAGONOREMONTEN ZAVOD-99" JSCo	Pazardzhik	Septemvri	Septemvri	10
2	"VAGONO-REMONTEN ZAVOD-KARLOVO" JSCo	Plovdiv	Karlovo	Karlovo	8
35.42	Bicycle production				
1	"MAKSKOM" Ltd.	Plovdiv	Plovdiv	Plovdiv	9
E 40	Production and Distribution of Electricity, Gas Fuel and Heat Energy				
40.11	Electricity Production				
1	"EKSPLOATATIONNA KOMPANIYA MARITSA IZTOK	Stara Zagora	Galabovo	Mednikarovo village	9
2	"TETS MARITSA 3" JSCo	Haskovo	Dimitrovgrad	Dimitrovgrad	9
3	"BRIKEL" PJSCo	Stara Zagora	Galabovo	Galabovo	10
4	"TETS MARITSA IZTOK 2" PJSCo	Stara Zagora	Radnevo	Kovachevo village	10
5	"TOPLOFIKATSIYA-SLIVEN" PJSCo	Sliven	Sliven	Sliven	8
40.30	Production and Distribution of Heat Energy				
1	"TOPLOFIKATSIYA PLOVDIV" PJSCo	Plovdiv	Plovdiv	Plovdiv	10

ID acc. to the N CIA *	Name	Region	Municipality	Settlement	Group acc. to the prod. - 2005
E 41 Collection, Treatment and Distribution of Water					
41.00 Collection, Treatment and Distribution of Water					
1	"VODOSNABDYAVANE I KANALIZATSIYA" Ltd.	Stara Zagora	Stara Zagora	Stara Zagora	9
2	"VODOSNABDYAVANE I KANALIZATSIYA" Ltd.	Plovdiv	Plovdiv	Plovdiv	10

Data Source: NSI

N CIA* *National Classification of Economic Activities*
Groups according to the production - year 2005:

- 1 - from 10000 to 350000 Euro
- 2 - from 350001 to 650000 Euro
- 3 - from 650001 to 1000000 Euro
- 4 - from 1000001 to 1500000 Euro
- 5 - from 1500001 to 2000000 Euro
- 6 - from 2000001 to 3000000 Euro
- 7 - from 3000001 to 4500000 Euro
- 8 - from 4500001 to 6500000 Euro
- 9 - from 6500001 to 12500000 Euro
- 10 - over 12500000 Euro

Annex C.1.4 Main Industries and Animal Breeding Farms in WABD

ID acc. to the NCIA*	Name	Region	Municipality	Settlement	Group acc. to the prod. - 2005
A 01.2 Animal Breeding					
01.21 Breeding of cattle					
1	"BAYKAL 1" Ltd.	Pernik	Radomir	Baykalsko village	1
2	"MELNIKLIYSKI-3" PS	Blagoevgrad	Blagoevgrad	Blagoevgrad	1
01.23 Breeding of pigs					
1	"KEMBAROU-MM-5" JSCo	Blagoevgrad	Blagoevgrad	Zelen Dol village	1
2	"GHT-PIRINPLAST" PLC	Blagoevgrad	Blagoevgrad	Blagoevgrad	1
CA 10. Coal Mining					
10.20 Brown and Lignite coals production					
1	"MINI OTKRIT VAGLEDOBIV" PJSCo	Pernik	Pernik	Pernik	10
2	"ORANOVO" Ltd.	Pernik	Pernik	Pernik	1
DA 15. Food & Beverages Production					
15.11 Meat production					
1	"SAMI-M" Ltd.	Pernik	Pernik	Pernik	9
15.13 Meat products					
1	"KAROL FERNANDES MEET" PLC	Blagoevgrad	Blagoevgrad	Blagoevgrad	9
2	"PRIM" PLC	Pernik	Pernik	Pernik	3
15.33 Manufacturing and canning fruits and vegetables					
1	"M.K.D. EOOD" Ltd.	Blagoevgrad	Bansko	Bansko	6
2	"OLIMPOS-99" PLC	Blagoevgrad	Blagoevgrad	Blagoevgrad	1
15.61 Grain mill products					
1	"MELNICHEN KOMBINAT RILA-S.T.H." JSCo	Blagoevgrad	Blagoevgrad	Blagoevgrad	4
15.81 Bread and sweets production					
1	"SLADKA KASHA ASYA" PLC	Blagoevgrad	Blagoevgrad	Blagoevgrad	5
15.82 Chip's biscuits, biscuits and dry sweets production					
1	"LIDER BREND" PLC	Pernik	Breznik	Breznik	2
15.93 Vine production					
1	"DAMYANITSA" JSCo	Blagoevgrad	Sandanski	Damyanita village	6
DA 16. Tobacco production					
16.00 Tobacco substitutes production					
1	"BLAGOEVGRAD-BT-AD" JSCo	Blagoevgrad	Blagoevgrad	Blagoevgrad	10
DE 21 Production of Pulp, Paper, Carboard and Products made of Paper and Cardboard					
21.12 Paper and paperboard production					
1	"PIRINHART" JSCo	Blagoevgrad	Razlog	Razlog	2
DG 24 Production of Chemical Substances					
24.42 Medical goods and medicaments					
1	"BALKANFARMA-DUPNITSA" JSCo	Kyustendil	Dupnitsa	Dupnitsa	10
2	"SALVAMED" JSCo	Blagoevgrad	Sandanski	Sandanski	8
3	"FARMA-AD" JSCo	Kyustendil	Dupnitsa	Dupnitsa	4
24.52 Parfumery and toilet goods					
1	"VETPROM" JSCo	Pernik	Radomir	Radomir	6
DH 25 Production of Rubber and Plastic Products					
25.13 Rubber and articles thereof					
1	TPK "STRUMONA"	Pernik	Pernik	Pernik	1
25.21 Plastics and articles thereof					
1	"PIRINPLAST" JSCo	Blagoevgrad	Gotse Delchev	Gotse Delchev	9
25.22 Plastic packages production					
1	KOOPERATSIYA "PKI GEORGI KAZEPOV"	Blagoevgrad	Sandanski	Sandanski	2
2	TPK "RODINA"	Kyustendil	Kyustendil	Kyustendil	1
25.23 Plastic articles for construction					
1	"NIDEKS" PLC	Blagoevgrad	Gotse Delchev	Gotse Delchev	3
25.24 Other plastic articles					
1	"VMS" Ltd.	Kyustendil	Kyustendil	Kyustendil	2
2	"MIPAPLAST-OOD" PLC	Blagoevgrad	Blagoevgrad	Blagoevgrad	4
DI 26 Production of Other Products Made of Non-mineral Resources					
26.22 Ceramic products					
1	"MEZHHDUNARODEN KOMPOZIT BG" JSCo	Kyustendil	Kyustendil	Kyustendil	5
26.70 Cutting, profiling and processing of construction and decoration rock materials					
1	ILINDENTSI MRAMOR" JSCo	Blagoevgrad	Strumyani	Ilindentsi village	4
DJ 27 Production & Molding of Metals					
27.10 Production of Cast Iron, Steel and Ferro-alloys					
1	"STOMANA INDUSTRI" JSCo	Pernik	Pernik	Pernik	10
27.52 Steel Foundry					
1	"ENERGOREMONT-KRESNA" JSCo	Blagoevgrad	Kresna	Kresna	4

ID acc. to the NCIA*	Name	Region	Municipality	Settlement	Group acc. to the prod. - 2005
DJ 28	Production of Products Made of Metals, Except for Mashinery and Equipment				
28.11	Metal constructions and parts to them production				
1	"GALKO" JSCo	Pernik	Radomir	Radomir	6
28.30	Steam-boilers production				
1	"ENERGOREMONT-BOBOV DOL" JSCo	Kyustendil	Bobov Dol	Golemo Selo village	6
2	"TERS-MOSHINO" JSCo	Pernik	Pernik	Pernik	6
3	"SPETSIALREMONT" Ltd.	Kyustendil	Dupnitsa	Dupnitsa	3
28.52	Metal mechanical treatment				
1	"RILA-SNM" PLC	Kyustendil	Rila	Rila	3
28.73	Wire articles production				
1	"NOVO-TEH" PLC	Blagoevgrad	Petrich	Petrich	3
28.74	Attachment elements, chains and springs production				
1	"SANEL" JSCo	Blagoevgrad	Sandanski	Sandanski	3
28.75	Other metal articles not classified elsewhere				
1	"ZINO-P-AD" JSCo	Blagoevgrad	Petrich	Petrich	2
DK 29	Production of Mashinery, Equipment and Household Appliances				
29.14	Bearings, gears and connectors production				
1	"KOLHIDA-METAL" JSCo	Pernik	Pernik	Pernik	6
29.24	Other machines with common designation production				
1	"TORGOTERM" JSCo	Kyustendil	Kyustendil	Kyustendil	7
29.43	Other processing mashines production				
1	"ZMM-YAKORUDA" JSCo	Blagoevgrad	Yakoruda	Yakoruda	4
29.51	Mashines and equipment for metalurgy and foundry production				
1	"BESTTEHNIKA TM-RADOMIR" JSCo	Pernik	Radomir	Radomir	8
2	"RADOMIR-METALI" JSCo	Pernik	Radomir	Radomir	10
DL 31	Production of Electric Mashines & Devices which are not listed elsewhere				
31.10	Electromotors, electrical generators and transformers production				
1	"ELPROM-TRAFO SN" JSCo	Kyustendil	Kyustendil	Kyustendil	6
31.50	Illuminaters and lamps production				
1	"BONANA" PLC	Blagoevgrad	Petrich	Petrich	7
E 40	Production and Distribution of Electricity, Gas Fuel and Heat Energy				
40.11	Electricity Production				
1	"TETS BOBOV DOL" PJSCo	Kyustendil	Bobov Dol	Golemo Selo village	10
40.30	Production and Distribution of Heat Energy				
1	"TOPLOFIKATSIYA-PERNIK" PJSCo	Pernik	Pernik	Pernik	10

Data Source: NSI

NCIA* National Casification of Iconomic Activities
Groups according to the production - year 2005:

- 1 - from 10000 to 350000 Euro
- 2 - from 350001 to 650000 Euro
- 3 - from 650001 to 1000000 Euro
- 4 - from 1000001 to 1500000 Euro
- 5 - from 1500001 to 2000000 Euro
- 6 - from 2000001 to 3000000 Euro
- 7 - from 3000001 to 4500000 Euro
- 8 - from 4500001 to 6500000 Euro
- 9 - from 6500001 to 12500000 Euro
- 10 - over 12500000 Euro

Annex C.2

Flow Diagram and Typical Layout of the Proposed WWTPs

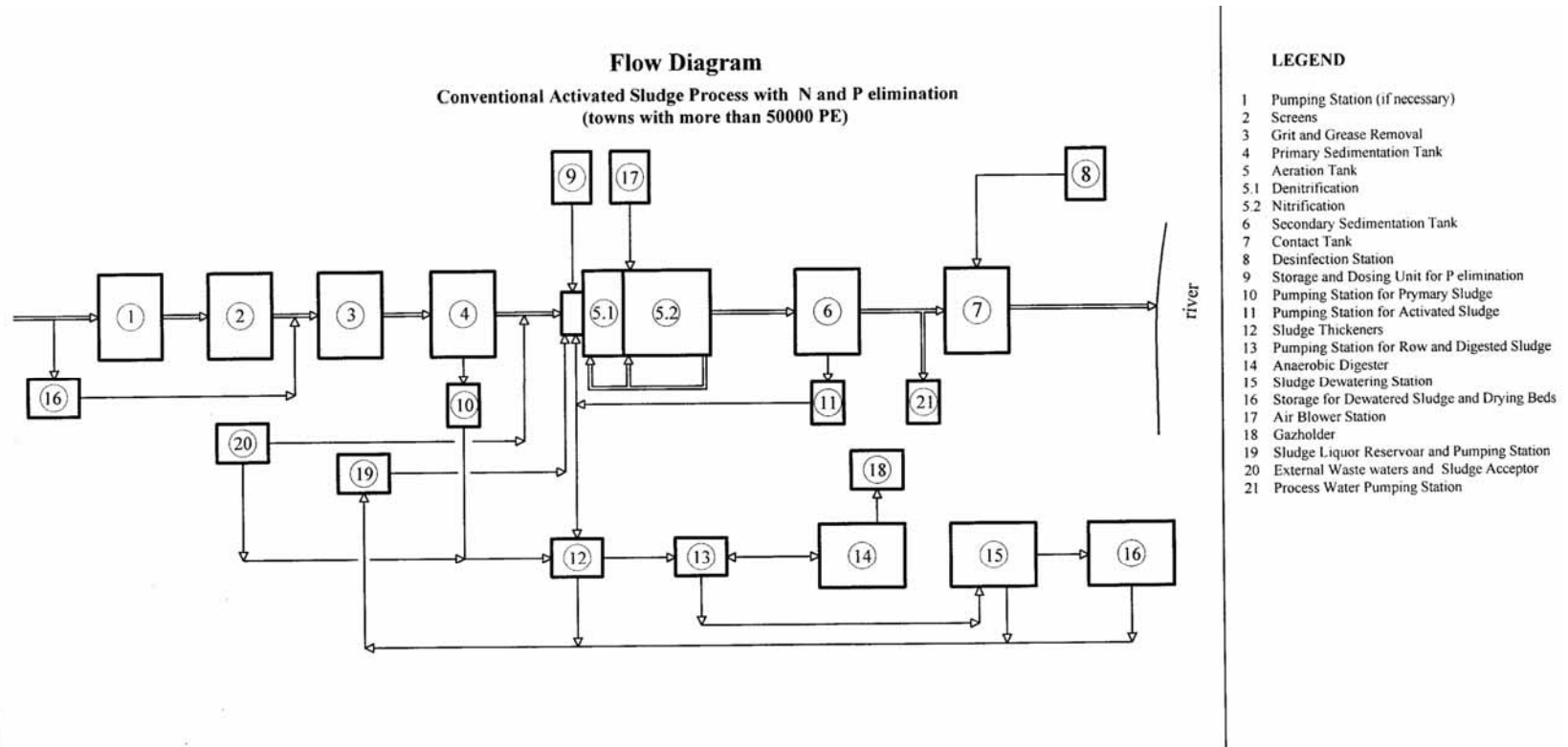

Annex C.2.1 Flow Diagram for WWTP with more than 50,000 PE

Layout
(example for towns with more than 50000 PE)

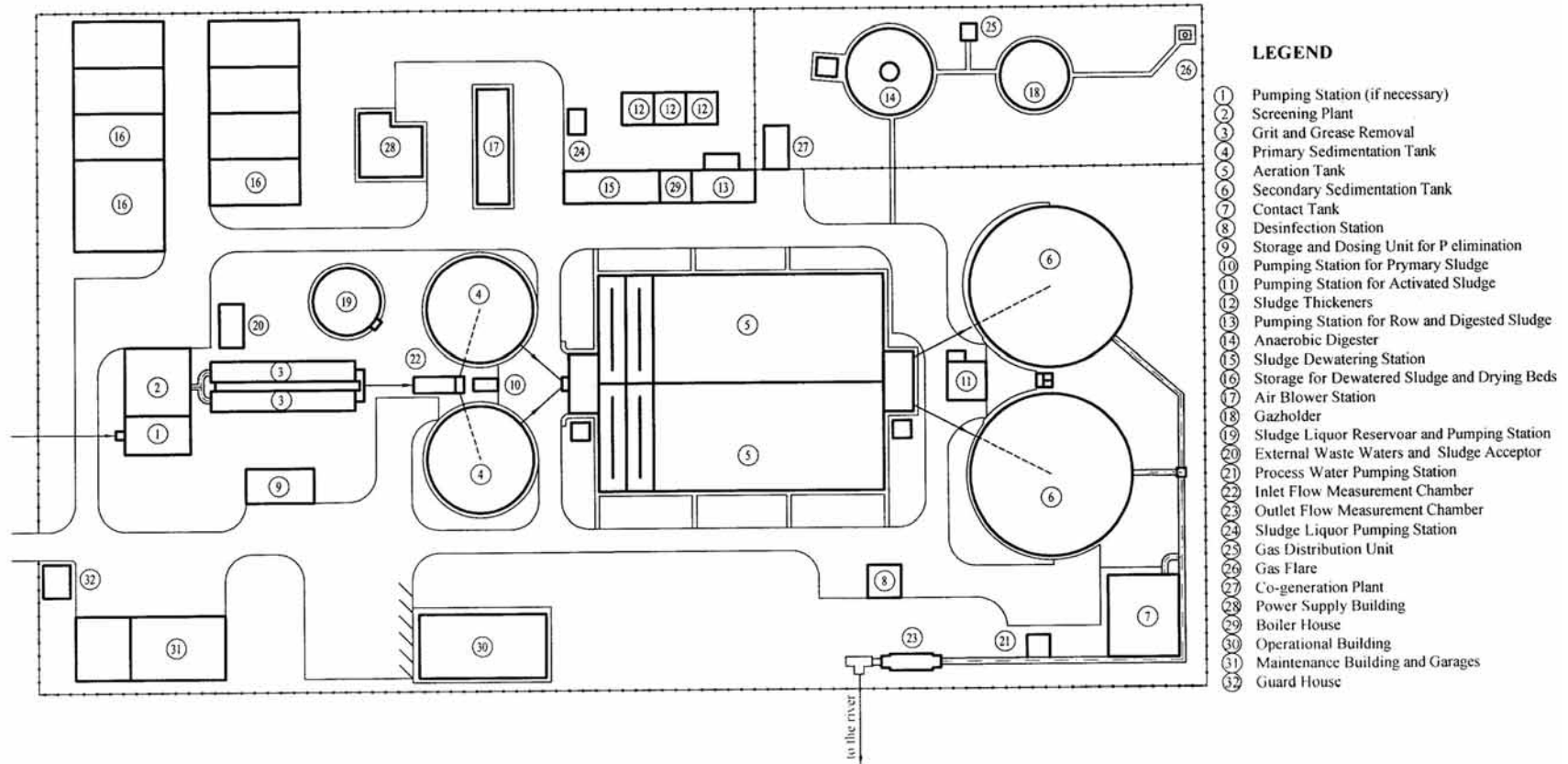

- LEGEND**
- ① Pumping Station (if necessary)
 - ② Screening Plant
 - ③ Grit and Grease Removal
 - ④ Primary Sedimentation Tank
 - ⑤ Aeration Tank
 - ⑥ Secondary Sedimentation Tank
 - ⑦ Contact Tank
 - ⑧ Desinfection Station
 - ⑨ Storage and Dosing Unit for P elimination
 - ⑩ Pumping Station for Primary Sludge
 - ⑪ Pumping Station for Activated Sludge
 - ⑫ Sludge Thickeners
 - ⑬ Pumping Station for Row and Digested Sludge
 - ⑭ Anaerobic Digester
 - ⑮ Sludge Dewatering Station
 - ⑯ Storage for Dewatered Sludge and Drying Beds
 - ⑰ Air Blower Station
 - ⑱ Gazholder
 - ⑲ Sludge Liquor Reservoir and Pumping Station
 - ⑳ External Waste Waters and Sludge Acceptor
 - ㉑ Process Water Pumping Station
 - ㉒ Inlet Flow Measurement Chamber
 - ㉓ Outlet Flow Measurement Chamber
 - ㉔ Sludge Liquor Pumping Station
 - ㉕ Gas Distribution Unit
 - ㉖ Gas Flare
 - ㉗ Co-generation Plant
 - ㉘ Power Supply Building
 - ㉙ Boiler House
 - ㉚ Operational Building
 - ㉛ Maintenance Building and Garages
 - ㉜ Guard House

Annex C.2.2 Typical Layout for WWTP with more than 50,000 PE

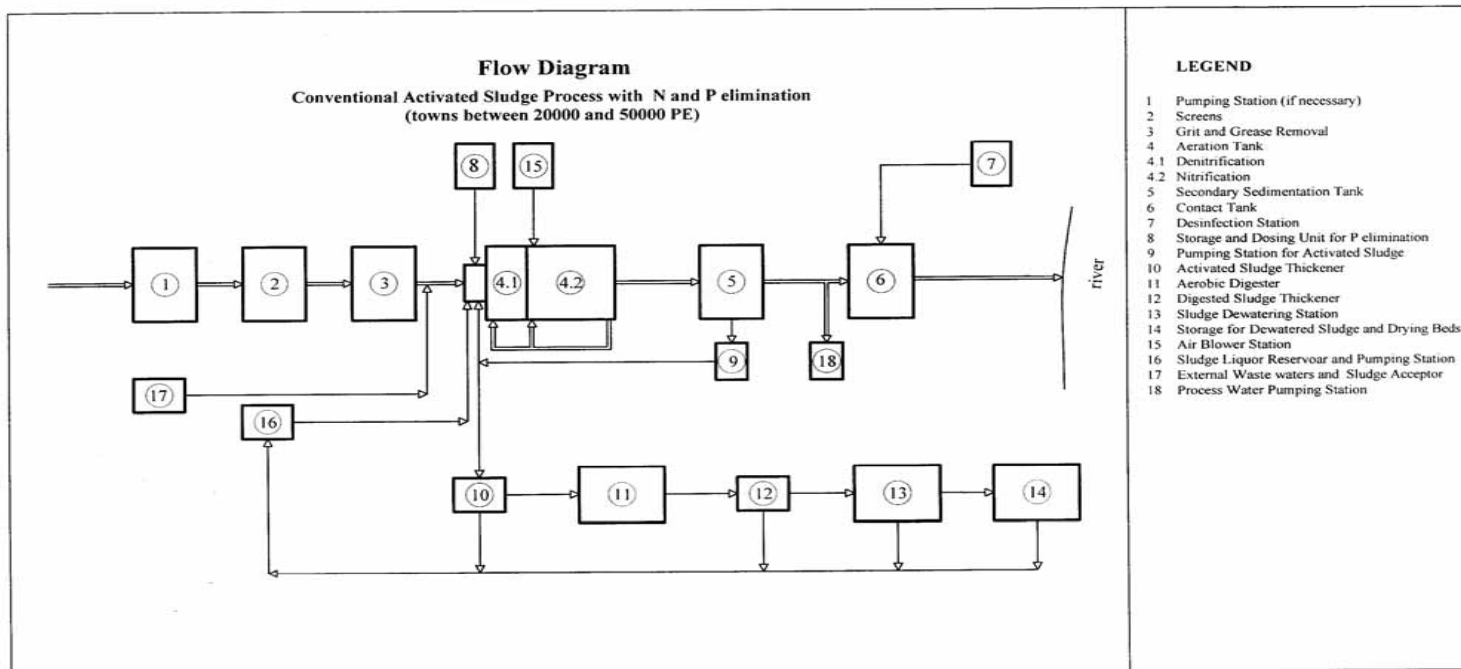

Annex C.2.3 Flow Diagram for WWTP with 20,000 to 50,000 PE

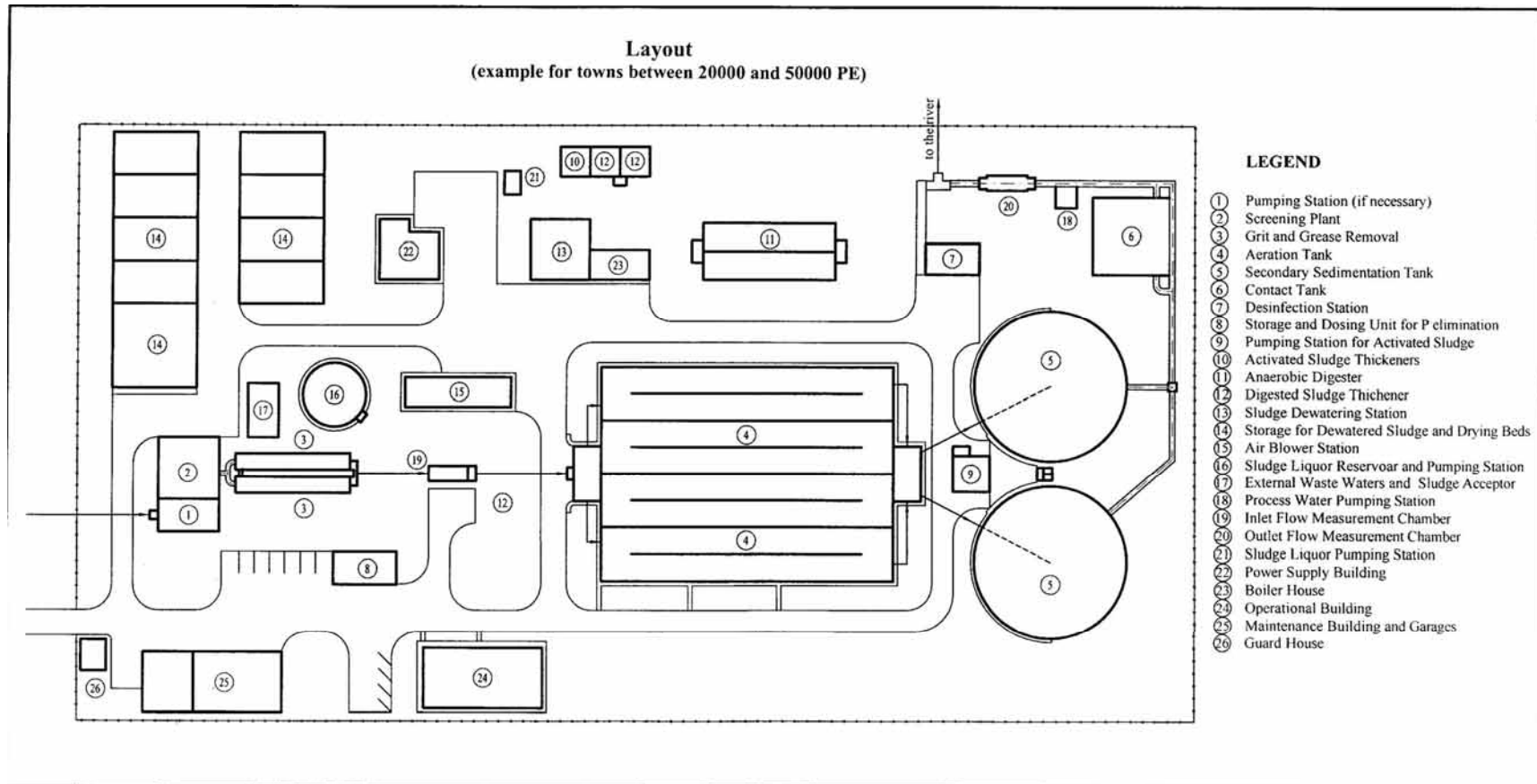

Annex C.2.4 Typical Layout for WWTP with 20,000 to 50,000 PE

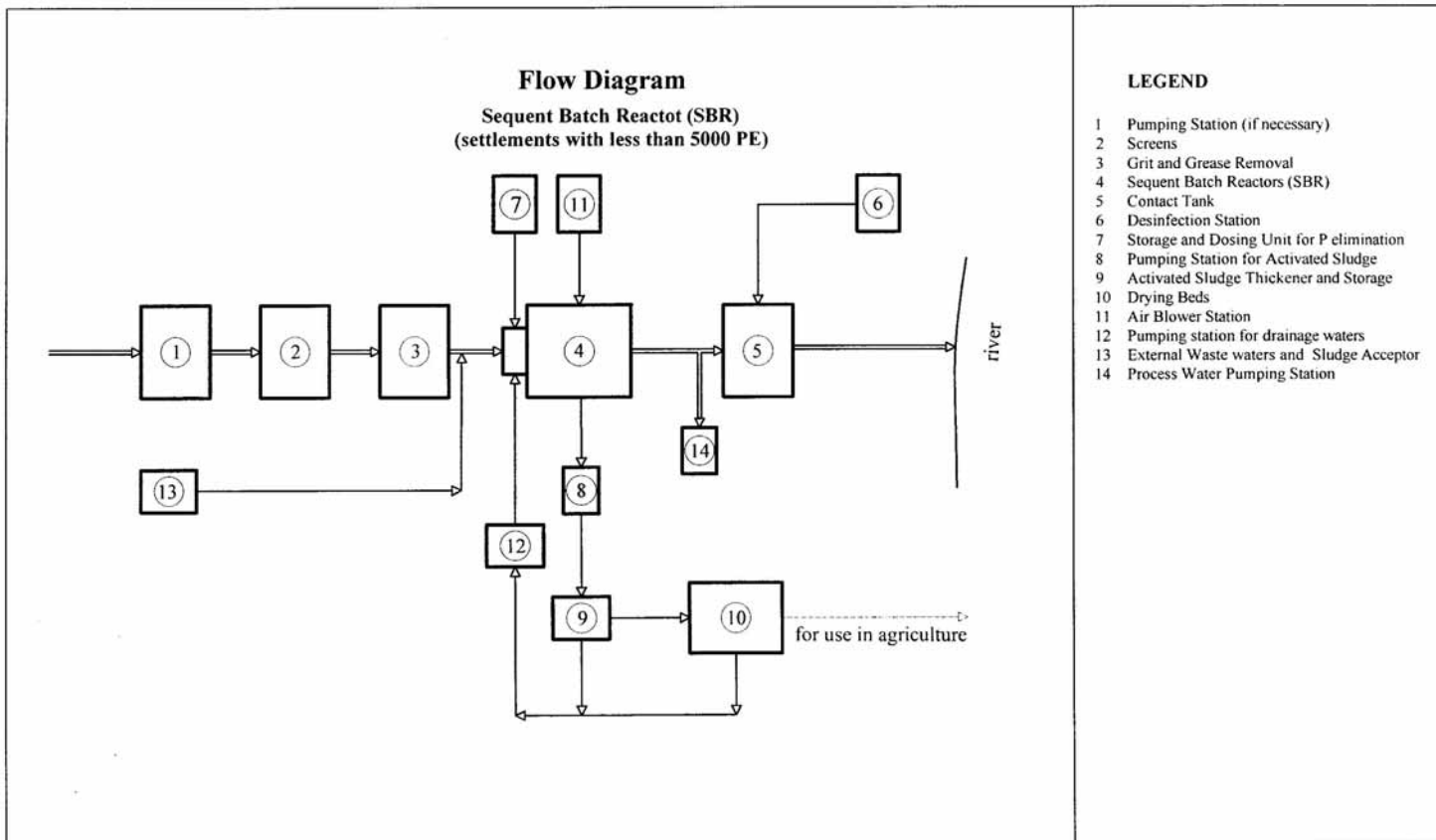

Annex C.2.5 Flow Diagram for WWTP with less than 50,000 PE

Layout
(example for settlements with less than 5000 PE)

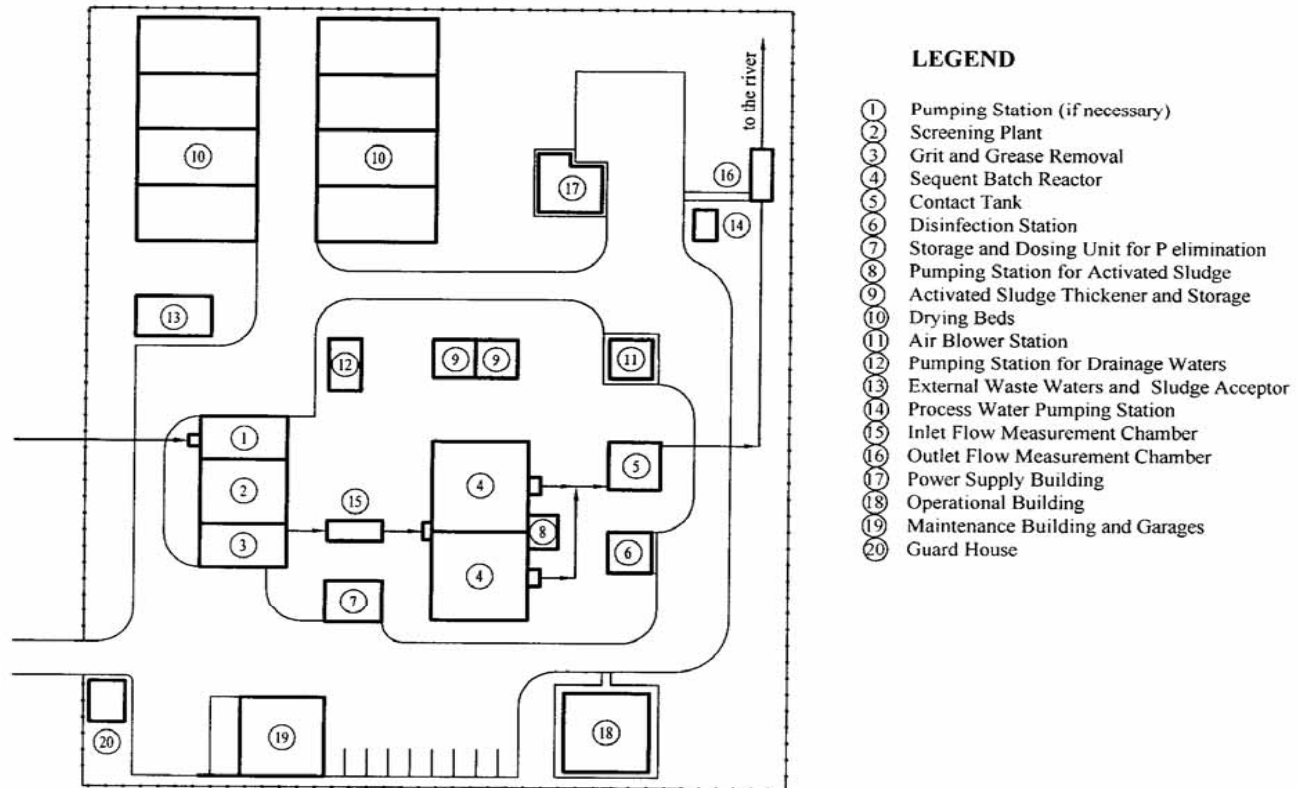

Annex C.2.6 Typical Layout for WWTP with less than 5,000 PE

Annex C.3

Estimation

of

Unit Cost for WWTPs, Sewer Improvement and Improvement of Water Supply Pipes

Annex C.3.1 Procedure of Estimating Unit Construction Cost for WWTP, Sewer Network and Water Supply Network

I. Costs for Construction of WWTP

I.1 New WWTP's

The costs for new WWTP's with nitrogen and phosphorus elimination were estimated on the base of People Equivalent (PE) and the unit costs (in Euro per PE) for the different sizes of the towns and the settlements.

The unit costs were calculated on the base of the information from the Financial Memorandums for WWTP, financed by ISPA and PHARE Programs for different WWTPs and the resources for some plants, financed by EMEPA and State Budget of Bulgaria. The unit costs were corrected according to the inflation for the relevant periods of time.

The data from some Technical Designs and Feasibility Studies were used for dividing the costs to different kind of works in percents (non-constructive, civil, mechanical, electrical and SCADA works).

I.2 Renovation of the Existing WWTPs

The costs for renovation of the existing WWTPs with nitrogen and phosphorus elimination were estimated on the basis of People Equivalent (PE) of towns and settlements and different percents of the relevant unit costs (depending of the condition of the facilities, mechanical and electrical equipment, necessity of enlargement for N and P elimination and other conditions). The division of the costs to different kind of works was made in accordance of the state of the civil works and mechanical and electrical equipment.

II. Cost for Construction of Sewer Networks

The costs for new and improvement of the existing Sewer Networks were estimated on the basis of required length per PE of different sizes of towns and settlements and unit costs (in Euro per m')

The costs for Sewer networks were calculated on the basis of;

- required length (m/PE),
- real costs for fully construction of m' of different diameters of pipes at average depth (including manholes according to the Bulgarian norms and house connections via 20 m)
- percent of division of the diameters according to the sizes of the towns and the settlements

Then the unit costs (Euro/m') for construction of networks for different sizes of settlements were calculated.

III. Cost for Construction of Water Supply Networks

The costs for water supply networks were calculated on the basis of:

- the required length (m/PE),
- real costs for fully construction of m' of different diameters of pipes at average depth (including house connections)
- percentage division of diameters according to sizes of towns and settlements

Then the unit costs (Euro/m') for construction of networks for different sizes of towns and settlements were calculated.

IV. Treatment Methods

For municipal wastewaters, mechanical and biological processes with N and P elimination, disinfection and sludge stabilization are proposed.

A pumping station (if it is necessary) for the raw waste waters for all flow diagrams is foreseen.

A facility for internal sludge and wastewaters is proposed.

IV.1 Conventional activated Sludge Process with anaerobic sludge stabilization

(1) The mechanical stage consists of screens, grit and grease removal and primary sedimentation. The biological stage consists of an aeration tank with nitrification and denitrification and the necessary number of secondary sedimentation tanks. The treated water is disinfected before discharging. Proper coagulant is added for P elimination

The primary and the excess activated sludge are thickened and they are stabilized in anaerobic conditions (heated digesters). Storage for gas and facilities for its utilization are proposed. The stabilized sludge is thickened and dewatered with proper equipment. Dried sludge goes to the sludge storage.

Sludge liquor is collected in a reservoir and is dosed to the biological treatment during the night time.

- (2) The same mechanical and biological treatment of the wastewater is proposed but the anaerobic sludge treatment is in the open digesters and there are no gas facilities.

IV.2 Conventional Activated Sludge Process with Aerobic Sludge Stabilization

The mechanical stage consists of screens, grit and grease removal. The biological stage consists of an aeration tank with nitrification and denitrification and the necessary number of secondary sedimentation tanks. The treated water is disinfected before discharging. Proper coagulant is added for P elimination.

The excess activated sludge is thickened and it is stabilized in aerobic conditions. The stabilized sludge is thickened and dewatered with proper equipment. Dried sludge goes to the sludge storage.

Sludge liquor is collected in a reservoir and is dosed to the biological treatment during the night-time.

IV.3 Extended Aeration Process

The mechanical stage consists of screens, grit and grease removal. The biological stage consists of an aeration tank with nitrification and denitrification and the necessary number of secondary sedimentation tanks. The treated water is disinfected before discharging. Proper coagulant is added for P elimination

The stabilized sludge is thickened and dewatered with proper equipment. Dried sludge goes to the sludge storage.

Sludge liquor is collected in a reservoir and is dosed to the biological treatment during the night time.

IV.4 Sequent Batch Reactors

The mechanical stage consists of screens, grit and grease removal. The biological stage consists of Sequent Batch Reactors (SBR) where nitrification, denitrification and sedimentation are taking place. The treated water is disinfected before discharging. Proper coagulant is added into the SBR for P elimination.

The stabilized sludge is thickened and storage in the reservoir and is dried on the drying beds.

IV.5 Extended aeration process – Oxidation ditch

This process is proposed for the small settlements, and consist of a mechanical stage and oxidation ditches. Biological treatment is without denitrification and P elimination. If there are requirements for N and P elimination, some additional facilities should be constructed.

Storage for the sludge and drying beds are necessary or the sludge should be transported to another WWTP for a further treatment.

Annex C.3.2 Unit Construction Cost of Water Supply Pipe

Inhabitants - 1000
 L [m] 14350
 m/I 14.35

Diameter PE	%	Lenght	Cost EU/m	Total per Φ-EU
90	80	11480	90	1033200
110	10	1435	105	150675
125	10	1435	115	165025
Total:				1348900
Unit cost:			EU/Inh.	1349
Unit cost:			EU/m	94

Inhabitants - 11000
 L [m] 46000
 m/I 4.2

Diameter PE	%	Lenght	Cost EU/m	Total per Φ-EU
90	23.00	10580	90	952200
110	54.00	24840	105	2608200
125	6.00	2760	115	317400
140	5.00	2300	132	303600
160	3.00	1380	144	198720
200	2.50	1150	170	195500
250	2.25	1035	200	207000
280	2.00	920	225	207000
315	2.25	1035	250	258750
Total:				5248370
Unit cost:			EU/Inh.	477
Unit cost:			EU/m	114

Inhabitants - 54000
 L [m] 104000
 m/I 1.9

Diameter PE	%	Lenght	Cost EU/m	Total per Φ-EU
90		3400	90	306000
110		56500	105	5932500
125		7500	115	862500
140		6400	132	844800
160		5800	144	835200
200		5500	170	935000
250		5300	200	1060000
315		8300	250	2075000
355		1400	265	371000
400		780	290	226200
500		450	370	166500
600		650	440	286000
700		500	500	250000
800		1200	575	690000
Total:				14840700
Unit cost:			EU/Inh.	275
Unit cost:			EU/m	143

 Main Pipe from Reservoir

Annex C.3.3 Unit Construction Cost of Sewer Network

Cost for m' PE pipe in urban areas

Diameter	Cost*	Incl. RM**	Incl. HC***	Other Info*
Φ	EU/m'	EU/m'	EU/m'	EU/m'
200	190	210	286	200
300	243	260	336	270
400	262	278	354	360
500	358	370	446	450
600	377	390	466	480
700	432	442	518	520
800	450	460	536	560

* without VAT

** Manholes for Revision (RM) - according to the Bulgarian Norms

*** house connection (HC) via 20 m

Lengths and Costs* [EU] for P

P	m'/PE	Cost of SS	EU/P	Length	EU/m'
1000000	0.8			800000	900
100000	2.7	119988000	1200	270000	444
50000	3.7	64861000	1297	185000	351
20000	4.3	27193200	1360	86000	326
10000	5.8	18513600	1851	58000	319
5000	7.1	10685500	2137	35500	301
2000	7.5	4402500	2201	15000	294
1000	7.9	2279150	2279	7900	289
500	8.3	1186900	2374	4150	286

* without VAT

Conditions for cost estimation

P	
1000000	
100000	
50000	40% Φ 200, 20% Φ 300, 20% Φ 400, 10% Φ 500, 10% Φ 800
20000	45% Φ 200, 20% Φ 300, 20% Φ 400, 15% Φ 500
10000	50% Φ 200, 30% Φ 300, 15% Φ 400, 5% Φ 500
5000	70% Φ 200, 30% Φ 300
2000	85% Φ 200, 15% Φ 300
1000	95% Φ 200, 5% Φ 300
500	100% Φ 200

m'/PE	PE	EU/m'
8.3	500	286
7.9	1000	289
7.5	2000	294
7.4	3000	296
7.2	4000	299
7.1	5000	301
6.8	6000	305
6.6	7000	308
6.3	8000	312
6.1	9000	315
5.8	10000	319
5.7	11000	320
5.5	12000	320
5.4	13000	321
5.2	14000	322
5.1	15000	323
4.9	16000	323
4.8	17000	324
4.6	18000	325
4.5	19000	325
4.3	20000	326
4.2	25000	330
4.1	30000	334
4.0	35000	339
3.9	40000	343
3.8	45000	347
3.7	50000	351
3.5	60000	370
3.3	70000	388
3.1	80000	407
2.9	90000	425
2.7	100000	444

Annex C.3.2 Unit Construction Cost for WWTP

№	WWTP	PE	Year of the Finance Memorandum (FM)	Total amount		Inflation for the period to 2006		Cost for PE		Cost for PE - 2007	
				accordingg to the FM	accordingg to the Contract	%	k	FM	C	FM	C
				EU	EU			EU/PE	EU/PE	EU/PE	EU/PE
1	2	3	4	5	6	7	8	9	10	11	12
1	Montana	98000	2002	15067000	11272585	39	1.39	154	115.03	214	160
2	Etropole	17213		4235450				1.39	246		342
3	Lovech	85700	2002	17812000	9446773	39	1.39	208	110	289	153
4	Sevlievo	54000	2002	13988000	8134830	39	1.39	259	151	360	209
5	Gorna Oryahovitsa	100000	2001	14971000	9013292	49	1.49	150	90	223	134
6	Popovo	37720	2002	11860000	9638260	39	1.39	314	256	437	355
7	Balchik	28800	2002	3870000		39	1.39	134		187	
8	Sozopol	100000		11972596				1.39	120		166
9	Meden Rudnik	56850	2002	7219000	6612562	39	1.39	127	116	177	162
10	Targovishte	62426	2002	15236000	6258057	39	1.39	244	100	339	139
11	Blagoevgrad	100000	2001	11322000	7300000	49	1.49	113	73	169	109
12	Razlog	18834	2002	4835443		39	1.39	257		357	
13	Stara Zagora	256300	2000	23853208		59	1.59	93		148	
14	Dimitrovgrad	70350	2000	19546480		59	1.59	278		442	
15	Haskovo	109600	2000	18013494		59	1.59	164		261	
16	Pazargzhik	150000	2001	17200000		49	1.49	115		171	
17	Rudozem	9767	2001	2968589		49	1.49	304		453	
18	Madan	9750	2001	2705312		49	1.49	277		413	
19	Smolyan	55550	2002	7219000	6623507	39	1.39	130	119	181	166
20	Zlatograd	9913	2001	2927875		49	1.49	295		440	

Cost [FM] EU/PE	PE
148	256300
171	150000
261	109600
217	100000
166	100000
169	100000
214	98000
289	85700
442	70350
339	62426
177	56850
181	55550
360	54000
437	37720
187	28800
357	18834
342	17213
440	9913
453	9767
413	9750

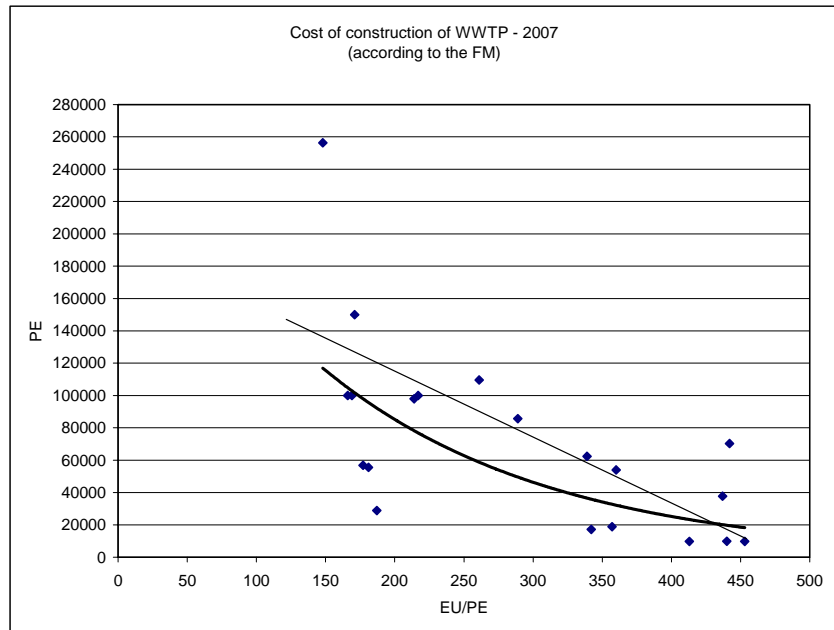

Annex C.4

Status

of

Procedure of Implementing the WWTPs of
High Priority Towns

**Annex C.4 Status of Procedure by December 2007
for Implementation of the WWTPs for the High Priority Towns
in EABD and WABD**

1. High Priority Towns and Settlements - EABD

No.	Town / Settlement	Municipality	PE in 2015	Design Phase	Available Land yes/no	Note
1	2	3	4	5	6	7
A-1 WWTPs in the Maritsa River Basin						
A-1-1	Asenovgrad	Asenovgrad	78054	Feasibility Study	yes	
A-1-2	Karlovo	Karlovo	37181	Detail Design*	yes	*WWTP is under construction
A-1-3	Velingrad	Velingrad	28752	no	no	
A-1-4	Peshtera	Peshtera	28691	Preliminary Design	yes**	**in procedures
A-1-5	Harmanli	Harmanli	28538	Feasibility Study	yes**	**in procedures
A-1-6	Svilengrad	Svilengrad	28050	no	yes	
A-1-7	Chirpan	Chirpan	25413	no	yes**	**in procedures
A-1-8	Rakovski	Rakovski	23453	Technical Design	yes	
A-1-9	Panagyurishte	Panagyurishte	23029	no	yes	
A-1-10	Parvomay	Parvomay	22200	no (Detail Design-1990)	yes	
A-1-11	Stamboliyski	Stamboliyski	18068	no (Detail Design-1990)	yes**	**in procedures
A-1-12	Kostenets	Kostenets	11048	no	no	
A-2 WWTPs in the Tundzha River Basin						
A-2-1	Yambol	Tundzha	118971	no	no	
A-2-2	Karnobat	Karnobat	28916	Preliminary Design	yes**	**in procedures
A-2-3	Elhovo	Elhovo	16808	no	no	
A-2-4	Kalofer	Karlovo	4229	Feasibility Study	no	
A-3 WWTPs in the Arda River Basin						
A-3-1	Kardzhali	Kardzhali	67346	no	yes	

2. High Priority Towns and Settlements - WABD

No.	Town / Settlement	Municipality	PE in 2015	Design Phase	Available Land yes/no	Note
1	2	3	4	5	6	7
B-1 WWTPs in the Struma River Basin						
B-1-2	Petrich	Petrich	45020	Feasibility Study	yes*	* no procedures yet
B-1-1	Sandanski	Sandanski	40358	Feasibility Study	yes*	* no procedures yet
B-1-3	Simitli	Simitli	8242	no	no	
B-2 WWTPs in the Mesta River Basin						
B-2-1	Gotse Delchev	Gotse Delchev	30185	Detail Design	yes	
B-2-2	Bansko	Bansko	11493	no	no	
B-3 WWTPs in the Dospat River Basin						
B-3-1	Dospat	Dospat	3218	no	yes*	* no procedures yet

