

S. RIGHT OF WAY ACQUISITION PLAN

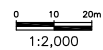
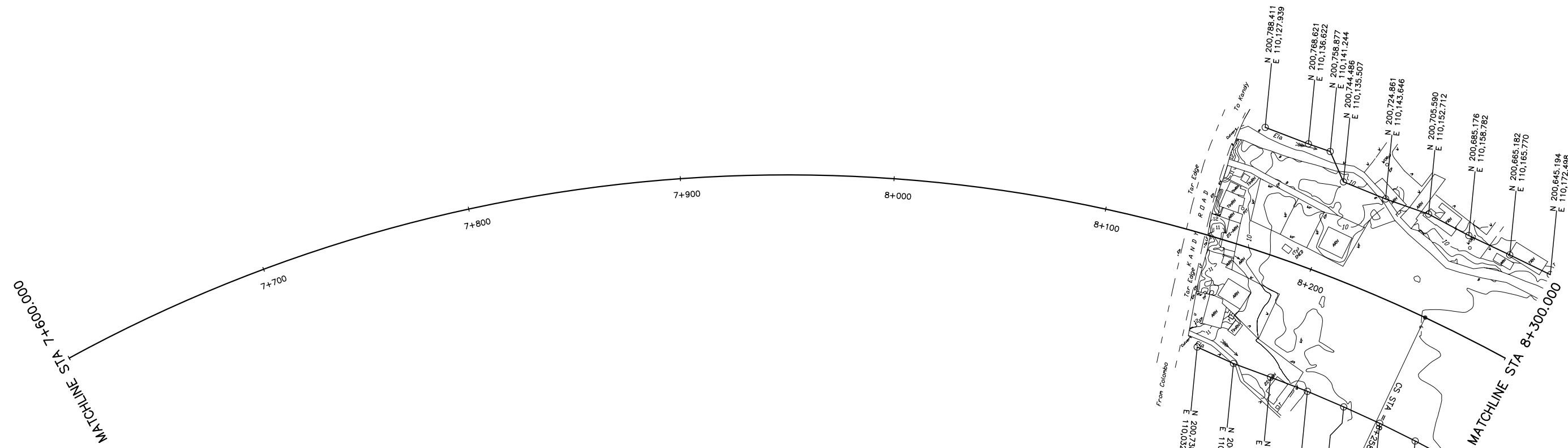
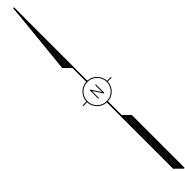

THE DEMOCRATIC SOCIALIST REPUBLIC OF SRI LANKA
 MINISTRY OF HIGHWAYS & ROAD DEVELOPMENT
Road Development Authority

JICA JAPAN INTERNATIONAL COOPERATION AGENCY
ORIENTAL CONSULTANTS COMPANY LIMITED
 in association with
PACIFIC CONSULTANTS INTERNATIONAL

No	REVISION	DATE

COLOMBO OUTER CIRCULAR HIGHWAY PROJECT
 (NORTHERN SECTION 1)
RIGHT OF WAY ACQUISITION PLAN
 STA. 7+600.000 TO 8+300.000

DESIGNED BY:	
CHECKED BY:	
APPROVED BY:	
DWG. NO.	S-01

C:\CH\2006\Yom\07+600\row.dwg

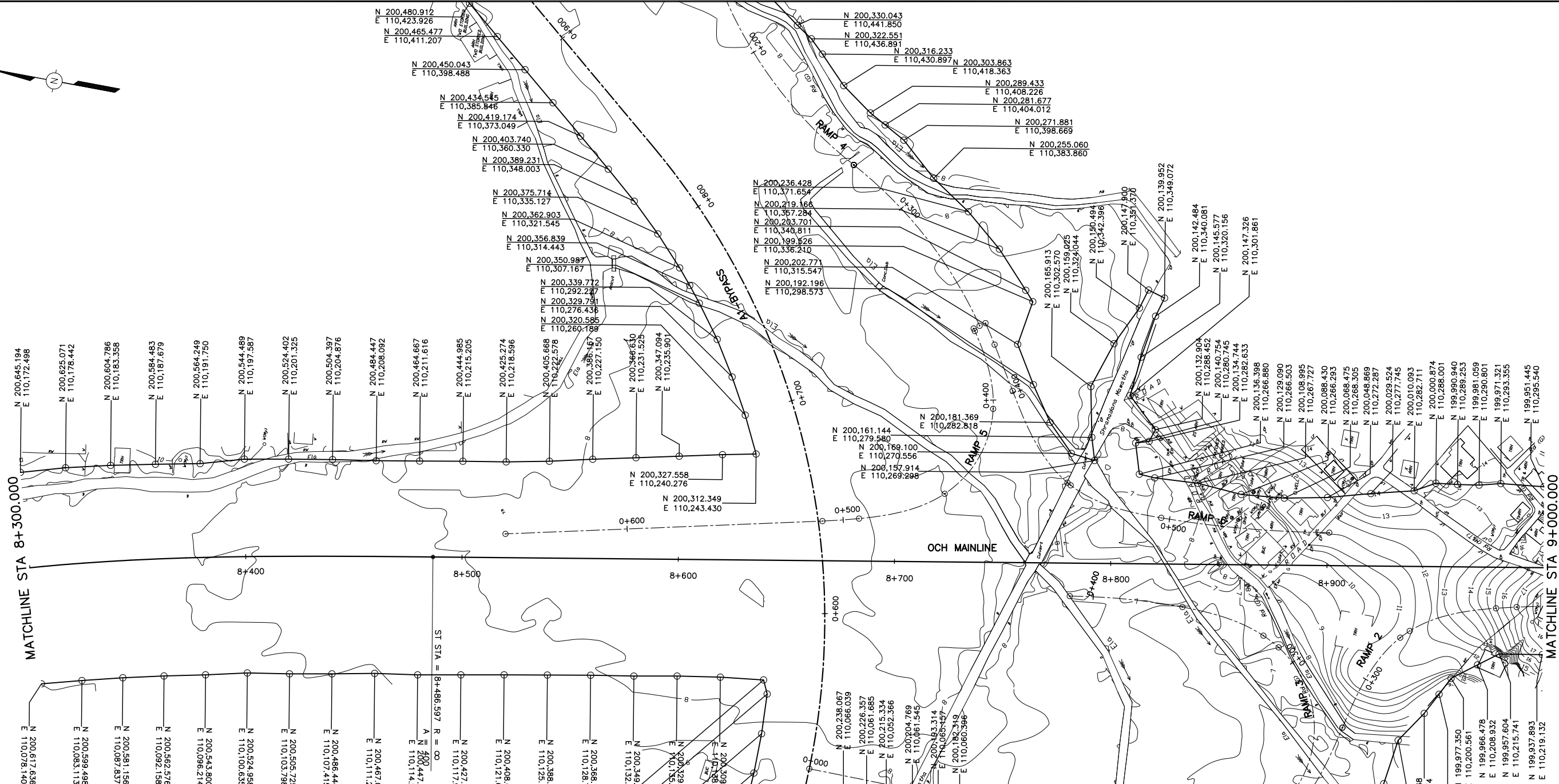
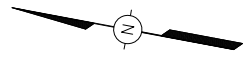

MATCHLINE STA 8+300.000

MATCHLINE STA 9+000.000

KEY

	EP HT ELECTRIC POST HIGH TENSION		TOILET
	EP ELECTRIC POST		CB2 CONCRETE BUILDING
	TP TELECOM POST		UNDER CONSTRUCTION
	LARGE TREE (MORE 1.5M DIAMETER)		P PADDY
	BO-TREE		MAR MARSHY
	MH(E) MANHOLE (ELECTRICITY)		RB RUBBER
	MH(T) MANHOLE (TELECOM)		SCR SCRUB/BUSH
	MH(D) MANHOLE (DRAINAGE)		GN GARDEN
	W(E) WELL (EARTH)		CIN CINNAMON
	W(MV) WELL (MASONRY)		C COCONUT
	W(CON) WELL (CONCRETE)		TEA TEA
	TRH TILED ROOFED HOUSE		PLA. CUL PLANTATION / CULTIVATED LAND
	TRS TILED ROOFED SHOP		F FOREST
	TRB TILED ROOFED BOUTIQUE		CEM CEMETERY
	ARH ASBESTOS ROOFED HOUSE		OA OPEN AREA
	TRH TIN ROOFED HOUSE		CY CONTAINER YARD

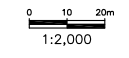

C:\GCH\2006\Yom\08+300row.dwg

KEY

	EP HT ELECTRIC POST HIGH TENSION		TOILET
	EP ELECTRIC POST		CONCRETE BUILDING
	TP TELECOM POST		UNDER CONSTRUCTION
	LARGE TREE (MORE 1.5M DIAMETER)		P PADDY
	BO-TREE		MAR MARSHY
	MH(E) MANHOLE (ELECTRICITY)		RB RUBBER
	MH(T) MANHOLE (TELECOM)		SCR SCRUB/BUSH
	MH(D) MANHOLE (DRAINAGE)		GN GARDEN
	W(E) WELL (EARTH)		CIN CINNAMON
	W(MV) WELL (MASONRY)		C COCONUT
	W(CON) WELL (CONCRETE)		TEA TEA
	TILED ROOFED HOUSE		PLA. CUL PLANTATION / CULTIVATED LAND
	TILED ROOFED SHOP		F FOREST
	TILED ROOFED BOUTIQUE		CEM CEMETERY
	ASBESTOS ROOFED HOUSE		OA OPEN AREA
	TIN ROOFED HOUSE		CY CONTAINER YARD

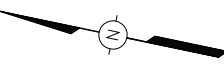

MATCHLINE STA 9+000.000

MATCHLINE STA 9+700.000

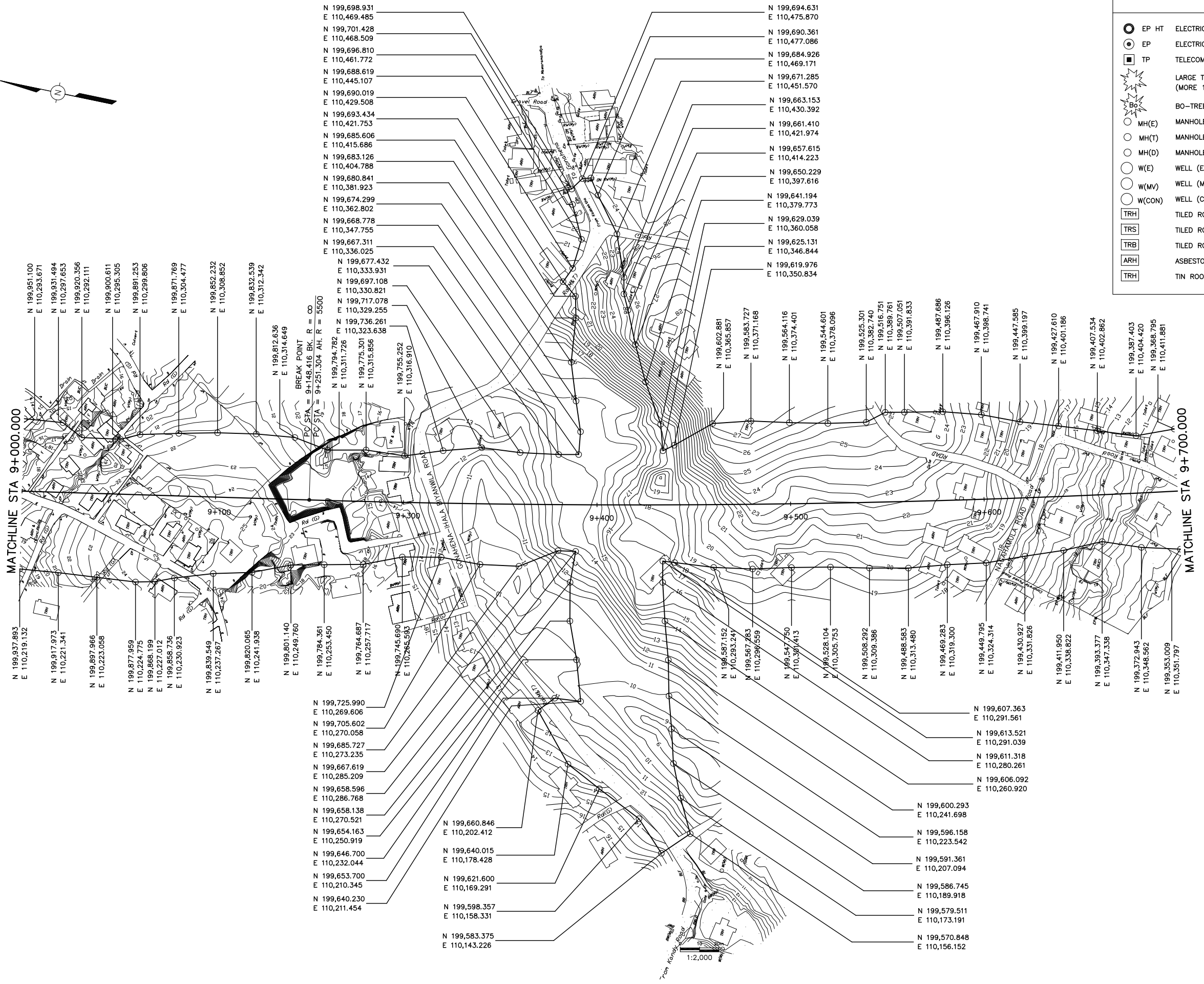

C:\GCH\2006\Yom\09+000\row.dwg

No	REVISION	DATE

DESIGNED BY:	
CHECKED BY:	
APPROVED BY:	
DWG. NO.	S-03

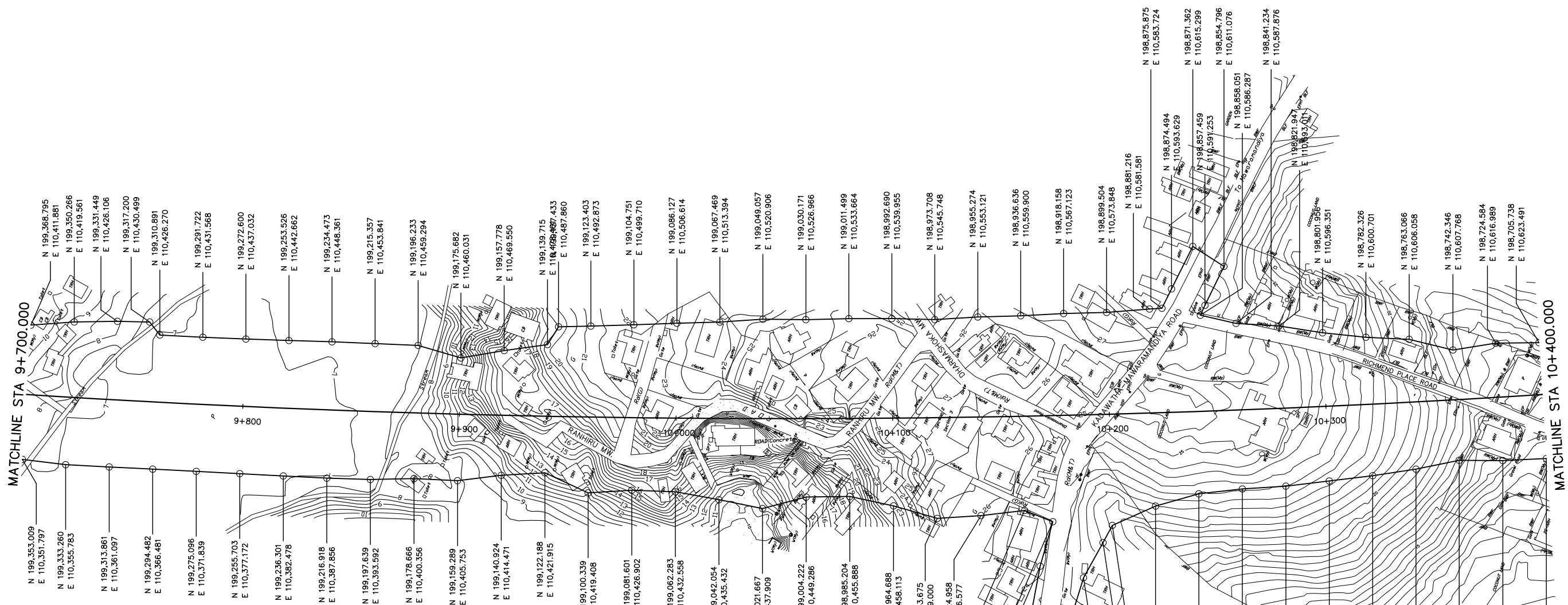
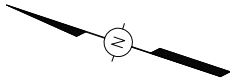

KEY

	EP HT	ELECTRIC POST HIGH TENSION		TOILET	TOILET
	EP	ELECTRIC POST		CB2	CONCRETE BUILDING
	TP	TELECOM POST			UNDER CONSTRUCTION
		LARGE TREE (MORE 1.5M DIAMETER)		P	PADDY
	BO-TREE			MAR	MARSHY
	MH(E)	MANHOLE (ELECTRICITY)		RB	RUBBER
	MH(T)	MANHOLE (TELECOM)		SCR	SCRUB/BUSH
	MH(D)	MANHOLE (DRAINAGE)		GN	GARDEN
	W(E)	WELL (EARTH)		C	COCONUT
	W(M)	WELL (MASONRY)		TEA	TEA
	W(CON)	WELL (CONCRETE)		PLA. CUL	PLANTATION / CULTIVATED LAND
	TRH	TILED ROOFED HOUSE		F	FOREST
	TRS	TILED ROOFED SHOP		CEM	CEMETERY
	TRB	TILED ROOFED BOUTIQUE		OA	OPEN AREA
	ARH	ASBESTOS ROOFED HOUSE		CY	CONTAINER YARD
	TRH	TIN ROOFED HOUSE			

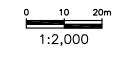

THE DEMOCRATIC SOCIALIST REPUBLIC OF SRI LANKA
MINISTRY OF HIGHWAYS & ROAD DEVELOPMENT



JICA JAPAN INTERNATIONAL COOPERATION AGENCY

ORICON

ORIENTAL CONSULTANTS COMPANY LIMITED
in association with
PACIFIC CONSULTANTS INTERNATIONAL

No											
REVISION			DATE		COLOMBO OUTER CIRCULAR HIGHWAY PROJECT (NORTHERN SECTION 1) RIGHT OF WAY ACQUISITION PLAN STA. 9+700.000 TO 10+400.000						
DESIGNED BY:											
CHECKED BY:											
APPROVED BY:											
DWG. NO.								S-04			

C:\CH-2006\Y09+700row.dwg

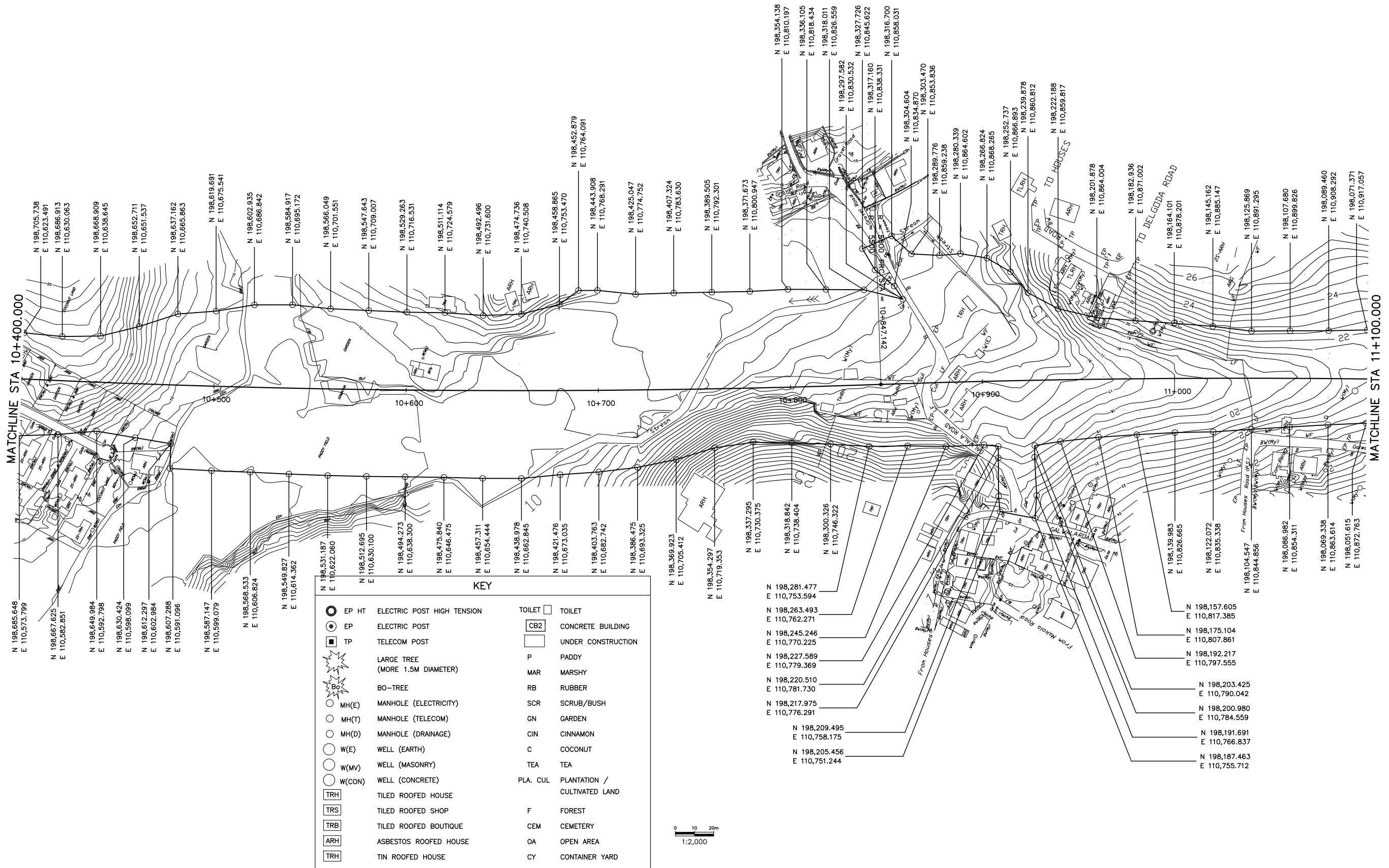
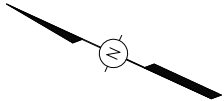

MATCHLINE STA 10+400.000

MATCHLINE STA 11+100.000

KEY

○ EP HT	ELECTRIC POST HIGH TENSION	□ TOILET	TOILET
● EP	ELECTRIC POST	□ CB2	CONCRETE BUILDING
■ TP	TELECOM POST	□	UNDER CONSTRUCTION
★	LARGE TREE (MORE 1.5M DIAMETER)	P	PADDY
★ Bo	BO-TREE	MAR	MARSHY
○ MH(E)	MANHOLE (ELECTRICITY)	RB	RUBBER
○ MH(T)	MANHOLE (TELECOM)	SCR	SCRUB/BUSH
○ MH(D)	MANHOLE (DRAINAGE)	GN	GARDEN
○ W(E)	WELL (EARTH)	CIN	CINNAMON
○ W(MV)	WELL (MASONRY)	C	COCONUT
○ W(CON)	WELL (CONCRETE)	TEA	TEA
TRH	TILED ROOFED HOUSE	PLA. CUL	PLANTATION / CULTIVATED LAND
TRS	TILED ROOFED SHOP	F	FOREST
TRB	TILED ROOFED BOUTIQUE	CEM	CEMETERY
ARH	ASBESTOS ROOFED HOUSE	OA	OPEN AREA
TRH	TIN ROOFED HOUSE	CY	CONTAINER YARD

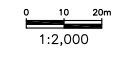

C:\GCH_2006\Yom\10+400row.dwg

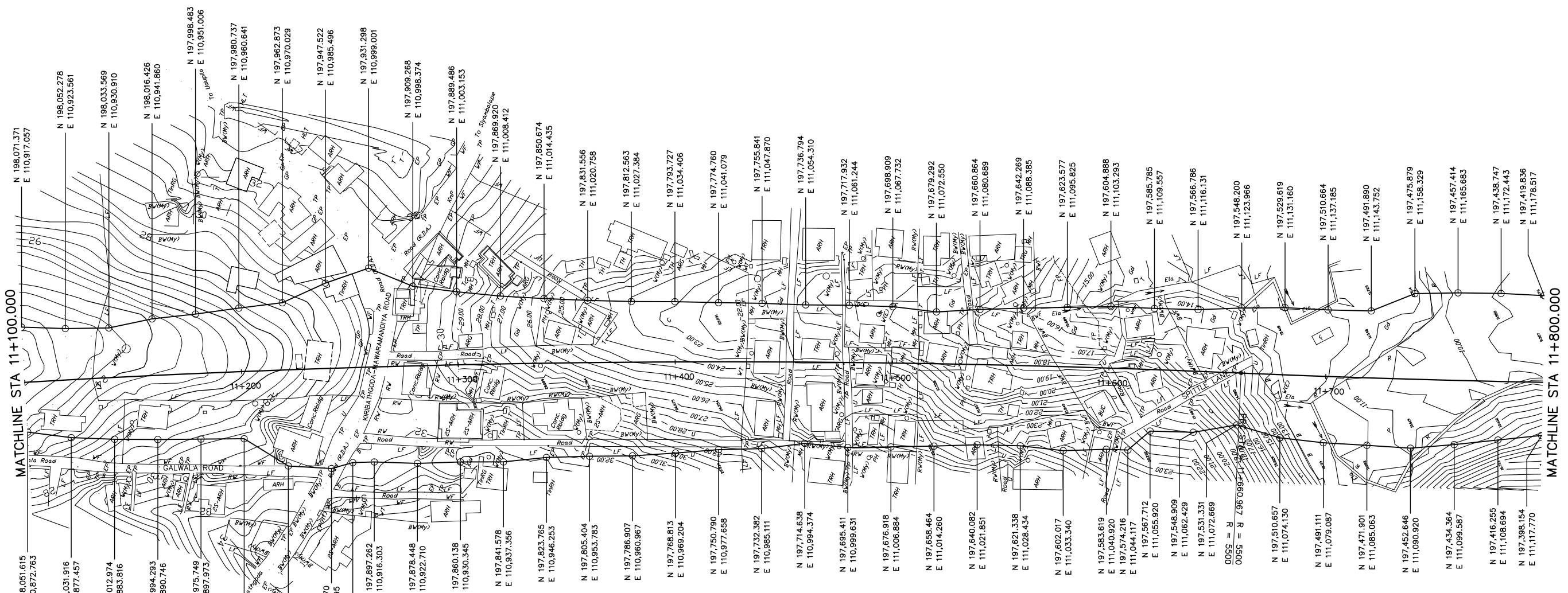
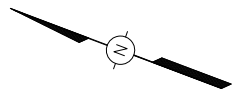

KEY

● EP HT	ELECTRIC POST HIGH TENSION	TOILET	TOILET
● EP	ELECTRIC POST	CB2	CONCRETE BUILDING
■ TP	TELECOM POST	□	UNDER CONSTRUCTION
⊛	LARGE TREE (MORE 1.5M DIAMETER)	P	PADDY
⊛	BO-TREE	MAR	MARSHY
○ MH(E)	MANHOLE (ELECTRICITY)	RB	RUBBER
○ MH(T)	MANHOLE (TELECOM)	SCR	SCRUB/BUSH
○ MH(D)	MANHOLE (DRAINAGE)	GN	GARDEN
○ W(E)	WELL (EARTH)	CIN	CINNAMON
○ W(MV)	WELL (MASONRY)	C	COCONUT
○ W(CON)	WELL (CONCRETE)	TEA	TEA
TRH	TILED ROOFED HOUSE	PLA. CUL	PLANTATION / CULTIVATED LAND
TRS	TILED ROOFED SHOP	F	FOREST
TRB	TILED ROOFED BOUTIQUE	CEM	CEMETERY
ARH	ASBESTOS ROOFED HOUSE	OA	OPEN AREA
TRH	TIN ROOFED HOUSE	CY	CONTAINER YARD

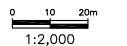

THE DEMOCRATIC SOCIALIST REPUBLIC OF SRI LANKA
 MINISTRY OF HIGHWAYS & ROAD DEVELOPMENT
Road Development Authority

JICA JAPAN INTERNATIONAL COOPERATION AGENCY
ORIENTAL CONSULTANTS COMPANY LIMITED
 in association with
PACIFIC CONSULTANTS INTERNATIONAL

No	REVISION	DATE
----	----------	------

COLOMBO OUTER CIRCULAR HIGHWAY PROJECT
 (NORTHERN SECTION 1)
RIGHT OF WAY ACQUISITION PLAN
 STA. 11+100.000 TO 11+800.000

DESIGNED BY:	
CHECKED BY:	
APPROVED BY:	
DWG. NO.	S-06

G:\CH\2006\com\11+100row.dwg

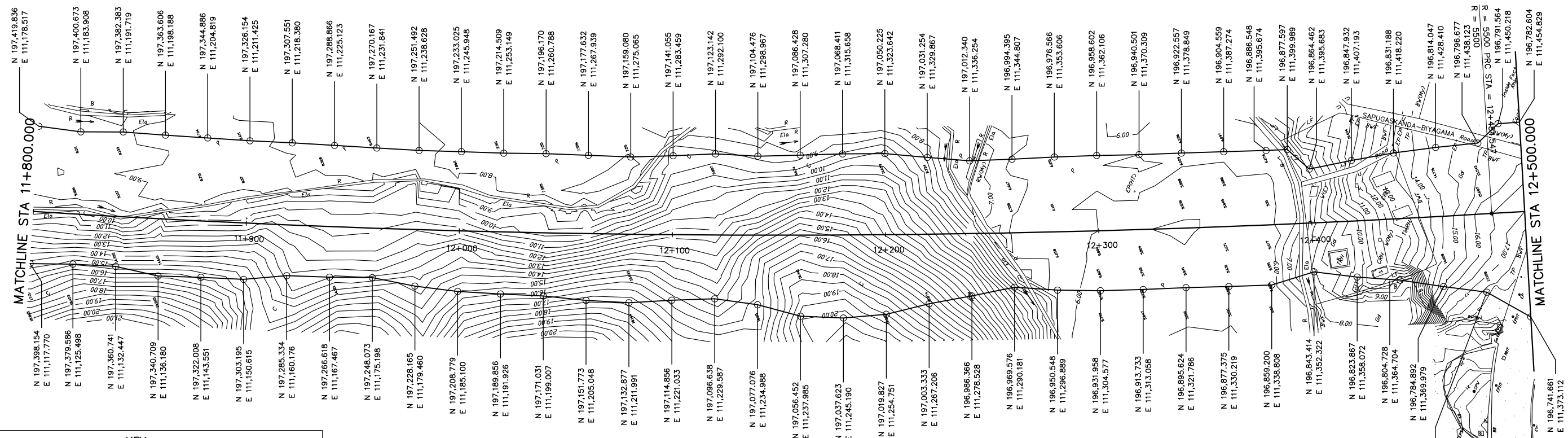
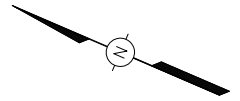

KEY

○ EP HT	ELECTRIC POST HIGH TENSION	TOILET □	TOILET
○ EP	ELECTRIC POST	□ CB2	CONCRETE BUILDING
■ TP	TELECOM POST	□	UNDER CONSTRUCTION
⊙	LARGE TREE (MORE 1.5M DIAMETER)	P	PADDY
⊙ BO	BO-TREE	MAR	MARSHY
○ MH(E)	MANHOLE (ELECTRICITY)	RB	RUBBER
○ MH(T)	MANHOLE (TELECOM)	SCR	SCRUB/BUSH
○ MH(D)	MANHOLE (DRAINAGE)	GN	GARDEN
○ W(E)	WELL (EARTH)	CIN	CINNAMON
○ W(MV)	WELL (MASONRY)	C	COCONUT
○ W(CON)	WELL (CONCRETE)	TEA	TEA
TRH	TILED ROOFED HOUSE	PLA. CUL	PLANTATION / CULTIVATED LAND
TRS	TILED ROOFED SHOP	F	FOREST
TRB	TILED ROOFED BOUTIQUE	CEM	CEMETERY
ARH	ASBESTOS ROOFED HOUSE	OA	OPEN AREA
TRH	TIN ROOFED HOUSE	CY	CONTAINER YARD

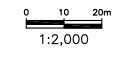

THE DEMOCRATIC SOCIALIST REPUBLIC OF SRI LANKA
 MINISTRY OF HIGHWAYS & ROAD DEVELOPMENT
Road Development Authority

JICA JAPAN INTERNATIONAL COOPERATION AGENCY
ORIENTAL CONSULTANTS COMPANY LIMITED
 in association with
PACIFIC CONSULTANTS INTERNATIONAL

No	REVISION	DATE

COLOMBO OUTER CIRCULAR HIGHWAY PROJECT
 (NORTHERN SECTION 1)
RIGHT OF WAY ACQUISITION PLAN
 STA. 11+800.000 TO 12+500.000

DESIGNED BY:	
CHECKED BY:	
APPROVED BY:	
DWG. NO.	S-07

C:\GCH\2006\com\11+800\row.dwg

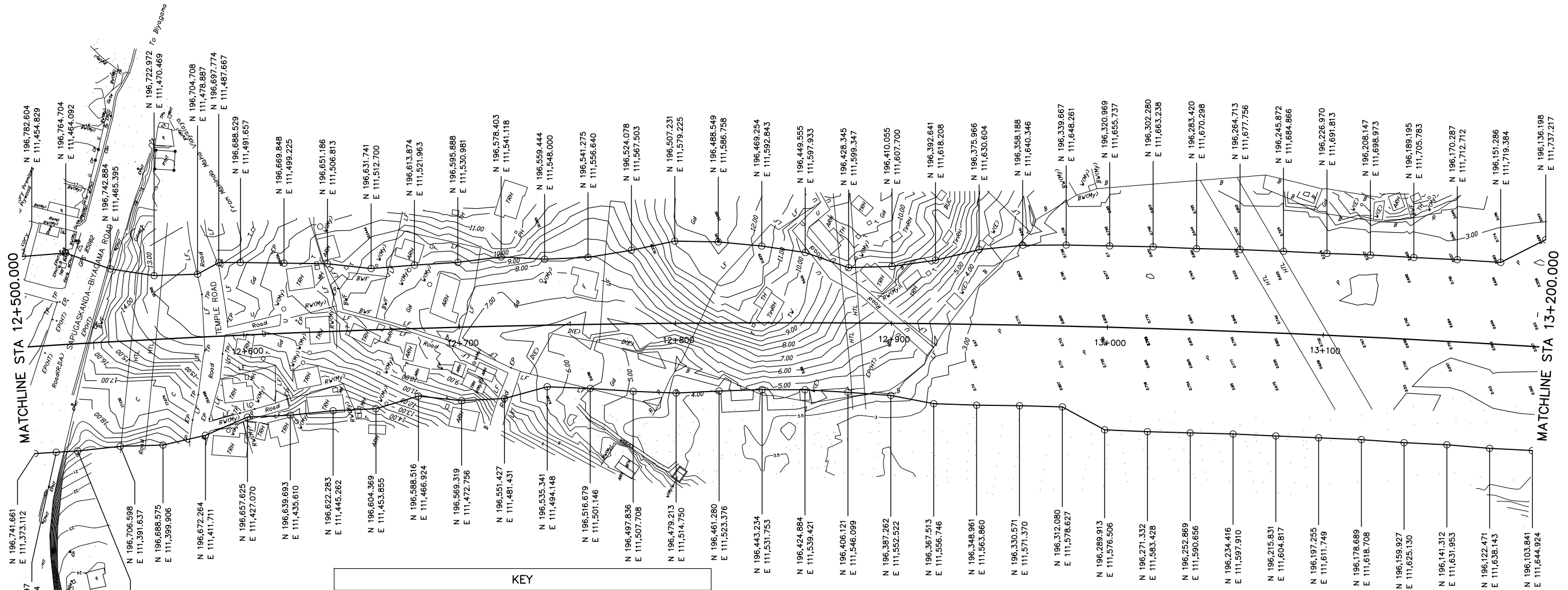
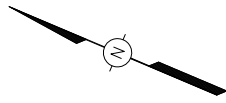

KEY			
○ EP HT	ELECTRIC POST HIGH TENSION	TOILET □	TOILET
● EP	ELECTRIC POST	CB2	CONCRETE BUILDING
■ TP	TELECOM POST	□	UNDER CONSTRUCTION
⊛	LARGE TREE (MORE 1.5M DIAMETER)	P	PADDY
⊙	BO-TREE	MAR	MARSHY
○ MH(E)	MANHOLE (ELECTRICITY)	RB	RUBBER
○ MH(T)	MANHOLE (TELECOM)	SCR	SCRUB/BUSH
○ MH(D)	MANHOLE (DRAINAGE)	GN	GARDEN
○ W(E)	WELL (EARTH)	CIN	CINNAMON
○ W(MV)	WELL (MASONRY)	C	COCONUT
○ W(CON)	WELL (CONCRETE)	TEA	TEA
TRH	TILED ROOFED HOUSE	PLA. CUL	PLANTATION / CULTIVATED LAND
TRS	TILED ROOFED SHOP	F	FOREST
TRB	TILED ROOFED BOUTIQUE	CEM	CEMETERY
ARH	ASBESTOS ROOFED HOUSE	OA	OPEN AREA
TRH	TIN ROOFED HOUSE	CY	CONTAINER YARD

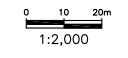

C:\GCH\2006\com\12+500row.dwg

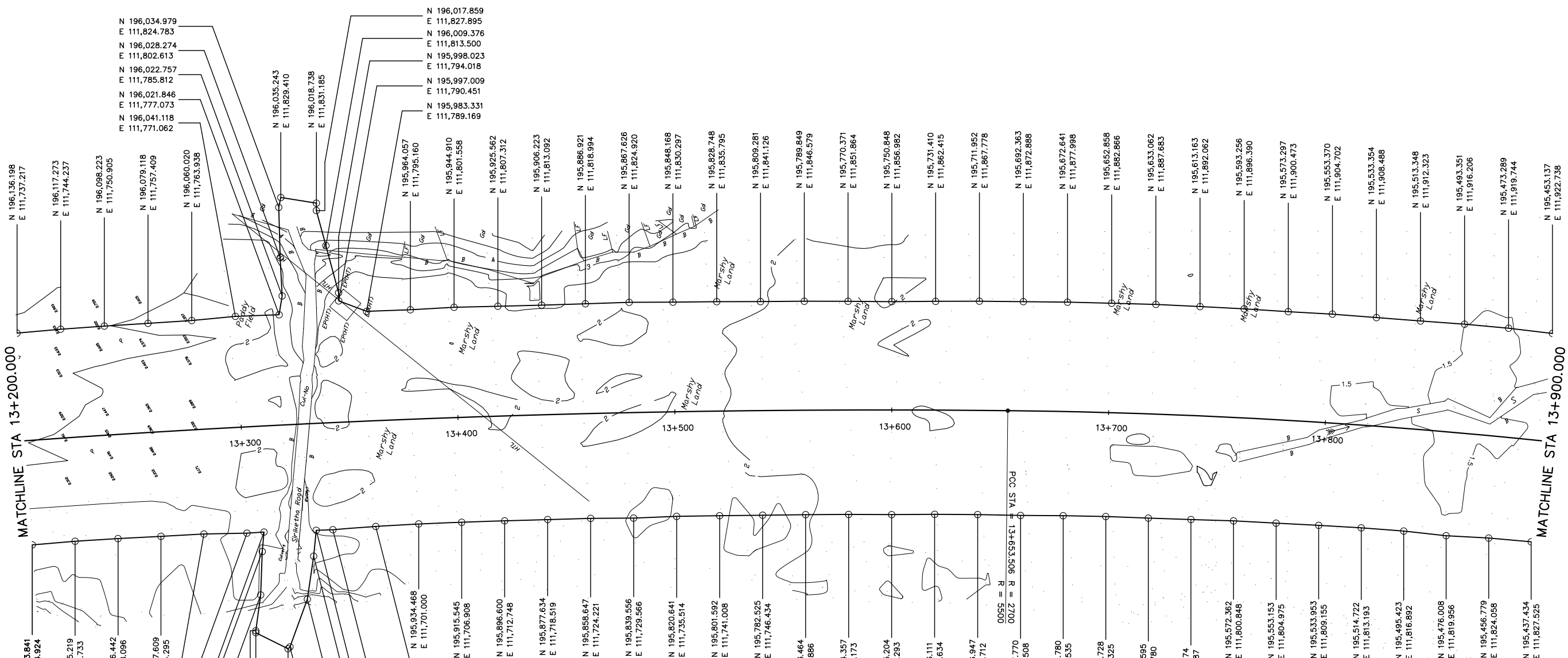
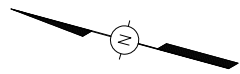

MATCHLINE STA 13+200.000

MATCHLINE STA 13+900.000

KEY	
	EP HT ELECTRIC POST HIGH TENSION
	EP ELECTRIC POST
	TP TELECOM POST
	LARGE TREE (MORE 1.5M DIAMETER)
	BO-TREE
	MH(E) MANHOLE (ELECTRICITY)
	MH(T) MANHOLE (TELECOM)
	MH(D) MANHOLE (DRAINAGE)
	W(E) WELL (EARTH)
	W(MV) WELL (MASONRY)
	W(CON) WELL (CONCRETE)
	TRH TILED ROOFED HOUSE
	TRS TILED ROOFED SHOP
	TRB TILED ROOFED BOUTIQUE
	ARH ASBESTOS ROOFED HOUSE
	TRH TIN ROOFED HOUSE
	TOILET TOILET
	CB2 CONCRETE BUILDING
	UNDER CONSTRUCTION
	P PADDY
	MAR MARSHY
	RB RUBBER
	SCR SCRUB/BUSH
	GN GARDEN
	CIN CINNAMON
	C COCONUT
	TEA TEA
	PLA. CUL PLANTATION / CULTIVATED LAND
	F FOREST
	CEM CEMETERY
	OA OPEN AREA
	CY CONTAINER YARD

THE DEMOCRATIC SOCIALIST REPUBLIC OF SRI LANKA
 MINISTRY OF HIGHWAYS & ROAD DEVELOPMENT
Road Development Authority

JICA JAPAN INTERNATIONAL COOPERATION AGENCY
ORIENTAL CONSULTANTS COMPANY LIMITED
 in association with
PACIFIC CONSULTANTS INTERNATIONAL

No	REVISION	DATE

COLOMBO OUTER CIRCULAR HIGHWAY PROJECT
 (NORTHERN SECTION 1)
RIGHT OF WAY ACQUISITION PLAN
 STA. 13+200.000 TO 13+900.000

DESIGNED BY:	
CHECKED BY:	
APPROVED BY:	
DWG. NO.	S-09

C:\GCH\2006\com\13+200\row.dwg

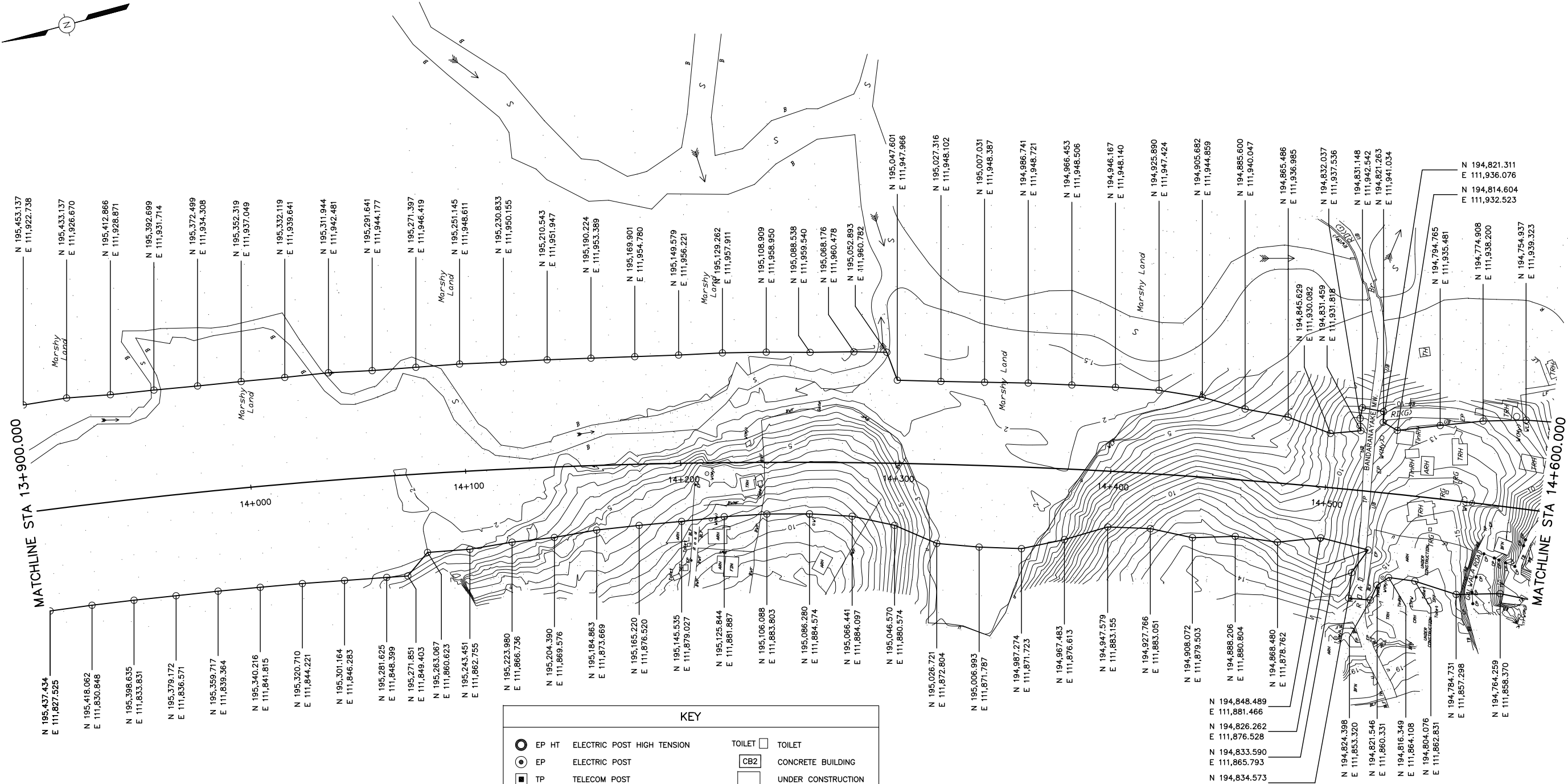
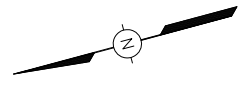

KEY				
	EP HT	ELECTRIC POST HIGH TENSION		TOILET
	EP	ELECTRIC POST		CONCRETE BUILDING
	TP	TELECOM POST		UNDER CONSTRUCTION
	LARGE TREE	(MORE 1.5M DIAMETER)		PADDY
	BO-TREE			MARSHY
	MH(E)	MANHOLE (ELECTRICITY)		RUBBER
	MH(T)	MANHOLE (TELECOM)		SCRUB/BUSH
	MH(D)	MANHOLE (DRAINAGE)		GARDEN
	W(E)	WELL (EARTH)		CINNAMON
	W(MV)	WELL (MASONRY)		COCONUT
	W(CON)	WELL (CONCRETE)		TEA
	TRH	TILED ROOFED HOUSE		PLANTATION / CULTIVATED LAND
	TRS	TILED ROOFED SHOP		FOREST
	TRB	TILED ROOFED BOUTIQUE		CEMETERY
	ARH	ASBESTOS ROOFED HOUSE		OPEN AREA
	TRH	TIN ROOFED HOUSE		CONTAINER YARD

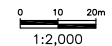

No	REVISION	DATE

DESIGNED BY:	
CHECKED BY:	
APPROVED BY:	
DWG. NO.	S-10

C:\GCH_2006\com\13+900row.dwg

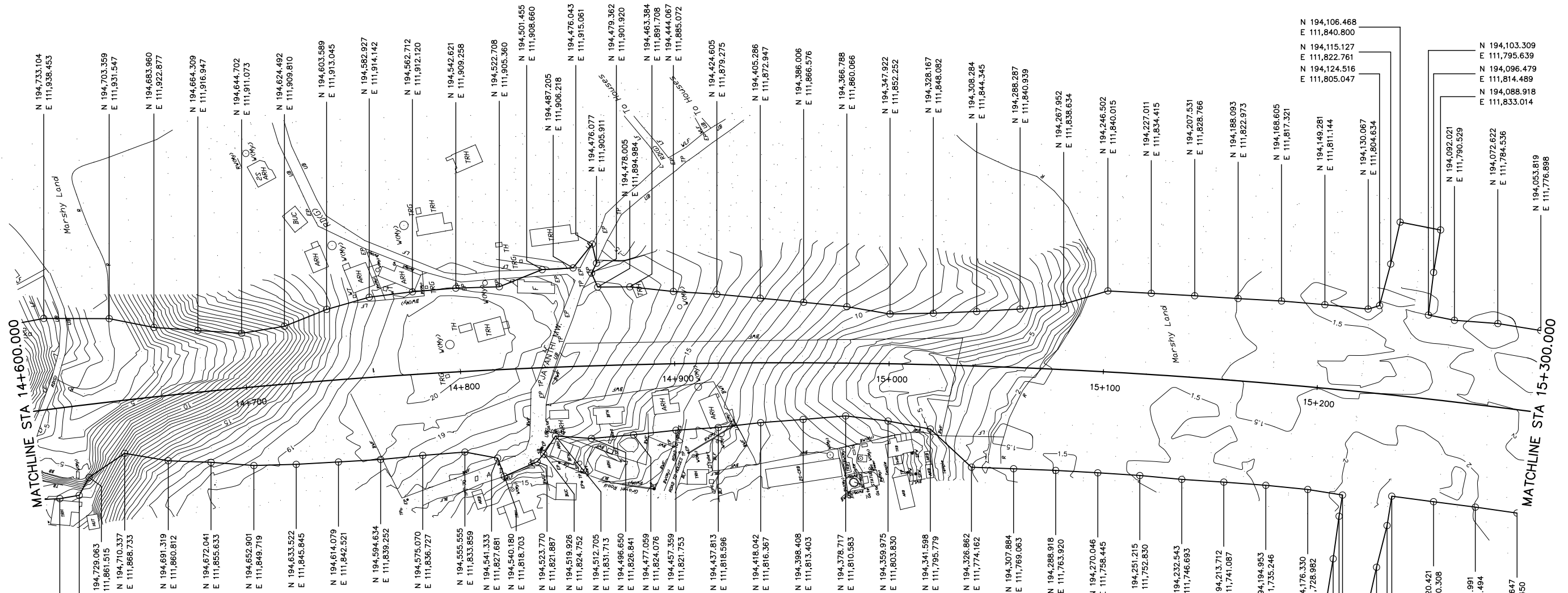
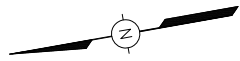

N 194,729.063
E 111,861.515
N 194,710.337
E 111,866.733
N 194,691.319
E 111,860.812
N 194,672.041
E 111,855.633
N 194,652.901
E 111,849.719
N 194,633.522
E 111,845.845
N 194,614.079
E 111,842.521
N 194,594.634
E 111,839.252
N 194,575.070
E 111,836.727
N 194,555.555
E 111,833.859
N 194,541.333
E 111,827.661
N 194,540.180
E 111,818.703
N 194,523.770
E 111,821.887
N 194,519.926
E 111,824.752
N 194,512.705
E 111,831.713
N 194,498.650
E 111,826.841
N 194,477.059
E 111,824.076
N 194,457.359
E 111,821.753
N 194,437.813
E 111,818.596
N 194,418.042
E 111,816.367
N 194,398.408
E 111,813.403
N 194,378.717
E 111,810.583
N 194,359.975
E 111,803.830
N 194,341.598
E 111,795.779
N 194,326.862
E 111,774.162
N 194,307.884
E 111,769.063
N 194,288.918
E 111,763.920
N 194,270.046
E 111,758.445
N 194,251.215
E 111,752.830
N 194,232.543
E 111,746.693
N 194,213.712
E 111,741.087
N 194,194.953
E 111,735.246
N 194,176.330
E 111,728.982
N 194,120.421
E 111,710.308
N 194,101.991
E 111,703.494
N 194,083.647
E 111,696.450

N 194,181.485
E 111,671.692
N 194,179.549
E 111,676.303
N 194,171.987
E 111,694.828
N 194,164.883
E 111,713.556
N 194,161.103
E 111,722.818
N 194,138.838
E 111,717.175
N 194,144.042
E 111,704.311
N 194,153.157
E 111,686.475
N 194,161.815
E 111,668.436
N 194,163.934
E 111,663.906

KEY				
●	EP HT	ELECTRIC POST HIGH TENSION	TOILET	TOILET
○	EP	ELECTRIC POST	CB2	CONCRETE BUILDING
■	TP	TELECOM POST	□	UNDER CONSTRUCTION
⊙		LARGE TREE (MORE 1.5M DIAMETER)	P	PADDY
⊙		BO-TREE	MAR	MARSHY
○	MH(E)	MANHOLE (ELECTRICITY)	RB	RUBBER
○	MH(T)	MANHOLE (TELECOM)	SCR	SCRUB/BUSH
○	MH(D)	MANHOLE (DRAINAGE)	GN	GARDEN
○	W(E)	WELL (EARTH)	CIN	CINNAMON
○	W(MV)	WELL (MASONRY)	C	COCONUT
○	W(CON)	WELL (CONCRETE)	TEA	TEA
TRH		TILED ROOFED HOUSE	PLA. CUL	PLANTATION / CULTIVATED LAND
TRS		TILED ROOFED SHOP	F	FOREST
TRB		TILED ROOFED BOUTIQUE	CEM	CEMETERY
ARH		ASBESTOS ROOFED HOUSE	OA	OPEN AREA
TRH		TIN ROOFED HOUSE	CY	CONTAINER YARD



C:\GCH\2006\com\14+600row.dwg

No	REVISION	DATE
----	----------	------

DESIGNED BY:	
CHECKED BY:	
APPROVED BY:	
DWG. NO.	S-11

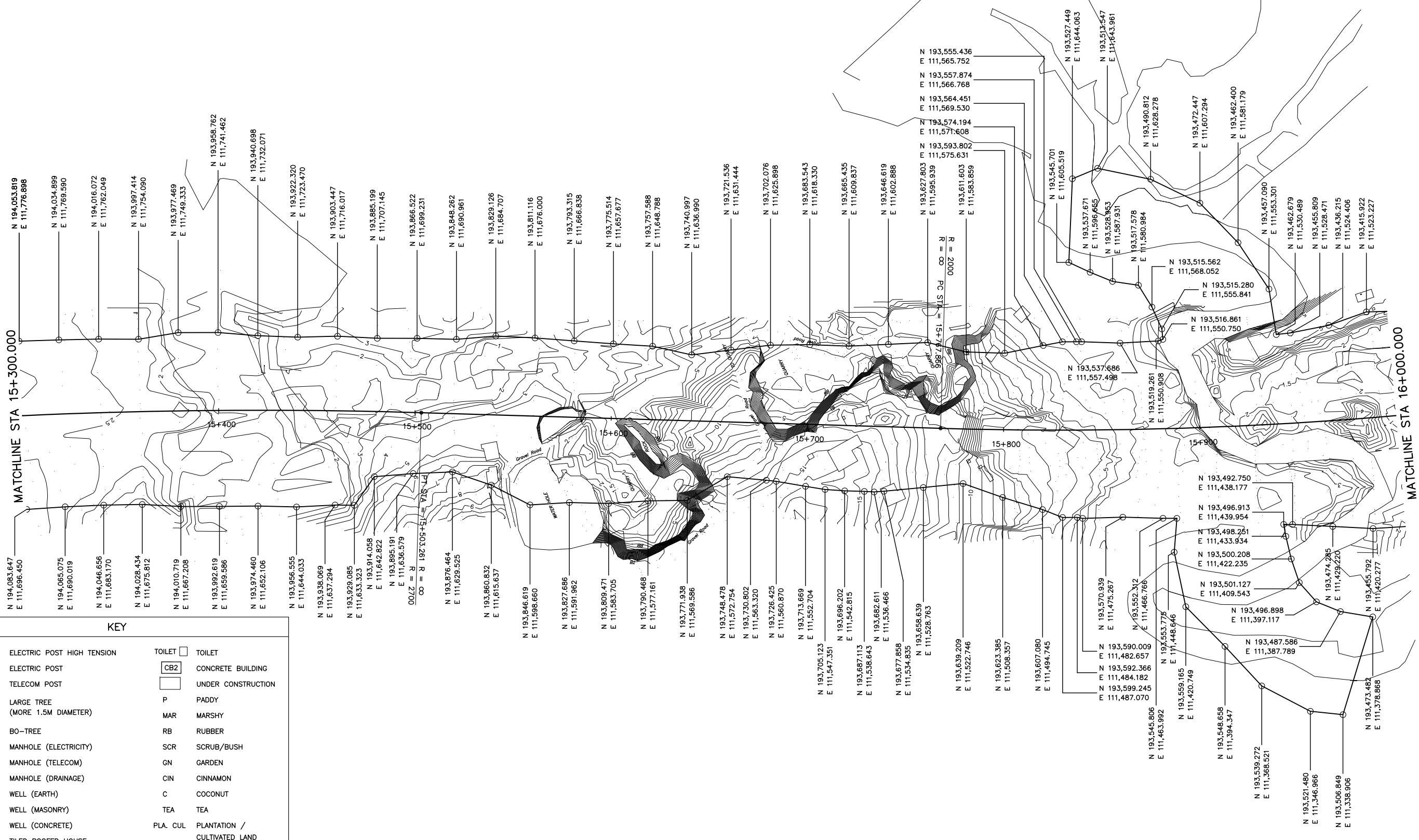
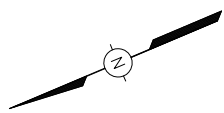

KEY

	EP HT ELECTRIC POST HIGH TENSION		TOILET
	EP ELECTRIC POST		CB2 CONCRETE BUILDING
	TP TELECOM POST		UNDER CONSTRUCTION
	LARGE TREE (MORE 1.5M DIAMETER)		P PADDY
	BO-TREE		MAR MARSHY
	MH(E) MANHOLE (ELECTRICITY)		RB RUBBER
	MH(T) MANHOLE (TELECOM)		GN GARDEN
	MH(D) MANHOLE (DRAINAGE)		CIN CINNAMON
	W(E) WELL (EARTH)		C COCONUT
	W(MV) WELL (MASONRY)		TEA TEA
	W(CON) WELL (CONCRETE)		PLA. CUL PLANTATION / CULTIVATED LAND
	TRH TILED ROOFED HOUSE		F FOREST
	TRS TILED ROOFED SHOP		CEM CEMETERY
	TRB TILED ROOFED BOUTIQUE		OA OPEN AREA
	ARH ASBESTOS ROOFED HOUSE		CY CONTAINER YARD
	TRH TIN ROOFED HOUSE		

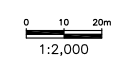

No	REVISION	DATE
----	----------	------

DESIGNED BY:	
CHECKED BY:	
APPROVED BY:	
DWG. NO.	S-12

C:\GCH_2006\com\15+300\row.dwg



KEY				
	EP HT	ELECTRIC POST HIGH TENSION		TOILET
	EP	ELECTRIC POST		CONCRETE BUILDING
	TP	TELECOM POST		UNDER CONSTRUCTION
		LARGE TREE (MORE 1.5M DIAMETER)		PADY
		BO-TREE		MARSHY
	MH(E)	MANHOLE (ELECTRICITY)		RUBBER
	MH(T)	MANHOLE (TELECOM)		SCRUB/BUSH
	MH(D)	MANHOLE (DRAINAGE)		GARDEN
	W(E)	WELL (EARTH)		CINNAMON
	W(MV)	WELL (MASONRY)		COCONUT
	W(CON)	WELL (CONCRETE)		TEA
	TRH	TILED ROOFED HOUSE		PLANTATION / CULTIVATED LAND
	TRS	TILED ROOFED SHOP		FOREST
	TRB	TILED ROOFED BOUTIQUE		CEMETERY
	ARH	ASBESTOS ROOFED HOUSE		OPEN AREA
	TRH	TIN ROOFED HOUSE		CONTAINER YARD

THE DEMOCRATIC SOCIALIST REPUBLIC OF SRI LANKA
 MINISTRY OF HIGHWAYS & ROAD DEVELOPMENT
Road Development Authority

JICA JAPAN INTERNATIONAL COOPERATION AGENCY
ORIENTAL CONSULTANTS COMPANY LIMITED
 in association with
PACIFIC CONSULTANTS INTERNATIONAL

No	REVISION	DATE
----	----------	------

COLOMBO OUTER CIRCULAR HIGHWAY PROJECT
 (NORTHERN SECTION 1)
RIGHT OF WAY ACQUISITION PLAN
 STA. 16+000.000 TO 16+700.000

DESIGNED BY:	
CHECKED BY:	
APPROVED BY:	
DWG. NO.	S-13

C:\CH\2008\Yom\16+000\rdw.dwg

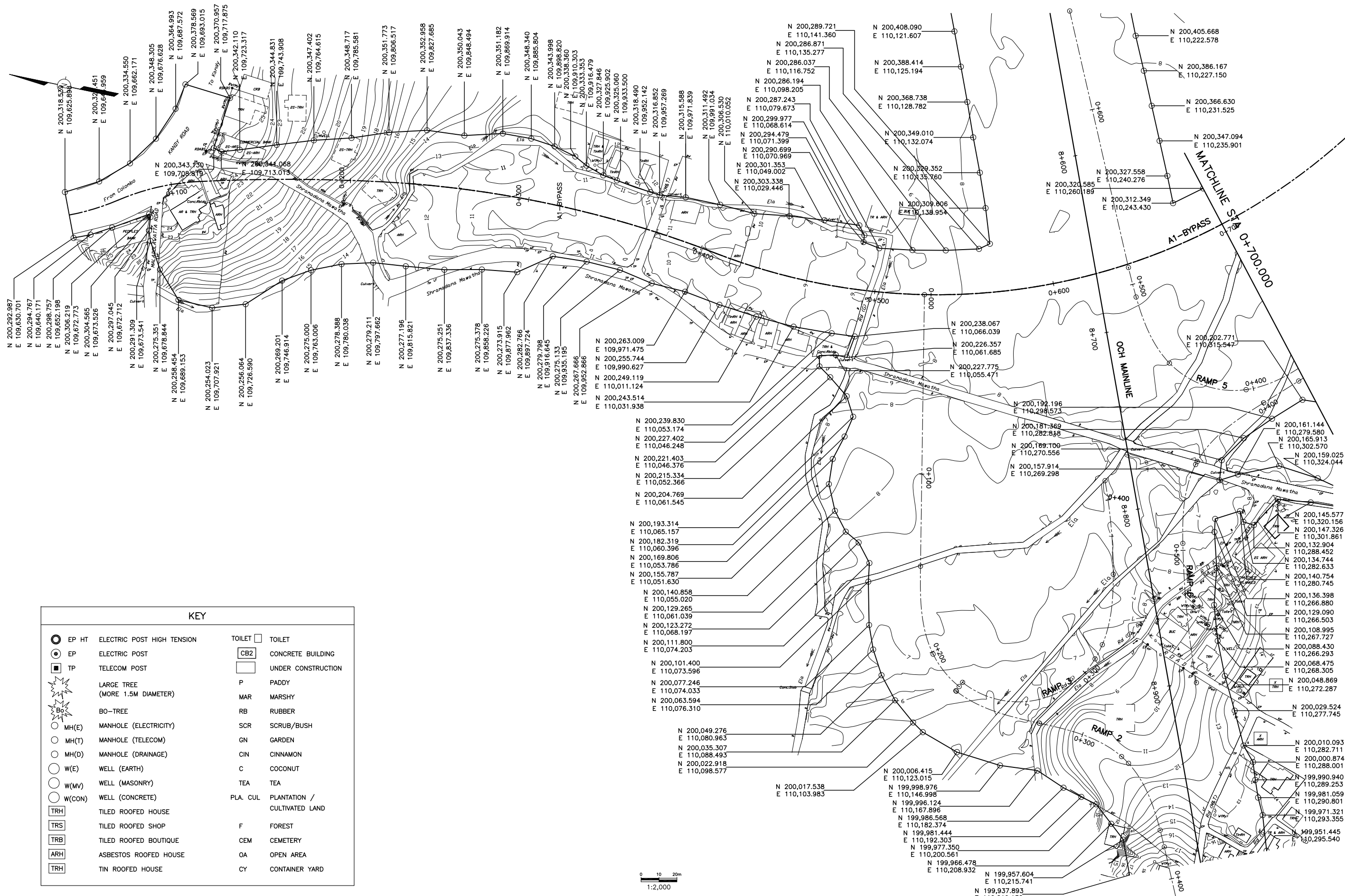

KEY				
	EP HT	ELECTRIC POST HIGH TENSION		TOILET
	EP	ELECTRIC POST		CONCRETE BUILDING
	TP	TELECOM POST		UNDER CONSTRUCTION
	LARGE TREE	(MORE 1.5M DIAMETER)		PADDY
	BO-TREE			MARSHY
	MH(E)	MANHOLE (ELECTRICITY)		RUBBER
	MH(T)	MANHOLE (TELECOM)		SCRUB/BUSH
	MH(D)	MANHOLE (DRAINAGE)		GARDEN
	W(E)	WELL (EARTH)		CINNAMON
	W(MV)	WELL (MASONRY)		COCONUT
	W(CON)	WELL (CONCRETE)		TEA
	TRH	TILED ROOFED HOUSE		PLANTATION / CULTIVATED LAND
	TRS	TILED ROOFED SHOP		FOREST
	TRB	TILED ROOFED BOUTIQUE		CEMETERY
	ARH	ASBESTOS ROOFED HOUSE		OPEN AREA
	TRH	TIN ROOFED HOUSE		CONTAINER YARD

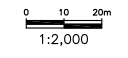

C:\GCH\2006\Yom\09+000\row.dwg

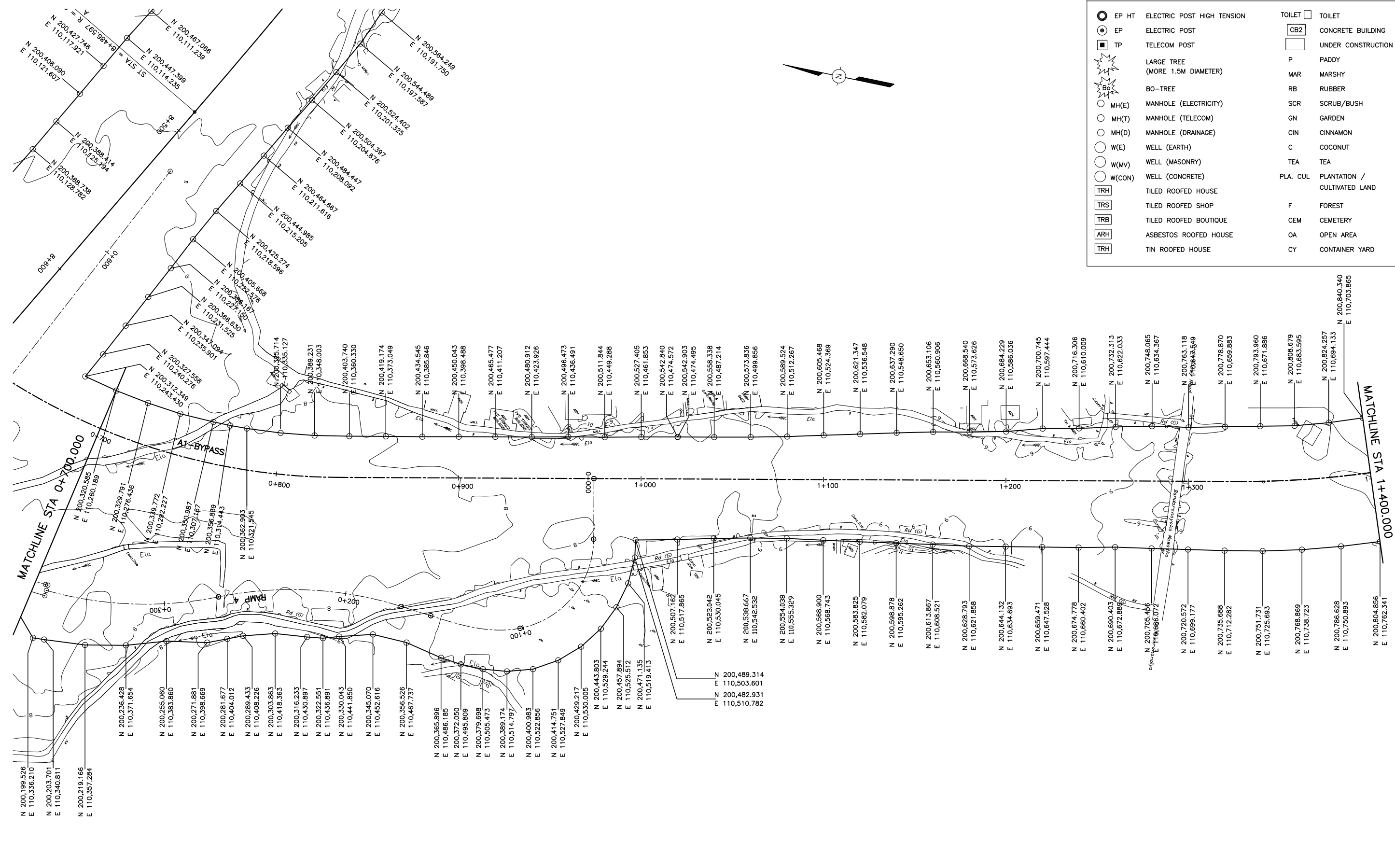

KEY				
	EP HT	ELECTRIC POST HIGH TENSION		TOILET
	EP	ELECTRIC POST		CONCRETE BUILDING
	TP	TELECOM POST		UNDER CONSTRUCTION
	LARGE TREE	(MORE 1.5M DIAMETER)		PADY
	BO-TREE			MARSHY
	MH(E)	MANHOLE (ELECTRICITY)		RUBBER
	MH(T)	MANHOLE (TELECOM)		SCRUB/BUSH
	MH(D)	MANHOLE (DRAINAGE)		GARDEN
	W(E)	WELL (EARTH)		CINNAMON
	W(MV)	WELL (MASONRY)		COCONUT
	W(CON)	WELL (CONCRETE)		TEA
	TRH	TILED ROOFED HOUSE		PLANTATION / CULTIVATED LAND
	TRS	TILED ROOFED SHOP		FOREST
	TRB	TILED ROOFED BOUTIQUE		CEMETERY
	ARH	ASBESTOS ROOFED HOUSE		OPEN AREA
	TRH	TIN ROOFED HOUSE		CONTAINER YARD



THE DEMOCRATIC SOCIALIST REPUBLIC OF SRI LANKA
 MINISTRY OF HIGHWAYS & ROAD DEVELOPMENT
 Road Development Authority

JICA JAPAN INTERNATIONAL COOPERATION AGENCY
 ORICONSUL
 PACIFIC CONSULTANTS INTERNATIONAL
 ORIENTAL CONSULTANTS COMPANY LIMITED
 in association with

No	REVISION	DATE
----	----------	------

COLOMBO OUTER CIRCULAR HIGHWAY PROJECT
 (NORTHERN SECTION 1)
RIGHT OF WAY ACQUISITION PLAN
 A1 BYPASS STA. 0+700.000 TO 1+400.000

DESIGNED BY:	
CHECKED BY:	
APPROVED BY:	
DWG. NO.	S-15

KEY

	EP HT ELECTRIC POST HIGH TENSION		TOILET
	EP ELECTRIC POST		CONCRETE BUILDING
	TP TELECOM POST		UNDER CONSTRUCTION
	LARGE TREE (MORE 1.5M DIAMETER)		P PADDY
	BO-TREE		MAR MARSHY
	MH(E) MANHOLE (ELECTRICITY)		RB RUBBER
	MH(T) MANHOLE (TELECOM)		SCR SCRUB/BUSH
	MH(D) MANHOLE (DRAINAGE)		GN GARDEN
	W(E) WELL (EARTH)		CIN CINNAMON
	W(MV) WELL (MASONRY)		C COCONUT
	W(CON) WELL (CONCRETE)		TEA TEA
	TILED ROOFED HOUSE		PLA. CUL PLANTATION / CULTIVATED LAND
	TILED ROOFED SHOP		F FOREST
	TILED ROOFED BOUTIQUE		CEM CEMETERY
	ASBESTOS ROOFED HOUSE		OA OPEN AREA
	TIN ROOFED HOUSE		CY CONTAINER YARD

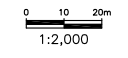
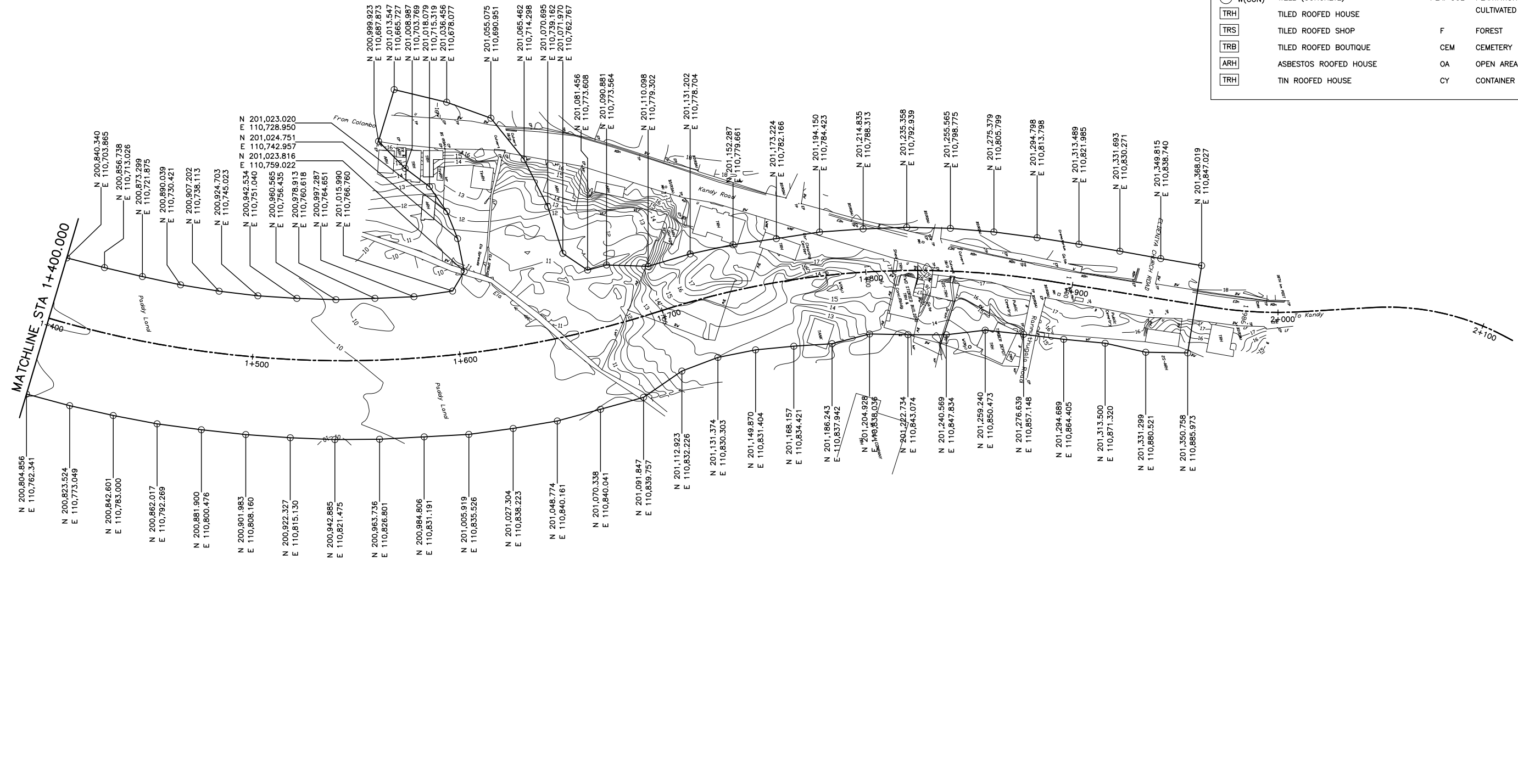
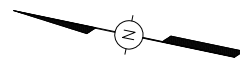

C:\GCH\2006\09\09-000\row.dwg

No	REVISION	DATE

DESIGNED BY:	
CHECKED BY:	
APPROVED BY:	
DWG. NO.	S-16

T. REFERENCE DRAWING
(CONCRETE BRIDGE FOR A11C)

VIADUCT NO.1 (V1) A1 INTERCHANGE VIADUCT

(STA. 8+648.00 - STA. 8+970.00)

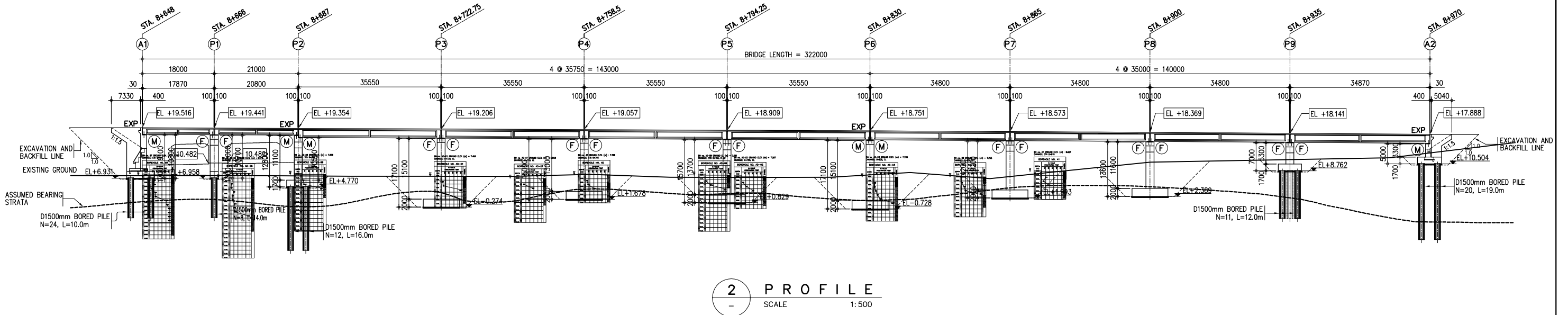

GRADE																			
FINISHED ROAD LEVELS	19.549	19.466	19.383	19.300	19.217	19.134	19.051	18.968	18.885	18.798	18.703	18.600	18.498	18.399	18.242	18.106	17.963	17.811	
EXISTING GROUND LEVELS	7.552	7.628	7.568	7.428	7.415	7.381	7.355	7.151	7.111	7.149	8.341	6.833	8.897	10.932	00.000	00.000	12.018	14.430	17.811
STATION (km)	8640	8660	8680	8700	8720	8740	8760	8780	8800	8820	8840	8860	8880	8900	8920	8940	8960	8980	9000
CURVE BAND SUPERELEVATION																			

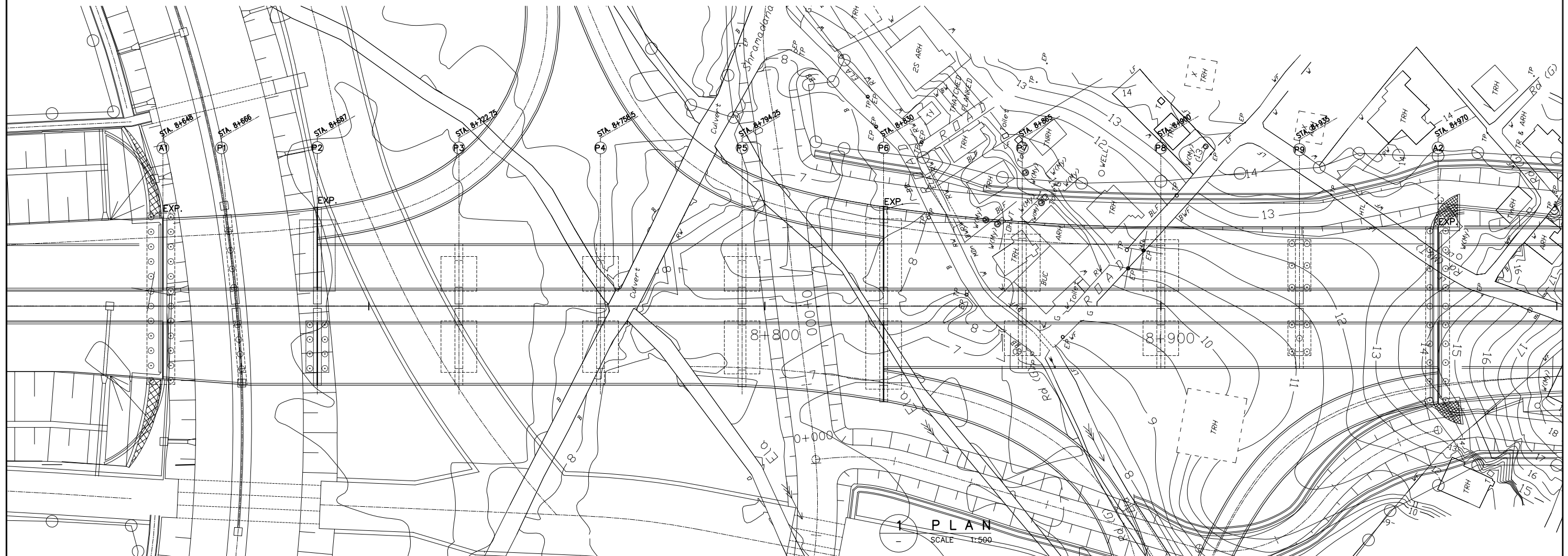

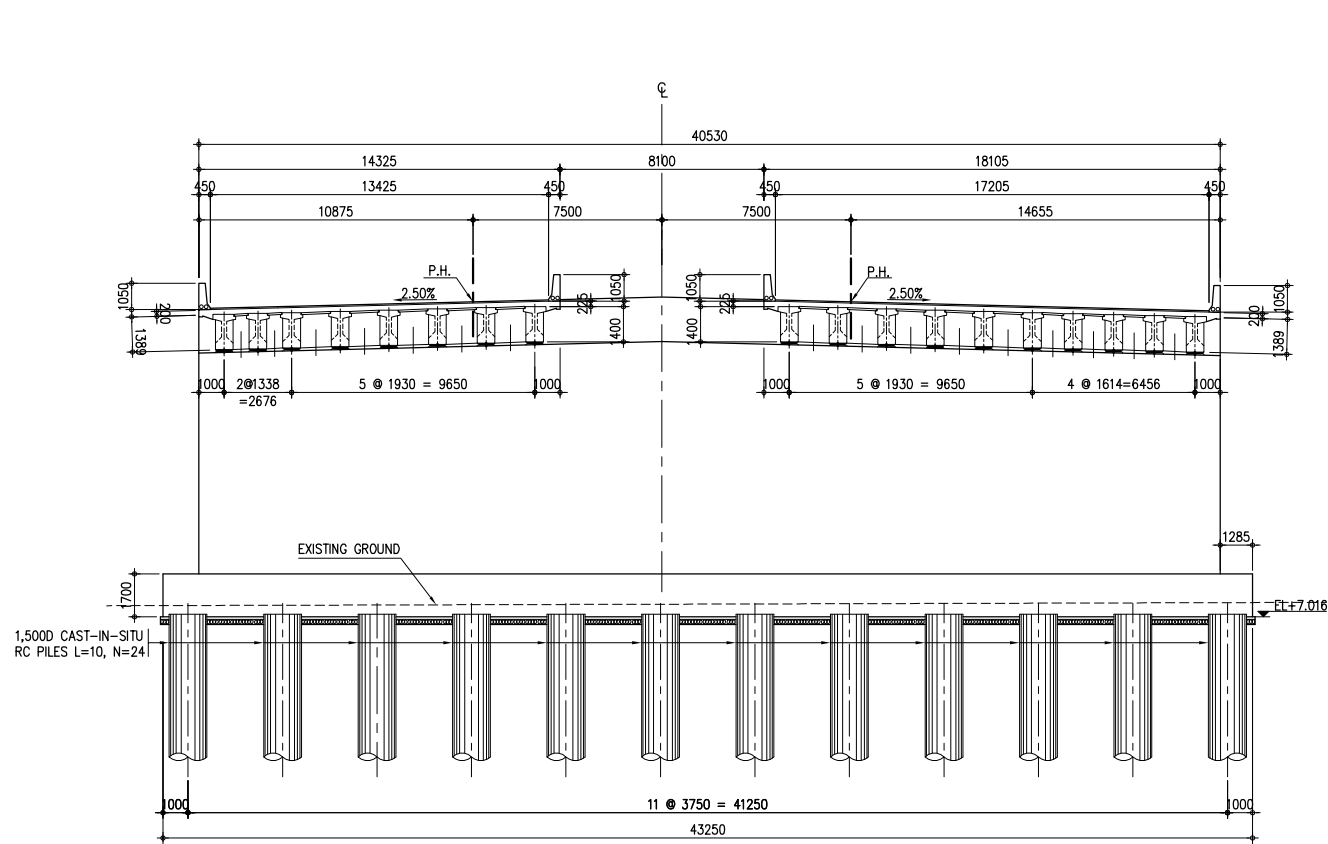

1 TYPICAL CROSS SECTION OF ABUTMENT
SCALE 1:150

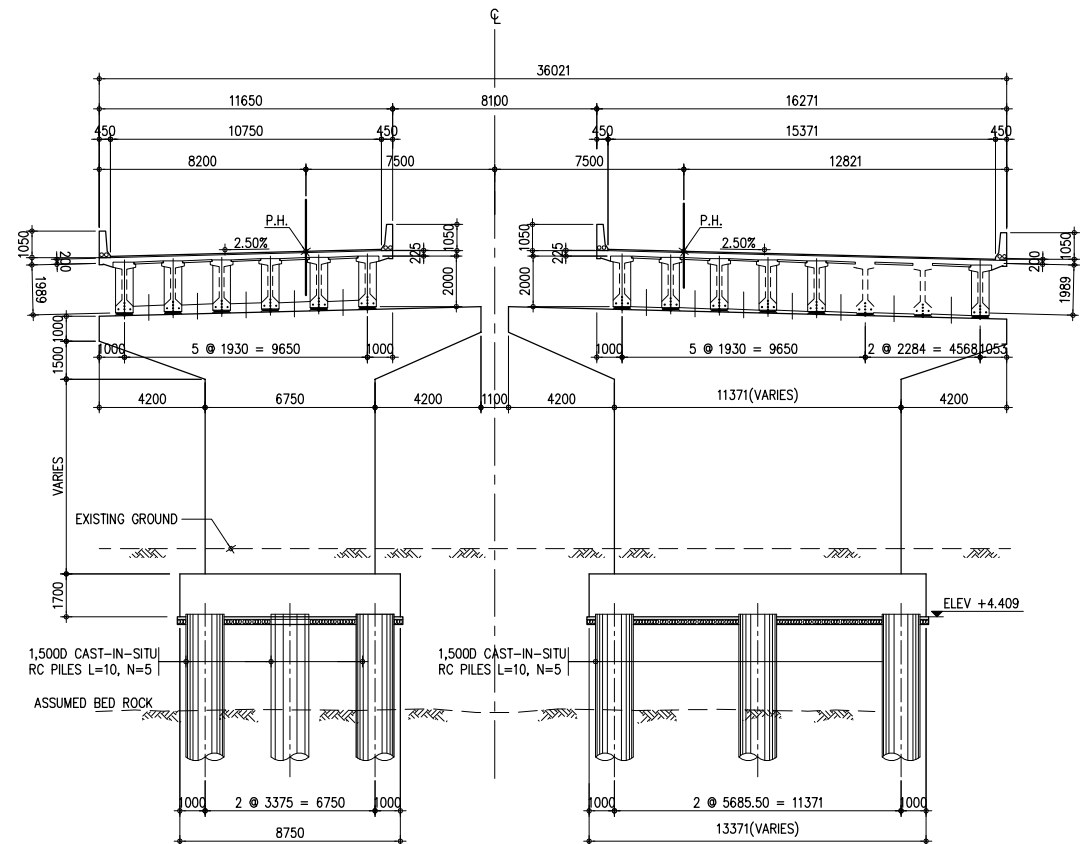

2 TYPICAL CROSS SECTION OF PIER
SCALE 1:150

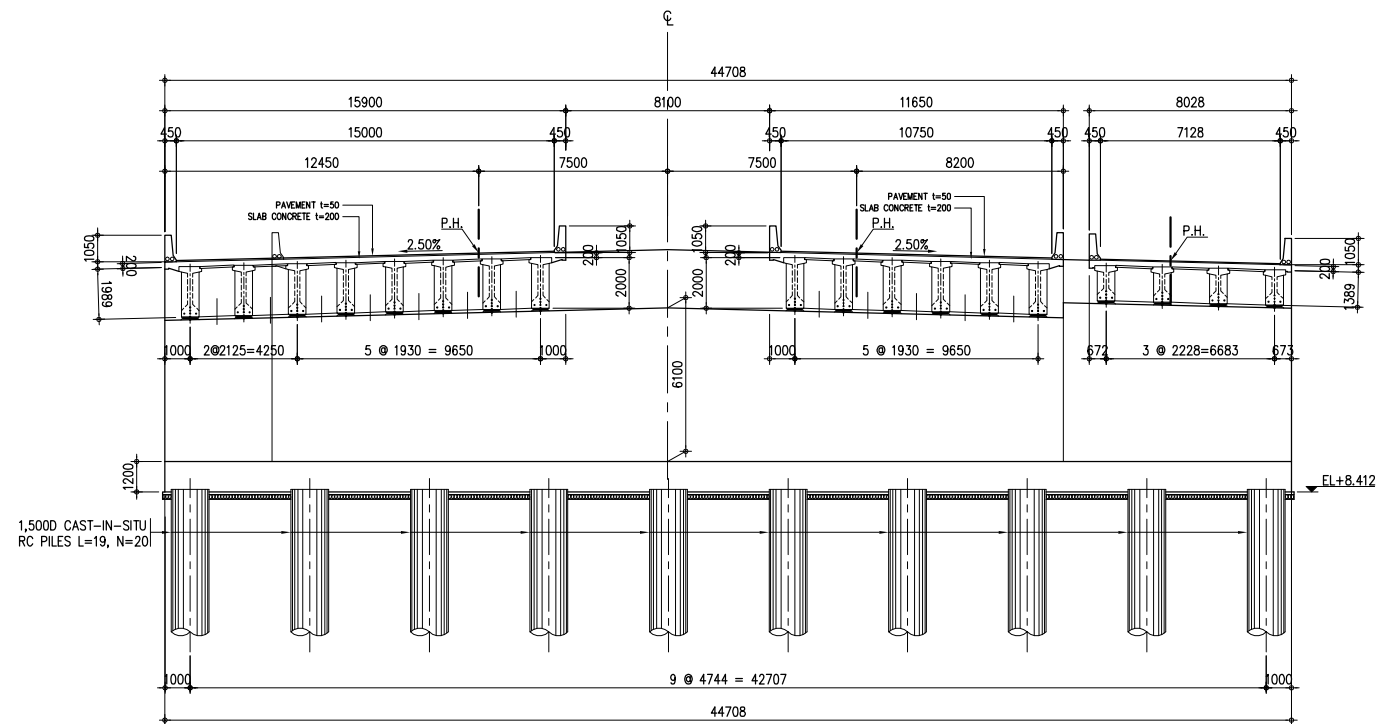

3 CROSS SECTION OF ABUTMENT 2
SCALE 1:150

TABLE FOR P.H	
PIER NO.	P.H
P1	19.441
P2	19.354
P3	19.206
P4	19.057
P5	18.909
P6	18.751
P7	18.573
P8	18.369
P9	18.141
ABUT-A1	19.516
ABUT-A2	17.888

VIADUCT NO. 5 (V5) - A1 IC RAMP-2 BRIDGE

(GENERAL VIEW STA.0+241.285 - STA.0+363.785)

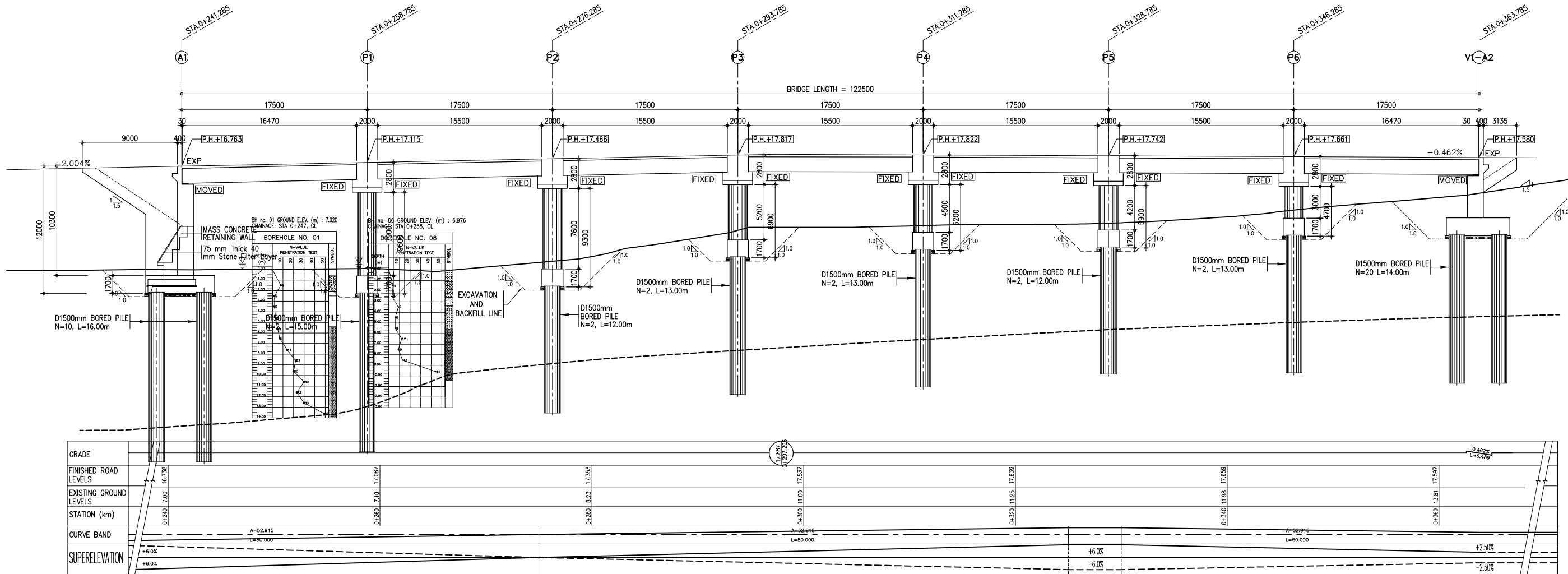

2 PROFILE
SCALE 1:200

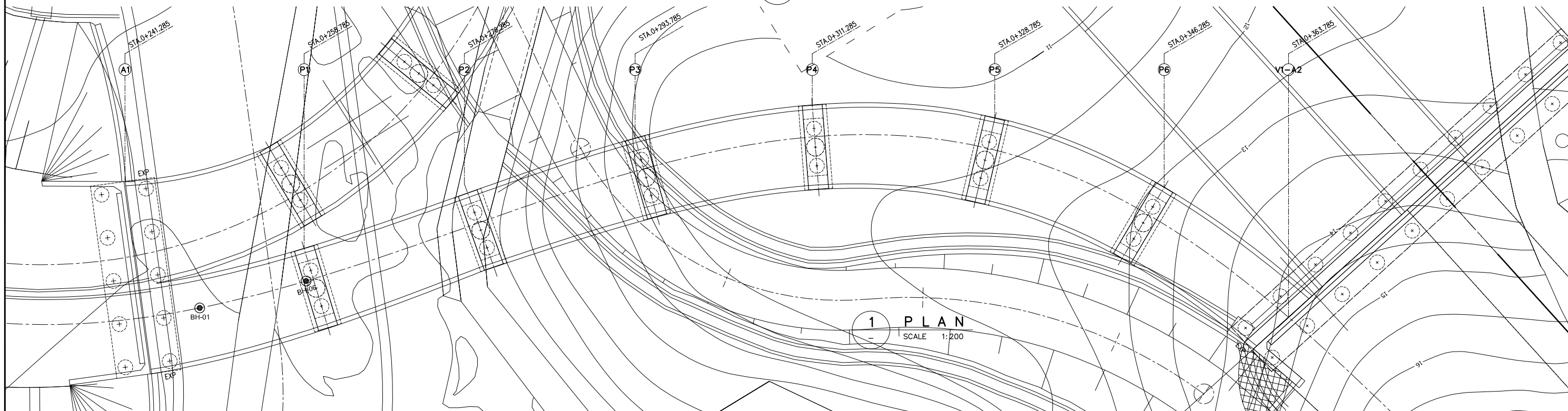

1 PLAN
SCALE 1:200

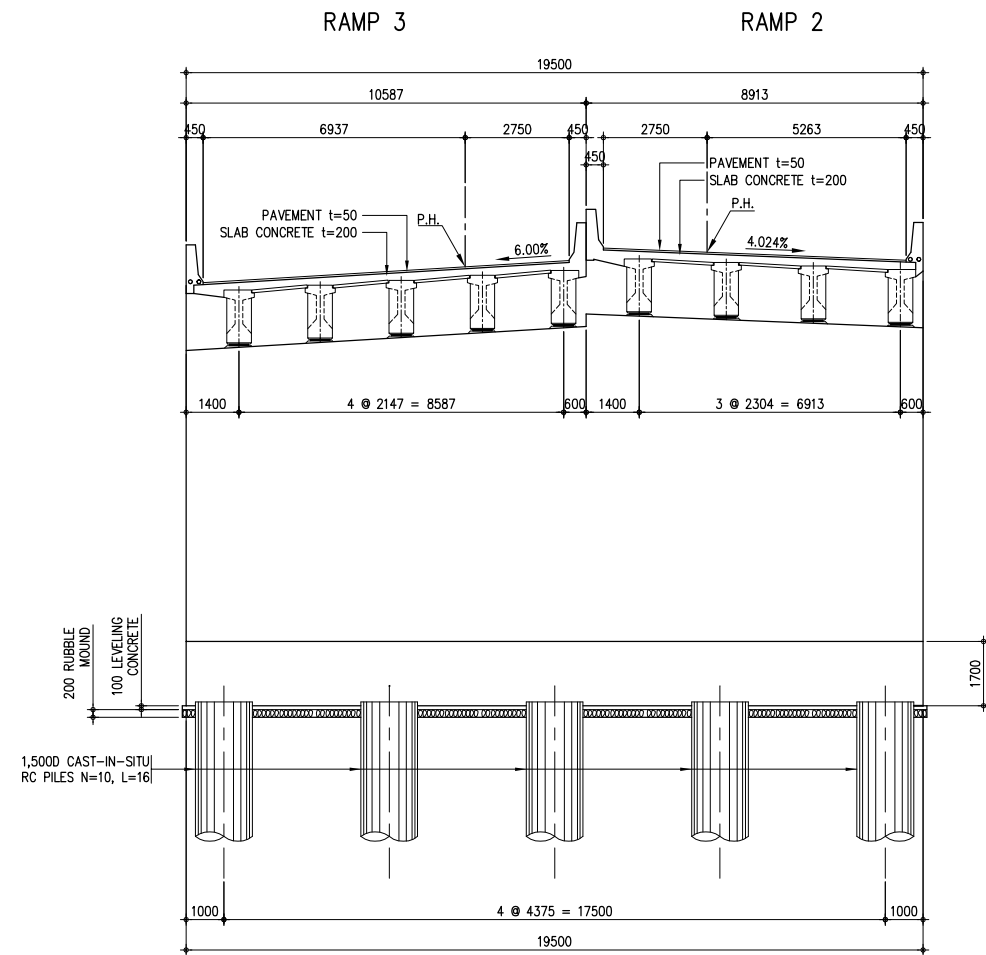

1 CROSS SECTION OF ABUTMENT
SCALE 1:100

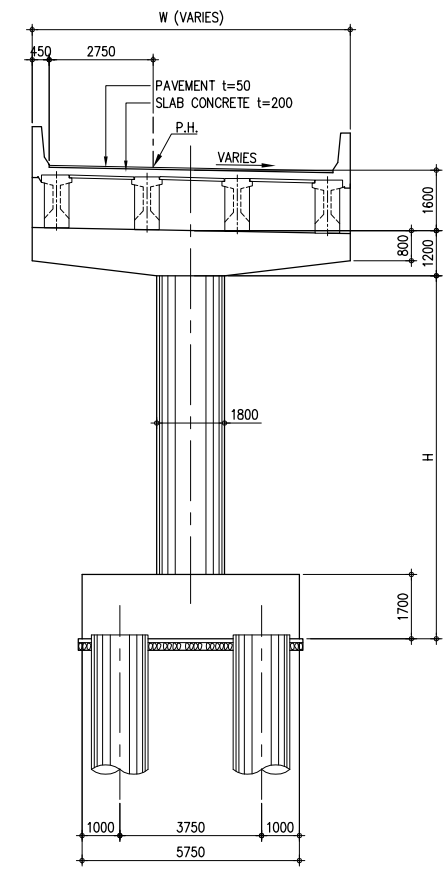

2 TYPICAL CROSS SECTION OF PIER
SCALE 1:100

TABLE FOR P.H	
PIER NO.	P.H
P1	17.115
P2	17.466
P3	17.817
P4	17.822
P5	17.742
P6	17.661
ABUT-A1	16.763
V1-A2	17.580

VIADUCT NO. 6 (V6) A1 IC RAMP-3 BRIDGE

GENERAL VIEW (STA.0+239.766 - STA.0+361.835)

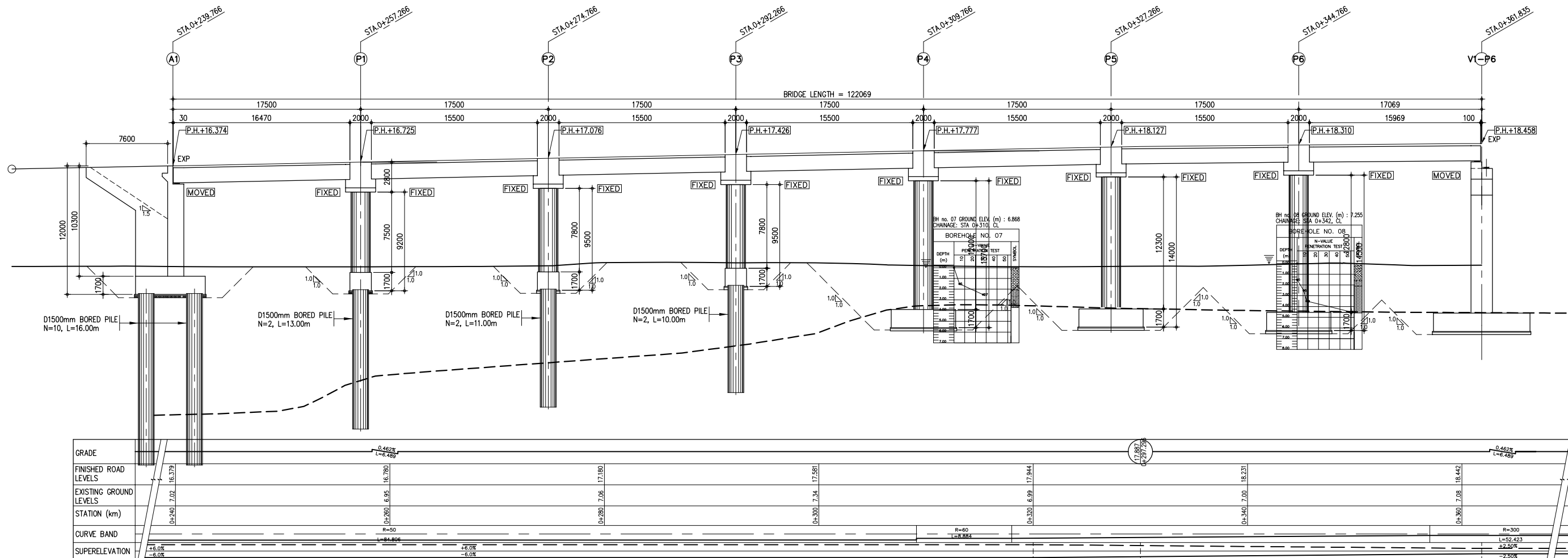

2 PROFILE
SCALE 1:200

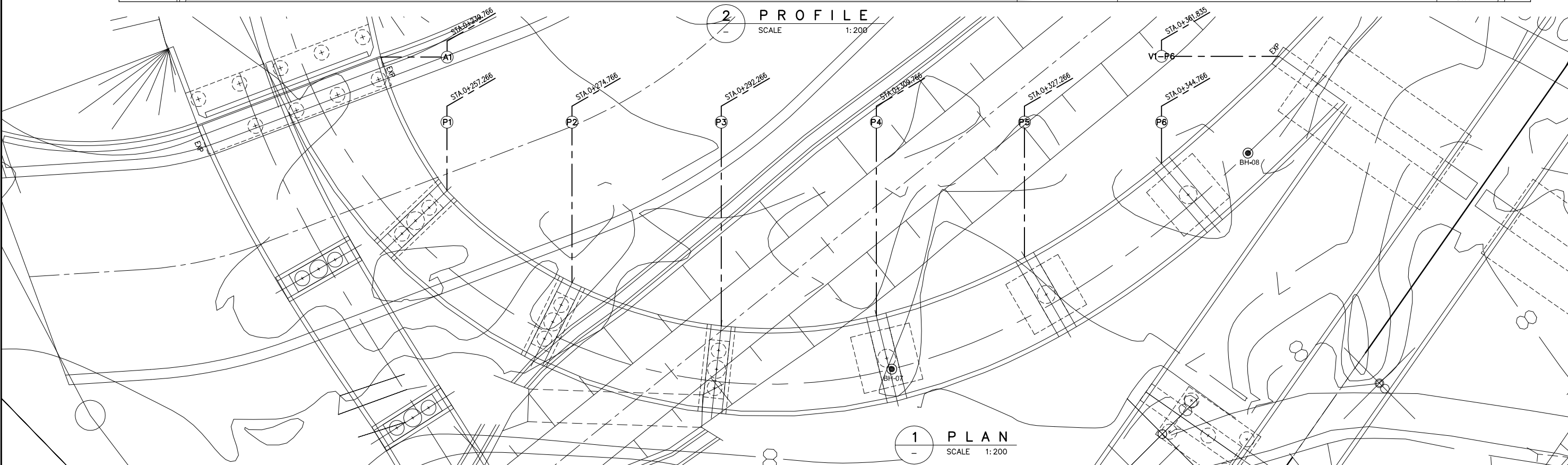

1 PLAN
SCALE 1:200

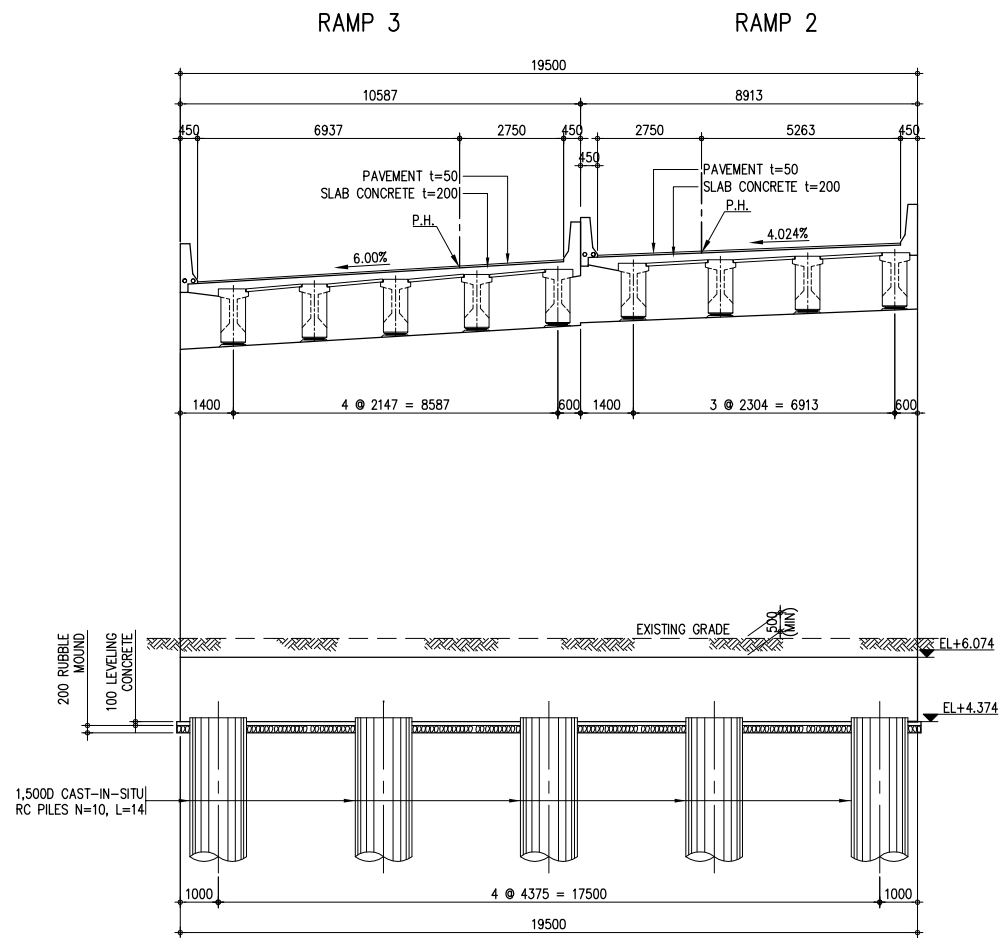

1 CROSS SECTION OF ABUTMENT A1
SCALE 1:100

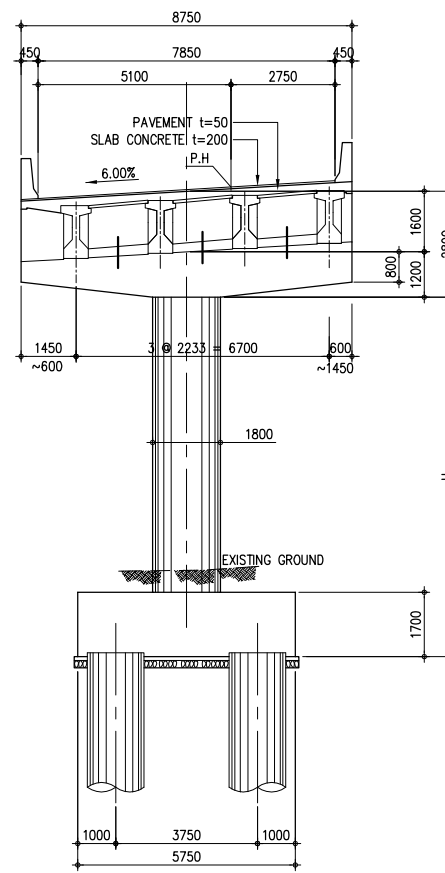

2 TYPICAL CROSS SECTION OF PIER
SCALE 1:100

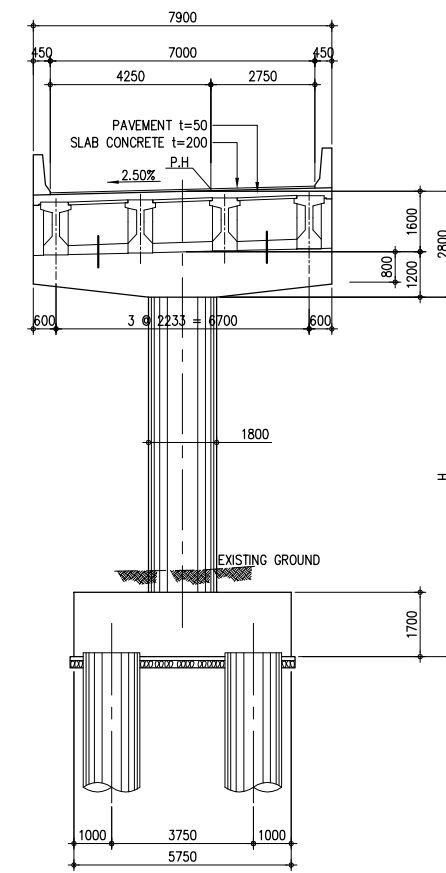
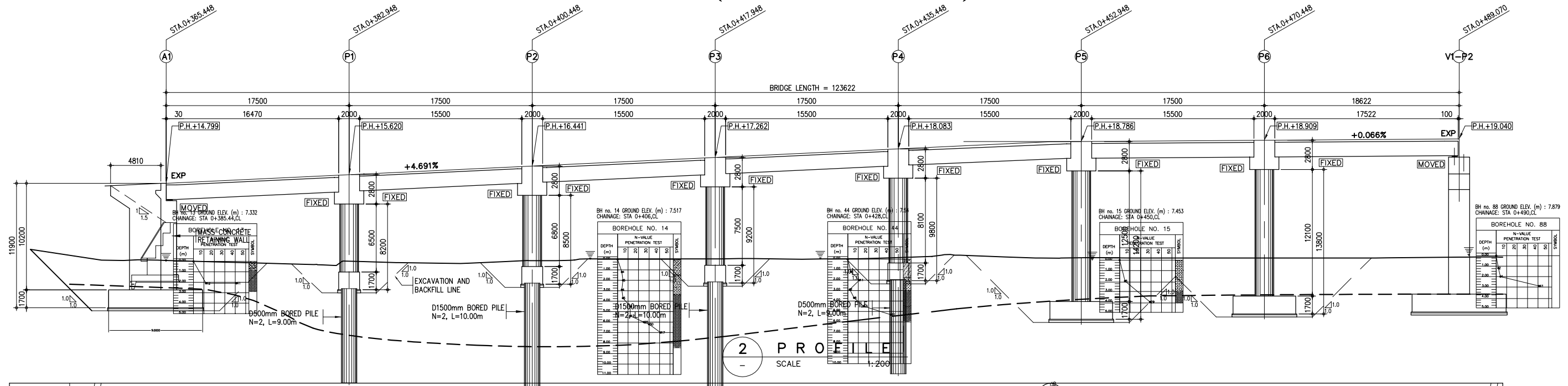

TABLE FOR P.H	
PIER NO.	P.H
P1	16.725
P2	17.076
P3	17.426
P4	17.777
P5	18.127
P6	18.310
ABUT-A1	16.374
V1-P6	18.458

VIADUCT NO. 7 (V7) A1 IC RAMP-5 BRIDGE

GENERAL VIEW (STA.0+365.448 - STA.0+489.070)



STATION (km)	GRADE	FINISHED ROAD LEVELS	EXISTING GROUND LEVELS	CURVE BAND	SUPERELEVATION
0+365	0.462%	14.729	7.42	L=37.310	+5.0%
0+382	0.462%	15.620	7.04	L=46.932	+5.0%
0+400	0.462%	16.200	7.59	L=46.932	+5.0%
0+417	0.462%	17.351	7.98	L=46.932	+5.0%
0+435	0.462%	18.118	8.118	L=46.932	+5.0%
0+452	0.462%	18.657	7.65	L=46.932	+5.0%
0+470	0.462%	18.969	7.66	L=46.932	+5.0%
0+489	0.462%	19.04	7.732	L=46.932	+5.0%

2 PROFILE
SCALE 1:200

1 PLAN
SCALE 1:200

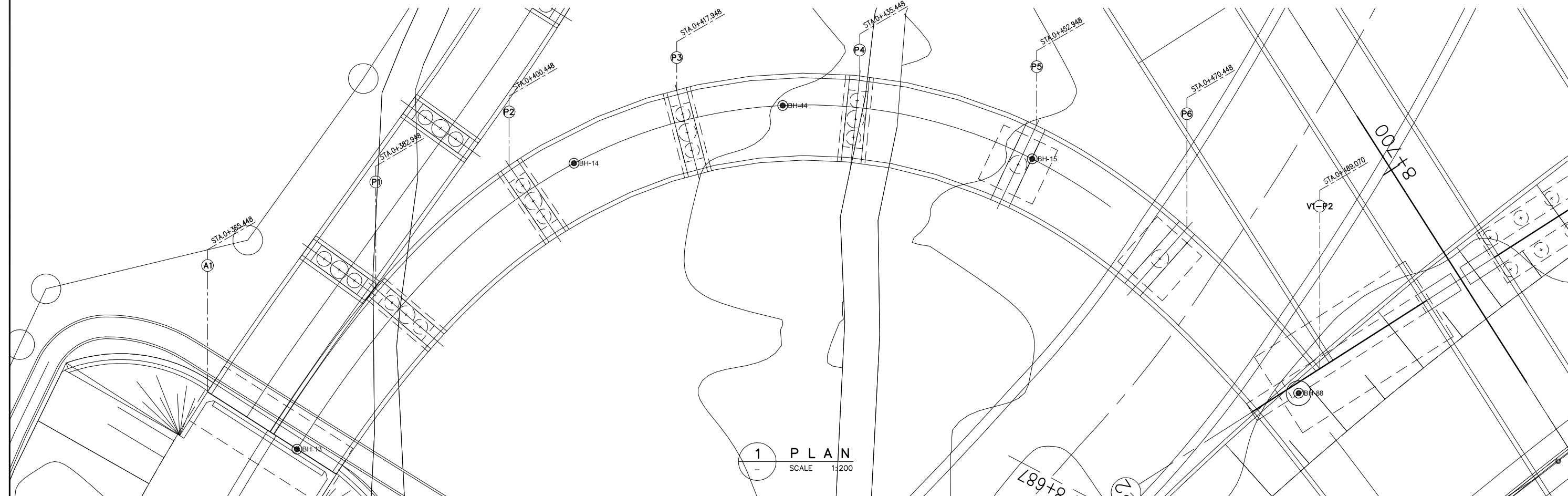

THE DEMOCRATIC SOCIALIST REPUBLIC OF SRI LANKA MINISTRY OF HIGHWAYS & ROAD DEVELOPMENT Road Development Authority	JICA JAPAN INTERNATIONAL COOPERATION AGENCY ORICON ORICON ORIENTAL CONSULTANTS COMPANY LIMITED in association with PACIFIC CONSULTANTS INTERNATIONAL		COLOMBO OUTER CIRCULAR HIGHWAY PROJECT (NORTHERN SECTION 1)		DESIGNED BY:
			VIADUCT NO. 7 (V7) A1 IC RAMP-5 BRIDGE GENERAL VIEW (STA.0+365.448 - STA.0+489.070)		CHECKED BY:
No. _____ DATE _____			REVISION _____		APPROVED BY:
					DWG. NO. T-07

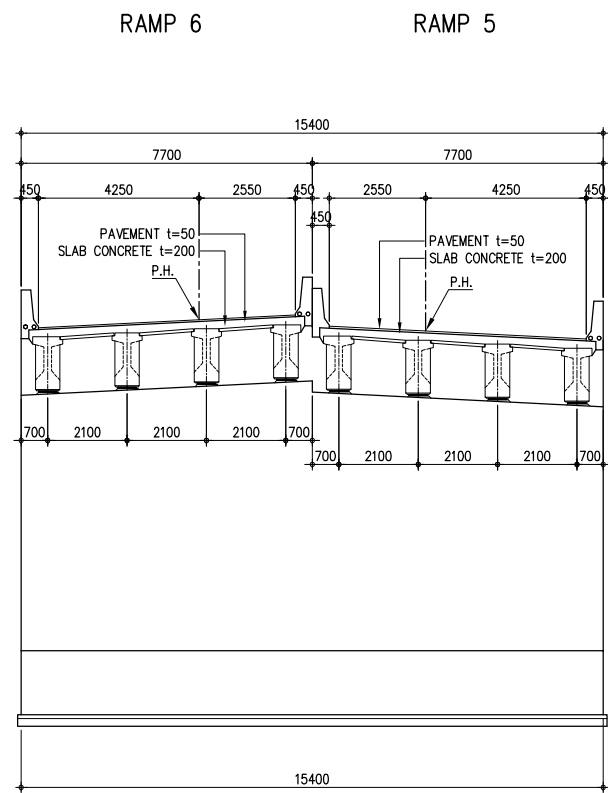

1 CROSS SECTION OF OF ABUTMENT
SCALE 1:100

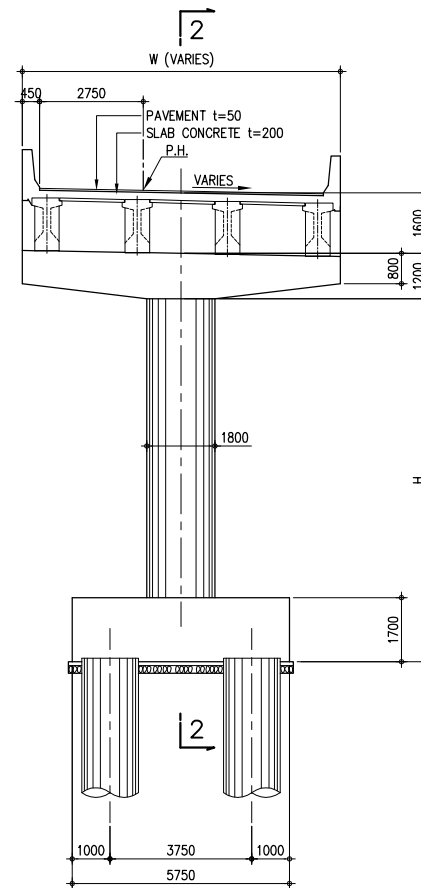

2 TYPICAL CROSS SECTION OF PIER
SCALE 1:100

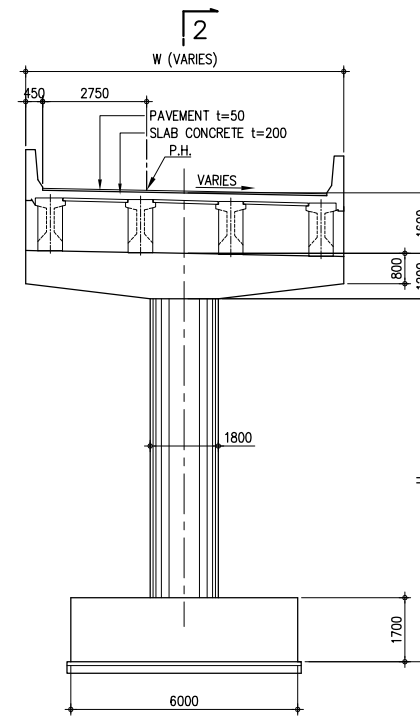
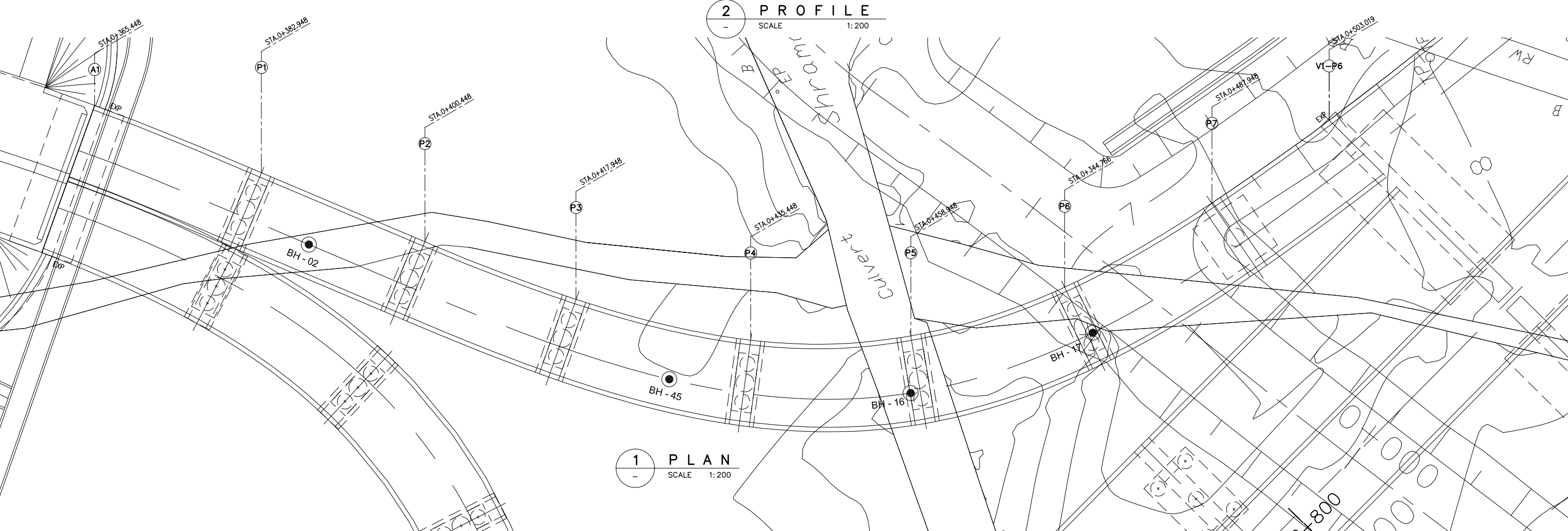
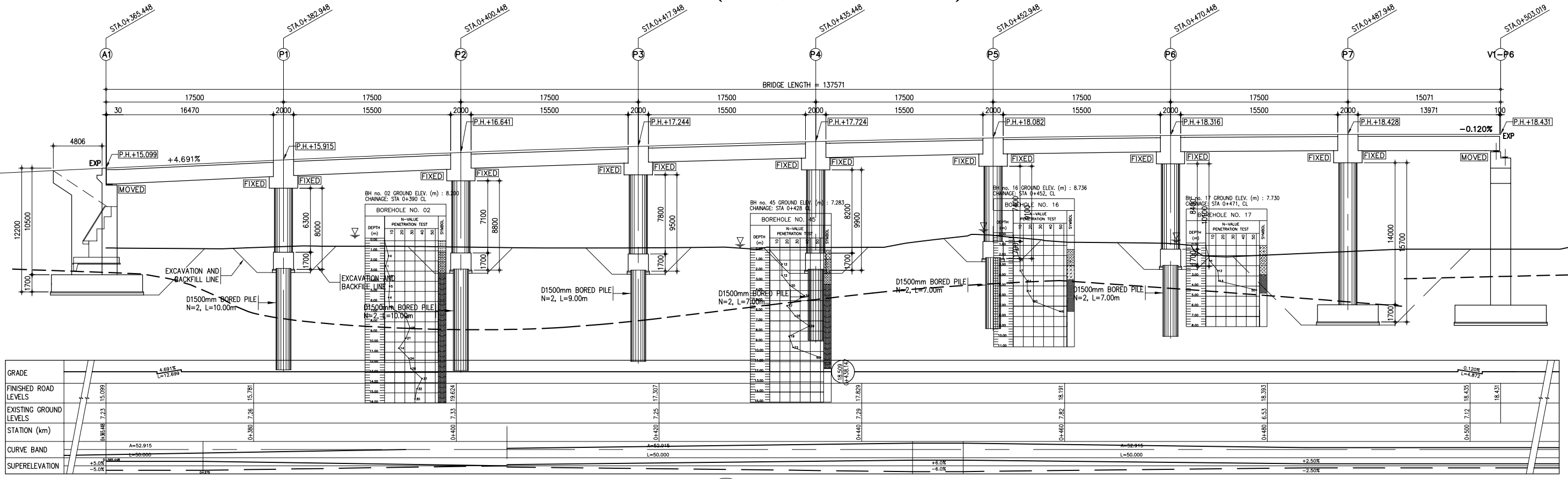

TABLE FOR P.H	
PIER NO.	P.H
P1	15.620
P2	16.441
P3	17.262
P4	18.083
P5	18.786
P6	18.909
ABUT-A1	14.799
V1-P2	19.040

VIADUCT NO. 8 (V8) A1 IC RAMP-6 BRIDGE

GENERAL VIEW (STA.0+365.448 - STA.0+503.019)



THE DEMOCRATIC SOCIALIST REPUBLIC OF SRI LANKA MINISTRY OF HIGHWAYS & ROAD DEVELOPMENT Road Development Authority	JICA JAPAN INTERNATIONAL COOPERATION AGENCY ORIENTAL CONSULTANTS COMPANY LIMITED in association with PACIFIC CONSULTANTS INTERNATIONAL		No	REVISION	DATE	COLOMBO OUTER CIRCULAR HIGHWAY PROJECT (NORTHERN SECTION 1) VIADUCT NO. 8 (V8) A1 IC RAMP-6 BRIDGE GENERAL VIEW (STA.0+365.448 - STA.0+503.019)	DESIGNED BY: CHECKED BY: APPROVED BY:
						DWG. NO. T-09	

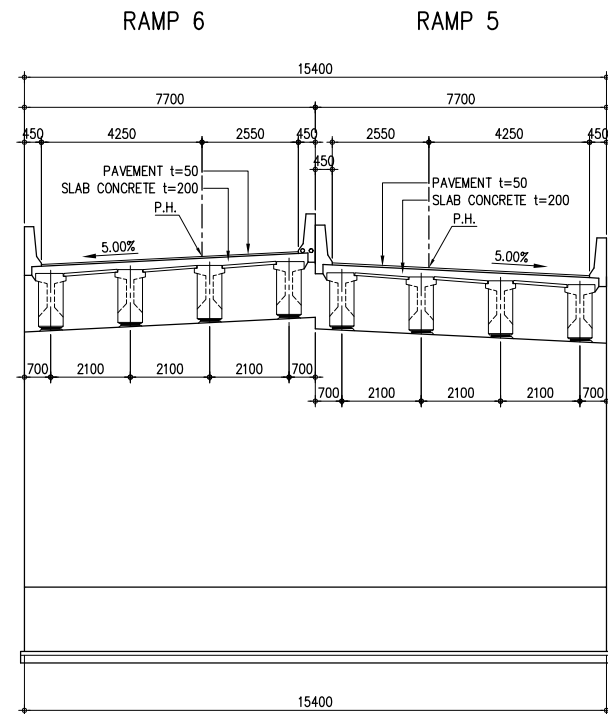

1 CROSS SECTION OF ABUTMENT A1
SCALE 1:100

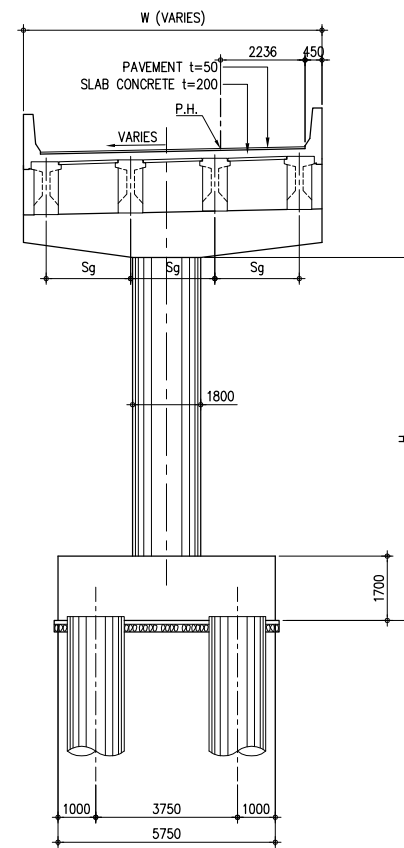

2 TYPICAL CROSS SECTION OF PIER
SCALE 1:100

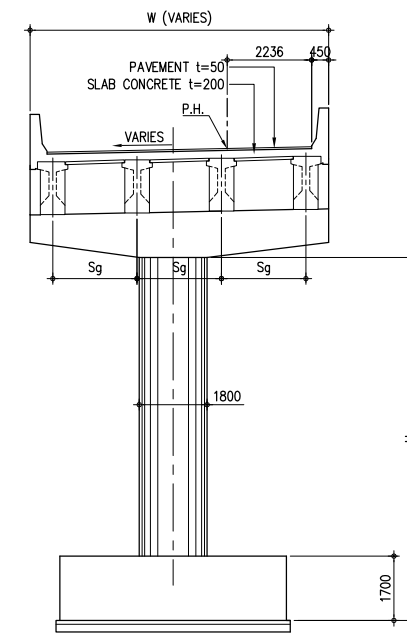

TABLE FOR P.H	
PIER NO.	P.H
P1	15.915
P2	16.641
P3	17.244
P4	17.724
P5	18.082
P6	18.316
P7	18.428
ABUT-A1	15.099
V1-P6	18.431

