

Appendix 4-3-3 Result of Preliminary Detailed Design(Draft)

(Drawings)

The Project for Capacity Development of Mt. Semeru  
Volcanic Disaster Structural Measure Planning  
S2 Area

DETAILED DESIGN OF SABO FACILITIES

YACHIYO ENGINEERING CO.,LTD.



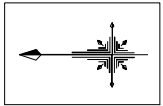

General Layout  
1:5000

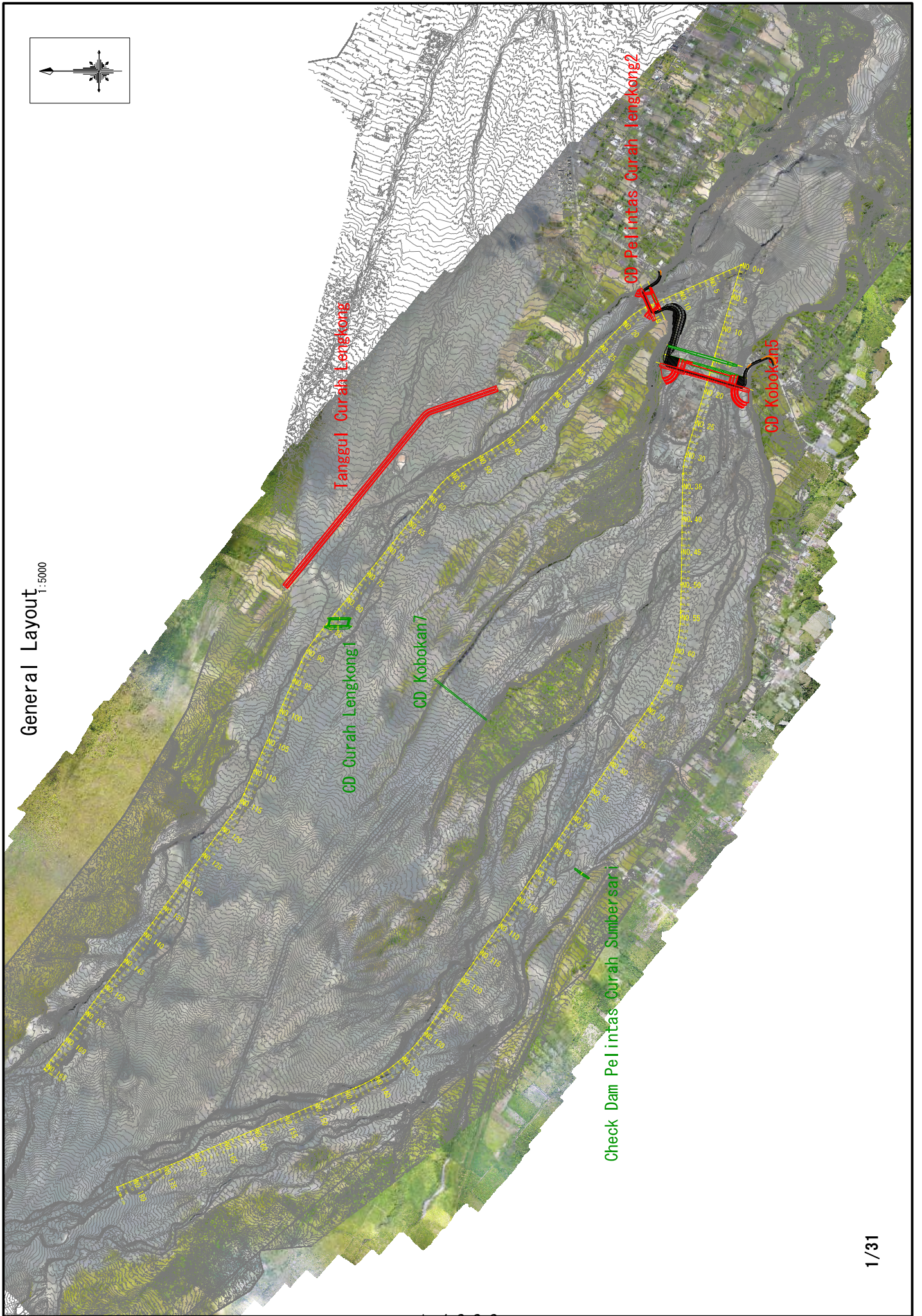

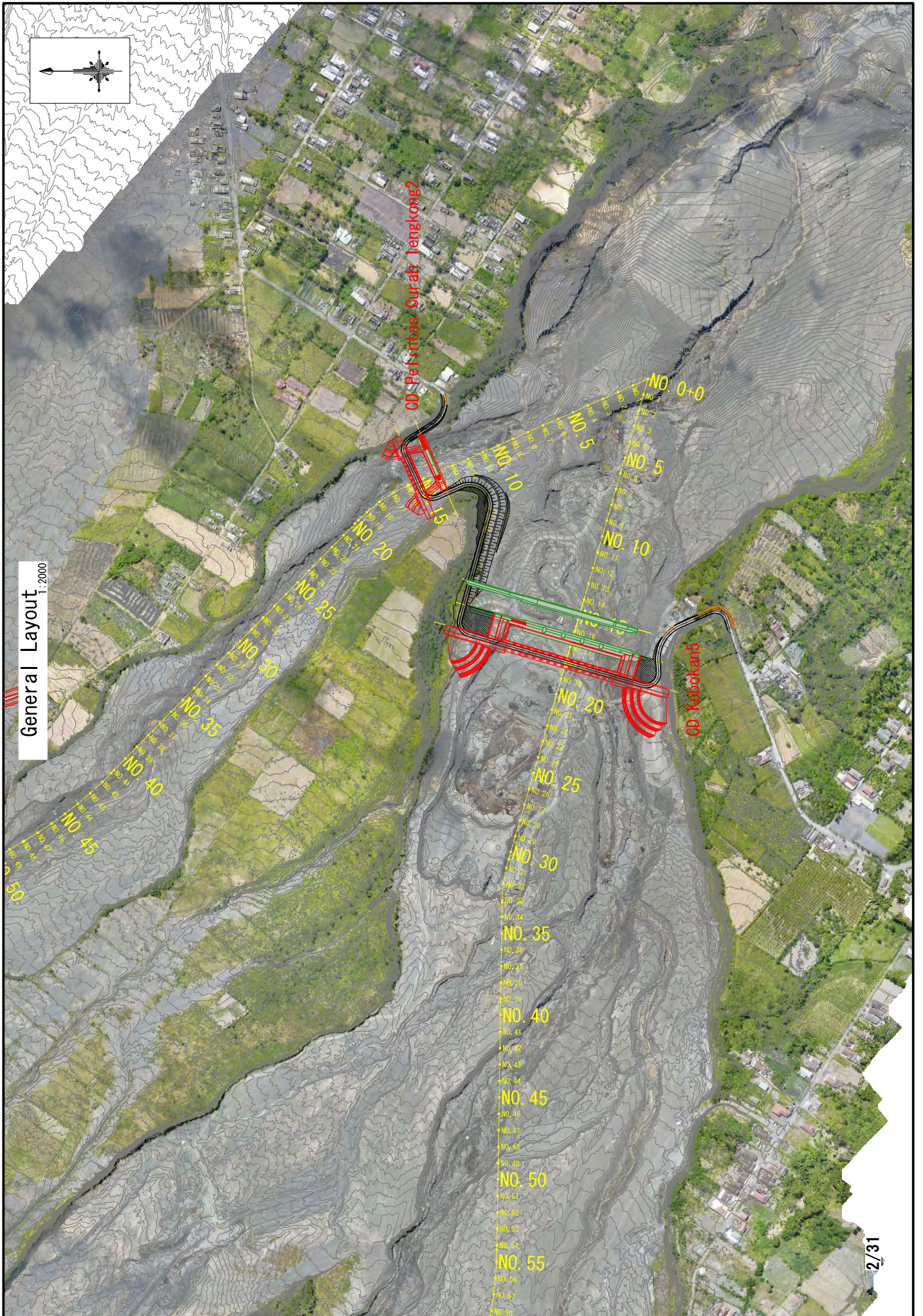







CD Kobokan 5 Structure (2/2)  
S=1:500

Plan View

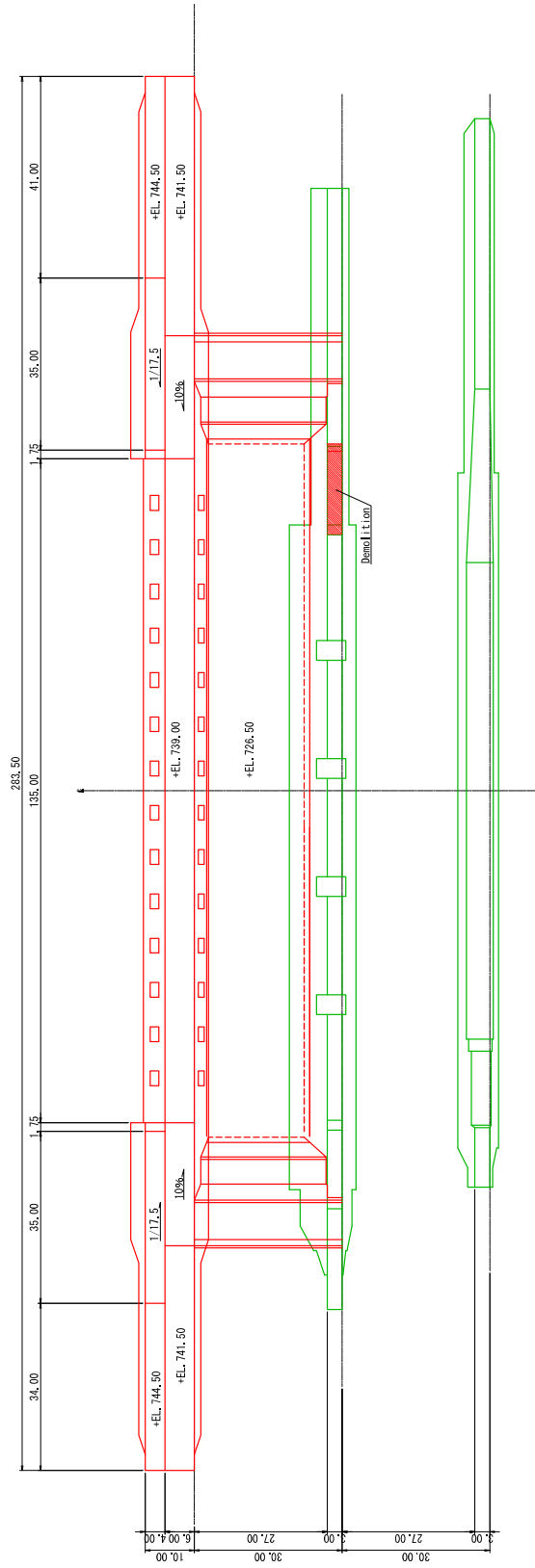

CD Pelintas Curah Lengkong2 Layout

1:300

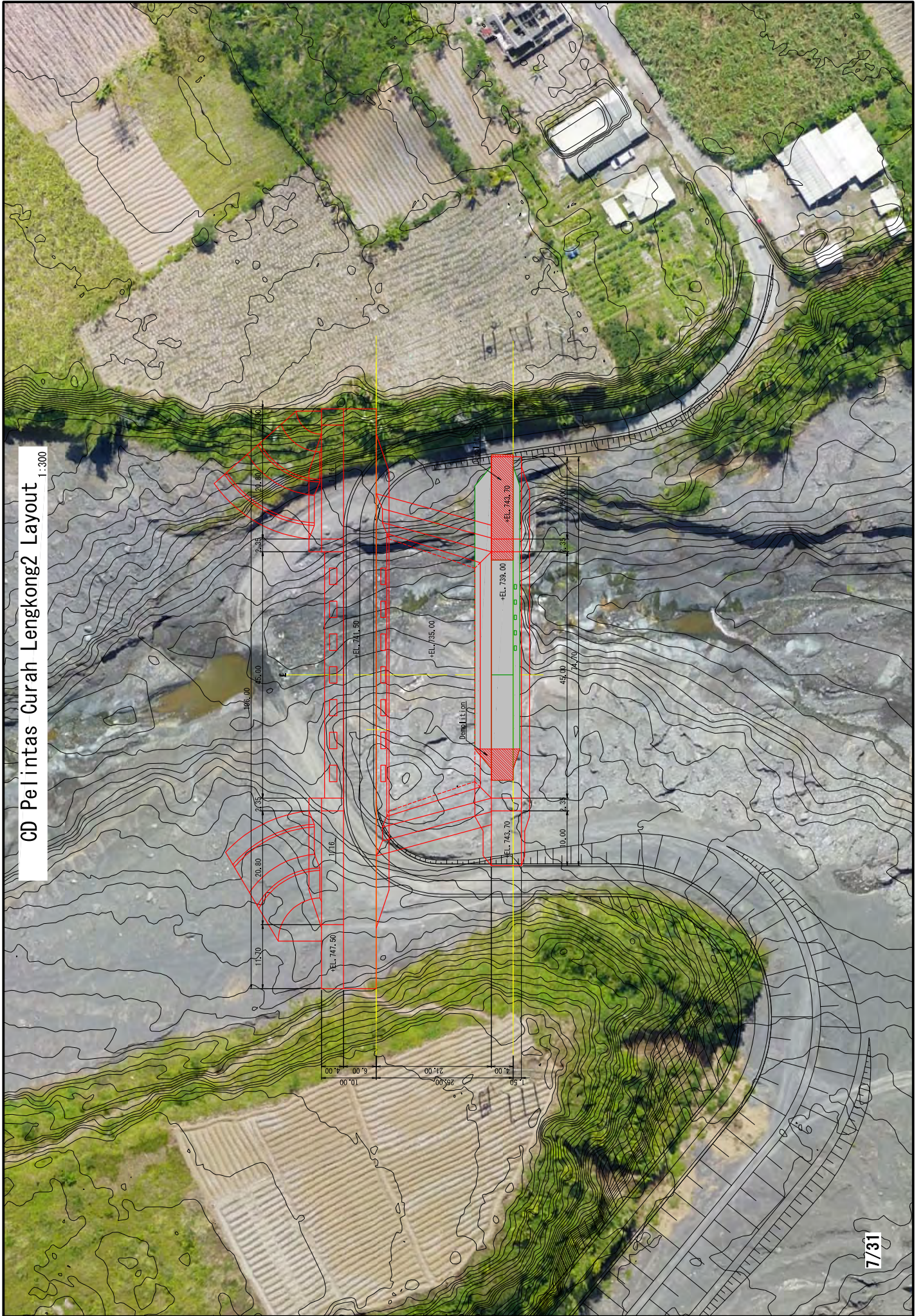

# Curah Lengkong Long Profile

REF: 00 - Curah Lengkong

SHEET: 1.000  
SHEET: 5.000



No	Distance	Cumulative distance	Design sediment Slope	H.W.L.	Freeboard	Riveted slope
No. 12	0.00	240.00	741.50	744.80	746.20	726.90
No. 15	60.00	300.00				
No. 20	100.00	400.00				
No. 25	150.00	500.00				
No. 30	200.00	600.00				
No. 35	250.00	700.00				
No. 40	300.00	800.00				
No. 45	350.00	900.00				
No. 50	400.00	1000.00	780.11			
No. 55	450.00	1100.00				
No. 60	500.00	1200.00				
No. 65	550.00	1300.00				
No. 70	600.00	1400.00				
No. 75	650.00	1500.00				
No. 80	700.00	1600.00				
No. 85	750.00	1700.00				
No. 90	800.00	1800.00				
No. 95	850.00	1900.00				
No. 100	900.00	2000.00				
No. 105	950.00	2100.00				
No. 110	1000.00	2200.00				
No. 115	1050.00	2300.00				
No. 120	1100.00	2400.00				
No. 125	1150.00	2500.00				
No. 130	1200.00	2600.00				
No. 135	1250.00	2700.00				
No. 140	1300.00	2800.00				
No. 145	1350.00	2900.00				
No. 150	1400.00	3000.00				
No. 155	1450.00	3100.00				
No. 160	1500.00	3200.00				
No. 165	1550.00	3300.00				
No. 166	1560.00	3300.00				
No. 167	1570.00	3300.00				
No. 168	1580.00	3300.00				
No. 169	1590.00	3300.00				
No. 170	1600.00	3300.00				
No. 171	1610.00	3300.00				
No. 172	1620.00	3300.00				
No. 173	1630.00	3300.00				
No. 174	1640.00	3300.00				
No. 175	1650.00	3300.00				
No. 176	1660.00	3300.00				
No. 177	1670.00	3300.00				
No. 178	1680.00	3300.00				
No. 179	1690.00	3300.00				
No. 180	1700.00	3300.00				
No. 181	1710.00	3300.00				
No. 182	1720.00	3300.00				
No. 183	1730.00	3300.00				
No. 184	1740.00	3300.00				
No. 185	1750.00	3300.00				
No. 186	1760.00	3300.00				
No. 187	1770.00	3300.00				
No. 188	1780.00	3300.00				
No. 189	1790.00	3300.00				
No. 190	1800.00	3300.00				
No. 191	1810.00	3300.00				
No. 192	1820.00	3300.00				
No. 193	1830.00	3300.00				
No. 194	1840.00	3300.00				
No. 195	1850.00	3300.00				
No. 196	1860.00	3300.00				
No. 197	1870.00	3300.00				
No. 198	1880.00	3300.00				
No. 199	1890.00	3300.00				
No. 200	1900.00	3300.00				
No. 201	1910.00	3300.00				
No. 202	1920.00	3300.00				
No. 203	1930.00	3300.00				
No. 204	1940.00	3300.00				
No. 205	1950.00	3300.00				
No. 206	1960.00	3300.00				
No. 207	1970.00	3300.00				
No. 208	1980.00	3300.00				
No. 209	1990.00	3300.00				
No. 210	2000.00	3300.00				
No. 211	2010.00	3300.00				
No. 212	2020.00	3300.00				
No. 213	2030.00	3300.00				
No. 214	2040.00	3300.00				
No. 215	2050.00	3300.00				
No. 216	2060.00	3300.00				
No. 217	2070.00	3300.00				
No. 218	2080.00	3300.00				
No. 219	2090.00	3300.00				
No. 220	2100.00	3300.00				
No. 221	2110.00	3300.00				
No. 222	2120.00	3300.00				
No. 223	2130.00	3300.00				
No. 224	2140.00	3300.00				
No. 225	2150.00	3300.00				
No. 226	2160.00	3300.00				
No. 227	2170.00	3300.00				
No. 228	2180.00	3300.00				
No. 229	2190.00	3300.00				
No. 230	2200.00	3300.00				
No. 231	2210.00	3300.00				
No. 232	2220.00	3300.00				
No. 233	2230.00	3300.00				
No. 234	2240.00	3300.00				
No. 235	2250.00	3300.00				
No. 236	2260.00	3300.00				
No. 237	2270.00	3300.00				
No. 238	2280.00	3300.00				
No. 239	2290.00	3300.00				
No. 240	2300.00	3300.00				
No. 241	2310.00	3300.00				
No. 242	2320.00	3300.00				
No. 243	2330.00	3300.00				
No. 244	2340.00	3300.00				
No. 245	2350.00	3300.00				
No. 246	2360.00	3300.00				
No. 247	2370.00	3300.00				
No. 248	2380.00	3300.00				
No. 249	2390.00	3300.00				
No. 250	2400.00	3300.00				
No. 251	2410.00	3300.00				
No. 252	2420.00	3300.00				
No. 253	2430.00	3300.00				
No. 254	2440.00	3300.00			</	



Tanggul Curah Lengkong Plan

1:1500

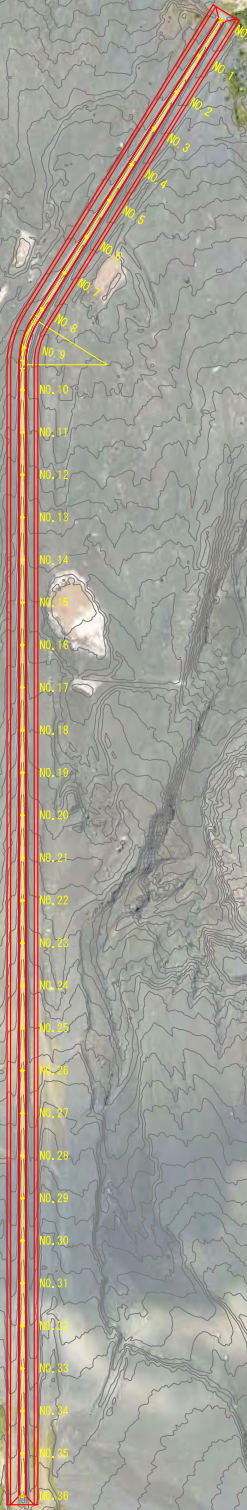

# Tanggul Curah Lengkong Long Profile

SV=1 : 200  
SH=1 : 2,000

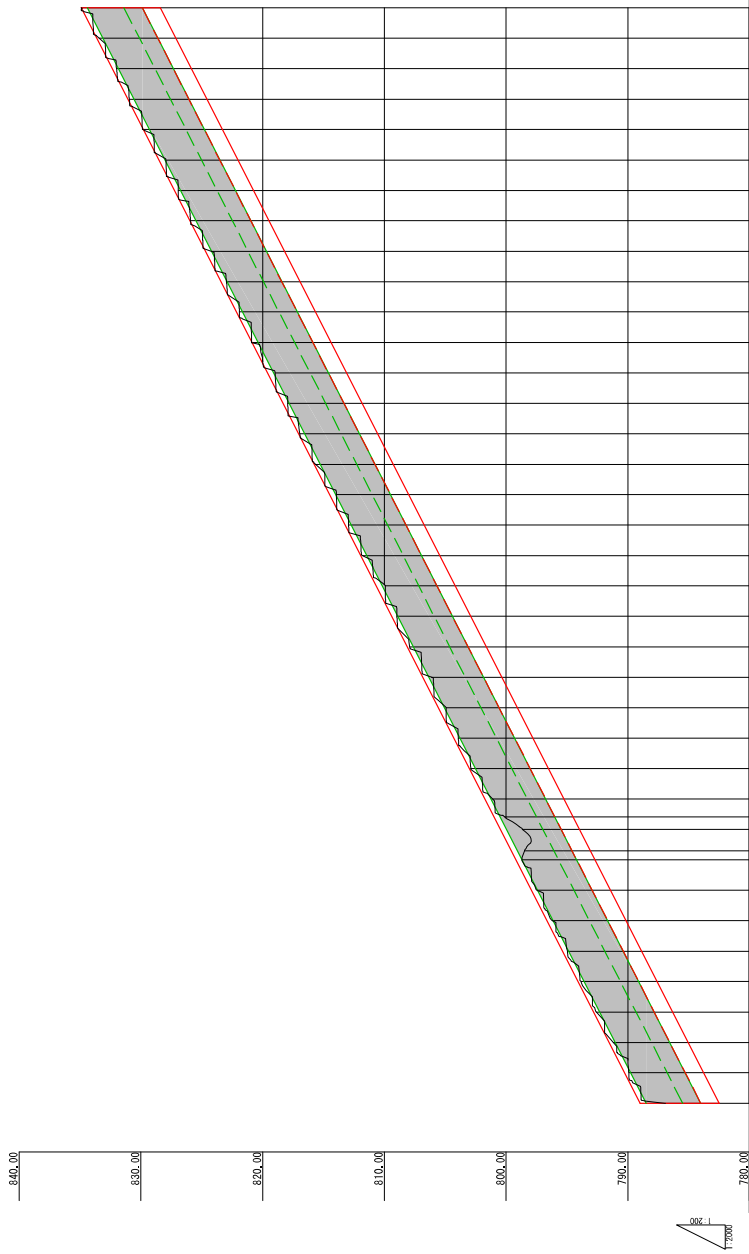

No	Distance	Cumulative distance	Foundation Elevation	Top Elevation	Foundation Plan of slope	Top Plan of slope
NO.0	0.000	0.000	782.500	783.775	782.500	789.000
NO.1	25.000	25.000	790.275	790.275	782.500	782.500
NO.2	25.000	50.000	785.050	791.550	785.050	785.050
NO.3	25.000	75.000	786.325	792.825	786.325	786.325
NO.4	25.000	100.000	787.600	794.100	787.600	787.600
NO.5	25.000	125.000	788.875	795.375	788.875	788.875
NO.6	25.000	150.000	790.150	796.650	790.150	790.150
NO.7	25.000	175.000	791.425	797.925	791.425	791.425
NO.8	25.000	200.000	792.700	799.200	792.700	792.700
NO.8-1-0	7.413	207.413	793.078	799.578	793.078	793.078
NO.9	17.587	225.000	793.975	800.475	793.975	793.975
EC-1-0	10.213	235.213	794.496	800.996	794.496	794.496
NO.10	14.787	250.000	795.250	801.750	795.250	801.750
NO.11	25.000	275.000	796.525	803.025	796.525	803.025
NO.12	25.000	300.000	797.800	804.300	797.800	804.300
NO.13	25.000	325.000	799.075	805.575	799.075	805.575
NO.14	25.000	350.000	800.350	806.850	800.350	806.850
NO.15	25.000	375.000	801.625	808.125	801.625	808.125
NO.16	25.000	400.000	802.900	809.400	802.900	809.400
NO.17	25.000	425.000	804.175	810.675	804.175	810.675
NO.18	25.000	450.000	805.450	811.950	805.450	811.950
NO.19	25.000	475.000	806.725	813.225	806.725	813.225
NO.20	25.000	500.000	808.000	814.500	808.000	814.500
NO.21	25.000	525.000	809.275	815.775	809.275	815.775
NO.22	25.000	550.000	810.545	817.050	810.545	817.050
NO.23	25.000	575.000	811.825	818.325	811.825	818.325
NO.24	25.000	600.000	813.100	819.600	813.100	819.600
NO.25	25.000	625.000	814.375	820.875	814.375	820.875
NO.26	25.000	650.000	815.650	822.150	815.650	822.150
NO.27	25.000	675.000	816.925	823.425	816.925	823.425
NO.28	25.000	700.000	818.200	824.700	818.200	824.700
NO.29	25.000	725.000	819.475	825.975	819.475	825.975
NO.30	25.000	750.000	820.750	827.250	820.750	827.250
NO.31	25.000	775.000	822.025	828.525	822.025	828.525
NO.32	25.000	800.000	823.300	829.800	823.300	829.800
NO.33	25.000	825.000	824.570	831.075	824.570	831.075
NO.34	25.000	850.000	825.850	832.350	825.850	832.350
NO.35	25.000	875.000	827.125	833.625	827.125	833.625
NO.36	25.000	900.000	828.400	834.900	828.400	834.900

# Tanggul Curah Lengkong General structure

S-1:50

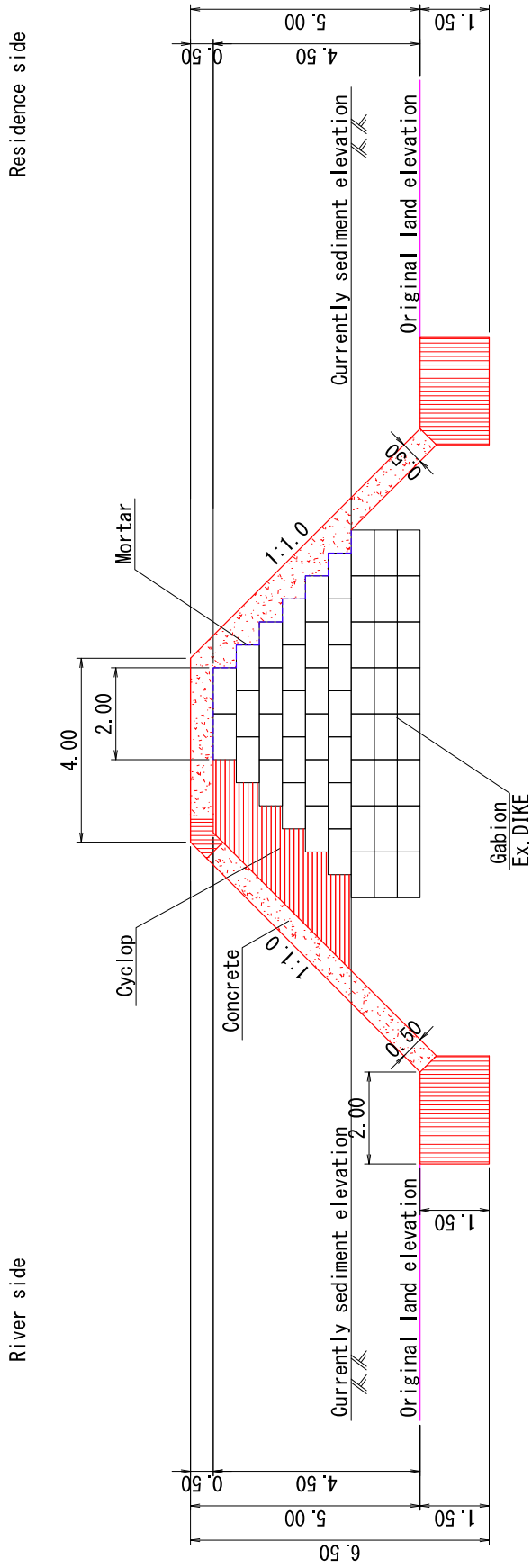

# Tanggul Churah Lengkung Cross section (1/7)

S=1:100

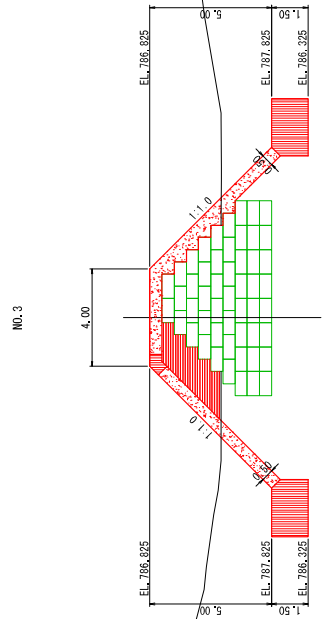
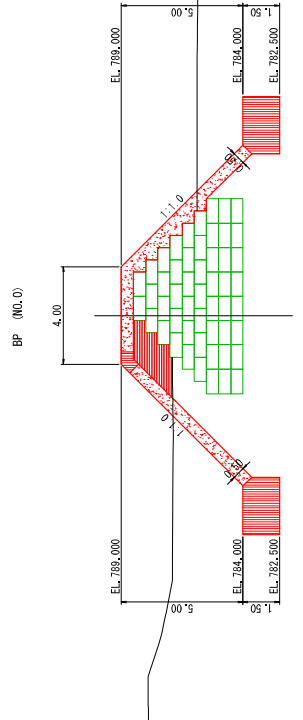
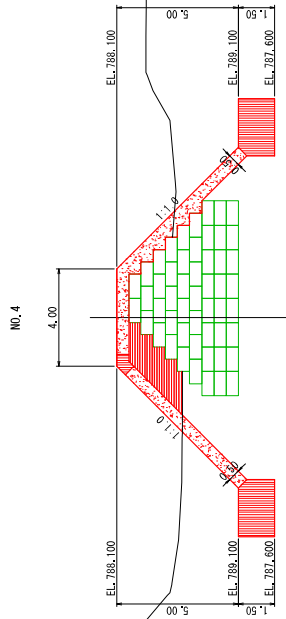
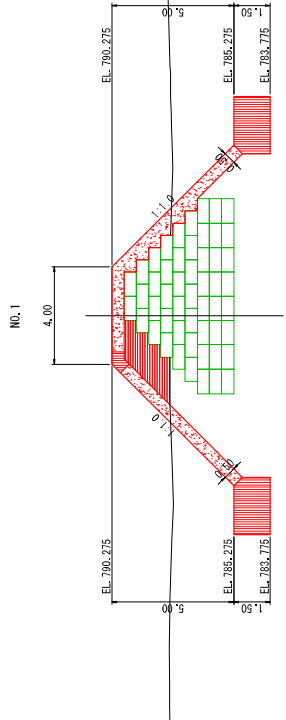
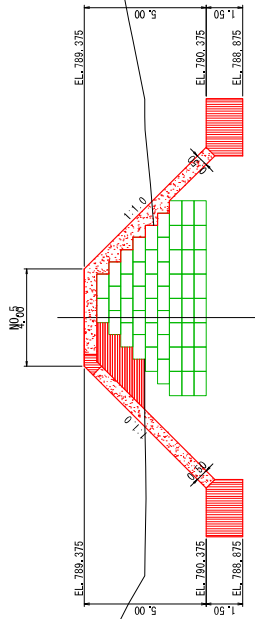
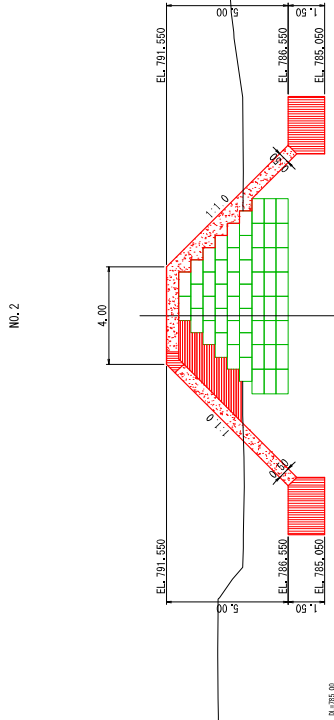

# Tanggul Churah Lengkung Cross section (2/7) S=1:100

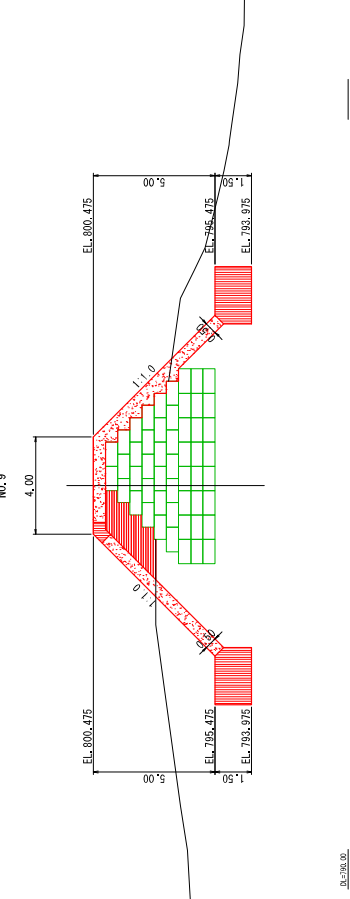
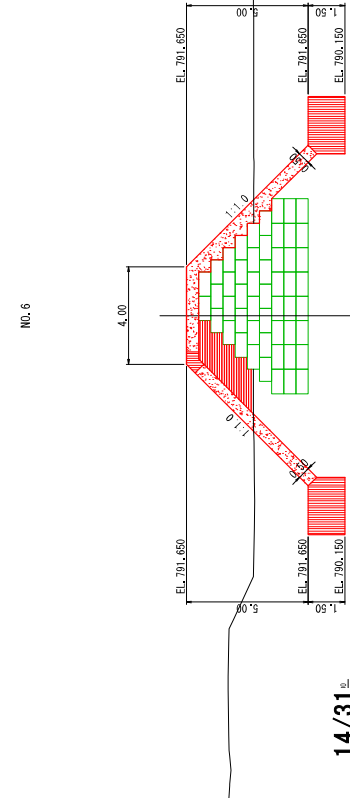
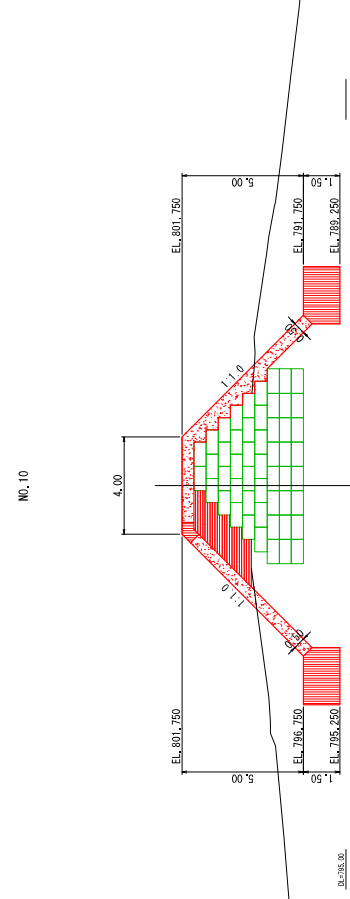
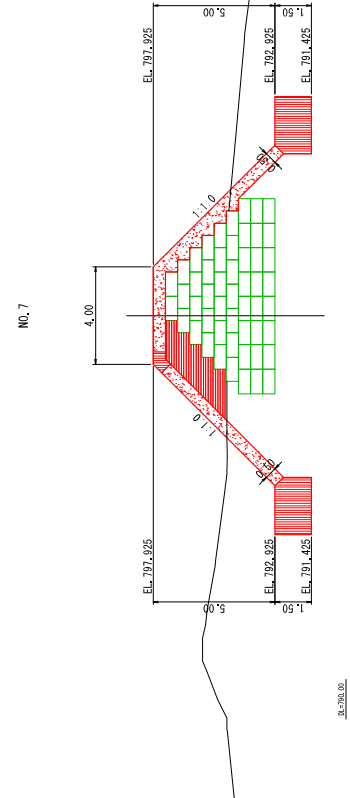
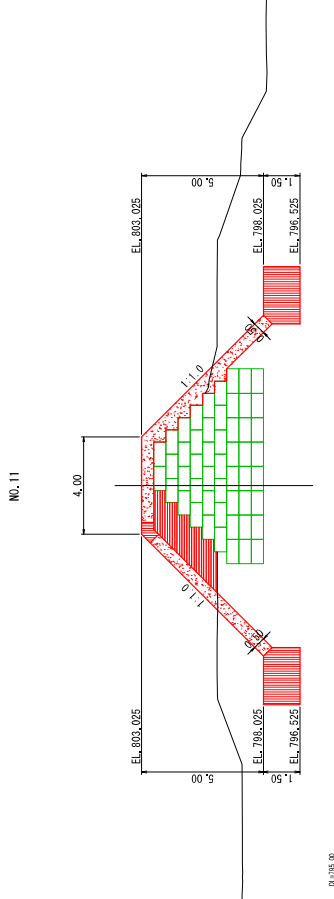
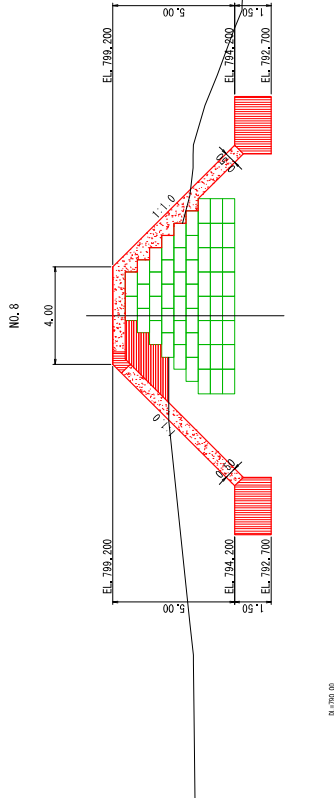

# Tanggul Churah Lengkung Cross section (3/7) S=1:100

NO. 14

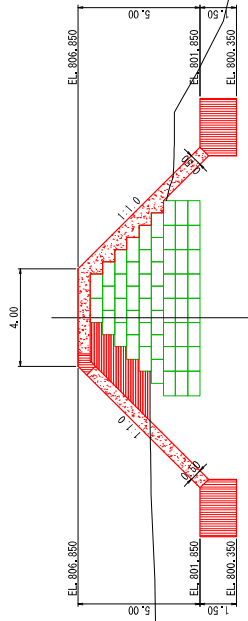

NO. 17

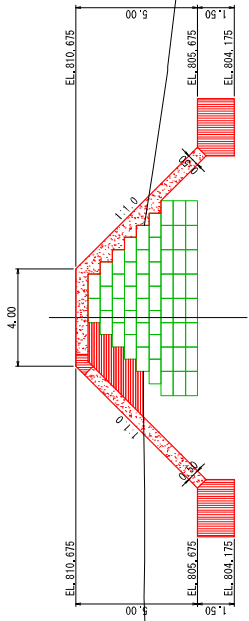

NO. 13

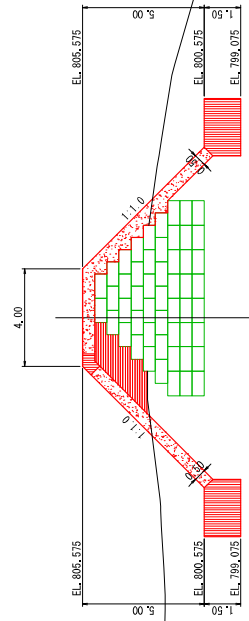

NO. 16

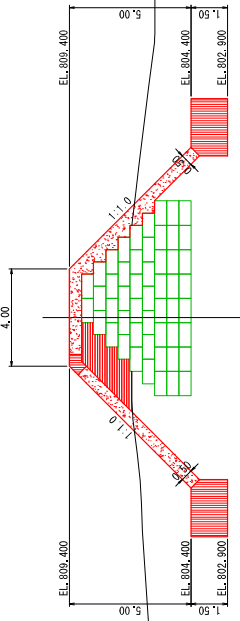

NO. 12

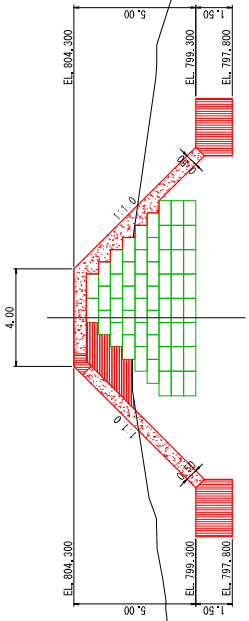

NO. 15

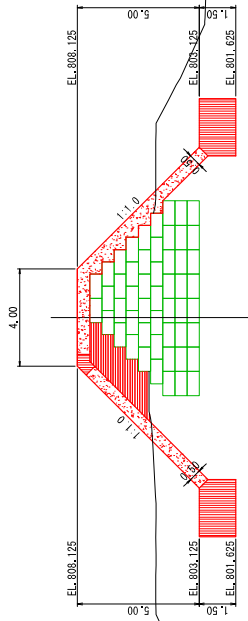

# Tanggul Churah Lengkong Cross section (4/7) S=1:100

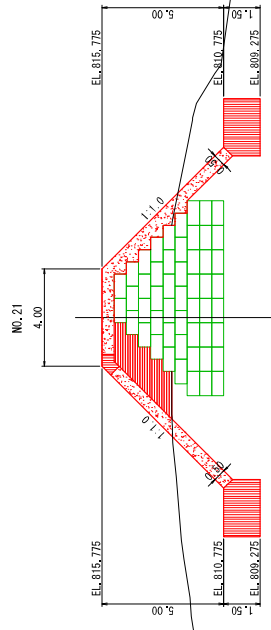
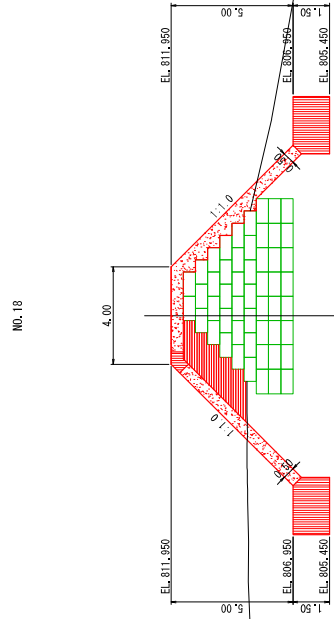
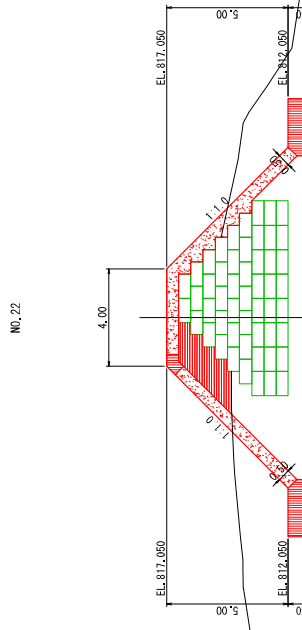
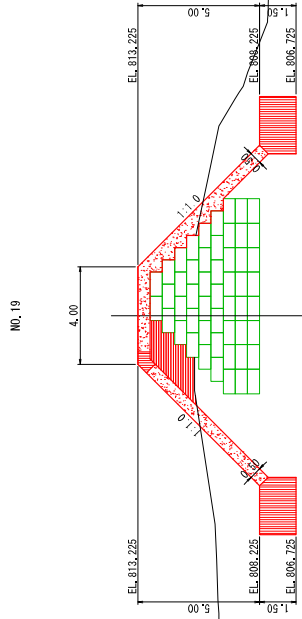
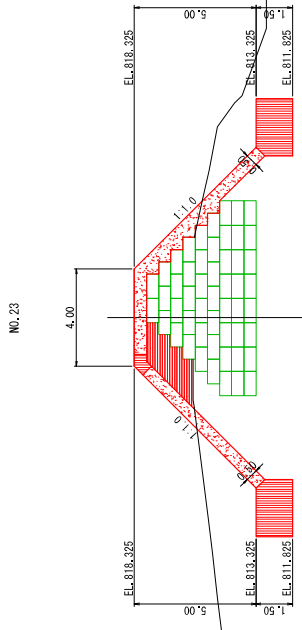
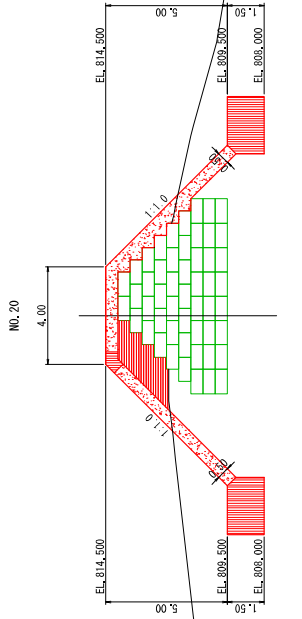

# Tanggul Churah Lengkong Cross section (5/7) S=1:100

NO. 26

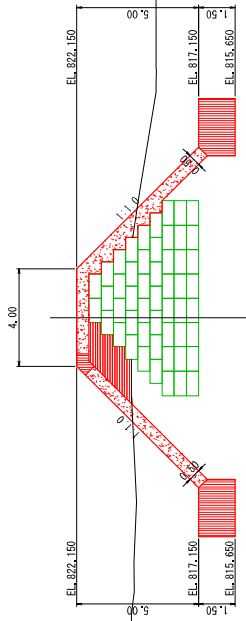

NO. 29

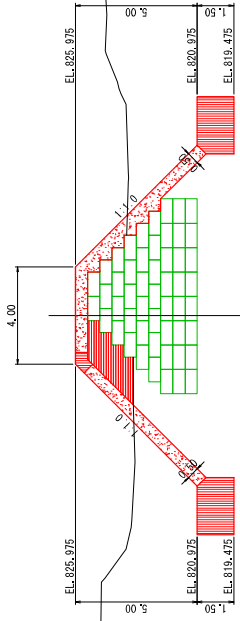

NO. 25

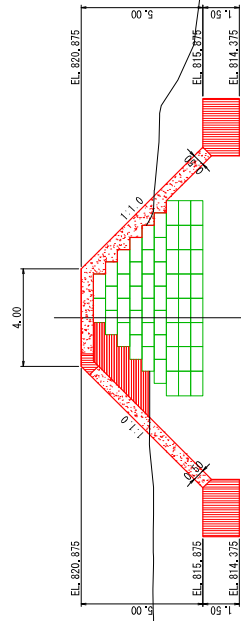

NO. 28

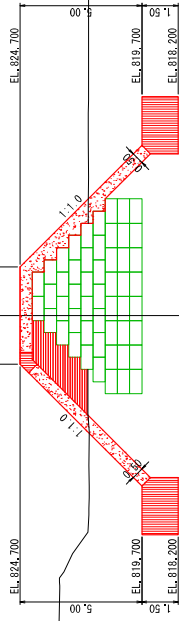

NO. 24

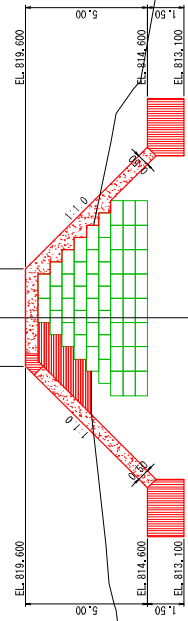

NO. 27

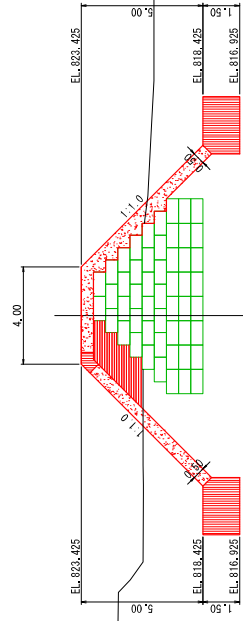

# Tanggul Churah Lengkung Cross section (6/7) S=1:100

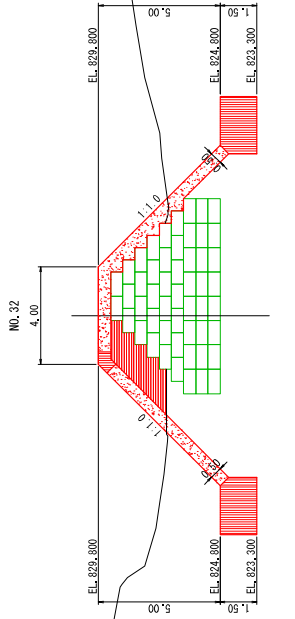

0.0000.00

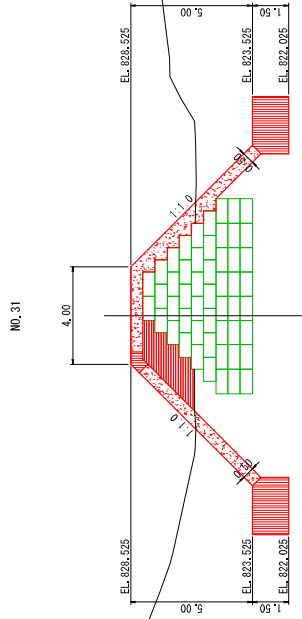

0.0000.00

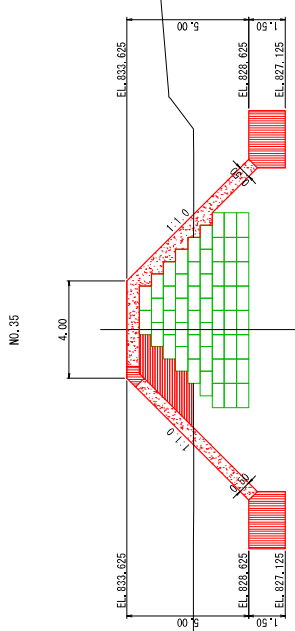
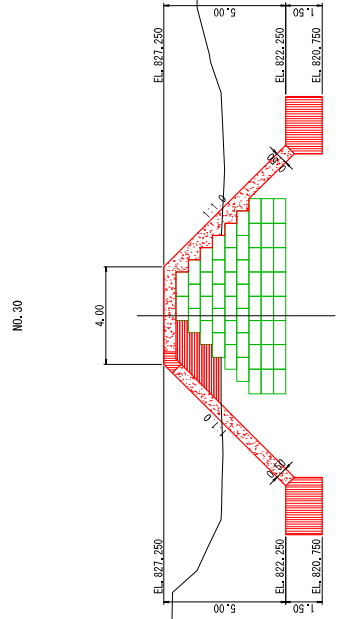

0.0000.00

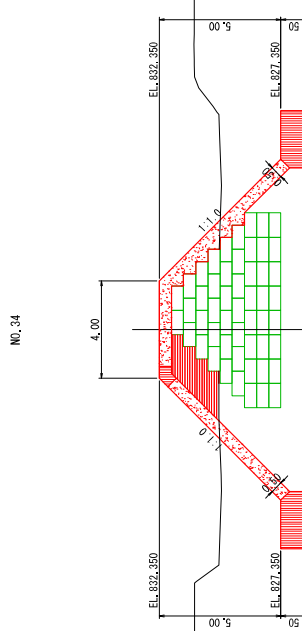

0.0000.00

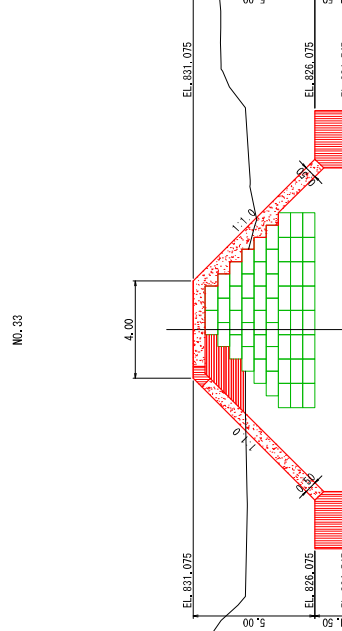

Tanggul Churah Lengkong Cross section (7/7)  
S=1:100

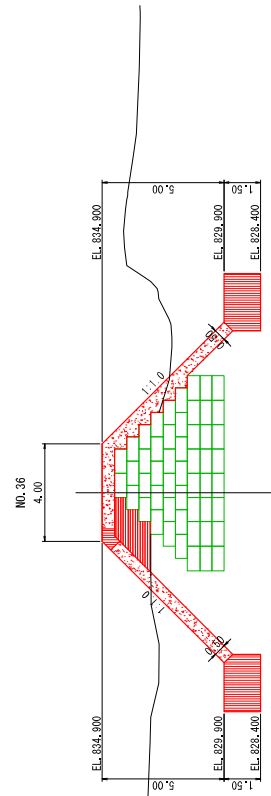



Maintenance road Plan  
1:1000

20/31



Maintenance road General structure  
S=1:50

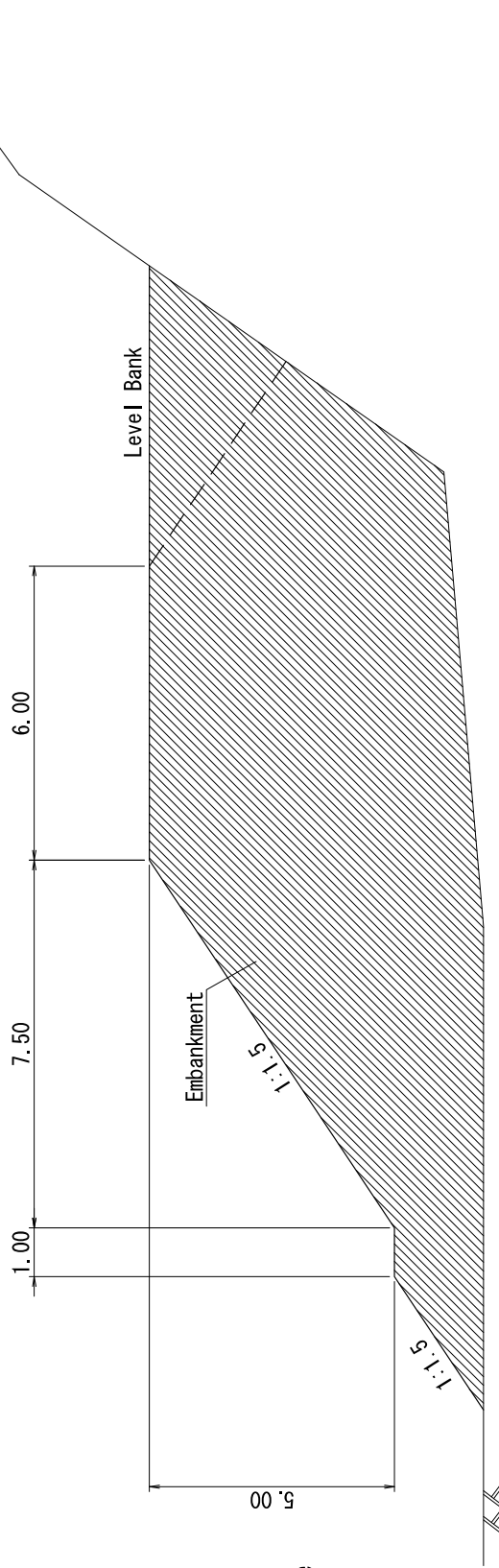

River side

# Maintenance road Cross section (1/9) S=1:200

NO. 3

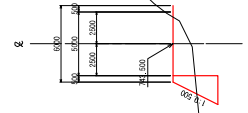

NO. 2

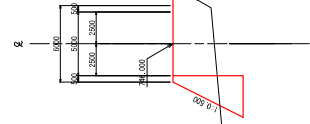

NO. 1

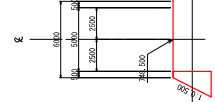

NO. 0

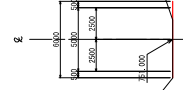

0.5% 0.00

0.5% 0.00

0.5% 0.00

0.5% 0.00

# Maintenance road Cross section (2/9) S=1:200

NO. 7

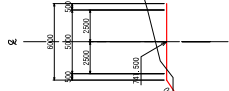

0.01200.00

NO. 6

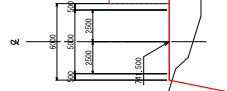

0.01200.00

NO. 5

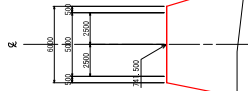

0.01200.00

NO. 4

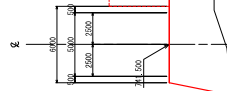

0.01200.00



# Maintenance road Cross section (4/9) $S=1:200$

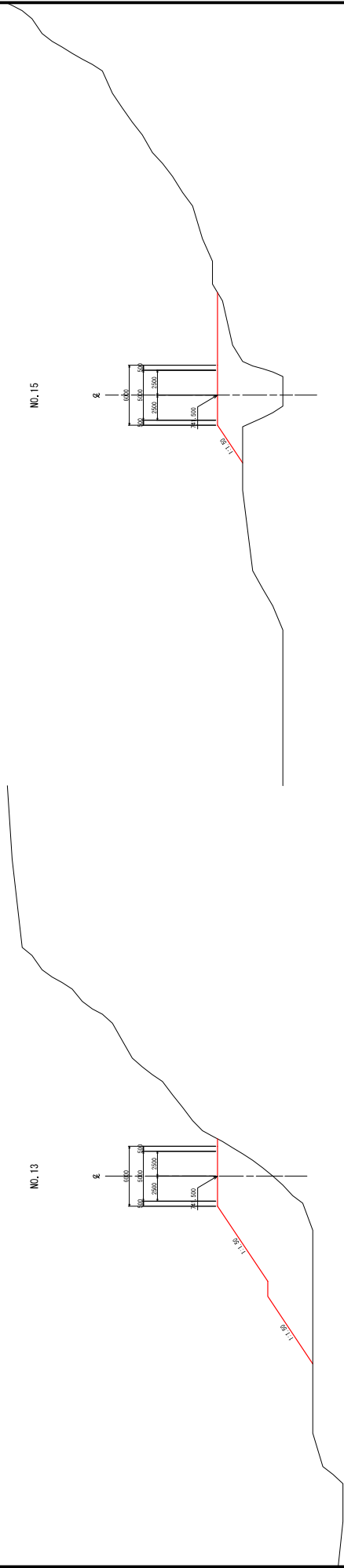

04.1720.00

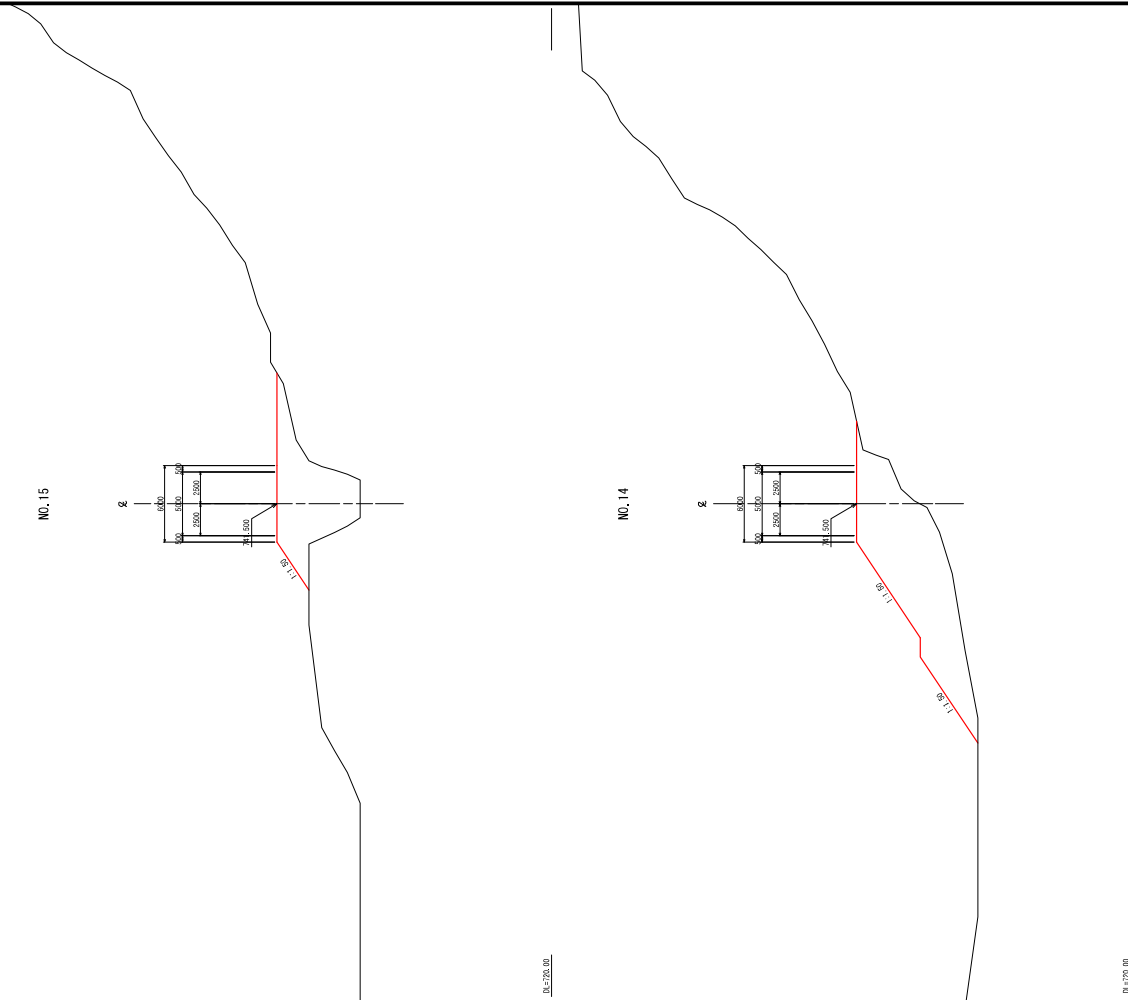

04.1720.00

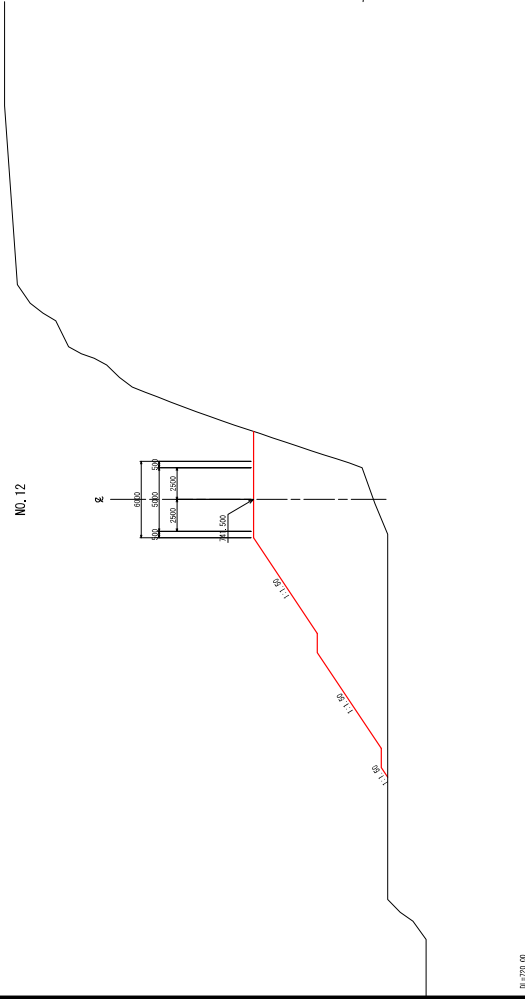

04.1720.00

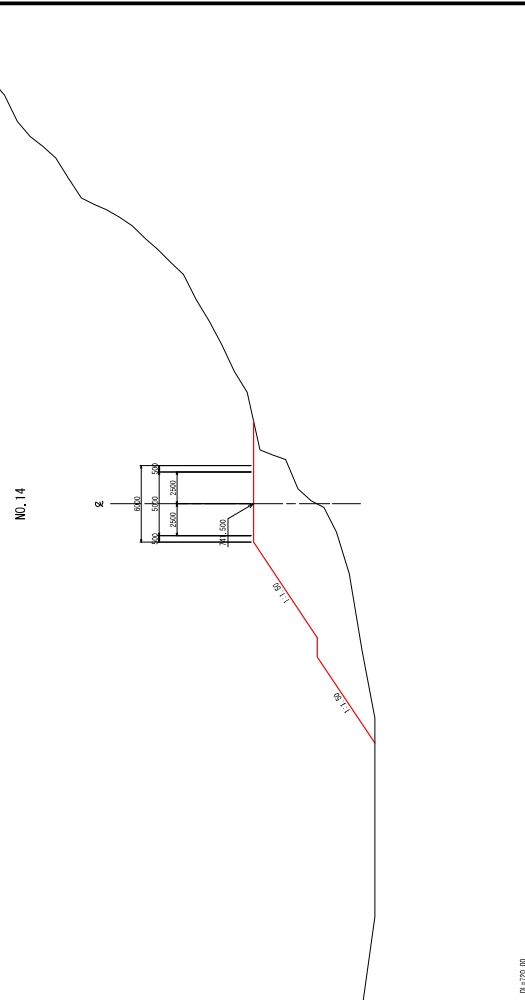

04.1720.00

# Maintenance road Cross section (5/9) S=1:200

NO. 19

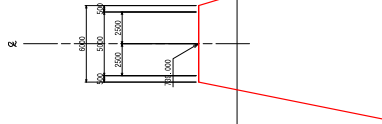

D.L. 1720.00

NO. 18

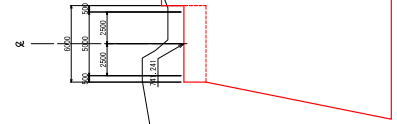

D.L. 1720.00

NO. 17

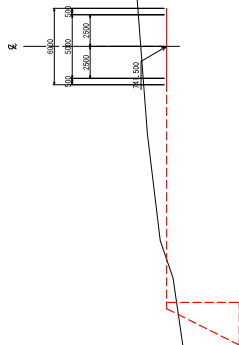

D.L. 1720.00

NO. 16

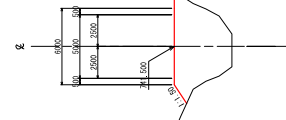

D.L. 1720.00

# Maintenance road Cross section (6/9) S=1:200

NO. 23

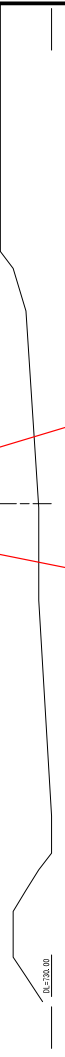
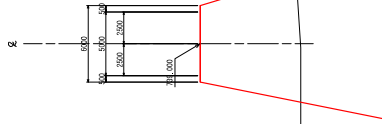

0.000

NO. 21

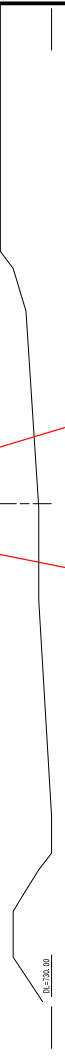
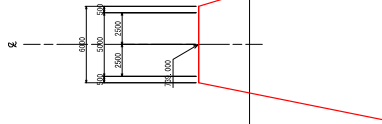

0.000

NO. 22

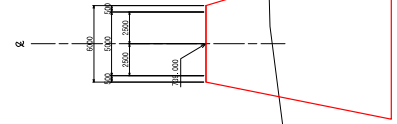

0.000

NO. 20

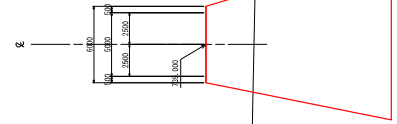

0.000

# Maintenance road Cross section (7/9) $S=1:200$

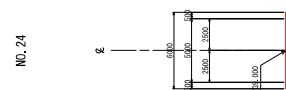
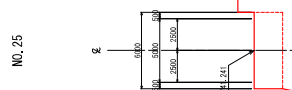
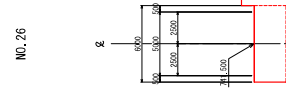
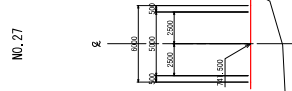

DL 120A.00

DL 120A.00

# Maintenance road Cross section (8/9) S=1:200

NO. 29

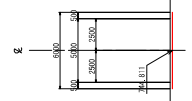

0.1% 200.00

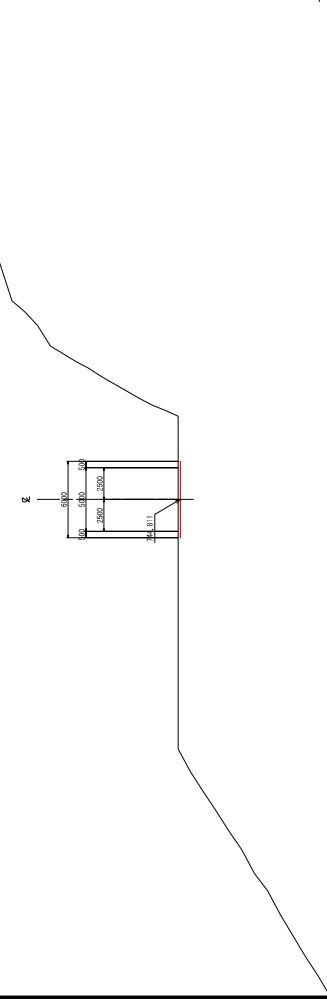

NO. 31

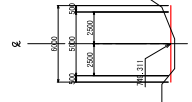

0.11% 200.00

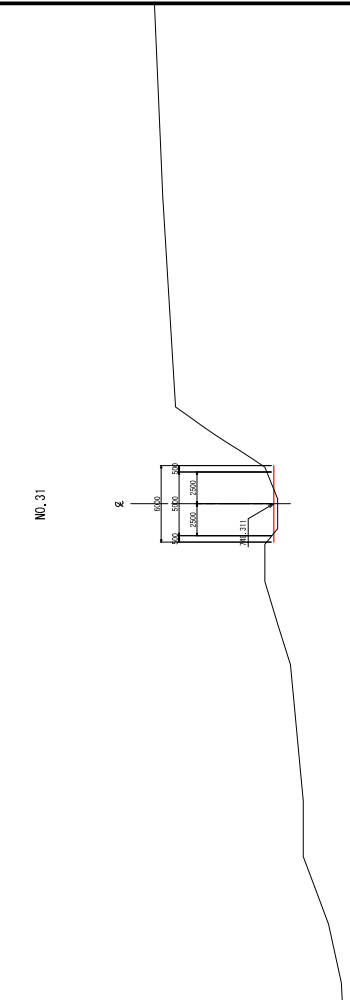

NO. 28

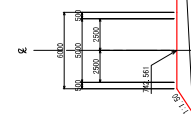

0.1% 200.00

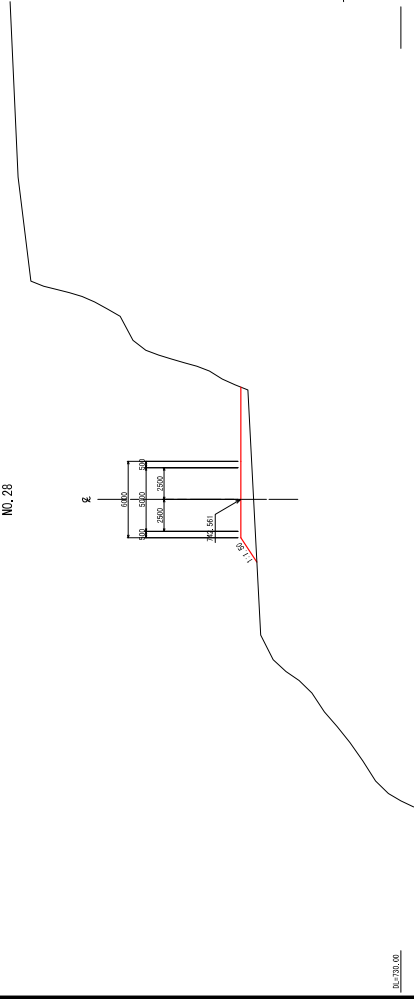

NO. 30

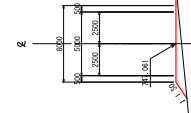

0.11% 200.00

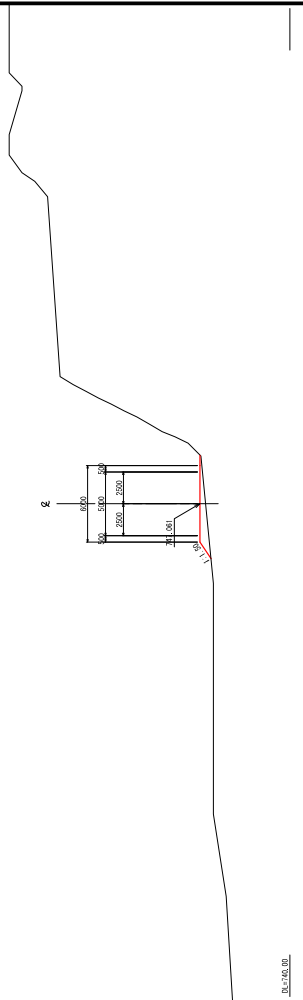

Maintenance road Cross section (9/9)  $S=1:200$

EP (NO. 32+15, 9864)

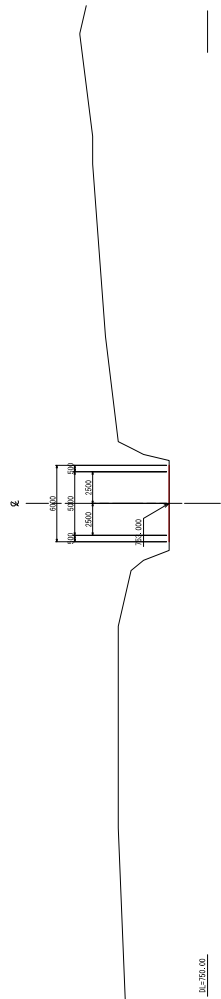

NO. 32

