

スリランカ民主社会主義共和国
行政・内務・州議会・地方議会省
西部州廃棄物管理局

スリランカ国西部州における
廃棄物管理計画（マスタープラン）
策定支援プロジェクト

業務完了報告書
別添資料

2023年6月

独立行政法人 国際協力機構

株式会社エックス都市研究所
国際航業株式会社

環境
JR
23-064

別添資料一覧

- 別添資料 1 : 合同調整委員会の協議議事録
- 別添資料 2 : Strategic Environmental Assessment 報告書
- 別添資料 3 : Mahara Pradeshiya Sabha の廃棄物事業継続計画
- 別添資料 4 : 廃棄物管理に関わる組織の役割と課題
- 別添資料 5 : 小規模の廃棄物積み替え中継基地オペレーションマニュアル
- 別添資料 6 : ごみアプリの導入ガイドライン
- 別添資料 7 : 西部州における廃棄物管理グッドプラクティス
- 別添資料 8 : エアレーションシステムのオペレーションマニュアル
- 別添資料 9 : 住民との合意形成に関するガイドライン
- 別添資料 10 : 西部州における廃棄物管理計画 (マスタープラン) (英文)
- 別添資料 11 : Project Completion Report

別添資料 1

合同調整委員会の協議議事録

RECORD OF DISCUSSIONS

FOR

**THE PROJECT FOR FORMULATION OF WESTERN PROVINCE
SOLID WASTE MANAGEMENT MASTER PLAN**

AGREED UPON BETWEEN

AUTHORITIES CONCERNED

OF

DEMOCRATIC SOCIALIST REPUBLIC OF SRI LANKA

AND

JAPAN INTERNATIONAL COOPERATION AGENCY

Dated *12th December* 2018

g *R* *26* *3*

Based on the Minutes of Meetings (M/M) of the Detailed Planning Survey for the Project for Formulation of Western Province Solid Waste Management Master Plan (hereinafter referred to as "the Project") signed on May 18, 2018 between Ministry of Provincial Councils, Local Government and Sports (hereinafter referred to as "MoPCLGS"), Western Provincial Council (hereinafter referred to as "WPC") and the Department of External Resources, Ministry of National Policies and Economic Affairs (hereinafter referred to as "ERD") of the Democratic Socialist Republic of Sri Lanka (hereinafter referred to as "The Counterpart") and the Japan International Cooperation Agency (hereinafter referred to as "JICA"), JICA held a series of discussions with the MoPCLGS, WPC, ERD and other authorities concerned to develop a detailed plan of the Project.

The purpose of this Record of Discussions (hereinafter referred to as "the R/D") is to establish a mutual agreement for implementation by both parties and to agree on the detailed plan of the Project as described in the followings and the Annexes, which will be implemented within the framework of the Agreement on Technical Cooperation signed on October 12, 2005 (hereinafter referred to as "the Agreement") and the Note Verbals exchanged on August 17, 2018 between the Government of Japan and the Government of the Democratic Socialist Republic of Sri Lanka.

The Counterpart will be responsible for the implementation of the Project in cooperation with JICA, to coordinate with other relevant organizations and ensure that the self-reliant operation of the Project is sustained during and after the implementation period in order to contribute toward social and economic development of the Democratic Socialist Republic of Sri Lanka.

Both parties also agreed that the Project will be implemented in accordance with the "Basic Principles for Technical Cooperation" published in December 2016 (hereinafter referred to as "the BP"), unless other arrangements are agreed upon in the R/D.

The R/D is delivered at Colombo as of the day and year first above written. The R/D may be amended by a Minutes of Meetings between both parties, except the plan of operation to be modified in monitoring sheets. The minutes of meetings will be signed by authorized persons of each side.

g D 2 1

For

Japan International
Cooperation Agency

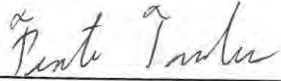

Mr. Fusato TANAKA
Chief Representative
JICA Sri Lanka Office

For

Ministry of Provincial Councils, Local
Government and Sports



Mr. H. T. Kamal Pathmasiri
Secretary

For

Western Provincial Council



Mr. Pradeep Yasaratne
Chief Secretary

Pradeep Yasaratne
Chief Secretary - Western Province

For

Department of External Resources
Ministry of National Policies and
Economic Affairs



Mr. R.M.P. Rathnayake
Director General

- Annex 1: Main Points Discussed
- Annex 2: Project Design Matrix (PDM)
- Annex 3: Plan of Operation (PO)
- Annex 4: Implementation Structure
- Annex 5: List of Proposed Members of Joint Coordinating Committee

Main Points Discussed

1. Distribution of Roles

The roles of organizations of the Working Group are as follows along with activities for the Project Outputs:

	Main Implementer	Co-implementers / Key collaborators
Activities for the Output 1	WPC / WMA	Members of Working Group: 1. General issues (e.g. overall planning and monitoring): MoMDE, CEA, NPD, NSWMSC 2. Municipal solid waste: MoMDE, CEA, CMC, NSWMSC, SLLRDC, SWM Project of MoMWD, UDA 3. Industrial waste: BOI, MoMDE, CEA, IDB, SLLRDC, UDA, MoIC 4. Construction and demolition (C&D) waste: MoMDE, CEA, CIDA 5. Infectious and hazardous waste: MoMDE, CEA, MoH
Activities for the Output 2	WPC / WMA	
Activities for the Output 3	WPC / WMA CMC, and target LAs	NSWMSC, MoMDE, CEA and other institutions depending on the nature of the pilot projects
Activities for the Output 4	WPC/WMA, NSWMSC, MoMDE, CEA, CMC, UDA, SLLRDC, SWM Project of MoMWD and other institutions depending on the nature of the pilot activities	
Activities for the Output 5	WPC / WMA	Members of Working Group and LAs in Western Province

2. TOR for Environmental and Social Considerations

Since the Project is classified as a "Category B" under the "JICA Guideline for Environmental and Social Considerations (April 2010)" (hereinafter referred to as "JICA Guidelines"), both sides agreed that the Project should include a Terms of Reference (TOR) for Environmental and Social Considerations including Strategic Environmental Assessment (SEA) in line with the JICA Guidelines as outlined below;

- (1) Review of existing development policies, plans, projects, studies, and public private investment;
- (2) Identification and analysis of development constrains and factors promoting development;
- (3) Analysis of alternatives for achieving the goals of the Project;
- (4) Consideration of the contents of the Master Plan;
- (5) Conducting baseline surveys for Environmental and Social

g D 7. m

- Considerations, including;
- 1) Laws, regulations, and standards related to environmental and social considerations (environmental impact assessment, resettlement, public participation, information disclosure, and others);
 - 2) SEA study reports conducted in Sri Lanka development projects, and other relevant information;
 - 3) Gaps between the JICA Guidelines and the legal framework of the Sri Lanka on environmental and social considerations;
 - 4) Review of relevant organizations responsible for implementation of projects and their roles on environmental and social considerations including Environmental Impact Assessment (EIA) and SEA;
 - (6) Scoping on possible environmental and social impacts and its evaluation methods at the time of decision-making of the projects proposed by the Master Plan;
 - (7) Prediction of likely impacts of the proposed projects under the Master Plan based on the scoping;
 - (8) Evaluation of likely impacts of the plans and comparative analysis of alternative proposed plans, including the 'without project' option;
 - (9) Examination of the mitigation measures (to be avoided, minimized, and compensated);
 - (10) Examination of the monitoring methods (monitoring items, frequencies, and methods);
 - (11) Support to hold stakeholder meetings;
 - (12) Provisional scoping for prioritized projects; and
 - (13) Perform other duties deemed necessary.

Both sides also agreed that no pilot projects and/or activities classified as "Category A" under the JICA Guidelines will be conducted in the Project.

3. Contribution to Climate Change Mitigation

Both parties acknowledged that enhancement of proper waste management in line with the M/P can possibly contribute to climate change mitigation.



Project Design Matrix

Project Title: The Project for Formulation of Western Province Solid Waste Management Master Plan
Implementing Agency: National Solid Waste Management Support Center (NWSMSC), Waste Management Authority (WMA), and relevant organizations
Target Group: Western Province, and organizations relevant to waste management in Western Province
Duration: 2019.3–2022.2 (3 years)
Project Site: Western Province

Narrative Summary		Objectively Verifiable Indicators	Means of Verification	Important Assumption
<p>Overall Goal Appropriate solid waste management practices in accordance with Western Province Solid Waste Management Master Plan (MP) are undertaken in Western Province.</p>	<p>1. X % of Local Authorities (LAs) implement appropriate solid waste management in accordance with the MP. 2. More than X good practices on 3Rs (Reduce, Reuse and Recycle) and/or appropriate waste disposal are confirmed in a year as a result of the implementation of the MP.</p>	<p>1. Reports on waste management from LAs 2. Reports on good practices from LAs and other relevant institutions</p>	<p>1. National policies regarding waste management do not change significantly 2. Financial resources for the implementation of the MP are secured by LAs.</p>	<p>Counterpart (C/P) staff and other staff from relevant organizations continuously engage in the project.</p>
<p>Project Purpose Western Province's planning capacity on solid waste management is strengthened through the formulation of Western Province Solid Waste Management Master Plan (MP).</p>	<p>1. The final draft of the MP is prepared. 2. Western Provincial Council (WPC) and MoPCLGS start the MP approval process.</p>	<p>1. The final draft of the MP 2. The MP in the process of approval</p>	<p>1. Documented list of roles and responsibilities 2. List of the Working Group members 3. Minutes of meetings of the Working Group 4. Reports of the workshops or meetings 5. Draft Master Plan</p>	
<p>Outputs 1. Roles and responsibilities of organizations relevant to solid waste management in Western Province are clarified and institutional arrangements for the formulation of the MP are established.</p>	<p>1. Roles and responsibilities of relevant organizations are clarified and documented in the MP and/or other documents. 2. A Working Group for MP formulation is established. 3. Regular meetings are held (at least once in three months) by the Working Group for MP formulation. 4. The process and outputs of activities of the Working Group are shared at the Provincial and Central levels by holding workshops or meetings X times. 5. Draft Master Plan is prepared by the Working Group.</p>			

Ver.0.0

<p>2. Current situations and challenges of solid waste management in Western Province are clarified.</p>	<ol style="list-style-type: none"> 1. Data on current situations on solid waste management in Western Province are collected. 2. A database using the existing data is created 3. An analysis report on solid waste management in Western Province is prepared. 	<ol style="list-style-type: none"> 1. Data on solid waste management in Western Province 2. The database 3. The analysis report 	
<p>3. Knowledge and experience which contribute to MP formulation are acquired through the implementation of pilot projects on appropriate waste management and 3Rs. (Target areas: Colombo Municipality and other LAs)</p>	<ol style="list-style-type: none"> 1. Trainings on appropriate waste management and 3Rs for LAs and other relevant organizations are conducted X times. 2. Pilot projects are implemented at X LAs. 3. The results of Capacity Assessment (posttest) for WMA and target LAs improve from those of pretest. 4. Reports on pilot projects are prepared. 	<ol style="list-style-type: none"> 1. Records of trainings 2. Records of pilot project implementation 3. The results of Capacity Assessment 4. Reports on pilot projects 	
<p>4. Knowledge and experience which contribute to MP formulation are acquired through pilot activities for improving planning/ operation of waste management facilities.</p>	<ol style="list-style-type: none"> 1. Trainings on planning/ operation of waste management facilities for CMC and other relevant organizations are conducted X times. 2. Pilot activities are implemented at X waste management facilities. 3. The results of Capacity Assessment (posttest) for CMC and other relevant organizations of target waste management facilities improve from those of pretest. 4. Reports on pilot activities are prepared. 	<ol style="list-style-type: none"> 1. Records of trainings 2. Records of pilot activities implementation 3. The results of Capacity Assessment 4. Reports on pilot activities 	
<p>5. Collaboration and coordination among relevant organizations in Western Province for the formulation and implementation of the MP, its sub-plans and other related plans (e.g. LA action plans, plans on waste management facilities) are strengthened.</p>	<ol style="list-style-type: none"> 1. Meetings for the explanation of the MP are organized for LAs in Western Province and other relevant organizations (including central government organizations) are held X times. 2. XX staff members of WMA and other related organization are given trainings and/or OJT on supporting LAs. 3. Support and guidance for the formulation of sub-plans and other related plans (e.g. LA action plans, plans on waste management facilities) in line with the MP are given to LAs and other relevant organizations X times. 4. The monitoring system is documented. 5. Budget plans for the implementation of the MP and a guidance for budget plan formulation to implement LAs' action plans are prepared. 	<ol style="list-style-type: none"> 1. Records on the meeting for the explanation of the MP 2. Records on training and/ or OJT 3. Records on support and guidance 4. Documented monitoring system 5. Budget plans 	
<p>Activities</p> <p>1.1 Roles and responsibilities of relevant organizations relevant to solid waste management in Western Province are clarified by examining policies and legal documents (e.g. national laws, ordinances).</p> <p>1.2 A Working Group for MP formulation is established.</p> <p>1.3 Terms of Reference (TOR) of the Working Group for MP formulation are clarified.</p> <p>1.4 Regular meetings and special meetings or sub-group meetings, where necessary, are held.</p> <p>1.5 Draft Master Plan based on the knowledge gained through activities for Output 2-5 is prepared through discussions by</p>	<p>[Japanese side]</p> <ul style="list-style-type: none"> • Experts - Waste Management - Collection and Transportation - Intermediate Treatment and Final Disposal - 3Rs/ Public Awareness - Environmental and Social Considerations - Financial / Economic Analysis/Institutional plan - Data base - Project Coordination/ Training <p>• Provision of machinery and equipment</p>	<p>[Sri Lankan side]</p> <ul style="list-style-type: none"> • C/P • Personnel cost and operational cost for C/P • Office space and facilities for Experts 1. NSWMSC 2. WMA 	<p>Large-scale consolidation and/or restructuring of LAs do not occur.</p>

(Handwritten initials)

•Trainings in Japan/Third Countries

- the Working Group.
- 1.6 The process and outputs of activities of the Working Group are shared with relevant organizations (including those which authorize the Master Plan) both at the Provincial and Central levels by holding workshops or meetings.
 - 1.7 An inter-organizational coordination body such as Provincial Solid Waste Management Committee which takes over the work of the Working Group is proposed.
 - 2.1 The Working Group for MP formulation decides a. types of waste, b. target year, c. areas and population.
 - 2.2 Organizations in Western Province relevant to solid waste management are investigated and data on solid waste management is collected.
 - 2.3 A database is created using existing data on Western Province's solid waste management.
 - 2.4 Based on the data, current situations and challenges regarding solid waste management are clarified and reported.
 - 3.1 Trainings on appropriate waste management and 3Rs for LAs and other relevant organizations are conducted.
 - 3.2 Target LAs for pilot projects are selected.
 - 3.3 Capacity Assessment (pretest) for WMA and target LAs is conducted.
 - 3.4 The pilot projects on appropriate waste management and 3Rs are planned at the target LAs (The pilot projects may include a study to collect good practices of various LAs).
 - 3.5 3.4 is implemented.
 - 3.6 Capacity Assessment (posttest) for WMA and target LAs is conducted.
 - 3.7 3.5 is monitored and its results and knowledge are reflected in the draft MP.
 - 4.1 Complaints/ requests made by residents, NGOs and other stakeholders with regard to waste management are studied to identify important issues.
 - 4.2 Target waste management facilities for pilot activities are selected.
 - 4.3 Trainings on planning/ operation of waste management facilities are conducted for CMC and other relevant organizations.

9

29

D and

別添資料1

<p>4.4 Capacity Assessment (pretest) for CMC and other relevant organizations is conducted.</p> <p>4.5 Pilot activities for seeking optimal technical/ social interventions for improved planning and operation of waste management facilities are planned at the target waste management facilities.</p> <p>4.6 4.5 is implemented.</p> <p>4.7 Capacity Assessment (posttest) for CMC and other relevant organizations is conducted.</p> <p>4.8 4.6 is monitored and its results and knowledge are reflected in the draft MP.</p> <p>5.1 Meetings for the explanation of the MP are organized for LAs in Western Province and other relevant organizations (including central government organizations) are held.</p> <p>5.2 The staff of WMA and other relevant organizations enhance their knowledge and skills for supporting LAs and other organizations in their formulation and implementation of the MP, its sub-plans and other related plans (e.g. LA action plans, plans on waste management facilities) through trainings and OJT.</p> <p>5.3 Support and guidance for the formulation of sub-plans and other related plans (e.g. LA action plans, plans on waste management facilities) in line with MP are given to LAs and other relevant organizations.</p> <p>5.4 A system to monitor the implementation of sub-plans and other related plans (e.g. LA action plans, plans on waste management facilities) in line with MP is established and documented.</p> <p>5.5 Budget plans for the implementation of the MP and a guidance for budget plan formulation to implement LAs' action plans are prepared.</p>			<p><u>Pre-Condition</u> Staff from relevant organizations in Western Province are assigned for the project.</p>
---	--	--	--

① 2

R

Tentative Plan of Operation

Version 0

Dated 14, May, 2018

Project Title: The Project for Formulation of Western Province Solid Waste Management Master Plan										Monitoring							
Inputs	Year	1st Year				2nd Year				3rd Year				Remarks	Issue	Solution	
		I	II	III	IV	I	II	III	IV	I	II	III	IV				
Expert																	
Waste Management	Plan																
Actual																	
Collection and Transportation	Plan																
Actual																	
Intermediate Treatment and Final Disposal	Plan																
Actual																	
3Rs/ Public Awareness	Plan																
Actual																	
Environmental and Social Considerations	Plan																
Actual																	
Financial / Economic Analysis/Institutional plan	Plan																
Actual																	
Data base	Plan																
Actual																	
Project Coordination/ Training	Plan																
Actual																	
Equipment																	
	Plan																
	Actual																
	Plan																
	Actual																
Training in Japan																	
Training mentioned activity 3.1, 4.2 and 4.3	Plan																
Actual																	
In-country/Third country Training																	
Training mentioned activity 3.1, 4.2 and 4.3	Plan																
Actual																	
Activities																	
Sub-Activities																	
Output 1:																	
1.1 Roles and responsibilities of relevant organizations relevant to solid waste management in Western Province are clarified by examining policies and legal documents (e.g. national laws, ordinances).	Plan																
Actual																	
1.2 A Working Group for MP formulation is established.	Plan																
Actual																	
1.3 Terms of Reference (TOR) of the Working Group for MP formulation are clarified.	Plan																
Actual																	
1.4 Regular meetings and special meetings or sub-group meetings, where necessary, are held.	Plan																
Actual																	
1.5 Draft Master Plan based on the knowledge gained through activities for Output 2-5 is prepared through discussions by the Working Group.	Plan																
Actual																	
1.6 The process and outputs of activities of the Working Group are shared with relevant organizations (including those which authorize the Master Plan) both at the Provincial and Central levels by holding workshops or meetings.	Plan																
Actual																	
1.7 An inter-organizational coordination body such as Provincial Solid Waste Management Committee which takes over the work of the Working Group is proposed.	Plan																
Actual																	
Output 2:																	
2.1 The Working Group for MP formulation decides a. types of waste, b. target year, c. areas and population.	Plan																
Actual																	
2.2 Organizations in Western Province relevant to solid waste management are investigated and data on solid waste management is collected.	Plan																
Actual																	
2.3 A database is created using existing data on Western Province's solid waste management.	Plan																
Actual																	
2.4 Based on the data, current situations and challenges regarding solid waste management are clarified and reported.	Plan																
Actual																	
Output 3:																	
3.1 Trainings on appropriate waste management and 3Rs for LAs and other relevant organizations are conducted.	Plan																
Actual																	
3.2 Target LAs for pilot projects are selected.	Plan																
Actual																	
3.3 Capacity Assessment (pretest) for WMA and target LAs is conducted.	Plan																
Actual																	
3.4 The pilot projects on appropriate waste management and 3Rs are planned at the target LAs (The pilot projects may include a study to collect good practices of various LAs).	Plan																
Actual																	
3.5 3.4 is implemented.	Plan																
Actual																	
3.6 Capacity Assessment (posttest) for WMA and model LAs is conducted.	Plan																
Actual																	
3.7 3.5 is monitored and its results and knowledge are reflected in the draft MP.	Plan																
Actual																	
Output 4:																	
4.1 Complaints/ requests made by residents, NGOs and other stakeholders with regard to waste management are studied to identify important issues.	Plan																
Actual																	
4.2 Target waste management facilities for pilot activities are selected.	Plan																
Actual																	
4.3 Trainings on planning/ operation of waste management facilities are conducted for CMC and other relevant organizations.	Plan																
Actual																	
4.4 Capacity Assessment (pretest) for CMC and other relevant organizations is conducted.	Plan																
Actual																	
4.5 Pilot activities for seeking optimal technical/ social interventions for improved planning and operation of waste management facilities are planned at the target waste management facilities.	Plan																
Actual																	
4.6 4.5 is implemented.	Plan																
Actual																	
4.7 Capacity Assessment (posttest) for CMC and other relevant organizations is conducted.	Plan																
Actual																	
4.8 4.6 is monitored and its results and knowledge are reflected in the draft MP.	Plan																
Actual																	
Output 5:																	
5.1 Meetings for the explanation of the MP are organized for LAs in Western Province and other relevant organizations (including central government organizations) are held.	Plan																
Actual																	
5.2 The staff of WMA and other relevant organizations enhance their knowledge and skills for supporting LAs and other organizations in their formulation and implementation of the MP, its sub-plans and other related plans (e.g. LA action plans, plans on waste management facilities) through trainings and OJT.	Plan																
Actual																	
5.3 Support and guidance for the formulation of sub-plans and other related plans (e.g. LA action plans, plans on waste management facilities) in line with MP are given to LAs and other relevant organizations.	Plan																
Actual																	
5.4 A system to monitor the implementation of sub-plans and other related plans (e.g. LA action plans, plans on waste management facilities) in line with MP is established and documented.	Plan																
Actual																	
5.5 Budget plans for the implementation of the MP and a guidance for budget plan formulation to implement LAs' action plans are prepared.	Plan																
Actual																	
Duration / Phasing																	
	Plan																
	Actual																
Monitoring Plan																	
Monitoring																	
Joint Coordinating Committee	Plan																
Actual																	
Set-up the Detailed Plan of Operation	Plan																
Actual																	
Submission of Monitoring Sheet	Plan																
Actual																	
Monitoring Mission from Japan	Plan																
Actual																	
Joint Monitoring	Plan																
Actual																	
Post Monitoring	Plan																
Actual																	
Reports/Documents																	
Interim Report	Plan																
Actual																	
Project Completion Report	Plan																
Actual																	
Public Relations																	
	Plan																
	Actual																
	Plan																
	Actual																

Handwritten signatures and initials in blue ink.

Implementation Structure

Annex 4

別添資料1

Joint Coordinating Committee (JCC)

Chair : MoPCLGS Secretary

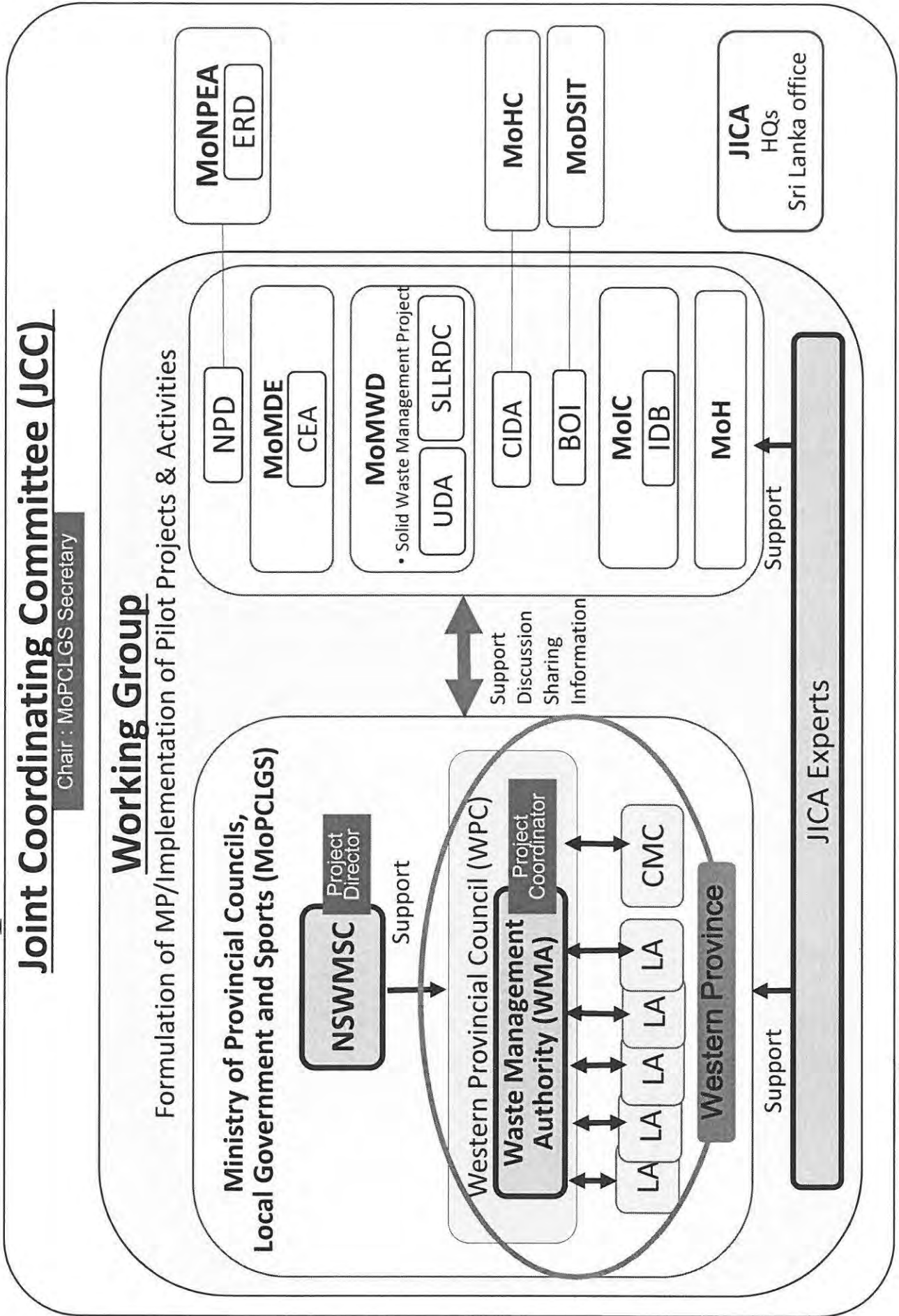

→ Indicates the main Project Team. The Project Office will be located at WMA and NSWMSC.

Handwritten notes and signatures at the bottom of the page.

Annex 5

**List of Proposed Members of Joint Coordinating Committee for
the Project for Formulation of Western Province Solid Waste
Management Master Plan**

Sri Lankan Side

(1) Chairperson

Secretary, Ministry of Provincial Councils, Local Government and Sports

(2) Project Director

Director, National Solid Waste Management Support Center

(3) Project Coordinator

Director, Waste Management Authority

(4) Personnel from organizations of the Working Group

**(5) Other persons that the Sri Lankan side might consider necessary
(consultants, technicians, etc.)**

Japanese Side

(1) JICA Experts

**(2) Chief Representative, representatives and staff of JICA Sri Lanka
Office**

**(3) Staff from JICA Headquarters, other domestic and foreign offices, if
necessary**

**(4) Other persons that the Japanese side might consider necessary
(consultants, technicians, etc.)**



MINUTES OF MEETINGS
BETWEEN
AUTHORITIES CONCERNED OF DEMOCRATIC SOCIALIST REPUBLIC OF SRI LANKA
AND
JAPAN INTERNATIONAL COOPERATION AGENCY
FOR AMENDMENT OF THE RECORD OF DISCUSSIONS
ON
THE PROJECT FOR FORMULATION OF WESTERN PROVINCE SOLID WASTE
MANAGEMENT MASTER PLAN

The Japan International Cooperation Agency (hereinafter referred to as "JICA"), State Ministry of Provincial Councils and Local Government, Western Provincial Council, and the Department of External Resources, Ministry of Finance hereby agree that the Record of Discussions on The Project for Formulation of Western Province Solid Waste Management Master Plan signed on 12th December, 2018 is amended as follows;

1. Distribution of Roles

In accordance with restructuring ministries and governmental organizations in Sri Lanka after the election held on August 2020, the names of counterparts of the Project have been changed from the Record of Discussions, signed on 12th December 2018 (Annex 1). Accordingly, the roles of organizations of the Working Group are as follows along with activities for the Project Outputs:



	Main Implementer	Co-implementers / Key collaborators
Activities for the Output 1	WPC / WMA	Members of WG: 1. General issues (e.g. overall planning and monitoring): MoE, CEA, NPD, and NSWMSC 2. Municipal solid waste: MoE, CEA, CMC, NSWMSC, SLLDC, SWM Project of SMoUDCCWD&CC, UDA 3. Industrial waste: BOI, MoE, CEA, IDB, SLLDC, UDA, MoI 4. Construction and demolition (C&D) waste: MoE, CEA, CIDA 5. Infectious and hazardous waste: MoE, CEA, MoH
Activities for the Output 2	WPC / WMA	
Activities for the Output 3	WPC / WMA CMC, and target LAs	NSWMSC, MoE, CEA and other institutions depending on the nature of the pilot projects
Activities for the Output 4	WPC/WMA, NSWMSC, MoE, CEA, CMC, UDA, SLLDC, SWM Project of SMoUDCCWD&CC and other institutions depending on the nature of the pilot activities	
Activities for the Output 5	WPC / WMA	Members of WG and LAs in Western Province

Change of Distribution of Roles is shown as Attachment 1, and Abbreviations is shown as Attachment 4.

Additionally, the implementation structure is as follows:

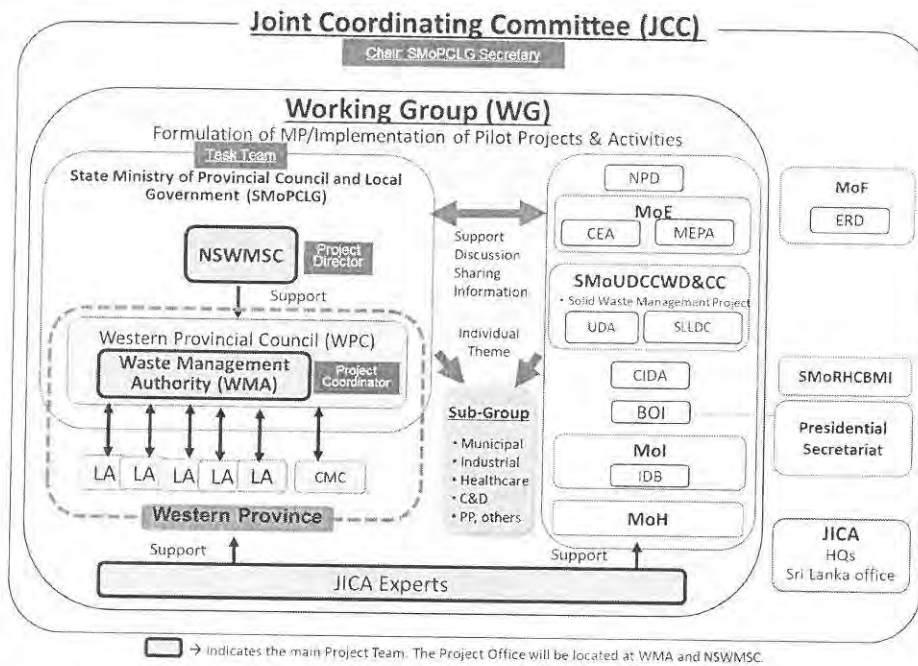

□ → Indicates the main Project Team. The Project Office will be located at WMA and NSWMSC.

Change of Implementation Structure is shown as Attachment 2.

Handwritten signatures and initials at the bottom right of the page.

2. Project Design Matrix (PDM) / Project Description (Annex 2)

(1) Duration

Before	Amended Version
Duration: 2019.2-2022.2 (3 years)	Duration: 2019.2-2022.12 (3 years and 10 months)
Reason: Because of the global spread of the coronavirus disease 2019 (COVID-19), some of the project activities have been suspended. In order to achieve the project purpose after the project team resume the activities, project duration needs to be extended. The duration may be further amended (shortened or extended) depending on the COVID-19 situation.	

(2) Amendment of each Output, Activity, and Objectively Verifiable Indicators

While implementing the activities in the field, the activities were revised based on the progress made. Each revision of PDM was approved through 1st and 2nd JCC meeting. The updated version of the PDM approved at 2nd JCC meeting held on 26 November 2020 is shown as Annex 2. Comparison of PDM that is explained about amendment history is shown as Attachment 3.

Colombo, 8th April 2021

for 高嶺清史

YAMADA Tetsuya
Chief Representative
JICA Sri Lanka Office



S. D. A. B. Boralessa
Secretary
State Ministry of Provincial Council
And Local Government

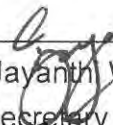

J.M.C Jayanthi Wijethunga
Chief Secretary
Western Provincial Council



Ajith Abeysekera
Director General
Department of External Resources
Ministry of Finance

Annex 1 : Record of Discussions (signed on 12th December 2018)

Annex 2 : Amended Project Design Matrix ver.3

Attachment 1: Distribution of Roles

Attachment 2: Implementation Structure

Attachment 3: Comparison of PDM

Attachment 4: Abbreviations

RECORD OF DISCUSSIONS
FOR
THE PROJECT FOR FORMULATION OF WESTERN PROVINCE
SOLID WASTE MANAGEMENT MASTER PLAN
AGREED UPON BETWEEN
AUTHORITIES CONCERNED
OF
DEMOCRATIC SOCIALIST REPUBLIC OF SRI LANKA
AND
JAPAN INTERNATIONAL COOPERATION AGENCY

Dated 12th December 2018

Handwritten signatures and initials at the bottom right of the page, including a signature that appears to be 'S.S.' and another that appears to be 'M.'.

Based on the Minutes of Meetings (M/M) of the Detailed Planning Survey for the Project for Formulation of Western Province Solid Waste Management Master Plan (hereinafter referred to as "the Project") signed on May 18, 2018 between Ministry of Provincial Councils, Local Government and Sports (hereinafter referred to as "MoPCLGS"), Western Provincial Council (hereinafter referred to as "WPC") and the Department of External Resources, Ministry of National Policies and Economic Affairs (hereinafter referred to as "ERD") of the Democratic Socialist Republic of Sri Lanka (hereinafter referred to as "The Counterpart") and the Japan International Cooperation Agency (hereinafter referred to as "JICA"), JICA held a series of discussions with the MoPCLGS, WPC, ERD and other authorities concerned to develop a detailed plan of the Project.

The purpose of this Record of Discussions (hereinafter referred to as "the R/D") is to establish a mutual agreement for implementation by both parties and to agree on the detailed plan of the Project as described in the followings and the Annexes, which will be implemented within the framework of the Agreement on Technical Cooperation signed on October 12, 2005 (hereinafter referred to as "the Agreement") and the Note Verbals exchanged on August 17, 2018 between the Government of Japan and the Government of the Democratic Socialist Republic of Sri Lanka.

The Counterpart will be responsible for the implementation of the Project in cooperation with JICA, to coordinate with other relevant organizations and ensure that the self-reliant operation of the Project is sustained during and after the implementation period in order to contribute toward social and economic development of the Democratic Socialist Republic of Sri Lanka.

Both parties also agreed that the Project will be implemented in accordance with the "Basic Principles for Technical Cooperation" published in December 2016 (hereinafter referred to as "the BP"), unless other arrangements are agreed upon in the R/D.

The R/D is delivered at Colombo as of the day and year first above written. The R/D may be amended by a Minutes of Meetings between both parties, except the plan of operation to be modified in monitoring sheets. The minutes of meetings will be signed by authorized persons of each side.

Handwritten signatures and initials at the bottom of the page, including a large signature on the right and several smaller initials on the left.

For

Japan International
Cooperation Agency



Mr. Fusato TANAKA
Chief Representative
JICA Sri Lanka Office

For

Ministry of Provincial Councils, Local
Government and Sports



Mr. H. T. Kamal Pathmasiri
Secretary

For

Western Provincial Council



Mr. Pradeep Yasaratne
Chief Secretary

Pradeep Yasaratne
Chief Secretary - Western Province

For

Department of External Resources
Ministry of National Policies and
Economic Affairs



Mr. R.M.P. Rathnayake
Director General

- Annex 1: Main Points Discussed
- Annex 2: Project Design Matrix (PDM)
- Annex 3: Plan of Operation (PO)
- Annex 4: Implementation Structure
- Annex 5: List of Proposed Members of Joint Coordinating Committee



Main Points Discussed

1. Distribution of Roles

The roles of organizations of the Working Group are as follows along with activities for the Project Outputs:

	Main Implementer	Co-implementers / Key collaborators
Activities for the Output 1	WPC / WMA	Members of Working Group: 1. General issues (e.g. overall planning and monitoring): MoMDE, CEA, NPD, NSWMSC 2. Municipal solid waste: MoMDE, CEA, CMC, NSWMSC, SLLRDC, SWM Project of MoMWD, UDA 3. Industrial waste: BOI, MoMDE, CEA, IDB, SLLRDC, UDA, MoIC 4. Construction and demolition (C&D) waste: MoMDE, CEA, CIDA 5. Infectious and hazardous waste: MoMDE, CEA, MoH
Activities for the Output 2	WPC / WMA	
Activities for the Output 3	WPC / WMA CMC, and target LAs	NSWMSC, MoMDE, CEA and other institutions depending on the nature of the pilot projects
Activities for the Output 4	WPC/WMA, NSWMSC, MoMDE, CEA, CMC, UDA, SLLRDC, SWM Project of MoMWD and other institutions depending on the nature of the pilot activities	
Activities for the Output 5	WPC / WMA	Members of Working Group and LAs in Western Province

2. TOR for Environmental and Social Considerations

Since the Project is classified as a "Category B" under the "JICA Guideline for Environmental and Social Considerations (April 2010)" (hereinafter referred to as "JICA Guidelines"), both sides agreed that the Project should include a Terms of Reference (TOR) for Environmental and Social Considerations including Strategic Environmental Assessment (SEA) in line with the JICA Guidelines as outlined below;

- (1) Review of existing development policies, plans, projects, studies, and public private investment;
- (2) Identification and analysis of development constrains and factors promoting development;
- (3) Analysis of alternatives for achieving the goals of the Project;
- (4) Consideration of the contents of the Master Plan;
- (5) Conducting baseline surveys for Environmental and Social

Considerations, including;

- 1) Laws, regulations, and standards related to environmental and social considerations (environmental impact assessment, resettlement, public participation, information disclosure, and others);
- 2) SEA study reports conducted in Sri Lanka development projects, and other relevant information;
- 3) Gaps between the JICA Guidelines and the legal framework of the Sri Lanka on environmental and social considerations;
- 4) Review of relevant organizations responsible for implementation of projects and their roles on environmental and social considerations including Environmental Impact Assessment (EIA) and SEA;
- (6) Scoping on possible environmental and social impacts and its evaluation methods at the time of decision-making of the projects proposed by the Master Plan;
- (7) Prediction of likely impacts of the proposed projects under the Master Plan based on the scoping;
- (8) Evaluation of likely impacts of the plans and comparative analysis of alternative proposed plans, including the 'without project' option;
- (9) Examination of the mitigation measures (to be avoided, minimized, and compensated);
- (10) Examination of the monitoring methods (monitoring items, frequencies, and methods);
- (11) Support to hold stakeholder meetings;
- (12) Provisional scoping for prioritized projects; and
- (13) Perform other duties deemed necessary.

Both sides also agreed that no pilot projects and/or activities classified as "Category A" under the JICA Guidelines will be conducted in the Project.

3. Contribution to Climate Change Mitigation

Both parties acknowledged that enhancement of proper waste management in line with the M/P can possibly contribute to climate change mitigation.



Annex 2

Project Design Matrix

Project Title: The Project for Formulation of Western Province Solid Waste Management Master Plan
Implementing Agency: National Solid Waste Management Support Center (NWSMSC), Waste Management Authority (WMA), and relevant organizations
Target Group: Western Province, and organizations relevant to waste management in Western Province
Duration: 2019.3–2022.2 (3 years)
Project Site: Western Province

Narrative Summary		Objectively Verifiable Indicators	Means of Verification	Important Assumption
<p>Overall Goal Appropriate solid waste management practices in accordance with Western Province Solid Waste Management Master Plan (MP) are undertaken in Western Province.</p>	<p>1. X % of Local Authorities (LAs) implement appropriate solid waste management in accordance with the MP. 2. More than X good practices on 3Rs (Reduce, Reuse and Recycle) and/or appropriate waste disposal are confirmed in a year as a result of the implementation of the MP.</p>	<p>1. Reports on waste management from LAs 2. Reports on good practices from LAs and other relevant institutions</p>	<p>1. National policies regarding waste management do not change significantly 2. Financial resources for the implementation of the MP are secured by LAs.</p>	
<p>Project Purpose Western Province's planning capacity on solid waste management is strengthened through the formulation of Western Province Solid Waste Management Master Plan (MP).</p>	<p>1. The final draft of the MP is prepared. 2. Western Provincial Council (WPC) and MoPCLGS start the MP approval process.</p>	<p>1. The final draft of the MP 2. The MP in the process of approval</p>	<p>1. Documented list of roles and responsibilities 2. List of the Working Group members 3. Minutes of meetings of the Working Group 4. Reports of the workshops or meetings 5. Draft Master Plan</p>	
<p>Outputs Roles and responsibilities of organizations relevant to solid waste management in Western Province are clarified and institutional arrangements for the formulation of the MP are established.</p>	<p>1. Roles and responsibilities of relevant organizations are clarified and documented in the MP and/or other documents. 2. A Working Group for MP formulation is established. 3. Regular meetings are held (at least once in three months) by the Working Group for MP formulation. 4. The process and outputs of activities of the Working Group are shared at the Provincial and Central levels by holding workshops or meetings X times. 5. Draft Master Plan is prepared by the Working Group.</p>	<p>1. Roles and responsibilities of relevant organizations are clarified and documented in the MP and/or other documents. 2. A Working Group for MP formulation is established. 3. Regular meetings are held (at least once in three months) by the Working Group for MP formulation. 4. The process and outputs of activities of the Working Group are shared at the Provincial and Central levels by holding workshops or meetings X times. 5. Draft Master Plan is prepared by the Working Group.</p>	<p>1. Roles and responsibilities of relevant organizations are clarified and documented in the MP and/or other documents. 2. A Working Group for MP formulation is established. 3. Regular meetings are held (at least once in three months) by the Working Group for MP formulation. 4. The process and outputs of activities of the Working Group are shared at the Provincial and Central levels by holding workshops or meetings X times. 5. Draft Master Plan is prepared by the Working Group.</p>	

Ver:0.0

Handwritten signatures and initials at the bottom of the page.

<p>2. Current situations and challenges of solid waste management in Western Province are clarified.</p> <p>3. Knowledge and experience which contribute to MP formulation are acquired through the implementation of pilot projects on appropriate waste management and 3Rs. (Target areas: Colombo Municipality and other LAs)</p>	<p>1. Data on current situations on solid waste management in Western Province are collected.</p> <p>2. A database using the existing data is created</p> <p>3. An analysis report on solid waste management in Western Province is prepared.</p> <p>1. Trainings on appropriate waste management and 3Rs for LAs and other relevant organizations are conducted X times.</p> <p>2. Pilot projects are implemented at X LAs.</p> <p>3. The results of Capacity Assessment (posttest) for WMA and target LAs improve from those of pretest.</p> <p>4. Reports on pilot projects are prepared.</p>	<p>1. Data on solid waste management in Western Province</p> <p>2. The database</p> <p>3. The analysis report</p> <p>1. Records of trainings</p> <p>2. Records of pilot project implementation</p> <p>3. The results of Capacity Assessment</p> <p>4. Reports on pilot projects</p>	
<p>4. Knowledge and experience which contribute to MP formulation are acquired through pilot activities for improving planning/ operation of waste management facilities</p>	<p>1. Trainings on planning/ operation of waste management facilities for CMC and other relevant organizations are conducted X times.</p> <p>2. Pilot activities are implemented at X waste management facilities.</p> <p>3. The results of Capacity Assessment (posttest) for CMC and other relevant organizations of target waste management facilities improve from those of pretest.</p> <p>4. Reports on pilot activities are prepared.</p>	<p>1. Records of trainings</p> <p>2. Records of pilot activities</p> <p>3. The results of Capacity Assessment</p> <p>4. Reports on pilot activities</p>	
<p>5. Collaboration and coordination among relevant organizations in Western Province for the formulation and implementation of the MP, its sub-plans and other related plans (e.g. LA action plans, plans on waste management facilities) are strengthened.</p>	<p>1. Meetings for the explanation of the MP are organized for LAs in Western Province and other relevant organizations (including central government organizations) are held X times.</p> <p>2. XX staff members of WMA and other related organization are given trainings and/or OJT on supporting LAs.</p> <p>3. Support and guidance for the formulation of sub-plans and other related plans (e.g. LA action plans, plans on waste management facilities) in line with the MP are given to LAs and other relevant organizations X times.</p> <p>4. The monitoring system is documented.</p> <p>5. Budget plans for the implementation of the MP and a guidance for budget plan formulation to implement LAs' action plans are prepared.</p>	<p>1. Records on the meeting for the explanation of the MP</p> <p>2. Records on training and/ or OJT</p> <p>3. Records on support and guidance</p> <p>4. Documented monitoring system</p> <p>5. Budget plans</p>	
<p>Activities</p> <p>1.1 Roles and responsibilities of relevant organizations relevant to solid waste management in Western Province are clarified by examining policies and legal documents (e.g. national laws, ordinances).</p> <p>1.2 A Working Group for MP formulation is established.</p> <p>1.3 Terms of Reference (TOR) of the Working Group for MP formulation are clarified.</p> <p>1.4 Regular meetings and special meetings or sub-group meetings, where necessary, are held.</p> <p>1.5 Draft Master Plan based on the knowledge gained through activities for Output 2-5 is prepared through discussions by</p>	<p>Inputs</p> <p>[Sri Lankan side]</p> <ul style="list-style-type: none"> • C/P • Personnel cost and operational cost for C/P • Office space and facilities for Experts 1. NSWMSC 2. WMA <p>[Japanese side]</p> <ul style="list-style-type: none"> • Experts - Waste Management - Collection and Transportation - Intermediate Treatment and Final Disposal - 3Rs/ Public Awareness - Environmental and Social Considerations - Financial / Economic Analysis/Institutional plan - Data base - Project Coordination/ Training • Provision of machinery and equipment 	<p>Large-scale consolidation and/or restructuring of LAs do not occur.</p>	

Handwritten signatures and initials are present at the bottom of the page, including a large signature on the right and several smaller initials or marks on the left and center.

<p>the Working Group.</p> <p>1.6 The process and outputs of activities of the Working Group are shared with relevant organizations (including those which authorize the Master Plan) both at the Provincial and Central levels by holding workshops or meetings.</p> <p>1.7 An inter-organizational coordination body such as Provincial Solid Waste Management Committee which takes over the work of the Working Group is proposed.</p> <p>2.1 The Working Group for MP formulation decides a. types of waste, b. target year, c. areas and population.</p> <p>2.2 Organizations in Western Province relevant to solid waste management are investigated and data on solid waste management is collected.</p> <p>2.3 A database is created using existing data on Western Province's solid waste management.</p> <p>2.4 Based on the data, current situations and challenges regarding solid waste management are clarified and reported.</p> <p>3.1 Trainings on appropriate waste management and 3Rs for LAs and other relevant organizations are conducted.</p> <p>3.2 Target LAs for pilot projects are selected.</p> <p>3.3 Capacity Assessment (pretest) for WMA and target LAs is conducted.</p> <p>3.4 The pilot projects on appropriate waste management and 3Rs are planned at the target LAs (The pilot projects may include a study to collect good practices of various LAs).</p> <p>3.5 3.4 is implemented.</p> <p>3.6 Capacity Assessment (posttest) for WMA and target LAs is conducted.</p> <p>3.7 3.5 is monitored and its results and knowledge are reflected in the draft MP.</p> <p>4.1 Complaints/ requests made by residents, NGOs and other stakeholders with regard to waste management are studied to identify important issues.</p> <p>4.2 Target waste management facilities for pilot activities are selected.</p> <p>4.3 Trainings on planning/ operation of waste management facilities are conducted for CMC and other relevant organizations.</p>	<p>• Trainings in Japan/Third Countries</p>	
--	---	--

Handwritten mark: a stylized character resembling 'H' or 'F'.

Handwritten initials: 'M' and 'Y'.

Handwritten mark: a small scribble.

Handwritten signature: 'Cuo' with a large flourish.

<p>4.4 Capacity Assessment (pretest) for CMC and other relevant organizations is conducted.</p> <p>4.5 Pilot activities for seeking optimal technical/ social interventions for improved planning and operation of waste management facilities are planned at the target waste management facilities.</p> <p>4.6 4.5 is implemented.</p> <p>4.7 Capacity Assessment (posttest) for CMC and other relevant organizations is conducted.</p> <p>4.8 4.6 is monitored and its results and knowledge are reflected in the draft MP.</p> <p>5.1 Meetings for the explanation of the MP are organized for LAs in Western Province and other relevant organizations (including central government organizations) are held.</p> <p>5.2 The staff of WMA and other relevant organizations enhance their knowledge and skills for supporting LAs and other organizations in their formulation and implementation of the MP, its sub-plans and other related plans (e.g. LA action plans, plans on waste management facilities) through trainings and OJT.</p> <p>5.3 Support and guidance for the formulation of sub-plans and other related plans (e.g. LA action plans, plans on waste management facilities) in line with MP are given to LAs and other relevant organizations.</p> <p>5.4 A system to monitor the implementation of sub-plans and other related plans (e.g. LA action plans, plans on waste management facilities) in line with MP is established and documented.</p> <p>5.5 Budget plans for the implementation of the MP and a guidance for budget plan formulation to implement LAs' action plans are prepared.</p>		<p><u>Pre-Condition</u> Staff from relevant organizations in Western Province are assigned for the project.</p>
---	--	---

12

13

14

15

16

17

18

Tentative Plan of Operation													Version 0 Dated 18 May 2010				
Project Title: The Project for Formulation of Western Province Solid Waste Management Master Plan													Monitoring				
Inputs	Year	1st Year				2nd Year				3rd Year				Remarks	Issue	Solution	
		I	II	III	IV	I	II	III	IV	I	II	III	IV				
Expert																	
Waste Management	Plan																
Collection and Transportation	Plan																
Intermediate Treatment and Final Disposal	Plan																
3Rs/Rubbic Awareness	Plan																
Environmental and Social Considerations	Plan																
Financial / Economic Analysis/Institutional plan	Plan																
Data base	Plan																
Project Coordination Training	Plan																
Equipment																	
Training in Japan	Plan																
Training mentioned activity 3.1, 4.2 and 4.3	Plan																
Two country/Third country Training	Plan																
Training mentioned activity 3.1, 4.2 and 4.3	Plan																
Activities																	
Sub-Activities																	
Output 1																	
1.1 Roles and responsibilities of relevant organizations relevant to solid waste management in Western Province are clarified by examining policies and legal documents (e.g. national laws, ordinances)	Plan																
1.2 A Working Group for MP formulation is established	Plan																
1.3 Terms of Reference (TOR) of the Working Group for MP formulation are clarified	Plan																
1.4 Regular meetings and special meetings of sub-group meetings where necessary, are held	Plan																
1.5 Draft Master Plan based on the knowledge gained through activities for Output 2.5 is prepared through discussions by the Working Group	Plan																
1.6 The process and outputs of activities of the Working Group are shared with relevant organizations including those which submit to the Master Plan, both at the Provincial and Central levels by holding workshops or meetings	Plan																
1.7 An inter-organizational coordination body such as Provincial Solid Waste Management Committee which takes over the work of the Working Group is proposed	Plan																
Output 2																	
2.1 The Working Group for MP formulation decides a types of waste, 5 target areas and population	Plan																
2.2 Organizations in Western Province relevant to solid waste management are investigated and data on solid waste management is collected	Plan																
2.3 A database is created using existing data on Western Province's solid waste management	Plan																
2.4 Based on the data, current situations and challenges regarding solid waste management are clarified and reported	Plan																
Output 3																	
3.1 Trainings on appropriate waste management and 3Rs for LAs and other relevant organizations are conducted	Plan																
3.2 Target LAs for pilot projects are selected	Plan																
3.3 Capacity Assessment (pre-test) for WMA and target LAs is conducted	Plan																
3.4 The pilot projects on appropriate waste management and 3Rs are launched at the target LAs (The pilot projects may include a study to collect good practices of various LAs)	Plan																
3.5 3-4 is implemented	Plan																
3.6 Capacity Assessment (post-test) for WMA and target LAs is conducted	Plan																
3.7 3-6 is monitored and its results and knowledge are reflected in the draft MP	Plan																
Output 4																	
4.1 Campaign requests made by residents, NGOs and other stakeholders with regard to waste management are studied to identify important issues	Plan																
4.2 Target waste management facilities for pilot activities are selected	Plan																
4.3 Trainings on planning operation of waste management facilities are conducted for CMC and other relevant organizations	Plan																
4.4 Capacity Assessment (pre-test) for CMC and other relevant organizations is conducted	Plan																
4.5 Pilot activities for seeking optimal technical and social interventions for improved planning and operation of waste management facilities are planned at the target waste management facilities	Plan																
4.6 4-5 is implemented	Plan																
4.7 Capacity Assessment (post-test) for CMC and other relevant organizations is conducted	Plan																
4.8 4-7 is monitored and its results and knowledge are reflected in the draft MP	Plan																
Output 5																	
5.1 Meetings for the expansion of the MP are organized for LAs in Western Province and other relevant organizations (including central government organizations) are held	Plan																
5.2 The staff of WMA and other relevant organizations enhance their knowledge and skills for supporting LAs and other organizations in their formulation and implementation of the MP, its sub-plans and other related plans (e.g. LA action plans, plans on waste management facilities) through trainings and JTT	Plan																
5.3 Support and guidance for the formulation of sub-plans and other related plans (e.g. LA action plans, plans on waste management facilities) in line with MP are given to LAs and other relevant organizations	Plan																
5.4 A system is established for the implementation of sub-plans and other related plans (e.g. LA action plans, plans on waste management facilities) in line with MP is established and documented	Plan																
5.5 Budget plans for the implementation of the MP and a guidance for budget plan formulation to implement LAs action plans are developed	Plan																
Duration / Phasing																	
Monitoring Plan																	
Monitoring																	
Joint Coordinating Committee	Plan																
Setup the Detailed Plan of Operation	Plan																
Submission of Monitoring Staff	Plan																
Monitoring Mission from Japan	Plan																
Joint Monitoring	Plan																
Post-Monitoring	Plan																
Reports/Documents																	
Initial Report	Plan																
Project Completion Report	Plan																
Public Relations																	

Handwritten signatures and initials at the bottom right of the page.

Implementation Structure

Annex 4

Joint Coordinating Committee (JCC)

Chair: MoPCLGS Secretary

Working Group

Formulation of MP/Implementation of Pilot Projects & Activities

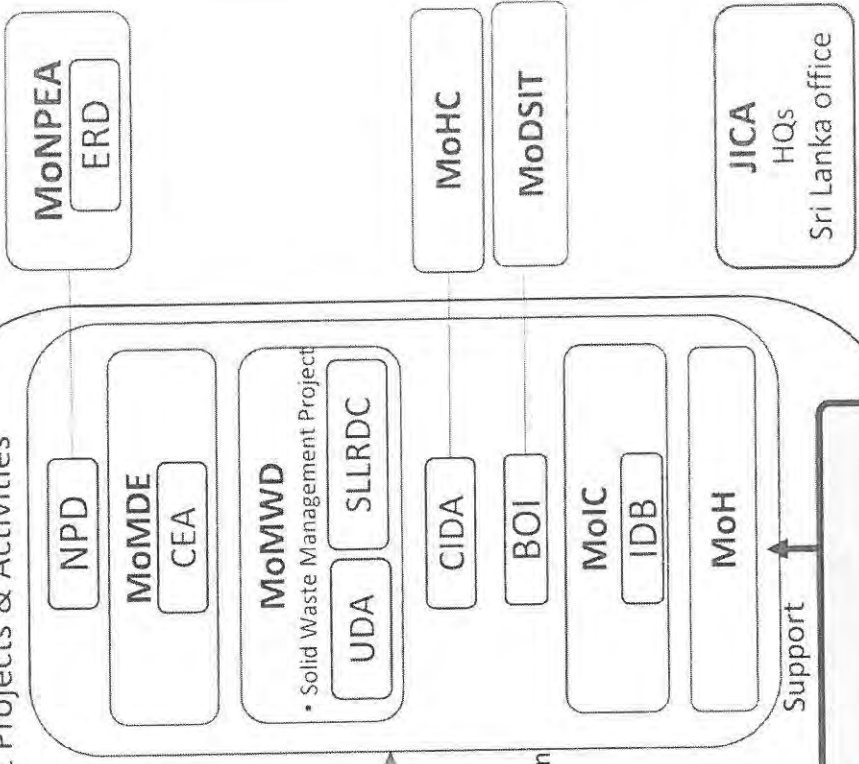
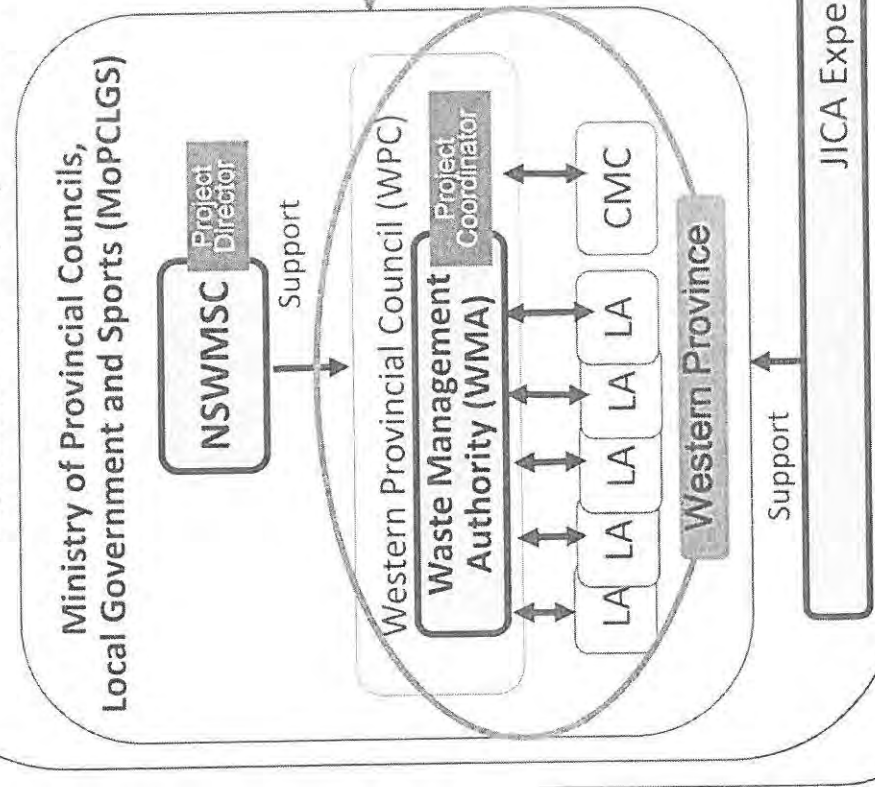

→ Indicates the main Project Team. The Project Office will be located at WMA and NSWMSC.

Handwritten notes and signatures at the bottom of the page.

Annex 5

List of Proposed Members of Joint Coordinating Committee for
the Project for Formulation of Western Province Solid Waste
Management Master Plan

Sri Lankan Side

- (1) **Chairperson**
Secretary, Ministry of Provincial Councils, Local Government and Sports
- (2) **Project Director**
Director, National Solid Waste Management Support Center
- (3) **Project Coordinator**
Director, Waste Management Authority
- (4) **Personnel from organizations of the Working Group**
- (5) **Other persons that the Sri Lankan side might consider necessary
(consultants, technicians, etc.)**

Japanese Side

- (1) **JICA Experts**
- (2) **Chief Representative, representatives and staff of JICA Sri Lanka
Office**
- (3) **Staff from JICA Headquarters, other domestic and foreign offices, if
necessary**
- (4) **Other persons that the Japanese side might consider necessary
(consultants, technicians, etc.)**



Project Design Matrix

Project Title: The Project for Formulation of Western Province Solid Waste Management Master Plan
Implementing Agency: National Solid Waste Management Support Center (NWSMSC), Waste Management Authority (WMA), and relevant organizations
Target Group: Western Province, and organizations relevant to waste management in Western Province
Duration: 2019.2-2022.12 (3.9 years)
Project Site: Western Province

Version 3
Dated 8th April 2021

Narrative Summary	Objectively Verifiable Indicators	Means of Verification	Important Assumption
<p>Overall Goal Appropriate solid waste management practices in accordance with Western Province Solid Waste Management Master Plan (MIP) are undertaken in Western Province.</p>	<p>1. All Local Authorities (LAs) prepare/update and implement their solid waste management action plan in line with the MP within one year after publishing the MP.</p>	<p>1. LA's Action Plans 2. Reports on waste management from LAs</p>	
<p>Project Purpose Western Province's planning capacity on solid waste management is strengthened through the formulation of Western Province Solid Waste Management Master Plan (MIP).</p>	<p>1. The final draft of the MP is prepared. 2. Western Provincial Council (WPC) and MoPCLGS start the MP approval process.</p>	<p>1. The final draft of the MP 2. The MP in the process of approval</p>	<p>1. National policies regarding waste management do not change significantly 2. Financial resources for the implementation of the MP are secured by LAs.</p>
<p>Outputs 1. Roles and responsibilities of organizations relevant to solid waste management in Western Province are clarified and institutional arrangements for the formulation of the MP are established.</p>	<p>1. Roles and responsibilities of relevant organizations are clarified and documented in the MP and/or other documents. 2. A Working Group for MP formulation is established. 3. Regular meetings are held (at least once in three months) by the Working Group for MP formulation. 4. The process and outputs of activities of the Working Group are shared at the Provincial and Central levels by holding workshops or meetings 6 times. 5. Draft Master Plan is prepared by the Working Group.</p>	<p>1. Documented list of roles and responsibilities 2. List of the Working Group members 3. Minutes of meetings of the Working Group 4. Reports of the workshops or meetings 5. Draft Master Plan</p>	<p>Counterpart (C/P) staff and other staff from relevant organizations continuously engage in the project.</p>
<p>2. Current situation, trend, potentials and challenges of solid waste management in Western Province are clarified.</p>	<p>1. Data on current situations on solid waste management in Western Province are collected. 2. A database using the collected data is created 3. An analysis report on solid waste management in Western Province is prepared.</p>	<p>1. Data on solid waste management in Western Province 2. The database 3. The analysis report on</p>	

Annex 2

<p>3. Knowledge and experience which contribute to MP formulation and implementation are acquired through the implementation of pilot projects on 3Rs. (Target areas: Colombo Municipality and other LAs)</p>	<p>1. Trainings on appropriate waste management and 3Rs for LAs and other relevant organizations are conducted three times. 2. Pilot projects are implemented at more than three LAs. 3. The results of Capacity Assessment (posttest) for WMA and target LAs improve from those of pretest. 4. Progress of Pilot Projects are monitored by WG for MP formulation.</p>	<p>solid waste in Western Province</p> <p>1. Records of trainings 2. Records of pilot project implementation 3. Reports of Capacity Assessment 4. Progress reports on pilot projects</p>	
<p>4. Knowledge and experience which contribute to MP formulation and implementation are acquired through pilot projects for improving planning/ operation of waste management facilities.</p>	<p>1. Trainings on planning/ operation of waste management facilities for relevant organizations are conducted more than three times. 2. Pilot projects are implemented at one or more than one waste management facilities. 3. The results of Capacity Assessment (posttest) for relevant organizations of target waste management facilities improve from those of pretest. 4. Progress of pilot projects are monitored by WG for MP formulation.</p>	<p>1. Records of trainings 2. Records of pilot projects implementation 3. Reports of Capacity Assessment 4. Reports on pilot projects</p>	
<p>5. Collaboration and coordination among relevant organizations in Western Province for the implementation of MP, and formulation and implementation of its related plans (e.g. LA action plans, plans on waste management facilities) are strengthened.</p>	<p>1. Meetings for the explanation of the MP are organized for LAs in Western Province and other relevant organizations (including central government organizations) are held more than three times. 2. XX staff members of WMA and other related organization are given trainings and/or OJT on supporting LAs. 3. Support and guidance for the formulation of sub-plans and other related plans (e.g. LA action plans, plans on waste management facilities) in line with the MP are given to LAs and other relevant organizations. 4. The monitoring system is documented. 5. Budget plans for the implementation of the MP and a guidance for budget plan formulation to implement LAs' action plans are prepared.</p>	<p>1. Records on the meeting for the explanation of the MP 2. Records on training and/ or OJT 3. Records on support and guidance 4. Documented monitoring system 5. Budget plans</p>	
<p>Activities</p> <p>1.1 Roles and responsibilities of relevant organizations relevant to solid waste management in Western Province are clarified by examining policies and legal documents (e.g. national laws, ordinances). 1.2 A Working Group for MP formulation is established. 1.3 Terms of Reference (TOR) of the Working Group for MP formulation are clarified. 1.4 Regular meetings and special meetings or sub-group meetings, where necessary, are held. 1.5 Draft Master Plan is prepared through discussions by the Working Group. 1.6 The process and outputs of activities of the Working Group</p>	<p>Inputs</p> <p>[Japanese side] • Experts - Waste Management - Collection and Transportation - Intermediate Treatment and Final Disposal - 3Rs/ Public Awareness - Financial / Economic Analysis/Institutional plan - Database • Provision of machinery and equipment • Trainings in Japan/Third Countries</p> <p>[Sri Lankan side] • C/P • Personnel cost and operational cost for C/P • Office space and facilities for Experts at 1. NSWMSC 2. WMA</p>	<p>Large-scale consolidation and/or restructuring of LAs do not occur.</p>	

<p>are shared with relevant organizations (including those which authorize the Master Plan) both at the Provincial and Central levels by holding workshops or meetings.</p> <p>1.7 An inter-organizational coordination body such as Provincial Solid Waste Management Committee which takes over the work of the Working Group is proposed.</p> <p>2.1 The Working Group for MP formulation decides a. types of waste, b. target year, c. areas and population.</p> <p>2.2 Organizations in Western Province relevant to solid waste management are investigated and data on solid waste management is collected.</p> <p>2.3 A database is created using existing data on Western Province's solid waste management.</p> <p>2.4 Based on the data, current situations and challenges regarding solid waste management are clarified and reported.</p> <p>3.1 Trainings on appropriate waste management and 3Rs for L.As and other relevant organizations are conducted.</p> <p>3.2 Target L.As for pilot projects are selected.</p> <p>3.3 Capacity Assessment (pretest) for WMA and target L.As is conducted.</p> <p>3.4 The pilot projects on appropriate waste management and 3Rs are planned at the target L.As.</p> <p>3.5 3.4 is implemented.</p> <p>3.6 Capacity Assessment (posttest) for WMA and target L.As is conducted.</p> <p>3.7 3.5 is monitored and its results and knowledge are reported in written form.</p> <p>4.1 Complaints/ requests made by residents, NGOs and other stakeholders with regard to waste management are studied to identify important issues.</p> <p>4.2 Target waste management facilities for pilot activities are selected.</p> <p>4.3 Trainings on planning/ operation of waste management facilities are conducted for relevant organizations.</p> <p>4.4 Capacity Assessment (pretest) for relevant organizations is conducted.</p> <p>4.5 Pilot projects for seeking optimal technical/ social interventions for improved planning and operation of waste</p>		
--	--	--

Handwritten signatures and initials at the bottom of the page.

Annex 2

<p>management facilities are planned at the target waste management facilities.</p> <p>4.6 4.5 is implemented.</p> <p>4.7 Capacity Assessment (posttest) for relevant organizations is conducted.</p> <p>4.8 4.6 is monitored and its results and knowledge are reported in written form.</p> <p>5.1 Meetings for the explanation of the MP are organized for LAs in Western Province and other relevant organizations (including central government organizations) are held.</p> <p>5.2 The staff of WMA and other relevant organizations enhance their knowledge and skills for supporting LAs and other organizations in their formulation and implementation of the MP, its sub-plans and other related plans (e.g. LA action plans, plans on waste management facilities) through trainings and OJT.</p> <p>5.3 Support and guidance for the formulation of sub-plans and other related plans (e.g. LA action plans, plans on waste management facilities) in line with MP are given to LAs and other relevant organizations.</p> <p>5.4 A system to monitor the implementation of sub-plans and other related plans (e.g. LA action plans, plans on waste management facilities) in line with MP is established and documented.</p> <p>5.5 Budget plans for the implementation of the MP and a guidance for budget plan formulation to implement LAs' action plans are prepared.</p>	<p><u>Pre-Condition</u> Staff from relevant organizations in Western Province are assigned for the project.</p>
--	---

Change of Distribution of Roles

Before

	Main Implementer	Co-implementers / Key collaborators
Activities for the Output 1	WPC / WMA	Members of WG: 1. General issues (e.g. overall planning and monitoring): MoMDE, CEA, NPD, NSWMSC 2. Municipal solid waste: MoMDE, CEA, CMC, NSWMSC, SLLRDC, SWM Project of MoMWD, UDA 3. Industrial waste: BOI, MoMDE, CEA, IDB, SLLRDC, UDA, MoIC 4. Construction and demolition (C&D) waste: MoMDE, CEA, CIDA 5. Infectious and hazardous waste: MoMDE, CEA, MoH
Activities for the Output 2	WPC / WMA	
Activities for the Output 3	WPC / WMA CMC, and target LAs	NSWMSC, MoMDE, CEA and other institutions depending on the nature of the pilot projects
Activities for the Output 4	WPC/WMA, NSWMSC, MoMDE, CEA, CMC, UDA, SLLRDC, SWM Project of MoMWD and other institutions depending on the nature of the pilot activities	
Activities for the Output 5	WPC / WMA	Members of WG and LAs in Western Province

After

	Main Implementer	Co-implementers / Key collaborators
Activities for the Output 1	WPC / WMA	Members of WG: 1. General issues (e.g. overall planning and monitoring): MoE, CEA, NPD, and NSWMSC 2. Municipal solid waste: MoE, CEA, CMC, NSWMSC, SLLRDC, SWM Project of SMOUDCCWD&CC, UDA 3. Industrial waste: BOI, MoE, CEA, IDB, SLLRDC, UDA, MoI 4. Construction and demolition (C&D) waste: MoE, CEA, CIDA 5. Infectious and hazardous waste: MoE, CEA, MoH
Activities for the Output 2	WPC / WMA	
Activities for the Output 3	WPC / WMA CMC, and target LAs	NSWMSC, MoE, CEA and other institutions depending on the nature of the pilot projects
Activities for the Output 4	WPC/WMA, NSWMSC, MoE, CEA, CMC, UDA, SLLRDC, SWM Project of SMOUDCCWD&CC and other institutions depending on the nature of the pilot activities	
Activities for the Output 5	WPC / WMA	Members of WG and LAs in Western Province

Change of Implementation Structure

Before

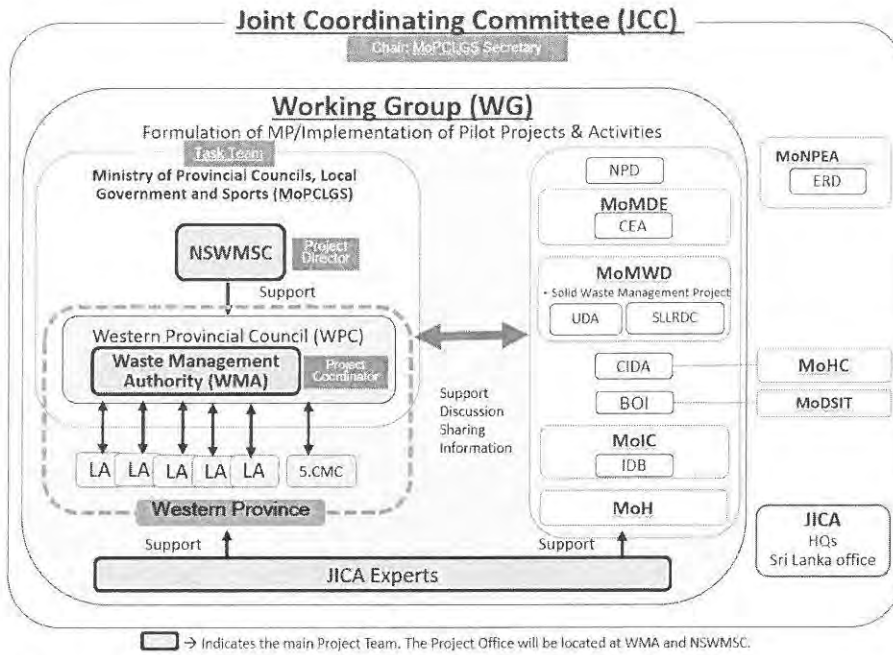

After

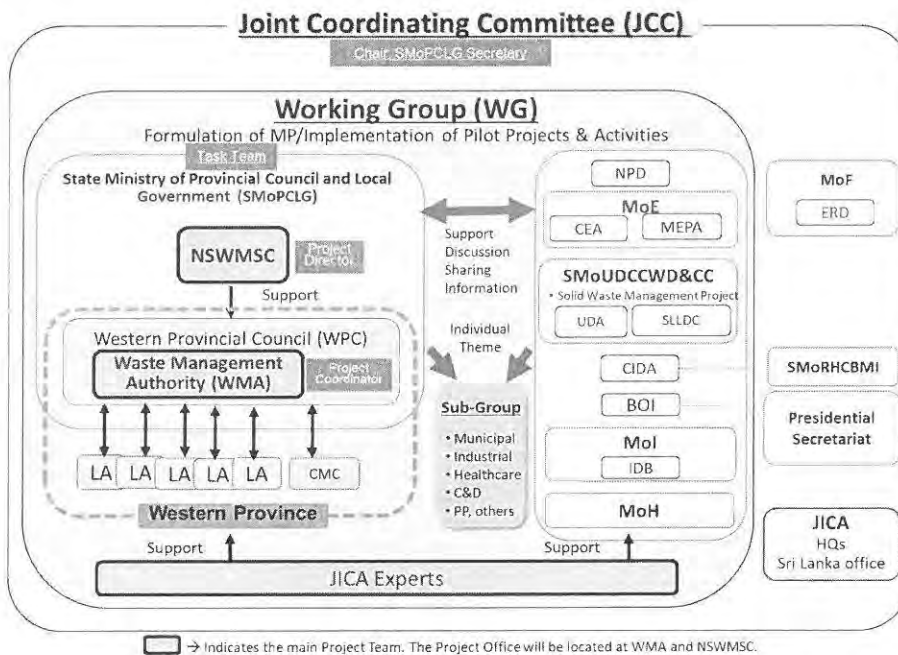

[Handwritten signatures and initials]

Comparison of PDM

Narrative Summary (Before Revising)	Narrative Summary (After Revising)	Reason	Objectively Verifiable Indicators (Before Revising)	Objectively Verifiable Indicators (After Revising)	Reason	Means of Verification (Before Revising)	Means of Verification (After Revising)	Reason	Important Assumption
<p><u>Overall Goal</u> Appropriate solid waste management practices in accordance with Western Province Solid Waste Management Master Plan (MP) are undertaken in Western Province.</p>			<p>1. X % of Local Authorities implement appropriate solid waste management in accordance with the MP. 2. More than X good practices on 3Rs (Reduce, Reuse and Recycle) and/or appropriate waste disposal are confirmed in a year as a result of the implementation of the MP.</p>	<p>1. All Local Authorities (LAs) prepare/update and implement their solid waste management action plan in line with the MP within one year after publishing the MP.</p>	<p>1. To implement appropriate solid waste management means to prepare / update their solid waste management action plan in line with the MP, so it was revised (in order to be mentioned in detail). To respond to C/P's request, the number of local authority is changed from X% to "all", but to add "within one year after publishing the MP". 2. It was deleted because good practices on 3Rs are just</p>	<p>1. Reports on waste management from LAs 2. Reports on good practices from LAs and other relevant institutions</p>	<p>1. LA's Action Plans 2. Reports on waste management from LAs</p>	<p>1. LA's Action Plans which prepared/updated regularly are to be the document to check the indicator. 2. It was deleted because good practices from LAs and other relevant are just one part of solid waste management activities and it doesn't fit this indicator.</p>	

Attachment 3

				<p>one part of solid waste management activities and it doesn't fit this indicator.</p>		<p>1. The final draft of the MP is prepared. 2. Western Provincial Council (WPC) and MoPCLGS start the MP approval process.</p>		<p>1. Roles and responsibilities of relevant organizations are clarified and documented in the MP and/or other documents. 2. A Working Group for MP formulation is established.</p>	<p>Project Purpose Western Province's planning capacity on solid waste management is strengthened through the formulation of Western Province Solid Waste Management Master Plan (MP). Outputs 1. Roles and responsibilities of organizations relevant to solid waste management in Western Province are clarified and institutional arrangement</p>
<p>1. National policies regarding waste management do not change significantly. 2. Financial resources for the implementation of the MP are secured by LAs.</p>			<p>1. The final draft of the MP 2. The MP in the process of approval</p>					<p>1. Documented list of roles and responsibilities 2. List of the Working Group members 3. Minutes of meetings of</p>	<p>Counterpart (C/P) staff and other staff from relevant organizations continuously engage in the project.</p>

Attachment 3

<p>s for the formulation of the MP are established.</p>			<p>3.Regular meetings are held (at least once in three months) by the Working Group for MP formulation.</p> <p>4.The process and outputs of activities of the Working Group are shared at the Provincial and Central levels by holding workshops or meetings 6 times.</p> <p>5.Draft Master Plan is prepared by the Working Group.</p>			<p>the Working Group</p> <p>4. Reports of the workshops or meetings</p> <p>5. Draft Master Plan</p>			
<p>2. Current situations and challenges of solid waste management in Western Province are clarified.</p>	<p>2. Current situations, potentials and challenges of solid waste management in Western Province are clarified.</p>	<p>2. In order to explain in detail about "situation", the word "trend" and "potentials" are added.</p>	<p>1. Data on current situations on solid waste management in Western Province are collected.</p> <p>2. A database using the existing data is created</p> <p>3. An analysis report on</p>	<p>1. Data on current situations on solid waste management in Western Province are collected.</p> <p>2. A database using the collected data is created</p> <p>3. An analysis report on</p>	<p>2. Data is not existing but to be collected.</p>	<p>1. Data on solid waste management in Western Province</p> <p>2. The database</p> <p>3. The analysis report on solid waste in Western Province</p>			

Attachment 3

<p>experience which contribute to MP formulation and implementation on are acquired through pilot projects for improving planning/operation of waste management facilities.</p>		<p>operation of waste management facilities for CMC and other relevant organizations are conducted X times. 2. Pilot projects are implemented at X waste management facilities. 3. The results of Capacity Assessment (posttest) for CMC and other relevant organizations of target waste management facilities improve from those of pretest. 4. Reports on pilot projects are prepared.</p>	<p>nings on planning/operation of waste management facilities for relevant organizations are conducted more than three times. 2. Pilot projects are implemented at one or more waste management facilities. 3. The results of Capacity Assessment (posttest) for relevant organizations of target waste management facilities improve from those of pretest. 4. Progress of pilot projects are monitored by WG for MP</p>	<p>training are conducted at first seminar in Sri Lanka in 2019, first seminar in Japan in 2020, and second seminar in Sri Lanka in 2021. 2. In Kalutara pilot project site, two waste management facilities (compost plant and transfer station) are planned to be developed / rehabilitated, so it should mention "one or more than one". 3. Delete CMC. 4. "Report" is the document which to confirm the indicator, therefore it was changed to "progress."</p>	<p>trainings Records of pilot projects implementation on results of Capacity Assessment Report on pilot projects</p>	<p>orts of Capacity Assessment</p>	<p>from "result" to "reports" since the result of capacity development are to be reported in the "reports".</p>	
---	--	--	--	---	--	------------------------------------	---	--

Attachment 3

<p>5. Collaboration and coordination among relevant organizations in Western Province for the implementation of MP, and formulation and implementation of its related plans (e.g. LA action plans, plans on waste management facilities) are strengthened</p>		<p>1. Meetings for the explanation of the MP are organized for LAs in Western Province and other relevant organizations (including central government organizations) are held 2 times.</p> <p>2. 21 staff members of WMA and other related organization are given trainings and/or OJT on supporting LAs.</p> <p>3. Support and guidance for the formulation of sub-plans and other related plans (e.g. LA action plans,</p>	<p><u>formulation.</u></p> <p>1. Meetings for the explanation of the MP are organized for LAs in Western Province and other relevant organizations (including central government organizations) are held <u>more than three</u> times.</p> <p>2. <u>XX</u> staff members of WMA and other related organization are given trainings and/or OJT on supporting LAs.</p> <p>3. Support and guidance for the formulation of sub-plans and other related plans (e.g. LA action plans, waste</p>	<p>1. Meeting will be held in three district (Gampaha, Colombo and Kalutara). The number of people are easily to be changed and it is difficult to fix at the moment.</p> <p>3. It was initially planned to conduct the seminar once in each zones (7 zones), however, there is a possibility of increasing the number of seminar, so at the moment it cannot be fixed.</p>	<p>1. Records on the meeting for the explanation of the MP</p> <p>2. Records on training and / or OJT</p> <p>3. Records on support and guidance</p> <p>4. Documented monitoring system</p> <p>5. Budget plans</p>			
---	--	--	---	---	---	--	--	--

Handwritten marks and signatures at the bottom of the page.

Attachment 3

Activities (Before Revising)	Activities (After Revising)	Reason	Inputs (Before Revising)	Inputs (After Revising)	Reason	Inputs (Before Revising)	Inputs (After Revising)	Reason
4.3 Trainings on planning/operation of waste management facilities are	4.3 Trainings on planning/operation of waste management facilities are	Delete CMC since "relevant organizations" include CMC as well.	[Japanese side] - Experts - Waste Management - Collection and Transportation	[Japanese side] - Experts - Waste Management - Collection and	The Pilot Project has been agreed between Japanese side and Sri Lankan	[Sri Lankan side] - C/P - Personnel cost and operational cost for C/P - Office space	[Sri Lankan side] - C/P - Personnel cost and operational cost for C/P - Office space	Large-scale consolidation and/or restructuring of LAs do not occur.
management facilities) in line with the MP are given to LAs and other relevant organizations. The monitoring system is documented.	plans on waste management facilities) in line with the MP are given to LAs and other relevant organizations. The monitoring system is documented.							
4. The monitoring system is documented.	4. The monitoring system is documented.							
5. Budget plans for the implementation of the MP and a guidance for budget plan formulation to implement LAs' action plans are prepared.	5. Budget plans for the implementation of the MP and a guidance for budget plan formulation to implement LAs' action plans are prepared.							

Attachment 3

<p>conducted for CMC and other relevant organizations. 4.4 Capacity Assessment (pretest) for CMC and other relevant organizations is conducted. 4.7 Capacity Assessment (posttest) for CMC and other relevant organizations is conducted.</p>	<p>conducted for relevant organizations. 4.4 Capacity Assessment (pretest) for relevant organizations is conducted. 4.7 Capacity Assessment (posttest) for relevant organizations is conducted.</p>	<p>n - Intermediate Treatment and Final Disposal - 3Rs/ Public Awareness - Financial / Economic Analysis/Institutional plan - Database • Provision of machinery and equipment • Trainings in Japan/Third Countries</p>	<p>Transportation - Intermediate Treatment and Final Disposal - 3Rs/ Public Awareness - Financial / Economic Analysis/Institutional plan - Database • Provision of machinery and equipment - Equipment of 3Rs at high-rise apartment and/or low-income housing - Small scale solid waste transfer station in Kalutara composting facility - Forced aeration system in existing Kalutara composting facility • Trainings in</p>	<p>side at JCC on 18th June 2020.</p>	<p>and facilities for Experts 1. NS 2. WM</p>	<p>and facilities for Experts at 1. NSWMSC 2. WMA</p>	<p><u>Pre-Condition</u> Staff from relevant organizations in Western Province are assigned for the project.</p>
---	---	--	--	--	---	---	---

Attachment 3

Japan/Third Countries										

~~Handwritten signature~~ Handwritten signature

Abbreviations

BOI	Board of Investment
CEA	Central Environmental Authority
C&D waste	Construction Demolition Waste
CIDA	Construction Industry Development Authority
CMC	Colombo Municipal Council
ERD	External Resource Department
IDB	Industrial Development Board
JCC	Joint Coordinating Committee
JICA	Japan International Cooperation Agency
LA	Local Authority
MEPA	Marine Environmental Protection Authority
MoE	Ministry of Environment
MoF	Ministry of Finance
MoI	Ministry of Industries
MoH	Ministry of Health
NPD	Department of National Planning
NSWMSC	National Solid Waste Management Support Centre
SMoPCLG	State Ministry of Provincial Councils and Local Government
SMoRHCBMI	State Ministry of Rural Housing and Construction & Building Material Industries
SMoUDCCWD&CC	State Ministry of Urban Development, Coast Conservation, Waste Disposal and Community Cleanliness
SLLDC	Sri Lankan Land Development Cooperation
WMA	Waste Management Authority
WPC	Western Provincial Council



MINUTES OF MEETINGS
BETWEEN
AUTHORITIES CONCERNED OF DEMOCRATIC SOCIALIST REPUBLIC OF SRI LANKA
AND
JAPAN INTERNATIONAL COOPERATION AGENCY
FOR AMENDMENT OF THE RECORD OF DISCUSSIONS
ON
THE PROJECT FOR FORMULATION OF WESTERN PROVINCE SOLID WASTE
MANAGEMENT MASTER PLAN

The Japan International Cooperation Agency (hereinafter referred to as "JICA"), Ministry of Public Administration, Home Affairs, Provincial Councils and Local Government, Western Provincial Council, and the Department of External Resources, Ministry of Finance Economic Stabilization and National Policies hereby agree that the Record of Discussions on The Project for Formulation of Western Province Solid Waste Management Master Plan signed on 12th December 2018 thereafter amended on 8th April 2021 shall be amended as below;

1. Duration

Before	Amended Version
Duration: 2019.2-2022.12 (3 years and 10 months)	Duration: 2019.2-2023.6 (4 years and 3 months)
Reason: Because of the global spread of the coronavirus disease 2019 (COVID-19), some of the project activities have been suspended. In addition, Sri Lankan Government took a Cabinet Decision to cancel the construction of Waste to Energy facility in Karadiyana Resource Management Centre, which is a core waste management facility in Solid Waste Management Master Plan, thus the draft Master Plan must be modified with consensus among counterpart and relevant organizations. In order to achieve the project purpose after the project team resume the activities, project duration needs to be extended.	

2. Amendment of each Output, Activity, and Objectively Verifiable Indicators

While implementing the activities in the field, the activities were revised based on the progress made. These changes to the PDM were basically agreed in the 3rdJCC meeting



and were to be finalized after the confirmation by JICA. The latest PDM (ver.4) reflecting these changes is confirmed by both sides as Annex 4.

3. Amendment on name change of State Ministry of Provincial Councils and Local Government Affairs after the 3rd JCC meeting.

Before	After
State Ministry of Provincial Councils and Local Government Affairs (SMOPCLGA)	Ministry of Public Administration, Home Affairs, Provincial Councils and Local Government (MoPAHAPCLG)



Colombo, 20th September 2022



Tetsuya YAMADA
Chief Representative
JICA Sri Lanka Office

2

M.M.P.K. Mayadunne
Secretary
Ministry of Public Administration,
Home Affairs, Provincial Councils
and Local Government

M.M.P.K. Mayadunne
Secretary
Ministry of Public Administration, Home
Provincial Councils & Local Government
No. 330, Union Place, Colombo 02



J.M.C. Jayanthi Wijethunga
Chief Secretary
Western Provincial Council



Ajith Abeysekera
Director General
Department of External Resources
Ministry of Finance
The Secretariat
Colombo 04 - Sri Lanka
Ministry of Finance, Economic
Stabilization and National Policies

D.A.P. Abeysekera

Director General
Department of External Resources
Ministry of Finance
The Secretariat
Colombo 04 - Sri Lanka

Annex 1: Record of Discussions (signed on 12th December 2018)

Annex 2: Minutes of Meetings (signed on 8th April 2021)

Annex 3: Minutes of Meeting of The Third Joint Coordinating Committee (signed on 21st April 2022)

Annex 4: Amended Project Design Matrix ver.4

RECORD OF DISCUSSIONS

FOR

**THE PROJECT FOR FORMULATION OF WESTERN PROVINCE
SOLID WASTE MANAGEMENT MASTER PLAN**

AGREED UPON BETWEEN

AUTHORITIES CONCERNED

OF

DEMOCRATIC SOCIALIST REPUBLIC OF SRI LANKA

AND

JAPAN INTERNATIONAL COOPERATION AGENCY

Dated 12th December 2018

Handwritten initials and marks in blue ink, including a signature and the number 2.

Based on the Minutes of Meetings (M/M) of the Detailed Planning Survey for the Project for Formulation of Western Province Solid Waste Management Master Plan (hereinafter referred to as "the Project") signed on May 18, 2018 between Ministry of Provincial Councils, Local Government and Sports (hereinafter referred to as "MoPCLGS"), Western Provincial Council (hereinafter referred to as "WPC") and the Department of External Resources, Ministry of National Policies and Economic Affairs (hereinafter referred to as "ERD") of the Democratic Socialist Republic of Sri Lanka (hereinafter referred to as "The Counterpart") and the Japan International Cooperation Agency (hereinafter referred to as "JICA"), JICA held a series of discussions with the MoPCLGS, WPC, ERD and other authorities concerned to develop a detailed plan of the Project.

The purpose of this Record of Discussions (hereinafter referred to as "the R/D") is to establish a mutual agreement for implementation by both parties and to agree on the detailed plan of the Project as described in the followings and the Annexes, which will be implemented within the framework of the Agreement on Technical Cooperation signed on October 12, 2005 (hereinafter referred to as "the Agreement") and the Note Verbals exchanged on August 17, 2018 between the Government of Japan and the Government of the Democratic Socialist Republic of Sri Lanka.

The Counterpart will be responsible for the implementation of the Project in cooperation with JICA, to coordinate with other relevant organizations and ensure that the self-reliant operation of the Project is sustained during and after the implementation period in order to contribute toward social and economic development of the Democratic Socialist Republic of Sri Lanka.

Both parties also agreed that the Project will be implemented in accordance with the "Basic Principles for Technical Cooperation" published in December 2016 (hereinafter referred to as "the BP"), unless other arrangements are agreed upon in the R/D.

The R/D is delivered at Colombo as of the day and year first above written. The R/D may be amended by a Minutes of Meetings between both parties, except the plan of operation to be modified in monitoring sheets. The minutes of meetings will be signed by authorized persons of each side.





For

Japan International
Cooperation Agency

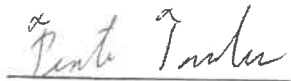

Mr. Fusato TANAKA
Chief Representative
JICA Sri Lanka Office

For

Ministry of Provincial Councils, Local
Government and Sports

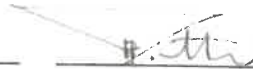

Mr. H. T. Kamal Pathmasiri
Secretary

For

Western Provincial Council



Mr. Pradeep Yasaratne
Chief Secretary

Pradeep Yasaratne
Chief Secretary - Western Province

For

Department of External Resources
Ministry of National Policies and
Economic Affairs

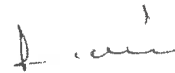

Mr. R.M.P. Rathnayake
Director General

- Annex 1: Main Points Discussed
- Annex 2: Project Design Matrix (PDM)
- Annex 3: Plan of Operation (PO)
- Annex 4: Implementation Structure
- Annex 5: List of Proposed Members of Joint Coordinating Committee



Main Points Discussed

1. Distribution of Roles

The roles of organizations of the Working Group are as follows along with activities for the Project Outputs:

	Main Implementer	Co-implementers / Key collaborators
Activities for the Output 1	WPC / WMA	Members of Working Group: 1. General issues (e.g. overall planning and monitoring): MoMDE, CEA, NPD, NSWMSC 2. Municipal solid waste: MoMDE, CEA, CMC, NSWMSC, SLLRDC, SWM Project of MoMWD, UDA 3. Industrial waste: BOI, MoMDE, CEA, IDB, SLLRDC, UDA, MoIC 4. Construction and demolition (C&D) waste: MoMDE, CEA, CIDA 5. Infectious and hazardous waste: MoMDE, CEA, MoH
Activities for the Output 2	WPC / WMA	
Activities for the Output 3	WPC / WMA CMC, and target LAs	NSWMSC, MoMDE, CEA and other institutions depending on the nature of the pilot projects
Activities for the Output 4	WPC/WMA, NSWMSC, MoMDE, CEA, CMC, UDA, SLLRDC, SWM Project of MoMWD and other institutions depending on the nature of the pilot activities	
Activities for the Output 5	WPC / WMA	Members of Working Group and LAs in Western Province

2. TOR for Environmental and Social Considerations

Since the Project is classified as a "Category B" under the "JICA Guideline for Environmental and Social Considerations (April 2010)" (hereinafter referred to as "JICA Guidelines"), both sides agreed that the Project should include a Terms of Reference (TOR) for Environmental and Social Considerations including Strategic Environmental Assessment (SEA) in line with the JICA Guidelines as outlined below;

- (1) Review of existing development policies, plans, projects, studies, and public private investment;
- (2) Identification and analysis of development constrains and factors promoting development;
- (3) Analysis of alternatives for achieving the goals of the Project;
- (4) Consideration of the contents of the Master Plan;
- (5) Conducting baseline surveys for Environmental and Social

Handwritten marks: a checkmark, a signature, and the initials "Z. M."

Considerations, including;

- 1) Laws, regulations, and standards related to environmental and social considerations (environmental impact assessment, resettlement, public participation, information disclosure, and others);
- 2) SEA study reports conducted in Sri Lanka development projects, and other relevant information;
- 3) Gaps between the JICA Guidelines and the legal framework of the Sri Lanka on environmental and social considerations;
- 4) Review of relevant organizations responsible for implementation of projects and their roles on environmental and social considerations including Environmental Impact Assessment (EIA) and SEA;
- (6) Scoping on possible environmental and social impacts and its evaluation methods at the time of decision-making of the projects proposed by the Master Plan;
- (7) Prediction of likely impacts of the proposed projects under the Master Plan based on the scoping;
- (8) Evaluation of likely impacts of the plans and comparative analysis of alternative proposed plans, including the 'without project' option;
- (9) Examination of the mitigation measures (to be avoided, minimized, and compensated);
- (10) Examination of the monitoring methods (monitoring items, frequencies, and methods);
- (11) Support to hold stakeholder meetings;
- (12) Provisional scoping for prioritized projects; and
- (13) Perform other duties deemed necessary.

Both sides also agreed that no pilot projects and/or activities classified as "Category A" under the JICA Guidelines will be conducted in the Project.

3. Contribution to Climate Change Mitigation

Both parties acknowledged that enhancement of proper waste management in line with the M/P can possibly contribute to climate change mitigation.

2

f

Q

?

Annex 2

Project Design Matrix

Project Title: The Project for Formulation of Western Province Solid Waste Management Master Plan
Implementing Agency: National Solid Waste Management Support Center (NWSMSC), Waste Management Authority (WMA), and relevant organizations
Target Group: Western Province, and organizations relevant to waste management in Western Province
Duration: 2019.3–2022.2 (3 years)
Project Site: Western Province

		Ver:0.0	
Narrative Summary	Objectively Verifiable Indicators	Means of Verification	Important Assumption
<p>Overall Goal Appropriate solid waste management practices in accordance with Western Province Solid Waste Management Master Plan (MP) are undertaken in Western Province.</p>	<p>1. X % of Local Authorities (LAs) implement appropriate solid waste management in accordance with the MP. 2. More than X good practices on 3Rs (Reduce, Reuse and Recycle) and/or appropriate waste disposal are confirmed in a year as a result of the implementation of the MP.</p>	<p>1. Reports on waste management from LAs 2. Reports on good practices from LAs and other relevant institutions</p>	<p>1. National policies regarding waste management do not change significantly 2. Financial resources for the implementation of the MP are secured by LAs.</p>
<p>Project Purpose Western Province's planning capacity on solid waste management is strengthened through the formulation of Western Province Solid Waste Management Master Plan (MP).</p>	<p>1. The final draft of the MP is prepared. 2. Western Provincial Council (WPC) and MoPCLGS start the MP approval process.</p>	<p>1. The final draft of the MP 2. The MP in the process of approval</p>	
<p>Outputs 1. Roles and responsibilities of organizations relevant to solid waste management in Western Province are clarified and institutional arrangements for the formulation of the MP are established.</p>	<p>1. Roles and responsibilities of relevant organizations are clarified and documented in the MP and/or other documents. 2. A Working Group for MP formulation is established. 3. Regular meetings are held (at least once in three months) by the Working Group for MP formulation. 4. The process and outputs of activities of the Working Group are shared at the Provincial and Central levels by holding workshops or meetings X times. 5. Draft Master Plan is prepared by the Working Group.</p>	<p>1. Documented list of roles and responsibilities 2. List of the Working Group members 3. Minutes of meetings of the Working Group 4. Reports of the workshops or meetings 5. Draft Master Plan</p>	

9

Handwritten signatures and initials: *ms*, *me*, *M*

<p>2. Current situations and challenges of solid waste management in Western Province are clarified.</p>	<p>1. Data on current situations on solid waste management in Western Province are collected. 2. A database using the existing data is created 3. An analysis report on solid waste management in Western Province is prepared.</p>	<p>1. Data on solid waste management in Western Province 2. The database 3. The analysis report</p>	
<p>3. Knowledge and experience which contribute to MP formulation are acquired through the implementation of pilot projects on appropriate waste management and 3Rs. (Target areas: Colombo Municipality and other LAs)</p>	<p>1. Trainings on appropriate waste management and 3Rs for LAs and other relevant organizations are conducted X times. 2. Pilot projects are implemented at X LAs. 3. The results of Capacity Assessment (posttest) for WMA and target LAs improve from those of pretest. 4. Reports on pilot projects are prepared.</p>	<p>1. Records of trainings 2. Records of pilot project implementation 3. The results of Capacity Assessment 4. Reports on pilot projects</p>	
<p>4. Knowledge and experience which contribute to MP formulation are acquired through pilot activities for improving planning/ operation of waste management facilities.</p>	<p>1. Trainings on planning/ operation of waste management facilities for CMC and other relevant organizations are conducted X times. 2. Pilot activities are implemented at X waste management facilities. 3. The results of Capacity Assessment (posttest) for CMC and other relevant organizations of target waste management facilities improve from those of pretest. 4. Reports on pilot activities are prepared.</p>	<p>1. Records of trainings 2. Records of pilot activities 3. The results of Capacity Assessment 4. Reports on pilot activities</p>	
<p>5. Collaboration and coordination among relevant organizations in Western Province for the formulation and implementation of the MP, its sub-plans and other related plans (e.g. LA action plans, plans on waste management facilities) are strengthened.</p>	<p>1. Meetings for the explanation of the MP are organized for LAs in Western Province and other relevant organizations (including central government organizations) are held X times. 2. XX staff members of WMA and other related organization are given trainings and/or OJT on supporting LAs. 3. Support and guidance for the formulation of sub-plans and other related plans (e.g. LA action plans, plans on waste management facilities) in line with the MP are given to LAs and other relevant organizations X times. 4. The monitoring system is documented. 5. Budget plans for the implementation of the MP and a guidance for budget plan formulation to implement LAs' action plans are prepared.</p>	<p>1. Records on the meeting for the explanation of the MP 2. Records on training and/ or OJT 3. Records on support and guidance 4. Documented monitoring system 5. Budget plans</p>	
<p>Activities 1.1 Roles and responsibilities of relevant organizations relevant to solid waste management in Western Province are clarified by examining policies and legal documents (e.g. national laws, ordinances). 1.2 A Working Group for MP formulation is established. 1.3 Terms of Reference (TOR) of the Working Group for MP formulation are clarified. 1.4 Regular meetings and special meetings or sub-group meetings, where necessary, are held. 1.5 Draft Master Plan based on the knowledge gained through activities for Output 2-5 is prepared through discussions by</p>	<p>Inputs [Japanese side] • Experts - Waste Management - Collection and Transportation - Intermediate Treatment and Final Disposal - 3Rs/ Public Awareness - Environmental and Social Considerations - Financial / Economic Analysis/Institutional plan - Data base - Project Coordination/ Training • Provision of machinery and equipment</p> <p>[Sri Lankan side] • C/P • Personnel cost and operational cost for C/P • Office space and facilities for Experts 1. NSW/ MSC 2. WMA</p>	<p>Large-scale consolidation and/or restructuring of LAs do not occur.</p>	

Handwritten signatures and initials: R, Z, 1/3, and other marks.

<p>the Working Group.</p> <p>1.6 The process and outputs of activities of the Working Group are shared with relevant organizations (including those which authorize the Master Plan) both at the Provincial and Central levels by holding workshops or meetings.</p> <p>1.7 An inter-organizational coordination body such as Provincial Solid Waste Management Committee which takes over the work of the Working Group is proposed.</p> <p>2.1 The Working Group for MP formulation decides a. types of waste, b. target year, c. areas and population.</p> <p>2.2 Organizations in Western Province relevant to solid waste management are investigated and data on solid waste management is collected.</p> <p>2.3 A database is created using existing data on Western Province's solid waste management.</p> <p>2.4 Based on the data, current situations and challenges regarding solid waste management are clarified and reported.</p> <p>3.1 Trainings on appropriate waste management and 3Rs for LAs and other relevant organizations are conducted.</p> <p>3.2 Target LAs for pilot projects are selected.</p> <p>3.3 Capacity Assessment (pretest) for WMA and target LAs is conducted.</p> <p>3.4 The pilot projects on appropriate waste management and 3Rs are planned at the target LAs (The pilot projects may include a study to collect good practices of various LAs).</p> <p>3.5 3.4 is implemented.</p> <p>3.6 Capacity Assessment (posttest) for WMA and target LAs is conducted.</p> <p>3.7 3.5 is monitored and its results and knowledge are reflected in the draft MP.</p> <p>4.1 Complaints/ requests made by residents, NGOs and other stakeholders with regard to waste management are studied to identify important issues.</p> <p>4.2 Target waste management facilities for pilot activities are selected.</p> <p>4.3 Trainings on planning/ operation of waste management facilities are conducted for CMC and other relevant organizations.</p>	<p>• Trainings in Japan/Third Countries</p>	
--	---	--

9

29

D

<p>4.4 Capacity Assessment (pretest) for CMC and other relevant organizations is conducted.</p> <p>4.5 Pilot activities for seeking optimal technical/ social interventions for improved planning and operation of waste management facilities are planned at the target waste management facilities.</p> <p>4.6 4.5 is implemented.</p> <p>4.7 Capacity Assessment (posttest) for CMC and other relevant organizations is conducted.</p> <p>4.8 4.6 is monitored and its results and knowledge are reflected in the draft MP.</p>	<p>Pre-Condition Staff from relevant organizations in Western Province are assigned for the project.</p>
<p>5.1 Meetings for the explanation of the MP are organized for LAs in Western Province and other relevant organizations (including central government organizations) are held.</p> <p>5.2 The staff of WMA and other relevant organizations enhance their knowledge and skills for supporting LAs and other organizations in their formulation and implementation of the MP, its sub-plans and other related plans (e.g. LA action plans, plans on waste management facilities) through trainings and OJT.</p> <p>5.3 Support and guidance for the formulation of sub-plans and other related plans (e.g. LA action plans, plans on waste management facilities) in line with MP are given to LAs and other relevant organizations.</p> <p>5.4 A system to monitor the implementation of sub-plans and other related plans (e.g. LA action plans, plans on waste management facilities) in line with MP is established and documented.</p> <p>5.5 Budget plans for the implementation of the MP and a guidance for budget plan formulation to implement LAs' action plans are prepared.</p>	

4

① ② ③

K

P

M

Tentative Plan of Operation

Version 0

Annex 3

Dated 14, Mar, 2018

Project Title: The Project for Formulation of Western Province Solid Waste Management Master Plan										Monitoring							
Inputs	Year	1st Year				2nd Year				3rd Year				Remarks	Monitoring		
		I	II	III	IV	I	II	III	IV	I	II	III	IV		Issue	Solution	
Expert																	
Waste Management	Plan																
Collection and Transportation	Actual																
Intermediate Treatment and Final Disposal	Plan																
3R/ Public Awareness	Actual																
Environmental and Social Considerations	Plan																
Financial / Economic Analysis/Subnational plan	Actual																
Data base	Plan																
Project Coordination/ Training	Actual																
Equipment																	
Training in Japan	Plan																
Training mentioned activity 3.1, 4.2 and 4.3	Actual																
In-country/Third country Training	Plan																
Training mentioned activity 3.1, 4.2 and 4.3	Actual																
Activities																	
Sub-Activities																	
Output 1:																	
1.1 Roles and responsibilities of relevant organizations relevant to solid waste management in Western Province are clarified by examining policies and legal documents (e.g. national laws, ordinances)	Plan																
	Actual																
1.2 A Working Group for MP formulation is established	Plan																
	Actual																
1.3 Terms of Reference (TOR) of the Working Group for MP formulation are clarified	Plan																
	Actual																
1.4 Regular meetings and special meetings or sub-group meetings, where necessary, are held	Plan																
	Actual																
1.5 Draft Master Plan based on the knowledge gained through activities for Output 1.5 is prepared through discussions by the Working Group	Plan																
	Actual																
1.6 The process and outputs of activities of the Working Group are shared with relevant organizations (including those which authorize the Master Plan) both at the Provincial and Central levels by holding workshops or meetings	Plan																
	Actual																
1.7 An inter-organizational coordination body such as Provincial Solid Waste Management Committee which takes over the work of the Working Group is proposed	Plan																
	Actual																
Output 2:																	
2.1 The Working Group for MP formulation decides a types of waste, its target year, area and population	Plan																
	Actual																
2.2 Organizations in Western Province relevant to solid waste management are investigated and data on solid waste management is collected	Plan																
	Actual																
2.3 A database is created using existing data on Western Province's solid waste management	Plan																
	Actual																
2.4 Based on the data, current situations and challenges regarding solid waste management are clarified and reported	Plan																
	Actual																
Output 3:																	
3.1 Trainings on appropriate waste management and 3Rs for LAs and other relevant organizations are conducted	Plan																
	Actual																
3.2 Target LAs for pilot projects are selected	Plan																
	Actual																
3.3 Capacity Assessment (pretest) for WMA and target LAs is conducted	Plan																
	Actual																
3.4 The pilot projects on appropriate waste management and 3Rs are planned at the target LAs (The pilot projects may include a study to collect good practices of selected LAs)	Plan																
	Actual																
3.5 3.4 is implemented	Plan																
	Actual																
3.6 Capacity Assessment (posttest) for WMA and model LAs is conducted	Plan																
	Actual																
3.7 3.5 is monitored and its results and knowledge are reflected in the draft MP	Plan																
	Actual																
Output 4:																	
4.1 Complaint requests made by residents, NGOs and other stakeholders with regard to waste management are studied to identify important issues	Plan																
	Actual																
4.2 Target waste management facilities for pilot activities are selected	Plan																
	Actual																
4.3 Trainings on planning/ operation of waste management facilities are conducted for CMC and other relevant organizations	Plan																
	Actual																
4.4 Capacity Assessment (pretest) for CMC and other relevant organizations is conducted	Plan																
	Actual																
4.5 Pilot activities for seeking optimal technical/ social interventions for improved planning and operation of waste management facilities are planned at the target waste management facilities	Plan																
	Actual																
4.6 4.5 is implemented	Plan																
	Actual																
4.7 Capacity Assessment (posttest) for CMC and other relevant organizations is conducted	Plan																
	Actual																
4.8 4.6 is monitored and its results and knowledge are reflected in the draft MP	Plan																
	Actual																
Output 5:																	
5.1 Meetings for the explanation of the MP are organized for LAs in Western Province and other relevant organizations (including central government organizations) are held	Plan																
	Actual																
5.2 The staff of WMA and other relevant organizations enhance their knowledge and skills for supporting LAs and other organizations in their formulation and implementation of the MP, its sub-plans and other related plans (e.g. LA action plans, plans on waste management facilities) through trainings and QJT	Plan																
	Actual																
5.3 Support and guidance for the formulation of sub-plans and other related plans (e.g. LA action plans, plans on waste management facilities) in line with MP are given to LAs and other relevant organizations	Plan																
	Actual																
5.4 A system to monitor the implementation of sub-plans and other related plans (e.g. LA action plans, plans on waste management facilities) in line with MP is established and documented	Plan																
	Actual																
5.5 Budget plans for the implementation of the MP and a guidance for budget plan formulation to implement LAs' action plans are prepared	Plan																
	Actual																
Duration / Phasing																	
	Plan																
	Actual																
Monitoring Plan																	
	Year																
Monitoring																	
Joint Coordinating Committee	Plan																
	Actual																
Set-up the Detailed Plan of Operation	Plan																
	Actual																
Submission of Monitoring Sheet	Plan																
	Actual																
Monitoring Mission from Japan	Plan																
	Actual																
Joint Monitoring	Plan																
	Actual																
Post Monitoring	Plan																
	Actual																
Reports/ Documents																	
Interim Report	Plan																
	Actual																
Project Completion Report	Plan																
	Actual																
Public Relations																	
	Plan																
	Actual																

Handwritten signatures and initials at the bottom right of the page.

Implementation Structure

Annex 4

Joint Coordinating Committee (JCC)

Chair : MoPCLGS Secretary

Working Group

Formulation of MP/Implementation of Pilot Projects & Activities

Ministry of Provincial Councils,
Local Government and Sports (MoPCLGS)

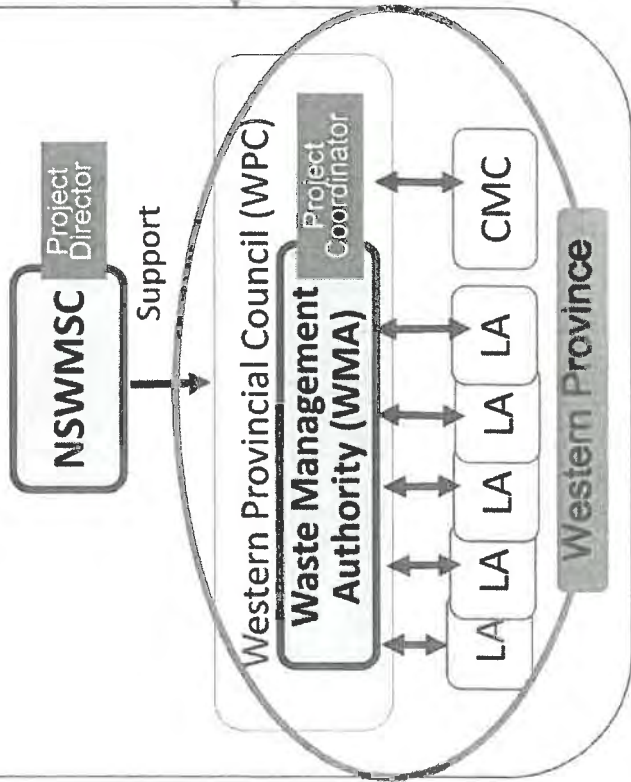

Support Discussion Sharing Information

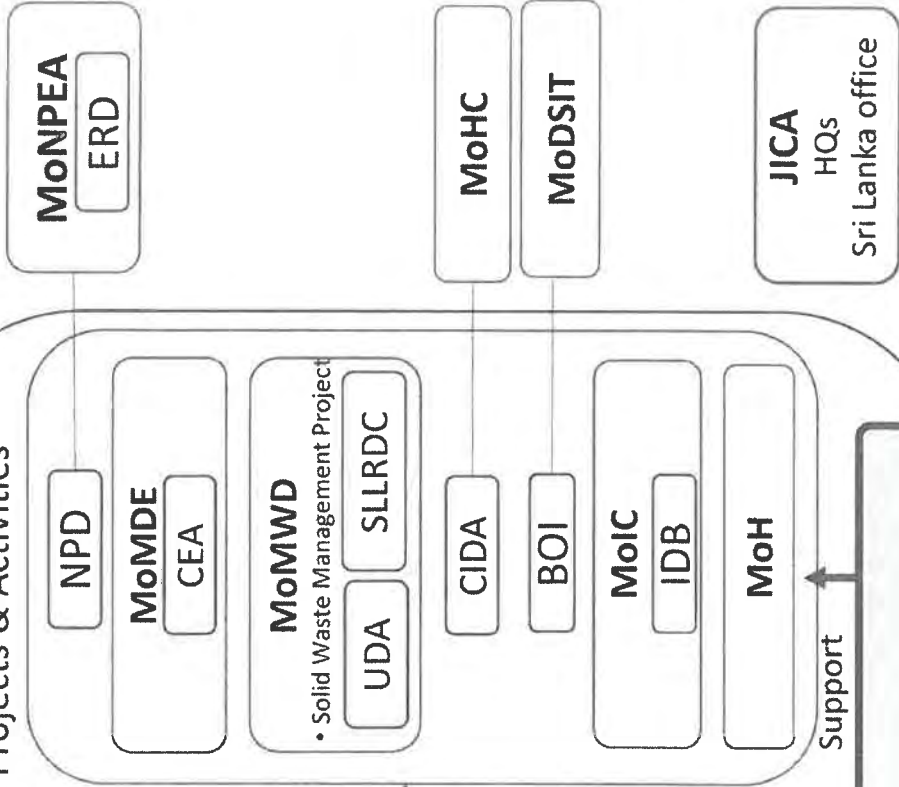

→ Indicates the main Project Team. The Project Office will be located at WMA and NSWMSC.

Handwritten notes and signatures at the bottom of the page.

Annex 5

**List of Proposed Members of Joint Coordinating Committee for
the Project for Formulation of Western Province Solid Waste
Management Master Plan**

Sri Lankan Side

(1) Chairperson

Secretary, Ministry of Provincial Councils, Local Government and Sports

(2) Project Director

Director, National Solid Waste Management Support Center

(3) Project Coordinator

Director, Waste Management Authority

(4) Personnel from organizations of the Working Group

**(5) Other persons that the Sri Lankan side might consider necessary
(consultants, technicians, etc.)**

Japanese Side

(1) JICA Experts

**(2) Chief Representative, representatives and staff of JICA Sri Lanka
Office**

**(3) Staff from JICA Headquarters, other domestic and foreign offices, if
necessary**

**(4) Other persons that the Japanese side might consider necessary
(consultants, technicians, etc.)**







**MINUTES OF MEETINGS
BETWEEN
AUTHORITIES CONCERNED OF DEMOCRATIC SOCIALIST REPUBLIC OF SRI LANKA
AND
JAPAN INTERNATIONAL COOPERATION AGENCY
FOR AMENDMENT OF THE RECORD OF DISCUSSIONS
ON
THE PROJECT FOR FORMULATION OF WESTERN PROVINCE SOLID WASTE
MANAGEMENT MASTER PLAN**

The Japan International Cooperation Agency (hereinafter referred to as "JICA"), State Ministry of Provincial Councils and Local Government, Western Provincial Council, and the Department of External Resources, Ministry of Finance hereby agree that the Record of Discussions on The Project for Formulation of Western Province Solid Waste Management Master Plan signed on 12th December, 2018 is amended as follows;

1. Distribution of Roles

In accordance with restructuring ministries and governmental organizations in Sri Lanka after the election held on August 2020, the names of counterparts of the Project have been changed from the Record of Discussions, signed on 12th December 2018 (Annex 1). Accordingly, the roles of organizations of the Working Group are as follows along with activities for the Project Outputs:

	Main Implementer	Co-implementers / Key collaborators
Activities for the Output 1	WPC / WMA	Members of WG 1. General issues (e.g. overall planning and monitoring): MoE, CEA, NPD, and NSWMSC 2. Municipal solid waste: MoE, CEA, CMC, NSWMSC, SLLDC, SWM Project of SMOUDCCWD&CC, UDA
Activities for the Output 2	WPC / WMA	3. Industrial waste: BOI, MoE, CEA, IDB, SLLDC, UDA, MoI 4. Construction and demolition (C&D) waste: MoE, CEA, CIDA 5. Infectious and hazardous waste: MoE, CEA, MoH
Activities for the Output 3	WPC / WMA CMC, and target LAs	NSWMSC, MoE, CEA and other institutions depending on the nature of the pilot projects
Activities for the Output 4	WPC/WMA, NSWMSC, MoE, CEA, CMC, UDA, SLLDC, SWM Project of SMOUDCCWD&CC and other institutions depending on the nature of the pilot activities	
Activities for the Output 5	WPC / WMA	Members of WG and LAs in Western Province

Change of Distribution of Roles is shown as Attachment 1, and Abbreviations is shown as Attachment 4.

Additionally, the implementation structure is as follows:

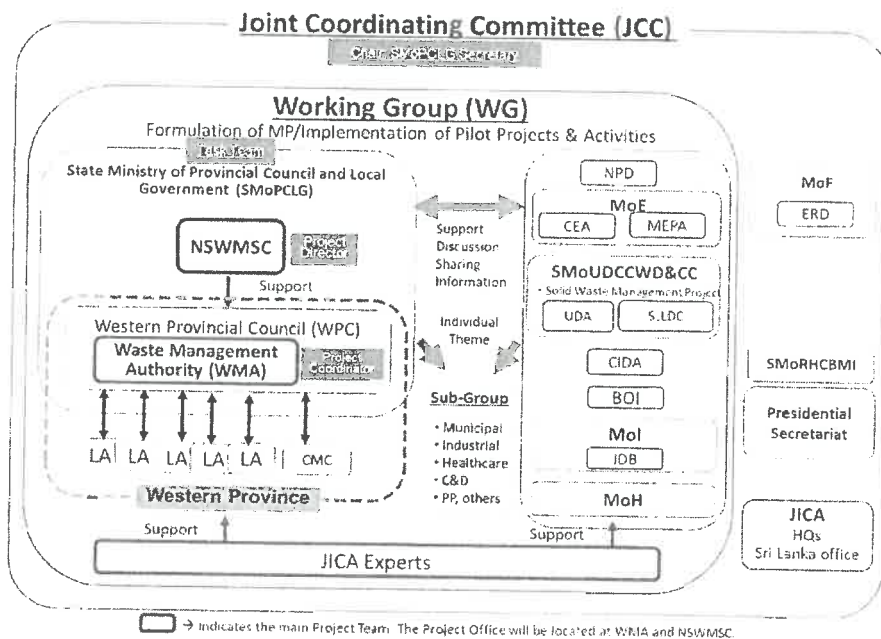

Change of Implementation Structure is shown as Attachment 2.

Handwritten signatures and initials in blue ink, including a large signature and several smaller initials.

2. Project Design Matrix (PDM) / Project Description (Annex 2)

(1) Duration

Before	Amended Version
Duration: 2019.2-2022.2 (3 years)	Duration: 2019.2-2022.12 (3 years and 10 months)
Reason: Because of the global spread of the coronavirus disease 2019 (COVID-19), some of the project activities have been suspended. In order to achieve the project purpose after the project team resume the activities, project duration needs to be extended. The duration may be further amended (shortened or extended) depending on the COVID-19 situation.	

(2) Amendment of each Output, Activity, and Objectively Verifiable Indicators

While implementing the activities in the field, the activities were revised based on the progress made. Each revision of PDM was approved through 1st and 2nd JCC meeting. The updated version of the PDM approved at 2nd JCC meeting held on 26 November 2020 is shown as Annex 2. Comparison of PDM that is explained about amendment history is shown as Attachment 3.

[Handwritten signatures and initials]

Colombo, 8th April 2021

for 高根清史

YAMADA Tetsuya
Chief Representative
JICA Sri Lanka Office

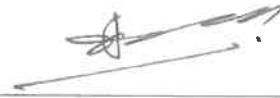

S. D. A. B. Boralessa
Secretary
State Ministry of Provincial Council
And Local Government

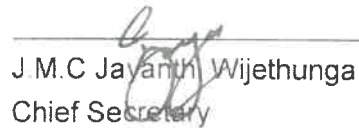

J. M. C. Jayarath Wijethunga
Chief Secretary
Western Provincial Council



Ajith Abeysekera
Director General
Department of External Resources
Ministry of Finance

- Annex 1 : Record of Discussions (signed on 12th December 2018)
- Annex 2 : Amended Project Design Matrix ver.3
- Attachment 1: Distribution of Roles
- Attachment 2: Implementation Structure
- Attachment 3: Comparison of PDM
- Attachment 4: Abbreviations



RECORD OF DISCUSSIONS
FOR
THE PROJECT FOR FORMULATION OF WESTERN PROVINCE
SOLID WASTE MANAGEMENT MASTER PLAN
AGREED UPON BETWEEN
AUTHORITIES CONCERNED
OF
DEMOCRATIC SOCIALIST REPUBLIC OF SRI LANKA
AND
JAPAN INTERNATIONAL COOPERATION AGENCY

Dated 12th December 2018

13

Handwritten signatures and initials at the bottom right of the page.

Based on the Minutes of Meetings (M/M) of the Detailed Planning Survey for the Project for Formulation of Western Province Solid Waste Management Master Plan (hereinafter referred to as "the Project") signed on May 18, 2018 between Ministry of Provincial Councils, Local Government and Sports (hereinafter referred to as "MoPCLGS"), Western Provincial Council (hereinafter referred to as "WPC") and the Department of External Resources, Ministry of National Policies and Economic Affairs (hereinafter referred to as "ERD") of the Democratic Socialist Republic of Sri Lanka (hereinafter referred to as "The Counterpart") and the Japan International Cooperation Agency (hereinafter referred to as "JICA"), JICA held a series of discussions with the MoPCLGS, WPC, ERD and other authorities concerned to develop a detailed plan of the Project.

The purpose of this Record of Discussions (hereinafter referred to as "the R/D") is to establish a mutual agreement for implementation by both parties and to agree on the detailed plan of the Project as described in the followings and the Annexes, which will be implemented within the framework of the Agreement on Technical Cooperation signed on October 12, 2005 (hereinafter referred to as "the Agreement") and the Note Verbals exchanged on August 17, 2018 between the Government of Japan and the Government of the Democratic Socialist Republic of Sri Lanka.

The Counterpart will be responsible for the implementation of the Project in cooperation with JICA, to coordinate with other relevant organizations and ensure that the self-reliant operation of the Project is sustained during and after the implementation period in order to contribute toward social and economic development of the Democratic Socialist Republic of Sri Lanka.

Both parties also agreed that the Project will be implemented in accordance with the "Basic Principles for Technical Cooperation" published in December 2016 (hereinafter referred to as "the BP"), unless other arrangements are agreed upon in the R/D.

The R/D is delivered at Colombo as of the day and year first above written. The R/D may be amended by a Minutes of Meetings between both parties, except the plan of operation to be modified in monitoring sheets. The minutes of meetings will be signed by authorized persons of each side.

f

2

2

4

4

4

4

For

Japan International
Cooperation Agency

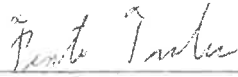

Mr. Fusato TANAKA
Chief Representative
JICA Sri Lanka Office

For

Ministry of Provincial Councils, Local
Government and Sports



Mr. H. T. Kamal Pathmasiri
Secretary

For

Western Provincial Council



Mr. Pradeep Yasaratne
Chief Secretary

Pradeep Yasaratne
Chief Secretary - Western Province

For

Department of External Resources
Ministry of National Policies and
Economic Affairs

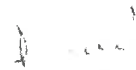

Mr. R.M.P. Rathnayake
Director General

- Annex 1: Main Points Discussed
- Annex 2: Project Design Matrix (PDM)
- Annex 3: Plan of Operation (PO)
- Annex 4: Implementation Structure
- Annex 5: List of Proposed Members of Joint Coordinating Committee

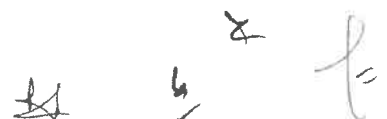

Main Points Discussed

1. Distribution of Roles

The roles of organizations of the Working Group are as follows along with activities for the Project Outputs:

	Main Implementer	Co-implementers / Key collaborators
Activities for the Output 1	WPC / WMA	Members of Working Group: 1. General issues (e.g. overall planning and monitoring): MoMDE, CEA, NPD, NSWMSC 2. Municipal solid waste: MoMDE, CEA, CMC, NSWMSC, SLLRDC, SWM Project of MoMWD, UDA 3. Industrial waste: BOI, MoMDE, CEA, IDB, SLLRDC, UDA, MoIC 4. Construction and demolition (C&D) waste: MoMDE, CEA, CIDA 5. Infectious and hazardous waste: MoMDE, CEA, MoH
Activities for the Output 2	WPC / WMA	
Activities for the Output 3	WPC / WMA CMC, and target LAs	NSWMSC, MoMDE, CEA and other institutions depending on the nature of the pilot projects
Activities for the Output 4	WPC/WMA, NSWMSC, MoMDE, CEA, CMC, UDA, SLLRDC, SWM Project of MoMWD and other institutions depending on the nature of the pilot activities	
Activities for the Output 5	WPC / WMA	Members of Working Group and LAs in Western Province

2. TOR for Environmental and Social Considerations

Since the Project is classified as a "Category B" under the "JICA Guideline for Environmental and Social Considerations (April 2010)" (hereinafter referred to as "JICA Guidelines"), both sides agreed that the Project should include a Terms of Reference (TOR) for Environmental and Social Considerations including Strategic Environmental Assessment (SEA) in line with the JICA Guidelines as outlined below;

- (1) Review of existing development policies, plans, projects, studies, and public private investment;
- (2) Identification and analysis of development constrains and factors promoting development;
- (3) Analysis of alternatives for achieving the goals of the Project;
- (4) Consideration of the contents of the Master Plan;
- (5) Conducting baseline surveys for Environmental and Social

Considerations, including:

- 1) Laws, regulations, and standards related to environmental and social considerations (environmental impact assessment, resettlement, public participation, information disclosure, and others);
- 2) SEA study reports conducted in Sri Lanka development projects, and other relevant information;
- 3) Gaps between the JICA Guidelines and the legal framework of the Sri Lanka on environmental and social considerations;
- 4) Review of relevant organizations responsible for implementation of projects and their roles on environmental and social considerations including Environmental Impact Assessment (EIA) and SEA;
- (6) Scoping on possible environmental and social impacts and its evaluation methods at the time of decision-making of the projects proposed by the Master Plan;
- (7) Prediction of likely impacts of the proposed projects under the Master Plan based on the scoping;
- (8) Evaluation of likely impacts of the plans and comparative analysis of alternative proposed plans, including the 'without project' option;
- (9) Examination of the mitigation measures (to be avoided, minimized, and compensated);
- (10) Examination of the monitoring methods (monitoring items, frequencies, and methods);
- (11) Support to hold stakeholder meetings;
- (12) Provisional scoping for prioritized projects; and
- (13) Perform other duties deemed necessary.

Both sides also agreed that no pilot projects and/or activities classified as "Category A" under the JICA Guidelines will be conducted in the Project.

3. Contribution to Climate Change Mitigation

Both parties acknowledged that enhancement of proper waste management in line with the M/P can possibly contribute to climate change mitigation.

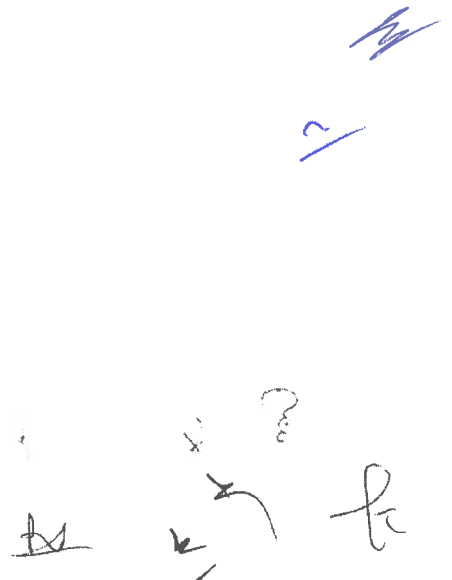

Handwritten signatures and initials in blue and black ink, including a large blue signature at the top right and several smaller signatures and initials at the bottom right.

Project Design Matrix

Project Title: The Project for Formulation of Western Province Solid Waste Management Master Plan
Implementing Agency: National Solid Waste Management Support Center (NWSMSC), Waste Management Authority (WMA), and relevant organizations
Target Group: Western Province, and organizations relevant to waste management in Western Province
Duration: 2019.3–2022.2 (3 years)
Project Site: Western Province

Narrative Summary		Objectively Verifiable Indicators	Means of Verification	Important Assumption
<p>Overall Goal Appropriate solid waste management practices in accordance with Western Province Solid Waste Management Master Plan (MP) are undertaken in Western Province.</p>	<p>1. X % of Local Authorities (LAs) implement appropriate solid waste management in accordance with the MP. 2. More than X good practices on 3Rs (Reduce, Reuse and Recycle) and/or appropriate waste disposal are confirmed in a year as a result of the implementation of the MP.</p>	<p>1. Reports on waste management from LAs 2. Reports on good practices from LAs and other relevant institutions</p>	<p>1. National policies regarding waste management do not change significantly 2. Financial resources for the implementation of the MP are secured by LAs</p>	
<p>Project Purpose Western Province's planning capacity on solid waste management is strengthened through the formulation of Western Province Solid Waste Management Master Plan (MP).</p>	<p>1. The final draft of the MP is prepared. 2. Western Provincial Council (WPC) and MOPCLOS start the MP approval process.</p>	<p>1. The final draft of the MP 2. The MP in the process of approval</p>	<p>1. Documented list of roles and responsibilities 2. List of the Working Group members 3. Minutes of meetings of the Working Group 4. Reports of the workshops or meetings 5. Draft Master Plan</p>	
<p>Outputs Roles and responsibilities of organizations relevant to solid waste management in Western Province are clarified and institutional arrangements for the formulation of the MP are established.</p>	<p>1. Roles and responsibilities of relevant organizations are clarified and documented in the MP and/or other documents. 2. A Working Group for MP formulation is established. 3. Regular meetings are held (at least once in three months) by the Working Group for MP formulation. 4. The process and outputs of activities of the Working Group are shared at the Provincial and Central levels by holding workshops or meetings X times. 5. Draft Master Plan is prepared by the Working Group.</p>	<p>1. Roles and responsibilities of relevant organizations are clarified and documented in the MP and/or other documents. 2. A Working Group for MP formulation is established. 3. Regular meetings are held (at least once in three months) by the Working Group for MP formulation. 4. The process and outputs of activities of the Working Group are shared at the Provincial and Central levels by holding workshops or meetings X times. 5. Draft Master Plan is prepared by the Working Group.</p>	<p>1. National policies regarding waste management do not change significantly 2. Financial resources for the implementation of the MP are secured by LAs</p>	

Handwritten notes and signatures in the bottom right corner of the page, including a signature and the number '15'.

<p>2. Current situations and challenges of solid waste management in Western Province are clarified.</p>	<p>1. Data on current situations on solid waste management in Western Province are collected</p> <p>2. A database using the existing data is created</p> <p>3. An analysis report on solid waste management in Western Province is prepared.</p>	<p>1. Data on solid waste management in Western Province</p> <p>2. The database</p> <p>3. The analysis report</p>
<p>3. Knowledge and experience which contribute to MP formulation are acquired through the implementation of pilot projects on appropriate waste management and 3Rs. (Target areas: Colombo Municipality and other LAs)</p>	<p>1. Trainings on appropriate waste management and 3Rs for LAs and other relevant organizations are conducted X times</p> <p>2. Pilot projects are implemented at X LAs.</p> <p>3. The results of Capacity Assessment (posttest) for WMA and target LAs improve from those of pretest.</p> <p>4. Reports on pilot projects are prepared.</p>	<p>1. Records of trainings</p> <p>2. Records of pilot project implementation</p> <p>3. The results of Capacity Assessment</p> <p>4. Reports on pilot projects</p>
<p>4. Knowledge and experience which contribute to MP formulation are acquired through pilot activities for improving planning/ operation of waste management facilities</p>	<p>1. Trainings on planning/ operation of waste management facilities for CMC and other relevant organizations are conducted X times.</p> <p>2. Pilot activities are implemented at X waste management facilities.</p> <p>3. The results of Capacity Assessment (posttest) for CMC and other relevant organizations of target waste management facilities improve from those of pretest.</p> <p>4. Reports on pilot activities are prepared</p>	<p>1. Records of trainings activities</p> <p>2. Records of pilot implementation</p> <p>3. The results of Capacity Assessment</p> <p>4. Reports on pilot activities</p>
<p>5. Collaboration and coordination among relevant organizations in Western Province for the formulation and implementation of the MP, its sub-plans and other related plans (e.g. LA action plans, plans on waste management facilities) are strengthened.</p>	<p>1. Meetings for the explanation of the MP are organized for LAs in Western Province and other relevant organizations (including central government organizations) are held X times</p> <p>2. XX staff members of WMA and other related organization are given trainings and/or OJT on supporting LAs.</p> <p>3. Support and guidance for the formulation of sub-plans and other related plans (e.g. LA action plans, plans on waste management facilities) in line with the MP are given to LAs and other relevant organizations X times.</p> <p>4. The monitoring system is documented</p> <p>5. Budget plans for the implementation of the MP and a guidance for budget plan formulation to implement LAs' action plans are prepared.</p>	<p>1. Records on the meeting for the explanation of the MP</p> <p>2. Records on training and/ or OJT</p> <p>3. Records on support and guidance</p> <p>4. Documented monitoring system</p> <p>5. Budget plans</p>
<p>Activities</p> <p>1.1 Roles and responsibilities of relevant organizations relevant to solid waste management in Western Province are clarified by examining policies and legal documents (e.g. national laws, ordinances).</p> <p>1.2 A Working Group for MP formulation is established.</p> <p>1.3 Terms of Reference (TOR) of the Working Group for MP formulation are clarified</p> <p>1.4 Regular meetings and special meetings or sub-group meetings, where necessary, are held</p> <p>1.5 Draft Master Plan based on the knowledge gained through activities for Output 2-5 is prepared through discussions by</p>	<p>Inputs</p> <p>[Japanese side]</p> <ul style="list-style-type: none"> • Experts - Waste Management - Collection and Transportation - Intermediate Treatment and Final Disposal - 3Rs/ Public Awareness - Environmental and Social Considerations - Financial / Economic Analysis/Institutional plan - Data base - Project Coordination/ Training - Provision of machinery and equipment <p>[Sri Lankan side]</p> <ul style="list-style-type: none"> • C/P • Personnel cost and operational cost for C/P • Office space and facilities for Experts 1. NSWMSC 2. WMA 	<p>Large-scale consolidation and/or restructuring of LAs do not occur.</p>

Handwritten signatures and initials are present at the bottom of the page, including a large signature on the right and several initials on the left.

<p>the Working Group.</p> <p>1.6 The process and outputs of activities of the Working Group are shared with relevant organizations (including those which authorize the Master Plan) both at the Provincial and Central levels by holding workshops or meetings.</p> <p>1.7 An inter-organizational coordination body such as Provincial Solid Waste Management Committee which takes over the work of the Working Group is proposed.</p>	<p>• Trainings in Japan/Third Countries</p> <p>2.1 The Working Group for MP formulation decides a. types of waste, b. target year, c. areas and population.</p> <p>2.2 Organizations in Western Province relevant to solid waste management are investigated and data on solid waste management is collected.</p> <p>2.3 A database is created using existing data on Western Province's solid waste management.</p> <p>2.4 Based on the data, current situations and challenges regarding solid waste management are clarified and reported.</p> <p>3.1 Trainings on appropriate waste management and 3Rs for L.As and other relevant organizations are conducted.</p> <p>3.2 Target L.As for pilot projects are selected.</p> <p>3.3 Capacity Assessment (pretest) for WMA and target L.As is conducted.</p> <p>3.4 The pilot projects on appropriate waste management and 3Rs are planned at the target L.As (The pilot projects may include a study to collect good practices of various L.As).</p> <p>3.5 3.4 is implemented.</p> <p>3.6 Capacity Assessment (posttest) for WMA and target L.As is conducted.</p> <p>3.7 3.5 is monitored and its results and knowledge are reflected in the draft MP.</p> <p>4.1 Complaints/ requests made by residents, NGOs and other stakeholders with regard to waste management are studied to identify important issues.</p> <p>4.2 Target waste management facilities for pilot activities are selected</p> <p>4.3 Trainings on planning/ operation of waste management facilities are conducted for CMC and other relevant organizations.</p>
---	---

+

1/3

+

1/3

+

M

<p>4.3 Capacity Assessment (pretest) for CMC and other relevant organizations is conducted.</p> <p>4.5 Pilot activities for seeking optimal technical/ social interventions for improved planning and operation of waste management facilities are planned at the target waste management facilities.</p> <p>4.6.1.5 is implemented.</p> <p>4.7 Capacity Assessment (posttest) for CMC and other relevant organizations is conducted.</p> <p>4.8.4.6 is monitored and its results and knowledge are reflected in the draft MP.</p>	<p>5.1 Meetings for the explanation of the MP are organized for LAs in Western Province and other relevant organizations (including central government organizations) are held.</p> <p>5.2 The staff of WMA and other relevant organizations enhance their knowledge and skills for supporting LAs and other organizations in their formulation and implementation of the MP its sub-plans and other related plans (e.g. LA action plans, plans on waste management facilities) through trainings and OJT.</p> <p>5.3 Support and guidance for the formulation of sub-plans and other related plans (e.g. LA action plans, plans on waste management facilities) in line with MP are given to LAs and other relevant organizations.</p> <p>5.4 A system to monitor the implementation of sub-plans and other related plans (e.g. LA action plans, plans on waste management facilities) in line with MP is established and documented.</p> <p>5.5 Budget plans for the implementation of the MP and a guidance for budget plan formulation to implement LAs' action plans are prepared.</p>
--	---

Pre-Condition
 Staff from relevant organizations in Western Province are assigned for the project.

Handwritten notes and signatures:

- Handwritten number "4" at the top right.
- Handwritten signature "P" at the bottom left.
- Handwritten signature "M" at the bottom right.
- Handwritten signature "R" at the bottom right.
- Handwritten signature "P" at the bottom right.

Tentative Plan of Operation

Project Title: The Project for Reinforcement of Western Province Solid Waste Management Master Plan	Duration / Phasing												Remarks	Start	End
	1st Year				2nd Year				3rd Year						
	1	2	3	4	1	2	3	4	1	2	3	4			
Inputs															
Output															
Activities															
Sub-Activities															
Output 1															
Output 2															
Output 3															
Output 4															
Output 5															
Output 6															
Output 7															
Output 8															
Output 9															
Output 10															
Output 11															
Output 12															
Output 13															
Output 14															
Output 15															
Output 16															
Output 17															
Output 18															
Output 19															
Output 20															
Output 21															
Output 22															
Output 23															
Output 24															
Output 25															
Output 26															
Output 27															
Output 28															
Output 29															
Output 30															
Output 31															
Output 32															
Output 33															
Output 34															
Output 35															
Output 36															
Output 37															
Output 38															
Output 39															
Output 40															
Output 41															
Output 42															
Output 43															
Output 44															
Output 45															
Output 46															
Output 47															
Output 48															
Output 49															
Output 50															
Output 51															
Output 52															
Output 53															
Output 54															
Output 55															
Output 56															
Output 57															
Output 58															
Output 59															
Output 60															
Output 61															
Output 62															
Output 63															
Output 64															
Output 65															
Output 66															
Output 67															
Output 68															
Output 69															
Output 70															
Output 71															
Output 72															
Output 73															
Output 74															
Output 75															
Output 76															
Output 77															
Output 78															
Output 79															
Output 80															
Output 81															
Output 82															
Output 83															
Output 84															
Output 85															
Output 86															
Output 87															
Output 88															
Output 89															
Output 90															
Output 91															
Output 92															
Output 93															
Output 94															
Output 95															
Output 96															
Output 97															
Output 98															
Output 99															
Output 100															
Duration / Phasing															
Monitoring Plan															
Monitoring															
Reporting															
Review / Assessments															
Public Relations															

Handwritten notes and signatures in blue ink, including initials and a large signature.

Implementation Structure

Joint Coordinating Committee (JCC)

Annex 4

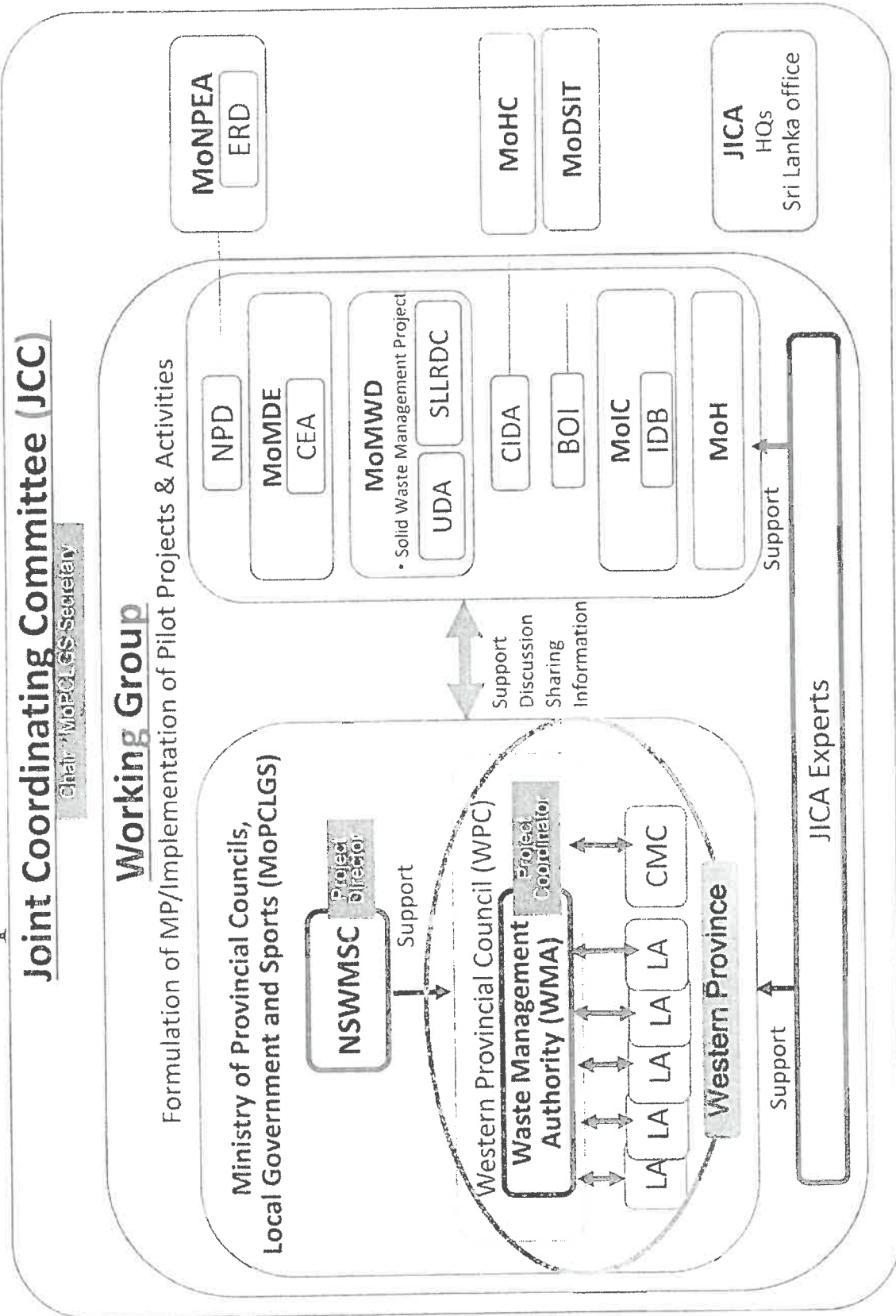

→ Indicates the main Project Team. The Project Office will be located at WMA and NSWMSC.

Handwritten notes and signatures in blue ink at the bottom right of the page.

Annex 5

List of Proposed Members of Joint Coordinating Committee for
the Project for Formulation of Western Province Solid Waste
Management Master Plan

Sri Lankan Side

- (1) Chairperson**
Secretary, Ministry of Provincial Councils, Local Government and Sports
- (2) Project Director**
Director, National Solid Waste Management Support Center
- (3) Project Coordinator**
Director, Waste Management Authority
- (4) Personnel from organizations of the Working Group**
- (5) Other persons that the Sri Lankan side might consider necessary
(consultants, technicians, etc.)**

Japanese Side

- (1) JICA Experts**
- (2) Chief Representative, representatives and staff of JICA Sri Lanka
Office**
- (3) Staff from JICA Headquarters, other domestic and foreign offices, if
necessary**
- (4) Other persons that the Japanese side might consider necessary
(consultants, technicians, etc.)**







Project Design Matrix

Project Title: The Project for Formulation of Western Province Solid Waste Management Master Plan
Implementing Agency: National Solid Waste Management Support Center (NWSMSC), Waste Management Authority (WMA), and relevant organizations
Target Group: Western Province, and organizations relevant to waste management in Western Province
Duration: 2019.2-2022.12 (3.9 years)
Project Site: Western Province

Version 3
Dated 8th April 2021

Narrative Summary	Objectively Verifiable Indicators	Means of Verification	Important Assumption
<p>Overall Goal Appropriate solid waste management practices in accordance with Western Province Solid Waste Management Master Plan (MP) are undertaken in Western Province.</p>	<p>1. All Local Authorities (LAs) prepare/update and implement their solid waste management action plan in line with the MP within one year after publishing the MP.</p>	<p>1. L.A's Action Plans 2. Reports on waste management from L.As</p>	
<p>Project Purpose Western Province's planning capacity on solid waste management is strengthened through the formulation of Western Province Solid Waste Management Master Plan (MP).</p>	<p>1. The final draft of the MP is prepared. 2. Western Provincial Council (WPC) and MoPCLGS start the MP approval process.</p>	<p>1. The final draft of the MP 2. The MP in the process of approval</p>	<p>1. National policies regarding waste management do not change significantly 2. Financial resources for the implementation of the MP are secured by L.As</p>
<p>Outputs 1. Roles and responsibilities of organizations relevant to solid waste management in Western Province are clarified and institutional arrangements for the formulation of the MP are established.</p>	<p>1. Roles and responsibilities of relevant organizations are clarified and documented in the MP and/or other documents. 2. A Working Group for MP formulation is established. 3. Regular meetings are held (at least once in three months) by the Working Group for MP formulation. 4. The process and outputs of activities of the Working Group are shared at the Provincial and Central levels by holding workshops or meetings 6 times. 5. Draft Master Plan is prepared by the Working Group.</p>	<p>1. Documented list of roles and responsibilities 2. List of the Working Group members 3. Minutes of meetings of the Working Group 4. Reports of the workshops or meetings 5. Draft Master Plan</p>	<p>Counterpart (C/P) staff and other staff from relevant organizations continuously engage in the project.</p>
<p>2. Current situation, trend, potentials and challenges of solid waste management in Western Province are clarified.</p>	<p>1. Data on current situations on solid waste management in Western Province are collected. 2. A database using the collected data is created 3. An analysis report on solid waste management in Western Province is prepared.</p>	<p>1. Data on solid waste management in Western Province 2. The database 3. The analysis report on</p>	

Annex 2

	solid waste in Western Province	
<p>3. Knowledge and experience which contribute to MP formulation and implementation are acquired through the implementation of pilot projects on 3Rs. (Target areas: Colombo Municipality and other LAs)</p>	<p>1. Trainings on appropriate waste management and 3Rs for LAs and other relevant organizations are conducted three times. 2. Pilot projects are implemented at more than three LAs. 3. The results of Capacity Assessment (posttest) for WMA and target LAs improve from those of pretest. 4. Progress of Pilot Projects are monitored by WG for MP formulation.</p>	<p>1. Records of trainings 2. Records of pilot project implementation 3. Reports of Capacity Assessment 4. Progress reports on pilot projects</p>
<p>4. Knowledge and experience which contribute to MP formulation and implementation are acquired through pilot projects for improving planning/ operation of waste management facilities</p>	<p>1. Trainings on planning/ operation of waste management facilities for relevant organizations are conducted more than three times. 2. Pilot projects are implemented at one or more than one waste management facilities. 3. The results of Capacity Assessment (posttest) for relevant organizations of target waste management facilities improve from those of pretest. 4. Progress of pilot projects are monitored by WG for MP formulation.</p>	<p>1. Records of trainings 2. Records of pilot projects implementation 3. Reports of Capacity Assessment 4. Reports on pilot projects</p>
<p>5. Collaboration and coordination among relevant organizations in Western Province for the implementation of MP, and formulation and implementation of its related plans (e.g. 1.A action plans, plans on waste management facilities) are strengthened.</p>	<p>1. Meetings for the explanation of the MP are organized for LAs in Western Province and other relevant organizations (including central government organizations) are held more than three times. 2. XX staff members of WMA and other related organization are given trainings and/or OJT on supporting LAs. 3. Support and guidance for the formulation of sub-plans and other related plans (e.g. 1.A action plans, plans on waste management facilities) in line with the MP are given to LAs and other relevant organizations. 4. The monitoring system is documented 5. Budget plans for the implementation of the MP and a guidance for budget plan formulation to implement LAs' action plans are prepared.</p>	<p>1. Records on the meeting for the explanation of the MP 2. Records on training and/ or OJT 3. Records on support and guidance 4. Documented monitoring system 5. Budget plans</p>
<p>1.1 Roles and responsibilities of relevant organizations relevant to solid waste management in Western Province are clarified by examining policies and legal documents (e.g. national laws, ordinances). 1.2 A Working Group for MP formulation is established. 1.3 Terms of Reference (TOR) of the Working Group for MP formulation are clarified. 1.4 Regular meetings and special meetings or sub-group meetings, where necessary, are held. 1.5 Draft Master Plan is prepared through discussions by the Working Group. 1.6 The process and outputs of activities of the Working Group</p>	<p>Inputs</p> <p>[Sri Lankan side] • C/P • Personnel cost and operational cost for C/P • Office space and facilities for Experts at 1. NSW/MSC 2. WMA</p>	<p>Inputs</p> <p>[Japanese side] • Experts - Waste Management - Collection and Transportation - Intermediate Treatment and Final Disposal - 3Rs/ Public Awareness - Financial / Economic Analysis/Institutional plan - Database • Provision of machinery and equipment • Trainings in Japan/Third Countries</p>

[Handwritten mark]

[Handwritten mark]

[Handwritten mark]

[Handwritten mark]

<p>are shared with relevant organizations (including those which authorize the Master Plan) both at the Provincial and Central levels by holding workshops or meetings.</p> <p>1.7 An inter-organizational coordination body such as Provincial Solid Waste Management Committee which takes over the work of the Working Group is proposed.</p>				
<p>2.1 The Working Group for MP formulation decides a. types of waste, b. target year, c. areas and population.</p> <p>2.2 Organizations in Western Province relevant to solid waste management are investigated and data on solid waste management is collected.</p> <p>2.3 A database is created using existing data on Western Province's solid waste management.</p> <p>2.4 Based on the data, current situations and challenges regarding solid waste management are clarified and reported.</p>		<p>3.1 Trainings on appropriate waste management and 3Rs for LAs and other relevant organizations are conducted.</p> <p>3.2 Target LAs for pilot projects are selected.</p> <p>3.3 Capacity Assessment (pretest) for WMA and target LAs is conducted.</p> <p>3.4 The pilot projects on appropriate waste management and 3Rs are planned at the target LAs.</p> <p>3.5 3.4 is implemented.</p> <p>3.6 Capacity Assessment (posttest) for WMA and target LAs is conducted.</p> <p>3.7 3.5 is monitored and its results and knowledge are reported in written form.</p>		<p>4.1 Complaints/ requests made by residents, NGOs and other stakeholders with regard to waste management are studied to identify important issues.</p> <p>4.2 Target waste management facilities for pilot activities are selected.</p> <p>4.3 Trainings on planning/ operation of waste management facilities are conducted for relevant organizations.</p> <p>4.4 Capacity Assessment (pretest) for relevant organizations is conducted.</p> <p>4.5 Pilot projects for seeking optimal technical/ social interventions for improved planning and operation of waste</p>

Handwritten marks and signatures at the bottom of the page, including a large signature on the right and several initials on the left.

Annex 2

<p>management facilities are planned at the target waste management facilities.</p> <p>4.6 4.5 is implemented.</p> <p>4.7 Capacity Assessment (posttest) for relevant organizations is conducted.</p> <p>4.8 4.6 is monitored and its results and knowledge are reported in written form.</p> <p>5.1 Meetings for the explanation of the MP are organized for LAs in Western Province and other relevant organizations (including central government organizations) are held.</p> <p>5.2 The staff of WMA and other relevant organizations enhance their knowledge and skills for supporting LAs and other organizations in their formulation and implementation of the MP, its sub-plans and other related plans (e.g. LA action plans, plans on waste management facilities) through trainings and OJT.</p> <p>5.3 Support and guidance for the formulation of sub-plans and other related plans (e.g. LA action plans, plans on waste management facilities) in line with MP are given to LAs and other relevant organizations.</p> <p>5.4 A system to monitor the implementation of sub-plans and other related plans (e.g. LA action plans, plans on waste management facilities) in line with MP is established and documented.</p> <p>5.5 Budget plans for the implementation of the MP and a guidance for budget plan formulation to implement LAs' action plans are prepared.</p>		<p><u>Pre-Condition</u> Staff from relevant organizations in Western Province are assigned for the project.</p>
--	--	---

13/12

Change of Distribution of Roles

Before

	Main Implementer	Co-implementers / Key collaborators
Activities for the Output 1	WPC / WMA	Members of WG: 1. General issues (e.g. overall planning and monitoring): MoMDE, CEA, NPD, NSWMSC 2. Municipal solid waste: MoMDE, CEA, CMC, NSWMSC, SLLRDC, SWM Project of MoMWD, UDA 3. Industrial waste: BOI, MoMDE, CEA, IDB, SLLRDC, UDA, MoI 4. Construction and demolition (C&D) waste: MoMDE, CEA, CIDA 5. Infectious and hazardous waste: MoMDE, CEA, MoH
Activities for the Output 2	WPC / WMA	
Activities for the Output 3	WPC / WMA CMC, and target LAs	NSWMSC, MoMDE, CEA and other institutions depending on the nature of the pilot projects
Activities for the Output 4	WPC/WMA, NSWMSC, MoMDE, CEA, CMC, UDA, SLLRDC, SWM Project of MoMWD and other institutions depending on the nature of the pilot activities	
Activities for the Output 5	WPC / WMA	Members of WG and LAs in Western Province

After

	Main Implementer	Co-implementers / Key collaborators
Activities for the Output 1	WPC / WMA	Members of WG: 1. General issues (e.g. overall planning and monitoring): MoE, CEA, NPD, and NSWMSC 2. Municipal solid waste: MoE, CEA, CMC, NSWMSC, SLLRDC, SWM Project of SMOUDCCWD&CC, UDA 3. Industrial waste: BOI, MoE, CEA, IDB, SLLRDC, UDA, MoI 4. Construction and demolition (C&D) waste: MoE, CEA, CIDA 5. Infectious and hazardous waste: MoE, CEA, MoH
Activities for the Output 2	WPC / WMA	
Activities for the Output 3	WPC / WMA CMC, and target LAs	NSWMSC, MoE, CEA and other institutions depending on the nature of the pilot projects
Activities for the Output 4	WPC/WMA, NSWMSC, MoE, CEA, CMC, UDA, SLLRDC, SWM Project of SMOUDCCWD&CC and other institutions depending on the nature of the pilot activities	
Activities for the Output 5	WPC / WMA	Members of WG and LAs in Western Province

Change of Implementation Structure

Before

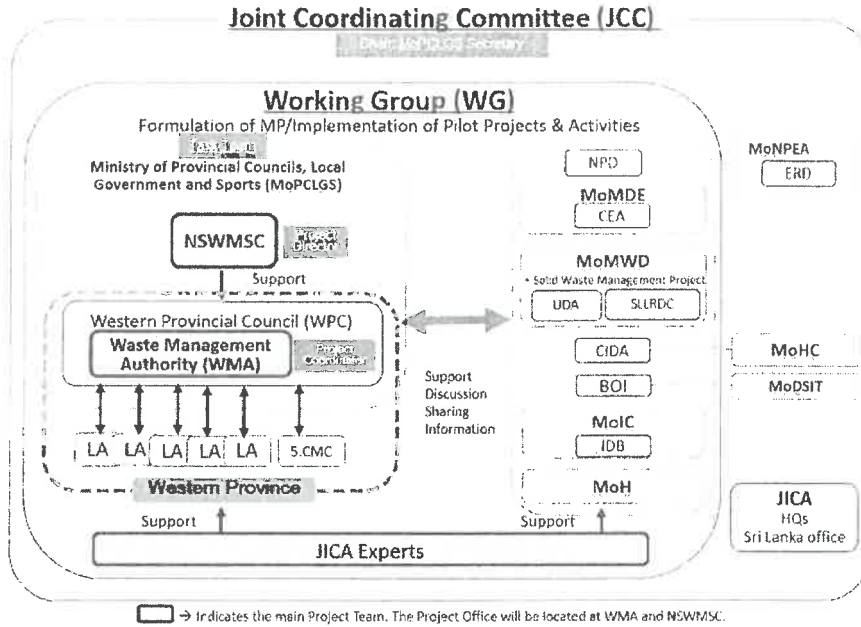

After

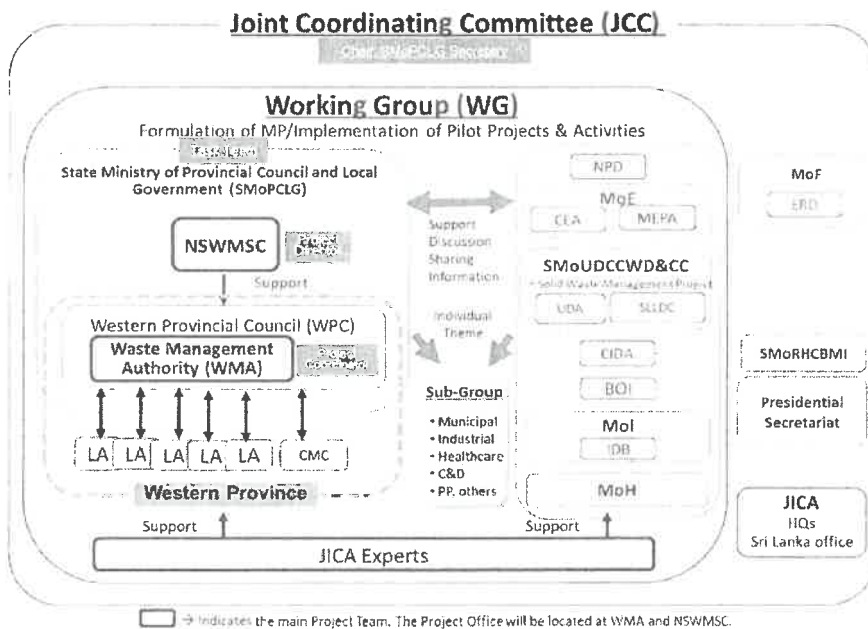

[Handwritten signatures and initials in blue ink]

Attachment 3

Comparison of PDM

Narrative Summary (Before Revising)	Narrative Summary (After Revising)	Reason	Objectively Verifiable Indicators (Before Revising)	Objectively Verifiable Indicators (After Revising)	Reason	Means of Verification (Before Revising)	Means of Verification (After Revising)	Reason	Important Assumption
Overall Goal Appropriate solid waste management practices in accordance with Western Province Solid Waste Management Master Plan (MP) are undertaken in Western Province.			1. X % of Local Authorities (LAs) implement appropriate solid waste management in accordance with the MP. 2. More than X good practices on 3Rs (Reduce, Reuse and Recycle) and/or appropriate waste disposal are confirmed in a year as a result of the implementation of the MP.	1. All Local Authorities (LAs) prepare/update and implement their solid waste management action plan in line with the MP within one year after publishing the MP.	1. To implement appropriate solid waste management means to prepare / update their solid waste management action plan in line with the MP, so it was revised (in order to be mentioned in detail). To respond to C/P's request, the number of local authority is changed from X% to "all", but to add "within one year after publishing the MP". 2. It was deleted because good practices on 3Rs are just	1. Reports on waste management from LAs 2. Reports on good practices from LAs and other institutions	1. LA's Action Plans 2. Reports on waste management from LAs	1. LA's Action Plans which prepared/updated regularly are to be the document to check the indicator. 2. It was deleted because good practices from LAs and other relevant are just one part of solid waste management activities and it doesn't fit this indicator.	

13

Attachment 3

<p><u>Project Purpose</u> Western Province's planning capacity on solid waste management is strengthened through the formulation of Western Province Solid Waste Management Master Plan (MP).</p>	<p>1. The final draft of the MP is prepared. 2. Western Provincial Council (WPC) and MoPCLGS start the MP approval process.</p>	<p>one part of solid waste management activities and it doesn't fit this indicator.</p>	<p>1. The final draft of the MP 2. The MP in the process of approval</p>	<p>1. National policies regarding waste management do not change significantly. 2. Financial resources for the implementation of the MP are secured by LAs.</p>	<p>Counterpart (C/P) staff and other staff from relevant organizations continuously engage in the project.</p>
<p><u>Outputs</u> 1. Roles and responsibilities of organizations are clarified and documented in the MP and/or other documents. 2. A Working Group for MP formulation is established.</p>	<p>1. Roles and responsibilities of relevant organizations are clarified and documented in the MP and/or other documents. 2. A Working Group for MP formulation is established.</p>		<p>1. Documented list of roles and responsibilities 2. List of the Working Group members 3. Minutes of meetings of</p>		

Handwritten signatures and initials in blue ink, including a large signature and several smaller initials.

Attachment 3

<p>s for the formulation of the MP are established.</p>	<p>2. Current situations and challenges of solid waste management in Western Province are clarified.</p>	<p>2. In order to explain in detail about "situation", the word "trend" and "potentials" are added.</p>	<p>3. Regular meetings are held (at least once in three months) by the Working Group for MP formulation.</p> <p>4. The process and outputs of activities of the Working Group are shared at the Provincial and Central levels by holding workshops or meetings 6 times.</p> <p>5. Draft Master Plan is prepared by the Working Group.</p>	<p>1. Data on current situations on solid waste management in Western Province are collected.</p> <p>2. A database using the existing data is created.</p> <p>3. An analysis report on</p>	<p>1. Data on current situations on solid waste management in Western Province are collected.</p> <p>2. A database using the existing data is created.</p> <p>3. An analysis report on</p>	<p>4. Reports of the workshops or meetings</p> <p>5. Draft Master Plan</p>				

Attachment 3

<p>3. Knowledge and experience which contribute to MP formulation and implementation are acquired through the implementation of pilot projects on appropriate waste management and 3Rs. (Target areas: Colombo Municipality and other LAs)</p>	<p>solid waste management in Western Province is prepared.</p>	<p>solid waste management in Western Province is prepared.</p>	<p>solid waste management in Western Province is prepared.</p>	<p>solid waste management in Western Province is prepared.</p>	<p>solid waste management in Western Province is prepared.</p>	<p>solid waste management in Western Province is prepared.</p>	<p>solid waste management in Western Province is prepared.</p>	<p>solid waste management in Western Province is prepared.</p>	<p>solid waste management in Western Province is prepared.</p>	<p>solid waste management in Western Province is prepared.</p>
<p>3. Knowledge and experience which contribute to MP formulation and implementation are acquired through the implementation of pilot projects on appropriate waste management and 3Rs. (Target areas: Colombo Municipality and other LAs)</p>	<p>1. Trainings on appropriate waste management and 3Rs for LAs and other relevant organizations are conducted X times.</p> <p>2. Pilot projects are implemented at X LAs.</p> <p>3. The results of Capacity Assessment (posttest) for WMA and target LAs improve from those of pretest.</p> <p>4. Reports on pilot projects are prepared.</p>	<p>1. Trainings on appropriate waste management and 3Rs for LAs and other relevant organizations are conducted X times.</p> <p>2. Pilot projects are implemented at more than three LAs.</p> <p>3. Progress of Pilot Projects are monitored by WG for MP formulation.</p>	<p>1. Three times training (planning period, implementing period, and operation period) are conducted at first seminar in Sri Lanka in 2019, first seminar in Japan in 2020, and second seminar in Sri Lanka in 2021.</p> <p>2. More than three LAs include several 3R Pilot Project sites and transfer station.</p> <p>4. Report on pilot project is the document which confirm the indicator, therefore, it is changed to "progress"</p>	<p>1. Three times training (planning period, implementing period, and operation period) are conducted at first seminar in Sri Lanka in 2019, first seminar in Japan in 2020, and second seminar in Sri Lanka in 2021.</p> <p>2. More than three LAs include several 3R Pilot Project sites and transfer station.</p> <p>4. Report on pilot project is the document which confirm the indicator, therefore, it is changed to "progress"</p>	<p>1. Three times training (planning period, implementing period, and operation period) are conducted at first seminar in Sri Lanka in 2019, first seminar in Japan in 2020, and second seminar in Sri Lanka in 2021.</p> <p>2. More than three LAs include several 3R Pilot Project sites and transfer station.</p> <p>4. Report on pilot project is the document which confirm the indicator, therefore, it is changed to "progress"</p>	<p>1. Trainings on appropriate waste management and 3Rs for LAs and other relevant organizations are conducted X times.</p> <p>2. Pilot projects are implemented at more than three LAs.</p> <p>3. The results of Capacity Assessment (posttest) for WMA and target LAs improve from those of pretest.</p> <p>4. Reports on pilot projects are prepared.</p>	<p>1. Trainings on appropriate waste management and 3Rs for LAs and other relevant organizations are conducted X times.</p> <p>2. Pilot projects are implemented at more than three LAs.</p> <p>3. Progress of Pilot Projects are monitored by WG for MP formulation.</p>	<p>1. Three times training (planning period, implementing period, and operation period) are conducted at first seminar in Sri Lanka in 2019, first seminar in Japan in 2020, and second seminar in Sri Lanka in 2021.</p> <p>2. More than three LAs include several 3R Pilot Project sites and transfer station.</p> <p>4. Report on pilot project is the document which confirm the indicator, therefore, it is changed to "progress"</p>	<p>1. Three times training (planning period, implementing period, and operation period) are conducted at first seminar in Sri Lanka in 2019, first seminar in Japan in 2020, and second seminar in Sri Lanka in 2021.</p> <p>2. More than three LAs include several 3R Pilot Project sites and transfer station.</p> <p>4. Report on pilot project is the document which confirm the indicator, therefore, it is changed to "progress"</p>	<p>1. Trainings on appropriate waste management and 3Rs for LAs and other relevant organizations are conducted X times.</p> <p>2. Pilot projects are implemented at more than three LAs.</p> <p>3. Progress of Pilot Projects are monitored by WG for MP formulation.</p>
<p>4. Knowledge and</p>	<p>1. Trainings on planning/</p>	<p>1. Trainings on planning/</p>	<p>1. Trainings on planning/</p>	<p>1. Trainings on planning/</p>	<p>1. Trainings on planning/</p>	<p>1. Trainings on planning/</p>	<p>1. Trainings on planning/</p>	<p>1. Trainings on planning/</p>	<p>1. Trainings on planning/</p>	<p>1. Trainings on planning/</p>
<p>4. Knowledge and</p>	<p>1. Trainings on planning/</p>	<p>1. Trainings on planning/</p>	<p>1. Trainings on planning/</p>	<p>1. Trainings on planning/</p>	<p>1. Trainings on planning/</p>	<p>1. Trainings on planning/</p>	<p>1. Trainings on planning/</p>	<p>1. Trainings on planning/</p>	<p>1. Trainings on planning/</p>	<p>1. Trainings on planning/</p>
<p>4. Knowledge and</p>	<p>1. Trainings on planning/</p>	<p>1. Trainings on planning/</p>	<p>1. Trainings on planning/</p>	<p>1. Trainings on planning/</p>	<p>1. Trainings on planning/</p>	<p>1. Trainings on planning/</p>	<p>1. Trainings on planning/</p>	<p>1. Trainings on planning/</p>	<p>1. Trainings on planning/</p>	<p>1. Trainings on planning/</p>

Attachment 3

<p>experience which contribute to MP formulation and implementation on are acquired through pilot projects for improving planning/ operation of waste management facilities.</p>	<p>operation of waste management facilities for CMC and other relevant organizations are conducted X times.</p> <p>2. Pilot projects are implemented at X waste management facilities.</p> <p>3. The results of Capacity Assessment (posttest) for CMC and other relevant organizations of target waste management facilities improve from those of pretest.</p> <p>4. Reports on pilot projects are prepared.</p>	<p>nings on planning/ operation of waste management facilities for relevant organizations are conducted more than three times.</p> <p>2. Pilot projects are implemented at <u>one or more</u> waste management facilities.</p> <p>3. The results of Capacity Assessment (posttest) for relevant organizations of target waste management facilities improve from those of pretest.</p> <p>4. Progress of pilot projects are monitored by WG for MP</p>	<p>training are conducted at first seminar in Sri Lanka in 2019, first seminar in Japan in 2020, and second seminar in Sri Lanka in 2021.</p> <p>2. In Kalutara pilot project site, two waste management facilities (compost plant and transfer station) are planned to be developed / rehabilitated, so it should mention "one or more than one".</p> <p>3. Delete CMC.</p> <p>4. "Report" is the document which to confirm the indicator, therefore it was changed to "progress."</p>	<p>trainings Records of pilot projects implementation on results of Capacity Assessment Report on pilot projects</p>	<p>orts of Capacity Assessment</p>	<p>from "result" to "reports" since the result of capacity development are to be reported in the "reports".</p>
--	--	--	---	--	------------------------------------	---

13

Attachment 3

<p>5 Collaboration and coordination among organization in Western Province for the implementation of MP, and formulation and implementation of its related plans (e.g. LA action plans, plans on waste management facilities) are strengthened</p>	<p>1 Meetings for the explanation of the MP are organized for LAs in Western Province and other relevant organizations (including central government organizations) are held 2 times.</p> <p>2 21 staff members of WMA and other related organization are given trainings and/or OJT on supporting LAs.</p> <p>3 Support and guidance for the formulation of sub-plans and other related plans (e.g. LA action plans.</p>	<p>1 Meetings for the explanation of the MP are organized for LAs in Western Province and other relevant organizations (including central government organizations) are held <u>more</u> than <u>three</u> times.</p> <p>2 XX staff members of WMA and other related organization are given trainings and/or OJT on supporting LAs.</p> <p>3 Support and guidance for the formulation of sub-plans and other related plans (e.g. LA action plans, waste</p>	<p>1 Meeting will be held in three district (Gampaha, Colombo and Kalutara). The number of people are easy to be changed and it is difficult to fix at the moment.</p> <p>3. It was initially planned to conduct the seminar once in each zones (7 zones), however, there is a possibility of increasing the number of seminar, so at the moment it cannot be fixed.</p>	<p>1. Records on the meeting for the explanation of the MP</p> <p>2. Records on training and / or OJT</p> <p>3. Records on support and guidance</p> <p>4. Documented monitoring system</p> <p>5. Budget plans</p>			
--	---	---	--	---	--	--	--

15

Attachment 3

Activities (Before Revising)	Activities (After Revising)	Reason	Inputs (Before Revising)	Inputs (After Revising)	Reason	Inputs (Before Revising)	Inputs (After Revising)	Reason
4.3 Trainings on planning/operation of waste management facilities are	4.3 Trainings on planning/operation of waste management facilities are	Delete CMC since "relevant organizations" include CMC as well.	[Japanese side] - Experts - Waste Management and Transportation	[Japanese side] - Experts - Waste Management and	The component of Pilot Project has been agreed between Japanese side and Sri Lankan	[Sri Lankan side] - C/P - Personnel cost and operational cost for C/P - Office space	[Sri Lankan side] - C/P - Personnel cost and operational cost for C/P - Office space	Large-scale consolidation and/or restructuring of LAs do not occur.
plans on waste management facilities) in line with the MP are given to LAs and other relevant organizations. The monitoring system is documented.	management facilities) in line with the MP are given to LAs and other relevant organizations. The monitoring system is documented.							
4. The monitoring system is documented.	4. The monitoring system is documented.							
5. Budget plans for the implementation of the MP and a guidance for budget plan formulation to implement LAs' action plans are prepared.	5. Budget plans for the implementation of the MP and a guidance for budget plan formulation to implement LAs' action plans are prepared.							

Attachment 3

<p>conducted for CMC and other relevant organizations.</p> <p>4.4 Capacity Assessment for CMC and other relevant organizations is conducted.</p> <p>4.7 Capacity Assessment (posttest) for CMC and other relevant organizations is conducted.</p>	<p>conducted for relevant organizations.</p> <p>4.4 Capacity Assessment for relevant organizations is conducted.</p> <p>4.7 Capacity Assessment (posttest) for relevant organizations is conducted.</p>	<p>Intermediate and Final Disposal - 3Rs/ Public Awareness</p> <p>Financial / Economic Analysis/Institutional plan</p> <p>Database</p> <p>Provision of machinery and equipment</p> <p>Trainings in Japan/Third Countries</p>	<p>Transportation</p> <p>Intermediate Treatment and Final Disposal - 3Rs/ Public Awareness</p> <p>Financial / Economic Analysis/Institutional plan</p> <p>Database</p> <p>Provision of machinery and equipment</p> <p>Equipment of 3Rs at high-rise apartment and/or low-income housing</p> <p>Small scale solid waste transfer station in Kalutara composting facility</p> <p>Forced aeration system in existing Kalutara composting facility</p> <p>Trainings in</p>	<p>side at JCC on 18th June 2020.</p>	<p>and facilities for Experts</p> <p>1. NS WMSC</p> <p>2. WMMA</p>	<p>and facilities for Experts at</p> <p>1. NSWMSC</p> <p>2. WMMA</p>	<p>Pre-Condition Staff from relevant organizations in Western Province are assigned for the project.</p>
---	---	--	--	--	--	--	--

Attachment 3

Japan/Third Countries										

~~1~~
2
3
4

Abbreviations

BOI	Board of Investment
CEA	Central Environmental Authority
C&D waste	Construction Demolition Waste
CIDA	Construction Industry Development Authority
CMC	Colombo Municipal Council
ERD	External Resource Department
IDB	Industrial Development Board
JCC	Joint Coordinating Committee
JICA	Japan International Cooperation Agency
LA	Local Authority
MEPA	Marine Environmental Protection Authority
MoE	Ministry of Environment
MoF	Ministry of Finance
MoI	Ministry of Industries
MoH	Ministry of Health
NPD	Department of National Planning
NSWMSC	National Solid Waste Management Support Centre
SMoPCLG	State Ministry of Provincial Councils and Local Government
SMoRHCBMI	State Ministry of Rural Housing and Construction & Building Material Industries
SMoUDCCWD&CC	State Ministry of Urban Development, Coast Conservation, Waste Disposal and Community Cleanliness
SLLDC	Sri Lankan Land Development Cooperation
WMA	Waste Management Authority
WPC	Western Provincial Council

**MINUTES OF MEETING
ON
THE THIRD JOINT COORDINATING COMMITTEE
OF
THE PROJECT FOR FORMULATION OF WESTERN PROVINCE SOLID WASTE
MANAGEMENT MASTER PLAN**

The Japan International Cooperation Agency (hereinafter referred to as "JICA") Expert Team (hereinafter referred to as "the Team") submitted revised PDM and PO to State Ministry of Provincial Councils and Local Government Affairs (hereinafter referred to as "SMOPCLGA"). The authorities in Sri Lanka concerned with the Project, JICA and the Team conducted a discussion on the Project based on PDM at the Joint Coordinating Committee (hereinafter referred to as "JCC") held on 21st April 2022.

SMOPCLGA, WMA, JICA, and the Team confirmed the matters discussed in the JCC as referred to in the document attached hereto.

Colombo, 21 April 2022

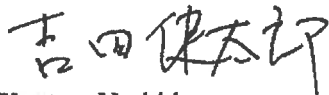

Kentaro Yoshida
Senior Representative
JICA Sri Lanka Office



W.M.M.B. Weerasekara
Secretary
State Ministry of Provincial Councils and
Local Government Affairs
No. 330, Union Place, Colombo 02.
W.M.M.B. Weerasekara Secretary
State Ministry of Provincial Council and
Local Government Affairs



Naofumi Sato
Team Leader
JICA Expert Team



J.M.C. Jayanthi Wijethunga
Chief Secretary
Western Provincial Council
J. M. C. Jayanthi Wijethunga
Chief Secretary (Western Province)
Office of the Chief Secretary (W.P.)
204, Denzil Kobbekaduwa Mawatha,
Battaramulla

ATTACHED DOCUMENT

1 Mutual agreement on draft Master Plan

Both sides discussed and agreed on the contents of the draft Western Province Solid Waste Management Master Plan. Both sides confirmed the necessary procedure and demarcation of authorization of the Master Plan.

2 Outline of the Project and review of its progress

The Team explained the progress of the project up to February 2022 including the progress of Pilot Projects. Both sides confirmed the schedule of the activities and undertakings to be done by both sides.

3 Modification of framework (PDM) and extension of Project duration

The Team proposed PDM ver.4, the revision of the PDM ver.3. Both sides basically agreed on the following changes and these are to be finalized after the confirmation by JICA.

1) Overall Goal: Appropriate solid waste management practices in accordance with Western Province Solid Waste Management Master Plan (MP) are undertaken in Western Province.

In order to clarify the overall goal, following two objectively verifiable indicators are added:

- An inter-organizational coordination body functions to monitor the progress and support the implementation of LA action plan in Western Province.

2) Project Purpose: Western Province's planning capacity on solid waste management is strengthened through the formulation of Western Province Solid Waste Management Master Plan (MP).

In order to clarify the project purpose, following two objectively verifiable indicators are added:

- Sub-plans and other related plans (e.g. LA action plans, plans on waste management facilities) in line with the MP are formulated.
- An inter-organizational coordination body is being established to monitor the progress and provide support implementation of the sub-plans and other related plans in Western Province.

Means of above mentioned verifications are as follows:

- Draft LA's Action Plans
- Plan of formulation of inter-organizational coordination body

3) Output 3: Knowledge and experience which contribute to MP formulation and implementation are acquired through the implementation of pilot projects on appropriate waste management and 3Rs.

Initially, target areas of pilot project of 3Rs were Colombo Municipality and other LAs, however, Colombo municipality was excluded from the pilot project sites since it is decided that they will implement the similar project by themselves.

4) Output 5: Collaboration and coordination among relevant organizations in Western Province for the implementation of MP, and formulation and implementation of its related plans (e.g. LA action plans, plans on waste management facilities) are strengthened.

The number of staff members of WMA and other related organization given trainings and/or OJT on supporting LAs are decided, so it shall be modified from XX to 11 (7 Zonal Managers and 4 district managers).

5) Inputs from Japanese side

In line with the agreement by both sides on components of pilot project, "small scale solid

3/2

2/1/2

+

2

waste transfer station in Kalutara composting facility”, “forced aeration system in existing Kalutara composting facility” and “equipment for rehabilitating existing compost plant in Karadiyana” were added as inputs from Japanese side.

In addition, the Sri Lankan side and the team proposed extension of the project duration. Since March 2020, in response to spread of infection of COVID-19, JICA suspended dispatching Japanese experts to any project site so that all activities were implemented by remote work before February 2021. In addition, Sri Lankan Government took a Cabinet Decision to cancel the construction of Waste to Energy facility in Karadiyana Resource Management Centre, which is a core waste management facility in Solid Waste Management Master Plan, thus the draft Master Plan must be modified with consensus among counterpart and relevant organizations. JICA took note of them and will consider modifying PDM including extension of the project duration.

4 Other issues

Both sides reconfirmed that the Project will be implemented in accordance with the “Basic Principles for Technical Cooperation” published in December 2016 (hereinafter referred to as “the BP”). In the BP, it is mentioned that “The Counterpart and the government of the recipient country will take necessary measures to grant JICA, the members of JICA missions and the JICA experts privileges, exemptions and benefits in accordance with international agreements concluded between the government of Japan and the government of the recipient country”.

Attachment :

- Attachment 1 Concept of Draft Master Plan
- Attachment 2 Outline of Progress of the Project
- Attachment 3 Draft Project Design Matrix ver.4
- Attachment 4 List of Attendance of JCC

} 1/2

9
4/11

1/1

2

2

2

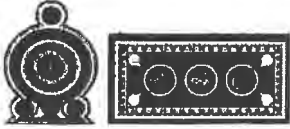

THE PROJECT FOR WESTERN PROVINCE SOLID WASTE MANAGEMENT MASTER PLAN IN SRI LANKA



The 3rd Joint Coordination Committee (ICC)

Concept of Draft Master Plan of SWM in Western Province

21st April, 2022

Location Chart of
Western Province
and 3 Districts in Sri
Lanka

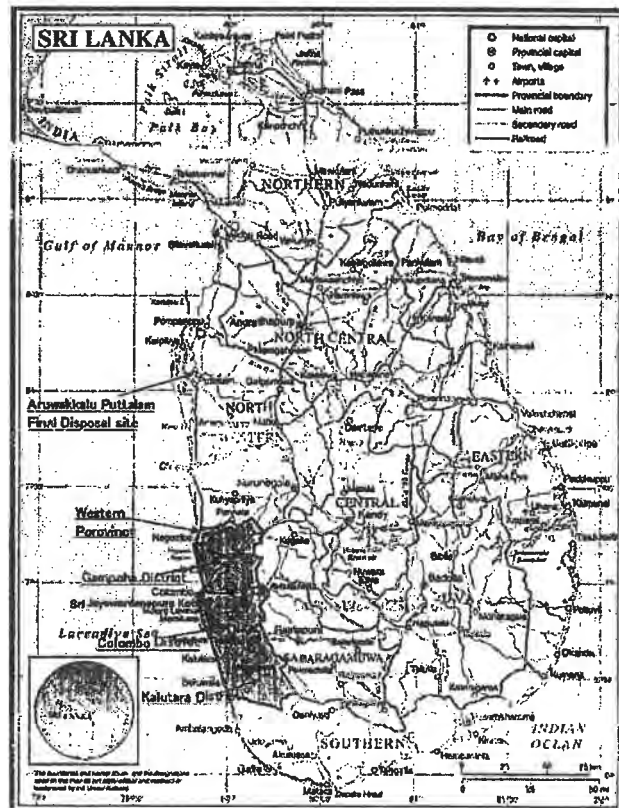

Contents

1. Current situation and issues on SWM
2. Prediction of future waste flow
3. Formulation of SWM alternatives and selection of the most appropriate SWM system
4. Draft SWM Master Plan
5. SWM MP implementation projects in the short to medium term
3. Economic and Financial Analysis of the Master Pan

1. Current situation and issues on SWM

Main current situation and issues on SWM are as follows.

1. **Waste generation:** 3,730 ton/day
2. **Waste discharge including informal recycling:** 1,900 ton/day, Improper discharge: 890 ton/day (24%)
3. **Waste collection:** 1,730 ton/day, Collection coverage: 51%

		
<p>Tractor-trailers are typical collection vehicles used in western states.</p>	<p>Some LAs collect and transport organic waste with compactor trucks.</p>	<p>Waste collectors collect recyclables during collection work, and they sell it to buyers.</p>

α ✓

372

✓

7

✓

1. Current situation and issues on SWM

4. Transfer of collected waste

Transfer places have few facilities, and the collected waste is dumped directly on the ground and transferred to large capacity dump trucks by shovel loaders, excavators, etc. for transportation to intermediate treatment facilities or disposal sites. This results in a negative impact on the surrounding environment, such as foul odors and animal scavenging.

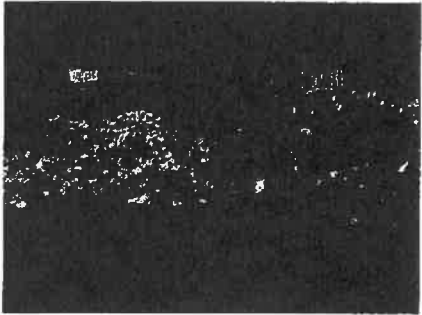
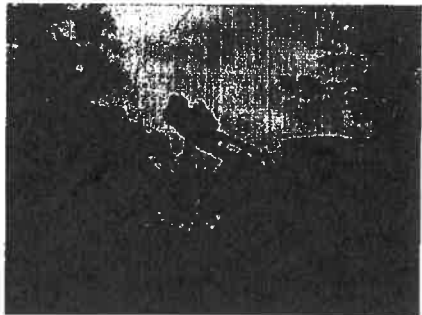
	
<p>Collected waste is unloaded into separate biodegradable and non-biodegradable waste piles at the transfer station.</p>	<p>Unloaded waste is transferred to a large capacity of dump truck.</p>



1. Current situation and issues on SWM

5. Intermediate treatment

a) Composting: Total capacity of LAs and cluster based composting facility is 324 tons/day, which is insufficient to compost for the amount of organic waste collected.

b) Recycling: Other waste is collected mixed with recyclables, which adversely affects the efficiency of sorting recyclables and the quality of the sorted recyclables.

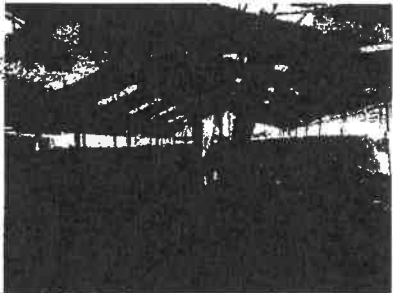
c) Waste to Energy (WtE): In the Western Power at Kerawalapitiya (WPK) WtE facility with capacity of 750 tons/day, mix waste including organic waste of CMC are mainly incinerated, and burnable waste collected from surrounding LAs is also incinerated.

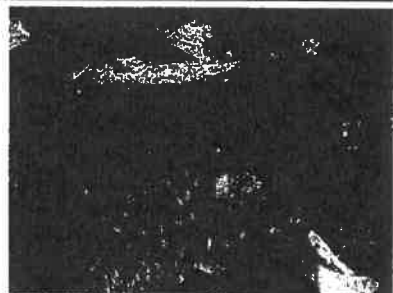
		
<p>A yard with sufficient space is needed to compost and age biodegradable waste.</p>	<p>Recyclables are sorted by manual from non-biodegradable waste at recycling facilities.</p>	<p>Polyolefin, etc., are sorted, baled and transported to a cement factory, INSEE, as a fuel substitute.</p>

Handwritten marks and signatures at the bottom of the page, including a large checkmark on the left and several scribbles on the right.

1. Current situation and issues on SWM

- 6. Final disposal: 22 LAs use their disposal sites and 10 LAs have outsourced disposal to the private sector. These dump sites have no environmental measures in place.
- 7. SW data management: With the exception of a few LAs that transporting waste to cluster-based treatment and disposal facilities, waste data such as the amount collected and disposed of is not managed.

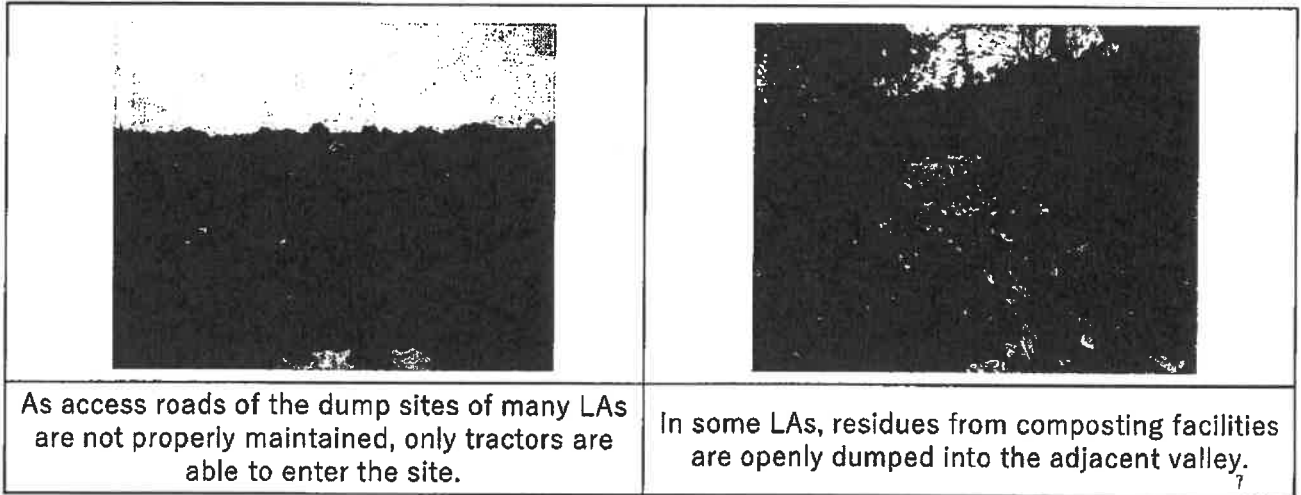

Present waste flow of Western Province

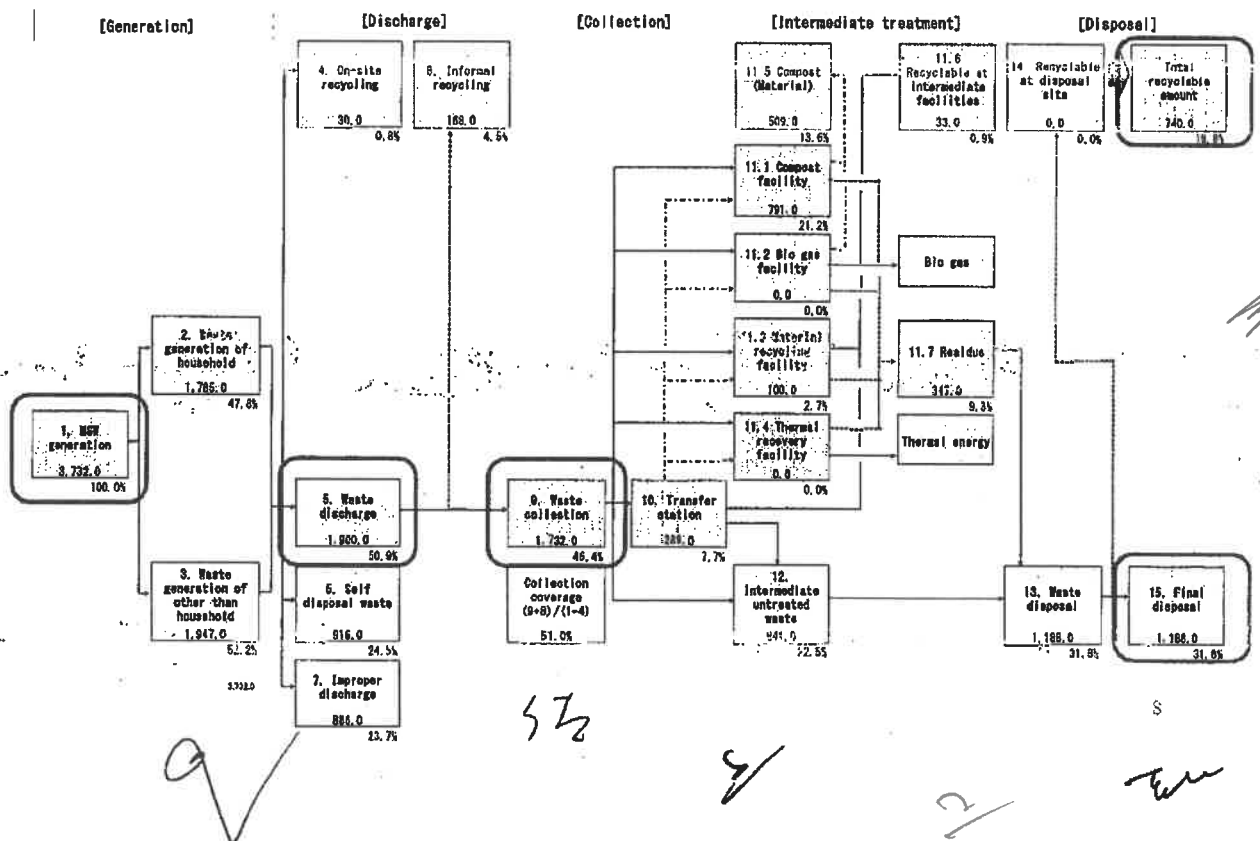

2. Prediction of future waste flow

Projection factors for future generation and collection waste amount

	Population Annual growth rate of 0.79%	Generation rate (gram per capita per day) • Per capita GDP growth rate: 4.1% p.a. • Elasticity: 0.4	Developing plan in CMC • CPC • MC	Reduction effort 0% (2023) 1% (2025) 3% (2030) 10% (2042)	Collection rate (2023-2042) MC 72%-95% UC 68%-95% PS 34%-60%
Without MP	✓	✓	✓	✓	✓
With MP	✓	✓	✓	✓	✓

9

a. Quantity of future waste generation

A function of (a) generation rate, (b) population,
(c) reduction effort

(a) Generation rate (gram per capita per day) is a function of (1) per capita GDP growth rate and (2) elasticity [correlation between GDP growth and waste generation]

(0) Generation rate as of 2020: MC 970g;
IC 630g; PS 440g

(1) Per capita GDP growth rate: 4.1% p.a.

(2) Elasticity: 0.4 [when per capita GDP increase 1%, waste generation increase by 0.4%]

(b) Population: annual growth rate of 0.79%

(c) Reduction effort: 0% (2022); -1% (2025); -5% (2030); -10% (2042)

Province/District	Without MP				With MP			
	2022	2025	2030	2042	2022	2025	2030	2042
Western Province	3,926	4,272	4,811	6,422	3,926	4,342	4,952	6,181
Colombo District	2,010	2,188	2,465	3,290	2,010	2,278	2,579	3,365
Gampaha District	1,290	1,405	1,580	2,112	1,290	1,326	1,532	1,898
Kalutara District	626	678	766	1,020	626	641	741	918

1/2

10

α

1/2

1/2

1/2

b. Quantity of future generation and collection for with MP

➤ Target of waste collection rate:

Category of LA	2022	2042
MC	72%	95%
UC	68%	95%
PS	34%	60%

➤ Special development projects estimated separately:
 ✓ Colombo Port City(CPC),
 ✓ Marine City(MC)

Province/District	Generation				Collection			
	2022	2025	2030	2042	2022	2025	2030	2042
Western Province	3,926	4,342	4,952	6,181	1,994	2,396	3,093	4,756
Colombo District	2,010	2,278	2,679	3,365	1,274	1,548	2,005	2,937
Gampaha District	1,290	1,326	1,532	1,898	486	577	745	1,258
Kalutara District	626	641	741	918	234	271	343	561

Future generation and collection amounts in WP

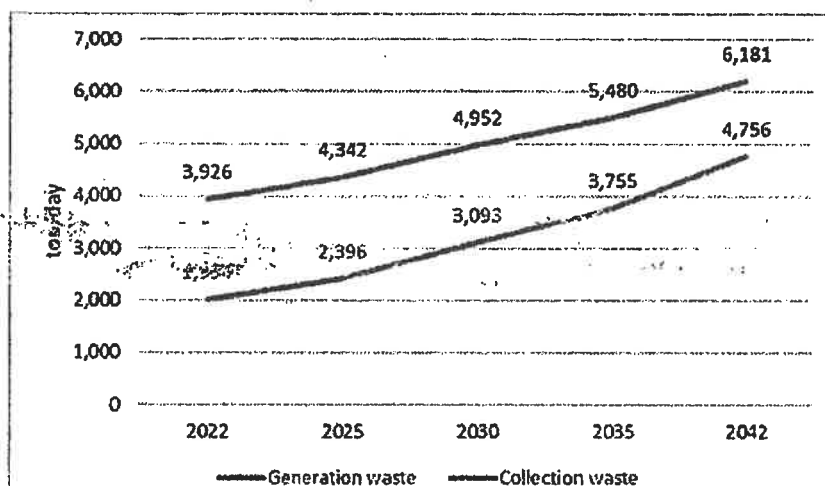

5/2

4/

2

20

3. Formulation of alternatives and selection of the most appropriate SWM system

		Primary transfer stations (PTS)	Compost facilities(t/d)		Recycling facilities(ton/day)		Thermal Recovery Facilities (ton/day)	Disposal site
			LAs & cluster based	Waste Park	LAs	Waste Park		
Without MP	Baseline	Five (5) PTS will be constructed. •Colombo •Kalutara west •Kalutara east •Gampaha west •Gampaha east	Continue current capacity 324	-	Increase facilities capacity according to the amount of separated recyclable waste	-	WPK: 750	Aruwakkalu DS throw Kelaniya TS Incombustible waste including residue generated from composting facilities, recycling facilities (SK), and WtE facilities
	Alternative A		Increase capacity to 930	-	-	-	WPK: 750	
With MP	Alternative B		Increase capacity to 930	400	-	150	2,900	
	Alternative C		Increase capacity to 930	-	-	-	3,300	

Baseline(Without MP); Continuation of current SWM technical system with composting capacity of 324t/d and FWK WtE (750t/d)

Baseline (Without MP) as of 2042

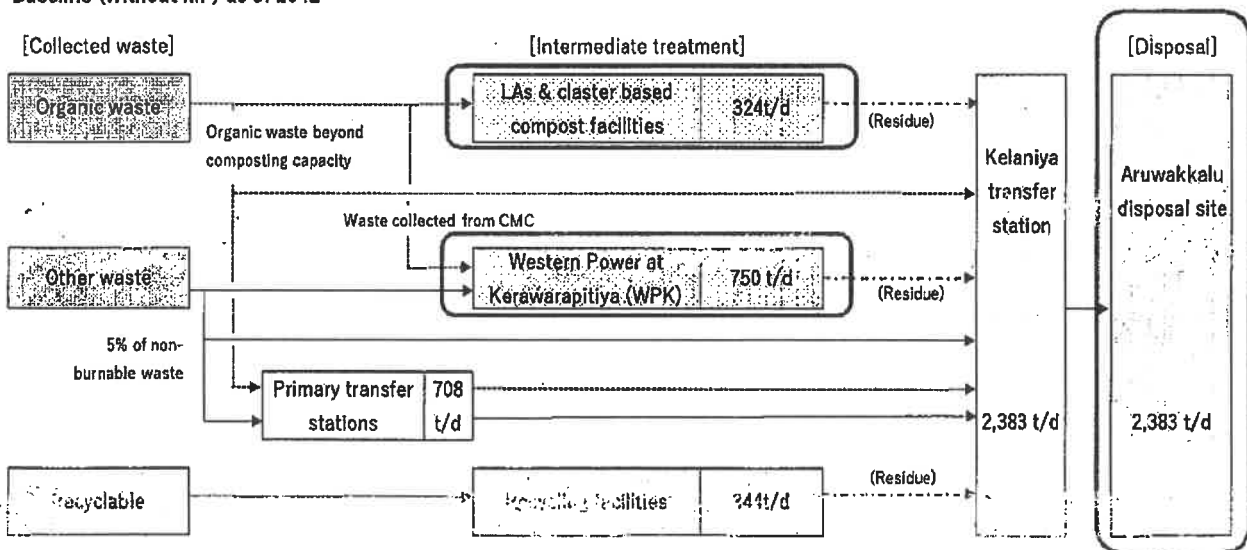

Handwritten notes and signatures at the bottom of the page, including '5/2', 'd', '2/2', and 'Ecu'.

Alternative A; Considering the reduction of waste generation and improvement of collection coverage. Composting capacity will be increased by 930t/d and FWK WtE capacity be kept 750t/d.

Alternative A as of 2042

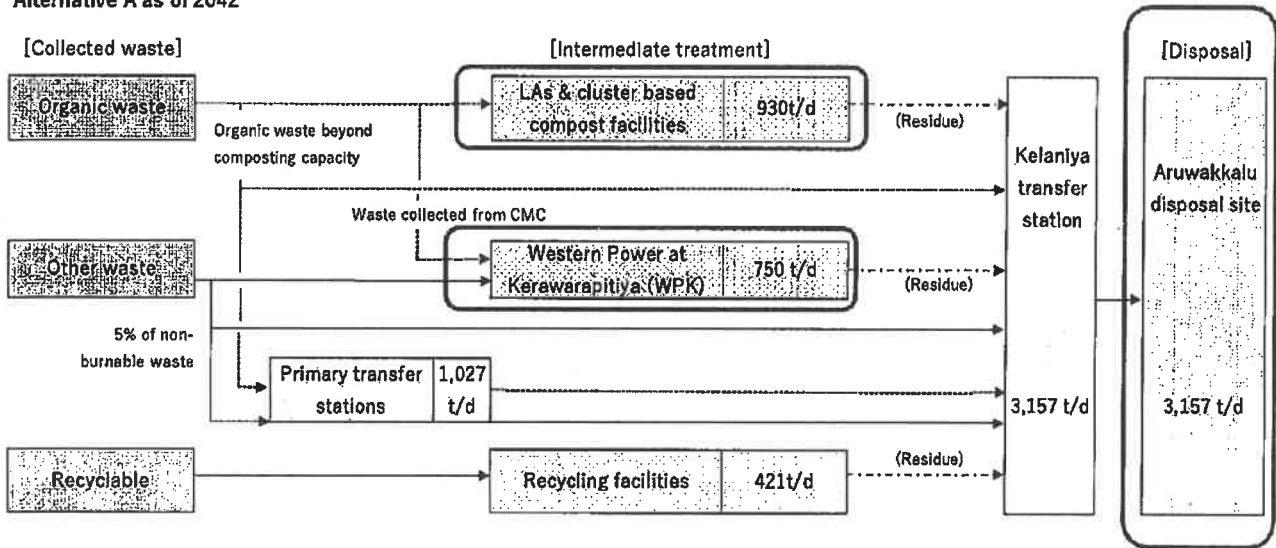

Alternative B; Considering the reduction of waste generation and improvement of collection coverage. TRF capacity will be increased by 2,900t/d. Composting and recycling capacities will be increased by 1,330t/d and 420t/d respectively including Waste Parks.

Alternative B as of 2042

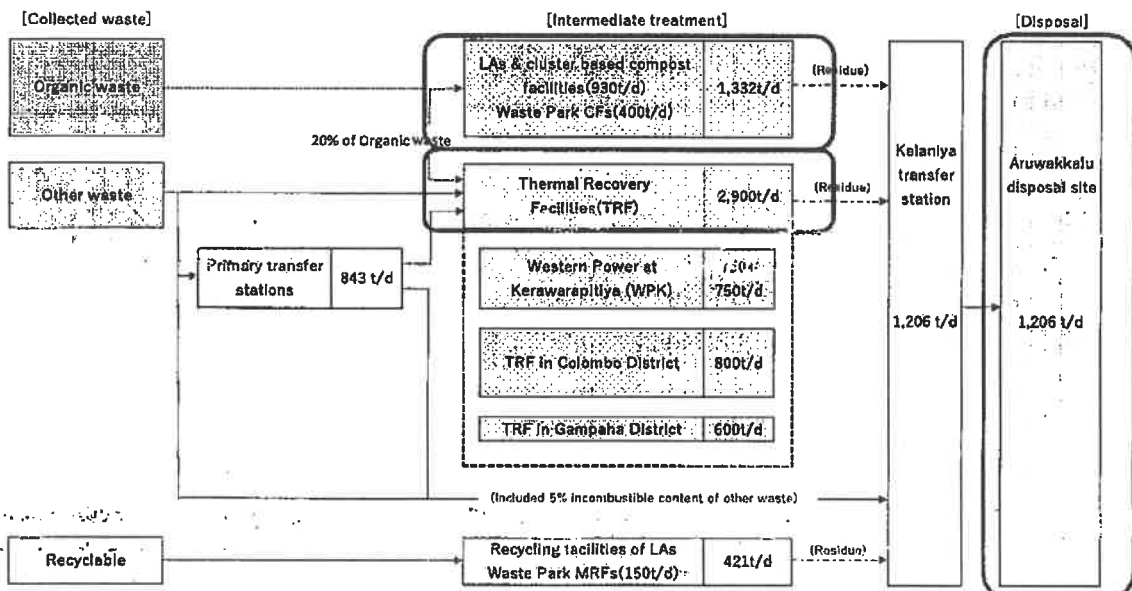

Alternative C; Considering the reduction of waste generation and improvement of collection coverage. Composting capacity will be increased by 930t/d and TRF capacity will be increased by 3,300t/d

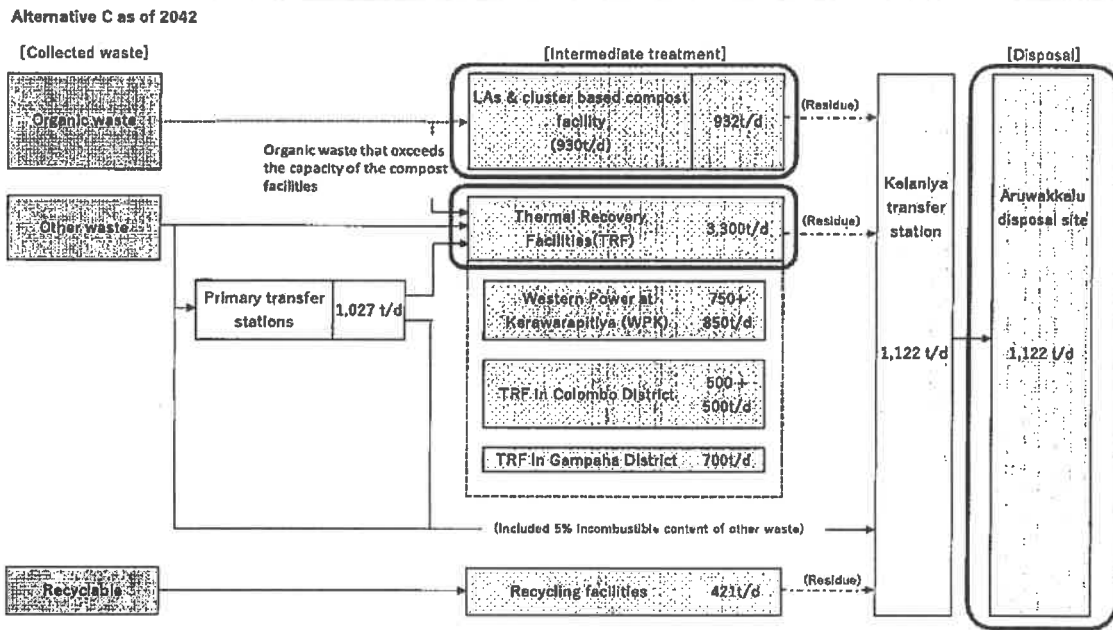

a. Comparison of waste amount of Alternatives as of 2041

Waste Type	Without MP		With MP					
	Baseline		Alternative A		Alternative B		Alternative C	
	Vol. (tpd)	(%)	Vol. (tpd)	(%)	Vol. (tpd)	(%)	Vol. (tpd)	(%)
1. Generation	6,827	100.0%	6,181	100.0%	6,181	100.0%	6,181	100.0%
7. Improper discharge	1,913	28.0%	515	8.3%	515	8.3%	515	8.3%
5. Discharge	3,805	55.7%	4,985	80.7%	4,985	80.7%	4,985	80.7%
8. Informal recycling	290	4.2%	229	3.7%	229	6.8%	229	3.7%
11.1 Compost	325	4.8%	932	15.1%	1,332	21.5%	932	15.1%
11.3 Recycling	344	5.0%	421	6.8%	421	5.4%	421	6.8%
11.4 Thermal recovery	750	11.0%	750	12.1%	2,874	46.5%	3,300	53.4%
12. Intermediate untreated waste	2,096	30.7%	2,653	42.9%	129	2.1%	103	1.7%
15. Final Disposal	2,383	34.9%	3,157	51.1%	1,206	19.5%	1,122	18.2%

Handwritten notes and signatures at the bottom of the page, including checkmarks and scribbles.

b. Comparison of breakdown of generation waste

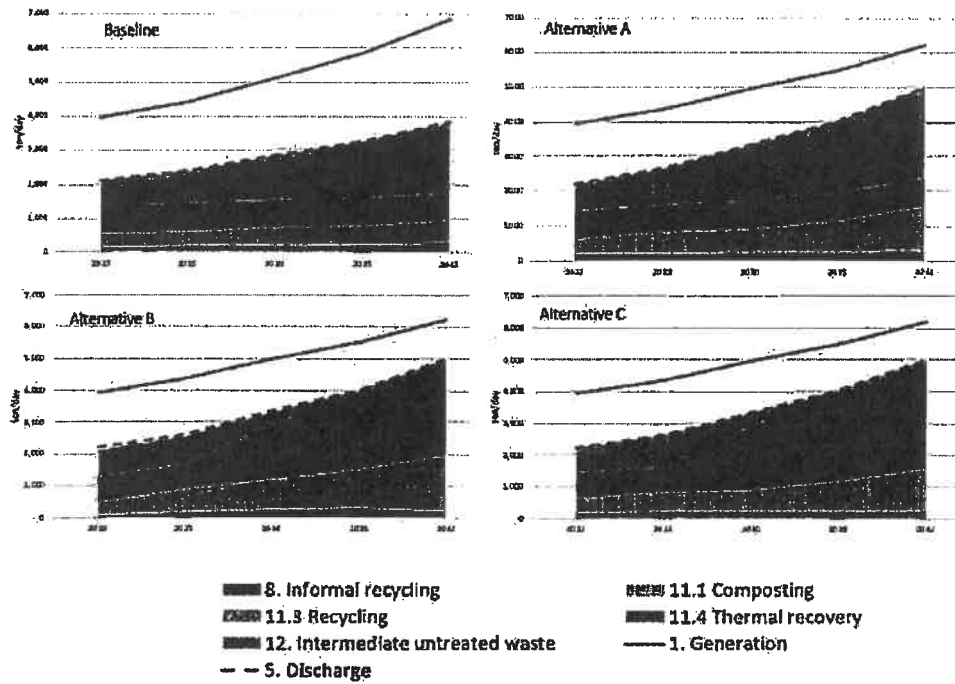

b. Comparison of cumulative disposal volume including covering soil in Aruwakkalu DS over 20 years

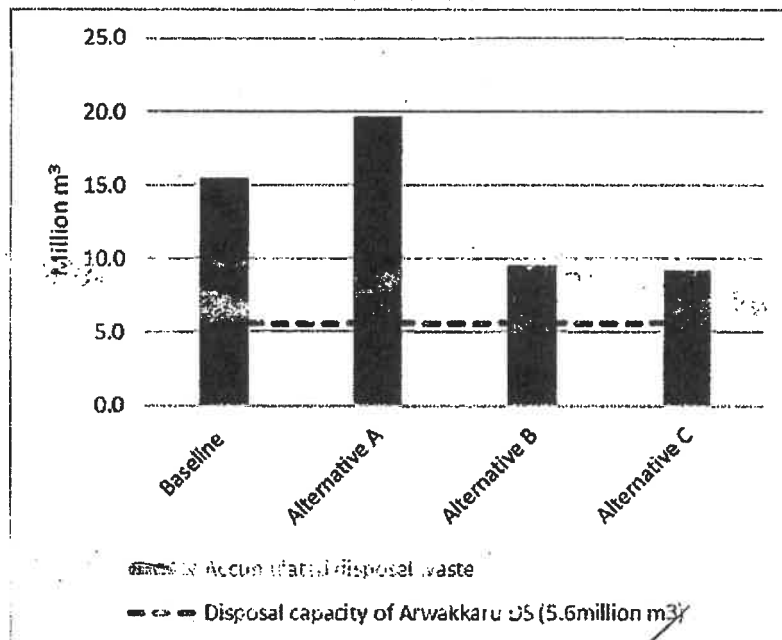

Handwritten notes and signatures at the bottom of the page, including a large checkmark and the number '13'.

c. Comparison of intermediate treatment and disposal of organic waste

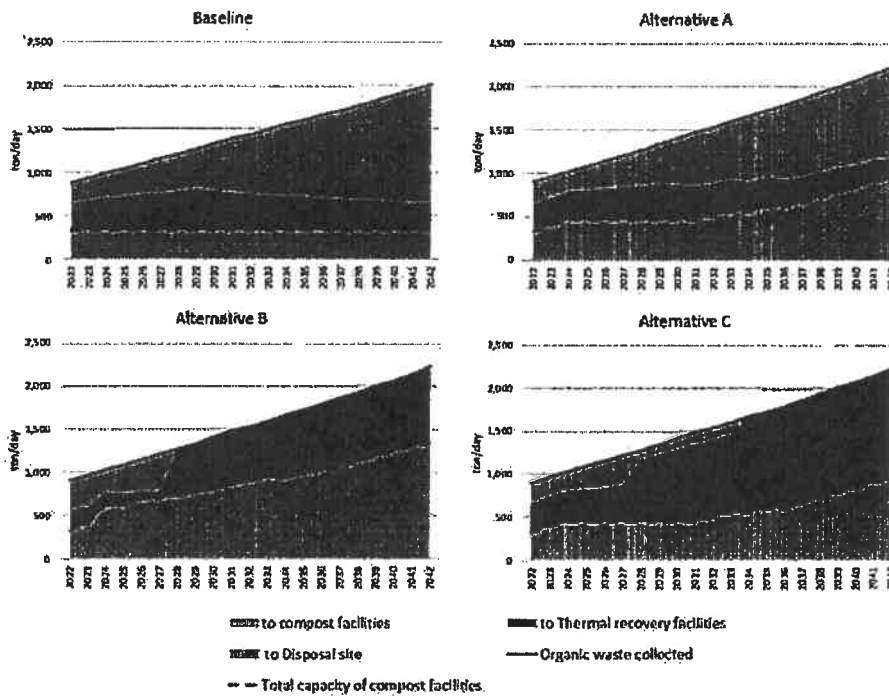

21

d. Comparison of cumulative cost of SWM and unit cost per ton of waste collected for 2023-2042

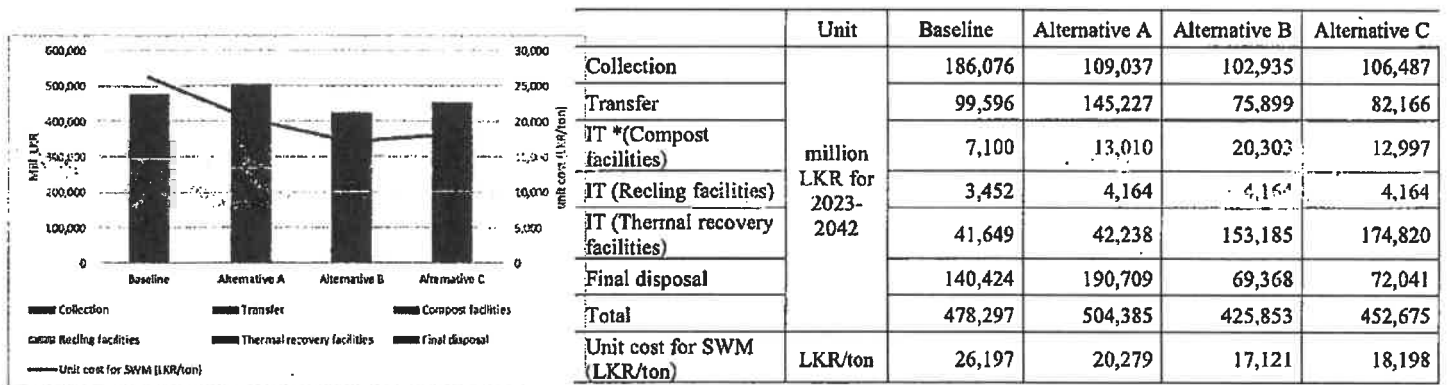

h2

9

26

10

22

Ell

e. Selection of the most appropriate SWM system

- ◆ Alternatives B and C, which can recover the energy associated with incineration and reduce the volume of final disposal waste by actively promoting incineration, are compared with the other plans. The amount of disposal is very small, and they are suitable as treatment systems in Western Province where disposal sites have to be sought outside of the province.
- ◆ alternatives A, B and C actively promote the recycling of organic waste by composting, and in particular, alternative B is a system that can promote the recycling of waste products most and can compost all the remaining organic waste, except the 20% of the collected organic waste that is incinerated.
- ◆ Economically, alternative B was evaluated as the cheapest system compared to other plans.

Based on the above, alternative B is selected as the optimal SWM system for waste management in Western Province.

4. Draft SWM CP (Milestones for achieving SWM MP)

	Short term				Medium term					Long term												
	2022	2023	2024	2025	2026	2027	2028	2029	2030	2031	2032	2033	2034	2035	2036	2037	2038	2039	2040	2041	2042	
Reduction of generation waste				1%					3%													10%
Separation of discharge waste																						
Improvement of collection rate	FFC	65%																				95%
	UC	72%																				95%
	PS	32%																				60%
Thermal Recovery Facilities (TRF)(ton/day)																						
WPK WtE facility																						
TRF in Colombo District																						
TRF in Gampaha District																						
Compost facilities(CF)(ton/day)																						
LAs CFs	92			117					131													136
Cluster-based CFs	232			333					319													794
Waste Park CFs	0			160					400													400
Recycling facilities (MRF)(ton/day)																						
LAs recycling facilities	116			116					116													270
Waste Park MRFs	0			60					150													150
Transfer station (TS)(ton/day)																						
Primary TS				396					479													843
Cluster based TS (Kelaniya transfer station)	1,065			1,242					997													1,200
Final disposal (million m ³)																						
Auwakkaru DS				1.5					4.0													9.5
By Product																						
Amount of electricity (GWh/year)				74					170													279
Compost product (ton/year)				6,700					8,700													14,600

Handwritten marks and signatures at the bottom of the page, including the number '33' and several illegible signatures.

Future waste flows in the long-term target year of 2042

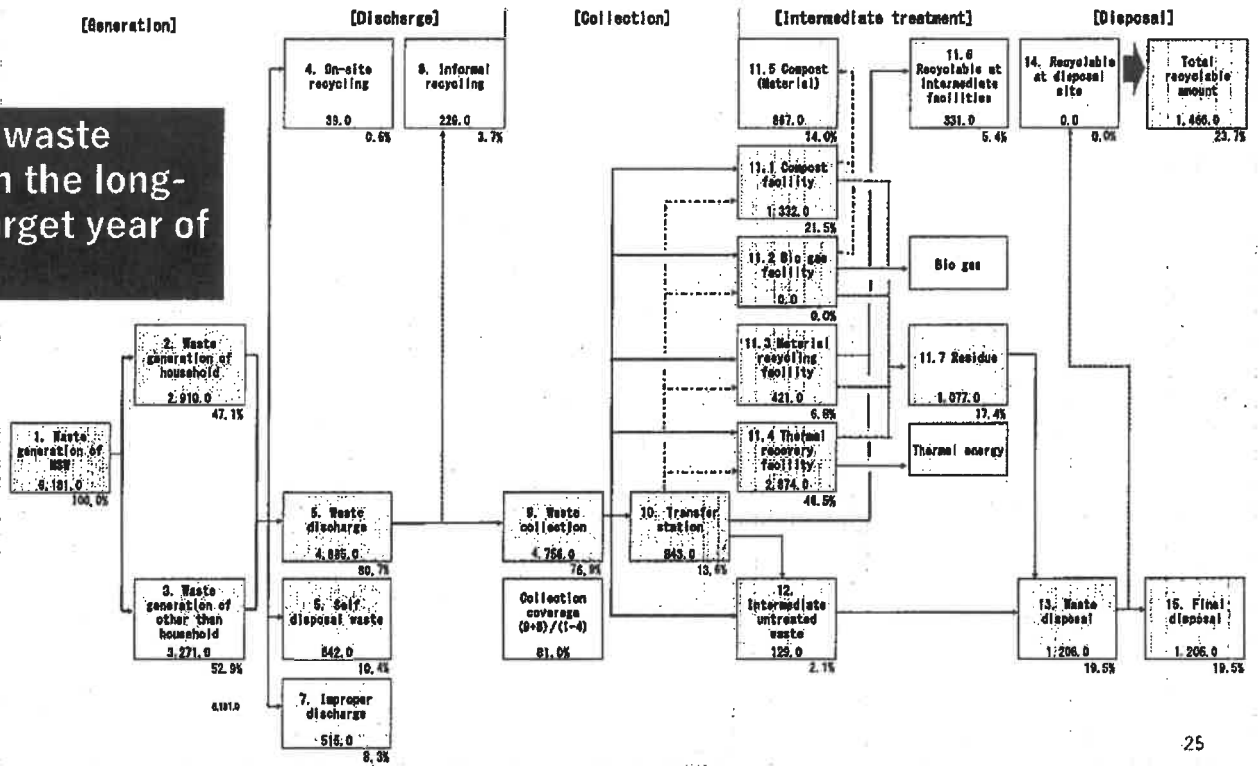

5. SWM MP implementation projects in the short to medium term

The solid waste management projects (SWM Projects) implemented in short and medium terms

- Project 1: Development of five Primary Transfer Stations (PTS)
- Project 2: Improvement of Kelaniya Transfer Station (KTS)
- Project 3: Development of Cluster based Waste Treatment Facility (CWTF)
- Project 4: Improvement of compost facilities
- Project 5: Improvement of recycling facilities for formal recyclables
- Project 6: Procurement of collection and transfer vehicles
- Project 7: Closure of current dump sites managed by LAs
- Project 8: Encourage of waste-separation

Handwritten notes and signatures at the bottom of the page, including the number '570' and several illegible signatures.

SWM MP implementation projects

	2022	Short term			Medium term					
		2023	2024	2025	2026	2027	2028	2029	2030	
Project 1: Development of five Primary Transfer Stations (PTS)										
Colombo TS : 90ton/day										Operation
Kalutara west TS : 90/day			Budgeting, Land purchase, Environmental process, DD, T/D	Tender, Construction						Operation
Kalutara east TS : 40/day	Site selection									Operation
Gampaha waste TS : 1300/day										Operation
Gampaha east TS : 170/day										Operation
Project 2: Improvement of Kelaniya Transfer Station (KTS)										
Amount of waste transferred (ton/day)	1,070	1,240	1,130	1,240	1,320	1,430	920	990	1,000	
Compared to 2022 (%)	100%	116%	106%	116%	123%	134%	86%	89%	93%	
Project 3: Development of Ternal Recovery Facility (TRF)										
WPK W/E facility (750/day)	Operation									
Additional WPK W/E facility (750/day)			PS, BIA, Tender, Contract & DD		Construction		Operation			
TRF in Colombo District (400 ton/day)			PS, BIA, Tender, Contract & DD		Construction		Operation			
Project 4: Improvement of compost facilities										
Waste Park compost facilities										
Waste Park(t/day) No.1,2	Site selection	Construction	160	160	160	160	160	160	160	160
Waste Park(t/day) No.3		Site selection, Tender, Contract		Construction	80	80		80	80	80
Waste Park(t/day) No.4				Site selection, Tender, Contract		Construction	80	80	80	80
Waste Park(t/day) No.5						Site selection, Tender, Contract		Construction		80
Total			160	160	240	240	320	320	320	400
LA and Cluster-based Compost facilities										
Cluster based facilities(t/day)	232	300	340	340	340	340	340	340	340	
LA's facilities(t/day)	92	100	110	120	130	130	130	130	130	130
Total	324	400	450	460	470	470	470	470	470	470

SWM MP implementation projects

	2022	Short term			Medium term					
		2023	2024	2025	2026	2027	2028	2029	2030	
Project 5: Improvement of recycling facilities for formal recyclables										
Recyclable amount(t/day)	120	130	150	170	190	200	220	240	260	
Waste Park MRF facilities										
Waste Park(t/day) No.1,2	Site selection	Construction	60	60	60	60	60	60	60	60
Waste Park(t/day) No.3		Site selection, Tender, Contract		Construction	30	30	30	30	30	30
Waste Park(t/day) No.4				Site selection, Tender, Contract		Construction	30	30	30	30
Waste Park(t/day) No.5						Site selection, Tender, Contract		Construction		30
Total			60	60	90	90	120	120	150	
Project 6: Procurement of collection and transfer vehicles										
Compactor truck for organic waste		Subsidies and support systems	Procurement plan, approval, budgeting	99	101	108	108	111	114	
Compactor truck for other waste				358	378	407	360	373	391	
Tractor trailer for recyclable				94	105	115	126	137	144	
Project 7: Closure of current dumping sites operated by LA										
Preparation of Guideline for closing dumping sites	Guideline									
Setting of budget for closure and Technical guidance by		Budgeting Technical								
Implement of closure			Implementation							
Project 8: Development of waste separation promotion program										
Development of waste separation guidelines	Guidelines									
WMA to hold seminar on understanding guidelines for preparation and implementation of promotion program		Seminar Preparation								
Implementation of separate collection of waste			Implementation							28

33

9

2/

2

The

Project 1: Development of five Primary Transfer Stations (PTS)

【Plan】

Primary Transfer Station	LAs to be used Primary TS	Classification of waste to be transferred	Transfer waste amount (t/day)		
			2023	2024	2042
Colotoho TS	Hamagana PS, Horana UC, Horana PS, Seethawakapura UC, Seethawaka PS	Burnable waste	40	80	140
		Disposal waste	50	10	0
		Total	90	90	140
Kahurana west TS	Kahurana PS, Beruwala UC, Beruwala PS, Kahurana UC, Madurawala PS, Madurawala PS, Madurawala PS, Dedagala PS	Burnable waste	0	88	120
		Disposal waste	60	10	10
		Total	60	98	130
Kahurana east TS	Miliyaya PS, Bulandibhala PS, Palindamawara PS, Apalawata PS, Salalawa PS	Burnable waste	0	20	60
		Disposal waste	20	10	10
		Total	20	30	70
Gampaha west TS	Biyagama PS, Gampaha M.C, Aruawakala PS, Gampaha PS, Mahasa PS, Donpe PS	Burnable waste	0	0	230
		Disposal waste	110	150	10
		Total	110	150	240
Gampaha east TS	Nagambo M.C, Katayayala Seedana UC, Mimuwangoda UC, Ja-Bia UC, Katana PS, Mimuwangoda PS, Ja-Bia PS	Burnable waste	0	0	270
		Disposal waste	140	170	10
		Total	140	170	280

【Implementation schedule】

Activities	2022			2023			2024			2025			2026			2027			
	01	02	03	01	02	03	01	02	03	01	02	03	01	02	03	01	02	03	
Identification of sites																			
Preparation of project proposal																			
Proposal to MoPCLD																			
Approval from MoPCLD																			
Government budget approval																			
Preparation for land acquisition																			
Land acquisition																			
Preparation of tender documents																			
Tender and contract																			
Construction																			
Commencement of operation																			

【Responsible organization】

Phase	Item	Responsible Organization
Construction	Identification of land	WMA
	Construction of TS and procurement of equipment	WMA
	Financing capital cost	MoPCLD
Operation	Operation of transfer stations, including transportation to next destinations	WMA
	Cost recovery	WMA charges tipping fee on LAs

【Project cost】

Item for expenditure	2022	2023	2024	2025	2026	2027
Administrative cost (planning, preparation etc)	10	10	10	0	0	0
Operation and maintenance cost	0	0	0	41	43	46
Construction cost	0	0	4,700	0	0	0
Purchase of equipment/machinery	0	0	691	23	58	347
Miscellaneous expenses	1	1	549	7	10	39
Total	11	11	6,040	76	111	432

Project 2: Improvement of Kelaniya Transfer Station (KTS)

【Plan】

- Types of waste transported:
 - Intermediate untreated waste (waste which be exceeded the capacity of intermediate treatment facilities, non-burnable waste)
 - Residue generated at composting, recycling, and thermal recovery facilities
- Transfer system: railway transferring system

	2023	2024	2025	2026	2027	2028	2029	2030
Total waste transferred (t/d)	1,147	1,134	1,242	1,315	1,434	915	954	997
Incineration residue (t/d)	150	150	149	150	150	310	323	340
Intermediate untreated waste (t/d)	997	984	1,093	1,165	1,284	605	631	657
Required number of containers (uni/d)	1,027	1,014	1,123	1,195	1,314	667	696	725
Trip number per day (trip/d)	11	11	12	12	14	7	7	8

【Implementation schedule】

Activities	2022			2023			2024			2025			2026			2027		
	01	02	03	01	02	03	01	02	03	01	02	03	01	02	03	01	02	03
Identification of sites at Kelaniya TS																		
Construction, including procurement of Loco and wagons																		
Financing capital cost																		
Operation of KTS, including transportation to Aruwakkalu																		
Cost recovery																		

【Responsible organization】

Phase	Action	Responsible Organization
Construction	Construction, including procurement of Loco and wagons	MoUD
	Financing capital cost	MoUD
Operation	Operation of KTS, including transportation to Aruwakkalu	MoUD (designated operator)
	Cost recovery	Operator charges tipping fee on users

【Project cost】

Item for expenditure	2022	2023	2024	2025	2026	2027
Administrative cost (planning, preparation etc)	0	0	0	0	0	0
Operation and maintenance cost	976	1,065	1,147	1,134	1,242	1,315
Construction cost	-	-	0	0	0	0
Purchase of equipment/machinery	-	-	0	0	0	0
Miscellaneous expenses	98	107	115	113	124	132
Total	1,074	1,172	1,262	1,247	1,366	1,447

Handwritten signatures and initials: SZ, a, b, 12, TUC

Project 3: Development of Cluster based Waste Treatment Facility (CWTF)

Project 3-1: TRF in Colombo District: 400ton/day 【Implementation schedule】

【Responsible organization】

Phase	Activity	Responsible Organization
Construction	Design, procurement, construction	Investor
	Approvals	WMA and relevant organizations
	Financing capital cost	Investor
Operation	Operation of WtE plant	Investor
	Waste supply	WMA in coordination with LAs
	Revenue collection	Electricity, balance financing by WMA arrangement with MoF and LAs

【Project cost】

Item for expenditure	2022	2023	2024	2025	2026	2027
Administrative cost (planning, preparation etc)	10	10	10	0	0	0
Operation and maintenance cost	0	0	0	0	0	0
Construction cost	0	0	0	3,333	3,333	3,333
Purchase of equipment/machinery	0	0	0	0	0	0
Miscellaneous expenses	1	1	1	332	333	333
Total	11	11	11	3,666	3,666	3,666

Project 3-2: Development of New WtE next to Western Power at Kerawalapitiya: 750ton/day 【Implementation schedule】

【Responsible organization】

Phase	Activity	Responsible Organization
Construction	Project formation	WMA in consultation with relevant organizations
	Procurement method and procurement plan	WMA in consultation with relevant organizations
	Tender award and contract	CEB/WMA
Operation	Design, procurement, construction	Investor
	Approvals	WMA and relevant organizations
	Financing capital cost	Investor
Operation	Operation of WtE plant	Investor
	Waste supply	WMA in coordination with LAs
	Revenue collection	Electricity, balance financing by WMA arrangement with MoF and LAs

【Project cost】

Item for expenditure	2022	2023	2024	2025	2026	2027
Administrative cost (planning, preparation etc)	10	10	10	0	0	0
Operation and maintenance cost	0	0	0	0	0	0
Construction cost	0	0	0	6250	6250	6250
Purchase of equipment/machinery	0	0	0	0	0	0
Miscellaneous expenses	1	1	1	625	625	625
Total	11	11	11	6,875	6,875	6,875

Project 4: Improvement of compost facilities (Waste parks)

【Plan】

Breakdown of treatment of collected organic waste

- 20 percent of organic waste collected will be treated at TRF.
- Remaining of 80 percent of organic waste will be composted.
- Organic waste that exceeds the treatment capacity of TRFs and compost facilities is disposed to disposal sites.

Year	Organic waste			Capacity of compost facilities				to Disposal site
	Collected	to TRF*	to compost facilities	Waste park	LAs compost facilities	Cluster based compost facilities	Total capacity of facilities	
2022	896	237	325	0	92	232	324	334
2023	962	199	399	0	100	300	400	364
2024	1,021	171	596	160	110	340	610	254
2025	1,084	136	611	160	120	340	620	337
2026	1,146	108	677	240	130	340	710	361
2027	1,207	72	692	240	130	340	710	443
2028	1,266	566	700	320	130	340	790	0
2029	1,335	591	744	320	130	340	790	0
2030	1,402	616	786	400	130	340	870	0

【Implementation schedule】

【Responsible organization】

Phase	Activity	Responsible Organization
Construction	Identification of land	MoUD
	Construction of waste parks and procurement of equipment	MoUD
	Financing capital cost	MoUD
Operation	Operation of waste parks	WMA (Or other mechanism)
	Cost recovery for operation and maintenance	Revenue from sales, Balance to charge tipping fee on LAs

【Project cost】

Item for expenditure	2022	2023	2024	2025	2026	2027
Administrative cost (planning, preparation etc)	10	10	10	30	10	10
Operation and maintenance cost	0	0	175	175	263	263
Construction cost	0	80	0	40	0	40
Purchase of equipment/machinery	0	0	0	0	0	0
Miscellaneous expenses	1	9	19	23	27	37
Total	11	99	204	248	300	344

Handwritten notes and signatures at the bottom of the page, including '422', 'a', 'y', '2', and 'bmc'.

Project 4: Improvement of compost facilities (Karadiyana compost facility)

【Plan】

Breakdown of treatment of collected organic waste

- 20 percent of organic waste collected will be treated at TRF.
- Remaining of 80 percent of organic waste will be composted.
- Organic waste that exceeds the treatment capacity of TRFs and compost facilities is disposed to disposal sites.

Year	Organic waste			Capacity of compost facilities				to Disposal site
	Collected	to TRF*	to compost facilities	Waste park	LAs compost facilities	Cluster based compost facilities	Total capacity of facilities	
2022	896	237	325	0	92	232	324	334
2023	962	199	399	0	100	300	400	364
2024	1,021	171	596	160	110	340	610	254
2025	1,084	136	611	160	120	340	620	337
2026	1,146	108	677	240	130	340	710	361
2027	1,207	72	692	240	130	340	710	443
2028	1,266	566	700	320	130	340	790	0
2029	1,335	591	744	320	130	340	790	0
2030	1,402	616	786	400	130	340	870	0

【Implementation schedule】

	2021			2022			2023			2024			2025			2026			2027		
	Q1	Q2	Q3	Q1	Q2	Q3	Q1	Q2	Q3	Q1	Q2	Q3	Q1	Q2	Q3	Q1	Q2	Q3	Q1	Q2	Q3
Phase 1: Final layout and zoning approval																					
Phase 2: Landfill rehabilitation; Landfill closing, stabilization and composting at Area 1																					
Phase 3: Window compost operation at area 2 & 3 of Site A																					

【Responsible organization】

Stage	Action	Responsible Organization
Construction	Procurement of equipment and works at site	WMA
	Financing capital cost	WMA and JICA
Operation	Operation of compost plant	WMA
	Cost recovery for operation and maintenance	Revenue from sales, Balance to charge tipping fee on LAs

【Project cost】

Item for expenditure	2022	2023	2024	2025	2026	2027
Administrative cost (if handling, preparation etc)	0	0	0	0	0	0
Operation and maintenance cost	0	23	23	10	10	10
Construction cost	0	6	0	0	0	0
Purchase of equipment/machinery	42	2	0	0	0	0
Miscellaneous expenses	4	3	2	1	0	0
Total	46	34	25	10	0	0

Project 5: Improvement of recycling facilities for formal recyclables

【Plan】

- Recyclable amount collected is increased according to the improving collection coverage and increasing total waste collected.
- Construct a MRF with a capacity of 30 tons/day per location in the waste park to promote recycling.

Recyclable be collected

Year	WP	District									
		Colombo	Gampaha	Kalutara	Kotte	Dehiwala	Negambo	Gampaha	Kelaniya	Horana	Kalutara
2022	116	46	37	15	34	12	7	42	8	8	7
2023	132	56	38	15	45	14	9	42	8	8	7
2024	151	72	61	18	55	17	9	44	8	10	8
2025	169	84	67	18	65	19	12	45	10	11	7
2026	186	98	68	20	76	22	12	45	11	12	8
2027	202	110	70	22	85	25	13	46	11	13	9
2028	219	122	73	24	96	26	15	46	13	14	10
2029	241	139	77	25	109	30	16	46	13	14	11
2030	255	153	77	25	120	33	18	46	13	14	11

【Implementation schedule】

	2021			2022			2023			2024			2025			2026			2027		
	Q1	Q2	Q3	Q1	Q2	Q3	Q1	Q2	Q3	Q1	Q2	Q3	Q1	Q2	Q3	Q1	Q2	Q3	Q1	Q2	Q3
Finalization and approval of MRF/RF																					
Final approval in MRF/RF																					
Preparation of land																					
Finalization of MRF/RF																					
Construction of MRF/RF																					
Operation of MRF/RF																					
Commissioning of a person at MRF/RF																					

【Responsible organization】

Stage	Action	Responsible Organization
Construction	Identification of land	MoUD
	Construction of waste parks and procurement of equipment	MoUD
Operation	Final approval of MRF/RF	MoUD
	Operation of waste parks	WMA
	Cost recovery for operation and maintenance	Revenue from sales of recycling materials

【Project cost】

Item for expenditure	2022	2023	2024	2025	2026	2027
Administrative cost (if handling, preparation etc)	10	0	0	0	0	0
Operation and maintenance cost	86	96	110	123	136	147
Construction cost	0	0	0	0	0	0
Purchase of equipment/machinery	0	0	0	0	0	0
Miscellaneous expenses	10	10	11	12	14	15
Total	106	106	121	135	150	162

Project 6: Procurement of collection and transfer vehicles

【Plan】 Required number of collection vehicle												
Required number of vehicle for organic waste (unit)												
Year	WP	District					Zone					
		Colombo	Gampaha	Kalutara	Kotte	Dekkers	Negombo	Gampaha	Kelaniya	Hirun	Kalutara	
2022	46	32	28	23	12	23	7	10	11	11	11	11
2023	53	39	33	22	15	24	9	11	12	11	11	11
2024	54	40	35	23	15	25	10	13	13	11	11	11
2025	55	40	33	24	11	23	10	13	12	11	11	11
2026	101	41	36	24	16	25	10	14	12	11	11	11
2027	108	46	37	23	17	24	11	16	12	11	11	11
2028	106	43	41	22	19	26	11	16	14	11	11	11
2029	111	46	45	22	19	27	11	16	15	11	11	11
2030	114	47	44	23	20	27	12	16	15	11	11	11

Required number of vehicle for other waste (unit)												
Year	WP	District					Zone					
		Colombo	Gampaha	Kalutara	Kotte	Dekkers	Negombo	Gampaha	Kelaniya	Hirun	Kalutara	
2022	299	194	87	34	138	56	26	28	21	28	18	18
2023	300	201	87	37	148	55	26	21	20	28	17	17
2024	298	199	87	31	151	49	26	18	19	16	15	15
2025	306	219	87	33	159	52	26	19	18	18	15	15
2026	316	219	85	32	169	50	27	19	18	17	15	15
2027	333	230	91	34	177	53	29	22	20	17	17	17
2028	357	246	91	36	183	51	29	23	20	17	18	18
2029	371	258	93	42	193	53	28	23	22	17	19	19
2030	399	288	99	45	205	55	28	25	23	18	19	19

Required number of vehicle for recyclable (unit)												
Year	WP	District					Zone					
		Colombo	Gampaha	Kalutara	Kotte	Dekkers	Negombo	Gampaha	Kelaniya	Hirun	Kalutara	
2022	49	29	31	4	19	8	22	4	4	4	4	4
2023	53	34	31	6	24	10	5	22	4	4	4	4
2024	61	39	33	10	29	10	5	23	4	4	4	4
2025	64	46	37	11	33	12	8	24	4	4	4	4
2026	101	37	39	19	41	12	8	24	4	4	4	4
2027	113	40	40	25	41	13	8	25	4	4	4	4
2028	126	43	44	27	39	13	10	26	4	4	4	4
2029	137	47	46	28	37	13	11	26	4	4	4	4
2030	144	49	48	30	42	14	11	26	4	4	4	4

【Implementation schedule】

Activities	2022				2023				2024				2025				2026				2027			
	Q1	Q2	Q3	Q4	Q1	Q2	Q3	Q4	Q1	Q2	Q3	Q4	Q1	Q2	Q3	Q4	Q1	Q2	Q3	Q4	Q1	Q2	Q3	Q4
Establishment of administrative and support systems for the procurement of self-owned vehicles by MoPCLG and WMA	■	■	■	■																				
Development and execution of procurement plan of collection vehicles by LA		■	■	■	■	■	■	■	■	■	■	■	■	■	■	■	■	■	■	■	■	■	■	
Review and approval of procurement program by MoPCLG and WMA					■	■	■	■	■	■	■	■	■	■	■	■	■	■	■	■	■	■	■	
Bidding based procurement plan and conduct on vehicle by MoPCLG									■	■	■	■	■	■	■	■	■	■	■	■	■	■	■	

【Responsible organization】

Stage	Action	Responsible Organization
Procurement of vehicles	Preparation of LA Action Plan	LAs
	Concurrence to LA Action Plan	WMA
	Procurement of Vehicles	NSWMSC
Operation	Financing of capital cost	MoPCLG
	Operation of vehicles	LAs

【Project cost】

Item for expenditure	2022	2023	2024	2025	2026	2027
Administrative cost (planning, preparation etc)	10	10	10	10	10	10
Operation and maintenance cost	0	0	0	0	0	0
Construction cost	0	0	0	0	0	0
Purchase of equipment/machinery	0	3,843	25	112	248	510
Miscellaneous expenses	1	385	4	12	26	52
Total	11	4,238	39	134	284	572

Project 7: Closure of current dump sites managed by LAs

【Plan】												
<p>By 2024, LAs aim to dispose of the waste to the Aruwakkaru disposal site via Kelaniya TS. Closure of disposal sites used by LAs will begin at any time from the LAs that are ready. A disposal sites closure manual will be developed to guide the proper closure of disposal sites.</p>												

【Implementation schedule】													
Activities	2022				2023				2024				2025
	Q1	Q2	Q3	Q4	Q1	Q2	Q3	Q4	Q1	Q2	Q3	Q4	Q1
Preparation of Manual for closing the current dump sites of LA	■	■	■	■									
Securing of budget for closure of current dump sites		■	■	■	■	■	■	■	■	■	■	■	■
Closure work at the current dump sites									■	■	■	■	■
Stop dumping a waste to current dump sites													■

Stage	Action	Responsible Organization
Planning	Development of closure manual	CEA, NSWMSC, WMA
	Planning of site closure	LAs with WMA assistance
Implementation	Implementation	LAs with WMA assistance
	Financing of capital cost	WMA (WPC)

【Project cost】							
Item for expenditure	2022	2023	2024	2025	2026	2027	
Administrative cost (planning, preparation etc)	10	10	0	0	0	0	
Operation and maintenance cost	0	0	0	0	0	0	
Construction cost	0	0	280	0	0	0	
Purchase of equipment/machinery	0	0	0	0	0	0	
Miscellaneous expenses	1	1	28	0	0	0	
Total	11	11	308	0	0	0	

Project 8: Encourage of waste separation

<p>【Plan】 Promote waste separation by implementing the following measures.</p> <ul style="list-style-type: none"> ■ Development of waste separation guidelines ■ Hold seminars for municipalities on the necessity of waste separation and guidance on waste separation methods. ■ Preparation and implementation of promotion program in line with the Guideline 	<p>【Implementation schedule】</p> <table border="1"> <thead> <tr> <th rowspan="2">Activities</th> <th colspan="3">2022</th> <th colspan="3">2023</th> <th colspan="3">2024</th> <th colspan="3">2025</th> <th colspan="3">2026</th> <th colspan="3">2027</th> </tr> <tr> <th>Q1</th><th>Q2</th><th>Q3</th> <th>Q1</th><th>Q2</th><th>Q3</th> <th>Q1</th><th>Q2</th><th>Q3</th> <th>Q1</th><th>Q2</th><th>Q3</th> <th>Q1</th><th>Q2</th><th>Q3</th> <th>Q1</th><th>Q2</th><th>Q3</th> </tr> </thead> <tbody> <tr> <td>Understand the actual situation and issues</td> <td></td><td></td><td></td><td></td><td></td><td></td><td></td><td></td><td></td><td></td><td></td><td></td><td></td><td></td><td></td><td></td><td></td><td></td> </tr> <tr> <td>Development of waste separation guidelines by WMA</td> <td></td><td></td><td></td><td></td><td></td><td></td><td></td><td></td><td></td><td></td><td></td><td></td><td></td><td></td><td></td><td></td><td></td><td></td> </tr> <tr> <td>WMA to hold seminar on understanding guidelines for LAs</td> <td></td><td></td><td></td><td></td><td></td><td></td><td></td><td></td><td></td><td></td><td></td><td></td><td></td><td></td><td></td><td></td><td></td><td></td> </tr> <tr> <td>Preparation and implementation of promotion program in line with the Guideline</td> <td></td><td></td><td></td><td></td><td></td><td></td><td></td><td></td><td></td><td></td><td></td><td></td><td></td><td></td><td></td><td></td><td></td><td></td> </tr> <tr> <td>Implement measures of separate collection of waste</td> <td></td><td></td><td></td><td></td><td></td><td></td><td></td><td></td><td></td><td></td><td></td><td></td><td></td><td></td><td></td><td></td><td></td><td></td> </tr> </tbody> </table>	Activities	2022			2023			2024			2025			2026			2027			Q1	Q2	Q3	Q1	Q2	Q3	Q1	Q2	Q3	Q1	Q2	Q3	Q1	Q2	Q3	Q1	Q2	Q3	Understand the actual situation and issues																			Development of waste separation guidelines by WMA																			WMA to hold seminar on understanding guidelines for LAs																			Preparation and implementation of promotion program in line with the Guideline																			Implement measures of separate collection of waste																		
Activities	2022			2023			2024			2025			2026			2027																																																																																																																					
	Q1	Q2	Q3	Q1	Q2	Q3	Q1	Q2	Q3	Q1	Q2	Q3	Q1	Q2	Q3	Q1	Q2	Q3																																																																																																																			
Understand the actual situation and issues																																																																																																																																					
Development of waste separation guidelines by WMA																																																																																																																																					
WMA to hold seminar on understanding guidelines for LAs																																																																																																																																					
Preparation and implementation of promotion program in line with the Guideline																																																																																																																																					
Implement measures of separate collection of waste																																																																																																																																					
<p>【Responsible organization】</p> <table border="1"> <thead> <tr> <th>Item</th> <th>Responsible Organization</th> </tr> </thead> <tbody> <tr> <td>Preparation guidelines suitable for WP intermediate facilities and recycling</td> <td>CE/NSWMS/CWMA in line with national regulations and guidelines</td> </tr> <tr> <td>Guidelines</td> <td>LAs</td> </tr> <tr> <td>Implementation</td> <td>LAs</td> </tr> </tbody> </table>		Item	Responsible Organization	Preparation guidelines suitable for WP intermediate facilities and recycling	CE/NSWMS/CWMA in line with national regulations and guidelines	Guidelines	LAs	Implementation	LAs																																																																																																																												
Item	Responsible Organization																																																																																																																																				
Preparation guidelines suitable for WP intermediate facilities and recycling	CE/NSWMS/CWMA in line with national regulations and guidelines																																																																																																																																				
Guidelines	LAs																																																																																																																																				
Implementation	LAs																																																																																																																																				
<p>【Project cost】</p> <table border="1"> <thead> <tr> <th>Item for expenditure</th> <th>2022</th> <th>2023</th> <th>2024</th> <th>2025</th> <th>2026</th> <th>2027</th> </tr> </thead> <tbody> <tr> <td>Administrative cost (planning, preparation etc)</td> <td>30</td> <td>30</td> <td>30</td> <td>0</td> <td>0</td> <td>0</td> </tr> <tr> <td>Operation and maintenance cost</td> <td>0</td> <td>0</td> <td>0</td> <td>0</td> <td>0</td> <td>0</td> </tr> <tr> <td>Construction cost</td> <td>0</td> <td>0</td> <td>0</td> <td>0</td> <td>0</td> <td>0</td> </tr> <tr> <td>Purchase of equipment/machinery</td> <td>0</td> <td>0</td> <td>0</td> <td>0</td> <td>0</td> <td>0</td> </tr> <tr> <td>Miscellaneous expenses</td> <td>3</td> <td>3</td> <td>3</td> <td>0</td> <td>0</td> <td>0</td> </tr> <tr> <td>Total</td> <td>33</td> <td>33</td> <td>33</td> <td>0</td> <td>0</td> <td>0</td> </tr> </tbody> </table>		Item for expenditure	2022	2023	2024	2025	2026	2027	Administrative cost (planning, preparation etc)	30	30	30	0	0	0	Operation and maintenance cost	0	0	0	0	0	0	Construction cost	0	0	0	0	0	0	Purchase of equipment/machinery	0	0	0	0	0	0	Miscellaneous expenses	3	3	3	0	0	0	Total	33	33	33	0	0	0																																																																																			
Item for expenditure	2022	2023	2024	2025	2026	2027																																																																																																																															
Administrative cost (planning, preparation etc)	30	30	30	0	0	0																																																																																																																															
Operation and maintenance cost	0	0	0	0	0	0																																																																																																																															
Construction cost	0	0	0	0	0	0																																																																																																																															
Purchase of equipment/machinery	0	0	0	0	0	0																																																																																																																															
Miscellaneous expenses	3	3	3	0	0	0																																																																																																																															
Total	33	33	33	0	0	0																																																																																																																															

6. Economic and Financial Analysis of the Master Plan

57

9

1

PL

PL

6.1. Methodology

(1) Cost-Effective Analysis (CEA)

- To confirm that selected methods are the least cost among the technical and environmentally feasible alternatives

(2) Financial Sustainability Analysis (FSA)

- To confirm that concerned authorities have sufficient financial capacity to afford the implementation cost

(3) Cost-Benefit Analysis (CBA)

- To confirm the adequate return of investment by comparing cost and benefit \leq **CBA not applied** because (1) waste management not financially profitable, (2) difficulty in estimating economic (environmental) benefit into monetary value

39

6.2 Cost-Effectiveness Analysis (1)

- Comparison of unit cost for waste management (Rs./ton) among alternatives (Average (levelized) cost including both capital & operation)

	(1) Composting	(2) Thermal Recovery	(3) Direct Disposal
Input	Organic waste only	Mix waste (Organic waste and recyclable waste can be included)	Any municipal waste
Process	From 1 ton of organic waste, 100kg of compost is produced.	Through incineration with the energy recovery process, 274kWh of electricity is generated from 1 ton of mixed waste. 250kg kilograms of residue is leftover and transported to Aruwakkalu and disposed.	Without intermediate processing, waste is transported from Kelaniya Transfer Station and disposed of by sanitary landfilling at the Aruwakkalu disposal site.
Output	250kg kilograms of residue is leftover and transported to Aruwakkalu and disposed.	The entity sells electricity to CEB. Economic value of electricity Rs.19/kWh is counted as the revenue.	
Disposal	Compost is sold at the market at LKR 10/kg.		

40

6.2 Cost-Effectiveness Analysis (2)

- Estimated cost of waste management alternatives (Rs./ton):
Average (levelized) cost including both capital and operation

Method	(1) Composting	(2) Thermal Recovery (WtE)	(3) Direct Disposal
Capital	Rs. 100	Rs. 5,100	Rs. 8,000
Operation	Rs. 3,000	Rs. 7,700	Rs. 4,000
Transportation	Rs. 4,400*	Rs. 4,400*	Rs. 5,400
Revenue (-)	(-)Rs. 1,000	(-)Rs. 5,200	
Total	Rs. 6,500	Rs. 12,000	Rs. 17,400

*) Transportation for (1) and (2) is for transportation cost of residues & their disposal.

41

6.2 Cost-Effectiveness Analysis (3)

• Summary of Cost-effective Analysis

- Average (levelized) net cost: (1) Composting Rs. 6,500/ton;
(2) Waste-to-energy Rs. 12,000/ton; (3) Disposal Rs. 17,400/ton

• (1) Composting and (2) Waste-to-energy are less costly than (3) Disposal without intermediate treatment. Thus, both (1) and (2) are to be encouraged.

- If financial constraints to do both (1) and (2), (1) Composting is preferred to (2) Waste-to-energy from a financial viewpoint.

3/2

9 ✓

2/

2

True

42

6.3 Financial Sustainability Analysis (1)

- **Local authorities bear operation costs;** Government assumes capital investment cost

Master Plan implementation cost (2023-2042) (Rs. Mil)					
Waste Management Process	Cost		Benefit (-)	Total	%
	Capital	O&M			
Collection	7,513	95,754	0	103,267	29%
Transfer/Transportation	10,417	69,601	0	80,018	23%
Composting	503	19,638	-6,546	13,595	4%
Recycling	2000	4,164	0	6,164	2%
Thermal Recovery	53,748	99,437	-73,953	79,232	23%
Final Disposal	31,291	38,046	0	69,337	20%
Total	105,472	326,640	-80,499	351,613	100%
%	30%	93%	-23%	100%	

43

6.3 Financial Sustainability Analysis (2)

- Percentage of Waste Management Expenditure in LAs Recurrent Expenditure (2021)

	0% - 10%	10% - 20%	20% - 30%	30% - 40%	40% - 50%
Number of LA	9	12	15	5	1

Source: Local Authority's Budget Book 2021 (42 out of 49LAs in Western Province)

⇒ The average waste management expenditure is **20%** of LAs total recurrent expenditure.

44

6.3 Financial Sustainability Analysis (3)

• Case 1: Annual Operation Cost of Waste Management

					(Rs. Mil)
	2023	2027	2032	2037	2042
Collection	3,376	3,802	4,687	5,564	6,501
Transfer/Transportati	3,065	4,033	3,379	3,310	4,066
Composting	437	756	958	1,161	1,456
Recycling	96	147	208	258	307
Thermal Recovery	625	765	1,181	1,661	1,882
Final Disposal	2,010	2,513	1,895	1,751	2,113
Total	9,610	12,015	12,308	13,705	16,325
% of Recur. Budget	33%	34%	27%	24%	22%

45

Financial Sustainability Analysis (4)

• Case 2: Annual Operation Cost of Waste Management

Case 1 + Capital cost of Thermal Recovery

					(Rs. Mil)
	2023	2027	2032	2037	2042
Collection	3,376	3,802	4,687	5,564	6,501
Transfer/Transportati	3,065	4,033	3,379	3,310	4,066
Composting	437	756	958	1,161	1,456
Recycling	96	147	208	258	307
Thermal Recovery	2,403	2,939	4,539	6,381	7,232
Final Disposal	2,010	2,513	1,895	1,751	2,113
Total	11,388	14,190	15,666	18,426	21,675
% of Recur. Budget	39%	40%	35%	32%	29%

46

6.3 Financial Sustainability Analysis (5)

- Summary of Financial Sustainability Analysis
 - **In Case 1**, the total operation cost starts from 33% of LAs' recurrent expenditure in 2023, up to 34% in 2027, and ends at 22% in 2042.
 - High level between 2023 and 2027 is caused by the large volume of untreated wastes transported and disposed in Aruwakkalu due to the unavailability of intermediate treatment facilities.
 - **In Case 2**, by adding the capital portion of thermal recovery, LAs' expenditure goes up to 39-40% in 2023-27 period, doubling from the present 20% level.
 - Support by the government for LAs' financial sustainability is crucial; e.g. slicing out the capital portion of the thermal recovery facilities from LAs and transferring to the government.

-END-

47

32

9

2

12

tw



THE PROJECT FOR FORMULATION OF WESTERN PROVINCE SOLID WASTE MANAGEMENT MASTER PLAN SRI LANKA (Phase II)

The 3rd Joint Coordination Committee (JCC)

Outline & Progress of the Project

21 April 2022

JICA Expert team
Chief consultant
Dr. Naofumi SATO

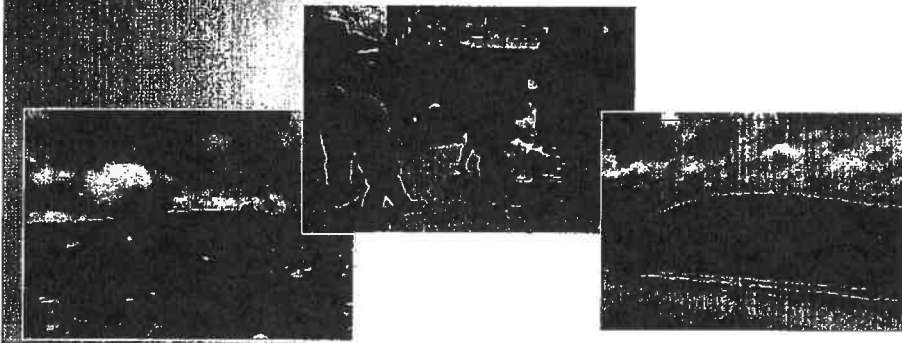

Contents

1. Outline of Project
2. Expected Outputs
3. Schedule of the Project
4. Activities of Outputs and progress
5. Others

5/2

2

1/2

2

2

2

1.1 Background/current condition

(1) Technical

- ✓ There are more than 23 dumping sites in Western Province and most of them are open dumping and limited capacity for disposing.
- ✓ Construction of new final disposal site is difficult

(2) Operational

- ✓ There are nearly 20 related organizations of waste management tackling SWM issues.
- ✓ Coordination, sharing information, and proper demarcation of role are required among related organization

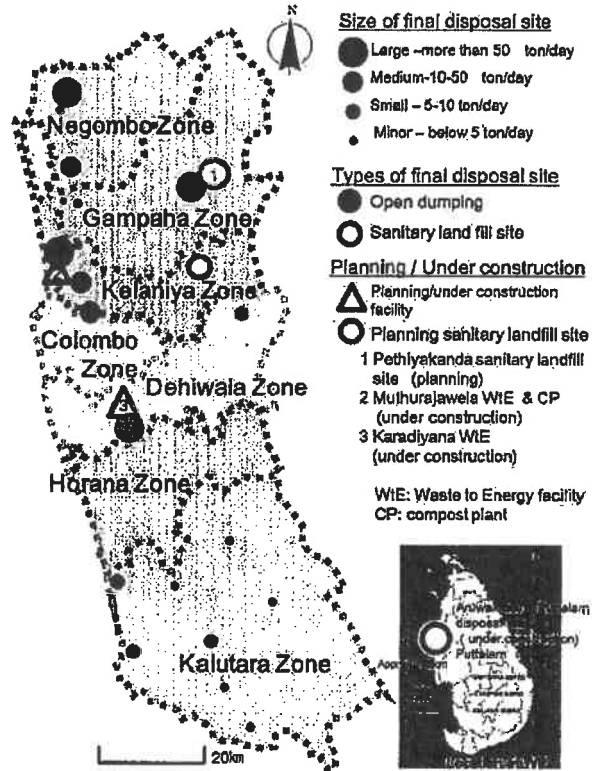

1.1 Background/current condition

(1) Collapse at Meethotamulla Waste Disposal Site

A collapse at Meethotamulla Waste Disposal Site in April 2017 caused a disaster resulting in the loss of many lives of nearby residents and massive physical damages. In response to the crisis, the Government of Japan (GOJ) provided emergency relief goods and dispatched the Japan Disaster Relief Expert Team, consisting of relevant technical expert members.

(2) Master plan project for WP requested by former President of SL

In 2017, the former President and Government of Sri Lanka (GOSL) made a request to GOJ to formulate a Solid Waste Management MP for Western Province, that well coordinates among Central Government, Provincial Government, and Local Authorities (LAs). In response to the request made by GOSL, Japan International Cooperation Agency (JICA) has dispatched the expert team to carry out a technical cooperation project since February 2019.

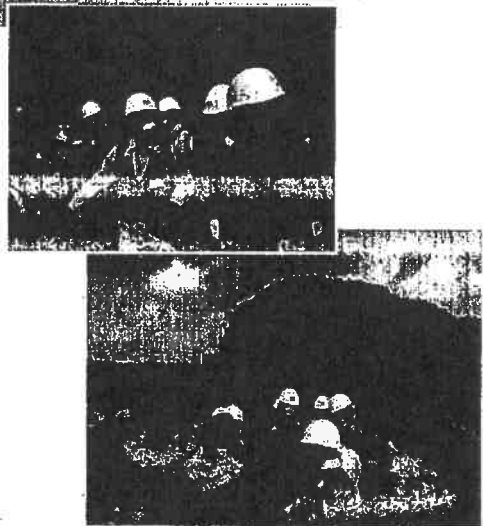

Japan Provides Relief Assistance To Victims And Expertise To Resolve Meethotamulla Garbage Crisis

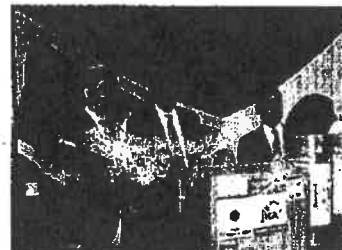

JICA Disaster Response Support Activities in Sri Lanka and Prabhakaran, Chief Representative of UNICEF in Colombo, jointly held a press conference for emergency relief items from Japan to the victims of the disaster. (Photo courtesy of the Ministry of Disaster Management and Relief)

5/2

Handwritten signatures and marks at the bottom of the page.

1.2 Overall goal/Project purpose/Target Waste

(1) Overall goal

Appropriate SWM practices in accordance with Western Province Solid Waste Management Master Plan are undertaken in Western Province

(2) Project purpose

Western Province's planning capacity on SWM is strengthened through the formulation of Western Province Solid Waste Management MP. "Planning capability" includes the ability to build cooperative structures and coordination capacity among related organizations in accordance with the plan at the implementation stage of the plan

(3) Target waste planned in the MP

✓ Primarily focusing on municipal solid waste.

✓ Healthcare

✓ Industrial Waste, and

✓ C&D Waste

} basic information collection level

(4) Target year

20 years : short(5years), mid (10years) and long term(20years)

5

Output 1. Roles and responsibilities of organizations relevant to solid waste management in Western Province are clarified and institutional arrangements for the formulation of the MP are established.

Output 2. Current situations and challenges of solid waste management in Western Province are clarified. (Waste Flow & Database)

Output 3. Knowledge and experience which contribute to MP formulation and implementation are acquired through the implementation of pilot projects (Transfer station) on appropriate waste management and 3Rs. (Target areas: Colombo Municipality and other LAs.)

Output 4. Knowledge and experience which contribute to MP formulation and implementation are acquired through pilot projects (Development of compost plant) for improving planning/ operation of waste management facilities.

Output 5. Collaboration and coordination among relevant organizations in Western Province for the implementation of MP, and formulation and implementation of its related plans (e.g. LA action plans, plans on waste management facilities) are strengthened.

Handwritten marks and signatures at the bottom of the page, including a large checkmark and several initials.

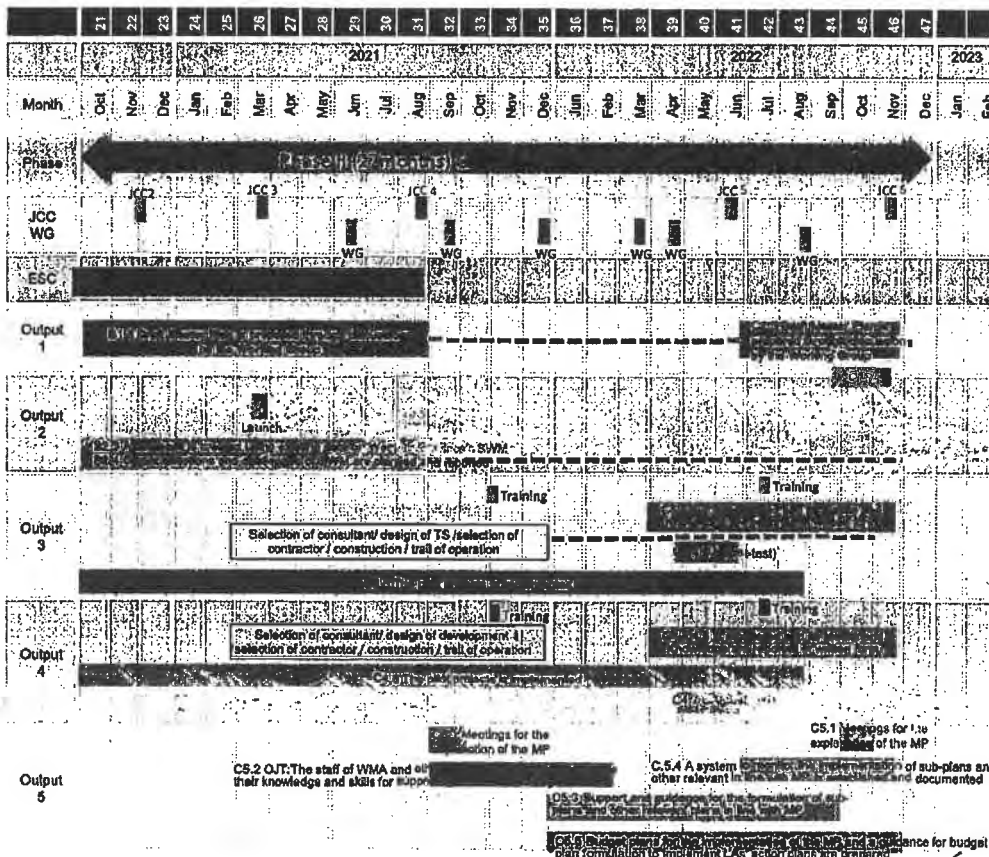
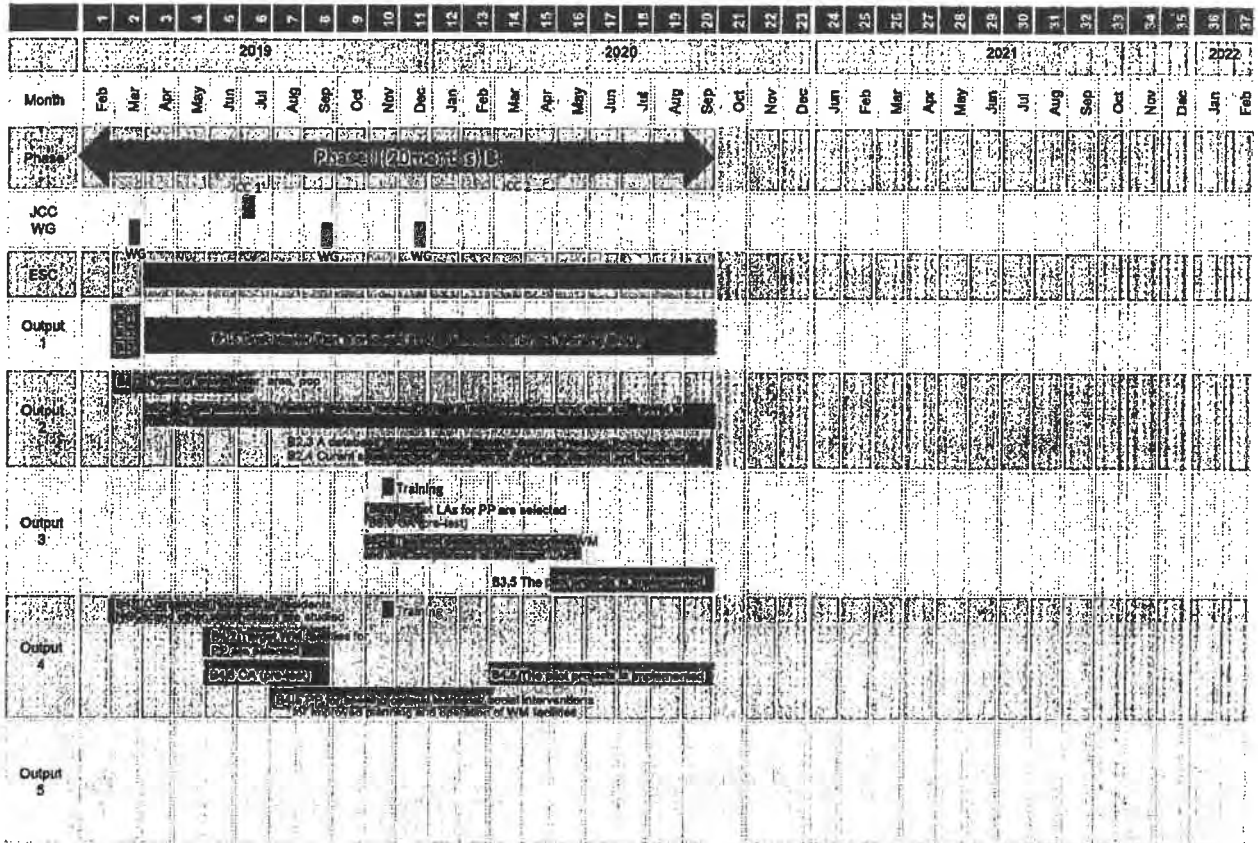

57

3

3

9⁸ Tue

4. Activities Progress Output 1

Output1: Roles and responsibilities of organizations relevant to solid waste management in Western Province are clarified and institutional arrangements for the formulation of the MP are established.

Activity	Progress
1.1 Roles and responsibilities of relevant organizations relevant to solid waste management in Western Province are clarified by examining policies and legal documents.	The roles and responsibilities are clarified in the draft MP.
1.2 A Working Group for MP formulation is established.	A Working Group for MP formulation was established on 2 nd April 2019.
1.3 Terms of Reference (TOR) of the Working Group for MP formulation are clarified.	TOR of the WG for MP formulation was clarified.
1.4 Regular meetings and special meetings or sub-group meetings, where necessary, are held.	Regular meetings and sub-group meetings for MP formulation were held from December 2020 to September 2021. The modification of draft Master Plan was made from November 2021 to March 2022.

4. Activities Progress Output 1

Output1: Roles and responsibilities of organizations relevant to solid waste management in Western Province are clarified and institutional arrangements for the formulation of the MP are established.

Activity	Progress
1.5 Draft Master Plan is prepared through discussions by the Working Group.	Draft Master Plan was prepared through a series of discussion by the Working Group.
1.6 The process and outputs of activities of the Working Group are shared with relevant organizations (including those which authorize the Master Plan) both at the Provincial and Central levels by holding workshops or meetings.	This activity will be conducted after the draft master plan is finalized in accordance with the comments from relevant counterpart organizations.
1.7 An inter-organizational coordination body such as Provincial Solid Waste Management Committee which takes over the work of the Working Group is proposed.	This activity will be conducted after the draft master plan is finalized in accordance with the comments from relevant counterpart organizations.

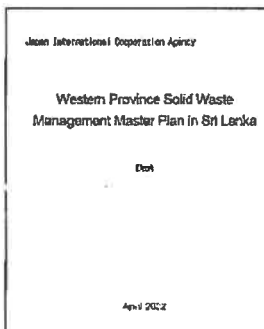

5/2

1/2

4

9/10

Handwritten signature

Output 2 Current situations and challenges of solid waste management in Western Province are clarified.

(2) A database is created using existing data on Western Province's SWM

Purpose

The database is built for three purposes:

- (i) To manage basic data related to waste management,
- (ii) To collect the daily data of waste management, and
- (iii) To visualize these data.

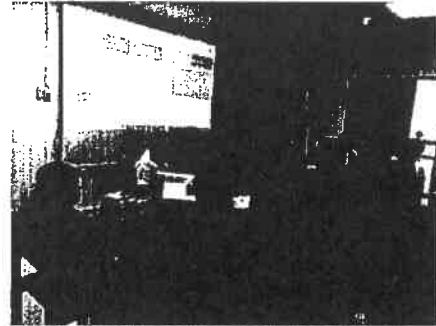

Daily data entry workshop for LAs

Structure

The database is a cloud-based database that networks each organizations. The database consists of five modules: user setting, basic data entry, daily data entry, data analysis and reporting.

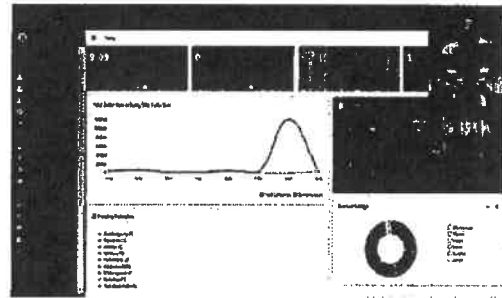

Online workshop for LAs 11

Output2: Current situations and challenges of solid waste management in Western Province are clarified.

<p>2.1. The Working Group for MP formulation decides a. types of waste, b. target year, c. areas and population.</p>	<p>Types o waste, target year, areas and population were decided by the Working Group for MP formulation.</p>
<p>2.2. Organizations in Western Province relevant to solid waste management are investigated and data on solid waste management is collected.</p>	<p>This activity was completed in Phase 1 of the project and the collected data is used as a baseline for the draft master plan, as well as for the creation of waste flow diagrams and a database.</p>
<p>2.3. A database is created using existing data on Western Province's solid waste management.</p>	<p>The development of all module was completed except for the dashboard. The procedure for Database transfer to State Ministry of Local Government and Provincial Council is ongoing.</p>
<p>2.4 Based on the data, current situations and challenges regarding solid waste management are clarified and reported.</p>	<p>Based on the data in (2), current situation and issues of waste management have been studied and the results have been reported by the survey report of waste management in Western Province.</p>

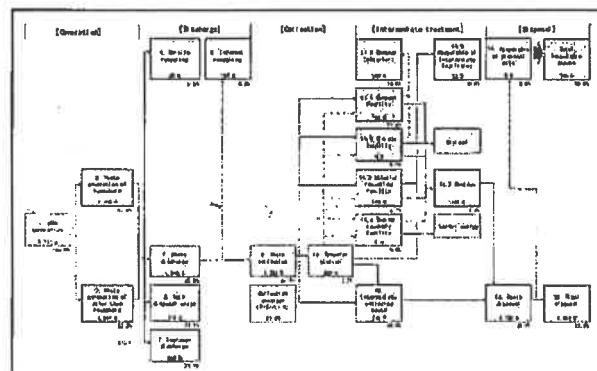

33

12

9 12

11

4. ACTIVITIES

1. Pilot project: New Approach of 3Rs

Support Local Authority and residents to segregate waste

- i. The app can be downloaded from the Google Play or Apple app store.
- ii. Waste collection route (Schedule) it will show all the waste type collection schedule of that route. (biodegradable, nondegradable, etc.)
- iii. View the waste collection calendar of the route.
- iv. User will be able to register multiple Local Authorities.
- v. Waste sorting dictionary by item.
- vi. Registered recyclers information

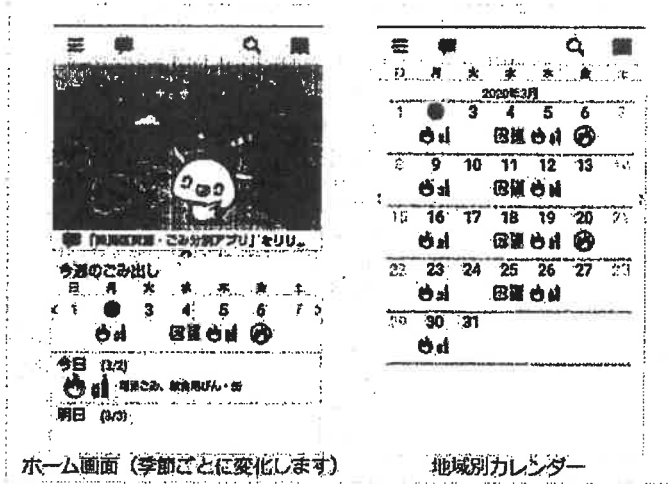

Nerima City Resource and Waste Sorting App

4. ACTIVITIES

2. Pilot project for development of small-scale solid waste transfer station in Kalutara composting facility

Outline

- The efficiency of transfer and transportation of solid waste is developed,
- The negative environmental issues are improved and
- Operation capacity of transferring is developed by the small-scale solid waste transfer station.

Project site

- Address : Premises of Kalutara compost plant owned by Kalutara UC within Kalutara PS boundary.
- Owner of Compost plant: Kalutara UC
- Execution body of Kalutara compost plant: Waste Management Authority (WMA)

Contribution and Necessity: experience of

- Site selection of solid waste transfer station
- Environmental consideration
- Plan and design of facility of solid waste transfer station
- Technical transfer
- Operation of solid waste transfer station
- Monitoring in terms of environmental social consideration

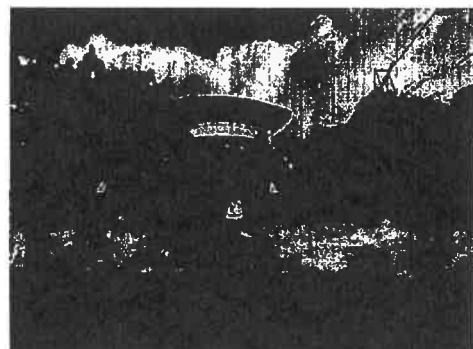

Handwritten signatures and marks at the bottom of the page, including a large '320' and several checkmarks.

2. Pilot project for development of small scale solid waste transfer station in Kalutara composting facility

The pilot project consists of the following activities

- Basic plan and detailed design of the small-scale solid waste transfer station
- Construction of facility and procurement of equipment
- Operation of small-scale solid waste transfer station
- Closure plan of current open dump site designed by the JICA expert team.
- Closing current open dumping site properly by the counterparts with their own funds
- Monitoring in terms of environmental social consideration

The facility and equipment of small-scale solid waste transfer station

- Static compactor with input hopper: Loading capacity 20 ton/day x 1
- Waste container: Capacity 26m³x2
- Container hauler trailer vehicle with hook system: More than GVW 15ton x 1

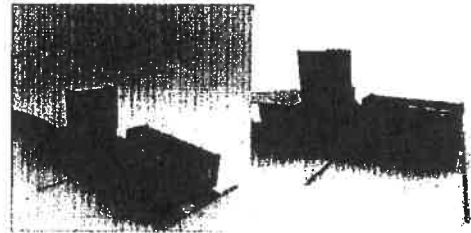
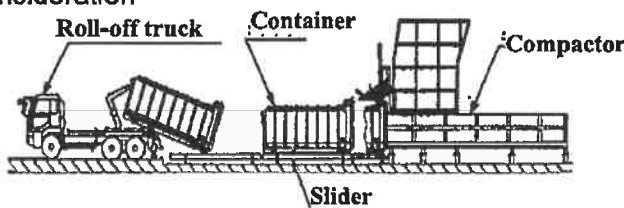

Output3: Knowledge and experience that contribute to MP formulation and implementation are acquired through the implementation of pilot projects on appropriate waste management and 3Rs. (Target areas: Colombo Municipality and other LAs).

Output	Progress
3.1 Trainings on appropriate waste management and 3Rs for LAs and other relevant organizations are conducted.	The training in Japan, that was planned for Phase II has been suspended to be planned due to restrictions on entry into Japan caused by the spread of the new coronavirus infection.
3.2. Target LAs for pilot projects are selected.	Although the target LAs of pilot projects had been selected.
3.3. Capacity Assessment (pretest) for WMA and target LAs is conducted.	The pilot projects on appropriate waste management and 3Rs have been planned at the target LAs (The pilot projects may include a study to collect good practices of various LAs).
3.4 The pilot projects on appropriate waste management and 3Rs are planned at the target LAs.	The detailed design of a small transfer station at Kalutara Composting Plant have been completed. The contents of the Pilot Project have been changed to the development of 3R mobile.
3.5 3.4 is implemented.	As of March 2022, the User-Interface design has been mostly completed and input is being sought from WMA and Sri Jayawarudanapura Kotte.
3.6 Capacity Assessment (posttest) for WMA and target LAs is conducted.	The post-test is scheduled to be implemented just before the end of the pilot project.
3.7 3.5 is monitored and its results and knowledge are reported in written form	The monitoring is scheduled to be done after the end of the pilot project.

Handwritten notes and signatures at the bottom of the page, including a large '2' and various initials and marks.

3. Pilot project for development of forced aeration system in existing Kalutara composting facility

Output 4

Outline

Introduce forced aeration system in the existing Kalutara composting facility.

- Mitigation of negative environmental impact such as offensive odors
- Accelerate of aerobic digestion (reducing composting period)

Project site

- Address : Premises of Kalutara compost plant owned by Kalutara UC within Kalutara PS boundary.
- Owner of Compost plant: Kalutara UC
- Execution body of Kalutara compost plant: Waste Management Authority (WMA)

Contribution and Necessity: experience of

- Obtain Environmental Protection License
- Plan and design of facility of large-scale compost plant
- Technical transfer
- Operation of large-scale compost plant
- Monitoring in terms of environmental social consideration

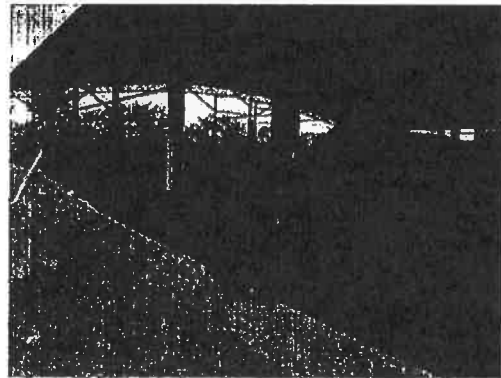

3. Pilot project for development of forced aeration system in existing Kalutara composting facility

Output 4

The pilot project consists of the following activities

- Basic plan and detail design of facility
- Construction of facility and procurement of equipment
- Operation of developed compost plant
- Monitoring

The details of the facilities and equipment of the developed compost plant

Development of compost plant (Acceleration of aeration system) :

Treatment capacity 20 ton/day

- Design and construction supervision of development of compost plant

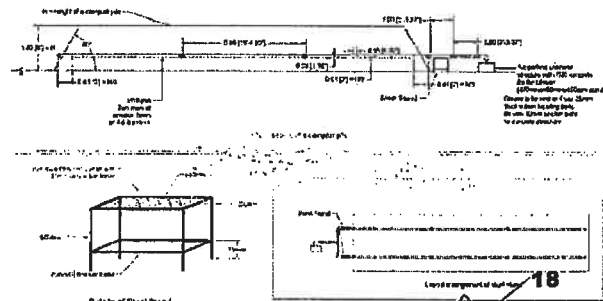
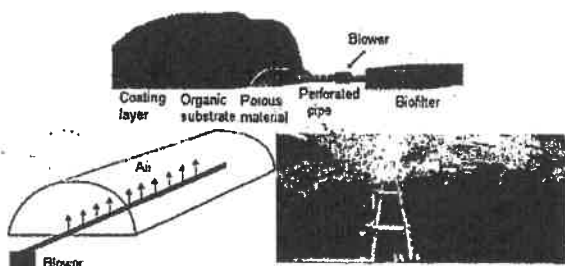

Handwritten marks and signatures at the bottom of the page, including '572' and various initials.

4. Activities of

Output 4

4. Pilot project of Rehabilitation of Karadiyana Compost Plant (Site A)

- (i) To improve the treatment capacity of existing compost process,
- (ii) To reduce environmental pollution such as offensive odor and leachate leakage, and
- (iii) To be a model of rehabilitation and improvement of final disposal site.

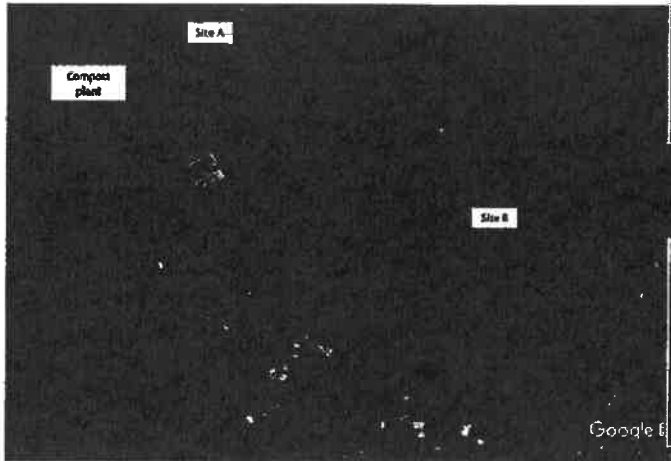

Karadiyana Final Disposal site

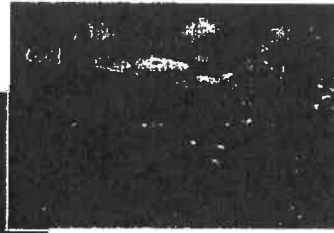

Site A condition
(biodegradable waste)

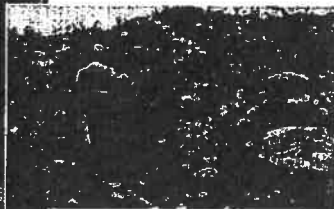

Site B condition
(non biodegradable mixed waste)

4. Activities of

Output 4

4. Pilot project of Rehabilitation of Karadiyana Compost Plant (Site A)

Rehabilitation Phases

- Phase 1: The trammel setup and sieving practice
- Phase 2: Landfill mining and composting
- Phase 3: Windrow Composting at entire area of Site A

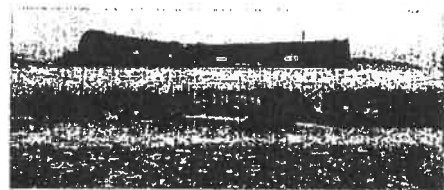

Trommel to be introduced for compost sieving

Landfill mining and leveling Area1 and composting at Area 2

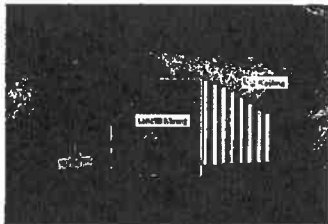

Landfill mining Area1 (7,395.6m³)

Landfill mining and leveling Area2 and composting at Area1

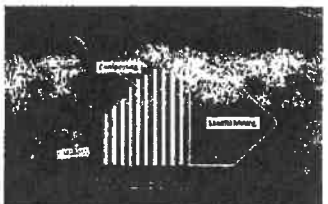

Landfill mining Area2 (8,980.7m³)

Handwritten notes and signatures at the bottom of the page, including a signature and the number '20'.

4. ACTIVITIES

4. Pilot project of Rehabilitation of Karadiyana Compost Plant (Site A)

Before & After Rehabilitation

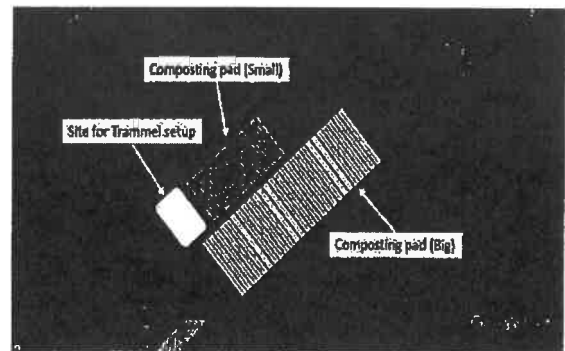
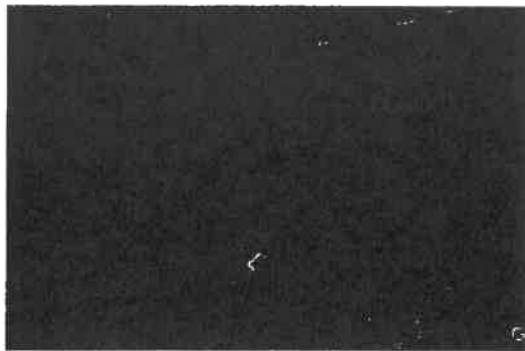

Before rehabilitation at Site A

- ✓ Open dumping amount of biodegradable waste : Approx. 250 ton/day
- ✓ Sieving capacity: approx. 10 ton/day
- ✓ Accumulation of biodegradable waste: 250 ton/day x 40% - 10ton/day = 90ton/day
- ✓ Produced compost amount : approx. 10 ton/day



After rehabilitation at Site A

- ✓ Treatment amount of biodegradable waste : Approx. 268 ton/day
- ✓ Sieving capacity: approx. 200 ton/day
- ✓ Accumulation of biodegradable waste: zero ton/day
- ✓ Produced compost amount : approx. 268 x 20% = 53.6 ton/day

4. ACTIVITIES

5. Pilot project: Optimal social interventions for improved planning and operation of waste management facilities

- Site location : Community surround Kalutara compost plant
- Manage by: WMA, Kalutara UC & PS

1. Support to coordination with residents

- Support to coordination with existing committee
- Regular meetings to report management conditions of compost plant and new plan (construction of transfer station and close of dumping site) including water quality and odor analysis
- Support to communication with localities through events
- Cultural / sports events may helps developing good communication with residents and deepening better understanding between both parties



2. Public Relations

- Information disclosure
- Disclosing the expenditure and revenue of compost plant, environmental monitoring data, and etc in order to improve transparency of management of the facility

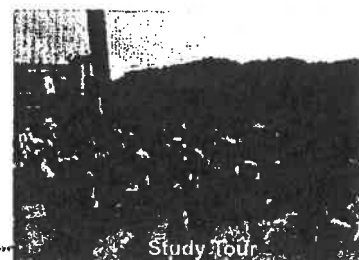

32

4. Activities

Output 4

4. Pilot project: Optimal social interventions for improved planning and operation of waste management facilities

Expected Schedule of Consensus Building

2019	2020			2021			2022	
Jan	Jun	Dec	Jan	Jun	Dec	Jan		
Focus Group Discussion (FGD) Public opinion Survey (POS)	COVID-19 Lockdown	M/M/A Contract	DD & Procurement	construction		Completion	Operation	
		★	★	★		★	★	
		TT to WMA	Monitoring Committee X 4 times					

*Schedule shall be changed due to progress of construction schedule.

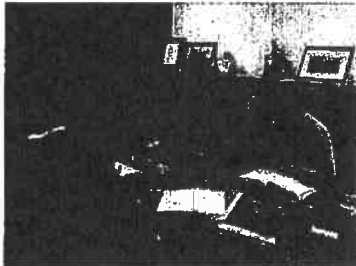

FGD X 8 groups
Officials directly connected with Kalutara compost plant, Director of WMA, Assistant Director, Zonal manger, etc.



POS at Kalutara area (250 Households)

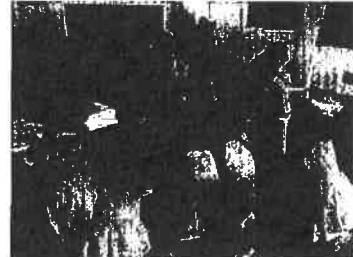

POS at school

4. Activities

Output 4

Output4: Knowledge and experience that contribute to MP formulation and implementation are acquired through the implementation of pilot projects on appropriate waste management and 3Rs

Output	Progress
4.1. Complaints/ requests made by residents, NGOs and other stakeholders with regard to waste management are studied to identify important issues.	Complaints/ requests made by residents, NGOs and other stakeholders with regard to waste management were studied to identify important issues.
4.2. Target waste management facilities for pilot activities are selected.	Target waste management facilities for pilot projects were selected.
4.3. Trainings on planning/ operation of waste management facilities are conducted for relevant organizations.	The training in Japan that was planned for Phase II has been suspended to be planned after restrictions on entry into Japan caused by the spread of the new coronavirus infection.
4.4. Capacity Assessment (pretest) for relevant organizations is conducted.	The pretest has yet to be conducted. As soon as the construction starts, the capacity assessment will be made among relevant organizations.
4.5. Pilot projects for seeking optimal technical/ social interventions for improved planning and operation of waste management facilities are planned at the target waste management facilities.	Pilot projects have been planned at the target waste management facilities.

4. Activities Progress

Output 4

Output4: Knowledge and experience that contribute to MP formulation and implementation are acquired through the implementation of pilot projects on appropriate waste management and 3Rs.

Output	Progress
4.6 4.5 is implemented	(1) Kaluthara Compost Improvement On December 24, 2021, the air blower and perforated pipe were installed into the windrow pile and the performance test has been started. (2) Karadiyana Compost Improvement The equipment for Karadiyana Compost Rehabilitation are being procured.
4.7 Capacity Assessment (posttest) for relevant organizations is conducted.	The post-test is scheduled to be implemented just before the end of the pilot project.
4.8 4.6 is monitored and its results and knowledge are reported in written form.	The project will be implemented after the pilot project is completed.

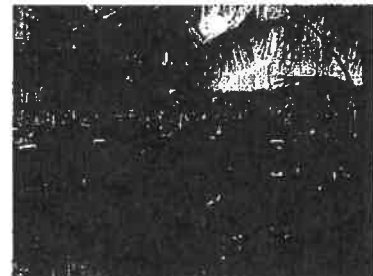

4.5 Output 5

4.5 Output 5 :Collaboration and coordination among relevant organizations in Western Province for the implementation of MP, and formulation and implementation of its related plans (e.g. LA action plans, plans on waste management facilities) are strengthened.

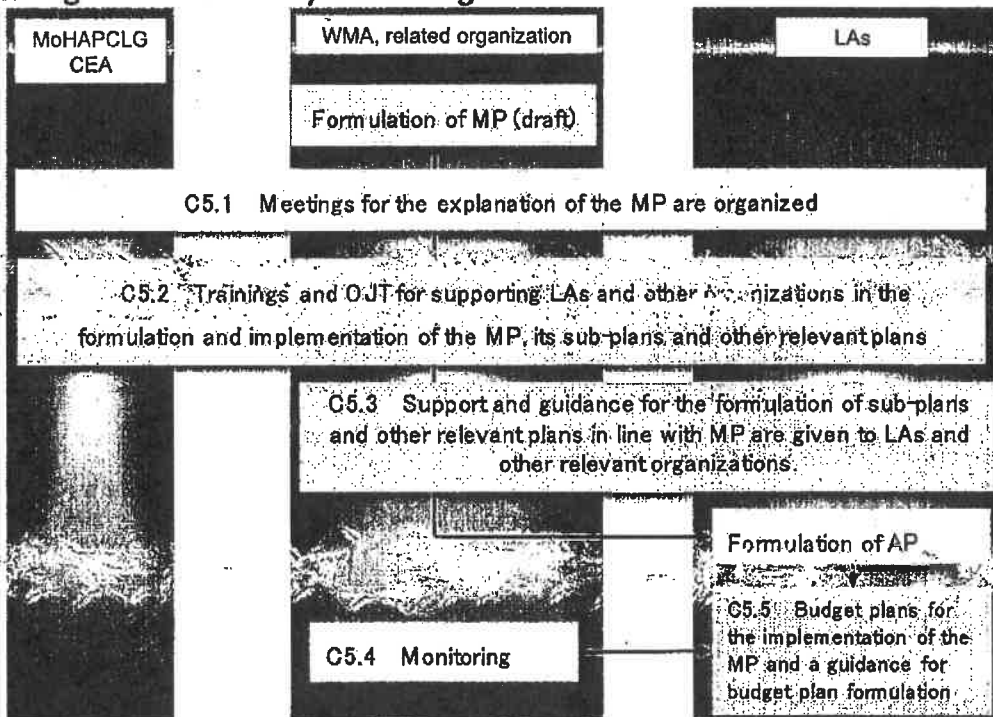

4. Activities Progress Output 5

Output5: Collaboration and coordination among relevant organizations in Western Province for the implementation of MP, and formulation and implementation of its related plans (e.g. LA action plans, plans on waste management facilities) are strengthened.

Output	Progress
5.1 Meetings for the explanation of the MP are organized for LAs in Western Province and other relevant organizations (including central government organizations) are held.	A briefing session will be held after the draft master plan is finalized in accordance with the comments from relevant organizations.
5.2. The staff of WMA and other relevant organizations enhance their knowledge and skills for supporting LAs and other organizations in their formulation and implementation of the MP, its sub-plans and other related plans	Training to strengthen project formulation capacity for district and zonal managers of WMA was taken place.
5.3. Support and guidance for the formulation of sub-plans and other related plans (e.g. LA action plans, plans on waste management facilities) in line with MP are given to LAs and other relevant organizations	The activity will be implemented after the draft MP is finalized in accordance with the comments from relevant organizations.
5.4 A system to monitor the implementation of sub-plans and other related plans (e.g. LA action plans, plans on waste management facilities) in line with MP is established and documented.	A unified form and guidelines to develop SWM AP has been prepared for LAs.
5.5. Budget plans for the implementation of the MP and a guidance for budget plan formulation to implement LAs' action plans are prepared.	The activity will be implemented after the draft MP is finalized in accordance with the comments from relevant organizations.

1. Donation of PPE for LAs in WP in 2020 and 2021

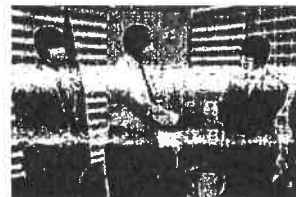

2. Plan of Disaster Waste Management caused by Marine Pollution of S'pore-registered Ship

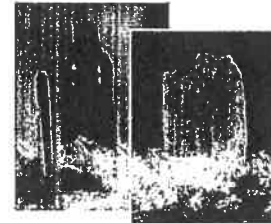
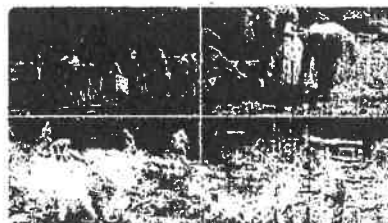
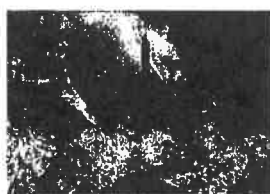

Handwritten marks: a checkmark, '5/2', '4', and a signature.

Project Design Matrix

Project Title: The Project for Formulation of Western Province Solid Waste Management Master Plan
Implementing Agency: National Solid Waste Management Support Center (NWSMC), Waste Management Authority (WMA), and relevant organizations
Target Group: Western Province, and organizations relevant to waste management in Western Province
Duration: 2019.2-2022.12
Project Site: Western Province

Version 4
 Dated 21st April 2022

Narrative Summary	Objectively Verifiable Indicators	Means of Verification	Important Assumption
<p>Overall Goal Appropriate solid waste management practices in accordance with Western Province Solid Waste Management Master Plan (MP) are undertaken in Western Province.</p>	<p>1. All Local Authorities (LAs) prepare, update and implement their solid waste management action plan (LA action plan) in line with the MP within one year after publishing the MP. 2. An inter-organizational coordination body functions to monitor the progress and support the implementation of LA action plans in Western Province.</p>	<p>1. LA's Action Plans 2. Reports on waste management from LAs</p>	
<p>Project Purpose Western Province's planning capacity on solid waste management is strengthened through the formulation of Western Province Solid Waste Management Master Plan (MP).</p>	<p>1. The final draft of the MP is prepared. 2. Western Provincial Council (WPG) and SMOPCLGA start the MP approval process. 3. Sub-plans and other related plans (e.g. LA action plans, plans on waste management facilities) in line with the MP are formulated. 4. An inter-organizational coordination body is established to monitor the progress and provide support implementation of the sub-plans and other related plans in Western Province.</p>	<p>1. The final draft of the MP 2. The MP in the process of approval 3. Draft LA's Action Plans/plans on waste management facilities 4. Plan of formulation of execution and monitoring body (e.g. inter-organizational coordination body)</p>	<p>1. National policies regarding waste management do not change significantly 2. Financial resources for the implementation of the MP are secured by LAs.</p>
<p>Outputs 1. Roles and responsibilities of organizations relevant to solid waste management in Western Province are clarified and institutional arrangements for the formulation of the MP are established.</p>	<p>1. Roles and responsibilities of relevant organizations are clarified and documented in the MP and/or other documents. 2. A Working Group for MP formulation is established. 3. Regular meetings are held (at least once in three months) by the Working Group for MP formulation. 4. The process and outputs of activities of the Working Group are shared at the Provincial and Central levels by holding workshops or meetings 6 times. 5. Draft Master Plan is prepared by the Working Group.</p>	<p>1. Documented list of roles and responsibilities 2. List of the Working Group members 3. Minutes of meetings of the Working Group 4. Reports of the workshops or meetings 5. Draft Master Plan</p>	<p>Counterpart (C/P) staff and other staff from relevant organizations continuously engage in the project.</p>

<p>2. Current situation, trend, potentials and challenges of solid waste management in Western Province are clarified.</p>	<p>1. Data on current situations on solid waste management in Western Province are collected. 2. A database using the collected data is created 3. An analysis report on solid waste management in Western Province is prepared.</p>	<p>1. Data on solid waste management in Western Province 2. The database 3. The analysis report on solid waste in Western Province</p>	
<p>3. Knowledge and experience which contribute to MP formulation and implementation are acquired through the implementation of pilot projects on 3Rs. (Target areas: Galle, Matugama and other LAs)</p>	<p>1. Trainings on appropriate waste management and 3Rs for LAs and other relevant organizations are conducted three times. 2. Pilot projects are implemented at more than three LAs. 3. The results of Capacity Assessment (posttest) for WMA and target LAs improve from those of pretest. 4. Progress of Pilot Projects are monitored by WG for MP formulation.</p>	<p>1. Records of trainings 2. Records of pilot project implementation 3. Reports of Capacity Assessment 4. Reports on pilot projects</p>	
<p>4. Knowledge and experience which contribute to MP formulation and implementation are acquired through pilot projects for improving planning/ operation of waste management facilities.</p>	<p>1. Trainings on planning/ operation of waste management facilities for relevant organizations are conducted more than three times. 2. Pilot projects are implemented at one or more than one waste management facilities. 3. The results of Capacity Assessment (posttest) for relevant organizations of target waste management facilities improve from those of pretest. 4. Progress of pilot projects are monitored by WG for MP formulation.</p>	<p>1. Records of trainings projects 2. Records of pilot implementation 3. Reports of Capacity Assessment 4. Reports on pilot projects</p>	
<p>5. Collaboration and coordination among relevant organizations in Western Province for the implementation of MP, and formulation and implementation of its related plans (e.g. LA action plans, plans on waste management facilities) are strengthened.</p>	<p>1. Meetings for the explanation of the MP are organized for LAs in Western Province and other relevant organizations (including central government organizations) are held more than three times. 2. 11 staff members of WMA and other related organization are given trainings and/or OJT on supporting LAs. 3. Support and guidance for the formulation of sub-plans and other related plans (e.g. LA action plans, plans on waste management facilities) in line with the MP are given to LAs and other relevant organizations. 4. The monitoring system is documented. 5. Budget plans for the implementation of the MP and a guidance for budget plan formulation to implement LAs' action plans are prepared.</p>	<p>1. Records on the meeting for the explanation of the MP 2. Records on training and/ or OJT 3. Records on support and guidance 4. Documented monitoring system 5. Budget plans</p>	
<p>1.1 Roles and responsibilities of relevant organizations relevant to solid waste management in Western Province are clarified by examining policies and legal documents (e.g. national laws, ordinances). 1.2 A Working Group for MP formulation is established. 1.3 Terms of Reference (TOR) of the Working Group for MP formulation are clarified. 1.4 Regular meetings and special meetings or sub-group meetings, where necessary, are held.</p>	<p>Activities</p> <p>[Japanese side] • Experts - Waste Management - Collection and Transportation - Intermediate Treatment and Final Disposal • 3Rs/ Public Awareness - Financial / Economic Analysis/Institutional plan - Database • Provision of machinery and equipment</p>	<p>Inputs</p> <p>[Sri Lankan side] • C/P • Personnel cost and operational cost for C/P • Office space and facilities for Experts at 1. NSW/MSC 2. WMA</p>	<p>Large-scale consolidation and/or restructuring of LAs do not occur.</p>

<p>1.5 Draft Master Plan is prepared through discussions by the Working Group.</p> <p>1.6 The process and outputs of activities of the Working Group are shared with relevant organizations (including those which authorize the Master Plan) both at the Provincial and Central levels by holding workshops or meetings.</p> <p>1.7 An inter-organizational coordination body such as Provincial Solid Waste Management Committee which takes over the work of the Working Group is proposed.</p> <p>2.1 The Working Group for MP formulation decides a. types of waste, b. target year, c. areas and population.</p> <p>2.2 Organizations in Western Province relevant to solid waste management are investigated and data on solid waste management is collected.</p> <p>2.3 A database is created using existing data on Western Province's solid waste management.</p> <p>2.4 Based on the data, current situations and challenges regarding solid waste management are clarified and reported.</p> <p>3.1 Trainings on appropriate waste management and 3Rs for LAs and other relevant organizations are conducted.</p> <p>3.2 Target LAs for pilot projects are selected.</p> <p>3.3 Capacity Assessment (pretest) for WMA and target LAs is conducted.</p> <p>3.4 The pilot projects on appropriate waste management and 3Rs are planned at the target LAs.</p> <p>3.5 3.4 is implemented.</p> <p>3.6 Capacity Assessment (posttest) for WMA and target LAs is conducted.</p> <p>3.7 3.5 is monitored and its results and knowledge are reported in written form.</p> <p>4.1 Complaints/ requests made by residents, NGOs and other stakeholders with regard to waste management are studied to identify important issues.</p> <p>4.2 Target waste management facilities for pilot activities are selected.</p> <p>4.3 Trainings on planning/ operation of waste management facilities are conducted for relevant organizations.</p> <p>4.4 Capacity Assessment (pretest) for relevant organizations is</p>	<p>- Small scale solid waste transfer station at Kalutara composting facility</p> <p>- Forced aeration system in existing Kalutara composting facility</p> <p>- Equipment for rehabilitating existing compost plant in Karadiyana</p> <p>• Trainings in Japan/Third Countries</p>		
---	---	--	--

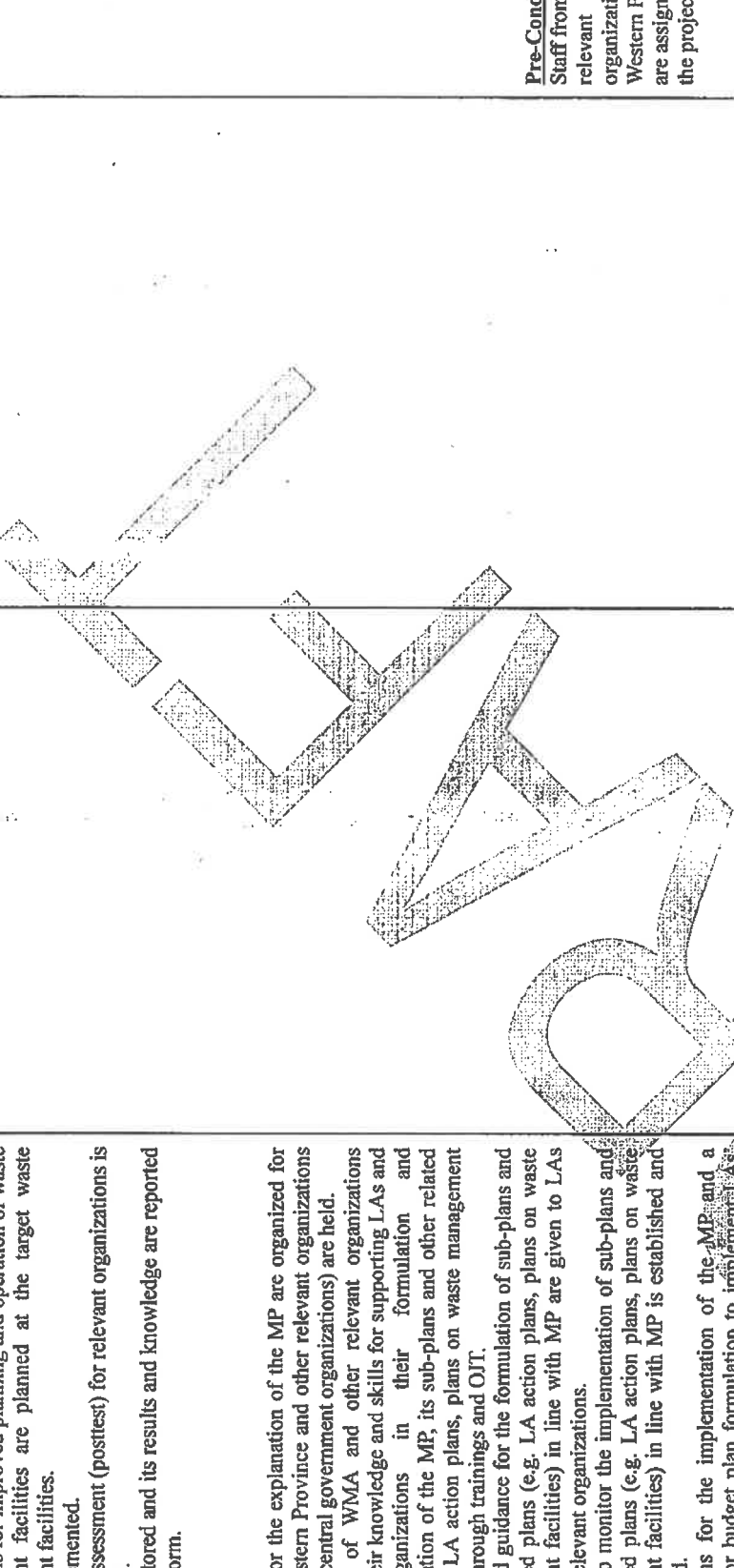
<p>conducted.</p> <p>4.5 Pilot projects for seeking optimal technical/ social interventions for improved planning and operation of waste management facilities are planned at the target waste management facilities.</p> <p>4.6 4.5 is implemented.</p> <p>4.7 Capacity Assessment (posttest) for relevant organizations is conducted.</p> <p>4.8 4.6 is monitored and its results and knowledge are reported in written form.</p> <p>5.1 Meetings for the explanation of the MP are organized for LAs in Western Province and other relevant organizations (including central government organizations) are held.</p> <p>5.2 The staff of WMA and other relevant organizations enhance their knowledge and skills for supporting LAs and other organizations in their formulation and implementation of the MP, its sub-plans and other related plans (e.g. LA action plans, plans on waste management facilities) through trainings and OJT.</p> <p>5.3 Support and guidance for the formulation of sub-plans and other related plans (e.g. LA action plans, plans on waste management facilities) in line with MP are given to LAs and other relevant organizations.</p> <p>5.4 A system to monitor the implementation of sub-plans and other related plans (e.g. LA action plans, plans on waste management facilities) in line with MP is established and documented.</p> <p>5.5 Budget plans for the implementation of the MP and a guidance for budget plan formulation to implement LAs' action plans are prepared.</p>		<p><u>Pre-Condition</u> Staff from relevant organizations in Western Province are assigned for the project.</p>
--	---	---

3

33

1

[Handwritten signature]

Joint Coordinating Committee (JCC) Meeting for the Project for Formulation of Master Plan for Solid Waste Management in Western Province

Venue: State Ministry of Provincial Councils & Local Government Affairs

Date: 21.04.2022

Time: 9.00 a.m.

Name	Designation	Institute	Contact Number	Email Address	Signature
1 Mr. K. Yoshida	Senior Representative	JICA			
2 Mr. T. Kondo	Representative	JICA			
3 Dr. N. Sato	Expert	JICA Project			
4 W.M.W.B. Udayarajah	Secretary	MOLCPC			
5 M. S. Rathnayake	M. C. C. O	Director of Local Authorities			
6 Eng (Mrs) Shabina Alysah	D. Dir Eng (San)	CWC			
7 Eng. N.C. Rathnayake	Asst Sec (Tech)	State Min of Housing & Cons			
8 Shankaja Ulagalla	Exec. Specialist	MeswMP			

32

2

2

M

Joint Coordinating Committee (JCC) Meeting for the Project for Formulation of Master Plan for Solid Waste Management in Western Province

Venue: State Ministry of Provincial Councils & Local Government Affairs

Date: 21.04.2022

Time: 9.00 a.m.

10	M. M. Nanyamunna	Adj. Sec	Provincial Council & Local Govt. Ministry					
11	Ranell Bandula	Project Director	MECS/DAEP					SKK
12	A.K.N. Sewardani Amarasekara	Deputy Director	ERD					Phu
13	Chaminda Pathiraja	Asst. Sec	Ministry of Industries					Phu
14	Nalin Ramapernera	Director	UNWA					
15	Eng. Upali Indaratne	DDG (WMD)	CEA					
16	H. P. D. Pindaniya	Ecologist	SLLDC					
17	N. Sivarajah	ERPM	TDB					
18	M. Kodippiti Arada	Adl. Sec.	MPCLG					
19	Dr. N. S. Jayaratne	Dr. (Gen)	SNL					

32

19

25

2

M

Joint Coordinating Committee (JCC) Meeting for the Project for Formulation of Master Plan for Solid Waste Management in Western Province

Venue: State Ministry of Provincial Councils & Local Government Affairs

Date: 21.04.2022

Time: 9.00 a.m.

20	Hasthe Balan	Asst Director	UDA	[Redacted]	[Redacted]	[Signature]
21	Rajini de Silva	Project Specialist	TICA	[Redacted]	[Redacted]	[Signature]
22	No Samarapera	Consultant	JICA	[Redacted]	[Redacted]	[Signature]
23	FST Hewatharanga	Assistant Director NSWMS	MOLG/PC	[Redacted]	[Redacted]	[Signature]

13

32

31

9/10





Project Design Matrix

Annex 4

Project Title: The Project for Formulation of Western Province Solid Waste Management Master Plan
Implementing Agency: National Solid Waste Management Support Center (NWSMSC), Waste Management Authority (WMA), and relevant organizations
Target Group: Western Province, and organizations relevant to waste management in Western Province
Duration: 2019.2-2023.6
Project Site: Western Province

Version 4
Dated 20th September 2022

Narrative Summary	Objectively Verifiable Indicators	Means of Verification	Important Assumption
<p>Overall Goal Appropriate solid waste management practices in accordance with Western Province Solid Waste Management Master Plan (MP) are undertaken in Western Province.</p>	<ol style="list-style-type: none"> All Local Authorities (LAs) prepare/update and implement their solid waste management action plan (LA action plan) in line with the MP within one year after publishing the MP. An inter-organizational coordination body functions to monitor the progress and support the implementation of LA action plan in Western Province. 	<ol style="list-style-type: none"> LA's Action Plans Reports on waste management from LAs 	/
<p>Project Purpose Western Province's planning capacity on solid waste management is strengthened through the formulation of Western Province Solid Waste Management Master Plan (MP).</p>	<ol style="list-style-type: none"> The final draft of the MP is prepared. Western Provincial Council (WPC) and MoPAHAPCLG start the MP approval process. Sub-plans and other related plans (e.g. LA action plans, plans on waste management facilities) in line with the MP are formulated. An inter-organizational coordination body is established to monitor the progress and provide support for the implementation of the sub-plans and other related plans in Western Province. 	<ol style="list-style-type: none"> The final draft of the MP The MP in the process of approval Draft LA's Action Plans/plans on waste management facilities Plan of formulation of execution and monitoring body (e.g. inter-organizational coordination body) 	<ol style="list-style-type: none"> National policies regarding waste management do not change significantly Financial resources for the implementation of the MP are secured by LAs.
<p>Outputs 1. Roles and responsibilities of organizations relevant to solid waste management in Western Province are clarified and institutional arrangements for the formulation of the MP are established.</p>	<ol style="list-style-type: none"> Roles and responsibilities of relevant organizations are clarified and documented in the MP and/or other documents. A Working Group for MP formulation is established. Regular meetings are held (at least once in three months) by the Working Group for MP formulation. The process and outputs of activities of the Working Group are shared at the Provincial and Central levels by holding workshops or meetings 6 times. Draft Master Plan is prepared by the Working Group. 	<ol style="list-style-type: none"> Documented list of roles and responsibilities List of the Working Group members Minutes of meetings of the Working Group Reports of the workshops or meetings Draft Master Plan 	<p>Counterpart (C/P) staff and other staff from relevant organizations continuously engage in the project.</p>

<p>2.Current situation, trend, potentials and challenges of solid waste management in Western Province are clarified.</p>	<p>1. Data on current situations on solid waste management in Western Province are collected. 2. A database using the collected data is created 3. An analysis report on solid waste management in Western Province is prepared.</p>	<p>1. Data on solid waste management in Western Province 2. The database 3. The analysis report on solid waste in Western Province</p>	
<p>3.Knowledge and experience which contribute to MP formulation and implementation are acquired through the implementation of pilot projects on appropriate waste management and 3Rs.</p>	<p>1. Trainings on appropriate waste management and 3Rs for LAs and other relevant organizations are conducted three times. 2. Pilot projects are implemented at more than three LAs. 3. The results of Capacity Assessment (posttest) for WMA and target LAs improve from those of pretest. 4. Progress of Pilot Projects are monitored by WG for MP formulation.</p>	<p>1.Records of trainings 2.Records of pilot project implementation 3.Reports of Capacity Assessment 4.Reports on pilot projects</p>	
<p>4.Knowledge and experience which contribute to MP formulation and implementation are acquired through pilot projects for improving planning/ operation of waste management facilities.</p>	<p>1. Trainings on planning/ operation of waste management facilities for relevant organizations are conducted more than three times. 2. Pilot projects are implemented at one or more than one waste management facilities. 3. The results of Capacity Assessment (posttest) for relevant organizations of target waste management facilities improve from those of pretest. 4. Progress of pilot projects are monitored by WG for MP formulation.</p>	<p>1.Records of trainings 2.Records of pilot projects implementation 3.Reports of Capacity Assessment 4.Reports on pilot projects</p>	
<p>5.Collaboration and coordination among relevant organizations in Western Province for the implementation of MP, and formulation and implementation of its related plans (e.g. LA action plans, plans on waste management facilities) are strengthened.</p>	<p>1. Meetings for the explanation of the MP are organized for LAs in Western Province and other relevant organizations (including central government organizations) are held more than three times. 2. 11 staff members of WMA and other related organization are given trainings and/or OJT on supporting LAs. 3. Support and guidance for the formulation of sub-plans and other related plans (e.g. LA action plans, plans on waste management facilities) in line with the MP are given to LAs and other relevant organizations. 4. The monitoring system is documented. 5. Budget plans for the implementation of the MP and a guidance for budget plan formulation to implement LAs' action plans are prepared.</p>	<p>1.Records on the meeting for the explanation of the MP 2.Records on training and/ or OJT 3.Records on support and guidance 4.Documented monitoring system 5. Budget plans</p>	
<p>Activities 1.1 Roles and responsibilities of relevant organizations relevant to solid waste management in Western Province are clarified by examining policies and legal documents (e.g. national laws, ordinances). 1.2 A Working Group for MP formulation is established. 1.3 Terms of Reference (TOR) of the Working Group for MP formulation are clarified. 1.4 Regular meetings and special meetings or sub-group meetings, where necessary, are held.</p>	<p>[Japanese side] •Experts - Waste Management - Collection and Transportation - Intermediate Treatment and Final Disposal - 3Rs/ Public Awareness - Financial / Economic Analysis/Institutional plan - Database •Provision of machinery and equipment</p>	<p>Inputs [Sri Lankan side] •C/P •Personnel cost and operational cost for C/P •Office space and facilities for Experts at 1.NSWMSC 2.WMA</p>	<p>Large-scale consolidation and/or restructuring of LAs do not occur.</p>

<p>1.5 Draft Master Plan is prepared through discussions by the Working Group.</p> <p>1.6 The process and outputs of activities of the Working Group are shared with relevant organizations (including those which authorize the Master Plan) both at the Provincial and Central levels by holding workshops or, meetings.</p> <p>1.7 An inter-organizational coordination body such as Provincial Solid Waste Management Committee which takes over the work of the Working Group is proposed.</p> <p>2.1 The Working Group for MP formulation decides a. types of waste, b. target year, c. areas and population.</p> <p>2.2 Organizations in Western Province relevant to solid waste management are investigated and data on solid waste management is collected.</p> <p>2.3 A database is created using existing data on Western Province's solid waste management.</p> <p>2.4 Based on the data, current situations and challenges regarding solid waste management are clarified and reported.</p> <p>3.1 Trainings on appropriate waste management and 3Rs for LAs and other relevant organizations are conducted.</p> <p>3.2 Target LAs for pilot projects are selected.</p> <p>3.3 Capacity Assessment (pretest) for WMA and target LAs is conducted.</p> <p>3.4 The pilot projects on appropriate waste management and 3Rs are planned at the target LAs.</p> <p>3.5 3.4 is implemented.</p> <p>3.6 Capacity Assessment (posttest) for WMA and target LAs is conducted.</p> <p>3.7 3.5 is monitored and its results and knowledge are reported in written form.</p> <p>4.1 Complaints/ requests made by residents, NGOs and other stakeholders with regard to waste management are studied to identify important issues.</p> <p>4.2 Target waste management facilities for pilot activities are selected.</p> <p>4.3 Trainings on planning/ operation of waste management facilities are conducted for relevant organizations.</p> <p>4.4 Capacity Assessment (pretest) for relevant organizations is</p>	<p>- Small scale solid waste transfer station at Kalutara composting facility</p> <p>- Forced aeration system in existing Kalutara composting facility</p> <p>- Equipment for rehabilitating existing compost plant in Karadiyana</p> <p>• Trainings in Japan/Third Countries</p>	
--	---	--

Handwritten marks: a blue 'X' and several blue lines and scribbles.

<p>conducted.</p> <p>4.5 Pilot projects for seeking optimal technical/ social interventions for improved planning and operation of waste management facilities are planned at the target waste management facilities.</p> <p>4.6 4.5 is implemented.</p> <p>4.7 Capacity Assessment (posttest) for relevant organizations is conducted.</p> <p>4.8 4.6 is monitored and its results and knowledge are reported in written form.</p> <p>5.1 Meetings for the explanation of the MP are organized for LAs in Western Province and other relevant organizations (including central government organizations) are held.</p> <p>5.2 The staff of WMA and other relevant organizations enhance their knowledge and skills for supporting LAs and other organizations in their formulation and implementation of the MP, its sub-plans and other related plans (e.g. LA action plans, plans on waste management facilities) through trainings and OJT.</p> <p>5.3 Support and guidance for the formulation of sub-plans and other related plans (e.g. LA action plans, plans on waste management facilities) in line with MP are given to LAs and other relevant organizations.</p> <p>5.4 A system to monitor the implementation of sub-plans and other related plans (e.g. LA action plans, plans on waste management facilities) in line with MP is established and documented.</p> <p>5.5 Budget plans for the implementation of the MP and a guidance for budget plan formulation to implement LAs' action plans are prepared.</p>		<p>Pre-Condition Staff from relevant organizations in Western Province are assigned for the project.</p>
--	--	---

[Handwritten mark]

[Handwritten mark]

[Handwritten mark]

[Handwritten signature]

**MINUTES OF MEETING
ON
THE THIRD JOINT COORDINATING COMMITTEE
OF
THE PROJECT FOR FORMULATION OF WESTERN PROVINCE SOLID WASTE
MANAGEMENT MASTER PLAN**

The Japan International Cooperation Agency (hereinafter referred to as “JICA”) Expert Team (hereinafter referred to as “the Team”) submitted revised PDM and PO to State Ministry of Provincial Councils and Local Government Affairs (hereinafter referred to as “SMOPCLGA”). The authorities in Sri Lanka concerned with the Project, JICA and the Team conducted a discussion on the Project based on PDM at the Joint Coordinating Committee (hereinafter referred to as “JCC”) held on 21st April 2022.

SMOPCLGA, WMA, JICA, and the Team confirmed the matters discussed in the JCC as referred to in the document attached hereto.

Colombo, 21 April 2022



Kentaro Yoshida
Senior Representative
JICA Sri Lanka Office

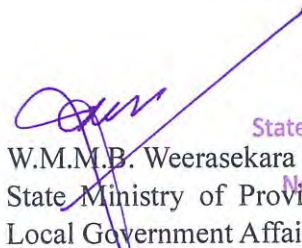

W.M.M.B. Weerasekara
Secretary
State Ministry of Provincial Councils and
Local Government Affairs
No. 339, Union Place, Colombo 02.



Naofumi Sato
Team Leader
JICA Expert Team

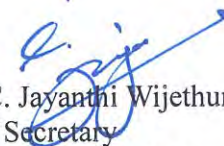

J.M.C. Jayanthi Wijethunga
Chief Secretary
Western Provincial Council
J. M. C. Jayanthi Wijethunga
Chief Secretary (Western Province)
Office of the Chief Secretary (W.P.)
204, Denzil Kobbekaduwa Mawatha,
Battaramulla

waste transfer station in Kalutara composting facility”, “forced aeration system in existing Kalutara composting facility” and “equipment for rehabilitating existing compost plant in Karadiyana” were added as inputs from Japanese side.

In addition, the Sri Lankan side and the team proposed extension of the project duration. Since March 2020, in response to spread of infection of COVID-19, JICA suspended dispatching Japanese experts to any project site so that all activities were implemented by remote work before February 2021. In addition, Sri Lankan Government took a Cabinet Decision to cancel the construction of Waste to Energy facility in Karadiyana Resource Management Centre, which is a core waste management facility in Solid Waste Management Master Plan, thus the draft Master Plan must be modified with consensus among counterpart and relevant organizations. JICA took note of them and will consider modifying PDM including extension of the project duration.

4 Other issues

Both sides reconfirmed that the Project will be implemented in accordance with the “Basic Principles for Technical Cooperation” published in December 2016 (hereinafter referred to as “the BP”). In the BP, it is mentioned that “The Counterpart and the government of the recipient country will take necessary measures to grant JICA, the members of JICA missions and the JICA experts privileges, exemptions and benefits in accordance with international agreements concluded between the government of Japan and the government of the recipient country”.

Attachment :

Attachment 1 Concept of Draft Master Plan

Attachment 2 Outline of Progress of the Project

Attachment 3 Draft Project Design Matrix ver.4

Attachment 4 List of Attendance of JCC

3/2 9/ 4/2

✓

✓

ATTACHED DOCUMENT

1 Mutual agreement on draft Master Plan

Both sides discussed and agreed on the contents of the draft Western Province Solid Waste Management Master Plan. Both sides confirmed the necessary procedure and demarcation of authorization of the Master Plan.

2 Outline of the Project and review of its progress

The Team explained the progress of the project up to February 2022 including the progress of Pilot Projects. Both sides confirmed the schedule of the activities and undertakings to be done by both sides.

3 Modification of framework (PDM) and extension of Project duration

The Team proposed PDM ver.4, the revision of the PDM ver.3. Both sides basically agreed on the following changes and these are to be finalized after the confirmation by JICA.

1) Overall Goal: Appropriate solid waste management practices in accordance with Western Province Solid Waste Management Master Plan (MP) are undertaken in Western Province.

In order to clarify the overall goal, following two objectively verifiable indicators are added:

- An inter-organizational coordination body functions to monitor the progress and support the implementation of LA action plan in Western Province.

2) Project Purpose: Western Province's planning capacity on solid waste management is strengthened through the formulation of Western Province Solid Waste Management Master Plan (MP).

In order to clarify the project purpose, following two objectively verifiable indicators are added:

- Sub-plans and other related plans (e.g. LA action plans, plans on waste management facilities) in line with the MP are formulated.
- An inter-organizational coordination body is being established to monitor the progress and provide support implementation of the sub-plans and other related plans in Western Province.

Means of above mentioned verifications are as follows:

- Draft LA's Action Plans
- Plan of formulation of inter-organizational coordination body

3) Output 3: Knowledge and experience which contribute to MP formulation and implementation are acquired through the implementation of pilot projects on appropriate waste management and 3Rs.

Initially, target areas of pilot project of 3Rs were Colombo Municipality and other LAs, however, Colombo municipality was excluded from the pilot project sites since it is decided that they will implement the similar project by themselves.

4) Output 5: Collaboration and coordination among relevant organizations in Western Province for the implementation of MP, and formulation and implementation of its related plans (e.g. LA action plans, plans on waste management facilities) are strengthened.

The number of staff members of WMA and other related organization given trainings and/or OJT on supporting LAs are decided, so it shall be modified from XX to 11 (7 Zonal Managers and 4 district managers).

5) Inputs from Japanese side

In line with the agreement by both sides on components of pilot project, "small scale solid

372

9/4/22

3

20

**MINUTES OF MEETING
ON
THE FOURTH JOINT COORDINATING COMMITTEE
OF
THE PROJECT FOR FORMULATION OF WESTERN PROVINCE SOLID WASTE
MANAGEMENT MASTER PLAN**

The Japan International Cooperation Agency (hereinafter referred to as “JICA”) Expert Team (hereinafter referred to as “the Team”) submitted draft progress report to Ministry of Public Administration, Home Affairs, Provincial Councils (hereinafter referred to as “MoPAHAPCLG”). The authorities in Sri Lanka concerned with the Project, JICA and the Team conducted a discussion on the Project based on the draft progress report at the Joint Coordinating Committee (hereinafter referred to as “JCC”) held on 4th November 2022.

MoPAHAPCLG, Western Provincial Council, JICA, and the Team confirmed the matters discussed in the JCC as referred to in the document attached hereto.

Colombo, 4 November 2022

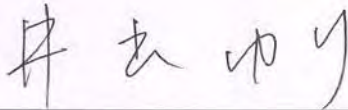

Yuri Ide
Senior Representative
JICA Sri Lanka Office



Mr. M.M.P.K Mayadunne
Secretary
Ministry of Public Administration, Home
Affairs, Provincial Councils & Local
Government

M.M.P.K. MAYADUNNE
Secretary
Ministry of Public Administration, Home
Affairs, Provincial Councils and Local
Government
Colombo



Naofumi Sato
Team Leader
JICA Expert Team

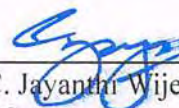

J.M.C. Jayanthi Wijethunga
Chief Secretary
Western Provincial Council

J. M. C. Jayanthi Wijethunga
Chief Secretary (Western Province)
Office of the Chief Secretary (W.P.)
204, Denzil Kobbekaduwa Mawatha,
Battaramulla

Восточная
30-й Департамент Копеекского Министерства
Office of the Chief Secretary (W.P.)
Chief Secretary (Western Province)
J. M. C. Jeyaraj W. Jeyaraj

ATTACHED DOCUMENT

1 Outline & Progress of the Project

The Team explained the progress of the project up to 4th November 2022 including the progress of Pilot Projects. Both sides confirmed the schedule of the activities and undertakings to be done by both sides. [Attachment 1](#) [Attachment 2](#) The progress report was approved by both sides.

2 Extension of the Duration

Because of the global spread of the coronavirus disease 2019 (COVID-19), some of the project activities have been suspended. In addition, Sri Lankan Government took a Cabinet Decision to cancel the construction of Waste to Energy facility in Karadiyana Resource Management Centre, which is a core waste management facility in Solid Waste Management Master Plan, thus the draft Master Plan must be modified with consensus among counterpart and relevant organizations. In order to achieve the project purpose after the project team resume the activities, project duration needs to be extended from 2019.2-2022.12 (3 years and 10 months) to 2019.2-2023.6 (4 years and 4 months) [Attachment 3](#). Amendment of Record of Discussions on the Project is being signed by JICA, MoPAHAPCLG, Western Provincial Council, and the Department of External Resources, Ministry of Finance Economic Stabilization and National Policies.

3 Project Design Matrix ver. 5

The originally planned 3Rs application development pilot project in three Local authorities was significantly behind schedule due to COVID-19 restrictions on face-to-face meetings; the pilot project in one local authority is almost complete, but with six months of project fieldwork remaining, it is difficult to implement pilot project in the other two local authorities. Taking the project duration into account, both sides agreed to change the Objectively Verifiable Indicators under output 3 from "Pilot projects are implemented at more than three LAs." to "Pilot projects are implemented at one or more than one LAs" and Project Design Matrix (PDM) ver. 5. Regarding training, both sides agreed to organize video training instead of training in Japan / third countries, taking into account the strict entry restrictions and the remaining duration of the project. [Attachment 4](#)

4 Mutual agreement on Draft Final Master Plan

Both sides discussed and agreed on the contents of the draft final Western Province Solid Waste Management Master Plan. Both sides confirmed the necessary procedure and demarcation of authorization of the Master Plan. [Attachment 5](#)

5 Authorization Procedure of MP and Establishment of Inter-organizational Body

Both sides confirmed the authorization procedure of MP and establishment of inter-organizational body. as [Attachment 6](#). Sri Lankan side agreed to take necessary actions for the authorization of MP and to establish the inter-organizational body.

Attachment :

Attachment 1 Outline of the Project

Attachment 2 Monitoring Sheet Ver.6 (PM Form 3-1, 3-2, 3-3)

Attachment 3 Plan of operation Ver.7

Attachment 4 PDM ver.5

Attachment 5 Concept of Draft Final Master Plan

Attachment 6 Authorization Procedure of MP and Establishment of Inter-organizational Body

Attachment 7 List of Attendance of JCC

1/2

2

5/2



THE PROJECT FOR FORMULATION OF WESTERN PROVINCE SOLID WASTE MANAGEMENT MASTER PLAN SRI LANKA (Phase II)

The 4th Joint Coordination Committee (JCC)
Outline & Progress of the Project



4 November 2022
JICA Expert team
Chief consultant
Dr. Naofumi SATO

1. Outline of project

1.2 Expected output

- Output 1. Roles and responsibilities of organizations relevant to solid waste management in Western Province are clarified and institutional arrangements for the formulation of the MP are established. (Draft MP)
- Output 2. Current situations and challenges of solid waste management in Western Province are clarified. (Waste Flow & Database)
- Output 3. Knowledge and experience which contribute to MP formulation and implementation are acquired through the implementation of pilot projects on appropriate waste management (Transfer station) and 3Rs.
- Output 4. Knowledge and experience which contribute to MP formulation and implementation are acquired through pilot projects (Development of compost plant) for improving planning/ operation of waste management facilities.
- Output 5. Collaboration and coordination among relevant organizations in Western Province for the implementation of MP, and formulation and implementation of its related plans (e.g. LA action plans, plans on waste management facilities) are strengthened.

2. Outputs and progress

Output 1

Output 1. Roles and responsibilities of organizations relevant to solid waste management in Western Province are clarified and institutional arrangements for the formulation of the MP are established.

Progress

- (1.1) Roles and responsibilities of relevant organizations relevant to solid waste management in Western Province have been clarified by examining policies and legal documents (e.g. national laws, ordinances).
- (1.2) A Working Group for MP formulation have been established.
- (1.3) Terms of Reference (TOR) of the Working Group for MP formulation have been clarified.
- (1.4) Regular meetings and special meetings or sub-group meetings, where necessary, have been held.
- (1.5) Draft Master Plan has been prepared through discussions by the Working Group. The number of working groups is totally twenty two (22).
- (1.6) The process and outputs of activities of the Working Group have NOT been shared with relevant organizations (including those which authorize the Master Plan) both at the Provincial and Central levels by holding meetings and JCC.
- (1.7) An inter-organizational coordination body such as Provincial Solid Waste Management Committee which takes over the work of the Working Group has NOT been proposed.

1. Outline of project

1.1 Overall goal/Project purpose/Target Waste

(1) Overall goal

Appropriate SWM practices in accordance with Western Province Solid Waste Management Master Plan are undertaken in Western Province

(2) Project purpose

Western Province's planning capacity on SWM is strengthened through the formulation of Western Province Solid Waste Management MP. "Planning capability" includes the ability to build cooperative structures and coordination capacity among related organizations in accordance with the plan at the implementation stage of the plan

(3) Target waste planned in the MP

✓ Primarily focusing on municipal solid waste.

- ✓ Healthcare
- ✓ Industrial Waste, and
- ✓ C&D Waste

basic information collection level

(4) Target year
20 years : short (5years), mid (10years) and long term (20years)

2. Outputs and progress

Output 3

Output 3: Knowledge and experience that contribute to MP formulation and implementation are acquired through the implementation of pilot projects on appropriate waste management and 3Rs.

(1) Pilot project: Support Local Authority and residents to segregate waste

- The app can be downloaded from the Google Play or Apple app store.
- Waste collection route (Schedule) it will show all the waste type collection schedule of that route. (biodegradable, nondegradable, etc.)
- View the waste collection calendar of the route.
- User will be able to register multiple Local Authorities.
- Waste sorting dictionary by item.
- Registered recyclers information



53

2. Outputs and progress

Output 3

Output 3: Knowledge and experience that contribute to MP formulation and implementation are acquired through the implementation of pilot projects on appropriate waste management and 3Rs.

(2) Pilot project for development of small-scale solid waste transfer station in Kalutara composing facility

Outline

- The efficiency of transfer and transportation of solid waste is developed.
- The negative environmental issues are improved and
- Operation capacity of transferring is developed by the small-scale solid waste transfer station.

Project site

- Address: Premises of Kalutara compost plant owned by Kalutara UC within Kalutara PS boundary.
- Owner of Compost plant: Kalutara UC
- Execution body of Kalutara compost plant: Waste Management Authority (WMA)

Contribution and Necessity: experience of

- Site selection of solid waste transfer station
- Environmental consideration
- Plan and design of facility of solid waste transfer station
- Technical transfer
- Operation of solid waste transfer station
- Monitoring in terms of environmental social consideration

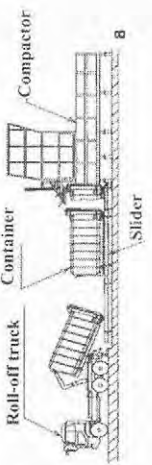

17 5

2. Outputs and progress

Output 2

Output 2: Current situations and challenges of solid waste management in Western Province are clarified.

(1) Waste flow in 2020 was formulated

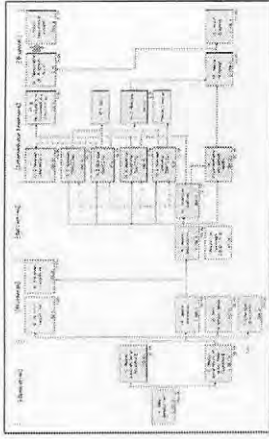

(2) A database is created using existing data on Western Province's SWM

- The database is built for three purposes:
- To manage basic data related to waste management,
 - To collect the daily data of waste management, and
 - To visualize these data.

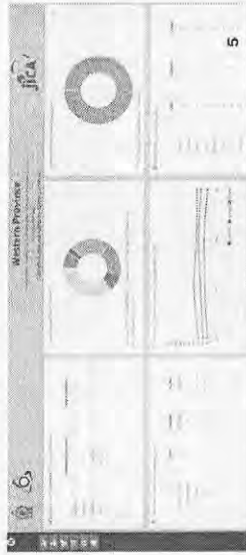

2. Outputs and progress

Output 2

Output 2: Current situations and challenges of solid waste management in Western Province are clarified.

Progress

- The Working Group for MP formulation has decided a. types of waste, b. target year, c. areas and population.
- Organizations in Western Province relevant to solid waste management have been investigated and data on solid waste management is collected.
- A database has been created by IT Expert. The existing data on Western Province's solid waste management has been input to the database system by 49 Local Authorities in the database workshop. The dashboard has been developed. The transfer of database system to cloud space of WMA has been under procedure.
- Based on the data, current situations and challenges regarding solid waste management have been clarified and reported.

2. Outputs and progress

Output 4

Knowledge and experience that contribute to MP formulation and implementation are acquired through the implementation of pilot projects on appropriate waste management and 3Rs

(2) Pilot project of Rehabilitation of Karadlyana Compost Plant (Site A)

Before & After Rehabilitation



Before rehabilitation at Site A

- ✓ Open dumping amount of biodegradable waste : Approx. 250 ton/day
- ✓ Sieving capacity: approx. 10 ton/day
- ✓ Accumulation of biodegradable waste: 250 ton/day x 40% = 100 ton/day
- ✓ Produced compost amount : approx. 10 ton/day

After rehabilitation at Site A

- ✓ Treatment amount of biodegradable waste : Approx. 268 ton/day
- ✓ Sieving capacity: approx. 200 ton/day
- ✓ Accumulation of biodegradable waste: zero ton/day
- ✓ Produced compost amount : approx. 268 x 20% = 53.6 ton/day

11

2. Outputs and progress

Output 3

Knowledge and experience that contribute to MP formulation and implementation are acquired through the implementation of pilot projects on appropriate waste management and 3Rs. (Target areas: Colombo Municipality and other LAs).

Progress

- (3.1) Trainings on appropriate waste management and 3Rs for LAs and other relevant organizations have been conducted.
- (3.2) Target LAs for pilot projects have been selected.
- (3.3) Capacity Assessment (pretest) for WMA and target LA has NOT yet been conducted.
- (3.4) Pilot projects on appropriate waste management and 3Rs have been planned at the target LAs. A mobile application for 3Rs promotion in Sri Jayawardenapura Koite Municipal Council has been developed by IT Expert.
- (3.5) 3.4 has been implemented.
- (3.6) Capacity Assessment (posttest) for WMA and target LAs has NOT yet been conducted.
- (3.7) 3.5 has NOT yet been monitored and its results and knowledge has not yet been reported in written form.

9

2. Outputs and progress

Output 4

Knowledge and experience that contribute to MP formulation and implementation are acquired through the implementation of pilot projects on appropriate waste management and 3Rs

(2) Pilot project of Rehabilitation of Karadlyana Compost Plant (Site A)

Before & After Rehabilitation



Before rehabilitation at Site A

- ✓ Open dumping amount of biodegradable waste : Approx. 250 ton/day
- ✓ Sieving capacity: approx. 10 ton/day
- ✓ Accumulation of biodegradable waste: 250 ton/day x 40% = 100 ton/day
- ✓ Produced compost amount : approx. 10 ton/day

After rehabilitation at Site A

- ✓ Treatment amount of biodegradable waste : Approx. 268 ton/day
- ✓ Sieving capacity: approx. 200 ton/day
- ✓ Accumulation of biodegradable waste: zero ton/day
- ✓ Produced compost amount : approx. 268 x 20% = 53.6 ton/day

11

2. Outputs and progress

Output 4

Knowledge and experience that contribute to MP formulation and implementation are acquired through the implementation of pilot projects on appropriate waste management and 3Rs

(3) Pilot project: Optimal social interventions for improved planning and operation of waste management facilities

- Site location : Community surround Kalutara compost plant
- Manage by: WMA, Kalutara UC & PS

1. Support to coordination with residents

- Support to coordination with existing committee
- Support to communication with localities through events

2. Public Relations

- Information disclosure



12

2. Outputs and progress

Output 4

Knowledge and experience that contribute to MP formulation and implementation are acquired through the implementation of pilot projects on appropriate waste management and 3Rs

(1) Pilot project for development of forced aeration system in existing Kalutara composting facility

Outline

Introduce forced aeration system in the existing Kalutara composting facility.

- Mitigation of negative environmental impact such as offensive odors
- Accelerate of aerobic digestion (reducing composting period)

Project site

- Address : Premises of Kalutara compost plant owned by Kalutara UC within Kalutara PS boundary.
- Owner of Compost plant: Kalutara UC
- Execution body of Kalutara compost plant: Waste Management Authority (WMA)

Contribution and Necessity; experience of

- Obtain Environmental Protection License
- Plan and design of facility of small/middle scale compost plant
- Technical transfer
- Operation of small-scale compost plant
- Monitoring in terms of environmental social consideration

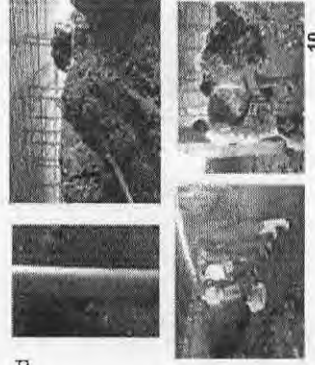

10

2. Outputs and progress

Output 5: Collaboration and coordination among relevant organizations in Western Province for the implementation of MP, and formulation and implementation of its related plans (e.g. LA action plans, plans on waste management facilities) are strengthened.

Progress

- 5.1 Meetings for the explanation of the MP are organized for LAs in Western Province and other relevant organizations (including central government organizations) are held.
- 5.2: Eleven (11) staff members of WMA have been given trainings.
- 5.3. Support and guidance for the formulation of sub-plans and other related plans (e.g. LA action plans, plans on waste management facilities) in line with MP are given to LAs and other relevant organizations.
- 5.4 A system to monitor the implementation of sub-plans and other related plans (e.g. LA action plans, plans on waste management facilities) in line with MP is established and documented.
- 5.5: Budget plans for the implementation of the MP and a guidance for budget plan formulation to implement LAs' action plans are prepared.

-END-

2. Outputs and progress

Output 4: Knowledge and experience that contribute to MP formulation and implementation are acquired through the implementation of pilot projects on appropriate waste management and 3Rs

Progress

- (4.1) Complaints/ requests made by residents, NGOs and other stakeholders with regard to waste management were studied to identify important issues.
- (4.2) Target waste management facilities for pilot activities were selected.
- (4.3) Trainings on planning/ operation of waste management facilities were conducted for relevant organizations.
- (4.4) Capacity Assessment (pretest) for relevant organizations has NOT been conducted.
- (4.5) Pilot projects for seeking optimal technical/ social interventions for improved planning and operation of waste management facilities have been planned at the target waste management facilities.
- (4.6) Pilot project in Kalutara Compost Plant has been monitored and reported in written form.
- (4.7) Capacity Assessment (posttest) for relevant organizations is NOT yet conducted.
- (4.8) 4.6 is NOT yet monitored and its results and knowledge are reported in written form.

2. Outputs and progress

Output 5: Collaboration and coordination among relevant organizations in Western Province for the implementation of MP, and formulation and implementation of its related plans (e.g. LA action plans, plans on waste management facilities) are strengthened.

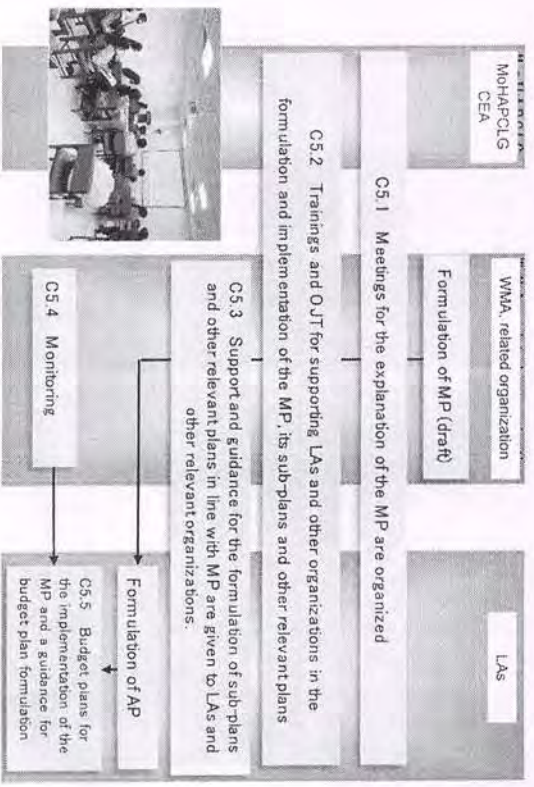

12
27

11

13

To CR of JICA Sri Lanka Office

Name: N.D.N Pushpakumara

Title: Project Director

Name: Nalin Mannapperuma

Title: Project Coordinator

Project Monitoring Sheet

Project Title: The project for formulation of Western Province solid waste management master plan

Version of the Sheet: Ver.06 (Term: February 2022 - September 2022)

Submission Date: 18th October 2022

I. Summary

1 Progress

1-1 Progress of Inputs

(Japan side)

Input of Japanese experts as of 30th September 2022 are shown as below:

✓ Waste Management/Team leader	:12.45 M/M (83.9% of Total 14.83M/M)
✓ Waste Management/Deputy team leader	:4.15 M/M (72.8% of Total 5.70M/M)
✓ Intermediate treatment and final disposal	:2.31 M/M (30.4% of Total 7.60M/M)
✓ Financial economic analysis/Institutional Plan	:6.20 M/M (99.2% of Total 6.25M/M)
✓ Collection and transportation	:6.53 M/M (80.6% of Total 8.10M/M)
✓ 3R /Public awareness 1	:4.80 M/M (73.8% of Total 6.50M/M)
✓ 3R /Public awareness 2	:2.87 M/M (38.9% of Total 7.40M/M)
✓ Database	:2.04 M/M (84.0% of Total 2.43M/M)
✓ Business Continuity Plan	:2.27 M/M (75.6% of Total 3.00M/M)
✓ Procurement of Equipment	:2.42 M/M (96.7% of Total 2.50M/M)
Total	:46.03 M/M (71.58 % of Total 64.31M/M)

(Sri Lankan side)

- Assignment of counterpart
- Personnel cost and operational cost for counterpart
- Office space and facilities for Experts

-NSWMSC

-WMA

1-2 Progress of Activities

1. Roles and responsibilities of organizations relevant to solid waste management in Western Province are

clarified and institutional arrangements for the formulation of the MP are established.
 (1.1) Roles and responsibilities of relevant organizations relevant to solid waste management in Western Province have been clarified by examining policies and legal documents (e.g. national laws, ordinances).

(1.2) A Working Group for MP formulation have been established.

(1.3) Terms of Reference (TOR) of the Working Group for MP formulation have been clarified.

(1.4) Regular meetings and special meetings or sub-group meetings, where necessary, have been held.

(1.5) Draft Master Plan has been prepared through discussions by the Working Group.

Working group / Sub-group meeting of MP

- ✓ 1st 5th December 2020 – Alternatives for SWM technical system in Master Plan
- ✓ 2nd 31st December 2020 – Alternatives for SWM technical system in Master Plan
- ✓ 3rd 9th January 2021 – Alternatives for SWM technical system in Master Plan
- ✓ 4th 16th January 2021 – Alternatives for SWM technical system in Master Plan
- ✓ 5th 13th February 2021 – Alternatives for SWM technical system in Master Plan
- ✓ 6th 25th February 2021 – Alternatives for SWM technical system in Master Plan
- ✓ 7th 28th April 2021 – Improvement of intermediate treatment for organic waste
- ✓ 8th 24th May 2021 – Alternatives for SWM technical system in Master Plan
- ✓ 9th 22nd July 2021 – Improvement of waste collection and 3Rs
- ✓ 10th 13th August 2021 – Strategic Environmental Assessment
- ✓ 11th 27th August 2021 – Operation of SWM Master Plan project for 5 years
- ✓ 12th 17th September 2021 – Operation of SWM Master Plan project for 5 years
- ✓ 13th 29th November 2021 – Discussion on the revision of MP due to the cancellation of WtE at Karadiyana
- ✓ 14th 20th December 2021 – Discussion on the revision of MP due to the cancellation of WtE at Karadiyana
- ✓ 15th 12th January 2022 – Discussion on the revision of MP due to the cancellation of WtE at Karadiyana
- ✓ 16th 17th February 2022 – Discussion on the revision of MP due to the cancellation of WtE at Karadiyana
- ✓ 17th 3rd March 2022 – Brief explanation on the revised draft MP to NSWMSC, WMA, and CEA
- ✓ 18th 8th April 2022 – Completion of draft MP and request for the comments from relevant organizations
- ✓ 19th 17th June 2022 – Issuance of request letter for the comments from WMA
- ✓ 21st 19th August 2022 – Submission of WMA comments
- ✓ 22nd 26th & 27th August 2022 – Reply to the comments from WMA

(1.6) The process and outputs of activities of the Working Group have NOT been shared with relevant organizations (including those which authorize the Master Plan) both at the Provincial and Central levels by holding meetings and JCC.

Handwritten marks: 'A' and '25'

(1.7) An inter-organizational coordination body such as Provincial Solid Waste Management Committee which takes over the work of the Working Group has NOT been proposed.

2. Current situations and challenges of solid waste management in Western Province are clarified.

(2.1) The Working Group for MP formulation has decided a. types of waste, b. target year, c. areas and population.

(2.2) Organizations in Western Province relevant to solid waste management have been investigated and data on solid waste management is collected.

(2.3) A database has been created by IT Expert. The existing data on Western Province's solid waste management has been input to the database system by 49 Local Authorities in the database workshop. The dashboard has been developed. The transfer of database system to cloud space of WMA has been under procedure.

(2.4) Based on the data, current situations and challenges regarding solid waste management have been clarified and reported.

3. Knowledge and experience which contribute to MP formulation and implementation are acquired through the implementation of pilot projects on appropriate waste management and 3Rs.

(3.1) Trainings on appropriate waste management and 3Rs for LAs and other relevant organizations have been conducted.

(3.2) Target LAs for pilot projects have been selected.

(3.3) Capacity Assessment (pretest) for WMA and target LA has NOT yet been conducted.

(3.4) Pilot projects on appropriate waste management and 3Rs have been planned at the target LAs. A mobile application for 3Rs promotion in Sri Jayawardanapura Kotte Municipal Council has been developed by IT Expert.

(3.5) 3.4 has been implemented.

(3.6) Capacity Assessment (posttest) for WMA and target LAs has NOT yet been conducted.

(3.7) 3.5 has NOT yet been monitored and its results and knowledge has not yet been reported in written form.

4. Knowledge and experience which contribute to MP formulation and implementation are acquired through pilot projects for improving planning/ operation of waste management facilities.

(4.1) Complaints/ requests made by residents, NGOs and other stakeholders with regard to waste management were studied to identify important issues.

(4.2) Target waste management facilities for pilot activities were selected.

(4.3) Trainings on planning/ operation of waste management facilities were conducted for relevant organizations.

(4.4) Capacity Assessment (pretest) for relevant organizations has NOT been conducted.

(4.5) Pilot projects for seeking optimal technical/ social interventions for improved planning and operation of

waste management facilities have been planned at the target waste management facilities.

(4.6) Pilot project in Kalutara Compost Plant has been monitored and reported in written form.

(4.7) Capacity Assessment (posttest) for relevant organizations is NOT yet conducted.

(4.8) 4.6 is NOT yet monitored and its results and knowledge are reported in written form.

1-3 Achievement of Output

Output 1

1. Roles and responsibilities of relevant organizations were clarified and documented in the MP and/or other documents.

2. A Working Group for MP formulation was established.

3. Regular meetings were held by the Working Group for MP formulation.

4. The process and outputs of activities of the Working Group were shared at the Provincial and Central levels by holding meetings and JCC.

5. Draft Master Plan was prepared by the Working Group.

Output 2

1. Data on current situations on solid waste management in Western Province were collected.

2. A database using the collected data was created.

3. An analysis report on solid waste management in Western Province was prepared.

Output 3

1. Trainings on appropriate waste management and 3Rs for LAs and other relevant organizations was conducted twice.

2. Pilot projects have been implemented at Sri Jayewardenepura Kotte MC.

Output 4

1. Trainings on planning/ operation of waste management facilities for relevant organizations are conducted at twice.

2. Pilot projects have been implemented at Kalutara Compost Plant and Karadiyana Compost Plant.

4. Progress of pilot project at Kalutara Compost has been monitored by WG for MP formulation.

Output 5

2. 11 staff members of WMA have been given trainings.

1-4 Achievement of the Project Purpose

None.

1-5 Changes of Risks and Actions for Mitigation

<p>None</p>	<p>1-6 Progress of Actions undertaken by JICA</p>
<p>None</p>	<p>1-7 Progress of Actions undertaken by Gov. of Sri Lanka</p>
<p>None</p>	<p>1-8 Progress of Environmental and Social Considerations (if applicable)</p>
<p>The procedure of strategic environmental assessment (SEA) for formulation of Master plan has been studied. Besides the procedure of environmental impact assessment (EIA) for formulation of master plan and pilot project facilities have been studied.</p>	<p>1-9 Progress of Considerations on Gender/Peace Building/Poverty Reduction (if applicable)</p>
<p>None</p>	<p>1-10 Other remarkable/considerable issues related/affect to the project (such as other JICA's projects, activities of counterparts, other donors, private sectors, NGOs etc.)</p>
<p>None</p>	<p>2 Delay of Work Schedule and/or Problems (if any)</p>
<p>2-1 Detail</p>	<p>Since March 2020, in response to spread of infection of COVID-19, JICA suspended dispatching Japanese experts to any project site so that all activities were implemented by remote work before February 2021. Japanese experts have been dispatched to Sri Lanka since February 2021.</p>
<p>Sri Lankan Government took a Cabinet Decision to cancel the construction of WtE facility in Karadiyana Resource Management Centre, which was a core waste management facility in SWM Master Plan. Therefore, the draft Master Plan must be modified with consensus among counterpart and relevant organizations.</p>	<p>Since tax exemption of pilot projects had not been decided by Sri Lankan Government until August 2022, pilot projects of transfer station in Kalutara Compost Plant delayed for one (1) year.</p>
<p>2-2 Cause</p>	<p>2-3 Action to be taken</p>
<p>The project period is extended until June 2023.</p>	<p>2-4 Roles of Responsible Persons/Organization (JICA, Gov. of Sri Lanka, etc.)</p>
<p>None</p>	<p></p>

<p>3 Modification of the Project Implementation Plan</p>	<p>3-1 PO</p>
<p>Plan of Operation is modified in accordance with the extension of the project period.</p>	<p>3-2 Other modifications on detailed implementation plan</p>
<p>(Remarks: The amendment of R/D and PDM (title of the project, duration, project site(s), target group(s), implementation structure, overall goal, project purpose, outputs, activities, and input) should be authorized by JICA HDQs. If the project team deems it necessary to modify any part of R/D and PDM, the team may propose the draft.)</p>	<p>None</p>
<p>The originally planned 3Rs application development pilot project in three Local authorities was significantly behind schedule due to COVID-19 restrictions on face-to-face meetings; the pilot project in one local authority is almost complete, but with six months of project fieldwork remaining, it is difficult to implement pilot project in the other two local authorities.</p>	<p>It is proposed to change from "Pilot projects are implemented at more than three L.As." to "Pilot projects are implemented at one or more than L.As." of the Objectively Verifiable Indicators under output 3. Knowledge and experience which contribute to MP formulation and implementation are acquired through the implementation of pilot projects on appropriate waste management and 3Rs.</p>
<p>4 Current Activities of Gov. of Sri Lanka to Secure Project Sustainability after its Completion</p>	<p>None</p>

II. Project Monitoring Sheet I, II, III as Attached

35

Project Monitoring Sheet I (Project Design Matrix)

Project Title: The Project for Formulation of Western Province Solid Waste Management Master Plan
Implementing Agency: National Solid Waste Management Support Center (NSWMSMC), Waste Management Authority (WMA), and relevant organizations
Target Group: Western Province, and organizations relevant to waste management in Western Province
Duration: 2019.2-2022.12
Project Site: Western Province

Version 4
 Dated 22 April 2022

Narrative Summary	Objectively Verifiable Indicators	Means of Verification	Important Assumption
Overall Goal Appropriate solid waste management practices in accordance with Western Province Solid Waste Management Master Plan (MP) are undertaken in Western Province.	1. All Local Authorities (LAs) prepare/update and implement their solid waste management action plan (LA action plan) in line with the MP within one year after publishing the MP. 2. An inter-organizational coordination body functions to monitor the progress and support the implementation of LA action plan in Western Province.	1. LA's Action Plans 2. Reports on waste management from LAs	
Project Purpose Western Province's planning capacity on solid waste management is strengthened through the formulation of Western Province Solid Waste Management Master Plan (MP).	1. The final draft of the MP is prepared. 2. Western Provincial Council (WPC) and MoPAHAPCLG start the MP approval process. 3. Sub-plans and other related plans (e.g. LA action plans, plans on waste management facilities) in line with the MP are formulated. 4. An inter-organizational coordination body is established to monitor the progress and provide support implementation of the sub-plans and other related plans in Western Province.	1. The final draft of the MP 2. The MP in the process of approval 3. Draft LA's Action Plans/plans on waste management facilities 4. Plan of formulation of execution and monitoring body (e.g. inter-organizational coordination body)	1. National policies regarding waste management do not change significantly 2. Financial resources for the implementation of the MP are secured by LAs.
Outputs 1. Roles and responsibilities of organizations relevant to solid waste management in Western Province are clarified and institutional arrangements for the formulation of the MP are established.	1. Roles and responsibilities of relevant organizations are clarified and documented in the MP and/or other documents. 2. A Working Group for MP formulation is established. 3. Regular meetings are held (at least once in three months) by the Working Group for MP formulation. 4. The process and outputs of activities of the Working Group are shared at the Provincial and Central levels by holding workshops or meetings 6 times. 5. Draft Master Plan is prepared by the Working Group.	1. Documented list of roles and responsibilities 2. List of the Working Group members 3. Minutes of meetings of the Working Group 4. Reports of the workshops or meetings 5. Draft Master Plan	Counterpart (C/P) staff and other staff from relevant organizations continuously engage in the project.

2. Current situation, trend, potentials and challenges of solid waste management in Western Province are clarified.	1. Data on current situations on solid waste management in Western Province are collected. 2. A database using the collected data is created 3. An analysis report on solid waste management in Western Province is prepared.	1. Data on solid waste management in Western Province 2. The database 3. The analysis report on solid waste in Western Province	
3. Knowledge and experience which contribute to MP formulation and implementation are acquired through the implementation of pilot projects on appropriate waste management and 3Rs.	1. Trainings on appropriate waste management and 3Rs for LAs and other relevant organizations are conducted three times. 2. Pilot projects are implemented at more than three LAs. 3. The results of Capacity Assessment (posttest) for WMA and target LAs improve from those of pretest. 4. Progress of Pilot Projects are monitored by WG for MP formulation.	1. Records of trainings 2. Records of pilot project implementation 3. Reports of Capacity Assessment 4. Reports on pilot projects	
4. Knowledge and experience which contribute to MP formulation and implementation are acquired through pilot projects for improving planning/ operation of waste management facilities.	1. Trainings on planning/ operation of waste management facilities for relevant organizations are conducted more than three times. 2. Pilot projects are implemented at one or more than one waste management facilities. 3. The results of Capacity Assessment (posttest) for relevant organizations of target waste management facilities improve from those of pretest. 4. Progress of pilot projects are monitored by WG for MP formulation.	1. Records of trainings 2. Records of pilot projects implementation 3. Reports of Capacity Assessment 4. Reports on pilot projects	
5. Collaboration and coordination among relevant organizations in Western Province for the implementation of MP, and formulation and implementation of its related plans (e.g. LA action plans, plans on waste management facilities) are strengthened.	1. Meetings for the explanation of the MP are organized for LAs in Western Province and other relevant organizations (including central government organizations) are held more than three times. 2. If staff members of WMA and other related organization are given trainings and/or OJT on supporting LAs. 3. Support and guidance for the formulation of sub-plans and other related plans (e.g. LA action plans, plans on waste management facilities) in line with the MP are given to LAs and other relevant organizations. 4. The monitoring system is documented. 5. Budget plans for the implementation of the MP and a guidance for budget plan formulation to implement LAs' action plans are prepared.	1. Records on the meeting for the explanation of the MP 2. Records on training and/ or OJT 3. Records on support and guidance 4. Documented monitoring system 5. Budget plans	
Activities	Inputs		
1.1 Roles and responsibilities of relevant organizations relevant to solid waste management in Western Province are clarified by examining policies and legal documents (e.g. national laws, ordinances). 1.2 A Working Group for MP formulation is established. 1.3 Terms of Reference (TOR) of the Working Group for MP formulation are clarified. 1.4 Regular meetings and special meetings or sub-group meetings, where necessary, are held.	[Japanese side] • Experts - Waste Management - Collection and Transportation - Intermediate Treatment and Final Disposal - 3Rs/ Public Awareness - Financial / Economic Analysis/Institutional plan - Database • Provision of machinery and equipment	[Sri Lankan side] • C/P • Personnel cost and operational cost for C/P • Office space and facilities for Experts at 1. NSWMSMC 2. WMA	Large-scale consolidation and/or restructuring of LAs do not occur.

5/2

3

5

<p>1.5 Draft Master Plan is prepared through discussions by the Working Group.</p> <p>1.6 The process and outputs of activities of the Working Group are shared with relevant organizations (including those which authorize the Master Plan) both at the Provincial and Central levels by holding workshops or meetings.</p> <p>1.7 An inter-organizational coordination body such as Provincial Solid Waste Management Committee which takes over the work of the Working Group is proposed.</p> <p>2.1 The Working Group for MP formulation decides a. types of waste, b. target year, c. areas and population.</p> <p>2.2 Organizations in Western Province relevant to solid waste management are investigated and data on solid waste management is collected.</p> <p>2.3 A database is created using existing data on Western Province's solid waste management.</p> <p>2.4 Based on the data, current situations and challenges regarding solid waste management are clarified and reported.</p> <p>3.1 Trainings on appropriate waste management and 3Rs for LAs and other relevant organizations are conducted.</p> <p>3.2 Target LAs for pilot projects are selected.</p> <p>3.3 Capacity Assessment (pretest) for WMA and target LAs is conducted.</p> <p>3.4 The pilot projects on appropriate waste management and 3Rs are planned at the target LAs.</p> <p>3.5 3.4 is implemented.</p> <p>3.6 Capacity Assessment (posttest) for WMA and target LAs is conducted.</p> <p>3.7 3.5 is monitored and its results and knowledge are reported in written form.</p> <p>4.1 Complaints/ requests made by residents, NGOs and other stakeholders with regard to waste management are studied to identify important issues.</p> <p>4.2 Target waste management facilities for pilot activities are selected.</p> <p>4.3 Trainings on planning/ operation of waste management facilities are conducted for relevant organizations.</p> <p>4.4 Capacity Assessment (pretest) for relevant organizations is</p>	<ul style="list-style-type: none"> - Small scale solid waste transfer station at Kalutara composting facility - Forced aeration system in existing Kalutara composting facility - Equipment for rehabilitating existing compost plant in Karadiyana - Trainings in Japan/Third Countries 		
---	--	--	--

<p>conducted.</p> <p>4.5 Pilot projects for seeking optimal technical/ social interventions for improved planning and operation of waste management facilities are planned at the target waste management facilities.</p> <p>4.6 4.5 is implemented.</p> <p>4.7 Capacity Assessment (posttest) for relevant organizations is conducted.</p> <p>4.8 4.6 is monitored and its results and knowledge are reported in written form.</p> <p>5.1 Meetings for the explanation of the MP are organized for LAs in Western Province and other relevant organizations (including central government organizations) are held.</p> <p>5.2 The staff of WMA and other relevant organizations enhance their knowledge and skills for supporting LAs and other organizations in their formulation and implementation of the MP, its sub-plans and other related plans (e.g. LA action plans, plans on waste management facilities) through trainings and OJT.</p> <p>5.3 Support and guidance for the formulation of sub-plans and other related plans (e.g. LA action plans, plans on waste management facilities) in line with MP are given to LAs and other relevant organizations.</p> <p>5.4 A system to monitor the implementation of sub-plans and other related plans (e.g. LA action plans, plans on waste management facilities) in line with MP is established and documented.</p> <p>5.5 Budget plans for the implementation of the MP and a guidance for budget plan formulation to implement LAs' action plans are prepared.</p>			<p>Pre-Condition Staff from relevant organizations in Western Province are assigned for the project.</p>
--	--	--	---

5/2

6/

5
2/

Project Monitoring Sheet I (Project Design Matrix)

Project Title: The Project for Formulation of Western Province Solid Waste Management Master Plan
 Implementing Agency: National Solid Waste Management Support Center (NSWMSMC), Waste Management Authority (WMA), and relevant organizations
 Target Group: Western Province, and organizations relevant to waste management in Western Province
 Duration: 2019.2-2023.6
 Project Site: Western Province

Version 5
 Dated 4 November 2022

Narrative Summary	Objectively Verifiable Indicators	Means of Verification	Important Assumption
Overall Goal Appropriate solid waste management practices in accordance with Western Province Solid Waste Management Master Plan (MP) are undertaken in Western Province.	1. All Local Authorities (LAs) prepare/update and implement their solid waste management action plan (LA action plan) in line with the MP within one year after publishing the MP. 2. An inter-organizational coordination body functions to monitor the progress and support the implementation of LA action plan in Western Province.	1. LA's Action Plans 2. Reports on waste management from LAs	
Project Purpose Western Province's planning capacity on solid waste management is strengthened through the formulation of Western Province Solid Waste Management Master Plan (MP).	1. The final draft of the MP is prepared. 2. Western Provincial Council (WPC) and MoPAHAPCLG start the MP approval process. 3. Sub-plans and other related plans (e.g. LA action plans, plans on waste management facilities) in line with the MP are formulated. 4. An inter-organizational coordination body is established to monitor the progress and provide support implementation of the sub-plans and other related plans in Western Province.	1. The final draft of the MP 2. The MP in the process of approval 3. Draft LA's Action Plans/plans on waste management facilities 4. Plan of formulation of execution and monitoring body (e.g. inter-organizational coordination body)	1. National policies regarding waste management do not change significantly 2. Financial resources for the implementation of the MP are secured by LAs.
Outputs 1. Roles and responsibilities of organizations relevant to solid waste management in Western Province are clarified and institutional arrangements for the formulation of the MP are established.	1. Roles and responsibilities of relevant organizations are clarified and documented in the MP and/or other documents. 2. A Working Group for MP formulation is established. 3. Regular meetings are held (at least once in three months) by the Working Group for MP formulation. 4. The process and outputs of activities of the Working Group are shared at the Provincial and Central levels by holding workshops or meetings 6 times. 5. Draft Master Plan is prepared by the Working Group.	1. Documented list of roles and responsibilities 2. List of the Working Group members 3. Minutes of meetings of the Working Group 4. Reports of the workshops or meetings 5. Draft Master Plan	Counterpart (C/P) staff and other staff from relevant organizations continuously engage in the project.

2. Current situation, trend, potentials and challenges of solid waste management in Western Province are clarified.	1. Data on current situations on solid waste management in Western Province are collected. 2. A database using the collected data is created 3. An analysis report on solid waste management in Western Province is prepared.	1. Data on solid waste management in Western Province 2. The database 3. The analysis report on solid waste in Western Province	
3. Knowledge and experience which contribute to MP formulation and implementation are acquired through the implementation of pilot projects on appropriate waste management and 3Rs.	1. Trainings on appropriate waste management and 3Rs for LAs and other relevant organizations are conducted three times. 2. Pilot projects are implemented at one or more than one LAs more than three LAs. 3. The results of Capacity Assessment (posttest) for WMA and target LAs improve from those of pretest. 4. Progress of Pilot Projects are monitored by WG for MP formulation.	1. Records of trainings 2. Records of pilot project implementation 3. Reports of Capacity Assessment 4. Reports on pilot projects	
4. Knowledge and experience which contribute to MP formulation and implementation are acquired through pilot projects for improving planning/ operation of waste management facilities.	1. Trainings on planning/ operation of waste management facilities for relevant organizations are conducted more than three times. 2. Pilot projects are implemented at one or more than one waste management facilities. 3. The results of Capacity Assessment (posttest) for relevant organizations of target waste management facilities improve from those of pretest. 4. Progress of pilot projects are monitored by WG for MP formulation.	1. Records of trainings 2. Records of pilot projects implementation 3. Reports of Capacity Assessment 4. Reports on pilot projects	
5. Collaboration and coordination among relevant organizations in Western Province for the implementation of MP, and formulation and implementation of its related plans (e.g. LA action plans, plans on waste management facilities) are strengthened.	1. Meetings for the explanation of the MP are organized for LAs in Western Province and other relevant organizations (including central government organizations) are held more than three times. 2. 11 staff members of WMA and other related organization are given trainings and/or OJT on supporting LAs. 3. Support and guidance for the formulation of sub-plans and other related plans (e.g. LA action plans, plans on waste management facilities) in line with the MP are given to LAs and other relevant organizations. 4. The monitoring system is documented. 5. Budget plans for the implementation of the MP and a guidance for budget plan formulation to implement LAs' action plans are prepared.	1. Records on the meeting for the explanation of the MP 2. Records on training and/ or OJT 3. Records on support and guidance 4. Documented monitoring system 5. Budget plans	
Activities	Inputs		
1.1 Roles and responsibilities of relevant organizations relevant to solid waste management in Western Province are clarified by examining policies and legal documents (e.g. national laws, ordinances). 1.2 A Working Group for MP formulation is established. 1.3 Terms of Reference (TOR) of the Working Group for MP formulation are clarified. 1.4 Regular meetings and special meetings or sub-group meetings, where necessary, are held.	[Japanese side] • Experts - Waste Management - Collection and Transportation - Intermediate Treatment and Final Disposal - 3Rs/ Public Awareness - Financial / Economic Analysis/Institutional plan - Database • Provision of machinery and equipment	[Sri Lankan side] • C/P • Personnel cost and operational cost for C/P • Office space and facilities for Experts at 1. NSWMSMC 2. WMA	Large-scale consolidation and/or restructuring of LAs do not occur.

5/2

3

PS

<p>1.5 Draft Master Plan is prepared through discussions by the Working Group.</p> <p>1.6 The process and outputs of activities of the Working Group are shared with relevant organizations (including those which authorize the Master Plan) both at the Provincial and Central levels by holding workshops or meetings.</p> <p>1.7 An inter-organizational coordination body such as Provincial Solid Waste Management Committee which takes over the work of the Working Group is proposed.</p> <p>2.1 The Working Group for MP formulation decides a. types of waste, b. target year, c. areas and population.</p> <p>2.2 Organizations in Western Province relevant to solid waste management are investigated and data on solid waste management is collected.</p> <p>2.3 A database is created using existing data on Western Province's solid waste management.</p> <p>2.4 Based on the data, current situations and challenges regarding solid waste management are clarified and reported.</p> <p>3.1 Trainings on appropriate waste management and 3Rs for LAs and other relevant organizations are conducted.</p> <p>3.2 Target LAs for pilot projects are selected.</p> <p>3.3 Capacity Assessment (pretest) for WMA and target LAs is conducted.</p> <p>3.4 The pilot projects on appropriate waste management and 3Rs are planned at the target LAs.</p> <p>3.5 3.4 is implemented.</p> <p>3.6 Capacity Assessment (posttest) for WMA and target LAs is conducted.</p> <p>3.7 3.5 is monitored and its results and knowledge are reported in written form.</p> <p>4.1 Complaints/ requests made by residents, NGOs and other stakeholders with regard to waste management are studied to identify important issues.</p> <p>4.2 Target waste management facilities for pilot activities are selected.</p> <p>4.3 Trainings on planning/ operation of waste management facilities are conducted for relevant organizations.</p> <p>4.4 Capacity Assessment (pretest) for relevant organizations is</p>	<p>- Small scale solid waste transfer station at Kalutara composting facility</p> <p>- Forced aeration system in existing Kalutara composting facility</p> <p>- Equipment for rehabilitating existing compost plant in Karadiyana</p> <p>• Video Trainings in Japan/Third-Countries</p>		
---	---	--	--

<p>conducted.</p> <p>4.5 Pilot projects for seeking optimal technical/ social interventions for improved planning and operation of waste management facilities are planned at the target waste management facilities.</p> <p>4.6 4.5 is implemented.</p> <p>4.7 Capacity Assessment (posttest) for relevant organizations is conducted.</p> <p>4.8 4.6 is monitored and its results and knowledge are reported in written form.</p> <p>5.1 Meetings for the explanation of the MP are organized for LAs in Western Province and other relevant organizations (including central government organizations) are held.</p> <p>5.2 The staff of WMA and other relevant organizations enhance their knowledge and skills for supporting LAs and other organizations in their formulation and implementation of the MP, its sub-plans and other related plans (e.g. LA action plans, plans on waste management facilities) through trainings and OJT.</p> <p>5.3 Support and guidance for the formulation of sub-plans and other related plans (e.g. LA action plans, plans on waste management facilities) in line with MP are given to LAs and other relevant organizations.</p> <p>5.4 A system to monitor the implementation of sub-plans and other related plans (e.g. LA action plans, plans on waste management facilities) in line with MP is established and documented.</p> <p>5.5 Budget plans for the implementation of the MP and a guidance for budget plan formulation to implement LAs' action plans are prepared.</p>			<p><u>Pre-Condition</u> Staff from relevant organizations in Western Province are assigned for the project.</p>
--	--	--	---

3/2

3/

2/5



Contents

1. Plan of future waste flow
2. Draft SWM Master Plan
3. SWM MP implementation projects in the short to medium term
4. Financial sustainability analysis (FSA)

Outline of Draft Final Western Province SWM Master Plan

The 4th Joint Coordination Committee
4 November, 2022

1. Plan of future waste flow

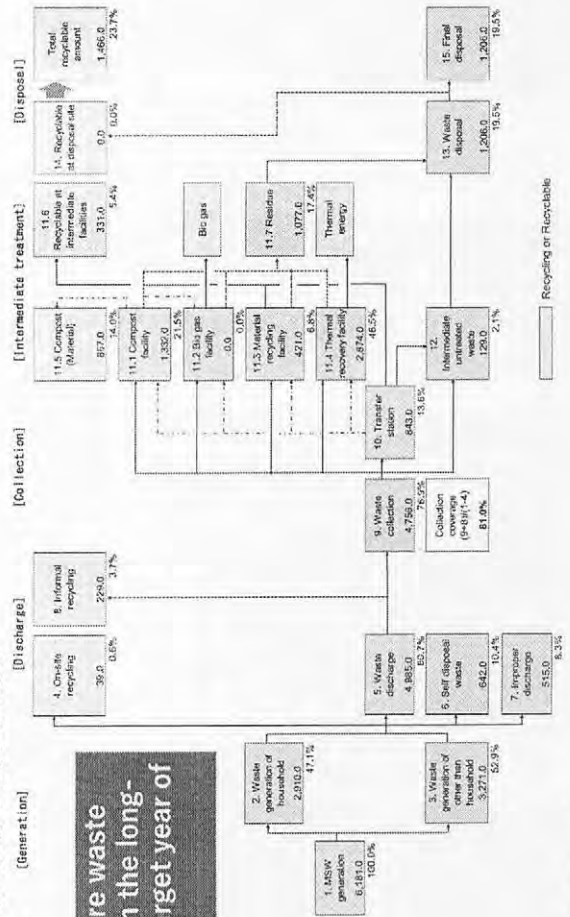

Location Chart of Western Province and 3 Districts in Sri Lanka

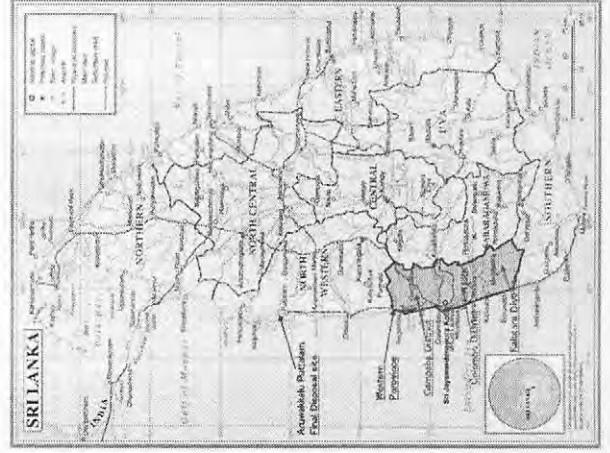

12/27

別添資料1

1. Plan of future waste flow

b. Amount of waste generation, intermediate treatment waste and waste disposal from 2022 to 2042

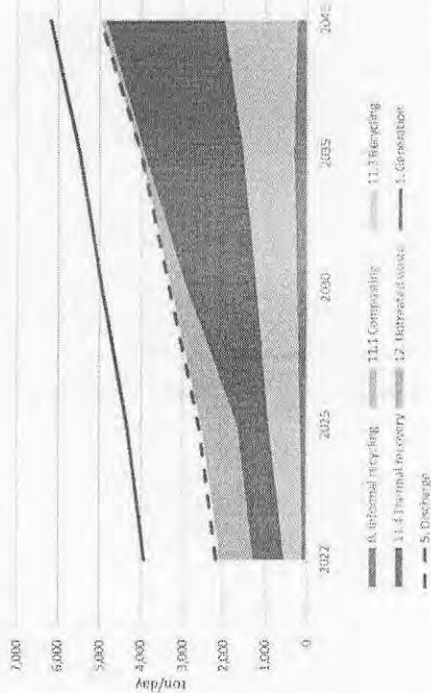

3. SWM MP implementation projects in the short to medium term

The solid waste management projects (SWM Projects) implemented in short and medium terms

- Project 1: Development of five Primary Transfer Stations (PTS)
- Project 2: Improvement of Kelaniya Transfer Station (KTS)
- Project 3: Development of Cluster based Waste Treatment Facility (CWTF)
- Project 4: Improvement of compost facilities
- Project 5: Improvement of recycling facilities for formal recyclables
- Project 6: Procurement of collection and transfer vehicles
- Project 7: Closure of current dump sites managed by LAs
- Project 8: Encouragement of waste separation

33

SWM MP implementation projects(1)

Project	Short term	Medium term			2027	2030
		2022	2024	2027		
Project 1: Development of five Primary Transfer Stations (PTS)						
Construction	1,070	1,240	1,320	1,430	920	1,089
Operation	0	0	0	0	0	0
Project 2: Improvement of Kelaniya Transfer Station (KTS)						
Construction	1,240	1,160	1,240	1,240	800	974
Operation	0	0	0	0	0	0
Project 3: Development of Thermal Recovery Facility (TRF)						
Construction	0	0	0	0	0	0
Operation	0	0	0	0	0	0
Project 4: Improvement of compost facilities						
Construction	160	160	160	160	160	160
Operation	0	0	0	0	0	0
Project 5: Improvement of recycling facilities for formal recyclables						
Construction	160	160	160	160	160	160
Operation	0	0	0	0	0	0
Project 6: Procurement of collection and transfer vehicles						
Construction	160	160	160	160	160	160
Operation	0	0	0	0	0	0
Project 7: Closure of current dump sites managed by LAs						
Construction	160	160	160	160	160	160
Operation	0	0	0	0	0	0
Project 8: Encouragement of waste separation						
Construction	160	160	160	160	160	160
Operation	0	0	0	0	0	0

12

12/27

2. Draft SWM MP (Milestones for achieving SWM MP)

Milestone	Short term			Medium term			Long term				
	2022	2024	2027	2024	2027	2030	2030	2034	2037	2040	2041
Reduction of generation waste	1%	3%	10%	1%	3%	10%	1%	3%	10%	10%	10%
Separation of discharge waste	15%	25%	35%	15%	25%	35%	15%	25%	35%	35%	35%
Improvement of collection rate	72%	75%	78%	72%	75%	78%	72%	75%	78%	78%	78%
Thermal Recovery Facility (TRF) (ton/day)	0	0	0	1,500	1,500	1,500	1,500	1,500	1,500	1,500	1,500
WPF, WLF Facility	0	0	0	1,000	1,000	1,000	1,000	1,000	1,000	1,000	1,000
TRF in Colombo District	0	0	0	1,000	1,000	1,000	1,000	1,000	1,000	1,000	1,000
TRF in Gampaha District	0	0	0	1,000	1,000	1,000	1,000	1,000	1,000	1,000	1,000
Compost facilities (CF) (ton/day)	0	0	0	117	133	136	117	133	136	136	136
LAF, CFS	0	0	0	222	240	294	222	240	294	294	294
Cluster-based CFS	0	0	0	140	160	180	140	160	180	180	180
Waste Park CFS	0	0	0	82	80	114	82	80	114	114	114
Recycling facilities (MRF) (ton/day)	116	116	116	116	116	116	116	116	116	116	116
Low recycling facilities	0	0	0	60	60	60	60	60	60	60	60
Waste Park MRFs	0	0	0	400	400	400	400	400	400	400	400
Transfer station (TS) (ton/day)	1,095	1,242	1,422	1,095	1,242	1,422	1,095	1,242	1,422	1,422	1,422
Primary TS	0	0	0	400	400	400	400	400	400	400	400
Secondary TS	0	0	0	697	842	1,022	697	842	1,022	1,022	1,022
Transfer station (TS) (ton/day)	1.5	1.5	1.5	4.0	4.0	4.0	4.0	4.0	4.0	4.0	4.0
Final disposal (Dumwarkale DS) (million m ³)	179	179	179	179	179	179	179	179	179	179	179
By Product	0	0	0	0	0	0	0	0	0	0	0
Amount of electric power (GWh/year)	0	0	0	0	0	0	0	0	0	0	0
Compost production (million m ³)	0	0	0	0	0	0	0	0	0	0	0

ACHIEVEMENTS

別添資料1

Project 2: Improvement of Kelaniya Transfer Station (KTS)

- [Plan]**
- Types of waste transported:
 - ✓ Intermediate untreated waste (waste which be exceeded the capacity of intermediate treatment facilities, non-burnable waste)
 - ✓ Residue generated at composting, recycling, and thermal recovery facilities
 - Transfer system: railway transferring system

Year	Implementation schedule				
	2022	2023	2024	2025	2026
Construction	147	134	124	115	97
Operation				112	131
Total	147	134	124	115	97

[Responsible organization]

Stage	Action	Responsible Organization
Construction	Construction including procurement of Leco and various equipment	MetUP
Operation	Franchising capital cost, Operation of KTS, including transportation to Anuradhapura, Cost recovery	MohID, MoJIP (designated operator), Operator charges (lifting fee on users)

[Project cost]

Item for expenditure (including operation cost)	2022	2023	2024	2025	2026	2027
Construction cost	0	6	6	6	0	6
Operation and maintenance cost	976	1,665	1,127	1,124	1,421	1,315
Purchase of equipment/machinery	0	0	0	0	0	0
Miscellaneous expenses	98	107	115	113	124	132
Total	1,074	1,772	1,242	1,239	1,545	1,447

SWM MP implementation projects (2)

Project 5: Improvement of recycling facilities for formal recyclables

Year	2022	2023	2024	2025	2026	2027	2028	2029	2030
Construction	120	130	150	170	190	200	210	240	240
Operation									
Total	120	130	150	170	190	200	210	240	240

Project 6: Procurement of collection and transfer vehicles

Year	2022	2023	2024	2025	2026	2027	2028	2029	2030
Construction	99	101	106	111	114				
Operation									
Total	99	101	106	111	114				

Project 7: Closure of current dumping sites agreed by LA

Year	2022	2023	2024	2025	2026	2027	2028	2029	2030
Construction	0	0	0	0	0	0	0	0	0
Operation	156	378	407	540	373	531			
Total	156	378	407	540	373	531			

Project 8: Development of waste separation promotion program

Year	2022	2023	2024	2025	2026	2027	2028	2029	2030
Construction	0	0	0	0	0	0	0	0	0
Operation	44	115	136	137	144				
Total	44	115	136	137	144				

Project 3: Development of Cluster based Waste Treatment Facility (CWTF)

- [Plan]**
- Types of waste transported:
 - ✓ Intermediate untreated waste (waste which be exceeded the capacity of intermediate treatment facilities, non-burnable waste)
 - ✓ Residue generated at composting, recycling, and thermal recovery facilities
 - Transfer system: railway transferring system

Project 3-1: TRF in Colombo District: 400ton/day

[Implementation schedule]

Year	2022	2023	2024	2025	2026	2027
Construction	10	10	10	10	0	0
Operation	0	0	0	0	0	0
Total	10	10	10	10	0	0

[Responsible organization]

Stage	Action	Responsible Organization
Construction	Design, procurement, construction	Invetiv
Operation	Franchising capital cost, Operation of WTE Plant, Waste supply, Revenue collection	WMA and relevant organizations, Invetiv, WMA in coordination with L&A, Electricity, finance financing by Government with arrangement with M&P and L&A

[Project cost]

Item for expenditure (including operation cost)	2022	2023	2024	2025	2026	2027
Construction cost	10	10	10	10	0	0
Operation and maintenance cost	0	0	0	0	0	0
Purchase of machinery/equipment	0	0	1,133	3,332	3,332	3,332
Miscellaneous expenses	1	1	303	733	334	334
Total	11	11	1,436	3,369	3,666	3,666

- Project 3-2: Development of New WTE next to Western Power at Kerawalapitiya: 750ton/day
- [Implementation schedule]**
- | Year | 2022 | 2023 | 2024 | 2025 | 2026 | 2027 |
|--------------|----------|----------|----------|----------|----------|----------|
| Construction | 0 | 0 | 0 | 0 | 0 | 0 |
| Operation | 0 | 0 | 0 | 0 | 0 | 0 |
| Total | 0 | 0 | 0 | 0 | 0 | 0 |
- [Responsible organization]**
- | Stage | Action | Responsible Organization |
|--------------|---|--|
| Construction | Design, procurement, construction, Franchising capital cost, Operation of WTE Plant, Waste supply, Revenue collection | WMA in coordination with L&A, Electricity, finance financing by Government with arrangement with M&P and L&A |
- [Project cost]**
- | Item for expenditure (including operation cost) | 2022 | 2023 | 2024 | 2025 | 2026 | 2027 |
|---|----------|----------|-----------|-----------|--------------|--------------|
| Construction cost | 0 | 0 | 0 | 0 | 0 | 0 |
| Operation and maintenance cost | 0 | 0 | 0 | 0 | 0 | 0 |
| Purchase of machinery/equipment | 0 | 0 | 0 | 0 | 0 | 0 |
| Miscellaneous expenses | 1 | 1 | 11 | 11 | 6,875 | 6,875 |
| Total | 1 | 1 | 11 | 11 | 6,875 | 6,875 |

18/25

[Implementation schedule]

Year	2022	2023	2024	2025	2026	2027
Construction	0	0	0	0	0	0
Operation	0	0	0	0	0	0
Total	0	0	0	0	0	0

[Responsible organization]

Stage	Action	Responsible Organization
Construction	Design, procurement, construction, Franchising capital cost, Operation of WTE Plant, Waste supply, Revenue collection	WMA in coordination with L&A, Electricity, finance financing by Government with arrangement with M&P and L&A

[Project cost]

Item for expenditure (including operation cost)	2022	2023	2024	2025	2026	2027
Construction cost	0	0	0	0	0	0
Operation and maintenance cost	0	0	0	0	0	0
Purchase of machinery/equipment	0	0	0	0	0	0
Miscellaneous expenses	1	1	11	11	6,875	6,875
Total	1	1	11	11	6,875	6,875

Project 1: Development of five Primary Transfer Stations (PTS)

- [Plan]**
- Types of waste transported:
 - ✓ Intermediate untreated waste (waste which be exceeded the capacity of intermediate treatment facilities, non-burnable waste)
 - ✓ Residue generated at composting, recycling, and thermal recovery facilities
 - Transfer system: railway transferring system

Project 1-1: TRF in Colombo District: 400ton/day

[Implementation schedule]

Year	2022	2023	2024	2025	2026	2027
Construction	10	10	10	10	0	0
Operation	0	0	0	0	0	0
Total	10	10	10	10	0	0

[Responsible organization]

Stage	Action	Responsible Organization
Construction	Design, procurement, construction	Invetiv
Operation	Franchising capital cost, Operation of WTE Plant, Waste supply, Revenue collection	WMA and relevant organizations, Invetiv, WMA in coordination with L&A, Electricity, finance financing by Government with arrangement with M&P and L&A

[Project cost]

Item for expenditure (including operation cost)	2022	2023	2024	2025	2026	2027
Construction cost	10	10	10	10	0	0
Operation and maintenance cost	0	0	0	0	0	0
Purchase of machinery/equipment	0	0	1,133	3,332	3,332	3,332
Miscellaneous expenses	1	1	303	733	334	334
Total	11	11	1,436	3,369	3,666	3,666

- Project 1-2: TRF in Colombo District: 400ton/day
- [Implementation schedule]**
- | Year | 2022 | 2023 | 2024 | 2025 | 2026 | 2027 |
|--------------|----------|----------|----------|----------|----------|----------|
| Construction | 0 | 0 | 0 | 0 | 0 | 0 |
| Operation | 0 | 0 | 0 | 0 | 0 | 0 |
| Total | 0 | 0 | 0 | 0 | 0 | 0 |
- [Responsible organization]**
- | Stage | Action | Responsible Organization |
|--------------|---|--|
| Construction | Design, procurement, construction, Franchising capital cost, Operation of WTE Plant, Waste supply, Revenue collection | WMA in coordination with L&A, Electricity, finance financing by Government with arrangement with M&P and L&A |
- [Project cost]**
- | Item for expenditure (including operation cost) | 2022 | 2023 | 2024 | 2025 | 2026 | 2027 |
|---|----------|----------|-----------|-----------|--------------|--------------|
| Construction cost | 0 | 0 | 0 | 0 | 0 | 0 |
| Operation and maintenance cost | 0 | 0 | 0 | 0 | 0 | 0 |
| Purchase of machinery/equipment | 0 | 0 | 0 | 0 | 0 | 0 |
| Miscellaneous expenses | 1 | 1 | 11 | 11 | 6,875 | 6,875 |
| Total | 1 | 1 | 11 | 11 | 6,875 | 6,875 |

[Plan]

Year	2022	2023	2024	2025	2026	2027
Construction	10	10	10	10	0	0
Operation	0	0	0	0	0	0
Total	10	10	10	10	0	0

[Implementation schedule]

[Responsible organization]

Stage	Action	Responsible Organization
Construction	Design, procurement, construction, Franchising capital cost, Operation of WTE Plant, Waste supply, Revenue collection	WMA and relevant organizations, Invetiv, WMA in coordination with L&A, Electricity, finance financing by Government with arrangement with M&P and L&A

[Project cost]

Item for expenditure (including operation cost)	2022	2023	2024	2025	2026	2027
Construction cost	10	10	10	10	0	0
Operation and maintenance cost	0	0	0	0	0	0
Purchase of machinery/equipment	0	0	1,133	3,332	3,332	3,332
Miscellaneous expenses	1	1	303	733	334	334
Total	11	11	1,436	3,369	3,666	3,666

18/25

[Implementation schedule]

Year	2022	2023	2024	2025	2026	2027
Construction	0	0	0	0	0	0
Operation	0	0	0	0	0	0
Total	0	0	0	0	0	0

[Responsible organization]

Stage	Action	Responsible Organization
Construction	Design, procurement, construction, Franchising capital cost, Operation of WTE Plant, Waste supply, Revenue collection	WMA in coordination with L&A, Electricity, finance financing by Government with arrangement with M&P and L&A

[Project cost]

Item for expenditure (including operation cost)	2022	2023	2024	2025	2026	2027
Construction cost	0	0	0	0	0	0
Operation and maintenance cost	0	0	0	0	0	0
Purchase of machinery/equipment	0	0	0	0	0	0
Miscellaneous expenses	1	1	11	11	6,875	6,875
Total	1	1	11	11	6,875	6,875

別添資料1

Project 4: Improvement of compost facilities (Waste parks)

[Plan]

Breakdown of treatment of collected organic waste

- 20 percent of organic waste collected will be treated at TRF.
- Remaining of 80 percent of organic waste will be composted.
- Organic waste that exceeds the treatment capacity of TRFs and compost facilities is disposed to disposal sites.

Capacity of compost facilities

Year	Organic waste collected	TRF	Waste park	LAO compost facilities	Total capacity of compost facilities	Total capacity of disposal sites	Total organic waste disposed
2022	898	237	325	0	562	324	334
2023	982	198	394	0	592	360	394
2024	1,021	171	546	160	817	440	294
2025	1,094	154	611	160	925	520	377
2026	1,146	108	677	240	1,016	710	361
2027	1,207	72	792	240	1,104	710	443
2028	1,266	56	900	240	1,196	790	410
2029	1,315	39	1,029	330	1,400	790	590
2030	1,402	616	786	400	1,602	870	530

[Implementation schedule]

[Responsible organization]

Stage	Action	Responsible Organization
Construction	Manufacturing of land	MAJTD
	Construction of waste parks and improvement of equipment	MAJTD
	Financing capital cost	MAJTD
	Operation of waste parks	WMA (for other maintenance)
Operation	Operation and maintenance	WMA (for other maintenance)
	Operation of machinery for operation and maintenance	WMA (for other maintenance)

[Project cost]

Item for expenditure	2022	2023	2024	2025	2026	2027	2028	2029	2030	Total
Administrative cost	10	0	0	0	0	0	0	0	0	10
Construction cost	16	96	110	123	176	147	0	0	0	668
Operation and maintenance cost	0	0	0	0	0	0	0	0	0	0
Manufacturing equipment	0	0	0	0	0	0	0	0	0	0
Miscellaneous expense	0	0	0	0	0	0	0	0	0	0
Total	16	96	110	123	176	147	0	0	0	676

Project 5: Improvement of recycling facilities for formal recyclables

[Plan]

Recyclable amount collected is increased according to the improving collection coverage and increasing total waste collected.

- Construct a MRF with a capacity of 30 tons/day per location in the waste park to promote recycling.

Recyclable be collected

Year	WF	Colony	Schools	Business	Public	Others	Total
2022	46	27	11	34	11	7	136
2023	118	58	12	41	11	42	322
2024	132	98	12	47	11	47	347
2025	151	72	12	53	12	44	344
2026	168	94	12	57	12	45	388
2027	186	98	12	57	12	45	410
2028	202	112	12	57	12	46	441
2029	214	132	12	54	12	46	468
2030	241	139	12	54	12	46	504
Total	220	151	12	231	13	46	1,173

[Implementation schedule]

[Responsible organization]

Stage	Action	Responsible Organization
Construction	Construction of waste parks and improvement of equipment	MAJTD
	Financing capital cost	MAJTD
	Operation of waste parks	WMA
Operation	Operation and maintenance	WMA
	Operation of machinery for operation and maintenance	WMA

[Project cost]

Item for expenditure	2022	2023	2024	2025	2026	2027	2028	2029	2030	Total
Administrative cost	10	0	0	0	0	0	0	0	0	10
Construction cost	16	96	110	123	176	147	0	0	0	668
Operation and maintenance cost	0	0	0	0	0	0	0	0	0	0
Manufacturing equipment	0	0	0	0	0	0	0	0	0	0
Miscellaneous expense	0	0	0	0	0	0	0	0	0	0
Total	16	96	110	123	176	147	0	0	0	676

Project 6: Procurement of collection and transfer vehicles

[Plan]

Required number of collection vehicle

Year	WF	Colony	Schools	Business	Public	Others	Total
2022	46	27	11	34	11	7	136
2023	118	58	12	41	11	42	322
2024	132	98	12	47	11	47	347
2025	151	72	12	53	12	44	344
2026	168	94	12	57	12	45	388
2027	186	98	12	57	12	45	410
2028	202	112	12	57	12	46	441
2029	214	132	12	54	12	46	468
2030	241	139	12	54	12	46	504
Total	220	151	12	231	13	46	1,173

[Implementation schedule]

[Responsible organization]

Stage	Action	Responsible Organization
Construction	Procurement of collection and transfer vehicles	WMA
	Financing capital cost	NSWNSC
	Operation of vehicles	MAJTD
	Operation of vehicles	LAC

[Project cost]

Item for expenditure	2022	2023	2024	2025	2026	2027	2028	2029	2030	Total
Administrative cost	10	0	0	0	0	0	0	0	0	10
Construction cost	16	96	110	123	176	147	0	0	0	668
Operation and maintenance cost	0	0	0	0	0	0	0	0	0	0
Manufacturing equipment	0	0	0	0	0	0	0	0	0	0
Miscellaneous expense	0	0	0	0	0	0	0	0	0	0
Total	16	96	110	123	176	147	0	0	0	676

Project 4: Improvement of compost facilities (Karadiyana compost facility)

[Plan]

Breakdown of treatment of collected organic waste

- 20 percent of organic waste collected will be treated at TRF.
- Remaining of 80 percent of organic waste will be composted.
- Organic waste that exceeds the treatment capacity of TRFs and compost facilities is disposed to disposal sites.

Capacity of compost facilities

Year	Organic waste collected	TRF	Waste park	LAO compost facilities	Total capacity of compost facilities	Total capacity of disposal sites	Total organic waste disposed
2022	898	237	325	0	562	324	334
2023	982	198	394	0	592	360	394
2024	1,021	171	546	160	817	440	294
2025	1,094	154	611	160	925	520	377
2026	1,146	108	677	240	1,016	710	361
2027	1,207	72	792	240	1,104	710	443
2028	1,266	56	900	240	1,196	790	410
2029	1,315	39	1,029	330	1,400	790	590
2030	1,402	616	786	400	1,602	870	530

[Implementation schedule]

[Responsible organization]

Stage	Action	Responsible Organization
Construction	Procurement of equipment and works at site	WMA
	Financing capital cost	WMA and JICA
	Operation of compost plant	WMA
	Cost recovery for operation and maintenance	Revenue from sales, balance to charge dipping for on 1 As
Operation	Operation of machinery for operation and maintenance	WMA
	Operation of machinery for operation and maintenance	WMA

[Project cost]

Item for expenditure	2022	2023	2024	2025	2026	2027	2028	2029	2030	Total
Administrative cost	10	0	0	0	0	0	0	0	0	10
Construction cost	16	96	110	123	176	147	0	0	0	668
Operation and maintenance cost	0	0	0	0	0	0	0	0	0	0
Manufacturing equipment	0	0	0	0	0	0	0	0	0	0
Miscellaneous expense	0	0	0	0	0	0	0	0	0	0
Total	16	96	110	123	176	147	0	0	0	676

4. Financial Sustainability Analysis (FSA)

FSA is to confirm concerned authorities have sufficient financial capacity to afford the implementation cost

Total Waste Management Cost (2023-2042) (Rs. Mil)

Waste Management Process	Cost		Revenue (-)	Total	%
	Capital	O&M			
Collection	7,513	95,754	0	103,267	29%
Transfer/Transportation	10,417	69,601	0	80,018	23%
Composting	503	19,638	-6,546	13,595	4%
Recycling	2,000	4,164	0	6,164	2%
Thermal Recovery	53,748	99,437	-73,953	79,232	23%
Final Disposal	31,291	38,046	0	69,337	20%
Total	105,472	326,640	-80,499	351,613	100%
%	30%	70%			

5/2

4. Financial Sustainability Analysis (FSA)

Annual Cost for Waste Management in Western Province

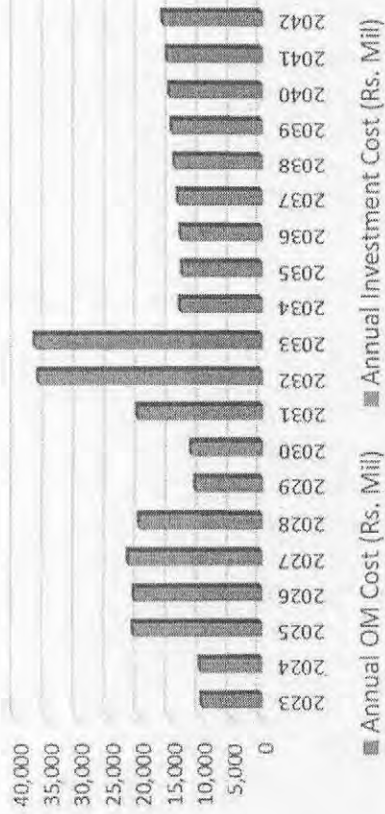

7/2

Project 7: Closure of current dump sites managed by LAs

[Plan]
By 2024, LAs aim to dispose of the waste to the Aruwakkaru disposal site via Kelaniya TS. Closure of disposal sites used by LAs will begin at any time from the LAs that are ready.
A disposal sites closure manual will be developed to guide the proper closure of disposal sites.

[Implementation schedule]



[Responsible organization]

Stage	Action	Responsible Organization
Planning	Development of closure manual	CEA, NSWMSC, WMA
Implementation	Planning of site closure	LAs with WMA assistance
Implementation	Financing of capital cost	LAs with WMA assistance, WMA (WPC)

[Project cost]

Item for expenditure	2023	2024	2025	2026	2027
Administrative cost	0	0	0	0	0
Operational cost	0	0	0	0	0
Construction cost	0	0	268	0	0
Specialized equipment	0	0	0	0	0
Material/transportation	1	1	28	0	0
Total	1	1	298	0	0

Project 8: Encourage of waste separation

[Plan]
Promote waste separation by implementing the following measures.

- Development of waste separation guidelines
- Hold seminars for municipalities on the necessity of waste separation and guidance on waste separation methods.
- Preparation and implementation of promotion program in line with the Guideline

[Implementation schedule]



[Responsible organization]

Stage	Action	Responsible Organization
Preparation of guidelines	Preparation of guidelines suitable for municipalities	CEA/NSWMSC/WMA in line with local regulations and standards
Seminars	Appoint involvement of municipalities to hold seminars	LAs
Promotion program	Preparation of waste separation program	LAs

[Project cost]

Item for expenditure	2023	2024	2025	2026	2027
Administrative cost	0	0	0	0	0
Operational cost	0	0	0	0	0
Construction cost	0	0	0	0	0
Specialized equipment	0	0	0	0	0
Material/transportation	1	1	31	0	0
Total	1	1	31	0	0

4. Financial Sustainability Analysis (FSA)

Operation Cost and Percentage in Recurrenet Budget (Rs. Mil)										
Year	2023	2027	2032	2037	2042	2023-42				
Collection	3,376	3,802	4,687	5,564	6,501	95,746				
Transfer/Transportati	3,065	4,033	3,379	3,310	4,066	68,701				
Composting	437	756	958	1,161	1,456	19,638				
Recycling	96	147	208	258	307	4,164				
Thermal Recovery	625	765	1,181	1,661	1,882	25,485				
Final Disposal	2,010	2,513	1,895	1,751	2,113	38,056				
Total	9,610	12,015	12,308	13,705	16,325	251,790				
Recurrent Budget	29,135	35,413	45,197	57,685	73,622	963,365				
% of Recur. Budget	33%	34%	27%	24%	22%	26%				

52

12

4. Financial Sustainability Analysis (FSA)

Percentage of Waste Management Expenditure in LAs Recurrent Expenditure (2021)

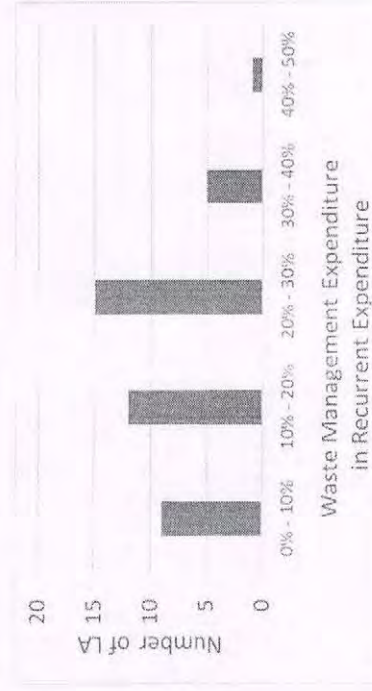

⇒ The average waste management expenditure is 20% of LAs total recurrent expenditure.

12



THE PROJECT FOR WESTERN PROVINCE
SOLID WASTE MANAGEMENT MASTER PLAN
IN SRI LANKA



Authorization Procedure of Master Plan
and Establishment of Inter-organizational Body

5/2

The 4th Joint Coordination Committee
4 November, 2022

別添資料1
Authorization Procedure of the Master Plan

- (1) By the Western Provincial Council
1. WMA Board decision for obtaining Provincial Council approval for the Master Plan
 2. WMA forward it to the Chief Secretary through the Secretary in charge of local government
 3. Chief Secretary submit the Master Plan to the Board of Ministers of Western Province for its approval
 4. Board of Ministers' approval for the Master Plan

Authorization Procedure of the Master

- (2) By the Government
1. Western Provincial Council forward the Master Plan to the Ministry in charge of Provincial Council and Local Government for the Cabinet approval [Cabinet approval sought for the sectoral strategies and plans, and for the financial and technical support by the government]
 2. Cabinet approval for the above

Coordination Committee on Waste Management in Western Province

1. Objective & Functions of the Committee

- To facilitate the implementation of development projects and operations for waste management in Western Province through inter-organizational coordination. Functions include, among other matters;
 - To draw five-year action plan in accordance with the Master Plan of Waste Management in Western Province
 - To recommend large-scale infrastructure development projects
 - To monitor the progress of ongoing development projects and facilitate the implementation
 - To monitor the province and LA levels' waste management operations and their outcomes

1/2 4

Coordination Committee on Waste Management in Western Province

2. Organizations

- Coordination Committee
- Secretaries, Heads of organization
- Biannual meetings
- 5/2 ■ Working Committee
- Management level, who is responsible for development and operation
- Quarterly meetings

Coordination Committee on Waste Management in Western Province

3. Members

- Ministry of Provincial Councils and Local Government (MoPCLG)
- Ministry of Environment and CEA
- Ministry of Urban Development, UDA and SLLDC
- Western Provincial Council and WMA

Coordination Committee on Waste Management in Western Province

4. Responsibilities

- MoPCLG – National Solid Waste Management Support Center (NSWMS):
- Convenor and Secretariat of the Committee
- WMA:
- To draft the five-year action plan under the Master Plan for Waste Management in Western Province
- To monitor and report on situation analysis, including progress of development projects and province and LAs waste management operations and outcomes
- All members
- To take action per the recommendations made by the Committee and report the progress

1/2

1/2 5

別添資料1

Title : 4th Joint Coordinating Committee (JCC) Meeting for the Project for Formulation of Solid Waste Management Master Plan for Western Province
 Date : 04.11.2022
 Time : 02.00 p.m. to 04.00 p.m.
 Venue : Auditorium of Ministry of Public Administration, Home Affairs, Provincial Councils and Local Government

No	Name	Institute	Designation
01	Priyantha Mayadunne	Ministry of PAHPC&LG	Secretary
02	M. Kodippili Arachchi	Ministry of PAHPC&LG	Additional Secretary
03	Eng Wanessa Kanakarathne		Additional Secretary (Technical) Ministry of Urban development & Housing
04	Eng Shahina Mysan	CMC	Director-Engineering (SWM)
05	N.D.N. Pushpakumara	Ministry of PAHPC&LG	Director (Engineering)
06	Nilantha Indika Piyadasa	MEPA	Assistant Manager
07	R. Shanmugapriya	WMA	Assistant Director
08	Malkanthi Vijewardana	Department of Local Government-WP	Asst. Commissioner of Community Development
09	K.A.D.K. Siriwardana	WPC	Deputy Chief Secretary (Planning)
10	R.A. Tishani Ramanayake	Ministry of Local Government -WPC	Director Planning
11	Sarojini Jayasekara	CEA	Director-SWM
12	Sujeewa Fernando	EPCICM /Ministry of Environment	Asst. Director
13	Shankaja Uggalla	Metro Colombo SWM Project	Environment Specialist
14	P.D.Pindeniya	SLLDC	
15	N.Sivarajan	IDB	
16	Naoki Yano	JICA headquarter	
17	Yuka Kitamatsu	JICA headquarter	
18	Yuri Ide	JICA SL Office	
19	Takashi Kondo	JICA SL Office	
20	Rajini de Silva	JICA SL office	
21	Naofumi Sato	JICA Expert	
22	Koji Kusunoki	JICA Expert	
23	Rie Kawanishi	JICA Expert	
24	Hachiro IDA	JICA Expert	
25	Youko Aoki	JICA Expert	
26	Chiaki Nishi	JICA Expert	
27	N. Samaraweera	JICA Project	
28	S. Pulukkody	JICA Project	
29	L.S.W. Gunasekara	JICA Project	

23

24

24

**MINUTES OF MEETING
ON
THE FITFTH JOINT COORDINATING COMMITTEE
OF
THE PROJECT FOR FORMULATION OF WESTERN PROVINCE SOLID WASTE
MANAGEMENT MASTER PLAN**

The Japan International Cooperation Agency (hereinafter referred to as “JICA”) Expert Team (hereinafter referred to as “the Team”) submitted draft progress report to Ministry of Public Administration, Home Affairs, Provincial Councils and Local Government (hereinafter referred to as “MoPAHAPCLG”). The authorities in Sri Lanka concerned with the Project, JICA and the Team conducted a discussion on the Project based on the draft final report at the Joint Coordinating Committee (hereinafter referred to as “JCC”) held on 18th May 2023.

MoPAHAPCLG, Western Provincial Council, JICA, and the Team confirmed the matters discussed in the JCC as referred to in the document attached hereto.

Colombo, 18 May 2023

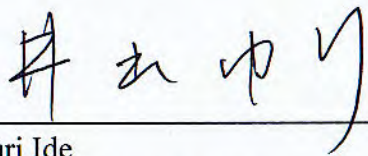

Yuri Ide
Senior Representative
JICA Sri Lanka Office

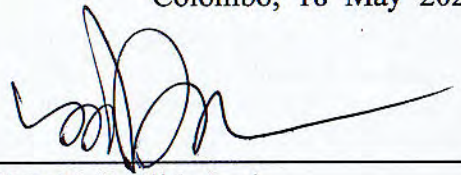

Mr. K.D.N. Ranjith Asoka
Secretary
Ministry of Public Administration, Home
Affairs, Provincial Councils and Local
Government



Naofumi Sato
Team Leader
JICA Expert Team

Pradeep Yasarathne
Chief Secretary
Western Provincial Council

ATTACHED DOCUMENT

1 **Change of scope of pilot projects and their implementation**

Both sides confirmed in Attachment 1 that the scope of the pilot projects agreed in the Minutes of Discussion on Pilot Project dated 30th November 2020 was partially changed due to the COVID-19 pandemic. The team explained the details of each implementation and both sides confirmed that all pilot projects had been completed.

2 **Approval of project completion**

The Team explained the result of project as Attachment 2. Both sides agreed to approve the project completion report as Attachment 3 and final report.

3 **Mutual agreement on Western Province Solid Waste Management Master Plan**

Both sides discussed and agreed on the contents of the Western Province Solid Waste Management Master Plan as Attachment 4.

4 **Authorization Procedure of MP and Establishment of Inter-organizational Body**

Both sides confirmed the authorization procedure of MP and establishment of the Coordination Committee on Waste Management in Western Province as inter-organizational body as Attachment 5. Sri Lankan side agreed to take necessary actions for the authorization of MP.

Attachment :

Attachment 1 Change of scope of pilot projects

Attachment 2 Result of project

Attachment 3 Project completion report

Attachment 4 Western Province Solid Waste Management Master Plan

Attachment 5 Authorization procedure and establishment of Inter-organizational body

Attachment 6 List of Attendance of JCC

ST2 #2

**MINUTES OF MEETING
ON
THE FIFTH JOINT COORDINATING COMMITTEE
OF
THE PROJECT FOR FORMULATION OF WESTERN PROVINCE SOLID WASTE
MANAGEMENT MASTER PLAN**

The Japan International Cooperation Agency (hereinafter referred to as “JICA”) Expert Team (hereinafter referred to as “the Team”) submitted draft progress report to Ministry of Public Administration, Home Affairs, Provincial Councils and Local Government (hereinafter referred to as “MoPAHAPCLG”). The authorities in Sri Lanka concerned with the Project, JICA and the Team conducted a discussion on the Project based on the draft final report at the Joint Coordinating Committee (hereinafter referred to as “JCC”) held on 18th May 2023.

MoPAHAPCLG, Western Provincial Council, JICA, and the Team confirmed the matters discussed in the JCC as referred to in the document attached hereto.

Colombo, 18 May 2023

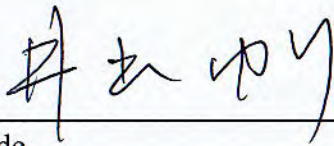

Yuri Ide
Senior Representative
JICA Sri Lanka Office

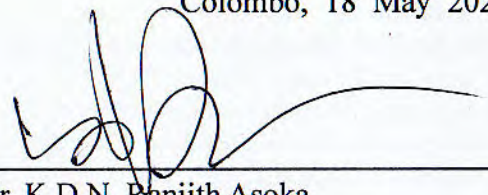

Mr. K.D.N. Ranjith Asoka
Secretary
Ministry of Public Administration, Home
Affairs, Provincial Councils and Local
Government



Naofumi Sato
Team Leader
JICA Expert Team

Pradeep Yasarathne
Chief Secretary
Western Provincial Council

ATTACHED DOCUMENT

1 Change of scope of pilot projects and their implementation

Both sides confirmed in Attachment 1 that the scope of the pilot projects agreed in the Minutes of Discussion on Pilot Project dated 30th November 2020 was partially changed due to the COVID-19 pandemic. The team explained the details of each implementation and both sides confirmed that all pilot projects had been completed.

2 Approval of project completion

The Team explained the result of project as Attachment 2. Both sides agreed to approve the project completion report as Attachment 3 and final report.

3 Mutual agreement on Western Province Solid Waste Management Master Plan

Both sides discussed and agreed on the contents of the Western Province Solid Waste Management Master Plan as Attachment 4.

4 Authorization Procedure of MP and Establishment of Inter-organizational Body

Both sides confirmed the authorization procedure of MP and establishment of the Coordination Committee on Waste Management in Western Province as inter-organizational body as Attachment 5. Sri Lankan side agreed to take necessary actions for the authorization of MP.

Attachment :

Attachment 1 Change of scope of pilot projects

Attachment 2 Result of project

Attachment 3 Project completion report

Attachment 4 Western Province Solid Waste Management Master Plan

Attachment 5 Authorization procedure and establishment of Inter-organizational body

Attachment 6 List of Attendance of JCC

ST2 #

**MINUTES OF MEETING
ON
THE FIFTH JOINT COORDINATING COMMITTEE
OF
THE PROJECT FOR FORMULATION OF WESTERN PROVINCE SOLID WASTE
MANAGEMENT MASTER PLAN**

The Japan International Cooperation Agency (hereinafter referred to as “JICA”) Expert Team (hereinafter referred to as “the Team”) submitted draft progress report to Ministry of Public Administration, Home Affairs, Provincial Councils and Local Government (hereinafter referred to as “MoPAHAPCLG”). The authorities in Sri Lanka concerned with the Project, JICA and the Team conducted a discussion on the Project based on the draft final report at the Joint Coordinating Committee (hereinafter referred to as “JCC”) held on 18th May 2023.

MoPAHAPCLG, Western Provincial Council, JICA, and the Team confirmed the matters discussed in the JCC as referred to in the document attached hereto.

Colombo, 18 May 2023

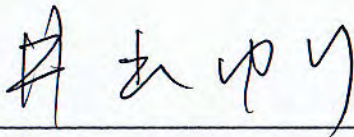

Yuri Ide
Senior Representative
JICA Sri Lanka Office

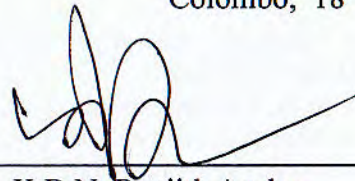

Mr. K.D.N. Ranjith Asoka
Secretary
Ministry of Public Administration, Home
Affairs, Provincial Councils and Local
Government



Naofumi Sato
Team Leader
JICA Expert Team

Pradeep Yasarathne
Chief Secretary
Western Provincial Council

ATTACHED DOCUMENT

1 **Change of scope of pilot projects and their implementation**

Both sides confirmed in Attachment 1 that the scope of the pilot projects agreed in the Minutes of Discussion on Pilot Project dated 30th November 2020 was partially changed due to the COVID-19 pandemic. The team explained the details of each implementation and both sides confirmed that all pilot projects had been completed.

2 **Approval of project completion**

The Team explained the result of project as Attachment 2. Both sides agreed to approve the project completion report as Attachment 3 and final report.

3 **Mutual agreement on Western Province Solid Waste Management Master Plan**

Both sides discussed and agreed on the contents of the Western Province Solid Waste Management Master Plan as Attachment 4.

4 **Authorization Procedure of MP and Establishment of Inter-organizational Body**

Both sides confirmed the authorization procedure of MP and establishment of the Coordination Committee on Waste Management in Western Province as inter-organizational body as Attachment 5. Sri Lankan side agreed to take necessary actions for the authorization of MP.

Attachment :

Attachment 1 Change of scope of pilot projects

Attachment 2 Result of project

Attachment 3 Project completion report

Attachment 4 Western Province Solid Waste Management Master Plan

Attachment 5 Authorization procedure and establishment of Inter-organizational body

Attachment 6 List of Attendance of JCC

Handwritten signatures in blue ink.

**MINUTES OF MEETING
ON
THE FIFTH JOINT COORDINATING COMMITTEE
OF
THE PROJECT FOR FORMULATION OF WESTERN PROVINCE SOLID WASTE
MANAGEMENT MASTER PLAN**

The Japan International Cooperation Agency (hereinafter referred to as “JICA”) Expert Team (hereinafter referred to as “the Team”) submitted draft progress report to Ministry of Public Administration, Home Affairs, Provincial Councils and Local Government (hereinafter referred to as “MoPAHAPCLG”). The authorities in Sri Lanka concerned with the Project, JICA and the Team conducted a discussion on the Project based on the draft final report at the Joint Coordinating Committee (hereinafter referred to as “JCC”) held on 18th May 2023.

MoPAHAPCLG, Western Provincial Council, JICA, and the Team confirmed the matters discussed in the JCC as referred to in the document attached hereto.

Colombo, 18 May 2023

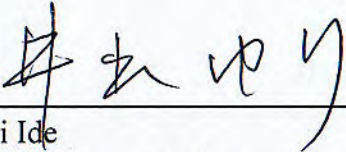

Yuri Ide
Senior Representative
JICA Sri Lanka Office

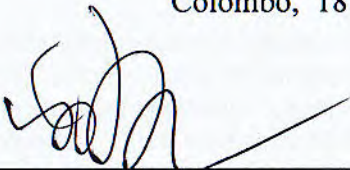

Mr. K.D.N. Ranjith Asoka
Secretary
Ministry of Public Administration, Home
Affairs, Provincial Councils and Local
Government



Naofumi Sato
Team Leader
JICA Expert Team



Pradeep Yasarathne
Chief Secretary
Western Provincial Council

ATTACHED DOCUMENT

1 Change of scope of pilot projects and their implementation

Both sides confirmed in Attachment 1 that the scope of the pilot projects agreed in the Minutes of Discussion on Pilot Project dated 30th November 2020 was partially changed due to the COVID-19 pandemic. The team explained the details of each implementation and both sides confirmed that all pilot projects had been completed.

2 Approval of project completion

The Team explained the result of project as Attachment 2. Both sides agreed to approve the project completion report as Attachment 3 and final report.

3 Mutual agreement on Western Province Solid Waste Management Master Plan

Both sides discussed and agreed on the contents of the Western Province Solid Waste Management Master Plan as Attachment 4.

4 Authorization Procedure of MP and Establishment of Inter-organizational Body

Both sides confirmed the authorization procedure of MP and establishment of the Coordination Committee on Waste Management in Western Province as inter-organizational body as Attachment 5. Sri Lankan side agreed to take necessary actions for the authorization of MP.

Attachment :

Attachment 1 Change of scope of pilot projects

Attachment 2 Result of project

Attachment 3 Project completion report

Attachment 4 Western Province Solid Waste Management Master Plan

Attachment 5 Authorization procedure and establishment of Inter-organizational body

Attachment 6 List of Attendance of JCC

Handwritten signatures in blue ink.

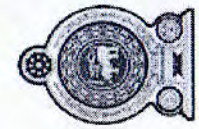

**THE PROJECT FOR FORMULATION
OF WESTERN PROVINCE SOLID
WASTE MANAGEMENT MASTER PLAN
SRI LANKA (Phase II)**

**Authorization procedure
and establishment of Inter-organizational body**

21

The 5th Joint Coordination Committee
18 May 2023

JICA Expert team
Hachiro Ida



1. Master Plan authorization

- Once developed by WMA through a consultation process with all stakeholders, the WMA Board submits the MP to the Minister for concurrence by the Board of Ministers of Western Province.
- Once concurred by the Board of Ministers, the Minister submits the SWM MP to the Western Provincial Council for approval.
- The Provincial Council, through the (national level) Minister in charge of Local Governments, forwards the MP to the Cabinet of Minister for approval. This process is necessary as the MP contains sectoral strategies and plans, and requires technical and financial support from the national government for its implementation.

52

H 2

2. Coordination Committee on Waste Management in Western Province

Coordination Committee on Waste Management in Western Province

Coordination Committee Members: Secretary/Head of Institution

- M/PCLG (Secretary: Chairing the coordination committee)
- M/Environment & CEA
- M/Urban Development., UDA & SLLDC
- Western Provincial Council & WMA
(Convenor/Chief secretary/Chairman/CLG/ACLG)

Invitees

- NPD
- Local Authorities
- JICA
- Other relevant organizations

Role of Coordination Committee

- To facilitate implementation of infrastructure development projects
- To oversee waste management performances in Western Province through coordinations among government organizations

Coordination Committee meets once a year, and as needed;

- To concur Five-year Action Plan in line with Master Plan
- To recommend major development projects to higher authorities
- To facilitate implementation of development projects
- To monitor waste management performance in Western Province

Working Committee

- Members: Management level staff for development and operations of above relevant authorities
- Meeting frequency: Quarterly
- Duties of Working Committee:
 - To submit draft Five-year Action Plan to Coordination Committee
 - To recommend major development projects to Coordination Committee
 - To take actions as per recommendations of Coordination Committee
- Preparatory Works for Working Committee by WMA and LAs:
 - To draft Five-year Action Plan
 - To prepare Annual Progress Report

572 # [Signature]



THE PROJECT FOR FORMULATION OF WESTERN PROVINCE SOLID WASTE MANAGEMENT MASTER PLAN SRI LANKA (Phase II)

Result of Project



The 5th Joint Coordination Committee
18 May 2023

JICA Expert team
Chief consultant
Dr. Naofumi SATO

1. Basic information of the project

1.1 Duration of the project

Planned:

February 2019-February 2022 (3 years)

Actual:

February 2019-June 2023 (4 years and 3 months)

1.2 Overall Goal and Project Purpose (from Record of Discussions(R/D))

(1) Overall goal

Appropriate SWM practices in accordance with Western Province Solid Waste Management Master Plan are undertaken in Western Province

(2) Project purpose

Western Province's planning capacity on SWM is strengthened through the formulation of Western Province Solid Waste Management MP. "Planning capability" includes the ability to build cooperative structures and coordination capacity among related organizations in accordance with the plan at the implementation stage of the plan

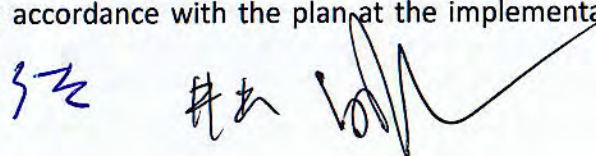

2. Results of the Project

2.1 Achievements of the Project : Outputs and indicators

Target values
<p>Output 1: Roles and responsibilities of organizations relevant to solid waste management in Western Province are clarified and institutional arrangements for the formulation of the MP are established. Degree of Achievement: high (100% has been achieved)</p>
<p>Output 2: Current situation, trend, potentials and challenges of solid waste management in Western Province are clarified. Degree of Achievement: high (100% has been achieved.)</p>
<p>Output 3: Knowledge and experience which contribute to MP formulation and implementation are acquired through the implementation of pilot projects on appropriate waste management and 3Rs. Degree of Achievement: high (87.5% has been achieved.)</p> <ol style="list-style-type: none"> 1. Trainings on appropriate waste management and 3Rs for LAs and other relevant organizations was conducted two times. One more training is scheduled to be conducted. 2. Pilot projects have been implemented at Sri Jayewardenepura Kotte MC. 3. The results of Capacity Assessment (posttest) for WMA and target LAs improve from those of pretest. 4. Progress of Pilot Projects are monitored by WG for MP formulation, however, the duration of monitoring was less than one month due to the delay of the pilot projects schedule.

3

2. Results of the Project

2.1 Achievements of the Project : Outputs and indicators

Target values
<p>Output 4: Knowledge and experience which contribute to MP formulation and implementation are acquired through pilot projects for improving planning/ operation of waste management facilities. Degree of Achievement: high (87.5% has been achieved.)</p> <ol style="list-style-type: none"> 1. Trainings on planning/ operation of waste management facilities for relevant organizations were conducted twice. 2. Pilot projects have been implemented at Kalutara Compost Plant and Karadiyana Compost Plant. 3. The results of Capacity Assessment (posttest) for WMA and target LAs were improved from those of pretest. 4. Progress of Pilot Projects was monitored by WG for MP formulation, however, the duration of monitoring was less than one month due to the delay of the pilot projects schedule.
<p>Output 5: Collaboration and coordination among relevant organizations in Western Province for the implementation of MP, and formulation and implementation of its related plans (e.g. LA action plans, plans on waste management facilities) are strengthened. Degree of Achievement: high (100% has been achieved.)</p>

SR

4

2. Results of the Project

2.2 Achievements of the Project : Project Purpose and indicators (Target values and actual values achieved at completion)

Project Purpose
Western Province's planning capacity on solid waste management is strengthened through the formulation of Western Province Solid Waste Management Master Plan (MP).
Target values
<p>1. The final draft of the MP is prepared. Achievement degree: high: 100% has been achieved.</p> <p>2. Final MP is scheduled to be forwarded to Western Provincial Council (WPC) and MoPAHAPCLG for approval process. Achievement degree: high: 100% has been achieved,</p> <p>3. Sub-plans and other related plans (e.g. LA action plans, plans on waste management facilities) in line with the MP are formulated. Achievement degree: high: 100% has been achieved,</p> <p>4. An inter-organizational coordination body is in the process of establishment to monitor the progress. Achievement degree: medium: 50% has been achieved.</p>

5

3. Results of joint review

3.1 Results of Review based on DAC Evaluation Criteria

Criteria	Key Perspectives	Rating
(1)Relevance: Consistency with development policies, high-level plans, and needs, etc. of the partner country	<ul style="list-style-type: none"> Consistency with Development Policy Consistency with Development Needs Appropriateness of project plan and approach 	+++
(2)Coherence: Synergistic effect/mutual relations and complementarities with other projects (by JICA, Japan, and other development partners), consistency with global frameworks, and consistency with the development assistance policies of the Japanese Government and JICA.	<ul style="list-style-type: none"> Collaboration with JICA's other projects Collaboration with other projects Consistency with global frameworks 	++
(3) Effectiveness: Achievement level of the project purpose, influence of impediments, relations between outputs and project purpose, etc	<ul style="list-style-type: none"> Degree of the achievement of the project purpose 	+++
(4) Efficiency: Relations with the achievement level of inputs and outputs, etc.	<ul style="list-style-type: none"> Project Cost Project Period Causal Relationship 	+++
(5) Impact: Contribution to the achievement level of the overall goal, level of contribution to policies and communities, contributions to other projects, etc.	<ul style="list-style-type: none"> Prospects to achieve the overall goal Causal relationship Ripple effect 	+++
(6)Sustainability: Likely continuation from the aspects of policy, technology, organization, finance, etc.	<ul style="list-style-type: none"> Policy and System Institutional and Organizational aspect of the implementing agency Technical Aspect of the implementing agency Financial Aspect (Only if applicable) Social and Environmental Aspect 	+++

6

33 # # W

3. Results of joint

3.2 Evaluation on the results of the Project Risk Management

Risk management results	
(a) The COVID-19 pandemic	<ul style="list-style-type: none"> JICA and the Sri Lankan Government decided to extend the project period for one year until December 2022. JICA expert team field activities were resumed in March 2021, but the resumption was relatively smooth as the online remote project continued to some extent for almost a year.
(b) Cancellation of Karadiyana WtE project	<ul style="list-style-type: none"> It required a review of the MP, which postponed the project by a further six months to June 2023 after discussions between JICA and the Sri Lankan Government in October 2021. The WtE in the MP was addressed by amending it to read 'one WtE to be planned in the central region of the Western Province' instead of the Karadiyana WtE.
(c) Tax exemption of pilot project	<ul style="list-style-type: none"> by August 2022, the MoLGPC in Sri Lanka understood the importance of the pilot project and resolved the tax exemption issue.
(d) The economic crisis in Sri Lanka and the Ukrainian-Russian conflict have led to a surge in global material prices.	<ul style="list-style-type: none"> The Sri Lankan Government also assisted the contractor with the "L/C" (letter of credit) process so that the contractor could smoothly procure materials from overseas in US dollars, despite Sri Lanka's strict restrictions on taking foreign currency out of the country.
(e) Changes to 3Rs pilot project content	<ul style="list-style-type: none"> The Government of Sri Lanka and JICA, in consultation, decided to implement a pilot project on the development of a municipal 'waste App', which can work without contact, as an alternative to the 3Rs pilot project in communal housing.

7

3. Results of joint

3.3 Lessons Learnt

Obtain basic data from each local authority

- Many local authorities do not have a weigh bridge, and the amount of waste collected reported by the local authorities was not consistent with the waste flow.
- JICA expert team visited 25 local authorities, which do not have weigh bridge data, among 49 local authorities to investigate the collection schedule by collection vehicle, type of collection waste, number of collection trips, loading capacity (actual measurement), etc.
- WMA staff were instructed on how to estimate the amount of waste collected using these survey results, and this amount of waste collected was applied as data for the waste flow.



Measuring the size of container

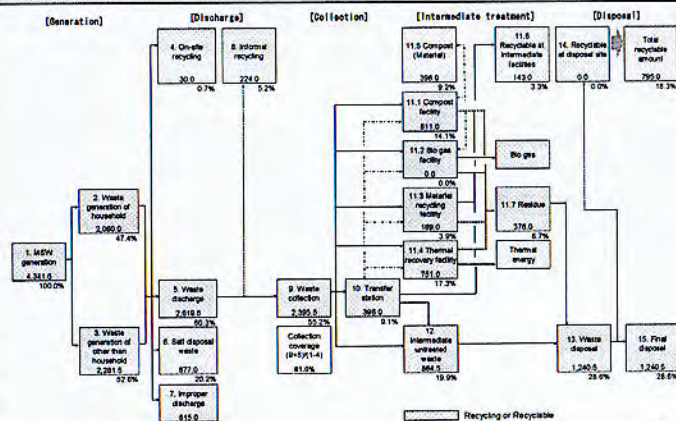

8

Handwritten signatures and initials in blue ink.

3. Results of joint

3.3 Lessons Learnt

Database system

(i) Software Development

The development phase should be kept to the minimum necessary, and features to be added after the system is implemented and in operation should be considered.

(ii) Installation

- Before installing the database, it should be agreed to ensure the organization structure for the database management. In particular, it is important to ensure that personnel with basic IT knowledge are available.

(iii) Operation

- The database should be improved and modified from the testing phase to allow user LAs to enter daily waste collection data. Especially for LAs with a large number of waste collection trips, inputting the data requires time-consuming effort.
- It is necessary to introduce solutions which reduce the amount of workload required LAs, such as connecting the database to the truck scale at final disposal sites.



Training for database entering

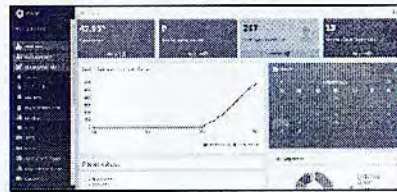

Dashboard of Database

3. Results of joint

3.3 Lessons Learnt

SEA

- In formulation of the MP, several alternative plans and programs for the facilities and equipment included in the MP were considered based on the Strategic Environmental Assessment (SEA).
- The SEA procedure was carried out according to the provisional procedure developed by the CEA, as the SEA is not yet a legal instrument in mid of 2023.
- In February 2023, the JICA project submitted a draft MP to the CEA for SEA review.
- This was followed by a stakeholder and technical meetings by the CEA in March 2023, and comments were issued in April 2023.
- As the SEA had not been formally finalized, the procedures and timelines were unclear with regard to the SEA.



Stakeholder meeting by CEA

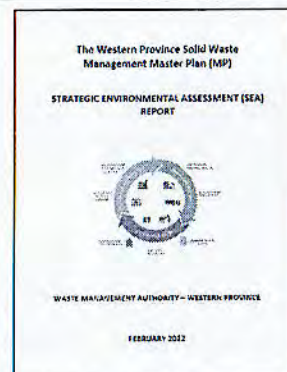

SEA report

Handwritten signatures and initials in blue ink at the bottom of the page.

3. Results of joint

3.3 Lessons Learnt

Aeration pilot project Kalutara

- In the Western Province, there are more than 20 composting plants of a similar size to the Kalutara composting plant (20-30 ton/day capacity), with odour and leachate problems.
- One of the reasons for this is that not enough oxygen is supplied to the windrow compost, resulting anaerobic conditions inside.
- In the pilot project, a perforated PVC pipe connected to a blower was inserted into the windrow compost with the aim of supplying sufficient oxygen to create an aerobic condition.
- Based on the practical operational issues modifications were introduced after the trial for easy handling.
- The experience of the Kalutara compost pilot project can be applied to the similar issues of the other composting plants to solve their problems.



Performance test

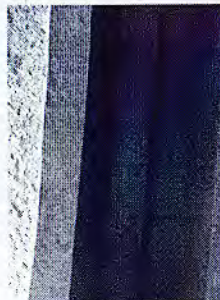

Laying the perforated PVC pipes in covered trenches

11

3. Results of joint

3.3 Lessons Learnt

Small-scale waste transfer station pilot project at Kalutara

- The MP mentions the establishment of five number of small-scale waste transfer stations in the Western Province, one of which was constructed and modelled in the pilot project.
- The purpose of the small-scale waste transfer stations is to efficiently transport the generated residues to a regional treatment and disposal facilities.
- Waste transfer stations can be of the compaction type, drum type or open dumping type, but the compaction type was selected for the Kalutara pilot project because of its efficiency, environment and initial cost.
- The experience of the pilot project of the Small-scale waste transfer station at Kalutara will help in the establishment of four other planned small-scale waste transfer stations in the Western Province.



Feeding residue to hopper

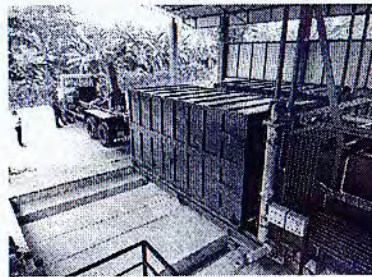

Compacting residue to container



Loading container

12

Handwritten signatures and initials in blue and black ink.

3. Results of joint

3.3 Lessons Learnt

- Compost plant rehabilitation PP, Karadiyana
- At the inception it was decided to introduce Trommel technology as sieving method which largely used in landfill mining projects since Karadiyana PP involves landfill mining that has no previous experience in Sri Lanka.
- Performance should be evaluated and all other required adjustment should be done to reach the expected efficiency.
- It is necessary to consider the moisture balance of the material when considering a similar system.
- In addition, moisture and temperature measurements at different depths of the organic waste piles should be included in the daily management of the organic waste pile in order to monitor the decomposition of organic matter in the organic waste.



Layout of Karadiyana site

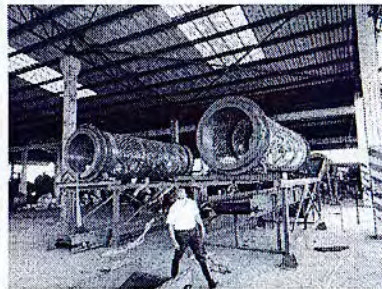

Installed trommels



Feeding old compost to trommels

3. Results of joint

3.3 Lessons Learnt

- Mobile App at Kotte MC**
- A pilot project was made to introduce an app to promote waste sorting by residents, encourage separation and building a good relationship with the residents and local authority.
 - The first issue was that the residents did not have better understanding about waste sorting and handling. This problem was solved by given guidance to the technical officers of WMA to develop 'waste classification dictionary' to identify nature of the garbage and the dispose of such waste category.
 - Further this app provides facilities to link the recyclable waste collectors with the general public.
 - The next challenge is that local authorities have limited capacity to carry out separate collection, even if separate collection is mandatory at the state or national level. It is necessary to consider measures at national and state level on how to support municipalities without such 'capital'.

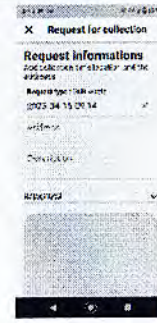
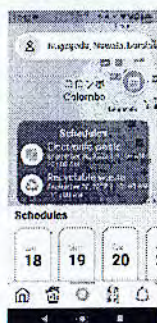
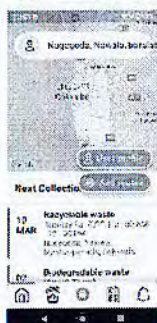

Handwritten signatures and initials at the bottom of the page.

3. Results of joint

3.3 Lessons Learnt

- Making good relationship between WMA and residents
- Consensus building with the surrounding community for the rehabilitation of existing compost plant and construction of transfer station in Kalutara was carried out by WMA.
- However, as the issue was very sensitive, it was difficult to move things forward at the working level. In view of the Sri Lankan context, things should have been discussed first between the decision makers (top level) and then brought down to the working level.



Interview survey

3. Results of joint

3.3 Lessons Learnt

Action plans of each local authority

- The planning period of MP was changed to 2023-2042 due to the delays of schedule, mainly due to the impact of COVID-19 pandemic.
- The future waste volumes for the MP are projected based on the status of each local authority in 2020.
- Therefore, the action plan was also based on the 2022 forecast data based on the status in 2020, although it was planned to develop a five-year action plan for the period 2023-2027, it was pointed out by some local authority's officials that there was a difference between the current and projected waste volumes in 2022.
- The planning period of the Local Authority Action Plans in line with the MP had to be changed accordingly.



Workshop for 49LAs

3/2



Formulation of action plan of Mahara PS

21 11

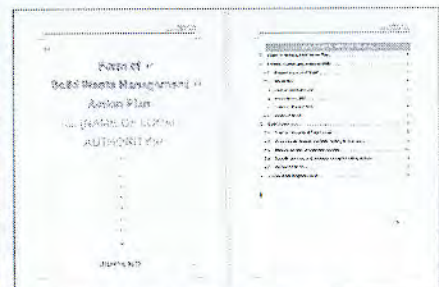

Format of action plan

3. Results of joint review

3.4 Performance

(1) Extra budget for development of small-scale waste transfer station at Kalutara pilot project

JICA understood the importance of the Small-scale waste transfer station at Kalutara in the MP and decided to add the cost of equipment purchase to solve the issue. The estimated construction cost of the small-scale waste transfer station at Kalutara pilot project development in 2022 was found to exceed the initial budget prepared in 2019.

A breakdown of the original budget and final estimate is given below.

- Estimate December 2019 LKR 37,790,000 (¥23,094,225, USD 210,935)
- Final estimate January 2022 LKR 87,689,800 (¥48,115,518, USD440,835)

JICA understood the importance of the rehabilitation of the Karadiyana composting plant for large-scale composting in the MP and decided to budget the cost of equipment purchase to solve the issue. A breakdown of final estimate is provided below.

(2) Extra budget for procurement of Karadiyana compost rehabilitation project

Table: Breakdown of equipment procurement at Karadiyana compost rehabilitation

No.	Machine	USD
1	Trommel	188,820.00
2	Tractor	56,996.00
3	Bagging Machine	15,283.00
4	Shredding Machine	21,992.00
5	Bob cat	37,929.51
		321,021.00

17

4. For the Achievement of Overall Goals after the Project Completion

4.1 Prospects to achieve Overall Goal

- (1) Cooperation of relevant authorities to implement the MP .
- (2) Roll of three administration layers, namely central government, provincial government and local government.
- (3) Role of inter-organizational coordination body
- (4) Five years update of local authority's Action Plan.
- (5) Operation cost of local authority's SWM.
- (6) Discussion for the large-scale development projects in advance by the inter-organizational coordination bodies.

Handwritten signature and initials in blue ink.

18

4. For the Achievement of Overall Goals after the Project Completion

4.2 Recommendations for the Sri Lankan side

(1) MP authorization

The MP will act as a guideline for LAs in developing their SWM Action Plans and annual work programmes. After the WMA has developed it through a consultation process with all stakeholders, the WMA Board will submit the MP to the Minister responsible for local authorities for and submitted to the Western Provincial Council of Ministers for concurrence. The Provincial Council, through the Minister in charge of Local Authorities (at national level), submits the MP to the Cabinet for approval; this process is necessary because the MP contains sector-specific strategies and plans, the implementation of which requires technical and financial support from the national government.

(2) Implementation of MP for optimal SWM system

It is recommended that the Sri Lankan side should implement the detailed project activities according to alternative B of the MP immediately after the MP and the inter-organizational coordination body structure have been authorized; The system in alternative B allows all the collected biodegradable waste to be composted, except for the 20% that is incinerated, while maximizing the recycling of recyclable materials. Economically, alternative B was evaluated as the cheapest system compared to the other options. Based on the above, alternative B is recommended as the MP for optimal SWM in the Western Province.

19

4. For the Achievement of Overall Goals after the Project Completion

4.2 Recommendations for the Sri Lankan side

(3) Economic financial aspects

A comparison of the waste management costs incurred during the MP period (20 years from 2023 to 2042) by management process, separated for capital investment costs and operating costs, shows that collection costs account for 29% and transportation costs for 23%, which means that transportation-related costs represent more than half. This is followed by thermal recovery (incineration with power generation), final disposal, and composting.

In 2020 in the Western Province, LAs' own revenue covered only one quarter of their total expenditure. The remaining three quarters have been taken over by the national government. In that context, LAs' room for maneuver to allocate a budget to their priority areas is limited. Waste management currently receives 20% of the total recurrent expenditure, the highest among expenditure heads. It is unlikely that the percentage allocated to waste management will increase significantly. The share of waste management in LAs' budget is within a reasonable range of financial affordability, except for the first five years (from 2023 to 2027). The proportion of 33% in 2023 and peak of 34% in 2027 are 1.7 times the current level (20%). The sharp increase during this period is caused by the large volume of untreated waste transported to and disposed of in Aruwakkalu DS due to the lack of intermediate treatment facilities.

The percentage then gradually lowers as intermediate treatment facilities develop and the amount of waste disposed of without treatment decreases. The above scenario is based on the assumption that capital expenditure is borne by the government. Removing the capital component from LAs' burden can be done either by financing the capital cost, e.g. through viability gap funding (VGF) by the national government at the initial stage, or by subsidizing the capital portion through annual fund transfers from the Treasury to the concessionaire. It is essential that the national government, Provincial Council and LAs discuss and agree on this matter when formulating the project.

-END- 20

Handwritten signatures and initials in blue ink.

Attachment 1 Change of scope of pilot projects

CHANGE OF SCOPE OF PILOT PROJECTS

Scope of pilot projects agreed in Minutes of Discussions on Pilot Projects for the Project Formulation of Western Province Solid Waste Management Master Plan signed on 30th November 2020 had amended as follows;

Change of scope 1

<Before>

I. Overview of Pilot Project

5. The implementation period of Pilot Project is tentatively from December 2020 to February 2021, and it shall be changed in accordance with the situation of COVID-19 pandemic. The scope of Pilot Projects implemented under the Project is as follows:

- 1) New Approach of 3R at high-rise apartment and/or low-income housing (under Output 3)

In many regions in Sri Lanka, there have been many examples of separate collection of waste from individual houses. On the other hand, few example can be found in the case of high- rise apartment buildings, even though more high-rise apartment building are expected to be built with increased urbanization. Taking the above background into account, both sides agreed to promote 3Rs at following four high-rise condominiums. Current situation of the site and objective of this Pilot Project are stipulated in "Attachment 5 of minutes of discussions on pilot project signed on 30 November 2020" as Annex 1 and the detail scope is as follows:

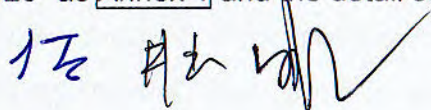

Attachment 1 Change of scope of pilot projects

Sites	Samagipura	Police Flat	Laksanda Sewava	2000 Plaza
Local Authority (LA)	CMC	CMC	Kolonnawa UC	Maharagama UC
Income Category	Low-income	Middle-income	Low-income	High-income
Approach (Tentative)	Strengthening management committee and establishing monitoring system by residents. Distribution of separation bins for organic waste and establishment of communal discharge points. Cooperation with neighbouring community. Development of collection system for the recyclables.	Regular collection according to collection schedule by LA. Establishment of monitoring system by residents as well as personnel in charge of the flat from the Police HQ. Proposal of method for separate discharge of organic waste. Proposals for waste reduction and separate collection of recyclables.	Strengthening management committee and establishing monitoring system by residents. Distribution of separation bins for organic waste and establishment of communal discharge points. Development of collection system for the recyclables. Support by National Housing Development Authority (NHDA)/WMA to LA	Approaching to every level including residents, their maids, cleaning staff for promotion of separate discharge. Establishment of monitoring system by residents as well as management company's person in charge. Proposal of reduction in waste generation.

<Amended Version:>

I. Overview of Pilot Project

5. The implementation period of Pilot Project is from December 2020 to June 2023. The scope of Pilot Projects implemented under the Project is as follows:

1) 3Rs application development (under Output 3)

In this pilot project, an application equipped with a garbage classification dictionary, garbage collection routes, and collection date data will be developed. The Project let the residents in the pilot area try the app to promote waste separation (especially organic waste from other waste). This is a pilot project aimed at encouraging the cooperation of residents regarding the waste separation at the source. The application developed in the project includes:

- i. Waste Dictionary (to be able to look up the waste category of each item);
- ii. Waste collection schedule of respective local authorities (to be able to know which waste category would be collected on what day of the week);
- iii. Notice board for information from WMA and local authorities (to inform citizens about sudden changes of collection schedule, or schedule of special collections and events in advance).

Handwritten signature and the number 2.

Attachment 1 Change of scope of pilot projects

Target Municipality:

Sri Jayawardenepura Kotte Municipal Council, the collection routes in Rajagiriya area.

Reason:

The "Promotion of 3Rs at high rise apartment" pilot project became "3Rs application development" because it could not be implemented due to the spread of COVID-19 infection. Regarding the target municipality, Colombo Municipality, Maharagama Urban Council and Kolonnawa Urban Council are planned for 3R at high-rise apartment and/or low-income housing, however, it had become difficult for Kolonnawa UC to try out new activity in addition to their daily work due to the pandemic of COVID-19. In addition, Colombo MC had withdrawn themselves because the contents of the new pilot project would overlap with their own project. As a replacing local authority, Kotte Municipality was nominated, considering the aspects of a stable provision of waste collection that would be required for the utilization of the above mentioned mobile application and the proximity from WMA office that would allow their monitoring relatively easily even under the pandemic.

Change of scope 2

<Before:>

- 2) Development of forced aeration system in existing Kalutara composting facility (under Output 4)

Although some big scale waste management facilities are functioning in Western Province, many of them are facing with environmental issues, such as offensive odours and social issues due to improper operation. After the series of discussion, both sides agreed to implement rehabilitation of existing compost plant in Kalutara as Pilot Project. Current situation of the site and objective of this Pilot Project are stipulated in Attachment 6 and the detail scope is as follows:

No.	Item	Specification	Qty.	Details
1	Development of compost plant (Acceleration of aeration system)	Treatment capacity 20 ton/day	1 unit	Installation of blower and aeration pipe. Modification of slab floor to accelerate aerobic condition. Construction of partition wall to accelerate aerobic conditions by small machine turning
2	Design and construction supervision of development of compost plant		1 unit	Make a contract with local consultant to conduct detail design, bid and construction supervision of development of above mentioned compost plant.

Handwritten signature and the number 3.

Attachment 1 Change of scope of pilot projects

<Amended Version:>

2) Development of Kalutara and Karadiyana composting facility (under Output 4)

In Western Province, many existing compost facilities are facing environmental issues, such as offensive odours and social issues due to improper operation. Scope of the pilot project is as follows:

No.	Item	Specification	Qty.	Details
1	Development of compost plant (Acceleration of aeration system)	Treatment capacity 20 ton/day	1unit	Installation of blower and aeration pipe. Modification of slab floor to accelerate aerobic condition. Construction of partition wall to accelerate aerobic conditions by small machine turning
2	Design and construction supervision of development of compost plant		1unit	Make a contract with local consultant to conduct detail design, bid and construction supervision of development of above mentioned compost plant.

After the series of discussion, both sides agreed to implement rehabilitation of existing compost plant in Kalutara as small-scale compost plant pilot project and in Karadiyana as big-scale compost plant pilot project in Minutes of Discussions signed on 17 September 2021 as Annex 2.

Annex 1: Minutes of Discussions on Pilot Project (signed on 30th November 2020)

Annex 2: Minutes of Discussions on Rehabilitation Plan of Karadiyana Compost Pilot Project (signed on 17th September 2021)

3/2 # 2021

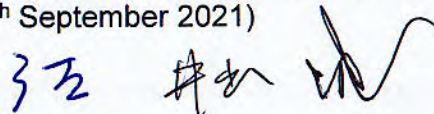

69

ATTACHED DOCUMENT

I. Overview of Pilot Projects:

- The implementation of the Pilot Projects was agreed in Minutes of Meetings on 18th May 2018 and "Record of Discussions for the Project for Formulation of Western Province Solid Waste Management Master Plan" (R/D) signed on December 12th, 2018, between concerned authorities including Ministry of Provincial Councils, Local Government and Sports (hereinafter referred to as "MoPCLGS") and Western Province and JICA.
- The Pilot Projects are implemented under the framework of above mentioned R/D and the Agreement on Technical Cooperation signed on 12th October, 2005 and the Note Verbales exchanged on 17th August, 2018 between the Government of Japan and the Government of Sri Lanka.
- The Pilot Projects are expected to achieve acquiring knowledge and experience which contribute to Western Province Solid Waste Management Master Plan (hereinafter referred to as "MP") formulation and implementation and to contribute to the achievement of strengthening Western Province's planning capacity on solid waste management.
- In accordance with the agreements mentioned above, Pilot Project sites and activities were examined between JICA expert, NSWMSC and WMA (hereinafter referred to as "Sri Lankan side") by exchanging letters (Attachment 1 and 2). In addition, local authorities of Pilot Project site (Kalutara UC and PS) also agreed to conduct the Pilot Project (Attachment 3 and 4).
- The implementation period of Pilot Project is tentatively from December 2020 to February 2021, and it shall be changed in accordance with the situation of COVID-19 pandemic. The scope of Pilot Projects implemented under the Project is as follows:
 - New Approach of 3R at high-rise apartment and/or low-income housing (under Output 3) in many regions in Sri Lanka, there have been many examples of separate collection of waste from individual houses. On the other hand, few example can be found in the case of high-rise apartment buildings, even though more high-rise apartment building are expected to be built with increased urbanization. Taking the above background into account, both sides agreed to promote 3Rs at following four high-rise condominiums. Current situation of the site and objective of this Pilot Project are stipulated in Attachment 5 and the detail scope is as follows:



MINUTES OF DISCUSSIONS
 BETWEEN
 STATE MINISTRY OF PROVINCIAL COUNCILS AND LOCAL GOVERNMENT
 AND
 JAPAN INTERNATIONAL COOPERATION AGENCY
 ON
 PILOT PROJECTS
 FOR
 THE PROJECT FOR FORMULATION OF WESTERN PROVINCE SOLID WASTE
 MANAGEMENT MASTER PLAN

Japan International Cooperation Agency (hereinafter referred to as "JICA") and Ministry of Public Services, Provincial Councils and Local Government and subsequently State Ministry of Provincial Councils and Local Government (hereinafter referred to as "MoPCLG") held a series of discussions to establish a mutual agreement concerning Pilot Projects for the Project for Formulation of Western Province Solid Waste Management Master Plan.

As a result of the discussions, both sides confirmed the issues shown in the document attached hereto.

Colombo, 30th January, 2020

[Signature]
 N.H.M. Chilthrananda
 Secretary
 State Ministry of Provincial Councils
 and Local Government

[Signature]
 J.M.C. Jayasinghe
 Chief Secretary
 Western Provincial Council

[Signature]
 Fusato Tanaka
 Chief Representative
 JICA Sri Lanka Office

[Signature]
 Naofumi Sato
 Team Leader
 JICA Expert Team

32

33

SP

Sites	Samejapura	Police Flat	Laksanda Sawaya	2000 Plaza
Local Authority	CMC	CMC	Kolomewa UC	Maharagama UC
Income Category	Low-income	Middle-income	Low-income	High-income
Approach (Theme)	Strengthening management committee and establishing monitoring system by residents. Distribution bins for separation bins for organic waste and establishment of communal discharge points. Cooperation with neighbouring community. Development of collection system for the recyclables.	Regular collection according to schedule by LA. Establishment of monitoring system by residents as well as personnel in charge of the flat from the Police HQ. Proposal of method for separate discharge of organic waste. Proposals for waste reduction and separate collection of recyclables.	Strengthening management committee and establishing monitoring system by residents. Distribution bins for organic waste and establishment of communal discharge points. Development of collection system for the recyclables. Support by National Housing Development Authority (NHDA)/MMA to LA	Approaching to every level including residents, their meals, cleaning staff for promotion of separate discharge. Establishment of monitoring system by residents as well as management company's person in charge. Proposal of reduction in waste generation.

2) Development of forced aeration system in existing Kalutara composting facility (under Output 4)

Although some big scale waste management facilities are functioning in Western Province, many of them are facing with environmental issues, such as offensive odours and social issues due to improper operation. After the series of discussion, both sides agreed to implement rehabilitation of existing compost plant in Kalutara as Pilot Project. Current situation of the site and objective of this Pilot Project are stipulated in Attachment 6 and the detail scope is as follows:

No.	Item	Specification	Qty.	Details
1	Development of compost plant (Acceleration of aeration system)	Treatment capacity 20 ton/day	1unit	Installation of blower and aeration pipe. Modification of slab floor to accelerate aerobic condition. Construction of partition wall to accelerate aerobic conditions by small machine turning
2	Design and construction supervision of compost plant		1unit	Make a contract with local consultant to conduct detail design, bid and construction supervision of development of above mentioned compost plant.

3) Development of small-scale waste transfer station at Kalutara compost plant (under Output 3)

In Western Province, many local authorities have been facing with the problems of waste transport efficiency and negative environmental impacts from existing waste transfer station. In order to solve the issues mentioned

SE

SP

above, both sides agreed to develop small-scale waste transfer station as Pilot Project. Current situation of the site and objective of the Pilot Project are stipulated in Attachment 6 and the detailed scope is as follows:

No.	Item	Specification	Qty.	Detail
1	Static compactor with input hopper	Loading capacity 20 ton/day	1unit	It consists of the static compactor loading the waste from hopper to container, driving system and hopper.
2	Waste container	Capacity 26m ³	2unit	It stores the residue with leachate for transportation to WIE plant at Karadiyana or Anuwelkaruwa final disposal site.
3	Container hauler trailer vehicle with hook system	More than GVW 15 ton	1unit	Its purpose is to haul the waste containers.

4) Pilot activities for seeking optimal social intervention for improved planning and operation of waste management facilities (under Output 4)

Both sides agreed that during planning and implementing the Pilot Project 2) and 3) mentioned above, social issues identified in the Pilot site are necessary to be scrutinized by studying complaints and requests raised by neighbouring communities. Current situation of the site and objective of the Pilot Project are stipulated in Attachment 7 and the detailed scope is as follows:

Survey Item	Objectives	Survey Method
Focus Group Discussion	<ul style="list-style-type: none"> Identification of stakeholders, interests of each stakeholder, impacts of their interests, and risks to management of final disposal site Examining actors to propose to each stakeholder 	<ul style="list-style-type: none"> Literature review Focus group discussion Interviews
Socio-economic survey	<ul style="list-style-type: none"> Survey of opinions by residents, commercial facilities, industries (including dischargers, neighbouring residents and lands) regarding facility plan, monitoring, evaluation of facilities. 	<ul style="list-style-type: none"> Questionnaire survey for 250 households
Social Awareness	<ul style="list-style-type: none"> Social Awareness for the people affected by the waste management facilities Making better communication between the management side of waste management facilities and the neighbouring residents 	<ul style="list-style-type: none"> Stakeholder meeting Monitoring Committee

II. Measures to be taken by Sri Lankan side

For the implementation of Pilot Projects mentioned above 1, 2) and 3), which includes Facility Construction, Sri Lankan side will take necessary measures to provide services, facilities and local-cost bearing listed hereto at its own expense. Detailed demarcation is attached as Attachment 8.

- Review and concurrence of the design of the facility;
- Concurrence of the result of completion inspections and defect inspections of developed facility in cooperation with a consultant procured by JICA;

SE

25

- c) (A) Lot(s) of land necessary for the implementation of Facility Construction;
- d) Necessary permissions for Facility Construction;
- e) Environmental and social considerations in the implementation of Facility Construction;
- f) Facilities for distribution of electricity, water supply and drainage, and other incidental facilities necessary for the implementation of Facility Construction;
- g) Security of relevant persons related to Facility Construction;
- h) Transferring the ownership of developed facility at the completion of Facility Construction as property of WMA;
- i) Appropriate operation and maintenance of developed facility with allocating necessary expenses;
- j) To bear claims, if any arises, against the experts and members of the missions resulting from, occurring in the course of, or otherwise connected with, the performance of their duties; except when the two Governments agree that such claims arise from gross negligence or willful misconduct on the part of the experts and members of the missions;
- k) To ensure that customs duties, internal taxes including VAT and other fiscal levies which may be imposed with respect to the implementation of Facility Construction to be borne by its designated authority; and
- l) Necessary supports, including the following items, as requested throughout the implementation period in cooperation with other organizations concerned in Democratic Socialist Republic of Sri Lanka at its own expense:
 (1) Appointment of Sri Lankan side's counterpart personnel;
 (2) Provision of available data (including maps and photographs) and information related to Facility Construction such as geological survey data; and
 (3) To ensure conducting necessary procedures for Environmental Recommendation (ER) and Environmental Protection License (EPL). JICA expert can provide the Sri Lankan side with technical support in order to conduct ER and EPL, if necessary.

- m) To ensure the necessary procedures for the facilities to be handed over to the Government of Sri Lanka right after completion of construction without delay and that the facilities shall be owned and properly maintained by the Government of Sri Lanka.

25

III. Measures to be taken by WMA

For the implementation of Pilot Projects mentioned above 1, 2) and 3), which includes facility construction, WMA shall take necessary arrangement with Kalutara UC, which is the owner of the land and existing facility, by making MoU or agreement before starting of procurement. WMA shall ensure that the facilities developed and rehabilitated by the Project, will be properly operated and maintained during and after the period of the Project, including necessary environmental and social considerations, through full and active involvement in the Project by all related authorities, beneficiary groups and institutions.

IV. Other Relevant Issues

Both sides confirmed that the names of ministries mentioned in R/D has been changed according to the Extraordinary Gazette of the Democratic Socialist Republic of Sri Lanka dated August 9th, 2020. Both sides also confirmed that roles and responsibilities related to waste management in Western Province and also in the Project are not changed. Both sides also confirmed the agreements signed under the previous names of the ministries are also valid and the R/D of the Project will be changed accordingly later.

V. Mutual Consultations

Any major issues that may arise from or in connection with this Attached Document will be resolved through mutual consultations by both sides.

ATTACHMENT:

- Attachment 1: Letter from JICA Expert
- Attachment 2: Replying letter from WMA
- Attachment 3: Letter from Kalutara UC
- Attachment 4: Letter from Kalutara PS
- Attachment 5: Outline of 3Rs
- Attachment 6: The detail scope of facility construction of the Pilot Project
- Attachment 7: Outline of social intervention
- Attachment 8: Demarcation between JICA and Sri Lankan side



PROJECT FOR FORMULATION OF WESTERN PROVINCE SOLID WASTE MANAGEMENT MASTER PLAN
WEST- WASTE- MAP

National Solid Waste Management Support Centre, No.330, Union Place Colombo 02
 JICA Project Office, New Western Provincial Council Building No.504, Doral Kolibekshera, Marawila, Dissanawadi

10.09.2019



Director, National Solid Waste Management Support Centre (NSWMSQ)
 Director, Waste Management Authority (WMA)

Dear Sir,

Confirmation of site selection for Pilot Projects

After having series of discussions, the Municipal Solid Waste subgroup of the Project for formulation of Western Province Solid Waste Management Master Plan decided that Pohorawita compost plant in Kalutara district is officially selected as the pilot project site in accordance with the results of the each pilot project site selection depicted in the Attachment-1, Attachment-2 and Attachment-3 for

1. Pilot model scale transfer station in the output 3 of the PDM,
2. Optimal technical intervention for improved planning and operation of waste management facility in the output 4 of the PDM,
3. Optimal social intervention for improved planning and operation of waste management facility in the output 4 of the PDM

You are kindly request to confirm the mutual understanding of site selection for pilot project to establish a collaborative work between the Sri Lanka Authorities and Japan International Cooperation Agency project team undersigned as a gesture of mutual cooperation.

Thanking you!

(Signature)

Dr. Naofumi SATO
 Team leader of JICA Project
 EX Research Institute Ltd.

Attachment-1: the result of pilot project site selection for pilot model scale transfer station in the output 3 of the PDM
 Attachment-2: the result of pilot project site selection for optimal technical intervention for improved planning and operation of waste management facility in the output 4 of the PDM
 Attachment-3: the result of pilot project site selection for optimal social intervention for improved planning and operation of waste management facility in the output 4 of the PDM

(Handwritten initials)

Table1-2: Evaluation of each candidate site for transfer station Pilot Project

Items	Rating	Kalutara			Panadura			Homagama		
		Selected	Not Selected	Total	Selected	Not Selected	Total	Selected	Not Selected	Total
There are complaints and/or requests for waste management from residents and/or NGOs.	Two or more(++), Just one(+), Non (-)	++	++	++	++	++	++	++	++	++
Proper operation management is possible even after the end of the pilot project.	Enough (++) Additional budgetary measures needed (+) Non (-)	++	+	+	++	+	+	++	+	+
Budget allocation Facility/ Equipment	Enough (++) Additional explanation necessary (+), Non (-)	++	+	+	++	+	+	++	+	+
Human resources	Enough (++) Additional explanation necessary (+), Non (-)	++	+	+	++	+	+	++	+	+
Intention of decision maker	Enough (++) Additional explanation necessary (+), Non (-)	++	+	+	++	+	+	++	+	+
Total score		10	6	6	10	6	6	10	6	6

(2) Selection of compost plant rehabilitation Pilot Project candidate
More than 20 tons/day of compost treatment capacity

- Kalutara compost plant : 20 ton/day (30 ton/day)
- Muthurajawela compost plant: 200 ton/day
- Karadiyana compost plant: 200 ton/day

Table 2-2 : Selection of candidate site for compost plant rehabilitation Pilot Project

Item	Rating	Kalutara	Muthurajawela	Karadiyana
The optimal technical interventions for improved planning and operation of SWM facility is applicable	In case "No, it is not applicable", it is not selected	Applicable	Applicable	Applicable
The effects of the pilot project should appear during the project period.	If the effect can be expressed, it is not select	Appear	Not appear	Appear
EIA and various permits and approvals for those are not completed in a short time; it is unnecessary or completed in a short time	In case "No, those are not completed in a short time", it is not selected	Unnecessary	Unnecessary	Unnecessary
There is no pending in court	In case "No, there are not, it is not selected	Yes	Yes	Yes
Land acquisition or land use procedure has been completed	In case "No, it has not yet completed", it is not selected	Completed	Completed	Completed
There is no any other ongoing or planning project.	In case "Yes, there is, it is not selected	No	Yes (SLLRDC)	No
Power supply is available or possibility to supply.	In case "No, it is not selected	available	available	available
Water supply is available or possibility to supply	In case "No, it is not selected	available	available	available
Access to the facility is easy	In case "No, it is not selected	easy	Easy	Easy
There are some negative environmental issues in the vicinity of facility	In case "No, there is not, it is not selected	Yes there are.	Yes there are.	Yes there are
Judgment		Selected	Not selected	Selected

4 32 32

Attachment 3: the result of pilot project site selection for optimal social intervention for improved planning and operation of waste management facility in the output 4 of the PDM

In order to maximize the effects of awareness programme, it is desirable to be conducted to residents nearby disposal site which receive the general municipal solid waste more than 200 tons or compost plant which treatment capacity is more than 20 tons and following sites are selected.

Selected disposal site:

- Karadiyana disposal site : approximately 544 ton/day (2018)
- Muthurajawela disposal site : approximately 720 ton/day (2018)

Selected compost plant:

- Kalutara compost plant : 20 ton/day (30 ton/day)
- Muthurajawela compost plant: 200 ton/day
- Karadiyana compost plant: 200 ton/day

Table 3-1: Selection of candidate site for awareness programme

Item	Rating	Karadiyana	Muthurajawela	Kalutara
There are some negative environmental issues in the vicinity of facility	In case "No, it is not applicable", it is not selected	Yes	Yes	Yes
There is no pending in court	In case "No, there are not, it is not selected	Yes	Yes	Yes
Land acquisition or land use procedure has been completed	In case "No, it has not yet completed", it is not selected	Completed	Completed	Completed
There is no closing planning project.	In case "Yes, there is, it is not selected	No	Yes (SLLRDC)	No
There is no existing social awareness programme conducted at the site	In case "Yes, it is not applicable", it is not selected	Yes	No	No
Judgment		Not selected	Not selected	Selected



අපද්‍රව්‍ය කළමනාකරණ අධිකාරිය (විස්තාරිත පළාත)
கழிவுப் பொருள் முகாமைத்துவ அధිකார சபை (மேல் பரிகாரம்)
WASTE MANAGEMENT AUTHORITY (WESTERN PROVINCE)

අධිකාරියේ පිටින සහ කළමනාකරණ කාර්යාලය
 අංක 204, පොරොත්තු පාර, පොරොත්තු පාර, පොරොත්තු පාර
 204, පොරොත්තු පාර, පොරොත්තු පාර, පොරොත්තු පාර
 Western Provincial Council Office Complex
 No. 204, Pothorattuwa Road, Pothorattuwa, Battaramulla, Sri Lanka.

දුරකථන අංකය
 034-2222211
 034-2222276
 034-55141582
 034-2722715-700

ආයතන අංකය
 W/P/WMA/T/A/80

ඔබගේ නම
 Your No.

දිනය
 30.10.2019

Dr. Naofumi SATO
 Team leader of JICA Project
 EX Research Institute Ltd.

Dear Sir,

Confirmation of site selection for Pilot Project

This refers to your letter dated 10.09.2019 on the subject cited above and Waste Management Authority extends our sincere thanks for your willingness to conduct Pilot Project related to,

- Pilot model scale transfer station in the output 3 of the PDM,
- Optimal technical intervention for improved planning and operation of waste management facility in the output 4 of the PDM,
- Optimal social intervention for improved planning and operation of waste management facility in the output 4 of the PDM.

Accordingly, I hereby confirm the site selection, Pothorattuwa compost plant for the pilot project to establish the Pilot Project.

Thanking you,
 Yours faithfully,

M. Jayasinghe Peruma
 Director
 Waste Management Authority (W.P.)

Copy - Chairperson, WMA - f.i.pl.



කළුතර නගර සභාව
சேந்துத்தறை நகர சபை
URBAN COUNCIL, KALUTARA

සභාපති
 034-2222111
 034-2222276
 034-55141582
 034-2722715-700

ඔබගේ නම
 Your No.

දිනය
 2020-01-23

නවීන් මහානායක රජයේ මහානායක,
 අධ්‍යක්ෂ,
 අදාල කළමනාකරණ අධිකාරිය (ව.ප.)
 බදානගිරි පළාත් සහ නාරියා ප්‍රදේශය,
 අංක 204,
 මහින්දානන්ද කොමන්ඩර් ජනරාල් මාවත,
 බත්තරමුල්ල.

කළුතර නගර සභාවේ නවීන් මහානායක රජයේ මහානායක සඳහා පිටින සහ කළමනාකරණ කාර්යාලයේ ස්ථාන සේවා පිළිබඳව තීරණය කිරීමේදී

සමස්ත සේවකයන්ගේ සහයෝගයෙන් 2020.01.22 දිනැති ලිපිය හා එකී ලිපියට සම්බන්ධ ඇමුණුම 01 වන සේවකයාට හා බැඳේ.

එම ව්‍යාපෘති සේවකයා වන ලිපියේ කරුණු අනුව සහයෝගයෙන් කොමන්ඩර් ජනරාල් ආරාමය තුළ කොමන්ඩර් ජනරාල් ආරාමය හා එහි සබැඳි භූමියේ කොමන්ඩර් ජනරාල් ආරාමයේ අදාල කළමනාකරණ කාර්යාලයක් පිහිටුවීම සඳහා සහයෝගයෙන් JICA ආයතනයේ අරමුදල් හා තාක්ෂණ සහයෝගය ආරම්භ කිරීමට හේතුවන ව්‍යාපෘතිය තුළින් කොමන්ඩර් ජනරාල් ආරාමයේ පිහිටුවීමට ප්‍රයෝජනීය බැවින් ඒ සඳහා කළුතර නගර සභාවේ පුළුල් ව්‍යාපෘතියට මෙයින් ප්‍රශංසා කර සිටිමි.

කළුතර ලිපියට ඉදිරිපත් කර ඇති ව්‍යාපෘති සේවකයාගේ 3 දේපලේ සඳහන් ව්‍යාපෘතියේ පුළුල් ව්‍යාපෘතියට කළුතර නගර සභාවට පමණක් සීමිත වශයෙන් සහයෝගය විය යුතු බවද පෙන්වා දෙමි.

එමෙන්ම ඉහත සඳහන් සහයෝගයෙන් තුළ කොමන්ඩර් ජනරාල් ආරාමය / ඩිලි බලය නිෂ්පාදනය සහ සිසිලිය පද්ධතියක් ස්ථාපිත කිරීමේ ව්‍යාපෘතියක් සඳහා එම භූමියෙන් කොමන්ඩර් ජනරාල් ආරාමයට පුළුල් ව්‍යාපෘතියට මෙහි වන වටිනාකම පිළිබඳව ඇති බව වැඩිදුරටත් කරුණු සඳහන් කරමි.

ඉදිරිපත්කරු
 ජනරාල් ජනරාල් ජනරාල්
 කළුතර නගර සභාව.

Handwritten signature and stamp

39610
 24 JAN 2020
 2020-01-23

Annex 1
Attachment 4
034-2222424



Annex 1
Attachment 5
034-2222424

කළුතර ප්‍රාදේශීය සභාව
கலுத்தறை பிரதேச சபை
KALUTARA PRADESHIYA SABHA

විද්‍යා මධ්‍යස්ථානයේ, කලුතර - කදු, ද. ගා, B
අංක 2020.01.22 දිනැති ලිපිය හා බැඳේ.

නැවින් මානිකරණය වූ ලේඛන,
දැනුම
දැනුම
දැනුම

කළුතර ප්‍රාදේශීය සභාව
කළුතර ප්‍රාදේශීය සභාව

කළුතර ප්‍රාදේශීය සභාව
කළුතර ප්‍රාදේශීය සභාව
කළුතර ප්‍රාදේශීය සභාව

කළුතර ප්‍රාදේශීය සභාව
කළුතර ප්‍රාදේශීය සභාව

කළුතර ප්‍රාදේශීය සභාව
කළුතර ප්‍රාදේශීය සභාව

New Approach of 3Rs at High Rise Apartment and/or Low-Income Housing

- 1. 3Rs promotion in large-scale low-income condominium in CMC (Sarnagapur)
2. Project Objective
3. Project Scope, Activity
4. Project Outputs
5. Project Outcomes
6. Implementation Mechanism

Handwritten signature and initials: SZ, AK, MW

informing the residents about their rules and regulations and promoting 3Rs. Ensuring the continuation of the above activities.

- Police HQ: Reviewing their contract with the residents in terms of solid waste management in cooperation with WMA and CMC
- Residents: Supporting information dissemination and monitoring of residents discharge manner
- Environmental Police: Cooperation with CMC for implementation of their SWM rules and smooth implementation of the pilot project
- WMA: Coordination among the relevant stakeholders, recording of the activities and compilation of report to develop a guideline for SWM in urban condominiums, and ensuring the continuation of the above activities in cooperation with CMC.
- JICA Project: Supporting implementation of initial stage (1st year and 2nd year) of the above activities, providing technical advises and equipment and materials required.

III. 3Rs promotion in new large scale low-income condominium in Mahagarama UC (Laksanda Sewana)

1. Need/Problem to address
 - Wastes are thrown to the street from high-level apartments despite collection service being provided.
 - A very small number of residents practice separate discharge of waste
 - Sampah Kendraya (recyclable collection center) was introduced, but not managed in a sustainable manner. KUC has a problem in availability of final disposal site as well as transfer station.
 - Vehicle and labor allocation and waste collection schedule adequate for the waste amount discharged in the UC needs to be developed by KUC.
2. Project Objective
 - KUC's adequate collection service will be accepted by the residents
 - KUC's separate collection of bio-degradable waste will be cooperated by the residents
 - KUC's efforts to reduce waste will be cooperated by the residents
3. Project Scope, Activity
 - Involvement of condominium management committee in SWM
 - Coordination with KUC in order to deliver waste collection on schedule
 - Development of method for communal discharge for bio-degradable waste
 - Development of community-based monitoring system to manage the communal discharge as well as for proper discharge manner.
 - Improvement of communication between KUC and the condominium management committee
 - Awareness activities such as leaflet distribution and community meetings for informing about the above activities.
 - Meetings to coordinate between KUC, WMA, NSWMS, UDA (and the residents when and if necessary).
4. Project Outputs
 - Collection schedule and discharge manner information leaflet / signboard
 - Communal discharge points for kitchen waste will be established
 - Illegal waste discharge including throwing from windows will be ended.
 - Record of activities will be filmed.

Handwritten initials: SZ and #2

Handwritten signature and initials: #2

Awareness activities such as leaflet distribution and community meetings for informing about the above activities.

4. Project Outputs
 - Collection schedule and discharge manner information leaflet / signboard
 - Communal discharge points for kitchen waste will be established
 - Illegal waste discharge will be eliminated.
 - Record of activities will be filmed.
 - Record of activities will be compiled to a report.
5. Project Outcomes
 - Proper discharge of waste will be conducted by a majority of the residents
 - Separate discharge of kitchen waste from the discharge source will be conducted by a majority of the residents
 - Separated waste will be discharged to MUC's collection by the cleaning staffs.
6. Implementation Mechanism
 - MUC: delivering adequate collection services by sending vehicles appropriate for the waste discharged amount of the site on schedule, and informing the residents and their staffs about their rules and regulations. Ensuring the continuation of the above activities.
 - Condominium Authority: reviewing their contract with the residents in terms of solid waste management in cooperation with WMA
 - Condominium Management Committee: Supporting information dissemination and monitoring of residents discharge manner
 - Environmental Police: Cooperation with MUC for implementation of their SWM rules and smooth implementation of the pilot project
 - WMA: Coordination among the relevant stakeholders, recording of the activities and compilation of report to develop a guideline for SWM in urban condominiums, and ensuring the continuation of the above activities in cooperation with MUC.
 - JICA Project: Supporting implementation of initial stage (1st year and 2nd year) of the above activities, providing technical advises and equipment and materials required.

The detail scope of Facility Construction of the Pilot Project

1. Project Title: Pilot project for development of small scale solid waste transfer station in Kaituma composting facility

1.1 Need/Problem to address¹

- Currently, biodegradable and non-biodegradable wastes are brought into the Kaituma composting facility from Kaituma PS and UIC.
- Biodegradable waste is put into the composting facility, and the residue from the composting process is disposed in the disposal area of the premise of the facility.
- Non-biodegradable wastes also are disposed into the disposal area of the premise of the facility.
- Bad odor, which generated from the disposal area of the premise composting facility, is deteriorated the surrounding environment of the facility.

1.2 Project Objective

- Introduce a waste relay transportation system which knowledge and experience contributes to understand and fully utilize the master plan.
- Stop loading waste into the landfill facility at Kaituma compost facility.

1.3 Project Scope, Activity

- Introduce the compactor machine, two containers, slider and trailer to transport waste that is currently landfilled to an appropriate disposal site in a remote area.
- Instruct the proper operation of small scale solid waste transfer station.

1.4 Project Outputs²

- Waste landfilling activities in the Kaituma composting facility will stop.
- Waste is transferred to long distance regional treatment facility.

1.5 Project Outcomes³

- The negative environmental impact (offensive odor) caused by the waste landfilling activities in the Kaituma composting facility will reduce, and a living environment around the facility is improved.
- Proper transportation system contribute to establishment of regional solid waste management of master plan which consists of large scale intermediate facility and final disposal site.

1.6 Financing Plan

1.6.1 Cost breakdown, including operation and maintenance if applicable

Operating Expense (OPEX): not available

1.6.2 Method of financing, Revenue forecast if applicable

Capital Expenditure (CAPEX): Financing by WMA

¹ With an indication of who's problem
² Two types of output: (i) outputs made through project implementation process, e.g. facilities developed, awareness created; (ii) outputs produced by using developed facilities & materials, e.g. compost produced by new plant, trained staff by using new course materials. All of outputs are typically linked with the needs/problems of its beneficiary groups.

2. Project Title : Pilot project for development of forced aeration system in existing Kaituma composting facility

2.1 Need/Problem to address

- The Kaituma composting facility is currently operating with a manual turning system that uses small heavy machinery.
- Currently, the frequency of turning activity is low, and the inside of the compost pile becomes anaerobic conditions, therefore a bad odor is generating.
- Bad odors have deteriorated the surrounding environment of the composting facilities.

2.2 Project Objective

- Keep the inside of the compost pile aerobic and prevents the generation of odors.
- Confirm the effects of remodeling existing facilities to forced aeration composting facilities.

2.3. Project Scope, Activity

- Install forced aeration system which knowledge and experience contributes to understand and fully utilize the master plan.
- Operate and monitor the installed forced aeration system, and obtain the appropriate design parameter to improve other existing composting facilities by forced aeration composting facilities.

2.4 Project Outputs

- Bad odor generated by the operation of the Kaituma composting facility reduces.

2.5 Project Outcomes

- The negative environmental impact caused by the operation of the Kaituma composting facility is reduced, and the living environment around the facility is improved.
- A guideline is prepared for remodeling and operating other existing composting facilities that adopt the same system as the Kaituma composting facility into a forced aeration composting system

7. Financing Plan

7.1 Cost breakdown, including operation and maintenance if applicable

Operation Expense (OPEX): not available

7.2 Method of financing, Revenue forecast if applicable

Capital Expenditure (CAPEX) : Financing by WMA

Handwritten signature and initials: 7/2, \$/2, WMA

Pilot Activities of Seeking Optimal Social Intervention for Improving Planning and operation of Waste Management Facilities

1. Need/Problem to address¹
 - Complaints from neighbouring residents about offensive odor from the compost plant and the disposal site is deteriorated the living environment of neighbouring communities.
 - Understanding and cooperation from neighbouring residents for improvement of compost plant and development of transfer station is needed.

2. Project Objective

- The objective of the Pilot Project is to build good relationship between WMA and the neighbouring residents for the compost plant and transfer station which are to be rehabilitated and developed by other Pilot Projects, thereby contributing the proper and continuous operation of solid waste management facilities.

3. Project Scope, Activity

Activity	Objectives	Survey Method
Focus Group Discussion	<ul style="list-style-type: none"> • Identification of stakeholders, interests of each stakeholder, impacts of their interests, and risks to management of final disposal site • Examining actions to propose to each stakeholder 	<ul style="list-style-type: none"> • literature review • Focus group discussion • Interviews
Socio-economic survey	<ul style="list-style-type: none"> • Survey of opinions by residents, commercial facilities, industries (including dischargers, neighbouring residents and lands) regarding facility plan, monitoring, evaluation of facilities. 	<ul style="list-style-type: none"> • Questionnaire survey for 250 HH
Social Awareness	<ul style="list-style-type: none"> • Social Awareness for the people affected by the waste management facilities • Making better communication between the management side of waste management facilities and the neighbouring residents 	<ul style="list-style-type: none"> • Stakeholder meeting • Monitoring Committee

4. Project Outputs²

- Report on Focus Group Discussion
- Report and record (film) on Socio-economic survey (report on questionnaire survey for 250HH)
- Report and record (film) on monitoring committee
- Monitoring sheet and its record which is used for monitoring of facilities

5. Project Outcomes³

- Understanding and cooperation from neighbouring residents are obtained for proper and continuous operation of Kalutara compost plant and transfer station.

¹ With an indication of whose problem

² Two types of output: (i) outputs made through project implementation process: e.g. facilities developed, awareness created; (ii) outputs produced by using developed facilities & materials: e.g. compost produced by new plant, trained staff by using new course materials. All of them are project outputs.

³ Outcomes are typically linked with the needs/problems of its beneficiary groups.

Handwritten signature and initials.

Handwritten signature and initials.

Demarcation of the Pilot Project between JICA and Sri Lankan side

Item	Detail	JICA	Sri Lankan side	
			NSW/MSC	WMA / CEA
1.A. pilot model scale transfer station at Kalutara compost plant site: Output 3				
1.0 Environmental social consideration	1.0.1 Submitting of Environmental recommendation and Environmental protection license			✓
	1.0.2 Convenor to the monitoring committee comprising CEA, NSW/MSC and social representatives			✓
1.1 Selection of contractor and supervision	1.1.1 Tender and employment of contractor for design and build of transfer station	✓		
	1.1.2 Approval of design	✓		✓
	1.1.3 Construction management	✓		✓
	1.1.4 Supervision of construction	✓		✓
	1.1.5 Completion inspection	✓		✓
	1.1.6 Defect inspection (monthly during defect liability period- one year)	✓		✓
1.2 Procurement of equipment	1.2.1 Preparation of specification for equipment	✓		✓
	1.2.2 Static compactor with input hopper	✓		✓
	1.2.3 Waste container	✓		✓
	1.2.4 Container haul trailer vehicle with hook system	✓		✓
1.3 Construction of transfer station	1.3.1 Electricity			✓
	(1) The mainline to the site			✓
	(2) The drop wiring and internal wiring within the site			✓
	(3) The main circuit breaker and transformer			✓
	1.3.2 Water Supply			✓
	(1) Main water supply to the site			✓
	(2) The supply system within the site (receiving and/or elevated tanks)			✓
	1.3.3 Drainage			✓
	(1) The public main drainage (for storm water) to the site			✓
	(2) The drainage system within the site			✓
	1.3.4 Necessary modifications to current building			✓
	1.3.5 Installation of static compactor with input hopper			✓
	1.3.6 Safety information provision and ensuring security at the site during construction			✓
1.4 Closing of current disposal site	1.4.1 Design of closure plan of current disposal site			✓
	1.4.2 Closing of current disposal site in accordance with closure plan			✓
1.5 Operation and Management including pilot project period	1.5.1 Making agreement between Kalutara DC and WMA			✓
	1.5.2 Technical advice (during the Project period) to WMA	✓		
	1.5.3 Technical advice to WMA (after completion of the Project) by NSW/MSC			✓
	1.5.4 Human resource (Manager:1, Supervisor:1, worker:2, driver:1) Ensure above mentioned minimum staff during operation by WMA			✓
	1.5.5 Electricity bill by WMA			✓
	1.5.6 Water supply bill WMA			✓
	1.6 Monitoring of operation and management			✓
1.7 Overall maintenance	1.7.1 Fuel and lubrication of container haul trailer vehicle			✓
	1.7.2 Maintain the static compactor with input hopper			✓
	1.7.3 Other maintenance and repair work of equipment and			✓

Attachment 8

Item	Detail	JICA	Sri Lanka side		
			NSWASC	WMA	CEA
2. Plan activities for seeking optimal technical interventions for improved planning and operation of waste management facilities (Development of Kalutara compost plant); Output 4					
2.0 Environmental social consideration	2.0.1 Submitting of Environmental recommendation and Environmental protection license				
	2.02 Convenir to the monitoring committee comprising CEA, NSWASC and social representatives				
2.1 Selection of consultant	2.1.1 Tender and employment of consultant				
	2.1.2 Approval of design				
2.2 Selection of contractor and supervision	2.2.1 Tender and employment of contractor				
	2.2.2 Supervision of construction				
	2.2.3 Completion inspection				
	2.2.4 Defect inspection(monthly during defect liability period- one year)				
2.3)Procurement of equipment	2.3.1 Preparation of specifi cationfor equipment				
	2.3.2 Aviation pine				
	2.3.3 Air supply units (blower or compressor etc)				
2.4 Development of compost plant	2.4.1 Electricly				
	(1)The main line to the site				
	(2)The drop wiring and internal wiring within the site				
	(3)The main circuit breaker and transformer				
	2.4.2 Water Supply				
	(1)Main water supply to the site				
	(2)The supply system within the site (receiving and/or elevated tanks)				
	2.4.3 Drainage				
	(1)The public main drainage (for storm water) to the site				
	(2)The drainage system within the site				
	2.4.4 Necessary modifi cations to current building				
	2.4.5 Installation of aeration pipes and air supply units				
	2.4.6 Safety information provision during construction				
2.5 Operation and Management including pilot project period	2.5.1 Making agreement between Kalutara ULC and WMA				
	2.5.2 Technical advice (during the Project period) to WMA				
	2.5.3 Technical advice to WMA (after completion of the Project) by NSWASC				
	2.5.4 Human resource (Manager, Supervisor, worker)				
	Ensure above mentioned minimum staff for operation				
	2.5.5 Electricly bill				
	2.5.6 Water supply bill				
2.6 Monitoring of operation and management	2.6.1 Monitoring of operation and management				
2.7 Overall maintenance	2.7.1 Maintain Aviation system				
	2.7.2 Other maintenance and repair work of equipment and services				

5/2

#4

W

ATTACHED DOCUMENT

1. Overview of Pilot Projects:

- The implementation of the Pilot Projects was agreed in Minutes of Meetings on 18th May 2018 and "Record of Discussions for the Project for Formulation of Western Province Solid Waste Management Master Plan" (R/D) signed on December 12th, 2018, between concerned authorities including Ministry of Provincial Councils, Local Government and Sports and Western Provincial Council, and JICA.
- The Pilot Projects are implemented under the framework of the above mentioned R/D and the Agreement on Technical Cooperation signed on 12th October, 2005 and the Note Verbales exchanged on 5th May, 2021 between the Government of Japan and the Government of Sri Lanka.
- The Pilot Projects are expected to achieve acquiring knowledge and experience which contribute to Western Province Solid Waste Management Master Plan (hereinafter referred to as "MP") formulation and implementation and to contribute to the achievement of strengthening Western Province's planning capacity on solid waste management.
- In accordance with the agreements mentioned above, Pilot Project sites and activities were examined between JICA expert, National Solid Waste Management Support Center and Waste Management Authority (hereinafter referred to as "Sri Lankan side").
- The implementation period of the Pilot Project is tentatively from September 2021 to December 2022, and it shall be changed in accordance with the situation of COVID-19 pandemic, etc. The scope of Pilot Project implemented under the Project is as follows:
 - Rehabilitation of Karadiyana Compost (under Output 4)
Karadiyana final disposal site, located at Boralesgamuwa - Borupana in Colombo District, has received about 500 ton/day municipal solid waste from seven Local Authorities. The terrain instability was encountered with two sites, site A for biodegradable waste and site B for mixed waste, recently, National Building Research Organization (hereinafter referred to as "NBRO") studied the issue with subject specialists and WMA-W/P and recommended stopping dumping waste at the both sites on 5th March 2020. Based on NBRO report, the court in Sri Lanka judged on 22nd March 2021 that WMA must submit a short-term plan of dump site operation with the date to close the site. It requires Karadiyana project to stop waste disposal at the both dump sites, by the date stipulated in the plan. However, the Site A is still receiving around 250 metric tons biodegradable waste on daily basis. Under the situation, WMA requested the technical assistance by JICA expert to rehabilitate the Site A in Karadiyana and improve the biodegradable waste treatment capacity. Taking the above background into account, both sides agreed to implement the Pilot Project. Current situation of the site and objective of this Pilot Project are stipulated in "Rehabilitation Plan of Karadiyana Compost Plant" (Attachment 1). JICA agreed to support WMA to implement the plan by



MINUTES OF DISCUSSIONS
BETWEEN
STATE MINISTRY OF PROVINCIAL COUNCILS AND LOCAL GOVERNMENT
AND
JAPAN INTERNATIONAL COOPERATION AGENCY
ON
REHABILITATION PLAN OF KARADIYANA COMPOST PILOT PROJECT
FOR
THE PROJECT FOR FORMULATION OF WESTERN PROVINCE SOLID WASTE
MANAGEMENT MASTER PLAN

Colombo, September 17, 2021

The Japan International Cooperation Agency (hereinafter referred to as "JICA") and Ministry of Public Services, Provincial Councils and Local Government and subsequently State Ministry of Provincial Council and Local Government (hereinafter referred to as "SMoLGPC") held a series of discussions to establish a mutual agreement concerning Rehabilitation plan of Karadiyana compost Pilot Project for the Project for Formulation of Western Province Solid Waste Management Master Plan.

As a result of the discussions, both sides confirmed the issues shown in the document attached hereto.

Tetsuya Yamada
Chief Representative
JICA Sri Lanka Office

S.D.A.B Boralesssa
Secretary
State Ministry of Provincial Council and
Local Government

for
Naofumi Sato
Team Leader
JICA Expert Team

J.M.C Jayanthi Wijethunga
Chief Secretary
Western Provincial Council

SZ # 2

Handwritten initials and marks at the top right of the page.

project completion (i.e., December 2022) and WMA agreed to take necessary actions until the completion of the plan. The detailed scope of the Pilot Project is as follows:

No.	Item	Specification	Qty.	Details
1	Development of compost plant (improvement of sieving capacity)	Treatment capacity 100 ton/day	1 unit	Installation of two heavy-duty sieving machines (trailer referred to as "Trommel"), two sets of tractor mounted with a bucket, crushing machine, compost bagging machine and forklift. Design of entire rehabilitation plan of Site A in Karadityana.
2	Landfill mining earthwork at Site A	Landfill mining ton/day 100	1 unit	Technical assistance to WMA staff for landfill mining earthwork at Site A.
3	Windrow composting at Site A	Windrow composting	1 unit	Technical assistance to WMA staff for windrow composting at Site A.
4	Operation and Management		1 unit	Technical assistance to WMA for operation and management of the entire rehabilitation by December 2022.

II. Measures to be taken by Sri Lankan side

For the implementation of Pilot Project mentioned above 1. 5. 1), which includes the procurement and the installation of 2 units of Trommel, 2 sets of tractor mounted with a bucket, crushing machine, compost bagging machine, and forklift, and the rehabilitation earth work, which includes landfill mining and windrow composting at Site A, Sri Lankan side will take necessary measures to provide services, facilities and local-cost bearing listed hereto at its own expense. The detailed demarcation between JICA and Sri Lankan side is confirmed in the Attachment 2.

- a) Review and concurrence of the design of the facility;
- b) Concurrence of the result of completion inspections and defect inspections of developed facility in cooperation with a consultant procured by JICA;
- c) (A) Lot(s) of land necessary for the implementation of Facility Construction;
- d) Necessary permissions for Facility Construction;
- e) Environmental and social considerations in the implementation of Facility Construction;
- f) Facilities for distribution of electricity, water supply and drainage, and other incidental facilities necessary for the implementation of Facility Construction;
- g) Security of relevant persons related to Facility Construction;

h) Transferring the ownership of developed facility at the completion of Facility Construction as property of WMA;

i) Appropriate operation and maintenance of developed facility with allocating necessary expenses;

j) To bear claims, if any arises, against the experts and members of the missions resulting from, occurring in the course of, or otherwise connected with, the performance of their duties, except when the two Governments agree that such claims arise from gross negligence or willful misconduct on the part of the experts and members of the missions;

k) To ensure that customs duties, internal taxes including VAT and other fiscal levies which may be imposed with respect to the implementation of Facility Construction to be borne by its designated authority; and

l) Necessary supports, including the following items, as requested throughout the implementation period in cooperation with other organizations concerned in Democratic Socialist Republic of Sri Lanka at its own expense:

- (1) Appointment of Sri Lankan side's counterpart personnel;
- (2) Provision of available data (including maps and photographs) and information related to Facility Construction such as geological survey data; and
- (3) To ensure conducting necessary procedures for obtaining Environmental Recommendation (ER) and Environmental Protection License (EPL), JICA expert can provide the Sri Lankan side with technical support in order to obtain ER and EPL, if necessary.

m) To ensure the necessary procedures for the procured machines to be handed over to the Government of Sri Lanka right after the procurement without delay and that the procured machines shall be owned and properly maintained by the Government of Sri Lanka.

III. Measures to be taken by WMA

For the implementation of Pilot Projects mentioned above 1. 5. 1), which includes the procurement and the installation, and the rehabilitation earth work, WMA shall take necessary arrangement with Karadityana Resource Management Centre, Boralesgamuwa Urban Council, by making MoU or agreement before starting of procurement. WMA shall ensure that the facilities developed and rehabilitated by the Project, will be properly operated and maintained during and after the period of the Project, including necessary environmental and social considerations, through full and active involvement in the Project by all related authorities, beneficiary groups and institutions.

IV. Mutual Consultations

Any major issues that may arise from or in connection with this Attached Document will be resolved through mutual consultations by both sides.

Handwritten initials and signatures at the bottom of the first page.

Handwritten initials and signatures at the bottom of the second page.

別添資料1

ATTACHMENT:
Attachment 1: Rehabilitation Plan of Karadiyana Compost Plant
Attachment 2: Demarcation of Karadiyana Compost Improvement Plan between JICA
and Sri Lankan side

52 # 2

52 # 2

52 # 2

