

Republik Indonesia
Kementerian Perhubungan
Direktorat Jenderal Perhubungan Laut

Republik Indonesia
Proyek Kajian Studi
Untuk
Maritime Traffic Safety System
Development Plan

(Rencana Pengembangan Sistem Keselamatan Lalu Lintas Maritim)

Volume Terpisah (Fase 1)
(Figur/Tabel)

April, 2023



Japan International Cooperation Agency (JICA)



Japan Aids to Navigation Association (JANA)

IM
JR
23-053

Bab 1

Introduction

Outline of DISNAV Service Area

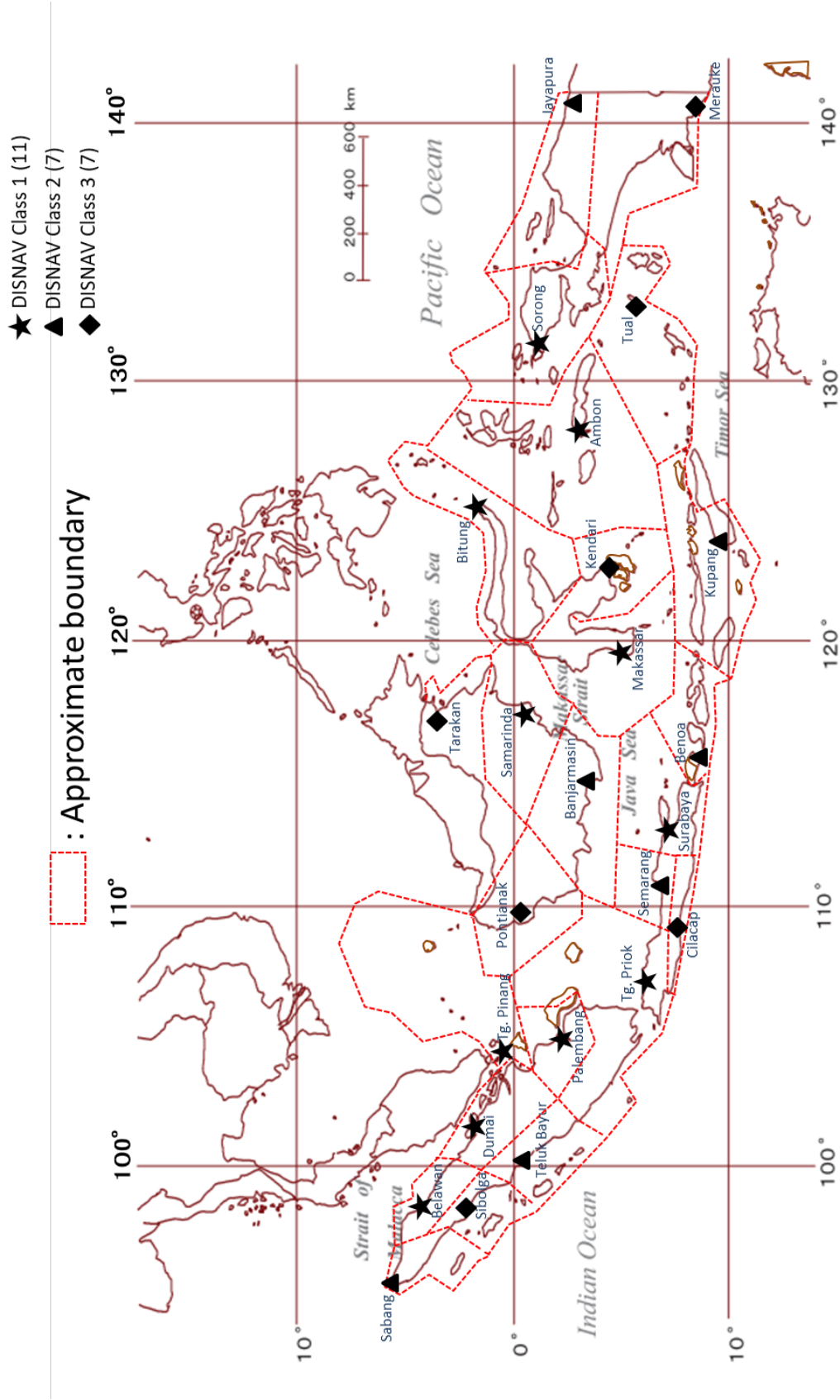

Figure 1-3-1

Figure 1.3-1 : Jurisdiction Area of DISNAV

Indonesia Map & Location of DISNAV Offices

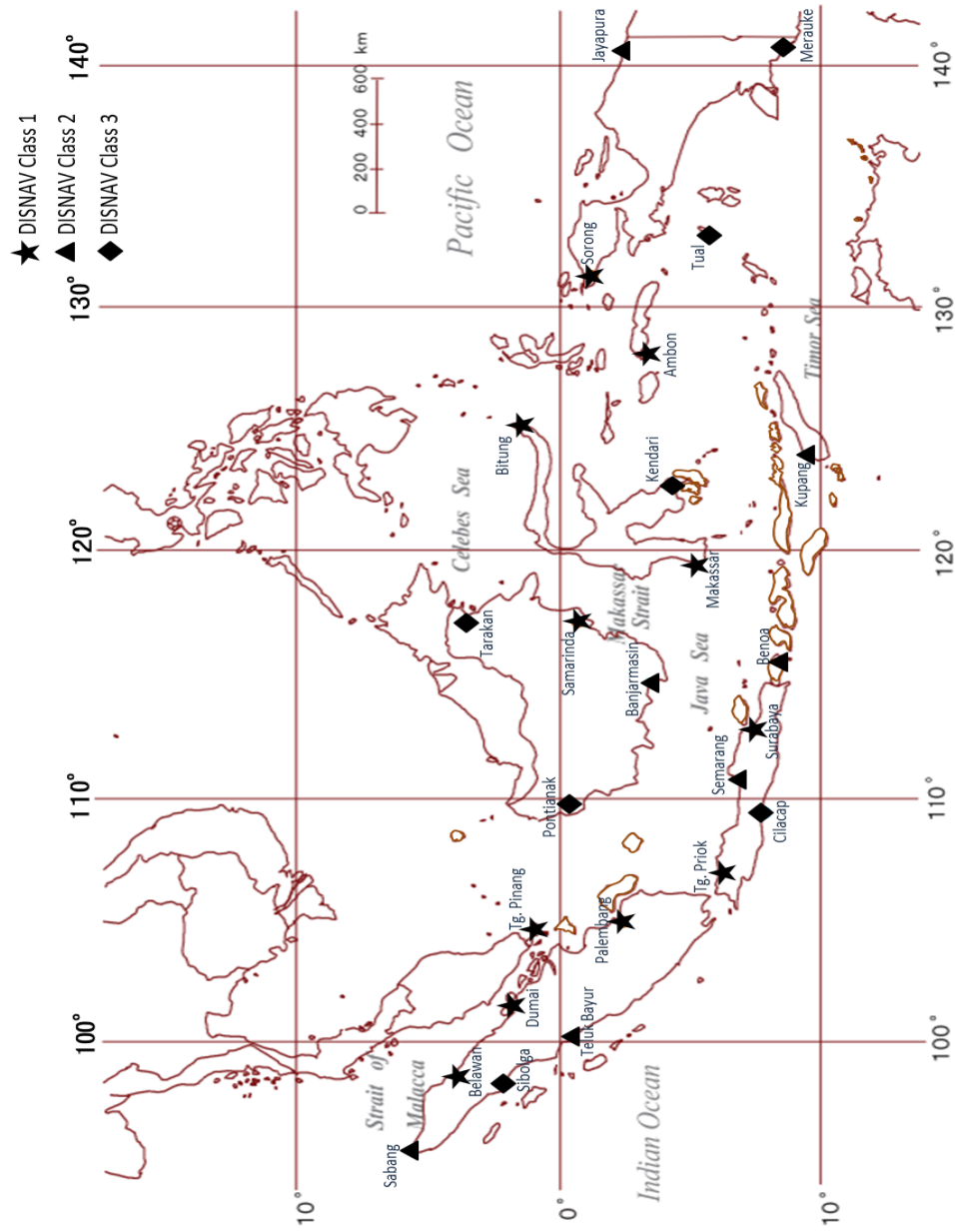

Figure 3.1-1'

Reference : Name of DISNAV

DISNAV Class 1	DISNAV Class 2	DISNAV Class 3
11	7	7

NO	DISNAV Office	Class	Province
1	Sabang	2	Special Dist. Aceh
2	Belawan	1	North Sumatera
3	Sibolga	3	ditto
4	Teluk Bayur	2	West Sumatera
5	Tg. Pinang	1	Riau
6	Dumai	1	Riau
7	Palembang	1	South Sumatera
8	Pontianak	3	West Kalimantan
9	Tg. Priok	1	Special Dist. Jakarta
10	Cilacap	3	Central Java
11	Semarang	2	ditto
12	Surabaya	1	East Java
13	Benua	2	Bali
14	Kupang	2	East Nusa Tenggara
15	Benjarmasin	2	South Kalimantan
16	Tarakan	3	East Kalimantan
17	Samarinda	1	East Kalimantan
18	Makassar	1	South Sulawesi
19	Kendari	3	South East Sulawesi
20	Marado/Bitung	1	North Sulawesi
21	Ambon	1	Maluku
22	Sorong	1	Papua
23	Jayapura	2	ditto
24	Merauke	3	ditto
25	Tual	3	Maluku

Figure 1.5.2 -1 : Structure of the Project

Implementation Structure of the Project

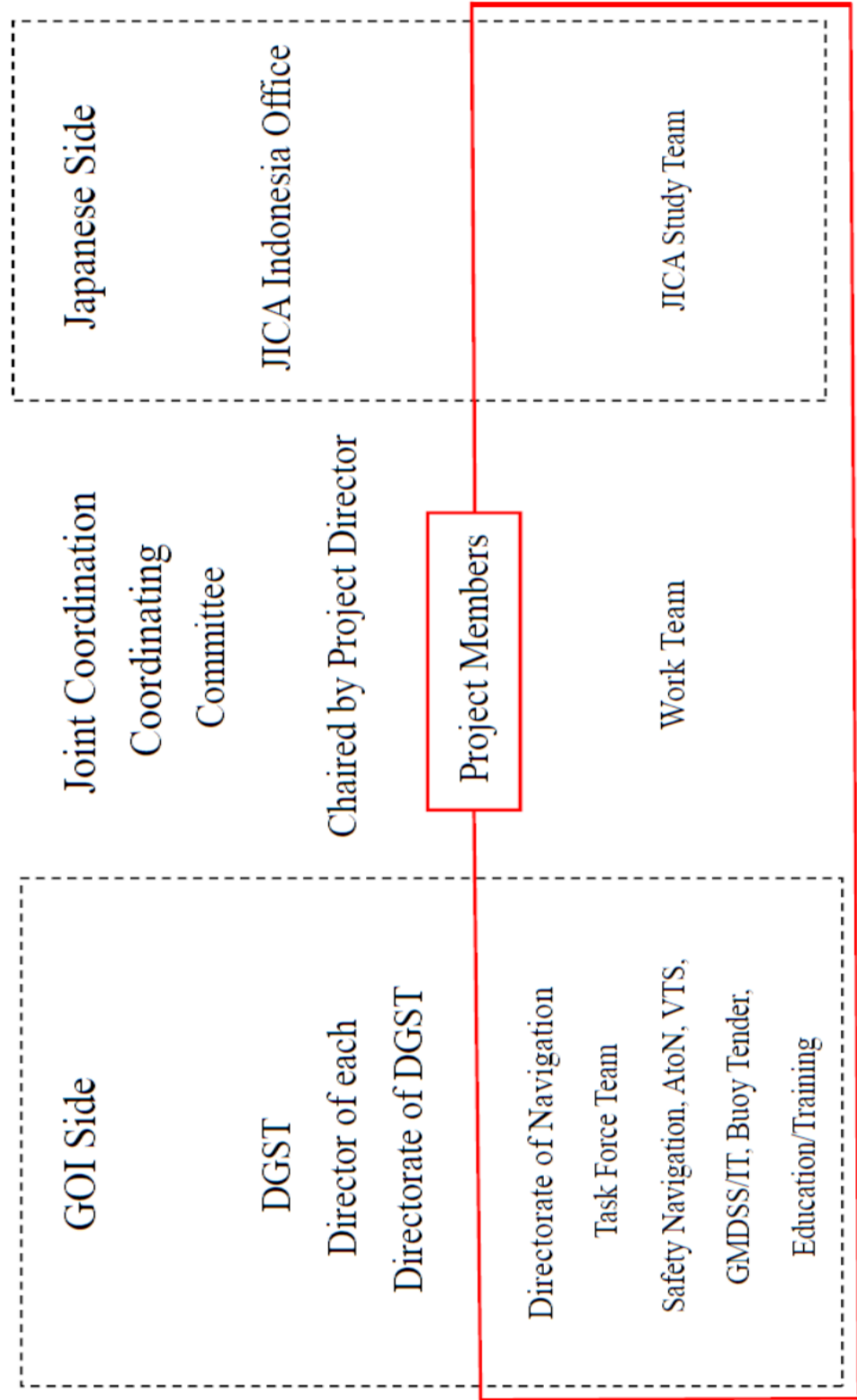

Figure 1.5.2 -2 : Organization Chart of DGST (1/2)

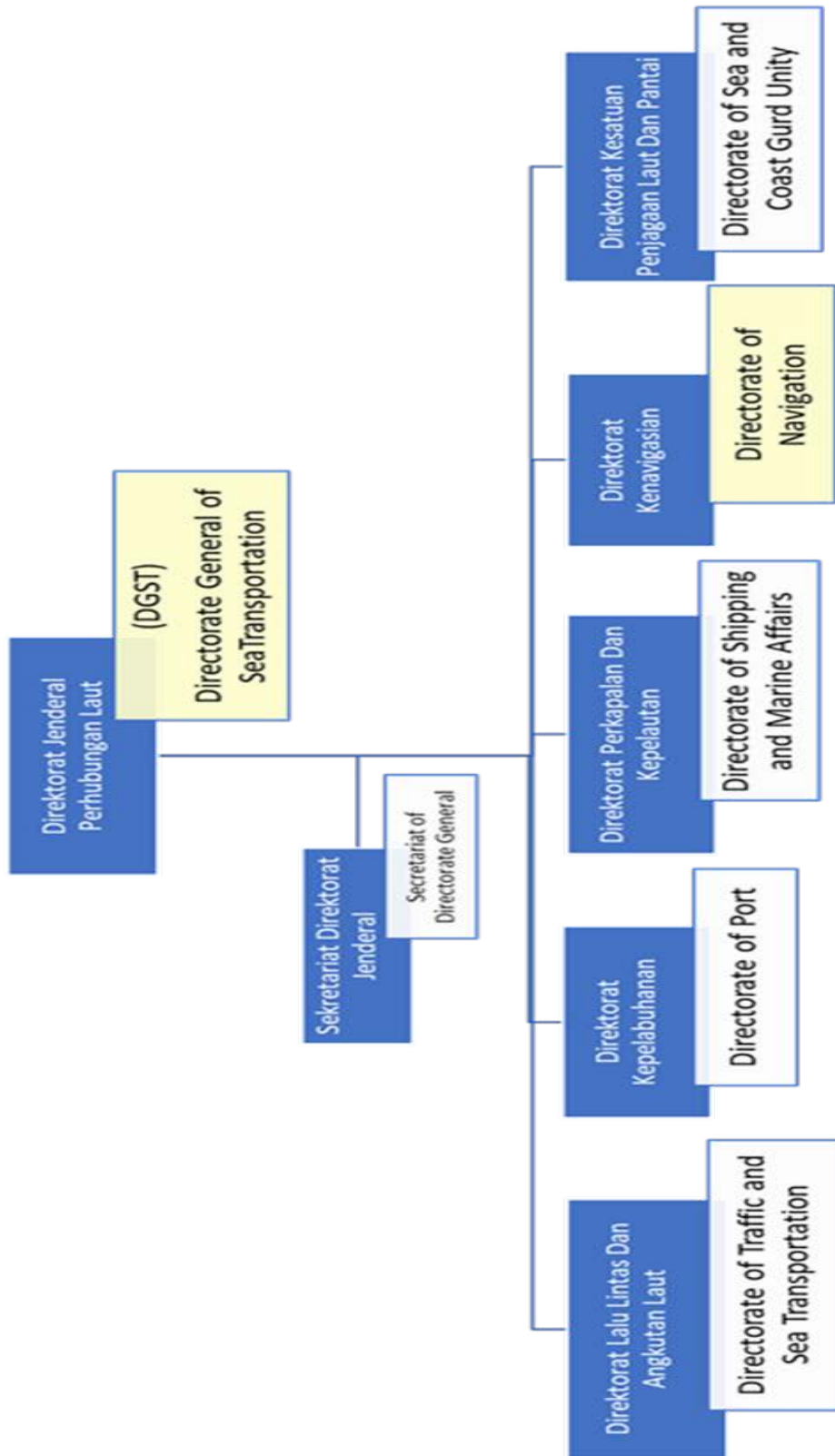

Figure 1.5.2 -2 : Organization Chart of DGST (2/2)

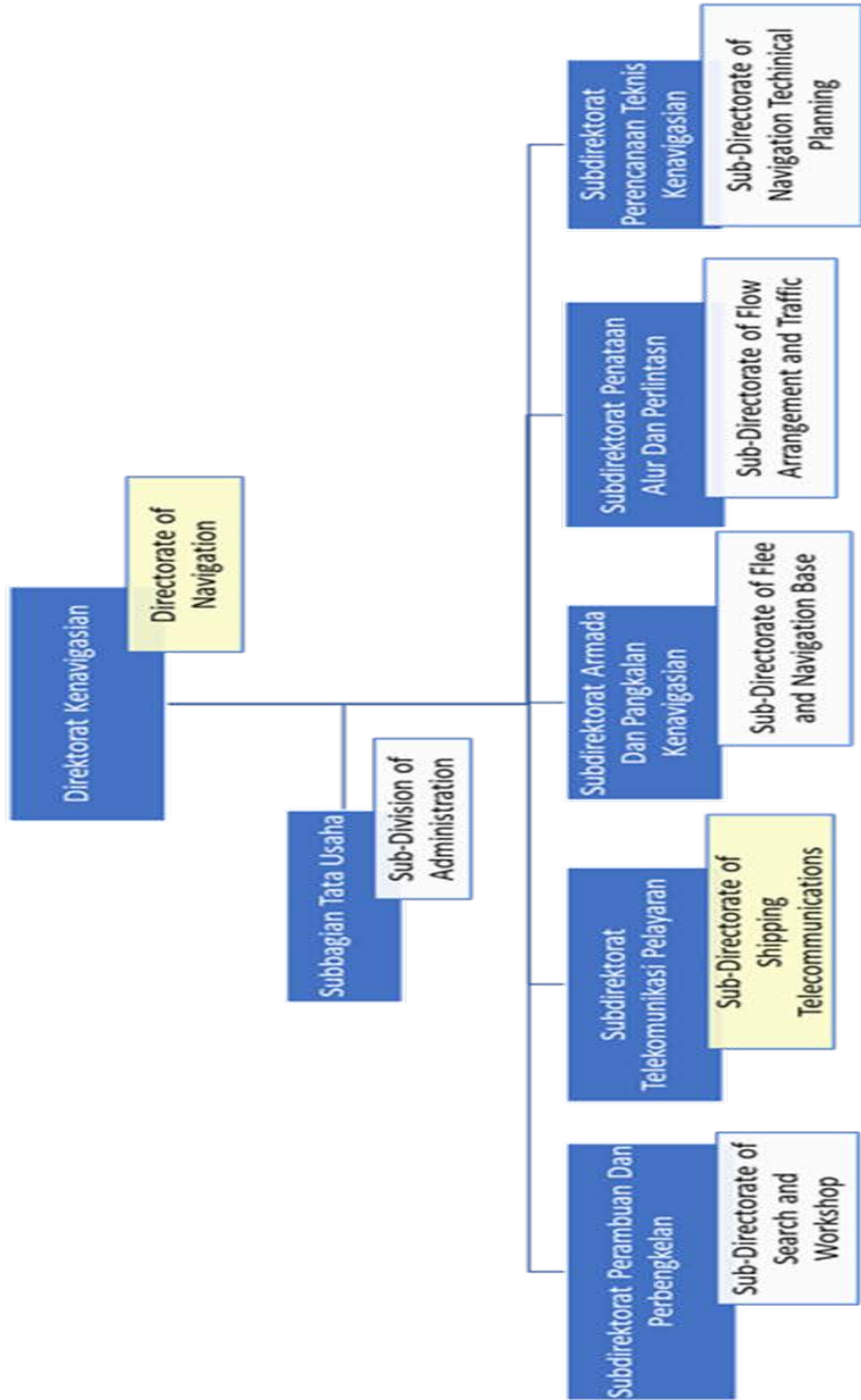
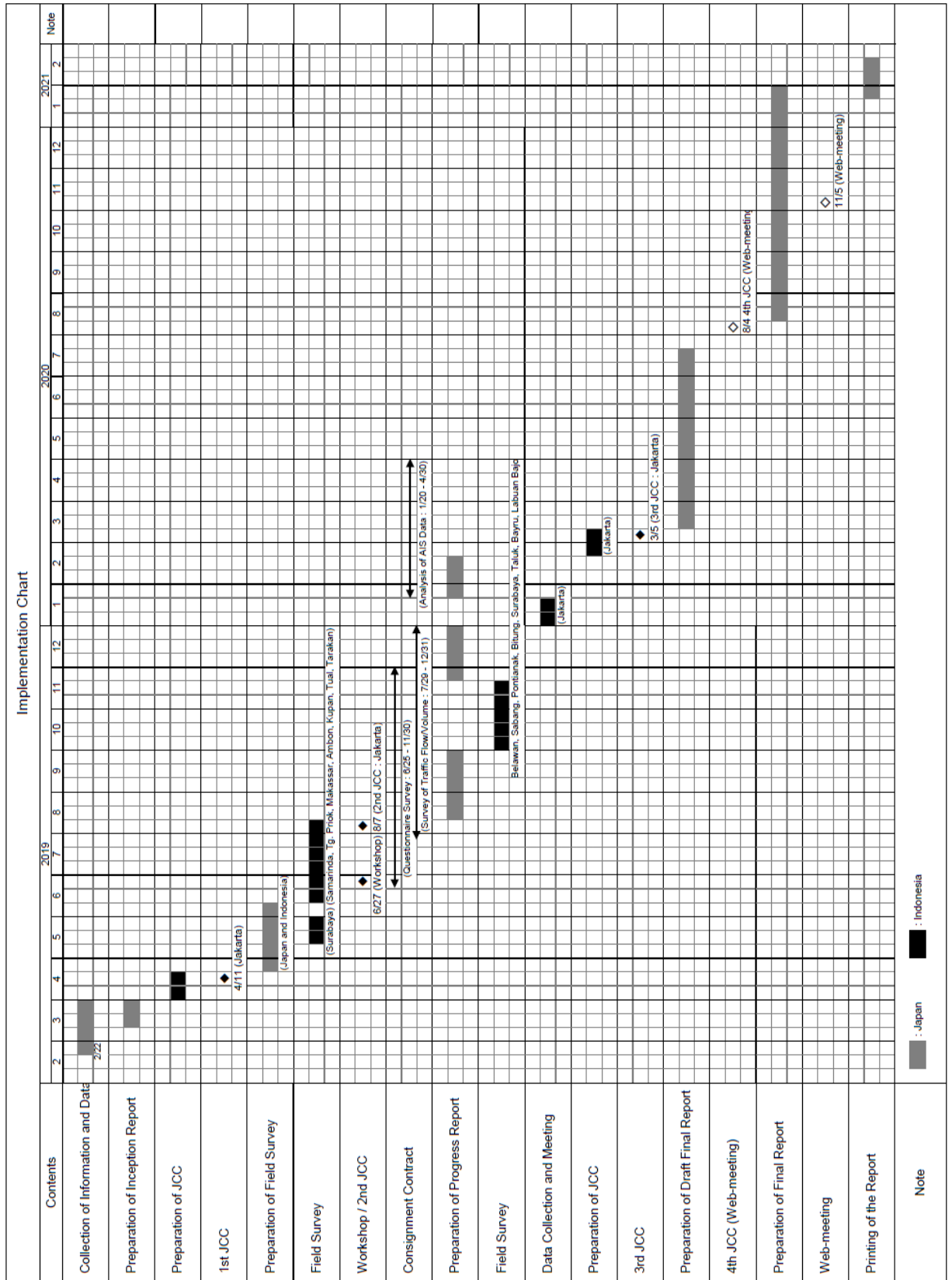

Table 1.5.3 -1 : Implementation Schedule



Bab 2

Current Situation Surrounding the Maritime Traffic Safety

Figure 2.1 -1 : Frame of Five Pillars for Maritime Nation

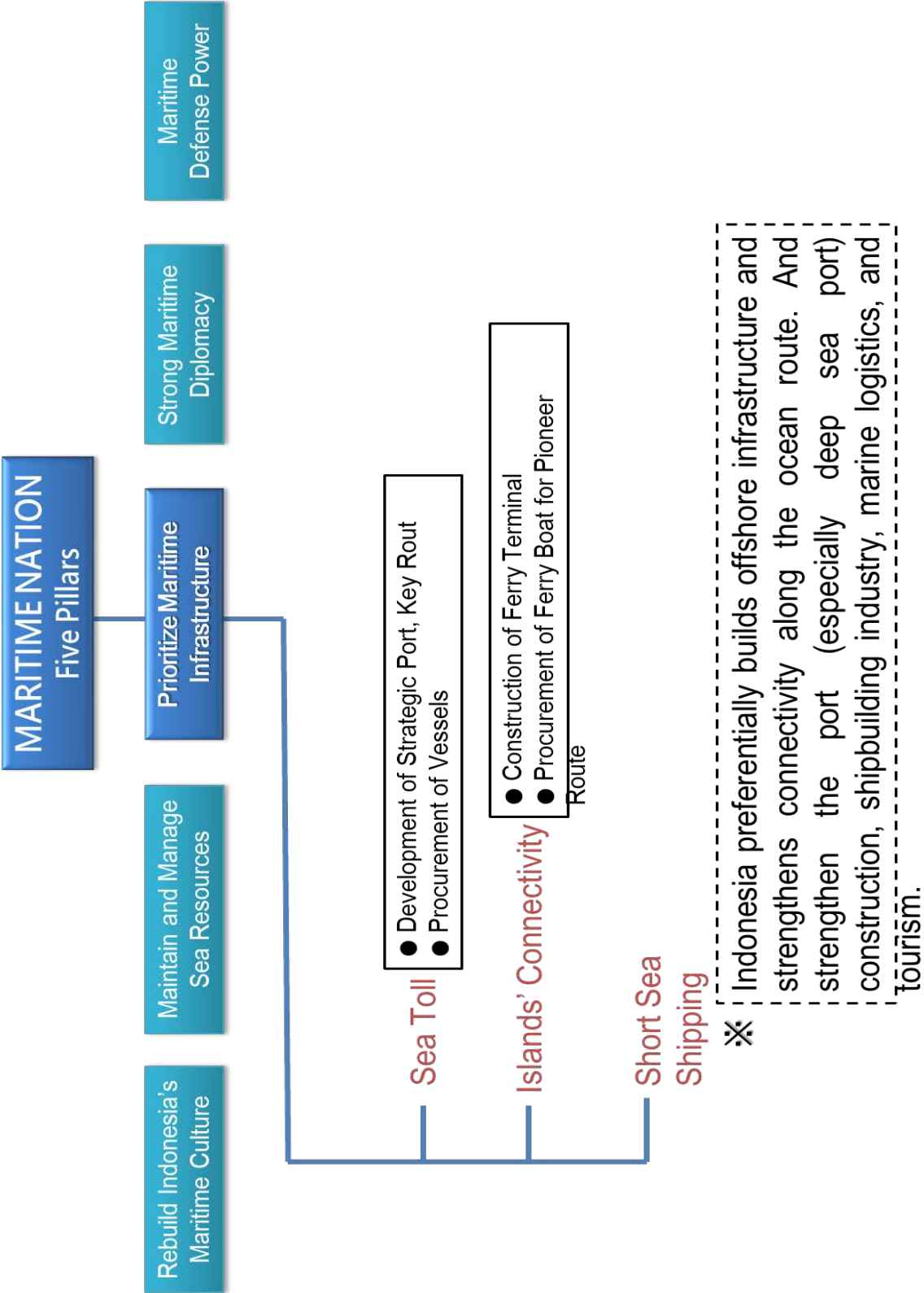

Figure 2.1 -2 : Locations of Strategic Ports

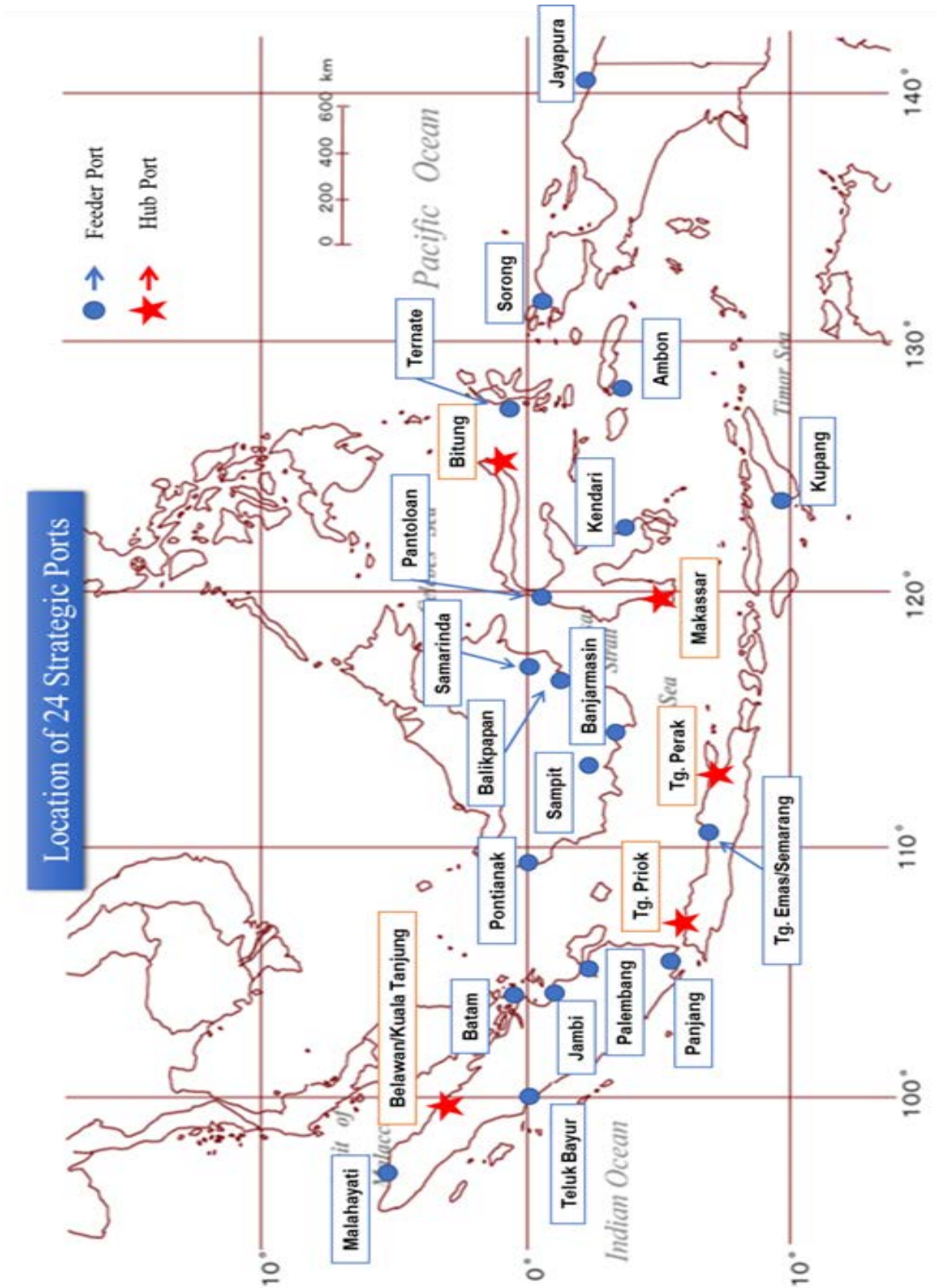
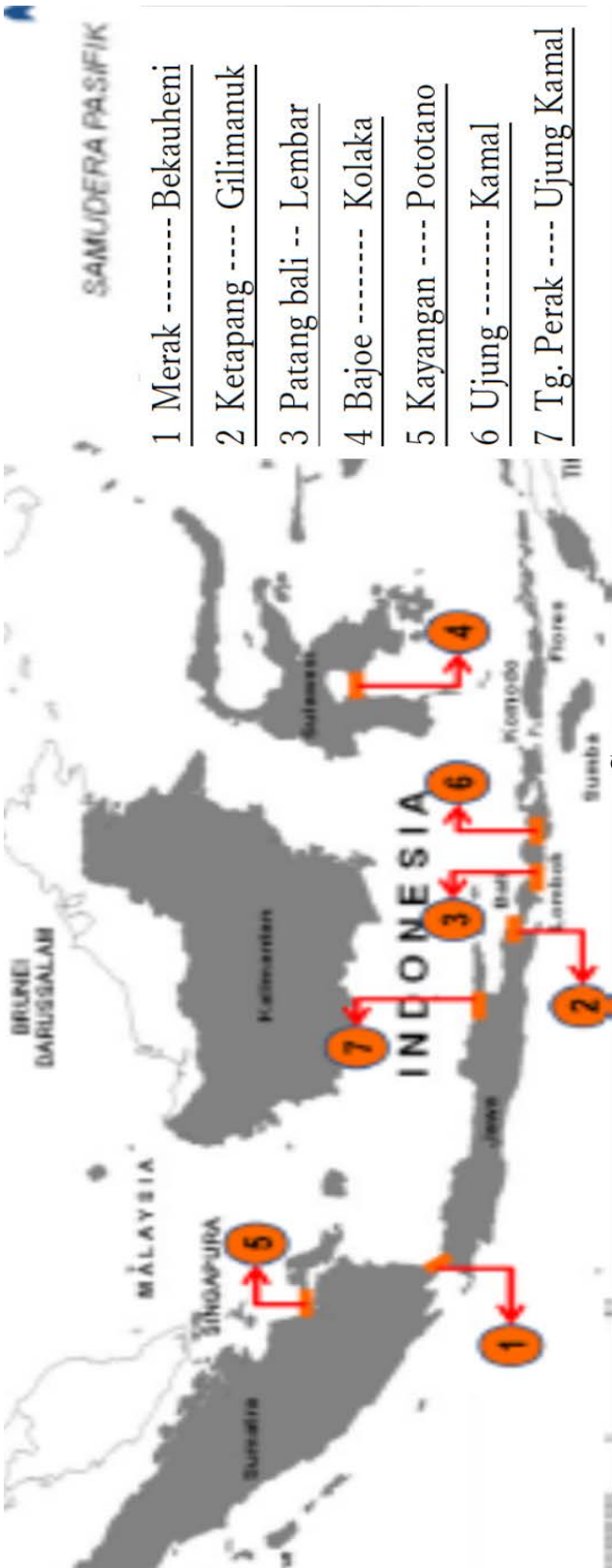

Figure 2.1 -3 : Main Ferry Terminals



Source : Interferry Conference, 2016 Oct.

Figure 2.1 -6 : Ship's Routing

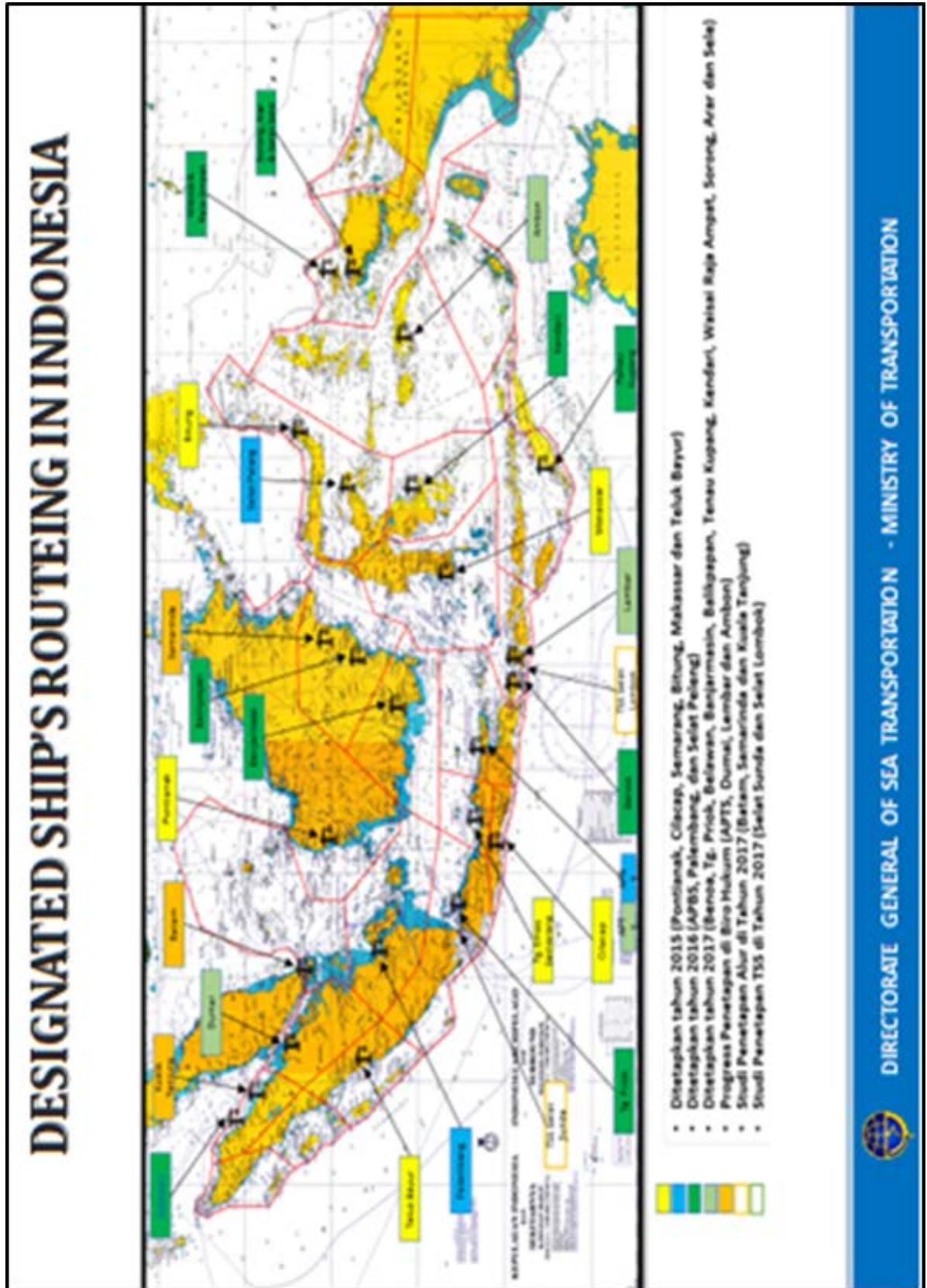
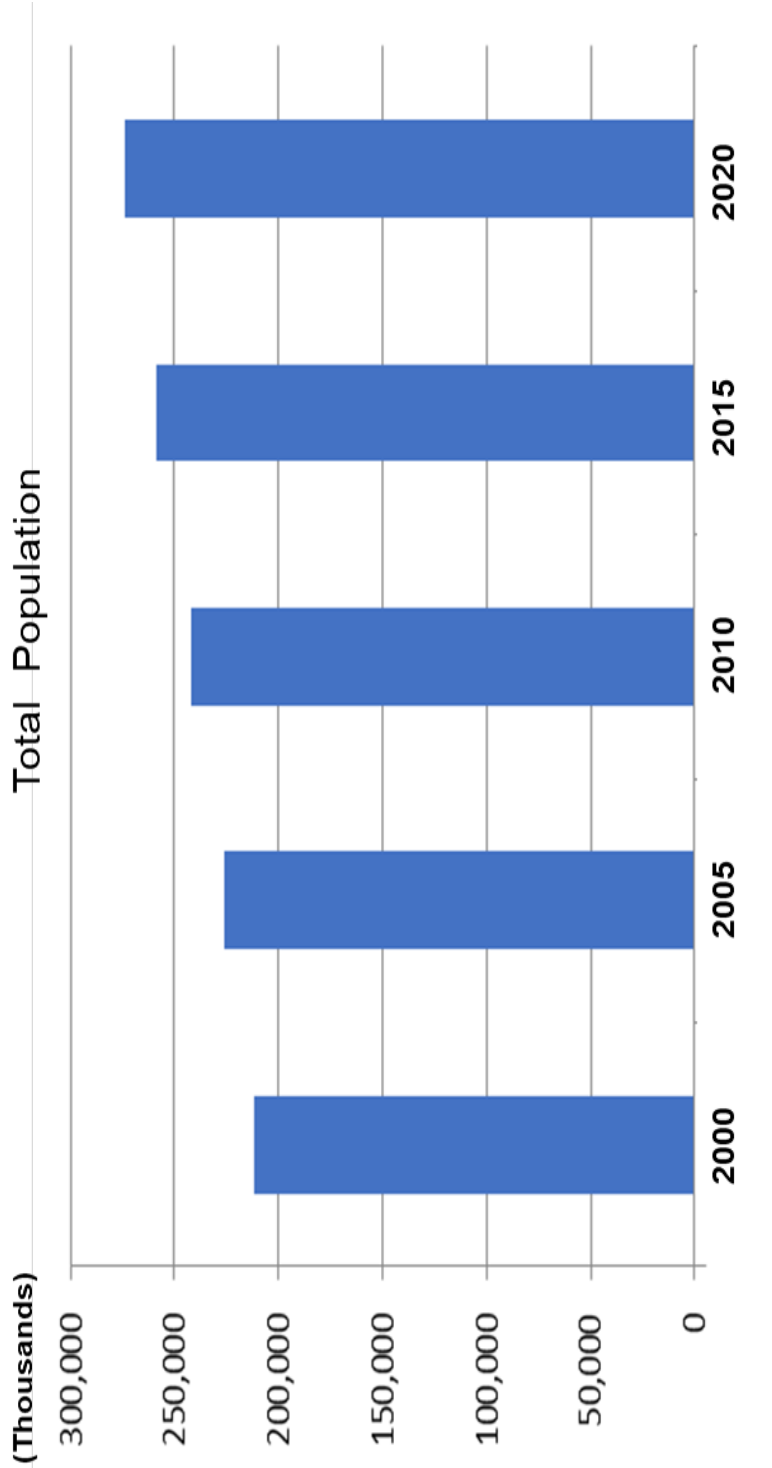

Table 2.2 -1 : Total Population and Change Rate

Total Population and Changing Rate of Indonesia

Year	2000	2005	2010	2015	2020
Population (Thousands)	211,510	226,290	241,830	258,380	273,520
Rates of Population Change	1.4		1.3		
			1.3		1.2



Population Pyramid

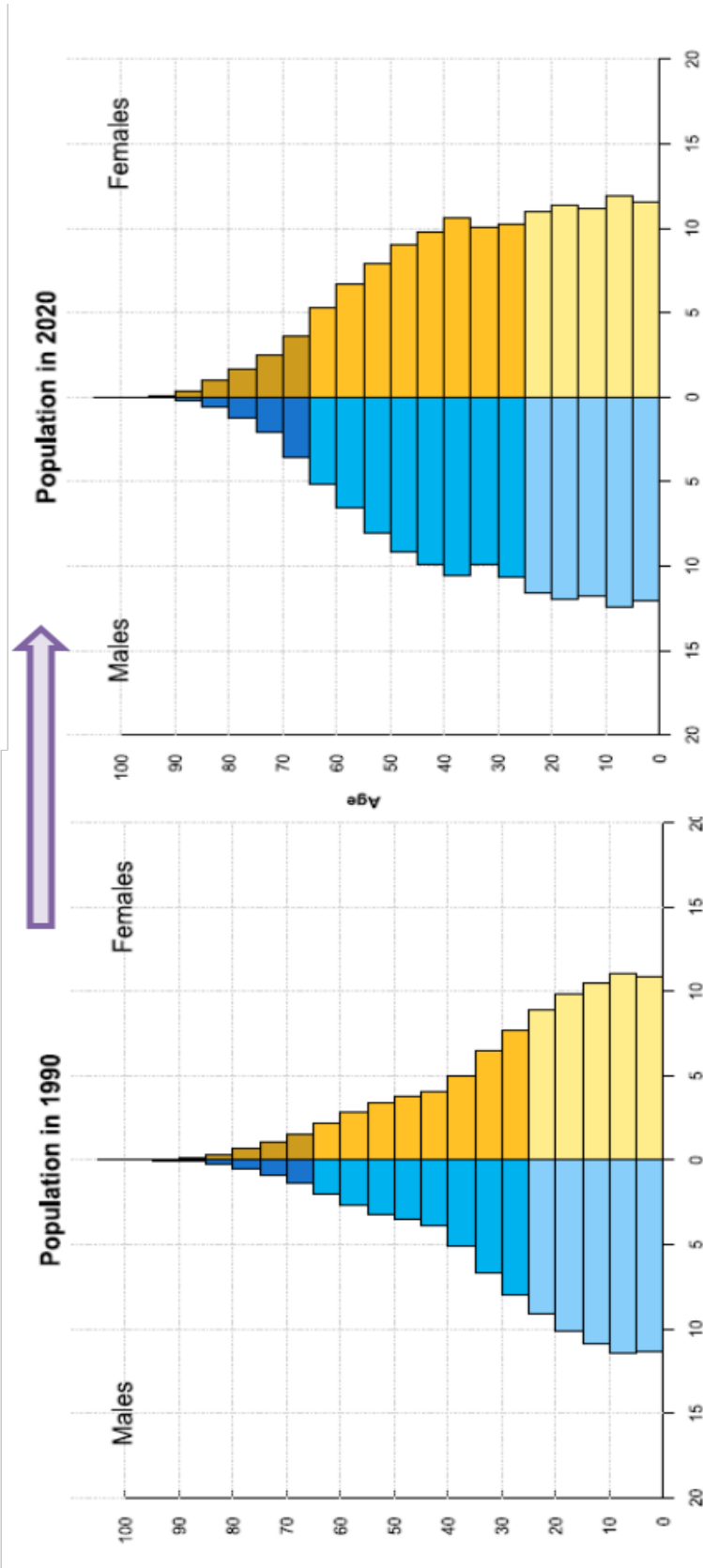

Figure 2.2.1 -1: Population Pyramid

United Nations, Department of Economic and Social Affairs, Population Division
World Population Prospects 2019, Volume II: Demographic Profiles

Table 2.2.2 -1 : Economic Growth Rate

Year	2001	2002	2003	2004	2005	2006	2007	2008	2009	2010
Rate	3.6	4.5	4.8	5	5.7	5.5	6.3	7.4	4.7	6.4
Year	2011	2012	2013	2014	2015	2016	2017	2018	2019	
Rate	6.2	6	5.6	5	4.9	5	5.1	5.2	5.2	

※Data from SNA (System of National Accounts)

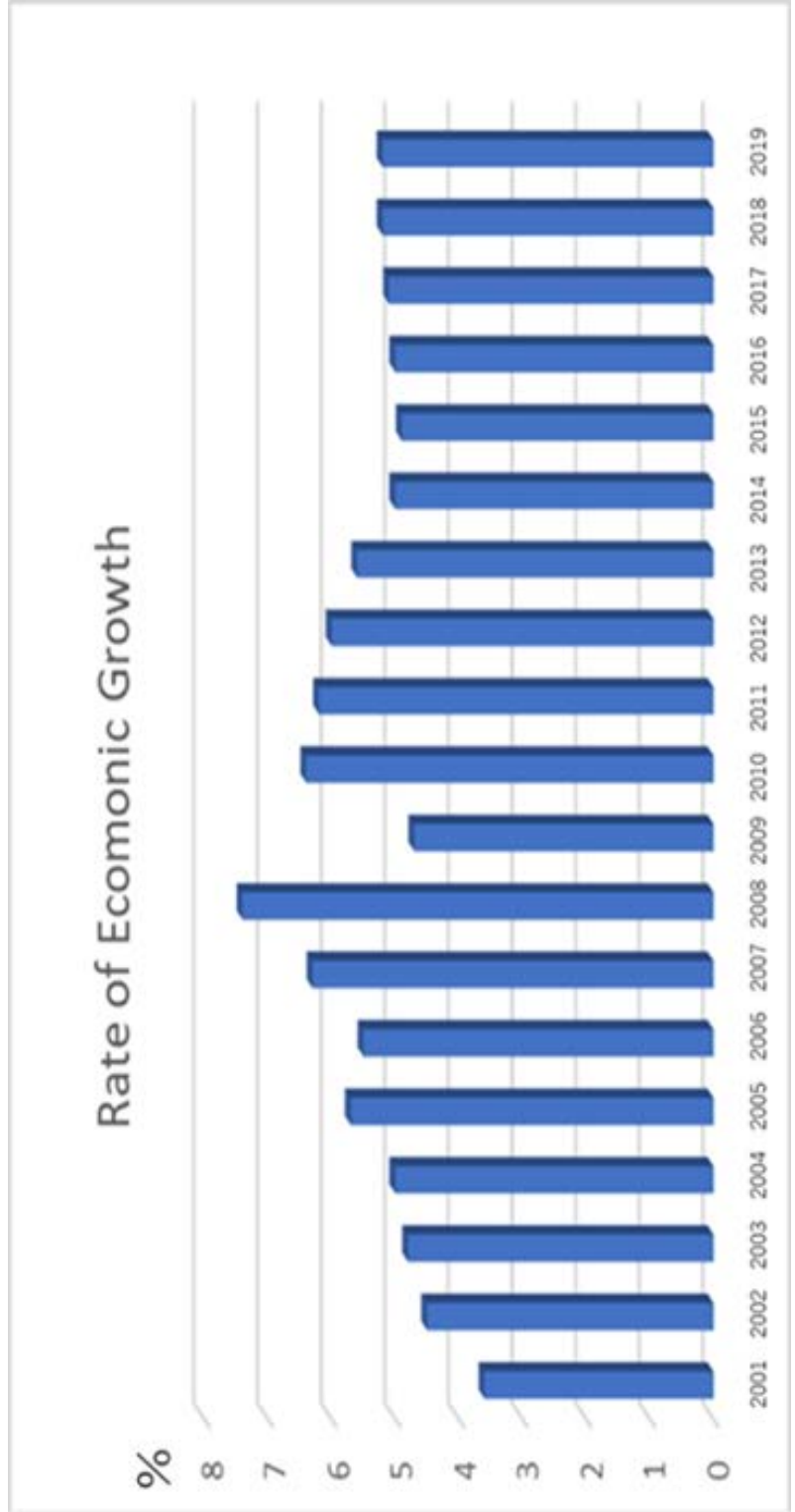

Table 2.2.2 -2 : Real GDP Growth Rates of Transportation and Warehouse

Year	2011	2012	2013	2014	2015	2016	2017	2018
Rate (%)	8.3	7.1	7	7.4	6.7	7.5	8.5	7

* Source: Compiled from Indonesia Central Bank Statistics

Table 2.2.2 -3 : Inter-Island and International Cargo Loading and Unloading 2000 – 2018

(Thousands Ton)

Year	Inter Island	International	Total
2000	265,252	186,568	451,820
2001	291,340	206,095	497,435
2002	308,150	217,118	525,268
2003	305,459	223,056	528,515
2004	301,177	205,994	507,171
2005	312,864	211,129	523,993
2006	274,552	191,063	465,615
2007	326,784	274,083	600,867
2008	414,207	190,045	604,252
2009	491,162	284,815	775,977
2010	404,161	298,863	703,024
2011	523,232	455,488	978,720
2012	640,314	557,909	1,198,223
2013	639,944	600,211	1,240,155
2014	710,345	517,725	1,228,070
2015	614,850	441,186	1,056,036
2016	686,372	406,116	1,092,488
2017	743,444	377,895	1,121,339
2018	775,290	405,469	1,180,759

Source : Bodon Pusat Statistik
(BPS Statistics Indonesia, Port Authority)

Reference : Graph of Table 2.2.2 -3

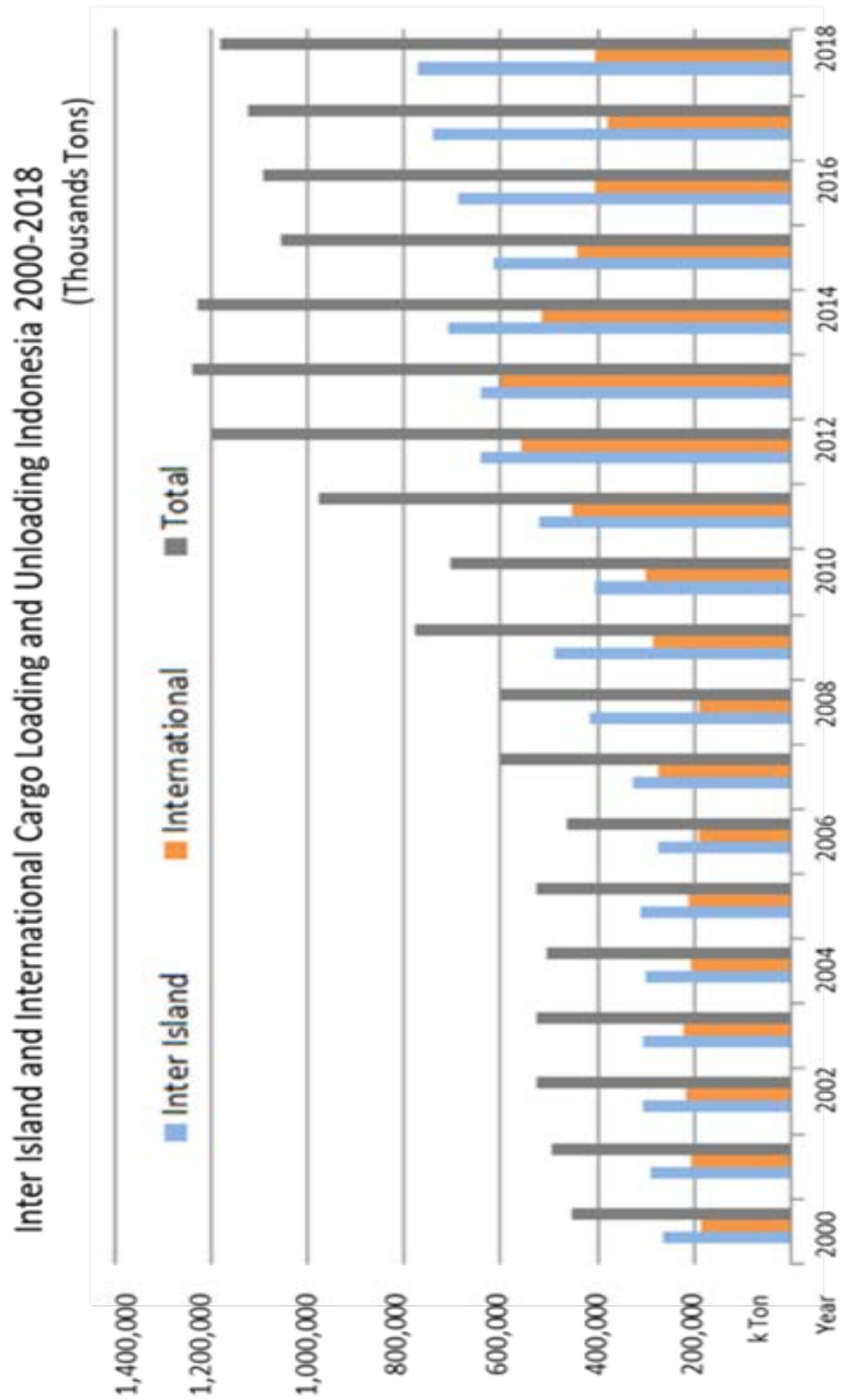

Graph 2.2.3 -1 : Number of Ships Call at Port Indonesia, 1995-2018

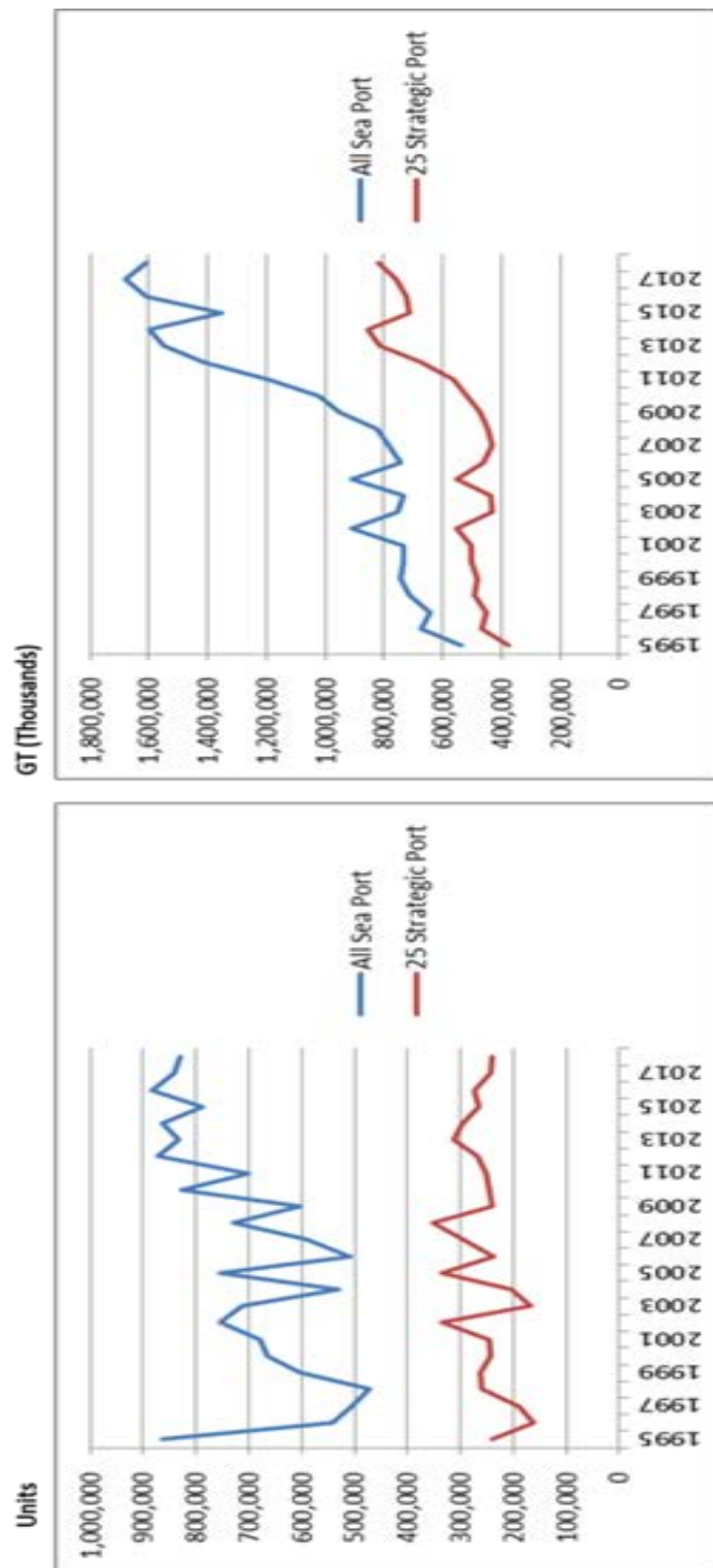

Source : Badan Pusat Statistik
(BPS - Statistics Indonesia)

Figure 2.2.3 -1 : The number of Ships-Call at the 25 strategic ports, 2018

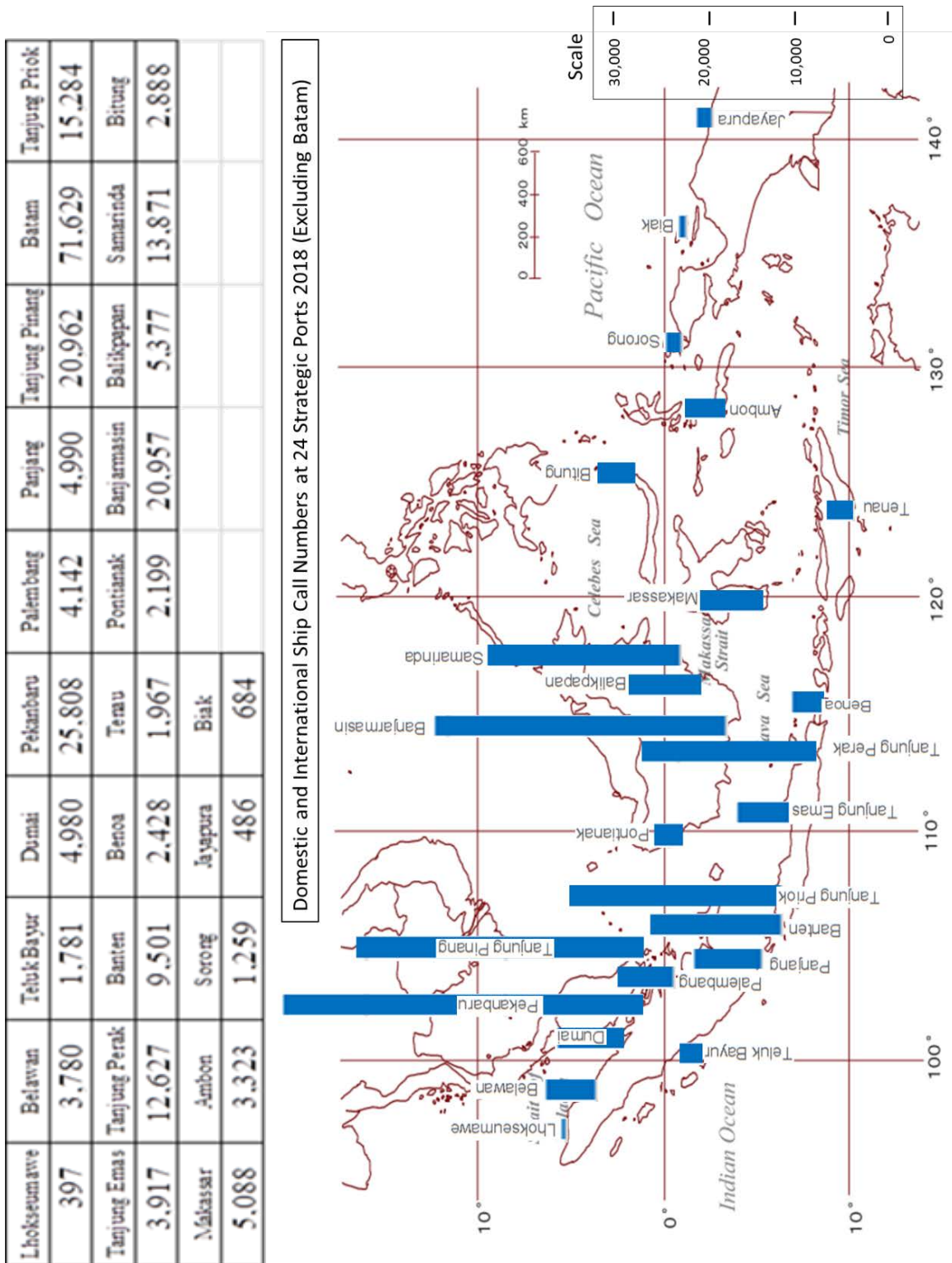
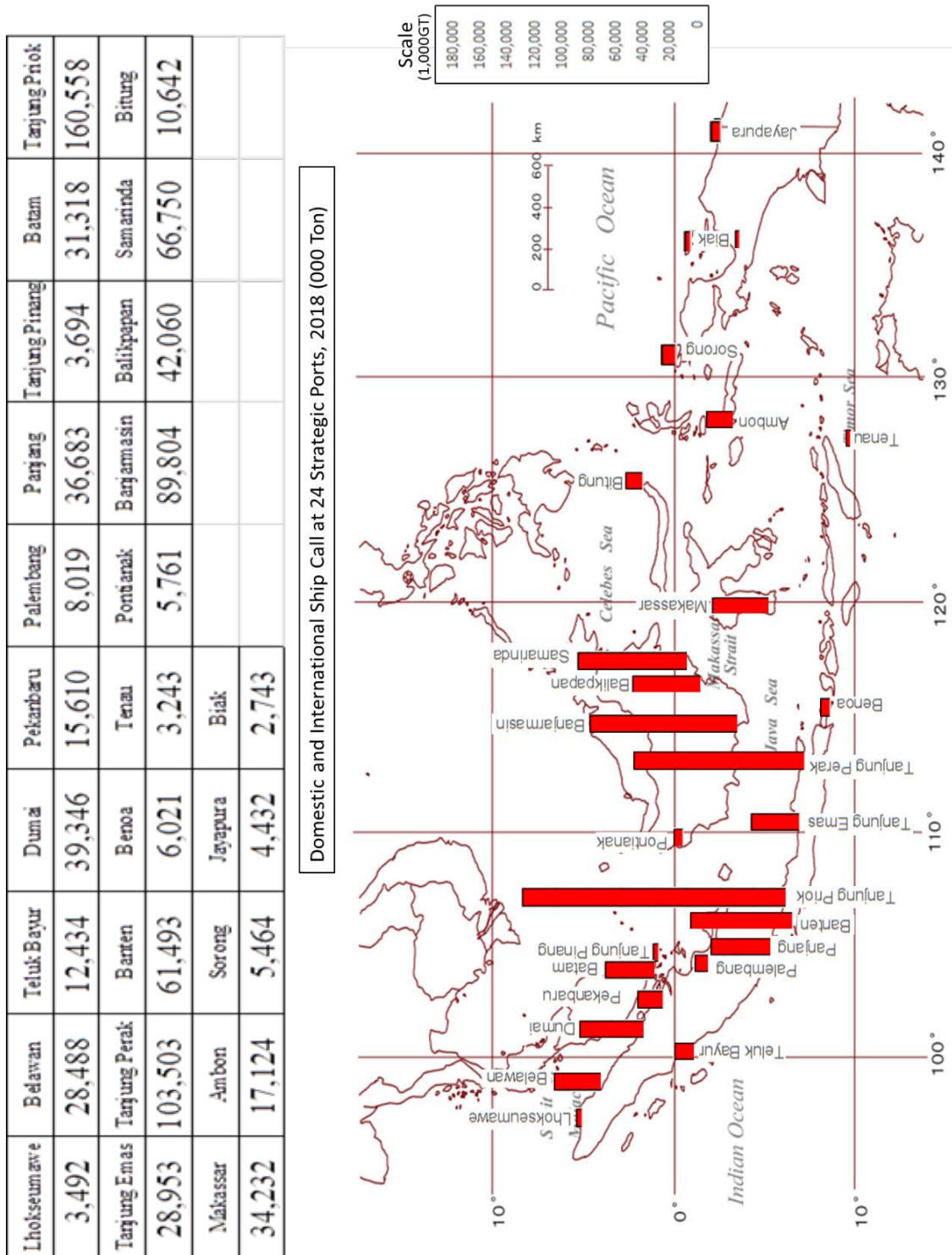

Figure 2.2.3 -2 : The volume of Ships-Call at the 25 strategic ports, 2018



Graph 2.2.3 -2 : Number of Ships Passenger
(at Commercial and Non Commercial Sea Port, 1995-2018)

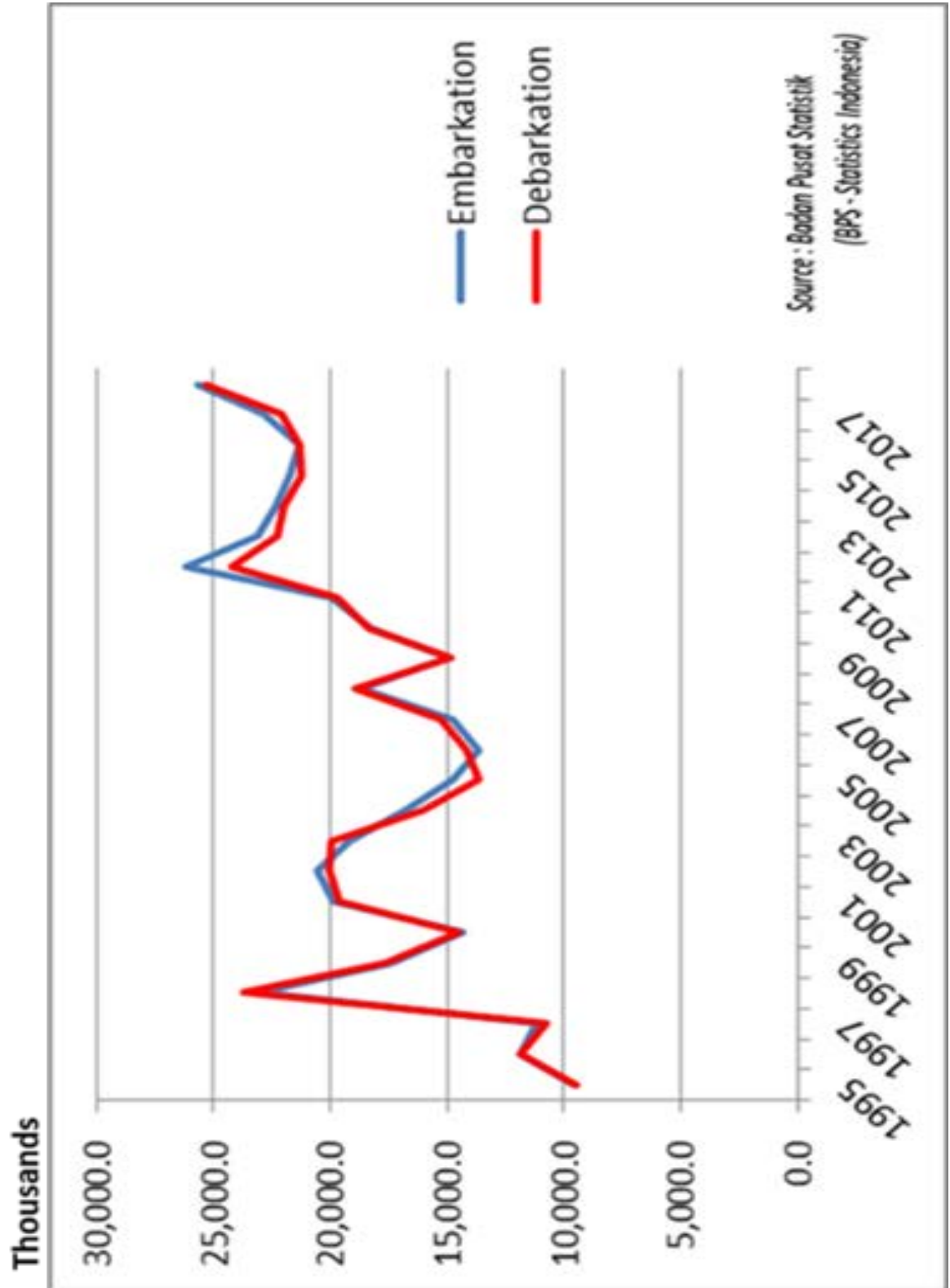

Table 2.2.3 -1 : Comparison of West and East

	West	East	Remarks
Population	84%	16%	Total 255mil (2015)
Cargo volume	80%	20%	
Ship calls	88%	12%	Excluding Batam
Passenger	27%	73%	Excluding Batam & Tg Pinang

Figure 2.2.3 -4 : Total of Em/De-barkation Passenger of Domestic Voyage at 5 Main Ports, 2006-2020 (Persons)

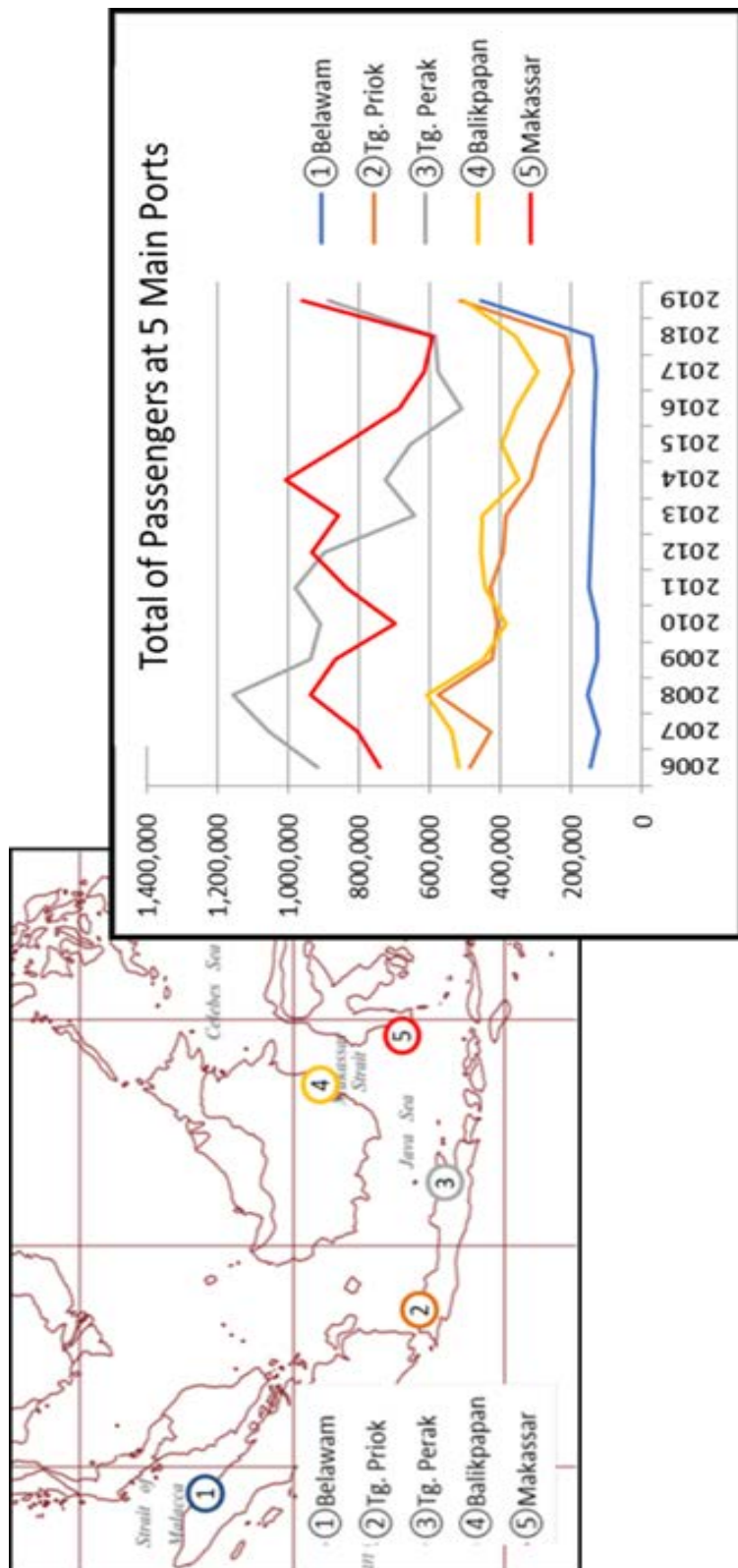
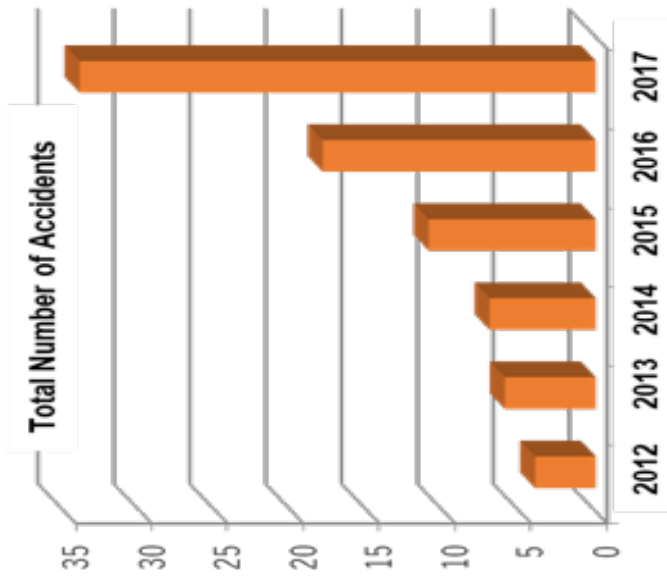

Table 2.3 -1 : Marine Accident in Indonesia

Year	Number of Accidents	Accident Type				Fatalities		
		Sinking	Fire / Explosion	Collision	Aground	Other	Dead / Missing	Injure
2012	4	0	2	2	0	0	13	10
2013	6	2	2	2	0	0	65	9
2014	7	2	3	2	0	0	22	4
2015	11	3	4	3	1	0	85	2
2016	18	6	4	3	3	2	46	18
2017	34	6	14	6	6	2	42	2

Data on Shipping Transportation Accidents

Investigated by KNKT (2012 - 2017)



Source : KOMITE NASIONAL KESELAMATAN TRANSPORTASI
NATIONAL TRANSPORTATION SAFETY COMMITTEE

Figure 2.3-1 : Distribution Map and Percentage Map of Marine Accidents

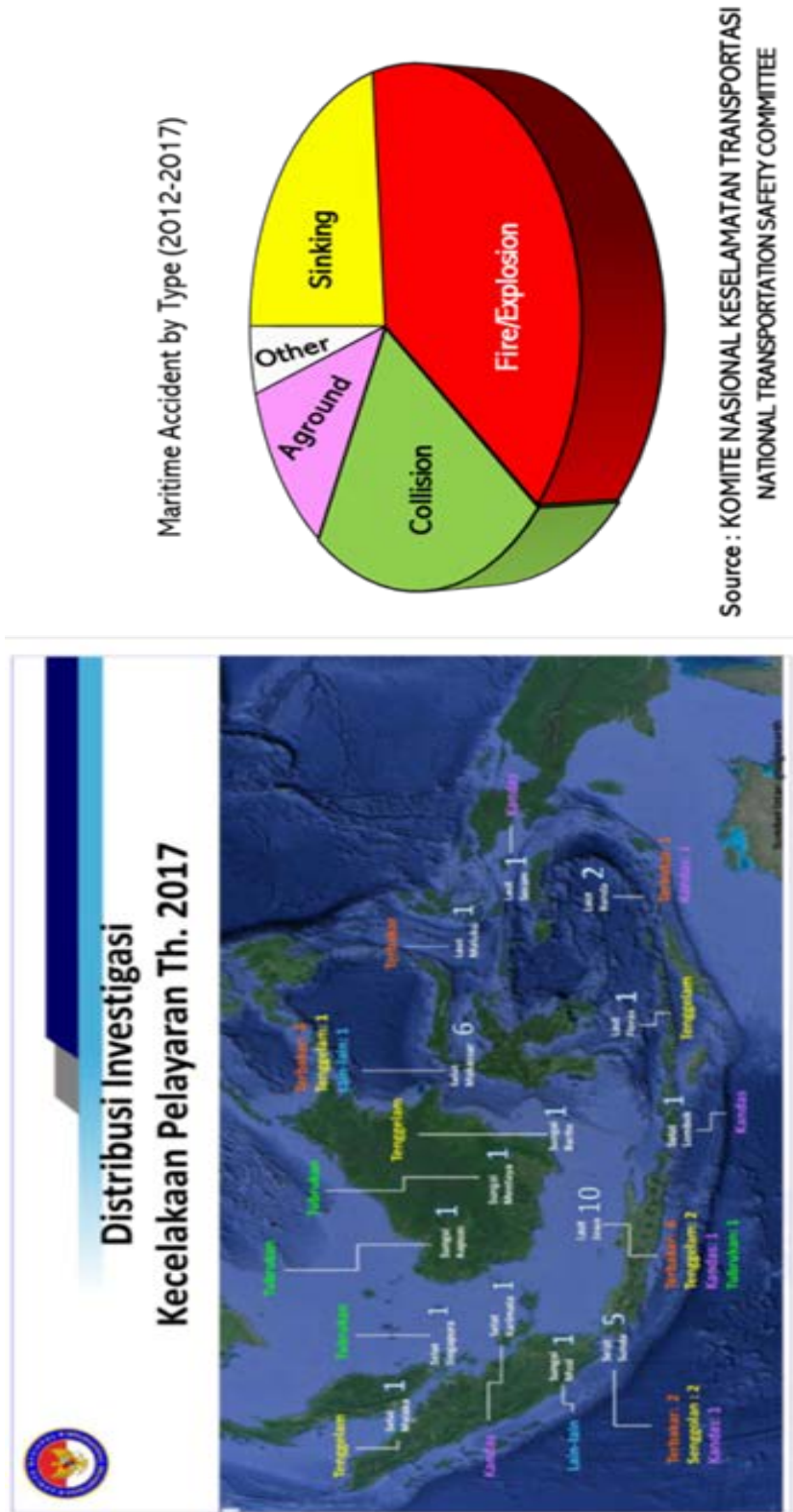

Figure 2.4 -2 : TSS Sunda Strait

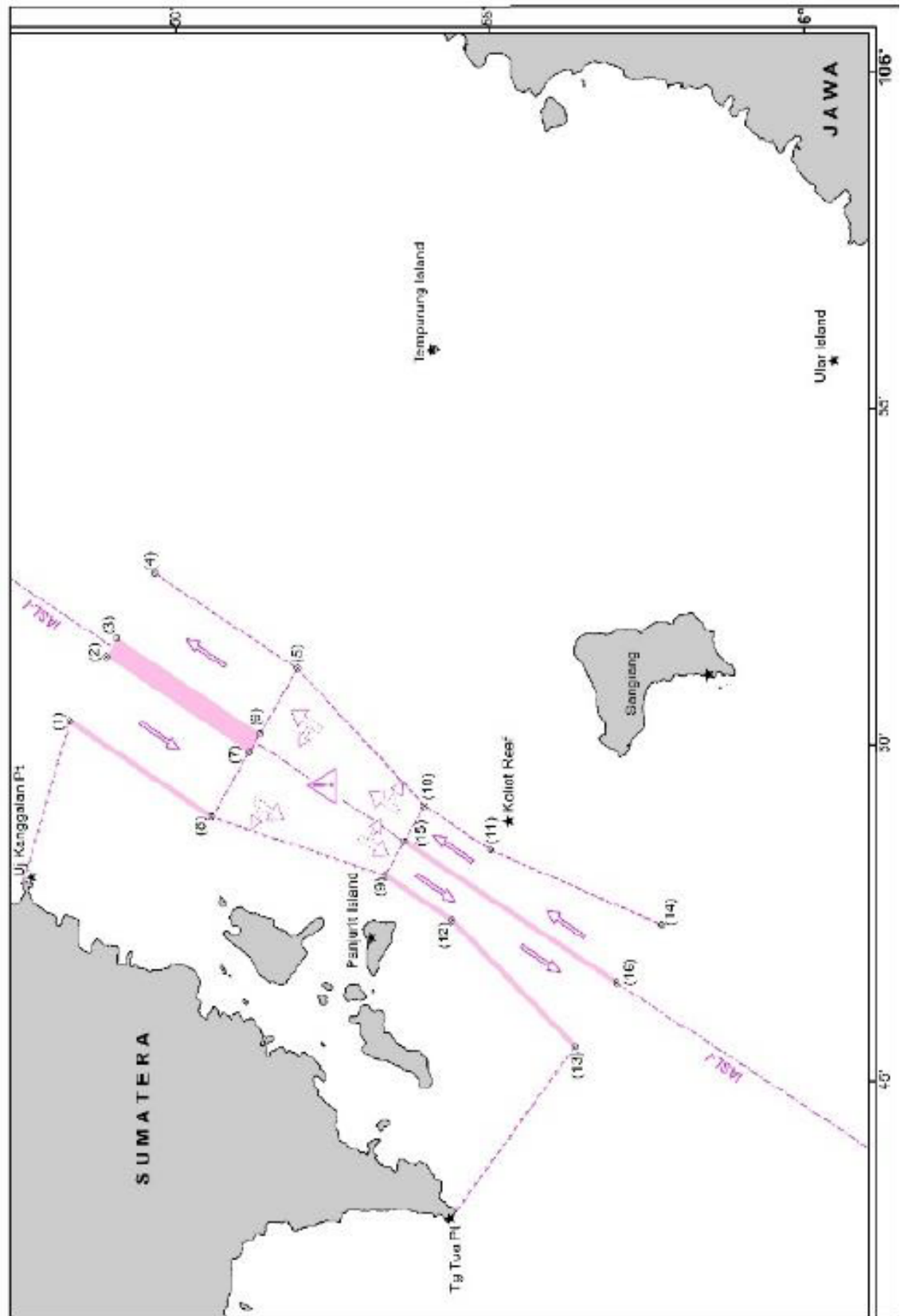

Figure 2.4 -3 : TSS Lombok Strait

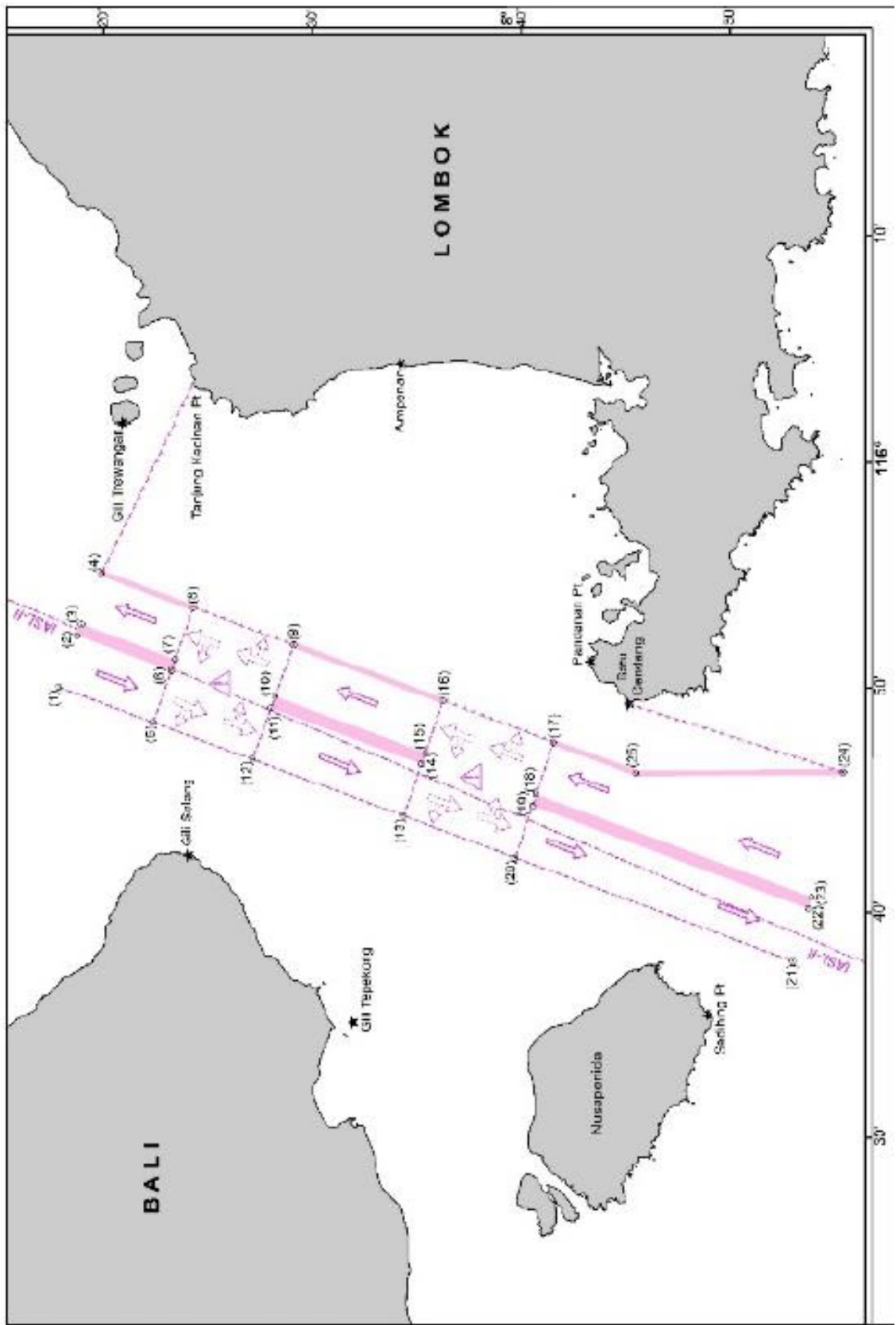

Figure 2.5 -1 : Density Map of AIS Vessels

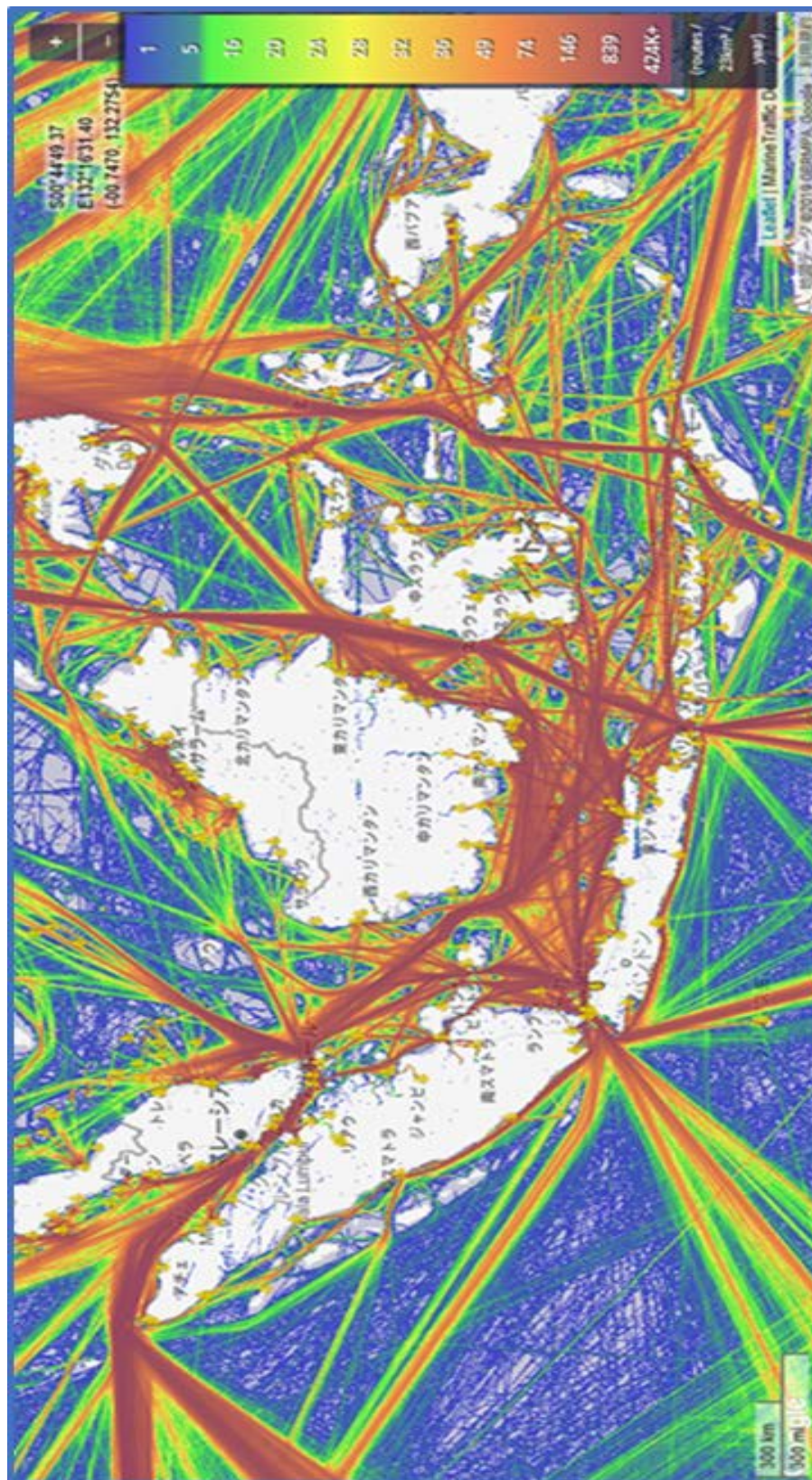

Figure 2.6 -1 : The Map of INAPORTNET in Operation

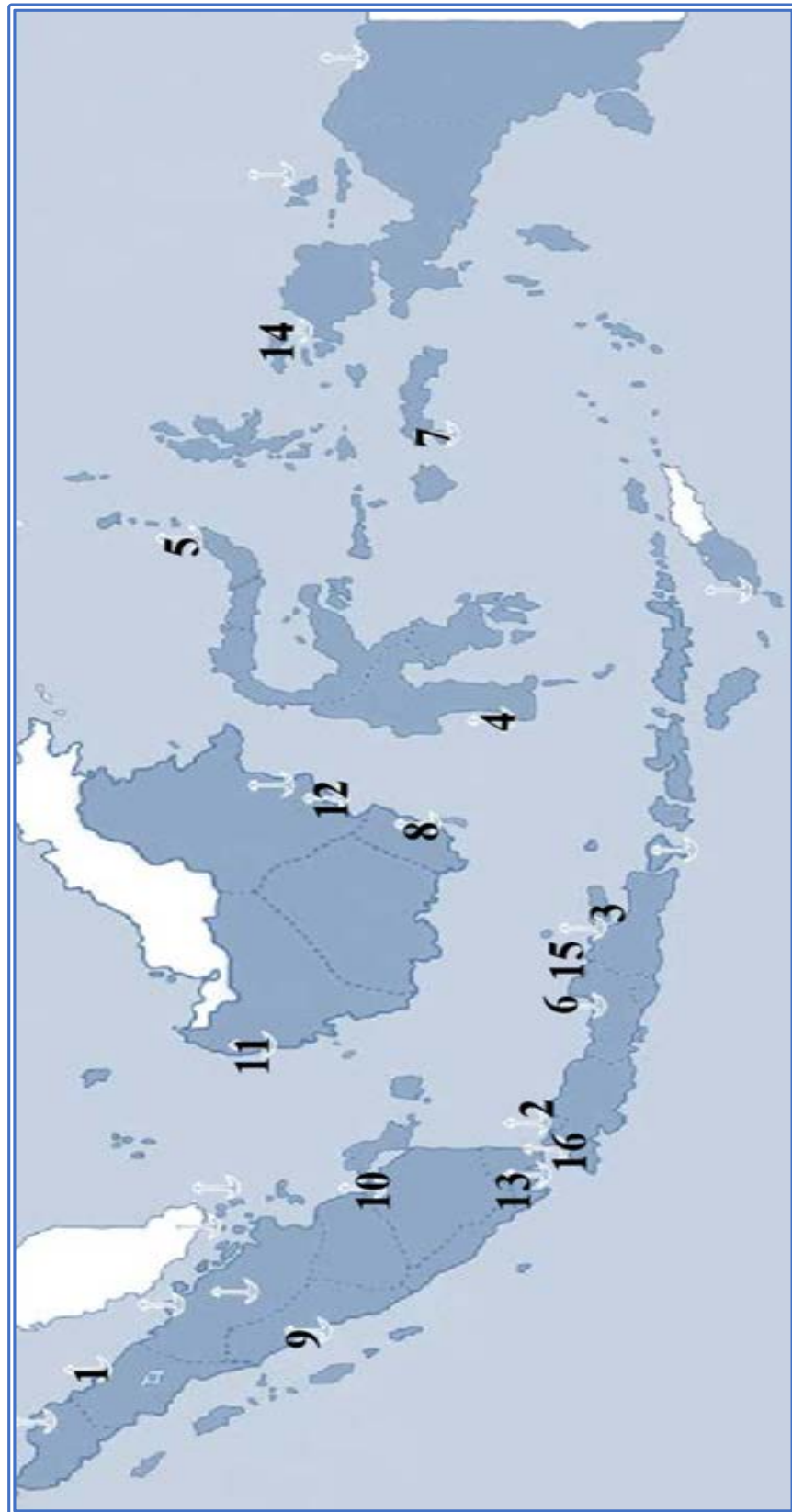

Table 2.7.1 -1 : Change in Population and Changing Rate

Year	2000	2005	2010	2015	2020	2025	2030	2035	2040
Population(Thousands)	211,510	226,290	241,830	258,380	273,520	287,090	299,200	309,760	318,640
Rates of Population Change	1.4				1.3		1.1		1.0
	1.3		1.2		1.0		0.9		

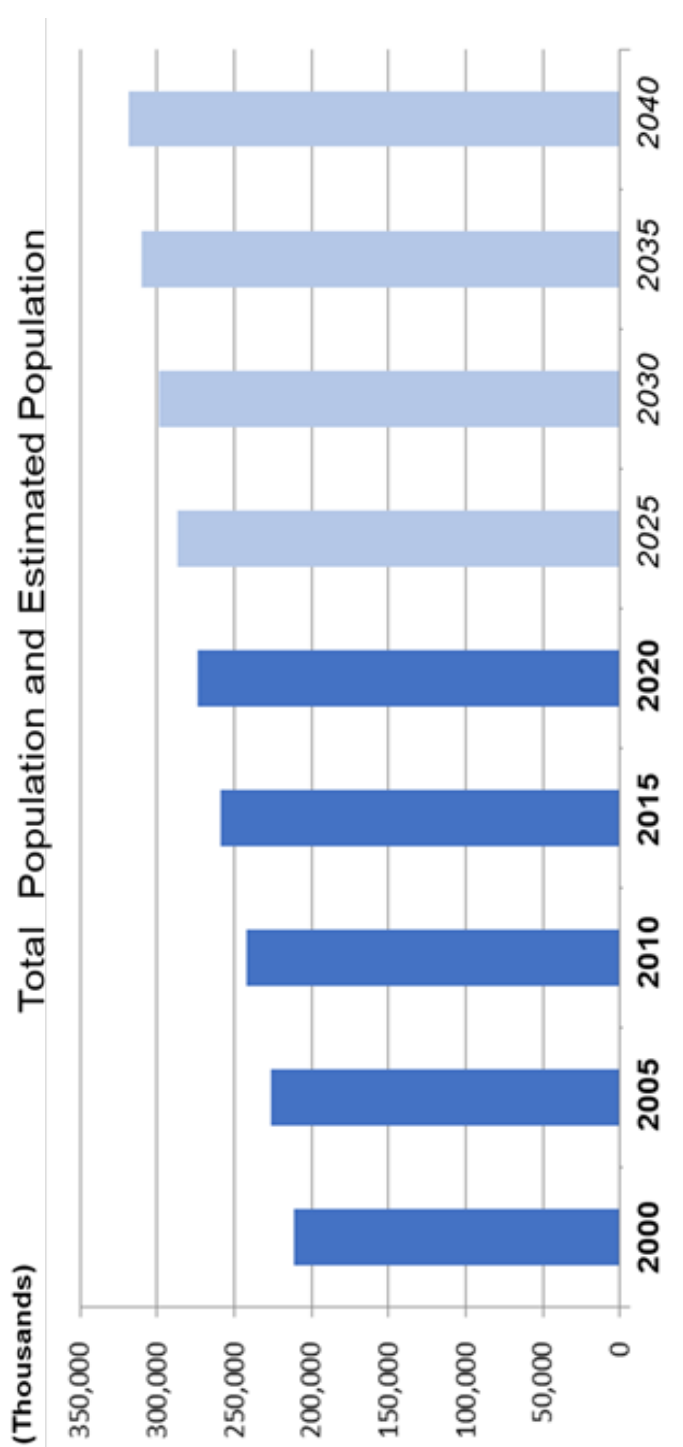

Figure 2.7.1 -1 : Population Pyramid in 2040

Sources : Populationpyramid.net, United Nations, Department of Economic and Social Affairs, Population Division, World Population Prospects

Population in 2040 : 318,637,860

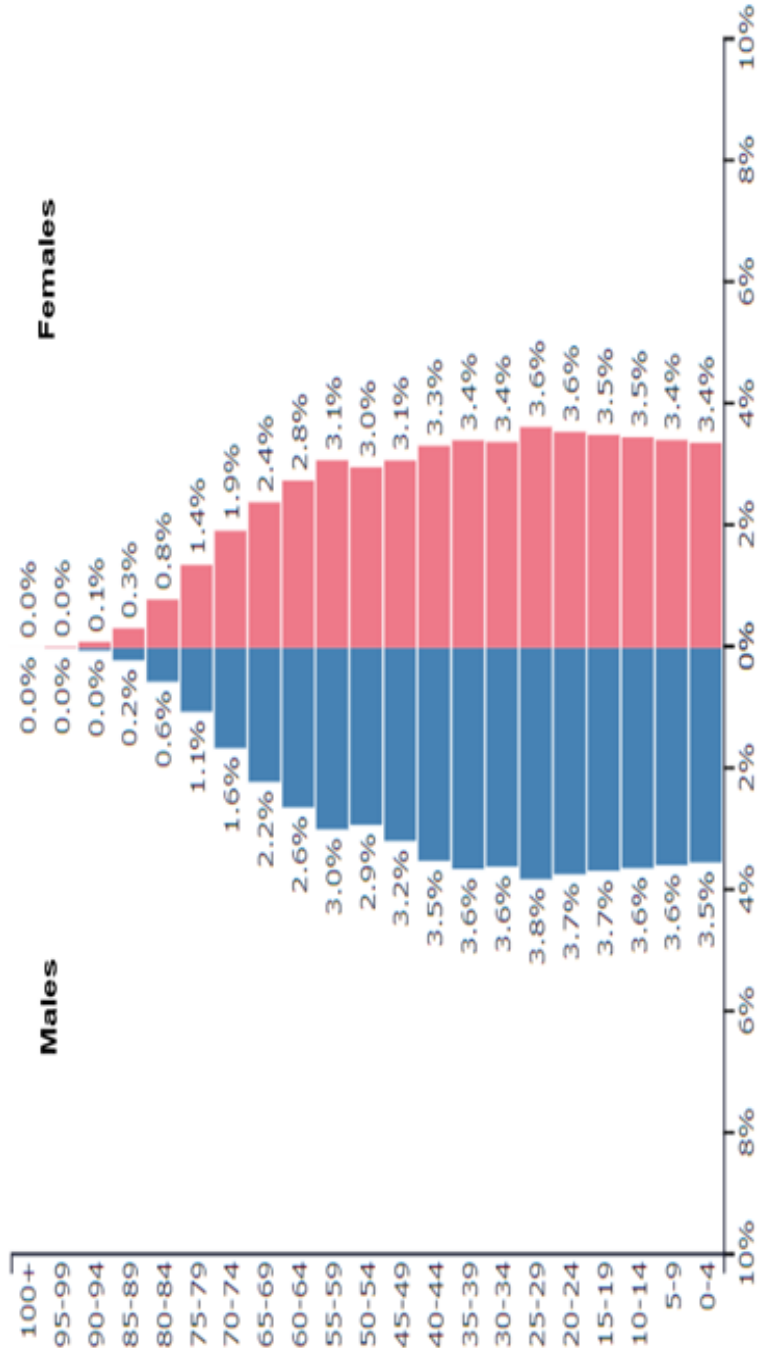

Table 2.7.2 -1: Economic Growth Forecast

Rate of Economic Growth						
Year	2010	2015	2020	2025	2030	2040
Rate	6.4	4.9	5.2	5.3	5.4	5.6

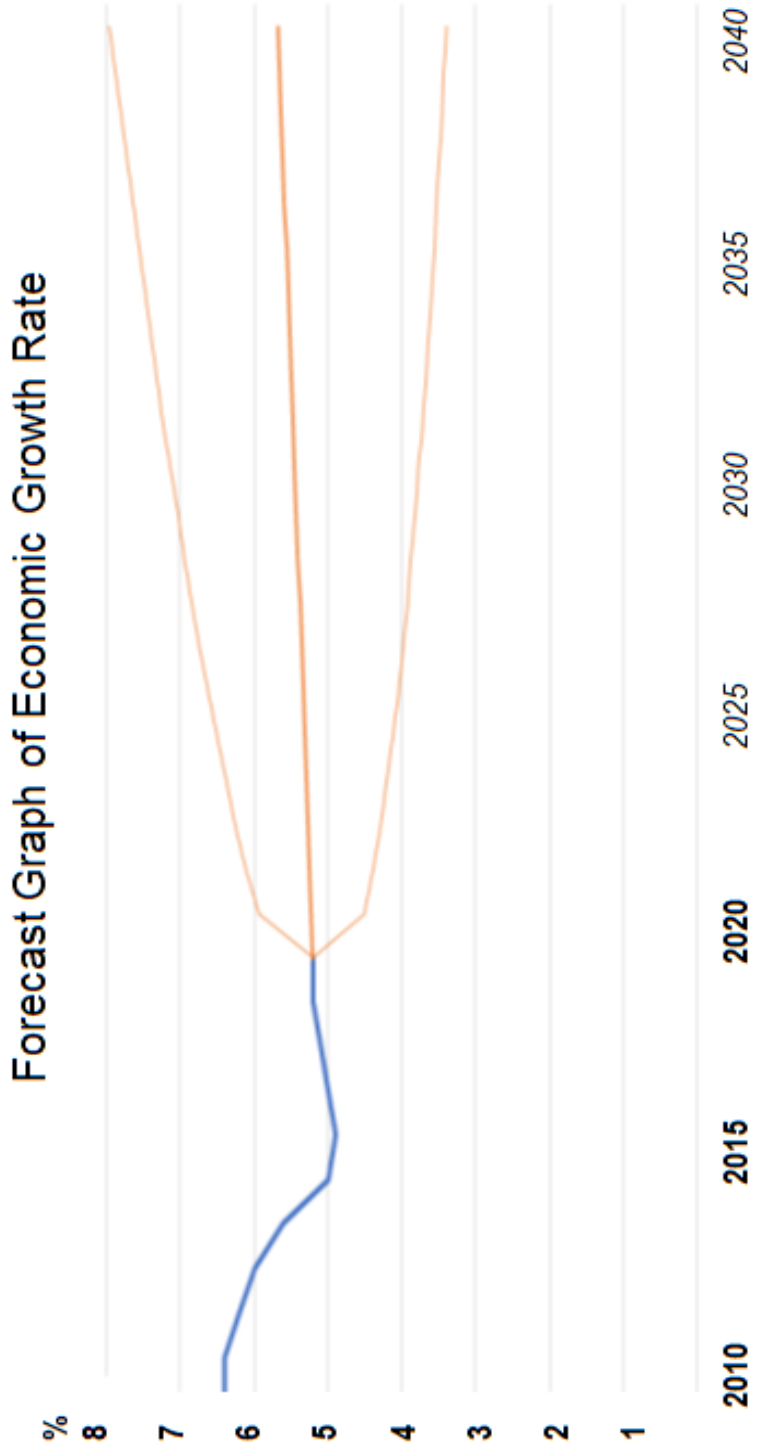

Table 2.7.2 -2: Economic Growth Forecast with Corona Shock

Rate of Economic Growth											
Year	2001	2005	2008	2009	2010	2015	2020	2025	2030	2035	2040
Rate (%)	3.6	5.7	7.4	4.7	6.4	4.9	5.2	5.3	5.4	5.5	5.6

Figure 2.7.2 -2 : Forecast Graph of Growth Rate with Corona Shock

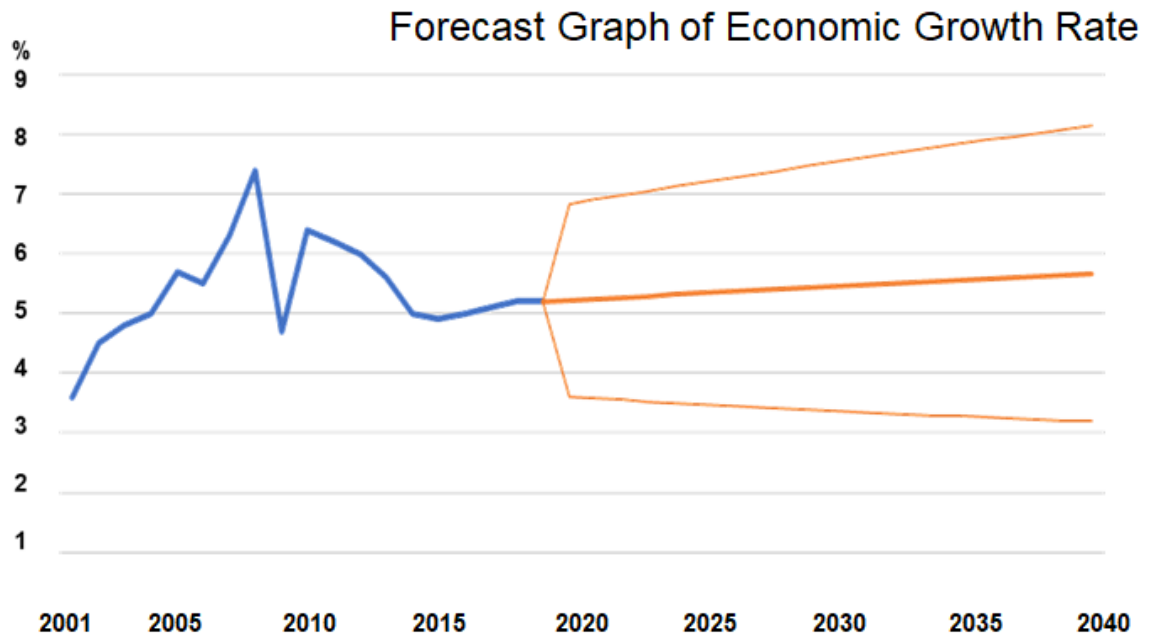

Table 2.7.2 -3: Economic Growth Rate Forecast

GDP Growth Rate of Transportation and Warehouse									
Year	2012	2014	2016	2018	2020	2025	2030	2035	2040
Rate (%)	7.1	7.4	7.5	7.0	7.1	7	6.9	6.8	6.7

Figure 2.7.3 -1 : Forecast Graph of Marine Transportation Cargo

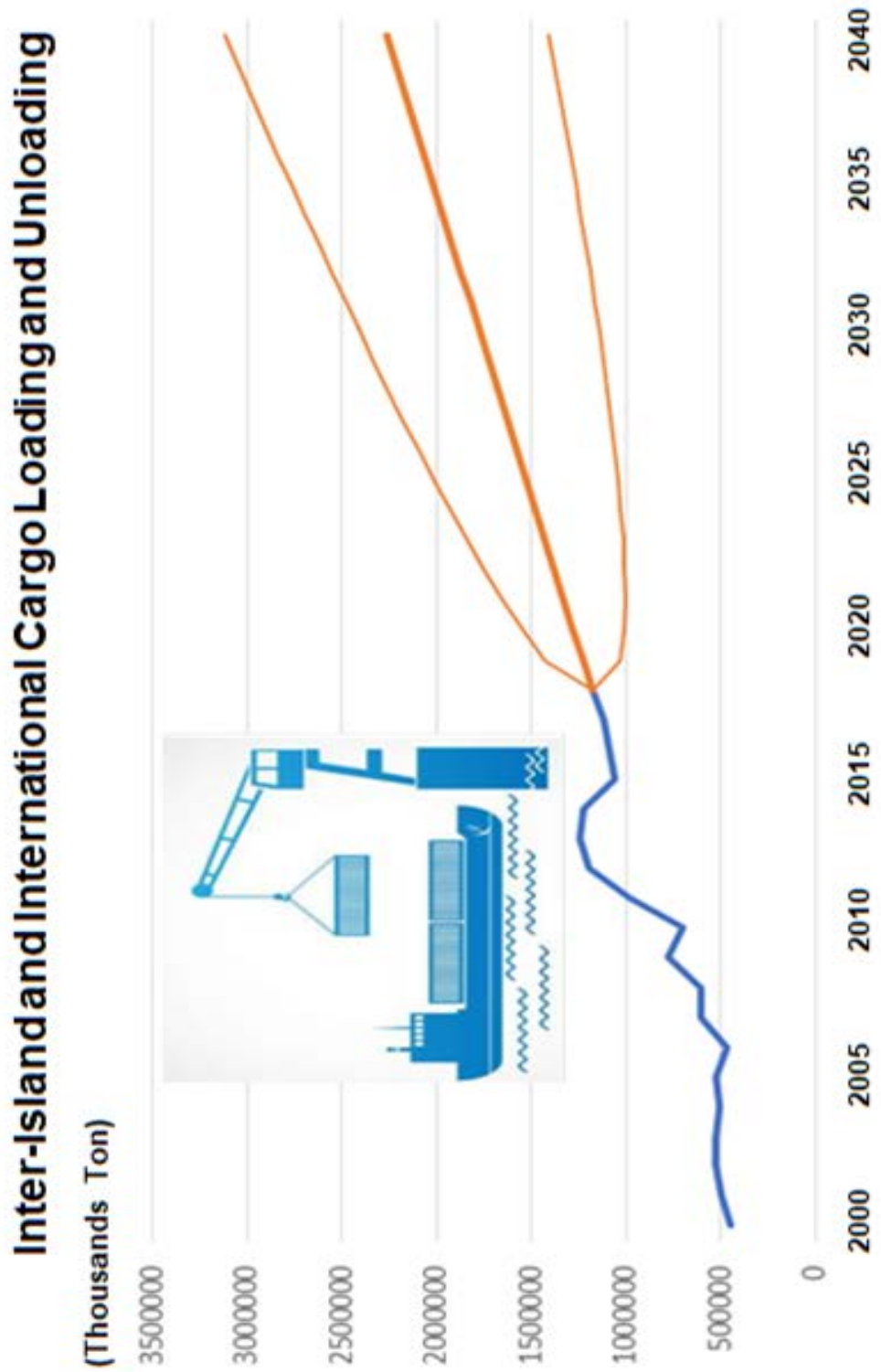

Figure 2.7.3 -2 : Forecast Graph of Inter-Island and International Cargo

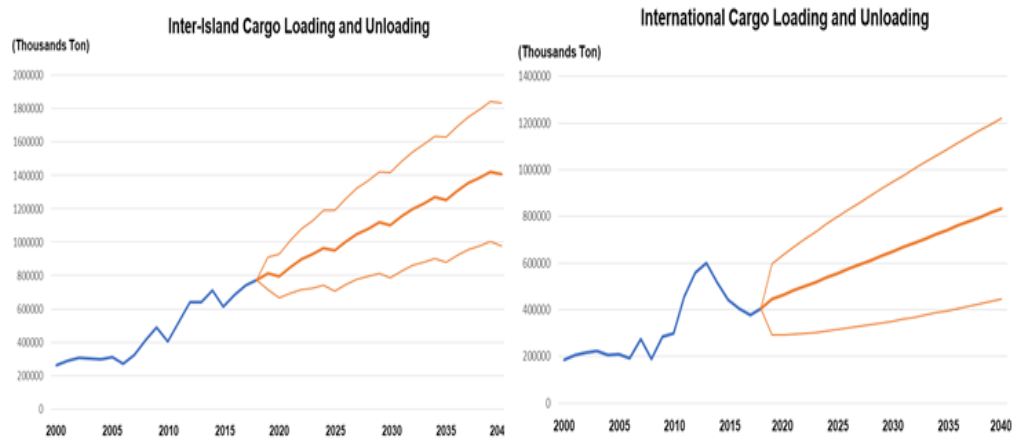

Figure 2.7.3 -3 : Forecast Graph of Change Ratio

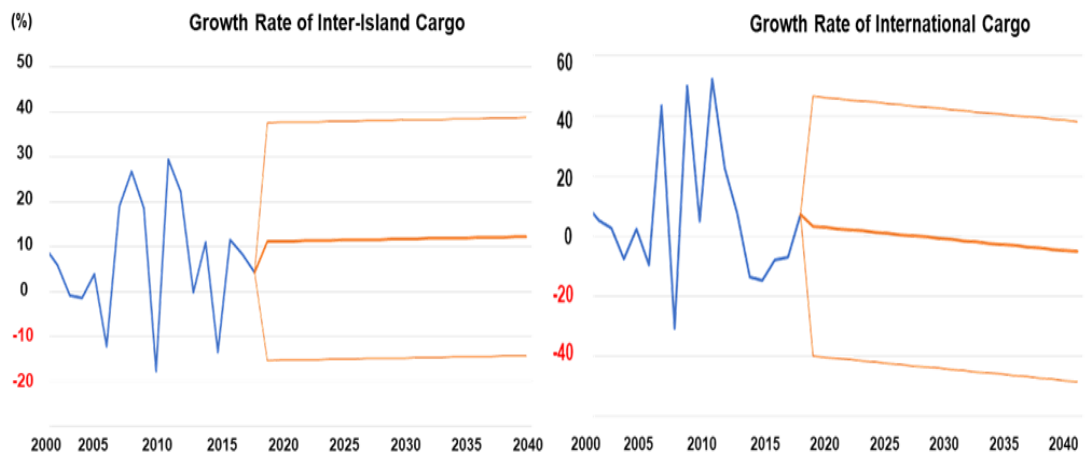

Figure 2.7.3 -6 : Forecast Graph of Cargo at Main Ports

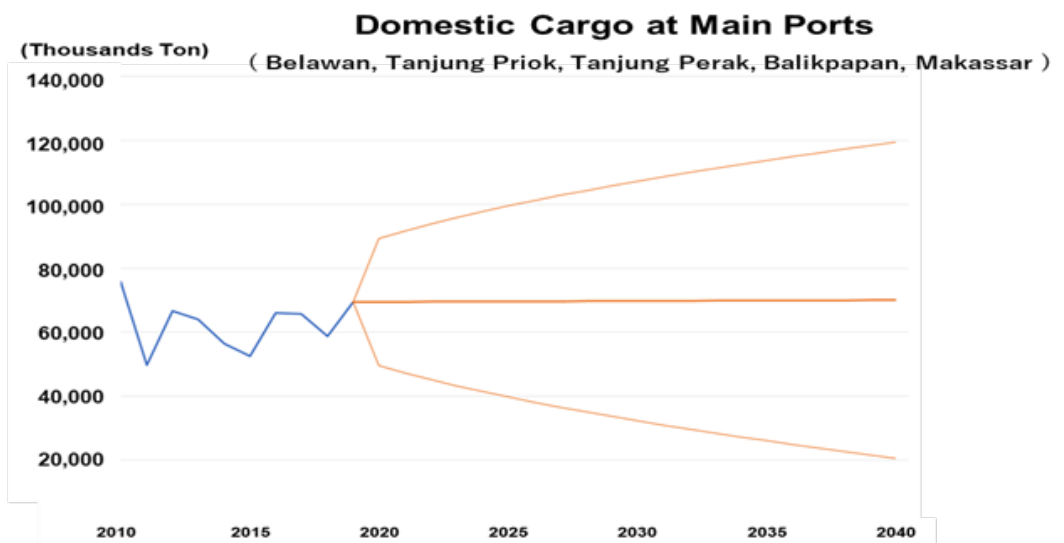

Figure 2.7.4 -1 : Number and Gross Tonnage of Ships Call (Nationwide)

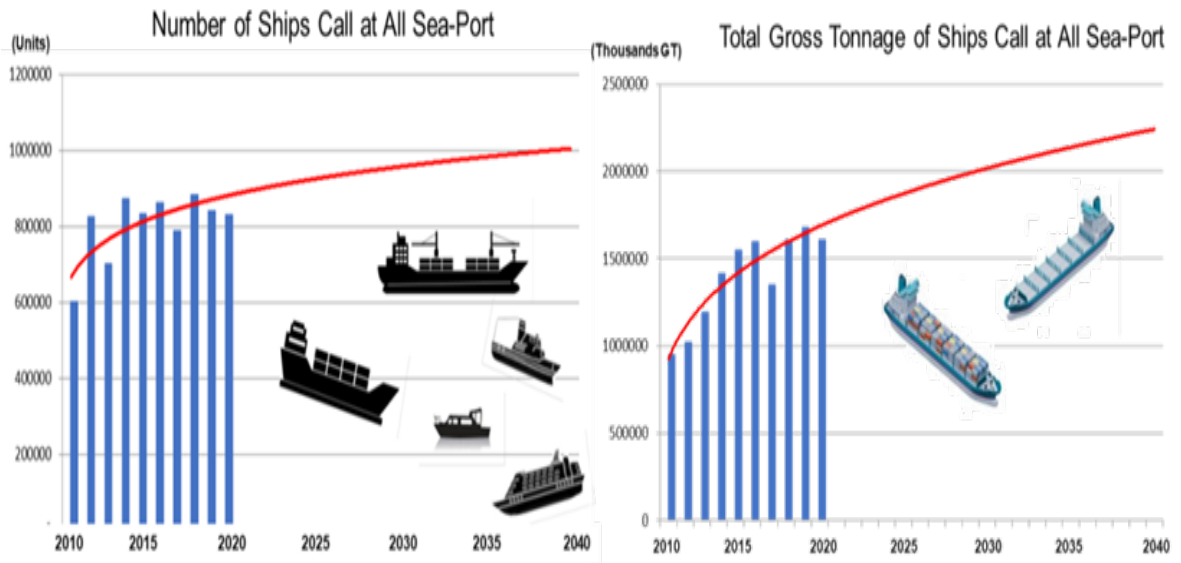

Figure 2.7.4 -2 : Number and Gross Tonnage of Ships Call (Strategic Port)

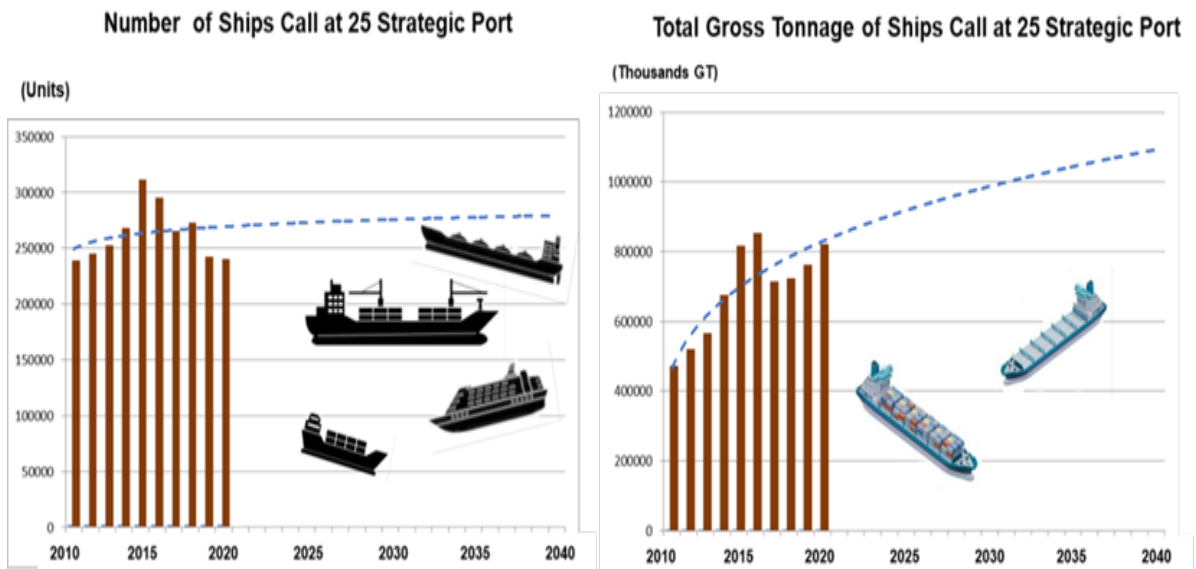
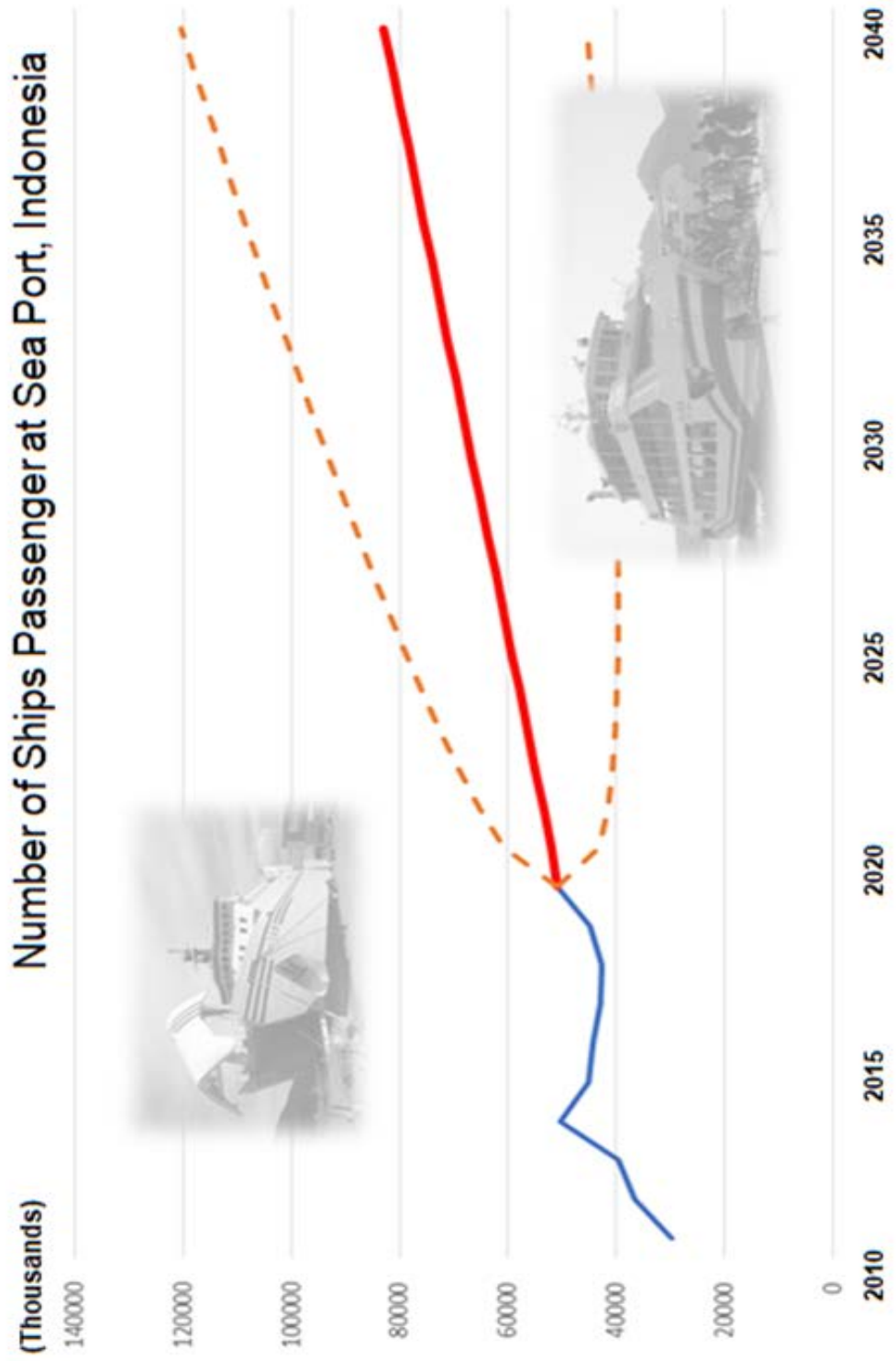
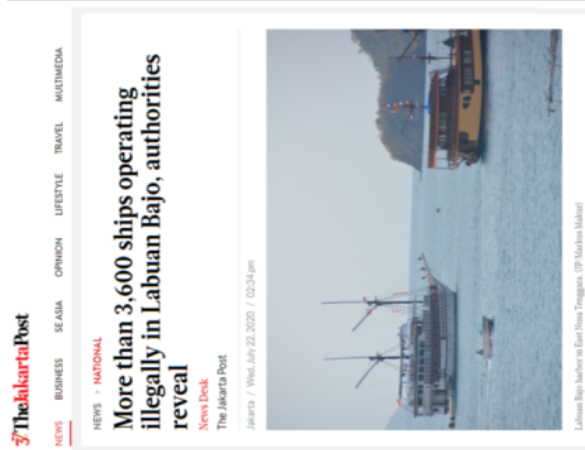

Figure 2.7.5 : Number of Ships Passenger



Reference : Tourism and Marine Accidents on Pleasure-Boats



<<Partial copy of the article>>

Of 4,081 ships inspected between February and July, only about 400 ships carried proper documentation and were registered to the local administration. The inspection was carried out by officials from the West Mangarai administration and Komodo National Park in Labuan Bajo.

Source : Internet News

Figure 2.7.6 : Cargo Volume at the Strategic Ports

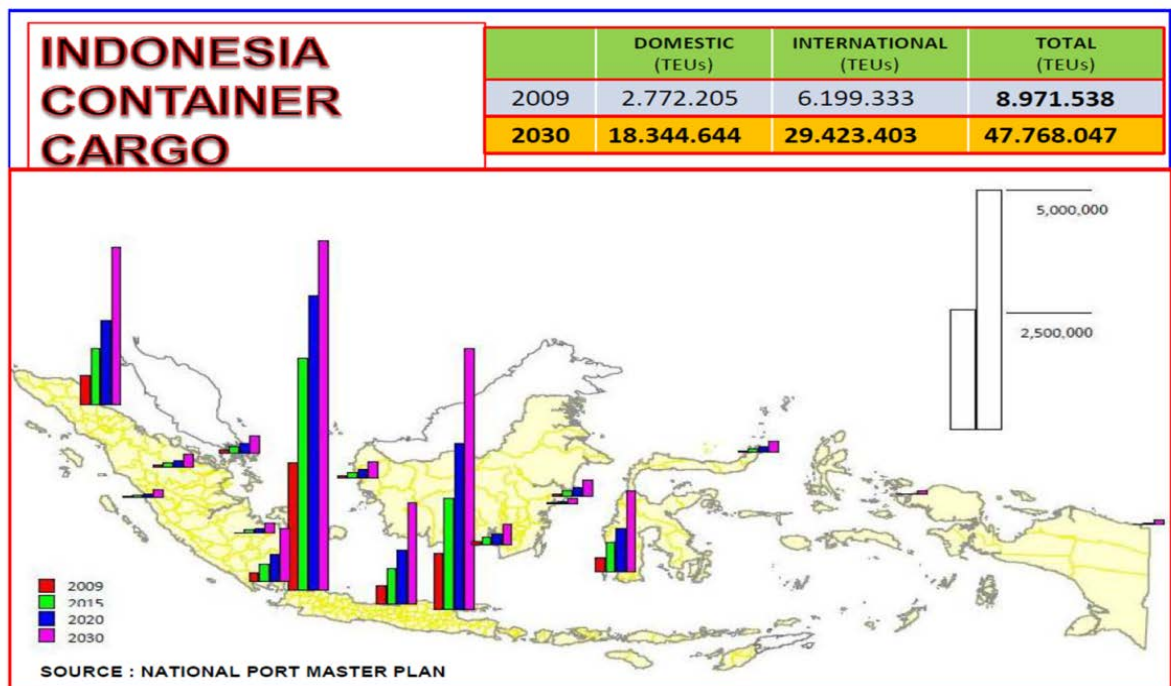
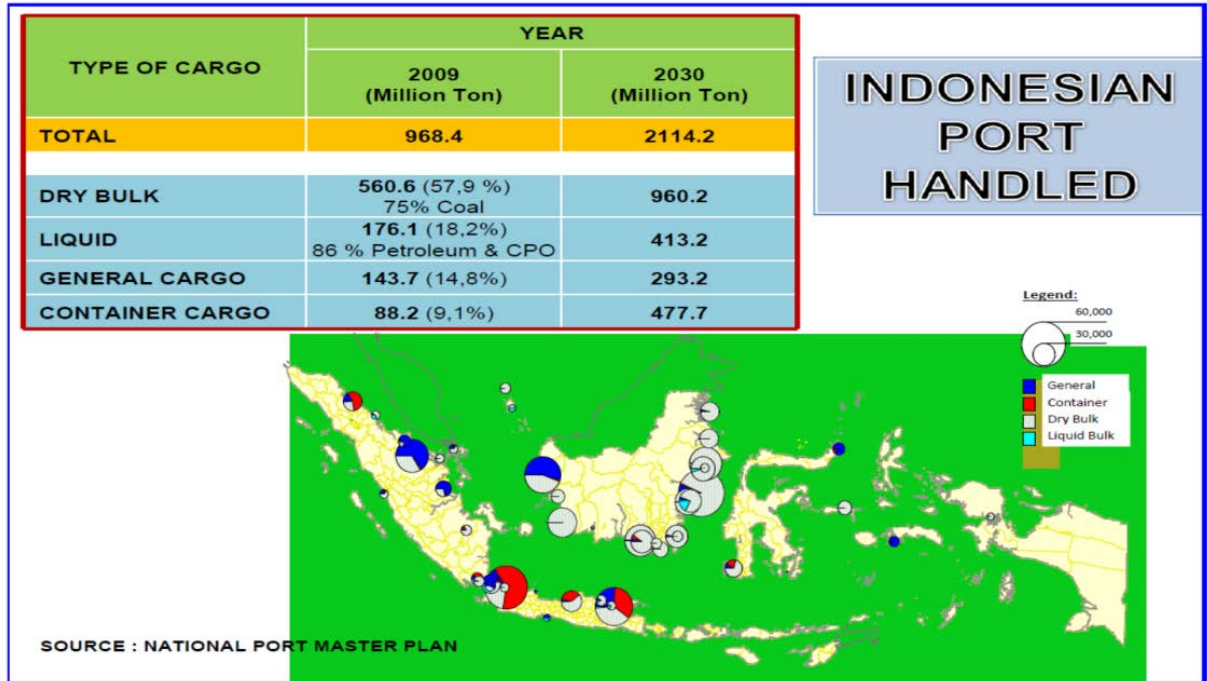

Bab 3

Overview of Previous Master Plan

Table 3.1.1 -1 : Number of Visual Aids to Navigation in Indonesia

List of ATON (DGST, non-DGST)													as of March, 2019	
DISNAV	Lighthouse	Light-Beacon		Light-Buoy		Unlighted-Beacon		Unlighted-Buoy		DGST	non-DGST	Total		
		DGST	non-DGST	DGST	non-DGST	DGST	non-DGST	DGST	non-DGST					
1	Sabang	10	35	1	28	10	0	0	0	0	73	11	84	
2	Belawan	5	50	17	42	35	0	0	0	0	97	52	149	
3	Sibolga	9	65	1	2	10	3	2	0	0	79	13	92	
4	Teluk Bayur	9	71	22	10	2	2	0	0	0	92	24	116	
5	Tg. Pinang	25	93	114	44	29	57	2	9	0	228	145	373	
6	Dumai	6	55	61	52	40	0	0	0	0	113	101	214	
7	Palembang	4	87	1	39	6	0	0	1	0	131	7	138	
8	Pontianak	7	51	6	30	7	0	0	1	0	89	13	102	
9	Tg. Priok	29	91	137	48	73	8	0	0	0	176	210	386	
10	Cilacap	8	35	33	5	60	0	0	0	0	48	93	141	
11	Semarang	7	52	33	14	16	11	3	3	0	87	52	139	
12	Surabaya	22	51	18	29	53	0	11	11	0	113	82	195	
13	Benoa	16	91	29	33	15	6	3	1	7	147	54	201	
14	Kupang	21	92	30	13	6	12	2	0	3	138	41	179	
15	Banjarmashin	11	97	68	15	75	0	2	4	0	127	145	272	
16	Tarakan	3	49	17	10	15	0	0	0	0	62	32	94	
17	Samarinda	6	64	142	41	139	2	1	5	3	118	285	403	
18	Makassar	16	109	16	20	0	0	0	0	0	145	16	161	
19	Kendari	6	87	33	12	1	1	17	0	0	106	51	157	
20	Bitung	24	134	7	25	6	0	11	0	0	183	24	207	
21	Ambon	12	154	24	6	0	10	11	4	3	186	38	224	
22	Sorong	6	93	20	33	29	0	5	1	7	133	61	194	
23	Jayapura	8	48	1	2	0	4	1	0	0	62	2	64	
24	Merauke	3	51	0	0	0	0	0	2	0	56	0	56	
25	Tual	11	72	12	0	0	10	0	0	0	93	12	105	
Total		284	1,877	843	553	627	126	71	42	23	2,882	1,564	4,446	
Number of ATON in 2002		235	1,168	437	332	396	260	105	103	45	2,098	983	3,081	

Figure 3.1.1 -1 : Concept of Cross-Bearing Navigation

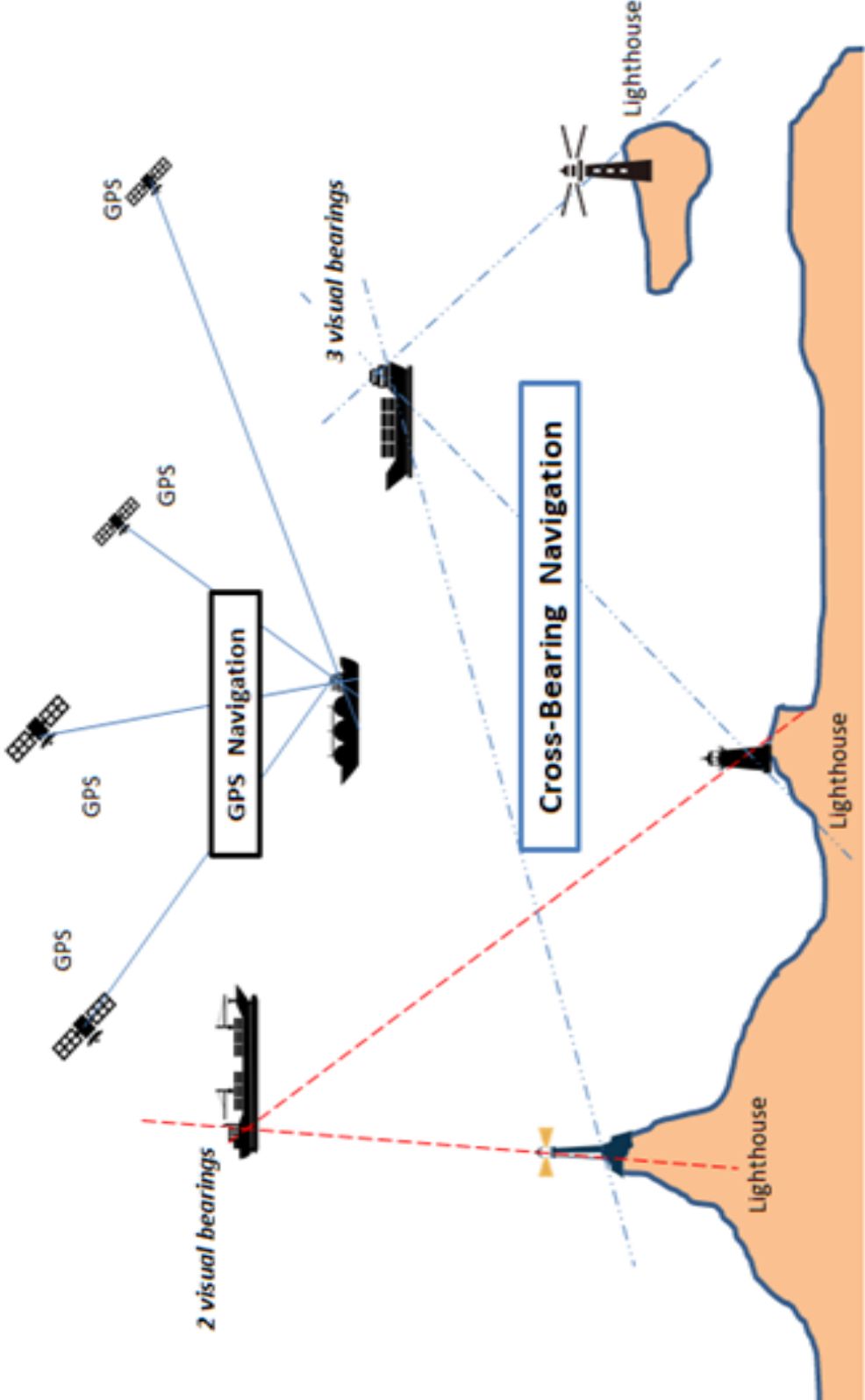
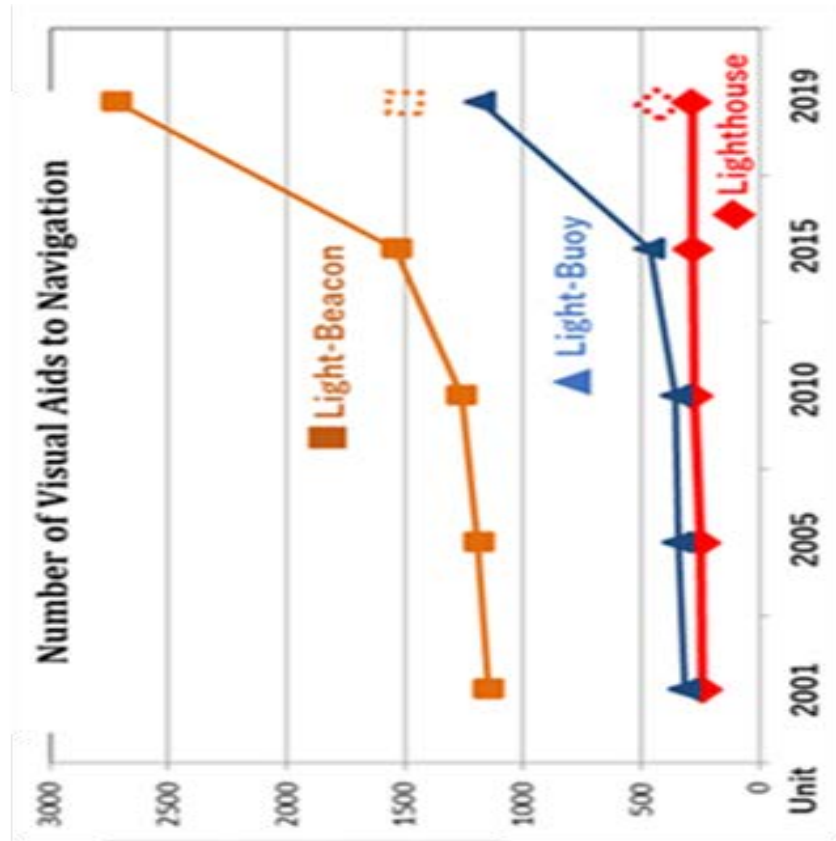

Figure 3.1.1 -2 : Transition of Visual Aids to Navigation



Number of Visual Aids to Navigation

Type	2001	2005	2010	2015	2019
Lighthouse	241	247	277	282	284
Light-Beacon	1,147	1,192	1,263	1,540	2,720
Light Buoy	318	346	356	466	1,180

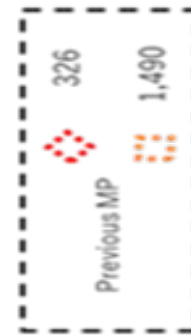

Table 3.1.3 -1 : Area of Workshop and Buoy-Base

ID NO.	DISNAV / CLASS(KLS)	OFFICE(m ²)		WORKSHOP(m ²)		BUOY BASE(m ²)		STOREHOUSE(m ²)		JETTY(m)		BT (KIP)
		2001	2019	2001	2019	2001	2019	2001	2019	2001	2019	
1	SABANG / KLS II	360	600	80	240	0	190	80	140	40	40	
2	BELAWAN / KLS I	282	660	142	630	415	140	242	360	38	28	⊙
3	SIBOLGA / KLS III	200	710	80	650	0	0	80	330	0	65	
4	DUMAI / KLS I	810	810	550	550	1,000	1,000	352	352	70	70	⊙
5	TG.PINANG / KLS I	1,000	1,000	230	420	0	3,200	170	300	40	550	⊙
6	PALEMBANG / KLS I	550	1,160	550	490	300	445	350	1,070	33	720	⊙
7	TLK BAYUR / KLS II	250	900	200	320	0	500	135	300	40	40	⊙
8	TG. PRIOK KLS I	2,000	2,000	2,050	2,050	6,050	6,050	3,315	3,315	175	175	⊙
9	CILACAP / KLS III	550	500	160	390	300	240	0	0	25	200	⊙
10	SEMARANG / KLS II	784	784	280	400	0	0	80	80	40	40	⊙
11	SURABAYA / KLS I	2,625	520	770	340	897	897	285	285	115	115	⊙
12	BENOA / KLS II	215	215	80	600	0	0	0	200	0	0	⊙
13	KUPANG / KLS II	418	830	200	400	0	10,000	0	200	0	320	⊙
14	BANJARMASIN / KLS II	318	318	80	80	0	0	0	0	0	0	⊙
15	PONTIANAK / KLS III	550	600	600	600	0	1,470	0	400	0	0	
16	SAMARINDA / KLS I	550	720	1,600	600	3,156	430	416	350	50	190	⊙
17	TARAKAN / KLS III	750	820	0	300	0	780	0	200	0	70	⊙
18	MAKASSAR/ KLS I	400	1,000	400	300	0	480	177	400	40	70	⊙
19	KENDARI / KLS III	300	300	600	600	0	0	0	0	0	40	
20	BITUNG / KLS I	735	890	600	600	750	750	80	80	0	50	⊙
21	AMBON / KLS I	844	844	80	80	0	0	80	80	40	40	⊙
22	SORONG / KLS III	420	1,200	600	900	870	1,420	120	250	40	40	⊙
23	JAYAPURA / KLS II	375	450	426	400	0	0	55	55	0	40	
24	MERAUKE / KLS III	150	550	335	540	0	750	464	300	0	290	
25	TUAL ^{*1} / KLS III	----	1,125	----	700	----	0	----	150	----	250	
Total		15,436	19,506	10,693	13,180	13,738	28,742	6,481	9,197	786	3,443	

NOTE ; *1 DISNAV Tual was founded after the time when the previous master plan in 2002 was completed.

*2 DISNAVs with ⊙ indicates that Buoy Tenders (KIP) are being allocated.

Picture 3.1.3 -1 : Supporting Facilities for Aids to Navigation



Buoy-Base

Workshop

Picture 3.1.3.-2 : Vessels for Aids to Navigation



Table 3.1.3 -2 : Number of Vessels by Type and Class

DIS-NAV	ID. NO.	Type of Vessel	Buoy Tender	Aids Tender(KBP)				Inspection Boat(KPP)				Total
		Ship Class		I	II	III	IV	II	III	IV	V	
DISNAV Class I	2	BELAWAN	1	1 (1)		1 (2)						3 (3)
	4	DUMAI	2 (1)			(4)			1 (1)			3 (6)
	5	T.G.PINANG	1 (1)	1 (1)		2 (2)			1 (1)		1	6 (5)
	6	PALEMBANG	1			1 (4)			1 (1)			3 (5)
	8	T.G. PRIOK	2	(2)		(2)	(2)		2			4 (6)
	11	SURABAYA	2 (1)	(1)		1 (2)			1 (1)			4 (5)
	16	SAMARINDA	2 (1)			1 (2)			1 (1)			4 (4)
	18	MAKASSAR	1	1 (1)		1 (2)			1			4 (3)
	20	BITUNG	1	1 (1)		1 (2)						3 (3)
	21	AMBON	1	1 (1)								2 (1)
	22	SORONG	2 (1)	(1)			(1)	(1)	1			3 (4)
		Sub Total	16 (5)		5 (9)	0 (0)	8 (22)	0 (3)	0 (1)	9 (5)	0 (0)	1 (0)
				13 (34)				10 (6)				
DISNAV Class II	1	SABANG		1 (1)		(1)			1			2 (2)
	7	TLK BAYUR	1	1 (1)								2 (1)
	10	SEMARANG	1			2 (4)			1			4 (4)
	12	BENOA	1	1 (1)	(1)							2 (2)
	13	KUPANG	1	1 (1)		(1)						2 (2)
	14	BANJARMASIN	1	1	(1)	1 (1)			1 (2)			4 (4)
	23	JAYAPURA		1 (1)	(2)				1	(1)		2 (4)
		Sub Total	5 (0)		6 (5)	0 (4)	3 (7)	0 (0)	0 (0)	4 (2)	0 (1)	0 (0)
				9 (16)				4 (3)				
DISNAV Class III	3	SIBOLGA		1 (1)								1 (1)
	9	CILACAP	1			2 (2)						3 (2)
	15	PONTIANAK		1	(1)				2 (1)			3 (2)
	17	TARAKAN	1		(1)	(1)			1			2 (2)
	19	KENDARI		2	(2)							2 (2)
	24	MERAUKE		1 (1)					(1)	1 (1)		2 (3)
	25	TUAL		1								1 (0)
		Sub Total	2 (0)		6 (2)	0 (4)	2 (3)	0 (0)	0 (0)	3 (2)	1 (1)	0 (0)
				8 (9)				4 (3)				
Total			23 (5)	17 (16)	0 (8)	13 (32)	0 (3)	0 (1)	16 (9)	1 (2)	1 (0)	71 (76)
				30 (59)				18 (12)				

Table 3.1.3 -3 : Classes of Vessels

Class	I	II	III, IV, V
Length	40m >	30m -- 40m	30m <

Table 3.1.3 -3 : Classes of Vessels

Range of Age	As of Oct., 2018		As of May, 2001	
	No. of Ship	Percentage (%)	No. of Ship	Percentage (%)
0 - 15	31	43.7	15	19.7
16 - 25	15	21.2	7	9.2
26 - 35	0	0	25	32.9
36 - 40	4	5.6	8	10.5
41 >	21	29.6	21	27.6

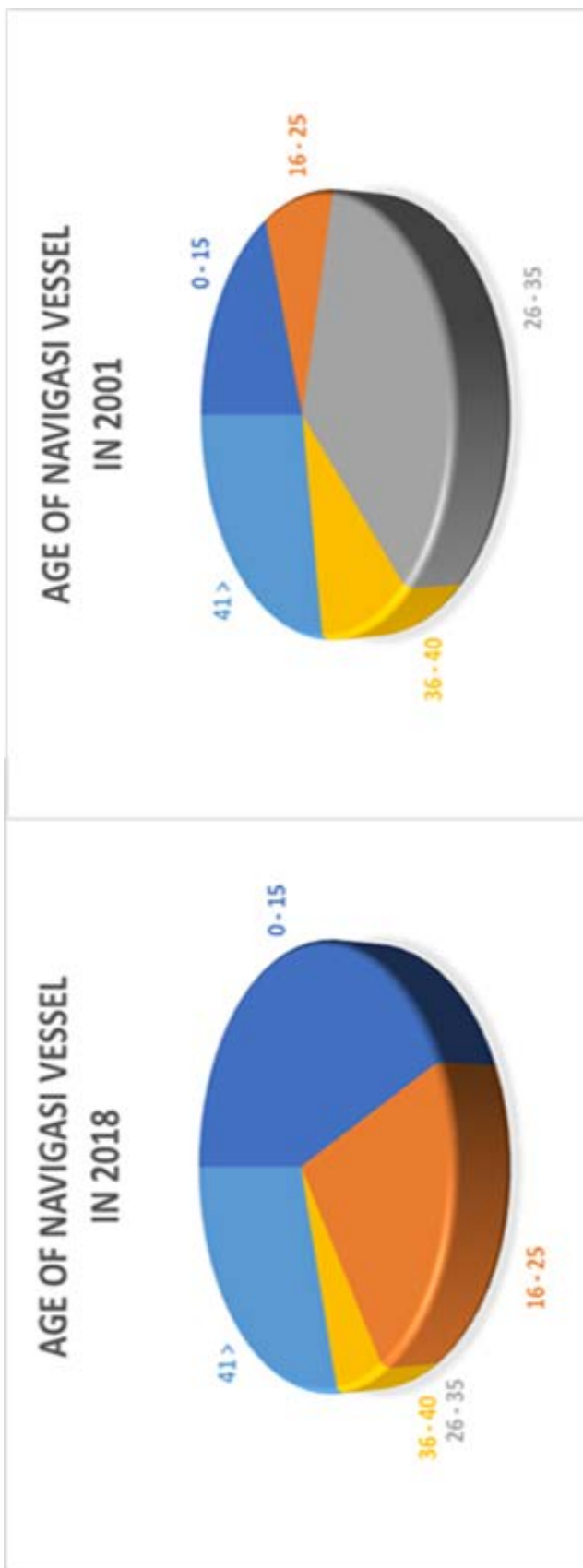

Table 3.1.3 -4 : New Buoy-Tender and Aids-Tender

NO.	Shipbuilder	Disnav	Ship Name	Year of Built	DWT/GRT (tons)	Prinpijal Dimensions Loa x B x D (m)
1	NIIGATA SHIPBUILDING & REPAIR INC.	TG.PINANG	KN JADAYAT	2003	649 / 856	58.00 x 11.00 x 4.50
2	PT. DUMAS TANJUNG PERAK SHIPYARD	SURABAYA	KN BIMA SAKTI UTAMA	2008	--- / 1271	59.95 x 11.40 x 4.70
3	Ditto	BANJARMASIN	KN KUNYIT	2016	--- / 1,127	60.00 x 12.00 x 4.70
4	Ditto	TARAKAN	KN MARATUA	2016	--- / 1,127	Ditto
5	Ditto	SAMARINDA	KN MIANG BESAR	2017	--- / 1,125	Ditto
6	PT. CAPUTRA MITRA SEJATI	TELUK BAYUR	KN SIBARU-BARU	2017	628 / ---	60.00 x 12.00 x 4.70
7	Ditto	PALEMBANG	KN KALIAN	2017	628 / ---	Ditto
8	PT. ORELA SHIPYARD	AMBON	KN BACAN	2017	--- / 1,180	60.00xX 12.00 x 4.70
9	PT. MULTI OCEAN SHIPYARD	MAKASSAR	KN DE BRILL	2017	890 / 1,212	60.00xX 12.00 x 4.70
10	Ditto	BENOA	KN NUSAPENIDA	2017	890 / 1,212	Ditto
11	PT. PALINDO MARINE	BITUNG	KN MIANGAS	2017	--- / 1,208	60.00 x 12.00 x 4.70
12	Ditto	BELAWAN	KN BERHALA	2017	--- / 1,208	Ditto
13	Ditto	DUMAI	KN RUPAT	2017	--- / 1,208	Ditto
14	Ditto	TG. PRIOK	KN EDAM	2017	--- / 1,208	Ditto
15	Ditto	SORONG	KN YEFYUS	2017	--- / 1,208	Ditto
16	PT. CITRA SHIPYARD	KUPANG	KN NIPA	2017	--- / 1,208	60.00 x 12.00 x 4.70
17	Ditto	SURABAYA	KN MASALEMBO	2017	--- / 1,208	Ditto
I	PT. DUMAS TANJUNG PERAK SHIPYARD	PONTIANAK	KN ALNILAM	2008	410 / 838	51.94 x 10.20 x 4.35
II	Ditto	KENDARI	KN ANDROMEDA	2008	410 / 838	Ditto
III	Ditto	AMBON	KN ALPHARD	2008	410 / 838	Ditto
NOTE : NO.1 - 17 --> Buoy Tenders						
NO. I - III --> Aids Tenders						

Figure 3.1.4 -1 : Location Map of VTS

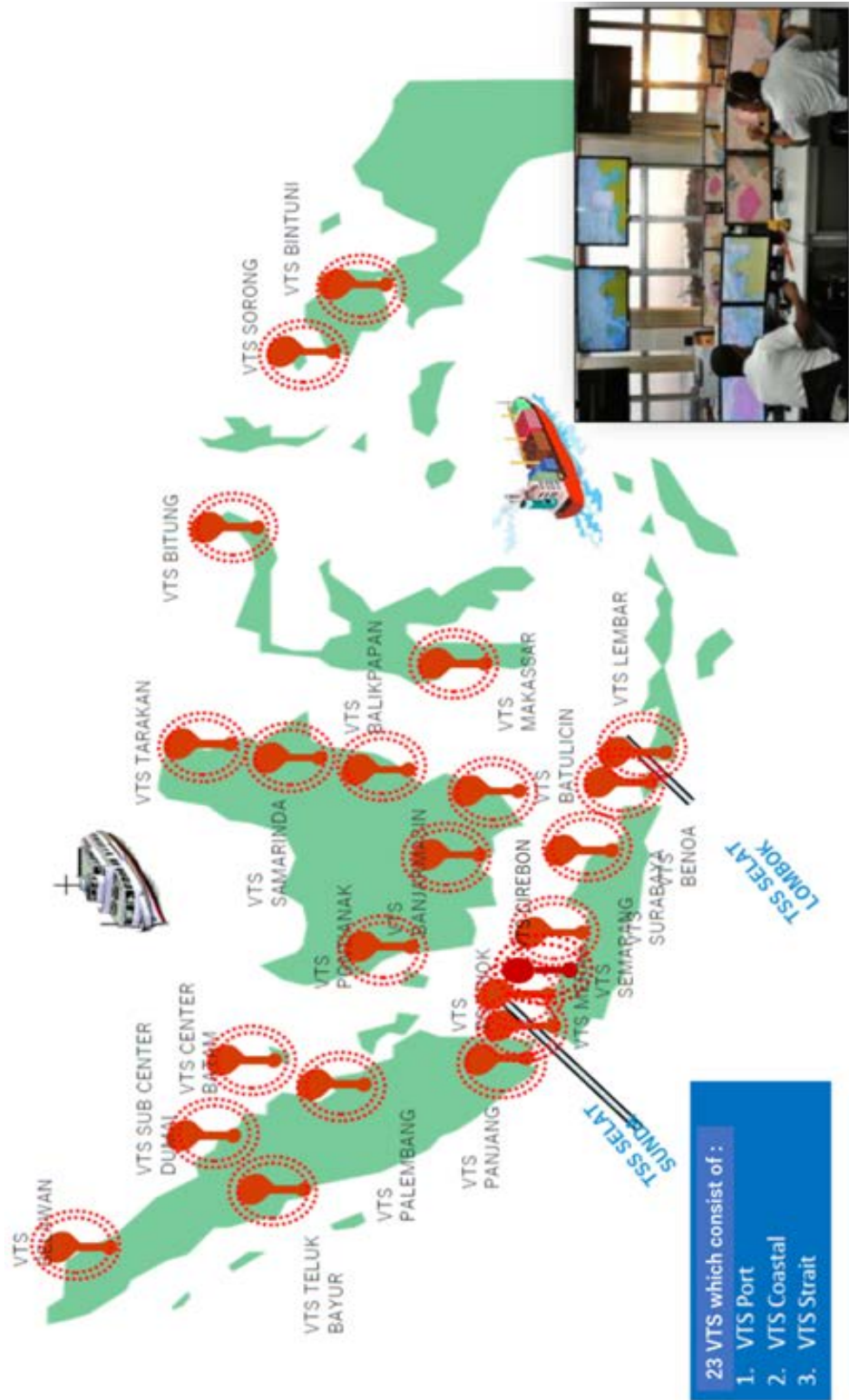

Table 3.1.4 -1 : List of VTS

No.	VTS	Brand	DISNAV
1	Belawan VTS	Transas	1 st Class Belawan
2	Teluk Bayur VTS	Transas	2 nd Class Teluk Bayur
3	Batam VTS Center	JRC	1 st Class Tanjung Pinang
4	Dumai VTS Sub-Center	JRC	1 st Class Dumai
5	Palembang VTS	Transas	1 st Class Palembang
6	Panjang VTS	Kongsberg	1 st Class Tanjung Priok
7	Merak VTS	Kongsberg	1 st Class Tanjung Priok
8	Tanjung Priok VTS	Kongsberg & Transas	1 st Class Tanjung Priok
9	Cirebon VTS	Kongsberg	1 st Class Tanjung Priok
10	Semarang VTS	Transas	2 nd Class Semarang
11	Surabaya VTS	Sanatos	1 st Class Surabaya
12	Benoa VTS	Transas & Kongsberg	2 nd Class Benoa
13	Lembar VTS	Transas	2 nd Class Benoa
14	Pontianak VTS	Transas	3 rd Class Pontianak
15	Banjarmasin VTS	Transas	2 nd Class Banjarmasin
16	Batulicin VTS	Transas	2 nd Class Banjarmasin
17	Balikpapan VTS	Transas	1 st Class Samarinda
18	Samarinda VTS	Transas	1 st Class Samarinda
19	Tarakan VTS	Vissim	3 rd Class Tarakan
20	Makassar VTS	Vissim	1 st Class Makassar
21	Bitung VTS	Vissim	1 st Class Bitung
22	Sorong VTS	Transas & Kongsberg	1 st Class Sorong
23	Bintuni VTS	Kongsberg	1 st Class Sorong

Picture : VTS Building and Operation Room



Belawan



Pontianak



Bitung



Tanjung Priok



Table 3.1.5 -1 : Classification of CRS

GMDSS Area	Station
A2	94
A3	18
Total	112
Non-GMDSS	39
Total CRS	151

Class	Station
I	12
II	6
III A	48
III B	6
IV A	66
IV B	13
Total	151

Figure 3.1.5 -1 : Location Map of CRS

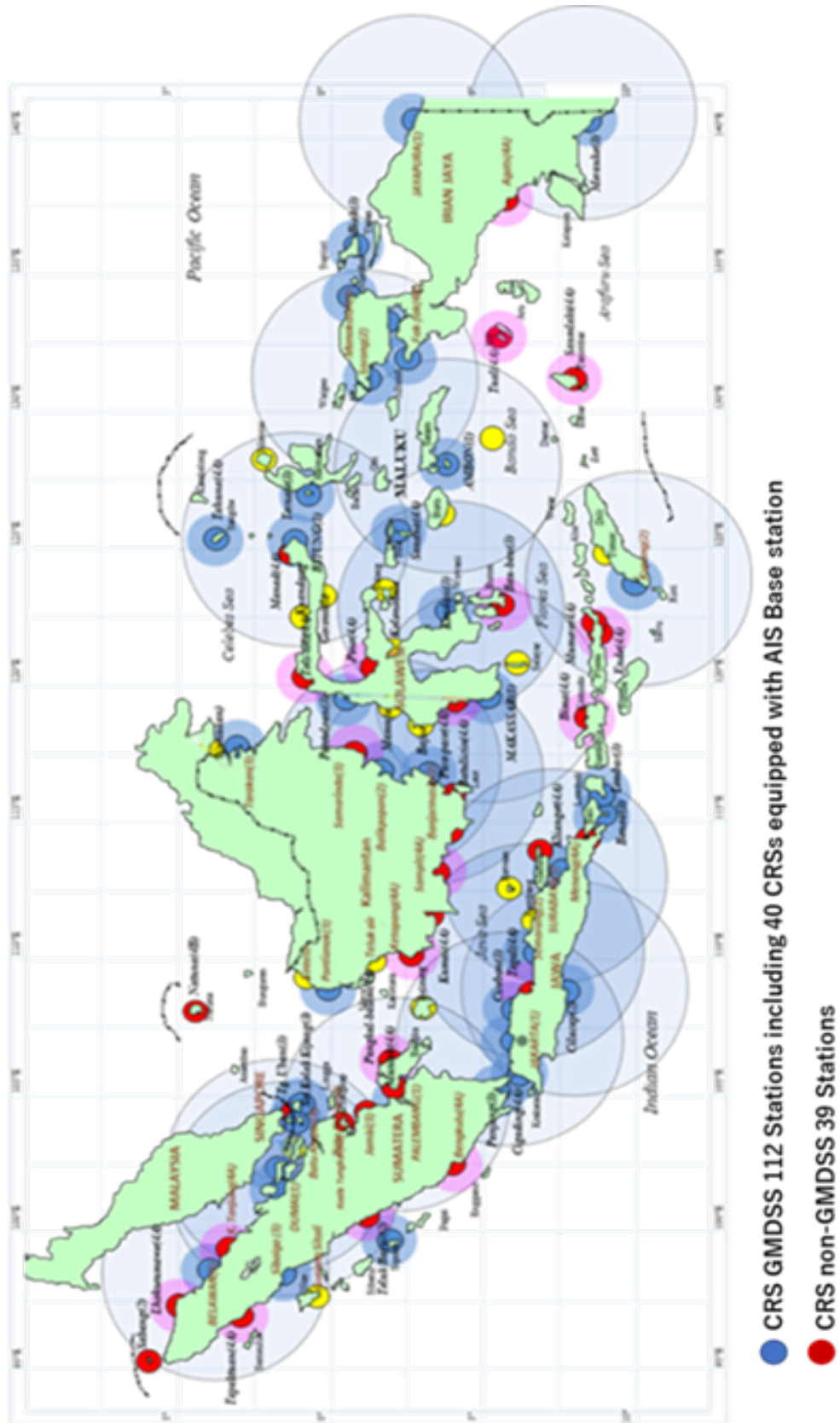

Figure 3.1.5 -2 : Map of Transmitting Sites and Coverage of NAVTEX

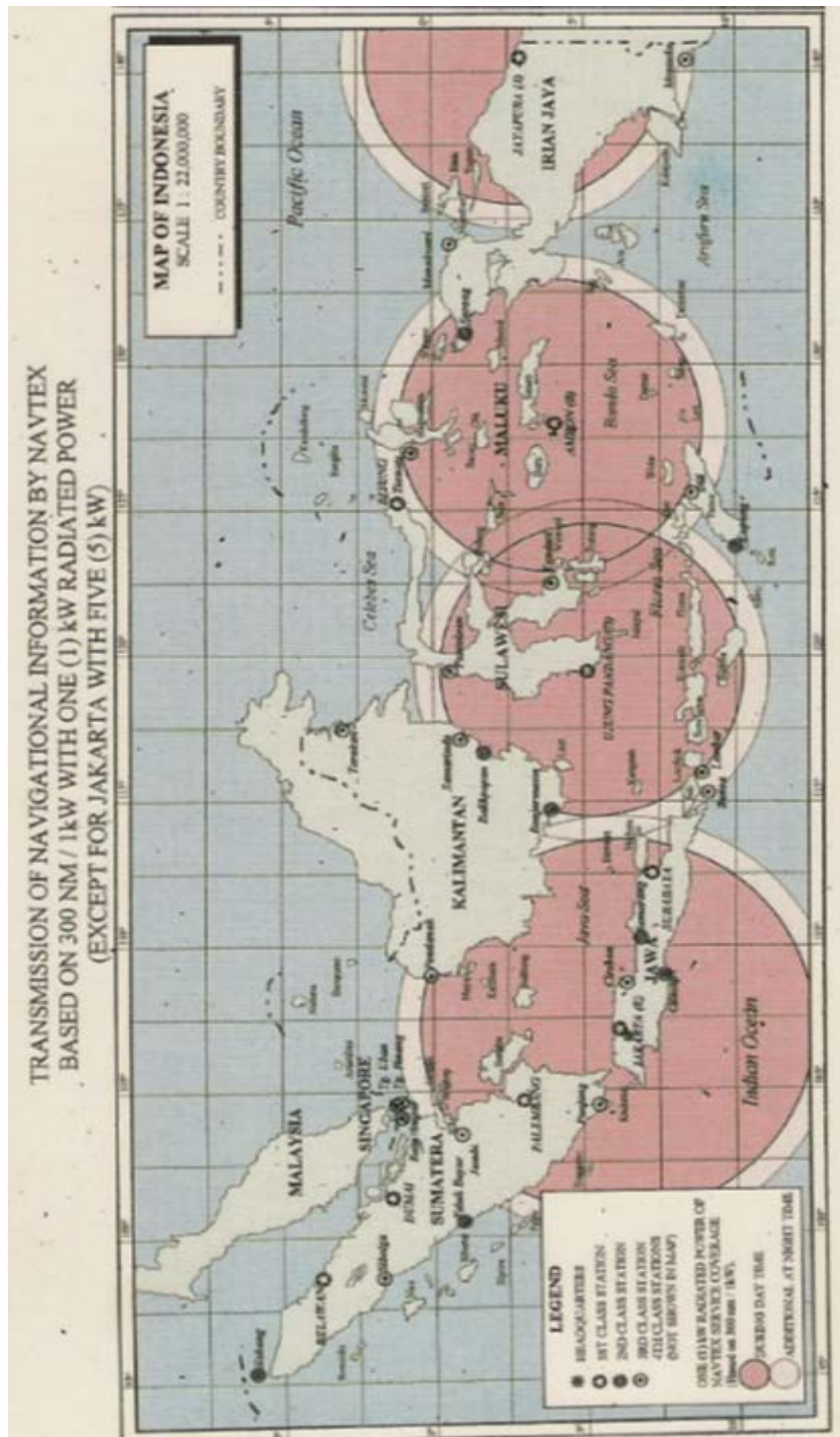

Figure 3.3 -1 : The Cover of the Report of Strategic Plan

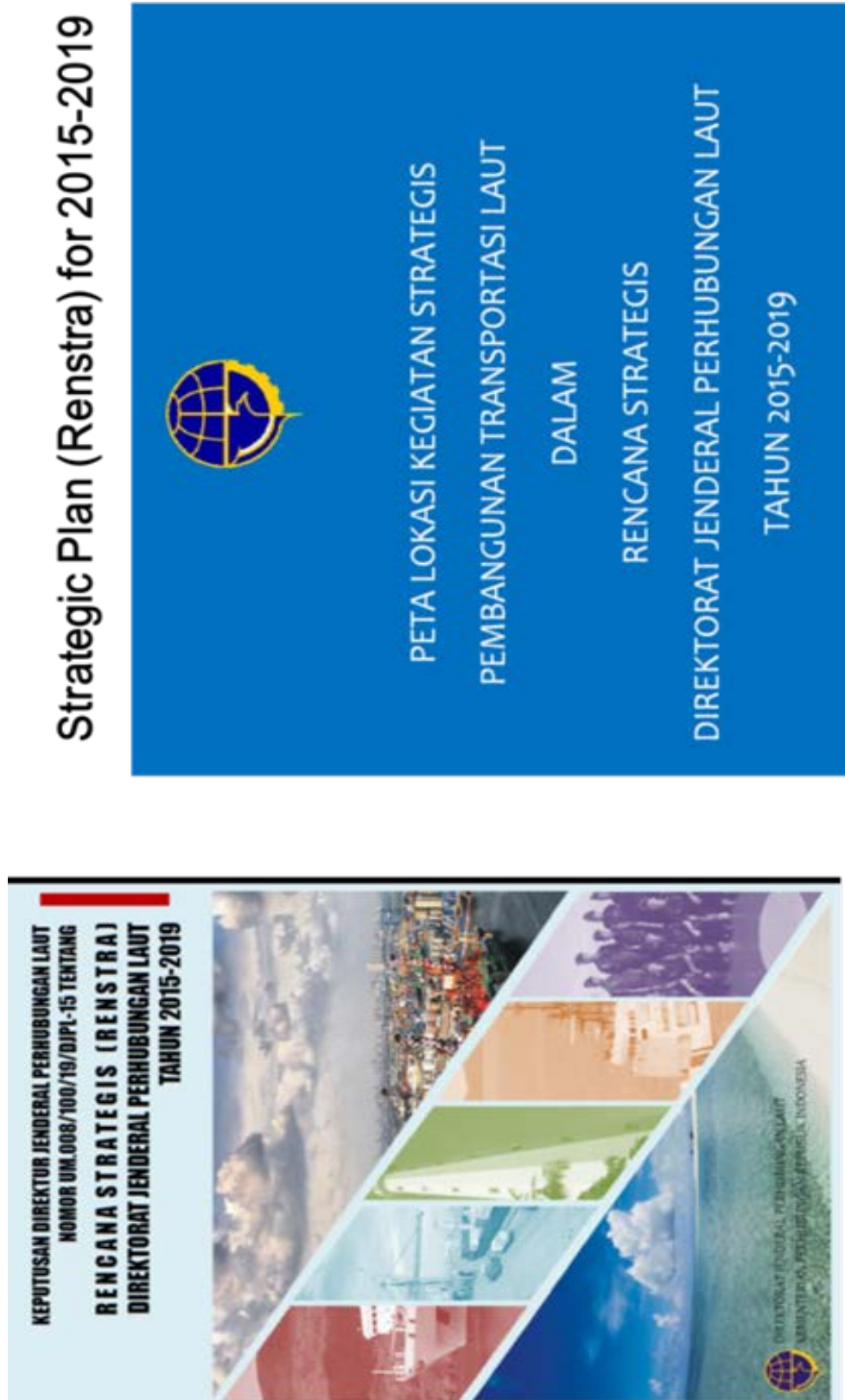

Figure 3.3 -2 : Copy of the Presentation Report

DUKUNGAN KEAMANAN DAN KESELAMATAN PELAYARAN
PENBANGUNAN SARANA BANTU NAVIGASI PELAYARAN (SBNP) DAN TELEKOMUNIKASI PELAYARAN

NO.	KEGIATAN	EKISTING	REVISI TAHUN 2015	REVISI TAHUN 2016	REVISI TAHUN 2015
1	<p>Tidakmumkan Pelengkapan</p> <p>a. Stasiun Visual Puffin Service (VPS)</p> <p>1) Pembangunan Stasiun VPS</p> <p>2) Upgrade Stasiun VPS</p> <p>b. Stasiun Radar Pante yang dilengkapi perangkat Global Maritime Distress and Safety System (GMDSS)</p> <p>1) Pembangunan GMDSS</p> <p>2) Upgrade GMDSS</p>	<p>20 Stasiun</p> <p>8 Stasiun</p> <p>84 Stasiun</p>	<p>0 Stasiun</p> <p>8 Stasiun</p> <p>13 Stasiun</p> <p>9 Stasiun</p>	<p>0 Stasiun</p> <p>3 Stasiun</p> <p>9 Stasiun</p> <p>4 Stasiun</p>	<p>0 Stasiun</p> <p>34 Stasiun</p> <p>32 Stasiun</p> <p>69 Stasiun</p>
2	<p>Survei Radar Navigasi pelayaran (SARNP)</p> <p>a. Merau Laut</p> <p>b. Rantau Laut</p> <p>c. Puncung Laut</p> <p>d. Pulau Jang</p> <p>e. Anai Pampang</p>	<p>282 Unit</p> <p>1349 Unit</p> <p>466 Unit</p> <p>15 Unit</p> <p>40 Unit</p>	<p>0 Unit</p> <p>116 Unit</p> <p>86 Unit</p> <p>0 Unit</p> <p>0 Unit</p>	<p>4 Unit</p> <p>100 Unit</p> <p>18 Unit</p> <p>2 Unit</p> <p>0 Unit</p>	<p>20 Unit</p> <p>525 Unit</p> <p>201 Unit</p> <p>0 Unit</p> <p>0 Unit</p>
3	<p>Kapal Negeri Keamanan (KAK)</p> <p>a. Kapal Keras 1</p> <p>b. Kapal Keras 2</p> <p>c. Kapal Keras 3</p> <p>d. Kapal Keras 4</p> <p>e. Kapal Keras 5</p> <p>f. Kapal Keras 6</p>	<p>27 Unit</p> <p>32 Unit</p> <p>4 Unit</p> <p>44 Unit</p> <p>5 Unit</p> <p>0 Unit</p>	<p>10 Unit</p> <p>0 Unit</p> <p>5 Unit</p> <p>44 Unit</p> <p>5 Unit</p> <p>0 Unit</p>	<p>5 Unit</p> <p>0 Unit</p> <p>0 Unit</p> <p>0 Unit</p> <p>0 Unit</p> <p>0 Unit</p>	<p>24 Unit</p> <p>0 Unit</p> <p>25 Unit</p> <p>0 Unit</p> <p>0 Unit</p> <p>0 Unit</p>

1.444
1.006
2.281
171

DIREKTORAT JENDERAL PEMBANGUNAN LAUT DAN PERIKANAN

PENYELENGGARAAN KEWAJIBAN PELAYANAN PUBLIK
UNTUK ANGGUTAN BARANG DI LAUT
DALAM RANGKA PELAKSANAAN TOL LAUT

Disampaikan Pada Acara:
Rapat Koordinasi Tindak Lanjut Pelaksanaan Program Tol Laut Sesuai Perpres 156 Tahun 2015

30 MEI 2016

Direktoral Jenderal Pembangunan Laut - Kementerian Perikanan

Table 3.3 -1 : Development of Aids to Navigation for 2015 - 2019

DEVELOPMENT OF Aids to Navigation (SBNP) AND Radio Telecommunicatons					
	Existing	Implementation		Plan 2015 – 2019	Total
		2015	2016		
Shipping Telecommunications					
a. Vessel Traffic Service (VTS) Station	20 Station				20 Station
1) VTS Station Development		0 Station	0 Station	0 Station	0 Station
2) Upgrade VTS Station		6 Station	3 Station	34 Station	
b. Beach Radio Stations (GMDSS)	84 Station				138 Station
1) GMDSS Development		13 Station	9 Station	32 Station	54 Station
2) GMDSS upgrade		9 Station	4 Station	69 Station	
Visual Aids to Navigaton (SBNP)					
a. Light House	282 Unit	0 Unit	4 Unit	20 Unit	306 Unit
b. Light Beacon	1540 Unit	116 Unit	100 Unit	525 Unit	2281 Unit
c. Lighted Buoy	466 Unit	86 Unit	18 Unit	201 Unit	771 Unit
d. Day Marks	135 Unit	0 Unit	2 Unit	0 Unit	137 Unit
e. Small Buoy	40 Unit	0 Unit	0 Unit	0 Unit	40 Unit
Navigating State Vessel (KNK)					
a. Class I ship	27 Unit	10 Unit	5 Unit	24 Unit	66 Unit
b. Class II Ship	32 Unit	0 Unit	0 Unit	0 Unit	32 Unit
c. Class III ships	4 Unit	5 Unit	0 Unit	25 Unit	34 Unit
d. Rigid Inflatable Boat (RIB)	44 Unit	44 Unit	0 Unit	0 Unit	88 Unit
e. Flat Work	5 Unit	5 Unit	0 Unit	0 Unit	10 Unit

Bab 4

Field Survey

Table 4.1 -1 : Date of Visit to DISNAV

DISNAV Headquarters Visited in the Survey

No	Name of DISNAV	Class	Date	Remarks
1	Kupang	2	2019, 7/1-5	Survey of Traffic Volume
2	Ambon	1	2019, 7/1-5	
3	Tual	3	2019, 7/1-5	
4	Tanjung Priok	1	2019, 7/10	
5	Samarinda	1	2019, 7/15-19	
6	Tarakan	3	2019, 7/15-19	
7	Makassar	1	2019, 7/15-19	Survey of Traffic Volume
8	Belawan	1	2019, 10/13-15	
9	Sabang	2	2019, 10/16-18	Survey of Traffic Volume
10	Pontianak	3	2019, 10/21-24	
11	Bitung	1	2019, 10/22-27	
12	Surabaya	1	2019, 10/28-31	Survey of Traffic Volume
13	Teluk Bayur	2	2019, 11/4-7	
14	(Labuan Bajo)		2019, 11/4-7	Survey of Traffic Volume

Figure 4.1 : Location of Visit to DISNAV

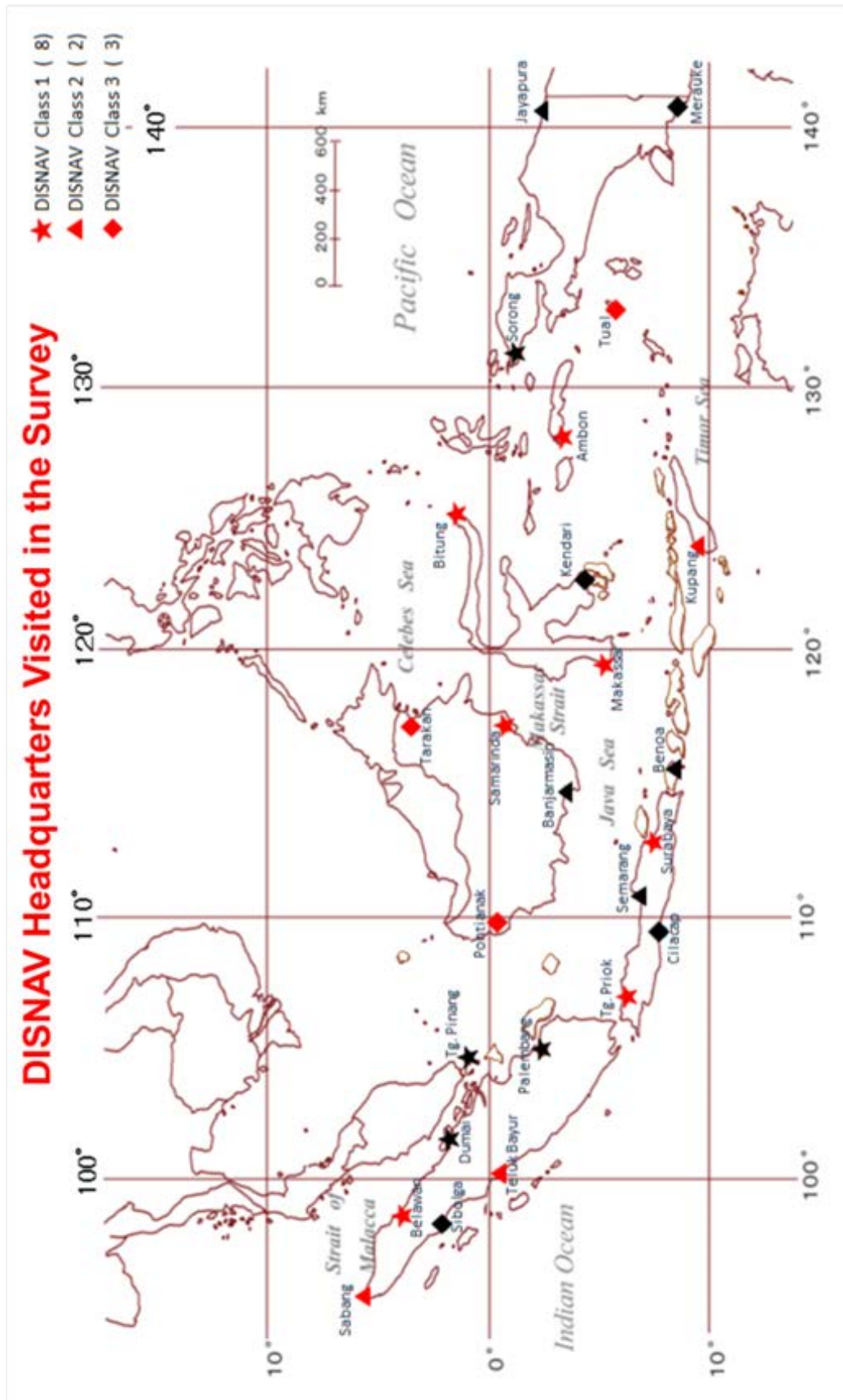

Figure 4.1.1 -1 : Location of DISNAV Kupang

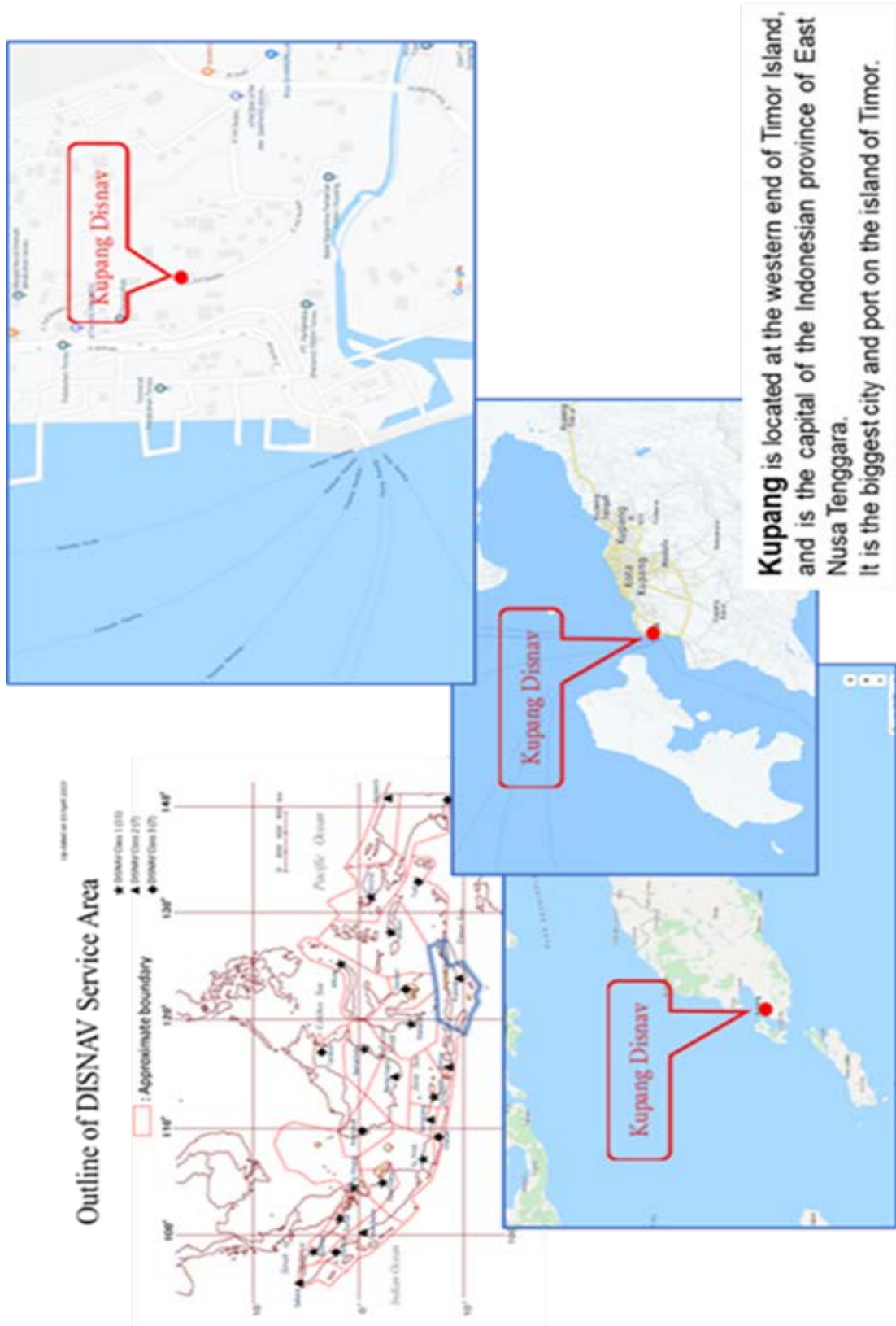

Figure 4.1.1 -2 : Master Cable System

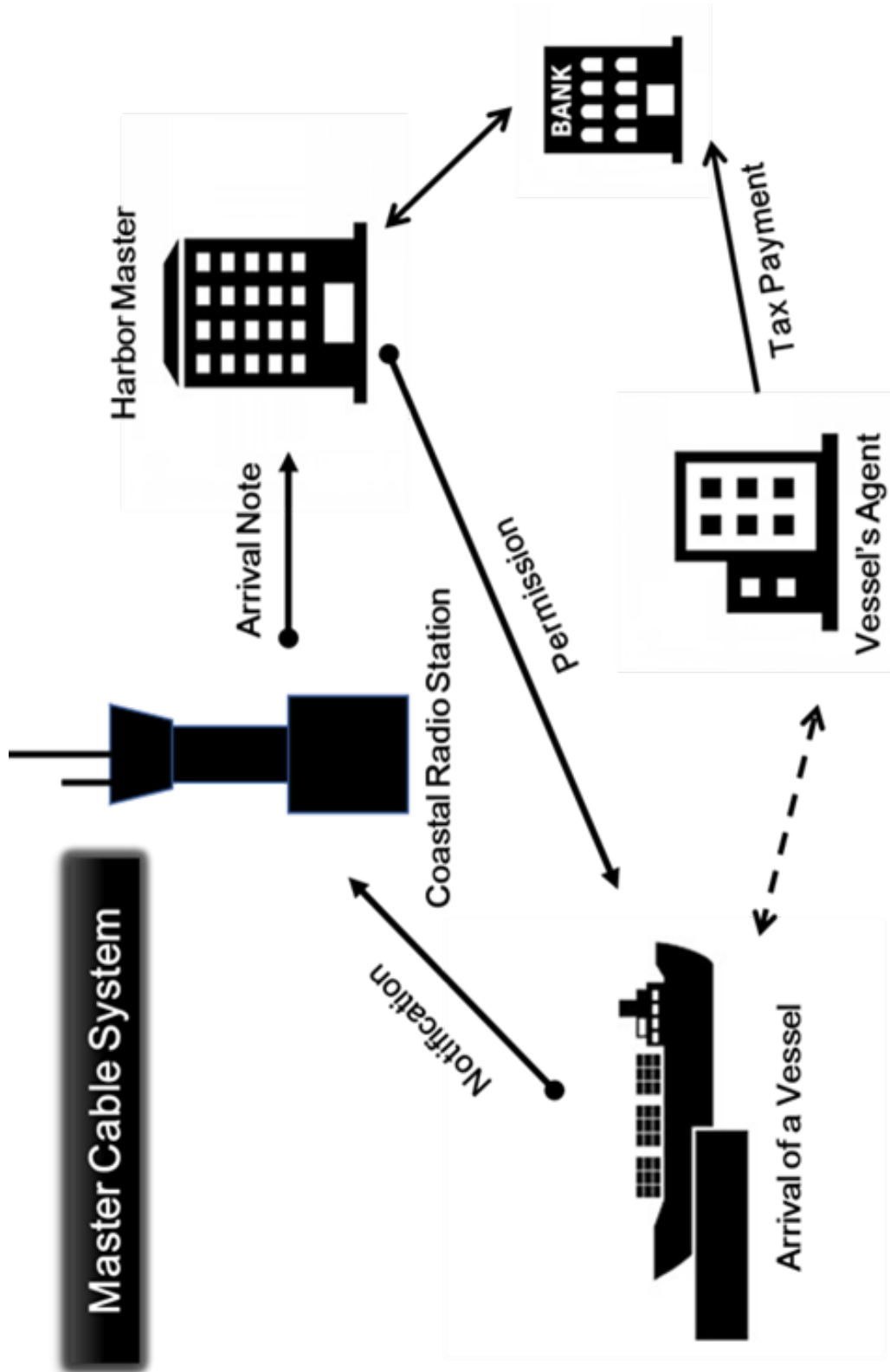
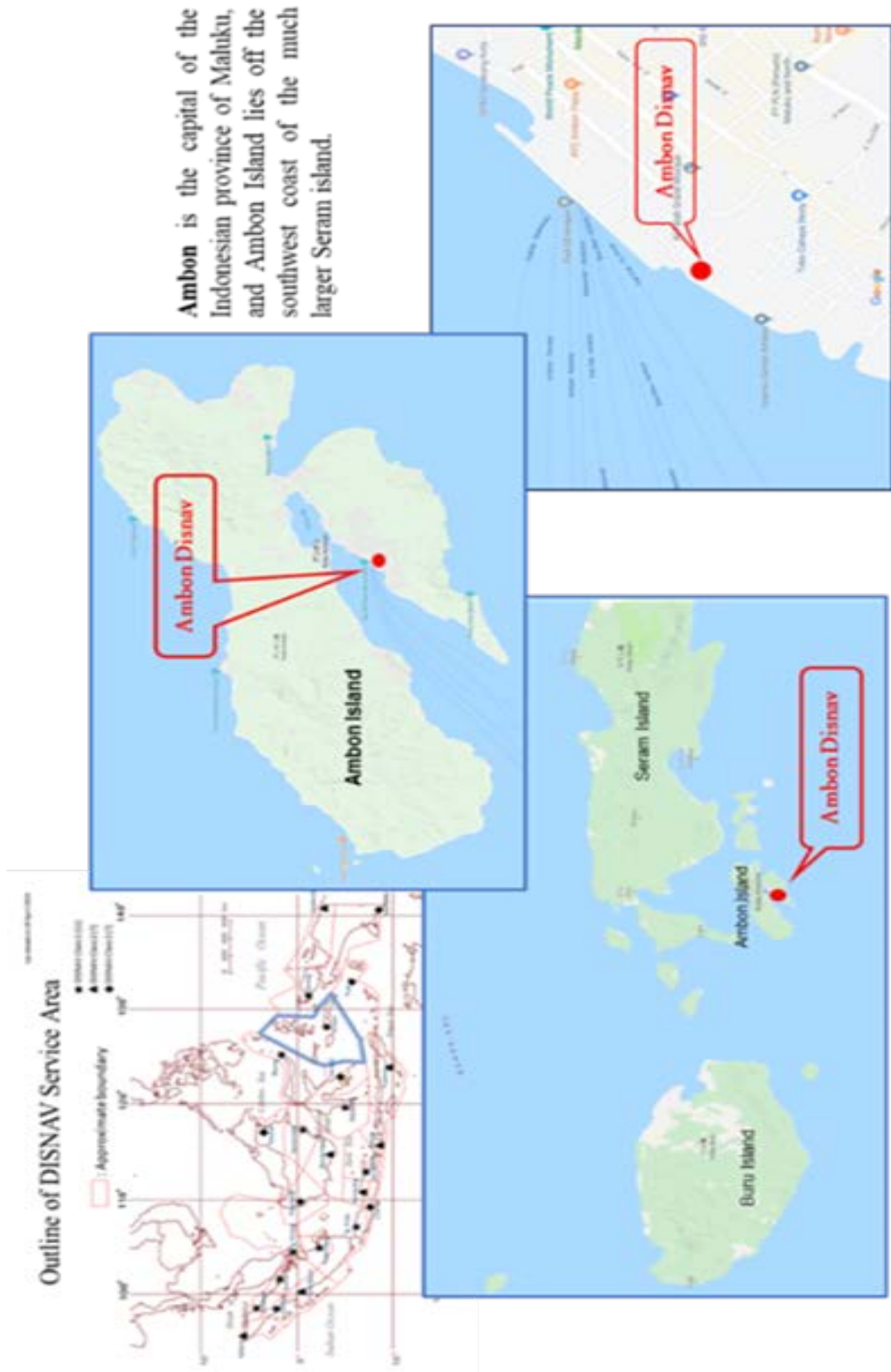
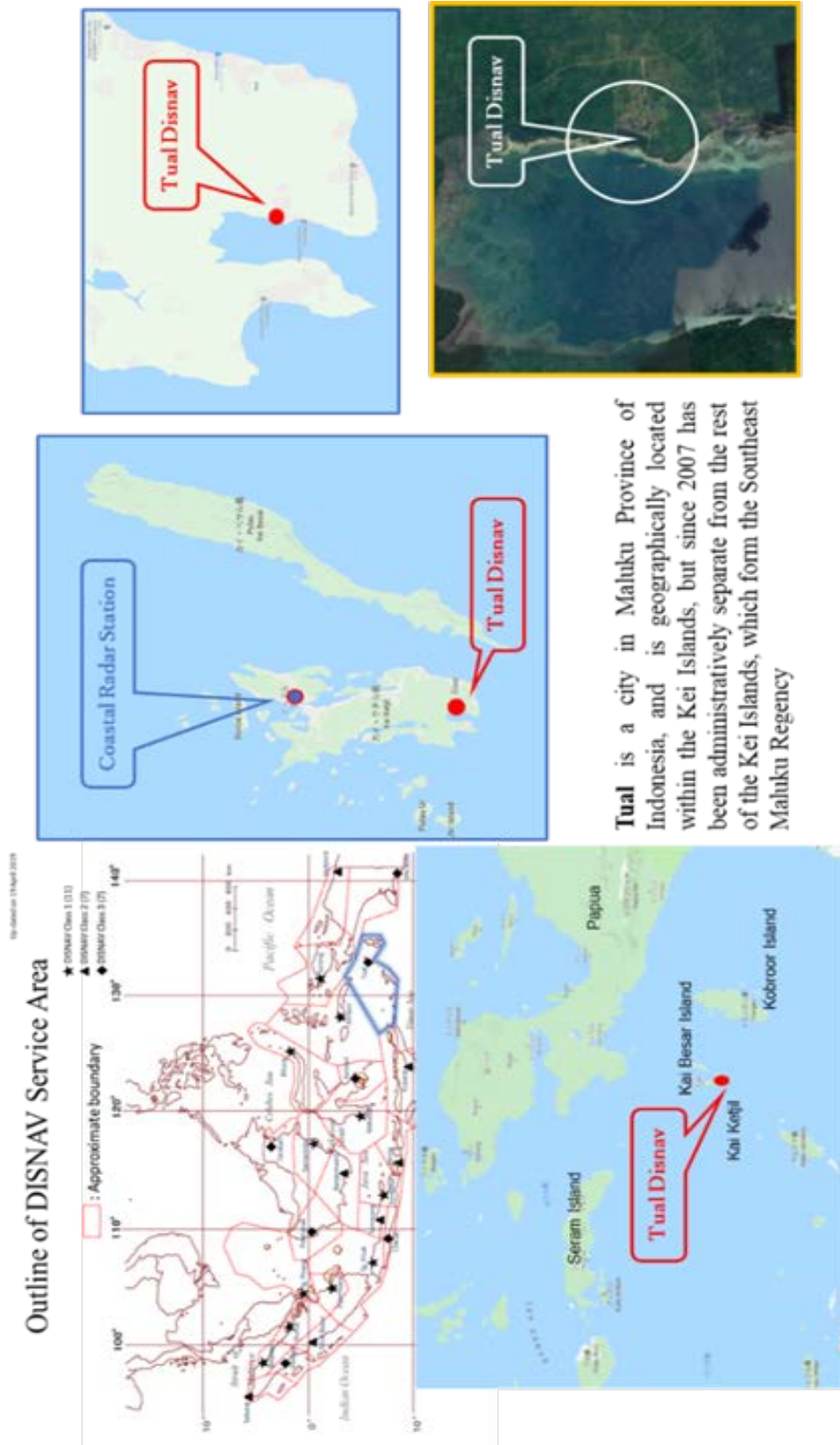

Figure 4.1.2 -1 : Location of DISNAV Ambon



Ambon is the capital of the Indonesian province of Maluku, and Ambon Island lies off the southwest coast of the much larger Seram island.

Figure 4.1.3 -1 : Location of DISNAV Tual



Tual is a city in Maluku Province of Indonesia, and is geographically located within the Kei Islands, but since 2007 has been administratively separate from the rest of the Kei Islands, which form the Southeast Maluku Regency

Figure 4.1.3 -2 : Location of Office, CRS, Lighthouse

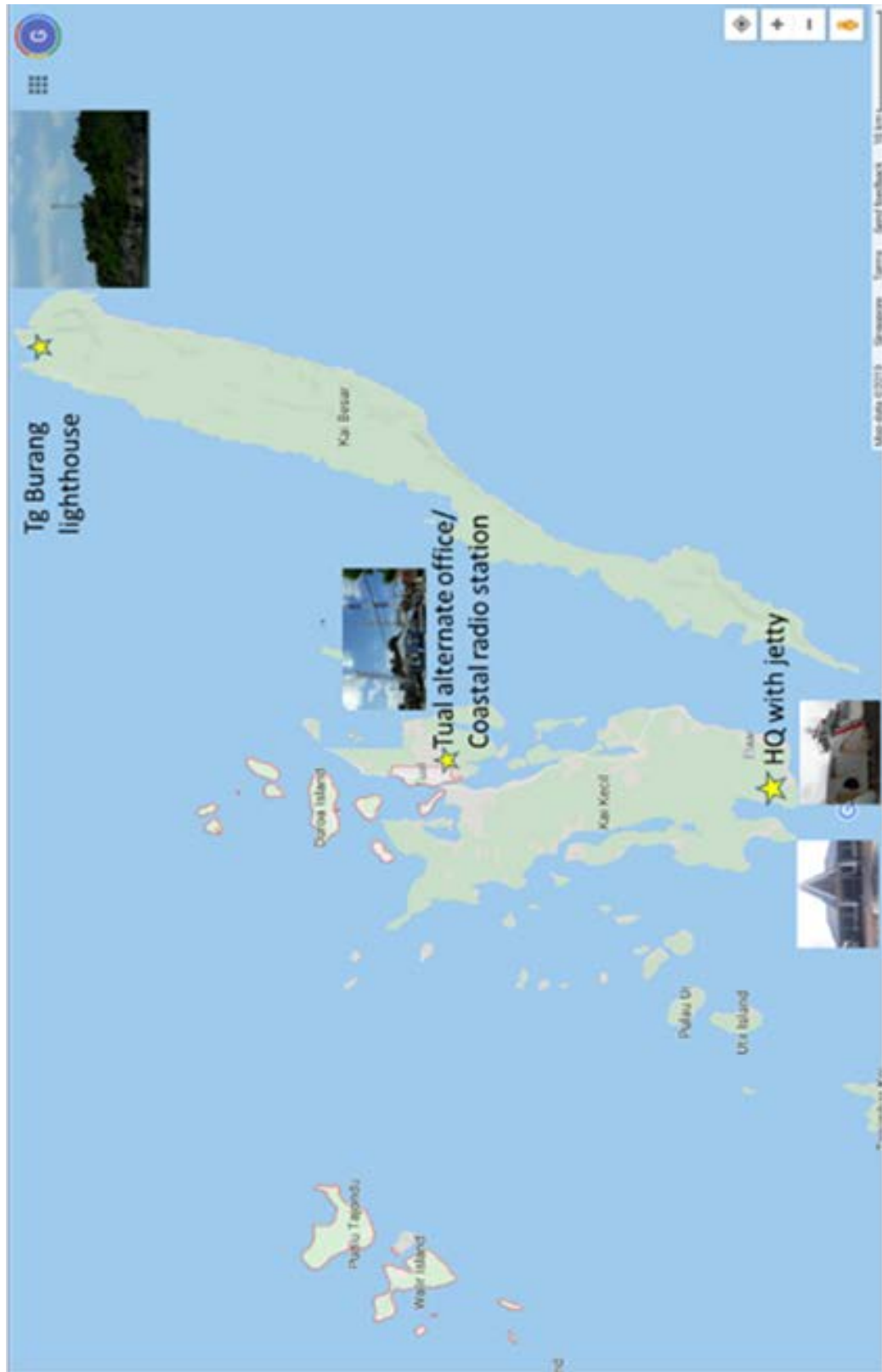

Figure 4.1.3 :-3 : Location of Office, CRS, Lighthouse

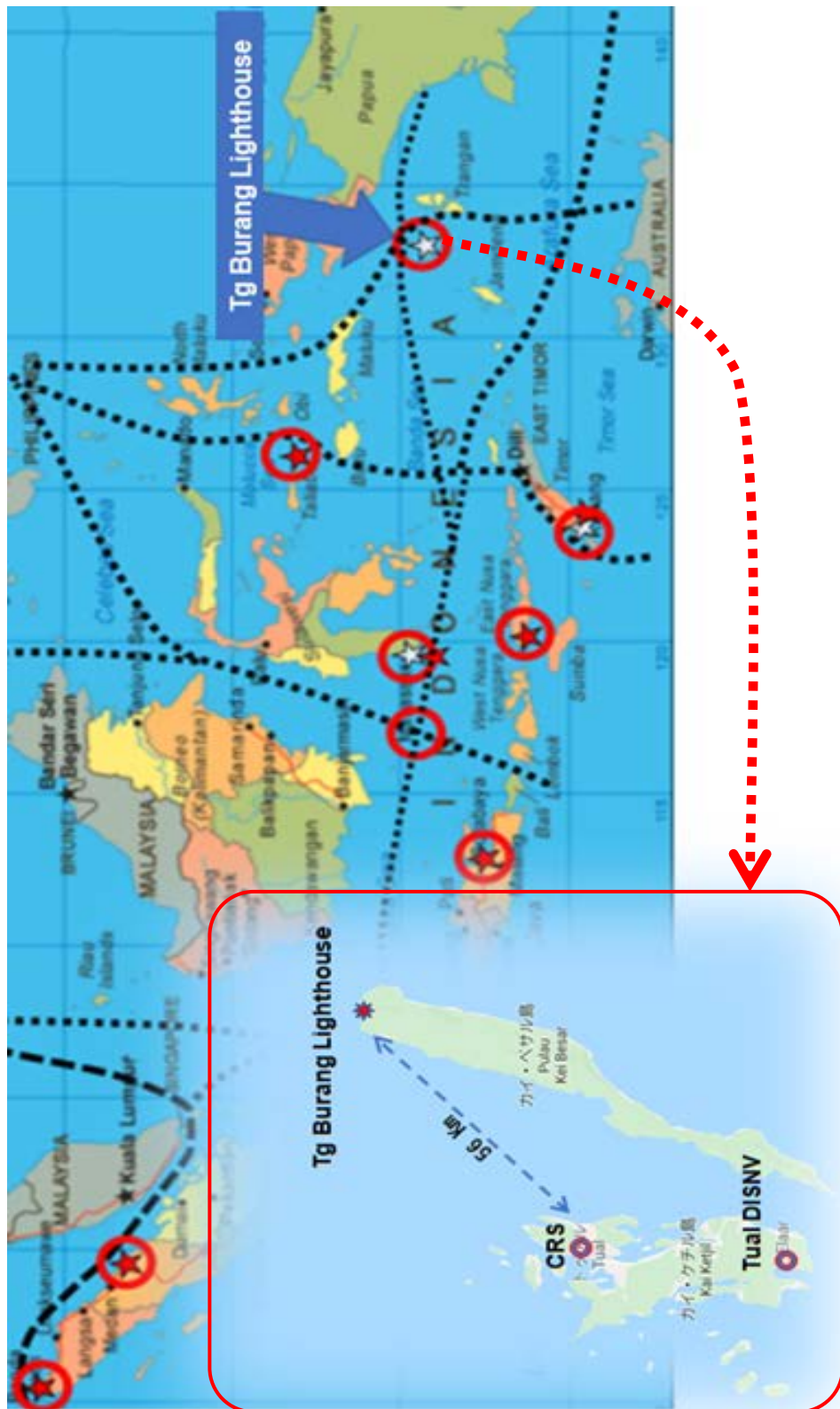

Figure 4.1.3 -4 : Location of CRS, Lighthouse

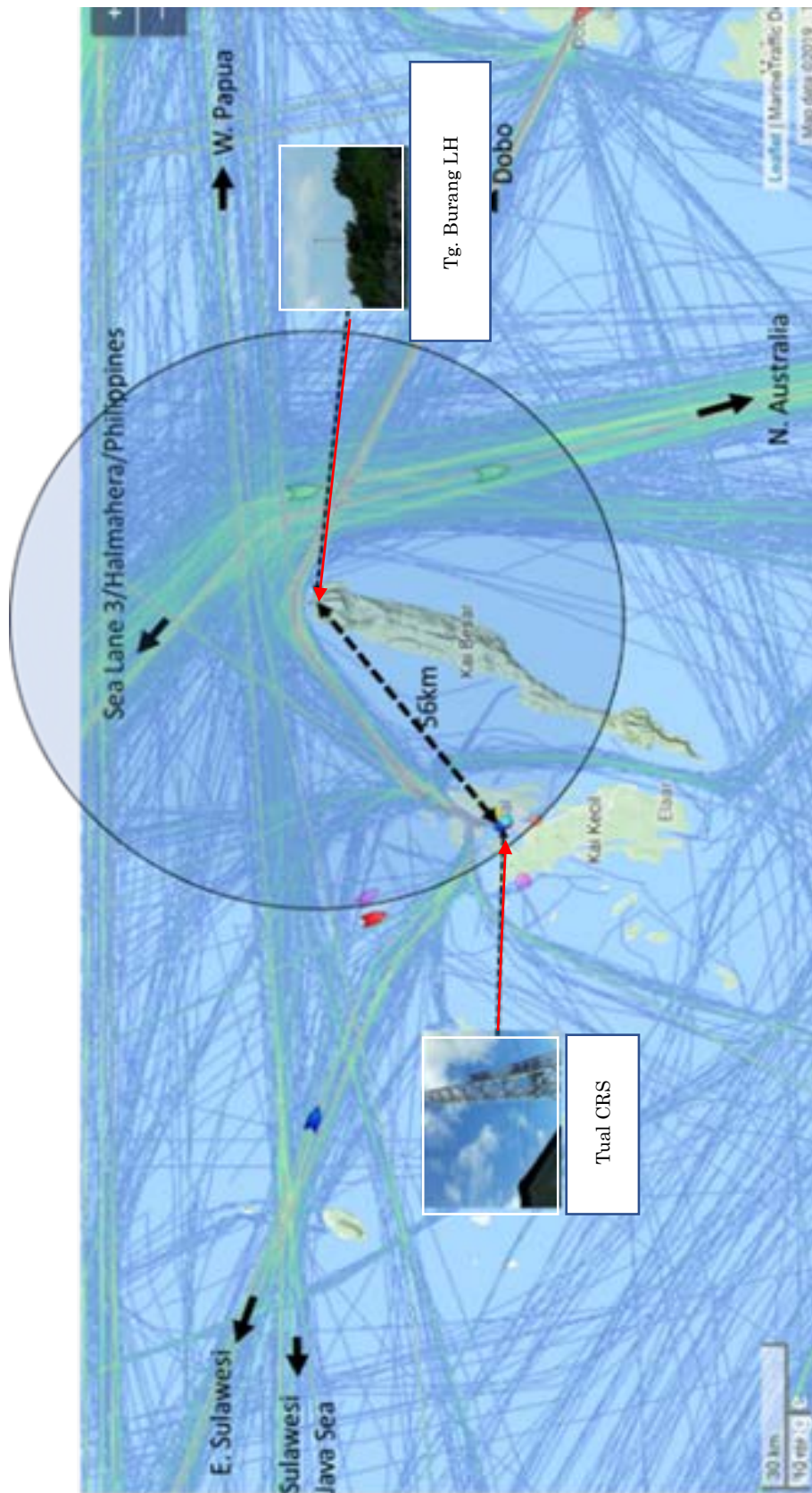

Figure 4.1.3 -5 : Traffic Route of PELNI

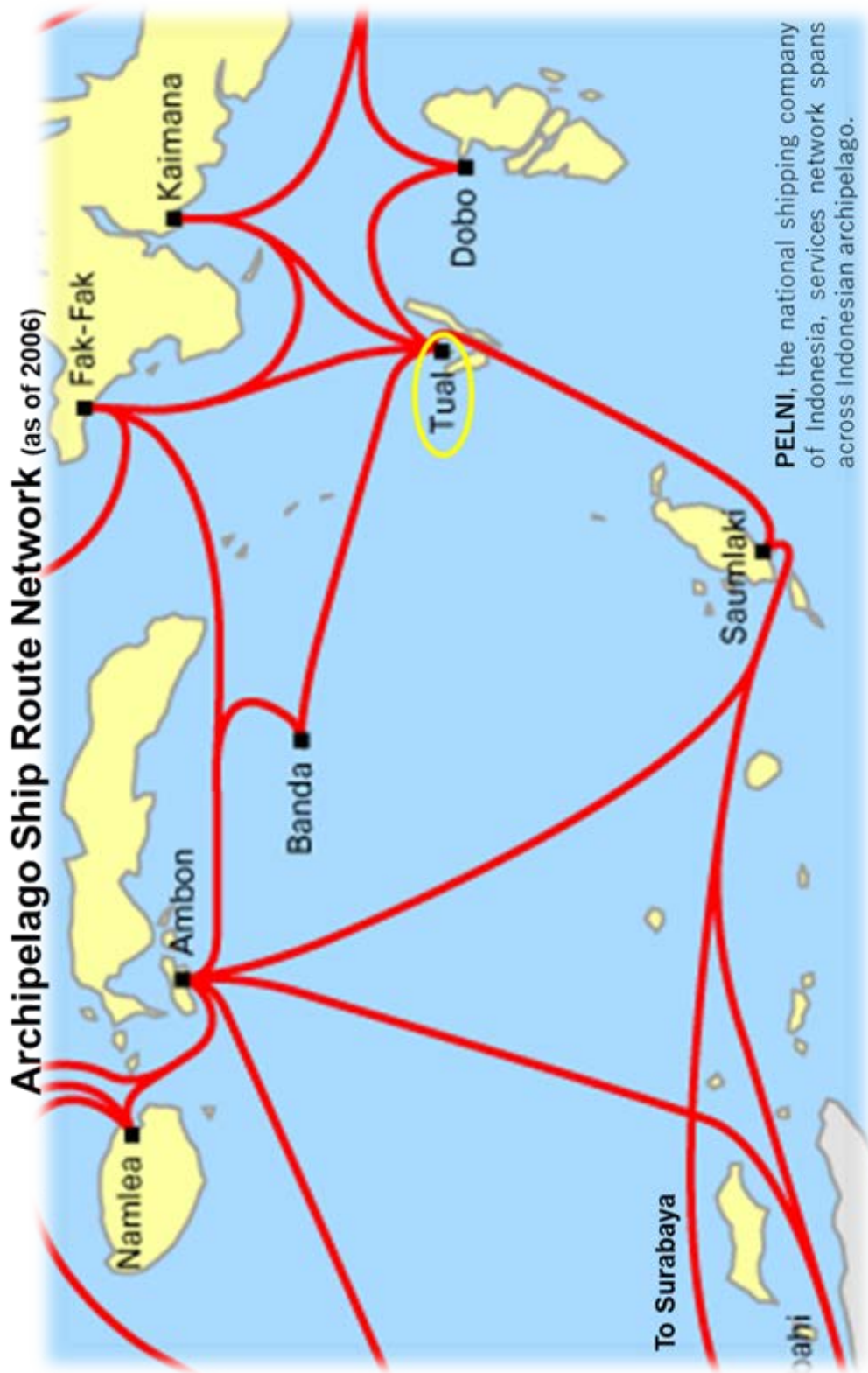

Table 4.1.3 -1 : Current Situation of Network Speed

Place	Ambon	Tual	Tual	Tual
Area	Airport	Town	South Jetty	CRS
Checking time	15:50	18:29	11:31	15:30
Line	4G/LTE	4G/LTE	4G/LTE	IP
Down (Mb/s)	32.8	19.23	3.28	18.8
Upper (Mb/s)	23.8	5.64	5.62	4.2
Ping ms	69	182	326	86

Figure 4.1.4 -1 : Location of DISNAV Tanjung Priok

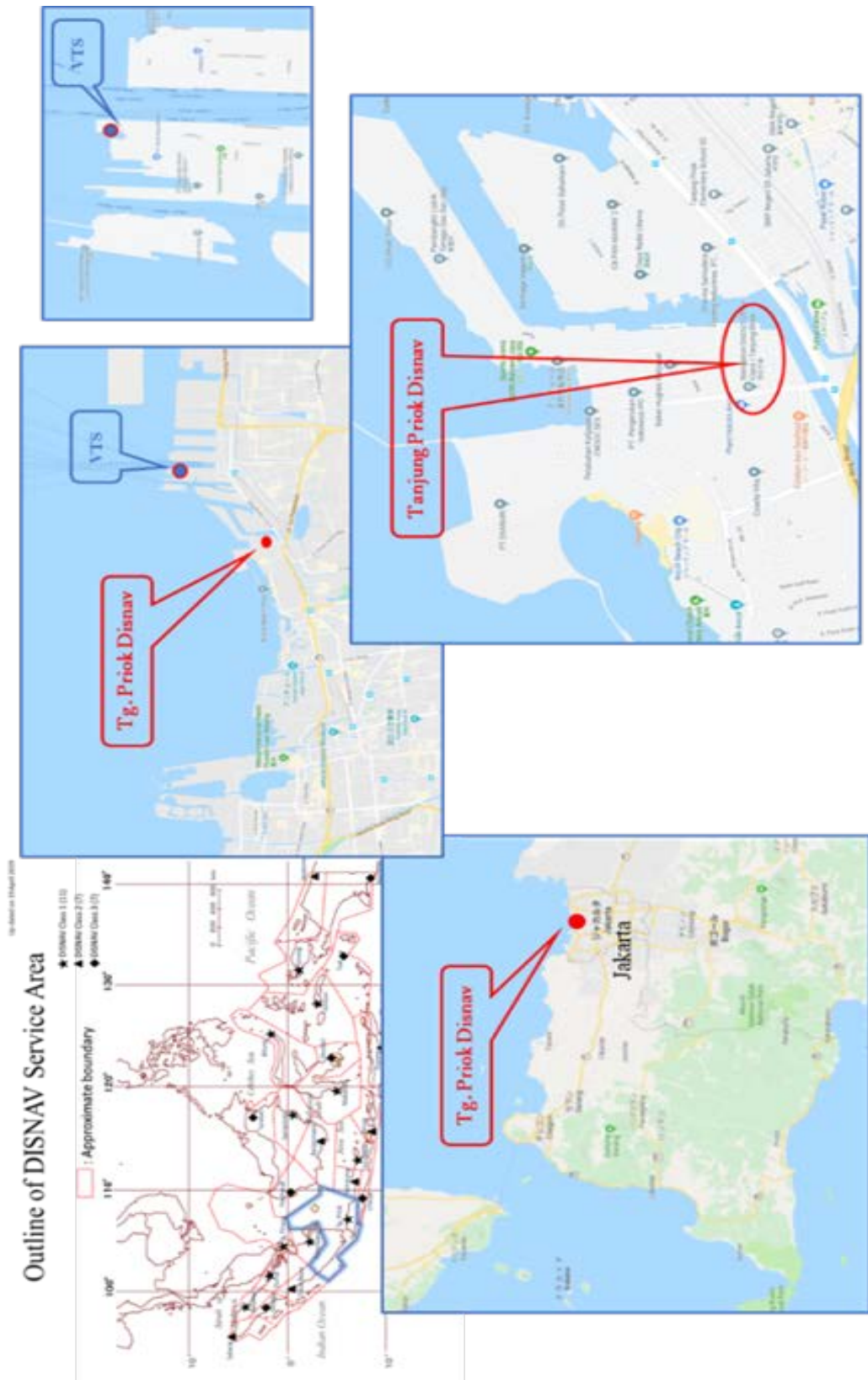

Figure 4.1.4 -2 : Source of Information

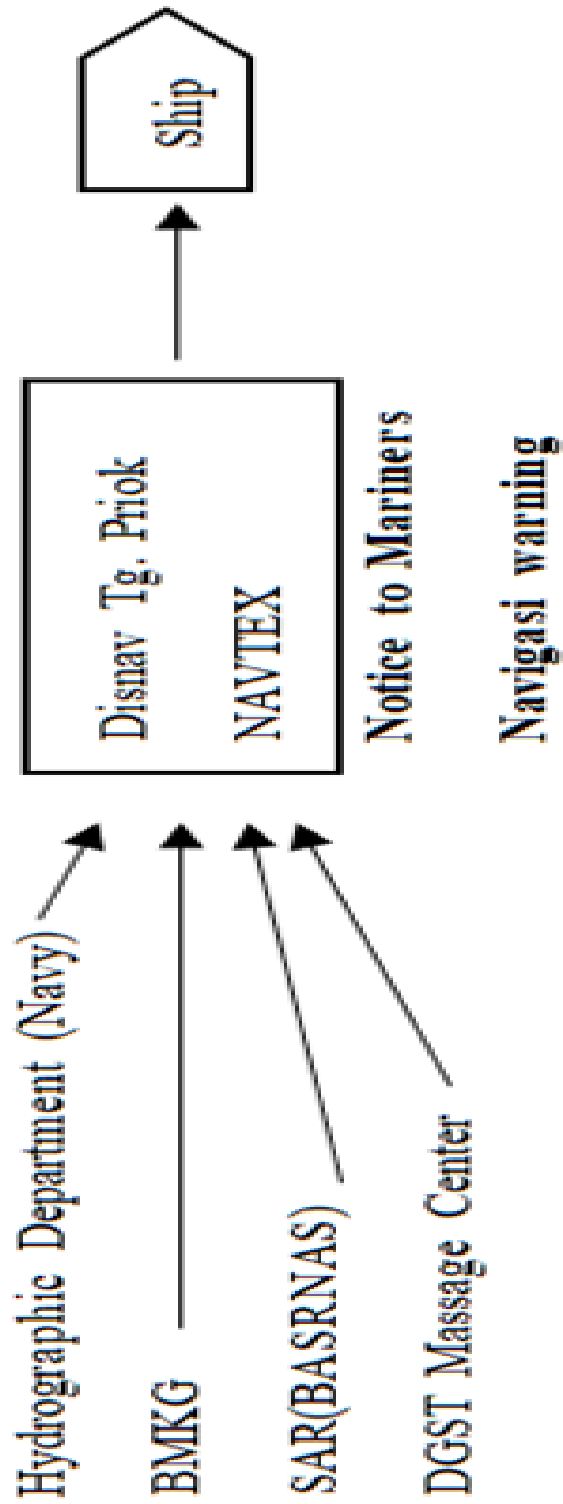

Figure 4.1.5 -1 : Location of DISNAV Samarinda

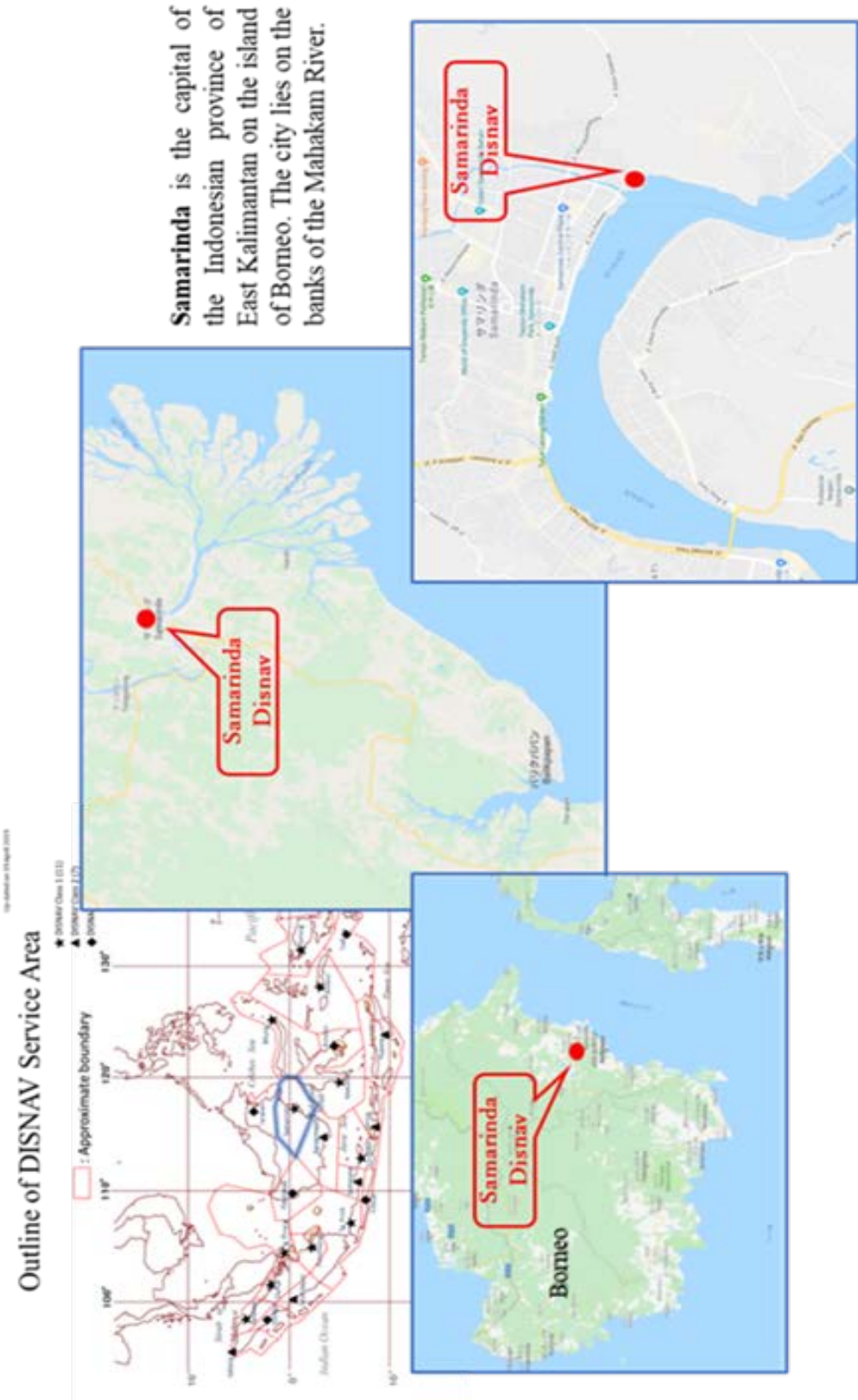

Figure 4.1.5 -2 : Samarinda VTS and Pengah AIS Station

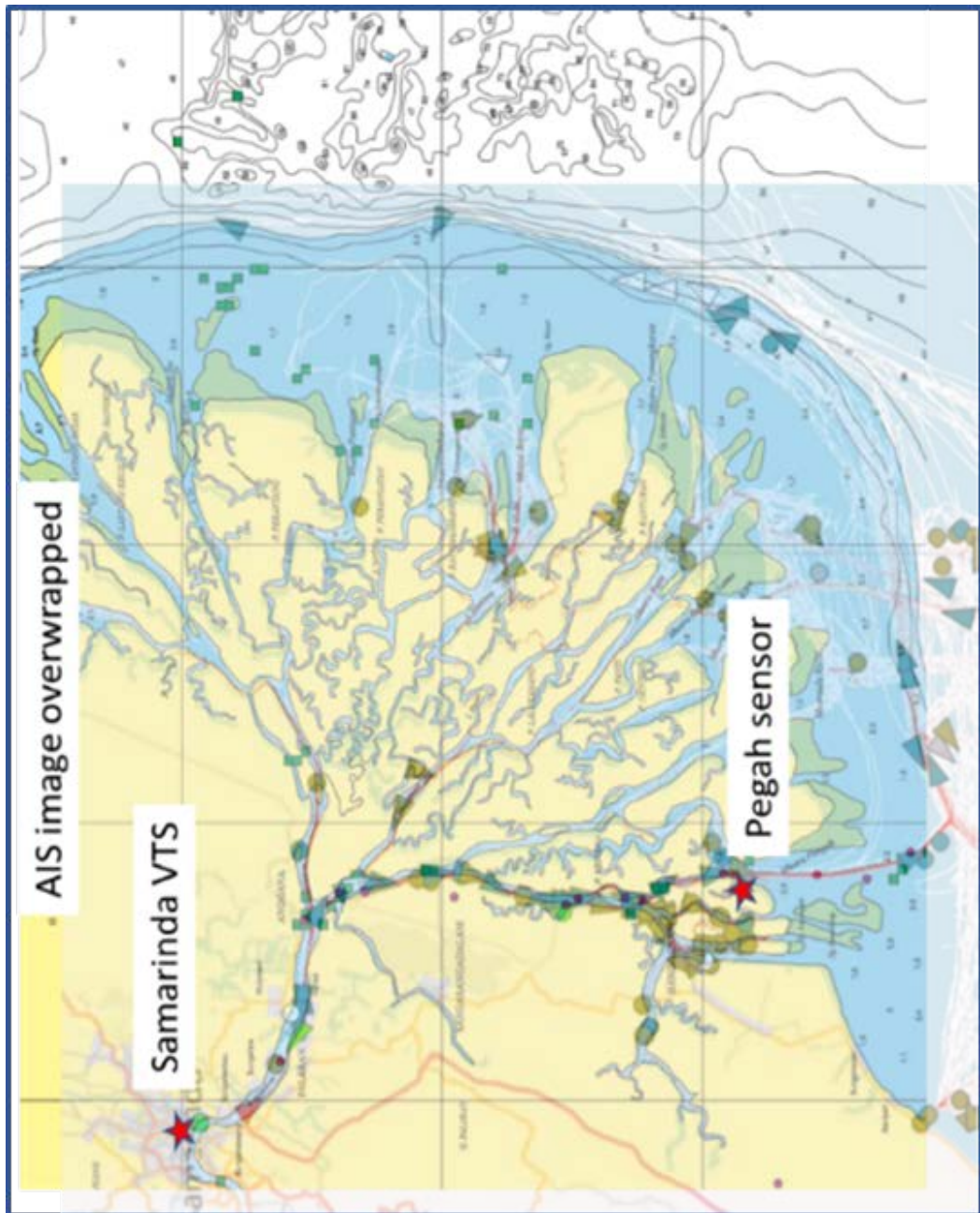

Figure 4.1.5 -4 : Flow of Information

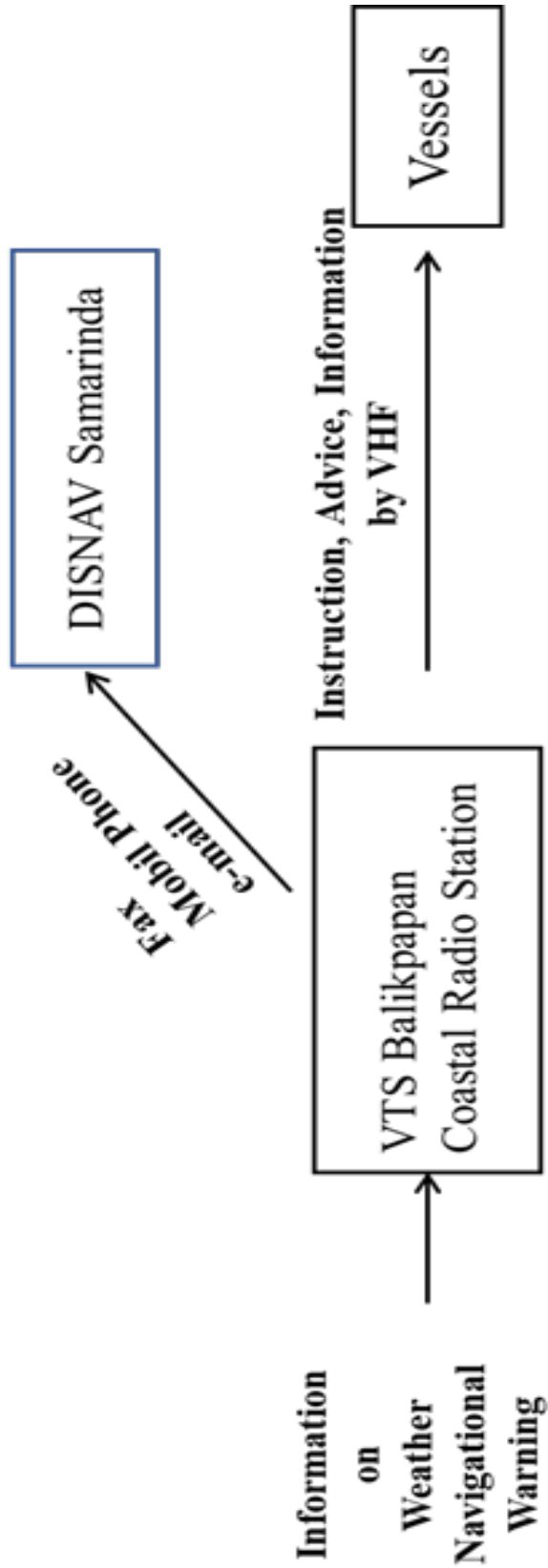

Figure 4.1.5 -5 : Information Flow when a marine accident occurs

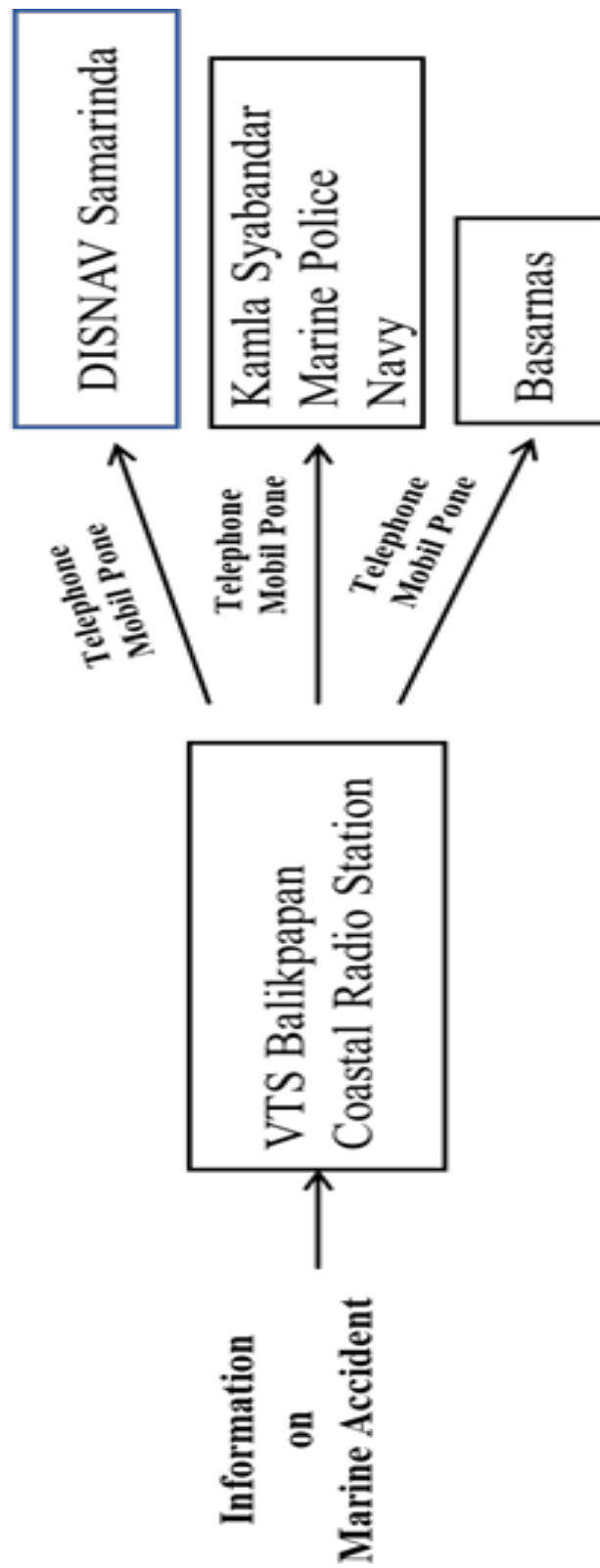

Figure 4.1.5 -6 : Vessels Flow around Samarinda

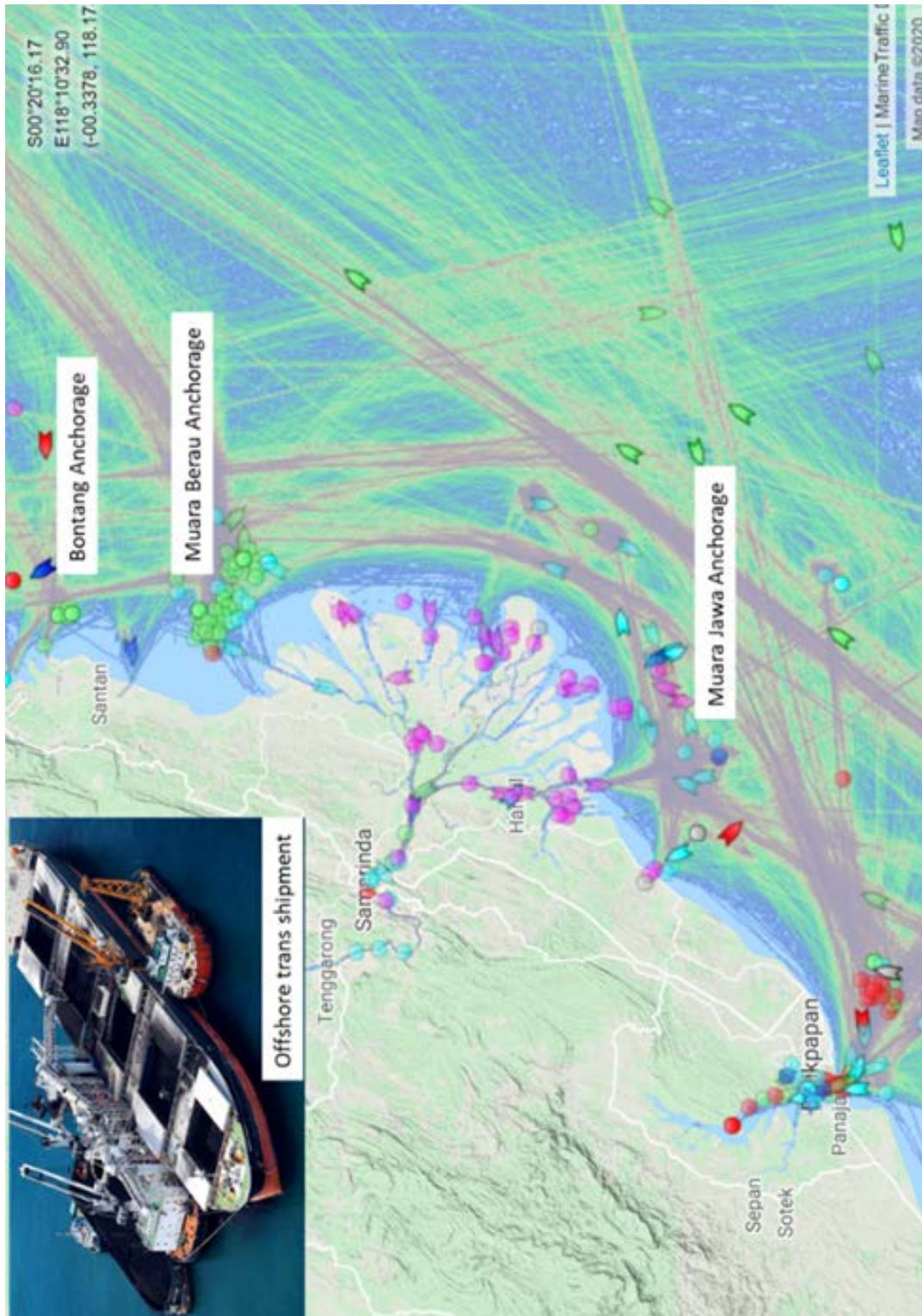
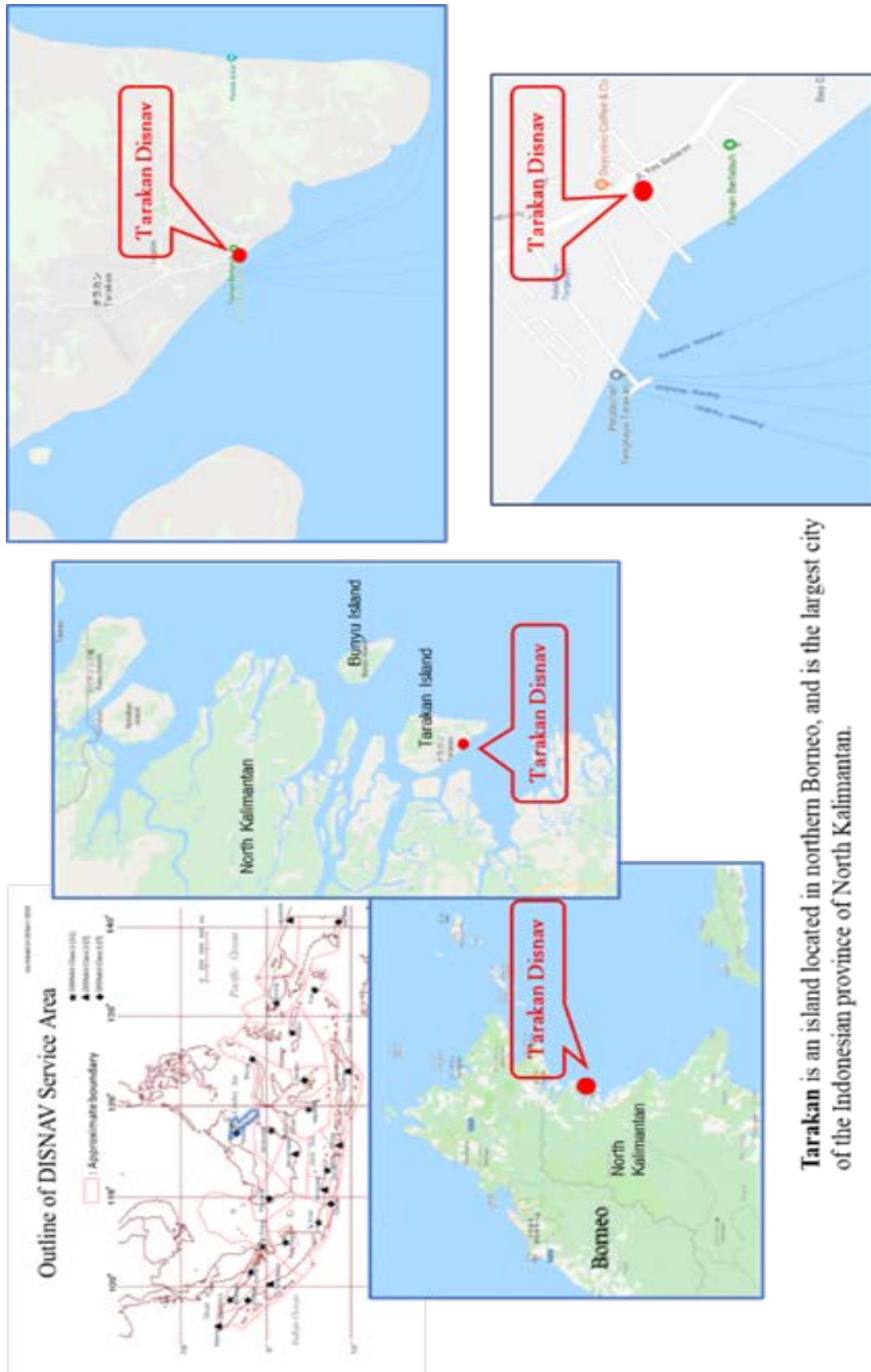

Figure 4.1.6 -1 : Location of DISNAV Tarakan



Tarakan is an island located in northern Borneo, and is the largest city of the Indonesian province of North Kalimantan.

Figure 4.1.6 -2 : Regular Sea Routes



Figure 4.1.7 -1 : Location of DISNAV Makassar

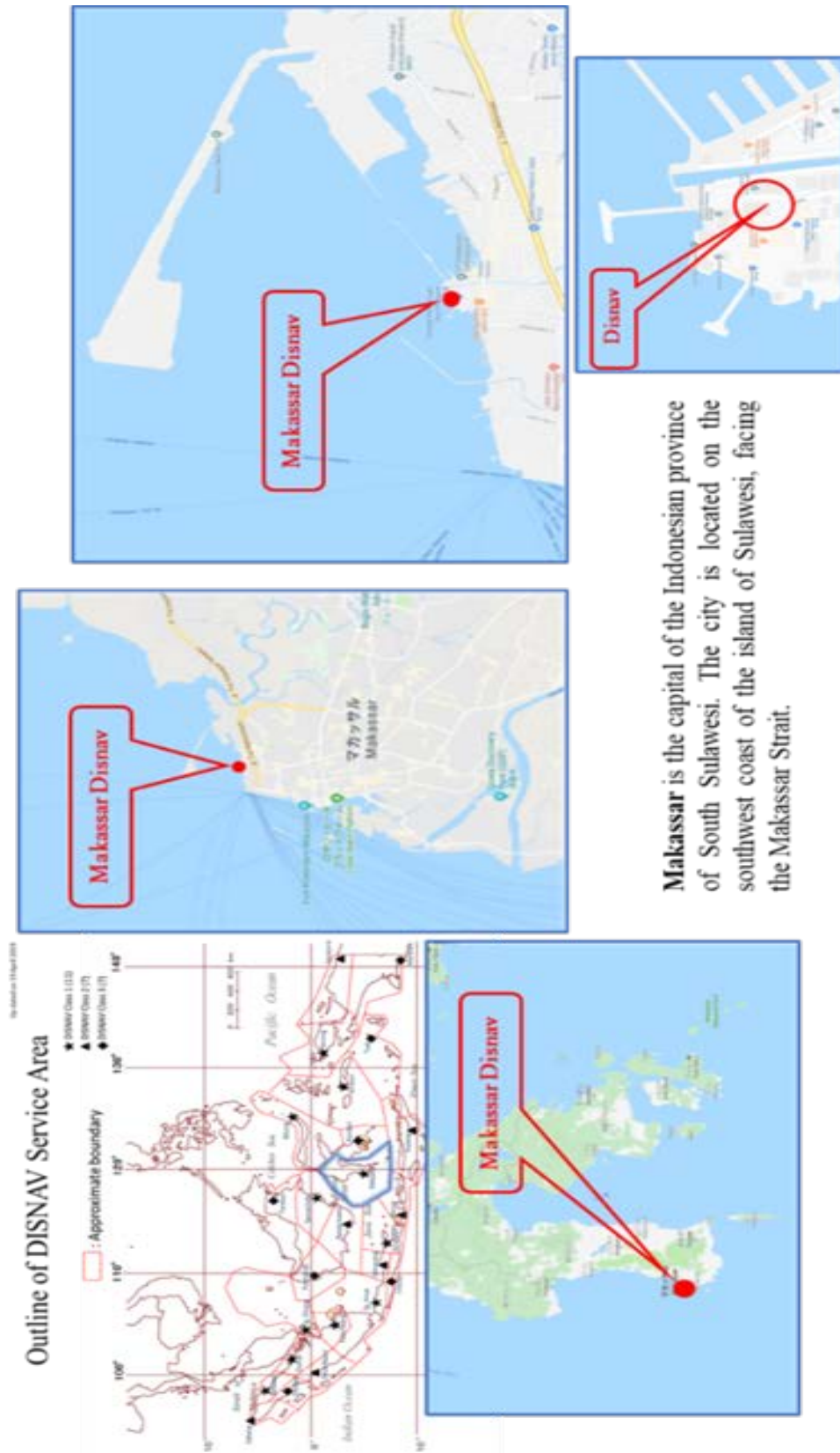

Figure 4.1.7 -2 : Imaginary Traffic Flow

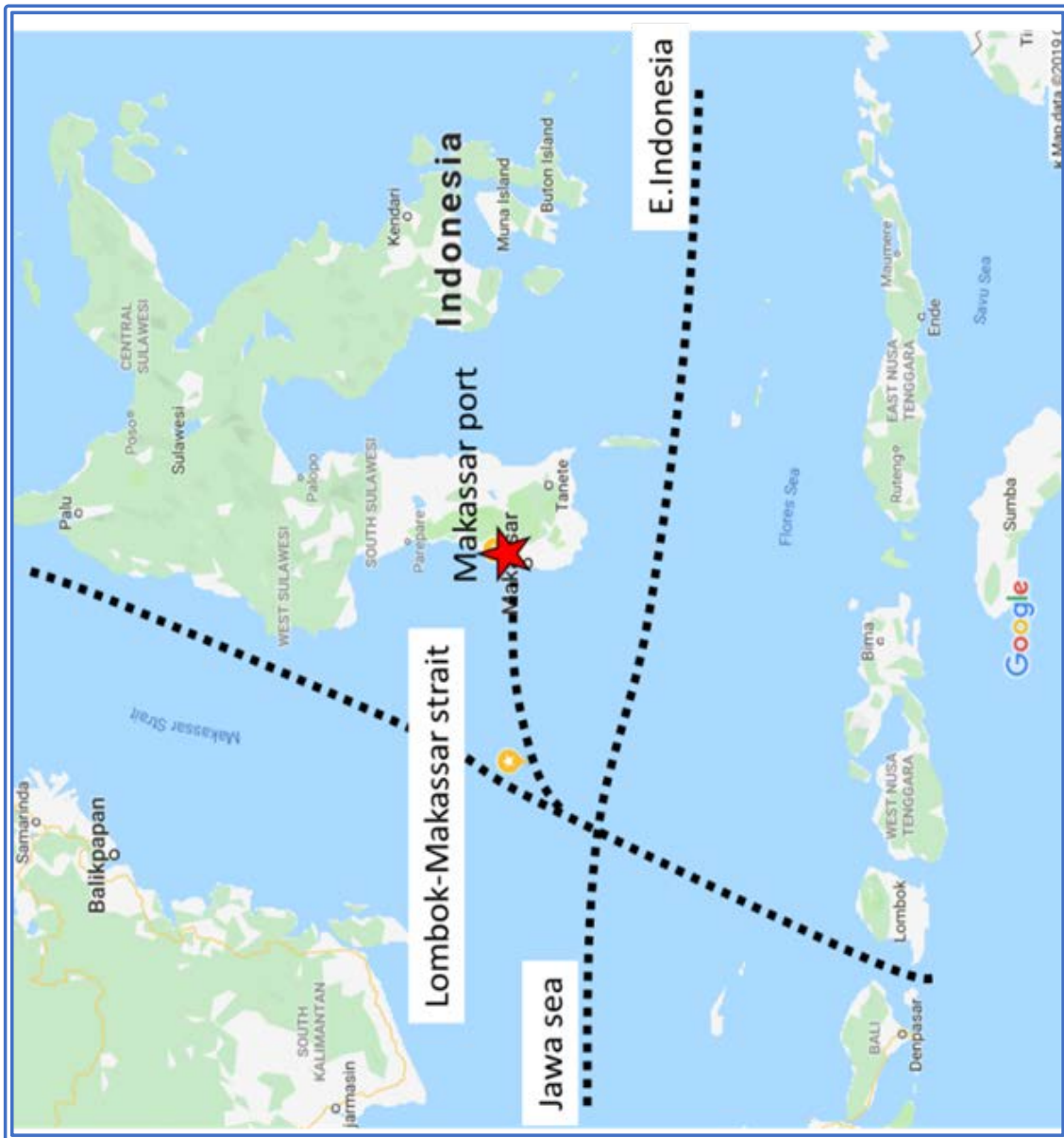

Figure 4.1.8 -1 : Location of DISNAV Belawan

Outline of Belawan Disnav

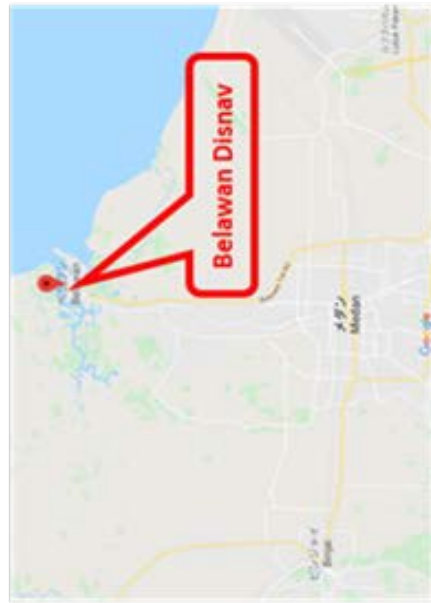
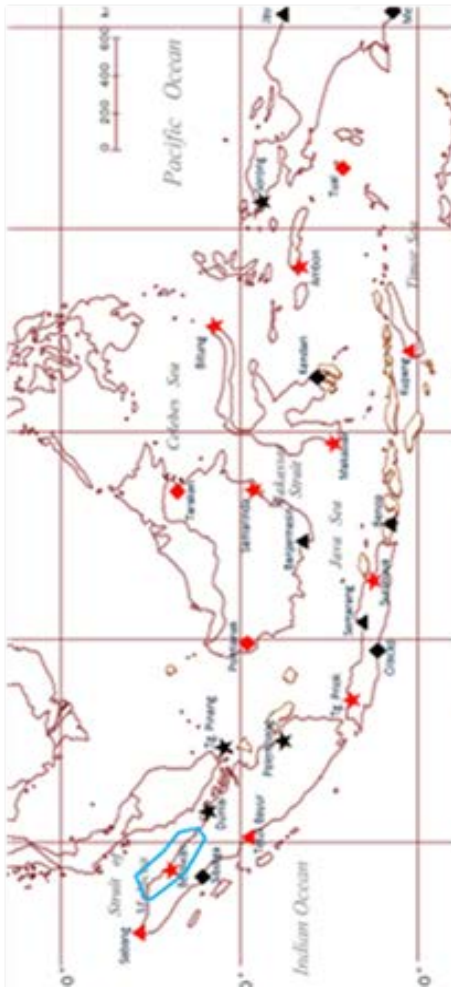
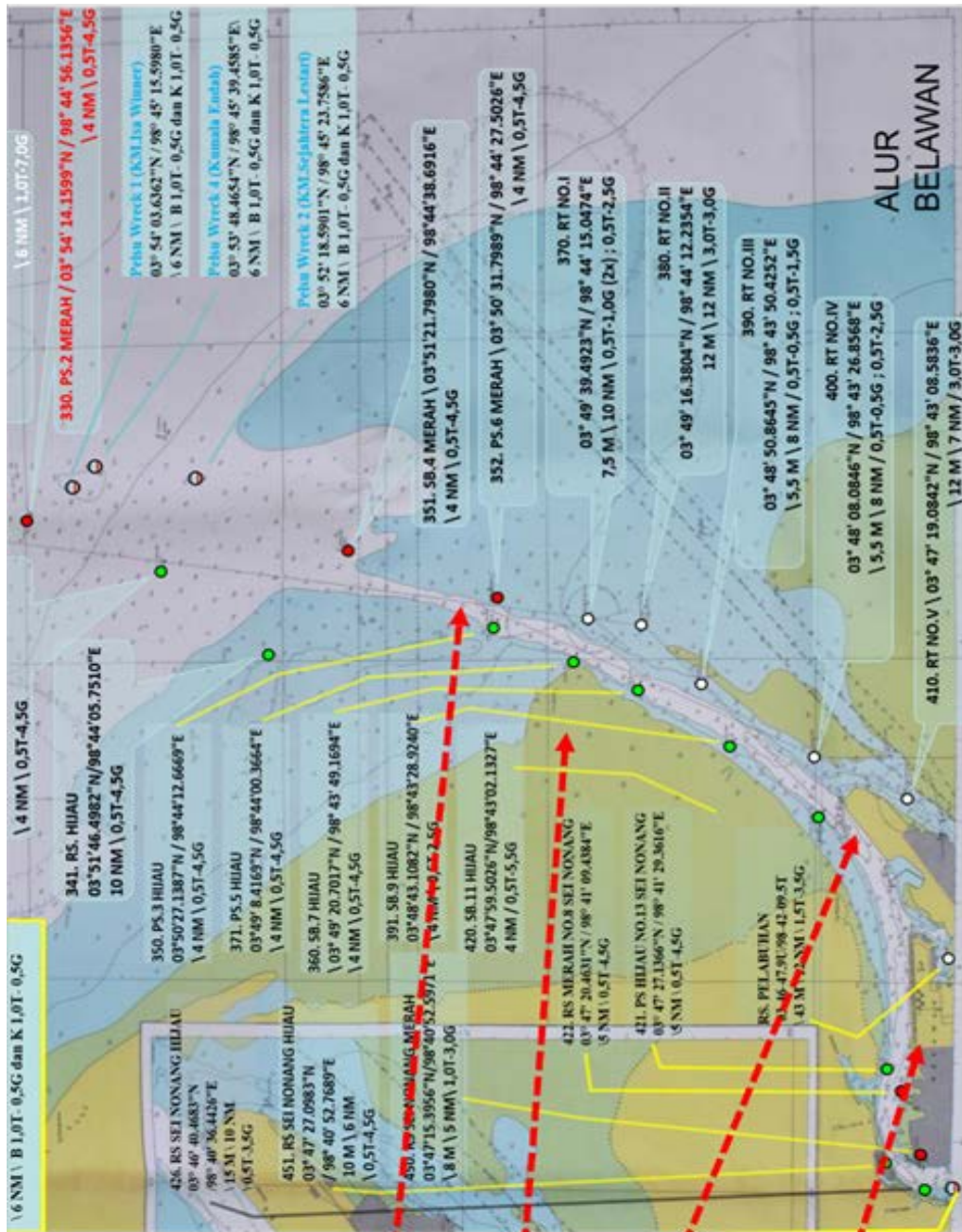

Figure 4.1.8 -2 : Port of Belawan



Annual handling
1.2mil TEU

Max 100m width

Depth 1m contained by
sludge

Dredging twice a year to
clear only up to 7m
depth = 50,000GT class
max

Limited handling
capacity by 16 Nos
Gantry cranes

Figure 4.1.8 -3 : Location of CRS



Figure 4.1.8 -5 : Location of Aids to Navigation

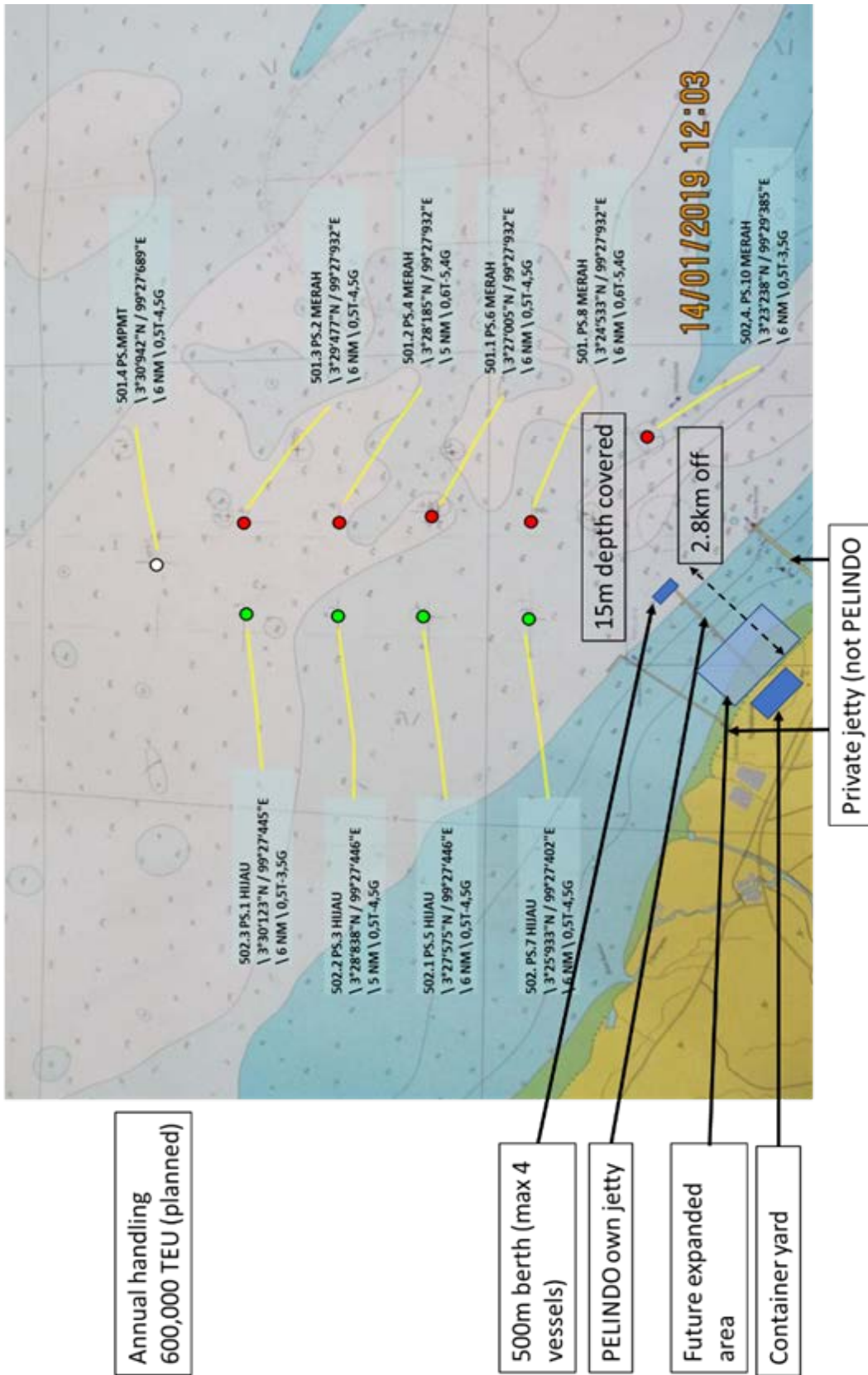

Figure 4.1.9 -1 : Location of DISNAV Sabang

Outline of Sabang Disnav

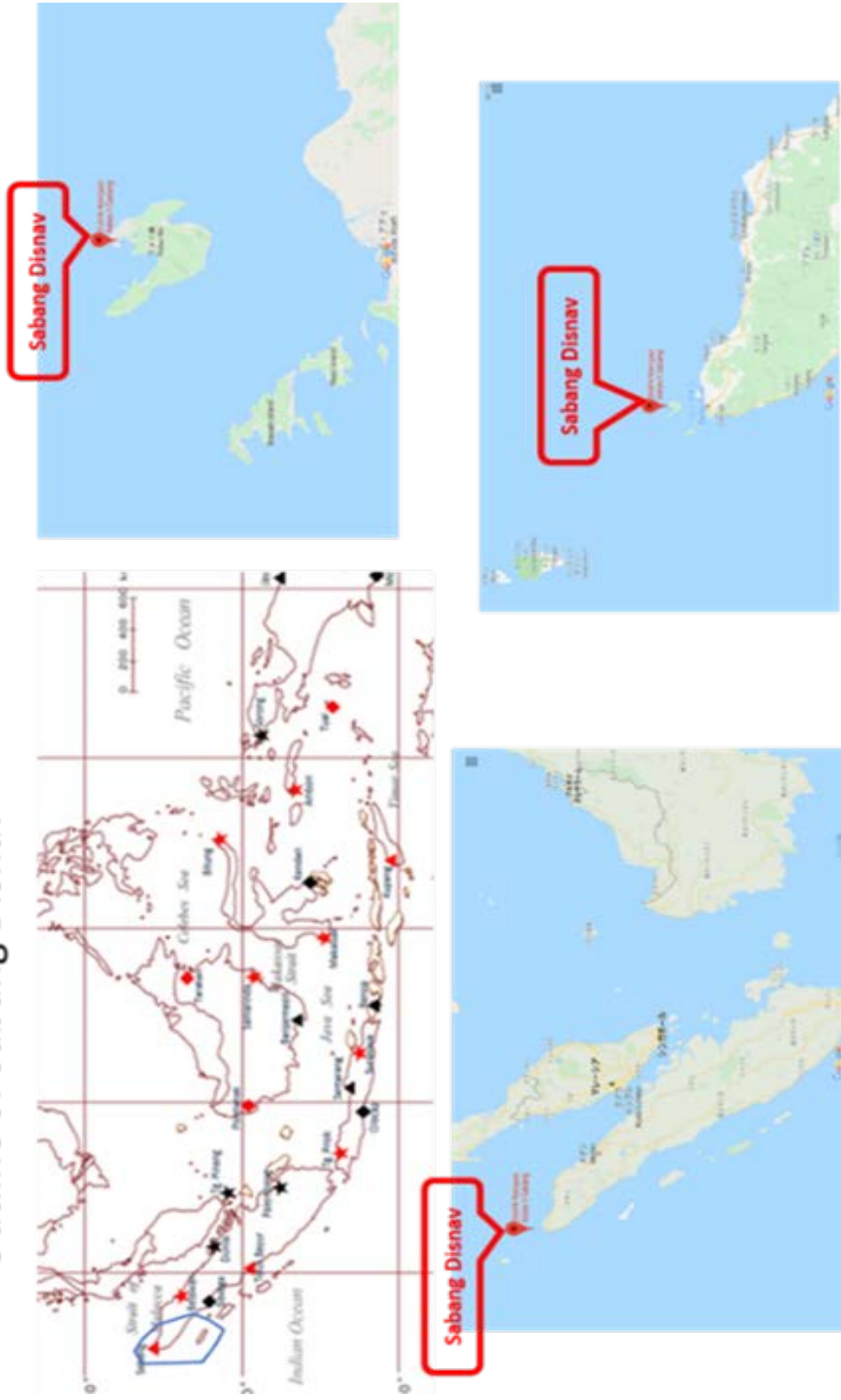
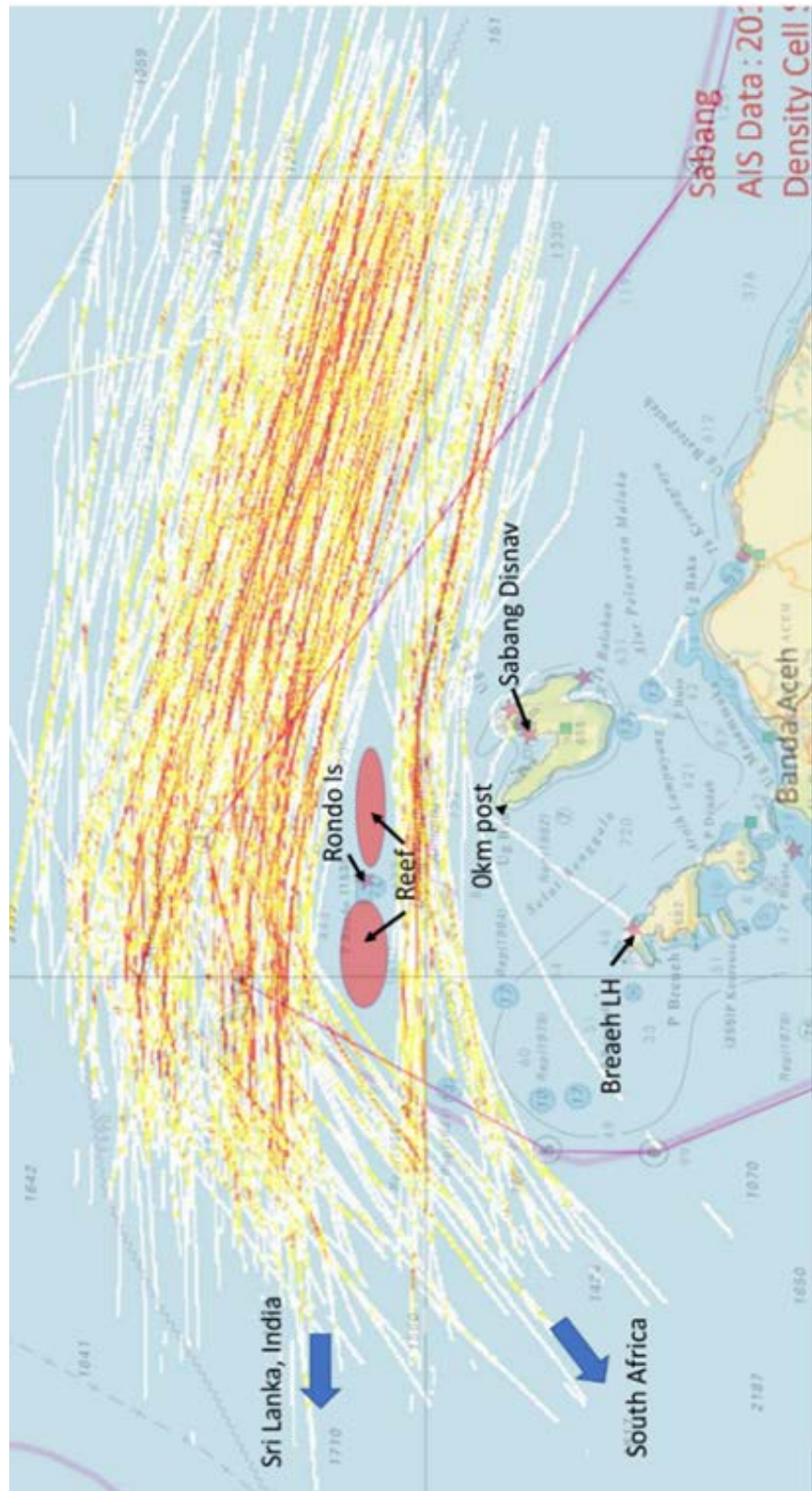

Figure 4.1.9 -2 : AIS Density Map



4.1.10 DISNAV Pontianak Class III

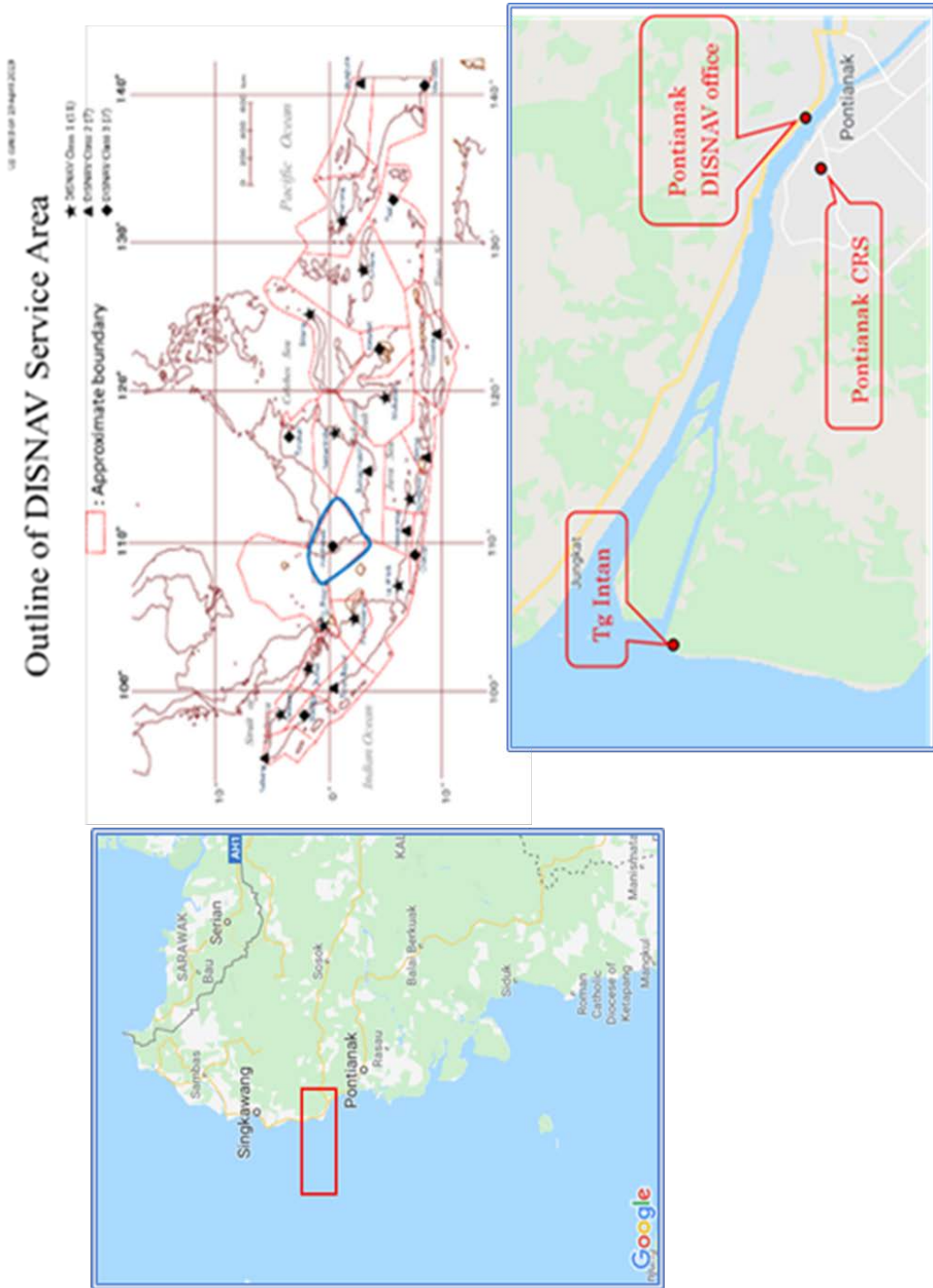

Figure 4.1.10 -2 : Location of CRS



Figure 4.1.11 -1 : Location of DISNAV Bitung

Outline of DISNAV Bitung

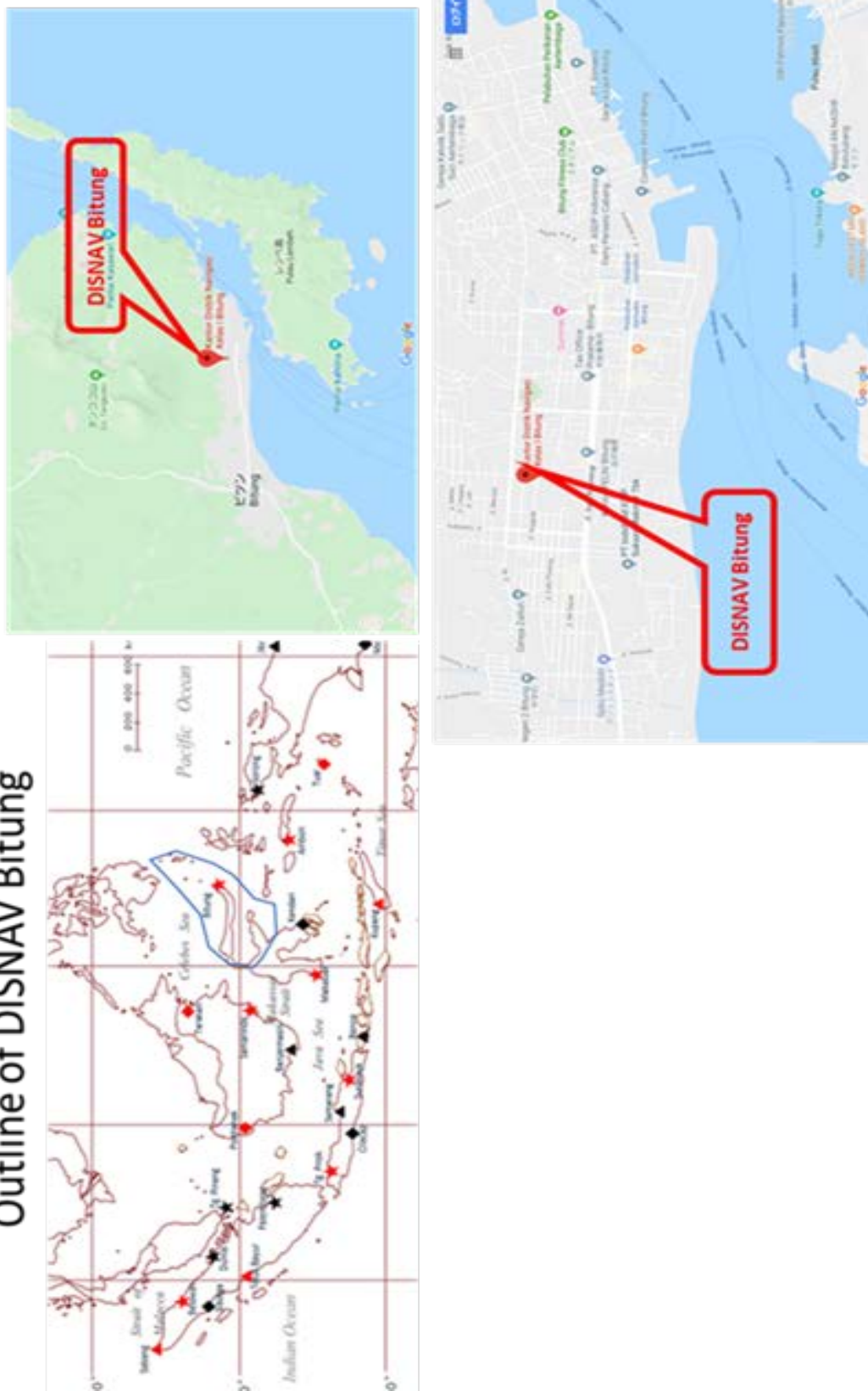

Figure 4.1.11 -2 : Highway and Railroad under construction

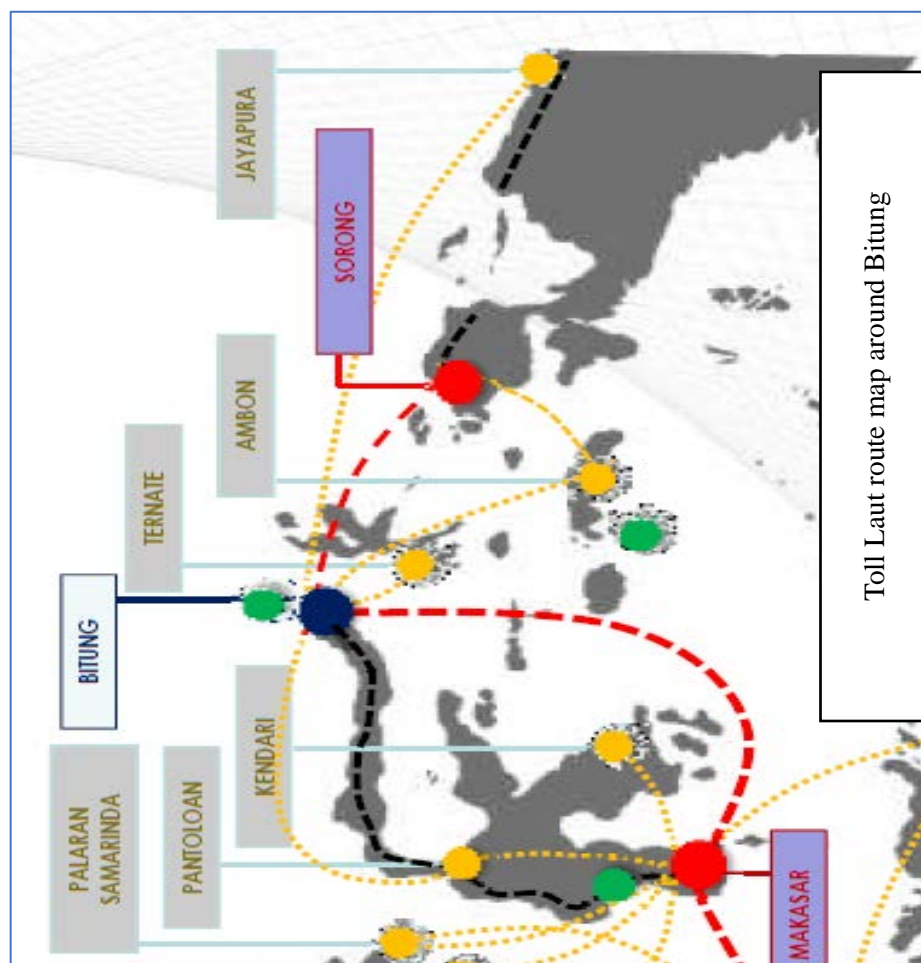
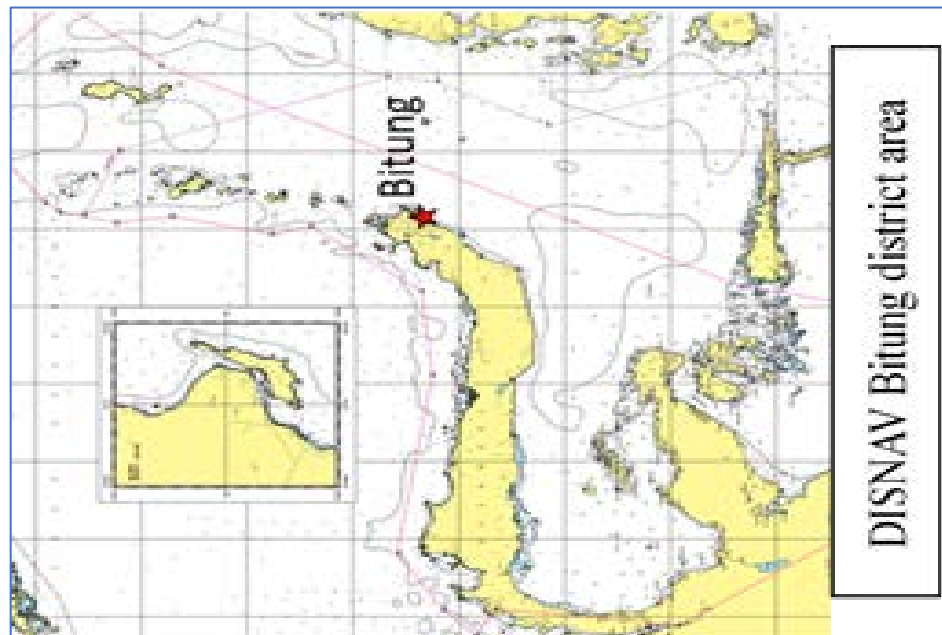

Figure 4.1.11 -3 : Location of CRS

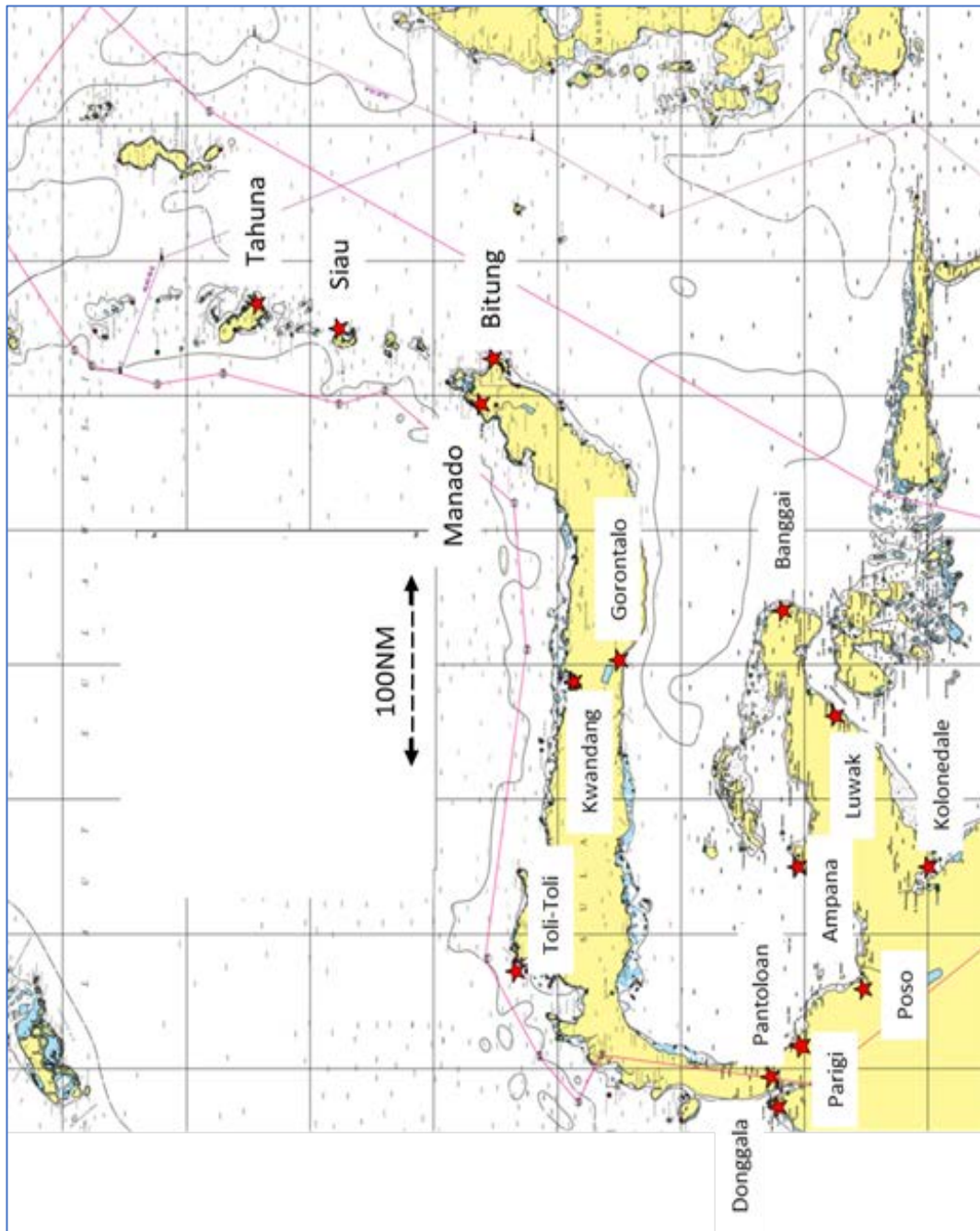

Figure 4.1.11 -4 : Tanjung Kapas Lighthouse



Figure 4.1.11 -5 : Manado CRS



Figure 4.1.12 -1 : Location of DISNAV Surabaya



Figure 4.1.12 -3 : Traffic Flow in Surabaya

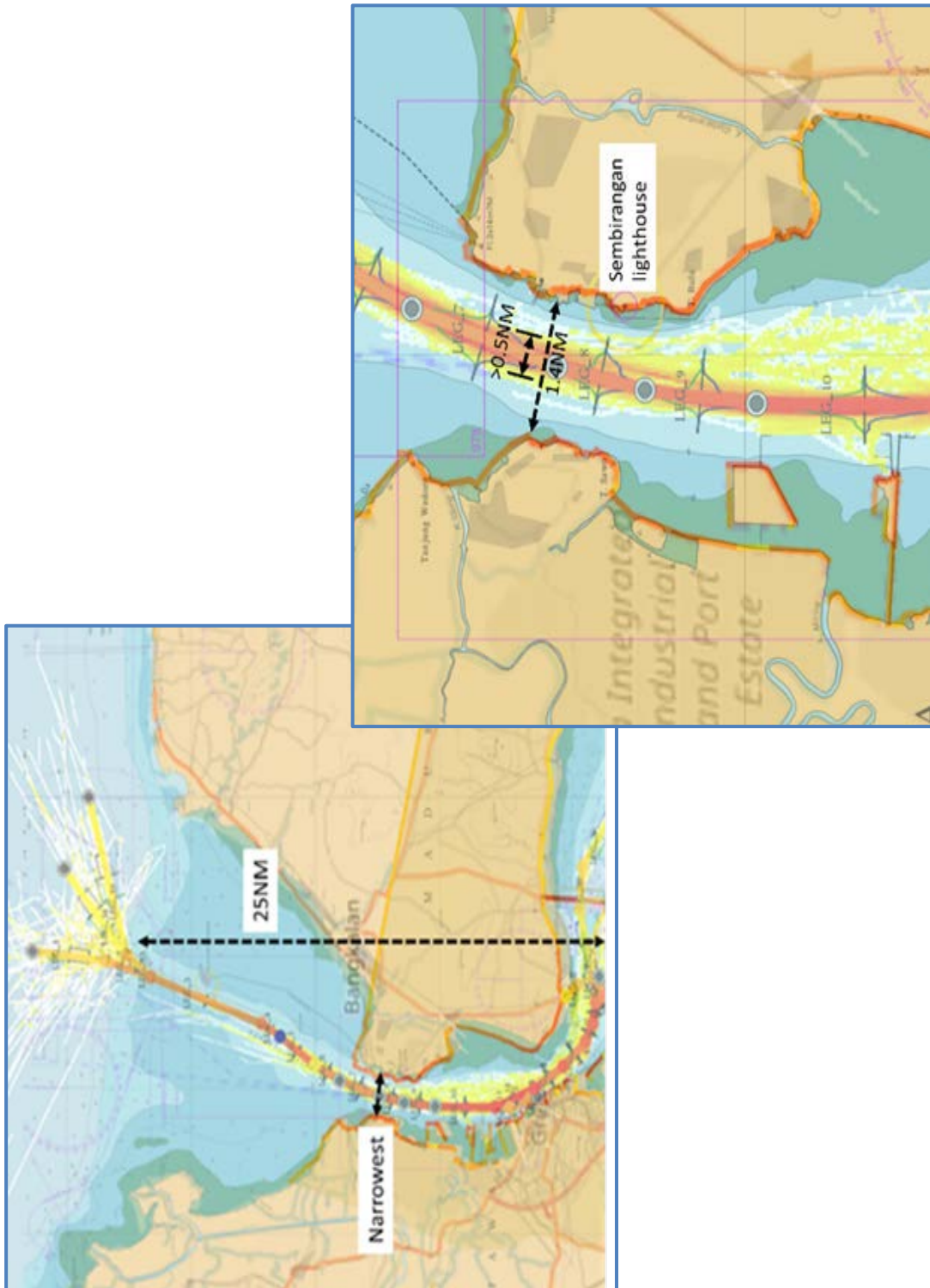

Figure 4.1.12 -4 : Location of VTS



Figure 4.1.12 -5 : Location of CRS

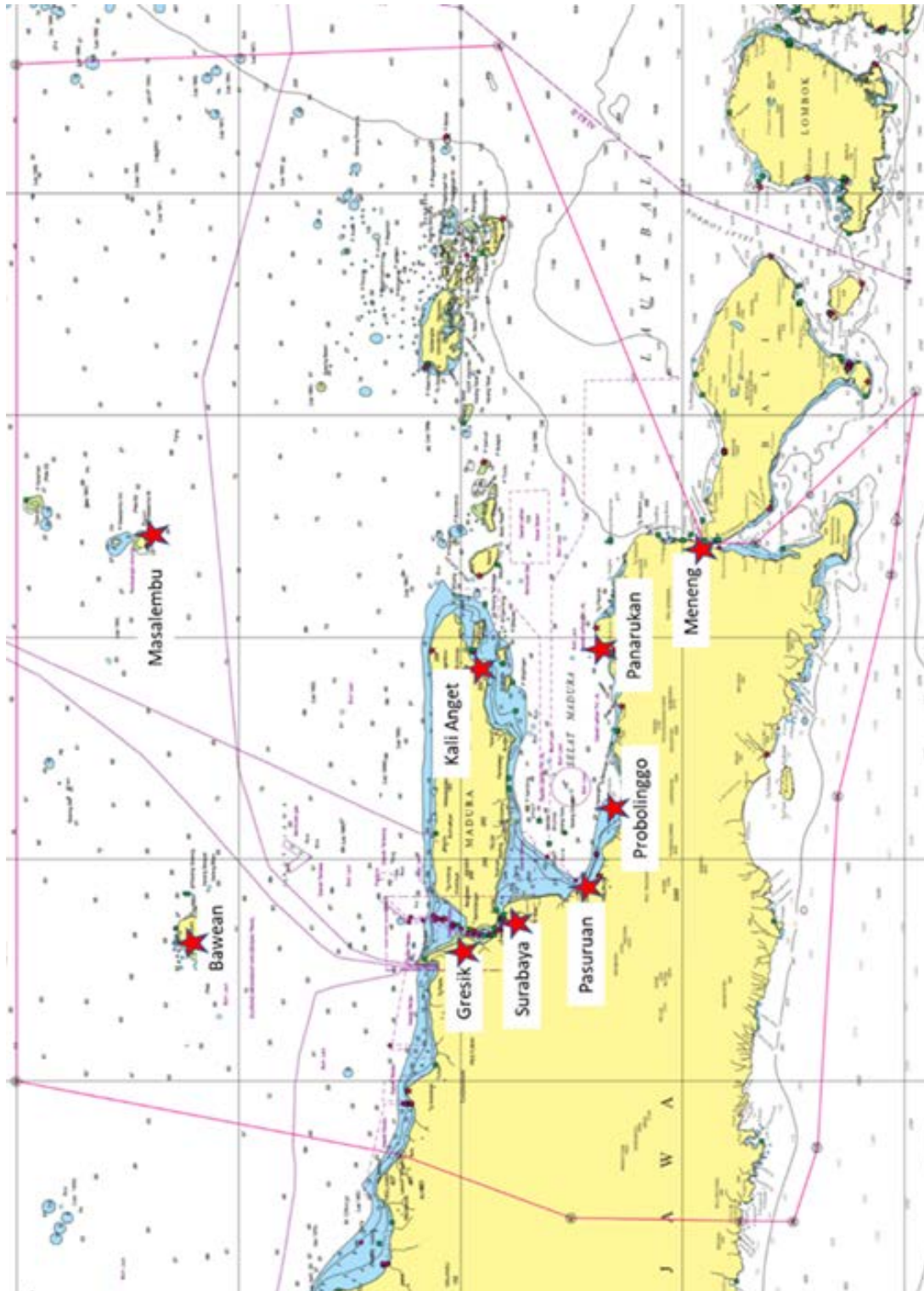

Table 4.1.12 -1 : Record of Marine Accident

Marine accident statistics (APBS)				Annex 3
				2014
No	Date	Vessei's name	Position	Type of accident
1	01 Apr. 2014	KM JOURNEY KMLAMBELU	7-10'667"S 112-41'500E	Collision and JOURNEY sinking
2	31 Dec. 2104	KM TANTO HARI KM SIRIUS	7-10'667"S 112-41'500E	Collision and SIRIUS sinking
				2015
1	28 Jun. 21015	KM.NAVIGATOR ARIES KM. LEO PERDANA	6-55'38.6 S 112-41'50.8E	Collision
2	16 Dec. 2015	KM. WIHAN SEJAHTERA	7-11'03.302S 112-41'49.18"E	Sinking
				2016
1	04 Jun. 2016	KM.ASIKE-1 KM.MENTARI SUCCES	7-10'667S 112-41'500"E	Collision
2	15 July, 2016	KMINTAN DAYA 8 KM.GEORGIA	6-52'564"S 112-44'068"E	Collision
3	27 July, 2016	KM.MERATUSSPIRIT	6-56'31.5"S 112-43'05.19"E	Engine trouble
4	30 July, 2016	KM.ISE BARU	7-11'28.35S 112-43'47.95"E	Collision
5	23 Sep. 2016	KM.BERKAT MULIA	7-11'00.00S 112-41'09.00E	contating wreck ship
6	27 Sep. 2016	KM.ANUGERAH INDAH	7-11'00.00S 112-41'09.00E	contating wreck ship
7	27 Sep. 2016	KM.RED ROVER TB.SDC 2	7-06'30.59S 112-39'37.90"	Collision
8	9 Oct. 2016	KM.DHARMA KARTIKA9	7-11'00.00S 112-41'09.00E	Engine trouble
9	1 Nov. 2016	KM.DEWA RUCI PERKASA	7-07'26.88"S 112-39'37.39"E	Sinking
10	21 Dec. 2016	TB.APRILIDO	6-52'27.90"S 112-44'44.48"E	Sinking
				2017
1	3 Feb. 2017	KM.MUTIARA SENTOSA1	6-51'42.80"S 112-44'33.70"E	Empty fuel
2	21 Mar. 2017	KM.MITRA PROGRESS3	6-55'06.19"S 112-43'35.58"E	Grounding
3	5 May, 2017	KM.ASIA PRIMA1	7-12'01.12S 112-93'20.79"E	Fire
4	10 July, 2017	MV.CAPE MORETON	6-52'27.90"S 112-44'44.48"E	Grounding
5	10 July, 2017	KLM.ARTO SURO	7-08'02.57"S 112-40'04.16"E	Fire
6	12 July, 2017	KM.PEKAN FAJAR	6-51'42.80"S 112-44'33.70"E	Fire
7	7 Aug. 2017	KLM.SINAR PURNAMA JA	6-55'01.78"S 112-43'15.48"E	Grounding
8	27 Aug. 2017	KM MULTI ABADI 01	7-12'01.12S 112-43'20.79"E	Fire
9	4 Oct. 2017	KM.KTC1	6-53'20.00"S 112-44'11.00E	Grounding
10	9 Dec. 2017	MV.ALTAMANDA	6-55'06.19S 112-43'35.58"E	Engine trouble
11	10 Dec. 2017	MV.ST ISLAND	6-52'27.90"S 112-44'44.48"E	Grounding
12	13 Dec. 2017	MT.FASTRON	6-58'23.00S 112-42'10.00"E	Engine trouble
13	20 Dec. 2017	MT.SELE KM.SML9	7-08'07.49S 112-40'42.09"E	Contacting during anchoring

Figure 4.1.13 -1 : Location of DISNAV Teluk Bayur

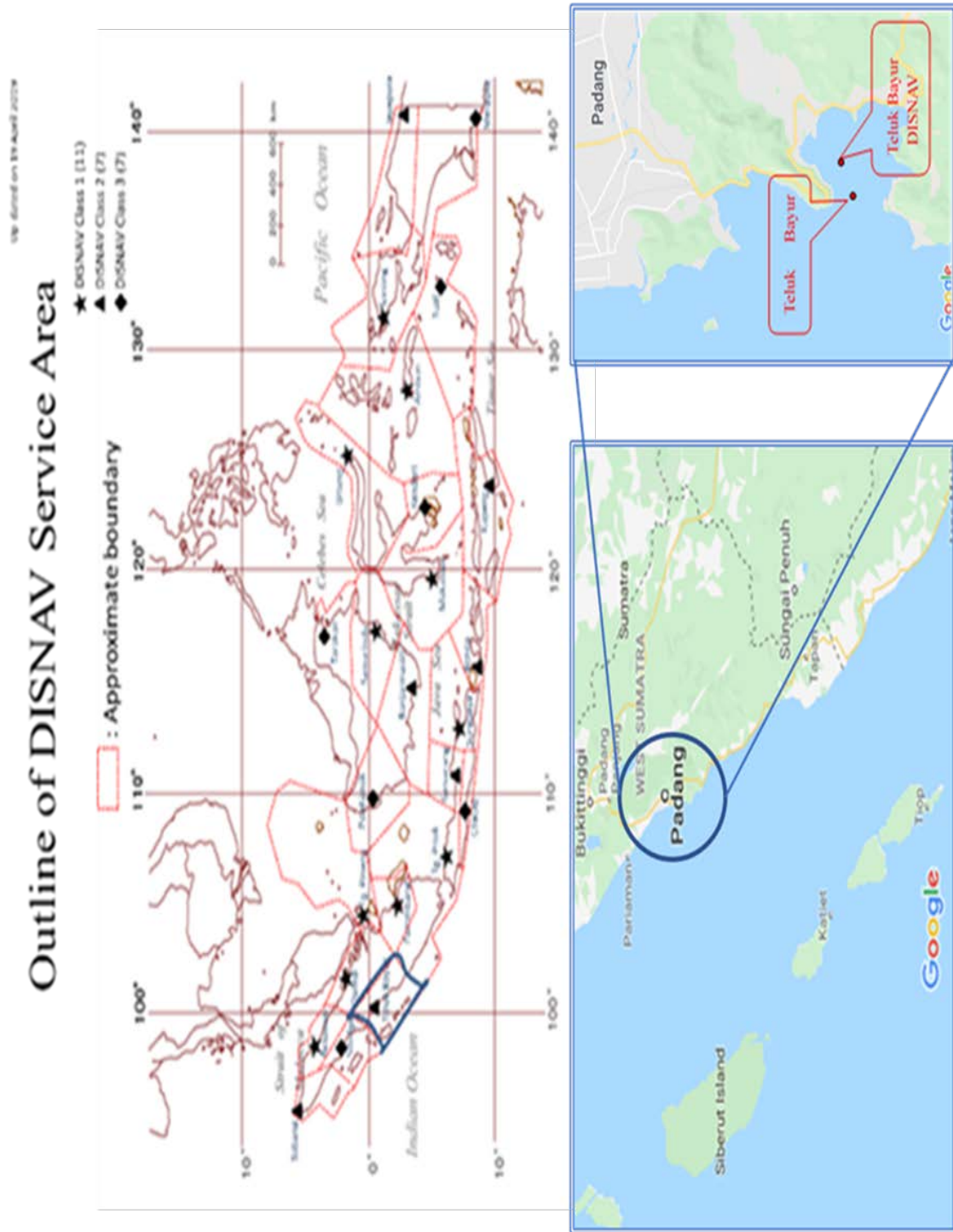

Figure 4.1.13 -2 : Location of CRS



Figure 4.1.14 -1 : Location of DISNAV Labuan Bajo

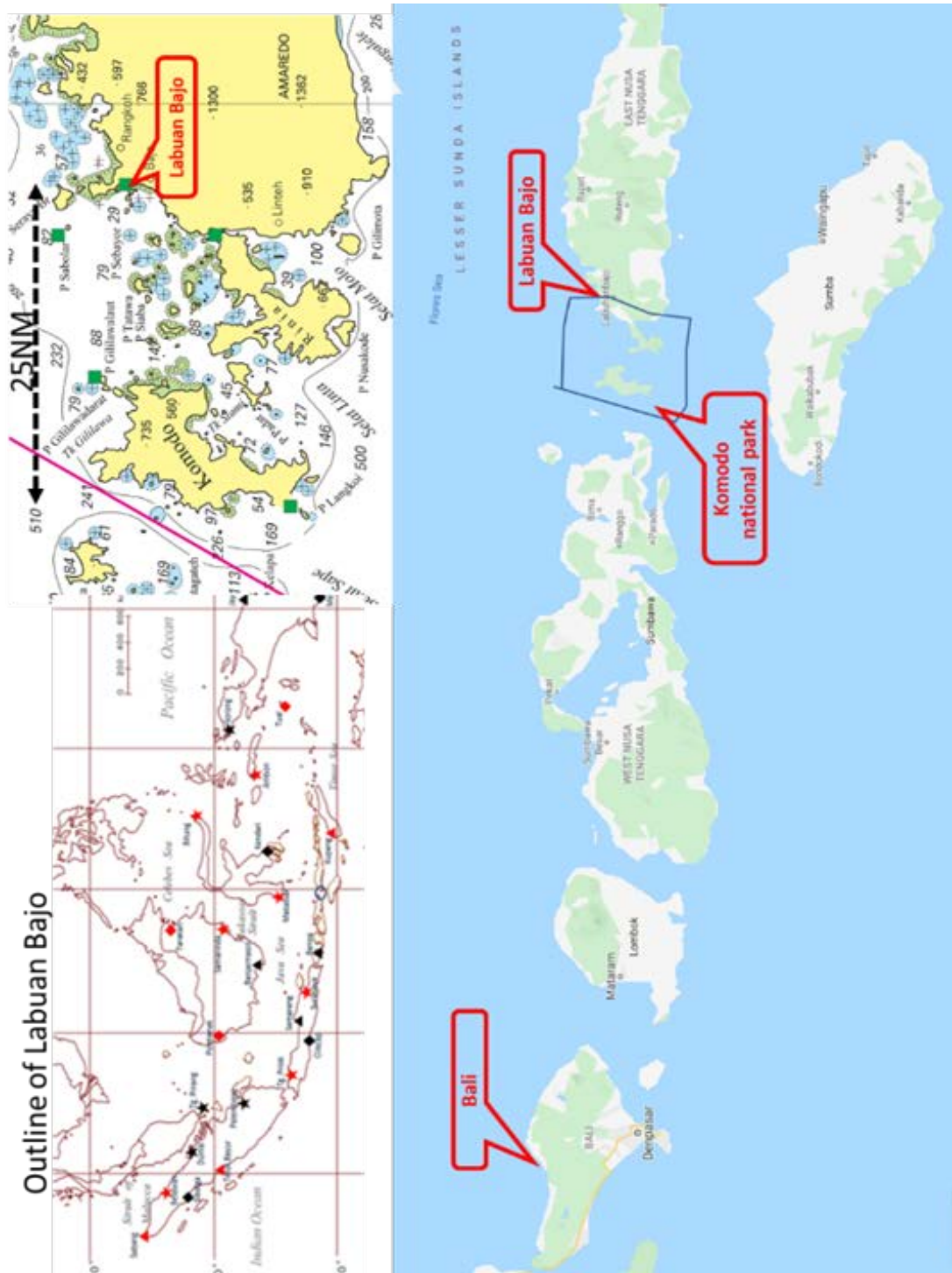

Figure 4.1.14 -3 : AIS Tracking Trace



Bab 5

Surveys of Maritime Traffic Flow

and Volume

Table 5 -1 : Place and Date of Survey

Maritime Traffic Flow/Volume Survey

No	Location	Means of Collection	Date at Site	AIS DATA
1	Sabang	AIS	Sep. 23 - 24, 2019	9.23~24
2	Tanjung Perak (Surabaya)	AIS, Radar	Oct. 1 - 8, 2019	9.25, 10.~7
3	Kuala Tanjung (Belawan)	AIS	Sept. 18 - 20, 2019	9.18~19
4	Makassar	AIS, Radar	Sept. 1 - 9, 2019	9.2~10
5	Kalukalakuang (Makassar Offshore)	AIS	Sept. 9 - Oct. 6, 2019	8.29~30, 9.4, 9.10~18, 9.29~10.5
6	Labuan Bajo	AIS, Radar	Nov. 1 -7, 2019	11.4~6
7	Kupang	AIS	Oct. 10 - 13, 2019	7.3~4, 11.10~12
8	Tanjung Dehekalano (Ambon)	AIS	Oct. 23 - 28, 2019	10.23~28
9	Merak	AIS	Jan. 8 - 20, 2020	1.8~20

Figure 5 -1 : Location of Maritime Traffic Flow/Volume Survey

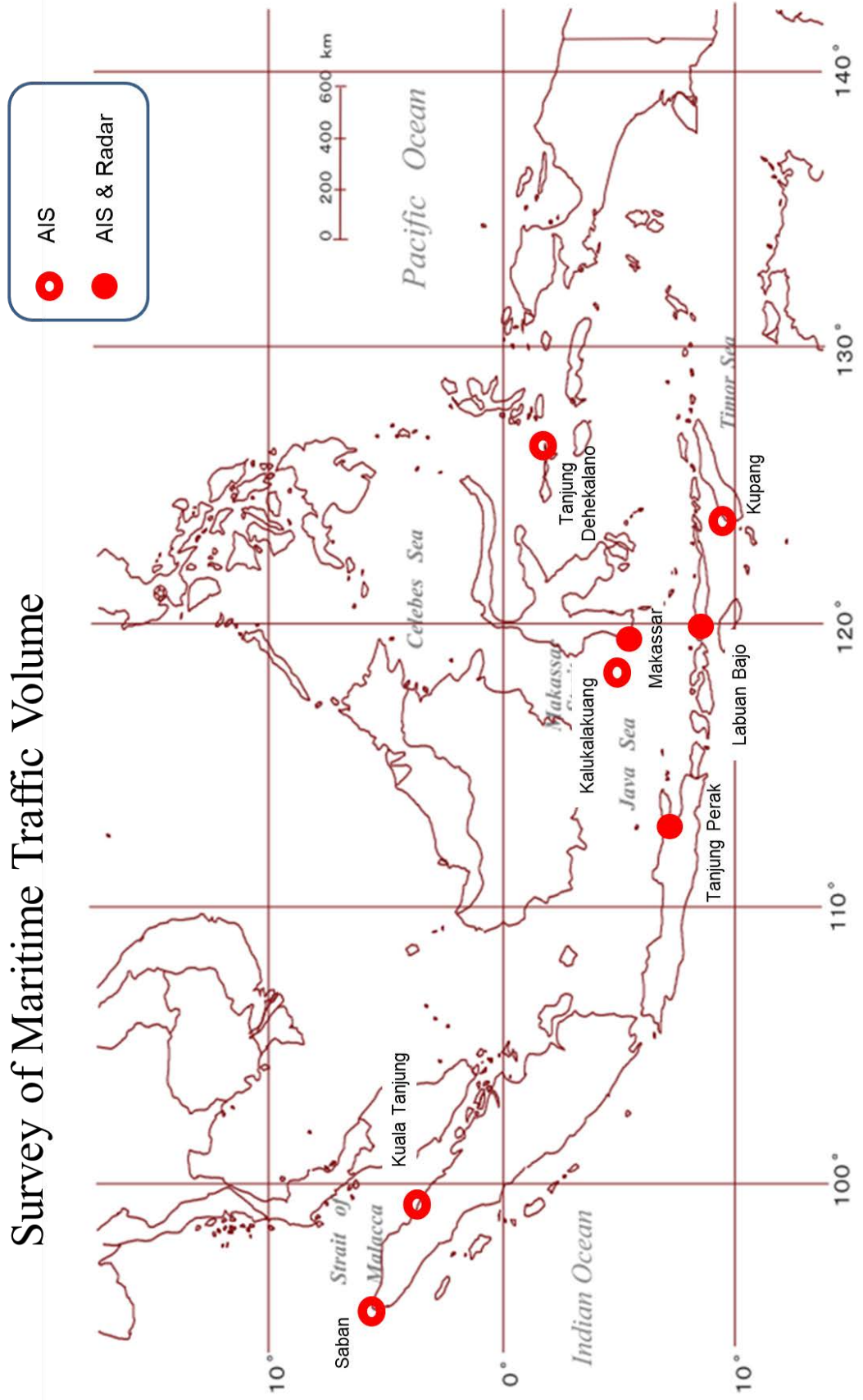

Picture 5 -1 : AIS Equipment
Picture 5 -2 : Installation of AIS and GPS Antenna



Picture 5 -3 : Installation of Radar

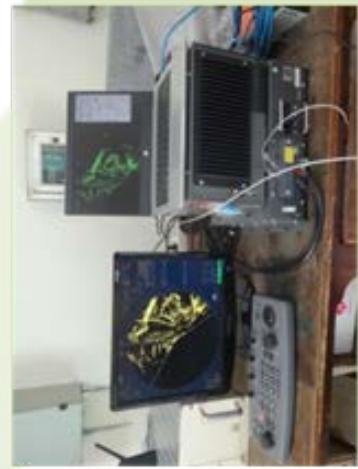

6 Feet Radar Antenna

Control Unit and Display →



Table 5 -2 : Classification of Size

Legend

Classification	Visually Observed Size of Vessel		Reference (Grounds of Classification)		
	Gross Tonnage	Reference Length	Navigational Obligation for Traffic	Mandatory Installation of AIS	Obligation to notify of Position Report
S	Less than 30 G/T	Less than 25 m	△	×	×
M	30 G/T ~ 500 G/T	25 m ~ 50 m	△	△	×
L	More than 500 G/T	More than 50 m	○	○	△

S : less than 30 G/T



Boat 0.8 G/T LOA 6 m



Boat 8.5 G/T LOA 15 m



Fishing 15 G/T LOA 18 m



Boat 30 G/T LOA 23 m

M : 30 G/T ~ 500 G/T



Passenger 60 G/T LOA 26 m



Cargo 100 G/T LOA 30 m



Cargo 200 G/T LOA 30 m



Cargo 270 G/T LOA 31 m

L : more than 500 G/T



Cargo 499 G/T LOA 40 m



Container 700 G/T LOA 70 m



Tanker 1,000 G/T LOA 80 m



Cargo 10,000 G/T LOA 170 m

Figure 5.1 -1 : Location of AIS Base-Station

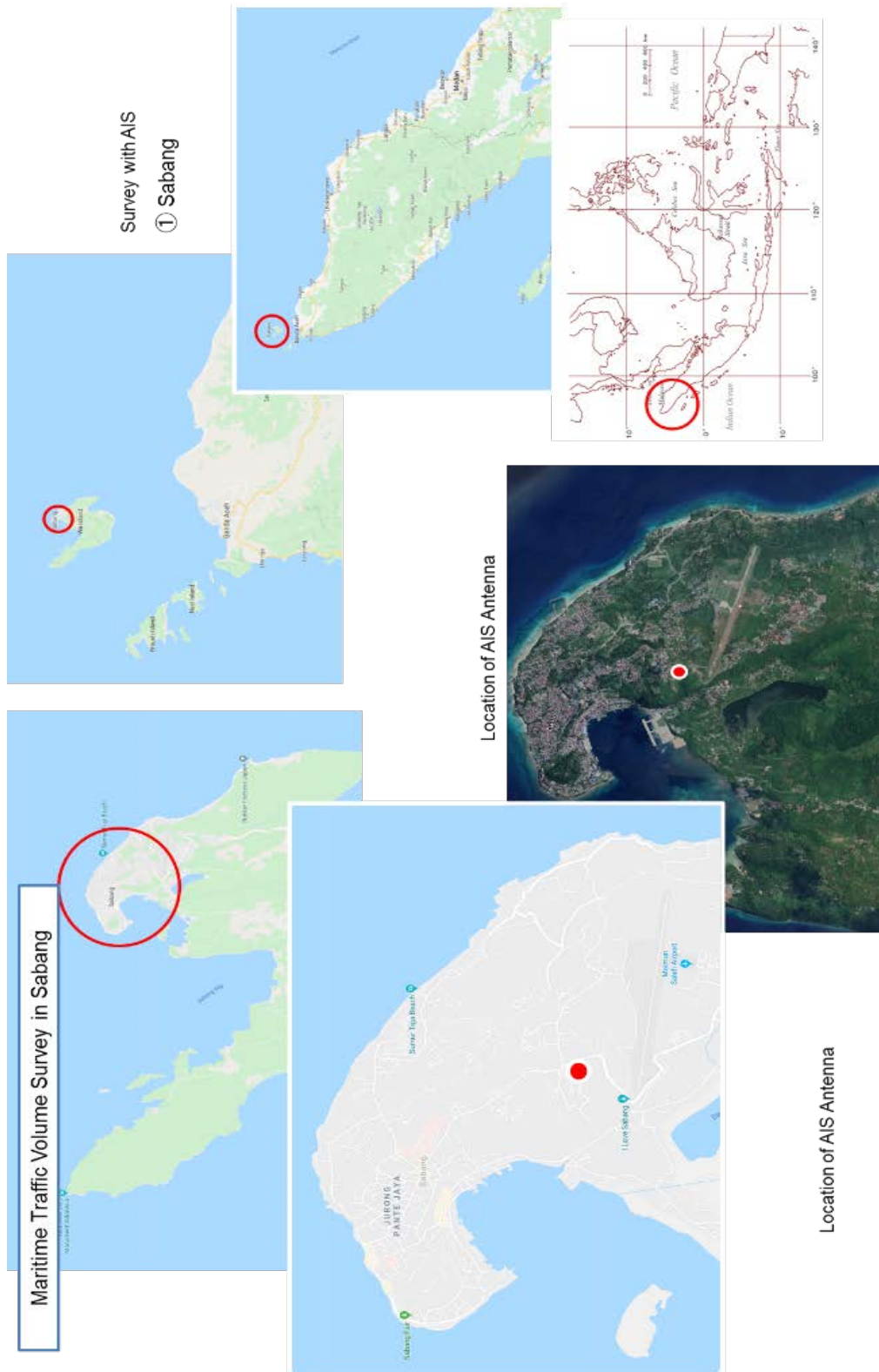

Figure 5.1 -2 : Density Plot of AIS

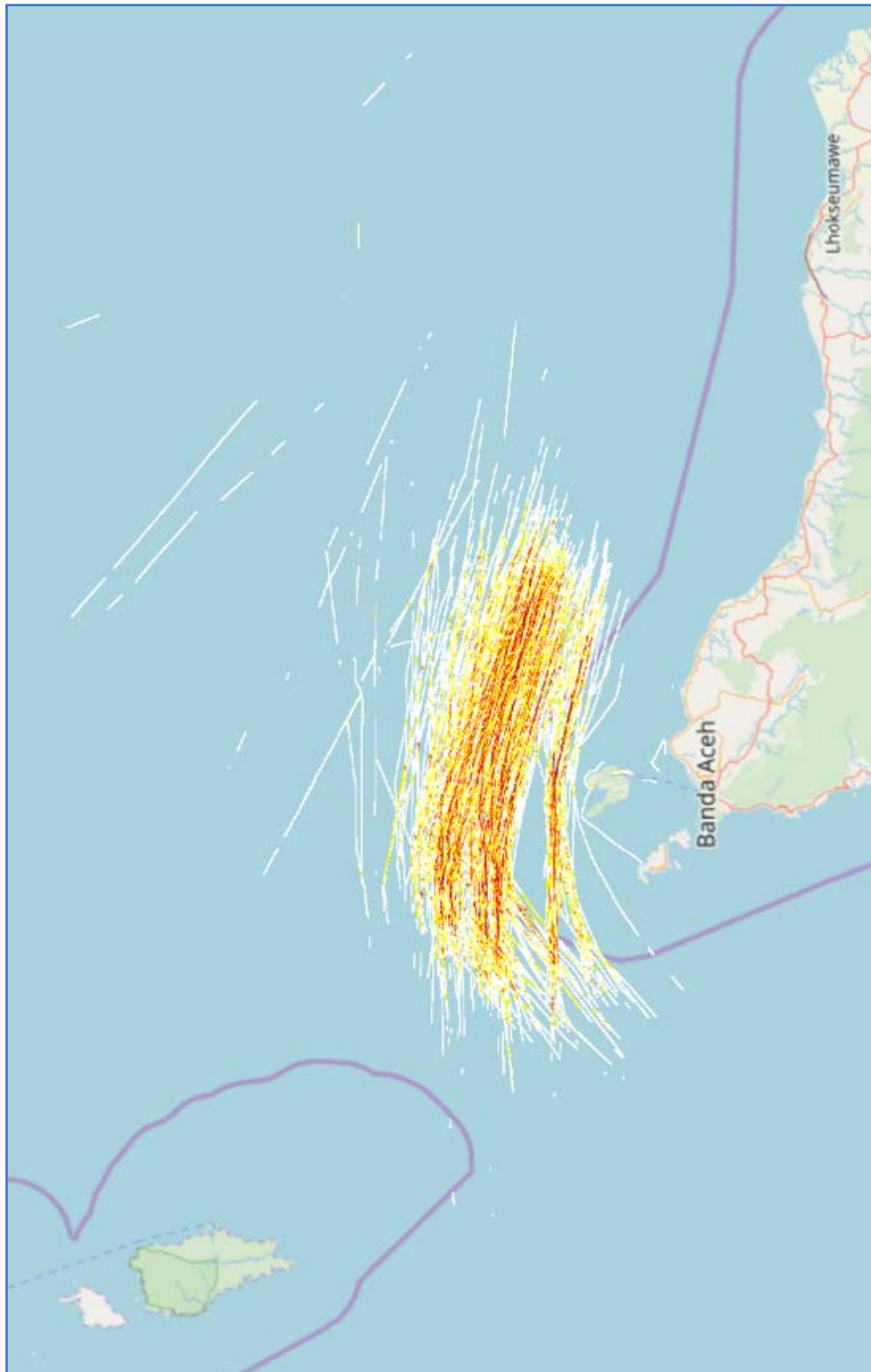

Table 5.1 -1 : Type of Vessels

Ship Type Length	Fast ferry	Fishing ship	General cargo ship	Oil products tanker	Passenger ship	Pleasure boat	Support ship	Other ship	Total
1~50m	0	0	0	2	1	0	0	28	31
51~150m	0	4	6	10	0	0	0	1	21
151~250m	0	0	92	29	0	0	0	4	125
251m以上	0	0	83	50	0	0	0	0	133
Total of ship types	0	4	181	91	1	0	0	33	
Total of all ship types	310								

Figure 5.1 -3 : Density Map for each Type

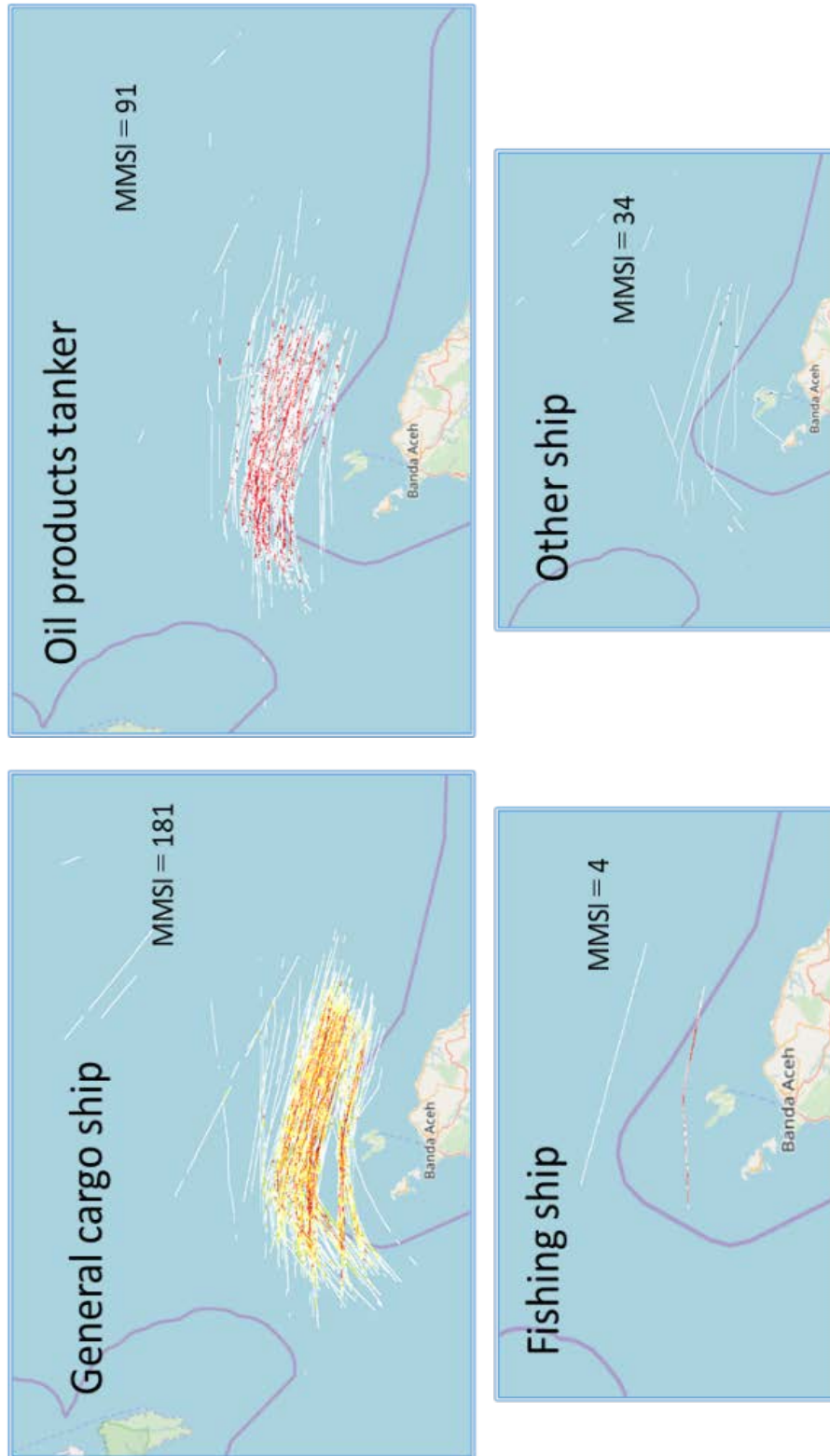

Figure 5.1 -4 : Histogram of Lateral Distribution

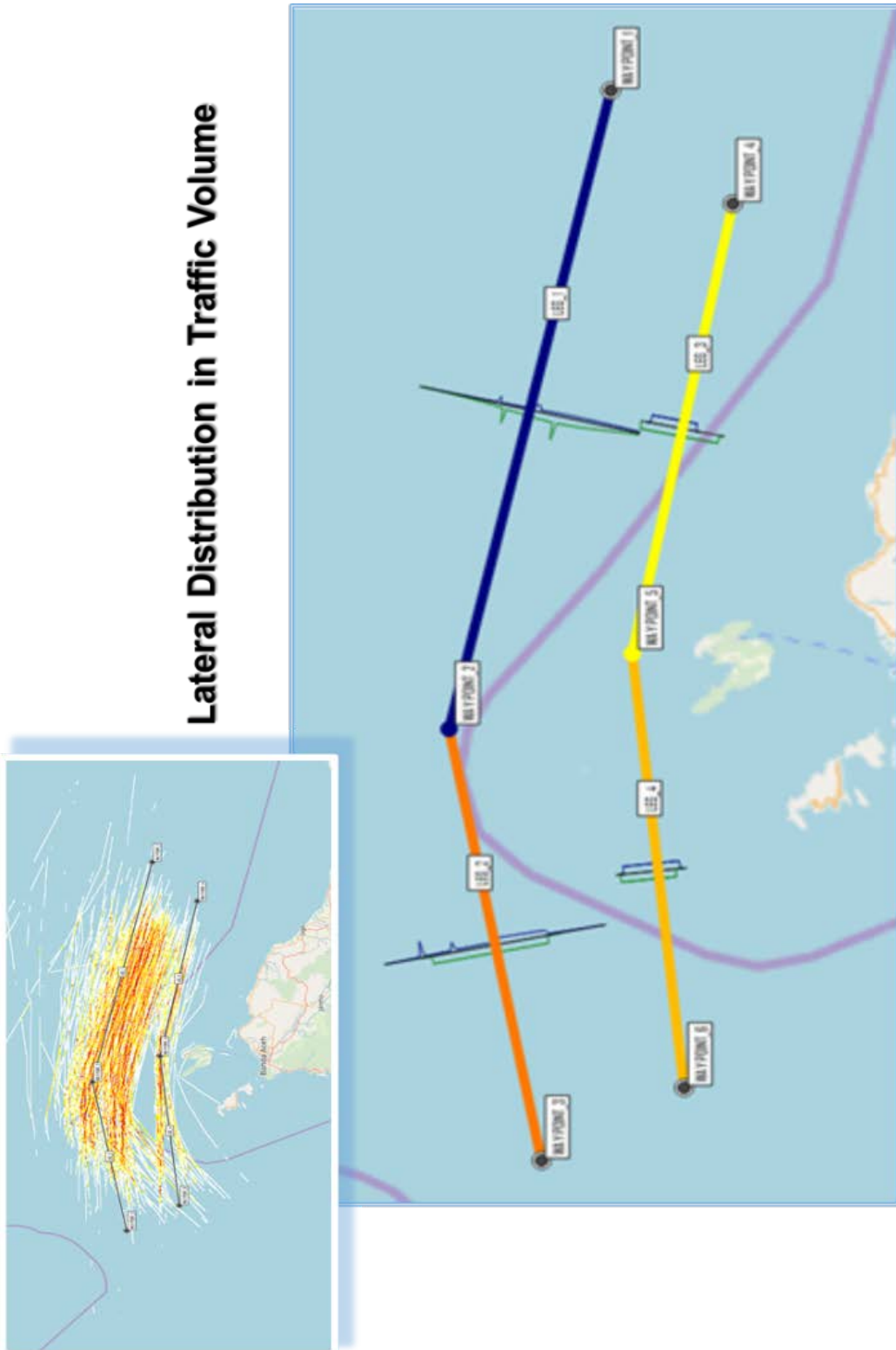
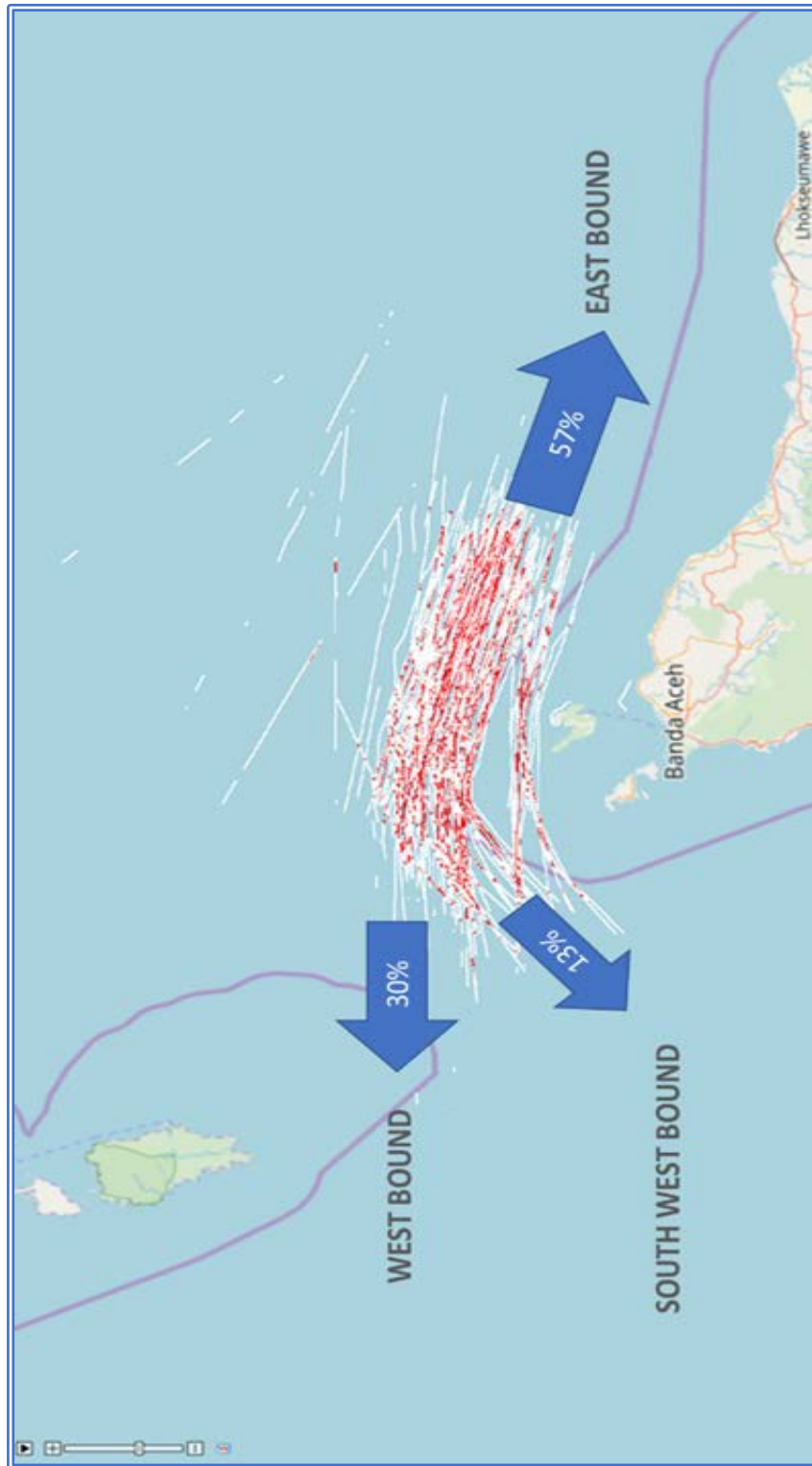

Table 5.1 -2 : Results of IWRAP Calculation

01-Sabang-310320100758		Unit
Powered Grounding	---	Incidents/Year
Drifting Grounding	---	Incidents/Year
Total Groundings	---	Incidents/Year
Powered Allision	---	Incidents/Year
Drifting Allision	---	Incidents/Year
Total Allisions	---	Incidents/Year
Overtaking	0.001786	Incidents/Year
HeadOn	0.00829	Incidents/Year
Crossing	---	Incidents/Year
Merging	---	Incidents/Year
Bend	0.0007655	Incidents/Year
Area	---	Incidents/Year
Total Collisions	0.01084	Incidents/Year

01-Sabang-310320100758		Unit
Powered Grounding	---	Years between incidents
Drifting Grounding	---	Years between incidents
Total Groundings	---	Years between incidents
Powered Allision	---	Years between incidents
Drifting Allision	---	Years between incidents
Total Allisions	---	Years between incidents
Overtaking	559.9	Years between incidents
HeadOn	120.6	Years between incidents
Crossing	---	Years between incidents
Merging	---	Years between incidents
Bend	1,306	Years between incidents
Area	---	Years between incidents
Total Collisions	92.24	Years between incidents

Figure 5.1 -5 : Movement of Vessels



Graph 5.1 : Destination of Vessels

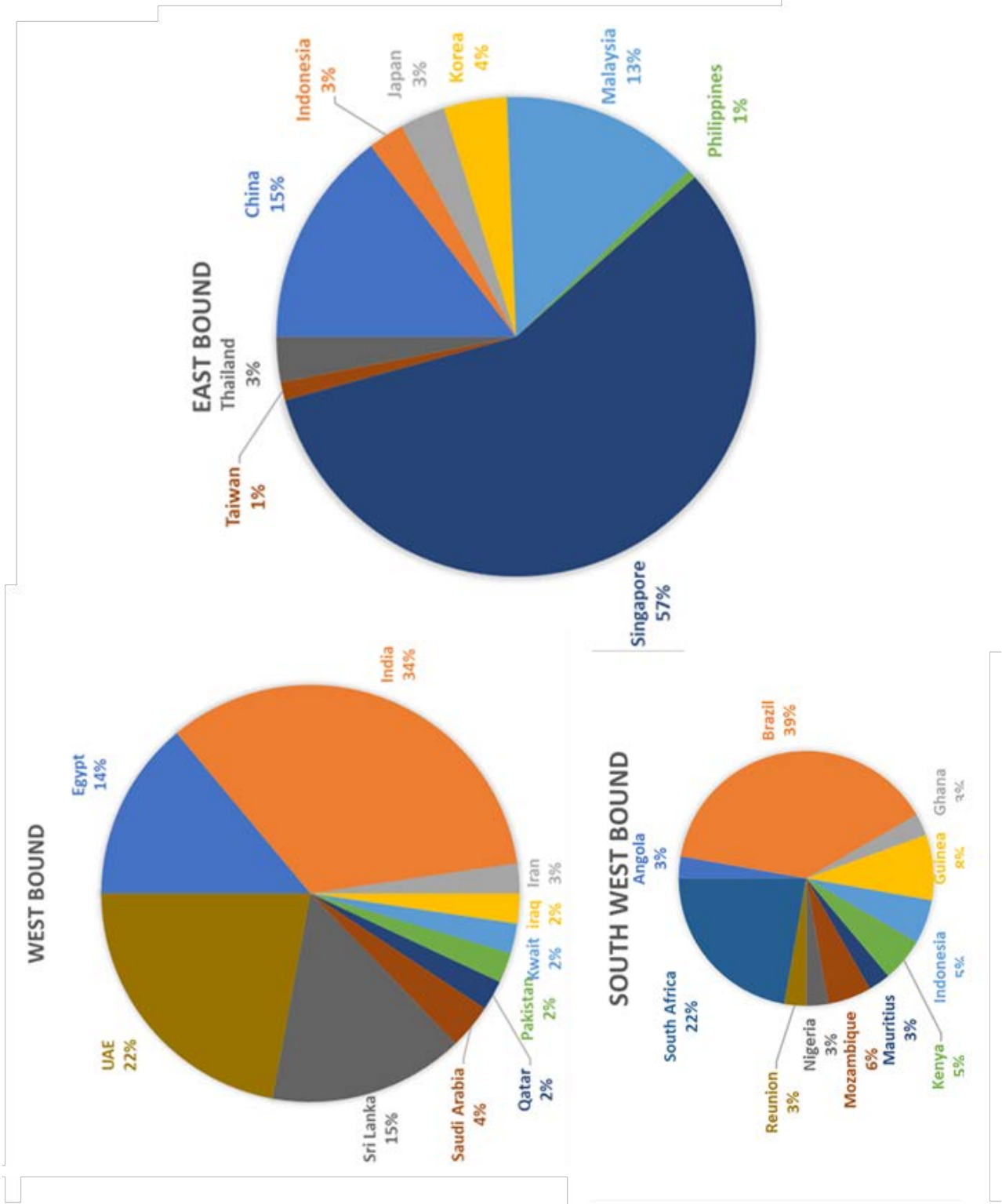

Figure 5.1 -6 : AIS Density Map from Marinetrtraffic Com.

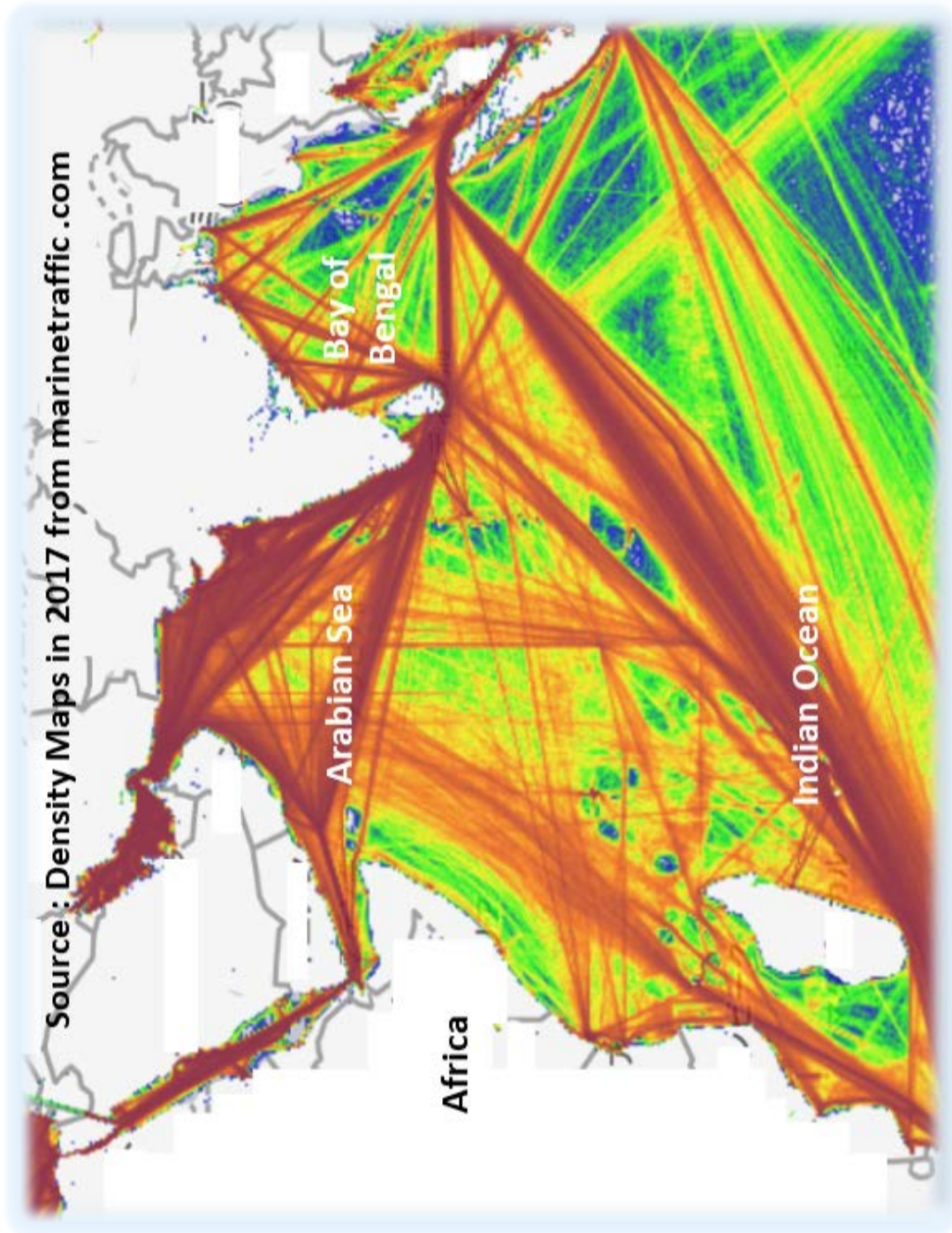

Figure 5.2 -1 : Location of Port of Tanjung Perak



Figure 5.2 -2 : Location of AIS and Radar

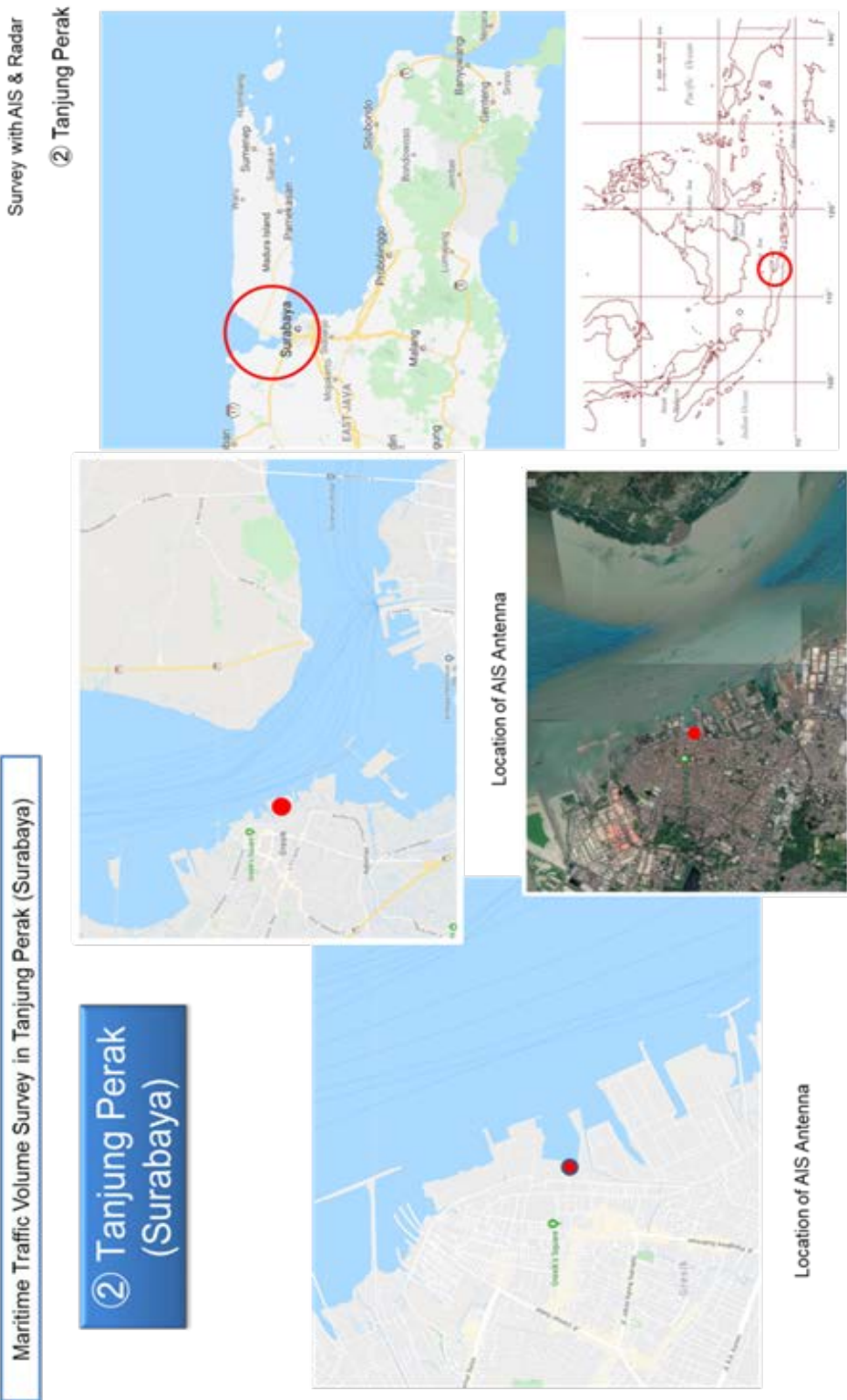

Figure 5.2 -3 : AIS Tracks and the Classification Table

Ship Type Length	Fast ferry	Fishing ship	General cargo ship	Oil products tanker	Passenger ship	Pleasure boat	Support ship	Other ship	Total
1~50m	2	0	45	13	14	18	89	71	252
51~150m	0	0	119	41	23	2	5	24	214
151~250m	0	0	46	14	6	0	0	0	66
251m以上	0	0	10	1	0	0	0	1	12
Total of ship types	2	0	220	69	43	20	94	96	
Total of all ship types	544								

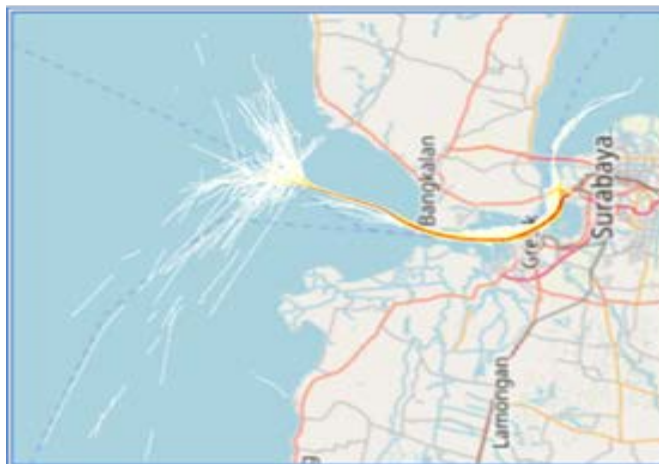

Figure 5.2 -4 : Channel Width



Picture 5.2 -1 : Radar Image and Picture of Vessels at Anchor

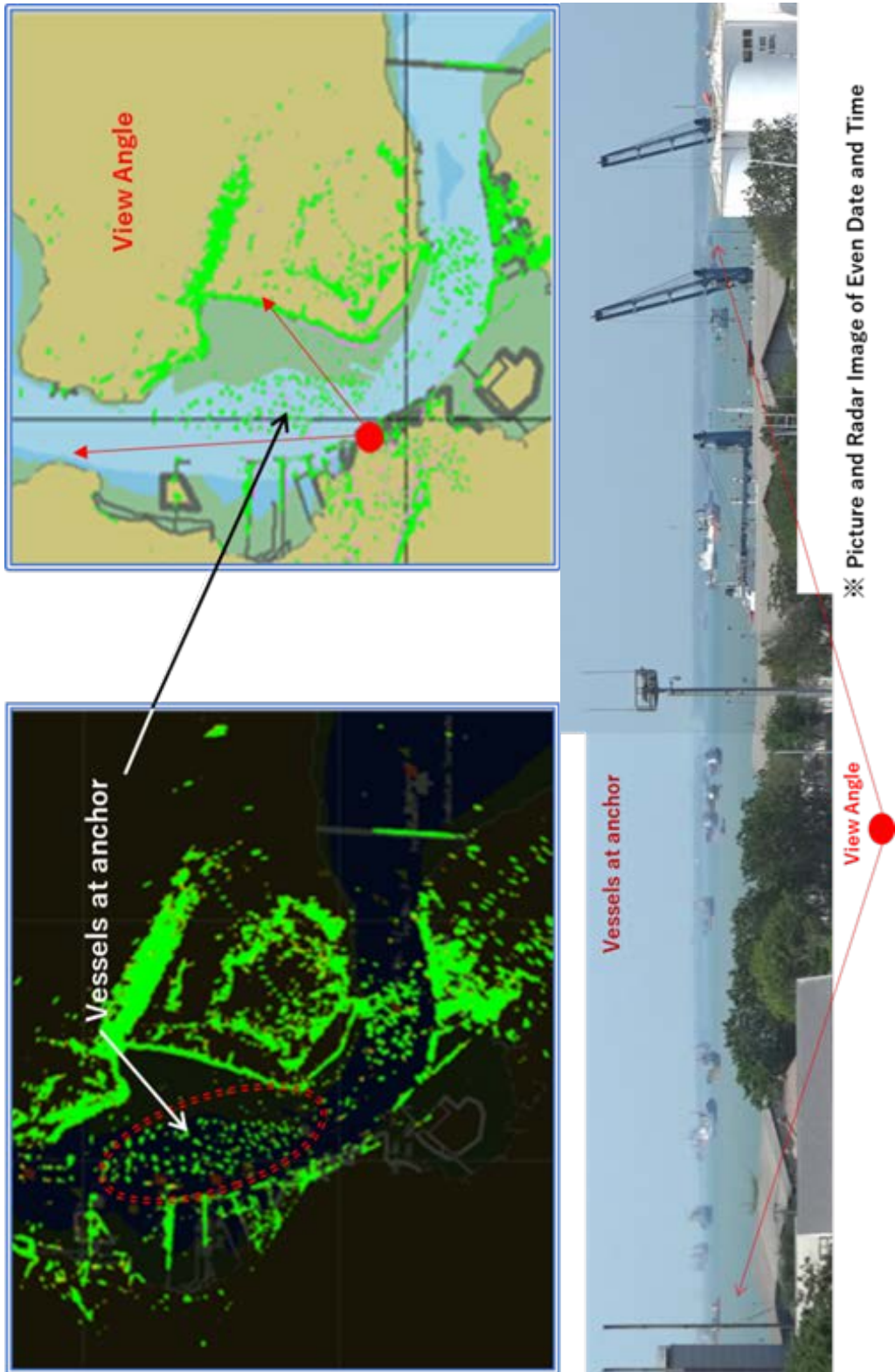

Figure 5.2 -5 : Histogram of Lateral Distribution



Figure 5.2 -6 : Chart and Density Map

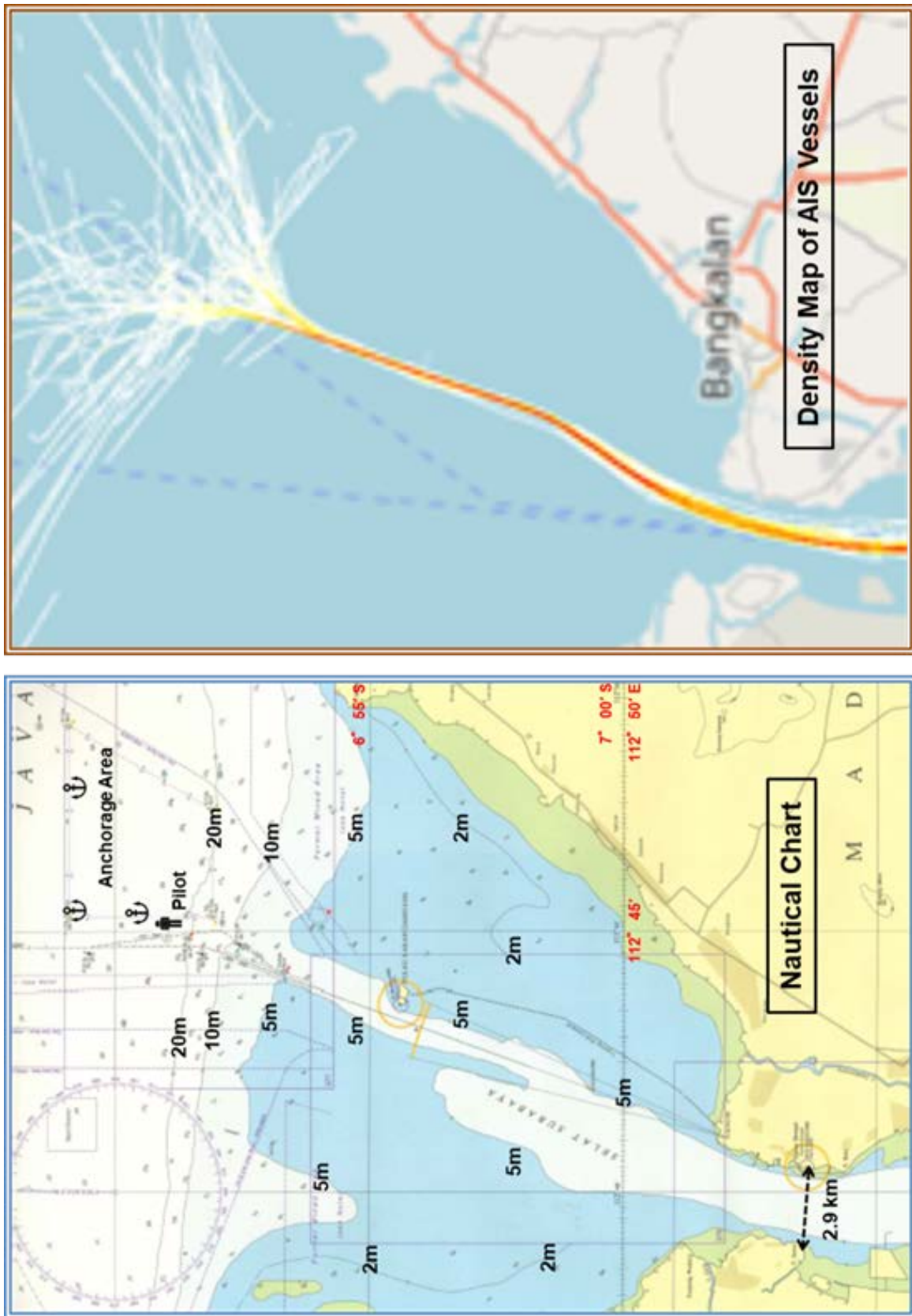

Figure 5.2 -7 : Marine Grounding Map in 2017

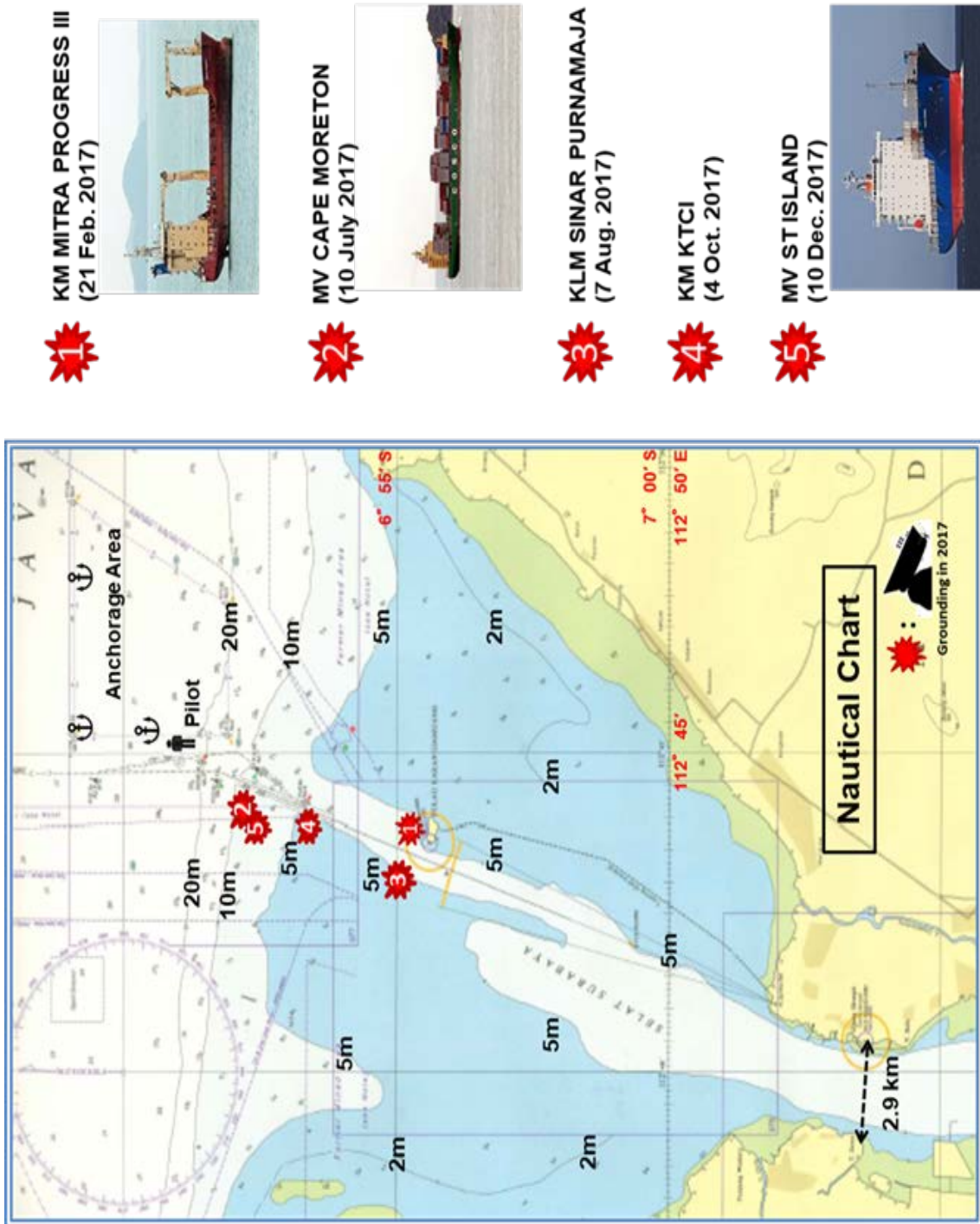

Table 5.2 -1 : Result of IWRAP Calculation

	02-Tanjung-Perak-2-020420114131	Unit
Powered Grounding	---	Years between incidents
Drifting Grounding	---	Years between incidents
Total Groundings	---	Years between incidents
Powered Allision	---	Years between incidents
Drifting Allision	---	Years between incidents
Total Allisions	---	Years between incidents
Overtaking	62.06	Years between incidents
HeadOn	13.85	Years between incidents
Crossing	2,998	Years between incidents
Merging	1,122	Years between incidents
Bend	69.96	Years between incidents
Area	---	Years between incidents
Total Collisions	9.63	Years between incidents

	02-Tanjung-Perak-2-020420114131	Unit
Powered Grounding	---	Incidents/Year
Drifting Grounding	---	Incidents/Year
Total Groundings	---	Incidents/Year
Powered Allision	---	Incidents/Year
Drifting Allision	---	Incidents/Year
Total Allisions	---	Incidents/Year
Overtaking	0.01611	Incidents/Year
HeadOn	0.07221	Incidents/Year
Crossing	0.0003335	Incidents/Year
Merging	0.0008914	Incidents/Year
Bend	0.01429	Incidents/Year
Area	---	Incidents/Year
Total Collisions	0.1038	Incidents/Year

Figure 5.2 -8 : Elements of Channel Width

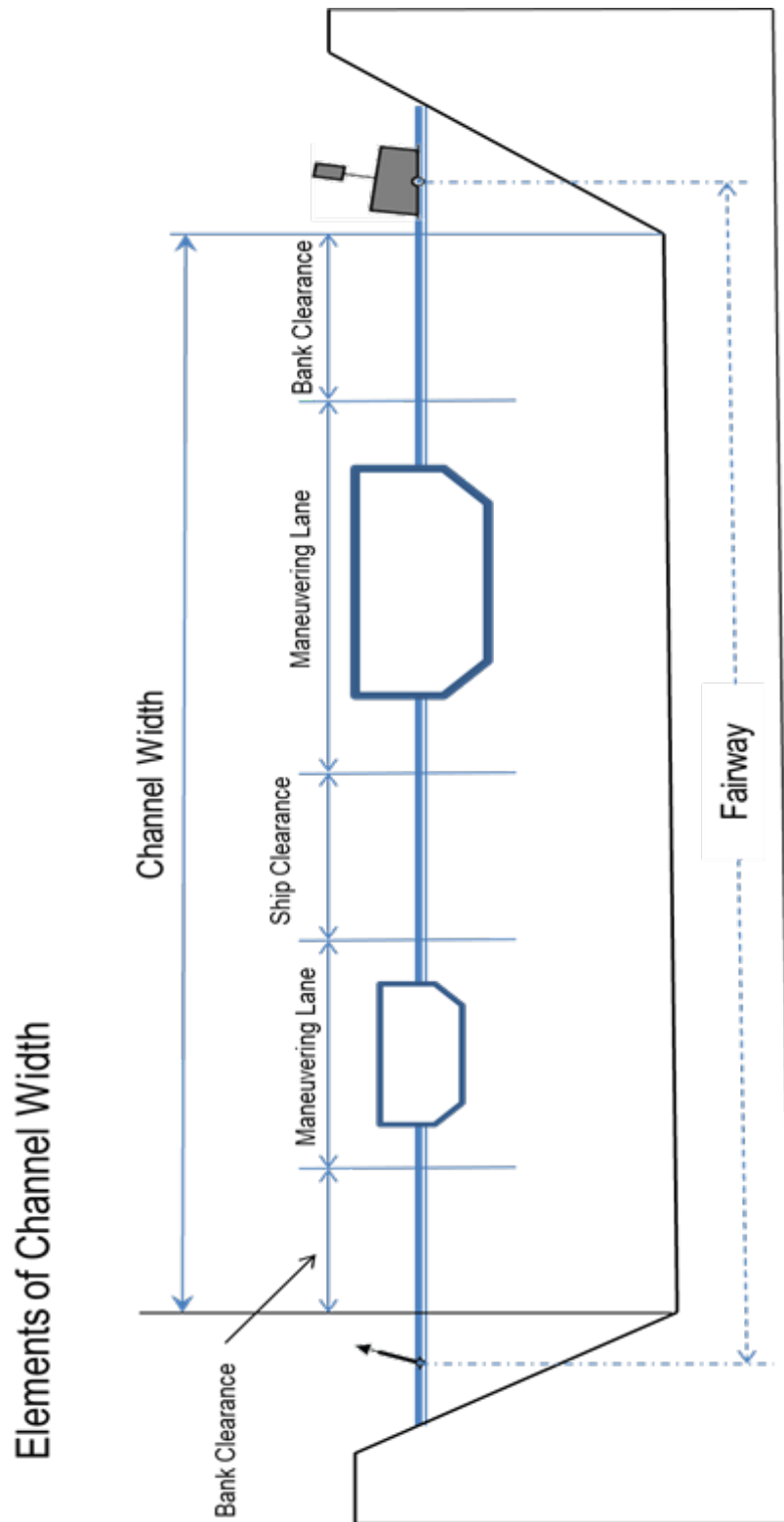

Figure 5.2 -9 : Image of Passing Each Other

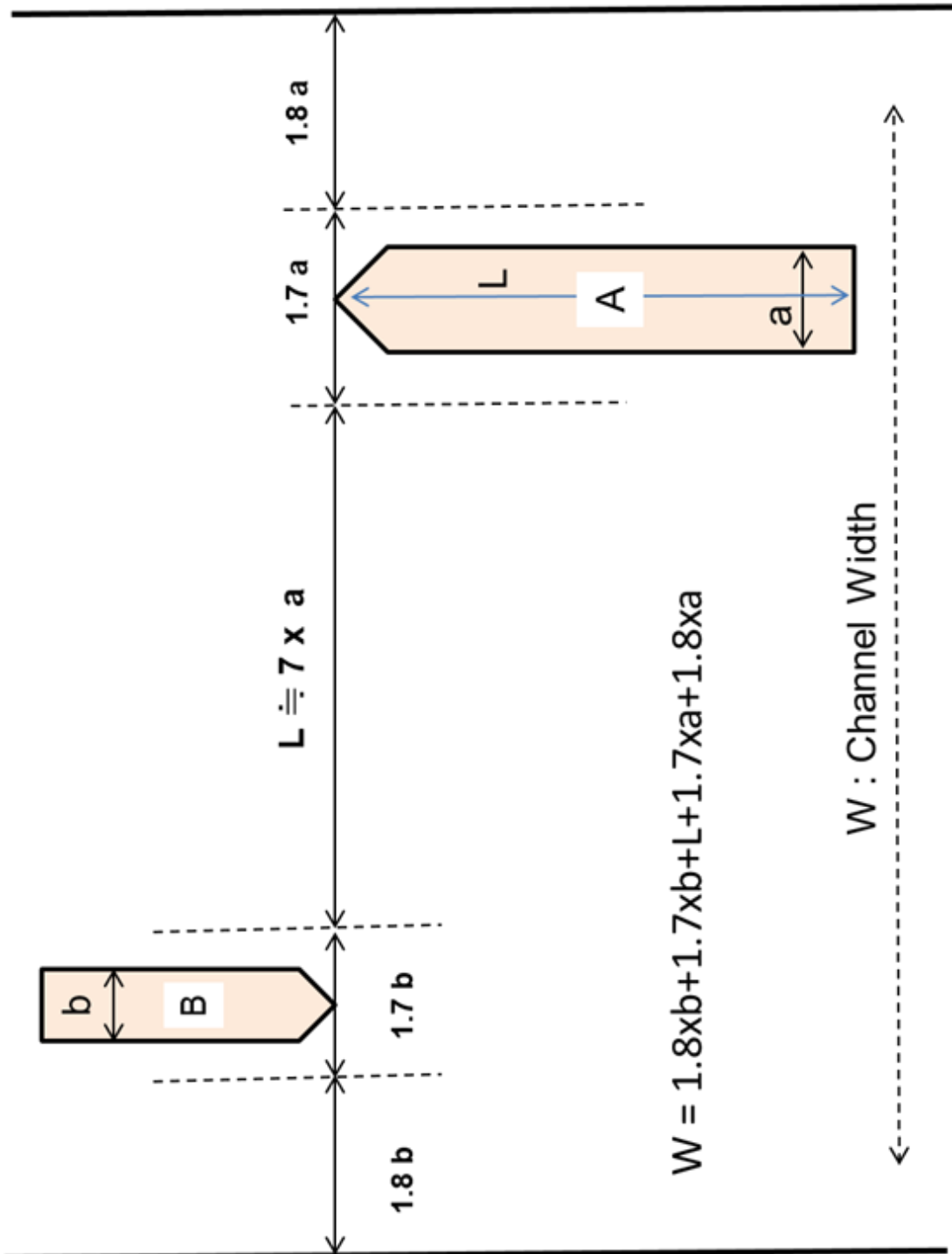
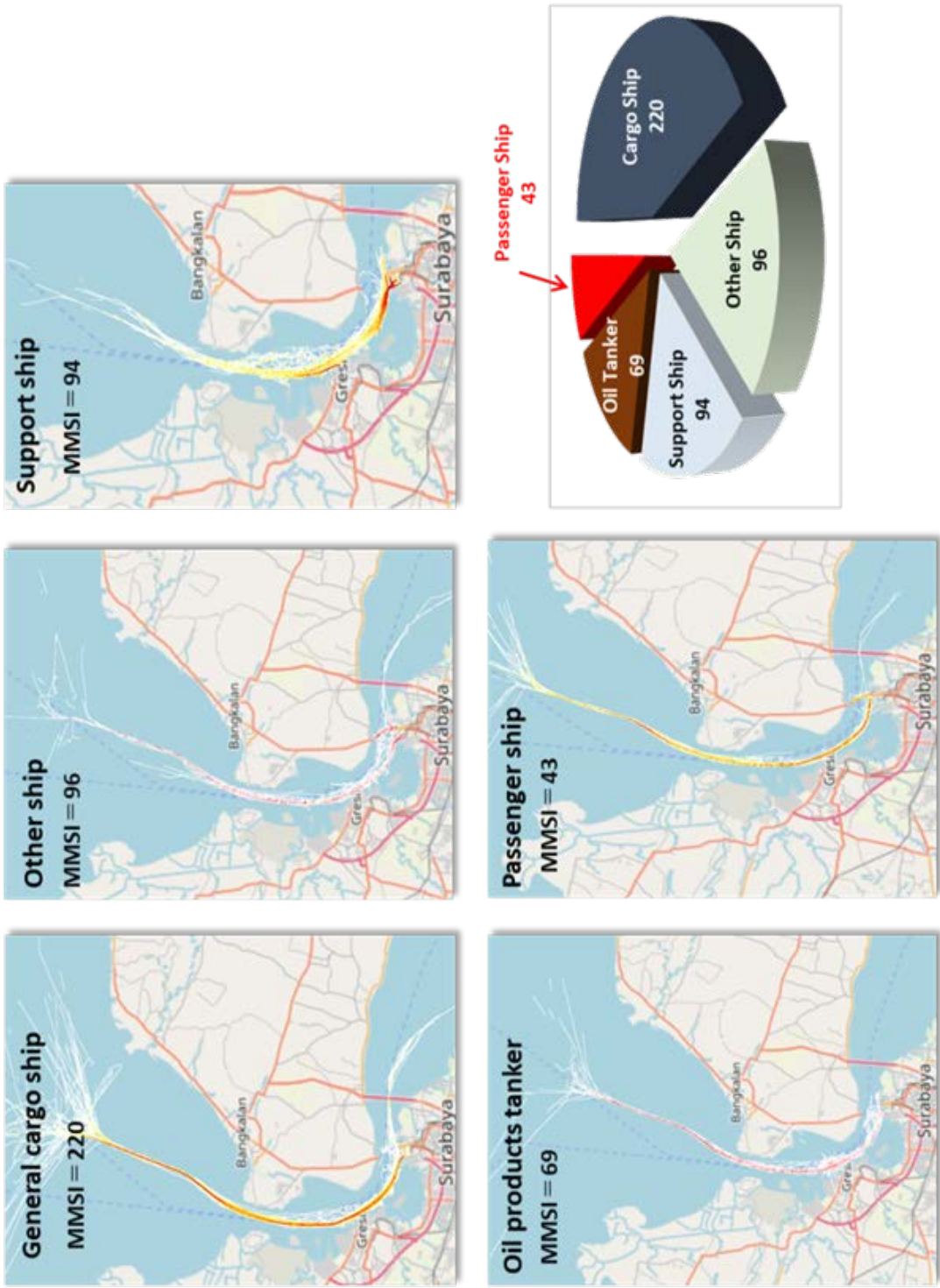

Figure 5.2 -10 : Density Map for Each Type



Picture 5.2 -2 : Temporary Installation of Radar



Picture 5.2 -3 : Radar Images (1/3)

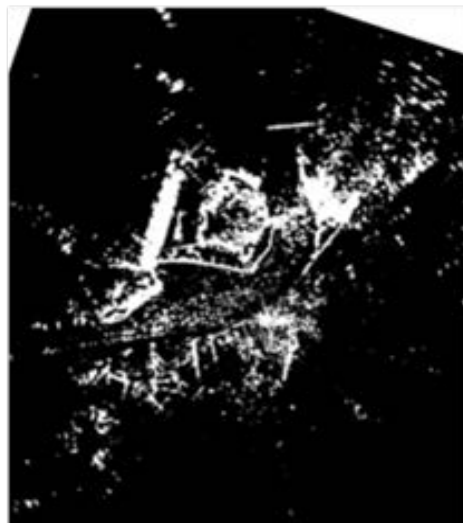
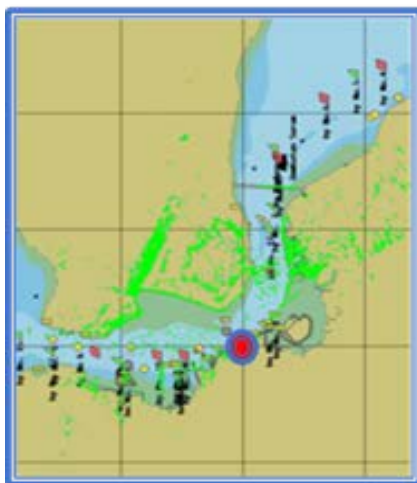
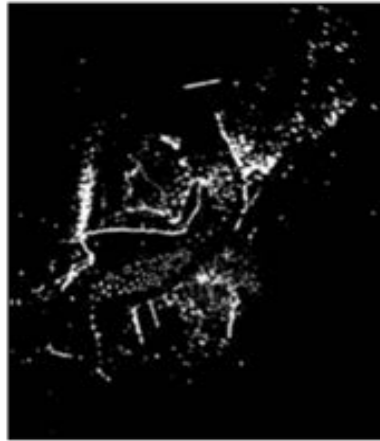
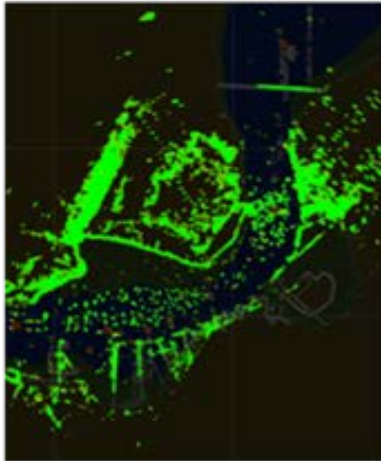
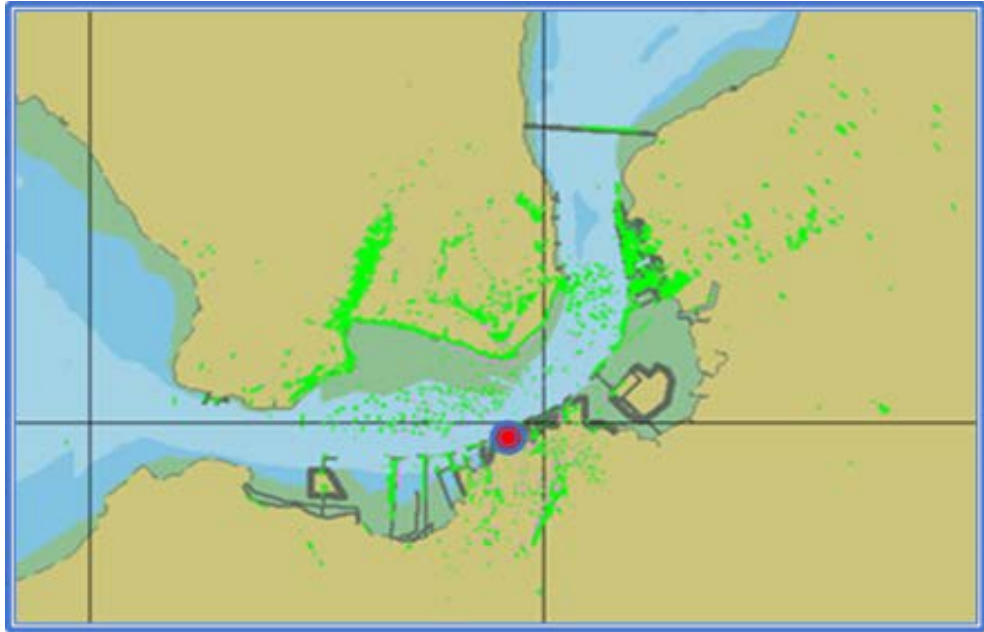

Radar Images of Tanung Perak

Picture 5.2 -3 : Radar Images and Background (2/3)

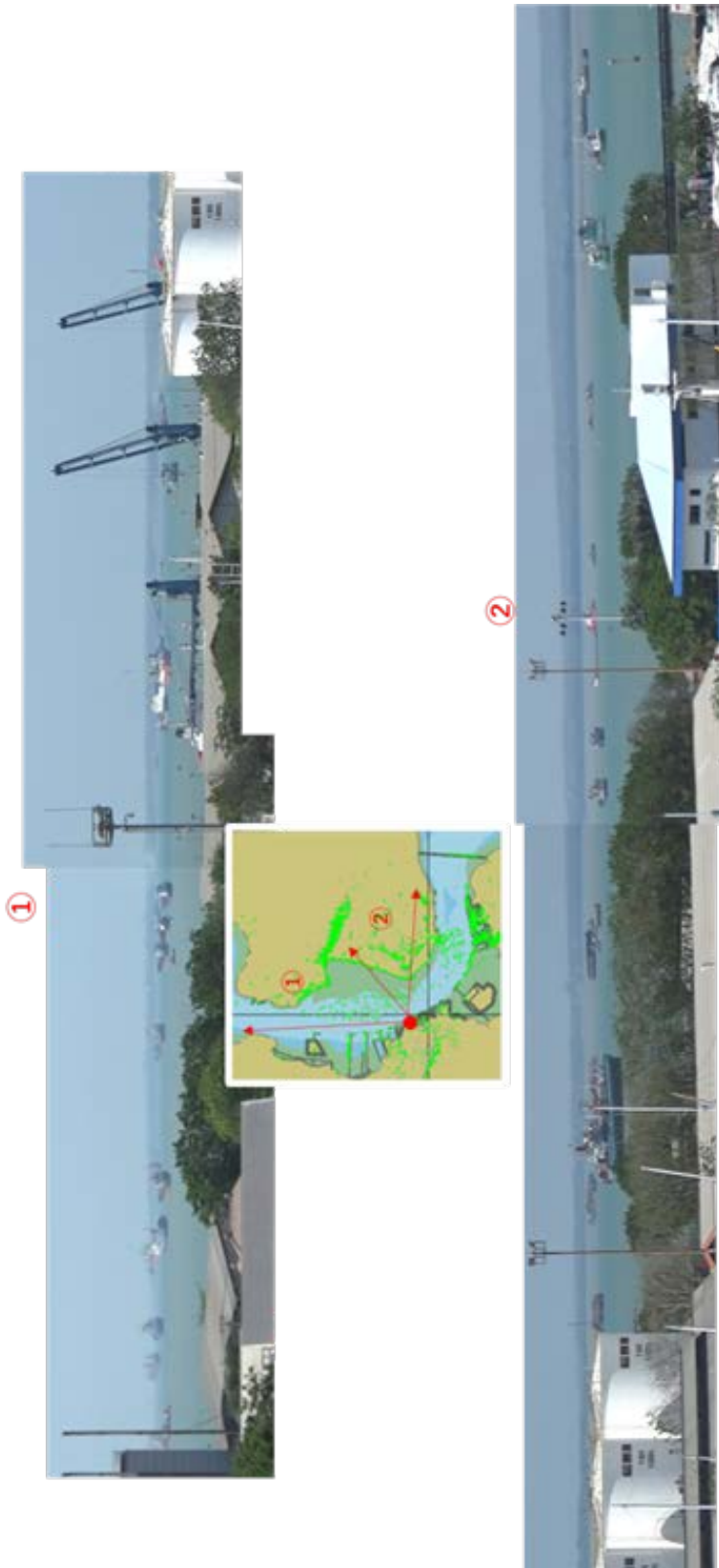

Picture 5.2 -3 : Radar Images and Background (3/3)

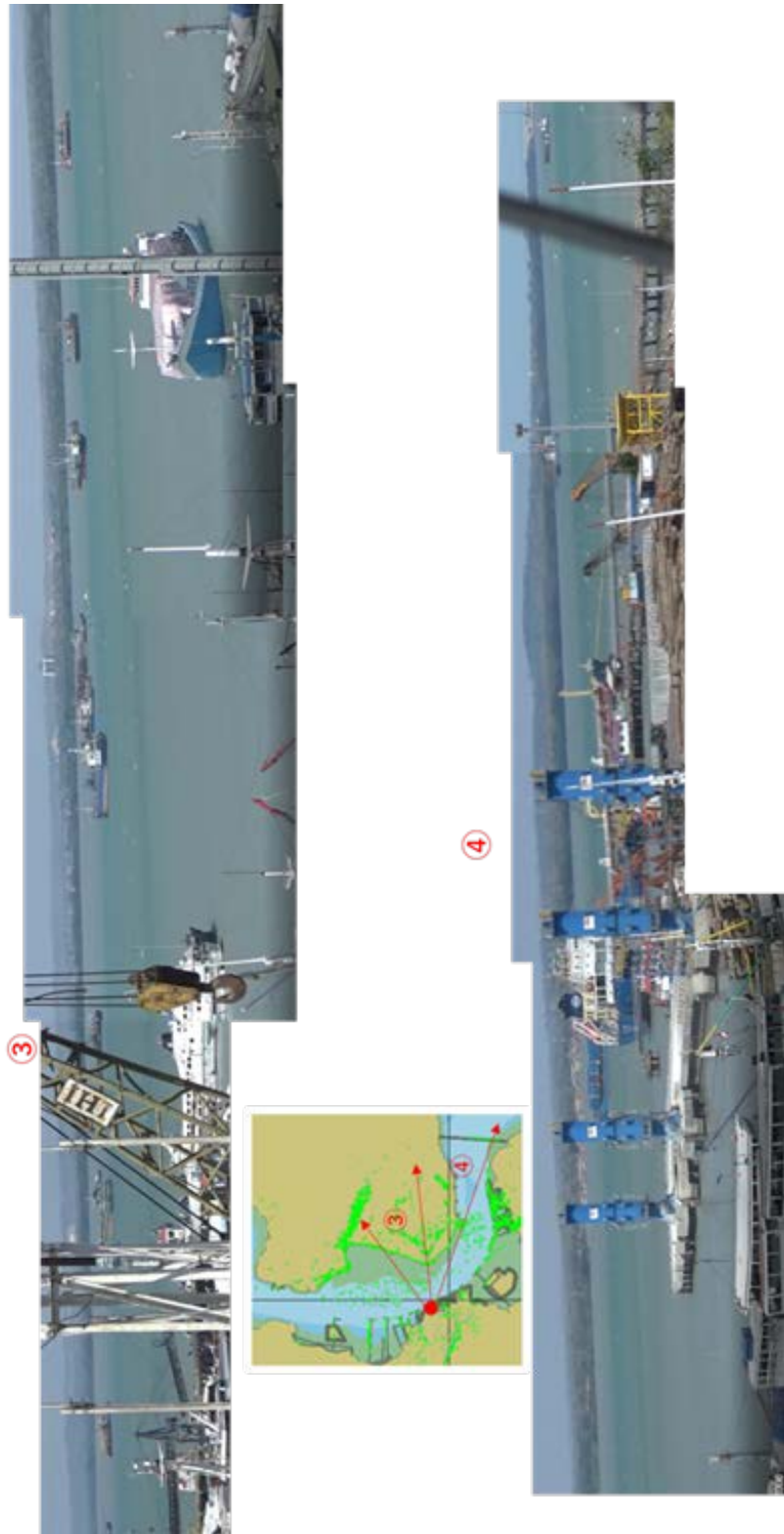

Table 5.2 -2 : Result of Visual Survey

Duration of Visual Survey for Maritime Traffic Volume (Surabaya)

D/M	Start	End	Period (h)	Number of Observed Vessels				Number of Vessels / Hour			
				Total	S	M	L	Total	S	M	L
5-Oct-19	14 : 34	18 : 14	3.66	77	49	26	2	21.04	13.39	7.10	0.55
6-Oct-19	11 : 13	18 : 16	7.05	88	45	34	9	12.48	6.38	4.82	1.28
7-Oct-19	12 : 01	18 : 29	6.46	53	7	33	13	8.20	1.08	5.11	2.01

Average Number of Vessels / Hour 13.91 6.95 5.68 1.28

Duration of Visual Survey for Maritime Traffic Volume (Surabaya)

D/M	Start	End	Period (h)	Number of Observed Vessels by Type							
				Total	Cargo	Tanker	Passenger	Fishing	Barge	Other	Gvernment
5-Oct-19	14 : 34	18 : 14	3.66	77	9	1	4	42	14	7	0
6-Oct-19	11 : 13	18 : 16	7.05	88	24	1	5	37	13	8	0
7-Oct-19	12 : 01	18 : 29	6.46	53	13	3	4	3	20	4	6

Average Number of Vessels / Hour 13.90 2.62 0.29 0.81 5.73 2.92 1.22 0.31

Reference : Graph of Visual Survey

Classification	Visually Observed Size of Vessel	
	Gross Tonnage	Reference Length
S	Less than 30 G/T	Less than 25 m
M	30 G/T ~ 500 G/T	25 m ~ 50 m
L	More than 500 G/T	More than 50 m

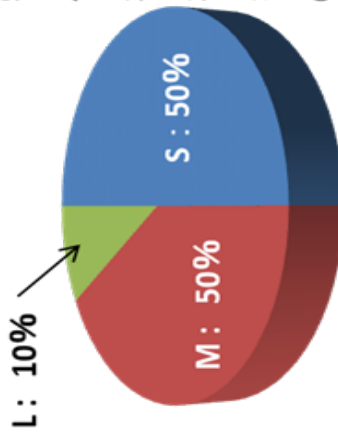
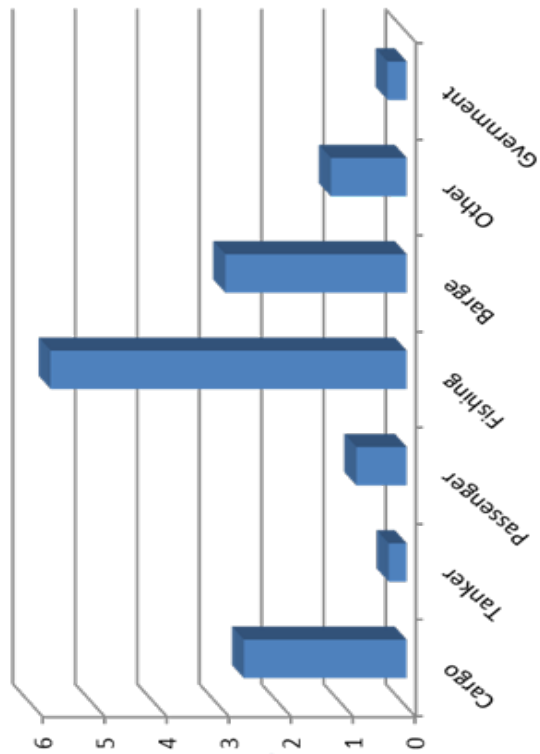
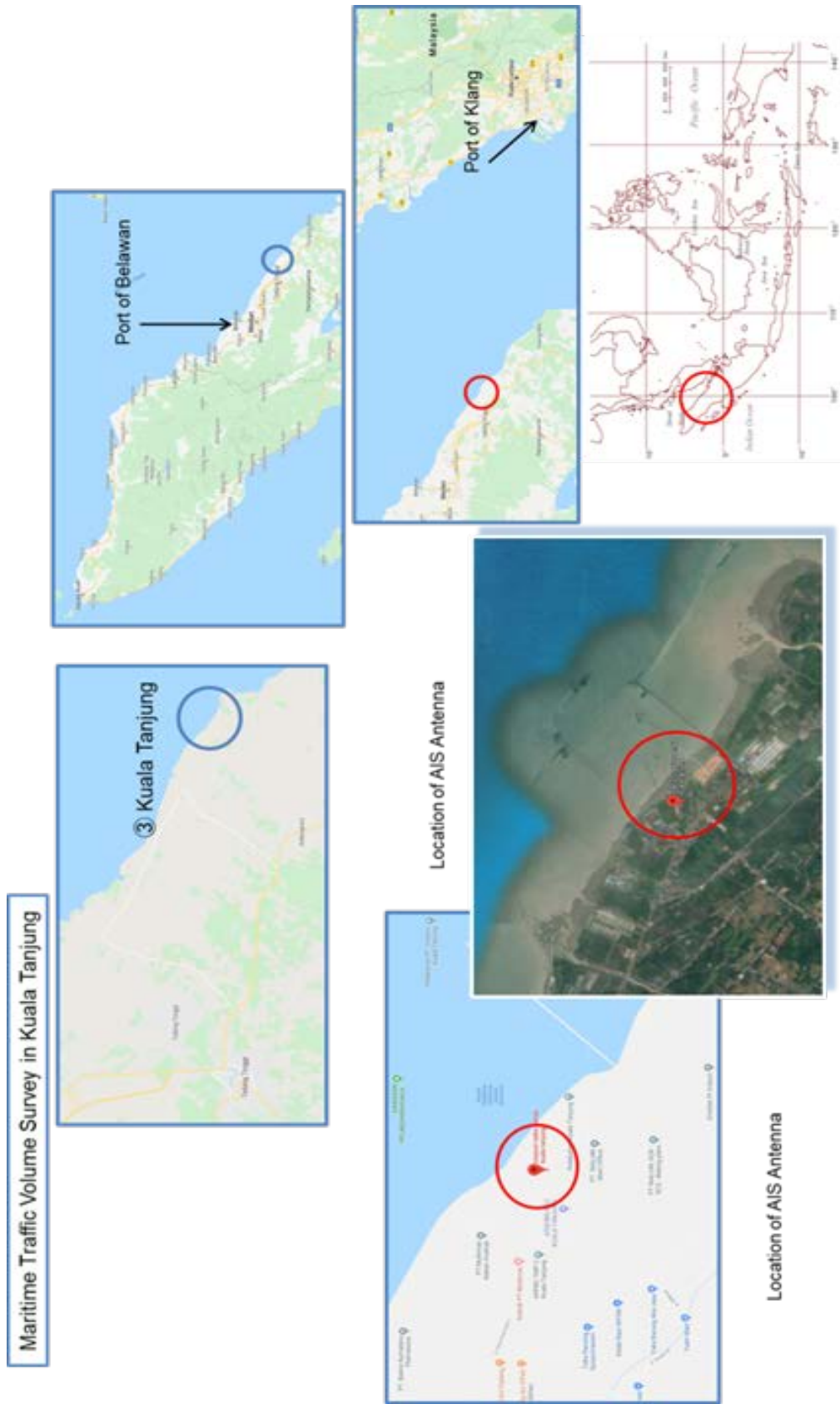

Figure 5.3 -1 : Location of AIS Base-Station



Picture 5.3.-1 : Installation of AIS Antenna

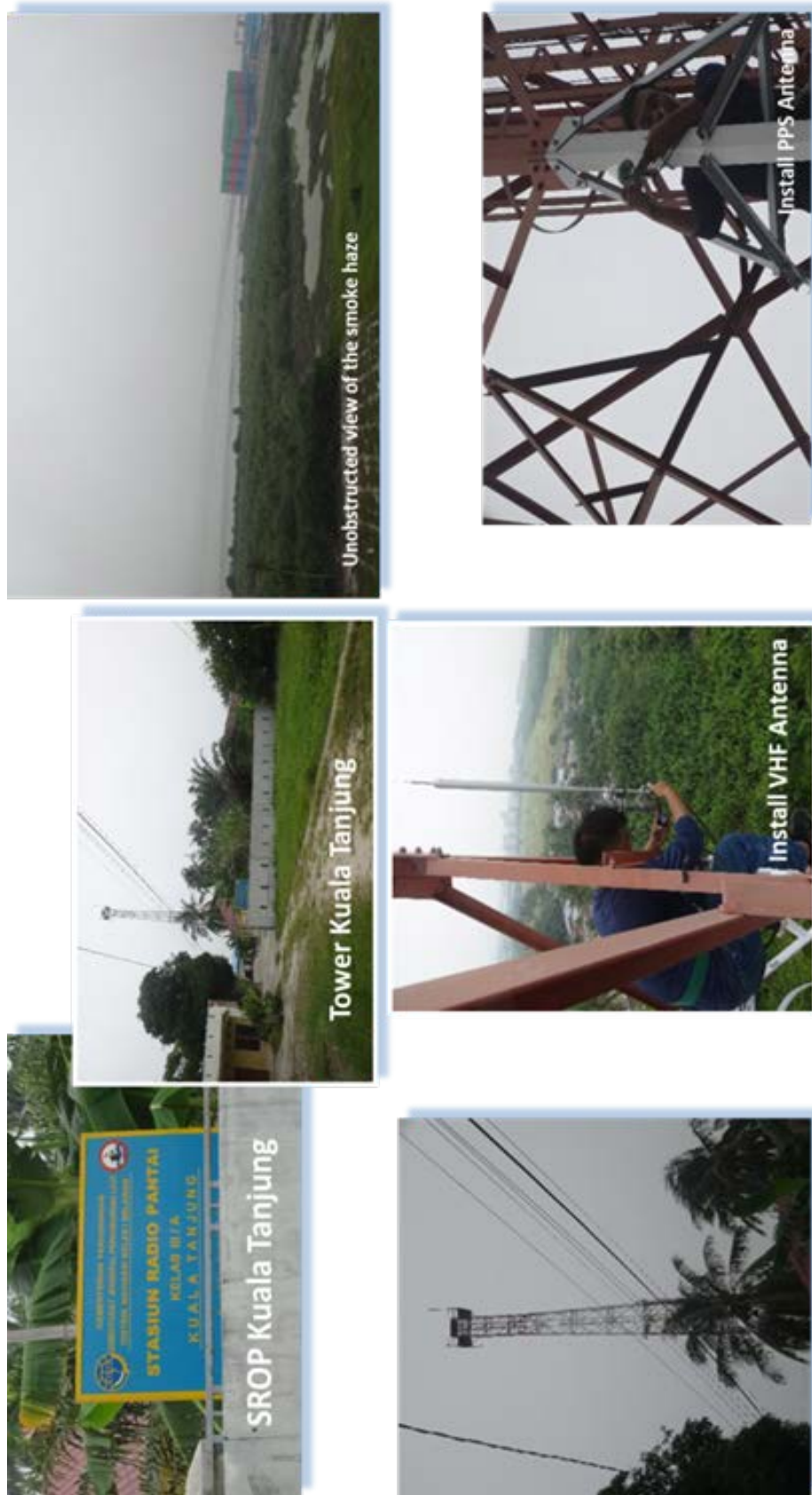

Figure 5.3 -2 : Density Plot of AIS

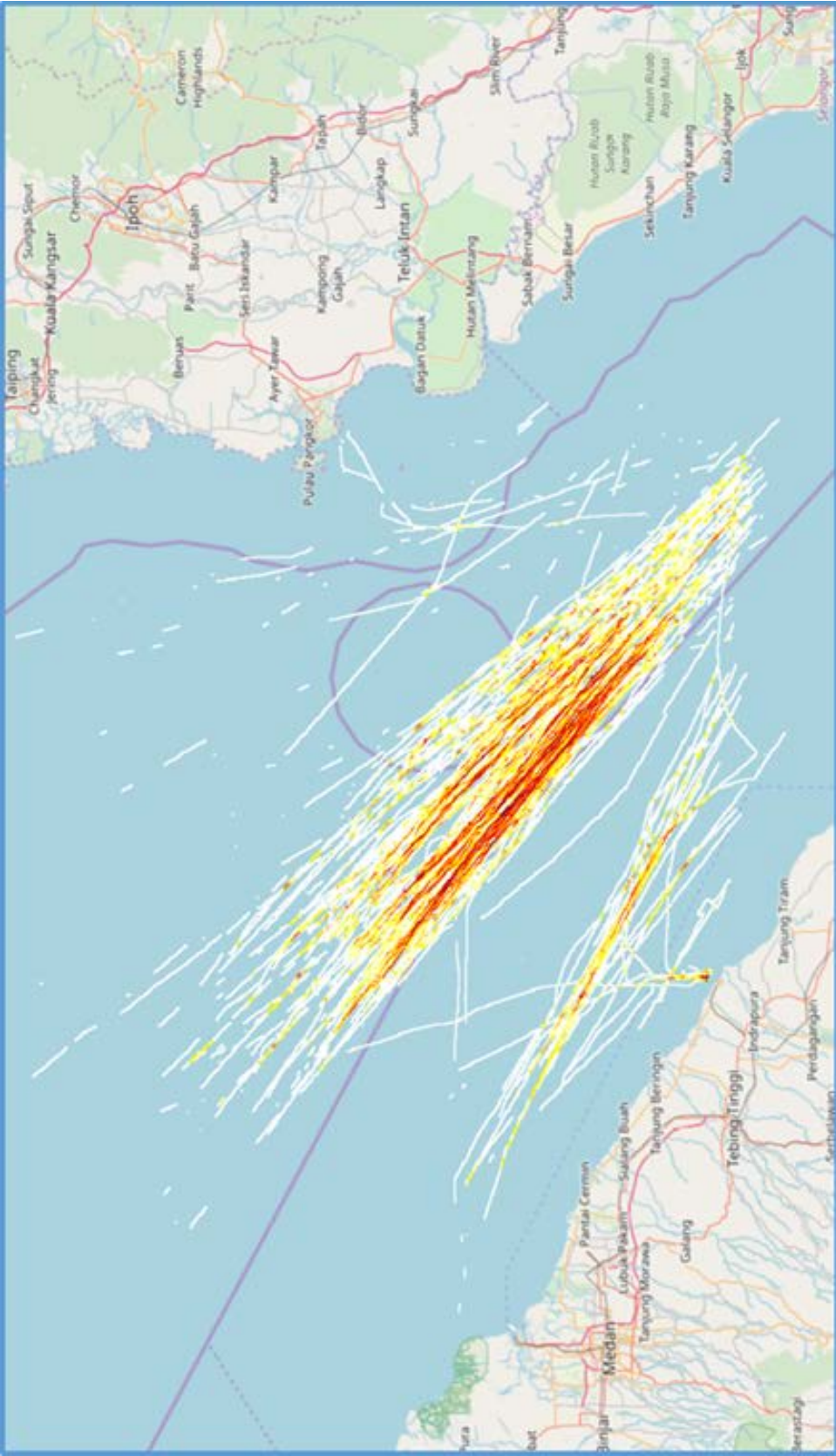

Table 5.3 -1 : Type of Vessels

Ship Type Length	Fast ferry	Fishing ship	General cargo ship	Oil products tanker	Passenger ship	Pleasure boat	Support ship	Other ship	Total
1~50m	2	0	45	6	5	3	21	124	206
51~150m	1	0	49	30	12	2	0	10	104
151~250m	0	0	45	9	3	0	0	1	58
251m以上	0	0	36	2	0	0	0	0	38
Total of ship types	3	0	175	47	20	5	21	135	
Total of all ship types	406								

Figure 5.3 -3 : Density Map for each Type

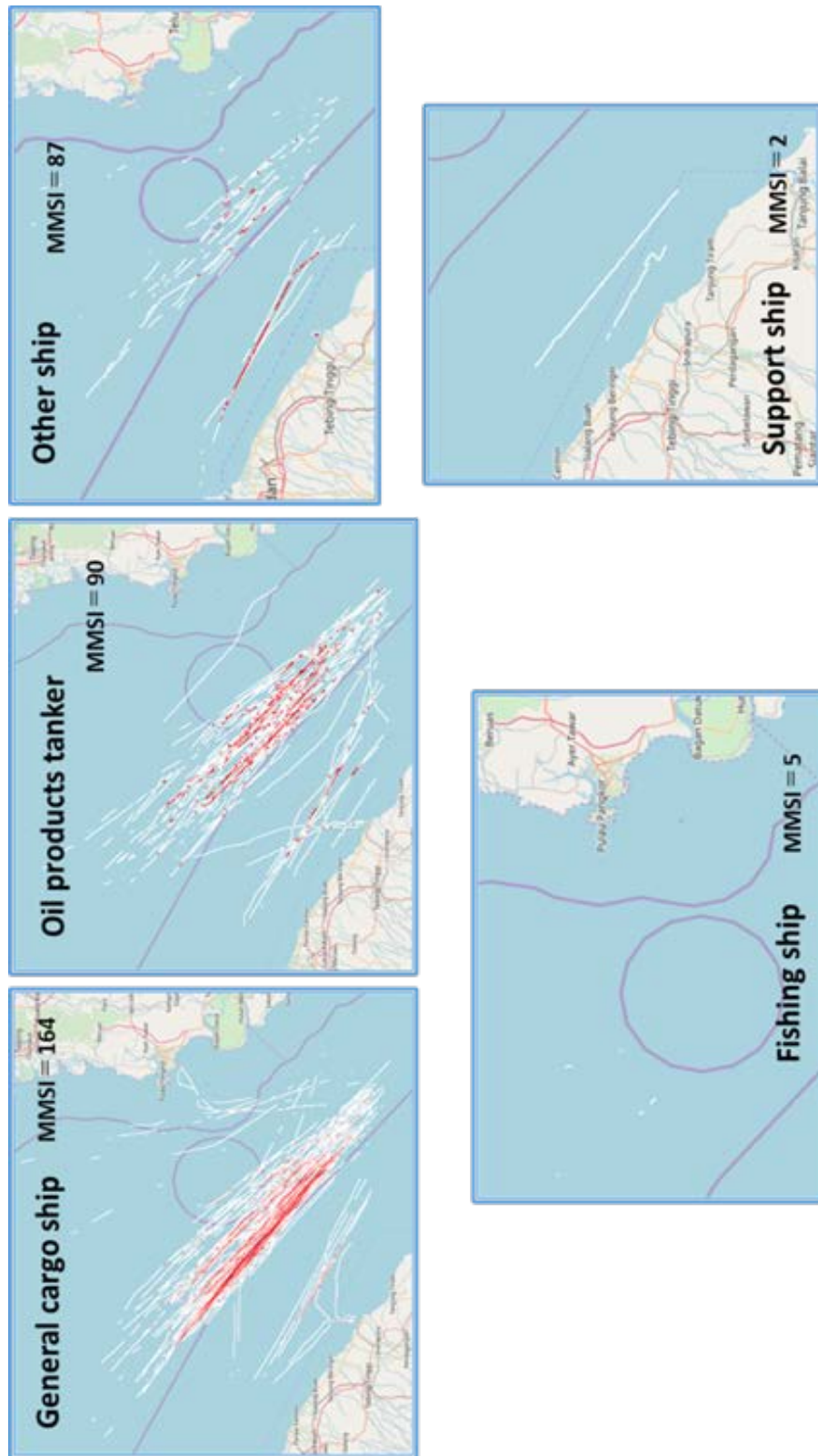

Figure 5.3 -4 : Histogram of Lateral Distribution.

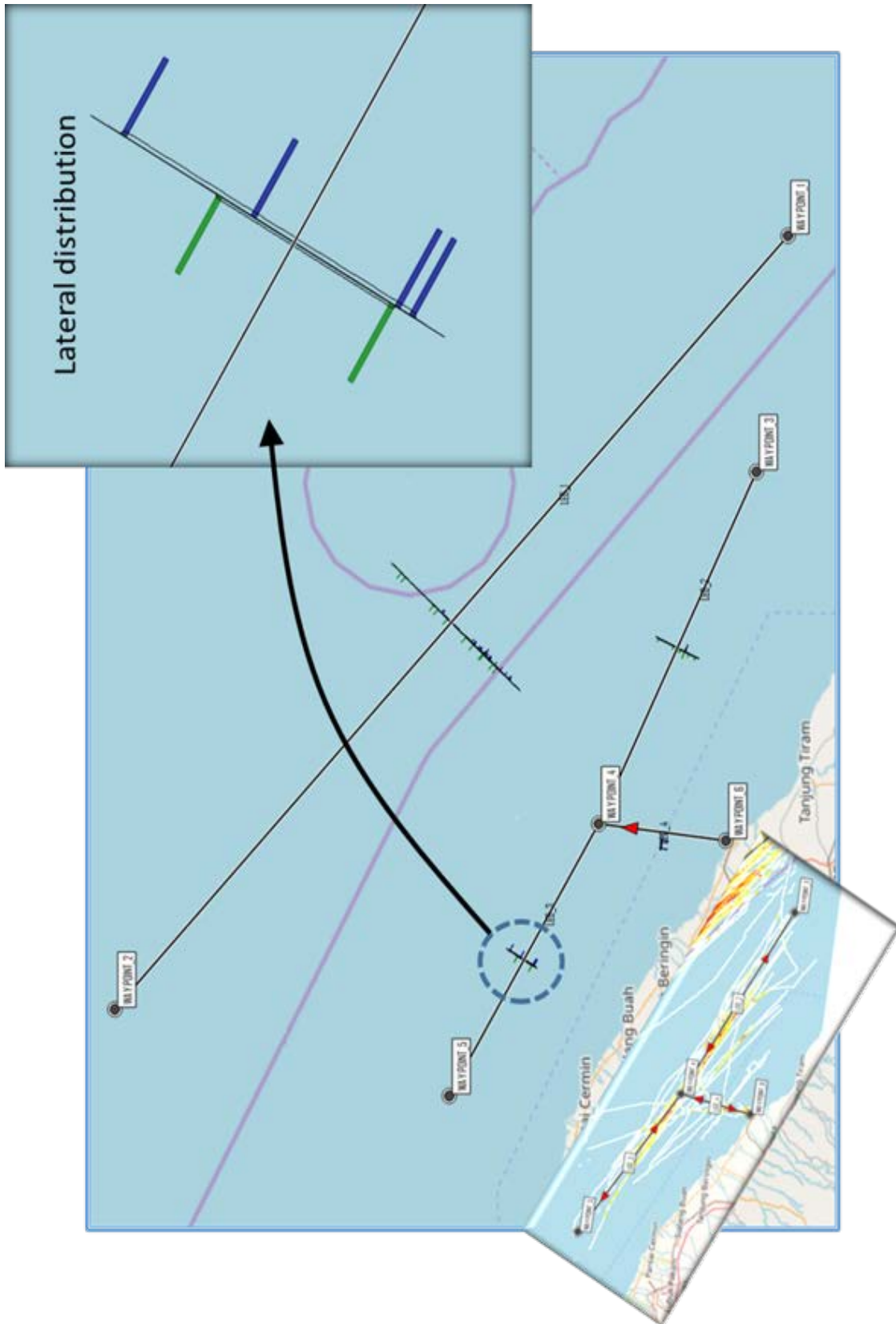

Table 5.3 -2 : Results of IWRAP Calculation

	03-Kuala-Tanjung-020420144107	Unit
Powered Grounding	---	Incidents/Year
Drifting Grounding	---	Incidents/Year
Total Groundings	---	Incidents/Year
Powered Allision	---	Incidents/Year
Drifting Allision	---	Incidents/Year
Total Allisions	---	Incidents/Year
Overtaking	0.001429	Incidents/Year
HeadOn	0.001368	Incidents/Year
Crossing	---	Incidents/Year
Merging	---	Incidents/Year
Bend	---	Incidents/Year
Area	---	Incidents/Year
Total Collisions	0.002797	Incidents/Year
	03-Kuala-Tanjung-020420144107	Unit
Powered Grounding	---	Years between incidents
Drifting Grounding	---	Years between incidents
Total Groundings	---	Years between incidents
Powered Allision	---	Years between incidents
Drifting Allision	---	Years between incidents
Total Allisions	---	Years between incidents
Overtaking	699.9	Years between incidents
HeadOn	730.7	Years between incidents
Crossing	---	Years between incidents
Merging	---	Years between incidents
Bend	---	Years between incidents
Area	---	Years between incidents
Total Collisions	357.5	Years between incidents

Figure 5.4 -1 : Location of the Port of Makassar and Kalukalukuang

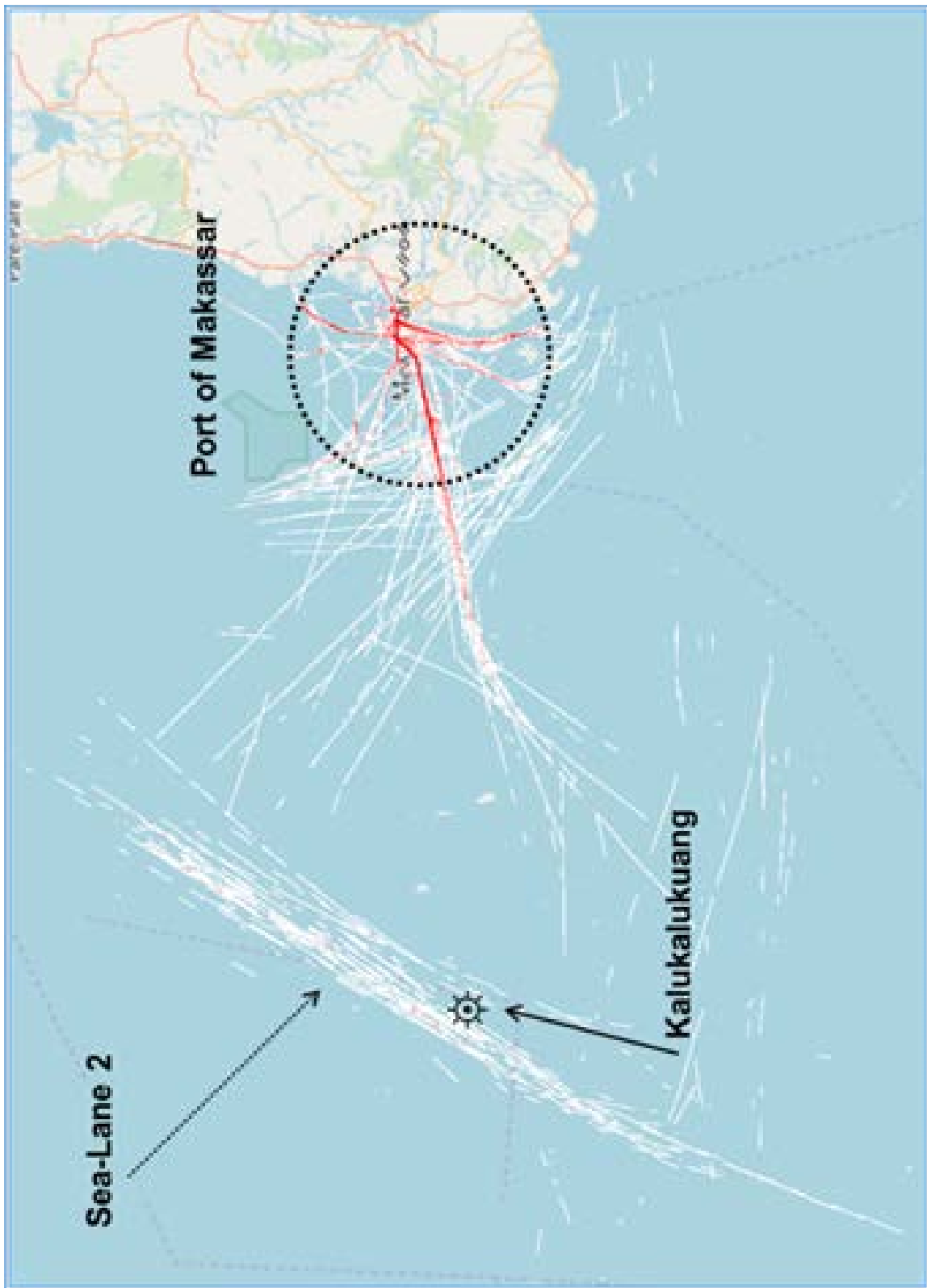

Figure 5.4 -2 : Location of AIS and Radar

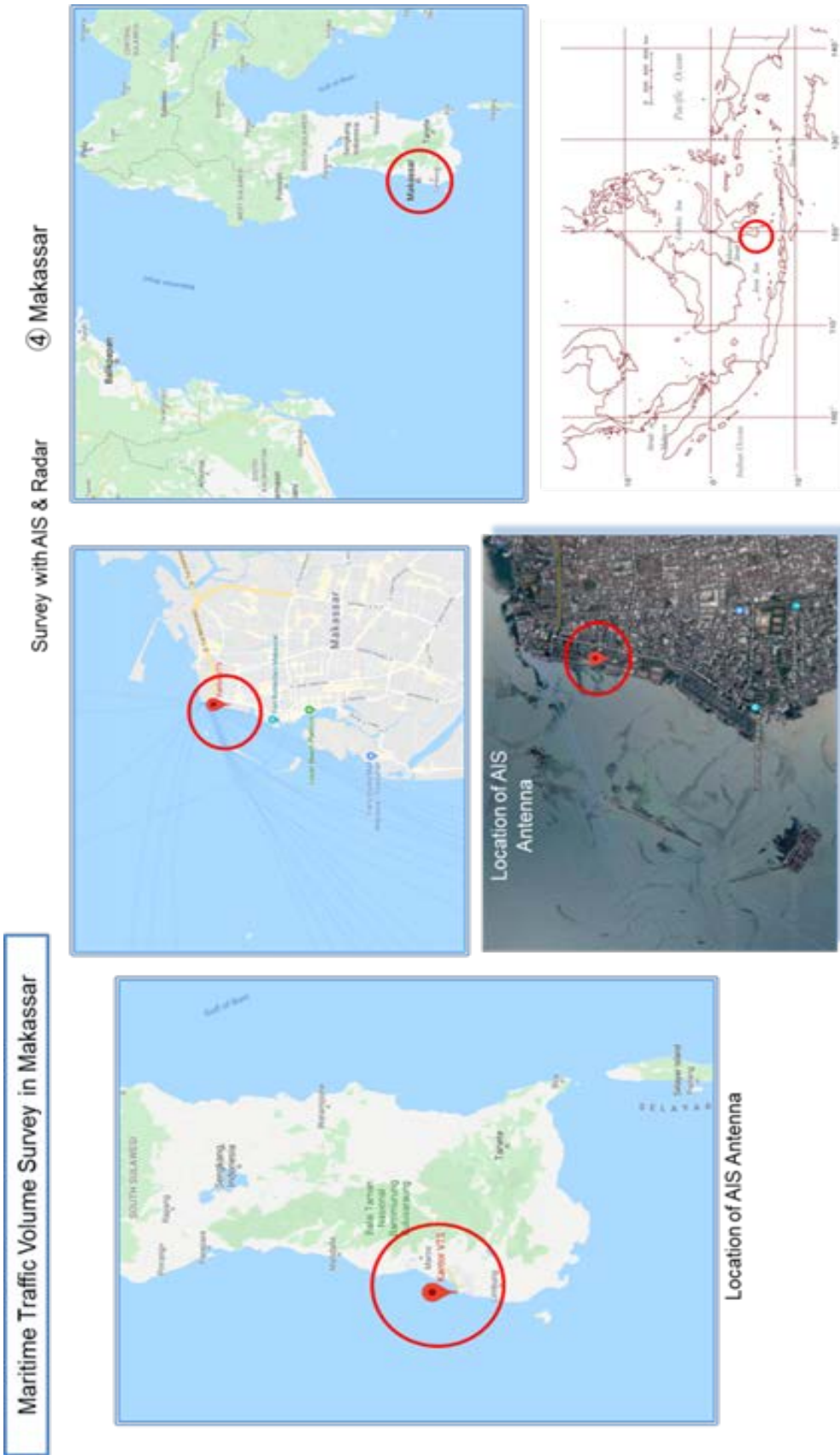

Table 5.4 -1 : Type of Vessel

Ship Type Length	Fast ferry	Fishing ship	General cargo ship	Oil products tanker	Passenger ship	Pleasure boat	Support ship	Other ship	Total
1~50m	0	5	0	0	0	0	2	79	86
51~150m	0	0	16	21	0	0	0	2	39
151~250m	0	0	94	37	0	0	0	6	137
251m以上	0	0	54	32	0	0	0	0	86
Total of ship types	0	5	164	90	0	0	2	87	
Total of all ship types	348								

Figure 5.4 -3 : Density Map for each Type

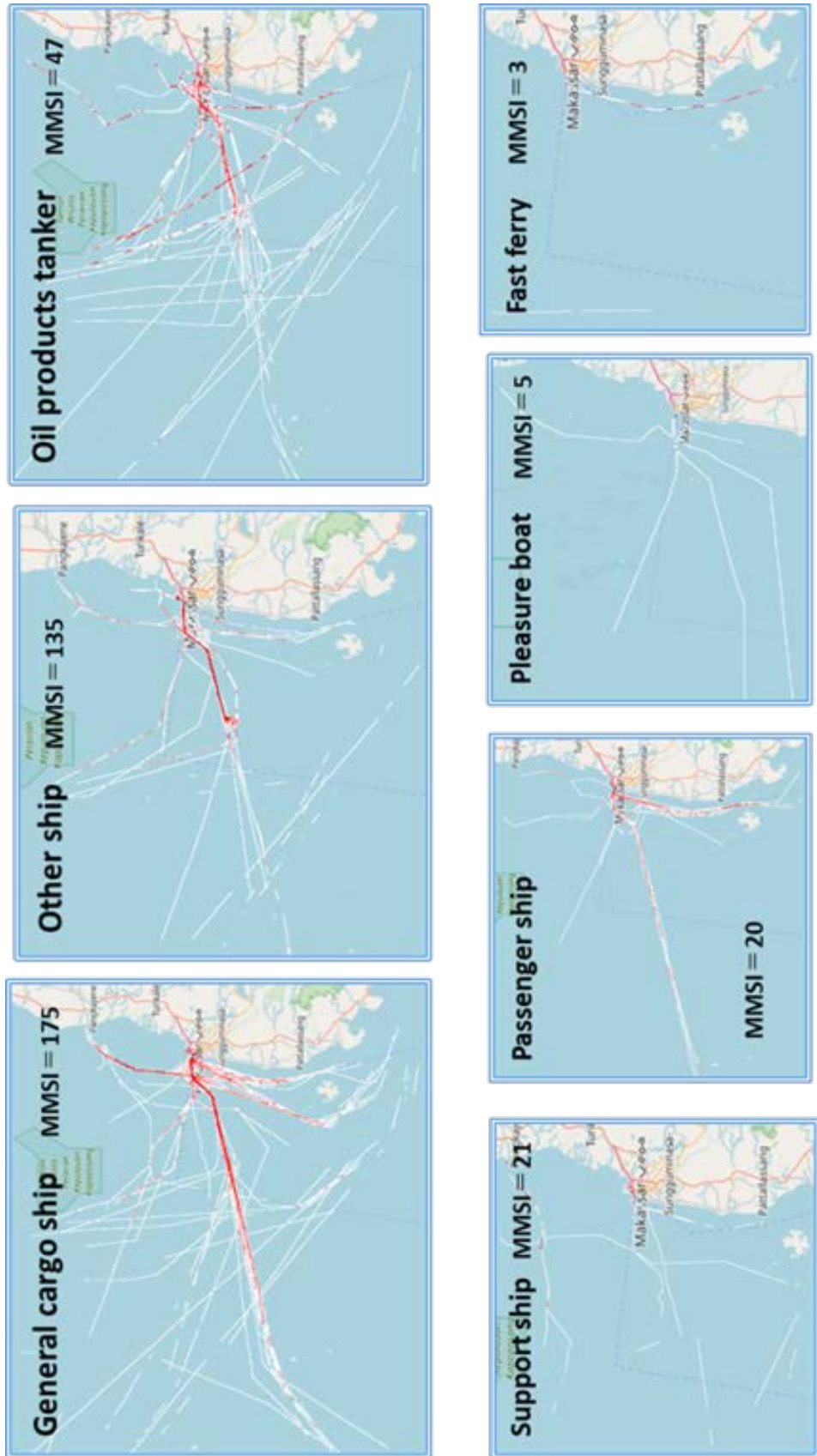

Table 5.4 -2 : Result of IWRAP Calculation

	04-Makassar-030420103826	Unit
Powered Grounding	---	Years between incidents
Drifting Grounding	---	Years between incidents
Total Groundings	---	Years between incidents
Powered Allision	---	Years between incidents
Drifting Allision	---	Years between incidents
Total Allisions	---	Years between incidents
Overtaking	519.1	Years between incidents
HeadOn	200.7	Years between incidents
Crossing	1,517	Years between incidents
Merging	1.132e+04	Years between incidents
Bend	806.7	Years between incidents
Area	---	Years between incidents
Total Collisions	112.4	Years between incidents

	04-Makassar-030420103826	Unit
Powered Grounding	---	Incidents/Year
Drifting Grounding	---	Incidents/Year
Total Groundings	---	Incidents/Year
Powered Allision	---	Incidents/Year
Drifting Allision	---	Incidents/Year
Total Allisions	---	Incidents/Year
Overtaking	0.001927	Incidents/Year
HeadOn	0.004982	Incidents/Year
Crossing	0.0006592	Incidents/Year
Merging	8.831e-05	Incidents/Year
Bend	0.00124	Incidents/Year
Area	---	Incidents/Year
Total Collisions	0.008895	Incidents/Year

Figure 5.4 -4 : Histogram of Lateral Distribution (1/3)

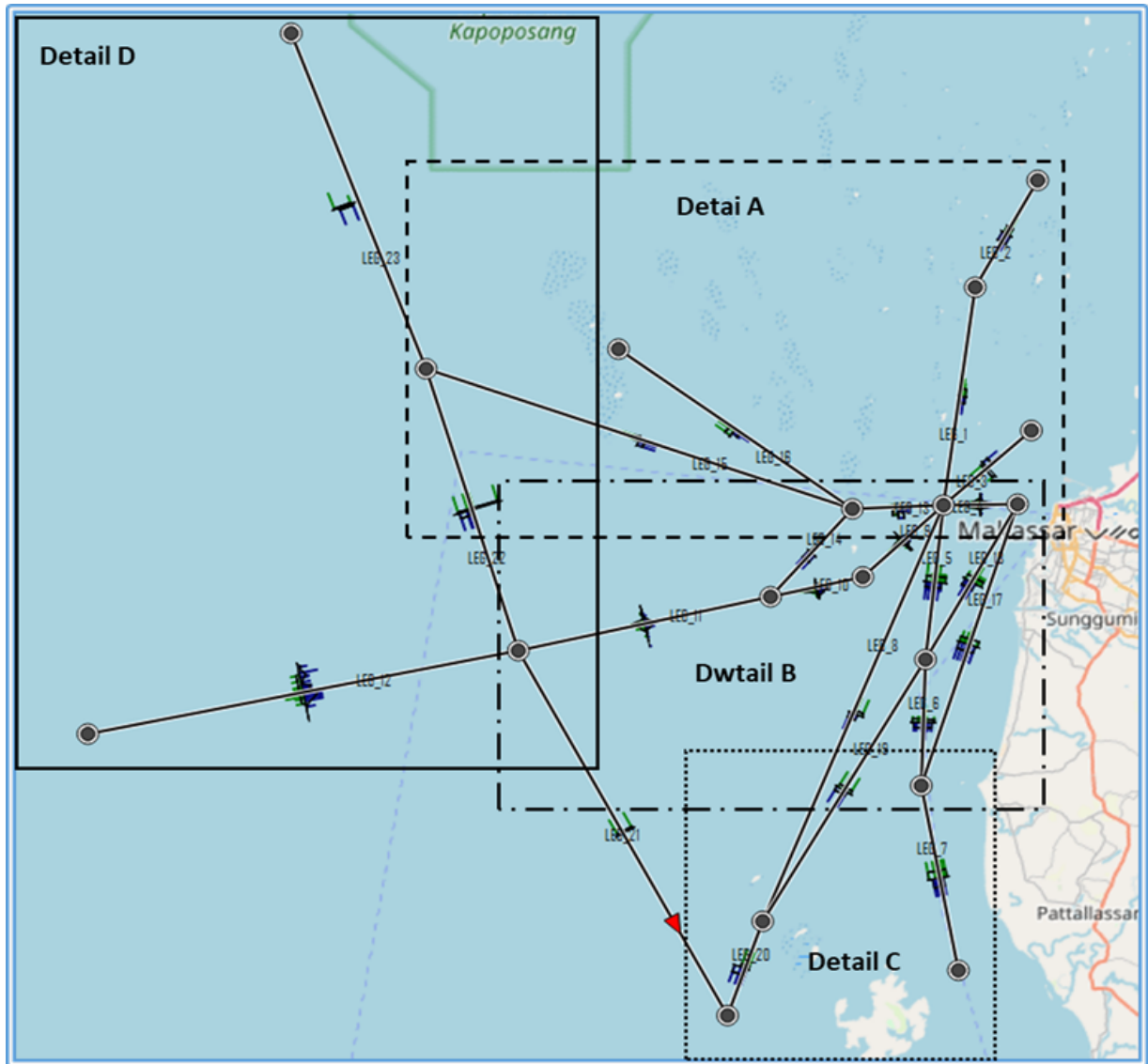

Figure 5.4 -4 : Histogram of Lateral Distribution (2/3)

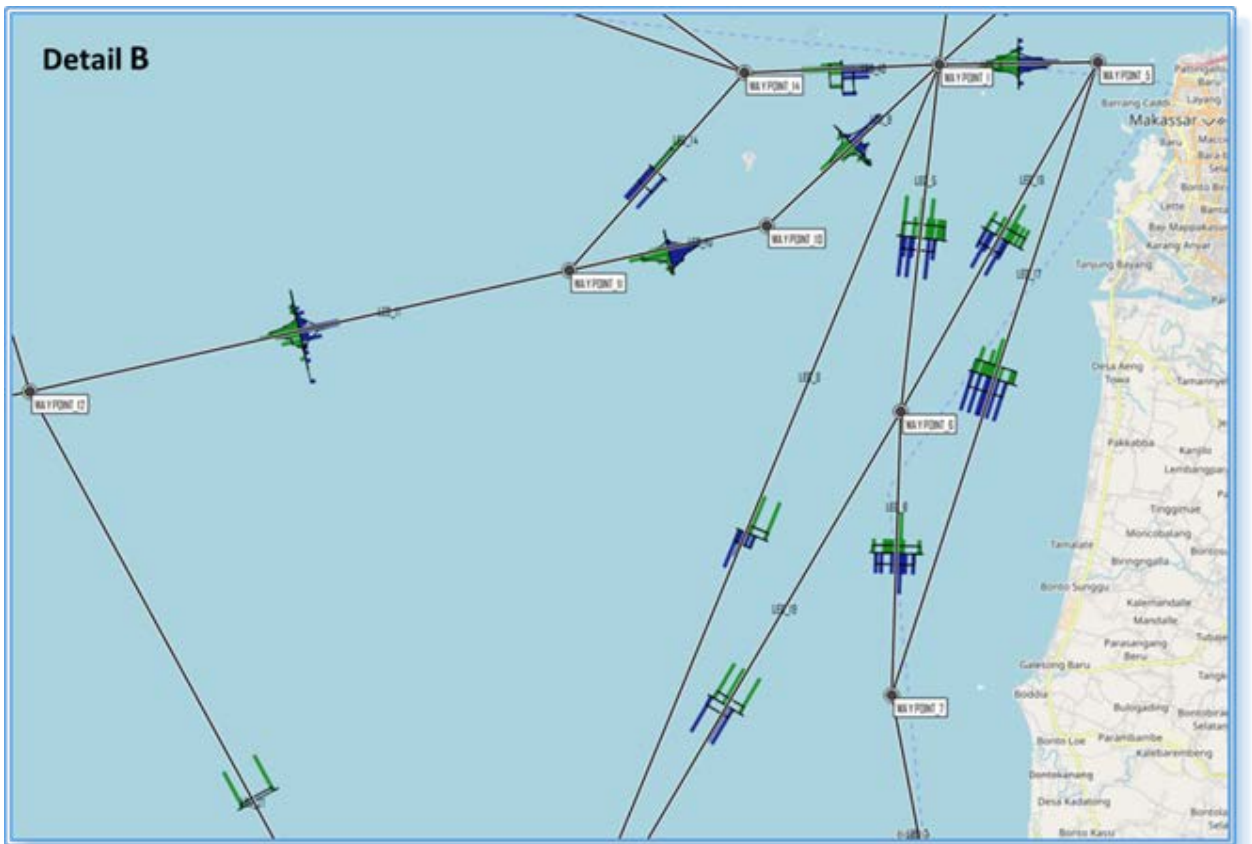
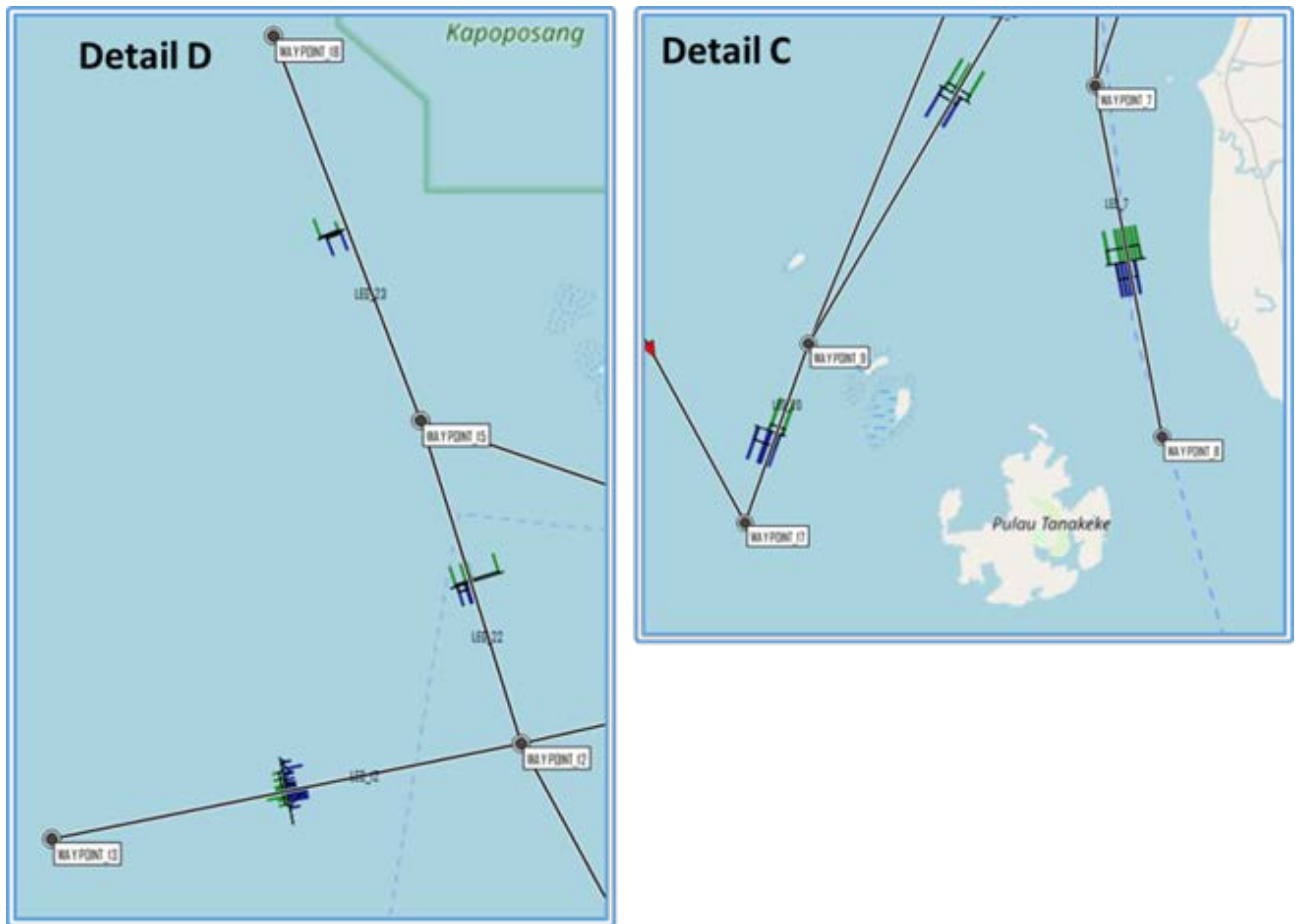
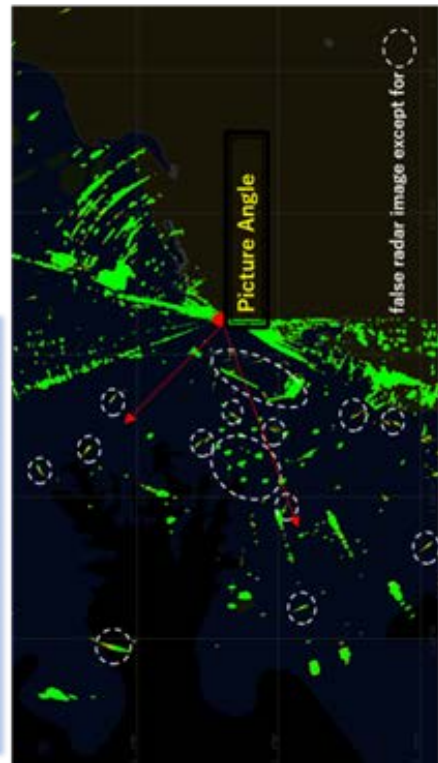
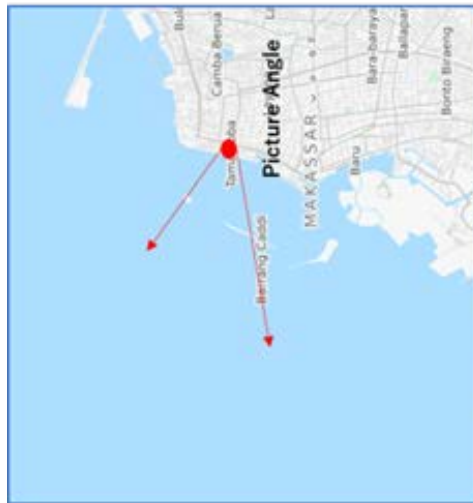
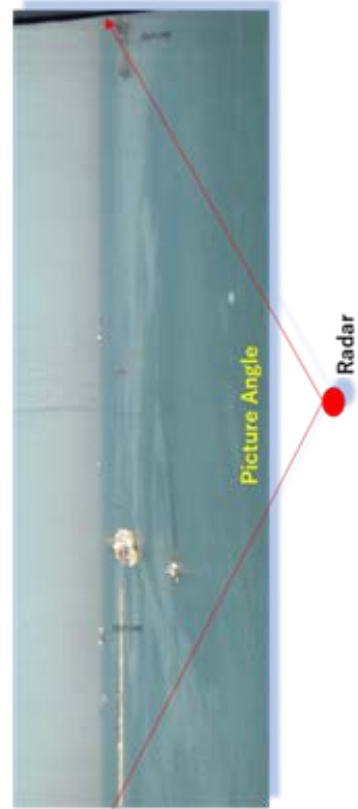

Figure 5.4 -4 : Histogram of Lateral Distribution (3/3)



Picture 5.4 -1 : Radar Images and Its view (1/2)



Picture 5.4 -1 : Radar Images and Its view (2/2)



Table 5.4 -3 : Result of Visual Survey (1/2)

Duration of Visual Survey for Maritime Traffic Volume (Makassar)

D/M	Start	End	Period (h)	Number of Observed Vessels				Number of Vessels / Hour			
				Total	S	M	L	Total	S	M	L
4-Sep-19	06 : 04	18 : 10	12:10	100	76	19	5	8.26	6.28	1.57	0.41

Average Number of Vessels / Hour 8.26 6.28 1.57 0.41

Duration of Visual Survey for Maritime Traffic Volume (Makassar)

D/M	Start	End	Period (h)	Number of Observed Vessels by Type							
				Total	Cargo	Tanker	Passenger	Fishing	Barge	Other	Government
4-Sep-19	06 : 04	18 : 10	12:10	100	5	4	3	32	11	44	1

Average Number of Vessels / Hour 8.26 0.41 0.33 0.25 2.64 0.91 3.64 0.08

Table 5.4 -3 : Result of Visual Survey (2/2)

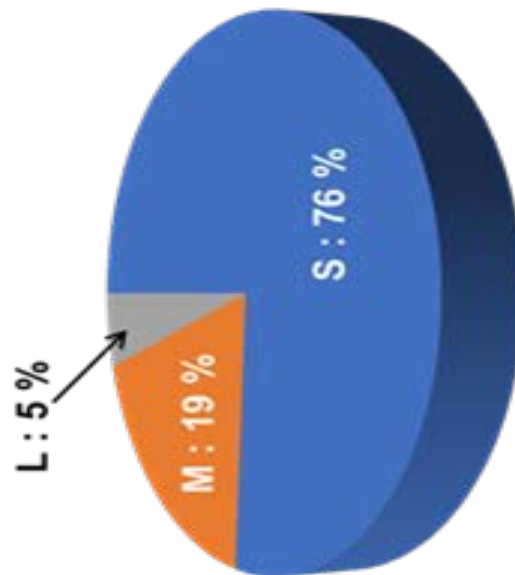
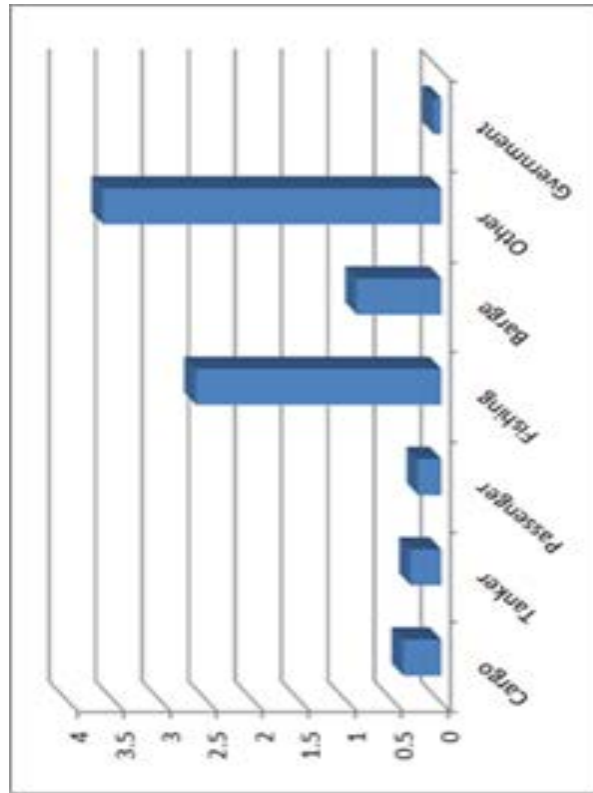

Picture 5.4 -2 : Sea dotted with small boats



Picture 5.5 -1 : Carrying AIS Equipment in Island

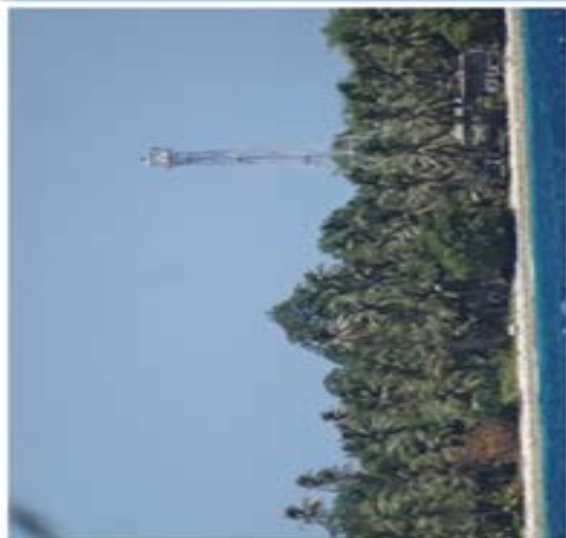

Figure 5.5 -1 : Location of AIS Base-Station

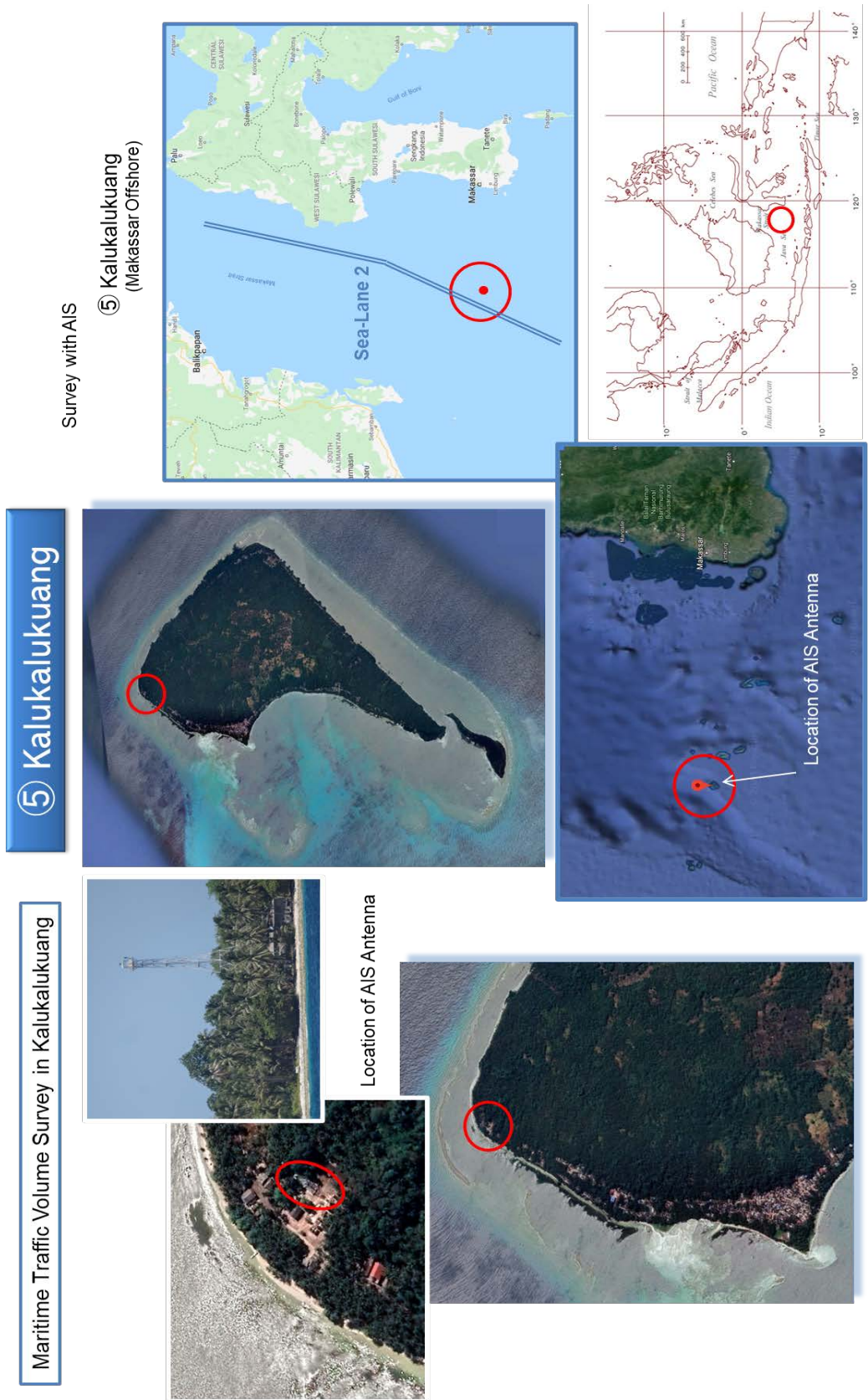

Figure 5.5 -2 : Density Plot of AIS

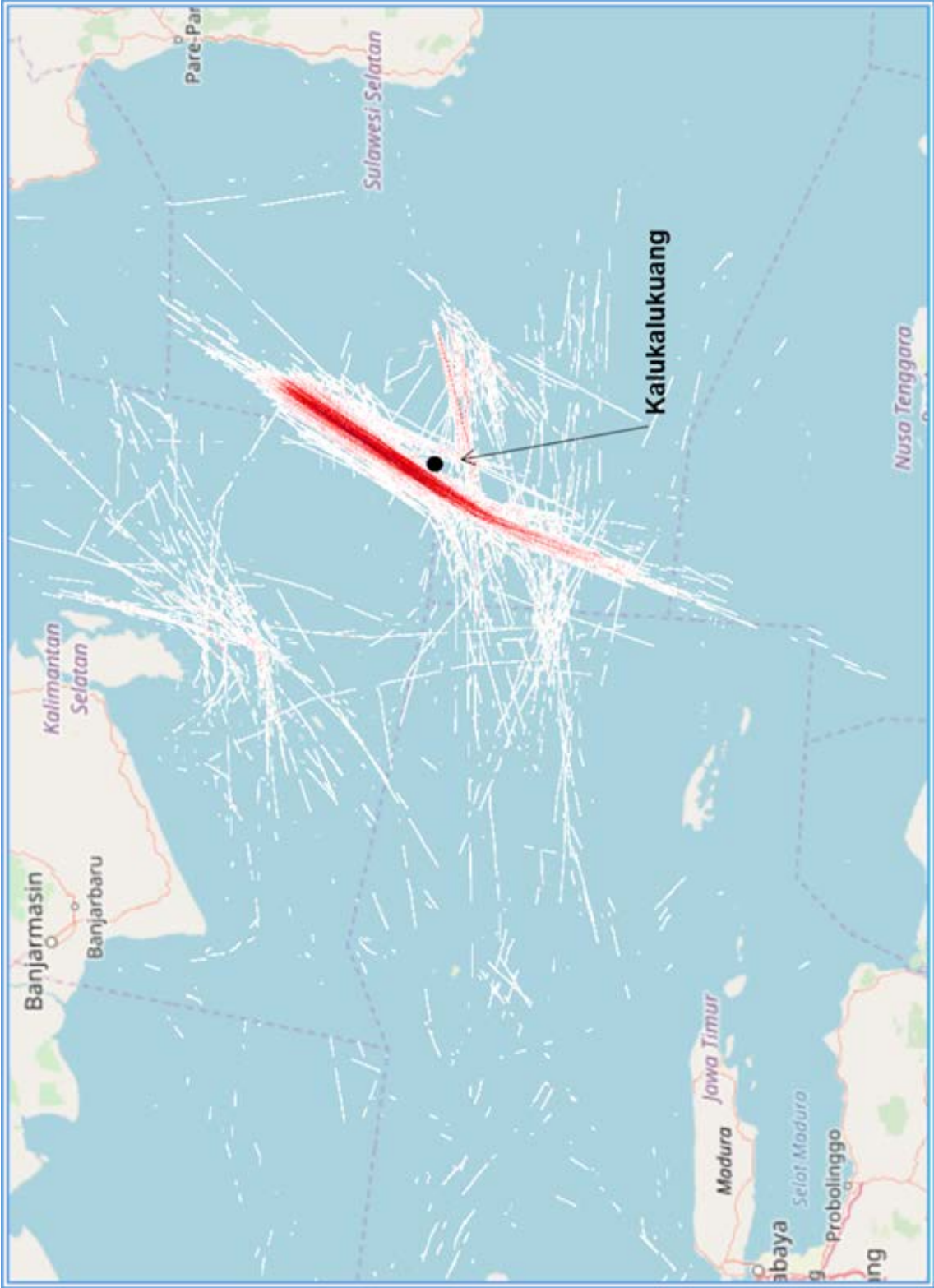

Table 5.5 -1 : Type of Vessel

Ship Type Length	Fast ferry	Fishing ship	General cargo ship	Oil products tanker	Passenger ship	Pleasure boat	Support ship	Other ship	Total
1~50m	0	0	17	6	5	1	29	256	314
51~150m	0	0	126	50	11	1	10	28	226
151~250m	0	0	276	58	5	0	1	7	347
251m以上	0	0	300	0	1	0	0	6	307
Total of ship types	0	0	719	114	22	2	40	297	
Total of all ship types	1,194								

Graph 5.5 -1 : Vessels by Nationality



Table 5.5 -2 Vessels by Nationality

1	2	3	4	5	6	7	8	9	10
Indonesia	Hong Kong	Liberia	Panama	Marshall Islands	Singapore	Greece	China	Malta	Cyprus
890	135	106	82	69	50	22	17	16	14
11	12	13	14	15	16	17	18	19	20
Japan	Northern Ireland	Malta	Bahamas	Viet Nam	Italy	Madeira	Taiwan	Malaysia	UK
13	9	8	8	7	6	6	6	6	4
21	22	23	24	25	26	27	28	29	30
Luxembourg	Norway	Korea	Bermuda	Cayman Islands	Tuvalu	Netherlands	Antigua and Barbuda	India	Mongolia
4	4	4	3	3	3	2	2	2	2
31	32	33	34	35	36	37	38	39	40
Niue	Philippines	Thailand	Germany	Spain	Gibraltar	Dominica	US	Saudi Arabia	Pakistan
2	2	2	1	1	1	1	1	1	1
41	42	43	44	45	-----				
Australia	Cambodia	Kiribati	New Caledonia	Togo	Vanuatu				
1	1	1	1	1	118				

Figure 5.5 -3 : Density for each Type

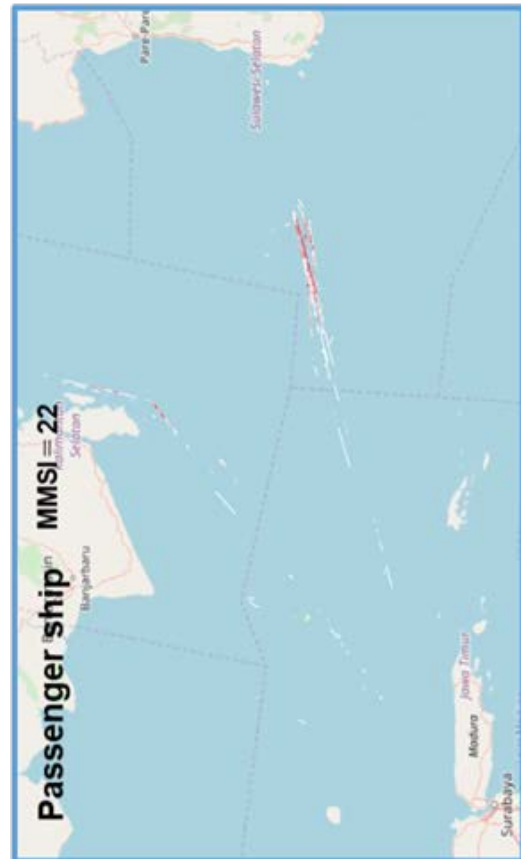
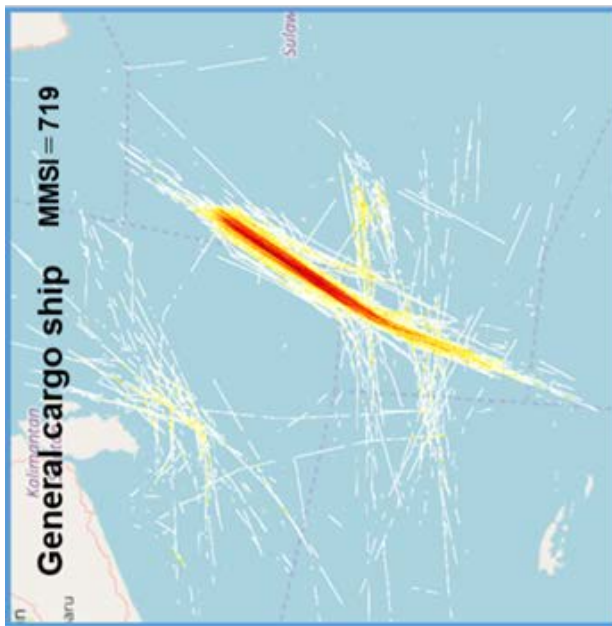
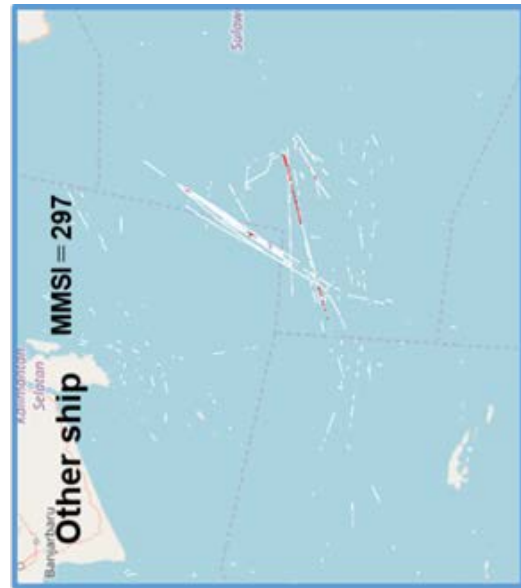

Figure 5.5 -4 : Designation of Leg for Calculation

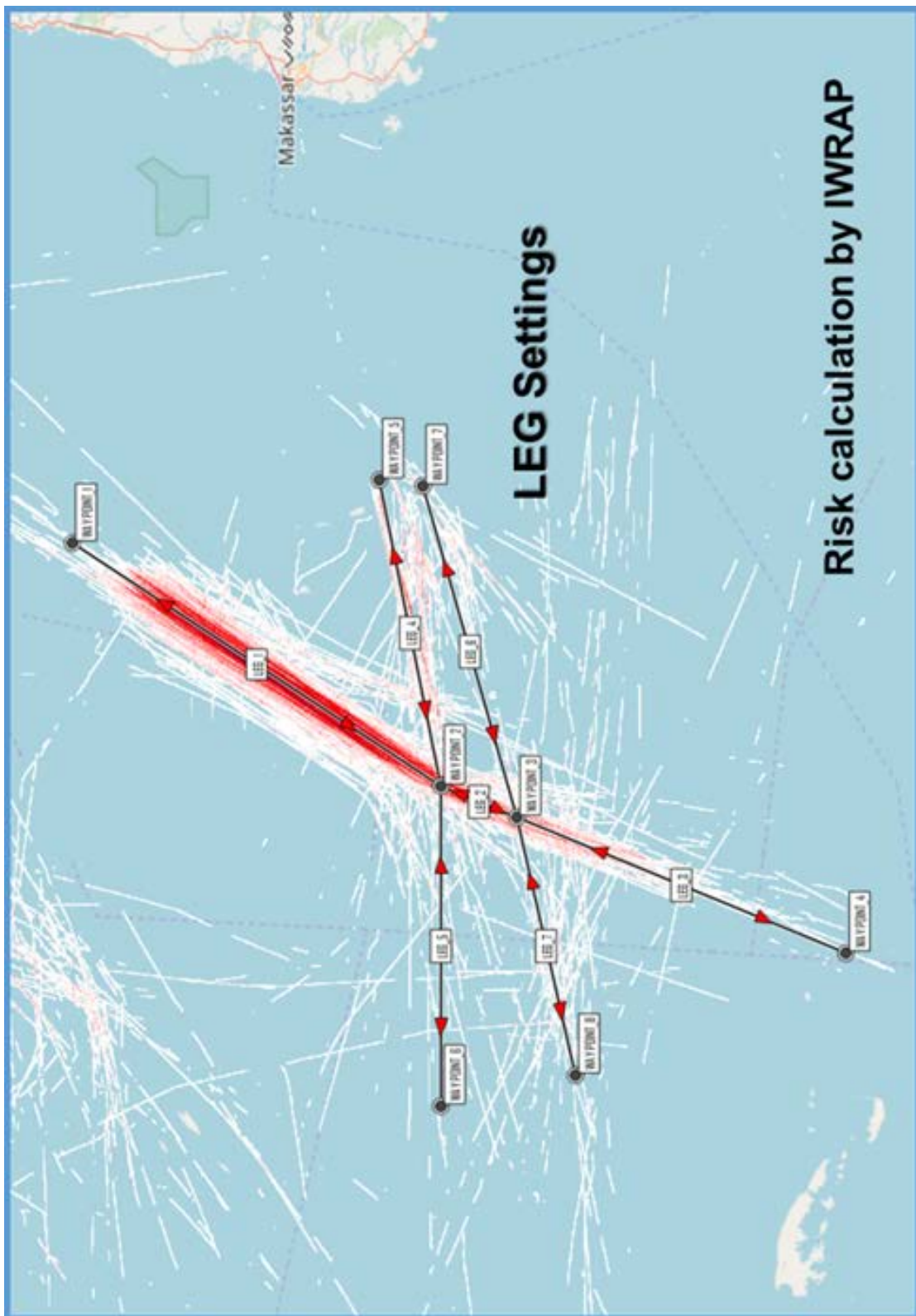

Figure 5.5 -5 : Histogram of Lateral Distribution

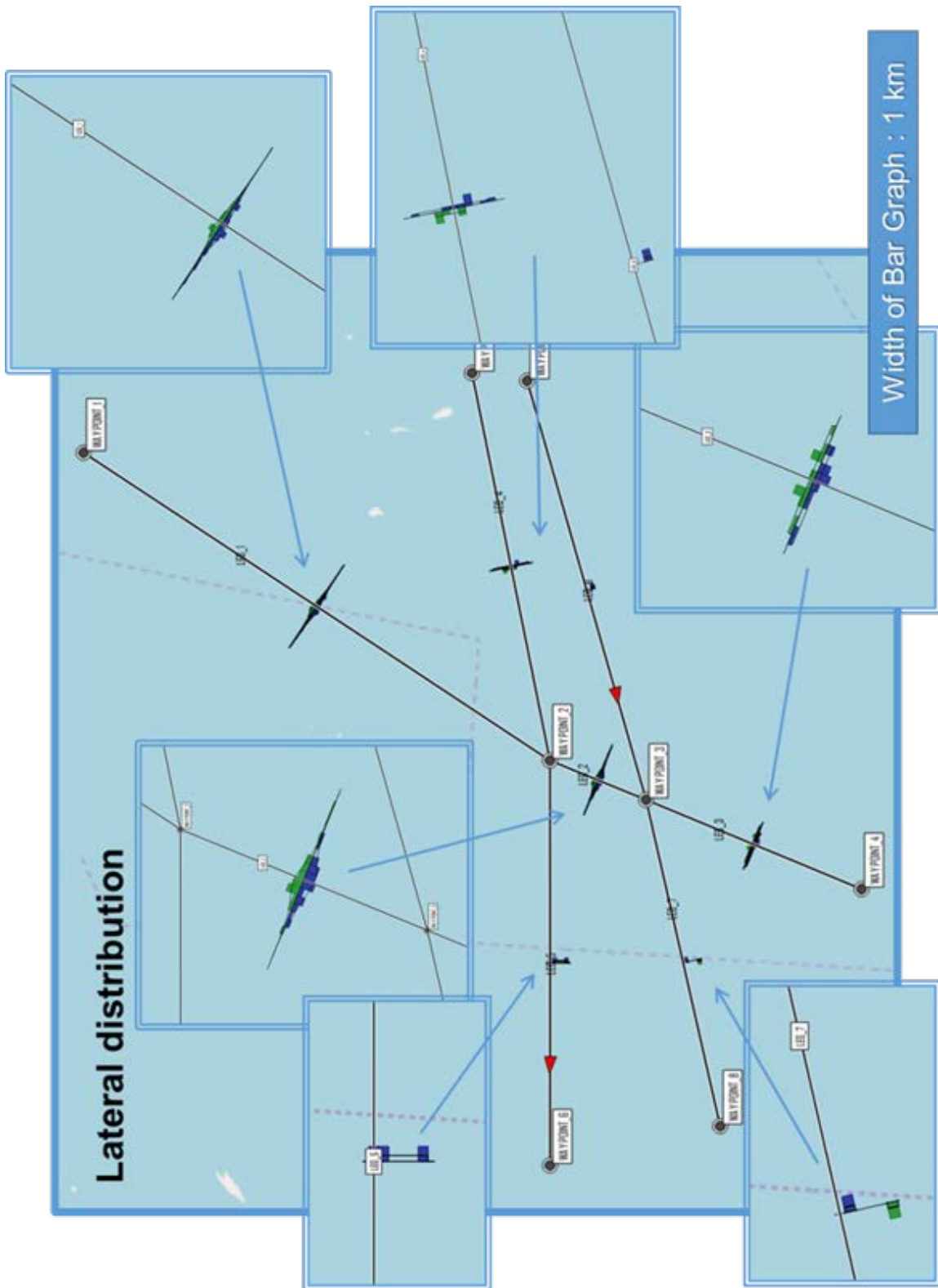

Table 5.5 -3 : Results of IWRAP Calculation

	05-Kalulakauang-030420132925	Unit
Powered Grounding	---	Years between incidents
Drifting Grounding	---	Years between incidents
Total Groundings	---	Years between incidents
Powered Allision	---	Years between incidents
Drifting Allision	---	Years between incidents
Total Allisions	---	Years between incidents
Overtaking	4,233	Years between incidents
HeadOn	418.3	Years between incidents
Crossing	2.159e+05	Years between incidents
Merging	4.903e+05	Years between incidents
Bend	1.602e+04	Years between incidents
Area	---	Years between incidents
Total Collisions	370.9	Years between incidents

	05-Kalulakauang-030420132925	Unit
Powered Grounding	---	Incidents/Year
Drifting Grounding	---	Incidents/Year
Total Groundings	---	Incidents/Year
Powered Allision	---	Incidents/Year
Drifting Allision	---	Incidents/Year
Total Allisions	---	Incidents/Year
Overtaking	0.0002363	Incidents/Year
HeadOn	0.002391	Incidents/Year
Crossing	4.633e-06	Incidents/Year
Merging	2.04e-06	Incidents/Year
Bend	6.241e-05	Incidents/Year
Area	---	Incidents/Year
Total Collisions	0.002696	Incidents/Year

Figure 5.6 -1 : Location of AIS and Radar

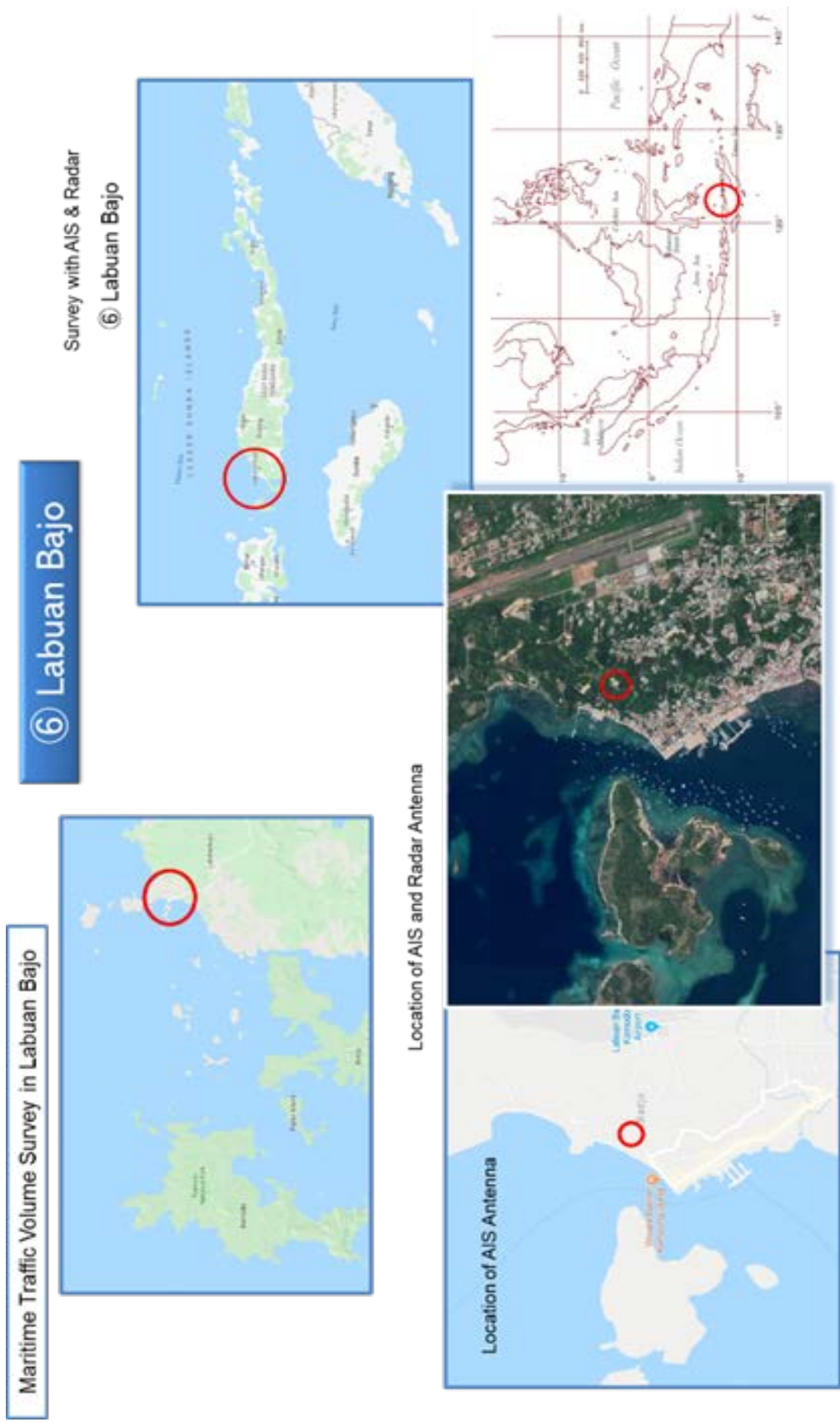

Figure 5.6 -2 : Density Plot of AIS



Table 5.6 -1 : Type of Vessel

Ship Type	Fast ferry	Fishing ship	General cargo ship	Oil products tanker	Passenger ship	Pleasure boat	Support ship	Othership	Total
Length									
1~25m	1	0	0	0	1	8	1	2	13
26~50m	0	0	1	0	5	2	0	18	26
51~150m	0	0	12	8	4	2	1	1	28
151~250m	0	0	4	1	0	0	0	0	5
251m以上	0	0	10	0	0	0	0	0	10
Total of ship types	1	0	27	9	10	12	2	21	
Total of all ship types	82								

Figure 5.6 -3 : Density Map for each Type

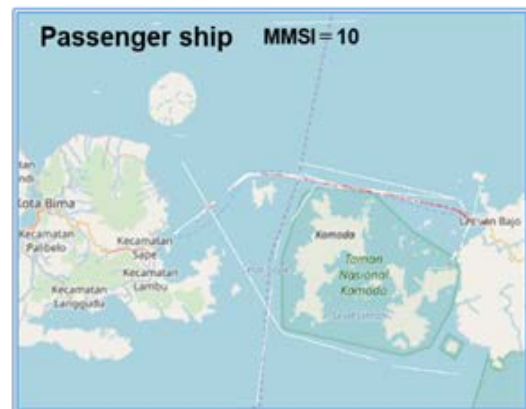
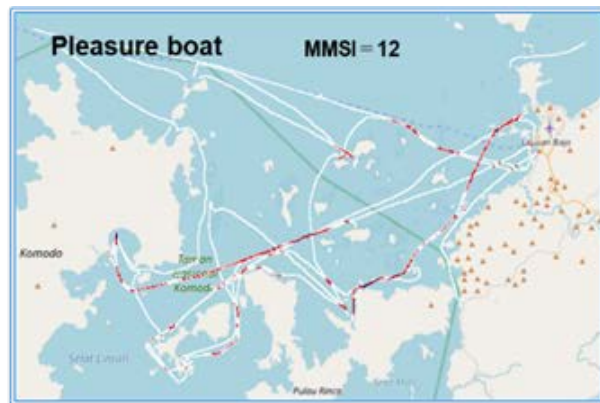
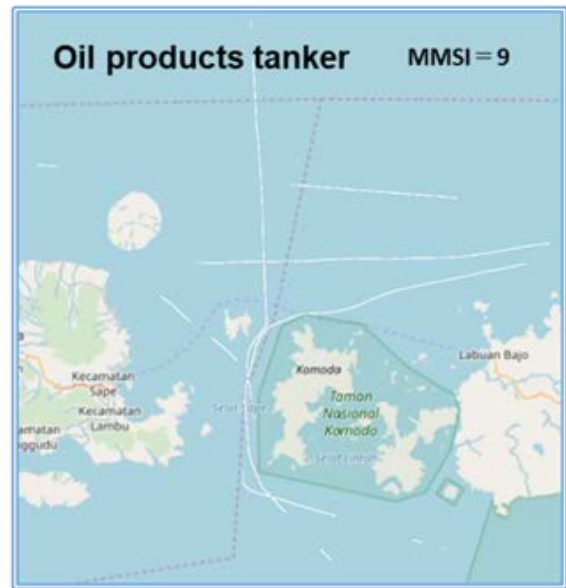

Picture 5.6 -1 : Installation of Radar



⑥ Labuan Bajo

Figure 5.6 -4 : Expected Radar Coverage

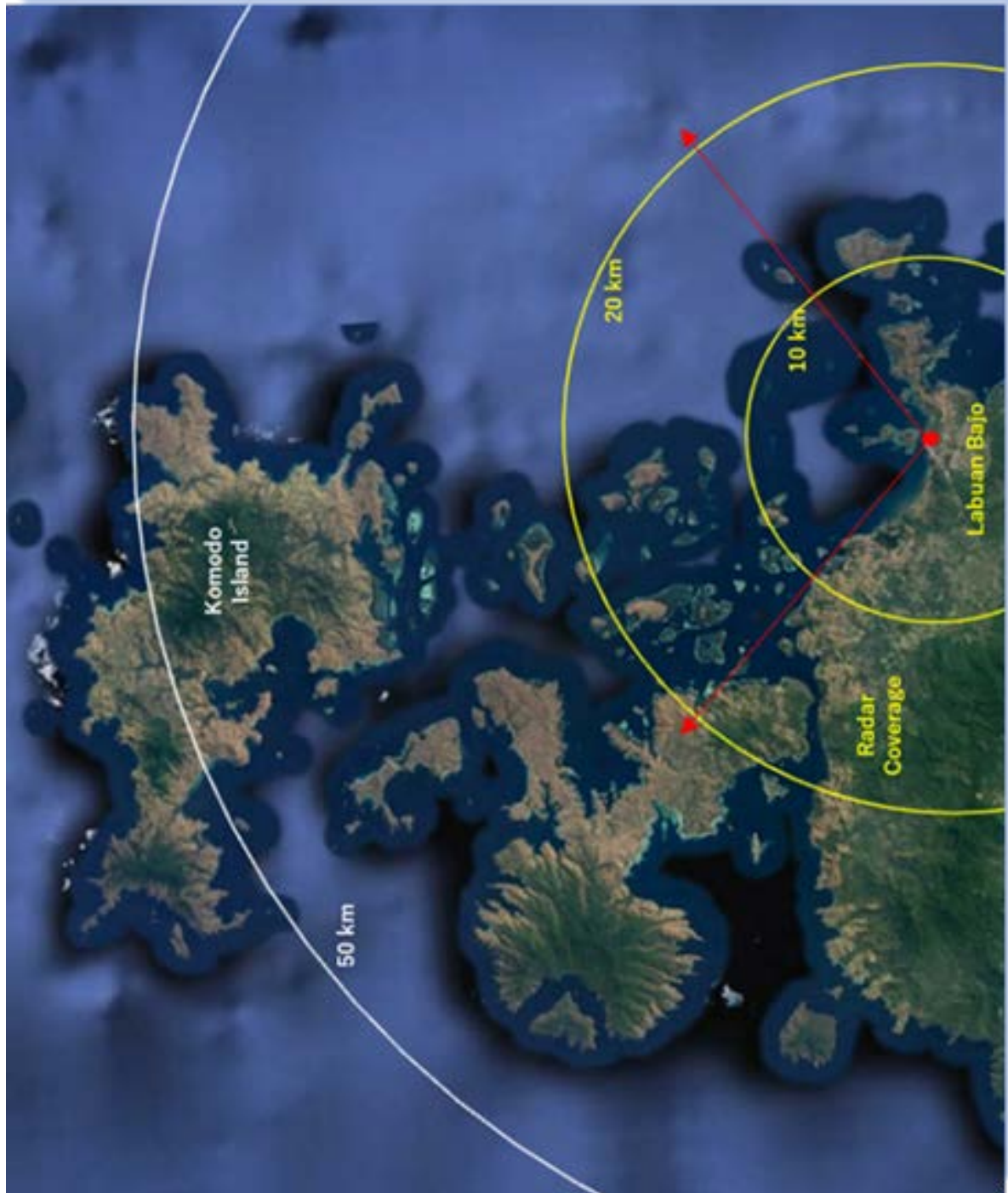
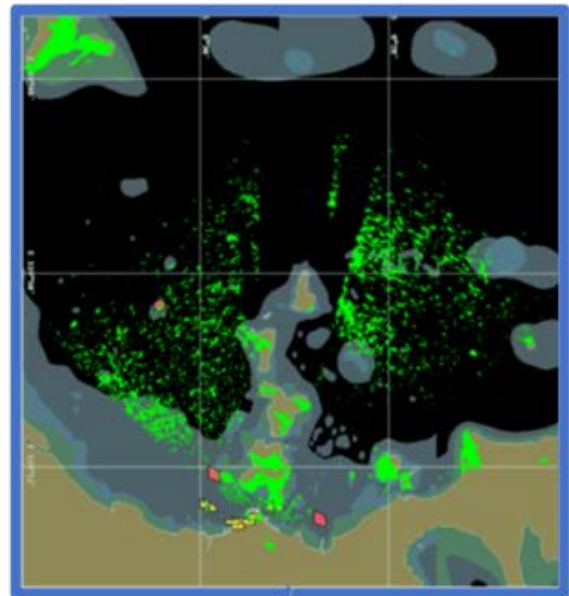
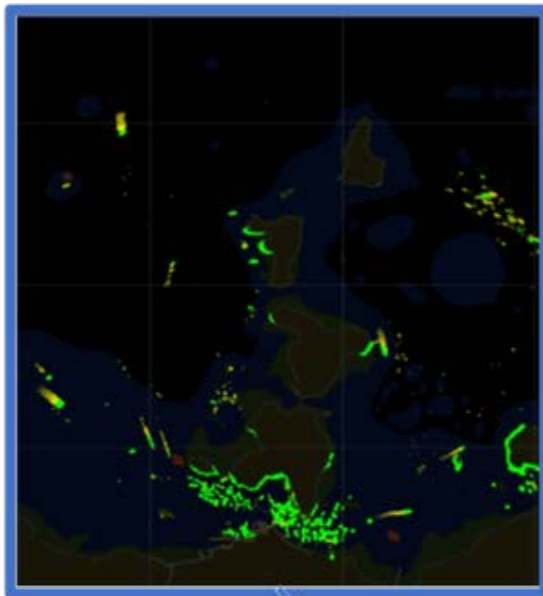
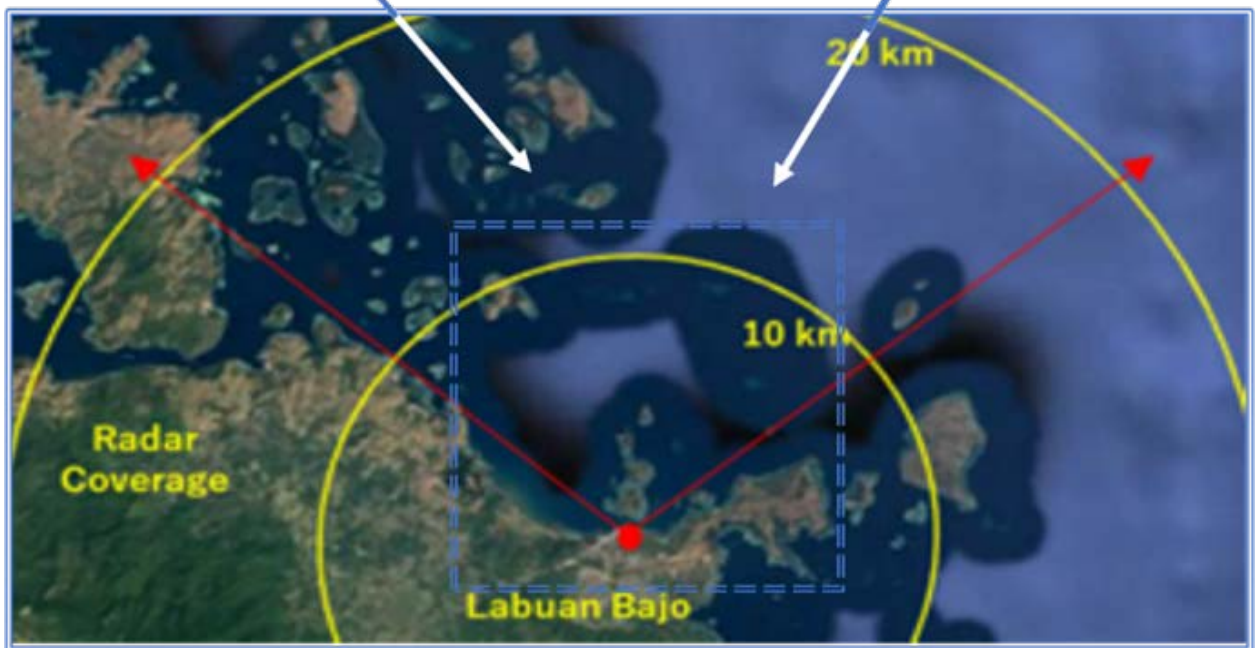

Figure 5.6 -5 : Radar Images in the Port



Radar Images



Radar Coverage (Hand Drawing)

Picture 5.6 -2 : View toward Komodo Island

Komodo National Park has been selected as one of the New 7 Wonders of Nature. The waters surrounding Komodo Island contain rich marine biodiversity. Komodo Island is also a part of the Coral Triangle, which contains some of the richest marine biodiversity on Earth.

..... from Wikipedia

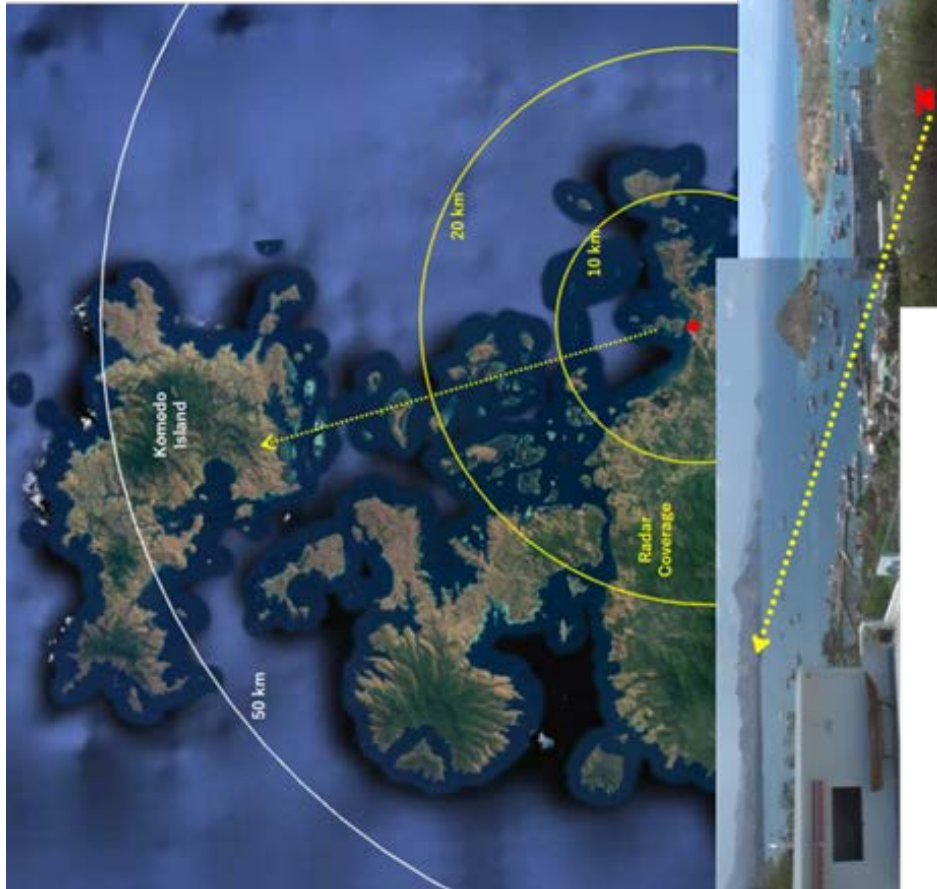

Table 5.6 -2 : Result of Visual Survey (1/2)

Duration of Visual Survey for Maritime Traffic Volume (Labuan Bajo)

D/M	Start	End	Period (h)	Number of Observed Vessels				Number of Vessels / Hour			
				Total	S	M	L	Total	S	M	L
8-Nov-19	16 : 56	17 : 59	1.05	22	22	0	0	20.95	20.95	0.00	0.00
9-Nov-19	07 : 07	08 : 16	1.15	35	34	0	1	30.44	29.57	0.00	0.87
				Average Number of Vessels / Hour				25.70 25.26 0.00 0.44			

Duration of Visual Survey for Maritime Traffic Volume (Labuan Bajo)

D/M	Start	End	Period (h)	Number of Observed Vessels by Type							Average Number of Vessels / Hour	
				Total	Cargo	Tanker	Passenger	Fishing	Barge	Other		Government
8-Nov-19	16 : 56	17 : 59	1.05	22	0	0	21	1	0	0	0	0.44
9-Nov-19	07 : 07	08 : 16	1.15	35	1	0	34	0	0	0	0	0.48
				Average Number of Vessels / Hour							25.71 0.44 0.00 24.79 0.48 0.00 0.00 0.00	

Table 5.6 -2 : Result of Visual Survey (2/2)

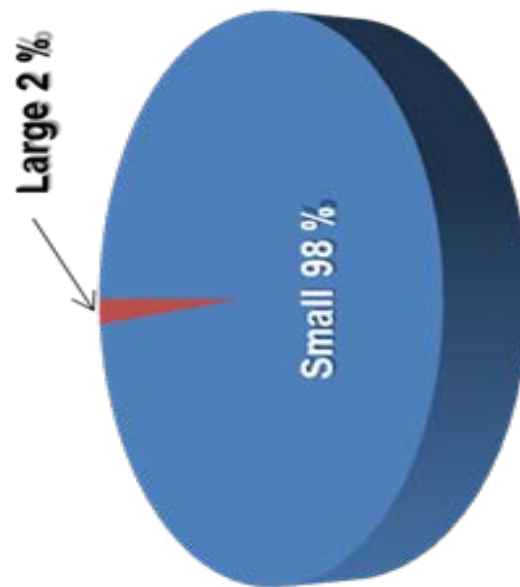
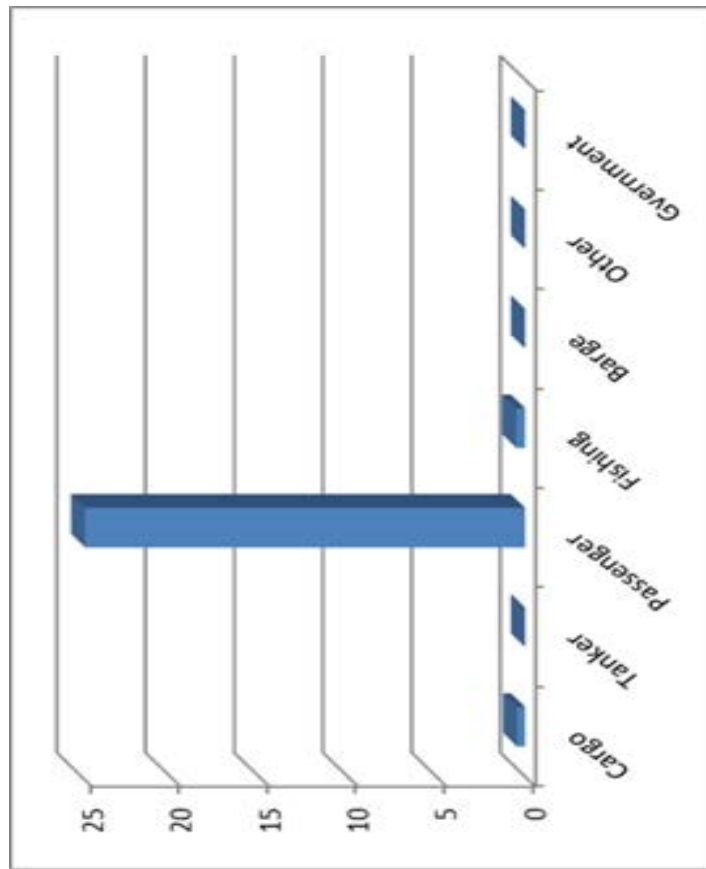

Picture 5.6 -3 : View of Labuan Bajo

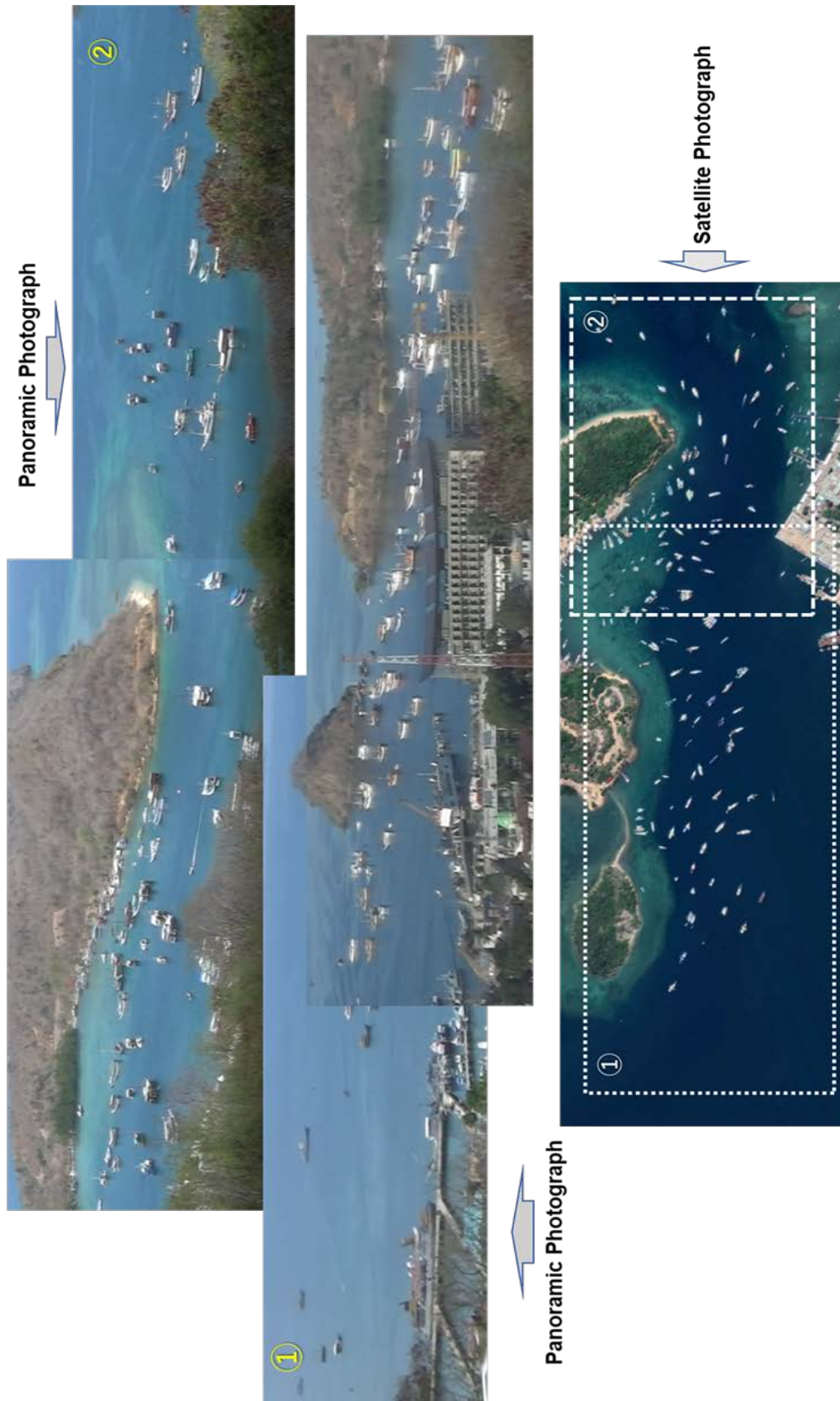

Picture 5.6 -4 : Dive Spots

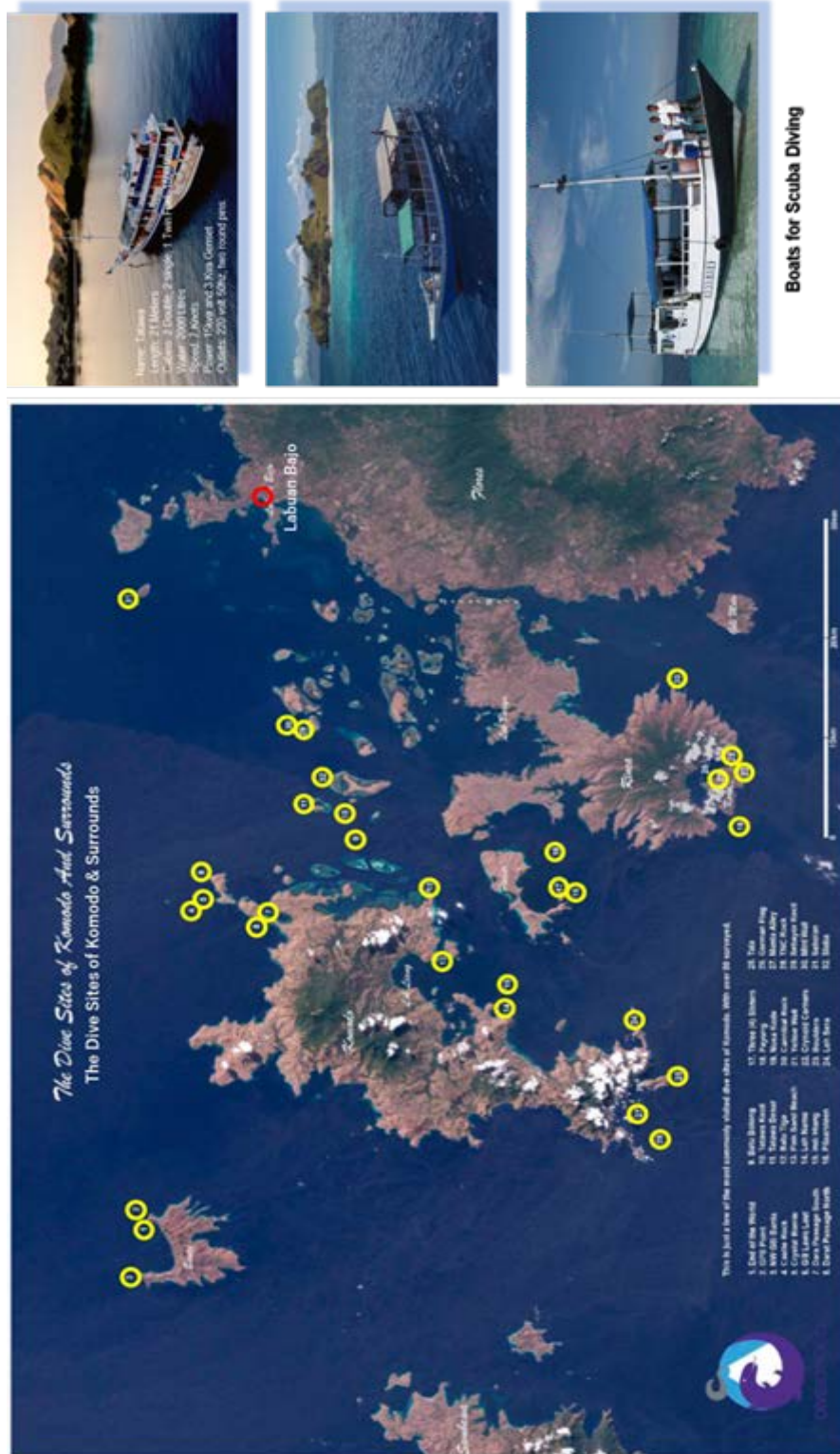

Picture 5.6 -5 : Cruise Ship in Labuan Bajo



Cruise Ships in Labuan Bajo

Figure 5.7 -1 : Location of AIS Base-Station

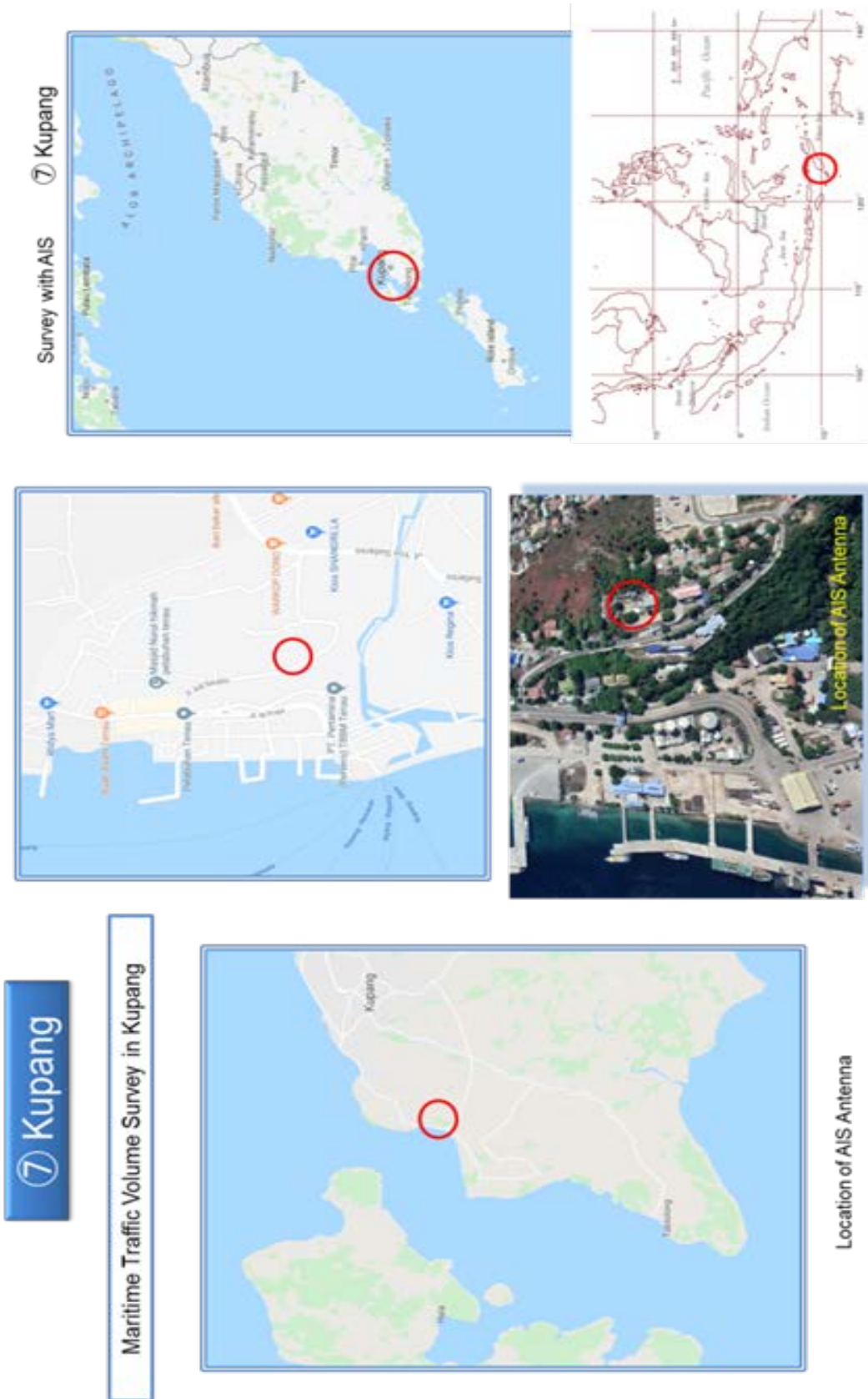

Picture 5.7 -1 : Installation of AIS Antenna



Figure 5.7 -2 : Density Plot of AIS

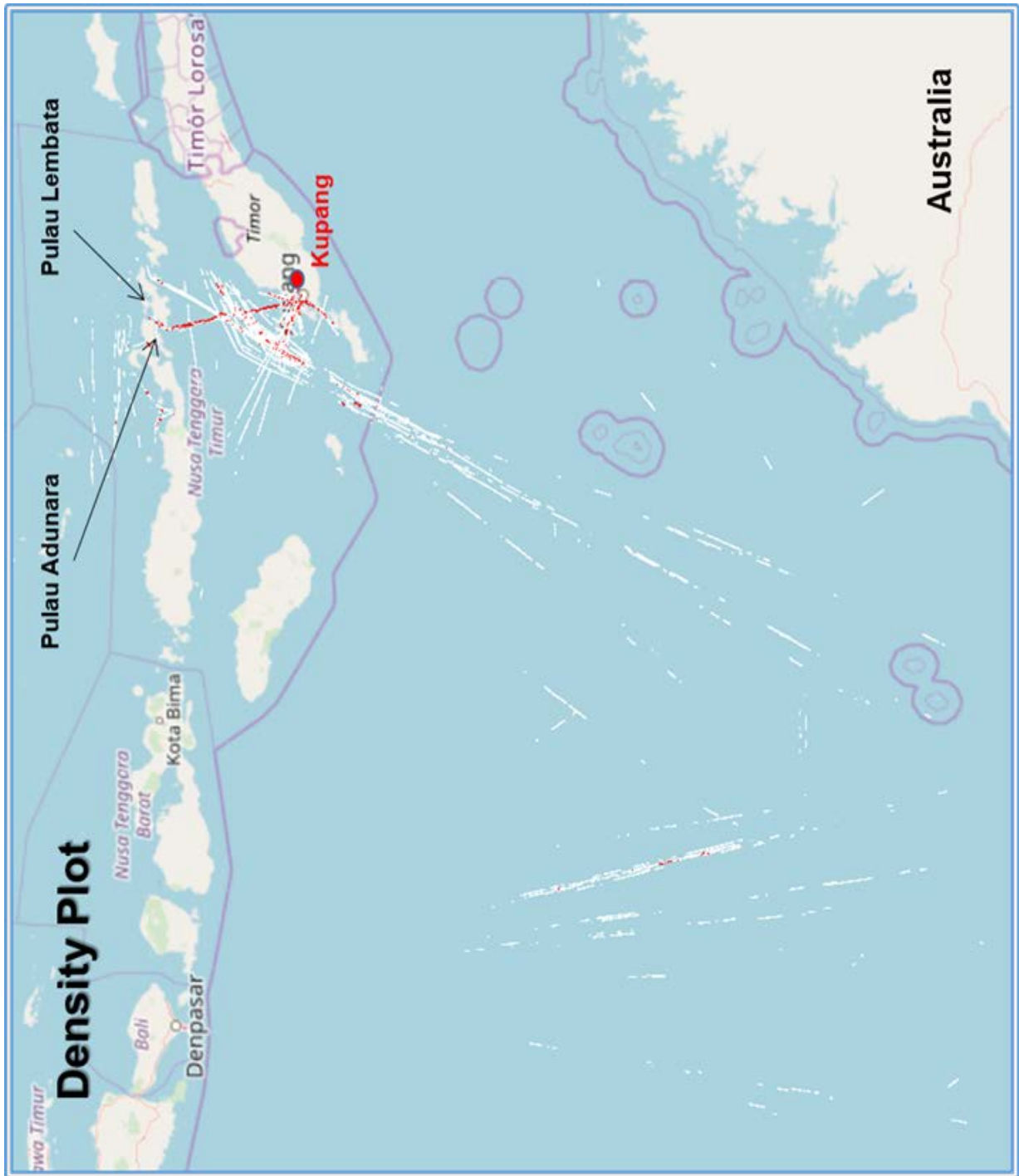

Table 5.7 -1 : Type of Vessels

Ship Type	Fast ferry	Fishing ship	General cargo ship	Oil products tanker	Passenger ship	Pleasure boat	Support ship	Other ship	Total
Length									
1~50m	1	1	3	0	10	4	6	46	71
51~150m	0	0	15	12	8	0	1	11	47
151~250m	0	0	13	5	0	0	0	1	19
251m以上	0	0	60	11	0	0	0	1	72
Total of ship types	1	1	91	28	18	4	7	59	
Total of all ship types	209								

Figure 5.7 -3 : Density Map for each Type (1/2)

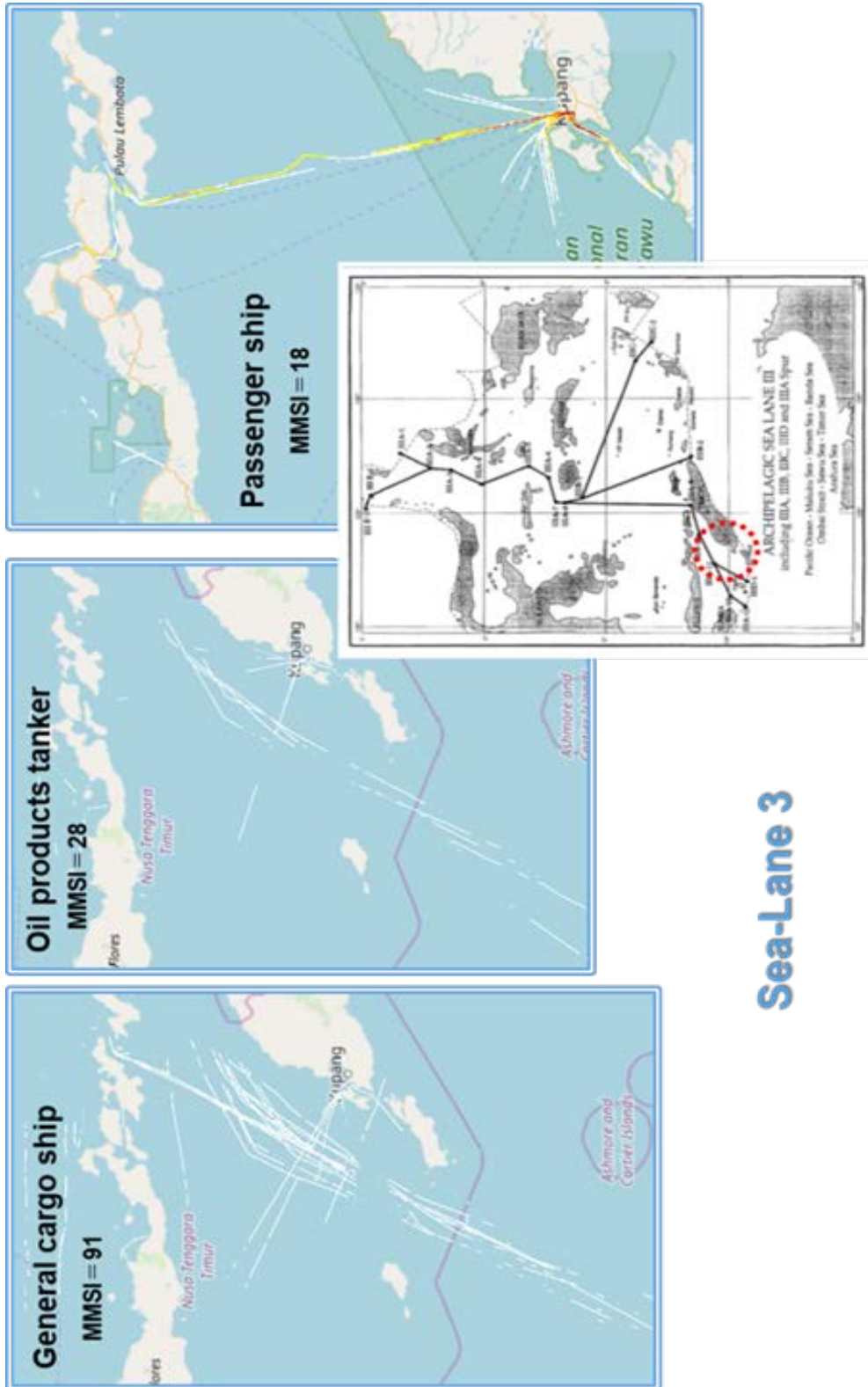

Figure 5.7 -3 : Density Map for each Type (2/2)

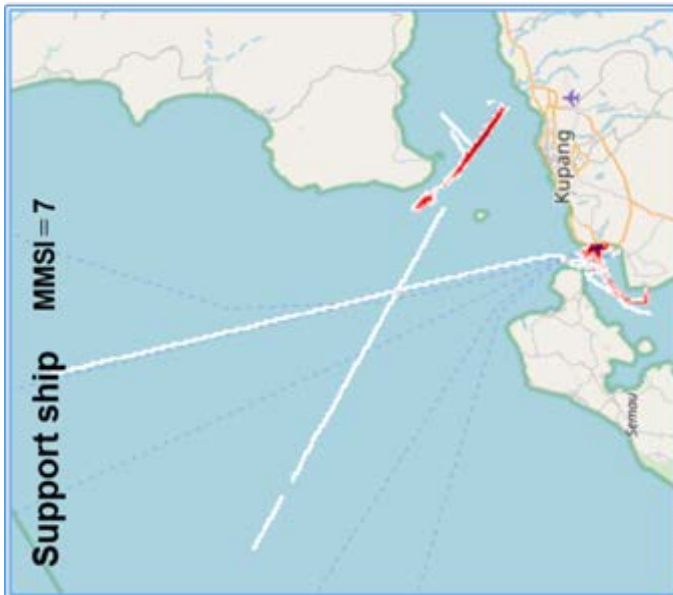

Figure 5.7 -4 : Histogram of Lateral Distribution

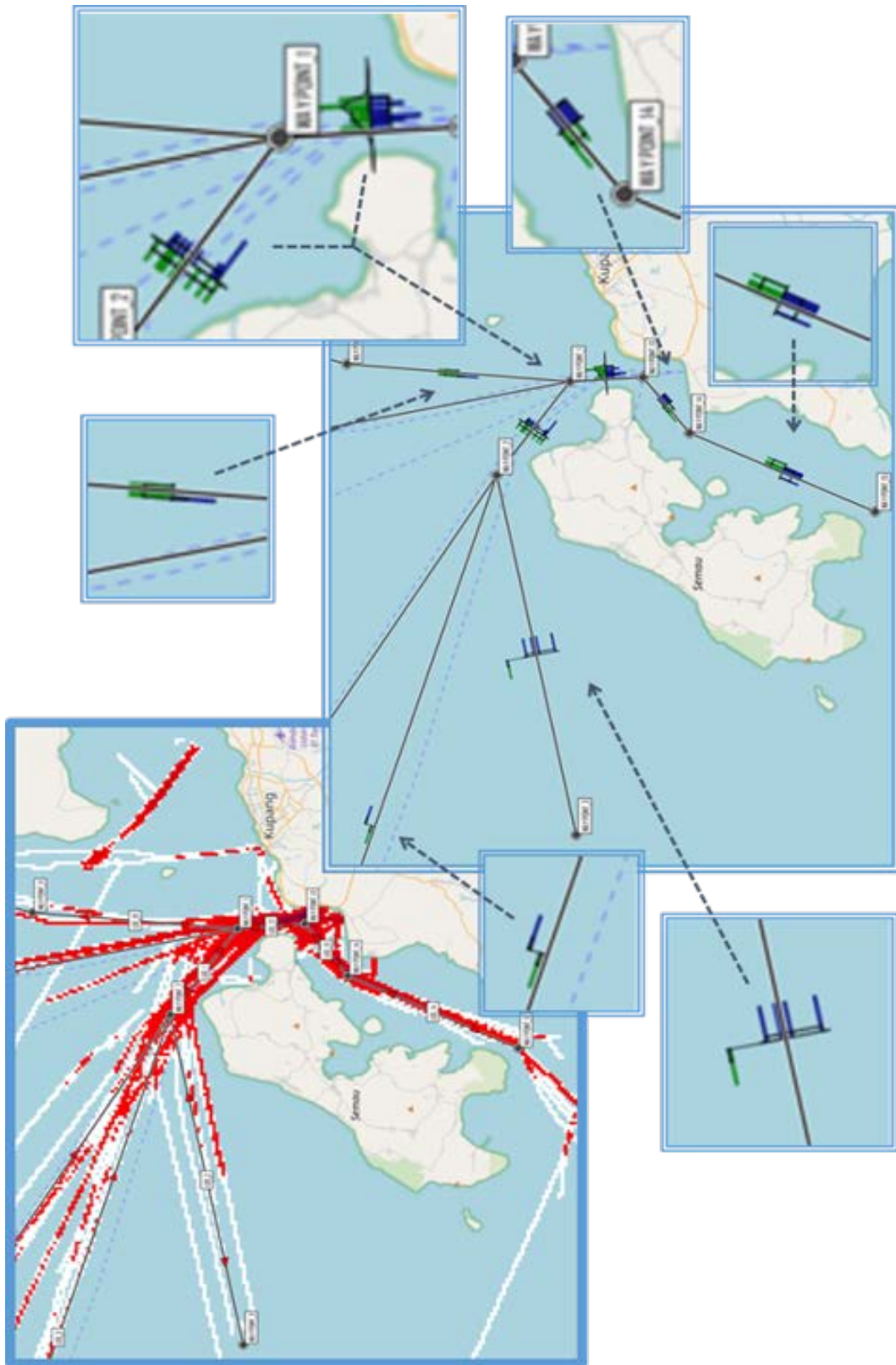
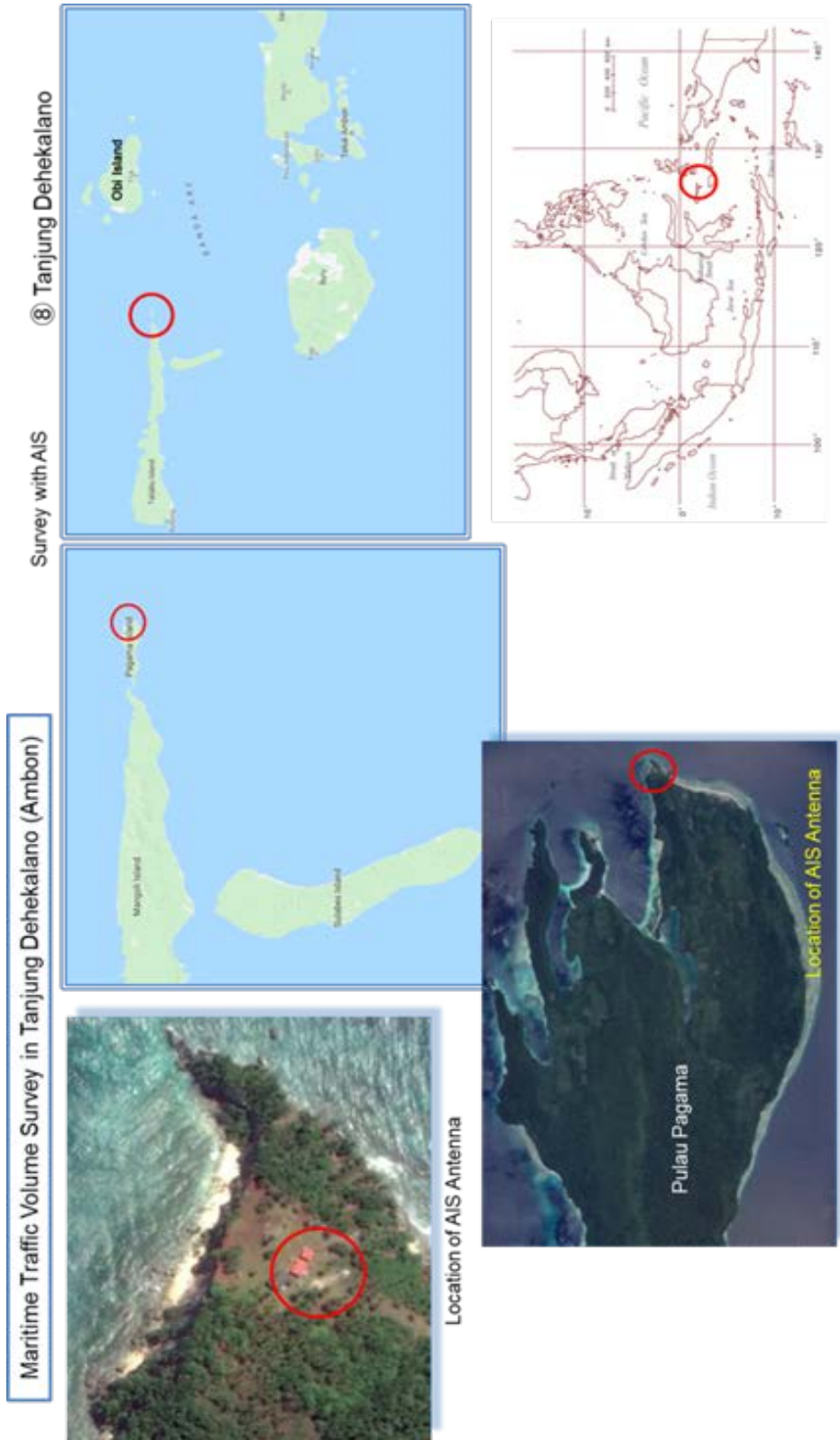

Figure 5.8 -1 : Location of AIS Base-Station



Picture : Installation of AIS Antenna



Figure 5.8 -2 : Density Plot of AIS

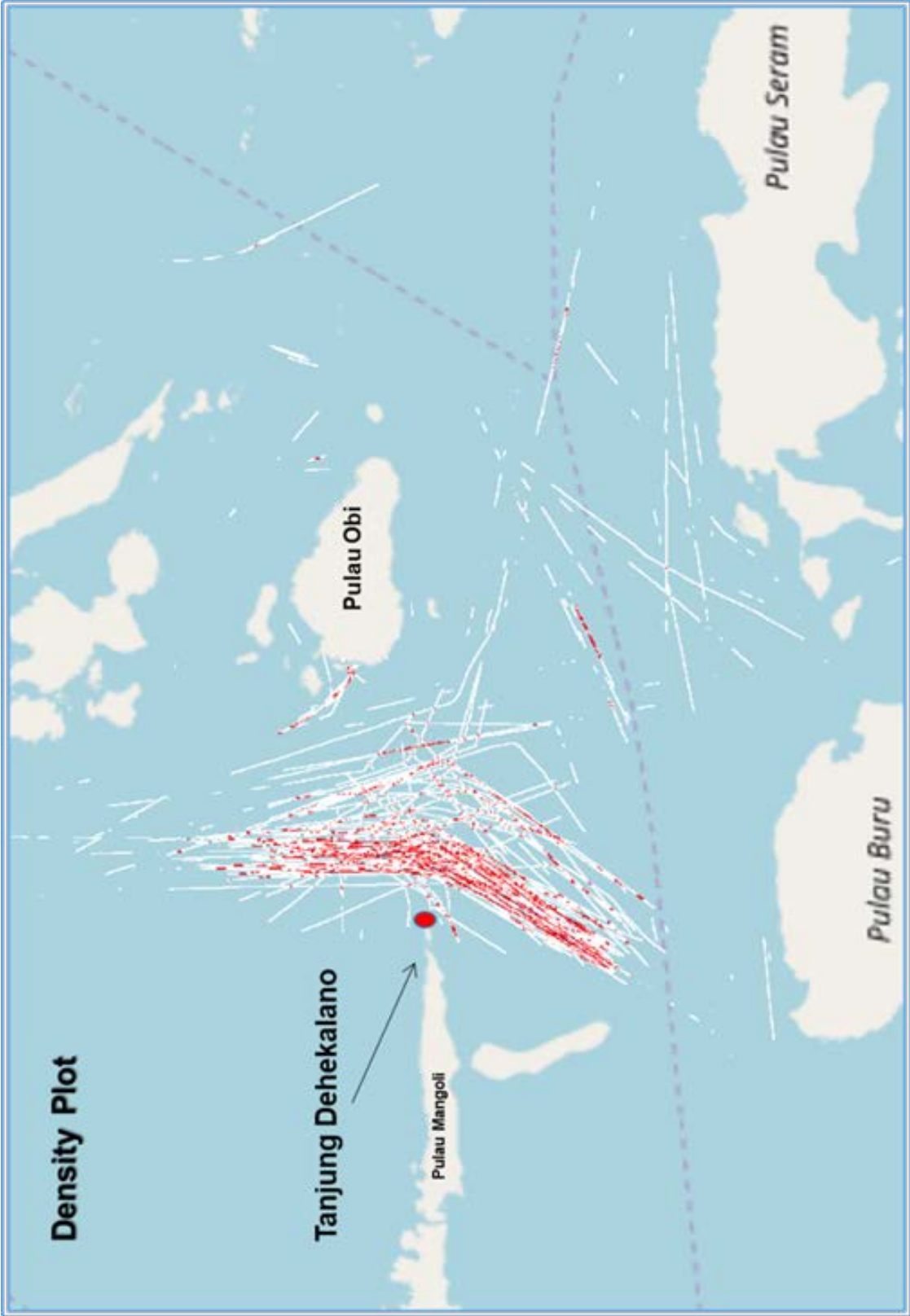
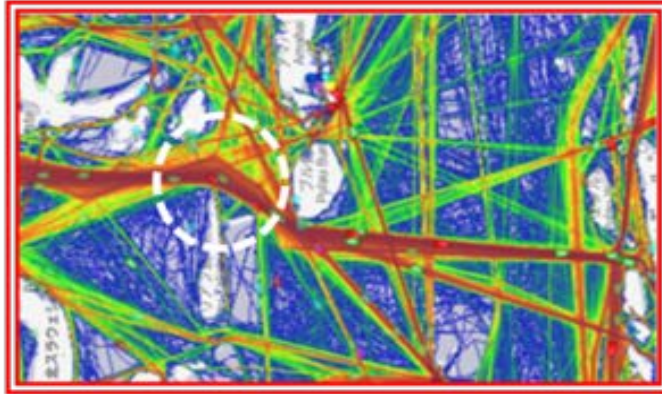

Figure 5.8 -3 : Traffic Flow of Sea-Lane 3

Density Map in 2017



Source : marinetraffic.com

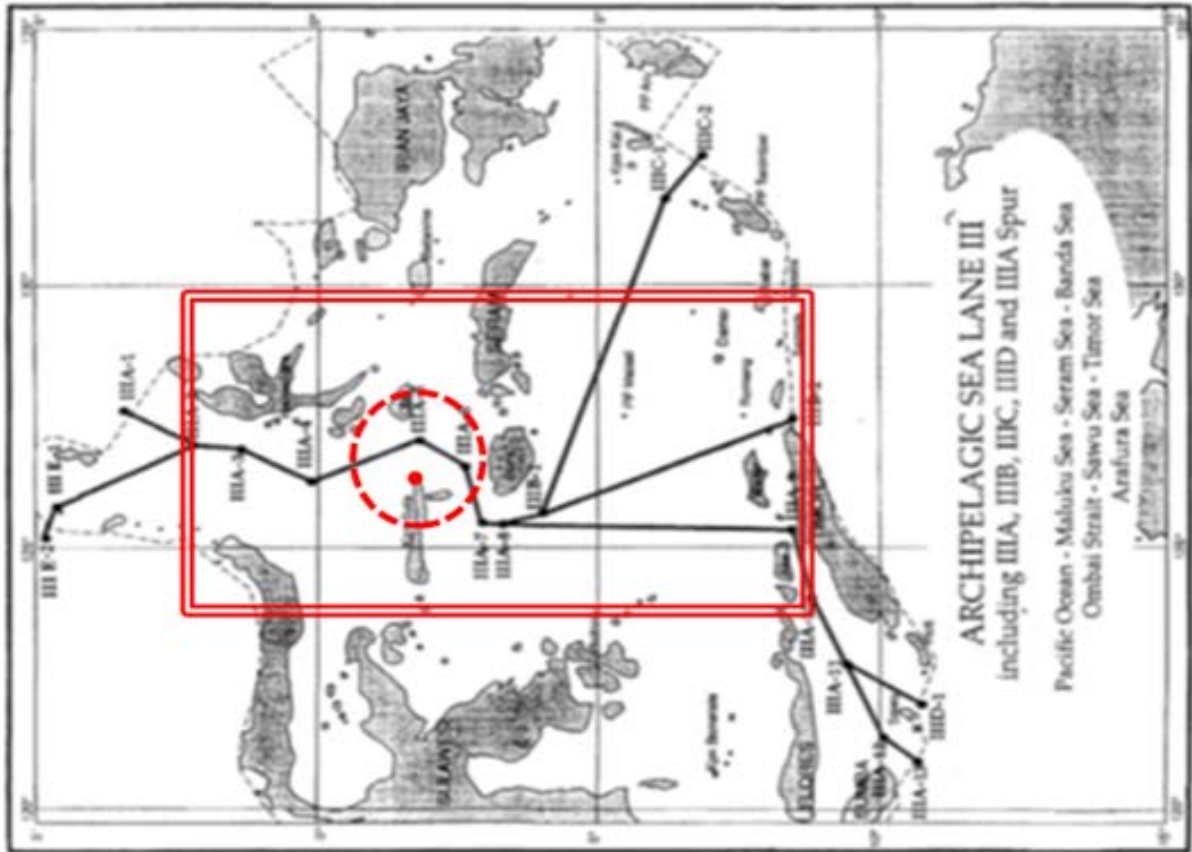

Table 5.8 -1 : Type of Vessel

Ship Type Length	Fast ferry	Fishing ship	General cargo ship	Oil products tanker	Passenger ship	Pleasure boat	Support ship	Other ship	Total
1~50m	0	0	1	1	3	2	10	18	35
51~150m	0	0	11	8	3	0	0	4	26
151~250m	0	0	26	0	0	0	0	0	26
251m以上	0	0	38	25	0	0	0	0	63
Total of ship types	0	0	76	34	6	2	10	22	
Total of all ship types	150								

Figure 5.8 -4 : Density Map for each Type

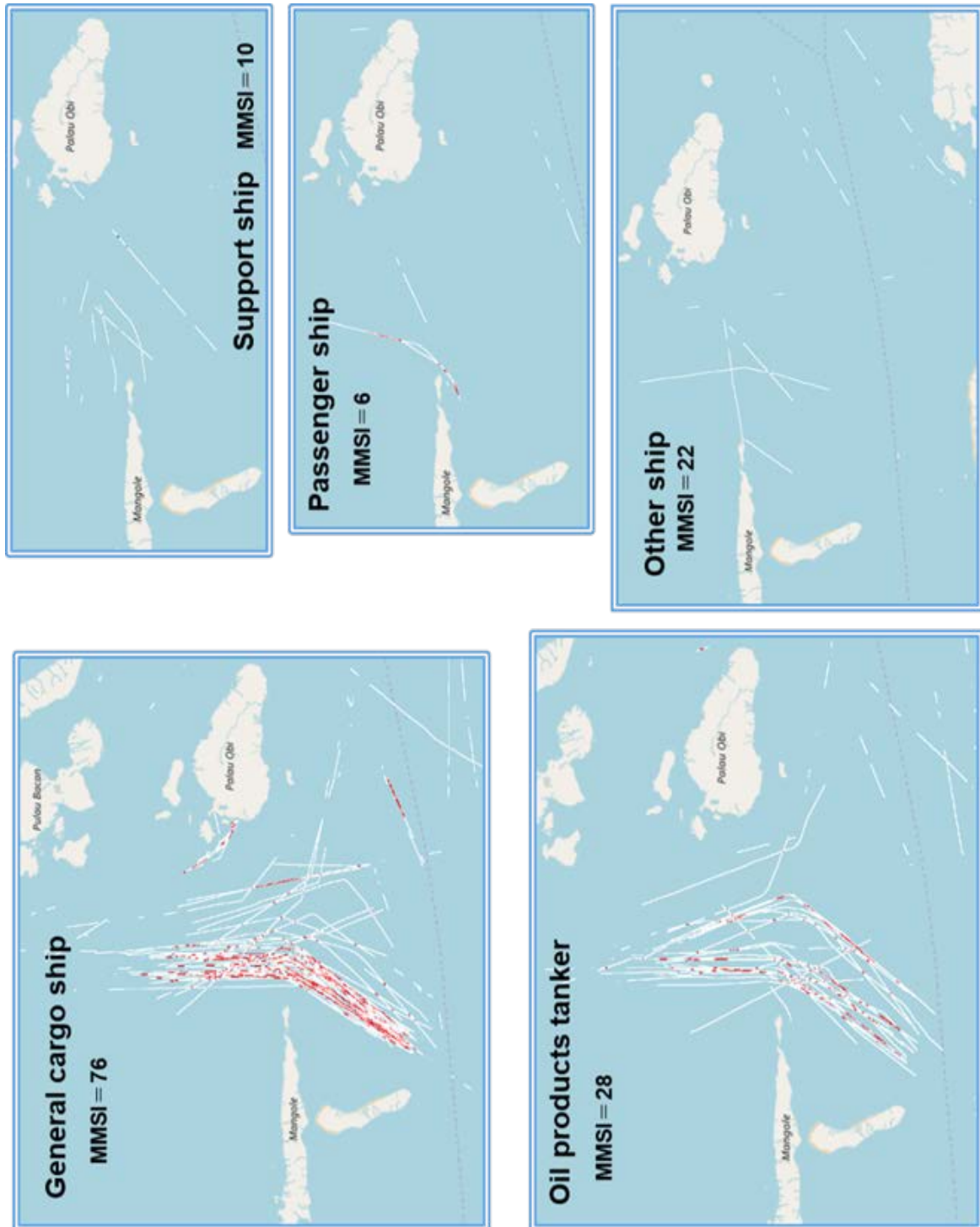

Figure 5.8 -5 : Histogram of Lateral Distribution

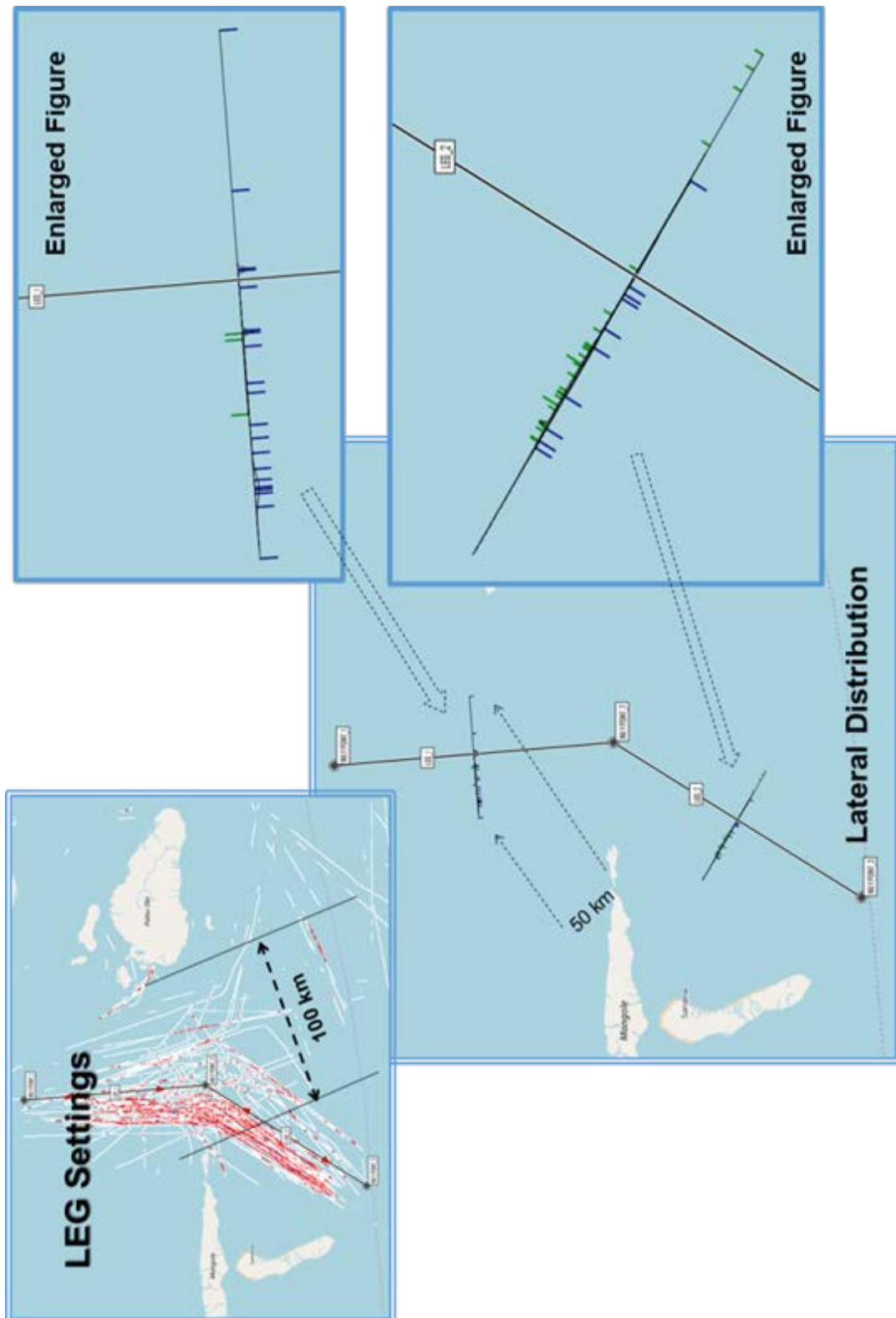

Table 5.8.-2 : Result of IWRAP Calculation

	08-Tanjung-Dehekalano-060420163146	Unit
Powered Grounding	---	Years between incidents
Drifting Grounding	---	Years between incidents
Total Groundings	---	Years between incidents
Powered Allision	---	Years between incidents
Drifting Allision	---	Years between incidents
Total Allisions	---	Years between incidents
Overtaking	7,346	Years between incidents
HeadOn	6,336	Years between incidents
Crossing	---	Years between incidents
Merging	---	Years between incidents
Bend	3,092e+04	Years between incidents
Area	---	Years between incidents
Total Collisions	3,065	Years between incidents

	08-Tanjung-Dehekalano-060420163146	Unit
Powered Grounding	---	Incidents/Year
Drifting Grounding	---	Incidents/Year
Total Groundings	---	Incidents/Year
Powered Allision	---	Incidents/Year
Drifting Allision	---	Incidents/Year
Total Allisions	---	Incidents/Year
Overtaking	0,0001361	Incidents/Year
HeadOn	0,0001578	Incidents/Year
Crossing	---	Incidents/Year
Merging	---	Incidents/Year
Bend	3,234e-05	Incidents/Year
Area	---	Incidents/Year
Total Collisions	0,0003263	Incidents/Year

Figure 5.9 -1 : Location of AIS Base-Station

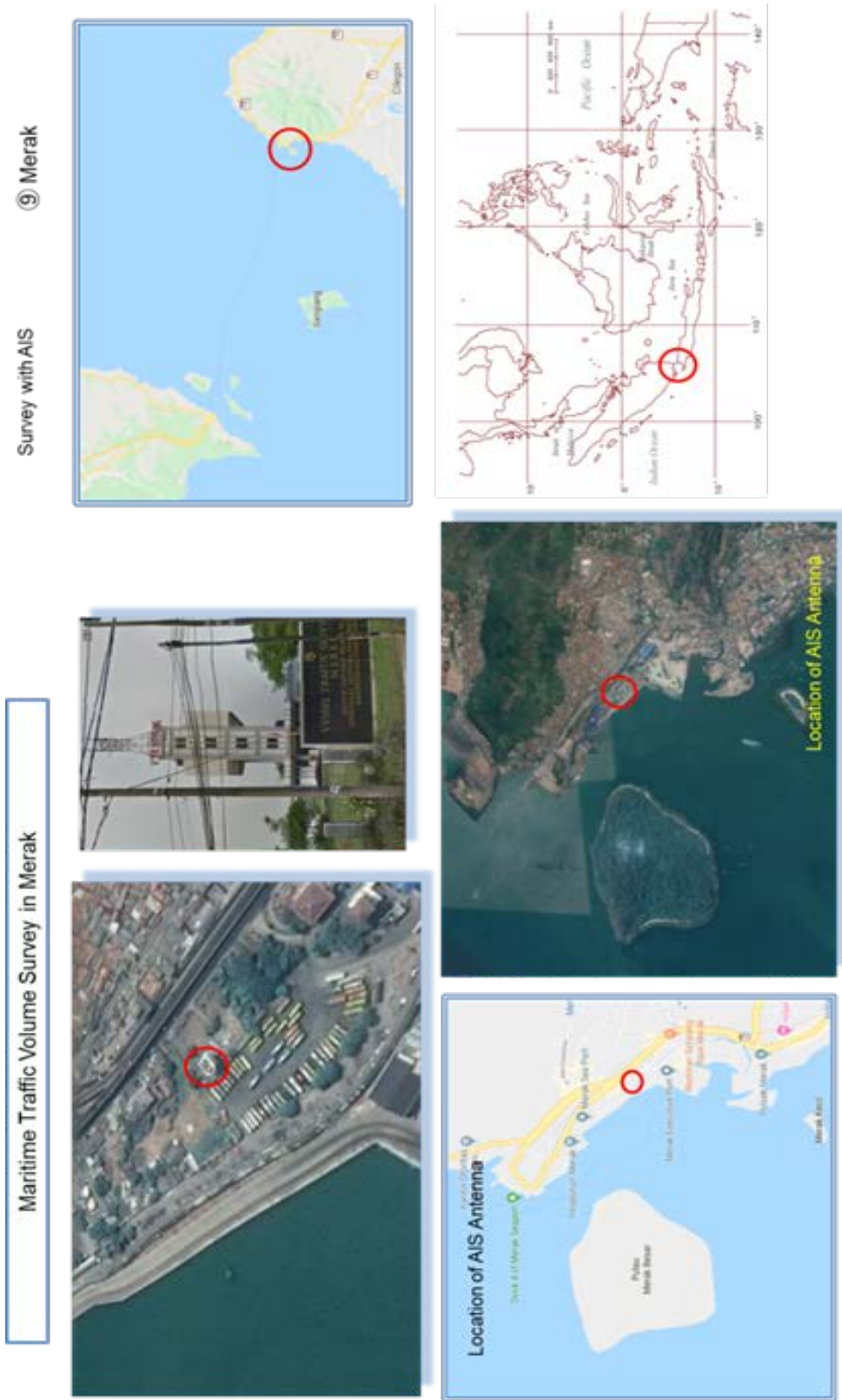

Figure 5.9 -2 : Density Plot of AIS

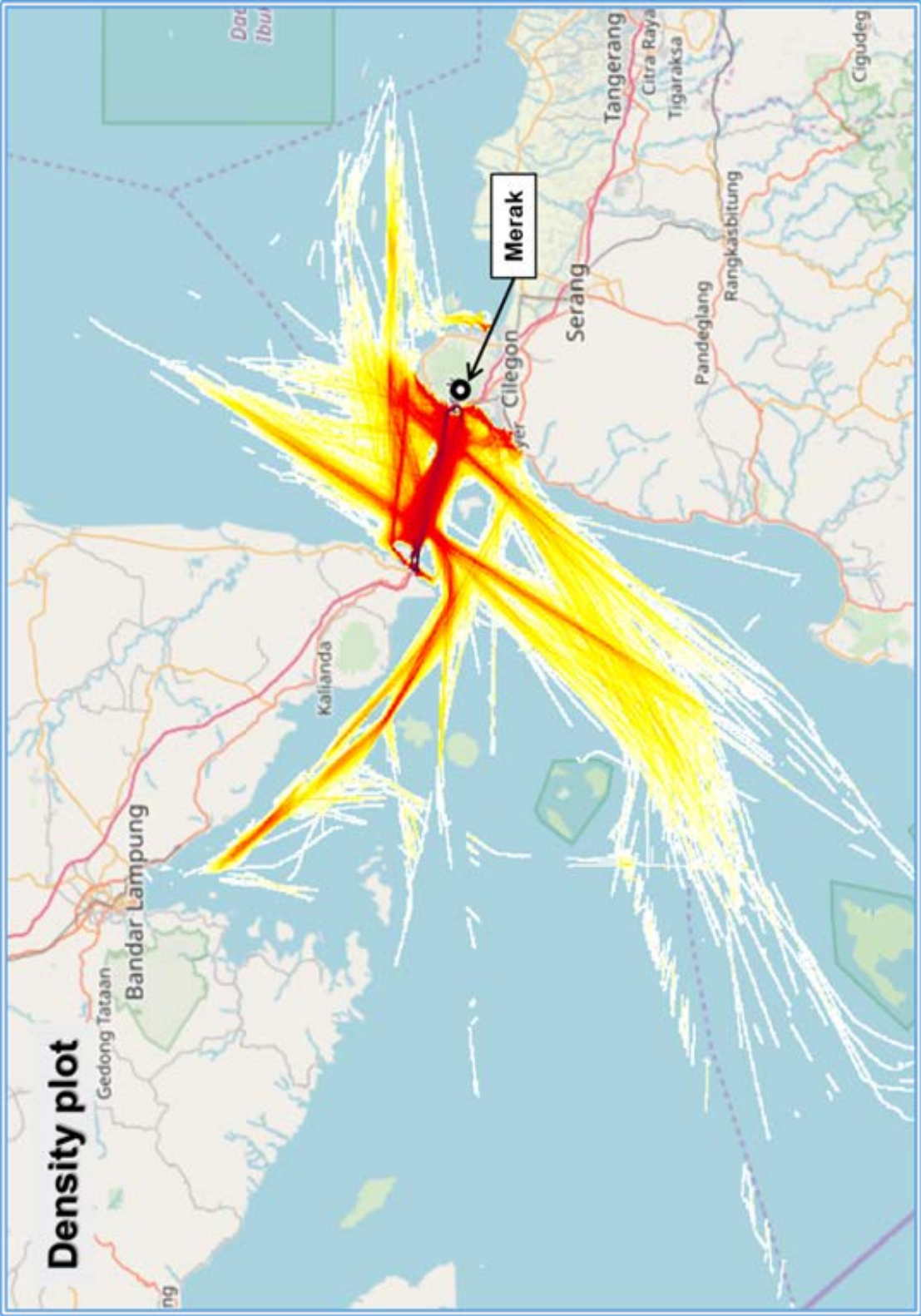
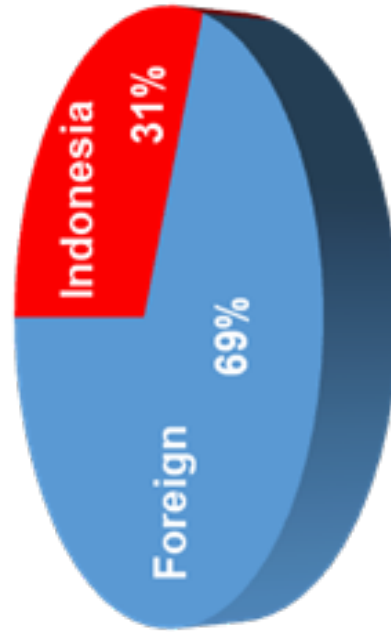

Table 5.9 -1 : Type of Vessels

Ship Type Length	Fast ferry	Fishing ship	General cargo ship	Oil products tanker	Passenger ship	Pleasure boat	Support ship	Other ship	Total
1~50m	3	4	15	14	13	10	193	90	342
51~150m	0	0	95	115	53	2	6	24	295
151~250m	0	0	198	75	7	0	1	0	281
251m以上	0	0	67	13	0	0	0	0	80
Total of ship types	3	4	375	217	73	12	200	114	
Total of all ship types	998								

Table 5.9 -2 : Ratio of Indonesian Flagship (1/2)

General Cargo		Oil Tanker	
Indonesia	Foreign	Indonesia	Foreign
116	259	118	99
31 %	69 %	54 %	46 %



General Cargo

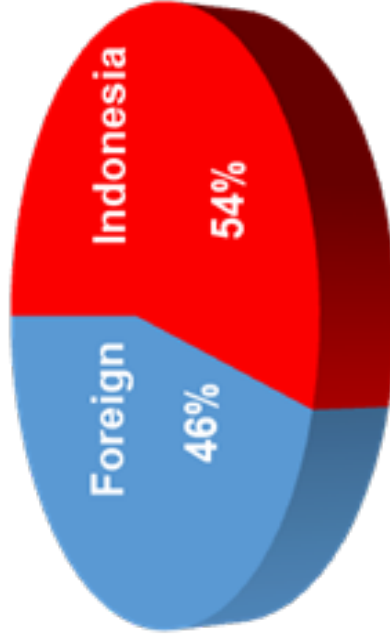

Oil Tanker

Table 5.9 -2 : Ratio of Indonesian Flagship (2/2)

Passenger		Support Ship		Other Ship	
Indonesia	Foreign	Indonesia	Foreign	Indonesia	Foreign
71	2	185	15	80	34
97 %	3 %	93 %	7 %	70 %	30 %

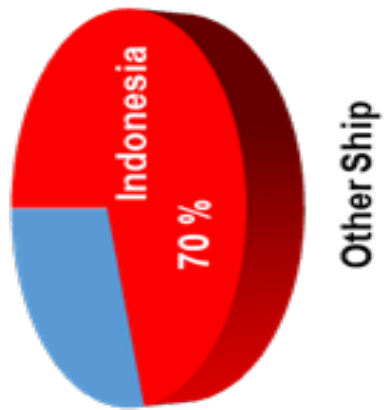
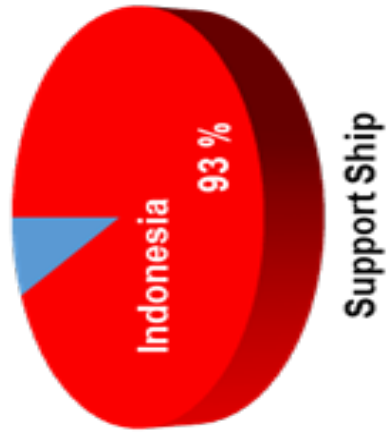
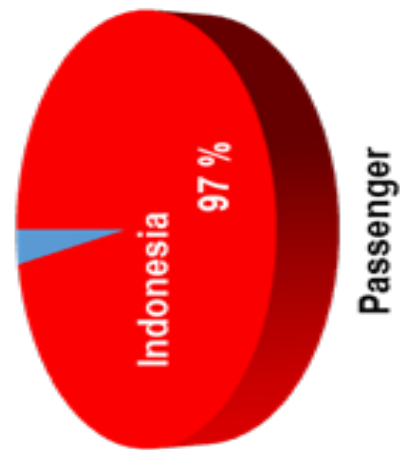

Figure 5.9 -3 : Density Map for each Type

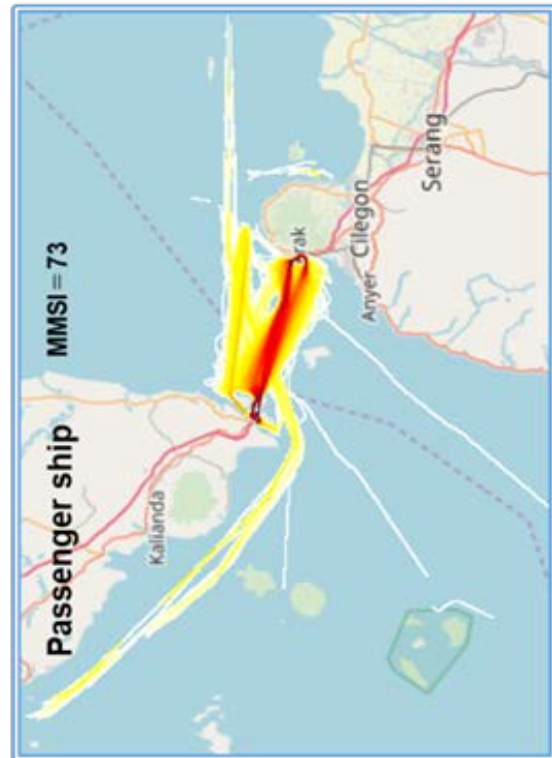
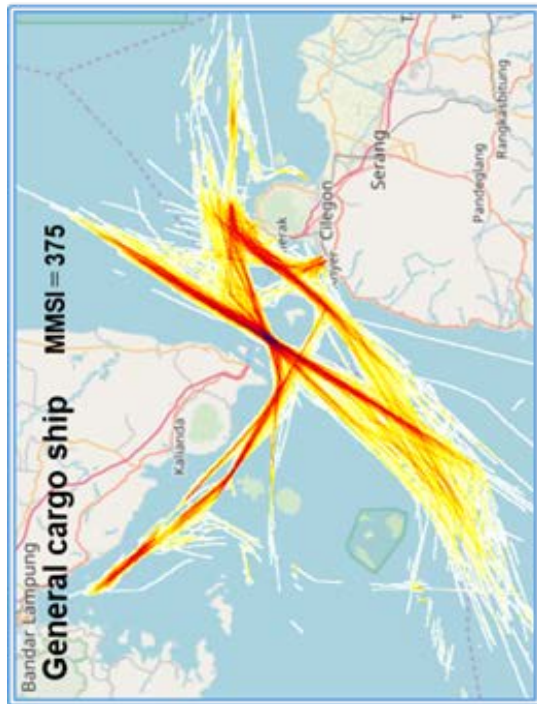
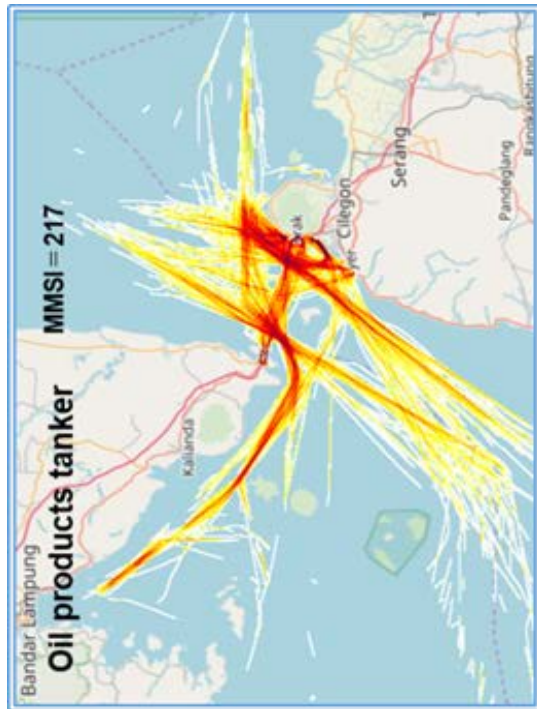

Figure 5.9 -5 : Histogram of Lateral Distribution

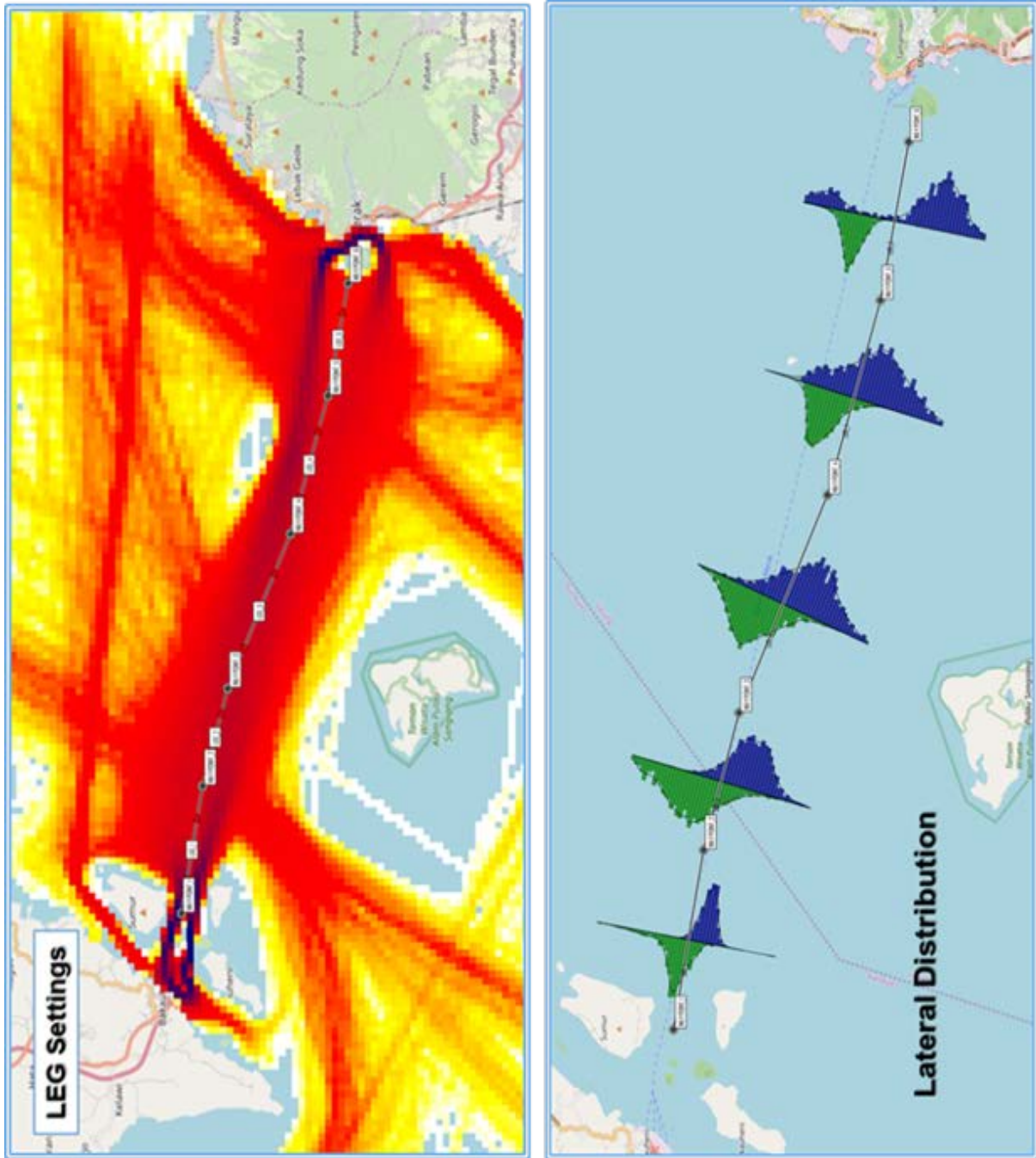

Table 5.9 -3 : Results of IWRAP Calculation

	09-Merak-080420140051	Unit
Powered Grounding	---	Incidents/Year
Drifting Grounding	---	Incidents/Year
Total Groundings	---	Incidents/Year
Powered Allision	---	Incidents/Year
Drifting Allision	---	Incidents/Year
Total Allisions	---	Incidents/Year
Overtaking	0.002033	Incidents/Year
HeadOn	0.005006	Incidents/Year
Crossing	---	Incidents/Year
Merging	---	Incidents/Year
Bend	---	Incidents/Year
Area	---	Incidents/Year
Total Collisions	0.00704	Incidents/Year

	09-Merak-080420140051	Unit
Powered Grounding	---	Years between incidents
Drifting Grounding	---	Years between incidents
Total Groundings	---	Years between incidents
Powered Allision	---	Years between incidents
Drifting Allision	---	Years between incidents
Total Allisions	---	Years between incidents
Overtaking	491.8	Years between incidents
HeadOn	199.8	Years between incidents
Crossing	---	Years between incidents
Merging	---	Years between incidents
Bend	---	Years between incidents
Area	---	Years between incidents
Total Collisions	142.1	Years between incidents

Figure 5.9 -6 : Histogram of Lateral Distribution

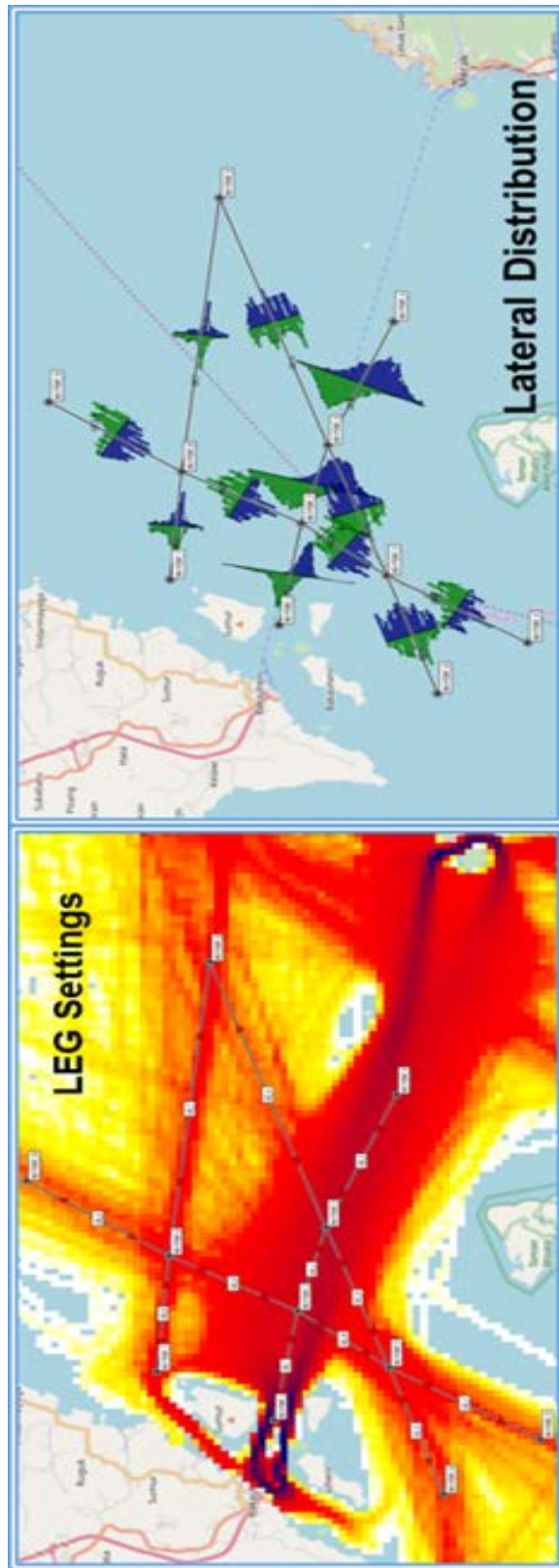

Table 5.9 -4 : Results of IWRAP Calculation

	09-Merak-2-080420152922	Unit
Powered Grounding	---	Incidents/Year
Drifting Grounding	---	Incidents/Year
Total Groundings	---	Incidents/Year
Powered Allision	---	Incidents/Year
Drifting Allision	---	Incidents/Year
Total Allisions	---	Incidents/Year
Overtaking	0.001584	Incidents/Year
HeadOn	0.004077	Incidents/Year
Crossing	0.00775	Incidents/Year
Merging	8.724e-05	Incidents/Year
Bend	1.847e-05	Incidents/Year
Area	---	Incidents/Year
Total Collisions	0.01352	Incidents/Year

	09-Merak-2-080420152922	Unit
Powered Grounding	---	Years between incidents
Drifting Grounding	---	Years between incidents
Total Groundings	---	Years between incidents
Powered Allision	---	Years between incidents
Drifting Allision	---	Years between incidents
Total Allisions	---	Years between incidents
Overtaking	631.5	Years between incidents
HeadOn	245.3	Years between incidents
Crossing	129	Years between incidents
Merging	1.146e+04	Years between incidents
Bend	5.416e+04	Years between incidents
Area	---	Years between incidents
Total Collisions	73.98	Years between incidents

Figure 5.9 -7 : Histogram of Lateral Distribution (1/2)

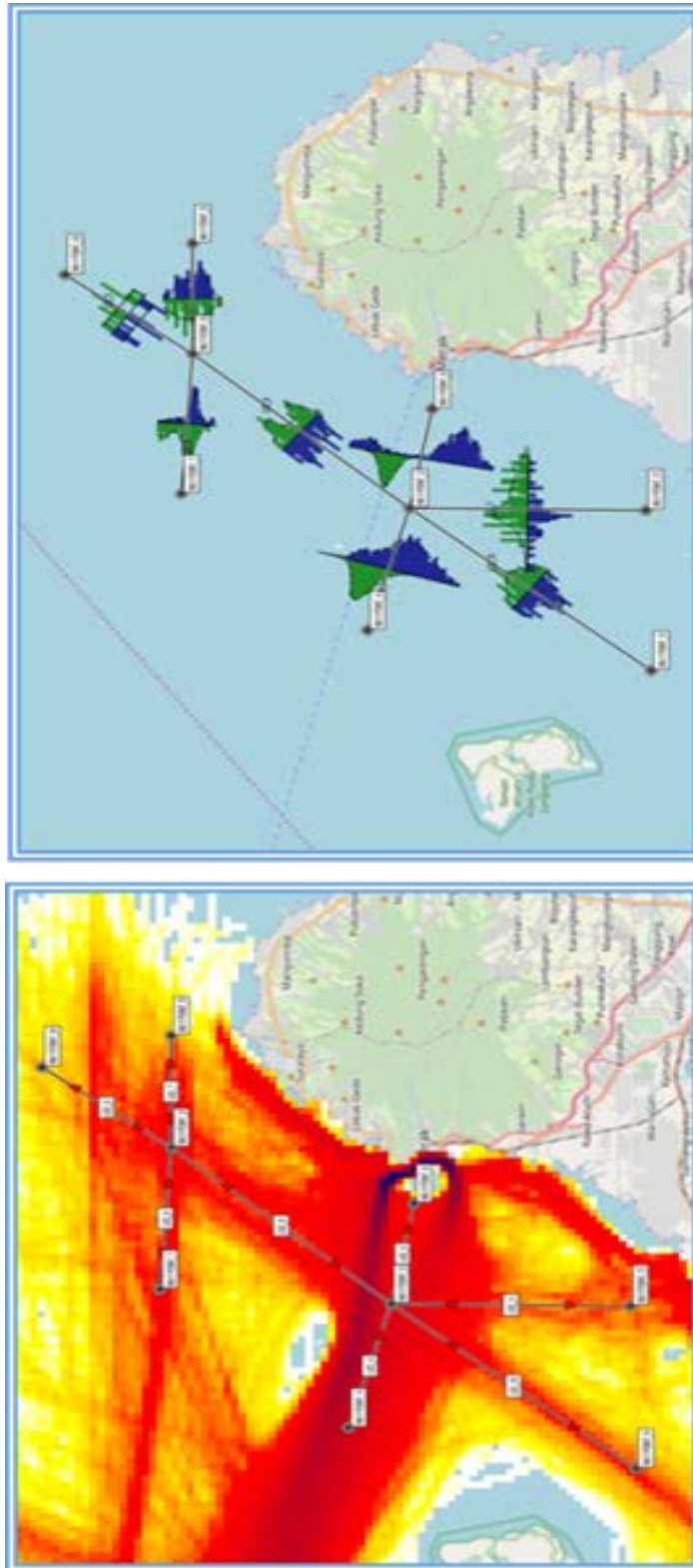

Figure 5.9 -7 : Histogram of Lateral Distribution (2/2)

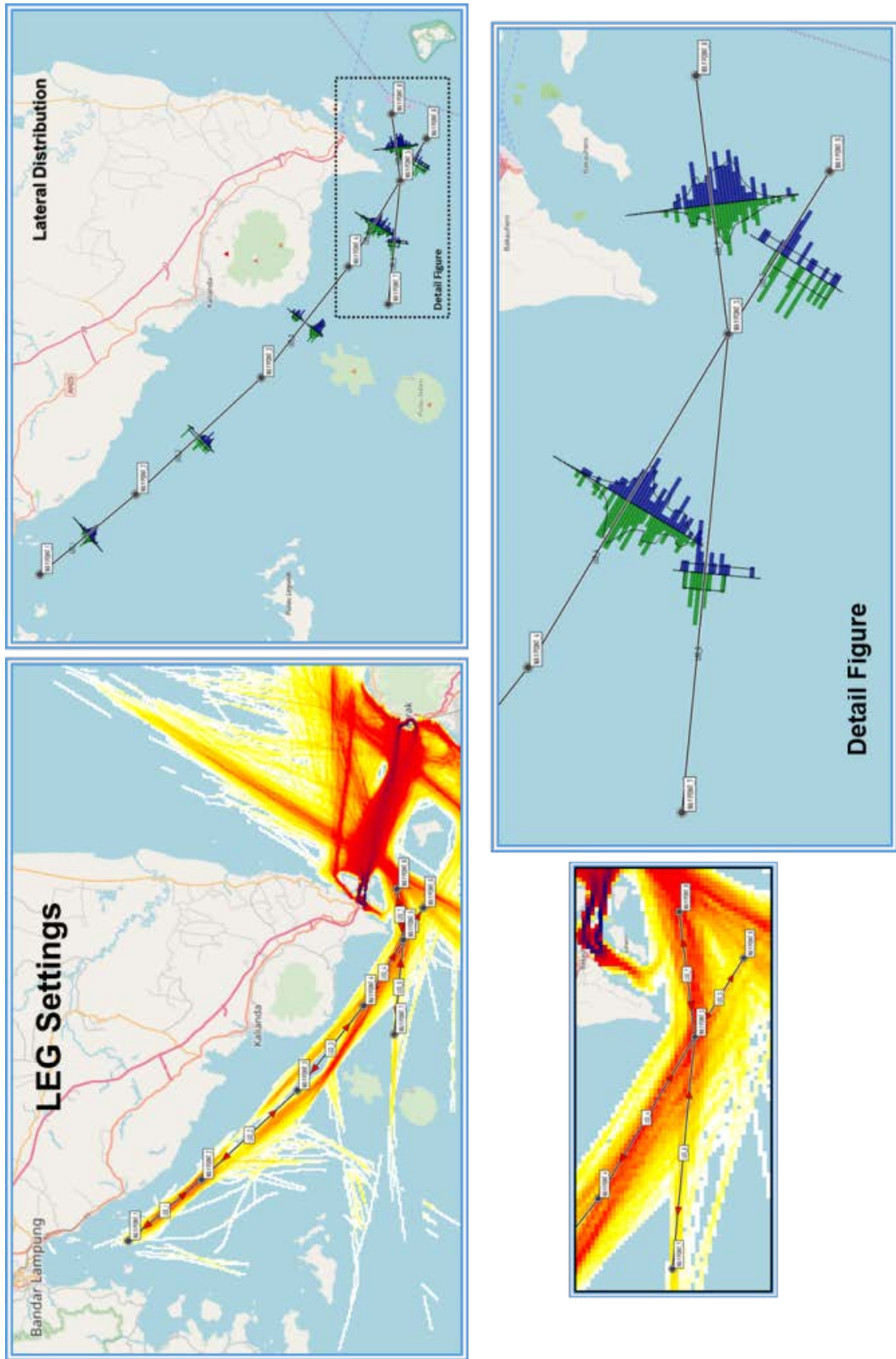

Table 5.9 -5 : Calculation Results for the East Side Traffic Zone

	09-Merak-3-080420161650	Unit
Powered Grounding	---	Incidents/Year
Drifting Grounding	---	Incidents/Year
Total Groundings	---	Incidents/Year
Powered Allision	---	Incidents/Year
Drifting Allision	---	Incidents/Year
Total Allisions	---	Incidents/Year
Overtaking	0.001132	Incidents/Year
HeadOn	0.002403	Incidents/Year
Crossing	0.003064	Incidents/Year
Merging	9.559e-05	Incidents/Year
Bend	3.995e-05	Incidents/Year
Area	---	Incidents/Year
Total Collisions	0.006734	Incidents/Year

	09-Merak-3-080420161650	Unit
Powered Grounding	---	Years between incidents
Drifting Grounding	---	Years between incidents
Total Groundings	---	Years between incidents
Powered Allision	---	Years between incidents
Drifting Allision	---	Years between incidents
Total Allisions	---	Years between incidents
Overtaking	883.7	Years between incidents
HeadOn	416.2	Years between incidents
Crossing	326.4	Years between incidents
Merging	1.046e+04	Years between incidents
Bend	2.503e+04	Years between incidents
Area	---	Years between incidents
Total Collisions	148.5	Years between incidents

Table 5.9 -6 : Calculation Results for the Sumatra Side Traffic Zone

	09-Merak-4-100420090409	Unit
Powered Grounding	---	Years between incidents
Drifting Grounding	---	Years between incidents
Total Groundings	---	Years between incidents
Powered Allision	---	Years between incidents
Drifting Allision	---	Years between incidents
Total Allisions	---	Years between incidents
Overtaking	2,906	Years between incidents
HeadOn	1,275	Years between incidents
Crossing	1.248e+04	Years between incidents
Merging	2.406e+04	Years between incidents
Bend	7,795	Years between incidents
Area	---	Years between incidents
Total Collisions	725.5	Years between incidents

	09-Merak-4-100420090409	Unit
Powered Grounding	---	Incidents/Year
Drifting Grounding	---	Incidents/Year
Total Groundings	---	Incidents/Year
Powered Allision	---	Incidents/Year
Drifting Allision	---	Incidents/Year
Total Allisions	---	Incidents/Year
Overtaking	0.0003441	Incidents/Year
HeadOn	0.0007843	Incidents/Year
Crossing	8.01e-05	Incidents/Year
Merging	4.156e-05	Incidents/Year
Bend	0.0001283	Incidents/Year
Area	---	Incidents/Year
Total Collisions	0.001378	Incidents/Year

Picture 5.9 -2 : Port of Merak (View from the VTS Operation Room)

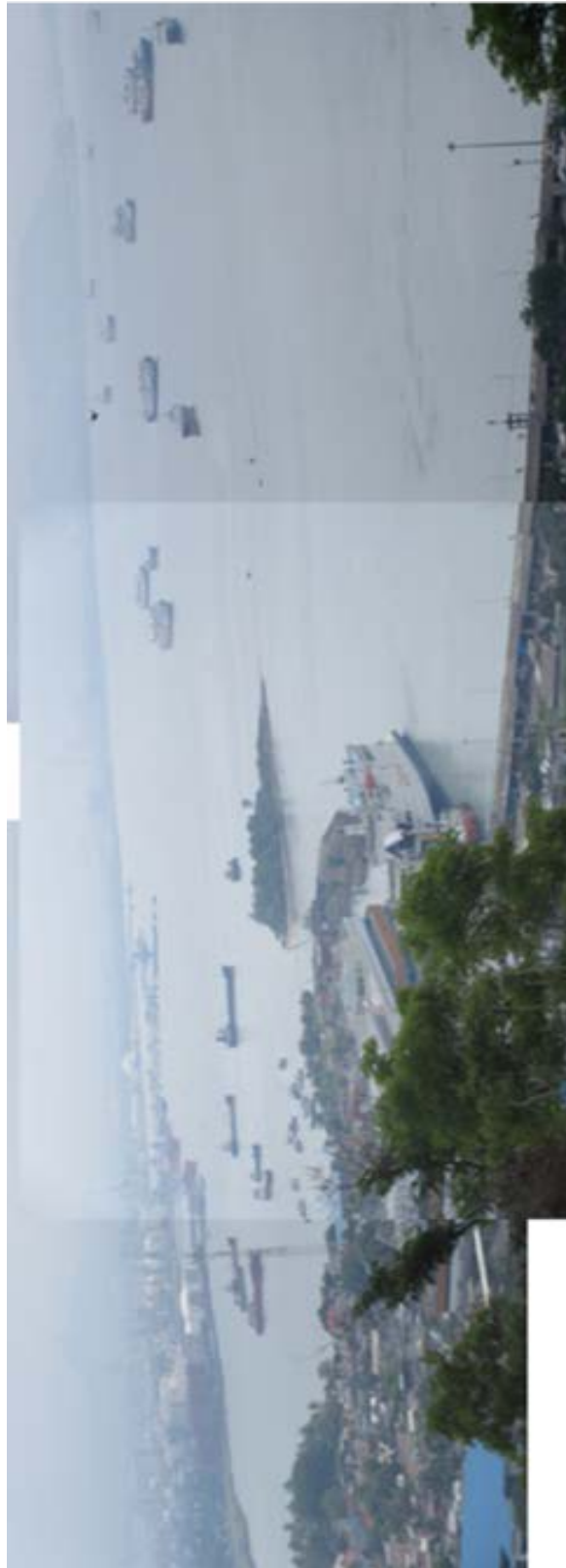

Picture 5.9 -3 : Digitalized Radar and AIS Images

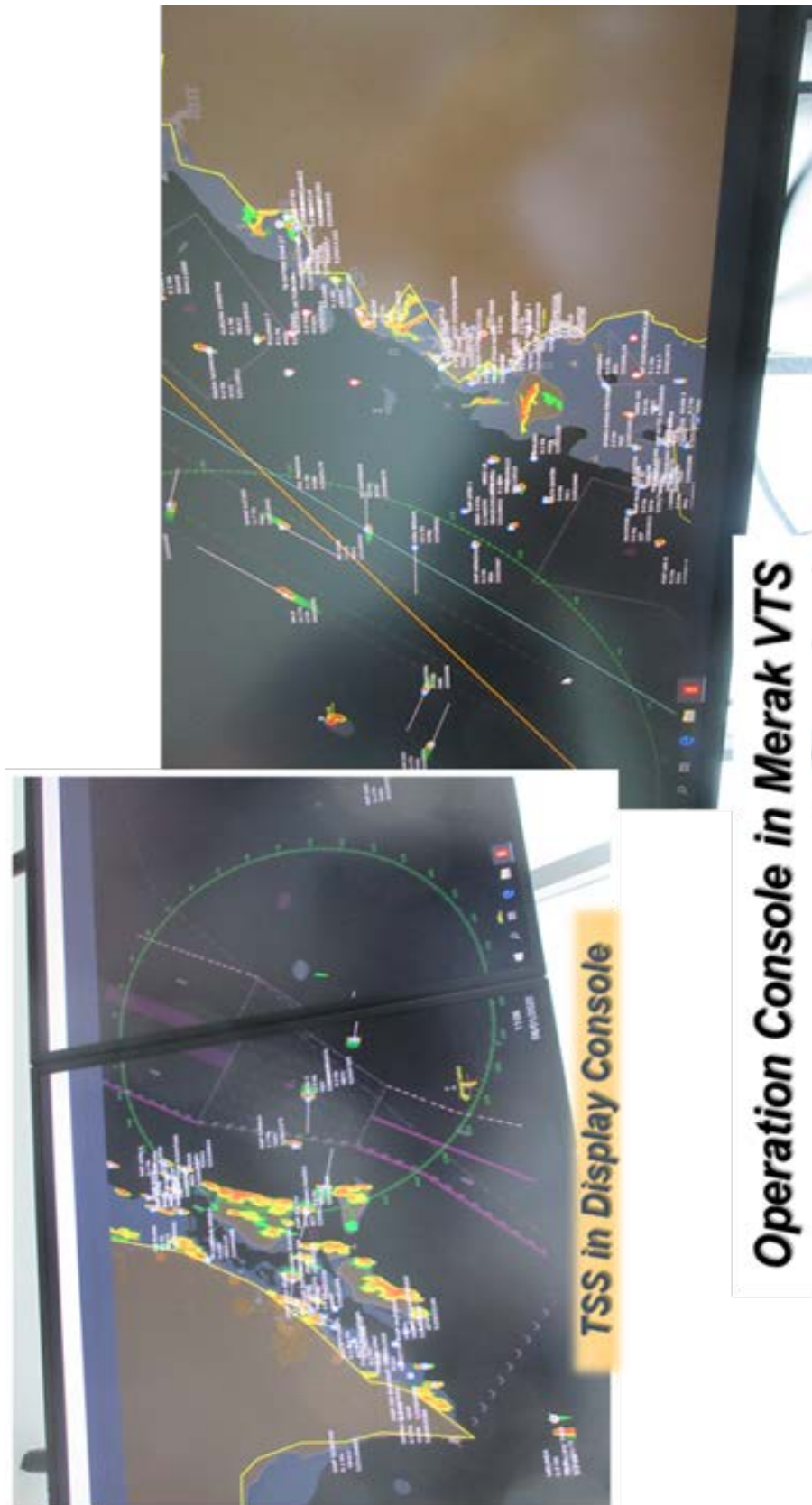

Figure 5.10 -1 : Location of AIS Base-Station

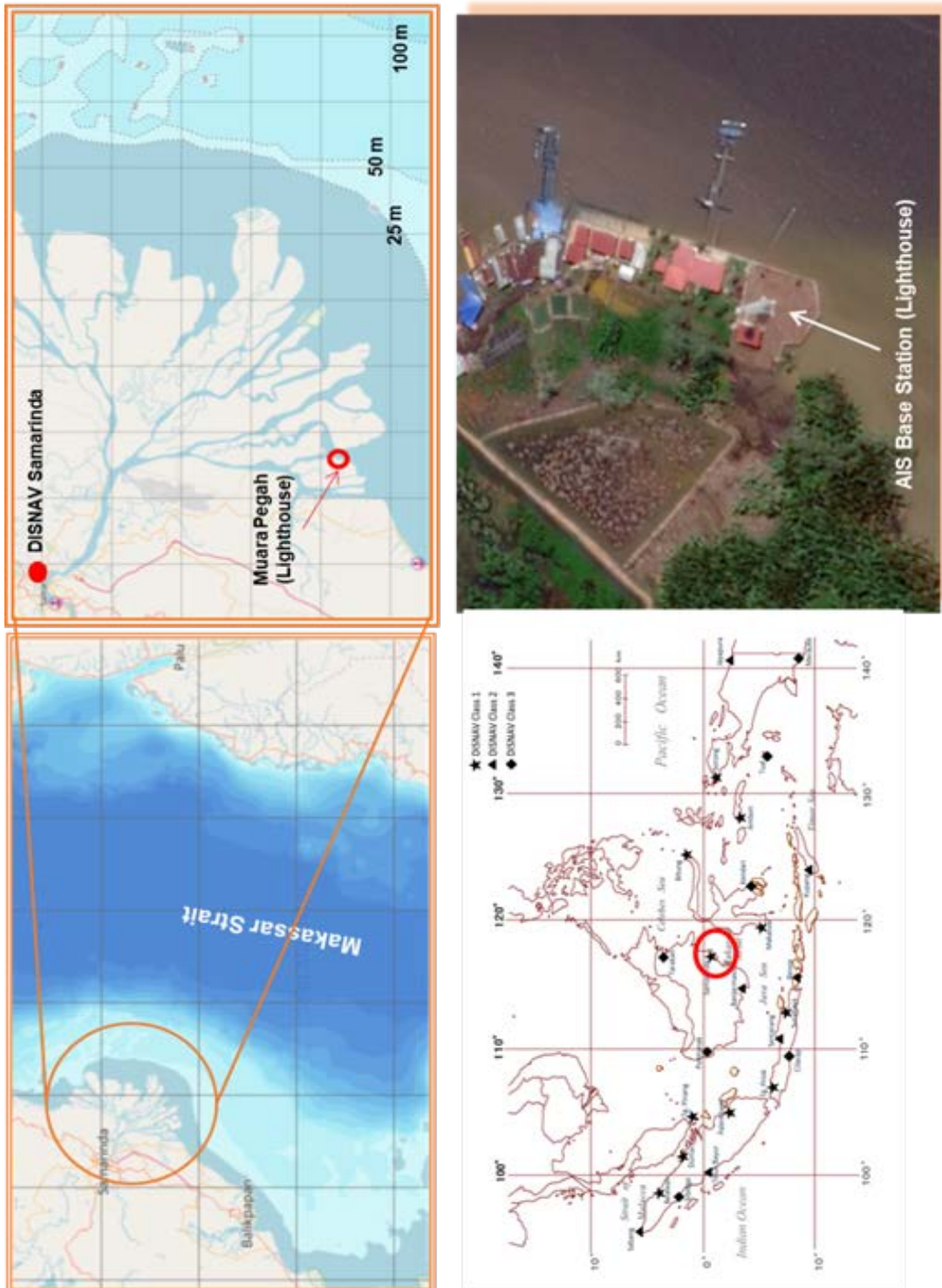

Figure 5.10 -2 : Density Plot of AIS

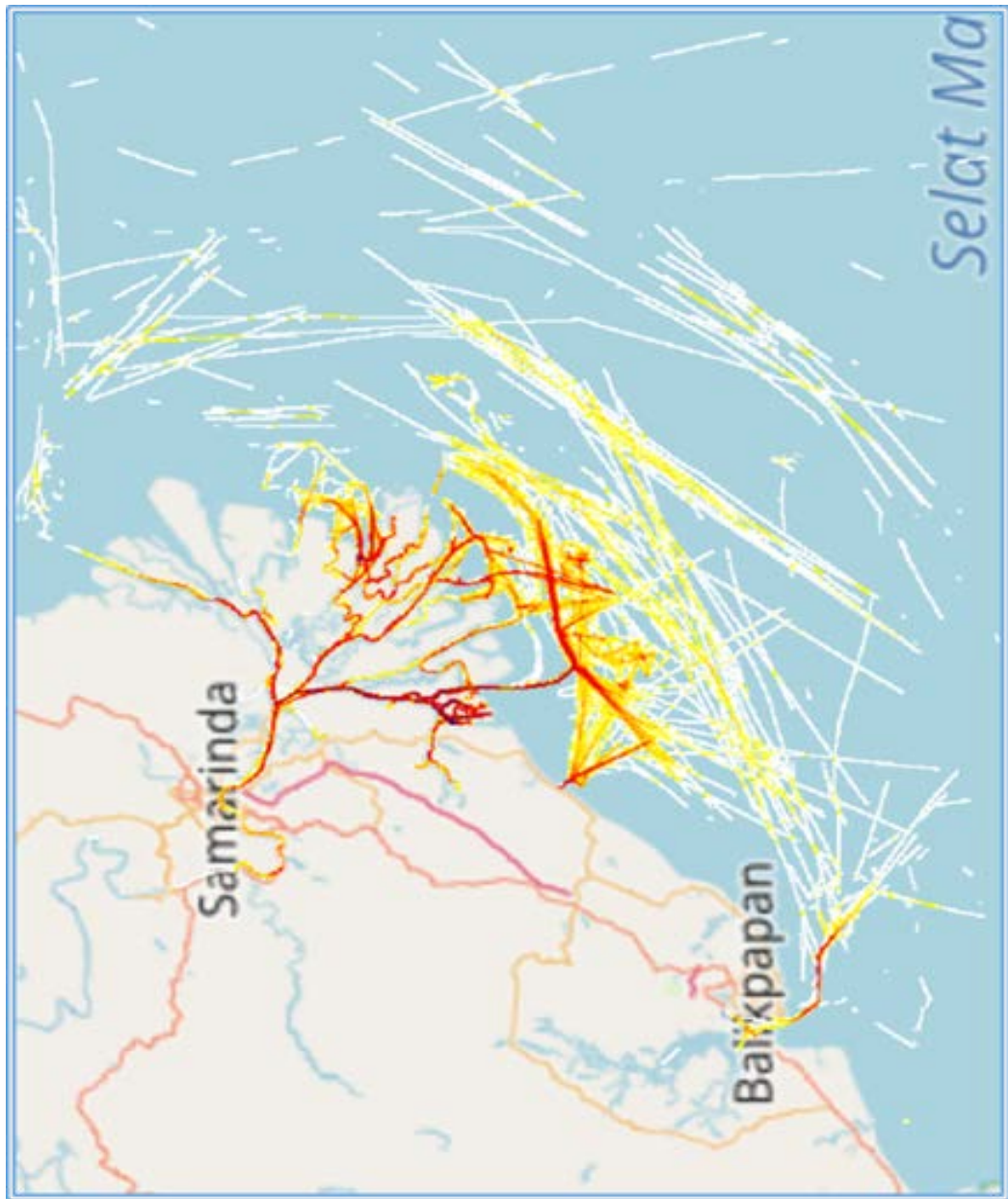

Table 5.10 -1 : Type of Vessels

Ship Type	Fast ferry	Fishing ship	General cargo ship	Oil products tanker	Passenger ship	Pleasure boat	Support ship	Other ship	Total
Length									
1~25m	0	0	10	0	0	256	116	65	447
26~50m	1	0	2	5	9	4	147	124	292
51~150m	0	0	12	10	2	0	8	14	46
151~250m	0	0	56	29	5	1	0	5	96
251m以上	0	0	41	6	0	0	1	2	50
Total of ship types	1	0	121	50	16	261	272	210	
Total of all ship types	931								

Figure 5.10 -3 : Density Map for each Type (1/2)

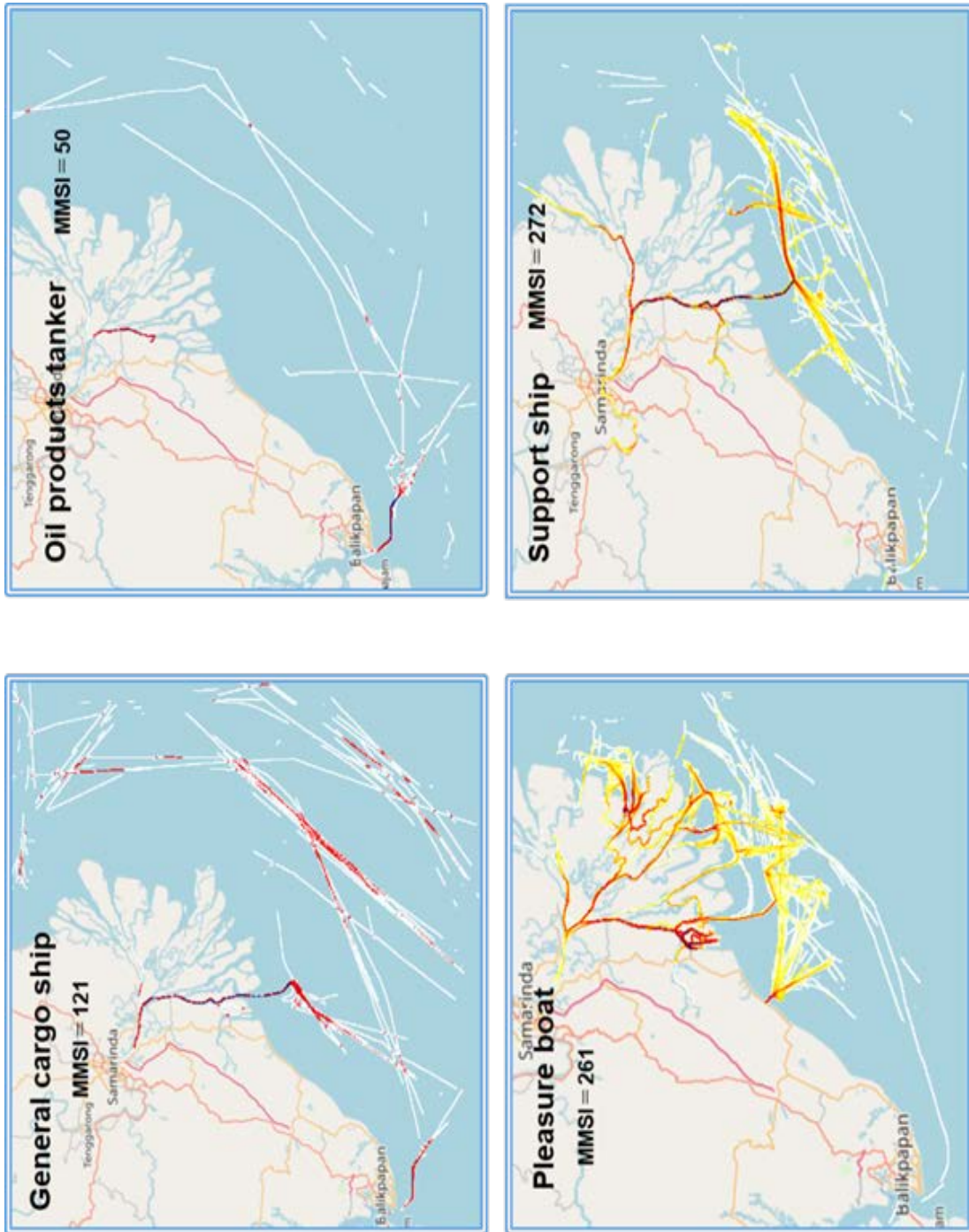

Figure 5.10 -3 : Density Map for each Type (2/2)



Figure 5.10 -4 : Lateral Distribution

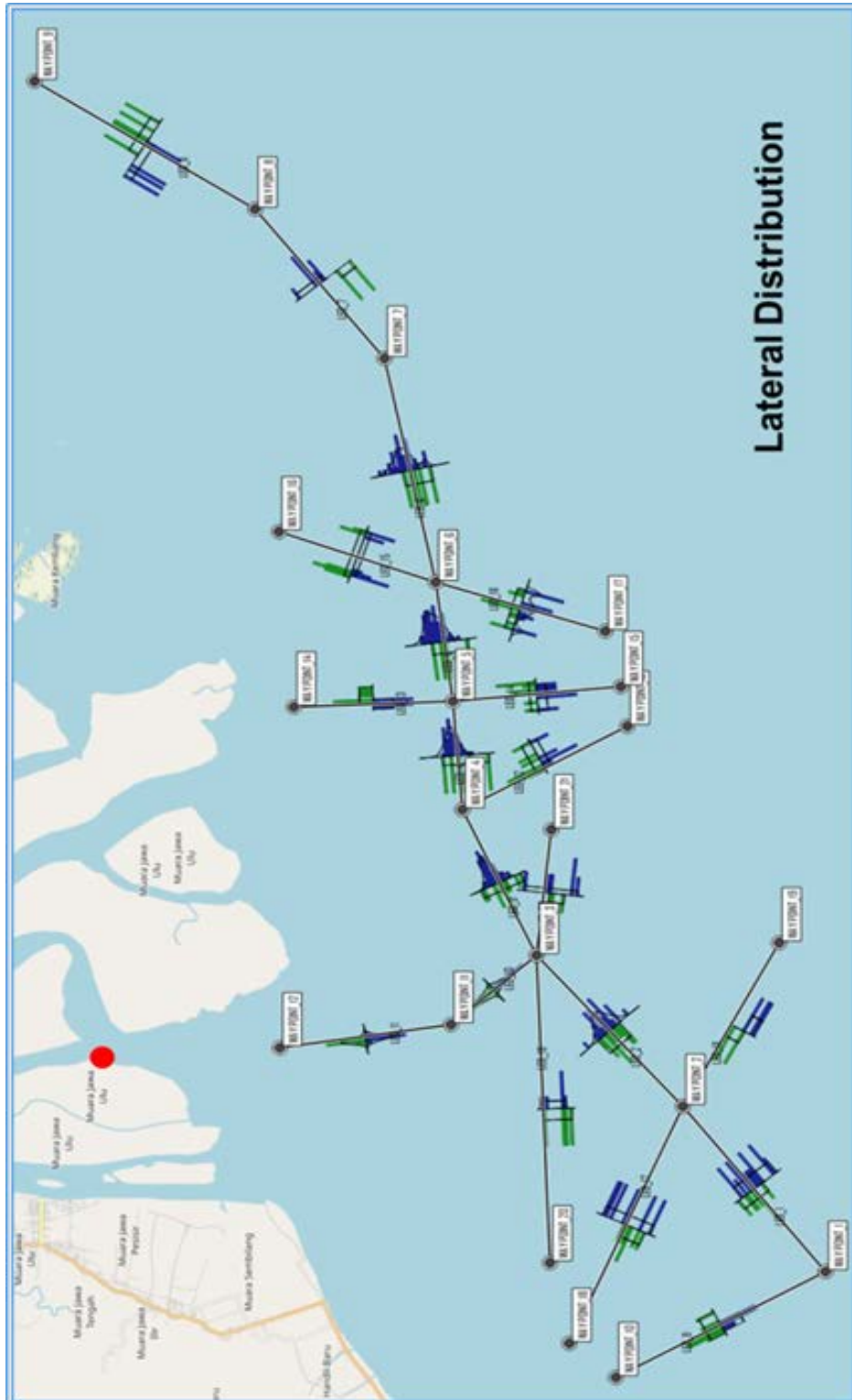

Table 5.10 -2 : Result of IWRAP Calculation

	10-Samarinda- 100420114923	Unit
Powered Grounding	---	Incidents/Year
Drifting Grounding	---	Incidents/Year
Total Groundings	---	Incidents/Year
Powered Allision	---	Incidents/Year
Drifting Allision	---	Incidents/Year
Total Allisions	---	Incidents/Year
Overtaking	0.03958	Incidents/Year
HeadOn	0.1435	Incidents/Year
Crossing	0.01765	Incidents/Year
Merging	0.002285	Incidents/Year
Bend	0.04485	Incidents/Year
Area	---	Incidents/Year
Total Collisions	0.2479	Incidents/Year

	10-Samarinda- 100420114923	Unit
Powered Grounding	---	Years between incidents
Drifting Grounding	---	Years between incidents
Total Groundings	---	Years between incidents
Powered Allision	---	Years between incidents
Drifting Allision	---	Years between incidents
Total Allisions	---	Years between incidents
Overtaking	25.27	Years between incidents
HeadOn	6.967	Years between incidents
Crossing	56.66	Years between incidents
Merging	437.6	Years between incidents
Bend	22.3	Years between incidents
Area	---	Years between incidents
Total Collisions	4.034	Years between incidents

Figure 5.10 -5 : Histogram of Lateral Distribution

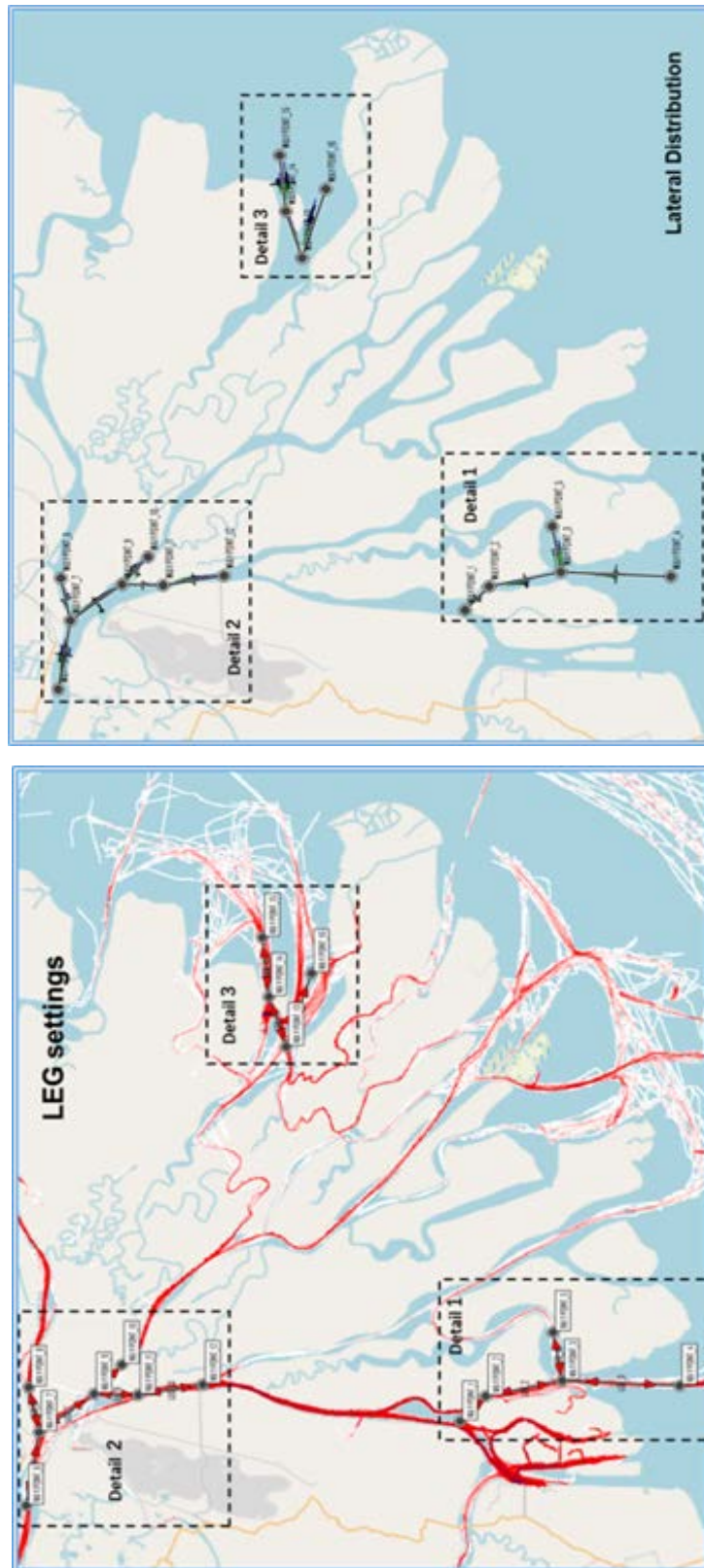

Table 5.10 -3 : Result of IWRAP Calculation

10-Samarinda-2-100420134828		Unit
Powered Grounding	---	Years between incidents
Drifting Grounding	---	Years between incidents
Total Groundings	---	Years between incidents
Powered Allision	---	Years between incidents
Drifting Allision	---	Years between incidents
Total Allisions	---	Years between incidents
Overtaking	4.091	Years between incidents
HeadOn	2.827	Years between incidents
Crossing	355.5	Years between incidents
Merging	159.3	Years between incidents
Bend	9.22	Years between incidents
Area	---	Years between incidents
Total Collisions	1.397	Years between incidents

10-Samarinda-2-100420134828		Unit
Powered Grounding	---	Incidents/Year
Drifting Grounding	---	Incidents/Year
Total Groundings	---	Incidents/Year
Powered Allision	---	Incidents/Year
Drifting Allision	---	Incidents/Year
Total Allisions	---	Incidents/Year
Overtaking	0.2444	Incidents/Year
HeadOn	0.3537	Incidents/Year
Crossing	0.002813	Incidents/Year
Merging	0.006278	Incidents/Year
Bend	0.1085	Incidents/Year
Area	---	Incidents/Year
Total Collisions	0.7156	Incidents/Year

Figure 5.10 -7 : Histogram of Lateral Distribution (1/2)

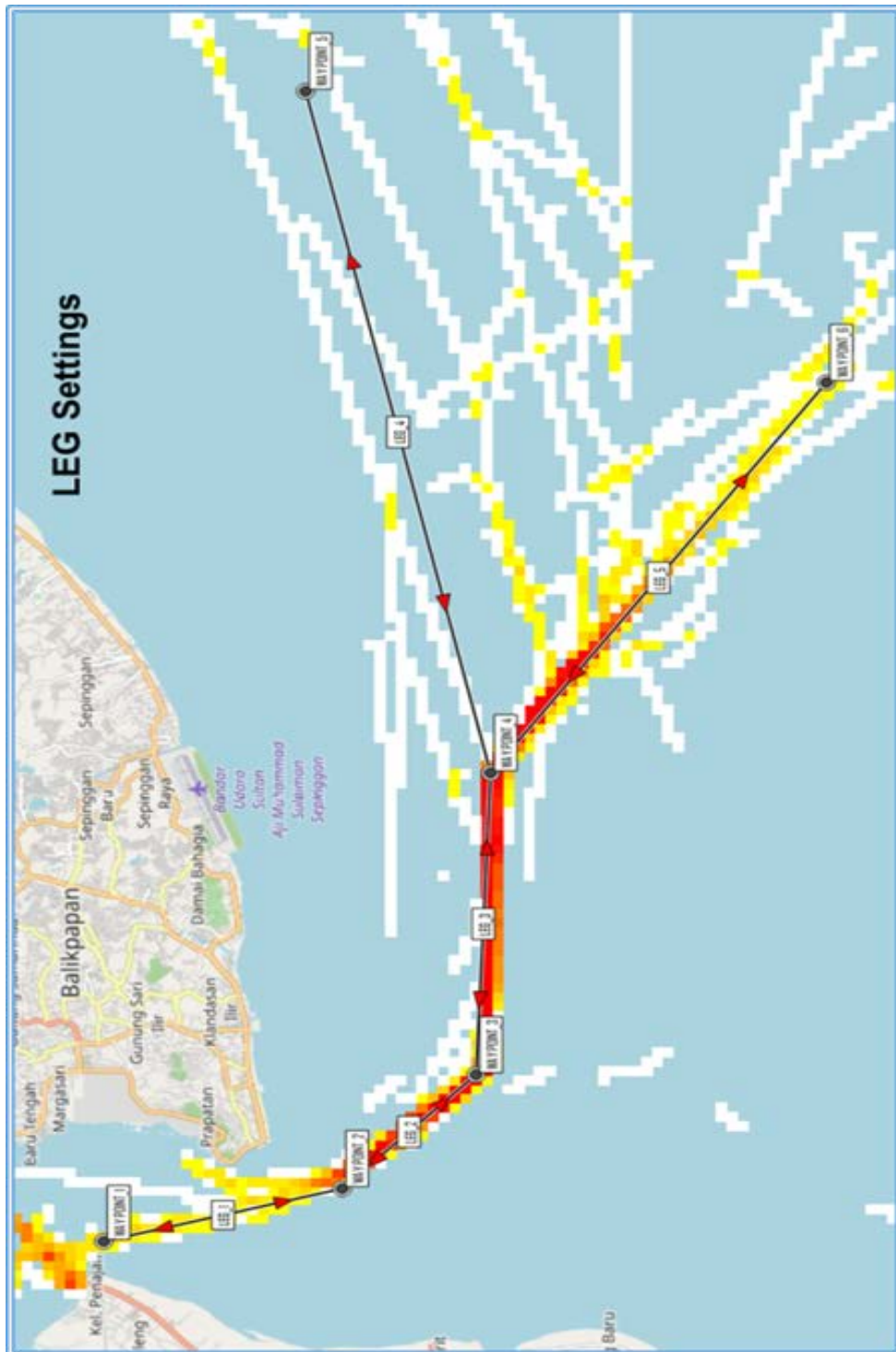

Figure 5.10 -7 : Histogram of Lateral Distribution (2/2)



Bab 6

Current Status and Issues
in Establishing Development Plan

Figure 6.2 -1 : The Change of the Positioning System

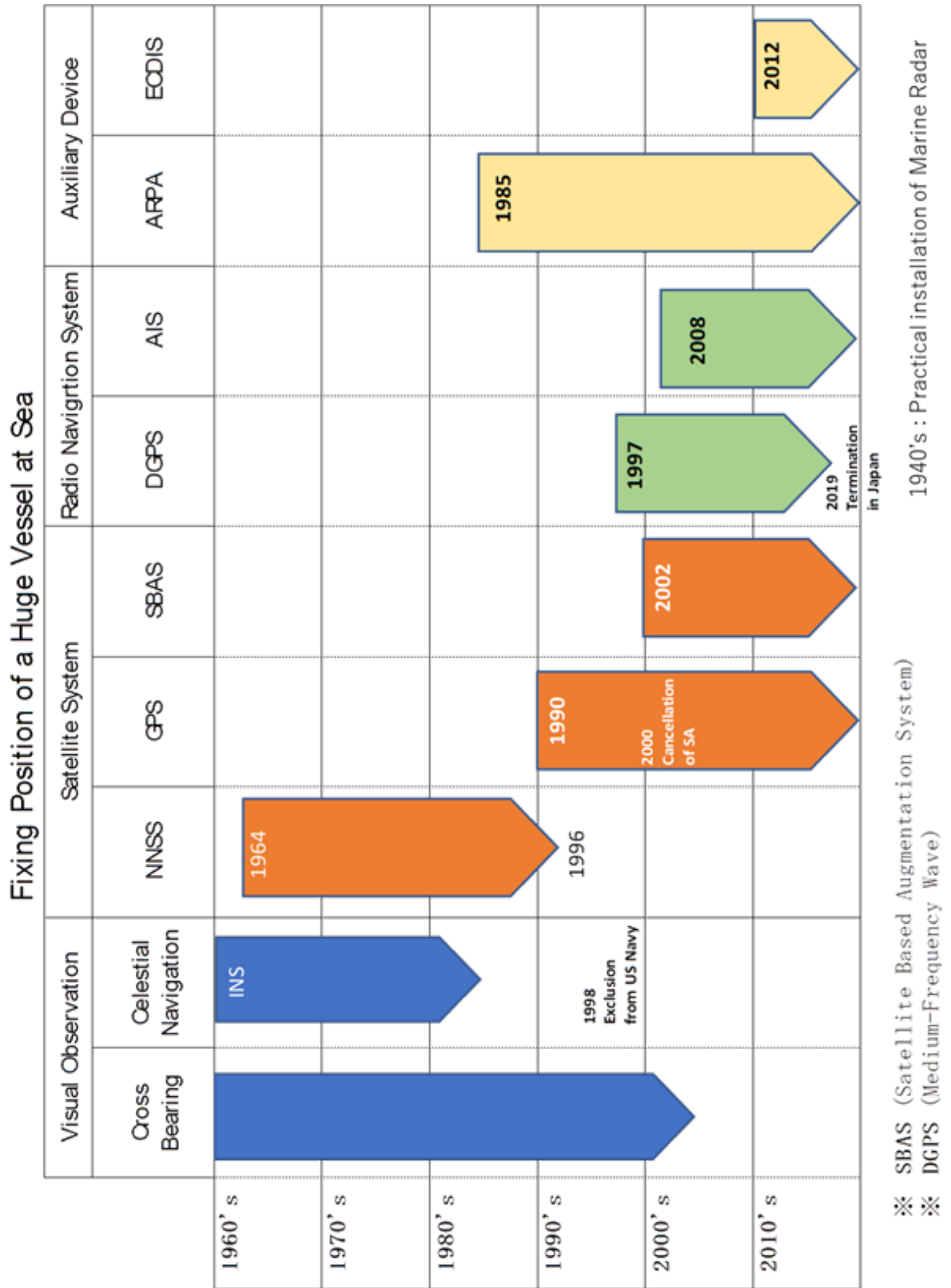

Figure 6.2 -2 : SBAS (Satellite-based Augmentation System)

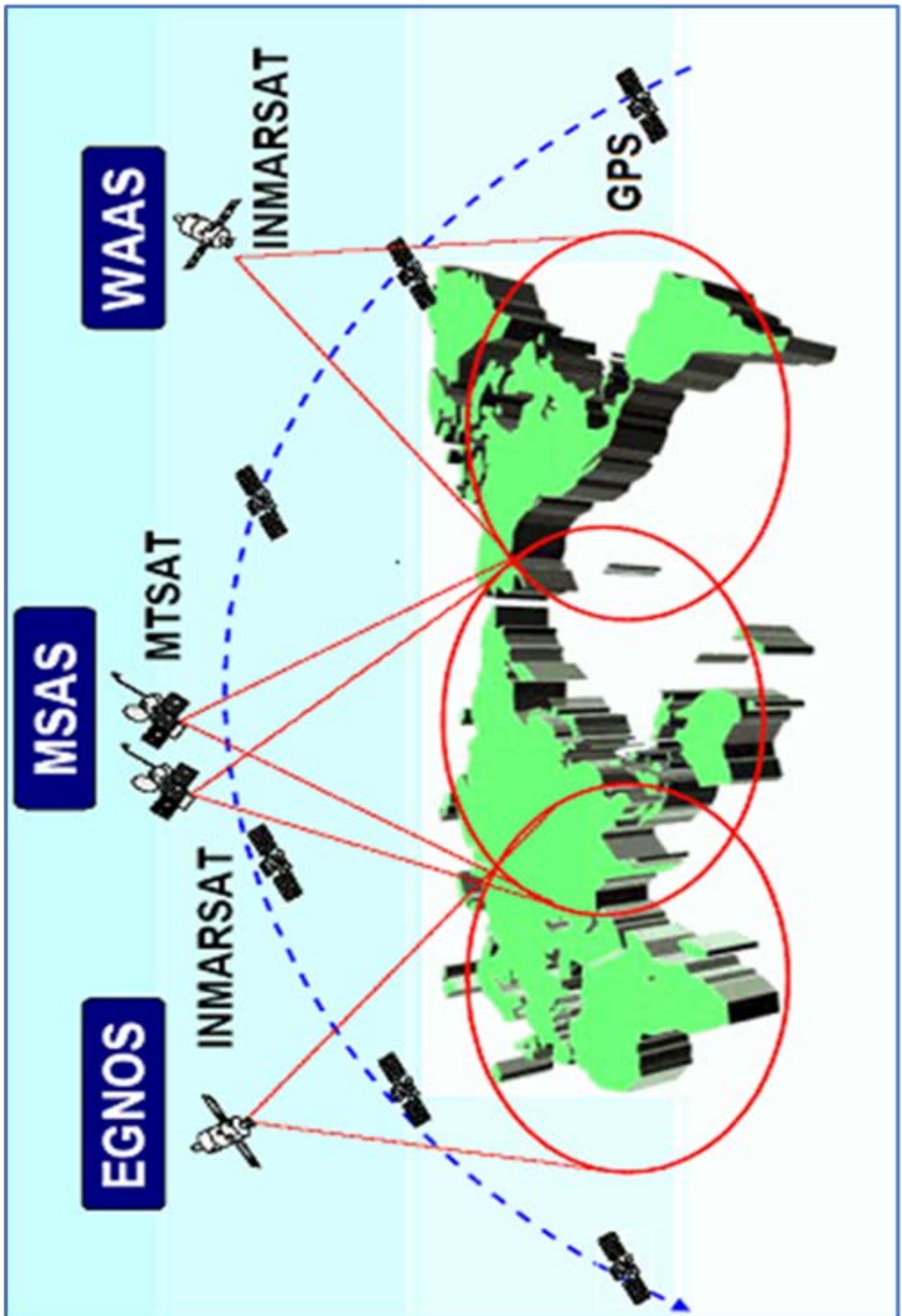

Figure 6.4.1 -1 : Adequacy of Visual Aids to Navigation

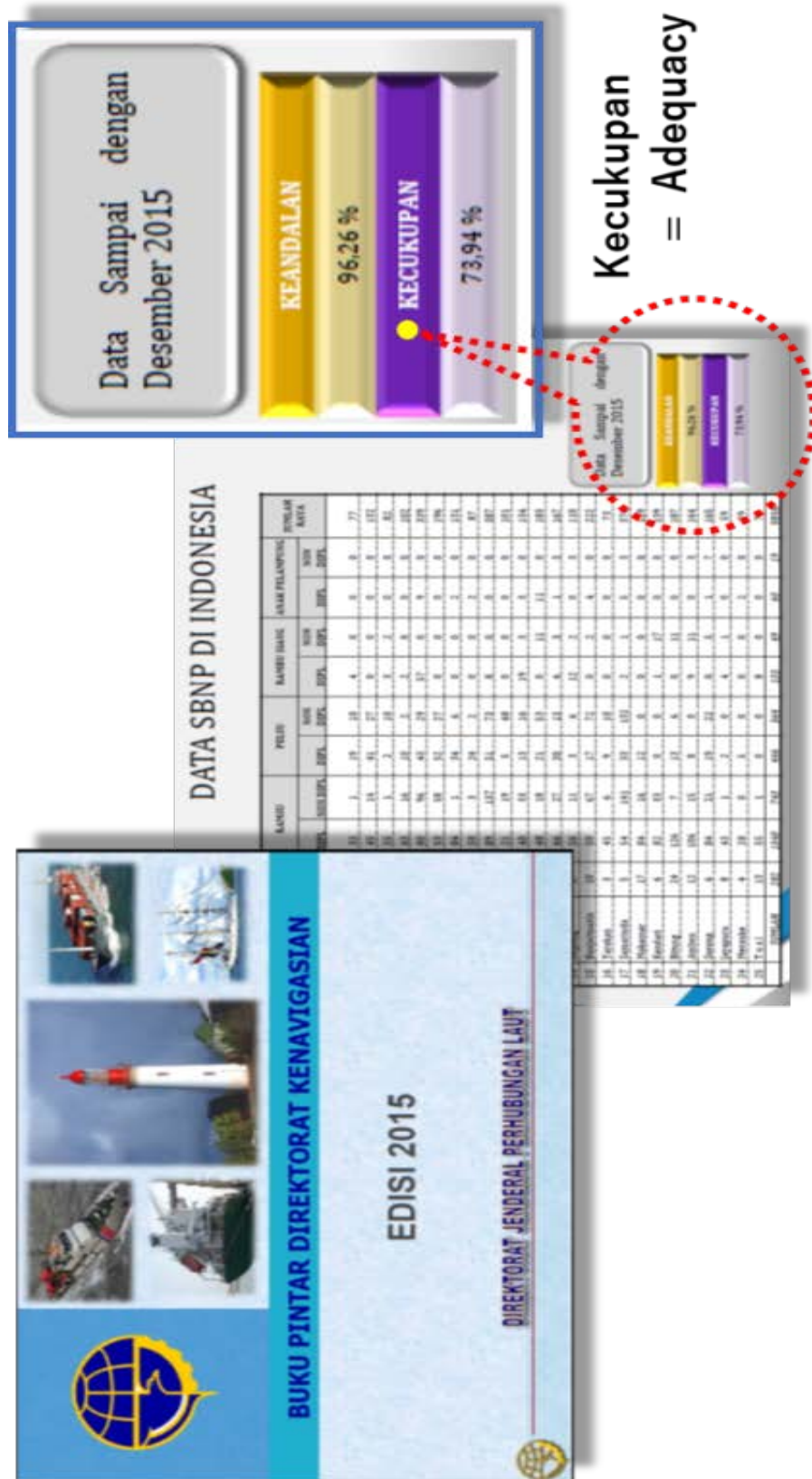

Figure 6.4.1 -2 : Concept of “Adequacy”

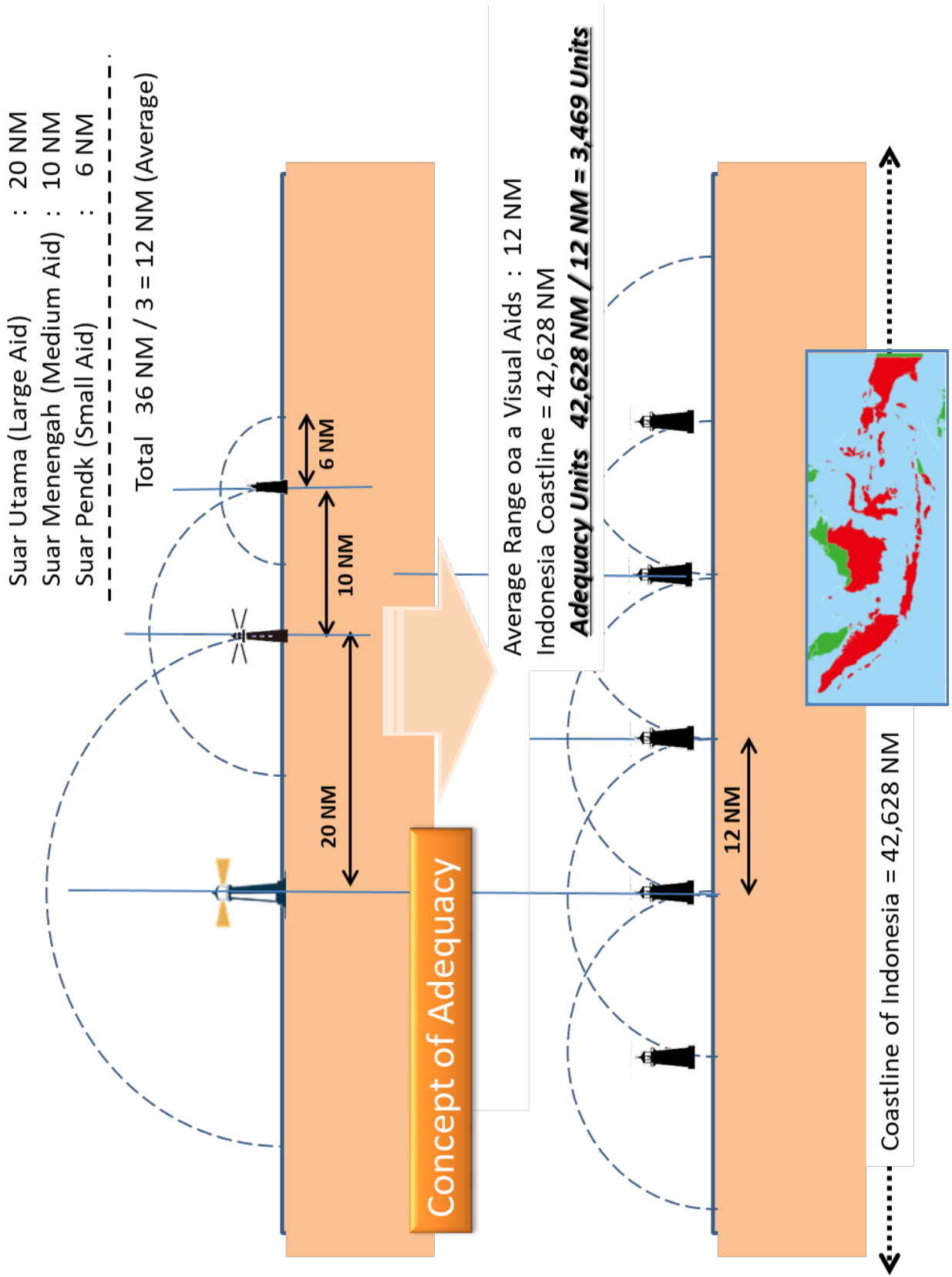

Table 6.4.1 -1 : “Adequacy” of Visual Aids to Navigation

Development/Establishment Status	2002		2016		2019	
	Existing		Five-Year Plan	Existing	Five-Year Plan	Existing
Lighthouse	235		286	282	306	284
Light Beacon	1,168		1,756	1,557	2,281	1,877
	437			743		843
Total	1,840		(2,042)	2,582	(2,587)	3,004
Adequacy (%)	53 %			74 %		87 %

Calculated Adequacy Number of SBNP 3,469 Units / 41,628 Mile, as of 2015

The features of Spar (Resilient) Buoys

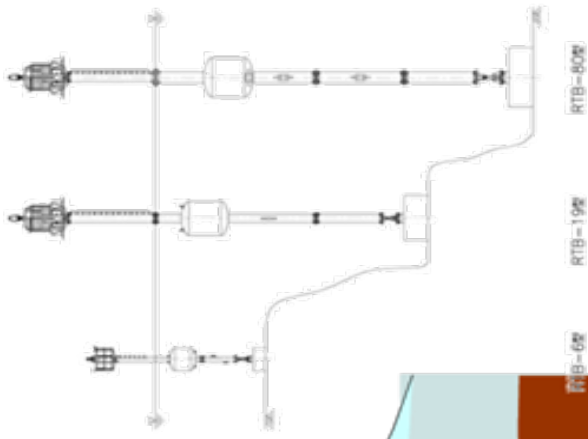
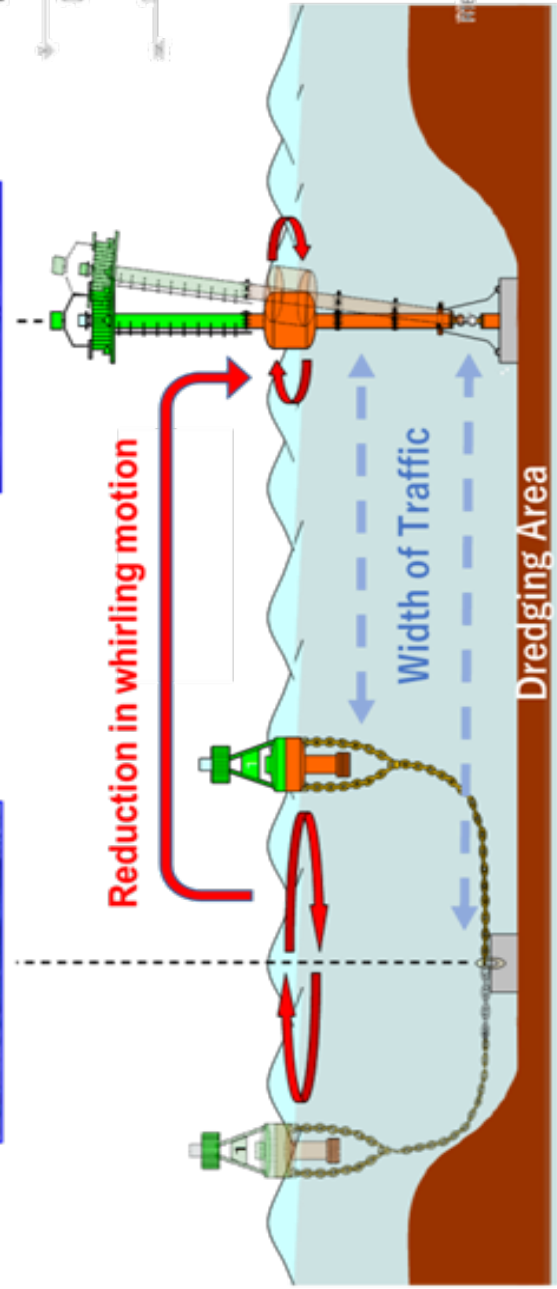
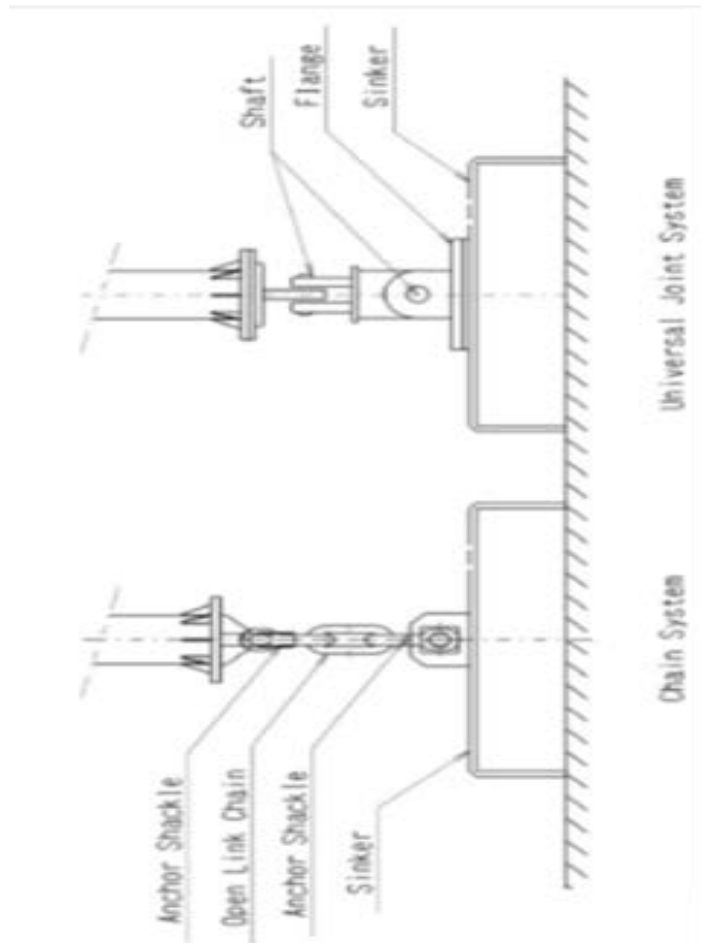

Figure 6.4.2 -1 : Merit of Spar Buoy

Figure 6.4.2 -2 : Connection of Body to Sinker



Universal Joint System



Picture from ZENI LIGHT BUOY HP

Figure 6.4.2 -3 : Synchronized Flashing (“Region-B”)

The features of Spar Buoys

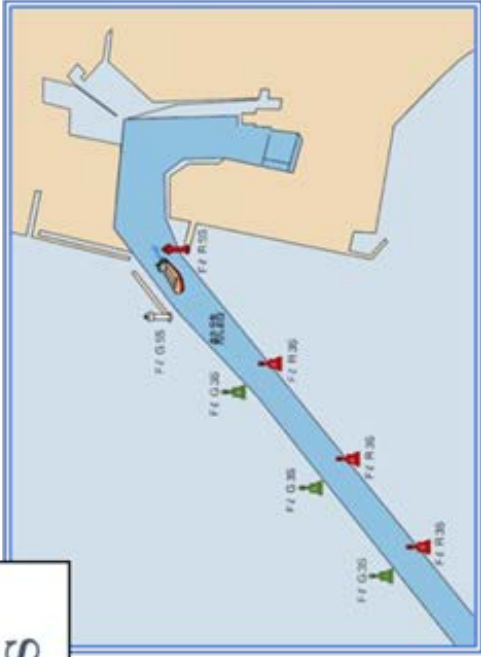

For better a line-sight path



For better viewability with synchronous flashing at nighttime

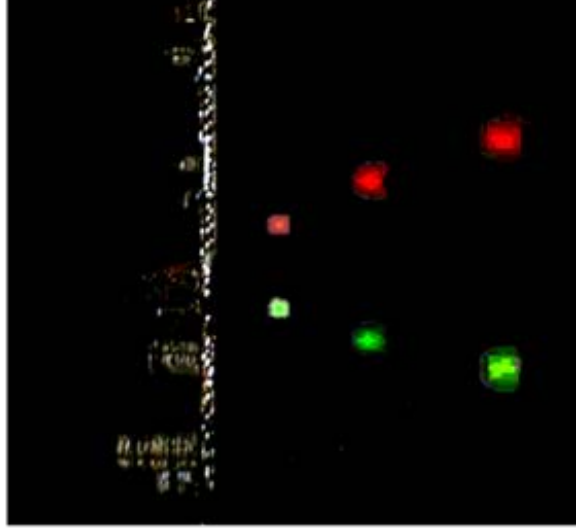

Figure 6.4.2 -5 : Leading Light

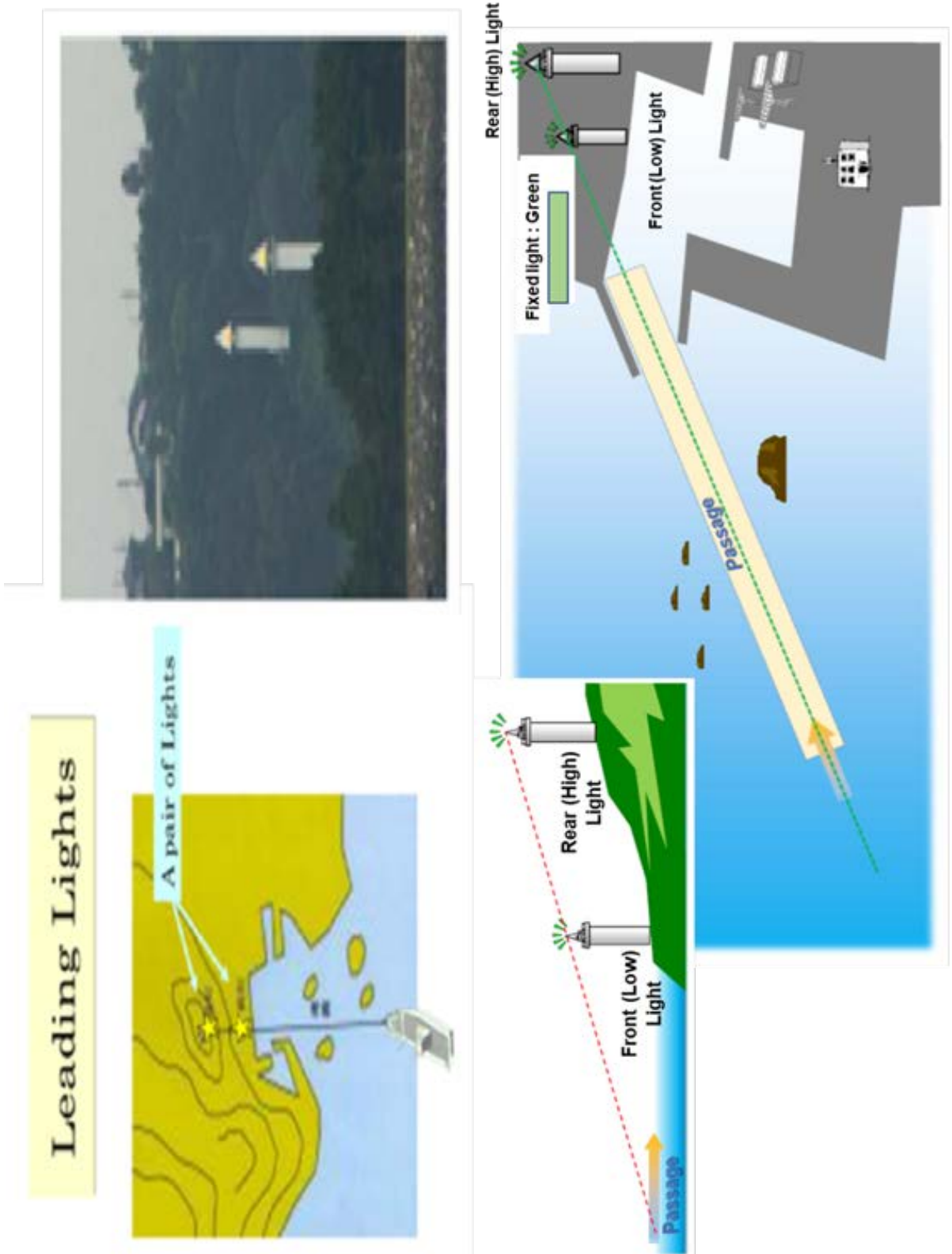

Figure 6.4.2 -6 : Sector Light

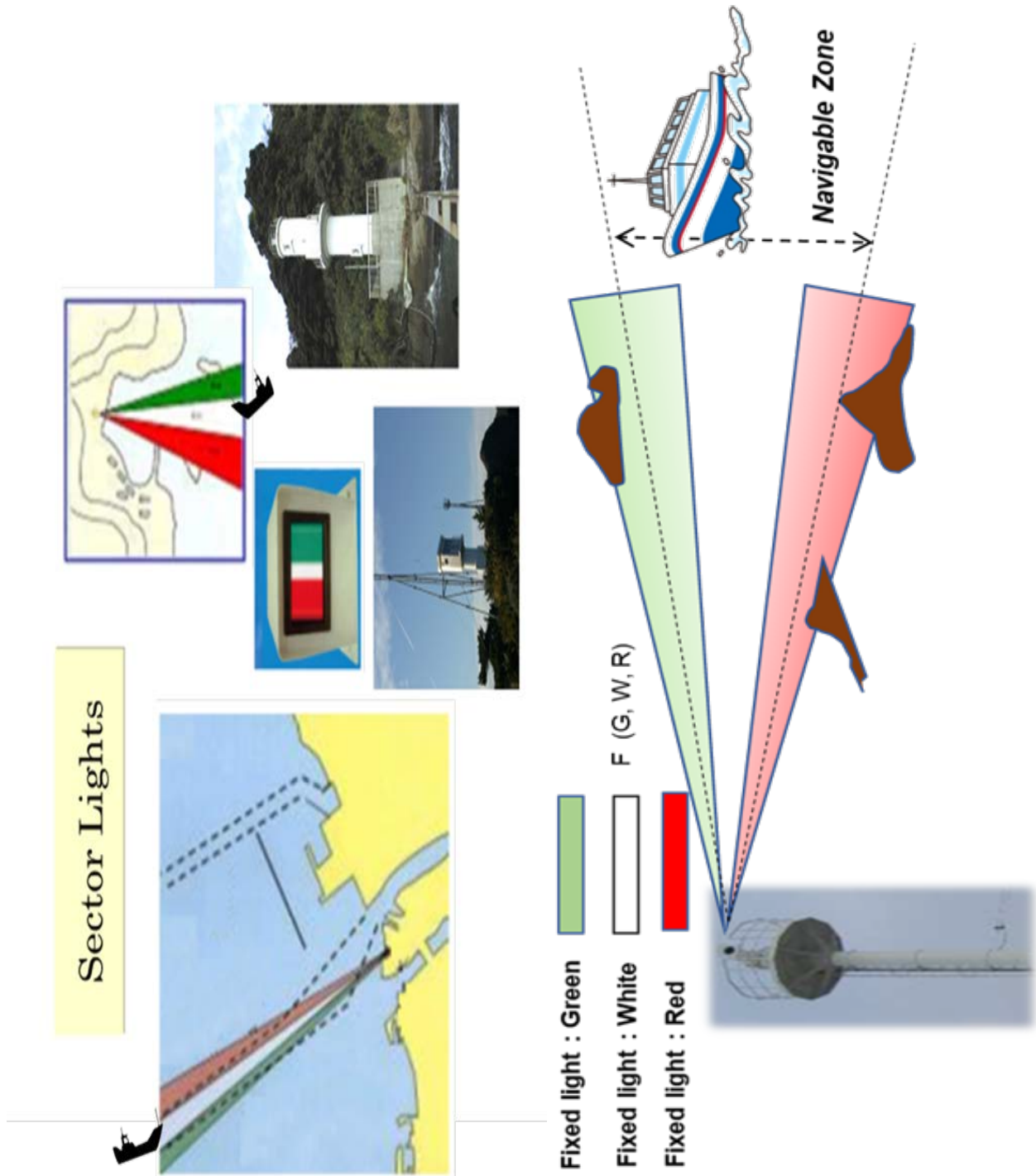

Figure 6.4.2 -7 : Sector Light at Tip Point of Pier

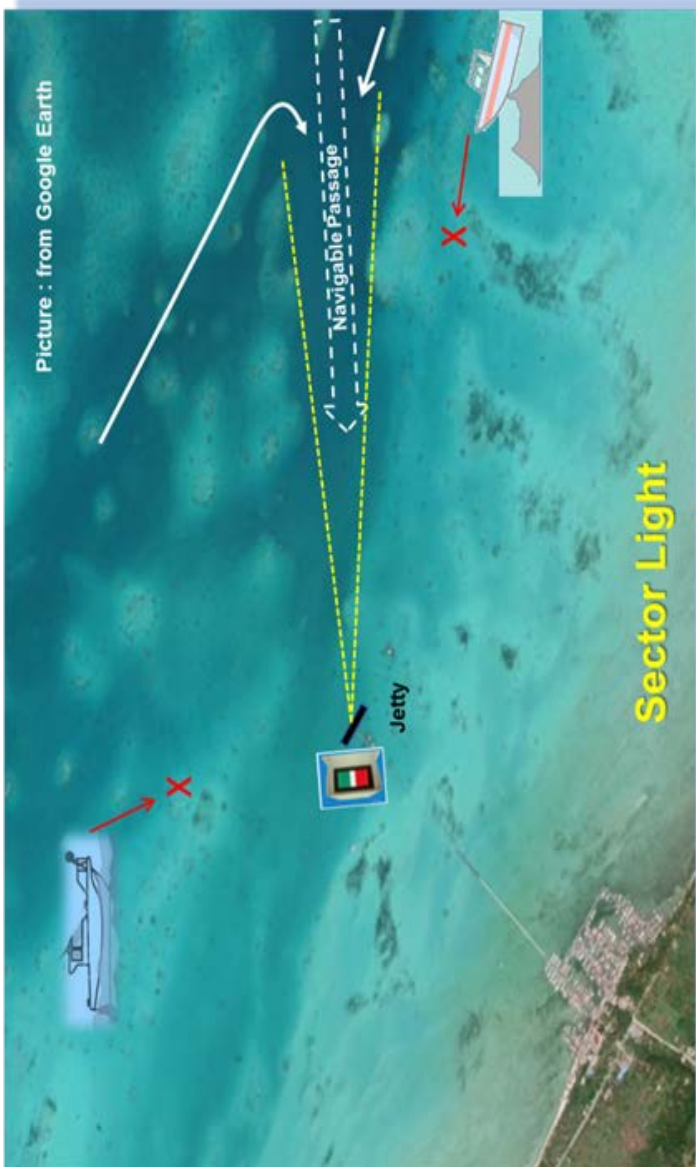
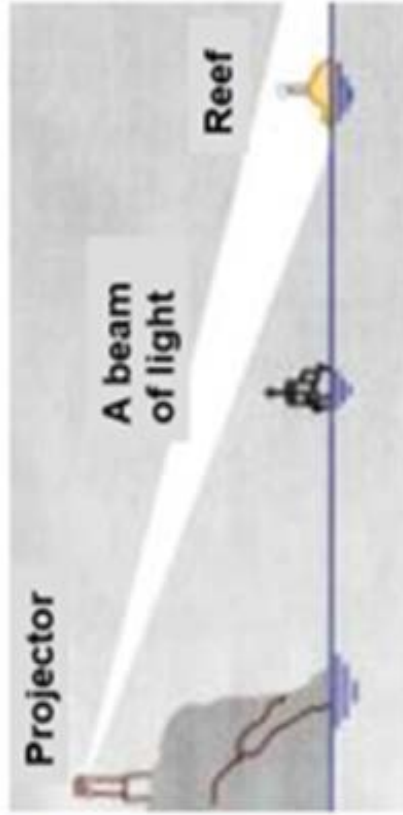

Figure 6.4.2 -8 : Projector

Projector



Lighthouse and Projector

Exposed hazard
by a beam

Figure 6.4.2 -9 : IALA Buoyage System (Region A)

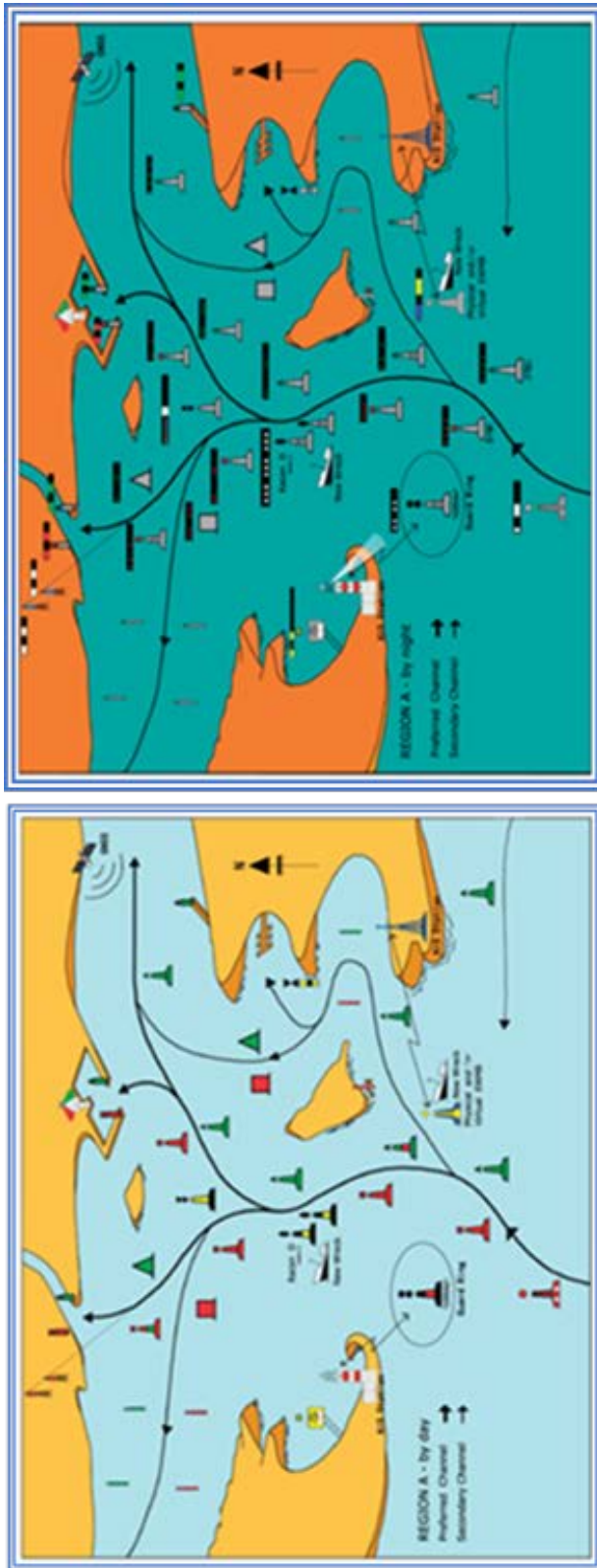

“ Region – A “



(Port) (Left) (Red)



(Starboard) (Right) (Green)

Direction of Buoyage

Figure 6.4.2 -10 : Symbol for Buoyage Direction

When the direction of buoyage is not obvious, it is indicated by this symbol on the chart.

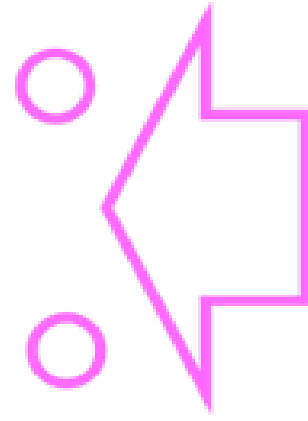
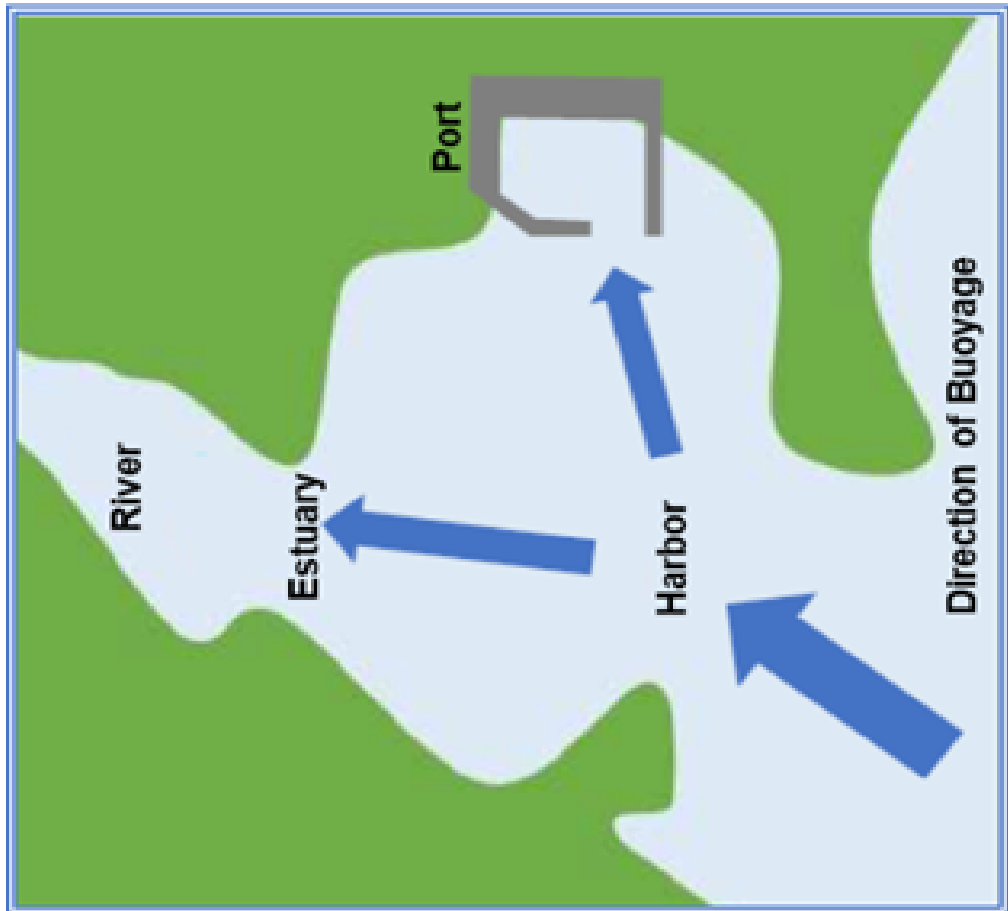

Figure 6.4.2 -11 : Direction of Buoyage

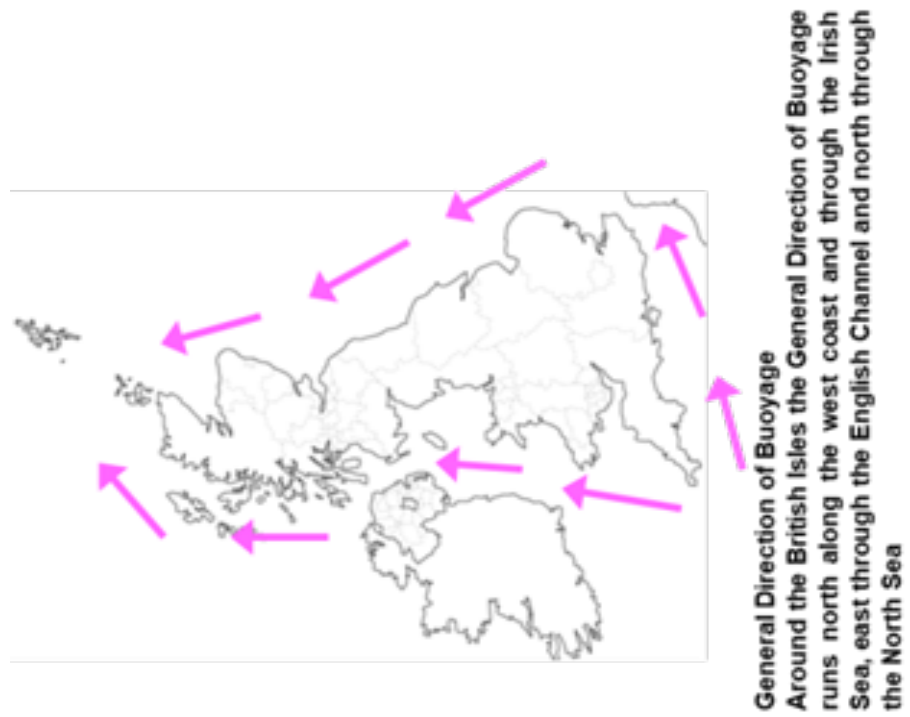
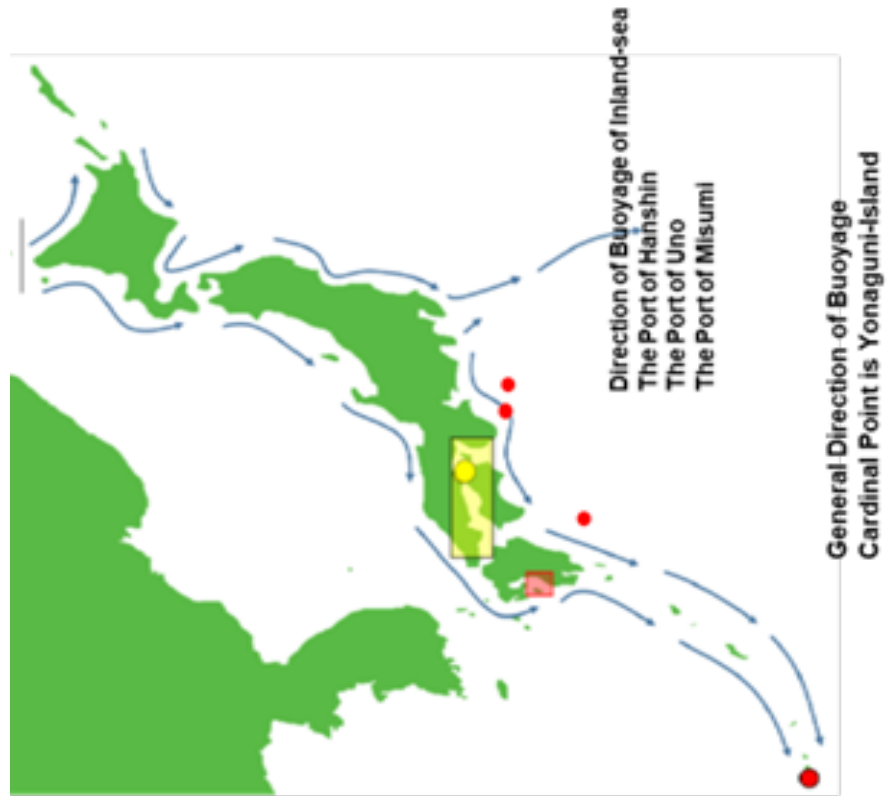

Figure 6.4.2 -12 : Arrangement of Light-Beacon at the Breakwater

Indication of Breakwater

Purpose	Showing the entrance of a harbor, Preventing the collision of vessels		
Method of Indication	Instalolation of Light-Beacon on the Breakwater		
Requirement of Beacon			
▪ Location	Tip area or Outer area of Breakwater on Traffic side		
▪ Paint Color, Structure	Port Side	Red	Tower, Pillar or Stand Pipe
	Starboard Side	White	Tower, Pillar or Stand Pipe
▪ Light Color	Port Side	Red	
	Starboard Side	White	
▪ Light Characteristic	Single-Flashing, Group-Flashing, Isophase Light, Single-Occulting, Group-Occulting, Continous Quick-Flashing, Group Quick-Flashing or Fixed Light		
	※ Synchronized flashing, when beacons show the same entrance of a port		
▪ Luminous Intensity	The range of a light is that the light can be seen from a distance where a ship can avoid the colision with the breakwater, when the ship approaches the breakwater.		

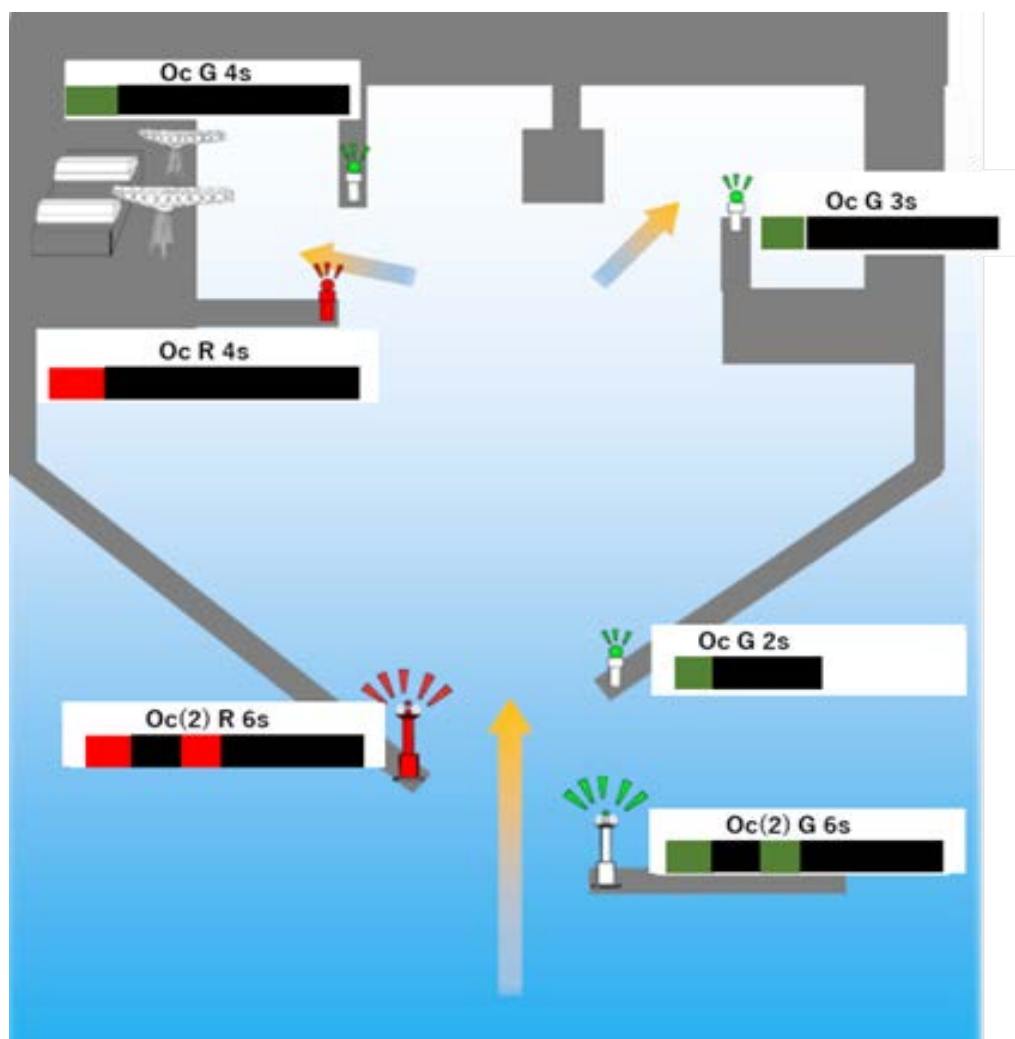

Figure 6.4.2 -13 : Arrangement of Light-Beacon at the Reefs

Indication of Reef (Ledge)

Purpose	Preventing the grounding and the collision of vessels
Method of Indication	Instalolation of Light-Beacon on the Reef or Ledge
Requirement of Beacon	
▪ Location	Appropriate Place on the Reef or Ledge
▪ Paint Color	Divide the body horizontally into three equal parts, the upper part is black, the central part is red, and the lower part is black.
▪ Structure	Tower, Pillar, Angle Flame
▪ Top Mark	Paint Color : Black
	Shape : Put two spheres on a vertical line (Refer to the figure on the right)
	Dimension : Refer to the figure on the right
▪ Light Characteristic	Group Flashing White, 2 Flashes every 5 seconds or 2 Flashes every 10 deconds
▪ Luminous Intensity	The range of a light is that the light can be seen from a distance where a ship can avoid the grounding on the reef or the colision with the reef, when the ship sails on a course approaching a reef.

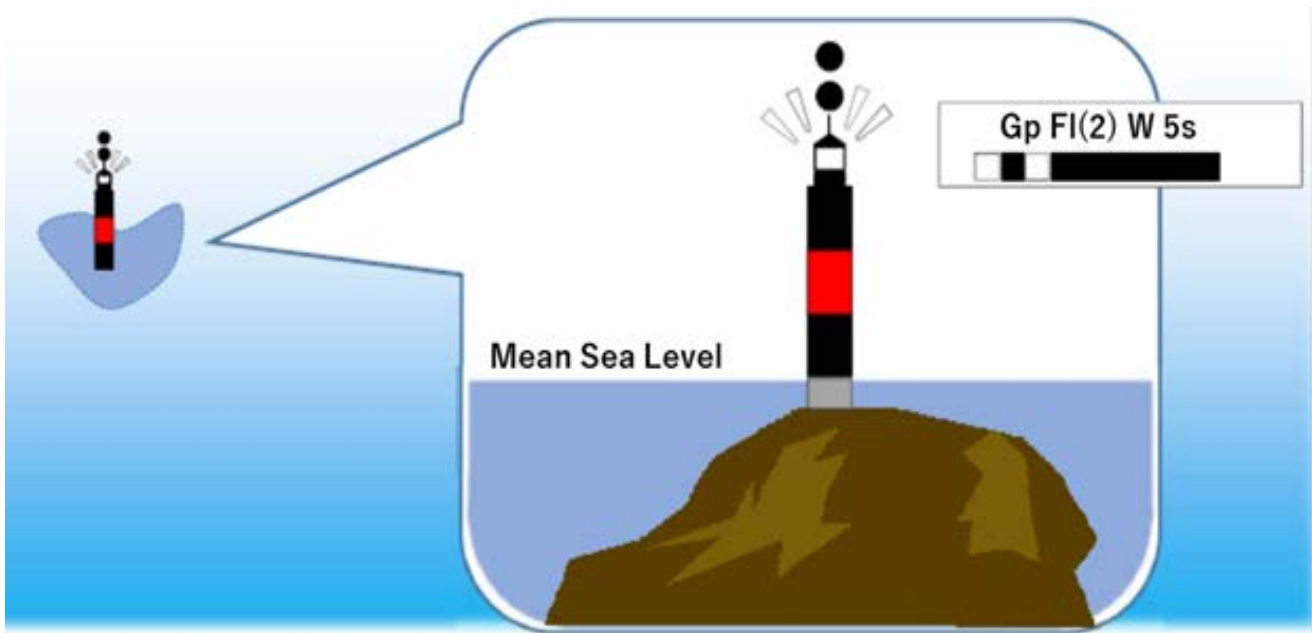
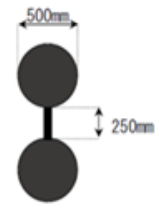

Figure 6.4.2 -14 : Arrangement of Light-Beacon at the Construction Area

Indication of Offshore Construction Areas

Purpose	Preventing vessels from entering
Method of Indication	Instalolation of Floating Buoy (Light-Beacon) at important points
Requirement of Beacon	
<ul style="list-style-type: none"> Location 	All comeres of the area
	If one side of the area is long, some units should be evenly spaced.
	Installation of a unit may be omitted on the side facing the sea area where vessels do not pass.
<ul style="list-style-type: none"> Paint Color Structure 	Yellow
	Tower, Pillar, Angle Flame
<ul style="list-style-type: none"> Top Mark 	Paint Color : Yellow
	Shape : X (Refer to the figure on the right)
	Dimension : Refer to the figure on the right
<ul style="list-style-type: none"> Light Characteristic 	Flashing White
<ul style="list-style-type: none"> Luminous Intensity 	The range of a light is that the light can be seen from a distance where a ship can avoid the entering the construction area.

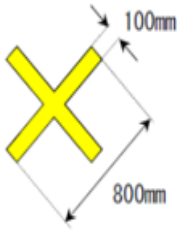

Figure 6.4.2 -15 : Arrangement of Light-Beacon at the Traffic Route

Indication of Traffic Route

Purpose	Showing the side-track (lateral line), Regulating traffic		
Method of Indication	Instalolation of Floating Buoy at Light-Beacon at key points		
Requirement of Beacon			
Location	Entrance (Exit) of Traffic Rout, and the bent comer on the line of Traffic Route		
	If the route is long, some units should be evenly spaced.		
	Installation of the unit may be omitted if it interferes with entrance into and leave from Traffic Route.		
Paint Color	Port Side	Red	"Reagion A"
	Starboard Side	Green	
	Center	Red and White vertical stripes (eight equal parts)	Safe Water Marks
Structure	Angle Frame, Pillar		
Top Mark	Port Side	Paint Color : Red	Shape : Cone
	Starboard Side	Paint Color : Green	
	Center	Paint Color : Red	Shape : Sphere
Light Color	Port Side	Red	
	Starboard Side	Green	
	Center	White	
Light Characteristic	Port Side Staraboard Side	① Entrance (Exit) and Bent : Group Flashing, 2 Flashes every 6 seconds Cases other then ① : Singl Flashing, every 2, 3, 4 or 5 seconds	
	Center	① Entrance (Exit) and Bent : Isophase, Light 2 seconds and Darkness 2 seconds (A light in which all the durations of light and darkness are clearly equal.) Cases other then ① : Isophase, Light 2 seconds and Darkness 2 seconds, Long Flashing, 1 long-flashing every 10 seconds or Morse code, A(—) every 8 seconds	
Luminous Intensity	The range of a light is that the light can be seen from a distance where a ship can avoid the colision with the other vessel, when the ship approaches the traffic route.		

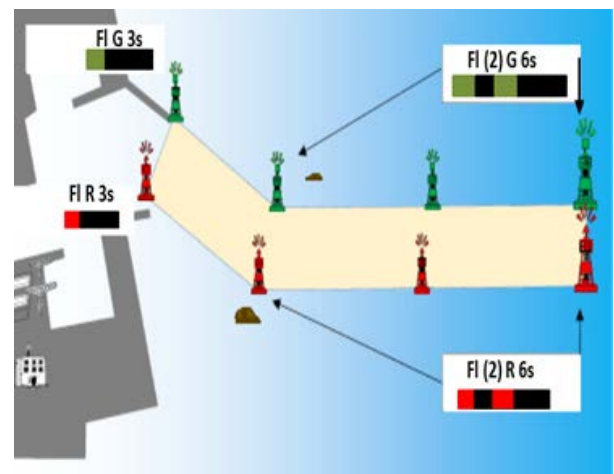
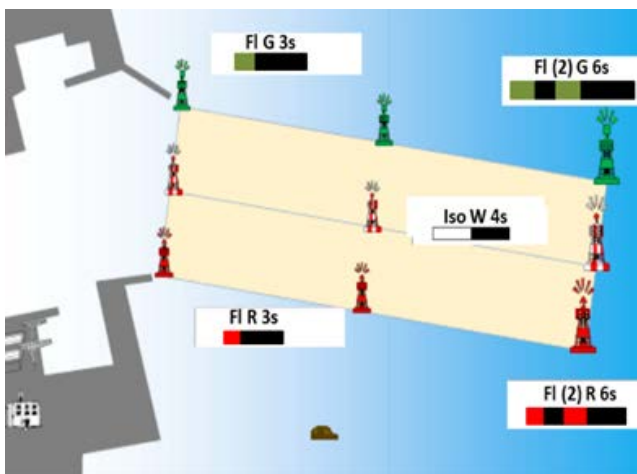
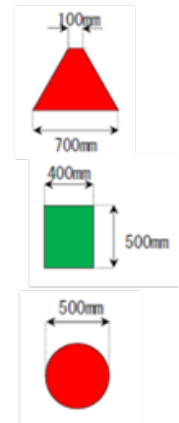

Figure 6.4.2 -16 : Standard Model of Small Lighted Beacon

General Specification

Fresnel Lens	φ 123mm
Light Source	LED
Characteristics	Fl (1) 4s Y/R/G/W
Intensity	19 cd
Range	3 nm (5.5 km)
Solar Panel	5 W x 1/2 unit
Battery	5 Ah x 1/2 unit

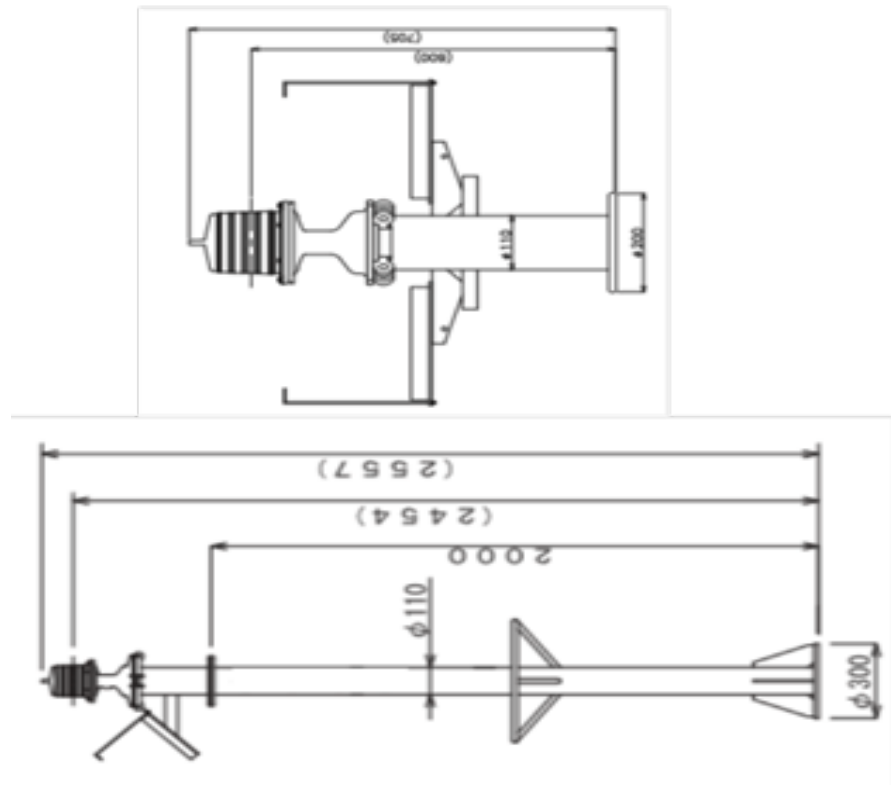
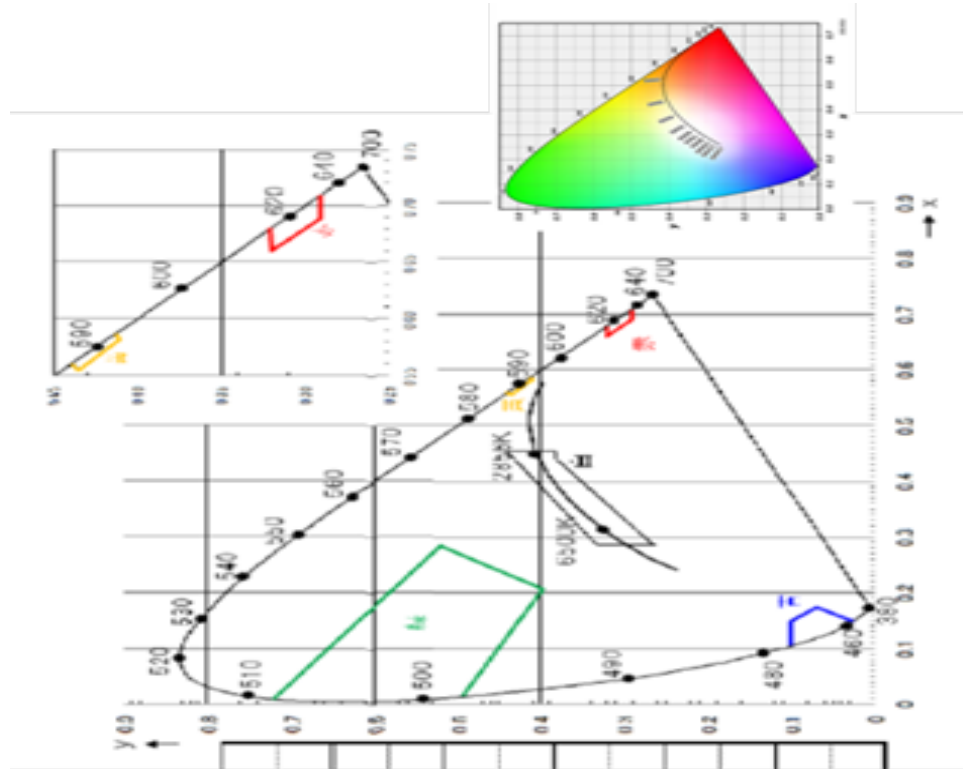

Figure 6.4.2 -17 : Standard Model of LED Lantern

Type	I	II	III	V	High Intensity
Range	3 nm	5 nm	6 nm	8.5 nm	20 nm
Luminous Intensity	20 cd	80 cd	200 cd	780 cd	3,200 cd
Power Supply	2 w DC 12 v	2 w DC 12 v	4 w DC 12 v	16 w DC 12 v, 24 v	16 w DC 12 v, 24 v



Figure 6.4.2 -18 : Chromaticity Range for Light Color



Chromaticity Coordinate

Color	Chromaticity Coordinate	Point				
		1	2	3	4	5
White	X	0.440	0.285	0.285	0.453	0.453
	Y	0.382	0.264	0.332	0.440	0.382
Red	X	0.710	0.690	0.660	0.680	
	Y	0.290	0.290	0.320	0.320	
Yellow	X	0.5865	0.581	0.555	0.560	
	Y	0.413	0.411	0.435	0.440	
Green	X	0.009	0.284	0.207	0.013	
	Y	0.720	0.520	0.397	0.494	
Blue	X	0.104	0.150	0.175	0.149	
	Y	0.100	0.100	0.070	0.025	

Figure 6.4.3 -1 : Coverage of Mobile Phone

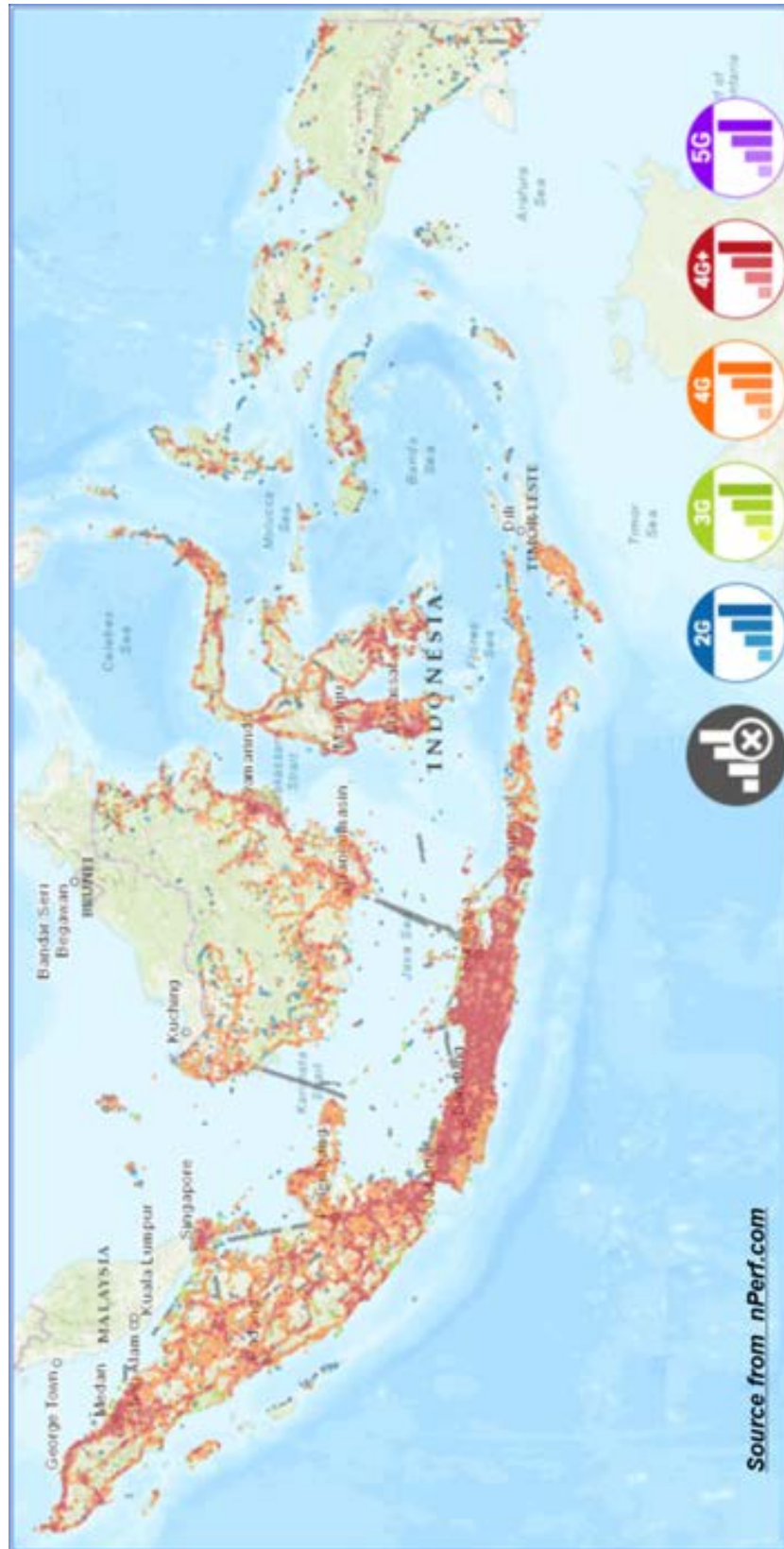

Figure 6.4.3 -2 : Remote Monitoring System

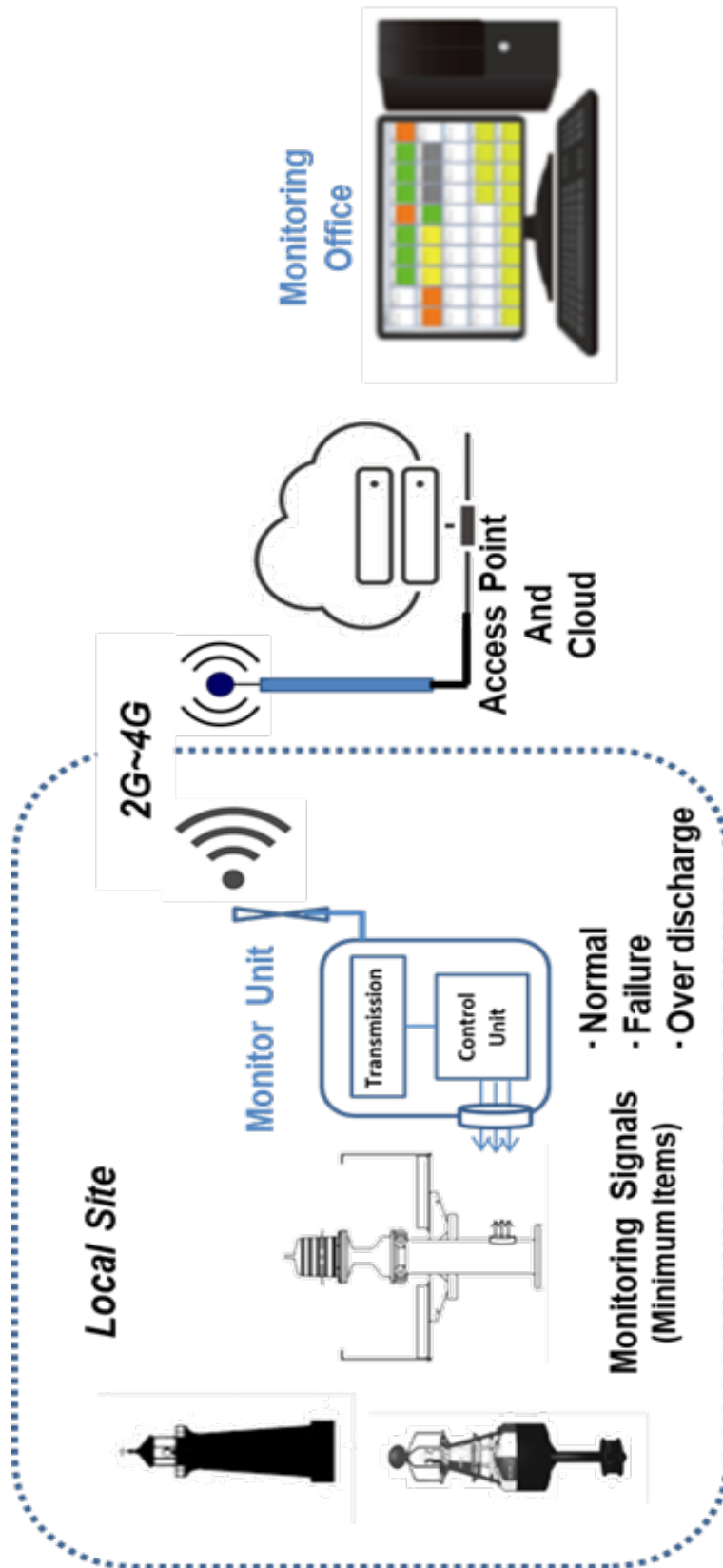

Figure 6.5 -1 : Accuracy of GPS (FAA Report)

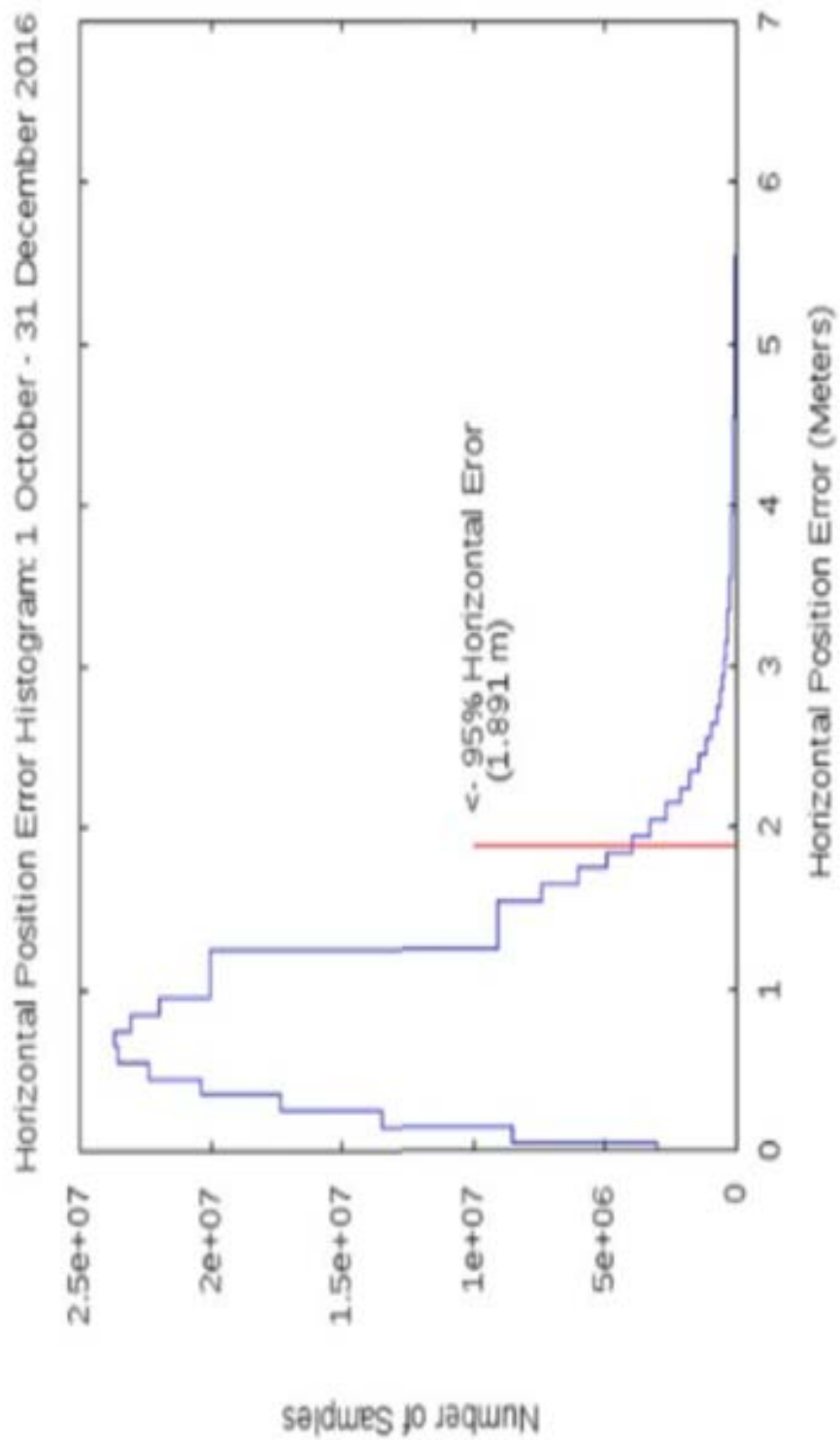

Figure 6.5.1 -1 : Real AIS

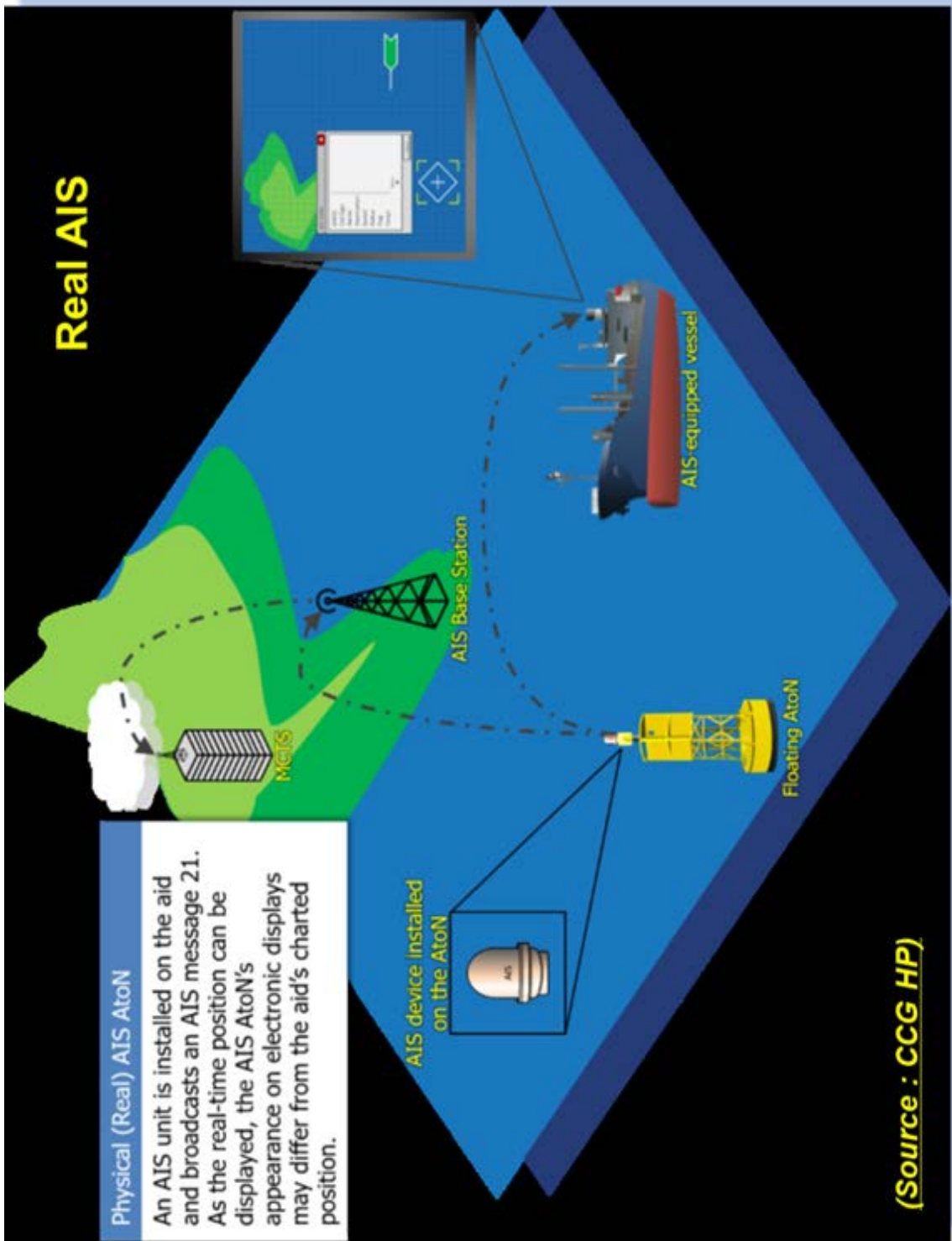

Figure 6.5.1 -2 : Virtual AIS

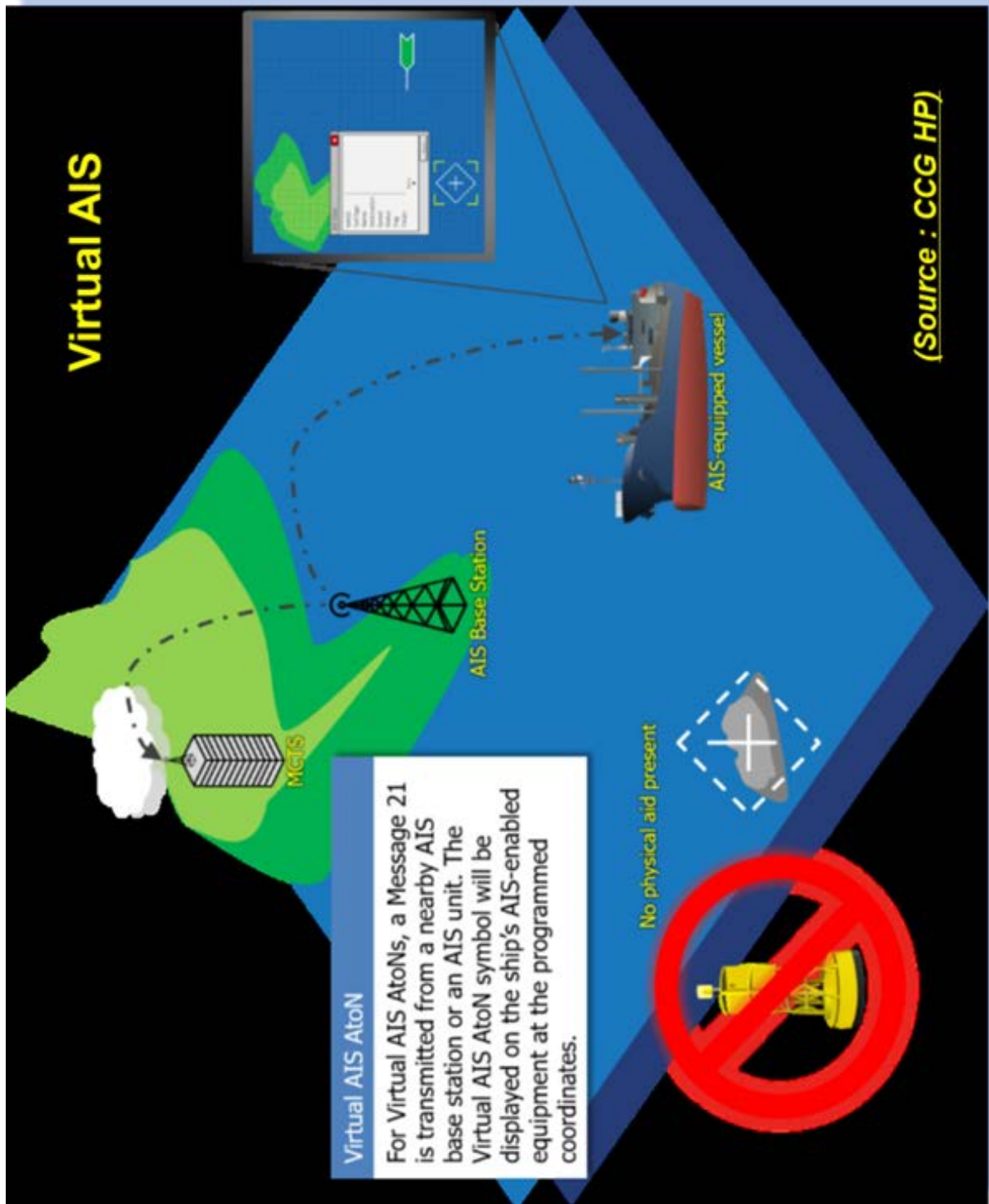

Figure 6.5.1 -3 : Placement of Real and Virtual AIS

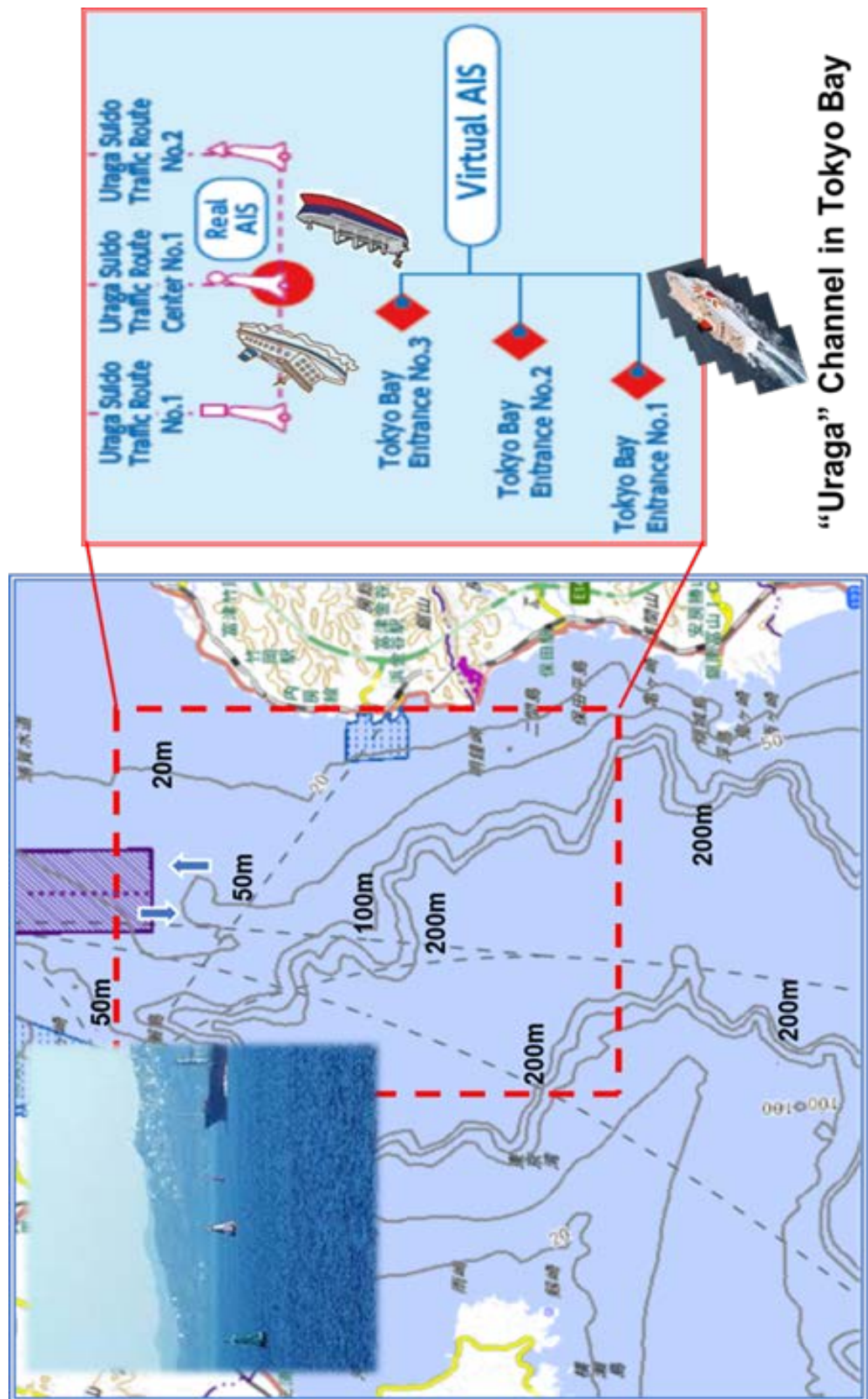
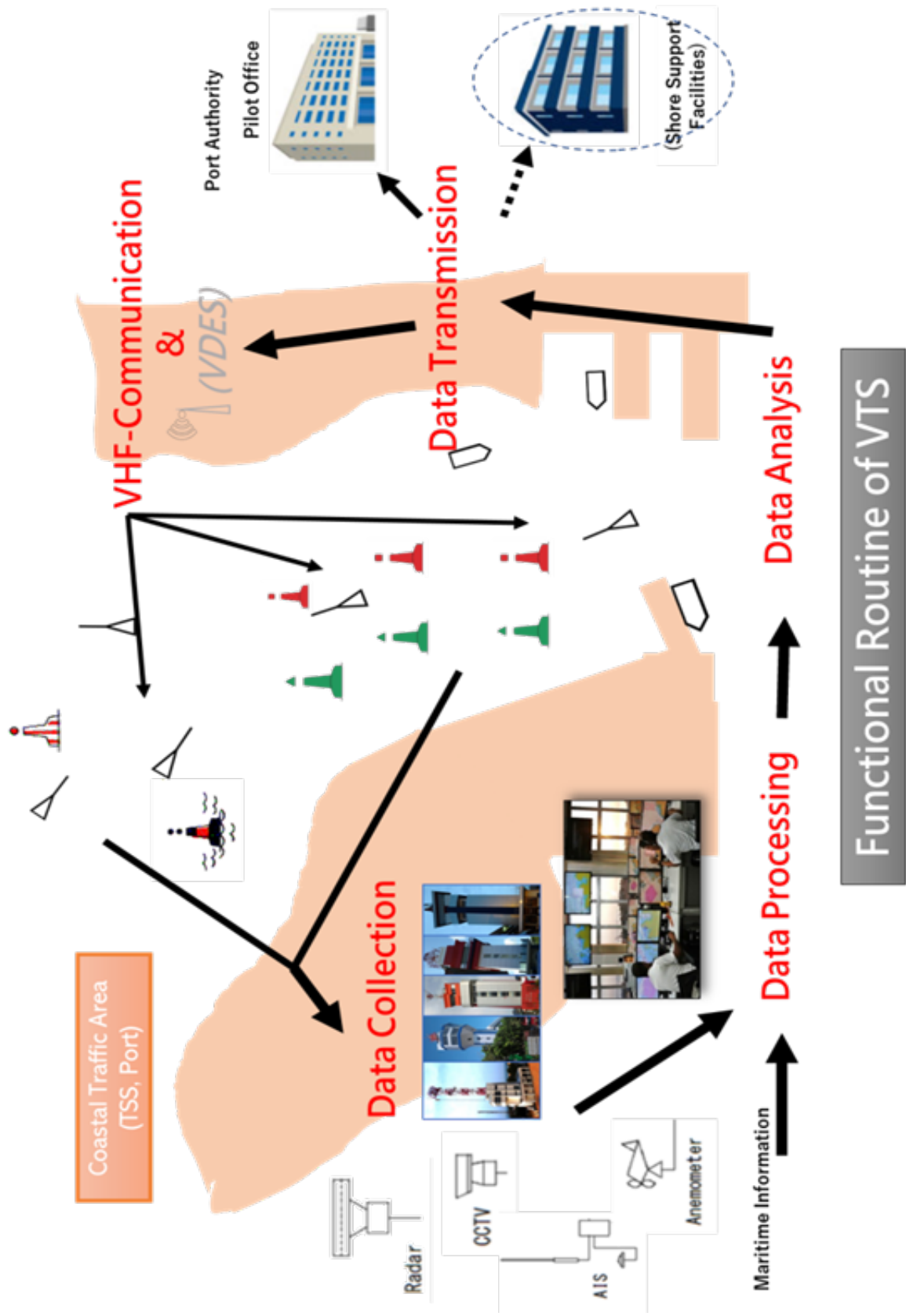

Figure 6.6.1 -1 : Functional Routine of VTS



**Procedure Prescribing for the Implementation
of
VTS Operation
(Example)**

CONTENTS

Chapter 1 General

1.1 Purpose

1.2 Applicable Legislation

1.3 Definition

1.4 -----

1.5 -----

Chapter 2 Communication

2.1 Communication System

2.2 Type of Communication

2.2.1 Important (Emergency) Communication

2.2.2 Traffic Control Communication

2.2.3 Information Communication

2.2.4 -----

2.2.5 -----

Chapter 3 Collection and Organization of Information

3.1 Contents of Information

3.1.1 Items of Collecting Information

3.1.2 Details of Collecting Information

3.2 Route of Obtaining and Processing Information

(1) Marine Accident

(2) Restricted Navigation

(3) Anchorage

(4) Dredging Anchor

(5) Weather

(6) Vessel

(6) Construction, Activity

() Other Necessary Information

Chapter 4 Provision of Information

4.1 Classes of Information

(1) General Information

(2) Individual, Particular Information

(3) Emergency Information

4.2 Method of Provision

(1) Items of Provided Information

(2) Procedure of Provision

(3) Processing after Provision

(4) Succession

Chapter 5 Position Report and Instruction, Recon

5.1 Position Report

(1) Timing

(2) Contents

(3) Location

(4) Method

(5) Confirmation

5.2 Traffic Control

5.3 Instruction and Recommendation

5.4 Amendment of Report

5.5 Another Report

Chapter 6 Traffic Control

6.1 Application

Chapter 7 Monitoring, Watching

7.1 Radar

7.2 AIS

Chapter 8 Operation in Emergency Situation

8.1 Accident

8.2 Unusual Weather

Chapter 9 Record and Report

(Supplementary Provision)

Supplementary Char / Diagram

※ 1 -----

※ 2 -----

※ 3 -----

Tokyo MATICE
400 pages

Figure 6.6.1 -3 : Copy of Operation Manual (in Japanese)

①. 21 72.27% (乗組員が航行中の速度を維持する) .dot A01

②. 22 72.27% (乗組員が航行中の速度を維持する) .dot A02

③. 23 72.27% (乗組員が航行中の速度を維持する) .dot A03

④. 24 72.27% (乗組員が航行中の速度を維持する) .dot A04

⑤. 25 72.27% (乗組員が航行中の速度を維持する) .dot A05

⑥. 26 72.27% (乗組員が航行中の速度を維持する) .dot A06

情報提供等マニュアル

(〇〇〇七) - 運航管理(航行管理)

1. 航行管理に必要となる情報(航行管理)の提供(航行管理) .dot A01

2. 航行管理の提供(航行管理) .dot A02

3. 航行管理の提供(航行管理) .dot A03

4. 航行管理の提供(航行管理) .dot A04

5. 航行管理の提供(航行管理) .dot A05

6. 航行管理の提供(航行管理) .dot A06

①. 27 72.27% (乗組員が航行中の速度を維持する) .dot A07

②. 28 72.27% (乗組員が航行中の速度を維持する) .dot A08

③. 29 72.27% (乗組員が航行中の速度を維持する) .dot A09

④. 30 72.27% (乗組員が航行中の速度を維持する) .dot A10

⑤. 31 72.27% (乗組員が航行中の速度を維持する) .dot A11

⑥. 32 72.27% (乗組員が航行中の速度を維持する) .dot A12

項目	内容	備考
1	航行管理に必要となる情報(航行管理)の提供(航行管理)	航行管理に必要となる情報(航行管理)の提供(航行管理)
2	航行管理の提供(航行管理)	航行管理の提供(航行管理)
3	航行管理の提供(航行管理)	航行管理の提供(航行管理)
4	航行管理の提供(航行管理)	航行管理の提供(航行管理)
5	航行管理の提供(航行管理)	航行管理の提供(航行管理)
6	航行管理の提供(航行管理)	航行管理の提供(航行管理)
7	航行管理に必要となる情報(航行管理)の提供(航行管理)	航行管理に必要となる情報(航行管理)の提供(航行管理)
8	航行管理の提供(航行管理)	航行管理の提供(航行管理)
9	航行管理の提供(航行管理)	航行管理の提供(航行管理)
10	航行管理の提供(航行管理)	航行管理の提供(航行管理)
11	航行管理の提供(航行管理)	航行管理の提供(航行管理)
12	航行管理の提供(航行管理)	航行管理の提供(航行管理)

項目	内容	備考
1	航行管理に必要となる情報(航行管理)の提供(航行管理)	航行管理に必要となる情報(航行管理)の提供(航行管理)
2	航行管理の提供(航行管理)	航行管理の提供(航行管理)
3	航行管理の提供(航行管理)	航行管理の提供(航行管理)
4	航行管理の提供(航行管理)	航行管理の提供(航行管理)
5	航行管理の提供(航行管理)	航行管理の提供(航行管理)
6	航行管理の提供(航行管理)	航行管理の提供(航行管理)
7	航行管理に必要となる情報(航行管理)の提供(航行管理)	航行管理に必要となる情報(航行管理)の提供(航行管理)
8	航行管理の提供(航行管理)	航行管理の提供(航行管理)
9	航行管理の提供(航行管理)	航行管理の提供(航行管理)
10	航行管理の提供(航行管理)	航行管理の提供(航行管理)
11	航行管理の提供(航行管理)	航行管理の提供(航行管理)
12	航行管理の提供(航行管理)	航行管理の提供(航行管理)

①. 27 72.27% (乗組員が航行中の速度を維持する) .dot A07

②. 28 72.27% (乗組員が航行中の速度を維持する) .dot A08

③. 29 72.27% (乗組員が航行中の速度を維持する) .dot A09

④. 30 72.27% (乗組員が航行中の速度を維持する) .dot A10

⑤. 31 72.27% (乗組員が航行中の速度を維持する) .dot A11

⑥. 32 72.27% (乗組員が航行中の速度を維持する) .dot A12

Picture 6.6.1 : Cover of the User Manual



Picture from Brochure of JCG

Figure 6.6.2 -1 : Integrated Information System (1/2)

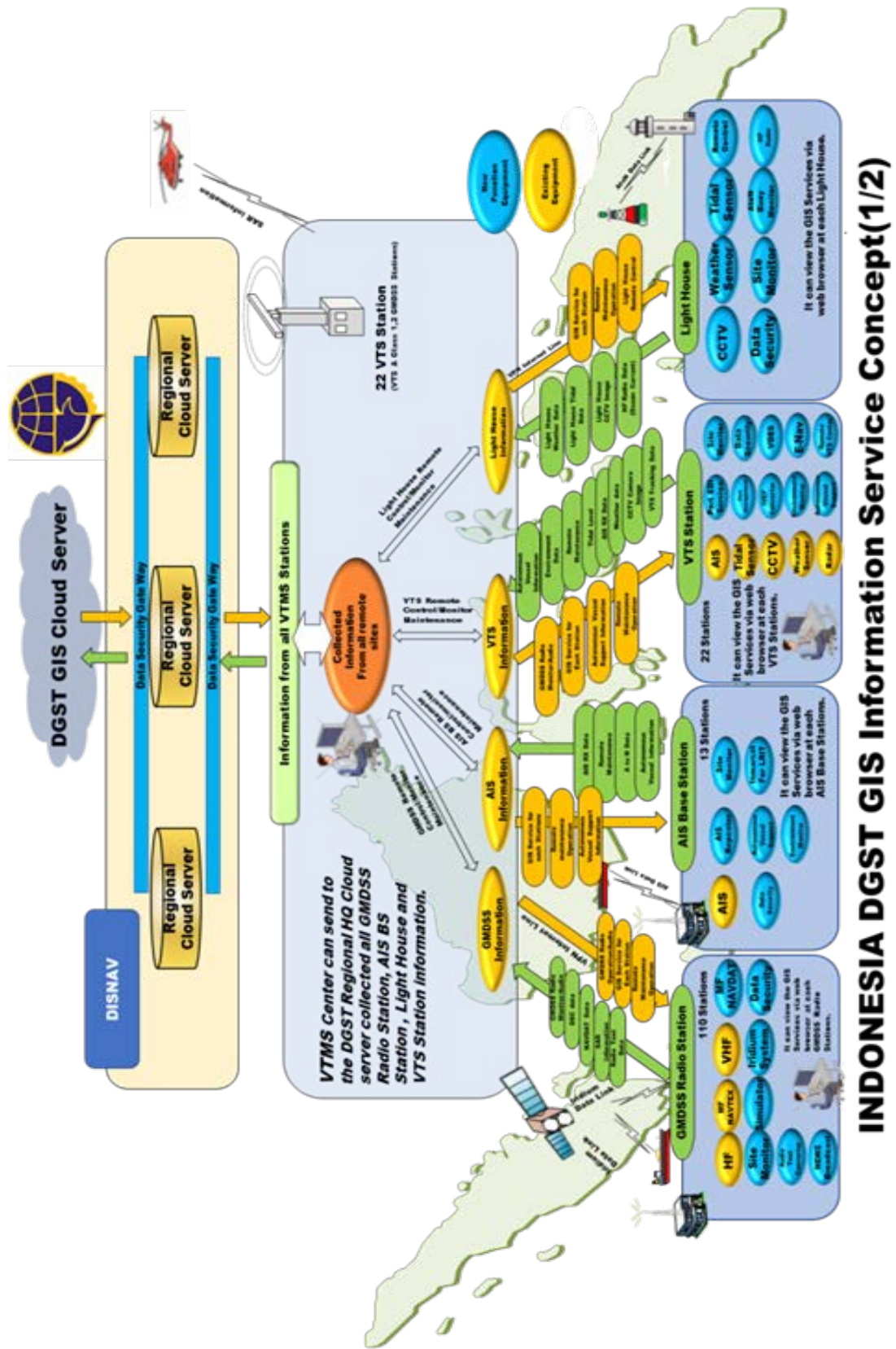
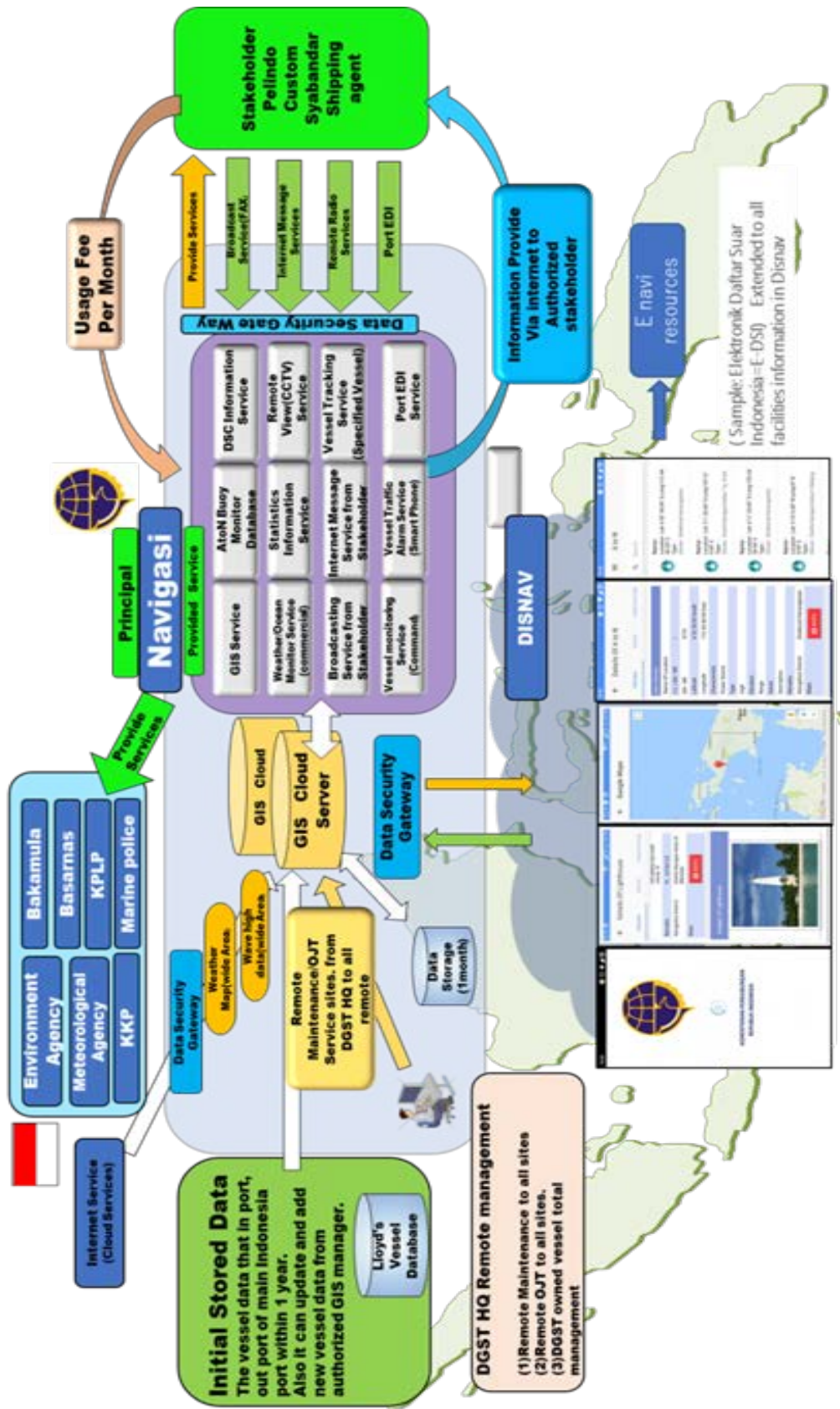
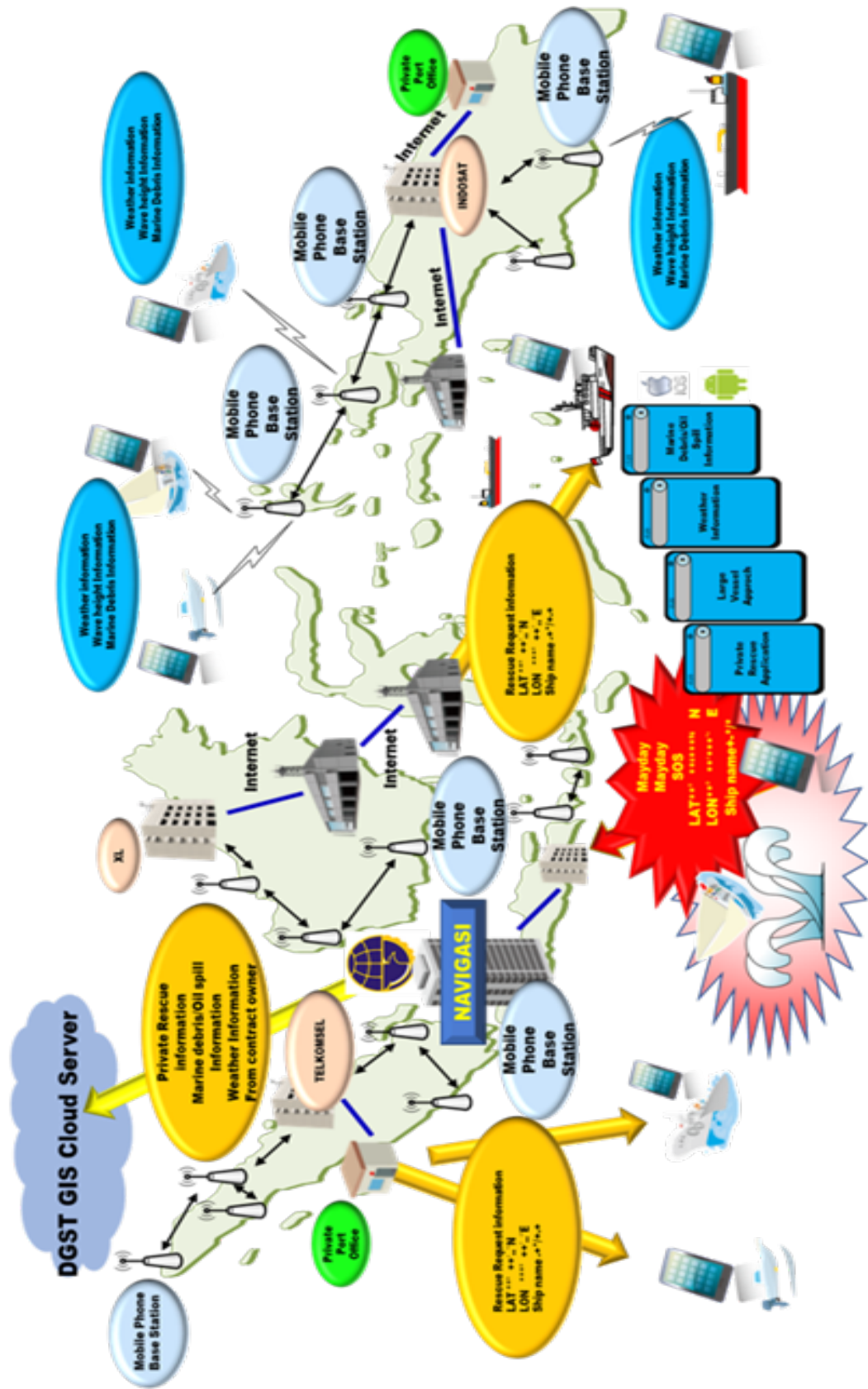

Figure 6.6.2 -1 : Integrated Information System (2/2)



INDONESIA DGST GIS Information Service Concept(2/2)

Figure 6.6.2 -2 : Extended Search and Rescue Network System



Application for Rescue Service Concept

Picture 6.7.1 -1 : Buoy Base Station in Japan

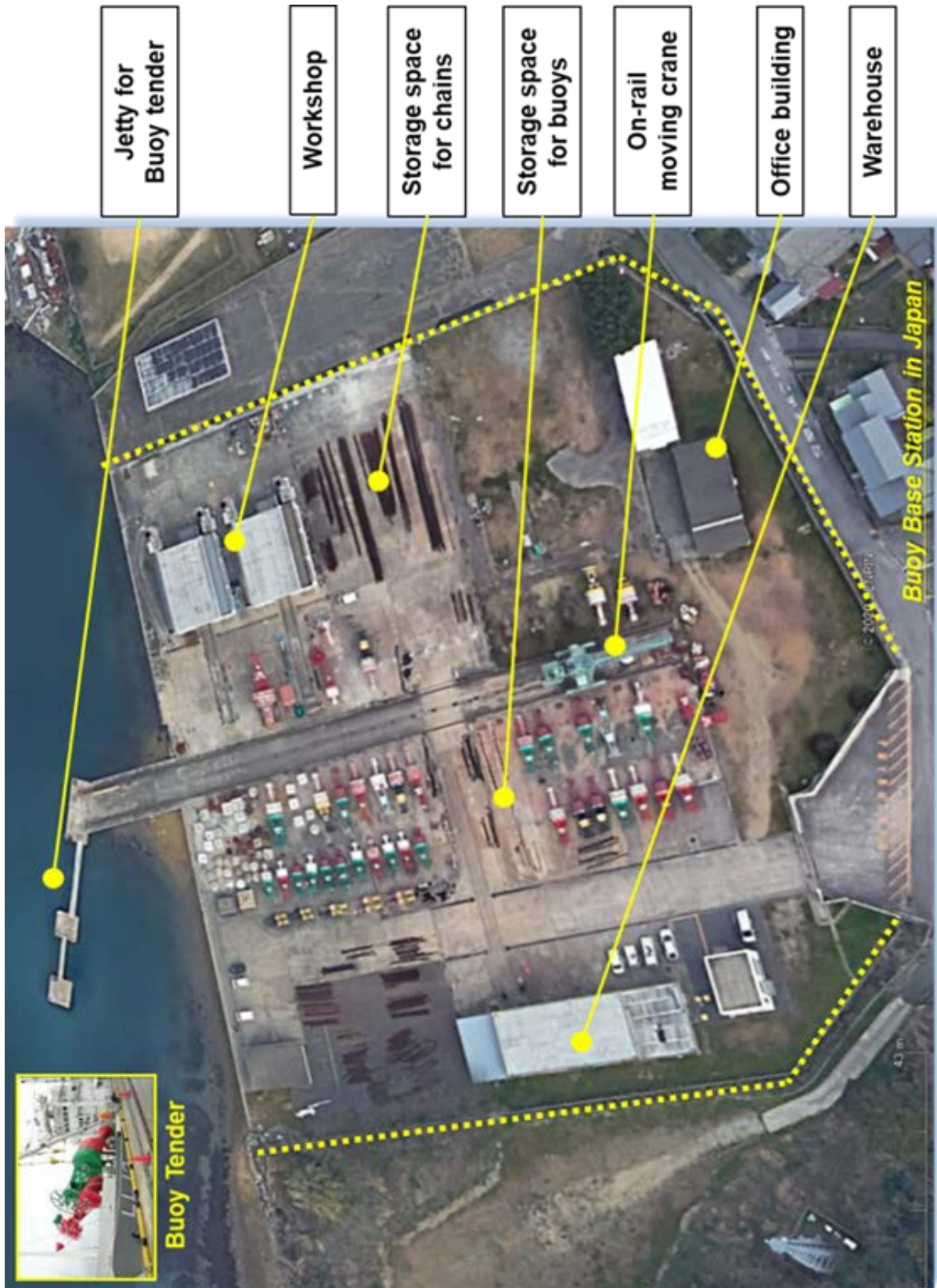

Picture 6.7.1 -2 : Floating Buoy for Maintenance



Adhered shell
on the body and chain



Picture 6.7.1 -3 : Spare Body, Sinkers, Chain



Figure 6.7.1 -1 : Layout of the Buoy Base



Figure 6.8 -1 : Age of Vessels

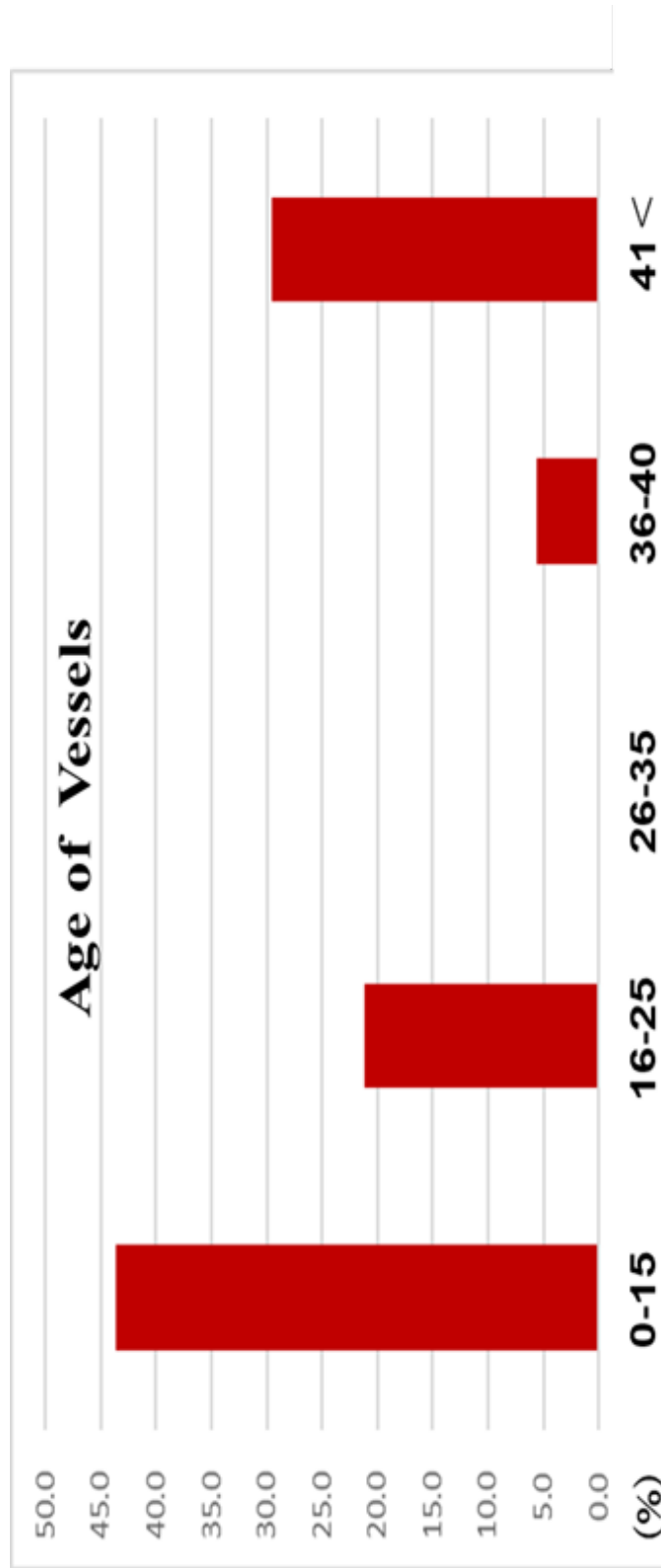

※ 15 Buoy Tenders were built in 2016 and 2017.

Figure 6.8.1 -1 : SOLAS Requirement

**Cargo Ships - Case C. Non-Tankers
with $L < 85$ m**

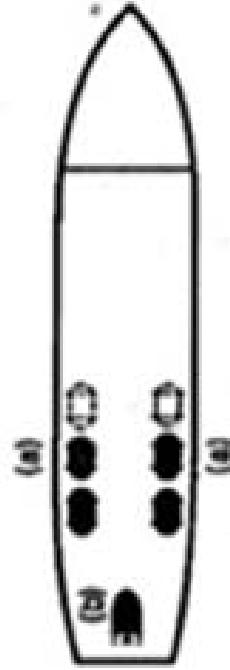

- a) 100% life rafts capable of being launched at either side. If the life rafts are not possible to launch from either side, 150 % at each side
- b) Rescue boat
- c) With 1 life raft out of service, 100% of the capacity at each side

SOLAS Requirement

Figure 6.8.1 -2 : Life Raft and Rescue Boat

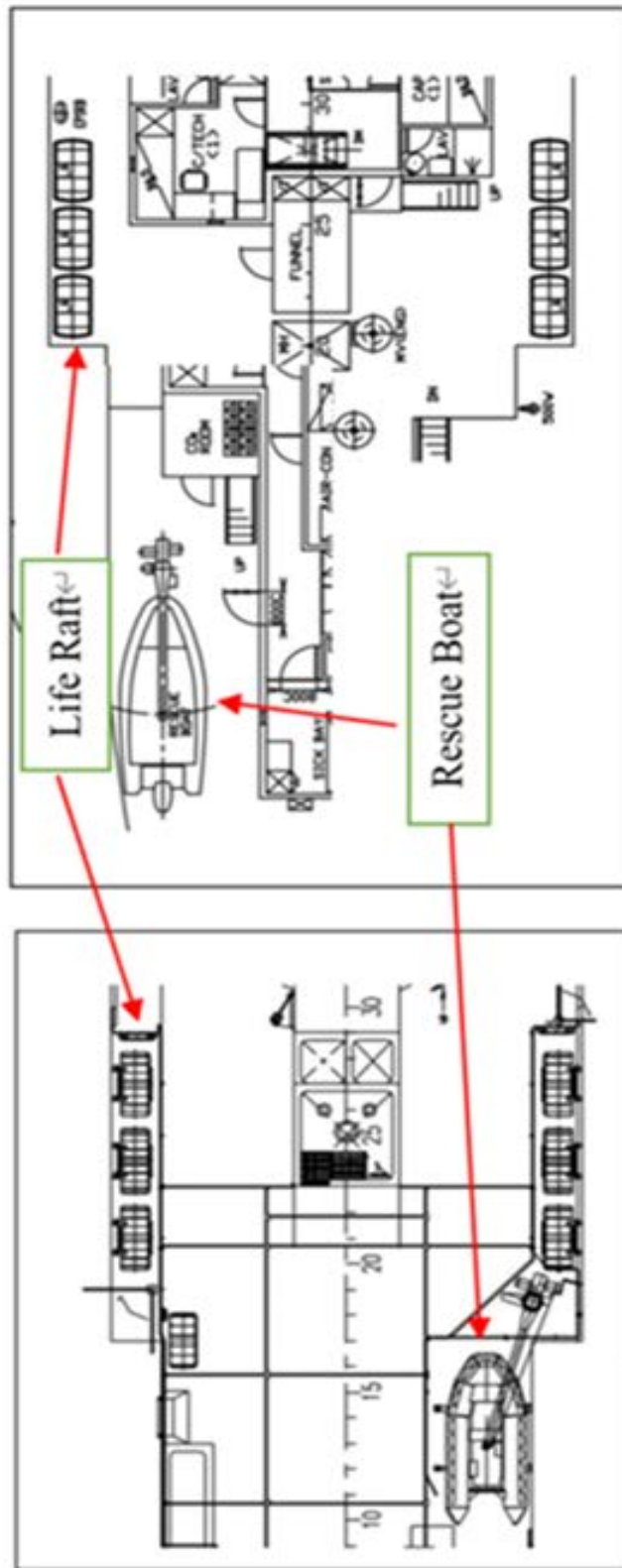

KN Jadayat

KN Bimasakti Utama

Picture 6.8.1 -1 : Inflated Life Raft



Inflated Life Raft

Picture 6.8.1 -2 : Life Boat and Rescue Boat



Rescue Boat



Life Boat

Picture 6.8.1 -3 : Area of Crack and Allowance Graph

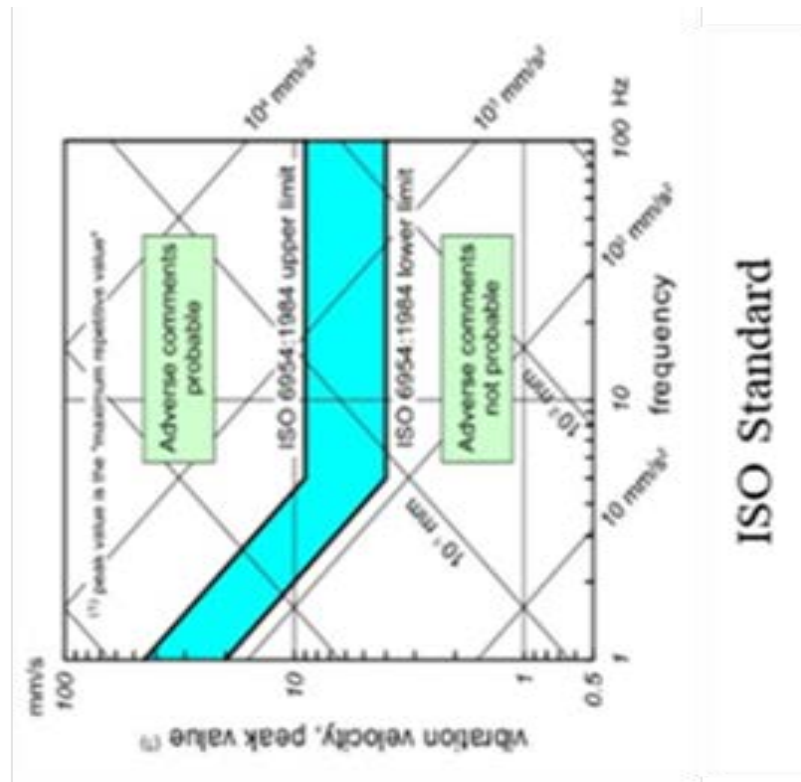

Table 6.8.1 -1 : Power and Number of Cylinder of Buoy Tenders

Name of Buoy Tender	Designed by	Main Engine	No. of Cylinder
KN Jadayat	NIIGATA	1 set x 735kW x 390rpm	In-line 6
KN Bimasakti Utam	DAMEN	1 set x 1,020kW x 900rpm	In-line 6
KN Maratua	Indonesia	2 sets x 970kW x 1,800rpm	V type 12
KN Edam	Indonesia	2 sets x 1,920kW x 750rpm	In-line 6

Picture 6.8.1 -4 : View of Fore-Part



Visibility from Wheel House

Figure 6.8.1 -3 : Buoy Handling Gear

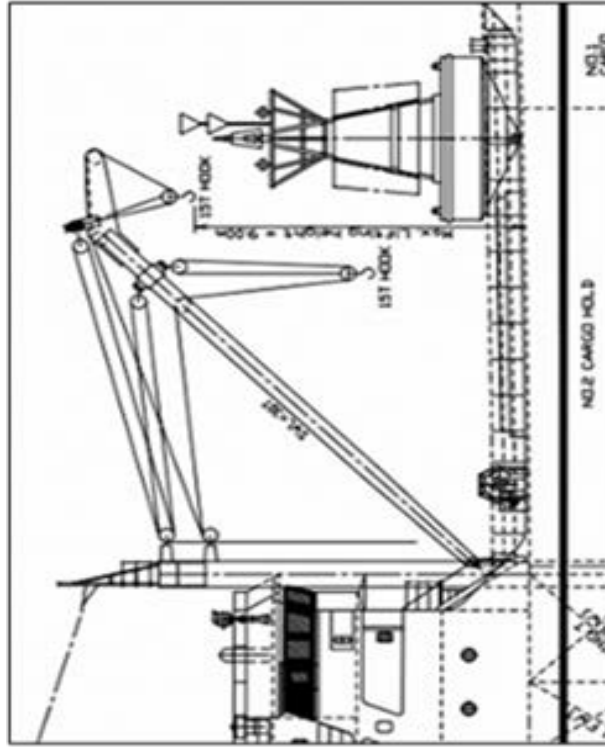

Boom system (KN Jadayat)



Crane system (New Buoy Tender)

Picture 6.8.1 -5 : Shaft Bearing



Picture 6.8.1 -6 : Rudder Shaft and Cylinder



Hydraulic cylinder

Hydraulic Cylinder



Temporary connection by welding

Rudder Shaft

Figure 6.8.1 -5 : Sea Chest

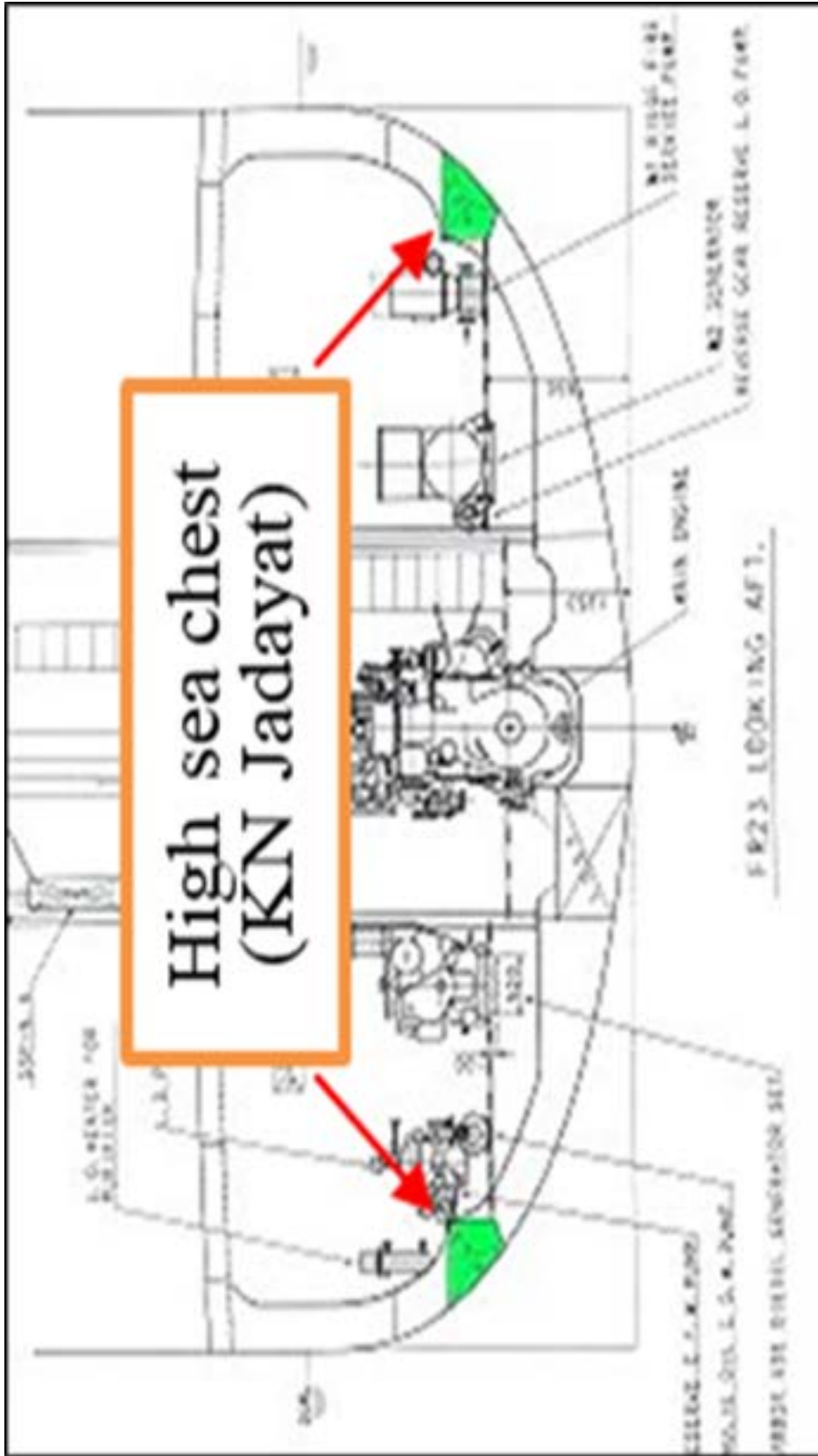

Example of H.S. Chest

Figure 6.8.2 -1 : Production of Palm Oil

Production Volume of Palm Oil by country (in 2014)

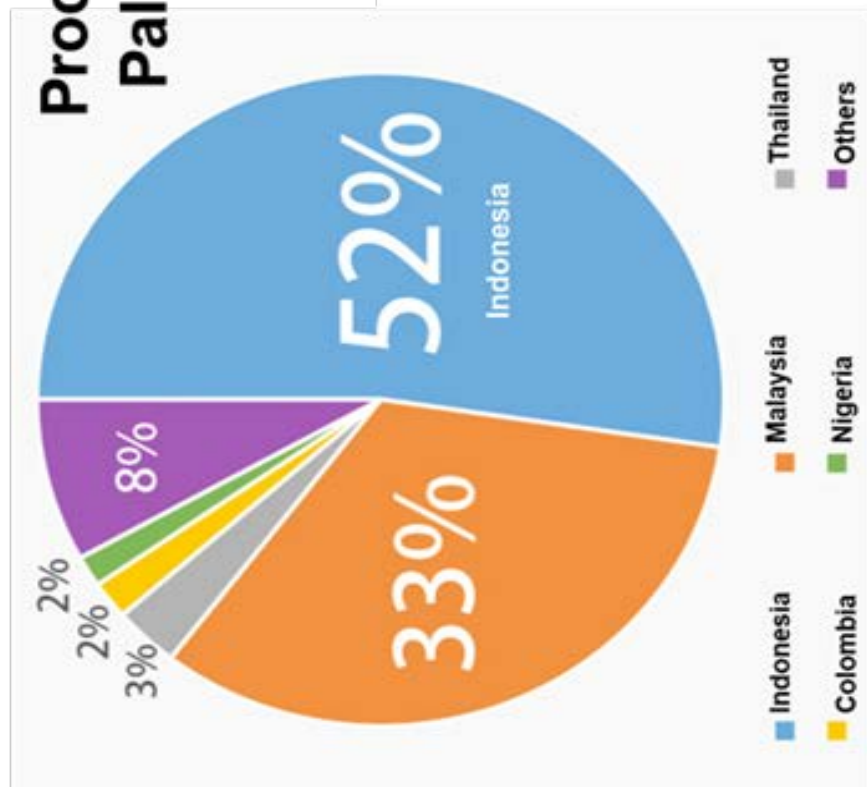

Crop yield comparison

Plant Oil	Average Productivity
	(Ton / ha / year)
Soy	0.38
Sunflower	0.48
Palm oil	3.74

Picture 6.8.2 -1 : FO Filter

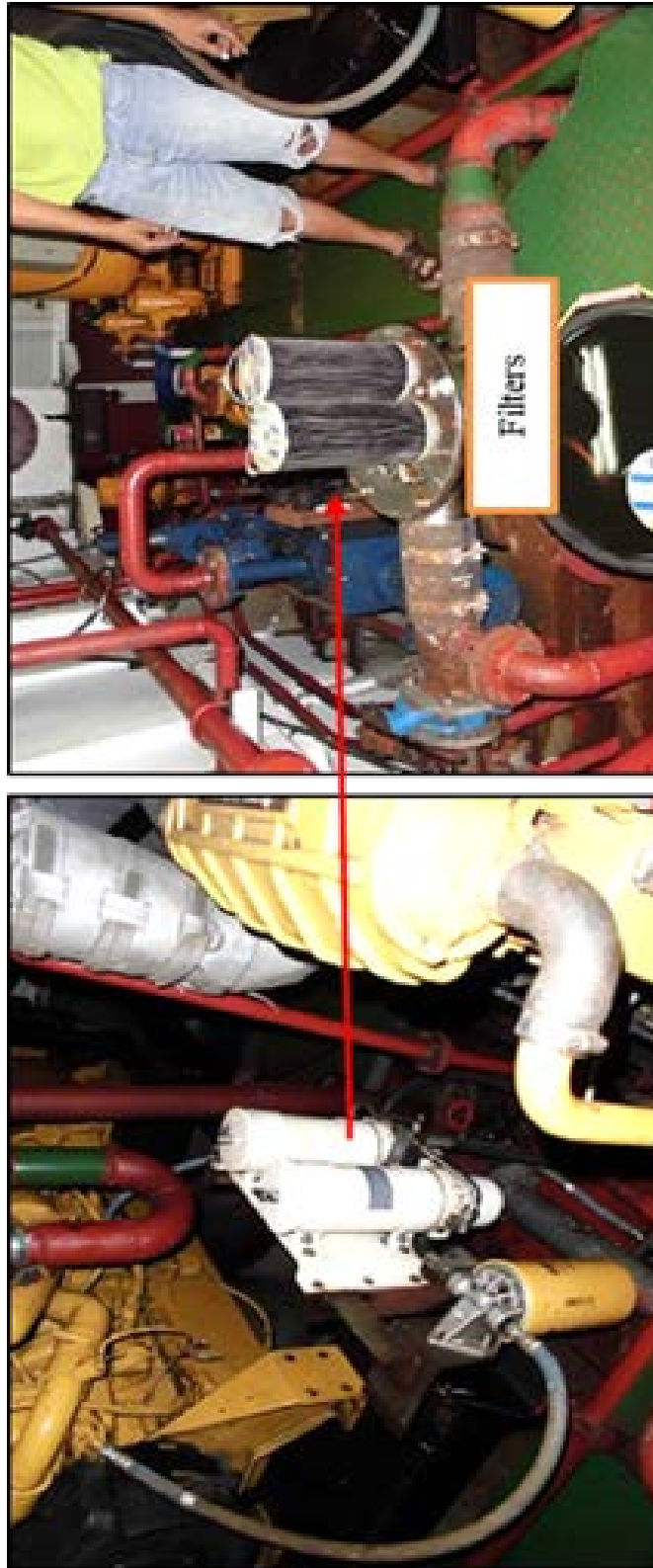

FO Filters of Generator Engine

Table 6.8.3 -1 : Comparison between Original Engine and Replaced Engine

	Original Engine	Replaced Engine
Maker	Niigata	Dresser-Rand's Guascor
Engine Power	850 PS	1,500 PS
Engine Revolution	380 rpm (low speed)	1,800 rpm (high speed)
No. of Cylinders	6 (Inline type)	16 (V type)
Reduction Gear	Not mounted	Mounted

Table 6.8.3 -2 : Engine Type by Speed

Engine Type	Low Speed	Middle Speed	High Speed
Engine Revolution	500 rpm <	500 - 1,500 rpm	< 1,500 rpm
FOC	abt. 190 g/kW·h	abt. 190 g/kW·h	abt. 200 g/kW·h
Reduction Gear	Not required	Required	Required
Life Time	Longer	Middle	Shorter
Weight of Engine	Heavier	Middle	Lighter
Dimension	Bigger	Middle	Smaller

Table 6.8.4 -1 : Comparison between Navigasi Vessels and Japanese Vessel

	Navigasi Vessels	Japanese Vessel	Remarks
Ship Name	KN Mahkota, KN Mina KN Mengkara	Chiyoda	Main engines of Chiyoda were replaced 15 years ago
Kind of Vessel	Aids Tender	Fisheries Patrol Vessel	
Shipbuilder	PT. Doc Surabaya	Mitsubishi Heavy I.	
Delivery year	1997	1988	
Age of Vessel	22	31	
Loa x B x D	43.00 x 9.00 x 3.70	78.10 x 12.40 x 6.30	

Picture 6.8.4 -1 : Comparison by Pictures between Aids Tender and Chiyoda

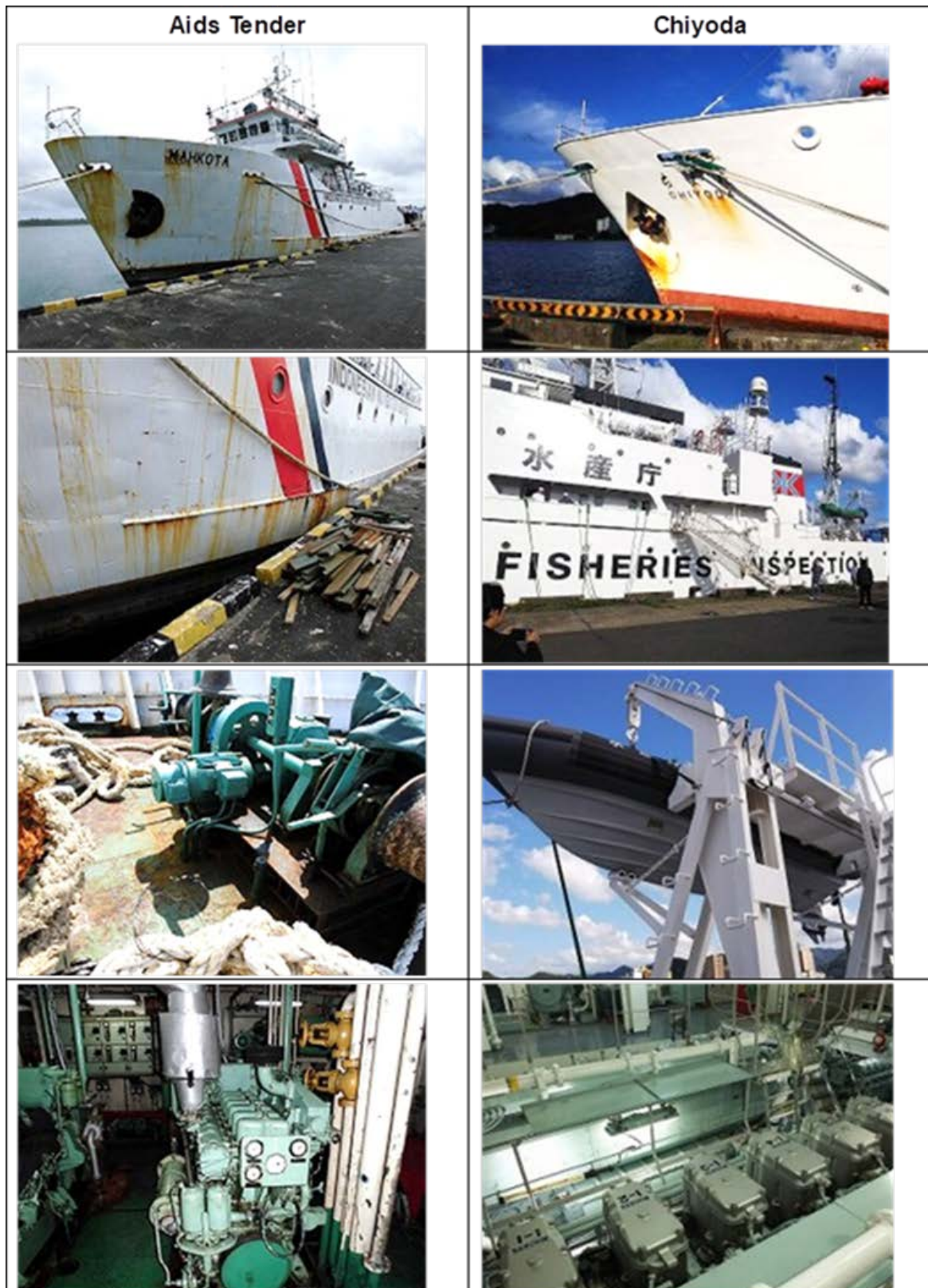

Picture 6.8.4 -2 : Surface of Floor and Step of Aids Tender



Figure 6.8.5 -1 : Type of Crane

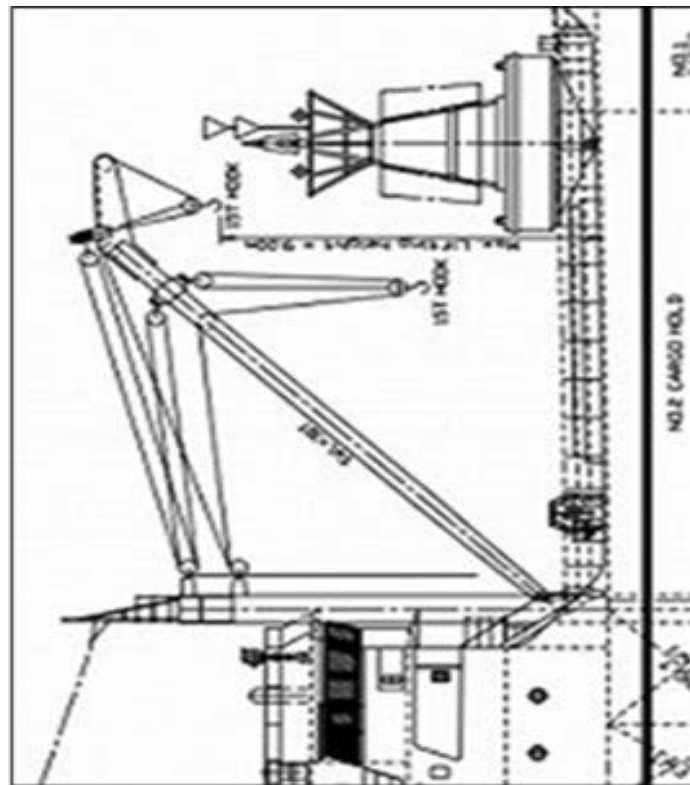

Boom System

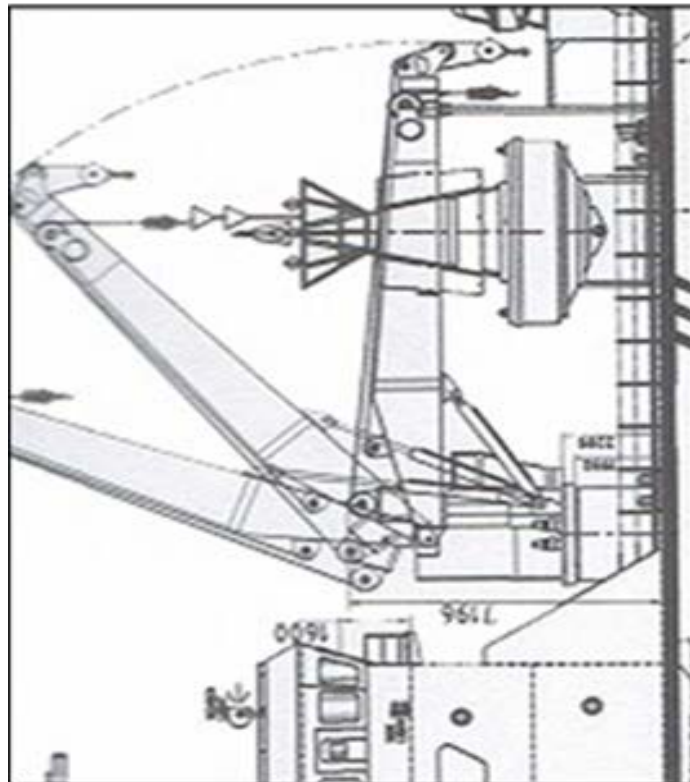

Crane System

Figure 6.8.5 -2 : Central Cooling System

Central Cooling System

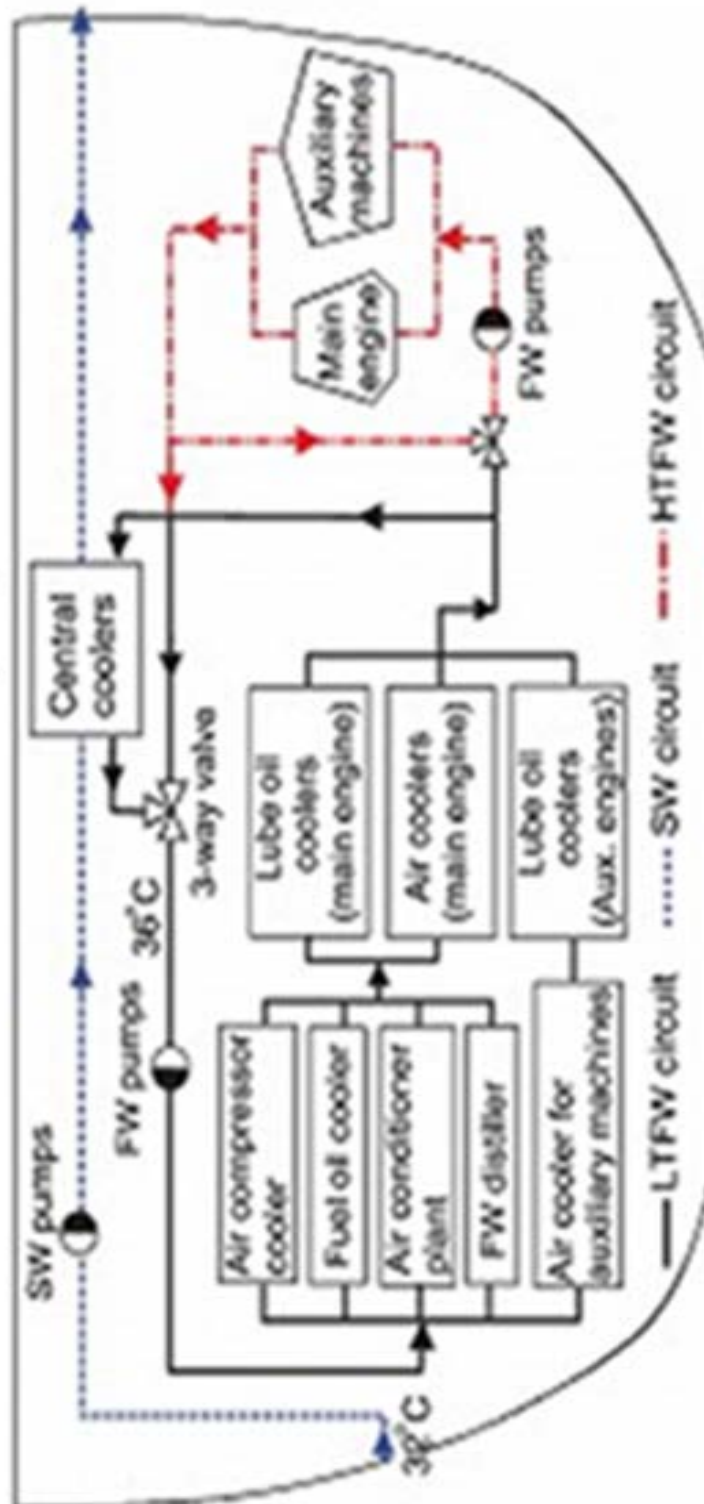

Figure 6.9 -1 : Consolidation of CRS

Consolidation of Coastal Radio Station

Class- I	12	Class- II	6
----------	----	-----------	---



Class- III	54	Class- IV	79
------------	----	-----------	----

Figure 6.9 -1 : Conceptual Diagram of New GMDSS

Existing System of GMDSS

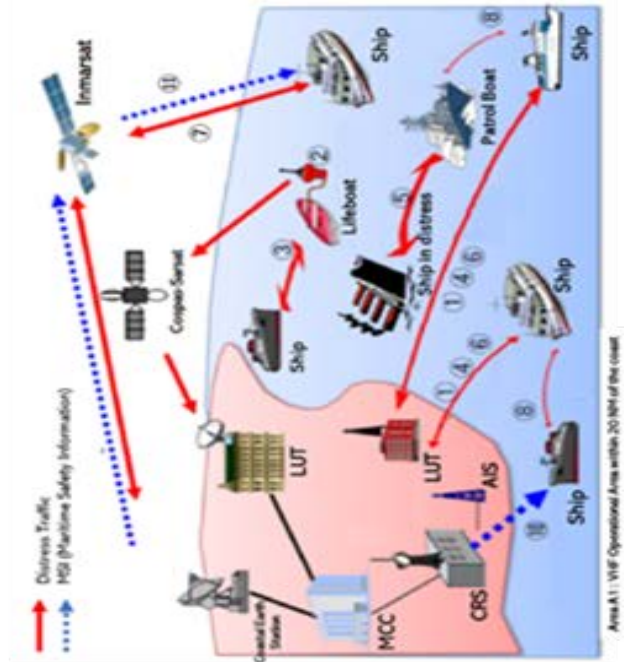

MEOSAR: Cospas-Sarsat
 Medium-altitude Earth Orbit Search and Rescue System
 LUT : Local User Terminal
 RCC : Rescue Coordination Center
 MCC : Mission Coordination Center

Modernizing System of GMDSS

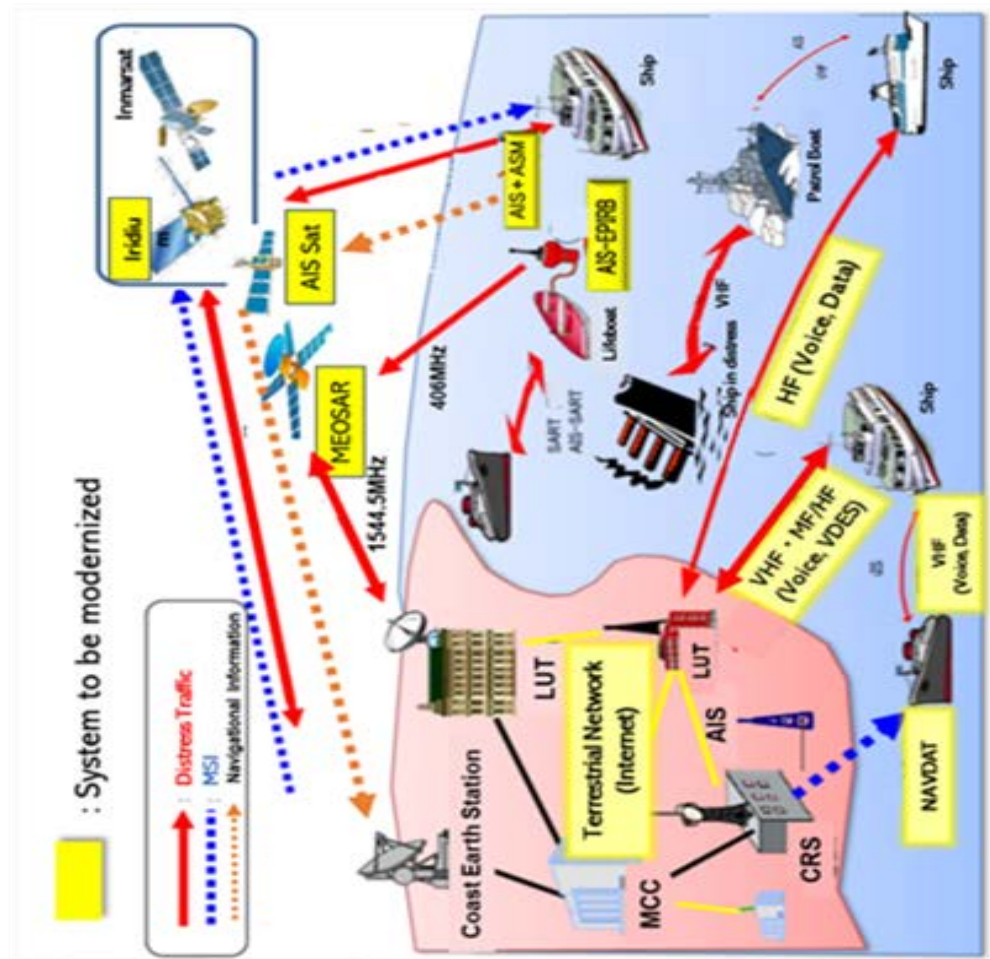

Table 6.10.1 -1 : Syllabus of VTS Basic Training Course

SYLLABUS CURRICULUM OF VESSEL TRAFFIC SYSTEM (BASIC) TRAINING (SEA TRANSPORTATION FUNCTIONAL TECHNICAL TRAINING)

Program : VESSEL TRAFFIC SYSTEM TECHNICAL TRAINING (BASIC)
 Program Objective : Participants have the ability and skill of Vessel Traffic Service equipment
 Curricular Objective : Participants are expected to know and understand Vessel Traffic Service equipment
 Study Period : 28 days
 Study Load : 155 lesson hours
 Legal Basis : 1. Law No.17 of 2008, concerning Shipping
 2. Government Regulation No. 5 of 2010 concerning Navigation
 3. Minister of Transportation Regulation No. PM 26 of 2011 concerning Shipping Telecommunications
 4. International of Association of Lighthouse Authorities (IALA)

(155 lesson hours / 28 days)

GROUP	SUBJECT MATTER	SUBJECT	LESSON HOUR		
			T	P	TOTAL
Personality Development Course (Personality)	1. Discretion Discourse Sub Sector of Sea Transportation	a. Discretion of DGST	5	-	5
		b. Discretion of Human Resources Development Agency and Center of Sea Transportation	10	-	10
		c. Discretion of Head of Sea Transportation Education and Training Center (BPPTL)	5	-	5
	2. Character Building	a. Personality of Civil Service Employee b. Cooperation c. Employee Discipline d. Employee Development	10	-	10
3. Basic Military Regulation	a. Line-up regulation b. Military Ceremonies c. Military Respect Regulations d. Attitude and Discipline	-	10	10	
4. English	a. Grammar b. Making VTS news c. Standard sentence for ship communication d. Information Collection	10	-	10	
SUB TOTAL I			40	10	50
Science and Skill Course (Know how and why)	1. Traffic Management	a. Requirements according to regulations b. Duties and responsibilities c. VTS environment d. The principle of flow and management of traffic e. Traffic arrangements and organization	10	-	10
	2. Equipment	a. Telecommunication b. Vessel Traffic Management (Management of ship traffic) c. Radar, Audio, Video and other sensors d. VHF / Direction Finding (VHF / DF) e. Tracking System (automatic searching system) f. Technology/Development	10	-	10
	3. Nautical Knowledge	a. Chart Work b. COLREG c. Aid to Navigation d. Shipboard knowledge e. Port Operation and Other Allied Services	5	5	10
	4. Communication Coordination	a. General communication skill b. Communication procedure c. Log and Record Keeping	10	-	10
	5. VHF Radio Operator Communication Practice and Procedure	a. Radio operator activities and procedures b. VHF radio system and its use in VTS c. Operation of radio equipment d. Communication procedures include SAR	-	10	10
	6. Personal Skill	a. Diplomacy b. Interaction c. Emergency management d. Management attributes e. Reliability	5	-	5
7. Emergency Situation	a. International, National, Regional, and Local regulations b. Internal and external emergencies c. Responses to contingencies d. Enforcement of priorities and responses to the circumstances e. Coordination, and support for shared services (with other institutions) f. Recording activities in an emergency situation g. Maintain the security of the flow in an emergency situation	10	-	10	
SUB TOTAL II			70	35	105
Social Living Course (Able to live together)	1. Field Work Practice	a. Field survey b. Data / information collection c. Question and Answer / Discussion	Paket	-	Paket
	2. Evaluation	a. Manuscript making b. Participant exams c. Supervision of examinations d. Test correction e. Assessment	Paket	-	Paket
SUB TOTAL III			-	-	-
TOTAL AMOUNT			110	45	155

Remarks:

Practice can be interpreted as a demonstration in the laboratory / simulator, counting exercises, or field explanations during field study to the port / b the ship

T: Theory
P: Practical

Bab 7

Development Plan

for Maritime Traffic Safety System

Figure 7.1 -3 Undeveloped Port/Harbor

Maritime Traffic Safety Measures
- establishing Process

Undeveloped Port/Harbor

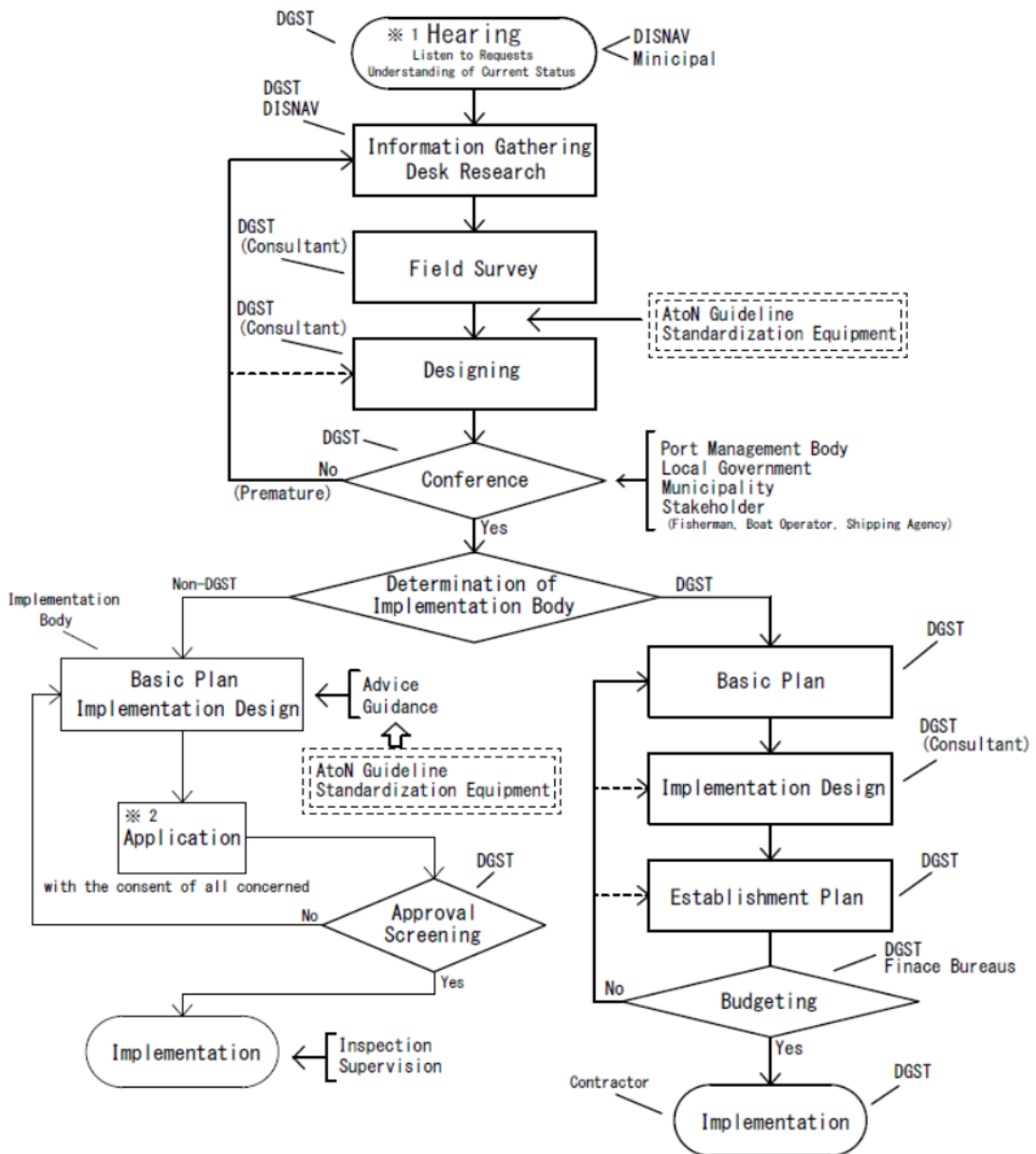

※ 1 Hearing will be held as needed (as necessity requires).

※ 2 The application is made under the appropriate laws or regulations.

Figure 7.1 -4 Existing Port/Harbor

Maritime Traffic Safety Measures
- establishing Process

Existing Port/Harbor

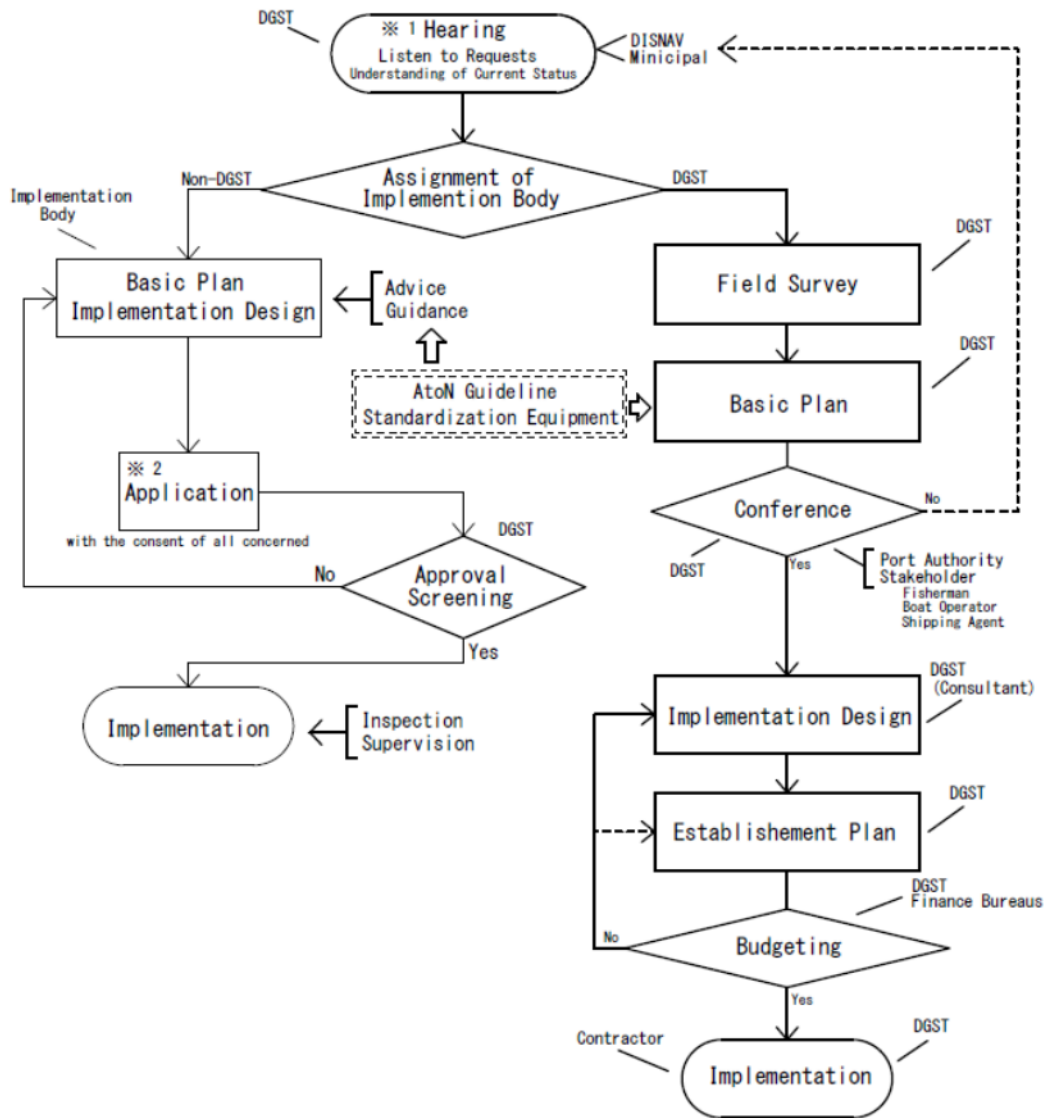

※ 1 Hearing will be held once a year at DISNAV.

※ 2 The application is made under the appropriate laws or regulations.

Figure 7.1 -5 New Port/Harbor

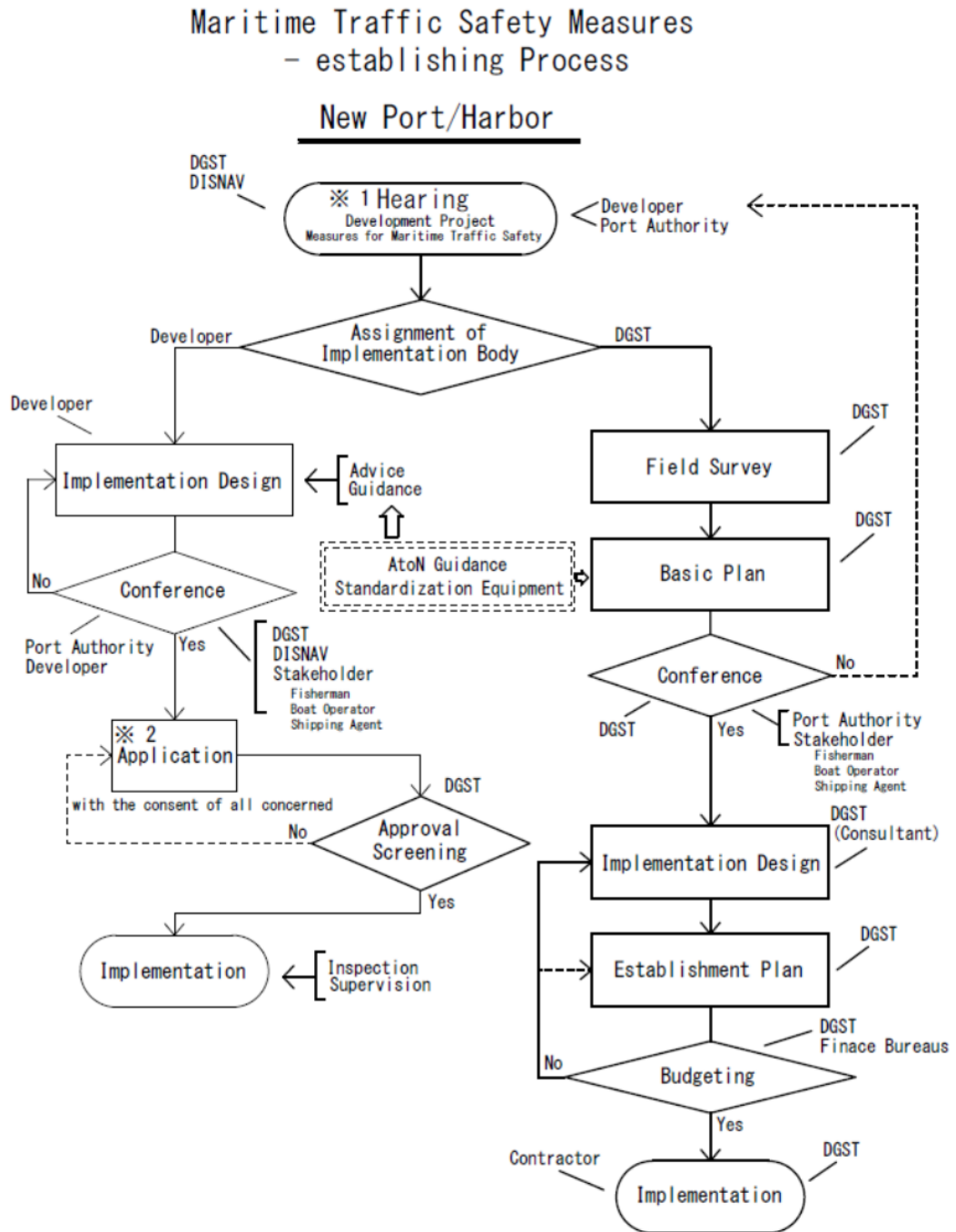

※ 1 Hearing will be held when development plans for the most part have been made.

※ 2 The application is made under the appropriate laws or regulations.

Figure 7.1 -6 Ships' Routing Port/Harbor

Ships' Routing Measures
- establishing Process

- including
- Traffic Separation Schemes (TSS)
 - Two-way Routes
 - Recommended Tracks (Routes)
 - Deep Water Routes
 - Precautionary Areas
 - Area to be avoided
 - Sea Lanes (in a broad sense)

These are established in most of the heavily congested shipping areas.

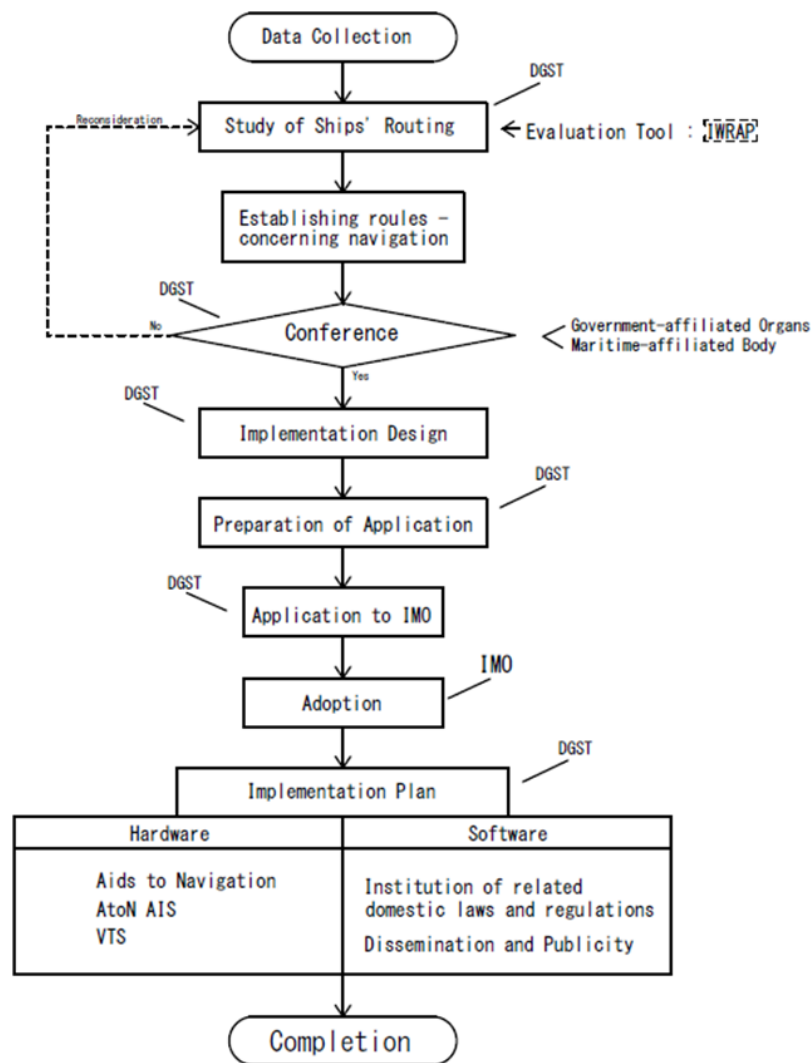

Figure 7.2.2 -1 Location of Sea-lane 2

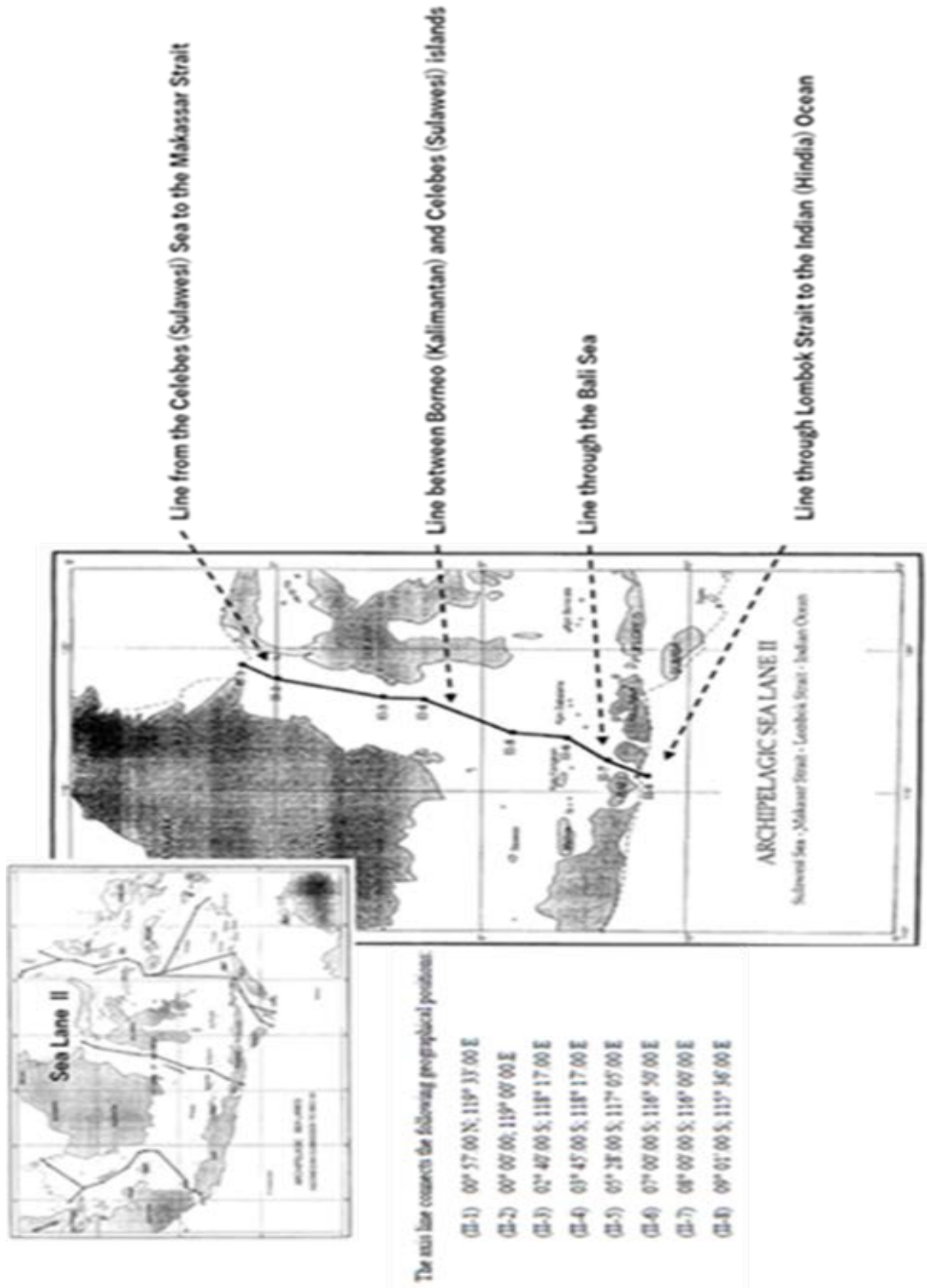
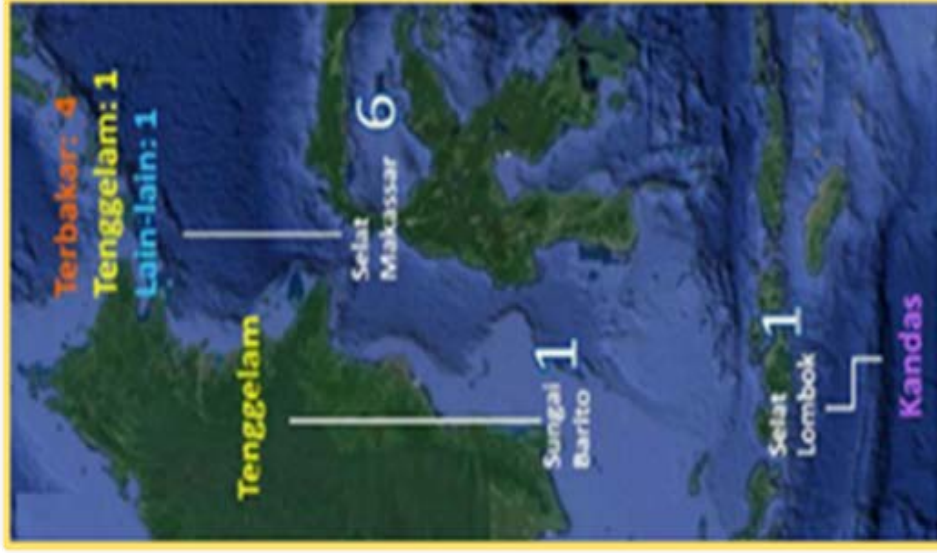

Figure 7.2.2 -2 Location of Marine Accident

Marine Accident in 2017



Marine Accident in 2012-2016



Data Kecelakaan Transportasi Pelayaran Yang Diinvestigasi KNKT

Tahun 2012 - 2017

Figure 7.2.2 -3 : Location of Lighthouse and AIS Coverage

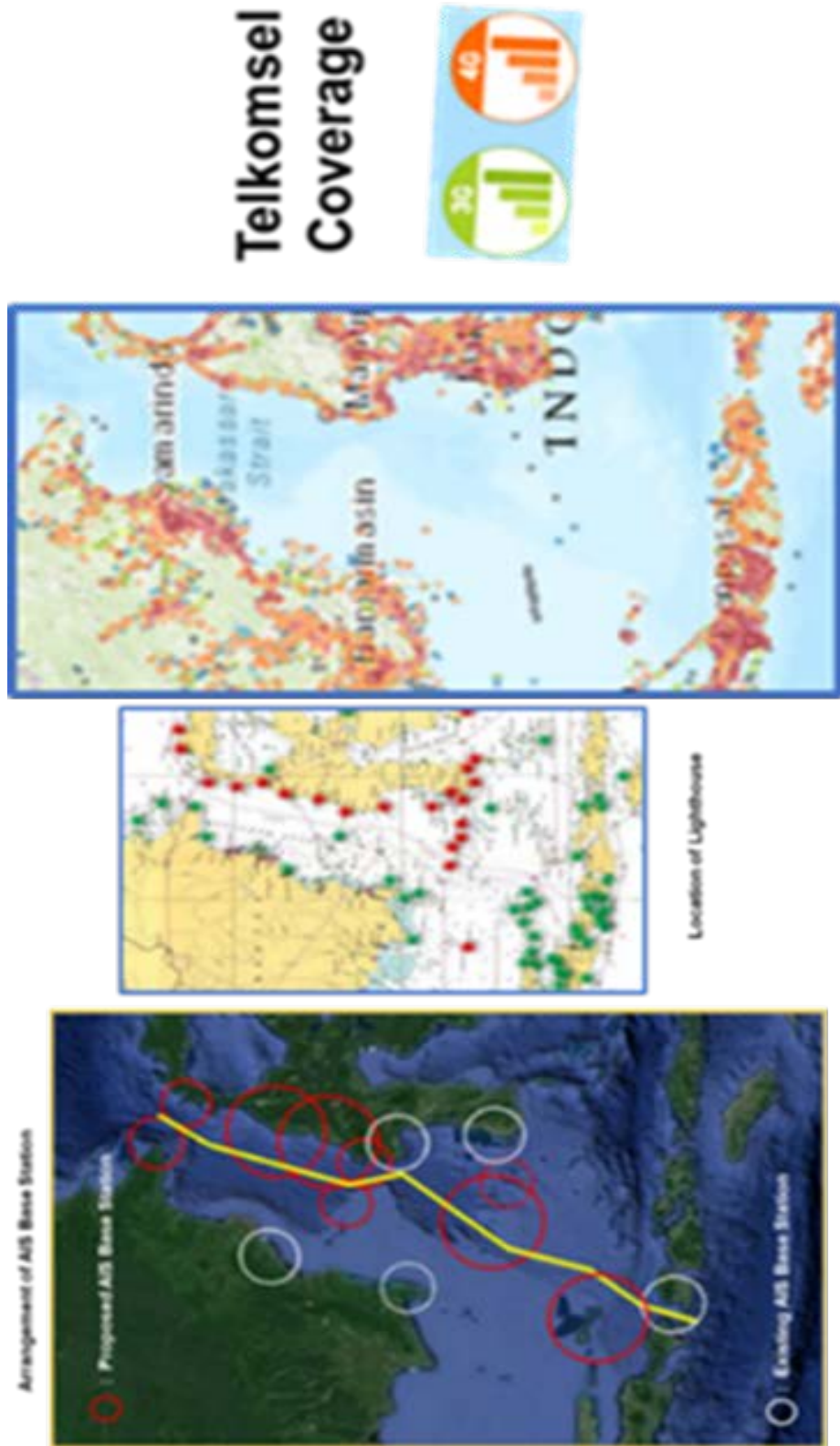

Figure 7.2.2 -4 : Location of VTS

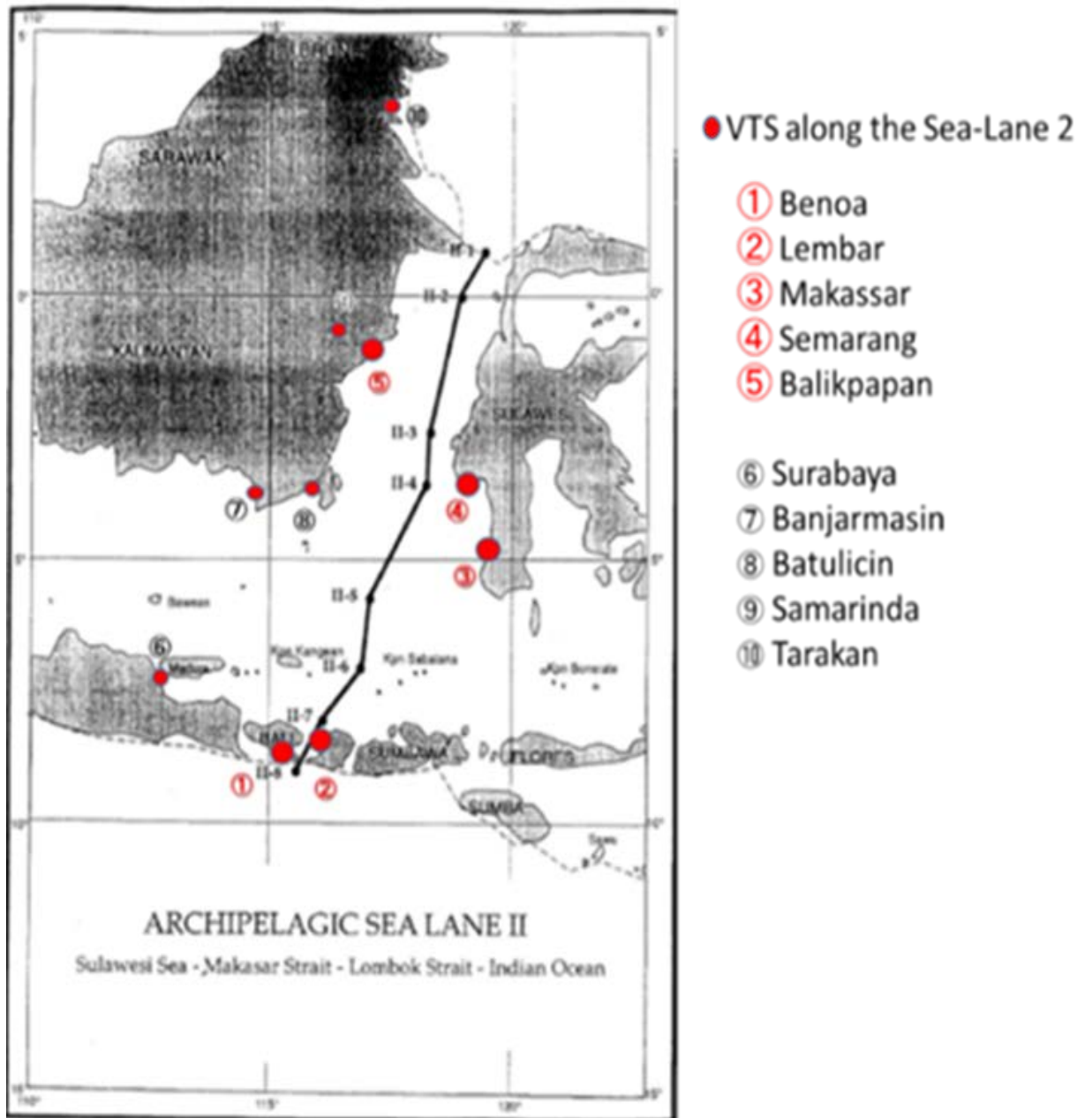

Figure 7.2.2 -5 : System Configuration of AIS

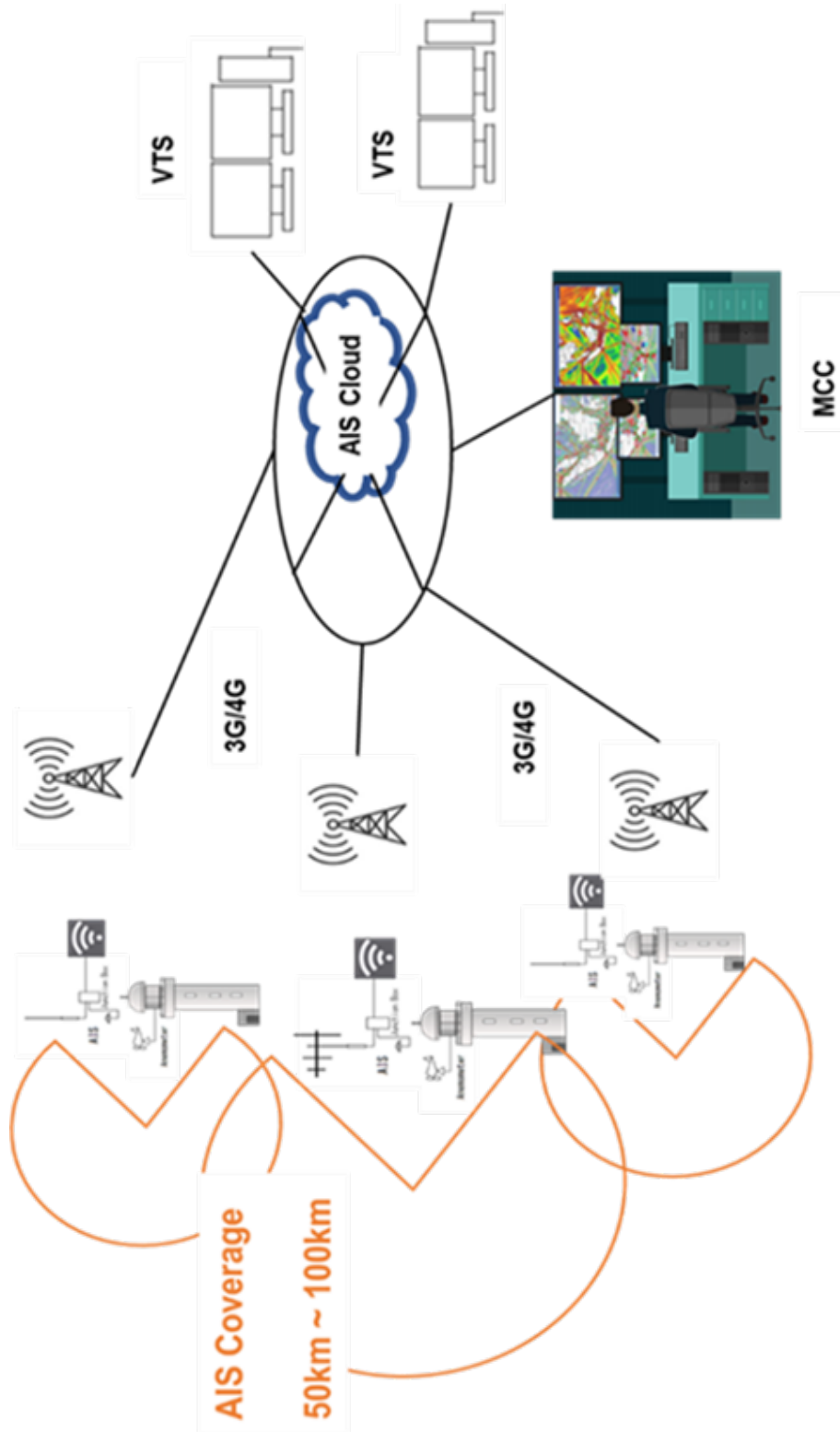

Figure 7.2.3 -1 : Configuration of the System

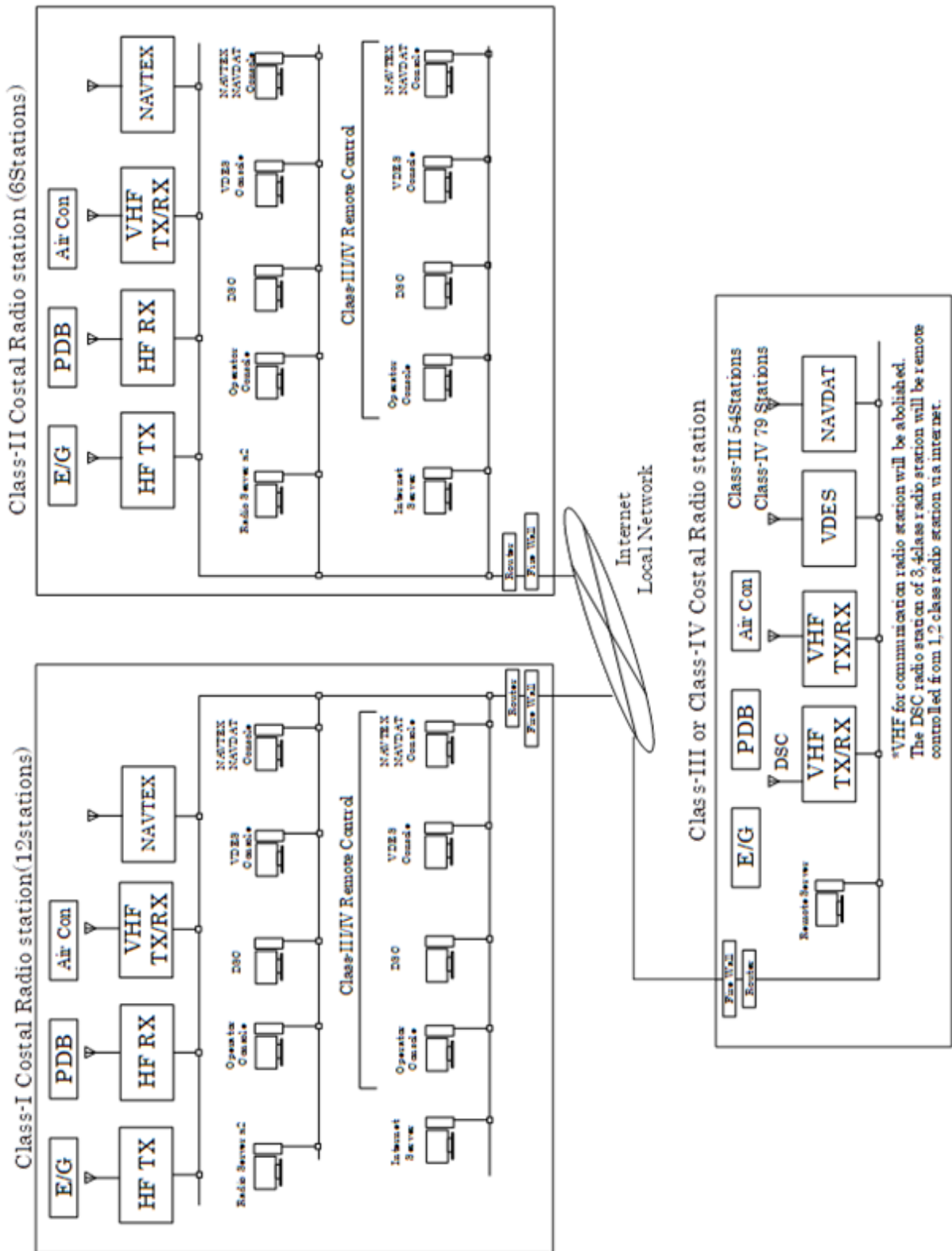
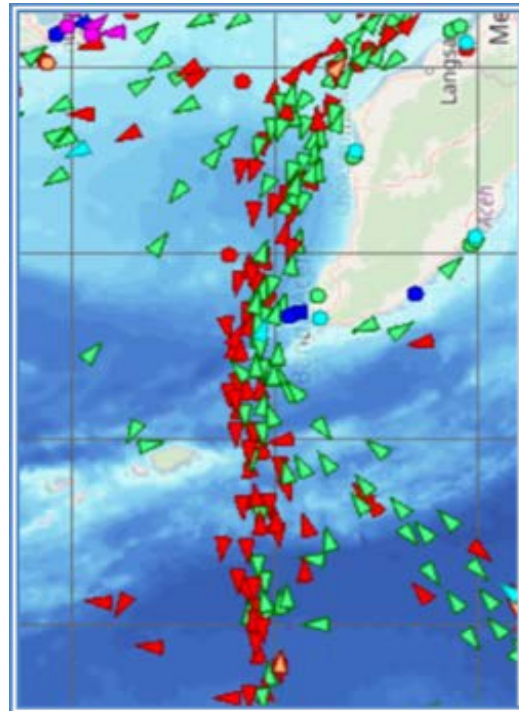
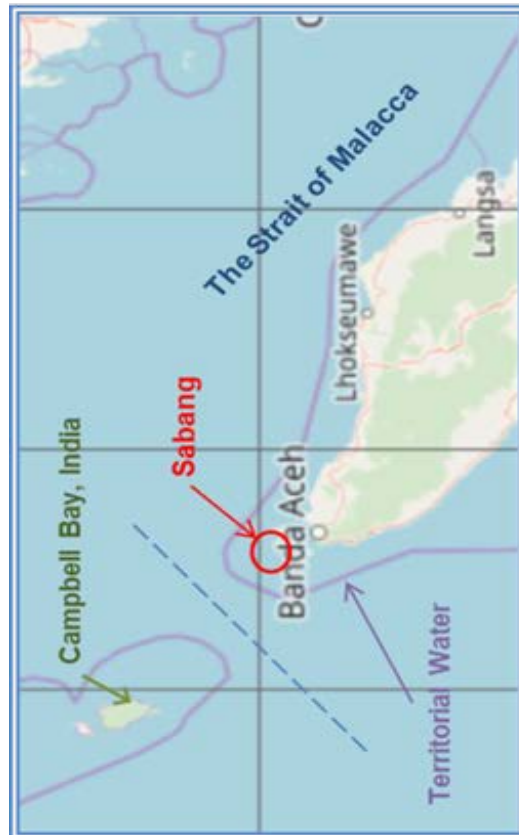

Figure 7.2.4 -1 : Location and Traffic Flow of Offshore Sabang



Traffic Flow



Location of Sabang

Figure 7.2.4 -2 : Gateways of the Straits of Malacca and Singapore

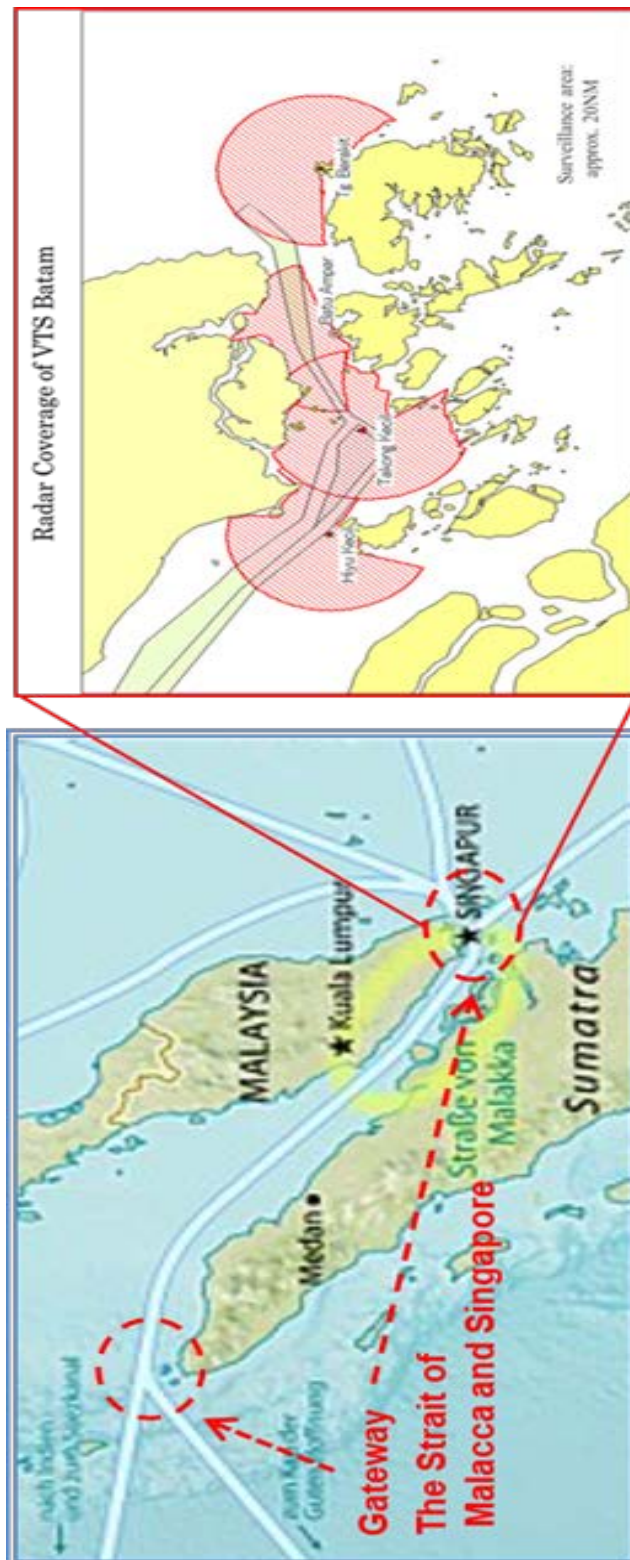

Figure 7.2.4 -3 : Fundamental Configuration of VTS

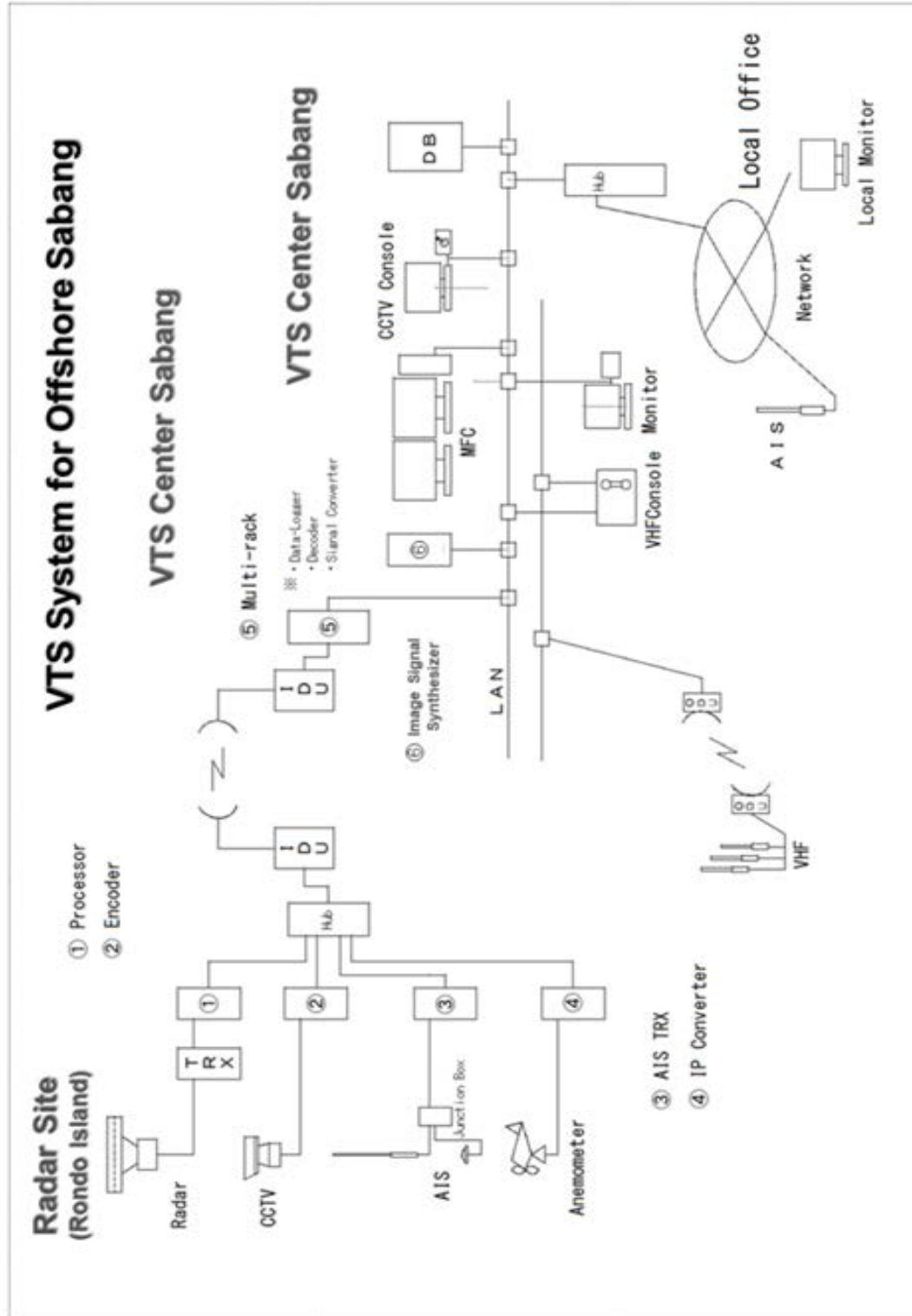

Figure 7.2.4 -4 : Territorial Water and Contiguous Zone

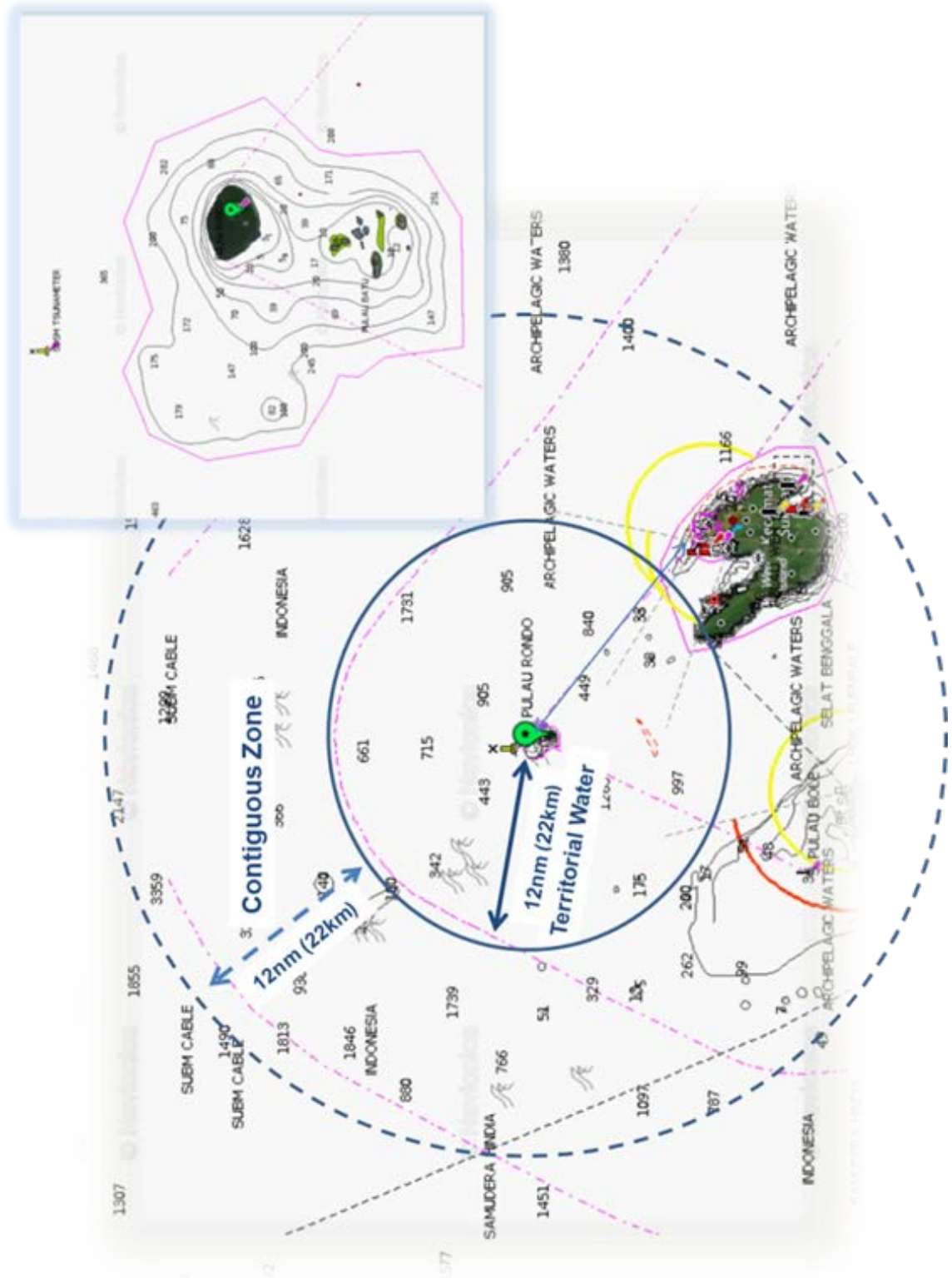

Figure 7.2.4 -5 : Coverage of Radar and AIS

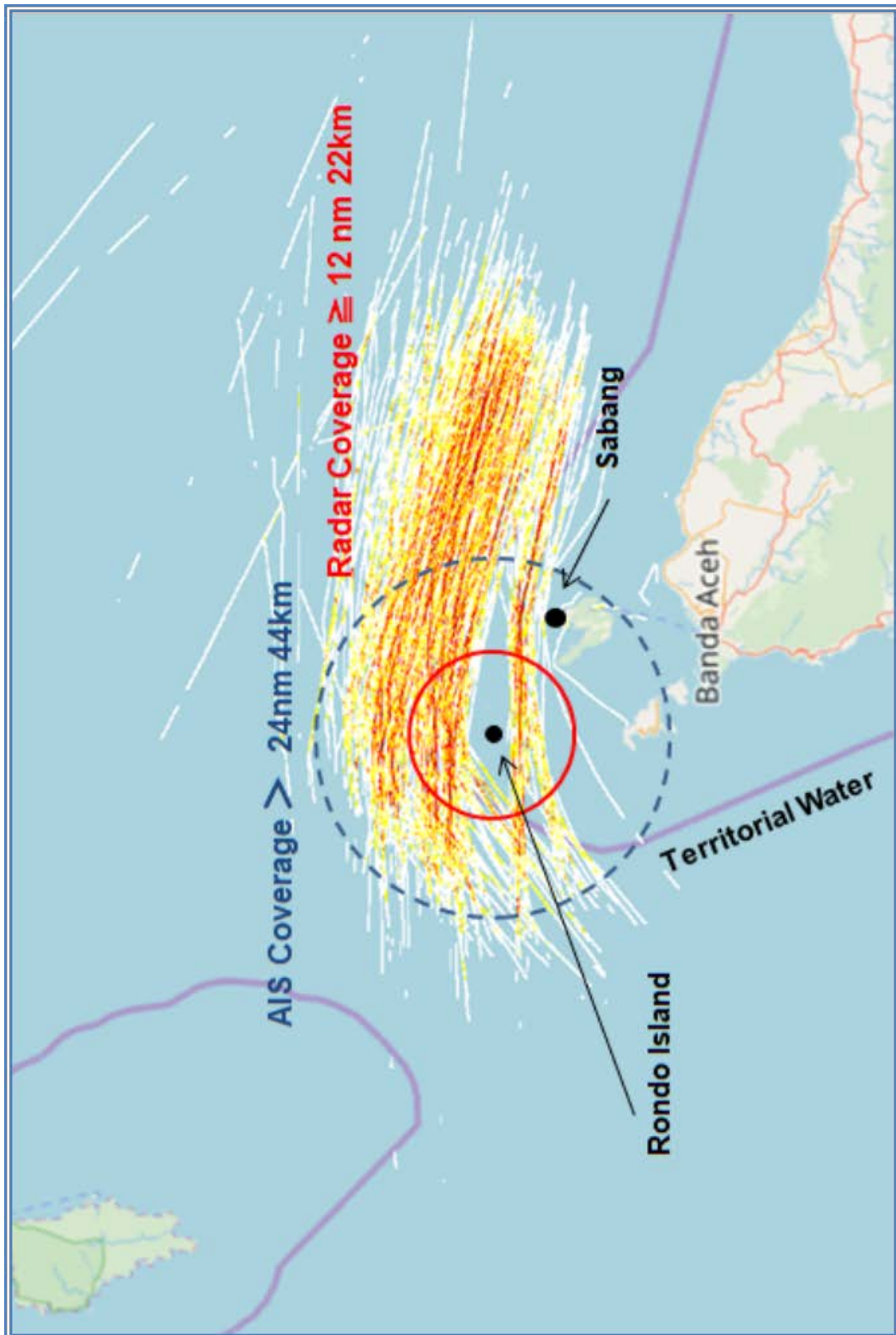

Figure 7.2.4 -6 : Mahakam River and Bridge

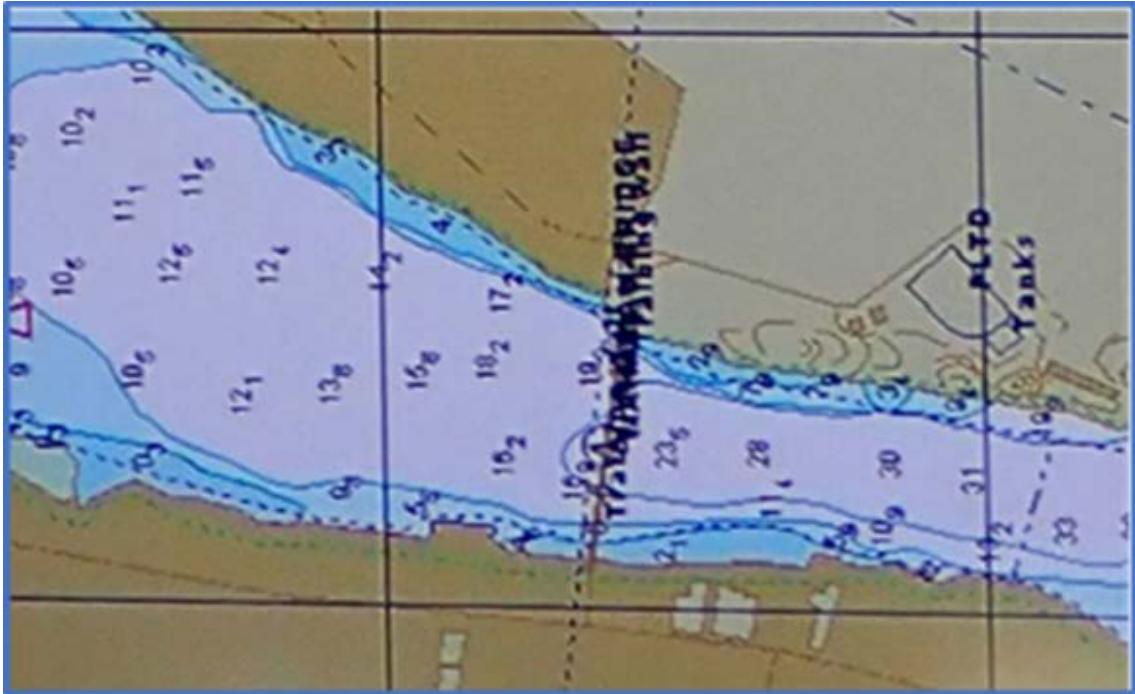

Figure 7.2.4 -7 : Location of AIS Station and Movement of Vessel

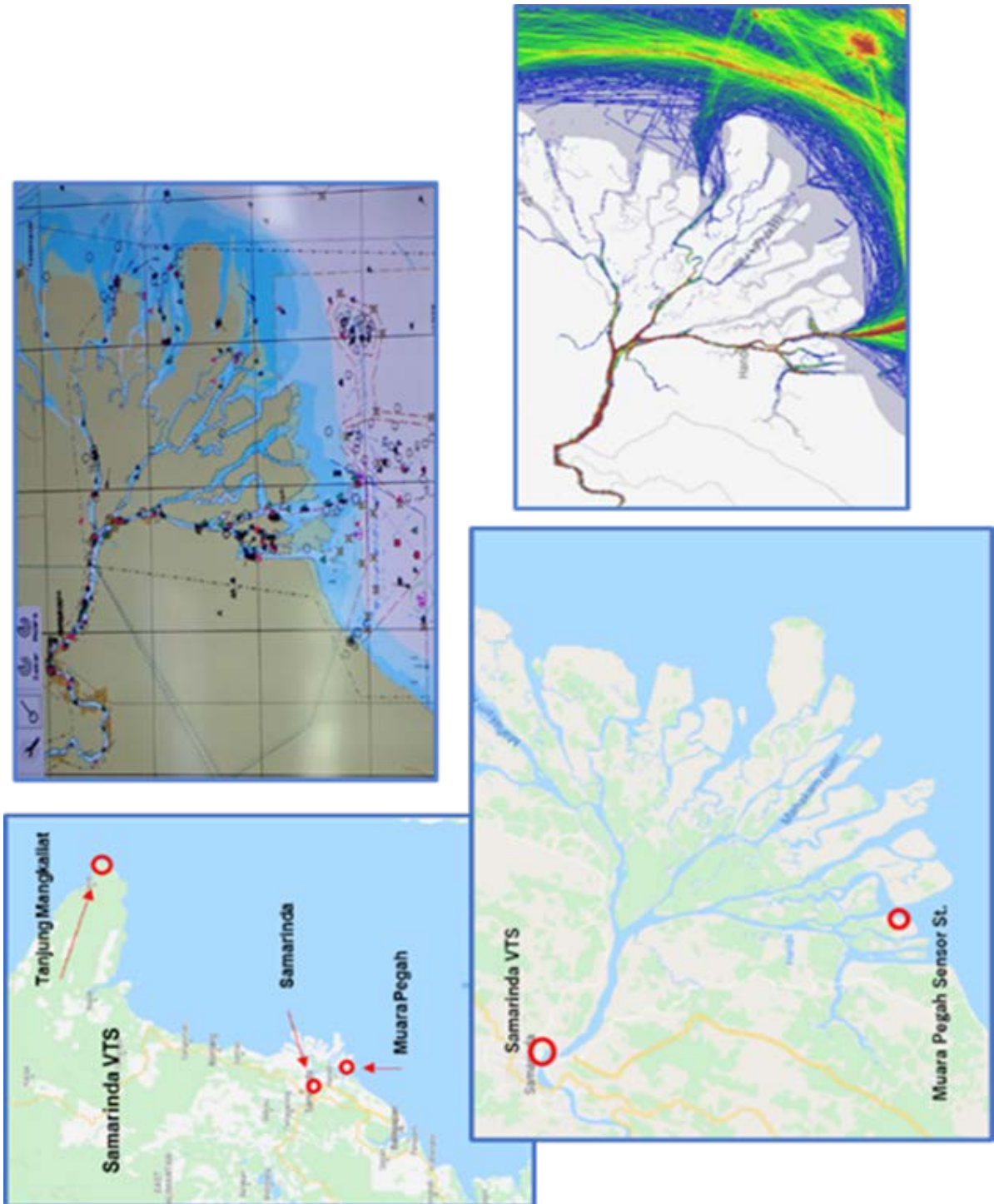

Figure 7.2.4 -8 : Layout of New AIS Station and Signal Station

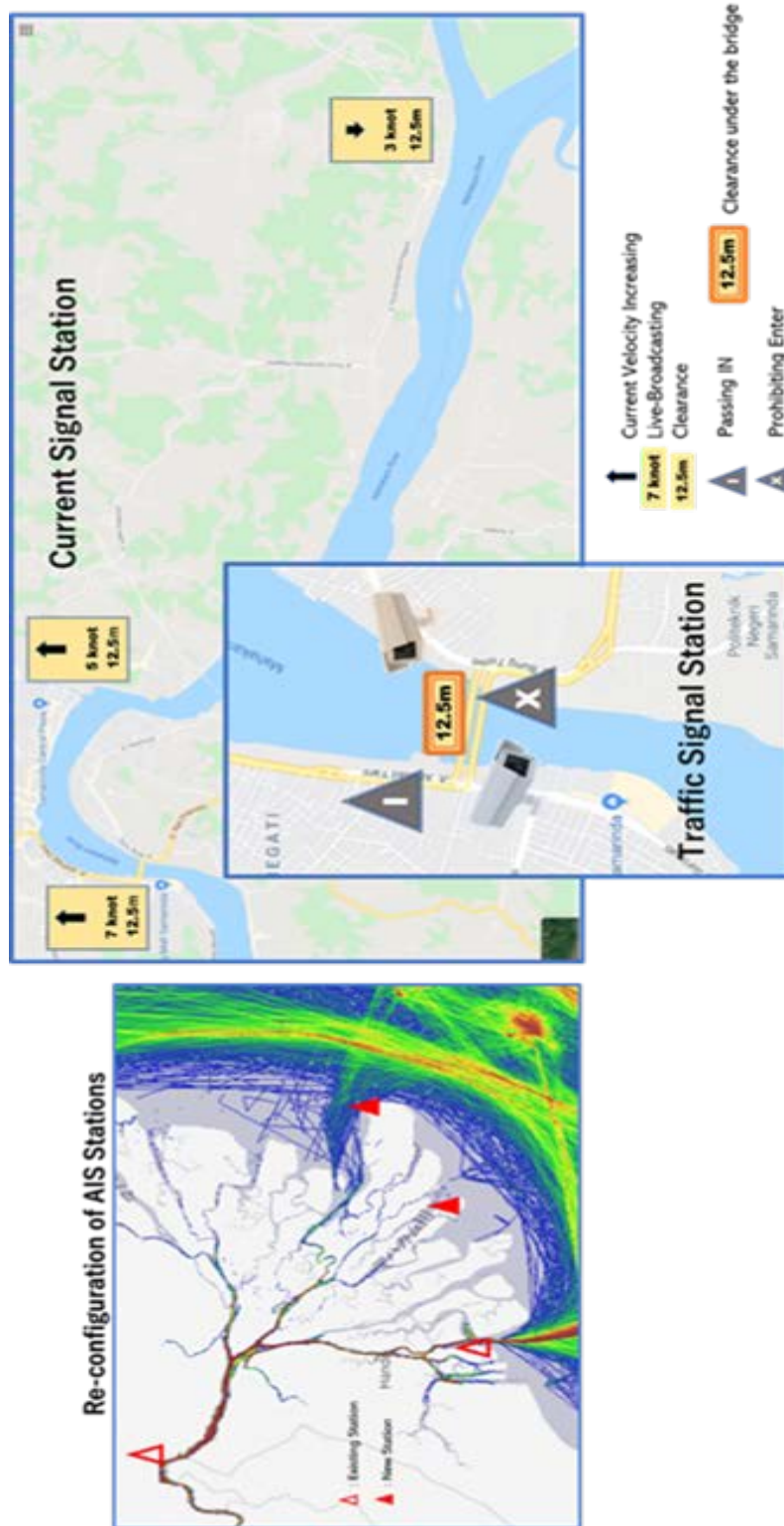

Figure 7.2.4 -9 : System Configuration of New Information System

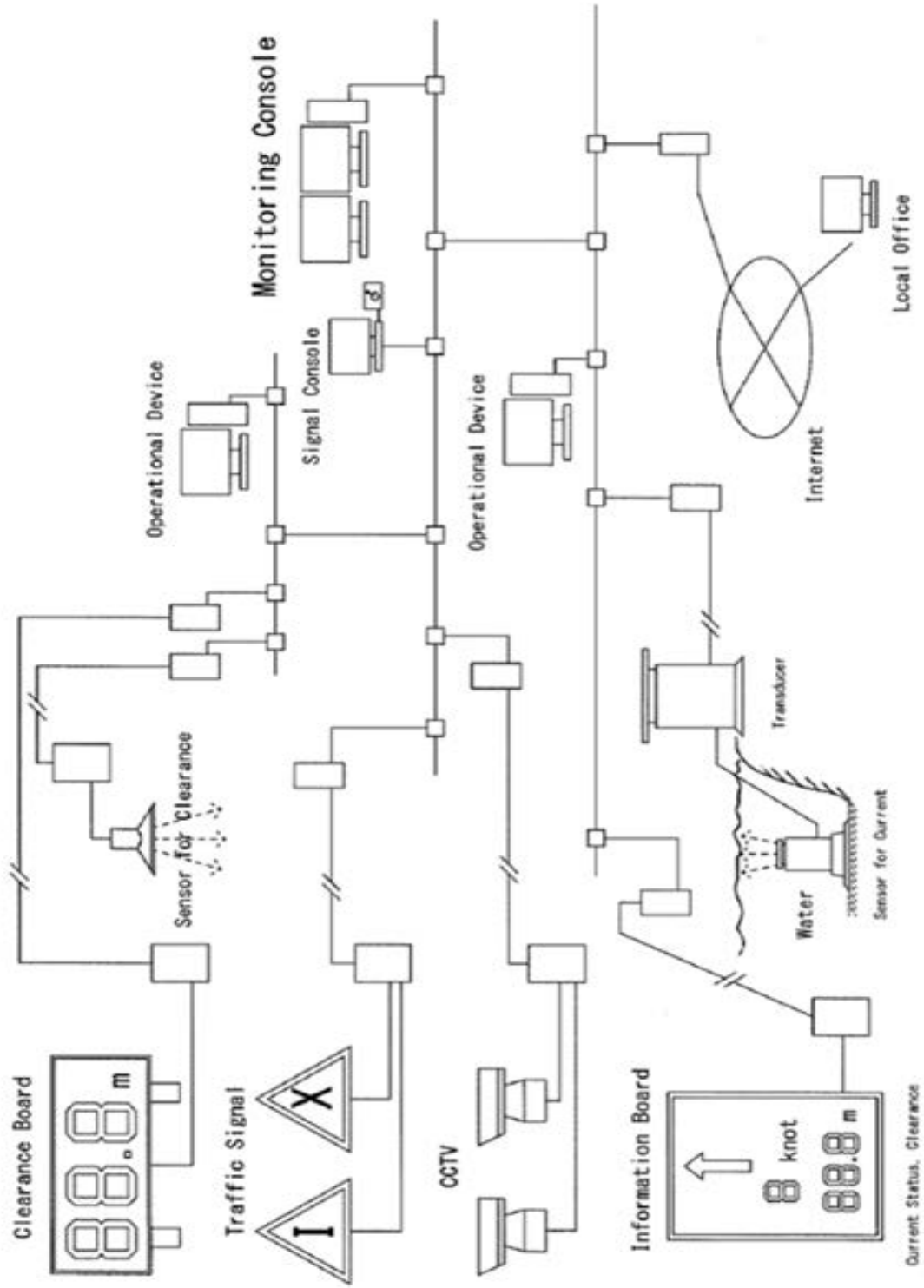
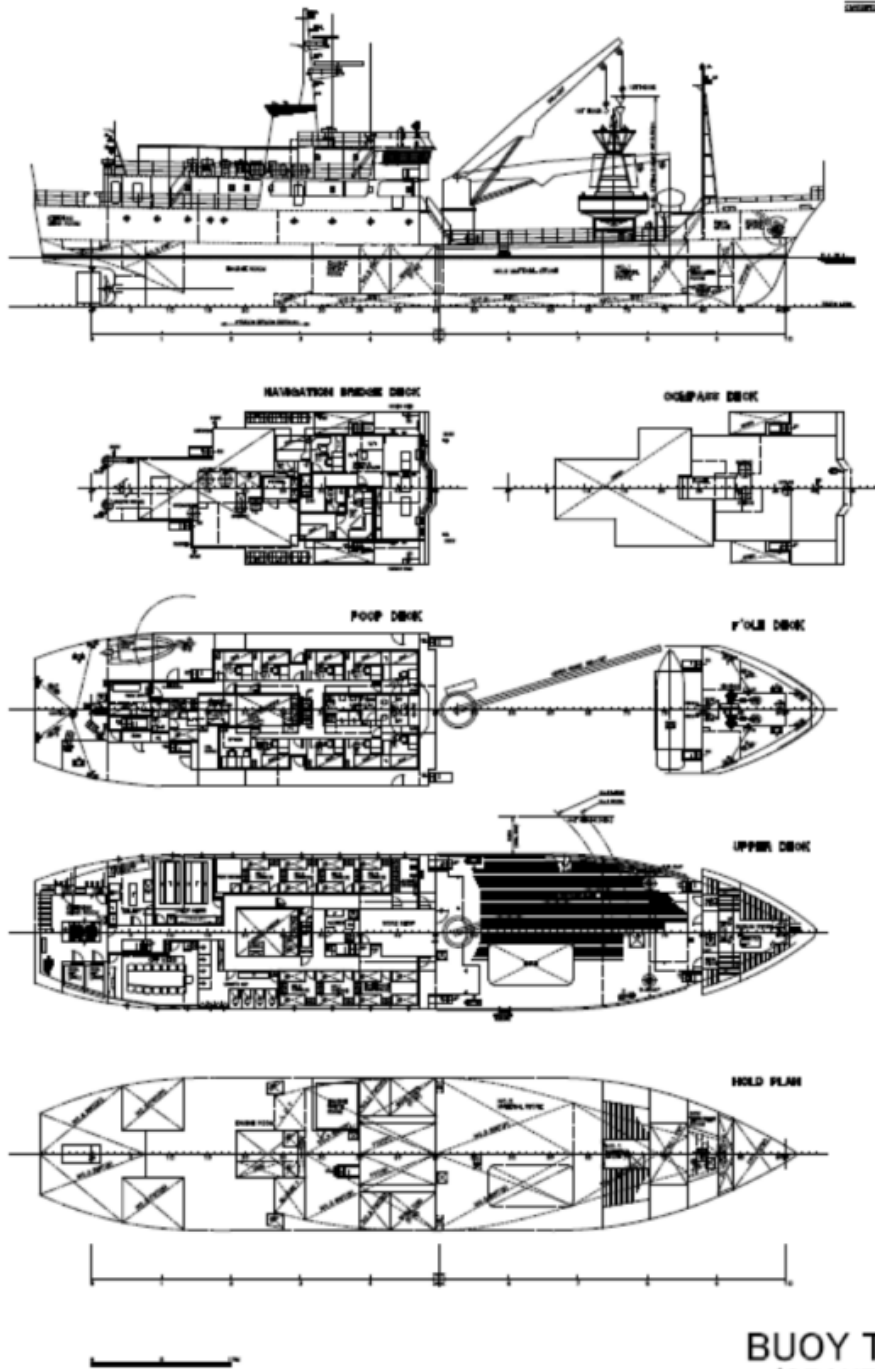

Figure 7.2.5 -1 : Design Drawing of Hull Line (1/2)

GENERAL ARRANGEMENT

REVISIONS	
NO.	DESCRIPTION
1	ISSUED FOR APPROVAL
2	ISSUED FOR APPROVAL
3	ISSUED FOR APPROVAL
4	ISSUED FOR APPROVAL
5	ISSUED FOR APPROVAL
6	ISSUED FOR APPROVAL
7	ISSUED FOR APPROVAL
8	ISSUED FOR APPROVAL
9	ISSUED FOR APPROVAL
10	ISSUED FOR APPROVAL



BUOY TENDER
(CRANE TYPE)

Figure 7.2.5 -1 : Design Drawing of Hull Line (2/2)

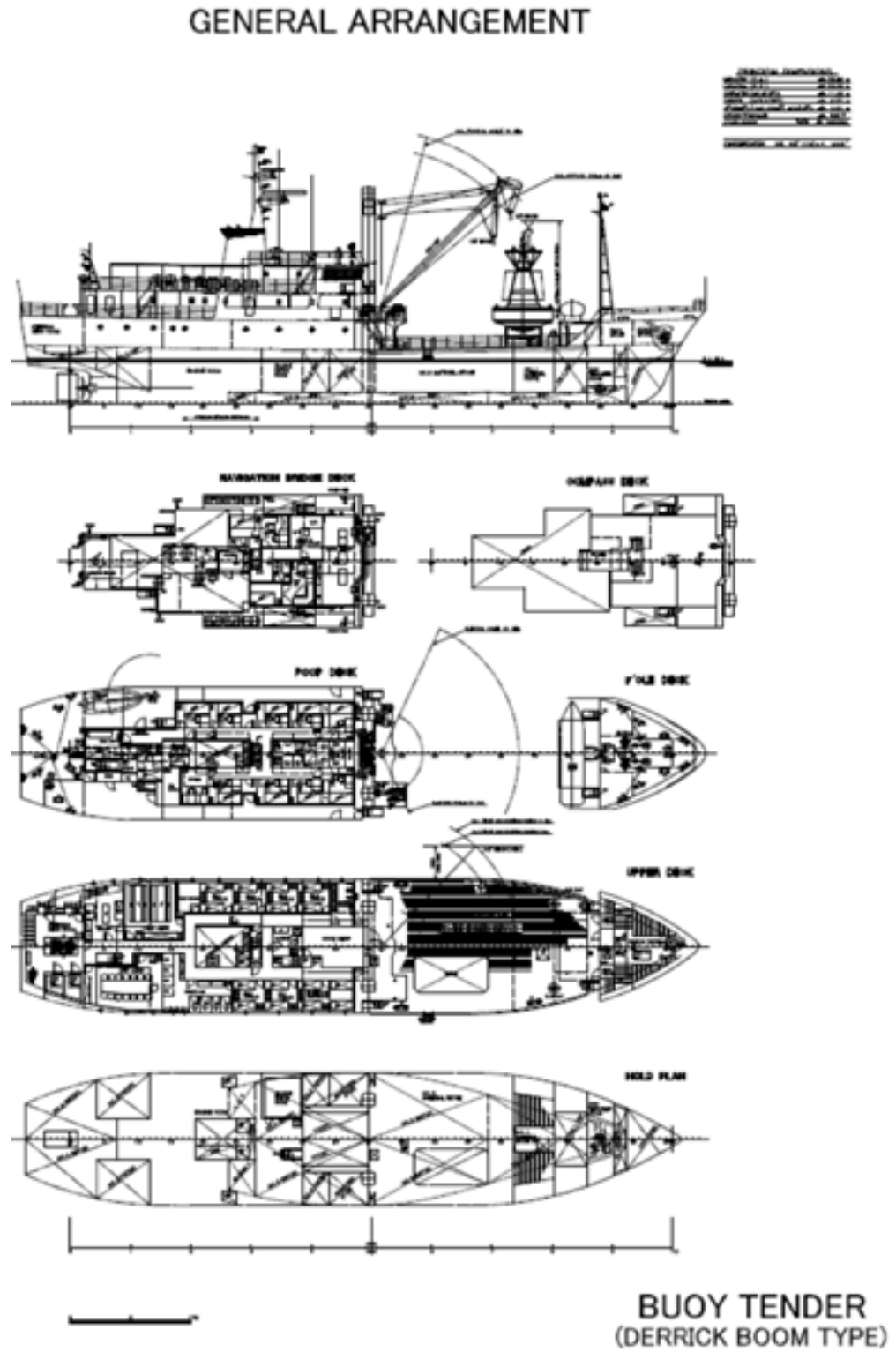
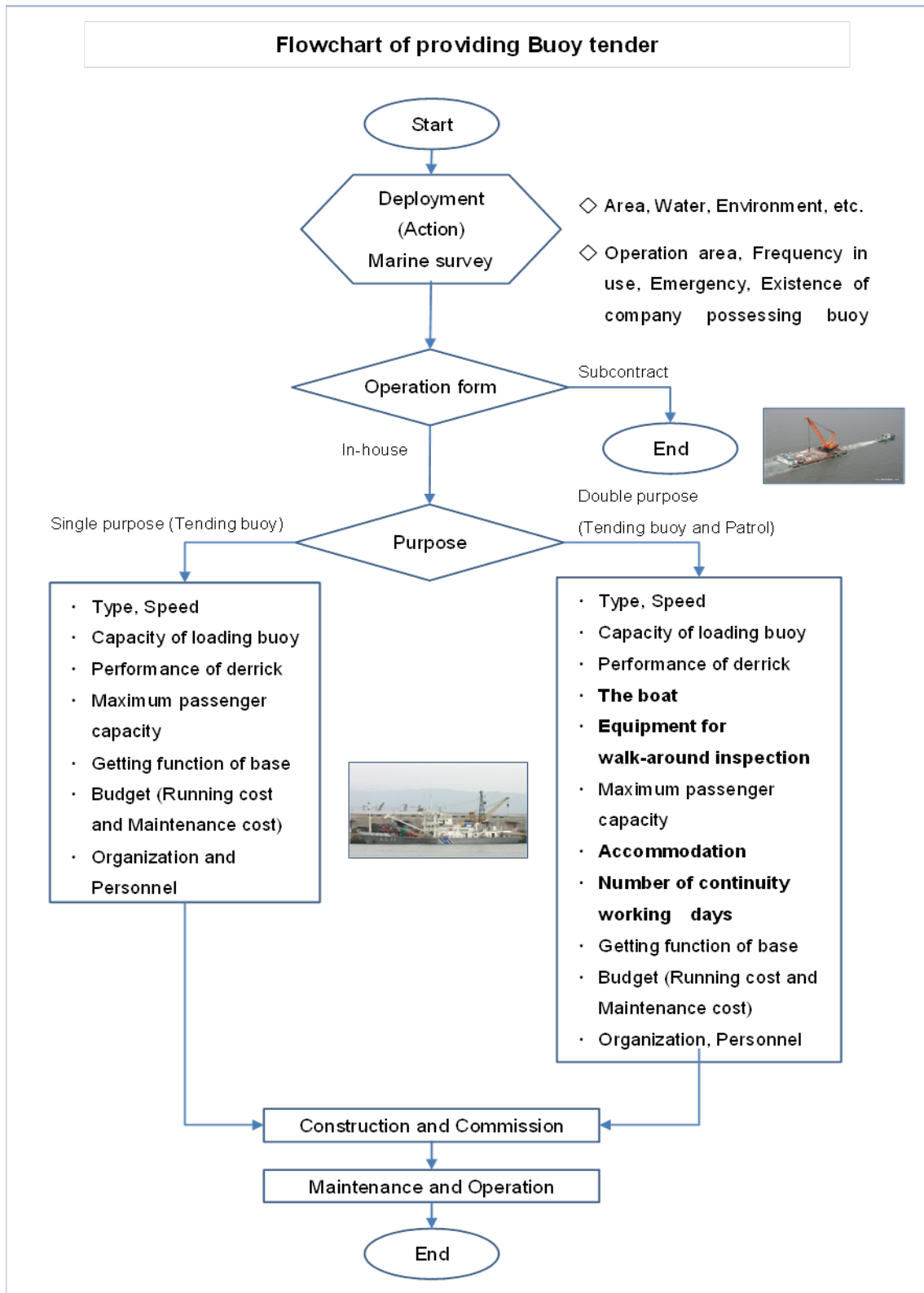

Figure 7.2.5 -2 : General Process



**Table 7.2.6 -1 : Curriculum Subjects
for Basic Maritime Knowledge Course**

	Subject		
	Item	Basic Level	General Knowledge
1	Ocean	What is the sea?	
		Size	
		Depth	
		Territorial waters	Baseline, UNCLOS, Right of Passage, The Open Sea, EEZ
		Straight	Waterway, Traffic routes, Chanals
2	Ship	Types	Merchant, Work, Fishing, Special and Naval vessels
		Size	Tonnage, LOA,
		Speed	Nautical miles, Knot
		Shipbuilding	Body, Painting, Ship-power, Fuel, Electricity, Drinking water
		Maneuvering	Steering wheel, Ladder, Side-thrusters, Mooring, Ballast
		Cargo	Loading, Unloading, Quantity and Weight of the cargo
		Ship marks	Ship's name, Nationality-Port, Load Water Line, Deck Line, Pushlines, Funnel marks
		Inspection	Global standards, Insurance, P&I Insurance
3	Navigation	Fixing position	Celestial navigation, Radio navigation,
		Nautical charts	Marks, ECDIS
		Course	Gyrocompass
		Aids to Navigation	Visual aids, Radio aids, Buoyage
		Navigation roubles	Act on Preventing Collision at Sea, Maritime Traffic Law, Lights
		Marine accident	Stranding, Collision, Distress signals, Search and Rescue
		Sailor	Captain, Engineer, Navigator, Deck crew, Watchstander
		Radio Communication	Morse code, Flag signals, Hand signals, Radio
		Other	UTC, Anchor, Pilot, Pirate, Call sign
4	Marine Transportation	Trade	Import and Export, Number and nationality of ships, Flag of convenience
		Port	Passenger terminal, Cargo terminal, Cointainer Terminal, Fishing port

Table 7.2.6 -2 : Outline of Curriculum

Outline of Curriculum in the "Information Course" and the "VTS Operator Course" in JCG

Course	Outline	Subjects 1	Subjects 2
		(Common)	(Expertized)
Information System	To study/learn knowledge and technical skill necessary for operation and management in maritime traffic safety services, and also knowledge necessary for guard and rescue mission	(Common 1) ➤ Fundamental knowledge >Outline of domestic laws >International law >Outline of JCG mission >Knowledge as Governmental officials ➤ English (Basic) ➤ Data Processing (Basic) ➤ Physical training ➤ Group behavior ➤ Small-craft handling ➤ Onboard training and training ➤ Comprehensive practice (Common 2) ➤ Criminal Code	➤ English (Advanced) ➤ Mathematics ➤ Physics ➤ Data Processing (Advanced) ➤ Radio Engineering (Basic) ➤ Navigation Safety ➤ AtoN Equipment and their Management ➤ Operational Skill for Telecommunication ➤ Electric Devices and Equipment ➤ VTS ➤ AIS
VTS Operator	To study/learn knowledge and technical skill necessary for operation of vessel traffic services (VTS)	➤ Criminal Procedure Code ➤ Maritime Police ➤ Maritime Environment ➤ Search & Rescue ➤ Disaster Protection	➤ English (Advanced) ➤ Navigation Safety ➤ VTS Equipment ➤ Overview of Maritime Affairs ➤ Practice of VTS Simulation

Figure 7.2.6 -1 : General Career Path after the Graduation

Completion of
the “Information Course” / the “VTS Operator Course”
 (Japan Coast Guard School)

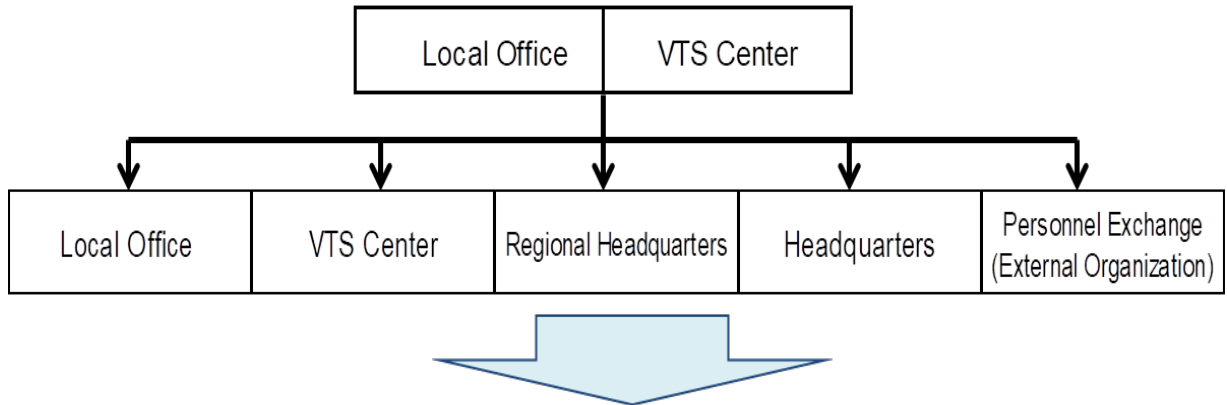

- 3 years Experience	Work as one of staff at local office Participation in training courses (Domestic)
- 6 years Experience	Work as one of staff at local office Participation in training courses (Domestic, Overseas) Personnel transfer between Local offices / VTS Centers
7 - 35 years Experience	Promotion test Promotion to an instructor, a section chief, a director Participation in training courses (Domestic, Overseas) Personnel transfer between offices / VTS Centers / Regional Headquarters / Headquarters
- Until retired Experience	Promotion test Promotion to an instructor, a chief of office, a director, a director general Participation in training courses (Domestic, Overseas) Personnel transfer between offices / VTS Centers / Regional Headquarters / Headquarters

Figure 7.2.6 -2 : Training and Career Path of VTS Operator in Singapore



Table 7.2.7 -1 : Establishment Schedule of Integrated Information System

Subjects		1st Year				2nd Year				3rd Year				4th Year			
		I	II	III	IV	I	II	III	IV	I	II	III	IV	I	II	III	IV
1	Study Committee Discussion about Fundamental Function Verification of the Base System Approval of the System Outline																
2	Feasibility Study Preparation Site Investigation Design of Base System																
3	Detail Design Preparation Site Survey Preparation of Plan Decide on Specification																
4	Procurement of Supplies and Equipment Preparation Contract, Delivery Inspection																
5	System Setting Up Preparation Contract Setting Up System Change Inspection																

Figure 7.2.7 -3 : Correlation Diagram with Related Organization

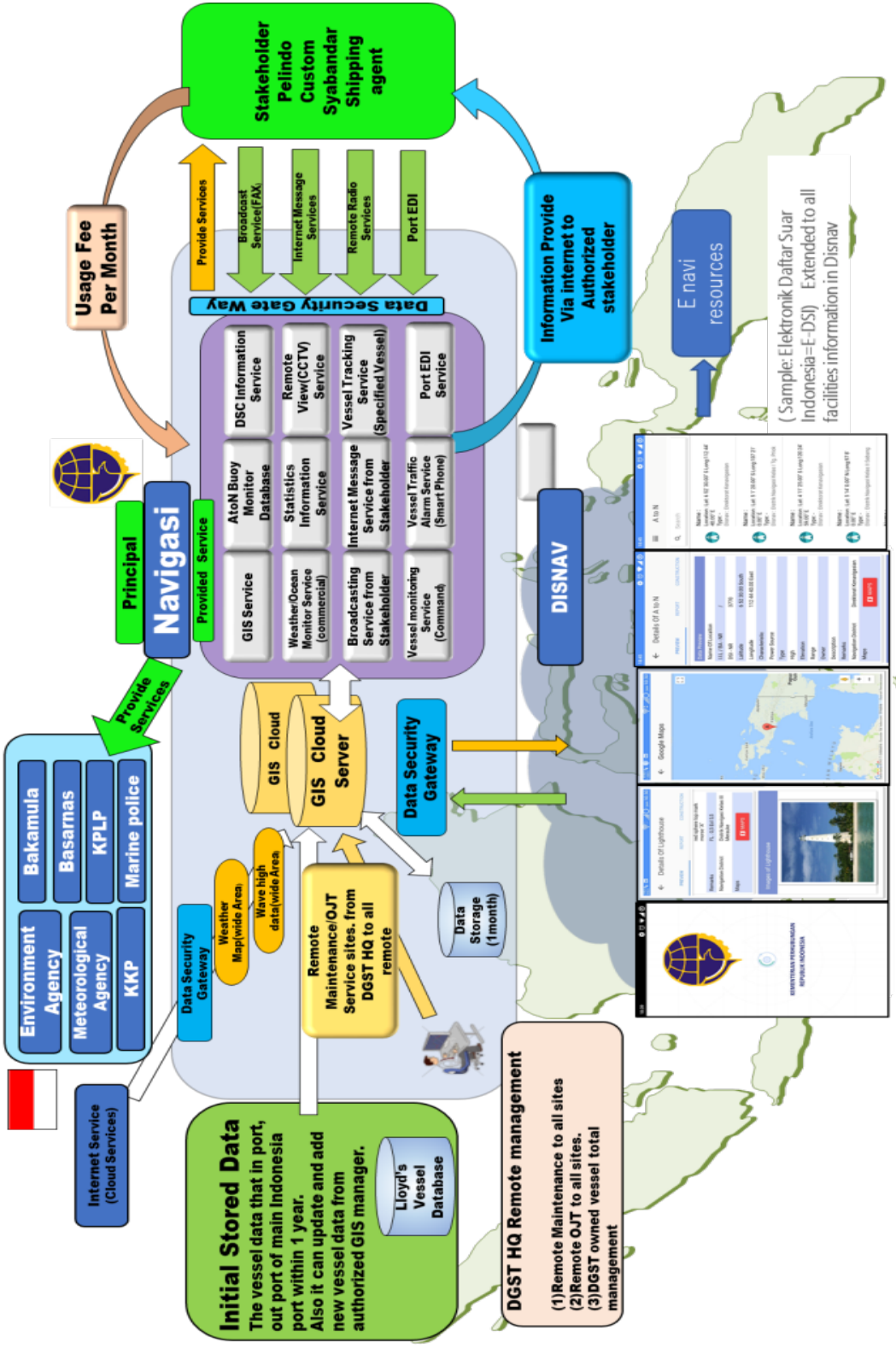

Correlation Diagram with External Organizations and Stakeholders

● Development of Capacity Building

★ Setting up the Management Group

- 1 Group : 4 ~ 5 Person
- Term : 6 Months
- Practical Term : 3 Months
- Project Period : Triennial (3) Plan

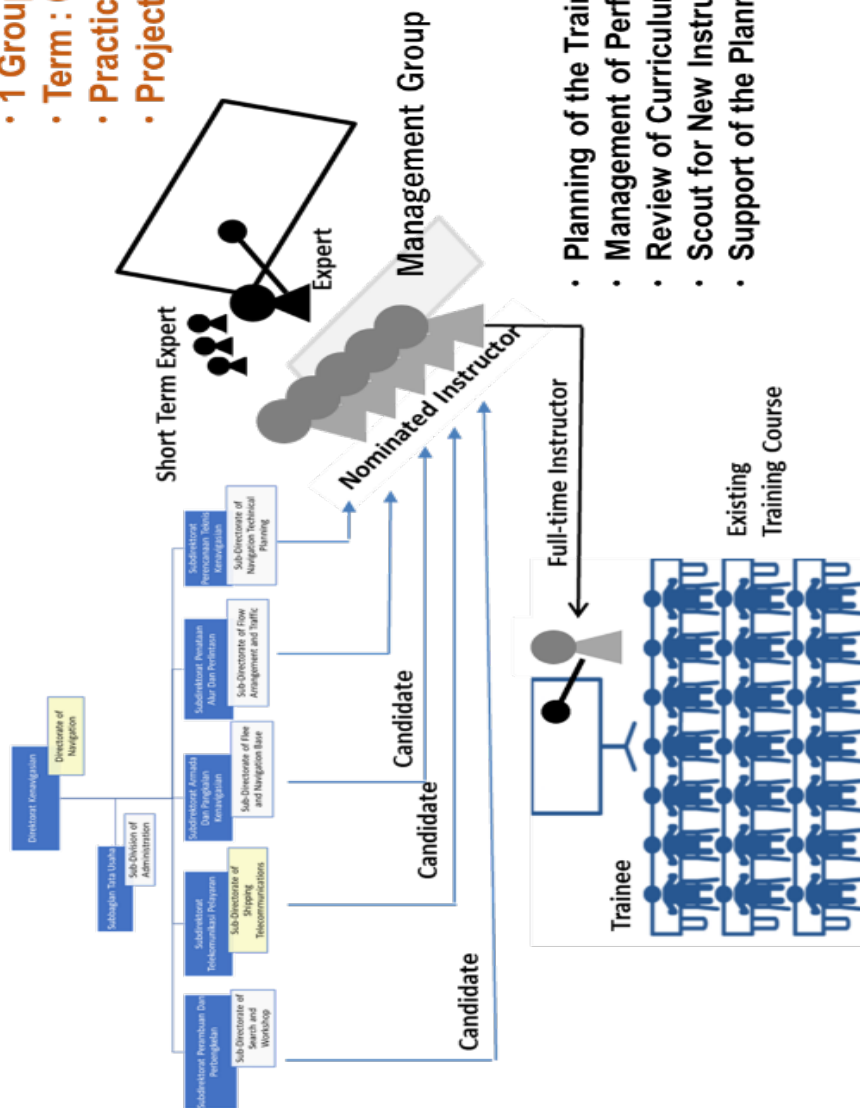

- Planning of the Training System
- Management of Performance at Local Training
- Review of Curriculum and Syllabus
- Scout for New Instructors
- Support of the Planning Section

Figure 7.3.1 -1 : Image of Training

Table 7.3.1 -1 : Training Course for Instructor

Capacity Building
Training framework for Instructor

			1st Year				2nd Year				3rd Year			
			I	II	III	IV	I	II	III	IV	I	II	III	IV
1	Adoption of Long Term Expert	1	※ JICA Scheme											
	Request of Expert													
	Setting up the preparatory office	Jakarta												
	Invitation of Short Term Experts	3x 3												
2	Selection of candidates for Instructor	4 x 3												
	Setting up the group of a preparatory Instructor													
	Orientation													
3	General Course													
	General Discipline													
	(Marine Affairs, Laws and Regulations)													
	Academic Discipline													
	(Hydrographic, Ship, Radio-communication, IT)													
4	Specialized Course													
	Visual Aids to Navigation													
	VTS, AIS													
	Radio Operator (VTS, GMDSS)													
5	Practical Exercise													
	Excursion (VTS, CRS, Lighthouse, Ship)													

Figure 7.3.1 -2 : E-Learning System for VTS Operator

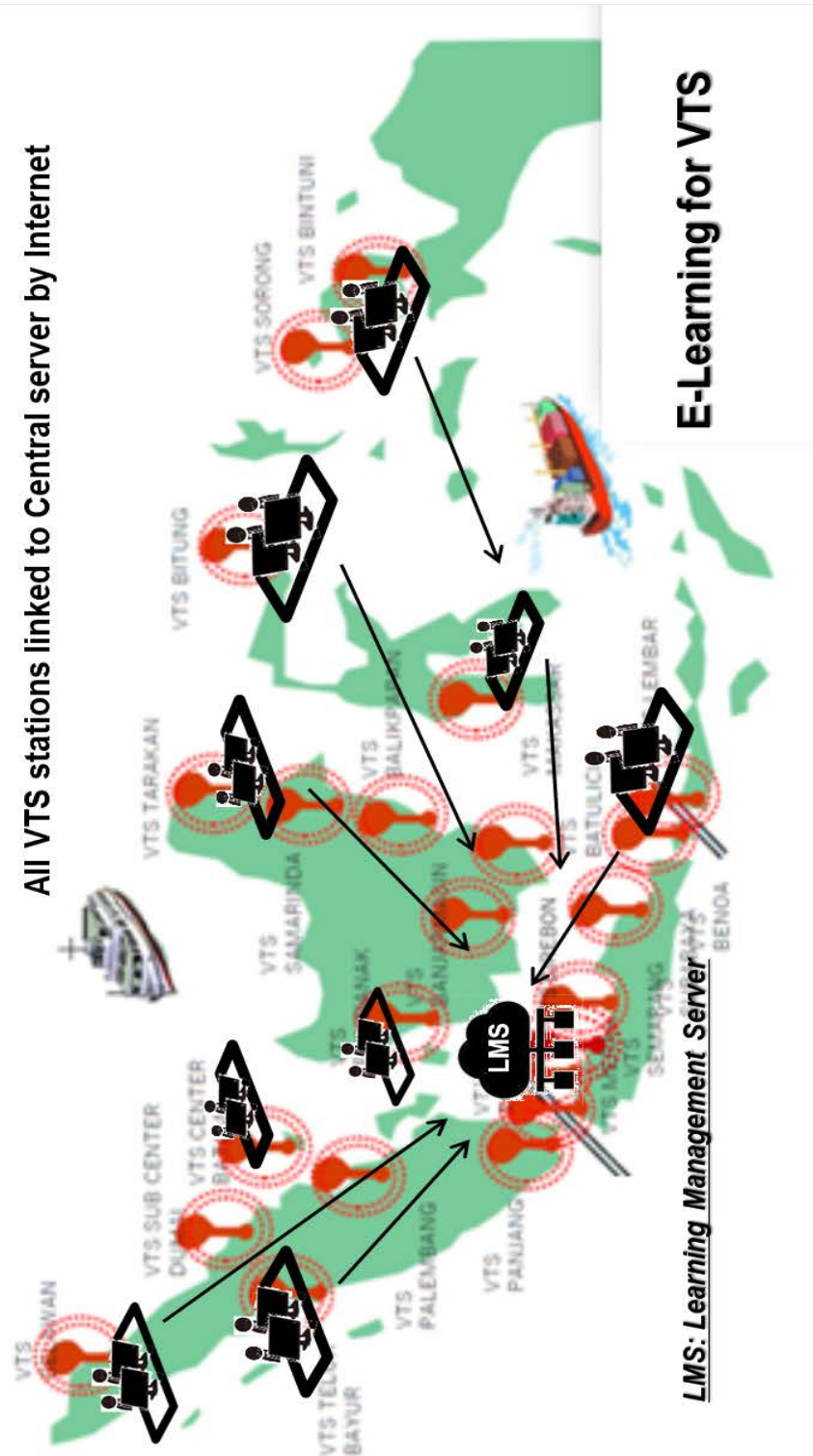

Figure 7.3.1 -3 : System Configuration of E-Learning System

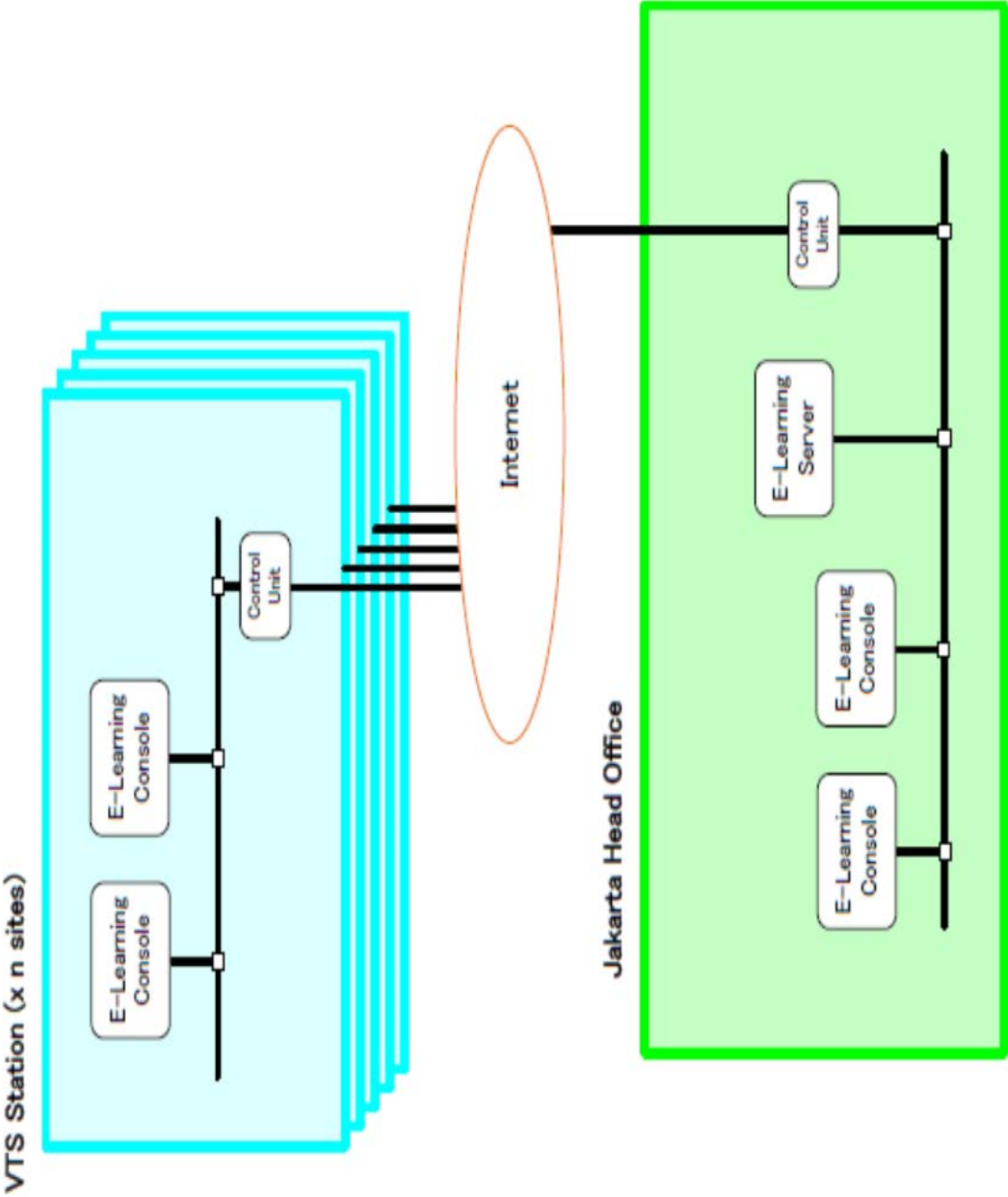

Table 7.3.1 -2 : Establishment of E-Learning System

Capacity Building E-Learning System for VTS Operator												
Items	1st Year				2nd Year							
	I	II	III	IV	I	II	III	IV				
1 Implementation Design												
Preparation of Specification for Contract		■										
Contract		■										
Design				■								Customized Program
2 Establishment of Communication Network and Procurement of Equipment												
Contract with Telecommunication Company								■	■			
Purchase of Equipment								■				PC, Server
3 Setting up the System and Exercise												
Contract with Execution Supplier								■	■			
Setting up the System									■			
Exercise										■		

Figure 7.3.2 -1 : System Configuration of Data Base for AIS (1/2)

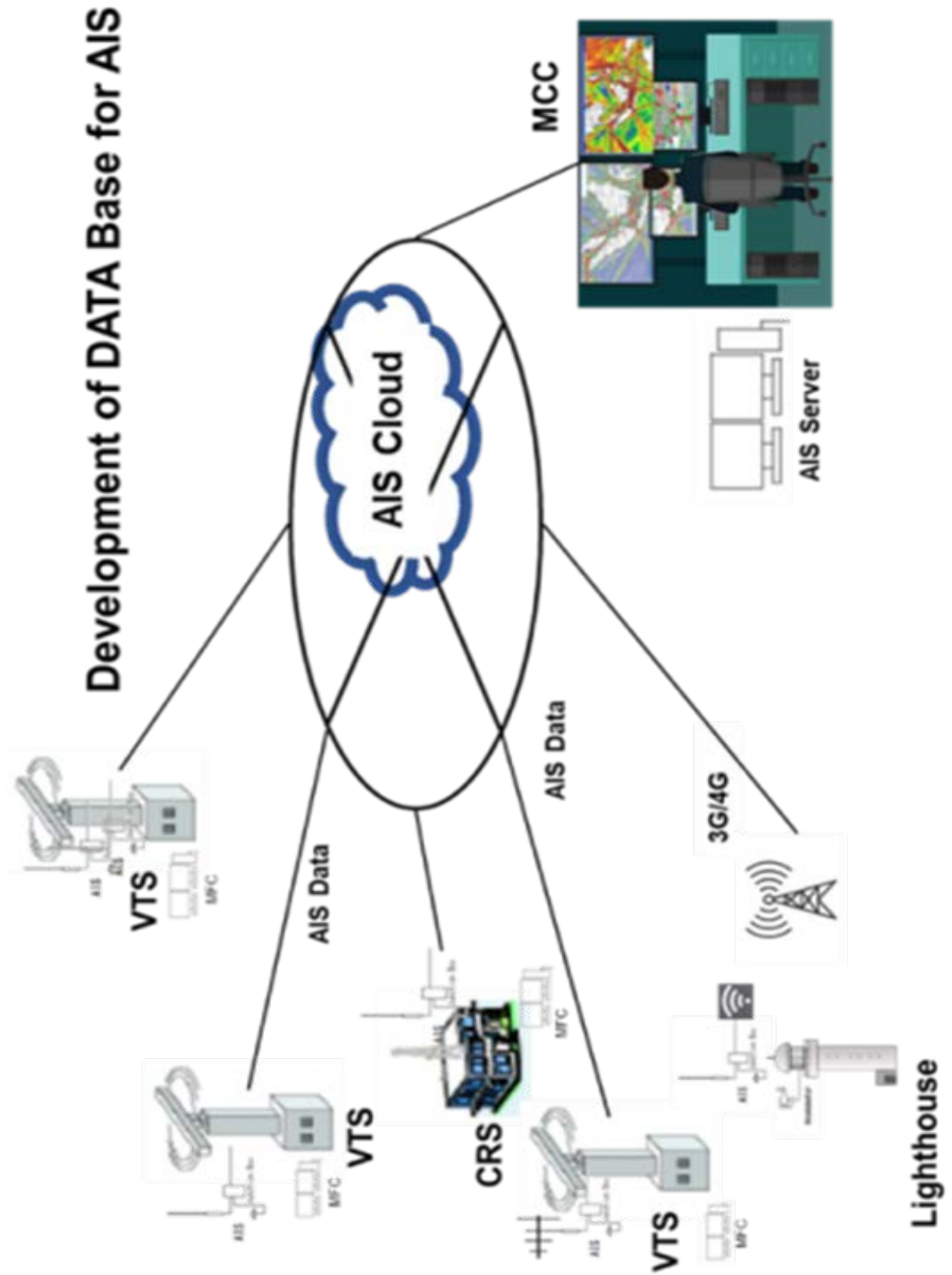

Figure 7.3.2 -1 : System Configuration of Data Base for AIS (2/2)

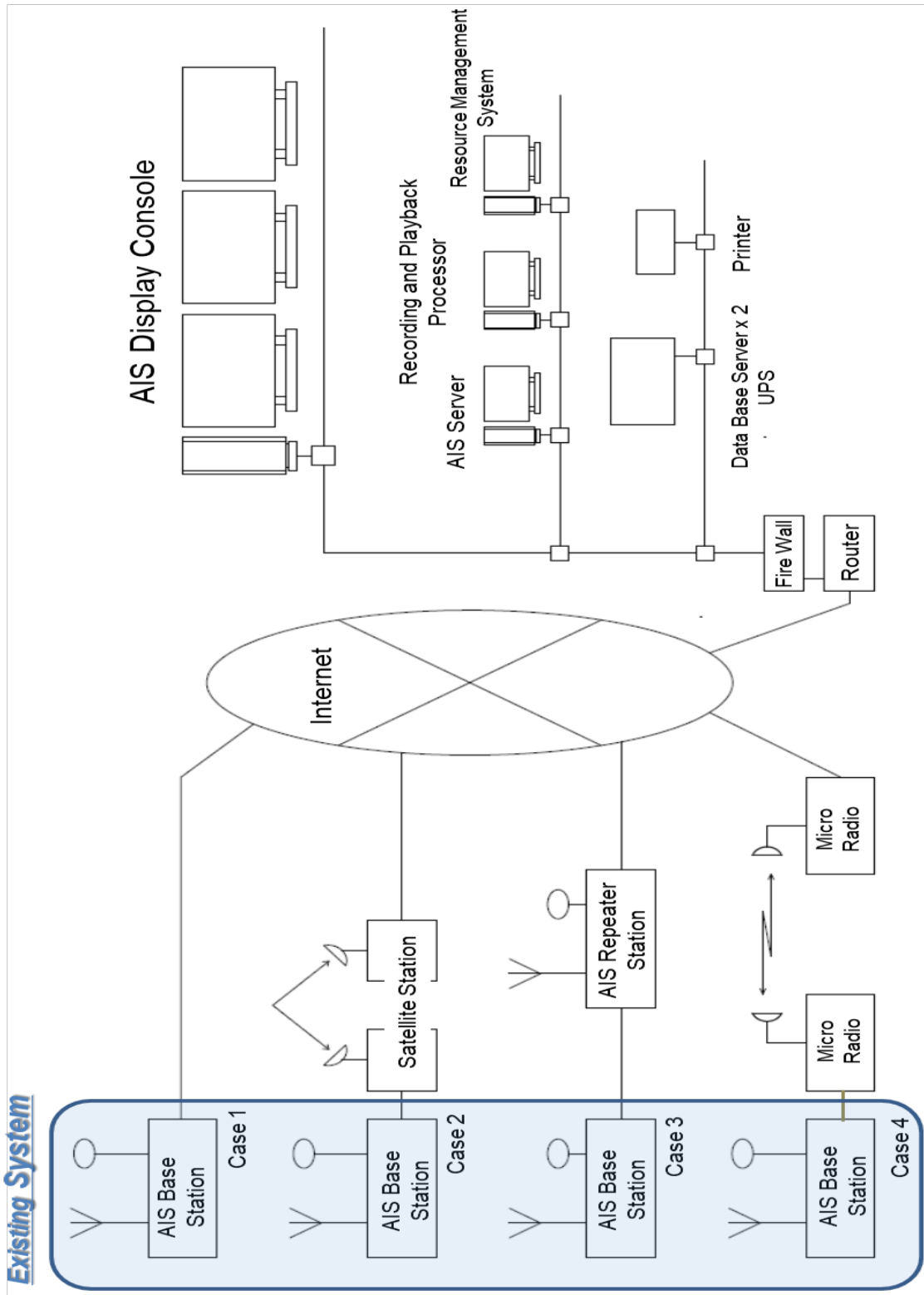

Table 7.3.2 -1 : Establishment of Data Base for AIS

Establishment of AIS Data Base

Items	1st Year				2nd Year			
	I	II	III	IV	I	II	III	IV
1 Implementation Design								
Preparation of Specification for Contract	—							
Contract	==							
Design			—					62 stations
2 Establishment of Communication Network and Procurement of Equipment								
Contract with Telecommunication Company					==			
Perchase of Equipment					—			Server, Operatinal Console, Network Equipment
3 Setting up the System and Exercise								
Contract with Execution Supplier					—			
Setting up the System						—		
Guidance							—	Training (WRAP)

Figure 7.3.3 -1 : Configuration of Equipment for VTS Station

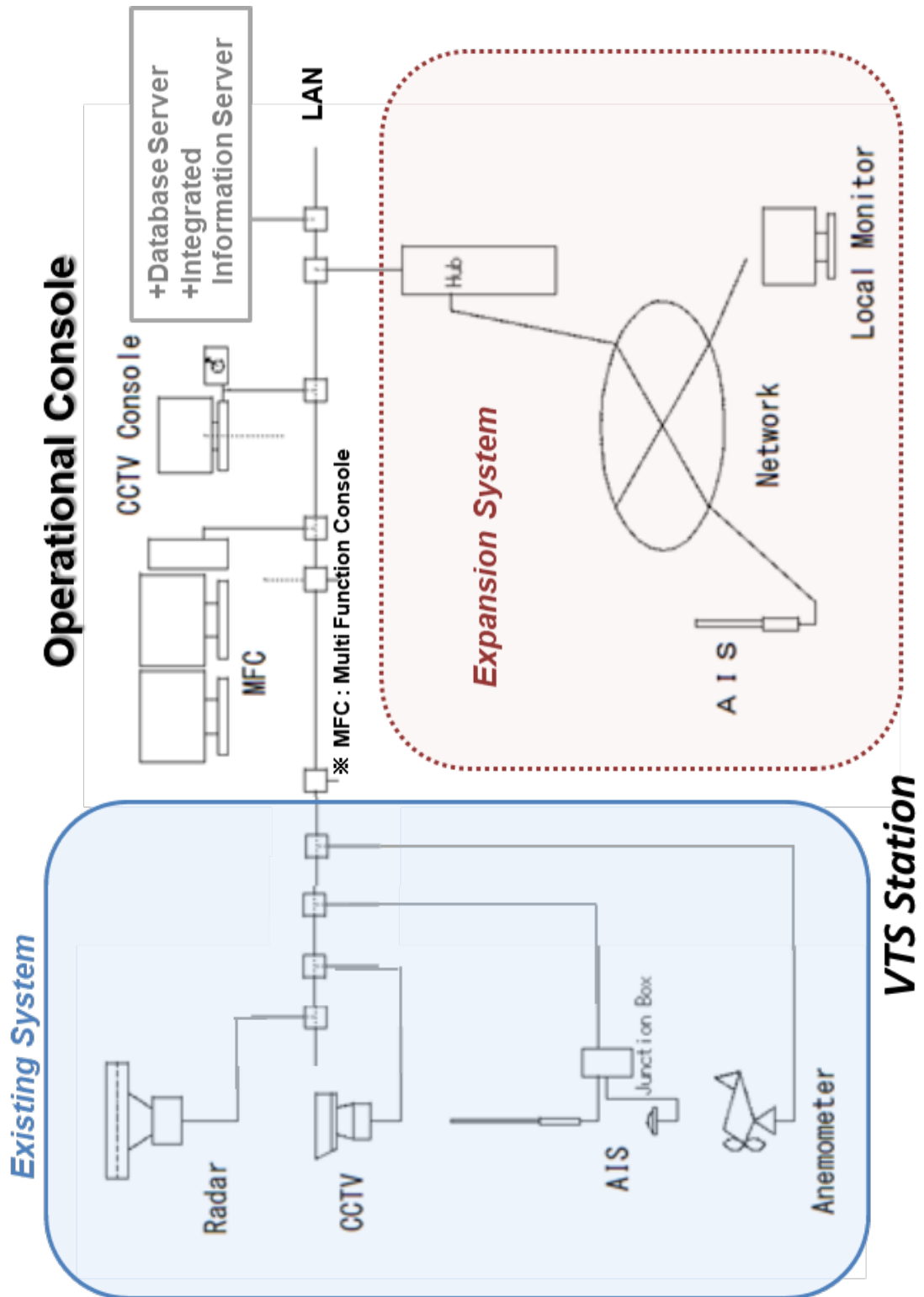
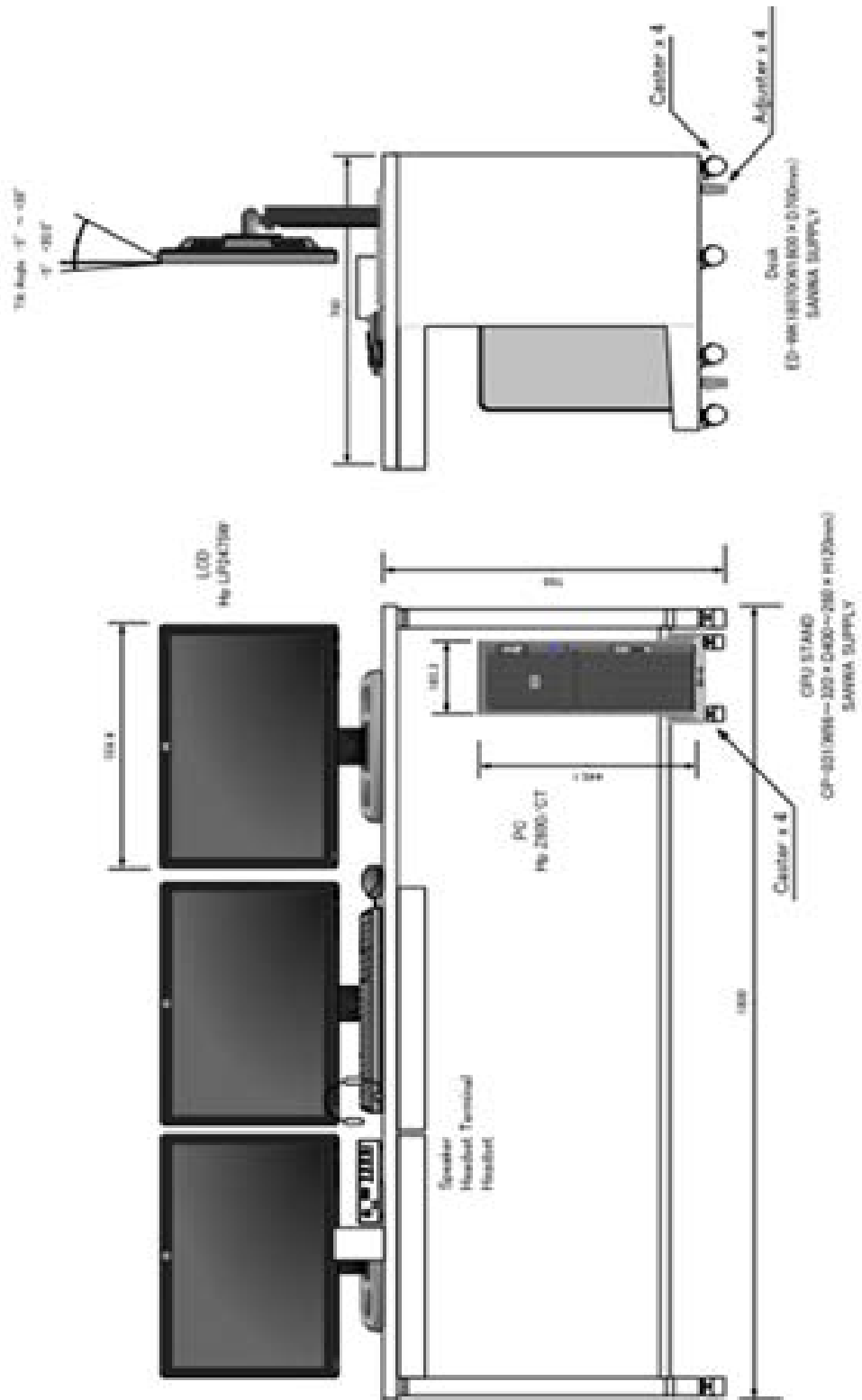
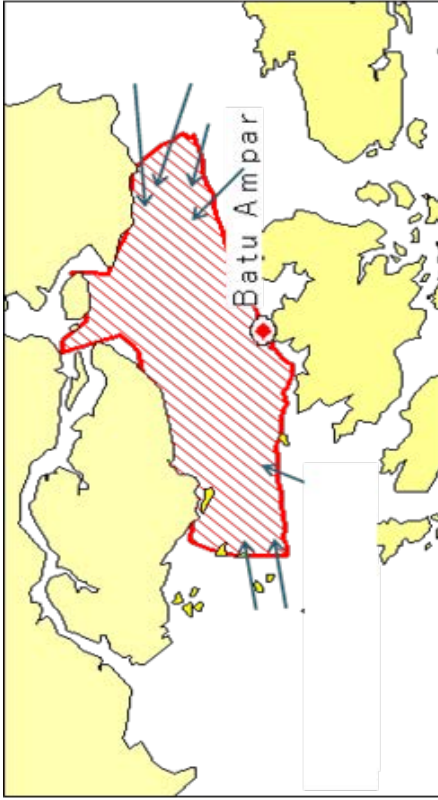

Figure 7.3.3 -2 : Operational Console



Reference : Display Function



Counting the number of vessels entering the monitoring area

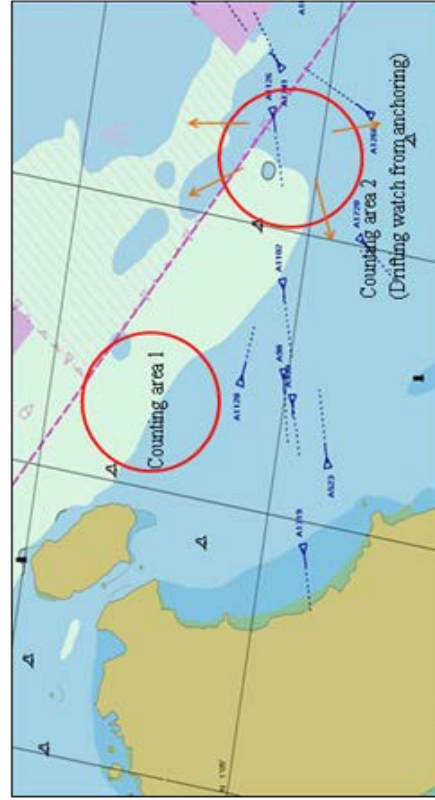

Monitoring area for anchoring with automatic alarm system



Measuring line to count the number of vessels crossing over the line

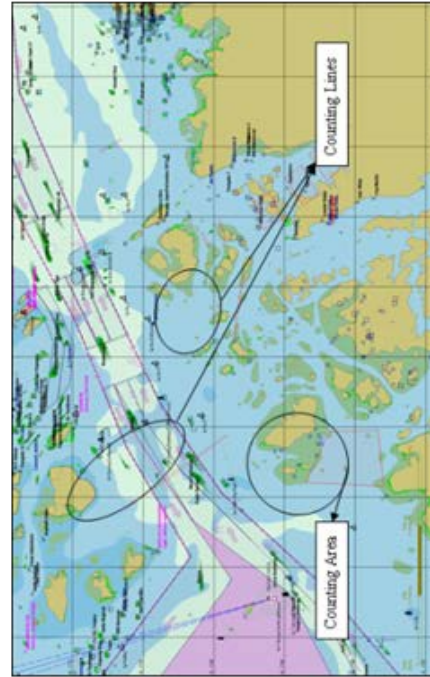

Counting line and area for congestion situation

Table 7.3.3 -1 : Innovation of VTS Operation

Development of Customized Operation Console and OJT

Items	1st Year				2nd Year				3rd Year			
	I	II	III	IV	I	II	III	IV	I	II	III	IV
1 Implementation Design												
Preparation of Specification for Contract	—————											
Contract	=====											
Design	—————											
												Several stations
												Customized Software
2 Procurement of Equipment including Setting Up												
Contract with Supplier									=====			
Manufacturing of Equipment									—————			
Installation of Equipment									-----			
												Several stations
												MFC, DB Server
												Several stations
3 Review of SOP and OJT with New Console												
Contract with Consultant									=====			
Preparation (Review of SOP)									—————			
Workshop and Training									-----			
OJT									-----			
												Several stations

Picture 7.3.4 -1: Many Small Vessels berthing off the Port

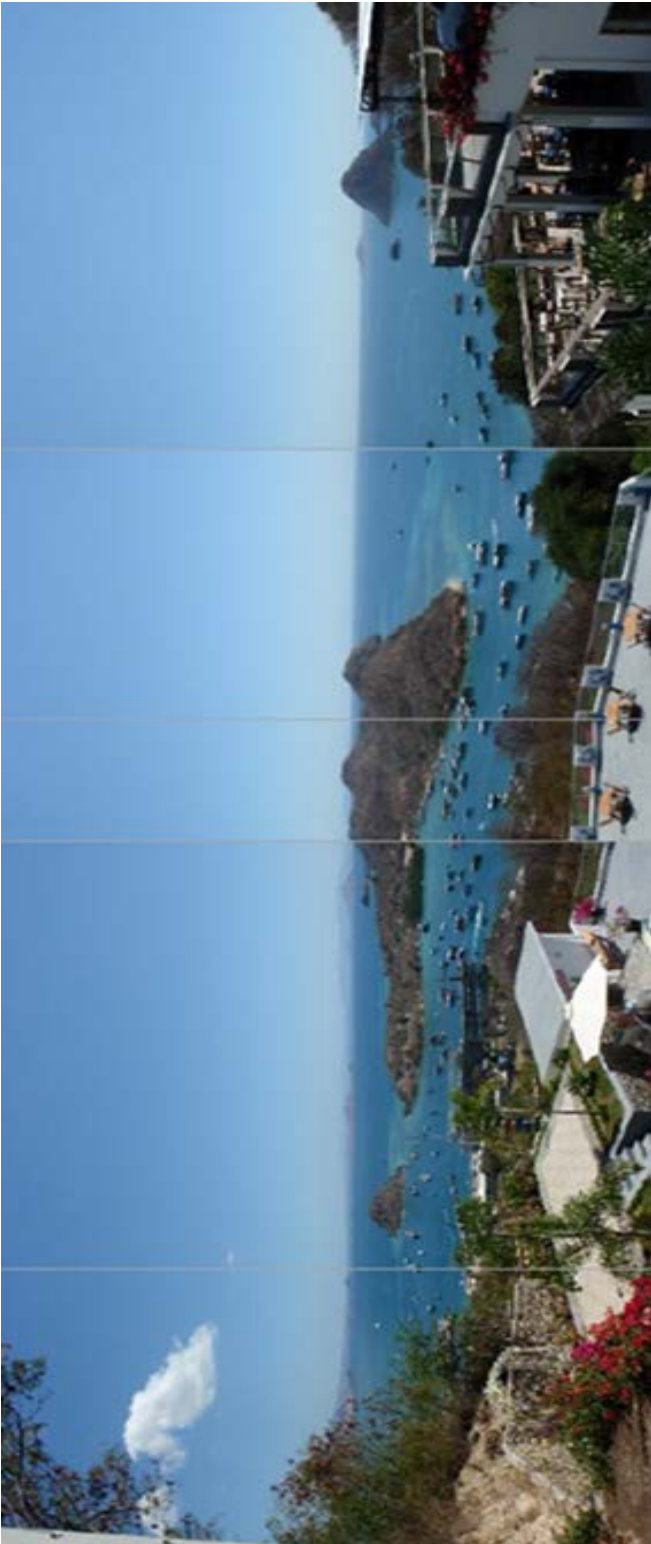

Figure 7.3.4 -1 : Marine Safety System for Small Craft

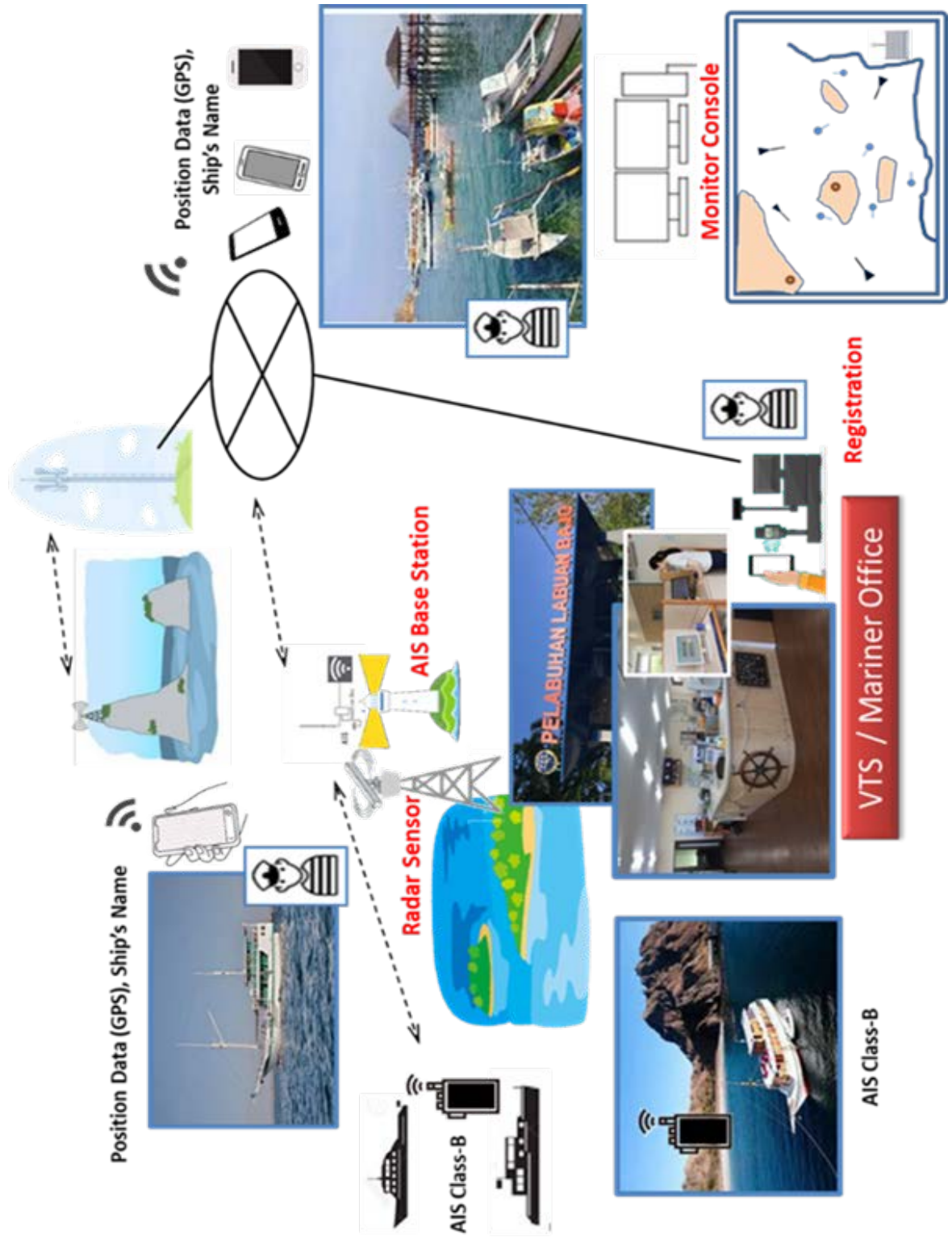

Figure 7.3.4 -3 : Coverage of Radar, AIS

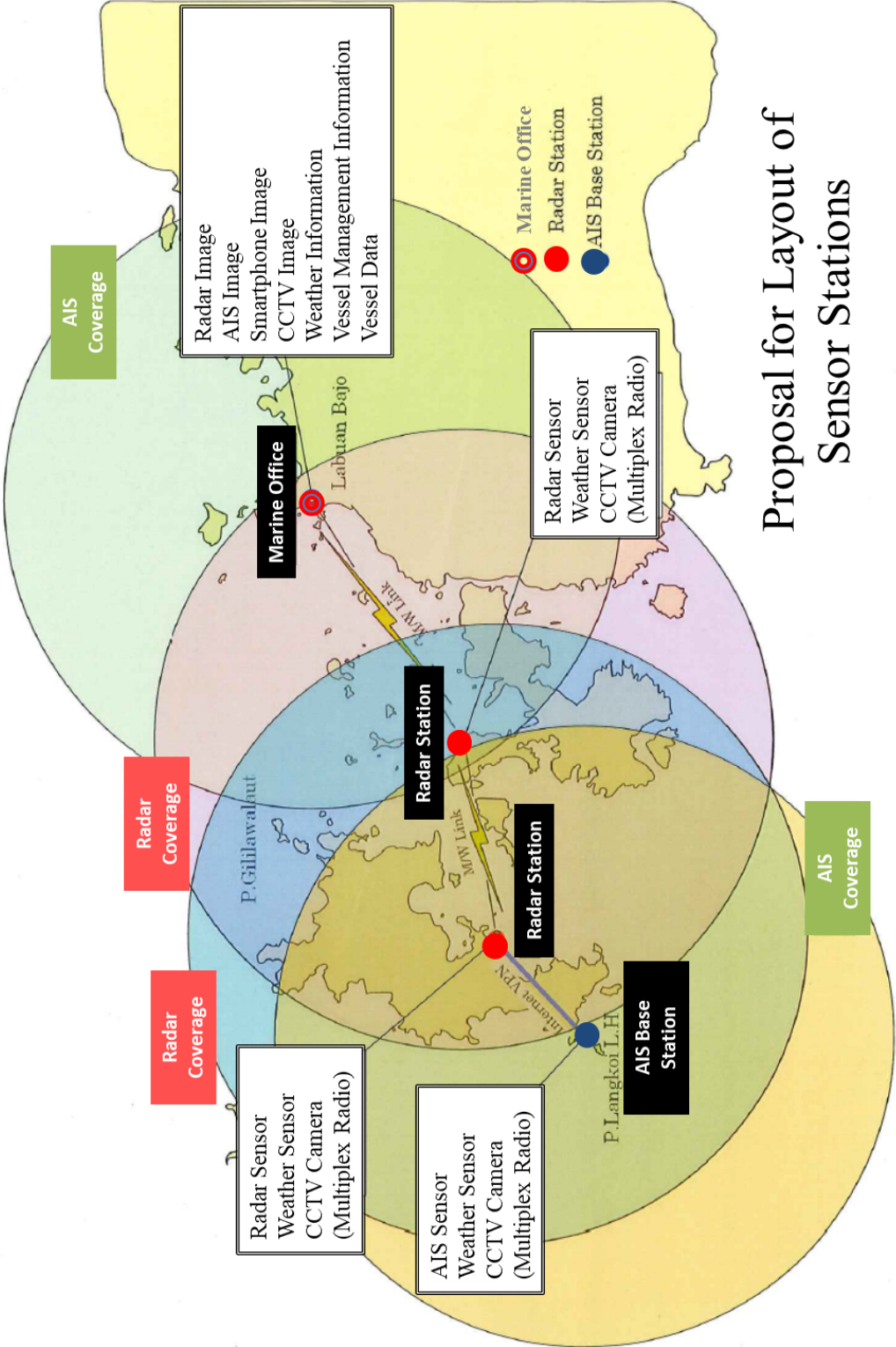

Figure 7.3.4 -4 : Configuration of Equipment for Main Office

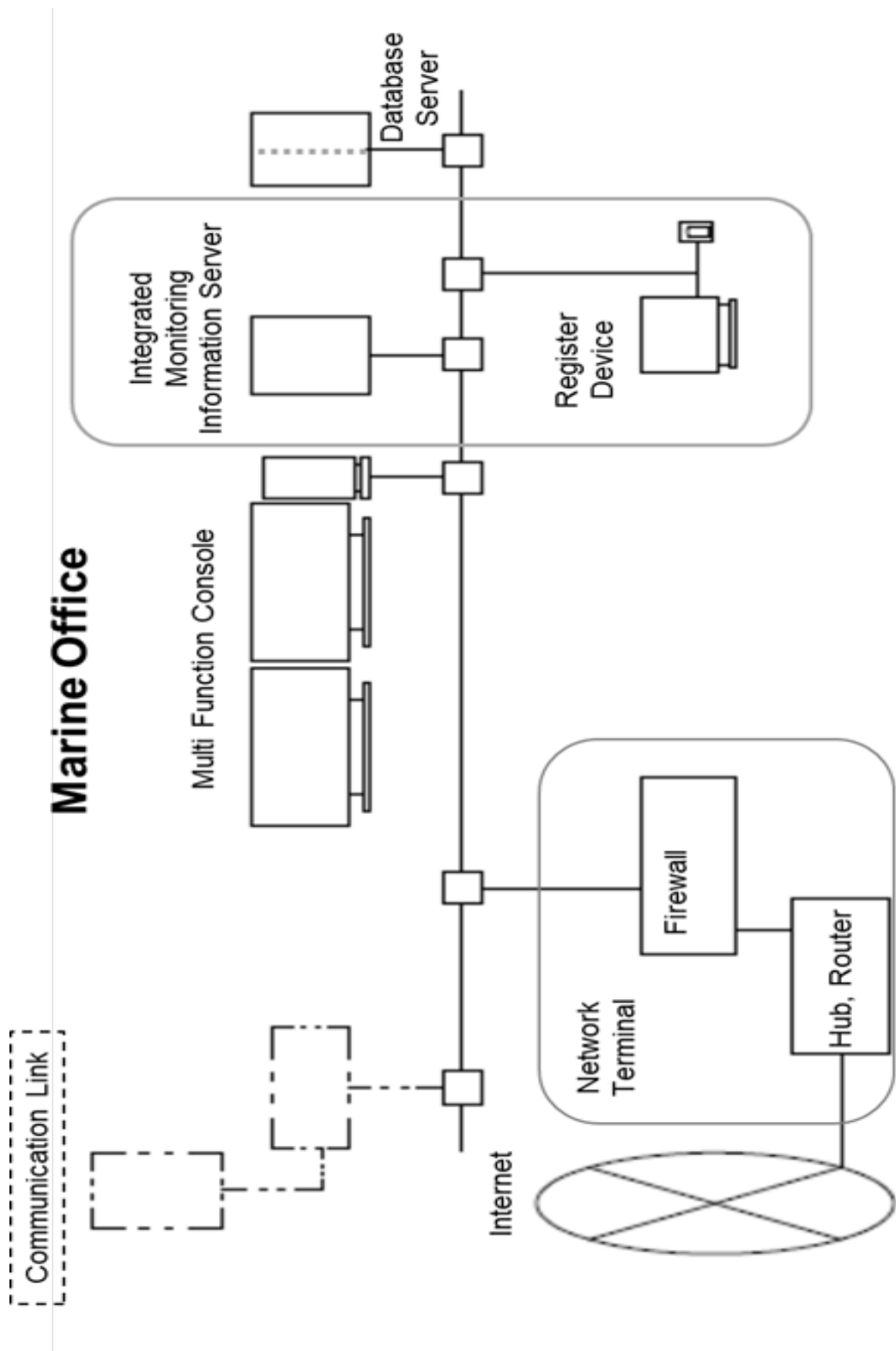

Figure 7.3.4 -5 : Configuration of Equipment for AIS Base Station

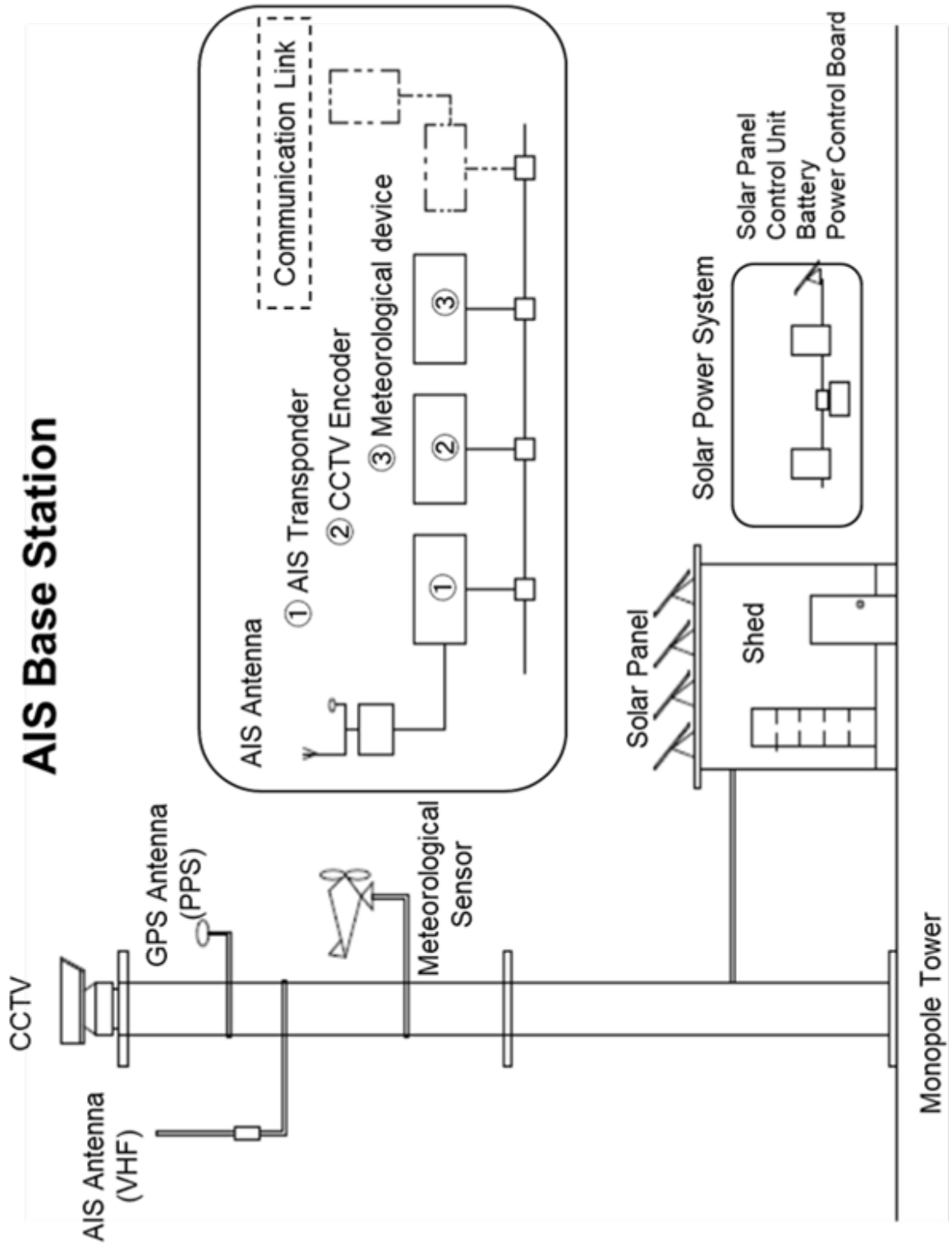

Figure 7.3.4 -6 : Configuration of Equipment for Radar Station

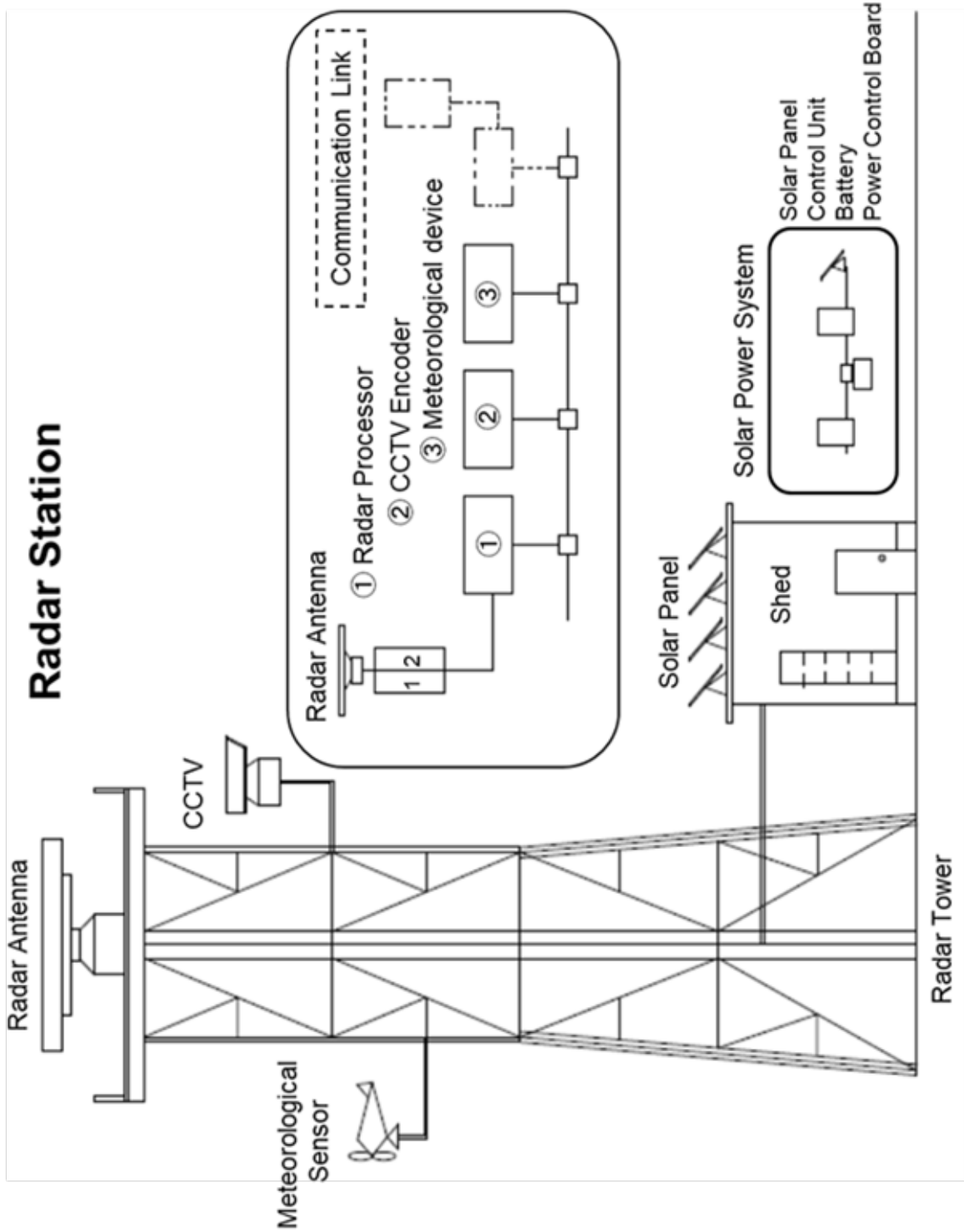

Figure 7.3.4 –3 : Image of Marine Office



Figure 7.3.4 -4 : Image of Operation Console

