

# Output Limitation in Renewable Energy (RE)

May, 2020

JICA Expert Team

# 1 Outline of Output Limitation in RE

- ◆ History of Installation of RE in Japan;
  - Feed in Tariff (FIT) system has accelerated introducing Renewable Energy (RE)
  - RE output power increased and reached remarkable power output that makes influence over the power system stability.

Trend of increasing RE installation in Japan

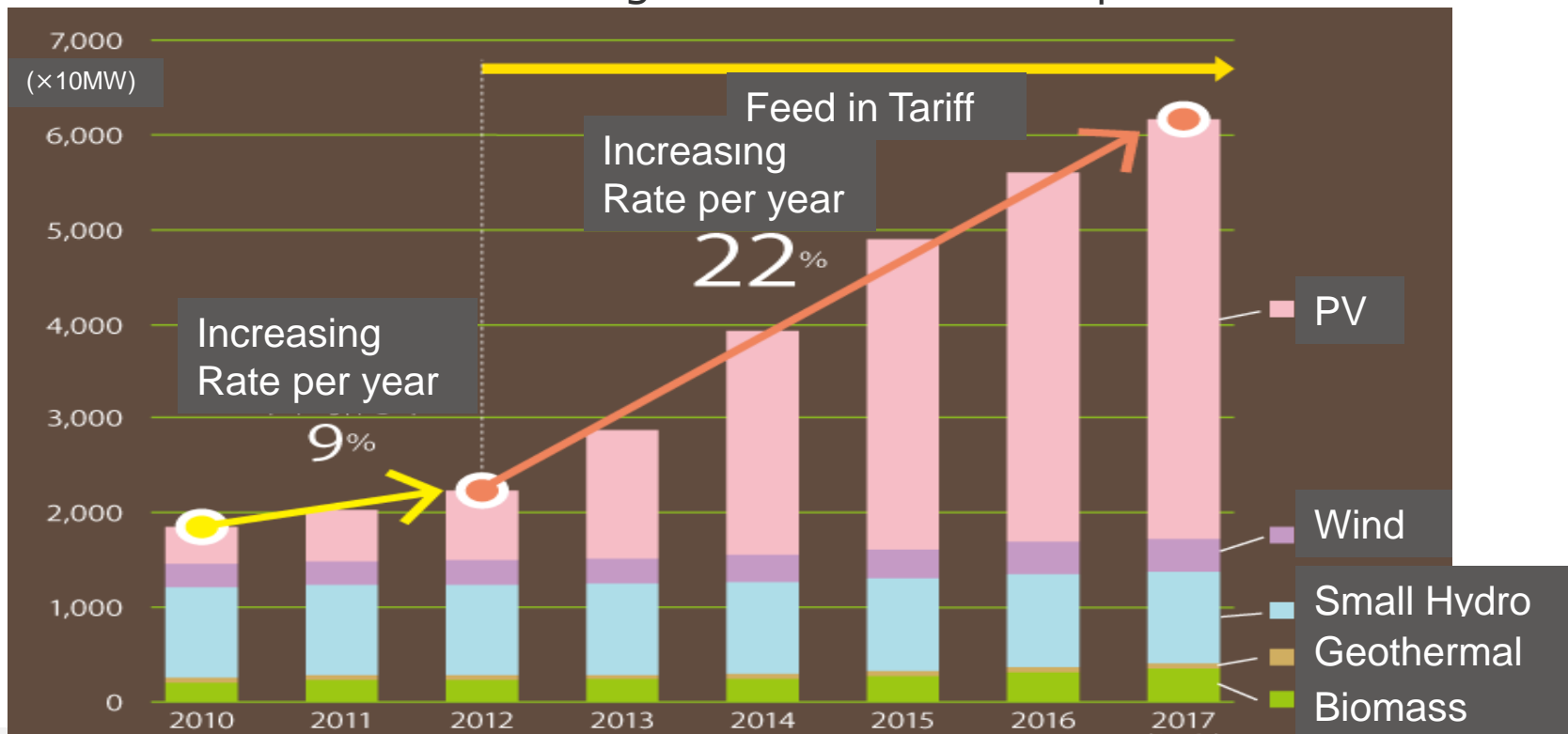

# 1 Outline of Output Limitation in RE

## ◆ Ratio of RE Power Output in Japan

➤ After introducing FIT system, RE power output ratio has rapidly increased from 9% in 2010 to 16% in 2017.

➤ Target ratio of RE power output is 22 -24 % in 2030. Japanese Government leads to install RE facilities with low burden on consumers

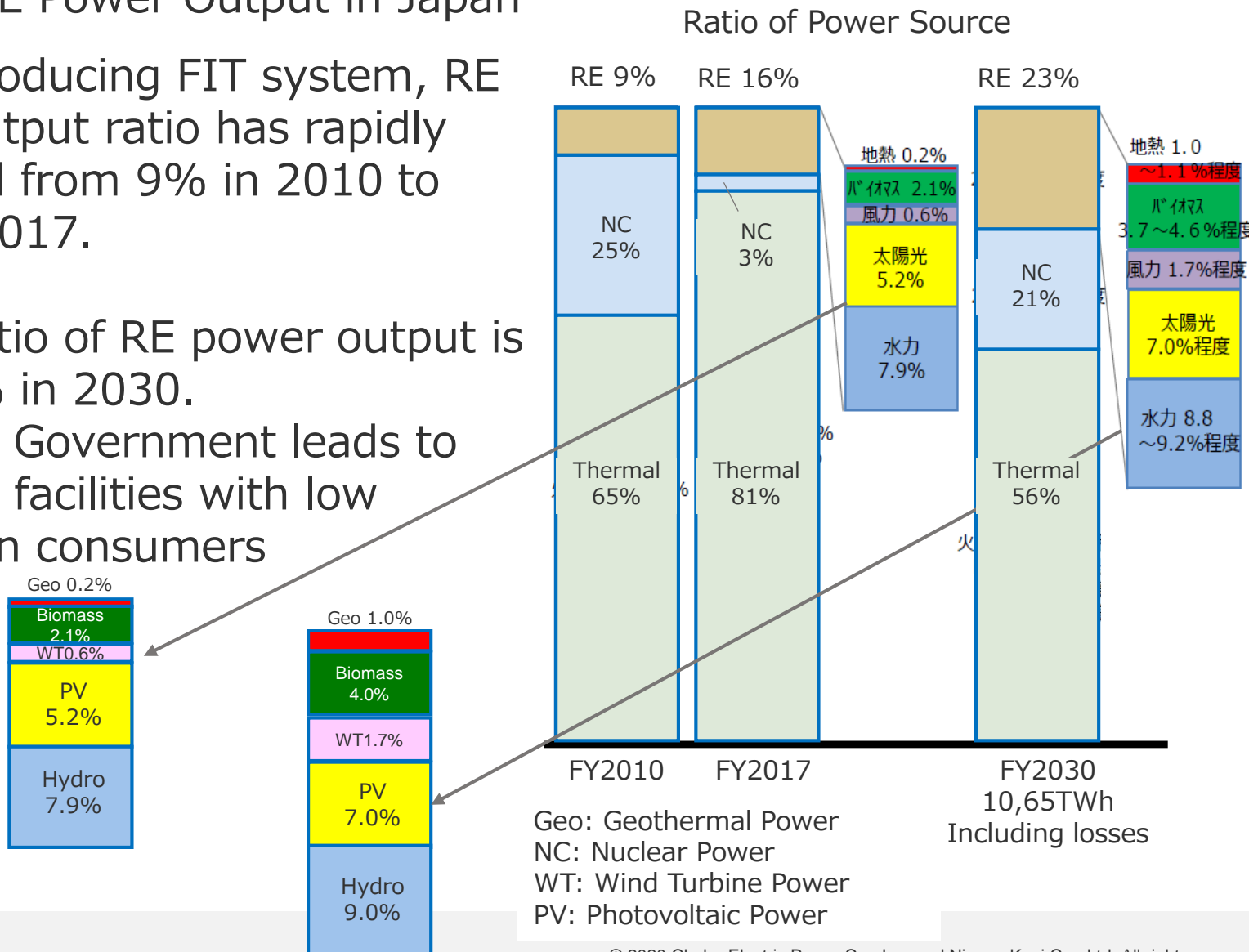

# 1 Outline of Output Limitation in RE

- ◆ Daily Load Curve & Necessity of Output Limitation
- Low load & high output from RE makes the power system unstable.
- Under above situation, blackout will occur if no-limitation execute for output from RE.

## Image of daily load curve in Japan (Fine day in May)

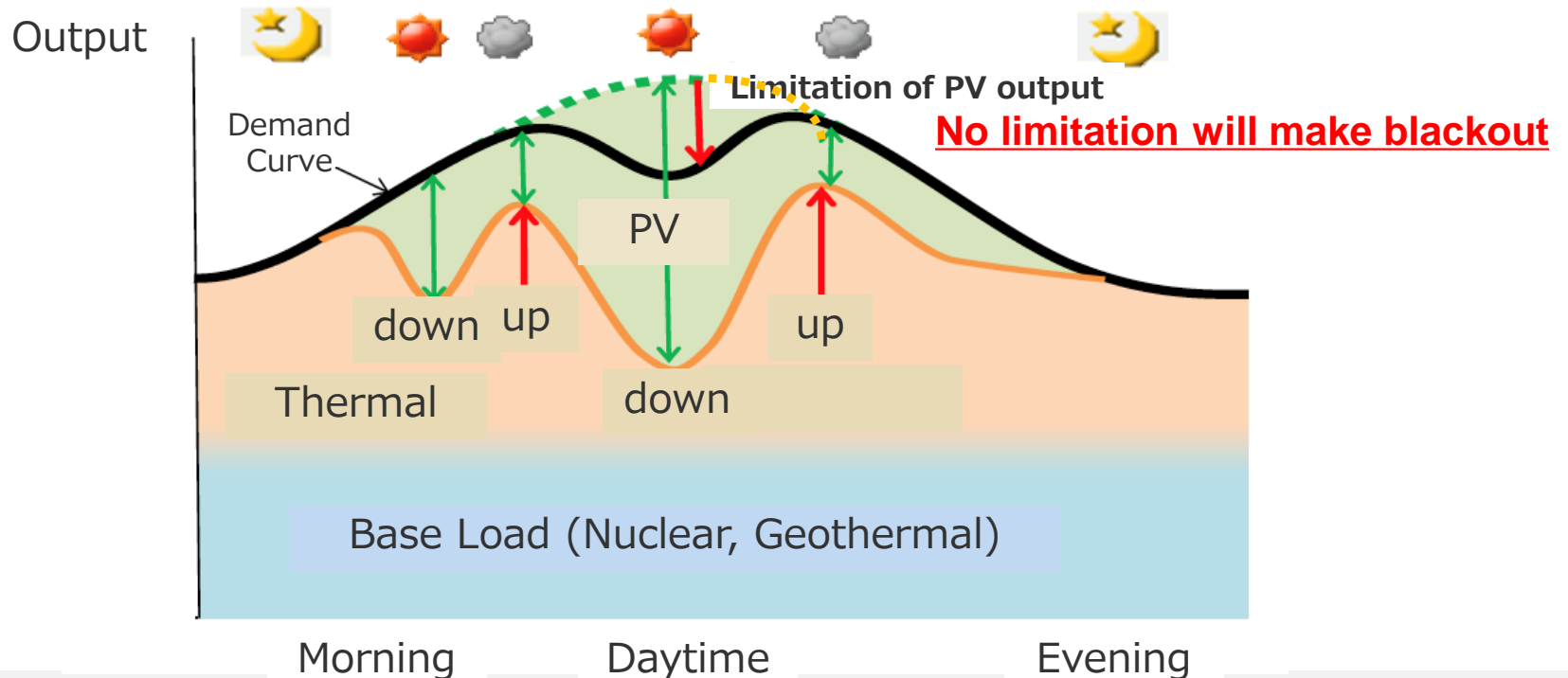

# 1 Outline of Output Limitation in RE

- ◆ Example of RE Output Influence in CEPCO
  - May is lowest power load season in Japan.
  - In daytime of fine day in the season, RE output (PV & Wind) reach 65% of power demand. Thermal Power Plant has no adjustment margin, only Pumped Storage Hydro Power Plant has absorbed margin.

Example of load curve (2<sup>nd</sup> May 2019 CEPCO)

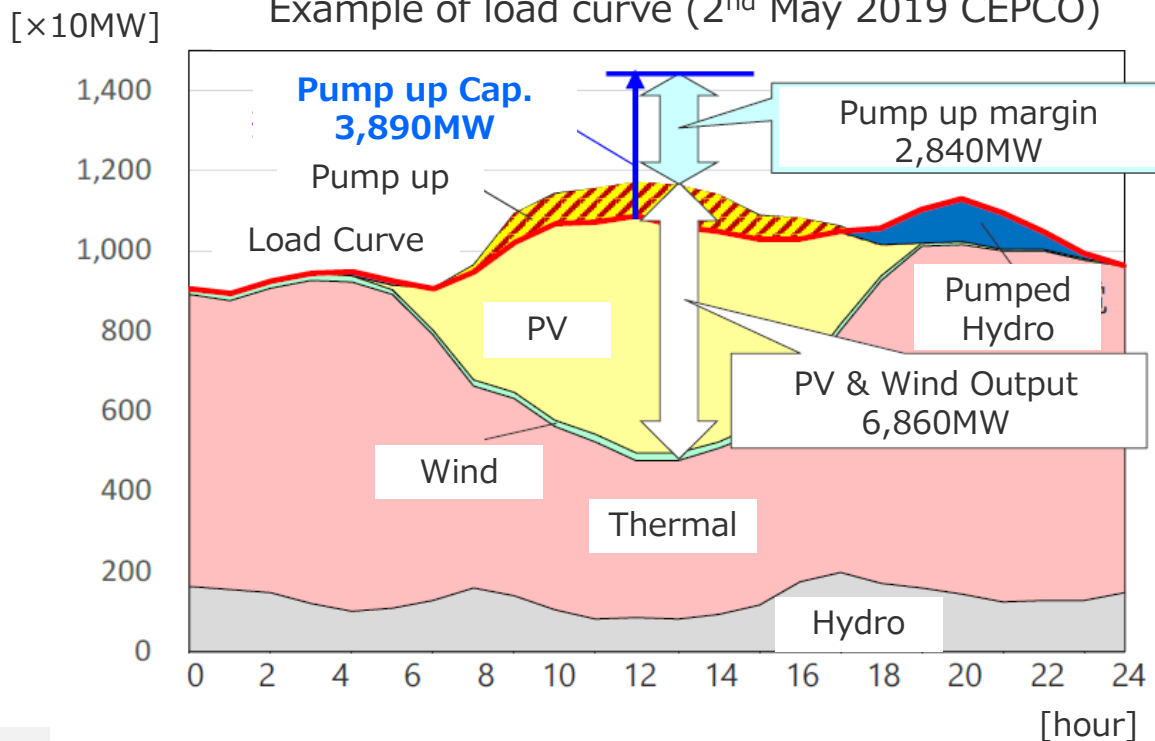

Power balance at 13 PM

Title	Power [MW]	Note
Demand	10,590	Minimum demand is 10,300MW in last 5 years
Pumped up	Δ1,050	
PV	6,680	Ratio to power demand 65%
Wind	180	
Thermal	3,960	No adjust margin
Hydro etc.	810	Draught season

# 1 Outline of Output Limitation in RE

(Reference) Influence by output fluctuation of big wind firm

- Large capacity wind firm has big fluctuation risk that will give a damage to power system.
- More installation of large wind power firm needs countermeasure to fluctuation of voltage & frequency.

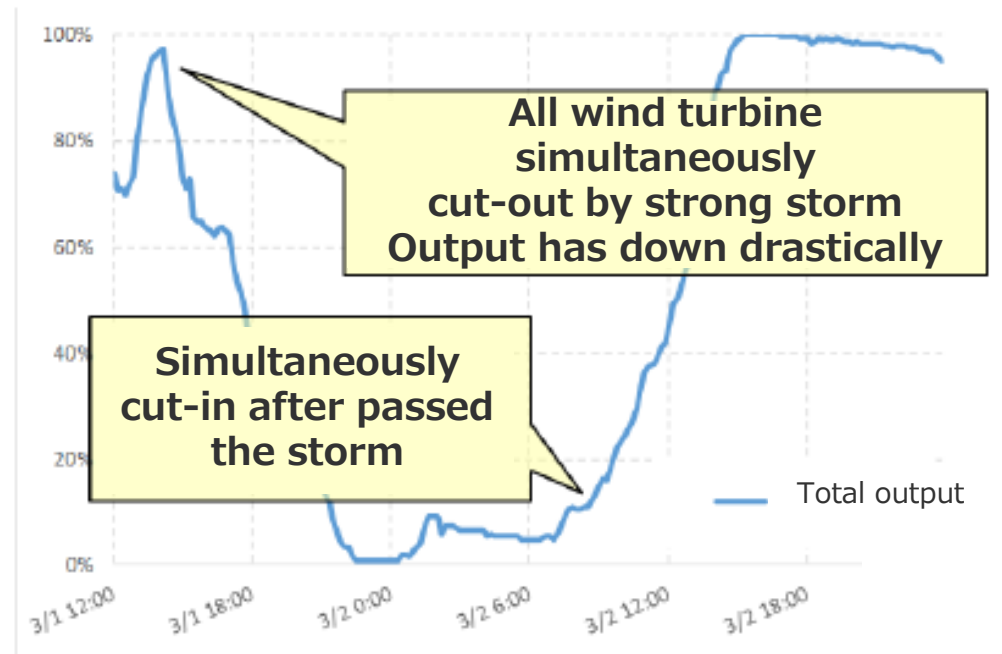
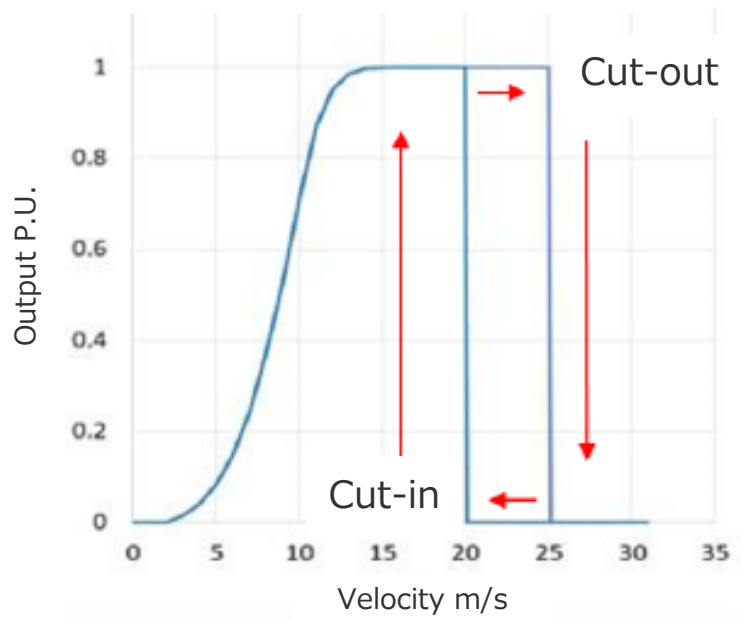

# 1 Outline of Output Limitation in RE

**There are two main Impacts on existing Power System by installation of VRE**  
**i) on Power Fluctuation and ii) on Capacity**

## **Impact on Fluctuation**

**Necessity of power facility for adjustment against fluctuation of RE output**

## **Impact on Capacity**

### **Balance of Supply and Demand**

**Necessity of control over power output to keep even balance between supply and demand**

### **Transmission Available Capacity**

**Necessity of reinforcement of transmission line and so on to install RE to power system.**

## 2 How to Manage the Limitation of Output from RE

### ◆ Control of Power Plant to keep power system stable in Japan

#### i) In case, over-supply of power owing to faults, low load etc.

- a) Control of planned adjustment margin or PSPP operation in the Power Co.
- b) Online control of power plant or PSPP operation in the Power Co.

#### ii) In case, over-supply of power even after above measures

- c) Control of other power plant than above plants in the Power Co.
- d) Supplying power to another Power Co. area via interconnection power line.
- e) Control of output by Biomass single purpose Power Plant
- f) Control of VRE output such as PV, Wind Power Plant
- g) Management by Wide Area Power Operation Organization  
e.g. OCCTO in Japan (Organization for Cross-regional Coordination of Transmission Operators)
- h) Control of Base Operation Power Plant such as Hydro PP, Geothermal PP and Nuclear PP.



## 2 How to Manage the Limitation of Output from RE

There are three (3) rules in Japan for limitation of RE output. Different limitation rule will be applied to each area, depending on the power system condition or capability of connecting power generation.

### **(1) 30 days Rule (Previously Applied Rule)**

→ **Applied to application for installation before 25 Jan.2015**

In case over-supply power even if Power Co. (PC) controls his power plant, PC can request RE plant, above 500kW in capacity, for depression of output of RE. PC can request for the control maximum **30 days per year without compensation.**

### **(2) 360 hours Rule (New Rule)**

In case over-supply power even if PC controls his power plant, PC can request RE plant, above 500kW in capacity, for depression of output of RE. PC can request for the control maximum **360 hours per year without compensation.**

## 2 How to Manage the Limitation of Output from RE

There are three (3) rules in Japan for limitation of RE output  
Different limitation rule will be applied to each area, depending on the power system condition of capability of connecting power generation.

### **(3) Designated Rule (by each Power Co.)**

Some of PCs has been designated for applying this rule by the Government. The designated PCs can request RE plant for depression of output of RE with no limit of hours per year without compensation, in case over over-supply power even if PC controls his power plant.

Designated Power Co. in Japan

>Hokkaido, Tohoku, Hokuriku, Chugoku, Shikoku, Kyushu, Okinawa Power Co., which has relatively low power demand.

## 2 How to Manage the Limitation of Output from RE

Configuration of Power Plant in designated Power Co. in Japan (As of 2018)  
 >Hokkaido, Tohoku, Hokuriku, Chugoku, Shikoku, Kyushu, Okinawa Power Co.,

Power Co.	Maximum Generated Power [MW]	Thermal [MW]	Hydro [MW]	Renewable Energy [MW]	Nuclear [MW]
Hokkaido	8,381	4,630	1,650	30	2,070
Tohoku	16,820	11,430	2,450	190	2,750
Hokuriku	8,500	4,820	1,930	0	1,750
Chugoku	11,540	7,800	2,910	10	820
Shikoku	5,434	3,390	1,150	0	890
Kyushu	18,860	10,380	3,580	210	4,700
Okinawa	216	2,160	0	Low	0

## 2 How to Manage the Limitation of Output from RE

Under acceleration of the nationwide introduction of RE in Japan, total amount of installed/applied power in PV and Wind Power have exceeded 30 days control permitted amount, in some Power Co.

Furthermore, Power Co. having large power capacity are also facing the power system problem, such as;

- Deficit of capacity for new introduction of RE power in trunk transmission line owing to existing large amount of RE installation.
- Increasing ratio of RE power to total power in local area.
- Large capacity Wind Power Plant need to be considered for connection to existing power system.

## 2 How to Manage the Limitation of Output from RE

### Installed and applied capacity of PV and Wind Power in each Power Co.

#### <PV>

[MW]	Hokkaido	Tohoku	Tokyo	Chubu	Hokuriku	Kansai	Chugoku	Shikoku	Kyushu	Okinawa
30days Limitation volume	1,170	5,520	-	-	1,100	-	6,600	2,570	8,170	495
Installed +applied Capacity	2,340	11,720	25,120	11,730	1,320	7,800	7,830	3,460	15,250	461
Installed Capacity	1,840	5,400	14,180	8,650	1,000	5,590	4,800	2,670	9,240	352
Applied Capacity	500	6,320	10,940	3,080	320	2,210	3,030	790	6,010	109

#### <Wind Power>

[MW]	Hokkaido	Tohoku	Tokyo	Chubu	Hokuriku	Kansai	Chugoku	Shikoku	Kyushu	Okinawa
30days Limitation volume	360	2,510	-	-	590	-	1,090	710	1,800	183
Installed +applied Capacity	1,810	3,720	3,030	2,940	990	1,620	1,860	780	4,140	21
Installed Capacity	450	1,580	430	370	160	120	360	260	570	14
Applied Capacity	1,360	2,140	2,600	2,570	830	1,500	1,500	520	3,570	7

As of December 2019

## 2 How to Manage the Limitation of Output from RE

### ◆ Amendment of Rules

On 26 January 2015, RE related law had amended in Japan.  
Rules on control for RE output had changed.

- i) **Capacity range, which can be requested for control in RE plant, had expanded from above 500kW previously to all RE plant.**

Previously, above 500 kW capacity of RE plant was requested to control, but under this amendment of law, capacity range for control of RE plant had expanded from above 500 kW to all RE plant because of drastically increase of RE installation.

Roof top PV at consumers home also had become a target system to control. However, above 10 kW RE system are priority in control than below 10 kW PV system.

## 2 How to Manage the Limitation of Output from RE

### ◆ Amendment of Rules

On 26 January 2015, RE related law had amended in Japan.  
Rules on control for RE output had changed.

**ii) Maximum number of days/hours for depression request to RE plant had changed from 30 days per year to 360 hours per year. Both of depression request needs no compensation.**

Previously, for above 500 kW capacity RE plant, maximum 30 days per year can be requested for depression control.

After amendment of the law, Maximum number of days/hours for depression request to 360 hours or no limit hours without compensation.

**iii) Obligation of installation of Power Conditioner System for depression control by remote**

RE plant shall install Power Conditioner System(PCS)

## 2 How to Manage the Limitation of Output from RE

Connection Rule for RE is different from each Power Co., since power system condition is different from each area.

Other than Tokyo, Chubu, Kansai Electric Power Co., “total capacity of application” have exceeded over “possible capacity for RE”

“**New Rule**” or “**Designation Rule**” applied to new application.

	under 10kW	10~50kW	50kW~500kW	above 500kW
Tokyo Chubu Kansai	Out of limitation		<b>New Rule</b> applied to application after 1 <sup>st</sup> Apr. 2015	<b>New Rule</b> applied to application after 26th Jan. 2015

Example of other Power Co.

	under 10kW	10~50kW	50kW~500kW	above 500kW
Kyushu etc.	<b>Designation Rule</b> applied to application after 1 <sup>st</sup> Apr. 2015	<b>Designation Rule</b> applied after excess over possible capacity for RE		



### Process of Control of RE Plant Output

1. Forecasting the power demand by Power Co. and calculate the necessary depression amount in RE power output.
2. Selecting RE plants to request for depression of output
3. Preparing depression schedule for designated RE plants
4. Notification to designated RE plant by one day before the control day  
Reviewing the depression schedule with taking latest supply-demand condition whether information into consideration
5. Execution of depression control of the RE plant on designated day
6. If RE plant has PCS, power output schedule is automatically installed to PCS in the RE plant and automatically operated as programmed output schedule.

# 2 How to Manage the Limitation of Output from RE

## Example of Output Schedule in RE plant

Daily output schedule

Output Schedule

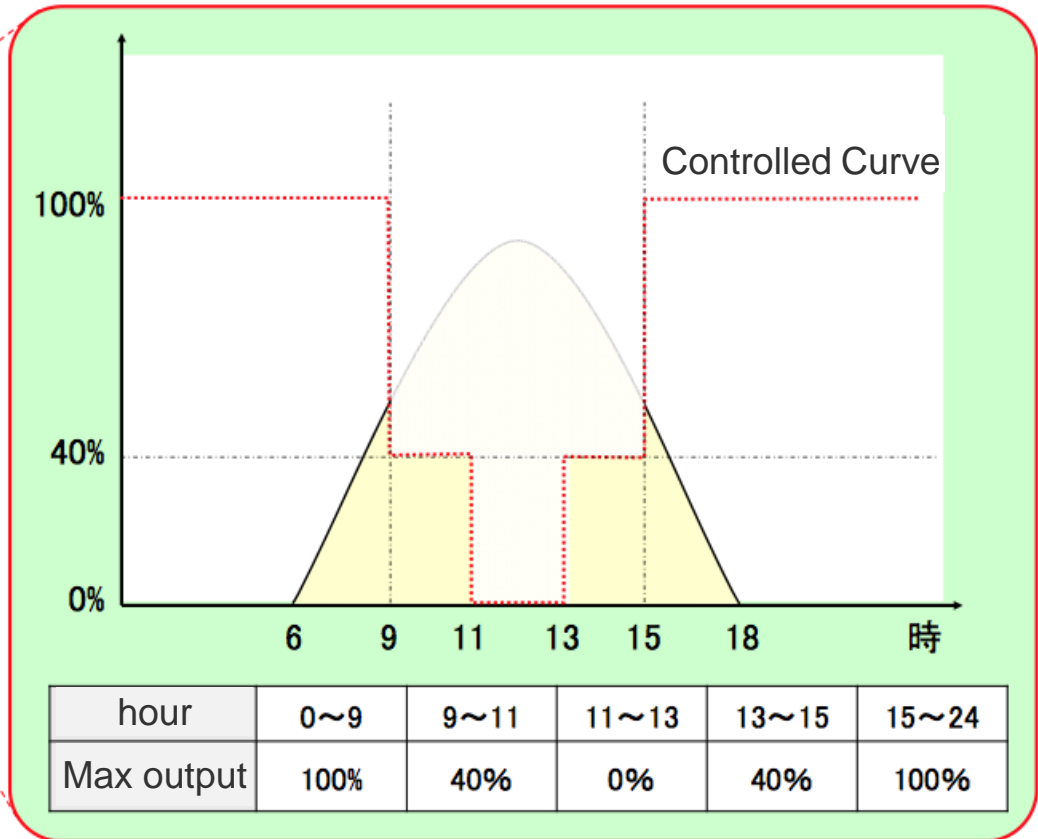
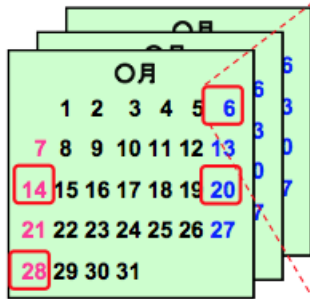

\* Minimum schedule unit is 30 minutes and 1% of rated output

# 3 Power Conditioner System (PCS) for RE

## Image of Power Conditioner System (PCS)

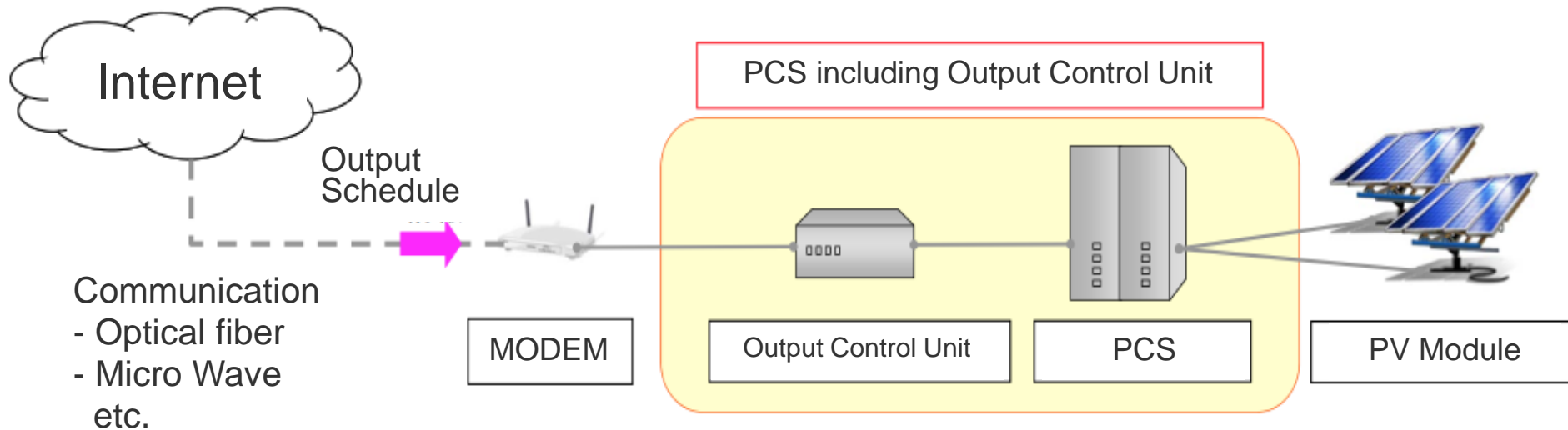



**CHUBU**  
Electric Power

***NIPPON KOEI***

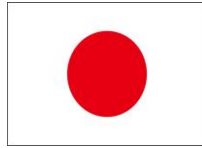

# Priority Dispatch

October, 2020

Chubu Electric Power Co., Inc.  
Nippon Koei Co., Ltd.

# Main Causes of Power Output Limitation

Two factors exist to control the power output from the generators

- ① Output control by supply and demand balance
- ② Output control by transmission line capacity (including grid stability)

## ① Output control by supply and demand balance

It is the control caused by constraints of supply and demand balance. It maintains the balance between by adjusting power output to meet constantly fluctuating demand

## ② Output control by transmission line capacity (including grid stability)

It is the control caused by thermal capacity of transmission lines and restrictions of power system stability. It is conducted when there is a risk of exceeding the upper limit in daily system operation

# Priority Dispatch

- This is the rule related to "① Output control by supply and demand balance"
- If the amount of electricity generated exceeds the amount of demand, it is necessary to adjust the amount of electricity generated. In this case, this rule defines the order and approach for matching the amount of electricity generated and the amount of demand
- This rule was defined in 2016 as guidelines, Electricity Transmission and Distribution Business Guidelines, that electric utilities must comply with under the Electricity Business Act.

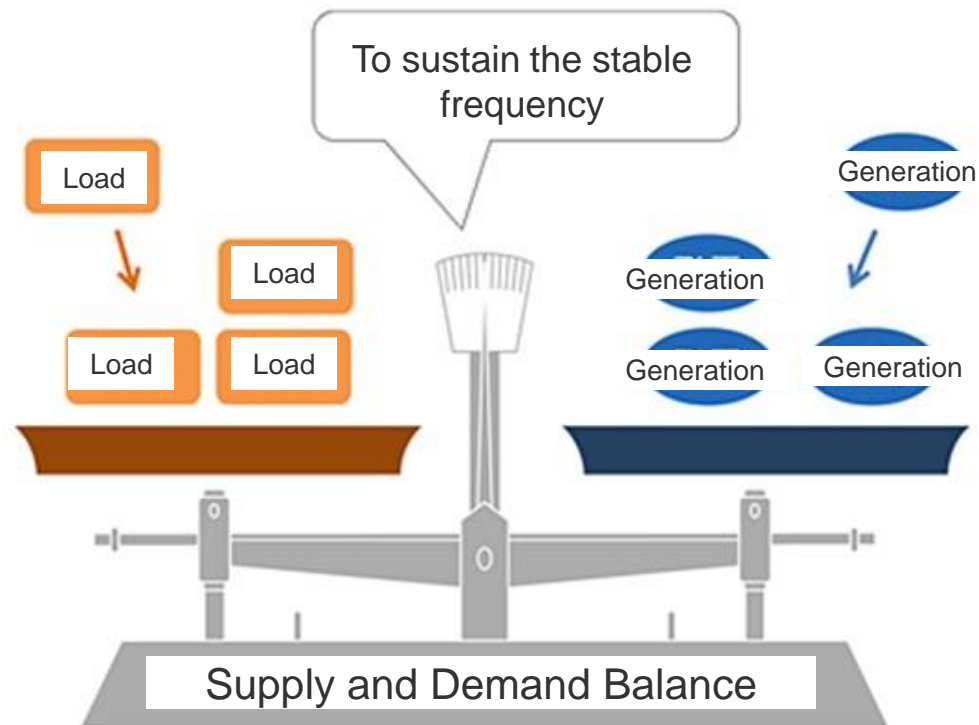

# Operation based on the Rule of “Priority Dispatch”

- The order of control of the output is determined by the cost of power generation and technical characteristics of the generating system.

The order in which the output is suppressed

- ① Absorption of surplus power from VRE through water pumping operations and control of output of thermal power generation, etc.
- ② Transmission of power to other regions using interconnected lines
- ③ Biomass output control
- ④ Solar and wind power control
- ⑤ Output control of long-term fixed power sources (hydro, nuclear, geothermal)



# Why Nuclear Power does not stop earlier than VRE

- Hydropower (Run of river type), nuclear power, and geothermal power are referred to as "long-term fixed power sources," and because it is technically difficult to adjust output in small increments over a short period of time, and because once output is reduced, it cannot be restored immediately, they are the last to be curtailed.
- If long-term fixed power sources are shut down before VRE, and VRE is used without suppression, there will be periods of time when VRE will not generate because their output is variable. This would require thermal power generation to cover those times, and CO2 emissions would increase. This would also lead to an increase in the cost of power generation, which in turn would lead to an increase in the burden on the public.

If 1GW of nuclear power plants stopped and same amount of electricity was supplied from VRE and thermal power, the cost to the public would increase by 130 million yen per day, according to the estimate.\*

\*Generation Cost: Nuclear power (10yen/kWh), PV (24yen/kWh), LNG Thermal Power (14yen/kWh), Capacity factor of VRE: 14%

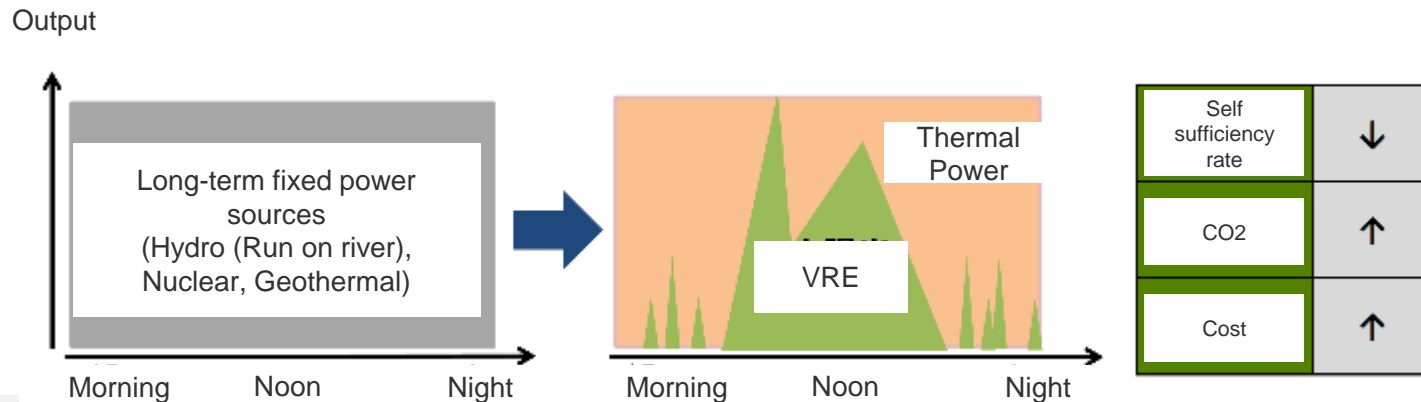

# Summary

- “Priority dispatch” is positioned as a rule for the introduction of renewable energy, and the power producers are informed about it in advance.
- Even in the case of solar and wind power generation, which has the difficulty of fluctuating the amount of power generated depending on natural conditions, this rule serves as a safety valve that allows output control in the event of excessive power generation.

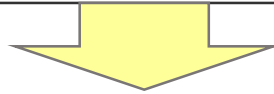

- Grid operators can increase the amount of renewable energy sources connected to the power system with peace of mind.
- There will be a momentary output limitation control, but over the course of a year, this will lead to an increase in renewable energy generation.

Ireland and Spain, two of the most advanced countries in the field of renewable energy, are also promoting the introduction of renewable energy under the condition of output control, and in fact, output control is being implemented now.



**CHUBU**  
Electric Power

***NIPPON KOEI***

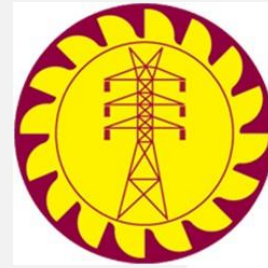
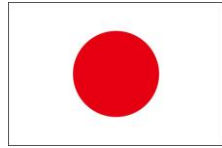
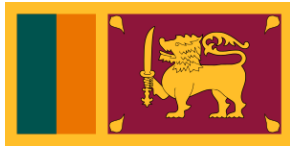

# Connect & Manage in Japan

September, 2020

Chubu Electric Power Co., Inc.  
Nippon Koei Co., Ltd.

# Present Status of TL Usage

- Of the two line capacities, one line capacity has been set as the operational capacity (upper limit), and TL facilities have been developed in line with it so that TL can transmit power in any cases such as the maximum output from generators and the minimum demand.
- For this reason, in a two-line system, the TL utilization factor does not exceed 50% under normal operation, and the average utilization factor is further smaller due to CF of the generators.
- Electricity demand has not increased, on the other hand VRE (Variable Renewable Energy) are increasing, It causes the suppression of thermal power generation, resulting in a further decrease in the TL utilization factor.

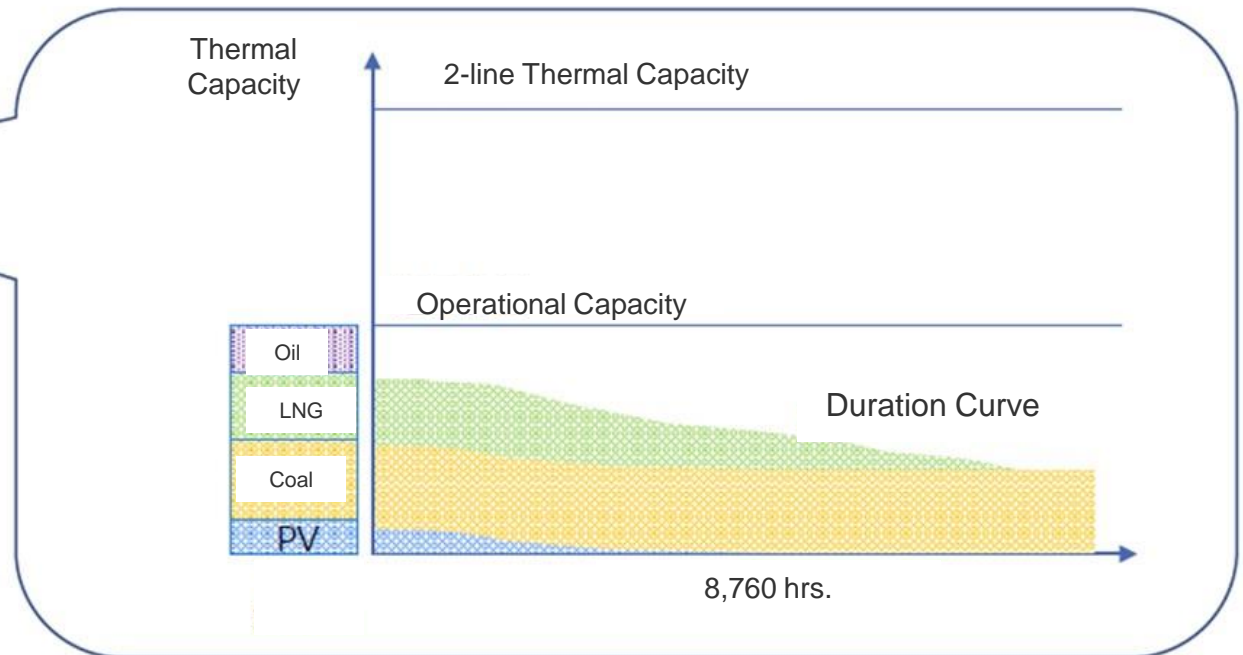
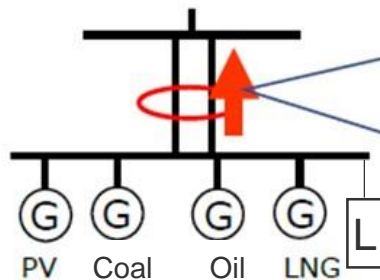

# Predicted Status of TL Usage in the future

## Back ground of the Scheme enforcement

<Case: Route of 2 circuits (thermal capacity is 2GW) connected by only PV>

- Maximum output of PV in total is 1 GW according to current standards [Operating capacity: 1 line thermal capacity]
- Maximum power flow is 0.8GW
- Annual TL utilization factor is only **7%**  
(= 1 GW x 8760 hours x 14% [General CF of PV] / 2 GW x 8760 hours)

Annual TL utilization factor becomes considerably low because CF of PV is low.

→ It causes the insufficient facility usage

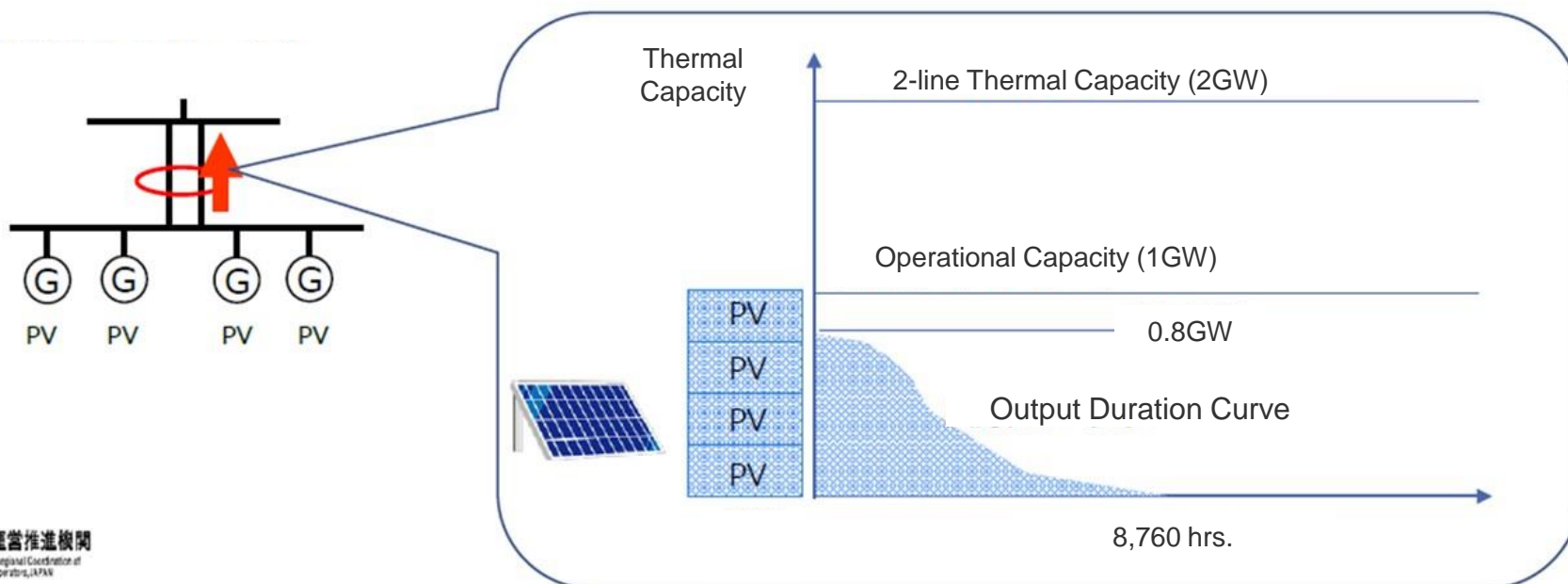

# “Connect and Manage” in Japan

## Basic concept

To make use of the power system efficiently, and enlarge the introduction of renewable power, “Connect and Manage” at the power system planning stage is introduced.

### So far

At the power system planning stage, power flow was assumed on the premise that all power generators are fully operated, and then necessity of upgrade the power system was judged.

### Connect and Manage in Japan

- ① Rational Assumption of power flow (Consider the conditions that may actually occur)
- ② “N-1” generation shedding (In case of a failure, generation shedding is mandatory)
- ③ “Non-firm type connection to the power system (Utilize the unused capacity)

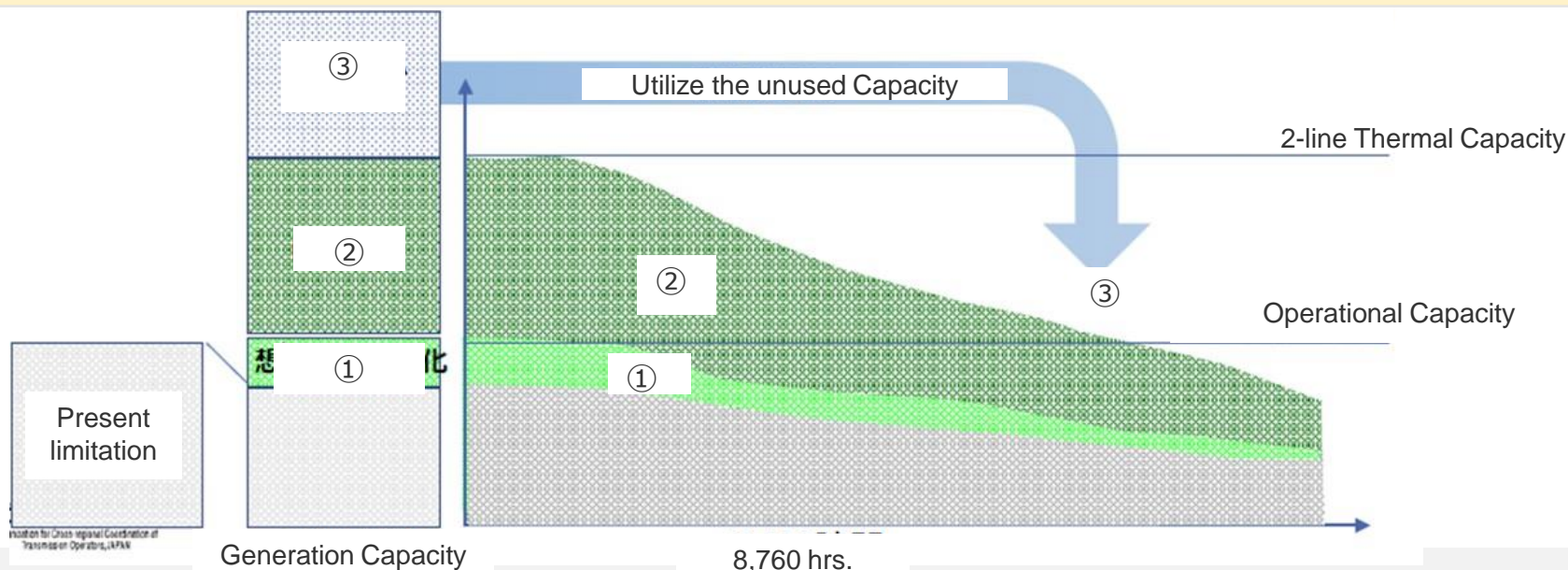

# ① Rational Assumption of Power Flow

- ✓ So far, to avoid the congestion of power system in any situations, the power flow was assumed on the premise that all power generators are fully operated.
- ✓ However, low-efficiency thermal power plant can't be fully operated especially in low demand, so the actual power flow is lower.
- ✓ By assuming the actual operation state of thermal power plant, power flow can be rationally assumed.

## Previous Assumption

Evaluation on the premise that all power generation are fully operated regardless of efficiency

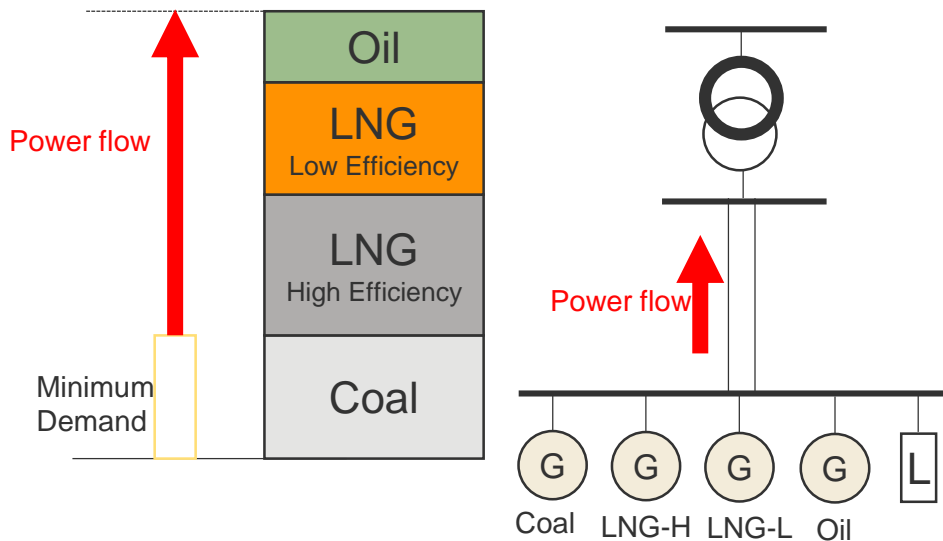

## Rational Assumption

Evaluation on the premise considering the actual operating state of thermal power plant

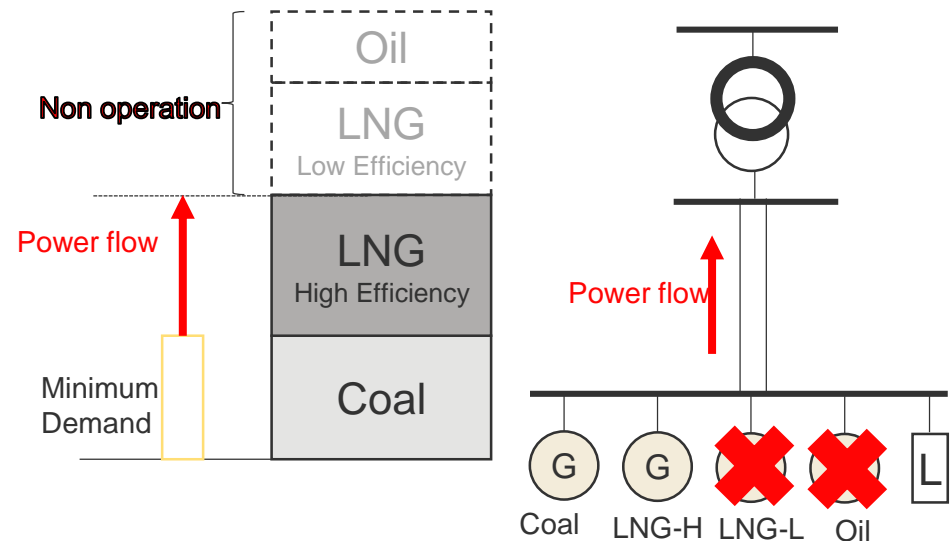



## ② “N-1” generation shedding

- ✓ Transmission capacity is usually secured for emergency.
- ✓ When a fault occurs in a transmission line, generators is promptly shed.
- ✓ N-1 generation shedding enables additional generator’s connection by utilizing the capacity secured for emergency.

### Without “N-1” generation shedding

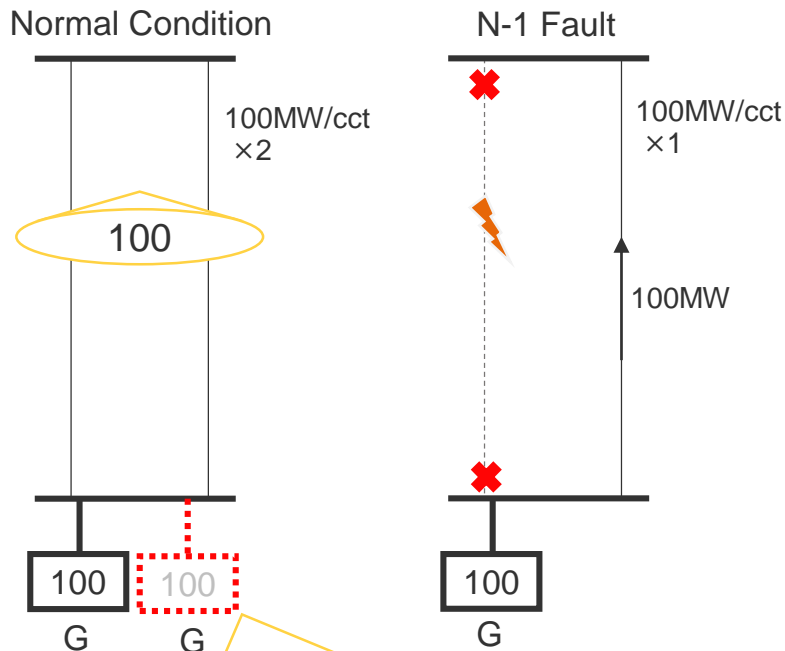

Additional connection is **Not approved**

### With “N-1” generation shedding

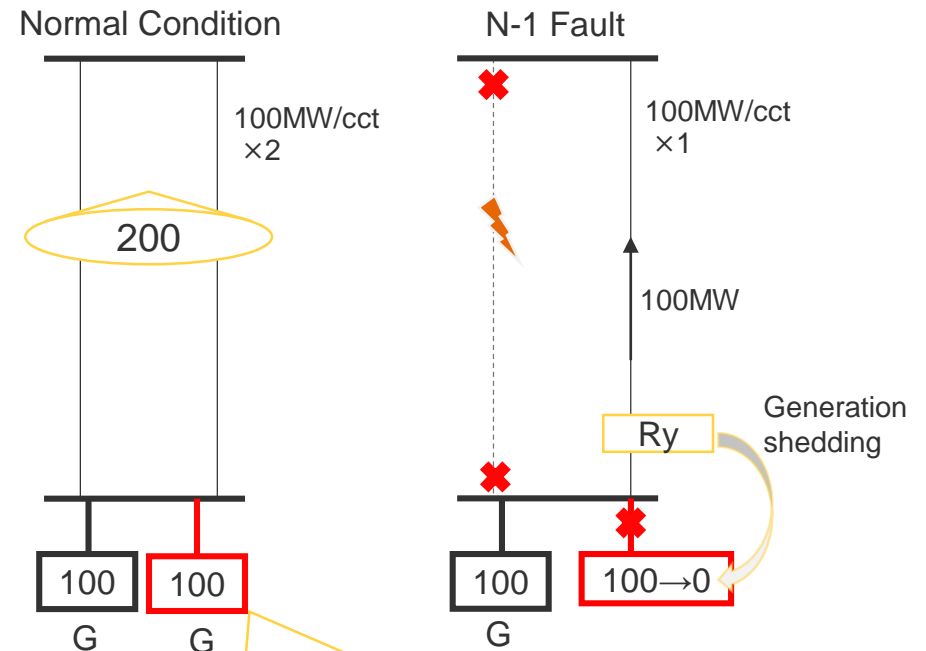

Additional connection is **approved**

### ③ Adopt the “Non-firm type connection to the power system

✓ The operation of generation is approved only in the premise that there is an room in capacity. This type of connection of generation is called “Non-firm connection”.

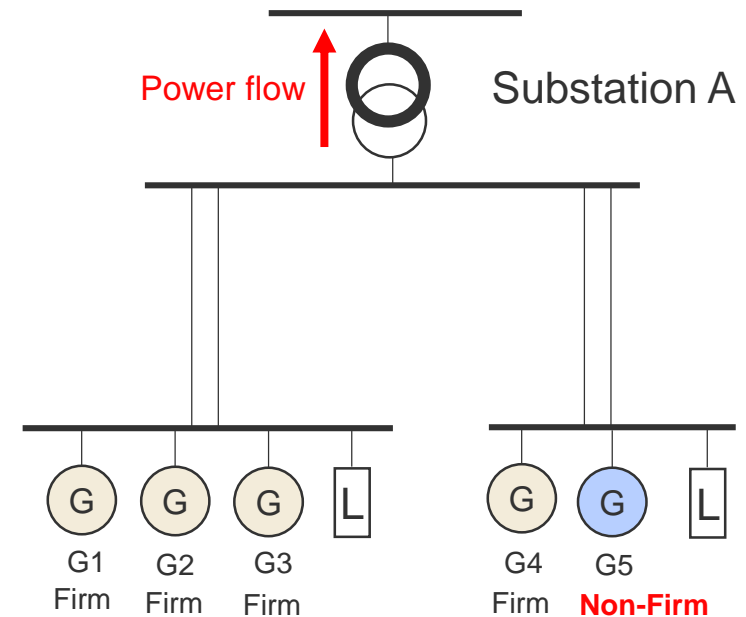
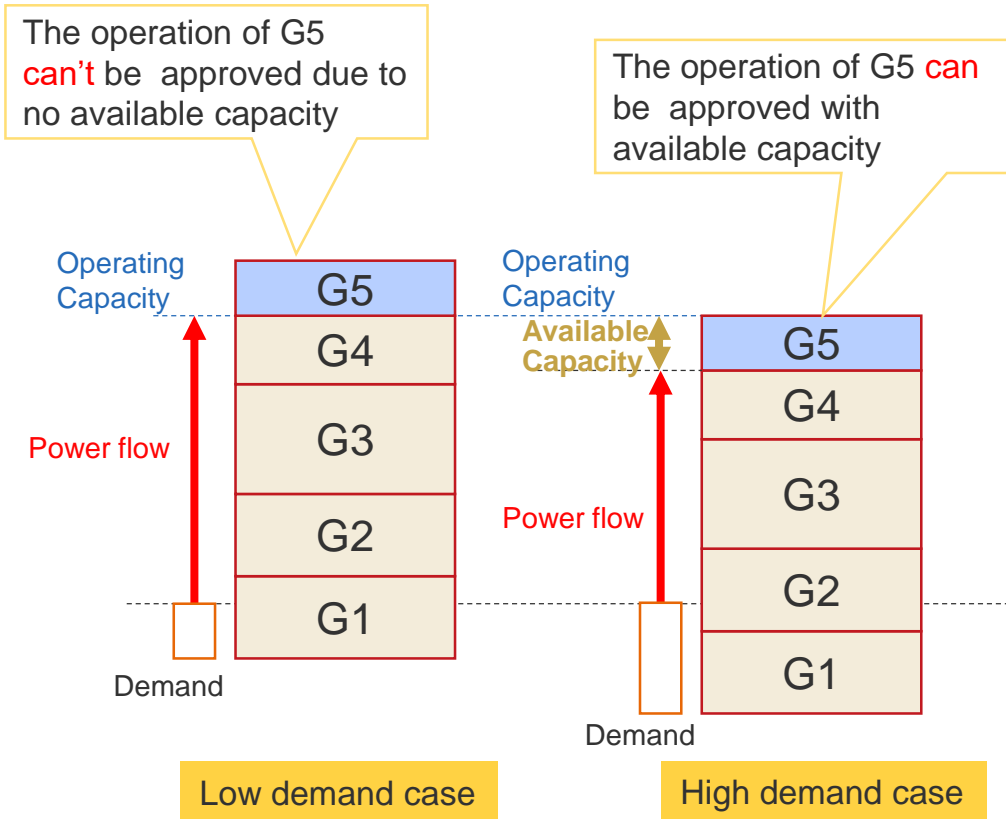

# Image of each countermeasure

<N-1 generation shedding>  
N-1 generation shedding enables  
operating capacity increased

<Rational Assumption of power flow>  
By assuming the actual operation  
state of thermal power plant, power  
flow can be reduced.

<Non-firm connection>  
By Non-firm connection, the room of  
unused capacity of facility is used  
effectively.

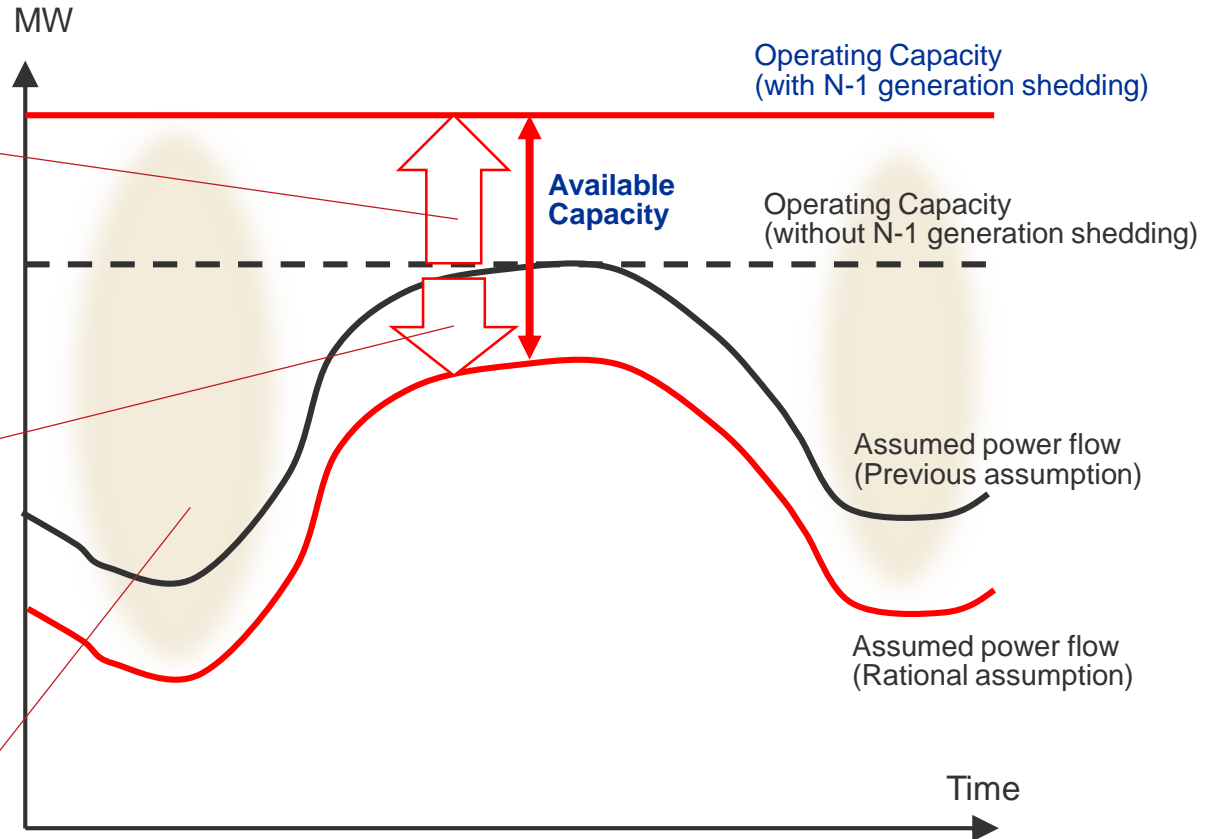

# Approach Status in the Developed Countries for “N-1 generation shedding”

- In Europe and the United States, they comply with the N-1 standard in principle, do not develop facilities on the premise of “N-1 generation shedding”.
- When “N-1 generation shedding” is applied, it is difficult to operate when there is a failure in the mesh or loop system, and if the “N-1 generation shedding” fails, it will lead to a large-scale power outage.

Country	Approach Status of “N-1 generation shedding”
UK	<p>According to the SQSS<sup>※1</sup>, basically not accepted. However, in case that IPPs accept the generation shedding of theirs in the N-1 condition, they may be permitted to connect over the capacity of one-line rated capacity.</p> <p>※1 National Electricity Transmission System Security and Quality of Supply Standard</p>
France	<p>According to the general rule<sup>※2</sup>, basically not accepted. However, “N-1 generation shedding” can be accepted only in the limited period until related transmission system reinforcement is finished and in the case that related transmission reinforcement is very difficult.</p> <p>※2 ENTOS-E, Operating Handbook P3-Policy: Operational Security</p>
Germany	<p>According to the general rule, basically not accepted. However, in case that IPPs accept the generation shedding of theirs in the N-1 condition, they can connect to the power system</p>
USA	<p>According to the general rule<sup>※3</sup>, basically not accepted.</p> <p>※3 NERC Reliability Standard (TPL) Transmission Planning PJM Manual 14B: PJM Region Transmission Planning Process (Oct.2017)</p>

# Condition Differences between Europe/USA and Japan on “N-1 generation shedding”

Applying N-1 generation shedding in Japan is

- Difficult to apply to the loop operation of the backbone system, on the other hand, no problem to apply to the radial system in reliability because of the past record.
- Applicable to the most of the system reinforcement associated with power connection because they are radial system.

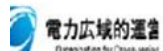
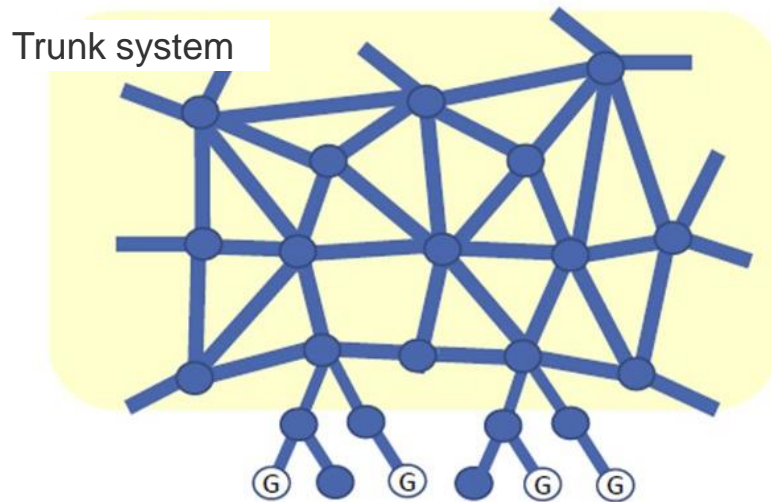

Mesh trunk system in Europe/USA [Image]

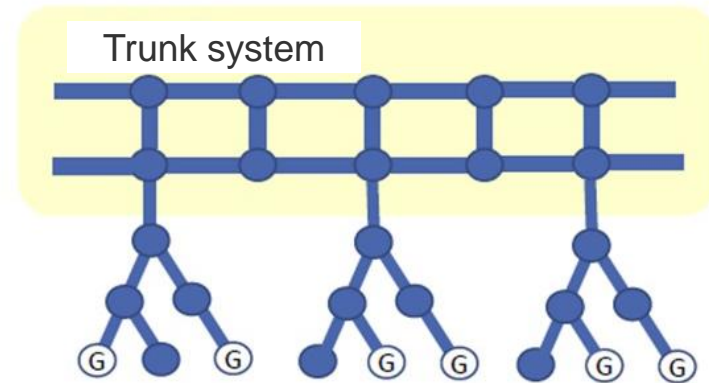

Radial trunk system in Japan [Image]

Japanese unique new facility formation standard, "Japan Connect & Manage" is developed, by constructing a mechanism that can immediately shut down when there is a failure and implementing “N-1 generation shedding”.

→ It is probably able to be adopted to Sri Lanka system which is not connected with neighboring countries and is basically ??radial operation?? (Please tell us).

# (Reference) Trunk System in Japan

- A long and narrow power system in skewer shape from north to south
- The maximum utilization of the existing grid will be promoted, and at the same time, the interconnection will be reinforced, which are Hokkaido and Tohoku where a lot of VRE are expected to connect, and then interconnection between east and west area where FC converter exist.

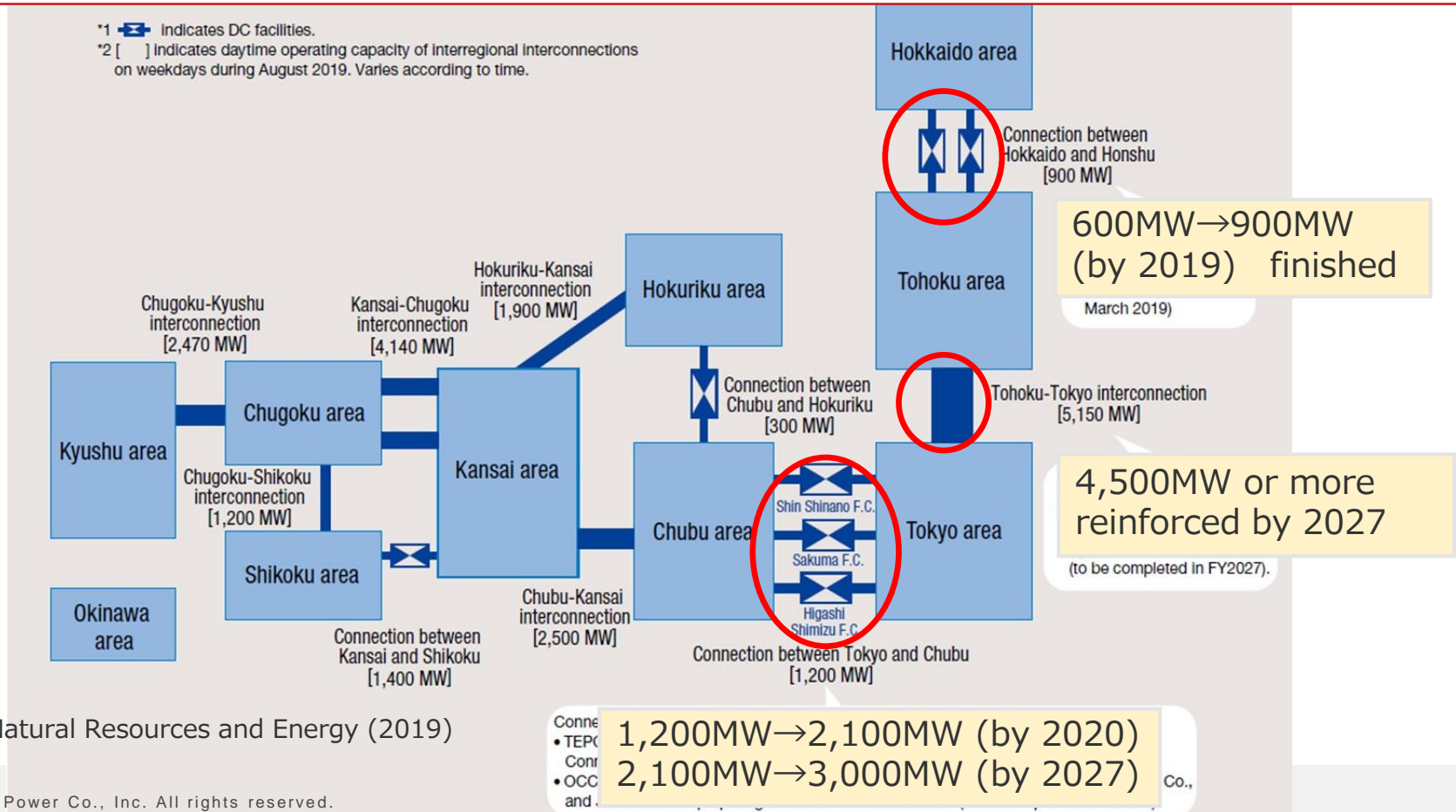

Source: Agency for Natural Resources and Energy (2019)

# Power Network Development in the Future (Japan)

The government intends to reduce the total cost of “VRE generation + power system” from the viewpoint of achieving the next generation power system / expansion of VRE installation and suppressing the burden on people at the same time.

## Government Basic Policy on network cost reform

1. Compression of existing NW cost

2. Cost increase for the NW investment for the next generation (Reinforcement, Balancing power, etc.)

3. Mechanism for minimizing NW cost on generation side

- Conversion to next-generation NW to accept huge installation of VRE
- Minimization of total cost of generation and NW

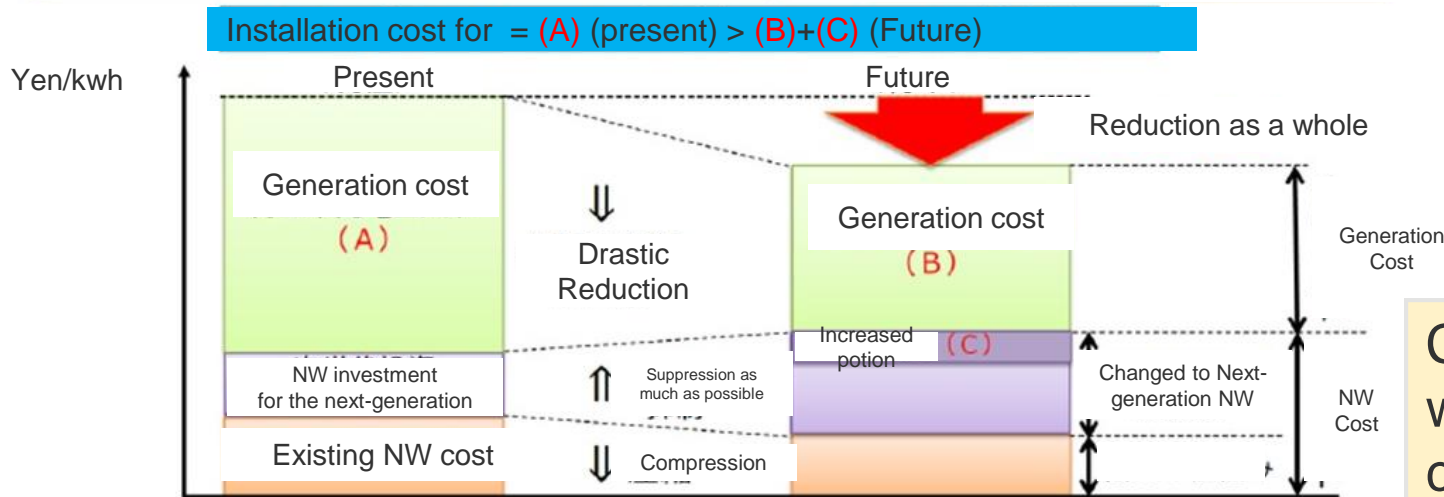

**(Reference, Japanese Case)  
Public Announcement of Power System Related Info.**



# Disclosure of grid information by Power Grid Companies

- Since it is expected that a large amount of VRE will be connected to the grid, it is required to disclose grid information that is extremely important for installers of power generation facilities that use the power grid.
- It is essential to provide sufficient information from the viewpoint of ensuring a fair competition environment between the power generation department of the former general electric utilities and the new coming power generation business owners
- Since the OCCTO was established in 2015, the grid information has been published by the power grid companies and OCCTO based on the Electricity Business Act.
- Disclosure of such information will reduce business risks associated with power source development and grid interconnection, and will also improve investment incentives.

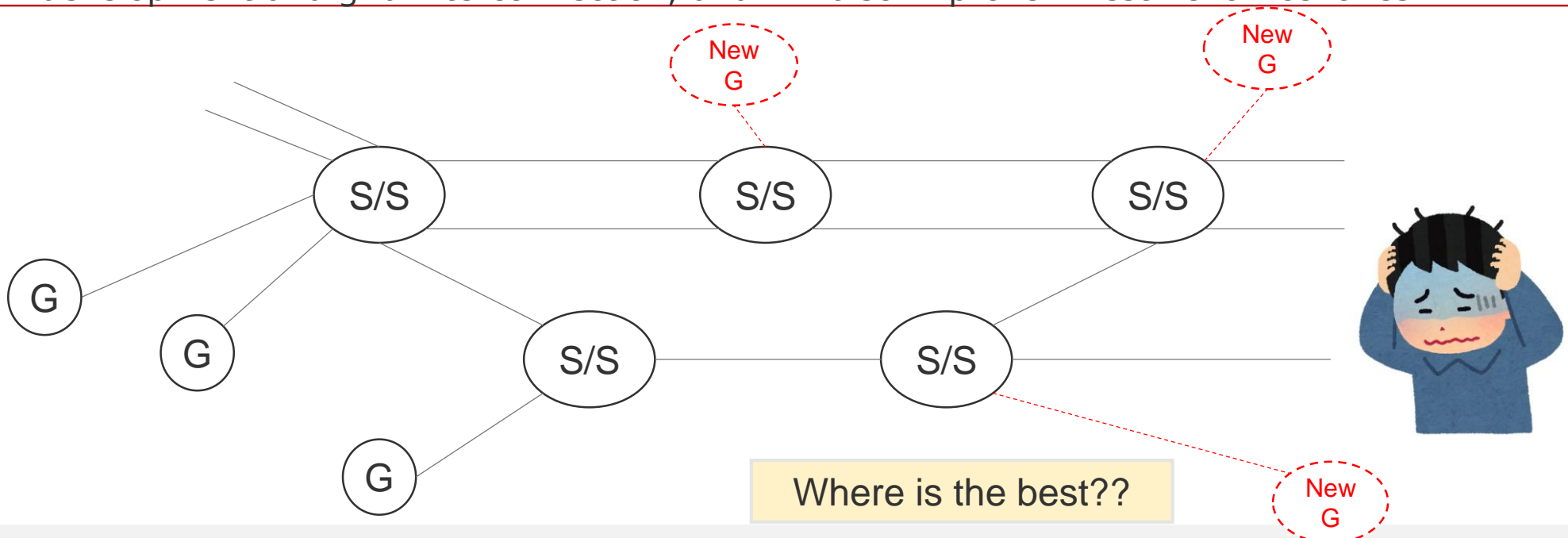

# System Information to be published

- A) Information that contributes to increasing the predictability of power generation business owners when considering interconnection to the grid. Published on the websites of OCCTO and power grid companies
- Info. related to the Acceptable Capacity to be connected to the Grid  
Number of lines, Rated capacity, operating capacity, constraint factor of operating capacity (heat capacity restriction), N-1 shedding applicable / not applicable, N-1 shedding applicable amount, cost / construction period for connecting to the grid, etc.
  - Long term power system development plan

- B) Information that contributes to actual operation after interconnection
- Information about the Trunk system
  - Information about inter-area connection lines
  - Information about supply and demand situation
  - Information on the past record of VRE output suppression

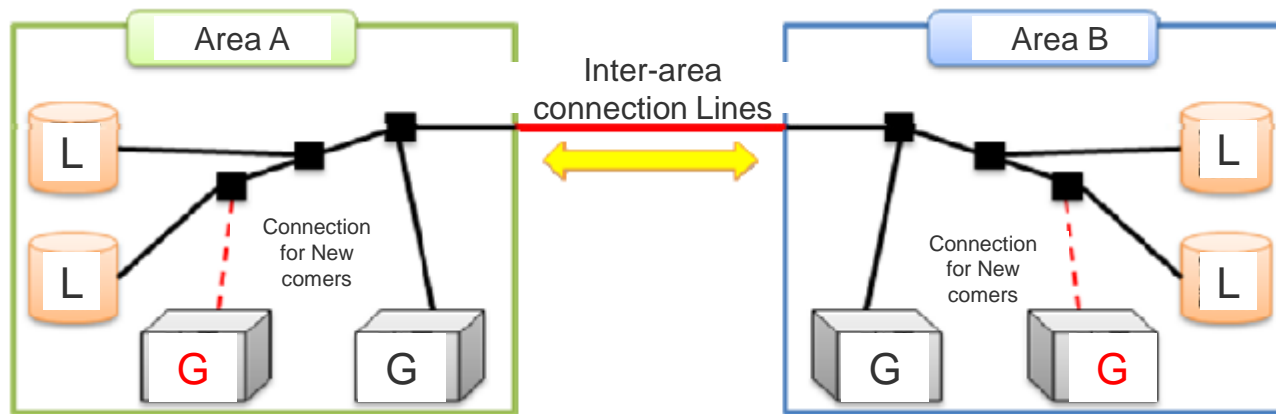

# Acceptable Capacity to be connected to the Grid in Shikoku Area for 187kV and more

- Clear info. to the public
- Power generation business owners can make an initial examination of the generation site and its connection point to the grid

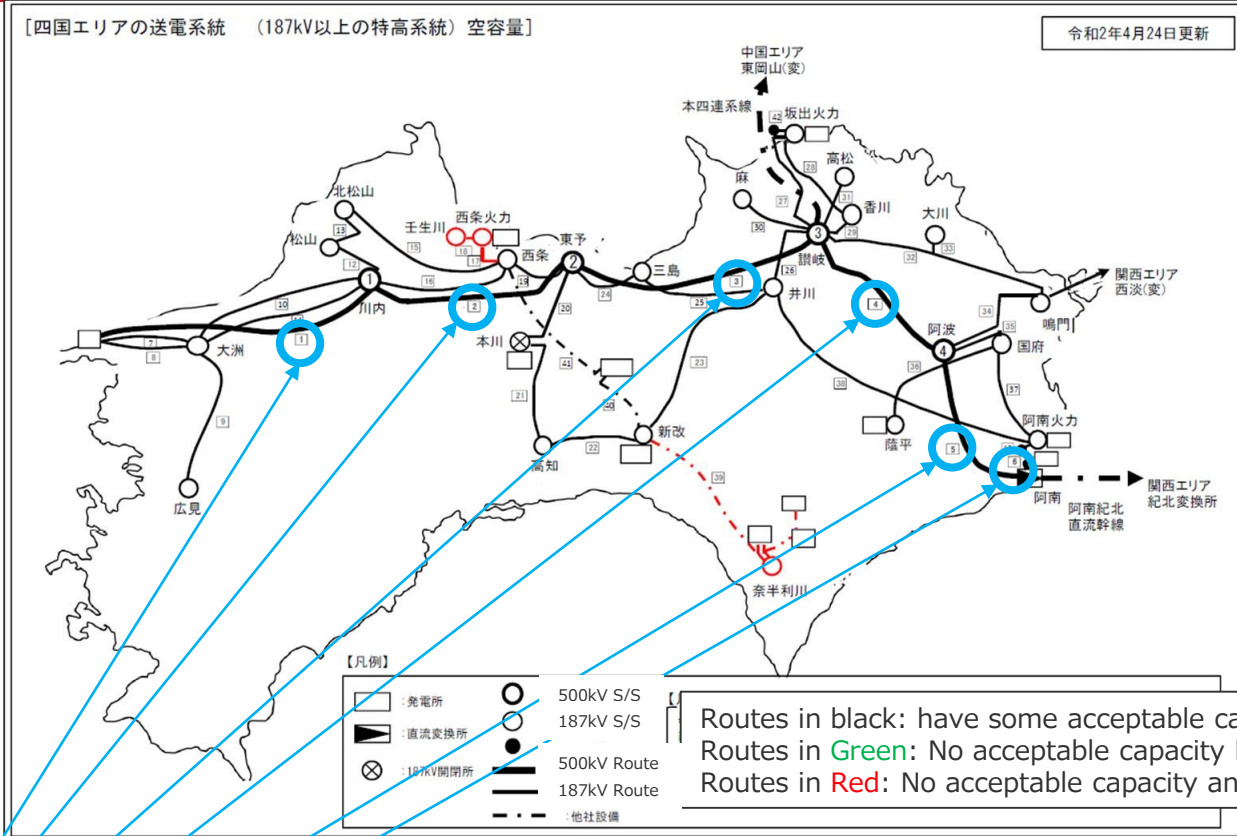

送電線 No	送電線名	電圧 (kV)	回線数	設備容量 (100×回線数) (MW)	運用容量値 (MW)	Limitation causes	空容量(MW)		Connection Availability with N-1 shedding	Available Capacity with N-1 shedding (MW)	備考
							当該設備	上位系等考慮			
1	四国中央西幹線	500	2	-	-	熱容量	710	710	-	-	◇
2	四国中央中幹線	500	2	6,580	2,060	安定度限界	710	710	不可#1	-	
3	四国中央東幹線	500	2	6,580	2,060	安定度限界	500	500	不可#1	-	Available or Not
4	阿波幹線	500	2	6,580	3,290	熱容量	1190	1190	不可#1	-	
5	高阿波幹線	500	2	6,580	3,290	熱容量	1190	1190	不可#1	-	
6	橋湾火力線	500	2	5,732	3,290	熱容量	490	490	可	0	※3

Thermal limitation, Stability limitation

# Question from CEB

How much Capacity of VRE can be connected to the Grid thanks to the Japanese “Connect & Manage”

## Japan

- Idea of “Rational Assumption of power flow” leads to additional about 5.9GW VRE.
- Idea of “N-1 generation shedding” leads to additional about 40.4GW VRE
- The data of “Non-firm type connection” is under collection.

- Demand of whole Japan is 159GW (2020)
- Total contribution amount is about 46.3GW

## Sri Lanka

- Demand of whole Sri Lanka is 2.616GW (2018)

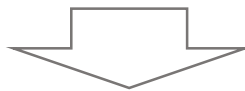

Precondition: using same ratio as Japan

- Possible total contribution amount is 0.76GW

Source: Agency for Natural Resources and Energy  
: LTGEP 2020-2039



**CHUBU**  
Electric Power

***NIPPON KOEI***



# Aggregator Business in Japan

Ceylon Electricity Board  
JICA Expert Team

August, 2022

Chubu Electric Power Co., Inc.  
Nippon Koei Co., Ltd.

1. Back ground of Aggregator Appearance
2. Role of and Rule for Aggregator
3. Effect from the perspective of power system
4. Outline of transactions centered on Aggregators
5. Actual Transactions
6. Transactions with Aggregators from the perspective of consumers
7. Summary

# 01 Environmental Changes surrounding the Power Sector

- Supply control has become difficult due to the promotion of introduction of PV and WT.
- Introduction of Distributed Energy Resources (DER) such as household storage batteries, EVs, and NegaWatt (Saving power) that has been promoted.
- Advanced energy management technology utilizing IoT has been improving a mechanism to utilize Energy Resources on the consumer side.
- Each energy resource on the consumer side is small, but it can be used for keeping balance between supply and demand by bundling them together and controlling them remotely through IoT technology.



- The bundled resources are called "virtual power plant (VPP)" because they function as if they were one power plant.



Appearance of Aggregator

Although it is difficult for small-scale DER owners to do business, thanks to the aggregators, it has become possible to participate in the balancing market and capacity market where the minimum bid amount is 1,000 kW or more.

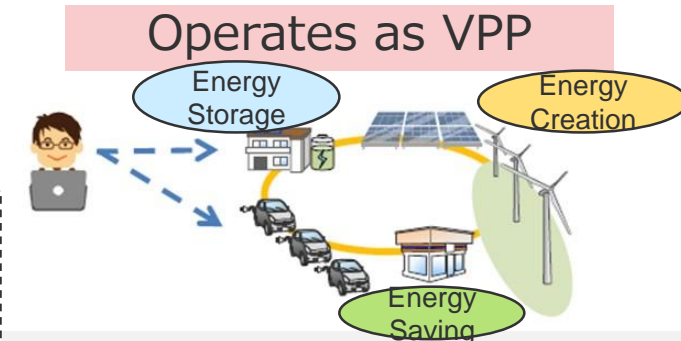



# 01 VPP Operation and Services provided by Aggregator

## ERAB: Energy Resource Aggregation Business

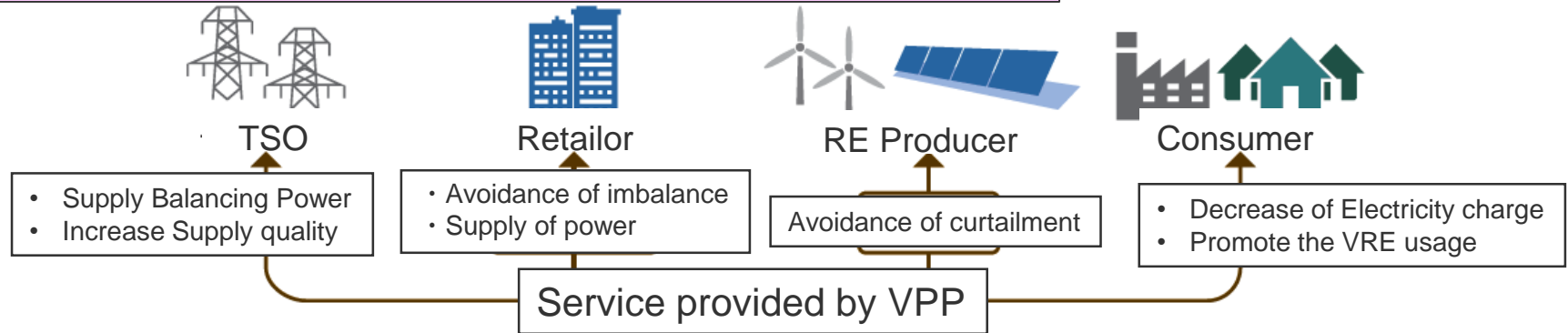

### Market participants

Effective usage of IoT (Internet of things)

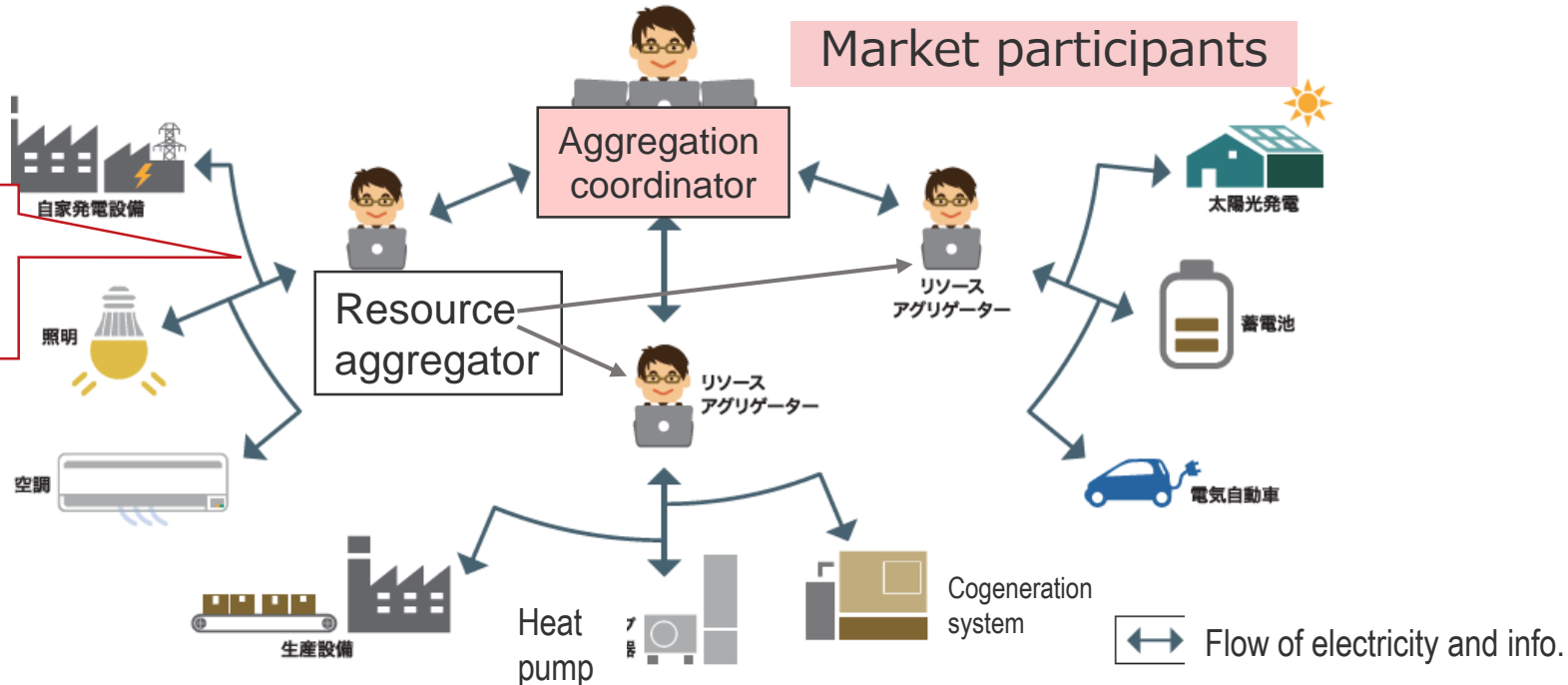

## 02 Aggregator Scheme

- From the perspective of strengthening the resilience of the electric power system and further expanding the DER, an aggregator that bundles DER and provides capacity is newly positioned under the Electricity Act as a “Specified wholesale supplier”.
- By clarifying the application of regulations, it is expected that the reliability of aggregators and the business environment will be improved.

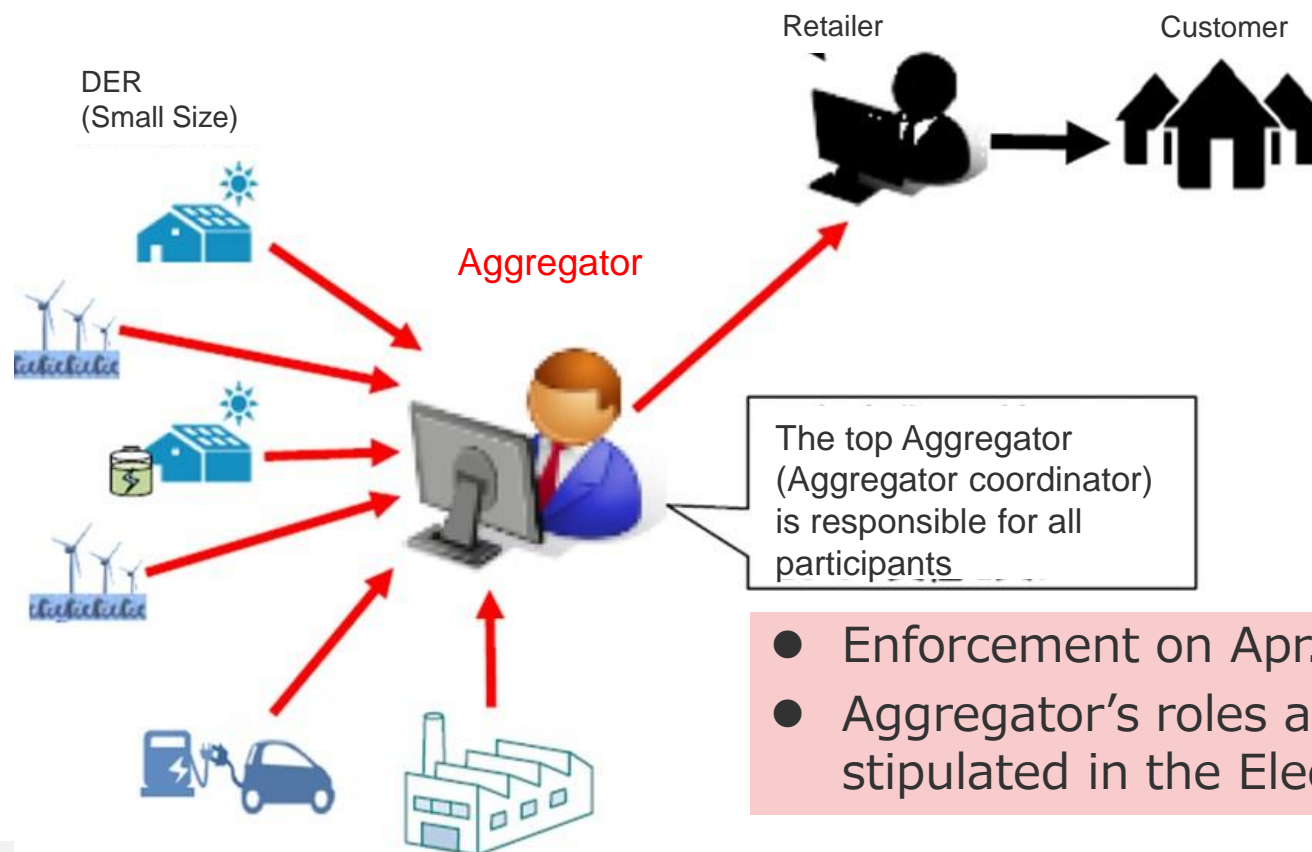

- Enforcement on Apr. 1, 2022
- Aggregator's roles are clearly stipulated in the Electricity Act.

## 02 Provision Items of Aggregator License

Enforcement on Apr. 1, 2022

- The provision items are similar to those of power generation companies.
- Notification system to the Minister of METI as same as power generation companies
- To become target receiving “order for change” from the regulator due to cyber security, which require special measures

### Main obligations/regulations

Almost as same as that of generation companies

- Supply balancing power based on contract with TSOs
- Join OCCTO※
- Prepare and submit a supply plan to the Minister of METI
- Comply with METI's supply orders
- Comply with commands from the Minister of METI, report collection, on-site inspection, and business improvement

※[Organization for Cross-regional Coordination of Transmission Operators, Japan](#)



# 03 Economical Power System Development (Reduction of Generation Cost)

- Although the peak demand period is short, the generation facilities are developed and managed to meet this period.
- By utilizing DR, it is possible to level out the load by lowering the demand during peak time and moving it to another time zone.



- It is possible to reduce investment in power generation equipment.
- Fuel costs can be reduced (in many cases, power sources using high price fuel are operating during peak hours)

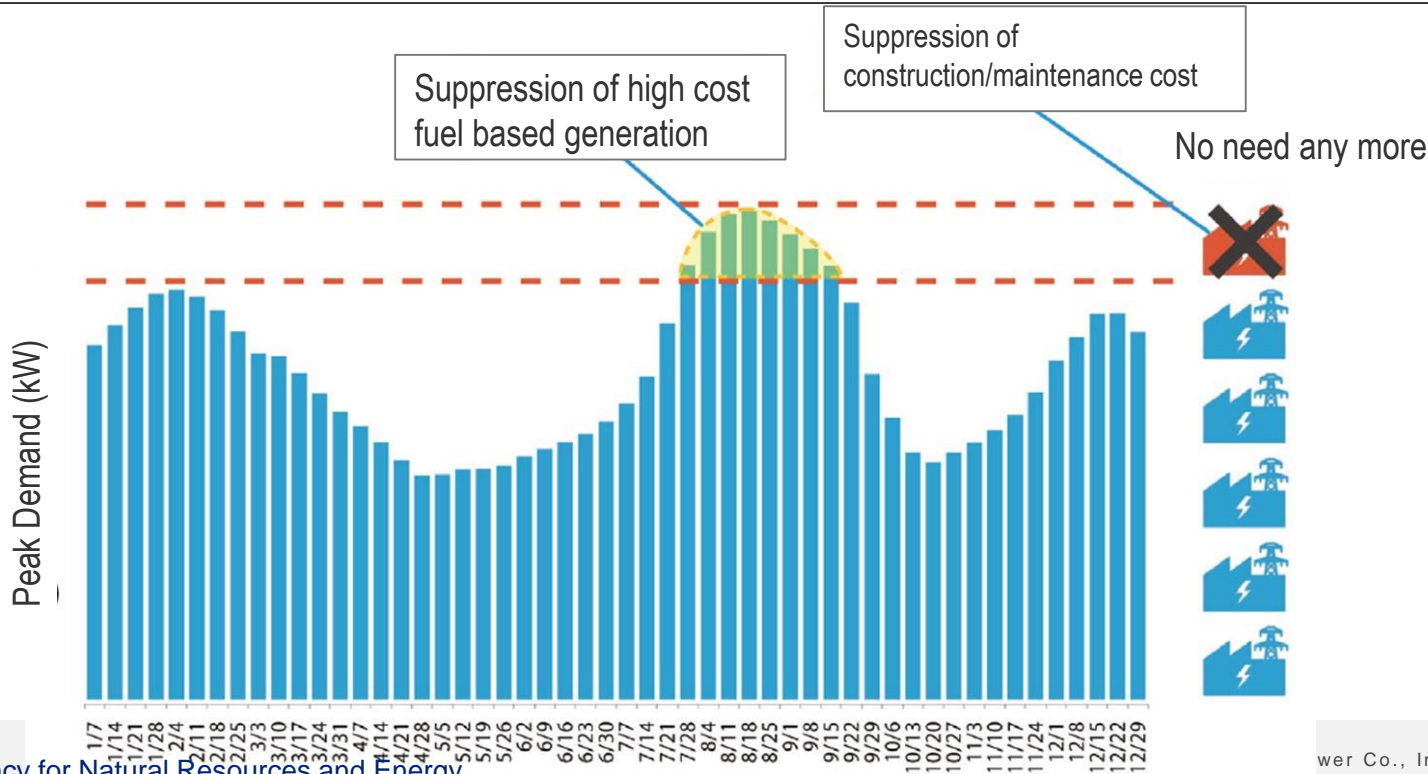

# 03 Expansion of RE introduction (Utilization RE without Waste)

If the RE introduction progresses and it exceeds the demand no matter how the output of other power sources such as thermal power is regulated, it is necessary to suppress the RE output.



By using DR\* to create demand, it enables to utilize the power generated from the RE effectively.

\*Demand Response

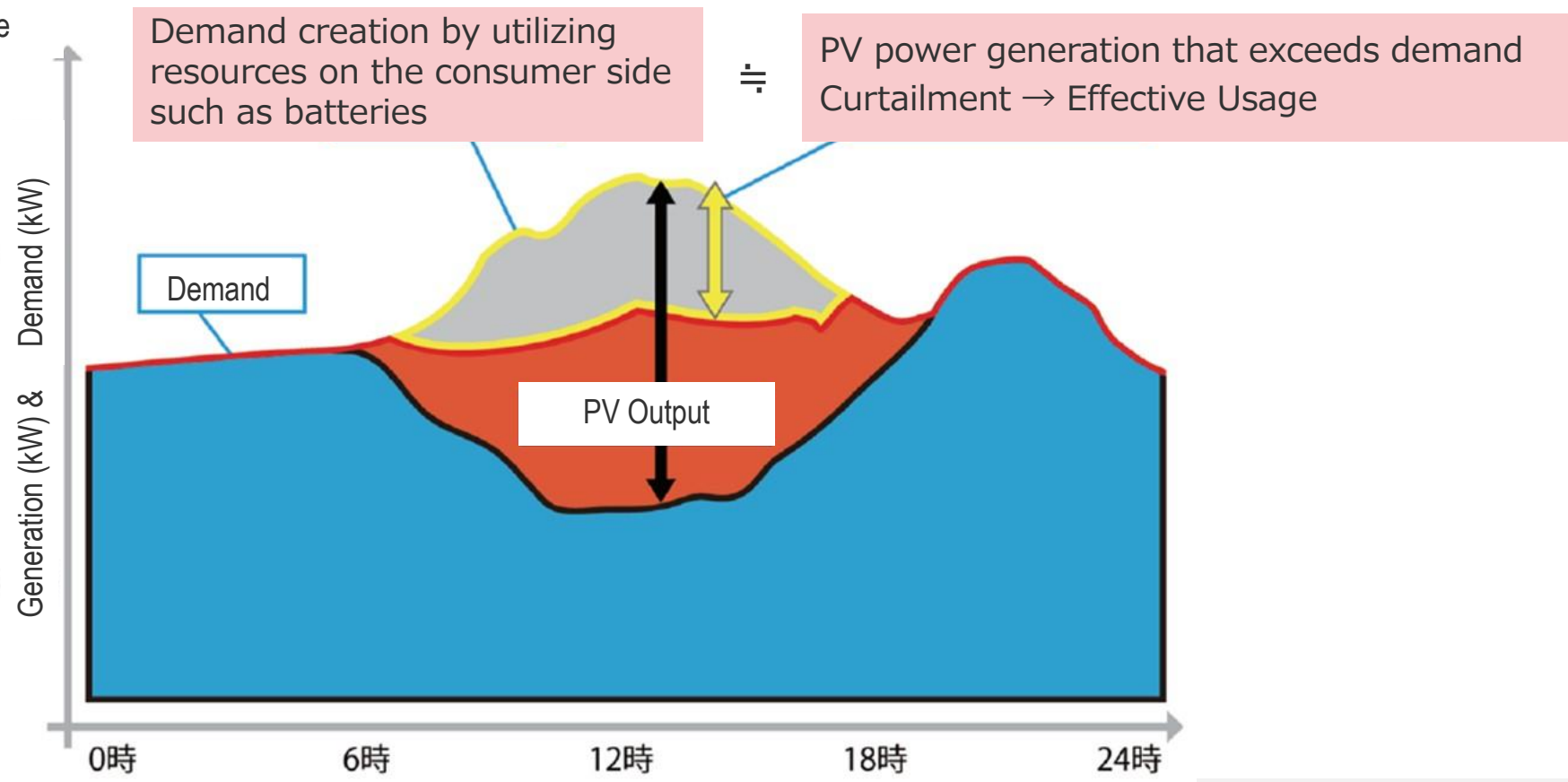

# 04 Transaction flow (NegaWatt transaction)

- Incentive-type of Decrease-DR transaction that saves electricity at the system peak by prior contract with Aggregator
- Not only large businesses but also general households can participate and get rewards through Aggregator.

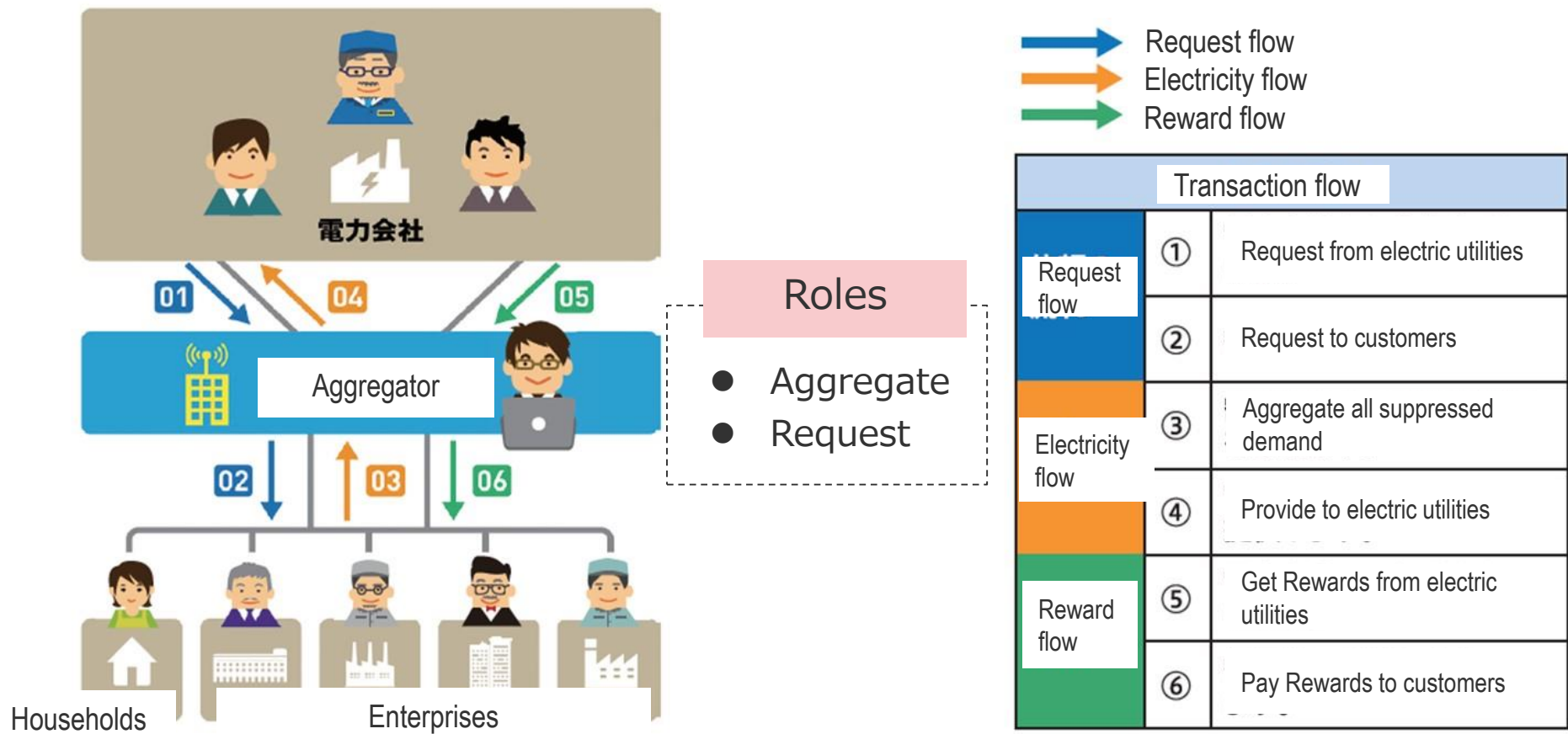

# 04 Ex., DR Image (Adjustment/stop of equipment)

- Air conditioner temperature control
- Lighting adjustment

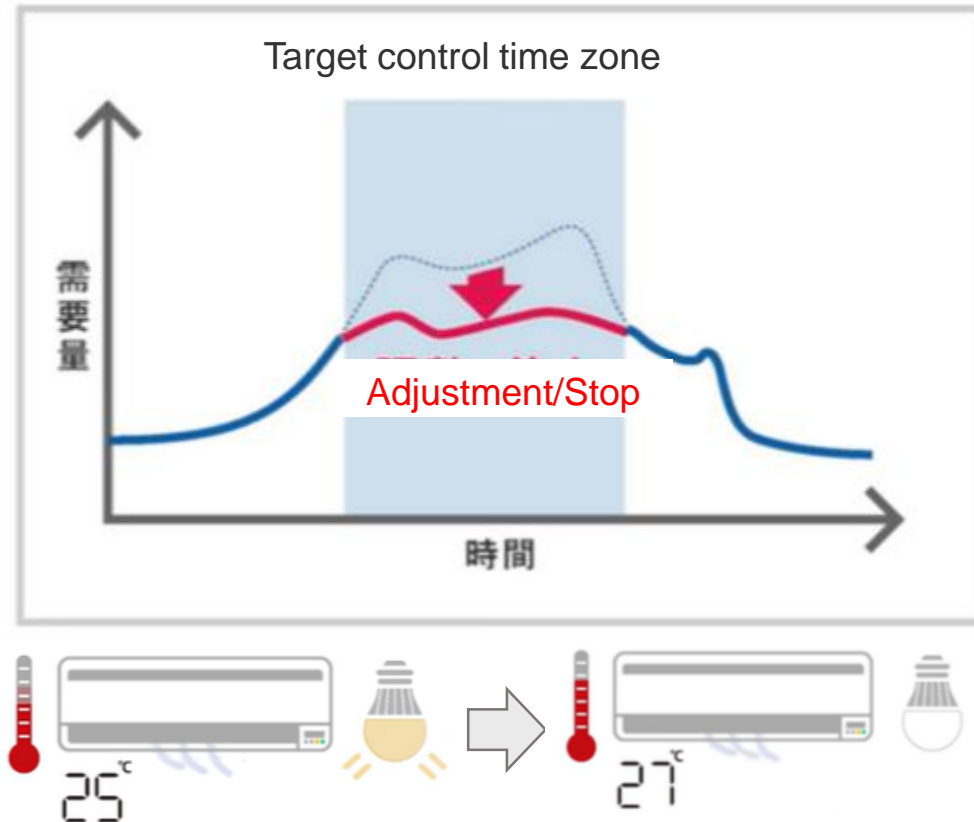
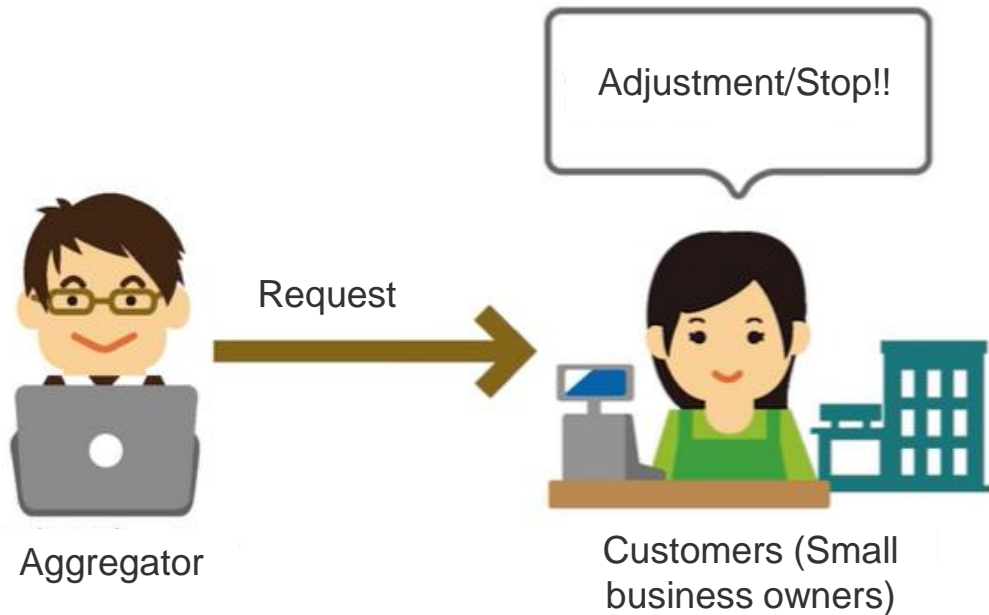

# 04 Ex., DR Image (Production Plan Change)

- Shift production time to suppress electricity demand

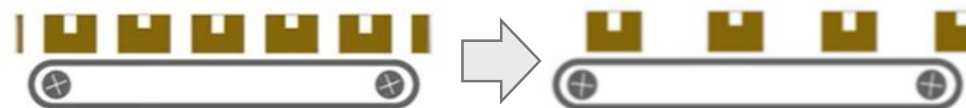
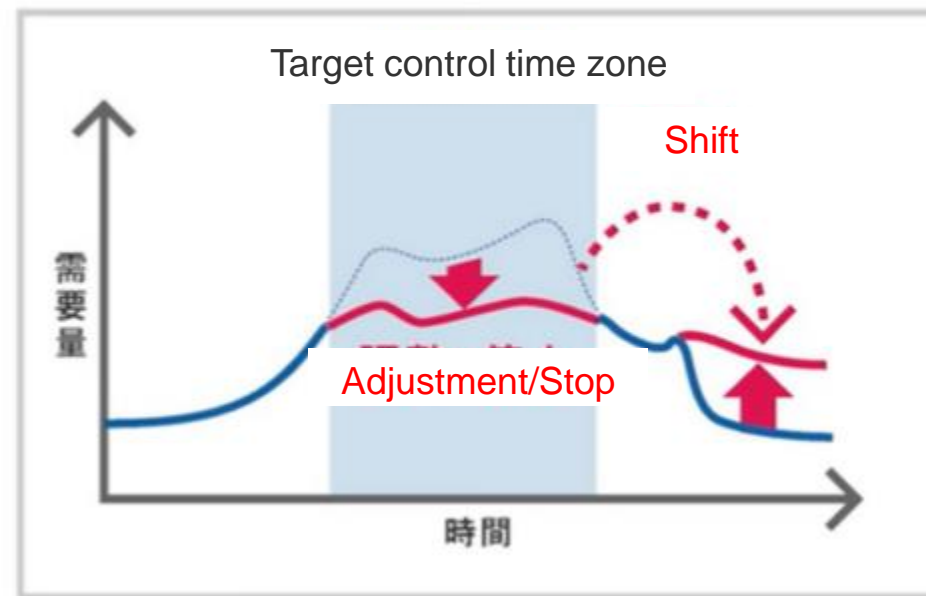
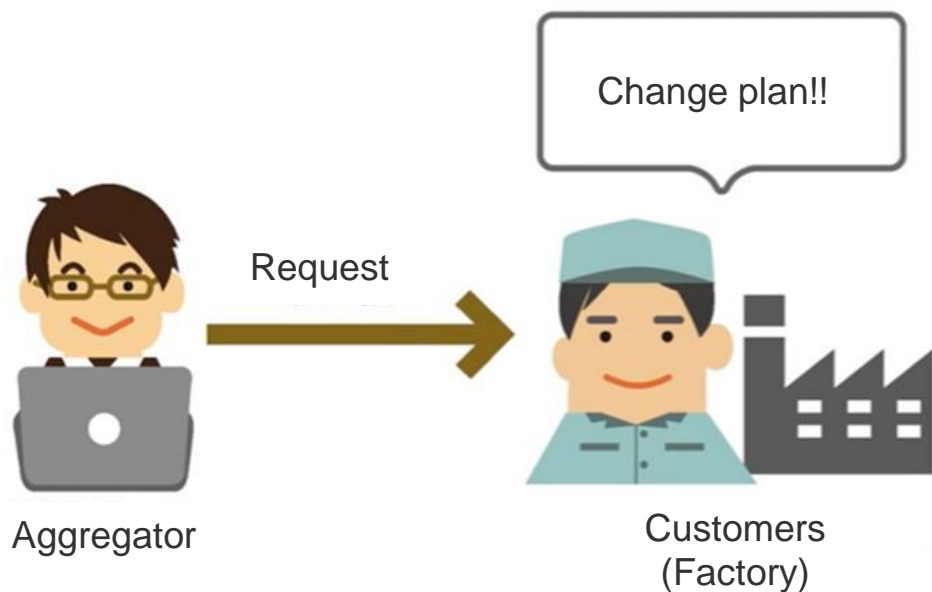



# 04 Ex., DR Image (Discharge from Battery)

- Suppressing the electricity supply from electric power company by discharging the battery

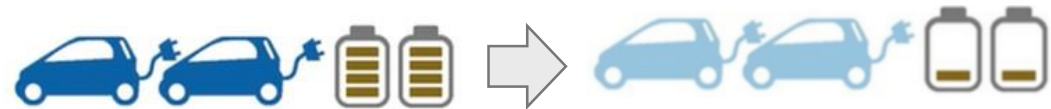
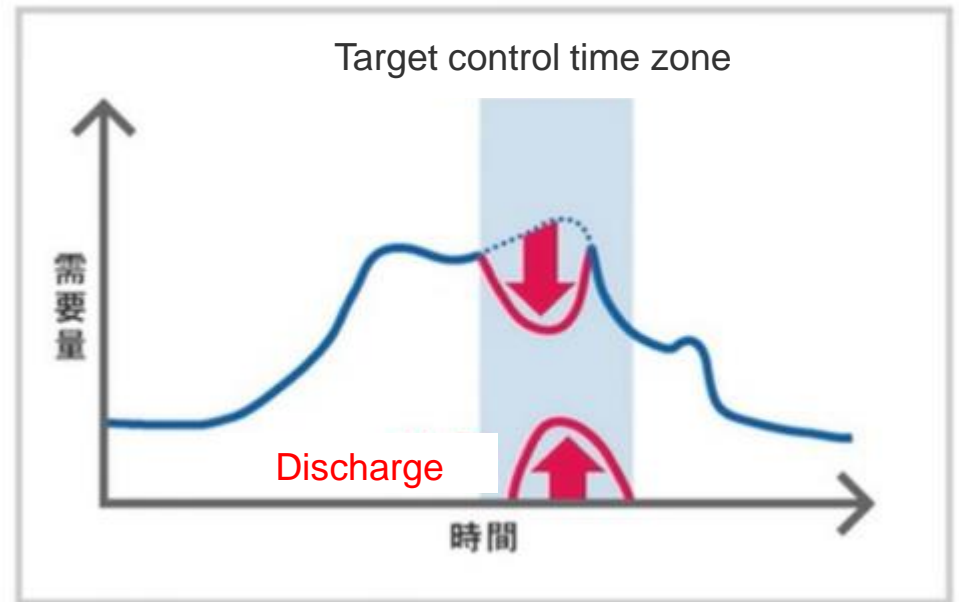
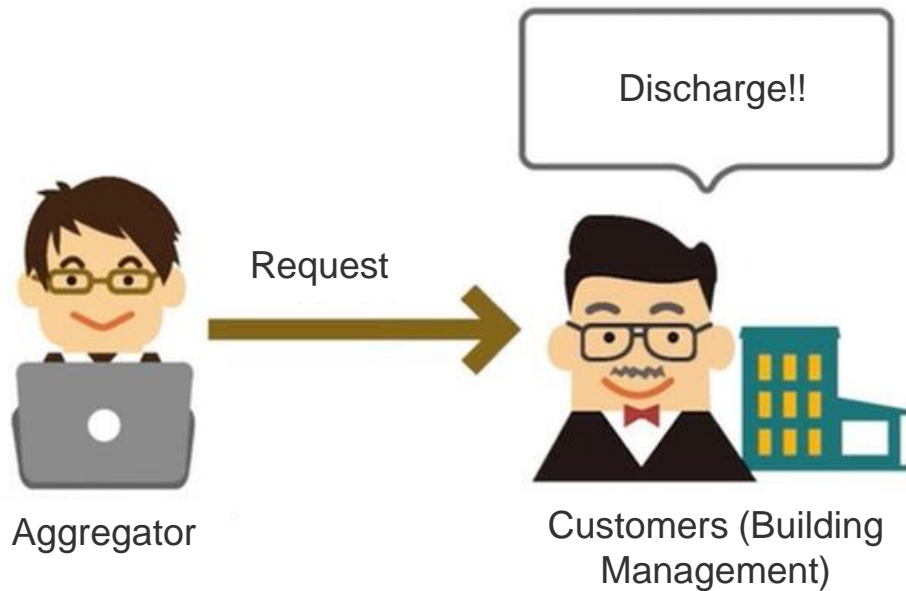

# 04 Ex., DR Image (Demand-Increase) (Charge Battery)

By charging the Battery when a lot of RE generates, it is possible to utilize the power generated from the RE without wasting.

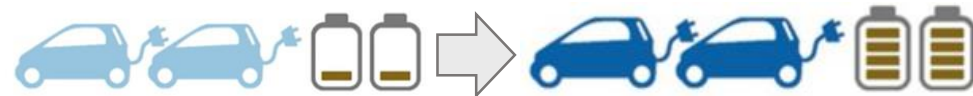
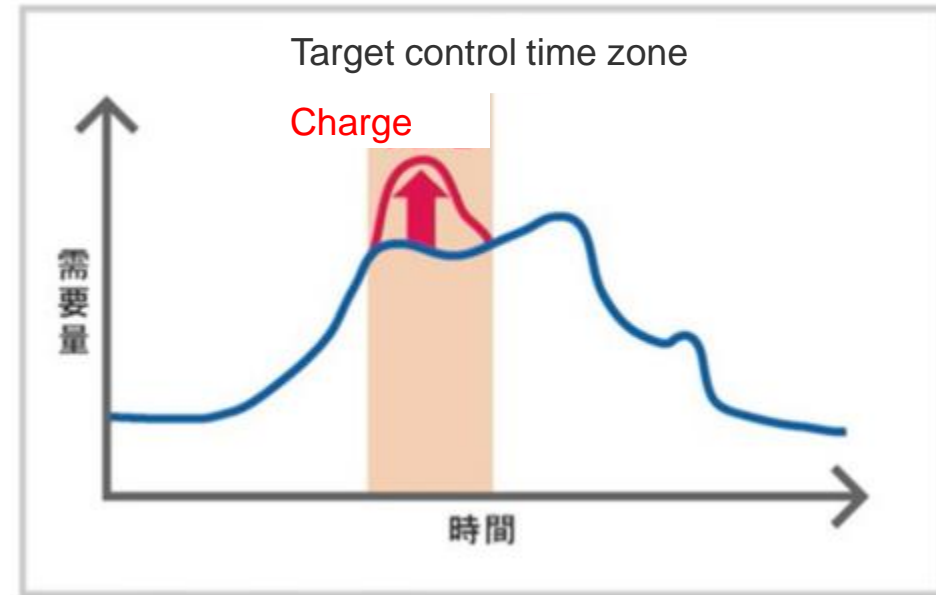
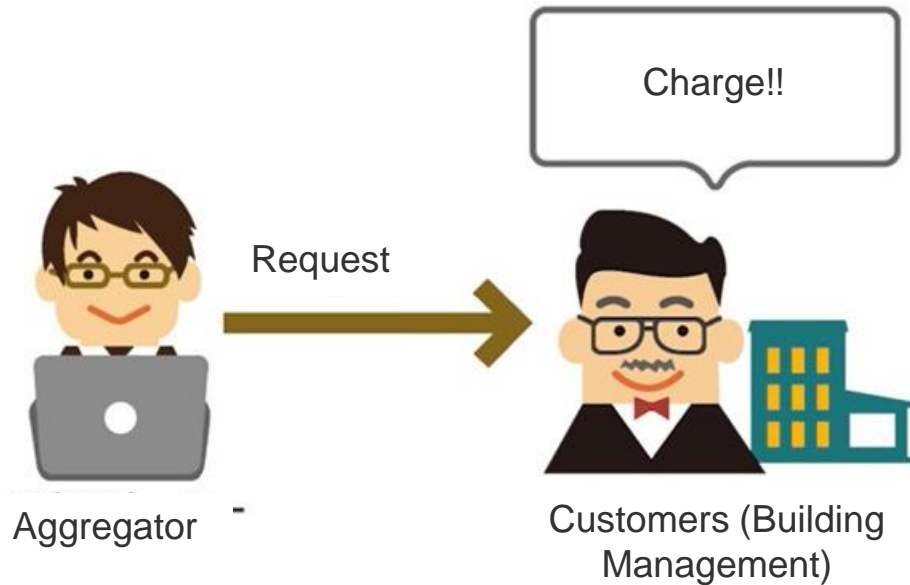

# 04 Benefits on the consumer Side

By responding to requests from Aggregators and curbing demand, it is possible to get rewards in addition to reducing electricity costs.

Item	Outline
kW Reward	Since the Decrease-DR may be activated at any time during the contract period, it is necessary to prepare the demand status to meet the offer. Therefore, the contracted capacity (kW) is paid regardless of whether or not it is activated.
kWh Reward	Rewards are paid according to the amount of electricity actually reduced (KWh) by the Decrease-DR.



# 05 Actual Case (DR utilizing an idle generator)

Item	Outline
Type of Customer	Manufacturing
Target Facilities	An Idle generator at Manufacturing Factory
Contents of implementation	DR using an idle generator
Effect	<ul style="list-style-type: none"> <li>To be able to make effective use of idle assets</li> <li>To be able to offset the electricity which had to pay so far</li> <li>To be able to get basic reward (kW) and pay-as-you-go reward (kWh)</li> </ul>

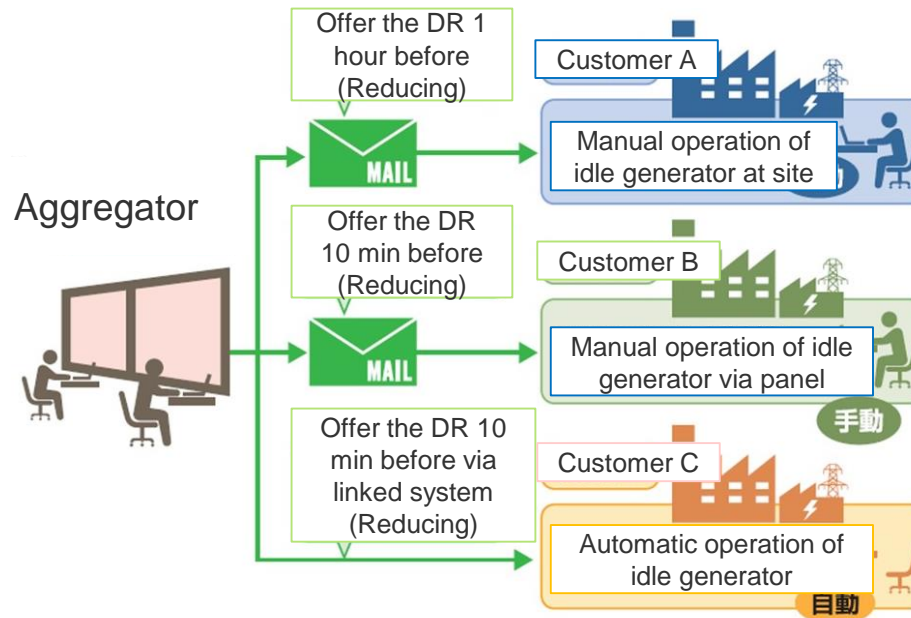

# 05 Actual Case (Energy Saving via DR Automation)

Item	Outline
Type of Customer	Retailer
Target Facilities	Battery and AC at supermarket
Contents of implementation	<ul style="list-style-type: none"> <li>● Load leveling by charging the battery during the night off peak and discharging it during the daytime peak</li> <li>● Control AC load during daytime peak to reduce demand</li> </ul>
Effect	<ul style="list-style-type: none"> <li>● Energy saving</li> <li>● No increase of work load because of automatic DR</li> <li>● To be able to get basic reward (kW) and pay-as-you-go reward (kWh)</li> </ul>

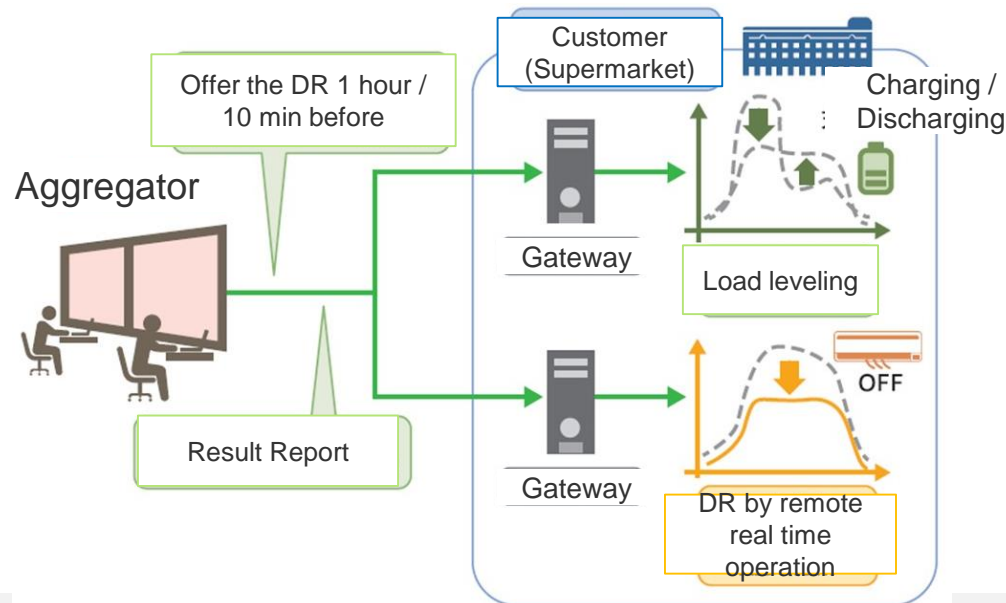

# 06 Procedure with Aggregator (Preparation before contract)



① Consumers with resources and interest approach Aggregator

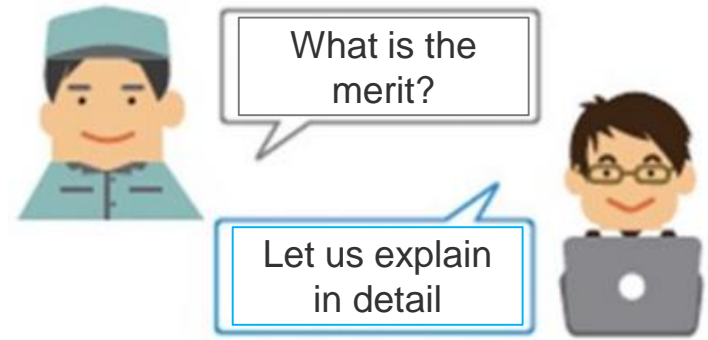

② Understand the merits, etc.

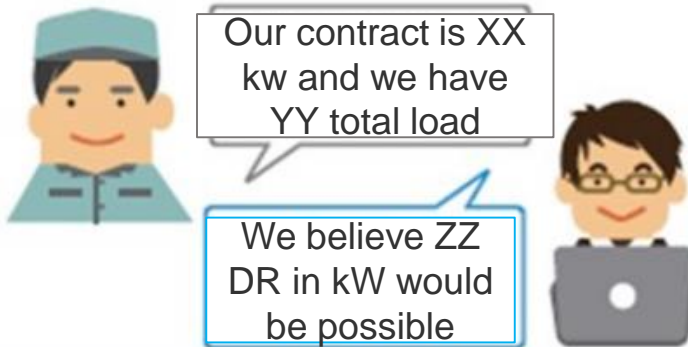

③ Specific discussions regarding service



④ Decide rewards, penalties, etc. and make a contract

# 06 Procedure with Aggregator (Implementation)

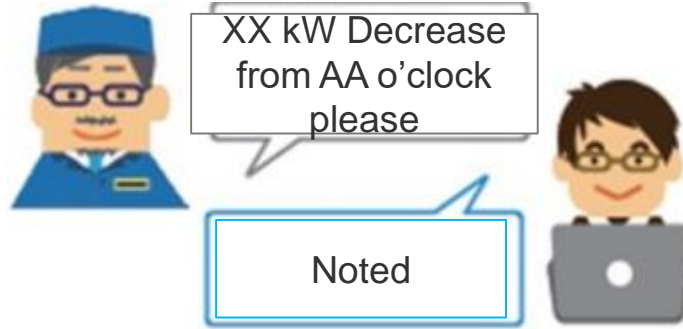

① Order of DR (Decrease)  
(Electric power company → Aggregator)

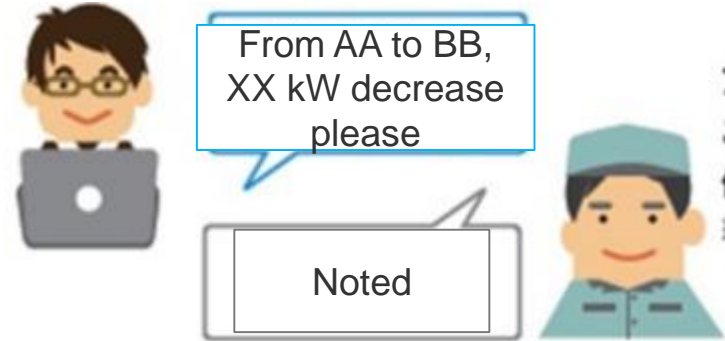

② Order of DR (Decrease)  
(Aggregator → Customer)



③ DR implementation



④ Reward payment

- Through Aggregator, small general consumers are able to enter the market.
- Business platform can be built by recognizing Aggregator as a market participant under legislation development
- Unlike energy saving, it is an incentive type that can be paid as a reward, so the satisfaction of consumers is high and a great effect can be obtained by increasing the number of new comers
- Through participating in advanced activities, consumers can feel that they can contribute to the construction of rational power systems and a low-carbon society

Firm legislation is very important





**CHUBU**  
Electric Power

***NIPPON KOEI***

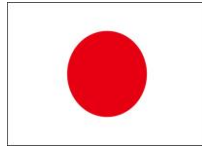

# Fade out of inefficient Coal Thermal Plant & Reviewing the Utilization rule of existing transmission lines for acceleration of the Renewable Energy

October, 2020

Chubu Electric Power Co., Inc.  
Nippon Koei Co., Ltd.

# 01 Background

---

## Basic Policy and Strategy for target in 2030

### ( 1 ) Basic Policy

#### Coal

- ◆ Coal is evaluated as stable and high economical fuel for the base power supply in Japan, since Japan has no fossil resources and need to consider geopolitics risk in terms of fossil fuel import.
- ◆ However, Japan will tackle the issues of inefficient coal thermal plant and proceed the promotion of changing them with new high efficient and next generation plant so that we can shift to clean energy consumption and.
- ◆ Japan will advance technologies by adopting of power plant rehabilitation and develop new technologies for the GHG reduction from power plant such as IGCC<sup>\*1</sup> & CCUS<sup>\*2</sup>.

\*1: Integrated coal Gasification Combined Cycle

\*2: Carbon dioxide Capture, Utilization and Storage

Basic Policy and Strategy which focused on target in 2030

## (2) Strategy for Target in 2030

Establish regulation of setting the Indicator for the periodical evaluation on the degree of inefficient Coal Thermal Plants to promote fade-out

## 【July 2020 Minister of Economy, Trade and Industry】

The Minister announced that the Ministry have to examine the concrete measures as below base on the Energy Basic Policy 2018

- (1) To stipulate new regulation to constrain the inefficient Coal Thermal Power Plants fading out***
- (2) To establish new mechanism for early retirement of the inefficient Coal Thermal Plant under securing sufficient power supply capability***
- (3) To review the rule on using existing transmission lines for promotion of new VRE with reducing the inefficient Coal Thermal Power Plants***

# 02 Study for fading out of inefficient Coal Thermal Plants

---

# Situation of inefficient Coal Thermal Plant

## Ratio of Coal Thermal Plant (CTP)

Ratio of CTP (including Power producer, Own consumption) is 32% in energy base and inefficient CTP is 16% among them

### Ratio of each category of CTP

Total 330TWh(2018) estimated

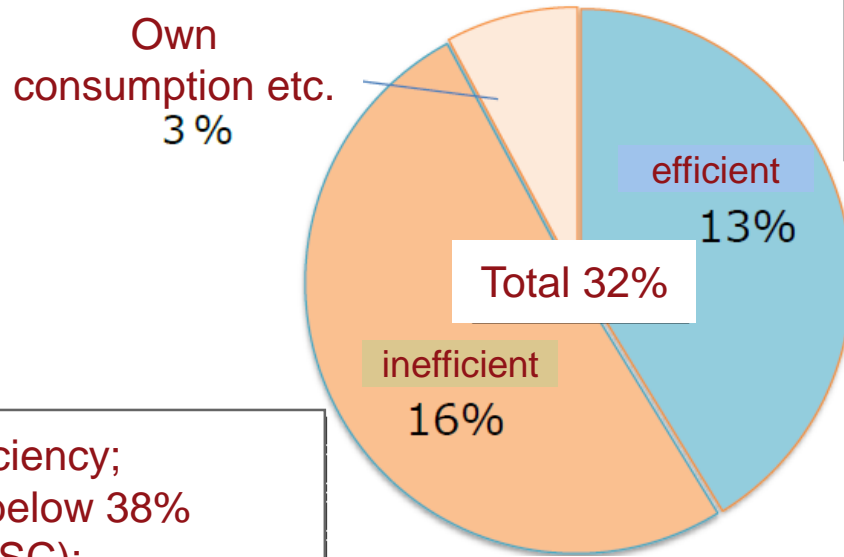

In generating Efficiency;  
■ IGCC: 46 – 50%  
■ Ultra Super Critical(USC): 41 – 43%  
26 Nos of plants in total

Ratio of efficient CTP would reach about 20% because of starting operation by new high efficient CTP.

In generating Efficiency;  
■ SUB-Critical: below 38%  
■ Super Critical(SC): 38 – 40%  
114 Nos of plants in total



# Countermeasures to achieve the appropriate Energy Mixture

## Present Strategy in Japan

### ① Energy Saving Law

- To require switching to high efficient Thermal power Plant

### ② Sophisticated Methods of Energy Supply Structures

- To request for small power producers to procure un-fossil energy power

### ③ New Framework in Power Sector

- To stipulate “Action plan for low carbon society in power sector”
- To set “GHG emission factor” for generated power such as “Emission Factor (kg-CO<sub>2</sub>/kWh)”

# Countermeasures to achieve the appropriate Energy Mixture

## ① Regulation on Generation Stage (Energy Saving Law)



Required to Power Producers to improve efficiency of Thermal Power Plant (as USC)

## ② Regulation on Retail Stage (Sophisticated Methods of Energy Supply Structures)



Required to Retailers to procure un-fossil fuel power  
(Target ratio **44% in 2030**)

Minister will order/instruct/recommend in consideration of results of achievement

## ③ Development of Self Framework by Power Producers



Target of Emission Factor in 2030 is **0.37kg-CO2/kWh**  
Power Producers must develop each kind of energy source to reach appropriate energy mixture

# Regulation for Power Producer (Energy Saving Law) ①

## Present Strategy in Japan

- Required to Power Producers to improve efficiency of Thermal Power Plant (like USC)
- Such as;
  - (a) Generation efficiency of new Thermal Plant (TP) have to be equal or more than that of the recent value of state-of-the-art TP.
  - (b) Generation efficiency of existing TPs should be improved the efficiency to equal or more than that of the highest level of efficiency.

# Regulation for Power Producer (Energy Saving Law) ②

## Target efficiency for new constructed thermal power plant

Fuel	Generation Efficiency (Standard)	Rational
Coal	42.0%	Referred to generation efficiency of existing USC commercial Thermal Plant
LNG	50.5%	Referred to generation efficiency of existing Combined Cycle commercial Thermal Plant
Oil etc.	39.0%	Referred to generation efficiency of the latest type of oil Thermal Plant

## Target by each Power Producers in 2030

- ◆ Generation Efficiency by each kind of fuel (Target is the highest value of existing plant)



Coal: 41% or more, LNG; 48% or more, oil 39% or more

- ◆ Generation Efficiency for all type of Thermal Power Plant (including existing)



Weighted Average should be 44.3% or more

# Regulation for Power Company (Sophisticated Methods of Energy Supply Structures)

- Strategy in Japan

- (a) Required to Retailers to procure un-fossil fuel power  
(Target ratio value **44% in 2030**)

- (b) To set yearly target from 2020 to achieve the above target

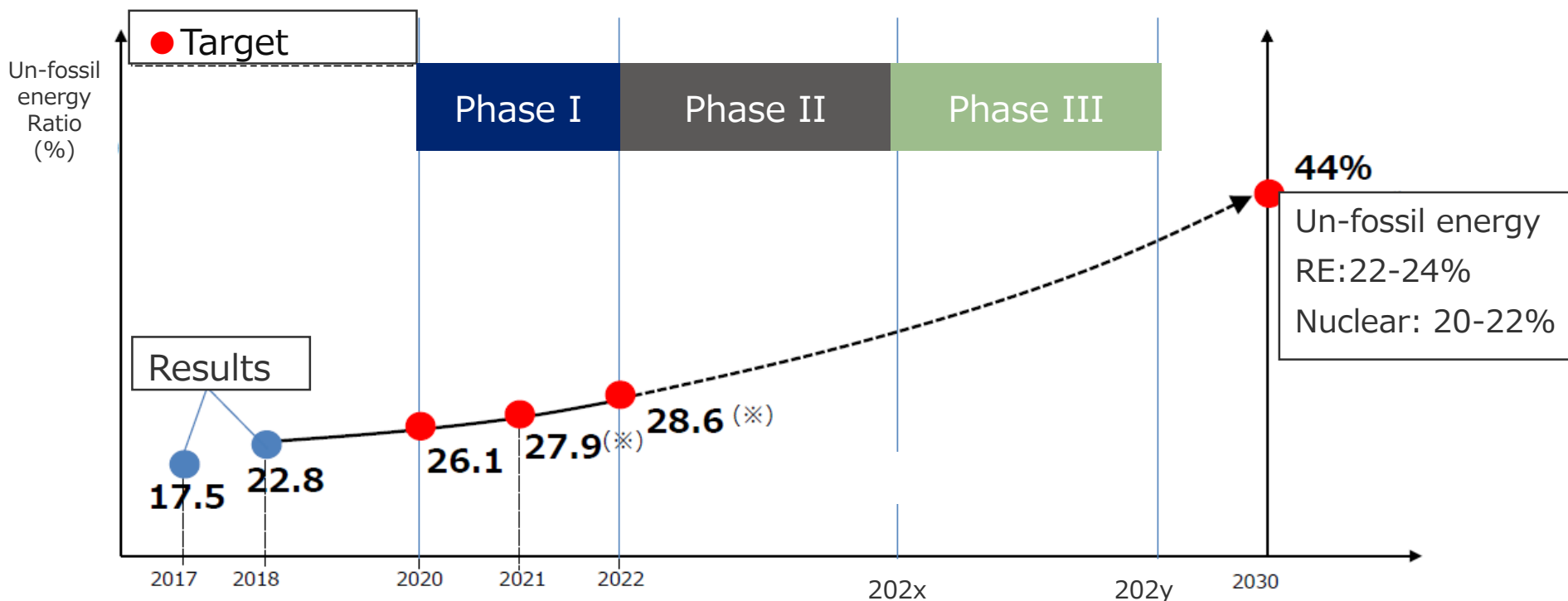

# Trends related to the Coal Thermal Plant in another countries

## Trends related to the Coal Thermal Plant in another countries

UK	CTP will be closed down by 2025 (Policy)
France	Announced that CTP will be closed down by 2020 (Legislated in June 2019)
Germany	CTP will be gradually closed down by 2018 (Policy)
USA	Keep operating CTP with reducing the generation energy ratio of CTP from 33% in 2015 to 21% in 2030 (Forecasted)
Korea	Reducing the generation capacity ratio of CTP from about 30% presently to 23% in 2030 (Policy)
Australia	30% of generation power derived from CPT. Recently, some of aged CTP are closing down.

# Necessity of Fading out of inefficient Plant

- At present, about 40% in numbers of CTP started operation from '70s to '90s. Those CTPs are inefficient generation plant.

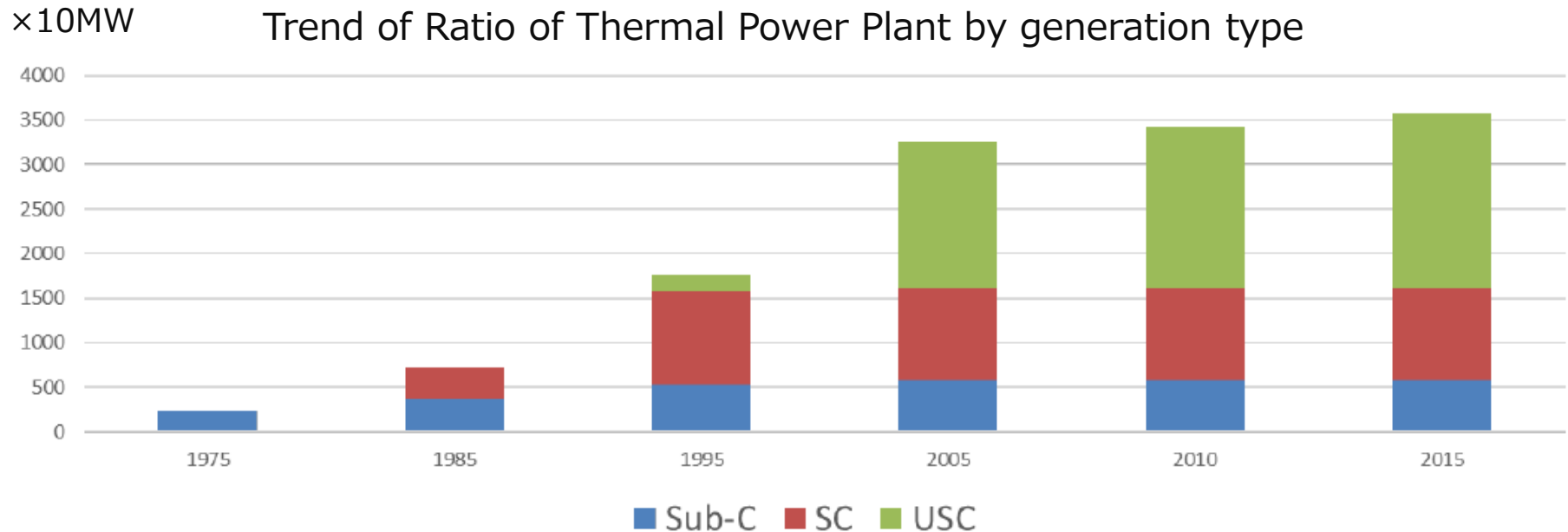

## Main type of Thermal Power Plant in each years

1970 - 1980: Sub-C type

1980 - 1990: Introducing SC type

1990 - middle of '2000: Increase of USC type

# Realization of Stable Supply and Energy Mixture

- Appropriate energy mixture is very important for carbon emission and strengthening resilience
  - >>Renewable Energy would become to the main power source

## Issues for development RE and becoming to main power source

### <To develop competitive RE industries>

To make effort on cost down and to make incentive for introduction of RE to power market

- Introducing FIP scheme and promoting RE to power market
  - >Self-standing of RE in power market
- Establish of new RE business in new situation such as distributed energy sources or self-consumption of energy
- Strategic development of off-shore Wind Power Plants
- Appropriate framework for entry and leave of power producers
  - >Setting proper tariff, termination of approval etc.



# Realization of Stable Supply and Energy Mixture

- Appropriate energy mixture is very important for carbon emission and strengthening resilience

## Issues for development RE and becoming to main power source

### <Development of local community in association with RE >

- Development and promotion of “local community in association with RE”
  - >From the view point of Resilience, Local development etc.
- To stipulate regulation to make RE as long life & stable energy sources
  - >Considering disposal cost, keep approval condition

### <Development of infrastructures for promotion of RE>

To make the constraints caused by power system small and to certainly develop middle and long term required infrastructures

- To develop push type power system
  - >Formulation of master plan, Cost for power system development will be covered by whole country
- Review the rules of using power system
  - >Connection of non-firm type power plant in whole country
- Development of related industry
  - >Establish and applying the new technology



**CHUBU**  
Electric Power

***NIPPON KOEI***

# Mandatory Battery Installation when VRE is introduced (Case Study of Hokkaido in Japan)

JICA Expert Team

July, 2020

Chubu Electric Power Co., Inc.  
Nippon Koei Co., Ltd.

# Suitable Sites for VRE and Installation Potential

- Japan has a long and narrow land from the South to North. As a result, it forms a skewer shape power system that basically maintains supply and demand balance in each area.
- In particular, Hokkaido and Kyushu are at the end of the grid, and it is difficult to interchange power and these areas are suitable for VRE generation. Therefore it is difficult to operate power system

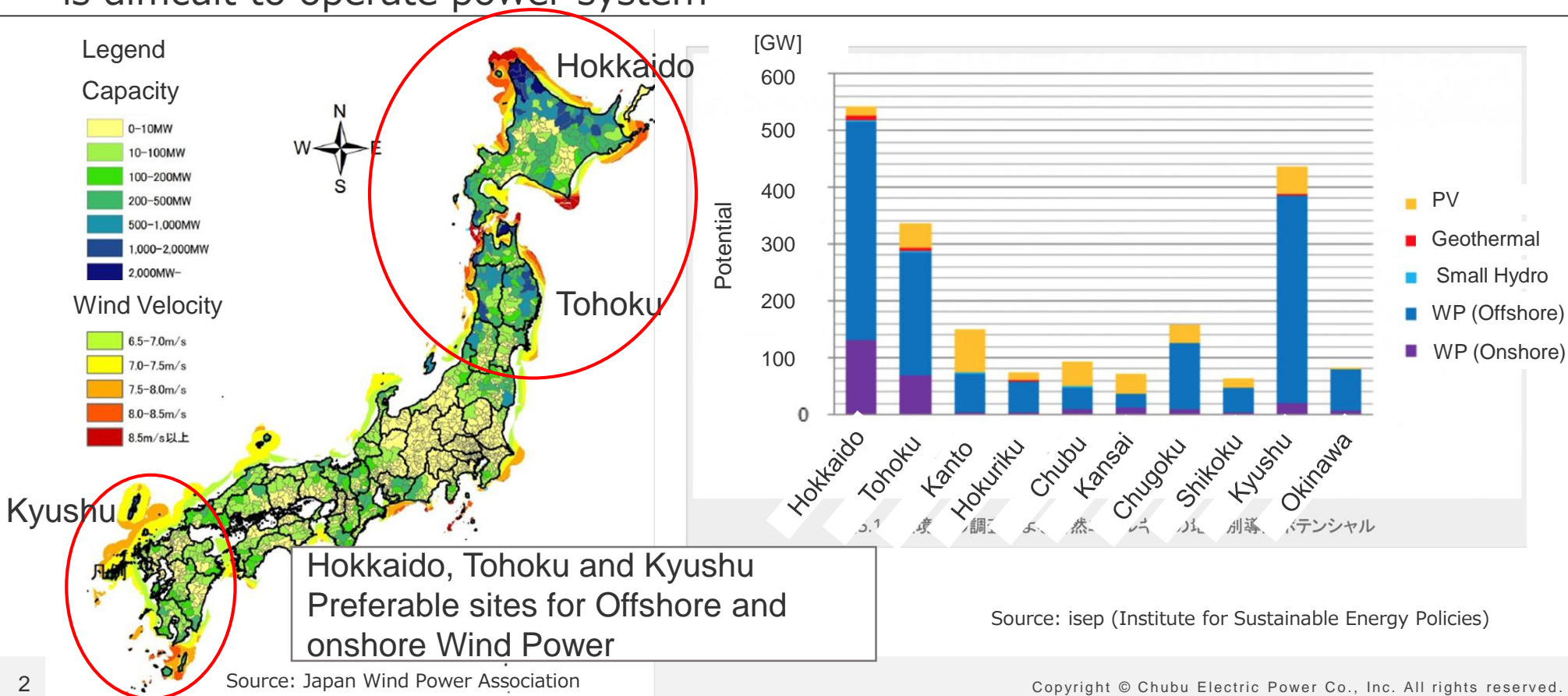

# Issues and Countermeasures Each EPCO facing

- Problems of the power system due to the increase of the VRE interconnection amount → Insufficient balancing power, lack of transmission capacity  
7 electric power utilities are certified as a designated electric power companies that are concerned about lack of balancing power (Hokkaido, Tohoku, Hokuriku, Chugoku, Shikoku, Kyushu and Okinawa)
- Hokkaido Electric Power Company started the “Recruitment process of utility scale battery” due to lack of balancing power

## Issues of Each area on power system

	Hokkaido	Tohoku	Hokuriku	Chugoku	Shikoku	Kyusyu	Okinawa	
Issues	<ul style="list-style-type: none"> <li>• Lack of TL's CP</li> <li>• Short-term Fluctuation</li> <li>• Lack of Down side Margin</li> </ul>	<ul style="list-style-type: none"> <li>• Lack TL's CP</li> <li>• Lack of Down side Margin</li> </ul>	<ul style="list-style-type: none"> <li>• Lack of Down side Margin</li> </ul>	<ul style="list-style-type: none"> <li>• Lack of TL's CP</li> <li>• Lack Down side Margin</li> </ul>	<ul style="list-style-type: none"> <li>• Lack of TL's CP</li> <li>• Lack Down side Margin</li> </ul>	<ul style="list-style-type: none"> <li>• Lack of TL's CP</li> <li>• Lack Down side Margin</li> </ul>	<ul style="list-style-type: none"> <li>• Lack of TL's CP</li> <li>• Lack Down side Margin</li> </ul>	<ul style="list-style-type: none"> <li>• Lack of Down side Margin</li> </ul>

Power system in Hokkaido particularly has big issues.  
Measures by the grid operator are necessary.

# Guideline of Power System Interconnection for HEPCO (PV)

Technical requirements against output fluctuation in case that output is 2MW or more

- Mandatory installation of storage battery
- Measures for mitigating short-cycle output fluctuations

At any time, the change rate of the power plant is 1% or less of the rated output of power generation per minute

## View of Countermeasure

Control the output change speed so that it can be followed even with thermal power generators which have relatively slow speed of output control

## Notes

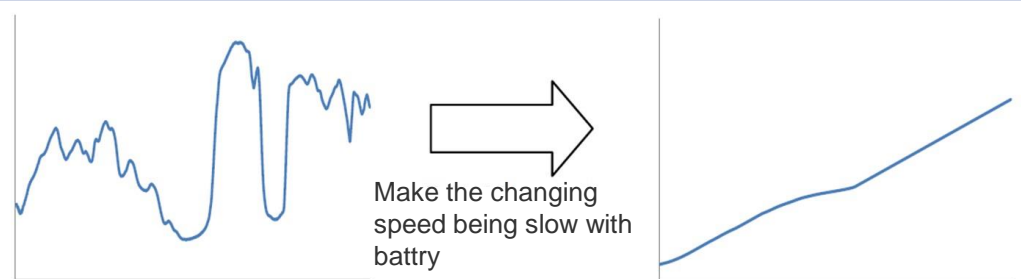

General thermal power can Not follow the sharp change

Now, Relatively slow output changing function of General thermal power can follow

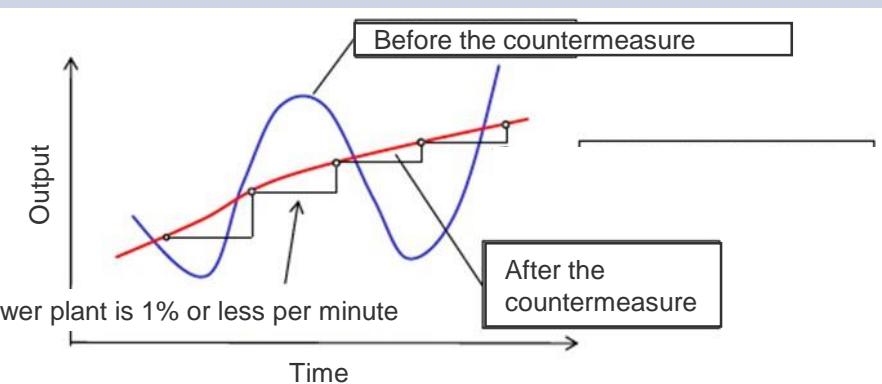

the change rate of the power plant is 1% or less per minute

託送供給等約款別冊

系統連系技術要件

“Guideline of Power System Interconnection”

Public release

令和2年4月1日実施

北海道電力ネットワーク株式会社

# Guideline of Power System Interconnection for HEPSCO (Wind Power)

Technical requirements against output fluctuation in case that output is 2MW or more

- Mandatory installation of storage battery
- Measures for mitigating short-term cycle output fluctuations
  - At any time, the change rate of the power plant is 1% or less of the rated output of power generation per minute
- Measures for mitigating Long-term cycle output fluctuations
  - 7:00~10:00 : Do not reduce the output of the power plant
  - 11:30~13:30 : Do not increase nor decrease the output of the power plant
  - 16:00~19:00 : Do not reduce the output of the power plant
  - 20:00~23:00 : Do not increase the output of the power plant

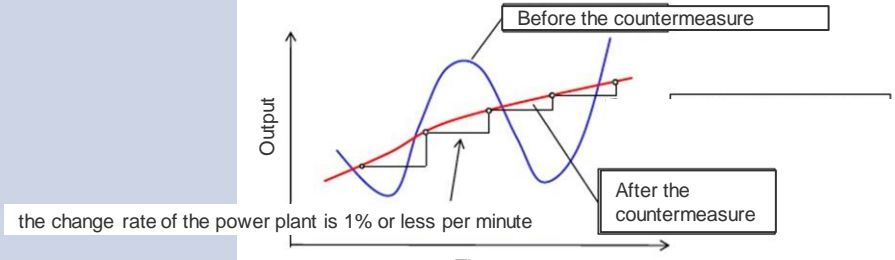
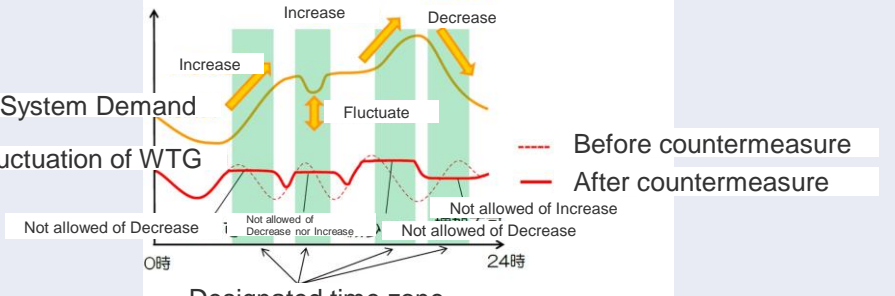
Type	View of Countermeasure	Notes
Long-term cycle	Control the output change speed so that it can be followed even with thermal power generators which have relatively slow speed of output control	
Short-term cycle	Control the output to keep VRE from encouraging the system demand fluctuation	

# Promotion of Wind Power Development through Joint Development of Batteries

- Since independent development is a heavy burden, bidding is organized assuming that they will jointly bear the costs of utility scale batteries.
- "Wind power generation application process using utility scale batteries in the power system" divided into two periods for bidding
  - Phase 1: Target Capacity is 600MW, which is the volume where technological certainty is certified.

Chronological Order (I)	Notes	Chronological Order (II)	Notes
28/3/2017	Public Announcement of Process	2018/4~2018/5	Application
10/5/2017	Due date of EOI (Expression of Interest)	2018/7~2018/8	Bidding (Does not take place if the application is 600MW or less. Not executed this time)
25/5/2017~7/9/2017	System Impact Study	2018/9~2019/1	Deposit payment, consideration of reconnection
3/2018~4/2018	Preparation of application guidelines (including public hearing)	2019/2	Closed

- Phase 2: Target capacity is 400MW. After the evaluation and examination for one year of the Phase I, Final decision will be made.

## Outline Scheme of Project

	WTG	Battery
1st Phase	600MW	90MW-4hours
2nd Phase	400MW	60MW-4hours

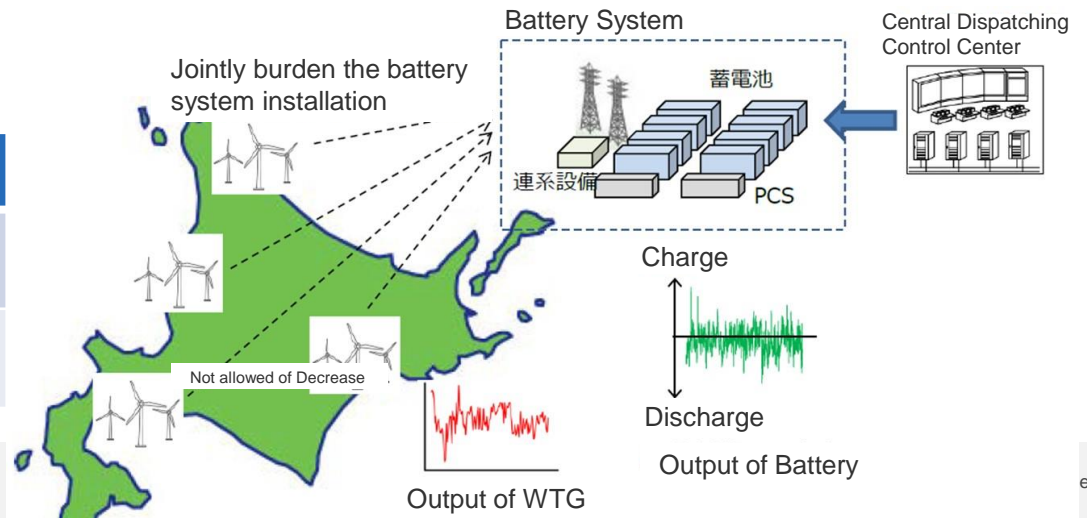



# Result of 1<sup>st</sup> Phase, “Wind power generation application process using utility scale batteries in the power system”

## Result of 1st Phase

	Number	Capacity
Applied	31	210MW
Final participants	15	162MW
Unit price of contribution	¥39,000/kW	

¥1=0.58 LKR

## Concept of cost burden for installation of batteries on the grid side

- Of the costs related to the batteries, the following ① to ④ are burdened by participants, which account for 95% of total.
  - ① Battery procurement costs, construction costs
  - ② System interconnection costs and its Procurement costs
  - ③ Battery O&M cost during the operation period
  - ④ Decommissioning Cost
- Remaining 5% will be burdened by grid operator as general costs and it will be recovered through wheeling charges



**CHUBU**  
Electric Power

***NIPPON KOEI***

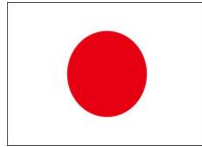
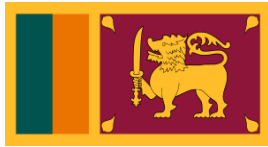

# Power Development Promotion Tax Auxiliary measures to stabilize the CEB Business

July , 2020

Chubu Electric Power Co., Inc.  
Nippon Koei Co., Ltd.

# Back ground of Enforcement of Power Development Promotion Tax

- Enforced in 1974 to seek alternative energy to oil due to the oil shock and to promote the installation of nuclear power plants, hydroelectric power plants, geothermal power plants, etc.
- It is a national tax and objective tax※ levied on electricity for the purpose of promoting the installation of power generation facilities, operation, promoting usage, ensuring safety, facilitating the electricity supply.

※ Usage is specified in advance, then the tax is collected, which is called “objective tax”  
On the other hand, a tax that does not specify a particular use is called an ordinary tax.

# Collection by Electricity Charge

- Electricity tariff consists of the items calculated by electric utilities' discretion and the items calculated by laws and regulations.
- "Power development promotion tax (PDPT)" is collected and paid as part of the wheeling charge<sup>※</sup>. The final bearer is the consumer.

※It is set by the electric utilities as the charge for using the power system after getting approval from METI.

## Breakdown of the electricity tariff

### Items calculated by electric utilities' discretion

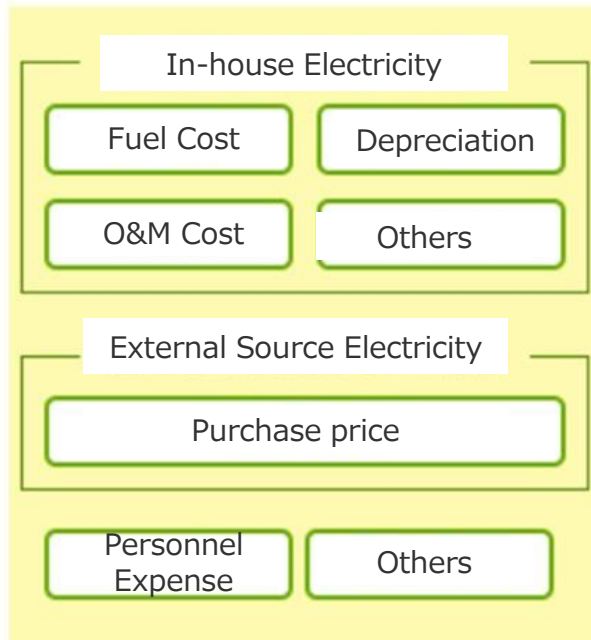

### Items calculated by laws and regulations

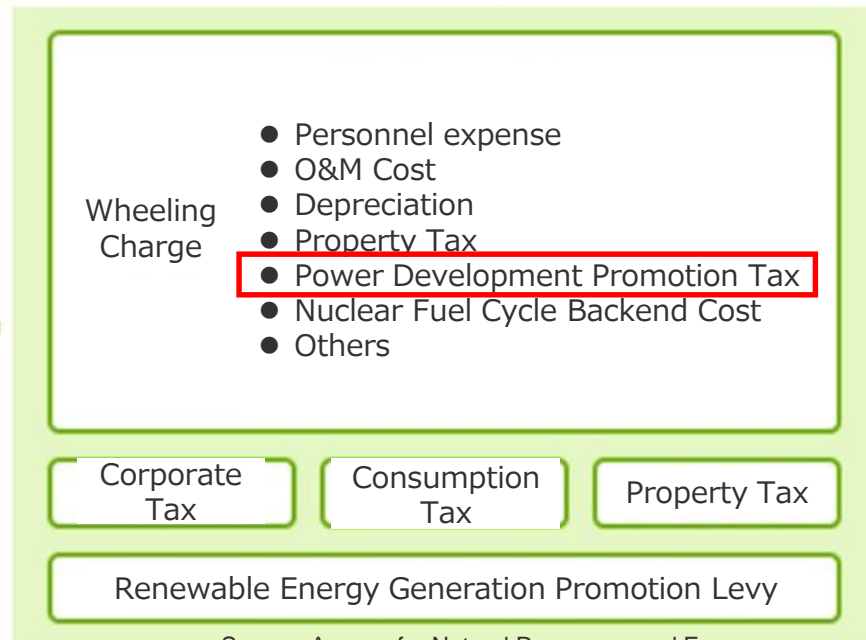

Source: Agency for Natural Resources and Energy

# What we Use them for (Main Usage)

Once PDPT is entered into “General Account”, the necessary amount is incorporated into the “Power development promotion account” which is the special account for energy measures, then they are mainly used for the followings:

- Grant to local government of power generation site
- Activities for stable and efficient power supply
- Nuclear safety regulation measures
- Nuclear power related technology development

Huge money

310~370 billion yen/year  
(1997~2019)

1LKR = 0.58 Yen

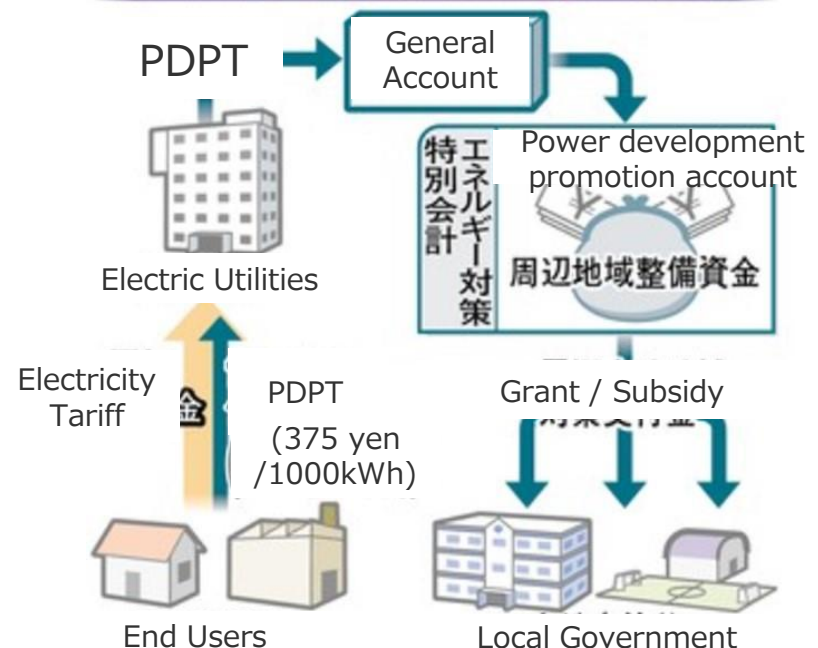

Source: Research Institute for Environmental Finance: RIEF

# Power Source Siting Laws

## (Three Laws related to power generation)

- “Power development promotion tax Law”, “Act on Special Account”, “Regional development Law of areas adjacent to power generation site” are collectively as “Power Source Siting Laws”
- Funds collected by the “Power Development Promotion Tax Law” are delivered and utilized as grants and subsidies

Power development promotion tax Law (PDPTL)

Already explained

Act on Special Account (ASA)

Money allocation for Grant and subsidy for the maintenance and safety measures of the area around the power generation facility and for the installation and operation of the power generation

Regional development Law of areas adjacent to power generation site (RDL)

- The purpose is to promote the development of public facilities in the area surrounding the power generation and improve the welfare of local residents. It eventually leads to facilitation of the installation and operation of the power generation.
- The relevant prefectures create “Facility development plan for public” and a “Business plan for improving the convenience, etc.”

# Main Grants and Subsidies

## ① PDPTL

Fund Collection

## ② ASA

Securing financial resources

## ③ RDL

Implementation of Grants and Subsidies

- Used for facility development in the area adjacent to power generation site

➤ (A) Grant for Measures for power generation area

- Used for smooth installation and operation of power generation

➤ (B) Special subsidy for Nuclear power site  
 ➤ (C) Business promotion subsidy for power generation area  
 ➤ (D) Industry development subsidy for power generation area, etc.

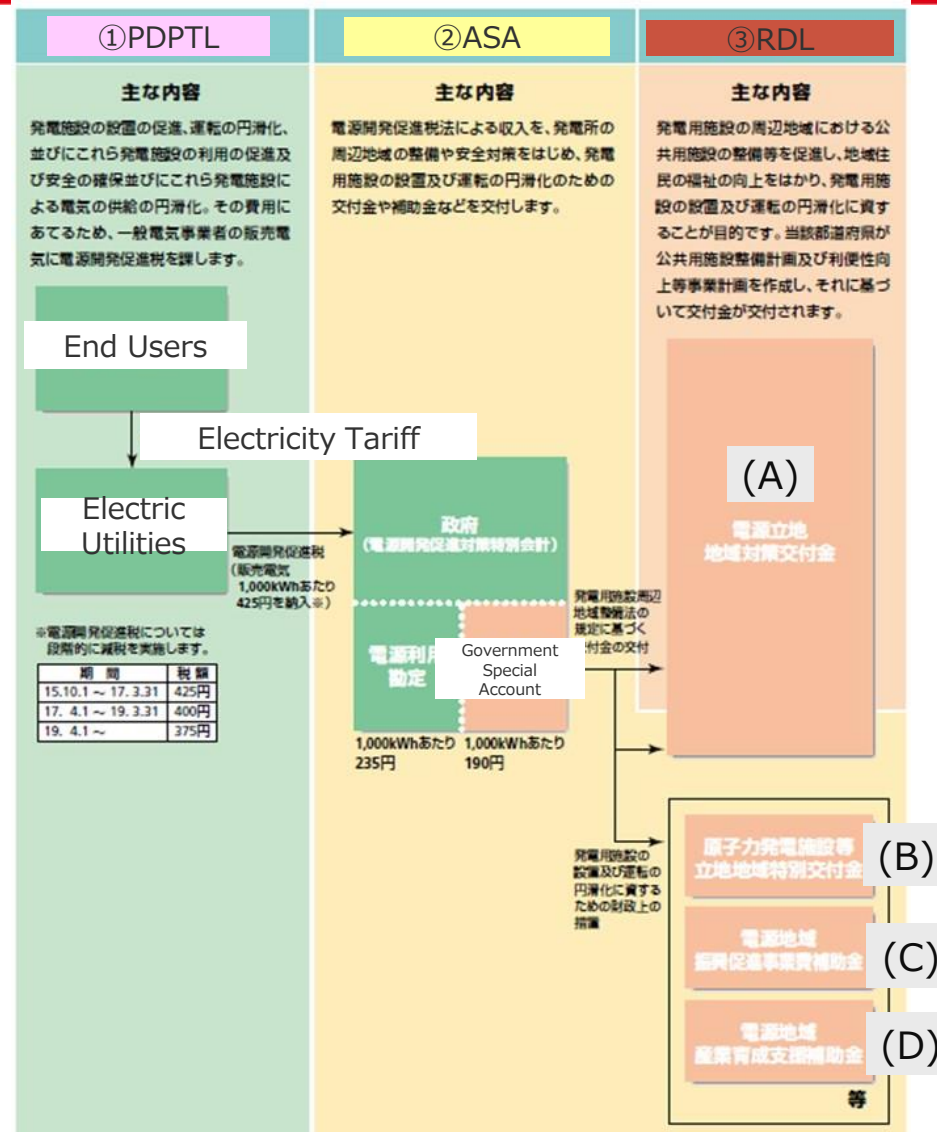

Source: Agency for Natural Resources and Energy



# Ex. 1 Use Case of Grants and Subsidies

Business Owner: Anan City, Tokushima Prefecture

Outline: Main Community Road Expansion

Project Cost: 88Million yen (Subsidy: 80Million yen)

Achievement: Face-to-face transportation of vehicles became possible and the living environment was improved



1LKR = 0.59yen

# Ex. 2 Use Case of Grants and Subsidies

Business Owner: Hidaka town, Hokkaido

Outline: Development of educational and cultural facilities for geology, plants and animals of Hidaka Mountains

Project Cost: 133Million yen (Subsidy: 55Million yen)

Achievement: Research Basement development, provision of information, tourist increase



# Ex. 3 Use Case of Grants and Subsidies

Business Owner: Shikatsu town, Miyagi prefecture

Outline: Development of intermediate breeding facility for abalone seeding

Project Cost: 57Million yen (Subsidy: 25Million yen)

Achievement: Growing them to the appropriate size for releasing became possible, and the production effect increased



# Ex. 4 Use Case of Grants and Subsidies

Business Owner: Mito town, Shimane prefecture

Outline: Development of multi-purpose hall with library function for the purpose of training agricultural successors

Project Cost: 493Million yen (Subsidy: 307Million yen)

Achievement: Contributes to regional revitalization through using freely by many agricultural personnel



# Ex. 5 Use Case of Grants and Subsidies

Business Owner: Takaoka city, Toyama prefecture

Outline: Facility development that comprehensively supports planning, development, distribution and sales in order to improve the quality of designers and develop design companies

Project Cost: 393Million yen (Subsidy: 190Million yen)

Achievement: Training and events are being held to improve the quality of designers and develop design companies

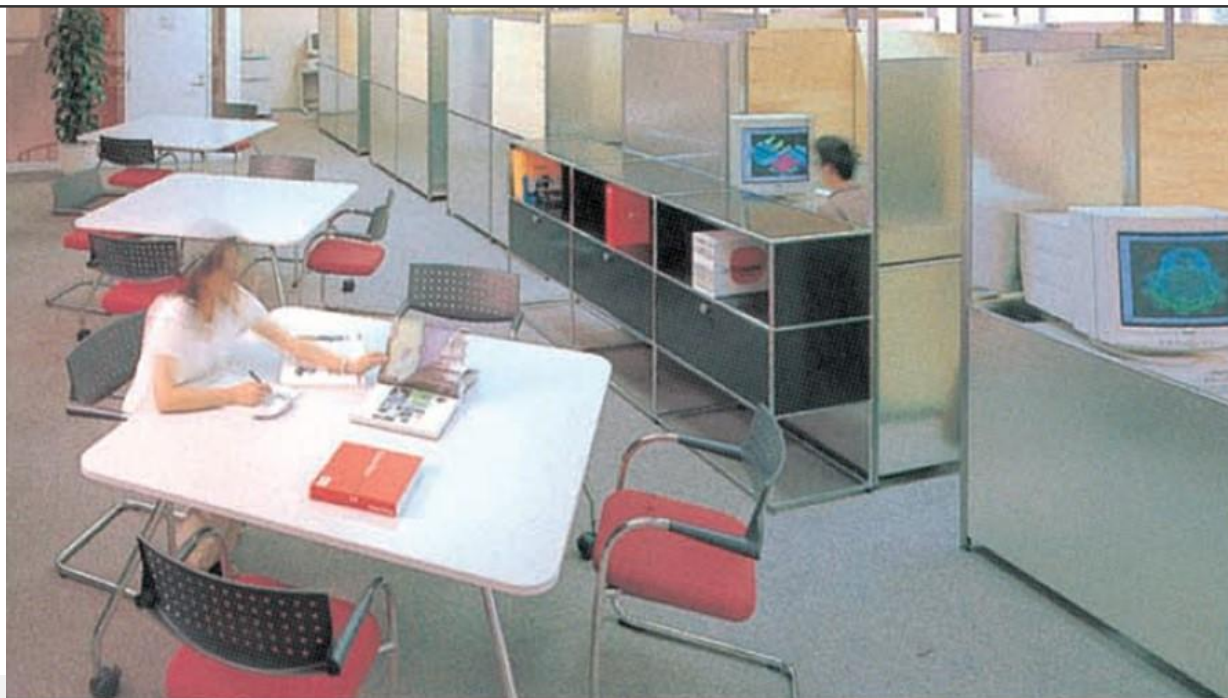

# Ex. 6 Use Case of Grants and Subsidies

Business Owner: Takamatsu city, Kagawa prefecture

Outline: Development of open type measurement test facility (large anechoic chamber, etc.)

Project Cost: 1,700Million yen (Subsidy: 640Million yen)

Achievement: Utilized for the development of new products and technologies and new business

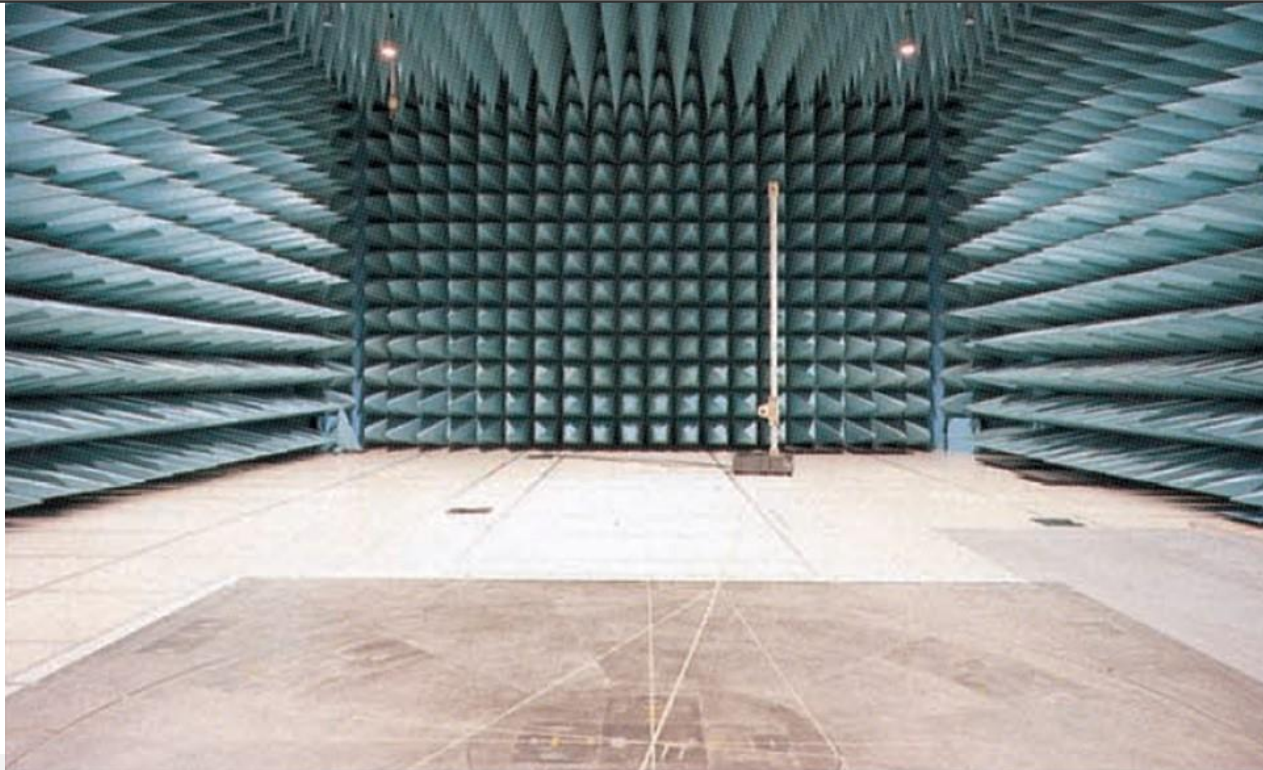

# Ex. 7 Use Case of Grants and Subsidies

Business Owner: Tsuruga city, Fukui prefecture

Outline: Development of base facilities for R&D, training, and exchange related to energy

Project Cost: 15,300Million yen (Subsidy: 8,659Million yen)

Achievement: Contribute to a vigorous community and internationalization





**CHUBU**  
Electric Power

***NIPPON KOEI***





**NIPPON KOEI**

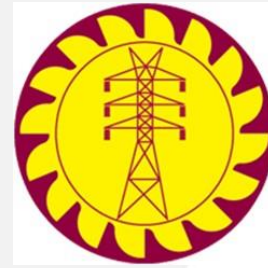

# Petroleum and Coal Tax & Global Warming Tax Auxiliary measures to stabilize the CEB Business

JICA Expert Team

September, 2020

Chubu Electric Power Co., Inc.  
Nippon Koei Co., Ltd.

# Background of Enforcement of Petroleum and Coal Tax

- Japan has a very low self-sufficiency rate of oil and depends on imported oil for 99% or more
- “Petroleum Tax” was introduced in 1978 as a measure against oil shortage in the future because oil was widely used for any products. This tax is used for alternative energy countermeasure.
- The target was gradually expanded to ensure fairness of the burden for each fuel. Name was changed to “Petroleum and Coal Tax” in 2003.



1978

Crude oil/petroleum products

Petroleum Tax



Gas and liquefied  
gas was added



2003

Coal was added as well

Petroleum and Coal Tax

Source: Agency for Natural Resource and Energy

# Tax Introduced to prevent Global Warming

- In order to realize a low-carbon society, "Global Warming Tax" was introduced to strengthen global warming countermeasures (CO2 emission control measures from energy sources) such as boosting introduction of renewable energy and energy saving.
- Users are extensively, lightly and fairly taxed depending on the usage of all fossil fuel products considering environmental impact. Tax is imposed on the amount of CO2 emission
- To avoid a sudden increase in burden, the tax rate was raised in three stages.
- Utilizing the current "Petroleum and coal tax" collection scheme, additional tax was levied.

## Tax rate raised gradually

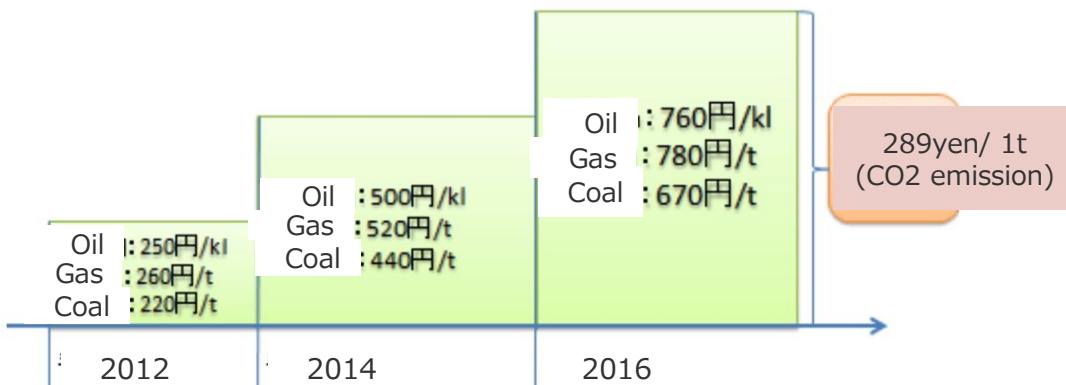

## Additionally taxed on "Petroleum and coal tax"

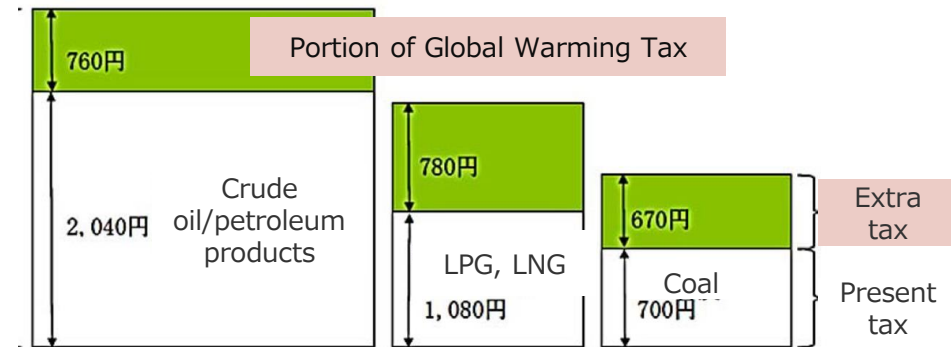

# Scale of Global Warming Tax Revenue and its Burden

- 2012 (Enforcement year): 39.1 billion yen, 2016: 262.3 billion yen
- Household burden for average household
  - About 100 yen / month, about 1,200 yen / year
  - About 500 yen / year, when electricity tariff is focused
- Tax revenue is used for CO<sub>2</sub> emission control measures, which accounts for 90% of greenhouse gases
  - Promotion of attracting innovative low-carbon technology industries such as lithium-ion batteries
  - Promotion of energy-saving equipment introduction by small and medium-sized enterprises
  - Promotion of renewable energy introduction, which matches the characteristics of the region

	Increased price caused by tax	Consumption / year	Household Burden
Petroleum	0.76円/L	448L	1,228 Yen/year
Kerosene	0.76円/L	208L	
Electricity	0.11円/kWh	4,748kWh	
Gas	0.647円/Nm <sup>3</sup>	214Nm <sup>3</sup>	
LPG	0.78円/kg	89kg	

1LKR = 0.57 yen

# Effect of Global Warming Tax

- Two major effects in terms of CO<sub>2</sub> control are expected
  - Price effect: Effect through taxation
  - Financial resource effect: Effect of utilizing tax revenue for various measures to reduce emissions
- In 2030, it is expected to decrease by 4.4% compared to 2013 emissions (approximately 54 million tons reduction of CO<sub>2</sub>)

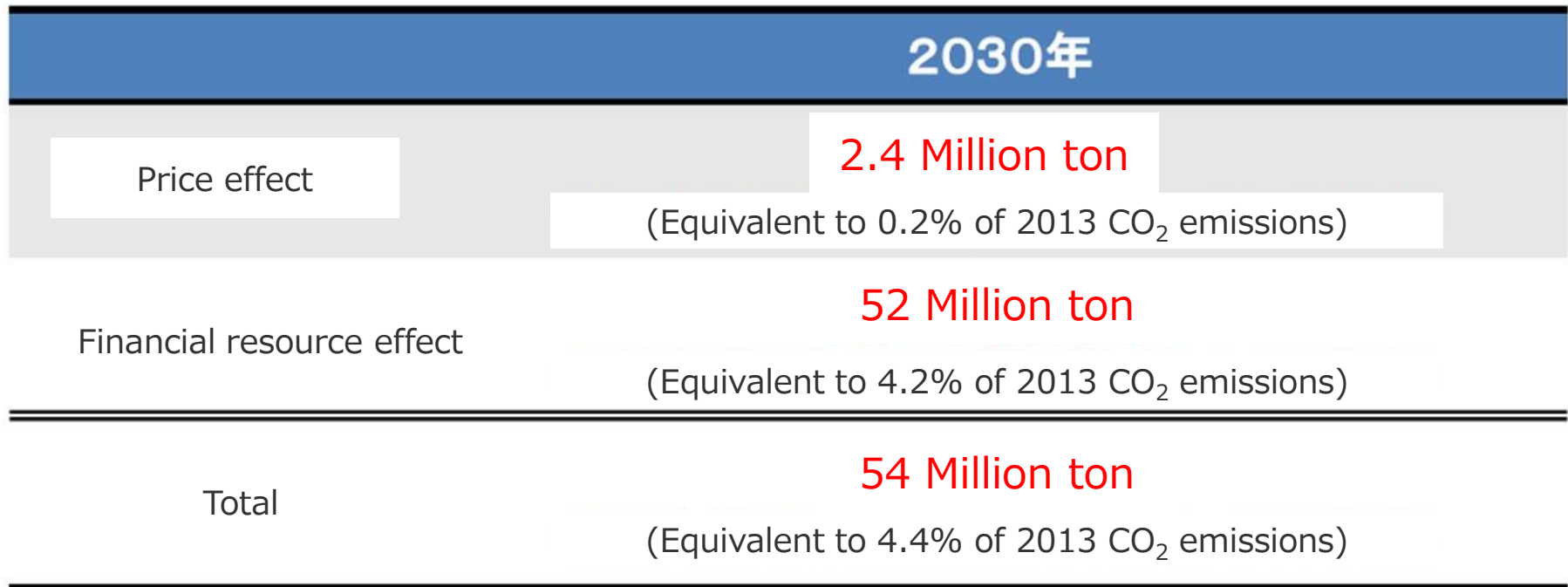

Source: Ministry of the Environment



**CHUBU**  
Electric Power

***NIPPON KOEI***

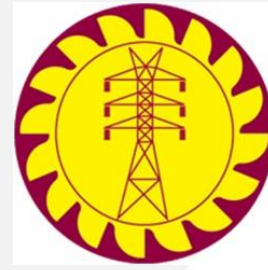

# Power System Upgrade Cost Allocation

Ceylon Electricity Board  
JICA Expert Team

September, 2022

Chubu Electric Power Co., Inc.  
Nippon Koei Co., Ltd.

1. Basic concept of cost sharing for transmission and substation facilities reinforcement
2. Calculation example of construction cost burden in low-voltage grid connection
3. Concept of construction cost burden in high-voltage grid connection
4. Summary



# 01

## Basic concept of cost sharing for transmission and substation facilities reinforcement

---

# Background to the introduction of the concept of cost sharing

- Due to the expansion of the introduction of distributed power sources such as renewable energy, the number of cases of reinforcement caused by generation companies, not transmission companies, is increasing.
- It is not efficient from the viewpoint of the whole system if local countermeasure construction is carried out each time a generation facility is installed. It is necessary to consider how to develop optimal NW facilities from the perspective of all stakeholders.



It is not appropriate to make the entire amount borne by the generation company or the entire amount borne by the transmission company (recovery of the transmission fee) simply because the installation of the generation facility triggered the expansion.



It is necessary to determine the cost sharing of the reinforcement cost considering the profit of the generation operator and the degree of contribution to the system stability.

# Basic concept of cost sharing

- Specific generator installer is beneficiary: The generation operator bears the cost according to the extent of benefit.
- Specific generator installer is not beneficiary: the transmission company bears the cost of reinforcement.

The cost burden ratio is determined based on the beneficiary burden

## Trunk system

Transmission company burden in general

Trunk system is the transmission facilities of the upper two voltages

Chubu: 500kV, 275kV

## Other than trunk system

Generation operator burden and transmission company burden are calculated from the following viewpoints

(details will be described later)

- A) Benefits of future facilities upgrades
- B) Benefits from streamlined facilities
- C) Benefits from improved supply reliability

# A) What are the benefits of future facilities upgrades?

If it is necessary to update/enhance facilities in the future due to aging deterioration measures or future demand increase measures, it is necessary to consider how to share costs in consideration of such circumstances on the NW side.



Step 1 Appropriately evaluate the residual value of the target facilities

Step 2 Calculate the cost for renewal/ enhancement

Step 3 Appropriate allocation

Identify the range that can be evaluated as benefiting the NW operator

Transmission  
company burden

Calculate the renewal/enhancement cost after deducting the cost on the left

Generation  
operator burden

# Cost burden calculation example (1)

When it becomes necessary to reinforce the transmission line before its expected useful time is exceeded

## Precondition

- Useful life: 36 years
- Asset value: 1 billion yen
- Cost for enhancement: 2 billion yen
- Equipment expansion in 18<sup>th</sup> year

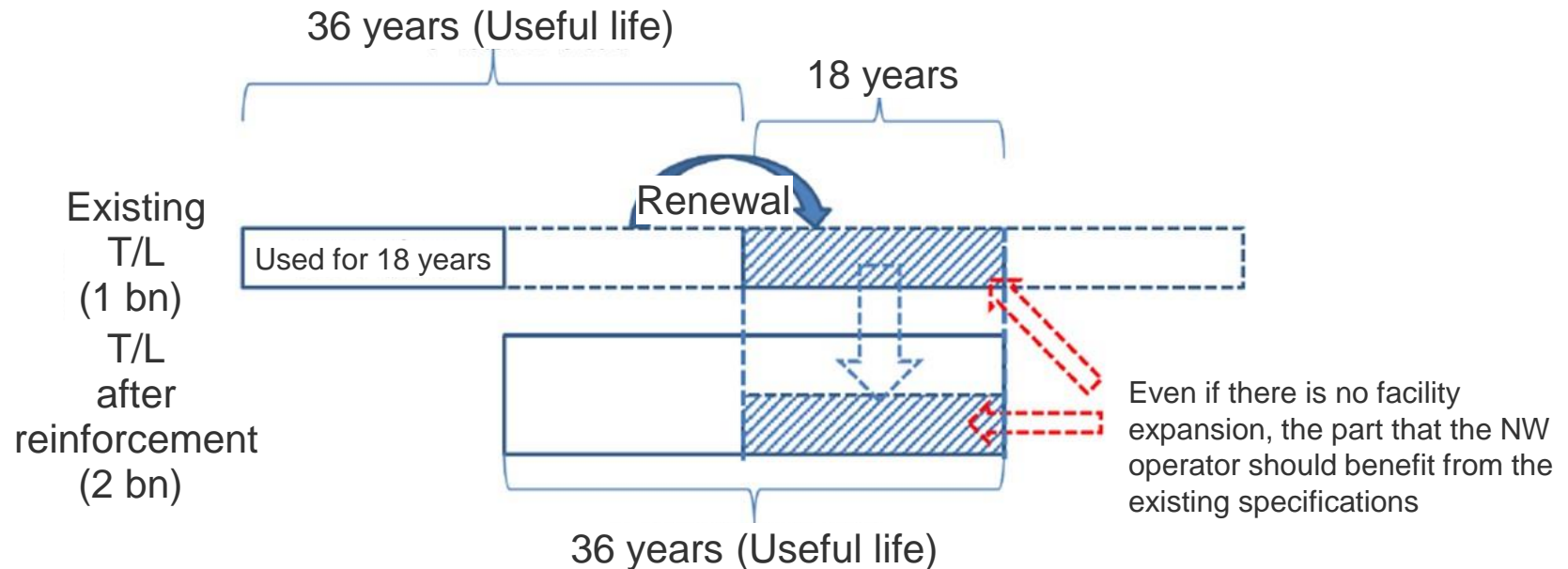

Transmission company burden

Generation operator burden

$$1 \text{ bn yen} \times (18 \text{ years} / 36 \text{ years}) = 0.5 \text{ bn yen}$$

$$2 \text{ bn yen} - 0.5 \text{ bn yen} = 1.5 \text{ bn yen}$$

Source: Cost allocation of power system reinforcement when new generation installed, Agency for Resources and Energy

# Cost burden calculation example (2)

When it becomes necessary to reinforce a T/L that has exceeded its useful life, and there is a specific renewal plan after that

## Precondition

- Useful lifetime: 36 years
- Asset value: 1 billion yen
- Cost for enhancement: 2 billion yen
- T/L enhancement in 40<sup>th</sup> year (However, there is an update plan in 50<sup>th</sup> year)

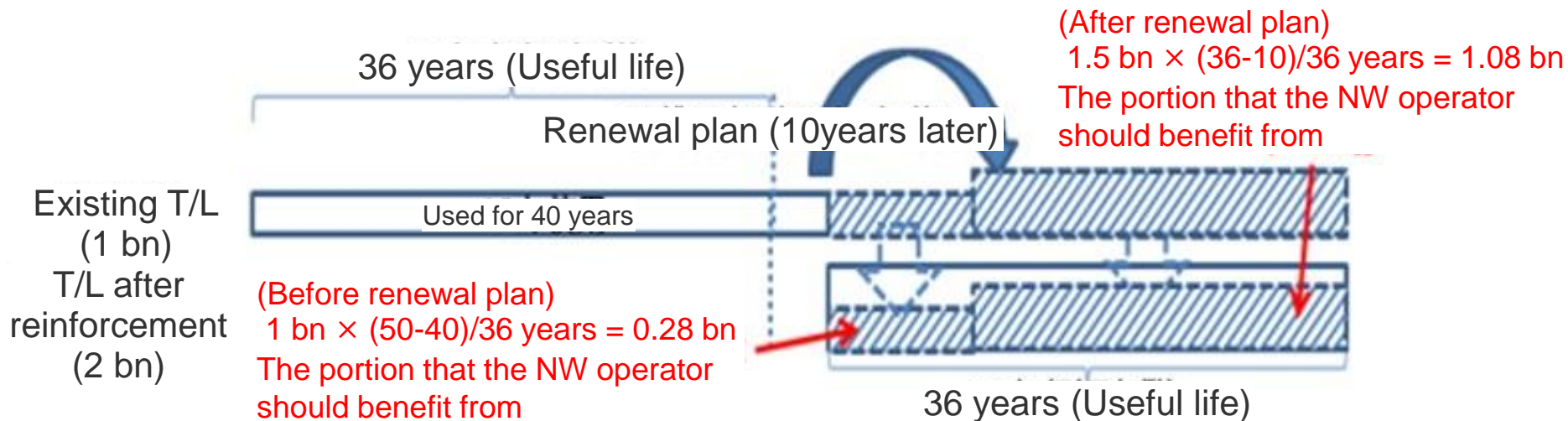

Transmission company burden

Generation operator burden

$$1 \text{ bn yen} \times (50-40)/36 \text{ years} = 0.28 \text{ bn yen}$$

$$1.5 \text{ bn yen} \times (36-10)/36 \text{ years} = 1.08 \text{ bn yen}$$

Total 1.36 bn yen

$$2 \text{ bn yen} - 1.36 \text{ bn yen} = 0.64 \text{ bn yen}$$

## B) What are the benefits of streamlining facilities?

When planning to reinforce the network due to the installation of generation facilities, it is necessary to consider to the specifications of the reinforcement , as well as the streamlining of existing facilities in the vicinity.



Step 1 Appropriately evaluate the value of the streamlined facilities

Step 2 Calculate the cost for renewal/enhancement

Step 3 Appropriate allocation

The value of the facility to be streamlined was originally judged to be borne by the transmission company because it was the value that the NW operator was supposed to receive.

Transmission company burden

Calculate the renewal/enhancement cost after deducting the cost specified on the left

Generation operator burden

# Cost burden calculation example(3)

When other facility renewal investments become unnecessary due to the enhancement of T/L, etc.

## Precondition

- Useful lifetime of transformer: 22 years
- New facility cost: 1 billion yen
- Cost for transformers that no longer require replacement investment: 0.5 billion yen
- New transformer is installed 11 years after installation of old transformer

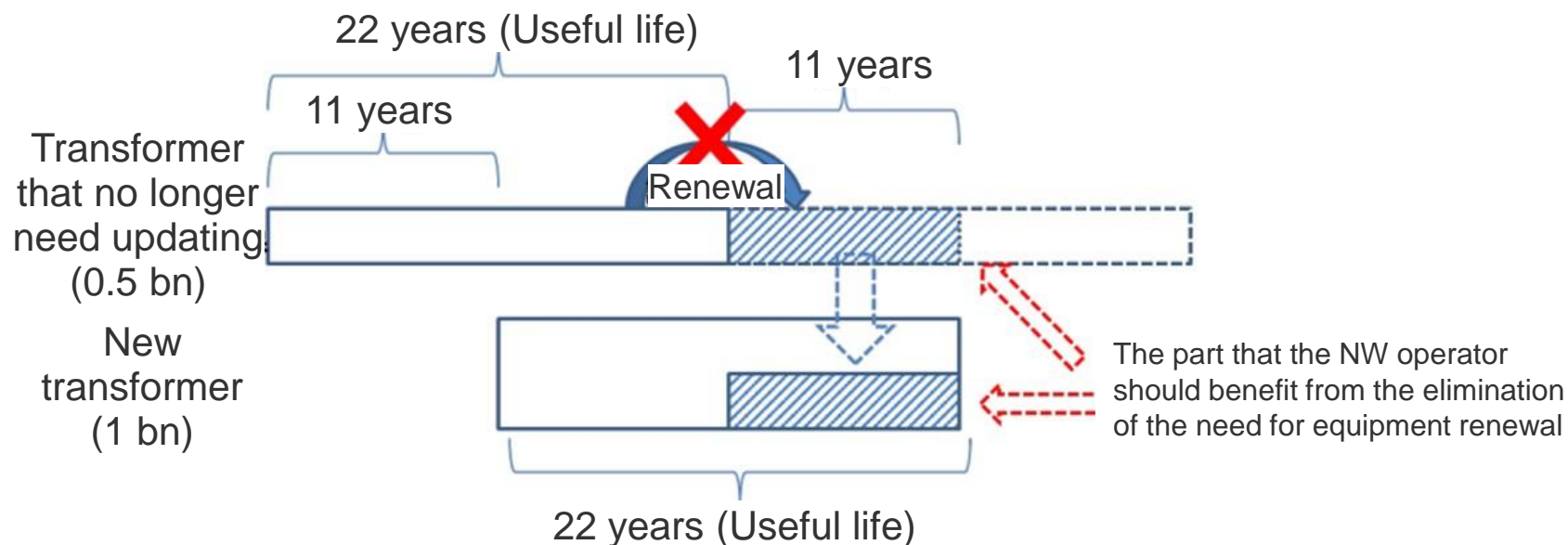

Transmission company burden

$$0.5 \text{ bn yen} \times (11/22 \text{ years}) = 0.25 \text{ bn yen}$$

Generation operator burden

$$1 \text{ bn yen} - 0.25 \text{ bn yen} = 0.75 \text{ bn yen}$$



# C) What are the benefits of improved supply reliability?

## Case of reliability improvement

By enhancing the T/L facilities etc. on the NW side, it will be possible to avoid power outages and curtailment of the output of large-scale generation facilities that occurred in the event of a fault in existing T/L facilities, and improve system operation. In cases, it is necessary to consider the burden ratio appropriately because these will be the benefits of the NW operator.

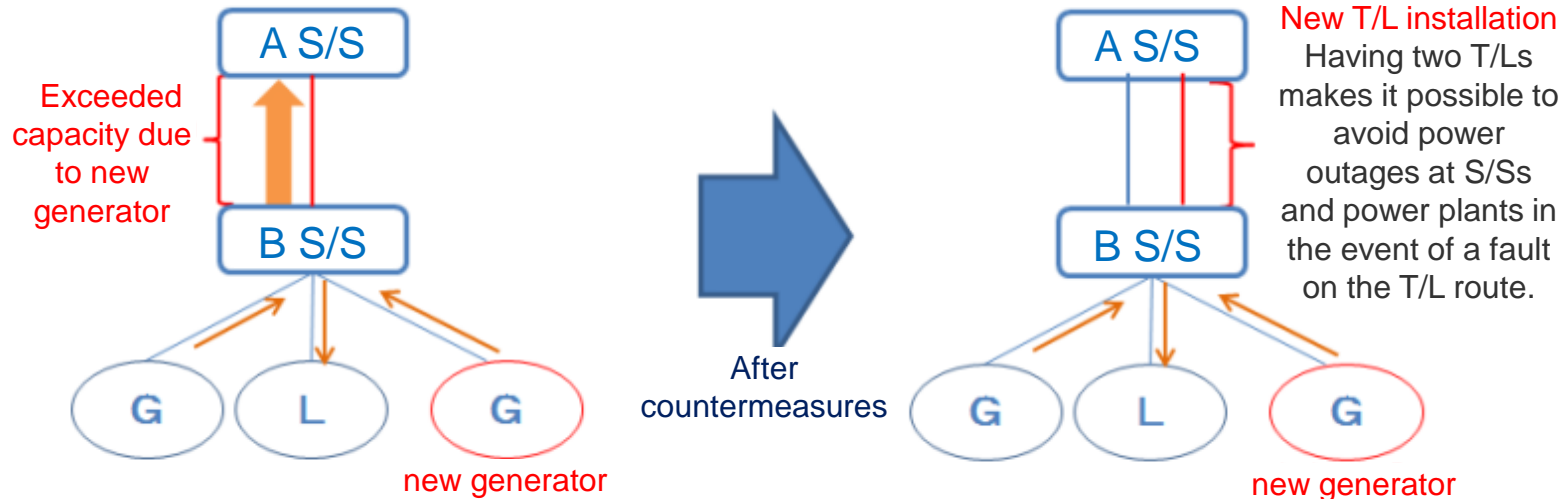

The ratio that contributes to the amount borne by generation operator

- a: Generation capacity that can be interconnected (kW)
- b: Generation capacity that can avoid output curtailment when fault in one T/L (kW)
- c: Average demand capacity that enables power outage avoidance when the route is interrupted (kW)

$$\frac{a}{a+b+c}$$

Source: Cost allocation of power system reinforcement when new generation installed, Agency for Resources and Energy

# C) What are the benefits of improved supply reliability?

## Case of improving system operation

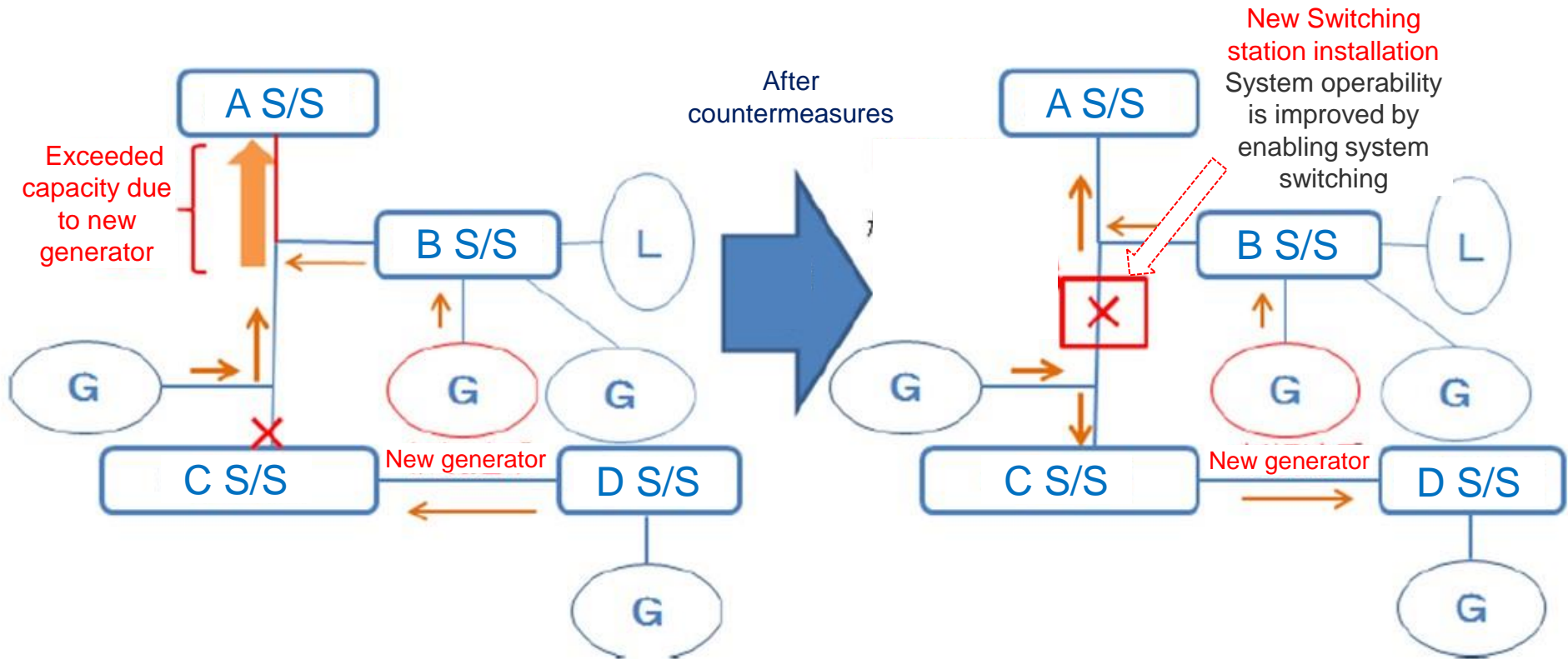

By installation of new switching station,

- Overload can be avoided and new power plant can be interconnected
- Grid operability is improved, and output of generation and demand curtailment during power outage on T/L are eased.

Source: [Cost allocation of power system reinforcement when new generation installed](#), Agency for Resources and Energy

# Matters to be considered in cost sharing in the trunk system

If the T/L company bears the cost of upgrading T/L facilities on the NW side, there is a possibility that inefficient network facilities will be formed by the generation company selecting the installation location of the power plant without considering the network facility enhancement cost.



It is important to promote the installation of power plants in areas where the cost of NW facility enhancement is relatively small. It is desirable to voluntarily disclose system information so that it will be reflected in the consideration of the location of power plants.

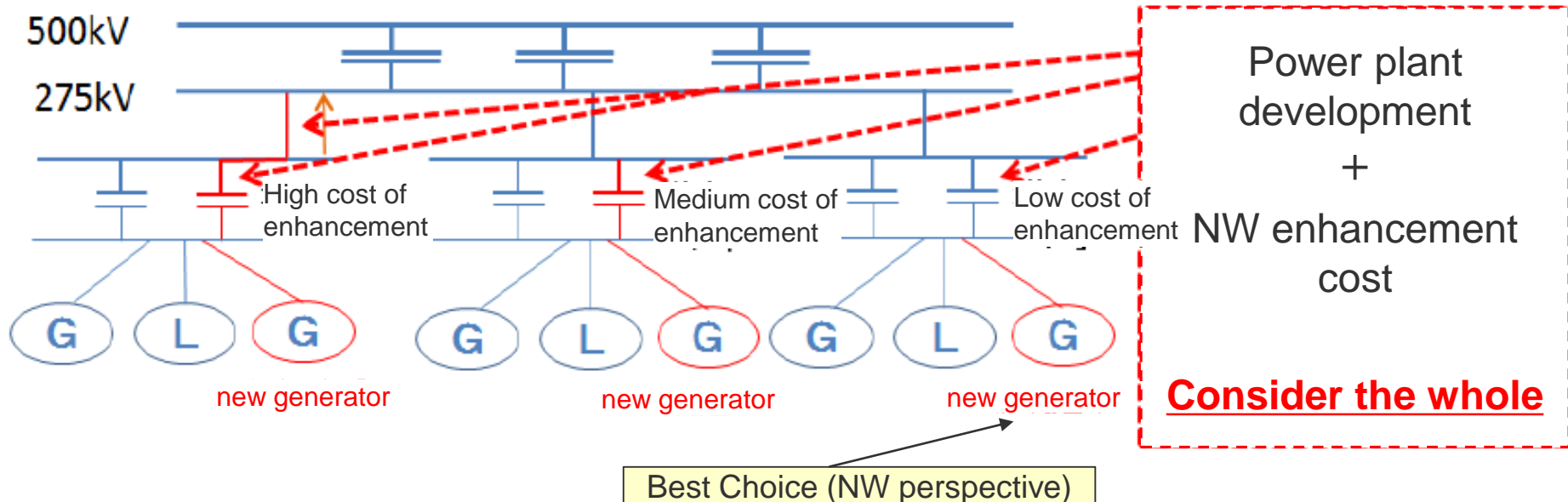

# 02

## Calculation example of construction cost burden in low-voltage grid connection

---

# Construction cost burden (burden by generation operator) judgment flow

Determine the burden based on the benefits of the generation operator

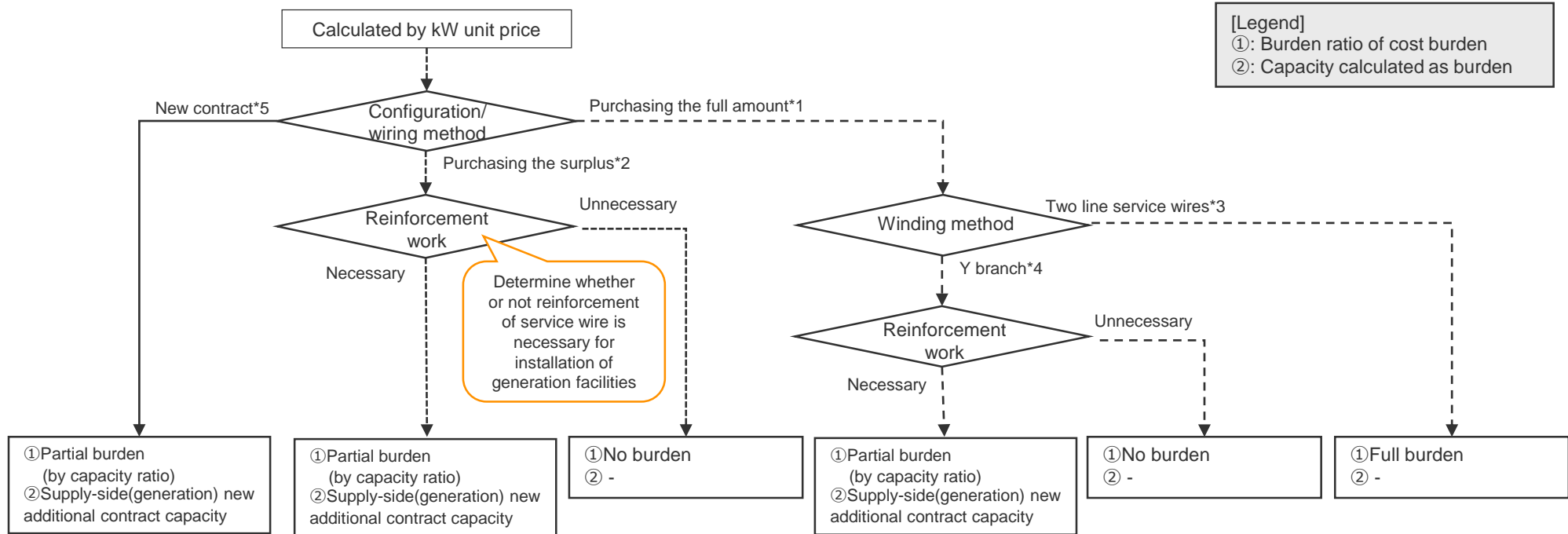

- \*1: A method in which the electric power company purchases the power generated by the renewable energy power generation facility through a dedicated service wire.
- \*2: A method of self-consumption of electricity generated by renewable energy power generation facility and purchasing the surplus by the electric power company (using the existing service wire)
- \*3: Separate service wires for supply and demand
- \*4: Add a generation service wire as a branch line to the existing demand service wire(Y branch)
- \*5: Case of contract with new demand

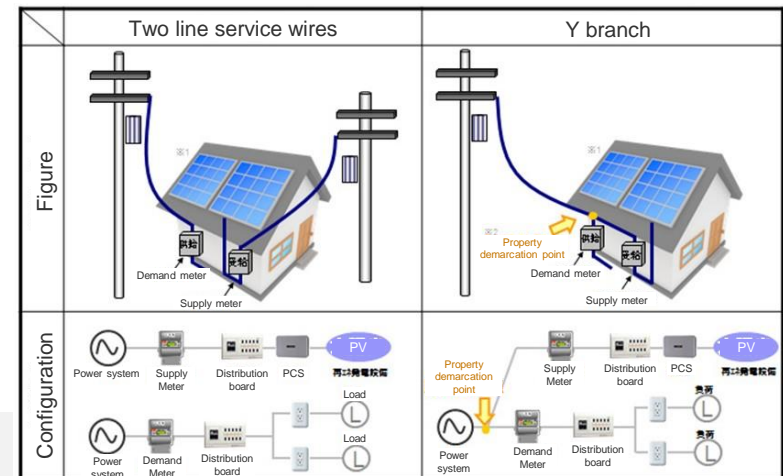

# Construction cost burden unit price

- A uniform construction unit price is set according to the part to be constructed

\*FY 2021 unit price

Construction scale	Unit price [yen]	Construction cost burden [yen]
Service wire	2,800	$2,800 \times (\text{generation output})$
Low voltage line ~ Service wire	3,700	$3,700 \times (\text{generation output})$
Transformer ~ Service wire	7,100	$7,100 \times (\text{generation output})$
High voltage line ~ Service wire	12,900	$12,900 \times (\text{generation output})$
Erecting poles, High voltage line ~ Service wire	$12,900x + 156,800y$	$12,900 \times (x: \text{generation output}) + 156,800 \times (y: \text{number of pole})$

# Proportion of costs for joint design (many RE generators jointly connecting)

- Even in case of installing distribution facilities by joint design, the target is for grid side from the PV generator installed point.
- Regarding the number of erected poles, only those used by the target generators are considered.

[In case of No pole construction]

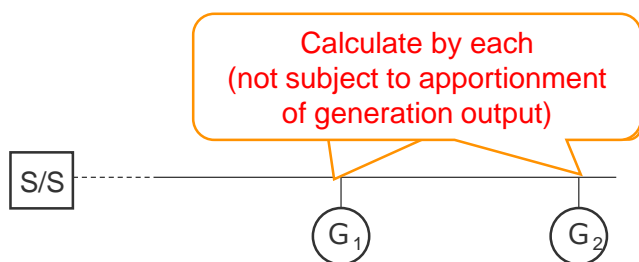

[In case of pole construction]

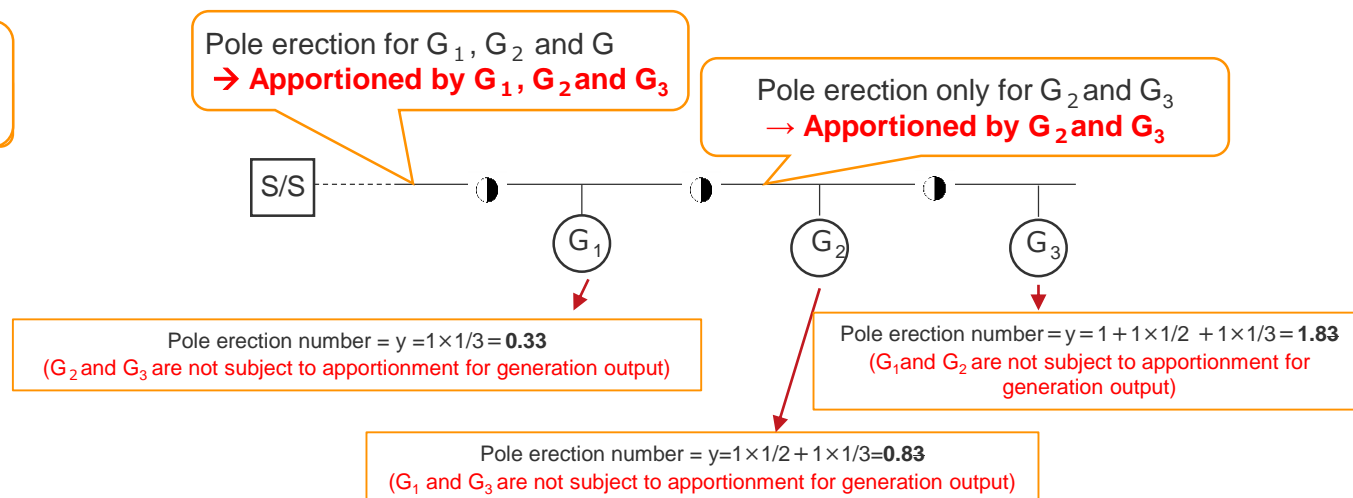

# Construction cost burden calculation example (1)

## Precondition

- Wiring method: Purchasing the surplus
- Reinforcement work: Necessary
- Generation output: 12.3kW
- Supplier contract: 60A (existing)
- Construction: Service wire replacement

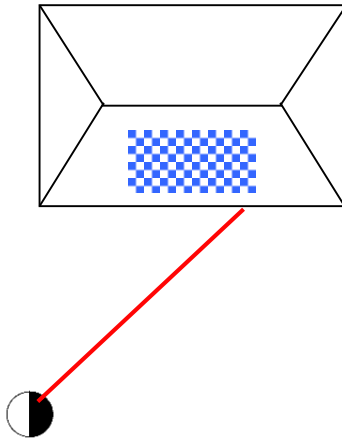

## STEP1 : Calculation preparation

Construction scale: Service wire

Round off the generation output after the decimal point: 12kW

## STEP2 : Calculate the total construction cost burden

$$2,800\text{yen/kW} \times 12\text{kW} = \mathbf{33,600\text{yen}}$$

## STEP3 : Apportion of the burden of the transmission company and generation operator based on the capacity ratio

Since there is no new expansion on the supply side, the entire cost will be borne by the generation operator



# Construction cost burden calculation example (2)

## Precondition

- Wiring method: Purchasing the full amount (Y branch)
- Supplier contract: 40A→60A(expansion)
- Reinforcement work: Necessary
- Generation output: 40.5kW
- Construction: Service wire replacement, new transformer installation

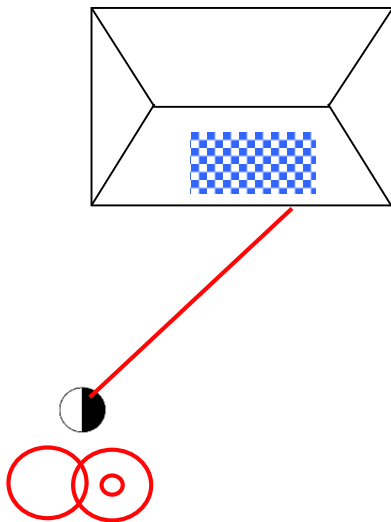

## STEP1 : Calculation preparation

Construction scale: Transformer ~ Service wire  
Round off the generation output after the decimal point:  
41kW

## STEP2 : Calculation the total construction cost burden

$$7,100\text{yen/kW} \times 41\text{kW} = 291,100\text{yen}$$

## STEP3 : Apportionment of the burden of the transmission company and generation operator based on the capacity ratio

$$291,100\text{yen} \times \left\{ \frac{41\text{kW}}{41\text{kW} + 2\text{kW}} \right\} = \underline{277,560\text{yen}}$$

(Round off the decimal point)

# Construction cost burden calculation example (3)

## Precondition

- Wiring method: Purchasing the full amount (Two line service wires)
- Generation output: 40.5kW
- Construction: New service wire, new transformer

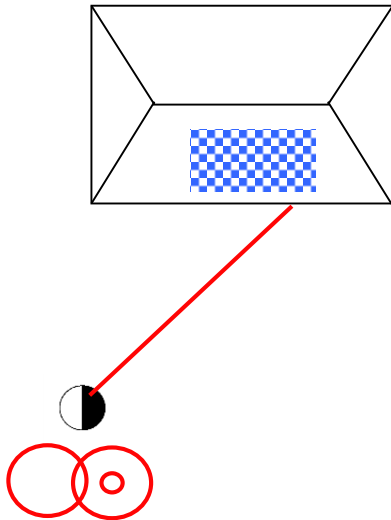

## STEP1 : Calculation preparation

Construction scale: Transformer ~ Service wire  
Round off the generation output after the decimal point:  
41kW

## STEP2 : Calculate the total construction cost burden

$$7,100\text{yen/kW} \times 41\text{kW} = \underline{291,100\text{yen}}$$

## STEP3 : Apportionment of the burden of the transmission company and generation operator based on the capacity ratio

Due to purchasing the full amount, the entire cost will be borne by the generation operator

# Construction cost burden calculation example (4)

## Precondition

- Generation output: 49.5kW
- Supplier contract: 0.5kW (new contract)
- Construction location: New site
- Construction: New service wire, new transformer, new three poles, new high voltage line

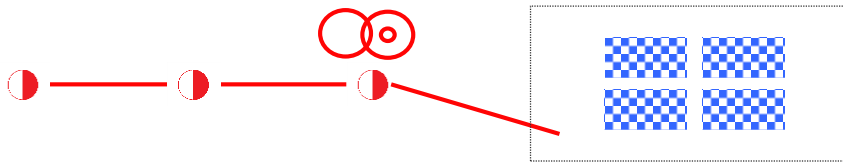

## STEP1 : Calculation preparation

Construction scale: Erecting poles, high voltage line ~ service wire

Round off the generation output after the decimal point: 50kW

## STEP2 : Calculate the total construction cost burden

$$12,900\text{yen/kW} \times 50\text{kW} + 156,800\text{yen/pole} \times 3 \text{ poles} \\ = 1,115,400\text{yen}$$

## STEP3 : Apportion of the burden of the transmission company and generation operator based on the capacity ratio

$$1,115,400\text{yen} \times \left\{ \frac{50\text{kW}}{50\text{kW} + 0.5\text{kW}} \right\} = \\ \underline{\underline{1,104,356\text{yen}}}$$

# 03 Concept of construction cost burden in high-voltage system interconnection

---

# Basic concept of cost sharing related to NW reinforcement

- In principle, the generation operator bars the cost of the reinforcement for the power line (from the power receiving point to the outlet of the distribution substation) when reinforcement is necessary due to the connection of the generation facility.
- However, due to this, although it is rare, it may be necessary to strengthen the NW side. In principle, this cost is borne by the transmission company.

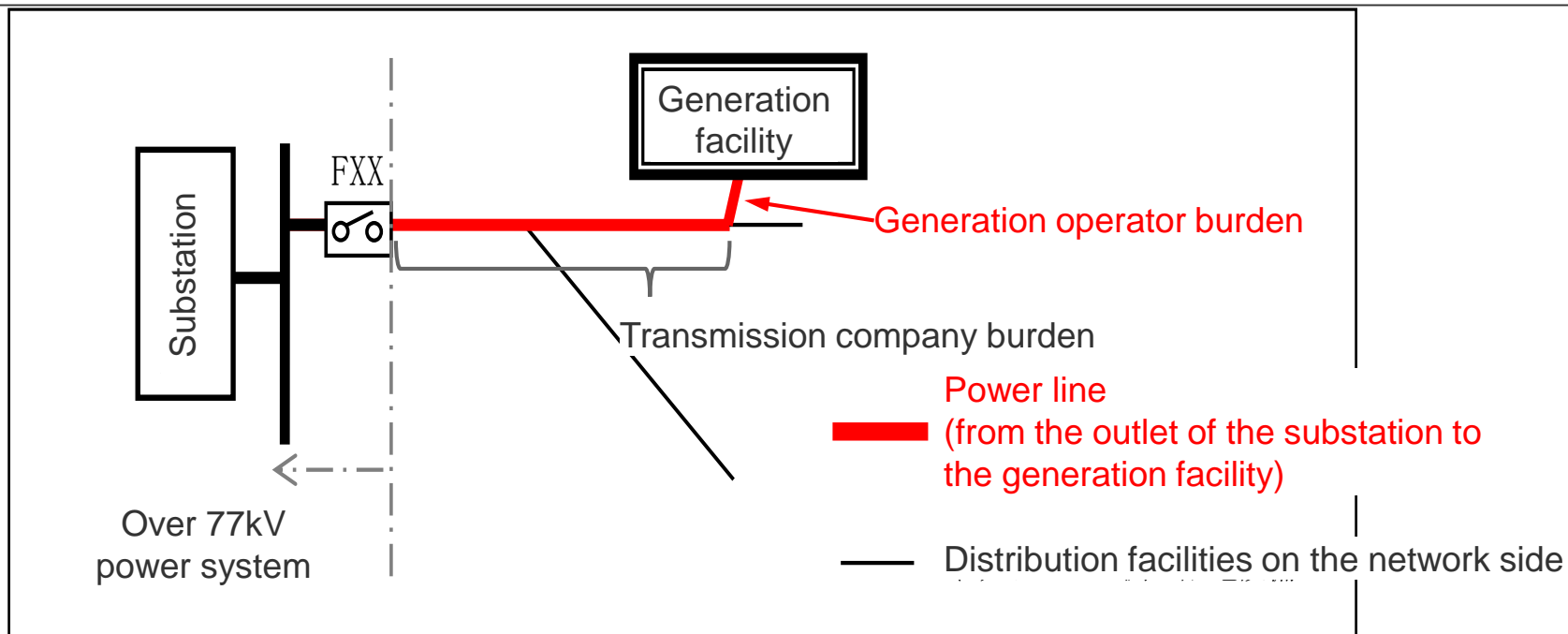

Since the high-voltage distribution system is operated flexibly while changing the system, it is difficult to identify the beneficiary even if the cause of the reinforcement is the interconnection of the generation facilities. Therefore, it will be borne by the transmission company.

# Cost burden related to transformer reverse power flow countermeasure construction

- Due to the increase in interconnection of RE such as PV, there are many cases where reverse power flow occurs in units of transformers of distribution substations from the PV side.
- It is necessary to install failure detection relays and reverse power flow monitoring meters, etc., and the burden is uniformly charged to the causer.

Item	Contents
Construction timing	-Timing when reverse power flow occurs in transformer units
Range of countermeasures	-Distribution substation unit
Bearer of construction burden	-Generation facilities connected to high-voltage lines -Generation facility that causes reverse power flow countermeasure construction and generation facility that receives power from the substation with in 3 years after start of use of the countermeasure equipment.
Construction cost unit price	3,850 yen per 1kW of additional contract power received

# 04 Summary

---

- Generation operator burden: When a specific generation facility installer is benefiting.
- Transmission company burden: When it cannot be said that a specific generation facility installer is benefiting.



- In principle, transmission company bears the cost of reinforcement of the transmission facilities that constitutes the trunk system(500kV, 275kV).
- The cost for the reinforcement of transmission facilities under 275kV system will be borne by the generation operator and transmission company.
- In the case of installing a generation facility in a low-voltage distribution system, the burden amount is determined according to the rules.
- The cost of reverse power flow countermeasures for distribution substation transformers is determined by the unit price according to the generation capacity.





**CHUBU**  
Electric Power

***NIPPON KOEI***

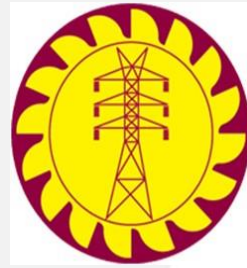
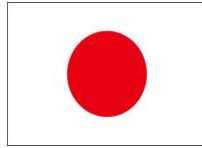
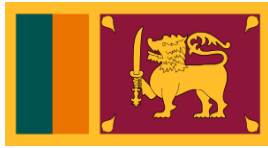

# Amendment of the Act on “Special Measures concerning Electricity Procurement from Renewable Energy”

October, 2020

Chubu Electric Power Co., Inc.  
Nippon Koei Co., Ltd.

# 01

## Background and Contents of the revision of the Act

---

# Background to the Amendment

- In terms of environmental changes related to electricity supply such as frequent natural disasters, becoming tense of international energy situation in the Middle East, expansion of renewable energy, it is necessary to secure a sustainable electricity supply system through measures such as prompt restoration in the event of a disaster, smooth investment in TL/DL, and **VRE installation expansion**.
- Against this backdrop, to establish resilient and sustainable electricity supply systems, the revised Acts are to take the following measures, including those for: requiring electricity transmission/distribution business owners to formulate action plans on their collaboration in disaster responses, **establishing a new scheme for supporting businesses in introducing renewable energy**.

Cabinet Approval (Feb.25, 2020)

Approved by congress (June 5, 2020)



Amendment will become effective on April 1. 2022

## 3 Major Points

- ① Strengthening cooperation in case of disasters
- ② Strengthening of TL/DL
- ③ Disaster-resistant power system with distributed power generation

## Major Revisions related to Renewable Energy

- ① Market-linked system introduction → Creation of a system (FIP system) that delivers a fixed premium to the market price
- ② System enhancement to make full use of RE potential → Scheme to support for some portion of grid reinforcement costs such as inter-regional interconnection lines necessary for expanding RE introduction supported by a levy system
- ③ Appropriate disposal of RE facilities → External reserve obligation against business owners

# 02

## Movement to “Renewable energy-type economic society”

---

# Environment surrounding the Introduction of Renewable Energy

- Since enactment of the Act on Renewable Energy Special Measures in 2012, we have promoted the expansion of the introduction of renewable energy through the FIT scheme. And we have been working on overcoming the barriers of national burden and power system constraints that occur in this process.
- The production ratio by renewable energy has improved to about 17% (2018), and it is the sixth largest in the world (2017). On the other hand, reducing the burden on consumers continues to be a major issue, and at the same time, expectations for a decarbonized and distributed renewable energy society are increasing.

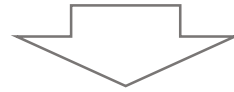

Based on the idea of creating a renewable energy-type economic society, it is necessary to consider policies in three aspects: (1) Strengthening the competitiveness of industry, (2) Developing infrastructure, and (3) Coexisting with local communities (Quoted from Minister of Economy, Trade and Industry).

Increasing awareness that the creation of the “Renewable energy-type economic society” is necessary

# Elements necessary for the creation of a Renewable energy-type Economic Society

(1) Strengthening the competitiveness of industry;

How to evolve into a “competitive industry” that enables low cost and stable installation in Japan while the renewable energy installation with business competitiveness is progressing in other countries?

(2) Developing infrastructure;

How to proceed the development of "industrial social infrastructure" such as the electric power system in order to use large quantities of distributed renewable energy efficiently?

(3) Coexisting with local communities;

How to build a “Renewable energy-type economic society” that will embrace renewable energy and increase it in a sustainable manner?

<Up to Now> Expansion of RE and Problem solving

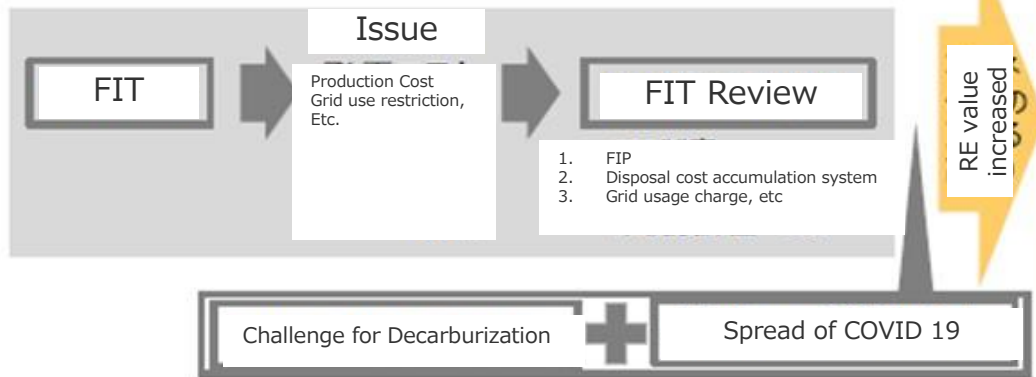

<Future> Creation of Renewable energy-type Economic Society

(1) Strengthening the competitiveness of industry

(2) Developing infrastructure

(3) Coexisting with local communities

RE centered Economy



# Practical efforts toward “Renewable energy-type economic society”

## (1) Evolution into competitive Renewable energy industry

~Evolving renewable energy into a competitive industry through the cost reduction and integration into the electricity market~

- ① Introduction of FIP system and activation of aggregator business
- ② Acceleration of introduction of distributed power sources centered on “Supply and demand integration”, and the reform of consumer sense
- ③ Expansion of storage batteries
- ④ To Strengthen the competitiveness of offshore wind power, which is the key to the main power source in the future

## (2) Improvement of social infrastructure such as power grid that supports renewable energy

~Medium- and long-term development while suppressing the effects of power grid constraints~

- ① Review of the rules for using the main transmission line
- ② Push-type<sup>※</sup> power grid formation considering future power source potential
- ③ Development of industrial basement that supports renewable energy (Research and development of innovative technologies, etc.)

※Systematically build a power grid taking into the potential volume of VRE connection in to consideration

## (3) Building a community that coexists with renewable energy

~Business operation with the understanding and trust of local communities~

- ① Development of appropriate business discipline to gain local understanding and trust
- ② Mechanism for ensuring effective utilization of the grid
- ③ Promotion of efforts to realize sustainable expansion in response to local demands such as resilience and “supply and demand integration”

# 03

<Review>

Background of the Transition to “Renewable energy-type economic society”

(Issues surrounding the promotion of renewable energy)

---

# Heavy Burden for Consumers

- Initially, the fixed purchase price was set high.
- 70% of total levy, the 3.6 trillion yen, is PV. 90% of which is 2012,13,14 and is a volume zone, which is a heavy burden on people.

## High purchase price

(Yen/kwh), 0.6yen/LKR

電源 [調達期間]	2012年度	2013年度	2014年度	2015年度	2016年度	2017年度	2018年度	2019年度	2020年度	2021年度	2030年 価格目標
Non-residential PV(20years)	4 0円	3 6円	3 2円	2 9円 2 7円※1	2 4円	入札制移行 (2,000kW以上) 2 1円 (20,000kW未満) 1 8円 (10,000kW未満)					7円
Residential PV(10years)	4 2円	3 8円	3 7円	3 3円※2 3 5円※2	3 1円※2	2 8円 3 0円※2	2 6円※2	2 4円※2	2 6円※2		市場価格 (2020年以降の目標)
Wind (20years)	2 2円(20kW以上)※4			5 5円(20kW未満)※3			Onshore 2 0円※4	1 9円※4	1 8円※4		8~9円
	3 6円 (Offshore ) )			3 6円 (浮体式)			3 6円 (離床式)※5	3 6円(浮床)			
Geothermal (15years)	2 6円(1500kW以上)※4			4 0円(1500kW未満)※4							
Hydro (20years)	2 4円(1000kW以上30000kW未満)※4			2 4円			2 0円(5000kW以上30000kW未満)※4	2 7円 (1000kW以上5000kW未満)※4			
	2 9円(200kW以上1000kW未満)※4			3 4円(200kW未満)※4							
	3 9円 (メタン発酵ガス)			4 0円(2000kW未満)							
	3 2円(間伐材等由来の木質バイオマス)			3 2円(2000kW以上)							
Biomass (20years)	2 4円(一般木材等/バイオマス)			2 4円 (20,000kW以上) 2 1円 (10,000kW以上)			入札制移行 (10,000kW以上) 2 4円 (10,000kW未満)				
	2 4円(バイオマス液体燃料)			2 4円 (20,000kW以上) 2 1円 (10,000kW以上) 2 4円 (20,000kW未満)			入札制移行				
	1 3円(建設資材廃棄物)			1 7円(General waste マス)							

90% of levy is concentrated in 3yrs

## <Breakdown of Levy> (unit: trillion yen)

電源	2012	2013	2014	2015	2016	2017	2018	2019	(Total)	割合
PV (Residential)				0.2						5%
PV (Non-residential)	0.8	1.0	0.4	0.1	0.1	0.03	0.03	0.01	(2.5)	70%
			63%							23%
										10%
Wind									0.1	4%
Geothermal									0.02	0.5%
Mini0-Hydro									0.06	2%
Biomass									0.4	10%
Others									0.3	9%
Grand Total									3.6	—

Source: Agency for Natural Resource and Energy

# Achievement of National Energy Plan with limited Budget

- 2.1 trillion yen levy was required to achieve a RE ratio of 10% to 16% (mostly VRE).
- Further increase of 8% is necessary to achieve 22-24% of RE ratio by 2030
- To minimize the burden is necessary while the RE ratio is achieved

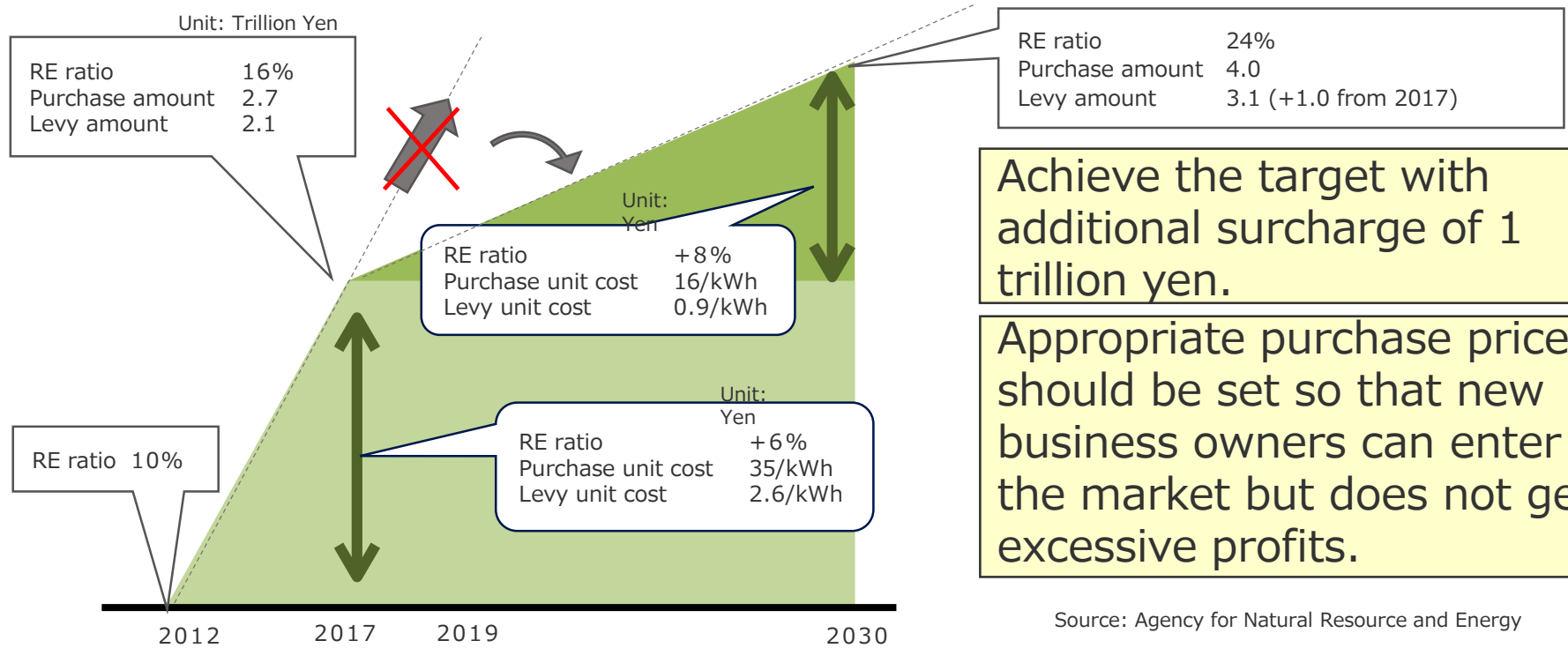

Achieve the target with additional surcharge of 1 trillion yen.

Appropriate purchase price should be set so that new business owners can enter the market but does not get excessive profits.

Source: Agency for Natural Resource and Energy

# Market Integration Delay of Renewable Energy

In the FIT scheme, promotion of the introduction of renewable energy is the top priority, so power is generated with ignoring the market trend, and as a result, it will be difficult to reduce the cost of the whole and to expand the introduction of renewable energy.

In the FIT scheme,  
Renewable energy companies are exempt from market transactions and are shielded from the risk of unsold and imbalance (deviation between planned value and actual result). This had the positive effect of lowering the barriers to enter the RE business.  
On the other hand, RE business owners act to maximize the amount of power generation (income) without considering the current supply and demand balance and the market price.

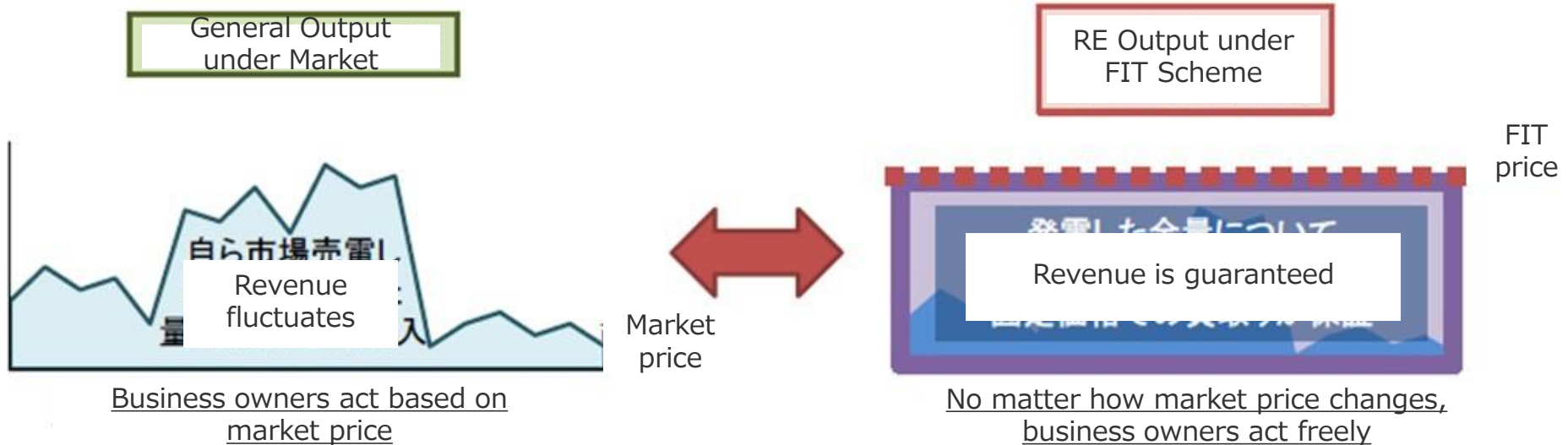

# Ensuring long-term stable Business operation

- In order to make renewable energy the "main power source", it is necessary to become a responsible and long-term stable power source.
- Among solar power which has rapidly entered the market, concerns emerge such as safety due to poor construction, issues in coordination with the local community regarding impact on landscape and environment, measures to dispose of PV facilities after use, and etc.

No fence



Inappropriate fence setting



Inadequate Management



Damage by heavy rain



# 04 Challenge for creating a Renewable energy-type economic society

---

## Actual condition

- Power sources with low power generation costs need to be integrated into the electricity market, and the revised law that will come into effect in 2022 has decided to introduce a market-linked FIP system in addition to the FIT system.
- An investment incentive will be secured by delivering the difference between the standard price and the market price as a premium.
- Activation of environment for aggregator business, considering that renewable energy power generation companies will newly enter the market.

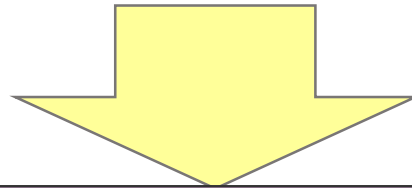

## Discussions needed in the future

- Mechanism for encouraging power generation in response to fluctuations in market prices
- Applicable to the FIP system
- Improving the market environment for activation the aggregator business



# (Ref.) Efforts to develop aggregators

- Revise related guidelines and create aggregator licenses to further promote renewable energy
- Expected to spread and expand the aggregator business that provides power supply capacity by utilizing various distributed power sources such as renewable energy power sources subject to FIP, solar power, EVs and storage batteries for small consumers such as homes.

## Trouble of power generation company

How can I sell as much electricity as I can in the most profitable time?

The amount of power generation is affected by the weather and imbalance occurs.

I want to make effective use of small-scale renewable energy power generation.

The selling price of electricity in the wholesale electricity market changes from hour to hour (FIP system).

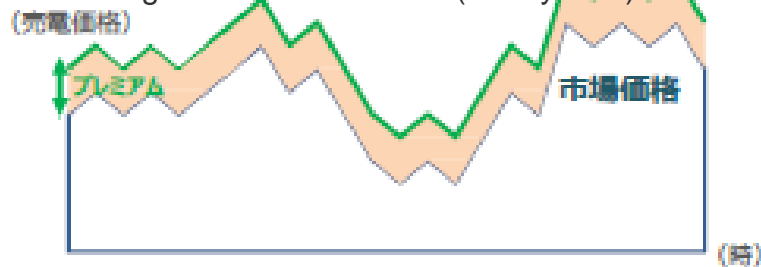

## Image of aggregator business

Bundle small-scale distributed equipment with IoT to provide power supply capacity.

### Aggregator

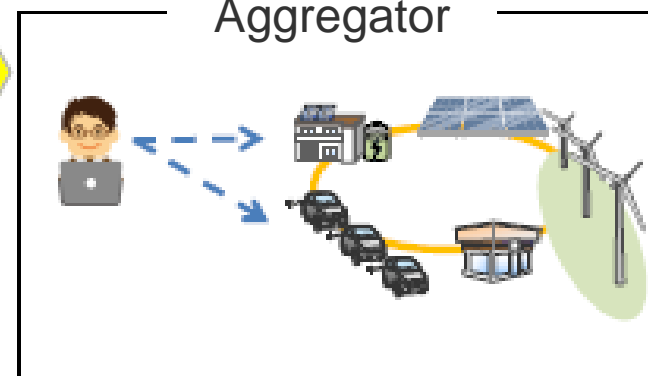

# (1) ② Accelerate the introduction of distributed power sources centered on the integrated supply and demand system, and reform consumer awareness

## Actual condition

- Further promotion of supply-demand integrated model including self-consumption and utilization of regional system
- Further expansion of the introduction of renewable energy in the home. Promote ZEH(net Zero Energy House) and support the introduction of equipment that contributes to improving the self-consumption rate.
- Launched a distributed energy platform in which businesses and local governments related to the distributed energy model participate, and need to discuss issues for the spread of the integrated supply and demand model.

## Discussions needed in the future

- Promotion of ZEH to general house makers other than major house makers. And arousing the needs of those who build houses.
- Need for a mechanism to evaluate and promote efforts for self-consumption of renewable energy.

PV introduction rate by contractor

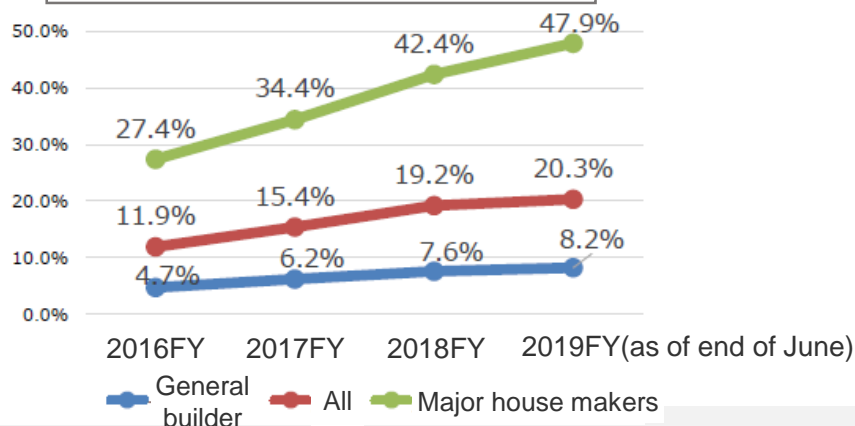

Source: METI

Regional level supply and demand integrated model



# (1) ③ Expanding the spread of storage batteries that support new energy systems

## Actual condition

- In order to realize the self-sustaining expansion of the introduction of storage batteries, a target price has been set, and introduction support is provided for storage batteries that are below the target prices. The average price of household storage batteries that were supported for introduction was reduced from 188,000yen (2017) to 130,000yen (2019).
- Created performance evaluation guidelines for used EV batteries.

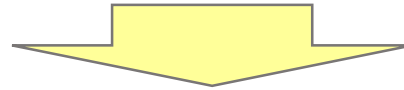

## Discussions needed in the future

- Necessity of further price reduction measures to realize self-sustaining dissemination.
- Measures to reduce the cost of storage batteries by effectively utilizing used EV batteries.

Efforts to reduce the price of household storage batteries

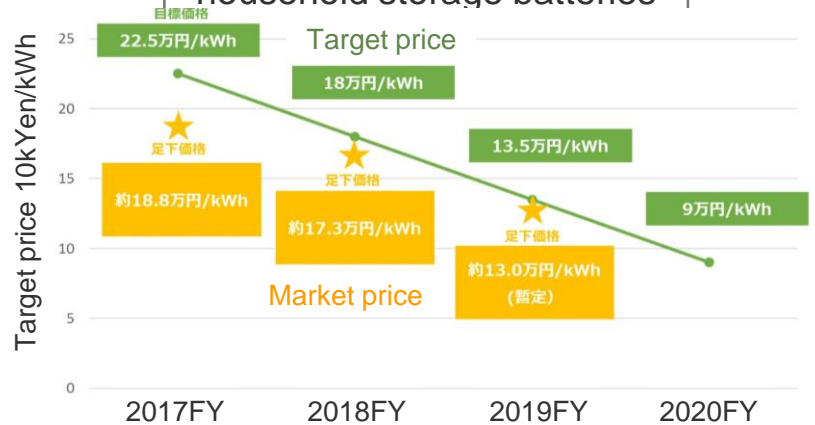

## Promotion of diversion of used batteries

- ✓ The cost of storage batteries will be reduced by effectively utilizing used EV batteries, which will be available in large quantities with the spread of EVs in the future.
- ✓ Therefore, solving problems such as performance evaluation of used EV batteries and safety assurance are necessary.

# (1) ④ Strengthening the competitiveness of offshore wind power, which holds the key to becoming a main power source

## Actual condition

- Offshore wind power generation has three advantages among renewable energy: (a) mass introduction is possible, (b) cost reduction can reduce the burden on the people, and (c) economic ripple effect is large. And it is the trump card for the main power source of renewable energy.
- Four places have been designated as promotion areas. Of these, open offering has started off the coast of Goto City, Nagasaki Prefecture.

## Discussions needed in the future

- Strengthening the competitiveness of the offshore wind industry, reduce costs and discussion of how to proceed with efforts to promote investment by businesses to strengthen their competitiveness are necessary.
- Improvements and verification of issues such as continuous designation of promotion areas for future continuous introduction expansion

Investment expansion

**Planned and continuous expansion of offshore wind power**

(Steady enforcement of the renewable energy sea area utilization law)



Cost reduction

**Strengthening the competitiveness of related industries**

(Domestic / regional promotion, supply chain resilience, industry accumulation)

Source: METI

# (Ref.) Most Progressing Areas toward Designation of Promotion Area

- As of April 2020, 11 areas for which certain preparations had already been conducted were selected. Four areas are designated as promising areas. There are many prospective areas in Tohoku with good natural conditions
- At present (July 2020), four promising areas are upgraded as Promotion areas. Of them, most proceeded area, Goto, has already started the public tender.
- The law defines six criteria for designating the promotion area such as natural conditions.

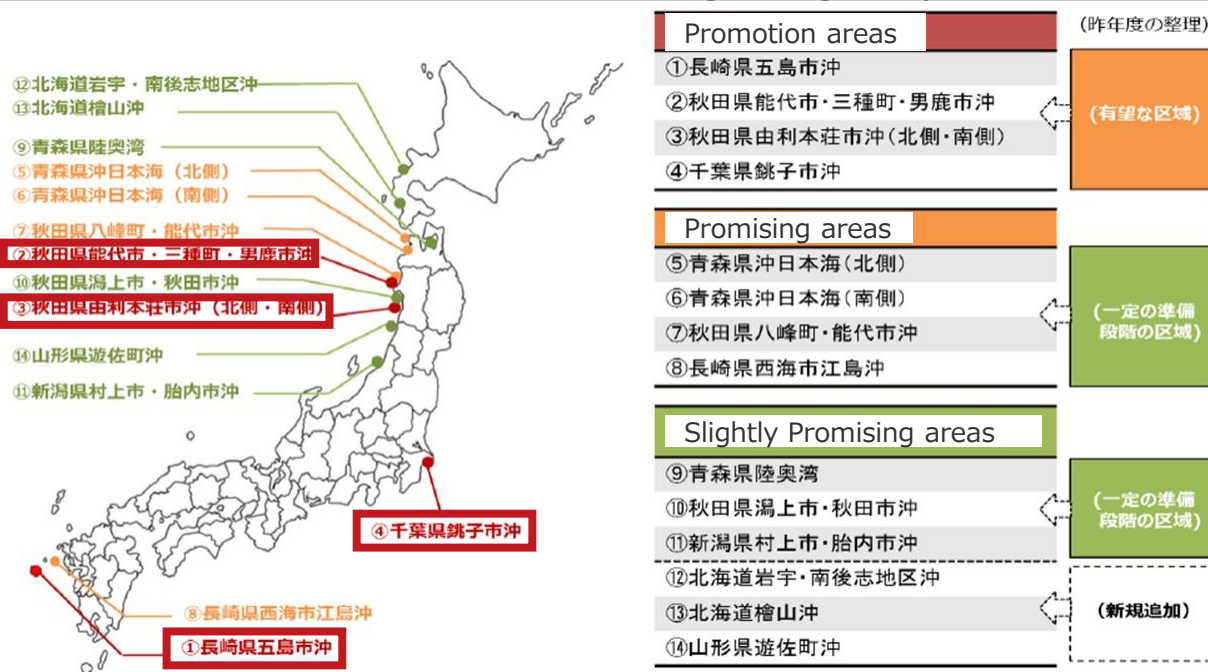

- Criteria for designating the promotion (Chapter 8)
- 1) Good Natural Conditions (Wind, Geology)
  - 2) Least Affect toward existing ferry route
  - 3) Comprehensive usage of harbor
  - 4) Securing of System connection
  - 5) Least affect toward fishery
  - 6) No overlapping with area designated by other Acts

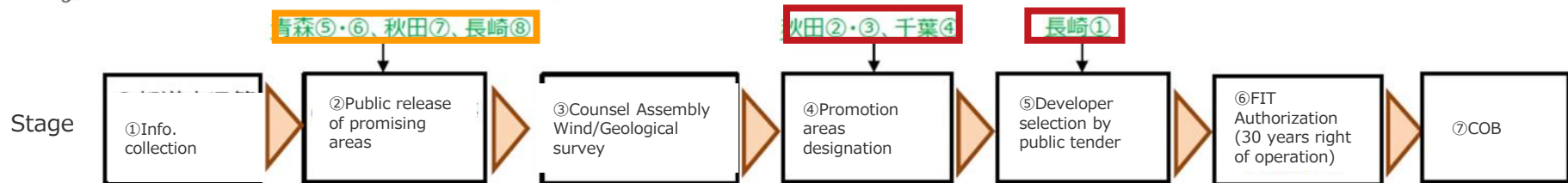

# (2) ① Review of trunk transmission line usage rules for main power supply

## Actual condition

- In order to make the best use of the existing system for mass introduction of renewable energy, the conventional operation was reviewed and the application of "Japanese version Connect & Managed" was considered and implemented.
- Appropriate output control methods such as ensuring fairness among operators in renewable energy output control and making output control online were examined and implemented.

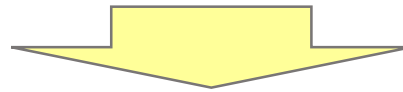

## Discussions needed in the future

- Procedure for nationwide expansion of non-farm type connections
- Improvement points for inter-regional interconnection lines that manage congestion through indirect auctions
- Procedure for economic output control (online control) and grid code maintenance to ensure appropriate adjustment power

# (2) ② Push-type system formation based on future power supply potential

## Actual condition

- In order to promote the mass introduction of renewable energy power sources and reduce the burden on the people, the existing system will be utilized to the maximum extent, and a push-type wide area interconnected improvement plan (master plan) based on potential connection needs is formulated, and the next-generation system formation needs to be promoted.

Push-type system formation: A method of systematically forming a system based on potential connection needs while making the best use of the existing system.

## Discussions needed in the future

- Prospect of renewable energy potential
- Sharing costs for system expansion

### Master Plan

Formulated by a wide-area organization and reported to the national government

**Wide area system long-term policy**  
: Basic direction of wide area transmission network development

+

**Wide area system development plan**  
: **Main transmission line development plan** based on cost-effectiveness analysis

**Power grid developed by the operator**  
Cost sharing by **national development scheme**

○ Social benefits (Effects : 3E)

1. Price reduction  
(wide area distribution of cheap electricity)

2. CO2 reduction

3. Stable supply  
(Reduction of power outage rate)

Nationwide burden in principle

Local burden

Nationwide transmission fee

Levy method of the Renewable Energy Special Measures Law

Transmission fee for each region

Utilize the difference profit of JEPX (Wholesale Electric Power Exchange)

Effect derived from renewable energy

## (2) ③ Improvement of industrial infrastructure to support renewable energy (research and development of innovative technologies)

### Actual condition

- Until now, technology development and demonstration related to renewable energy has focused on reducing power generation costs. Some results have been achieved, such as achieving the world's highest conversion efficiency.
- If mass introduction is promoted, area restrictions will eventually become a problem. Issues will be resolved through technological innovation, such as drastically improving power generation efficiency to overcome area constraints.

### Discussions needed in the future

- Consideration in order to promote the early realization of technological innovation that contributes to the main power source of renewable energy and the social implementation of new technology. (Example: PV with no installation location restrictions, floating offshore wind power generation)
- Industrial infrastructure required to create a renewable energy-type economic society. How to proceed with the development of the industrial infrastructure

Flexible, lightweight, highly efficient PV  
with no installation location restrictions



Example of PV installation on the wall of a building (NEDO)



Perovskite PV that is lightweight and can follow curved surfaces(NEDO)

Source: METI

Floating offshore wind turbines  
applicable to harsh natural conditions



Prototype barge type floating body (NEDO, Marubeni, etc. Consortium)



### (3) ① Optimization of business discipline to gain the understanding and trust of the region

#### Actual condition

- In order for the renewable energy power generation business to become established as a social foundation as a long-term stable business rooted in the region, it is necessary to ensure that it is carried out consistently and appropriately from the start to the end of the business.
- Based on the establishment of business plan formulation guidelines and publication of certification plans, guidance on inappropriate projects and information liaison meetings were held as a place to share advanced case studies.
- A system for accumulating the disposal cost of solar power generation has been established. Preparing for enforcement in the future.

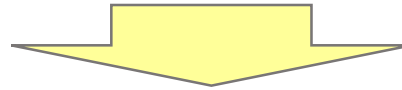

#### Discussions needed in the future

- Support for local governments to facilitate smooth coordination with the local community
- Creating laws and regulations for the enforcement of the disposal cost reserve system for photovoltaic power generation facilities

### (3) ② Mechanism to ensure project implementation and effective utilization of the system at a timely price (certification revocation system)

#### Actual condition

- ✓ A large number of projects that do not start operation stay for a long time while retaining the right to a high procurement price. Problems such as (a) concerns about an increase in the burden on the people in the future, (b) stagnation of new development and cost reduction, and (c) emptying of system capacity have arisen.
- ✓ If the operation is not started for a long period of time, the certification revocation system has been newly incorporated by this revision of the law.

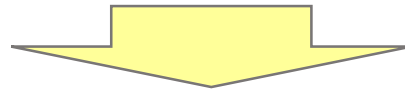

#### Discussions needed in the future

- ✓ Setting an expiration period for the enforcement of the revised law

### (3) ③ Promotion of efforts to realize sustainable introduction expansion in response to local demands such as resilience and supply and demand integration

#### Actual condition

- Demand for integrated supply and demand, local production for local consumption, and locally distributed energy systems are increasing as it contributes to strengthening resilience in the event of a recent disaster.
- Implemented a regional micro grid construction support project. In addition, a distribution business license has been established due to the recent revision of the law.

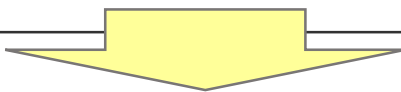

#### Discussions needed in the future

- Small-scale geothermal power, small-scale hydropower, biomass self-consumption requirements and regional integrated requirements
- Arrangement of institutional, technical issues and improvement of business environment related to utilization of existing grid distribution system and construction of regional micro grids
- How to promote the introduction of renewable energy that brings value to the region and is needed in the region

# (Ref.) Outline of power distribution business system

- From the perspective of strengthening resilience, there is a need for new operators to utilize AI and IoT technologies in specific areas by utilizing the transmission and distribution network of general transmission and distribution business operators. The distribution company will be newly positioned under the Electricity Business Act on the premise that stable supply can be achieved.
- It is expected that local governments and local companies will be able to carry out distribution business in collaboration with IT companies with advanced technology, and in the event of a disaster, it will be possible to disconnect the power grid in a specific area and operate it independently.

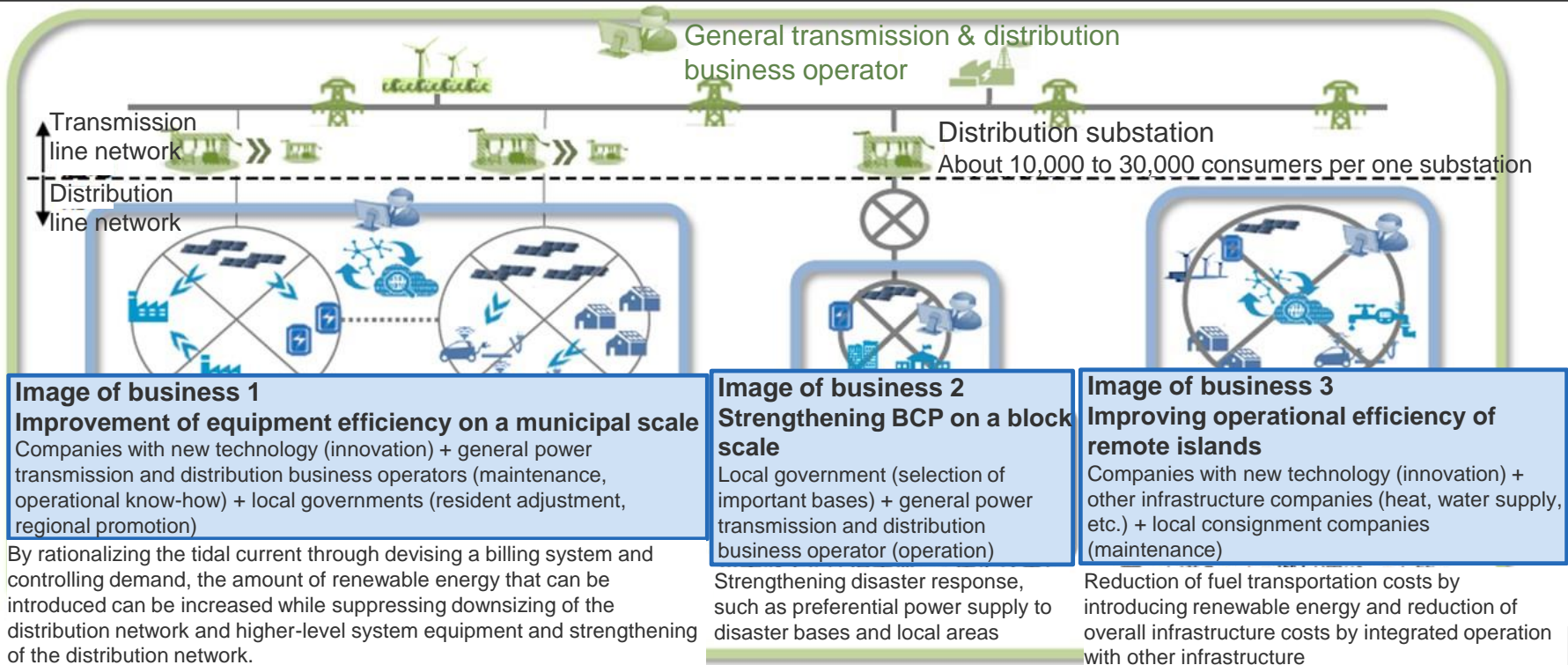



**CHUBU**  
Electric Power

***NIPPON KOEI***

# FIT Scheme in Japan

JICA Expert Team

May, 2020

Chubu Electric Power Co., Inc.  
Nippon Koei Co., Ltd.

VREs (Variable Renewable Energy) are expected to become important power sources in Japan where there are little fossil natural resources. Effectiveness is described below:

## VREs

- Contribute to improve the energy sufficiency-rate because it is not necessary fuel is imported from abroad
- Achieve global warming countermeasures
- Contribute green industry growth and employment expansion
- Become energy of local production for local consumption
- Leads to regional revitalization, etc.

# Early Days of Introducing VREs

Since the oil crisis of the 1970s, VREs, along with energy conservation and nuclear energy, has been an main role of national energy policy. However, the efforts in the early days were not to try to expand the introduction of regulations like Europe, but to push forward with Japan's industrial competitiveness and technological development mainly.

Schemes	Contents
Subsidy	In 1994, monitor business of home solar power generation started <ul style="list-style-type: none"> <li>➤ Initially 1/2 assistance, then 1/3 assistance</li> <li>➤ In some cases, in addition to national subsidies, local government subsidies are available</li> <li>➤ Subsidies from country lasted until 2005</li> </ul> Although it is a limited number of households, this created opportunities to introduce it to general households
Surplus power purchasing system	In 1992, <b>voluntary</b> purchase scheme started at the selling price of surplus power from PV business owners

Source: Ministry of the Environment



# Improvement of Technics

The solar power generation market grew due to the subsidy and surplus electricity purchase system.

Japanese manufacturers conquered the global market.

At the same time, the unit price of power generation dropped from about 1.8 million yen / KW (1994) to about 700,000 yen / KW (2002).

1 yen = 0.57 LKR

Generated amount (2005)

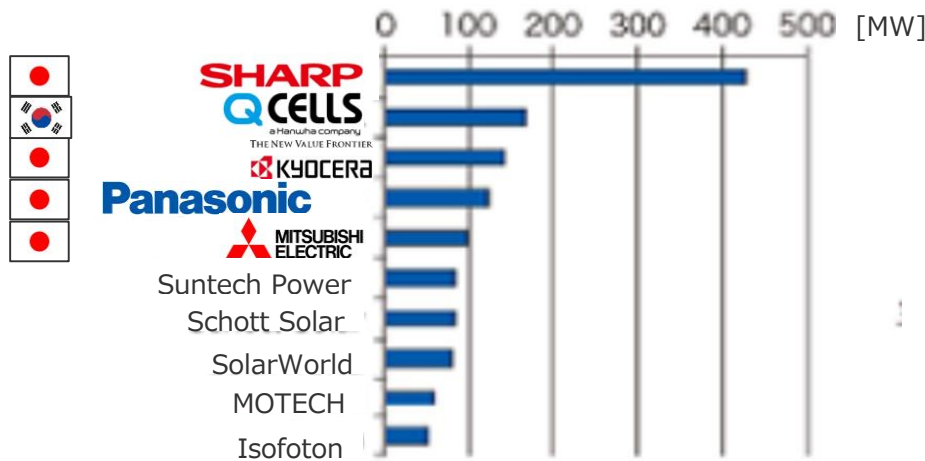

Established Japan as a technical nation

- Japan became the No. 1 country in the world for solar panel production from 1999 to 2007
- Japanese manufacturers ranked four of the world's top five in 2005

# Decline of Japanese Presence in Share

Due to the simplicity of the elements of solar power generation in terms of technology, commoditization has progressed rapidly, and due to the expansion of solar panel production capacity in China, Taiwan, etc., Japanese manufacturers have disappeared from the world share best ten by 2012.

Generated amount (2012)

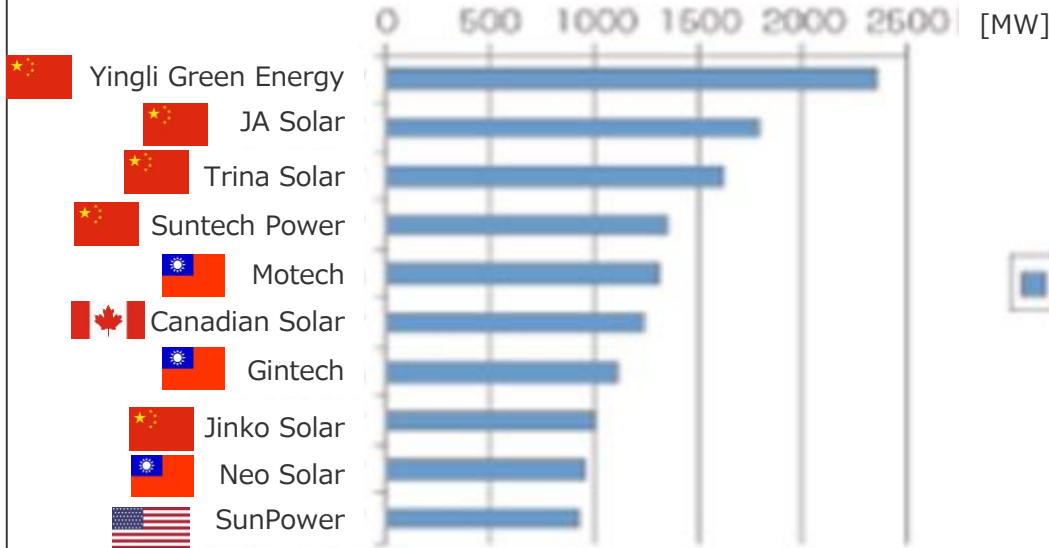

Support for technical development, subsidy, voluntary effort by utilities are not enough

New scheme in line with Japanese condition is necessary

# RPS (Renewable Portfolio Standard)

- A certain amount generated from RE (Wind, PV, Geothermal, Hydro, Biobass) is required  
→ **Mandatory requirement** toward Electric power utilities
- Electric power utilities fulfill their obligations by (1) generating electricity by themselves, (2) purchasing electricity from others, or (3) purchasing electricity equivalent to their obligation from others (RPS certificate) .

## Benefits

- Contributes to environmental conservation by lowering dependence on thermal power generation.
- Drops the price of RE power generation equipment (such as wind turbines) since almost all business players use RE

## Issues

- The introduction target in volume is too low, which is an obstacle itself to the introduction of RE.
- Burdening the power company only
- Banking and Borrowing schemes eventually allow underachievement

Insufficient system design

# Revision of “Surplus Power Purchasing System”

- In 2009, the purchase of surplus electricity from solar power became an obligation of electric power companies  
Voluntary purchase (Enforced in 1992) → **Mandatory Purchase**
- Electricity selling price from the RE business owners is doubled

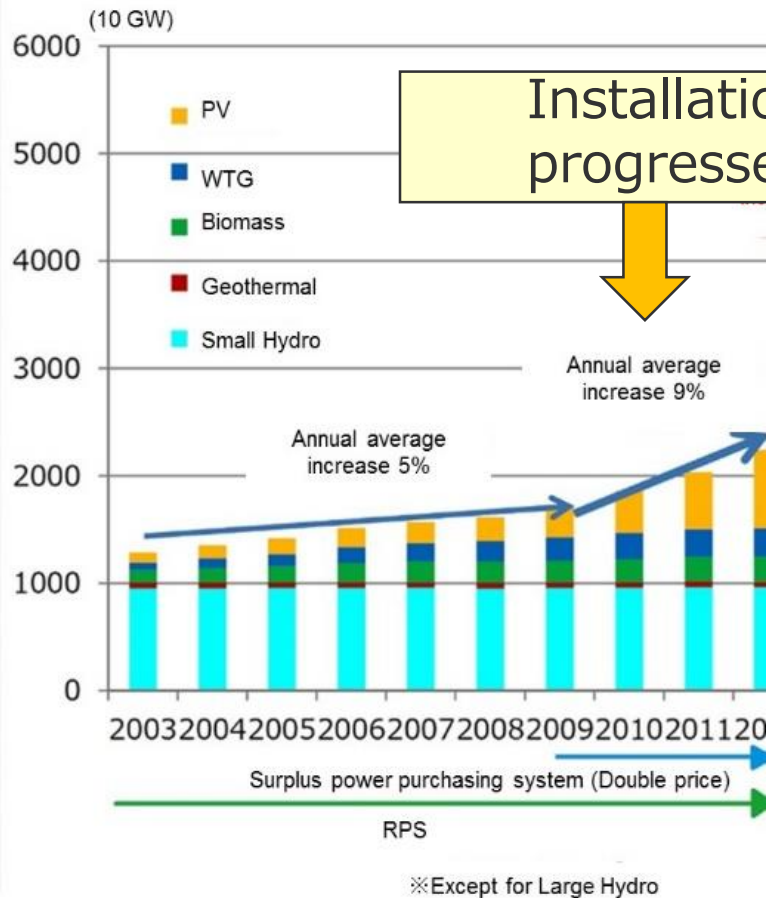

After the 2011 Great East Japan Earthquake (Fukushima Daiichi Nuclear Power Plant accident), momentum for expanding the introduction of renewable energy increased further.

# FIT (Feed in Tariff)

- A system that requires electric utilities to purchase electricity generated using renewable energy sources such as PV, wind, hydropower, geothermal energy, and biomass at a fixed price set by the country for a certain period, which was enforced in 2012.

## Difference between "Surplus electricity purchase system" and FIT

### Surplus electricity purchase system (Enforcement in 1992, Amendment in 2009)

This scheme targets power consumption in homes. It promotes energy saving and power saving at home, and sell surplus electricity.

### Fixed Price Purchase System (FIT, Enforcement in 2012)

The purpose is to support the promotion of not only solar power but also renewable energy in general. The intent is to establish a system that can secure a sufficient amount of power sales income to cover the expensive equipment installation costs.

# Promotion of RE Installation with FIT

- Installation promotion by FIT
- Drastic increase from 2.7% (2011) to 8.1% (2017)

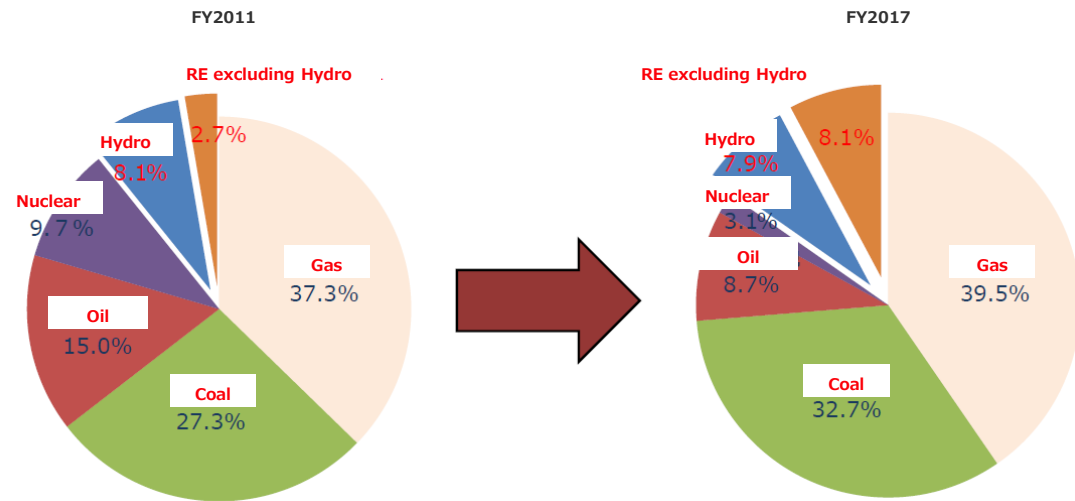
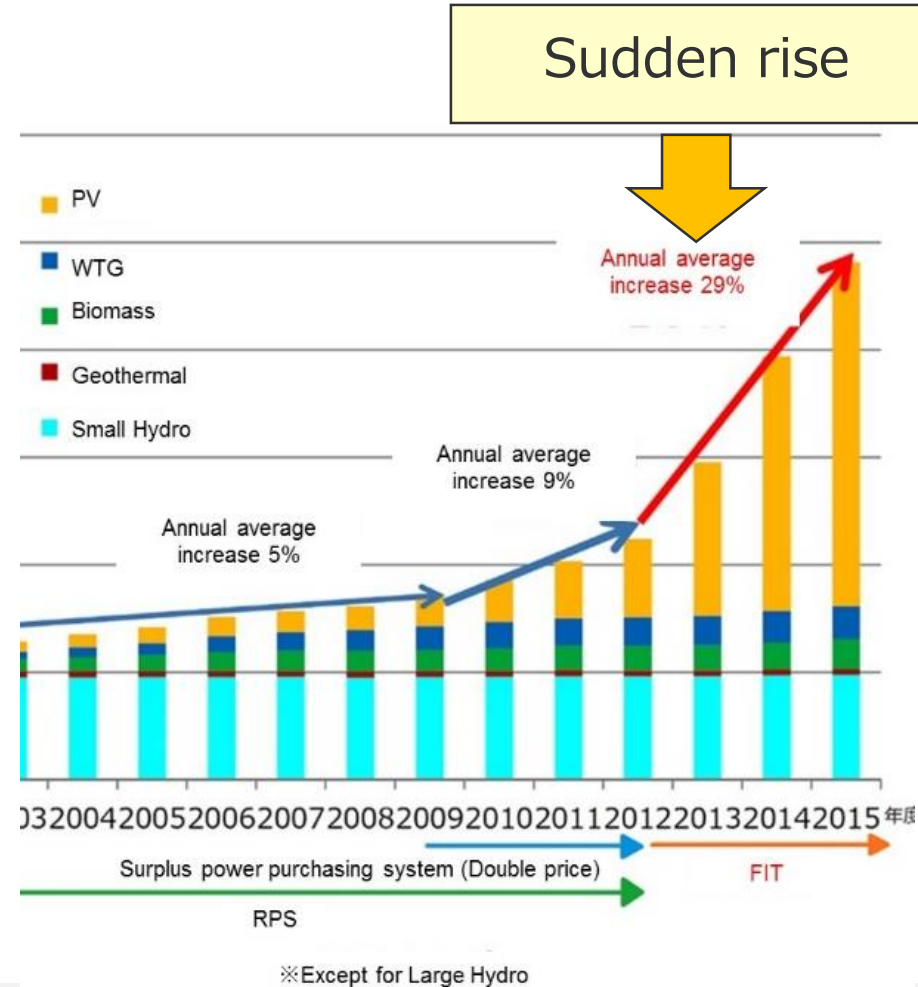

Source: Agency for Natural Resource and Energy

# Heavy Burden for Citizens

- Initially, the fixed purchase price was set high.
- 70% of total levy, the 3.6 trillion yen, is PV. 90% of which is 2012,13,14 and is a volume zone, which is a heavy burden on people.

## High purchase price

(Yen/kwh), 0.6yen/LKR

電源 【調達期間】	2012年度	2013年度	2014年度	2015年度	2016年度	2017年度	2018年度	2019年度	2020年度	2021年度	2030年 価格目標
Non-residential PV(20years)	4 0円	3 6円	3 2円	2 9円 <small>※1 7/1~(料率配当期間終了後)</small>	2 4円	入札制移行 (2,000kW以上) 2 1円 (10kW以上1,000kW未満)   1 8円 (10kW以上1,000kW未満)					7円
Residential PV(10years)	4 2円	3 8円	3 7円	3 3円 <small>※2 出力調整対応機器設置義務あり</small>	3 1円 <small>※2</small>	2 8円 <small>※2</small>	2 6円 <small>※2</small>	2 4円 <small>※2</small>	2 6円 <small>※2</small>		市場価格 2020年以降の目標
Wind (20years)	2 2円(20kW以上)※4			5 5円(20kW未満)※3			Onshore 2 0円 <small>※4</small>	1 9円 <small>※4</small>	1 8円 <small>※4</small>		8~9円
	3 6円 (Offshore ) )						3 6円 (離床式) ※5		3 6円(浮体式)		
Geothermal (15years)	2 6円(1500kW以上)※4			4 0円(1500kW未満)※4							
Hydro (20years)	2 4円(1000kW以上30000kW未満)※4			2 4円	2 0円(5000kW以上30000kW未満)※4			2 7円 (1000kW以上5000kW未満)※4			
	2 9円(200kW以上1000kW未満)※4			3 4円(200kW未満)※4							
	3 9円 (メタン発酵ガス)			4 0円(2000kW未満)			3 2円(2000kW以上)				
	3 2円(間伐材等由来の木質バイオマス)			2 4円   2 1円 (20,000kW以上)			入札制移行 (10,000kW以上)				
	2 4円(一般木材等バイオマス)			2 4円 (20,000kW未満)			2 4円 (10,000kW未満)				
	2 4円(バイオマス液体燃料)			2 4円   2 1円 (20,000kW以上)			2 4円 (20,000kW未満)			入札制移行	
	1 3円(建設資材廃棄物)			1 7円(General waste マス)							

## 90% of levy is concentrated in 3yrs

### <Breakdown of Levy> (unit: trillion yen)

電源	2012	2013	2014	2015	2016	2017	2018	2019	(Total)	割合
PV (Residential)	0.2									5%
PV (Non-residential)	0.8	1.0	0.4	0.1	0.1	0.03	0.03	0.01	2.5	70%
										90%
Wind									0.1	4%
Geothermal									0.02	0.5%
Mini0-Hydro									0.06	2%
Biomass									0.4	10%
Others									0.3	9%
Grand Total									3.6	—

# FIT Surcharge Price Setting and its Management

- The electric power companies collect the FIT surcharge, but the third-party “Green Investment Promotion Organization” manages it.
- METI decides FIT surcharge and period of it. Government submits comments to METI.

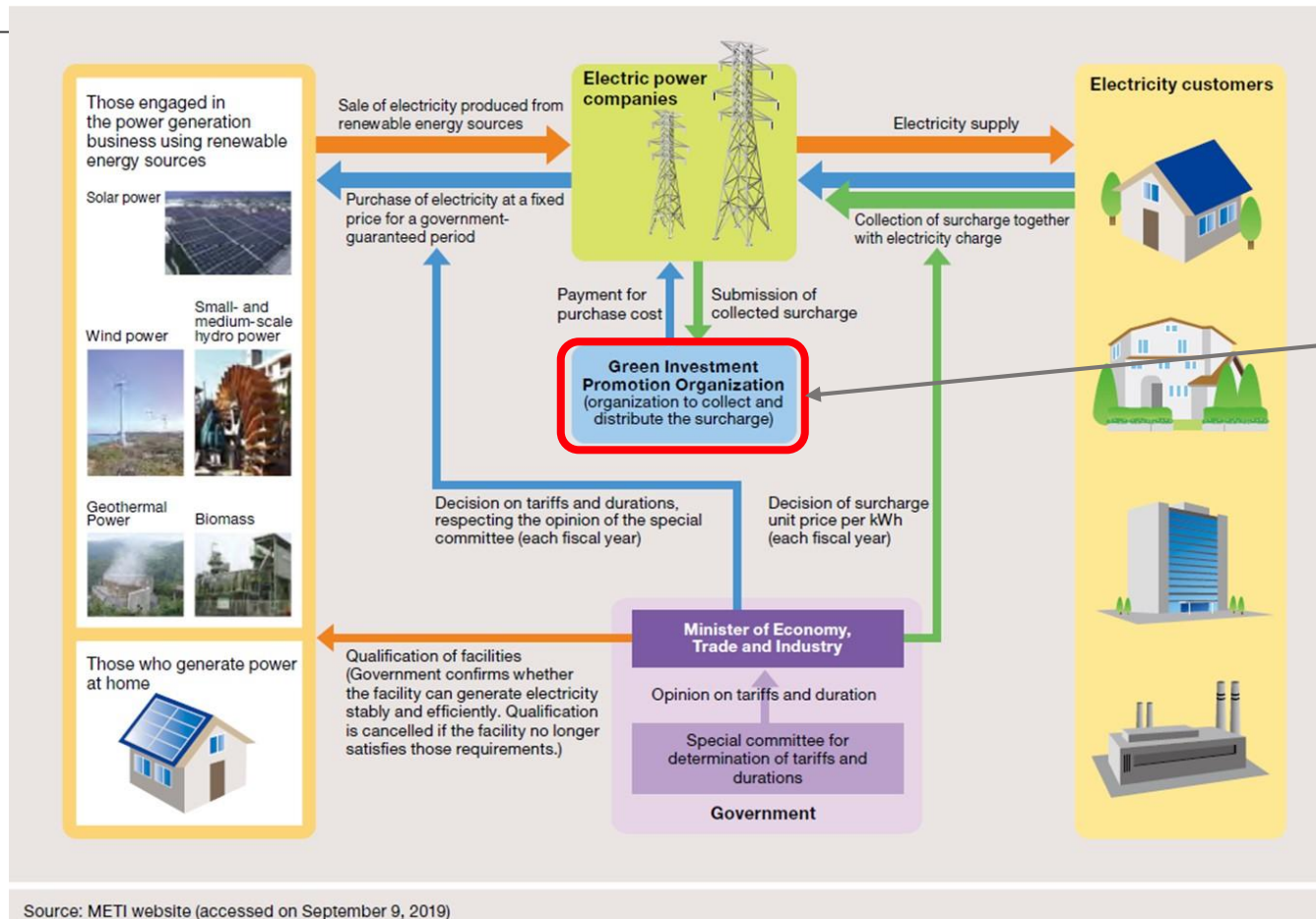

Centralized management of FIT Surcharge

Source: METI website (accessed on September 9, 2019)



# Achievement of National Energy Plan with limited Budget

- 2.1 trillion yen levy was required to achieve a RE ratio of 10% to 16% (mostly VRE).
- Further increase of 8% is necessary to achieve 22-24% of RE ratio by 2030
- To minimize the burden is necessary while the RE ratio is achieved

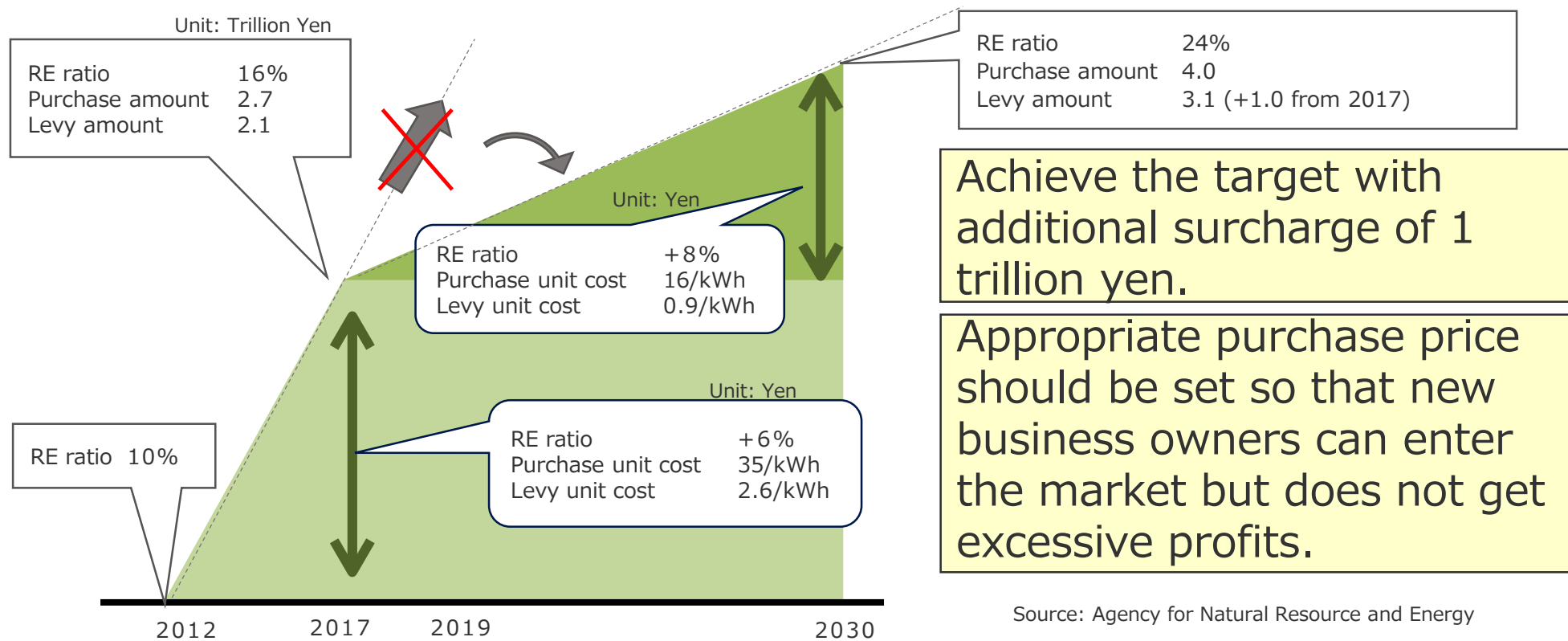

# Transition to FIP from FIT

- Cabinet passed “FIT amendment bill” on February 2020 to reduce public burden (levy)  
FIP (Feed-in Premium) scheme
- The timing of introduction will be decided in the future. (Expected to be implemented within 2020)
- Power generation companies are required to make price reduction efforts. Because the premium price is set based on the wholesale electricity market price (Baseline)

FIP price consists of “Market price” + “Premium”



# Comparison between FIP and FIT

- FIP is the leading candidate among successor systems of FIT
- While FIT aims at promotion of spread, FIP aims at independent spread



<E.g., Japan>

	F I P	F I T
<u>Purpose</u>	<ul style="list-style-type: none"> <li>➤ Independent spread of RE</li> <li>➤ Completely free competition for RE</li> </ul>	<ul style="list-style-type: none"> <li>➤ promotion of spread of RE</li> <li>➤ Reducing installation costs for RE facilities</li> </ul>
Selling price	“Market price” + “Premium”	Fixed electricity selling price so that business owners can quickly recover the investment
Period of selling	TBD (Depends on system design)	Depends on the scale of equipment Less than 10kW: 10 years 10KW or more: 20 years
<u>Levy</u>	Relatively little	Relatively much
Obligation of buying	TBD (Depends on system design but unlikely being arising)	Power grid companies have a purchase obligation
Sold to	TBD (Market sale directly)	Electric power utilities (Now, Power grid companies)
Commencement	TBD (2021?)	July, 2012

Source: Solar Support Center

# Premium Price Setting

- 3 types has been introduced in advanced RE countries
- Since price setting is the most important factor for business owners, sufficient discussion is required  
(E.g.) Whether it is constant or fluctuates depending on premium value, period, season/time zone

	Pros	Cons	Adopted Countries
<p>Fixed type</p> 	<p>Easy to calculate the premium portion</p>	<p>Difficult to predict overall sales income</p>	<p>Spain</p>
<p>Fixed type (with upper and lower limit)</p> 	<ul style="list-style-type: none"> <li>➤ Income for the premium is stable</li> <li>➤ Compared to the “fixed type”, it is easier to predict overall sales income</li> </ul>	<p>There is little room for increase in power sales income</p>	<p>Spain Denmark</p>
<p>Variable type</p> 	<ul style="list-style-type: none"> <li>➤ Overall sales income is stable</li> <li>➤ Similar to FIT</li> </ul>	<p>Nothing special</p>	<p>Italy Germany Netherlands Switzerland</p>

# <E.g., Japan> Correspondence to FIT Graduates

- The FIT preferential treatment has a limited period, therefore it is necessary to deal with it thereafter.
- For residential PV, there will be cases where the FIT period will end from November 2019.
- Such changes are an opportunity to shift to a lifestyle of self-consumption, and are a business opportunity for retail electric power companies and aggregators to utilize surplus electricity from the FIT graduates

## Options after FIT period

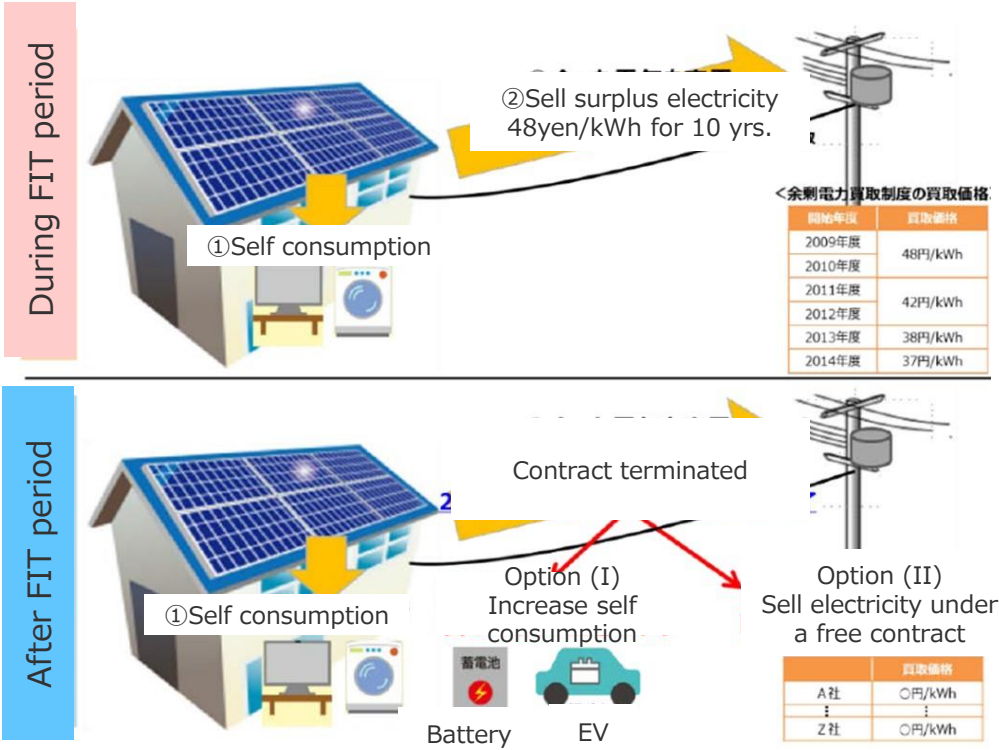

## Trend of FIT graduates in Number (Accumulation)

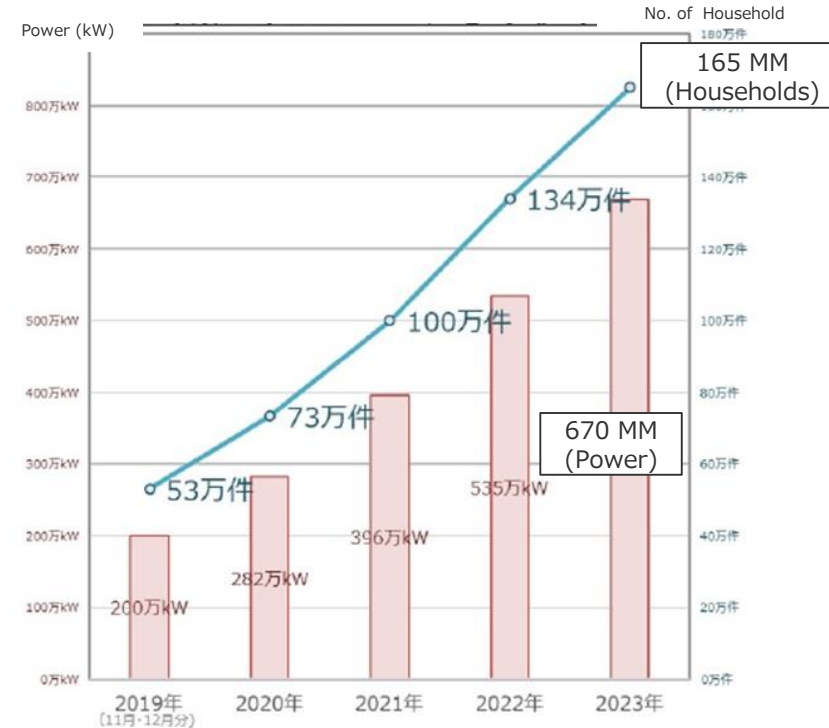

Source: Green Investment Promotion Organization

# Sales Competition among major Electric Power Companies

Seeking acquisition as an inexpensive power source by presenting each company's purchase price and additional accompanied services

Companies	Outline	1yen=0.56LKR
Hokkaido EPCO	8yen/kWh, 8yen + HEPCO Points (reward program)	
Tohoku EPCO	9yen/kWh, Deposit service (Offset from the bill)	
Tokyo EPCO	8.5yen/kWh, Deposit service (Offset from the bill)	
Chubu EPCO	7~8yen/kWh, 8.1yen/kWh (Amazon gift), 8yen + WAON Points (reward program)	
Hokuriku EPCO	8yen/kWh, Fixed purchase contract (15~35 thousand yen / year)	
Kansai EPCO	8yen/kWh	
Chugoku EPCO	7.15yen/kWh	
Shikoku EPCO	7yen/kWh, Deposit service (Offset from the bill, portion over 150kWh is purchased as 8yen/kWh)	
Kyusyu EPCO	7yen/kWh	
Okinawa EPCO	7.5yen/kWh	

Source: Each companies' HP, Data consolidation: Agency for Natural Resource and Energy

# Business competition among new comers

New electric power companies are also announcing unique purchase menu, and the competition for customer acquisition is in full swing.  
(Wide area type / regional type / limited type)

	Companies	Outline	
Fixed type	Idemitsu Kosan	8.5yen/kWh (Outside Kyusyu) 7.5yen/kWh (Kyusyu)	Whole of Japan excl. Okinawa
	JXTG	10yen/kWh	Tohoku, Kanto, Chubu, Kinki, Chugoku, Kyusyu Area
Fixed type (with upper and lower limit)	Sala	Point equivalent to 8yen /kWh Point equivalent to 10yen/kWh (loyal customers)	Chubu area
	Miyazaki electric power	8yen/kWh 10yen/kWh (loyal customers)	In Miyazaki prefecture
	Wakayama electric power	8yen/kWh 10~11yen/kWh (in July and August)	Kansai Area
Variable type	Sekisui House	11yen/kWh (House Owner)	(House Owner)
	Sekisui	8yen/kWh 12yen/kWh (with battery)	(House Owner)
	CWS (Nara electric power)	10yen/kWh 11yen/kWh (loyal customers)	Employees

# Current FIT Environment

- The FIT price is the almost same as the household retail price (24 yen / kWh), and the economic merit of self-consumption tends to increase.
- For power producers who have completed the FIT period, the selling price is much lower than the retail price for home use, so it is expected that self consumption will be increased by simply installing battery for surplus electricity.

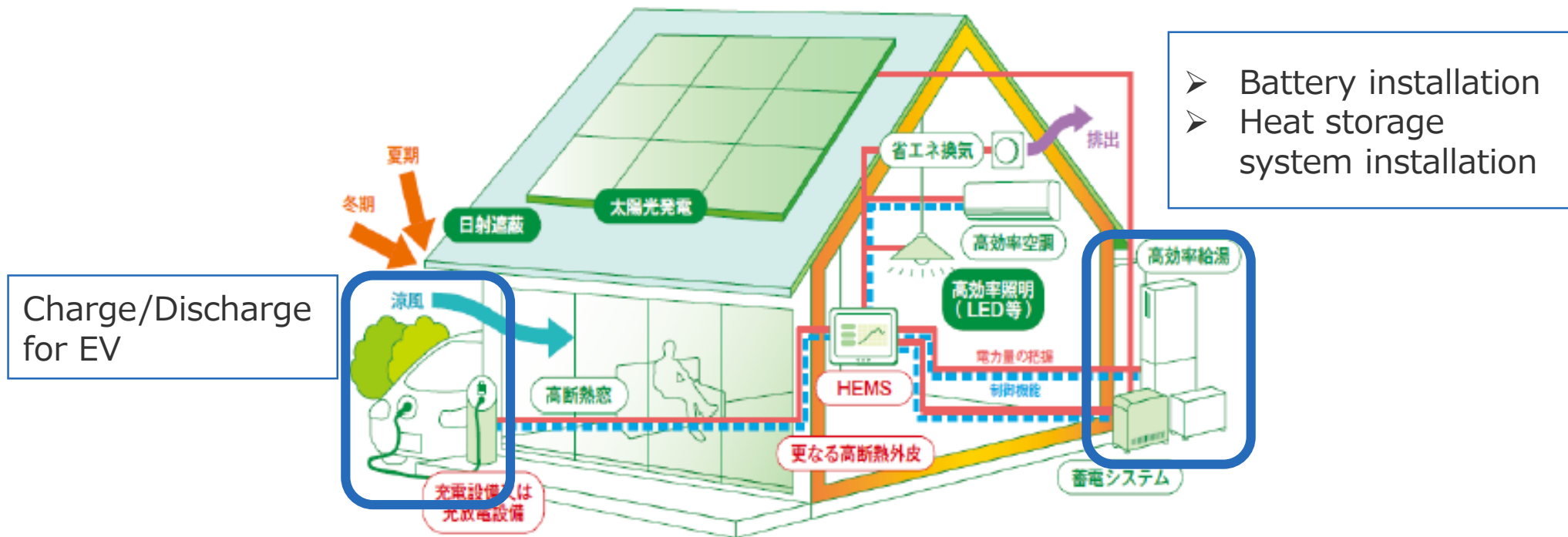

Source: Agency for Natural Resource and Energy





**CHUBU**  
Electric Power

***NIPPON KOEI***



# 1st System and Policy Seminar on Fuel Cost Adjustment of Japan

August, 2021

Ceylon Electricity Board  
Chubu Electric Power Co., Inc.  
Nippon Koei Co., Ltd.

- ✓ Fuel cost fluctuation and exchange rate variation, which cannot be controlled by electric utilities, is calculated independently and piled up on the basic rate.
- ✓ The results of the business efficiency improvement of the electric utilities can be clarified.
- ✓ The changes in the economic situation are reflected in the price as quickly as possible.
- ✓ This system was introduced in January 1996 for the purpose of stabilizing the business environment of electric utilities.

# Benefits of FCA system

Image of FCA

Adjusted fuel portion by fuel market price

Average Electricity Tariff

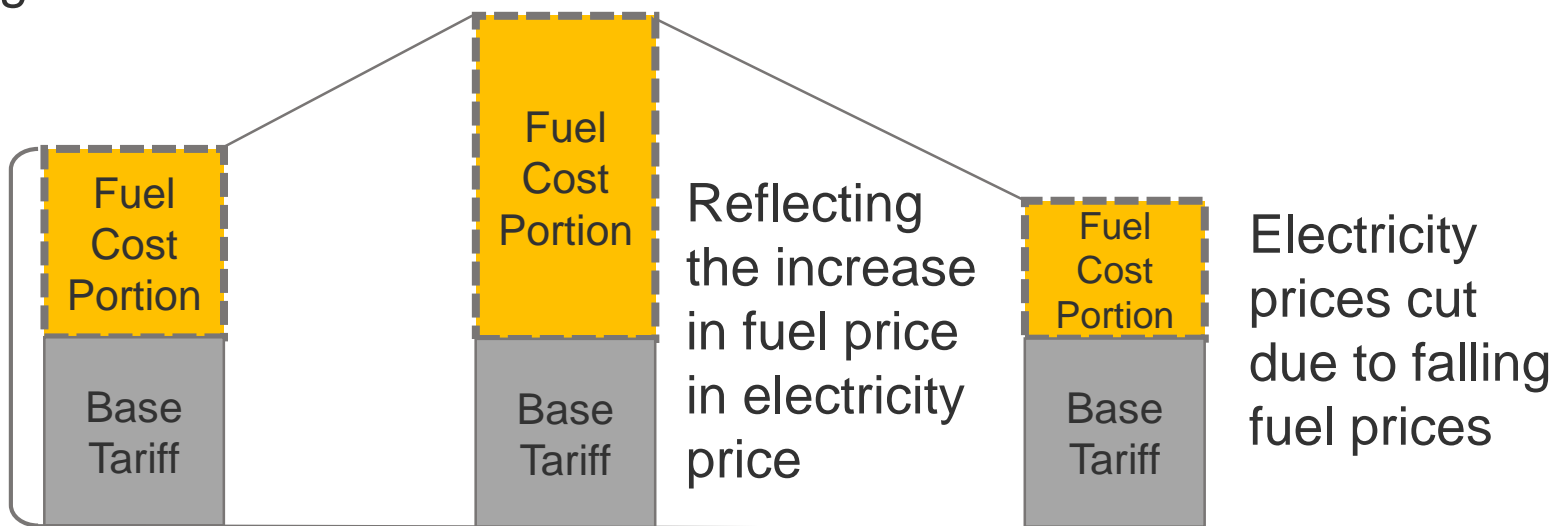

International crude oil price WTI

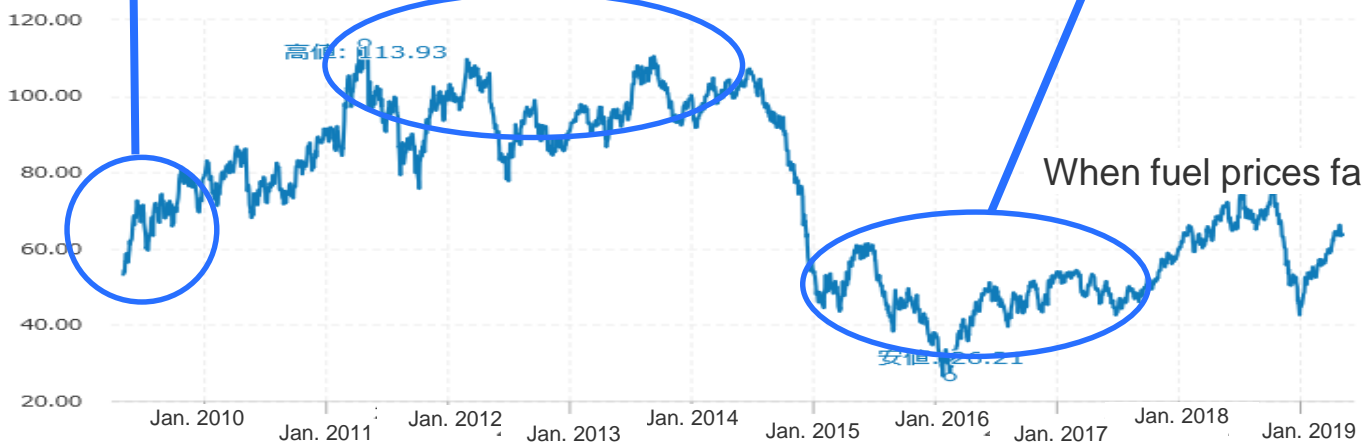

WTI原油

## ✓ **Tariff calculation method**

Monthly electricity tariff shall be calculated by adding (when fuel prices rise) or subtracting (when fuel prices fall) a fuel cost adjustment amount (defined as a fuel cost adjusted unit price multiplied by the monthly energy consumption).

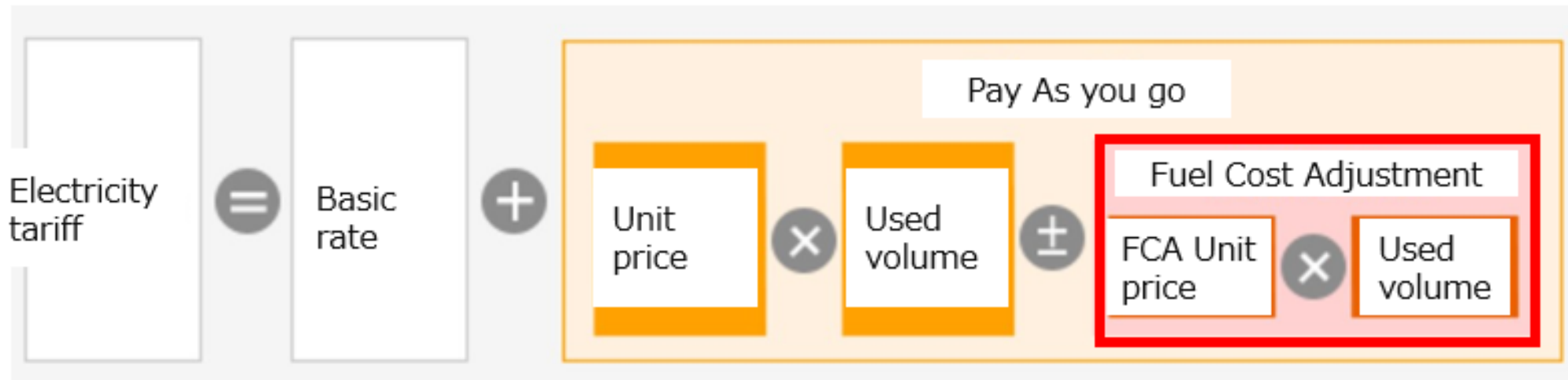

## ✓ Formula for calculating Fuel Cost Adjustment(FCA) Unit Price based on Japanese system

Unit price in FCA is calculated based on the average fuel price and the standard unit price.

### [Upward Adjustment]

If the average fuel price is above Standard Fuel Price (SFP)

FCA unit price = (Average Fuel Price – SFP) x Standard Unit Price/1,000

### [Downward Adjustment]

If the average fuel price is below SFP

FCA unit price = (SFP – Average Fuel Price) x Standard Unit Price/1,000

\*Adjustment value limitation

Upper limit: 50% of SFP

Lower limit: No limit

SFP: The standard fuel price when setting electricity price (p6)  
AFP: The 3-month (actual recorded) fuel prices (p7)  
SUP: The fuel cost adjustment unit price when an average fuel price has fluctuated by 1,000 yen/kl.(p8)

## [1] Standard Fuel Price

The Standard Fuel Price is the standard price when adjusting fuel costs.

Average Price Derived from the Foreign Trade Statistics for 3months	Average Crude Oil Price per Kiloliter	65,706 yen
	Average LNG Price per Tons	82,406 yen
	Average Coal Price per Ton	10,702 yen

(Crude Oil Equivalent per Kiloliter)  
45,900yen = Standard Fuel Price

### Formula

$$65,706\text{yen/kL} \times 0.0275 + 82,406\text{yen/t} \times 0.4792 + 10,702\text{yen/t} \times 0.4275 = 45,900\text{yen/kL}$$

Crude oil price       $\alpha$       LNG price       $\beta$       Coal price       $\gamma$

\*The signs " $\alpha$ ", " $\beta$ ", and " $\gamma$ " represent (constant) coefficients for calculating the average fuel price of crude oil equivalent from the average price of crude oil, LNG, and coal, respectively. Such coefficients are those multiplied by the composition ratio of each fuel and used for converting to crude oil equivalent.

\*Fuel price is an example of Chubu Electric Power application in 2014

# Mechanism of FCA system in Japan

## [2] Average Fuel Price

The "average fuel price" shall be calculated based on the following formula and the 3-month (actual recorded) prices derived from Foreign Trade Statistics for crude oil, LNG, and coal.

$$[\text{Average Fuel Price (crude oil equivalent per kiloliter)} = A \times \alpha + B \times \beta + C \times \gamma]$$

A: Average Crude Oil Price per Kiloliter for Every 3 Months

B: Average LNG Price per Ton for Every 3 Months

C: Average Coal Price per Ton for Every 3 Months

	Generation ratio (Calorie basis) a	Crude oil conversion factor b	Conversion factor $\alpha, \beta, \gamma$ (a x b)
Crude oil	0.0275	1.0000	0.0275= $\alpha$
LNG	0.6849	0.6996	0.4792= $\beta$
Coal	0.2876	1.4864	0.4275= $\gamma$
Total	1.0000	-	-

\*Crude oil conversion factor LNG: Crude oil calorific value per 1L (38.2MJ) /

LNG calorific value per 1L (54.6MJ)

Coal: Crude oil calorific value per 1L (38.2MJ)/

Coal calorific value per 1L (25.7MJ)

\*Calorie composition ratio is an example of Chubu Electric Power application in 2014



## [3] Standard Unit Price

The "standard unit price" defined in our Electricity Supply Provisions, etc. shall be a fuel cost adjusted unit price when an average fuel price has fluctuated by 1,000 yen/kl.

### Calculation example

$$77,543,000\text{kl} \quad / \quad 378,610.9\text{GWh}$$

Fuel consumption quantity / Total electricity sales  
(crude oil equivalent)



CEPCO area

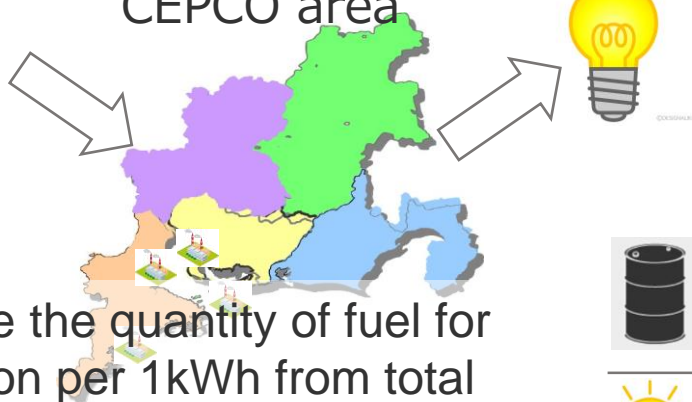

Calculate the quantity of fuel for generation per 1kWh from total quantity of fuel(crude oil equiv.) and total electricity sales in CEPCO



(kl)



(kWh)

x

$$1,000\text{yen/kl}$$

=

$$0.205\text{yen/kWh}$$

Standard Unit Price  
(per 1kWh)

Assuming that the Average Fuel Price(AFP) fluctuates by 1,000 yen/kl

Calculate the adjustment price per 1kWh when the AFP fluctuates by 1,000 yen/kl

## [4] Period for Estimating Fuel Costs & Application to Electricity Fee

A fuel cost adjusted unit prices for every month shall be calculated on the basis of average fuel prices actually recorded for 3 months.

For example, a fuel cost adjusted unit price calculated on the basis of (actual recorded) average fuel prices from January to March, shall be applied to electricity fees for June.

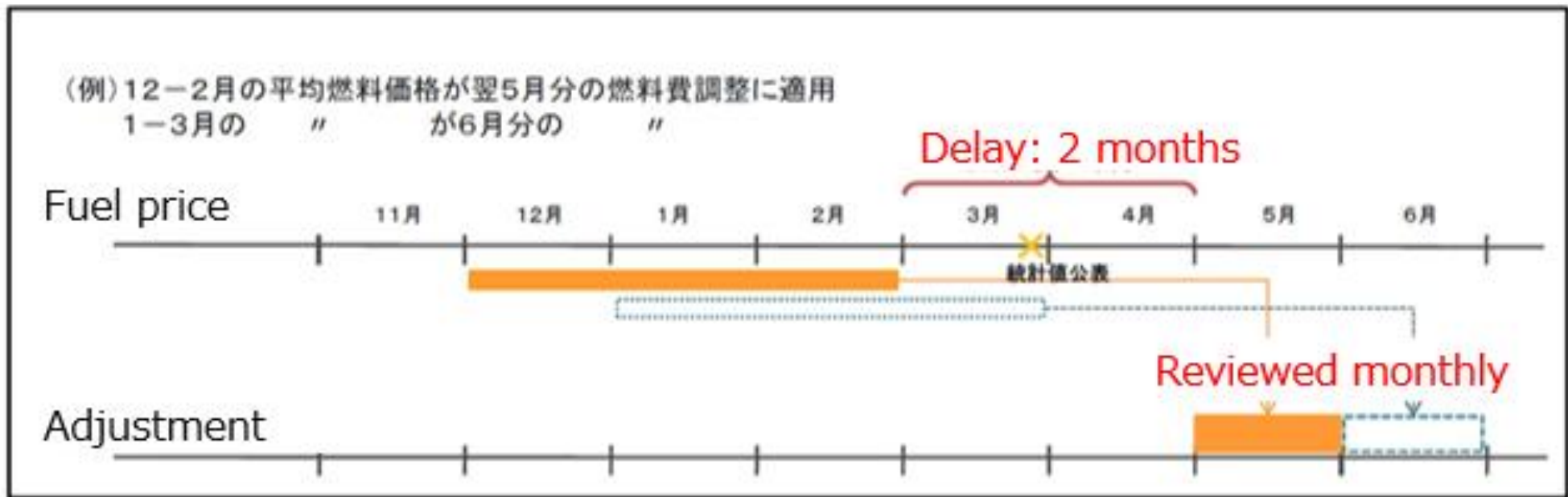

\*In Japan, the average fuel price of 3 months is applied to the FCA after 2 months, considering the time when the trade statistics of the fuel price are released and the period for determining the electricity price from the meter reading result.

- ✓ “Fuel Cost Adjustment System” is a system designed to automatically adjust monthly electricity tariff.
- ✓ To stabilize the business environment by externalizing the effects of fuel prices and exchange rates, which are beyond the efforts of electric power companies to improve efficiency. (Electric power companies benefit)
- ✓ To reflect changes in fuel prices in tariffs as quickly as possible. (Customer and Electric power companies benefit)



ලංකා විදුලිබල මණ්ඩලය  
இலங்கை மின்சார சபை  
CEYLON ELECTRICITY BOARD



**CHUBU**  
Electric Power

***NIPPON KOEI***

FY 2020 Solar PV purchase price for household level

Yellow color cell: Assumed value which can be find on Ministry Web page

Exchange rate (as of Dec. 4, 2020)  
 1 USD = 186 LKR  
 1 USD = 104 JPY

Scale of PV system	4.0	kW		
Unit cost for installation (including subsidy)	4,481	USD/kW	466,000 JPY/kW	
Capacity Factor	12.4	%		
Annual generated power in first installation year	1,086	kWh/kW		
Ratio of selling electricity to power generation	60	%		
Benefit produced from customers own consumption of generated power [USD]	0.24	USD/kWh	25.20 JPY/kWh	
Deterioration rate	0.27	% / year		
OM cost	45.19	USD/kW/year	4,700 JPY/kW/year	
Purchase price	1st - 10th year	0.40	USD/kWh	42 JPY/kWh
	11th - 20th year	0.23	USD/kWh	24.0 JPY/kWh

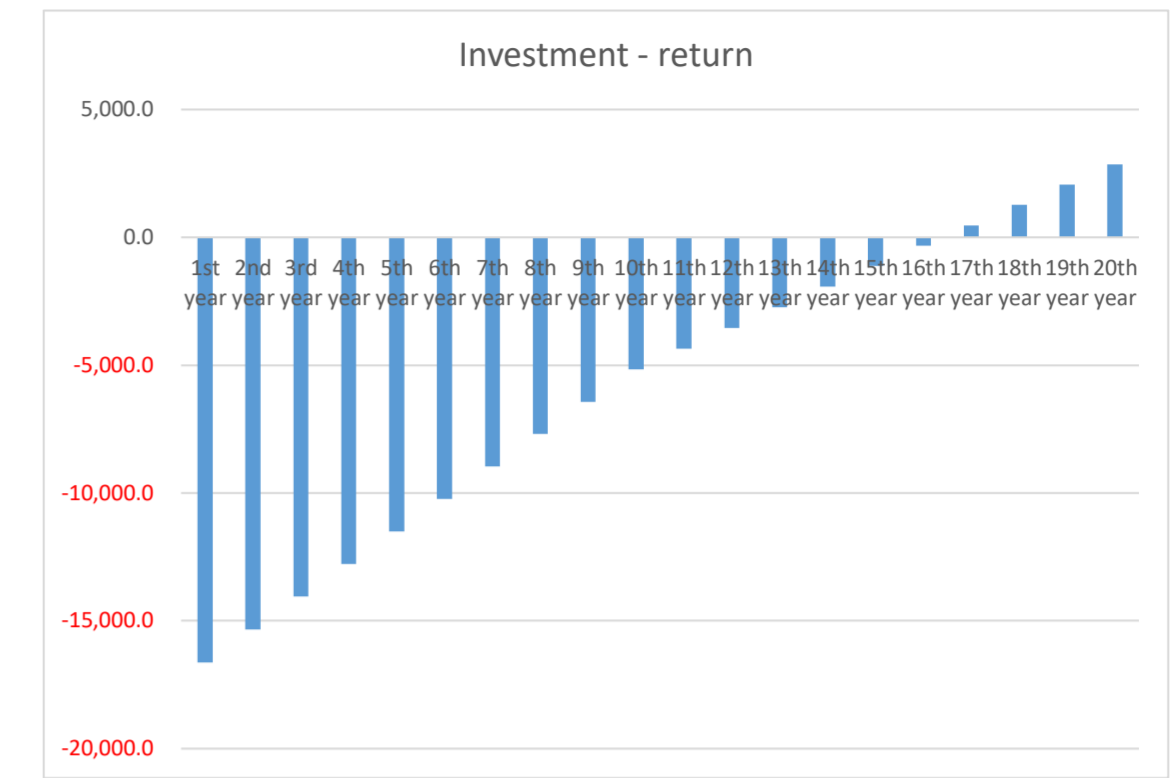

Item	1st year	2nd year	3rd year	4th year	5th year	6th year	7th year	8th year	9th year	10th year	11th year	12th year	13th year	14th year	15th year	16th year	17th year	18th year	19th year	20th year	
IRR calculation	Initial cost	-17,923.1																			
	Power generation efficiency [%]	100	99.73	99.46	99.19	98.92	98.65	98.38	98.11	97.84	97.57	97.30	97.03	96.76	96.49	96.22	95.95	95.68	95.41	95.14	94.87
	Amount of power generation [kWh]	4,345	4,333	4,321	4,310	4,298	4,286	4,275	4,263	4,251	4,239	4,228	4,216	4,204	4,192	4,181	4,169	4,157	4,146	4,134	4,122
	Amount of selling electricity [kWh]	2,607	2,600	2,593	2,586	2,579	2,572	2,565	2,558	2,551	2,544	2,537	2,530	2,523	2,515	2,508	2,501	2,494	2,487	2,480	2,473
	Revenue from selling electricity [USD]	1,052.8	1,050.0	1,047.1	1,044.3	1,041.4	1,038.6	1,035.8	1,032.9	1,030.1	1,027.2	1,024.4	1,021.6	1,018.8	1,016.0	1,013.2	1,010.4	1,007.6	1,004.8	1,002.0	999.2
	Benefit produced from customers own consumption of generated power [USD]	421.1	420.0	418.9	417.7	416.6	415.4	414.3	413.2	412.0	410.9	409.8	408.6	407.5	406.3	405.2	404.1	402.9	401.8	400.7	399.5
	OM cost [USD]	-180.8	-180.8	-180.8	-180.8	-180.8	-180.8	-180.8	-180.8	-180.8	-180.8	-180.8	-180.8	-180.8	-180.8	-180.8	-180.8	-180.8	-180.8	-180.8	-180.8
	Annual benefit [USD]	1,293.2	1,289.2	1,285.2	1,281.2	1,277.3	1,273.3	1,269.3	1,265.3	1,261.3	1,257.4	1,253.4	1,249.4	1,245.4	1,241.4	1,237.4	1,233.4	1,229.4	1,225.4	1,221.4	1,217.4
	Investment - return [USD]	-16,629.9	-15,340.7	-14,055.5	-12,774.3	-11,497.0	-10,223.7	-8,954.4	-7,689.1	-6,427.8	-5,170.4	-4,356.1	-3,544.5	-2,735.6	-1,929.6	-1,126.3	-325.7	472.1	1,267.1	2,059.4	2,848.9
	IRR	1.64%																			

IRR target of Ministry 3.20%

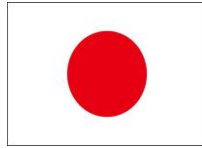
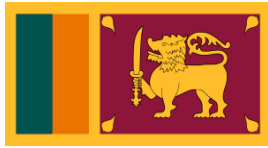

# Connection Charge of VRE to the Grid

September, 2020

Chubu Electric Power Co., Inc.  
Nippon Koei Co., Ltd.

# Costs of Promoting the Introduction of VRE

- There are three main costs related to promoting the VRE introduction in the table below:
- With respect to "grid connection charge," it is influenced by government policy for the introduction of VRE.

Cost Items	Contents
Costs associated with the installation of power generation equipment	FIT、RPS (Renewable Portfolio Standard), etc.
Cost of "Grid connection" and "Grid utilization"	<u>When grid reinforcement is required for grid connection from the viewpoint of grid stability and reliability, the cost of the grid connection is recovered by the "Connection charge",</u> and the cost of using the existing grid facilities is recovered by the use of "System charge".
Cost of adjusting supply and demand arising from VRE introduction	The cost of adjusting supply and demand or grid stabilization control in response to fluctuations in power output of VRE, which is recovered as "Balancing service charge".

# Cost Sharing (①Deep)

- The VRE operator bears all costs associated with the generation facilities, the power line facilities to connect to the existing grid, and the reinforcement of the existing grid.

## Pros. & Cons.

- Barriers to entry for VRE operators
- Expenses that conventional generations have not paid are passed on to only new comers of VRE

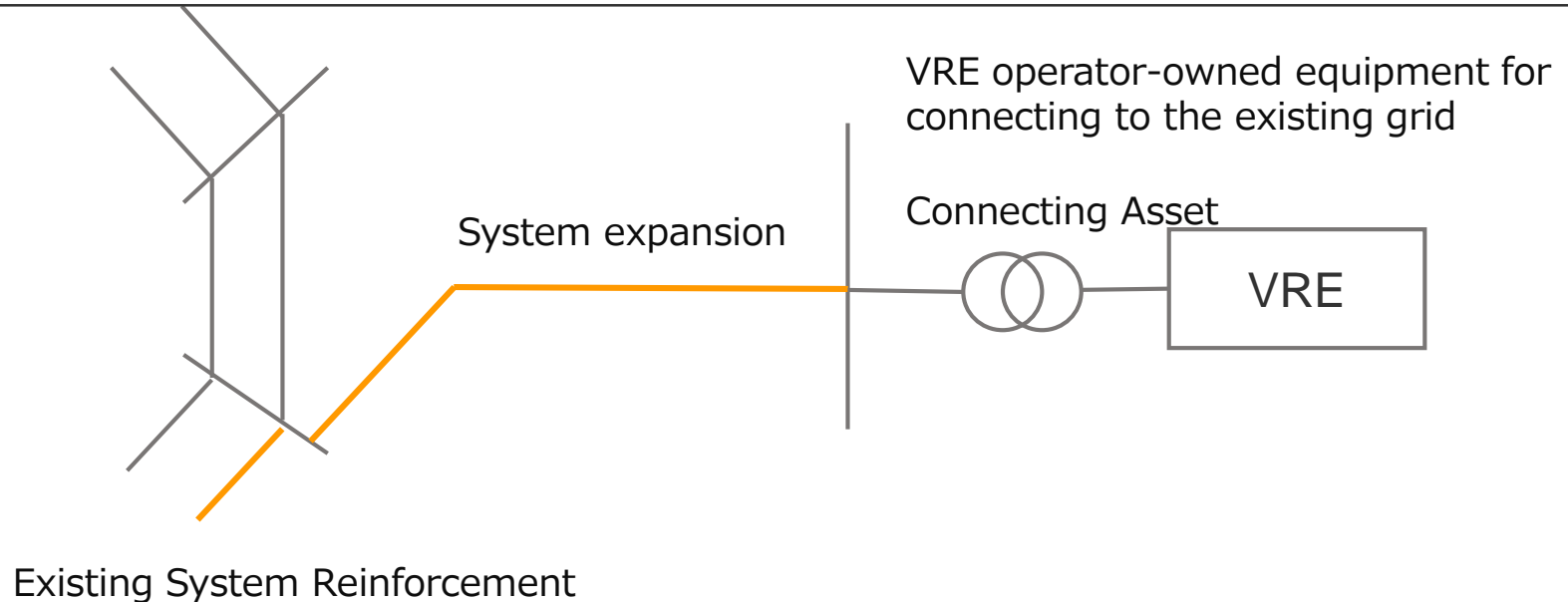



# Cost Sharing (③Shallow)

- New comers of VRE operator bears the cost of the power system expansion and power generation equipment.
- If the existing system is reinforced, TSO will recover the cost from all users through the Wheeling Charge.

## Pros. & Cons.

- It contribute to the promotion of VRE installation by reducing the burden on new VRE business owners
- There are few incentives to reduce power system reinforcement costs
- VRE may be concentrated in the congestion area of power flow.

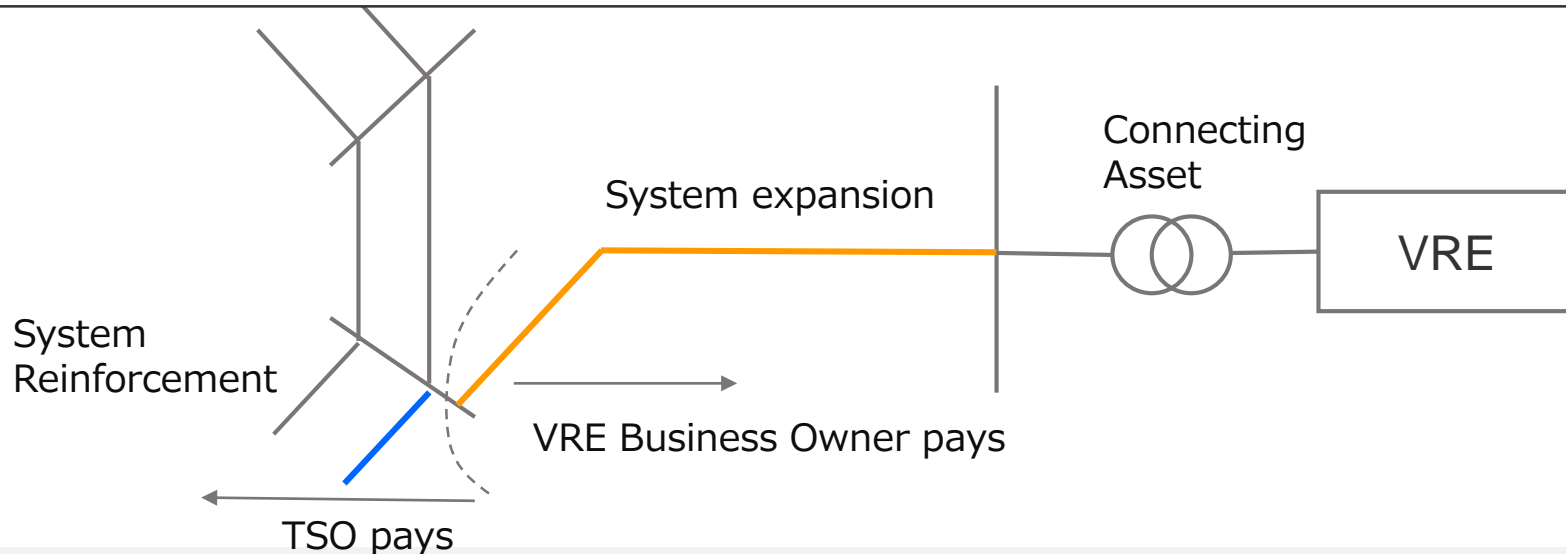

# Cost Sharing (Others)

## (② Semi-Shallow, ④ Super-Shallow)

- There are other scheme, Semi-Shallow and Super-Shallow, depending on how VRE operator bears the power system cost.
- In all cases of Shallow, Semi-Shallow, and Super-Shallow, the costs of the existing grid reinforcement and expansion of the power supply line, which are borne by TSO, are recovered from all grid users through the Wheeling Charge.

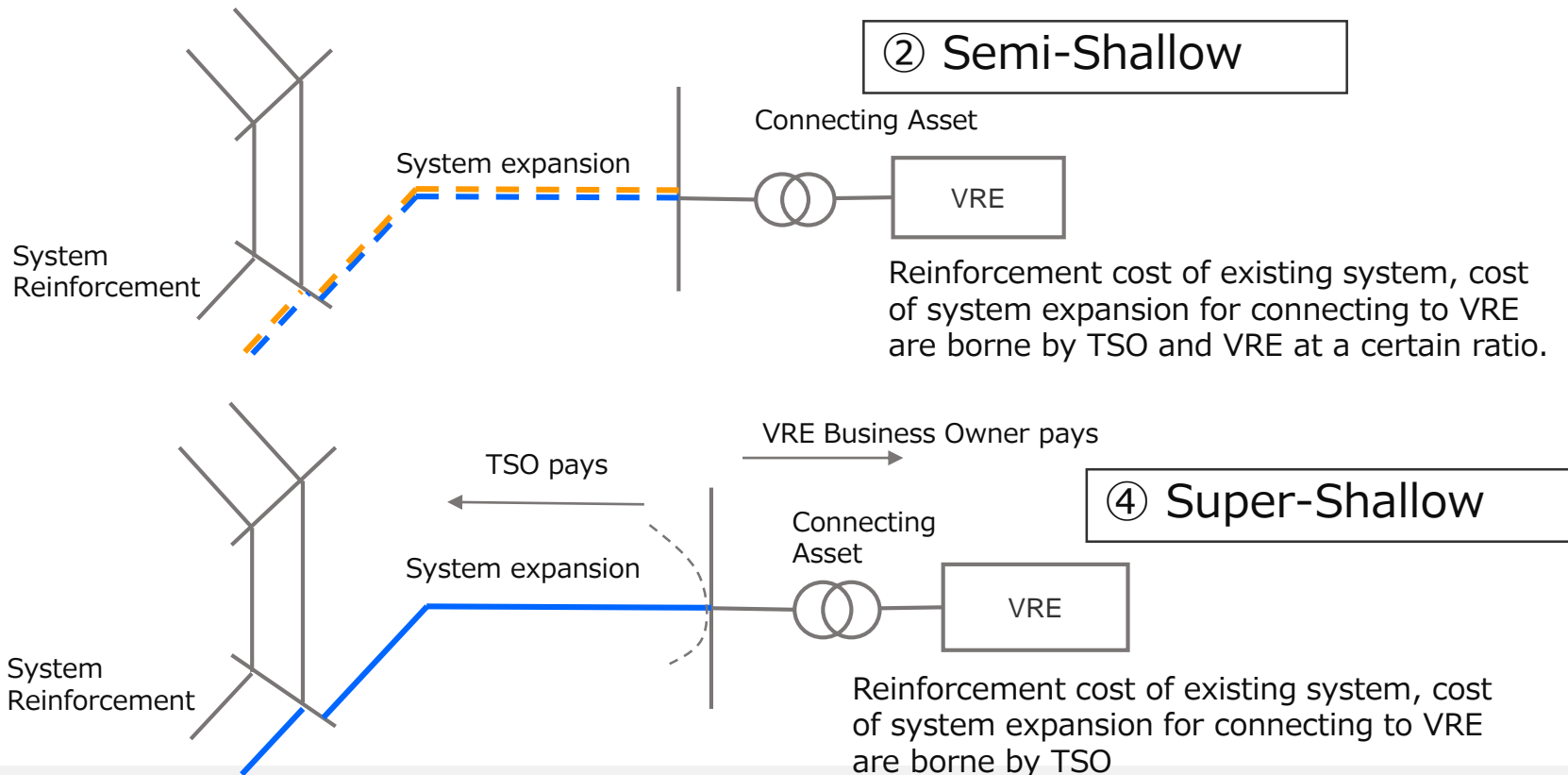

# Burden Level

Heavy burden for VRE owners  
(Light burden for TSO)

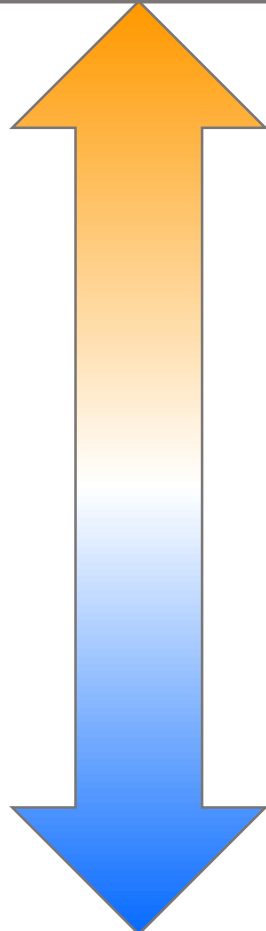

① Deep

② Semi-Shallow

③ Shallow

④ Super-Shallow

Light burden for VRE owners  
(Heavy burden for TSO)

# Adopted Scheme in each country

- Deep: adopted in Japan, Shallow: Mainly adopted in EU countries
- EU countries have adopted their own scheme due to differences in VRE policies, but the legally binding "EU Renewable Energy Promotion Directive (2009)" came into effect, it is expected to increase countries that hire the "Shallow" scheme
- It is dangerous to introduce the "Shallow" scheme in Japan where the deference of intensity of sunlight is remarkable (It is necessary to develop a VRE installation strategy).

Countries	Classification	Special Notes
Australia	Deep	● Reinforcement cost is lump-sum payment (0~265€/kWh)
France	Shallow	
Germany	Shallow	● TSO bears cost of system expansion only for offshore wind power
Nederland	Shallow or Deep	● Shallow: Up to 10MW. Deep: More than 10MW, burden amount decided in consultation with TSO
England	Shallow	
Japan	Deep	

# Summary

- Both the “Deep” and “Shallow” schemes have advantages and disadvantages. It is necessary to learn from the cases of advanced VRE countries and think over the vision in Sri Lanka.

## Shallow

- The power system is highly public. Users are fairly treated under “Shallow”
- System reinforcement cost does not decrease
- VRE might be concentrated in congestion areas, which may lead to worse condition.



## Deep

- Each utility will act to ensure that power system reinforcement cost does not increase.
- Unfair burden for power system usage

A combination of schemes, such as the “Shallow” plus “Zoom pricing” or “MLF”, might be a prospective solution.



**CHUBU**  
Electric Power

***NIPPON KOEI***

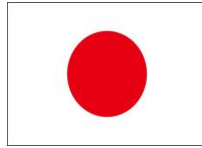
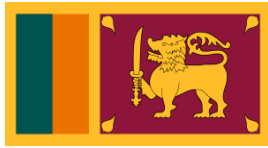

# Capacity Market in Japan

May, 2020

JICA Expert Team

# Rules of Interconnected lines (Before 2018)

## Hybrid system of "First come first serve" and Indirect bidding

- Capacity allocations of interconnected lines are currently determined on the basis of "First come first serve" rule, which is partly hatched by brown, and power of spot market is transacted within the capacity of one day ahead.
- There is a risk of barren competition to compete for applications
- It is difficult for new companies to enter the market because the quota has been applied by existing business players. →The competition cannot work and the market cannot be activated.

- ATCs (Available Transmission Capacity) of interconnection are determined as follows.  
 $ATC = \text{Operating Capacity} - \text{Margin} - \text{Scheduled power flow}$
- Operating Capacity of interconnection is the minimum of thermal capacity, stability, voltage, and system frequency.
- Margin means the reserve capacity on each interconnection for system security and power transaction in abnormal condition.

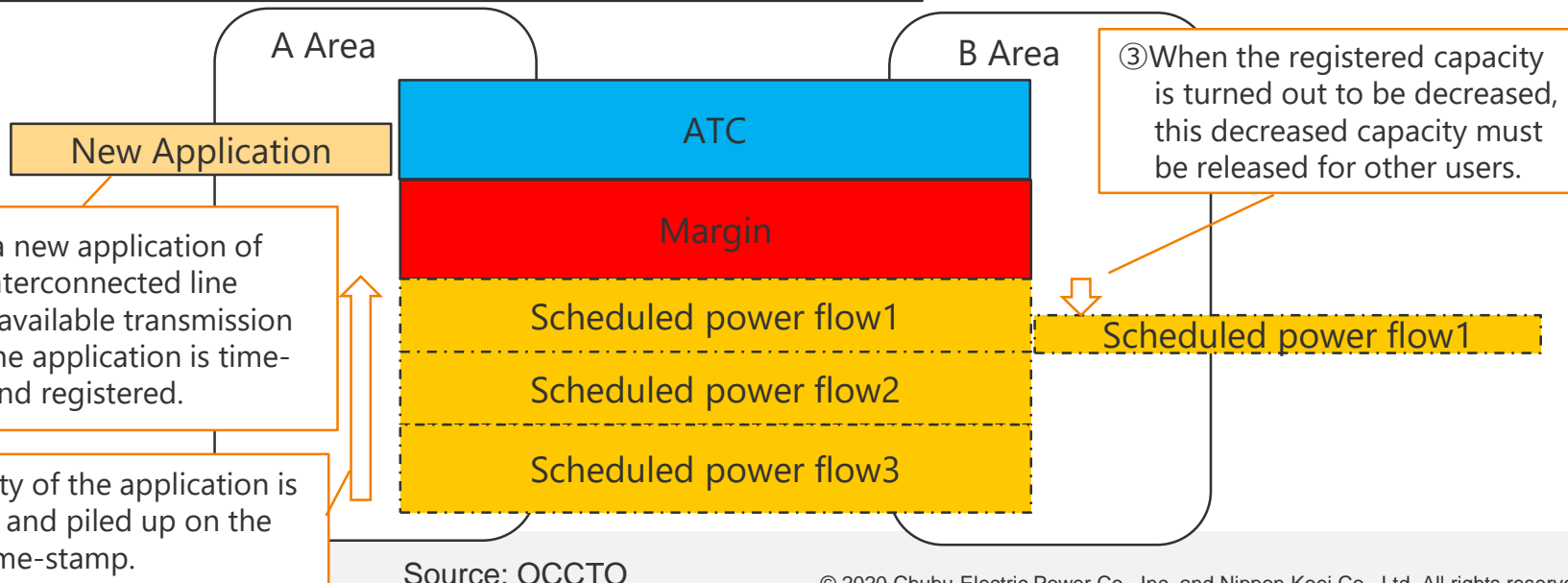
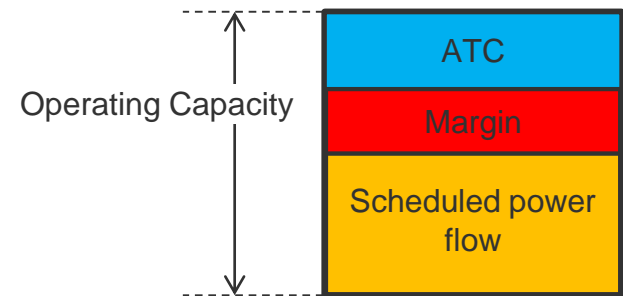



# Revised Rule after 2018

## Bidding scheme for full portion

- All capacity allocations of interconnected lines can be realized through spot market (day-ahead transaction in Power Exchange). This rule is called “implicit<sup>※</sup> auction”.
- Specifically, implicit auction can be realized by stopping reservation of capacity allocation based on “first come first serve” rule.

It leads to more fairness between users of interconnected lines, and increase of liquidity of the Power Exchange.

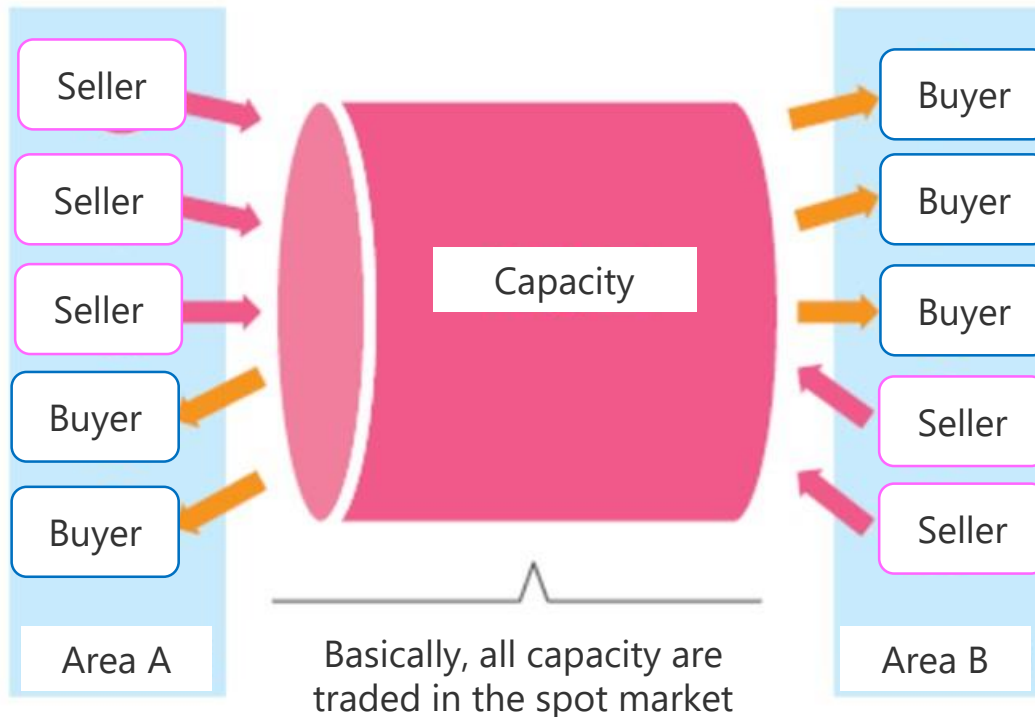

※Implicit represents that interconnection usage and power trade is the combination, while Explicit represents that right of interconnection usage and power trade are separately made a deal.



**CHUBU**  
Electric Power

***NIPPON KOEI***



# Renewable Energy Development Lesson from Vietnam Case

Ceylon Electricity Board  
JICA Expert Team

September, 2022

Chubu Electric Power Co., Inc.  
Nippon Koei Co., Ltd.



1. Country Outline of Vietnam
2. Potential of Vietnam
3. Promotion of Installation of PV and WP in Vietnam
  - (1) Policies for Promotion of RE
  - (2) Feed in Tariff
  - (3) Measures by the Government
  - (4) Carbon Pricing
4. Summary

# 01 Country Outline of Vietnam

---

# 1 Country Outline of Vietnam

## Basic information of Sri Lanka and of Vietnam

Contents	<b>Sri Lanka</b> <b>(Democratic Socialist Republic of Sri Lanka)</b> 	<b>Vietnam</b> <b>(Socialist Republic of Viet Nam)</b> 
Population	22.2 million people (2021)	97.6 million people (2020)
Land Area	65,610 km <sup>2</sup>	329,241 km <sup>2</sup>
GDP	84.5 billion USD (2021)	340.6 billion USD (2020)
GDP/Capita	3,815 USD (2021)	3,498 USD (2020)
GDP growth Rate	3.7% (2021)	2.9% (2020)

# 1 Country Outline of Vietnam

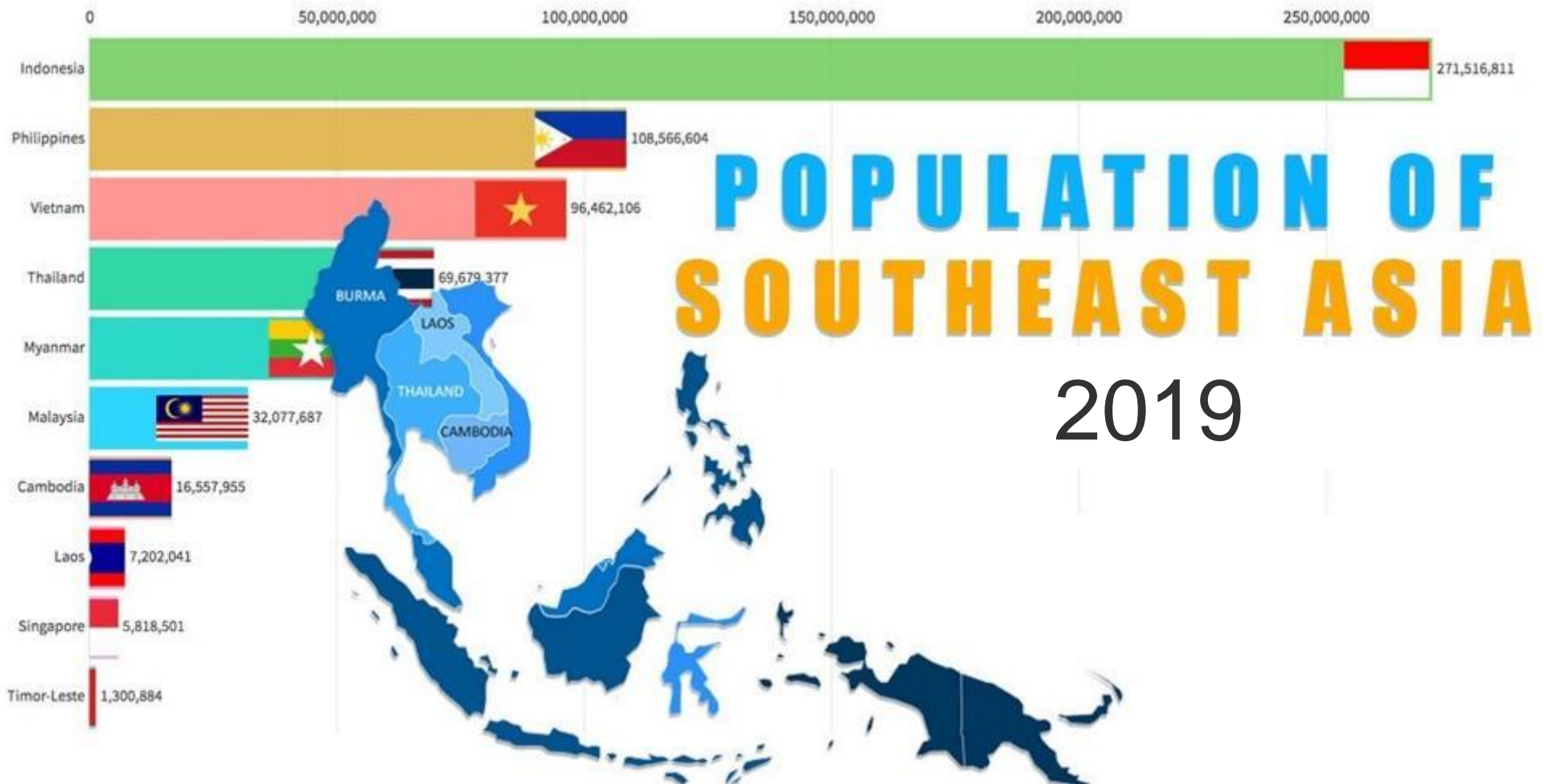

Vietnam has the third large population in South East Asia.  
It has almost 10 million people. → Big potential.

# 1 Country Outline of Vietnam

## Case of Vietnam

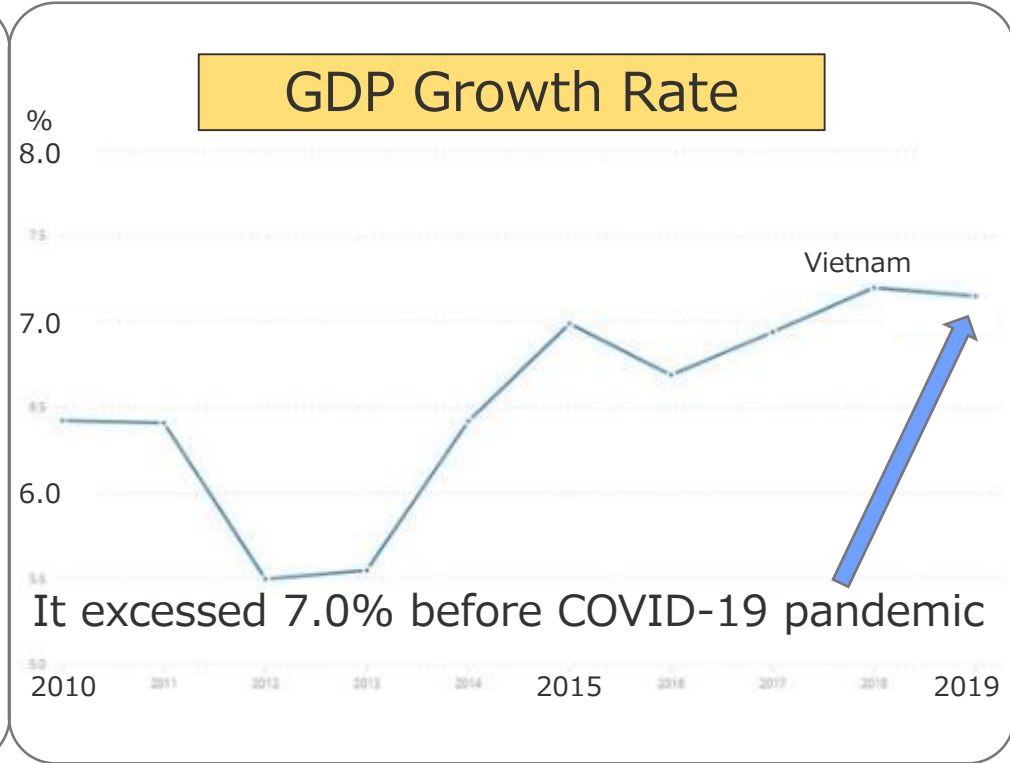
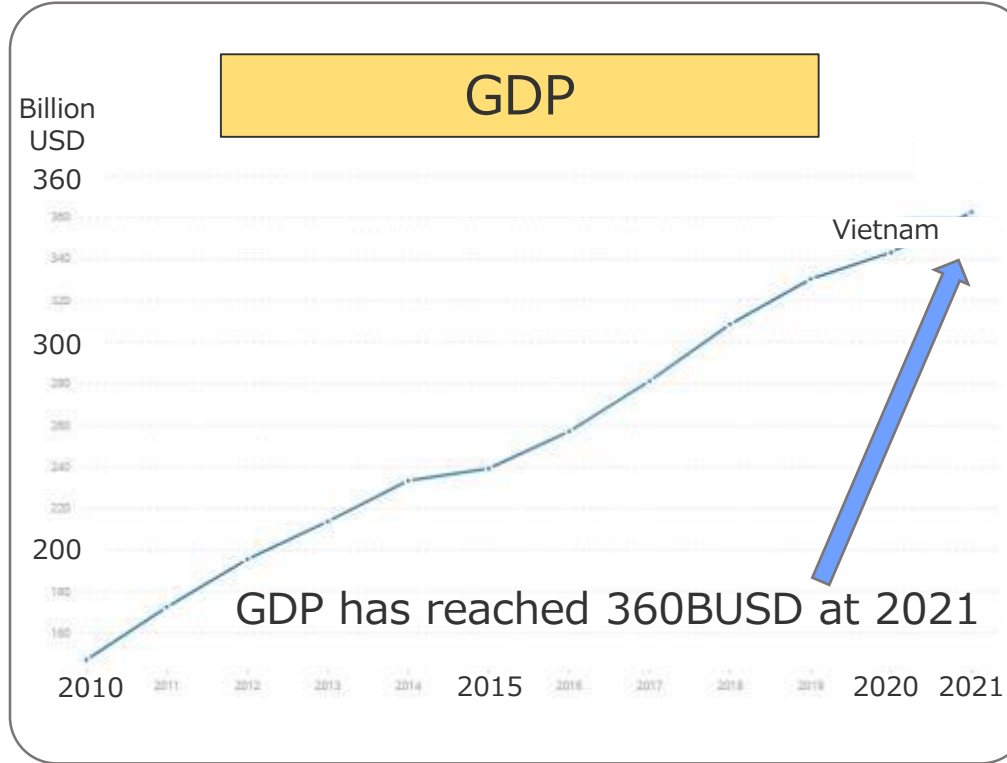

Source: World Bank



# 02 Potential of Vietnam (PV Solar Power and Wind Power)

---

# PV Potential

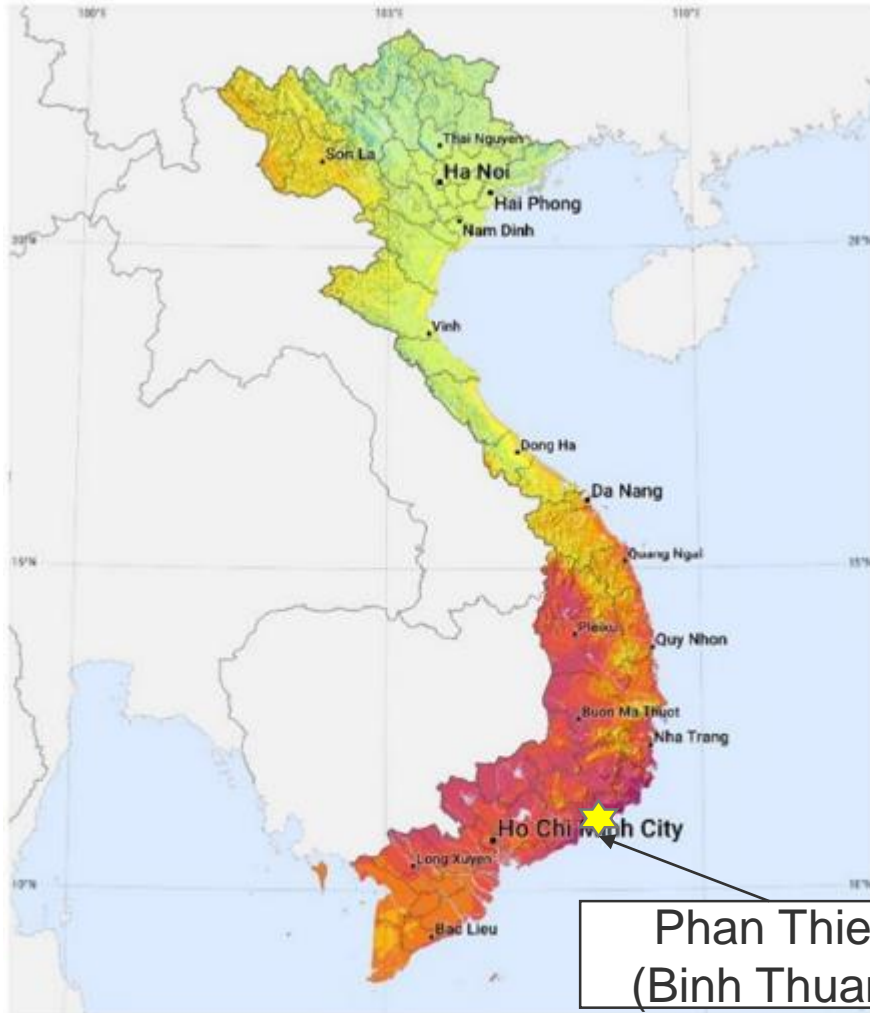

Phan Thiet  
(Binh Thuan)

- South Area of Vietnam has high potential of PV solar power.
- Capacity Factor is over 18%. Phan Thiet (Binh Thuan) site, which has highest Capacity Factor site, has 19.2% of CF.

TABLE 1: TOP 10 COUNTRIES FOR INSTALLATIONS AND TOTAL INSTALLED CAPACITY IN 2020  
FOR ANNUAL INSTALLED CAPACITY

FOR ANNUAL INSTALLED CAPACITY				FOR CUMULATIVE CAPACITY			
1		China	48,2 GW	1		China	253,4 GW
(2)		European Union	19,6 GW	(2)		European Union	151,3 GW
2		United States	19,2 GW	2		United States	93,2 GW
3		Vietnam	11,1 GW	3		Japan	71,4 GW
4		Japan	8,2 GW	4		Germany	53,9 GW
5		Germany	4,9 GW	5		India	47,4 GW
6		India	4,4 GW	6		Italy	21,7 GW
7		Australia	4,1 GW	7		Australia	20,2 GW
8		Korea	4,1 GW	8		Vietnam	16,4 GW
9		Brazil	3,1 GW	9		Korea	15,9 GW
10		Netherlands	3 GW	10		UK	13,5 GW

Vietnam has introduced no.8 highest capacity of PV over the world in 2020.

Source: Snapshot of Global PV Markets

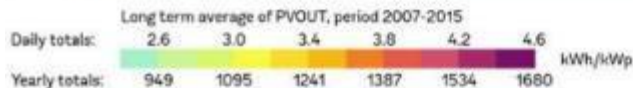

# Example of PV Site

## Dau Tieng 1 & 2 PV Solar Power Plant



Source: Web Site information

# Wind Power (WP) Potential

- Vietnam is considered to have the best wind resources in Southeast Asia. Located in the monsoon climate zone, and shaped by its over 3,000 km long coastline.
- Wind potential in Vietnam concentrates mostly in the southern coastal region with average wind speeds of 6 m/s or higher.

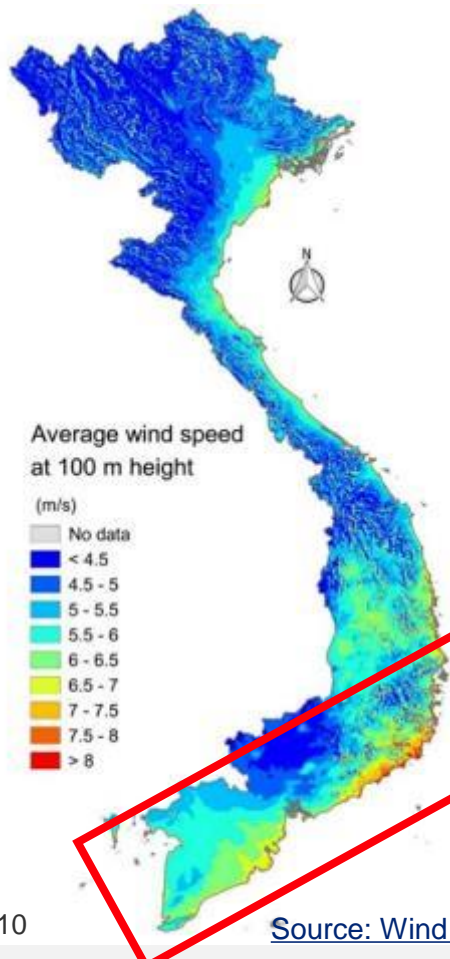

Source: Wind Energy Potential Vietnam

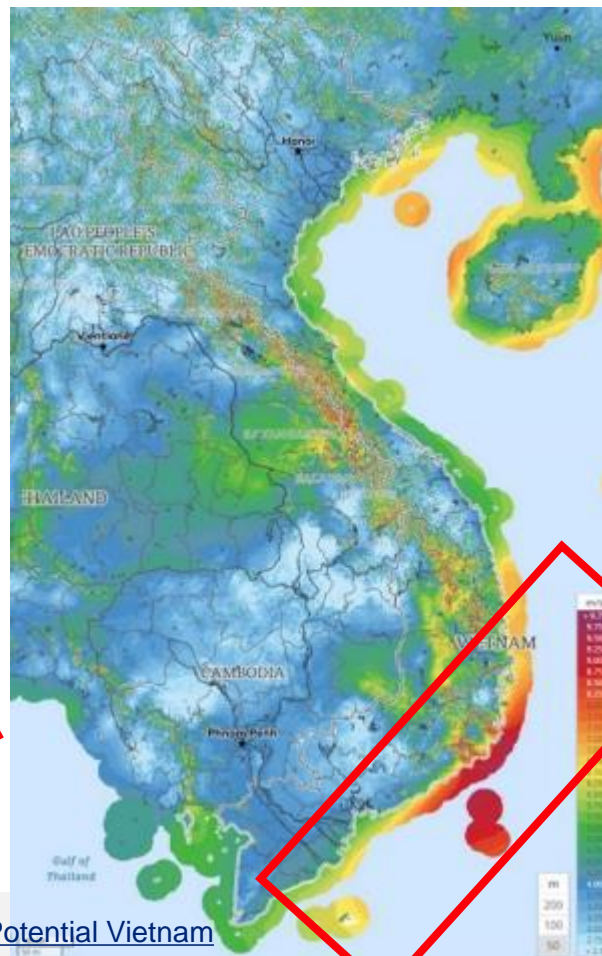

Region	Onshore Wind capacity factor	Offshore Wind capacity factor
Northeast	21%	27%
Northwest	21%	Land-locked
Red River Delta	23%	28%
North central Coast	22%	25%
<b>South central Coast</b>	<b>30%</b>	<b>47%</b>
Central highlands	20%	Land-locked
<b>Southeast</b>	<b>36%</b>	<b>54%</b>
Mekong Delta	34%	45%
Average	26%	38%

High Capacity Factor  
Southern region

Source: [Options for wind power in Vietnam by 2030](#)

# Total PV plus WP Installed Capacity in SEA Countries

- Vietnam has introduced large capacity of Wind Power Plant (WPP), since Vietnam has not only abundant Natural Resources but also Government assistance such as National Power Development Plan (PDP) and many kind of measures.
- According to the expert interviewees, the government's commitment to energy availability was the most important motivation for Vietnam's solar and wind policies.

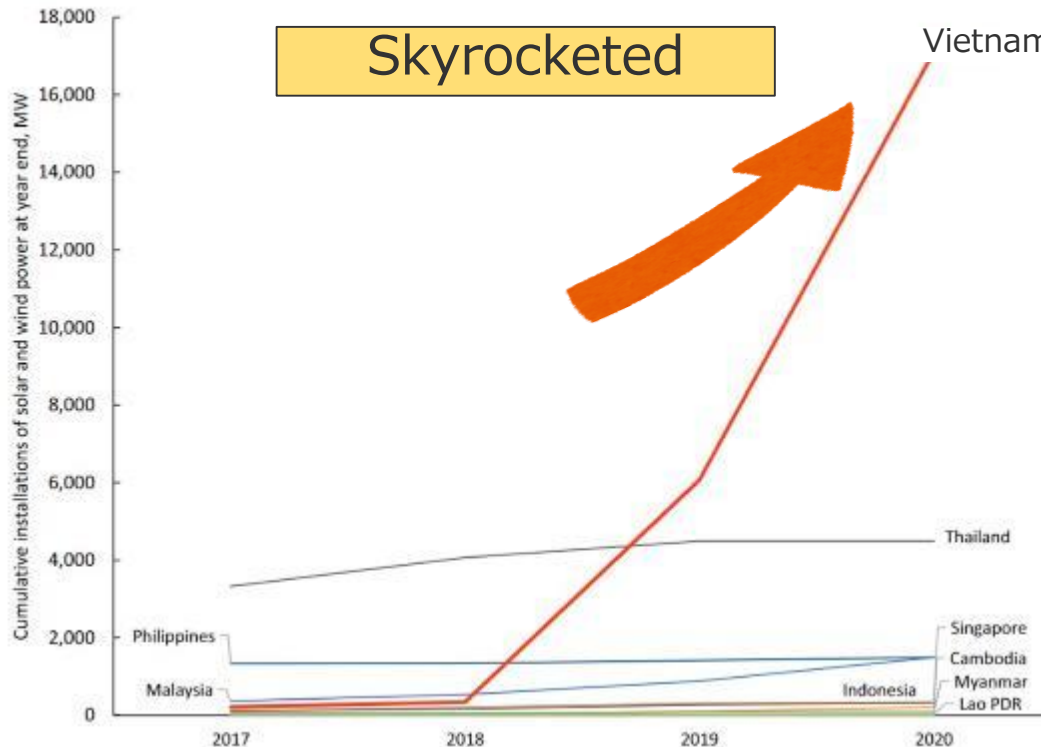

Source: Energy for Sustainable Development

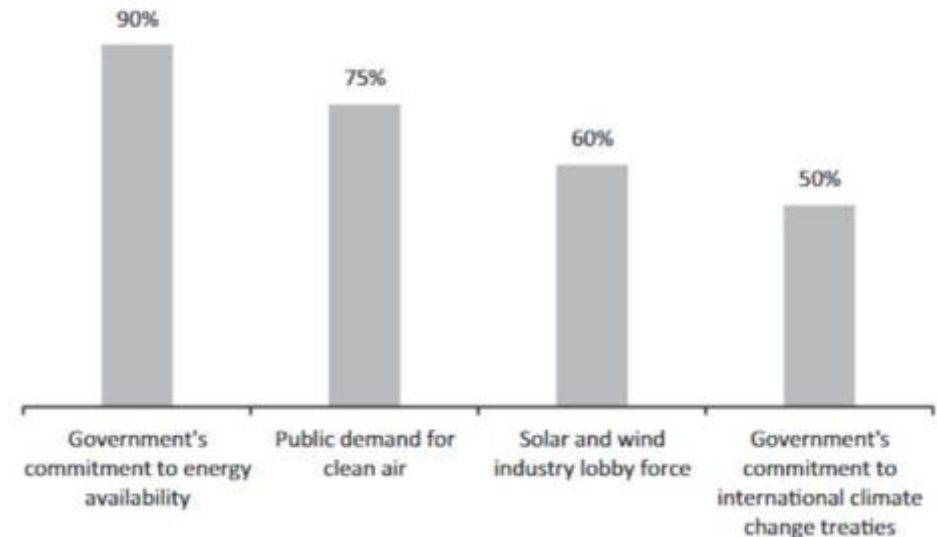

Key Drivers to enhance the Installation

# 03 Promotion of Installation of PV and WP in Vietnam

---

# 03(1) Policies for Promotion of RE

---

# Announcement of the Government Policy in COP26

- In November 2020, Prime Minister Mr. Pham Minh Chinh announced at COP26 that the government would aim for net zero greenhouse gas emissions by 2050.
- The Vietnamese government instructs the Ministry of Natural Resources and Environment to establish a "Managing Leadership Committee" to realize the goals announced at COP26.
- The Managing Leadership Committee was established at the end of 2021 to formulate carbon reduction strategies such as the National Strategy on Climate Change by 2050, the Action Plan to Reduce Methane Emissions by 2030, and the National Strategy for Green Growth.



Participation in  
International Framework



Established the Managing  
Leadership Committee

Reviewed  
in PDP 8

※PDP: Power Development Plan



# Power Development Plan 8 (PDP8)

- Draft PDP8 was submitted by “the Ministry of Industry and Trade” (MOIT) In September 2021. And it was updated in February 2022. (The ratio of renewable energy increased by the update, shifting from coal-fired to LNG-fired power.)
- Deputy Prime Minister Le Van Thanh (chief executive officer of the development of Vietnam's power development master plan) intends to agree in principle.
- PDP7: Development mainly for hydro, coal, and gas-fired power sources
- PDP8: It’s the first PDP which describes renewable energy as main energy
- Source of Thermal Power Plant will be induced from coal to LNG according to PDP8.

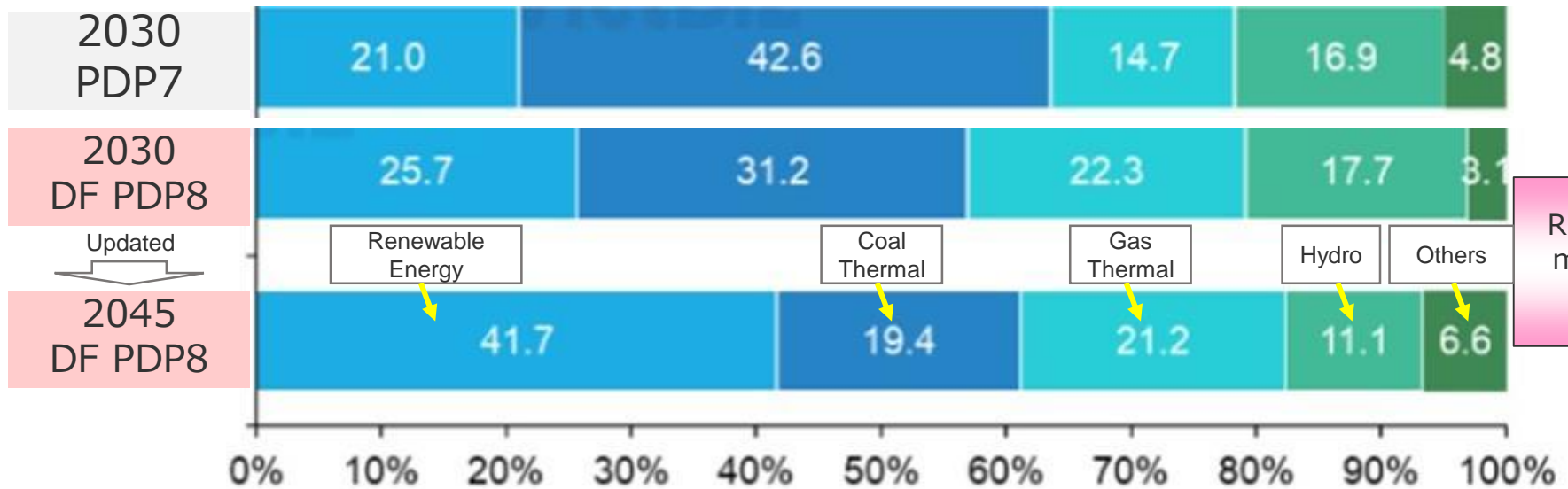

RE is treated as main energy in PDP8

# 03(2) Feed in Tariff & RPS

---

# Feed-in-Tariff PV: Policy in Vietnam

- The FIT system has been introduced for PV power generation, wind power generation, biomass power generation, waste-to-energy generation, and small hydroelectric power generation, and it is possible to sell electricity to the Vietnam Electricity for 20 years.
- The FIT system is reviewed on a periodical basis.
- PV is classified into three types and set Tariff on them.  
The FIT system will end in October 2021. However, Rooftop PV, which does not require much land and infrastructure reorganization, is expected to continue FIT Tariff.
- In the future, it is considered that the DPPA (Direct Power Purchase Agreement) or the bidding system will be applied instead of FIT.
- FIT Tariff is USD-based and can avoid foreign exchange risk.

## Celling Unit Price in FIT

	Phase 1 COD before Jun. 30 2019	Phase 2 COD from Jul. 1 2019 to Dec. 31 2020
Ground mounted PV	2,156 VND/kWh (9.35 USc/kWh)	1,664 VND/kWh (7.09USc/kWh)
Water Floating PV	2,156 VND/kWh (9.35 USc/kWh)	1,783 VND/kWh (7.69 USc/kWh)
Roof Top PV	2,156 VND/kWh (9.35 USc/kWh)	1,943 VND/kWh (8.38 USc/kWh)

Source: VietBiz    Source: JICA Report    Source: Vietnam: Achieving 12 GW of Solar PV Deployment by 2030

# Feed-in-Tariff PV: Comparison to neighboring Countries

- Along with the introduction of FIT, the introduction of PV equipment has increased dramatically.
- FIT Tariff is at the same level as other South East Asian countries, Therefore it is presumed that other preferential measures (described later) have facilitated its introduction.

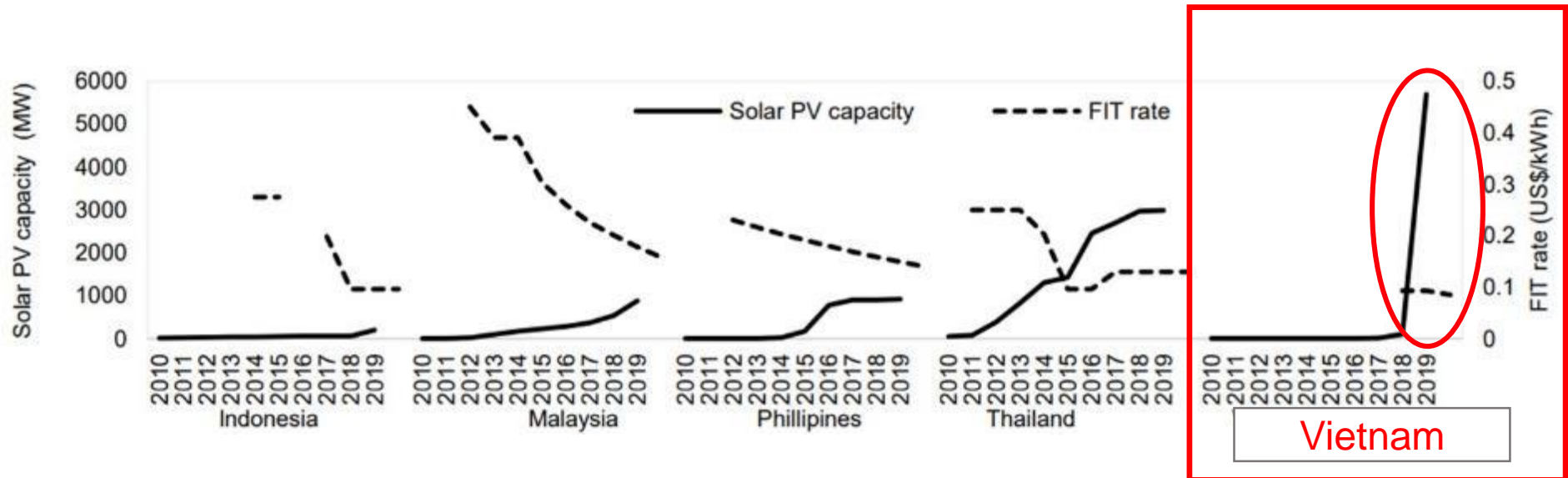

Source: [A comparative review of solar PV energy promotion policy in selected Southeast Asian countries](#)

# DPPA: Considered as a successor to FIT

- With the introduction of DPPA, power generation companies will be able to conclude purchase agreements directly with consumers.  
(It is also possible to transmit power to the EVN Power Grid.)
- EVN is the only off taker under the conventional FIT system, but the introduction of DPPA is expected to expand options for power producers and develop PV power generation.

## Solar Direct Power Purchase Agreement (DPPA) structure

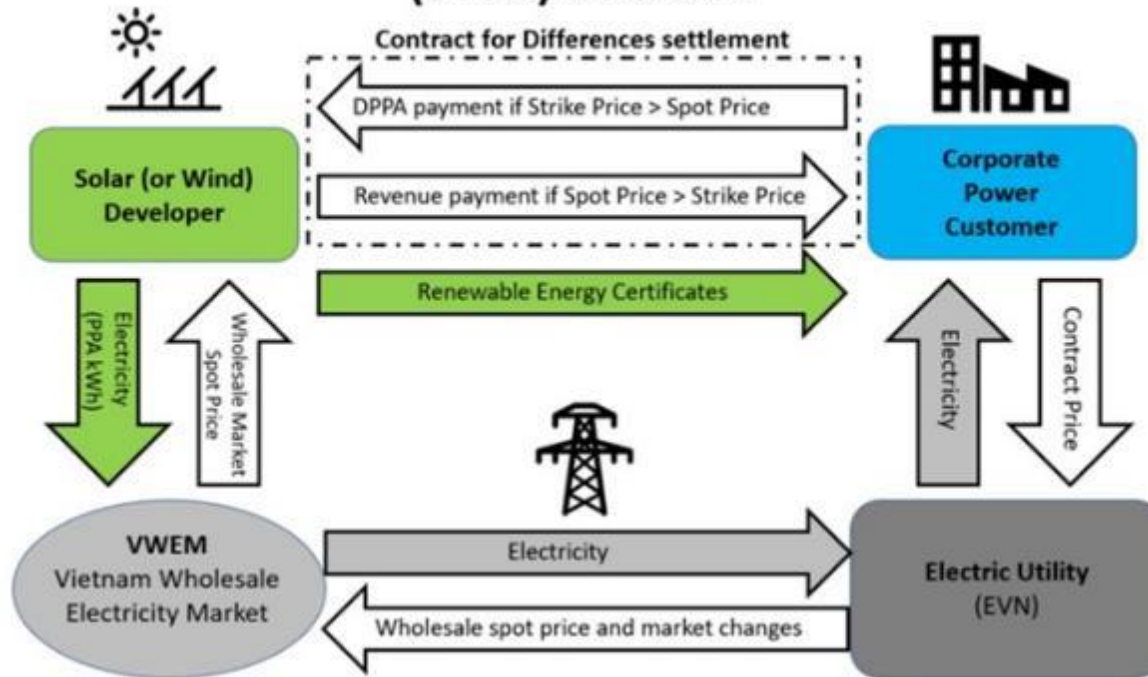

- At the beginning of the FIT system in 2011, FIT Tariff was established without dividing onshore and offshore wind power. However, since the amount of development plan was greatly lower than originally expected, it was divided into two categories and re-set by raising the tariff.
- MOIT (Ministry of Industry and Trade) proposes that the FIT application deadline be set to December 31, 2023. After that, in addition, MOIT is proposing that it be a competitive bid.
- Offshore wind power generation is mostly near-shore, and off-shore wind power is not progressing at this time due to technical, legal, and cost factors.

	Phase 1 COD before Oct. 31 2018	Phase 2 COD fafter Nov. 1 2018	COD fafter Nov. 1 2021
On-shore Wind Power	1,614 VND/kWh (7.8 USc/kWh)	1,928 VND/kWh (8.5 USc/kWh)	7.02 USc/kWh
Off-shore Wind Power	1,614 VND/kWh (7.8 USc/kWh)	2,223 VND/kWh (9.8 USc/kWh)	8.47 USc/kWh

[Source: VietBiz](#)

[Source: JICA Report](#)

## Decision No. 2068/2015/QD-TTg

- RPS (Renewable Portfolio Standard) is under proposed
- Large power generation companies (capacity over 1000 MW, excluding BOT projects); these companies will have to reach 3% of RE power by 2020, 10% by 2030 and 20% by 2050
- Same rates above for power sold by distribution companies
- Customers purchasing electricity from the National Power System to develop power RE projects will benefit from a compensate payment mechanism (net metering system) while renewable projects will benefit from preferential policies on taxes, land and environment.
- USAID is providing support for the introduction of RPS.

## Supports by USAID for introduction of the RPS

- USAID, Vietnamese Government, U.S. Department of State Work are considering together.
- NREL※ が released a report as “International Best Practices for Implementing and Designing Renewable Portfolio Standard (RPS) Policies) “ during conducting an examination on RPS system. Through the investigation of RPS cases in the United States, Mexico, China, South Korea, Australia, and the Philippines, the aim is to examine the feasibility of implementing RPS in Vietnam.

# 03(3) Measures by the Government

---



# Benefit on Corporate Tax

## Decree of Ministry of Industry & Trade: No. 78/2014/TT-BTC

- A preferential tax rate of 10% or 20% is applied for a certain period of time, depending on the nature of the business and the area of establishment for Investors of Renewable Energy.
- The corporate tax rate is further preferential compared to general areas in "economically and socially difficult areas" defined by the government, such as rural areas.

### Renewable Energy Project Firm



Tax Benefit

### General Company



Corporate Tax: at least 20%

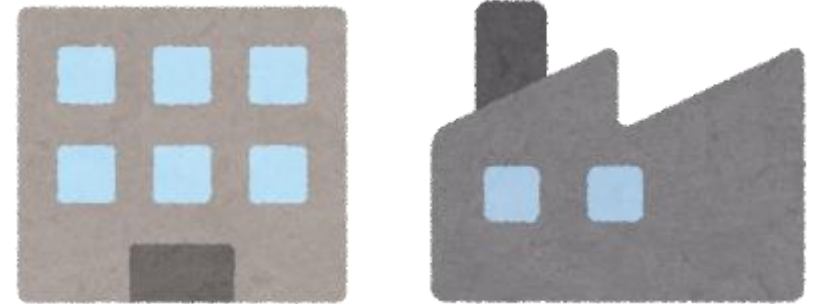

# Benefit on Import Tax

## Decree of Cabinet Announcement: No. 4/2009/ND-CP

- Import tax is exempted when products for manufacturing equipment that will become fixed assets of renewable energy power projects are imported from overseas.
- Imported products is defined as “materials or semi-finished products” that are not produced in Vietnam.



[Source: VietBiz](#)



Import Tax Exemption



[Source: JICA Report](#)

# Benefit on Land Lease Tax and on Land Lease Fee

Decision No. 2068/2015/QD-TTg

- Exemption or reduction of land use and lease fees for power projects, power grid connections and substation construction
- Depending on the region or province, company may be able to receive a land lease tax exemption, lease the land under construction (up to 3 years from the conclusion) or be tax-exempt for 11 ~ 15 years after construction is completed.

Land Lease Fee



Tax for Land Lease



Totally Free or Partially deduction

# Benefit on VAT

- VAT on costs incurred during the construction of the project will be refunded after the power plant COD.



HP Nang Luong Sach

Source: VietBiz Source: JICA Report

# 03(4) Carbon Pricing

---

# Introduction of Carbon Pricing

Europe is the world's most advanced area in carbon pricing, which has more than tripled in the past decade and is expected to penetrate emerging and even developing countries in the future.

## ① Carbon Tax

Taxation in proportion to CO2 emissions

## ② Emission Trading System

A mechanism for buying and selling between companies that set a ceiling on emissions for each company and those that exceed the upper limit and those that fall below

## ③ Credit Transaction

JCM (Joint Credit): A system in which the amount of reduction realized by measures implemented in cooperation with developing countries is shared bilaterally as credit.

## ④ Carbon Border Adjustment Measures

When importing products manufactured in countries where CO2 prices are low, business operators bear the cost difference in CO2 between the two countries

# Introduction of Carbon Pricing

① Carbon Tax

② Emission Trading System

③ Credit Transaction

④ Carbon Border Adjustment Measures



Emission Trading

“Emission Trading” will start from 2025, according to “No.06/2022/ND-CP”

Credit Transaction

Some JCM Credit Transitions has issued so far.

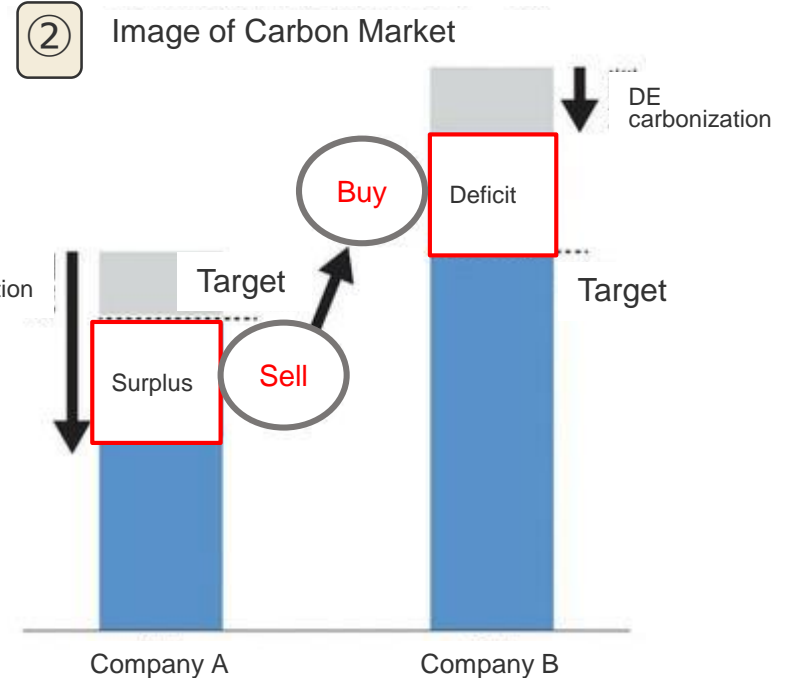

# 04 Summary

---



## 4 Summary

The reasons why the introduction of renewable energy progressing in Vietnam.

- ✓ Potential for PV and WP in Vietnam is high.  
South East area is one of the best resource for both PV and WP.  
Around 9 % of land area is suitable for Large Wind Firm.  
Over 39% of Area has annual average wind speed over 6 m/s.
- ✓ The Government invites foreign investors of RE.
- ✓ The Government provides many kinds of measures for benefit to RE investors.

## UNLEASHING VIETNAM'S CLEAN POWER POTENTIAL

Vietnam boasts the highest installed capacity of solar power in Southeast Asia, generating 16,500MW at the end of 2020



Within the top 10 countries with the highest capacity of solar energy installed in 2020



One of the best wind resources in Southeast Asia, with an estimated potential of 311 GWs



8.6 percent of land area suitable for large wind farms



Over 39% of area has annual average wind speed over 6 m/s, corresponding to wind resources potential of 512 GWs



Solar PV capacity increased from 86 MW in 2018 to about 16,500 MW in 2020



Solar PV systems provide roughly 10.6 TWh of electricity in 2020, accounting for nearly 4 percent of total output



Rooftop solar will contribute about 50% of Vietnam's total solar capacity in 2030.



Source: World Bank

# 05 National Strategy against Climate Change by 2050

---

Government of Vietnam has announced National Strategy on Prevention against Climate Change. (July 26, 2022)

## <Main Point of the Strategy>

- The Vietnamese government announced its National Strategy on Climate Change (Decision No. 896/2022/QD-TTg) for 2050.
- The National Strategy includes targets for reducing greenhouse gas (GHG) emissions toward achieving the 2050 net-zero target.
- Reduce GHG emissions by 43.5% compared to BAU (Business as Usual) by 2030 and achieve net zero GHG emissions by 2050.
- In the energy field, the development of renewable and new energy will be emphasized until 2030.
- No new coal-fired power plants will be built after 2030, and the development of nuclear power using the latest technology will be studied by 2050.
- GHG emissions in the energy field will be reduced by 32.6% compared to BAU by 2030 (up to 457 million CO<sub>2</sub> equivalent tons) and reduced by 91.6% compared to BAU by 2050 (up to 101 million CO<sub>2</sub> equivalent tons).



**CHUBU**  
Electric Power

***NIPPON KOEI***

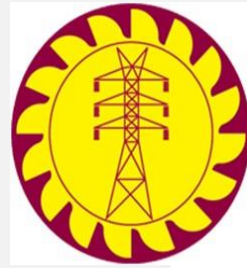
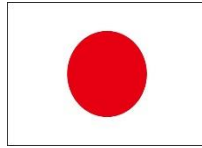
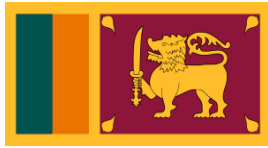

# Renewable energy introduction promotion system in major countries

July , 2020

Chubu Electric Power Co., Inc.  
Nippon Koei Co., Ltd.

1. Transition of introduction amount of renewable energy in worldwide
2. Ratio of renewable energy in major countries
3. Introduction target of renewable energy in major countries
4. Renewable energy introduction promotion system in major countries
5. Recent trends of renewable energy

# 1 Transition of introduction of renewable energy in world wide

## Global power generation capacity, by source, 2008-2018

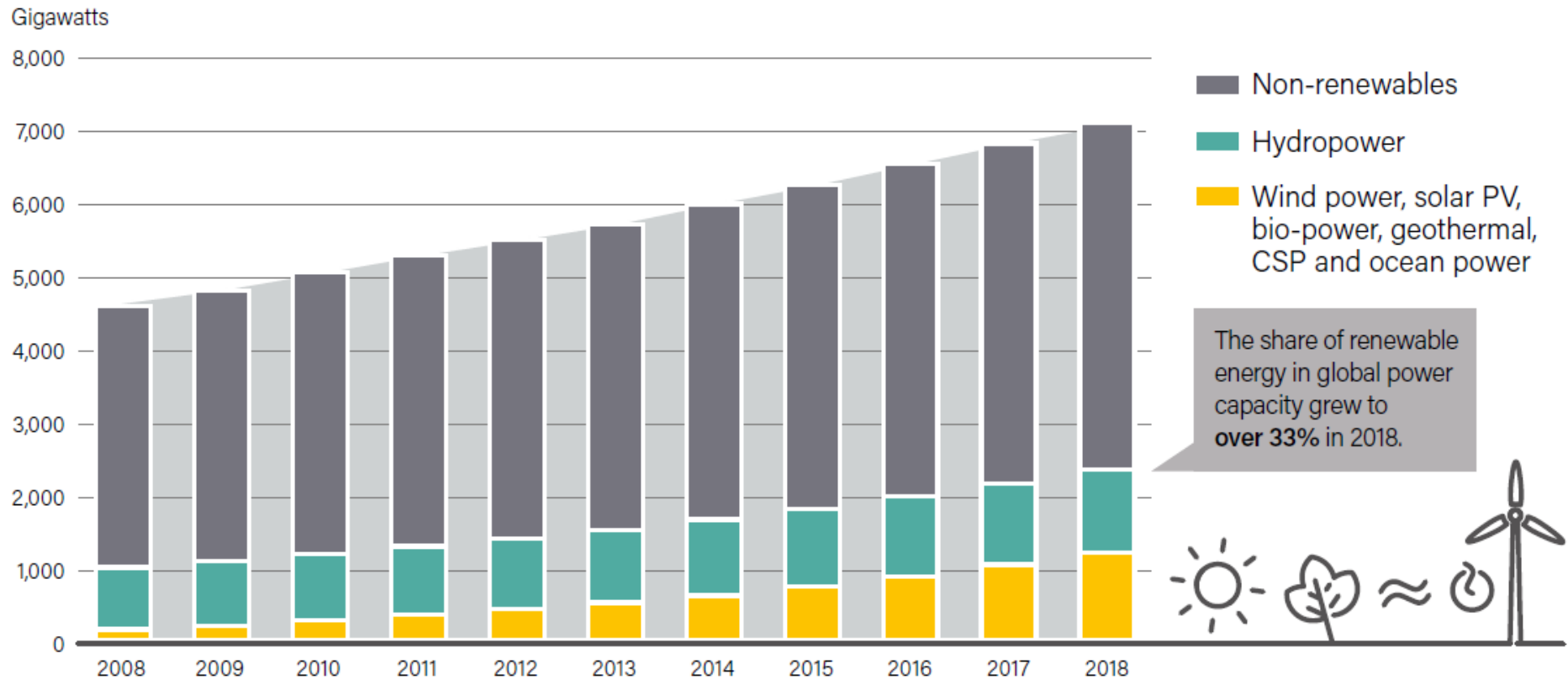

Source: Renewables 2019 Global status report (REN21)



# 1 Transition of introduction of renewable energy in world wide

## Annual additions of renewable power capacity, by technology and total, 2012-2018

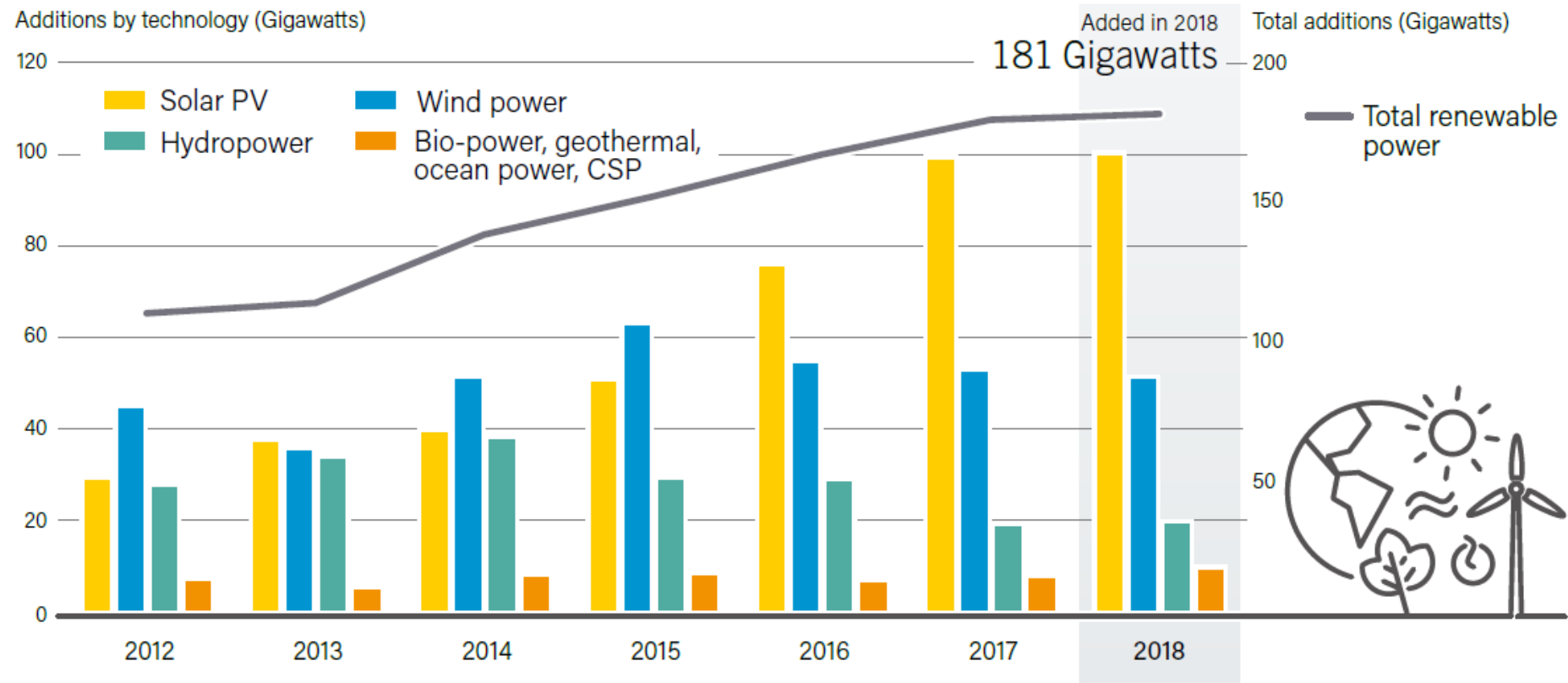

Source: Renewables 2019 Global status report (REN21)

# 2 Ratio of renewable energy in major countries

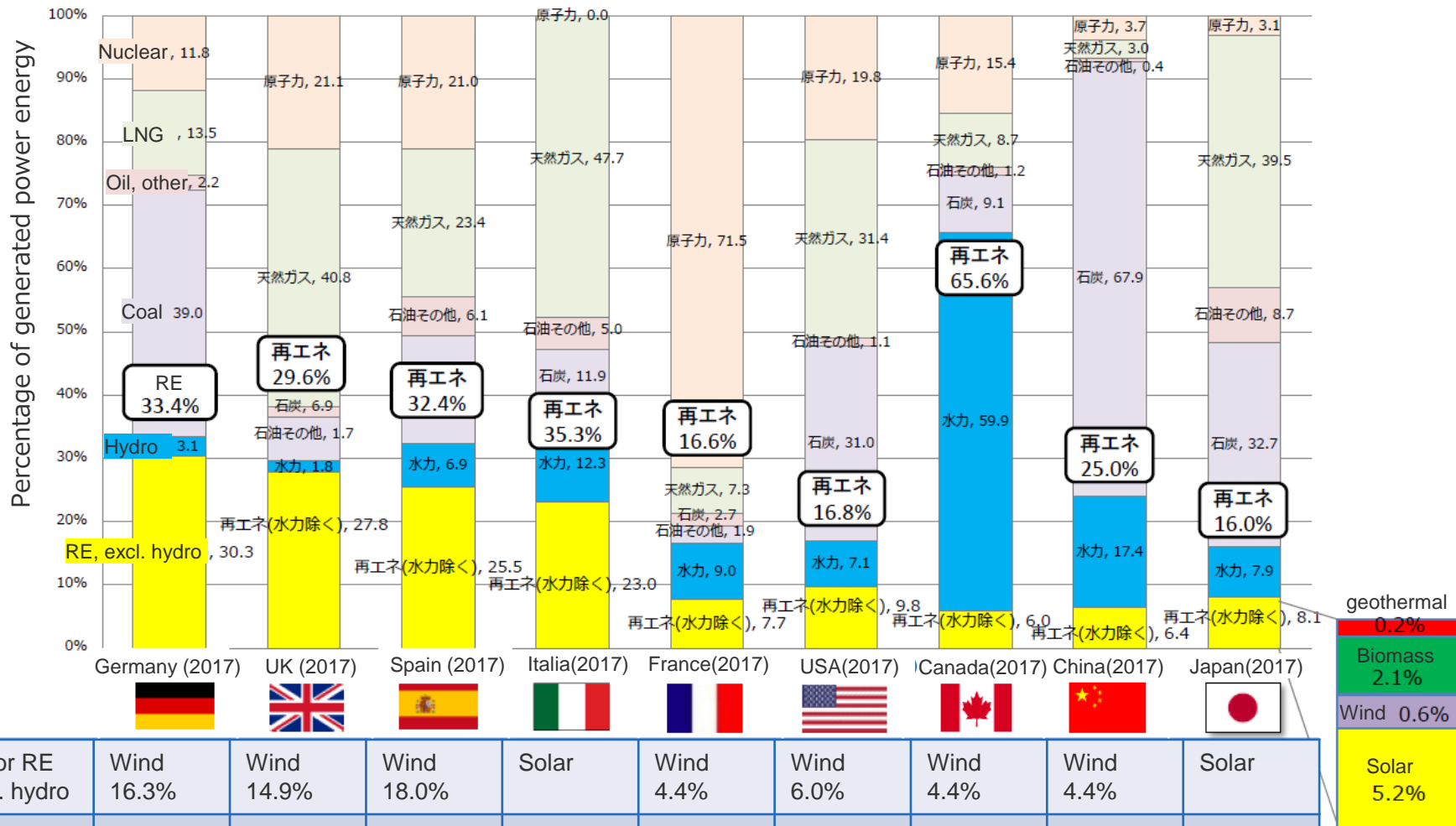

Major RE excl. hydro	Wind 16.3%	Wind 14.9%	Wind 18.0%	Solar	Wind 4.4%	Wind 6.0%	Wind 4.4%	Wind 4.4%	Solar
Target year	2025 2035	2030	2020	2020	2030	2035	-	2020	2030
RE target ratio	40-45% 55-60%	44%*	40%	35-38%	40%	80% (incl. N-power)	-	15%	22-24%

### 3 Introduction target of renewable energy in major countries

Country	Progress	Target
China	26.4%	35% by 2030
Denmark	60.4%	50% by 2020 100% by 2050
France	19.9%	40% by 2030
Germany	34.4%	40-45% by 2025 65% by 2030 80% by 2050
India	7.8%	40% by 2030
Italy	34.1%	26% by 2020
Japan		22-24% by 2030
Spain	36.3%	39% by 2020
Sri Lanka		20% by 2020 100% by 2050

Country	Progress	Target
Sweden	65.8%	100% by 2040
United Kingdom	28.1%	No national target
United States	18%	No national target
California		33% by 2020 50% by 2030 100% by 2045
New York		50% by 2030
Washington		15% by 2020
Hawaii		25% by 2020 40% by 2030 100% by 2045

Source: Renewables 2019 Global status report (REN21)

## 4 Renewable energy introduction promotion system In case of United States of America

Major Promotion system by federal government

- ✓ PTC (Renewable Electricity Production Tax Credit) from 1992
- ✓ ITC (Business Energy Investment Tax) from 2008

Applicable for major promotion system

Year	2016	2017	2018	2019	2020	2021	2022	After 2023
PTC								
Wind	2.3c/ kWh	1.84c/ kWh	1.38c/k Wh	0.92c/k Wh	N/A	N/A	N/A	N/A
ITC								
PV, Solar heating	30%	30%	30%	30%	26%	22%	10%	10%
Fuel Cells	30%	30%	30%	30%	26%	22%	22%	N/A
Geothermal Electric	10%	10%	10%	10%	10%	10%	10%	10%
Wind	30%	24%	18%	12%	N/A	N/A	N/A	N/A

Source: Database of State Incentives for Renewable & Efficiency

## 4 Renewable energy introduction promotion system In case of United States of America

### Major Promotion system by state

- ✓ RPS (Renewable Portfolio Standard) from 1983

29 States and DC have a RPS

A renewable energy standard (RES) requires utility companies to source a certain amount of the energy they generate or sell from renewable sources such as wind and solar. There are many variants to an RES policy, including clean energy standards (which allow nuclear and low-polluting non-renewable energy sources like natural gas) and renewable goals (which are non-binding). They are sometimes also called renewable portfolio standards (RPS).

- ✓ Net Metering Policies

40 States + DC, AS, GU, PR, & USVI have mandatory Net Metering rules  
Net metering policies have facilitated the expansion of renewable energy through on-site, also known as distributed, generation. Common distributed generation sources—which are often located at a house, school or business rather than utility-owned property—include:

- Solar panels
- Natural gas micro-turbines
- Methane digesters
- Small wind power generators

# 4 Renewable energy introduction promotion system In case of United States of America

## Renewable & Clean Energy Standards

www.dsireusa.org / June 2019

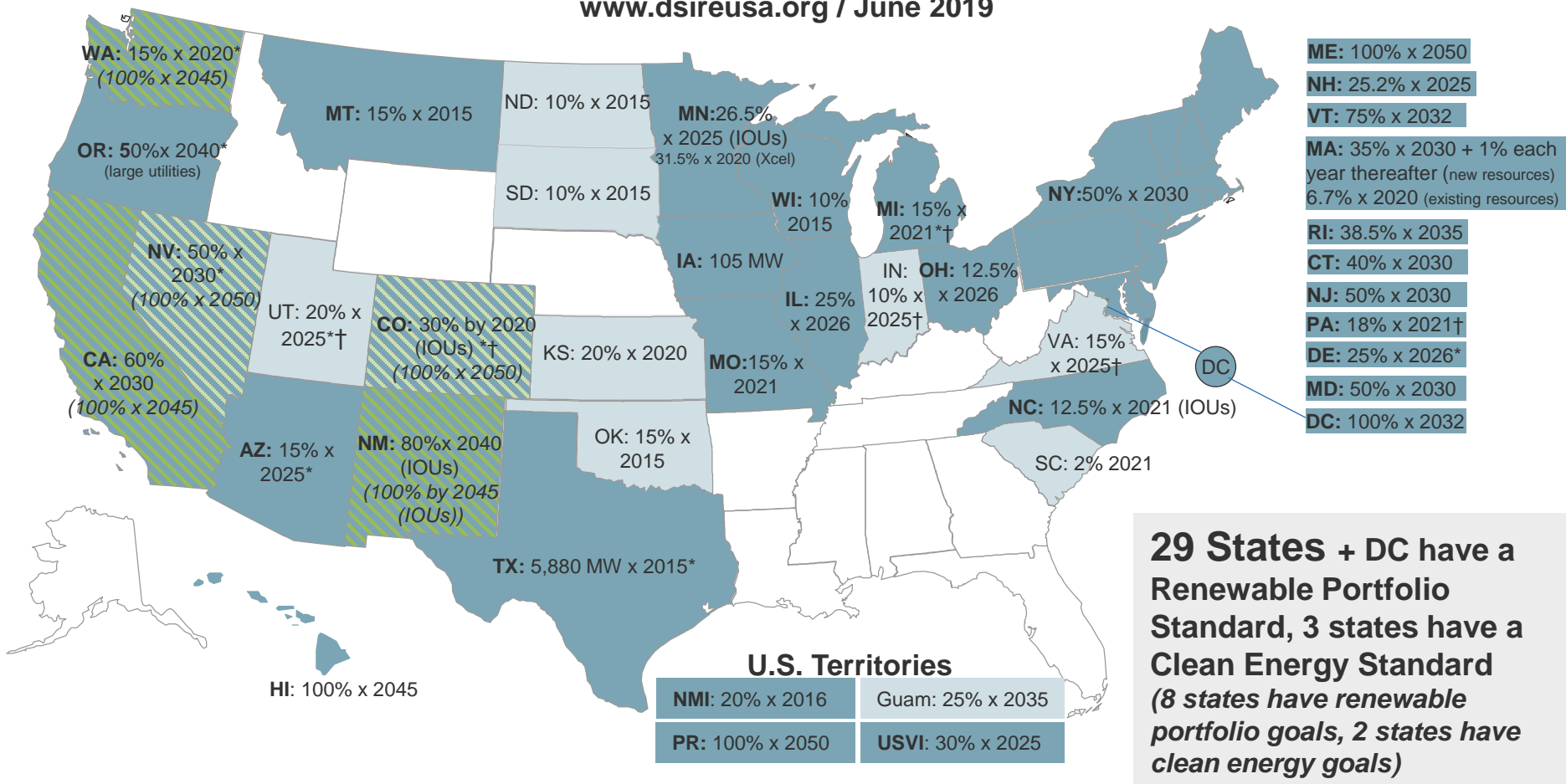

**29 States + DC have a Renewable Portfolio Standard, 3 states have a Clean Energy Standard (8 states have renewable portfolio goals, 2 states have clean energy goals)**

Renewable portfolio standard
  Clean energy standard
 \* Extra credit for solar or customer-sited renewables

Renewable portfolio goal
  Clean energy goal
 † Includes non-renewable alternative resources

# 4 Renewable energy introduction promotion system In case of United States of America

## Net Metering

www.dsireusa.org / June 2020

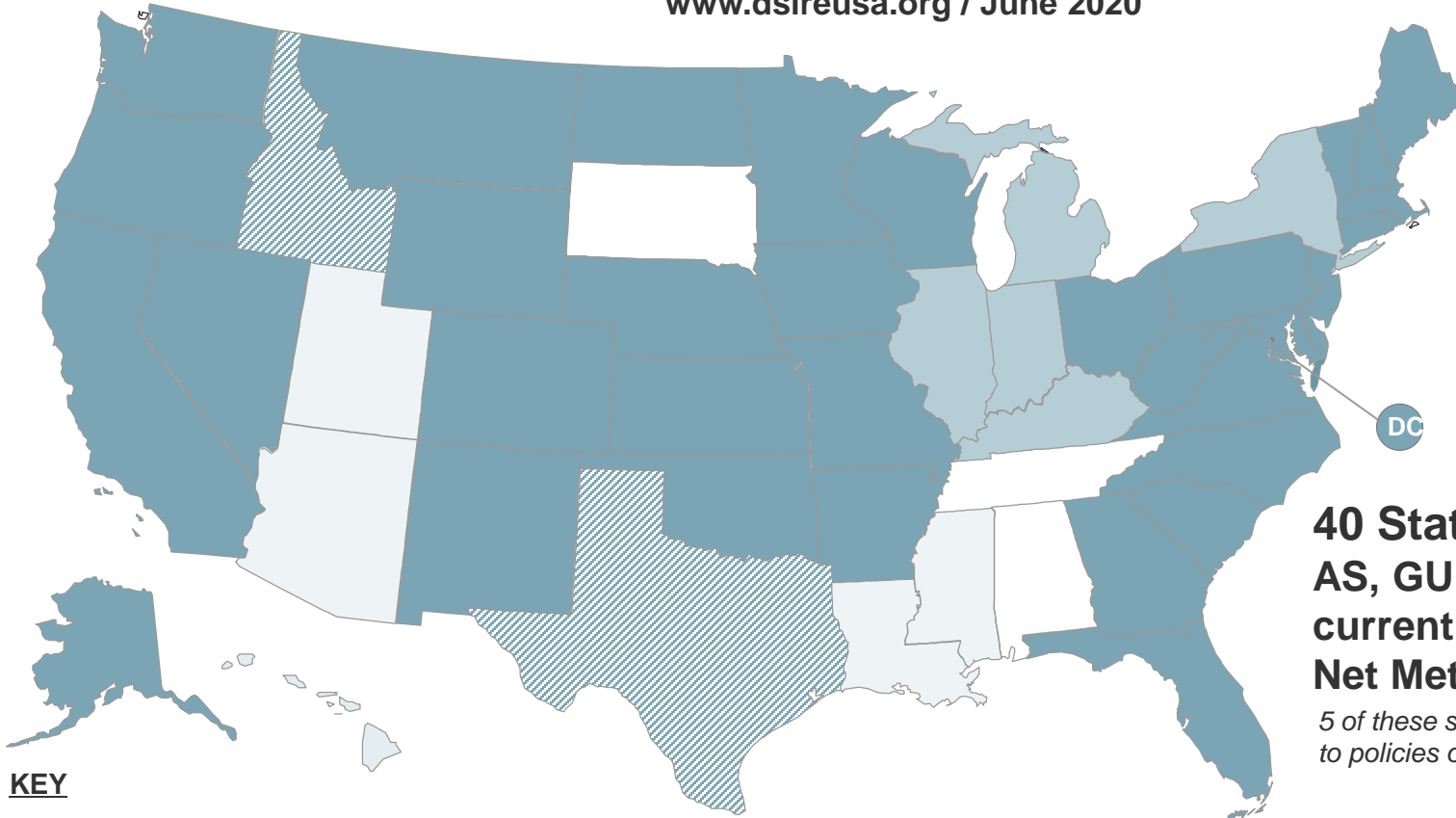

**40 States + DC,  
AS, GU, PR, & USVI  
currently have mandatory  
Net Metering rules**

*5 of these states are in transition  
to policies other than net metering*

- KEY**
- State-developed mandatory rules for certain utilities (35 states + DC+ 4 territories)
  - In transition to statewide distributed generation compensation rules other than net metering (5 states)
  - Statewide distributed generation compensation rules other than net metering (5 states)
  - No statewide mandatory rules, but some utilities allow net metering (2 states)

**U.S. Territories:**



Source: Database of State Incentives for Renewable & Efficiency

Copyright © Chubu Electric Power Co., Inc. All rights reserved.  
© 2020 Chubu Electric Power Co., Inc. and Nippon Koei Co., Ltd. All rights reserved.

## 4 Renewable energy introduction promotion system In case of United Kingdom

### Major Promotion system

- ✓ RO (Renewable Obligation) (RPS : Renewable Portfolio Standard) from 2002
- ✓ FIT (Feed in Tariff) for up to a capacity of 5MW from 2010
- ✓ FIT-CfD (FIT Contracts for Difference) for over a capacity of 5MW from 2014
- ✓ SEG (Smart Export Guarantee) for up to 5MW from 2020

### Applicable for major promotion system

	2002	2010	2014	2017	2020
Under 50kW	RO	FIT	FIT	FIT	SEG
50kW-5MW	RO	RO or FIT	RO or FIT	FIT	SEG
Over 5MW	RO	RO	RO or FIT-CfD	FIT-CfD	FIT-CfD



## 4 Renewable energy introduction promotion system In case of United Kingdom

### ✓ RO (Renewable Obligation)

The Renewables Obligation (RO) required UK electricity suppliers to source an increasing proportion of electricity from renewable sources. This obligation can be met by presenting Renewables Obligation Certificates (ROCs) or by paying into a 'buy out' fund.

Operators of eligible renewable generating stations are able to obtain ROCs for the renewable electricity they generate by seeking accreditation and meeting the ROC issuance requirements.

### ✓ SEG (Smart Export Guarantee)

SEG is a new system that replaces FIT, and electricity suppliers have the right to decide the purchase price period, and method, rather than collecting levies from all consumers uniformly throughout the nation like FIT.

The smart export guarantee (SEG) is an obligation set by the government for licensed electricity suppliers to offer a tariff and make payment to small-scale low-carbon generators for electricity exported to the National Grid, providing certain criteria are met.

The SEG is an opportunity for anyone who has installed one of the following technology types up to a capacity of 5MW, or up to 50kW for Micro-CHP:

- Solar PV, Wind, Micro combined heat and power (CHP), Hydro, Anaerobic digestion (AD)

## 4 Renewable energy introduction promotion system In case of United Kingdom

### ✓ FIT-CfD (FIT Contracts for Difference)

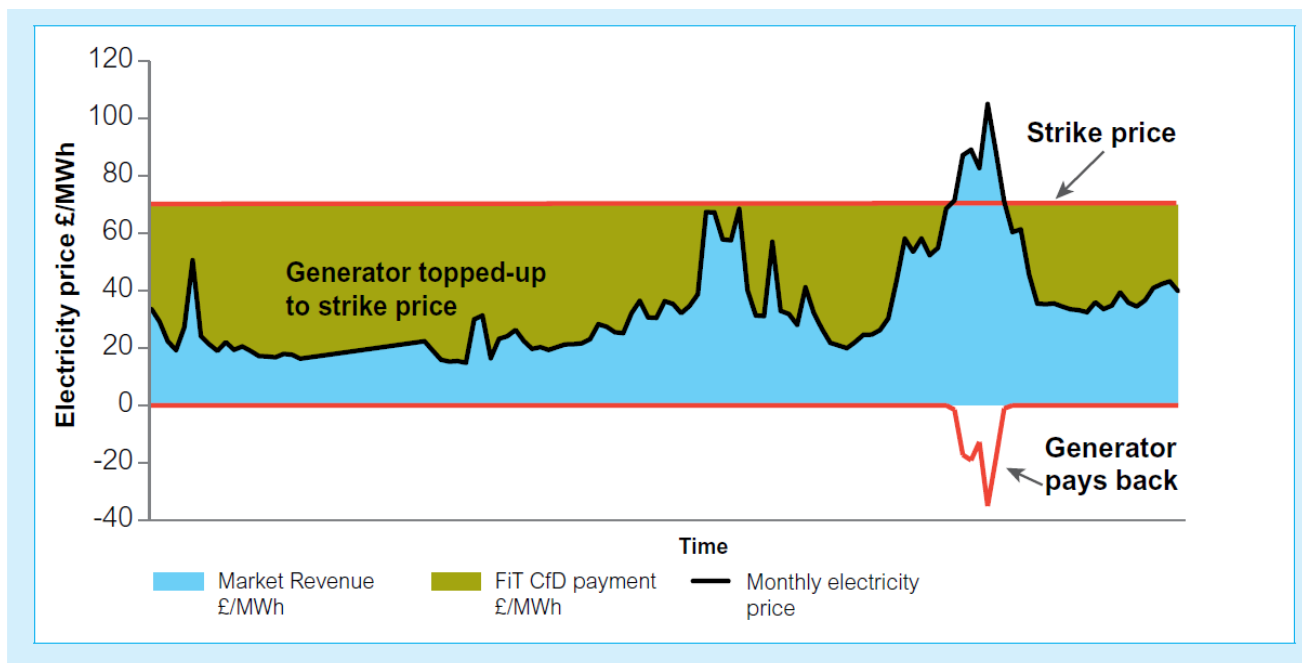

A Feed-in Tariff with Contract for Difference (FiT CfD) is a long-term contract between an electricity generator and a contract counterparty. The contract enables the generator to stabilise its revenues at a pre-agreed level (the strike price) for the duration of the contract. Under the FiT CfD, payments can flow from the contract counterparty to the generator, and vice versa.

A 'two-way' FiT CfD provides for payments to be made to a generator when the market price for its electricity (the reference price) is below the strike price set out in the contract. However, when the reference price is above the strike price, the generator pays back the difference. That is, generators return money to consumers if electricity prices are higher than the agreed tariff.

Source: UK Government White Paper, July 2011

## 4 Renewable energy introduction promotion system In case of Germany

### Major Promotion system

- ✓ FIT (Feed in Tariff) from 1991
- ✓ FIP (Feed in Premium) from 2012
- ✓ Auction from 2017

### Applicable for major promotion system

	1991	2012	2014	2016	2017
RE ratio	3.6%	22.8%	25.9%	29.2%	33.1%
Under 100kW	FIT	FIT or FIP	FIT or FIP	FIT	FIT
100kW-500kW	FIT	FIT or FIP	FIT or FIP	FIP	FIP
500kW-750kW	FIT	FIT or FIP	FIP	FIP	FIP
Over 750kW	FIT	FIT or FIP	FIP	FIP	FIP or Auction

# 5 Recent trends of renewable energy

## Transition of renewable power generation costs

### Transition of Levelized Cost of Energy(LCOE) for renewable power

(\$/MWh)

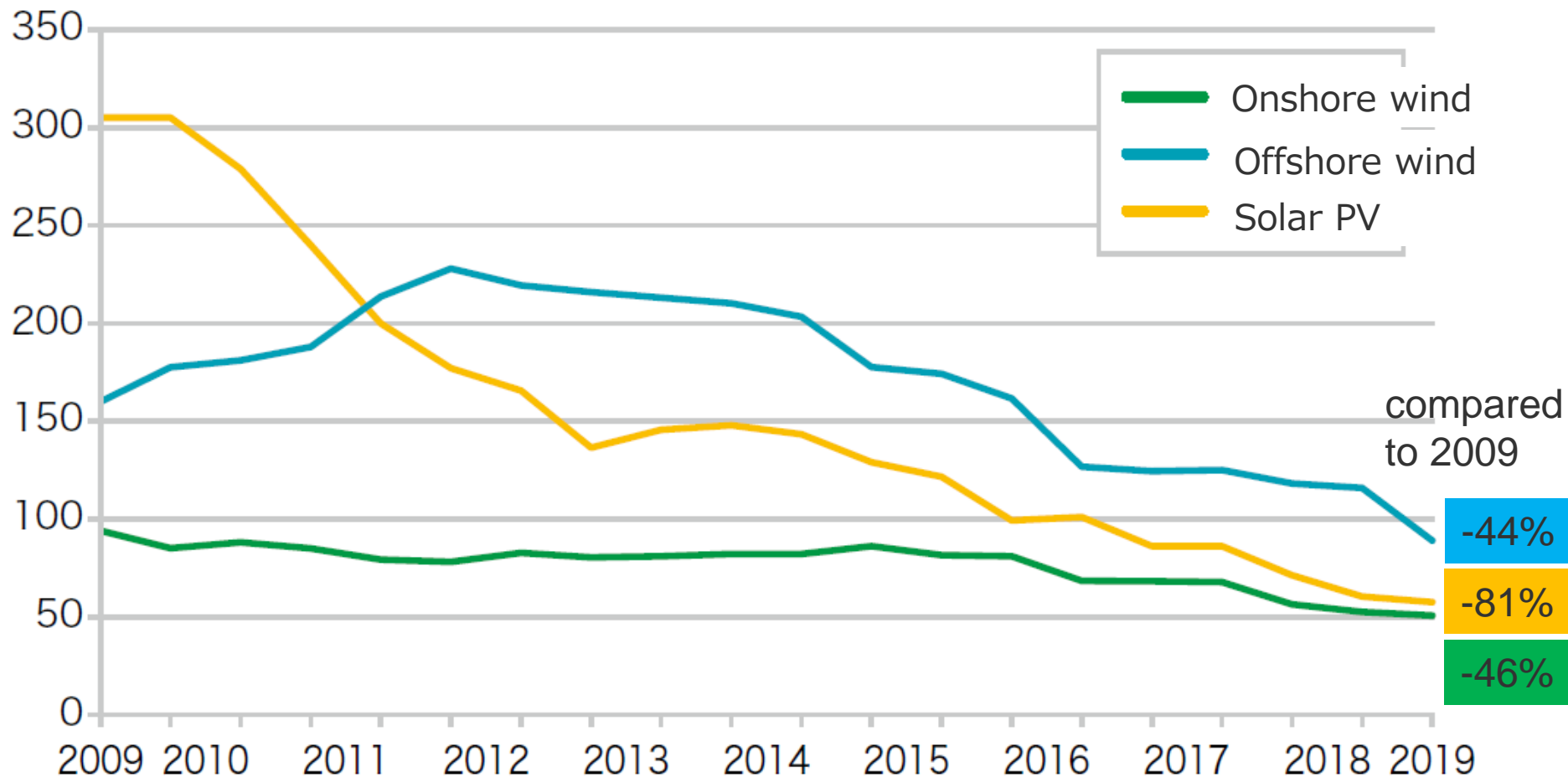

Source: UNEP, Bloomberg NEF(2019), "Global Trends in Renewable Energy Investment 2019"

# 5 Recent trends of renewable energy

## Expansion of renewable energy PPA

### Transition of global renewable energy PPA volume

Annual volume (GW)

Cumulative volume (GW)

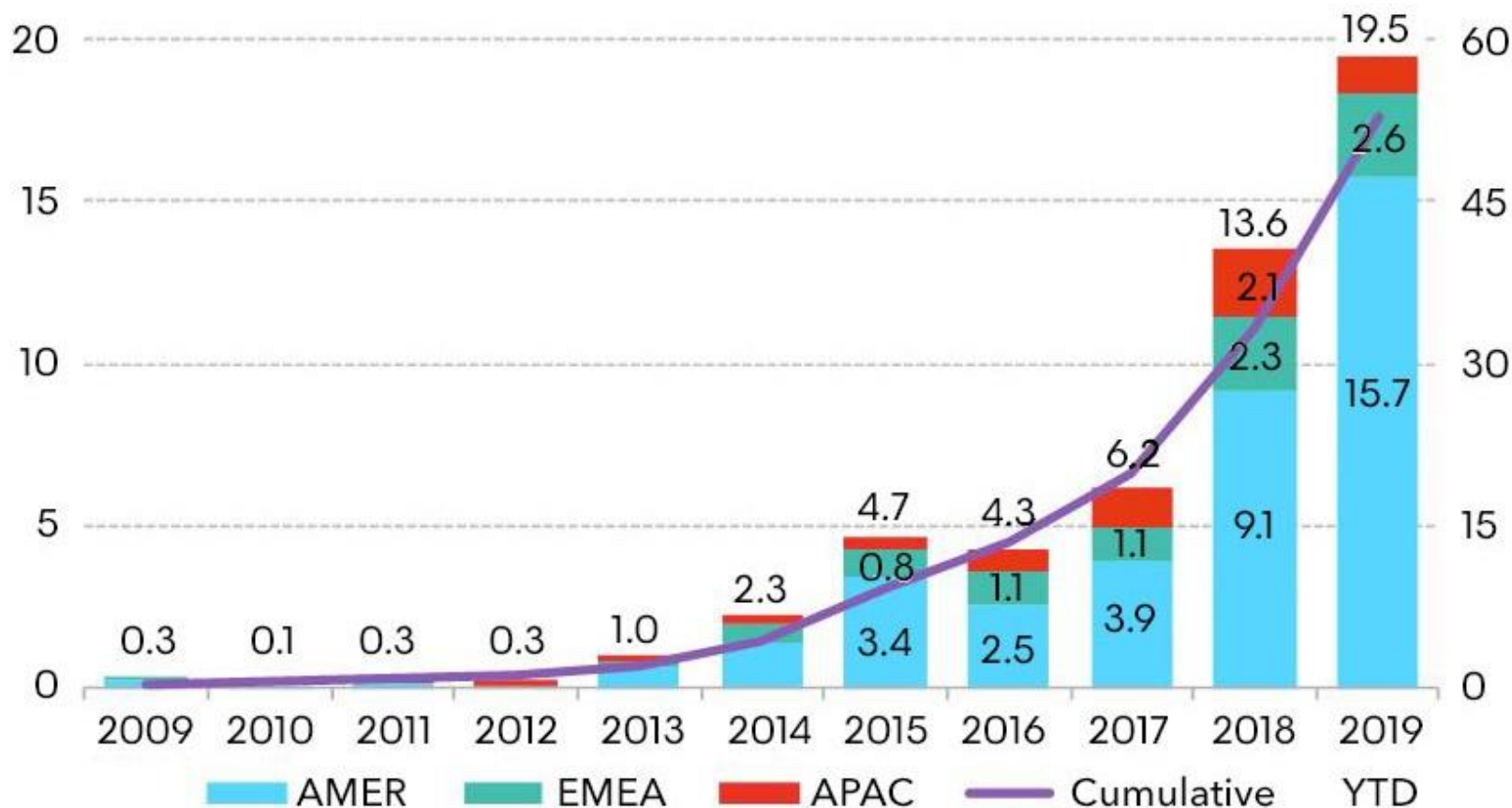

Source: Bloomberg NEF



**CHUBU**  
Electric Power

***NIPPON KOEI***

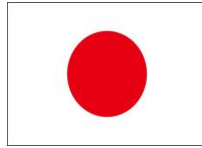
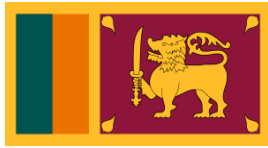

# Status of introduction of renewable power in Asian countries

September, 2020

Chubu Electric Power Co., Inc.  
Nippon Koei Co., Ltd.

# Table of contents

---

1. Basic information and introduction status of renewable power in Asian countries
2. Renewable power introduction promotion system in Thailand
3. Renewable power introduction promotion system in Malaysia
4. Renewable power introduction promotion system in Philippines



# 01 Basic Information

---

# 1. Basic information and introduction status of renewable power in Asian countries

Item	Thailand	Malaysia	Philippines	Sri Lanka
Population [million]	69 (2017)	32 (2017)	103 (2016)	21 (2018)
GDP [billion\$]	544 (2019)	354 (2018)	304 (2016)	84 (2019)
GDP per capita[\$]	7,808 (2019)	10,492 (2018)	2,947 (2016)	3,853 (2019)
Economic growth [%]	2.4 (2019)	5.9 (2017)	6.8 (2019)	2.3 (2019)
Electrification rate [%]	99.9 (2016)	99.9 (Malay Peninsula) (2016)	88 (2016)	99.6 (2018)
Electricity Sales [TWh/year]	182.8 (2016)	136.8 (2016)	74.2 (2016)	13.4 (2017)
Electricity Sales per Capita [MWh/year/capita]	2.7 (2016)	4.4 (2016)	0.7 (2016)	0.6 (2017)
Generation capacity [GW]	50.3 (2017)	31 (2016)	21.4 (2016)	4.1 (2017)
VRE capacity [GW]	7.8 (2017)	0.6 (2016)	1.4 (2016)	0.2 (2017)
VRE ratio [%]	15.4 (2017)	1.8 (2016)	6.6 (2016)	5.1 (2017)
Introduction target of RE	37% by 2036	9% by 2020 20% by 2030	40% by 2020 100% by 2050	20% by 2020 100% by 2050

VRE: Not include hydropower

# 02 VRE promotion in Thailand

---

## 2. Renewable power introduction promotion system in Thailand Outline of renewable introduction promotion system

Introduction promotion system have changed from Adder to FIT, Bidding

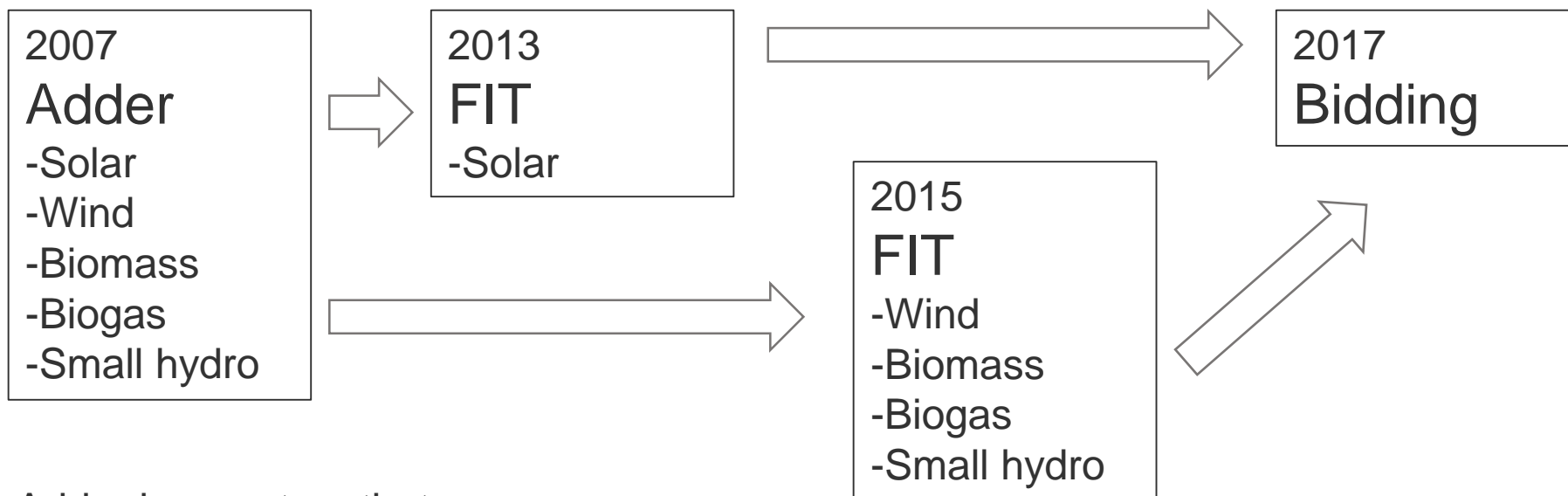

Adder is a system that adds a certain amount to the wholesale fee

## 2. Renewable power introduction promotion system in Thailand

- ✓ “Adder” program since 2007
- “Adder” system adds some rate of Bahts (Thailand currency unit) per kWh to the base tariff, depending on the type of technology.
- Special Adder rate are added for the introduction instead of diesel and introduction to the three southern provinces.
- Due to a sharp increase application for solar, the adder rate was reduced, from 8.0 to 6.5Baht/kWh, and new application was postponed in 2010

Adder rate by RE type

Type of RE	Installed cap.	Adder rate [Baht/kWh]	Special adder for diesel replacement [Baht/kWh]	Special adder for three southern provinces [Baht/kWh]	Years supported
Biomass	≤ 1 MW	0.5	1.0	1.0	7
	> 1 MW	0.3	1.0	1.0	7
Biogas	≤ 1 MW	0.5	1.0	1.0	7
	> 1 MW	0.3	1.0	1.0	7
Waste (land fill and digester)		2.5	1.0	1.0	7
Waste (thermal process)		3.5	1.0	1.0	7
Wind	≤ 50kW	4.5	1.5	1.5	10
	> 50kW	3.5	1.5	1.5	10
Small hydro	50kW - 200kW	0.8	1.0	1.0	7
	≤ 50kW	1.5	1.0	1.0	7
Solar		8.0→6.5	1.5	1.5	10

## 2. Renewable power introduction promotion system in Thailand

- ✓ Rooftop PV FIT program since 2013
- Thailand's first FIT program was introduced for rooftop PV
- Three types were classified by capacity for residential and commercial use, and the supported period were 25 years
- ERC(Energy Regulatory Commission) of Thailand have introduced the FIT program in consideration of the increased burden due to the increased application of Adder and the lowering of equipment prices due to technological progress.

FIT rate for roof top solar

Classification	Installed cap.	FIT rate [Baht/kWh]	Supported duration year	Target value
Residential	0 - 10kW	6.96	25	100MW
Small commercial	10 – 250kW	6.55	25	100MW
Medium/Large commercial	250 – 1,000kW	6.16	25	

## 2. Renewable power introduction promotion system in Thailand

- ✓ FIT for RE (Excluded Solar power) since 2015
- Renewable technologies other than rooftop solar were switched from Adder program to FIT by ERC(Energy Regulatory Commission)
- FIT rates are categorized by renewable technologies and the supported period are 10 or 20 years.

FIT rate by RE type

Type	FIT rate [Baht/kWh]	Supported duration year
Waste < 1MW	6.34	20
Waste >1-3MW	5.82	20
Waste >3MW	5.08	20
Landfill waste	5.6	10
Biomass < 1MW	5.34	20
Biomass > 1-3MW	4.82	20
Biomass >3MW	4.24	20
Biogas	3.76	20
Biogas(Energy crop)	3.76	20
Hydro < 200kW	4.9	20
Wind	6.06	20

## 2. Renewable power introduction promotion system in Thailand

- ✓ Bidding since 2017
  - Solar and Biomass development are increasing.
  - Wind power is not well developed due to poor wind condition in Thailand.
  - Solar was sluggish due to the introduction of bidding since 2017.
  - Biomass using agricultural byproducts was continue to grow steadily in Thailand, an agricultural country.

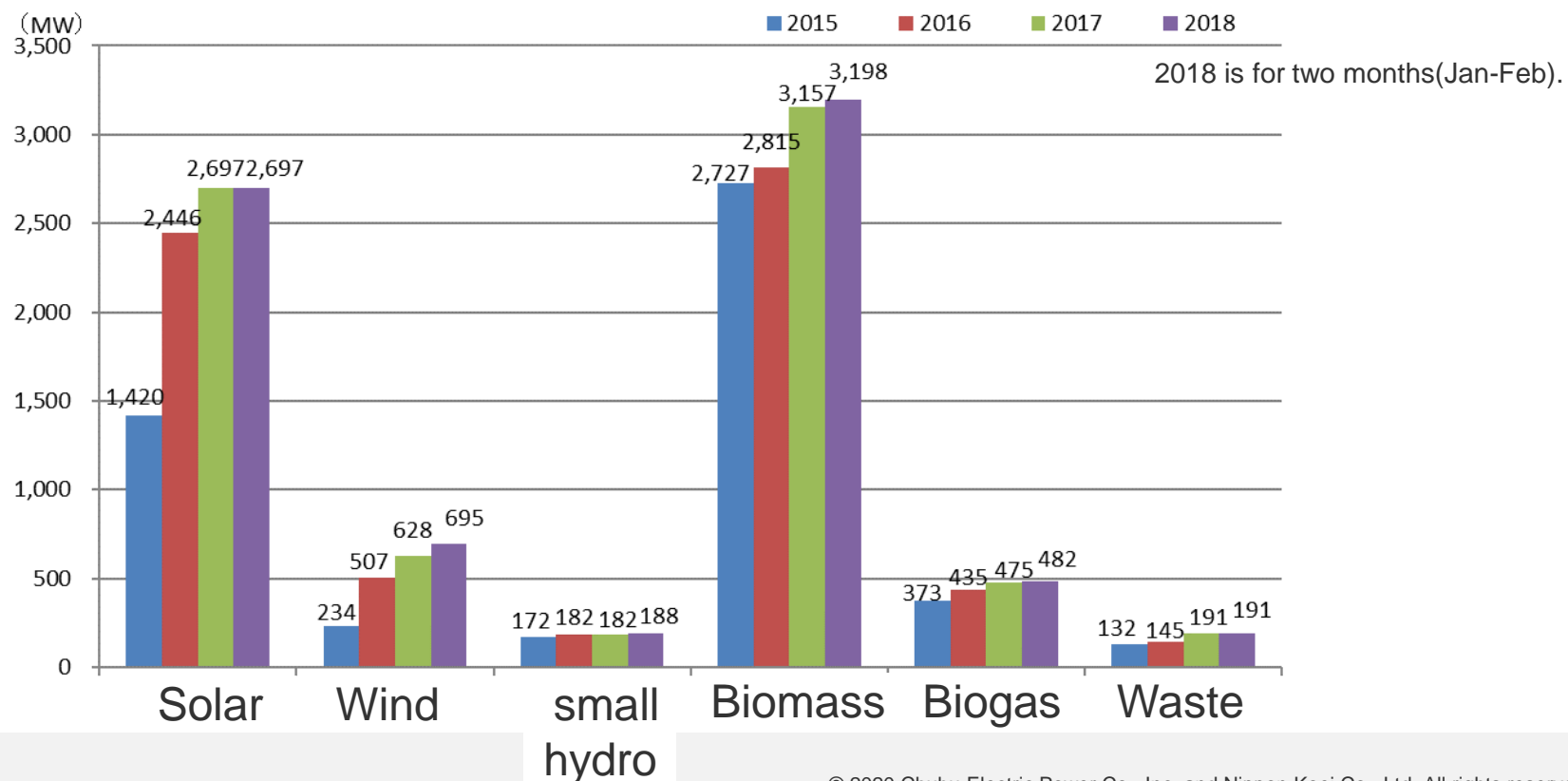



# 03 VRE promotion in Malaysia

---

### 3. Renewable power introduction promotion system in Malaysia

#### Outline of renewable introduction promotion system

FIT was introduced, and then Net metering and Bidding were added

2011

**FIT & REF** (Renewable Energy Fund)

-Solar, Wind, Biomass, Biogas, Small hydro

REF is fund to reduce  
the burden of FIT

2016

**Net metering**

-Rooftop solar

2016

**Bidding**

-Large scale solar  
(over 1MW)

### 3. Renewable power introduction promotion system in Malaysia

- ✓ FIT and REF system since 2011
- REF (Renewable Energy Fund) was established at the same time as FIT to reduce the burden of FIT.

#### How to collect funds for REF

- REF's financial resources are levied from large customers electricity bill.
- 1% of the electricity bill of customers with monthly usage of over 300kWh was allocated to REF.
- Since 2014, it has been raised to 1.6%.

- In order to control the introduction capacity, the quota was set by the type of technology to FIT.

Quota for FIT system [MW]

Year	Solar (Individual)	Solar (Non-individual)	Solar (Community)	Biogas	Biomass	Small hydro	Total
2012	5	45	0	30	60	30	170
2013	11	45	0	30	60	30	166
2014	13	51	5	25	50	45	189
2015	26	54	7	31	18	0	136
2016	15	53	7	25	20	50	170
2017	15	24	7	15	30	100	191

### 3. Renewable power introduction promotion system in Malaysia

- ✓ FIT and REF system since 2011
- FIT rates are categorized by capacity for renewable technologies and the supported period are 16 or 21 years.

#### FIT rate for biogas, biomass, small hydro, geothermal (as of Jan 2020)

Type	Installed cap.	FIT rate [Ringgit/kWh]	Supported duration year
Biogas	≤ 5MW	0.2210 – 0.2814	21
Biomass	≤ 10MW	0.3085	16
	10MW – 20MW	0.2886	16
	20MW – 30MW	0.2687	16
Small hydro	≤ 2MW	0.26	21
	2MW – 10MW	0.25	21
	10MW – 30MW	0.24	21
Geothermal	≤ 30MW	0.45	21

### 3. Renewable power introduction promotion system in Malaysia

- ✓ FIT and REF system since 2011
- In solar FIT, FIT rates are categorized by capacity and individual or non-individual and the supported period is 21 years.
- Bonuses are added to the FIT rate when conditions at introduction time are met for the introduction.

FIT rate and bonus FIT rate for solar (as of Jan 2020)

Type	Installed cap.	FIT rate [Ringgit/kWh]	Supported duration year
Solar	≤ 4kW(Individual)	0.5413	21
	4kW – 12kW(Individual)	0.5280	21
	≤ 4kW(Non-individual)	0.5413	21
	4kW – 24kW(Non-individual)	0.5280	21
	24kW – 72kW(Non-individual)	0.3205	21
	72kW – 1MW(Non-individual)	0.3096	21
Bonus FIT rate	use as installation in buildings or building structures	+0.1017	21
	use as building materials	+0.0542	21
	use of locally manufactured or assembled solar PV modules	+0.05	21
	use of locally manufactured or assembled solar inverters	+0.05	21

### 3. Renewable power introduction promotion system in Malaysia

- ✓ Net metering since 2016
  - Net metering was a system that subtracts the amount of renewable energy generated from the amount of electricity used by customers who have introduced rooftop solar. Solar capacity was limited by customer type.
  - Net metering was introduced, since the introduction of renewable power by FIT system did not reach the target.
  - In comparison with the target (500MW) of net metering, the actual introduction was only 20MW in October 2018.
  - Therefor the Malaysian government revised the rate calculation method at January 2019.

#### Net metering system conditions

Item	Contents
Capacity limit	Domestic or residential :12kWp for single-phase or 72kWp for 3-phase Commercial & industrial :1MWp or 75%of maximum demand (which is lower)
Installation types	On the rooftop of building, garage, car park or similar buildings
Calculation for net billing of electricity	Net billing = [Energy Consumed from DL (kWh) x Gazetted Tariff] – [Energy Exported to DL (kWh) x Displaced Cost]  From 2019 Net billing = [Energy Consumed from DL – Energy Exported to DL (kWh)] x [Gazetted Tariff]

### 3. Renewable power introduction promotion system in Malaysia

- ✓ Bidding system for large-scale solar since 2016
- In addition to the Net metering system, bidding system for large-scale solar, over 1MW, was introduced.  
(FIT system is applied to solar of 1MW or less)
- The bidding was conducted three times, with 451MW closed for the 250MW bid schedule for the first(2017), 562MW closed for the 460MW bid schedule for the second(2018) and a bid schedule of 500MW in 2019.

# 03 VRE promotion in Philippine

---



## 4. Renewable power introduction promotion system in Philippines Outline of renewable introduction promotion system

FIT was introduced, and then Net metering and RPS were added

2012

**FIT**

-Solar, Wind, Biomass, Run river hydro

2013

**Net metering** (up to 100kW)

-Solar, Wind, Biomass

2018

**RPS**(Renewable Portfolio Standards)

-Solar, Wind, Biomass, Run river hydro

## 4. Renewable power introduction promotion system in Philippines

- ✓ FIT system since 2012
- FIT rates are categorized by renewable technologies such as solar, wind, biomass, small hydro and the supported period are 20 years.
- In 2015, since the installed capacity of Solar and Wind power reached the target, the FIT tariff and target capacity had reviewed.

FIT rate by RE type and target/record value

Type of RE		FIT rate[P/kWh]	Introduction target	Introduction record
Solar (over 500kW)	Published in 2012	9.68	50MW	109.38MW
	Published in 2015	8.69	450MW	417.05MW
	Total		500MW	526.43MW
Wind	Published in 2012	8.53	200MW	249.90MW
	Published in 2015	7.40	200MW	177.00MW
	Total		400MW	426.90MW
Biomass	Published in 2012	6.63	250MW	126.38MW
Run of river hydro	Published in 2012	5.90	250MW	45.27MW

## 4. Renewable power introduction promotion system in Philippines

- ✓ Net metering since 2013
  - It is possible to deduct the selling price of renewable power from the electricity price of consumers.
  - Capacity limit of renewable power is up to 100kW.
  - Solar, wind, biomass or such other renewable power system are eligible to participate in the net metering program.
  
- ✓ RPS system since 2018
  - RPS (Renewable Portfolio Standards) requires electricity suppliers, such as distribution utilities and retailers, to procure more than a certain percentage of renewable energy.
  - In addition to the introduction of PRS, REM (Renewable Energy Market) was established and RECs (Renewable Energy Certificate) were issued. And RECs are traded on the REM.
  - The electric power supplier can allocate the purchased REC to the mandatory renewable energy amount determined by RPS.



**CHUBU**  
Electric Power

***NIPPON KOEI***

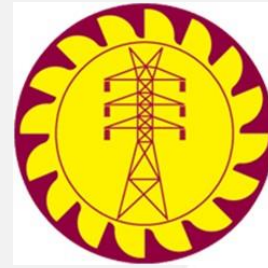
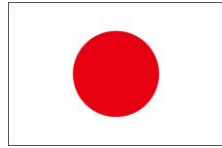
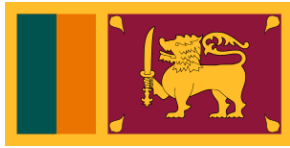

# Tax Benefit for VRE in USA (PTC, ITC) and VRE Business with Tax Equity

July , 2020

Chubu Electric Power Co., Inc.  
Nippon Koei Co., Ltd.

# Tax Benefit for VRE

- There are many direct and indirect support because the energy sector is one of the most important industries that support the economy and security of the United States.
- As a direct support, exemption of some amount of tax is “Tax Credit”
- There are two types of support VRE development: PTC (Production Tax Credit) for power generation and ITC (Investment Tax Credit) for investment.

## Investment Tax Credit

On any Investment



## Production Tax Credit

On any Generation

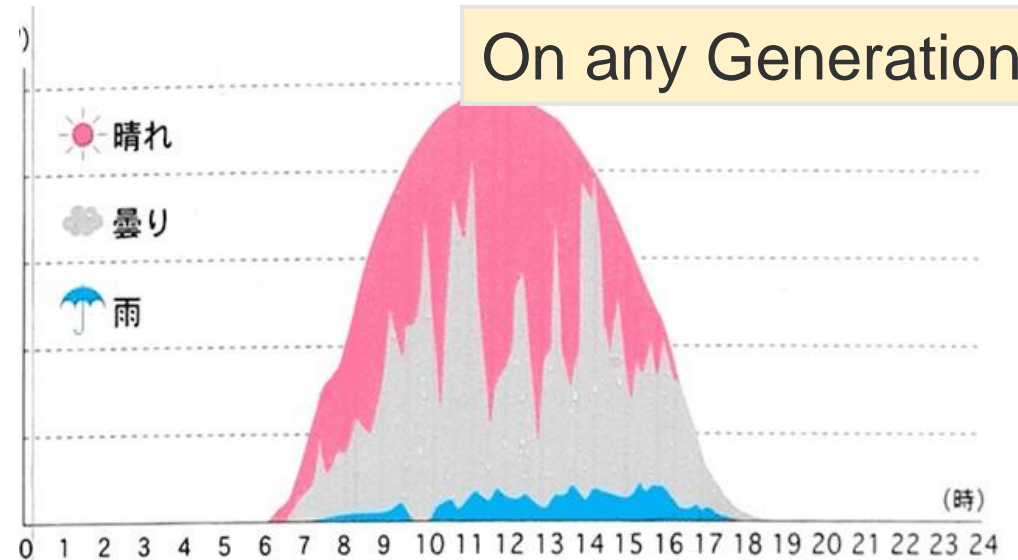

# Difference between Tax Deduction and Tax Credit

- Tax Deduction is the amount that can be deducted from total income when calculating taxable income.  
Tax saving effect: "Deduction amount x "Tax rate"
- Tax Credit is amount that can be directly deducted from the Tax amount.

Since Credit can directly reduce the tax amount, it is **more tax-effective** than Deduction.

	Tax Deduction by \$ 1,000	Tax Credit of \$ 1,000
Income	\$ 10,000	\$ 10,000
Tax Deduction	Δ \$1,000	N.A
Taxable Income	\$ 9,000	\$ 10,000
Tax (Cooperate Tax Rate in USA: 21%)	\$ 1,890	\$ 2,100
Tax Credit	N.A	Δ \$1,000
Tax Amount	\$1,890	\$ 1,100

# PTC (Production Tax Credit)

- Developers and equipment owners can enjoy Tax Credit for 10 years from the year including the date of commercial operation
- Credit is proportional to power generation
- To enjoy it, the following rules should be complied with:
  - ✓ Power generation starts within 4 years after construction starts
  - ✓ Generated electricity sold to third parties that are unrelated to the business owner
  - ✓ Operated by business owner
  - ✓ At least 5% of the project cost invested by business owner.

Date that construction starts	Unit Tax Credit
~ 31 Dec., 2016	¢ 2.3/kWh
~ 31 Dec., 2017	¢ 1.9/kWh
~ 31 Dec., 2018	¢ 1.4/kWh
~ 31 Dec., 2019	¢ 1.0/kWh
~ 31 Dec., 2020	¢ 1.5/kWh



# ITC (Investment Tax Credit)

- A certain percentage of the investment amount is exempted from the tax amount of the year when commercial operation starts.
- This is a single-year tax credit incentive, and it can not exceed the tax amount of the target business owner.
- There is a **problem that it can **Not** be applied for small businesses owners that do not have tax obligation.**
- ITC does not have the limited condition like PTC. Business owners can receive Credit even if ownership is sold to another owner or operation is outsourced to another owner.
- Incentives are gradually shrinking.

Date that construction starts	Rate of Tax Credit		
	Offshore/Onshore WTG	Small WTG ( $\leq 100\text{kW}$ )	PV
~ 31 Dec., 2018	18%	30%	30%
~ 31 Dec., 2019	12%	30%	30%
~ 31 Dec., 2020	N.A	26%	26%
~ 31 Dec., 2021	N.A	22%	22%
~ 31 Dec., 2022	N.A	22%	22%
~ 31 Dec., 2022	N.A	N.A	10%
~ 31 Dec., 2022	N.A	N.A	10%

# Tax Equity Utilization (Effective Usage)

## Business Owner (Developer)

- Many VRE project owners are small-scale venture companies.
- In many cases, tax credit is not an incentive because income is not constant and they are not taxpayers.
- Tax credit rights cannot be transferred to a third party.

## Lender



Financial institutions that are aggressive in financing VRE projects often have large corporate tax obligations. They are qualified to get tax incentives by investing rather than financing. They have incentives because tax obligation is reduced.



A mechanism whereby a financial institution that responds to a project developer's request to **participate as a capital participant and gets tax benefit is called "Tax Equity"**.

# Tax Equity Utilization (Effective Usage)

- While it is relatively easy for VRE developers to raise funds, lenders can also benefit from tax incentives by investing in projects and can get involved in projects they originally plan to finance.
- Even if they don't participate in the business directly (silent investors), they get transparent information of the project as an investor
- A mutually beneficial system for both VRE developers and lenders (financial institutions)

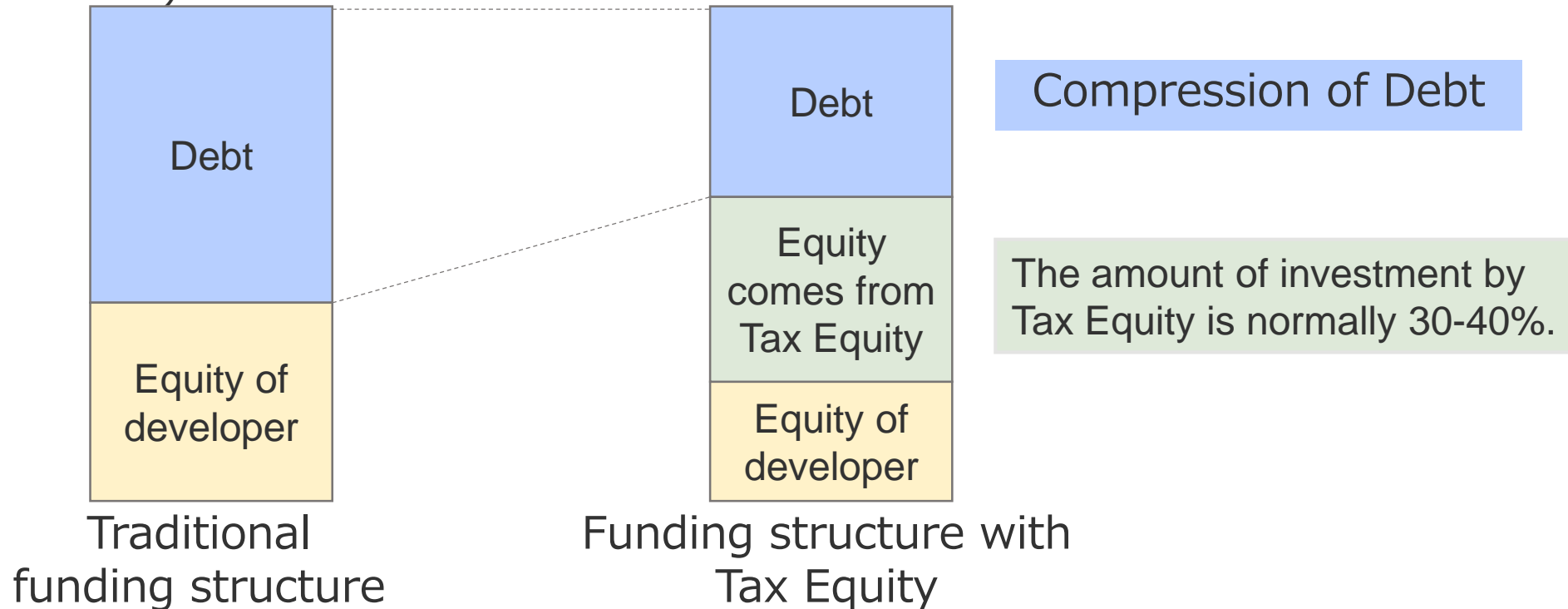

# Debate over Energy Support Measures

- Tax incentives that were mainly for fossil fuels are now mainly for renewable energy
- In 2017, tax benefit for fossil fuel was 26%, which accounted for 78% of total electricity generation, on the contrary, tax benefit for renewable energy was 65%, which accounted for only 13% of total.
- Discussions emerged about applying tax incentives to new power supply technologies in order to promote their widespread use.
  - Legislation to grant Tax Credits for the investments in power storage devices (batteries, pumped water, hydrogen, etc.) and household batteries of 5 kWh or more (April 2019)

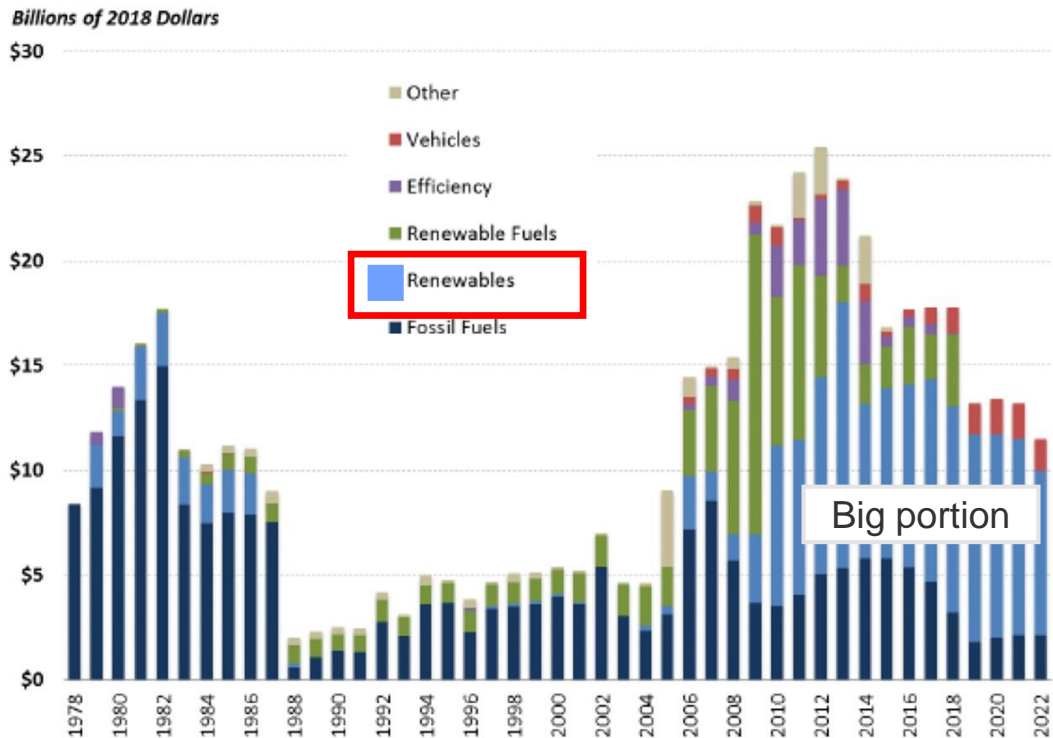

2017: 65%

Ratio allocated to renewable energy increased



**CHUBU**  
Electric Power

***NIPPON KOEI***

# The Report of the Reviewing FIT tariff for Rooftop PV

March 2022

Ceylon Electricity Board (CEB)

## Table of contents

Chapter 1 Background.....	1
1.1 Introduction record of rooftop PV by current FIT system.....	1
1.2 Achievement of renewable energy introduction target set by the government and need for sustainable rooftop PV introduction system.....	1
1.3 Reduction of solar PV introduction unit cost .....	3
1.4 Rooftop PV FIT tariff has not been reviewed since it had set in 2016.....	5
1.5 Necessity of reviewing the FIT system of rooftop PV .....	5
Chapter 2 Objective of the FIT system revision for rooftop PV .....	6
Chapter 3 Target of FIT system review .....	7
3.1 Review of FIT system for rooftop PV .....	7
3.2 Necessity of FIT tariff setting by capacity classification of rooftop PV .....	7
Chapter 4 Examination of proposed FIT tariff .....	9
4.1 Setting FIT tariff review conditions .....	9
4.2 Calculation of generation unit cost for each capacity of rooftop PV and setting of capacity classification to set FIT tariff .....	10
4.3 Setting FIT tariff by capacity classification of rooftop PV .....	10
Chapter 5 Recommendations .....	12
Chapter 6 Conclusion.....	13

## Figures

Figure 1-1	Rooftop PV and other renewable energy installation capacity .....	1
Figure 1-2	Renewable energy introduction plan .....	2
Figure 1-3	Trends in cost of solar PV introduction unit for residential use in India (USD denominated) .....	4
Figure 1-4	Trends in cost of solar PV introduction unit for residential use in India (Sri Lankan rupee denominated).....	4
Figure 3-1	Renewable energy introduction plan shown in draft LTGEP2022-2041 .....	7

## Tables

Table 1-1	Renewable energy introduction plan.....	2
Table 1-2	Residential sector solar PV introduction unit cost by country (2010-2019).....	3
Table 1-3	Comparison of rooftop PV installation unit costs in Sri Lanka.....	5
Table 3-1	Installation unit cost per rooftop PV capacity .....	7
Table 4-1	FIT tariff calculation conditions.....	9
Table 4-2	Capacity classification for generation unit cost and IFT tariff calculation for each capacity of rooftop PV.....	10
Table 4-3	Weighted average introduction unit cost for each capacity category of rooftop PV .....	10
Table 4-4	FIT tariff for each capacity category .....	11
Table 5-1	Price distribution of Japanese residential PV system .....	12



# Chapter 1 Background

## 1.1 Introduction record of rooftop PV by current FIT system

The introduction of rooftop PV was started by the Net Metering system introduced in 2010. As shown in Figure 1-1, the amount of rooftop PV introduced gradually increased due to the introduction of the Net Metering system, and as of 2015, 21.5MW rooftop PV was introduced. In this system, the power generated by rooftop PV is consumed on the customer’s premises. Even if there is surplus power, it is not be purchased.

After that, the power generated by rooftop PV was purchased at FIT tariff by the Net Accounting system and the Net Plus system introduced in 2016. With the introduction of these systems, the introduction of rooftop PV had increased sharply in Figure 1-1. Since 2019, rooftop PV has become the second largest renewable energy source after IPP small-scale hydropower. In the Net Accounting system, the power consumption of customer and the generated power by rooftop PV are measured by one electricity meter. The power consumption and the generated power are offset and the power purchase fee is paid to the customer when there is surplus power. On the other hand, in the Net Plus, the power consumption and the power generated by the rooftop PV are measured by each electricity meter (two in total), and the power purchase fee is paid for the total power generated by the rooftop PV. Both schemes have a 20-year contract with 22.0 LKR/kWh for the first 7 years and 15.5 LKR/kWh for the next 13 years.

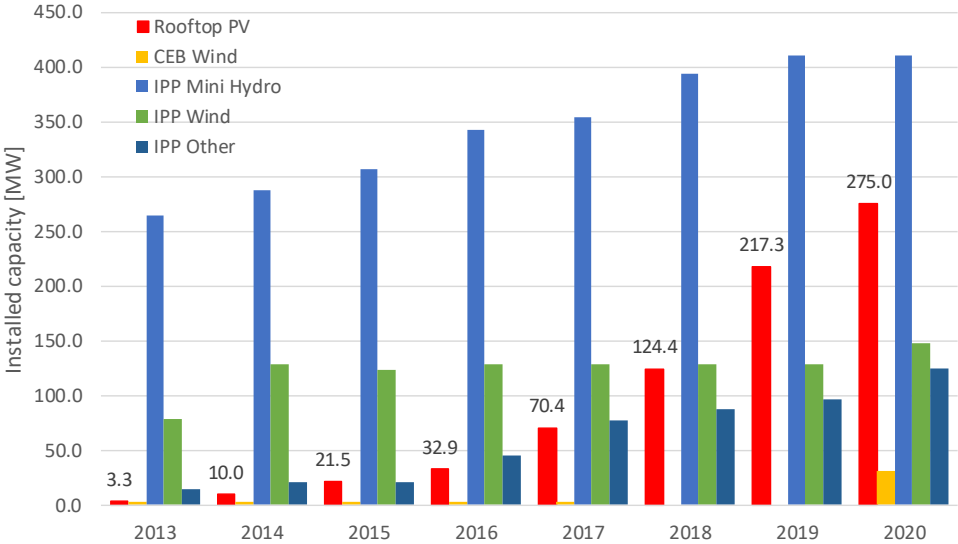

Source: Statistical Digest 2013-2020, CEB

Figure 1-1 Rooftop PV and other renewable energy installation capacity

## 1.2 Achievement of renewable energy introduction target set by the government and need for sustainable rooftop PV introduction system

The Sri Lankan government has announced a goal to cover 70% of Sri Lanka’s electricity demand with renewable energy such as solar and wind power by 2030.

To achieve this goal, SEA has shown that as of 2030, 4,200MW of Solar PV is required, as shown in Figure 1-2 and Table 1-1. This value accounts for 44% of renewable energy. Of the solar PV introduction target, rooftop PV accounts for 1,500MW, 36%, which is an important portion.

In this way, rooftop PV needs to be continuously introduced in order to achieve the renewable energy introduction target set by the Sri Lankan government.

On the other hand, as of 2020, the average cost per unit of 21.2 LKR/kWh (FIT tariff of rooftop PV is 22.0 LKR/kWh (1<sup>st</sup> to 7<sup>th</sup> years)) exceeds the average selling price per unit of 16.72 LKR/kWh, so CEB is in the negative spread. In order to sustainably purchase rooftop PV power generated by FIT system and achieve the government’s renewable energy introduction target, the CEB’s financial condition needs to be sound. Therefore, in addition to drastically improving the CEB operating balance by reviewing electricity tariff to reflect costs, government subsidies and capital increases for the development of transmission and distribution facilities will be provided, and the FIT system will be reviewed to make it more appropriate purchase price.

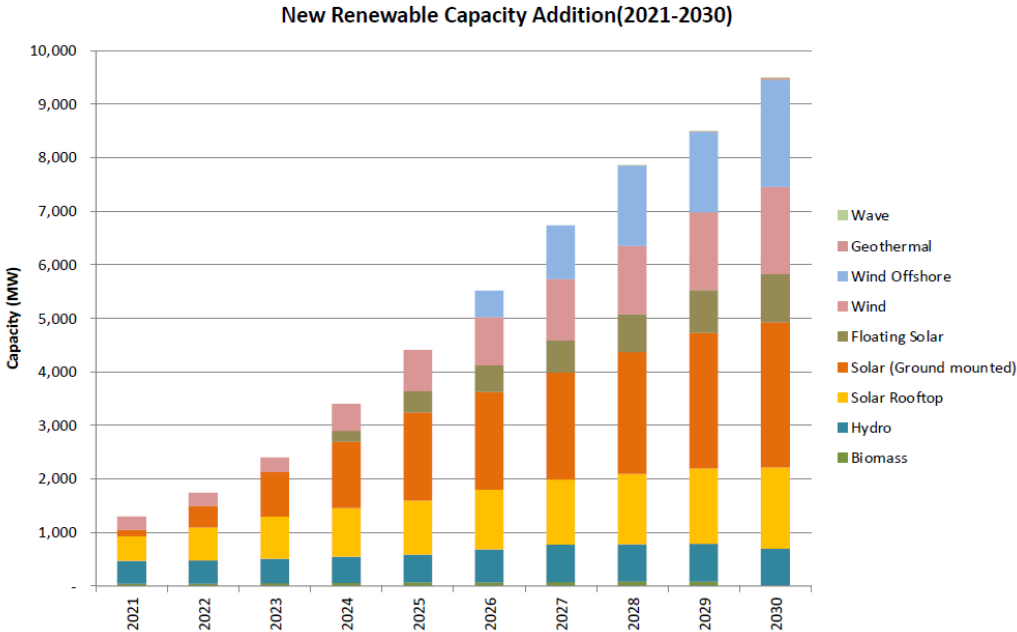

Source: SEA presentation material

Figure 1-2 Renewable energy introduction plan

Table 1-1 Renewable energy introduction plan

	2021	2022	2023	2024	2025	2026	2027	2028	2029	2030
Biomass	44	44	54	60	65	70	75	80	85	90
Mini Hydro	427	440	455	485	520	617	700	700	700	700
Solar Rooftop	463	613	788	913	1,013	1,113	1,213	1,313	1,413	1,513
Solar (Ground mounted)	118	395	838	1,238	1,643	1,823	1,998	2,278	2,528	2,713
Floating Solar				200	400	500	600	700	800	900
Wind	249	249	269	504	769	899	1,149	1,279	1,454	1,629
Wind Offshore						500	1,000	1,500	1,500	2,000
Geothermal									10	30
Wave								5	5	10
Battery Storage MWh (4hrs)		100	300	500	700	900	1,100	1,400	1,600	2,000
<b>Total Capacity (MW)</b>	<b>1,300</b>	<b>1,740</b>	<b>2,403</b>	<b>3,399</b>	<b>4,409</b>	<b>5,521</b>	<b>6,735</b>	<b>7,855</b>	<b>8,495</b>	<b>9,585</b>

Identified resources will be swapped with other to obtain planned capacity as per the requirement

Source: SEA presentation material

### 1.3 Reduction of solar PV introduction unit cost

#### (1) Lower global solar PV installation cost

Table 1-2 shows trends in unit costs for introducing rooftop PV for residential use in each country. In Germany, the total unit cost of the solar PV system installed in 2010 was 4,277 USD/kW, but it dropped to 1,646 USD/kW in 2019. This shows that the introduction unit cost has decreased by about 62% in the 9 years from 2010. In India, a neighboring country of Sri Lanka, the total unit cost of the installed solar PV system was 2,374 USD/kW in 2013, but it dropped to 840 USD/kW in 2019. This shows that the introduction unit cost has decreased by about 65% in the 6 years from 2013. According to the downward trend of the introduction unit cost in India, the average decrease rate for 6 years in USD is 15.9%/year as shown in Figure 1-3, and the average decrease for 6 years in Sri Lankan rupee is 11.2%/year as shown in Figure 1-4.

Table 1-2 Residential sector solar PV introduction unit cost by country (2010-2019)

Sector	Market	2010	2011	2012	2013	2014	2015	2016	2017	2018	2019
		2019 USD/kW									
Residential	Australia	7 715	6 126	4 301	3 670	3 424	2 198	1 988	1 738	1 557	1 380
	Brazil				3 947	3 657	3 458	2 664	2 126	1 604	1 350
	China			2 823	2 432	2 330	1 672	1 591	1 436	1 079	840
	France		9 797	6 950	5 773	4 231	2 359	2 174	1 967	1 771	1 600
	Germany	4 277	3 634	2 712	2 414	2 229	1 750	1 704	1 645	1 746	1 646
	India				2 374	2 276	1 501	1 326	1 093	916	840
	Italy	6 949	6 106	4 031	3 660	2 438	1 983	1 803	1 676	1 527	1 460
	Japan	7 314	7 228	6 237	4 601	3 771	3 313	2 927	2 685	2 361	2 250
	Malaysia				2 871	2 861	2 423	2 227	1 792	1 466	1 191
	Republic of Korea				3 036	3 056	2 166	2 079	1 707	1 527	1 440
	South Africa				4 140	3 684	3 109	2 916	2 602	2 231	1 843
	Spain				2 871	2 438	1 758	1 633	1 509	1 445	1 410
	Switzerland				3 864	3 440	3 216	3 022	2 716	2 421	2 173
	Thailand				4 019	3 121	2 798	2 726	2 362	1 944	1 388
	United Kingdom				3 300	3 475	3 007	2 668	2 692	2 597	2 566
	California (US)	7 756	7 325	6 323	5 475	5 155	5 231	5 053	4 529	4 294	4 096
	Other US states	7 705	7 049	5 697	4 921	4 954	4 925	4 280	3 844	3 702	3 652

Source: Renewable Power Generation Costs in 2019, IRENA

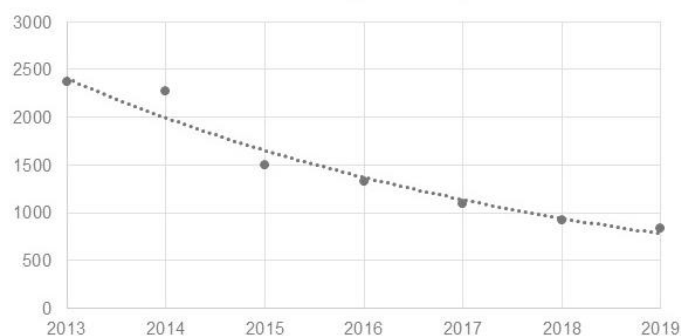

Source: Renewable Power Generation Costs in 2019, IRENA

Figure 1-3 Trends in cost of solar PV introduction unit for residential use in India (USD denominated)

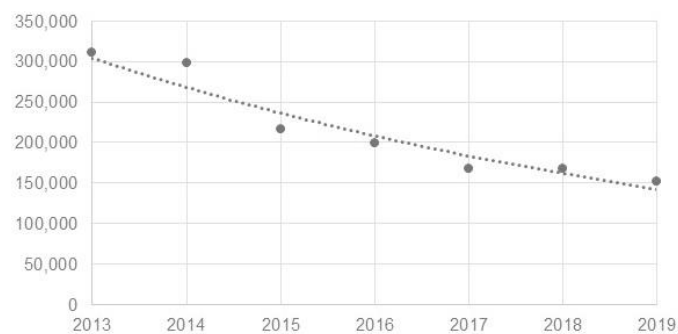

Source: Renewable Power Generation Costs in 2019, IRENA

Figure 1-4 Trends in cost of solar PV introduction unit for residential use in India (Sri Lankan rupee)

denominated)

(2) Large-scale rooftop PV introduction unit cost reduction

Due to the large scale of the large-capacity solar PV generation market, installation unit cost is generally lower than for smaller residential systems. Table 1-3 shows the introduction unit cost of under 5kW for general housing in Sri Lanka and the introduction unit cost of 1MW class rooftop PV installed in factories. The introduction unit cost of 1MW class rooftop PV is about half of the introduction unit cost of rooftop PV of under 5kW. The current FIT tariff for rooftop PV is the same regardless of installed capacity, so large rooftop PV business operators may be making excessive profits.

Table 1-3 Comparison of rooftop PV installation unit costs in Sri Lanka

Rooftop PV capacity	Average installation unit cost in 2020 (LKR/kW)
Less than 5kW	180,000*1
1MW	85,000*2

Source: KHM Solar(\*1) and Financial status and a four-year road map for financial recovery, Jan. 2021, CEB(\*2)

**1.4 Rooftop PV FIT tariff has not been reviewed since it had set in 2016**

As shown in 1.3, the introduction unit cost of rooftop PV has decreased, and the unit cost of large-scale rooftop PV has been significantly reduced. However, the FIT tariff for rooftop PV has not yet been reviewed.

**1.5 Necessity of reviewing the FIT system of rooftop PV**

The introduction of the rooftop PV was promoted by the introduction of the Net Metering system in 2010 and the FIT system in the Net Accounting / Net Plus system in 2016.

On the other hand, in order to realize the government’s plan to introduce 70% of renewable energy in 2030, continuous introduction of rooftop PV is necessary. It is necessary to review the FIT system so that it will be a sustainable rooftop PV introduction system, reflecting changes in the business environment such as the global reduction in solar PV introduction unit cost.

## **Chapter 2 Objective of the FIT system revision for rooftop PV**

Review the FIT system for rooftop PV, considering that the unit cost of introducing rooftop PV is declining worldwide. Examination will proceed in consideration of the following three points.

- ✓ Securing appropriate profits for rooftop PV business owners
- ✓ Reduction of CEB's financial burden
- ✓ Promote the continuous introduction of rooftop PV and contribute to the achievement of the renewable energy introduction target set by the government

### Chapter 3 Target of FIT system review

In this examination, rooftop PV is targeted for FIT review, and the FIT tariff is set according to the capacity classification of rooftop PV.

#### 3.1 Review of FIT system for rooftop PV

In draft LTGEP 2022-2041, CEB set the introduction target of solar PV to 1,829MW in 2025 and 2,684MW in 2030 shown in Figure 3-1. Rooftop PV has been introduced 275MW as of 2020, and goal is to introduce 945MW in 2030. This target value accounts for 16% of all renewable energy and 35% of solar PV. In this way, the sustainable introduction of rooftop PV is important for achieving the government’s goals.

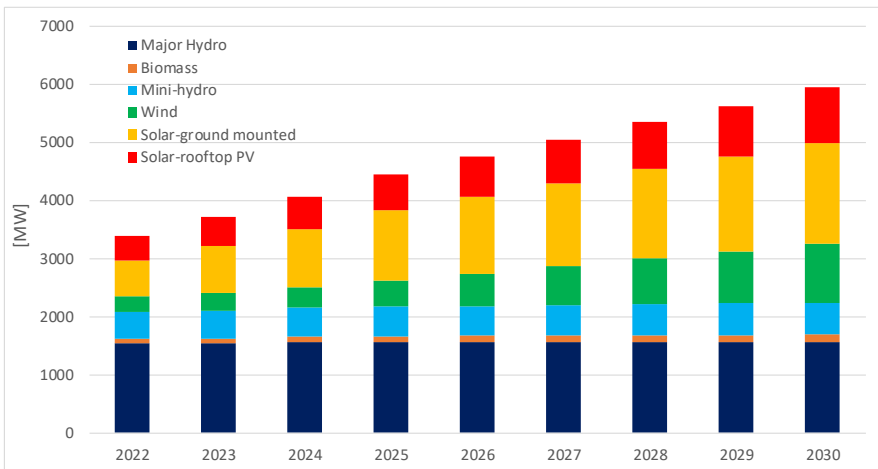

Source: LTGEP2022-2041 (Draft), CEB

Figure 3-1 Renewable energy introduction plan shown in draft LTGEP2022-2041

#### 3.2 Necessity of FIT tariff setting by capacity classification of rooftop PV

Table 3-1 shows the introduction unit cost of rooftop PV in Sri Lanka as of 2020 by capacity. As shown in Table 3-1, 0-5kW is 180,000 LKR/kW, while over 1MW is 85,000 MW/kW, and there is a big difference in the introduction unit cost depending on the installed capacity.

For this reason, FIT system for rooftop PV needs to set an appropriate tariff according to the capacity classification of rooftop PV, not the unified FIT tariff.

Table 3-1 Installation unit cost per rooftop PV capacity

Capacity classification for examination	Average installation unit cost
0-5kW	180,000 LKR/kW*1
5-10kW	170,000 LKR/kW*1
10-20kW	125,000 LKR/kW*2
20-40kW	
40-60kW	120,000 LKR/kW*2

60-100kW	
100kW-1MW	90,000 LKR/kW*2
More than 1MW	85,000 LKR/kW*2

Source: KHM Solar(\*1) and Financial status and a four-year road map for financial recovery, Jan. 2021, CEB(\*2)



## Chapter 4 Examination of proposed FIT tariff

### 4.1 Setting FIT tariff review conditions

The proposed FIT tariff is determined by calculating generation unit cost of rooftop PV that can secure a predetermined Equity IRR and calculating the FIT tariff for each capacity classification.

Table 4-1 shows the calculation conditions used for generation unit cost calculation.

Table 4-1 FIT tariff calculation conditions

Item	Value	Remarks	
Unit cost for installation	PV capacity	Installation cost	*1 KHM Solar *2 Financial status and a four-year road map for financial recovery, Jan. 2021, CEB
	0-5kW	180,000 LKR/kW* <sup>1</sup>	
	5-10kW	170,000 LKR/kW* <sup>1</sup>	
	10-20kW	125,000 LKR/kW* <sup>2</sup>	
	20-40kW	125,000 LKR/kW* <sup>2</sup>	
	40-60kW	120,000 LKR/kW* <sup>2</sup>	
	60-100kW	120,000 LKR/kW* <sup>2</sup>	
	100kW-1MW	90,000 LKR/kW* <sup>2</sup>	
	Over 1MW	85,000 LKR/kW* <sup>2</sup>	
Operation period	20 years	FIT program period	
Cost of Debt (Interest rate)	10.18% for 1 <sup>st</sup> year to 7 <sup>th</sup> year (7.18% on Oct. 29, 2021 * <sup>3</sup> +3%)	Average Weighted Prime Lending Rate (AWPLR)+3% margin *3 Data Library – Central bank of Sri Lanka <a href="https://www.cbsl.lk/eResearch/Modules/RD/SearchPages/CMB_LendingAndDeposit.aspx">https://www.cbsl.lk/eResearch/Modules/RD/SearchPages/CMB_LendingAndDeposit.aspx</a>	
Debt repayment period	10 years	Repayment period set by commercial bank for FIT user	
Equity return to be expected	13.05 % (10.05% on Sep. 15, 2021 * <sup>4</sup> +3%)	Latest Ten Year Bond rate +3% margin *4 Data Library – Central bank of Sri Lanka <a href="https://www.cbsl.lk/eResearch/Modules/RD/SearchPages/Indicators_GovernmentSecurities.aspx">https://www.cbsl.lk/eResearch/Modules/RD/SearchPages/Indicators_GovernmentSecurities.aspx</a>	
Debt / Equity ratio	Debt 70 / Equity 30	Based on the CEB's actual operation	
O&M cost per year	Depend on capacity (Including inverter replacement)	0.9% of unit cost for installation, escalated 4.2%, the five year average inflation rate from 2016 to 2020, 2.9%(2016 Jan.), 4.6%(2017 Jan.), 7.6%(2018 Jan.), 1.8%(2019 Jan.), 4.1%(2020 Jan.), NCPI (National Consumer Price Index). <a href="http://www.statistics.gov.lk/InflationAndPrices/StatisticalInformation/MonthlyNCPI/Inflation-FoodAndNonFoodGroups">http://www.statistics.gov.lk/InflationAndPrices/StatisticalInformation/MonthlyNCPI/Inflation-FoodAndNonFoodGroups</a> Based on the CEB's actual operation	
Capacity factor	17.0 %	Based on the CEB's actual operation	
Deterioration rate per year	0.7 %/year	Based on the CEB's actual operation	
Grid availability	99 %	Based on the CEB's actual operation	

#### 4.2 Calculation of generation unit cost for each capacity of rooftop PV and setting of capacity classification to set FIT tariff

The generation unit cost for each capacity of rooftop PV that secured the predetermined Equity IRR (13.05%) shown in Table 4-1 is calculated using the above-mentioned calculation conditions. The calculation results are shown in Table 4-2.

The generation unit cost is calculated assuming that it is basically constant for 20 years. Since the generation unit cost of 0-10kW exceeded the current FIT tariff (15.5 LKR/kWh, after 8 years), the generation unit cost after 8 years is set to 15.5 LKR/kWh, which is the same as the current FIT tariff, and the generation unit cost for the 1<sup>st</sup> to 7<sup>th</sup> years is calculated.

Comparing the calculated generation unit costs for each capacity, it is less than 20LKR/kWh at 0-10kW, about 12LKR/kWh at 10-100kW, and under 10LKR/kWh at over 100kW. From this, it was found that there are difference in the generation unit cost between 10kW and 100kW in the installed capacity, so using these as threshold values, the FIT tariff should be set by dividing into the three categories (Category 1 to 3) shown in Table 4-2.

Table 4-2 Capacity classification for generation unit cost and FIT tariff calculation for each capacity of rooftop PV

Capacity category		Category 1		Category 2			Category 3		
Rooftop PV capacity		0-5kW	5-10kW	10-20kW	20-40kW	40-60kW	60-100kW	100kW-1MW	Over 1MW
Installation unit cost [LKR/kW]		180,000	170,000	125,000	125,000	120,000	120,000	90,000	85,000
Generation unit cost [LKR/kWh]	1st-7th year	19.73	18.16	12.66	12.66	12.16	12.16	9.12	8.61
	8th-20th year	15.50	15.50	12.66	12.66	12.16	12.16	9.12	8.61
Project IRR		11.55%	11.59%	11.67%	11.67%	11.68%	11.68%	11.68%	11.67%
Equity IRR for customer		13.05%	13.05%	13.05%	13.05%	13.07%	13.07%	13.07%	13.05%

#### 4.3 Setting FIT tariff by capacity classification of rooftop PV

##### (1) Calculation of introduction unit cost for each capacity category

To set the FIT tariff of rooftop PV in each capacity category, the introduction unit costs of each capacity category are calculated by the weighted average of the introduction unit cost of each capacity and the introduction record (introduction amount, MW). Table 4-3 shows the introduction unit cost for each capacity of rooftop PV, the introduction amount as of June 2021, and the weighted average introduction unit cost for each capacity category.

Table 4-3 Weighted average introduction unit cost for each capacity category of rooftop PV

Category	PV capacity	Installation unit cost	Accumulating installation capacity (as of June 2021)*3	Weighted average installation cost
1	0-5kW	180,000 LKR/kW*1	65.11 MW	176,246 LKR/kW →177,000 LKR/kW
	5-10kW	170,000 LKR/kW*1	39.13 MW	
2	10-20kW	125,000 LKR/kW*2	59.84 MW	123,746 LKR/kW →124,000 LKR/kW
	20-40kW	125,000 LKR/kW*2	47.67 MW	
	40-60kW	120,000 LKR/kW*2	17.43 MW	

	60-100kW	120,000 LKR/kW*2	18.50 MW	
3	100kW-1MW	90,000 LKR/kW*2	18.83 MW	86,871 LKR/kW
	Over 1MW	85,000 LKR/kW*2	31.50MW	→87,000 LKR/kW

Source: \*1 KHM Solar, \*2 Financial status and a four-year road map for financial recovery, Jan. 2021,CEB, \*3 CEB

## (2) Setting FIT tariff for each capacity category of rooftop PV

As shown in Table 4-4, Category 1 is 19.26LKR/kWh, Category 2 is 12.56LKR/kWh and Category 3 is 8.82LKR/kWh. It has been shown that the current FIT tariff can be reduced from 22.0LKR/kWh (1-7 years) and 15.5LKR/kWh (8-20 years).

On the other hand, the average generation unit cost considering all generation methods of hydropower, gas-fired power, oil-fired power, coal-fired power, IPP-fired power and renewable energy, which was calculated in December 2020, was 13.53LKR.kWh. For category 2 and 3, which are below the average generation unit cost, the following FIT tariffs are proposed in order to secure the profitability of the business operator and promote the introduction of rooftop PV by the FIT system.

Category 1: 19.29LKR/kWh(1-7 years), 15.5LKR/kWh(8-20 years)

Category 2: 14.21LKR/kWh(1-20 years, 5% increase in average generation unit cost 13.53 LKR/kWh)

Category 3: 13.53LKR/kWh(1-20 years, Average generation unit cost 13.53LKR/kWh)

Table 4-4 FIT tariff for each capacity category

Item		Examination result			Current tariff level
Rooftop PV capacity		Category 1: Under 10kW	Category 2: 10-100kW	Category 3: Over 100kW	-
Installation unit cost [LKR/kW]		177,000	124,000	87,000	-
New FIT tariff	1st-7th year	<b>19.26 LKR/kWh</b> *1	12.56LKR/kWh*1 → <b>14.21LKR/kWh</b> *2	8.82 LKR/kWh*1 → <b>13.53 LKR/kWh</b> *3	22.00 LKR/kWh
	8th-20th year	<b>15.50 LKR/kWh</b> *1	12.56LKR/kWh*1 → <b>14.21LKR/kWh</b> *2	8.82 LKR/kWh*1 → <b>13.53 LKR/kWh</b> *3	15.50 LKR/kWh

\*1: Calculated FIT tariff using above installation cost

\*2: 5% increase in average generation cost (13.53LKR/kWh@2020 ×1.05)

\*3: Average generation cost (13.53LKR/kWh@2020)

## Chapter 5 Recommendations

### (1) Annual FIT tariff review

The calculation conditions such as the introduction unit cost, loan conditions and expected rate of return used to calculate the FIT tariff proposed this time change year by year. Therefore, in consideration of efficiency of revision procedure, it is desirable to construct a scheme that automatically reviews every year by updating the calculation conditions used for FIT tariff examination from the past records.

Here, we will introduce an example of Japan that automatically calculates the future installation unit cost. In Japan, the introduction unit cost is calculated from the introduction unit cost distribution two years before the calculation target year. As shown in Table 5-1, the 50% value of the introduced unit cost distribution in 2020 corresponds to the 36-37% value in 2018. Therefore, the introduction unit cost for 2022 will be automatically set at 259,000 yen, which is the 37% value for 2020.

As shown in the case of Japan, it may be easier to automatically and regularly review the FIT tariff in Sri Lanka by collecting statistics on past installation unit cost and using that information.

Table 5-1 Price distribution of Japanese residential PV system

%	PV system cost for household[Japanese Yen/kW]		
	Installed in 2020	Installed in 2019	Installed in 2018
5%	162,500	182,500	202,500
10%	175,800	202,900	233,300
15%	191,900	217,800	249,000
20%	210,400	228,500	257,300
25%	225,200	237,500	272,500
30%	238,700	247,900	288,100
35%	251,900	260,900	298,000
36%	255,000	263,300	300,500
37%	258,700	266,200	303,400
38%	261,700	269,100	305,600
39%	265,100	272,300	308,300
40%	268,600	275,400	311,100
45%	284,900	288,800	323,500
50%	300,800	303,100	335,200

Source: Natural Resource and Energy

## **Chapter 6 Conclusion**

The generation unit cost of rooftop PV is calculated based on the latest financial conditions such as the introduction cost and loan conditions as of 2020. Based on the results, the capacity categories were divided into three categories, and the FIT tariff for each category was examined in consideration of the average generation unit cost and appropriate profit.

The recommended FIT tariffs for rooftop PV for each capacity category are as follows.

Category 1 (0-10kW):	19.29LKR/kWh(1-7 years), 15.5LKR/kWh(8-20 years)
Category 2 (10-100kW):	14.21LKR/kWh(1-20 years)
Category 3(over 100kW):	13.53LKR/kWh(1-20 years)

### **Attachment**

FIT tariff calculation sheet

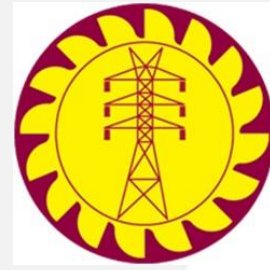

# FIT Scheme for PV in Japan Detailed information & Discussion Paper for FIT New Scheme in Sri Lanka

JICA Expert Team

December, 2020

Chubu Electric Power Co., Inc.  
Nippon Koei Co., Ltd.

# 01 Detailed FIT Scheme info. for PV in Japan

---

# PV Classification by Capacity

PV system is classified by capacity because Electricity Business Act, installation conditions and related regulations differ.

Capacity	Notes
<10kW	<ul style="list-style-type: none"> <li>➤ Classified as “Household ”</li> </ul>
=>10kW, <50kW	<ul style="list-style-type: none"> <li>➤ Classified as “Business” for 10kW and more in capacity</li> <li>➤ This category is the majority of “Business”</li> <li>➤ Notification regarding safety regulations is not required</li> <li>➤ Under the Electricity Business Act, this is considered as small power generation facility and classified as "general electrical facility".</li> <li>➤ Construction work must be carried out by The First-Class or Second-Class Electric Works Specialists in accordance with the Electrical Construction Law</li> </ul>
=>50kW	<ul style="list-style-type: none"> <li>➤ Classified as high voltage system interconnection. Under the Electricity Business Act, it is classified as power plant and "electric facilities for private use"</li> <li>➤ Construction work must be carried out by The First-Class Electric Works Specialists in accordance with the Electrical Construction Law</li> <li>➤ There are three obligations:               <ul style="list-style-type: none"> <li>● To maintain the electric facilities to conform to technical standards</li> <li>● To notify METI of “Safety regulations”</li> <li>● To assign and notify of chief electrical engineer</li> </ul> </li> </ul>

There is a difference in maintenance and management costs  
 (Q) How about is the condition in Sri Lanka?



# PV FIT Purchase Price 1/4

The procurement price and term are set for each power source in consideration of appropriate profits based on the costs normally required if the business is carried out efficiently. Specifically, the Minister of METI make a decision, respecting the opinions of the Neutral Calculation Committee for Procurement Price.

	=>250kW	=>50kW, <250kW	=>10kW, <50kW	<10kW	
				No obligation to install output control equipment	Obligation to install output control equipment
2020	Tender	¥12/kWh	¥13/kWh	¥21/kWh	
Term	20 years			10 years	

	=>500kW	=>250kW, <500kW	=>50kW, <250kW	=>10kW, <50kW	<10kW	
					No obligation to install output control equipment	Obligation to install output control equipment
2019	Tender	¥14/kWh	¥14/kWh	¥14/kWh	¥24/kWh	¥26/kWh
Term	20 years				10 years	

Bidding range has been expanding and FIT purchase price has been declining

# PV FIT Purchase Price 2/4

	=>2000kW	=>10kW, <2000kW	<10kW			
			PV only		PV + electricity self-generation	
			No obligation to install output control equipment	Obligation to install output control equipment	No obligation to install output control equipment	Obligation to install output control equipment
2018	Tender	¥18/kWh	¥26/kWh	¥28/kWh	¥25/kWh	¥27/kWh
Term	20 years		10 years			

	=>2000kW	=>10kW, <2000kW	<10kW			
			PV only		PV + electricity self-generation	
			No obligation to install output control equipment	Obligation to install output control equipment	No obligation to install output control equipment	Obligation to install output control equipment
2017	Tender	¥21/kWh	¥28/kWh	¥30/kWh	¥25/kWh	¥27/kWh
Term	20 years		10 years			

Bidding system started. And FIT purchase price declined gradually

# PV FIT Purchase Price 3/4

	=>10kW		<10kW			
			PV only		PV + electricity self-generation	
			No obligation to install output control equipment	Obligation to install output control equipment	No obligation to install output control equipment	Obligation to install output control equipment
2016	¥24/kWh		¥31/kWh	¥33/kWh	¥25/kWh	¥27/kWh
Term	20 years		10 years			

	=>10kW		<10kW			
			PV only		PV + electricity self-generation	
			No obligation to install output control equipment	Obligation to install output control equipment	No obligation to install output control equipment	Obligation to install output control equipment
	Apr.1 to June 30	July 1 ~				
2015	¥29/kWh	¥27/kWh	¥33/kWh	¥35/kWh	¥27/kWh	¥29/kWh
Term	20 years		10 years			

FIT purchase price declined further

# PV FIT Purchase Price 4/4

	=>10kW	<10kW	
		PV only	PV + electricity self-generation
2014	¥32/kWh	¥37/kWh	¥30/kWh
Term	20 years	10 years	

	=>10kW	<10kW	
		PV only	PV + electricity self-generation
2013	¥36/kWh	¥38/kWh	¥31/kWh
Term	20 years	10 years	

	=>10kW	<10kW	
		PV only	PV + electricity self-generation
2012	¥40/kWh	¥42/kWh	¥34/kWh
Term	20 years	10 years	

FIT purchase price declined further

# FIT Approval Procedure for less than 50kW

There are many tasks and procedures involved in business plan approval from the government, including the grid connection contract with electric power company.

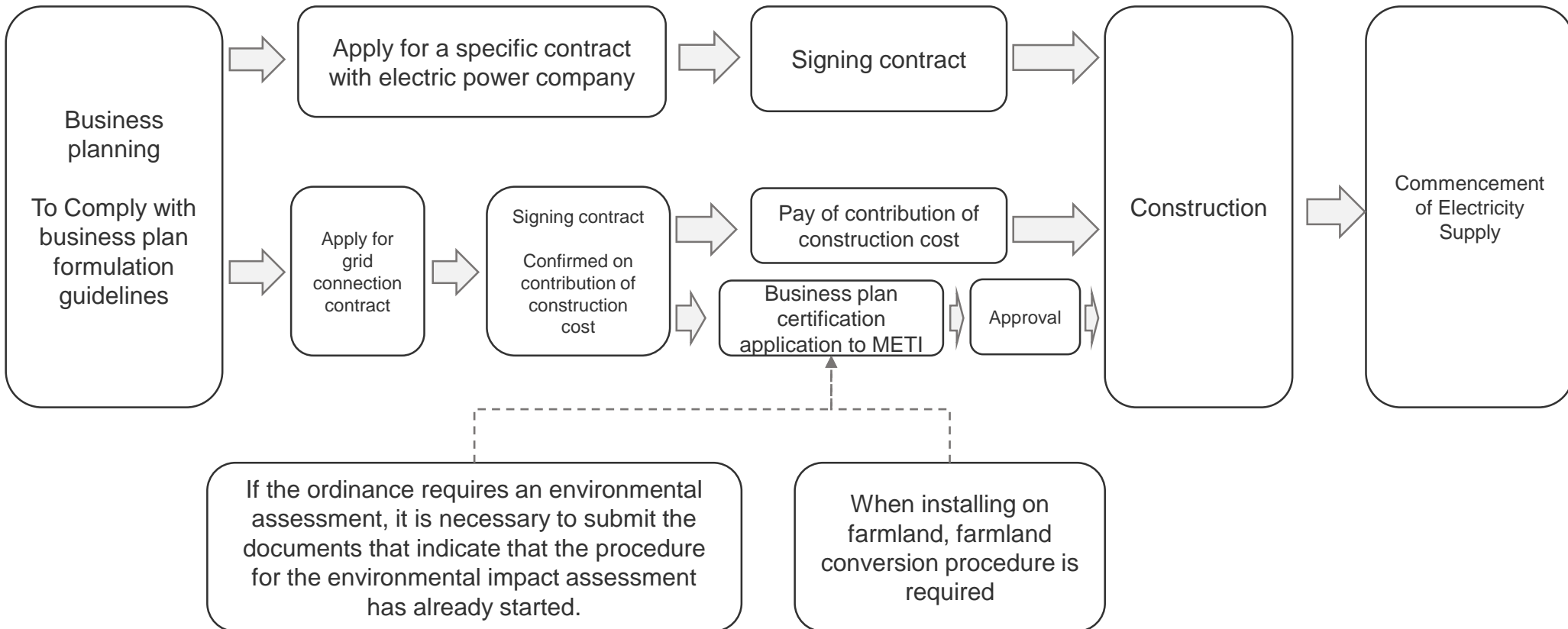

# FIT Approval Procedure for 50kW and more

There are many restrictions and the procedure is more complicated compared to case of less than 50kW

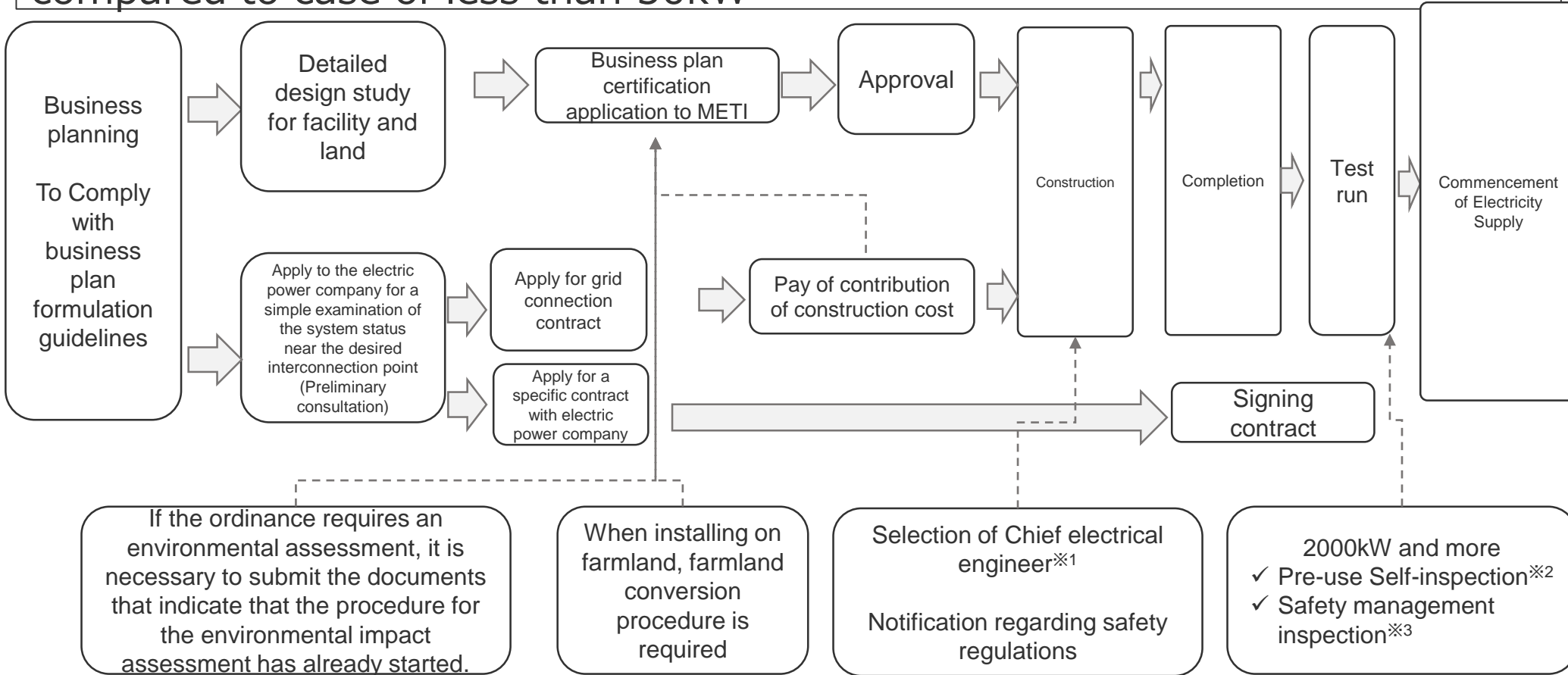

※1: Security supervisor for construction, maintenance, operation, etc. related to electric facility

※2: Business operator voluntarily confirms the electric facilities for business use that have been submitted of the construction plan notification.

※3: Conducted by a METI-approved inspection body within one month after the completion of Pre-use Self-inspection

# Condition of FIT Approval

To obtain certification, generation plan must meet all of the following criteria:

Items	Note
Land Acquisition	Being recognized as having ownership or the right to use or being able to obtain them for sure
No dividing project into small ones	Do not install multiple VRE power generation projects in the same place (Supplementary explanation) To avoid problems such as avoiding safety regulations by changing high-voltage equipment with low-voltage equipment and increasing management cost of electric power companies.
Facility fixed	Power generation facility has been decided
Consent acquisition on grid connection	Consent to connect to the electric line of the electric power company
Operation and Maintenance	To establish the necessary implementation organization for proper O&M
Disposal of equipment	Appropriate plan for handling generation facilities when finishing power generation
Compliance with relevant laws and regulations	To comply with the provisions of relevant laws and regulations (including ordinances)

If you violate these compliance items stipulated in the certification conditions, it will be considered as non-conformity with the certification criteria, and measures such as guidance/advice, improvement orders, and cancellation of certification will be taken.

(Q) What are the certification requirements in Sri Lanka?  
 By making it stricter, it is possible to carefully select businesses owners.

# Condition of FIT Approval

To obtain certification, generation plan must meet all of the following criteria:

**(Q) What are the certification requirements in Sri Lanka?**

By making it stricter, it is possible to carefully select businesses owners.

(Ans.)

For ground mounted Solar PV systems, the following documents are mandatory to connect the Power plant to the grid;

- Sri Lanka Sustainable Energy Authority (SLSEA) Energy Permit
- Generation License of PUCSL



# 02 FIT scheme improvement measures in Sri Lanka

---

# Comparison of Options

Comprehensively and quantitatively evaluate all alternatives.  
After evaluation, find the best one.

	①Reviewing FIT tariff	②FIT Applied Range Review	③Unifying to Net Metering	④Separately FIT Tariff Collection from Electricity Tariff
CEB Financial state				
Promotion of VRE installation				
Realization				
Others				
Comprehensive judgement				

# ① Reviewing FIT tariff

## FIT Tariff Option in Sri Lanka (Other than PV)

- The VRE based electricity purchase tariffs (Tariffs) will be calculated based on projected cash flow of a generic 1 MW plant over 20 years, including the Return on Equity (ROE) for 15 years
- There will be two options; (1) three tier tariff and (2) flat tariff

### Three tier tariff

	Period	Notes
Tier 1	first 8 years	Cash outflow will include, loan repayment for 6 years, annual O&M cost, Return on Equity and Fuel cost
Tier 2	next 7 years	Cash outflow will include, annual O&M cost, Return on Equity and Fuel cost
Tier 3	next 5 years	Cash outflow will include, annual O&M cost, Fuel cost and an Incentive Payment

Escalations will be applicable for O & M cost, Fuel cost and the Incentive payment

### Flat tariff

Constant tariff over 20 years, where the same cash outflows are taken with the year 1 estimated escalation applied to total SPPA (Standard Power Purchase Agreement) period, and a single all inclusive tariff is determined for each technology.

# ① Reviewing FIT tariff

## FIT Tariff Option in Sri Lanka (Other than PV) cont'd

- The tariff will be effective from 01/01/2012 until further notice

Technology/ Source	Escalable Base O&M Rate (year 1-20)	Escalable Base Fuel Rate (year 1-20)	Non-escalable (fixed rate)		
			Tier 1: Years 1-8	Tier 2: Years 9-15	Tier 3: Year 16-20
Mini-hydro	1.83	None	15.56	5.98	3.40
Mini-hydro-local	1.88	None	15.97	6.14	3.49
Wind	1.30	None	22.05	8.48	4.82
Wind-local	1.33	None	22.60	8.69	4.94
Biomass	1.52	12.25	9.67	3.72	2.11
Biomass 16yr onwards	1.90				
Agro & Industrial waste	1.52	6.13	9.65	3.71	2.11
Agro & Indus 16yr onwards	1.90				
Waste Heat	0.48	None	9.14	3.52	2.00
Escalation rate for year 2013	5.16%	3.44%			

Any other renewable energy technology other than those specified above would be offered a Flat tariff of LKR 23.10 / kWh (non-escalable for 20 years).

No review since 01/01/2012

# ① Reviewing FIT tariff

## FIT Tariff Option for **Roof Top PV** in Sri Lanka

- There are three (3) Metering Systems as below for Roof-Top PV system.
- Customers who install roof-top PV system can select the one of Metering System among three systems.

### i) Net Metering

Period	Notes
20 years	<ul style="list-style-type: none"><li>✓ This system started in 2010. Initially, started as 10 years contract scheme.</li><li>✓ No financial compensation for the excess energy exported by the consumer.</li><li>✓ All exports will be set-off against the consumer's own consumption.</li><li>✓ This scheme is open for all Renewable Energy forms including PV.</li></ul>

- The installed capacity shall not exceed the Contract Demand for household. (A few customers have one MW contract)
- Electricity bill will be prepared for the difference between the import & the export registers.
- If the export is more than the import, the Consumer will receive an export credit, and will be brought forward his next month's consumption.
- Such Credits may be carried-over to subsequent months, as long as there is no change in the legal

No review on this basic scheme since 2010  
Only Contract Period was changed in 2016 from 10 years to 20 years.

# ① Reviewing FIT tariff

## FIT Tariff Option for **Roof Top PV** in Sri Lanka

### ii) Net Accounting

Period	Notes
First 7 years	✓ LKR 22.00/unit for export energy from the customer
8 <sup>th</sup> year to 20 <sup>th</sup> year	✓ LKR 15.50/unit for export energy from the customer

- This scheme is limited only for roof-top PV
- The Contract Period is 20 years
- The installed capacity shall not exceed the Contract Demand for household. (A few customers have one MW contract).
- The energy will be measured by one energy meter. The meter measures difference of import/export energy.
- Expected generation capacity and the maximum generation units per month shall clearly indicate by the customer. Any units generated more than such agreed quantity will not be paid until the customer makes a request for the capacity increase.

No review on this scheme since 2016

# ① Reviewing FIT tariff

## FIT Tariff Option for **Roof Top PV** in Sri Lanka

### iii) Net Plus

Period	Notes
First 7 years	✓ LKR 22.00/unit for export energy from the customer
8 <sup>th</sup> year to 20 <sup>th</sup> year	✓ LKR 15.50/unit for export energy from the customer

- This scheme is limited only for roof-top PV.
- The Contract Period is 20 years
- The installed capacity shall not exceed the Contract Demand for household. (A few customers have one MW contract).
- Total energy of electricity from the roof-top PV will be metered through a dedicated export energy meter for which the customer will be paid.
- The energy import will be measured through a separate import energy meter.
- Expected generation capacity and the maximum generation units per month shall be clearly indicated by the customer. Any units generated more than such agreed quantity will not be paid until the customer makes a request for increased capacity.

No review on this scheme since 2016

# ① Reviewing FIT tariff

## FIT Tariff Option for **Roof Top PV** in Sri Lanka

Consideration of the flat tariff for PV generation in 2019

**(Q) Please let us know the results of consideration of introducing “the Flat Tariff” scheme. And why the flat rate for PV was not accepted?**

- As of June 2019, the Power and Renewable Energy Ministry intended to introduce a flat rate for all solar power producers in the country while removing the maximum capacity limitations introduced under the “Battle for Solar Power” programme launched in 2016.
- Accordingly, from 1 August, 2019, the solar power generators would be paid a LKR 19.75 flat rate up to 50 kW for a contract period of 20 years while systems above 50 kW would be paid a LKR 18.75 flat rate, also for 20 years.

Period	Flat tariff rate
20 years	✓ Up to 50 kW in capacity LKR 19.75/unit for export energy from the PV plant.
	✓ Above 50kW in capacity LKR 18.75/unit for export energy from the PV plant.



# ① Reviewing FIT Tariff

## Trend of FIT Purchase Price and Introduction Volume in Japan

- The FIT purchase price is reviewed every year. The volume of introduction has been reduced as it fell.
- It is necessary to lower the FIT purchase price from the viewpoint of appropriate business compensation as PV panel cost declines.

Type of PV	Before	After FIT scheme was introduced							
	~June, 2012	FY2012 July~	FY2013	FY2014	FY2015	FY2016	FY2017	FY2018	Total volume under FIT
PV, Household	4.70GW	0.97GW	1.31GW	0.82GW	0.85GW	0.79GW	0.66GW	0.42GW	5.83GW
=>10kW		¥42/kWh	¥38/kWh	¥37/kWh	¥33/kWh	¥31/kWh	¥28/kWh	¥26/kWh	
PV, Business	0.90GW	0.70GW	5.74GW	8.57GW	8.31GW	5.44GW	4.77GW	3.70GW	37.22GW
<10kW		¥40/kWh	¥36/kWh	¥32/kWh	¥29-27/kWh	¥24/kWh	¥21/kWh	¥18/kWh	

Detailed info. is shown in P.3 to 6

The FIT purchase price has not been reviewed in Sri Lanka, and it is highly possible that the business reward is unreasonably high.

→It should be reviewed

PV System cost for business category

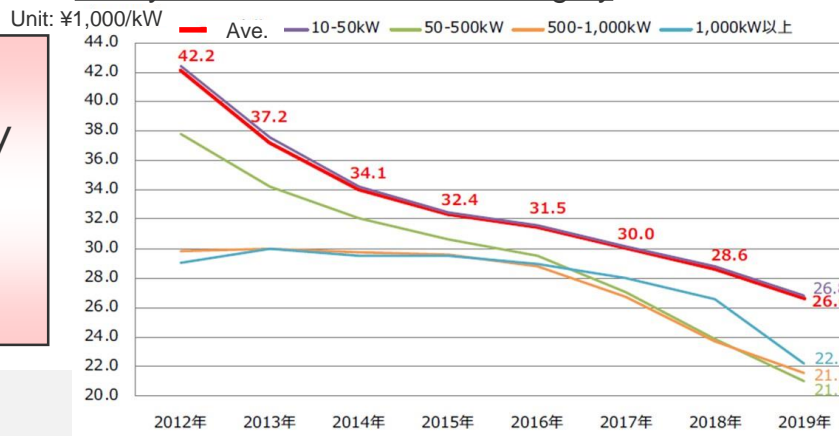

## ① Reviewing FIT tariff

### Specifications to determine the FIT Tariff in Sri Lanka

All costs are to be estimated at the current year terms. The estimation of cash flows, parameters for each technology shall be done.

#### Specifications to determine the FIT Tariff

- Capital Cost
- O&M Cost
- Plant Factor
- Fuel Cost (For types: Biomass, Agro & Indus, Municipal Waste)
- WACC (Interest rate, Return on Equity)
- Escalation

# ① Reviewing FIT tariff

## Specifications to determine the FIT Purchase Price (Tariff) in Japan

Specifications as of 2012

Specifications to be considered		Note
1) Subsidy for housing	From government: 48k ¥/kW From local government: 38k ¥/kW	
2) O&M Cost	1% of PV system cost	Power conditioners supposed to be changed every 10 yrs.
3) Decommissioning cost	No consideration	
4) Interest rate	No consideration (No borrowing)	
5) Voltage transformer/System connecting cost	No need generally	3% if you borrow from bank for this business
6) PV System unit price		

There is not big difference between Sri Lanka and Japan

# ① Reviewing FIT tariff

## Adequate FIT Tariff Calculation in Sri Lanka

- It is necessary to review the appropriate FIT tariff that is suitable for the current Sri Lanka. CEB's financial position will be improved by reviewing it.
- Based on the current conditions for introducing Roof Top PV, **please kindly calculate an appropriate FIT tariff.**

### FIT Tariff in 2012

Annex 01: PUBLIC UTILITIES COMMISSION OF SRI LANKA  
Parameters used for 2010 NCRE tariff revision

	Capital Cost (LKR Mn./MW)	O & M, % (Year 1-15)	O & M, % (Year 16-20)	Plant Factor, %	Fuel Cost (LKR/KWh)
Mini-hydro	179	3.00	3.00	38.00	None
Mini-hydro-local	183	3.00	3.00	38.00	None
Wind	212	4.00	4.00	32.00	None
Wind-local	218	4.00	4.00	32.00	None
Biomass*	226	4.00	5.00	80.00	9.10
Agro & Indus	226	4.00	5.00	80.00	4.55
Municipal Waste	339	7.00	7.00	60.00	1.75
Waste Heat	189	1.33	1.33	67.00	None

The Methodology for Feed-In-Tariffs - NCRE  
The basis for deciding purchase tariff for energy supplied by Non-Conventional Renewable Energy based Electricity Generation

October 04, 2011

### FIT Tariff in 2016

Period	Notes
First 7 years	LKR 22.00/unit for export energy from the customer
8th year to 20th year	LKR 15.50/unit for export energy from the customer

CEB or related organizations must have a calculation record and knowledge.



**(Request) Please use the current specifications to calculate the FIT tariff. JICA Expert Team will assist it.**  
→The calculated result will be review together and summarized.

Specifications		Note
Size	4kW	
PV System Cost	19USC/W	Most important
O&M Cost	Negligible	What is main item?
Decommissioning Cost	No need?	
System connection Cost	No need?	
Subsidy	??	
Interest rate	??%	What is ADB's rate?
Capacity Factor	17%	
Deterioration	0.5%	
Others		

# ① Reviewing FIT tariff

## Review of FIT Tariff linked to PV System Price Review

In the Roof Top PV business, system costs have a great influence on business feasibility. What do you think the FIT tariff is reviewed based on the downward trend of system costs in the past?

### Trend of average cost of Roof Top PV system in Japan

Unit: ¥1,000/kW

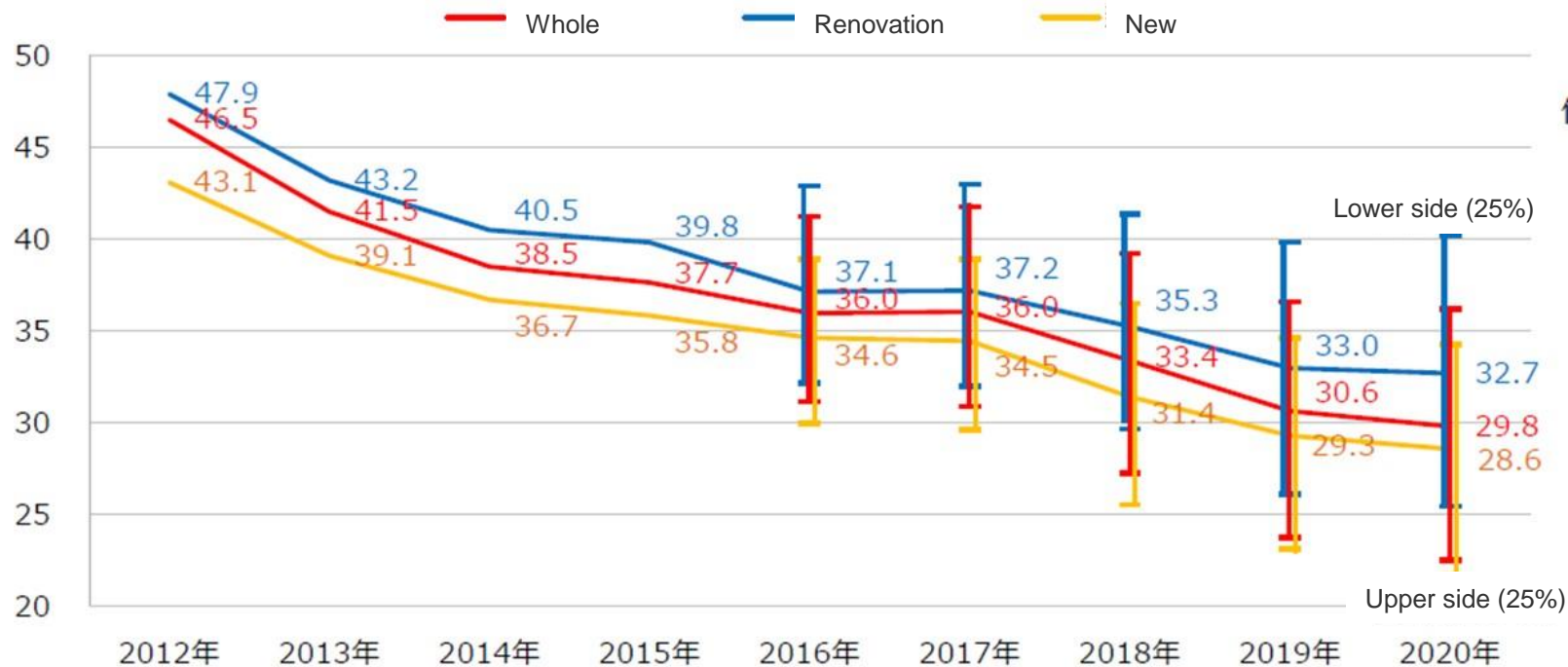

# ① Reviewing FIT tariff

## Review of FIT Tariff linked to PV System Price Review (Cont'd)

In Japan, the system price assumption for the 2022 installation is evaluated based on the last two-year price decline level. The median of projects in 2020 is in the top 36-37% of 2018. From this, we propose 259,000 yen / kW in 2022.

%	PV System Cost for Household		
	Installed in 2020	Installed in 2019	Installed in 2018
5%	16.25	18.25	20.25
10%	17.58	20.29	23.33
15%	19.19	21.78	24.90
20%	21.04	22.85	25.73
25%	22.52	23.75	27.25
30%	23.87	24.79	28.81
35%	25.19	26.09	29.80
36%	25.50	26.33	30.05
37%	25.87	26.62	30.34
38%	26.17	26.91	30.56
39%	26.51	27.23	30.83
40%	26.86	27.54	31.11
45%	28.49	28.88	32.35
50%	30.08	30.31	33.52

Price decline for two years

<Suggestion>

FIT tariff is annually reviewed in line with the past PV system price change

## ① Reviewing FIT tariff

### Introduction Volume Forecast when FIT Tariff changes in Sri Lanka

Forecast with reference to changes in the amount of PV introduction considering past FIT purchase price reviews in Japan

#### Prospective parameters

- Decline ratio of PV system cost
- Decline ratio of FIT purchase price
- Ratio of IRR for average project

Calculation Model would be prepared by excel.

# ① Reviewing FIT tariff

## (Review) Achievement of National Energy Plan with limited Budget

- 2.1 trillion yen levy was required to achieve a RE ratio of 10% to 16% (mostly VRE).
- Further increase of 8% is necessary to achieve 22-24% of RE ratio by 2030
- To minimize the burden is necessary while the RE ratio is achieved

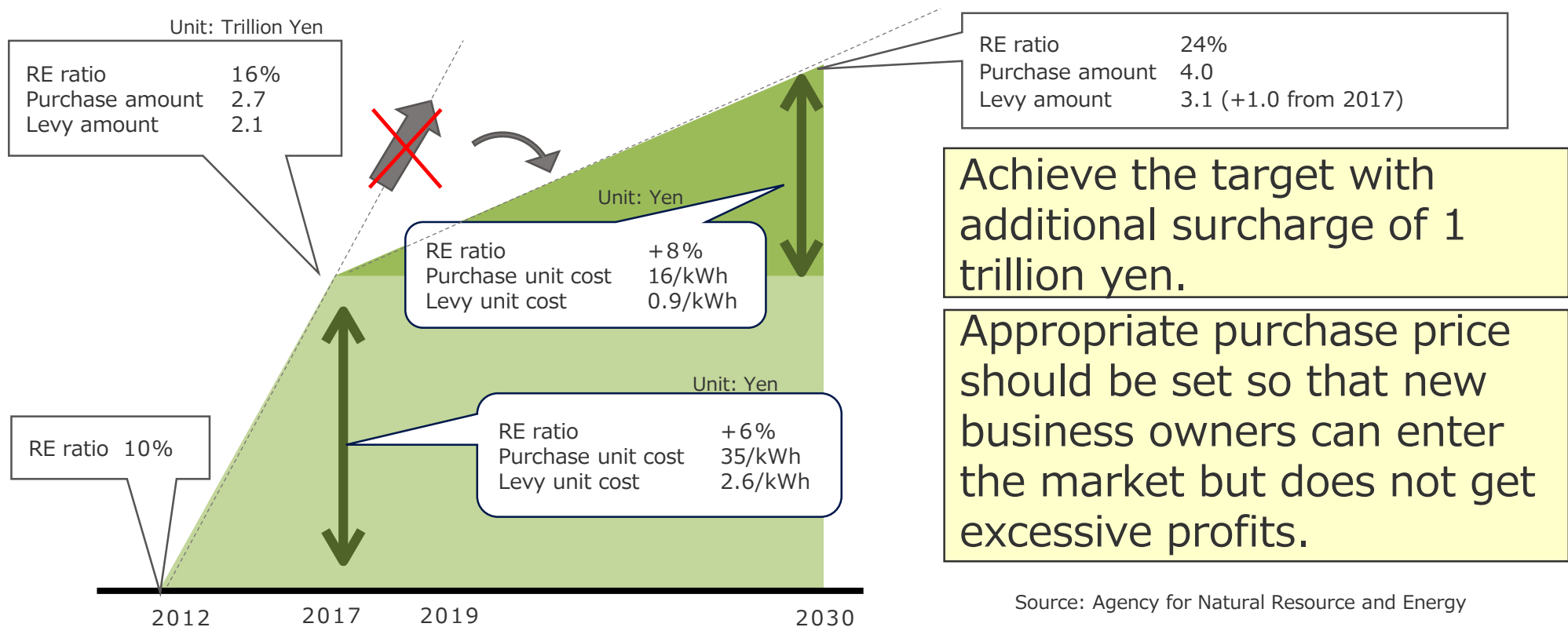

VRE introduction was promoted in Japan while suppressing FIT levy

Source: Agency for Natural Resource and Energy



## ② FIT Applied Range Review

### Levy Reduction by Review the FIT Applied Range

By grasping the quantity of each contract capacity base in Roof top PV, it is possible to confirm the effect when the FIT applied range is reduced. (Q) Is there more information?

Unit: MW

	Solar PV - Ground Mounted	Solar PV Rooftop			
		Net Metering	Net Accounting	Net Plus	Total
2011	1.36				
2012	1.36				
2013	1.36				
2014	1.36				
2015	1.36				
2016	21.36	33.10	0.63	0.31	34.04
2017	51.36	58.80	10.04	9.49	78.33
2018	51.36	79.00	26.67	47.94	153.61
2019	57.36	88.16	55.06	103.41	246.63
2020	69.36	94.94	78.54	127.33	300.82



#### ii) FIT Contracted PV in capacity basis [kW]

Year	<1kW	=>1kW <3kW	=>3kW <5kW	=>5kW <10kW	=>10kW <30kW	=>30kW <50kW	=>50kW
2020 (Present)	??	??	??	??	??	??	??
Cumulative percentage	100%	??	??	??	??	??	??

## ②FIT Applied Range Review

(Ref.) The Volume of PV introduction for business under FIT Scheme(by capacity)

In Japan, as shown in the table below, the amount of PV introduction for business under FIT scheme is managed by capacity, and it is easy to make forecast due to system changes.

FY of Installation	10 -50kW	50 -100kW	100- 200kW	200- 250kW	250- 300kW	300- 400kW	400- 500kW	500- 750kW	750- 1,000kW	1,000- 2,000kW	2,000kW-	10kW- 全体合計
2012年度	2,413	45	235	145	166	138	256	404	640	1,784	541	6,766
2013年度	3,582	23	145	116	189	127	247	462	536	1,947	1,000	8,374
2014年度	2,923	13	133	105	170	135	257	429	441	2,293	1,265	8,165
2015年度	1,936	8	81	62	96	96	164	266	250	1,342	1,145	5,446
2016年度	1,492	4	51	45	76	88	132	182	185	1,048	1,456	4,759
2017年度	1,523 (763)	4 (2)	42 (20)	41 (20)	61 (29)	77 (38)	129 (62)	143 (78)	160 (82)	881 (480)	1,847 (708)	4,908 (2,283)
2018年度	- (826)	- (1)	- (19)	- (18)	- (29)	- (39)	- (70)	- (75)	- (81)	- (350)	- (389)	- (1,898)
2019年度												
<b>Total</b>	<b>14,695</b>	<b>98</b>	<b>705</b>	<b>533</b>	<b>786</b>	<b>700</b>	<b>1,255</b>	<b>1,962</b>	<b>2,293</b>	<b>9,646</b>	<b>7,643</b>	<b>40,315</b>
Cumulative ratio	100.0%	63.6%	63.3%	61.6%	60.2%	58.3%	56.6%	53.4%	48.6%	42.9%	19.0%	—

The key is whether there is data by capacity for Roof top PV in Sri Lanka as well.

## ②FIT Applied Range Review Reconfirmation of definition “Roof Top PV”

(Request) Please kindly explain the definition of Roof Top PV.  
Please kindly provide written document for easy understanding.

(Q) Is the PV system on the commercial facilities (mall, factory) counted as roof top PV?

Yes!!

33kV connection for 1MW and more



(Q) Is the PV system on the ground in the factory premises counted as roof top PV?

No!!



## ②FIT Applied Range Review

### Reconfirmation of definition “Roof Top PV”

(Q) Are there any cases of contracting with CEB at once?  
If so, what is the purpose of it? What is the beneficiary for resource aggregator?



Resource Aggregator  
(Service Provider)

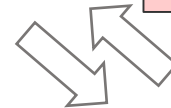

(Ans.) Memo based on discussion on Dec.8

Now is the concept stage not actual.

Beneficiary for CEB

- ✓ Lower contract price than the FIT Tariff

Beneficiary for Service providers

- ✓ Able to borrow roof for generation
- ✓ Higher contract price than open bidding (Expectation)



### ③Unifying to Net Metering

Net Metering scheme does not require the payment to VRE business owners for Net export. If three metering schemes are unified to Net Metering,;

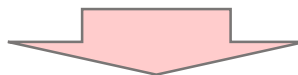

The burden of CEB on FIT tariff payment is reduced

(Request) Please kindly calculate how much it will be reduced

Unit: MW

	Solar PV - Ground Mounted	Solar PV Rooftop			Total
		Net Metering	Net Accounting	Net Plus	
2011	1.36				
2012	1.36				
2013	1.36				
2014	1.36				
2015	1.36				
2016	21.36	33.10	0.63	0.31	34.04
2017	51.36	58.80	10.04	9.49	78.33
2018	51.36	79.00	26.67	47.94	153.61
2019	57.36	88.16	55.06	103.41	246.63
2020	69.36	94.94	78.54	127.33	300.82

# ④ Separately FIT Tariff Collection from Electricity Tariff

Promotion of the introduction of VRE is a national policy, not CEB only. To collect FIT tariff separately from electricity tariff is one option.

- It is unfair that the CEB only has heavy burden, which leads to negative operation income
- Subsidies are paid by the government. The source of it is taxes. The fact that subsidies to the CEB are legally permitted means that all people who uses electricity bear the burden. Therefore, it is considered to be equal even if it is separated from the electricity bill and collected.

Notice of electricity usage in Japan (Case of Chubu Electric Power Company)

お客様番号	0001111223344	日数	01
従量電灯 B			
30A			
ご請求予定額 (概算)	7,624円		
消費税等相当額 (再掲)	363円		
基本料金	819円00銭		
電灯料	2,212円80銭		
力率料	4,046円40銭		
力率料	478円20銭		
口振付引落しと解行額	2,220円00銭		
燃料費調整額 (再掲)	2,220円00銭		
再生エネルギー発電促進料	121円		
当月燃料費調整率 (税込)	1円39銭/kWh		
再生エネルギー発電促進料率 (税込)	0円27銭/kWh		
太陽光発電促進料率 (税込)	0円11銭/kWh		

Electricity Usage Tariff

Fuel Cost Adjustment Charge

Surcharge comes from FIT scheme, fairly and transparently collected from all users

FIT Tariff can be collected separately from electricity usage fee in Sri Lanka.

# ④ Separately FIT Tariff Collection from Electricity Tariff (E.g. in Japan) FIT Surcharge Price Setting and its Management

➤ The electric power companies collect the FIT surcharge, but the third-party “Green Investment Promotion Organization” manages it.

## System surrounding FIT in Japan

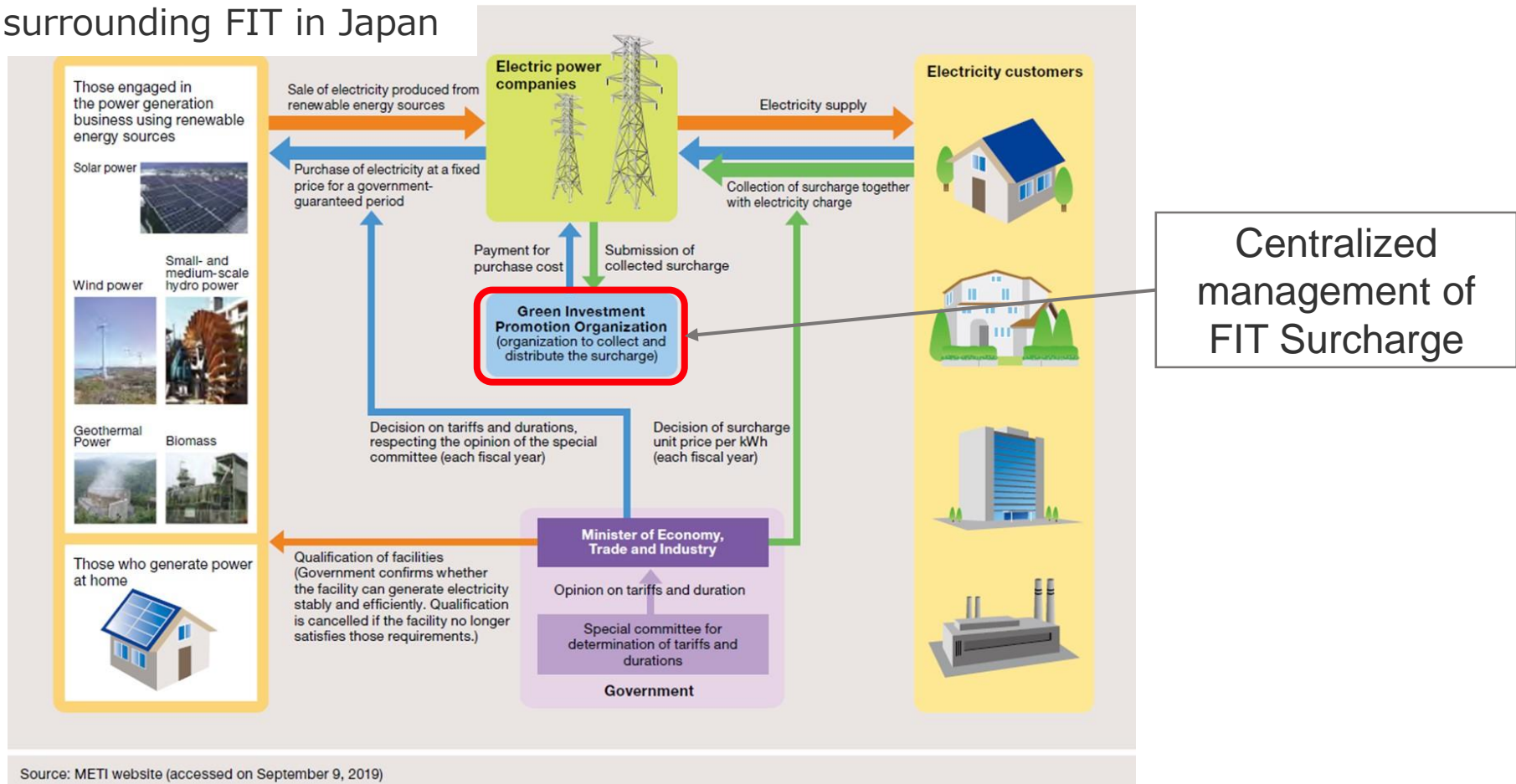

Source: METI website (accessed on September 9, 2019)

(Suggestion) New scheme setup, CEB collects FIT surcharge and pays them to VRE operators



**CHUBU**  
Electric Power

***NIPPON KOEI***



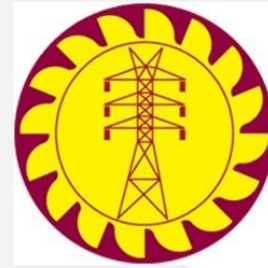

# FIT & Competitive Bidding Scheme applying to Roof Top PV

JICA Expert Team

February, 2021

Chubu Electric Power Co., Inc.  
Nippon Koei Co., Ltd.

# Target Image with expansion of Competitive Bid Scheme

Considering the current condition related to VRE, our best recommendation is combination of “Reviewing FIT tariff” and “FIT Applied Range Review (i.e. expansion of Competitive Bidding Scheme range)”

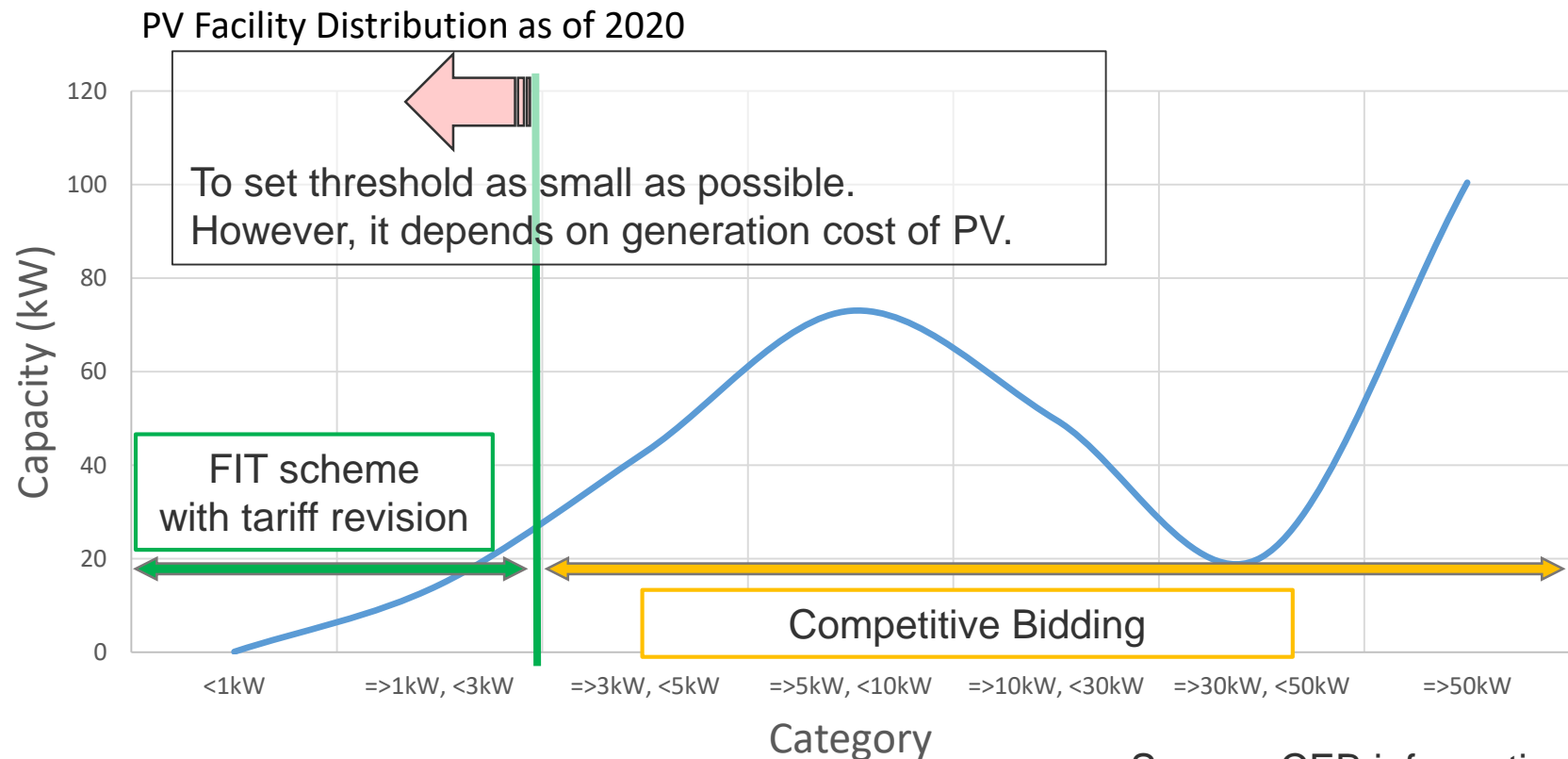

Source: CEB information

The study will be conducted by C/P and JICA Expert Team;

- Four (4) consideration should be studied on the way to “Competitive Bidding Scheme” for all Roof Top PV

Now we are focusing on

① **Reviewing FIT Applied Range**

→Expansion of Range of the Competitive Bidding Scheme

② **Reviewing FIT tariff**

**in accordance with price declining situation in PV system**

→FIT tariff have to be revised to proper tariff level

③ **Unifying 3 metering scheme into Net Metering**

→Burden of purchasing PV surplus generation in CEB would be reduced

④ **Separately FIT Tariff Collection from Electricity Tariff**

→Clear collection of FIT charge separated from electricity tariff

# Combination of FIT & Competitive Bidding Scheme

- ① FIT scheme should be applied, at least, to small capacity Roof Top PV system which has relatively high generation cost.
  - Roof Top PV FIT tariff in household level should be reviewed.  
i.e. employing “Reviewing FIT tariff” and “FIT Applied Range Review”

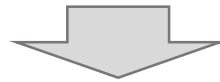

- ✓ Study on proper FIT tariff of the household Roof Top PV should be necessary.  
→The study requires information of calculation method & base factor/value of current FIT tariff
- ✓ Generation cost of each capacity type of the household PV need to be confirmed  
→Please provide generation cost in capacity base of PV.

# (Ref.) Stage of VRE Promotion Scheme

PV generation cost would be going to decline.

Current

FIT price review  
in accordance with  
PV generation price

After employing Whole  
Sale Market, FIP would  
be introduced.

FIP price is decided as  
the sum of "Market  
Price" and "subsidy".

Applying Competitive  
Bidding Scheme to all  
PV systems



Employing both "Reviewing FIT tariff" and "FIT Applied Range Review"

# Household level Roof Top PV Generation Cost (Japan)

JICA Expert Team tried calculation Unit generation Cost of PV in Sri Lanka with Japanese conditions below

Solar PV Capacity	Average Installation Cost*	Unit Generation Cost** (JICA Ex Team assumed)
Up to 10kW	200,000 LKR/kW	9.3 LKR/kWh
10kW to 42kW	150,000 LKR/kW	7.0 LKR/kWh
More than 42kW	100,000 LKR/kW	4.7 LKR/kWh

\* Source of average installation cost provided by CEB

\*\* It is assumed by sum of installation and O&M cost.

Conditions;

Operation period: 20 years

Capacity factor: 15.1%<sup>\*1</sup>

O&M cost: 1% of installation cost<sup>\*2</sup>

Deterioration rate: 0.27%<sup>\*2</sup>

\*1 Generation Performance in Sri Lanka 2016, PUCSL

\*2 Japan Photovoltaic Energy Association

# Household level Roof Top PV Generation Cost (Sri Lanka)

Please try calculating Unit Generation Cost of small Roof Top PV with condition in Sri Lanka

Solar PV Capacity	Average Installation Cost*	Levelized Cost of Electricity** (Sri Lanka assumed)
Up to 5kW	180,000LKR/kW	14.22LKR/kWh
5kW to 10kW (middle income class)	170,000LKR/kW	13.43LKR/kWh
10kW to 42kW	150,000 LKR/kW	LKR/kWh
More than 42kW	100,000 LKR/kW	LKR/kWh
Price Cap (one proposal) Up to 5kW		5% margin >> 14.93LKR/kW

## Conditions;

Operation period: 20 years

Capacity factor: 17.0%

O&M cost: 1% of installation cost

Deterioration rate: 0.7%

Discount rate: 8%

\* Source of average installation cost provided by CEB

\*\* It should be assumed by sum of installation and O&M cost.

# Household level Roof Top PV Generation Cost (Sri Lanka)

Please provide the following information and data

- Detailed installation cost and its transition in past & forecast
- ✓ We understand averaged installation cost up to 10kW is 200,000 LKR/kW. JICA Expert Team would like to know the installation cost of household Roof Top PV with small capacity and the cost would be higher than 200,000 LKR/kW.
- Capacity Factor and O&M cost of household level solar PV and its transition in past & forecast
- Original data to confirm the rational of received data by Word file (PV installation cost by capacity, provincial width number of PV customers etc.)
- ✓ CEB and JICA Expert Team need to analyze the scheme of household PV from other viewpoints



# Data Collection Image

- Detailed installation cost and its transition in past & forecast
- Capacity Factor and O&M cost of household level solar PV and its transition in past & forecast
- Original data to confirm the rational of received data by Word file (PV installation cost by capacity, provincial width number of PV customers etc.)

Breakdown is necessary for study. [Installation Cost LKR/kW]

Capacity		2016	2017	2018	2019	2020
Up to 10kW	Up to 5kW					200,000
	5kW ~ 10kW	From worldwide trend of price				
10kW to 42kW						150,000
More than 42kW						100,000

② Study is necessary if CEB applies Competitive Bidding Scheme to all category of Roof Top PV;

✓ Reviewed scheme in Roof Top PV promotion have to overcome the Government target on installation capacity of PV.  
→ Study on sensitive analysis on price cap should be necessary.

✓ Please provide information so that we can study.

Such as;

- What value to be set as Price Cap with reason? (See next slide)
- What value indicated as threshold between FIT & Competitive Bidding with reason? (See slide P2)

# Applying Competitive Bidding Scheme to Roof Top PV owners

Method of bidding scheme : e.g. Merit Order with Price Cap

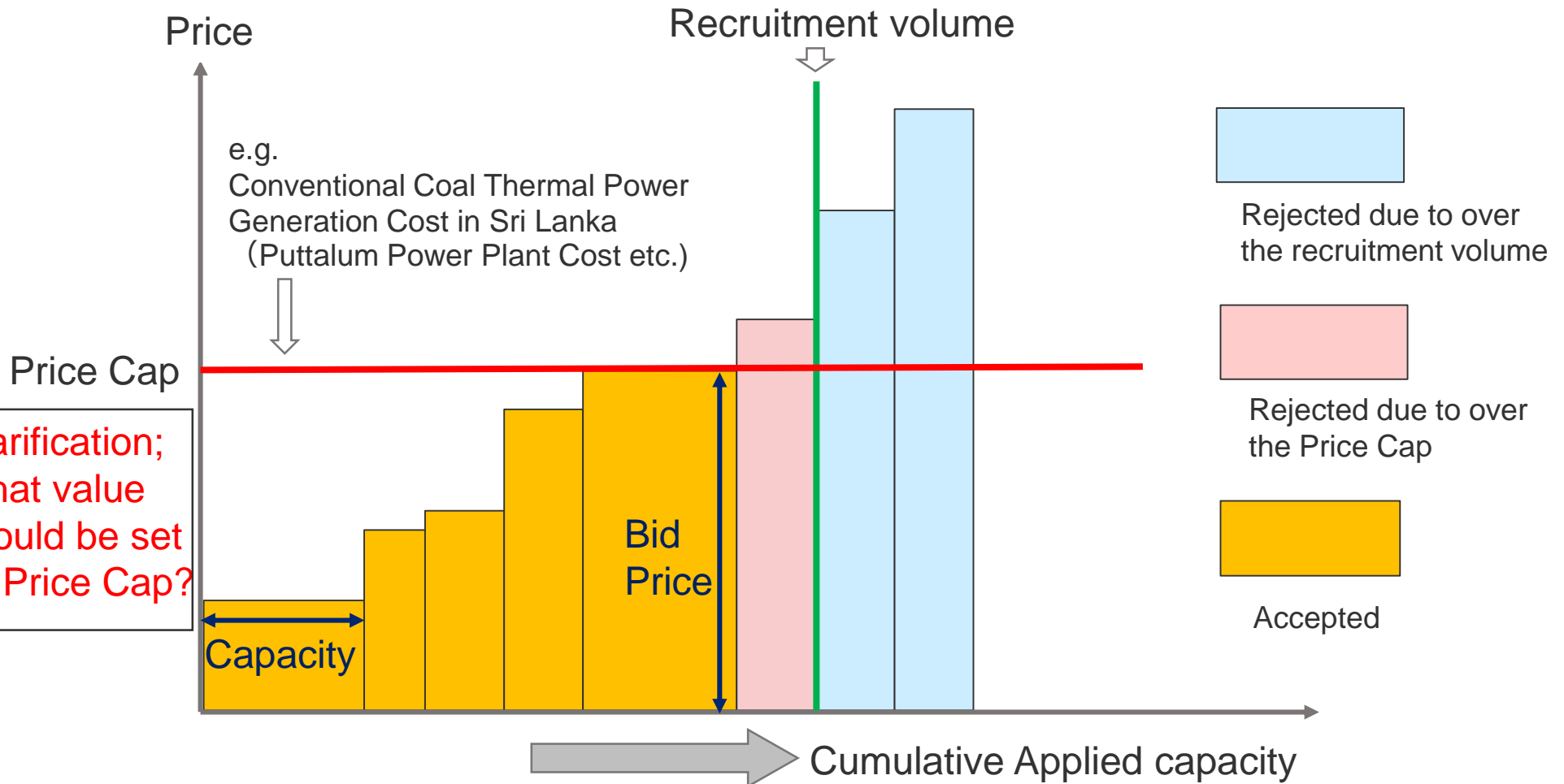

Clarification;  
What value  
should be set  
as Price Cap?

- Rejected due to over the recruitment volume
- Rejected due to over the Price Cap
- Accepted

C/P and JICA Expert Team need to study reviewing the scheme together.

# Competitive Bidding Scheme

## Switching the scheme from FIT to Competitive Bidding.

Expected matters of concern;

- ✓ Incentive in PV installation would be lowered among small PV Roof Top owners.
- ✓ Installation of household level PV expected to be stagnant.
- ✓ Achievement to national target in PV installation might be concerned about.

What is the solution under conditions below?

- National Target and CEB financial condition improvement should be coexisted.
- Both “CEB benefit” & “Government Policy” is necessary to Government and to acquire the approval from PUCSL.

## Clarification in case of applying Competitive Bidding scheme to small Roof-Top PV

- a) Small Roof Top PV generation cost should reach to near of the conventional Coal Thermal Power generation cost.

Please show us reasonability of Competitive Bidding Price (Price Cap) which CEB is considering for household Roof-Top PV owner.

Some clarification in this matter is shown in Slide P10

## Clarification in case of applying Competitive Bidding scheme to small Roof-Top PV

b) Roof-Top PV owner's incentive to install PV will be lowered,  
because;

>Competitive Bidding Price will become lower than current FIT price

>In addition, Roof-Top PV owners would feel vexatious for procedure of bid and exchange contract.

What kind of measure does CEB consider taking against the situation?

# PPA Contract with household Roof Top PV owners

Structure of Competitive Bidding for household PV need to be examined in some cases, for example as below.

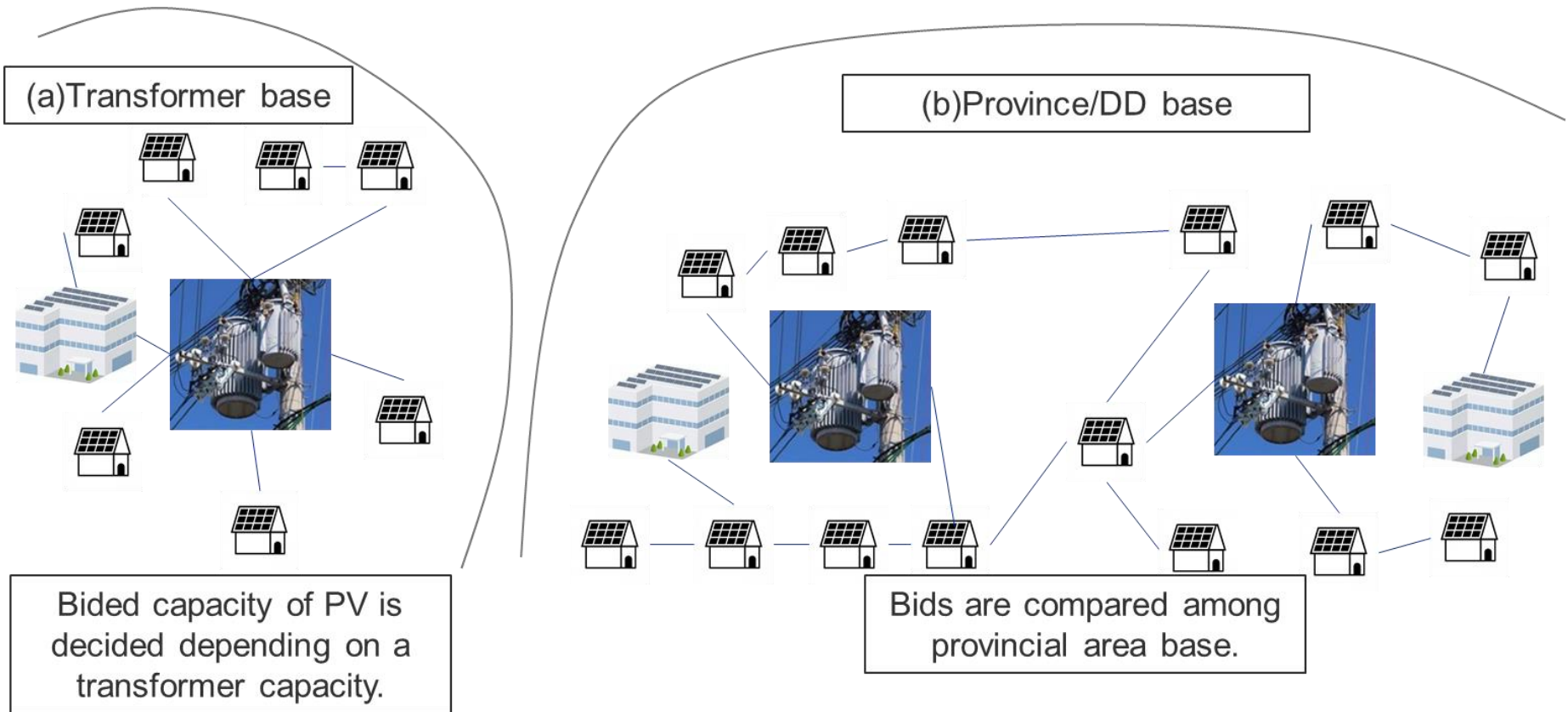

# PPA Contract with huge number of Roof Top PV owners

JICA Expert Team understand;

- ✓ Number of the PPA Contract on Roof Top PV will be huge.  
Therefore, contract work have to be conducted effectively.
- ✓ Merits and Demerits of Competitive Bidding Scheme would be considered under some case of Transformer base or Province/DD base or other base.

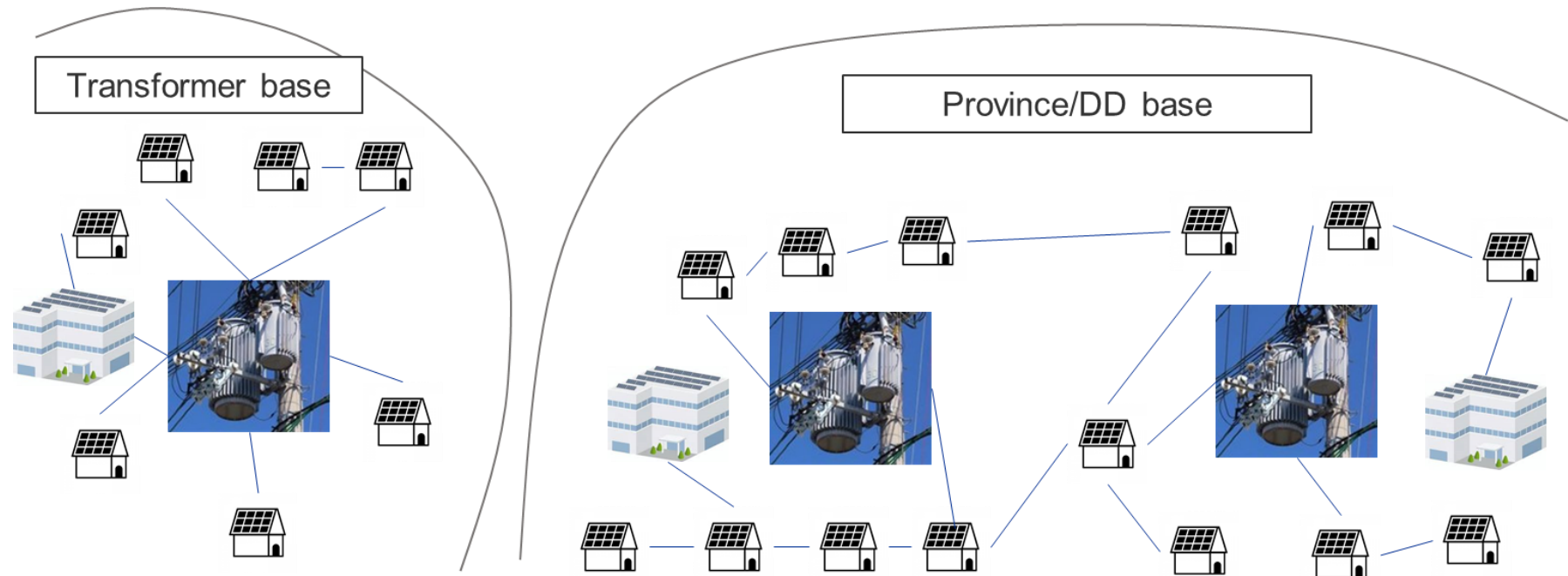



## Clarification in case of applying Competitive Bidding scheme to small Roof-Top PV

c) Some issues would appear in Competitive Bidding Scheme for household Roof-Top PV owners

✓ Please provide data for evaluation on validity of the scheme, if we request another information.

→ Now under studying with the data, for example;

- *Expected number of bids per unit area*
  - *General number of transformer per unit area*
  - *General available capacity for PV per transformer*
  - *Number of branch staff*
- etc.*

## Clarification in case of applying Competitive Bidding scheme to small Roof-Top PV

- c) Some issues would appear in Competitive Bidding Scheme for household Roof-Top PV owners

Please provide expected matters of concern in contract work for household PV with its solutions.

e.g.

- ✓ If CEB hire additional staff for treat of transaction of increasing contracts in Competitive Bidding for house hold PV, personnel management and evaluation etc. should be executed. Labor cost also should increase.
- ✓ How can you grasp & management of available capacity in distribution transformer which exists huge number in CEB?

## Clarification in case of applying Competitive Bidding scheme to small Roof-Top PV

d) Competitive Bidding Price must be different among Roof-Top PV owners

No problem is occurred, because the Bid Price is decided by each Roof Top PV owner and submitted.

→JICA Expert Team understood it.



**NIPPON KOEI**



# Parameters necessary to Calculate FIT Purchase Price

January, 2021

Ceylon Electricity Board  
Chubu Electric Power Co., Inc.  
Nippon Koei Co., Ltd.

# Premise of FIT Purchase Price Calculation by JICA Expert Team

- Ministry holds committee every year to decide FIT purchase price.
- Ministry has disclosed the minutes of meeting on Web page.
- Ministry has not disclosed formula to calculate the purchase price, but a part of parameter can be found on the minutes of meeting.

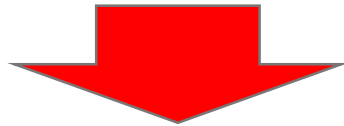

JICA Expert Team independently calculated FIT purchase price based on the part of parameters. Therefore, please understand the calculation sheet is not official.

In the calculation, JICA Expert Team considers deterioration rate of solar system in addition to disclosed parameters. As the result, we can get a close value compared with actual IRR and FIT purchase price. Therefore the parameters in the calculation sheet would be fine to calculate IRR and FIT purchase price.

# FIT Purchase Price and Parameters

- Ministry set 3.20% IRR target (same target since the start of FIT scheme).
- FIT purchase price in FY 2020 is 0.20 USD/kWh (1st - 10th year) and 0.09 USD/kWh (11th - 20th year)

Unit cost for installation (including subsidy)	2,788	USD/kW
Capacity Factor	13.7	%
Annual generated power in first installation year	1,200	kWh/kW
Ratio of selling electricity to power generation	70	%
Benefit produced from customers own consumption of generated power	0.25	USD/kWh
Deterioration rate	0.27	% / year
OM cost	28.85	USD/kW/year
Purchase price	1st - 10th year	0.20 USD/kWh
	11th - 20th year	0.09 USD/kWh

Exchange rate (as of Dec. 4, 2020)

1 USD = 186 LKR

1 USD = 104 JPY

JICA Expert Team independently add the parameters

Calculated IRR: 2.98%

# Unit Cost for Installation

Unit cost for installation: 2,788 USD/kW

- Ministry confirmed how much the average installation cost of the 2019 projects corresponds to the installation cost of the 2018 projects.
- The average of the 2019 projects (316,000 JPY/kW) is almost equivalent to between 39% and 40% in 2018 projects (refer to the following table). Based on the result, Ministry decided 290,000 JPY/kW (2,788 USD/kW) as unit cost for installation. (Improvements in production capacity and technological innovation are considered.)

%	Installed in 2019	Installed in 2018
5%	21.59	23.13
10%	22.73	24.67
15%	23.49	25.48
20%	24.39	26.85
25%	25.38	28.35
30%	26.57	29.49
35%	28.01	30.58
36%	28.30	30.83
37%	28.58	31.10
38%	28.80	31.25
39%	28.84	31.52
40%	29.03	31.76
41%	29.33	32.01
42%	29.56	32.27
43%	29.83	32.51
44%	30.07	32.75
45%	30.33	32.94
46%	30.55	33.17
47%	30.81	33.40
48%	31.09	33.63
49%	31.35	33.82
50%	31.60	34.00

[Unit: 10<sup>4</sup> JPY]

# Capacity Factor, Annual Generated Power in First Installation Year, Deterioration Rate

Capacity factor: 13.7%

The average capacity factor of several projects collected in 2019 was 13.9%.

Since the value may be change due to weather and other conditions, the average of the values examined over the past four years was 13.5%, which was almost the same level as the value assumed by Ministry (13.7%).

Therefore, the estimated value for FY 2020 has been left unchanged at 13.7% (estimated capacity factor in FY 2019 was 13.7%).

Annual generated power in first installation year: 1,200 kWh/kW

- JICA Expert Team independently add as the parameter
- Formula: 24 hours × 365 days × Capacity factor (13.7%)

Deterioration rate: 0.27%

- JICA Expert Team independently add as the parameter
- Japan Photovoltaic Energy Association (JPEA) researched deterioration rate in commercial solar PV projects in 2012 and the rate was 0.27% (there is no research for house level solar PV).



# Benefit Produced by Customers Own Consumption, Ratio of Selling Electricity to Power Generation

Benefit produced by customers own consumption of generated power:

0.25 USD/kWh

To reflect the latest trends in electricity tariff, Ministry adopted the average value of household electricity tariff in all electric power company for the past 7 years (26.33 JPY / kWh = 0.25 USD / kWh).

Ratio of selling electricity to power generation: 70%

The average ratio of several projects in 2019 was 70.4%, which was almost the same level as the value assumed by Ministry (70.0%). Therefore, the estimated value for FY 2020 has been left unchanged at 70% (estimated ratio in FY 2019 was 70%).

# OM Cost, Selling Price after Purchase under FIT Scheme

OM cost: 28.85 USD/kW/year

- Determined by hearing with industry groups.
- Including cost for periodical inspection (the value is not disclosed)
- Including PCS (Power Conditioning System) replacement cost, which will be replaced in 20 years.
- Not including retirement cost. Since the system is for home use, it is basically assumed that it will continue to be used.

Selling price after purchase under FIT scheme: 0.09 USD/kW/year

The average value was calculated based on the actual purchase plan of several company

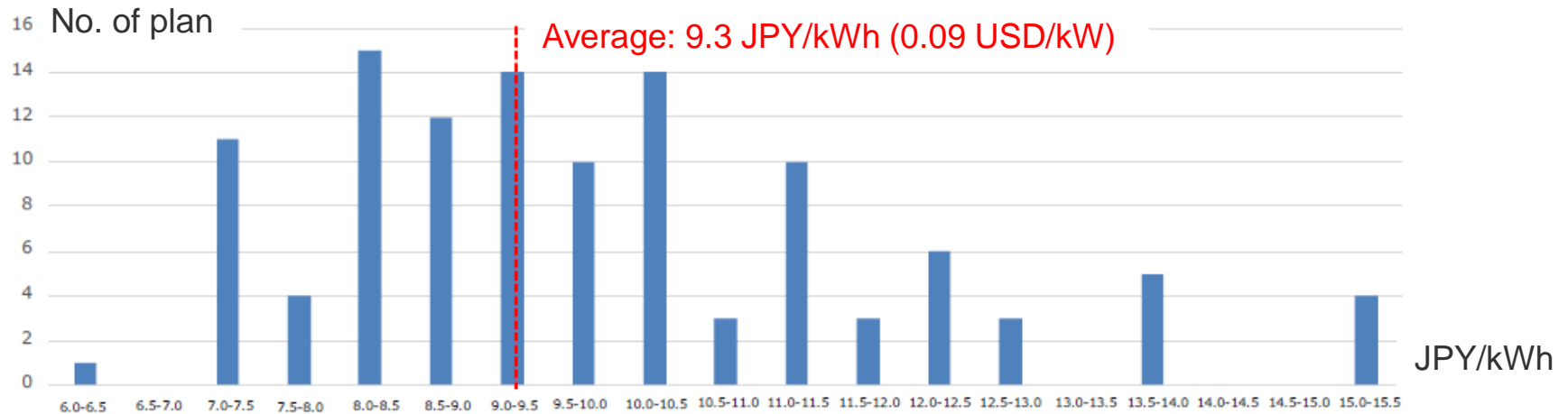



ලංකා විදුලිබල මණ්ඩලය  
இலங்கை மின்சார சபை  
CEYLON ELECTRICITY BOARD



**CHUBU**  
Electric Power

***NIPPON KOEI***

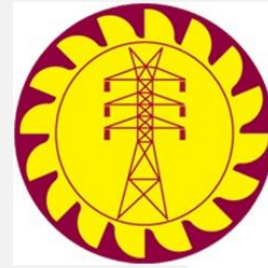

# Review of FIT tariff for Roof Top PV

Ceylon Electricity Board  
JICA Expert Team

January, 2021

Chubu Electric Power Co., Inc.  
Nippon Koei Co., Ltd.

1. Background
2. Objective of the FIT system revision for rooftop PV
3. Target of the FIT system revision
4. Flow of examination
5. Setting the premises for examination
6. Examination of FIT tariff category by rooftop PV capacity
7. Examination of FIT tariff for each capacity category
8. Recommendation
9. Conclusion

# Background

---

The FIT system has been promoted the introduction of rooftop PV.



The Target of developing renewable energy by the Government requires the consecutive rooftop PV introduction, and the introduction system for rooftop PV should be sustainable.



The installation cost of solar PV is decreasing.

Installation cost is further reduced for large-scale solar PV.

FIT tariff for rooftop PV have not been reviewed since 2016.



FIT tariff for rooftop PV need to be reviewed.

# Rooftop PV introduction status

- After the introduction of the Net Metering system in 2010, the introduction of rooftop PV has gradually progressed.
  - After the introduction of Net Accounting and Net Plus for Rooftop PV in 2016, the introduction of rooftop PV has increased sharply.
- \*Net Accounting: Measure power sale/purchase with 1 meter and sell surplus power at FIT tariff.  
 Net Plus: Measure power sale/purchase with each meter and sell generation power at FIT tariff.

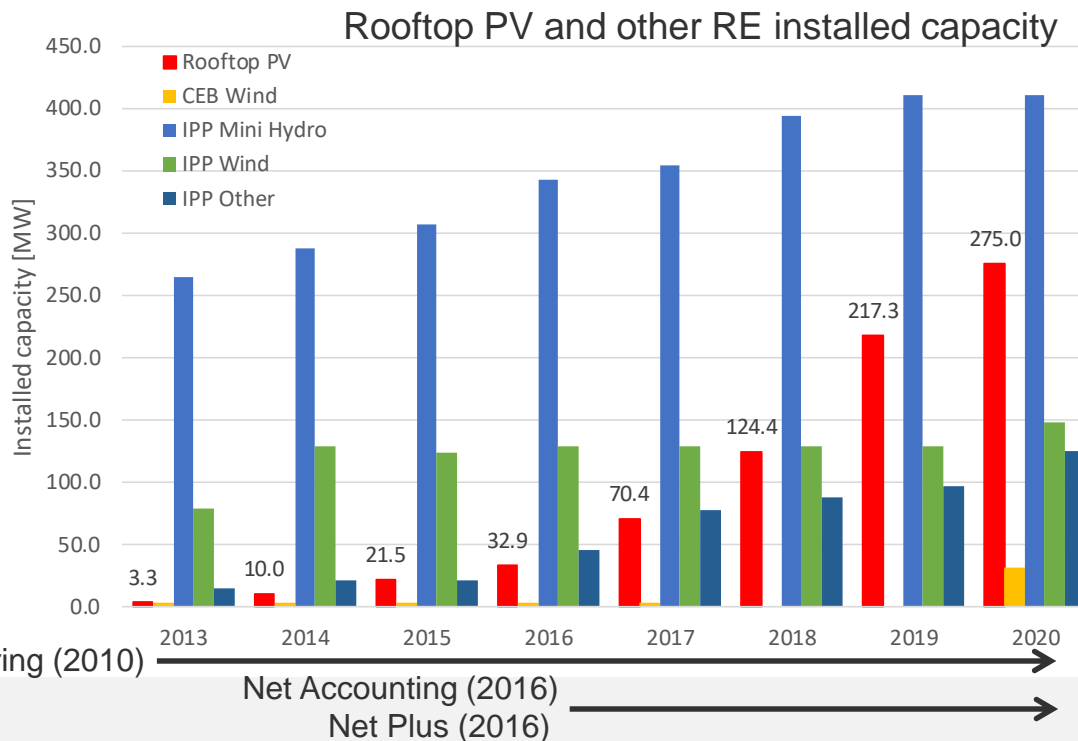

The introduction amount of rooftop PV began to increase from around 2016, and since 2019, it has grown to the amount of renewable energy introduced next to IPP small hydropower

Source: Statistical Digest 2013-2020, CEB

Copyright © Chubu Electric Power Co., Inc. All rights reserved.



# Achievement of new government target for introduction of renewable energy

- In order to achieve the government target of introducing 70% of renewable energy in 2030, PV has set an introduction target of 4,200MW (44% of renewable energy) in 2030, which is a major factor.
- Of the PV introduction target, rooftop PV accounts for 1,500MW, 36%, which is an important position.

A system to continuously introduce rooftop PV is needed

New Renewable Capacity Addition(2021-2030)

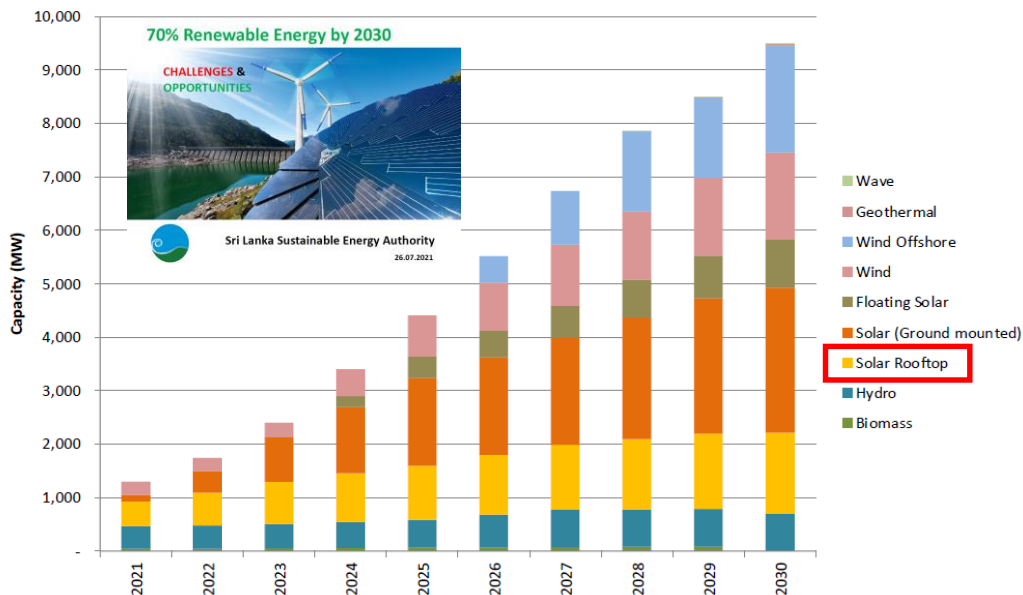

□ New Renewable Energy Capacity (MW) addition (2021-2030) Cont..

	2021	2022	2023	2024	2025	2026	2027	2028	2029	2030
Biomass	44	44	54	60	65	70	75	80	85	90
Mini Hydro	427	440	455	485	520	617	700	700	700	700
Solar Rooftop	463	613	788	913	1,013	1,113	1,213	1,313	1,413	1,513
Solar (Ground mounted)	118	395	838	1,238	1,643	1,823	1,998	2,278	2,528	2,713
Floating Solar				200	400	500	600	700	800	900
Wind	249	249	269	504	769	899	1,149	1,279	1,454	1,629
Wind Offshore						500	1,000	1,500	1,500	2,000
Geothermal									10	30
Wave									5	10
Battery Storage MWh (4hrs)		100	300	500	700	900	1,100	1,400	1,600	2,000
Total Capacity (MW)	1,300	1,740	2,403	3,399	4,409	5,521	6,735	7,855	8,495	9,585

Solar (Rooftop + Ground mounted) 4,200MW

Identified resources will be swapped with other to obtain planned capacity as per the requirement

# Global trend of lowering solar PV installation cost

- Significant price declines is occurring across the world
- For example, price decline in neighboring India on [PV Installation Cost for Residential] are:  
 Average rate of decline **11.2%** / year in 6 years on LKR denominated  
 (Average rate of decline 15.9% / year in 6 years on USD denominated)

Sector	Market	2010	2011	2012	2013	2014	2015	2016	2017	2018	2019
		2019 USD/kW									
Residential	Australia	7 715	6 126	4 301	3 670	3 424	2 198	1 988	1 738	1 557	1 380
	Brazil				3 947	3 657	3 458	2 664	2 126	1 604	1 350
	China			2 823	2 432	2 330	1 672	1 591	1 436	1 079	840
	France		9 797	6 950	5 773	4 231	2 359	2 174	1 967	1 771	1 600
	Germany	4 277	3 634	2 712	2 414	2 229	1 750	1 704	1 645	1 746	1 646
	India				2 374	2 276	1 501	1 326	1 093	916	840
	Italy	6 949	6 106	4 031	3 660	2 438	1 983	1 803	1 676	1 527	1 460
	Japan	7 314	7 228	6 237	4 601	3 771	3 313	2 927	2 685	2 361	2 250
	Malaysia				2 871	2 861	2 423	2 227	1 792	1 466	1 191
	Republic of Korea				3 036	3 056	2 166	2 079	1 707	1 527	1 440
	South Africa				4 140	3 684	3 109	2 916	2 602	2 231	1 843
	Spain				2 871	2 438	1 758	1 633	1 509	1 445	1 410
	Switzerland				3 864	3 440	3 216	3 022	2 716	2 421	2 173
	Thailand				4 019	3 121	2 798	2 726	2 362	1 944	1 388
	United Kingdom				3 300	3 475	3 007	2 668	2 692	2 597	2 566
	California (US)	7 756	7 325	6 323	5 475	5 155	5 231	5 053	4 529	4 294	4 096
	Other US states	7 705	7 049	5 697	4 921	4 954	4 925	4 280	3 844	3 702	3 652

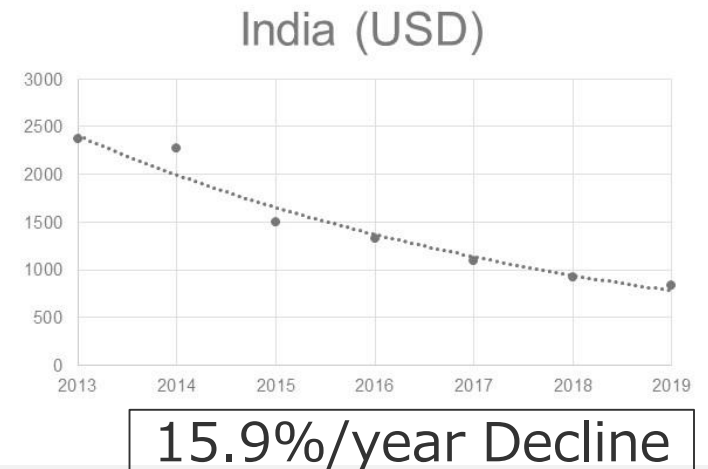
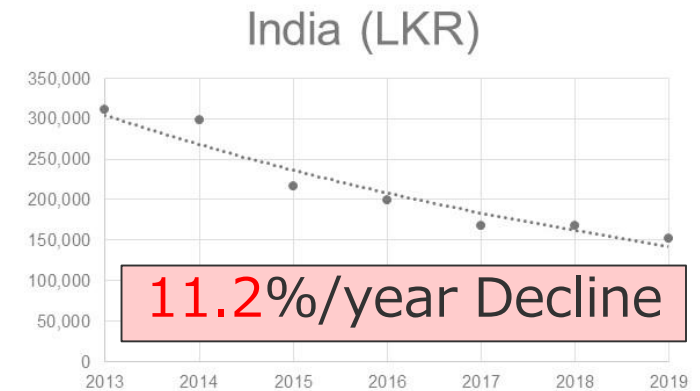

# Lowering the installation cost of large-scale PV

- The installation cost of rooftop PV of 1MW is about half of less than 5kW
- Since the FIT tariff of rooftop PV is the same regardless of the equipment size, it has possibility that the business owner of a large rooftop PV gets is making an excessive profit.

Rooftop PV Capacity	Average Installation Cost in 2020(LKR/kW)
Less than 5kW	180,000
1MW	85,000



Double installation cost difference in the same FIT system for rooftop PV

Source: KHM Solar and Financial status and a four-year road map for financial recovery, Jan. 2021,CEB

FIT tariff should be set for rooftop PV capacity category

# 02 Objective of the FIT system revision for rooftop PV

---

# Objective of the FIT system revision for rooftop PV

Considering the recent decrease in the installation cost of rooftop PV, the FIT system will be reviewed for the following items to make it a sustainable rooftop PV introduction system.

- Review the FIT tariff by rooftop PV capacity category, which contributes to secure appropriate profits for business owners, and reduce the financial burden on CEB as well.

# 03 Target of the FIT system revision

---

# Target of the FIT system (rooftop PV)

- PV will continue to grow. Among them, rooftop PV will greatly contribute to it.

CEB has set the introduction target of solar PV as 1,829MW in 2025 and 2,684MW in 2030 in the Long Term Generation Expansion Plan 2022-2041. As of 2020, 275MW rooftop PV has been introduced, and in this plan, the rooftop PV has a target of introducing 945MW in 2030, which accounts for 16% of ORE, and for 35% of Solar. Sustainable introduction of rooftop PV is an important item in achieving government goal.

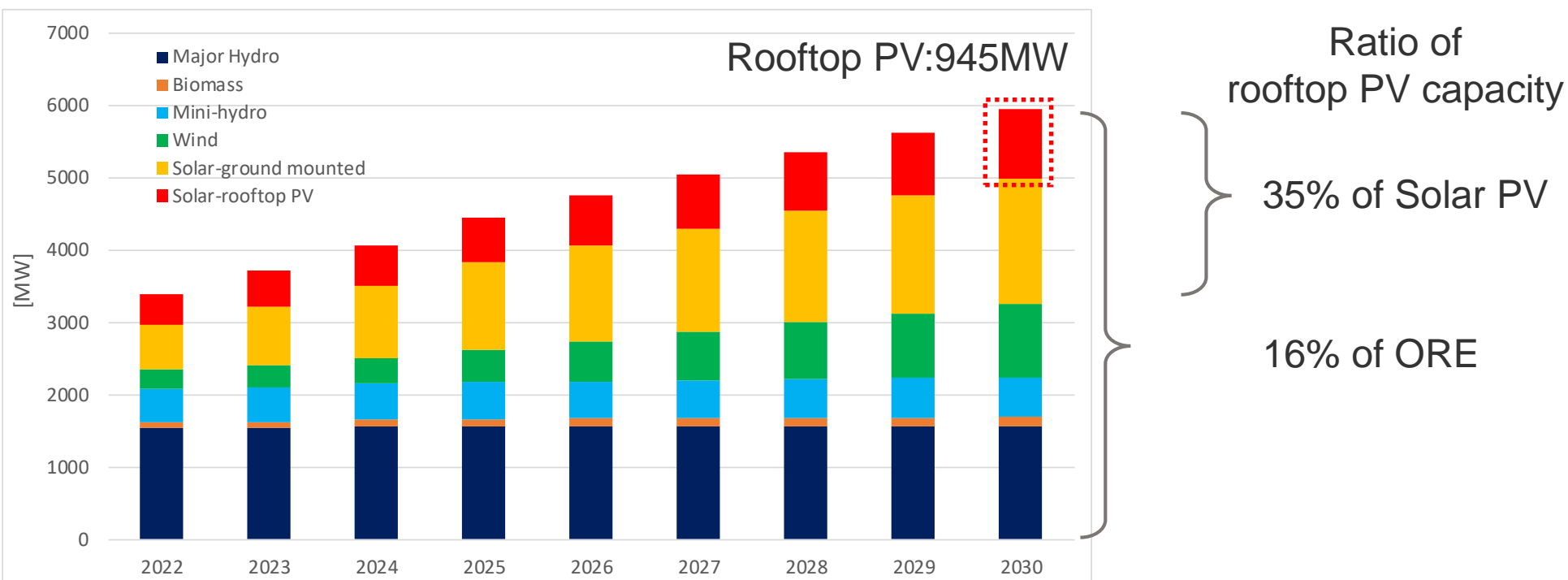

# Target of the FIT system for rooftop PV (by capacity category)

- There is a big difference in the installation cost depending on the introduction capacity.
- FIT tariff should be set for rooftop PV capacity category instead of a uniform FIT tariff.

Capacity classification for examination	Average installation cost
0-5kW	180,000 LKR/kW*1
5-10kW	170,000 LKR/kW*1
10-20kW	125,000 LKR/kW*2
20-40kW	
40-60kW	120,000 LKR/kW*2
60-100kW	
100kW-1MW	90,000 LKR/kW*2
More than 1MW	85,000 LKR/kW*2

Source \*1:KHM Solar, \*2: Financial status and a four-year road map for financial recovery, Jan. 2021,CEB



# 04 Flow of examination

---

## Step1

**Setting the premises for examination**

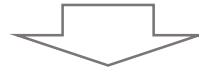

## Step2

**Examination of FIT tariff category by rooftop PV capacity**

Calculate the generation cost for each capacity of rooftop PV and examine the capacity category of FIT tariff.



## STEP3

**Examination of FIT tariff for each rooftop PV capacity category**

Calculate categorized FIT tariff using the weighted average of installation cost for each capacity category of rooftop PV.

# 05

## Step1 Setting the premises for examination

---

# Premises of unit generation cost calculation for the FIT tariff revision for rooftop PV

- We calculate the generation cost that can secure the Equity IRR using the calculation conditions in the table such as the unit cost for installation of each capacity of rooftop PV.

Item	Value	Remarks
Unit cost for installation	Depend on capacity	
Operation period	20 years	FIT program period
Cost of Debt(Interest rate)	10.18% for 1 <sup>st</sup> year to 7 <sup>th</sup> year (7.18% on Oct. 29, 2021 +3%)	Average Weighted Prime Lending Rate(AWPLR)+3% margin
Debt repayment period	10 years	Repayment period set by commercial bank for FIT user
Equity return to be expected	13.05 %	Latest Ten Year Bond rate (10.05% on Sep. 15, 2021) +3% margin
Debt / Equity ratio	Debt 70 / Equity 30	
O&M cost per year	Depend on capacity (Including inverter replacement)	0.9% of unit cost for installation, escalated 4.2%,the five year average inflation rate from 2016 to 2020, NCPI.
Capacity factor	17.0 %	
Deterioration rate per year	0.7 %/year	
Grid availability	99 %	

# Unit cost for installation

- Calculate the unit generation cost using the installation cost for each capacity of rooftop PV.

PV capacity	Average installation cost
0-5kW	180,000 LKR/kW
5-10kW	170,000 LKR/kW
10-20kW	125,000 LKR/kW
20-40kW	125,000 LKR/kW
40-60kW	120,000 LKR/kW
60-100kW	120,000 LKR/kW
100kW-1MW	90,000 LKR/kW
Over 1MW	85,000 LKR/kW

Source: KHM Solar and Financial status and a four-year road map for financial recovery, Jan. 2021,CEB

# Debt condition

## Cost of Debt

- The cost of debt is the nearest Average Weight Prime Lending Rate(AWPLR) plus 3% as a margin for interest rate fluctuations.  
AWPLR 7.18% (Oct. 29, 2021) +3%, taken as 10.18%
- Debt repayment period  
The repayment period is set to 10 years.

Commercial Bank Lending and Deposit Rates ( Per cent per annum )							
End Week	Average Weighted Lending Rate (AWLR)	Average Weighted Prime Lending Rate (AWPR)			Average Weighted Deposit Rate		Average Weighted Fixed Deposit Rate (AWFDR) Rate (%)
		Weekly	Monthly	6 months	Monthly	6 months	
2021-11-05		7.62					
2021-10-29		7.82	7.18	6.08	4.79	4.82	5.70
2021-10-22		7.23					
2021-10-15		6.95					
2021-10-08		6.71					
2021-10-01		6.42	6.39	5.82			
2021-09-30	9.37				4.75	4.86	5.64
2021-09-24		6.46					

Source: Data Library - Central bank of Sri Lanka

[https://www.cbsl.lk/eResearch/Modules/RD/SearchPages/CMB\\_LendingAndDeposit.aspx](https://www.cbsl.lk/eResearch/Modules/RD/SearchPages/CMB_LendingAndDeposit.aspx)

## Equity IRR

- Equity IRR (Cost of Equity) is the rate of the latest 10-year government bond plus 3% as a margin for interest rate fluctuations.
- 10.05% (Sep. 15, 2021) +3%, taken as 13.05%

Rates on Government Securities (Per cent per annum)																
End Week	Treasury Bill			Treasury Bond												
	91 days	182 days	364 days	02 year	03 year	04 year	05 year	06 year	07 year	08 year	09 year	10 year	12 year	15 year	20 year	30 year
2021-10-08	7.15	7.20	7.28													
2021-10-01	6.70	6.99	7.01													
2021-09-24	6.38	6.27	6.50													
2021-09-17	6.08		6.12													
2021-09-15					8.10							10.05				
2021-09-10	6.01		6.05													
2021-09-03	5.92	5.95	5.96													
2021-09-01				6.75		8.55										

Source: Data Library - Central bank of Sri Lanka  
[https://www.cbsl.lk/eResearch/Modules/RD/SearchPages/Indicators\\_GovernmentSecurities.aspx](https://www.cbsl.lk/eResearch/Modules/RD/SearchPages/Indicators_GovernmentSecurities.aspx)

# Other item

These premises were determined by CEB's actual operation and WG discussion

## Debt Equity ratio

- 70:30

## O&M cost

- 0.9% of installation cost
- Inverter replacement cost included in O&M cost
- Consideration of 5 years average inflation rate(2016-2020): 4.2%  
2.9%(2016 Jan.), 4.6%(2017 Jan.), 7.6%(2018 Jan.), 1.8%(2019 Jan.), 4.1%(2020 Jan.)  
source: NCPI (National Consumer Price Index)

<http://www.statistics.gov.lk/InflationAndPrices/StaticallInformation/MonthlyNCPI/Inflation-FoodAndNonFoodGroups>

## Capacity Factor

- 17%

## Deterioration rate per year

- 0.7%/year

## Grid availability

- 99%



# 05

## Step2 Examination of FIT tariff category by rooftop PV capacity

---

# Examination of FIT tariff category by rooftop PV capacity

Categorize the FIT tariff based on the generation cost.

- FIT tariffs are divided with a threshold of 10kW and 100kW.

Category 1

Category 2

Category 3

Rooftop PV capacity		0-5kW	5-10kW	10-20kW	20-40kW	40-60kW	60-100kW	100kW-1MW	Over 1MW
Installation cost [LKR/kW]		180,000	170,000	125,000	125,000	120,000	120,000	90,000	85,000
Generation Cost [LKR/kWh]	1st - 7th year	19.73	18.16	12.66	12.66	12.16	12.16	9.12	8.61
	8th - 20th year	15.50	15.50	12.66	12.66	12.16	12.16	9.12	8.61
Project IRR		11.55%	11.59%	11.67%	11.67%	11.68%	11.68%	11.68%	11.67%
Equity IRR for customer		13.05%	13.05%	13.05%	13.05%	13.07%	13.07%	13.07%	13.05%



There is a big difference in generation cost

# 06

## Step 3 Examination of FIT tariff for each rooftop PV capacity category

---

# Unit cost of installation for newly recommended FIT tariff calculation for rooftop PV

- In order to calculate the FIT tariff as three categories, the weight average installation cost of 0-10kW is 177,000 LKR/kW, 10-100kW is 124,000 LKR/kW and over 100kW is 87,000 LKR/kW.

Category	PV capacity	Installation cost	Accumulating installation capacity	Weighted average installation cost
1	0-5kW	180,000 LKR/kW	65.11 MW	176,246 LKR/kW →177,000 LKR/kW
	5-10kW	170,000 LKR/kW	39.13 MW	
2	10-20kW	125,000 LKR/kW	59.84 MW	123,746 LKR/kW →124,000 LKR/kW
	20-40kW	125,000 LKR/kW	47.67 MW	
	40-60kW	120,000 LKR/kW	17.43 MW	
	60-100kW	120,000 LKR/kW	18.50 MW	
3	100kW-1MW	90,000 LKR/kW	18.83 MW	86,871 LKR/kW →87,000 LKR/kW
	Over 1MW	85,000 LKR/kW	31.50MW	

# Calculation result of Generation cost(newly recommended FIT tariff for rooftop PV)

- As a result of calculation using the rooftop PV installation cost in 2020, then current FIT tariff of 22.00LKR/kWh(1<sup>st</sup> – 7<sup>th</sup> year) and 15.50LKR/kWh(8<sup>th</sup> – 20<sup>th</sup> year) can be reduced to 19.26 LKR/kWh for under 10kW, 12.56LKR/kWh for 10-100kW and 8.82 LKR/kWh for over 100kW while securing the appropriate profit of the business operator.
- For Category 2 and 3 below the average direct generation cost, the following tariffs are proposed in order to secure profitability and promoting the introduction by the FIT system.
  - ✓ Category 2 : 5% increase in average direct generation cost (14.21LKR/kWh)
  - ✓ Category 3 : Average direct generation cost (13.53LKR/kWh)

Item		Examination result			Current tariff level
Rooftop PV capacity		Category 1: Under 10kW	Category 2: 10-100kW	Category 3: Over 100kW	-
Installation cost [LKR/kW]		177,000	124,000	87,000	-
FIT tariff	1st - 7th year	19.26 LKR/kWh	12.56LKR/kWh <sup>*1</sup> ⇒ 14.21LKR/kWh <sup>*2</sup>	8.82 LKR/kWh <sup>*1</sup> ⇒ 13.53 LKR/kWh <sup>*3</sup>	22.00 LKR/kWh
	8th - 20th year	15.50 LKR/kWh	12.56LKR/kWh <sup>*1</sup> ⇒ 14.21LKR/kWh <sup>*2</sup>	8.82 LKR/kWh <sup>*1</sup> ⇒ 13.53 LKR/kWh <sup>*3</sup>	15.50 LKR/kWh

\*1: Calculated FIT tariff using above installation cost

\*2: 5% increase in average direct generation cost(13.53LKR/kWh@2020×1.05)

\*3: Average direct generation cost (13.53LKR/kWh@2020)

# 06 Recommendation

---

# Recommendation

- Rooftop PV will apply the new FIT tariff(19.26 LKR(1-7 year) and15.50LKR(8-20 year) for under 10kW, 12.56 LKR for 10-100kW and 12.17LKR for over 100kW).
- The FIT tariff will be reviewed annually to reflect lower installation cost and changes in financing conditions. (supplementary explanation is on page 29)

# Review of FIT Tariff linked to The PV System Price change

In Japan, the system price assumption for the 2022 installation is evaluated based on the last two-year price decline level. The median of projects in 2020 is in the top 36-37% of 2018. From this, we propose 259,000 yen / kW in 2022.

%	PV System Cost for Household		
	Installed in 2020	Installed in 2019	Installed in 2018
5%	16.25	18.25	20.25
10%	17.58	20.29	23.33
15%	19.19	21.78	24.90
20%	21.04	22.85	25.73
25%	22.52	23.75	27.25
30%	23.87	24.79	28.81
35%	25.19	26.09	29.80
36%	25.50	26.33	30.05
37%	25.87	26.62	30.34
38%	26.17	26.91	30.56
39%	26.51	27.23	30.83
40%	26.86	27.54	31.11
45%	28.49	28.88	32.35
50%	30.08	30.31	33.52

Price decline for two years

<One prospective solution>

FIT tariff shall be annually reviewed in line with the past PV system price change



# 07 Conclusion

---

## Outline of FIT system revision

- The rooftop PV generation cost was calculated using the rooftop PV installation cost for each capacity in 2020.
- Under 10kW rooftop PV is proposed to apply the new FIT tariff for 19.26 LKR(1-7 year) and 15.50LKR(8-20 year).
- 10-100kW rooftop PV is proposed to apply the new FIT tariff for 12.56LKR.
- Over 100kW rooftop PV is proposed to apply the new FIT tariff for 12.17LKR



**CHUBU**  
Electric Power

***NIPPON KOEI***

Purchase Price Calculation for household level solar PV

Exchange rate (as of Mar. 16, 2020)

Yellow color cell: Manual input cell  
 Orange color cell: Automatic calculated cell

1 USD = 197 LKR  
 1 USD = 109 JPY

D/E ratio	Debt ratio	70%	Debt	126,000 LKR	639.59 USD	69,716 JPY
	Equity ratio	30%	Equity	54,000 LKR	274.11 USD	29,878 JPY
Interest rate	1st - 7th year	10.18%	Lending rate	6.42%	Margin	1%
	8th year -	10.18%	Average Weighted Prime Lending rate(6.42% on 2021 September)		Risk	2%
Debt repayment period		10 years				

Purchase Price	1st - 7th year	19.73 LKR/kWh	0.10 USD/kW/year	10.9 JPY/kW/year
	8th - 20th year	15.50 LKR/kWh	0.08 USD/kW/year	8.6 JPY/kW/year

IRR calculation	
Project IRR	11.55%
Equity IRR	13.05%

less than Equity return to be expected 13.05%

Operation period	20 years		
Scale of PV system	1.0 kW		
Unit cost for installation	180,000 LKR/kW	914 USD/kW	99,594 JPY/kW
O&M cost per year (0.9% of installation cost)	1,620 LKR/kW/year	8.22 USD/kW/year	896 JPY/kW/year
5 year average inflation rate(2016-2020) for O&M	4.2%		
Capacity Factor	17.0%		
Deterioration rate per year	0.70% / year		
Grid availability	99%		

Breakdown

Item	Year																				total
	1	2	3	4	5	6	7	8	9	10	11	12	13	14	15	16	17	18	19	20	
Power generation efficiency [%]	100	99.30	98.60	97.90	97.20	96.50	95.80	95.10	94.40	93.70	93.00	92.30	91.60	90.90	90.20	89.50	88.80	88.10	87.40	86.70	
Generated power [kWh]	1,489	1,479	1,468	1,458	1,448	1,437	1,427	1,416	1,406	1,395	1,385	1,375	1,364	1,354	1,343	1,333	1,322	1,312	1,302	1,291	27,803
Selling power [kWh]	1,474	1,464	1,454	1,443	1,433	1,423	1,412	1,402	1,392	1,381	1,371	1,361	1,350	1,340	1,330	1,320	1,309	1,299	1,289	1,278	27,525
Revenue from selling power [LKR]	29,088	28,884	28,681	28,477	28,274	28,070	27,866	21,732	21,572	21,412	21,252	21,092	20,932	20,772	20,612	20,452	20,292	20,132	19,972	19,812	469,380
O&M cost [LKR]	For debt	1,134	1,182	1,231	1,283	1,337	1,393	1,452	1,512	1,576	1,642	1,711	1,783	1,858	1,936	2,017	2,102	2,190	2,282	2,378	34,478
	For equity	486	506	528	550	573	597	622	648	675	704	733	764	796	830	865	901	939	978	1,019	1,062

Debt repayment	Rate [LKR]	12,827	12,029	11,150	10,181	9,114	7,938	6,642	5,215	3,642	1,909	0	0	0	0	0	0	0	0	0	80,647	
	Principle [LKR]	7,838	8,636	9,515	10,484	11,551	12,727	14,022	15,450	17,023	18,755	0	0	0	0	0	0	0	0	0	0	126,000
Period: 10years	Total [LKR]	20,665	20,665	20,665	20,665	20,665	20,665	20,665	20,665	20,665	20,665	0	0	0	0	0	0	0	0	0	0	206,647

Benefit [LKR]	6,803	6,532	6,257	5,980	5,699	5,415	5,128	-1,093	-1,344	-1,599	18,808	18,545	18,278	18,007	17,731	17,450	17,163	16,872	16,575	16,273	213,479
---------------	-------	-------	-------	-------	-------	-------	-------	--------	--------	--------	--------	--------	--------	--------	--------	--------	--------	--------	--------	--------	---------

IRR calculation		Initial cost
P-IRR	11.6%	-180,000
E-IRR	13.0%	-54,000

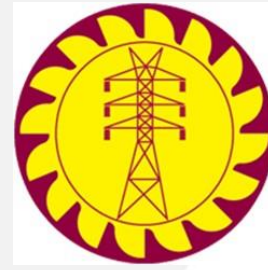

# Milestone of Roof Top PV FIT Tariff Revision

Ceylon Electricity Board  
JICA Expert Team

September, 2022

Chubu Electric Power Co., Inc.  
Nippon Koei Co., Ltd.

# 01 Purpose

- Before the economic got worse, the FIT Scheme basically made the CEB's financial situation worse.
- After the economic recovers, if the FIT Scheme has a negative impact on the CEB's financial situation as it was before, it is desirable to revise it promptly.



In order to make a smooth transition to revision work, it is desirable to grasp a general understanding of procedures, possible problems, periods, CEB organizations to deal with, etc.

Arranged as a milestone/structure

# 02 Milestones

	Procedure	Period (Month)	Note
1	Recalculation of FIT Tariff to reflect economic conditions	1.0	● It is possible for CEB to change the preconditions of the Draft Proposal (submitted by JICA Expert)
2	Internal Approval of CEB	0.5	● Already explained to Hendahewa AGM ● Information sharing in advance if there is a related Dep.
3	Setting offer of Expert Committee (EC) for Roof top PV	0.5	● CEB→MoP
4	Deliberation in the Expert Committee for Roof top PV	1.0	● Answering questions (requires solid understanding of calculation methods)
5	Deliberation in the State Ministry of Solar, Wind and Hydro power generation project	1.0	● Answering questions (requires solid understanding of calculation methods)
6	Deliberation in the Ministry of Power (Third opinion from CEB, PUCSL)	2.0	● Answering questions (requires solid understanding of calculation methods)
7	Deliberation in the Cabinet	1.0	
8	Cabinet Approval		● Careful explanation to developers after the revision

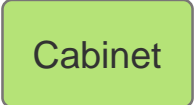
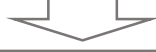

Around 7 months

# 03 Organization

- CEB (Renewable Energy Development) has the main role of outside correspondence
  - Setting offer of EC for Roof top PV FIT Tariff
  - Applying of Roof top PV FIT Tariff to EC
  - Answering questions
- Build a cross-departmental team that can answer multifaceted questions  
RE development, Planning, Financial assessment, Power System Impact, etc.

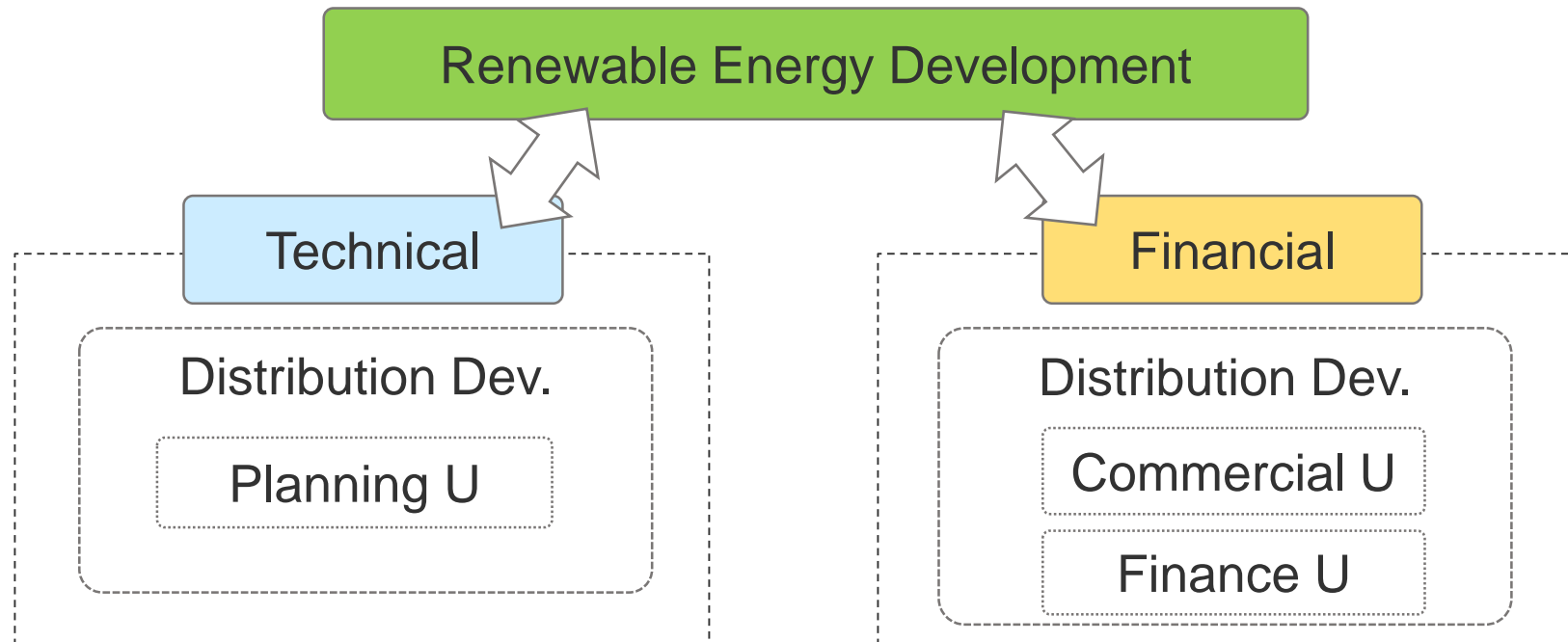





**CHUBU**  
Electric Power

***NIPPON KOEI***

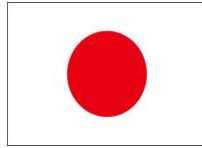
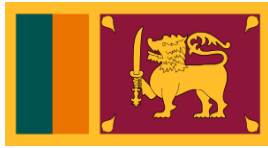

# Fuel Cost Adjustment System

## Auxiliary measures to stabilize the CEB Business

July , 2020

Chubu Electric Power Co., Inc.  
Nippon Koei Co., Ltd.

# Outline of Fuel Cost Adjustment System

- Fuel cost fluctuation and exchange rate variation, which cannot be controlled by electric utilities, is calculated independently and piled up on the basic rate.
- The results of the business efficiency improvement of the electric utilities can be clarified
- The changes in the economic situation are reflected in the price as quickly as possible.
- This system was introduced in January 1996 for the purpose of stabilizing the business environment of electric utilities

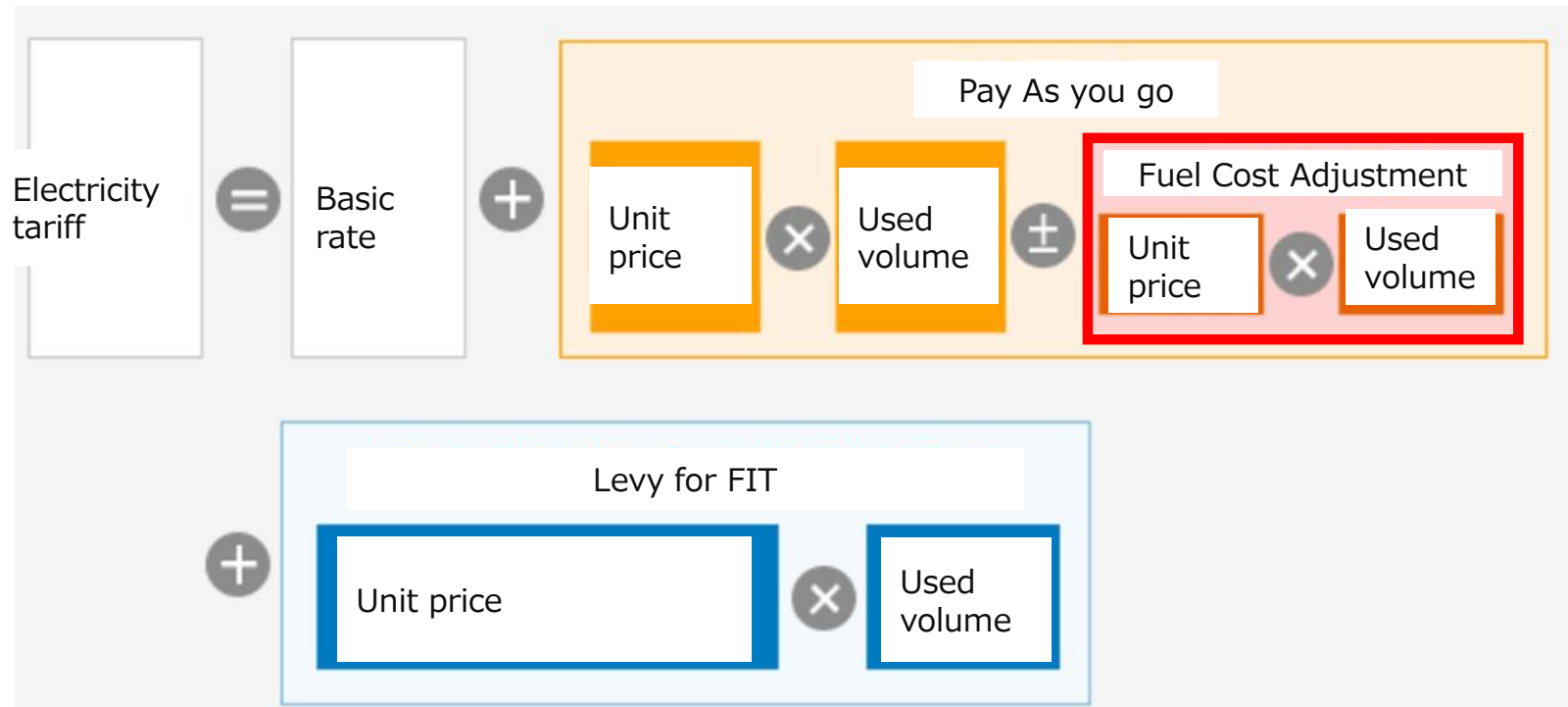

# Delayed Issues and System Revision

## Before revision

The charge price is automatically adjusted based on the average import price of each fuel comes from statistics two quarters ago

- 3 months delayed
- Review cycle is long every quarter

## Revised in 2008

To response to changes in the electric power industry such as large and rapid changes in fuel prices, the changes in fuel prices should be reflected more quickly.

- To Shorten the delay by one month
- To Review every month

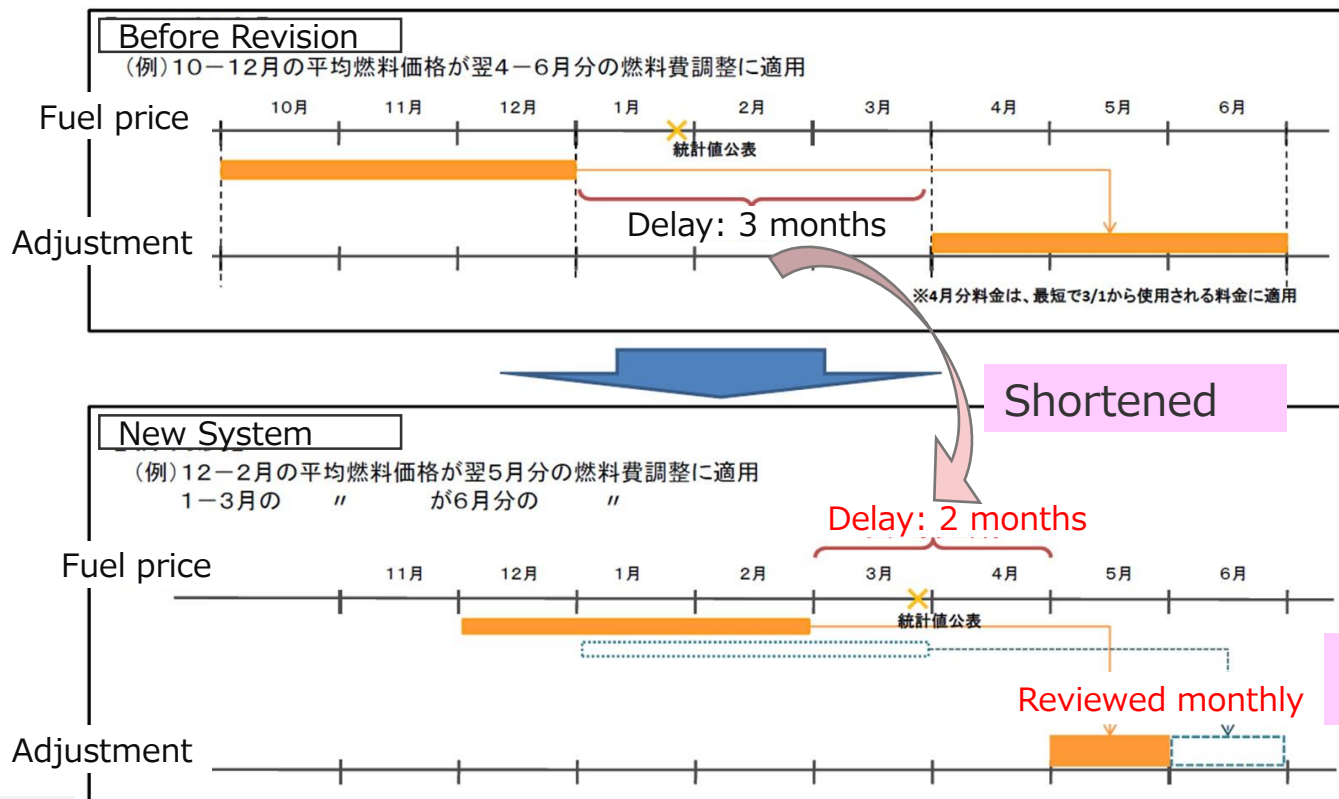

# Calculation Method of Fuel Cost Adjustment

- “Standard fuel price (SFP)” is set based on the cost of power generation  
→It is set for each electric utility based on the estimated fuel purchase price
- Fuel cost changes depending on exchange rates and market movements. Based on that, “Average fuel price (AFP)”, which is actual cost used in this term, is calculated.
- Compare the “SFP” and “AFP”, then adjustment is conducted.
- An upper limit (+50% from the “SFP”) is set in order to soften the large impact on customers when the fuel price rises significantly, while there is no lower limit setting

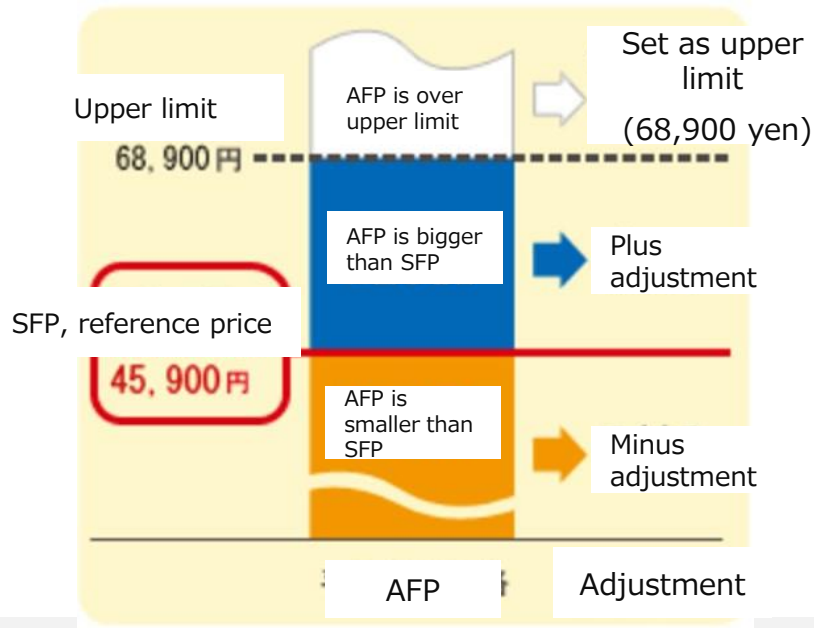

## SFP, reference price

CEPCO Area	45,900円
TEPCO Area	44,200円
KEPCO Area	27,100円

Ex., When AFP calculation formula

$$\text{Adjustment price is calculated:} \\ = \left( \text{(1) AFP} - \text{(2) SFP} \right) \times \frac{\text{(3) Standard Unit Price}}{1,000}$$

Standard Unit Price: Adjustment price when AFP fluctuates by 1000 yen/kl

Source: CEPCO

- The fuel cost adjustment will be reflected in the tariff after 2-4 months
- Although it is possible to reduce the financial impact, it affects the fiscal business result (financial statement)
  - Profit improves in the condition of falling of fuel prices
  - Profit deteriorates in the condition of rising of fuel prices

Fiscal business result is probably affected

# Impact on Electric Utility Performance

- “Standard fuel price (SFP)” is determined and varies by electric utilities depending on power source composition.
- As this scheme does not support change of power generation mix after the Great East Japan Earthquake, it cannot pass on the rise of fuel cost to tariff. In particular, the damage of financial statement of electric utilities with a large percentage of nuclear power was significant.
- Since it is also a national policy, it cannot be assumed that the nuclear power ratio will decline.

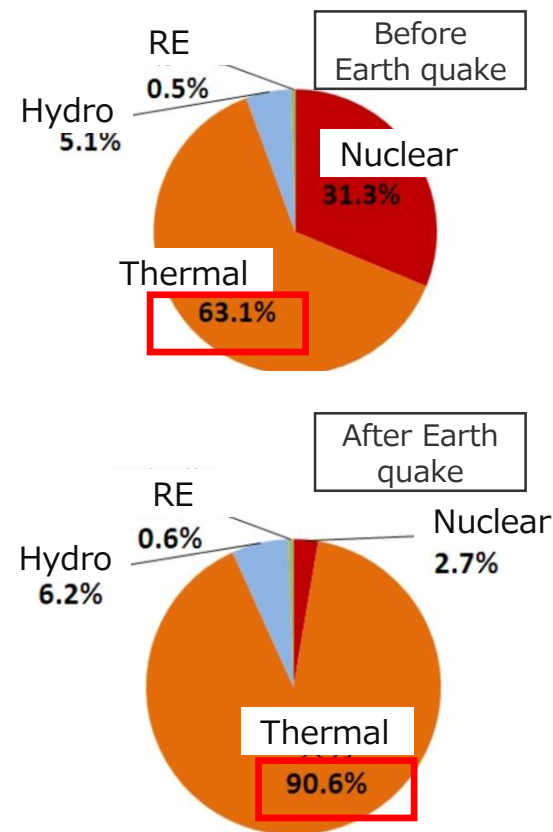
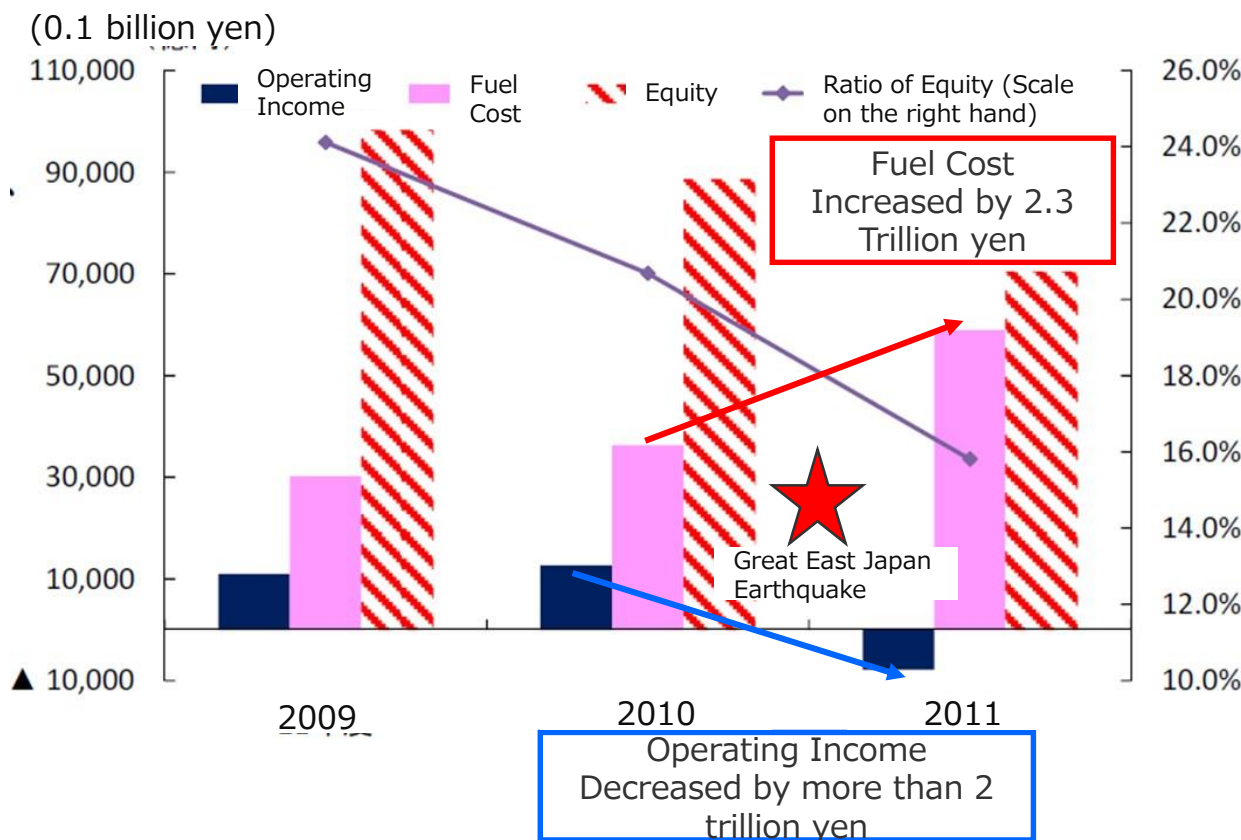

It is **Not** a system that supports the change power generation mix

Skyrocket



**CHUBU**  
Electric Power

***NIPPON KOEI***