

#### **4. Minutes of Discussions**

Copies of the following Minutes of Discussions (M / D) are attached in the following pages.

- (1) Minutes of Discussions on the Preparatory Survey for the Project for Explanation of Water Supply System in Svay Rieng in the Kingdom of Cambodia (Signed September 3<sup>rd</sup>, 2019)
- (2) Minutes of Discussions on the Preparatory Survey for the Project for Explanation of Water Supply System in Svay Rieng in the Kingdom of Cambodia (Signed February 13<sup>th</sup>, 2020)
- (3) Minutes of Discussions on the Preparatory Survey for the Project for Explanation of Water Supply System in Svay Rieng in the Kingdom of Cambodia (Signed April 12<sup>th</sup>, 2021)
- (4) Minutes of Discussions on the Preparatory Survey for the Project for Explanation of Water Supply System in Svay Rieng in the Kingdom of Cambodia (Signed December 15<sup>th</sup>, 2021)

**Minutes of Discussions**  
**on the Preparatory Survey for the Project for**  
**Expansion of Water Supply System in Svay Rieng in the Kingdom of Cambodia**

With reference to the minutes of discussions signed between Ministry of Industry & Handicraft (hereinafter referred to as "MIH") and the Japan International Cooperation Agency (hereinafter referred to as "JICA") on 24<sup>th</sup> August, 2017 and in response to the request from the Government of Kingdom of Cambodia (hereinafter referred to as "Cambodia") dated on 26<sup>th</sup> June, 2017, JICA dispatched the Preparatory Survey Team (hereinafter referred to as "the Team") for the explanation of Draft Preparatory Survey Report (hereinafter referred to as "the Draft Report") for the Project for Expansion of Water Supply System in Svay Rieng (hereinafter referred to as "the Project").

As a result of the discussions, both sides agreed on the main items described in the attached sheets.

Phnom Penh, September 03, 2019

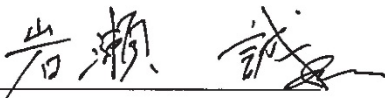

Mr. Makoto Iwase  
Leader  
Preparatory Survey Team  
Japan International Cooperation Agency

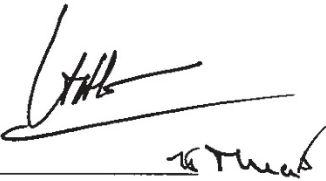

H.E. Oum Sotha  
Secretary of State  
Ministry of Industry & Handicraft  
Kingdom of Cambodia

## ATTACHMENT

### 1. Water Sources

In the Minutes of Discussions dated on 24<sup>th</sup> August, 2017, both sides agreed to change water source to be studied in the Preparatory Survey from Vay Kor Lake due to the concern about the structure of existing Vay Kor Dam. However, the Japan Water Agency investigated the soundness of the dam in detail based on expert knowledge in 2018, and concluded that the dam was deteriorated but could be used by repair reinforcement. Based on this results, both sides confirmed the Preparatory Survey for Svay Rieng project will survey the possibility to utilize the Vay Kor Lake as water sources. In this connection, the Team strongly request MIH to facilitate Ministry of Water Resources and Meteorology to implement necessary repairs and reinforcement for the Vay Kor Dam according to Annex which had been recommended by the Japan Water Agency.

### 2. Scope of the Project

Both side agreed to consider the scope of the project will cover the urban area under the coverage area of Svay Rieng waterworks and increase water supply capacity of Svay Rieng waterworks to respond to the government target in 2025.

### 3. Timeline for the Preparatory Survey for the Svay Rieng Project

The Team explained to the Cambodian side that the expected timeline for the project implementation is as follows:

- Field Survey from October 2019 to March 2020
- Domestic Analytical Work from April 2020 to August 2020
- Explanation on Draft Preparatory Survey Report in August 2020

Annex: Result of Survey by the Japan Water Agency on the Vay Kor Lake



## Survey results: Soundness of spillway

**Reinforcement and repair are recommended.**

**Soundness rank: S-2 "Noticeable deterioration" (based on Japanese evaluation tool for irrigation facilities)**

<b>S-2</b>	<b>Status of facility:</b> Recognize deformation affected on structural stability of the facility Status capable of countermeasure work with reinforcement	<b>Typical example of actual status:</b> ① Partial deficiency in cross-sectional area of concrete and/or reinforcing bar ② Obvious deformation of concrete structure due to ground deformation or increase of earth pressure	<b>Action:</b> Reinforcement or repair
------------	--	--	---

Reference: Ministry of Agriculture, Forestry and Fisheries of Japan

- Deterioration covers whole of dam structure.
- Bed protection is also severely damaged.
- Repairs of concrete surface and body are required to maintain dam stability.
- Damaged bed protection requires to recover the function by structural reinforcement.



**Insufficient thickness (designed as 30cm)**

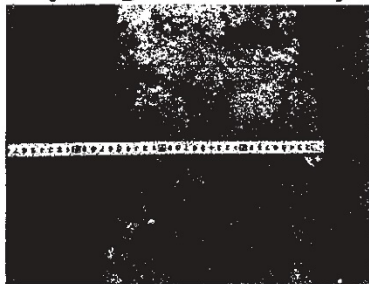

**Crack and leakage**

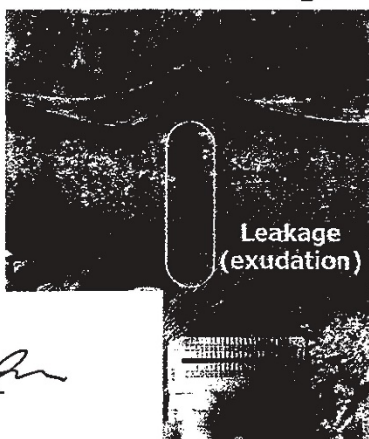

**Abrasion**

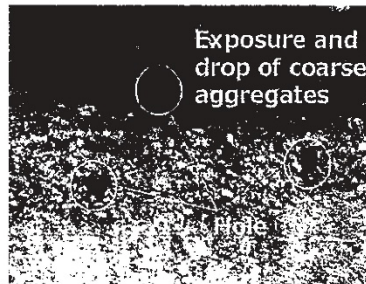

**Reinforcing bar exposure**

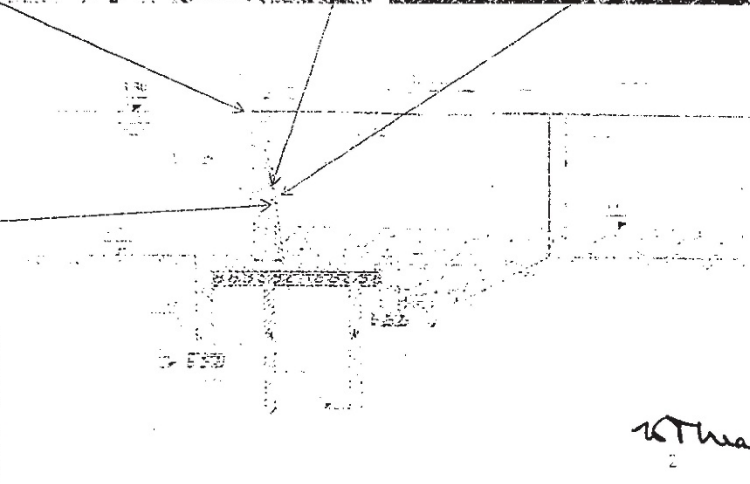
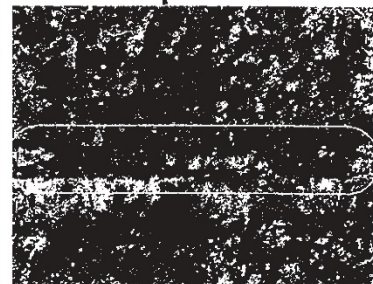

*Handwritten signature*

*Handwritten signature*

**Leakage from joint**

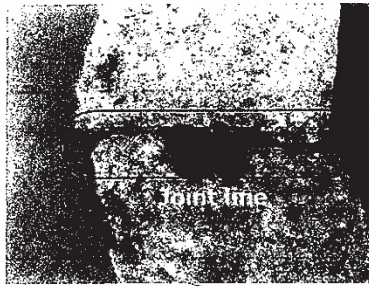

**Scour of bed protection**

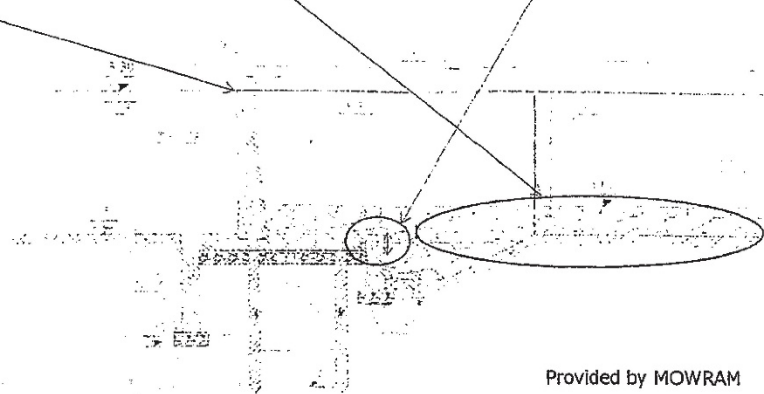

Provided by MOWRAM

**Inspection record of Vaico Dam**

Structure and layout design

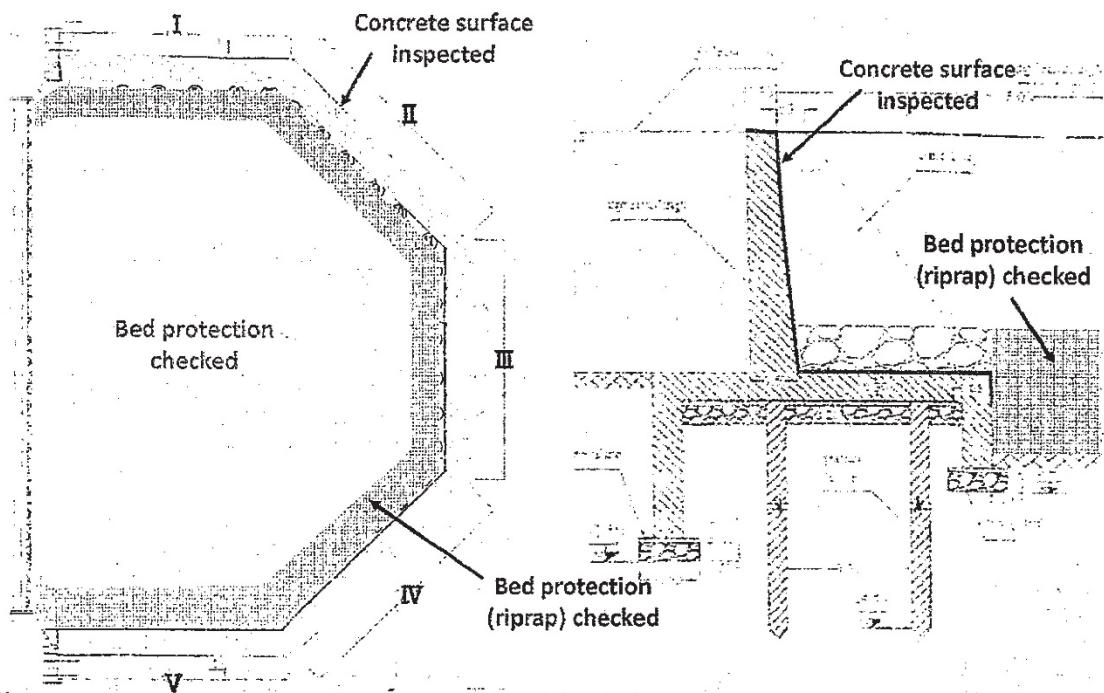

Provided by MOWRAM

*Signature*

*Signature*

## Status of deterioration for each segment

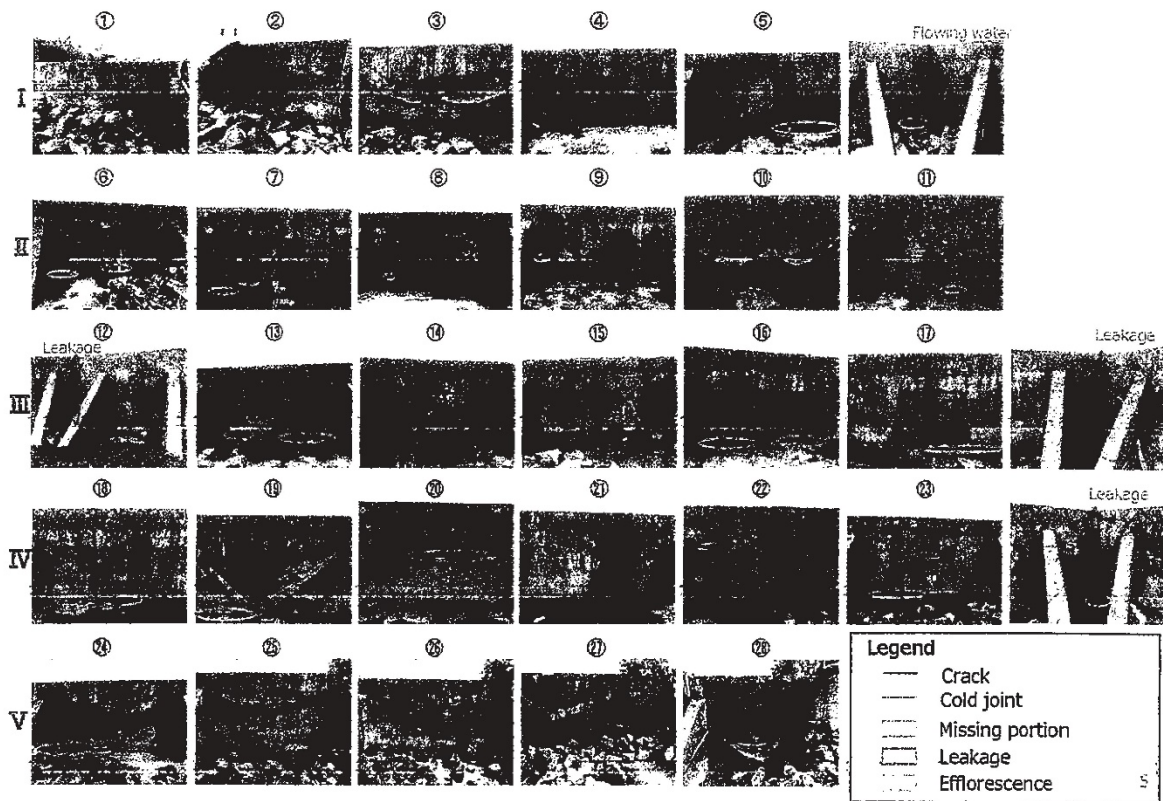

## Repair and reinforcement of Vaico Dam

### Technical options for repair and reinforcement

- Concrete surface coating and section repair
  - ✓ Removal and repair of deteriorated portion (crack, abrasion, fall-off, etc.)
- Bed protection improvement (preventing from scouring)
  - ✓ Relocation of flushed riprap or refilling new riprap
  - ✓ Replacement by larger-sized riprap
  - ✓ Caged riprap
  - ✓ Inverted filter (riprap and gravel layer formation)
- Expansion of dam structure
  - ✓ Concrete structure thickness increasing

*dm*



*to the end*

## Repair and reinforcement of Vaico Dam

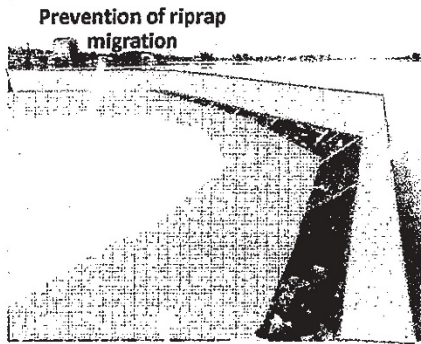

Prevention of riprap migration

### Concrete surface coating and section repair

Appropriate material and method depending on the cause and condition are selected.

Materials:

✓ Cement, Resin (epoxy, etc.), Polymer cement

Methods:

✓ Grouting, pre-packed, plastering, etc.

### Riprap rearrangement

### Bed protection improvement

Regular maintenance of riprap arrangement

- ✓ Relocation of flushed riprap
- ✓ Filling new riprap
- ✓ Replacing to larger riprap

Prevention of riprap migration and bed scouring

- ✓ Caged riprap
- ✓ Inverted filter (riprap and gravel layer formation)

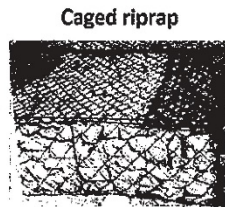

Caged riprap

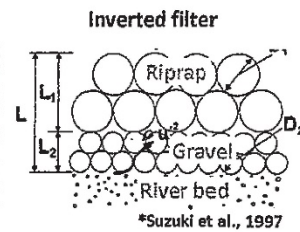

Inverted filter

\*Suzuki et al., 1997

## Repair and reinforcement of Vaico Dam

[Reference case]: Makara 7 Dam in Kandal Stueng



Makara 7 Dam

### Bed protection

Riprap design:

- Use riprap large enough not to be flushed
- Put riprap to cover whole area of spillway downstream
- Relocate flushed riprap in every dry season

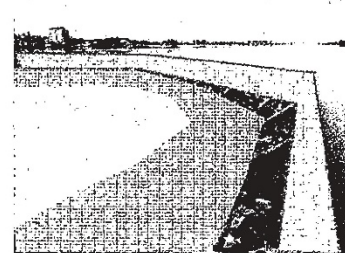

### Expansion of structure

Typical example of structure thickness increasing:

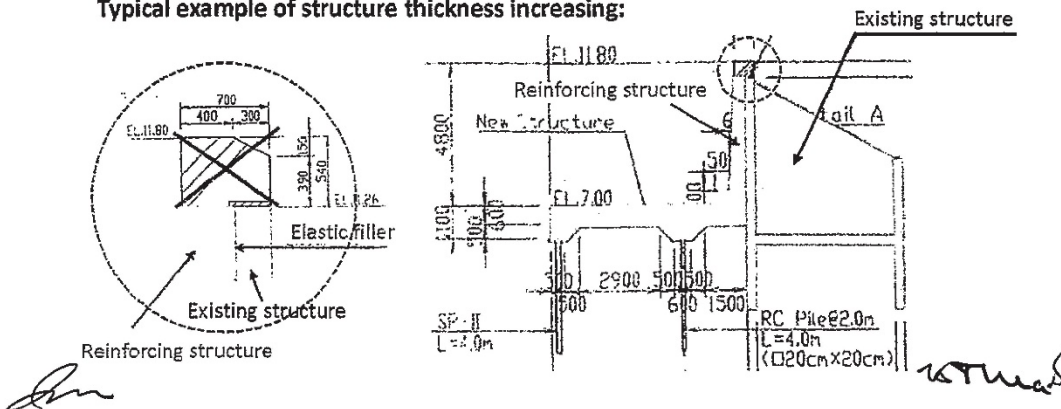

# Raising spillway height

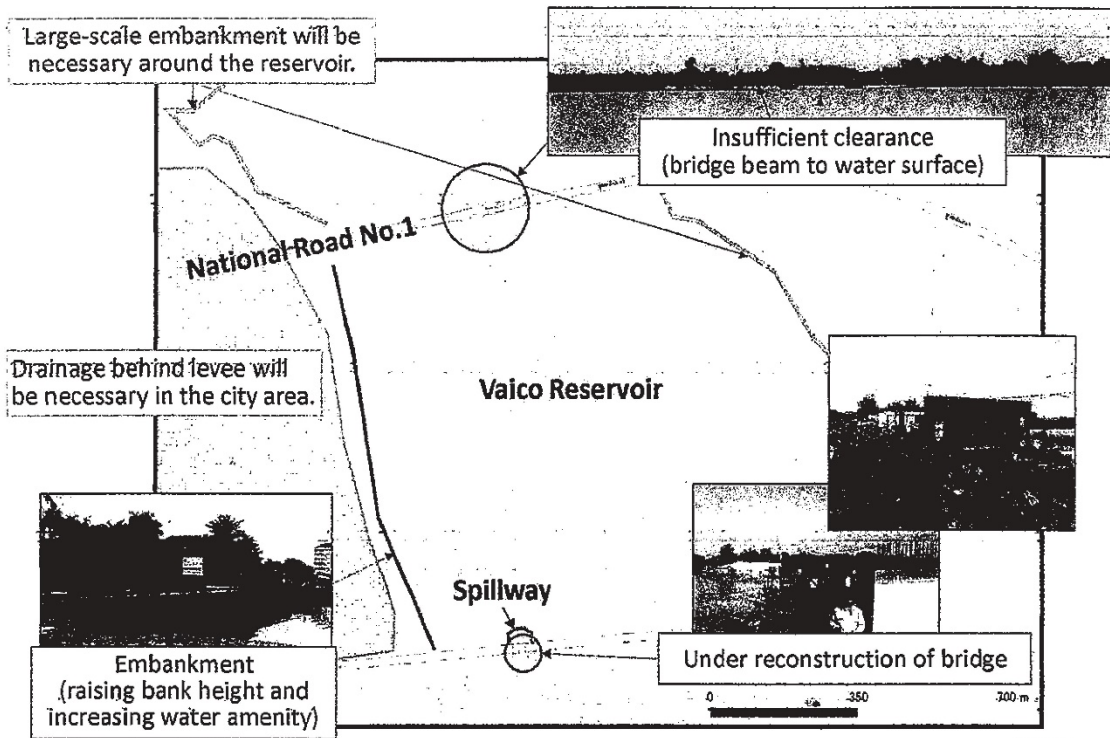

*Jan*

*KTH*



**Minutes of Discussions**  
**on the Preparatory Survey for the Project for**  
**Expansion of Water Supply System in Svay Rieng in the Kingdom of Cambodia**

With reference to the minutes of discussions signed between Ministry of Industry & Handicraft (hereinafter referred to as "MIH") and the Japan International Cooperation Agency (hereinafter referred to as "JICA") on 24<sup>th</sup> August, 2017, 28<sup>th</sup> June, 2018, and 3<sup>rd</sup> September 2019, and in response to the request from the Government of Kingdom of Cambodia (hereinafter referred to as "Cambodia") dated on 26<sup>th</sup> June, 2017, JICA dispatched the Preparatory Survey Team (hereinafter referred to as "the Team") for the Project for Expansion of Water Supply System in Svay Rieng (hereinafter referred to as "the Project").

As a result of the discussions, both sides agreed on the main items described in the attached sheets.

Phnom Penh, February 13, 2020

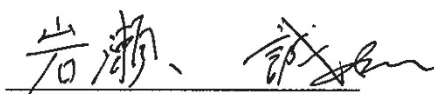

Mr. Makoto Iwase  
Leader  
Preparatory Survey Team  
Japan International Cooperation Agency



H.E. Oum Sotha  
Secretary of State  
Ministry of Industry & Handicraft  
Kingdom of Cambodia

## ATTACHMENT

### 1. Objective of the Project

The objective of the Project is to improve the access to safe water in the city of Svay Rieng through the expansion of water supply system.

### 2. Title of the Preparatory Survey

According to the minutes signed on 28<sup>th</sup> June, 2018, both sides confirmed the title of the Preparatory Survey as “the Preparatory Survey for the Project for Expansion of Water Supply System in Svay Rieng”.

### 3. Project site

Both sides confirmed that the site of the Project is in Svay Rieng, which is shown in Annex 1.

### 4. Responsible authority for the Project

Both sides confirmed the authorities responsible for the Project are as follows:

- 4-1. The Ministry of Industry and handicraft will be the executing agency for the Project (hereinafter referred to as “the Executing Agency”). The Executing Agency shall coordinate with all the relevant authorities to ensure smooth implementation of the Project and ensure that the undertakings for the Project shall be managed by relevant authorities properly and on time.

### 5. Basis for Project Design

- 5-1. Both sides discussed and confirmed that the basis for project design are the high investment efficiency and alignment of the following development policies in Cambodia.

#### Development policies for urban water supply in Cambodia

- To provide the population in urban area access to water supply service 100% in 2025, 90% to be covered by tap water and 10% to be covered by other sources, which in one of the targets of “National Strategic Development Plan from 2019 to 2023” of the Cambodian government.
  - Goal 6 of SDGs, to provide safe water to all by 2030.
- 5-2. Both sides confirmed that target year of the Project is the Year 2027.
  - 5-3. The both sides confirmed that the scope of the Project will mainly consist of the following works;
    - new intake and transmission facilities,



- water treatment facilities,
- distribution facilities.

5-4. The both sides agreed that the Project scope covered by Japanese Grant Project will be determined based on the preparatory survey results at the explanation on the draft preparatory survey report. The final decision of the Project scope will be, however, made by the Government of Japan.

## 6. Procedures and Basic Principles of Japanese Grant

6-1. The Cambodian side agreed that the procedures and basic principles and basic principles of Japanese Grant (hereinafter referred to as “the Grant”) as described in Annex 2 shall be applied to the Project.

As for the monitoring of the implementation of the Project, JICA requires Cambodian side to submit the Project Monitoring Report, the form of which is attached as Annex 3.

6-2. The Cambodian side agreed to take the necessary measures, as described in Annex 4, for smooth implementation of the Project. The contents of the Annex 4 will be elaborated and refined during the Preparatory Survey and be agreed in the mission dispatched for explanation of the Draft Preparatory Survey Report.

The contents of Annex 4 will be updated as the Preparatory Survey progresses, and eventually, will be used as an attachment to the Grant Agreement.

## 7. Tentative Schedule of the Survey

7-1. JICA will prepare a draft Preparatory Survey Report in English and Khmer and dispatch a mission to Cambodia in order to explain its contents around September-December, 2020.

7-2. The above schedule is tentative and subject to change.

## 8. Environmental and Social Considerations

8-1. The Cambodian side confirmed to give due environmental and social considerations before and during implementation, and after completion of the Project, in accordance with the JICA Guidelines for Environmental and Social Considerations (April, 2010).

8-2. The Project is categorized as “B” from the following considerations:

The Cambodian side confirmed that the project is not located in a sensitive area, nor has sensitive characteristics, nor falls into sensitive sectors under the JICA guidelines for environmental and social considerations (April 2010), and its



potential adverse impacts on the environment are not likely to be significant.

The Cambodian side confirmed to prepare Environmental Protection Contract (EPC) and make EPC on the Project between MIH and Ministry of Environment(MOE) according to the procedure of MOE.

- 8-3. Both sides confirmed that the Project is not expected to occur any resettlement. The Cambodian side confirmed that, in case of the Project would result in involuntary resettlement, the Cambodian side would prepare a Resettlement Action Plan (RAP)/Abbreviated Resettlement Action Plan (ARAP) and make it available to the public. In addition, the Cambodian side confirmed to provide the affected people with sufficient compensation and/or support in accordance with RAP/ARAP, which is consistent with JICA Guidelines for Environmental and Social Considerations (April, 2010), in a timely manner.

## 9. Other Relevant Issues

### 9-1. Assurance of Sustainability of Vay Kor Dam

The Team requested and MIH agreed to obtain the confirmation letter from Ministry of Water Resources and Meteorology before the explanation on the draft preparatory survey report for keeping the water level of the Vay Kor dam to intake enough water and for prompt recovery of the water level in case of accident. Both sides confirmed that the confirmation letter above mentioned would be referred on the minutes at the explanation on the draft preparatory survey report.

### 9-2. House Connection for New Supply Area

MIH agreed to arrange the smooth connection of service pipes in new water supply area which would be expanded by the Project and the details will be discussed at the explanation on the draft preparatory survey report.

### 9-3. Recruit of the New Staff

MIH agreed to secure and recruit necessary numbers of staff and the details will be discussed at the explanation on the draft preparatory survey report.

### 9-4. Land Preparation for the Project

MIH agreed to implement following land preparation for the Project.

- UXO survey for water treatment plant, intake site and temporary yard
- Land preparation for temporary yard and dump site
- Land elevation Work at WTP site





- Land acquisition for intake facility

Annex 1 Project Site

Annex 2 Japanese Grant

Annex 3 Project Monitoring Report (template)

Annex 4 Major Undertakings to be taken by the Government of Kingdom of Cambodia

*KB*

*[Handwritten signature]*

Annex 1 Project Site



*[Handwritten signature]*

*[Handwritten signature]*

**JAPANESE GRANT**

The Japanese Grant is non-reimbursable fund provided to a recipient country (hereinafter referred to as “the Recipient”) to purchase the products and/or services (engineering services and transportation of the products, etc.) for its economic and social development in accordance with the relevant laws and regulations of Japan. Followings are the basic features of the project grants operated by JICA (hereinafter referred to as “Project Grants”).

**1. Procedures of Project Grants**

Project Grants are conducted through following procedures (See “PROCEDURES OF JAPANESE GRANT” for details):

- (1) Preparation
  - The Preparatory Survey (hereinafter referred to as “the Survey”) conducted by JICA
- (2) Appraisal
  - Appraisal by the government of Japan (hereinafter referred to as “GOJ”) and JICA, and Approval by the Japanese Cabinet
- (3) Implementation
  - Exchange of Notes
    - The Notes exchanged between the GOJ and the government of the Recipient
  - Grant Agreement (hereinafter referred to as “the G/A”)
    - Agreement concluded between JICA and the Recipient
  - Banking Arrangement (hereinafter referred to as “the B/A”)
    - Opening of bank account by the Recipient in a bank in Japan (hereinafter referred to as “the Bank”) to receive the grant
  - Construction works/procurement
    - Implementation of the project (hereinafter referred to as “the Project”) on the basis of the G/A
- (4) Ex-post Monitoring and Evaluation
  - Monitoring and evaluation at post-implementation stage

**2. Preparatory Survey**

- (1) Contents of the Survey

*NS*



---

The aim of the Survey is to provide basic documents necessary for the appraisal of the the Project made by the GOJ and JICA. The contents of the Survey are as follows:

- Confirmation of the background, objectives, and benefits of the Project and also institutional capacity of relevant agencies of the Recipient necessary for the implementation of the Project.
- Evaluation of the feasibility of the Project to be implemented under the Japanese Grant from a technical, financial, social and economic point of view.
- Confirmation of items agreed between both parties concerning the basic concept of the Project.
- Preparation of an outline design of the Project.
- Estimation of costs of the Project.
- Confirmation of Environmental and Social Considerations

The contents of the original request by the Recipient are not necessarily approved in their initial form. The Outline Design of the Project is confirmed based on the guidelines of the Japanese Grant.

JICA requests the Recipient to take measures necessary to achieve its self-reliance in the implementation of the Project. Such measures must be guaranteed even though they may fall outside of the jurisdiction of the executing agency of the Project. Therefore, the contents of the Project are confirmed by all relevant organizations of the Recipient based on the Minutes of Discussions.

(2) Selection of Consultants

For smooth implementation of the Survey, JICA contracts with (a) consulting firm(s). JICA selects (a) firm(s) based on proposals submitted by interested firms.

(3) Result of the Survey

JICA reviews the report on the results of the Survey and recommends the GOJ to appraise the implementation of the Project after confirming the feasibility of the Project.

**3. Basic Principles of Project Grants**

(1) Implementation Stage

1) The E/N and the G/A

16 Am

 2



---

After the Project is approved by the Cabinet of Japan, the Exchange of Notes (hereinafter referred to as "the E/N") will be signed between the GOJ and the Government of the Recipient to make a pledge for assistance, which is followed by the conclusion of the G/A between JICA and the Recipient to define the necessary articles, in accordance with the E/N, to implement the Project, such as conditions of disbursement, responsibilities of the Recipient, and procurement conditions. The terms and conditions generally applicable to the Japanese Grant are stipulated in the "General Terms and Conditions for Japanese Grant (January 2016)."

2) Banking Arrangements (B/A) (See "Financial Flow of Japanese Grant (A/P Type)" for details)

- a) The Recipient shall open an account or shall cause its designated authority to open an account under the name of the Recipient in the Bank, in principle. JICA will disburse the Japanese Grant in Japanese yen for the Recipient to cover the obligations incurred by the Recipient under the verified contracts.
- b) The Japanese Grant will be disbursed when payment requests are submitted by the Bank to JICA under an Authorization to Pay (A/P) issued by the Recipient.

3) Procurement Procedure

The products and/or services necessary for the implementation of the Project shall be procured in accordance with JICA's procurement guidelines as stipulated in the G/A.

4) Selection of Consultants

In order to maintain technical consistency, the consulting firm(s) which conducted the Survey will be recommended by JICA to the Recipient to continue to work on the Project's implementation after the E/N and G/A.

5) Eligible source country

In using the Japanese Grant disbursed by JICA for the purchase of products and/or services, the eligible source countries of such products and/or services shall be Japan and/or the Recipient. The Japanese Grant may be used for the purchase of the products and/or services of a third country as eligible, if necessary, taking into account the quality, competitiveness and economic rationality of products and/or services necessary for achieving the objective of the Project. However, the prime contractors, namely, constructing and procurement firms, and the prime consulting firm, which enter into contracts with the Recipient, are limited to "Japanese nationals", in principle.

6) Contracts and Concurrence by JICA

The Recipient will conclude contracts denominated in Japanese yen with Japanese nationals. Those contracts shall be concurred by JICA in order to be verified as eligible for using the Japanese Grant.

7) Monitoring

16/11/16



---

The Recipient is required to take their initiative to carefully monitor the progress of the Project in order to ensure its smooth implementation as part of their responsibility in the G/A, and to regularly report to JICA about its status by using the Project Monitoring Report (PMR).

8) Safety Measures

The Recipient must ensure that the safety is highly observed during the implementation of the Project.

9) Construction Quality Control Meeting

Construction Quality Control Meeting (hereinafter referred to as the "Meeting") will be held for quality assurance and smooth implementation of the Works at each stage of the Works. The member of the Meeting will be composed by the Recipient (or executing agency), the Consultant, the Contractor and JICA. The functions of the Meeting are as followings:

- a) Sharing information on the objective, concept and conditions of design from the Contractor, before start of construction.
- b) Discussing the issues affecting the Works such as modification of the design, test, inspection, safety control and the Client's obligation, during of construction.

(2) Ex-post Monitoring and Evaluation Stage

- 1) After the project completion, JICA will continue to keep in close contact with the Recipient in order to monitor that the outputs of the Project are used and maintained properly to attain its expected outcomes.
- 2) In principle, JICA will conduct ex-post evaluation of the Project after three years from the completion. It is required for the Recipient to furnish any necessary information as JICA may reasonably request.

(3) Others

1) Environmental and Social Considerations

The Recipient shall carefully consider environmental and social impacts by the Project and must comply with the environmental regulations of the Recipient and JICA Guidelines for Environmental and Social Considerations (April, 2010).

2) Major undertakings to be taken by the Government of the Recipient



---

For the smooth and proper implementation of the Project, the Recipient is required to undertake necessary measures including land acquisition, and bear an advising commission of the A/P and payment commissions paid to the Bank as agreed with the GOJ and/or JICA. The Government of the Recipient shall ensure that customs duties, internal taxes and other fiscal levies which may be imposed in the Recipient with respect to the purchase of the Products and/or the Services be exempted or be borne by its designated authority without using the Grant and its accrued interest, since the grant fund comes from the Japanese taxpayers.

3) Proper Use

The Recipient is required to maintain and use properly and effectively the products and/or services under the Project (including the facilities constructed and the equipment purchased), to assign staff necessary for this operation and maintenance and to bear all the expenses other than those covered by the Japanese Grant.

4) Export and Re-export

The products purchased under the Japanese Grant should not be exported or re-exported from the Recipient.

*AM*

*[Signature]*

## PROCEDURES OF JAPANESE GRANT

Stage	Procedures	Remarks	Recipient Government	Japanese Government	JICA	Consultants	Contractors	Agent Bank
Official Request	Request for grants through diplomatic channel	Request shall be submitted before appraisal stage.	x	x				
1. Preparation	(1) Preparatory Survey Preparation of outline design and cost estimate		x		x	x		
2. Appraisal	(2) Preparatory Survey Explanation of draft outline design, including cost estimate, undertakings, etc.		x		x	x		
	(3) Agreement on conditions for implementation	Conditions will be explained with the draft notes (E/N) and Grant Agreement (G/A) which will be signed before approval by Japanese government.	x	x (E/N)	x (G/A)			
	(4) Approval by the Japanese cabinet			x				
3. Implementation	(5) Exchange of Notes (E/N)		x	x				
	(6) Signing of Grant Agreement (G/A)		x		x			
	(7) Banking Arrangement (B/A)	Need to be informed to JICA	x					x
	(8) Contracting with consultant and issuance of Authorization to Pay (A/P)	Concurrence by JICA is required	x			x		x
	(9) Detail design (D/D)		x			x		
	(10) Preparation of bidding documents	Concurrence by JICA is required	x			x		
	(11) Bidding	Concurrence by JICA is required	x			x	x	
	(12) Contracting with contractor/supplier and issuance of A/P	Concurrence by JICA is required	x				x	x
4. Ex-post monitoring & evaluation	(13) Construction works/procurement	Concurrence by JICA is required for major modification of design and amendment of contracts.	x			x	x	
	(14) Completion certificate		x			x	x	
	(15) Ex-post monitoring	To be implemented generally after 1, 3, 10 years of completion, subject to change	x		x			
	(16) Ex-post evaluation	To be implemented basically after 3 years of completion	x		x			
notes:								
		1. Project Monitoring Report and Report for Project Completion shall be submitted to JICA as agreed in the G/A.						
		2. Concurrence by JICA is required for allocation of grant for remaining amount and/or contingencies as agreed in the G/A.						

 6

# Financial Flow of Japanese Grant (A/P Type)

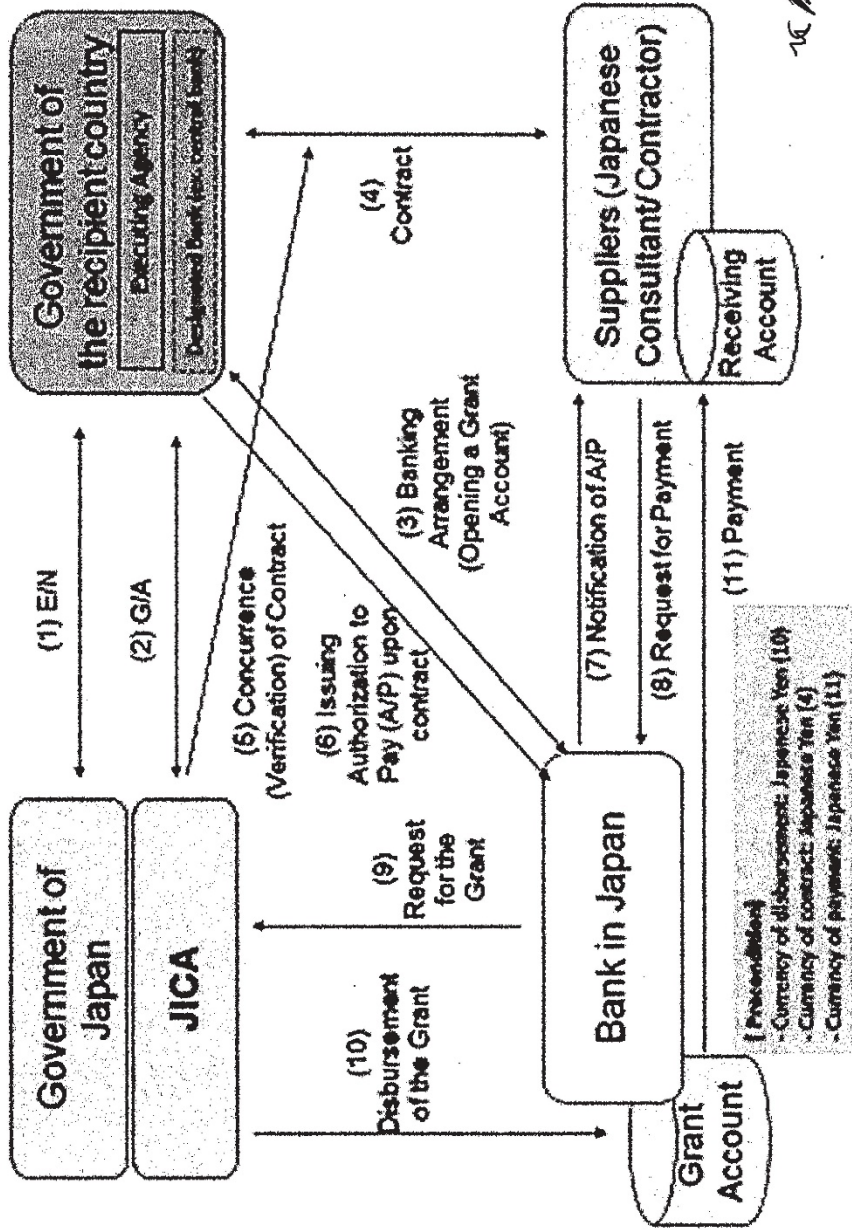

*[Handwritten signature]*

**Project Monitoring Report**  
**on**  
**Project Name**  
**Chapter 1. Grant Agreement No. XXXXXXX**  
20XX, Month

**Organizational Information**

<b>1) Signer of the G/A (Recipient)</b>	_____ Person in Charge (Designation) _____ _____ Contacts _____ Address: _____ _____ Phone/FAX: _____ _____ Email: _____
<b>Executing Agency</b>	_____ Person in Charge (Designation) _____ _____ Contacts _____ Address: _____ _____ Phone/FAX: _____ _____ Email: _____
<b>Line Ministry</b>	_____ Person in Charge (Designation) _____ _____ Contacts _____ Address: _____ _____ Phone/FAX: _____ _____ Email: _____

**General Information:**

<b>Project Title</b>	
<b>E/N</b>	Signed date: Duration:
<b>G/A</b>	Signed date: Duration:
<b>Source of Finance</b>	Government of Japan: Not exceeding JPY _____ mil. Government of (_____): _____



<b>1: Project Description</b>	
-------------------------------	--

**1-1 Project Objective**

--

**1-2 Project Rationale**

- Higher-level objectives to which the project contributes (national/regional/sectoral policies and strategies)
- Situation of the target groups to which the project addresses

--

**1-3 Indicators for measurement of "Effectiveness"**

Quantitative indicators to measure the attainment of project objectives		
Indicators	Original (Yr )	Target (Yr )
Qualitative indicators to measure the attainment of project objectives		

<b>2: Details of the Project</b>
----------------------------------

**2-1 Location**

Components	Original <i>(proposed in the outline design)</i>	Actual
1.		

**2-2 Scope of the work**

Components	Original* <i>(proposed in the outline design)</i>	Actual*
1.		

2

Reasons for modification of scope (if any).

(PMR)

**2-3 Implementation Schedule**

Items	Original		Actual
	(proposed in the outline design)	(at the time of signing the Grant Agreement)	

Reasons for any changes of the schedule, and their effects on the project (if any)

**2-4 Obligations by the Recipient**

**2-4-1 Progress of Specific Obligations**

See Attachment 2.

**2-4-2 Activities**

See Attachment 3.

**2-4-3 Report on RD**

See Attachment 11.

**2-5 Project Cost**

**2-5-1 Cost borne by the Grant (Confidential until the Bidding)**

Components			Cost (Million Yen)	
	Original (proposed in the outline design)	Actual (in case of any modification)	Original <sup>1)/2)</sup> (proposed in the outline design)	Actual
	1.			
Total				

Note: 1) Date of estimation:

2) Exchange rate: 1 US Dollar = Yen

**2-5-2 Cost borne by the Recipient**

Components			Cost (1,000 Taka)	
	Original (proposed in the outline design)	Actual (in case of any modification)	Original <sup>1)/2)</sup> (proposed in the outline design)	Actual





		<i>modification)</i>	<i>the outline design)</i>	
	1.			

Note: 1) Date of estimation:  
 2) Exchange rate: 1 US Dollar =

Reasons for the remarkable gaps between the original and actual cost, and the countermeasures (if any)

(PMR)

**2-6 Executing Agency**

- Organization's role, financial position, capacity, cost recovery etc,
- Organization Chart including the unit in charge of the implementation and number of employees.

**Original** (at the time of outline design)  
 name:  
 role:  
 financial situation:  
 institutional and organizational arrangement (organogram):  
 human resources (number and ability of staff):

---

**Actual** (PMR)

**2-7 Environmental and Social Impacts**

- The results of environmental monitoring based on Attachment 5 (in accordance with Schedule 4 of the Grant Agreement).
- The results of social monitoring based on in Attachment 5 (in accordance with Schedule 4 of the Grant Agreement).
- Disclosed information related to results of environmental and social monitoring to local stakeholders (whenever applicable).

**3: Operation and Maintenance (O&M)**

**3-1 Physical Arrangement**

- Plan for O&M (number and skills of the staff in the responsible division or section, availability of manuals and guidelines, availability of spareparts, etc.)

*Handwritten initials/signature*

*Handwritten signature*

<b>Original</b> (at the time of outline design)
<b>Actual</b> (PMR)

**3-2 Budgetary Arrangement**

- Required O&M cost and actual budget allocation for O&M

<b>Original</b> (at the time of outline design)
<b>Actual</b> (PMR)

**4: Potential Risks and Mitigation Measures**

- Potential risks which may affect the project implementation, attainment of objectives, sustainability
- Mitigation measures corresponding to the potential risks

**Assessment of Potential Risks** (at the time of outline design)

Potential Risks	Assessment
1. (Description of Risk)	Probability: High/Moderate/Low
	Impact: High/Moderate/Low
	Analysis of Probability and Impact:
	Mitigation Measures:
	Action required during the implementation stage:
2. (Description of Risk)	Probability: High/Moderate/Low
	Impact: High/Moderate/Low
	Analysis of Probability and Impact:
	Mitigation Measures:
	Action required during the implementation stage:
Contingency Plan (if applicable):	



3. (Description of Risk)	Probability: High/Moderate/Low
	Impact: High/Moderate/Low
	Analysis of Probability and Impact:
	Mitigation Measures:
	Action required during the implementation stage:
Contingency Plan (if applicable):	
<b>Actual Situation and Countermeasures</b>	
(PMR)	

**5: Evaluation and Monitoring Plan (after the work completion)**

**5-1 Overall evaluation**

Please describe your overall evaluation on the project.

**5-2 Lessons Learnt and Recommendations**

Please raise any lessons learned from the project experience, which might be valuable for the future assistance or similar type of projects, as well as any recommendations, which might be beneficial for better realization of the project effect, impact and assurance of sustainability.

**5-3 Monitoring Plan of the Indicators for Post-Evaluation**

Please describe monitoring methods, section(s)/ department(s) in charge of monitoring, frequency, the term to monitor the indicators stipulated in 1-3.

*NE/m*



Attachment

1. Project Location Map
2. Specific obligations of the Recipient which will not be funded with the Grant
3. Monthly Report submitted by the Consultant
- Appendix - Photocopy of Contractor's Progress Report (if any)
  - Consultant Member List
  - Contractor's Main Staff List
4. Check list for the Contract (including Record of Amendment of the Contract/ Agreement and Schedule of Payment)
5. Environmental Monitoring Form / Social Monitoring Form
6. Monitoring sheet on price of specified materials (Quarterly)
7. Report on Proportion of Procurement (Recipient Country, Japan and Third Countries) (PMR (final)only)
8. Pictures (by JPEG style by CD-R) (PMR (final)only)
9. Equipment List (PMR (final)only)
10. Drawing (PMR (final)only)
11. Report on RD (After project)

*16/11*

*[Signature]*

Monitoring sheet on price of specified materials

1. Initial Conditions (Confirmed)

Items of Specified Materials	Initial Volume A	Initial Unit Price (¥) B	Initial total Price C=A×B	1% of Contract Price D	Condition of payment Price (Decreased) E=C-D	Price (Increased) F=C+D
1 Item 1	●●t	●●	●●	●●	●	●
2 Item 2	●●t	●●	●●	●●		
3 Item 3						
4 Item 4						
5 Item 5						

2. Monitoring of the Unit Price of Specified Materials

(1) Method of Monitoring : ●●

(2) Result of the Monitoring Survey on Unit Price for each specified materials

Items of Specified Materials	1st month, 2015	2nd month, 2015	3rd month, 2015	4th	5th	6th
1 Item 1						
2 Item 2						
3 Item 3						
4 Item 4						
5 Item 5						

(3) Summary of Discussion with Contractor (if necessary)

KAs



Report on Proportion of Procurement (Recipient Country, Japan and Third Countries)  
 (Actual Expenditure by Construction and Equipment each)

	Domestic Procurement (Recipient Country) A	Foreign Procurement (Japan) B	Foreign Procurement (Third Countries) C	Total D
Construction Cost	(A/D%)	(B/D%)	(C/D%)	
Direct Construction Cost	(A/D%)	(B/D%)	(C/D%)	
others	(A/D%)	(B/D%)	(C/D%)	
Equipment Cost	(A/D%)	(B/D%)	(C/D%)	
Design and Supervision Cost	(A/D%)	(B/D%)	(C/D%)	
Total	(A/D%)	(B/D%)	(C/D%)	

*K. Ito*

*[Signature]*

**Annex 4**

**Major Undertakings to be taken by the Government of Kingdom of Cambodia**

**1. Specific obligations of the Government of Kingdom of Cambodia which will not be funded with the Grant**

**(1) Before the Tender**

NO	Items	Deadline	In charge	Estimated Cost	Ref.
1	To open bank account (B/A)	within 1 month after the signing of the G/A	MEF		
2	To issue A/P to a bank in Japan (the Agent Bank) for the payment to the consultant	within 1 month after the signing of the contract(s)	MIH		
3	To make a Environmental Protection Contract and secure the necessary budget for implementation	within 1 month after the signing of the G/A	MIH		
4	To contract land lease in order to secure the temporary yard	before notice of the bidding document(s)	MIH		
5	To obtain the planning, zoning, building permit	before notice of the bidding document(s)	MIH		
6	To clear, level and reclaim the following sites 1) Embankment at proposed water treatment plant site and intake pump station site 2) To explore landmines and UXO at construction site and temporary yard	before notice of the bidding document(s)	MIH MIH		
7	To submit Project Monitoring Report (with the result of Detail Design)	before preparation of bidding document(s)	MIH		

**(2) During the Project Implementation**

NO	Items	Deadline	In charge	Estimated Cost	Ref.
1	To issue A/P to a bank in Japan (the Agent Bank) for the payment to the Supplier(s)	within 1 month after the signing of the contract(s)	MIH		
2	To bear the following commissions to a bank in Japan for the banking services based upon the B/A 1) Advising commission of A/P 2) Payment commission for A/P	within 1 month after the signing of the contract(s) every payment	MIH MEF		
3	To ensure prompt unloading and customs clearance at ports of disembarkation in Cambodia and to assist the Supplier(s) with internal transportation therein	during the Project	MIH		
4	To accord Japanese physical persons and/or physical persons of third countries whose services may be required in connection with the supply of the products and the services such facilities as may be necessary for their entry into Cambodia and stay therein for the performance of their work	during the Project	MEF		
5	To ensure that customs duties, VAT, internal taxes and other fiscal levies which may be imposed in Cambodia with respect to the	during the Project	MEF		



NO	Items	Deadline	In charge	Estimated Cost	Ref.
	purchase of the products and/or the services be exempted by its designated authority without using the Grant;				
6	To bear all the expenses, other than those covered by the Grant, necessary for the implementation of the Project	during the Project			
7	1) To submit Project Monitoring Report	every month	MIH		
	2) To submit Project Monitoring Report (final)	within one month after signing of Certificate of Completion for the works under the contract(s)	MIH		
8	To submit a report concerning completion of the Project	within six months after completion of the Project	MIH		
9	To get permit for construction of temporary access bridges for laying water pipes and lease necessary land for approach road to the temporary access bridges (if necessary)	1 month before the start of the construction	Local Communities, MIH		
10	To provide facilities for distribution of electricity, water supply and drainage and other incidental facilities necessary for the implementation of the Project outside the site(s)				
	1) Electricity The distributing line to the site	before start of the construction	MIH		
	2) Information System Contracting process of broadband LAN connection for the distribution information system	2 months before completion of the construction	MIH		
11	To take necessary measure for safety construction - traffic control - rope off	during the construction	MIH		
12	To implement EMP and EMoP	during the construction	MIH		
13	To submit results of environmental monitoring to JICA, by using the monitoring form, on a quarterly basis as a part of Project Monitoring Report	during the construction	MIH		
14	To obtain permission for occupancy of roads for the pipe laying work	before start of the construction for conveyance, transmission and distribution pipes	MIH (PWW <sup>1</sup> )		
15	To obtain all permissions required for the project implementation such as construction permission for intake facility and water treatment facility	before start of the construction	MIH (PWW)		
16	To recruit new staff members who are necessary for the operation of new system	up to the end of 202X	MIH (PWW)		
17	To establish the construction scheme for the new service pipe connections, including hiring temporary work force. To carry out	up to the end of 202X	MIH (PWW)		

<sup>1</sup> PWW: Provincial Waterworks





NO	Items	Deadline	In charge	Estimated Cost	Ref.
	the technical guidance, budgeting, planning and publicity for enhancing new connections.				
18	To identify poor household (Provisional)	up to the end of 202X	MIH (PWW)		

(3) After the Project

NO	Items	Deadline	In charge	Estimated Cost	Ref.
1	To implement EMP and EMoP	for a period based on EMP and EMoP	MIH		
2	To submit results of environmental monitoring to JICA, by using the monitoring form, semiannually - The period of environmental monitoring may be extended if any significant negative impacts on the environment are found. The extension of environmental monitoring will be decided based on the agreement between MIH and JICA.	for 3 years after the Project	MIH		
3	To maintain and use properly and effectively the facilities constructed and equipment provided under the Grant Aid 1) Allocation of maintenance cost 2) Operation and maintenance structure 3) Routine check/Periodic inspection	after completion of the construction	MIH		
4	To work for service pipe connection 1) Establishment of construction scheme including hiring temporary staff for service connection work, providing guidance, budgeting, planning and publicity for enhancing new connections  2) Connection for the poor level 1 household (Provisional) - Connection work is under responsibility of Cambodian side.	up to the end of 202X	MIH (PWW)		
5	To sustain the enough water level of Vay Kor dam for intake the water.		MOWRAM		





**Minutes of Discussions**  
**on the Preparatory Survey for the Project for**  
**Expansion of Water Supply System in Svay Rieng in the Kingdom of Cambodia**

With reference to the minutes of discussions signed between Ministry of Industry, Science, Technology & Innovation (hereinafter referred to as "MISTI") and the Japan International Cooperation Agency (hereinafter referred to as "JICA") on 24<sup>th</sup> August, 2017, 28<sup>th</sup> June, 2018, 3<sup>rd</sup> September 2019, and 13<sup>th</sup> February 2020, and in response to the request from the Government of Kingdom of Cambodia (hereinafter referred to as "Cambodia") dated on 26<sup>th</sup> June, 2017, JICA Preparatory Survey Team (hereinafter referred to as "the Team") and MISTI have a series of discussions for the Project for Expansion of Water Supply System in Svay Rieng (hereinafter referred to as "the Project").

As a result of the discussions, both sides agreed on the main items described in the attached sheets.

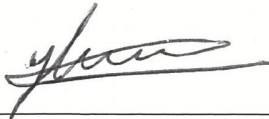
April 12, 2021



Mr. Yoichi INOUE  
Leader  
Preparatory Survey Team  
Japan International Cooperation Agency



H.E. Oum Sotha  
Secretary of State  
Ministry of Industry, Science, Technology  
& Innovation  
Kingdom of Cambodia

## ATTACHMENT

### 1. New Water Treatment Plant (WTP) funded by ADB in Svay Rieng

#### 1-1. Outline of ADB's project

MISTI explained that following outline of ADB's project in Svay Rieng and that there is no duplication of service area among Japanese grant project, bulk water supply by Chinese firm, and ADB's new scheme.

##### [Purpose of ADB's Project]

New WTP funded by ADB will be utilized to distribute safe water to additional 4 communes such as Por Reach, Svay Chrum, Ta Sous and Kampong Chamlorng and to replace existing WTP which has the treatment capacity of 4,560m<sup>3</sup>/day.

##### [Specification]

Intake Facility: 11,000 m<sup>3</sup>/day at Vay Kor dam

Conveyance Pipe: Length 63 m

Water Treatment Capacity: 9,000 m<sup>3</sup>/day

Distribution Main Pipe: Length 30.6 km

##### [Service Area]

Service area of ADB's project is existing service area, which is the area surrounded by blue line, and 4 communes composed of the commune "Por Reach", "Svay Chrum", "Ta Sous", and "Kampong Chamlorng" on the attached map.

##### [Schedule]

The construction of WTP will be completed by the middle of 2022. Installation of distribution pipe will be finished by the end of 2021.

##### [Usage of Existing WTP]

The existing WTP will be utilized as stand-by facility for an emergency.

#### 1-2. Expansion of distribution network and Operational Priority of WTP

MISTI promised to install distribution pipe network in additional 4 communes of ADB's Project area as soon as possible with the best effort and to put a priority on maximizing operational ratio of the WTP to be granted by Japan rather than ADB's one to provide water to the Project site described in 2-2.



## 2. Project Outline

### 2-1. Basis for the Project

Both sides reconfirmed that target year of the Project is the Year 2027 (2 year after the completion of the facilities) and the basis for project design are the high investment efficiency and alignment of the following development policies in Cambodia.

#### Development policies for urban water supply in Cambodia

- To provide the population in urban area access to water supply service 100% in 2025, 90% to be covered by tap water and 10% to be covered other sources, which in one of the targets of “National Strategic Development Plan from 2019 to 2023” of the Cambodian government.
- Goal 6 of SDGs, to provide safe water to all by 2030.

### 2-2. Tentative Project Scope

Both side confirmed the assumed Project scope as described below and the project site is shown in attachment. According to the tentative scope, the Team will proceed for the outline design and coordinating with relevant authorities. Both sides reconfirmed that the Project scope covered by Japanese Grant Project will be determined based on the preparatory survey results at the explanation on the draft preparatory survey report. The final decision of the Project scope will be, however, made by the Government of Japan.

Intake Facility: 7,480m<sup>3</sup>/day, Intake Pump Station

Intake Pump: 2 inverter pump to save electric consumption (1duty, 1 stand-by)

Conveyance pipe: Length 2.9km

Water Treatment Plant: 6,800m<sup>3</sup>/day

Clear Water Reservoir: 2,200m<sup>3</sup>

Distribution Pipe Length: Length: 124 km

Procurement equipment such as laboratory equipment, service pipe material for poor house holds 375 sets and etc..

## 3. Others

### 3-1. Intake Water Right

Both sides confirmed that MISTI had already requested Ministry of Water Resources and Meteorology (MOWRAM) to obtain additional water right for taking water from Vay Kor dam because of ADB’s project, and that approval would be obtained from



MOWRAM before the explanation on the draft preparatory survey report.

3-2. Assurance of Sustainability of Vay Kor Dam

Both sides reconfirmed that MISTI would obtain the guarantee letter from MOWRAM before the explanation on the draft preparatory survey report for keeping the water level of the Vay Kor dam to intake enough water and for prompt recovery of the water level in case of accident. Both sides confirmed that the guarantee letter above mentioned would be referred on the minutes at the explanation on the draft preparatory survey report.

3-3. Financial Soundness and Appropriate Water Tariff

Since the Team had confirmed there were discrepancies on financial statements of public water supply utility in Svay Rieng, the Team requested to MISTI to submit accurate financial statements for last 3 years.

The Team emphasized the importance of financial soundness in water utility for sustainable development and both sides agreed the necessity of setting appropriate water tariff for both of financial soundness and low income household.

3-4. Recruitment of New Staff for the Project and ADB's Project

The Team expressed the concern on the shortage of staff due to two additional WTPs to be provided by Japanese grant and ADB's project, and requested to MISTI to hire enough number and capable staff for appropriate maintenance for WTPs.

3-5. Environmental Protection Contract

MISTI obtained the agreement on Environmental Protection Contract (EPC) by the Ministry of Environment on 30th March, 2021. Cambodian side agreed to take initiative in following the EPC in the implementation of the Project.

3-6. Administrative Permission for Construction Works for the Project

MISTI agreed to obtain necessary administrative permission for construction works.

3-7. Land Elevation Works at Treatment Facility Site including access road

MISTI agreed to implement land elevation works for the Treatment Facility Site as well as access road.



### 3-8. Expansion of National Road No.1

MISTI explained Ministry of Public Works and Transport has a plan for expansion of the national road No.1 and the construction works will start in the year 2022. MISTI will update the detail information and coordinate with the Team.



Attachment:

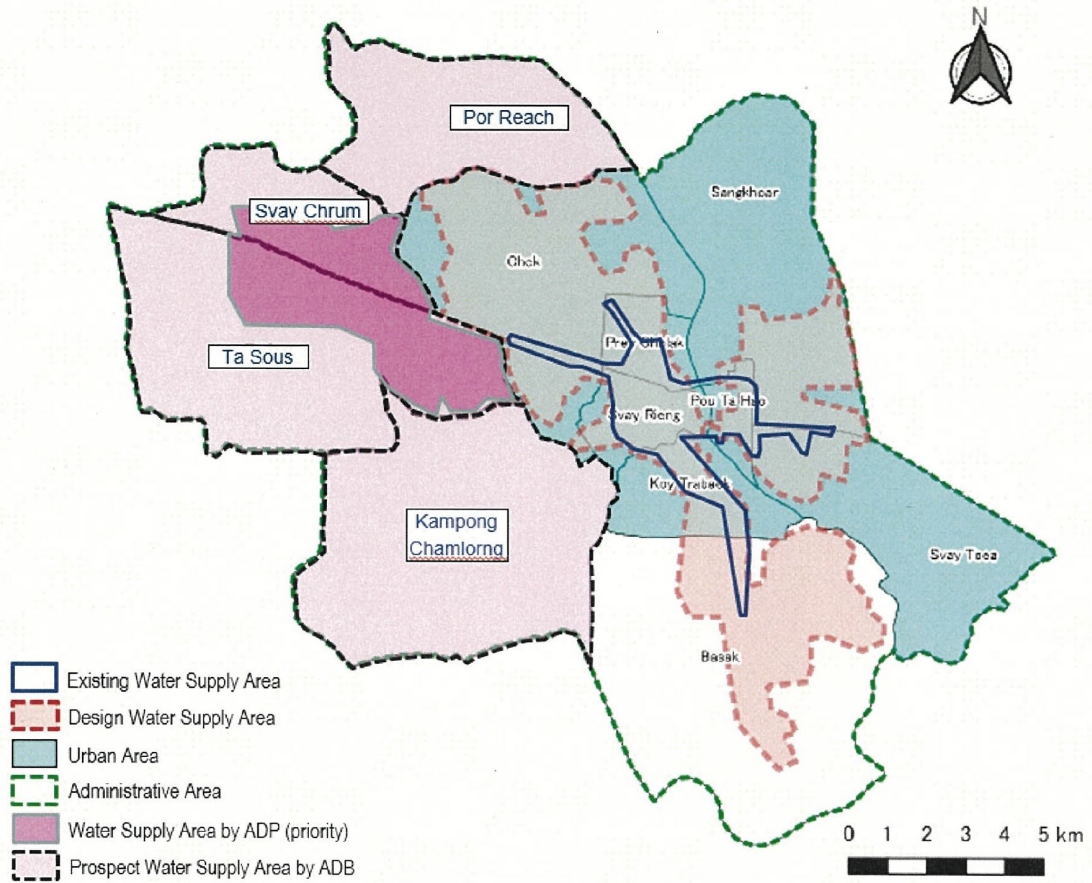

Water Supply Area