

ЗАГАЛЬНИЙ ПЛАН МИКОЛАЇВСЬКОГО МОСТУ (4) S=1:200

ПЕРЕТИН НАДБУДОВИ

МАРШРУТ 3

ГОЛОВНИЙ МІСТ (КАНАТНИЙ ВИСЯЧИЙ МІСТ)

ТИПОВА ЧАСТИНА

ПОПЕРЕЧНА БАЛКА

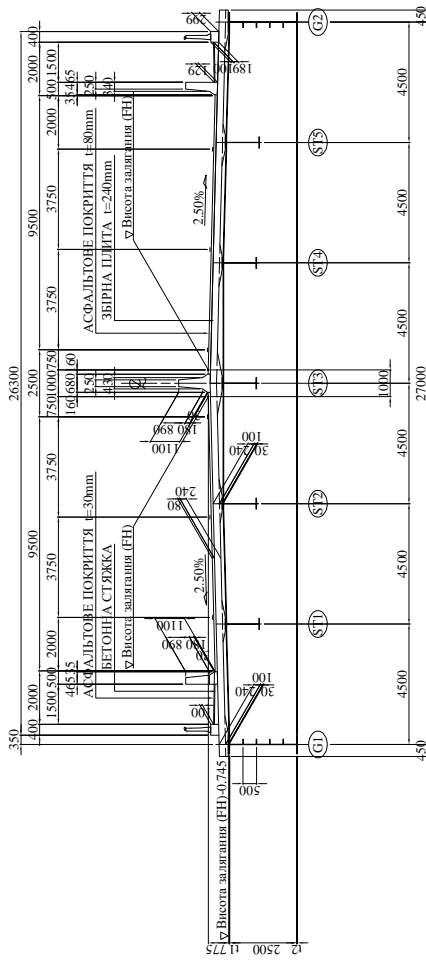
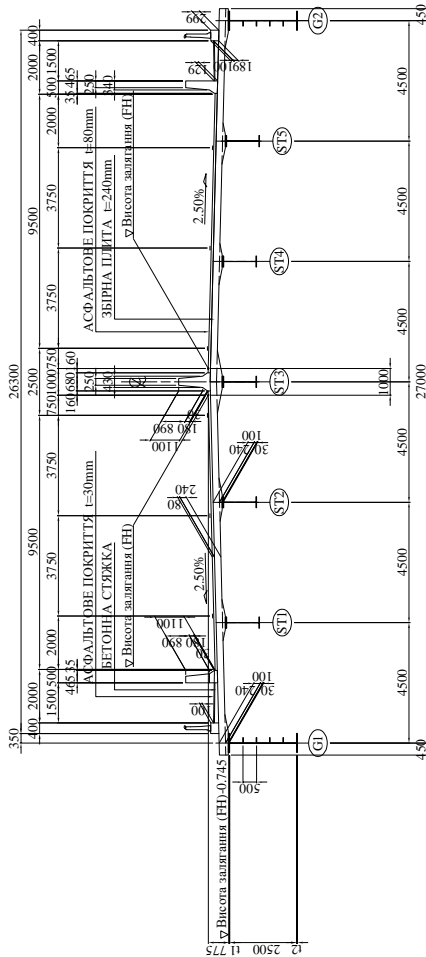

ПРОЕКТНІ УМОВИ

НАДБУДОВА	НЕРОЗРІВНИЙ КАБЕЛЬНИЙ МІСТ З ТРЬОМА ПРОЛІТЬОМІ (З/Б ГОЛОВНА БАШТА)
ОПОРНА КОНСТРУКЦІЯ	НЕРОЗРІВНИЙ СТАЛЬНИЙ БАЛОННИЙ МІСТ ЗВОРОТНИЙ Г СТОЯН ПІДЯСТР
ФУНДАМЕНТ	З/Б КОЛОДЯЗЬ (ОПОРА КОНСТРУКЦІЇ СТРИЖНЯ ПАЛІ) ϕ3000 СТАЛЕВА ТРУБЧАСТА ШПУНТОВА ПАЛІ ϕ12m З/Б КОЛОДЯЗЬ (ОПОРА КОНСТРУКЦІЇ СТРИЖНЯ ПАЛІ) ϕ900 НАВИВНА ПАЛІ ϕ1200, ϕ1500, ϕ3000
ДОВЖИНА МОСТА	275.000M +335.000M +395.000M +840.000M =2180.000M
ШИРИНА МОСТУ	26.300m
КОРИСНЕ НАВАНТАЖЕННЯ	КОРИСНЕ НАВАНТАЖЕННЯ В ЯПОНСЬКИЙ СТАНДАРТ

МАТЕРІАЛ

НАДБУДОВА	ГОЛОВНИЙ МІСТ	СТАЛЬ	SBHS500, SM490Y, SM400
		БЕТОН	сск=40Н/мм2
		КОЛЕСОВІДНИЙ	сск=24Н/мм2
		АРМАТУРНИЙ СТРИЖЕНЬ	SD345
ПІД'ЇВНИЙ МІСТ		КАБЕЛЬ	NEW PWS 1570Nmm2
		СТАЛЬ	SBHS500, SM400
		БЕТОН	сск=40Н/мм2
		КОЛЕСОВІДНИЙ	сск=24Н/мм2
ГОЛОВНА БАШТА		АРМАТУРНИЙ СТРИЖЕНЬ	SD345
		БЕТОН	сск=30Н/мм2
		АРМАТУРНИЙ СТРИЖЕНЬ	SD345
		БЕТОН	сск=24Н/мм2
ОПОРНА КОНСТРУКЦІЯ		АРМАТУРНИЙ СТРИЖЕНЬ	SD345
		СТАЛЬ	SKY490, SKY400
		БЕТОН	сск=24Н/мм2
		АРМАТУРНИЙ СТРИЖЕНЬ	SD345
ФУНДАМЕНТ		БЕТОН	сск=40Н/мм2
		АРМАТУРНИЙ СТРИЖЕНЬ	SD345
		З/Б КОЛОДЯЗЬ	SBPR1080/1230
		НАВИВНА ПАЛІ	БЕТОН сск=24(30)Н/мм2 АРМАТУРНИЙ СТРИЖЕНЬ SD345

ЛОДАТКОВОГО ДОСЛІДЖЕННЯ ДЛІЯ ПРОЄКТУ
БУДІВНИЦТВА МИКОЛАЇВСЬКОГО МОСТУ В УКРАЇНІ

ЯПОНСЬКЕ АГЕНТСТВО МІЖНАРОДНОГО СПІВРОБІТНИЦТВА(ІСА)

CENTRAL CONSULTANT INC. & NIPPON KOEI CO., LTD

НАЗВА
ЗАГАЛЬНИЙ ПЛАН МИКОЛАЇВСЬКОГО МОСТУ (4)

МАСШТАБ
1/200
№.
13

ЗАГАЛЬНИЙ ПЛАН МИКОЛАЇВСЬКОГО МОСТУ (5) S=1:200 ПЕРТИН НАДБУДОВИ

МАРШРУТ 3

ПІД'ІЗНИЙ МІСТ (СТАЛЕВИЙ БАЛОЧНИЙ МІСТ)

ТИПОВА ЧАСТИНА

ПОПЕРЕЧНА БАЛКА

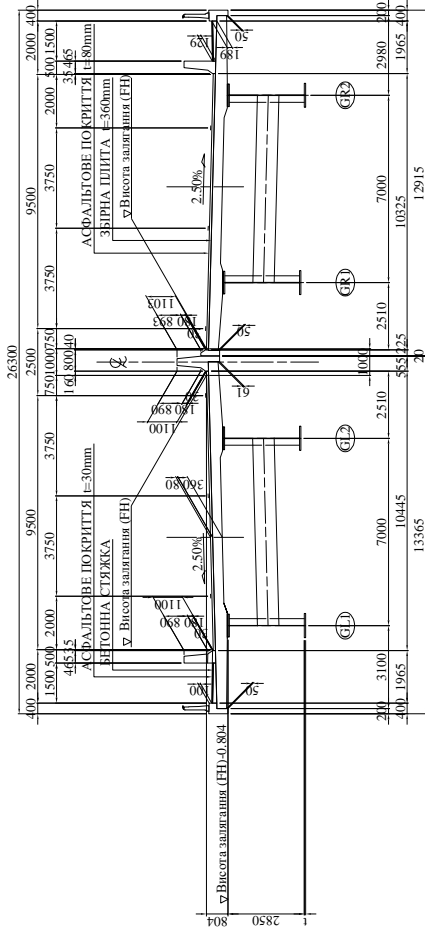
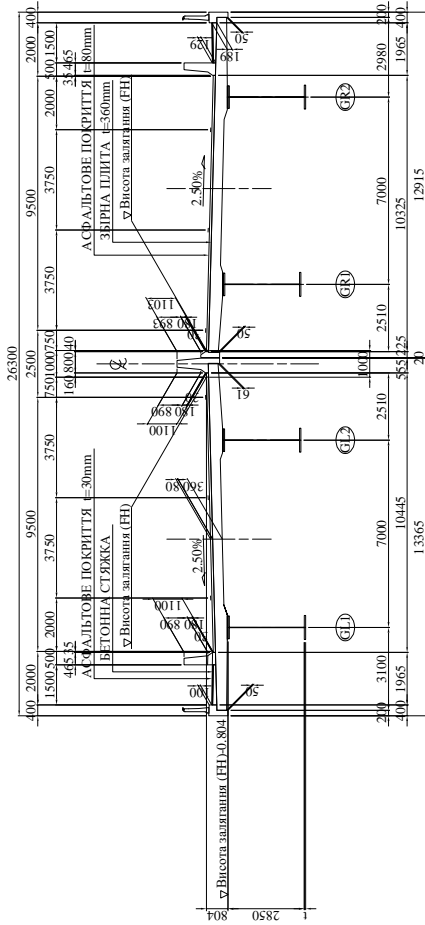

ДОДАТКОВОГО ДОСЛІДЖЕННЯ ДЛЯ ПРОЄКТУ
БУДІВНИЦТВА МИКОЛАЇВСЬКОГО МОСТУ В УКРАЇНІ

ЯПОНСЬКЕ АГЕНТСТВО МІЖНАРОДНОГО СПІВРІВНІТНИЦТВА(ІСА)

CENTRAL CONSULTANT INC. & NIPPON KOEI CO., LTD

НАЗВА

ЗАГАЛЬНИЙ ПЛАН МИКОЛАЇВСЬКОГО МОСТУ (5)

МАСШТАБ

1/200

№.

14

Місця розташування маршруту

S=1:40000



ЯПОНСЬКЕ АГЕНТСТВО МІЖНАРОДНОГО СПІВРОБІТНИЦТВА(ІСА)
CENTRAL CONSULTANT INC. & NIPPON KOEI CO., LTD

ДОДАТКОВОГО ДОСЛІДЖЕННЯ ДЛЯ ПРОЄКТУ
БУДІВНИЦТВА МИКОЛАЇВСЬКОГО МОСТУ В УКРАЇНІ

НАЗВА
МАРШРУТ 2, МАРШРУТ 3
Місця розташування маршруту

МАСШТАБ
1/40000
№.
1

Типовий перетин(1)

М-14 об'їзна дорога

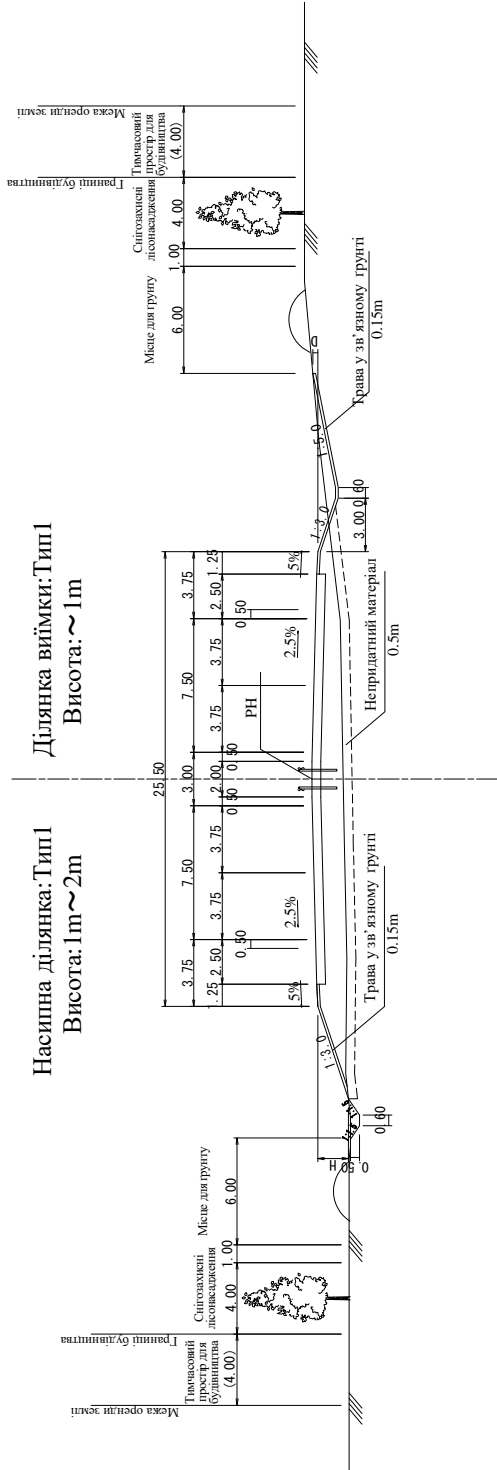

М-14 об'їзна дорога

Насипна ділянка: Туре2
Висота: 2m ~ 6m

Насипна ділянка: Туре3
Висота: 6m ~ 12m

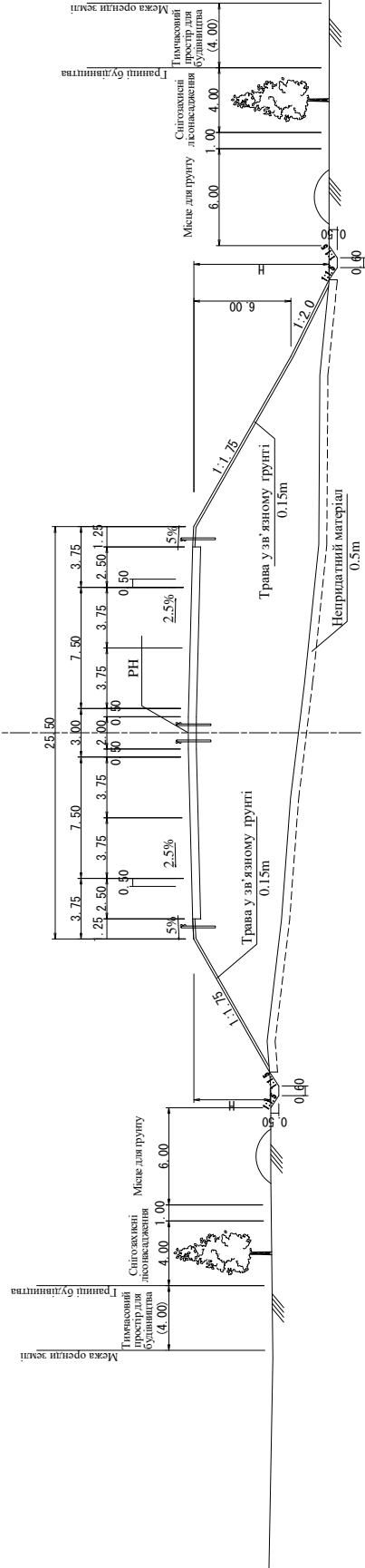

ДОДАТКОВОГО ДОСЛІДЖЕННЯ ДЛЯ ПРОЄКТУ
БУДІВНИЦТВА МИКОЛАЇВСЬКОГО МОСТУ В УКРАЇНІ

ЯПОНСЬКЕ АГЕНТСТВО МІЖНАРОДНОГО СПІВРІВНИЦТВА(ІСА)
CENTRAL CONSULTANT INC. & NIPPON KOEI CO., LTD

НАЗВА

Типовий перетин(1)

МАСШТАБ
1/300

No. 2

Типовий перетин(2)

М-14 об'їзна дорога

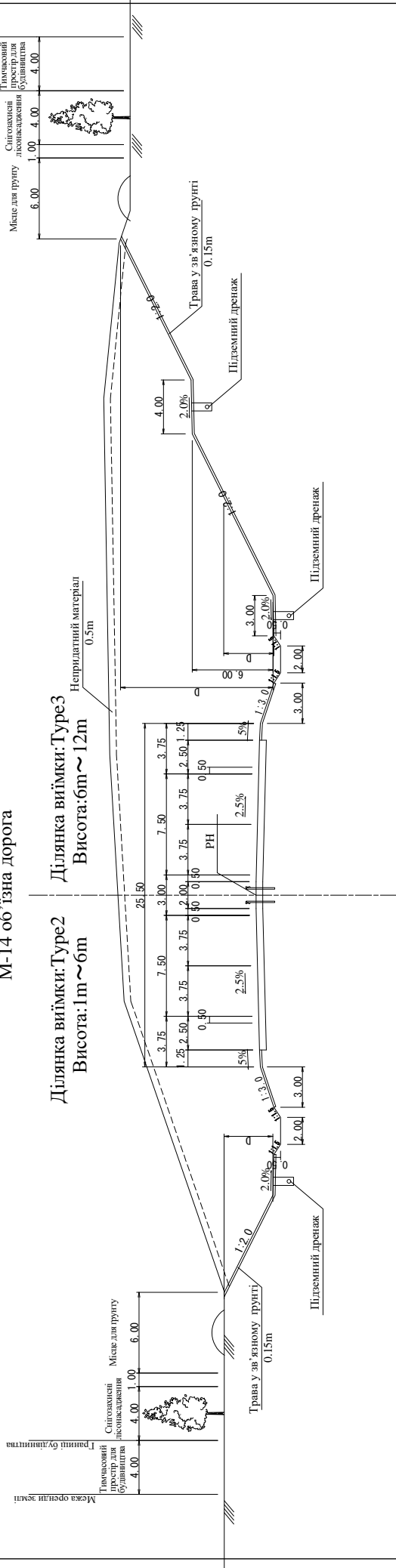

М-14 об'їзна дорога
лісАгеа

Насипна ділянка: Туре2
Висота: 2m ~ 6m

Насипна ділянка: Туре3
Висота: 6m ~ 12m

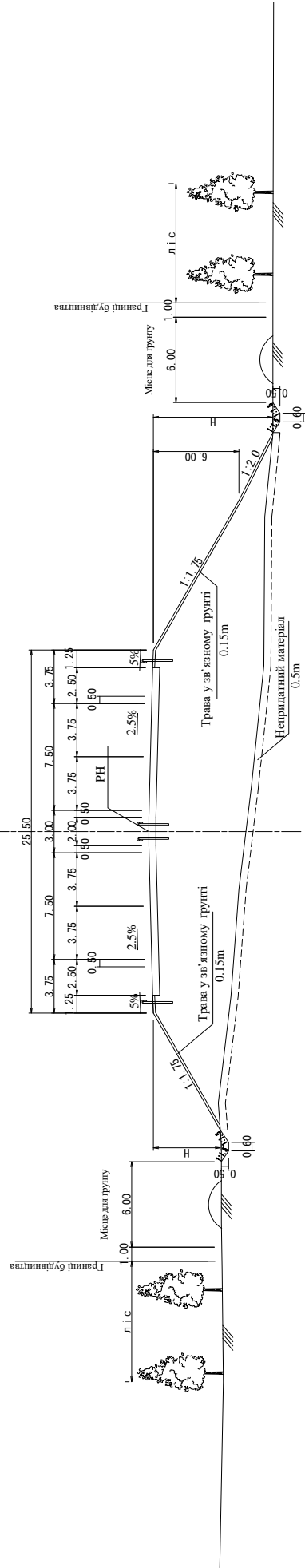

ДОДАТКОВОГО ДОСЛІДЖЕННЯ ДЛЯ ПРОЄКТУ
БУДІВНИЦТВА МИКОЛАЇВСЬКОГО МОСТУ В УКРАЇНІ

ЯПОНСЬКЕ АГЕНТСТВО МІЖНАРОДНОГО СПІВРОБІТНИЦТВА(ІСА)

CENTRAL CONSULTANT INC. & NIPPON KOEI CO., LTD

НАЗВА

Типовий перетин(2)

МАСШТАБ
1/300

№.
3

Типовий перетин(3)

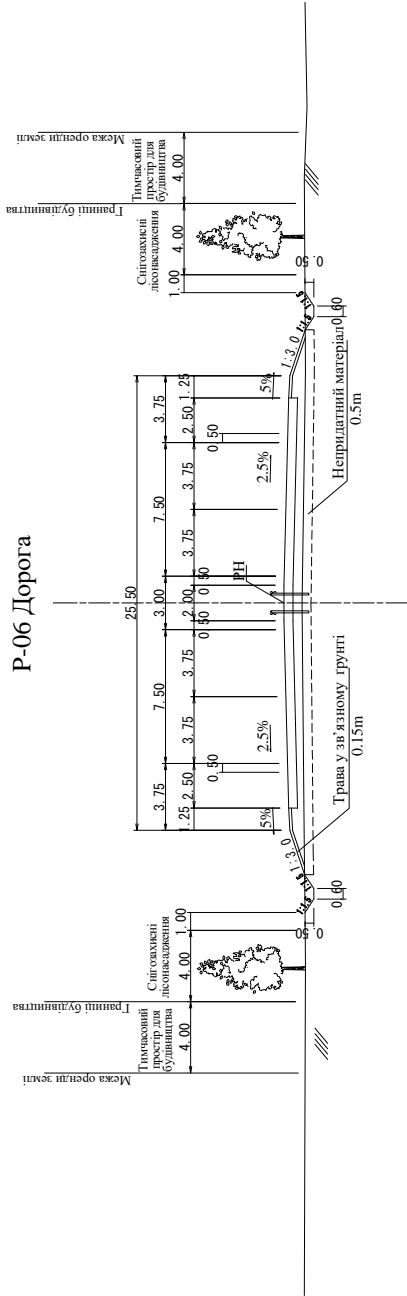

Місцева дорога (клас V)

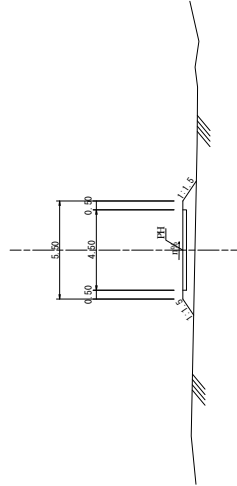

ДОДАТКОВОГО ДОСЛІДЖЕННЯ ДЛЯ ПРОЄКТУ
БУДІВНИЦТВА МИКОЛАЇВСЬКОГО МОСТУ В УКРАЇНІ

ЯПОНСЬКЕ АГЕНТСТВО МІЖНАРОДНОГО СПІВРОБІТНИЦТВА(ІІСА)

CENTRAL CONSULTANT INC. & NIPPON KOEI CO., LTD

НАЗВА

Типовий перетин(3)

МАСШТАБ
1/300

№.
4

Типовий перетин(5)

Конфігурація дорожнього покриття

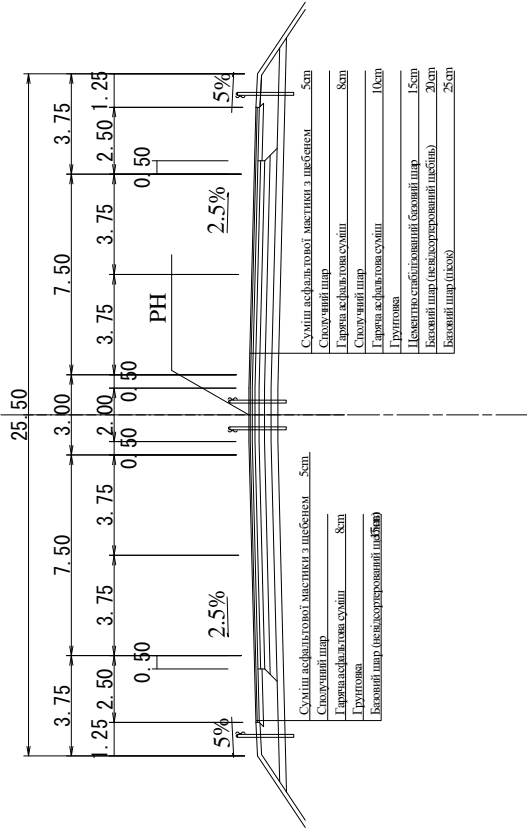

ДОДАТКОВОГО ДОСЛІДЖЕННЯ ДЛЯ ПРОЄКТУ
БУДІВНИЦТВА МИКОЛАЇВСЬКОГО МОСТУ В УКРАЇНІ

ЯПОНСЬКЕ АГЕНТСТВО МІЖНАРОДНОГО СПІВРОБІТНИЦТВА(ІСА)
CENTRAL CONSULTANT INC. & NIPPON KOEI CO., LTD

Типовий перетин(5)

МАСШТАБ
1/300
№.
6

ПЛАН NO.70+0.0~77+0.0

S=1:2000

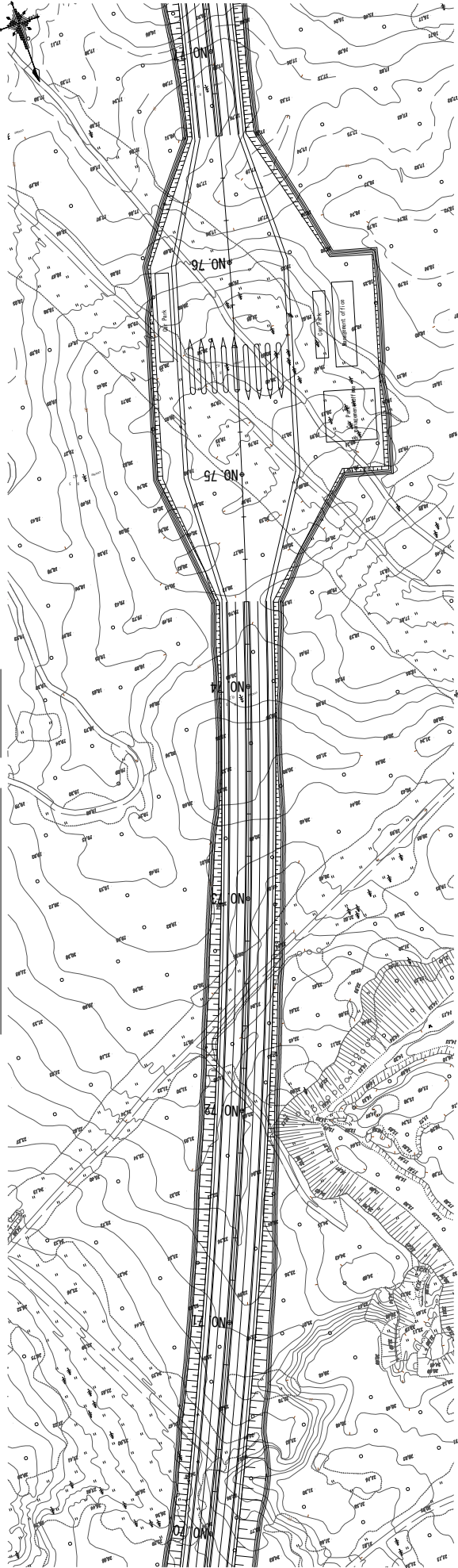

ПРОФІЛЬ NO.70+0.0~77+0.0

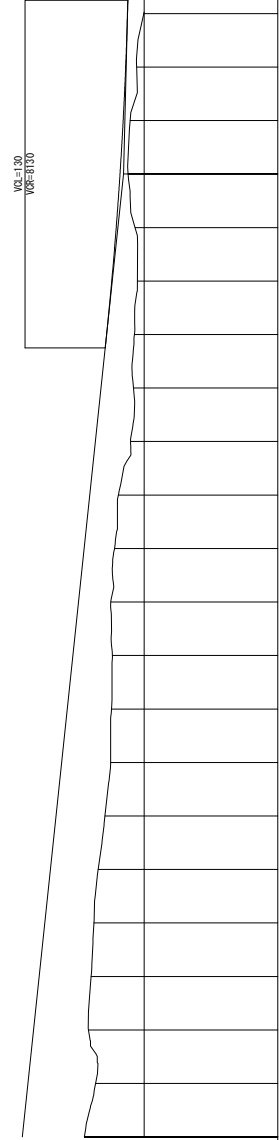

Станція	Початок	Кінець	Занесення	Висота	Підлога	Висота	Висота
NO. 70	24.474	29.100	4.826				
+20.000	23.634	28.680	5.046				
+40.000	24.160	28.260	4.100				
+60.000	22.953	27.840	3.887				
+80.000	23.755	27.420	3.665				
NO. 71	23.432	27.000	3.568				
+20.000	22.927	26.580	3.653				
+40.000	22.502	26.160	3.658				
+60.000	22.427	25.740	3.313				
+80.000	22.374	25.320	2.946				
NO. 72	22.487	24.900	2.413				
+20.000	22.213	24.480	2.267				
+40.000	21.921	24.060	2.139				
+60.000	21.012	23.640	2.628				
+80.000	20.792	23.220	2.428				
NO. 73	20.727	22.802	2.075				
+20.000	20.497	22.419	1.922				
+40.000	20.679	22.085	1.406				
+60.000	21.196	21.800	0.604				
+80.000	21.047	21.565	0.518				
NO. 74	20.558	21.379	0.821				
+20.000	20.025	21.242	1.217				
+40.000	19.828	21.140	1.312				
+60.000	20.138	21.040	0.902				
+80.000	20.131	20.940	0.808				
NO. 75	19.900	20.840	0.940				
+20.000	19.500	20.740	1.240				
+40.000	19.890	20.640	0.750				
+60.000	20.777	20.540	0.237				
+80.000	20.671	20.440	0.231				
NO. 76	19.094	20.340	1.246				
+20.000	17.779	20.240	2.461				
+40.000	17.515	20.140	2.625				
+60.000	17.986	20.040	2.054				
+80.000	18.000	19.940	1.940				
NO. 77	17.638	19.840	2.202				

ДОДАТКОВОГО ДОСЛІДЖЕННЯ ДЛЯ ПРОЄКТУ
БУДІВНИЦТВА МИКОЛАЇВСЬКОГО МОСТУ В УКРАЇНІ

ЯПОНСЬКЕ АГЕНТСТВО МІЖНАРОДНОГО СПІВРОБІТНИЦТВА(ЛІСА)
CENTRAL CONSULTANT INC. & NIPPON KOEI CO., LTD

МАРШРУТ 2
ПЛАН-ПРОФІЛЬ(11)

МАСШТАБ
1/2000
No. 17

ПЛАН NO.77+0.0~84+0.0

S=1:2000

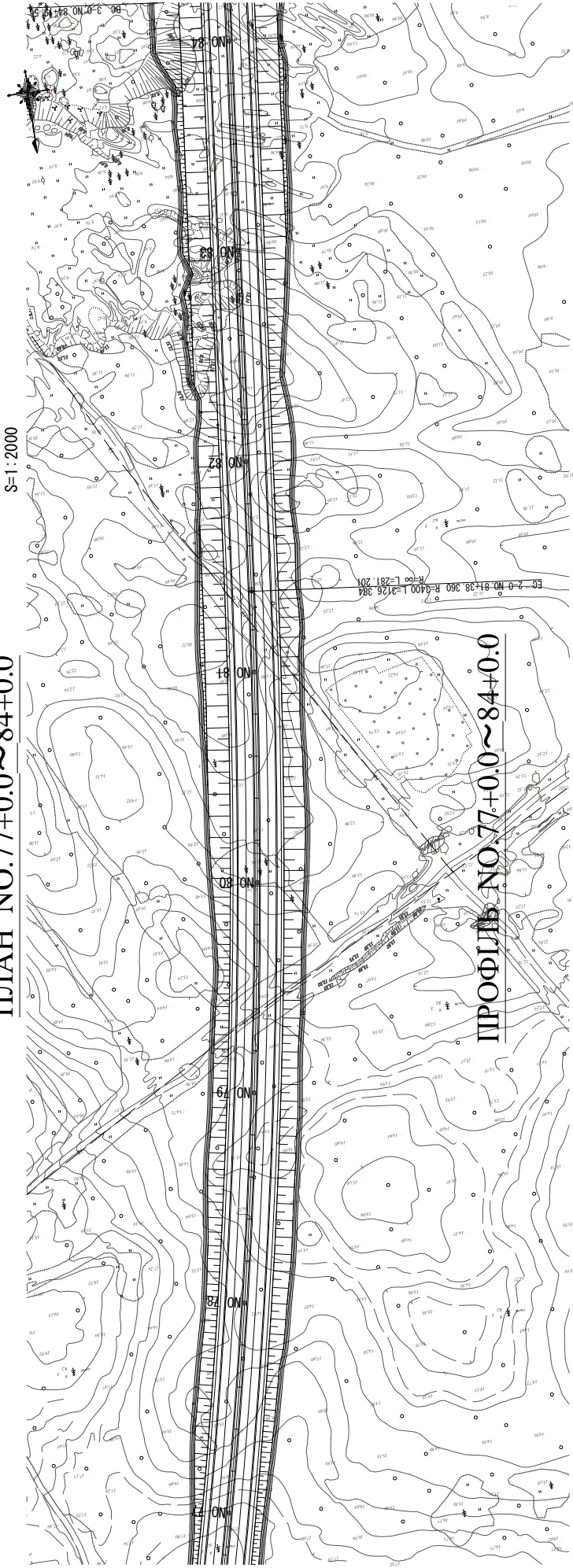

ПРОФІЛЬ NO.77+0.0~84+0.0

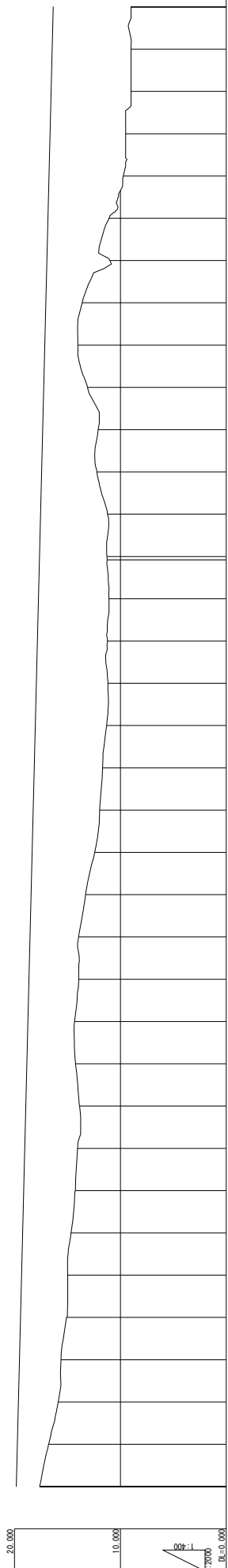

Станція	Висота	Підлога	Висота	Висота	Висота	Висота	Висота	Висота	Висота	Висота	Висота	Висота	Висота	Висота	Висота	Висота	Висота	Висота	Висота	Висота
NO. 77	17.638	19.840	2.202																	
+20.000	16.778	19.740	2.962																	
+40.000	15.877	19.640	3.763																	
+60.000	15.616	19.540	3.924																	
+80.000	15.079	19.440	4.361																	
NO. 78	14.982	19.340	4.358																	
+20.000	14.658	19.240	4.582																	
+40.000	14.270	19.140	4.870																	
+60.000	14.052	19.040	4.988																	
+80.000	13.861	18.940	5.079																	
NO. 79	14.231	18.840	4.609																	
+20.000	14.396	18.740	4.404																	
+40.000	13.942	18.640	4.998																	
+60.000	13.946	18.540	4.594																	
+80.000	11.686	18.440	6.454																	
+60.000	11.298	18.040	6.742																	
+80.000	11.185	17.940	6.755																	
NO. 81	11.224	17.840	6.616																	
+20.000	11.073	17.740	6.663																	
+40.000	11.244	17.640	6.405																	
+60.000	11.269	17.540	6.371																	
NO. 82	12.094	17.340	5.246																	
+20.000	13.107	17.240	4.133																	
+40.000	14.013	17.140	3.129																	
+60.000	13.610	17.040	3.430																	
+80.000	11.000	16.940	5.940																	
NO. 83	11.073	16.840	5.767																	
+20.000	9.724	16.740	7.016																	
+40.000	9.500	16.640	7.140																	
+60.000	9.000	16.540	7.540																	
+80.000	9.000	16.440	7.440																	
NO. 84	9.000	16.340	7.340																	

ДОДАТКОВОГО ДОСЛІДЖЕННЯ ДЛЯ ПРОЄКТУ БУДІВНИЦТВА МИКОЛАЇВСЬКОГО МОСТУ В УКРАЇНІ	ЯПОНСЬКЕ АГЕНТСТВО МІЖНАРОДНОГО СПІВРобІТНИЦТВА(ЛІСА)	НАЗВА МАРШРУТ 2 ПЛАН-ПРОФІЛЬ(12)	МАСШТАБ 1/2000
	CENTRAL CONSULTANT INC. & NIPPON KOEI CO., LTD	No.	18

ПЛАН NO.91+0.0~98+0.0

S=1:2000

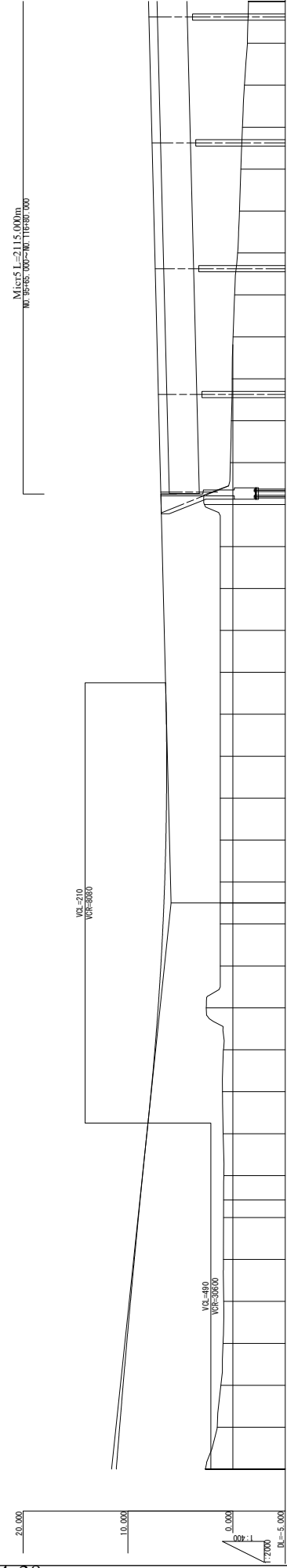
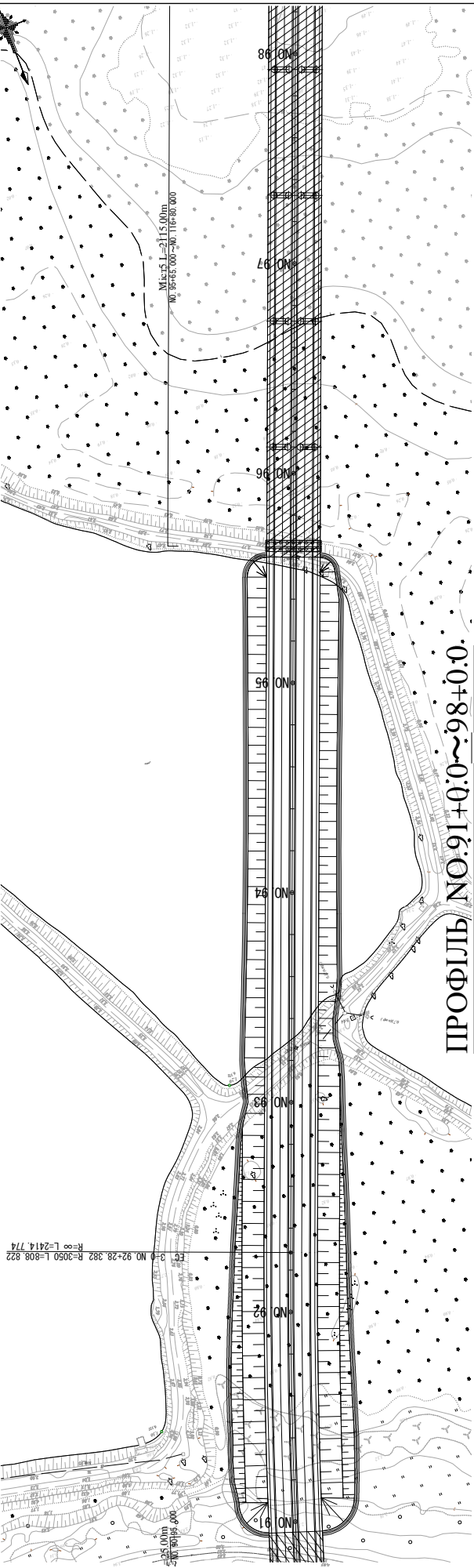

ДОДАТКОВОГО ДОСЛІДЖЕННЯ ДЛЯ ПРОЄКТУ БУДІВНИЦТВА МИКОЛАЇВСЬКОГО МОСТУ В УКРАЇНІ	ЯПОНСЬКЕ АГЕНТСТВО МІЖНАРОДНОГО СПІВРОБІТНИЦТВА(ІС)	НАЗВА	МАРШРУТ 2	МАСШТАБ
	CENTRAL CONSULTANT INC. & NIPPON KOEI CO., LTD	ПЛАН-ПРОФІЛЬ(14)	1/2000	No.
				20

ПЛАН NO.105+0.0~112+0.0

S=1:2000

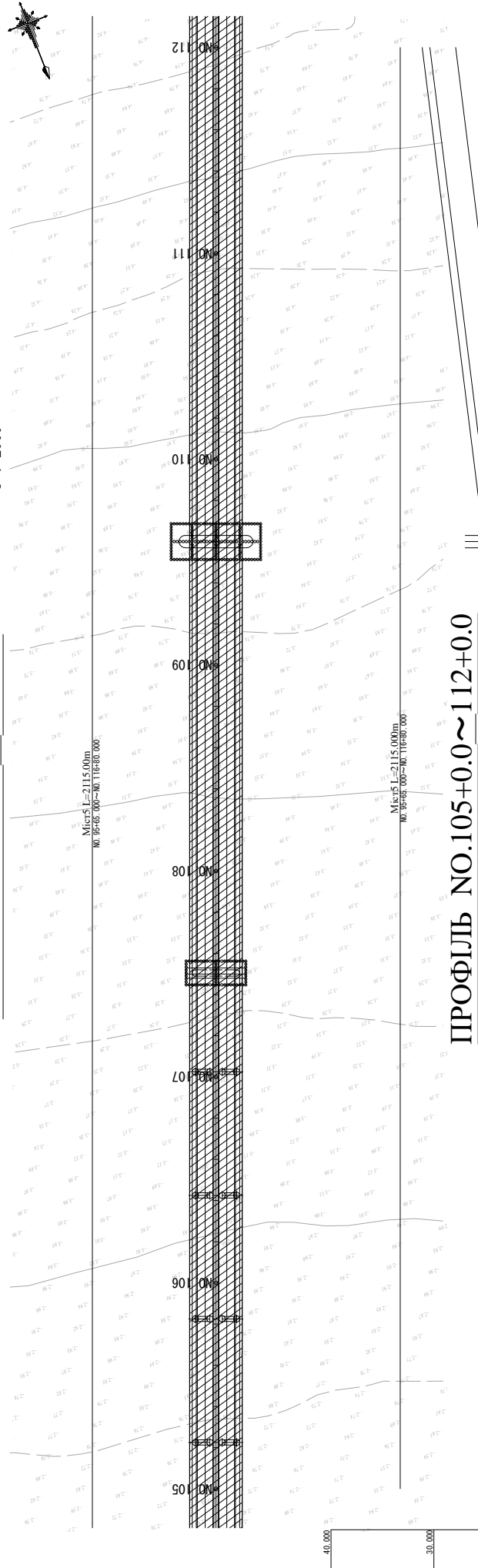

ПРОФІЛЬ NO.105+0.0~112+0.0

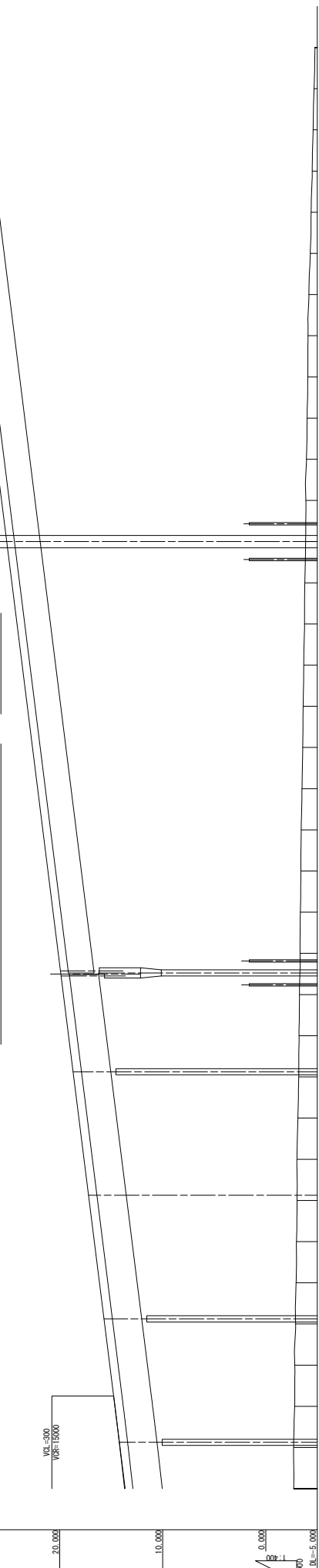

Станція	Земля	Висота	Підлога	Біляшки	Заклепки	Камінь
NO.105	-2.702	13.708	16.410	16.865	17.434	17.949
+20.000	-2.704	14.161	16.865	17.434	17.949	18.530
+80.000	-2.809	15.140	17.949	18.530	19.077	19.672
+20.000	-2.937	16.140	19.077	19.672	20.172	20.783
+40.000	-3.032	17.140	20.172	20.783	21.266	21.839
+80.000	-3.126	18.140	21.266	21.839	22.360	22.906
+20.000	-3.226	19.140	22.360	22.906	23.453	23.985
+40.000	-3.323	20.140	23.453	23.985	24.544	25.077
+80.000	-3.404	21.140	24.544	25.077	25.634	26.170
+20.000	-3.437	21.640	25.634	26.170	26.720	27.262
+40.000	-3.514	22.140	26.720	27.262	27.803	28.353
+80.000	-3.580	22.640	27.803	28.353	28.881	29.443
+20.000	-3.580	22.640	28.881	29.443	29.957	30.532
+40.000	-3.514	22.140	29.957	30.532	31.027	31.619
+80.000	-3.437	21.640	31.027	31.619	32.091	32.704
+20.000	-3.355	20.640	32.091	32.704	33.148	33.787
+40.000	-3.255	19.640	33.148	33.787	34.198	34.868
+80.000	-3.135	18.640	34.198	34.868	35.240	35.947
+20.000	-2.997	17.640	35.240	35.947	36.274	37.024
+40.000	-2.842	16.640	36.274	37.024	37.300	38.098
+80.000	-2.670	15.640	37.300	38.098	38.318	39.169
+20.000	-2.482	14.640	38.318	39.169	39.327	40.237
+40.000	-2.278	13.640	39.327	40.237	40.327	41.302
+80.000	-2.059	12.640	40.327	41.302	41.318	42.364
+20.000	-1.825	11.640	41.318	42.364	42.297	43.423
+40.000	-1.576	10.640	42.297	43.423	43.264	44.479
+80.000	-1.312	9.640	43.264	44.479	44.218	45.532
+20.000	-1.034	8.640	44.218	45.532	45.159	46.582
+40.000	-0.742	7.640	45.159	46.582	46.087	47.629
+80.000	-0.436	6.640	46.087	47.629	47.002	48.673
+20.000	-0.117	5.640	47.002	48.673	47.904	49.714
+40.000	0.212	4.640	47.904	49.714	48.793	50.752
+80.000	0.540	3.640	48.793	50.752	49.669	51.787
+20.000	0.866	2.640	49.669	51.787	50.532	52.819
+40.000	1.190	1.640	50.532	52.819	51.383	53.848
+80.000	1.511	0.640	51.383	53.848	52.222	54.874
+20.000	1.829	-0.360	52.222	54.874	53.049	55.897
+40.000	2.144	-1.360	53.049	55.897	53.864	56.918
+80.000	2.456	-2.360	53.864	56.918	54.667	57.936
+20.000	2.765	-3.360	54.667	57.936	55.458	58.951
+40.000	3.071	-4.360	55.458	58.951	56.237	59.963
+80.000	3.374	-5.360	56.237	59.963	57.004	60.972
+20.000	3.674	-6.360	57.004	60.972	57.758	61.978
+40.000	3.971	-7.360	57.758	61.978	58.500	62.981
+80.000	4.265	-8.360	58.500	62.981	59.230	63.981
+20.000	4.556	-9.360	59.230	63.981	59.948	64.978
+40.000	4.844	-10.360	59.948	64.978	60.654	65.972
+80.000	5.129	-11.360	60.654	65.972	61.348	66.963
+20.000	5.411	-12.360	61.348	66.963	62.030	67.951
+40.000	5.690	-13.360	62.030	67.951	62.699	68.936
+80.000	5.966	-14.360	62.699	68.936	63.356	69.918
+20.000	6.239	-15.360	63.356	69.918	64.001	70.897
+40.000	6.509	-16.360	64.001	70.897	64.633	71.873
+80.000	6.776	-17.360	64.633	71.873	65.253	72.846
+20.000	7.040	-18.360	65.253	72.846	65.860	73.816
+40.000	7.299	-19.360	65.860	73.816	66.454	74.783
+80.000	7.555	-20.360	66.454	74.783	67.035	75.747
+20.000	7.807	-21.360	67.035	75.747	67.603	76.708
+40.000	8.056	-22.360	67.603	76.708	68.158	77.666
+80.000	8.301	-23.360	68.158	77.666	68.700	78.621
+20.000	8.542	-24.360	68.700	78.621	69.229	79.573
+40.000	8.779	-25.360	69.229	79.573	69.746	80.522
+80.000	9.012	-26.360	69.746	80.522	70.251	81.468
+20.000	9.241	-27.360	70.251	81.468	70.743	82.411
+40.000	9.466	-28.360	70.743	82.411	71.223	83.351
+80.000	9.687	-29.360	71.223	83.351	71.690	84.288
+20.000	9.904	-30.360	71.690	84.288	72.144	85.222
+40.000	10.117	-31.360	72.144	85.222	72.585	86.153
+80.000	10.326	-32.360	72.585	86.153	73.013	87.081
+20.000	10.531	-33.360	73.013	87.081	73.428	88.006
+40.000	10.732	-34.360	73.428	88.006	73.830	88.928
+80.000	10.929	-35.360	73.830	88.928	74.219	89.847
+20.000	11.122	-36.360	74.219	89.847	74.595	90.763
+40.000	11.311	-37.360	74.595	90.763	74.958	91.676
+80.000	11.496	-38.360	74.958	91.676	75.308	92.586
+20.000	11.677	-39.360	75.308	92.586	75.645	93.493
+40.000	11.854	-40.360	75.645	93.493	75.969	94.397
+80.000	12.027	-41.360	75.969	94.397	76.280	95.298
+20.000	12.196	-42.360	76.280	95.298	76.578	96.196
+40.000	12.361	-43.360	76.578	96.196	76.863	97.091
+80.000	12.522	-44.360	76.863	97.091	77.135	97.983
+20.000	12.679	-45.360	77.135	97.983	77.394	98.872
+40.000	12.832	-46.360	77.394	98.872	77.640	99.758
+80.000	12.981	-47.360	77.640	99.758	77.873	100.641
+20.000	13.126	-48.360	77.873	100.641	78.093	101.521
+40.000	13.267	-49.360	78.093	101.521	78.299	102.398
+80.000	13.404	-50.360	78.299	102.398	78.492	103.272
+20.000	13.537	-51.360	78.492	103.272	78.672	104.143
+40.000	13.666	-52.360	78.672	104.143	78.839	105.011
+80.000	13.791	-53.360	78.839	105.011	78.993	105.876
+20.000	13.912	-54.360	78.993	105.876	79.134	106.738
+40.000	14.029	-55.360	79.134	106.738	79.262	107.597
+80.000	14.142	-56.360	79.262	107.597	79.377	108.453
+20.000	14.251	-57.360	79.377	108.453	79.479	109.306
+40.000	14.356	-58.360	79.479	109.306	79.568	110.156
+80.000	14.457	-59.360	79.568	110.156	79.644	111.003
+20.000	14.554	-60.360	79.644	111.003	79.707	111.847
+40.000	14.647	-61.360	79.707	111.847	79.757	112.688
+80.000	14.736	-62.360	79.757	112.688	79.794	113.526
+20.000	14.821	-63.360	79.794	113.526	79.818	114.361
+40.000	14.902	-64.360	79.818	114.361	79.829	115.193
+80.000	14.979	-65.360	79.829	115.193	79.827	116.022
+20.000	15.052	-66.360	79.827	116.022	79.812	116.848
+40.000	15.121	-67.360	79.812	116.848	79.784	117.671
+80.000	15.186	-68.360	79.784	117.671	79.743	118.491
+20.000	15.247	-69.360	79.743	118.491	79.689	119.308
+40.000	15.304	-70.360	79.689	119.308	79.622	120.122
+80.000	15.357	-71.360	79.622	120.122	79.542	120.933
+20.000	15.406	-72.360	79.542	120.933	79.449	121.741
+40.000	15.451	-73.360	79.449	121.741	79.343	122.546
+80.000	15.492	-74.360	79.343	122.546	79.224	123.348
+20.000	15.529	-75.360	79.224	123.348	79.092	124.147
+40.000	15.562	-76.360	79.092	124.147	78.947	124.943
+80.000	15.591	-77.360	78.947	125.000	78.790	125.736
+20.000	15.616	-78.360	78.790	125.800	78.621	126.526
+40.000	15.637	-79.360	78.621	126.600	78.440	127.313
+80.000	15.654	-80.360	78.440	127.400	78.247	128.097
+20.000	15.667	-81.360	78.247	128.200	78.042	128.878
+40.000	15.676	-82.360	78.042	129.000	77.825	129.656
+80.000	15.681	-83.360	77.825	129.800	77.597	130.431
+20.000	15.682	-84.360	77.597	130.600	77.357	131.203
+40.000	15.679	-85.360	77.357	131.400	77.105	131.972
+80.000	15.672	-86.360	77.105	132.200	76.842	132.738
+20.000	15.661	-87.360	76.842	133.000	76.568	133.501
+40.000	15.646	-88.360	76.568	133.800	76.283	134.261
+80.000	15.627	-89.360	76.283	134.600	75.987	135.018
+20.000	15.604	-90.360	75.987	135.400	75.680	135.772
+40.000	15.577	-91.360	75.680	136.200	75.362	136.523
+80.000	15.546	-92.360	75.362	137.000	75.033	137.271
+20.000	15.511	-93.360	75.033	137.800	74.693	138.016
+40.000	15.472	-94.360	74.693	138.600	74.342	138.758
+80.000	15.429	-95.360	74.342	139.400	73.980	139.497
+20.000	15.382	-96.360	73.980	140.200	73.607	140.233
+40.000	15.331	-97.360	73.607	141.000	73.223	140.966
+80.000	15.276	-98.360	73.223	141.800	72.828	141.696
+20.000	15.217	-99.360	72.828	142.600	72.422	142.423
+40.000	15.154	-100.360	72.422	143.400	72.005	143.147
+80.000	15.087	-101.360	72.005	144.200	71.577	143.868
+20.000	15.016	-102.360	71.577	145.000	71.138	144.586
+40.000	14.941	-103.360	71.138	145.800	70.688	145.301
+80.000	14.862	-104.360	70.688	146.600	70.227	146.013
+20.000	14.779	-105.360	70.227	147.400	69.755	146.722
+40.000	14.692	-106.360	69.755	148.200	69.272	147.428
+80.000	14.601	-107.360	69.272	14		

ПЛАН NO.112+0.0~119+0.0

S=1:2000

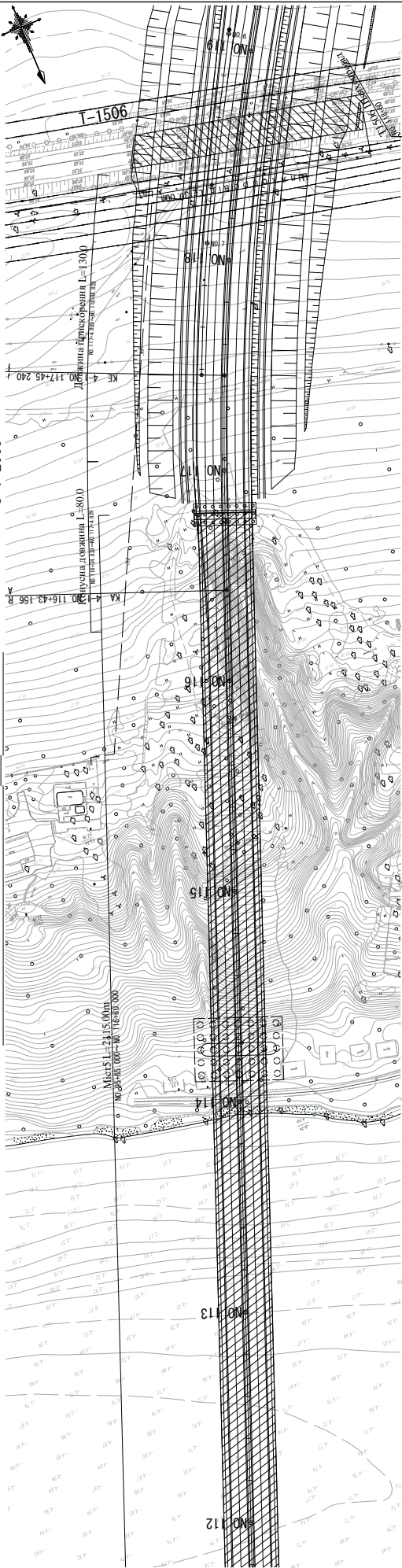

ПРОФІЛЬ NO.112+0.0~119+0.0

Місце: І-21145.000m
 № з'єдн. мосту: 112-119+0.000

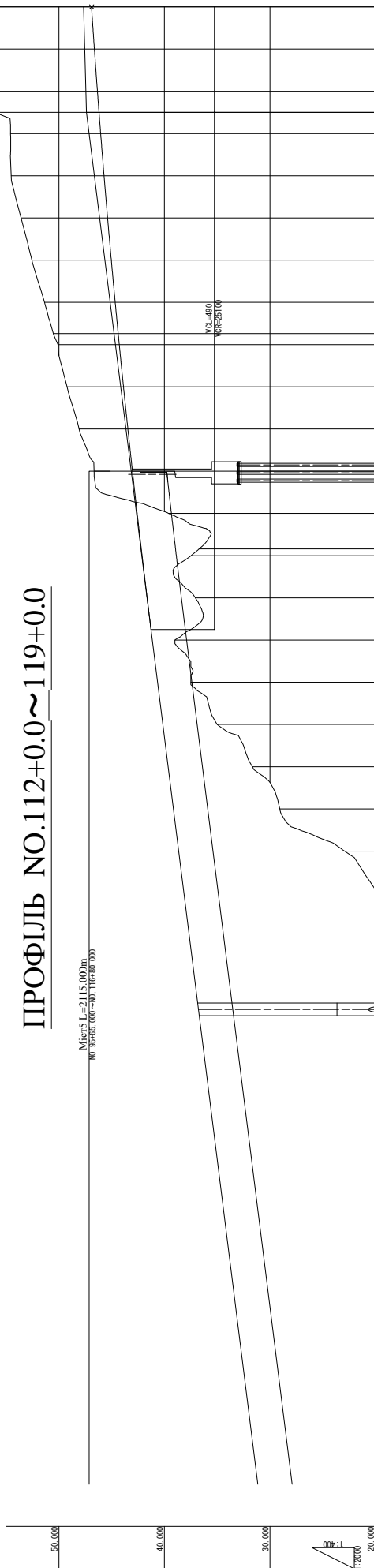

Станція	Висота	Підлога	Висота	Висота	Висота	Висота	Висота
мосту	підлоги	підлоги	підлоги	підлоги	підлоги	підлоги	підлоги
112+0.000	35.918	4.778	31.140	36.448	36.913	37.333	37.877
112+20.000	36.408	31.640	36.448	36.913	37.333	37.877	38.501
112+40.000	36.913	32.140	36.913	37.333	37.877	38.501	39.001
112+60.000	37.333	32.640	37.333	37.877	38.501	39.001	39.501
112+80.000	37.877	33.140	37.877	38.501	39.001	39.501	40.001
112+100.000	38.501	33.640	38.501	39.001	39.501	40.001	40.501
112+120.000	39.001	34.140	39.001	39.501	40.001	40.501	41.001
112+140.000	39.501	34.640	39.501	40.001	40.501	41.001	41.501
112+160.000	40.001	35.140	40.001	40.501	41.001	41.501	42.001
112+180.000	40.501	35.640	40.501	41.001	41.501	42.001	42.501
112+200.000	41.001	36.140	41.001	41.501	42.001	42.501	43.001
112+220.000	41.501	36.640	41.501	42.001	42.501	43.001	43.501
112+240.000	42.001	37.140	42.001	42.501	43.001	43.501	44.001
112+260.000	42.501	37.640	42.501	43.001	43.501	44.001	44.501
112+280.000	43.001	38.140	43.001	43.501	44.001	44.501	45.001
112+300.000	43.501	38.640	43.501	44.001	44.501	45.001	45.501
112+320.000	44.001	39.140	44.001	44.501	45.001	45.501	46.001
112+340.000	44.501	39.640	44.501	45.001	45.501	46.001	46.501
112+360.000	45.001	40.140	45.001	45.501	46.001	46.501	47.001
112+380.000	45.501	40.640	45.501	46.001	46.501	47.001	47.501
112+400.000	46.001	41.140	46.001	46.501	47.001	47.501	48.001
112+420.000	46.501	41.640	46.501	47.001	47.501	48.001	48.501
112+440.000	47.001	42.140	47.001	47.501	48.001	48.501	49.001
112+460.000	47.501	42.640	47.501	48.001	48.501	49.001	49.501
112+480.000	48.001	43.140	48.001	48.501	49.001	49.501	50.001
112+500.000	48.501	43.640	48.501	49.001	49.501	50.001	50.501
112+520.000	49.001	44.140	49.001	49.501	50.001	50.501	51.001
112+540.000	49.501	44.640	49.501	50.001	50.501	51.001	51.501
112+560.000	50.001	45.140	50.001	50.501	51.001	51.501	52.001
112+580.000	50.501	45.640	50.501	51.001	51.501	52.001	52.501
112+600.000	51.001	46.140	51.001	51.501	52.001	52.501	53.001
112+620.000	51.501	46.640	51.501	52.001	52.501	53.001	53.501
112+640.000	52.001	47.140	52.001	52.501	53.001	53.501	54.001
112+660.000	52.501	47.640	52.501	53.001	53.501	54.001	54.501
112+680.000	53.001	48.140	53.001	53.501	54.001	54.501	55.001
112+700.000	53.501	48.640	53.501	54.001	54.501	55.001	55.501
112+720.000	54.001	49.140	54.001	54.501	55.001	55.501	56.001
112+740.000	54.501	49.640	54.501	55.001	55.501	56.001	56.501
112+760.000	55.001	50.140	55.001	55.501	56.001	56.501	57.001
112+780.000	55.501	50.640	55.501	56.001	56.501	57.001	57.501
112+800.000	56.001	51.140	56.001	56.501	57.001	57.501	58.001
112+820.000	56.501	51.640	56.501	57.001	57.501	58.001	58.501
112+840.000	57.001	52.140	57.001	57.501	58.001	58.501	59.001
112+860.000	57.501	52.640	57.501	58.001	58.501	59.001	59.501
112+880.000	58.001	53.140	58.001	58.501	59.001	59.501	60.001
112+900.000	58.501	53.640	58.501	59.001	59.501	60.001	60.501
112+920.000	59.001	54.140	59.001	59.501	60.001	60.501	61.001
112+940.000	59.501	54.640	59.501	60.001	60.501	61.001	61.501
112+960.000	60.001	55.140	60.001	60.501	61.001	61.501	62.001
112+980.000	60.501	55.640	60.501	61.001	61.501	62.001	62.501
112+1000.000	61.001	56.140	61.001	61.501	62.001	62.501	63.001

ДОДАТКОВОГО ДОСЛІДЖЕННЯ ДЛЯ ПРОЄКТУ
 БУДІВНИЦТВА МИКОЛАЇВСЬКОГО МОСТУ В УКРАЇНІ

ЯПОНСЬКЕ АГЕНТСТВО МІЖНАРОДНОГО СПІВРОБІТНИЦТВА(ІС)
 CENTRAL CONSULTANT INC. & NIPPON KOEI CO., LTD

НАЗВА

МАРШРУТ 2
 ПЛАН-ПРОФІЛЬ(17)

МАСШТАБ
 1/2000

№.
 23

ПЛАН NO.126+0.0~132+0.0

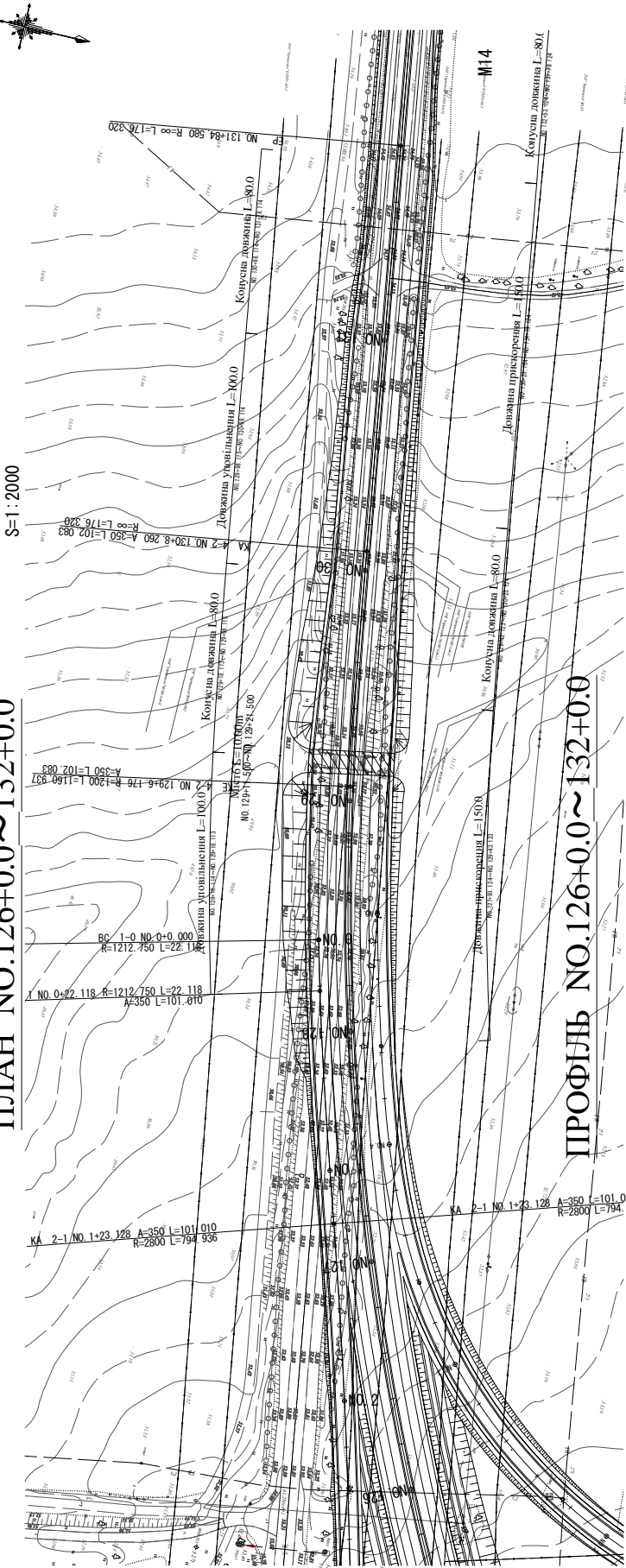

ПРОФІЛЬ NO.126+0.0~132+0.0

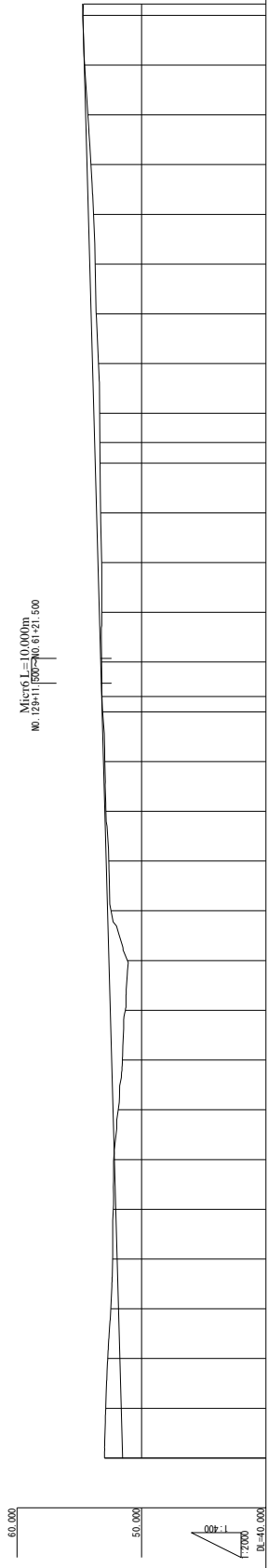

Місця: L=10.000м
 NO.129+11.000~NO.61+21.500

Станція	Висота очей	Висота проєкту	Висота вільного	Висота затопки	Висота затопки	Висота затопки
126+000	51.515	1.467				
126+000	52.878	51.625	1.253			
126+000	52.717	51.735	0.982			
126+000	52.471	51.845	0.626			
126+000	52.224	51.955	0.269			
126+000	52.000	52.175	0.175	0.202		
126+000	52.244	52.175	0.069			
126+000	51.868	52.285				0.417
126+000	51.535	52.395				0.860
126+000	51.299	52.505				1.206
126+000	51.134	52.615				1.481
126+000	52.443	52.725				0.282
126+000	52.630	52.835				0.205
126+000	52.858	52.945				0.087
126+000	52.946	53.055				0.109
126+000	53.119	53.165				0.046
126+000	53.178	53.199				0.021
126+000	53.206	53.275				0.069
126+000	53.199	53.385				0.188
126+000	53.201	53.495				0.294
126+000	53.282	53.605				0.323
126+000	53.325	53.715				0.390
126+000	53.340	53.761				0.421
126+000	53.362	53.825				0.463
126+000	53.455	53.935				0.480
126+000	53.637	54.045				0.408
126+000	53.724	54.155				0.431
126+000	53.861	54.265				0.404
126+000	54.063	54.375				0.312
126+000	54.313	54.485				0.172
126+000	54.574	54.595				0.021
126+000	54.708	54.705				0.003
126+000	54.781	54.815				0.003
126+000	54.815	54.925				0.003
126+000	54.849	55.035				0.003
126+000	54.883	55.145				0.003
126+000	54.917	55.255				0.003
126+000	54.951	55.365				0.003
126+000	54.985	55.475				0.003
126+000	55.019	55.585				0.003
126+000	55.053	55.695				0.003
126+000	55.087	55.805				0.003
126+000	55.121	55.915				0.003
126+000	55.155	56.025				0.003
126+000	55.189	56.135				0.003
126+000	55.223	56.245				0.003
126+000	55.257	56.355				0.003
126+000	55.291	56.465				0.003
126+000	55.325	56.575				0.003
126+000	55.359	56.685				0.003
126+000	55.393	56.795				0.003
126+000	55.427	56.905				0.003
126+000	55.461	57.015				0.003
126+000	55.495	57.125				0.003
126+000	55.529	57.235				0.003
126+000	55.563	57.345				0.003
126+000	55.597	57.455				0.003
126+000	55.631	57.565				0.003
126+000	55.665	57.675				0.003
126+000	55.699	57.785				0.003
126+000	55.733	57.895				0.003
126+000	55.767	58.005				0.003
126+000	55.801	58.115				0.003
126+000	55.835	58.225				0.003
126+000	55.869	58.335				0.003
126+000	55.903	58.445				0.003
126+000	55.937	58.555				0.003
126+000	55.971	58.665				0.003
126+000	56.005	58.775				0.003
126+000	56.039	58.885				0.003
126+000	56.073	58.995				0.003
126+000	56.107	59.105				0.003
126+000	56.141	59.215				0.003
126+000	56.175	59.325				0.003
126+000	56.209	59.435				0.003
126+000	56.243	59.545				0.003
126+000	56.277	59.655				0.003
126+000	56.311	59.765				0.003
126+000	56.345	59.875				0.003
126+000	56.379	59.985				0.003
126+000	56.413	60.095				0.003
126+000	56.447	60.205				0.003
126+000	56.481	60.315				0.003
126+000	56.515	60.425				0.003
126+000	56.549	60.535				0.003
126+000	56.583	60.645				0.003
126+000	56.617	60.755				0.003
126+000	56.651	60.865				0.003
126+000	56.685	60.975				0.003
126+000	56.719	61.085				0.003
126+000	56.753	61.195				0.003
126+000	56.787	61.305				0.003
126+000	56.821	61.415				0.003
126+000	56.855	61.525				0.003
126+000	56.889	61.635				0.003
126+000	56.923	61.745				0.003
126+000	56.957	61.855				0.003
126+000	56.991	61.965				0.003
126+000	57.025	62.075				0.003
126+000	57.059	62.185				0.003
126+000	57.093	62.295				0.003
126+000	57.127	62.405				0.003
126+000	57.161	62.515				0.003
126+000	57.195	62.625				0.003
126+000	57.229	62.735				0.003
126+000	57.263	62.845				0.003
126+000	57.297	62.955				0.003
126+000	57.331	63.065				0.003
126+000	57.365	63.175				0.003
126+000	57.399	63.285				0.003
126+000	57.433	63.395				0.003
126+000	57.467	63.505				0.003
126+000	57.501	63.615				0.003
126+000	57.535	63.725				0.003
126+000	57.569	63.835				0.003
126+000	57.603	63.945				0.003
126+000	57.637	64.055				0.003
126+000	57.671	64.165				0.003
126+000	57.705	64.275				0.003
126+000	57.739	64.385				0.003
126+000	57.773	64.495				0.003
126+000	57.807	64.605				0.003
126+000	57.841	64.715				0.003
126+000	57.875	64.825				0.003
126+000	57.909	64.935				0.003
126+000	57.943	65.045				0.003
126+000	57.977	65.155				0.003
126+000	58.011	65.265				0.003
126+000	58.045	65.375				0.003
126+000	58.079	65.485				0.003
126+000	58.113	65.595				0.003
126+000	58.147	65.705				0.003
126+000	58.181	65.815				0.003
126+000	58.215	65.925				0.003
126+000	58.249	66.035				0.003
126+000	58.283	66.145				0.003
126+000	58.317	66.255				0.003
126+000	58.351	66.365				0.003
126+000	58.385	66.475				0.003
126+000	58.419	66.585				0.003
126+000	58.453	66.695				0.003
126+000	58.487	66.805				0.003
126+000	58.521	66.915				0.003
126+000	58.555	67.025				0.003
126+000	58.589	67.135				0.003
126+000	58.623	67.245				0.003
126+000	58.657	67.355				0.003
126+000	58.691	67.465				0.003
126+000	58.725	67.575				0.003
126+000	58.759	67.685				0.003
126+000	58.793	67.795				0.003
126+000	58.827	67.905				0.003
126+000	58.861	68.015				0.003
126+000	58.895	68.125				0.003
126+000	58.929	68.235				0.003
126+000	58.963	68.345				0.003
126+000	58.997	68.455				0.003
126+000	59.031	68.565				0.003
126+000	59.065	68.675				0.003
126+000	59.099	68.785				0.003
126+000	59.133	68.895				0.003
126+000	59.167	69.005				0.003
126+000	59.201	69.115				0.003
126+000	59.235	69.225				0.003
126+000	59.269	69.335				0.003
126+000	59.303	69.445				0.003
126+000	59.337	69.555				0.003
126+000	59.371	69.665				0.003
126+000	59.405	69.775				0.003
126+000	59.439	69.885				0.003
126+000	59.473	69.995				0.003
126+000	59.507	70.105				0.003
126+000	59.541	70.215				0.003
126+000	59.575	70.325				0.003
126+000	59.609	70.435				0.003
126+000	59.643	70.545				0.003
126+000	59.677	70.655				0.003
126+000	59.711	70.765				0.003
126+000	59.745	70.875				0.003
126+000	59.779	70.985				0.003
126+000	59.813	71.095				0.003
126+000	59.847	71.205				0.003
126+000	59.881	71.315				0.003
126+000	59.915	71.425				0.003
126+000	59.949	71.535				0.003
126+000	59.983	71.645				0.003
126+000	60.017	71.755				0.003
126+000	60.051	71.865				0.003
126+000	60.085	71.975				0.003
126+000	60.119	72.085				0.003
126+000	60.153	72.195				0.003
126+000	60.187	72.305				0.003

ПЛАН NO.14+0.0~21+0.0

S=1:2000

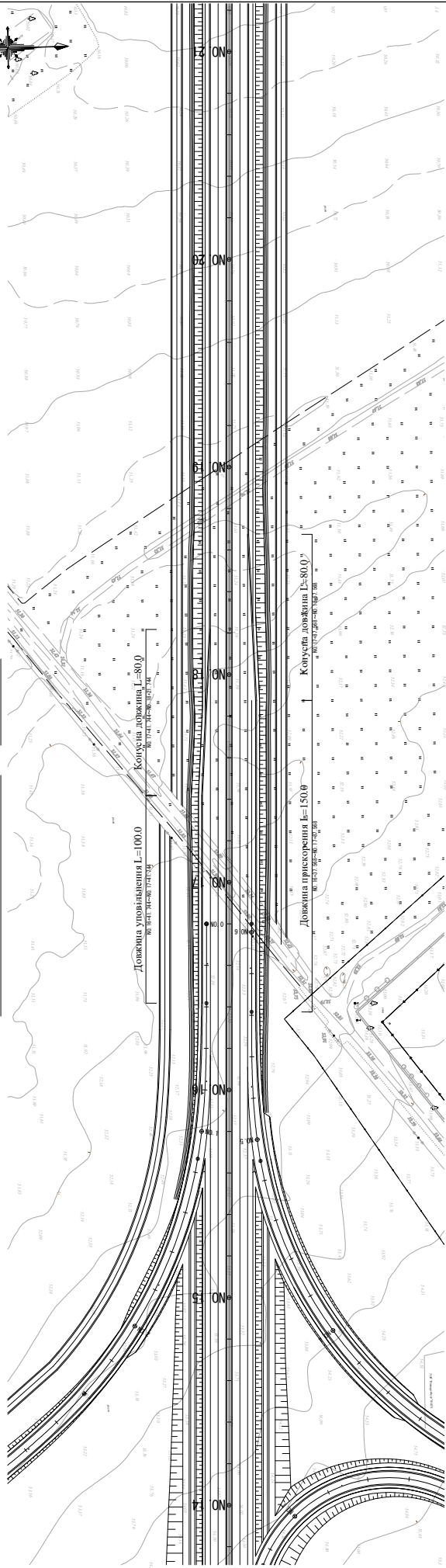

ПРОФІЛЬ NO.14+0.0~21+0.0

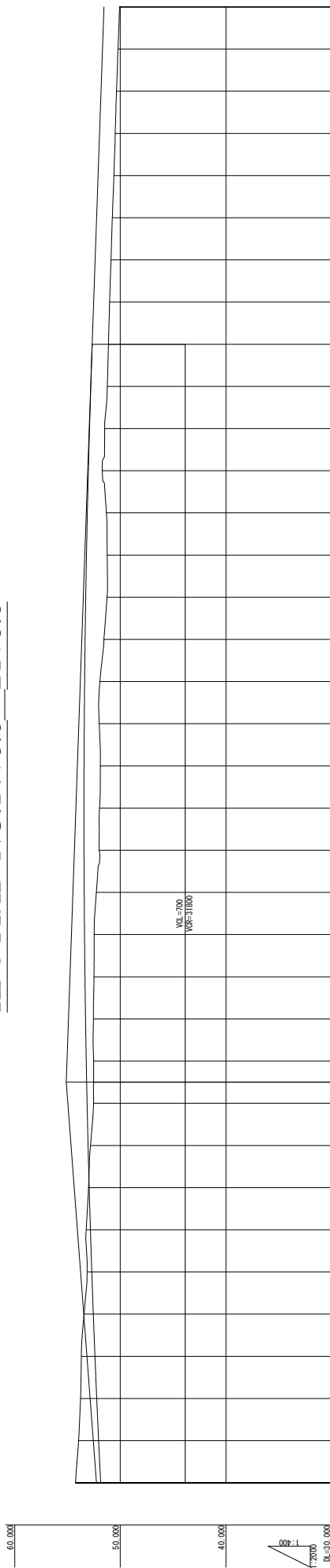

Станція	Висота	Початок	Висота	Заклик	Курс
NO. 14	54.239	51.858	2.381		
+20.000	53.947	52.051	1.896		
+40.000	53.765	52.231	1.534		
+60.000	53.684	52.399	1.285		
+80.000	53.434	52.555	0.879		
NO. 15	53.138	52.698	0.440		
+20.000	53.224	52.828	0.396		
+40.000	53.005	52.946	0.059		
+60.000	52.819	53.051	0.232		
+80.000	52.531	53.143	0.612		
+90.000	52.526	53.185	0.659	55.110	
NO. 16	52.531	53.223	0.692		
+20.000	52.541	53.291	0.750		
+40.000	52.496	53.246	0.950		
+60.000	52.478	53.388	0.910		
+80.000	52.268	53.418	1.150		
NO. 17	52.000	53.435	1.435		
+20.000	51.964	53.439	1.475		
+40.000	51.891	53.431	1.540		
+60.000	51.999	53.411	1.412		
+80.000	51.926	53.378	1.452		
NO. 18	51.550	53.332	1.782		
+20.000	51.253	53.274	2.021		
+40.000	51.243	53.203	1.966		
+60.000	51.312	53.119	1.807		
+80.000	51.696	53.023	1.327		
NO. 19	51.472	52.915	1.443		
+20.000	51.225	52.794	1.569		
+40.000	51.123	52.690	1.537		
+60.000	51.009	52.520	1.511		
+80.000	50.817	52.380	1.503		
NO. 20	50.754	52.240	1.486		
+20.000	50.611	52.100	1.489		
+40.000	50.476	51.960	1.484		
+60.000	50.352	51.820	1.468		
+80.000	50.215	51.680	1.465		
NO. 21	50.067	51.540	1.473		

ДОДАТКОВОГО ДОСЛІДЖЕННЯ ДЛЯ ПРОЄКТУ
БУДІВНИЦТВА МИКОЛАЇВСЬКОГО МОСТУ В УКРАЇНІ

ЯПОНСЬКЕ АГЕНТСТВО МІЖНАРОДНОГО СПІВРІБНІЦТВА(ЛІСА)

CENTRAL CONSULTANT INC. & NIPPON KOEI CO., LTD

НАЗВА

МАРШРУТ 3
ПЛАН-ПРОФІЛЬ(3)

МАСШТАБ
1/2000

№.
28

ПЛАН NO.21+0.0~28+0.0

S=1:2000

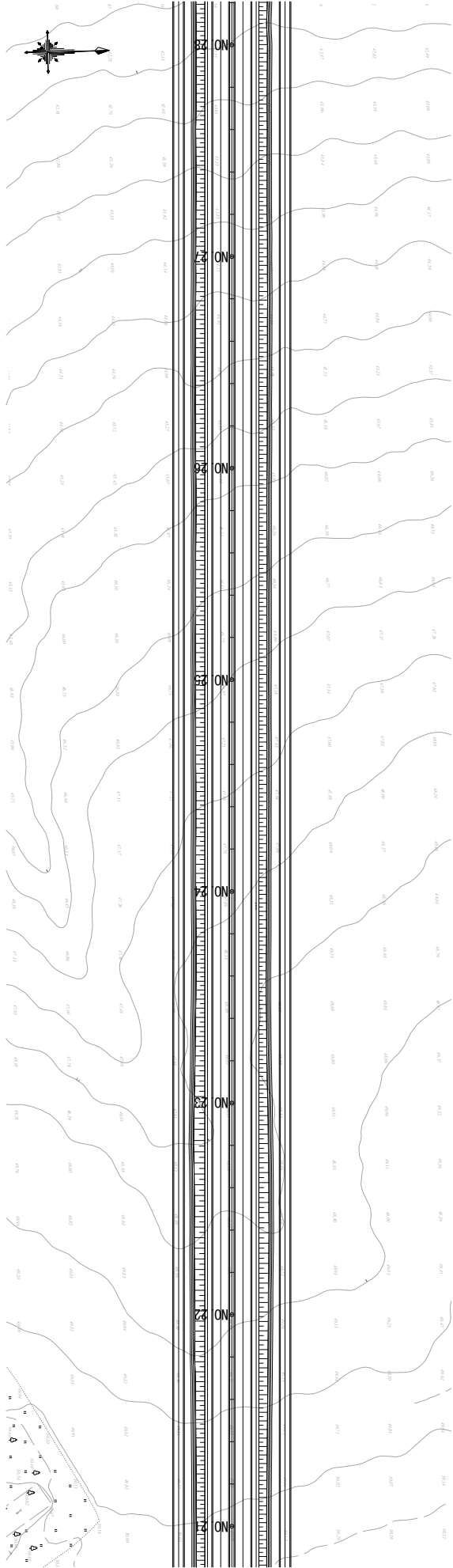

ПРОФІЛЬ NO.21+0.0~28+0.0

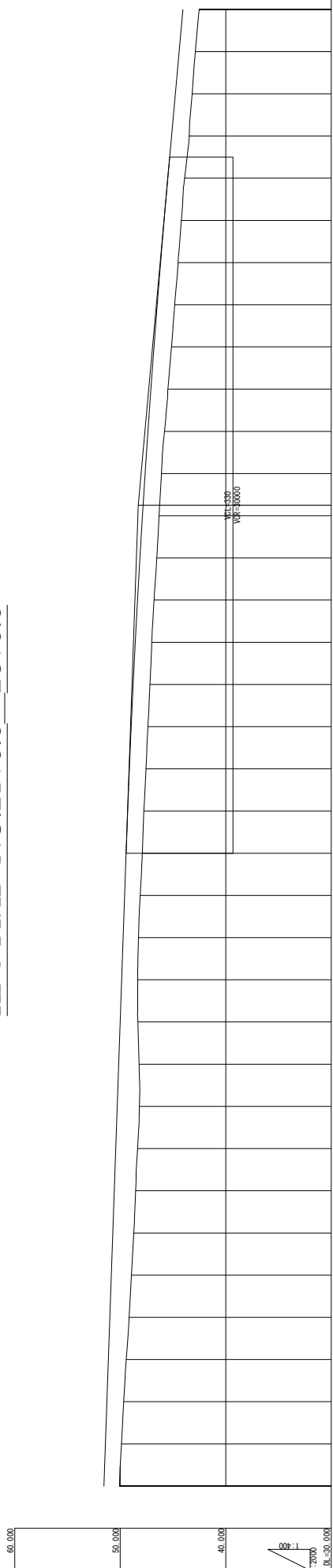

Станція	Висота зачепа	Підлога	Висота підлоги	Висота закладки	Висота закладки	Висота закладки
NO. 21	50.067	51.540	1.473	1.514	1.514	1.514
+20.000	49.886	51.400	1.514	1.514	1.514	1.514
+40.000	49.667	51.260	1.593	1.593	1.593	1.593
+60.000	49.432	51.120	1.688	1.688	1.688	1.688
+80.000	49.154	50.980	1.826	1.826	1.826	1.826
NO. 22	48.937	50.840	1.903	1.903	1.903	1.903
+20.000	48.714	50.700	1.986	1.986	1.986	1.986
+40.000	48.540	50.560	2.020	2.020	2.020	2.020
+60.000	48.356	50.420	2.064	2.064	2.064	2.064
+80.000	48.184	50.280	2.096	2.096	2.096	2.096
NO. 23	48.209	50.140	1.931	1.931	1.931	1.931
+20.000	48.334	50.000	1.666	1.666	1.666	1.666
+40.000	48.340	49.860	1.520	1.520	1.520	1.520
+60.000	48.266	49.720	1.454	1.454	1.454	1.454
+80.000	48.099	49.580	1.481	1.481	1.481	1.481
NO. 24	47.910	49.440	1.530	1.530	1.530	1.530
+20.000	47.761	49.293	1.532	1.532	1.532	1.532
+40.000	47.563	49.133	1.570	1.570	1.570	1.570
+60.000	47.374	48.960	1.586	1.586	1.586	1.586
+80.000	47.183	48.773	1.590	1.590	1.590	1.590
NO. 25	47.008	48.573	1.565	1.565	1.565	1.565
+20.000	46.796	48.390	1.564	1.564	1.564	1.564
+40.000	46.536	48.133	1.597	1.597	1.597	1.597
+60.000	46.317	47.831	1.576	1.576	1.576	1.576
+80.000	46.263	47.631	1.668	1.668	1.668	1.668
NO. 26	45.801	47.373	1.572	1.572	1.572	1.572
+20.000	45.472	47.093	1.621	1.621	1.621	1.621
+40.000	45.139	46.800	1.661	1.661	1.661	1.661
+60.000	44.843	46.493	1.650	1.650	1.650	1.650
+80.000	44.522	46.173	1.651	1.651	1.651	1.651
NO. 27	44.203	45.840	1.637	1.637	1.637	1.637
+20.000	43.899	45.493	1.594	1.594	1.594	1.594
+40.000	43.463	45.135	1.672	1.672	1.672	1.672
+60.000	43.183	44.775	1.592	1.592	1.592	1.592
+80.000	42.878	44.415	1.537	1.537	1.537	1.537
NO. 28	42.523	44.055	1.532	1.532	1.532	1.532

ДОДАТКОВОГО ДОСЛІДЖЕННЯ ДЛЯ ПРОЄКТУ БУДІВНИЦТВА МИКОЛАЇВСЬКОГО МОСТУ В УКРАЇНІ	ЯПОНСЬКЕ АГЕНТСТВО МІЖНАРОДНОГО СПІВРОБІТНИЦТВА(ІСА) CENTRAL CONSULTANT INC. & NIPPON KOEI CO., LTD	НАЗВА	МАРШРУТ 3 ПЛАН-ПРОФІЛЬ(4)	МАСШТАБ 1/2000
		№. 29	№.	№.

ПЛАН NO.28+0.0~35+0.0

S=1:2000

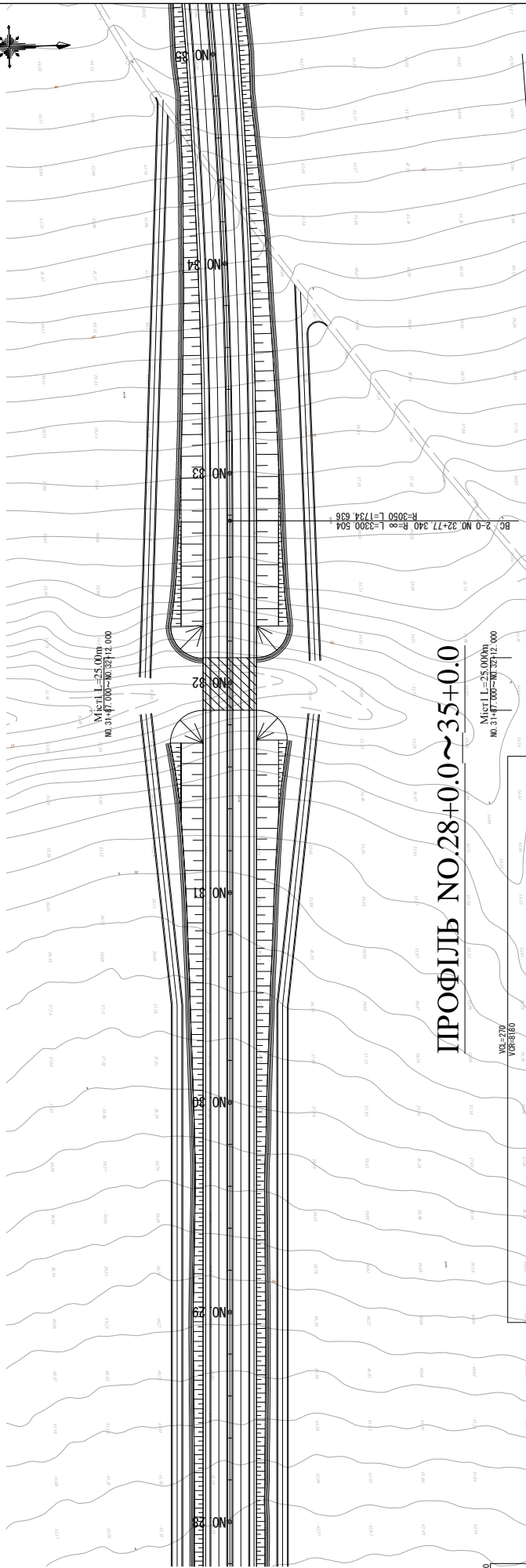

ПРОФІЛЬ NO.28+0.0~35+0.0

Міст L=25.000m
№ 31+87.000~№ 32+12.000

№ 277
УС-530

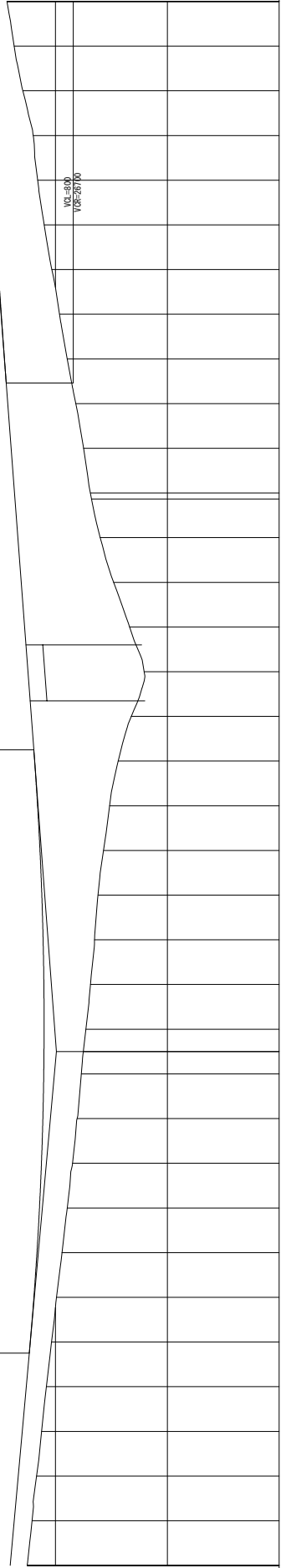

Станція	Висота	Підлога	Балістика	Закладка	Курс
NO. 28	42.523	44.055			1.523
+20.000	42.090	43.695			1.605
+40.000	41.696	43.335			1.639
+60.000	41.247	42.975			1.728
+80.000	40.814	42.615			1.801
NO. 29	40.354	42.257			1.903
+20.000	39.908	41.933			2.025
+40.000	39.419	41.659			2.240
+60.000	38.945	41.433			2.489
+80.000	38.479	41.257			2.778
NO. 30	38.060	41.129			3.069
+20.000	37.689	41.050			3.361
+40.000	37.285	41.020			3.735
+60.000	36.875	41.039			4.164
+80.000	36.512	41.107			4.595
NO. 31	36.200	41.223			5.023
+20.000	35.702	41.389			5.687
+40.000	35.158	41.603			6.445
+60.000	34.392	41.987			7.475
+80.000	33.227	42.165			8.938
NO. 32	32.082	42.465			10.383
+20.000	33.374	42.765			9.391
+40.000	34.798	43.065			8.267
+60.000	35.999	43.365			7.966
+80.000	36.879	43.665			6.789
NO. 33	37.491	43.965			6.474
+20.000	38.180	44.265			6.085
+40.000	38.949	44.563			5.614
+60.000	39.634	44.847			5.213
+80.000	40.327	45.117			4.790
NO. 34	41.010	45.371			4.361
+20.000	41.691	45.610			4.019
+40.000	41.991	45.835			3.844
+60.000	42.918	46.044			3.128
+80.000	43.687	46.239			2.552
NO. 35	44.336	46.418			2.082

ДОДАТКОВОГО ДОСЛІДЖЕННЯ ДЛЯ ПРОЄКТУ БУДІВНИЦТВА МИКОЛАЇВСЬКОГО МОСТУ В УКРАЇНІ	ЯПОНСЬКЕ АГЕНТСТВО МІЖНАРОДНОГО СПІВРОБІТНИЦТВА(ІСА)	НАЗВА	МАРШРУТ 3	МАСШТАБ
	CENTRAL CONSULTANT INC. & NIPPON KOEI CO., LTD		ПЛАН-ПРОФІЛЬ(5)	1/2000
				№.
				30

ПЛАН NO.42+0.0~49+0.0

S=1:2000

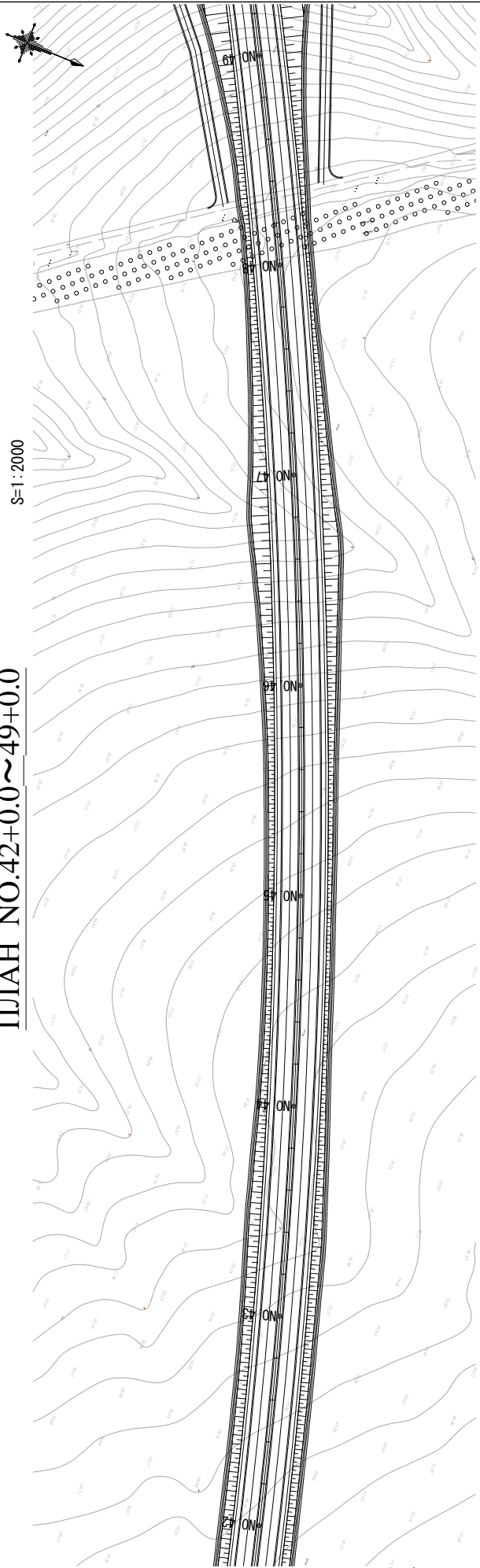

ПРОФИЛЬ NO.42+0.0~49+0.0

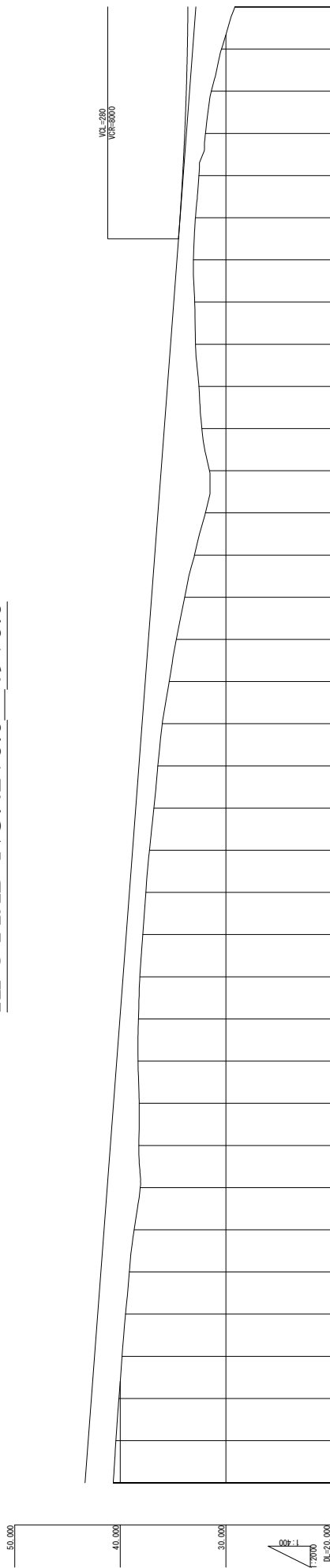

Station	Ground Height	Proposed Height	Cut	Fill	Grade
40.42	40.657	43.240			2.573
20.000	40.412	43.040			2.628
40.000	40.133	42.740			2.607
60.000	39.830	42.440			2.610
80.000	39.507	42.140			2.633
90.43	39.138	41.840			2.702
20.000	38.690	41.540			2.850
40.000	38.110	41.240			3.130
60.000	38.247	40.940			2.693
80.000	38.204	40.640			2.436
90.44	38.316	40.340			2.024
20.000	38.273	40.040			1.763
40.000	38.146	39.740			1.594
60.000	37.862	39.440			1.578
80.000	37.583	39.140			1.557
90.45	37.239	38.840			1.601
20.000	36.822	38.540			1.718
40.000	36.440	38.240			1.800
60.000	36.024	37.940			1.916
80.000	35.365	37.640			2.275
90.46	34.687	37.340			2.653
20.000	33.897	37.040			3.143
40.000	32.972	36.740			3.768
60.000	31.938	36.440			4.502
80.000	31.550	36.140			4.590
90.47	32.271	35.840			3.569
20.000	32.556	35.540			2.984
40.000	32.869	35.240			2.371
60.000	32.966	34.940			1.984
80.000	33.073	34.640			1.567
90.48	32.879	34.340			1.468
20.000	32.652	34.040			1.345
40.000	31.934	33.740			1.803
60.000	31.373	33.440			2.069
80.000	30.413	33.140			2.724
90.49	29.145	32.840			3.693

JAPAN INTERNATIONAL COOPERATION AGENCY (JICA)

CENTRAL CONSULTANT INC. & NIPPON KOEI CO., LTD

M-14 BYPASS Route3

ПЛАН-ПРОФІЛЬ(7)

SCALE 1/2000

No. 32

ADDITIONAL STUDY ON THE PROJECT FOR CONSTRUCTION OF MYKOLAJIV MIST IN UKRAINE

ПЛАН NO.70+0.0~77+0.0

S=1:2000

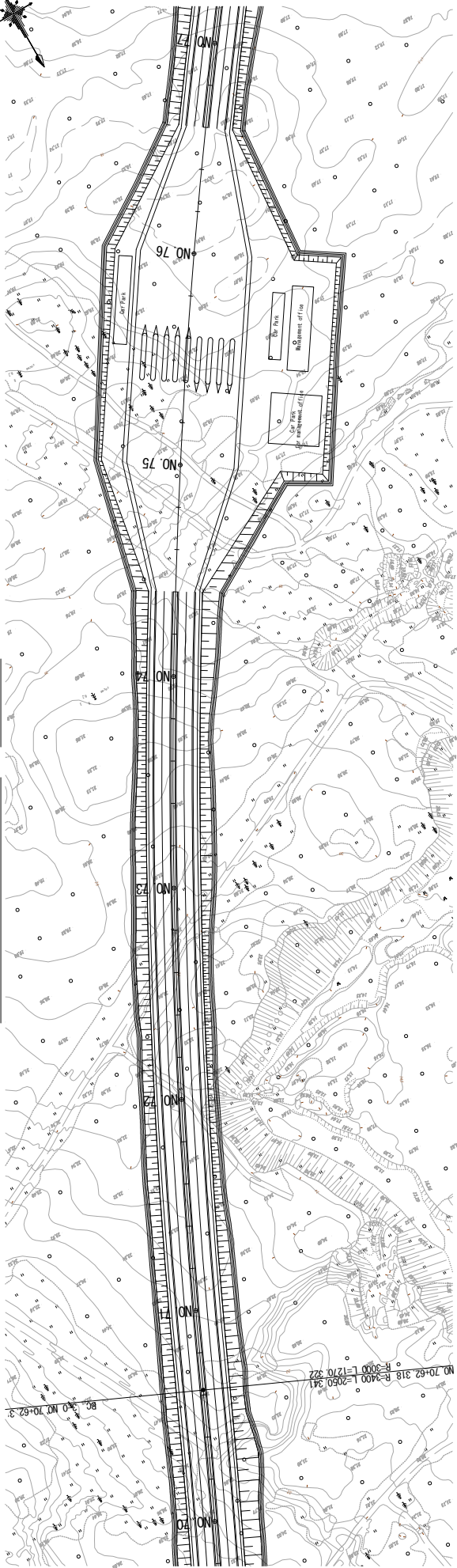

ПРОФІЛЬ NO.70+0.0~77+0.0

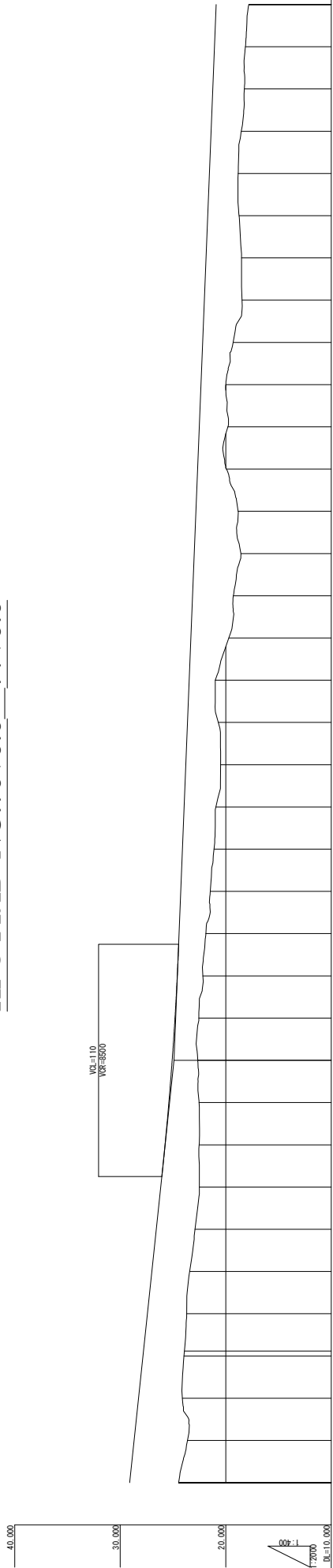

Станція	Висота	Підлога	Підлога	Висота	Закладка	Курс
NO. 70	24.474	29.100				4.626
+20.000	23.634	28.680				5.046
+40.000	24.112	28.260				4.148
+80.000	23.959	27.840				3.887
NO. 71	23.420	27.000				3.580
+20.000	22.921	26.580				3.659
+40.000	22.500	26.160				3.660
+60.000	22.524	25.754				3.230
+80.000	22.530	25.393				2.863
NO. 72	22.645	25.079				2.434
+20.000	22.558	24.813				2.265
+40.000	22.171	24.594				2.423
+60.000	21.887	24.420				2.533
+80.000	21.473	24.260				2.287
NO. 73	21.117	24.100				2.983
+20.000	20.935	23.940				3.005
+40.000	20.491	23.780				3.288
+60.000	20.703	23.620				2.917
+80.000	20.999	23.460				2.461
NO. 74	19.708	23.300				3.592
+20.000	19.283	23.140				3.857
+40.000	18.564	22.980				4.416
+60.000	18.821	22.820				3.999
+80.000	19.947	22.660				2.713
NO. 75	19.791	22.500				2.709
+20.000	19.997	22.340				2.343
+40.000	19.296	22.180				2.884
+60.000	18.451	22.020				3.569
+80.000	18.500	21.860				3.360
NO. 76	18.737	21.700				2.963
+20.000	18.820	21.540				2.720
+40.000	18.526	21.380				2.854
+60.000	18.237	21.220				2.983
+80.000	18.137	21.060				2.923
NO. 77	17.817	20.900				3.083

ДОДАТКОВОГО ДОСЛІДЖЕННЯ ДЛЯ ПРОЄКТУ
БУДІВНИЦТВА МИКОЛАЇВСЬКОГО МОСТУ В УКРАЇНІ

ЯПОНСЬКЕ АГЕНТСТВО МІЖНАРОДНОГО СПІВРІБНІЦТВА(ІСА)
CENTRAL CONSULTANT INC. & NIPPON KOEI CO., LTD

МАРШРУТ 3
ПЛАН-ПРОФІЛЬ(11)

МАСШТАБ
1/2000
№.
36