

東ティモール民主共和国
公共事業省

東ティモール国
道路維持管理水準向上プロジェクト
事業完了報告書

添付資料 2 : Products of the Project
(Checklists, Guidelines, Materials, etc.)

令和元年 12 月
(2019 年)

独立行政法人
国際協力機構 (JICA)

株式会社 アンジェロセック
株式会社 地球システム科学

基盤
JR
19-132

添付資料 2 : Products of the Project

成果品	番号	正称	言語	ページ
施工監理・品質管理・安全管理のチェックリスト	1	Checklist for Construction	英語	A 2 - 3
橋梁下部工洗掘対策の技術手引書	2	Bridge Substructure Protection Guideline	英語	A 2 - 91
	3	Mata Dalan Substrutura Ponte	テトクン語	A 2 - 153
横断排水施設の計画・設計の技術手引書	4	Road Guidelines – Drainage – Culvert Design	英語	A 2 - 215
	5	添付資料	英語	A 2 - 261
	6	Mata Dalan Estrada – Drenajem – Dezenu Culvert	テトクン語	A 2 - 341
法面保護の技術手引書	7	Road Guidelines – Slope Protection – Retaining Wall & Slope Collapse	英語	A 2 - 387
	8	Matadalan Estrada – Protesaun rai Halis – Moru Retensaun & Colapso de Declive	テトクン語	A 2 - 477
地すべり調査・観測の技術手引書	9	Road Guidelines – Slope Protection – Landslide Investigation	英語	A 2 - 561
	10	添付資料	英語	A 2 - 599
	11	Matadalan Estrada – Protesaun rai Halis – Investigasaun Rai Halai	テトクン語	A 2 - 663

注：テトクン語版は参照用



Democratic Republic of Timor-Leste

Ministry of Public Works

Directorate General of Public Works

National Directorate of Roads, Bridges and Flood Control

CHECKLIST for Construction —March 2019

CHECKLISTS for Construction

March 2019

Contents

1. Introduction	-----	1
2. Application of Checklist	-----	2
3. Utilization of Checklist for Construction	-----	2
4. Dissemination	-----	3
5. Checklists of Quality Control	-----	4
5-1 Earthwork	-----	4
(1) Excavation	-----	4
(2) Embankment	-----	6
(3) Aggregate Surface Course (Crushed Aggregate Course on Existing Pavement)	-----	8
(4) Widening of Embankment	-----	11
5-2 Small Structures	-----	13
(1) Pipe Culvert	-----	13
(2) Concrete Drainage	-----	15
(3) Stone Masonry Drainage	-----	18
(4) Stone Masonry Retaining Wall	-----	20
(5) Gabion Mat	-----	22
5-3 Box Culvert	-----	24
5-4 Road Pavement works	-----	33
(1) Base Course and Sub-base Course	-----	33
(2) Asphalt Pavement	-----	37
6. Checklists for Safety Control	-----	45
6-1 Daily Safety Checking	-----	45
6-2 Regular Safety Activities	-----	48
6-3 Safety organization and management	-----	51
6-4 Checklist for Safety Patrol	-----	54
7. Checklists for Construction Management	-----	57
7-1 Tender documents (Drafting; reference only)	-----	57
7-2 Inspection for the works done	-----	63
7-3 Drawings	-----	66
Reference	-----	70
Quality Control Plan	-----	70



REPÚBLICA DEMOCRÁTICA DE TIMOR-LESTE
MINISTÉRIO DAS OBRAS PÚBLICAS
GABINETE DO VICE MINISTRO
Av. Nicolau Lobato, Mandarin, Dili, Timor-Leste

Foreword

In the interest of constructing high quality and economically viable government infrastructure to serve the nation, these checklists for construction were prepared by the JICA Project for Capacity Development of Road Services in the Democratic Republic of Timor-Leste (CDRS) in collaboration with the *Direcção Nacional de Estradas, Pontes e Controlo de Cheias* (DNEPCC, 'National Directorate of Roads, Bridges and Flood Control') of the *Ministério das Obras Públicas* ('Ministry of Public Works'). We would like to thank JICA for their continuing support.

September, 2019



Eng. Nicolau Lino Freitas Belo
Vice Minister for Public Works
Ministry of Public Works

19-09-2019

Foreword by JICA

Japan International Cooperation Agency (JICA) has been conducting a technical cooperation project for development of capacity regarding road services, which is called CDRS, in order to facilitate the DNEPCC in properly managing and maintaining the road infrastructure that is the basis of social and economic activities. To this end, JICA has been dispatching a team of experts from March 2016 to December 2019. As a result of collaborative work with counterparts of the DNEPCC, these checklists for construction have been finalized. I hope that these checklists will contribute to infrastructure development and maintenance, and to the enhancement of friendly relations between our two countries.

Finally, I wish to express my sincere appreciation to the officials of the Government of the Democratic Republic of Timor-Leste for their close cooperation with the expert team.

September, 2019



Masafumi NAGAISHI
Chief Representative of JICA Timor-Leste Office
Japan International Cooperation Agency



1. Introduction

The field supervision of the DRBFC is to manage the quality of construction at each stage of the construction process in order to ensure that the construction is in accordance with the contract documents and national standards.

Quality control and safety management on site is being carried out by the experienced DRBFC senior engineers.

The CDRS Project compiled the CHECKLISTS for Construction as a tool for DRBFC staff in charge of construction management, local engineers and junior engineers with little experience in construction supervision in order to facilitate implementation of quality control and safety management on construction sites.

One of objective of the CDRS Project is the improvement of capacity of DRBFC construction management for maintenance and rehabilitation works. The CDRS Project carried out case studies and provided on-the-job training about how to apply the CHECKLISTS for Construction.

DRBFC staff will utilize the CHECKLISTS for Construction on site and it is expected the DRBFC will revise the checklists as necessary in the future.

2. Application of Checklist

The CHECKLISTS for Construction consists of three main sections corresponding to three aspects of construction supervision: I. Checklists for Quality Control, II. Checklists for Safety and III. Checklists for Construction Management. The application for each section is explained below.

I. Checklists for Quality Control should be applied during on-site inspections by inspectors of construction work. These checklists are very simple and focus on essential check points on site, so even junior staff can easily use them and can instruct contractors properly. In DRBFC, mainly the staff from the Department of Maintenance and Conservation (Dept. M&C) and junior staff from all departments should use these checklists.

II. Checklists for Safety Control should be applied by DRBFC supervisors and also by site staff from contractors. These checklists can be used by all personnel who are engaged and responsible for construction work.

III. Checklists for Construction Management, which includes a Checklist for Tender Documents and a Checklist for Inspection for the works done, should be used by staff in charge of procurement or evaluation of completed works on the site.

The DRBFC does not yet carry out tendering for the procurement, so the Checklist for Tender Documents is supplementary information for reference only.

3. Utilization of Checklist for Construction

The CHECKLISTS for Construction shall be utilized according to the aspect of activities;

1) Checklists for Quality Control

- Checklists for Quality Control (QC) are based on the “Standard Specifications for the Ministry of Public Works, Transport and Communications November 2014 Edition (SPC=MPWTC)”, which supersedes the “2005 Edition of MTCPW Standard Specifications for Highways, Bridges and Airport”.

- Checklists for QC are divided in four categories: Earthwork, Small Structures, Box Culverts and Road Pavement works.

A designated checklist will be used for each construction item, such as Excavation, Embankment and Widening of Embankment. Each checklist shall be filled in according to the guidance on procedures and work items.

- The performance result of the works inspected on the site can be recorded on the checklists for QC. Such records can be used for clarification during checking / evaluations of accomplished work before payments.

2) Checklists for Safety

- Safety on construction sites is essential for supervising personnel of the Government, and also all workers, contactors and the general public.

- Safety activities can be carried out according to Checklists for Safety. The following are recommendable processes for each safety activity:

- i] Establish a “site safety committee including all contractors”
- ii] Discussion and selection of a safety activity or each site
- iii] The safety activities on the site and feedback to the site

3) Checklists for Construction Management

- During procurement stages, Checklists for Tender Documents (TD) can be used.

First of all, the type of contract shall be selected and prepared while referring to Checklist for TD. Before announcement of invitations to tender, prepared document shall be checked again using the Checklist for TD.

- When the engineers in charge have to evaluate the works accomplished according to contract, the Checklist for Daily, Interim Payment and Final Inspection for the works done can be used. The filled in Checklist of Inspection for the works done can be used as evidence for clarifying / approval procedures.

4. Dissemination

On-the-job training (OJT) by DRBFC's Trainers should be carried out on possible construction sites under supervision by DRBFC In order to practice utilizing the "Checklists for Construction".

The DRBFC should later review the results of OJT, discuss about the contents of the checklists, and make improvements or amendment to the "Checklist for Construction".

As many times as possible, practice/ training/ OJT of using "Checklist for Construction" are carried out and its results will be feedback for brushing up "Checklist" and up-dating CHECKLIST.

Supplementary descriptions in the Tetun language shall be added in order to help staff better understand the contents of the checklists.

Using Checklist for construction are hoped by not only DRBFC staff but also other government officials and engineers of contractors in order that quality and safety of construction works in Timor Leste are to be improved

5. Checklists for Quality Control

5. Checklists for Quality Control

5-1 Earthwork
Terraplenagem

(1) Excavation (for Roadway)
Eskavasaun (ba estrada)

1/2

CL_Excavation
Edited_20190220

(this Checklist sheet apply for Roadway Excavation)
(Lista verifikasaun ida ne'e aplika ba eskavasaun ba estrada)

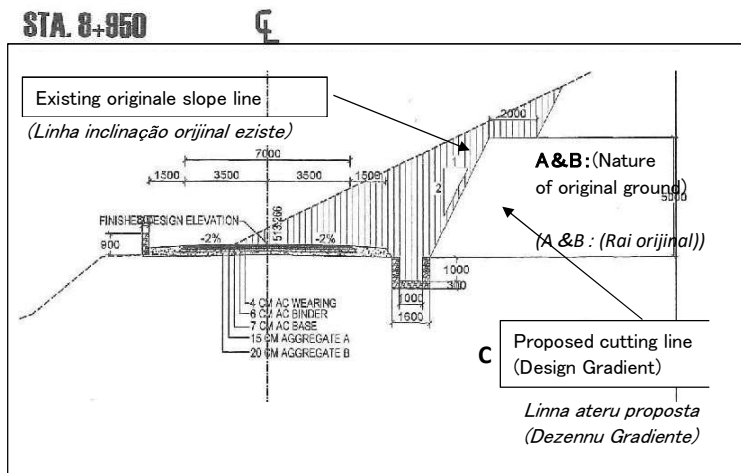

Table of volume at this
Cross Section

(Tabela Volume Seksaun Transversal ida ne'e)

WORK ITEM		
1	Excavation	200.03 m ²
2	Embankment	- m ²
3	AC Wearing	7.00 m ²
4	AC Binder	7.08 m ²
5	Base Course	7.18 m ²
6	Aggregate A	0.75 m ²
7	Aggregate B	1.50 m ²
8	Stone Masonry	1.35 m ²
9	Plaster	1.60 m ²

Example of Cross Section
Ezemplu Seksaun Transversal

CHECKLIST for Excavation

Lista verifikasaun ba eskavasaun

Name of Project: Naran Projeitu :	
Location: Fatin:	Date: / / (DD/MM/20YY)
Name of Contractor: Naran Kontraktor:	Location: STA km - km Fatin
Name of Inspector: Naran Inspektor:	Name of Department Naran Departementu

SPC= Standard Specification of MPWTC-Nov2014 Edition
Padraun spesifikasaun husi MOP-Edisaun Nov2014

No.	Check Items Verifika Itens	Judgements Jugamentu (Selection No.) Seleciona no.		Specification Spesifikasaun Standards Padraun		Remaks Observasaun (Printed figure is reference only) (Figura ne'ebe impressa hanesan referensia deit)
		Yes Sim	No Lae	SPC		
①	Preparatory activity Aktividade preparatoriu					
-1	Did you confirm the drawings? Ita bo'ot komfirma ona dezennu ka?	Yes Sim	No Lae			
-2	Did you confirm the construction work plan? Ita bo'ot komfirma plano servisu konstrusaun nia ka?	Yes Sim	No Lae			
①	Cross Section for Cutting Area of Road Excavation Siksaun transversal ba aterru area escavasaun estrada	Yes Sim	No Lae			
-1	Is the type of original ground stated in the Drawing or the Specification ? Tipu rai orijinal indika iha dezennu ou espekifikasaun?	Yes Sim	No Lae			
-2	Are the drawings of cross section for Roadway provided? Dezennu ba seksaun transversal ba estrada fornese ka lae?	Yes Sim	No Lae			

CHECKLIST for Excavation

Lista verifikasaun ba eskavasaun

No.	Check Items <i>Verifika Itens</i>	Judgements <i>Julgamentu</i> (Selection No.) <i>Seleljona no.</i>		Specification <i>Spesifikasaun</i> Standards <i>Padraun</i>		Remaks <i>Observasaun</i> (Printed figure is reference only) <i>(Figura ne'ebe impressa hanesan referensia deit)</i>
		Yes <i>Sim</i>	No <i>Lae</i>		SPC	
-3	Which interval length of cross section ? <i>Ida ne'ebe mak sai hanesan naruk interval ba seksaun transversal?</i> 1) 25m 3) 100m 2) 50m 4) other length:_____m	Please mark the number				
-4	Are the proposed gradient of cutting line/slope shown on the "Cross Section"(C) ? <i>Proposta gradiente linna ateru/declive hanesan hatudu iha "seksaun Transversal"(C) ?</i>	Yes <i>Sim</i>	No <i>Lae</i>			
-5	Are original ground line also shown on the "Cross Section" ? <i>Rai orijinal mos hatudu hotu iha "Seksaun transversal"?</i>	Yes <i>Sim</i>	No <i>Lae</i>			
-6	Are the results of calculation of the area (m ²), Excavated value, described on such Drawing ? <i>(Rezultadu husi kalkulasau ba area (m²), valor eskavasaun, descreve iha dezennu ?)</i>	Yes <i>Sim</i>	No <i>Lae</i>			
②	Excavation Work <i>Servisu eskavasaun</i>					
-1	Which type of Excavation ? <i>Tipu eskavasaun mak ida ne'ebe?</i> 1)Unclassified Excavation 3) Common soil Rail 2)Rock Excavation 4) Other Excavation <i>Fatuk</i> <i>Eskavasaun ne'ebe la klasifika</i>	Please mark the number <i>(Favor fo marka iha numero)</i>		203.1.1		* 1) & 2) can be excavated by blasting and Rippering. <i>* 1) & 2) bele halo eskavasaun liu husi peledakkan no utiliza ripper.</i>
-2	Are the stakes of setting out and/or leading frames provided on the site? <i>Monta staka no papan petunjuk ne'e fornese iha situ ka lae?</i>	Yes <i>Sim</i>	No <i>Lae</i>		203.2.1	
-3	Are the line, grades and dimension of slope/ excavated area followed to the Drawing or the instructions by the Engineer ? <i>(Linna,klase no dimensaun declive/ area eskavasaun tuir dezennu ou instrusaun husi Enjinneru?)</i>	Yes <i>Sim</i>	No <i>Lae</i>		203.1	
-4	Which kinds of machine or method of excavation are carried out ? <i>Tipu Makina no matodu saida mak realiza ba eskavasaun?</i> 1) Excavator 3) Bulldozer with ripper 2) Buldozzer 4) Balsting method	Please mark the number <i>(Favor marka iha numero)</i>				* In case of Blasting, works apply SPC section 203.2.5 "Presplitting" <i>* iha Kazu Peledakan, aplika iha Spesifikasaun seksaun 203.2.5 "Pre-</i>
-5	Have the Contractor instructed to the operator regading work procedure of Excavation ? <i>Kontraktor fo Intrusaun ba operador relasiona ho prosedimentu servisu eskavasaun ?</i>	Yes <i>Sim</i>	No <i>Lae</i>			
-6	Are conservation of Topsoil and Utilization of excavated material carried out satisfactory ? <i>Konservasaun husi rai superficial no utiliza material eskavasaun sira ne'e satisfatoriamente ka?</i>	Yes <i>Sim</i>	No <i>Lae</i>		203.2.2 203.2.3	
-7	Ground water and/or surface water from the cut surface is being processed appropriate? <i>Be rai okos no be superficial iha superficie corte ne'ebe atu prosesa apropiado ka lae?</i>	Yes <i>Sim</i>	No <i>Lae</i>			
-8	Is the floating stone on the slope appropriate removed? <i>Fatuk ne'ebe flutuamente iha declive ou taludes apropiado atu hasai ka lae?</i>	Yes <i>Sim</i>	No <i>Lae</i>			

(2) Embankment
Aterru

1/3

CL_Embankment

Edited_20181001

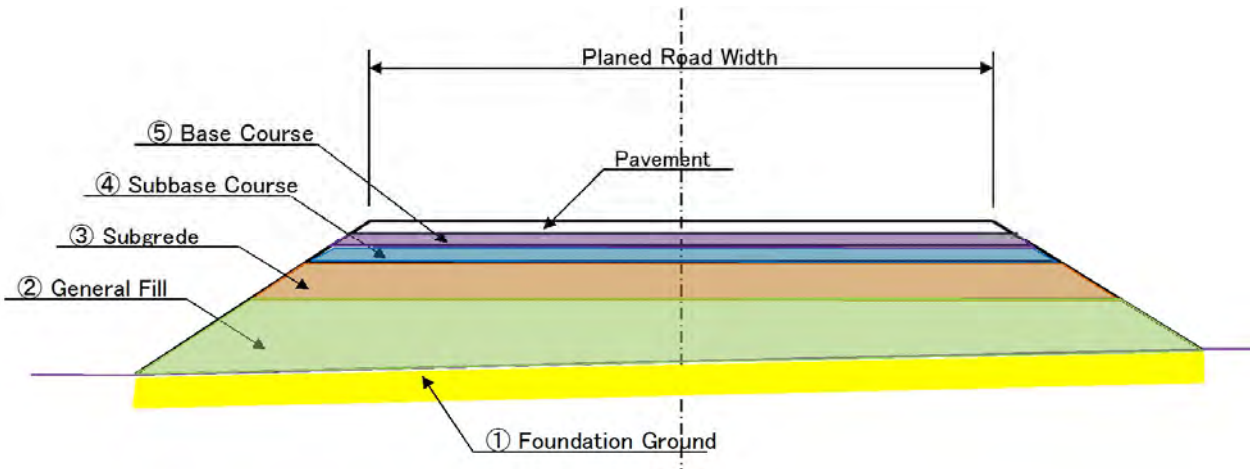

CHECKLIST for Road Embankment
List a verifikasaun aterru estrada

Name of Project: <i>Naran Projetu :</i>	
Location: <i>Fatin:</i>	Date: / / (DD/MM/20YY) Data:
Name of Contractor: <i>Naran Kontraktor :</i>	Location: STA km - km (<i>Fatin</i>)
Name of Inspector: <i>Naran Inspektor:</i>	Name of Department <i>Naran Departementu</i>

SPC= Standard Specification of MPWTC–Nov2014 Edition
Padraun spesifikasaun husi MOP–Edisaun Nov2014

No.	Check Items <i>Verifika Itens</i>	Judgements <i>Julgamentu</i>		Specification <i>Spesifikasaun</i>		Remaks <i>Observasaun</i> (Printed figure is reference only) <i>(Figura ne'ebe impressa hanesan)</i>
		(Selection No.) <i>Seleciona no.</i>	Standards <i>Padraun</i>	Standards <i>Padraun</i>	SPC	
①	Preparatory activity <i>Aktividade preparatoriu</i>					
	Did you confirm the drawings? <i>Ita bo'ot komfirma ona dezennu ka?</i>	Yes <i>Sim</i>	No <i>Lae</i>			
	Did you confirm the construction work plan? <i>Ita bo'ot komfirma ona planu servisu konstrusaun nia ka ?</i>	Yes <i>Sim</i>	No <i>Lae</i>			
①	Foundation Ground <i>Dasar Fondasi</i>					
	Is strength of bearing ground sufficient? <i>Forsa bantalan rai nia nia suficiente ka lae?</i>	Yes <i>Sim</i>	No <i>Lae</i>			
	If No, was replace damaged pipe with new pipe? <i>Se Lae, troka tiha ona pipa ne'ebe at ho pipa foun ka?</i>	Yes <i>Sim</i>	No <i>Lae</i>			

CHECKLIST for Road Embankment

2/3

Lista verifikasaun aterru estrada

No.	Check Items <i>Verifika Itens</i>	Judgements		Specification		Remaks <i>Observasaun</i> (Printed figure is reference only) (<i>Figura ne'ebe impressa hanesan</i>)
		<i>Julgamentu</i> (Selection No.) <i>Seleciona no.</i>		Standards <i>Padraun</i>	SPC	
②	General Fill <i>Preenchimento jeral</i>					150mm
	Did you check the general fill material? <i>Ita bo'ot verifika ona material preechimento jeral?</i>	Yes <i>Sim</i>	No <i>Lae</i>	—		Material on site (Material iha terenu)
	Did you check the type of compaction equipment? <i>Ita bo'ot verifika ona tipu ekipamentus ba Kompaktasaun?</i>	Yes	No			Road roller, Macadam 10~12t
	Did you check the number of compaction? <i>Ita bo'ot verifika ona numeru ba kompaktasaun?</i>	Yes <i>Sim</i>	No <i>Lae</i>			10 numbers
	Did you confirm the soil density test results? <i>Ita bo'ot komfirma ona rezultadu teste densidade rai nian?</i>	Yes <i>Sim</i>	No <i>Lae</i>	95%		Inspected density: 96% Densidade ne'ebe halo inspeksaun: 96%
	Did you confirm the compacted thickness? <i>Ita bo'ot komfirma ona kompaktasaun ninia mahar?</i>	Yes <i>Sim</i>	No <i>Lae</i>	30cm		Inspected thickness: 30cm Mahar ne'ebe halo inspeksaun tiha ona : 30 cm
③	Subgrade <i>Subleito</i>					
	Did you check the subgrade material? <i>Ita bo'ot verifika ona material ba subgrade?</i>	Yes <i>Sim</i>	No <i>Lae</i>	—		Selected Material, From Borrow Pit No.1 Material ne'ebe hili tiha ona husi posu impresta no.1
	Did you check the type of compaction equipment? <i>Ita bo'ot verifika ona tipu ekipamentu kompaktasaun?</i>	Yes <i>Sim</i>	No <i>Lae</i>			Road roller, Macadam 10~12t
	Did you check the number of compaction? <i>Ita bo'ot verifika ona numeru kompaktasaun?</i>	Yes <i>Sim</i>	No <i>Lae</i>			10 numbers
	Did you confirm the soil density test results? <i>Ita komfirma ona rezultadu teste densidade rai?</i>	Yes <i>Sim</i>	No <i>Lae</i>	95%		Inspected density: 96% densidade ne'ebe inspeksionado : 96%
	Did you confirm the compacted thickness? <i>Ita bo'ot komfirma ona kompaktasaun nia mahar?</i>	Yes <i>Sim</i>	No <i>Lae</i>	30cm		Inspected thickness: 30cm Mahar ne'ebe inspeksionado: 30 cm
④	Subbase Course <i>Subbase Course</i>					
	Did you check the subbase material? <i>Ita bo'ot verifika ona sub base nia material?</i>	Yes <i>Sim</i>	No <i>Lae</i>	—		Selected Material, From Borrow Pit No.1 Material ne'ebe selesionado husi borrow pit no.1
	Did you check the type of compaction equipment? <i>Ita bo'ot verifika ona ekipamentu kompaktasaun?</i>	Yes <i>Sim</i>	No <i>Lae</i>			Road roller, Macadam 10~12t
	Did you check the number of compaction? <i>Ita bo'ot verifika ona numeru kompaktasaun?</i>	Yes <i>Sim</i>	No <i>Lae</i>			10 numbers
	Did you confirm the soil density test results? <i>Ita bo'ot komfirma ona rezultadu teste densidade rai?</i>	Yes <i>Sim</i>	No <i>Lae</i>	95%		Inspected density: 96% densidade ne'ebe inspeksionado : 96%
	Did you confirm the compacted thickness? <i>Ita bo'ot komfirma ona kopaktasaun nia mahar?</i>	Yes <i>Sim</i>	No <i>Lae</i>	30cm		Inspected thickness: 30cm mahar ne'ebe inspeksionado: 30 cm

CHECK LIST for Road Embankment

3/3

Lista verifikasaun aterru estrada

No.	Check Items <i>Verifika Itens</i>	Judgements		Specification		Remaks <i>Observasaun</i> (Printed figure is reference only) <i>(Figura ne'ebe impressa hanesan)</i>
		<i>Julgamentu</i> (Selection No.) <i>Seleciona no.</i>		Standards <i>Padraun</i>	SPC	
⑤	Base Course <i>Kursu Baze</i>					
	Did you check the base material? <i>Ita bo'ot verifika ona material base?</i>	Yes <i>Sim</i>	No <i>Lae</i>	—		Crushed stone for mechanical stabilization, CLASS A <i>fatuk fera ba stabilizasaun mekanika klasse A</i>
	Did you check the type of compaction equipment? <i>Ita bo'ot verifika ona tipu ekipamentu kompaktasaun?</i>	Yes <i>Sim</i>	No <i>Lae</i>			Road roller, Macadam 10~12t
	Did you check the number of compaction? <i>Ita bo'ot verifika ona numeru kompaktasaun?</i>	Yes <i>Sim</i>	No <i>Lae</i>			10 numbers
	Did you confirm the soil density test results? <i>Ita bo'ot komfirma ona rezultado teste densidade rai?</i>	Yes <i>Sim</i>	No <i>Lae</i>	95%		Inspected density: 96% <i>densidade ne'ebe inspeksionado : 96%</i>
	Did you confirm the compacted thickness? <i>Ita bo'ot komfirma ona kompaktasaun nia mahar?</i>	Yes <i>Sim</i>	No <i>Lae</i>	30cm		Inspected thickness: 30cm <i>Mahar ne'ebe inspeksionado: 30 cm</i>

(3) Aggregate Surface (Wearing) Course
Crushed Aggregate Course on Existing Pavement, with

CL_Aggre. Surface Course

Edited_20181001

1/2

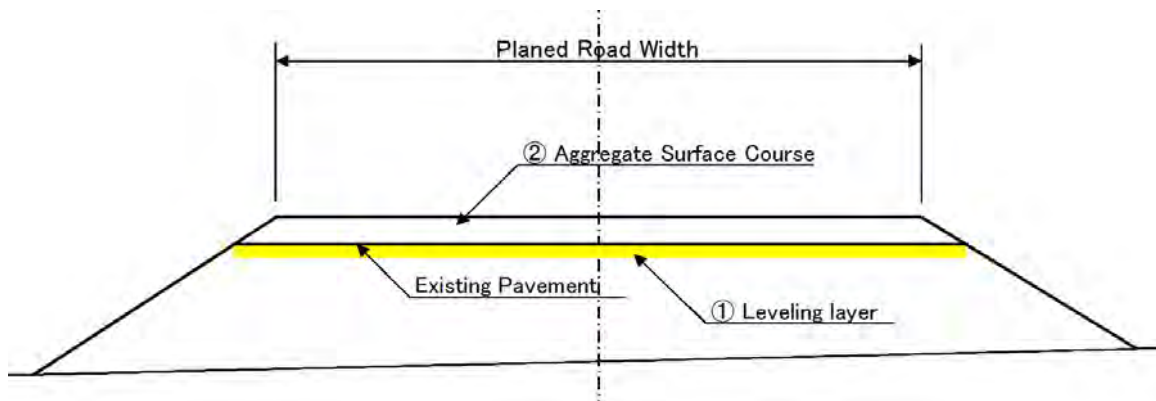

CHECKLIST for Aggregate Surface (Wearing) Course

Name of Project: <i>Naran Projetu :</i>	
Location: <i>Fatin:</i>	Date: / / (DD/MM/20YY) Data:
Name of Contractor: <i>Naran Kontraktor :</i>	Location: STA km - km (<i>Fatin</i>)
Name of Inspector: <i>Naran Inspektor:</i>	Name of Department <i>Naran Departementu</i>

SPC= Standard Specification of MPWTC–Nov2014 Edition
Padraun spesifikasaun husi MOP–Edisaun Nov2014

No.	Check Items <i>Verifika Itens</i>	Judgements <i>Julgamentu</i>		Specification <i>Spesifikasaun</i>		Remaks <i>Observasaun</i> (Printed figure is reference only) <i>(Figura ne'ebe impressa hanesan)</i>
		(Selection No.) <i>Seleciona no.</i>	Standards <i>Padraun</i>	Standards <i>Padraun</i>	SPC	
①	Preparatory activity <i>Aktividade preparatoriu</i>					
	Did you confirm the drawings? <i>Ita bo'ot komfirma ona dezenu ka?</i>	Yes <i>Sim</i>	No <i>Lae</i>			
	Did you confirm the construction work plan? <i>Ita bo'ot komfirma ona planu servisu konstrusaun?</i>	Yes <i>Sim</i>	No <i>Lae</i>			
①	Leveling Layer <i>Nivelamento dalas</i>					
	Has the existing pavement been removed properly? <i>Pavimentu ne'ebe eziste removido ho lolos ona ka?</i>	Yes <i>Sim</i>	No <i>Lae</i>			
	Was existing surface scarified, thoroughly loosened, reshaped, and recompact appropriate? <i>Superficie ne'ebe eziste klarifikadu, completamente halo longgar, reforma no halo kompaktasaun fila fali ne'e apropiadu ka lae?</i>	Yes <i>Sim</i>	No <i>Lae</i>			

CHECKLIST for Aggregate Surface (Wearing) Course 2/2

No.	Check Items <i>Verifika Itens</i>	Judgements		Specification		Remaks <i>Observasaun</i> (Printed figure is reference only) (<i>Figura ne'ebe impressa hanesan referensia deit</i>)
		(Selection No.) <i>Seleciona no.</i>	Standards <i>Padraun</i>	Standards	SPC	
②	Aggregate Surface Course <i>Kursu Superficie agregada</i>					
	Did you check the aggregate surface material? <i>Ita bo'ot verifika ona material superficje agregat ka?</i>	Yes	No	—		Crushed stone for mechanical stabilization, CLASS A fatuk fera ba stabilizasaun mekaniko kalsse A
	Did you check the type of compaction equipment? <i>Ita bo'otverifika ona tipu ekipamentus ba kompaktasaun?</i>	Yes	No			Road roller, Macadam 10~12t
	Did you check the number of compaction? <i>Ita bo'ot verifika ona numeru kompaksaun ka?</i>	Yes	No			10 numbers
	Did you confirm the soil density test results? <i>Ita bo'ot komfirma ona reuzltadu teste densidade rai nia ka?</i>	Yes	No	95%		Inspected density: 96% densidade ne'ebe inspeksionado : 96%
	Did you confirm the compacted thickness? <i>Ita bo'ot komfirma ona kompaksaun nia mahar ka?</i>	Yes	No	30cm		Inspected thickness: 30cm mahar ne'ebe inspeksionado : 30 cm

(4) Widening of Embankment
Aterru alargamentu

1/2

CL_Widening of Embankment

Edited_20181001

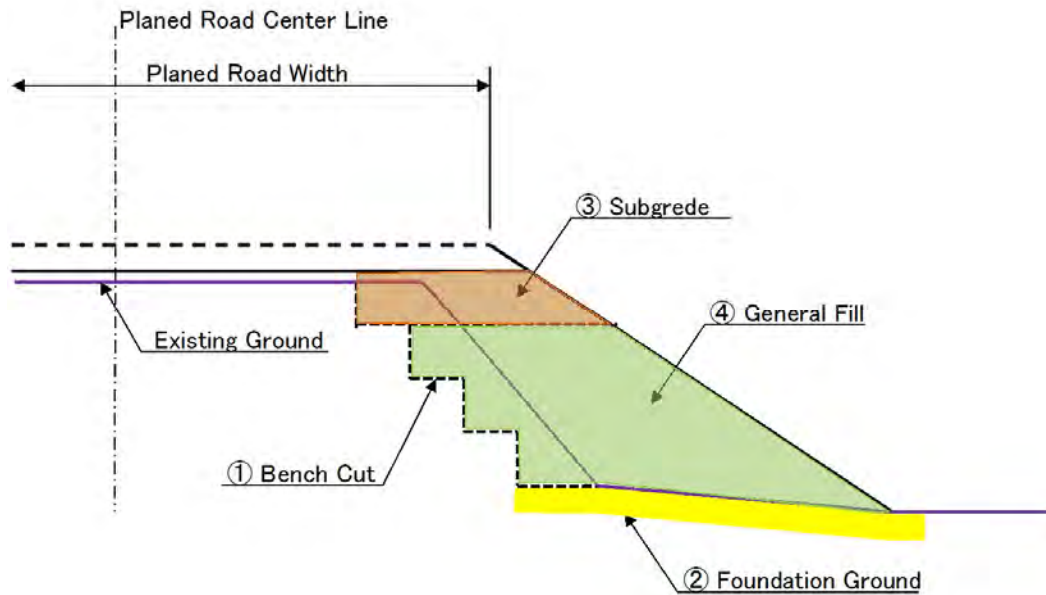

CHECKLIST for Road Widening of Embankment

Lista Verifikasaun ba aterru alargamentu estrada

Name of Project: <i>Naran Projetu :</i>	
Location: <i>Fatin:</i>	Date: / / (DD/MM/20YY)
Name of Contractor: <i>Naran Kontraktor:</i>	Location: STA km - km <i>Fatin</i>
Name of Inspector: <i>Naran Inspektor:</i>	Name of Department <i>Naran Departementu</i>

SPC= Standard Specification of MPWTC–Nov2014 Edition
Padraun spesifikasaun husi MOP–Edisaun Nov2014

No.	Check Items <i>Verifika Itens</i>	Judgements <i>Julgamentu</i>		Specification <i>Spesifikasaun</i>		Remaks <i>Observasaun</i> (Printed figure is reference only) <i>(Figura ne'ebe impressa hanesan referensia deit)</i>
		(Selection No.) <i>Seleciona no.</i>		Standards <i>Padraun</i>	SPC	
①	Preparatory activity <i>Actividade preparatorio</i>					
	Did you confirm the drawings? <i>Ita bo'ot komfirma ona dezennu ka?</i>	Yes <i>Sim</i>	No <i>Lae</i>			
	Did you confirm the construction work plan? <i>Ita bo'ot komfirma ona planu servisu konstrusaun ka?</i>	Yes <i>Sim</i>	No <i>Lae</i>			
①	Bench Cut <i>Corte bankada</i>					
	Was Bench Cut carried out appropriately? <i>Bench cut ne'e halao ho apropiado ona ka Lae?</i>	Yes <i>Sim</i>	No <i>Lae</i>			

CHECKLIST for Road Widening of Embankment

2/2

Lista Verifikasaun ba aterru alargamentu estrada

No.	Check Items <i>Verifika Itens</i>	Judgements		Specification		Remaks <i>Observasaun</i> (Printed figure is reference only) (<i>Figura ne'ebe impressa hanesan</i>)
		<i>Julgamentu</i> (Selection No.) <i>Seleciona no.</i>		<i>Spesifikasaun</i> Standards <i>Padraun</i>	SPC	
②	Foundation Ground <i>Dasar Fondasi</i>					
	Is strength of bearing ground sufficient? <i>Resistensia husi bantalan rai nian suficiente ka lae?</i>	Yes <i>Sim</i>	No <i>Lae</i>			
	If No, was the replacement of soft ground appropriate? <i>Se lae, substitui rai ne'ebe mamar ne'e apropiadu ka lae?</i>	Yes <i>Sim</i>	No <i>Lae</i>			Replacement, Thickness=60cm subtituisaun, mahar = 60 cm
③	Subgrade <i>Subleito</i>					
	Did you check the subgrade material? <i>Ita bo'ot verifika ona material subgrade ka?</i>	Yes <i>Sim</i>	No <i>Lae</i>			Procedure from borrow pit No.1 <i>Prosedimentu husi borrow pit no.1</i>
	Did you confirm the soil density test results? <i>Ita boot komfirma ona rezultadu teste densidade rai nian ka?</i>	Yes <i>Sim</i>	No <i>Lae</i>		95%	Inspected density: 96% densidade ne'ebe inspeksionado: 96%
	Did you confirm the compacted thickness? <i>Ita bo'ot komfirma ona kompaksaun nia mahar ka?</i>	Yes <i>Sim</i>	No <i>Lae</i>		30cm	Inspected thickness: 30cm Mahar ne'ebe inspeksionado: 30 cm
④	General Fill <i>Preenchimento jeral</i>					
	Did you check the general fill? <i>Ita bo'ot verifika ona preenchimento jeral ka lae?</i>	Yes <i>Sim</i>	No <i>Lae</i>		—	Procedure from site Prosedimentu iha terrenu
	Did you confirm the soil density test results? <i>Ita bo'ot komfirma ona rezultadu teste densidade rai nian ka?</i>	Yes <i>Sim</i>	No <i>Lae</i>		90%	Inspected density: 96% densidade ne'ebe halo inspeksaun tiha ona : 96%
	Did you confirm the compacted thickness? <i>Ita bo'ot komfirma ona kompaksaun nia mahar ka?</i>	Yes <i>Sim</i>	No <i>Lae</i>		30cm	Inspected thickness: 30cm Mahar ne'ebe inspeksionado : 30 cm

5-2 Small Structure

Estrutura kiik

(1) Pipe Culvert

1/2

CL_Pipe Culvert

Edited_20181002

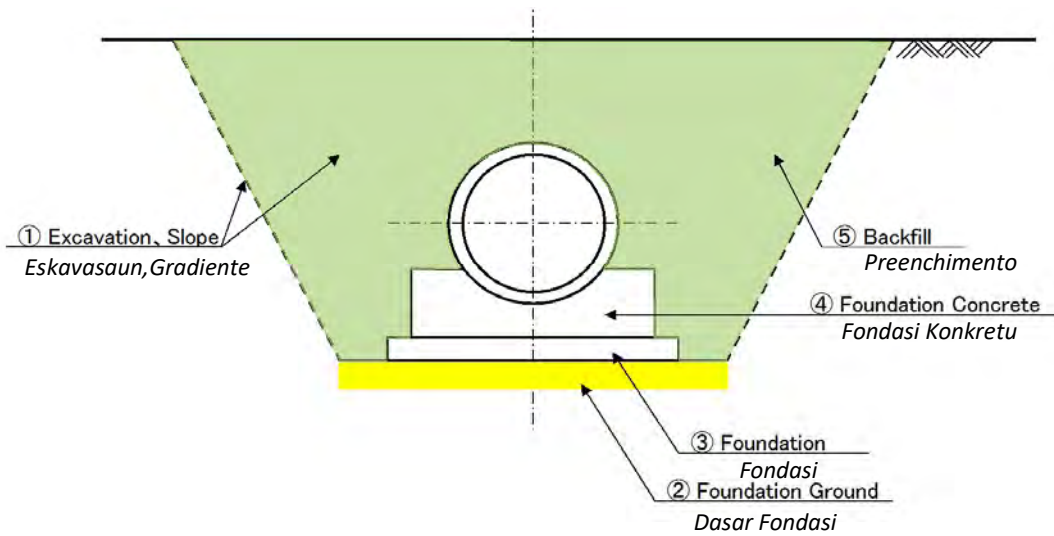

CHECKLIST for Pipe Culvert

Lista Verifikasaun ba Pipe culvert

Name of Project: <i>Naran Projetu :</i>	
Location: <i>Fatin:</i>	Date: / / (DD/MM/20YY) <i>Data:</i>
Name of Contractor: <i>Naran Kontraktor :</i>	Location: STA km - km <i>(Fatin)</i>
Name of Inspector: <i>Naran Inspektor:</i>	Name of Department: <i>Naran Departementu</i>

SPC= Standard Specification of MPWTC–Nov2014 Edition
Padraun spesifikasaun husi MOP–Edisaun Nov2014

No.	Check Items <i>Verifika Itens</i>	Judgements <i>Julgamentu</i>		Specification <i>Spesifikasaun</i>		Remaks <i>Observasaun</i> <small>(Printed figure is reference only) <i>(Figura ne'ebe impressa hanesan referensia deit)</i></small>
		(Selection No.) <i>Seleciona no.</i>		Standards <i>Padraun</i>	SPC	
①	Preparatory activity <i>Aktividade preparatoriu</i>					
	Did you confirm the drawings? <i>Ita bo'ot komfirma ona Dezennu ka?</i>	Yes <i>Sim</i>	No <i>Lae</i>			
	Did you confirm the construction work plan? <i>Ita bo'ot komfirma ona konstrusaun nia planu servisu ka?</i>	Yes <i>Sim</i>	No <i>Lae</i>			
①	Excavation, Slope <i>Ekavasaun, Gradiente</i>					
	Was excavation width appropriate? <i>Eskavasaun nia largura aproprado ona ka?</i>	Yes <i>Sim</i>	No <i>Lae</i>			
	Was excavation slope appropriate? <i>Eskavasaun nia gradiente apropradu ona ka?</i>	Yes <i>Sim</i>	No <i>Lae</i>			

CHECKLIST for Pipe Culvert

2/2

Lista verifikasaun ba pipe culvert

No.	Check Items <i>Verifika Itens</i>	Judgements <i>Julgamentu</i>		Specification <i>Spesifikasaun</i>		Remaks <i>Observasaun</i> (Printed figure is reference only) (<i>Figura ne'ebe impressa hanesan referensia deit</i>)
		(Selection No.) <i>Seleciona no.</i>	Standards <i>Padraun</i>	SPC		
	Was removal of water appropriate? <i>Hasai be ne'e apropiado ona ka?</i>	Yes <i>Sim</i>	No <i>Lae</i>			
②	Foundation Ground <i>Dasar Fondasi</i>					
	Is strength of bearing ground sufficient? <i>Resistencia bantalan rai nia suficiente ka lae?</i>	Yes <i>Sim</i>	No <i>Lae</i>			
	If No, was replace damaged pipe with new pipe? <i>Se lae, substitui pipe ne'ebe at ho pipe foun ka lae?</i>	Yes <i>Sim</i>	No <i>Lae</i>			
③	Foundation <i>Fondasi</i>					150mm
	Did you check the foundation material? <i>Ita bo'ot verifika material fondasi ka?</i>	Yes <i>Sim</i>	No <i>Lae</i>			Crashed stone <i>Fatuk fera</i>
	Did you check the thickness of foundation ground? <i>Ita bo'ot verifika dasar fondasi nia mahar ka lae?</i>	Yes <i>Sim</i>	No <i>Lae</i>			
④	Foundation concrete <i>Fondasi Konkretu</i>					
	Did you check the class of concrete or concrete mixing contents before concrete casting? <i>Ita bo'ot verifika klasse konkretu ou konteudu mistura konkretu antes concretagem?</i>	Yes <i>Sim</i>	No <i>Lae</i>			
	Did you check the thickness of foundation concrete? <i>Ita bo'ot verifika ona fondasi konkretu nia mahar ka?</i>	Yes <i>Sim</i>	No <i>Lae</i>	95%		250mm
⑤	Precast Concrete Pipe <i>Concretagem pipe concrete</i>					
	Did you check diameter of pipe? <i>Ita bo'ot verifika ona diametru pipe nian ka?</i>	Yes <i>Sim</i>	No <i>Lae</i>	—		Diameter 900 <i>diametru 900</i>
⑥	Backfill <i>Prenchimento</i>					
	Did you check the backfill material? <i>Ita bo'ot verifika ona material prechimento ka?</i>	Yes <i>Sim</i>	No <i>Lae</i>	—		Selected Material, From Borrow Pit No.1 <i>Material ne'ebe selesionado husi borrow pit no. 1</i>
	Has the compaction been carried out properly? <i>Kompaktasaun halao ho apropiado ona ka?</i>	Yes <i>Sim</i>	No <i>Lae</i>			Vibrating Compacter 40~60kg <i>kompaktador vibartorio 40~60kg</i>
	Did you confirm the soil density test results? <i>Ita bo'ot komfirma rezultadu teste densidade rai ka?</i>	Yes <i>Sim</i>	No <i>Lae</i>	95%		Inspected density: 96% <i>densidade ne'ebe inspeksionado : 96 %</i>
	Did you confirm the compacted thickness? <i>Ita bo'ot komfirma ona kopaktasaun nia mahar ka?</i>	Yes <i>Sim</i>	No <i>Lae</i>	30cm		Inspected thickness: 30cm <i>mahar ne'ebe inpeksionado : 30 cm</i>

(2) Concrete Drainage
Drenajem konkretu

1/3

CL_Concrete Drainage

Edited_20181002

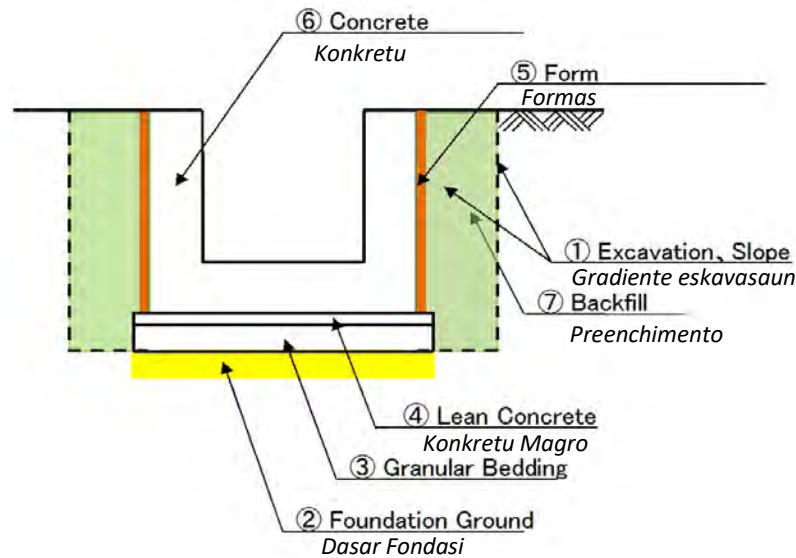

CHECKLIST for Concrete Drainage

Lista verifikasaun ba Drenajem konkretu

Name of Project: <i>Naran Projetu :</i>	
Location: <i>Fatin:</i>	Date: / / (DD/MM/20YY) <i>Data:</i>
Name of Contractor: <i>Naran Kontraktor :</i>	Location: STA km - km <i>(Fatin)</i>
Name of Inspector: <i>Naran Inspektor:</i>	Name of Department <i>Naran Departementu</i>

SPC= Standard Specification of MPWTC–Nov2014 Edition
Padraun spesifikasaun husi MOP–Edisaun Nov2014

No.	Check Items <i>Verifika Itens</i>	Judgements <i>Julgamentu</i>		Specification <i>Spesifikasaun</i>		Remaks <i>Observasaun</i> <small>(Printed figure is reference only) <i>(Figura ne'ebe impressa hanesan referensia deit)</i></small>
		(Selection No.) <i>Seleciona no.</i>	Standards <i>Padraun</i>	Standards <i>Padraun</i>	SPC	
①	Preparatory activity <i>Aktividade preparatoriu</i>					
-1	Did you confirm the drawings? <i>Ita bo'ot komfirma ona dezennu ka?</i>	Yes <i>Sim</i>	No <i>Lae</i>			
-2	Did you confirm the construction work plan? <i>Ita bo'ot komfima ona plano servisu konstrusaun ka?</i>	Yes <i>Sim</i>	No <i>Lae</i>			
①	Excavation, Slope <i>Eskavasaun, Gradiente</i>					
-1	Was excavation width appropriate? <i>Eskavasaun nia largura apropradu ona ka?</i>	Yes <i>Sim</i>	No <i>Lae</i>			
-2	Was excavation slope appropriate? <i>Eskavasaun nia gradiente apropradu ona ka?</i>	Yes <i>Sim</i>	No <i>Lae</i>			

CHECKLIST for Concrete Drainage

2/3

Lista verifikasaun ba Drenajem konkretu

No.	Check Items <i>Verifika Itens</i>	Judgements <i>Julgamentu</i>		Specification <i>Spesifikasaun</i>		Remaks <i>Observasaun</i> (Printed figure is reference only) (<i>Figura ne'ebe impressa hanesan referensia deit</i>)
		(Selection No.) <i>Seleciona no.</i>	Standards <i>Padraun</i>	SPC		
-3	Was removal of water appropriate? <i>Remosaun be ne'e apropridu ona ka?</i>	Yes <i>Sim</i>	No <i>Lae</i>			
②	Foundation Ground <i>Dasar Fondasi</i>					
-1	Is strength of bearing ground sufficient? <i>Resitensia husi bantalan rai nia ne'e suficiente ona ka?</i>	Yes <i>Sim</i>	No <i>Lae</i>			
-2	If No, was the replacement of soft ground appropriate? <i>se lae, substitui rai ne'ebe mamar ne'e apropradu ka?</i>	Yes <i>Sim</i>	No <i>Lae</i>			Replacement, Thickness=60cm subtituisaun, mahar = 60 cm
③	Foundation <i>Fondasi</i>					
-1	Did you check the foundation material? <i>Ita bo'ot verifika ona fondasi nia material ka?</i>	Yes <i>Sim</i>	No <i>Lae</i>			Crashed stone Fatuk fera
-2	Did you check the thickness of foundation ground? <i>Ita bo'ot verifika daasar fondasi nia mahar ka?</i>	Yes <i>Sim</i>	No <i>Lae</i>			150mm
④	Lean Concrete <i>Konkretu magro</i>					
-1	Did you check the class of concrete or concrete mixing contents before concrete casting? <i>Ita bo'ot verifika ona konkretu ou konteudu mistura konkretu antes concretagem ka?</i>	Yes <i>Sim</i>	No <i>Lae</i>			
-2	Did you check the thickness lean concrete? <i>Ita bo'ot verifika ona lean konkretu nia mahar ka?</i>	Yes <i>Sim</i>	No <i>Lae</i>			
⑤	Form <i>Formas</i>					
-1	Are the quality and thickness of the formwork material appropriate? <i>Kualidade no mahar material ba cofragem ne'e aproprado ka lae?</i>	Yes <i>Sim</i>	No <i>Lae</i>			
-2	Is there a hole, rot or warp in the formwork? <i>iha ne'eba iha koak, dodok ka kleuk iha cofragem?</i>	Yes <i>Sim</i>	No <i>Lae</i>			
-3	Is the form clamping metal fitting appropriately? <i>Forma logam ne'ebe habit apropradu ka lae?</i>	Yes <i>Sim</i>	No <i>Lae</i>			

CHECKLIST for Concrete Drainage

3/3

Lista verifikasaun ba Drenajem konkritu

No.	Check Items <i>Verifika Itens</i>	Judgements <i>Julgamentu</i>		Specification <i>Spesifikasaun</i>		Remaks <i>Observasaun</i> (Printed figure is reference only) <i>(Figura ne'ebe impressa hanesan referensia deit)</i>
		(Selection No.) <i>Seleciona no.</i>	Standards <i>Padraun</i>	SPC		
⑥	Concrete <i>Konkritu</i>					
-1	Did you check the class of concrete or concrete mixing contents before concrete casting? <i>Ita bo'ot verifika ona konkritu ou konteudu mistura konkritu antes concretagem ka?</i>	Yes <i>Sim</i>	No <i>Lae</i>			
-2	Did you check the dimension before casting? <i>Ita bo'ot verifika ona dimensaun antes concretagem?</i>	Yes <i>Sim</i>	No <i>Lae</i>			
-3	Has moist curing been carried out in a suitable method? <i>cura úmida halao ka lae ho metodu ne'ebe adequadu?</i>	Yes <i>Sim</i>	No <i>Lae</i>			Covered sheet on the concrete surface <i>folla koberta iha konkritu nia superficie</i>
⑦	Backfill <i>Preenchimento</i>					
-1	Did you check the backfill material? <i>Ita bo'ot verifika ona material preenchimento ka?</i>	Yes <i>Sim</i>	No <i>Lae</i>	—		Selected Material, From Borrow Pit No.1 <i>material ne'ebe selesionado husi borrow pit no. 1</i>
-2	Has the compaction been carried out properly? <i>Kompaktasaun halao ho los ona ka?</i>	Yes <i>Sim</i>	No <i>Lae</i>			Vibrating Compacter 40~60kg <i>kompaktador vibratorio 40~60kg</i>
-3	Did you confirm the soil density test results? <i>Ita bo'ot komfirma ona rezultadu densidade rai nian ka?</i>	Yes <i>Sim</i>	No <i>Lae</i>	95%		Inspected density: 96% <i>densidade inspeksionado : 96%</i>
-4	Did you confirm the compacted thickness? <i>Ita bo'ot komfirma ona kompaktasaun nia mahar ka?</i>	Yes <i>Sim</i>	No <i>Lae</i>	30cm		Inspected thickness: 30cm <i>mahar ne'ebe inspeksionado : 30 cm</i>

(3) Stone Masonry Drainage
Drenajem ho Fatuk (Pas. Batu belah)

1/2

CL_SM Drainage

Edited_20181002

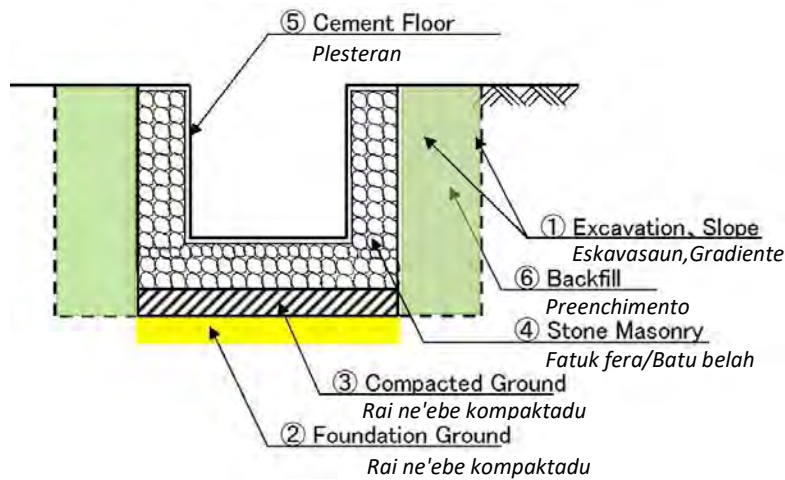

CHECKLIST for Stone Masonry Drainage

LISTA VERIFIKASAUN ba drenajem ho Fatuk

Name of Project: <i>Naran Projetu :</i>	
Location: <i>Fatin:</i>	Date: / / (DD/MM/20YY) Data:
Name of Contractor: <i>Naran Kontraktor :</i>	Location: STA km - km (<i>Fatin</i>)
Name of Inspector: <i>Naran Inspektor:</i>	Name of Department: <i>Naran Departementu</i>

SPC= Standard Specification of MPWTC–Nov2014 Edition
Padraun spesifikasaun husi MOP–Edisaun Nov2014

No.	Check Items <i>Verifika Itens</i>	Judgements <i>Julgamentu</i>	Specification <i>Spesifikasaun</i>		Remarks <i>Remaks Observasaun</i> (Printed figure is reference only) <i>(Figura ne'ebe impressa hanesan)</i>
			(Selection No.) <i>Seleciona no.</i>	Standards <i>Padraun</i>	
①	Preparatory activity <i>Aktividade preparatoriu</i>				
-1	Did you confirm the drawings? <i>Ita bo'ot komfirma ona dezennu ka?</i>	Yes <i>Sim</i>	No <i>Lae</i>		
-2	Did you confirm the construction work plan? <i>Ita bo'ot komfirma ona planu servisu konstrusaun ka?</i>	Yes <i>Sim</i>	No <i>Lae</i>		
①	Excavation, Slope <i>Eskavasaun, Gradiente</i>				
-1	Was excavation width appropriate? <i>Eskavasaun nia largura apropiado ona ka?</i>	Yes <i>Sim</i>	No <i>Lae</i>		
-2	Was excavation slope appropriate? <i>Eskavasaun nia gradiente apropiadu ona ka?</i>	Yes <i>Sim</i>	No <i>Lae</i>		
-3	Was removal of water appropriate? <i>Remosaun be apropiadu ona ka?</i>	Yes <i>Sim</i>	No <i>Lae</i>		

CHECKLIST for Stone Masonry Drainage

2/2

LISTA VERIFIKASAUN ba drenajem ho Fatuk

No.	Check Items <i>Verifika Itens</i>	<i>Julgamentu</i> <i>Seleciona no.</i>	Judgements		Specification <i>Spesifikasaun</i>		Remaks <i>Observasaun</i> (Printed figure is reference only) (<i>Figura ne'ebe impressa hanesan referensia deit</i>)
			(Selection No.)	Standards	SPC		
			<i>Padraun</i>				
②	Foundation Ground <i>Dasar Fondasi</i>						
-1	Is strength of bearing ground sufficient? <i>Resistensia bantalan rai suficiente ka lae?</i>	Yes <i>Sim</i>	No <i>Lae</i>				
-2	If No, was the replacement of soft ground appropriate? <i>se lae, substitui rai ne'ebe mamar apropiado ka lae?</i>	Yes <i>Sim</i>	No <i>Lae</i>			Replacement, Thickness=60cm Subtituisaun, Mahar = 60 cm	
③	Compacted Ground <i>Rai komspaktadu</i>						
-1	Did you use the compactor for compaction? <i>Ita bo'ot utilliza kompaktador ba halo kompaksaun ka?</i>	Yes <i>Sim</i>	No <i>Lae</i>				
④	Stone Masonry <i>Fatuk (Pasangan batu belah)</i>						
-1	Was Stone material appropriately? <i>Material fatuk sira ne'e apropiadu ka lae?</i>	Yes <i>Sim</i>	No <i>Lae</i>			150mm ≤ Stone thickness < 225mm 150mm ≤ Fatuk nia mahar < 225mm	
-2	Was cement mortar composed appropriately? <i>Sementi mortar ninia kompostu apropiadu ka lae?</i>	Yes <i>Sim</i>	No <i>Lae</i>			Cement 1 : Sand 3 semente 1 : rai henek 3	
⑤	Cement Floor <i>Plesteran</i>						
-1	Was cement mortar composed appropriately? <i>Sementi mortar ninia kompostu apropiadu ka lae?</i>	Yes <i>Sim</i>	No <i>Lae</i>			Cement 1 : Sand 3 semente 1 : rai henek 3	
⑥	Backfill <i>Preenchimento</i>						
-1	Did you check the backfill material? <i>Ita bo'ot verifika material preenchimento nia ka?</i>	Yes <i>Sim</i>	No <i>Lae</i>	—		Selected Material, From Borrow Pit No.1 Material ne'ebe elesiona husi borrow pit nu. 1	
-2	Has the compaction been carried out properly? <i>Kompaktasaun halao ho lolos ka lae?</i>	Yes <i>Sim</i>	No <i>Lae</i>			Vibrating Compacter 40~60kg Kompaktador vibratorio 40~60kg	
-3	Did you confirm the soil density test results? <i>Ita bo'ot komfirma rezultadu teste densidade rai nian ka lae?</i>	Yes <i>Sim</i>	No <i>Lae</i>	95%		Inspected density: 96% densidade ne'ebe inspeksionado : 96%	
-4	Did you confirm the compacted thickness? <i>Ita bo'ot komfirma kompaktasaun ninia mahar ka lae?</i>	Yes <i>Sim</i>	No <i>Lae</i>	30cm		Inspected thickness: 30cm mahar ne'ebe inspeksionadu : 30 cm	

(4) Stone Masonry Retaining Wall
Moru Retensaun ho Fatuk

1/2

CL_SM Retaining Wall

Edited_20190213

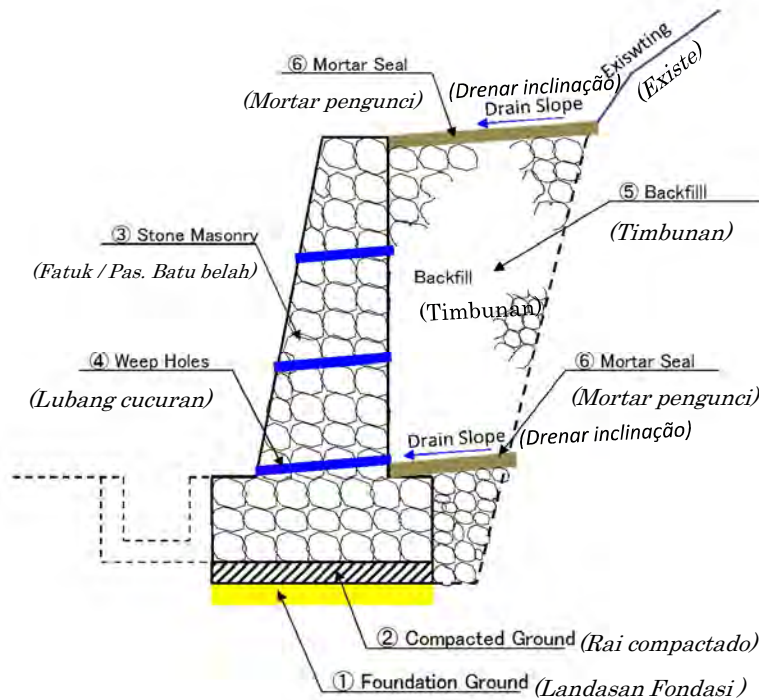

CHECKLIST for Stone Masonry Retaining Wall

LISTA VERIFIKASAUN ba Moru Retensaun ho Fatuk

Name of Project: <i>Naran Projeitu :</i>	
Location: <i>Fatin:</i>	Date: / / (DD/MM/20YY) Data:
Name of Contractor: <i>Naran Kontraktor :</i>	Location: STA km - km (<i>Fatin</i>)
Name of Inspector: <i>Naran Inspektor:</i>	Name of Department <i>Naran Departementu</i>

SPC= Standard Specification of MPWTC–Nov2014 Edition
Padraun spesifikasaun husi MOP–Edisaun Nov2014

No.	Check Items <i>Verifika Itens</i>	<i>Julgamentu</i> <i>Seleciona no.</i>	Judgements		Specification <i>Spesifikasaun</i>		Remaks <i>Observasaun</i> (Printed figure is reference only) <i>(Figura ne'ebe impressa hanesan referensia deit)</i>
			(Selection No.)	Standards	Standards	SPC	
			Padraun	Padraun	Padraun	SPC	
①	Preparatory activity <i>Aktividade preparatoriu</i>						
-1	Did you confirm the drawings? <i>Ita bo'ot komfirna ona dezennu?</i>	Yes <i>Sim</i>	No <i>Lae</i>				
-2	Did you confirm the construction work plan? <i>Ita bo'ot komfirna ona planu servisu Konstrusaun nian ka?</i>	Yes <i>Sim</i>	No <i>Lae</i>				

CHECKLIST for Stone Masonry Retaining Wall

2/2

CL_SM Retaining Wall

LISTA VERIFIKASAUN ba Moru Retensaun ho Fatuk

Edited_20190213

No.	Check Items <i>Verifika Itens</i>	<i>Julgamentu</i> <i>Seleciona no.</i>	Judgements		Specification <i>Spesifikasaun</i>		Remaks <i>Observasaun</i> (Printed figure is reference only) (<i>Figura ne'ebe impressa hanesan referensia deit</i>)
			(Selection No.)		Standards	SPC	
			<i>Padraun</i>				
①	Foundation Ground <i>Dasar Fondasi</i>						
-1	Is strength of bearing ground sufficient? <i>Resistensia bantalan tanah suficiente?</i>	Yes <i>Sim</i>	No <i>Lae</i>				
-2	If No, was the replacement of soft ground appropriate? <i>se Lae, substitui rai mamar ne'e apropriado ka?</i>	Yes <i>Sim</i>	No <i>Lae</i>			Replacement, Thickness=60cm (<i>Subtituisaun, mahar = 60cm</i>)	
②	Compacted Ground <i>Rai Kompactado</i>						
-1	Did you use the compactor for compaction? <i>Ita bo'ot utiliza Kompaktor ba Kompaktasaun?</i>	Yes <i>Sim</i>	No <i>Lae</i>				
③	Stone Masonry <i>Fatuk / Pasangan batu belah</i>						
-1	Was Stone material appropriately? <i>Material hanesan fatuk sira ne'e apropriado ka?</i>	Yes <i>Sim</i>	No <i>Lae</i>			150mm ≤ Stone thickness < 225mm 150mm ≤ Fatuk nia mahar < 225mm	
-2	Was cement mortar composed appropriately? <i>Komposto sementi mortar ne apropriado ona ka?</i>	Yes <i>Sim</i>	No <i>Lae</i>			Cement 1 : Sand 3 <i>Sementi 1 : Rai henek 3</i>	
④	Weep Holes <i>Lubang cucuran</i>						
-1	Was diameter of weep hole appropriate? <i>Lubang cucuran nia diametru apropriado ona ka?</i>	Yes <i>Sim</i>	No <i>Lae</i>			dia 100mm <i>diametru 100 mm</i>	
-2	Were Weep Holes laid out appropriately? <i>Lubang cucuran koloka ho lolos ona ka?</i>	Yes <i>Sim</i>	No <i>Lae</i>			Interval 1m <i>Intervallu 1 m</i>	
⑤	Backfill <i>Prenchimentu</i>						
-1	Did you check the backfill material? <i>Ita bo'ot verifika ona material tba prechimentu ka?</i>	Yes <i>Sim</i>	No <i>Lae</i>			Crashed stone <i>Fatuk fera</i>	
-2	Has the compaction been carried out properly? <i>compactação halo ho lolos ka?</i>	Yes <i>Sim</i>	No <i>Lae</i>			Vibrating Compactor 40~60kg <i>Compactador Vibratório 40 ~ 60kg</i>	
-3	Did you confirm the soil density test results? <i>Ita bo'ot komfirma ona rezultadu teste densidade rai ka?</i>	Yes <i>Sim</i>	No <i>Lae</i>			N/A <i>La bele aplika</i>	
-4	Did you confirm the compacted thickness? <i>Ita bo'ot komfirma ona compactação nia mahar ka?</i>	Yes <i>Sim</i>	No <i>Lae</i>			N/A <i>La bele aplika</i>	
⑥	Backfill <i>Prenchimento</i>						
-1	Did you check the thickness of mortar seal? <i>Ita bo'ot verifika mortar sheal nia mahar ka?</i>	Yes <i>Sim</i>	No <i>Lae</i>			100mm	
-2	Was cement mortar composed appropriately? <i>Sementi mortar ninia komposto apropriado ona ka?</i>	Yes <i>Sim</i>	No <i>Lae</i>			Cement 1 : Sand 3 <i>sementi 1 : rai henek 3</i>	

(5) Gabion Mat
rede Gabion

1/2

CL_Gabion

Edited_20181002

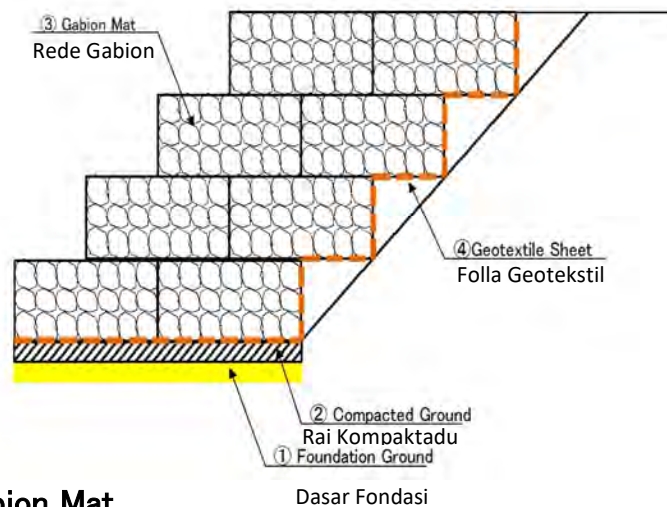

CHECKLIST for Gabion Mat

Lista verifikasaun ba rede Gabion

Name of Project: <i>Naran Projetu :</i>	
Location: <i>Fatin:</i>	Date: / / (DD/MM/20YY) Data:
Name of Contractor: <i>Naran Kontraktor :</i>	Location: STA km - km (<i>Fatin</i>)
Name of Inspector: <i>Naran Inspektor:</i>	Name of Department <i>Naran Departementu</i>

SPC= Standard Specification of MPWTC–Nov2014 Edition
Padraun spesifikasaun husi MOP–Edisaun Nov2014

No.	Check Items <i>Verifika Itens</i>	Judgements <i>Julgamentu</i>		Specification <i>Spesifikasaun</i>		Remaks <i>Observasaun</i> <small>(Printed figure is reference only) (<i>Figura ne'ebe impressa hanesan referensia deit</i>)</small>
		(Selection No.) <i>Seleciona no.</i>	Standards <i>Padraun</i>	SPC		
①	Preparatory activity <i>Aktividade preparatoriu</i>					
-1	Did you confirm the drawings? <i>Ita bo'ot komfirma ona dezennu ka?</i>	Yes <i>Sim</i>	No <i>Lae</i>			
-2	Did you confirm the construction work plan? <i>Ita bo'ot komfirma ona planu servisu konstrusaun ka?</i>	Yes <i>Sim</i>	No <i>Lae</i>			
①	Foundation Ground <i>Dasar Fondasi</i>					
-1	Is strength of bearing ground sufficient? <i>Resistensia bantalan rai suficiente ka?</i>	Yes <i>Sim</i>	No <i>Lae</i>			
-2	If No, was the replacement of soft ground appropriate? <i>se lae, substitui rai ne'ebe mamar apropiado ka?</i>	Yes <i>Sim</i>	No <i>Lae</i>			Replacement, Thickness=60cm substituisaun, mahar = 60 cm

CHECKLIST for Gabion Mat

2/2

CL_SM Retaining Wall

Lista verifikasaun ba rede gabion

Edited_20190213

No.	Check Items <i>Verifika Itens</i>	Judgements <i>Julgamentu</i>		Specification <i>Spesifikasaun</i>		Remaks <i>Observasaun</i> (Printed figure is reference only) <i>(Figura ne'ebe impressa hanesan referensia deit)</i>
		(Selection No.) <i>Seleciona no.</i>	Standards <i>Padraun</i>	SPC		
②	Compacted Ground <i>Rai kompaktadu</i>					
-1	Did you use the compactor for compaction? <i>Ita bo'ot utiliza komapktador ba komapkatausaun ka?</i>	Yes <i>Sim</i>	No <i>Lae</i>			
③	Gabion Mat <i>Rede Gabion</i>					
-1	Was Stone material appropriately? <i>Material fatuk apropiado ona ka?</i>	Yes <i>Sim</i>	No <i>Lae</i>			150mm ≤ Stone thickness < 225mm 150mm ≤ fatuk nia mahar < 225mm
-2	Was diameter of wire mesh appropriate? <i>Diametru wire mesh ne'e apropiado ka lae?</i>	Yes <i>Sim</i>	No <i>Lae</i>			
-3	Was amount of galvanized coating for wire mesh appropriate? <i>Kuantidade husi revelmento galvanizado ba wire mesh apropiado ona ka?</i>	Yes <i>Sim</i>	No <i>Lae</i>			350g/m ²
⑤	Backfill <i>Preenchimento</i>					
-1	Did you check the backfill material? <i>Ita bo'ot verifika ona material Preenchimento ka?</i>	Yes <i>Sim</i>	No <i>Lae</i>			Crashed stone fatuk fera
-2	Has the compaction been carried out properly? <i>Kompaksaun halao ho lolos ona ka?</i>	Yes <i>Sim</i>	No <i>Lae</i>			Vibrating Compacter 40~60kg <i>Compactador Vibratório 40 ~ 60kg</i>
-3	Did you confirm the soil density test results? <i>Ita bo'ot komfirma rezultadu teste densidade rai nian ka?</i>	Yes <i>Sim</i>	No <i>Lae</i>			N/A labela aplika
-4	Did you confirm the compacted thickness? <i>Ita bo'ot komfirma ona kompaktasaun ninia mahar ka?</i>	Yes <i>Sim</i>	No <i>Lae</i>			N/A labela aplika

5-3 Box Culvert
Box Culvert

1/5

CL_Box Culvert
Edited_20181002

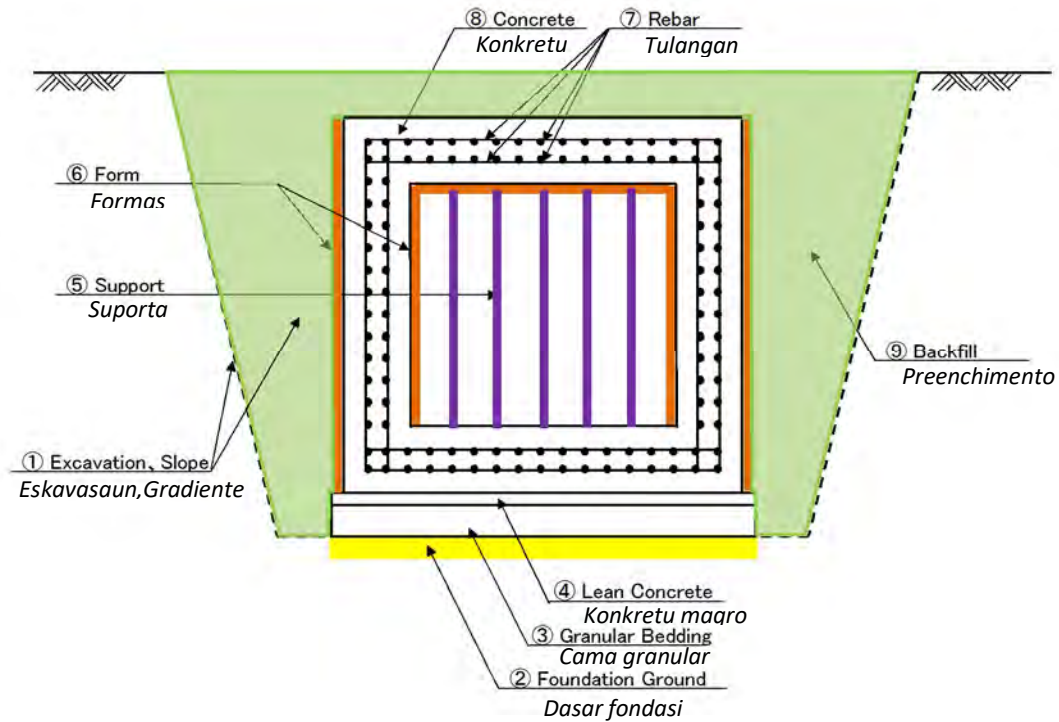

CHECKLIST for Box Culvert
Lista verifikasaun ba Box Culvert

Name of Project: <i>Naran Projetu :</i>	
Location: <i>Fatin:</i>	Date: / / (DD/MM/20YY) <i>Data:</i>
Name of Contractor: <i>Naran Kontraktor :</i>	Location: STA km - km <i>(Fatin)</i>
Name of Inspector: <i>Naran Inspektor:</i>	Name of Department <i>Naran Departementu</i>

SPC= Standard Specification of MPWTC–Nov2014 Edition
Padraun spesifikasaun husi MOP–Edisaun Nov2014

No.	Check Items <i>Verifika Itens</i>	Judgements <i>Julgamentu</i>		Specification <i>Spesifikasaun</i>		Remarks <i>Observasaun</i> (Printed figure is reference only) <i>(Figura ne'ebe impressa hanesan referensia deit)</i>
		(Selection No.) <i>Seleciona no.</i>	Standards <i>Padraun</i>	SPC		
①	Preparatory activity <i>Aktividade preparatoriu</i>					
-1	Did you confirm the drawings? <i>Ita bo'ot komfirma ona dezennu ka?</i>	Yes <i>Sim</i>	No <i>Lae</i>			
-2	Did you confirm the construction work plan? <i>Ita bao'ot komfirma ona planu servisu konstrusaun nian ka?</i>	Yes <i>Sim</i>	No <i>Lae</i>			

CHECKLIST for Box Culvert

2/5

Lista verifikasaun ba Box Culvert

No.	Check Items <i>Verifika Itens</i>	Judgements <i>Julgamentu</i>		Specification <i>Spesifikasaun</i>		Remaks <i>Observasaun</i> (Printed figure is reference only) (<i>Figura ne'ebe impressa hanesan referensia deit</i>)
		(Selection No.) <i>Seleciona no.</i>	Standards <i>Padraun</i>	SPC		
①	Excavation, Slope <i>Eskavasaun, Gradiente</i>					
	Was excavation width appropriate? <i>Eskavasaun nia largura apropradu ona ka?</i>	Yes <i>Sim</i>	No <i>Lae</i>			
	Was excavation slope appropriate? <i>Eskavasaun nia gradiente aproprado ona ka?</i>	Yes <i>Sim</i>	No <i>Lae</i>			
	Was removal of water appropriate? <i>Hasai be ne'e aproprado ka lae?</i>	Yes <i>Sim</i>	No <i>Lae</i>			
②	Foundation Ground <i>Dasar Fondasi</i>					
-1	Is strength of bearing ground sufficient? <i>Resistencia bantalan rai nia suficiente ka ale?</i>	Yes <i>Sim</i>	No <i>Lae</i>			
-2	If No, was the replacement of soft ground appropriate? <i>se lae, hasai rai mamar sira ne'e apropradu ka lae?</i>	Yes <i>Sim</i>	No <i>Lae</i>			Replacement, Thickness=60cm subtitui, mahar=60 cm
③	Granular Bedding <i>Cama granular</i>					
-1	Did you check the cama granular material? <i>Ita bo'ot verifika ona material ba granular bedding?</i>	Yes <i>Sim</i>	No <i>Lae</i>			Crashed stone fatuk fera
-2	Did you check the thickness of granular bedding? <i>Ita bo'ot verifika ona cama granular ninia mahar ka?</i>	Yes <i>Sim</i>	No <i>Lae</i>			150mm
④	Lean Concrete <i>Konkretu Magro</i>					
-1	Did you check the class of concrete or concrete mixing contents before concrete casting? <i>Ita bo'ot verifika ona klasse konkretu ka konteudu konkretu nia mistura antes konkretagem?</i>	Yes <i>Sim</i>	No <i>Lae</i>			
-2	Did you check the thickness lean concrete? <i>Ita bo'ot verifika ona konkretu magro nia mahar ka?</i>	Yes <i>Sim</i>	No <i>Lae</i>			

CHECKLIST for Box Culvert

List a verifikasaun ba Box Culvert

3/5

No.	Check Items <i>Verifika Itens</i>	Judgements <i>Julgamentu</i>		Specification <i>Spesifikasaun</i>		Remaks <i>Observasaun</i> (Printed figure is reference only) (<i>Figura ne'ebe impressa hanesan referensia deit</i>)
		(Selection No.) <i>Seleciona no.</i>	Standards <i>Padraun</i>	SPC		
⑤	Support <i>Suporta</i>					
-1	Are materials used not damaged, deformed, corroded etc? <i>Material sira ne'ebe utiliza la a'at, la deformado, corroídos ka?</i>	Yes <i>Sim</i>	No <i>Lae</i>			
-2	Did you check removal timing, method and procedure of the support? <i>Ita bo'ot verifika ona tempu remosaun, metodu no prosedimentu husi suporta?</i>	Yes <i>Sim</i>	No <i>Lae</i>			
⑥	Form <i>Formas</i>					
-1	Are the quality and thickness of the form material appropriate? <i>Qualidade no material formas nian apropiado ka lae?</i>	Yes <i>Sim</i>	No <i>Lae</i>			
-2	Is there a hole, rot or warp in the form? <i>Iha formas ne'e iha koak, dodok ka lae?</i>	Yes <i>Sim</i>	No <i>Lae</i>			
-3	Is there an asperity or gap in the form? <i>Iha Formas laran ne'e ita hetan aspereza ou lakuna ka?</i>	Yes <i>Sim</i>	No <i>Lae</i>			
-4	Is the form clamping metal fitting appropriately? <i>Forma logam ne'ebe habit apropiadu ka lae?</i>	Yes <i>Sim</i>	No <i>Lae</i>			
-5	Whether the concrete formwork releasing oil is sufficiently applied to the inner surface of the form <i>Se Oleo kofrajem ba konkreto mak aplika ho suficiente ba iha superficie formas nia laran</i>	Yes <i>Sim</i>	No <i>Lae</i>			
-6	Did you check removal timing, method and procedure of the formwork? <i>Ita bo'ot verifika ona tempu ba remosaun, metodu no prosedimentu cofragem ka lae?</i>	Yes <i>Sim</i>	No <i>Lae</i>			

CHECKLIST for Box Culvert

List a verifikasaun ba Box Culvert

4/5

No.	Check Items <i>Verifika Itens</i>	Judgements <i>Julgamentu</i>		Specification <i>Spesifikasaun</i>		Remaks <i>Observasaun</i> (Printed figure is reference only) (<i>Figura ne'ebe impressa hanesan referensia deit</i>)
		(Selection No.) <i>Seleciona no.</i>	Standards <i>Padraun</i>	SPC		
⑦	Rebar <i>Besi/Tulangan</i>					
-1	Did you confirm the quality of rebar? <i>Ita bo'ot komfirma ona qualidade tulangan ka lae?</i>	Yes <i>Sim</i>	No <i>Lae</i>			Confirmed by the certificate of quality Komfirma husi setifikadu qualidade
-2	Has the rebar been stored properly? <i>Besi/tulangan sira ne'e aruma ho didak ona ka lae?</i>	Yes <i>Sim</i>	No <i>Lae</i>			
-3	Has the rebar been thoroughly cleaned? <i>Besi/tulangan sira ne completamente mos tiha ona ka?</i>	Yes <i>Sim</i>	No <i>Lae</i>			
-4	Is the thickness of cover concrete been secured with an appropriate spacer? <i>kobre konkretu nia mahar seguru ho espaçador ne'ebe apropiadu ?</i>	Yes <i>Sim</i>	No <i>Lae</i>			Concrete clear cover 50mm
-5	Has the rebar been fixed sufficiently with binding wire? <i>besi/tulangan sira ne'e fixado ho suficiente uza arame ka lae?</i>	Yes <i>Sim</i>	No <i>Lae</i>			
-6	Are the number and diameter of rebars correct? <i>Numeru sira no diamentru tulangan los ona ka lae?</i>	Yes <i>Sim</i>	No <i>Lae</i>			
-7	Are the position and interval of rebar appropriate? <i>Pozisaun no intervallu tulangan apropiado ona ka lae?</i>	Yes <i>Sim</i>	No <i>Lae</i>			
⑧	Concrete <i>Konkretu</i>					
-1	Did you check the class of concrete or concrete mixing contents before concrete casting? <i>Ita bo'ot verifika ona klasse konkretu ka konteudu konkretu nia mistura antes pengecoran ka ?</i>	Yes <i>Sim</i>	No <i>Lae</i>			
-2	Did you check the thickness befor concrete casting? <i>Ita bo'ot verifika ninia mahar antes pengecoran?</i>	Yes <i>Sim</i>	No <i>Lae</i>			slab: 510mm(500mm), wall: 505mm(500mm) bottom: 510mm(500mm)
-3	Did you check the inner size befor concrete casting? <i>Ita bo'ot verifika ona medida interno antes pengecoran ka?</i>	Yes <i>Sim</i>	No <i>Lae</i>			width: 4020mm(4000mm), height: 4050mm(4000mm)
-4	Did you check the slump and concrete tempture at concrete casting site? <i>Ita bo'ot verifika ona slump no konkretu nia temperatura iha fatin pengecoran ka?</i>	Yes <i>Sim</i>	No <i>Lae</i>			slump: :100mm concrete tempture: 30°C
-5	Is the capacity and number of vibration compaction machines appropriate? <i>Kapasidade no numeru husi makina kompaksaun husi vibrasaun apropiado ona ka?</i>	Yes <i>Sim</i>	No <i>Lae</i>			a piece of vibrator Vibrator pedasuk ida

CHECKLIST for Box Culvert

Lista verifikasaun ba Box Culvert

5/5

No.	Check Items <i>Verifika Itens</i>	Judgements <i>Julgamentu</i>		Specification <i>Spesifikasaun</i>		Remaks <i>Observasaun</i> (Printed figure is reference only) (<i>Figura ne'ebe impressa hanesan referensia deit</i>)
		(Selection No.) <i>Seleciona no.</i>	Standards <i>Padraun</i>	SPC		
⑧	Concrete (continue) <i>Konkretu (Kontinua)</i>					
-1	Has concrete work been done in the proper time from complete of mixing to complete of concrete casting? <i>obra konkretu ne'e hotu iha tempo ne'ebe lolos, desde kompleta mistura to'o kompleta fundiçã de konkretu?</i>	Yes <i>Sim</i>	No <i>Lae</i>			
-2	Did you check test piece for concrete strength test? <i>Ita bo'ot verifika ona parte balun husi teste konkretu nia resistensia?</i>	Yes <i>Sim</i>	No <i>Lae</i>			6 test pieces Teste pedasuk 6
-3	Has moist curing been carried out early after concrete casting? <i>Cura umida halao tiha ona antes fundiçã de konkretu ka lae?</i>	Yes <i>Sim</i>	No <i>Lae</i>			
-4	Has moist curing been carried out in a suitable method? <i>cura úmida halao ka lae ho metodu ne'ebe adequadu?</i>	Yes <i>Sim</i>	No <i>Lae</i>			Covered sheet on the concrete surface Folla koberta iha superficie konkretu
⑨	Backfill <i>Preenchimento</i>					
-1	Did you check the backfill material? <i>Ita bo'ot verifika ona materia preenchimento ka lae?</i>	Yes <i>Sim</i>	No <i>Lae</i>	—		Selected Material, From Borrow Pit No.1 material ne'ebe selesiona husi borrow pit no.1
-2	Has the compaction been carried out properly? <i>Kompaksaun halo ho lolos ona ka lae?</i>	Yes <i>Sim</i>	No <i>Lae</i>			Vibrating Compacter 40~60kg Kompaktador vibratorio 40~60kg
-3	Did you confirm the soil density test results? <i>Ita bo'ot komfirma rezultadu teste densidade rai ka?</i>	Yes <i>Sim</i>	No <i>Lae</i>	95%		Inspected density: 96% Densidade ne'ebe inspeksionado : 96%
-4	Did you confirm the compacted thickness? <i>Ita bo'ot komfirma ona kompaksaun ninia mahar?</i>	Yes <i>Sim</i>	No <i>Lae</i>	30cm		Inspected thickness: 30cm Mahar ne'ebe inspeksionado: 30 cm

5-4 Road Pavement WORKS

Obra pavimentasaun estrada

(1) Base Course / Sub-base Course
(for Road Pavement)

1/4

CL_Base Course

Edited_20181004

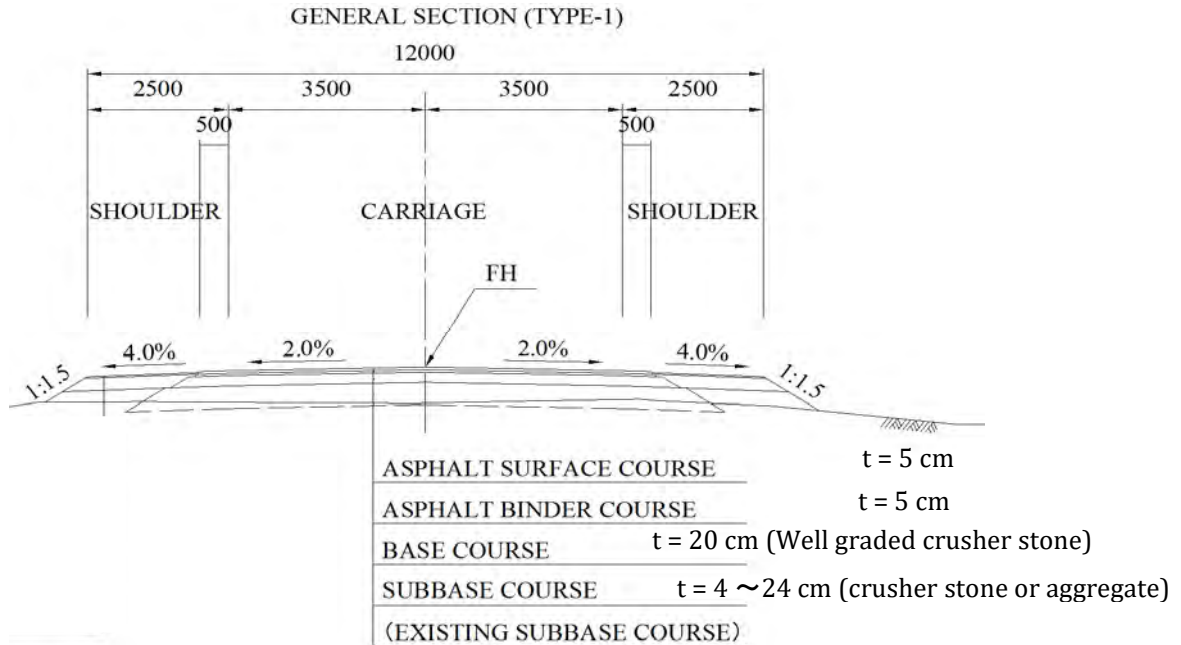

Figure 1. Example of Typical Section of Pavement (Rehabilitation Works)

Figura 1. Ezemplu kona ba Tipu seksaun pavimentasaun (obra Rehabilitasaun)

CHECKLIST for Base/Sub-base Course

Type of Course: (upper/lower)

Lista verifikasaun ba base/sub base

Tipu kona ba Kursu

Name of Project: <i>Naran Projetu :</i>	
Location: <i>Fatin:</i>	Date: / / (DD/MM/20YY) <i>Data:</i>
Name of Contractor: <i>Naran Kontraktor :</i>	Location: STA km - km <i>(Fatin)</i>
Name of Inspector: <i>Naran Inspektor:</i>	Name of Department <i>Naran Departementu</i>

SPC= Standard Specification of MPWTC–Nov2014 Edition
Padraun spesifikasaun husi MOP–Edisaun Nov2014

No.	Check Items <i>Verifika Itens</i>	Judgements <i>Julgamentu</i>		Specification <i>Spesifikasaun</i>		Remaks <i>Observasaun</i> (Printed figure is reference only) <i>(Figura ne'ebe impressa hanesan)</i>
		(Selection No.) <i>Seleciona</i>	Standards <i>Padraun</i>	Standards <i>Padraun</i>	SPC	
①	Construction Plan / Drawing <i>Planu konstrusaun / Dezennu</i>					
-1	Is Construction Plan prepared ? <i>Planu konstrusaun prepara ona ka?</i>	Yes <i>Sim</i>	No <i>Lae</i>			
-2	Is Drawing prepared on the site? <i>Dezennu prepara ona iha terrenu ka?</i>	Yes <i>Sim</i>	No <i>Lae</i>			

CHECKLIST for Base/Sub-base Course

2/4

Lista verifikasaun ba base/sub base

No.	Check Items <i>Verifika Itens</i>	Judgements <i>Julgamentu</i>		Specification <i>Spesifikasaun</i>		Remaks <i>Observasaun</i> (Printed figure is reference only) <i>(Figura ne'ebe impressa hanesan)</i>
		(Selection No.) <i>Seleciona</i>		Standards <i>Padraun</i>	SPC	
-3	Drawing is "Contract Drawing" or "Shop Drawing" <i>Dezennu ne'e "Dezennu kontratu ka Dezennu servisu"</i>	—	—			Contract Drawing / Shop Drawing
-4	Thickness is indicated on the Drawing ? <i>Mahar ne'e indika iha dezennu ka lae?</i>	Yes <i>Sim</i>	No <i>Lae</i>			
-5	Type/material of Base(sub-base) Course indicated on the drawing? <i>Tipu/Material husi base(sub base)course indika ona iha dezennu ka?</i>	Yes <i>Sim</i>	No <i>Lae</i>			

CHECKLIST Base Course / Sub-base Course 3/4

No.	Check Items <i>Verifika Itens</i>	Judgements		Specification		Remaks <i>Observasaun</i> <small>(Printed figure is reference only) (Figura ne'ebe impressa hanesan referensia-deit)</small>
		(Selection No.) <i>Seleciona</i>		Standards <i>Padraun</i>	SPC	
<In case of Crushed Aggregate Base Course:303 / Aggregate Sub-Base Course:301 >						
<Iha Kazu kona ba curso baziku agregado esmogado:303/curso sub-baze agregadu:301>						
②	Checking "Material"					
	<i>Verifika material</i>					
-1	Are the material stored on the site properly?	Yes	No		308	
	<i>Material sira armazenado iha situ ne'e apropriado ka lae?</i>	Sim	Lae			
-2	Are the material free from organick matter and other detariolating matters?	Yes	No		301.2 303.2	
	<i>Material sira ne'e livre husi materia organiku no sasan desariolantes?</i>	Sim	Lae			
-3	Is the material satisfied with required "Grading" ?	Yes	No	JIS A 1102	301.2 303.2	Test frequency= each 1000m2
	<i>Material hirak ne'e satisfaz ho "klasifikasaun" ne'ebe nessesario ka lae?</i>	Sim	Lae			Frekuensia ba teste = kada 1000m2
-4	Are the size of aggregate less than its maximum size?	Yes	No			subase and Class B<50mm, Class A<37.5mm
	<i>Agregado nia nia medida ne'e menus husi nia medida maximu ka lae?</i>	Sim	Lae			
-5	Is the material satisfied with required "Properties" ?	Yes	No			PI, LI, Abration and Soaked CBR
	<i>Material sira ne satisfaz ho nessesario "propriedades"?</i>	Sim	Lae	AASHT O T89,90, 193		
-6	Were the material tests resulted submitted for approval?	Yes	No			SPC Table301.1/2 and Table 303.1/2
	<i>Rezultado husi teste ba material sira haruka ona atu halo aprovasaun ka lae?</i>	Sim	Lae			
③	Checking "Compaction" workmanship					
	<i>Verifikasaun obra "Kompaktasaun"</i>					
-1	Are the spreading thickness proper ?	Yes	No		301.3.3 303.3.3	not exceed 150mm(in compacted)
	<i>Espalhamento ninia mahar adequada ka lae?</i>	Sim	Lae			la liu husi 150 mm (iha kompaktasaun)
-2	Are the compaction machine enough and properly ?	Yes	No			more than 8 ton roller is prefaerble
	<i>Makina kompaktasaun suficiente no adequada ka lae?</i>	Sim	Lae			Roler liu toneladas 8 mak preferivel liu
-3	The numbers of pasiing by compaction machine, are enough?	Yes	No		301.3 303.3	Subbase:>2 passes, Base Course:>4 passes
	<i>Numeru kompaktasaun ne'ebe passa ne'e suficiente ka lae?</i>	Sim	Lae			
-4	Are Field Density carried out as specified?	Yes	No			one test for every 200m of construction section
	<i>Densidade iha kompu halao tuir espezifikaun ka lae?</i>	Sim	Lae			teste ida ba kada 200 m iha seksaun konstrusaun

CHECKLIST Base Course / Sub-base Course 4/4

No.	Check Items <i>Verifika Itens</i>	Judgements <i>Julgamentu</i>		Specification <i>Spesifikasaun</i>		Remaks <i>Observasaun</i> (Printed figure is reference only) <i>(Figura ne'ebe impressa hanesan referensia deit)</i>
		(Selection No.) <i>Seleciona</i>		Standards <i>Padraun</i>	SPC	
-5	Have the Maximum Dry Density(MDD)already obtained ? <i>Densidade maran masimu hetan ona ka?</i>	Yes	No	AASHTO T180		
		Sim	Lae		301.3 303.3	
-6	Field Density(FD) tested by sand-replacement method, are satisfied with the criteria of the Specification ? <i>Teste Densidade iha Kampo (DK) liu husi metodu substitui rai henek, ne'e satisfaz ho ninia kriteria husi espezifikaun?</i>	Yes	No	AASHTO T199		refere to the Criterial of SPC: more than 100 %:
		Sim	Lae			refere ba criteria husi spesifikaun: liu husi 100%
-7	Other than sand-replacement method, wrote the what type of test are conducted ? <i>Alem de Metodu substituisaun rai henek, hakerek tok tipu husi teste saida mak ita uza ?</i>	—	—			
-8	Is the result of "⑩-4" satisfactory or not ? <i>Rezultado husi "⑩-4" ne'e satisfaz ka lae?</i>	Yes	No			
		Sim	Lae			
④	Checking measurement for completed Course <i>Verifika medida ba kursu ne'ebe kompletu</i>					
-1	Are the lines, grade and cross sections completed in accordance with the Drawing or as directed by the Engineer? <i>Linna, grau/klasse,seksaun transversal concludos tuir dezennu ou instrusaun husi Enjinneru ka?</i>	Yes	No		301.1 303.1	
		Sim	Lae			
-2	Is the thickness of layer () within permitted variation? <i>Dalas nia mahar tama ona ba variasaun ne'ebe permite ka?</i>	Yes	No			Allowable tolerance: + 20mm(± 10mm) (Base Course)
		Sim	Lae			toleransia ne'ebe permite: + 20mm(± 10mm) (Base Course)
-3	Is the Level of Surface within permitted variation? <i>Nivel superficie iha ona variasaun ne'ebe permite nia laran ona ka?</i>	Yes	No		301.3.5 303.3.5	ditto: +10mm, -20mm (+5mm, -10mm)
		Sim	Lae			
-4	Is the Surface Irreguraity within permitted variation? <i>Irregularidae superficie tama ona iha variasaun ne'ebe permitida ka?</i>	Yes	No	tes		ditto: 20mm
		Sim	Lae			

5-4 Road Pavement WORKS

Obra pavimentasaun estrada

(1) Base Course / Sub-base Course
(for Road Pavement)

1/4

CL_Base Course
Edited_20181004

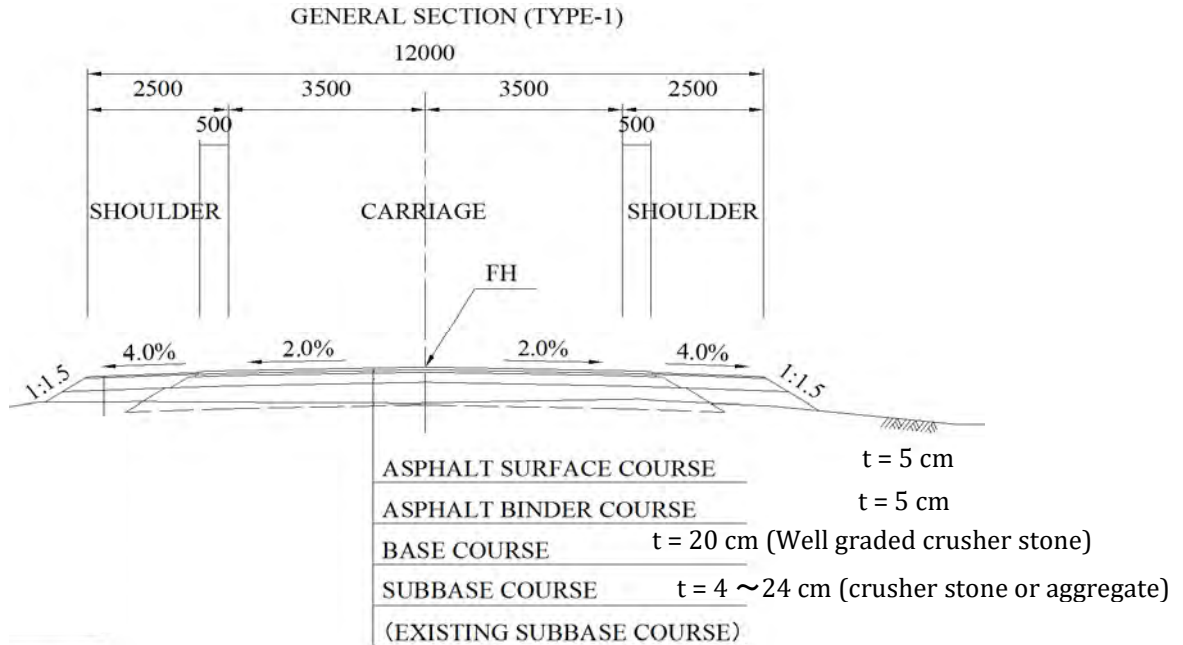

Figure 1. Example of Typical Section of Pavement (Rehabilitation Works)

Figura 1. Ezemplu kona ba Tipu seksaun pavimentasaun (obra Rehabilitasaun)

CHECKLIST for Base/Sub-base Course

Type of Course: (upper/lower)

Lista verifikasaun ba base/sub base

Tipu kona ba Kursu

Name of Project: <i>Naran Projetu :</i>	
Location: <i>Fatin:</i>	Date: / / (DD/MM/20YY) <i>Data:</i>
Name of Contractor: <i>Naran Kontraktor :</i>	Location: STA km - km <i>(Fatin)</i>
Name of Inspector: <i>Naran Inspektor:</i>	Name of Department <i>Naran Departementu</i>

SPC= Standard Specification of MPWTC–Nov2014 Edition
Padraun spesifikasaun husi MOP–Edisaun Nov2014

No.	Check Items <i>Verifika Itens</i>	Judgements <i>Julgamentu</i>		Specification <i>Spesifikasaun</i>		Remaks <i>Observasaun</i> (Printed figure is reference only) <i>(Figura ne'ebe impressa hanesan referensia deit)</i>
		(Selection No.) <i>Seleciona</i>	Standards <i>Padraun</i>	Standards <i>Padraun</i>	SPC	
①	Construction Plan / Drawing <i>Planu konstrusaun / Dezennu</i>					
-1	Is Construction Plan prepared ? <i>Planu konstrusaun prepara ona ka?</i>	Yes <i>Sim</i>	No <i>Lae</i>			
-2	Is Drawing prepared on the site? <i>Dezennu prepara ona iha terrenu ka?</i>	Yes <i>Sim</i>	No <i>Lae</i>			

CHECKLIST for Base/Sub-base Course

2/4

Lista verifikasaun ba base/sub base

No.	Check Items <i>Verifika Itens</i>	Judgements <i>Julgamentu</i>		Specification <i>Spesifikasaun</i>		Remaks <i>Observasaun</i> (Printed figure is reference only) (<i>Figura ne'ebe impressa hanesan referensia deit</i>)
		(Selection No.) <i>Seleciona</i>		Standards <i>Padraun</i>	SPC	
-3	Drawing is "Contract Drawing" or "Shop Drawing" <i>Dezennu ne'e "Dezennu kontratu ka Dezennu servisu"</i>	—	—			Contract Drawing / Shop Drawing
-4	Thickness is indicated on the Drawing ? <i>Mahar ne'e indika iha dezennu ka lae?</i>	Yes <i>Sim</i>	No <i>Lae</i>			
-5	Type/material of Base(sub-base) Course indicated on the drawing? <i>Tipu/Material husi base(sub base)course indika ona iha dezennu ka?</i>	Yes <i>Sim</i>	No <i>Lae</i>			

CHECKLIST Base Course / Sub-base Course 3/4

No.	Check Items <i>Verifika Itens</i>	Judgements		Specification		Remaks <i>Observasaun</i> (Printed figure is reference only) (<i>Figura ne'ebe impressa hanesan referensia-deit</i>)
		(Selection No.) <i>Seleciona</i>		Standards <i>Padraun</i>	SPC	
<In case of Crushed Aggregate Base Course:303 / Aggregate Sub-Base Course:301 >						
<Iha Kazu kona ba curso baziku agregado esmogado:303/curso sub-baze agregadu:301>						
②	Checking "Material"					
	<i>Verifika material</i>					
-1	Are the material stored on the site properly?	Yes	No		308	
	<i>Material sira armazenado iha situ ne'e apropriado ka lae?</i>	Sim	Lae			
-2	Are the material free from organick matter and other detariolating matters?	Yes	No		301.2 303.2	
	<i>Material sira ne'e livre husi materia organiku no sasan desariolantes?</i>	Sim	Lae			
-3	Is the material satisfied with required "Grading" ?	Yes	No	JIS A 1102	301.2 303.2	Test frequency= each 1000m2
	<i>Material hirak ne'e satisfaz ho "klasifikasaun" ne'ebe nessesario ka lae?</i>	Sim	Lae			Frekuensia ba teste = kada 1000m2
-4	Are the size of aggregate less than its maximum size?	Yes	No			subase and Class B<50mm, Class A<37.5mm
	<i>Agregado nia nia medida ne'e menus husi nia medida maximu ka lae?</i>	Sim	Lae			
-5	Is the material satisfied with required "Properties" ?	Yes	No			PI, LI, Abration and Soaked CBR
	<i>Material sira ne satisfaz ho nessesario "propriedades" ?</i>	Sim	Lae	AASHT O T89,90, 193		
-6	Were the material tests resulted submitted for approval?	Yes	No			SPC Table301.1/2 and Table 303.1/2
	<i>Rezultado husi teste ba material sira haruka ona atu halo aprovasaun ka lae?</i>	Sim	Lae			
③	Checking "Compaction" workmanship					
	<i>Verifikasaun obra "Kompaktasaun"</i>					
-1	Are the spreading thickness proper ?	Yes	No		301.3.3 303.3.3	not exceed 150mm(in compacted)
	<i>Espalhamento ninia mahar adequada ka lae?</i>	Sim	Lae			la liu husi 150 mm (iha kompaktasaun)
-2	Are the compaction machine enough and properly ?	Yes	No			more than 8 ton roller is prefaerble
	<i>Makina kompaktasaun suficiente no adequada ka lae?</i>	Sim	Lae			Roler liu toneladas 8 mak preferivel liu
-3	The numbers of pasiing by compaction machine, are enough?	Yes	No		301.3 303.3	Subbase:>2 passes, Base Course:>4 passes
	<i>Numeru kompaktasaun ne'ebe passa ne'e suficiente ka lae?</i>	Sim	Lae			
-4	Are Field Density carried out as specified?	Yes	No			one test for every 200m of construction section
	<i>Densidade iha kompu halao tuir espezifikaun ka lae?</i>	Sim	Lae			teste ida ba kada 200 m iha seksaun konstrusaun

CHECKLIST Base Course / Sub-base Course 4/4

No.	Check Items <i>Verifika Itens</i>	Judgements <i>Julgamentu</i>		Specification <i>Spesifikasaun</i>		Remaks <i>Observasaun</i> (Printed figure is reference only) <i>(Figura ne'ebe impressa hanesan referensia deit)</i>
		(Selection No.) <i>Seleciona</i>		Standards <i>Padraun</i>	SPC	
-5	Have the Maximum Dry Density(MDD)already obtained ? <i>Densidade maran masimu hetan ona ka?</i>	Yes	No	AASHTO T180		
		Sim	Lae		301.3 303.3	
-6	Field Density(FD) tested by sand-replacement method, are satisfied with the criteria of the Specification ? <i>Teste Densidade iha Kampo (DK) liu husi metodu substitui rai henek, ne'e satisfaz ho ninia kriteria husi espezifikaun?</i>	Yes	No	AASHTO T199		refere to the Criterial of SPC: more than 100 %:
		Sim	Lae			refere ba criteria husi spesifikaun: liu husi 100%
-7	Other than sand-replacement method, wrote the what type of test are conducted ? <i>Alem de Metodu substituisaun rai henek, hakerek tok tipu husi teste saida mak ita uza ?</i>	—	—			
-8	Is the result of "⑩-4" satisfactory or not ? <i>Rezultado husi "⑩-4" ne'e satisfaz ka lae?</i>	Yes	No			
		Sim	Lae			
④	Checking measurement for completed Course <i>Verifika medida ba kursu ne'ebe kompletu</i>					
-1	Are the lines, grade and cross sections completed in accordance with the Drawing or as directed by the Engineer? <i>Linna, grau/klasse,seksaun transversal concludos tuir dezennu ou instrusaun husi Enjinneru ka?</i>	Yes	No		301.1 303.1	
		Sim	Lae			
-2	Is the thickness of layer () within permitted variation? <i>Dalas nia mahar tama ona ba variasaun ne'ebe permite ka?</i>	Yes	No			Allowable tolerance: + 20mm(± 10mm) (Base Course)
		Sim	Lae			toleransia ne'ebe permite: + 20mm(± 10mm) (Base Course)
-3	Is the Level of Surface within permitted variation? <i>Nivel superficiei iha ona variasaun ne'ebe permite nia laran ona ka?</i>	Yes	No		301.3.5 303.3.5	ditto: +10mm, -20mm (+5mm, -10mm)
		Sim	Lae			
-4	Is the Surface Irreguraity within permitted variation? <i>Irregularidade superficiei tama ona iha variasaun ne'ebe permitida ka?</i>	Yes	No	tes		ditto: 20mm
		Sim	Lae			

(2) Asphalt Pavement (AsP)
Pavimentasaun Aspal

1/3

CL_ASP-1_Design

Edited_20181005

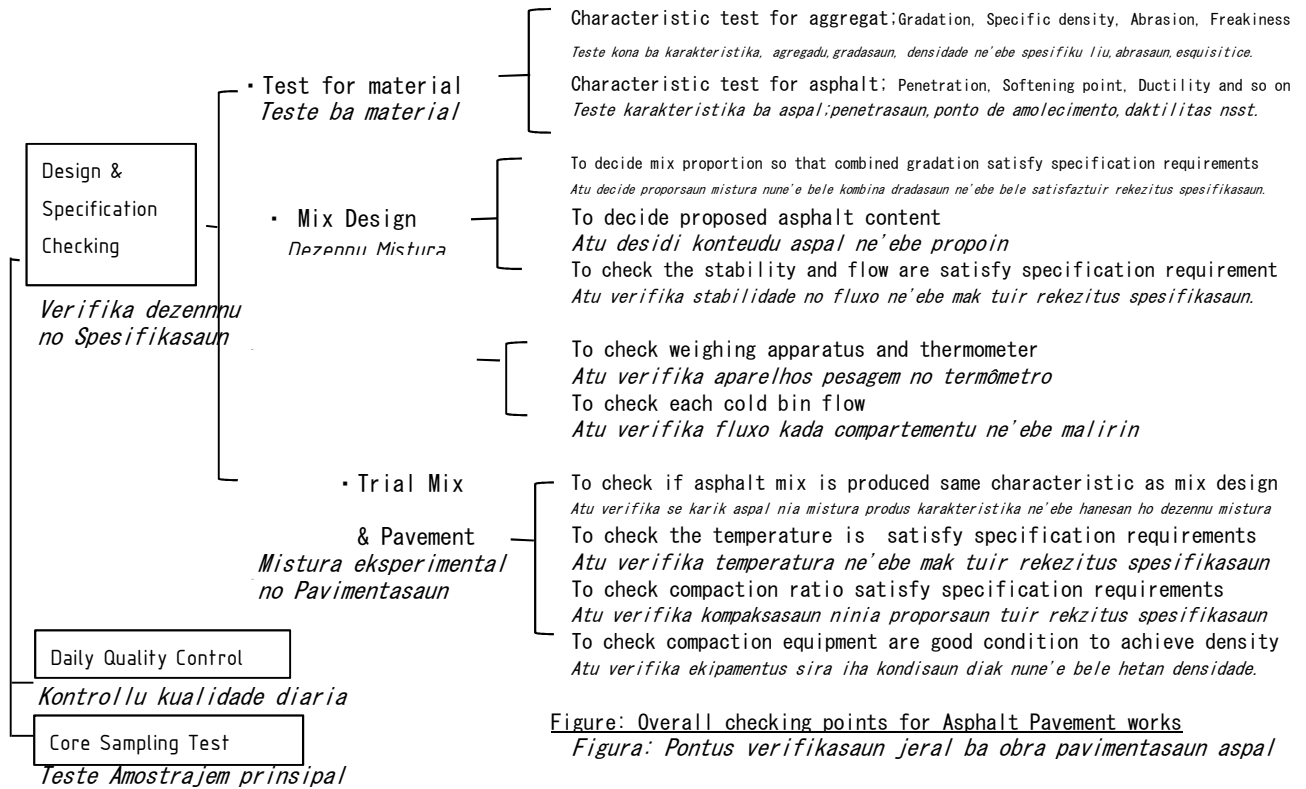

Figure: Overall checking points for Asphalt Pavement works
Figura: Pontus verifikasaun jeral ba obra pavimentasaun aspal

CHECKLIST for Design Mix & specification (AsP-1)
Lista verifikasaun ba dezennu mistura & Spesifikasaun (Aspal-1)

Type of Course: Surface(wearing) Course / Binder Course

Name of Project: <i>Naran Projetu :</i>	
Location: <i>Fatin:</i>	Date: / / (DD/MM/20YY) <i>Data:</i>
Name of Contractor: <i>Naran Kontraktor :</i>	Location: STA km - km <i>(Fatin)</i>
Name of Inspector: <i>Naran Inspektor:</i>	Name of Department <i>Naran Departementu</i>

SPC= Standard Specification of MPWTC–Nov2014 Edition
Padraun spesifikasaun husi MOP–Edisaun Nov2014

No.	Check Items <i>Verifika Itens</i>	Judgements <i>Julgamentu</i>		Specification <i>Spesifikasaun</i>		Remaks <i>Observasaun</i> (Printed figure is reference only) <i>(Figura ne'ebe impressa hanesan referensia deit)</i>
		(Selection No.) <i>Seleciona no.</i>	Standards <i>Padraun</i>	Standards <i>Padraun</i>	SPC	
①	Test for material <i>Teste ba material</i>					
-1	Have Sieve Tests for each type of aggregate ? <i>Iha kada tipo ba peneira agregat ka lae?</i>	Yes <i>Sim</i>	No <i>Lae</i>			
-2	Are characteristic of aggregate satisfied ? <i>Karakteristika agregat sira ne'e satifaz ka lae?</i>	Yes <i>Sim</i>	No <i>Lae</i>			Specific Gravity, Abrasion, Free from derteriate matter etc. <i>Gravidade spesifiku,abrasaun, livre husi deteriorar nsst</i>

CHECKLIST for Design Mix & specification (AsP-1)***Lista verifikasaun ba dezennu mistura & Spesifikasaun (Aspal-1)***

No.	Check Items <i>Verifika Itens</i>	Judgements <i>Julgamentu</i>		Specification <i>Spesifikasaun</i>		Remaks <i>Observasaun</i> <small>(Printed figure is reference only) (Figura ne'ebe impressa hanesan referensia deit)</small>
		(Selection No.) <i>Seleciona no.</i>	Standards <i>Padraun</i>	SPC		
②	Tests for characteristic of asphalt <i>Teste ba karakteristikas aspal</i>					<For Example figure only here> <Pur ezemplu figura deit iha ne'e>
-1	Penetration value of asphalt is within specification? <i>Valor penetrasaun aspal sira ne'e tama iha spesifikasaun ka lae?</i>	Yes <i>Sim</i>	No <i>Lae</i>			Specified value (1/10mm): 60-80 valor ne'ebe spesifika (1/10mm): 60-80
-2	Specific Gravity of asphalt is within specification? <i>Gravidade spesifika kona ba aspal nian iha spesifikasaun nia laran?</i>	Yes <i>Sim</i>	No <i>Lae</i>			Specified value: more than 1.0 Valor ne'ebe spesifika: bo'ot liu 1.0
-3	Softening point of asphalt is within specification? <i>ponto de amolecimento aspal nian iha spesifikasaun nia laran?</i>	Yes <i>Sim</i>	No <i>Lae</i>			Specified value (°C): 44-52 Valor ne'ebe spesifika (°C): 44-52
-4	Ductility of asphalt is within specification? <i>Ductilidade aspal ne tama iha spesifikasaun ka lae?</i>	Yes <i>Sim</i>	No <i>Lae</i>			Specified value [15°C](cm): more than 100 Valor ne'ebe spesifika [15°C](cm): liu husi 100

CHECKLIST for Design Mix & specification (AsP-1)***Lista verifikasaun ba dezennu mistura & Spesifikasaun (Aspal-1)***

No.	Check Items <i>Verifika Itens</i>	Judgements <i>Julgamentu</i>		Specification <i>Spesifikasaun</i>		Remaks <i>Observasaun</i> (Printed figure is reference only) <i>(Figura ne'ebe impressa hanesan referensia deit)</i>
		(Selection No.) <i>Seleciona no.</i>	Standards <i>Padraun</i>	SPC		
③	Mix Design <i>Dezennu mistura</i>					
-1	Has Seive tests for proposed combined aggregate been carried out and is the Combination Gradation satisfied ? <i>Teste peneira ba kobinasaun agregat ne'ebe proposta halao ona no kombinasaun gradasaun ne'e satifaz ka lae?</i>	Yes <i>Sim</i>	No <i>Lae</i>			
-2	Has Combination Ratio of each type of aggregate material already decided and is it Practicable? <i>Proposaun ba kada tipu material agregat desidi tiha ona no ida ne'e bele pratika ka lae?</i>	Yes <i>Sim</i>	No <i>Lae</i>			
-3	Is proposed Asphalt content of asphalt concrete reasonable and practicable? <i>Konteudu aspal konkretu ne'ebe propoin razoavel no praticavel ka lae?</i>	Yes <i>Sim</i>	No <i>Lae</i>			
④	Check As Plant <i>Verifika fabrika aspal</i>					
-1	Calibration of measuring equipment of asphalt plant is finished ? <i>Kalibrasaun ekipamntus sukat ba fabrika aspal nian hotu ona ka lae?</i>	Yes <i>Sim</i>	No <i>Lae</i>			
⑤	Trial Mix & Pavement <i>Mistura tentativus no Pavimentus</i>					
-1	Decide mixes at plant, cold & hot bin by Trail Mix or not? <i>Desidi mistura iha fabrika compartimento manas no malirin liu husi mistura experimental ka lae?</i>	Yes <i>Sim</i>	No <i>Lae</i>			
-2	Decide Optimum Compaction Temperature by Trial Pavement ? <i>Deside temperatura kompaktasaun ne'eebe ideal liu husi pavimento eksperimental?</i>	Yes <i>Sim</i>	No <i>Lae</i>			
-3	Decide targeting spreading thickness by Trail Pavement ? <i>Deside segmenta ninia mahar liu husi pavimentu eskperimental ?</i>	Yes <i>Sim</i>	No <i>Lae</i>			

CHECKLIST
Listaverifikasaun

Asphalt Pavement (AsP)
Pavimentasaun Aspal (AsP)

1/2

CL_AsP-2_Daily QC
Edited_20181005

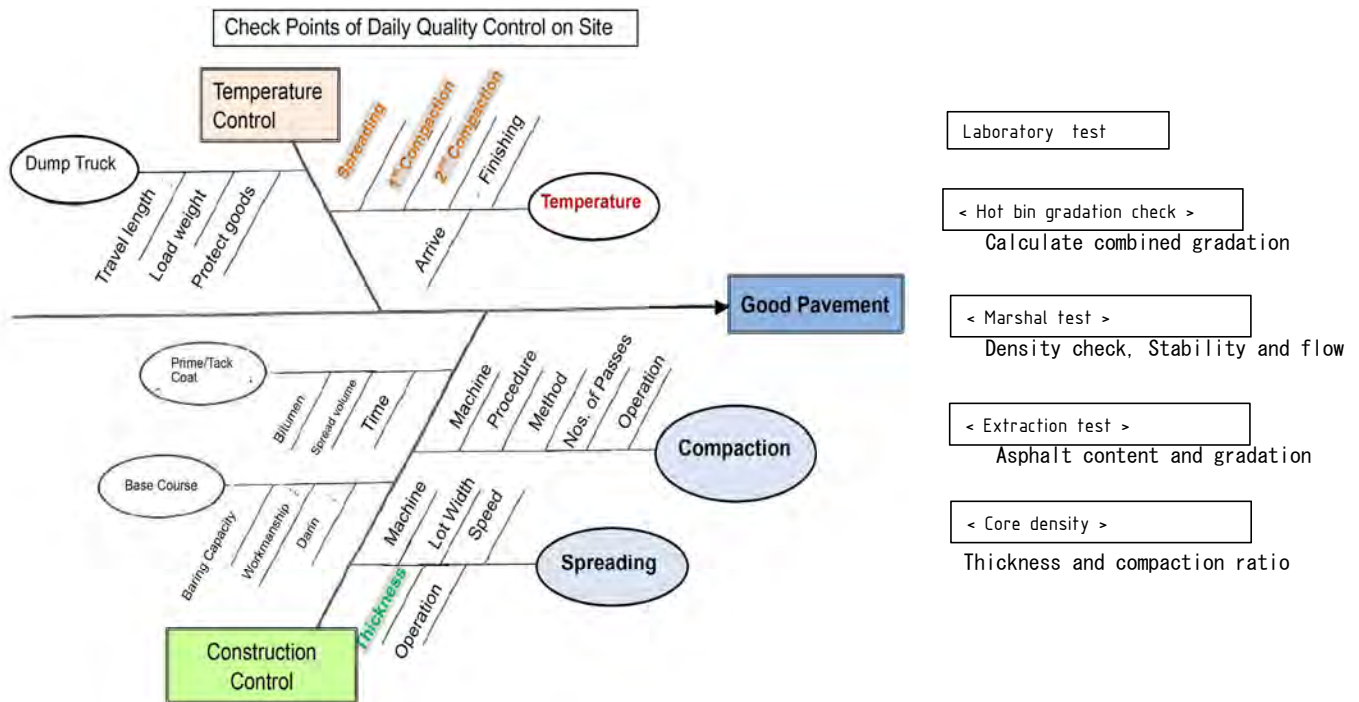

CHECKLIST for Daily Quality Control on site (AsP-2)

Lista verifikasaun ba Kontrollu qualidade diaria iha terrenu (AsP-2)

Name of Project: <i>Naran Projeitu :</i>		Type of Course: Surface(wearing) Course / Binder Course
Location: <i>Fatin:</i>		Date: / / (DD/MM/20YY) Data:
Name of Contractor: <i>Naran Kontraktor :</i>		Location: STA km - km (<i>Fatin</i>)
Name of Inspector: <i>Naran Inspektor:</i>	Name of Department <i>Naran Departementu</i>	

SPC= Standard Specification of MPWTC–Nov2014 Edition
Padraun spesifikasaun husi MOP–Edisaun Nov2014

No.	Check Items <i>Verifika Itens</i>	Judgements <i>Julgamentu</i>		Specification <i>Spesifikasaun</i>		Remaks <i>Observasaun</i> (Printed figure is reference only) <i>(Figura ne'ebe impressa hanesan referensia deit)</i>
		(Selection No.) <i>Seleciona no.</i>	Standards <i>Padraun</i>	Standards <i>Padraun</i>	SPC	
①	Construction Control Plan <i>Planu kontrollu konstrusaun?</i>					
-1	Is Consruction Plan prepared ? <i>Planu konstrusaun preparado ona ka?</i>	Yes <i>Sim</i>	No <i>Lae</i>			
②	Spreading of asphalt concrete <i>Espalhamento aspal konkretu</i>					
-1	Thickness of finisher is appropriate? <i>Mahar/espessura husi acabamento nian apropiado ka lae?</i>	Yes <i>Sim</i>	No <i>Lae</i>			

CHECKLIST for Daily Quality Control on site (AsP-2)***List a verifikasaun ba Kontrollu kualidade diaria iha terrenu (AsP-2)***

No.	Check Items <i>Verifika Itens</i>	Judgements <i>Julgamentu</i>		Specification <i>Spesifikasaun</i>		Remaks <i>Observasaun</i> (Printed figure is reference only) (<i>Figura ne'ebe impressa hanesan referensia deit</i>)
		(Selection No.) <i>Seleciona no.</i>		Standards <i>Padraun</i>	SPC	
-2	Speed of spreading is suite for compaction capacity? <i>Velosidade espalhamentu ne'e adequadu ba kapasidade kompaktasaun?</i>	Yes <i>Sim</i>	No <i>Lae</i>			
③	Compaction of asphalt concrete <i>Kompaktasaun aspal konkretu</i>					
-1	Combination of compaction machinery is adquate ? <i>Kombinasaun makina kompaktasaun ne'e adequada ona ka lae?</i>	Yes <i>Sim</i>	No <i>Lae</i>			Initial Comp=_____ Secondary comp=_____ <i>Kompaktasaun inisiu=_____ Kompaktasaun segundu=_____</i>
-2	Order of compaction is properly carried out ? <i>Ordem ba kompaktasaun ne'e halao ho lolos ona k lae?</i>	Yes <i>Sim</i>	No <i>Lae</i>			
-3	Numbers of passes of Machines are OK ? <i>Numero ne'ebe passa makinas sira ne OK ka lae?</i>	Yes <i>Sim</i>	No <i>Lae</i>			
④	Temperature Control <i>Kontrollu temperatura</i>					< note of actual temprature on site > <i>< nota temperatura real iha terrenu ></i>
-1	Arriving temperature of Asphalt(As) concrete is OK ? <i>Temperatura aspal ne'ebe to'o mai ne OK ka lae?</i>	Yes <i>Sim</i>	No <i>Lae</i>			
-2	Spreading temperature of As concrete is OK ? <i>Temperatura espalhamento konkretu nia OK ka lae?</i>	Yes <i>Sim</i>	No <i>Lae</i>			
-3	Initail Compaction temperature of As concrete is OK ? <i>Temperatura kampaksaun inisiu Aspal konkretu nian OK ka lae?</i>	Yes <i>Sim</i>	No <i>Lae</i>			
-4	Secondary Compaction temperature of As concrete is OK ? <i>Temperatura kompaksaun aspal konkretu nian ne OK ka lae?</i>	Yes <i>Sim</i>	No <i>Lae</i>			
-5	Temperrature of As concrete at Finishing works is OK ? <i>Temperatura aspal konkretu iha obra ne'e hotu ona ne'e OK ka lae?</i>	Yes <i>Sim</i>	No <i>Lae</i>			

* Table of Criteria of Temprature by Standard Specification, MoPWTC, (or as directed by the Engineer)

Tabela kona ba criteria temperatura husi padraun spesifikasaun, (ka direktamente husi Enjinerru)

Table 411.5.4 - Requirements for Viscosity and Temperature of Bituminous Binder for Mixing and Compaction

No	Construction Process	Viscosity of Bituminous Binder	Type I 60-70 pen Bitumen (°C)
1	Mixing Marshall Mix Specimen	0.2	155 + 1
2	Compacting Marshall Mix Specimen	0.4	145 + 1
3	Mixing, Target Temperature Range	0.2 – 0.5	145 – 155
4	Loading Asphalt into the Truck	+ 0.5	135 – 150
5	Delivery to finisher (paver)	0.5 – 1.0	130 – 150
6	Breakdown Rolling (Steel Drum)	1 – 2	125 – 145
7	Secondary Rolling (Rubber Tire)	2 – 20	100 – 125
8	Finishing Rolling (Steel Drum)	< 20	>95

CHECKLISTS Asphalt Pavement (AsP)
Lista Verifikasaun Pavimentasaun aspal (Asp)

1/2

Core Sampling Test

Core Sampling T

Edited_20181005

Teste Amostrjem Prinsipal

Amostrajem prinsipal

Marshall Test for each product of Asphalt concrete should be carried out as per production day.



Compaction of Marshall Sample
Kompaktasaun amostrajem Marsall



Marshall Tests for every product
Teste Marsall ba kada produdu

As per specified interval, Core Sampling (10cm dia) shall be taken from the completed pavement, to measure the thickness and the Density and to check other characteristics.



* Parameter for Evaluation of asphalt concrete;

$$(\%) \text{ Degree of Compaction (Dc)} = \frac{\text{Density of Core Sample (Ds)}}{\text{Marshall maximum Density (Dm)}} \times 100$$

= > or < Specified %

CHECKLIST for Core Sampling Test (AsP-3)

Lista Verifikasaun ba Teste amostrajem prinsipal (Aspal-3)

Type of Course: Surface(wearing) Course / Binder Course

Name of Project: <i>Naran Projetu :</i>	
Location: <i>Fatin:</i>	Date: / / (DD/MM/20YY) <i>Data:</i>
Name of Contractor: <i>Naran Kontraktor :</i>	Location: STA km - km <i>(Fatin)</i>
Name of Inspector: <i>Naran Inspektor:</i>	Name of Department <i>Naran Departementu</i>

SPC= Standard Specification of MPWTC–Nov2014 Edition
Padraun spesifikasaun husi MOP–Edisaun Nov2014

No.	Check Items <i>Verifika Itens</i>	Judgements <i>Julgamentu</i>		Specification <i>Spesifikasaun</i>		Remaks <i>Observasaun</i> (Printed figure is reference only) <i>(Figura ne'ebe impressa hanesan referensia deit)</i>
		(Selection No.) <i>Seleciona no.</i>	Standards <i>Padraun</i>	SPC		
①	Marshall Test <i>Teste Marsall</i>					

CHECKLIST for Core Sampling Test (AsP-3)

2/2

Lista Verifikasaun ba Teste amostrajem prinsipal (Aspal-3)

No.	Check Items <i>Verifika Itens</i>	Judgements <i>Julgamentu</i>		Specification <i>Spesifikasaun</i>		Remaks <i>Observasaun</i> (Printed figure is reference only) (<i>Figura ne'ebe impressa hanesan referensia deit</i>) (<i>Figura ne'ebe impressa hanesan referensia deit</i>) Checking Test record on Laboratory? <i>verifika rejistu teste iha laboratorio</i> <i>(Figura ne'ebe impressa hanesan referensia deit)</i>
		(Selection No.) <i>Seleciona no.</i>	Standards	Standards	SPC	
-1	Have Marshall Tests been carried out at every production day of Asphalt concrete at Plant ? <i>Teste marshall ne'e halao iha kada produsaun aspal konkritu loron-loron iha fabrica ka lae?</i>	Yes	No			
		<i>Sim</i>	<i>Lae</i>			
②	Core Sampling <i>Amostrajem prinsipal</i>					<i>(Figura ne'ebe impressa hanesan referensia deit)</i>
-1	Does Core on site sampled as per specified interval? <i>Core ne'ebe amostra iha terrenu hanesan hatudu iha intervallu spesifikasaun ka lae?</i>	Yes	No			Specified Interval: one core sampling as per 1,000m2 <i>Intervallu spesifiku : core sampling ida per 1,000 m2</i>
		<i>Sim</i>	<i>Lae</i>			
-2	In each test, 3 specimen are sampled ? <i>iha kada teste, iha especime 3 mak sei amostra?</i>	Yes	No			
		<i>Sim</i>	<i>Lae</i>			
③	Evaluation of Core Samples <i>Evaluasaun amostrajem prinsipal</i>					
-1	Thickness Are same as with Design thickness ? <i>Mahar/espessura hanesan ho mahar/espessura dezennu?</i>	Yes	No			Design thickness of Binder Course is 6 cm <i>Mahar dezennu nian ba binder course mak 6 cm</i>
		<i>Sim</i>	<i>Lae</i>			
-2	Degree of Compaction (Dc); Are same as with Specification ? <i>Grau kompaktasaun (GC); hanesan ho spesifikasaun ka ?</i>	Yes	No			Specified Dc=95 % <i>spesifikasaun grau kompaktasaun = 95 %</i>
		<i>Sim</i>	<i>Lae</i>			
-3	Has extraction test of material from core ? Is it OK? <i>Teste ba ekstrasaun material husi core iha ka? Id ne'e ok?</i>	Yes	No			Asphalt content, Gradation of Aggregate <i>konteudu aspal, gradasaun agregado</i>
		<i>Sim</i>	<i>Lae</i>			

6. Checklists for Safety Control

6. Checklists for Safety Control

Lista verifikasaun ba kontrolla seguransa

6-1 Daily Safety Checking

Verifikasaun diaria seguransa nian

1/3

CL_SC-10_Daily Checking

Edited_20190225

Activities for Safety construction **Circle**
Aktividade ba siklu seguransa ba konstrusaun

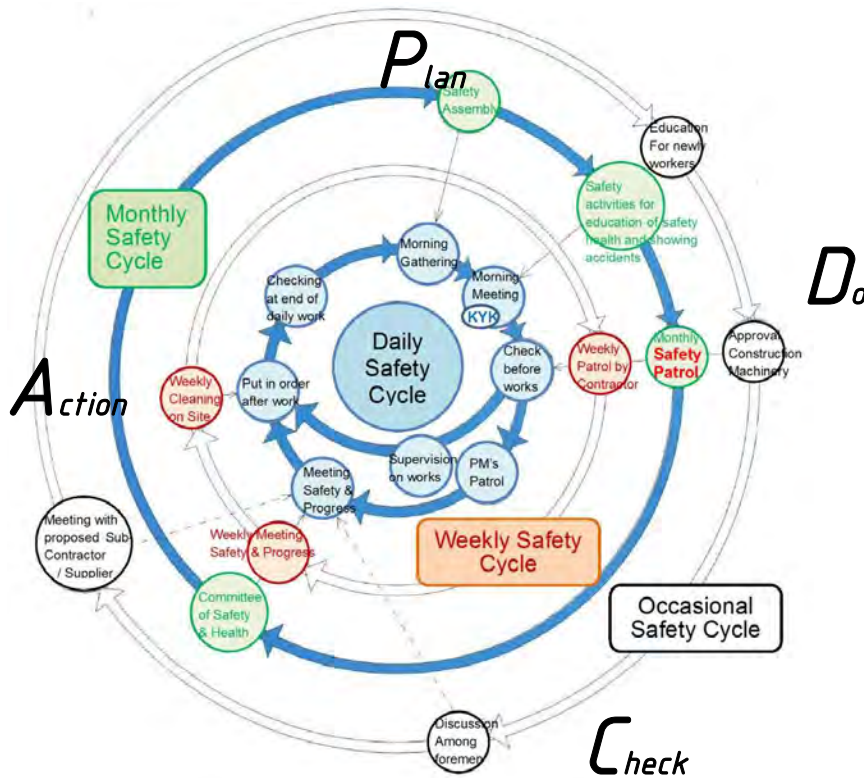

Example: Banner of Safety, presenting Slogan
Ezemplu :Spanduk seguransa nian,aprezenta slogan



CHECKLIST for Daily Safety Checking

(SC-10)

Lista verifikasaun ba verifikasaun seguransa diaria

Name of Project: <i>Projetu nia naran:</i>	
Location: <i>Fatin :</i>	Date: / / (DD/MM/20YY) Date: / /
Name of Contractor: Mejori and management by Jonise <i>Kontraktor nia Naran</i>	Location: STA km - km <i>Fatin</i>
Name of Inspector: <i>Inspektor nia naran</i>	Name of Department: <i>Departementu nia naran</i>

No.	Check Items <i>Verifika Itens</i>	Judgements <i>Julgamentu</i>		Specification <i>Spesifikasaun</i>		Remaks <i>Observasaun</i>
		(Selection No.) <i>Seleciona no.</i>	Standards <i>Padraun</i>	SPC	(Printed figure is reference only) <i>(Figura ne'ebe impressa hanesan referensia deit)</i>	
①	Protection equipment for workers					
-1	Safety Helmets are weared by workers ? <i>Traballador sira utiliza kapasete seguransa ka lae ?</i>	Yes <i>Sim</i>	No <i>Lae</i>			
-2	Does workers keep proper shoes for his jobs ? <i>Traballador sira kontinua uza sapatu ne'ebe adequada ka ?</i>	Yes <i>Sim</i>	No <i>Lae</i>			

CHECKLIST for Daily Safety Checking (SC-10) 2/3

Lista verifikasaun ba verifikasaun seguransa diaria

No.	Check Items <i>Verifika Itens</i>	Judgements <i>Julgamentu</i>		Specification <i>Spesifikasaun</i>		Remaks <i>Observasaun</i>
		(Selection No.) <i>Seleciona no.</i>	Standards <i>Padraun</i>	SPC	(Printed figure is reference only) <i>(Figura ne'ebe impressa hanesan referensia deit)</i>	
-3	In case of watchmen, works in the night and/or near heavy traffic; Do they wear a safety (reflecting) jacket? <i>Iha kazu vigias, servisu iha tempu kalam no/ka besik trafiku ne'ebe intensu; sira uza jaket seguransa ka lae?</i>	Yes <i>Sim</i>	No <i>Lae</i>			

CHECKLIST for Daily Safety Checking (SC-10) 3/3

No.	Check Items <i>Verifika Itens</i>	Judgements <i>Julgamentu</i>		Specification <i>Spesifikasaun</i>		Remaks <i>Observasaun</i> (Printed figure is reference only) <i>(Figura ne'ebe impressa hanesan)</i>
		(Selection No.) <i>(Seleciona no.)</i>		Standards <i>(Padraun)</i>	SPC	
②	Precaution/instruction to workers <i>Prekausaun/instrusaun ba Traballador sira</i>					
-4	Does contractor's supervisor (SV) give precaution? <i>Kontraktor nia supervisor fo esplikasaunkona ba prosedimentu servisu ka lae?</i>	Yes <i>Sim</i>	No <i>Lae</i>			Regarding today's works, SV give Safety instruction / precaution to workers before start the works <i>Relasiona ho servisu ohin loron nian, supervisor hato instrusaun /prosedimentu seguransa nia ba traballador sira antes sira komesa</i>
-5	Morning, do Tool Box Meeting carry out ? <i>Tool Box meeting ne'e halao ka lae?</i>	Yes <i>Sim</i>	No <i>Lae</i>			Before start the works, contractor SV and a group of workers for each working group have a morning meeting regarding today's work procedure and dangerous point of today's work. <i>antes komesa servisu supervisor husi kontraktor no grupo traballador ba kadar grupu servisu halo entkontru dader relasiona ho prosedimentu servisu ohin loron nian no pontu perigozu husi servisu ohin loron.</i>

• Finding out Dangerous points <i>Deskobre pontu perigozu</i>						
1)						
2)						
3)						

• Instructions and expecting counter-measures (if any) <i>Instrusaun no espektasaun konba ba kontra medida (se iha)</i>						
1)						
2)						
3)						

Overall comments:
Komentariu en jeral

6-2 Regularly Safety Activity
Aktividade seguransa regular

CL_SC-20_Sfety Activity

1/3

Edited_20181005

Following regularly safety activies are desired on the site:
Aktividade seguransa tuir mai ne'e mak dezeja iha terrenu:

Tool box meeting



As a each working group, supervisors explain today's work procedures and safety remarks to workers

Hanesan kada grupu servisu nian, supervisores sira esplika kona ba prosedimentu servisu ohin loron nian no observasaun seguransa ba traballador sira

Safety Patrol



Jointly site inspection and find out dangerous points and if necessary instructions are to be made
Inspeksaun konjunta iha terrenu no deskobe pontos perigozus sira no halo instrusaun ne'ebe nessesariu

Safety Assembly



Safety Gatheings are to be made in order to promote all workers' awarness of Safety on the construction site.
Reuniaun seguransa sira tenki halo nune'e bele realiza atu nune'e bele promote ba traballador sira nia concientizasaun kona ba seguran iha fatin konstrusaun.

CHECKLIST for Regular Safety Activities (SC-20)

Lista verifikasaun ba aktividade seguransa regular(SC-20)

Name of Project: <i>Projetu nia naran:</i>	
Location: <i>Fatin :</i>	Date: / / (DD/MM/20YY) Date: / /
Name of Contractor: Mejori and management by Jonise <i>Kontraktor nia Naran</i>	Location: STA km - km <i>Fatin</i>
Name of Inspector: <i>Inspektor nia naran</i>	Name of Department: <i>Departementu nia naran</i>

No.	Check Items <i>Verifika Itens</i>	Judgements <i>Julgamentu</i>		Specification <i>Spesifikasaun</i>		Remaks <i>Observasaun</i>
		(Selection No.) <i>Seleciona no.</i>	Standards <i>Padraun</i>	SPC	(Printed figure is reference only) <i>(Figura ne'ebe impressa hanesan referensia deit)</i>	
①	<i>Safety Patrol by the Contractor</i> <i>Patrulla seguransa husi kontraktor</i>					
-1	<i>Does PM or site engineer conduct Daily Safety Patrol ?</i> <i>PM ka Enjinerru iha terenu hala'o patrullamentu seguransa diaria ka?</i>	Yes <i>Sim</i>	No <i>Lae</i>			
-2	<i>Does PM or site engineer conduct Weekly Safety Patrol ?</i> <i>PM ka Enjinerru iha terenu hala'o patrullamentu seguransa semanal ka?</i>	Yes <i>Sim</i>	No <i>Lae</i>			<i>Joining sub-contractor is preferable.</i> <i>Hamutuk ho sub kontratantes ne'e preferivel liu</i>

CHECKLIST for Regular Safety Activities

2/3

Lista verifikasaun ba aktividade seguransa regular(SC-20)

No.	Check Items <i>Verifika Itens</i>	Judgements <i>Julgamentu</i>		Specification <i>Spesifikasaun</i>		Remaks <i>Observasaun</i>
		(Selection No.) <i>Seleciona no.</i>	Standards <i>Padraun</i>	SPC	(Printed figure is reference only) <i>(Figura ne'ebe impressa hanesan referensia deit)</i>	
-3	<i>Does PM or site engineer conduct Monthly Safety Patrol ?</i>	Yes	No			<i>Joining Employer is preferable.</i>
	<i>PM ou enjinerru iha terrrenu halao patrulla seguransa mensal ka lae?</i>	<i>Sim</i>	<i>Lae</i>			<i>hamutuk ho empregador ne'e preferivel liu</i>
②	<i>Progress and Safety Meeting</i>					
	<i>Progressu no enkontru seguransa</i>					
-1	<i>Weekly Progress & Safety meeting is held?</i>	Yes	No			<i>Joining Employer and sub-contractor is preferable.</i>
	<i>Enkontru ba Progressu semanal & seguransa nian halao ka lae?</i>	<i>Sim</i>	<i>Lae</i>			<i>hamutuk ho empregador no subkontratantes sir preferivel liu</i>
-2	<i>Montly Progress & Safety meeting is held?</i>	Yes	No			<i>Joining Emplyor is essential</i>
	<i>Enkontru ba Progressu mensal & seguransa nian halao ka lae?</i>	<i>Sim</i>	<i>Lae</i>			<i>hamutuk ho empregador sira nemak essensial liu</i>
-3	<i>Site Safety Committee meeting is held ?</i>	Yes	No			
	<i>Reuniaun komite seguransa iha terrenu realiza ka lae?</i>	<i>Sim</i>	<i>Lae</i>			

CHECKLIST for Regular Safety Activities

3/3

Lista verifikasaun ba aktividade seguransa regular(SC-20)

No.	Check Items <i>Verifika Itens</i>	Judgements <i>Julgamentu</i>		Specification <i>Spesifikasaun</i>		Remaks <i>Observasaun</i>
		(Selection No.) <i>Seleciona no.</i>	Standards <i>Padraun</i>	SPC	(Printed figure is reference only) <i>(Figura ne'ebe impressa hanesan referensia deit)</i>	
③	Regular Safety Activities <i>Atividade seguransa regular</i>					
-1	Have Safety Assembly been carried out ? <i>Asembleia seguransa halao ona ka lae?</i>	Yes <i>Sim</i>	No <i>Lae</i>			Safety Gatherings are to be made in order to promote all workers' awareness of Safety on the construction site <i>Reuniaun ba seguransa nia tenki halo duni nune'e bele prompve traballador sira nia konsiensia kona ba seguransa iha fatin konstrusaun.</i>
-2	Educational training to operators and workers, have been conducted? <i>Formasaun ne'ebe edukativu ba operador no traballador sira halao ona ka ?</i>	Yes <i>Sim</i>	No <i>Lae</i>			Especially, it is necessary when the workers come to the site first or the operators begins the new type of work procedure <i>especialmente, ida ne'e nessesario wainhira traballador sira halao sira nia servisu inisiu no operador sira comesa sira nia tipu prosedimentu ne'ebe foun.</i>
-3	Contractor's PM or site supervisors, do safety patrol/ checking to the site every day ? <i>PM kontraktor nia ka supervisor iha terrenu, halo patrulla seguransa / verifika situu lor-loron ka lae?</i>	Yes <i>Sim</i>	No <i>Lae</i>			Giving safety instruction and precaution is more important upon such patrol <i>Fo instrusaun kona ba seguransa nian ne'e importante liu do que patrulla.</i>

	• Finding out Dangerous points <i>Deskobre pontus perigosus</i>			
1)				
2)				
3)				

	• Instructions and expecting counter-measures (if any) <i>Instrusaun no hein katak bele halo kontra medida (Karik iha)</i>			
1)				
2)				
3)				

Overall comments:
(Komentariu en-jeral)

6-3 Safety organization and management
Organizasaun no jerenciamentu seguransa

CL_SC-30_Sfety Committee

Edited_20181005

Showing Example for Pilot Safety Activity site

Hatudu ezemplu ba pilotu aktividade seguransa iha terrenu

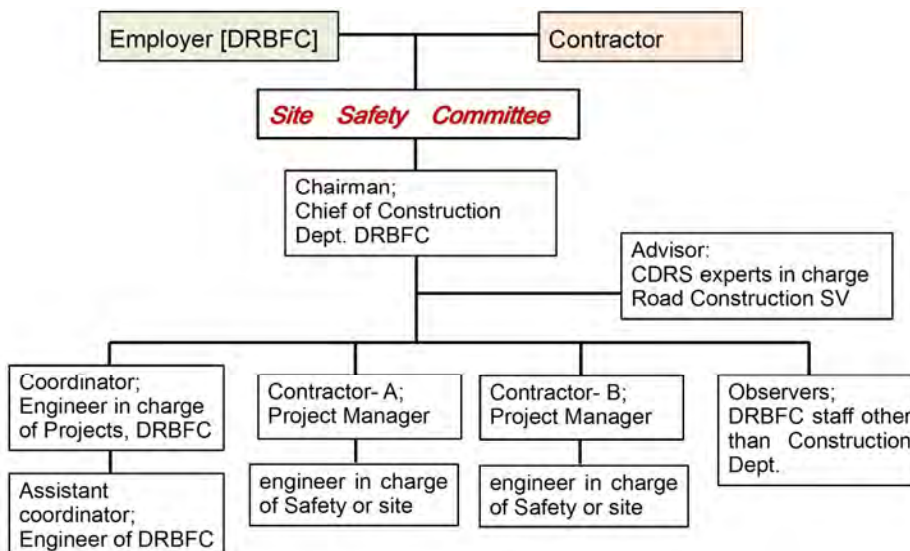

(SC-30)

CHECKLIST for Safety organization and management

Lista verifikasaun ba organizasaun no jerensiamentu seguransa

Name of Project: <i>Projetu nia naran:</i>	
Location: <i>Fatin :</i>	Date: / / (DD/MM/20YY) Date: / /
Name of Contractor: Mejori and management by Jonise <i>Kontraktor nia Naran</i>	Location: STA km - km <i>Fatin</i>
Name of Inspector: <i>Inspektor nia naran</i>	Name of Department: <i>Departementu nia naran</i>

No.	Check Items <i>Verifika Itens</i>	Judgements <i>Julgamentu</i>		Specification <i>Spesifikasaun</i>		Remaks <i>Observasaun</i>
		(Selection No.) <i>Seleciona no.</i>	Standards <i>Padraun</i>	SPC	(Printed figure is reference only) <i>(Figura ne'ebe impressa hanesan referensia deit)</i>	
①	Site management by the Contractor <i>Jestaun seguransa iha terrenu husi kontraktor</i>					
-1	Contractor's site supervisors, are stationaly on the site ? <i>kontraktor nia Supervisores lokal sira, iha terrenu ka lae?</i>	Yes <i>Sim</i>	No <i>Lae</i>			
-2	Has Contractor a resident engineer on the site ? <i>Kontraktor nia enjinerru residente iha terrenu ka lae?</i>	Yes <i>Sim</i>	No <i>Lae</i>			

CHECKLIST for Safety organization and management 2/2

Lista verifikasaun ba organizasaun no jerensiamentu seguransa

No.	Check Items <i>Verifika Itens</i>	Judgements <i>Julgamentu</i>		Specification <i>Spesifikasaun</i>		Remaks <i>Observasaun</i>
		(Selection No.) <i>Seleciona no.</i>		Standards <i>Padraun</i>	SPC	
③	Site Organization and management <i>Organizasaun iha terrenu no ninia jestaun</i>					(Printed figure is reference only) <i>(Figura ne'ebe impressa hanesan referensia deit)</i>
-1	Has the Contractor organization Scheme for management ? <i>Kontraktor sira iha eskema ba jerensiamentu ka lae?</i>	Yes <i>Sim</i>	No <i>Lae</i>			
-2	Site Safety Commiitee, does Contractor established ? <i>Kontraktor estabele komisaun ba seguransa iha terrenu ka lae?</i>	Yes <i>Sim</i>	No <i>Lae</i>			Involvement of Employer is preferable <i>involme an husi empregador sira ne'e preferivel liu.</i>

CHECKLIST for Safety organization and management 2/2

Lista verifikasaun ba organizasaun no jerensiamentu seguransa

No.	Check Items <i>Verifika Itens</i>	Judgements <i>Julgamentu</i>		Specification <i>Spesifikasaun</i>		Remaks <i>Observasaun</i> (Printed figure is reference only) <i>(Figura ne'ebe impressa hanesan referensia deit)</i>
		(Selection No.) <i>Seleciona no.</i>	Standards <i>Padraun</i>	SPC		
③	Keeping Safety data and/or document <i>Asegura dadus seguransa ka dokumentus sira</i>					
-1	Does keep record of numbers of workers and machinery? <i>Mantein rejistu numeru traballador no makina sira?</i>	Yes <i>Sim</i>	No <i>Lae</i>			
-2	Does reserve the accident record, if any? <i>Reserva rejistu asidente , karik iha ?</i>	Yes <i>Sim</i>	No <i>Lae</i>			

- Finding out Dangerous points <i>Deskobre pontu perigozus</i>						
1)						
2)						
3)						

- Instructions and expecting counter-measures (if any) <i>Instrusaun no hein katak bele halo konktra medida (Karik iha)</i>						
1)						
2)						
3)						

Overall comments:
Komentariu en-jeral

6-4 Checklist for Safety Patrol

Lista verifikasaun ba patrulla seguransa

1/3

CL_SC-40_Safety Patrol

Edited_20181005

CHECKLIST: Safety Patrol

Lista verifikasaun: Patrulla seguransa

Name of Project: <i>Projetu nia naran:</i>	
Location: <i>Fatin :</i>	Date: / / (DD/MM/20YY) Date: / /
Name of Contractor: Mejori and management by Jonise <i>Kontraktor nia Naran</i>	Location: STA km - km <i>Fatin</i>
Name of Inspector: <i>Inspektor nia naran</i>	Name of Department: <i>Departementu nia naran</i>

No.	Check Items <i>Verifika Itens</i>	Judgements <i>Julgamentu</i>		Specification <i>Spesifikasaun</i>		Remaks <i>Observasaun</i>
		(Selection No.) <i>Seleciona no.</i>	Standards <i>Padraun</i>	SPC	(Printed figure is reference only) <i>(Figura ne'ebe impressa hanesan referensia deit)</i>	
①	Participants and interval of "Safety Patrol" <i>Partisipante sira no intervallu "Patrulla seguransa"</i>					
-1	Have you received "Announcement" of today "Patrol"? <i>Ita bo'ot simu ona aviszu kona ba patrulla ohin lora ka?</i>	Yes <i>Sim</i>	No <i>Lae</i>			
-2	DRBFC staff in charge, attend the Patrol? <i>Funsionario DNEPCC ne'ebe toma konta atende patrulla ne'e ka lae?</i>	Yes <i>Sim</i>	No <i>Lae</i>			
-3	Contractor's staff in charge, attend the Patrol? <i>Kontraktor nia funsionariu sira atende patrulla ne'e ka lae?</i>	Yes <i>Sim</i>	No <i>Lae</i>			
②	Inspection Points for Safety <i>Pontus inspeksaun ba seguransa</i>					
-1	Workers wear safety helmets ? <i>Traballador sira uza kapasete seguransa ka lae?</i>	Yes <i>Sim</i>	No <i>Lae</i>			
-2	Workers wear safety color vests ? <i>Traballador sira uza coletes colorido ba seguransa nia ka lae?</i>	Yes <i>Sim</i>	No <i>Lae</i>			
-3	Were workers explained today's work procedure? <i>Traballador sira hetan esplikasaun kona ba prosedimentu servisu ohin lora nia ona ka seidak?</i>	Yes <i>Sim</i>	No <i>Lae</i>			
-4	Were workers explained today's dangerous points? <i>Traballador sira hetan esplikasaun kona ba pontus perigosus ba ohin lora nia ona ka seidak?</i>	Yes <i>Sim</i>	No <i>Lae</i>			

CHECKLIST: Safety Patrol

Lista verifikasaun: Patrulla seguransa

2/3

No.	Check Items <i>Verifika Itens</i>	Judgements <i>Julgamentu</i>		Specification <i>Spesifikasaun</i>		Remaks <i>Observasaun</i>
		(Selection No.) <i>Seleciona no.</i>	Standards <i>Padraun</i>	SPC	(Printed figure is reference only) <i>(Figura ne'ebe impressa hanesan referensia deit)</i>	
-5	Are there "watchman for Construction Machinery"? <i>Iha ne'eba iha vigia ba makina konstrusaun nia ka?</i>	Yes <i>Sim</i>	No <i>Lae</i>			

CHECKLIST: Safety Patrol

Lista verifikasaun: Patrulla seguransa

3/3

No.	Check Items <i>Verifika Itens</i>	Judgements <i>Julgamentu</i>		Specification <i>Spesifikasaun</i>		Remaks <i>Observasaun</i>
		(Selection No.) <i>Seleciona no.</i>		Standards <i>Padraun</i>	SPC	
-6	Precaution Singnboard for Safety are provided on site? <i>Quadro avizu Precuão ba seguransa nia fornese ona iha terrenu ka?</i>	Yes <i>Sim</i>	No <i>Lae</i>			(Printed figure is reference only) <i>(Figura ne'ebe impressa hanesan referensia deit)</i>
-7	Procedure of works is correct or not? <i>Prosedimentu servisu los ka lae?</i>	Yes <i>Sim</i>	No <i>Lae</i>			
-8	At same time, both works up/down are carried out or not? <i>Iha tempu ne'ebe hanesan , servisu rua iha leten / karaik halao hotu ka lae?</i>	Yes <i>Sim</i>	No <i>Lae</i>			
-9	Cutting gradient is OK, with no danger? <i>Gradiente corte nia los ona, no la iha perigozus?</i>	Yes <i>Sim</i>	No <i>Lae</i>			

	• Finding out Dangerous points <i>Deskobre pontus perigozus</i>			
1)				
2)				
3)				

	• Instructions and expecting counter-measures (if any) <i>Instrusaun no hein katak bele halo konktra medida (Karik iha)</i>			
1)				
2)				
3)				

Overall comments:
Komentariu en jeral

7. Checklists for Construction Management

< Drafting: Reference Only >

7. Checklists for Construction Management

Lista verifikasaun ba jestaun konstrusaun

CL_TD-1

7-1 Tender Documents

Dokumentus konkursu

1. Type of Tender

Tipu Konkursu

Edited_20181005

Select & decide the Type of Tender (Contract)

<i>Seleciona & decide tipu konkursu (Kontratu)</i>
--

According to the Type of Tender (Contract), requirements and documents of Tender are to be different. Firstly, Type of Tender or Contract are selected and decided among below classification:
Bazeia ba tipu konkursu (kontratu), rekerementu no dokumentus konkursu mak sei diferente.
Primeiru, tipu konkursu ka kontratu mak selecionadu no decide tuir klasifikasaun tuir mai ne'.

I. Category of Competitiveness

I. Categoria husi Kompetitividade

- 1 Open Tender (Bidding)
Konkursu aberta (licitaçãu)
 - 1-1: International Competitive Tender (Bid) ICB
1-1: Konkursu competitiva internacional (licitaçãu)
 - 1-2: Domestic Tender : Only Timor Leste company can participate
1-2: Konkursu domestiku : Empreza lokal deit mak bele partisipa
 - 1-3: Conditional domestic Tender : Limitation of tender with some condition among domestic company
1-3: Konkursu domestiku kondisional : Limitasaun kona-ba konkursu sira ho kondisaun balun entre empreza domestika
- 2 Nomination, proposal and Negotiation Tender
Nomeasaun, proposta no konkursu negosiasaun
 - 2-1: Single nomination company
2-1: Nomeasaun empreza unika
 - 2-2: Nomeasaun empreza plural : Procedure is almost the same as Type 1-2 and/or 1-3
: Prosedimentu sira mak kuaze hanesan ho tipu 1-2 no / ka 1-3

II. Category of Terms of Contract (responsibility of Contractor)

II. Categoria termos kontratu (responsabilidade kontratante)

- A Contract consists of Design and Construction
Kontratu kompostu husi dezennu no konstrusaun
- B Contract consists of only Construction
Kontratu kompostu husi konstrusaun deit
 - * This Check List applies only Domestic Type of Tender, because of 1-1 Tender are large scale of Project and made by almost Loan Project
 - * *Lista verifikasaun ida ne'e bele aplika deit iha tipu domestiku, tamba 1-1 konkursu ne'ebe ho skala bo'ot no maioria halo projetu imprestissimu.*
 - ** 1-2 is as same as 1-3 only conditions, so show the List only 1-2
 - ** *1-2 hanesan mos ho 1-3 ninia kondisaun, nune'e hatudu deit lista 1-2*
 - *** Requirements of Tender Document is the same of both open (pulatal nomination) and single nomination. Only the evaluation for Tender is different.
 - *** *Rekeзитус документус конкурсу сира не'е мак ханесан kona ba nomeasaun plural aberta no unika nomeasaun aberta. Evaluasaun ba konkursu deit mak diferente.*

(CL_TD-1)

1. **CHECKLIST for Selecting and decision of Type of Tender**
List a verifikasau n ba selesionado no desizaun kona ba tipu konkursu

Name of Project : <i>Naran Projetu :</i>	
Location : <i>Fatin:</i>	Date : / / (DD/MM/20YY) Data:
Name of Contractor: <i>Naran Kontraktor :</i>	Location: STA km - km <i>(Fatin)</i>
Name of Inspector: <i>Naran Inspektor:</i>	Name of Department <i>Naran Departementu</i>

SPC= Standard Specification of MPWTC–Nov2014 Edition
Padraun spesifikasau husi MOP–Edisaun Nov2014

No.	Check Items <i>Verifika Itens</i>	Judgements <i>Julgamentu</i>		Specification <i>Spesifikasau</i>		Remaks <i>Observasau</i> (Printed figure is reference only) <i>(Figura ne'ebe impressa hanesan referensia deit)</i>
		(Selection No.) <i>Seleciona no.</i>		Standards <i>Padraun</i>	SPC	
I	Category of Competitiveness Protection equipment for workers <i>Kategoria kona ba kompetividade ekipamentus protesaun ba traballador sira</i>					
①	Is Tender Open Bid or Nomination/Proposal Type? <i>Tipu konkursu abertu ka nomeasaun / Tipu proposta?</i>	Yes <i>Sim</i>	No <i>Lae</i>			If Yes: Forward ② Checking If No: it is Nomination/Proposal Type, Forward ③
②	Are there any conditions of the candidate (Tenderer)? <i>Iha ne'ebe iha requisitos kona ba kandidatus sira(proponente)?</i>	Yes <i>Sim</i>	No <i>Lae</i>			if yes: Type 1-2 If No: Type 1-3
③	Is Nomination to only one company ? <i>Nomeasaun ne'e ba kompanna ida deit ka?</i>	Yes <i>Sim</i>	No <i>Lae</i>			if yes: Type 2-1 If No: Type 2-2
II	Category of Terms of Contract (responsibility of Contractor) <i>Kategoria kona ba termus kontratu (responsavel kontratante)</i>					
①	Does Contract consists of Desing and Construction? <i>Kontratu sira kompostu husi dezennu no konstrusaun ka?</i>	Yes <i>sim</i>	No <i>Lae</i>			if yes: Type X-Y-A If No: Type X-Y-B

< Drafting: Reference Only >

CL_TD-2

CHECKLIST for Tender Document

Lista verifikasaun ba dokumentus konkursu

2. Documents for Type 1-3-B

Dokumentus ba Tipu 1-3-B

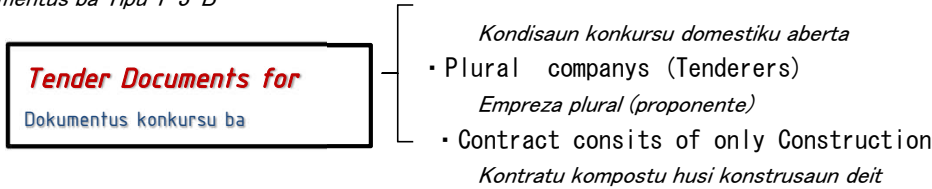

The Employer shall prepare following documents at each Procurement Stage

Empregador sira tenki prepara dokumentus tuir mai ne'e tuir kada etapa aprovizionamentu idak-idak

I. Announcement Stage

Etapa Anunsio

- 1 Notice of Tender to the Public on Newspaper, Home Page of the Emplpor (DRBFC)
Notifikasaun kona ba konkursu publiku iha Jornal, pagina Empregador (DNEPCC)
- 2 Qualification for proposed tenderer : anual turn over, similar construction experience, number of engineers etc
Kualifikasaun ba proponente proposta retornu annual, esperensia konstrusaun ne'ebe hanesan, numeru ingenerru sira nsst.
- 3 Providing of Tender Document for propsed candidate
Fornese dokumentu konkursu ba candidatu proposto

II. Preparation of Tender Stage

Preparasaun kona ba etapa konkursu

CHECKLIST for Tender Document

(CL_TD-2)

Lista Verifikasaun ba dokumentus konkursu

Example of necessary document for Type 1-3-B

Exemplu kona-ba dokumentu ne 'ebe nesesaríu ba Tipu 1-3-B

	Volume I		✓	Contents and requirements for each document
	<i>Volume I</i>			<i>Konteudu no rekeзитus ba kada dokumentus</i>
10	Instruction to Tenderers	Section 1		
	<i>Instusaun ba proponente</i>			
20	Tender Data Sheet	Section 2		
	<i>Folla dadus konkursu</i>			
30	Form of Contract Agreement	Section 3		
	<i>husi akordu kontratu</i>			
40	Particular Conditions of Contract (PCC)	Section 4		
	<i>Kondisaun partikular kona ba kontratu</i>			
50	General Conditions of Contract (GCC)	Section 5		
	<i>Kondisaun jeral kona ba kontratu</i>			
60	Specifications	Section 6		
	<i>spesifikasaun</i>			
61	Special Specification (if any)			
	<i>spesifikasaun spesial (se iha)</i>			
70	Tendering Forms	Section 7		
	<i>Formulario konkursu</i>			
	Power of Attorney	Appendix-B		
	<i>Procuração</i>			
	Certificate of Signature of the issuer	Appendix-C		
	<i>sertifikadu asinatura emissor</i>			

	Letter of Price/Technical Tender	Appendix-A,B		
	<i>Koarta kona ba presu / konkursu teknikal</i>			
	Proposed Construction Schedule	Appendix-D		
	<i>Kalendariu konstusaun ne'ebe propoin</i>			
	Proposed Contractor's key staff Schedule	Appendix-E		
	<i>Proposta kontratante nia funsionario ninia kalendariu</i>			
80	Form of Bill of Quantities			
	<i>Formulario fatura/conta husi kuantidade</i>			
	Volume II			
	<i>Volume II</i>			
	Drawing			
	<i>Dezennu</i>			
	Calculation Sheet of Quantities (Only Type A)			
	<i>Kalkulasaun folla kuantidade (Tipu A deit)</i>			

Notes: 1. In the Drawing, the length and width, dimensions of structure, dimensions of cross section and other values must be described in order calculate the quantities for each work item in the BoQ.

1. Iha dezennu, naruk no largura, dimensaun estrutura, dimensaun seksaun transversal no valor sira seluk tenki descreve atu nune'e bele kalkula kuantidade ba kada itens servisu iha BoQ.

2. Since existing site condition and other reasons, special provisions of specification are to be required, such special or particular provisions would be added the Specification, as a "Special Technical Specification"
 2. Desde kondisaun existante local no razaun sira seluk, spesifikasaun ninia provisau mak atu bele sai nesario, hanesan spesial ka partikular provisau ne'ebehatama spesifikasaun, hanesan "Spesifikasaun teknika spesial".

III. Negotiation Stage (after open the Tender)

Etapa Negosiasaun (depois Konkursu aberta)

2. Documents for Type 1-3-B

Dokumentus ba Tipu 1-3-B

Name of Project:	
<i>Naran Projetu :</i>	
Location:	Date: / / (DD/MM/20YY)
<i>Fatin:</i>	<i>Data:</i>
Name of Contractor:	Location: STA km - km
<i>Naran Kontraktor :</i>	<i>(Fatin)</i>
Name of Inspector:	Name of Department
<i>Naran Inspektor:</i>	<i>Naran Departementu</i>

< Drafting: Reference Only >

CL_TD-3

CHECKLIST for Tender Document

Lista verifikasaun ba dokumentus konkursu

3. Application of document for each Type of Tender

Aplikasaun kona ba dokumentus ba kada tipu konkursu

Edited_20181005

Number and kinds of required documents are different from the Type of Tender or Contract.

Numeru no dokumentus ne'ebe rekeзитus mak la hanesan husi tipu konkursu ka kontratu

Necessary documents: ● in right column <i>Dokumentus ne'ebe nesesariu : Iha koluna direta</i>		Type of Tender and/or Contract							
		Tipu kona ba konkursu no/ka kontratu							
		Open Tender (Bidding)			Nomination, proposal and Negotiation Tender				
		<i>Konkursu aberta (licitação)</i>			<i>Nomeasaun, proposta no konkursu negosiasaun.</i>				
		1-1-B	1-2-A	1-3-A		1-3-B	2-2-A	2-2-B	
I.	Announcement Stage <i>Etapa Anunsiu</i>								
1	Notice of Tender to the Public <i>Informa konkursu ba Publiku</i>	●	●	●		●			
2	Qualification for proposed tenderer <i>Kualifikasaun ba konkursu ne'ebe propoin</i>								
1)	Finacial record of anula turn over of the company <i>Registu finanseiro annual ne'ebe fo fila ba kompania</i>	●		●		●			
2)	Record / certificates of similar construction experience <i>Registu / certifikadu esperensia kontrusaun ne'ebe hanesan</i>	●		●		●			
3)	Certificates of engineers in charge the Works <i>Certifika ingenerru ne'ebe responsavel ba obra</i>	●		●		●			
3	Providing of Tender Document for proposed candidate <i>Fornese dokumentus konkursu ba kandidatu propostu</i>								

II. Preparation of Tender Stage

Preparasaun kona ba etapa konkursu

Tender Document

Dokumentus Konkursu

	Volume I <i>Volume I</i>	Open Tender (Bidding)			Nomination, proposal				
		<i>Konkursu aberta (licitação)</i>			<i>Nomeasaun, proposta</i>				
		1-1-B	1-2-A	1-3-A		1-3-B	2-2-A	2-2-B	
10	Instruction to Tenderers <i>Intrusaun ba proponente</i>	●	●	●		●			
20	Tender Data Sheet <i>Folla dadus konkursu nia.</i>	●	●	●		●			
30	Form of Contract Agreement <i>Formulario kontratu</i>	●	●	●		●	●	●	
40	Particular Conditions of Contract (PCC) <i>Kondisaun kontratu partikular</i>	●							
50	General Conditions of Contract (GCC) <i>Kondisaun kontratu jeral</i>	●	●	●		●	●	●	
60	Specifications <i>Spesifikasaun</i>	●	●	●		●	●	●	
61	Special Specification (if any) <i>Spesifikasaun special (Karik iha)</i>								
70	Tendering Forms <i>Formulario konkursu</i>								
	Power of Attorney <i>Procução</i>	●	●	●		●	●	●	

Certificate of Signature of the issuer <i>Certifikaduasinatara emissor</i>	●							
Letter of Price/Technical Tender <i>Karta kona ba presu/ konkursu tekniku</i>	●	●	●		●	●	●	
Proposed Construction Schedule <i>Proposta kalendariu konstrusaun</i>	●							
Proposed Contractor's key staff Schedule <i>proposta kalendariu fursionar husi kontratante</i>								
⁸⁰ Form of Bill of Quantities <i>Formulario lista husi kuantidade</i>	●	●	●		●	●	●	
Volume II <i>Volume II</i>								
Drawing <i>Dezennu</i>	●	●	●		●	●	●	
Calculation Sheet of Quantities (Only Type A) <i>Folla kalkulasau kuantidade (Tipu A deit)</i>		●	●			●		

Name of Project : <i>Naran Projetu :</i>	
Location : <i>Fatin:</i>	Date : / / (DD/MM/20YY) Data:
Name of Contractor: <i>Naran Kontraktor :</i>	Location: STA km - km (<i>Fatin</i>)
Name of Inspector: <i>Naran Inspektor:</i>	Name of Department <i>Naran Departementu</i>

< Drafting: Reference Only >

CL_03-20_Inspection for Paymet

7-2 Inspection for the works done
 7-2 *Inspeksaun ba obra ne'ebe realiza tiha ona*

1/3

(Interim / Final) Inspection
Inspeksaun (Interino / Final)

Flow of normal procedure for Inspection

Fluxo prosedimentu normal ba inspeksaun

I. Inspection for Documentation

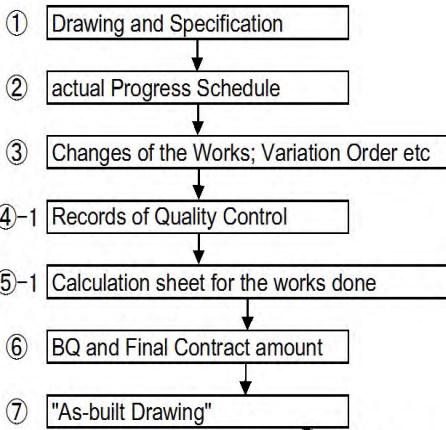

II. Inspection for the Quality and the measurement of the Works on the

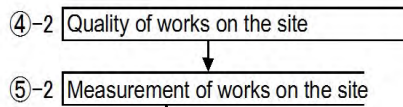

•Remarks

Observasaun

(Type of Inspection for Works and request checking points)

(Tipu inspeksaun ba obra no pedidu pontus verifikasaun)

1)Interim Inspection for the works done.

1) inspeksaun interinu ba obra ne'ebe finaliza ona

2)Final (Completion) Inspection

Inpeksaun final (acabamentu)

Type of Contract:

2/3
(CM_03-20)

Tipu kontratu

CHECKLIST for (Interim / Final) Inspection
Lista verifikasaun ba inspeksaun (interino/final)

Tender/Proposal, Design Built/only construction
Konkursu./proposta, Dezennu konstrusaun/konstrusaun deit

Name of Project: <i>Naran Projetu :</i>	
Location: <i>Fatin:</i>	Date: / / (DD/MM/20YY) <i>Data:</i>
Name of Contractor: <i>Naran Kontraktor :</i>	Location: STA km - km <i>(Fatin)</i>
Name of Inspector: <i>Naran Inspektor:</i>	Name of Department <i>Naran Departementu</i>

SPC= Standard Specification of MPWTC–Nov2014 Edition
Padraun spesifikasaun husi MOP–Edisaun Nov2014

No.	Check Items <i>Verifika Itens</i>	Judgements <i>Julgamentu</i>		Specification <i>Spesifikasaun</i>		Remaks <i>Observasaun</i> (Printed figure is reference only) <i>(Figura ne'ebe impressa hanesan referensia deit)</i>
		(Selection No.) <i>Seleciona no.</i>	Standards <i>Padraun</i>	SPC		
I	Inspection for Documentation <i>Inpeksaun ba dokumentus</i>					
①	Is Contract Drawing and Specification provided? <i>Dezennu no spesifikasaun husi kontrato fornese ka lae?</i>	Yes <i>Sim</i>	No <i>Lae</i>			
②	Is the actual Progress Schedule provided? <i>Calendariu ba progressu servisu atual ne'e fornese ka lae?</i>	Yes <i>Sim</i>	No <i>Lae</i>			
③	Is Variation Order(s), Claim(s) and other documents related the execution of the Works provided? <i>Pedidu variasaun, reklamasaun no dokumentus sira seluk ne'ebe relasiona ho ezekusaun obra nee forsesse tiha ona ka seidauk?</i>	Yes <i>Sim</i>	No <i>Lae</i>			
④	Is QC(Quality Control) records provided? <i>Rejistu ba kontrollu kualidade fornese ka lae?</i>	Yes <i>Sim</i>	No <i>Lae</i>			

CHECKLIST for (Interim / Final) Inspection

3/3

(CM_03-20)

Lista verifikasaun inspeksaun (interino / Final)

No.	Check Items <i>Verifika Itens</i>	Judgements <i>Julgamentu</i>		Specification <i>Spesifikasaun</i>		Remaks <i>Observasaun</i> (Printed figure is reference only) <i>(Figura ne'ebe impressa hanesan referensia deit)</i>
		(Selection No.) <i>Seleciona no.</i>	Standards <i>Padraun</i>	SPC		
⑤	Is the calculation sheet for the works done provided? <i>Folla kalkulasaun ba obra ne'ebe hotu ona ne'e fornese ka lae?</i>	Yes	No			
⑥	Is the BQ and Final Contract amount provided? <i>BQ no montante kontratu final fornese ka lae?</i>	Yes	No			
⑦	Is the "As-built Drawing" provided? <i>"As build Drawing" fornese ka lae?</i>	Yes	No			
II	Inspection for the Quality and the measurement of the Works on the Site <i>Inpeksaun ba qualidade no medisaun ba obra iha terrenu</i>					
①	Is the Quality of the works on site satisfactory? (is the site condition as same as QC records?) <i>Qualidade obra iha terrenu ne'e satisfatorio ka lae?(Kondisaun errenu nian hanesan ho registo kontrollu qualidade ka lae?)</i>	Yes	No			
②	Is the site condition as same as the calculation sheet for the works done? <i>Kondisaun iha terrenu hanesan ho folla kalkulasaun ba obra ne'ebe remata ona ka lae?</i>	Yes	No			
III.	Evaluation of the Inspection <i>Evaluasaun ba inspeksaun</i>	Yes	No			
If "YES", PLS wrote next procedure Or If "No" PLS wrote outstanding issue. <i>se "Los" favor hakerek prosedimento tuir mai ka se "Lae" favor hakerek problema pendente ne'e.</i>						
1)						
2)						
3)						
IV.	Note, Remark and/or Comment <i>Notas, Obervasaun no/ ka komentariu</i>					

< Drafting: Reference Only >

CL_DRW-1

7-3 Drawing
Dezennu

Contract/Shop/Reference Drawing

Edited_20181005

CHECKLIST for Drawing
Lista verifikasaun ba dezennu

1/3
(CM_03-30)

Type of Contract:
Tipu kontratu :

Tender/Proposal, Design Built/only construction

Name of Project: <i>Naran Projetu :</i>	
Location: <i>Fatin:</i>	Date: / / (DD/MM/20YY) Data:
Name of Contractor: <i>Naran Kontraktor :</i>	Location: STA km - km <i>(Fatin)</i>
Name of Inspector: <i>Naran Inspektor:</i>	Name of Department <i>Naran Departementu</i>

SPC= Standard Specification of MPWTC–Nov2014 Edition
Padraun spesifikasaun husi MOP–Edisaun Nov2014

No.	Check Items <i>Verifika Itens</i>	Judgements <i>Julgamentu</i>		Specification <i>Spesifikasaun</i>		Remaks <i>Observasaun</i> (Printed figure is reference only) <i>(Figura ne'ebe impressa hanesan referensia deit)</i>
		(Selection No.) <i>Seleciona no.</i>	Standards <i>Padraun</i>	Standards <i>Padraun</i>	SPC	
I	Type of Drawing <i>Tipu dezennu</i>					
①	Which kind of Drawing among following type? <i>Tipu dezennu ida ne'ebe mak tuir tipu hirak ne'e?</i>	—	—			
1)	Contract Drawing <i>Dezennu kontratu</i>					1); approved by Engineer for prosed drawing <i>1); Aprova husi Enjinerru ba dezennu proposta</i>
2)	Shop Drawing <i>Gambar kerja</i>					2); prepared by the Contractor <i>2); Prepara husi kontratante</i>
3)	Reference Drawing <i>Dezennu referensia</i>					3); for work done measurement at the Inspection <i>3);ba obra ne'ebe hotu ona bele sukat durante halo inspeksaun</i>
4)	Other Drawing; <i>dezennu sira seluk</i>					4)for; <i>4)ba;</i>
5)	As-Built Drawing; <i>Dezennu hanesan ho kontruido</i>					5);
②	When drawing is checked ? (What pourpse ?) <i>wainhira mak verifika dezennu? (nia propozito saida?)</i>	—	—			< Checking points on the Drawing > < <i>Pontus verifikasaun iha dezennu</i> >
1)	Tender stage or the time of making Contract <i>Etapa konkursu ka tempu halo kontratu</i>					1);
2)	Daily (regularly) Quality Control <i>Kontrollu Kualidade Diaria (regularmente)</i>					2);

2/3						
No.	Check Items <i>Verifika Itens</i>	Judgements <i>Julgamentu</i>		Specification <i>Spesifikasaun</i>		Remaks <i>Observasaun</i> (Printed figure is reference only) (<i>Figura ne'ebe impressa hanesan referensia deit</i>)
		(Selection No.) <i>Seleciona no.</i>		Standards <i>Padraun</i>	SPC	
3)	Cerfining the works done for Payment (time of Inspection) <i>sertifika obra ne'ebe hotu ona ba pagamentu (Tempu inspeksaun)</i>					3);
4)	Other occasion <i>Okaziaun sira seluk</i>					4);
II	Requirement for the Drawing <i>Rekerementu ba dezennu</i>					
③	Are the identities of Drawing shown on the Drawing ? <i>Indentidade dezennu nia hatudu ona iha dezennu ka?</i>	—	—			
1)	Name of Project and Drawing <i>Obra nia naran no dezennu</i>	Yes <i>Sim</i>	No <i>Lae</i>			
2)	Name of Drawing and providing <i>Naran dezennu nia ne'ebe fornese</i>	Yes <i>Sim</i>	No <i>Lae</i>			
3)	Name of approved and/or certified <i>Naran kona ba aprovasaun no/ka certifika tiha ona</i>	Yes <i>Sim</i>	No <i>Lae</i>			
4)	Date of drawing and/or approval <i>Data dezennu niana no/ka aprovasaun</i>	Yes <i>Sim</i>	No <i>Lae</i>			
④	Is the location of each work item described on the Drawing? <i>fatin ba kada obra sira ne'e deskreve ona iha dezennu ka?</i>	Yes <i>Sim</i>	No <i>Lae</i>			
⑤	Is dimension of the structure drawn? <i>estrutur nina dimensaun ne'e dezenna ka lae?</i>	Yes <i>Sim</i>	No <i>Lae</i>			
⑥	Are number or detailed shape of structure shown? <i>Numeru no estrutura sira nia forma ne'ebe detalladu sira hatudu ka lae?</i>	Yes <i>Sim</i>	No <i>Lae</i>			
⑦	Are Note or Specification of the works described ? <i>Nota ka obra sira nia spesifikasaun sira ne'e deskreve ka lae?</i>	Yes <i>Sim</i>	No <i>Lae</i>			
⑧	Does corresponde to the BQ(work item) on Quality? <i>Halo korespondensia ba BQ (item servisu) kona ba kualidade nian ka lae?</i>	Yes <i>Sim</i>	No <i>Lae</i>			
⑨	Does corresponde to the BQ(work item) on Quantity? <i>Halo korespondensia ba BQ (item servisu) kona ba kuantidade nian ka lae?</i>	Yes <i>Sim</i>	No <i>Lae</i>			

CHECKLIST for Drawing

3/3 (CM_03-30)

Lista verifikasaun ba dezennu

< Examples of the requirement

< *Ezemplu kona ba rekezitus*

- ④ Is the location of each work item described on the Drawing?

fatin ba kada item servisu ne'e descreve ona iha dezennu ka?

Indicating work items (such as "concrete Lining Dich" 350 × 350 L=86.60m) on the Plan Drawing

Indika item servisu (hanesan "concrete lining ditch" 350x350L=86.60m) iha planu dezennu nian.

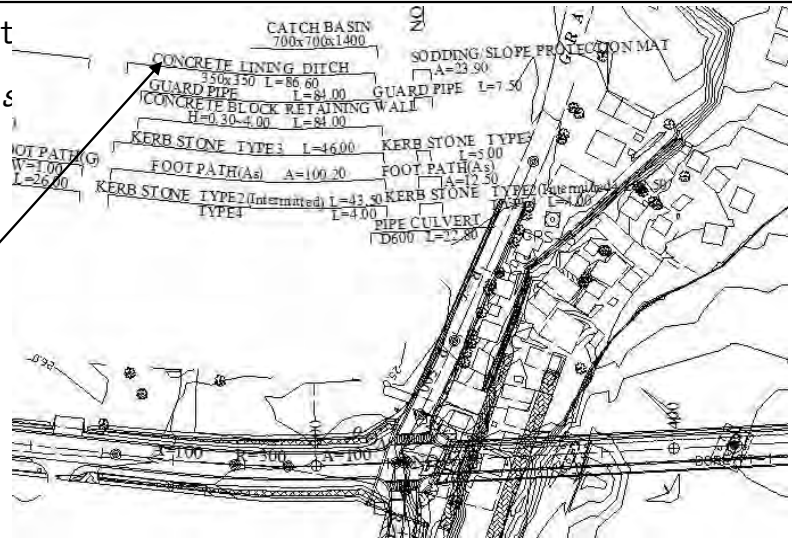

PROJECT NAME:	
THE PROJECT FOR CONSTRUCTION OF UPRIVER COMORO BRIDGE	
DRAWING TITLE:	
PLAN AND PROFILE (1)	
DATE: March 2016	DRAWING No.:
PREPARED BY: <i>[Signature]</i>	CB-R-001
CHECKED BY: <i>[Signature]</i>	

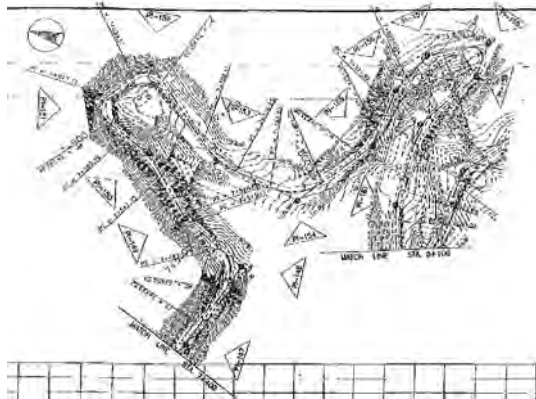

This Plan Drawing does not describe any location of the structure (works) only for the proposed center line of rehabilitaing Road and showing Sation *Planu dezennu ida ne'e la descreve fatin strutura (obra) deit ba proposta linna sentral ba rehabilitasaun estrada no hatudu numeru stasaun .*

PROJECT & LOCALIZACAO	DESENHO TITULO	OWS. NO.
EMERGENCY WORKS OF HUMBOE - LETEFOHO ROADS JCT. A04 GLENO - JCT. A10 LETEFOHO HUMBOE - LETEFOHO (6+700 - 26+000km)	PLAN & PROFILE	GL-PP-12 GL 37
MUNICIPIO ERNEIRA - JIMOR LESTE	ESCALA: 1:200 DATA: 2015	A3

⑤ Is dimension of the structure drawn?

Dimensaun ba estrutura sira dezennada ka lae?

Dimensions of thickness of each layer of Road and wides should be indicated on the Cross Section Drawing of a proposed road as like right

Dimensaun mahar ba kada dalas estrada nian no largura tenki indika iha dezennu seksaun transversal ne'ebe propoin iha estrada hanesan iha sorin ne'e.

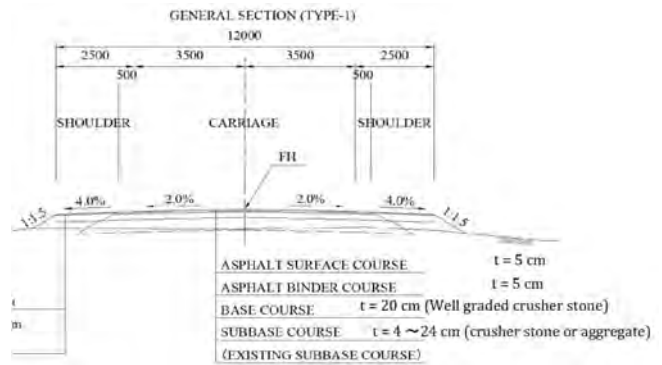

Even on the detailed cross section of the road, there is no description of the thickness of Base Courses and Sub-base Course

Maske iha detallu seksaun transversal estrada nin, iha ne'eba laiha deskrisaun kona ba mahar base course no sub base course

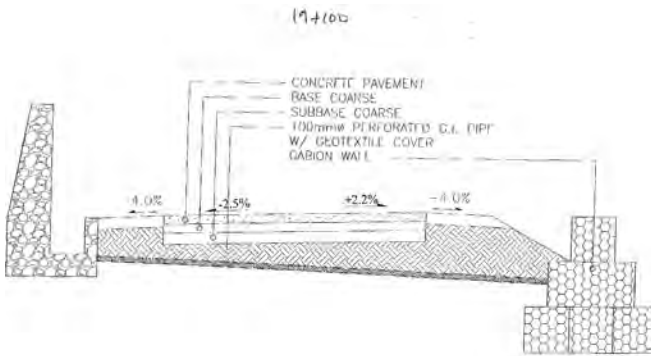

PROJECT & LOCALIZACAO	DESENHO TITULO	DWG. NO.
EMERGENCY WORKS OF HUMBOE - LETEFCHO ROADS JCT. A04 GLENO - JCT. A10 LETEFCHO HUMBOE - LETEFCHO (6+700 - 76+000Km)	CROSS SECTION	XS-11 GL 235
MUNICIPIO ERMAERA - TIMOR LESTE	ESCALA: 1:200	DATA: 2018 A3

References:

Quality Control Plan

Quality Control Plan

NO	Material	Control Item	Control Method	Standard range		Frequency	Submit DOC	Inspection	
				Criteria	採用元/Adoption				
1	Cement	Portland Cement	AASHTO M 85 (ASTM C 150)		SPC 506.2.1 (SPC 901.1)	Each delivery time	Factory test result	Check of D. O. C.	
		Grading		Table 412.1	SPC 506.2.2 (SPC 412.2.2)		Test Result	By the Engineer	
	Fine Aggregate	Sieve analysis	AASHTO T 27			SPC506.3.1		Test result	By the Engineer
		Specific Gravity and absorption	AASHTO T 84			SPC506.3.1		Test result	By the Engineer
	Coarse Aggregate	Grading			Table 412.2, Table 506.1	SPC 506.2.3 (SPC 412.2.3)		Test Result	By the Engineer
		Sieve analysis	AASHTO T 27			SPC506.3.1		Test result	By the Engineer
Water	Specific Gravity and absorption	AASHTO T 84		Table 915.1	SPC 506.2.4 (SPC 915.2)		Test result	By the Engineer	
Mixture			AASHTO M 154 AASHTO M 194		SPC 506.2.6 (SPC 412.2.7)		Factory test result	By the Engineer	
			AASHTO T 119	Table 506.2	SPC 506.4.1 SPC 506.3.1		Test result	By the Engineer	
2	Fresh Concrete	Air content	AASHTO T 121	N/A	SPC 506.3.1		Test result	By the Engineer	
		Temperature for concrete		30°C, Delivery time less than 1 hour	SPC 506.4.4.5				
		Delivery time		less than 1 hour	SPC 506.4.4.5				
		Chlorine ion content		N/A					
		Minimum Compressive Strength		Table 506.2		SPC 506.4.1			
		Sampling		3 concrete cylinder/1 sample (7 days and 28 days) 75m3/each class of concrete		SPC 506.3.1	each day	Test Result	By the Engineer
3	Reinforcing Steel	Evaluation		Statistical evaluation	SPC sub. 3.3.a SPC 506.3.3.h.3)		Factory test result	Check of D. O. C.	
		Grading	AASHTO M 31 AASHTO M 42		SPC 506.2.5 (SPC 911.1)	Each delivery time	Test Result	By the Engineer	
4	General Fill (Common Embankment)	Specific Gravity	AASHTO T 27	N/A					
		Water Content	AASHTO T 99	N/A					
		Liquid Limit	AASHTO T 88	N/A					
		Plasticity Index	AASHTO T 89	N/A					
		Four days soaked OBR	AASHTO T 193	N/A					
		Compaction (Maximum dry density)	AASHTO T 99	Max 95% (Layers 30cm or less below subgrade level) Max 100% (Layers more than 30cm below subgrade level)		SPC 205.2.1.b SPC 205.4.2.a SPC 205.4.2.b	every 1000m3 every 1000m3	Test Result	By the Engineer
4	General Fill (Selected Embankment)	Grading	AASHTO T 27	N/A					
		Specific Gravity	AASHTO T 99	N/A					
		Water Content	AASHTO T 90	N/A					
		Liquid Limit	AASHTO T 88	N/A					
		Plasticity Index	AASHTO T 89	N/A					
		Four days soaked OBR	AASHTO T 193	Max 95% (Layers 30cm or less below subgrade level) Max 100% (Layers more than 30cm below subgrade level)		SPC 205.2.2.b SPC 205.4.2.a SPC 205.4.2.b	every 1000m3 every 1000m3	Test Result	By the Engineer

Quality Control Plan

NO	Material	Control Item	Control Method	Standard range		Submit DOC	Inspection
				Criteria	採用元/Adoption		
5	Subgrade (Selected Borrow for Topping)	Grading	AAASHTO T 27	N/A			
		Specific Gravity	AAASHTO T 99	N/A			
		Water Content	AAASHTO T 90	N/A			
		Liquid Limit	AAASHTO T 88	N/A			
		Plasticity Index	AAASHTO T 89	N/A			
6	Sub Base course	Four days soaked CBR	AAASHTO T 193	≥ 10%	SPC 206.3.5 (SPC. 205. 2. 2b)	Test Result	By the Engineer
		Compaction (Maximum dry density)	AAASHTO T 99	Max 95%	SPC 206.3.5 (SPC. 205. 3. 3)		
		Proof Rolling	Visual check	N/A			
		In-situ CBR	Visual check	N/A			
		Grading	Table 301.1				
7	Base course	Liquid Limit	AAASHTO T 89	Max. 35%	SPC 301.2		
		Plasticity Index	AAASHTO T 90	Min. 12			
		Los Angeles Test	AAASHTO T 96	Max. 50%			
		Four days soaked CBR	AAASHTO T 193	Min. 25%			
		Compaction (Maximum dry density)	AAASHTO T 180, 191	≤ 100%	SPC 301.3.3	Test Result	By the Engineer
8	Stone Masonry Drainage Stone Masonry Retaining Wall	Modified CBR value at 95% Compaction Density (%)	AAASHTO T 193	N/A			
		Proof Rolling	Visual check	N/A			
		In-situ CBR	Visual check	N/A			
		Grading	Table 303.1				
		Liquid Limit	AAASHTO T 89	CLASS A : 0-25% CLASS B : 0-35%			
9	Stone Masonry Railing Culvert	Plasticity Index	AAASHTO T 90	CLASS A : Max. 25% CLASS B : _	every 1000m3 (SPC 303.4. c)	Test Result	By the Engineer
		Soft Fragments	AAASHTO T 112	CLASS A : 0-5% CLASS B : 0-5%			
		Four days soaked CBR	AAASHTO T 193	CLASS A : Min. 90% CLASS B : Min. 60%			
		Compaction (Maximum dry density)	AAASHTO T 180, 191	≤ 100%	SPC 303.3.3	As directed by the Engineer (SPC 303.4. c)	
		Modified CBR value at 98% Compaction Density (%)	AAASHTO T 193	N/A	every 1000m3 (SPC 303.4. c)		
10	Stone Masonry Railing	Stone material		150mm ≤ Stone thickness < 225mm	SPC 606.2.1		By the Engineer
		Cement mortar composed		Cement 1 : Sand 3	SPC 606.2.2		
		Stone material		150mm ≤ Stone thickness < 225mm	SPC 606.2.1		By the Engineer
		Cement mortar composed		Cement 1 : Sand 3	SPC 606.2.2		
		Stone material		150mm ≤ Stone thickness < 225mm	SPC 606.2.1		By the Engineer
11	Materials for Backfilling of Pipe Culvert	Cement mortar composed		Cement 1 : Sand 3	SPC 606.2.2		By the Engineer
		Four days soaked CBR	AAASHTO T 193	≥ 10%	SPC 601.3.6 (SPC. 205. 2. 2b)	every 1000m3 (SPC 205. 4. 1)	By the Engineer
		Compaction (Maximum dry density)	AAASHTO T 99	Max 95%	SPC 601.3.6 (SPC. 205. 3. 3)	every 1000m3 (SPC 205. 4. 2. c)	



Democratic Republic of Timor-Leste

Ministry of Public Works

Directorate General of Public Works

National Directorate of Roads, Bridges and Flood Control

Bridge Substructure Protection Guidelines

Guia de Proteção da Subestrutura de Ponte

Copyright notice

While the reproduction of this DNEPCC document in any form for use by staff involved in the CDRS Project or R4D-SP is permitted without prior permission from the DNEPCC, neither this document nor any extract from it may be reproduced, stored or transmitted in any form for any other purpose without prior written permission from the DNEPCC. Photocopies of the whole, or parts of this document may be made by academic institutions for students.

Requests for permission to reproduce this document for the purpose of selling it should be addressed to the following institution:

Ministério das Obras Públicas

Direcção Geral das Obras Públicas

Direcção Nacional de Estradas, Pontes e Controlo de Cheias (DNEPCC)

Address: Avenida da Restauração, Rai Kotu, Comoro, Dili, Timor-Leste

Telephone: +670 3311408

Disclaimer:

Although every effort has been made to ensure the accuracy and applicability of the information contained within this document, the authors cannot accept any liability or legal responsibility for any errors, for any omissions or for any other reason whatsoever.

Contents

Foreword	v
Foreword by JICA.....	vi
Acknowledgements.....	vii
Introduction.....	viii
1 Scope	1
2 Normative references.....	1
3 Terms and definitions	1
4 Characteristics of rivers in Timor-Leste.....	2
5 Condition of bridge substructures in Timor-Leste.....	2
6 Hydraulic phenomenon around bridge piers	5
7 Scour depth of bridge substructures.....	7
7.1 Scour depth around bridge piers	7
7.1.1 Procedure for estimating scour depth.....	7
7.2 Scour depth around abutments	8
7.3 Determination of scour hole width.....	8
7.4 Calculation example-1.....	12
8 Protection of bridge substructures.....	13
8.1 Types of foot protection blocks	14
8.2 Verification of dynamic stability of foot protection blocks.....	15
8.2.1 Basic policy	15
8.3 Calculation of weight of foot protection blocks.....	18
8.4 Calculation example-2	20
8.4.1 Average velocity	21
8.4.2 Determination of water level	22
8.5 Installation width of foot protection blocks.....	23
Annex A (informative) Case study of Sahen Bridge	24
A.1 Introduction	24
A.2 Remedial measures	25
A.3 Training materials.....	27
Annex B (informative) Training materials.....	32
B.1 Rational method	33
B.2 Protection method for scouring	37
B.3 Big sandbags	41
B.4 Groin method.....	44
B.5 Bridge substructure protection	49
Bibliography	54

(page intentionally left blank)



REPÚBLICA DEMOCRÁTICA DE TIMOR-LESTE
MINISTÉRIO DAS OBRAS PÚBLICAS
GABINETE DO VICE MINISTRO
Av. Nicolau Lobato, Mandarin, Dili, Timor-Leste

Foreword

In the interest of constructing high quality and economically viable government infrastructure to serve the nation, these guidelines for optimal design of bridge substructure protection components were prepared by the JICA Project for Capacity Development of Road Services in the Democratic Republic of Timor-Leste (CDRS) in collaboration with the *Direcção Nacional de Estradas, Pontes e Controlo de Cheias* (DNEPCC, 'National Directorate of Roads, Bridges and Flood Control') of the *Ministério das Obras Públicas* ('Ministry of Public Works'). We would like to thank JICA for their continuing support.

September, 2019

A handwritten signature in blue ink, consisting of several overlapping loops and lines, positioned above the printed name and title.

Eng. Nicolau Lino Freitas Belo
Vice Minister for Public Works
Ministry of Public Works

19-09-2019

Foreword by JICA

Japan International Cooperation Agency (JICA) has been conducting a technical cooperation project for development of capacity regarding road services, which is called as CDRS, in order to facilitate the DNEPCC in properly managing and maintaining the road infrastructure that is the basis of social and economic activities. To this end, JICA has been dispatching a team of experts from March 2016 to December 2019. As a result of collaborative works with counterparts of the DNEPCC, these guidelines for design of bridge substructure protection have been finalized. I hope that these guidelines will contribute to infrastructure development and maintenance and to the enhancement of friendly relations between our two countries.

Finally, I wish to express my sincere appreciation to the officials of the Government of the Democratic Republic of Timor-Leste for their close cooperation with the expert team.

September, 2019



Masafumi NAGAISHI
Chief Representative of JICA Timor-Leste Office
Japan International Cooperation Agency



Acknowledgements

The Project for Capacity Development of Road Services in the Democratic Republic of Timor-Leste wishes to thank all parties involved in preparing and revising these Bridge Substructure Protection guidelines.

In support of the project, the officials of the (former) Ministry of Development and Institutional Reform: M. R. M. Cruz, J. L. C. C. P. Mestre and J. Santos; and the officials of the Ministry of Public Works: C. M. Henrique and especially R. H. F. Guterres; are hereby acknowledged.

In contributing to the preparation of this document, the officials of the DNEPCC: M. R. C. Monteiro, J. P. Amaral, J. M. G. Sousa, J. G. Carvalho, I. M. L. Gutteres, N. Lobato, L. R. H. Corbafo, A. Araujo, J. L. Kehy and C. C. Monteiro; and the International Labour Organization's (ILO) technical assistance team of the Roads for Development Support Program (R4D-SP): A. O. Asare, K. H. Myaing and S. Done; are hereby acknowledged.

Feedback:

Any positive feedback for possible incorporation into future editions would be appreciated. Please send such comments or feedback to the below address.

Direcção Nacional de Estradas, Pontes e Controlo de Cheias (DNEPCC)
Address: Avenida da Restauração, Rai Kotu, Comoro, Dili, Timor-Leste
Telephone: +670 3311408

Introduction

The substructures of many river bridges in Timor-Leste do not have scour protection works installed. As a result, these bridges are easily damaged during floods and there is caving and settlement damage at the bottoms of abutments and piers.

If appropriate countermeasures are not applied to these bridges, there is risk of large scale damage such as overall bridge settlement or collapse.

From the aspect of operation and maintenance, repaired substructure is not sufficient.

As a result, substructures are repeatedly damaged by frequent flooding and become the level requiring total re-construction.

In response to this situation, these design guidelines describes the designs necessary for countermeasures to protect substructure from flood scour, based on engineering know-how.

These design guidelines primarily is prepared according to Japanese technical standards for countermeasures to protect bridge substructures from flood scour.

Sophisticated runoff simulations or require expensive materials for these countermeasures, like sheet piles or steel pipe piles, were exclude of these design guidelines with regard to the difficulty of implementing them by local contractures due to cost and technical level of manpower restraints.

It is expected that these design guidelines useful for flood countermeasures and help to reduce flood scour damage to bridge substructures in Timor-Leste.

Bridge Substructure Protection Guidelines

1 Scope

This document specifies minimum requirements and design methods for bridge substructure protection in Timor-Leste.

2 Normative references

There are no normative references in this document.

3 Terms and definitions

For the purposes of this document, the following terms and definitions apply.

ISO maintains terminological databases for use in standardization at the following addresses:

— ISO Online browsing platform: available at <https://www.iso.org/obp>

3.1

Scour

Removal of underwater sand and stone material by river flow, especially at the base or toe of a structure

[SOURCE: ISO 21650:2007, 2.60]

3.2

Scour protection

Materials to place on the riverbed to prevent scour from developing around the foundation where the foundation penetrates into the riverbed

[SOURCE: ISO 29400:2015(en), 3.124]

3.3

Settlement

Permanent downward movement of a structure as a result of its own weight and other actions

[SOURCE: ISO 19901-8:2014(en), 3.34]



Figure 1 — River map of Timor-Leste

4 Characteristics of rivers in Timor-Leste

The sources of many of the rivers in Timor-Leste are in the mountains, at an altitude of 1000 m to 2000 m; they tend to flow sharply down from the steep mountains through low-altitude plains and then out into the ocean. The average annual rainfall in the northern region is approximately 1000 mm to 2000 mm and in the southern region it is 1500 mm to 2000 mm. Similar to rivers in Japan, these rivers have characteristics that cause flash floods to easily occur.

As Timor-Leste is an island country, the length of their rivers is short and share many natural characteristics with rivers in Japan, allowing the related river standards that have been established in Japan to be easily applied to Timor-Leste.

5 Condition of bridge substructures in Timor-Leste

The following figures show the scouring damage of Sahen Bridge's right bank abutment and pier. Due to scouring damage, the piles of the abutment are exposed and the caving of the footings can be seen on the bridge piers.

Figure 4 and Figure 5 show the scouring damage of Mora Bridge's pier. Due to scouring damage, the caving of the footings can be seen.

If appropriate countermeasures are not applied out and scouring is allowed to progress into the long term, overall bridge settlement damage (as can be seen in the figures 6, 7) is likely to occur.



Figure 2 — Sahen Bridge abutment 2017



Figure 3 — Sahen Bridge pier 2017



Figure 4 — Mora Bridge pier 2011



Figure 5 — Mora Bridge Pier 2011



Figure 6 — Bridge settlement damage due to bridge pier scouring (Japan example)



Figure 7 — Bridge settlement damage due to bridge pier scouring (Japan example)

6 Hydraulic phenomenon around bridge piers

Figure 8 shows the hydraulic phenomenon that occurs around bridge piers during flood. Bridge piers located in a river cause complex vortices and waves that disturb the flow and water surface during flood; as a result, an increase in water level and riverbed scouring occur.

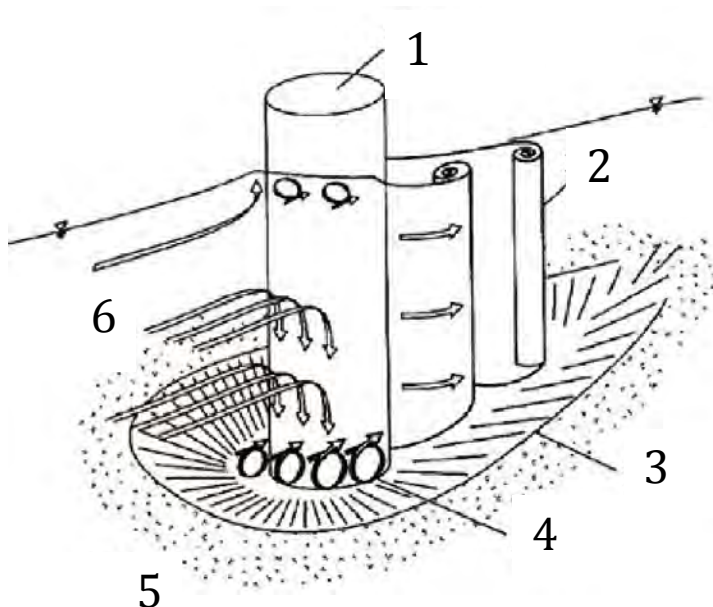

Key

- 1 bridge pier
- 2 Karman's vortex
- 3 scour hole
- 4 horseshoe vortex
- 5 riverbed
- 6 flow

Figure 8 - Hydraulic phenomenon around bridge piers

Figure 9 shows the actual phenomenon around a bridge pier during floods. The occurrence of complex flow around the bridge pier is apparent.



Figure 9 — Hydraulic phenomenon around bridge piers (Japan example)

The following figures (Figures 10 and Figure 11) show the state of scour on a bridge pier after a flood in Japan. The flood caused a scour hole to form around the bridge pier.



Figure 10 — Actual phenomenon of pier (Japan example)



Figure 11 — Actual phenomenon of pier (Japan example)

7 Scour depth of bridge substructures

7.1 Scour depth around bridge piers

While it is ideal to use the results of runoff simulations and hydraulic model simulations to determine the local scouring depth around a bridge substructure, due to the need for advanced technology, experience, and experimental facilities, these methods are not always possible. These guidelines use an estimation formula, Formula (1), for scour depth, which does not require the aforementioned resources and is also utilized in Japan.

$$\frac{Z}{D} = f \cdot \left(\frac{h_0}{D} \cdot \frac{h_0}{d_m} \cdot Fr \right) \quad (1)$$

where

h_0 is the average water depth;

D is the diameter of bridge pier;

d_m is the average grain diameter of riverbed material;

Fr is the Froude number; $\frac{V_m}{\sqrt{gh_0}}$

V_m is the average velocity.

Z is the scour depth.

7.1.1 Procedure for estimating scour depth

The average water depth h_0 is calculated through a method of hydraulic analysis method utilizing either the uniform flow calculation or the non-uniform calculation.

Step 1

Calculate the dimensionless scour depth Z/D using the target location's average water depth h_0 , the diameter of bridge pier D , average grain diameter of riverbed material d_m , and Froude number Fr , in accordance with Figure 14.

Step 2

The resulting Z/D should be corrected for changes in flow direction due to flooding or nearby bridge piers. After these corrections, the depth of scour hole around a bridge pier can be calculated.

7.2 Scour depth around abutments

The depth of scouring around abutments doesn't have a clear calculation method that is used, even in Japan. Therefore, it is recommended to estimate and determine the scour depth around abutments based on the results of past field investigations of the abutment or nearby abutments.

Additionally, many of the bridges in Timor-Leste have short lengths for the footings depth of their abutments, so when new bridges are being planned, it is necessary to conduct the field investigations mentioned above and ensure sufficient lengths for footing depth.

7.3 Determination of scour hole width

The scour hole width is calculated in Japan formula by imputing the maximum scour depth Z and the average underwater angle of repose θ and the maximum scour depth from Figure 12 into Formula (2):

$$R = Z / \tan \theta \tag{2}$$

where

- R is the scour hole width;
- Z is the maximum scour depth;
- θ is the average underwater angle of repose;

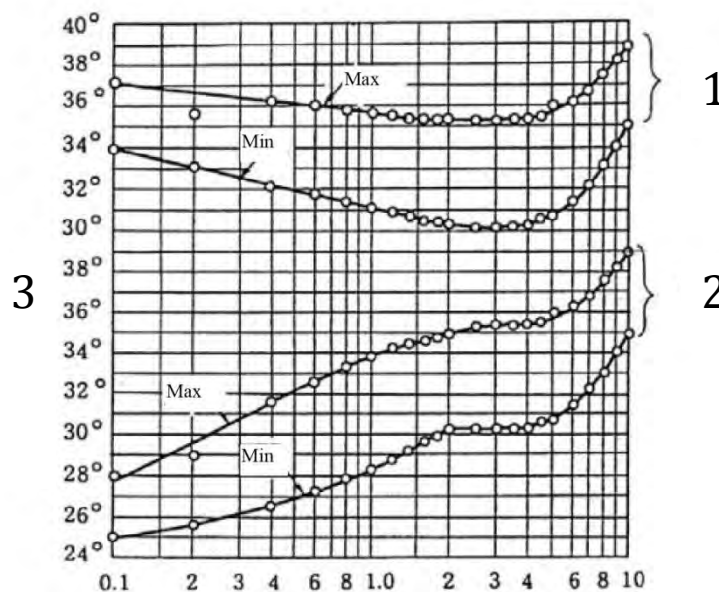

Key

- 1 in air
- 2 underwater
- 3 angle of repose θ
- 4 diameter of river bed material

Figure 12 — Relationship between angle of repose θ and average grain angle

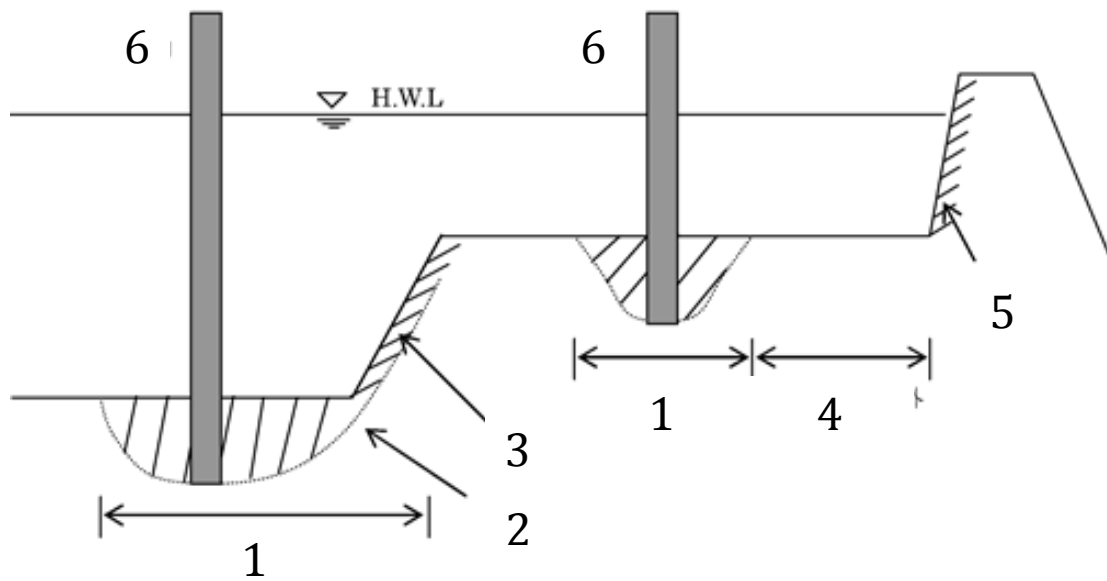
**Key**

- 1 scour hole width
- 2 bank erosion from scouring
- 3 erosion from increased flow velocity
- 4 outside of scour area
- 5 bank erosion from scouring
- 6 pier

Figure 13 — Image of scouring around bridge piers

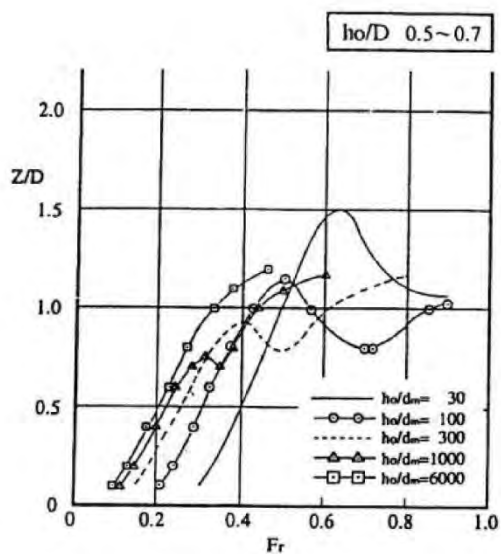

Relationship between Fr~Z/D and h_0/d_m
($h_0/D=0.5$ to 0.7)

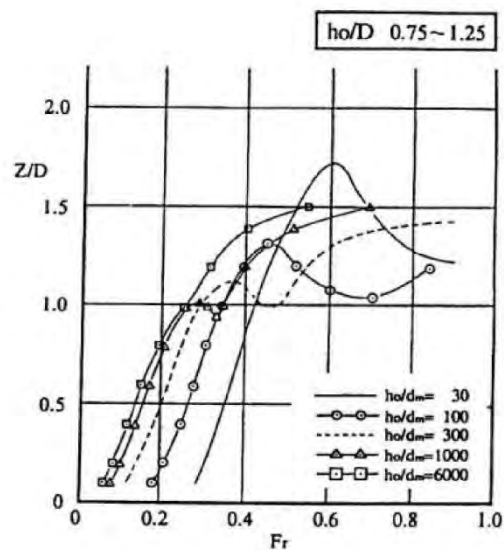

Relationship between Fr~Z/D and h_0/d_m
($h_0/D=0.75$ to 1.25)

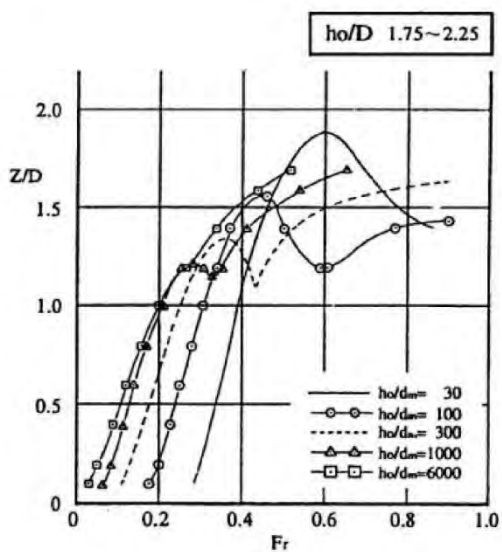

Relationship between Fr~Z/D and h_0/d_m
($h_0/D=1.75$ to 2.25)

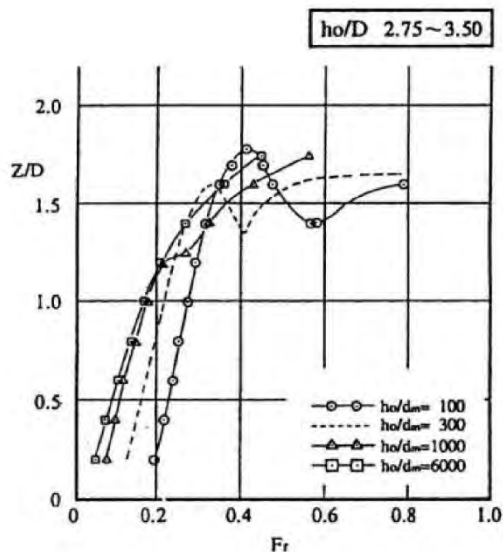

Relationship between Fr~Z/D and h_0/d_m
($h_0/D=2.75$ to 3.50)

Figure 14 — Relationship between Fr~Z/D and h_0/dm

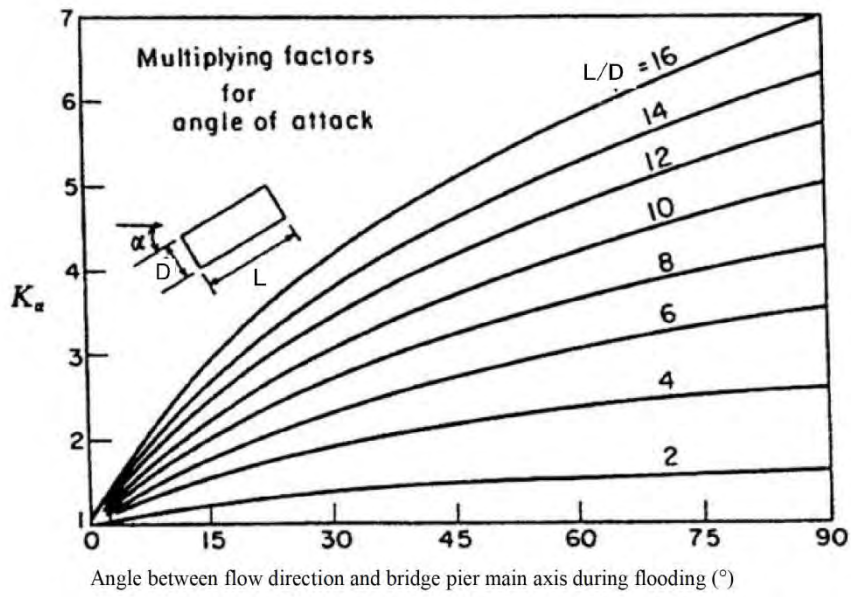

Figure 15 — Correction factor K_α for angle of attack

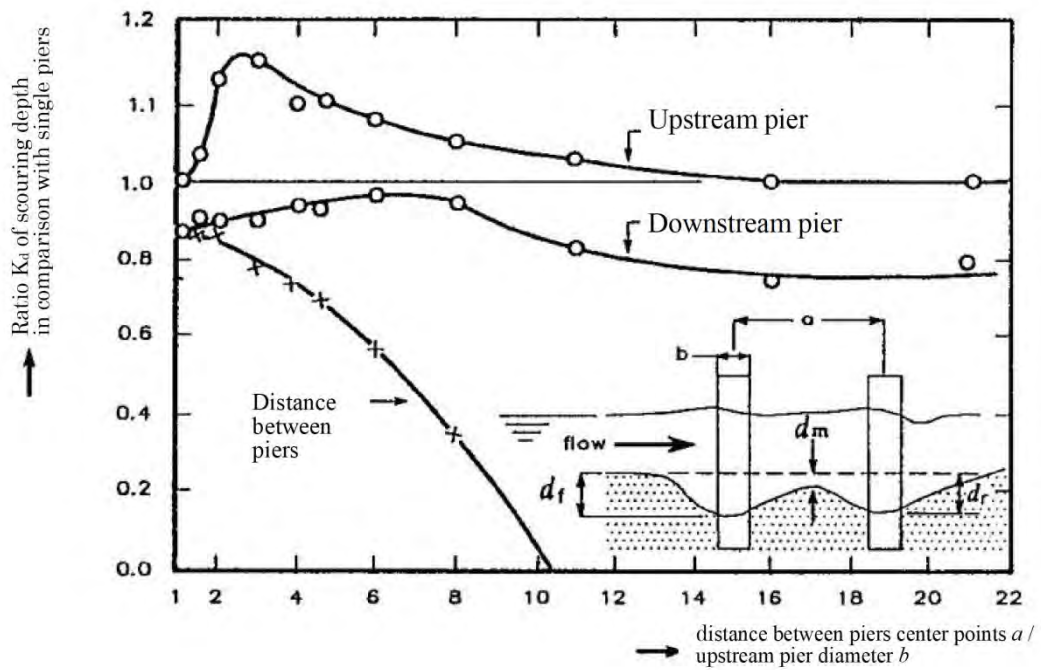

Figure 16 — Correction factor K_d for nearby piers

7.4 Calculation example-1

Examples are shown below

※ Calculation Condition:

Using Formula (1):

$$\frac{Z}{D} = f \cdot \left(\frac{h_0}{D} \cdot \frac{h_0}{d_m} \cdot Fr \right)$$

Here

- h_0 5.83m is the average water depth;
- D 2.0 m is the diameter of bridge pier;
- d_m 24.9 mm is the average grain diameter of riverbed material;
- Fr 0.54 is the Froude number;
- Z is the scour depth.

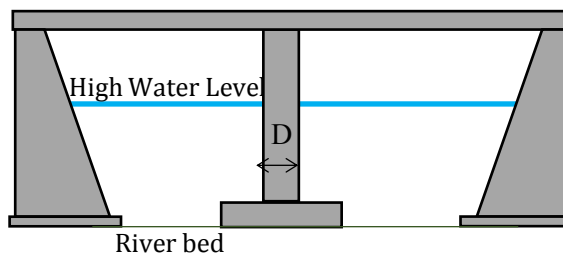

Figure 17 — Cross section

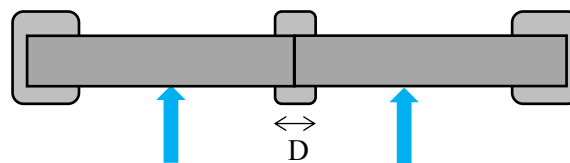

Figure 18 — Plan

To determine the average water depth, the high water level and the design riverbed are used:

High Water Level: 24.80m

Design riverbed; 18.97m

h_0 : Average water depth; 24.80-18.97= **5.83 m**

Now Z can be calculated as follows:

$$h_0/D = 5.83/2.0 = 2.915$$

$$h_0/d_m = 5.83/0.0249 = 234.1$$

$$Z/D = 1.5 \text{ (refer to Figure 19)}$$

Pier axis is parallel with river flow direction and there are not proximal bridges around the original bridge.

Therefore, correction factors $K\alpha = 1.0$ and $Kd = 1.0$ are adopted

$$\text{Scour depth } Z = (Z/D) \cdot D \cdot K\alpha \cdot Kd$$

$$= 1.52 \cdot 2.0 \cdot 1.0 \cdot 1.0 = \mathbf{3.0 \text{ m}}$$

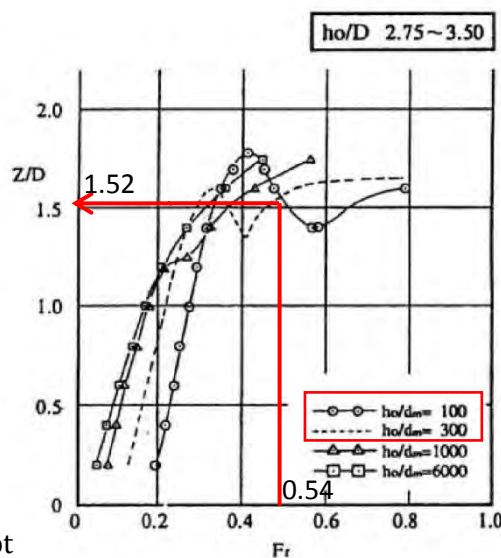

Relationship between Fr~Z/D and h_0/d_m

($h_0/D = 2.75$ to 3.50)

Figure 19 — Relationship between Fr~Z/D

8 Protection of bridge substructures

In Timor-Leste, protection works as countermeasures for scouring are not installed on many bridge abutments and piers, many of which are confirmed to have scouring damage. Therefore, it is recommended to implement countermeasures for scouring on abutments and piers.

There are two types of protection work: gabion and foot protection block. However, due to issues with the durability (due to deterioration, etc.) of the metal wire used for gabion, it is recommended that Timor-Leste take the same approach as Japan and use foot protection blocks.



Figure 20 — Gabion damaged situation Mora 2011



Figure 21 — Foot protection blocks in Japan



Figure 22 — Foot protection blocks in Japan

8.1 Types of foot protection blocks

Foot protection blocks are commonly used for bridges substructure protection in Japan. (As previously noted, rivers in Timor-Leste have many natural characteristics in common with those in Japan.) Therefore, there is an abundance of actual experience and data from hydraulic model experiment using foot protection blocks. The characteristic values of foot protection blocks differ according to their shape.

Table 1 — Types of foot protection blocks in Japan



8.2 Verification of dynamic stability of foot protection blocks

8.2.1 Basic policy

Foot protection work is required adequate weight to ensure stability against the hydrodynamic forces, width and height from estimated scouring.

1. Function

Foot protection work mitigates river scouring. It is directly exposed to the water flow. Therefore, it is necessary for the foot protection works to be stable against the water flow. This can be verified based on the fracture morphology from the same structural model as the slope protective works.

2. Damage Pattern

When the depth of embedment of the foundation is shallow and the foot protection works do not have enough width, the increased flow during floods will result in damage to the slope protective works. Additionally, if the foot protection work is not heavy enough for flow velocity, it will be washed away and cause damage to the entire revetment. Therefore to check for the necessary width of foot protection works, the same structural model as the slope protective works can be used to study the dynamic stability.

The same as the slope protective works, the damage pattern (rolling, sliding and traction) of the foot protection works is based on its shape and arrangement for this reason, the shape and arrangement are also reflected in the verification.

(1) Sliding

When the hydrodynamic force acting upon the component is greater than the friction on its bottom side, sliding occurs. This is taken into consideration for parts of foot protection work the furthest upstream, parts that stick out due to river fluctuations, or large irregular concrete blocks that receive flow force in their entirety. For example, this failure pattern can be seen in parts of the furthest upstream section of layered stacking type and random stacking type foot protection works.

(2) Rolling

This is when hydrodynamic force causes a component to turn over on a pivot point and roll. This damage pattern can be seen, for example, in parts of the furthest upstream section of layered stacking type and random stacking type foot protection works.

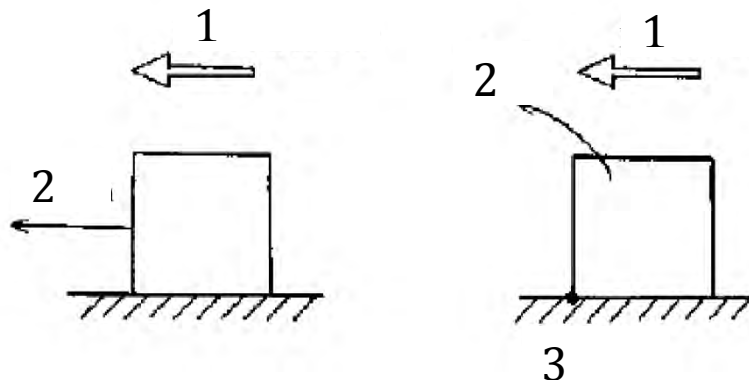

Key

- 1 direction of flow
- 2 motion
- 3 pivot point

Figure 23 — Sliding and Rolling

(3) Traction

The components receive drag and lift force from the directly of the flow and either repeatedly roll or experience some saltation in close proximity of the riverbed. This model is used for foot protection works with elements that are laid flat, such as natural stones or smooth, regular concrete blocks that are arranged in an orderly fashion.

For example, this can be seen in the damage of foot protection works using riprap or gabion.

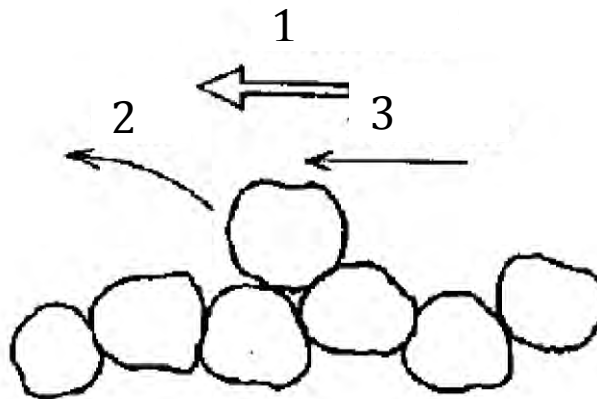

Key

- 1 direction of flow
- 2 motion
- 3 tractive force

Figure 24 — Traction

3. Installation types

(1) Layered Stacking

The materials are stacked in a regular pattern. For example: evenly stacked blocks

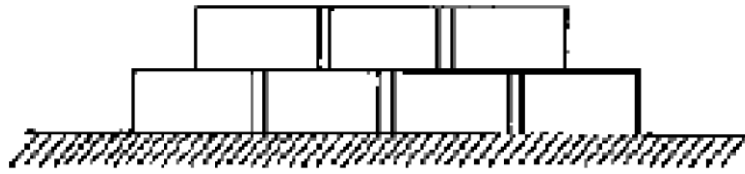

Figure 25 — Layered stacking

(2) Random Stacking

The materials are stacked in an irregular pattern. For example: stacked blocks, foot protective work using piled riprap

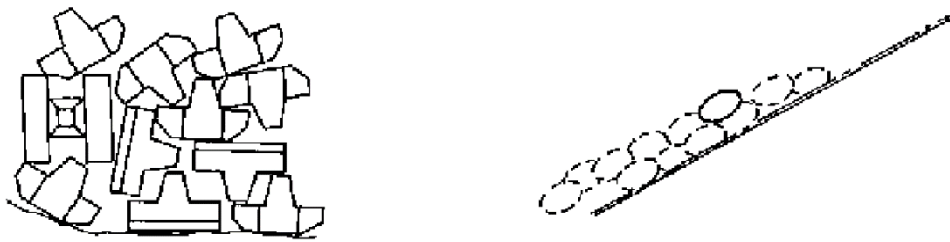

Figure 26 — Random stacking

(3) Gabion

A basket is filled with rocks or other materials. This refers to gabion foot protection work.

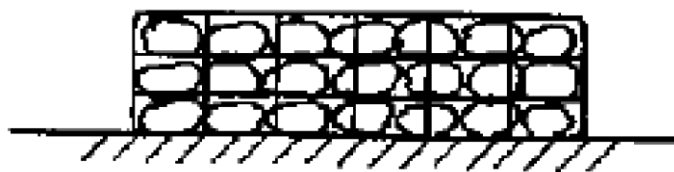

Figure 27 — Gabion

(4) Filled

The frame is filled with rocks or other materials. For example: fagot mattress or wooden mattress



Figure 28 — Filled

8.3 Calculation of weight of foot protection blocks

The following formula, Formula (3), is used in Japan to calculate the necessary weight of foot protection blocks:

$$W > a \left(\frac{\rho_w}{\rho_b - \rho_w} \right)^3 \frac{\rho_b}{g^2} \left(\frac{V_m}{\beta} \right)^6 \quad (3)$$

where

- W is the weight of foot protection block
- a is the factor of foot protection block shape
- β is the factor of setting type
- V_m is the average velocity
- ρ_w : is the density of water (980 kg/m³)
- ρ_b is the density of blocks (2030 kg/m³)
- g is the acceleration of gravity (9.8 m/s²)

Table 2 — Factor of α and β

Shape of block	specific gravity ρ_b/ρ_w	$a \times 10^{-3}$	β
Type A: Projection	2.22	1.2	1.5
Type B: Plane	2.03	0.54	2.0
Type C: Triangular conic	2.35	0.83	1.4
Type D: Triangular bearing	2.25	0.45	2.3
Type E: Rectangle	2.09	0.79	2.8

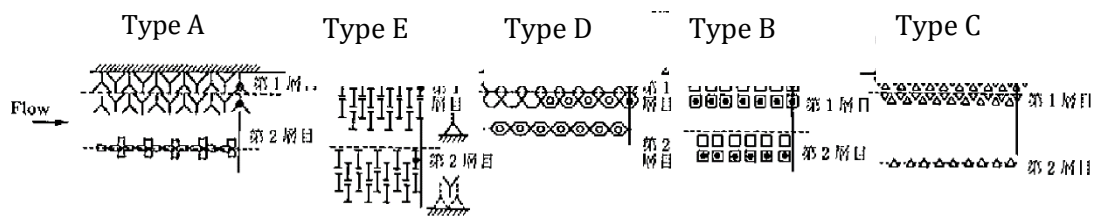

Figure 29 — Type of block arrangements

8.4 Calculation example-2

Examples are shown below

※ Calculation Condition:

Using Formula (1):

$$W > a \left(\frac{\rho_w}{\rho_b - \rho_w} \right)^3 \frac{\rho_b}{g^2} \left(\frac{V_m}{\beta} \right)^6$$

Here

W is the weight of foot protection block

V_m 5.1m/s is the river velocity;

Shape Type B is the block type;

α 0.54 is the block factor;

β 2.0 is the block factor;

ρ_w 980kg/m³ is the density of water

ρ_b 2030kg/m³ is the density of block

g 9.8m/s² is the acceleration of gravity

Now W can be calculated as follows:

$$W > 0.54 \times \left(\frac{1000}{2030 - 1000} \right)^3 \times \frac{2030}{9.8^2} \times \left(\frac{5.1}{2.0} \right)^6$$

$$W > 2872\text{N}$$

$$W > 293\text{kg}$$

8.4.1 Average velocity

The flow velocity used in the calculation of foot protection block weight is calculated using the Manning formula for calculating the average velocity. The roughness coefficient is selected from the table below based on the conditions at the target river site.

$$V_m = \frac{1}{N} \cdot R^{2/3} \cdot I^{1/2}$$

where

N is the roughness coefficient

R is the hydraulic radius

I is the riverbed slope

**Table 3 — Revised Ministry of Construction River and Erosion Control Standard (draft)
Japan 1997, Survey Section p132**

River or channel conditions		Scope of Manning's n
Artificial channel, improved river	Concrete artificial channel	0.014~0.020
	Spiral half-pipe channel	0.021~0.030
	Channel with stone masonry on both banks (mud bed)	0.025 (mean value)
	Bedrock excavation	0.035~0.05
	Bedrock forming	0.025~0.04
	Clay riverbed with flow velocity not enough to cause scouring	0.016~0.022
	Sandy loam, clayey soil loam	0.020 (mean value)
	Drag line dredging, little weeds	0.025~0.033
Natural river	Small channel on plain, with no grass	0.025~0.033
	Small channel on plain, with grass and shrubs	0.030~0.040
	Small channel on plain, with lots of grass and gravel bed	0.040~0.055
	Mountain channel, with gravel and boulders	0.030~0.050
	Mountain channel, with boulders and large boulders	0.040 or higher
	Large channel, with sandy bed and little meandering	0.018~0.035
	Large channel, with gravel bed	0.025~0.040

Where, Hydraulic Radius (m) = Cross Section Area (m²) / Wetted perimeter (m)

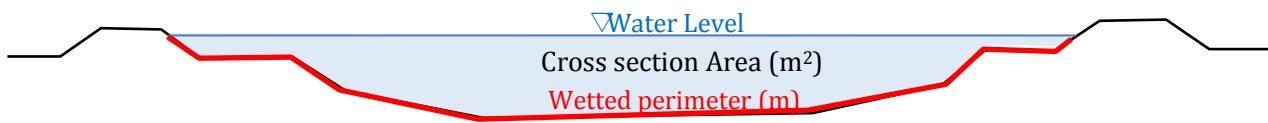

Figure 30 — Image of hydraulic radius

8.4.2 Determination of water level

Water level of using Manning formula for calculating the average velocity should be determined using the following method:

Solution 1. Calculation of non-uniform flow

Solution 2. Hearing survey with site residents, survey of past flood mark

In Timor-Leste, installation of rain fall station is insufficient for run off calculation and due to high cost topographic survey for calculation of non-uniform flow. As this reason, hearing survey with site resident or survey of past flood mark is realistic solution for set water level.

On the other hand, in the case of new bridge plan or new river plan for flood countermeasure, calculation of non-uniform flow should be encouraged for set water level in river. In this case, river discharge and return period are required for river study.it is encouraged to use same return period of original river plan.

These guidelines do not include an explanation about software operation for non-uniform flow. It is possible to get free software and operation manual below “US army Corps of Engineers” website.

<http://www.hec.usace.army.mil/software/hecras/>

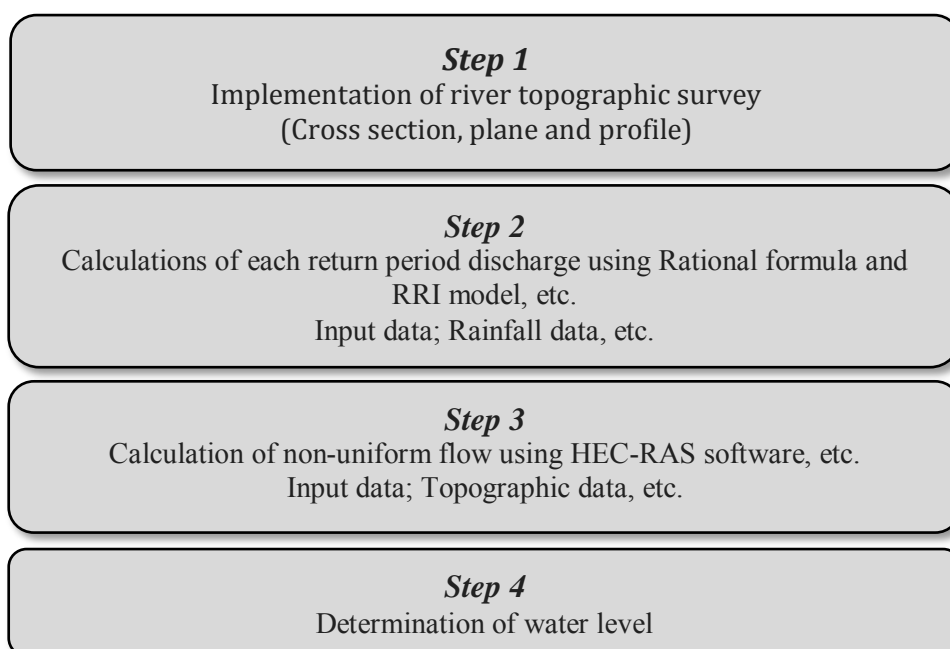

Figure 31 — Study procedure of solculation1

Reference

1. Uniform flow

Flow is said to be uniform, when the velocity of flow does not change either in magnitude or in direction at any point in a flowing fluid, for a given time. For example, the flow of liquids under pressure through long pipelines with a constant diameter is called uniform flow.

2. Non-uniform flow

Flow is said to be non-uniform, when there is a change in velocity of the flow at different points in a flowing fluid, for a given time. For example, the flow of liquids under pressure through long pipelines of varying diameter is referred to as non-uniform flow. All these type of flows can exist independently of each other. So there can be any of the four combinations of flows possible:

1. Steady uniform flow
2. Steady non-uniform flow
3. Unsteady uniform flow
4. Unsteady non-uniform flow.

8.5 Installation width of foot protection blocks

Installation width of foot protection blocks should be more than 5m, but in the case server riverbed scoring, it should be set as described 7.3 Determination of scour hole width.

Annex A (informative)

Case study of Sahen Bridge

A.1 Introduction

I. Reason of selection for case study

Reasons of selection for the case study for design check are as follows;

1) Generality of work item

The work items of the case study are protection work for bridge substructure.

Once the plan of these case study are successfully completed, the knowledge obtained by the case study will be developed to all the area of Timor-Leste.

2) Accessibility

The site is located near the major district town and it takes within 60 minutes' drive from the municipal office of DRBFC and the general security is also good.

3) Urgency and Importance

The road is considered the essential road and it is urgently required.

II. Protection works against scouring of bridges

1. Location of case study

The target site is located on the right side bank at Sahen River.

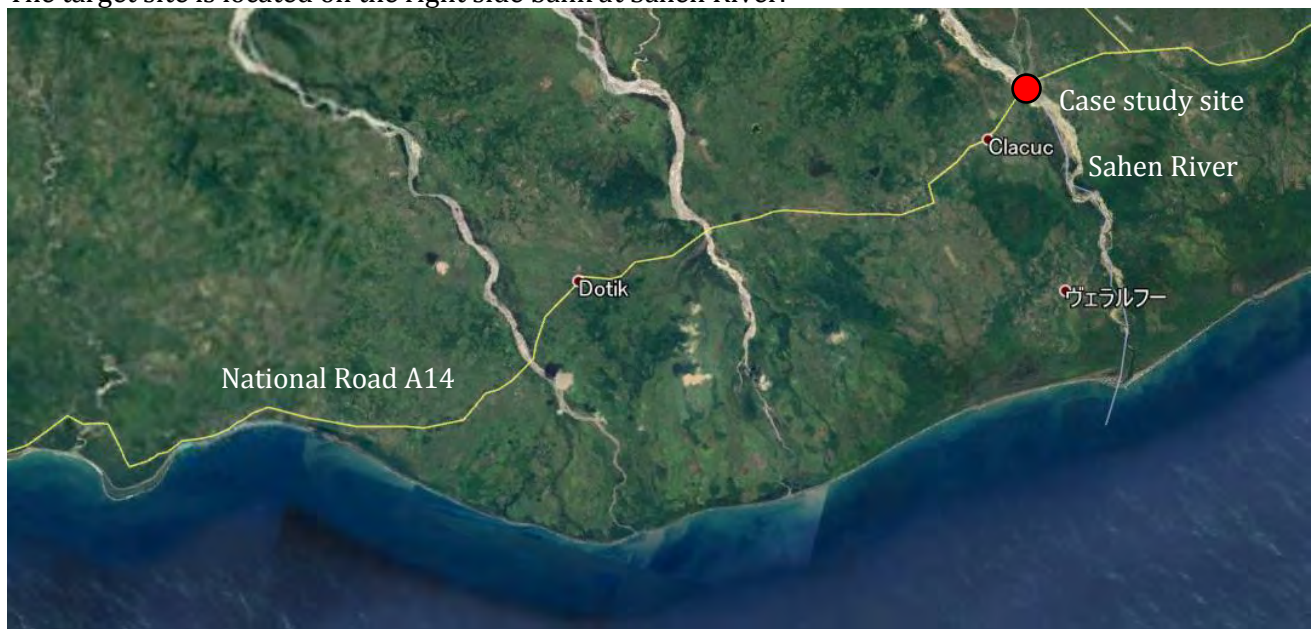

Figure Location of case study at Sahen

2. Current Situation

Following picture is shown scoring situation at right bank side abutment and right side pier. There is no protection work in front of the abutment and pier, therefore it is necessary to rehabilitate based on technical analysis.



Photo Situation of damaged abutment and pier

A.2 Remedial measures

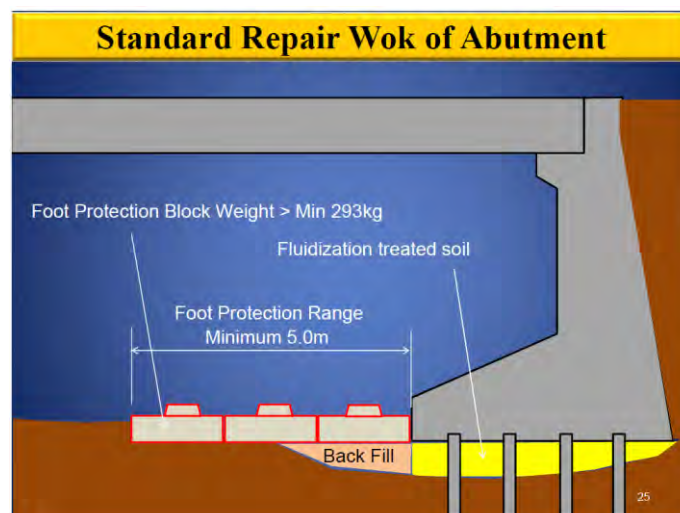
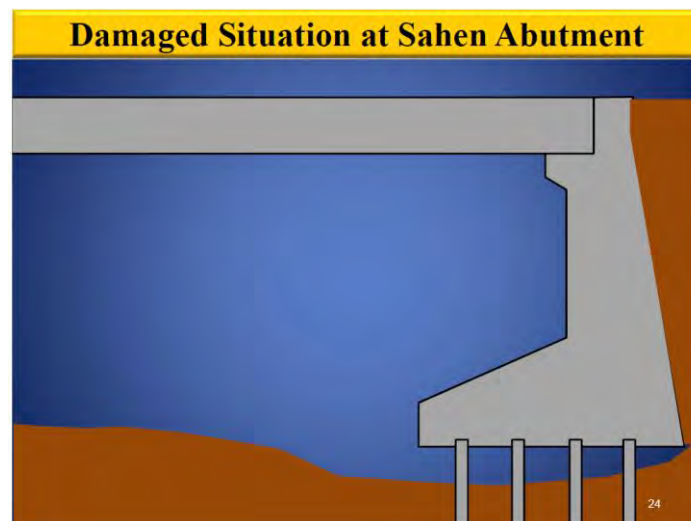

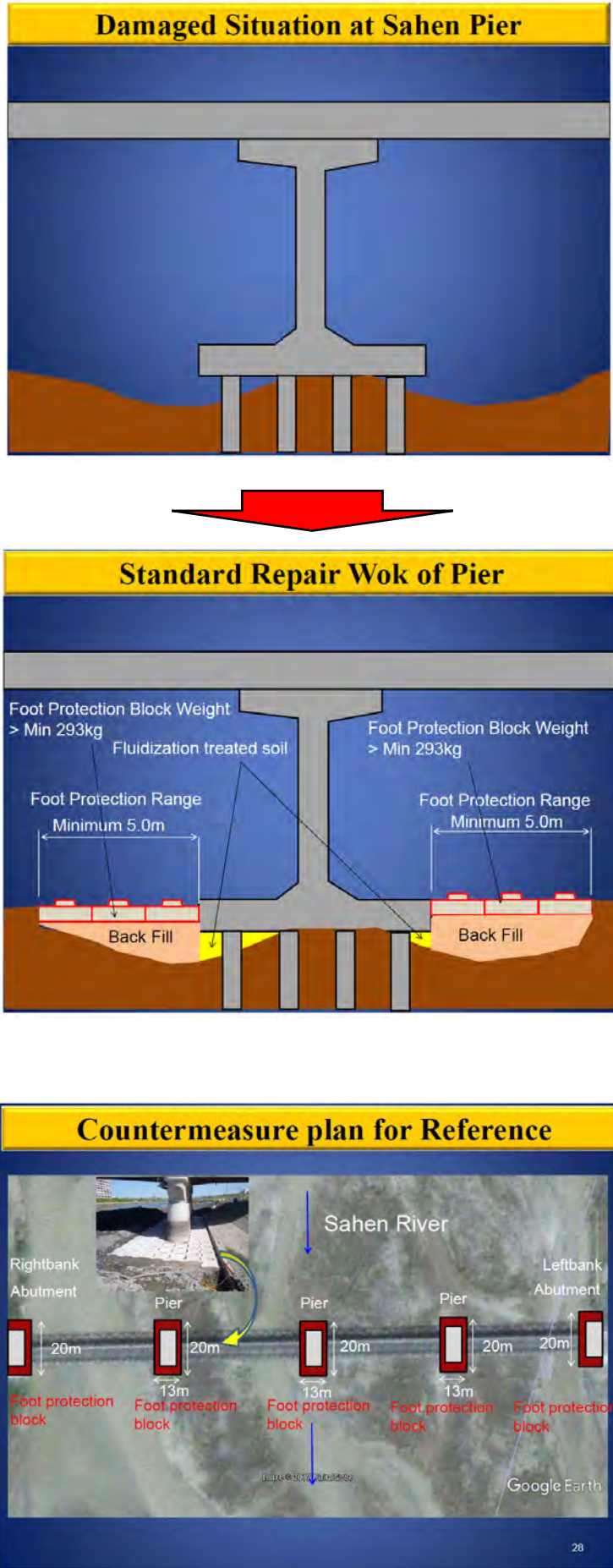

A.3 Training materials

The Project
for
Capacity Development of Road Services
in
the Democratic Republic of Timor-Leste

Case Study for Sahen

Mar 2018

JICA Expert Teams



Today's Training
Case study for Sahen

2

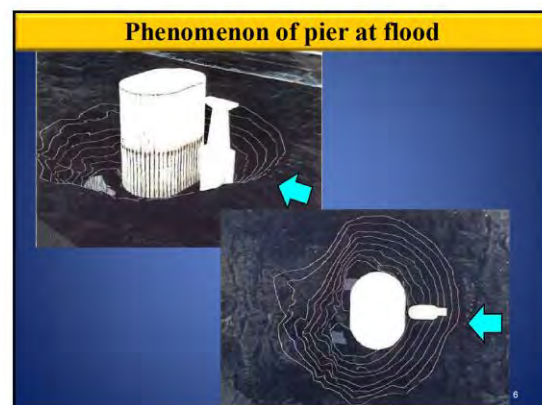
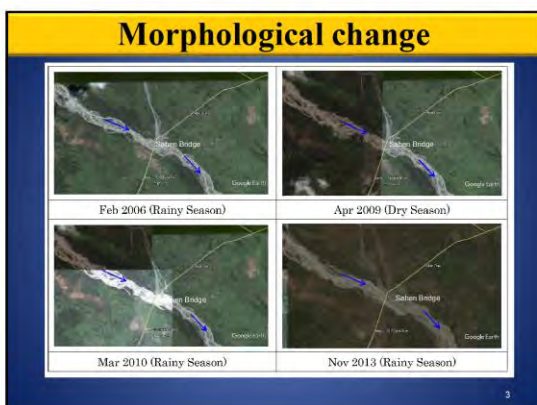
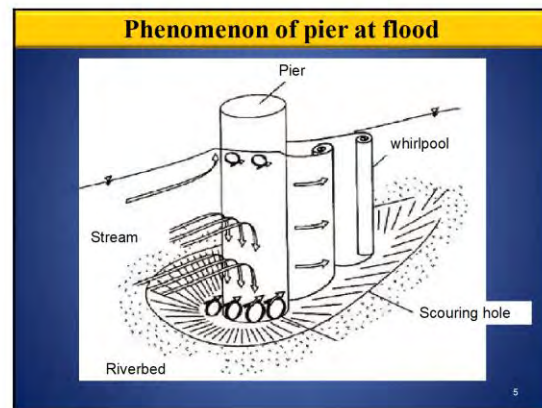

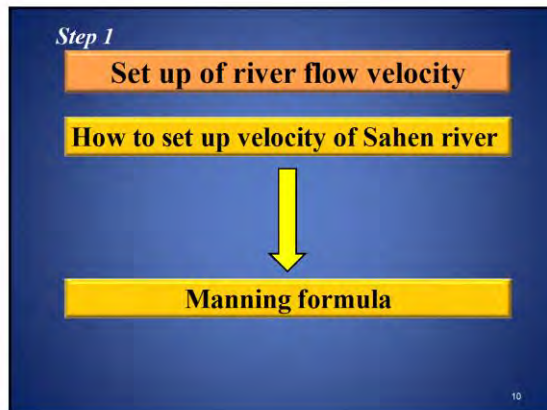
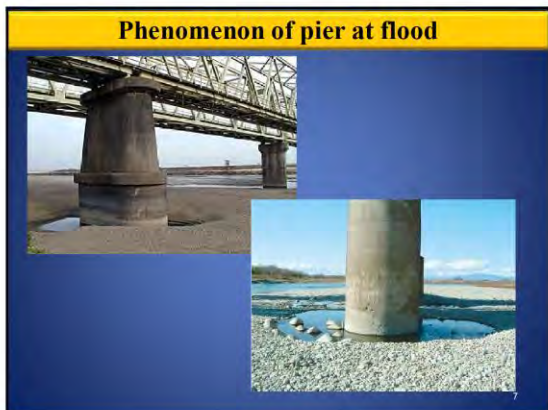

Manning's formula

$$V = \frac{1}{n} \times R^{\frac{2}{3}} \times I^{1/2}$$

V: Flow velocity (m/s)
 n: Coefficient of roughness
 R: Hydraulic radius (m) = Cross-sectional area of river/Wetted perimeter
 I: Riverbed gradient

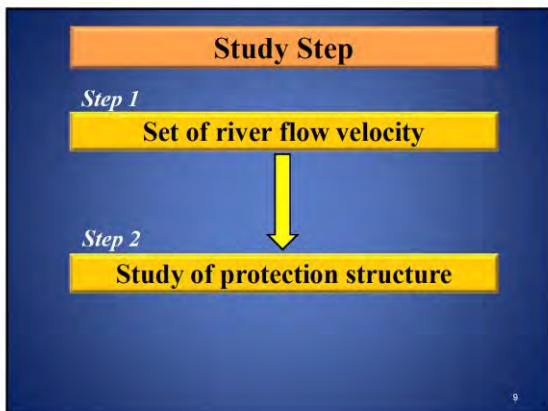

N: Coefficient of roughness

River or channel conditions		Scope of Manning's n
Artificial channel, imposed river	Concrete artificial channel	0.014~0.020
	Spiral half-pipe channel	0.021~0.030
	Channel with stone masonry on both banks (sand bed)	0.025 (mean value)
	Bedrock excavation	0.035~0.05
	Bedrock forming	0.025~0.04
	Clay riverbed with flow velocity not enough to cause scouring	0.016~0.022
	Sandy loam, clayey soil loam	0.020 (mean value)
Natural river	Drag line dredging, little weeds	0.025~0.033
	Small channel on plain, with no grass	0.025~0.033
	Small channel on plain, with grass and shrubs	0.030~0.040
	Small channel on plain, with lots of grass and gravel bed	0.040~0.055
	Mountain channel, with gravel and boulders	0.030~0.050
	Mountain channel, with boulders and large boulders	0.040 or higher
Large channel, with sandy bed and little meandering	0.018~0.035	
Large channel, with gravel bed	0.025~0.040	

Source: Revised Ministry of Construction River and Erosion Control Standard (draft) 1997

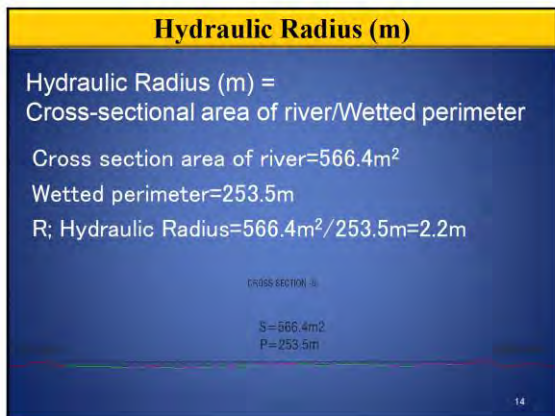
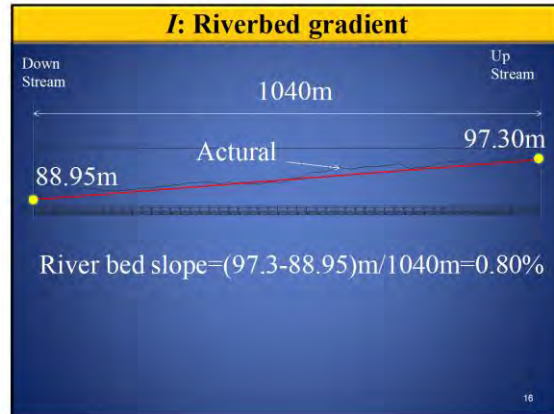
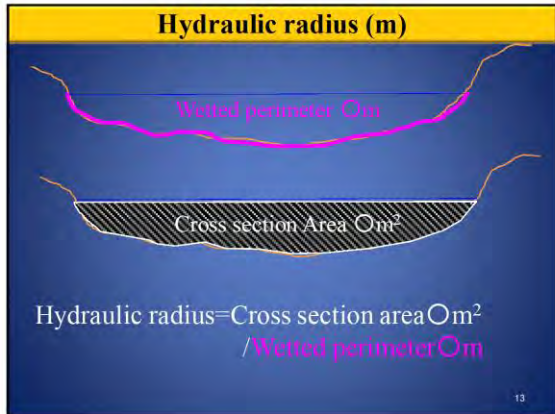

Result of calculation

Cross section No.	No.6
n: Coefficient of roughness	0.03
S: Cross-sectional area of river (m ²)	566.4
P: Wetted perimeter (m)	253.5
I: Riverbed gradient	0.008
R: Hydraulic radius	2.2
V _m : Mean flow velocity (m/s)	5.10
Q: Discharge (m ³ /s)	2886.1

17

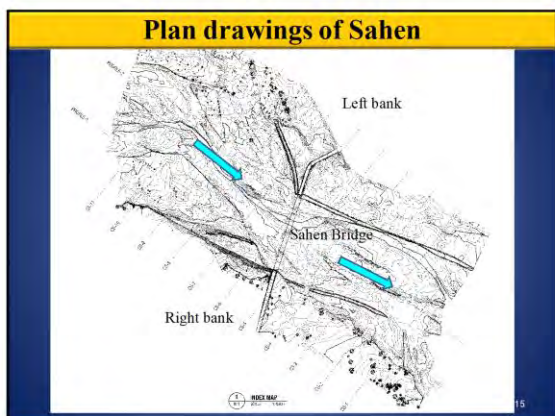

Step 2

Study of protection structure

18



$$W > a \left(\frac{\rho_w}{\rho_b - \rho_w} \right)^3 \cdot \frac{\rho_b}{g^2} \cdot \left(\frac{V_0}{\beta} \right)^6$$

$$0.54 \times \left(\frac{1000.0}{2030.0 - 1000.0} \right)^3 \times \frac{2030}{9.8} \times \left(\frac{5.1}{2} \right)^6$$

2872 (N)

293 kg

Formula for weight of foot protection block

$$W > a \left(\frac{\rho_w}{\rho_b - \rho_w} \right)^3 \cdot \frac{\rho_b}{g^2} \cdot \left(\frac{V_0}{\beta} \right)^6$$

W: Weight of Foot Protection Block
a: Factor of Foot Protection Block Shape
β: Factor of Setting type

V₀: Average Velocity
ρ_w: Density of water 980 (kg/m³)
ρ_b: Density of blocks 2030(kg/m³)
g: Acceleration of gravity (9.8m/s²)

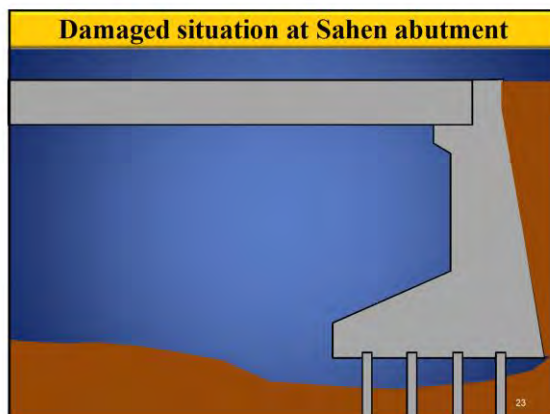

Design condition

V₀ = 5.1m/s
Type Protection Block = Plane
α = 0.54 β = 2.0 Refer to below Table of Coefficient of Deformed Foot Protection Block

Table Coefficient of Deformed Foot Protection Block

Shape of block	specific gravity ρ _b /ρ _w	a × 10 ⁻³	β
Plane	2.03	0.54	2.0

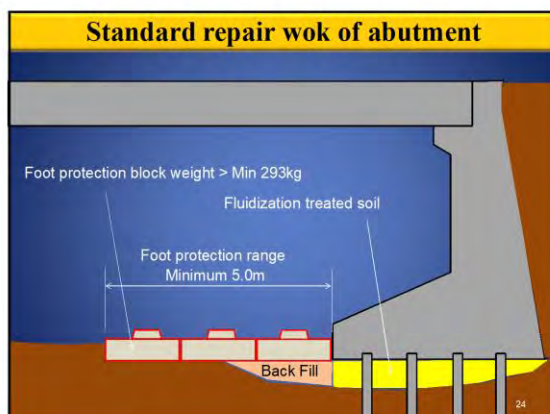

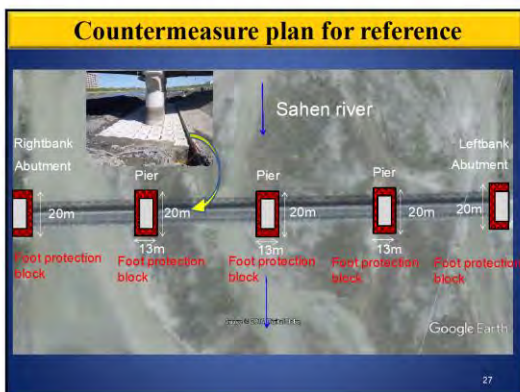
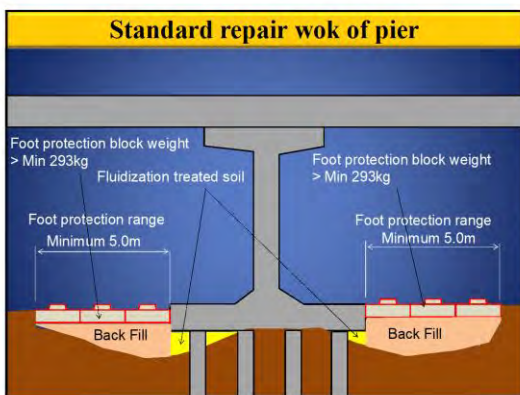
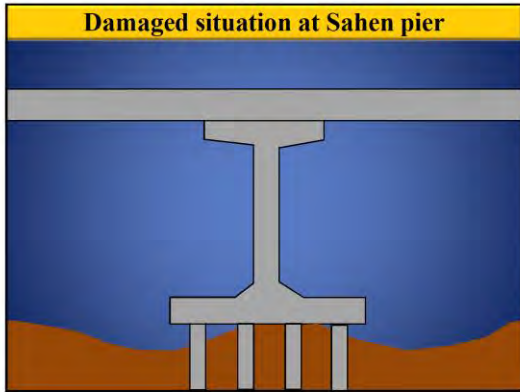

Annex B
(informative)

Training materials

B.1 Rational method

The Project
for
Capacity Development of Road Services
in
the Democratic Republic of Timor-Leste
Training No.1 Rational Formula

July 2016

JICA Expert Teams

Rational formula method

Runoff is estimated using the Rational formula method. The Rational formula is expressed in the following formula. coverage of this method is approximately basin area 200km² or less.

$$Q = \frac{1}{3.6} fRA$$

Input data

- f; run-off coefficient
- R; rainfall intensity within the time of flood concentration (mm/hr)
- A; Catchment area (km²)

Output Q is discharge volume (m³/s)

We have to prepare the input data at first !

Today's Training
Calculation example of Comoro river discharge

Set up below input data

- I. f; run-off coefficient
- II. R; rainfall intensity within the time of flood concentration (mm/hour)
- III. A; basin area (km²)

How to set up Comoro river discharge ?

↓

Rational formula method

I. Run-off coefficient

What is runoff coefficient ?

Runoff coefficients depend on the land use, land condition of river basin. runoff coefficients are needed to calculate rain water runoff using the Rational method.

7

What is Rainfall intensity ?

Rainfall intensity means momentary rainfall is converted one hour amount of rainfall.

Question

In the case rainfall is 2.5mm/one minute. Which value is rainfall intensity ○ mm/hour ?

10

Runoff coefficient is 0.9

Runoff coefficient of Comoro river basin is determined to be 0.9 based on standard values in “Manual for River Works in Japan, Technical Criteria for River Works”

Sleep mountainous region	0.75-0.90
Mountains of Tertiary strata	0.70-0.80
Rugged land and forests	0.50-0.75
Flat arable land	0.45-0.60
Irrigated paddy fields	0.70-0.80
Rivers in mountainous regions	0.75-0.85
Small rivers in level land	0.45-0.75
Large rivers in flat land	0.50-0.75

Source: Manual for River Works in Japan, Technical Criteria for River Works

8

Answer

$2.5\text{mm/one minute} \times 60 \text{ minutes} = 150\text{mm/hour}$

11

II. Rainfall Intensity

9

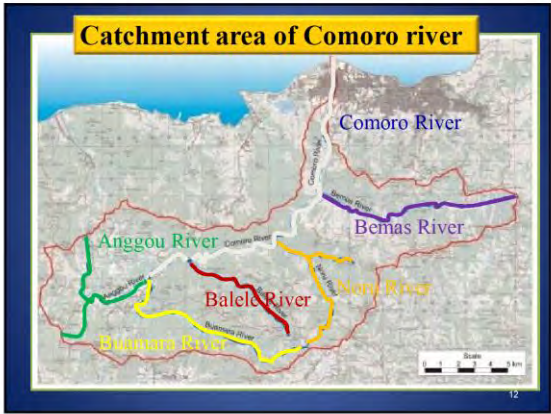

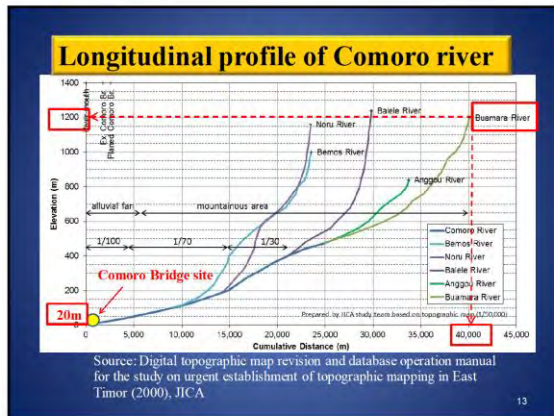

R: Rainfall Intensity

Rainfall intensity is calculated by the following Mononobe's formula based on daily rainfall shown in below.

$$R = \frac{R_{24}}{24} \left(\frac{24}{T} \right)^{0.66}$$

Where, R is rainfall intensity within flood concentration time (mm/hr), R₂₄ is 24-hour rainfall (mm), and T is flood concentration time. Rainfall intensity for each return period calculated using above formula is shown below table.

Return Period	R ₂₄ -Daily Rainfall (mm)	R-Rainfall Intensity (mm/hr)
2-year	144.2	30.5
5-year	193.8	37.6
10-year	226.6	42.2
30-year	276.3	49.2
50-year	298.9	52.5
100-year	329.5	56.9

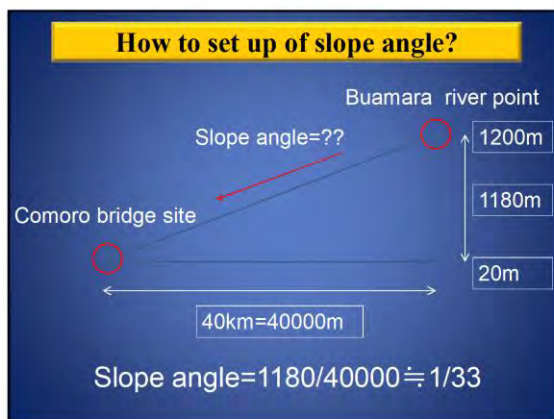

III. Basin Area

T: Flood concentration time

Flood concentration time is expressed using Kraven's formula as follows.

$$T = L/W$$

Where, T is flood concentration time (hour),
 L is watercourse length \Rightarrow 40,000(m),
 W is flood flow velocity (m/s) shown in below.

L: Watercourse slope	over 1/100	1/100-1/200	below 1/200
W: Flood runoff velocity	3.5 m/s	3.0 m/s	2.1 m/s

Watercourse slope is 1/33, and so flood runoff velocity is 3.5m/s. flood concentration time is calculated using these values as follows.

$$T = L/W = 40,000 (m) / 3.5 (m/s) = 3.1 (hour)$$

What is basin area ?

Basin area is an extent or an area of land where all surface water from rain, melting snow, or ice converges to a single point at a lower elevation, usually the exit of the basin, where the waters join another body of water, such as a river, lake, reservoir, estuary, sea, or ocean.

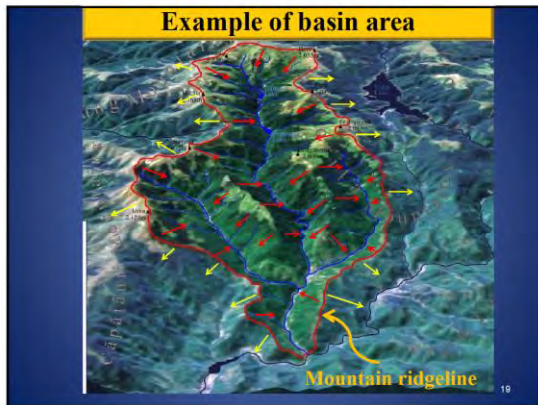

Result of run-off

Runoff is calculated based on the values mentioned using Rational Formula. Calculated each return period discharge are shown below Table.

Return Period	Discharge (m ³ /s)
2-year	1,100 (1,062)
5-year	1,500 (1,427)
10-year	1,700 (1,669)
30-year	2,100 (2,035)
50-year	2,200 (2,201)
100-year	2,500 (2,427)

Design Flood Discharge of Comoro River : **2,200m³/s** (50-year return period)

22



Run-off

Input data

- f; runoff coefficient
⇒ 0.9
- R; rainfall intensity within the time of flood concentration (mm/hr)
⇒ Each values
- A; basin area (km²)
⇒ 207.1km²

➔

$$Q = \frac{1}{3.6} fRA$$

21

B.2 Protection method for scouring

The Project
 for
Capacity Development of Road Services
 in
the Democratic Republic of Timor-Leste
Training No.2 Protection Method for Scouring
 January 2017
 JICA Expert Teams

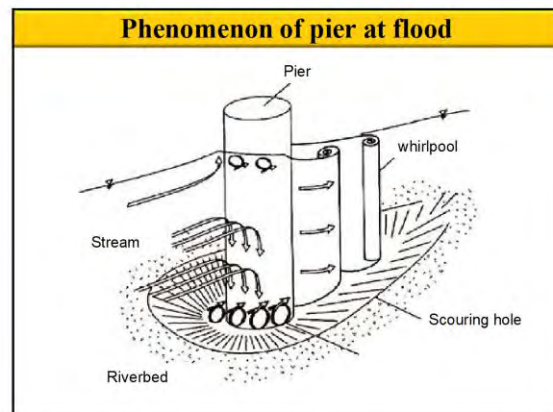

Today's Training
Foot protection works for scouring

2

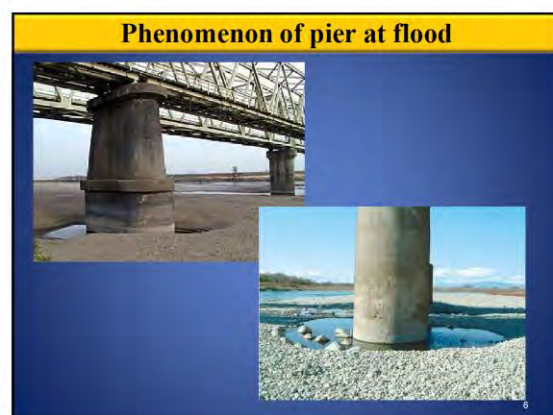
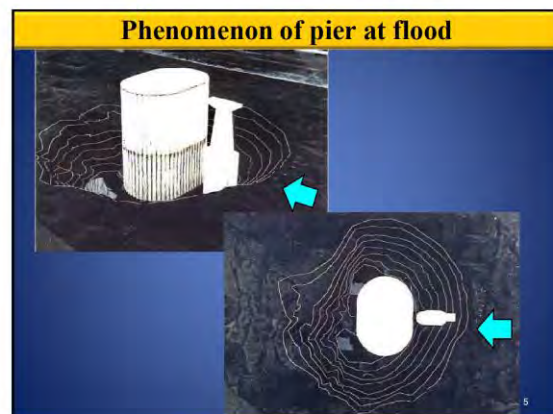

Formula of pier scouring depth

$$\frac{Z}{D} = f \left(\frac{h_0}{D} \cdot \frac{h_0}{dm} \cdot Fr \right)$$

Z: scouring depth,
D: width of piers,
h₀: water depth,
dm: mean particle size of river bed materials,
Fr: Froude number

Answer

$h_0/D = 5.83/2.0 = 2.915$
 $h_0/dm = 5.83/0.0249 = 234.1$
 $Z/D = 1.5$

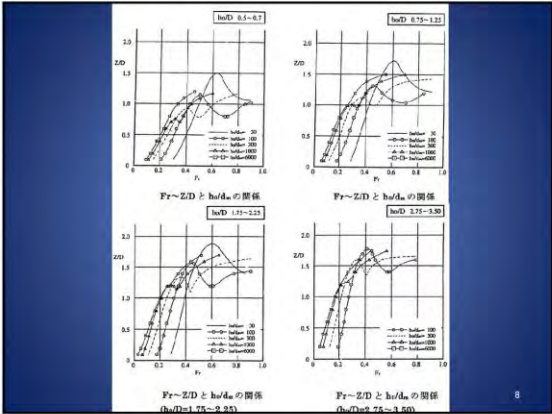
$$Z = \frac{Z}{D} \cdot D = 1.5 \cdot 2.0 = 3.0m$$

Example of calculation

Question

In the case below condition.
 Which depths is pier scouring Z?

Condition
H.W.L. = 24.80m
 Design river bed height = 18.97m
 $h_0 = 24.80 - 18.97 = 5.83m$
 $Fr = 0.54$
 $D = 2.0m$
 $dm = 24.9mm$

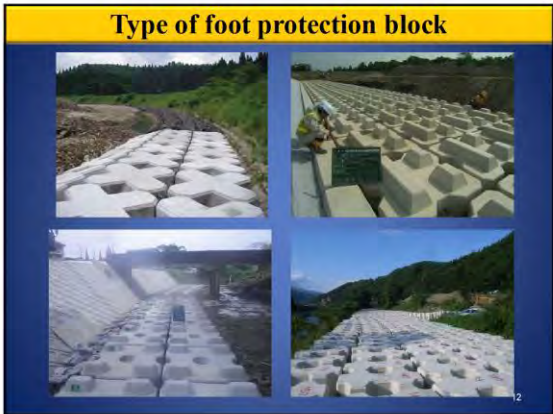

Formula for weight of foot protection block

$$W > a \left(\frac{\rho_w}{\rho_b - \rho_w} \right)^3 \cdot \frac{\rho_b}{g^2} \cdot \left(\frac{V_0}{\beta} \right)^6$$

W: Weight of Foot Protection Block
 a: Factor of Foot Protection Block Shape
 β: Factor of Setting type

V₀: Average Velocity
 ρ_w: Density of water 980 (kg/m³)
 ρ_b: Density of blocks 2030(kg/m³)
 g: Acceleration of gravity (9.8m/s²)

13

Answer

$$\begin{aligned} W &> a \left(\frac{\rho_w}{\rho_b - \rho_w} \right)^3 \cdot \frac{\rho_b}{g^2} \cdot \left(\frac{V_0}{\beta} \right)^6 \\ &= 0.54 \times \left(\frac{1000}{2030 - 1000} \right)^3 \times \frac{2030}{9.8^2} \times \left(\frac{3.0}{1.0} \right)^6 \\ &= 7615N \\ &= 777.04kg \end{aligned}$$

16

Table Coefficient of Deformed Foot Protection Block

Shape of block	specific gravity ρ _b /ρ _w	a × 10 ³	β
TypeA: Projection	2.22	1.2	1.5
TypeB: Plane	2.03	0.54	2.0
TypeC: Triangular conic	2.35	0.83	1.4
TypeD: Triangular bearing	2.25	0.45	2.3
TypeE: Rectangle	2.09	0.79	2.8

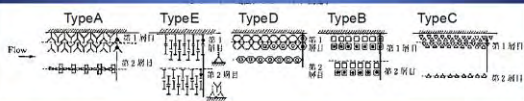

14

Standard damaged situation of abutment at flood

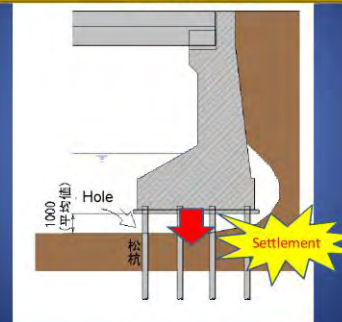

17

Example of Calculation

Question

In the case below condition.
 Which size is foot protection block?

Condition

V₀ = 3.0m/s
 Type Protection Block = TypeB: Plane
 α = 0.54 β = 1.0 Refer to Table of Coefficient of Deformed Foot Protection Block

15

Standard repair work of abutment

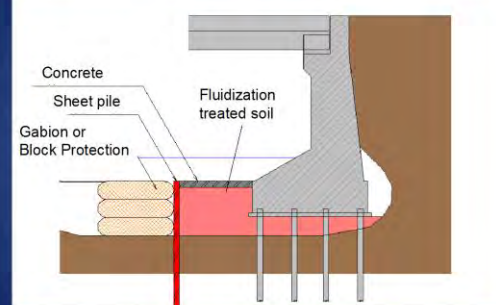

18

Fluidization treated soil

The feature of fluidization treated soil is able to construct in the small place.



Material; Soil +Cement +Water

19

Vibratory hammer method



20

B.3 Big sandbags

The Project
for
Capacity Development of Road Services
in
the Democratic Republic of Timor-Leste
**Training No.3 Introduction of Weather
Resistance Big Sandbag**
April 2017
JICA Expert Teams

Example of weather resistance big sand bag

4

Today's Training
Weather resistance big sand bag
method for damage site

2

Example of weather resistance big sand bag

5

Application works of weather resistance big sandbag

- ✓ Emergency works
- ✓ Temporary works

Notice:
Do not use weather resistance big sandbag for main civil works

3

Applied condition of weather resistance big sand bag for slope

6

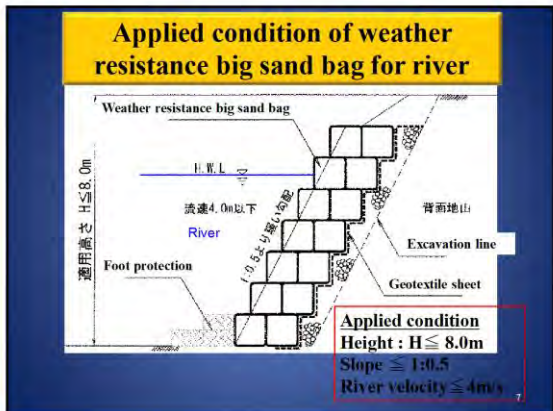

Safety factor for weather resistance big sand bag analysis

Item	Safety Factor
Compression Stress of Big Sand Bag	$F \geq 1.5$
Sliding	$F \geq 1.2$
Overturning	Eccentricity distance $E \geq B/3$
Bearing Capacity	$F \geq 2.0$
Circular Slip	$F \geq 1.05$

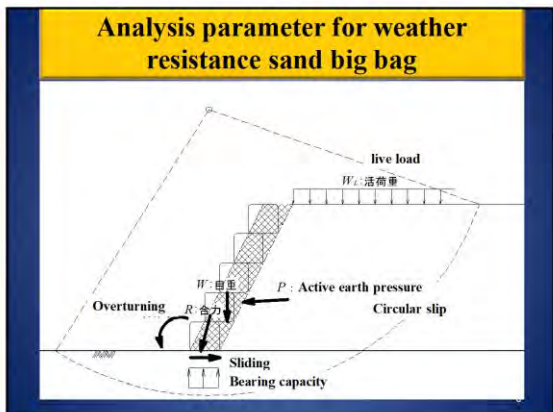

Standard drawing of weather resistance big sand bag analysis

Applied condition $H < 8\text{m}$
Internal material: sand soil

	適用高3.0m (適用高) $3.0 < H \leq 3.5\text{m}$	適用高3.5m (適用高) $3.5 < H \leq 4.0\text{m}$	適用高4.0m (適用高) $4.0 < H \leq 4.5\text{m}$	適用高4.5m (適用高) $4.5 < H \leq 5.0\text{m}$
標準圖				
適用高	適用高3.0m (適用高) $3.0 < H \leq 3.5\text{m}$	適用高3.5m (適用高) $3.5 < H \leq 4.0\text{m}$	適用高4.0m (適用高) $4.0 < H \leq 4.5\text{m}$	適用高4.5m (適用高) $4.5 < H \leq 5.0\text{m}$
適用高	適用高3.0m (適用高) $3.0 < H \leq 3.5\text{m}$	適用高3.5m (適用高) $3.5 < H \leq 4.0\text{m}$	適用高4.0m (適用高) $4.0 < H \leq 4.5\text{m}$	適用高4.5m (適用高) $4.5 < H \leq 5.0\text{m}$

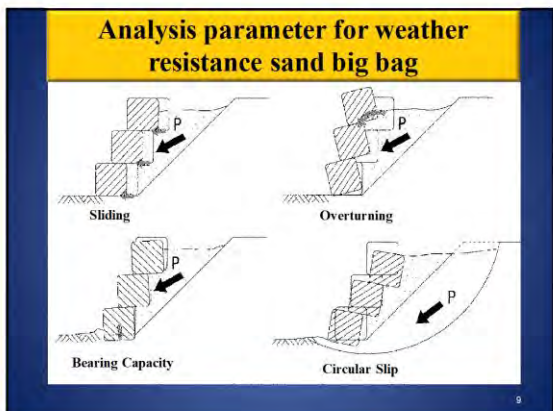

Standard drawing of weather resistance big sand bag analysis

Applied condition $H < 8\text{m}$
Internal material: gravel soil

	適用高3.0m (適用高) $3.0 < H \leq 3.5\text{m}$	適用高3.5m (適用高) $3.5 < H \leq 4.0\text{m}$	適用高4.0m (適用高) $4.0 < H \leq 4.5\text{m}$	適用高4.5m (適用高) $4.5 < H \leq 5.0\text{m}$
標準圖				
適用高	適用高3.0m (適用高) $3.0 < H \leq 3.5\text{m}$	適用高3.5m (適用高) $3.5 < H \leq 4.0\text{m}$	適用高4.0m (適用高) $4.0 < H \leq 4.5\text{m}$	適用高4.5m (適用高) $4.5 < H \leq 5.0\text{m}$
適用高	適用高3.0m (適用高) $3.0 < H \leq 3.5\text{m}$	適用高3.5m (適用高) $3.5 < H \leq 4.0\text{m}$	適用高4.0m (適用高) $4.0 < H \leq 4.5\text{m}$	適用高4.5m (適用高) $4.5 < H \leq 5.0\text{m}$

Standard drawing of weather resistance big sand bag analysis

**Applied condition H<8m
Internal material ; sand soil**

13

Normal big sand bag

The Normal type geo-bag is vulnerable to ultraviolet rays

16

Standard drawing of weather resistance big sand bag analysis

**Applied condition H<8m
Internal material ; gravel soil**

14

Recommended plan of weather resistance big sand bag

17

Comparison of normal and weather resistance type

	Normal type	Weather resistance type
Image		
Ultraviolet Rays	Weak	Strong
Cost	Cheap	Normal
Endurance	Weak	Strong
Strength	Weak	Strong

B.4 Groin method

The Project
for
Capacity Development of Road Services
in
the Democratic Republic of Timor-Leste
Training No.4 Groin Study
November 2017
JICA Expert Teams

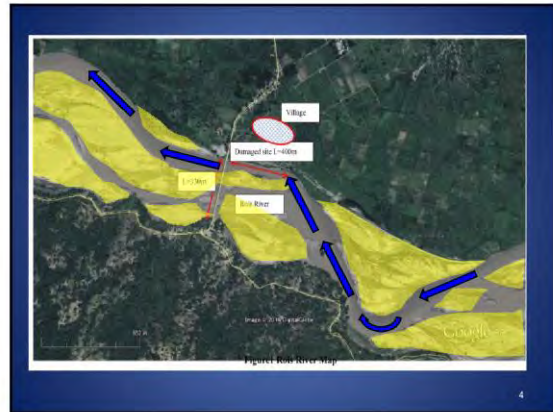

Today's Training
Groin study using Loes river



Morphological change

<p>Aug,2004 (Dry Season)</p>	<p>Jul,2005 (Dry Season)</p>
<p>Sep,2009 (Dry Season)</p>	<p>Feb,2013 (Rainy Season)</p>

Damage of embankment

<p>Damage site 1</p>	<p>Damage site 2</p>
<p>Damage site 3</p>	<p>Damage site 4</p>

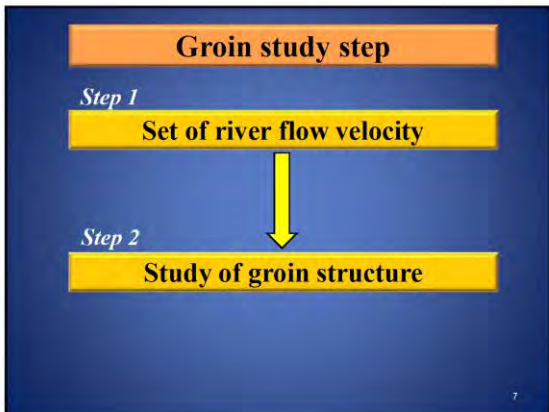

N: Coefficient of roughness

River or channel conditions		Scope of Manning's n	
Artificial channel, improved river	Concrete artificial channel	0.014~0.020	
	Spiral half-pipe channel	0.021~0.030	
	Channel with stone masonry on both banks (fixed bed)	0.025 (mean value)	
	Bedrock excavation	0.035~0.05	
	Bedrock forming	0.025~0.04	
	Clay riverbed with flow velocity not enough to cause scouring	0.016~0.022	
	Sandy loam, clayey soil loam	0.020 (mean value)	
	Drag line dredging, little weeds	0.025~0.033	
	Natural river	Small channel on plain, with no grass	0.025~0.033
		Small channel on plain, with grass and shrubs	0.030~0.040
Small channel on plain, with lots of grass and gravel bed		0.040~0.055	
Mountain channel, with gravel and boulders		0.030~0.050	
Mountain channel, with boulders and large boulders		0.040 or higher	
Large channel, with sandy bed and little meandering		0.018~0.035	
Large channel, with gravel bed	0.025~0.040		

Source: Revised Ministry of Construction River and Erosion Control Standard (draft) 1997

10

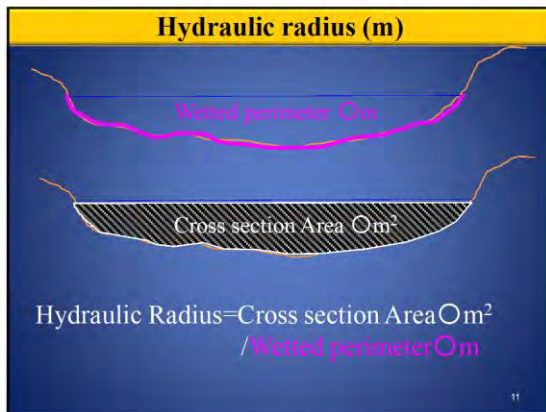
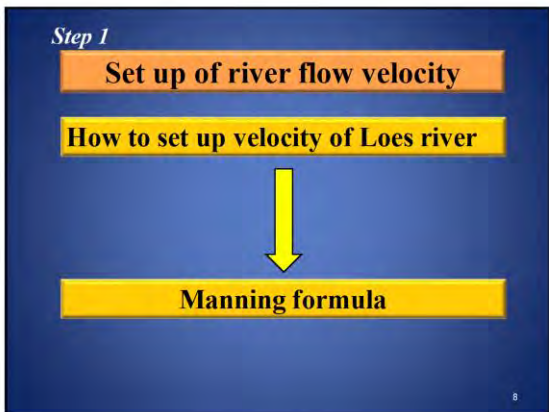

Manning's formula

$$V = \frac{1}{n} \times R^{\frac{2}{3}} \times I^{1/2}$$

V: Flow velocity (m/s)
 n: Coefficient of roughness
 R: Hydraulic radius (m) = Cross-sectional area of river/Wetted perimeter
 I: Riverbed gradient

9

Hydraulic radius (m)

Hydraulic Radius (m) =
 Cross-sectional area of river/Wetted perimeter

Cross section area of river=5417.9m²
 Wetted perimeter=503.4m

R; Hydraulic Radius=5417.9m²/503.4m=**10.762m**

12

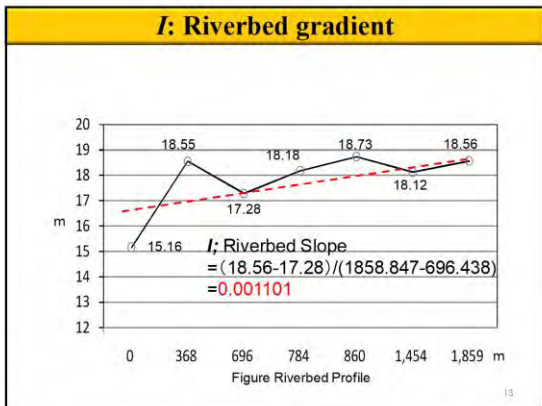

Result of calculation

Cross section No.	
n: Coefficient of roughness	0.035
S: Cross-sectional area of river (m ²)	5417.9
P: Wetted perimeter (m)	503.4
I: Riverbed gradient	0.001101
R: Hydraulic radius	10.8
Vm: Mean flow velocity (m/s)	4.62

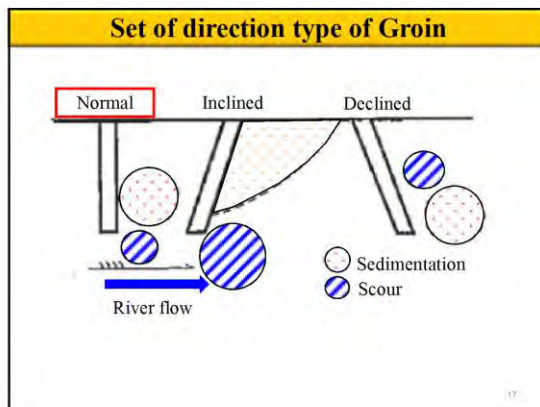

Step 2

Study of Groin structure

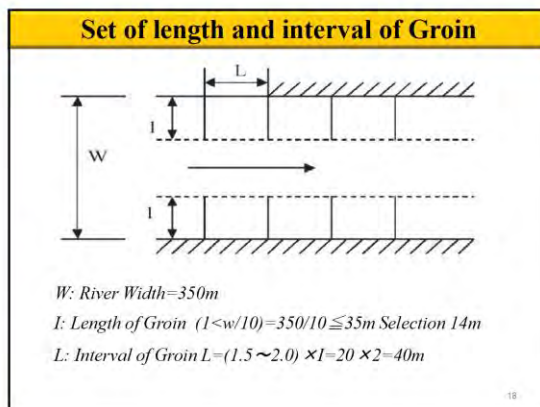

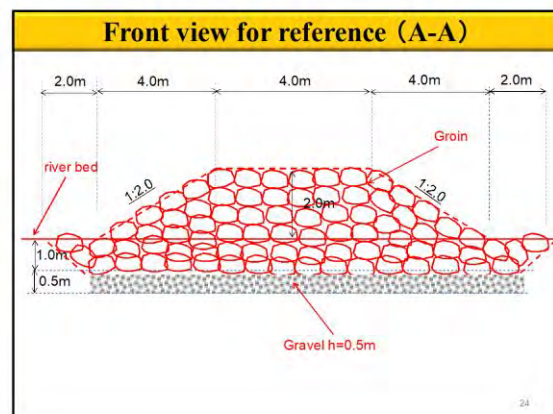
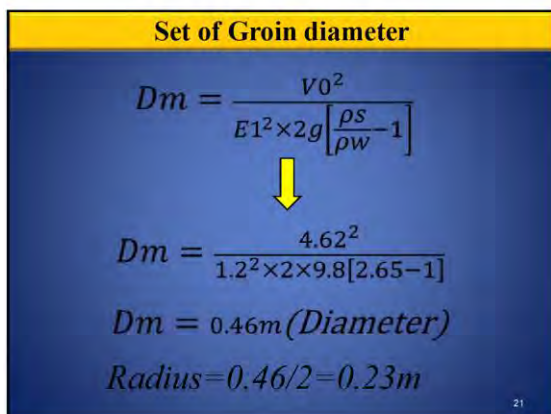
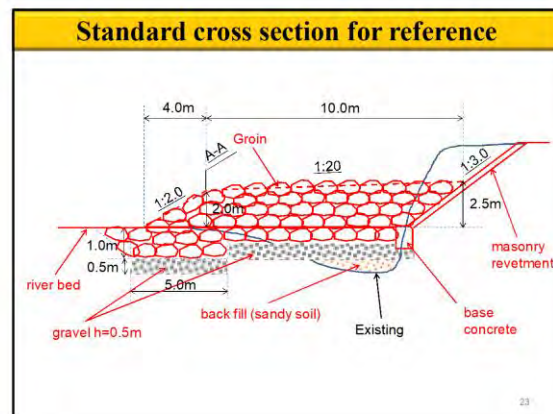
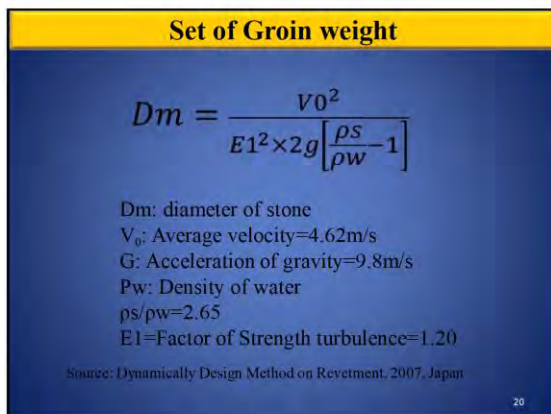
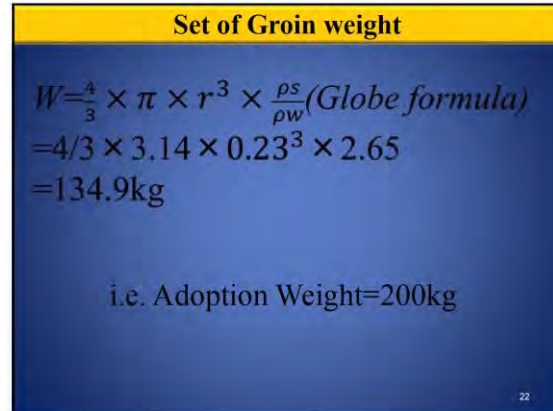
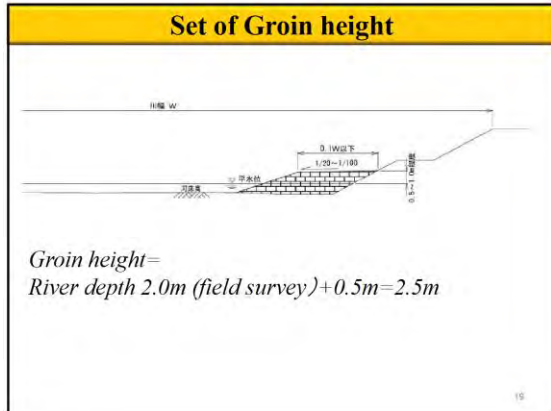

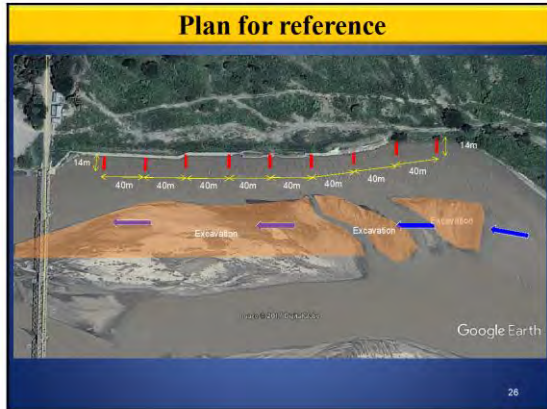
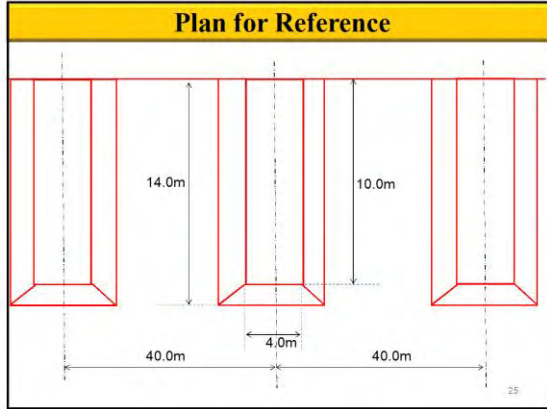

B.5 Bridge substructure protection

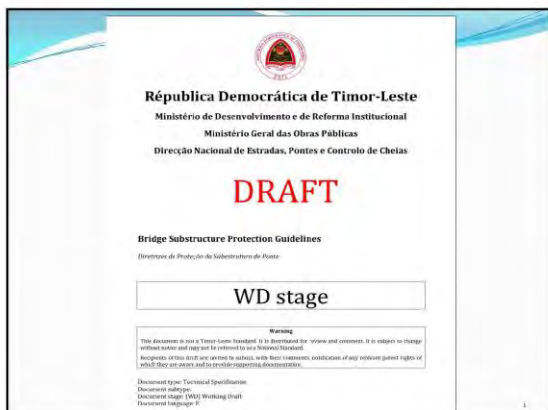

Contents	
Foreword	iv
Introduction	v
1 Scope	1
2 Normative references	1
3 Terms and definitions	1
4 Characteristics of rivers in Timor-Leste	2
5 Condition of bridge substructures in Timor-Leste	2
6 Hydraulic phenomenon around bridge piers	5
7 Scour depth of bridge substructure	7
7.1 Scour depth around bridge piers	7
7.1.1 Procedure for estimating scour depth	7
7.2 Scour depth around abutments	8
7.3 Determination of scour hole width	8
7.4 Calculation example 1	12
8 Protection of bridge substructures	13
8.1 Types of foot protection blocks	14
8.2 Verification of dynamic stability of foot protection blocks	15
8.2.1 Basic policy	15
8.2.2 Calculation of weight of foot protection blocks	18
8.4 Calculation example 2	20
8.4.1 Average velocity	21
8.4.2 Determination of water level	22
8.5 Installation width of foot protection blocks	23
Annex A (Informative) Case study of Sabea Bridge	24
A.1 Introduction	24
A.2 Remedial measures	25
A.3 Training materials	27
Annex B (Informative) Training materials	32
B.1 Rational method	32
B.2 Protection method for scouring	32
B.3 Big samplings	32
B.4 Grid method	32
Bibliography	49

Design Guideline For Bridge Substructure Protection In Timor-Leste

June 2018

Presented By :

1. Shutaro SAKANAKA
2. Julius Kehi
3. Antonio Araujo

Outline of the Presentation

- I. Introduction
- II. Objective
- III. Characteristics of rivers in Timor-Leste
- IV. Damage of bridge substructures in Timor-Leste
- V. Hydraulic phenomena around bridge pier
- VI. Study of bridge substructure and scour depth
- VII. Study for protection of bridge substructure

I. Introduction

II. Objective of the design guideline

Objective:

- To improve the design of countermeasure for bridge protection substructure from flood scour
- To reduce flood scour damage to bridge substructure in Timor-Leste

III. Characteristics of majority of Rivers in Timor-Leste

- ❖ Sources of many rivers in Timor-Leste are located in the mountainous area, at an altitude of 1000m to 2000m
- ❖ The average annual rainfall in the northern region of Timor-Leste is approximately 1000mm to 2000mm and in the southern region it is 1500 mm to 2000 mm
- ❖ The length of their rivers is short and share many natural characteristics with rivers in Japan

IV. Condition of Bridges Substructure in Timor Leste

- ❖ The following figures show the scouring damage of Sahen Bridges right bank abutment and pier.



Figure 1. Sahen bridge abutment 2017



Figure 2. Sahen bridge pier 2017

- ❖ Figures 3 and 4 show the scouring damage of Mola Bridges Pier. Due to scouring damage, the caving of the footing can be seen



Figure 3. Mola bridge abutment 2011



Figure 4. Mola bridge abutment 2011

- ❖ If appropriate countermeasure are not applied out and scouring is allowed to progress into the long term, overall bridge settlement damage (as can see in figure 5,6) is likely to occur



Figure 5. Bridge settlement damage due to bridge pier scouring (Japan Example)

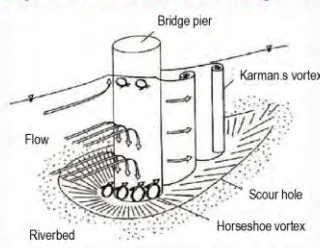

Figure 6. Bridge settlement damage due to bridge pier scouring (Japan Example)

V. Hydraulic Phenomena Around Bridge Pier



- The figure shows the hydraulic phenomenon that occurs around bridge piers during flood.
- Bridge piers located in a river cause complex vortices and waves that disturb the flow and water surface during flood; as a result, an increase in water level and riverbed scouring occur

Hydraulic Phenomenal around bridge pier (Japan Example)

The figure show the actual phenomenon around a bridge pier during floods.the occurrences of complex flow around the bridges pier apparent.





The figure show the state of scour on bridge pier after a flood in Japan.The flood caused a scour hole to form around the bridge pier





VI. Study of Bridge Substructure Scour Depth

1. Scour depth around bridge pier

h_0 : Average water depth
 D : Diameter of bridge pier
 d_m : Average grain diameter of riverbed material
 Fr : Froude number
 Z : Scour depth

$$\frac{Z}{D} = f \cdot \left(\frac{h_0}{D} \cdot \frac{h_0}{d_m} \cdot Fr \right)$$

Step 1
 Calculate the dimensionless scour depth Z/D using the target locations average water depth h_0 , the diameter of bridge pier D , average grain diameter of riverbed material d_m , and Froude number Fr .

Step 2
 The resulting Z/D should be corrected for changes in flow direction due to flooding or nearby bridge piers. After these corrections, the depth of scour hole around a bridge pier can be calculated.

2. Scour depth around abutments

Timor-Leste have short lengths for the footings depth of their abutments, so when new bridges are being planned, it is necessary to conduct the field investigations of the abutment or nearby abutments and ensure sufficient lengths for footing depth.

4. Calculation Example

Calculation Condition

High water level: 24.80 m
 Design river bed: 18.97 m
 Diameter bridge pier (D) = 2.0 m
 Average grain diameter of riverbed material (dm) = 24.9 mm
 Froude number (Fr) = 0.54

Study Process

Average Water depth $h_0 = 24.80 - 18.97 = 5.83$ m

$$\frac{h_0}{D} = \frac{5.83}{2.0} = 2.915$$

$$\frac{h_0}{d_m} = \frac{5.83}{0.0249} = 234.91$$

$Z/D = 1.5$ (Refer to right figure)

Scour depth $Z = (Z/D) \cdot D = 1.5 \cdot 2.0 = 3.0$ m

VII. Study for Protection of Bridge Substructure

There are two types of protection work: Gabion and foot protection block. However, due to issues with the durability (due to deterioration, etc) of the metal wire use for gabion, it is recommended that Timor-Leste take the same approach as Japan and use Foot Protection.

Types of foot protection block

Types of foot protection blocks in Japan

Calculation of weight of foot Protection blocks

The formula is used in Japan to calculate the necessary weight of foot protection blocks.

$$W > a \left(\frac{\rho_w}{\rho_B - \rho_w} \right)^3 \frac{\rho_B}{g^2} \left(\frac{V_m}{\beta} \right)^6$$

where

- W is the weight of foot protection block
- a is the factor of foot protection block shape
- β is the factor of setting type
- V_m is the average velocity
- ρ_w : is the density of water. (980 kg/m³)
- ρ_B is the density of blocks (2030 kg/m³)
- g is the acceleration of gravity (9.8 m/s²)

Table Factor of α and β

Shape of block	specific gravity		β
	ρ_b/ρ_w	$\alpha \times 10^{-2}$	
Type A: Projection	2.22	1.2	1.5
Type B: Plane	2.03	0.54	2.0
Type C: Triangular conic	2.35	0.83	1.4
Type D: Triangular bearing	2.25	0.45	2.3
Type E: Rectangle	2.09	0.79	2.8

Calculation Example for weight of foot Protection Block

- Calculation Condition**
- Now W can be calculated as follows**

$$W > a \left(\frac{\rho_w}{\rho_b - \rho_w} \right)^3 \frac{\rho_b}{g^2} \left(\frac{V_m}{\beta} \right)^6$$

Here

W is the weight of foot protection block

$V_m = 5.1 \text{ m/s}$ is the river velocity;

Shape Type B is the block type;

$\alpha = 0.54$ is the block factor;

$\beta = 2.0$ is the block factor;

$\rho_w = 980 \text{ kg/m}^3$ is the density of water

$\rho_b = 2030 \text{ kg/m}^3$ is the density of block

$g = 9.8 \text{ m/s}^2$ is the acceleration of gravity

$$W = 0.54 \times \left(\frac{1000}{2030 - 1000} \right)^3 \times \frac{2030}{9.8^2} \times \left(\frac{5.1}{2} \right)^6$$

$W = 2872 \text{ N}$

$W = 293 \text{ kg}$

Average Velocity

The flow velocity used in the calculation of foot protection block weight is calculated using the Manning formula for calculating the average velocity. The roughness coefficient is selected from the table below based on the conditions at the target river site.

	River or channel conditions	Scope of Manning's n
Artificial channel (imposed flow)	Concrete artificial channel	0.014~0.020
	Spiral half-pipe channel	0.021~0.036
	Channel with stone masonry on both banks (low level)	0.025 (mean value)
	Bedrock excavation	0.035~0.05
	Bedrock forming	0.025~0.04
	Clay riverbed with flow velocity not enough to cause scouring	0.016~0.022
	Sandy loam, clayey soil loam	0.020 (mean value)
	Drag line dredging, little weeds	0.025~0.033
	Small channel on plain, with no grass and debris	0.025~0.035
	Small channel on plain, with grass and debris	0.030~0.040
Natural river	Small channel on plain, with lots of grass and gravel bed	0.040~0.055
	Mountain channel, with gravel and boulders	0.030~0.050
	Mountain channel, with boulders and large boulders	0.040 or higher
	Large channel, with sandy bed and little meandering	0.018~0.035
	Large channel, with gravel bed	0.025~0.040

Table. Revised Ministry of Construction River and Erosion Control standard (draft) Japan 1997, Survey Section P13.

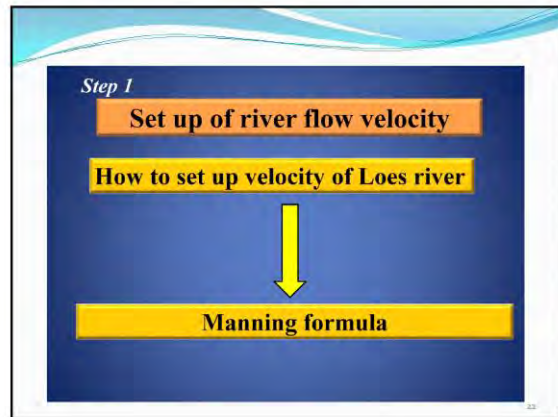

Manning's formula

$$V = \frac{1}{n} \times R^{\frac{2}{3}} \times I^{\frac{1}{2}}$$

V: Flow velocity (m/s)

n: Coefficient of roughness

R: Hydraulic radius (m) = Cross-sectional area of river/Wetted perimeter

I: Riverbed gradient

N: Coefficient of roughness

	River or channel conditions	Scope of Manning's n
Artificial channel (imposed flow)	Concrete artificial channel	0.014~0.020
	Spiral half-pipe channel	0.021~0.030
	Channel with stone masonry on both banks (low level)	0.025 (mean value)
	Bedrock excavation	0.035~0.05
	Bedrock forming	0.025~0.04
	Clay riverbed with flow velocity not enough to cause scouring	0.016~0.022
	Sandy loam, clayey soil loam	0.020 (mean value)
	Drag line dredging, little weeds	0.025~0.033
	Small channel on plain, with no grass	0.025~0.033
	Small channel on plain, with grass and shrubs	0.030~0.040
Natural river	Small channel on plain, with lots of grass and gravel bed	0.040~0.055
	Mountain channel, with gravel and boulders	0.030~0.050
	Mountain channel, with boulders and large boulders	0.040 or higher
	Large channel, with sandy bed and little meandering	0.018~0.035
	Large channel, with gravel bed	0.025~0.040

Source: Revised Ministry of Construction River and Erosion Control Standard (draft) 1997

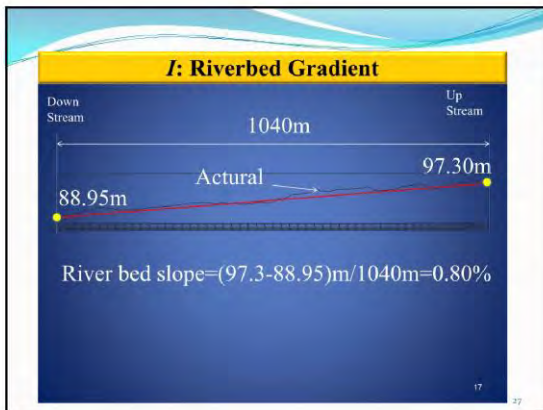
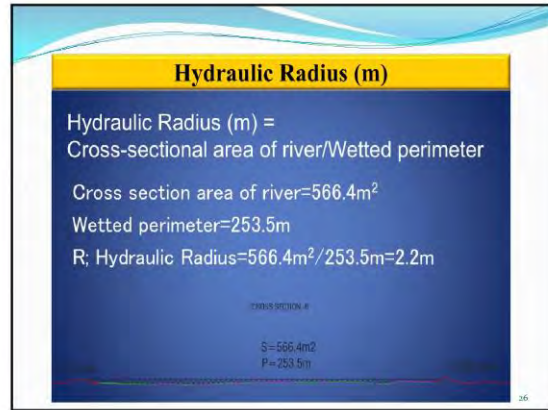
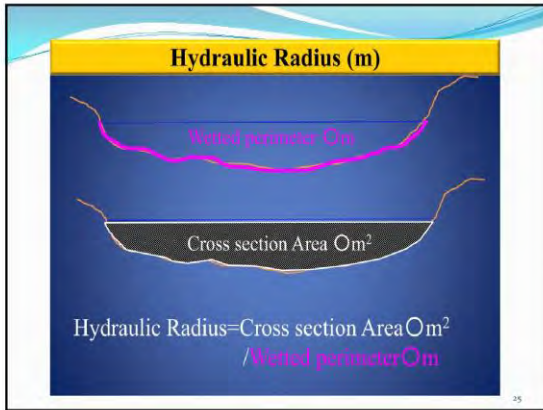

Result of Calculation

Cross section No.	No.6
n: Coefficient of roughness	0.03
S: Cross-sectional area of river (m ²)	566.4
P: Wetted perimeter (m)	253.5
I: Riverbed gradient	0.008
R: Hydraulic radius	2.2
V _m : Mean flow velocity (m/s)	5.10
Q: Discharge (m ³ /s)	2886.1



Bibliography

- [1] Dynamically design method on revetment, 2007, Japan Institute of Country and Engineering
- [2] Guidelines for river bridge plan (draft), 2009, Japan Institute of Construction Engineering.



República Democrática de Timor-Leste

Ministério das Obras Públicas

Direcção Geral das Obras Públicas

Direcção Nacional de Estradas, Pontes e Controlo de Cheias

Matadalan Substrutura Ponte

Bridge Substructure Protection Guidelines

Faze EFM

Atensaun

Documentos ida ne'e laos Padraun Nacional Timor Leste. Dokumentus ne'e sei fahe hodi halo revisaun no fo komentario. Materia ida ne bele halo mudansa no sein fo hatene no la refere hanesan padraun nacional.

Benefisiariu ba esbosu hetan convida atu submite, sira nia komentario, notifikasaun kona ba sira nia direitu ba patent nebe relevante no sira hatene no fornese apoio ba dokumentasaun.

Tipu Dokumentu: Spesifikasaun Teknikaocument

Subtipu Dokumentu:

Faze Dokumentu: (EFM) Esbosu Final Matadalan

Dokumentus ho lingua: TDT

Notifikasaun direitu author

Dokumentu DNEPCC ida ne hanesan esbosu nebe sei iha prosessu. Durante produs fila fali esbosu nebe iha prosesu nia laran sei uja husi funcionario nebe involve an iha projeitu CDRS ka R4D-SP permite sein iha autorizasaun husi DNEPCC, laos deit documentos nomos ninia extract husi esbosu ne bele produs fila fali, rai no transmite ba formatu seluk ba objektivu seluk la ho karta autorizasaun husi DNEPCC. Fotocopia tomak, ka parte balun husi documentus ida ne'e bele halo husi intituisaun akademika ba estudante.

Pedido ba lisensa atu produs fila fali dokumentus ida ne'e ba objektivu atu faan tenki hetan resposta husi Instituisaun tuir mai ne'e:

Ministério das Obras Públicas
Direcção Geral das Obras Públicas
Direcção Nacional de Estradas, Pontes e Controlo de Cheias (DNEPCC)
Enderesu: Avenida da Restauração, Rai Kotu, Comoro, Dili, Timor-Leste
Nu. Kontaktu: +670 3311408

Aviso legal:

Maske halo ona esforsu hotu-hotu atu garante ezatidaun no informasaun ba aplikasaun nebe tama iha dokumentus ida ne'e, author sei la responsabiliza ba responsabilidade legal kona ba erru ruma, ba omissaun ka razaun saida deit.

Konteudu

Prefasiu	v
Prefasiu husi JICA	vi
Agradesimentu.....	vii
Introdusaun	viii
1 Ambitu	1
2 Referensia normativu.....	1
3 Termu no definisaun	1
4 Karakteristika mota iha Timor-Leste	2
5 Kondisaun substrutura ponte nian iha Timor-Leste	2
6 Fenomena hidrauliku iha pilar ponte	5
7 Profundidade scour nian iha substrutura ponte	7
7.1 Profundidade scour nian besik pilar ponte.....	7
7.1.1 Prosedimentu ba estimasaun profundidade scour	7
7.2 Profundidade scour besik abutment.....	8
7.3 Deteminasau largura Scour nia koak	8
7.4 Ezemplu kalkulasaun 1	12
8 Protesaun ba ponte nian substrutura	13
8.1 Typu bloku protesau ba ponte nian pilar	14
8.2 Verifikasaun estabilidade dinamika bloku protesau ponte nian pilar	15
8.2.1 Politika baziku.....	15
8.3 Kalkulasaun ba todan bloku protesau pilar sira	18
8.4 Ezemplu kalkulasaun 2	20
8.4.1 Mediu velocidade	21
8.4.2 Determinasaun nivel be nian	22
8.5 Instalasaun largura ba bloku protesau pilar	23
Annex A (informativu) Estudu kazu Ponte Sahen	24
A.1 Introdusaun.....	24
A.2 Medida koretivas	25
A.3 Material treinamentu	27
Annex B (informativu) Material Treinamentu	32
B.1 Metodu Rasional.....	33
B.2 Metodu protesau ba scouring.....	37
B.3 Saku bo'ot rai henek.....	41
B.4 Metodu groin	44
B.5 Protesaun ba substrutura ponte nian	49
Bibliografia.....	54

(page intentionally left blank)



REPÚBLICA DEMOCRÁTICA DE TIMOR-LESTE
MINISTÉRIO DAS OBRAS PÚBLICAS
GABINETE DO VICE-MINISTRO
Av. Nicolau Lobato, Mandarin, Dili, Timor Leste

Prefasiu

Iha interese ba harii ho qualidade as no ekonomikamente viabiliza infraestrutura hodi servi nasaun, matadalan ida ne'e atu optimija dezeñu garante substrutura ponte nebe prepara ona husi JICA Projeto Desenvolvimento Kapasidade ba Servisu Estrada iha República Democrática de Timor-Leste (CDRS) nebe iha kolaborasaun ho Direcção Nacional de Estradas, Pontes e Controlo de Cheias (DNEPCC), Ministério das Obras Públicas. Ami hakarak hato'o agradece ba JICA ba kontinua suporta.

Setembru, 2019

Eng. Nicolau Lino Freitas Belo
Vice-Ministro das Obras Públicas
Ministério das Obras Públicas

Prefasiu husi JICA

Japan International Cooperation Agency (JICA) halao ona projetu kooperasaun téknika ida ba desenvolvimento kapasidade kona ba servisu estrada, nebe'e hanaran CDRS, nune atu fasilita DNEPCC jere no halo manutensaun ba infra-estrutura estrada bazea ba actividade sosial no ekonomiku. Ba ida-ne'e nia rohan, JICA despasa ona ekipa espesialista sira husi fulan-Marsu tinan 2016 to'o fulan Dezembru tinan 2019. Hanesan resultadu husi kolaborasaun servisu husi parseira DNEPCC, matadalan ba subestrutura ponte finalisa ona. Ha'u espera katak matadalan ida-ne'e sei kontribui ba dezentvolvimentu infra-estrutura no manutensaun, no valorizasaun relasaun belun di'ak entre nasaun rua.

Ikus liu, ha'u hakarak hatu'o ha'u-nia apresiasaun sinceramente ba funcionariu governu República Democrática de Timor-Leste nia ho equipa peritu.

Setembru, 2019

Masafumi NAGAISHI
Representante Chefe Gabinete JICA iha Timor-Leste
Japan International Cooperation Agency



Agradesimentu

Projetu ba Desenvolvimento Kapasidade Servisu Estrada iha República Democrática de Timor-Leste (CDRS) hakarak atu fó-agradese ba parte hotu-hotu ne'ebé envolve an hodi prepara no revisaun matadalan substrutura ponte.

Apoia projetu ne'e, ofisial husi (eis) Ministério de Desenvolvimento e de Reforma Institucional: M. R. M. Cruz, J. L. C. C. P. Mestre and J. Santos; no ofisial husi Ministerio Obras Publiku: C. M. Henrique no especialmente ba R. H. F. Guterres; hodi rekonese.

Durante halo preparasaun ba dokumentus ida ne'e hetan kontribuisaun husi ofisial DNEPCC: M. R. C. Monteiro, J. P. Amaral, J. M. G. Sousa, J. G. Carvalho, I. M. L. Gutteres, N. Lobato, L. R. H. Corbafo, A. Araujo, J. L. Kehy, C. C. Monteiro; no Organizaçaun Internacional Trabalho ou International Labour Organization's (ILO) nudar ekipa asistente teknika ba apoiu programa Desenvolvimento Estrada (R4D-SP): A. O. Asare, K. H. Myaing, S. Done; hodi rekonese.

Komentariu:

Sei apresia tebes ba komentariu nebe positivu ba possibilidade inkorporasaun ba edisaun tuir mai. Favor fo komentario no sugestaun ba iha enderusu tuir mai ne'e.

Direcção Nacional de Estradas, Pontes e Controlo de Cheias (DNEPCC)
Enderesu: Avenida da Restauração, Rai Kotu, Comoro, Dili, Timor-Leste
Nu. Kontaktu: +670 3311408

Introdusaun

Substrutura ba ponte mota nian iha Timor-Leste barak mak la iha protesau ba scour. Ne'ebe mak rezulta, ponte barak hetan estraga ho lalais durante mota bo'ot/inundasaun no halo koak bo'ot iha abutment no pilar nian okos.

Karik kontramedida ne'ebe apropriadu la aplika ba ponte sira ne'e, sei iha risku estraga ne'ebe ho skala bo'ot hanesan ponte sei hetan penurunan ka kolapsu.

Husi aspetu operasaun no manutensaun, hadia fila fali substrutura sei la suficiente.

Hanesan rezultadu, substrutura ne'ebe hetan estraga fila-fila husi inundasaun ne'ebe bebeik no sai nivel ne'ebe presiza re konstrusaun total.

Responde ba situasaun ida ne'e, dezenu matadalan ida ne'e deskreve dezenu ne'ebe mak presiza kontramedida ba protesau substrutura husi inundasaun scour, bazea ba enjineirru nia konnesementu.

Dezenu matadalan ida ne'e prinsipalmente elabora tuir padraun teknika japaun nian ba kontramedida protesau substrutura ponte nian husi inundasaun scour.

Simulasaun limpasan ne'ebe sofistikadu ka material ne'ebe karun ba kontramedida sira ne'e, hanesan sheet pile ka steel pipe piles, sire ne'ebe esklui iha matadalan relasiona ho difikuldade ba implementasaun husi kontraktor lokal sira hare ba iha nia kustu no nivel tekniku husi maundeobra restrisaun.

Espera katak matadalan ida ne'e bele ajuda ba kontramedida inundasaun no ajuda redus estragus husi inundasaun scour ba substrutura ponte iha Timor-Leste.

Matadalan Substrutura Ponte

1 Ambitu

This document specifies minimum requirements and design methods for bridge substructure protection in Timor-Leste.

2 Referensia normativu

There are no normative references in this document.

3 Termu no definisaun

Ba objektivu dokumentu ida ne'e, aplika termu no definisaun tuir mai ne'e.

ISO mantein terminalojia baze dados ba benifisiariu sira atu uja padraun iha enderesu tuir mai ne'e:

— Plataforma navigasaun online ISO: iha <https://www.iso.org/obp>

3.1

Scour

Foti sai rai henek iha be okos no material fatuk sira iha mota liu husi fluxo, especialmente iha baze no strutura nia ain okos

[FONTES: ISO 21650:2007, 2.60]

3.2

Protesaun ba Scour

Material ne'ebe atu tau iha riverbed atu prevene scour husi

[FONTES: ISO 29400:2015(en), 3.124]

3.3

Penurunan

Movimento descendente permanente strutura ida tamba nia todan no asaun sira seluk

[FONTES: ISO 19901-8:2014(en), 3.34]



Figura 1 — Mapa mota iha Timor-Leste

4 Karakteristika mota iha Timor-Leste

Mota iha Timor nia origem mak foho ho altitude 1000 m to'o 2000 m; sira sulin ho lalais husi foho lolon liu ba altitude neebe tetuk no sulin ba to'o tasi. Media udan ben anual iha regiaun norte mak aproksimamente entre 1000 mm to'o 2000 mm no iha regiaun sul nian wnre 1500 mm to'o 2000 mm. Atu hanesan ho mota iha Japaun, mota sira ne'e iha karakteristik ne'ebe bele kausa inundasaun ho lalais.

Timor-Leste hanesan pais insular, ho mota ne'ebe ladun naruk no ninia karakteristik natural atu hanesan ho Japaun, permite padraun Japaun ne'ebe estabele tiha ona iha Japaun atu aplika iha Timor-Leste.

5 Kondisaun substrutura ponte nian iha Timor-Leste

Figura tuir mai ne'e hatudu estragas husi scouring ponte sahen iha prte liman los ba abutmen no pilar. Relasiona ho estraga husi scouring, pilar abutmen nian no caving fondasi bele hare ho mos los iha pilar ponte.

Figura 4 no Figura 5 hatudu estragu husi scouring pilar Ponte Mola. Tanba estragu husi scouring, caving iha fondasi bele hare ho mos.

Se kontramedida ne'ebe apropiadu la aplika no scouring sei nafatin durante tempu naruk, mak ponte sei hetan penurunan tomak (bele hare iha Figura 6,7).



Figura 2 — Abutmen Ponte Sahen 2017



Figura 3 — Pilar Ponte Sahen 2017



Figura 4 — Pilar Ponte Mola 2011



Figura 5 — Pilar Ponte Mola 2011



Figura 6 — Penurunan ponte tamba pilar ponte ne'ebe hetan scouring (Ezemplu iha Japaun)



Figura 7 — Penurunan ponte tamba pilar ponte ne'ebe hetan scouring (Ezemplu iha Japaun)

6 Fenomena hidrauliku iha pilar ponte

Figura 8 hatudu fenomena hidrauliku ne'ebe mosu iha pilar ponte durante inundasaun. Pilar ponte nian lokaliza iha mota ne'ebe kauza complex vortices no laloran ne'ebe perturba fluxo no superficie be nian durante inundasaun; rezulta, nivel be nian nebe sae no scouring iha riverbed.

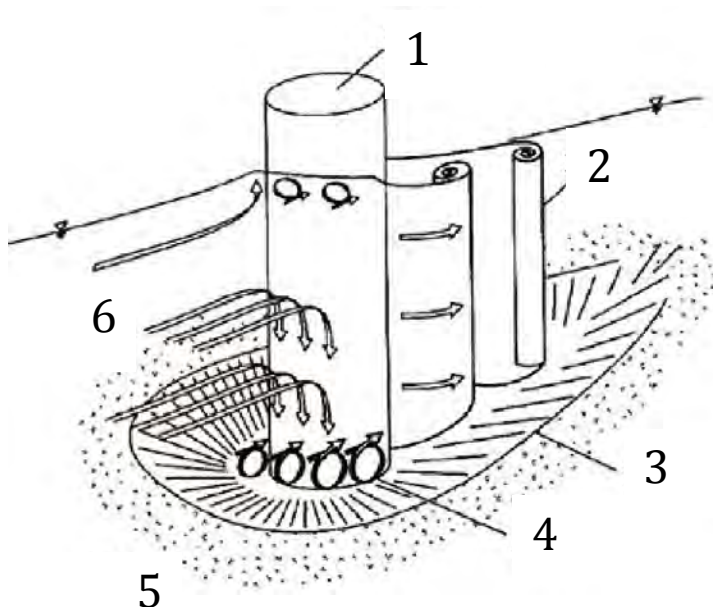

Chavi

- 1 pilar ponte
- 2 vórtice Karman
- 3 scouring na koak
- 4 vórtice horseshoe
- 5 mota laran
- 6 fluxo

Figura 8 - Fenomena hidrauliku iha pilar ponte

Figura 9 Hatudu fenomena atual iha pilar ponte nian durante inundasaun. Akontensimentu ba fluxo ne'ebe kompleksu iha pilar ponte nebe mak aparente.



Figura 9 — Fenomena hidrauliku iha pilar ponte (Ezemplu iha Japaun)

Figura sira tuir mai ne'e (Figura 10 no Figura 11) hatudu situasaun scour iha pilar pote depois de inundasaun iha Japaun. Kauza husi Inundasaun mak halo ona koak iha besik pilar ponte nian.



Figura 10 — Fenomena atual iha pilar (Ezemplu iha Japaun)



Figura 11 — Fenomena atual iha pilar (Ezemplu iha Japaun)

7 Profundidade scour nian iha substrutura ponte

7.1 Profundidade scour nian besik pilar ponte

Maske ida ne'e mak ideal liu atu uza rezultadu husi simulasaun limpasan no simulasaun modelu hidrauliku atu determina lokal profundidade besik substrutura ponte, relasiona ho nessesidade ba teknologia ne'ebe avansadu,esperensia, no facilidade esperimental, metodu hirak ne'e sei la sempre posivel. Matadalan ida ne'e uza formulula estimativ, formula (1), ba profundidade scour, ne'ebe la ezije rekursu ne'ebe temi tiha ona no utiliza mos iha Japaun.

$$\frac{Z}{D} = f \cdot \left(\frac{h_0}{D} \cdot \frac{h_0}{dm} \cdot Fr \right) \quad (1)$$

iha ne'ebe

- h_0 mak mediu profundidade be;
- D mak diametru pilar ponte nian;
- dm mak mediu diametru grauns material mota laran nian;
- Fr mak numeru Froude; $\frac{V_m}{\sqrt{gh_0}}$
- V_m mak mediu velocidade;
- Z mak profundidade scour nian.

7.1.1 Prosedimentu ba estimasaun profundidade scour

Mediu be nia profundidade h_0 mak kalkulasaun liu husi metodu analiza hidrauliku ne'ebe utiliza kalkulasaun fluxo uniforme ka kalkulasaun naun-uniforme.

Etapa 1

Kalkulasaun dimensaun profundidade scour Z/D uza mediu profundidade be nian h_0 ne'ebe targetu tiha ona, pilar nian nia diamtru D , diameru mediu a aterial mot laran nian dm , no nmeru froude Fr , tuir figura 14.

Etapa 2

Rezuadu Z/D tenki korize atu bele muda diresaun fuxo nian relasiona ho inundasan ne'ebe besik iha pilr ponte. Depois de korize, profundidade kok ne'ebe besik pilar ponte bele kalkula.

7.2 Profundidade scour besik abutment

Profundidade scour iha besik abutmen laiha metodu kalkulasaun ne'ebe klaro, maske iha Japaun. Tan ne'e, rekomenda ba estimasaun no determina profundidade scour besik iha abutment bazea ba rezultadu investigasaun iha abutment no besik abutment.

Aleinde ne'e, ponte barak iha Timor-Leste mak iha fondasi pilar no abutment badak, tan ne'e wainhira planea atu halo ponte foun, neseariu liu atu halo investigasaun hanesan mensiona tiha iha leten no asegura profundidade fondasi nian naruk ne'ebe suficiente.

7.3 Deteminaasaun largura Scour nia koak

Largura ba scour nia koak kalkula ho formula Japaun nian ho hatama profundidade masimu scour Z no mediu anglu iha be okos ne'ebe repousu θ no profundidade masimu husi Figura 12 ba iha formula (2):

$$R = Z / \tan \theta \tag{2}$$

iha ne'ebe

- R mak largura koak scour nian;
- Z mak profundidade masimu scour nian;
- θ mak mediu angulo be okos ne'ebe repousa.

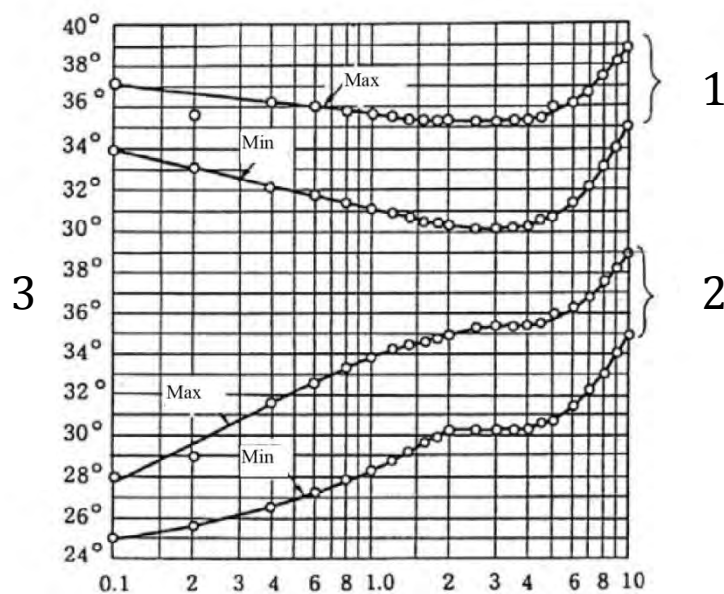

Chavi

- 1 iha anin
- 2 iha be laran
- 3 ângulo de repouso θ
- 4 diamentru material mota laran

Figura 12 — Relasaun entre Angulo repouza θ no media musan nia angulo

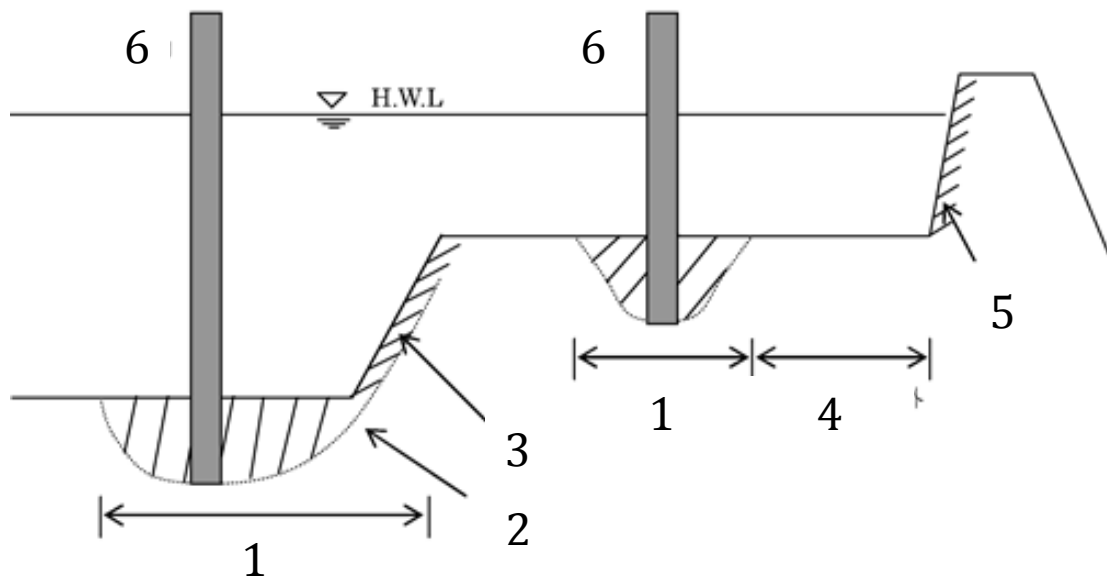
**Chavi**

- 1 largura koak scour
- 2 banco erosaun husi scouring
- 3 erosaun husi fluxo velocidade
- 4 sai husi area scour
- 5 banco erosaun husi scouring
- 6 pilar

Figura 13 — imagem husi scouring besik pilar

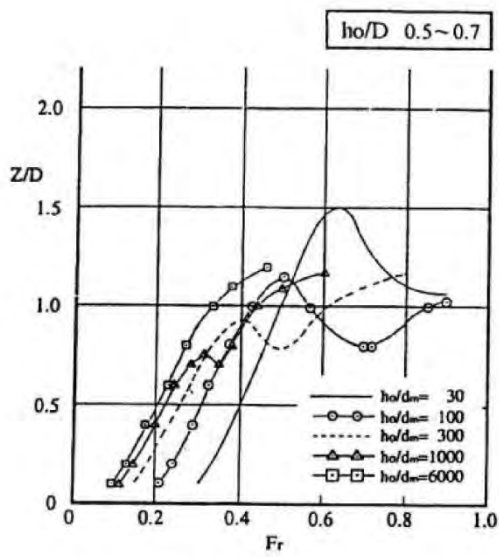

Relationship between $Fr \sim Z/D$ and h_0/d_m
($h_0/D=0.5$ to 0.7)

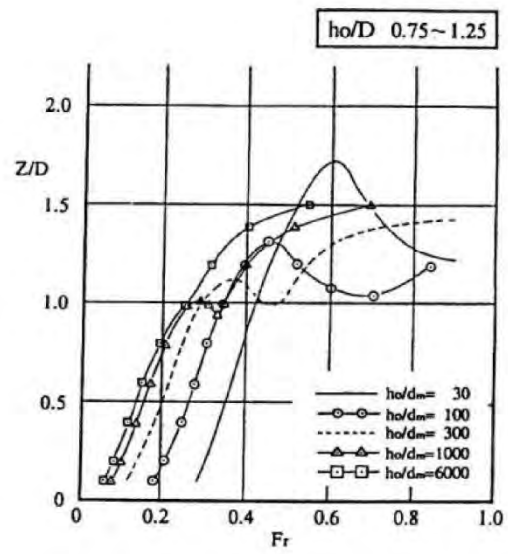

Relationship between $Fr \sim Z/D$ and h_0/d_m
($h_0/D=0.75$ to 1.25)

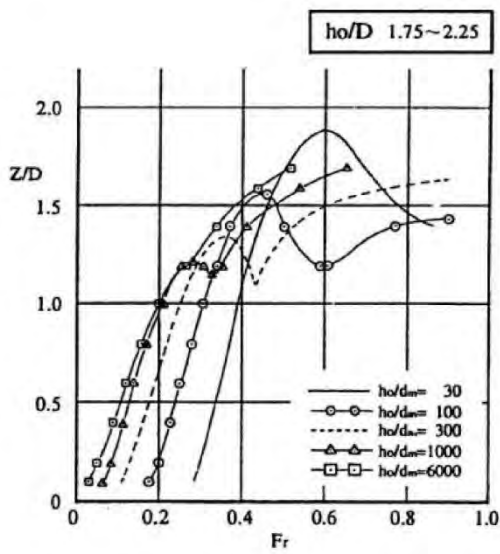

Relationship between $Fr \sim Z/D$ and h_0/d_m
($h_0/D=1.75$ to 2.25)

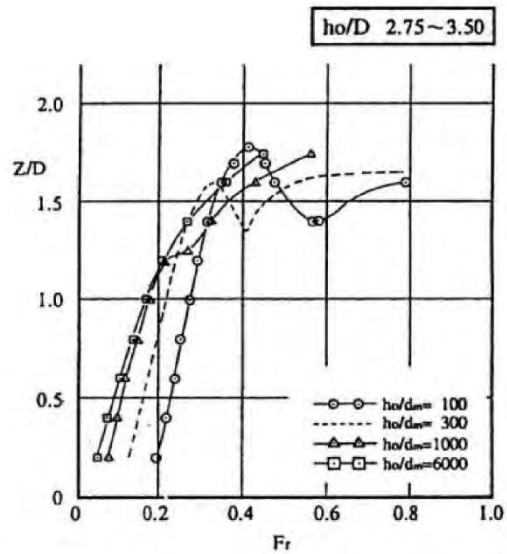

Relationship between $Fr \sim Z/D$ and h_0/d_m
($h_0/D=2.75$ to 3.50)

Figura 14 — Relasaun entre $Fr \sim Z/D$ no h_0/d_m



Figura 15 — Fatores koresaun K_α ba angulo ataka nian



Figura 16 — Fatores koresaun K_d ba besik pilar

7.4 Ezemplu kalkulasaun 1

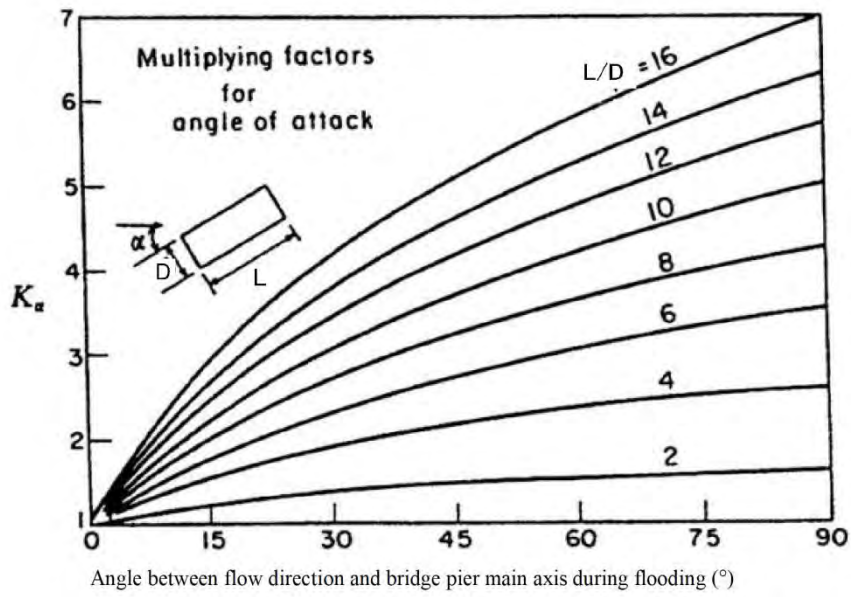
Ezemplu mak hatudu iha kraik ne'e.

※ Kondisaun kalkulasaun nian:

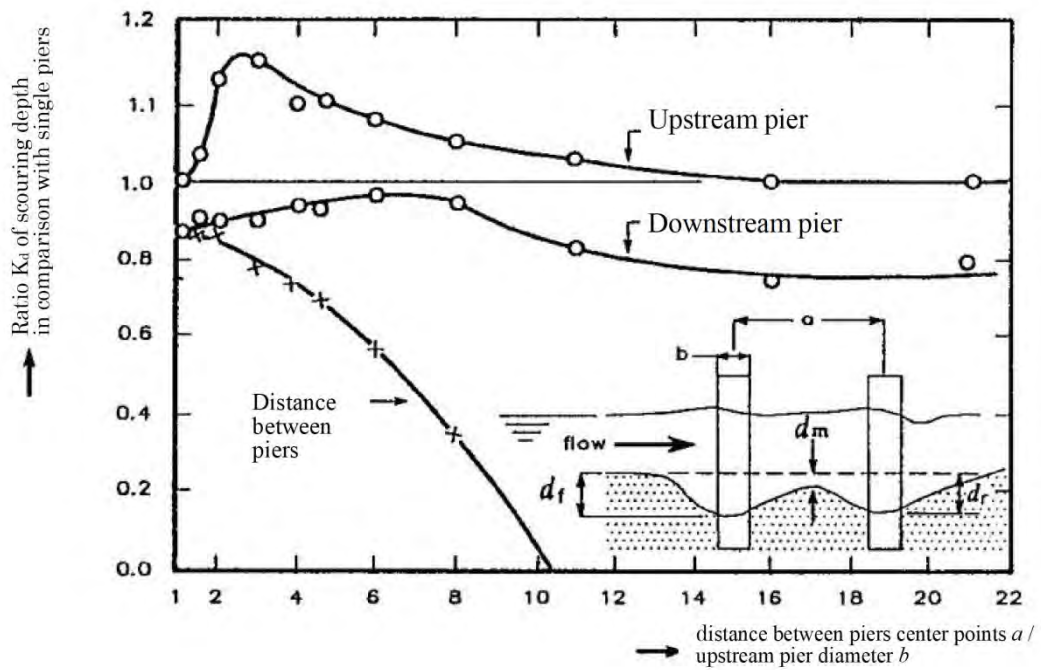
Uza Formula (1):

$$\frac{Z}{D} = f \cdot \left(\frac{h_0}{D} \cdot \frac{h_0}{d_m} \cdot Fr \right)$$

iha ne'e

h_0	5.83m	mak mediu profundidade be;
D	2.0 m	mak diamentru pilar ponte nian;
d_m	24.9 mm	mak mediu idamentru draun material mota laran;
Fr	0.54	mak numeru Froude;
Z		mak profundade scour.



Figura 17 — Corte transversal



Figura 18 — Planu

Atu determina media profundidade be nian, tenki uza nivel altu husi be:

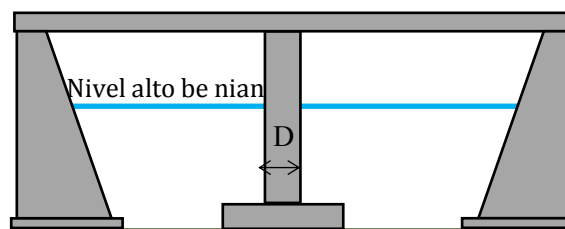
Be nian nivel altu: 24.80m

Dezenu mota laran: 18.97m

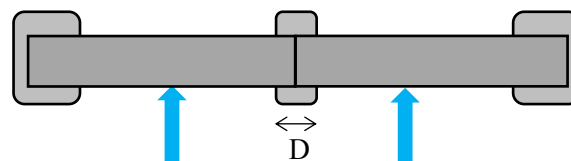
h_0 , Media profundidade be: 24.80-18.97= **5.83 m**

Agora Z bele kalkula hanesan tuir mai ne'e:

$$h_0/D = 5.83/2.0 = 2.915$$

$$h_0/d_m = 5.83/0.0249 = 234.1$$

$$Z/D = 1.5 \text{ (hare iha Figura 19)}$$

Pilar axis parrreru ho dirersaun fluxo no iha neba laiha

ponte proximais ne'ebe besik ponte original.

Tanba ne'e, fator koresaun $K\alpha = 1.0$ no $K_d = 1.0$ adopta.

Profundidade scour, $Z = (Z/D) \cdot D \cdot K\alpha \cdot K_d$

$$= 1.52 \cdot 2.0 \cdot 1.0 \cdot 1.0 = \mathbf{3.0 \text{ m}}$$

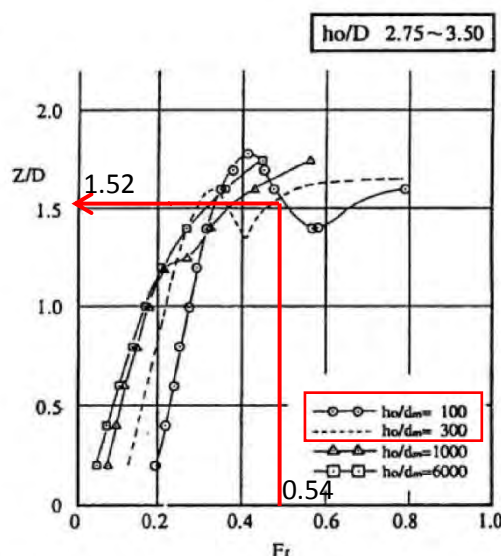

Relationship between $Fr \sim Z/D$ and h_0/d_m
($h_0/D = 2.75$ to 3.50)

Figura 19 — Relasaun entre $Fr \sim Z/D$

8 Protesaun ba ponte nian substrutura

Iha Timor-Leste, servisu protesaus hanesan kontramedida ba scouring la installa iha pilar no nia abutments, barak mak komfirma ona hetan estraga scouring. Tan ne'e mak rekomenda tebes atu implementa kontramedida ba scouring iha abutment no pilar.

Iha tipu 2 ba servisu protesaus nian: gabion no bloku protesaus. Maibe, tanba kestaun durabilidade (tanba deteriorasaun, etc.) husi arame besi sira ne'ebe uza ba gabion, tan nemak rekomenda ba Timor-Leste atu foti abordajen hanesan ho Japaun no uza bloku protesaus ba ponte nia pilar sira.



Figura 20 — Gabion ne'ebe hetan estraga iha Ponte Mola 2011



Figura 21 — Bloku protesaus ponte nia pilar iha Japaun



Figura 22 — Bloku protesaus ponte nia pilar iha Japaun

8.1 Tipu bloku protesaus ba ponte nian pilar

Bloku protesaus ba ponte nia pilar babain uza ba protesaus substrutura ponte iha Japaun. (Hanesan hatete tiha ona, mota sira iha Timor-Leste iha karakteristika natural ne'ebe hanesan ho Japaun.) Tanba ne'e, esperencia atual barak no dadus husi eksperimentu modelu hidrauliku uza bloku protesaus. Valor karakteristiku husi bloku protesaus ponte nia pilar lahanesan ho sira nia modelu.

Tabela 1 — Tipu Protesaus ponte nia Pilar iha Japaun



8.2 Verifikasaun estabilidade dinamika bloku protesaun ponte nian pilar

8.2.1 Politika baziku

Servisu protesaun pilar presiza tebes todan ne'ebe adequada atu aseguira estabilidade hasoru forsa hidrodinamika, largura no nia as husi estimasaun scouring.

1. Funsau

Protesau iha pilar hamenus scouring iha mota. Diretamente expostu ba iha fluxo be nian. Tanba ne'e, nessesariu tebes ba servisu protesaun pilar atu bele stabil hasoru fluxo be nian. Ida ne'e bele verifika bazea ba fratura morfologia husi modelu strutura ne'ebe hanesan hanesan mos ho protesaun ba rai halis.

2. Modelu estragu

Wainhira profundidade husi fondasi ne'ebe hakoi ba mak razu (dangkal) no servisu protesaun ba pilar la iha largura n'ebe mak suficiente, fluxo ne'ebe aumenta durante inundasaun sei rezulta iha estragu ba servisu protesaun rai halis. Aleinde ne'e, se servisu protesaun ba pilar mak ladun todan demais ba fluxo velocidade, ida ne'e sei halo bele lori hotu no bele mos halo estraga iha ba revetimentu tomak. Tanba ne'emak importante tebes atu kontrollu largura husi servisu protesaun ba pilar, modelu strutura ne'ebe hanesanho servisu protesaun ba rai halis bele uza ba estuda ninia stailidade dinamika.

Hanesan mos ho servisu protesaun rai halis, modelu estragus (rolling, sliding and traction) ba servisu protesaun ne'ebe mak bazea ba modelu no ninia aranjamentu ba razaun ida ne'e, ninia modelu no aranjamentu mos bazea ba verifikasaun.

(1) Sliding

Wainhira forsa hidrodinamika halo komponente mak diak liu friksaun iha sikun kraik, bele halo sliding. Ida ne'e tenki tau ba konsiderasaun ba parte servisu protesaun pilar ponte nian iha motaulun, prezemplu, modelu ne'ebe faila bele hare iha parte husi seksaun ne'ebe dok husi motaulun ne'ebe ninia tipu hada kada layer no tipu hada ne'ebe acak ba servisu protesaun pilar.

(2) Rolling

Ida ne'e bainhira forsa hidrodinamika hamosu komponente ida hadulas iha pivot point no roll. Modelu estragu ne'e bele hare, por ezemplu, iha parte balun dok husi motaulun nian.

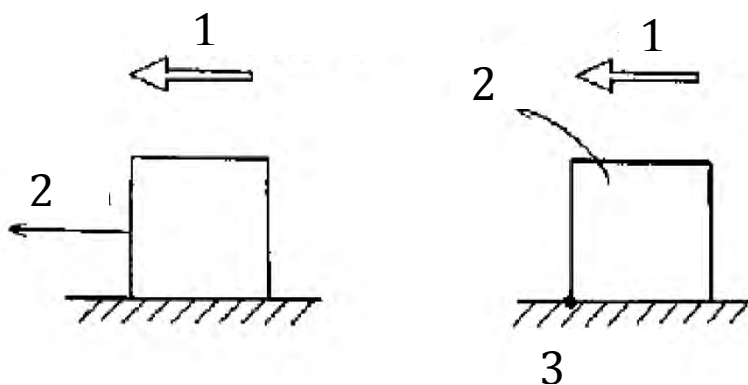

Chavi

- 1 fluxo nian diresaun
- 2 mosapun
- 3 pontu pivot

Figura 23 — Deslizamentu no rolamentu

(3) Trasaun

Komponentes sira simu forsa hasae no dada direktamente husi fluxo no laos bebeik rollu ka esperensia saltasi besik iha mota laran. Modelu ida ne'e uza ba servisu proteasaun pilar nia ain ho elementus ne'ebe hatoba deit, hanesan fatuk naural ka kaber, bloku konkretu babain ne'ebe forma ho rapidamente.

Por ezempluida ne'e bele hare husi estragu ne'ebe hetan husi servisu proteasaun ne'ebe utiliza riprap no gabion.

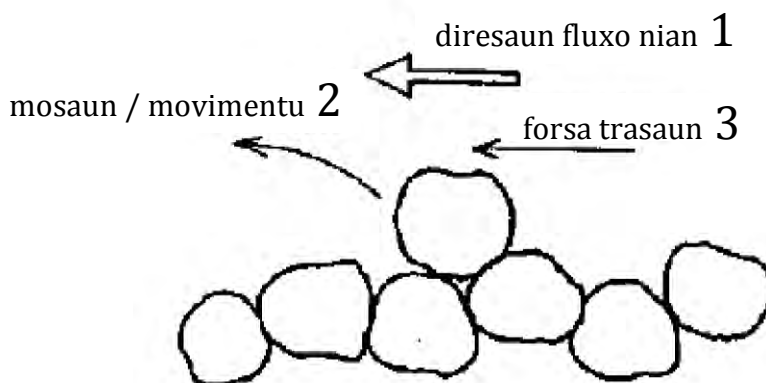

Chavi

- 1 diresaun fluxo nian
- 2 mosapun / movimentu
- 3 forsa trasaun

Figura 24 — Trasaun

3. Tipu installasaun

(1) Nivel empillamentu

Material sira ne'e hada ho modelu ne'ebe baibain. Por ezemplu: bloku ne'ebe hada uniforme.



Figura 25 — Layered stacking

(2) Empillamentu acak

Material sira hada ho modelu naun-uniforme. Por ezemplu: hada bloku, servisu protesaun ho rip rap.

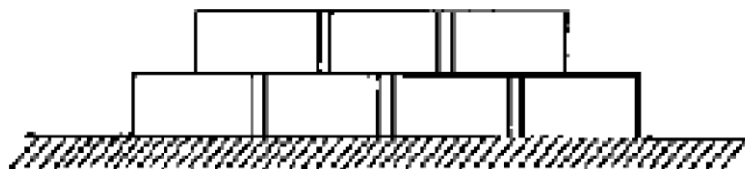

Figura 26 — Hada ho acak

(3) Gabion

Raga ne'e ense nakonu ho fatuk no material sira seluk. Ida ne'e refere ba iha servisu protesaun pilar ho gabion.

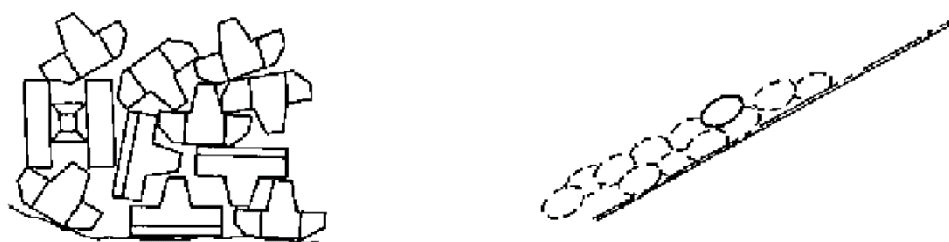

Figura 27 — Gabion

(4) Preense

Enkuadramentu ho preense ho fatuk ka material sira seluk. Ezemplu, matras fagot no matras ai.

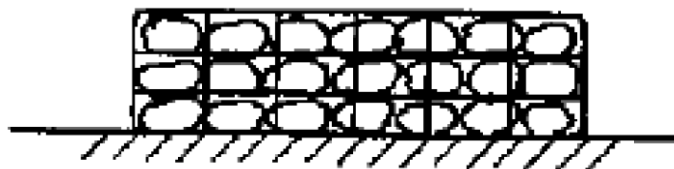

Figura 28 — Preense

8.3 Kalkulasaun ba todan bloku protesaun pilar sira

Formula tuir mai ne'e, formula (3), ne'ebe uza iha Japaunho kalkulasaun ho todan bloku protesaun pilar ne'ebe nessesario liu:

$$W > a \left(\frac{\rho_w}{\rho_b - \rho_w} \right)^3 \frac{\rho_b}{g^2} \left(\frac{V_m}{\beta} \right)^6 \left(\frac{\rho_w}{\rho_b - \rho_w} \right)^3 \cdot \frac{\rho_b}{g^2} \cdot \left(\frac{V_m}{\beta} \right)^6 \quad (3)$$

iha ne'ebe

- W mak todan bloku protesaun ba pilar
- a mak fator ba Modelu bloku protesaun pilar
- β mak fator ne'ebe define tipu
- Vm mak media velocidade
- ρ_w : mak densidade be nian (980 kg/m³)
- ρ_b mak densidade bloku nian (2030 kg/m³)
- g mak asselersaun gravidade nian (9.8 m/s²)

Tabela 2 — Fatores α no β

Bloku nian Modelu	Spesifiku gravidade ρ_b/ρ_w	$a \times 10^{-3}$	β
Tipu A: Projection	2.22	1.2	1.5
Tipu B: Plane	2.03	0.54	2.0
Tipu C: Triangular conic	2.35	0.83	1.4
Tipu D: Triangular bearing	2.25	0.45	2.3
Tipu E: Rectangle	2.09	0.79	2.8



Figura 29 — Tipu arranju bloku

8.4 Ezemplu kalkulasaun 2

Ezemplu mak hatudu hanesan tuir mai ne'e.

※ Kondisaun kalkulasaun:

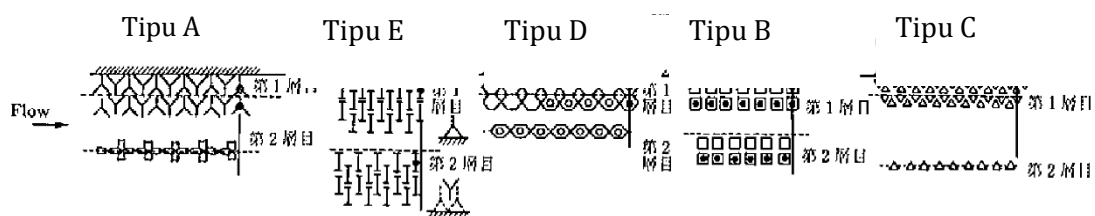
Uza Formula (1):

$$W > a \left(\frac{\rho_w}{\rho_b - \rho_w} \right)^3 \frac{\rho_b}{g^2} \left(\frac{V_m}{\beta} \right)^6 \left(\frac{\rho_w}{\rho_b - \rho_w} \right)^3 \cdot \frac{\rho_b}{g^2} \cdot \left(\frac{V_m}{\beta} \right)^6$$

iha ne'ebe

W		mak todan husi bloku protesaun pilar;
V _m	5.1m/s	mak velocidade mota;
Modelu/Bentuk	Tipu B	mak tipu bloku;
α	0.54	mak fator bloku;
β	2.0	mak fator bloku;
ρ _w	980kg/m ³	mak densidade be;
ρ _b	2030kg/m ³	mak densidade bloku;
g	9.8m/s ²	mak akselarsaun gravidade.

Agora W bele kalkula hanesan tuir mai ne'e:

$$W > 0.54 \times \left(\frac{1000}{2030 - 1000} \right)^3 \times \frac{2030}{9.8^2} \times \left(\frac{5.1}{2.0} \right)^6$$

$$W > 2872N$$

$$W > 293kg$$

8.4.1 Mediu velocidade

Velocidade fluxo nian ne'ebe uja ba kalkulasaun protesaun pilar nia todan ne'e kalkula uza formula Manning ba kalkulasaun media velocidade. Koefisiente roughness hili husi tabela iha kraik ne bazea ba kondisaun target mota iha terrenu.

$$Vm = \frac{1}{N} \cdot R^{2/3} \cdot I^{1/2}$$

iha ne'ebe

N mak koefisiente roughness

R mak radius hidrauliku

I mak mota laran nia klean

Tabela 3 — Revizaun Ministeriu konstrusaun iha Mota no Padraun kontrolu Erosaun (Esbosu) Japaun 1997, Seksaun Levantamentu p132

Kondisaun mota no Kanal		Eskopu husi Manning n
Kanal artfisial, mota ne'ebe hadia	Kanal artfisial husi konkretu	0.014~0.020
	Kanal meu spiral-pipa	0.021~0.030
	Kanal ho stone masonry iha ninia sorin-sorin (mud bed)	0.025 (mean value)
	Eskavasaun ba lapisan tanah keras	0.035~0.05
	Formalapisan tanah keras	0.025~0.04
	Mota laran ho rai tahu no nia velocidade fluxo la suficiente atu hamosu scouring	0.016~0.022
	Lempung pasir,tanah liat lempung	0.020 (mean value)
	Dragagem de dragagem, pequenas ervas daninhas	0.025~0.033
Mota natural	Kanal kiik ne'ebe iha rai tetuk,no laiha du'ut	0.025~0.033
	Kanak kiik iha rai tetuk, ho du'ut no arbustos	0.030~0.040
	Kanal kiik iha rai tetuk, ho du'ut no fatuk laran	0.040~0.055
	Kanal iha foho, ho gravel no fatuk bo'ot	0.030~0.050
	Kanal iha foho, ho fatuk bongkahan no bongkahan bo'ot	0.040 or higher
	Kanal bo'ot, ho material mota laran rai henek no kleur kleur oituan	0.018~0.035
	Kanal bo'ot, no iha fatuk laran	0.025~0.040

iha ne'ebe, Radius Hidrauliku (m) = Cross Section Area (m²) / Keliling basah (m)



Figura 30 — Iagem radius hidrauliku

8.4.2 Determinasaun nivel be nian

Nivel be nian ne'ebe uza Manning formula ba kalkulasaun velocidade nian media tenki determina uza Metodu tuir mai ne'e:

Solusaun 1. Kalkulasaun fluxo naun-uniforme

Solusaun 2. Halo levantamentu dadus liu husi entrevista ho komunidad sira ne'ebe besik, levantamentu dadus husi inundasaun iha passadu ninia marka.

Iha Timor-Leste, installasaun ba stasaun udan ben la suficiente ba kalkulasaun limpasan no relasiona ho levantamentu topografiku nebe karun liu ba kalkulasaun fluxo naun-uniforme. Hanesan razaun ida ne'e, levantamentu ho entrevista ho komunidad lokal ka levantamentu hoinundasaun passadu nian marka. Mak solusaun ne'ebe realistik ne'ebe bele uza ba define nivel be.

Iha parte seluk, iha kazu ba planu ponte foun ka planu ba mota ba kontramedida inundasaun, kalkulasaun naun-uniforme tenki enkoraja atu defini nivel be nian iha mota. Iha kazu ida ne'e, deskarga mota no periodu retornu mak prezisa ba estudo mota nian. Ida ne'e enkoraja tebes atu uza periodu retornu ne'ebe hanesan ho plano original mota ninian.

Matadalan ida ne'e eksklui esplikasaun kona ba oprasaun software fluxo naun-uniforme, iha prosibilidade atu hetan software ne'e ho gratuita no operasaun manual iha website tuir mai ne'e "US Army Corps of Engineers". <http://www.hec.usace.army.mil/software/hecras/>



Figura 31 — Estuda prosedimentu ba kalkulasaun 1

Referensia

1. Fluxo uniforme

Fluxo sei sai uniforme, wainhira fluxo nian velocidade la muda an iha magnetude ka iha diresaun ba qualaue pontus iha fluida ne'ebe sulin tuir tentu nebe'e determina tiha ona. Ezemplu, fluxo ne'ebe liquidu iha presau nia okos liu husi pipa ne'ebe naruk ho kontanta diameter ne'ebe hanran fluxo uniforma.

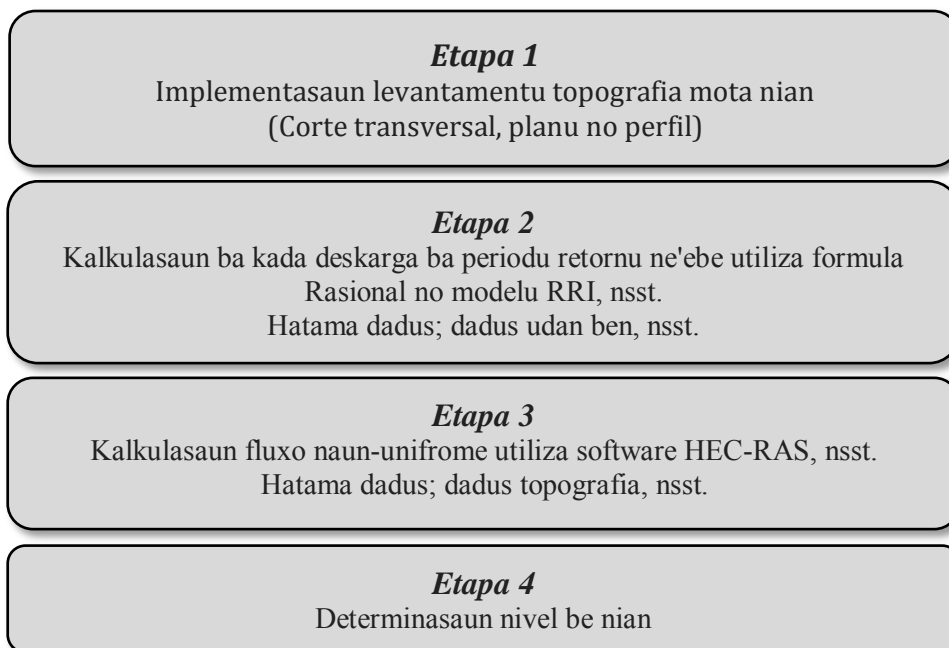
2. Fluxo naun-uniforme

Fluxo sei sai uniforme, wainhira iha mudansa iha velocidade fluxo iha pontus diferensia fluida ne'ebe sulin, iha tempu ne'ebe termina ona. Ezemplu, fluxo husi liquida iha presau nia okos ho varius diametru mak refere hanesan fluxo ne'ebe mak naun-uniforme. Tipu fluxo sira ne'e hotu bele eziste independentemente ida no ba sira seluk. Nune'e posibel tebes atu halo combinasaun ba fluxo 4 ne'e:

1. Fluxo uniforme ne'ebe stavel
2. Fluxo naun-Uniforme ne'ebe stavel
3. Fluxo uniforme ne'ebe la stavel
4. Fluxo naun-uniforme ne'ebe la stavel

8.5 Instalasaun largura ba bloku protesaun pilar

Instalasaun largura ba bloku protesaun pilar nian tenki liu husi 5 m, maibe iha kazu ida ne'e scoring iha mota laran, tenki define hanesan deskreve 7.3 Determinasaun husi largura scour nia koak.

Annex A (informativu)

Estudu kazu Ponte Sahen

A.1 Introdusaun

I. Razaun ba selesaun ba estudu kazu

Razaun ba selesaun ba estudu kazu ba kontrollu dezenu mak hanesan tuir mai ne'e:

1) Generalidade item servisu

Item servisu husi estudu kazu ne'e mak servisu protesaun ba substrutura ponte nian.

Hafoin planu kona ba estudu de kazu nemak kompleta, konesementu ne'ebe mak hetan husi estudu kazu ne'e sei dezenvolve ba area hotu-hotu iha Timor-Leste.

2) Acessibilidade

Fatin ne'e lokaliza besik ho sidade prinsipal distritu nian no han tempu minutu 60 husi edificio munisipal diresaun estrada e controlo de cheia no seguransa enjeral mos diak.

3) Urjenti no Importánsia

Estrada ne'e konsidera hanesan estrada ne'ebe importante tebes no prezisa atensaun urgente.

II. Servisu protesaun hasoru scouring ba ponte

1. Area estudu kazu

Fatin ne'ebe targetu lokaliza iha mota sorin los Mota Sahen.



Figura area estudu kazu iha Sahen

2. Situasoun atual

Figura tuir mai hatudu situasoun scoring iha mota ninin parte sorin los abutment no pilar iha parte sorin los. Iha ne'eba laiha servisu protesaun iha abutment ho pilar nian oin, tanba ne'e nessesariu tebes atu rehabilita bazeia ba analiza tekniku.

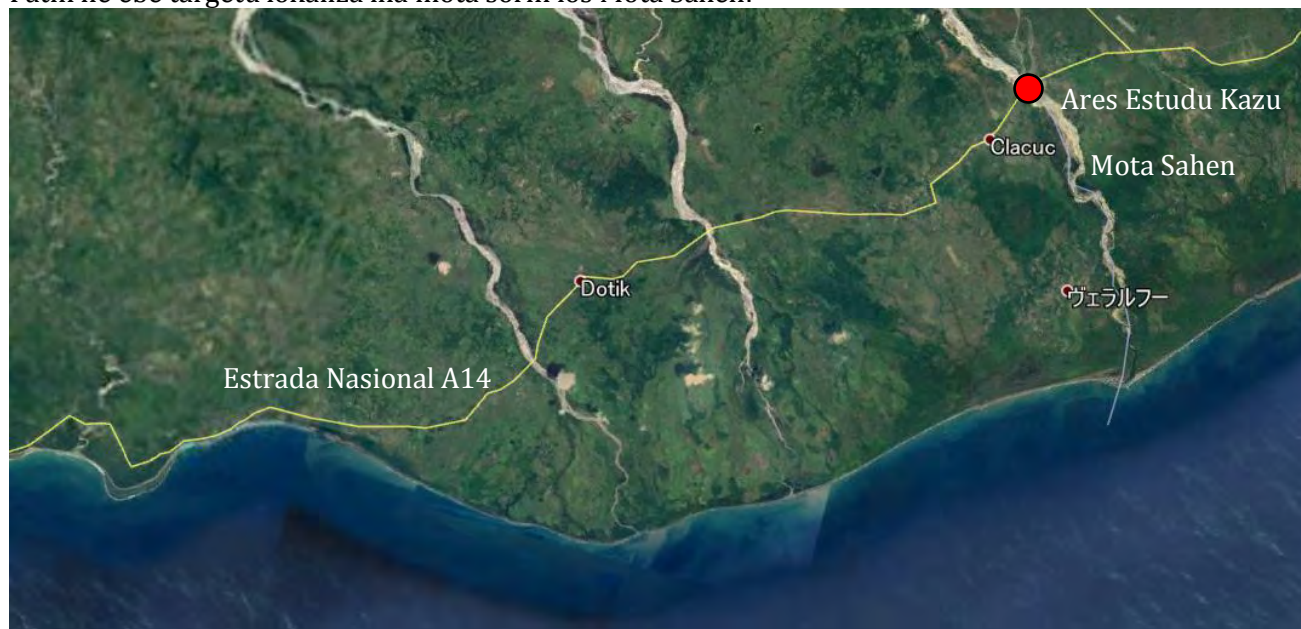

Imagem situasoun abut no pilar ne'ebe hetan estraga

A.2 Medida koretivas

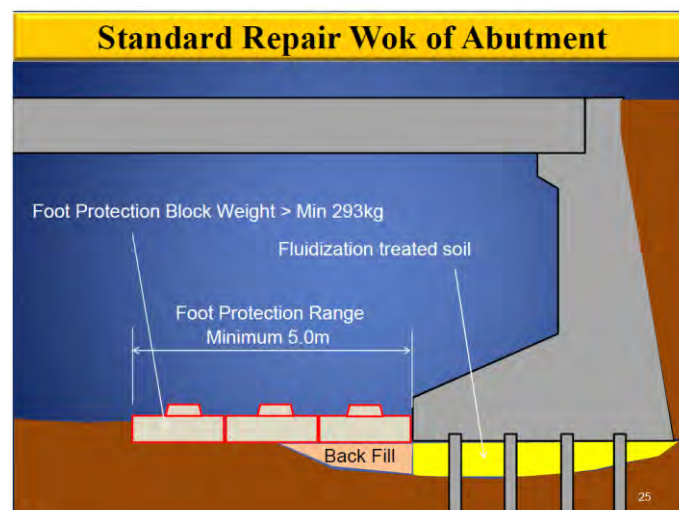
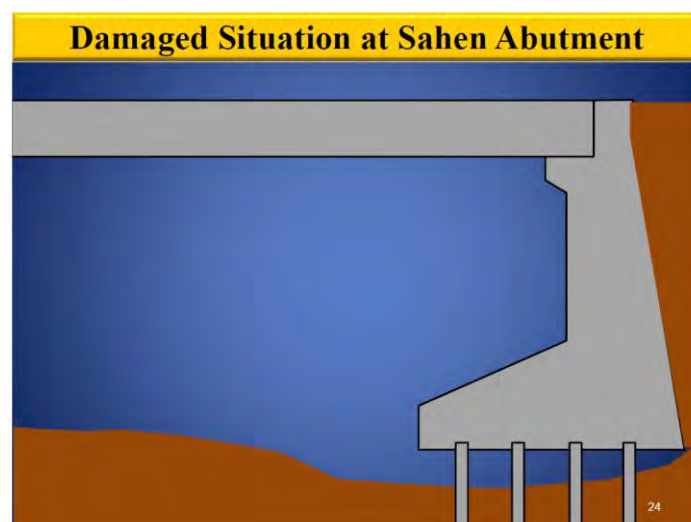

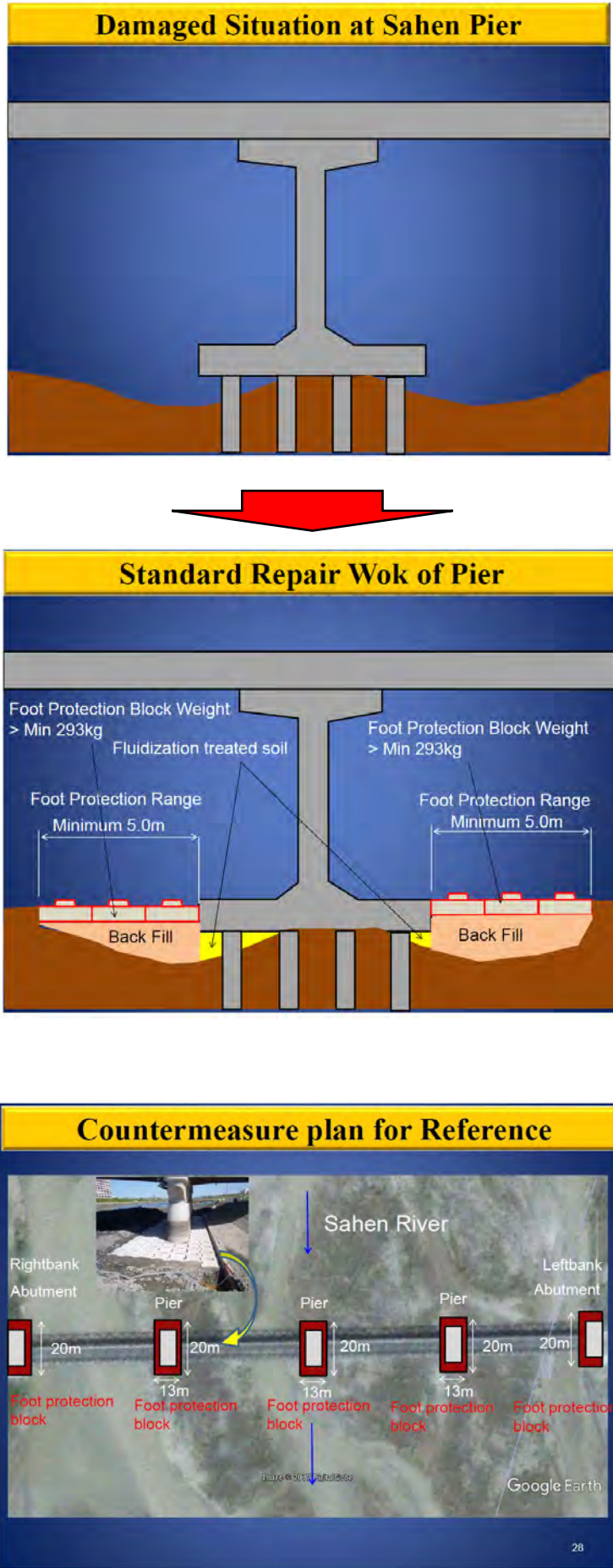

A.3 Material treinamentu

The Project
for
Capacity Development of Road Services
in
the Democratic Republic of Timor-Leste

Case Study for Sahen

Mar 2018

JICA Expert Teams



Today's Training
Case study for Sahen

2

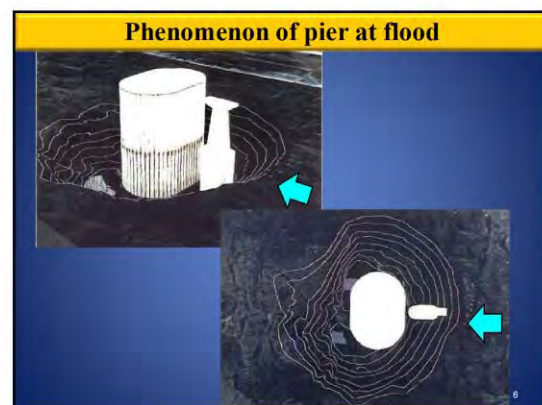
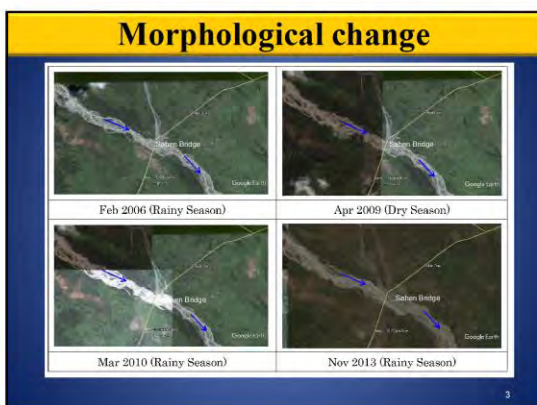
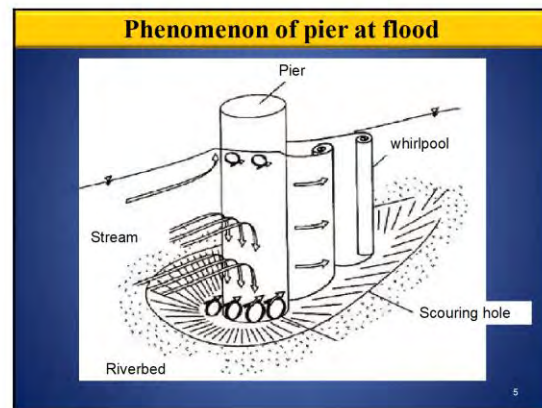

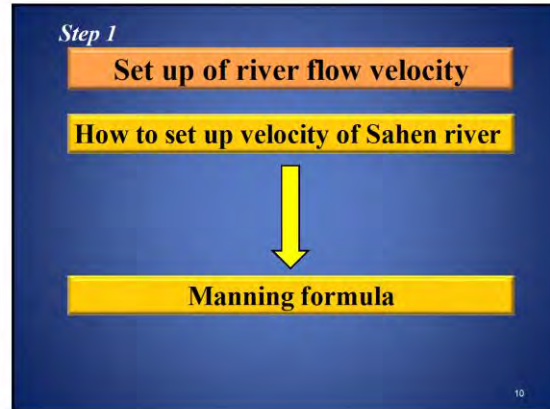
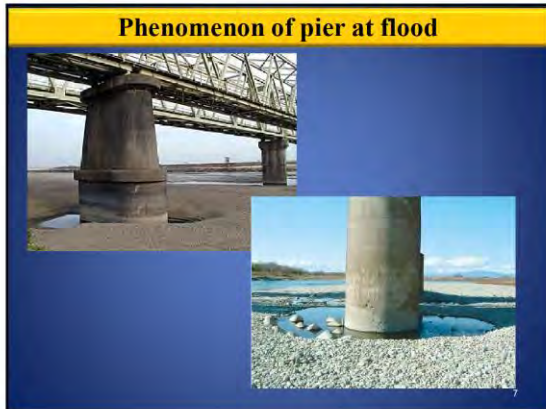

Manning's formula

$$V = \frac{1}{n} \times R^{\frac{2}{3}} \times I^{1/2}$$

V: Flow velocity (m/s)
 n: Coefficient of roughness
 R: Hydraulic radius (m) = Cross-sectional area of river/Wetted perimeter
 I: Riverbed gradient

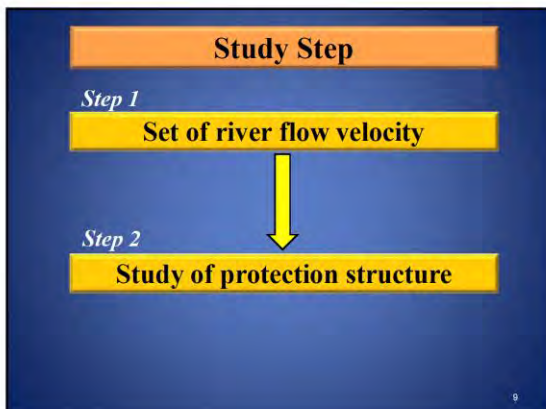

N: Coefficient of roughness

River or channel conditions		Scope of Manning's n
Artificial channel, improved river	Concrete artificial channel	0.014~0.020
	Spiral half-pipe channel	0.021~0.030
	Channel with stone masonry on both banks (sand bed)	0.025 (mean value)
	Bedrock excavation	0.035~0.05
	Bedrock forming	0.025~0.04
	Clay riverbed with flow velocity not enough to cause scouring	0.016~0.022
	Sandy loam, clayey soil loam	0.020 (mean value)
Natural river	Drag line dredging, little weeds	0.025~0.033
	Small channel on plain, with no grass	0.025~0.033
	Small channel on plain, with grass and shrubs	0.030~0.040
	Small channel on plain, with lots of grass and gravel bed	0.040~0.055
	Mountain channel, with gravel and boulders	0.030~0.050
	Mountain channel, with boulders and large boulders	0.040 or higher
Large channel, with sandy bed and little meandering	0.018~0.035	
Large channel, with gravel bed	0.025~0.040	

Source: Revised Ministry of Construction River and Erosion Control Standard (draft) 1997

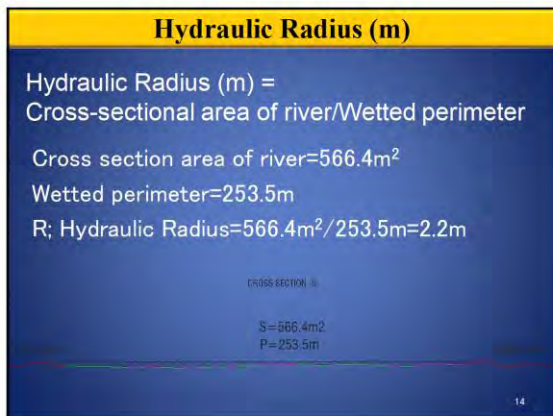
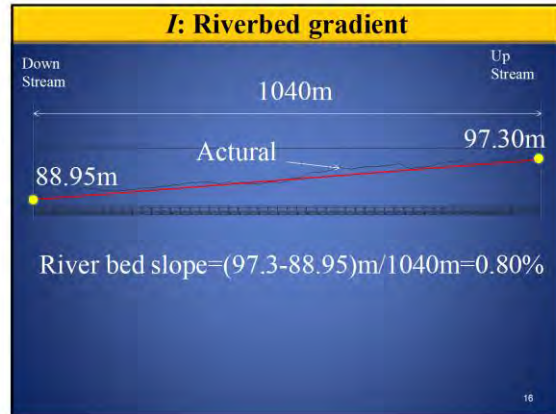
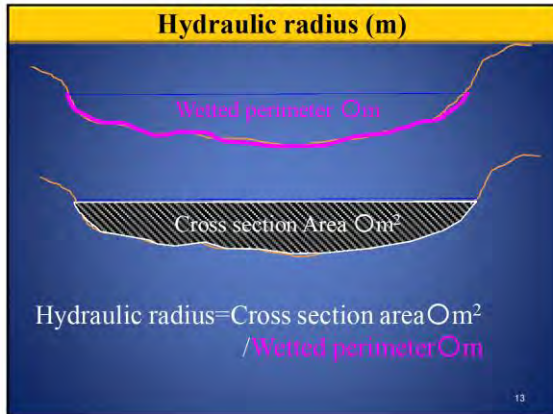

Result of calculation

Cross section No.	No.6
n: Coefficient of roughness	0.03
S: Cross-sectional area of river (m ²)	566.4
P: Wetted perimeter (m)	253.5
I: Riverbed gradient	0.008
R: Hydraulic radius	2.2
V _m : Mean flow velocity (m/s)	5.10
Q: Discharge (m ³ /s)	2886.1

17

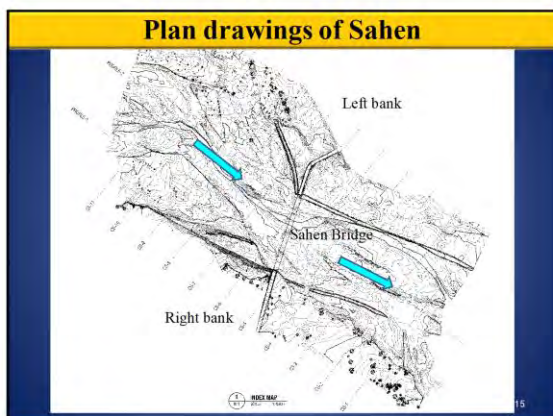

Step 2

Study of protection structure

18



$$W > a \left(\frac{\rho_w}{\rho_b - \rho_w} \right)^3 \cdot \frac{\rho_b}{g^2} \cdot \left(\frac{V_0}{\beta} \right)^6$$

$$0.54 \times \left(\frac{1000.0}{2030.0 - 1000.0} \right)^3 \times \frac{2030}{9.8} \times \left(\frac{5.1}{2} \right)^6$$

2872 (N)

293 kg

Formula for weight of foot protection block

$$W > a \left(\frac{\rho_w}{\rho_b - \rho_w} \right)^3 \cdot \frac{\rho_b}{g^2} \cdot \left(\frac{V_0}{\beta} \right)^6$$

W: Weight of Foot Protection Block
a: Factor of Foot Protection Block Shape
β: Factor of Setting type

V₀: Average Velocity
ρ_w: Density of water 980 (kg/m³)
ρ_b: Density of blocks 2030(kg/m³)
g: Acceleration of gravity (9.8m/s²)

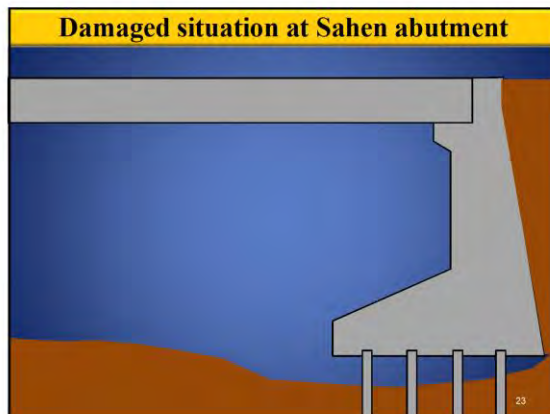

Design condition

V₀ = 5.1m/s
Type Protection Block = Plane
α = 0.54 β = 2.0 Refer to below Table of Coefficient of Deformed Foot Protection Block

Table Coefficient of Deformed Foot Protection Block

Shape of block	specific gravity ρ _b /ρ _w	a × 10 ⁻³	β
Plane	2.03	0.54	2.0

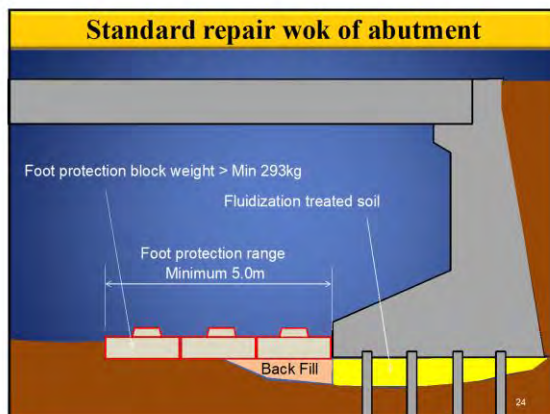

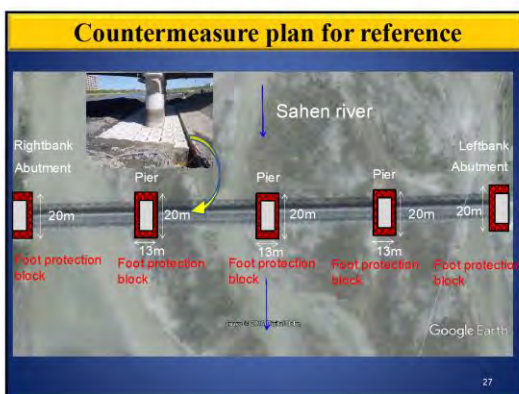
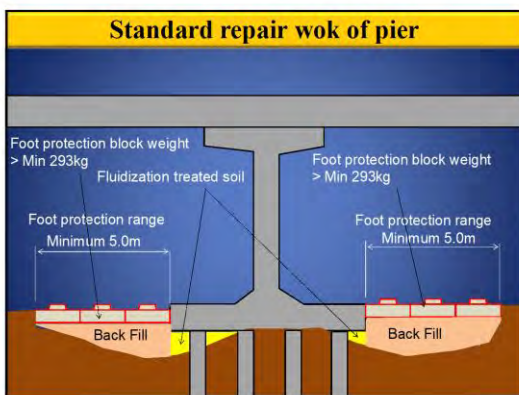
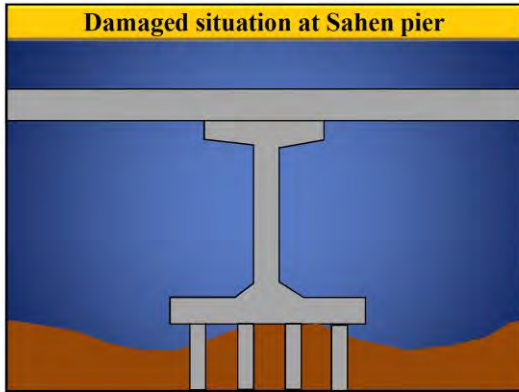

**Annex B
(informativu)**

Material Treinamentu

B.1 Metodu Rasional

The Project
for
Capacity Development of Road Services
in
the Democratic Republic of Timor-Leste
Training No.1 Rational Formula

July 2016

JICA Expert Teams

Rational formula method

Runoff is estimated using the Rational formula method. The Rational formula is expressed in the following formula. coverage of this method is approximately basin area 200km² or less.

$$Q = \frac{1}{3.6} fRA$$

Input data

- f; run-off coefficient
- R; rainfall intensity within the time of flood concentration (mm/hr)
- A; Catchment area (km²)

Output Q is discharge volume (m³/s)

We have to prepare the input data at first !

Today's Training
Calculation example of Comoro river discharge

Set up below input data

- I. f; run-off coefficient
- II. R; rainfall intensity within the time of flood concentration (mm/hour)
- III. A; basin area (km²)

How to set up Comoro river discharge ?

↓

Rational formula method

I. Run-off coefficient

What is runoff coefficient ?

Runoff coefficients depend on the land use, land condition of river basin. runoff coefficients are needed to calculate rain water runoff using the Rational method.

7

What is Rainfall intensity ?

Rainfall intensity means momentary rainfall is converted one hour amount of rainfall.

Question

In the case rainfall is 2.5mm/one minute. Which value is rainfall intensity ○ mm/hour ?

10

Runoff coefficient is 0.9

Runoff coefficient of Comoro river basin is determined to be 0.9 based on standard values in “Manual for River Works in Japan, Technical Criteria for River Works”

Sleep mountainous region	0.75-0.90
Mountains of Tertiary strata	0.70-0.80
Rugged land and forests	0.50-0.75
Flat arable land	0.45-0.60
Irrigated paddy fields	0.70-0.80
Rivers in mountainous regions	0.75-0.85
Small rivers in level land	0.45-0.75
Large rivers in flat land	0.50-0.75

Source: Manual for River Works in Japan, Technical Criteria for River Works

8

Answer

$2.5\text{mm/one minute} \times 60 \text{ minutes} = 150\text{mm/hour}$

11

II. Rainfall Intensity

9

Catchment area of Comoro river

12

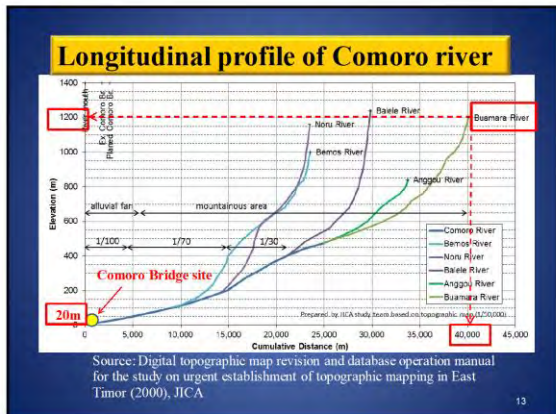

R: Rainfall Intensity

Rainfall intensity is calculated by the following Mononobe's formula based on daily rainfall shown in below.

$$R = \frac{R_{24}}{24} \left(\frac{24}{T} \right)^{0.66}$$

Where, R is rainfall intensity within flood concentration time (mm/hr), R24 is 24-hour rainfall (mm), and T is flood concentration time. Rainfall intensity for each return period calculated using above formula is shown below table.

Return Period	R24-Daily Rainfall (mm)	R-Rainfall Intensity (mm/hr)
2-year	144.2	30.5
5-year	193.8	37.6
10-year	226.6	42.2
30-year	276.3	49.2
50-year	298.9	52.5
100-year	329.5	56.9

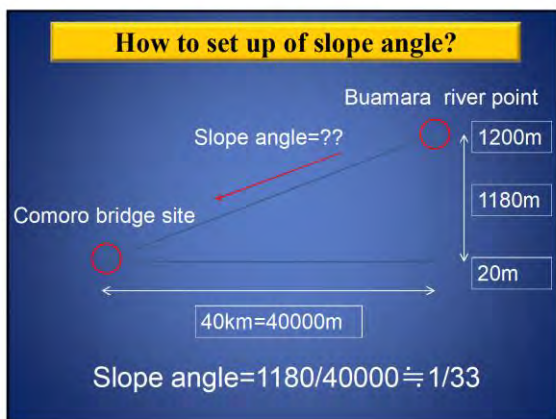

III. Basin Area

T: Flood concentration time

Flood concentration time is expressed using Kraven's formula as follows.

$$T = L/W$$

Where, T is flood concentration time (hour),
 L is watercourse length \Rightarrow 40,000(m),
 W is flood flow velocity (m/s) shown in below.

L: Watercourse slope	over 1/100	1/100-1/200	below 1/200
W: Flood runoff velocity	3.5 m/s	3.0 m/s	2.1 m/s

Watercourse slope is 1/33, and so flood runoff velocity is 3.5m/s. flood concentration time is calculated using these values as follows.

$$T = L/W = 40,000 (m) / 3.5 (m/s) = 3.1 (hour)$$

What is basin area ?

Basin area is an extent or an area of land where all surface water from rain, melting snow, or ice converges to a single point at a lower elevation, usually the exit of the basin, where the waters join another body of water, such as a river, lake, reservoir, estuary, sea, or ocean.

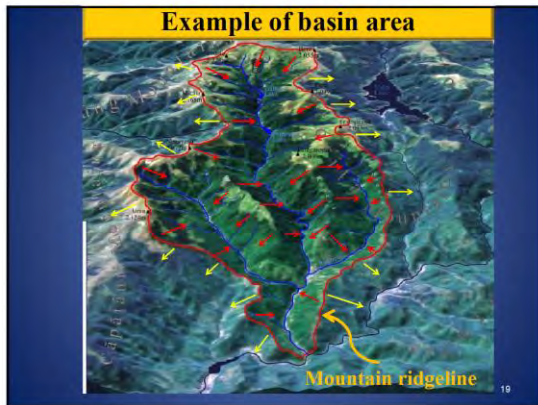

Result of run-off

Runoff is calculated based on the values mentioned using Rational Formula. Calculated each return period discharge are shown below Table.

Return Period	Discharge (m ³ /s)
2-year	1,100 (1,062)
5-year	1,500 (1,427)
10-year	1,700 (1,669)
30-year	2,100 (2,035)
50-year	2,200 (2,201)
100-year	2,500 (2,427)

Design Flood Discharge of Comoro River : **2,200m³/s** (50-year return period)



Source: Report on the Basic Design Study on the Project for the Implement of Roads and Bridges in the Democratic Republic of Timor-Leste, HCA

Run-off

Input data

- f; runoff coefficient
⇒ 0.9
- R; rainfall intensity within the time of flood concentration (mm/hr)
⇒ Each values
- A; basin area (km²)
⇒ 207.1km²

➔ $Q = \frac{1}{3.6} fRA$

B.2 Metodu protesaun ba scouring

The Project
for
Capacity Development of Road Services
in
the Democratic Republic of Timor-Leste
Training No.2 Protection Method for Scouring

January 2017

JICA Expert Teams

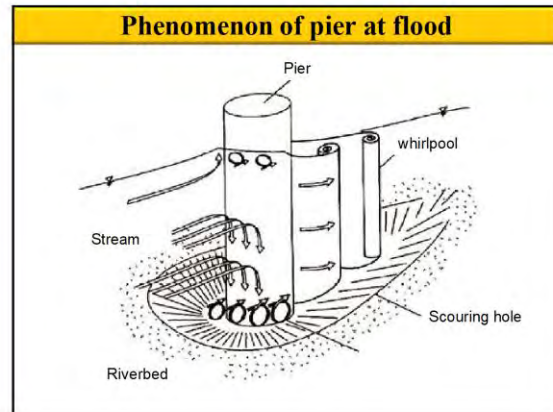

Today's Training
Foot protection works for scouring

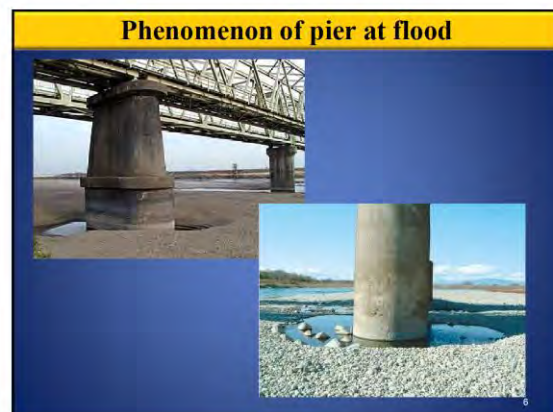
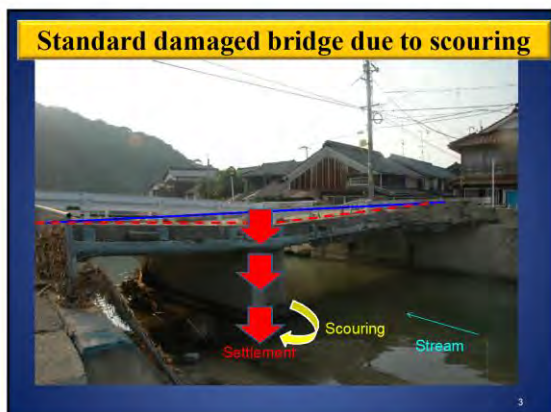
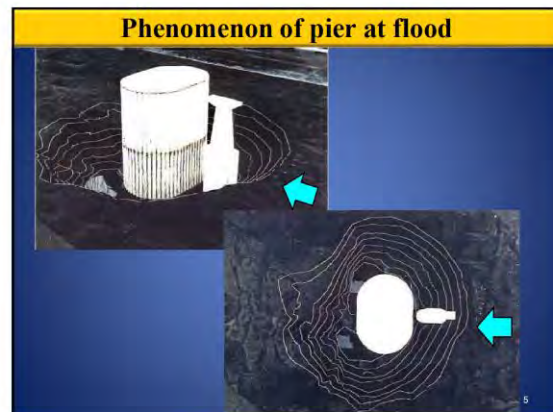

Formula of pier scouring depth

$$\frac{Z}{D} = f \left(\frac{h_0}{D} \cdot \frac{h_0}{dm} \cdot Fr \right)$$

Z: scouring depth,
D: width of piers,
h₀: water depth,
dm: mean particle size of river bed materials,
Fr: Froude number

Answer

$h_0/D = 5.83/2.0 = 2.915$
 $h_0/dm = 5.83/0.0249 = 234.1$
 $Z/D = 1.5$

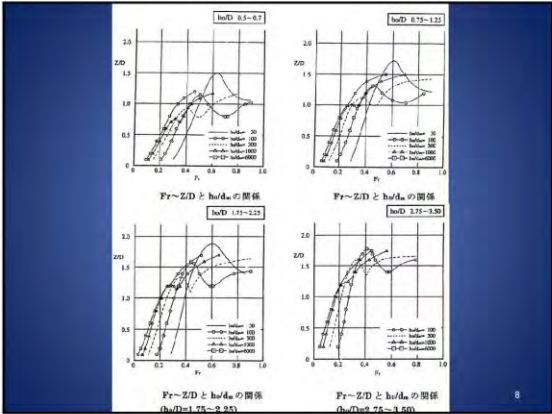
$$Z = \frac{Z}{D} \cdot D = 1.5 \cdot 2.0 = 3.0m$$

Example of calculation

Question

In the case below condition.
 Which depths is pier scouring Z?

Condition
H.W.L. = 24.80m
 Design river bed height = 18.97m
 $h_0 = 24.80 - 18.97 = 5.83m$
 $Fr = 0.54$
 $D = 2.0m$
 $dm = 24.9mm$

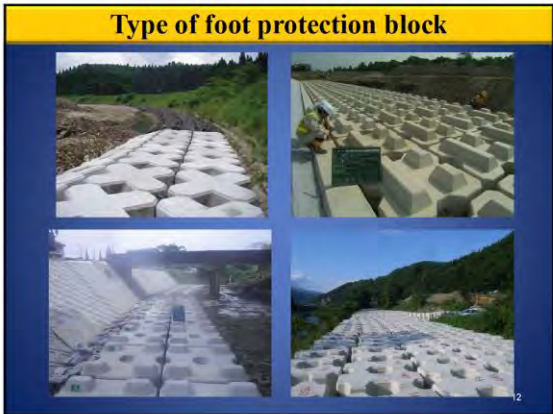

Formula for weight of foot protection block

$$W > a \left(\frac{\rho_w}{\rho_b - \rho_w} \right)^3 \cdot \frac{\rho_b}{g^2} \cdot \left(\frac{V_0}{\beta} \right)^6$$

W: Weight of Foot Protection Block
a: Factor of Foot Protection Block Shape
β: Factor of Setting type
V₀: Average Velocity
ρ_w: Density of water 980 (kg/m³)
ρ_b: Density of blocks 2030(kg/m³)
g: Acceleration of gravity (9.8m/s²)

13

Answer

$$\begin{aligned}
 W &> a \left(\frac{\rho_w}{\rho_b - \rho_w} \right)^3 \cdot \frac{\rho_b}{g^2} \cdot \left(\frac{V_0}{\beta} \right)^6 \\
 &= 0.54 \times \left(\frac{1000}{2030 - 1000} \right)^3 \times \frac{2030}{9.8^2} \times \left(\frac{3.0}{1.0} \right)^6 \\
 &= 7615N \\
 &= 777.04kg
 \end{aligned}$$

16

Table Coefficient of Deformed Foot Protection Block

Shape of block	specific gravity ρ _b /ρ _w	a × 10 ³	β
TypeA: Projection	2.22	1.2	1.5
TypeB: Plane	2.03	0.54	2.0
TypeC: Triangular conic	2.35	0.83	1.4
TypeD: Triangular bearing	2.25	0.45	2.3
TypeE: Rectangle	2.09	0.79	2.8

14

Standard damaged situation of abutment at flood

17

Example of Calculation

Question

In the case below condition.
Which size is foot protection block?

Condition
V₀ = 3.0m/s
Type Protection Block = TypeB: Plane
α = 0.54 β = 1.0 Refer to Table of Coefficient of Deformed Foot Protection Block

15

Standard repair work of abutment

18

Fluidization treated soil

The feature of fluidization treated soil is able to construct in the small place.



Material; Soil +Cement +Water

19

Vibratory hammer method



20

B.3 Saku bo'ot rai henek

The Project
for
Capacity Development of Road Services
in
the Democratic Republic of Timor-Leste
**Training No.3 Introduction of Weather
Resistance Big Sandbag**
April 2017
JICA Expert Teams

Example of weather resistance big sand bag

4

Today's Training
Weather resistance big sand bag
method for damage site

2

Example of weather resistance big sand bag

5

Application works of weather resistance big sandbag

- ✓ Emergency works
- ✓ Temporary works

Notice:
Do not use weather resistance big sandbag for main civil works

3

Applied condition of weather resistance big sand bag for slope

6

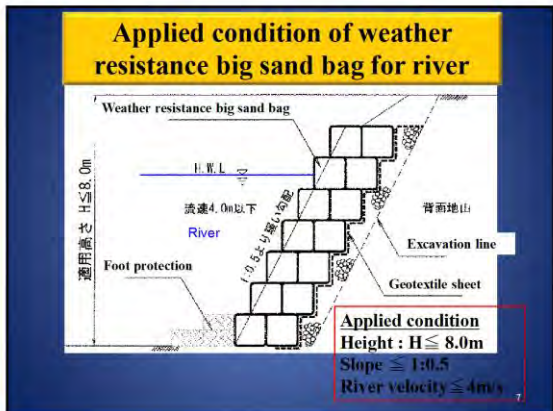

Safety factor for weather resistance big sand bag analysis

Item	Safety Factor
Compression Stress of Big Sand Bag	$F \geq 1.5$
Sliding	$F \geq 1.2$
Overturning	Eccentricity distance $E \geq B/3$
Bearing Capacity	$F \geq 2.0$
Circular Slip	$F \geq 1.05$

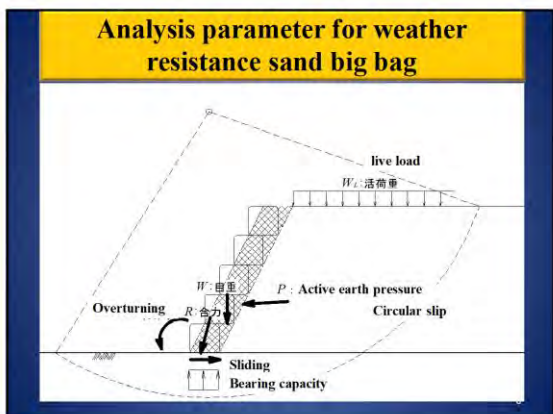

Standard drawing of weather resistance big sand bag analysis

Applied condition $H < 8m$
 Internal material: sand soil

	適用高3.0m (適用高) $H < 3.0m$ (適用高)	適用高3.0m (適用高) $3.0 < H < 4.0m$ (適用高)	適用高3.0m (適用高) $4.0 < H < 5.0m$ (適用高)	適用高3.0m (適用高) $5.0 < H < 8.0m$ (適用高)
標準圖				
說明	適用高3.0m (適用高) $H < 3.0m$ (適用高)	適用高3.0m (適用高) $3.0 < H < 4.0m$ (適用高)	適用高3.0m (適用高) $4.0 < H < 5.0m$ (適用高)	適用高3.0m (適用高) $5.0 < H < 8.0m$ (適用高)

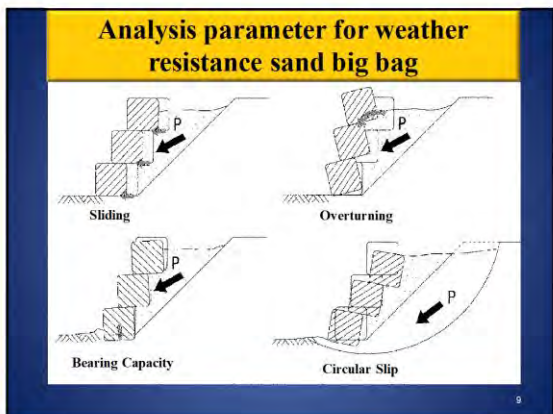

Standard drawing of weather resistance big sand bag analysis

Applied condition $H < 8m$
 Internal material: gravel soil

	適用高3.0m (適用高) $H < 3.0m$ (適用高)	適用高3.0m (適用高) $3.0 < H < 4.0m$ (適用高)	適用高3.0m (適用高) $4.0 < H < 5.0m$ (適用高)	適用高3.0m (適用高) $5.0 < H < 8.0m$ (適用高)
標準圖				
說明	適用高3.0m (適用高) $H < 3.0m$ (適用高)	適用高3.0m (適用高) $3.0 < H < 4.0m$ (適用高)	適用高3.0m (適用高) $4.0 < H < 5.0m$ (適用高)	適用高3.0m (適用高) $5.0 < H < 8.0m$ (適用高)

Standard drawing of weather resistance big sand bag analysis

**Applied condition H<8m
Internal material ; sand soil**

13

Normal big sand bag

The Normal type geo-bag is vulnerable to ultraviolet rays

16

Standard drawing of weather resistance big sand bag analysis

**Applied condition H<8m
Internal material ; gravel soil**

14

Recommended plan of weather resistance big sand bag

17

Comparison of normal and weather resistance type

	Normal type	Weather resistance type
Image		
Ultraviolet Rays	Weak	Strong
Cost	Cheap	Normal
Endurance	Weak	Strong
Strength	Weak	Strong

B.4 Metodu groin

The Project
for
Capacity Development of Road Services
in
the Democratic Republic of Timor-Leste
Training No.4 Groin Study
November 2017
JICA Expert Teams



Today's Training
Groin study using Loes river



Morphological change

<p>Aug,2004 (Dry Season)</p>	<p>Jul,2005 (Dry Season)</p>
<p>Sep,2009 (Dry Season)</p>	<p>Feb,2013 (Rainy Season)</p>

Damage of embankment

<p>Damage site 1</p>	<p>Damage site 2</p>
<p>Damage site 3</p>	<p>Damage site 4</p>

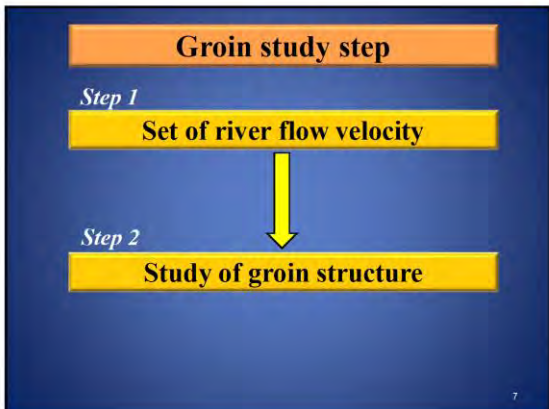

N: Coefficient of roughness

River or channel conditions		Scope of Manning's n	
Artificial channel, improved river	Concrete artificial channel	0.014~0.020	
	Spiral half-pipe channel	0.021~0.030	
	Channel with stone masonry on both banks (fixed bed)	0.025 (mean value)	
	Bedrock excavation	0.035~0.05	
	Bedrock forming	0.025~0.04	
	Clay riverbed with flow velocity not enough to cause scouring	0.016~0.022	
	Sandy loam, clayey soil loam	0.020 (mean value)	
	Drag line dredging, little weeds	0.025~0.033	
	Natural river	Small channel on plain, with no grass	0.025~0.033
		Small channel on plain, with grass and shrubs	0.030~0.040
Small channel on plain, with lots of grass and gravel bed		0.040~0.055	
Mountain channel, with gravel and boulders		0.030~0.050	
Mountain channel, with boulders and large boulders		0.040 or higher	
Large channel, with sandy bed and little meandering		0.018~0.035	
Large channel, with gravel bed	0.025~0.040		

Source: Revised Ministry of Construction River and Erosion Control Standard (draft) 1997

10

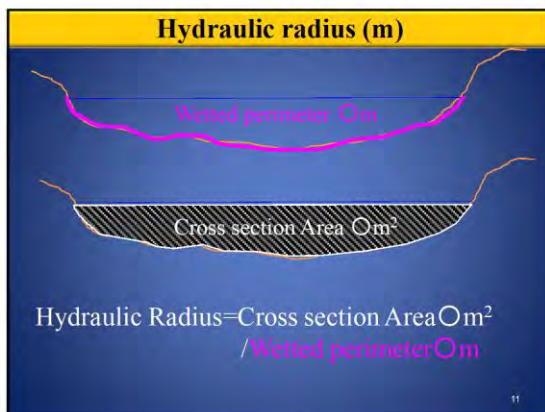
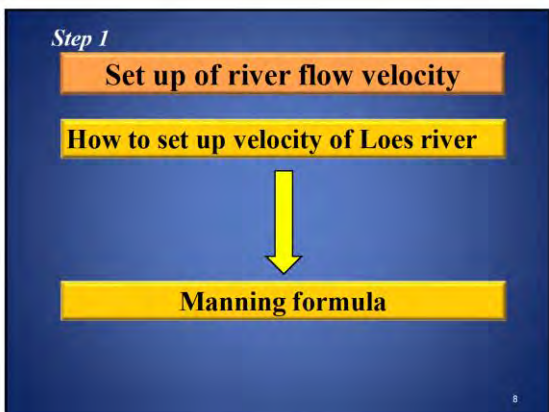

Manning's formula

$$V = \frac{1}{n} \times R^{\frac{2}{3}} \times I^{1/2}$$

V: Flow velocity (m/s)
 n: Coefficient of roughness
 R: Hydraulic radius (m) = Cross-sectional area of river/Wetted perimeter
 I: Riverbed gradient

9

Hydraulic radius (m)

Hydraulic Radius (m) =
 Cross-sectional area of river/Wetted perimeter

Cross section area of river=5417.9m²
 Wetted perimeter=503.4m

R; Hydraulic Radius=5417.9m²/503.4m=**10.762m**

12

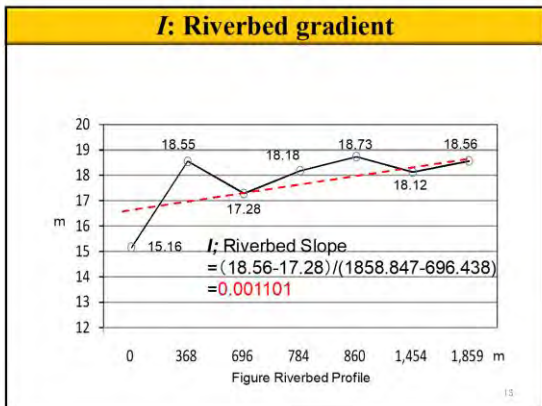

Result of calculation

Cross section No.	
n: Coefficient of roughness	0.035
S: Cross-sectional area of river (m ²)	5417.9
P: Wetted perimeter (m)	503.4
I: Riverbed gradient	0.001101
R: Hydraulic radius	10.8
Vm: Mean flow velocity (m/s)	4.62

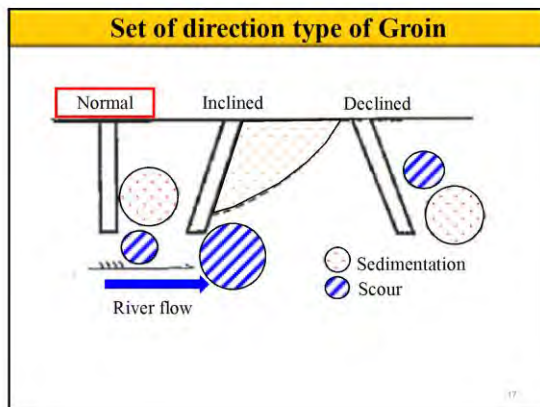

Step 2

Study of Groin structure

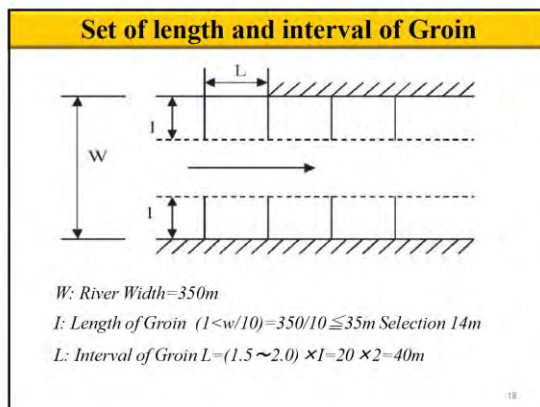

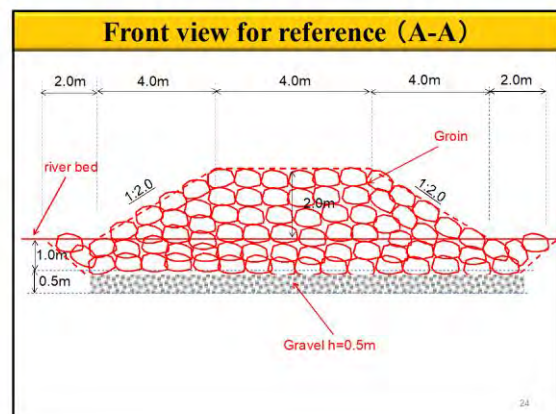
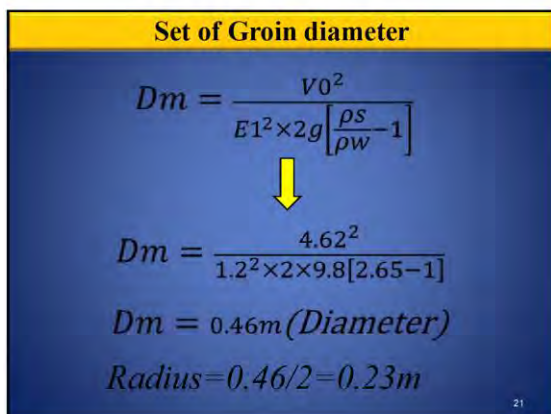
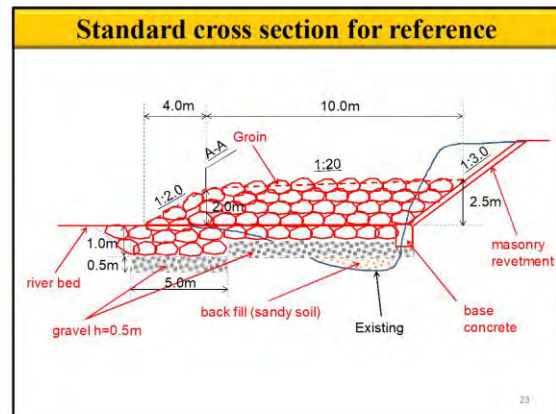
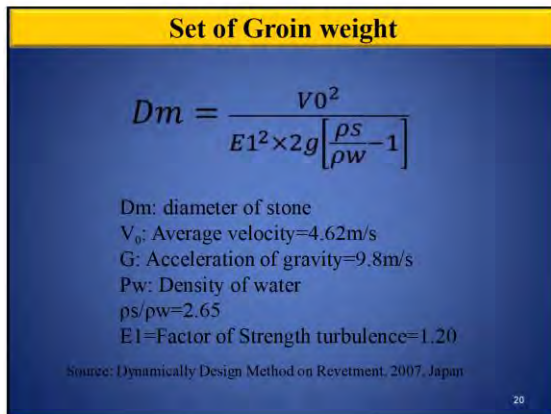
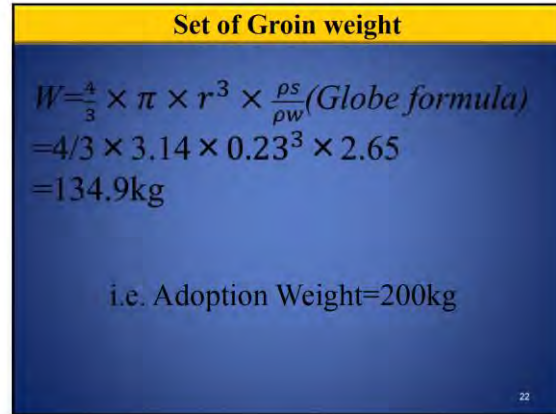
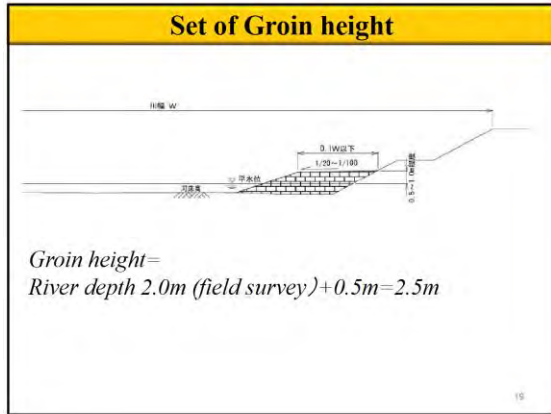

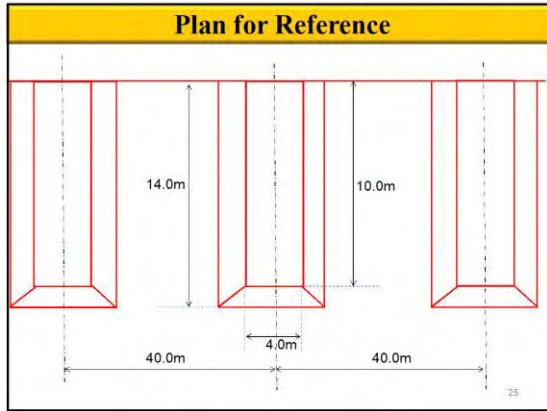

B.5 Protesaun ba subestrutura ponte nian

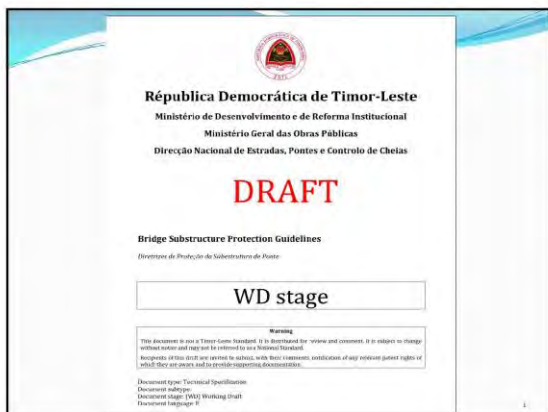

Contents	
Foreword	iv
Introduction	v
1 Scope	1
2 Normative references	1
3 Terms and definitions	1
4 Characteristics of rivers in Timor-Leste	2
5 Condition of bridge substructures in Timor-Leste	2
6 Hydraulic phenomenon around bridge piers	5
7 Scour depth of bridge substructures	7
7.1 Scour depth around bridge piers	7
7.1.1 Procedure for estimating scour depth	7
7.2 Scour depth around abutments	8
7.3 Determination of scour hole width	8
7.4 Calculation example 1	12
8 Protection of bridge substructures	13
8.1 Types of foot protection blocks	14
8.2 Verification of dynamic stability of foot protection blocks	15
8.2.1 Basic policy	15
8.2.2 Calculation of weight of foot protection blocks	18
8.4 Calculation example 2	20
8.4.1 Average velocity	21
8.4.2 Determination of water level	22
8.5 Installation width of foot protection blocks	23
Annex A (Informative) Case study of Sabin Bridge	24
A.1 Introduction	24
A.2 Remedial measures	25
A.3 Training materials	27
Annex B (Informative) Training materials	32
B.1 Rational method	32
B.2 Protection method for scouring	32
B.3 Big samplings	32
B.4 Grid method	32
Bibliography	49

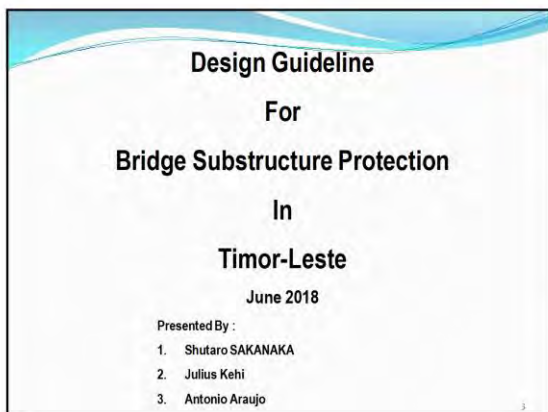

Outline of the Presentation

- I. Introduction
- II. Objective
- III. Characteristics of rivers in Timor-Leste
- IV. Damage of bridge substructures in Timor-Leste
- V. Hydraulic phenomena around bridge pier
- VI. Study of bridge substructure and scour depth
- VII. Study for protection of bridge substructure

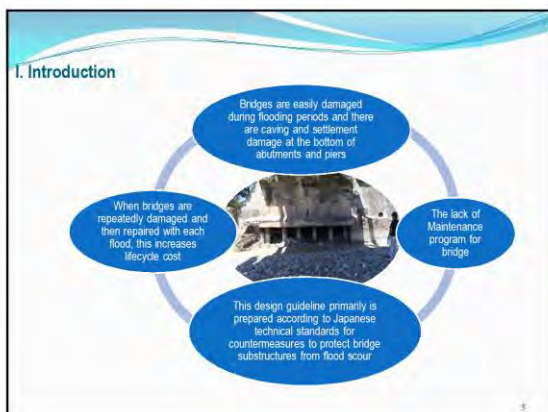

- ### II. Objective of the design guideline
- Objective:
- To improve the design of countermeasure for bridge protection substructure from flood scour
 - To reduce flood scour damage to bridge substructure in Timor-Leste

III. Characteristics of majority of Rivers in Timor-Leste

- ❖ Sources of many rivers in Timor-Leste are located in the mountainous area, at an altitude of 1000m to 2000m
- ❖ The average annual rainfall in the northern region of Timor-Leste is approximately 1000mm to 2000mm and in the southern region it is 1500 mm to 2000 mm
- ❖ The length of their rivers is short and share many natural characteristics with rivers in Japan

IV. Condition of Bridges Substructure in Timor Leste

- ❖ The following figures show the scouring damage of Sahen Bridges right bank abutment and pier.



Figure 1. Sahen bridge abutment 2017



Figure 2. Sahen bridge pier 2017

- ❖ Figures 3 and 4 show the scouring damage of Mola Bridges Pier. Due to scouring damage, the caving of the footing can be seen



Figure 3. Mola bridge abutment 2011



Figure 4. Mola bridge abutment 2011

- ❖ If appropriate countermeasure are not applied out and scouring is allowed to progress into the long term, overall bridge settlement damage (as can see in figure 5,6) is likely to occur



Figure 5. Bridge settlement damage due to bridge pier scouring (Japan Example)

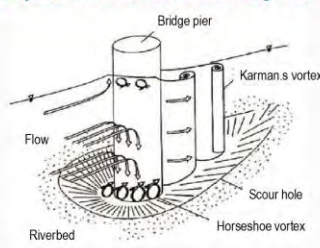

Figure 6. Bridge settlement damage due to bridge pier scouring (Japan Example)

V. Hydraulic Phenomena Around Bridge Pier



- The figure shows the hydraulic phenomenon that occurs around bridge piers during flood.
- Bridge piers located in a river cause complex vortices and waves that disturb the flow and water surface during flood; as a result, an increase in water level and riverbed scouring occur

Hydraulic Phenomenal around bridge pier (Japan Example)

The figure show the actual phenomenon around a bridge pier during floods.the occurrences of complex flow around the bridges pier apparent.





The figure show the state of scour on bridge pier after a flood in Japan.The flood caused a scour hole to form around the bridge pier





VI. Study of Bridge Substructure Scour Depth

1. Scour depth around bridge pier

h_0 : Average water depth
 D : Diameter of bridge pier
 d_m : Average grain diameter of riverbed material
 Fr : Froude number
 Z : Scour depth

$$\frac{Z}{D} = f \cdot \left(\frac{h_0}{D} \cdot \frac{h_0}{d_m} \cdot Fr \right)$$

Step 1
 Calculate the dimensionless scour depth Z/D using the target locations average water depth h_0 , the diameter of bridge pier D , average grain diameter of riverbed material d_m , and Froude number Fr

Step 2
 The resulting Z/D should be corrected for changes in flow direction due to flooding or nearby bridge piers. After these corrections, the depth of scour hole around a bridge pier can be calculated.

2. Scour depth around abutments

Timor-Leste have short lengths for the footings depth of their abutments, so when new bridges are being planned, it is necessary to conduct the field investigations of the abutment or nearby abutments and ensure sufficient lengths for footing depth.

4. Calculation Example

Calculation Condition
 High water level: 24.80 m
 Design river bed: 18.97 m
 Diameter bridge pier (D) = 2.0 m
 Average grain diameter of riverbed material (d_m) = 24.9 mm
 Froude number (Fr) = 0.54

Study Process

Average Water depth $h_0 = 24.80 - 18.97 = 5.83$ m

$$\frac{h_0}{D} = \frac{5.83}{2.0} = 2.915$$

$$\frac{h_0}{d_m} = \frac{5.83}{0.0249} = 234.91$$

$Z/D = 1.5$ (Refer to right figure)

Scour depth $Z = (Z/D) \cdot D = 1.5 \cdot 2.0 = 3.0$ m

VII. Study for Protection of Bridge Substructure

There are two types of protection work: Gabion and foot protection block. However, due to issues with the durability (due to deterioration, etc) of the metal wire use for gabion, it is recommended that Timor-Leste take the same approach as Japan and use Foot Protection.

Types of foot protection block

Types of foot protection blocks in Japan

Calculation of weight of foot Protection blocks

The formula is used in Japan to calculate the necessary weight of foot protection blocks.

$$W > a \left(\frac{\rho_w}{\rho_B - \rho_w} \right)^3 \frac{\rho_B}{g^2} \left(\frac{V_m}{\beta} \right)^6$$

where

- W is the weight of foot protection block
- a is the factor of foot protection block shape
- β is the factor of setting type
- V_m is the average velocity
- ρ_w is the density of water. (980 kg/m³)
- ρ_B is the density of blocks. (2030 kg/m³)
- g is the acceleration of gravity (9.8 m/s²)

Table Factor of α and β

Shape of block	specific gravity		β
	ρ_b/ρ_w	$\alpha \times 10^{-5}$	
Type A: Projection	2.22	1.2	1.5
Type B: Plane	2.03	0.54	2.0
Type C: Triangular conic	2.35	0.83	1.4
Type D: Triangular bearing	2.25	0.45	2.3
Type E: Rectangle	2.09	0.79	2.8

Calculation Example for weight of foot Protection Block

- Calculation Condition**
- Now W can be calculated as follows**

$$W > a \left(\frac{\rho_w}{\rho_b - \rho_w} \right)^3 \frac{\rho_b}{g^2} \left(\frac{V_m}{\beta} \right)^6$$

Here

W is the weight of foot protection block

$V_m = 5.1 \text{ m/s}$ is the river velocity;

Shape Type B is the block type;

$\alpha = 0.54$ is the block factor;

$\beta = 2.0$ is the block factor;

$\rho_w = 980 \text{ kg/m}^3$ is the density of water

$\rho_b = 2030 \text{ kg/m}^3$ is the density of block

$g = 9.8 \text{ m/s}^2$ is the acceleration of gravity

$$W = a \left(\frac{\rho_w}{\rho_b - \rho_w} \right)^3 \frac{\rho_b}{g^2} \left(\frac{V_m}{\beta} \right)^6$$

$$W = 0.54 \times \left(\frac{1000}{2030 - 1000} \right)^3 \times \frac{2030}{9.8^2} \times \left(\frac{5.1}{2} \right)^6$$

$$W = 2872 \text{ N}$$

$$W = 293 \text{ kg}$$

Average Velocity

The flow velocity used in the calculation of foot protection block weight is calculated using the Manning formula for calculating the average velocity. The roughness coefficient is selected from the table below based on the conditions at the target river site.

	River or channel conditions	Scope of Manning's n	
Artificial channel (imposed flow)	Concrete artificial channel	0.014~0.020	
	Spiral half-pipe channel	0.021~0.030	
	Channel with stone masonry on both banks (low level)	0.025 (mean value)	
	Bedrock excavation	0.035~0.05	
	Bedrock forming	0.025~0.04	
	Clay riverbed with flow velocity not enough to cause scouring	0.016~0.022	
	Sandy loam, clayey soil loam	0.020 (mean value)	
	Drag line dredging, little weeds	0.025~0.033	
	Natural flow	Small channel on plain, with no grass and debris	0.025~0.035
		Small channel on plain, with grass and debris	0.030~0.040
Small channel on plain, with lots of grass and gravel bed		0.040~0.055	
Mountain channel, with gravel and boulders		0.030~0.050	
Mountain channel, with boulders and large boulders		0.040 or higher	
Large channel, with sandy bed and little meandering		0.018~0.035	
Large channel, with gravel bed	0.025~0.040		

Table. Revised Ministry of Construction River and Erosion Control standard (draft) Japan 1997, Survey Section P13.

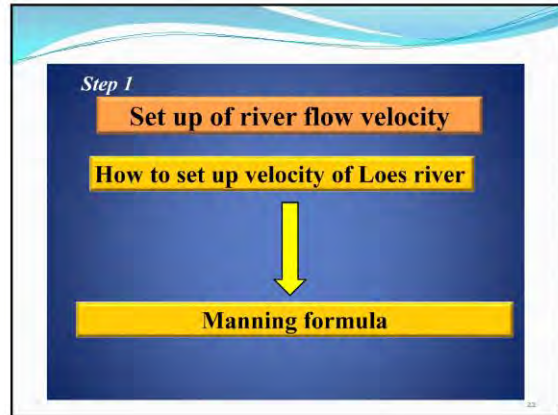

Manning's formula

$$V = \frac{1}{n} \times R^{\frac{2}{3}} \times I^{\frac{1}{2}}$$

V: Flow velocity (m/s)

n: Coefficient of roughness

R: Hydraulic radius (m) = Cross-sectional area of river/Wetted perimeter

I: Riverbed gradient

N: Coefficient of roughness

	River or channel conditions	Scope of Manning's n	
Artificial channel (imposed flow)	Concrete artificial channel	0.014~0.020	
	Spiral half-pipe channel	0.021~0.030	
	Channel with stone masonry on both banks (low level)	0.025 (mean value)	
	Bedrock excavation	0.035~0.05	
	Bedrock forming	0.025~0.04	
	Clay riverbed with flow velocity not enough to cause scouring	0.016~0.022	
	Sandy loam, clayey soil loam	0.020 (mean value)	
	Drag line dredging, little weeds	0.025~0.033	
	Natural flow	Small channel on plain, with no grass	0.025~0.033
		Small channel on plain, with grass and shrubs	0.030~0.040
Small channel on plain, with lots of grass and gravel bed		0.040~0.055	
Mountain channel, with gravel and boulders		0.030~0.050	
Mountain channel, with boulders and large boulders		0.040 or higher	
Large channel, with sandy bed and little meandering		0.018~0.035	
Large channel, with gravel bed	0.025~0.040		

Source: Revised Ministry of Construction River and Erosion Control Standard (draft) 1997

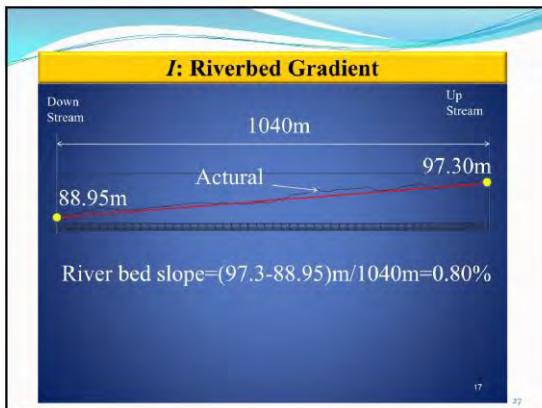
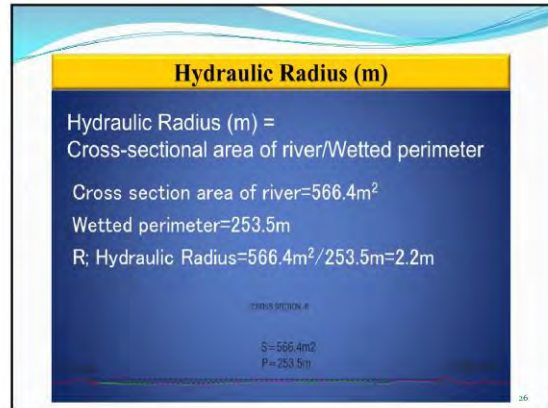
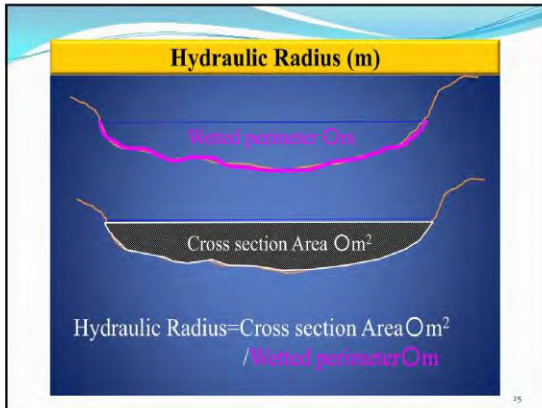

Result of Calculation

Cross section No.	No.6
n: Coefficient of roughness	0.03
S: Cross-sectional area of river (m ²)	566.4
P: Wetted perimeter (m)	253.5
I: Riverbed gradient	0.008
R: Hydraulic radius	2.2
V _m : Mean flow velocity (m/s)	5.10
Q: Discharge (m ³ /s)	2886.1

18



Bibliografia

- [1] Dynamically design method on revetment, 2007, Japan Institute of Country and Engineering
- [2] Guidelines for river bridge plan (draft), 2009, Japan Institute of Construction Engineering.



Democratic Republic of Timor-Leste

Ministry of Public Works

Directorate General of Public Works

National Directorate of Roads, Bridges and Flood Control

Road Guidelines — Drainage — Culvert Design

Guia de Estrada — Drenagem — Passagem Hidráulica

Copyright notice

While the reproduction of this DNEPCC document in any form for use by staff involved in the CDRS Project or R4D-SP is permitted without prior permission from the DNEPCC, neither this document nor any extract from it may be reproduced, stored or transmitted in any form for any other purpose without prior written permission from the DNEPCC. Photocopies of the whole, or parts of this document may be made by academic institutions for students.

Requests for permission to reproduce this document should be addressed to the following institution:

Ministério das Obras Públicas
Direcção Geral das Obras Públicas
Direcção Nacional de Estradas, Pontes e Controlo de Cheias (DNEPCC)
Address: Avenida da Restauração, Rai Kotu, Comoro, Dili, Timor-Leste
Telephone: +670 3311408

Third party materials:

7. © John Wiley & Sons Australia, Ltd., 2013. **Reproduction and communication for educational purposes:** The Australian *Copyright Act 1968* allows a maximum of one chapter or 10% of the pages of this work, whichever is the greater, to be reproduced and/or communicated by any educational institution for its educational purposes provided that the educational institution (or the body that administers it) has given a remuneration notice to Copyright Agency Limited (CAL). **Reproduction and communication for other purposes:** Except as permitted under the Act (for example, a fair dealing for the purposes of study, research, criticism or review), no part of this book may be reproduced, stored in a retrieval system, communicated or transmitted in any form or by any means without prior written permission. All inquiries should be made to the publisher.

Disclaimer:

Although every effort has been made to ensure the accuracy and applicability of the information contained within this document, the authors cannot accept any liability or legal responsibility for any errors, for any omissions or for any other reason whatsoever.

Contents

Foreword	v
Foreword by JICA.....	vi
Acknowledgements.....	vii
Introduction.....	viii
1 Scope	1
2 Normative references.....	1
3 Terms and definitions	1
4 Planning	3
4.1 Selection of structure.....	3
4.2 Overview of culverts	3
4.3 Application of culverts	4
4.4 Alignment of culverts.....	5
4.5 Design process	6
5 Data collection.....	7
5.1 Basic site investigation.....	7
5.2 Topographic investigation	7
5.3 Cartographic investigation.....	8
5.4 Rainfall data	8
6 Rainfall analysis	10
6.1 Classification of roads	10
6.2 Return period	11
6.3 Preparation of rainfall data	11
6.4 Frequency analysis.....	12
6.5 Synthetic procedure.....	13
7 Design flood.....	15
7.1 Catchment area.....	15
7.2 Watercourse properties.....	17
7.3 Time of concentration	17
7.3.1 Time for inlet flow	18
7.3.2 Time for channel flow.....	18
7.4 Intensity of rainfall.....	19
7.5 Coefficient of run-off.....	20
7.6 Rational method.....	21
8 Open-channel hydraulics.....	22
8.1 Material of culverts	23
8.2 Size of culvert.....	23
8.3 Geometry of culverts.....	25
8.4 Design capacity of culverts.....	26
8.5 Type of flow	28
9 Protection works	29
9.1 Inlet protection	29
9.2 Outlet protection.....	30
9.2.1 Selection of protection measure.....	30
9.2.2 Detailing of protection measures.....	32
Glossary.....	35
Bibliography	37

Annex A (informative) Case study of Sesurai Culvert.....	A-1
A.1.Introduction	A-1
A.2.Site Conditions.....	A-1
A.3.Data collection.....	A-2
A.4.Rainfall analysis.....	A-3
A.5.Design flood.....	A-5
A.6.Design capacity.....	A-9
A.7.Conditions of flow.....	A-11
A.8.Protection works	A-13
A.9.Design remarks	A-14
A.10. Calculation notes.....	A-15
Annex B (informative) Training materials.....	A-33
B.1.Summary of case study.....	A-35
B.2.Catchment and river profile.....	A-39
B.3.Design flood.....	A-45
B.4.Design capacity of culvert.....	A-55
B.5.Erosion protection.....	A-61
B.6.Design remarks	A-67
Annex C (informative) Weather stations in Timor-Leste.....	A-71
C.1 .Current locations of weather stations (Seeds of Life).....	A-73
C.2 .Historical locations of weather stations (Seeds of Life).....	A-77



REPÚBLICA DEMOCRÁTICA DE TIMOR-LESTE
MINISTÉRIO DAS OBRAS PÚBLICAS
GABINETE DO VICE MINISTRO
Av. Nicolau Lobato, Mandarin, Dili, Timor-Leste

Foreword

In the interest of constructing high quality and economically viable government infrastructure to serve the nation, these guidelines for optimal design of drainage components were prepared by the JICA Project for Capacity Development of Road Services in the Democratic Republic of Timor-Leste (CDRS) in collaboration with the *Direcção Nacional de Estradas, Pontes e Controlo de Cheias* (DNEPCC, 'National Directorate of Roads, Bridges and Flood Control') of the *Ministério das Obras Públicas* ('Ministry of Public Works'). We would like to thank JICA for their continuing support.

September, 2019

A handwritten signature in blue ink, consisting of several overlapping loops and lines, positioned above the printed name and title.

Eng. Nicolau Lino Freitas Belo
Vice Minister for Public Works
Ministry of Public Works

19-09-2019

Foreword by JICA

Japan International Cooperation Agency (JICA) has been conducting a technical cooperation project for development of capacity regarding road services, which is called CDRS, in order to facilitate the DNEPCC in properly managing and maintaining the road infrastructure that is the basis of social and economic activities. To this end, JICA has been dispatching a team of experts from March 2016 to December 2019. As a result of collaborative work with counterparts of the DNEPCC, these guidelines for design of culverts have been finalized. I hope that these guidelines will contribute to infrastructure development and maintenance, and to the enhancement of friendly relations between our two countries.

Finally, I wish to express my sincere appreciation to the officials of the Government of the Democratic Republic of Timor-Leste for their close cooperation with the expert team.

September, 2019



Masafumi NAGAISHI
Chief Representative of JICA Timor-Leste Office
Japan International Cooperation Agency



Acknowledgements

The Project for Capacity Development of Road Services in the Democratic Republic of Timor-Leste wishes to thank all parties involved in preparing these Culvert Design guidelines, and special thanks to M. Soares of DNEPCC for revising these guidelines.

In support of the project, the officials of the (former) Ministry of Development and Institutional Reform: M. R. M. Cruz, J. L. C. C. P. Mestre and J. Santos; and the officials of the Ministry of Public Works: C. M. Henrique and especially R. H. F. Guterres; are hereby acknowledged.

In contributing to the preparation of this document, the officials of the DNEPCC: M. R. C. Monteiro, J. P. Amaral, J. M. G. Sousa, J. G. Carlvalho, I. M. L. Guterres, N. Lobato, A. Araujo, V. N. P. Araujo, L. R. H. Corbafo, J. Costa, M. F. Costa, R. Costa, S. Laranjinha, D. X. Deus, B. Ferreira, R. C. Freitas, P. C. R. Noronha and C. E. Ximenes; and the International Labour Organization's (ILO) technical assistance team of the Roads for Development Support Program (R4D-SP): A. O. Asare, K. H. Myaing, S. Done, S. F. Egbali, V. Sam and D. H. Singh; are hereby acknowledged.

In addition, the Seeds of Life Program: S. Bacon is hereby acknowledged.

Feedback:

Any positive feedback for possible incorporation into future editions would be appreciated. Please send such comments or feedback to the below address.

Direcção Nacional de Estradas, Pontes e Controlo de Cheias (DNEPCC)
Address: Avenida da Restauração, Rai Kotu, Comoro, Dili, Timor-Leste
Telephone: +670 3311408

Introduction

These guidelines were developed by the JICA Project for Capacity Development of Road Services in the Democratic Republic of Timor-Leste in collaboration with the *Direcção Nacional de Estradas, Pontes e Controlo de Cheias* (DNEPCC, ‘National Directorate of Roads, Bridges and Flood Control’) for the purpose of developing capacity regarding drainage design of cross culverts.

The purpose of drainage design is to ensure reasonable capacity of drainage facilities, which means specifying culverts with sufficient drainage capacity to accommodate probable volumes of stormwater and at reasonable construction costs compared to their benefit to economic activities. Within the context of road crossings, the purpose of box culverts is to ensure the protection of road structures and road users.

The chronology of editions are as follows:

- First edition in English September 2019

The main changes compared to the previous edition are as follows:

- No changes

Road Guidelines — Drainage — Culvert Design

1 Scope

These guidelines aim to provide practical information for planning and design of box culverts for the purpose of culvert construction or reconstruction. These guidelines relate mainly to hydrological studies and hydraulic design. The design methodologies presented here have been recommended on the basis that they are easy in application and consistent in approach. Planning issues outlined in these guidelines are for reference and engineering judgement should be used concerning application based on site conditions, such as debris.

These guidelines do not cover cleaning, reconditioning, rehabilitation, repair, structural design or standard drawings of culverts. For information regarding construction management and maintenance on site, please see the relevant section in the *Standard Specifications* (Section 600 – Drainage and Slope Protection Structures) (1). For applications involving large rivers or long-span crossings, please adopt the *Bridge Design Standards & Manual* (2). For guidance on structural dimensions and reinforcement, please see the relevant structural design standard and standard drawings.

The language used in these guidelines is generally Latinized to facilitate comprehension by the engineers of the directorate.

2 Normative references

The following documents are referred to in the text in such a way that some or all of their content constitutes requirements of this document. For dated references, only the edition cited applies. For undated references, the latest edition of the referenced document (including any amendments) applies.

Standard Specifications (2014) (1)

Bridge Design Standards & Manual (2012) (2)

Road Geometric Design Standards (2010) (3)

3 Terms and definitions

For reference, a glossary of terms and their equivalent meaning in Tetun, Portuguese or Indonesian, and Japanese has been included at the back of these guidelines.

For the purpose of this document, the following terms and definitions apply.

ISO maintains terminological databases for use in standardization at the following addresses:

— ISO Online browsing platform: available at <https://www.iso.org/obp>

3.1

catchment

area of land where all of the water that is under it or drains off of it goes into the same place

[SOURCE: ISO 14055-1:2017(en), 3.2.19]

3.2

culvert

transverse drain or waterway structure under a road, railway, or canal, or through an embankment, in the form of a large pipe or enclosed channel

[SOURCE: ISO 6707-1:2017(en), 3.1.2.33]

3.3

return period

average number of years in which a stated action statistically is exceeded once

[SOURCE: ISO 12494:2017(en), 3.8]

3.4

river

natural body of water flowing continuously or intermittently along a well-defined course into an ocean, sea, lake, inland depression, marsh, or other watercourse

[SOURCE: ISO 5667-6:2014(en), 3.9]

3.5

subcritical flow

flow in an open channel at less than critical velocity, that has a Froude number of less than unity, and in which small surface disturbances can travel upstream

[SOURCE: ISO 772:2011(en), 1.7]

3.6

supercritical flow

flow in an open channel at more than critical velocity, that has a Froude number of greater than unity, and in which small surface disturbances cannot travel upstream

[SOURCE: ISO 772:2011(en), 1.8]

3.7

watercourse

channel on or below the earth's surface, through which water may flow

[SOURCE: ISO 6107-7:2006(en), 50]

3.8

wetted perimeter

contact length between a stream of flowing water and its containing open channel, measured in a direction normal to the flow

[SOURCE: ISO 772:2011(en), 1.54]

4 Planning

4.1 Selection of structure

The first step in planning is selection of the most appropriate type of structure for crossing a watercourse. The two main types of structure for crossing are bridges and culverts. They both have advantages and disadvantages, as shown in Figure 4.1. There may also be other factors that an engineer needs to consider. If a bridge is a more appropriate, then please refer to the *Bridge Design Standards & Manual* (2).

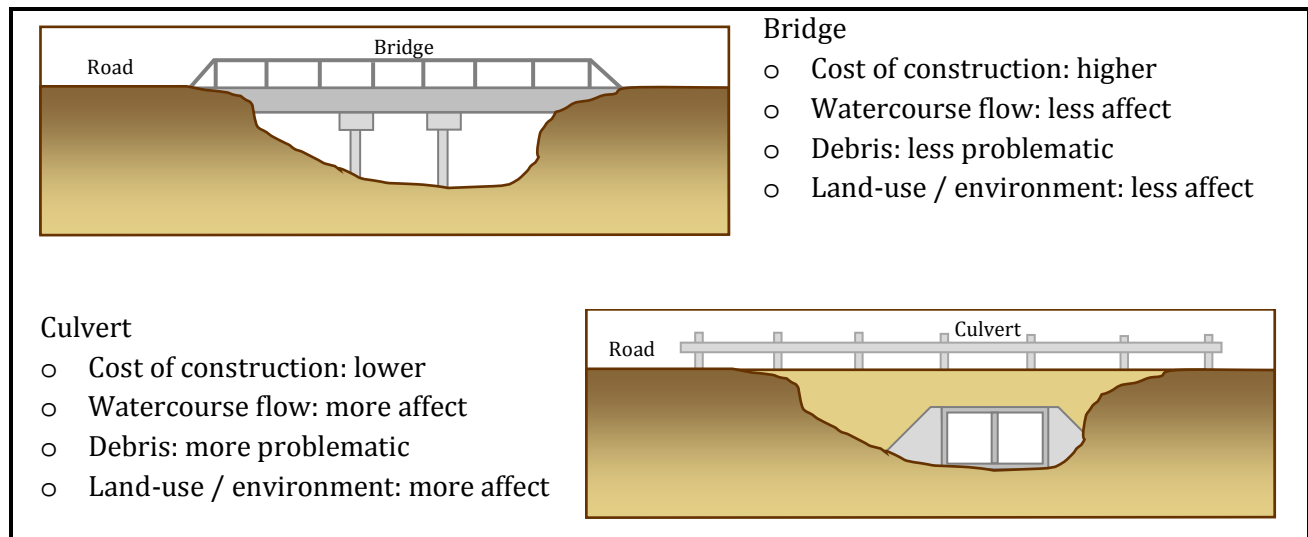

Figure 4.1 — Comparison of application of bridges and culverts

4.2 Overview of culverts

There are various shapes (rectangular box, circular pipe, elliptical pipe, arch pipe, etc.), materials (concrete, corrugated steel, etc.) and inlets (wing walls, flat headwall, square edge at crown, bevel at crown, etc.). These guidelines will primarily cover box culverts made of concrete. The parts of a culvert are shown in Figure 4.2 and Figure 4.3.

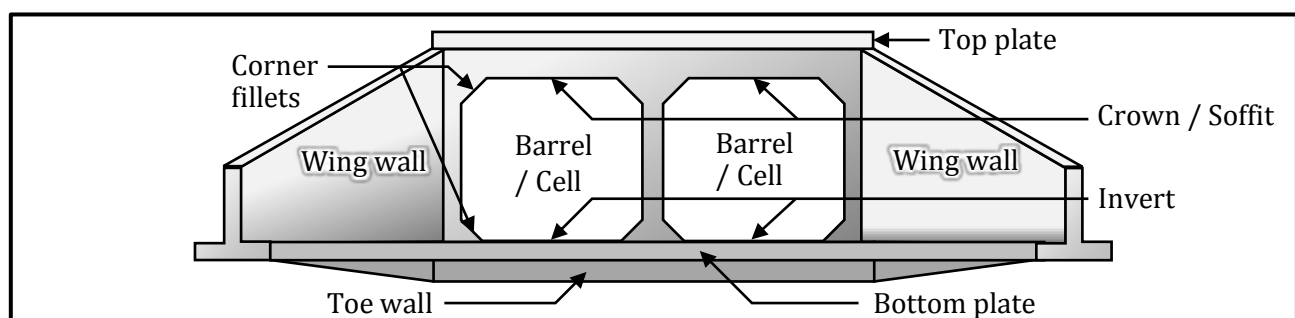

Figure 4.2 — Parts of a culvert on front elevation

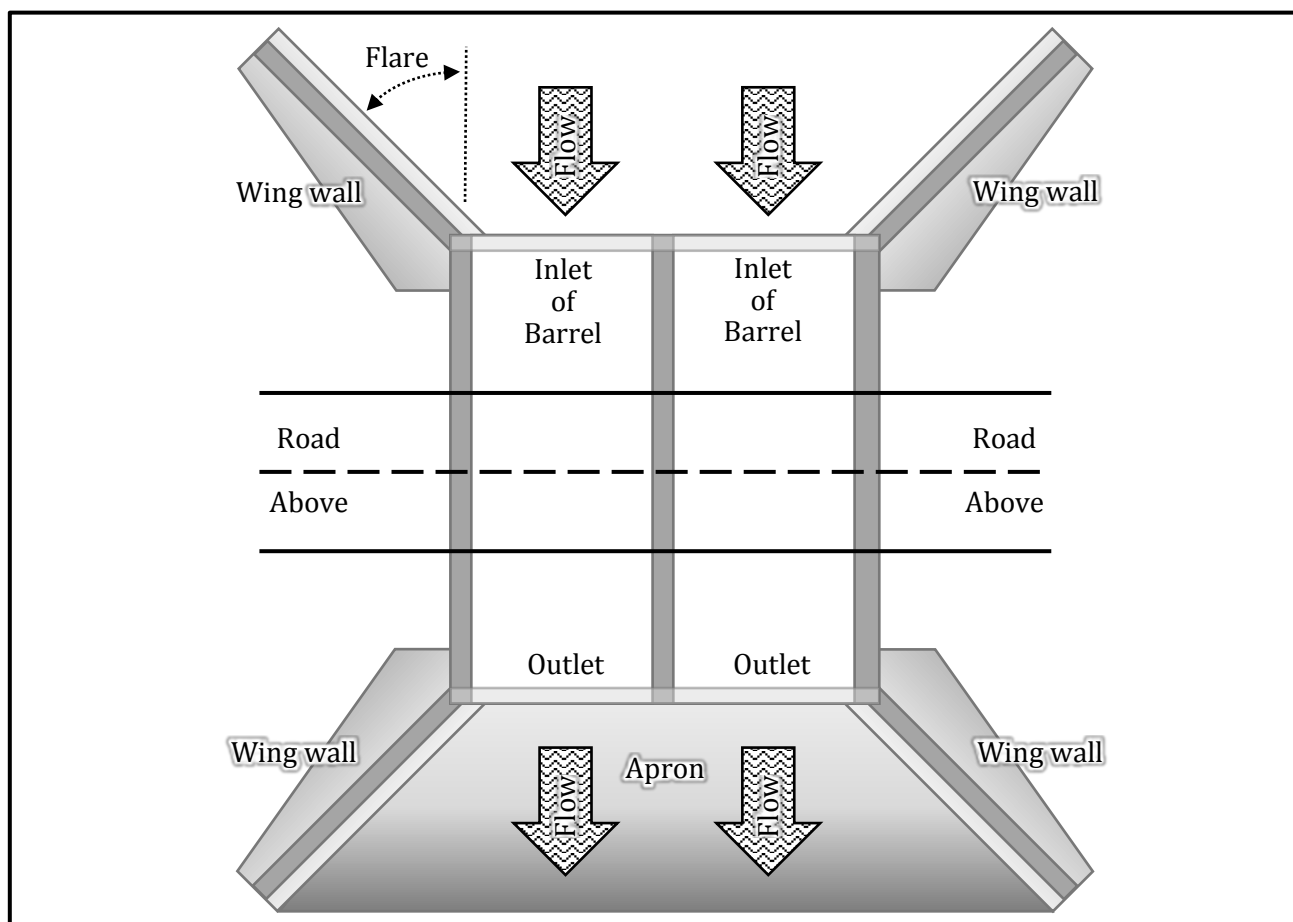

Figure 4.3 — Parts of a culvert on plan

4.3 Application of culverts

There are limitations to the application of culvert structures. The recommended range of application for each barrel of a concrete box culvert is shown in Table 4.1. It is possible to design beyond these limitations with sufficient consideration of structural design and traffic loads.

The proportion of a culvert (height : width) is normally in the range of 1 : 1 to 1 : 3. The most hydraulically efficient proportion is 1 : 2. However, the most normal proportion for road culverts is 1 : 1, because the culvert must structurally support the loads from traffic.

Table 4.1 — Recommended limits for a concrete box culvert (4) (5)

Property	Minimum	Maximum
Height, D	0.75 m (750 mm)	5.0 m (5000 mm)
Width, B	0.45 m (450 mm)	6.5 m (6500 mm)
Cover depth (of material) above top plate	0.5 m (500 mm)	—
Proportion (height : width)	1 : 1	1 : 3
Gradient of culvert	0.005 m/m (0.5%)	0.100 m/m (10%)

In principle, the geometry of a box culvert (width, gradient and bottom elevation) should be similar to the original watercourse in order to reduce sedimentation or erosion. The gradient should be more than (\geq) 0.5% or 0.005 m/m to reduce sedimentation, and less than (\leq) 10% or 0.100 m/m to ensure workability & prevent slippage.

4.4 Alignment of culverts

Culvert alignment is important for the function of the culvert and watercourse. If possible, the inlet and outlet of the culvert should be located in the natural channel at the intersection with the roadway fill slopes.

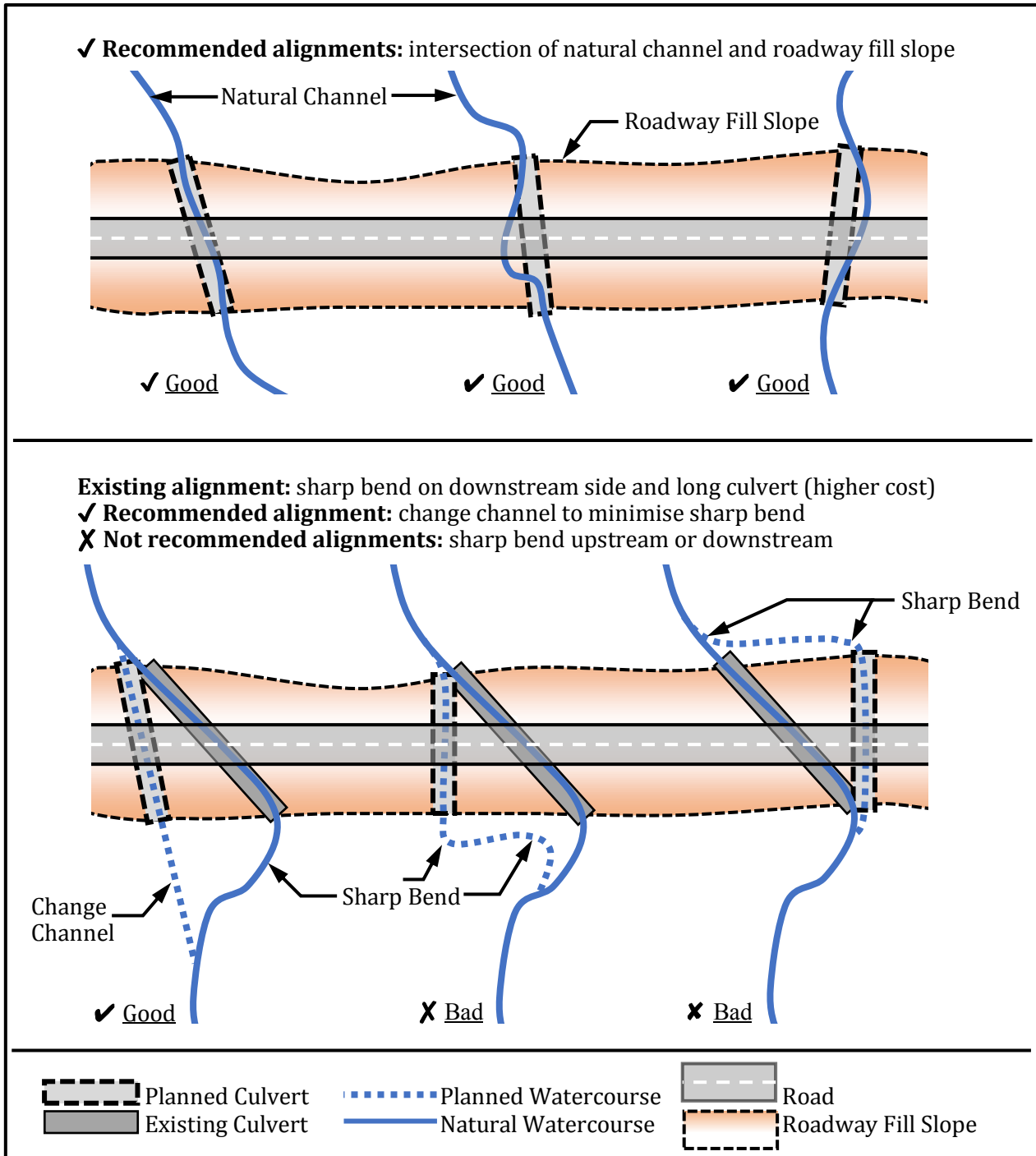

Figure 4.4 — Examples of culvert alignment

4.5 Design process

An outline of the stages for the process of design are shown in Figure 4.5.

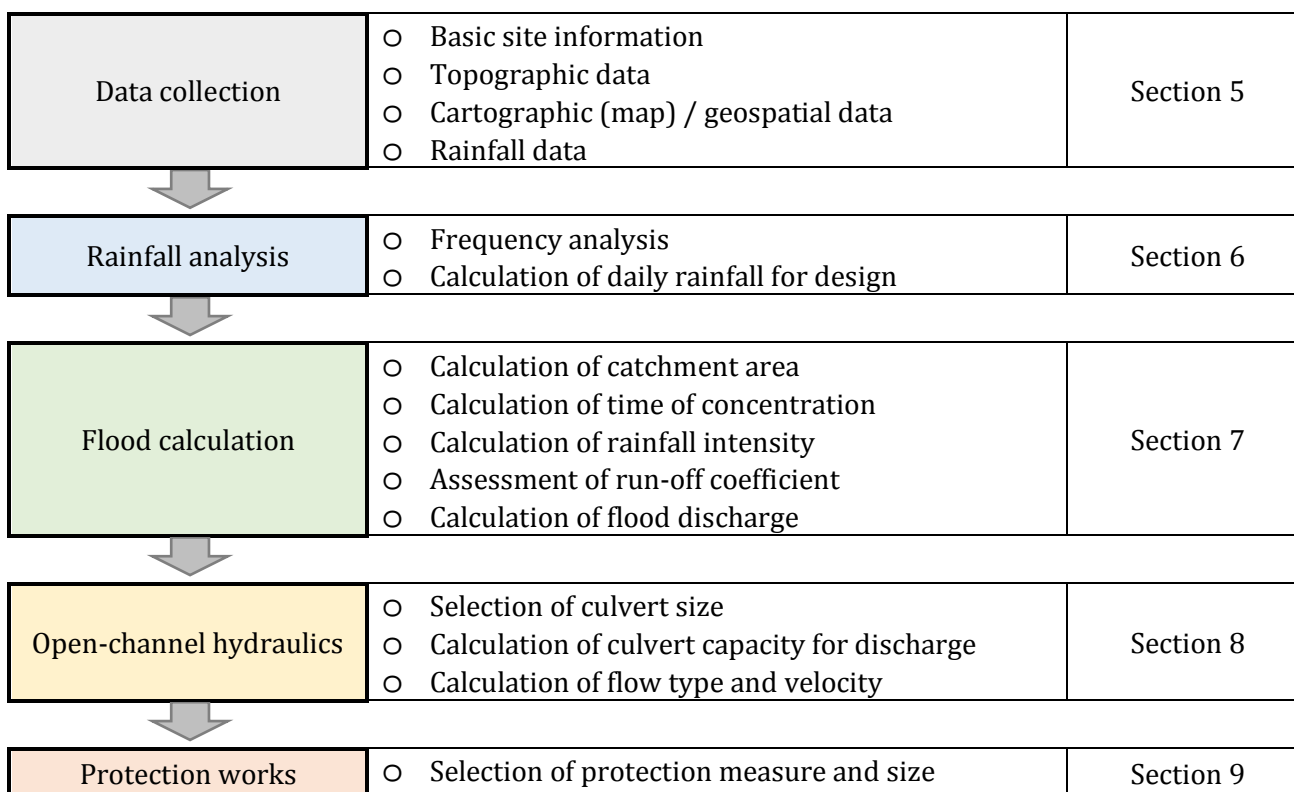

Figure 4.5 — Outline of process for design

In some cases, a simplified process for design could be adopted, as shown in Figure 4.6. This process is based on adoption of a rainfall intensity of 200 mm/hour from the *Bridge Design Standards & Manual (2)*. However, this process may result in excessive or insufficient designs and should be used with caution. This process should only be used for small applications on minor routes, such as rural local roads.

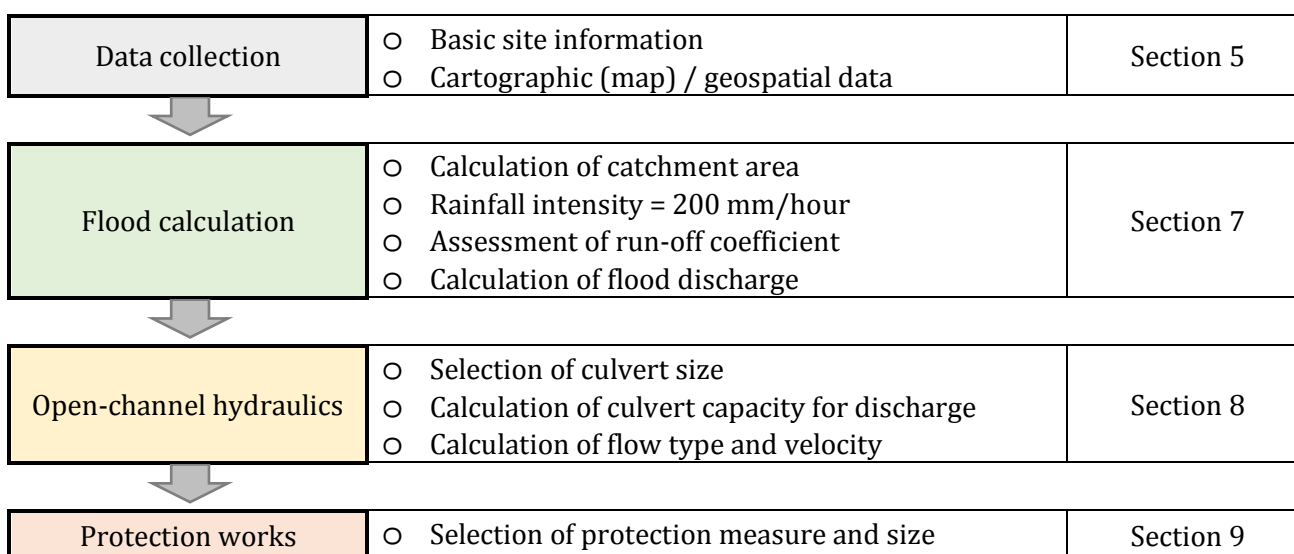

Figure 4.6 — Outline of simplified process for design

5 Data collection

The design of culverts requires an understanding of the site conditions. The following section outlines the various information that should be collected through site investigations and desk studies (off-site investigations).

5.1 Basic site investigation

A basic site investigation should be implemented on site for every culvert design. This information will be necessary for planning and also support the decisions made in the process of design regarding run-off. Examples of the information that is required are shown in Table 5.1 and Figure 5.1.

Table 5.1 — Example checklist of items for site investigation

<input checked="" type="checkbox"/>	Information / Item of investigation	Possible source
<input type="checkbox"/>	Coordinates of site location (latitude & longitude)	GNSS (GPS) receiver / smartphone
<input type="checkbox"/>	Measurement of size of existing culvert (m), if any	Tape measure
<input type="checkbox"/>	Measurement of level (m) of normal flow	Tape measure and marks on structures / land
<input type="checkbox"/>	Photograph of normal flow	Camera / smartphone / local residents
<input type="checkbox"/>	Measurement of level (m) of high flow / flood	Tape measure and marks on structures / land
<input type="checkbox"/>	Photograph of high flow / flood	Camera / smartphone / local residents
<input type="checkbox"/>	Date of high flow / flood	Local residents / officers / administration
<input type="checkbox"/>	Photographs of whole site on elevation / along road	Camera / smartphone
<input type="checkbox"/>	Photograph of surrounding mountains / terrain	Camera / smartphone
<input type="checkbox"/>	Photograph of surrounding buildings / land features	Camera / smartphone
<input type="checkbox"/>	Photographs of culvert inlet (proposed/existing)	Camera / smartphone
<input type="checkbox"/>	Photographs of upstream / ascending direction	Camera / smartphone
<input type="checkbox"/>	Photographs of culvert outlet (proposed/existing)	Camera / smartphone
<input type="checkbox"/>	Photographs of downstream / descending direction	Camera / smartphone
<input type="checkbox"/>	Aerial photograph of area	UAV (drone) / Satellite (Google Earth)

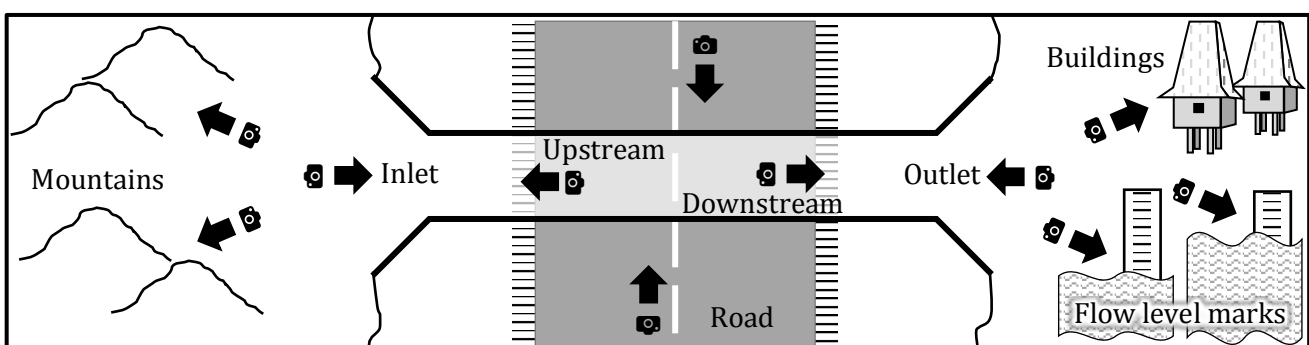

Figure 5.1 — Diagram of site photography

5.2 Topographic investigation

If possible, a topographic investigation should be implemented on site. This information will be necessary for planning and will form a fundamental part of the design calculations regarding the watercourse gradient. In addition, this information can improve the accuracy of a design and facilitate the verification of results. An example of the information that is required is shown in Table 5.2.

Table 5.2 — Example checklist of items for topographic investigation

<input checked="" type="checkbox"/>	Information / Item of investigation	Possible source
<input type="checkbox"/>	Level of invert (m AOD) at proposed/existing inlet	Total station / theodolite
<input type="checkbox"/>	Level of invert (m AOD) at proposed/existing outlet	Total station / theodolite
<input type="checkbox"/>	Level of road (m AOD)	Total station / theodolite
<input type="checkbox"/>	Profile of watercourse	Total station / theodolite
<input type="checkbox"/>	Cross sections of watercourse (2 / 3 sections in both directions)	Total station / theodolite

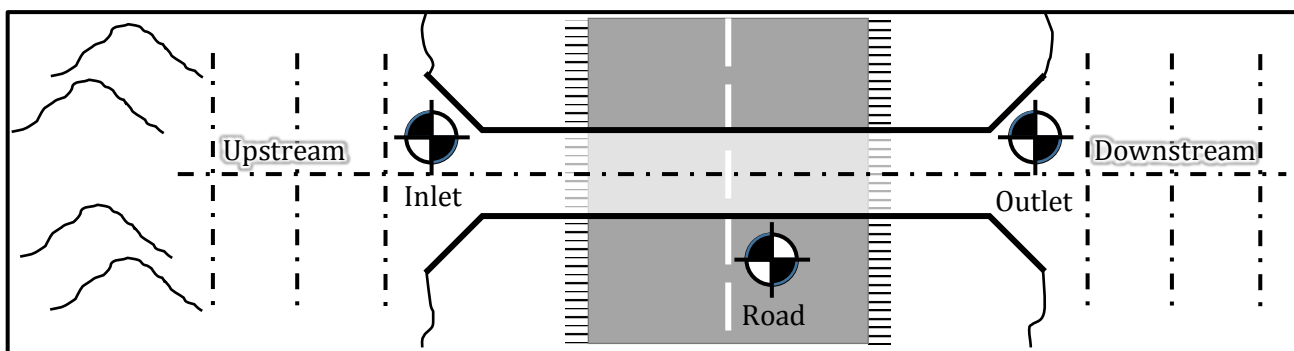

Figure 5.2 — Diagram of basic topographic survey

5.3 Cartographic investigation

A cartographic investigation should be implemented off-site for every culvert design. This map / geospatial information will form a fundamental part of the design calculations regarding the catchment. An example of the information that is required is shown in Table 5.3.

Table 5.3 — Example checklist of items for cartographic investigation

<input checked="" type="checkbox"/>	Information / Item of investigation	Possible source
<input type="checkbox"/>	Cartographic map (T755 series of 1:50,000 maps, etc.)	In-house resources (Mapping & GIS)
<input type="checkbox"/>	Digital elevation model (GIS DEM raster)	In-house resources (Mapping & GIS)
<input type="checkbox"/>	Watercourse line (GIS vector)	In-house resources (Mapping & GIS)
<input type="checkbox"/>	Road line (GIS vector)	In-house resources (Mapping & GIS)

5.4 Rainfall data

A pluvial investigation should be implemented off-site for every culvert design. This rainfall data will form a fundamental part of the design calculations regarding the rainfall intensity. An example of the information that is required is shown in Table 5.4.

Table 5.4 — Example checklist of items for pluvial investigation

<input checked="" type="checkbox"/>	Information / Item of investigation	Possible source
<input type="checkbox"/>	Monthly rainfall data	In-house resources / relevant authority (see Annex C)
<input type="checkbox"/>	Daily rainfall data	In-house resources / relevant authority (see Annex C)
<input type="checkbox"/>	Short-interval / hourly rainfall data	(currently unavailable in Timor-Leste)

The availability of rainfall data will influence the design. The following are considered ideal characteristics for a set of rainfall data:

- 1+ stations in the catchment or near the catchment

- Records at 15-minute, 30-minute, 1-hour, 2-hour, 3-hour, 6-hour, 12-hour and 24-hour intervals
- Long records (30+ years)

In this case, the process of design can utilise intensity-duration-frequency (IDF) curves, as shown in Figure 5.3. The advantage of IDF curves is that storms can be accurately predicted. The disadvantage is that the development of IDF curves requires a significant amount of rainfall data.

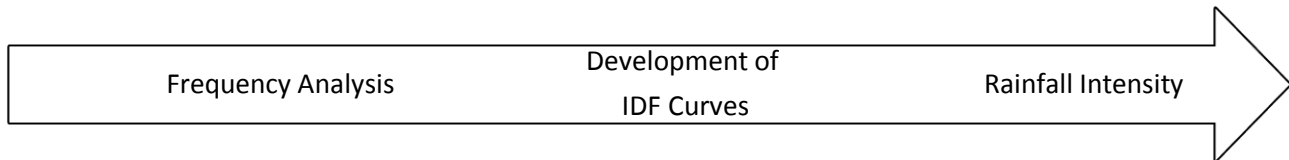

Figure 5.3 — IDF curves in the process of design

Currently, the method of IDF curves cannot be utilised in Timor-Leste, because of the limited length and limited detail of rainfall data. The following is a summary of characteristics for rainfall data in Timor-Leste:

- Currently 82 stations in operation across Timor-Leste (on average, 1 for every 180 km²)
- Monthly rainfall records exist from 1950s (for 36 stations with gaps)
- Daily rainfall records exist for 40 weather stations (approximate availability)
- Long record of 34 years for daily rainfall in Dili (with gaps)
- Short records of 7 – 11 years for daily rainfall in other areas (approximately)

In the case of Timor-Leste, short-interval rainfall data is not available and only daily rainfall data is available, so the Mononobe formula should be utilised in the process of design, as shown in Figure 5.4. The Mononobe formula is used to derive an approximation of rainfall intensity for any storm duration from daily rainfall data. The advantage of the Mononobe formula is simplicity. However, the disadvantage is that the approximation of storms with short duration (6 hours or less) may not be accurate. The Mononobe formula is explained in more detail in Section 7.4.

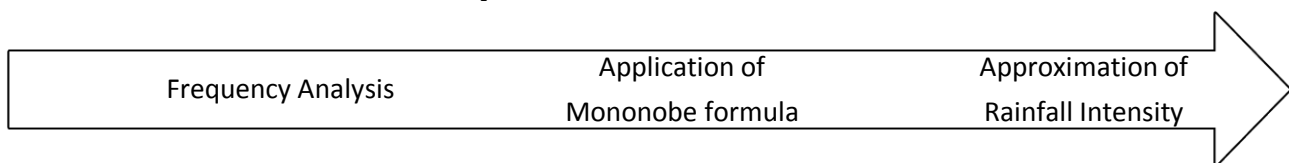

Figure 5.4 — Mononobe formula in the process of design

The rainfall varies depending on the region. The average of the monthly rainfall across the whole country is shown in Figure 5.5. In addition, the variance between the regions is indicated with the following summaries:

- Average of annual rainfall is approximately 1700 mm (whole country)
- Maximum of annual rainfall is approximately 3100 mm (Same)
- Minimum of annual rainfall is approximately 600 mm (Manatuto)

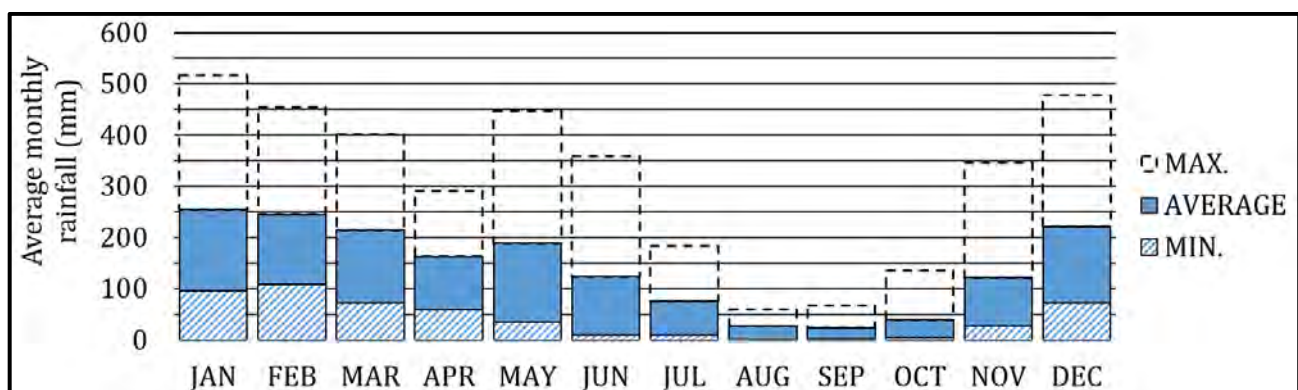

Figure 5.5 — Average of monthly rainfall in Timor-Leste

6 Rainfall analysis

Rainfall analysis reflects the hydrological risk for a road, and ensures protection against probable floods. The input of this process is a long record of daily rainfall, and the output is a maximum probable daily rainfall, also called the design daily rainfall.

The design daily rainfall is determined by analysis of historical rainfall records. The historical rainfall records show the relationship between the frequency of occurrence of storms and the magnitude of storms. The frequency of occurrence for a probable storm / design storm is called the ‘return period’. The prediction of the magnitude of the storm for the return period determines the design rainfall.

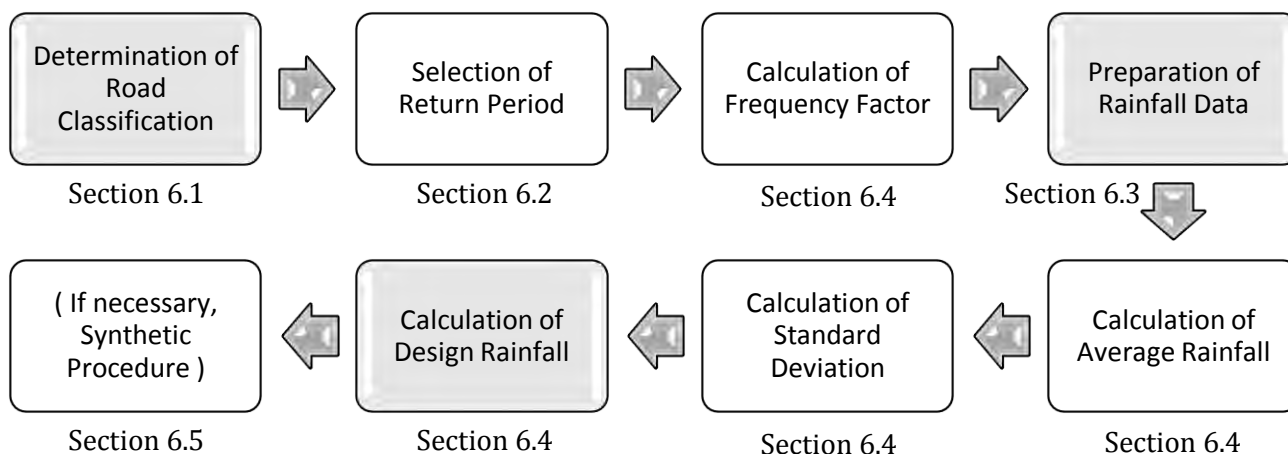

Figure 6.1 — Process of rainfall analysis

6.1 Classification of roads

According to the *Road Geometric Design Standards* (3), the roads in Timor-Leste are classified as shown in Table 6.1.

Table 6.1 — Classification of roads (3)

Rural Roads		Roads outside towns and cities.
National Roads	<ul style="list-style-type: none"> Arterial roads are centres of national and international importance and roads terminating at international boundaries, connecting nation’s capital and to region’s capitals. Provides high level of service for long distance movement of goods and people and thus to/from central corridors for especially heavy vehicles. These roads link locations where change of transport mode is possible. 	
Regional Roads	<ul style="list-style-type: none"> Roads that provides more local purposes, serve mainly traffic within regions and districts at lower speeds and shorter distances. Roads that serve as collector of traffic to/from local network to the national road network. 	
Local Roads	<ul style="list-style-type: none"> Local roads connecting sub-district capitals to villages and more remote areas with agricultural potential. 	
Urban Roads		Local roads inside towns and cities.
Urban Arterial Roads	<ul style="list-style-type: none"> An Urban Arterial Road is a continuous road with partial access control for through traffic within urban areas. Basically it conveys traffic from residential areas to the vicinity of the central business district or from one part of a city to another 	

	which does not intend to penetrate the city centre. Arterial roads do not penetrate identifiable neighbourhoods. Smooth traffic flow is essential since it carries large traffic volume.
Urban Collector Roads	<ul style="list-style-type: none"> A collector road is a road with partial access control designed to serve on a collector or distributor of traffic between the arterial and the local road systems. Collectors are the major roads that penetrate and serve identifiable neighbourhoods, commercial areas and industrial areas.
Urban Local Roads	<ul style="list-style-type: none"> The local street system is the basic road network within a neighbourhood and provides direct access to abutting land. They are links to the collector road and thus serve short trip lengths. Through traffic should be discouraged.

6.2 Return period

The return period reflects the hydrological risk for a road. The selection of an appropriate mitigation of risk depends on the economic value / importance of a road asset. The balance between the cost of the road asset and the cost to protect the road asset is important: inadequate protection may allow damage of a road asset and a loss of economic value; excessive protection will cause unnecessary expenditure and an uneconomical solution.

The return period (years) represents probability of occurrence. The return period does not represent a guaranteed period without flooding and it is not related to the design life of a road. The probability of occurrence has an inverse relationship to the magnitude of rainfall events. Therefore, a long return period equals a low probability, which means a high magnitude of rainfall event.

Table 6.2 — Recommended return periods of rainfall for culverts (4) (6)

Road class	Level of drainage capacity	Return period of rainfall
National Roads / Urban Arterial Roads	High	10 years
Regional Roads / Urban Collector Roads	Medium	7 years
Local Roads / Urban Local Roads	Low	5 years

The classification of a road is related to its economic value. Therefore, selection of a return period is recommended based on the classification of a road, as shown in Table 6.2. The return period may be modified by the engineer in situations where a higher level of drainage capacity is desirable. For example, roads that are designed for service of major national assets and where the level of risk must be agreed in conjunction with other national authorities.

6.3 Preparation of rainfall data

The rainfall data for frequency analysis is the maximum of daily rainfall per annum. The preparation of rainfall data for analysis should be implemented in the following manner:

1. Acquisition of daily rainfall data
2. Examination of all data (365 days) in same annum (coeval data)
3. Selection of maximum rainfall value (1 day) per annum
4. Repetition of 2 and 3 (above) for every annum

Complete rainfall records are necessary for analysis. The confirmation of data integrity should be implemented in the following manner:

- If data contains null or erroneous values (for example, “ ** ” or “ — “ or “ NA ” or “ -999.9 ”), deletion of these values is necessary.
- If data for 1 annum is missing approximately 90 days (¼ annum) of data, then that annum is invalid and cannot be utilized for analysis.

6.4 Frequency analysis

Frequency analysis utilises a probability distribution for the prediction of design rainfall. A probability distribution is a general relationship between the frequency and the magnitude. The probability distribution conforms to the rainfall data, similar to a trend line (or line of tendency). An example of a probability distribution on a bell-shaped diagram is shown in Figure 6.2.

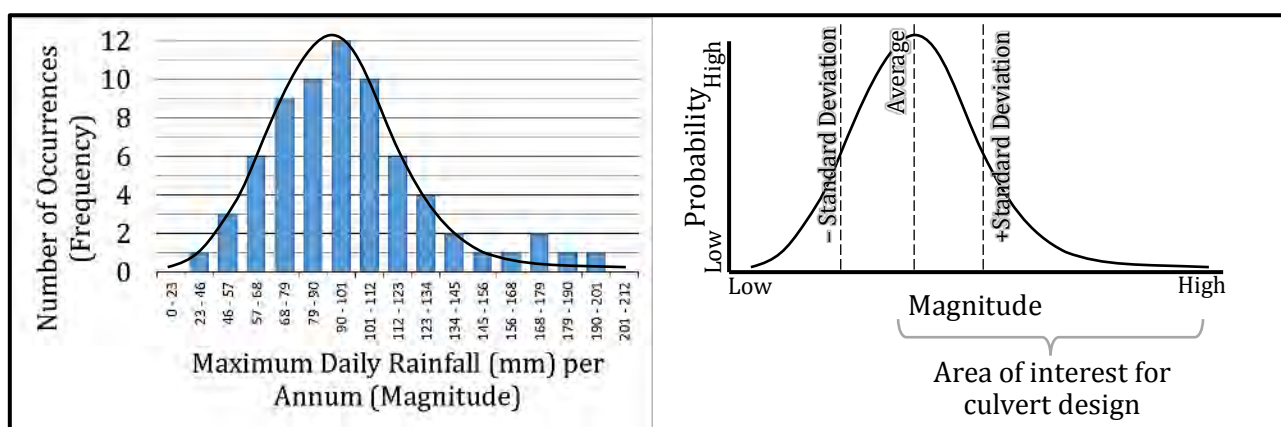

Figure 6.2 — Example of a probability distribution

For culvert design, it is necessary for prediction of higher-magnitude lower-probability for the design rainfall. The process of prediction utilises the ‘Gumbel’ distribution to represent the rainfall data.

The Gumbel distribution is adjusted to the rainfall data with two parameters: the average and the standard deviation. The return period is incorporated using a frequency factor. In essence, the Gumbel distribution predicts the magnitude of the design rainfall as a departure from the average rainfall. The departure depends on the number of standard deviations, where the number is the frequency factor (return period).

The following is the Gumbel distribution for calculation of the design rainfall:

$$R_{24} = \mu + \sigma \times K \tag{1}$$

where

- R_{24} design rainfall for a given return period (mm/day)
- μ average of rainfall records (mm/day), see equation 2
- σ standard deviation of rainfall records, see equation 3
- K frequency factor, see equation 4

The following is the equation for calculation of the average of rainfall data:

$$\mu = \frac{\sum X_i}{n} \tag{2}$$

where

- μ average of rainfall data (mm/day)
- X_i annual maximum of daily rainfall data values (mm/day)
- n number of rainfall data values

[NOTE: in spreadsheet software, this can be calculated using the AVERAGE function]

The following is the equation for calculation of the standard deviation of rainfall data:

$$\sigma = \sqrt{\frac{\sum(X_i - \mu)^2}{n-1}} \quad [3]$$

where

- σ standard deviation of rainfall data
- X_i annual maximum of daily rainfall data values (mm/day)
- μ average of rainfall records (mm/day)
- n number of rainfall data values

[NOTE: in spreadsheet software, this can be calculated using the STDEV or STDEV.S functions]

The following is the equation for calculation of the frequency factor (incorporation of return period):

$$K = -\frac{\sqrt{6}}{\pi} \times \left(\gamma + \ln \left(\ln \frac{T}{T-1} \right) \right) \quad [4]$$

where

- K frequency factor (normally between -1 and 5)
- π Pi mathematical constant = 3.14159
- γ Euler-Mascheroni constant = 0.5772
- T return period (years), see Table 6.2

[NOTE: in spreadsheet software, this can be calculated using the SQRT, PI and LN functions]

6.5 Synthetic procedure

In many cases in Timor-Leste, it is necessary to implement a synthetic (compensative) procedure. The reason is that most locations only have short records of rainfall data (see Section 5.4). Therefore, currently, Dili is the only location with rainfall data that is suitable for frequency analysis. Using the frequency analysis of design daily rainfall for Dili, it is possible to synthesise for other locations by scaling up / down (escalate / de-escalate) using the ratio of average annual rainfall as a multiplier. The procedure of deriving daily rainfall for any target location in Timor-Leste using Dili as a basis is shown in Table 6.3.

Table 6.3 — Synthetic procedure for deriving daily rainfall for a target location

Return period of rainfall	Design daily rainfall in Dili, R ₂₄ (mm/day)		Ratio of annual rainfall (multiplier)
10 years	131.4	×	(Target Location / Dili)
7 years	122.3		(... mm / 940 mm)
5 years	113.6		

For reference, a list of target locations and derived design daily rainfall are shown in Table 6.4.

Table 6.4 — List of target locations and derived design daily rainfall

Target location	Average annual rainfall (mm/day)	Multiplier	Design daily rainfall, R ₂₄ (mm/day) for return period		
			5 years	7 years	10 years
Dili	940	1.00	113.6	122.3	131.4
Ainaro	2653	2.82	320.5	345.3	370.8
Alas	1965	2.09	237.4	255.7	274.6
Algarve (Fazenda)	1870	1.99	225.9	243.4	261.3
Atauro (Mau-Meta)	871	0.93	105.2	113.4	121.7
Baguia	2399	2.55	289.8	312.2	335.3
Baucau	1208	1.29	145.9	157.2	168.8
Betano	1298	1.38	156.8	168.9	181.4
Bobonaro	2432	2.59	293.8	316.5	339.9
Dare	1533	1.63	185.2	199.5	214.2
Fatubessi	2929	3.12	353.8	381.2	409.3
Fohorem	1536	1.63	185.6	199.9	214.7
Gleno	1765	1.88	213.2	229.7	246.7
Hato-Builico	2418	2.57	292.1	314.7	337.9
Iliomar	2090	2.22	252.5	272.0	292.1
Laga	770	0.82	93.0	100.2	107.6
Laivai	696	0.74	84.1	90.6	97.3
Lautem	1511	1.61	182.5	196.6	211.2
Liquica	1383	1.47	167.1	180.0	193.3
Lore	1669	1.78	201.6	217.2	233.2
Lospalos	1918	2.04	231.7	249.6	268.0
Luro	1707	1.82	206.2	222.2	238.6
Maliana	2062	2.19	249.1	268.4	288.2
Manatuto	610	0.65	73.7	79.4	85.2
Oecusse	1070	1.14	129.3	139.3	149.5
Ossu	1948	2.07	235.3	253.5	272.2
Quelicaí	1728	1.84	208.8	224.9	241.5
Same	3117	3.32	376.5	405.7	435.6
Soibada	2396	2.55	289.4	311.8	334.8
Suai	1355	1.44	163.7	176.3	189.4
Tutuala	1511	1.61	182.5	196.6	211.2
Uatolari	1879	2.00	227.0	244.5	262.6
Vemasse	706	0.75	85.3	91.9	98.7
Venilale	1764	1.88	213.1	229.6	246.5
Viqueque	1577	1.68	190.5	205.2	220.4
Zumalai	1328	1.41	160.4	172.8	185.6

NOTE Average annual rainfall values were taken from data records of the Ministry of Agriculture, Forestry and Fisheries (MAFF) for the period 1950s – 1990s. These should be supplemented by recent rainfall data if possible.

7 Design flood

The calculation of design flood determines the volume of water that will be discharged from the catchment during the design rainfall. The design flood determines the required capacity of the culvert. The procedure for calculation of a design flood is shown in Figure 7.1.

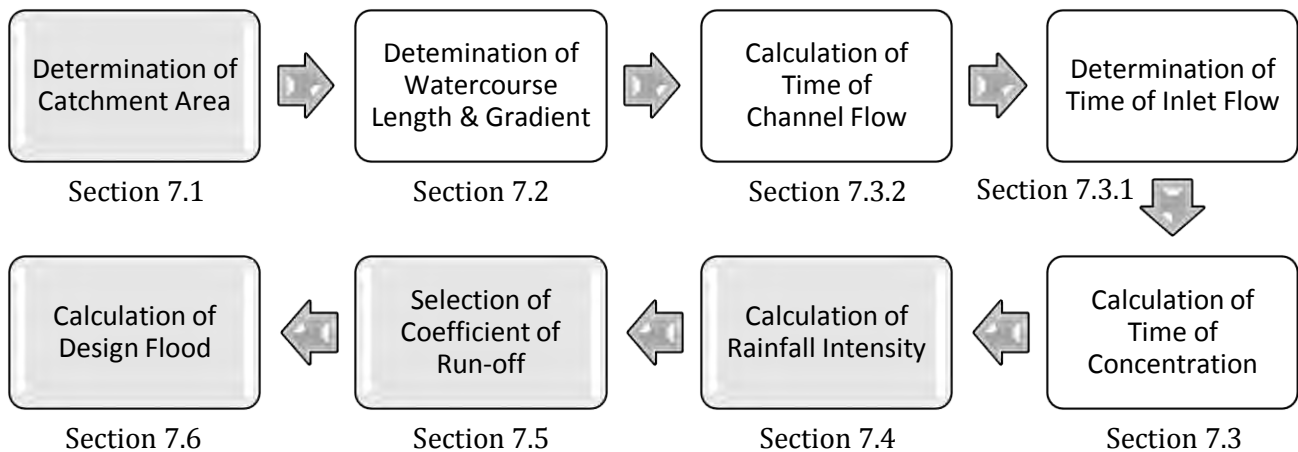

Figure 7.1 — Process of calculation of design flood

7.1 Catchment area

A catchment is an area of land that drains to a point of interest, such as a culvert, as shown in Figure 7.2. All water flow that originates inside the catchment area passes the point of interest before proceeding downstream. The watershed is the boundary between a catchment and its neighbour catchment. The extent of the watershed (boundary) can be identified by connecting the surrounding points with highest elevation, such as a mountain summits, hilltops, ridges, saddles and spurs as shown in Figure 7.3.

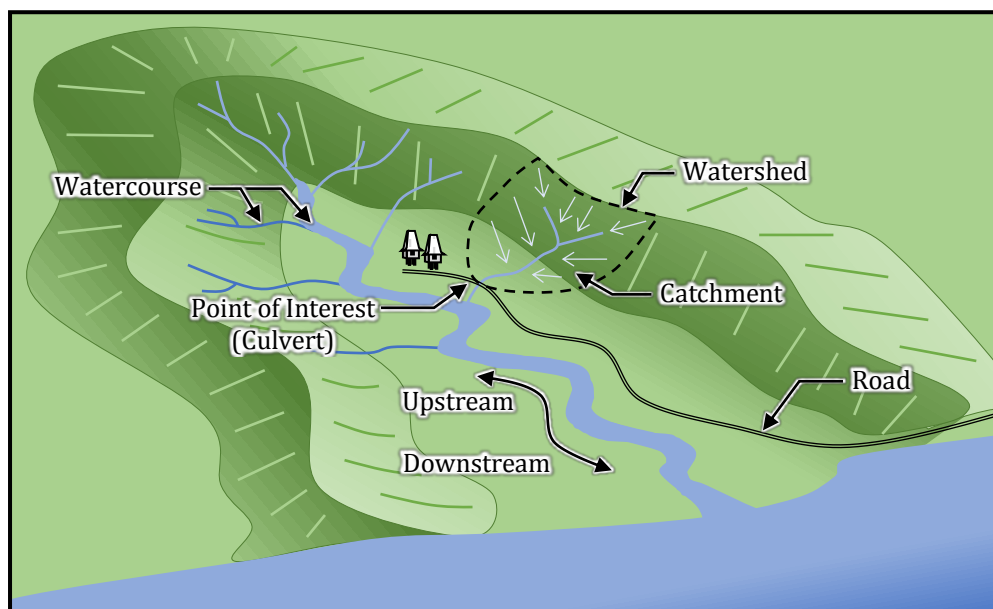

Figure 7.2 — Catchment area within a mountain basin

The size of a catchment has an important influence on the calculation of run-off. The size is expressed as area in terms of km^2 ($1 \text{ km}^2 = 1,000,000 \text{ m}^2 = 100 \text{ ha}$). Topographical maps (1:50,000, such as T755 series) can be used for determination of catchment area. However, smaller scale maps (1:10,000) or geographic information system (GIS) data are recommended for small catchments. It is important for the designer to visit a site personally to obtain an impression of the characteristics of the catchment.

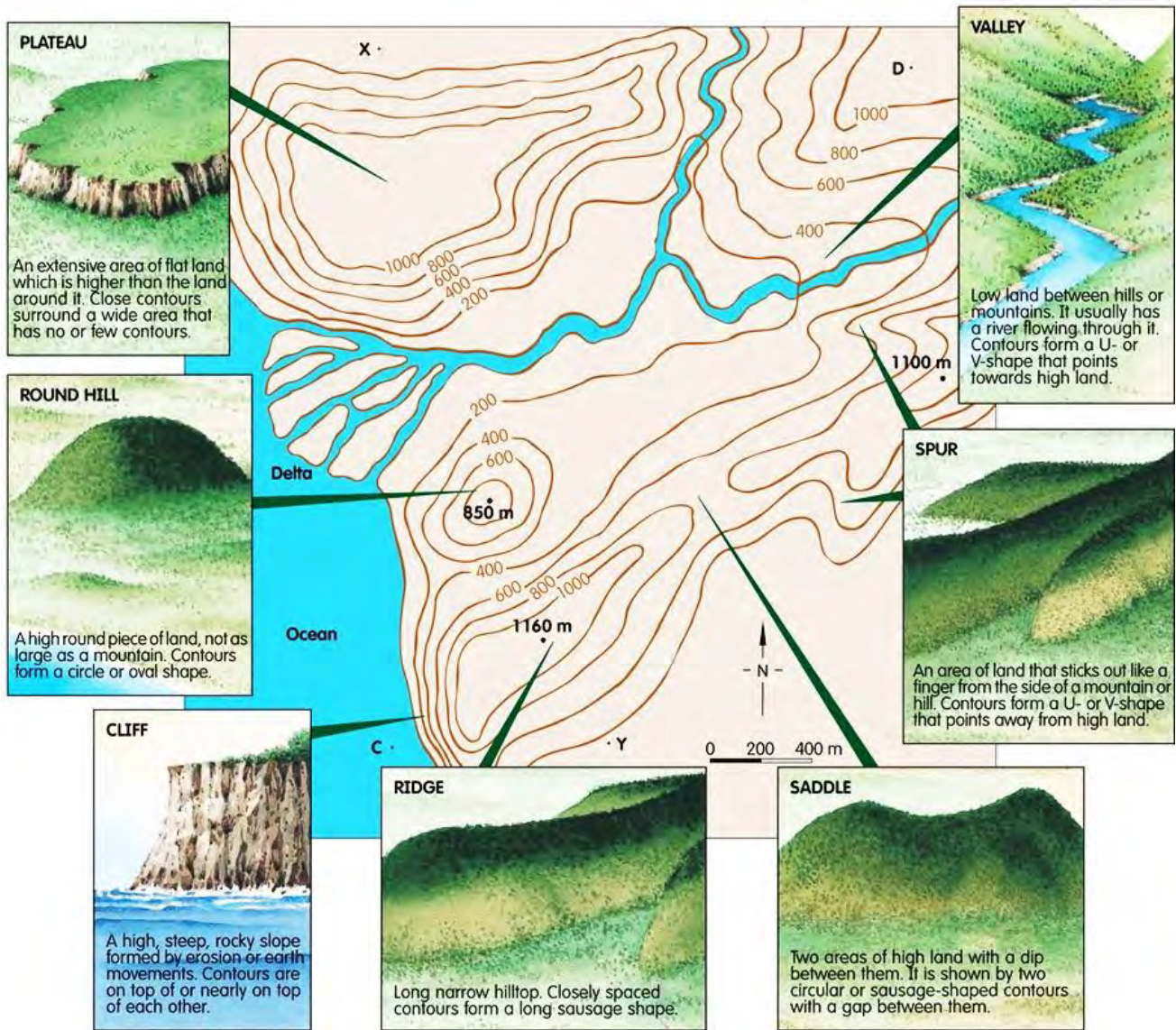

Figure 7.3 — Example of topographic features (7)

Measurement techniques for area include: transferring the catchment outline onto square-lined paper using tracing paper; importing and scaling maps into computer aided design (CAD) software; and using digital elevation models (DEMs, data) and spatial data in a geographic information systems (GISs, software). Usage of GISs is the recommended measurement technique for accurate results. If possible, a request for information should be made to the GIS & Mapping Section of DNEPCC.

The GIS & Mapping Section can analyse a catchment either by delineating a watershed based on contours (in other words, drawing a polygon shape file to represent a catchment) or by using algorithms to derive watersheds from digital elevation models (DEMs). Examples of algorithms for delineation include “r.watershed” and “r.water.outlet” in GRASS Tools of QGIS software, and “Watershed” in Spatial Analyst toolbox of ArcGIS software. An example sequence for delineating a watershed from a DEM is as follows:

- Step 1) Fill the depressions in the DEM
- Step 2) Calculate flow directions
- Step 3) Delineate the catchment and derive its area
 - Step 3.1) Choose the point of interest (“Outlet” in QGIS and “Pour Point” in ArcGIS)
 - Step 3.2) Delineate the watershed
 - Step 3.3) Calculate the area

In addition to the total catchment area, calculation of the sub-catchment areas is required if locations have distinctly different types of terrain. The boundary of terrain types can be analysed by site investigation, by satellite imagery or by land cover data.

7.2 Watercourse properties

Similar to Section 7.1, watercourse properties can be measured with topographical maps, CAD software or GIS. If possible, a request for information should be made to the GIS & Mapping Section of DNEPCC.

The watercourse properties required for calculation of time of concentration are the length and the gradient. The length of a watercourse (L) should be measured from the furthest discernible start of a watercourse to the point of interest, as shown in Figure 7.4.

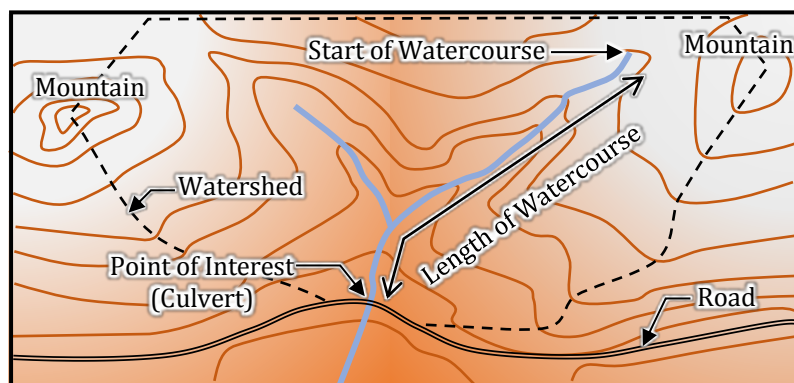

Figure 7.4 — Measurement of length of watercourse

The average gradient should be used for the gradient of a watercourse (G), as shown in Figure 7.5. The calculation of average gradient requires lengths (L values) and the heights (H values) at several points along the profile of the watercourse. In most spreadsheet software, the average gradient can be calculated utilising the LINEST function: $\text{LINEST}([H \text{ values}], [L \text{ values}], \text{FALSE})$ gives a result in m/m or $\text{LINEST}([H \text{ values}], [L \text{ values}], \text{FALSE}) * 100$ gives a result in percentage (%).

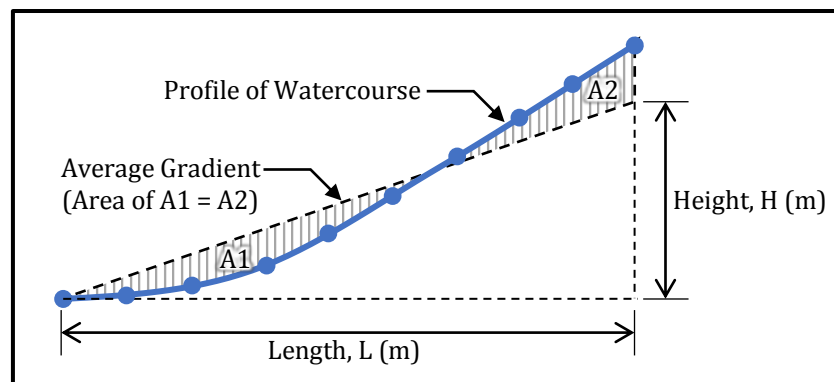

Figure 7.5 — Calculation of average gradient of watercourse

7.3 Time of concentration

The time of concentration is required for the calculation of rainfall intensity. The time of concentration is the time for water to flow from the furthest point in the watershed (i.e. the mountain) to the point of interest (i.e. the culvert). Different areas of a watershed contribute to run-off at different times after rainfall begins. Time at which all parts of the watershed begin contributing to the run-off from the basin, as shown in Figure 7.6. The time of concentration is calculated with equation 5.

The following is the equation for calculation of time of concentration:

$$t_c = t_e + t_f \tag{5}$$

where

- t_c time of concentration (hours)
- t_e time of flow from watershed to watercourse (hours), see Table 7.1
- t_f time of flow from start of watercourse to point of discharge (hours), see equation 6

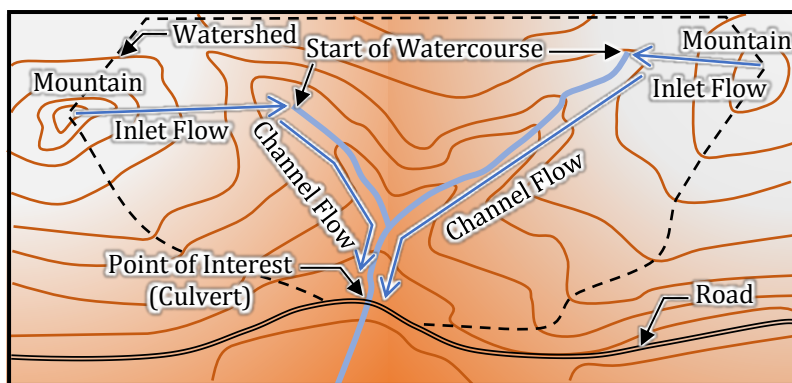

Figure 7.6 — Time of concentration

7.3.1 Time for inlet flow

The time for inlet flow is the time for surface flow to travel from the watershed to the start of the watercourse.

Table 7.1 — Inlet flow times (4)

Catchment type	Inlet time (minutes)	Inlet time (hours)
Mountainous land	15.0 – 30.0	0.25 – 0.50
Cut slopes	3.0 – 5.0	0.05 – 0.083
Urban areas	5.0	0.083

7.3.2 Time for channel flow

The time for channel flow is the time for surface flow to travel from the start of the watercourse to the point of interest (culvert). The Kraven Formula is an empirical equation based on basin data.

The following is the Kraven Formula for calculation of the time for channel flow:

$$t_f = \frac{L}{3600 \times W} \tag{6}$$

where

- t_f time of flow from start of watercourse to point of discharge (hours)
- L watercourse length (m)
- W velocity of run-off (m/s), see Table 7.2

Table 7.2 — Velocity of run-off (4)

Gradient of watercourse, G			Velocity of run-off, W (m/s)
> 1 / 100	> 1.0%	> 0.010 m/m	3.5
1 / 200 – 1 / 100	0.5% – 1.0%	0.005 – 0.010 m/m	3.0
< 1 / 200	< 0.5%	< 0.005 m/m	2.1

7.4 Intensity of rainfall

Generally, storm intensity is inversely proportionate to storm duration for most climates. This inverse relationship means that shorter-duration storms have higher intensity of rainfall and longer-duration storms have lower intensity of rainfall, as shown in Figure 7.7.

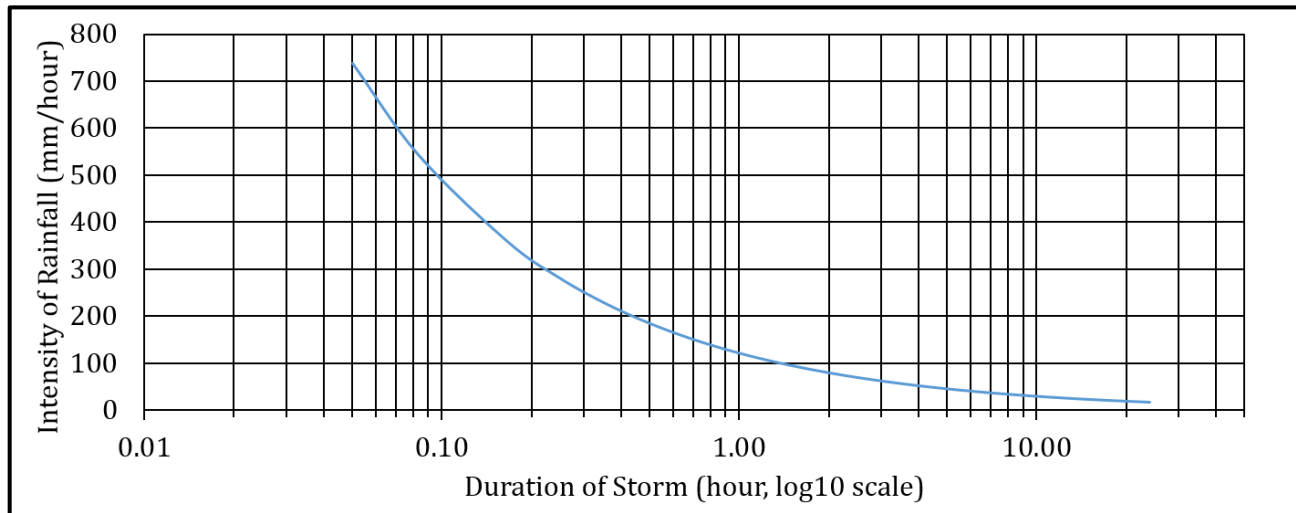

Figure 7.7 — Example of the inverse relationship of an intensity-duration curve

The design intensity of rainfall is when the duration of a storm is equal to the time of concentration, as shown by (b) in Figure 7.8. As shown in (a), when the duration of a storm is less than the time of concentration, then all of the catchment area is not discharging to the culvert, so it is not the maximum discharge. As shown in (c), when the duration of a storm is more than the time of concentration, then the intensity of rainfall will be lower, so it is also not the maximum discharge. Time of concentration is when all parts of the watershed start to contribute to the run-off from the basin and this is when the design intensity of rainfall occurs.

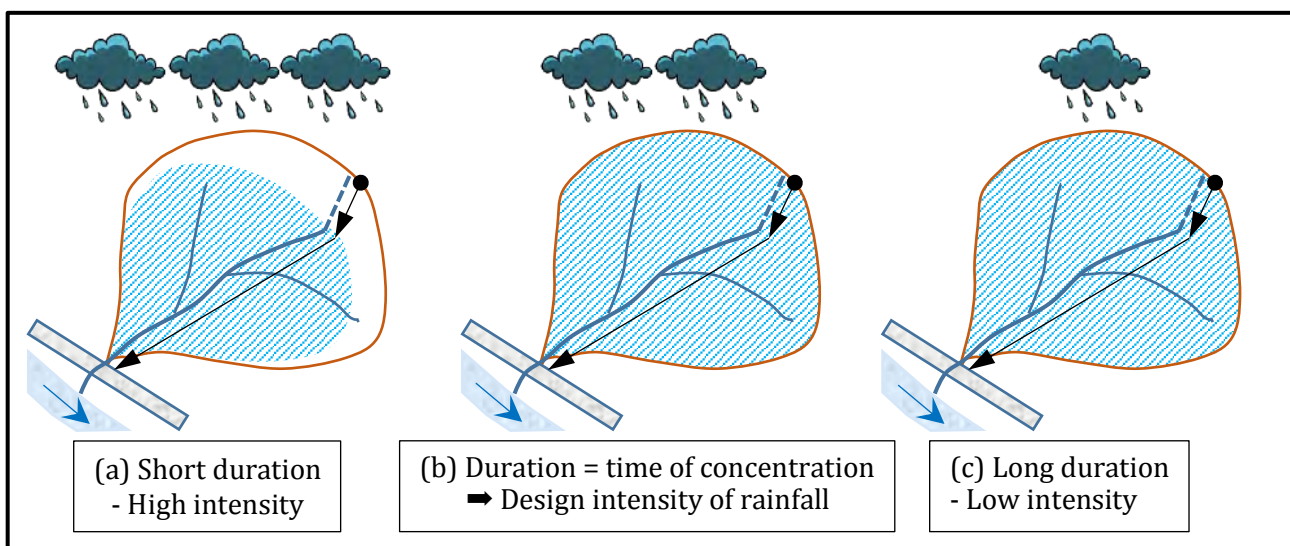

Figure 7.8 — Design intensity of rainfall for maximum probable discharge

As mentioned in Section 5.4, there is insufficient rainfall data in Timor-Leste for creation of intensity-duration curves, such as Figure 7.7. The Mononobe Formula is an empirical equation for estimation of intensity of rainfall. It is a practical solution for applications with few rainfall data.

The following is the Mononobe Formula for calculation of the rainfall intensity:

$$i = \frac{R_{24}}{24} \times \left(\frac{24}{t_c}\right)^{0.6} \quad [7]$$

where

- i rainfall intensity (mm/hour)
- R_{24} design daily rainfall (mm/day), see Section 6
- t_c time of concentration (hours), see equation 5

The disadvantage of the Mononobe Formula is that it may not accurately predict intensity of rainfall for storms with a short duration (<6 hours). It is recommended that Timor-Leste collects rainfall data at 15-minute, 30-minute, 1-hour, 2-hour, 3-hour, 6-hour, 12-hour and 24-hour intervals in all weather stations. Provided this data can be collected, intensity-duration-frequency (IDF) charts could be developed by 2050 and hydrological design techniques could be refined.

7.5 Coefficient of run-off

Run-off is water from rainfall that flows on the surface (in other words, surface flow). The amount of rainfall that becomes run-off flow depends on the amount of water lost by infiltration and evaporation. This loss of water due to infiltration and evaporation is represented by a coefficient of run-off. Therefore, the coefficient of run-off is the proportion of rainfall that becomes run-off.

Recommended coefficients of run-off, C , are shown in Table 7.3. A higher coefficient of run-off indicates that more rainfall becomes run-off, and likewise a lower coefficient of run-off indicates the less rainfall becomes run-off.

If you a catchment area contains different types of terrain, then application of a weighted coefficient is recommended. The weighted coefficient should be calculated as shown in equation 8.

Table 7.3 — Coefficients of run-off (4)

Terrain type	Coefficient of run-off	Average value
Road surfaces and sloped surfaces	0.70 – 1.00	0.85
Steep mountainous land	0.75 – 0.90	0.83
Gentle mountainous land	0.70 – 0.80	0.75
Undulating land and woods	0.50 – 0.75	0.63
Flat farmlands	0.45 – 0.60	0.53
Rice paddy (fields)	0.70 – 0.80	0.75
Urban areas	0.60 – 0.90	0.75
Forest zones	0.20 – 0.40	0.30
Catchment areas of mountain streams	0.75 – 0.85	0.80
Catchment areas of small rivers on flat land	0.45 – 0.75	0.60
Catchment areas of major rivers of which more than half run on flat land	0.50 – 0.75	0.63

The following is the equation for calculation of a weighted coefficient of run-off:

$$C = \frac{(C_1 \times A_1 + C_2 \times A_2 + \dots + C_n \times A_n)}{(A_1 + A_2 + \dots + A_n)} \quad [8]$$

where

- C weighted coefficient of run-off (dimensionless)
- $C_{1,2,n}$ coefficients of run-off for different types of terrain (dimensionless), see Table 7.3
- $A_{1,2,n}$ areas of catchments with different types of terrain (m²), see Section 7.1

7.6 Rational method

The Rational Method shall be applied for calculation of a design flood. It was first proposed in 1851 by an Irish engineer called Mulvaney. It is based on a simplistic relationship between rainfall and run-off for empirical prediction of discharge from a catchment. This method is appropriate for the following design conditions:

- Calculation of peak discharge
- Ungauged sites (without streamflow / river data)
- Deterministic analysis based on rainfall
- Catchments without significant water storage (no lakes, no ponds, no wetlands, etc.)
- Applicable < 15.0 km² (5)
- Best suited ≤ 0.8 km² (7)

The limitation of application to catchments < 15.0 km² is because the coefficient of run-off cannot accurately represent water storage (or hydrologically complex catchments). The method assumes that intensity of rainfall is uniform over the catchment; hence, the peak run-off is assumed to occur when duration of a storm equals the time of concentration.

The following is the Rational Method equation for calculation of peak discharge:

$$Q_p = \frac{1}{3.6} \times C \times i \times A \quad [9]$$

where

Q_p peak discharge or design flood of a watercourse (m³/s)

C coefficient of run-off, see Table 7.3

i rainfall intensity (mm/hour), see equation 7

A catchment area of watercourse (km²)

As mentioned in Section 4.5, a simplified process for design based on adoption of a rainfall intensity of 200 mm/hour from the *Bridge Design Standards & Manual* (2) could be used for small applications on minor routes, such as rural local roads. For reference, design floods of the simplified process are shown in Table 7.4.

Table 7.4 — Examples of design floods for small applications using the simplified process

Coefficient of run-off, C	Design flood, Q_p , (m ³ /s) for a catchment area of									
	0.1 km ²	0.2 km ²	0.3 km ²	0.4 km ²	0.5 km ²	0.6 km ²	0.7 km ²	0.8 km ²	0.9 km ²	1.0 km ²
0.20	1.2	2.3	3.4	4.5	5.6	6.7	7.8	8.9	10.0	11.2
0.30	1.7	3.4	5.0	6.7	8.4	10.0	11.7	13.4	15.0	16.7
0.40	2.3	4.5	6.7	8.9	11.2	13.4	15.6	17.8	20.0	22.3
0.45	2.5	5.0	7.5	10.0	12.5	15.0	17.5	20.0	22.5	25.0
0.50	2.8	5.6	8.4	11.2	13.9	16.7	19.5	22.3	25.0	27.8
0.55	3.1	6.2	9.2	12.3	15.3	18.4	21.4	24.5	27.5	30.6
0.60	3.4	6.7	10.0	13.4	16.7	20.0	23.4	26.7	30.0	33.4
0.65	3.7	7.3	10.9	14.5	18.1	21.7	25.3	28.9	32.5	36.2
0.70	3.9	7.8	11.7	15.6	19.5	23.4	27.3	31.2	35.0	38.9
0.75	4.2	8.4	12.5	16.7	20.9	25.0	29.2	33.4	37.5	41.7
0.80	4.5	8.9	13.4	17.8	22.3	26.7	31.2	35.6	40.0	44.5
0.85	4.8	9.5	14.2	18.9	23.7	28.4	33.1	37.8	42.5	47.3
0.90	5.0	10.0	15.0	20.0	25.0	30.0	35.0	40.0	45.0	50.0

NOTE: The above values are for the simplified process that adopts a rainfall intensity of 200 mm/hour. These values should be used with caution. Where possible, the full process should be used and rainfall intensity should be calculated.

8 Open-channel hydraulics

Open-channel hydraulics is characterised by water flowing under gravity and at atmospheric pressure due to the water surface being in contact with the air (a free surface). The process of design is outlined in Figure 8.1

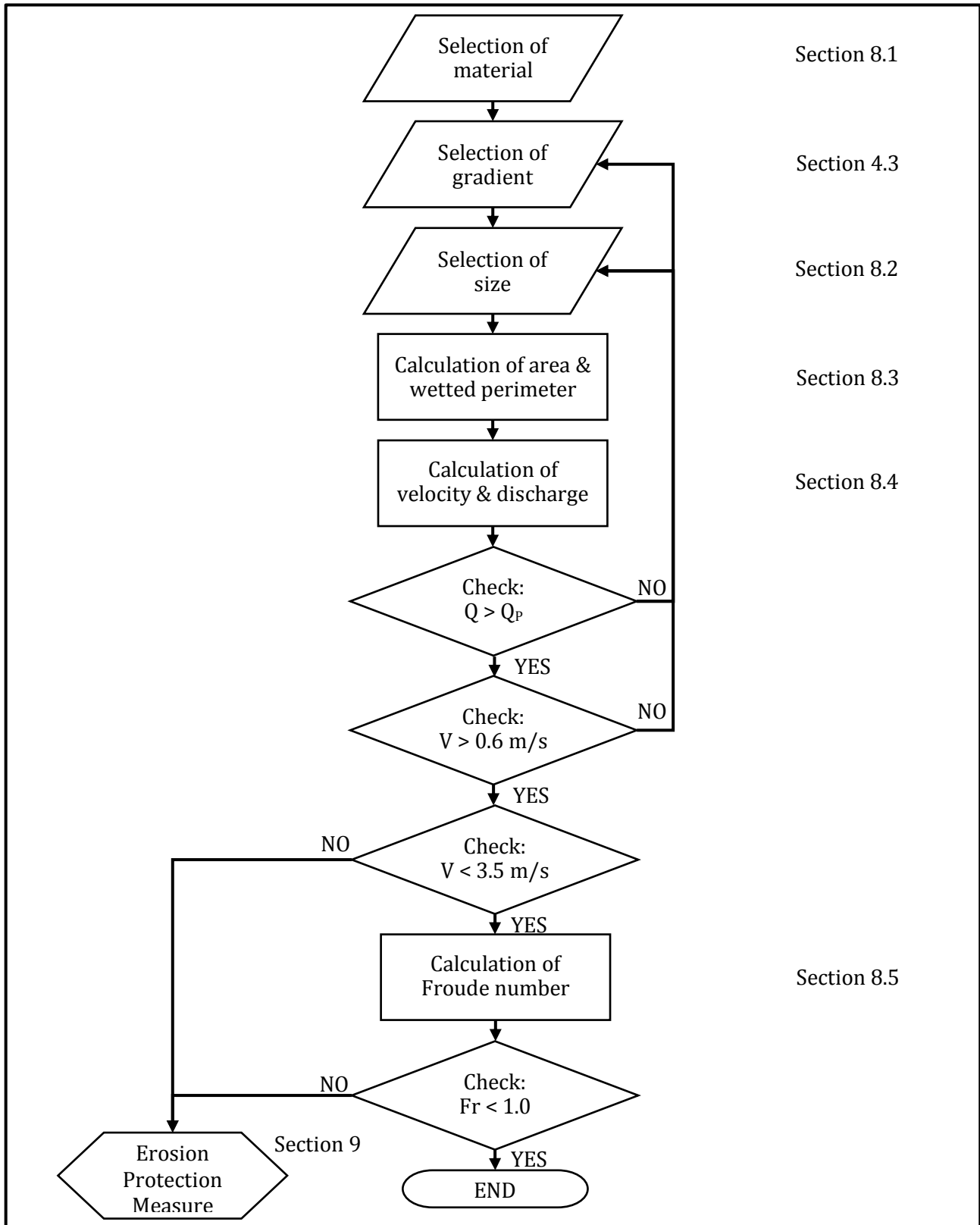

Figure 8.1 — Process of calculation of open-channel flow

8.1 Material of culverts

The material (and condition) of a channel determines the roughness. The roughness is the representation of the frictional resistance of the boundary shear force. For uniform flow calculations, the gravity forces must balance the frictional resistance forces which constitute the boundary shear force (τ). This concept is outlined in Figure 8.2.

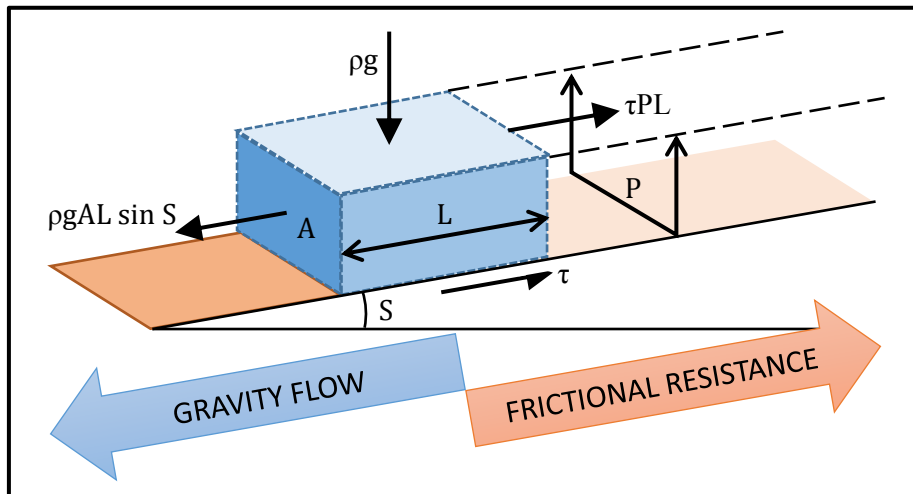

Figure 8.2 — Concept of uniform flow

The roughness is represented in the calculation of flow by the Manning number, n . The normal material for construction of box culverts is concrete. The recommended values of Manning number for concrete are shown in Table 8.1.

Table 8.1 — Recommended values of Manning number (4)

Material of culvert	Manning number, n
<u>Concrete:</u>	
Cast in-situ concrete	0.015
Factory-made concrete products	0.013

8.2 Size of culvert

It is recommended that selection of the size of a culvert is in accordance with the relevant structural design standard. For reference, the size of culverts are shown in Table 8.2, Table 8.3 and Table 8.4.

Table 8.2 — Standard dimensions for single culverts (8)

Width, b (mm)	Height, D (mm)	Thickness of wall & fillets, w (mm)
1000	1000	160
1000	1500	170
1000	2000	180
2000	1000	220
2000	1500	230
2000	2000	250
2000	2500	260
2000	3000	280
3000	1500	280
3000	2000	300
3000	2500	300
3000	3000	300

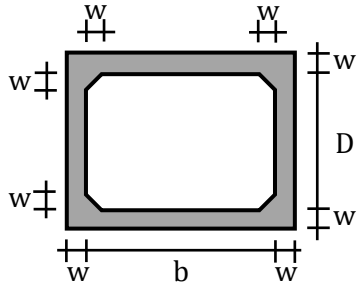

The diagram shows a cross-section of a single culvert. It is a rectangular structure with a central opening. The outer dimensions are labeled as width 'b' and height 'D'. The wall thickness is labeled as 'w'. The corners of the inner opening are chamfered with fillets. Dimension lines with arrows indicate the extent of each parameter.

Table 8.3 — Standard dimensions for double culverts (9)

Width, b (mm)	Height, D (mm)	Thickness of wall & fillets, w (mm)
1500	1000	200
2000	1000	240
2000	1500	240
2000	2000	240
2000	2500	250
2000	3000	260
2500	1500	260
2500	2000	260
2500	2500	260
2500	3000	280
3000	1500	300
3000	2000	300
3000	2500	300
3000	3000	300

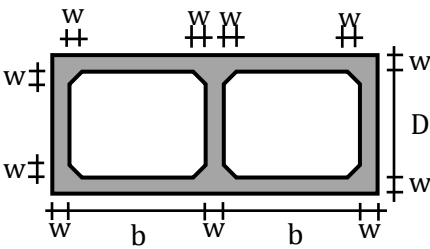

The diagram shows a cross-section of a double culvert. It consists of two adjacent rectangular openings within a single structure. The width of each opening is labeled as 'b', and the total width of the structure is '2b'. The height is labeled as 'D'. The wall thickness is labeled as 'w'. The corners of the openings are chamfered with fillets. Dimension lines with arrows indicate the extent of each parameter.

Table 8.4 — Standard dimensions for triple culverts (10)

Width, b (mm)	Height, D (mm)	Thickness of wall & fillets, w (mm)
1500	1000	160
1500	1500	170
1500	2000	180
1500	2500	220
1500	3000	260
2000	1000	200
2000	1500	220
2000	2000	250
2000	2500	260
2000	3000	300
2500	1500	280
2500	2000	280
2500	2500	280
2500	3000	300
3000	1500	300
3000	2000	300
3000	2500	300
3000	3000	300

8.3 Geometry of culverts

The geometry of a culvert affects the frictional resistance. In addition to the boundary roughness, frictional resistance will increase as the size of the boundary increases. The size of the boundary is calculated as follows.

The area is the cross-sectional area of flow in the direction normal (perpendicular) to the direction of flow. The wetted perimeter is the length of the perimeter that is in contact with the flow measured in the direction normal (perpendicular) to the direction of flow. The hydraulic radius is the ratio of the area to the wetted perimeter, as shown in equation 10. The surface width is the width of the channel at the free surface.

The following is the general equation for calculation of hydraulic radius:

$$R = \frac{A}{P} \quad [10]$$

where

- R hydraulic radius (m)
- A cross-sectional area of flow (m²)
- P wetted perimeter (m)

The equations for calculating the properties for geometries of some channels are shown in Table 8.5. These guidelines are concerning box culverts, so equations for rectangular geometries shall be applied. The equations for trapezoidal and circular geometries have been provided for reference only.

Table 8.5 — Geometric properties for channels

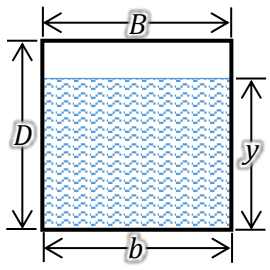
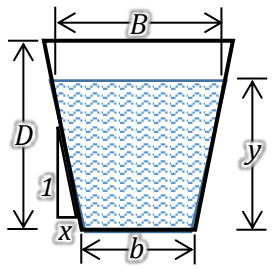
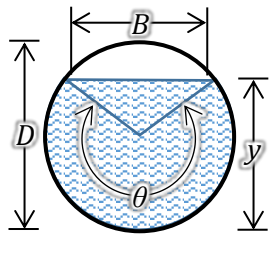
Geometry	 <p style="text-align: center;">Rectangle (box)</p>	 <p style="text-align: center;">Trapezoid</p>	 <p style="text-align: center;">Circle (pipe)</p>
Area of flow, A (m ²)	$b \times y$	$(b + x \times y) \times y$	$\frac{1}{8} \times (\theta - \sin \theta) \times D^2$
Wetted perimeter, P (m)	$b + 2 \times y$	$b + 2 \times y \times \sqrt{1 + x^2}$	$\frac{1}{2} \times \theta \times D$
Hydraulic radius, R (m)	$\frac{b \times y}{b + 2 \times y}$	$\frac{(b + x \times y) \times y}{b + 2 \times y \times \sqrt{1 + x^2}}$	$\frac{1}{4} \times \left(1 - \frac{\sin \theta}{\theta}\right) \times D$
Surface width, B (m)	b	$b + 2 \times x \times y$	$\left(\sin \frac{\theta}{2}\right) \times D$
Angle of flow, θ (radians)	—		$2 \times \cos^{-1} \left(1 - 2 \times \frac{y}{D}\right)$
where b base width (m) y depth of flow (m) D internal height or diameter (m) x width per 1-m height of side slope (m) θ angle of flow (radians)			

8.4 Design capacity of culverts

The design capacity of discharge for culverts is calculated with equation 11. The design capacity should be more than the design flood, ($Q > Q_P$).

The following is the equation for calculation of design capacity for culverts:

$$Q = \frac{A^{5/3} \times S_0^{1/2}}{P^{2/3} \times n} \tag{11}$$

where

- Q design capacity of culvert (m³/s)
- A area of flow (m²)
- P wetted perimeter (m)
- S_0 gradient of culvert (m/m)

For reference, it should be noted that equation 11 is a combination of the equation for discharge and the Manning equation, as shown below in equations 12 and 13, respectively.

The following is the general equation for calculation of discharge:

$$Q = A \times V \tag{12}$$

where

- Q design capacity of culvert (m³/s)
- A area of flow (m²)
- V velocity of flow (m/s), see equation 13

Sedimentation and debris affects the hydraulic performance of culverts. A margin of 20% of cross-sectional area (A) is recommended for anticipation of sedimentation. In other words, depth of flow should be designed as less than or equal to 80% of the internal height of a box culvert ($y \leq 0.8 \times D$).

The following is the Manning equation for calculation of velocity for culverts:

$$V = \frac{1}{n} \times R^{2/3} \times S_0^{1/2} \quad [13]$$

where

- V velocity of flow (m/s)
- n Manning coefficient of roughness, see Table 8.1
- R hydraulic radius (m), see Section 8.3
- S_0 culvert gradient (m/m)

The velocity of flow affects the erosion and sedimentation of a culvert. The normal range of velocity of flows are $0.6 \text{ m/s} \leq V < 3.5 \text{ m/s}$. In order to reduce the amount of sedimentation, it is recommended that flow velocities are more than 0.6 m/s; if not, regular maintenance should be considered. In order to reduce the amount of erosion, it is recommended that flow velocities are less than 3.5 m/s; if not, erosion protection measures should be considered.

Examples of the design capacity of culverts at various gradients is shown in Table 8.6.

Table 8.6 — Design capacities for example culverts

Size of culvert			Design capacity, Q, (m ³ /s) for gradient of							
b (m)	D (m)	y (m)	0.5%	1.0%	1.5%	2.0%	2.5%	3.0%	5.0%	7.0%
1.0	1.0	0.8	1.72	2.43	2.98	3.44	3.84	4.21	5.44	6.43
1.0	1.5	1.2	2.83	4.00	4.89	5.65	6.32	6.92	8.93	10.57
1.0	2.0	1.6	3.96	5.61	6.87	7.93	8.86	9.71	12.53	14.83
1.5	1.0	0.8	3.00	4.25	5.20	6.01	6.72	7.36	9.50	11.24
1.5	1.5	1.2	5.07	7.17	8.78	10.14	11.33	12.41	16.03	18.96
1.5	2.0	1.6	7.23	10.22	12.52	14.46	16.16	17.70	22.86	27.04
1.5	2.5	2.0	9.44	13.35	16.35	18.88	21.11	23.13	29.86	35.33
1.5	3.0	2.4	11.69	16.53	20.24	23.37	26.13	28.63	36.95	43.73
2.0	1.0	0.8	4.39	6.21	7.61	8.79	9.82	10.76	13.89	16.44
2.0	1.5	1.2	7.55	10.68	13.08	15.11	16.89	18.50	23.88	28.26
2.0	2.0	1.6	10.91	15.43	18.90	21.83	24.40	26.73	34.51	40.84
2.0	2.5	2.0	14.39	20.35	24.92	28.78	32.18	35.25	45.51	53.84
2.0	3.0	2.4	17.94	25.37	31.07	35.88	40.11	43.94	56.73	67.12
2.5	1.5	1.2	10.20	14.42	17.66	20.39	22.80	24.98	32.25	38.15
2.5	2.0	1.6	14.89	21.06	25.79	29.78	33.30	36.47	47.09	55.72
2.5	2.5	2.0	19.79	27.98	34.27	39.58	44.25	48.47	62.58	74.04
2.5	3.0	2.4	24.82	35.10	42.99	49.64	55.49	60.79	78.48	92.86
3.0	1.5	1.2	12.95	18.32	22.43	25.90	28.96	31.72	40.95	48.46
3.0	2.0	1.6	19.08	26.98	33.04	38.16	42.66	46.73	60.33	71.38
3.0	2.5	2.0	25.52	36.09	44.21	51.04	57.07	62.52	80.71	95.49
3.0	3.0	2.4	32.18	45.51	55.73	64.35	71.95	78.82	101.75	120.40

8.5 Type of flow

In addition to velocity of flow, the type of flow should be considered when assessing if erosion protection measures are necessary. The type of flow can be considered with the Froude number, as shown in Figure 8.3. The Froude number indicates the flow type as follows:

- $Fr > 1$: supercritical flow (fast)
- $Fr = 1$: critical flow (change point)
- $Fr < 1$: subcritical flow (slow)

The following is the equation for calculation of Froude number and simplification for box culverts:

$$Fr = \frac{V}{(g \times y)^{0.5}} = \left(\frac{Q_p^2 \times b}{g \times (y_n \times b)^3} \right)^{0.5} \quad [14]$$

where

- Fr Froude number (dimensionless)
- V velocity of flow (m/s)
- g gravitational acceleration (m/s^2) = 9.81 m/s^2
- y depth of flow (m)
- Q_p peak discharge or design flood of a watercourse (m^3/s)
- y_n normal depth of flow (m)
- b base width of culvert (m)
- g gravitational acceleration (m/s^2) = 9.81 m/s^2

Normal depth of flow, y_n , can be calculated by changing the depth of flow, y , and subsequently recalculating the area, A , and wetted perimeter, P , for equation 11 until the design capacity is equal to the design flood ($Q = Q_p$). Alternatively, the Newton-Raphson Method may also be used for efficient convergence of $Q = Q_p$.

In addition to high velocity of flow, erosion protection measures at outlets should be considered for supercritical flows where $Fr > 1$. Recommendations for selection and dimensions of erosion protection measures are outlined in Section 9.

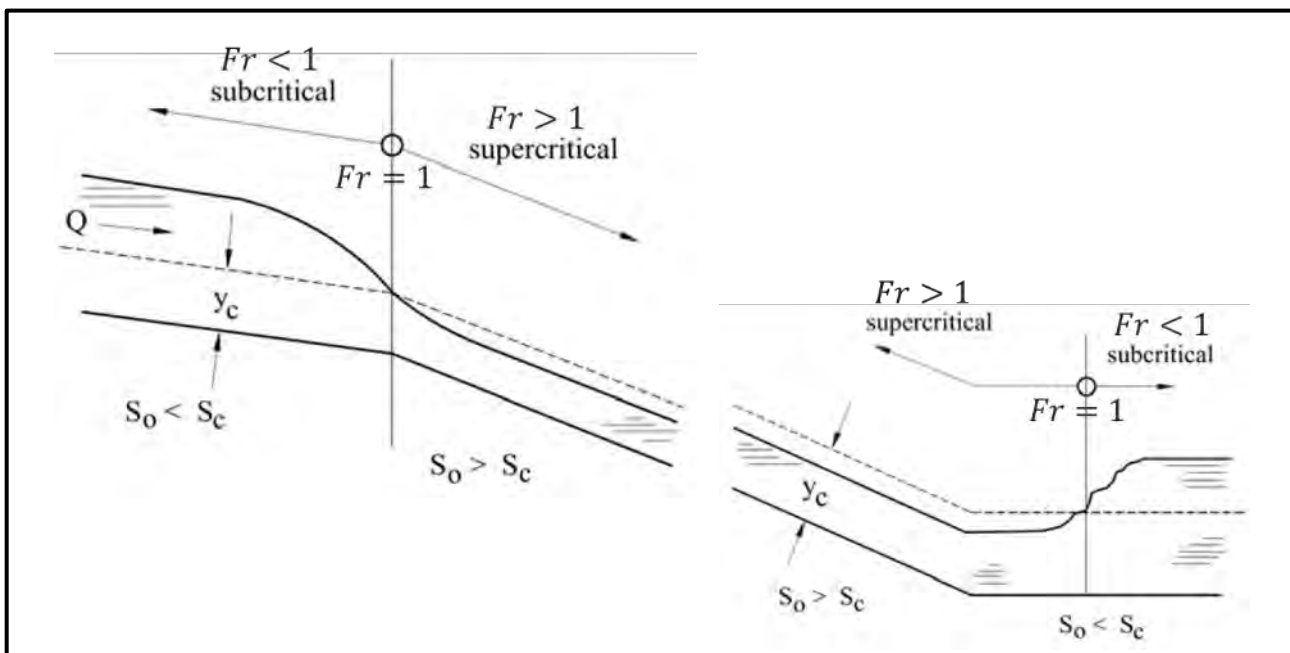

Figure 8.3 — Concept of Froude number indicating type of flow (5)

9 Protection works

Protection measures are necessary where erosion can occur. Outlets of culverts are more problematic and examples of erosion are shown in Figure 9.1. Generally, erosion occurs where:

- velocity of flow is high / flow is supercritical, see Sections 8.4 and 8.5
- direction of flow changes rapidly (i.e. sharp bends), see Section 4.4



Figure 9.1 — Examples of erosion at culvert outlets (7)

9.1 Inlet protection

Erosion upstream of culverts is rarely a problem if inlets have standard wing walls. In case of erosion, provision of stone pitching or gabion mat, or construction of a concrete apron between the wing walls is usually sufficient. Stone pitching of size 200 mm and for a distance of twice the culvert height is normal, as shown in Figure 9.2. A concrete apron at the inlet is shown in Figure 9.3.

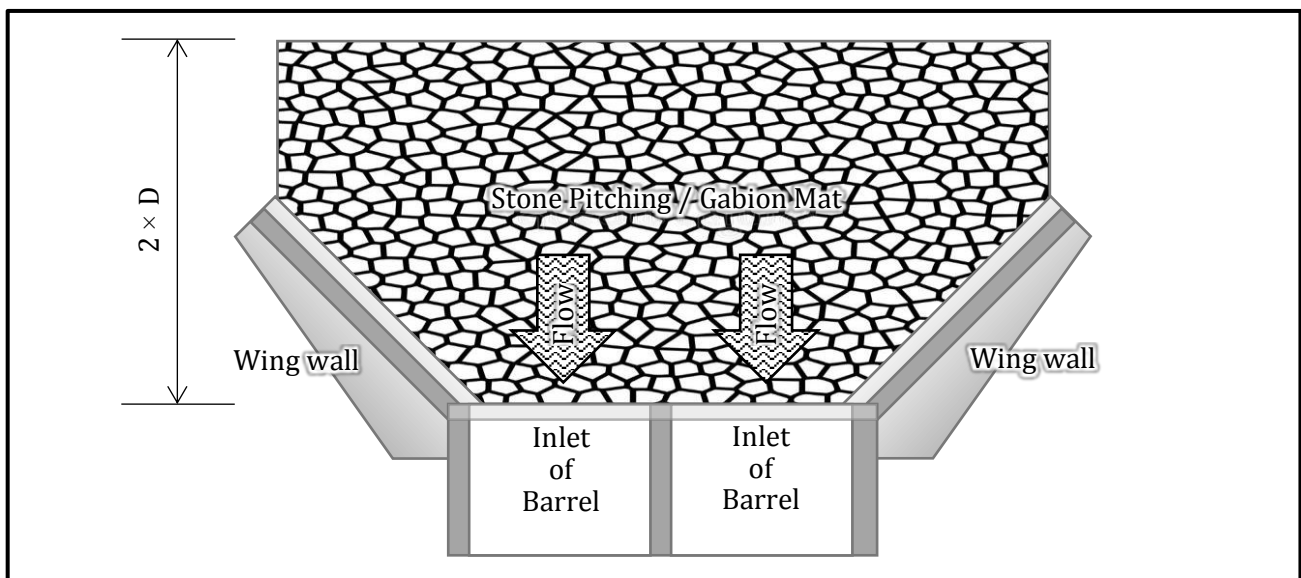

Figure 9.2 — Inlet protection using stone pitching / gabion mat

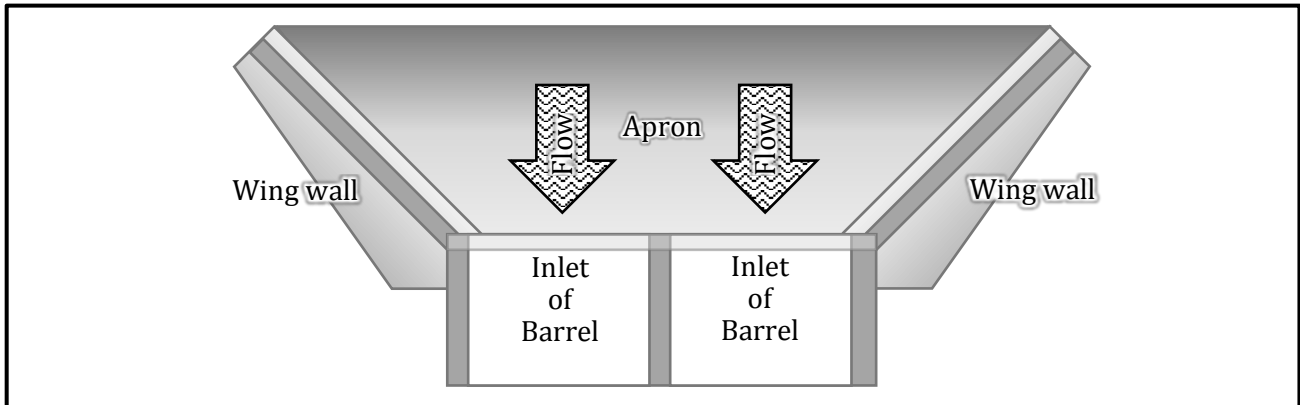

Figure 9.3 — Inlet protection using concrete apron

9.2 Outlet protection

Erosion downstream of culverts is more frequent because of the change in velocity of flow. The change in velocity of flow is because of the difference in cross-section and roughness of channel. The purpose of protection measures is to reduce the velocity until it is similar to the flow in the natural channel.

Erosion protection measures are a standard part of construction for outlets. For normal applications, measures for outlets are similar to inlets, as shown in Figure 9.2 and Figure 9.3. In cases where erosion is a serious concern, a structure for energy dissipation is recommended. The following structures are possible solutions for erosion protection at outlets:

- Type 1 stone stilling basin, see Figure 9.5
- Type 2 stone stilling basin, see Figure 9.6
- Type 3(a) and 3(b) stone stilling basins, see Figure 9.7 and Figure 9.8
- Type 5 concrete stilling basin, see Figure 9.9

9.2.1 Selection of protection measure

The method for selection of an appropriate erosion protection measure is shown in Figure 9.4. Two lines should be drawn perpendicular to axes. The intersection of two lines shows the recommended measure.

Normal flow depth at the outlet and Froude number are required for this selection method. Normal flow depth and subsequently the Froude number for box culverts can be calculated according to Section 8.5. The y-axis is ratio of the normal depth of flow to the height of culvert, y_n / D , and the x-axis is the Froude number, Fr .

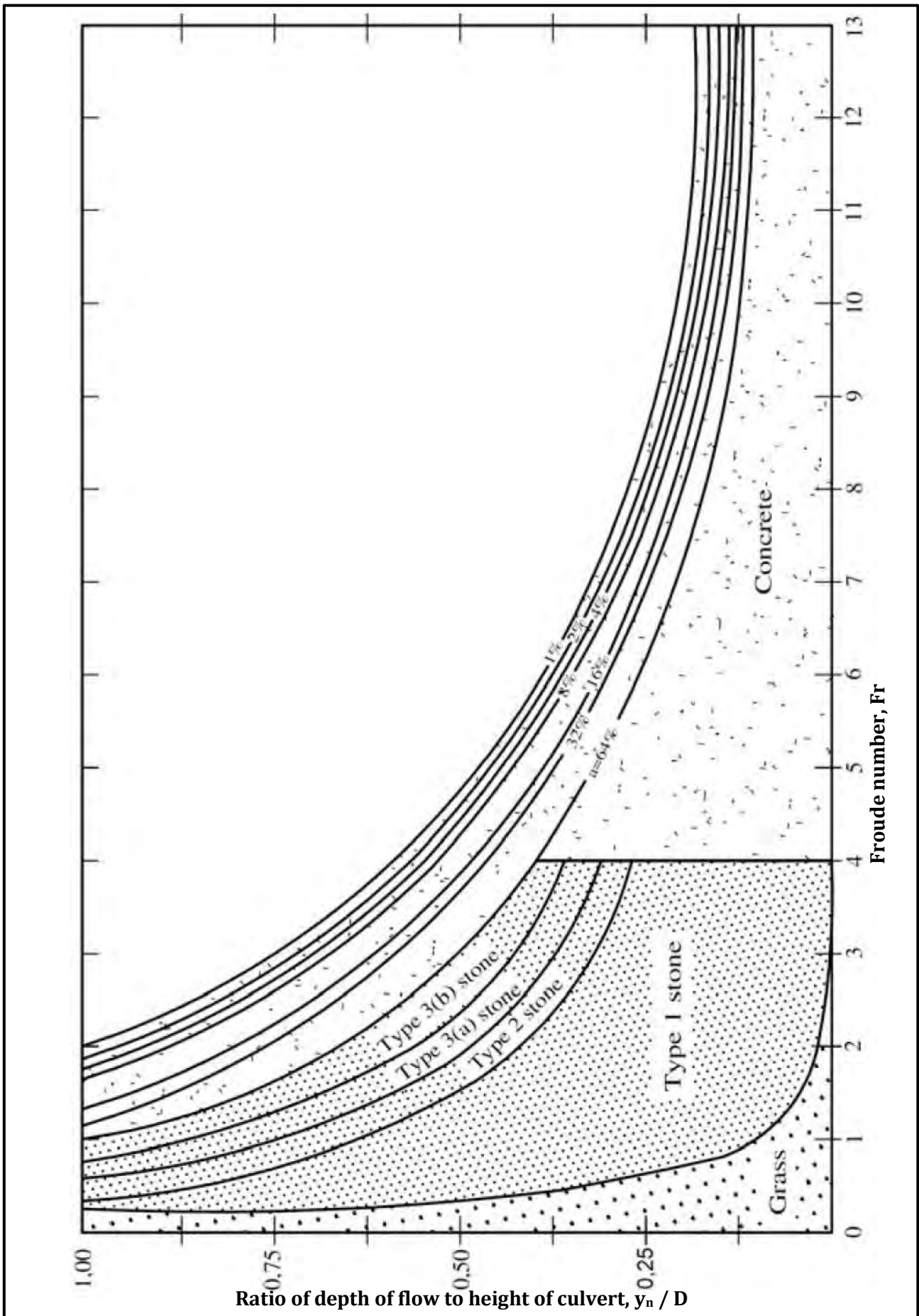

Figure 9.4 — Method of selection of erosion protection measure (5)

9.2.2 Detailing of protection measures

The recommended dimensions and construction of erosion protection measures are shown in Figure 9.5, Figure 9.6, Figure 9.7, Figure 9.8 and Figure 9.9.

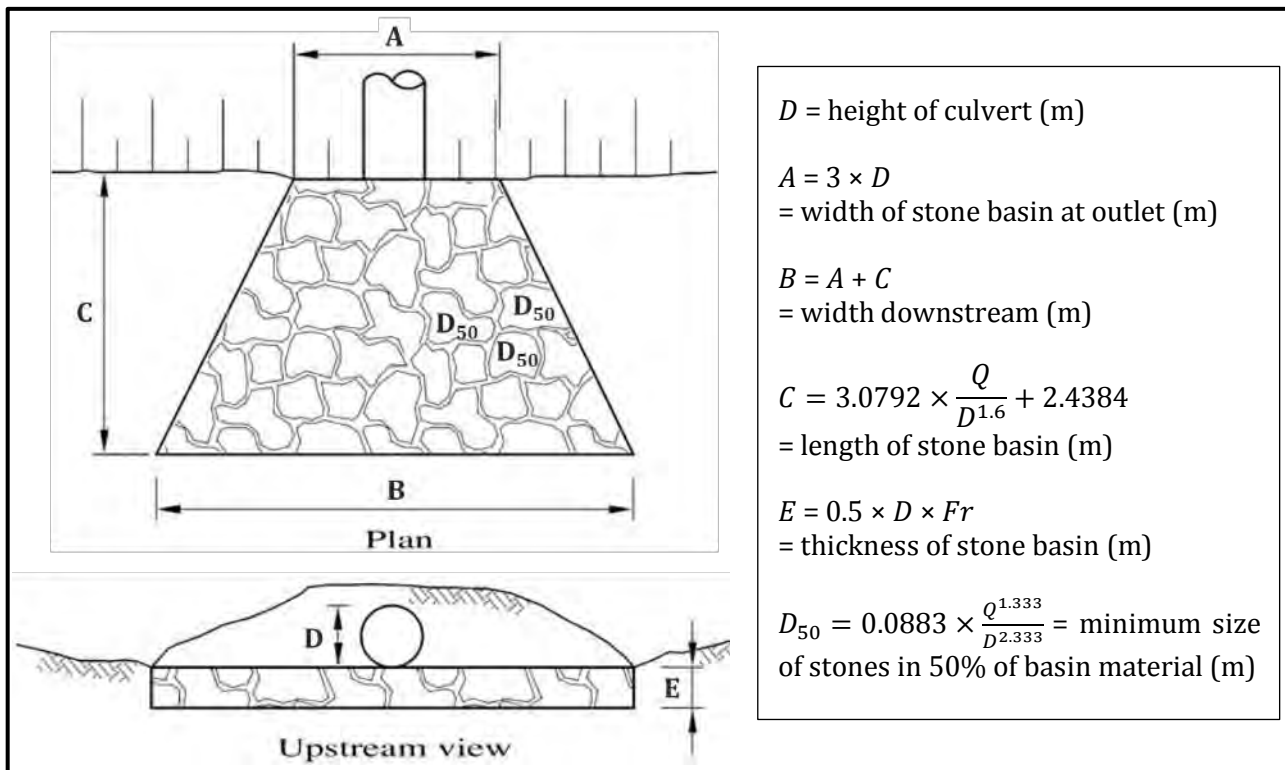

Figure 9.5 — Diagram of type 1 stone stilling basin (5)

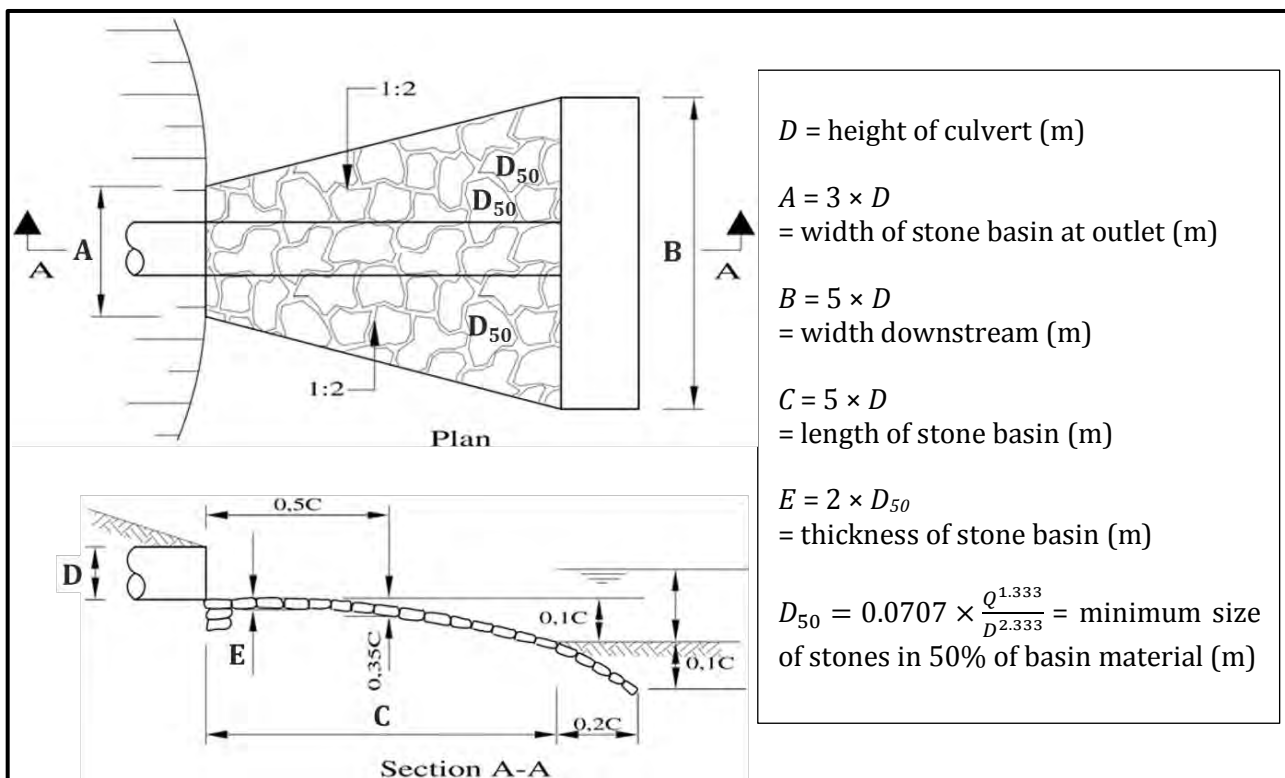

Figure 9.6 — Diagram of type 2 stone stilling basin (5)

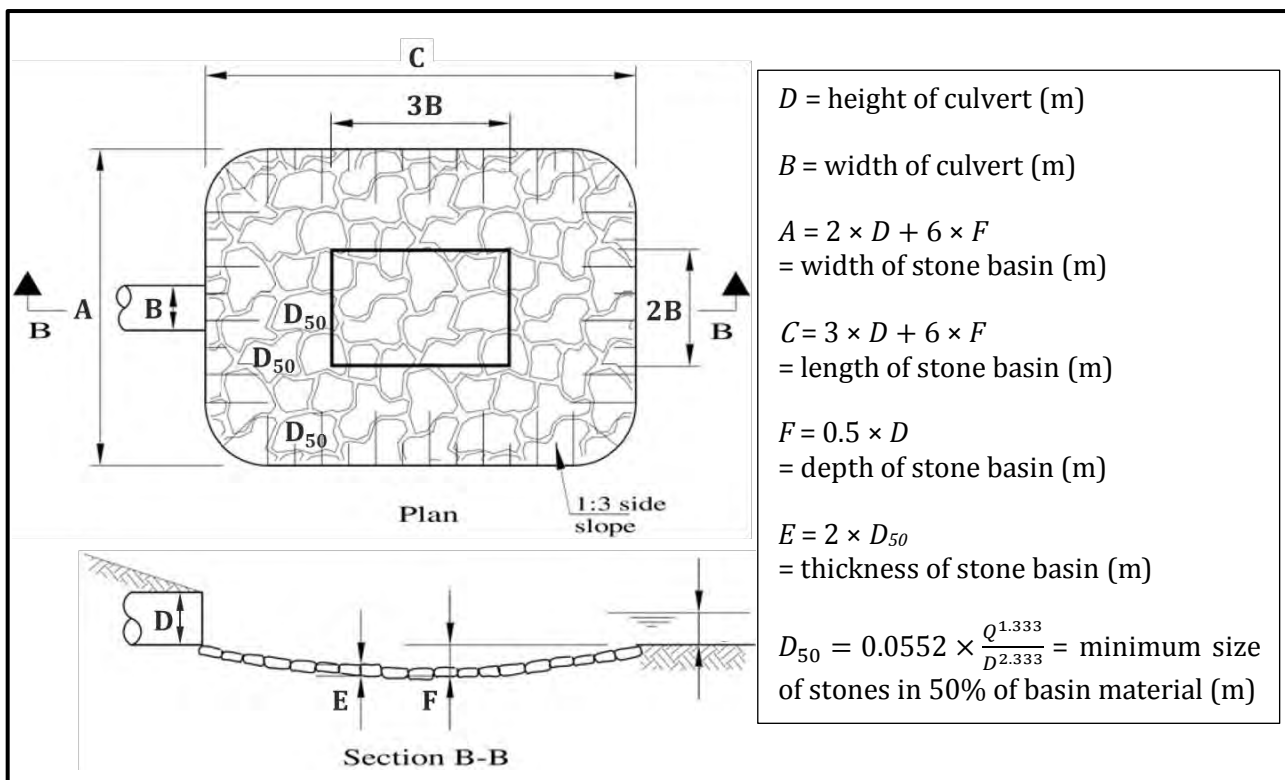

Figure 9.7 — Diagram of type 3a stone stilling basin (5)

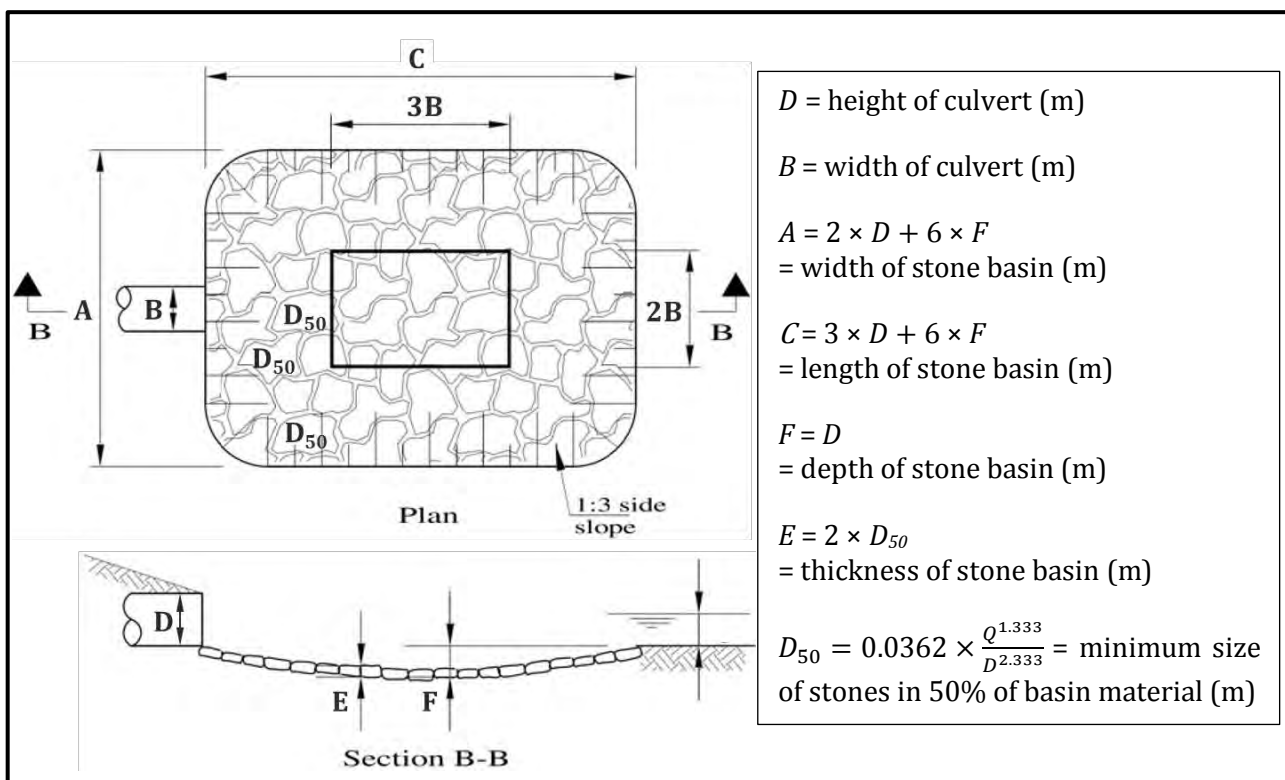

Figure 9.8 — Diagram of type 3b stone stilling basin (5)

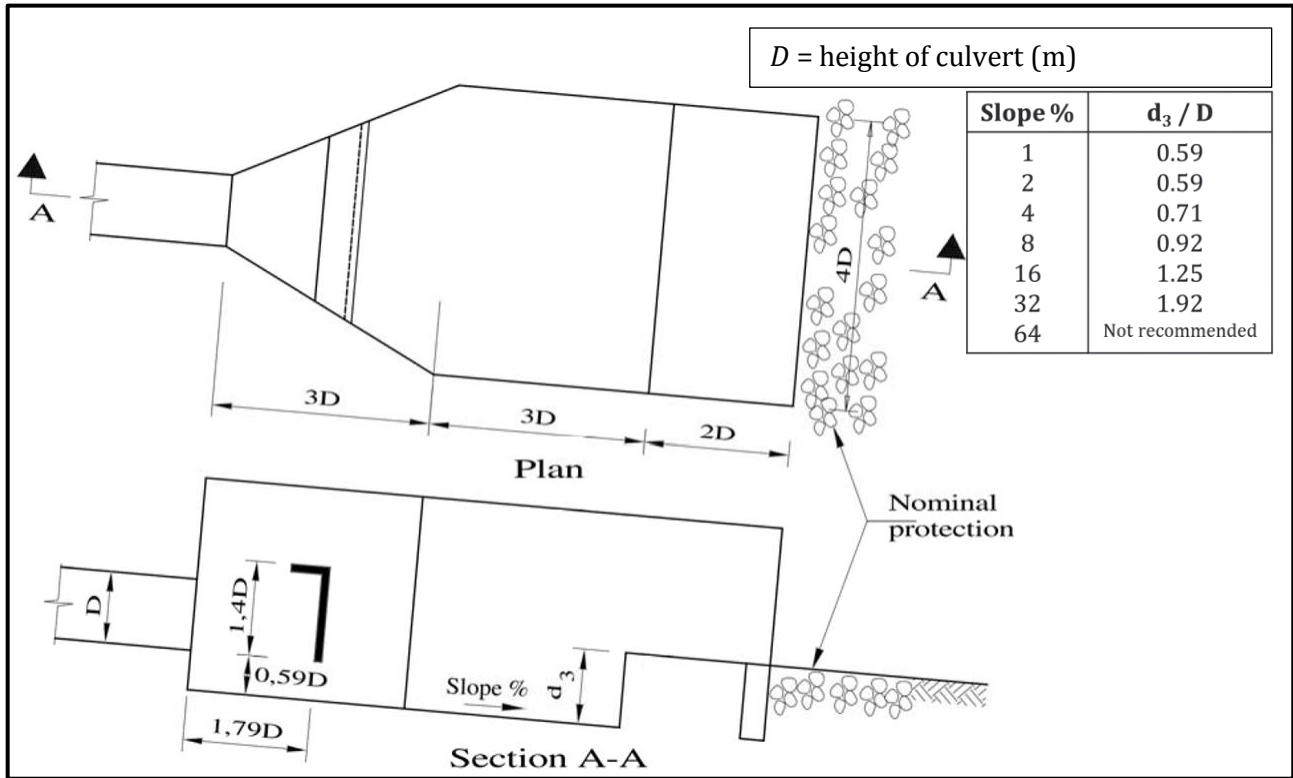

Figure 9.9 — Diagram of type 5 concrete stilling basin (5)

Glossary

English	Tetun / Portuguese / Indonesian	Japanese
Alignment	Alinhamento / Penjajaran	線型
Allowance height	Altura / Tunjangan tinggi	余裕高
Annual maximum daily rainfall	Chuva diária máxima anual	年最大日降雨量
Annual rainfall	Chuvvas anuais	年間降雨量
Area (cross-section of flow)	Área (seção transversal do fluxo)	通水断面積
Artificial channel	Canal artificial / Saluran buatan	人工水路
Basin	Bacia / Baskom	流域
Catastrophe	Catastrophe / Malapetaka	災害
Catchment area	Área de captação / Area tangkapan	集水地域
Channel profile	Perfil do canal	溝形断面
Coefficient	Coeficiente	係数
Critical depth	Profundidade crítica / Kedalaman kritis	臨界深度
Critical flow	Fluxo crítico / Aliran kritis	限界の流れ
Departure	Partida	偏差計算
Depth (of flow)	Profundidade (do fluxo) / Kedalaman (arus)	水深
Discharge	Descarga	排水
Discharge capacity	Capacidade de descarga / Merancang kapasitas debit	通水量
Duration	Duração	期間
Elongated	Alongada / Memanjang	伸びた
Empirical	Empírico	経験的
Erosion protection measure	Medida oinsa atu prvene erosaun	浸食防止工法
Evaporation	Evaporação	蒸発
Extrapolation	Extrapolação	外挿
Factor	Fator	因子
Flood hazard	Perigo de inundação / Bahaya banjir	洪水の危険
Flow	Aliran / Fluxo / Mengalir	流れ
Frequency	Frequência	周波数
Friction	Atrito / Gesekan	摩擦
Frictional resistance	Resistência à fricção / Resistensi gesekan	きしみ反応
Froude number	Numeru Froude / Nural Froude	フルード数
Gradient	Gradiente/Kemiringan	流路勾配
Gradient / bed slope	Gradiente / Encosta do rio / lereng sungai	勾配
Gravitational acceleration	Aceleração gravitacional / Percepatan gravitasi	重力加速度
Headwater	Kedalaman air di Upstream	上流
Height of culvert (internal)	Altura do cais (interno) / Tinggi gorong-gorong (internal)	高さ
Hydraulic jump	Salto hidráulico / Lompatan hidrolik	跳水
Hydraulic mean depth	Profundidade média hidráulica	流体平均深さ
Hydraulic radius	Raio hidráulico / Radius hidrolik	径深
Infiltration	Infiltração	浸潤
Influence	Influência	影響
Interpolation	Interpolação	内挿
Lag	Atraso / Ketinggalan	時差 (遅れ)
Limitation	Limitasaun / Limitação	制限
Longitudinal section	Seção longitudinal	縦断面
Magnitude	Magnitude	マグニチュード

English	Tetun / Portuguese / Indonesian	Japanese
Manning's roughness coefficient	Coeficiente de rugosidade de Manning / Koefisien kekasaran Manning	粗度係数
Maximum 24-hour rainfall / Probable daily rainfall	Chuva máxima de 24 horas / Chuva diária provável	確率日降雨量
Mean	Média	平均
Natural channel	Canal natural / Saluran alami	自然水路
Newton-Raphson method	Metodo Newthton-Rapshon	ニュートン・ラプソン法
Normal depth	Kedalaman normal	等流水深
Normal flow	Aliran normal	等流の流れ
Occurrence	Ocorrência / Kejadian	発生
Peak	Pico / Puncak	ピーク (最大)
Ponding	Ponding / Kolam	たん水
Prediction	Predição	予測
Probability	Probabilidade	確率
Probability distribution	Distribuição de probabilidade	確率分布
Rainfall	Udan / Chuva / Precipitação	降雨
Rainfall intensity	Intensidade da chuva	降雨強度
Rational Method	Método Racional (hidrología)	合理式
Return period	Período de retorno	確率年
Riprap	Riprap (Fatuk kasar nebe usa ba protesaun ba erosaun)	護床工
Runoff	Escoamento / Limpasan	流出
Sedimentation	Sedimentação / Pengendapan	堆積
Sharp bend	Curva acentuada / Tikungan tajam	急カーブ
Standard deviation	Desvio padrão	標準偏差 (SD)
Stilling basin	Posisi cekungan	減勢池
Storage	Armazenamento	貯水池
Subcritical flow	Fluxo subcrítico / Aliran subkritis	常流
Supercritical flow	Fluxo supercrítico / Aliran supercritical	射流
Tailwater	Kedalaman air di Downstream	下流
Time of concentration	Tempo de concentração	洪水到達時間
Trial-and-error method	Metodo trial no error	試行錯誤手法
Uniform	Uniforme	均一
Urbanised	Urbanizado	都市化された
Velocity	Velocidade / Kecepatan	洪水速度
Watercourse	Curso de água / Anak sungai	水路
Watershed	Bacias hidrográficas / Batas air	分水地点
Weighted average	Média ponderada	加重平均
Wetted perimeter	Perímetro molhado / Perimeter terbasah / Keliling basah	潤辺
Width (internal)	Largura (interna) / Lebar (internal)	幅

Bibliography

1. **Ministry of Public Works, Transport and Communication.** *Standard Specifications*. Dili : Democratic Republic of Timor-Leste, 2014. 140/MPWTT/EPCC/III/15.
2. —. *Bridge Design Standards & Manual*. Dili : Democratic Republic of Timor-Leste, 2012.
3. **Ministry of Infrastructure.** *Road Geometric Design Standards*. Dili : Democratic Republic of Timor-Leste, 2010. ADB-TA-No.4942.
4. **Japan Road Association.** 道路土工要綱 [*Manual for Highway Earthworks*]. Tokyo : Japan Road Association, 2009. ISBN 978-4-88950-414-9.
5. **The South African National Roads Agency SOC Limited.** *Drainage Manual*. 6th Ed. Pretoria : The South African National Roads Agency SOC Limited, 2013. ISBN 978-0-620-55429-2.
6. **Standard Nasional Indonesia.** *Tata Cara Perencanaan Drainase Permukaan Jalan Raya [Code for the Design of Drainage of Highway Surfaces]*. Jakarta : Badan Standardisasi Nasional, 1994. SNI 03-3424-1994.
7. **Mraz, Judy, et al.** *Jacaranda Geography Alive 8*. 1st Ed. Milton : John Wiley & Sons Australia, Ltd., 2013. ISBN 978-1118489185.
8. **Federal Highway Administration.** *Hydraulic Design of Highway Culverts*. 3rd Ed. Springfield : U.S. Department of Transportation, 2012. FHWA HIF-12-026.
9. **Direktorat Jenderal Bina Marga.** *Standar Gorong-gorong Persegi Beton Bertulang Tipe Single [Standard for Single Concrete Box Culverts]*. Jakarta : Indonesian Directorate General of Highways, 2009. BTI/S.
10. —. *Standar Gorong-gorong Persegi Beton Bertulang Tipe Double [Standard for Double Concrete Box Culverts]*. Jakarta : Indonesian Directorate General of Highways, 2009. BTI/D.
11. —. *Standar Gorong-gorong Persegi Beton Bertulang Tipe Triple [Standard for Double Concrete Box Culverts]*. Jakarta : Indonesian Directorate General of Highways, 2009. BTI/T.

(page intentionally left blank)