

**Myanmar Post**  
**Ministry of Transport and Communications**  
**The Government of the Republic of the Union of Myanmar**

**REPUBLIC OF THE UNION OF MYANMAR**  
**POSTAL SERVICES CAPACITY**  
**IMPROVEMENT PROJECT**

**PROJECT COMPLETION REPORT**  
**SEPARATE VOLUME 1**

**May 2019**

**Japan International Cooperation Agency (JICA)**

---

**JP Media Direct Co., Ltd.**  
**Japan Post Co., Ltd.**

# Unit section on Transportation (T01-T07)

# Materials relating to Transportation (T01-T03)

## **T01 Route map (Diagram)**

T01-1 Route map (Diagram)\_YGN(van)

T01-2\_Route map (Diagram)\_MDL and NPT(van)

T01-3\_Route map (Diagram)\_YGN(railway)

T01-4\_Route map (Diagram)\_MDL (railway)

## **T02 Kessoku correlation diagram**

T02-1\_Kessoku correlation diagram\_YGN

T02-2\_Kessoku correlation diagram\_MDY+NPT

## **T03 Network map**

T01-1

2018.7 UpDate

Shwepyithar Post Office

Tue~Fri(Sat.Sun.Mon.Holiday Off)

16:00  
Depature

Yangon  
CME/GPO

Ferry(MP  
Staff Bus)

18:00  
Arrive

Shwepyithar

09:15  
Arrive

07:15  
Depature

Htaukkyant Post Office

YGN CME ⇄ Htaukkyant, Htaukkyant ⇄ Palemyothit Tue ~ Fri (Sat. Sun. Mon. Holiday Off)

Hlegu ⇄ Yemon. Indine. Phaunggyi Daily

Hlegu ⇄ Ngarsutaung Mon. Wed. Fri

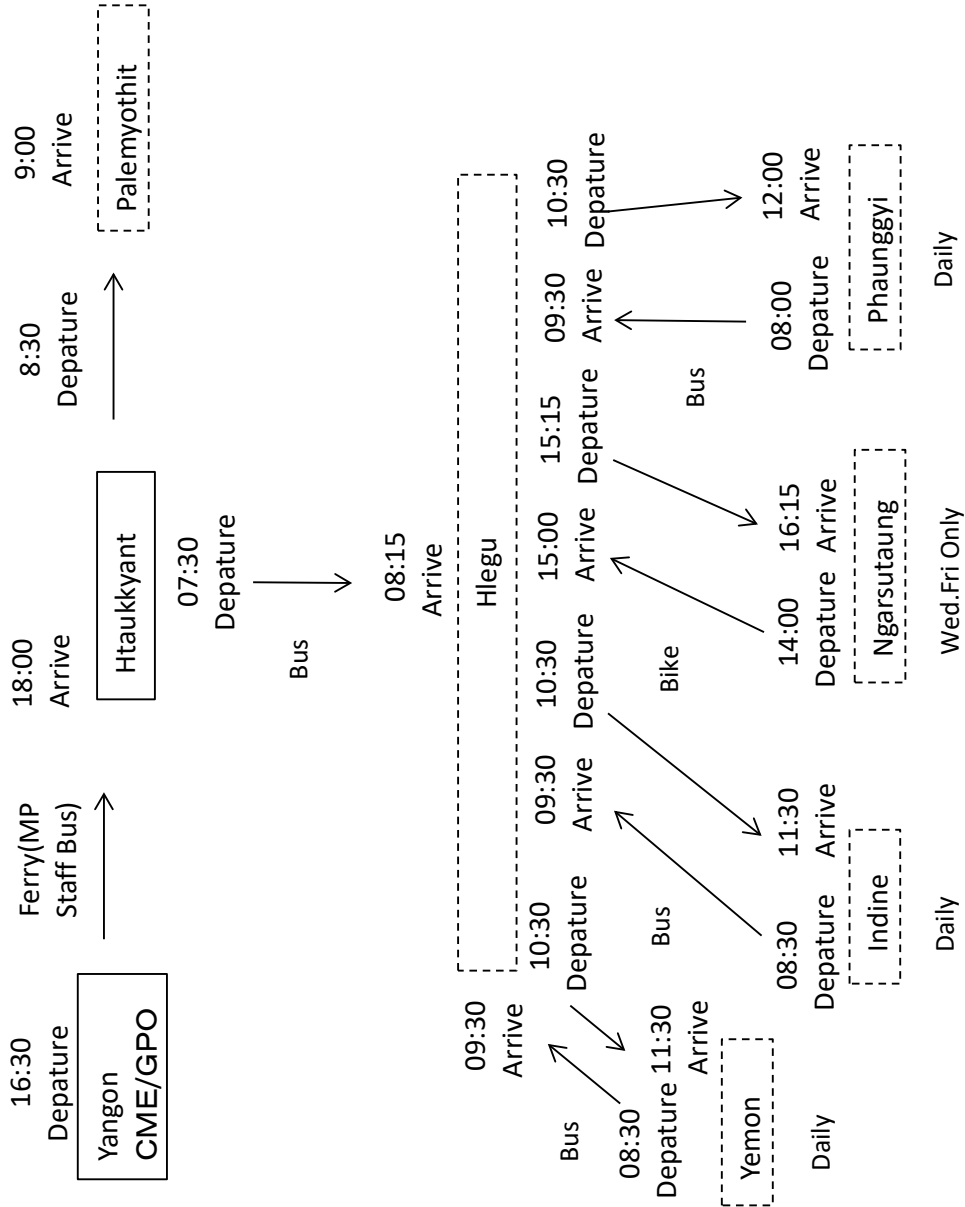

T01-1

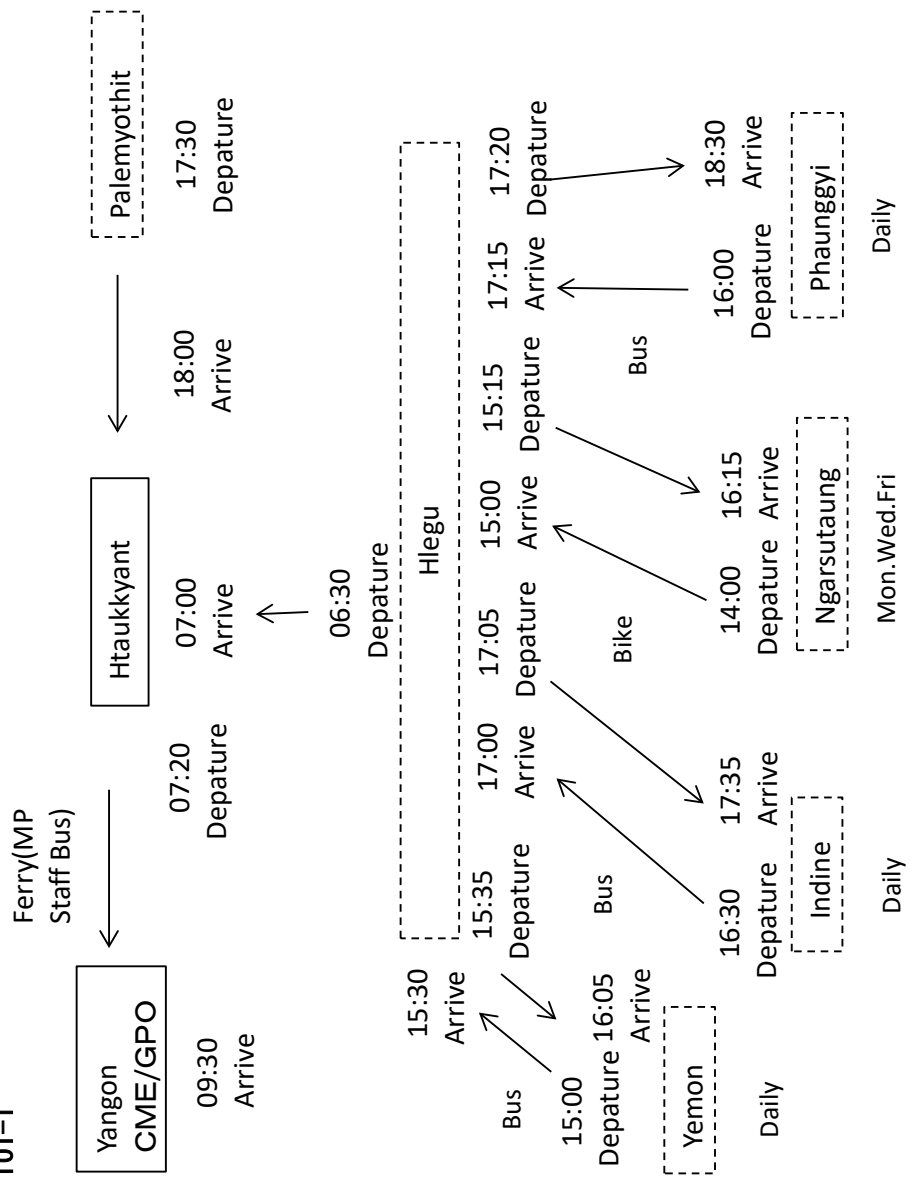

**Yangon CME Mail Route**

No	Mail Van & Departure Time	TRIP	Arrival Time
Van-3 Aung Zaw Zaw	7G-5581 (06:30)	<b>Kamayut, Hlaing(Hlaing UC), Bayintnaung Zay, Hlinethaya(Htantabin) DagonAyar Bus Terminal, Patheing(Einme), Phaypone TB(Kyaunggone), Phaypone TB(Phaypone, Kyaiklat), Maubin, Myaungmya, Labutta, Mawlamyinegyun, Hinthada TB(Hinthada, Danubyu, Zalun), Nyaungdon, Kyonepyaw, Bogalay,</b>	(11:30)

**【Van-3】 Sunday Off**

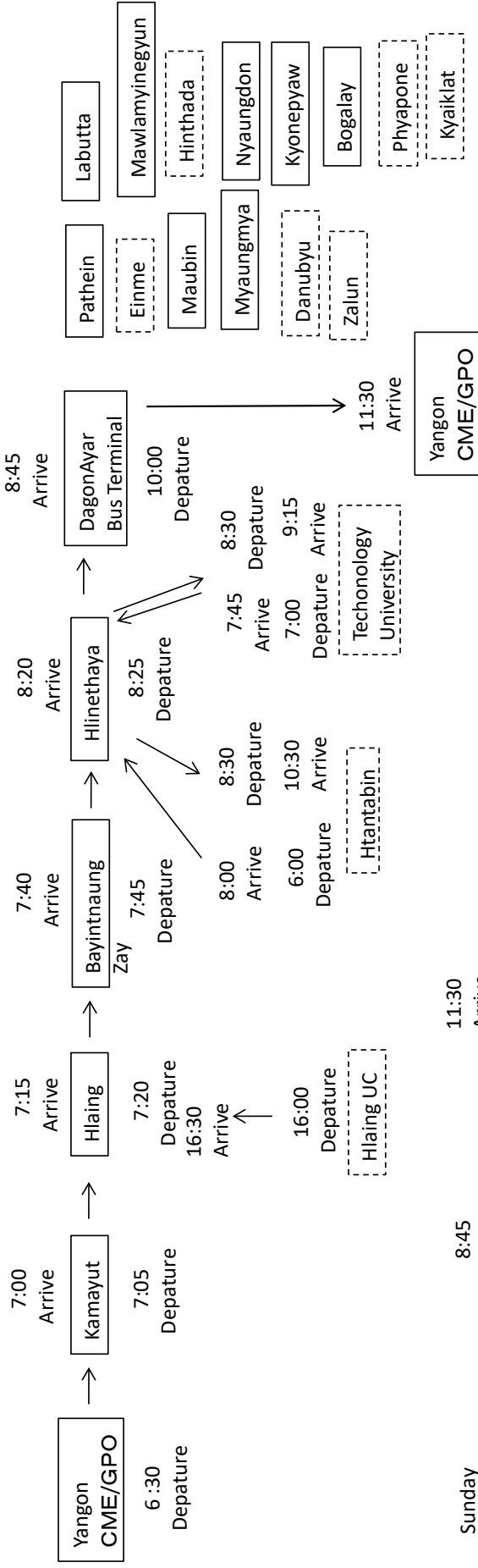

T01-1

【Van - 4】 Daily

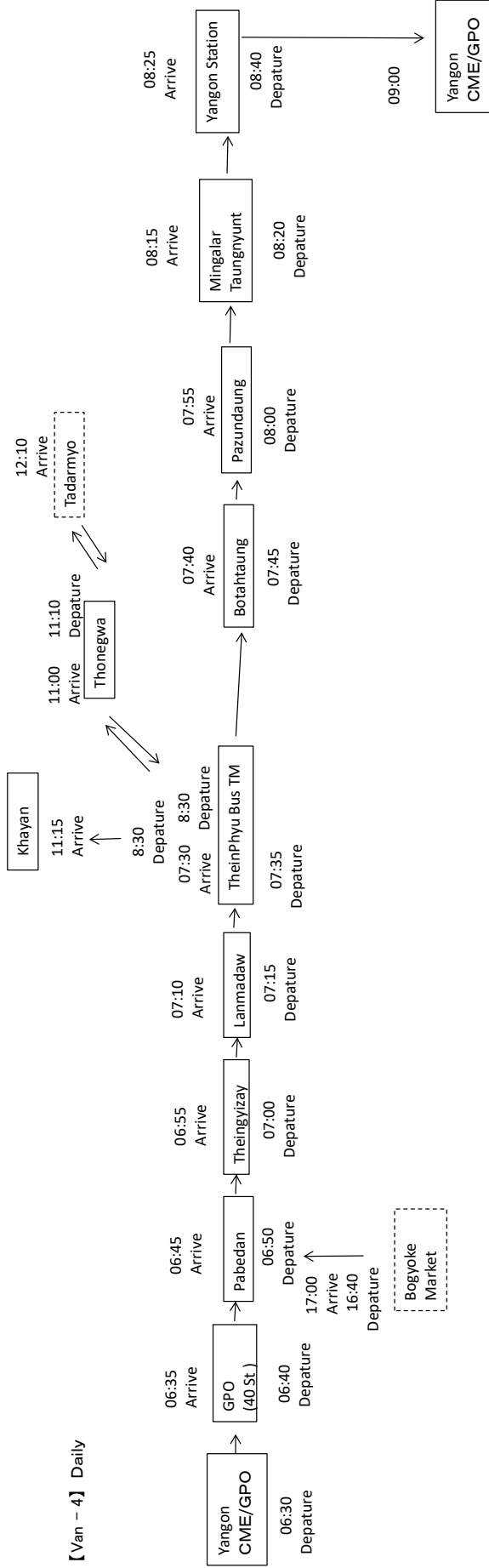



No	Mail Van & Departure Time	TRIP	Arrival Time
Van-5 Myat Maw	8K/2981 (09:00)	Mayangon, Kamayut, Hlaing(Hlaing UC), Bayintnaung Zay, Insein, Mingaladon,	(14:00)

【Van-5】 Daily

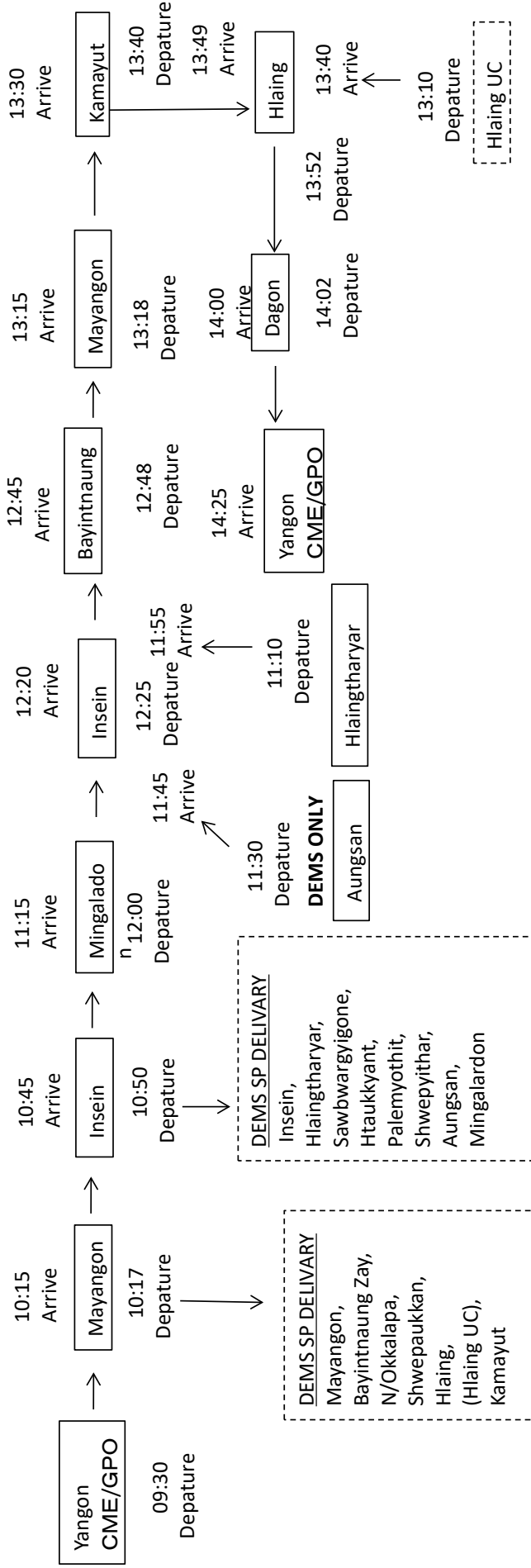

T01-1  
Yangon CME Mail Route

No	Mail Van & Departure Time	TRIP	Arrival Time
Van-6 Zaw Naing	8K/2989 (09:00)	Yankin, Tamway, Myittaryunt, South Okkalapa, Thuwunna <b>Dagon Myothit(South)</b> , (Dagon Myothit (North), Dagon Myothit(East), Dagon University, Dagon Myothit(Seikkan),Dagon(South)IndustrialZone)	(14:00)

【Van-6】 Daily

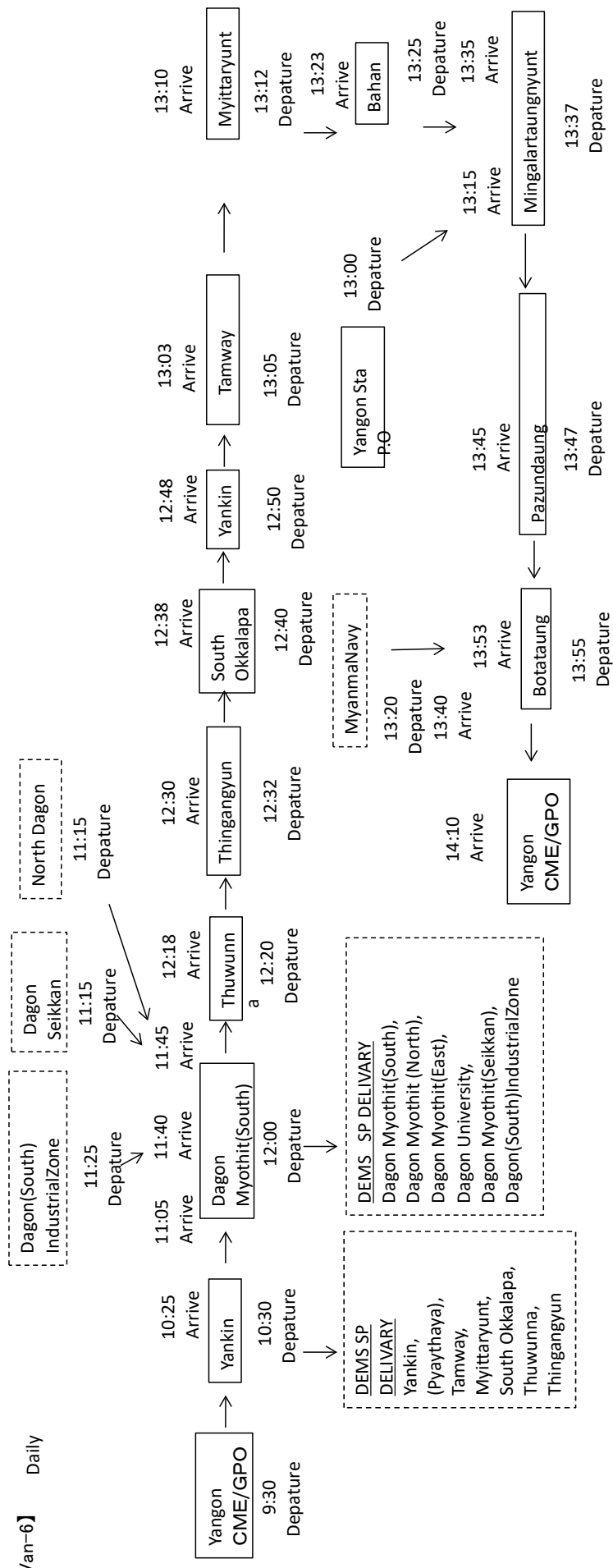

No	Mail Van & Departure Time	TRIP	Arrival Time
Van-7 Myint Zaw Win	8K/2987 (09:30)	R-2 In, R-3 Out, Thazi Sorting, Taungoo, Htongyi, Kawa, Dapain, Khayan, Thonegwa	(10:30)

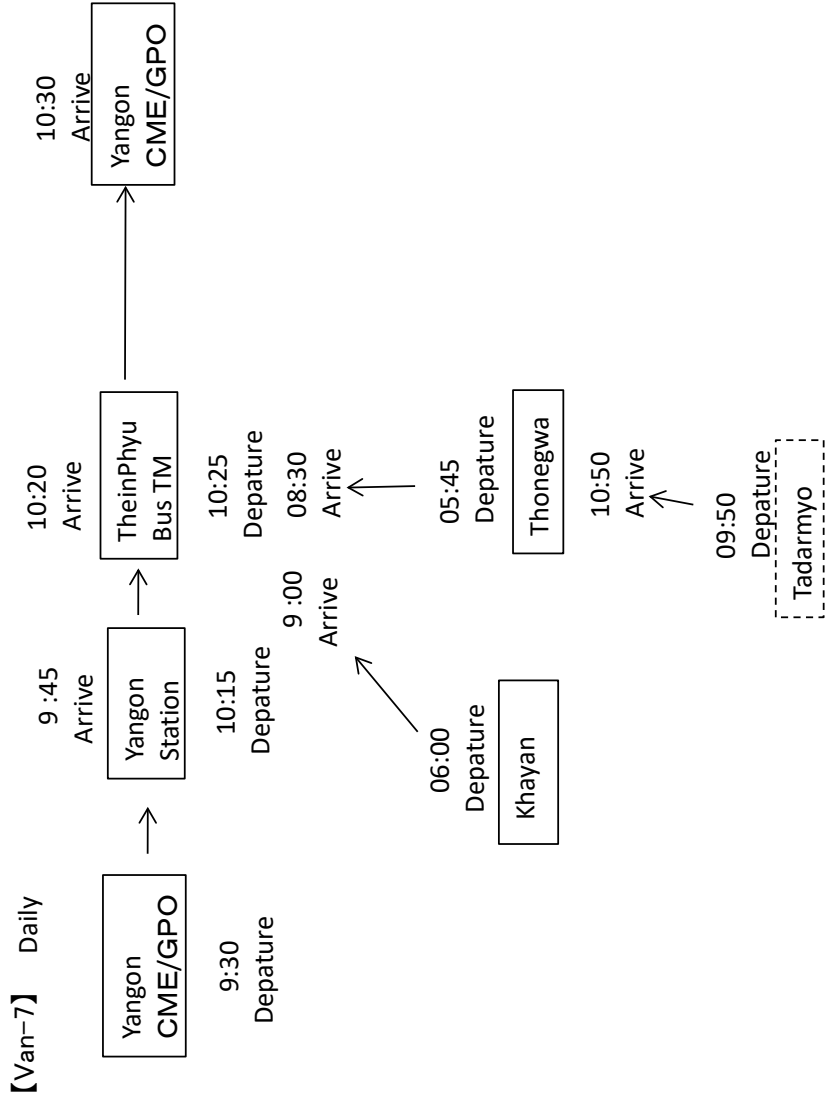

T01-1  
Yangon CME Mail Route

No	Mail Van & Departure Time	TRIP	Arrival Time
Van-8 Soe Moe Aung	(11:30)	Dawei, Pantanaw, R-1(In), Hmawbi(Hmawbi Cantoment), Wanetchaung, Phugyi, Taikkyi (Ahpyaug), Thanatchaung, Phalone, Okkan, Tharrawaddy, Letpadan, Minhla(tha), Gyobingauk, Paungde, Pyay, <b>Sanchaung, Kyimyindine, Ahlone, Lanmadaw</b>	(13:45)

【Van-8】 Daily

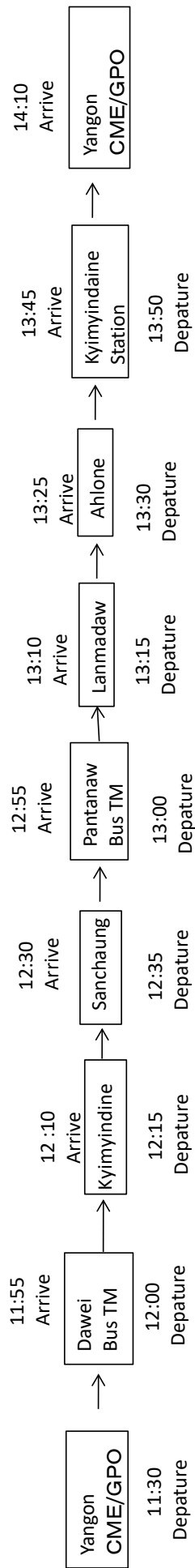

No	Mail Van & Departure Time	TRIP	Arrival Time
Van-9 San Win	2F/2400 (12:00)	Mayangon, Kamayut, Hlaing(Hlaing UC), Bayintnaung Zay, Insein, Mingaladon, Aungmyingala Buserminal, Magway(Minbu), Loikaw, Lashio, Muse	(15:00)

【Van-9】 Daily

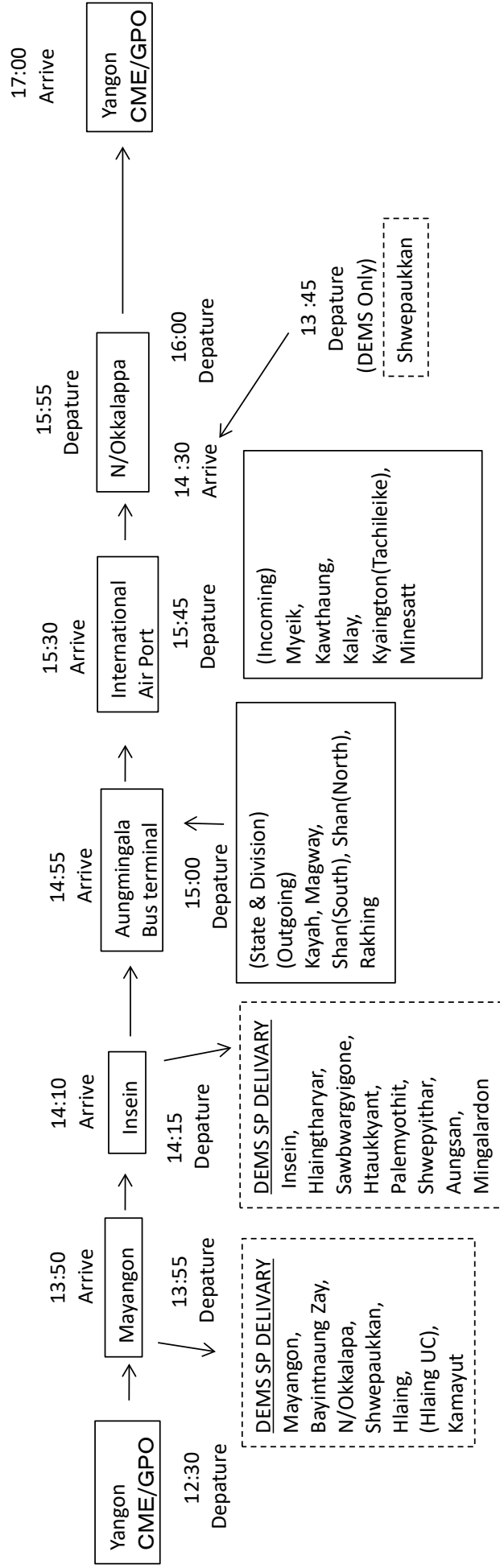

No	Mail Van & Departure Time	TRIP	Arrival Time
Van-10 Kyaw Thu	8K/2983 (12:00)	Yankin, Tamway, Myittaryunt, South Okkalapa, Thuwunna Dagon Myothit(South), (Dagon Myothit (North), Dagon Myothit(East), Dagon University, Dagon Myothit(Saikkan), Dagon(South)IndustrialZone)	(15:30)

【Van-10】 Daily

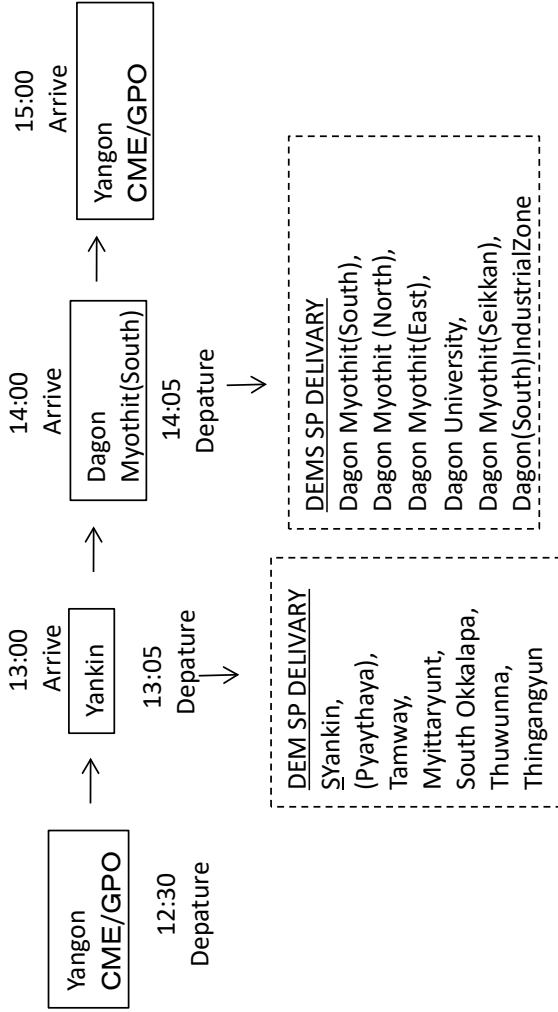

T01-1

**Yangon CME Mail Route**

No	Mail Van & Departure Time	TRIP	Arrival Time
Van-11 Myat Naw	8K/2981 (14:00)	Pegu, Taunggyi, Kalaw, Bahtu, Hakha, Myitgyina(Putao), Tatkon	Mail Route (Change)

**Van-11 Abolition**

No	Mail Van & Departure Time	TRIP	Arrival Time
Van-12 Aung Zaw Zaw	7G/5581 (15:30)	International Air Port, Sittwe, Myeik, Kawthaung, Kalay, Kyauington(Tachileike), Minesatt, Aungmingala Bus terminal, Hpaan, Myawady, Kawkarate, Hlineowe, Mawlmyaing, Thayet, Taungtwingyi, Aunglan, Chauk, Yenanchaung, Pakokku	(21:30)

【Van-12】 Daily

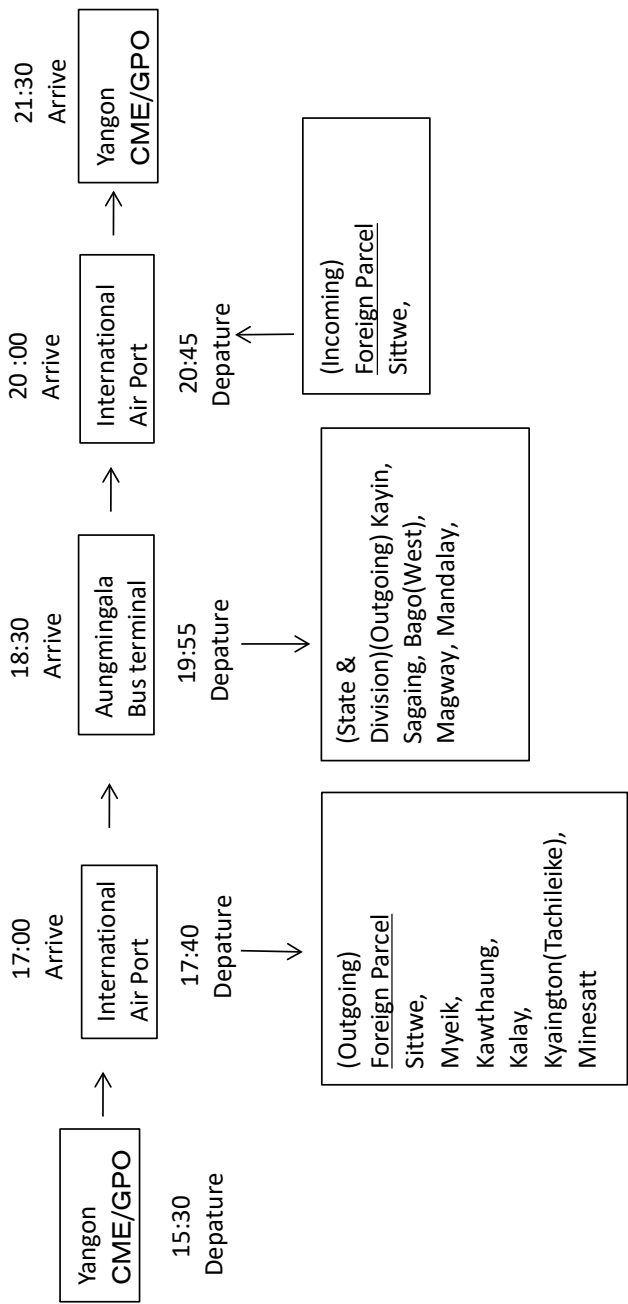



No	Mail Van & Departure Time	TRIP	Arrival Time
Van-13 Zaw Naing	8K/2989 (15:30)	(17:00 MDY 3up) – Pegu, Taungoo, Naypyitaw, Naypyitaw(TB), Naypyitaw(RB), Yezin, Pyinmana, Pyinmana Sorting, Tatkon, Meikhtila, Tharzi Sorting, Taunggyi, Kalaw, Bahtu, Yamethin, Myingyan, Mandalay(TB), Mandalay(CB), Mandalay, Monywa, Katha, Shwebo, Bhamaw, R-5(Out), R-6(Out), Sagaing, Pyinoolwin, Zeebingyi, Hakha, Myitgyina(Putao),	(16:30)

【Van-13】

Daily

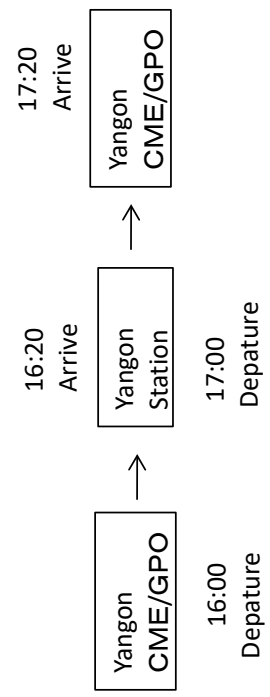

No	Mail Van & Departure Time	TRIP	Arrival Time
Van-14 Myint Zaw Win	8K/2987 (18:30)	R(10)In, Thohton, R-1(Out), Hmawbi(Hmawbi Cantoment), Wanetchaung, Phugyi, Taikkyi (Ahpauk), Thanatchaung, Phalone, Okkan, Tharrawaddy, Letpadan, Minhla(tha),Gyobingauk, Paungde, Pyay	(19:30)

【Van-14】 Daily

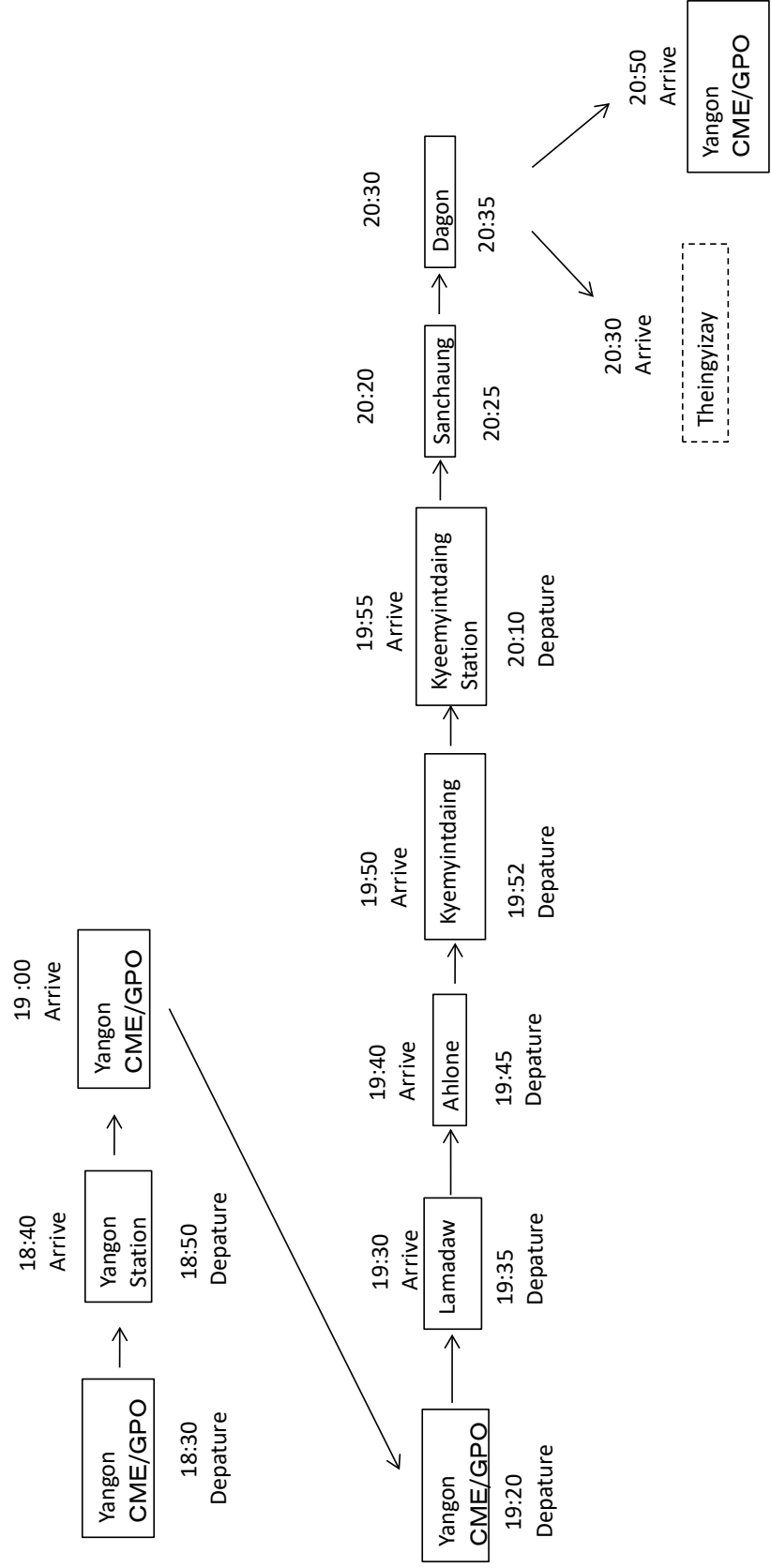

T01-1 Yangon CME Mail Route

No	Mail Van & Departure Time	TRIP	Arrival Time
Van-15 Soe Moe Aung	8K/2986 (20:00)	Dawbon, Thaketa, Dagon Myothit(South) (Dagon Myothit (North), Dagon Myothit(East), Dagon Myothit(South), Dagon Myothit(Seikkan), Dagon(South)IndustrialZone), Thuwunna, Thingangyun (University of Economics, Laydaungkan), South Okkalapa, Parrami Bus Terminal(Naypyitaw DEMS), Yankin, Pyaythaya, Myittanyunt, Tamway, Bahan, Dagon, Sanchaung, Kyimyindine, Ahlone, Lanmadaw	(23:30)

【Van-15】 Daily

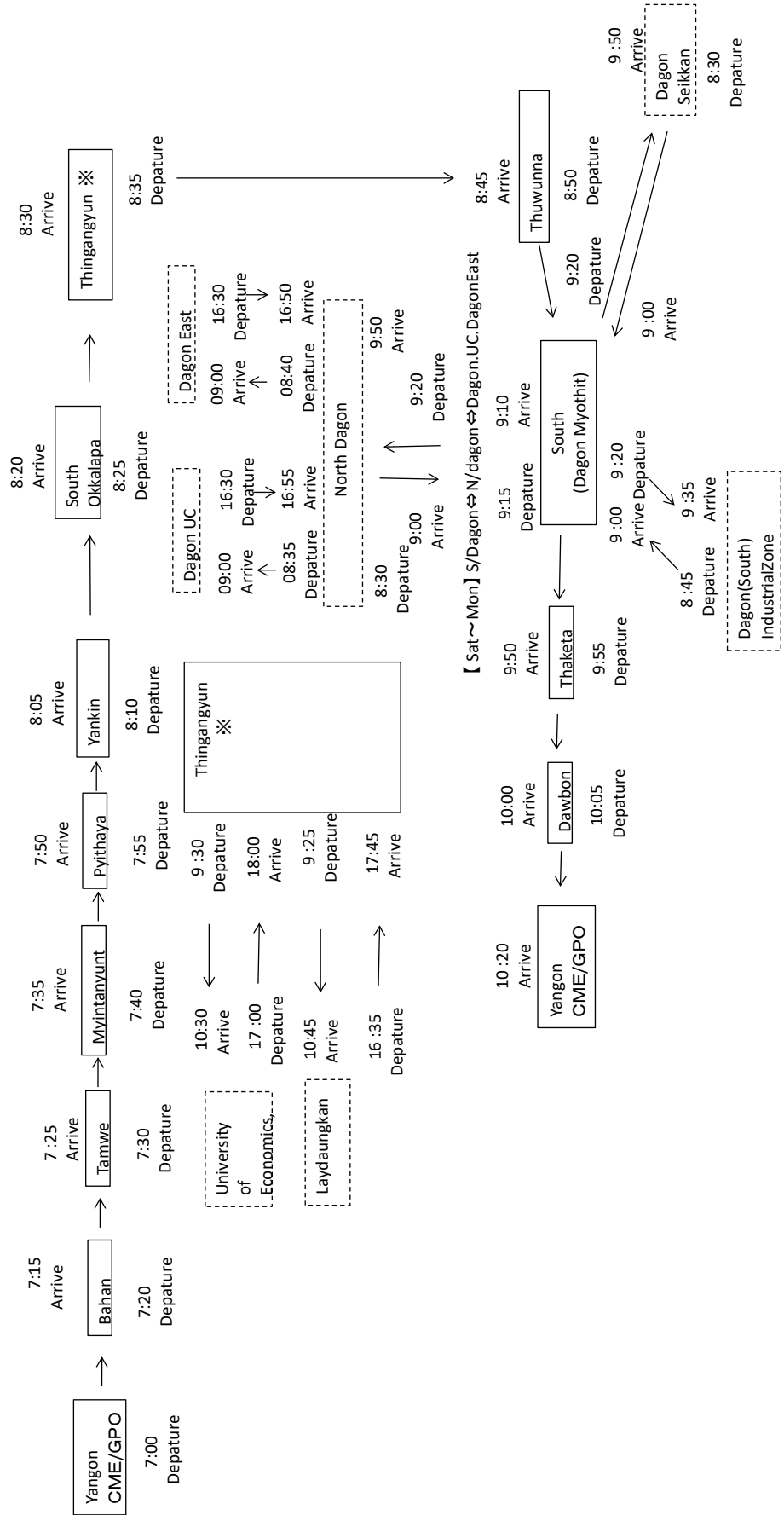

**Yangon CME Mail Route**

No	Mail Van & Departure Time	TRIP	Arrival Time
Van-15②	(19:00)	Parrami Bus TM (Naypyitaw DEMS)	(20:30)

【Van-15②】 Daily

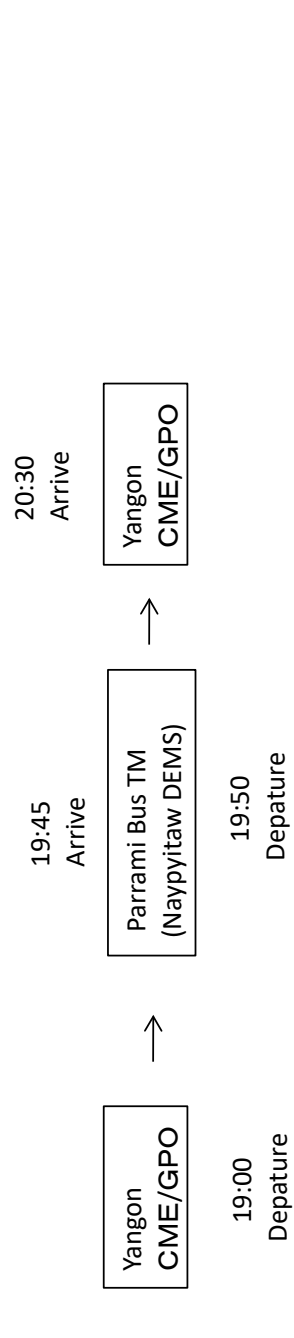

North Dagon Post Office

YGN CME ⇄ North Dagon Tue ~ Fri (Sat. Sun. Mon. Holiday Off)

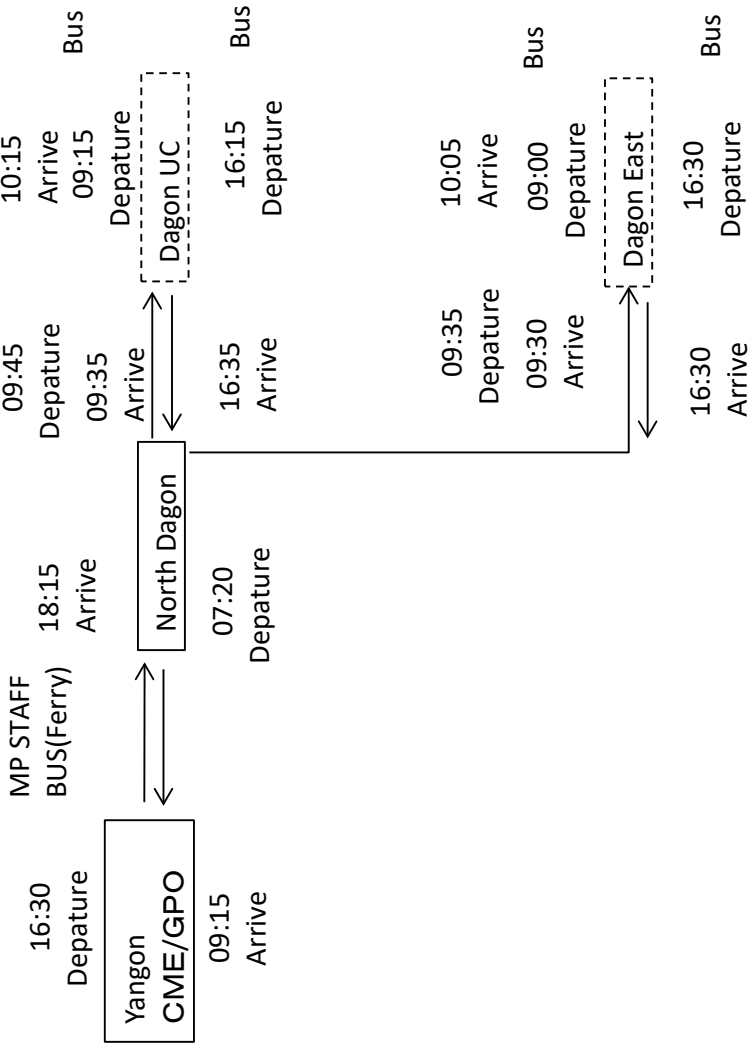

T01-1

YangonCME Mail Carrier①

2018.7 UPDATE

Sunday off

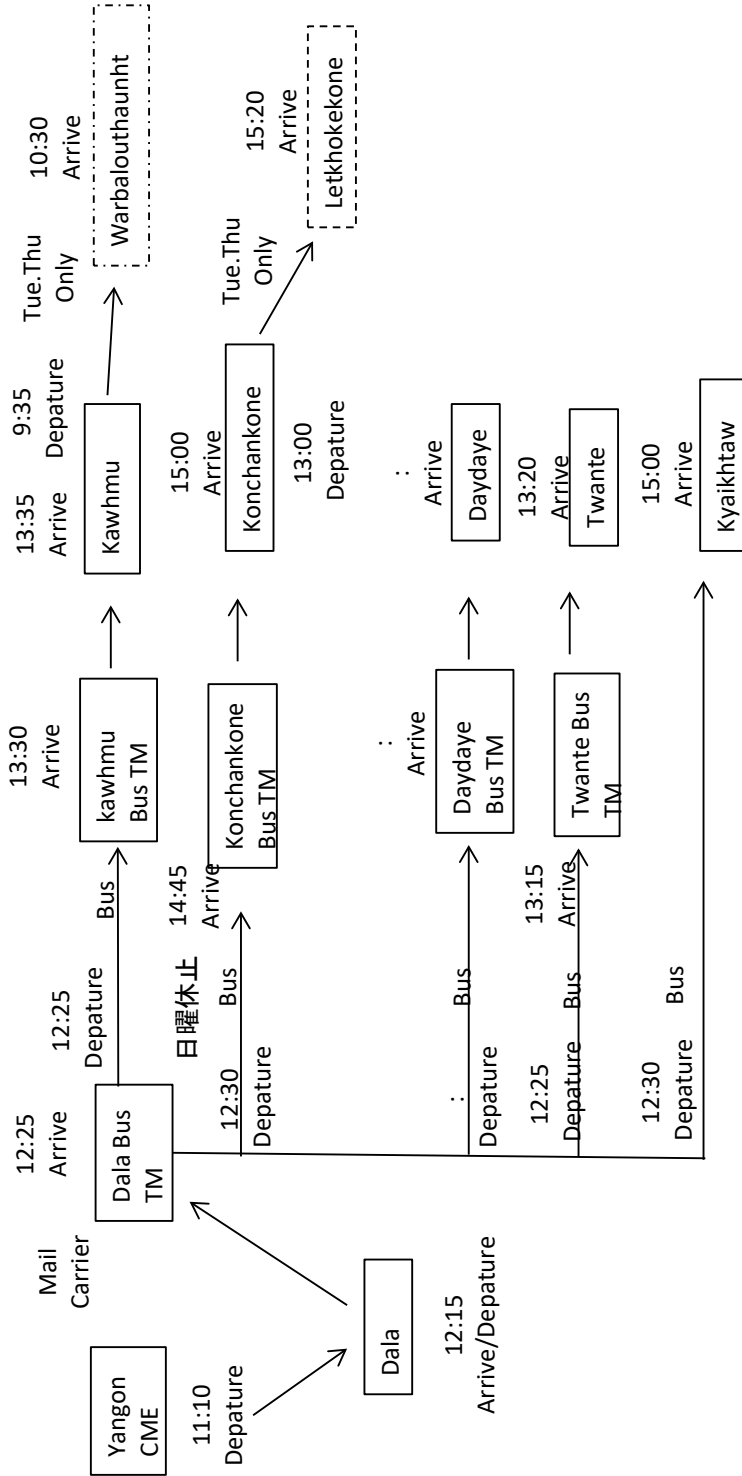

T01-1

Sunday off

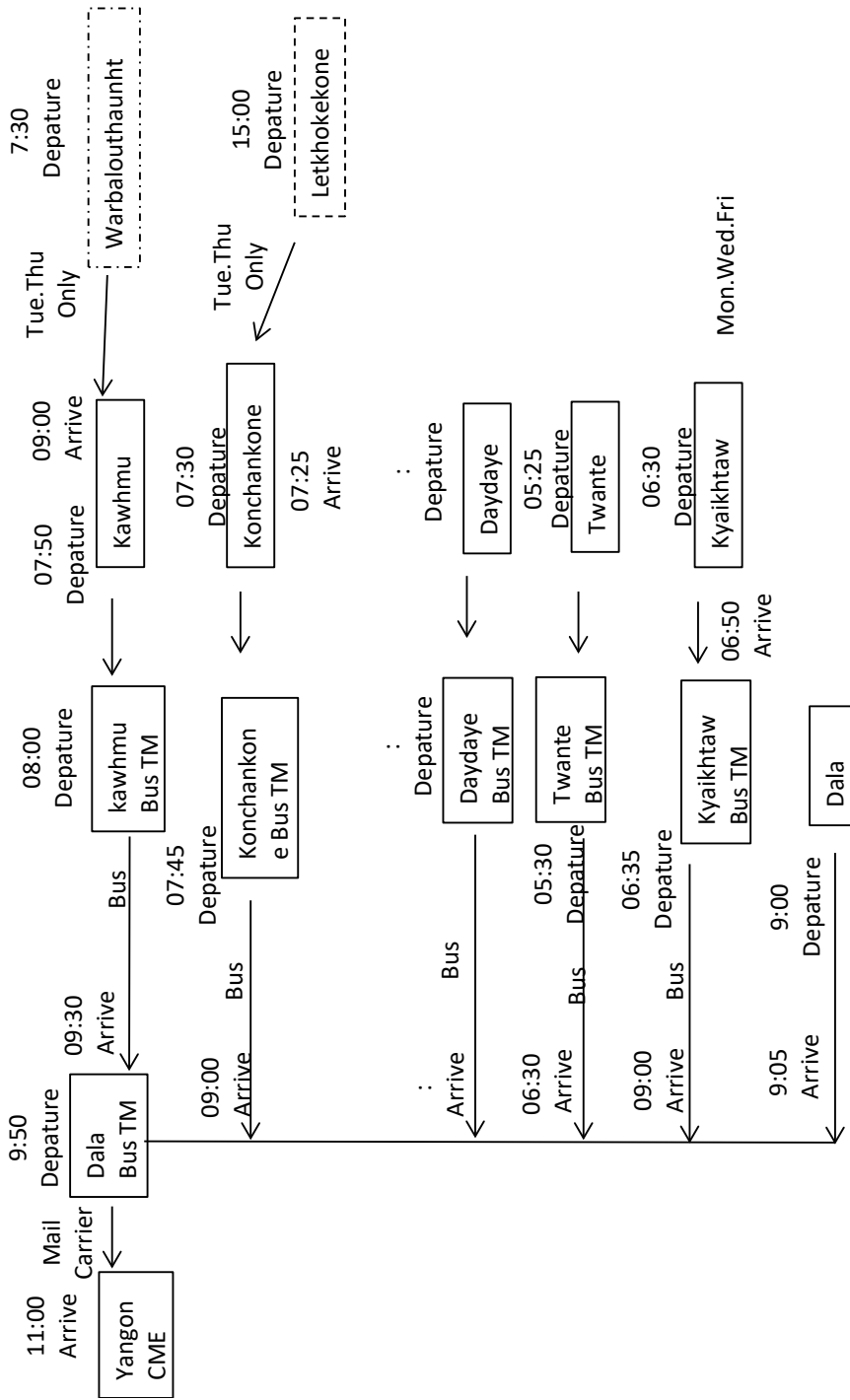

T01-1 **YangonCME Mail Carrier②** 2018.7 UPDATE

Thanlyin Post Office

YGN CME ⇄ Thanlyin① Sat.Sun Off

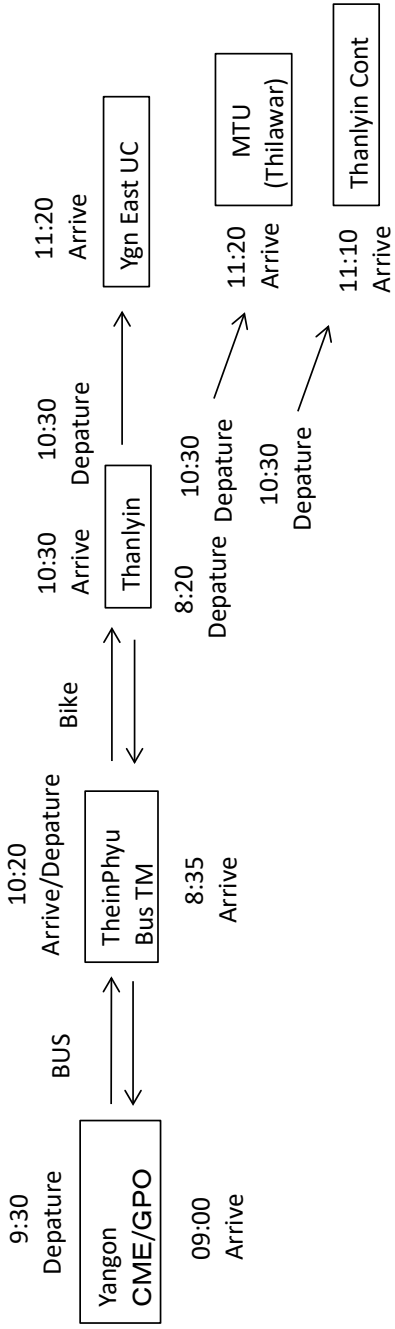

YGN CME ⇄ Thanlyin② Daily

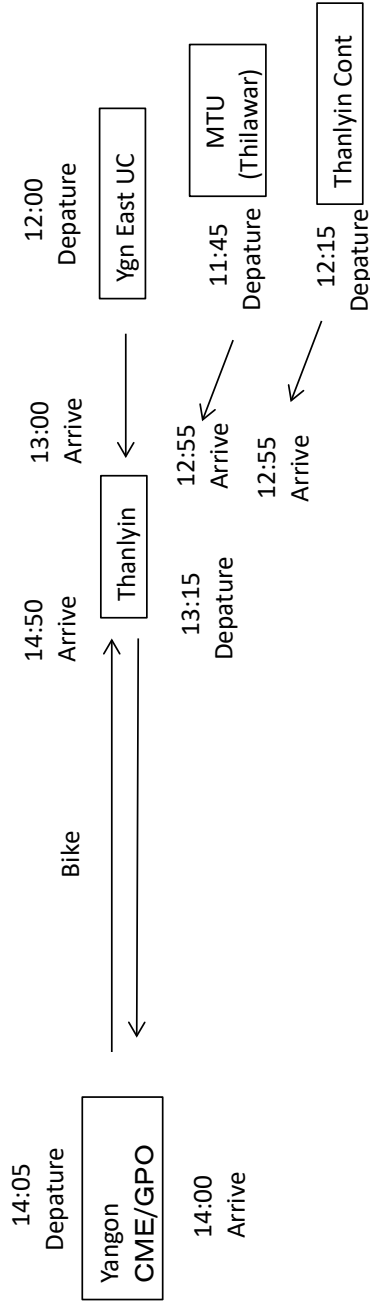



T01-1 **YangonCME Mail Carrier②** 2018.7 UPDATE

Kyauktan Post Office

YGN CME ⇄ Kyauktan Sat.Sun Off

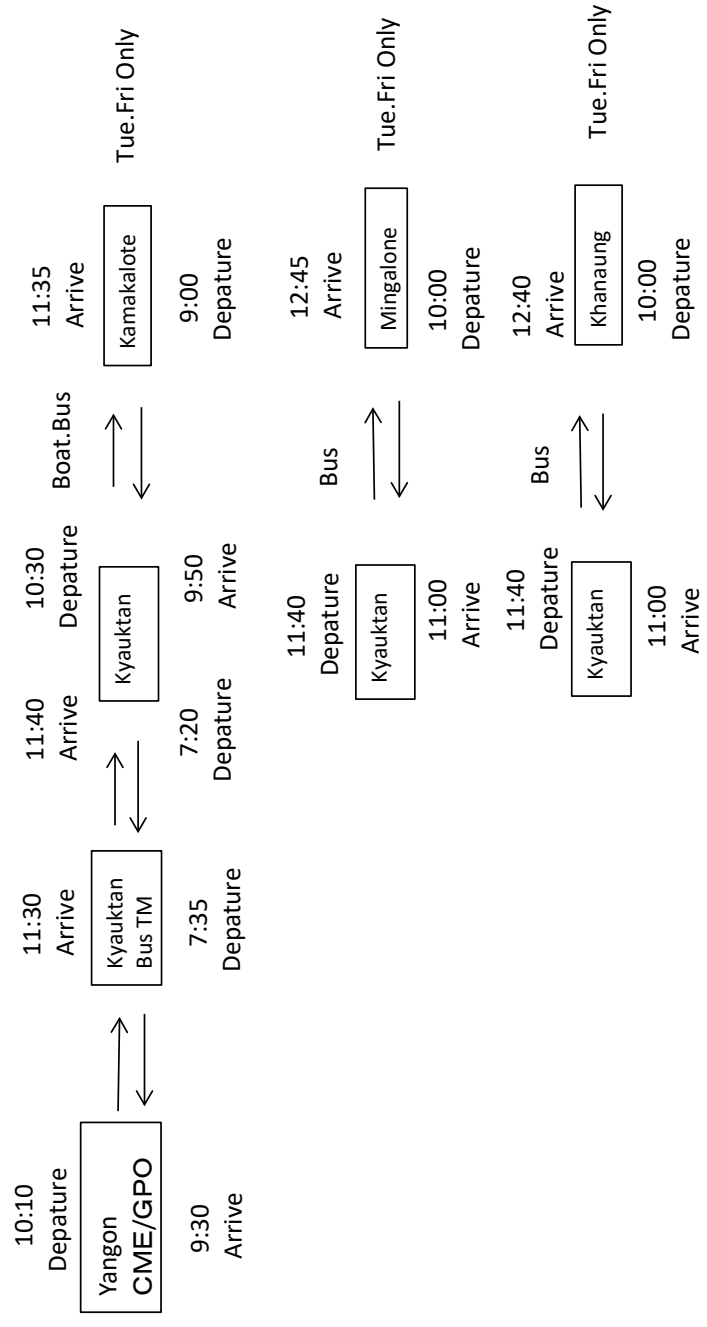

**YangonCME Mail Carrier③** 2018.7 UPDATE

YGN CME ⇄ Seikkyi Sat.Sun Off

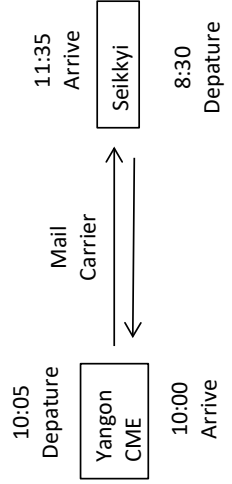

**T01-1  
CME Train Route(R-1)**

2018.7 UPDATE

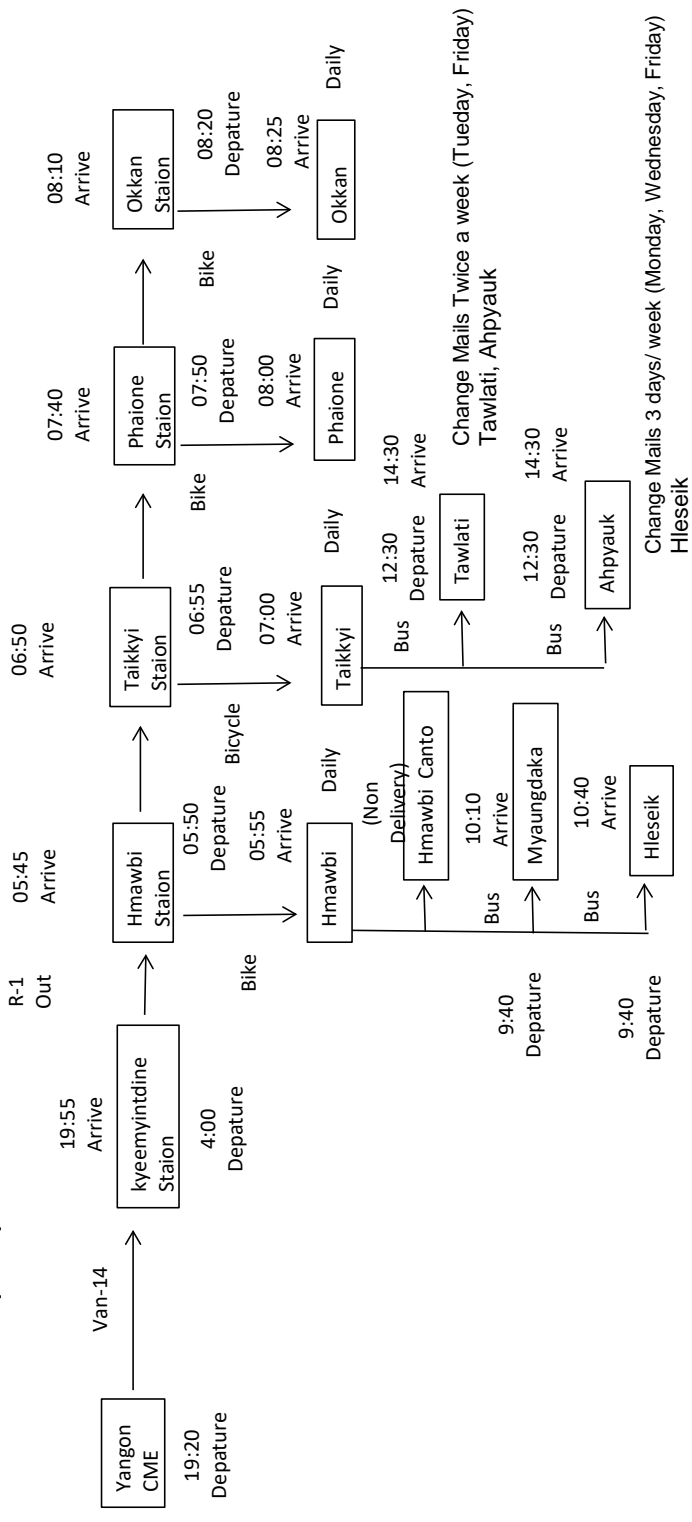



## NayPyiTaw, Mandalay, Yangon Bus Rout

2018.7 UPDATE

No.	BusTM Name	Bus Time Arr/Dep	Hand Over Post Office	Post Office	
1	Shwemanthu	21:00-22:00	Nay Pyi Taw	Nay Pyi Taw	start BusTM
2	Myatmandalarhtun	17:30-22:00	-	MDY GPO	Final BusTM
3			MDY GPO	Zaycho	
4			MDY GPO	Yonegyi	
5			MDY GPO	Mandalay Station	
6			MDY GPO	Man(West)	
7			MDY GPO	Shanzu	
8			MDY GPO	MDY U C	
9			MDY GPO	Amarapura	
10			MDY GPO	Pyaygyidakhon	
11			MDY GPO	Chanmyathazi	
12			MDY GPO	Man(Ashaepyin)	
13			MDY GPO	Man(myaukpyin)	
14	Mandalarmin	17:30-19:00	-	NyaungOo	
15			NyaungOo	Baagan	
16			NyaungOo	Kyaukpadaung	
17			NyaungOo	Popa	
18			NyaungOo	Singu(NYO)	
19			NyaungOo	Ngathayouk	
20	Myatmandalarhtun	17:30-21:00	-	PyinOoLwin	
21			PyinOoLwin	PyinOoLwin Cont;	
22			PyinOoLwin	Ahneesakhan	
23			PyinOoLwin	Padaythamyothit	
24			PyinOoLwin	CSTS	
25			PyinOoLwin	Zeebingyi	
26			PyinOoLwin	Mogoke	
27			PyinOoLwin	Kyatpyin	
28			PyinOoLwin	Yonepaungsone	
29	YBS	11:45-12:00	-	Dala	
30			12:00	Dala	Konchankone
31			12:00	Dala	Kawthmu
32			12:00	Dala	Letkhokekone
33			12:00	Dala	Warbaloutthaught
34			12:00	Dala	Kyaikhtaw
35			12:00	Dala	Twante
36			09:30-10:30	Dala	Seikkyi

T01-1

No.	BusTM Name	Bus Time Arr/Dep	Hand Over Post Office	Post Office
37	YBS	14:00-15:00	-	Thanlyin
38		10:00-10:05	Thanlyin	Ygn East U C
39		10:45-10:50	Thanlyin	MTU (Thilawar)
40		09:30-09:35	Thanlyin	Thanlyin Cont;
41	YBS	10:00-10:10	-	Kyauktan
42		12:30-12:35	Kyauktan	Kamakalote
43		11:30-11:35	Kyauktan	Mingalone
44		11:15-11:20	Kyauktan	Khanaung
45	YBS	07:00-07:30	-	Khayan
46		09:45-09:50	Khayan	Tadarmyo
47		07:00-07:30	-	Thonegwa
48	Ma.Hta.Th	06:30-06:45	-	Hlegu
49		09:30-09:35	Hlegu	Yemontat
50		10:00-10:05	Hlegu	Inndine
51		10:00-10:05	Hlegu	Ngarsutaung
52	Ma.Hta.Th	09:30-10:00	-	Phaunggyi

No	Mail Van & Departure Time	TRIP	Arrival Time
Van-2 San Win	2F/2400 (05:30)	Mayangone, Htayravada, International Air Port, Sawbwagyigon, Insein, Aungsan, Shwepyitha, Mingaladone, Pale, Htaukkyaht, Hlegu(Yemon, Indine, Ngarsutaung), Phaunggyi, Aungmingala Bus terminal, North Okkalapa, Shwepaukkan	(10:00)

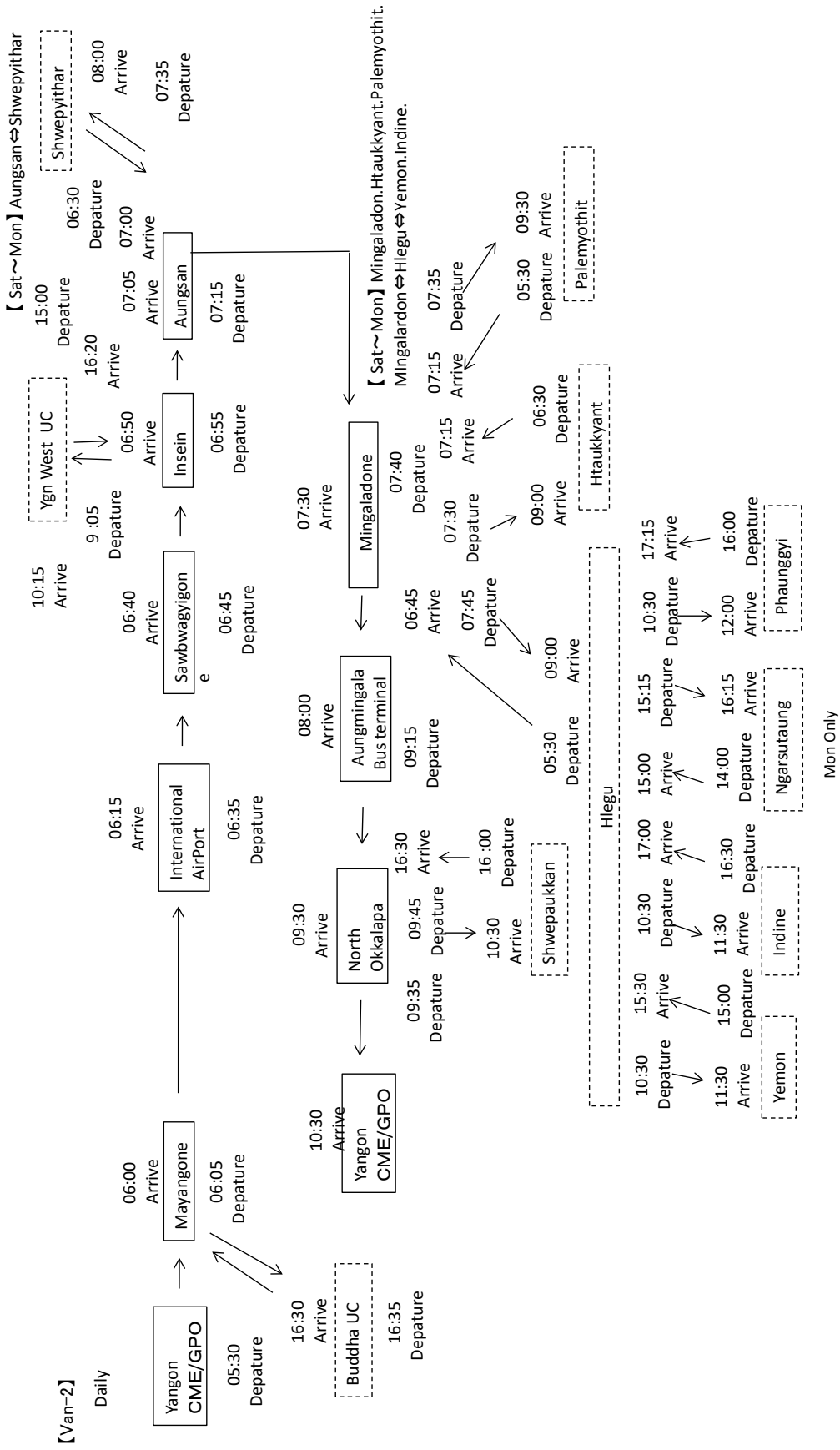

T01-1

2018.7 UpDate

**Yangon CME Mail Route**

No	Mail Van & Departure Time	TRIP	Arrival Time
Van-1 Kyawthu	8K/2983 (05:00)	Parrami Bus Terminal (Naypyitaw DEMS)	(06:00)

【Van-1】 Daily

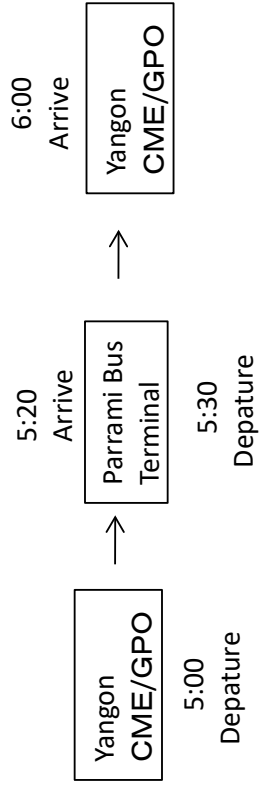





T01-2

Mandalay Mail Route

No	Mail Van & Departure Time	TRIP	Arrival Time
Van(1-1)	08:45-09:00	Thrimandatar Bus	Min Tad- HaKa- Shwe Ku- Ba Maw- Nga Oh- Pakokku - Gan Gaw- Moe Meik- Mon Ywa- Shwe Bo- Ka Lay - Tha Bak Kyin- Da Kaung- Ma Dayar- Singu-Let Pan Hla

【Van- 1 (1-1)】 Daily

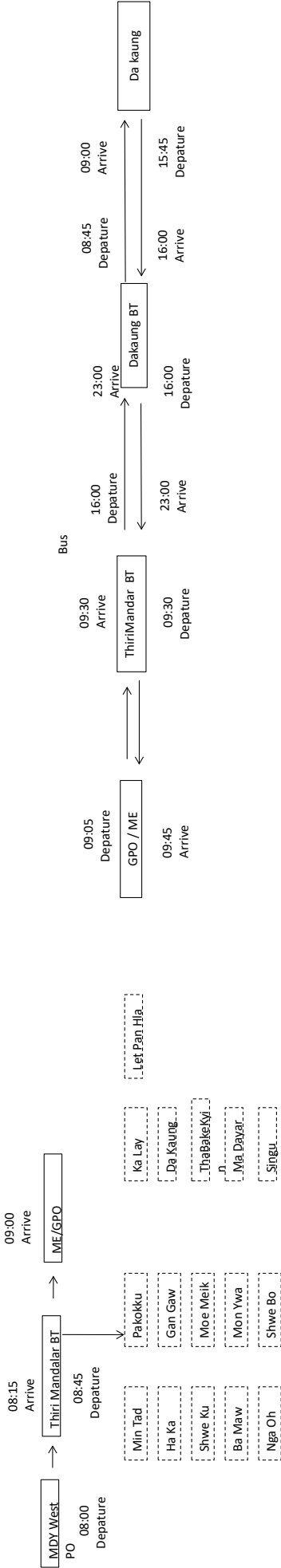

TSO Bike Route

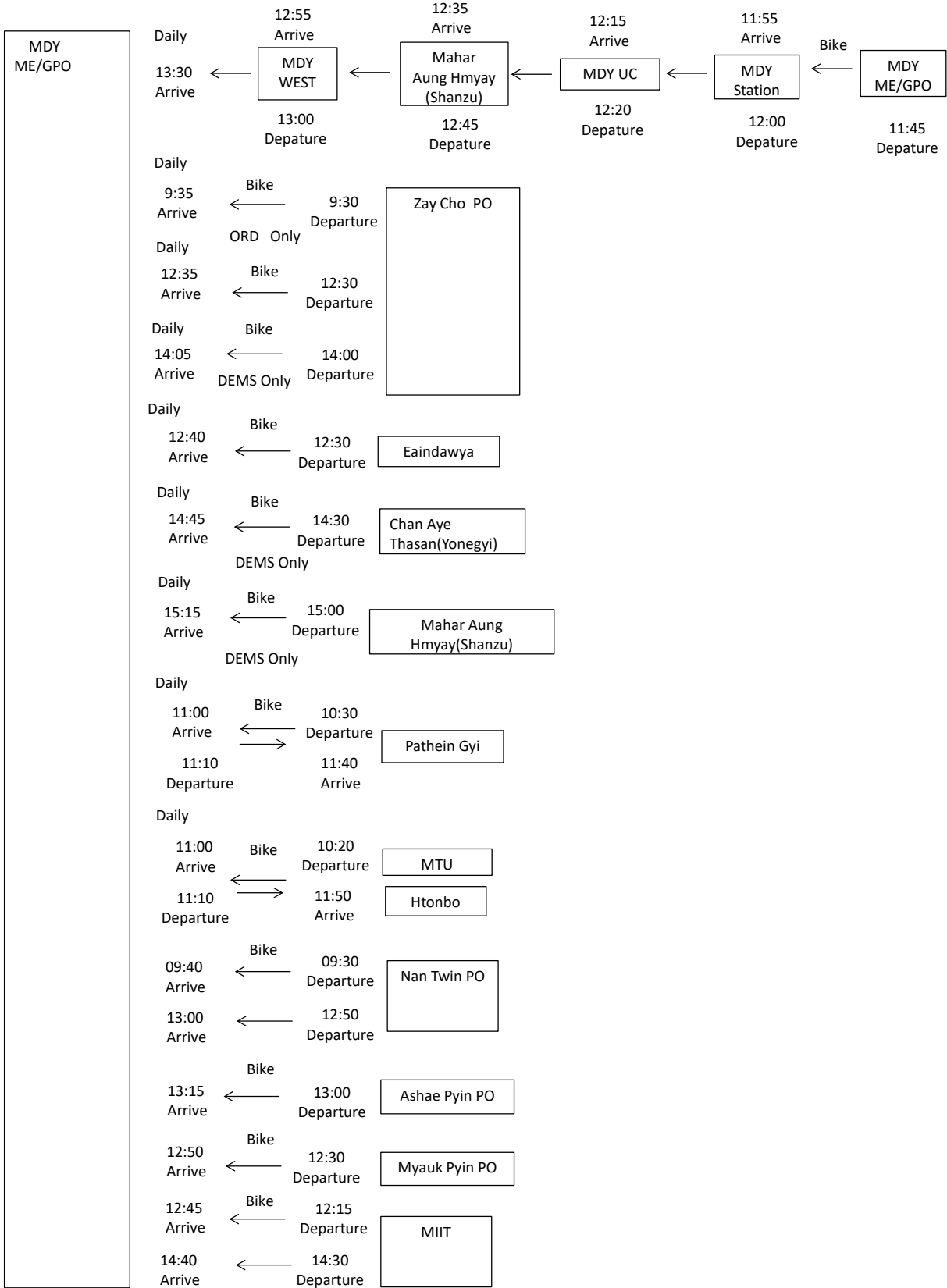



T01-2

Mandalay Mail Route

No	Mail Van & Departure Time	TRIP	Arrival Time
Van(1-3)	08:45-09:00	Mandalay Railway Station	-

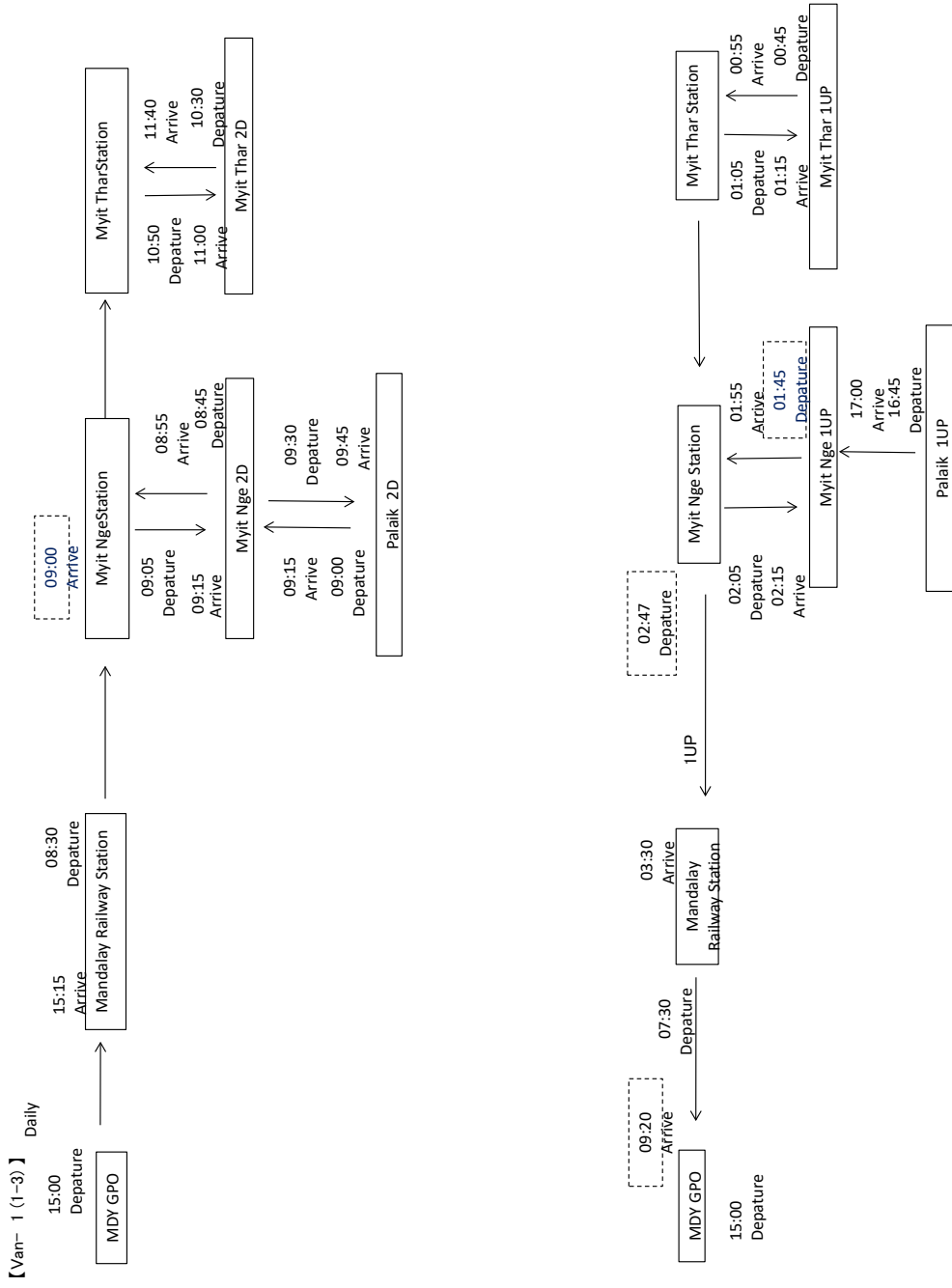

T01-2

**Mandalay Mail Route**

No	Mail Van & Departure Time	TRIP	Arrival Time
Van(2-1)	07:30-09:20	Chan Mya Shwe Pyay BT	Yangon-Pyay-NayPyiTaw-TaungGyi-Kalaw-Magway-MyinGyan-Aunglan-Chauk-LoiKaw-MawLamying-Hpan-Myawaddy-PyinOoLwin-Nyaung Oo- NgaZun

**【Van- 2 (2-1)】**

Daily

08:00  
Arrive

MDY West  
PO(駐車場)



ChanMyaShwePyay  
BT



08:45  
Arrive

From PyinOoLwin  
BT



09:00  
Arrive

From  
NyaungOo/Ngazun  
BT



09:20  
Arrive

ME/GPO

07:30  
Depature

- Yangon
- Pyay
- NayPyiTaw
- Kalaw
- Magway
- TaungGyi
- AungLan
- Chauk
- Loikaw
- Mawlmyaing
- Hpan
- Myawaddy

08:30  
Depature

- MyinGyan
- MyinGyan Myoma
- NgaHtogyi
- PyinSi
- TaungTha
- Weloung

08:50  
Depature

- PyinOoLwinrom
- PyinOoLwin Cant:
- SuPaung(Yonepaungsone)
- Padatha Myothit
- AhnesaKhan YadanarPon
- Myothit ZepinGyi
- Mogoke
- KyatPyin

09:05  
Depature

- NyaungOo
- Bagan
- Popa
- Singu(NYU)
- NgaThayouk
- KyaukPaDaung
- NgaZun
- MyoThar

All Allive

ChanMyaShwePyay BT    MyinGyan BT

T01-2

**Mandalay Mail Route**

No	Mail Van & Departure Time	TRIP	Arrival Time
Van(2-2)	11:00-11:55	PyiGyiMyatShin BT	Lashio- Muse- KyaukMe- NaungCho- ThiBaw

【Van- 2 (2-2)】

Daily

11:20  
Arrive

11:55  
Arrive

GPO / ME



PyiGyiMyatShin  
BT



ME/GPO

11:00  
Departure

11:40  
Departure

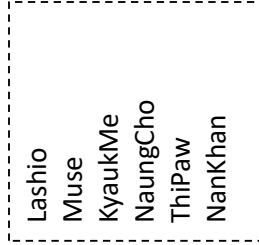



T01-2  
Mandalay Mail Route

No	Mail Van & Departure Time	TRIP	Arrival Time
Van(2-4)	15:30-17:30	ChanMyaShwePyi BT	Yangon-Pyay-NayPyiTaw-TaungGyi-Kalaw-Magway-MyinGyan-AungLan-Chauk-LoiKaw-MawLaMyaing-Hpan-Myawaddy- PyinOoLwin- NyaungOo- Ngazun

【Van- 2 (2-4)】

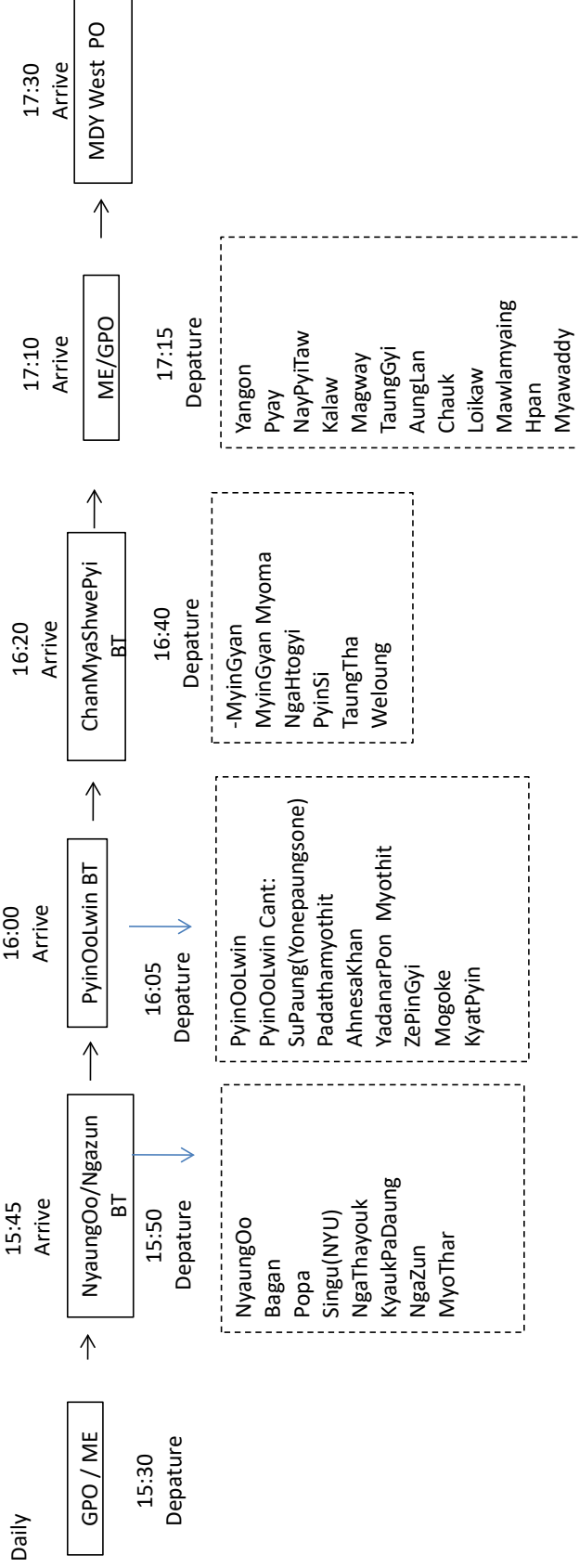



**T01-2**  
**[Van- 2 (2-1) ]**

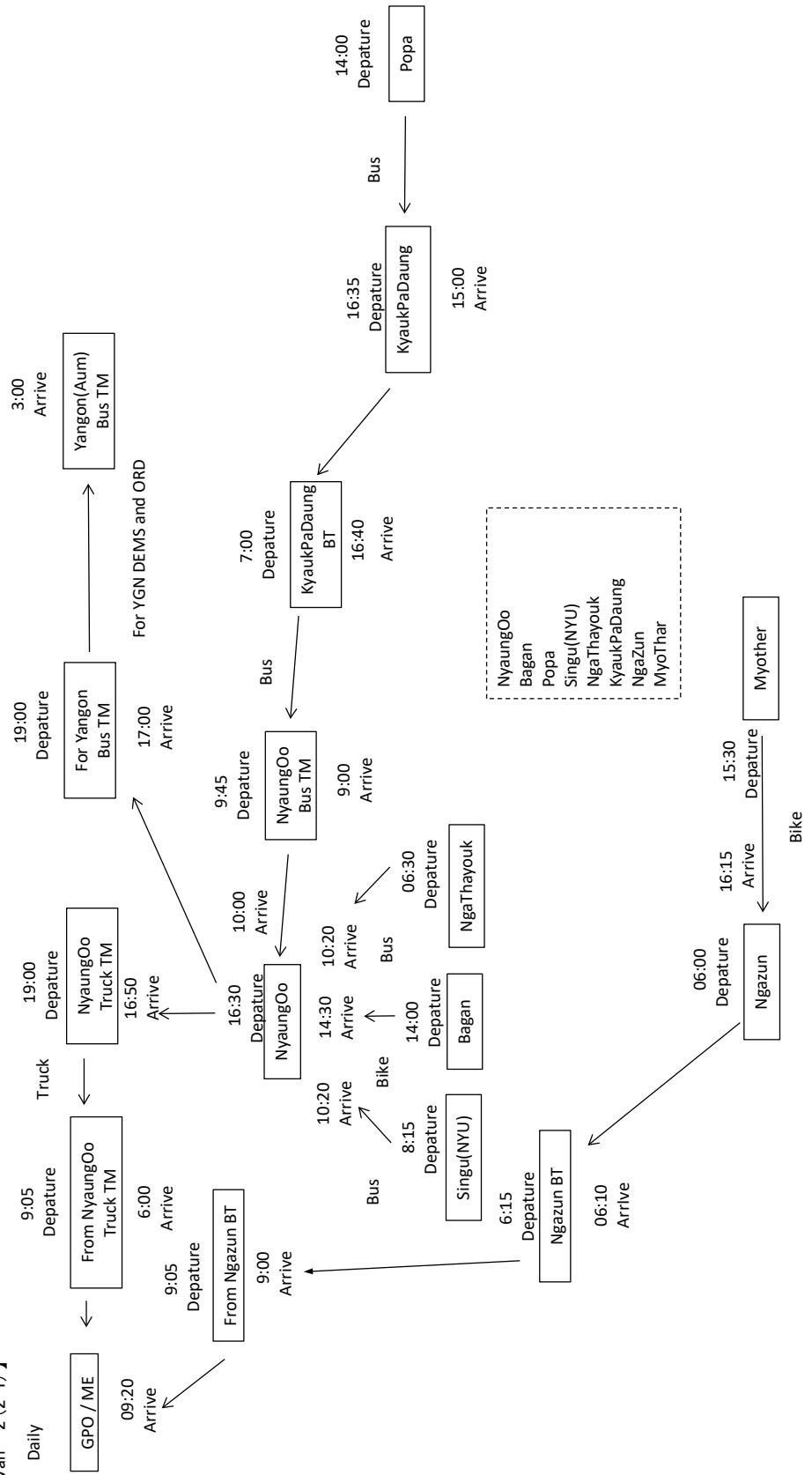

**T01-2**  
**【Van- 2-1】**

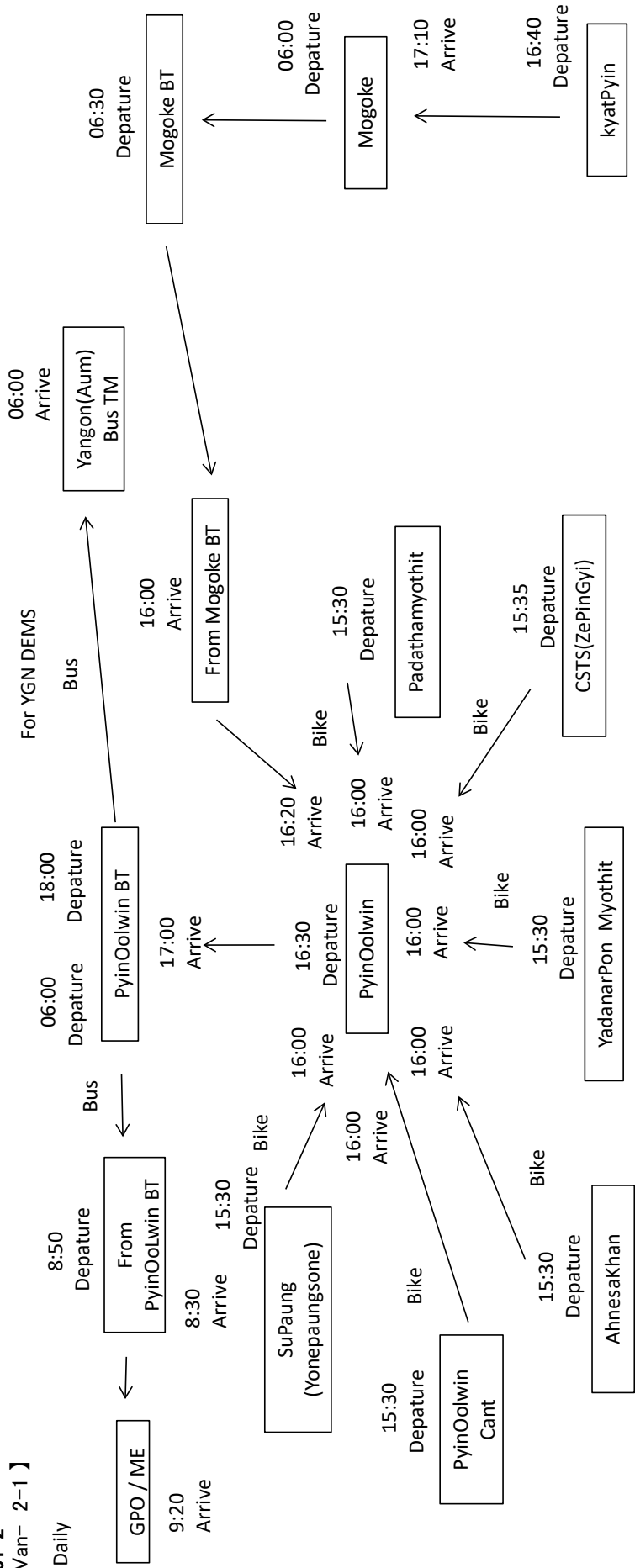

**T01-2**  
**[Van- 2 (2-4) ]**

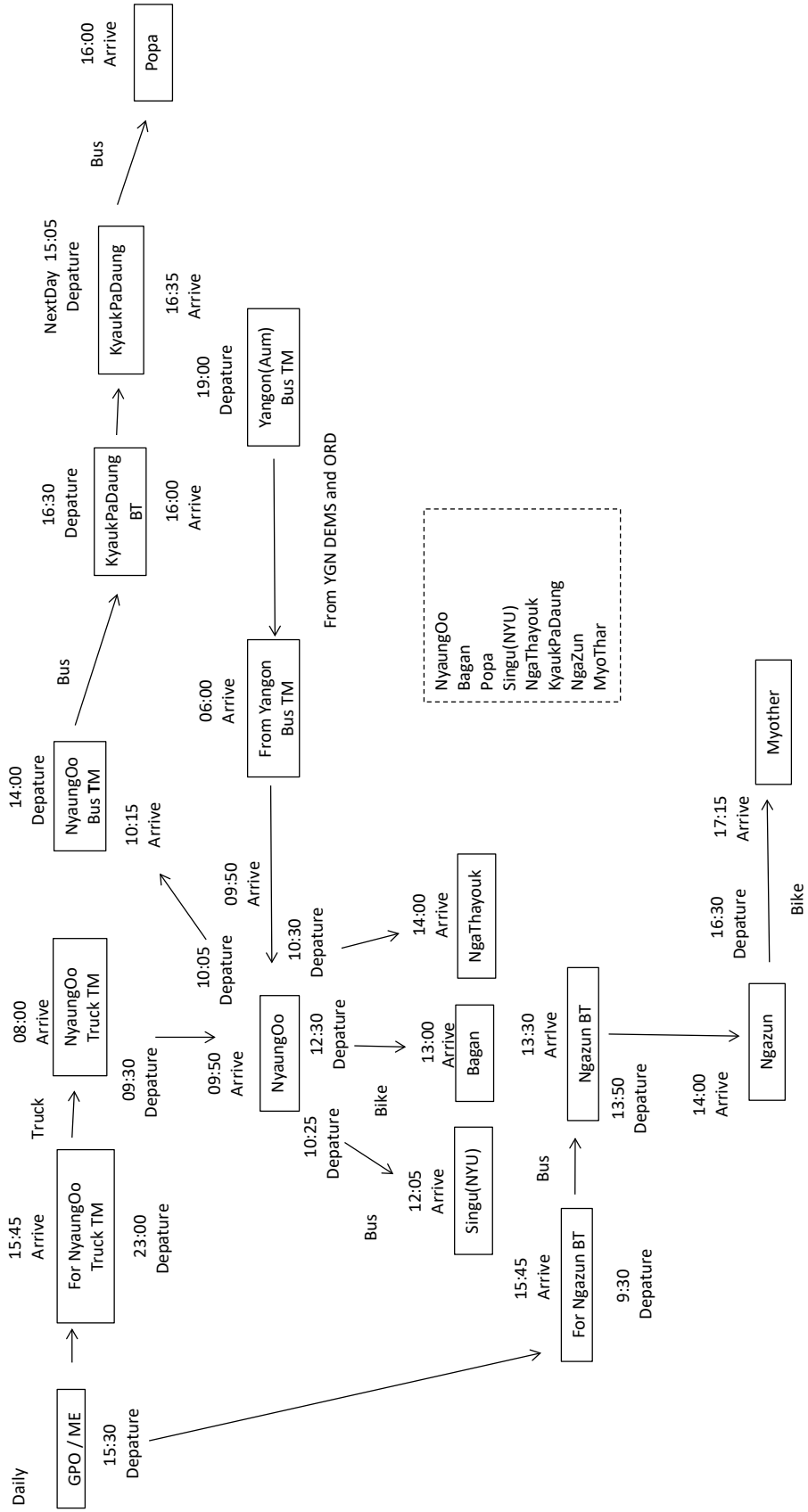

T01-2

【Van- 2-4】

Daily

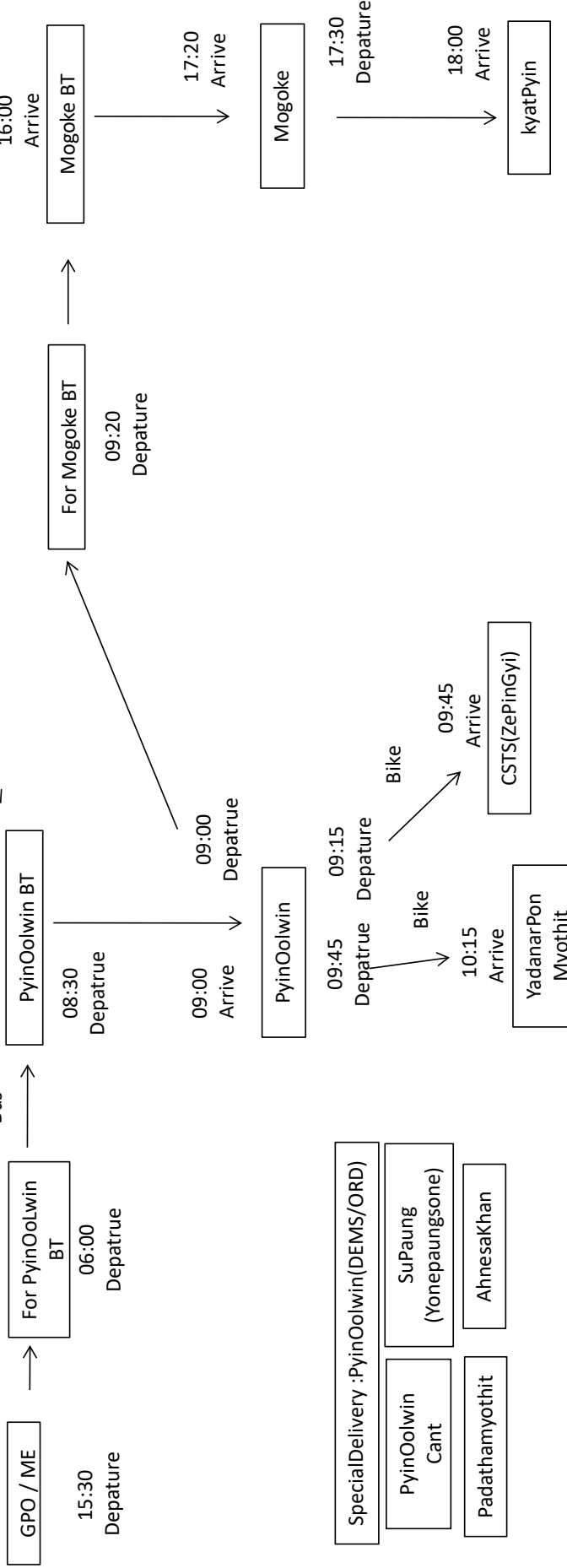

**T01-2**  
**【Van- 2-1】**

Daily

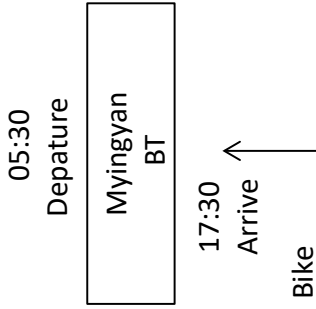
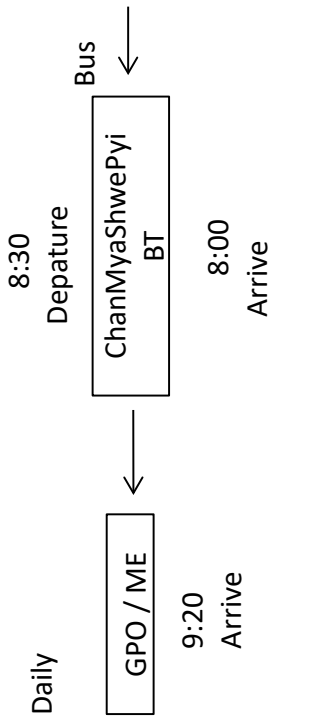

Myingyin Myoma  
 (Included : MyingyinP.O)

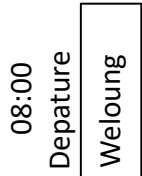
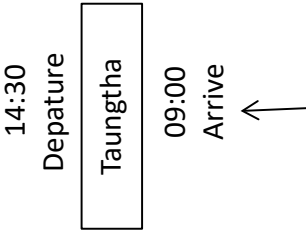
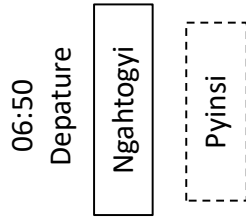
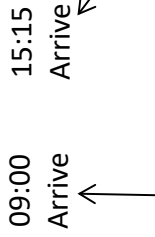
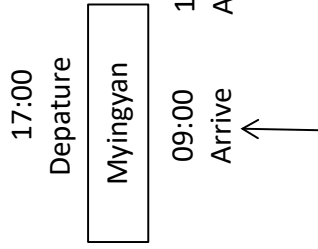

**T01-2**  
**【Van- 2-4】**

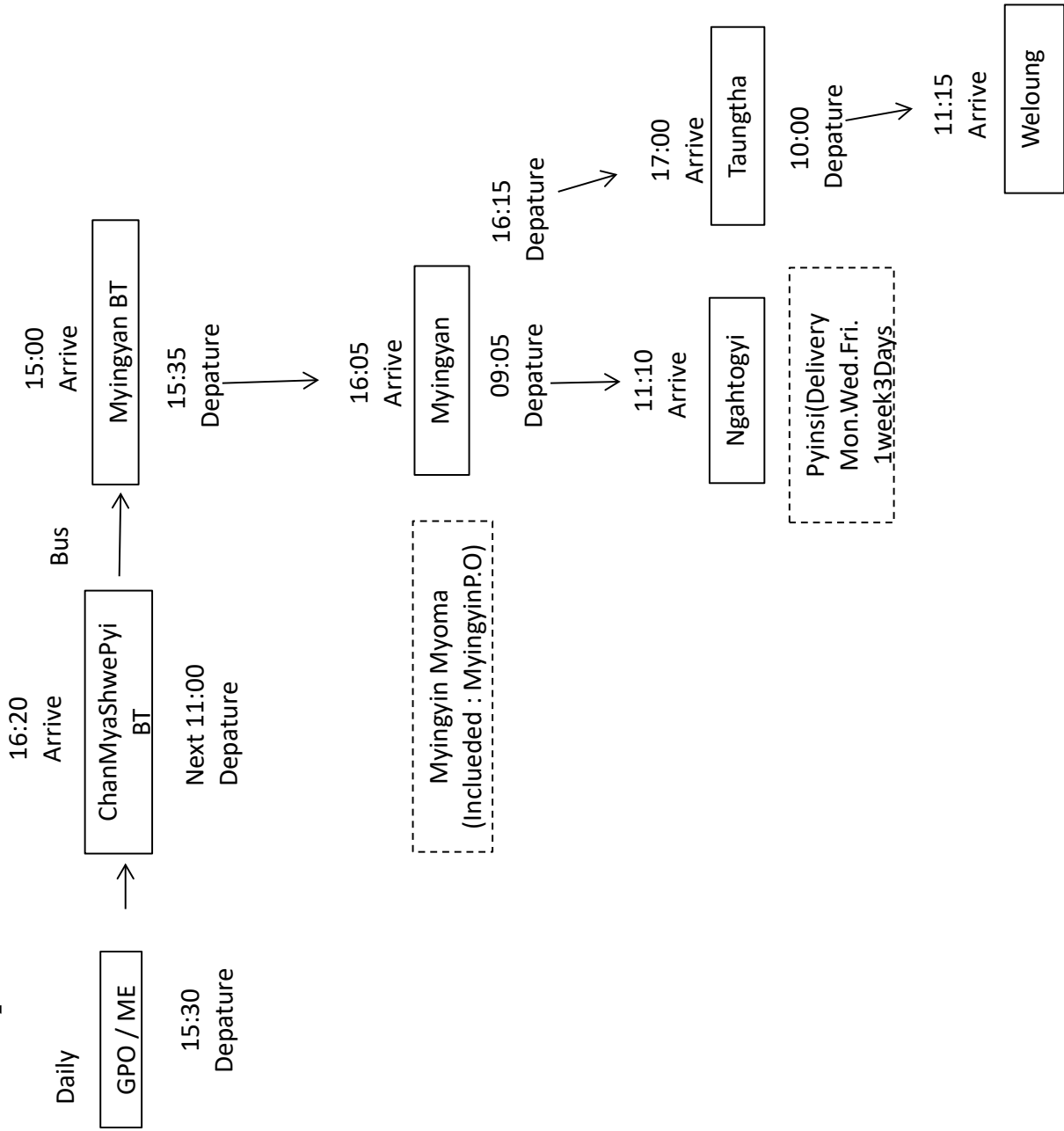

T01-2

**Mandalay Mail Route**

No	Mail Van & Departure Time	TRIP	Arrival Time
Van(3-1)	07:15-08:45	Mandalay Railway Station ( 3 UP)	Kyaukse-MyitTha-Thedaw-Wundwin-TharZi-MeikHtiLa-PyawBwe-Yamethin - Tatkon-NayPyiTaw-PyinMaNa- E Lar- TaungGoo-Phyu-KaNyuntKwin- KyaukTaGar-NyaungLayBin-Deik U- Bago-Yangon

VEN 3 (3-1)

Daily

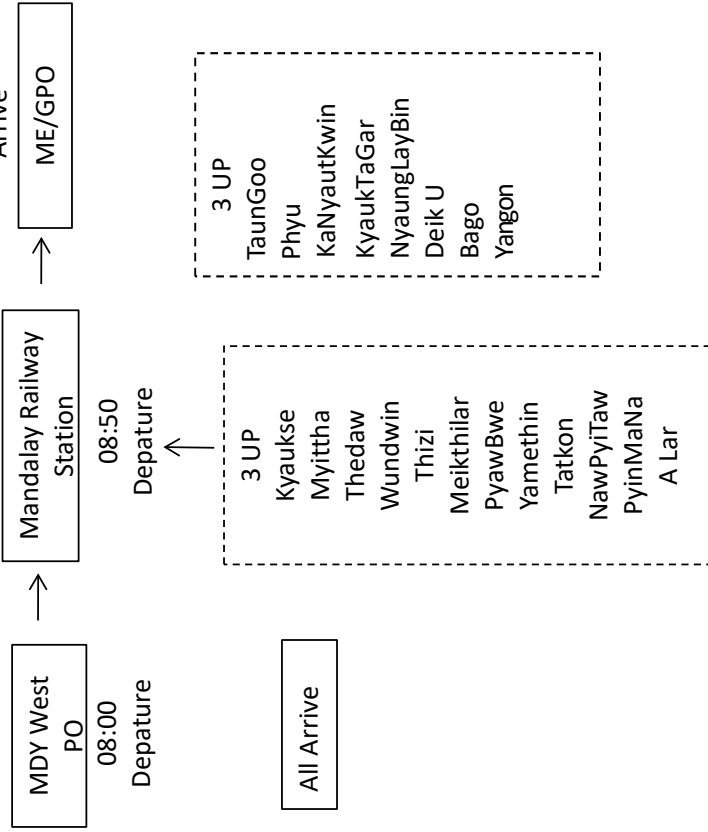

T01-2

**Mandalay Mail Route**

No	Mail Van & Departure Time	TRIP	Arrival Time
Van(3-2)	15:30-17:10	Mandalay Railway Station ( 4 Down)	Kyaukse-MyitTha-Thedaw-Wundwin-TharZi-MeikHtiLa-PyawBwe-Yamethin - Tatkon-NayPyiTaw-PyinMaNa- E Lar- TaungGoo-Phyu-KaNyuntKwin- KyaukTaGar-NyaungLayBin-Deik U- Bago-Yangon

VAN 3 (3-2)

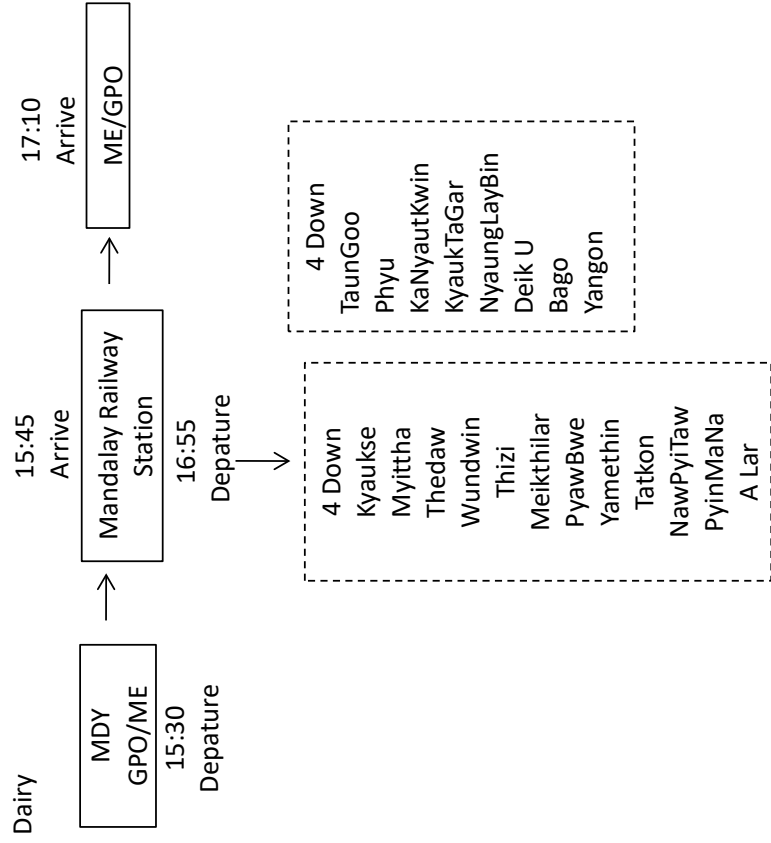



T01-2  
Mandalay Mail Route

No	Mail Van & Departure Time	TRIP	Arrival Time
Van(4-1)	10:30-12:30	TSO Car	MTU – PaTheinGyi – AShaePyin – MyaukPyin – NanTwin

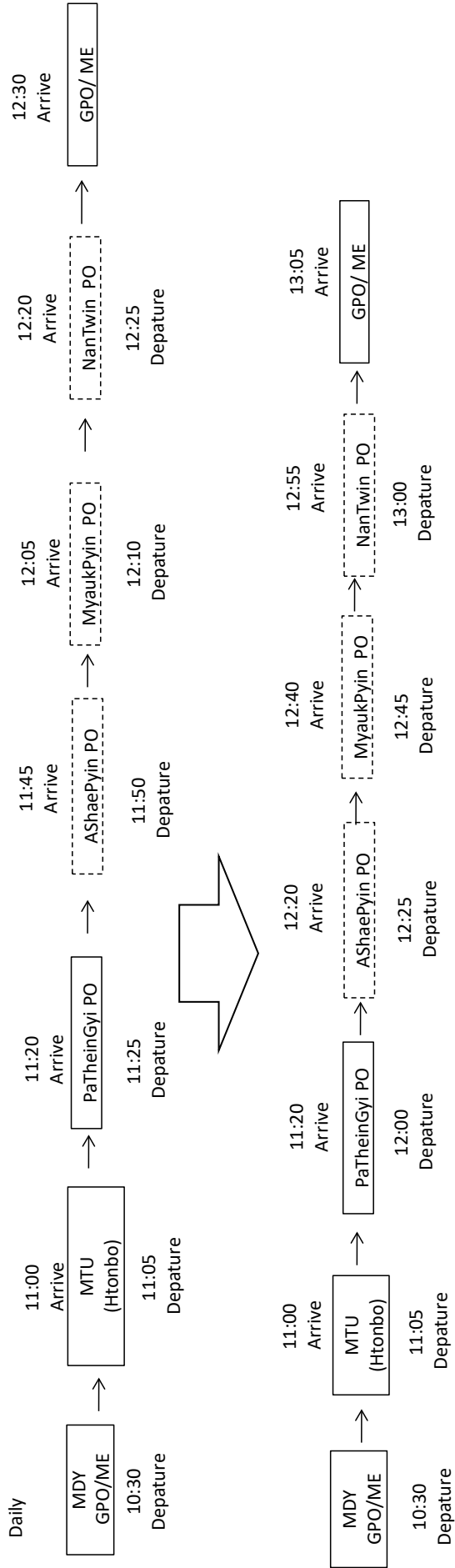

T01-2

**Mandalay Mail Route**

No	Mail Van & Departure Time	TRIP	Arrival Time
Van(4-2)	13:30-15:30	TADA U PO	Khan tee - HomaLin (By Air Mail)

VAN 4 (4-2)

Mon.Tue.Fri

MDY  
GPO/ME

11:30

Depature



MDY Airport

12:25  
Arrive



GPO/ME

13:30  
Arrive

12:30

Depature

Khan Tee PO

Tuesday / Friday

HomaLin

Monday / Friday

2018.4

T01-2  
**Mandalay → Yangon Bus Route**

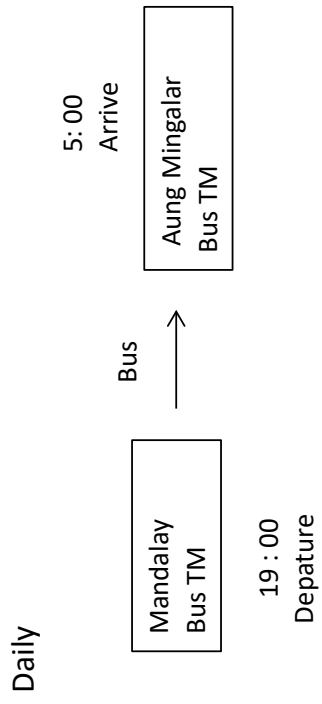

**【CPO⇄Pyinmana.Pyinmana Station SortingCenter.BusTM TransportationRoute】**

DailyOperation: Everyday

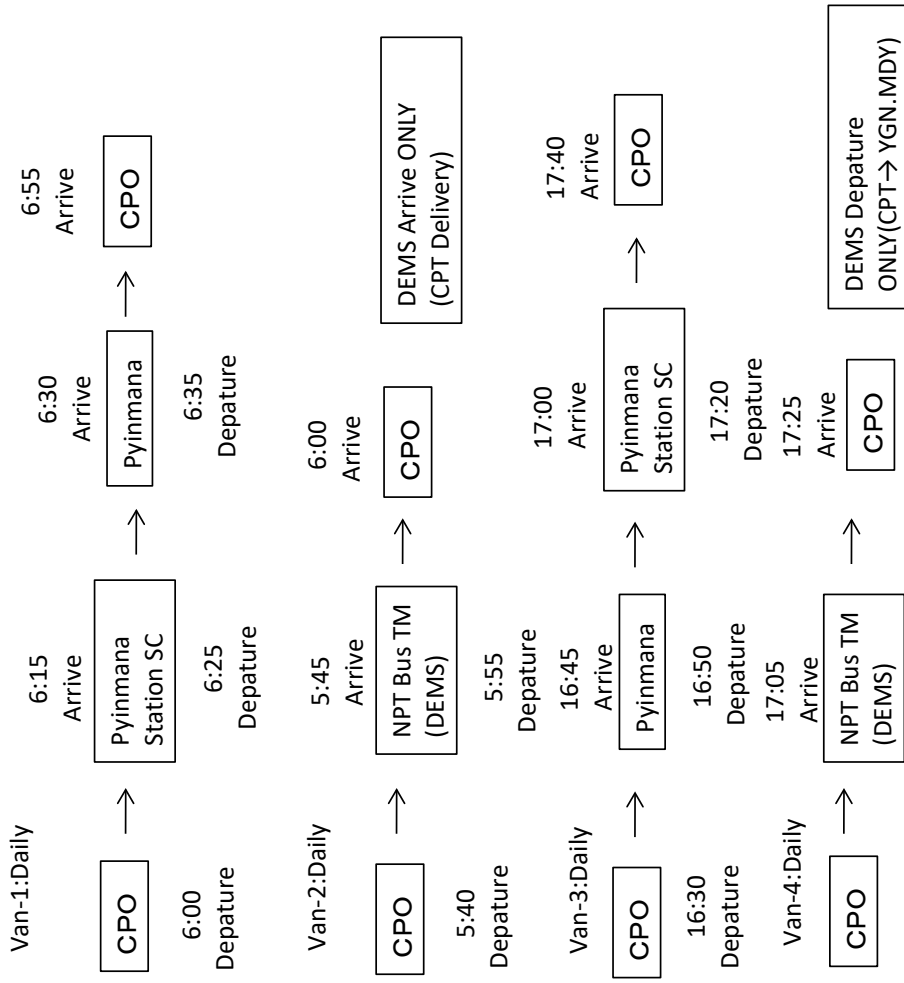

**【Bus Daia→DEMS Only】**

NPT Bus TM 22:00→ YGN BusTM 3:30

YGN Bus TM 22:00→ NPT BusTM 5:00

NPT Bus TM 22:00→ MDY BusTM 2:30

MDY Bus TM 22:00→ NPT BusTM 2:30

【Yesin⇄Pyinmana Station SortingCenter TransportationRoute】

DailyOperation : Everyday

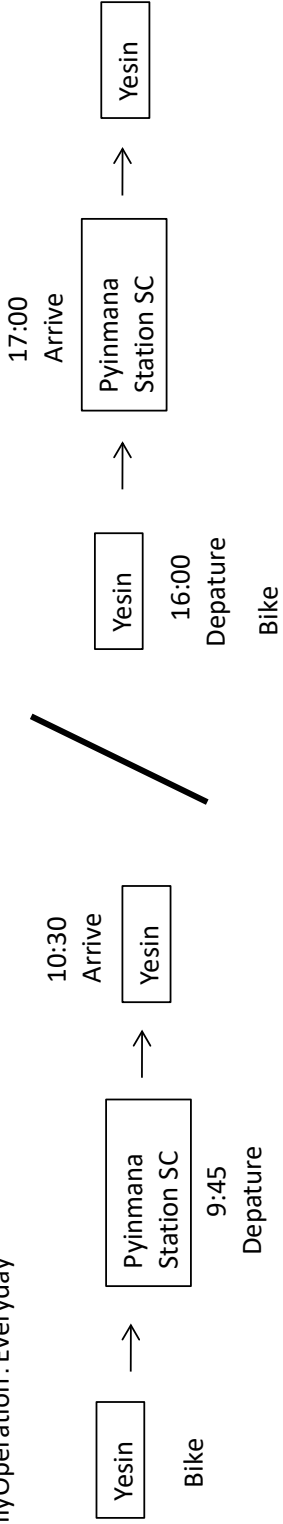

【Luwe⇄Pyinmana Station SortingCenter Transportation Route】

DailyOperation : Everyday

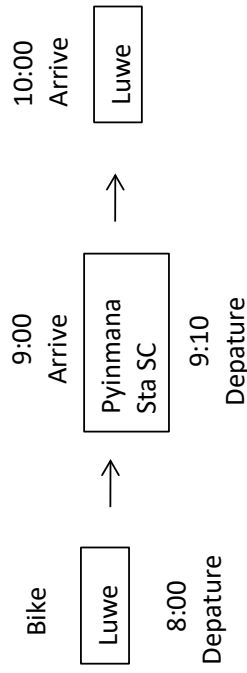

【Tatkone⇄Tatkone Station Transportation Route】

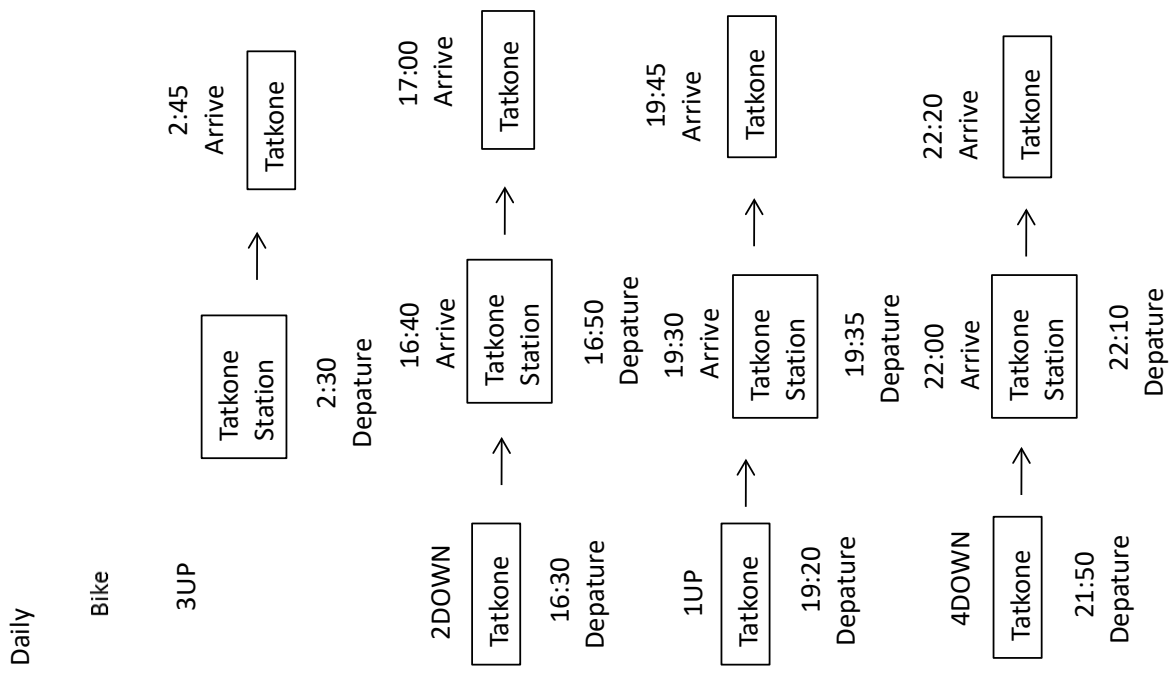

【Kyitaunkkan⇄Kyitaunkkan Station Transportation Route】

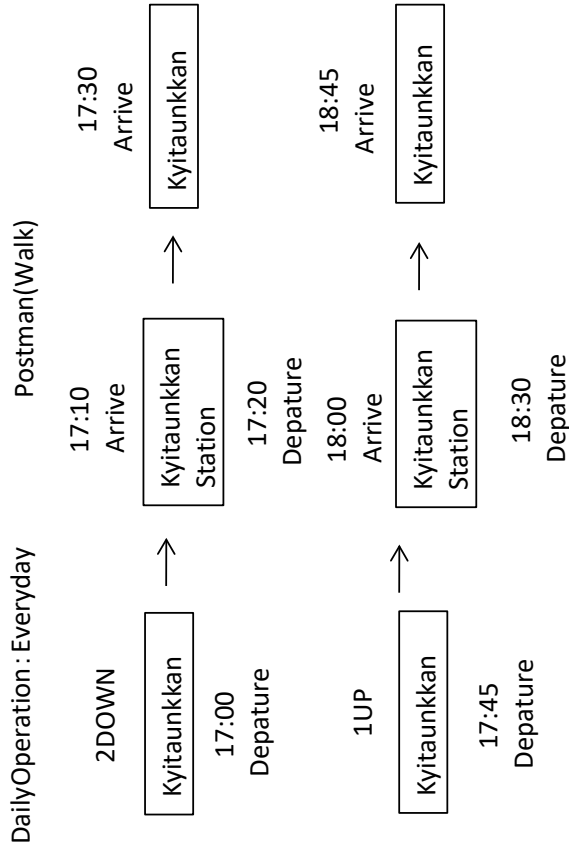

T01-2  
 【Alar⇄Alar Station Transportation Route】

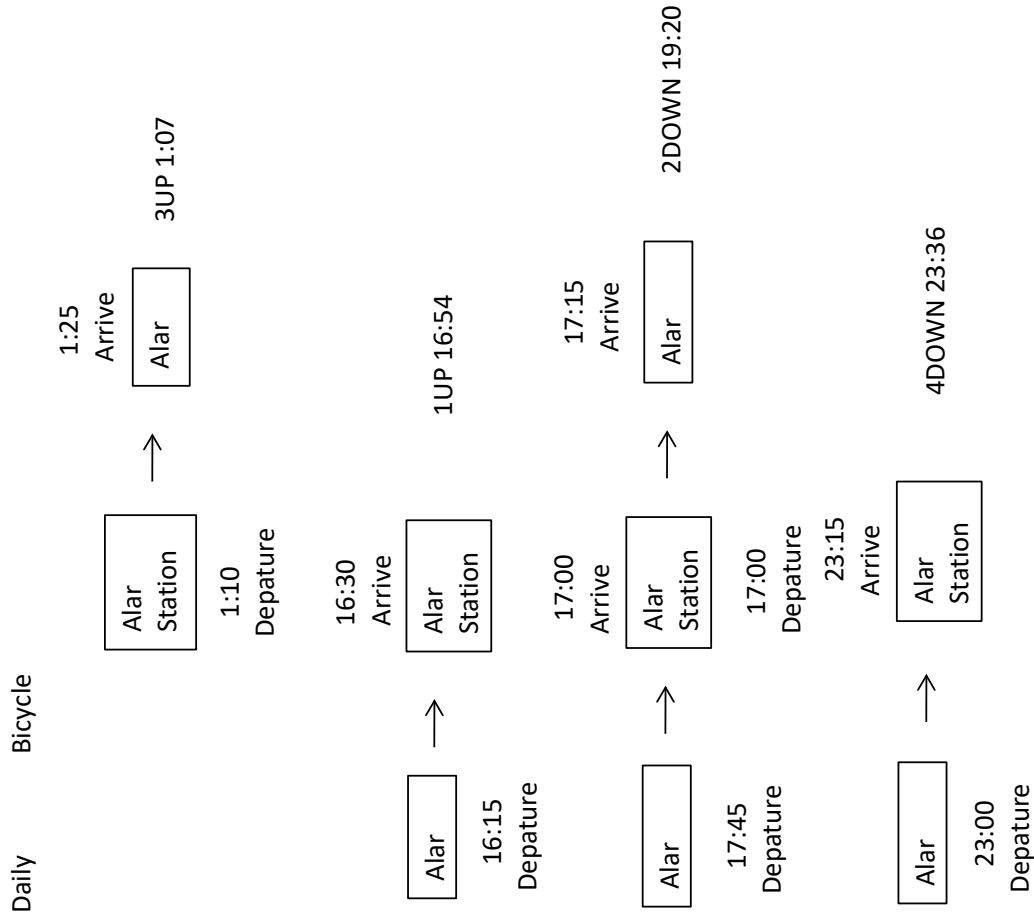

T01-2  
 【Tharwuthi ⇄ TharwuthiStation Transportation Route】

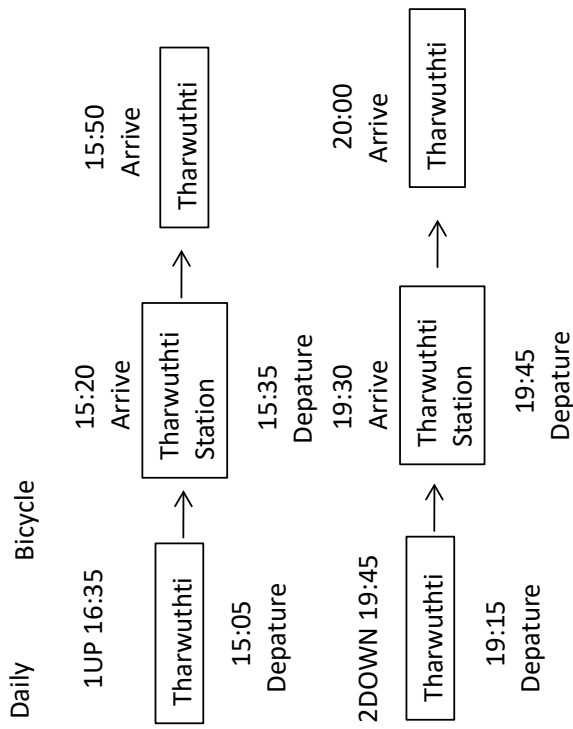



### Naypyitaw → Yangon Bus Route

Daily

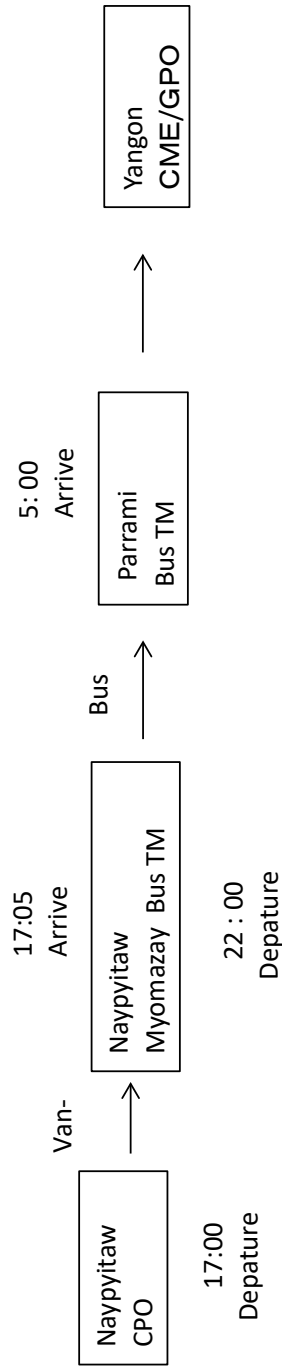

T01-3

Yangon - Pyin Ma Na (R-2/Out) / Pyin Ma Na - Mandalay (R-3/In)Sorting Due Mail ListTrain No. (1)up

Yangon Station Departure Time 04:00

No	Station Name	Train Time Arrive Departure	Post Office	Post Office Name	Amount
1	Dapain	05:00-05:05	Dapain	Yangon - Dapain	1
2	Htongyi	05:24	Htongyi	Yangon - Htongyi Yangon - Kawa	2
3	Bago	06:22	Bago	R - 2/Out - Bago Htongyi - Bago Kawa - Bago	3
4	Pyinpongyi	07:09	Pyinpongyi	Bago - Pyinpongyi	1
5	Phaungdawthi	07:41	Phaungdawthi	R-2/Out -Phaungdawthi	1
6	DeikU	08:13	DeikU	R-2/Out -DeikU	1
7	Pyuntansar	08:42	Pyuntansar	R-2/Out -Pyuntansar	1
8	Nyauglaybin	09:06	Nyauglaybin	R-2/Out -NyaugLayBin R-2/Out -ShweKyin	2
9	Painzalote	09:35	Painzalote	R-2/Out - Painzalote	1
10	Kyauktagar	10:09	Kyauktagar	R-2/Out - Kyauktagar	1
11	Penwegone	10:50	Penwegone	R-2/Out - Penwegone R-2/Out - Kyaukgyi	2
12	Kannyunkwin	11:05	Kannyunkwin	R-2/Out - Kannyunkwin	1
13	Phyu	11:58	Phyu	R-2/Out - Phyu	1
14	Zayyawadi	12:18	Zayyawadi	R-2/Out - Zayyawadi	1
15	Oaktwin	13:16	Oaktwin	R-2/Out - Oaktwin	1
16	Taungoo	14:26	Taungoo	R-2/Out - Taungoo Kannyunkwin - Taungoo Phyu - Taungoo Zayyawadi - Taungoo Oaktwin - Taungoo	5
				R-2/Out - R-2/In	1
17	Yedashe	15:13	Yedashe	R-3/Out - Yedashe Bago - Yedashe Taungoo - Yedashe	3
18	Swa	15:38	Swa	R-2/Out - Swa Taungoo - Swa	2

T01-3

19	Myohla	16:05	Myohla	R-2/Out - Myohla Taungoo - Myohla	2
----	--------	-------	--------	--------------------------------------	---

No	Station Name	Train Time Arrive Departure	Post Office	Post Office Name	Amount
20	Yeni	16:22	Yeni	R-2/Out - Yeni Taungoo - Yeni	2
21	Thawatti	16:37	Thawatti	R-2/Out - Thawatti	1
22	Ela	17:36	Ela	R-2/Out - Ela	1
23	Pyin Ma Na		Pyin Ma Na	R-2/Out - Naypyitaw R-2/Out - Pyinmana Sort R-10/In - Pyinmana Sort Taungoo - Pyinmana Sort Yeni - Pyinmana Sort Thawatti - Pyinmana Sort Alar - Pyinmana Sort Taungoo - Naypyitaw R-2/Out - R-2/IN	9
24	R-2/Out - R-3/In		Pyin Ma Na	R-2/Out - Kyitaunkkan R-2/Out - Yemethin R-2/Out - Pyawbwe R-2/Out - Pyinoolwin R-2/Out - Lashio R-2/Out - Monywa R-2/Out - Sagaing R-2/Out - Mandalay ME Taungoo - Mandalay ME R-2/Out - Thazi Sorting R-10/In - Thazi Sorting R-2/Out - R-6/Out R-2/Out - R-5/Out R-2/Out - R-3/In R-10/In - R-3/In Taungoo - R-3/In Yeni - R-3/In Thawatti - R-3/In Alar - R-3/In Yangon CME - R-3/In	21

T01-3

				R-1/In - R-3/In	
25	Kyitaunkkan	18:30	Kyitaunkkan	R-2/Out - Kyitaunkkan Pyinmana Sorting - Kyitaunkkan Naypyitaw - Kyitaunkkan(EMS) Yangon GPO - Kyitaunkkan(EMS)	4
26	Tatkone	19:33	Tatkone	R-3/In - Tatkone Naypyitaw - Tatkone	2
27	Yamethin	20:40	Yamethin	R-2/Out - Yemethin R-3/In - Yamethin Pyinmana - Yamethin(EMS) Naypyitaw - Yamethin(EMS)	4
28	Pyawbwe	21:34	Pyawbwe	R-2/Out - Pyawbwe R-3/In - Pyawbwe Naypyitaw - Pyawbwe (EMS) Yangon GPO - Pyawbwe (EMS)	4
29	Tharzi	22:43	Tharzi	R-2/Out - Tharzi Sorting R-10/In - Tharzi Sorting R-3/In - Tharzi Sorting Pyinmana Sorting - Tharzi Sorting Pyawbwe - Tharzi Sorting Nyaungyan- Tharzi Sorting	6
29	Tharzi	22:43	Tharzi	R-3/In - Tharzi Nyaungyan- Tharzi Naypyitaw - Meikthila Pyawbwe - Meikthila R-3/In - Meikthila Pyinmana - Meikthila(EMS)	6
30	Hanza	23:16	Hanza	R-3/In - Taunggyi Naypyitaw - Taunggyi	2
				R-3/In - Hanza Thazi - Hanza Thazi Sorting - Hanza	3
31	Thedaw	23:38	Thedaw	R-3/In - Thedaw R-3/In - Wundwin Naypyitaw - Wundwin(EMS)	3
32	Kume	00:38	Kume	R-3/In - Kume	1
33	Myitthar	01:00	Myitthar	R-3/In - Myitthar	1
34	Kyaukse	01:48	Kyaukse	R-3/In - Kyaukse	4

T01-3

				R-3/In - Sintkaing Pyinmana - Kyaukse(EMS) Naypyitaw - Kyaukse(EMS)	
35	Myitnge	2:47	Myitnge	R-3/In - Myitnge R-3/In - Paleik	2

36	Mandalay	03:30	Mandalay	R-2/Out - Monywa Naypyitaw - Monywa	2
				R-3/In - R-3/Out R-3/In - Shwebo R-3/In - R-6/Out R-3/In - R-5/Out Thazi Sorting - R-5/Out Pyinmana Sorting - R-5/Out R-2/Out - R-5/Out R-2/Out - R-6/Out R-2/Out - Sagaing Naypyitaw - Bhamaw Naypyitaw - Myitkyina Naypyitaw - Kawlin	12
				R-2/Out - Mandalay ME R-3/In - Mandalay ME Taungoo - Mandalay ME Yezin - Mandalay ME Pyinmana - Mandalay ME Pyinmana Sorting - Mandalay ME Naypyitaw - Mandalay ME Naypyitaw - Mandalay ME(TB) Thazi Sorting - MandalayME Taunggyi - Mandalay ME Meikthila - Mandalay ME Kyaukse - Mandalay ME Sintkaing - Mandalay ME Myitnge - Mandalay ME Paleik - Mandalay ME R-3/In - Mandalay AC Naypyitaw - Hakha Pyinmana Sorting - Magwe(TB) Pyinmana Sorting - Pakokku Taunggyi - Kyaukme Thazi Sorting - Lashio Thazi Sorting - Taungtha Thazi Sorting - Welaung Thazi Sorting - Myingyan R-3/Out - Myingyan	29

T01-3

				R-3/In - Myingyan R-2/Out - PyinOoLwin R-2/Out - Lashio Yedashe - Mandalay GPO(EMS)	
--	--	--	--	--	--

T01-3

T01\_3

Yangon - Mandalay  
Weightment DEMS Due Mail List

Train No.(3)Up

Yangon Station Departure Time 17:00

No	Station Name	Train Time Arrive Departure	Post Office	Post Office Name	Amount
1	Bago	18:45	Kyauk Se	Yangon - Bago R-1/In - Bago Pyay - Bago Yangon - Bago(EMS)	4
2	DeikU	19:55	DeikU	Yangon GPO - DeikU(EMS) Bago - DeikU	2
3	Nyaunglaybin	20:30	Nyaunglaybin	Bago - Nyaunglaybin Yangon GPO - Nyaunglaybin(EMS)	2
4	Kannyuntkwin	21:42	Kannyuntkwin	Bago - Kannyuntkwin Yangon GPO - Kannyuntkwin(EMS)	2
5	Phyu	22:08	Phyu	Bago - Phyu Yangon GPO - Phyu(EMS)	2
6	Taungoo	23:15	Taungoo	Yangoo - Taungoo Bago- Taungoo Yangoo - Taungoo(EMS) Bago - Taungoo(EMS) Kannyuntkwin - Taungoo(EMS) Phyu- Taungoo(EMS)	6
7	Alar	01:07	Alar	Yangon - Alar(EMS)	1
8	Pyin Ma Na	01:27	Pyin Ma Na	Yangon - Pyin Ma Na Sorting Yangon - Pyin Ma Na Yangon - YeZin Yangon - Naypyitaw Yangon - Naypyitaw(TB) Yangon - Naypyitaw(RB) Taungoo - Naypyitaw Bago - Naypyitaw R-1/In - Pyinmana Sorting Taungoo - Naypyitaw(EMS) Bago - Naypyitaw (EMS)	14



## T01-3

				Yangon GPO - Naypyitaw (EMS) Yangon GPO - Kyitaunkkan(EMS) Taungoo - Pyinmanna(EMS)	
9	Tatkone	02:47	Tatkone	Yangon - Tatkone Yangon GPO - Tatkone(EMS) Naypyitaw - Tatkone(EMS)	3

10	Yamethin	03:34	Yamethin	Yangon - Yamethin Yangon GPO - Yamethin(EMS) Naypyitaw - Yamethin(EMS) Pyinmana - Yamethin(EMS)	4
11	Pyawbwe	04:08	Pyawbwe	Yangon GPO - Pyawbwe(EMS) Naypyitaw - Pyawbwe(EMS)	2
12	Tharzi	04:55	Tharzi	Yangon - Tharzi Sorting R-1/In - Tharzi Sorting Yangon - Taunggyi Yangon - Meikthila Yangon - Bahtoo Yangon - Kalaw Yangon GPO - Tharzi(EMS) Naypyitaw - Tharzi(EMS) Naypyitaw - Meikthila(EMS) Yangon GPO - Meikthila(EMS)	10
13	Thedaw	05:30	Thedaw	Yangon GPO - Thedaw(EMS) Naypyitaw - Thedaw(EMS) Yangon GPO - Wundwin(EMS) Naypyitaw - Wundwin (EMS)	4
14	Myitthar	06:17	Myitthar	Yangon GPO - Myitthar (EMS) Naypyitaw - Myitthar (EMS)	2
15	Kyaukse	04:03	Kyaukse	Yangon GPO - Kyaukse (EMS) Naypyitaw - Kyaukse (EMS) Yangon GPO - Sintking (EMS) Naypyitaw - Sintking (EMS)	4
17	Mandalay	07:45	Mandalay	Yangon - Mandalay ME Yangon - Mandalay ME(TB) Yangon - Mandalay ME(CB)	20

T01-3

				Yangon - Sagaing Yangon - Monywa Yangon - Shwebo Yangon - Katha Yangon - Bhamaw Yangon - R-5/Out Yangon - R-6/out Yangon - Pyinoolwin Yangon - Zeebingyi Yangon - Myingyan	
--	--	--	--	---	--

				Bago - Mandalay(TB) Tatkone - Mandalay Pyinmana Sorting - Mandalay Yamethin - Mandalay R-1/In - Mandalay R-1/In - R-5/Out R-10/In - R-6/out	
	Mandalay	07:45	Mandalay	Tharzi - Mandalay(EMS) Meikthila - Mandalay(EMS) Thedaw - Mandalay(EMS) Wundwin - Mandalay(EMS) Kyaukse - Mandalay(EMS) Sintking - Mandalay(EMS) Taungoo - Mandalay(EMS) Pyinmana - Mandalay(EMS) Tatkone - Mandalay(EMS) Yamethin - Mandalay(EMS) Pyawbwe - Mandalay(EMS) Deiku - Mandalay(EMS) Bago - Mandalay(EMS) Nyaunglabin - Mandalay(EMS) Taungoo - Mandalay(EMS) Phyu - Mandalay(EMS) Alar - Mandalay(EMS) Naypyitaw - Hopin(EMS) Naypyitaw - Mohnyin(EMS) Naypyitaw - Mogaung(EMS)	57

				<p>Naypyitaw - Myitkyina(EMS)  Naypyitaw - Waingmaw(EMS)  Naypyitaw - Kawlin(EMS)  Naypyitaw - Katha(EMS)  Naypyitaw - Indaw(EMS)  Naypyitaw - Kantbalu(EMS)  Naypyitaw - Khin U(EMS)  Naypyitaw -Yeu(EMS)  Naypyitaw - Myinmu(EMS)  Naypyitaw - Chaung U(EMS)  Yangon GPO - Hopin(EMS)  Yangon GPO - Mohnyin(EMS)  Yangon GPO - Mogaung(EMS)  Yangon GPO - Myitkyina(EMS)  Yangon GPO - Waingmaw(EMS)  Yangon GPO - Kawlin(EMS)  Yangon GPO - Katha(EMS)</p>	
	Mandalay	07:45	Mandalay	<p>Yangon GPO - Indaw(EMS)  Yangon GPO - Kantbalu(EMS)  Yangon GPO - Khin U(EMS)  Yangon GPO -Yeu(EMS)  Yangon GPO - Myinmu(EMS)  Yangon GPO - Chaung U(EMS)  Yangon GPO - Wuntho(EMS)  Yangon GPO - Wetlet(EMS)  Yangon GPO - Moemate(EMS)  Yangon GPO - Myingyan(EMS)  Hpaan - Mandalay (EMS)  Twante - Mandalay (EMS)  Pathein - Mandalay (EMS)  Hinthada - Mandalay (EMS)  Myaungmya - Mandalay (EMS)  Warkema - Mandalay (EMS)  Pyapon - Mandalay (EMS)  Maubin - Mandalay (EMS)  Mawlamyaing - Mandalay (EMS)  Sittwe - Mandalay (EMS)</p>	

Mandalay- Pyin Ma Na (R-3/Out)Pyin Ma Na - Yangon (R-2/In)Sorting Due Mail ListTrain No. (2)Dn

Mandalay Station Departure Time 8:30

No	Station Name	Train Time Arrive Departure	Post Office	Post Office Name	Amount
1	MyitNge	09:00	MyitNge	MyitNge/ Paleik	2
2	Kyauk Se	10:00	Kyauk Se	Kyauk Se	1
3	MyitTha	10:48	MyitTha	MyitTha	1
4	Ku Me	11:10	Ku Me	Ku Me	1
5	The Daw	12:14	The Daw	The Daw/Wundwuin	2
6	Han Za	12:45	Han Za	Han Za	1
7	ThaZi	13:19	ThaZi	R-3/Out - Taungyi R-3/Out - MeikHtiLa R-3/Out - MyinGyan R-3/Out - ThaZi Sorting Han Za - ThaZi Sorting Han Za - ThaZi MyinGyan - R-3/In	7
8	NyaugYan	13:50	NyaugYan	ThaZi Sorting - NyaugYan ThaZi - NyaugYan	2
9	PyawBwe	14:45	PyawBwe	R-3/Out - PyawBwe ThaZi Sorting - PyawBwe	2
10	YaMeThin	15:37	YaMeThin	R-3/Out - YaMeThin	1
11	Tatkon	16:46	Tatkon	R-3/Out - Tatkon	1
12	KyiDaungGan	17:49	KyiDaungGan	R-3/Out - KyiDaungGan	1
13	Pyin Ma Na	18:45	Pyin Ma Na	R-3/Out - NayPyiTaw R-3/Out - R-3/In R-3/Out - PyinMaNa Sort R-5/In - PyinMaNa Sort ThaZi Sort - PyinMaNa Sort Pakokku - PyinMaNa Sort KyiDaungGan-PyinMaNa Sort	9

T01-4

				KyiDaungGan-Yangon(E) KyiDaungGan- NayPyiTaw(E)	
14	R-3/Out - R-2/In	18:45	Pyin Ma Na	Mandalay - R-2/In R-5/In - R-2/IN R-6/In - R-2/In PyinOoLwin- R-2/In Lashio- R-2/In Sagaing- R-2/In MonYwa- R-2/In ThaZi Sorting - R-2/In PyawBwe - R-2/In YaMeThin - R-2/In KyiDaungGan - R-2/In R-3/Out - R-2/In R-3/Out - Ela R-3/Out - ThaWatti R-3/Out - Yeni R-3/Out - TaungGoo R-3/Out - R-1/Out R-3/Out - R-10/Out R-3/Out - Yangon ThaZi Sorting - R-1/Out ThaZi Sorting - R-10/Out ThaZi Sorting - Yangon Mandalay - YeDaShe(E)	23
15	Ela	19:20	Ela	R-3/Out - Ela PyinMaNa Sort - Ela	2
16	ThaWatti	19:45	ThaWatti	R-3/Out - ThaWatti PyinMaNa Sort - ThaWatti	2
17	Yeni	19:58	Yeni	R-3/Out - Yeni PyinMaNa Sort - Yeni	2
18	MyoHla	20:15	MyoHla	R-2/In - MyoHla	1
19	Swa	20:42	Swa	R-2/In - Swa	1
20	YeDaShe		YeDaShe	R-2/In - YeDaShe NayPyiTaw - YeDaShe (E)	3

## T01-4

				Mandalay - YeDaShe(E)	
21	TaungGoo	21:55	TaungGoo	R-2/In -TaungGoo R-3/Out -TaungGoo Yeni-TaungGoo MyoHla-TaungGoo Swa-TaungGoo YeDaShe-TaungGoo PyinMaNa Sort-TaungGoo NayPyiTaw -TaungGoo NayPyiTaw -TaungGoo(E)	9
22	OkTwin	22:29	OkTwin	R-2/In -OkTwin TaungGoo - OkTwin	2
23	ZayYaWadi	23:55	ZayYaWadi	R-2/In -ZayYaWadi TaungGoo - ZayYaWadi	2
24	Phyu	00:35	Phyu	R-2/In -Phyu TaungGoo - Phyu NayPyiTaw -Phyu(E)	3
25	KaNyutKwin	01:13	KaNyutKwin	R-2/In -KaNyutKwin TaungGoo - KaNyutKwin	2
26	PeNweGone		PeNweGone	R-2/In -PeNweGoneKyaukGyi - PeNweGone	2
27	KyaukTaGar	02:03	KyaukTaGar	R-2/In -KyaukTaGar	1
28	PainZaLoke	02:26	PainZaLoke	R-2/In -PainZaLoke	1
29	NyaugLayBin	02:55	NyaugLayBin	R-2/In -NyaugLayBin R-2/In -ShweKyin NayPyiTaw-NyaugLayBin (E)	3
30	PyunTaSa	03:15	PyunTaZa	R-2/In -PyunTaSa	1
31	DeikU	03:40	DeikU	R-2/In -DeikU	1
32	PhaungDawThi	04:11	PhaungDawThi	R-2/In -PhaungDawThi	1
33	Bago	05:30	Bago	R-2/In -Bago R-2/In -Bago(TB) YeDaShe -Bago YeDaShe -Bago(E) Phyu -Bago	17

				TaungGoo -Bago NyaugLayBin -Bago DeikU -Bago DeikU -Bago(E) PyinPonGyi -Bago	
				OkTwin-Bago KaNyutKwin-Bago KyaukTaGar-Bago R-2/In - R-10/Out R-3/Out - R-10/Out ThaZi Sorting - R-10/Out PyinMaNa Sort - R-10/Out	
34	Bago(AC)	05:30	Bago	R-2/In -Bago(AC/TB) 📌 1) Yeni 2) MyoHla 3) Swa 4) TharGaYa 5) OkTwin 6) ZayYaWadi 7) KaNyutKwin 8) PeNweGone 9) KyaukGyi 10)KyaukTaGar 11)PainZaLoke 12)PyunTaZa 13)PhaungDawThi	13
35	Yangon	08:30	Yangon	R-2/In -LatPaDan Sort R-2/In - R-1/Out R-3/Out - R-1/Out ThaZi Sorting - R-1/Out PyinMaNa Sort - R-1/Out Bago - R-1/Out R-2/In - R-2/Out R-2/In - Yangon R-3/Out - Yangon	11

T01-4

				DarPain - Yangon ThaZi Sorting - Yangon	
--	--	--	--	--	--



**Mandalay- Yangon**  
**Weightment DEMS Due Mail List**

**Train No.(4)Dn**

**Mandalay Station Departure Time 17:00**

No	Station Name	Train Time Arrive Departure	Post Office	Post Office Name	Amount
1	Kyauk Se	17:59	Kyauk Se	Mandalay - Kyauk Se Mandalay - SinGaing Mandalay - KyaukSe(E)	3
2	MyitTha	18:22	MyitTha	Mandalay - MyitTha(E)	1
3	The Daw	19:12	The Daw	Mandalay -The Daw(E) Mandalay -Wundwuin(E)	2
4	ThaZi	19:46	ThaZi	Mandalay -ThaZi Sort Mandalay - TaungGyi R-5/ In - ThaZi Sorting Mandalay - MeikHtilaMandalay - MeikHtilaE) Mandalay - ThaZi(E)	6
5	YaMeThin	21:08	YaMeThin	YaMeThin - NayPyiTaw(E) YaMeThin - Yangon(E) YaMeThin - Yangon	3
6	Tatkon	21:59	Tatkon	Tatkon - NayPyiTaw(E) Tatkon - Yangon(E) Tatkon - Yangon	3
7	NayPyiTaw	22:48	-	-	-
8	Pyin Ma Na	23:15	Pyin Ma Na	Mandalay - YeZin Mandalay - Pyin Ma Na Mandalay - NayPyiTaw Mandalay - NayPyiTaw(TB) Mandalay - PyinMaNa Sort MyitKyiNa - NayPyiTaw	32

T01-4

				MyitKyina - NayPyiTaw(E) MoeGaung - NayPyiTaw(E) WineMaw - NayPyiTaw(E) KawLin - NayPyiTaw(E) InDaw - NayPyiTaw(E) KanBalu - NayPyiTaw(E) KhinU - NayPyiTaw(E) MyinMu - NayPyiTaw(E)	
--	--	--	--	---	--

				ChaungOO - NayPyiTaw(E) KaTha - NayPyiTaw(E) YeU - NayPyiTaw(E) ThaZi - NayPyiTaw(E) MeikHtiLa - NayPyiTaw(E) MonWya - NayPyiTaw(E) Mandalay - NayPyiTaw(E) KyaukSe - NayPyiTaw(E) SinGaing - NayPyiTaw(E) TheDaw - NayPyiTaw(E) WunDwin - NayPyiTaw(E) PhawBwe- NayPyiTaw(E) YeMeThin - NayPyiTaw(E) TatKon - NayPyiTaw(E) KyunHla - NayPyiTaw(E) ZeBinGyi - NayPyiTaw(E) TaungGyi - NayPyiTaw(E) YeMeThin - PyinMaNa(E)	
9	Ela	23:36	Ela	NayPyiTaw - Ela(E)	1
10	TaungGoo	01:07	TaungGoo	NayPyiTaw - TaungGoo NayPyiTaw - TaungGoo(E) PyinMaNa - TaungGooPyinMaNa - TaungGoo(E) Mandalay - TaungGoo Mandalay - TaungGoo(E)	6
11	Phyu	02:29	Phyu	TaungGoo - Phyu(E)	4

T01-4

				NayPyiTaw - Phyu (E) PyinMaNa - Phyu(E) Mandalay- Phyu(E)	
12	KaNyutkwin	02:53	KaNyutkwin	TaungGoo - KaNyutkwin (E)	1
13	KyaukTaGar	03:27	KyaukTaGar	NayPyiTaw - KyaukTaGar (E) PyinMaNa - KyaukTaGar (E)	2
14	PainZaLoke	03:45	-	-	-
15	NyaungLayBin	04:03	NyaungLayBin	NayPyiTaw-NyaungLayBin(E) PyinMaNa - NyaungLayBin(E) Mandalay- NyaungLayBin(E)	3
16	PyunTaSa	04:20			
17	DeikU	04:37	DeikU	NayPyiTaw- DeikU(E) Mandalay- DeikU (E)	2

18	Bago	04:56	Bago	DeikU - Bago NyaungLayBin - Bago Phyu - Bago TaungGoo - Bago Mandalay - Bago NayPyiTaw - Bago Mandalay - Bago (TB) KyaukTaGar - Bago KaNyutkwin - Bago PyinMaNa - Bago Mandalay - Bago NayPyiTaw - Bago MeikTiLar - Bago TaungGoo - Bago	14
19	Yangon(MB)	07:45	Yangon	R-5/In - R-1/Out Madalay- R-1/Out MeikTiLar-Yagon TaungGyi -Yagon Bahtu -Yagon KaLaw -Yagon YaMeThin -Yagon	29

T01-4

				<p>TatKon -Yagon  NayPyiTaw -Yagon  NayPyiTaw -Yagon (TB)  NayPyiTaw - Yangon (RB)  YeZin -Yagon  PyinMaNa -Yagon  PyinMaNa Sort -Yagon  PyinMaNa Sort - R-1Out  TaungGoo - Yagon  Bago - Yagon  Bago - R-1Out  Bago - Pyay  Mandalay - Yangon(TB)  Mandalay - Yangon(CB)  Mandalay - Yangon  MonWya - Yangon</p>	
--	--	--	--	---	--

19	Yangon(MB)			<p>Sagaing - Yangon  Bamo - Yangon  Katha - Yangon  ShweBo - Yangon  R-6/In - Yangon  R-5/In - Yangon</p>	
20	Yangon(EMS)	07:45	Yangon	<p>Mandalay- Hpa An  Mandalay- Pathein  Mandalay- TonTail  Mandalay- HinThaTa  Mandalay- MyaungMya  Mandalay- MawlaMyaing  Mandalay- MaAhuBin  Mandalay- WarKhelMa  Mandalay- PharPone  Mandalay- Sittwe  ThiBaw- Yangon</p>	51

				Hopin- Yangon InDaw- Yangon KawLin- Yangon MoGoke- Yangon KyatPyin- Yangon YeU- Yangon KhinU- Yangon KyineTone - Yangon TarChiLake- Yangon WineMaw- Yangon MyinMu- Yangon KyaukSe- Yangon SinGaing- Yangon MyitThar- Yangon WunDwin- Yangon TheDaw- Yangon TarZi- Yangon MeikTiLar- Yangon PyawBwe- Yangon YaMeThin- Yangon TatKon- Yangon KyeetaungKan- Yangon	
20	Yangon(EMS)	07:45		PyinMaNa- Yangon Yezin- Yangon NayPyiTaw- Yangon Elar - Yangon TaungGoo - Yangon KaNyutKwin- Yangon Phyu- Yangon KyaukTaGar- Yangon NyaungLayBin- Yangon DeikU- Yangon LeWei- Yangon TaungGoo - PaThein TaungGoo - HinThaTa	

T01-4

				TaungGoo - PharPone TaungGoo - MyaungMya TaungGoo - MaAhuBin Bago - Yangon Bago - Pyay	
--	--	--	--	--	--

Mandalay- MyitKyinaMandalay- KawLin (R-5/OUT) .KawLin- MyitKyina (R-6/OUT)Sorting Due Mail ListTrain No.(57)UPMandalay Station

No	Station Name	Train Time Arrive Departure	Post Office	Post Office Name	Amount
1	Sagaing	09:46	Sagaing	R-2/Out - Sagingaig, Yangon -Saggaing	2
2	ShweBo	11:53	ShweBo	R-5/Out -ShweBo, R-3/In -ShweBo, Saggaing -ShweBo, Mandalay - ShweBo, Yangon-ShweBo	5
3	KhinU	12:34	KhinU	R-5/Out -KhinU, R-5/Out- YeeU Mandalay - KhinU, Yangon- KhinU MonYwar- KhinU Mandalay - YeeU Yangon - YeeU MonYwar- YeeU	8
4	KanBalu	13:58	KanBlau	R-5/Out -KanBalu Mandalay-KanBalu Yangon-KanBalu MonYwar-KanBalu	4
5	KhunHla	14:25	KhunHla	R-5/Out -KhunHla Mandalay- KhunHla Yangon - KhunHla MonYwar- KhunHla	4
6	KoeHtaugBoe	16:14	KoeHtau ngBoe	R-5/Out -KoeHtaingBoe	1
7	R-5/Out			R-5/Out-R-5/In R-5/Out-R-5/In	2

T01-4

8	KawLin	16:40	KawLin	R-5/Out-KawLin R-5/Out-PinLeBu KoeHtaungBoe-KawLin Mandalay-KawLin Yangon-KawLin NayPyiTaw-KawLin	7
---	--------	-------	--------	--	---

9	R-6/Out			MonYwar - KawLin R-5/Out - WinTho R-5/Out-Bhanmaw R-5/Out-Kathar R-5/Out-MyitKyiNar R-5/Out- R-6/Out R-2/Out- R-6/Out R-3/In- R-6/Out KoeHtaungBoe - R-6/Out Yagon- R-6/Out Mandalay-R-6/Out Mandalay- MyitKyiNar Yangon- MyitKyiNar NayPyiTaw - MyitKyiNar Mandalay-Kathar Sagaing-Kathar Yangon-Kathar Yangon-BanMaw NayPyiTaw-BanMaw	18
---	---------	--	--	---	----



T01-4

				Mandalay - MoeNyin(E) Mandalay - MoeGaung(E) Mandalay - HoPin(E) Mandalay - MyitKyiNa(E) Mandalay - InTaw(E) Mandalay - KaTha(E) Mandalay - WinTho(E) Yangon - WinTho(E) MonYwar - WinTho(E) Yangon - MyitKyiNa(E) Yangon - MoeNyin(E) Yangon - MoeGaung(E) Yangon - HoPin(E) Yangon - WineMaw(E) Yangon - KaTha(E) Yangon - InDaw(E)	16
--	--	--	--	--	----

T01-4

10	WunTho	17:18		R-5 Out- Wuntho Yangon- Wuntho Mandalay- Wuntho NayPyiTaw- Wuntho MonYwa- Wuntho	5
11	MeZa	19:46		R-6 Out - MeZa	1
12	InDaw	20:24		R-6 Out - InDaw R-6 Out - BanMauk MeZa - InDaw Yangon - InDaw(E) Mandalay - InDaw(E)	5
13	R-22 In		NaBa	Yangon - KaTha Yangon - Bamo Mandalay - KaTha Sagging - KaTha InDaw - KaTha R-5 Out - KaTha R-5 Out - Bamo R-6 Out - Bamo R-6 Out - ShweKu R-6 Out - KaTha R-6 Out - NaBa Yangon - KaTha(E) Mandalay - KaTha(E) NaPyiTaw - Bam(E)	14
14	MawLu	22:22		R-6 Out - MawLu	1
15	NantSiAung	22:47	NantSiAung	R-6 Out - NantSiAung	1
16	MawHan	23:09	MawHan	R-6 Out - MawHan	1
17	MohNyin	00:20	MohNyin	R-6 Out - MohNyin Yangon - MohNyin (E) Mandalay - MohNyin (E) NaPyiTaw - MohNyin (E)	4
18	NanMar	00:54	NanMar	R-6 Out - NanMar	1
19	HoPin	01:25	HoPin	R-6 Out - HoPin Yangon - HoPin (E)	3

T01-4

				Mandalay - HoPin (E)	
20	PinBaw	02:07	PinBaw	R-6 Out - PinBaw	1
21	MoGaung	03:34	MoGaung	R-6 Out - MoGaung R-6 Out - SahMaw Yangon - MoGaung (E) Mandalay - MoGaung (E) NaPyiTaw - MoGaung (E)	5
22	NaMTi	03:56	NaMTi	R-6 Out - NaMTi R-6 Out - MaYan	2
23	MyitKyiNa	05:40	MyitKyiNa	R-5 Out - MyitKyiNa ShweKu - MyitKyiNa Bamo - MyitKyiNa R-6 Out - MyitKyiNa Yangon - MyitKyiNa Mandalay - MyitKyiNa NaPyiTaw - MyitKyiNa Yangon - MyitKyiNa(E) Mandalay - MyitKyiNa(E) NaPyiTaw - MyitKyiNa(E) Yangon - WineMaw(E) TaungGyi - MyitKyiNa(E) Lashio - MyitKyiNa(E) PyinOoLwin - MyitKyiNa(E) MoGaung - MyitKyiNa(E) HoPin - MyitKyiNa(E) MohNyin - MyitKyiNa(E)	17

Mandalay- MonYwa(MailGuard) (123)Due Mail ListTrain No (123)Up**Mandalay Station**

No	Station Name	Train Time Arrive Departure	Post Office	Post Office Name	Amount
1	SagGaing	06:30	SagGaing	Mandalay - SagGaing	1
2	YwaHtaung	06:39	YwaHtaung	Mandalay - YwaHtaung	1
3	YwaThitGyi	07:48	YwaThitGyi	Mandalay - YwaThitGyi R-5 In - YwaThitGyi SagGaing - YwaThitGyi	3
4	NyaungPinWine	08:19	NyaungPinWine	SagGaing - NyaungPinWine	1
5	MyinMu	08:51	MyinMu	Mandalay - MyinMu R-5 In - MyinMu SagGaing -MyinMu SagGaing -Myaung Yangon - MyinMu(E) Mandalay - MyinMu(E) NaPyiTaw - MyinMu(E)	7
6	ChaungU	10:18	ChaungU	Mandalay - ChaungU R-5 In - ChaungU SagGaing - ChaungU Yangon - ChaungU(E) Mandalay - ChaungU(E) NaPyiTaw - ChaungU(E)	6
7	MonWya	11:35		Yangon - MonWya NayPyiTaw - MonWya Mandalay - MonWya R-2Out - MonWya R-5 In- MonWya SagGaing- MonWya	22

T01-4

				<p>R-5 In - MonWya(AC/TB)</p> <p>YwaThitGyi- MonWya</p> <p>MyinMu- MonWya</p> <p>Chaung U - MonWya</p> <p>Chaung U - MonWya(E)</p> <p>MyinMu - MonWya(E)</p> <p>Yangon - MonWya</p> <p>NayPyiTaw - MonWya</p>	
				<p>Mandalay - MonWya (E)</p> <p>KantBaLu - MonWya (E)</p> <p>KyunHla - MonWya (E)</p> <p>WetLet - MonWya (E)</p> <p>WunTho - MonWya (E)</p> <p>InDaw - MonWya (E)</p> <p>KaYha - MonWya (E)</p> <p>KawLin - MonWya (E)</p>	

Yangon General POST OFFICE Kessoku Diagram

	0	1	2	3	4	5	6	7	8	9	10	11	12	13	14	15	16	17	18	19	20	21	22	23	0
Ordinary Delivery										30			30	0			30								
DEMS Delivery										30			30	0			30								
Area Post Pickup																									
P.O Counter and near Post										30							0								
Transportation Arr/Dep																									
CME/GPO																									
Transportation Arr/Dep																									

Mayangone POST OFFICE Kessoku Diagram

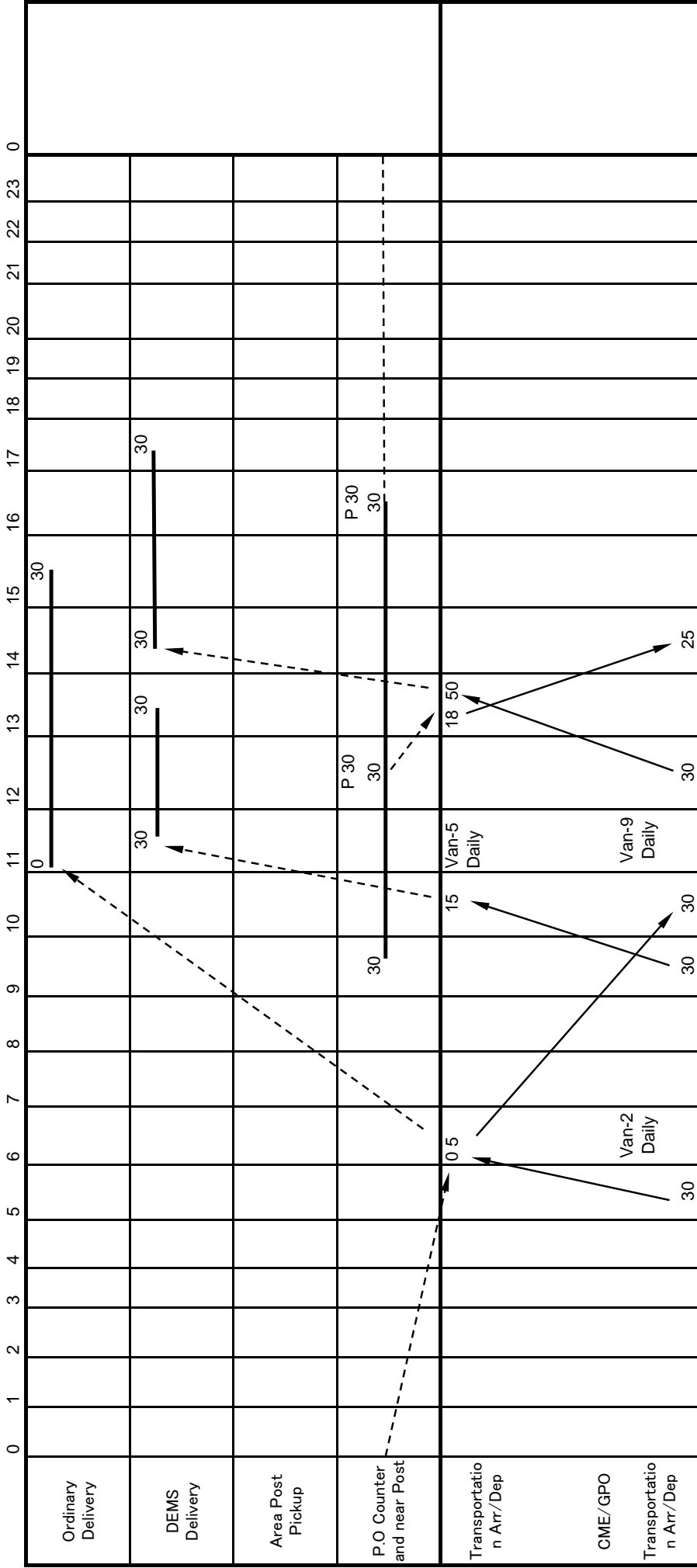

Buddha UC POST OFFICE Kessoku Diagram

	0	1	2	3	4	5	6	7	8	9	10	11	12	13	14	15	16	17	18	19	20	21	22	23	0
Ordinary Delivery										30	15														
DEMS Delivery																									
Area Post Pickup																									
P.O Counter and near Post										15	15		P.O				30								
Transportation Arr/Dep										15			15												
Mayangone P.O																									
Transportation Arr/Dep										0															

DEMS SPECIAL DELIVERY BY Mayangone

Postmaster only 1 Operation(transportation.Delivery.Counter)



Sawbwaryigone POST OFFICE Kessoku Diagram

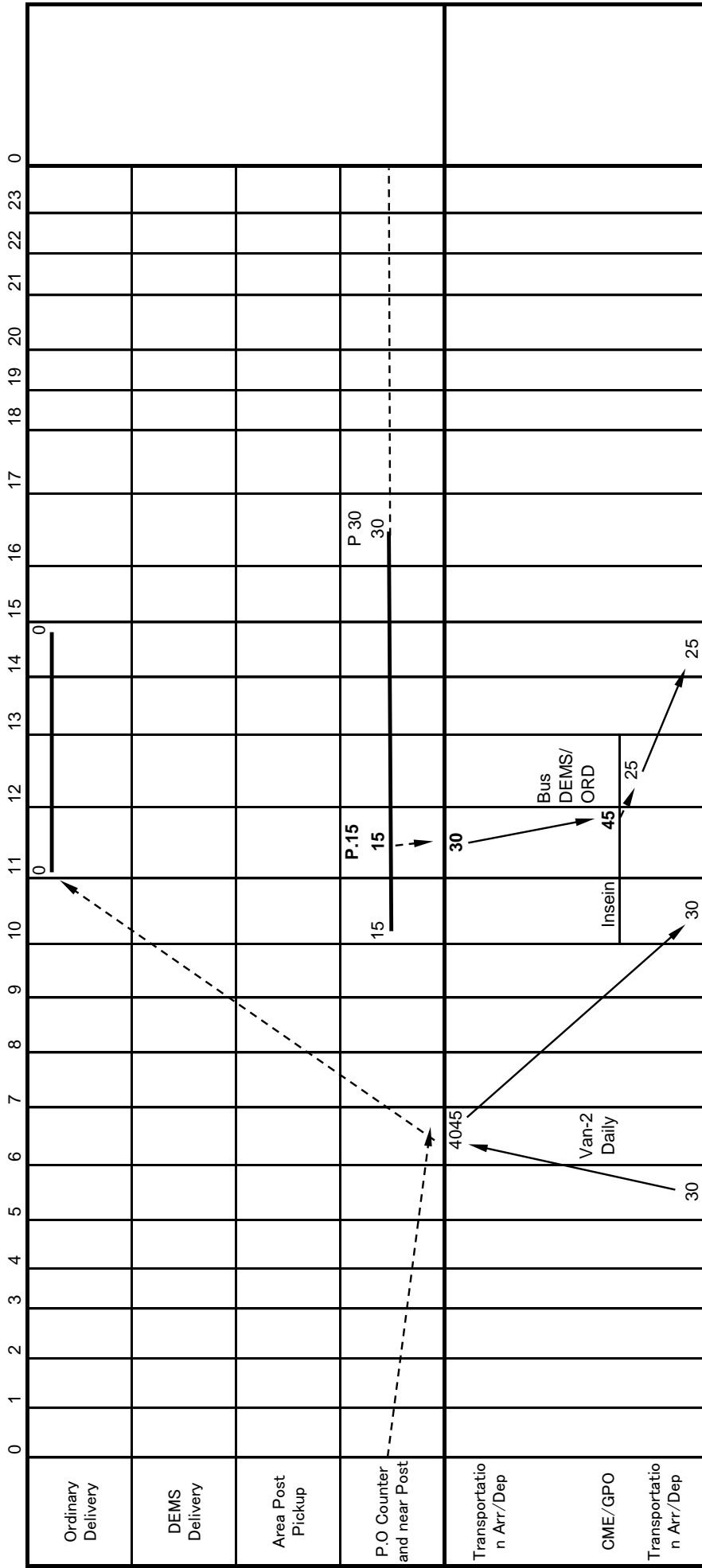

DEMS SPECIAL DELIVERY BY Insein

Sawbwaryigone P.O → Insein P.O  
11:45 → 12:00

Insein POST OFFICE Kessoku Diagram

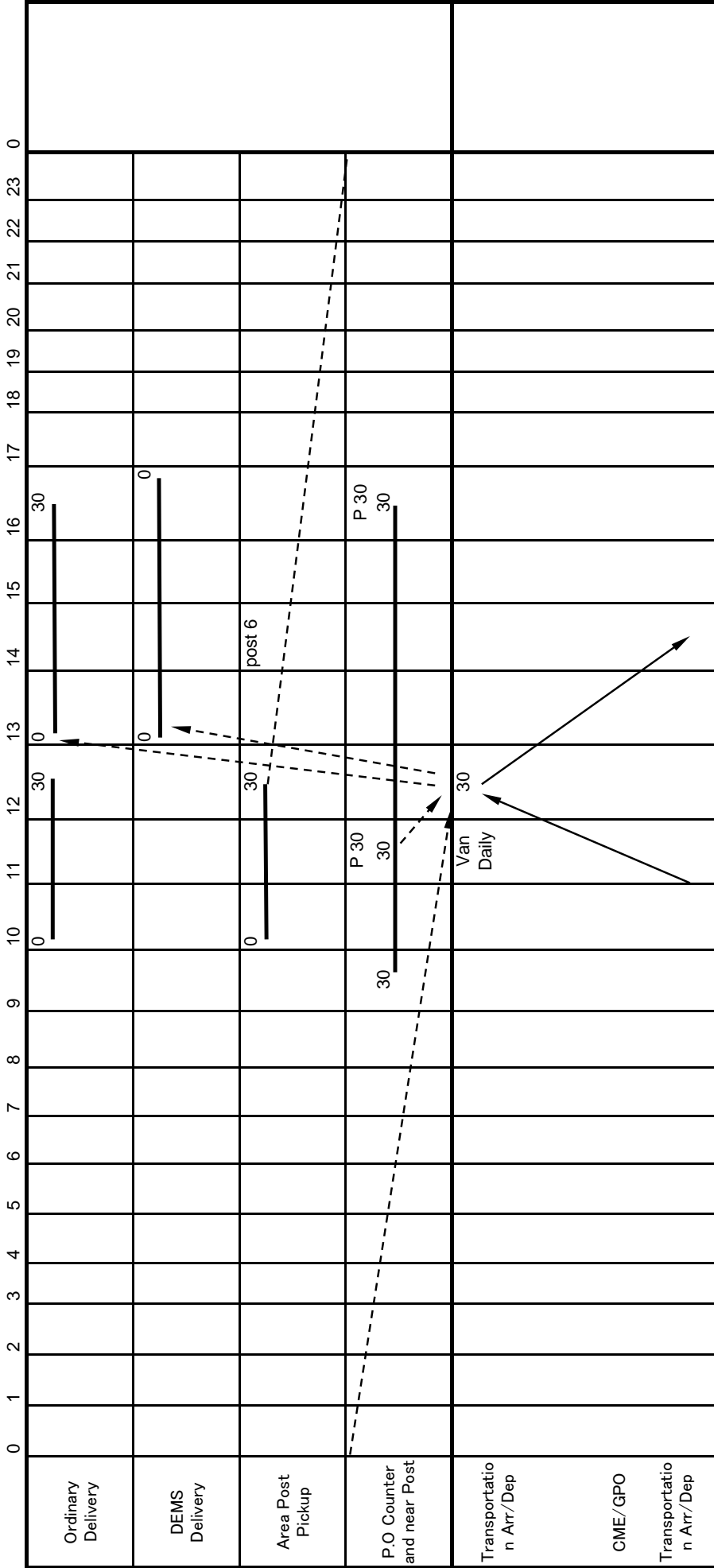

Aungsan POST OFFICE Kessoku Diagram

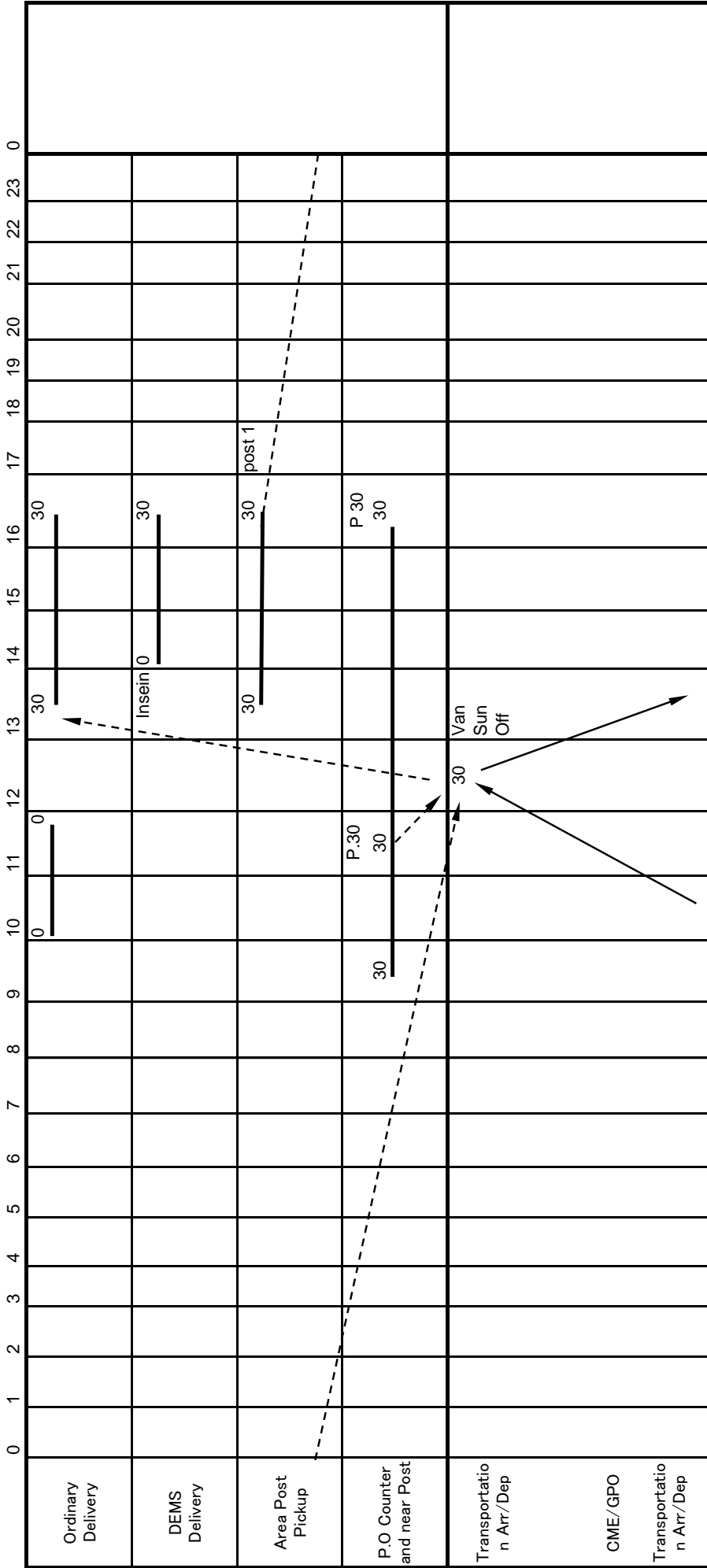

DEMS SPECIAL DELIVERY BY Insein

Ygn West U C POST OFFICE Kessoku Diagram

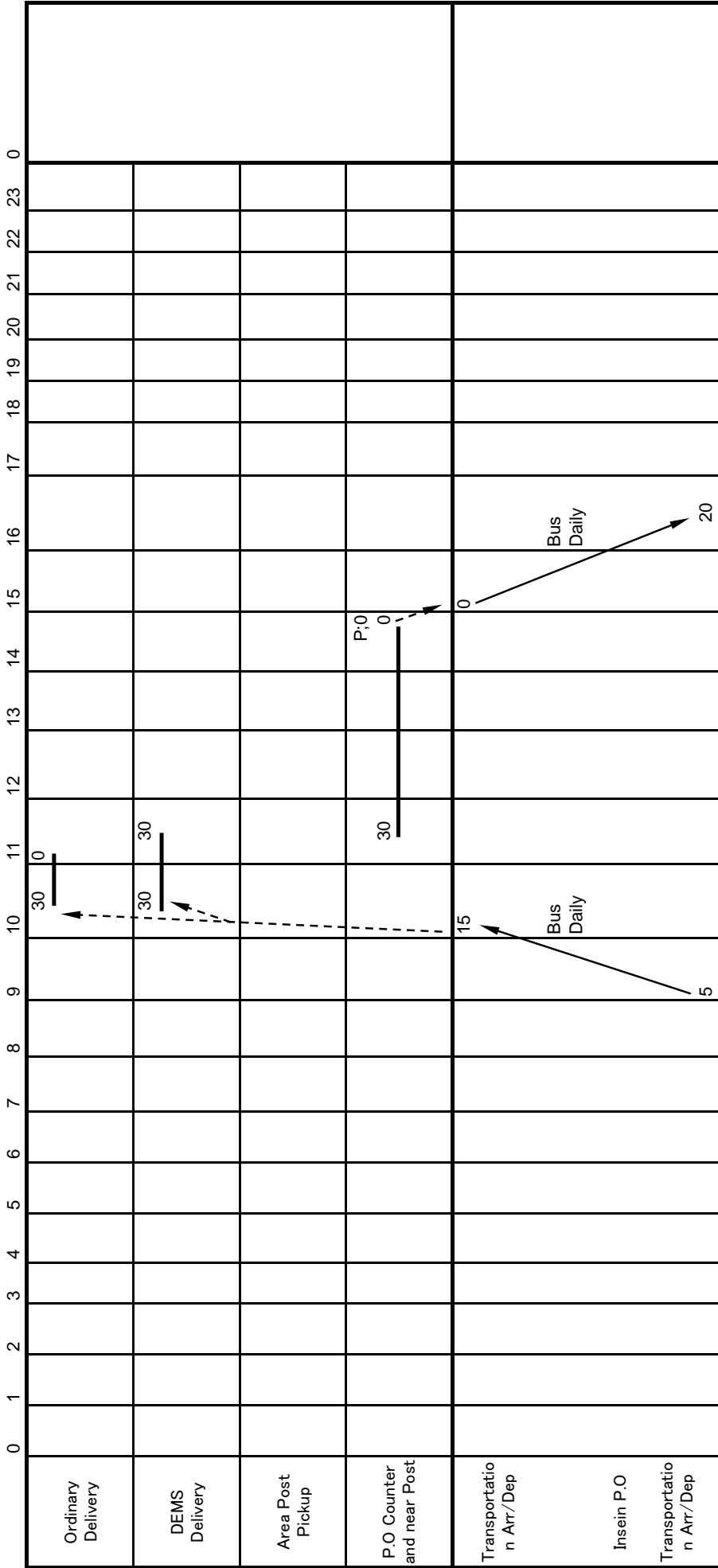

Ygn West U C P.O (POMaster Home) → 10:15 ← 15:00 →

Ygn West U C Bus (7:55) → 10:10 ← 15:05 →

Insein Bus (8:55) → 9:10 ← 16:15 →

Insein P.O (9:00) → 9:05 ← 16:20 →

Postmaster only 1 Operation(transportation.Delivery.Counter)

Shwepyithar POST OFFICE Kessoku Diagram

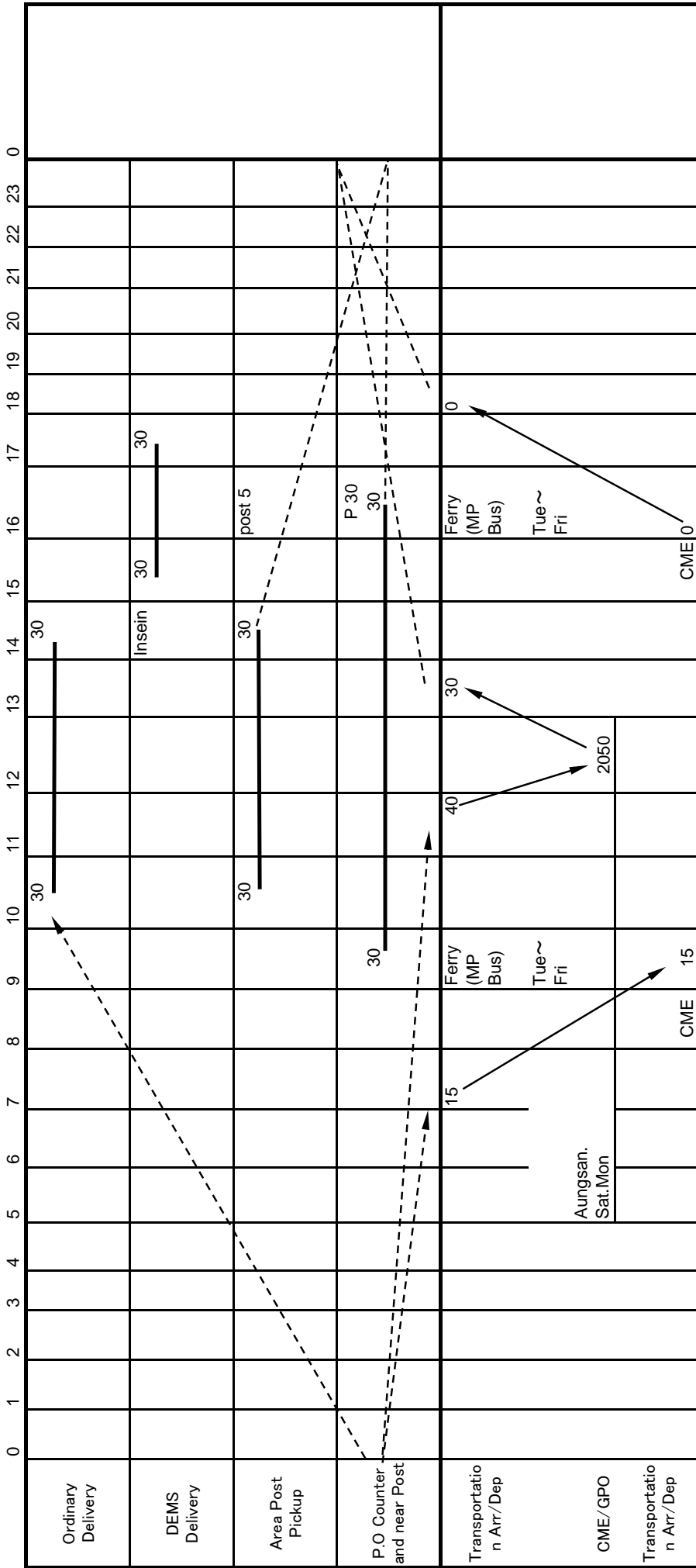

DEMS SPECIAL DELIVERY BY Insein

Mingalardon POST OFFICE Kessoku Diagram

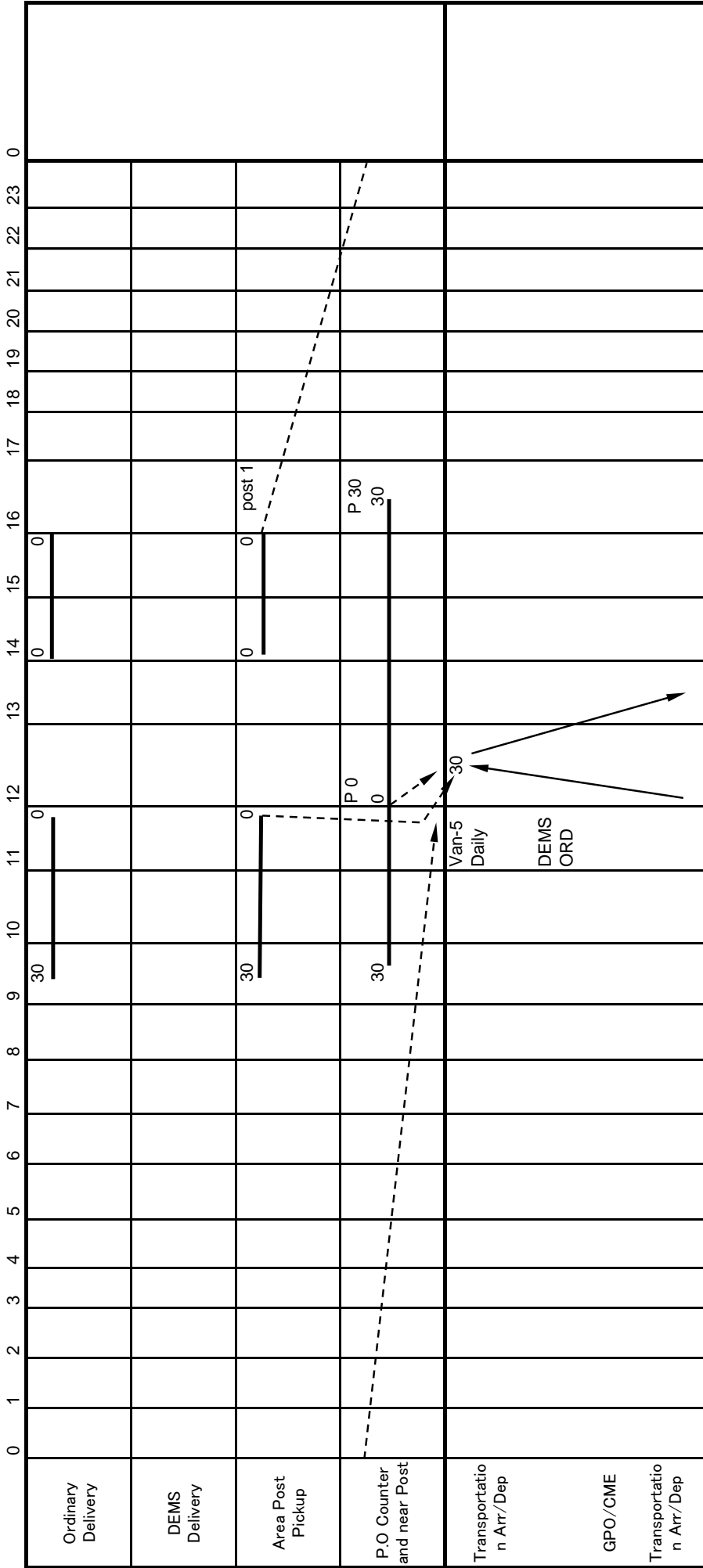

Palemthit POST OFFICE Kessoku Diagram

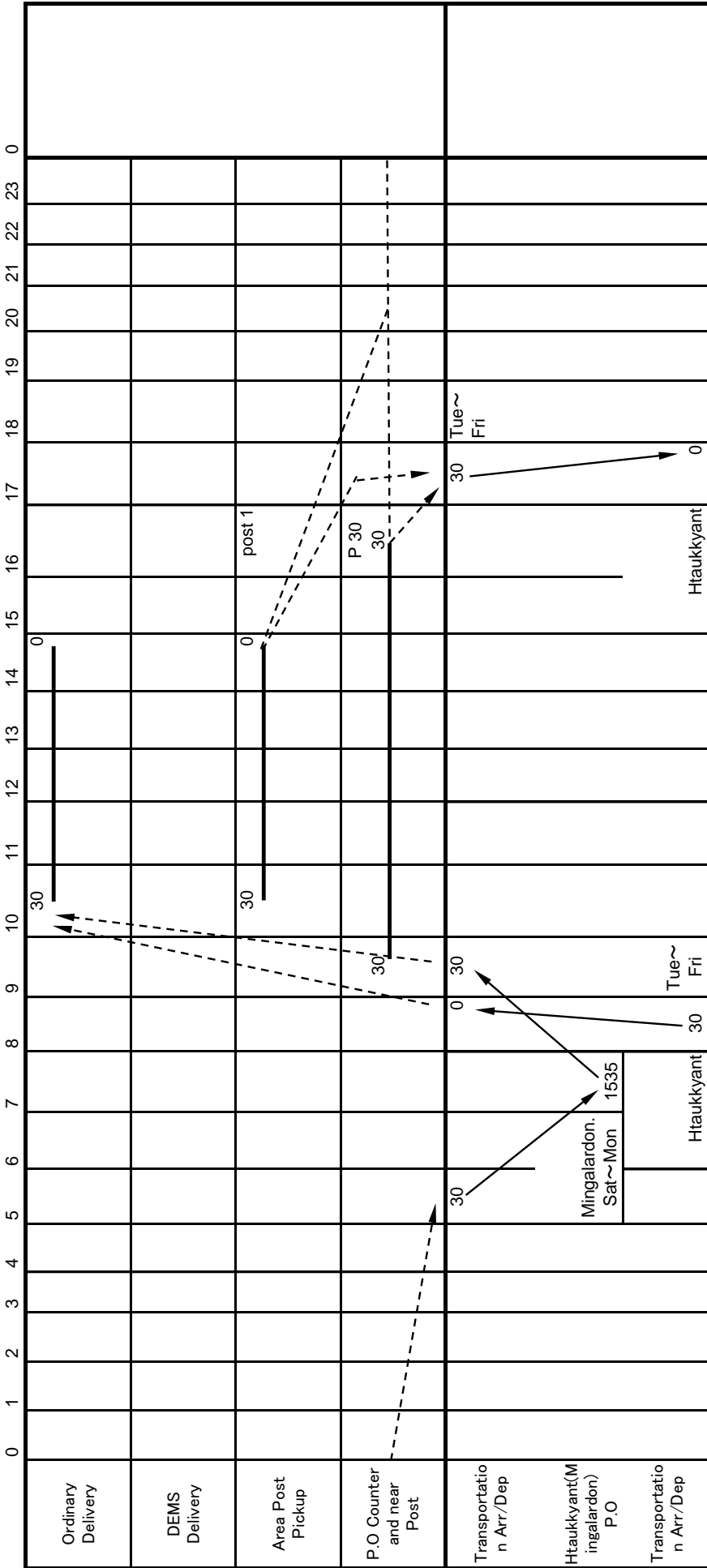

Htaukyant POST OFFICE Kessoku Diagram

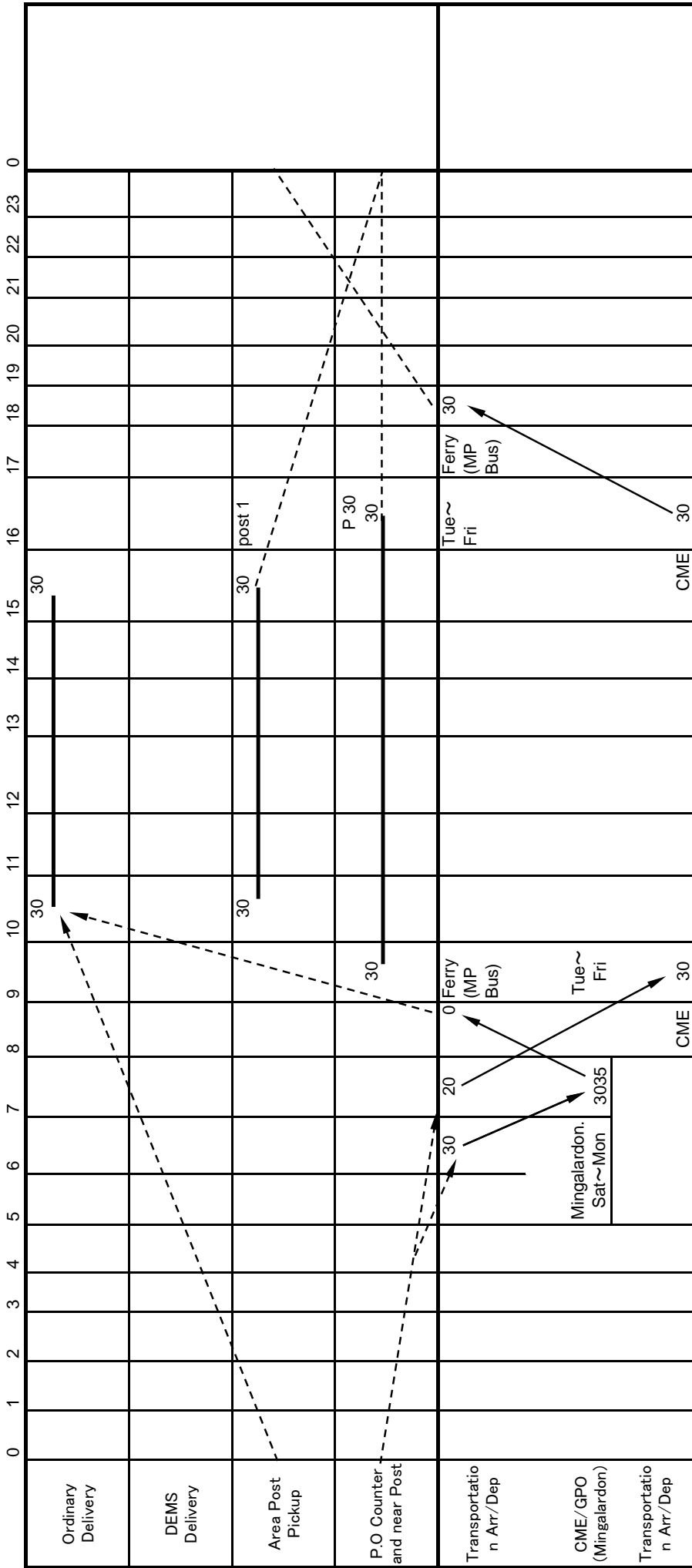

DEMS SPECIAL DELIVERY BY Insein



Hlegu POST OFFICE Kessoku Diagram

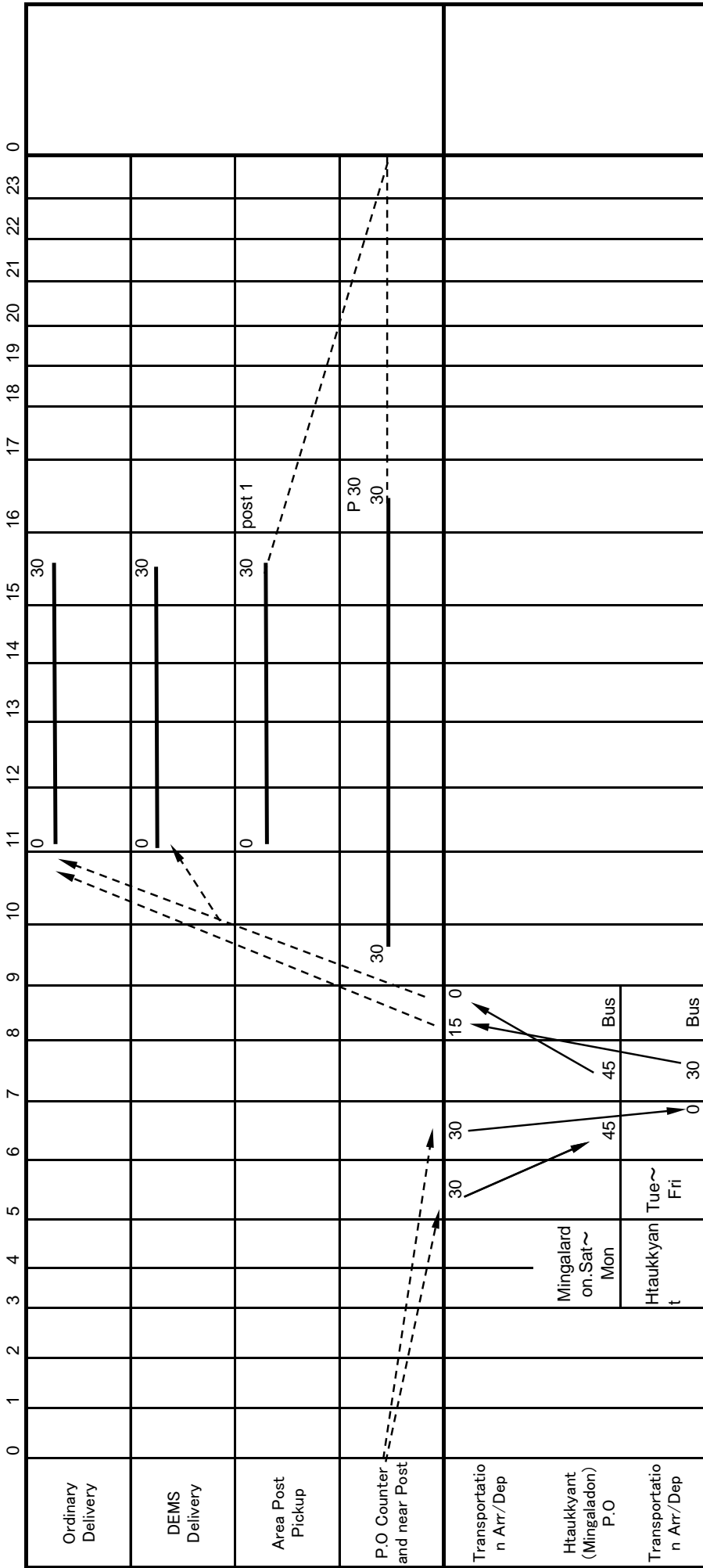



Yemontat POST OFFICE Kessoku Diagram

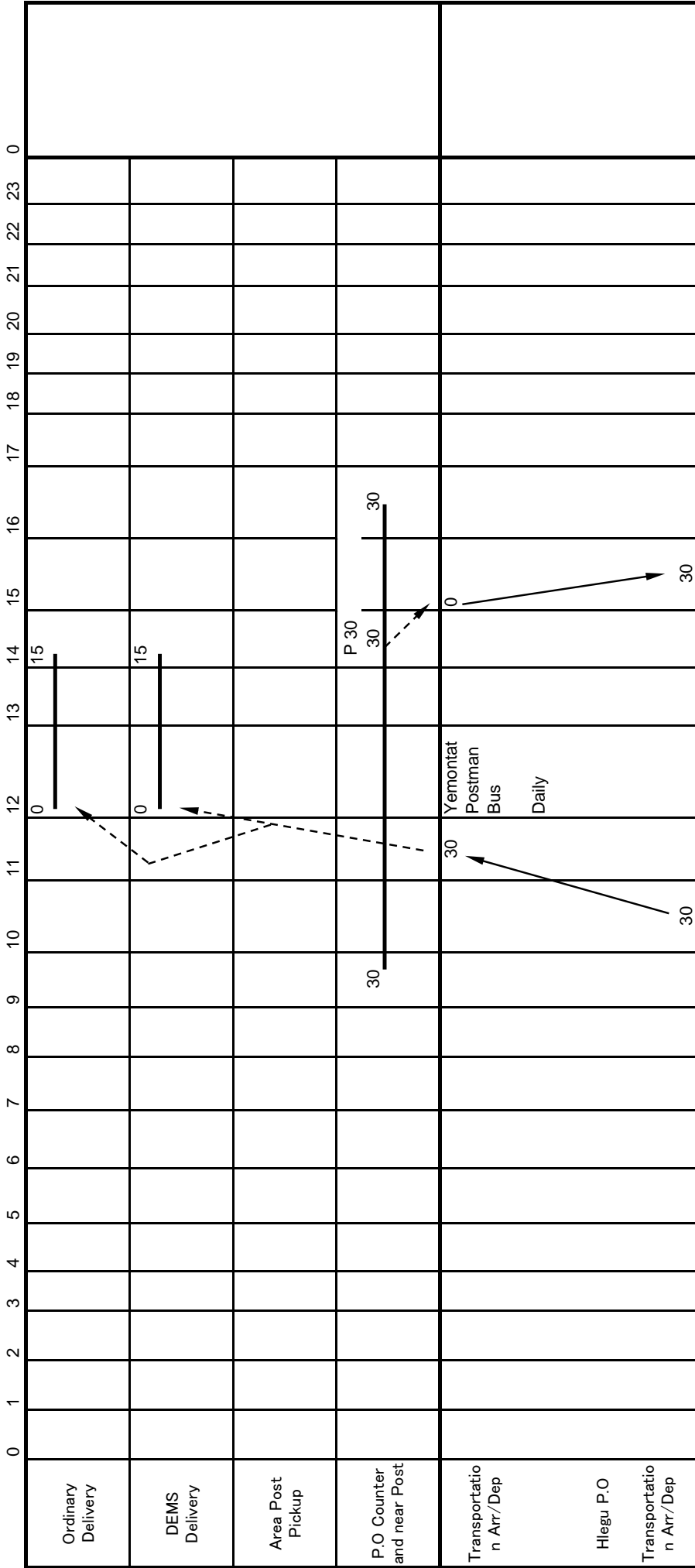

Inndine POST OFFICE Kessoku Diagram

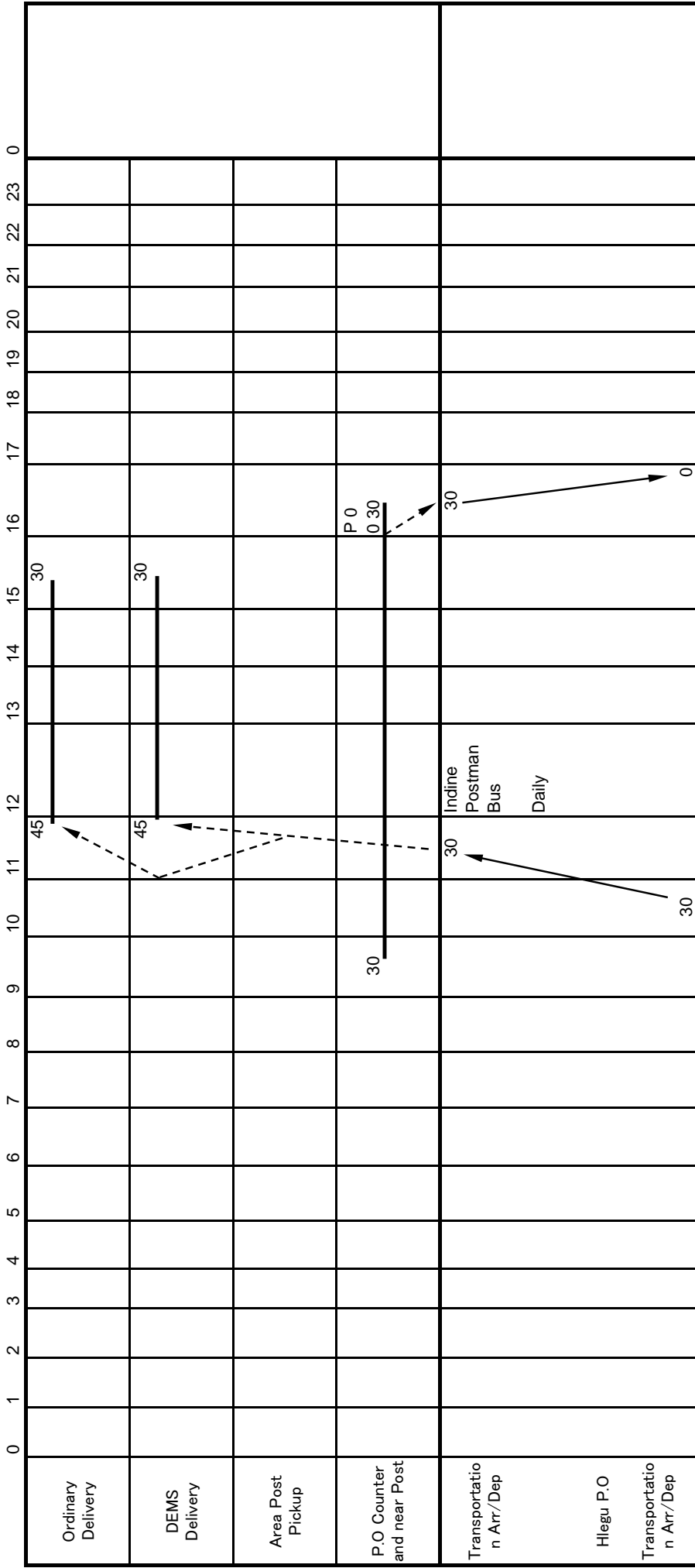

**Ngarsutaung POST OFFICE Kessoku Diagram**

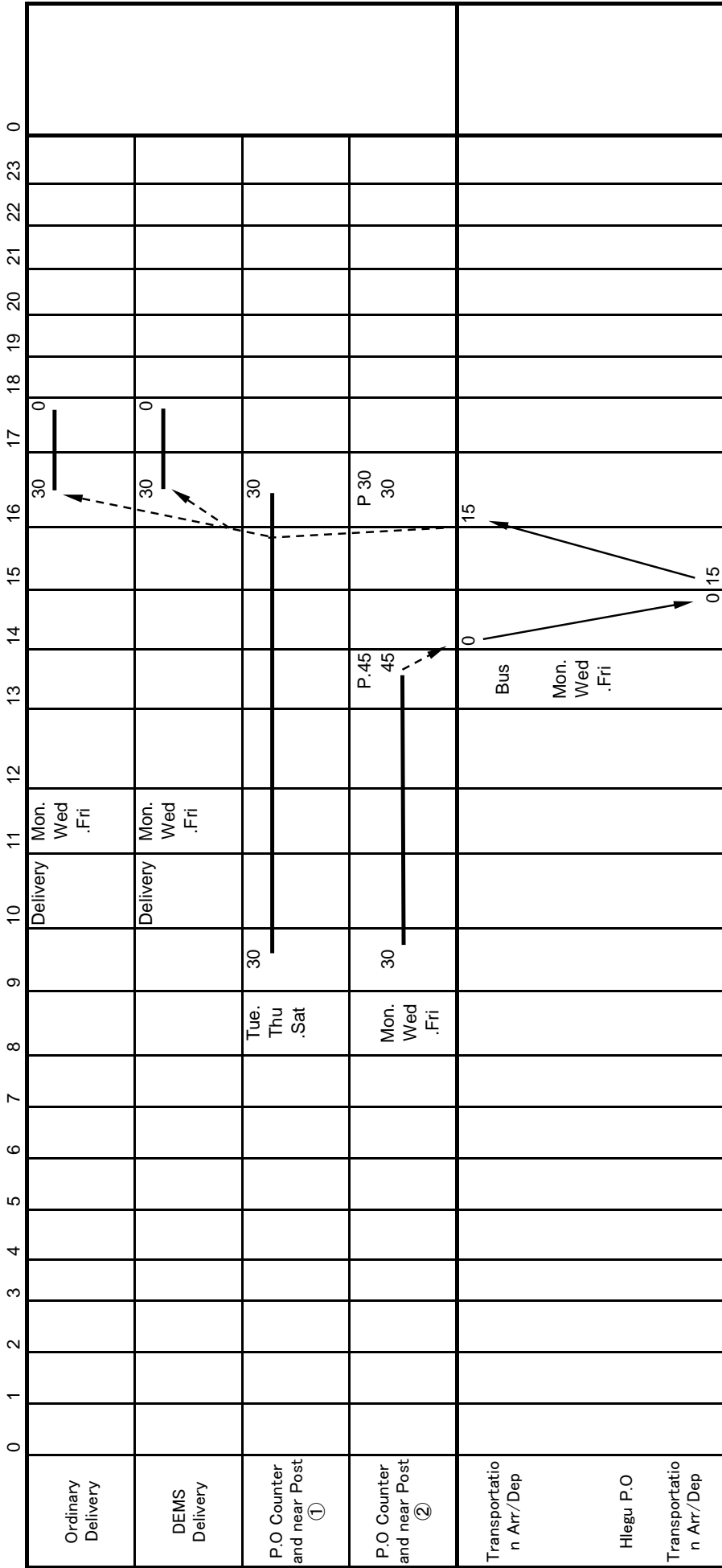

Bahan POST OFFICE Kessoku Diagram

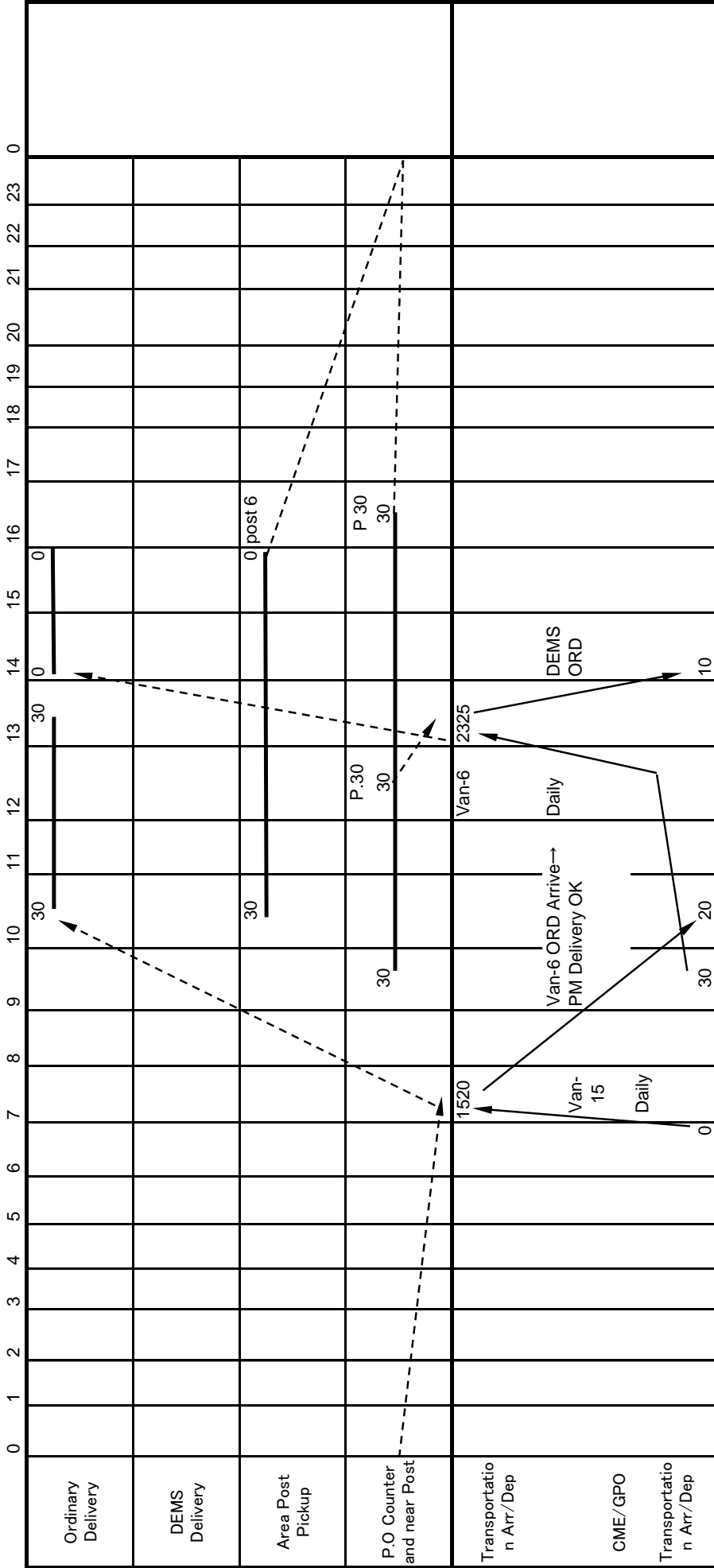

Aria Post Pick up → AM~PM(All AM x)

DEMS SPECIAL DELIVERY BY GPO

Kamayut POST OFFICE Kessoku Diagram

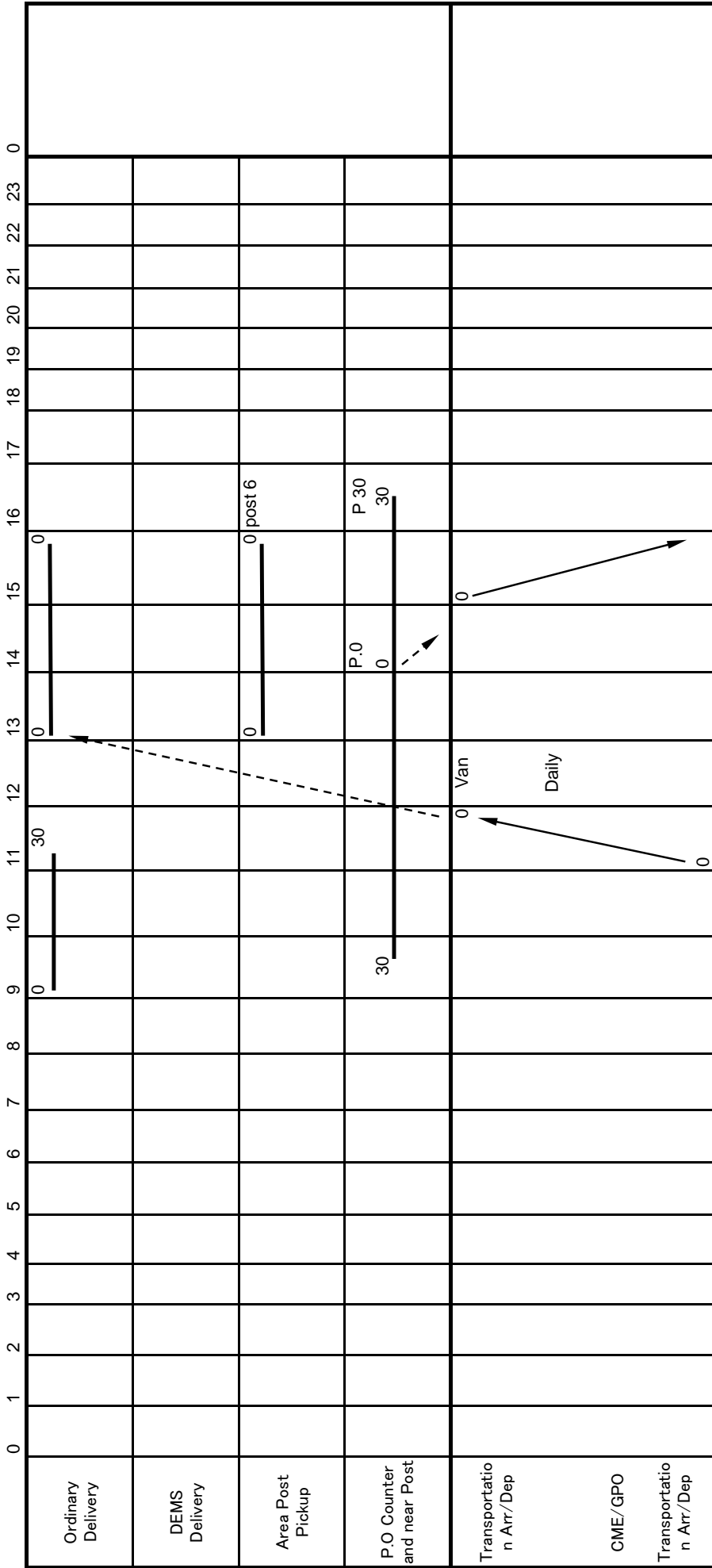

DEMS SPECIAL DELIVERY BY Mayangone

Hlaing POST OFFICE Kessoku Diagram

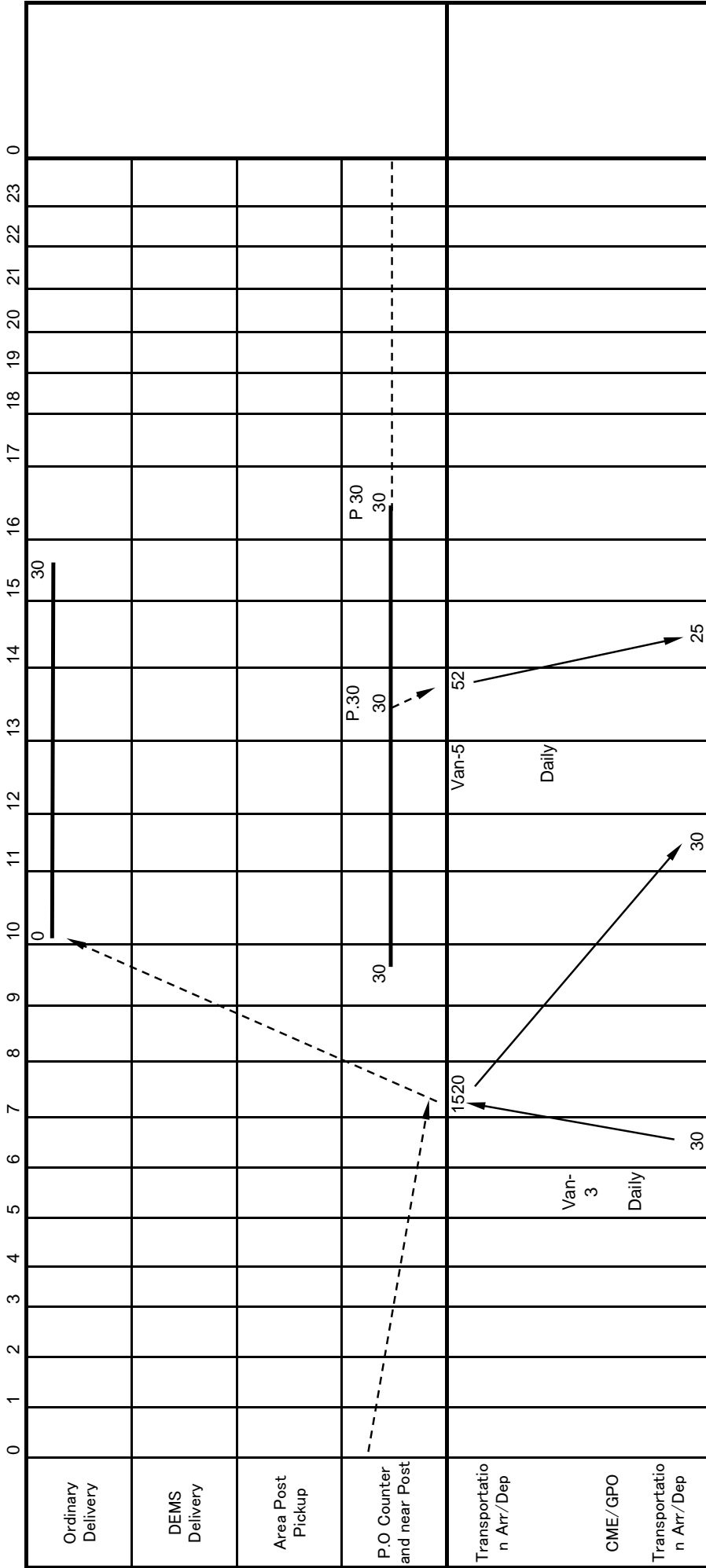

DEMS SPECIAL DELIVERY BY Mayangone



Hlaing U.C POST OFFICE Kessoku Diagram

	0	1	2	3	4	5	6	7	8	9	10	11	12	13	14	15	16	17	18	19	20	21	22	23	0
Ordinary Delivery																									
DEMS Delivery																									
Area Post Pickup																									
P.O Counter and near Post										30			P 50 50				P O 0 30								
Transportation Arr/Dep																									
Hling P.O																									
Transportation Arr/Dep																									

Non Delivery



Hlaingtharyar POST OFFICE Kessoku Diagram

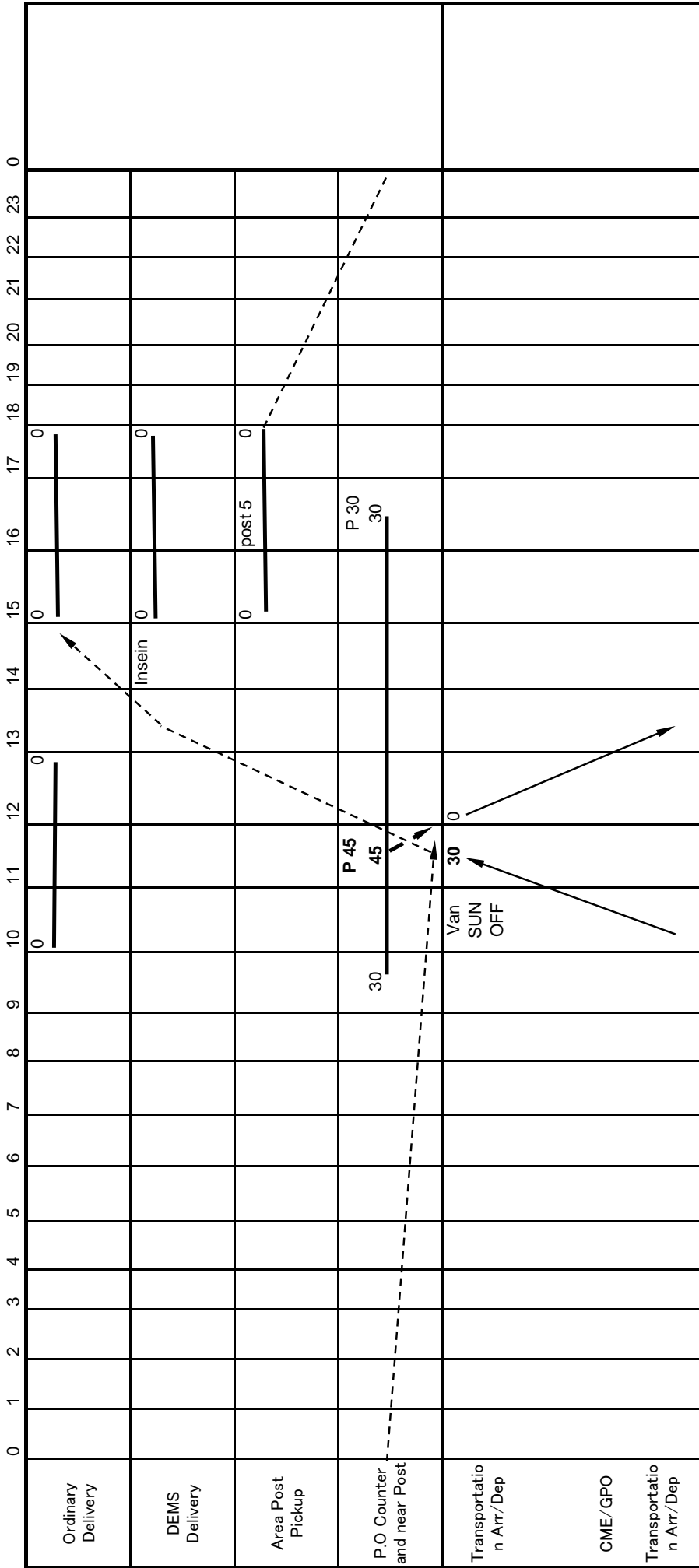

DEMS SPECIAL DELIVERY BY Insein

Tech; U C POST OFFICE Kessoku Diagram

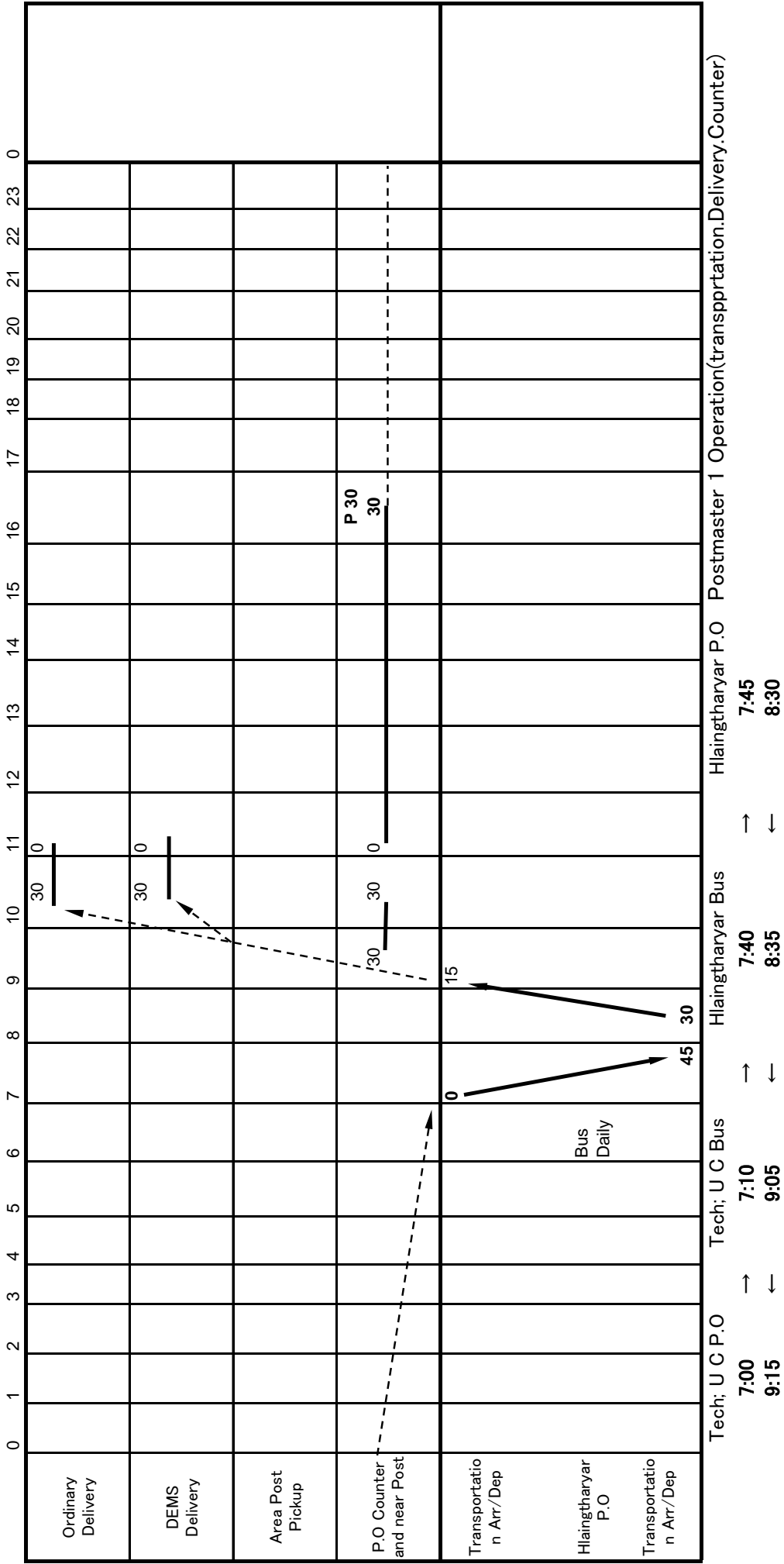

Htantabin POST OFFICE Kessoku Diagram

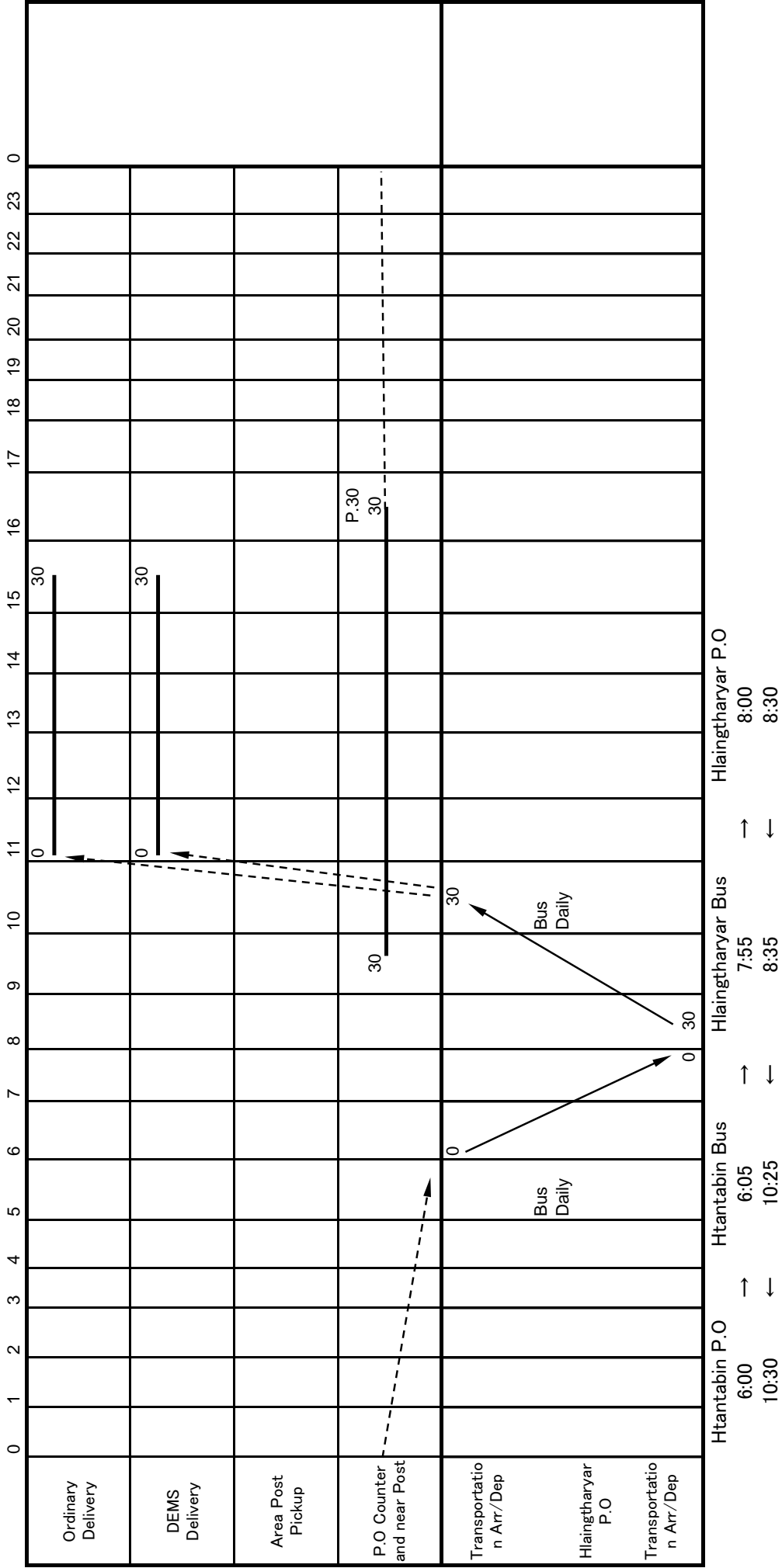

Taungnyunt POST OFFICE Kessoku Diagram

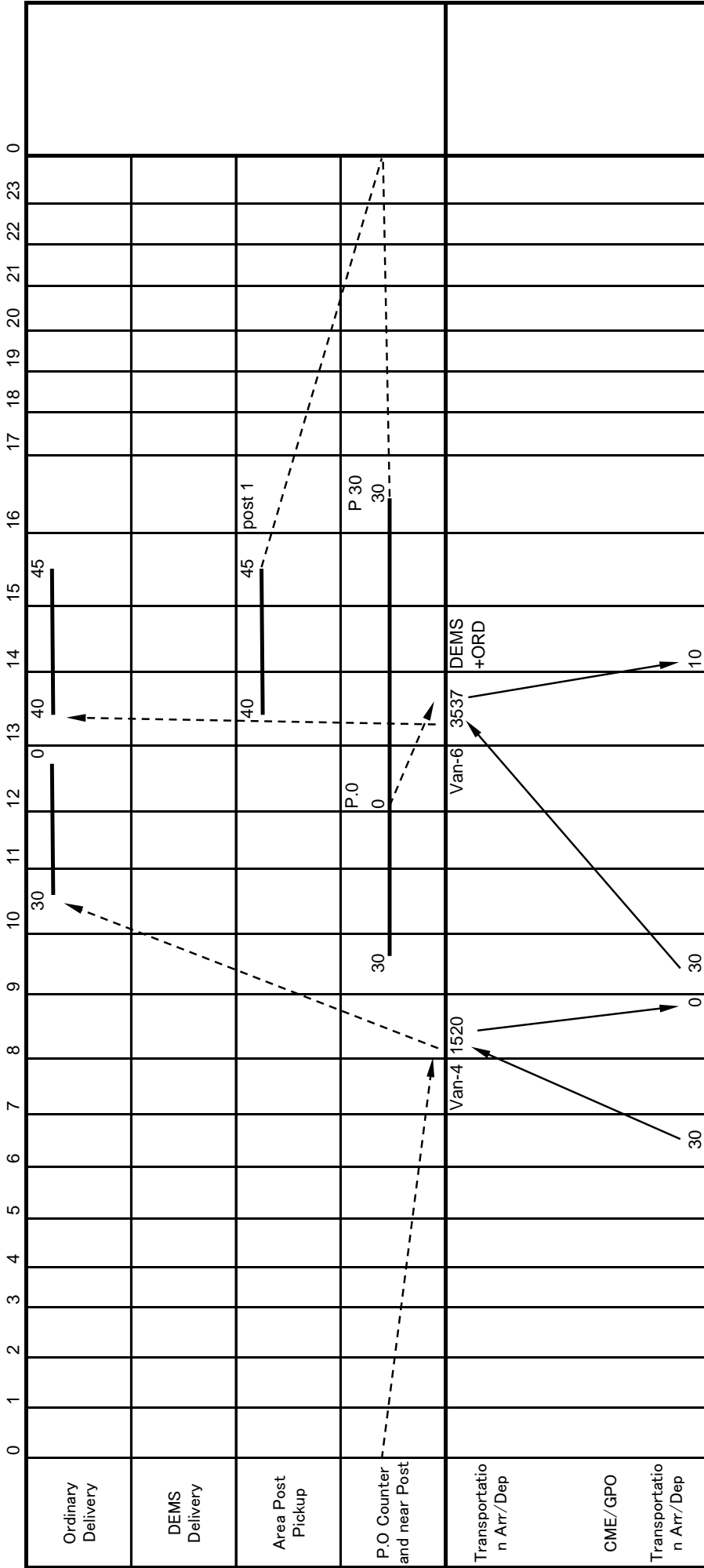

DEMS SPECIAL DELIVERY BY GPO

Aria Post Pick up → AM~PM(All AM x)

Tamwe POST OFFICE Kessoku Diagram

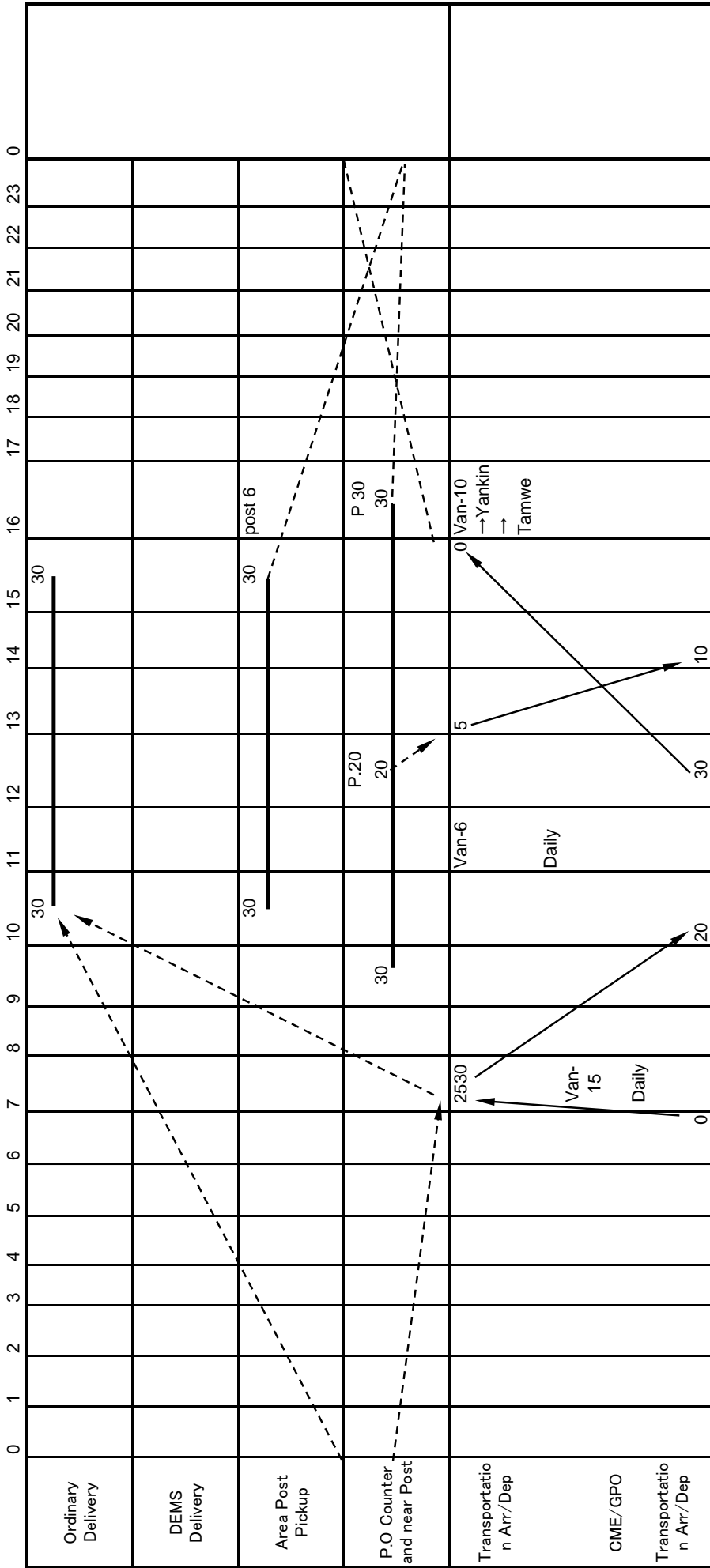

DEMS SPECIAL DELIVERY BY Yankin → AM~PM(All AM x)

Myitarmyunt POST OFFICE Kessoku Diagram

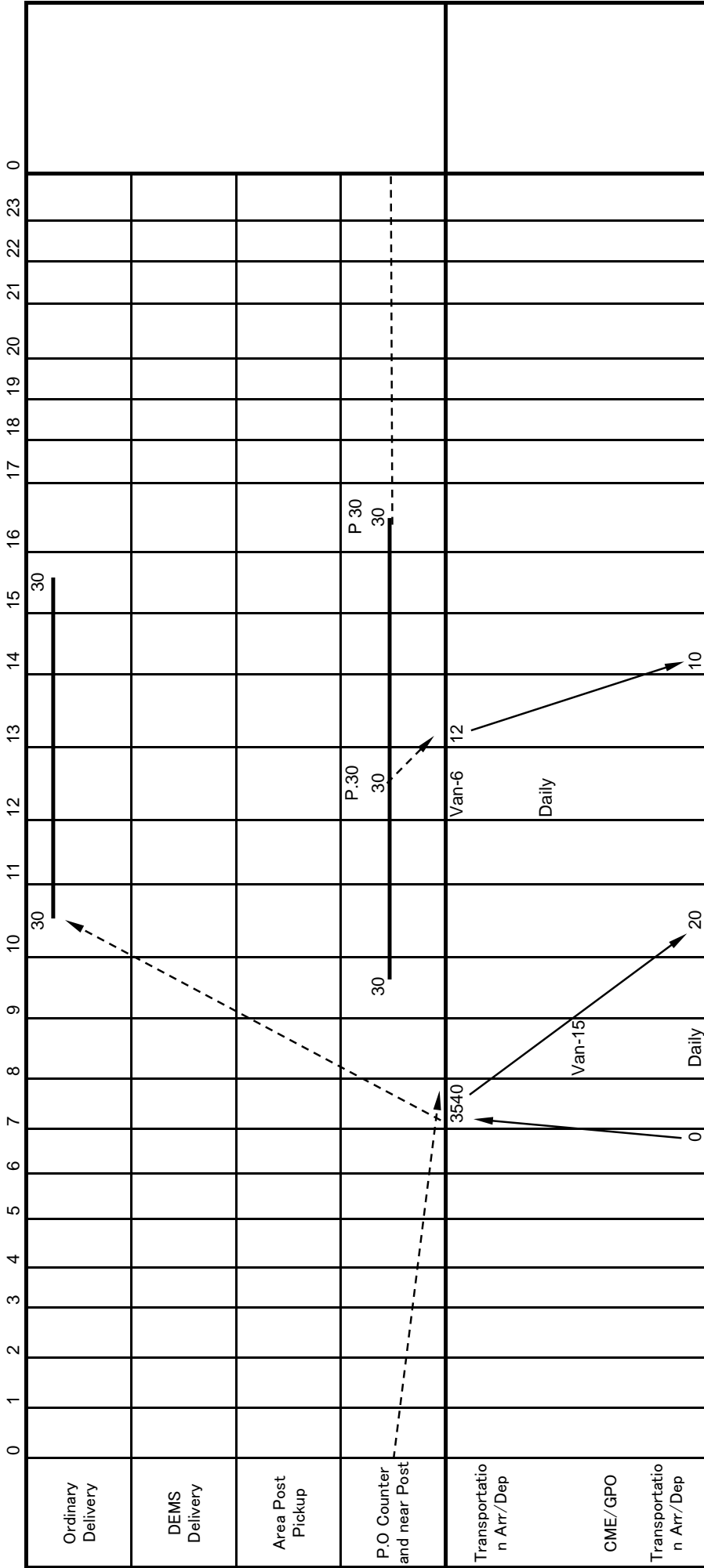

DEMS SPECIAL DELIVERY BY YanKin



Pyaythaya POST OFFICE Kessoku Diagram

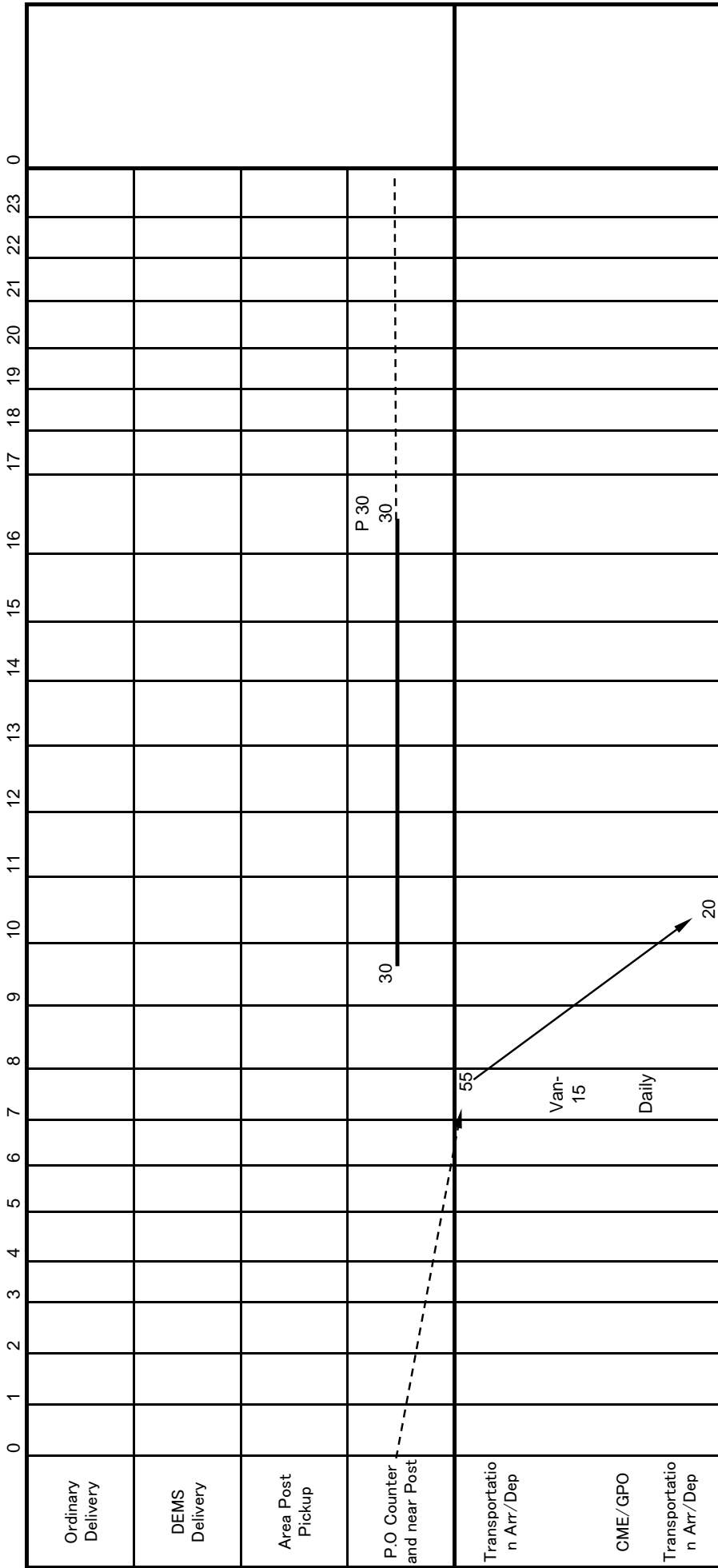

Non Delivery Postmaster 1 Only



South Okkalapa POST OFFICE Kessoku Diagram

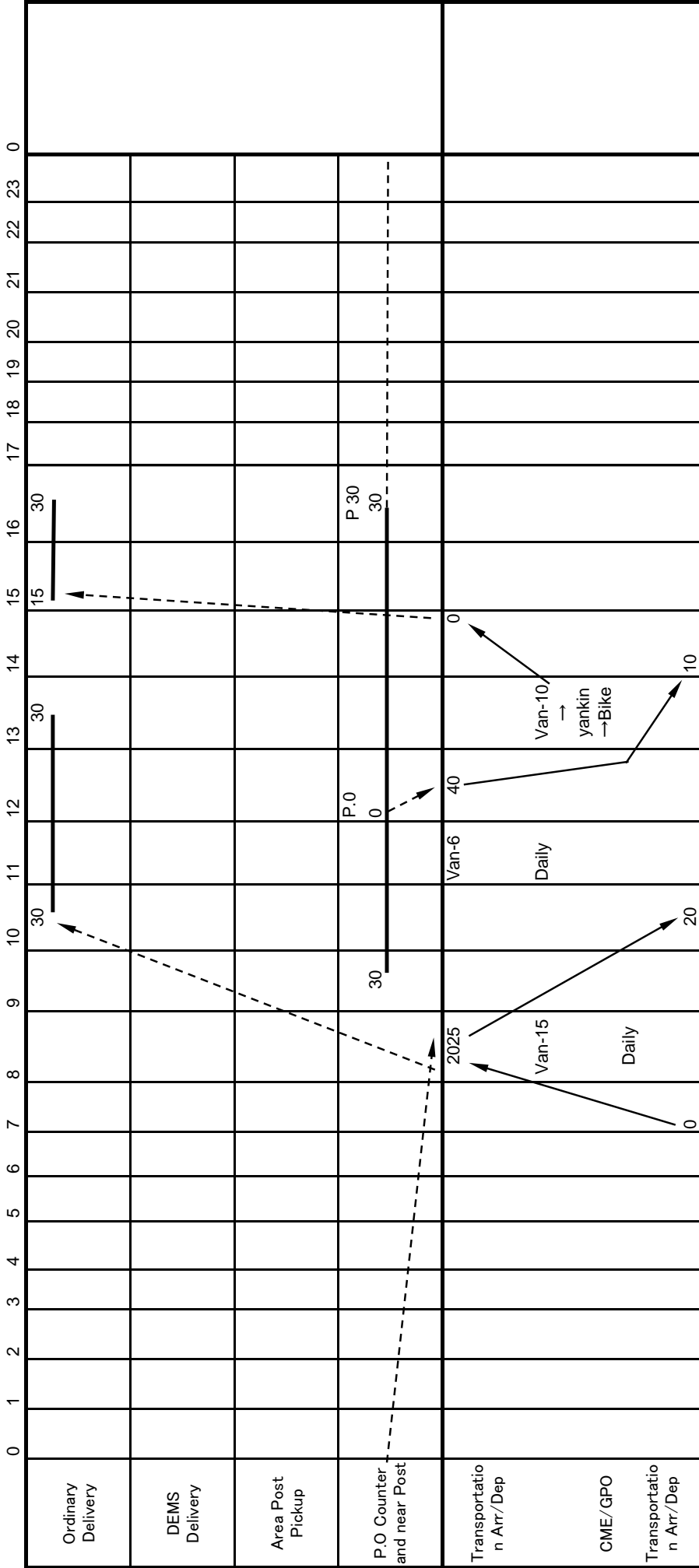

DEMS SPECIAL DELIVERY BY Yankin

North Dagon POST OFFICE Kessoku Diagram

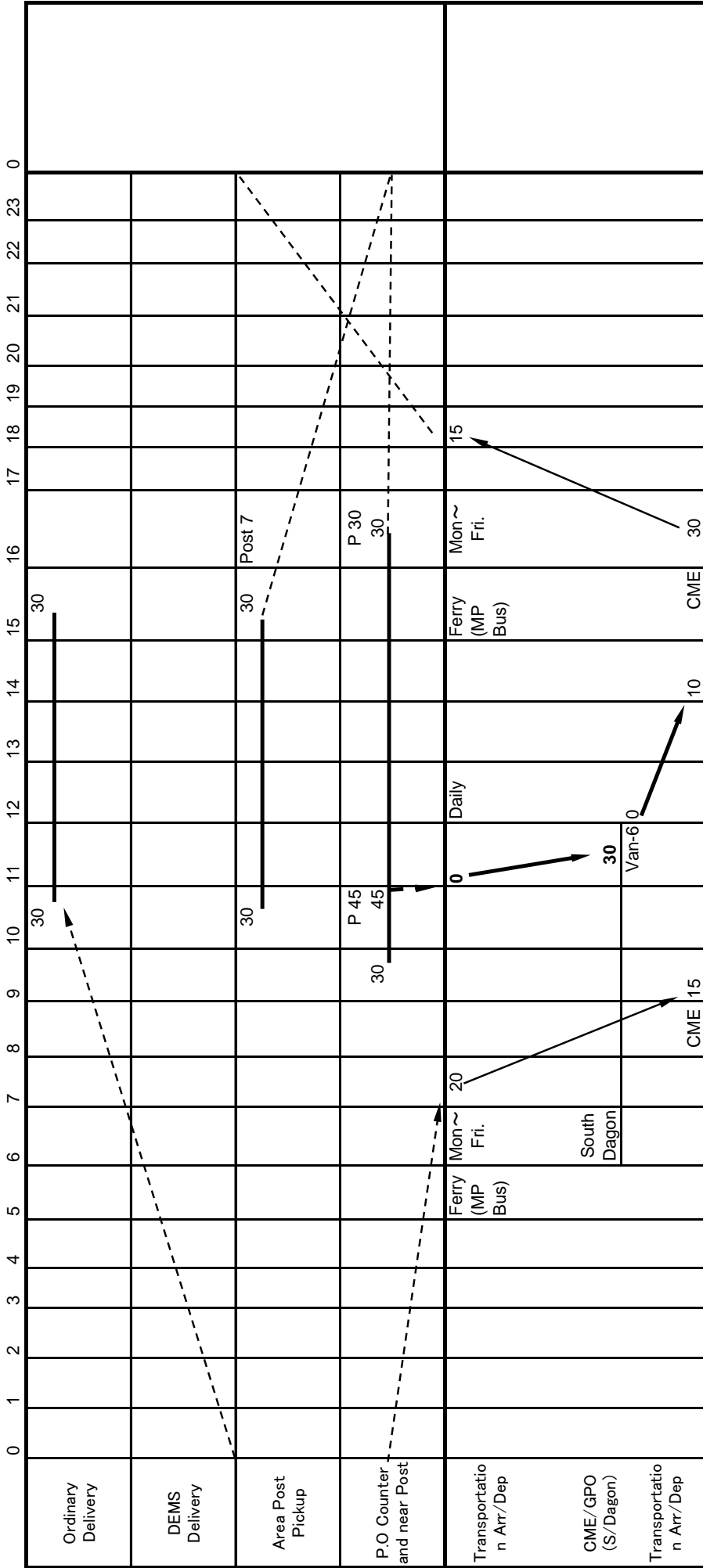

DEMS SPECIAL DELIVERY South Dagon

Dagon U C POST OFFICE Kessoku Diagram

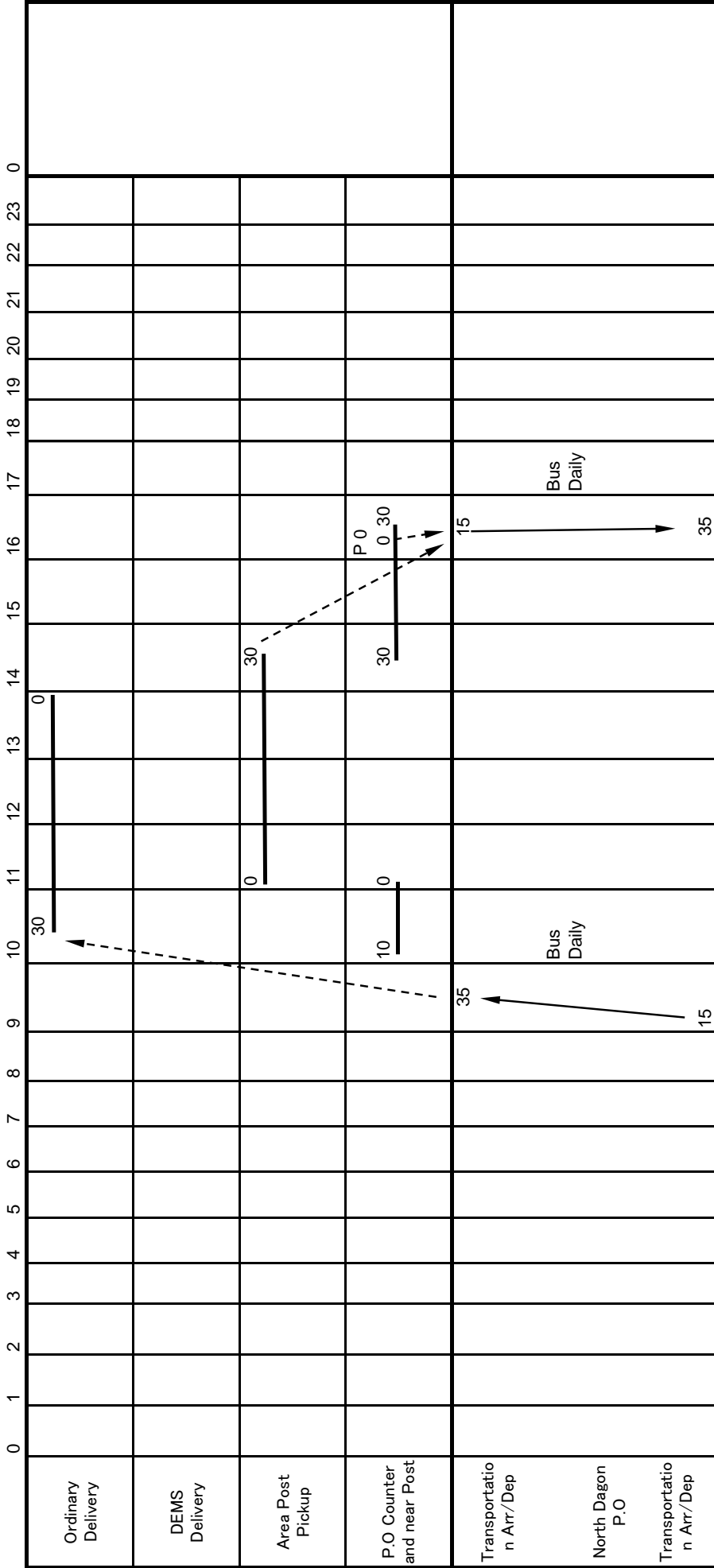

DEMS SPECIAL DELIVERY South Dagon  
Postmaster only 1 Operation(transprtation.Delivery.Counter)

East Dagon POST OFFICE Kessoku Diagram

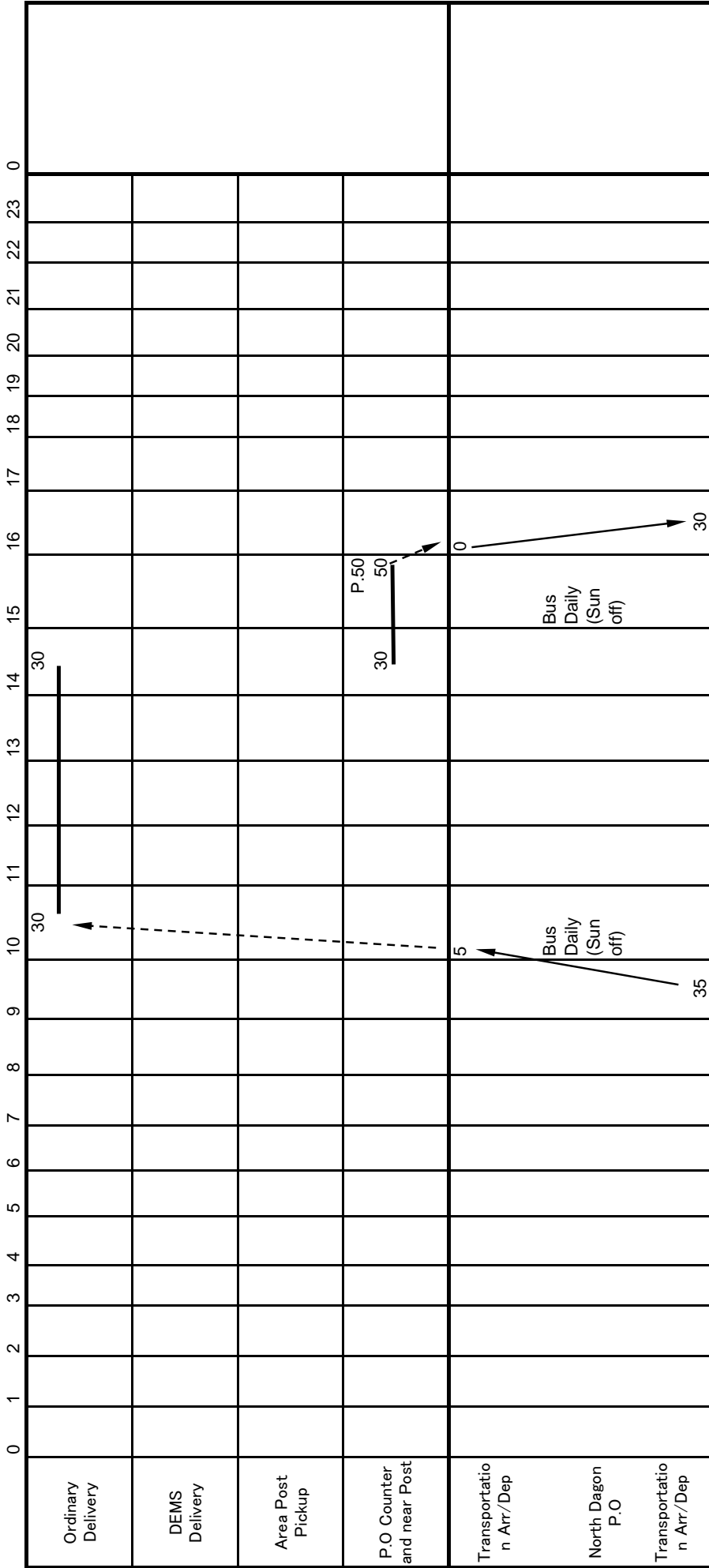

DEMS SPECIAL DELIVERY South Dagon  
Postmaster only 1 Operation(transprtation.Delivery.Counter)

Thingangyun POST OFFICE Kessoku Diagram

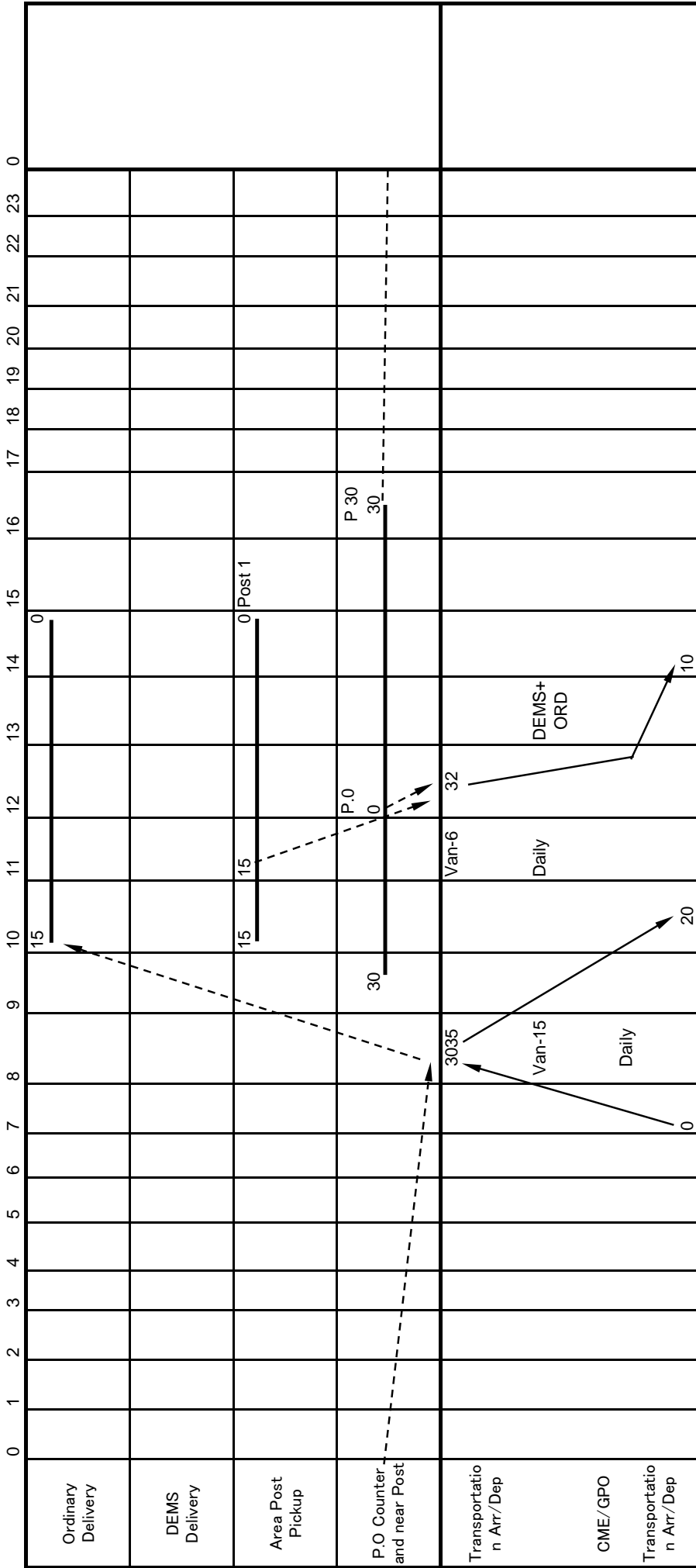

DEMS SPECIAL DELIVERY BY YanKin

Laydaungkan POST OFFICE Kessoku Diagram

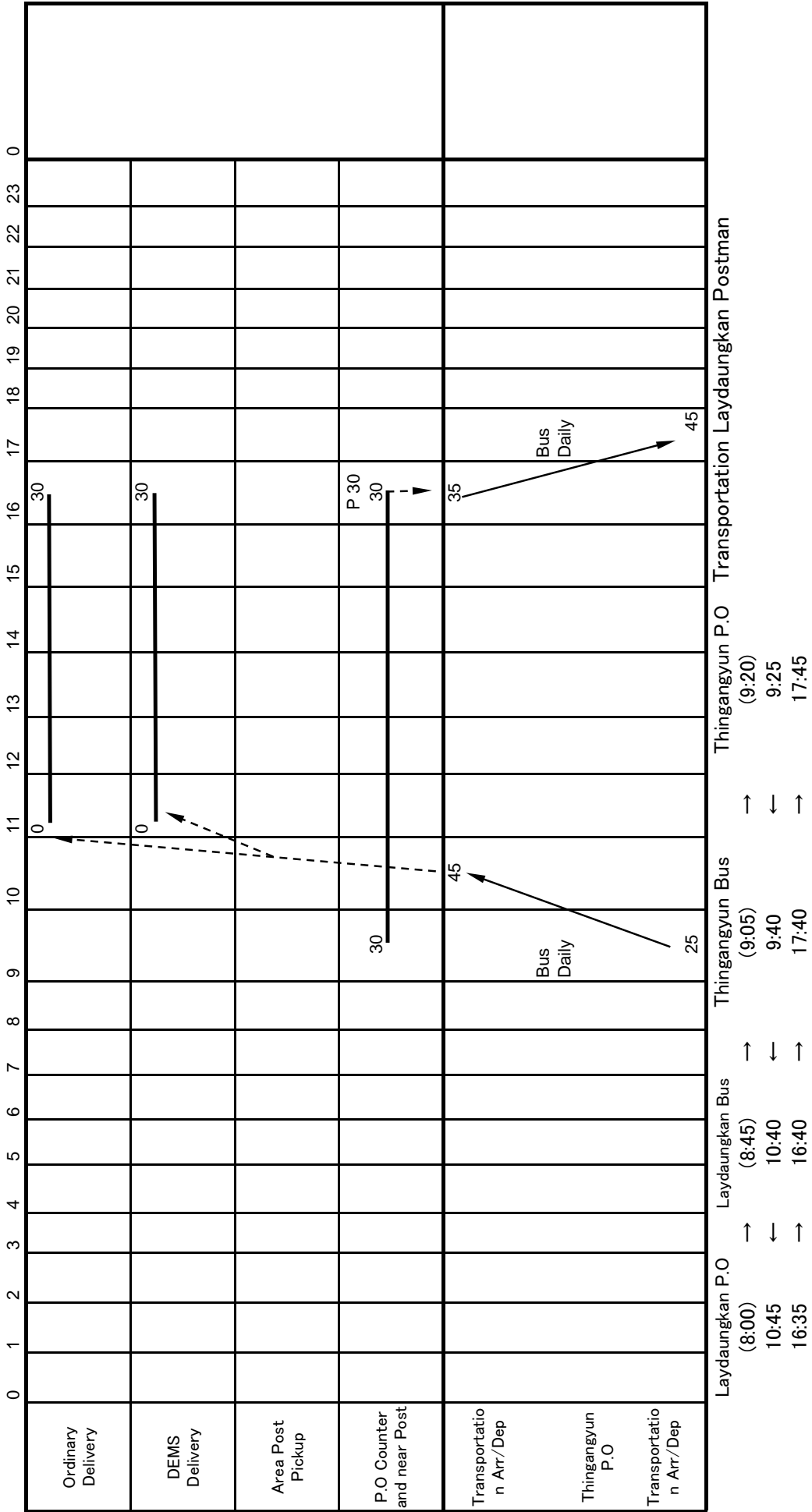



U C of Eco POST OFFICE Kessoku Diagram

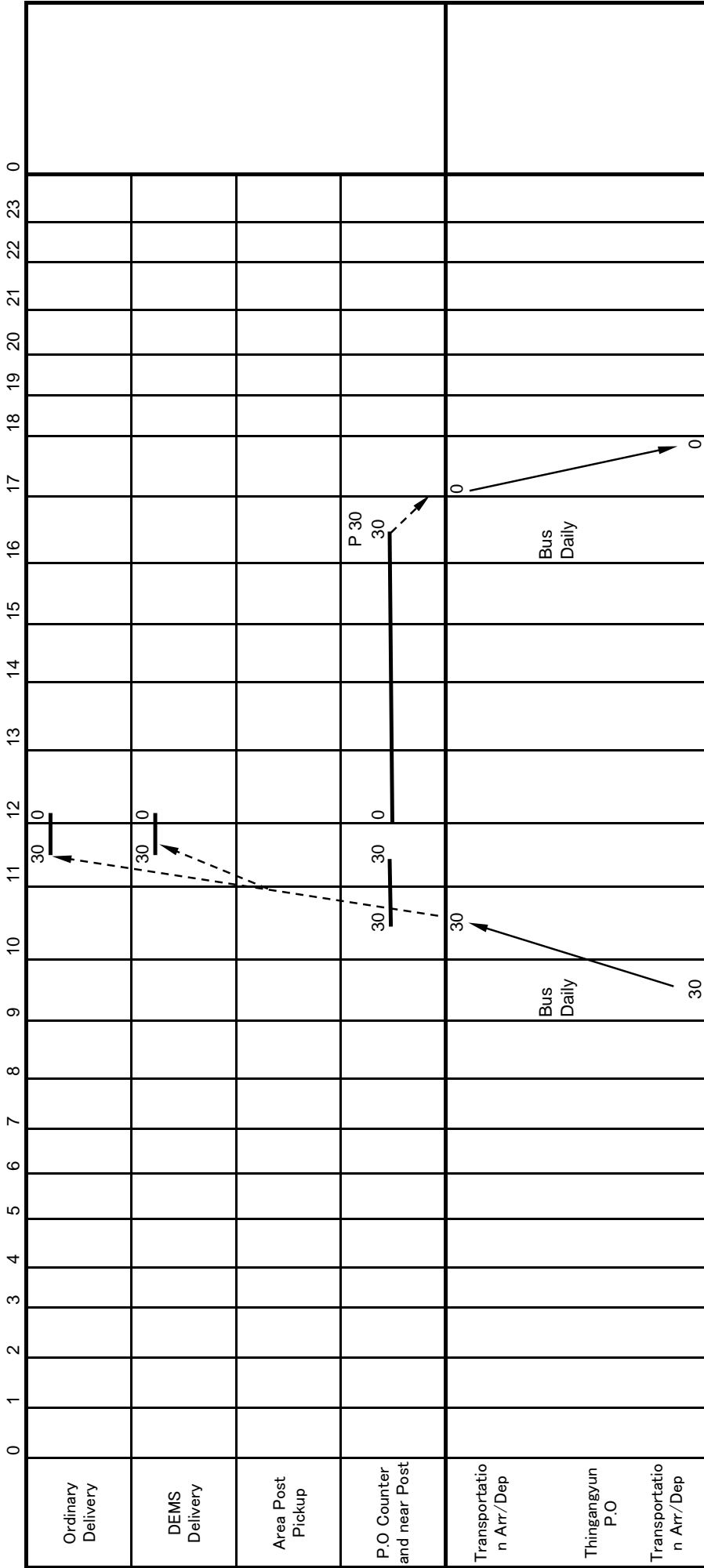



Dagon South POST OFFICE Kessoku Diagram

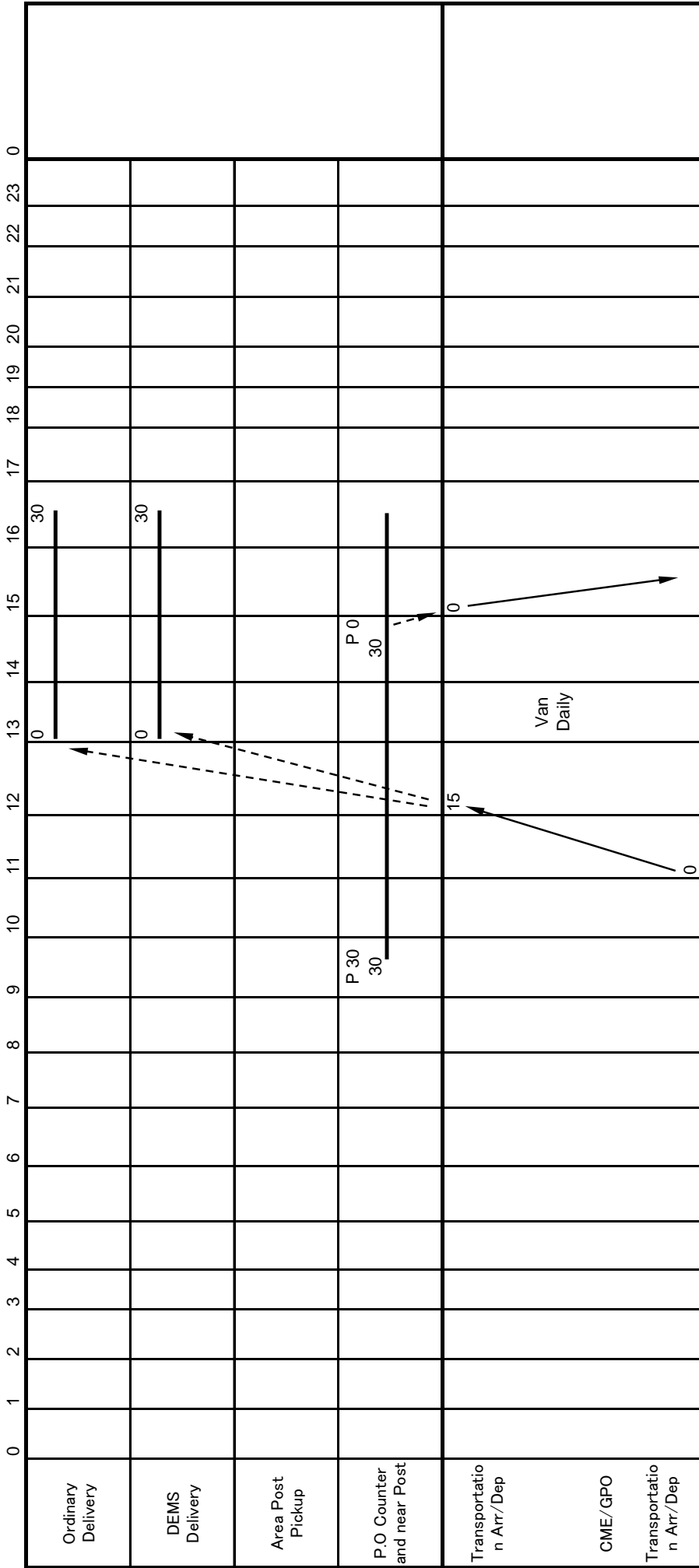

Industrial Zone(Dagn South) POST OFFICE Kessoku Diagram

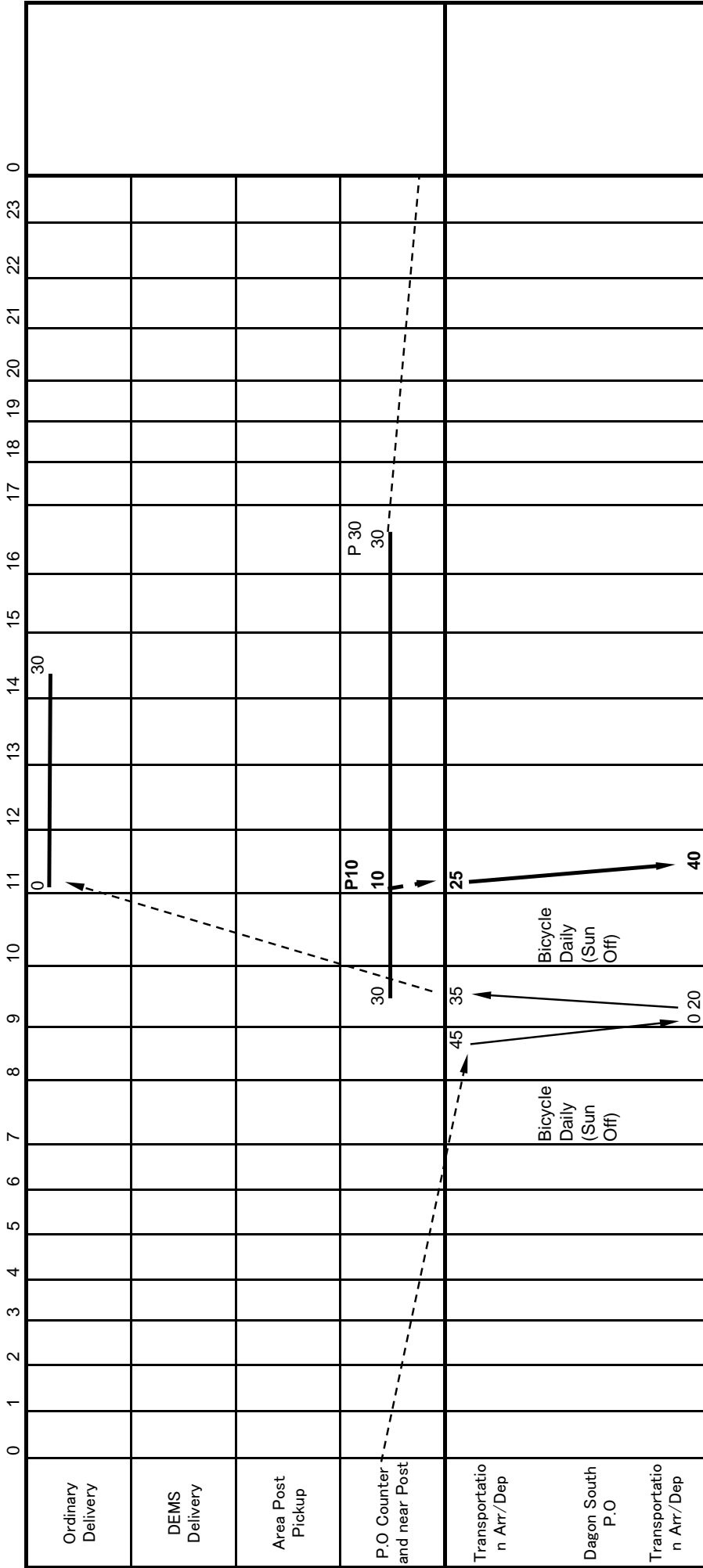

DEMS SPECIAL DELIVERY BY South Dagon

Dagon Seikkan POST OFFICE Kessoku Diagram

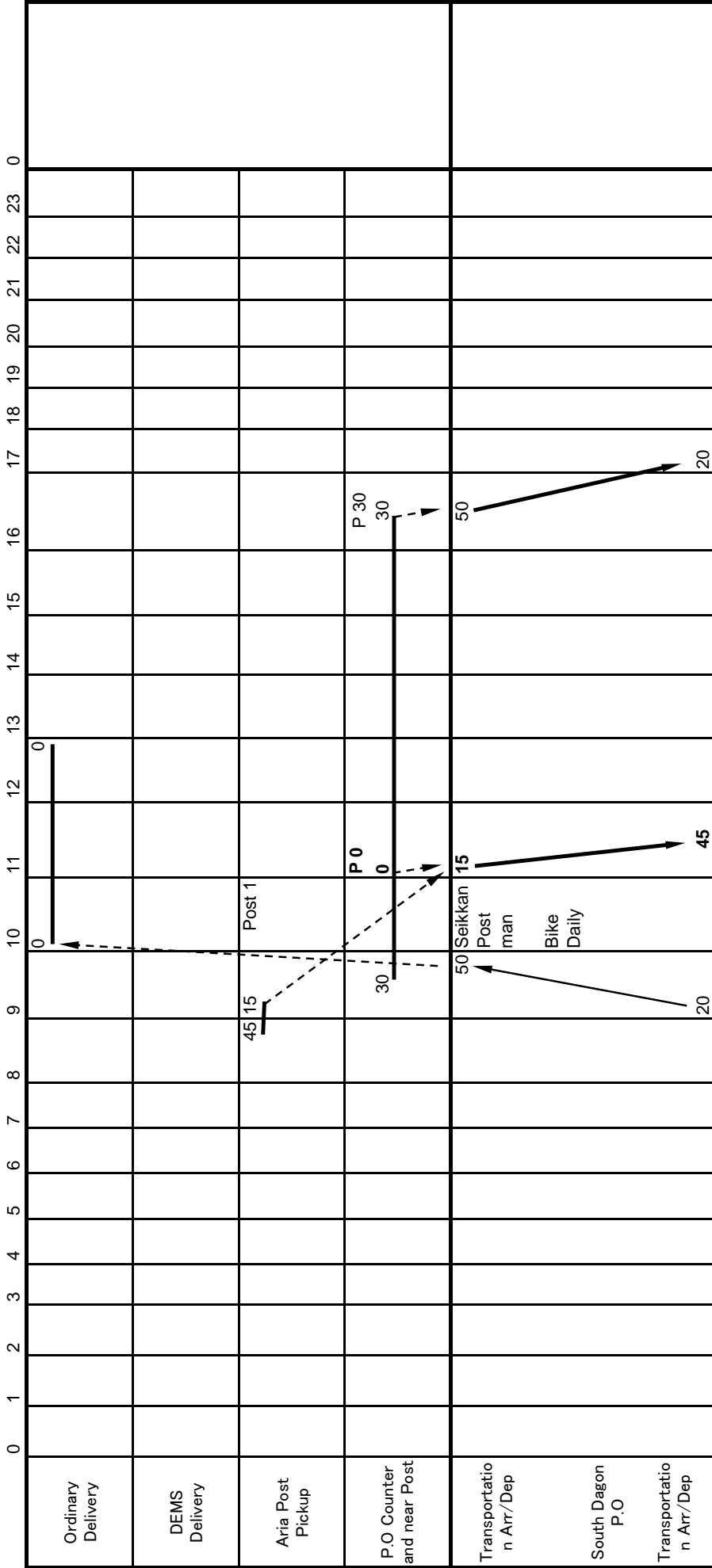

DEMS SPECIAL DELIVERY BY South Dagon



**Bogyokezay POST OFFICE Kessoku Diagram**

	0	1	2	3	4	5	6	7	8	9	10	11	12	13	14	15	16	17	18	19	20	21	22	23	0
Ordinary Delivery																									
DEMS Delivery																									
Area Post Pickup																									
P.O Counter and near Post										30							P. 30 30								
Transportation Arr/Dep																	40								
Pabedan P.O																									
Transportation Arr/Dep																									

Bogyokezay P.O → Sat.Sun Off  
Bogyokezay Market → Mon Off

Non Delivery

Theingyizay POST OFFICE Kessoku Diagram

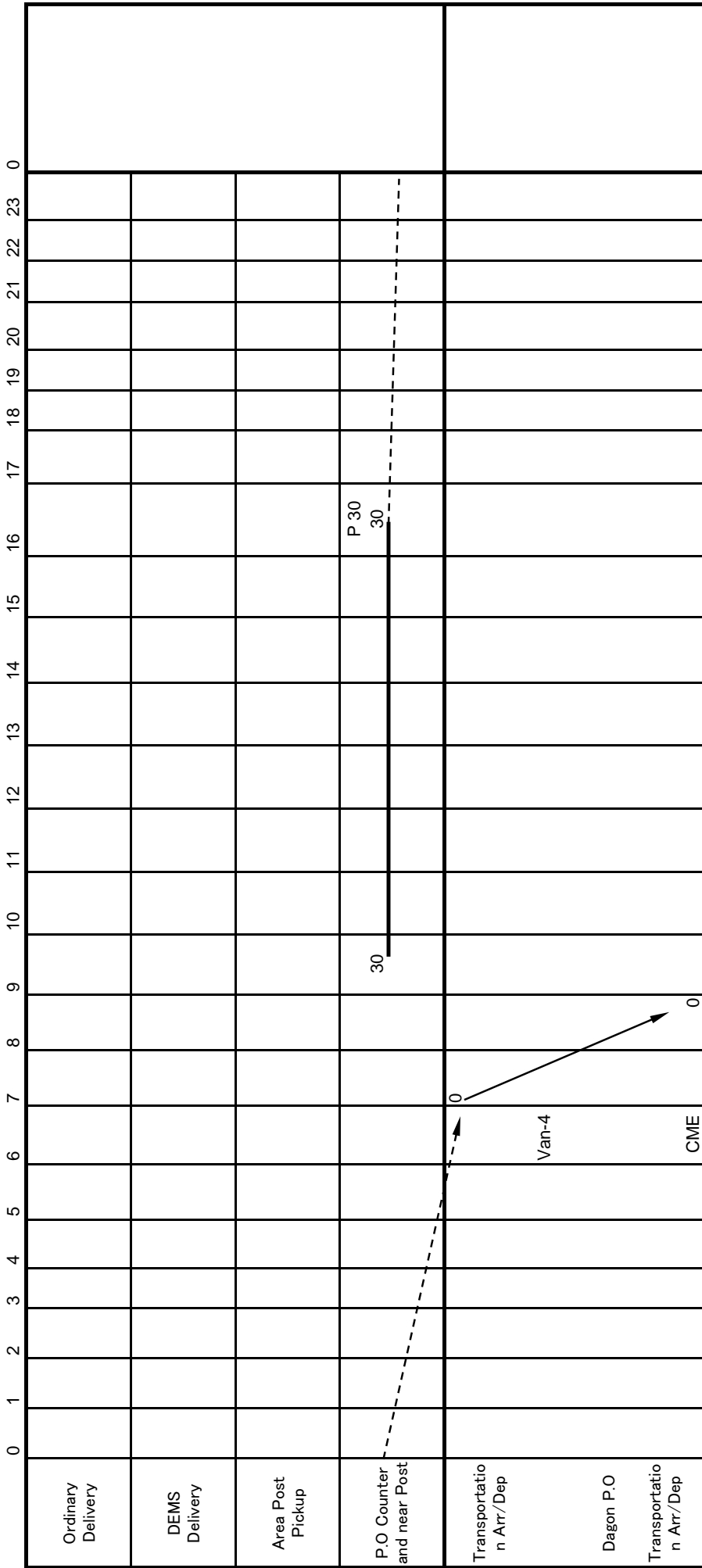

Non Delivery



Dagon POST OFFICE Kessoku Diagram

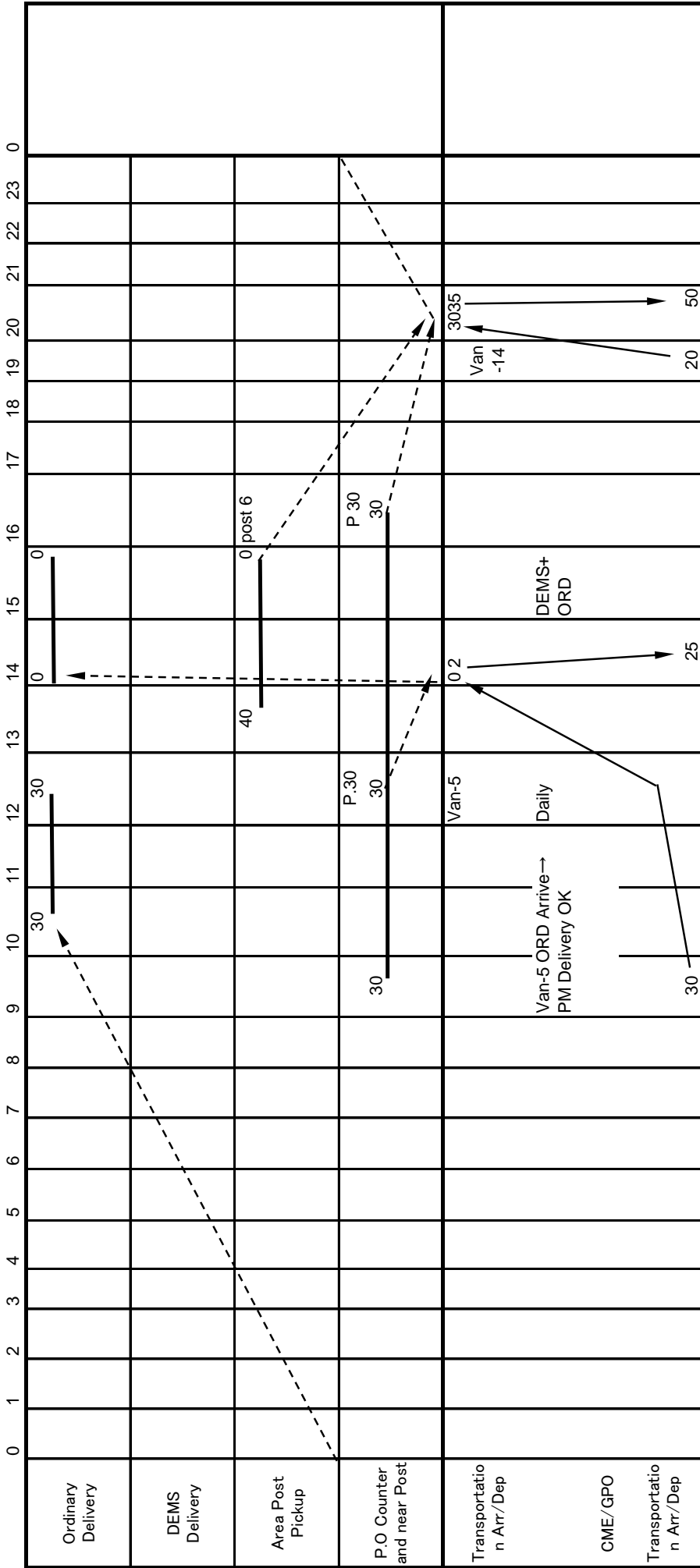

DEMS SPECIAL DELIVERY BY GPO

Sanchaung POST OFFICE Kessoku Diagram

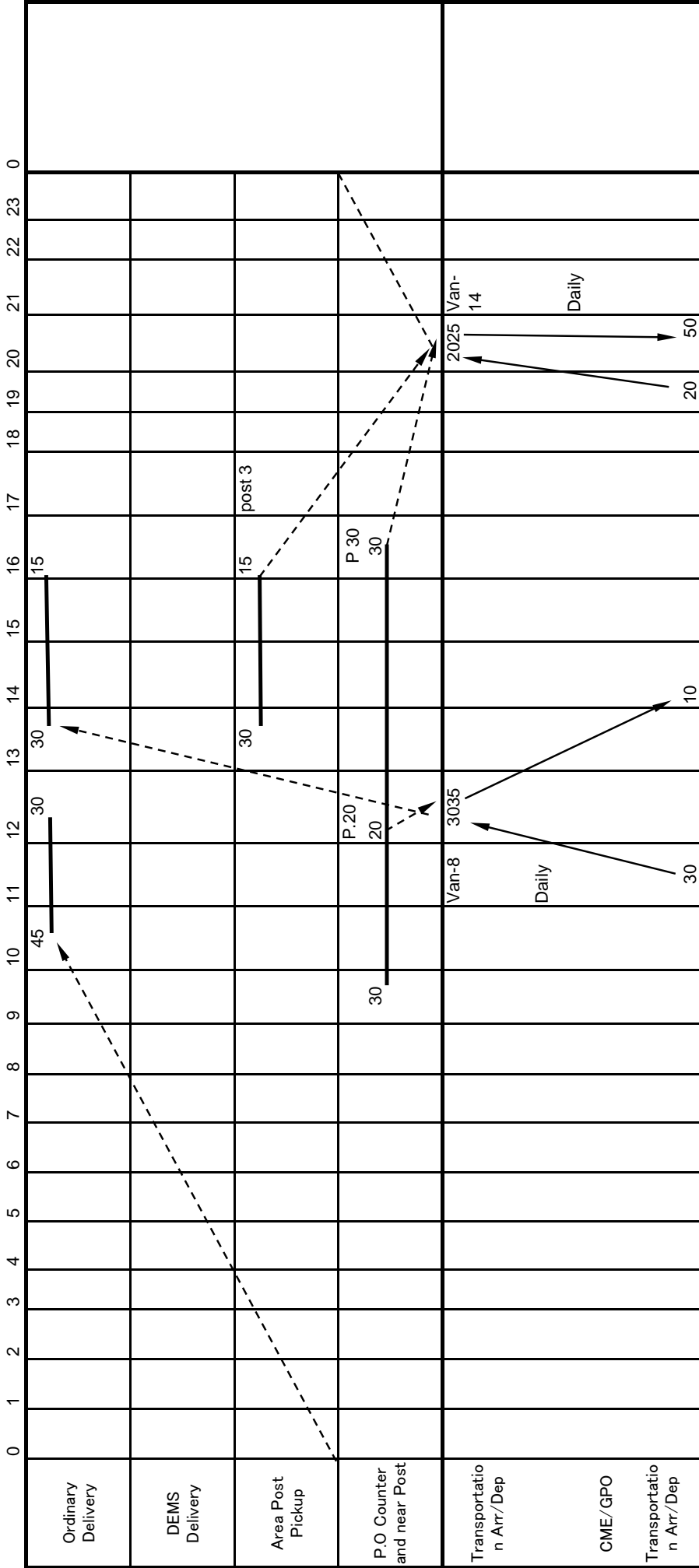

DEMS SPECIAL DELIVERY BY GPO

Aria Post Pick up → PM(All AM x)

Kyeemyindine POST OFFICE Kessoku Diagram

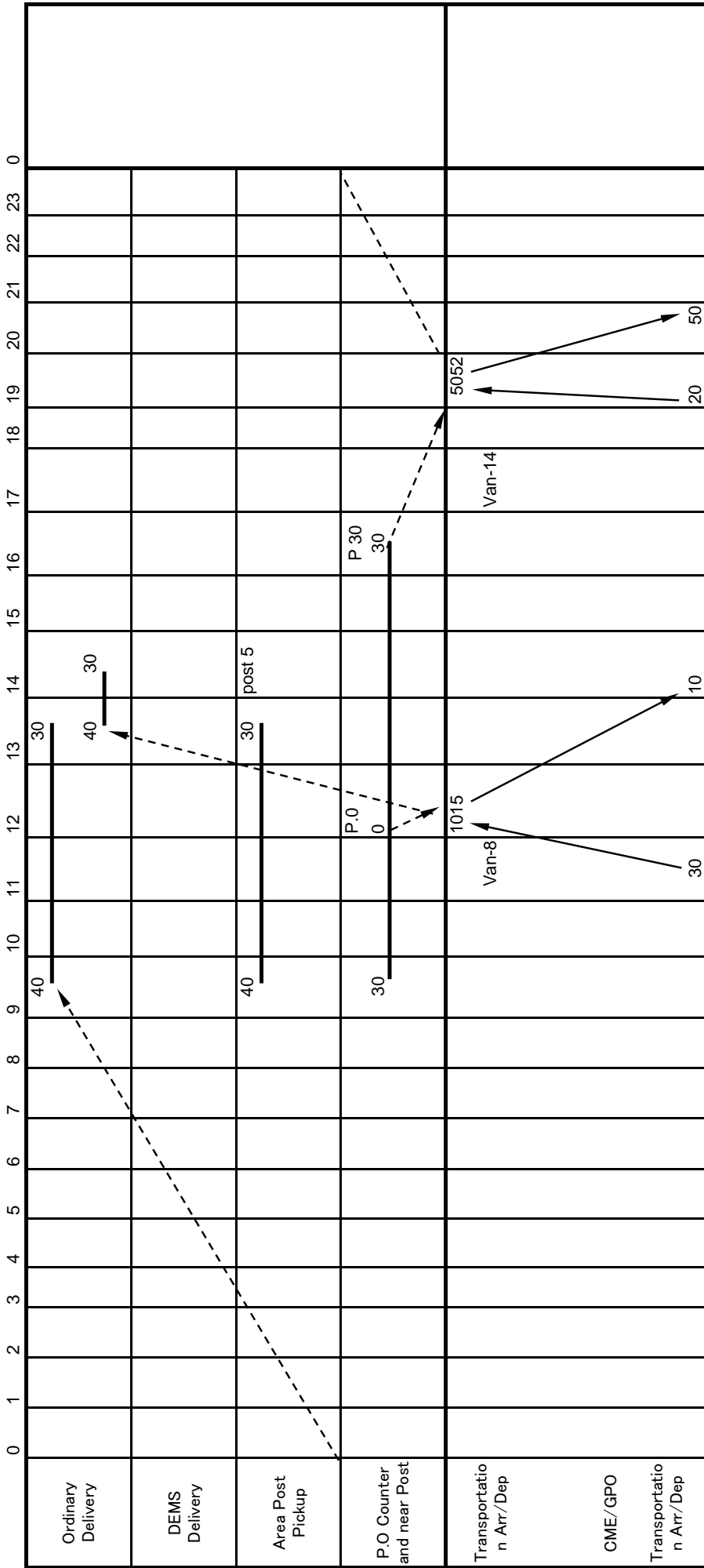

DEMS SPECIAL DELIVERY BY GPO

Aria Post Pick up → PM(All AM x)

Ahlonc POST OFFICE Kessoku Diagram

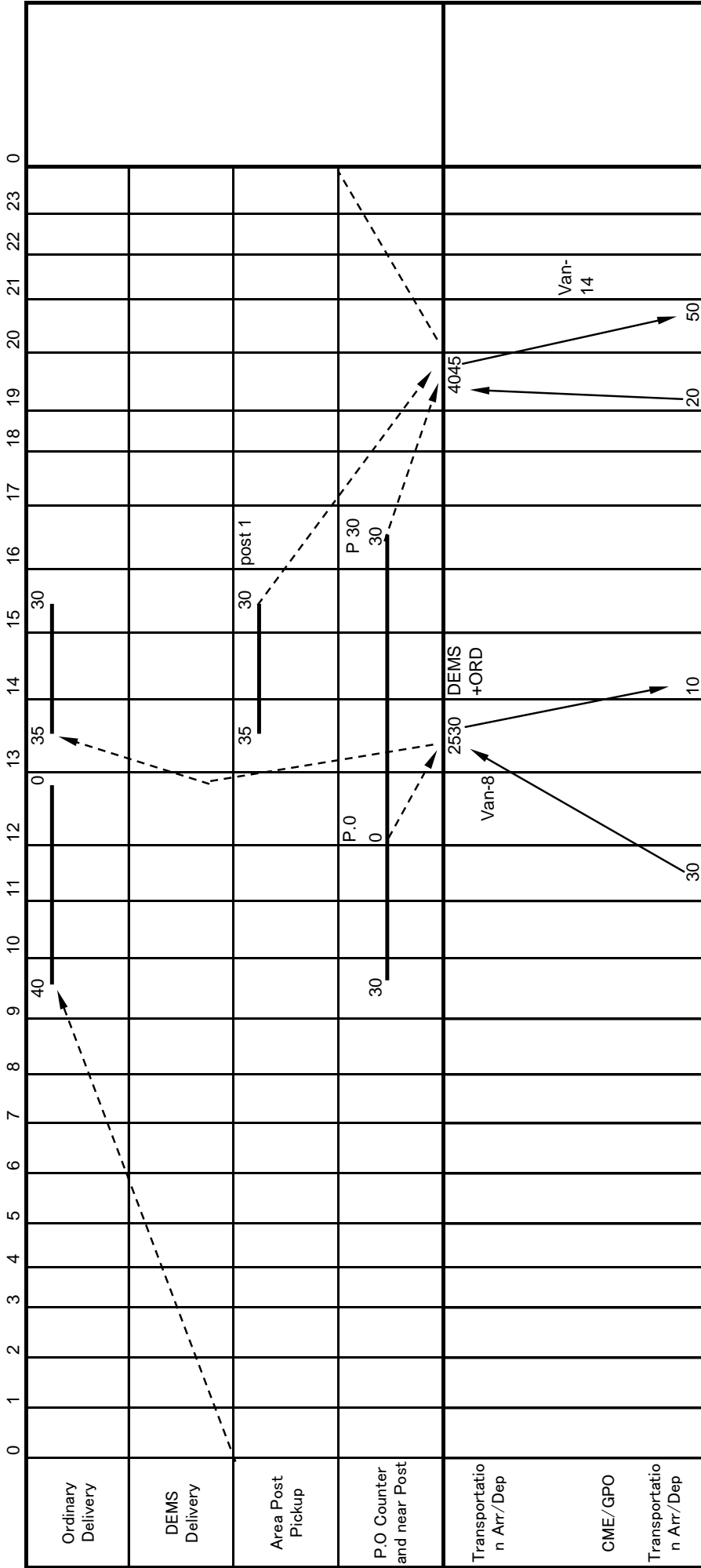

DEMS SPECIAL DELIVERY BY GPO

Lanmadaw POST OFFICE Kessoku Diagram

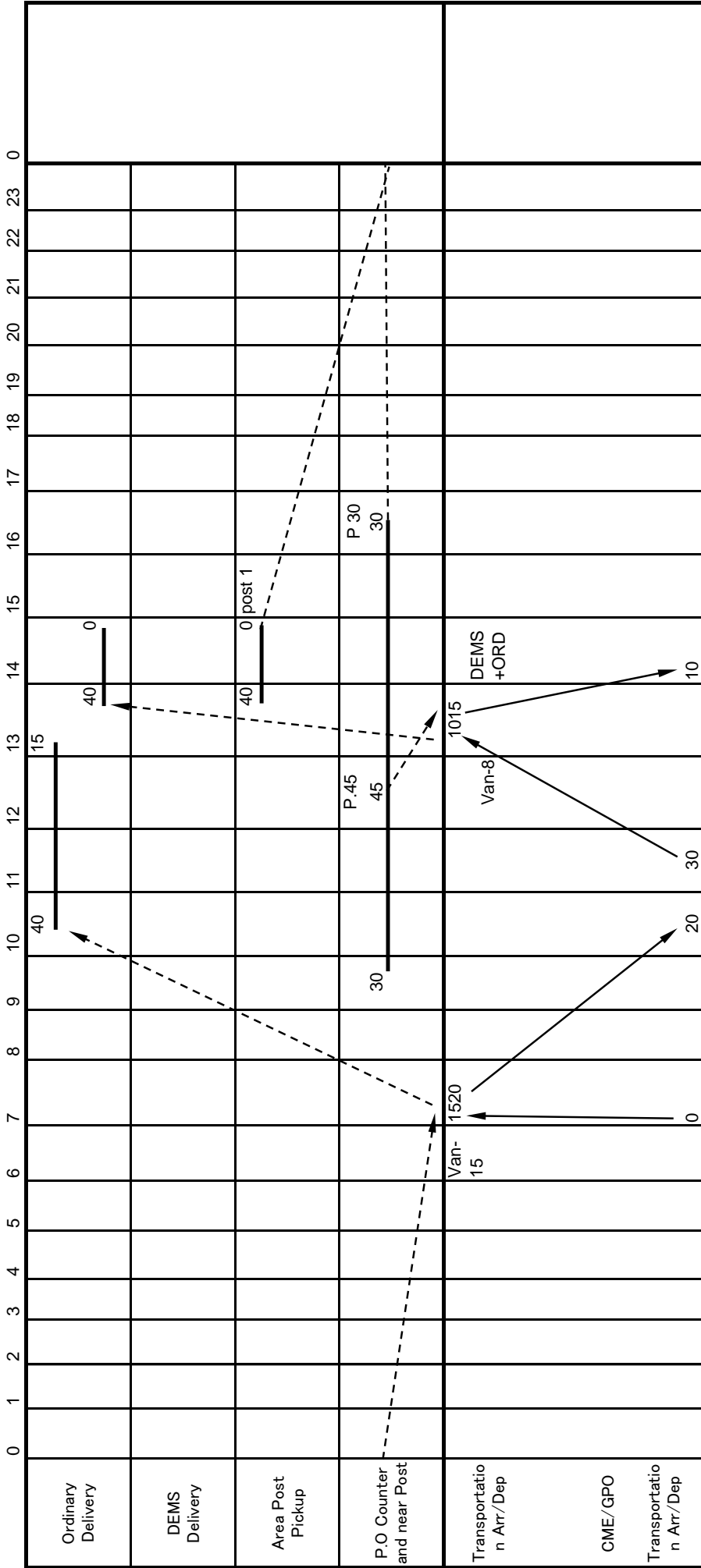

DEMS SPECIAL DELIVERY BY GPO

Botataung POST OFFICE Kessoku Diagram

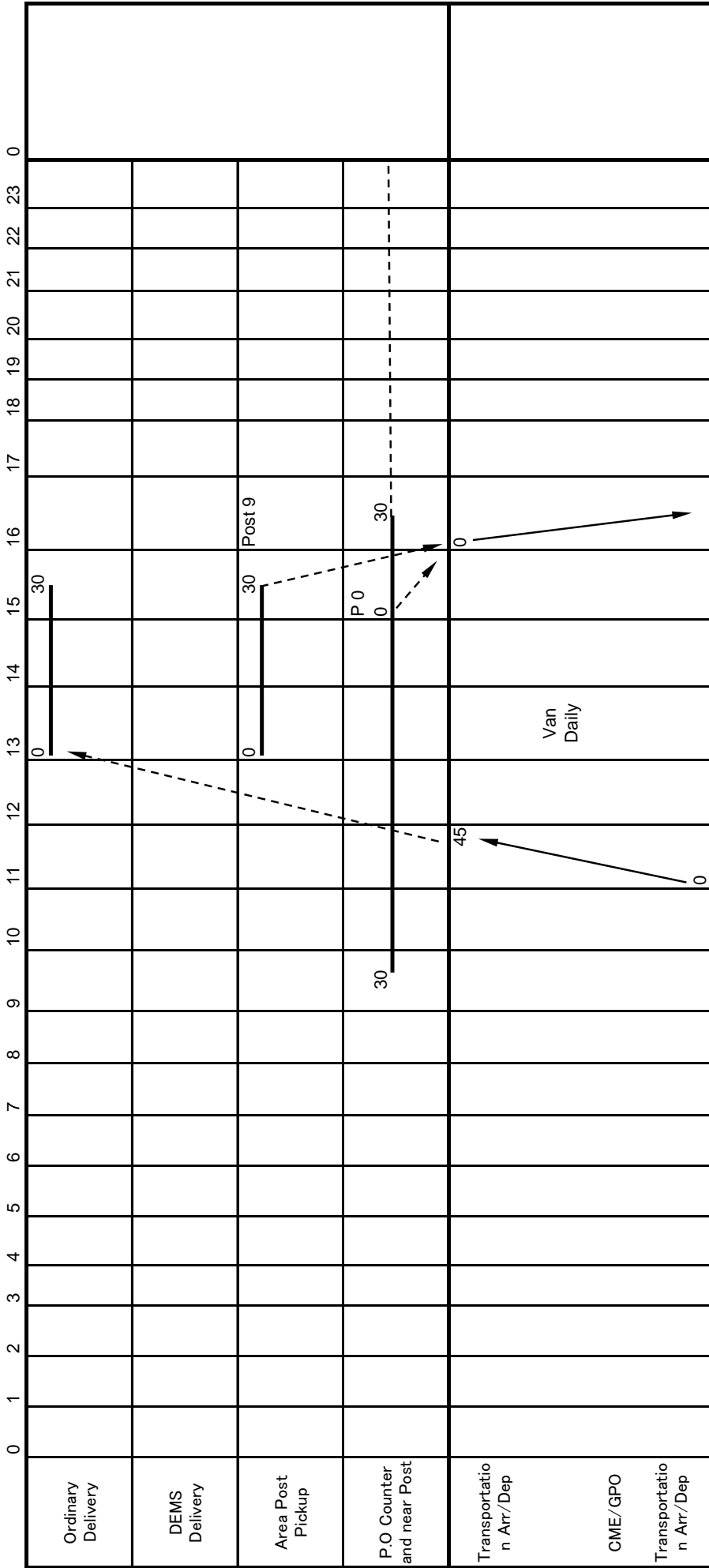

DEMS SPECIAL DELIVERY BY GPO

Myanma Naw POST OFFICE Kessoku Diagram

	0	1	2	3	4	5	6	7	8	9	10	11	12	13	14	15	16	17	18	19	20	21	22	23	0
Ordinary Delivery																									
DEMS Delivery																									
Area Post Pickup																									
P.O Counter and near Post										30				0			30								
Transportation Arr/Dep														20											
Botataung P.O																									
Transportation Arr/Dep																									

Bicycle  
Daily (sat,Sun .Off)

Non Delivery

Pazundaung POST OFFICE Kessoku Diagram

	0	1	2	3	4	5	6	7	8	9	10	11	12	13	14	15	16	17	18	19	20	21	22	23	0
Ordinary Delivery																									
DEMS Delivery																									
Area Post Pickup																									
P.O Counter and near Post										30				P 0			P 30								
Transportation Arr/Dep								Van-4	0				Van-6												
CME/GPO													DEMS+ ORD												
Transportation Arr/Dep																									

Non Delivery



Thaketa POST OFFICE Kessoku Diagram

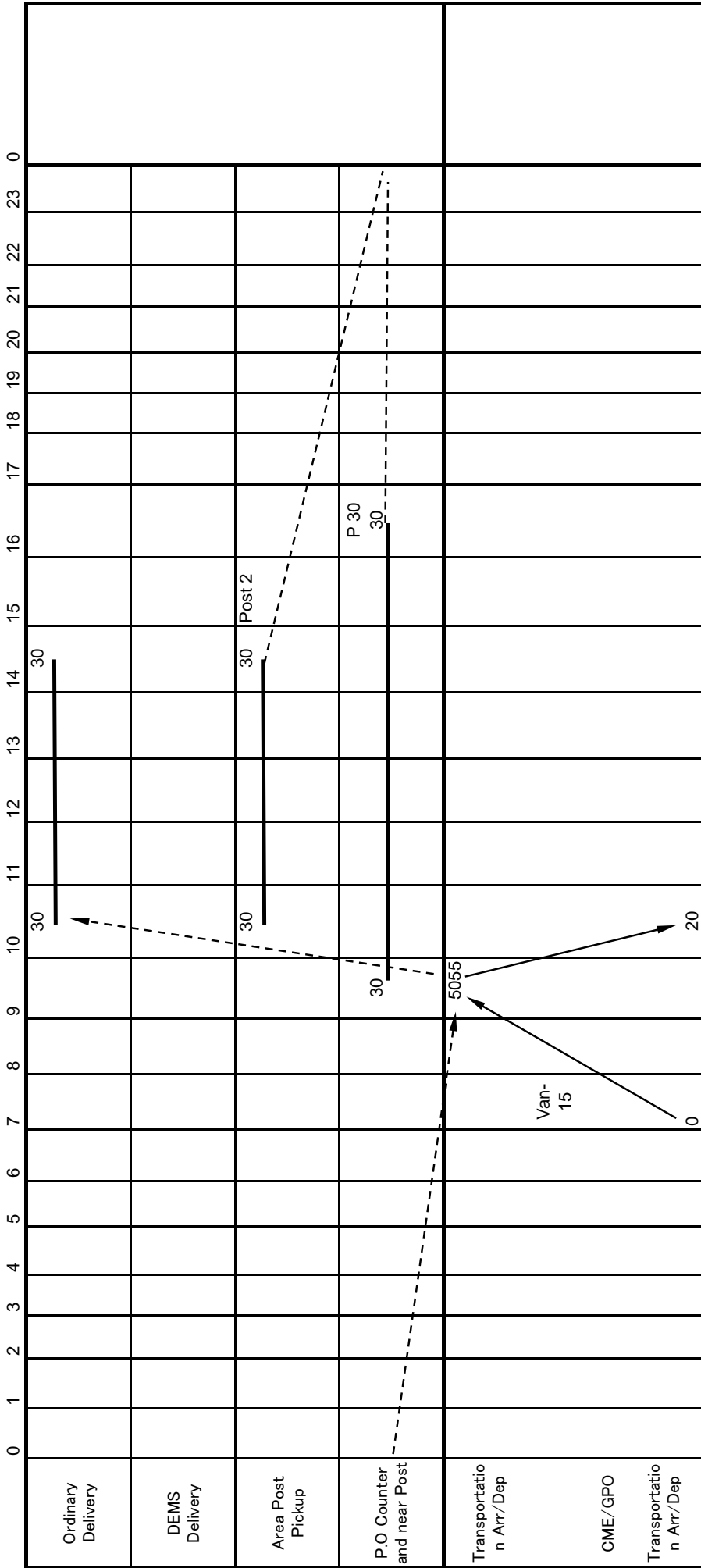

DEMS SPECIAL DELIVERY BY GPO

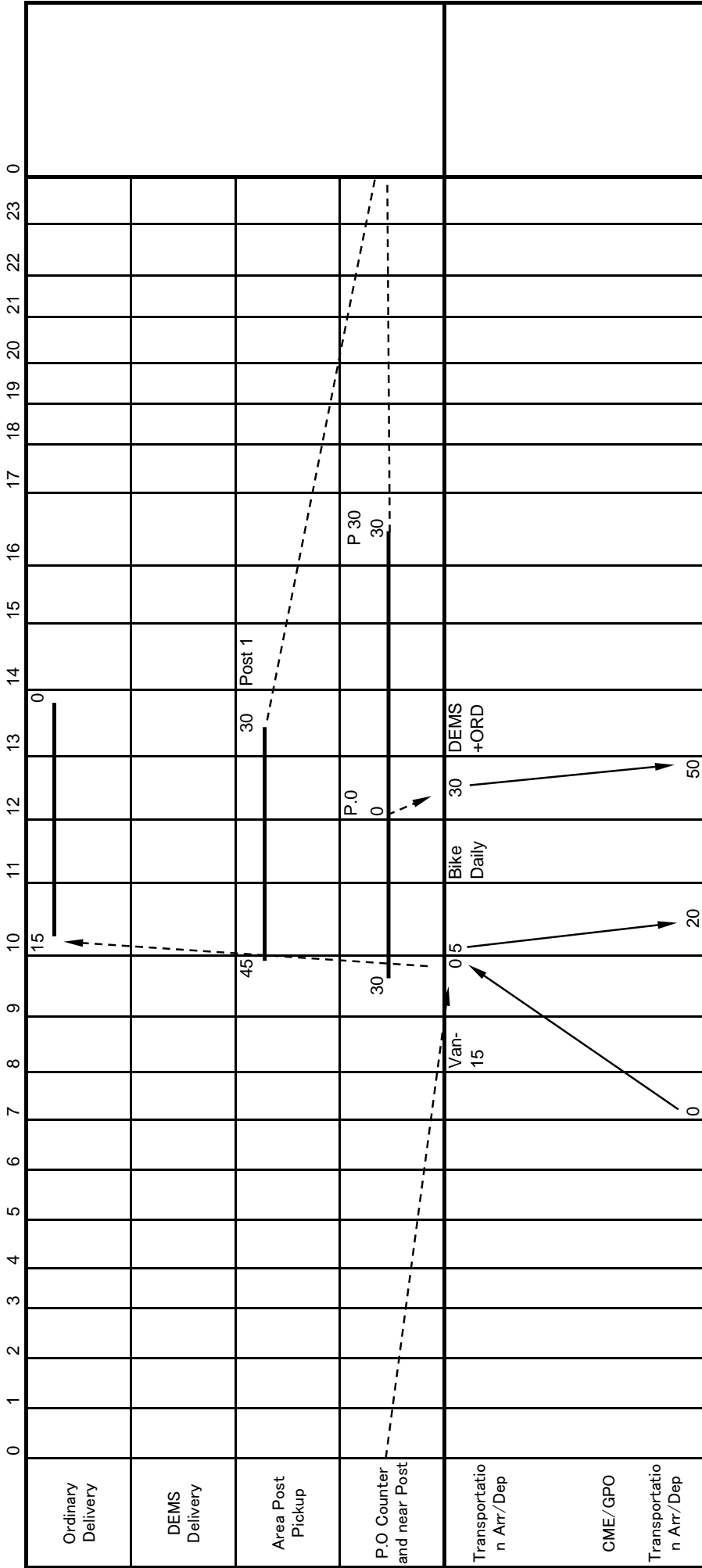

Dala POST OFFICE Kessoku Diagram

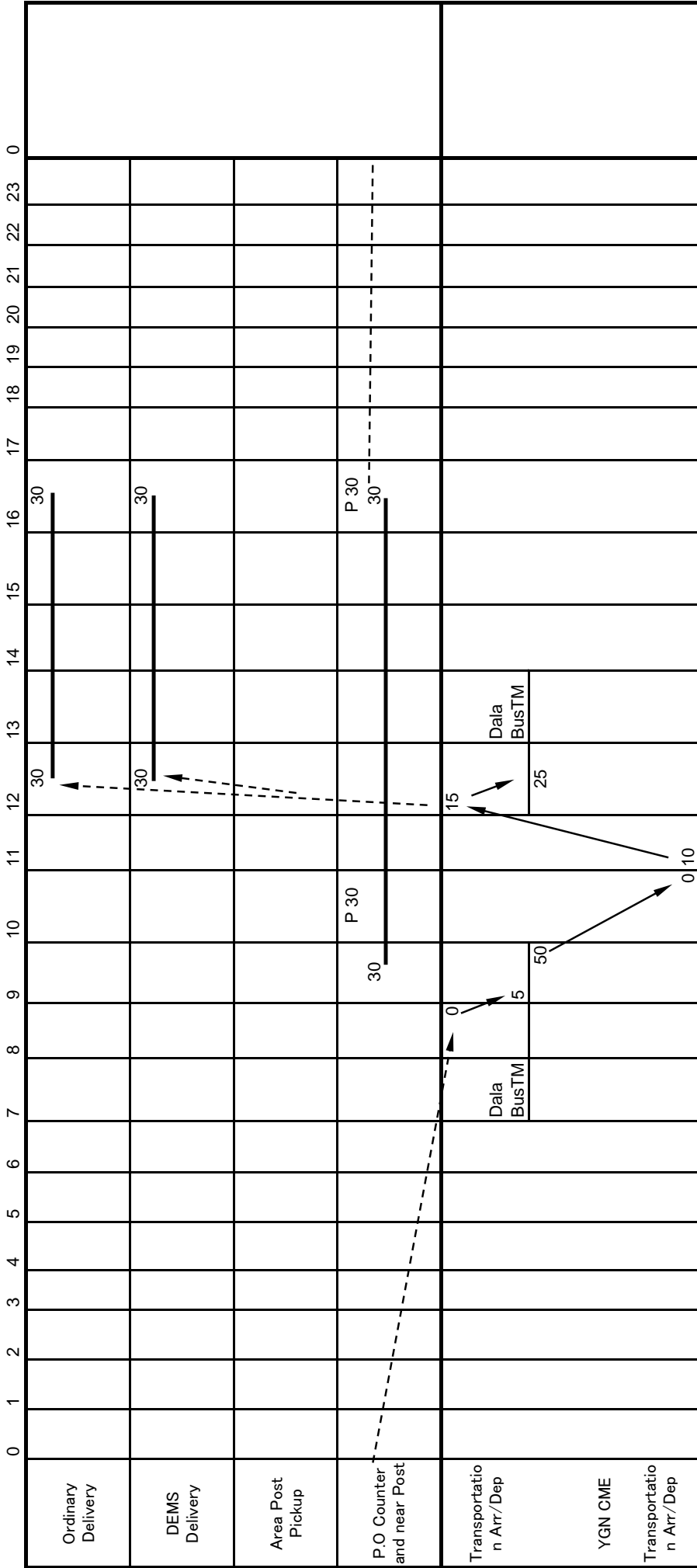

Twante POST OFFICE Kessoku Diagram

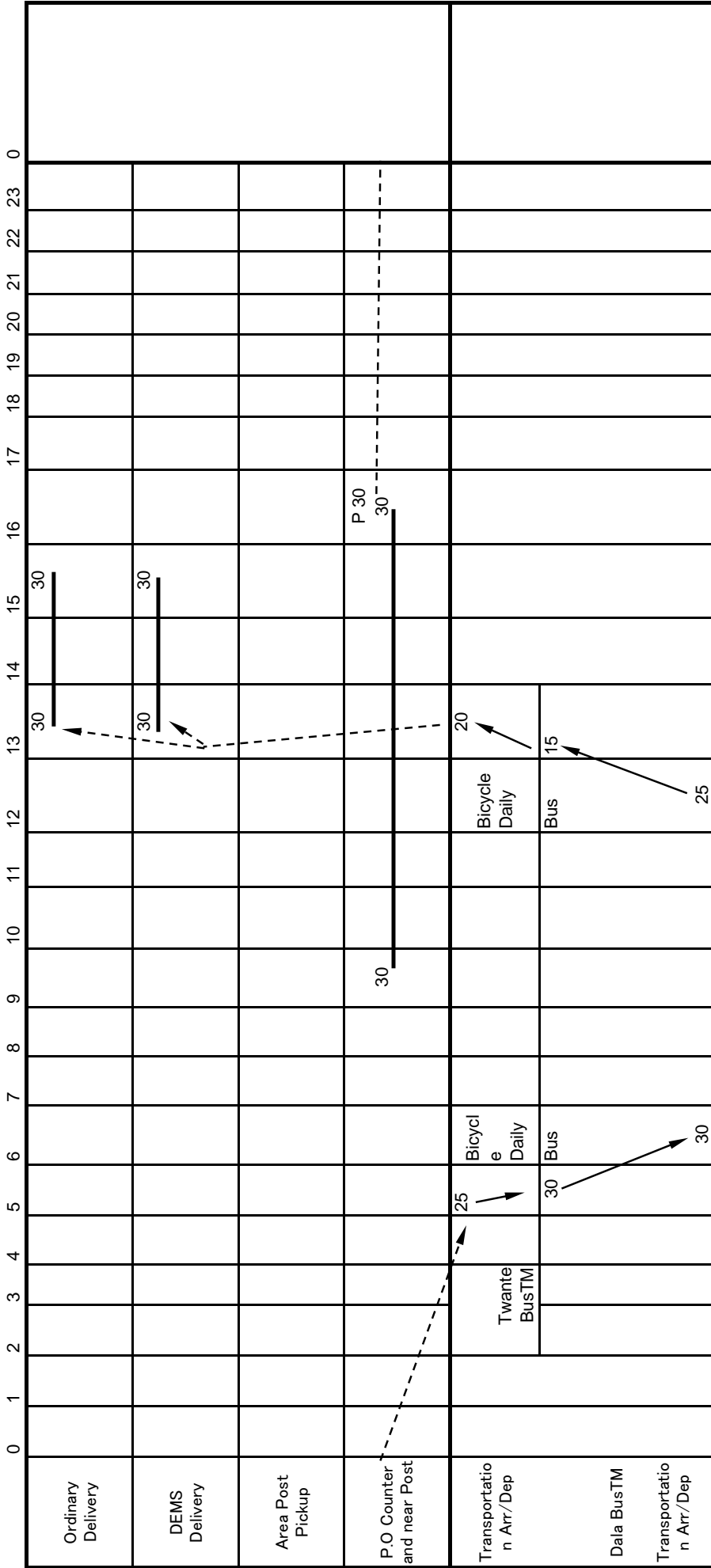

Konchankone POST OFFICE Kessoku Diagram

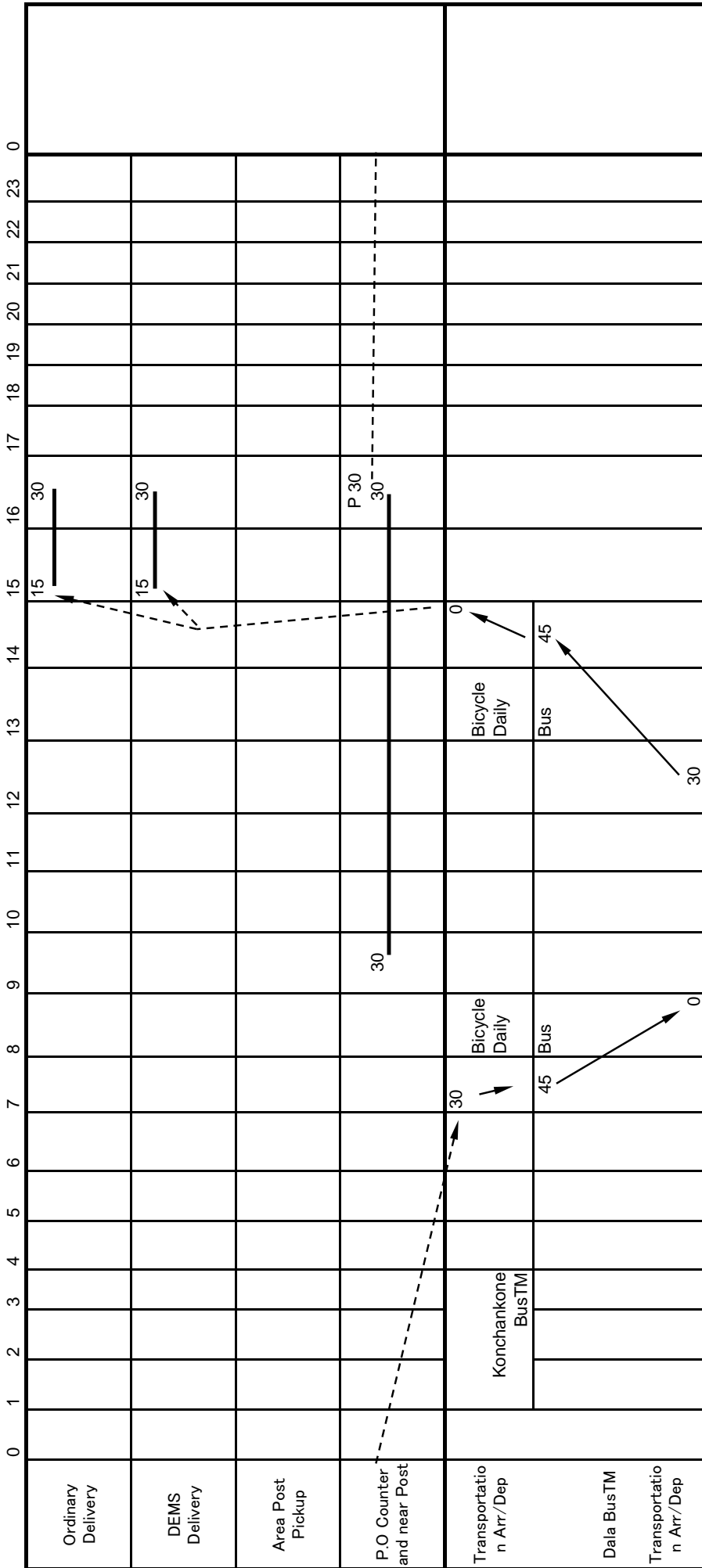





Warbaloutthaught POST OFFICE Kessoku Diagram

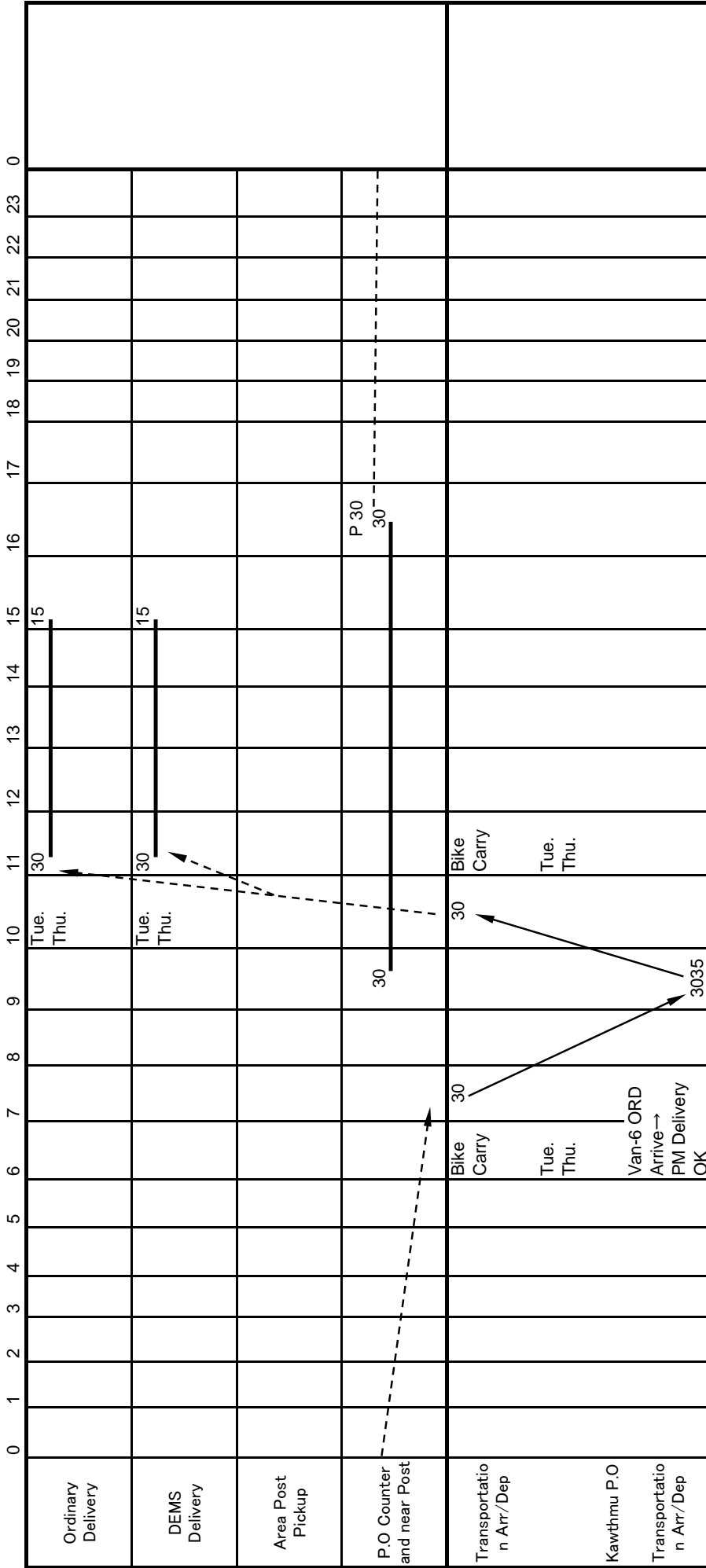



Kyaikhtaw POST OFFICE Kessoku Diagram

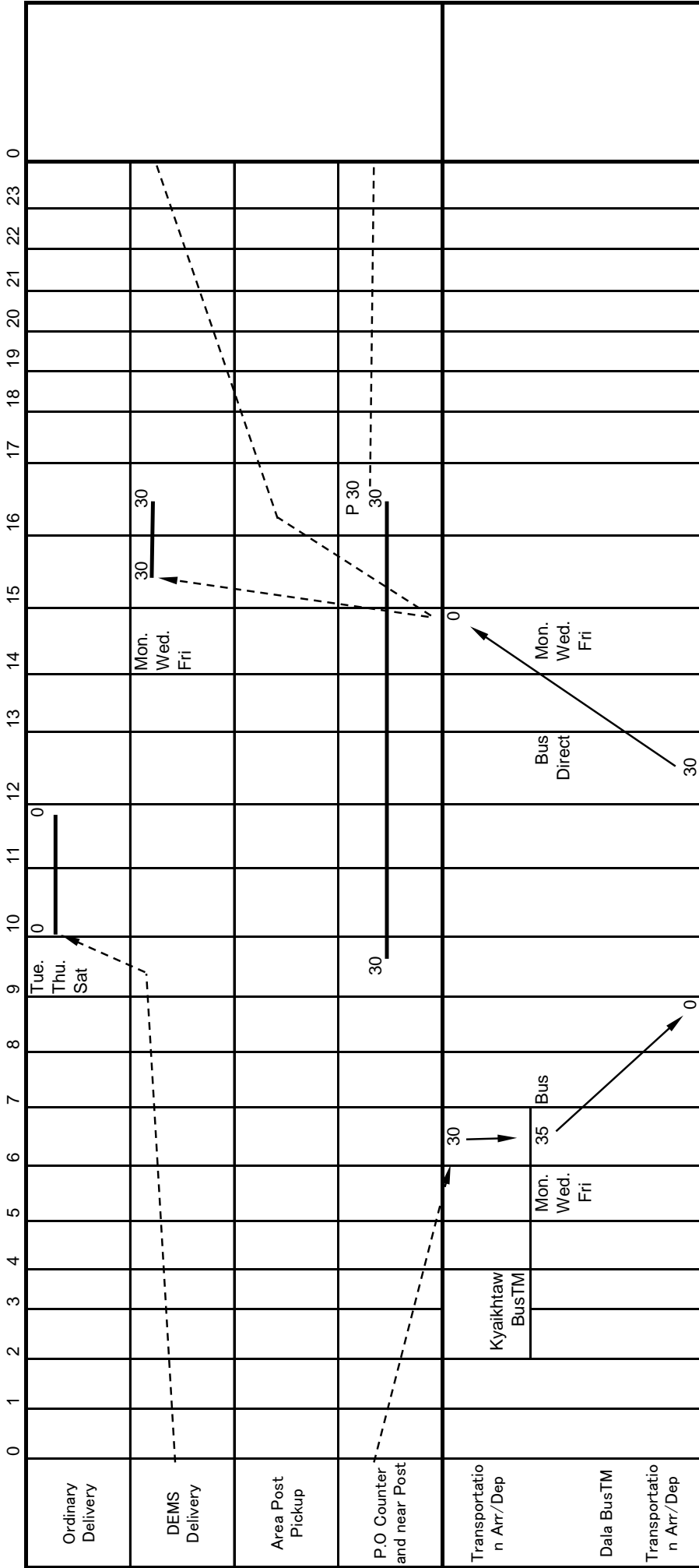

Yangon Station POST OFFICE Kessoku Diagram

	0	1	2	3	4	5	6	7	8	9	10	11	12	13	14	15	16	17	18	19	20	21	22	23	0
Ordinary Delivery																									
DEMS Delivery																									
Area Post Pickup																									
P.O Counter and near Post										30			P 50 50				30								
Transportation Arr/Dep														0											
Taungnyunt P.O																									
Transportation Arr/Dep																									

Daily (Sat. Sun Off)

Non Delivery. DEMS No Service

North Okkalapa POST OFFICE Kessoku Diagram

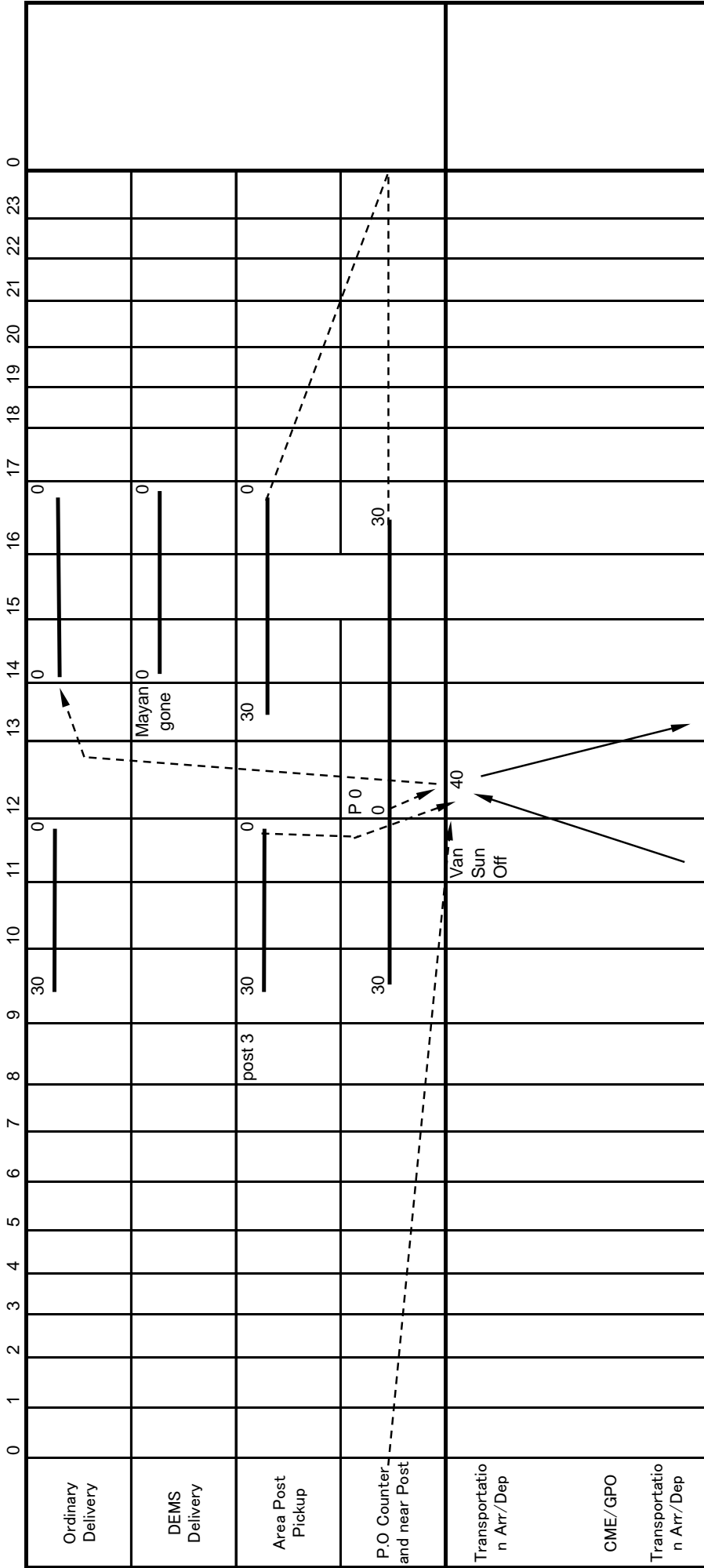

DEMS SPECIAL DELIVERY BY Mayangone

Shwepaukkan POST OFFICE Kessoku Diagram

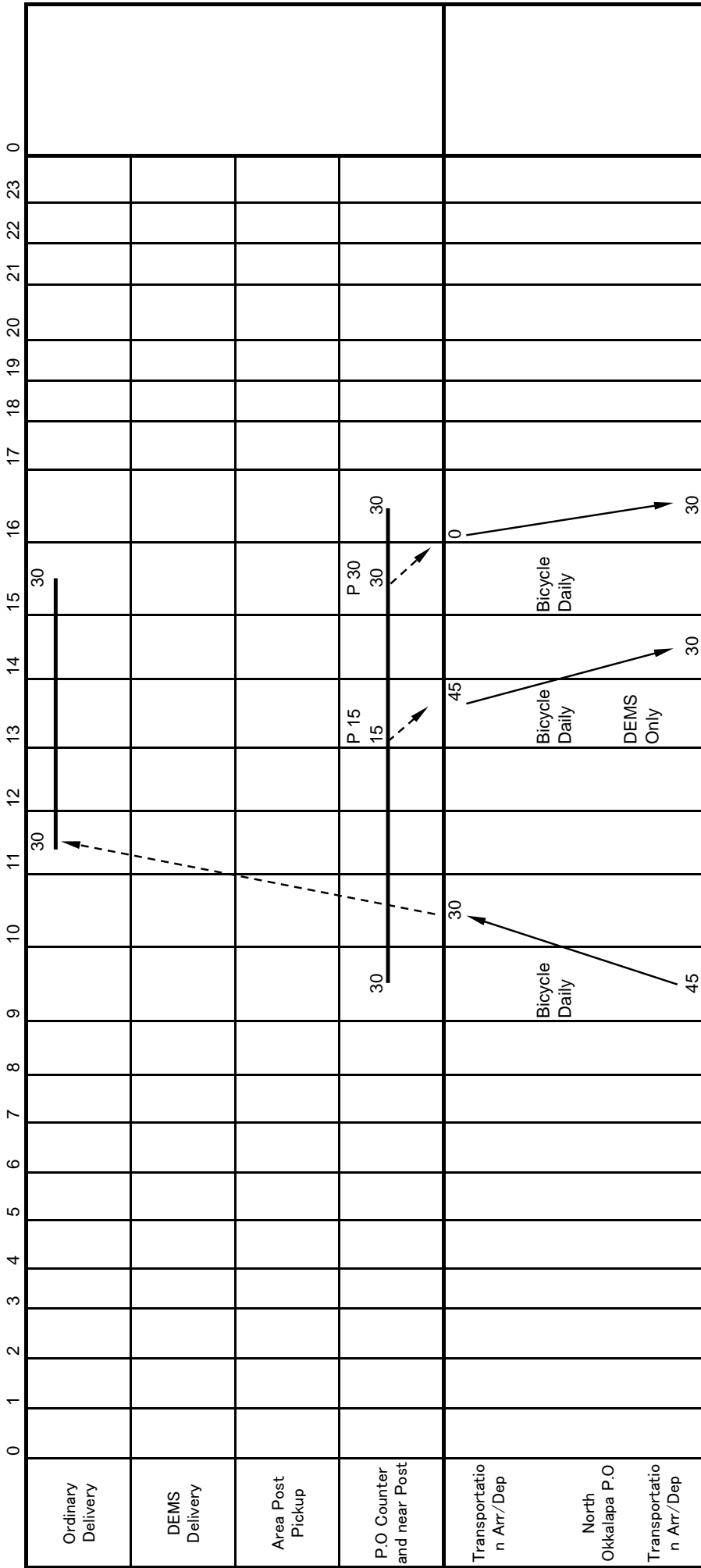

DEMS SPECIAL DELIVERY BY Mayangone



Thanlyin POST OFFICE Kessoku Diagram

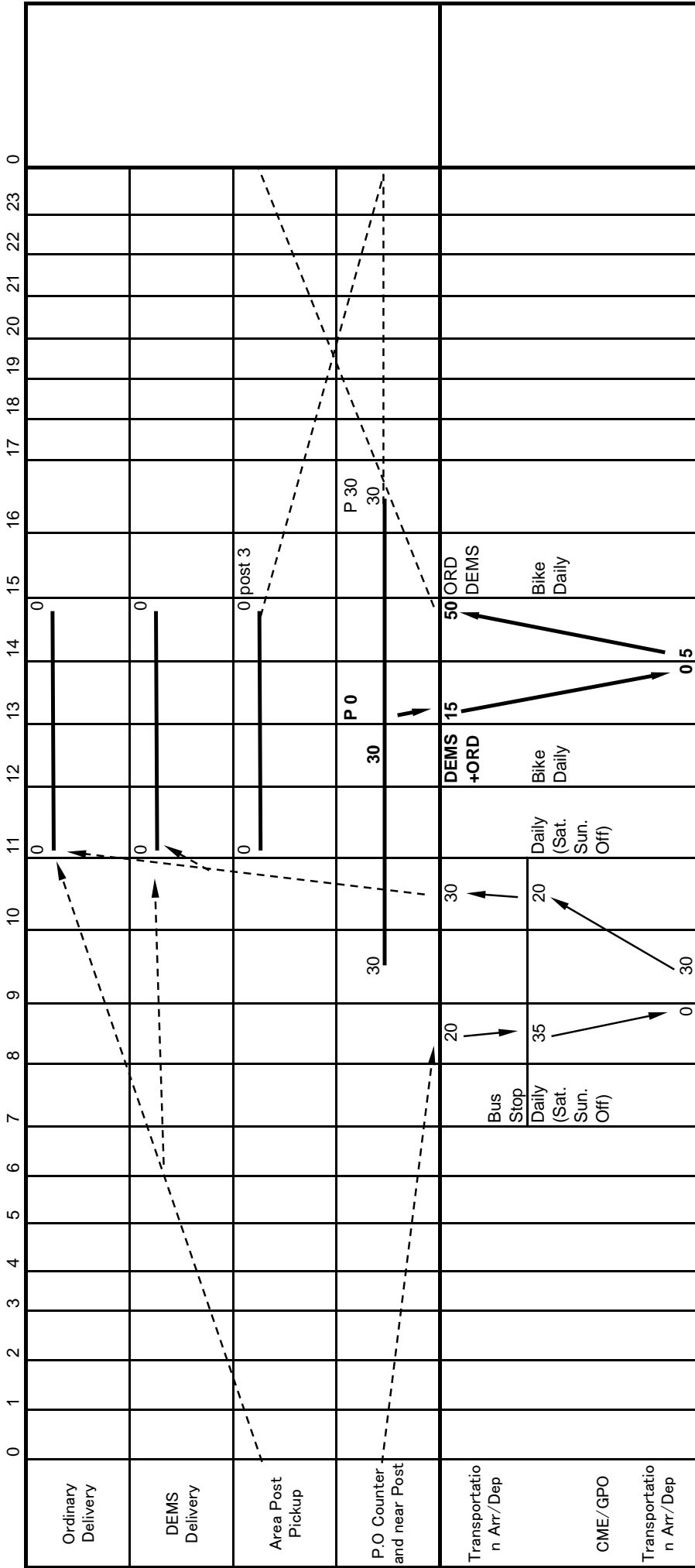

Ygn East U C POST OFFICE Kessoku Diagram

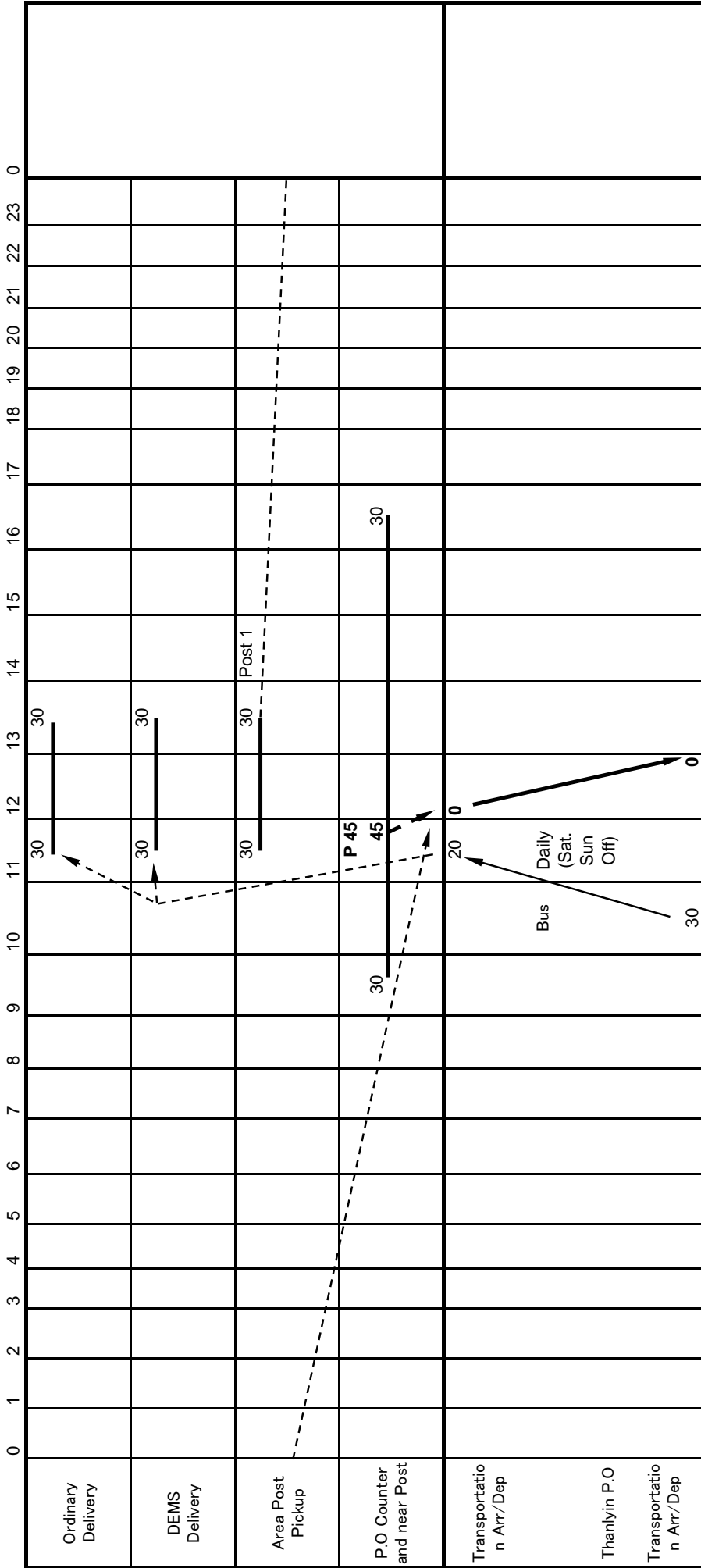

MTU (Thilawar) POST OFFICE Kessoku Diagram

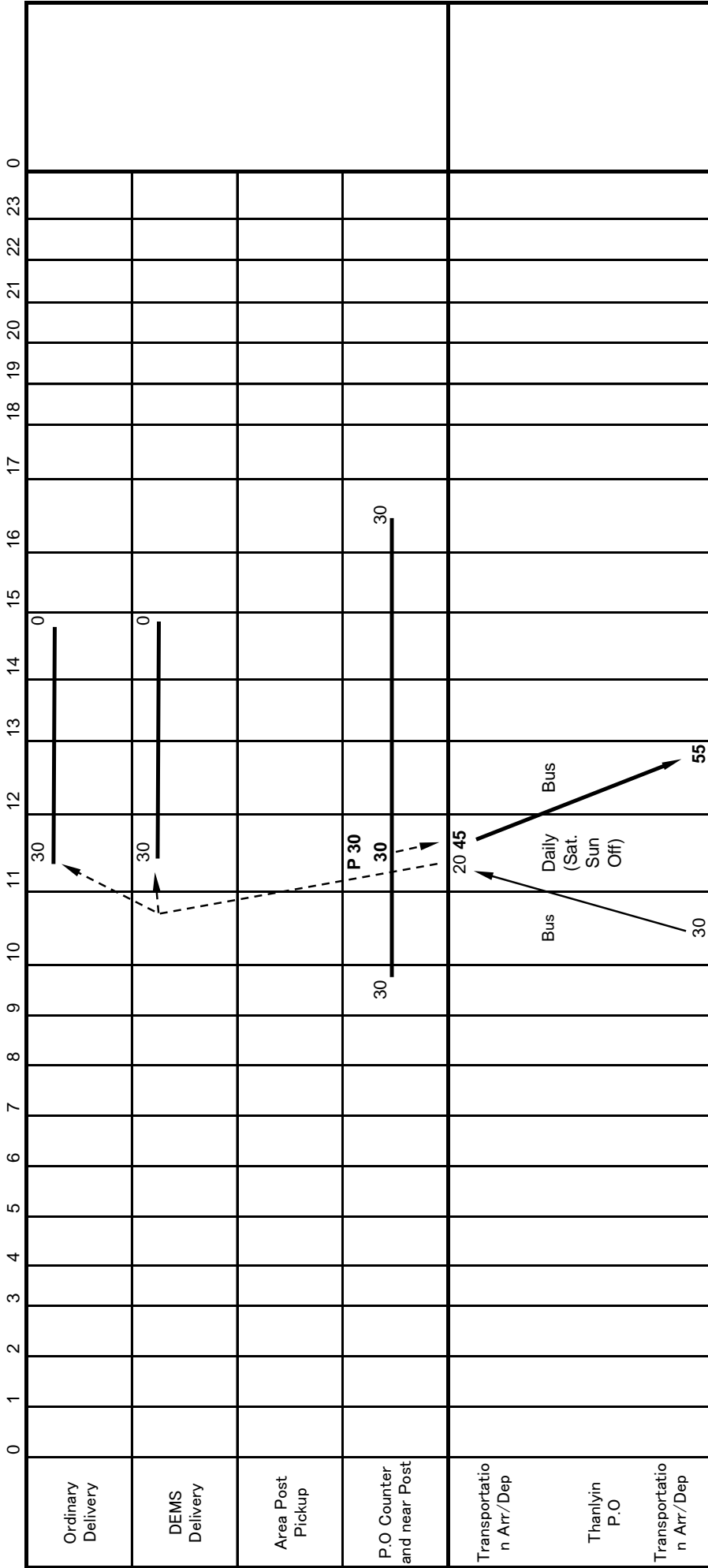



Kyauktan POST OFFICE Kessoku Diagram

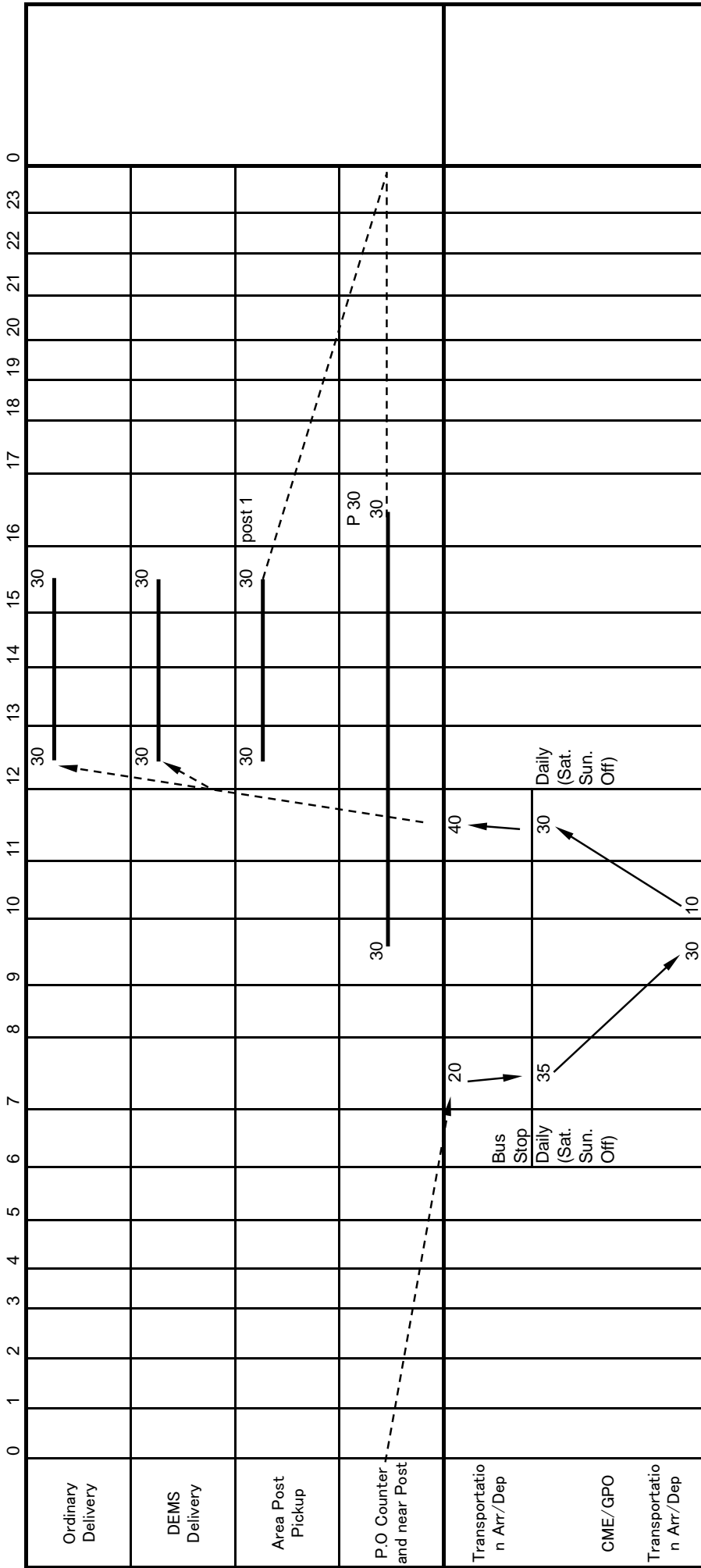

Thanlyin Cont; POST OFFICE Kessoku Diagram

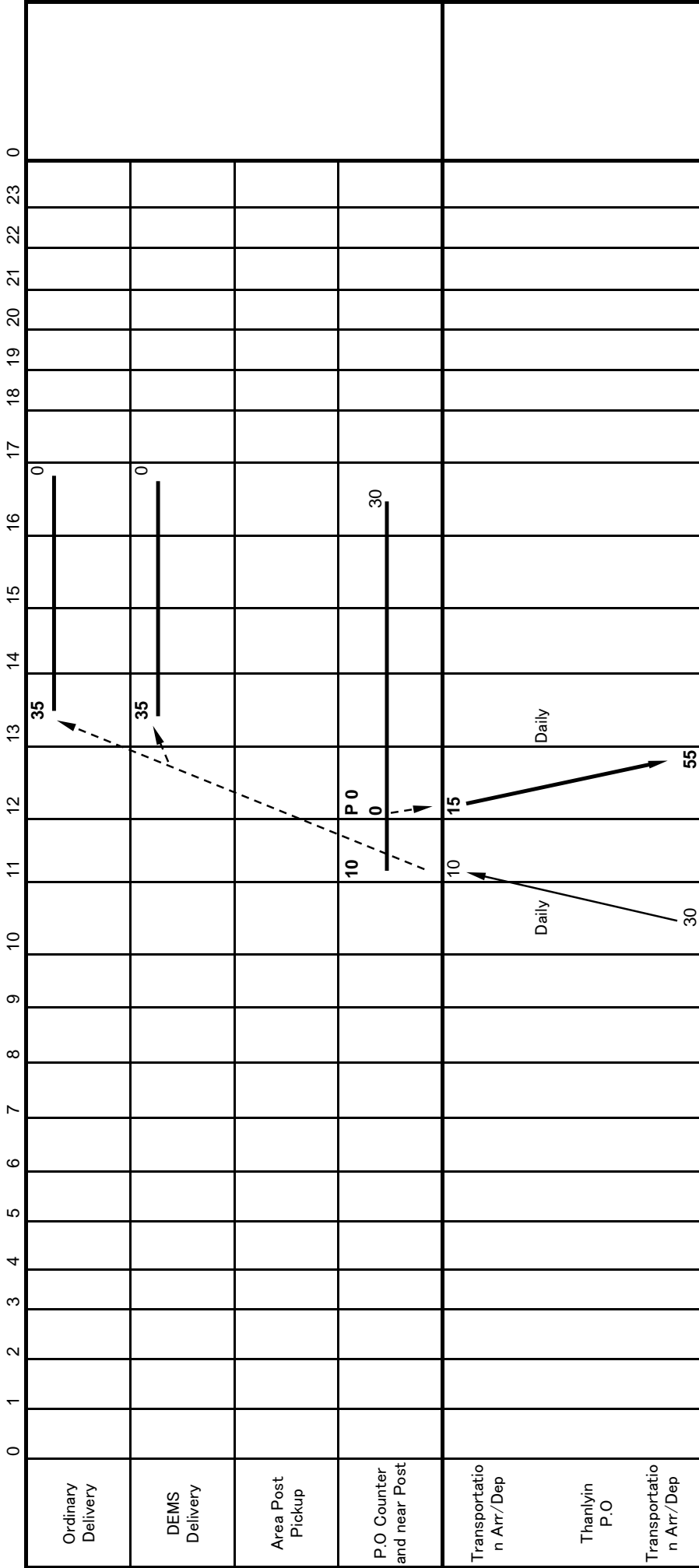

Postmaster 1 Operation(transprrtation.Delivery.Counter)

Kamakalote POST OFFICE Kessoku Diagram

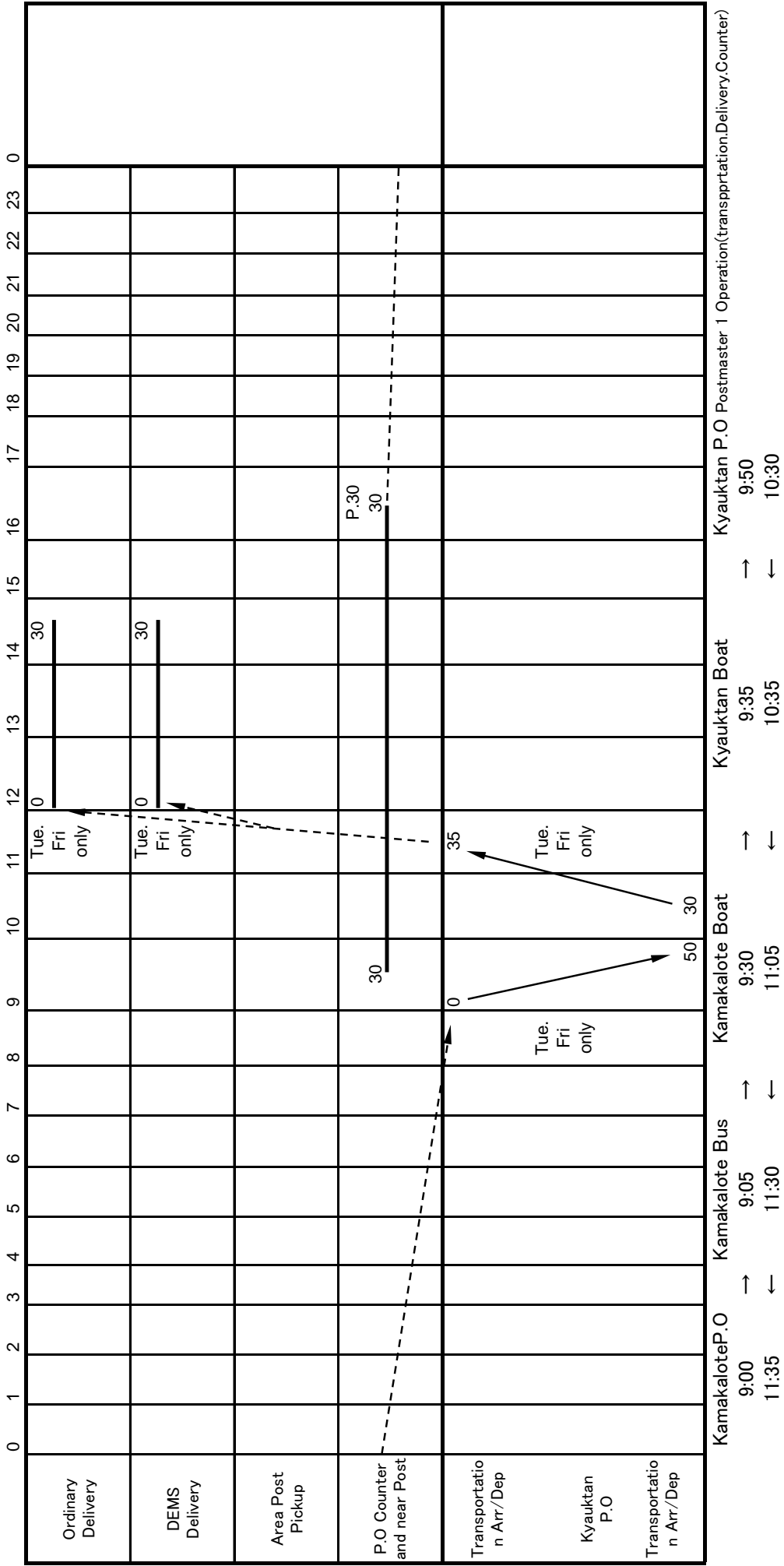

Mingalone POST OFFICE Kessoku Diagram

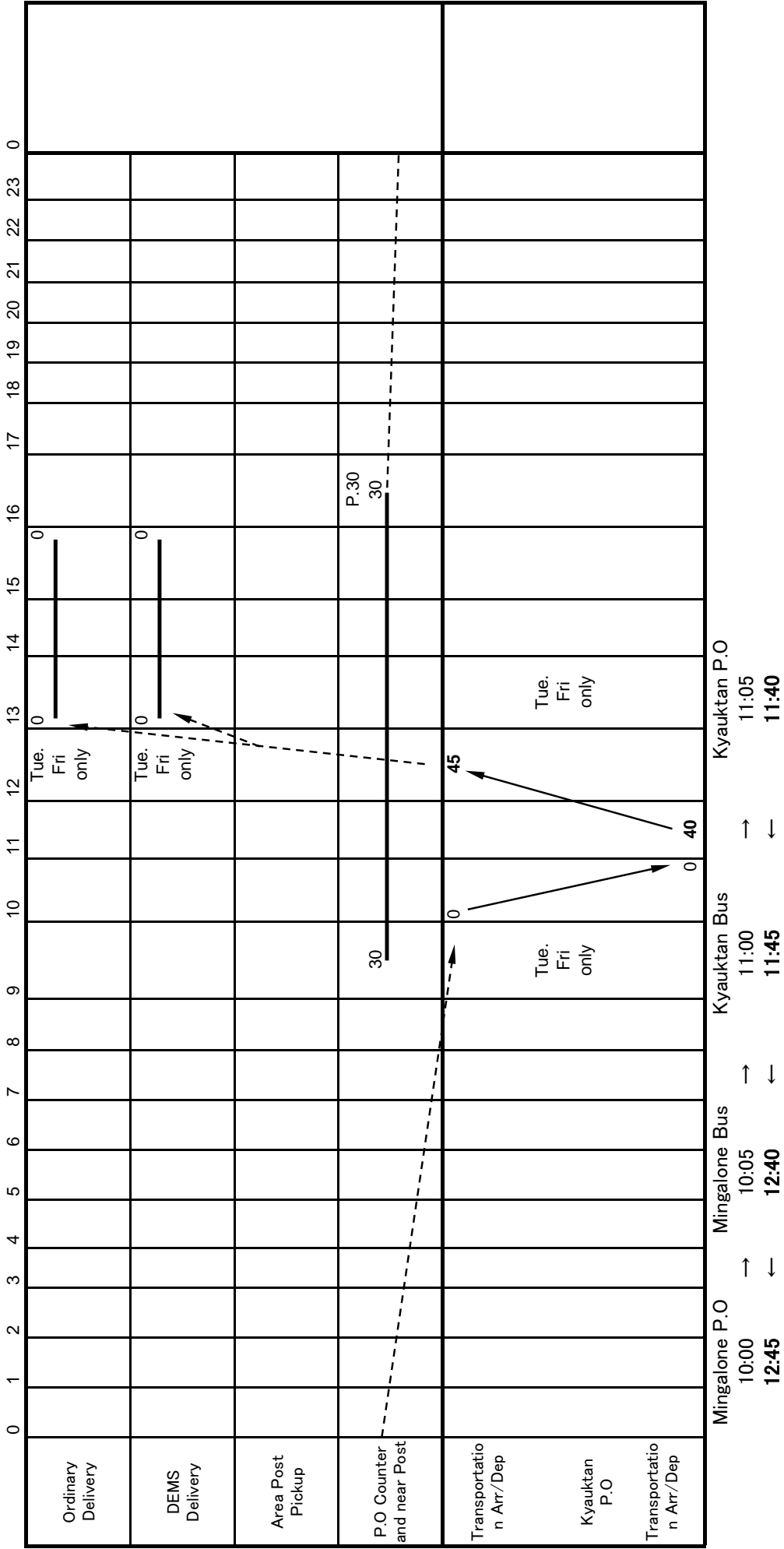

**Khanaung POST OFFICE Kessoku Diagram**

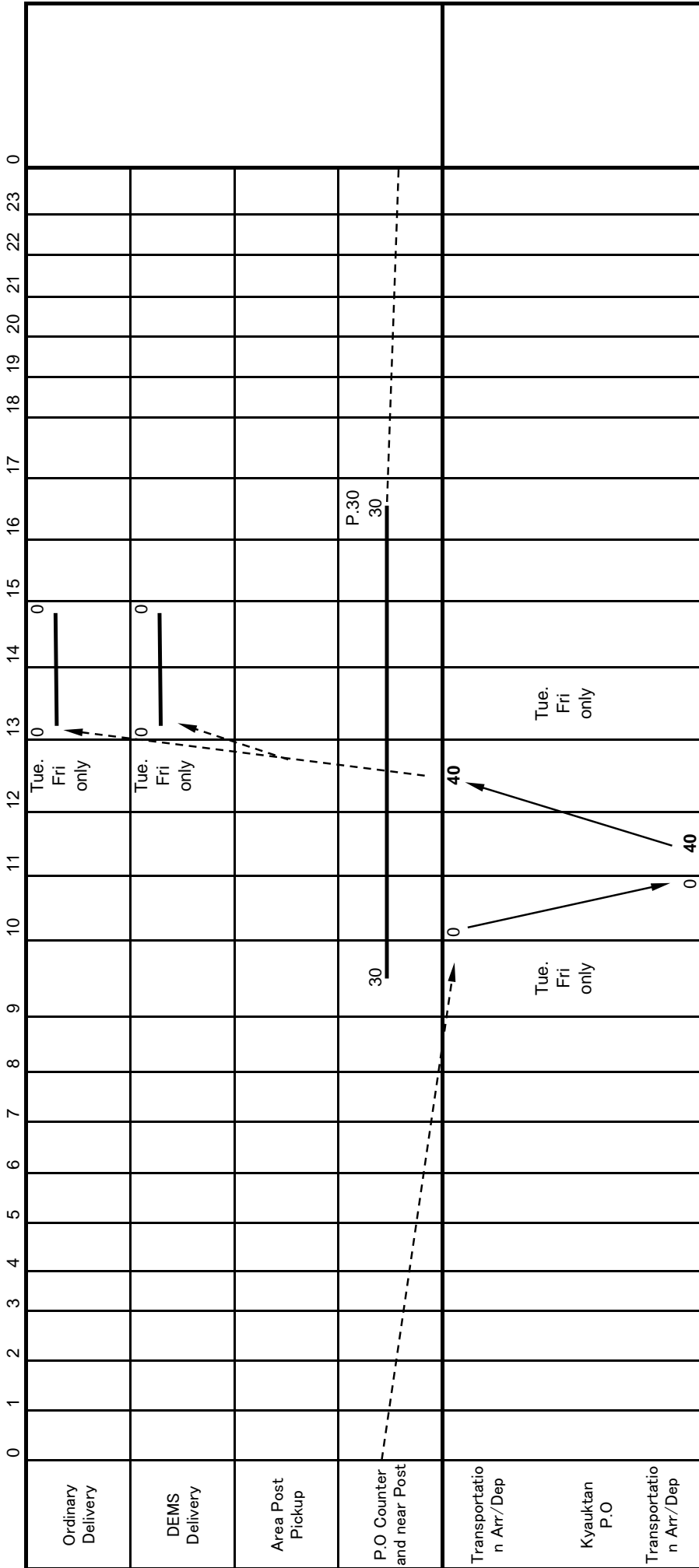

Khayan POST OFFICE Kessoku Diagram

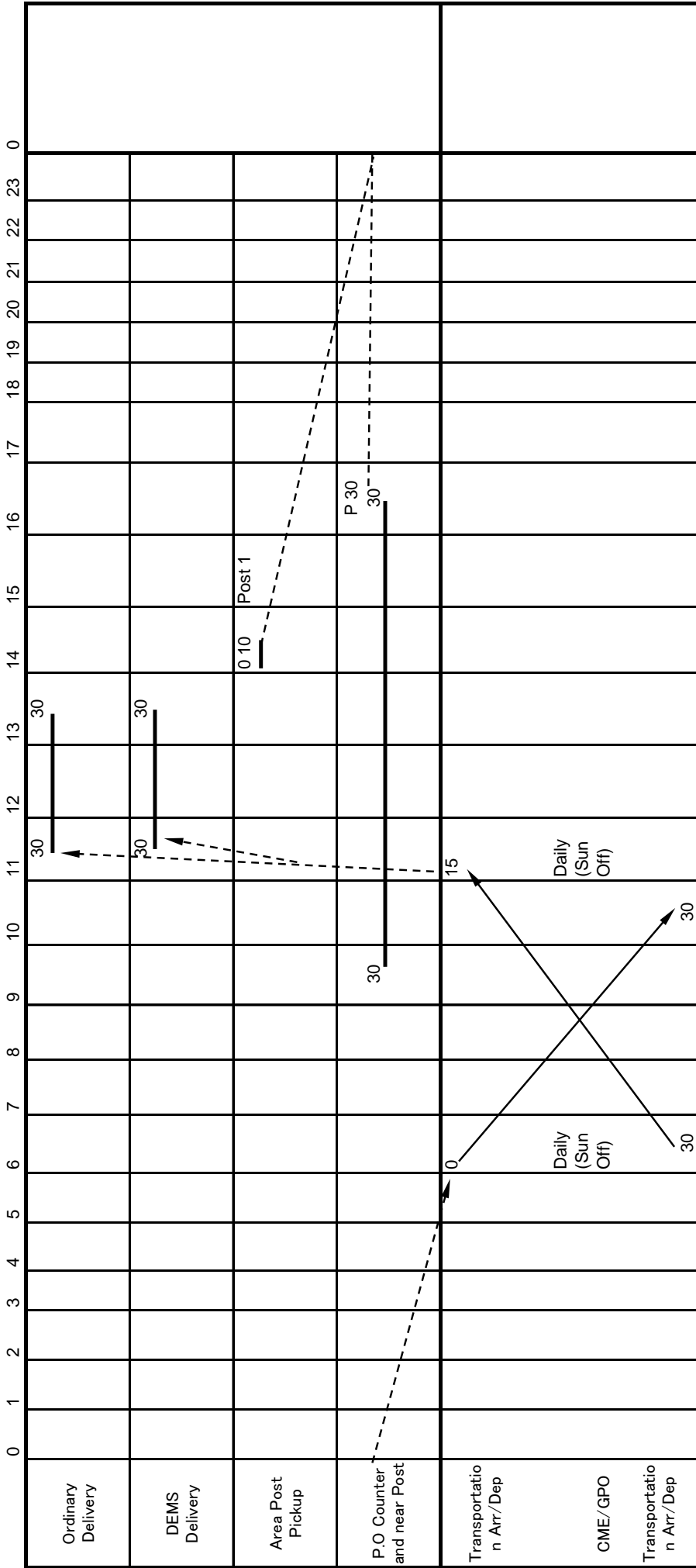

Thonegwa POST OFFICE Kessoku Diagram

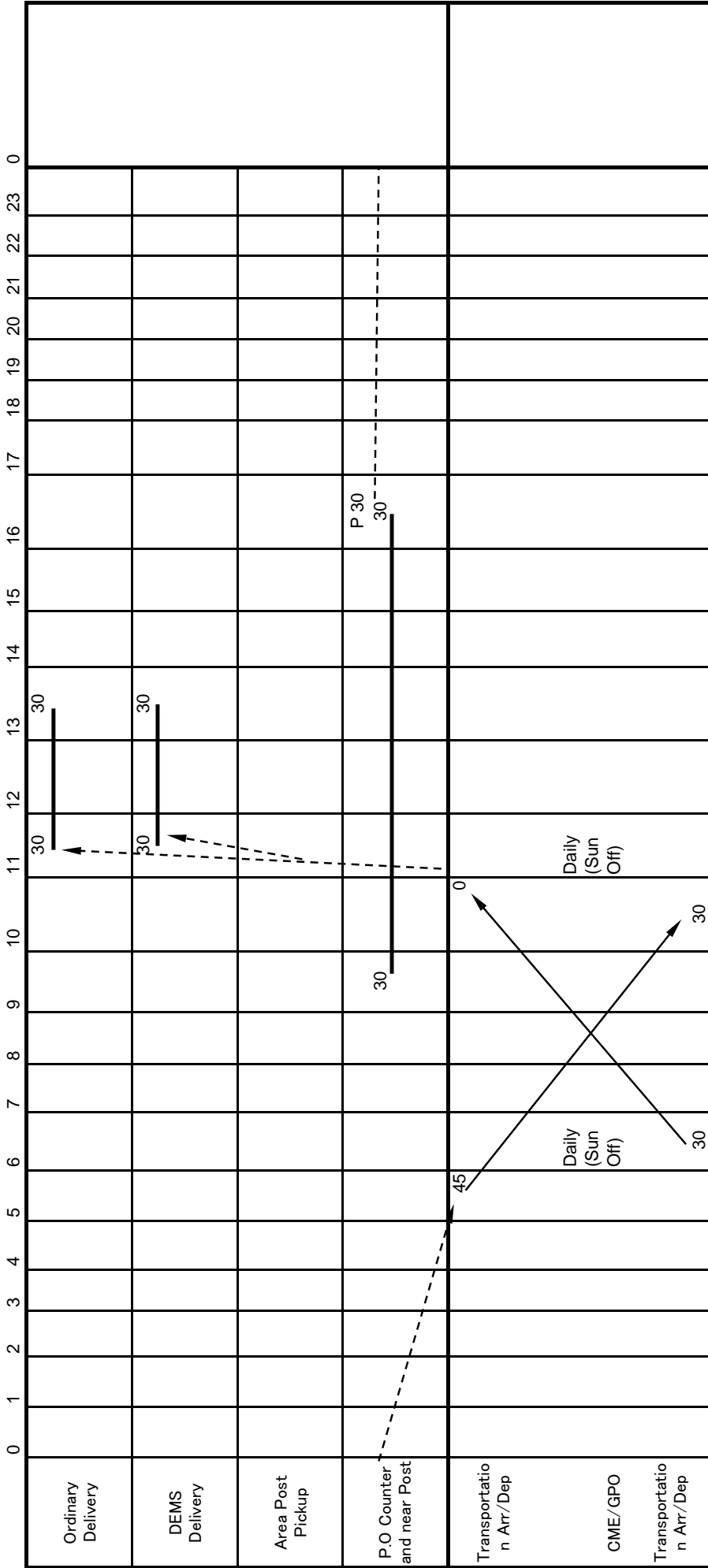

Tadarmyo POST OFFICE Kessoku Diagram

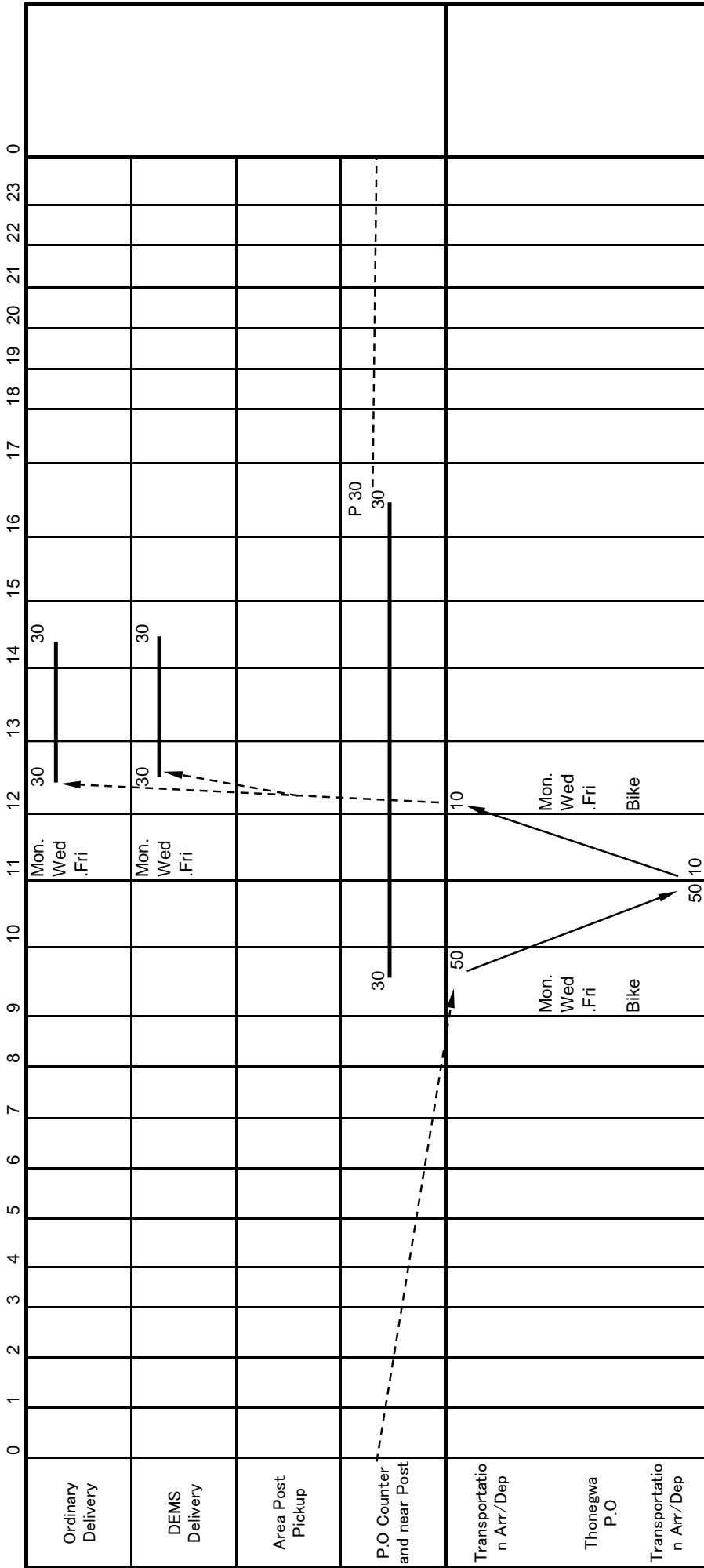



Dapain POST OFFICE Kessoku Diagram

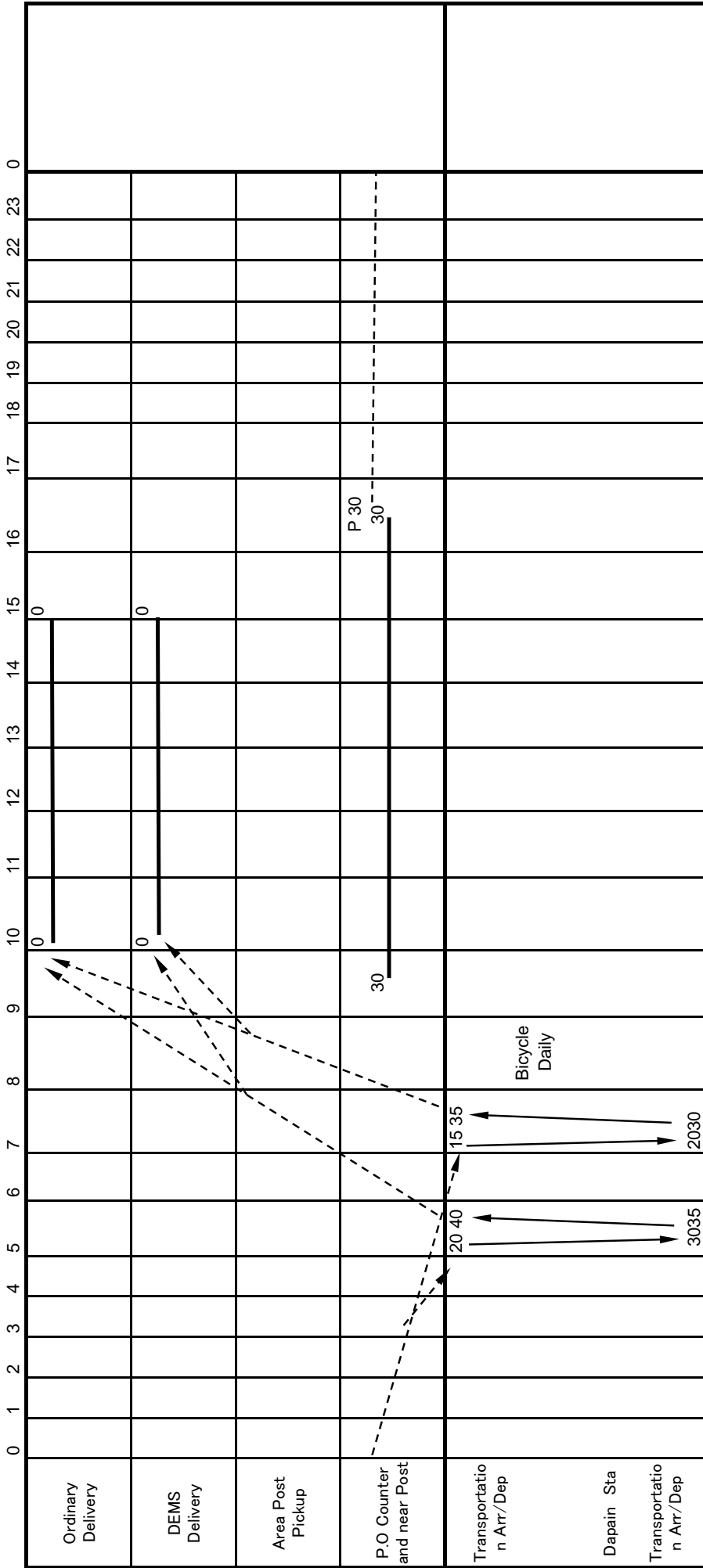

Mmawbi POST OFFICE Kessoku Diagram

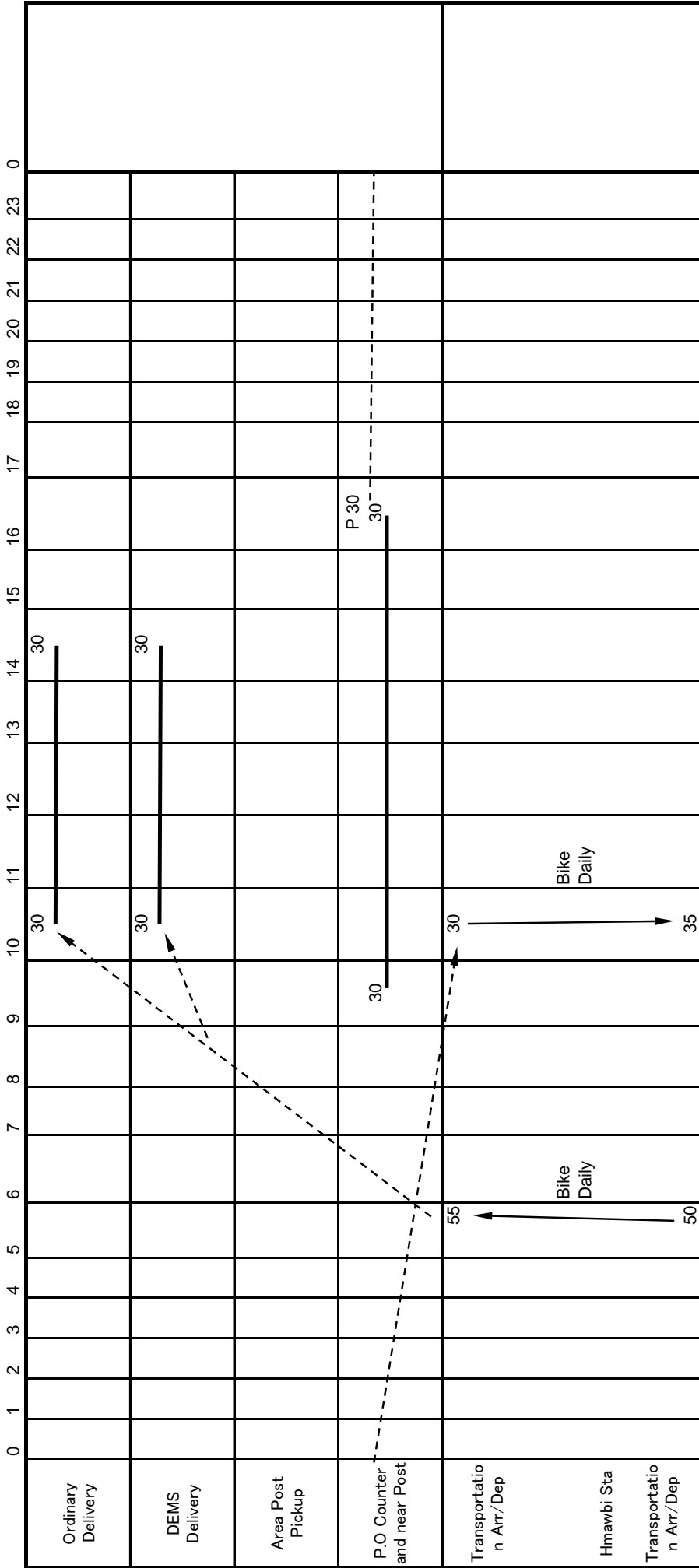

R-1 in  
10:45

R-1 out  
5:45

Myaungdaka POST OFFICE Kessoku Diagram

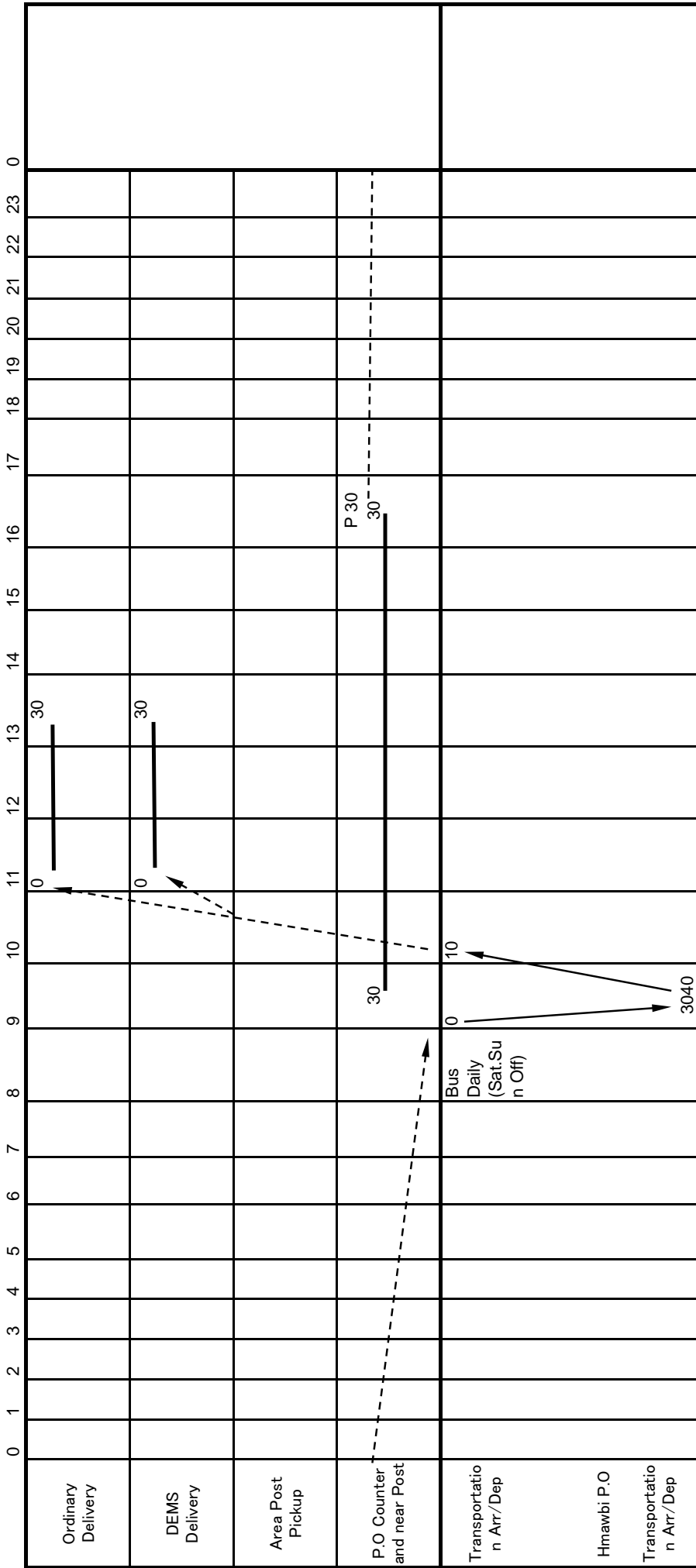

Mmawbi Canto; POST OFFICE Kessoku Diagram

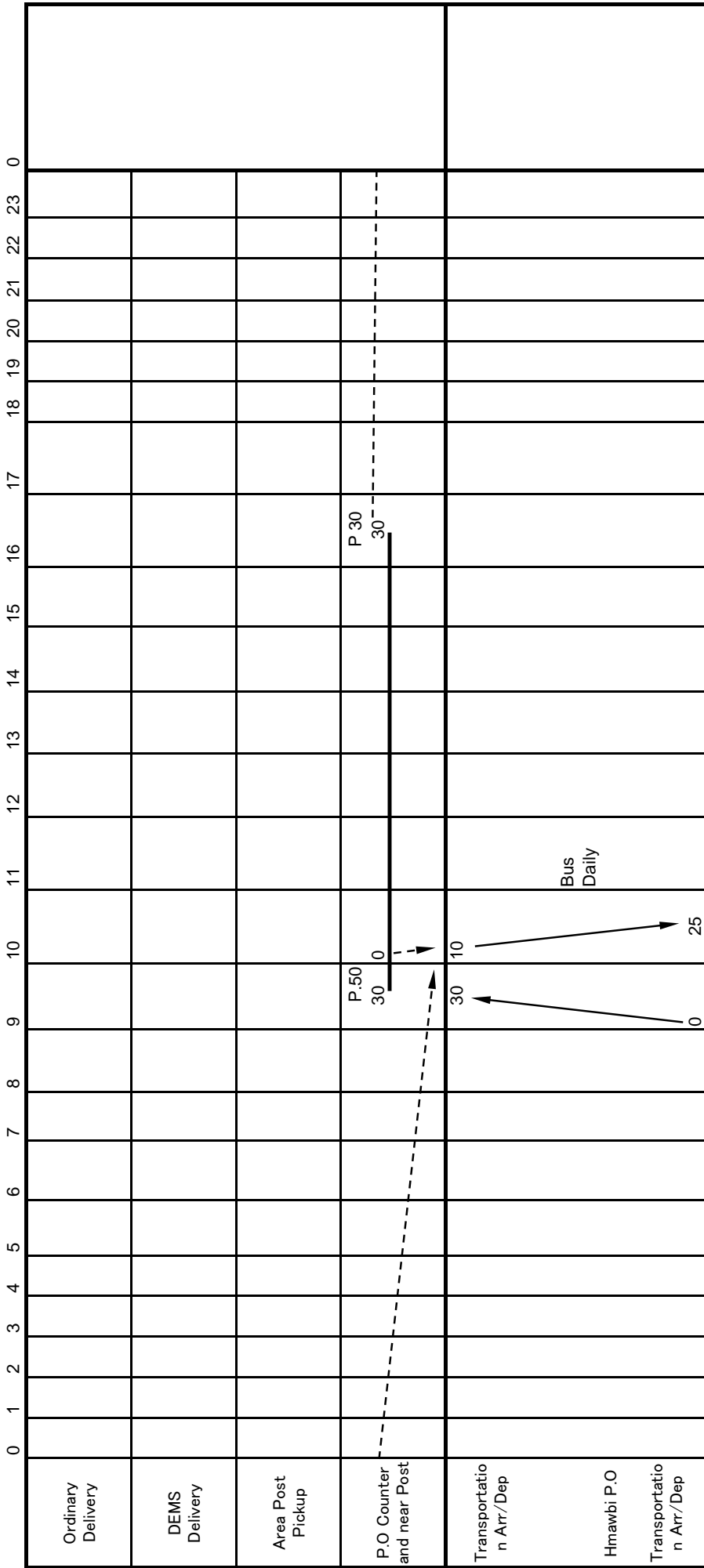

Hleseik POST OFFICE Kessoku Diagram

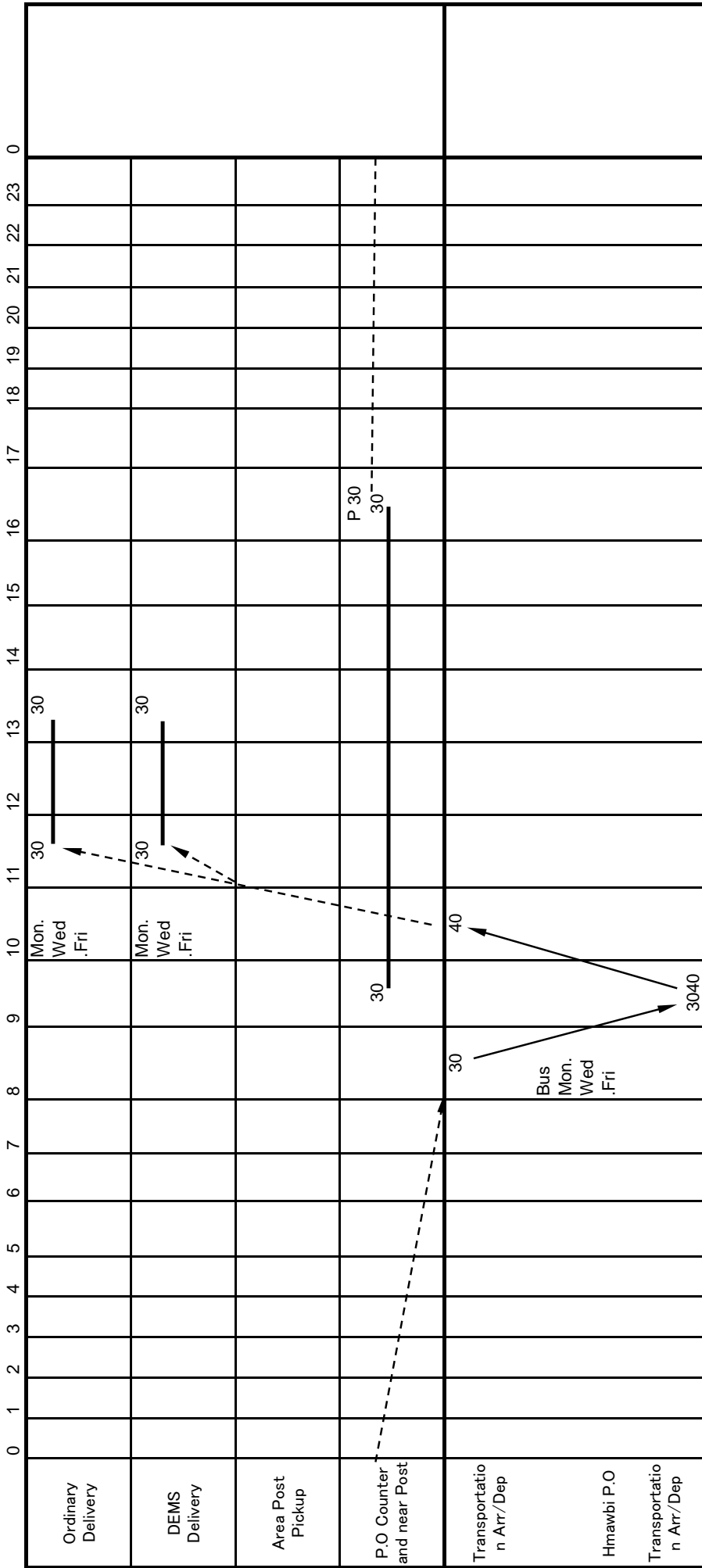

Taikkyi POST OFFICE Kessoku Diagram

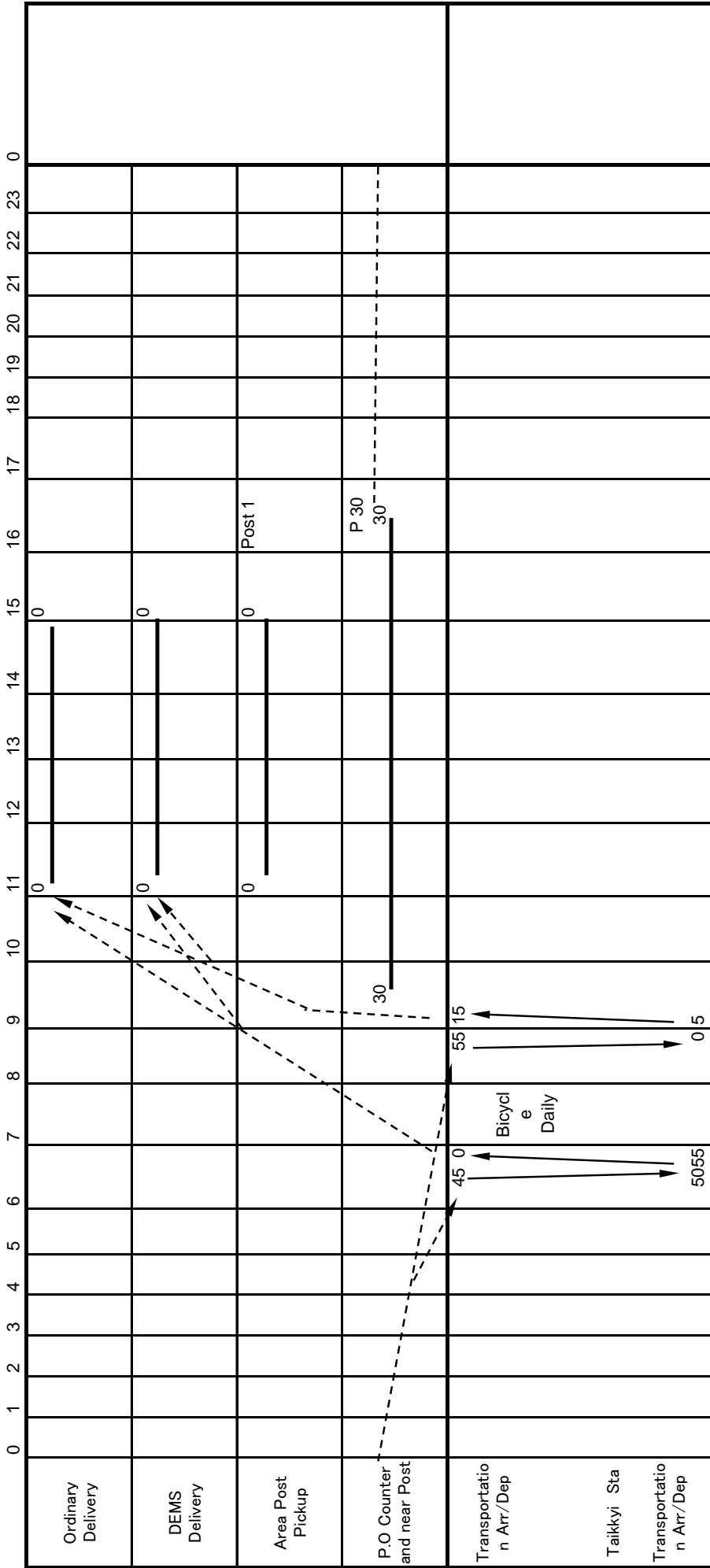

Aria Post Pick up → AM~PM(All AM x)

R-1 In 9:00

R-1 Out 6:50

Tawlati POST OFFICE Kessoku Diagram

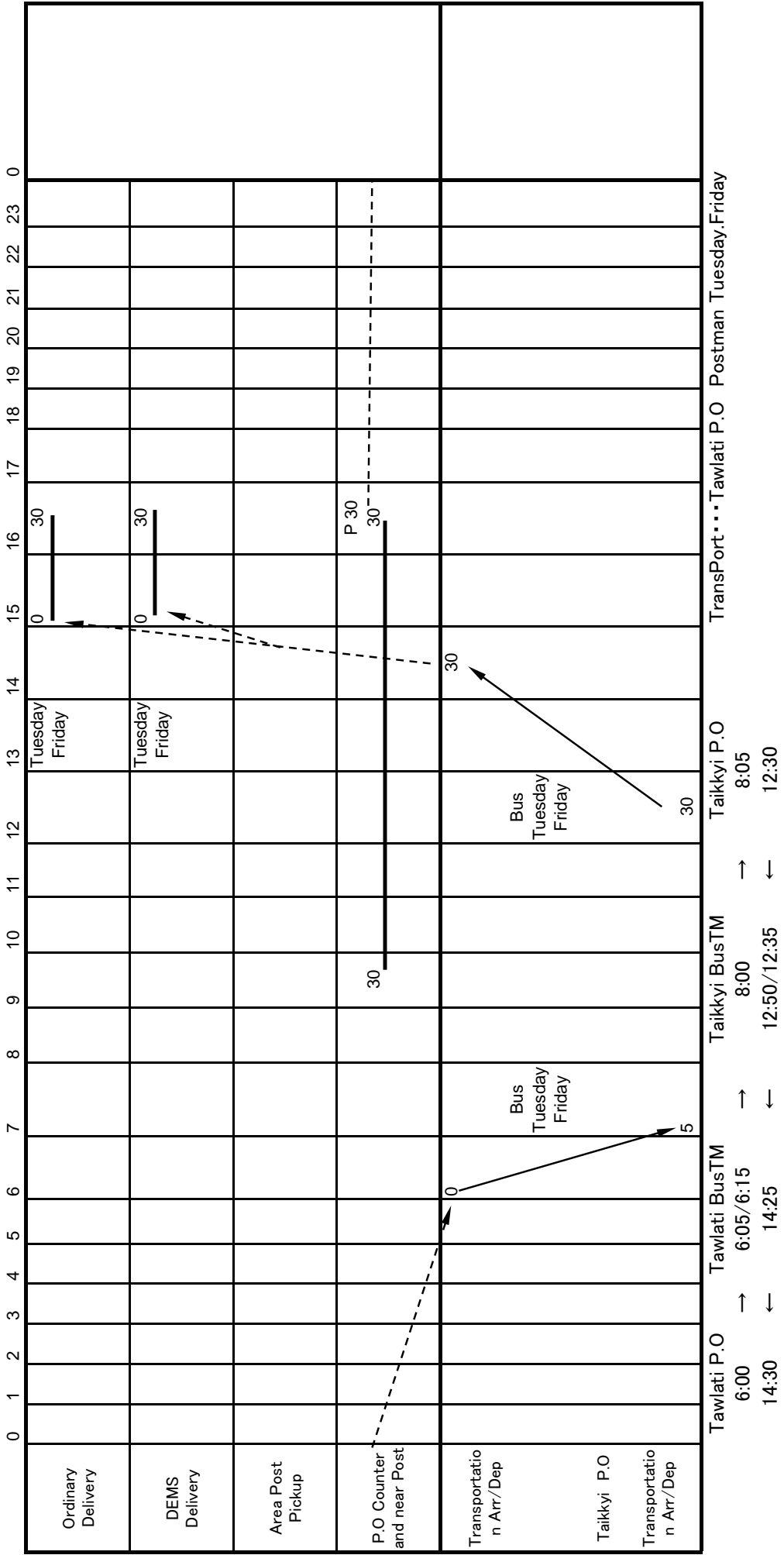

Okkan POST OFFICE Kessoku Diagram

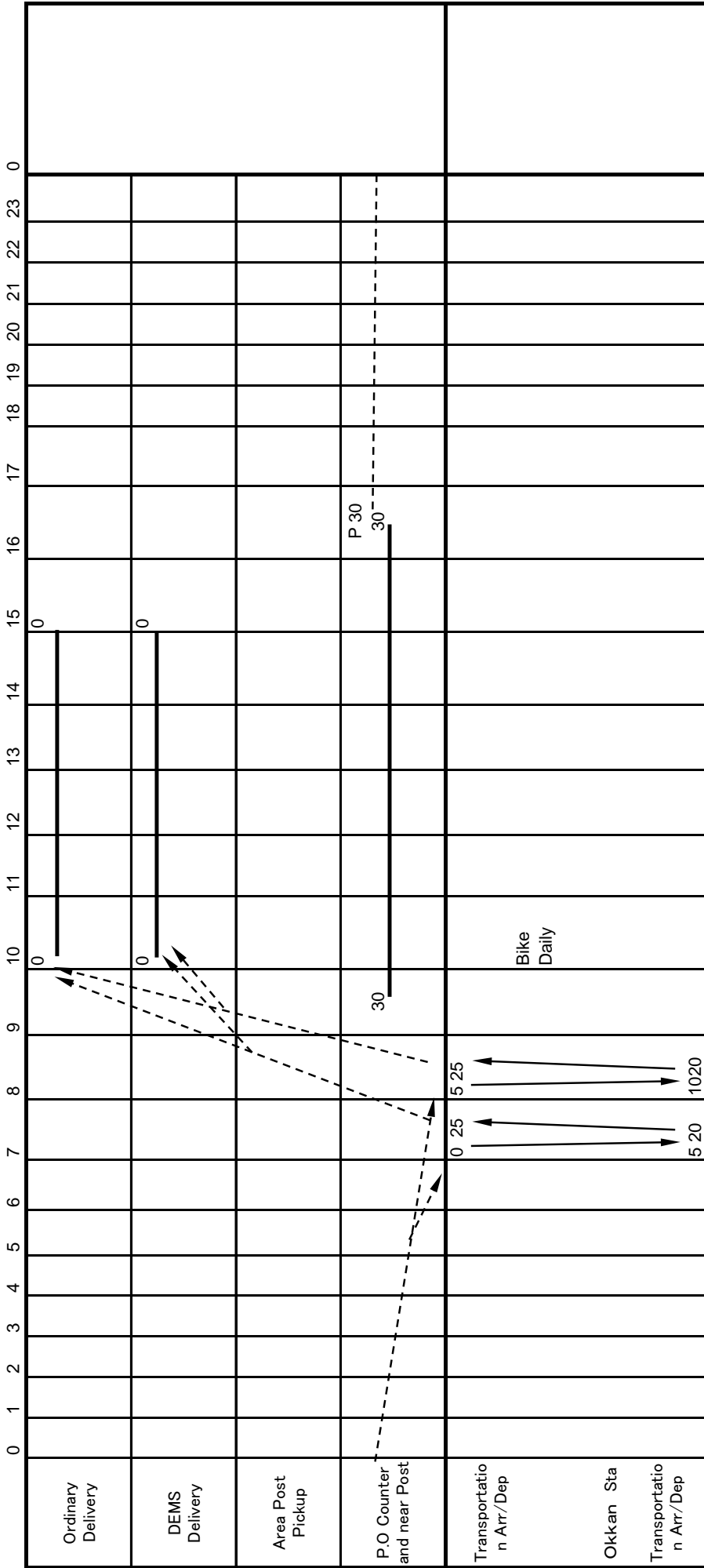

R-1 in R-1out  
7:10 8:10



Phalone POST OFFICE Kessoku Diagram

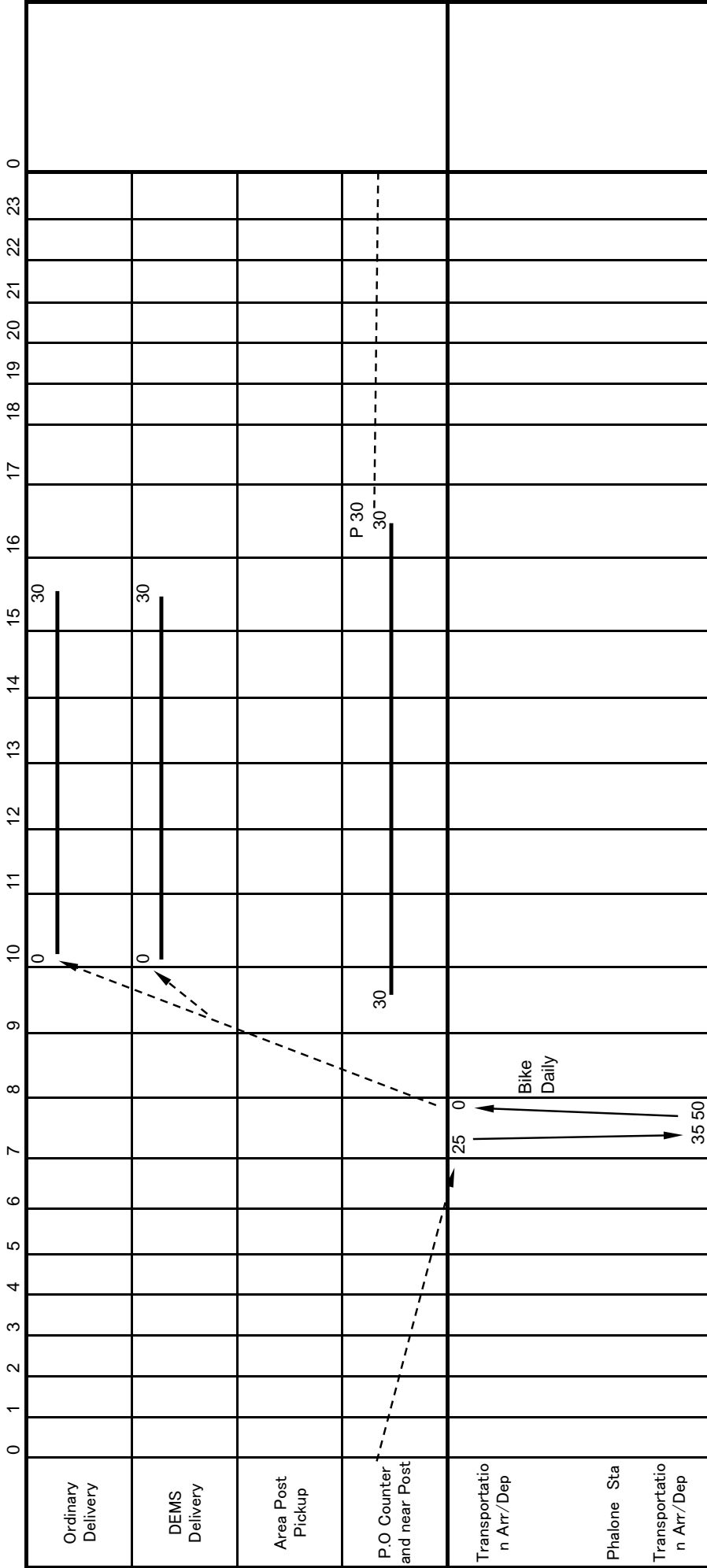

R-1 in R-1out  
7:35 7:40

Ahpyauk POST OFFICE Kessoku Diagram

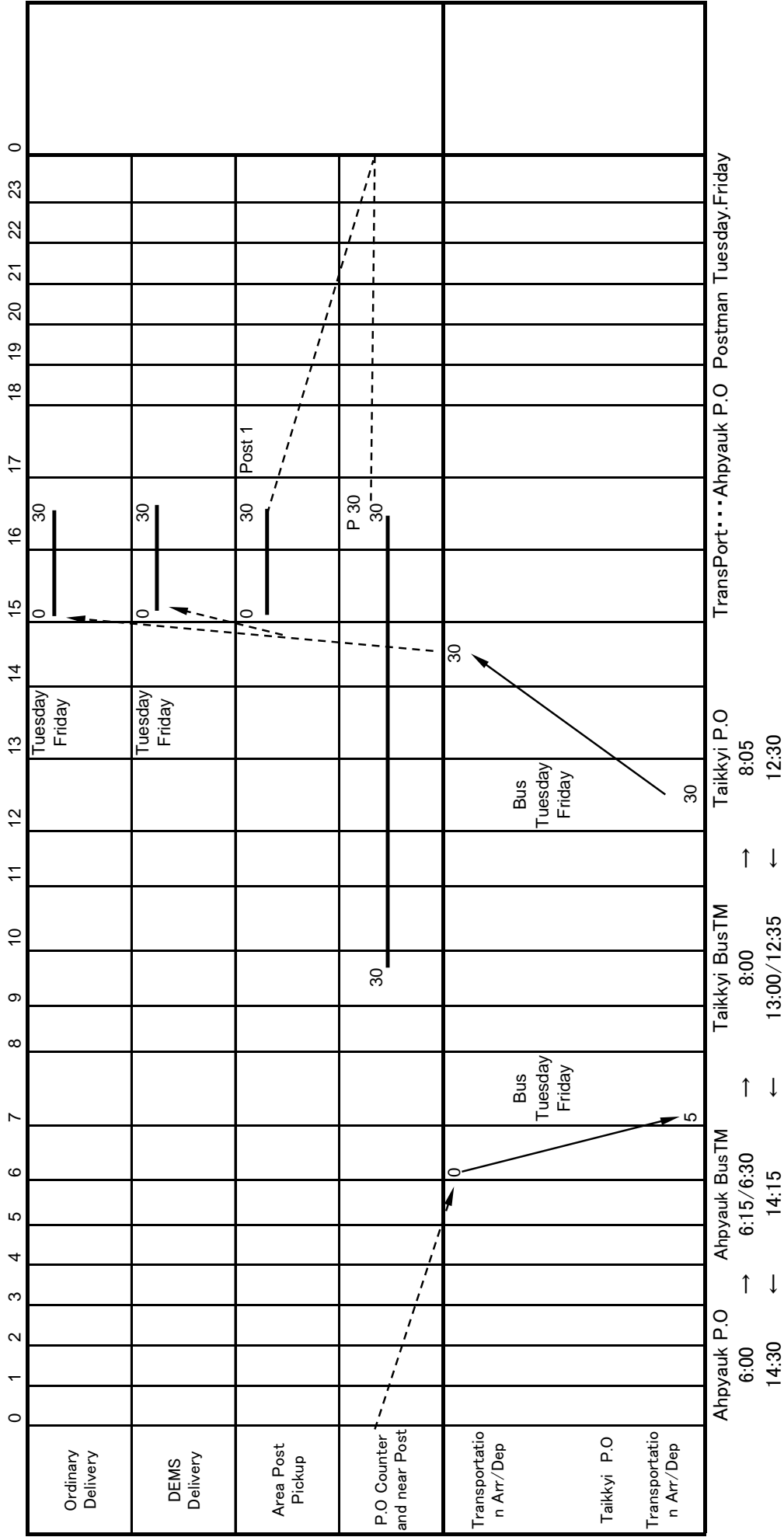

Kyauktada POST OFFICE Kessoku Diagram

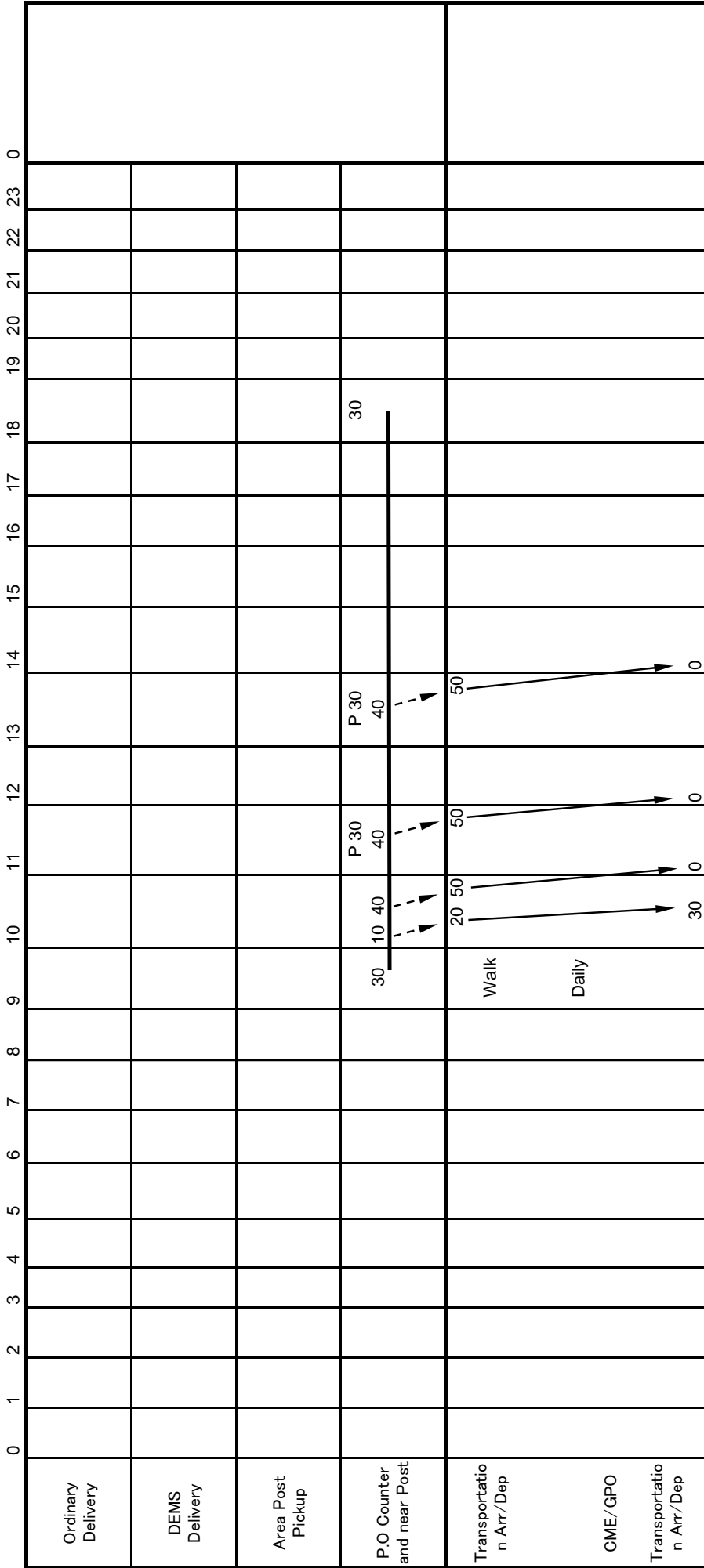

Non Delivery

Zaycho POST OFFICE Kessoku Diagram

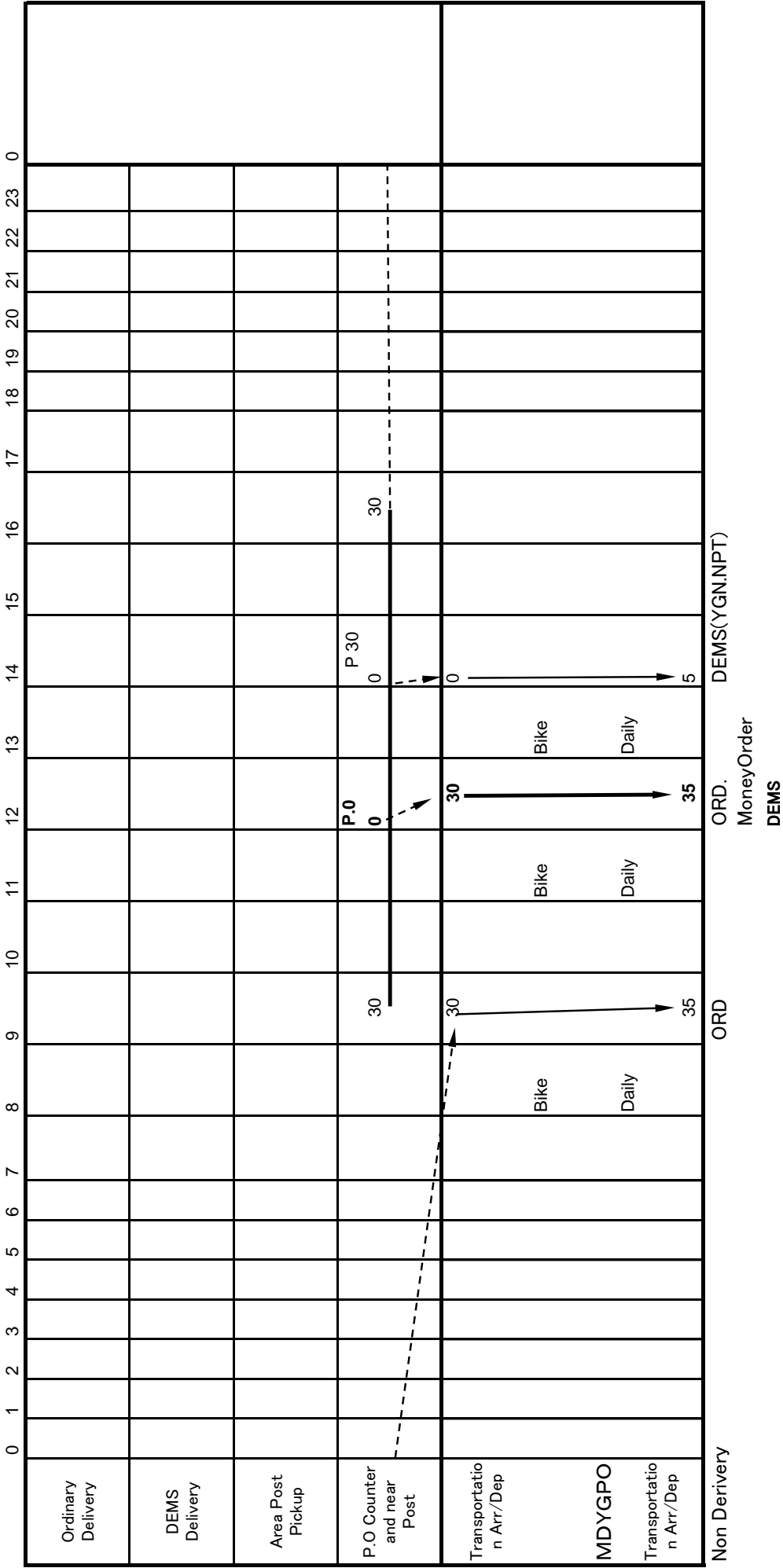

Eaindawya POST OFFICE Kessoku Diagram

	0	1	2	3	4	5	6	7	8	9	10	11	12	13	14	15	16	17	18	19	20	21	22	23	0
Ordinary Delivery																									
DEMS Delivery																									
Area Post Pickup																									
P.O Counter and near Post																									
Transportation Arr/Dep																									
MDYGPO																									
Transportation Arr/Dep																									
Non Delivery																									

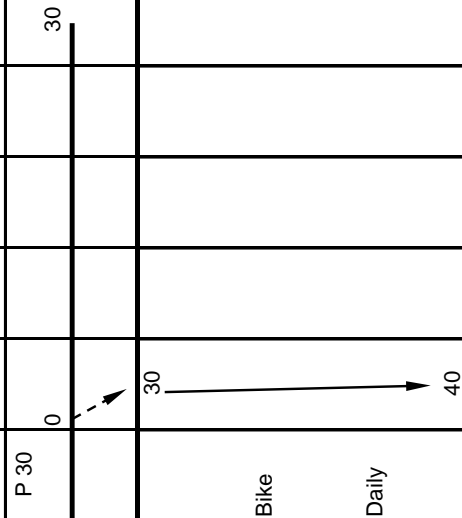

Yonegyi(Chan Aye Thasan) POST OFFICE Kessoku Diagram

	0	1	2	3	4	5	6	7	8	9	10	11	12	13	14	15	16	17	18	19	20	21	22	23	0
Ordinary Delivery																									
DEMS Delivery																									
Area Post Pickup																									
P.O Counter and near Post																									
Transportation Arr/Dep																									
MDYGPO																									
Transportation Arr/Dep																									

DEMS(YGN.NPT)···4Down

Special Delivery DEMS/Ord MDY GPO

MDY Station POST OFFICE Kessoku Diagram

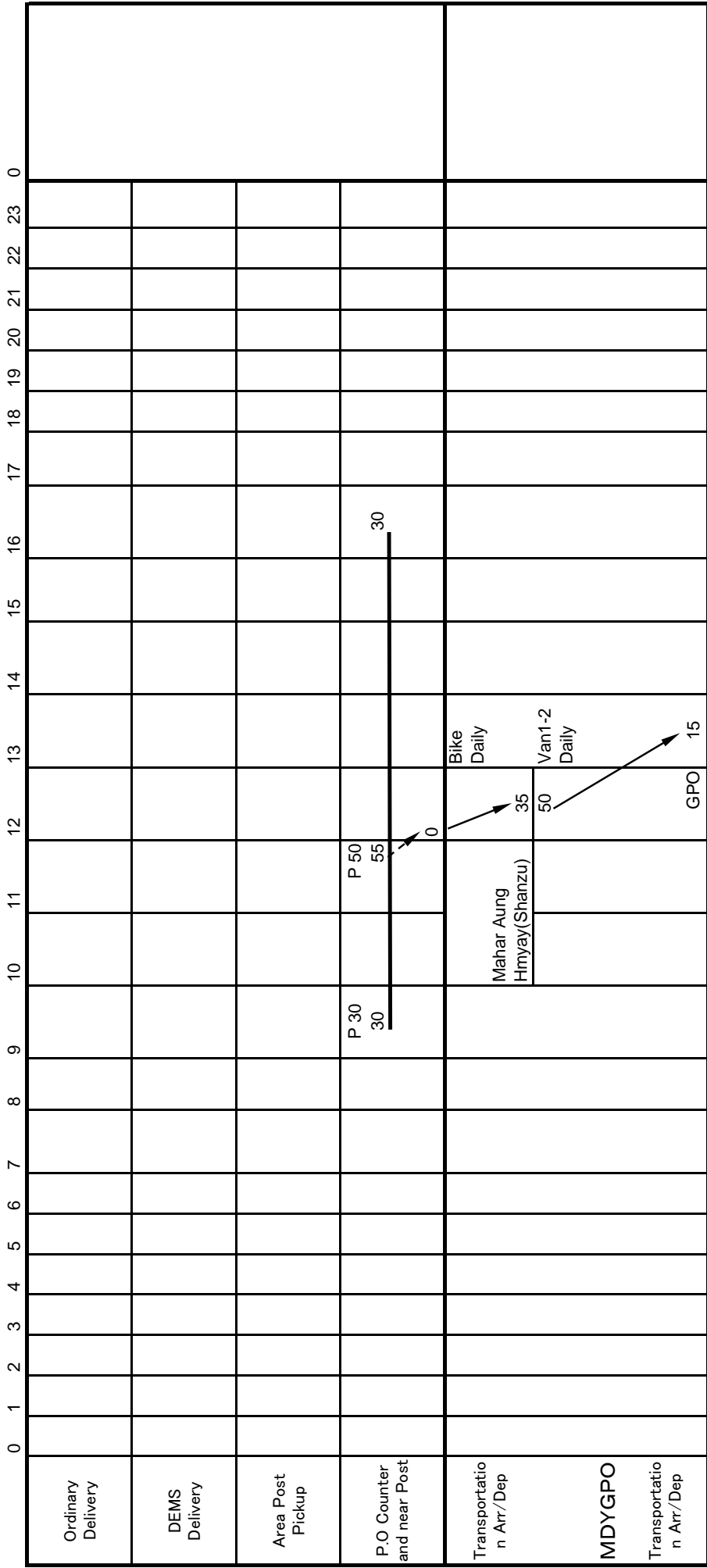

MDY West POST OFFICE Kessoku Diagram

	0	1	2	3	4	5	6	7	8	9	10	11	12	13	14	15	16	17	18	19	20	21	22	23	0
Ordinary Delivery																									
DEMS Delivery																									
Area Post Pickup																									
P.O Counter and near Post										P 30 30			P 50 55												
Transportation Arr/Dep																									
MDYGPO																									
Transportation Arr/Dep																									
Non Delivery																									



Mahar Aung Hmyay(Shanzu)POST OFFICE Kessoku Diagram

	0	1	2	3	4	5	6	7	8	9	10	11	12	13	14	15	16	17	18	19	20	21	22	23	0
Ordinary Delivery																									
DEMS Delivery																									
Area Post Pickup																									
P.O Counter and near Post										P:30 30			P:30 30												
Transportation Arr/Dep													4050												
MDYGPO																									
Transportation Arr/Dep																									

DEMS(YGN.NPT)\*\*\*4Down

Special Delivery DEMS/Ord MDY GPO

Kungyan POST OFFICE Kessoku Diagram

	0	1	2	3	4	5	6	7	8	9	10	11	12	13	14	15	16	17	18	19	20	21	22	23	0
Ordinary Delivery																									
DEMS Delivery																									
Area Post Pickup																									
P.O Counter and near Post																									
Transportation Arr/Dep																									
MDYGPO																									
Transportation Arr/Dep																									
Non Delivery																									

Postmaster 1 Only

Postmaster 1 Only

MDY U.C POST OFFICE Kessoku Diagram

	0	1	2	3	4	5	6	7	8	9	10	11	12	13	14	15	16	17	18	19	20	21	22	23	0
Ordinary Delivery																									
DEMS Delivery																									
Area Post Pickup																									
P.O Counter and near Post										P 30 30			P 10 10												
Transportation Arr/Dep																									
											Mahar Aung Hmyay(Shanzu)			20											
MDYGPO																									
														35											
Transportation Arr/Dep														50											
Non Delivery																									

Postmaster 1 Only

GPO 15



Yadanapon UC POST OFFICE Kessoku Diagram

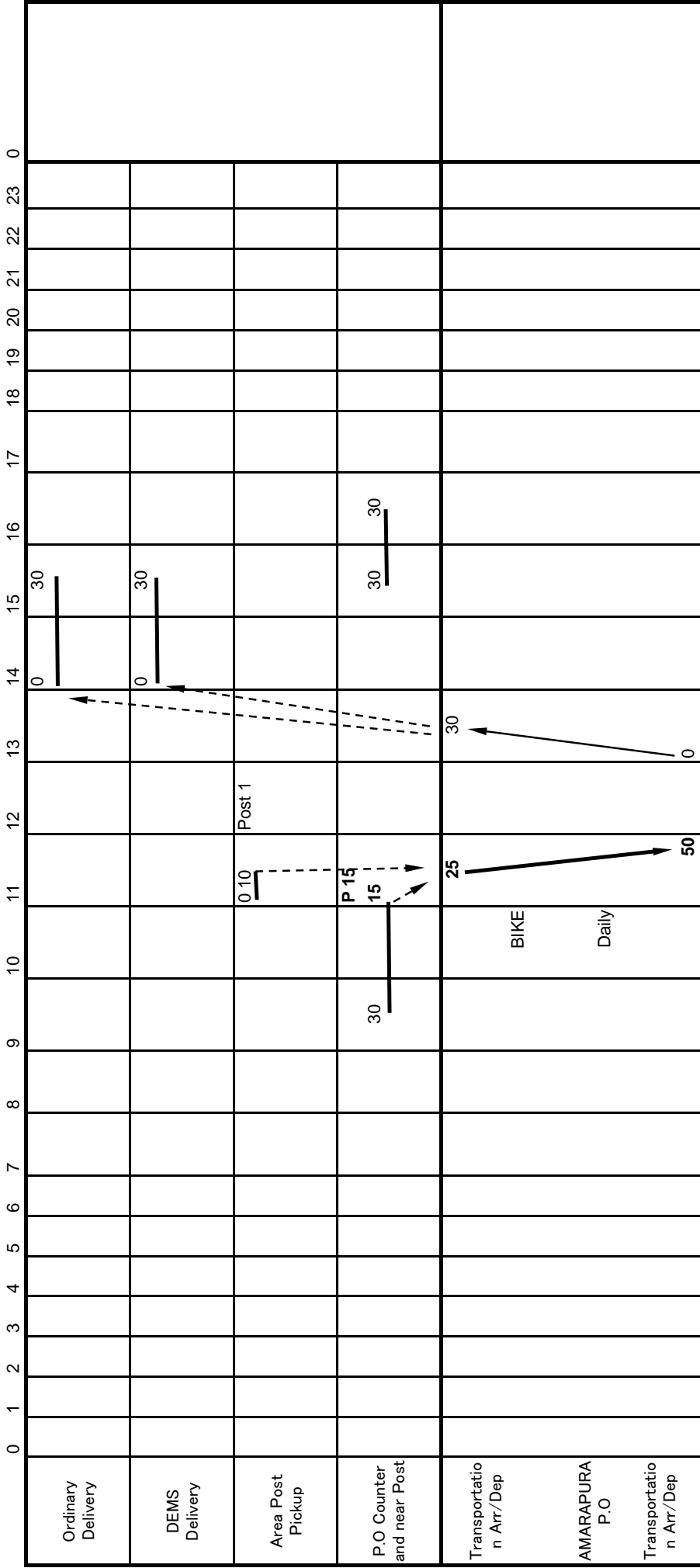

Postmaster 10pe(Transportation.Delivery.Counter)

Shanzu 0

Pyaygyidakhon POST OFFICE Kessoku Diagram

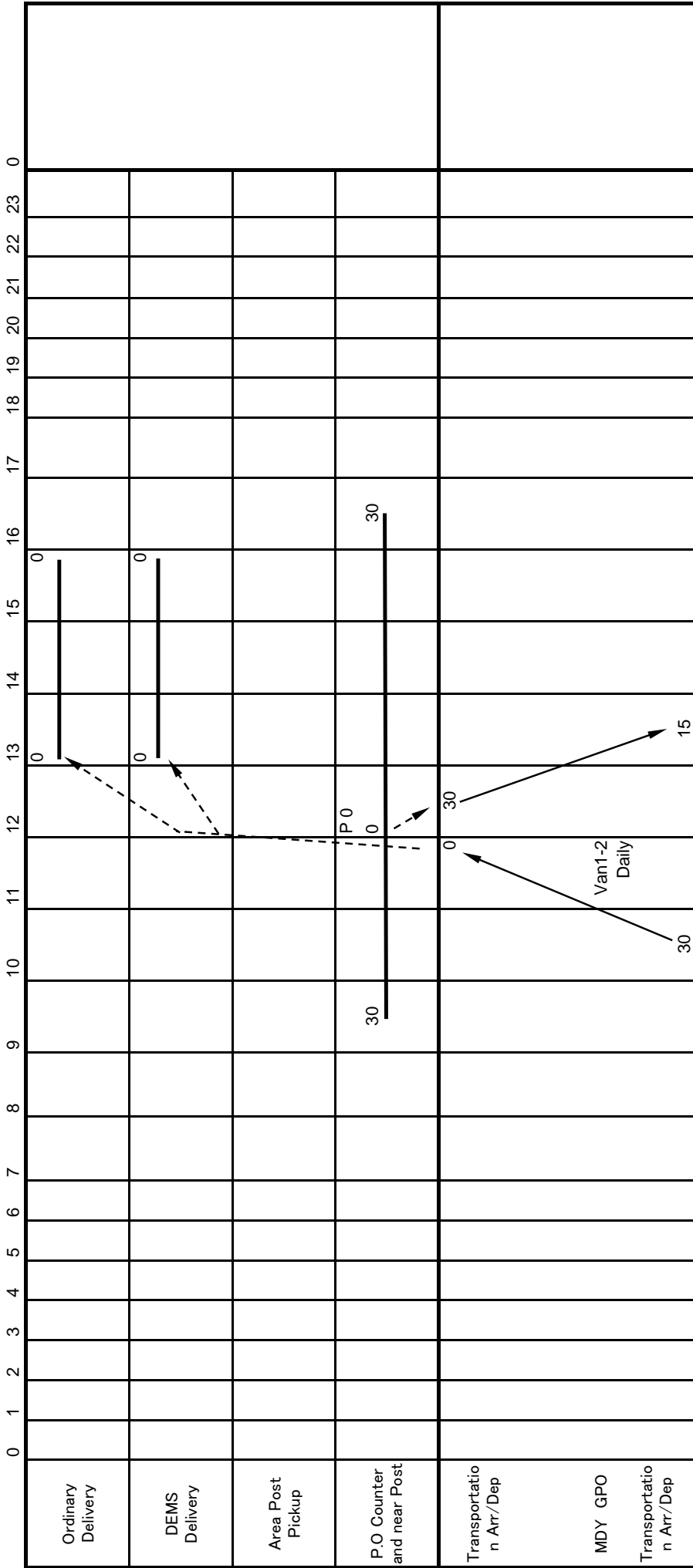

Chanmyathazi POST OFFICE Kessoku Diagram

	0	1	2	3	4	5	6	7	8	9	10	11	12	13	14	15	16	17	18	19	20	21	22	23	0
Ordinary Delivery																									
DEMS Delivery																									
Area Post Pickup																									
P.O Counter and near Post										30		P45 45													
Transportation Arr/Dep																									
Pyigyidagon P.O																									
Transportation Arr/Dep																									

Special Delivery Pyigyidagon OLD / DEMS

Satmumyothit POST OFFICE Kessoku Diagram

	0	1	2	3	4	5	6	7	8	9	10	11	12	13	14	15	16	17	18	19	20	21	22	23	0
Ordinary Delivery																									
DEMS Delivery																									
Area Post Pickup																									
P.O Counter and near Post										30		P 40 40					30								
Transportation Arr/Dep													55	20											
Pyigyidagon P.O																									
Transportation Arr/Dep																									

BIKE

Daily

Special Delivery Pyigyidagon OLD / DEMS



Patheingyi POST OFFICE Kessoku Diagram

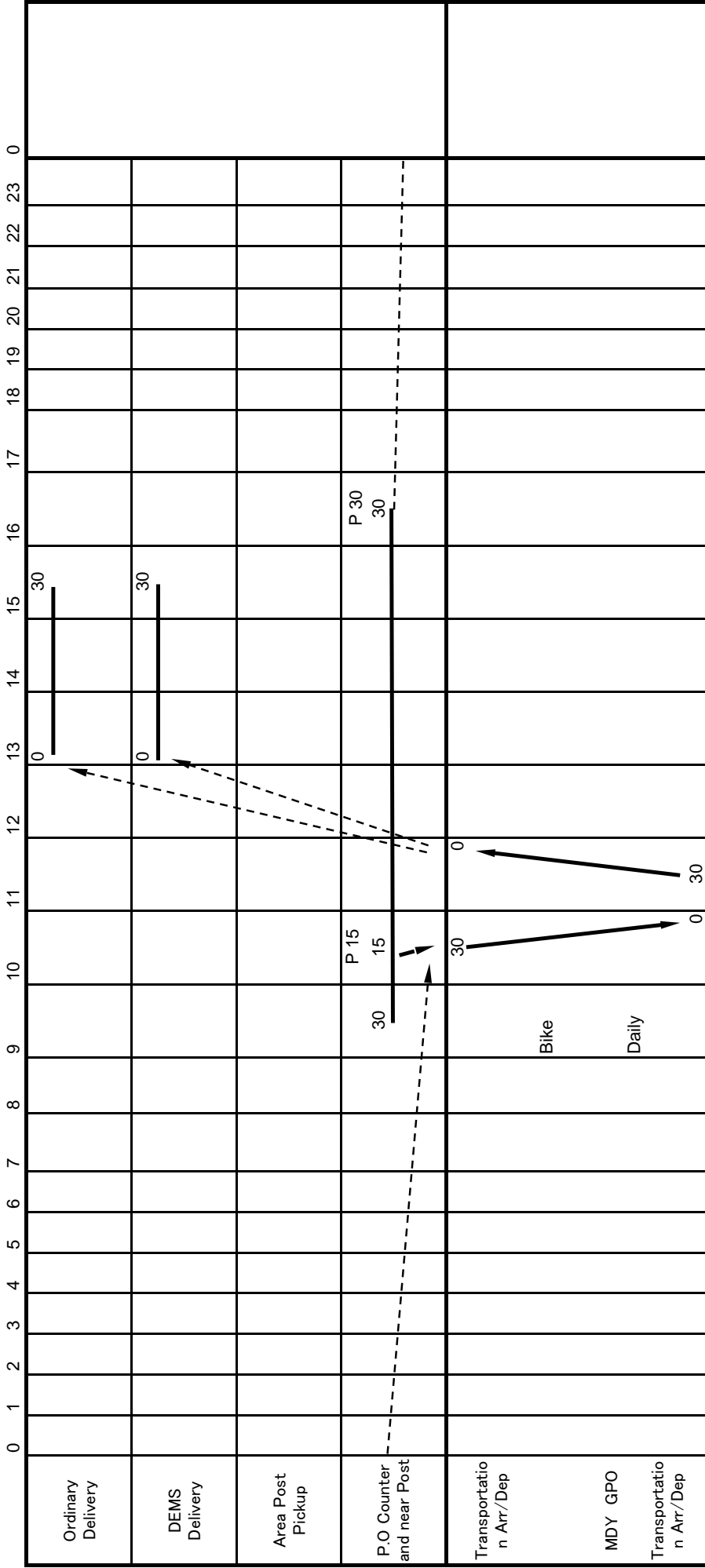

MTU(HTONEBO) POST OFFICE Kessoku Diagram

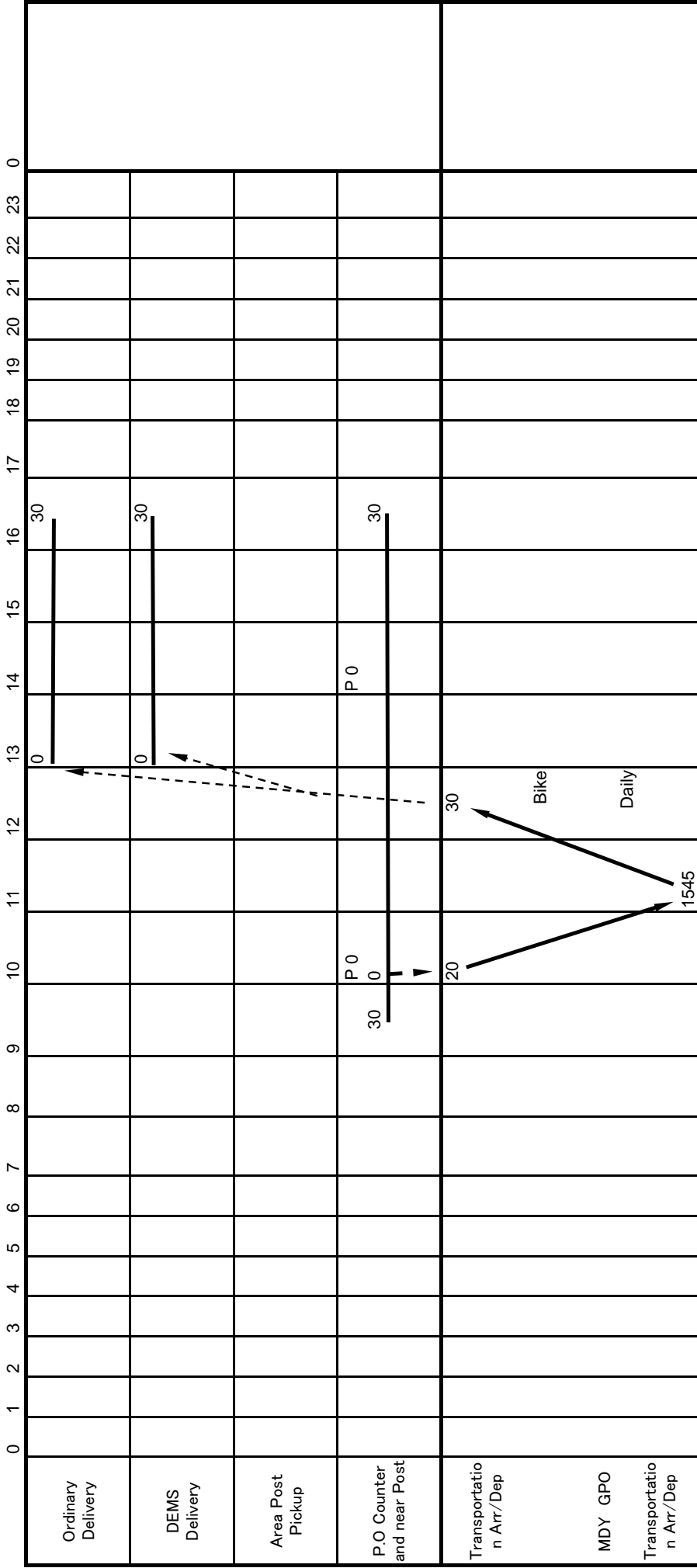



Myitrnge POST OFFICE Kessoku Diagram

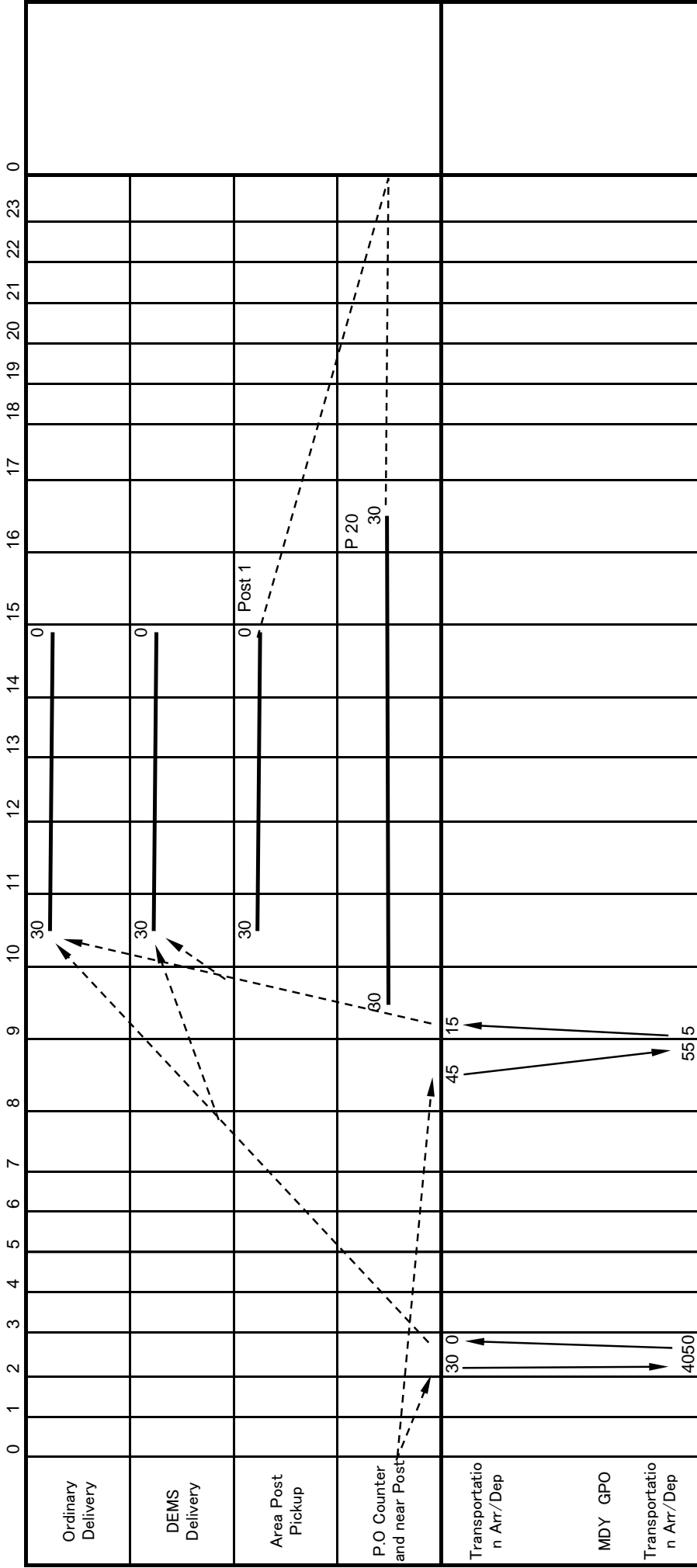

Paleik POST OFFICE Kessoku Diagram

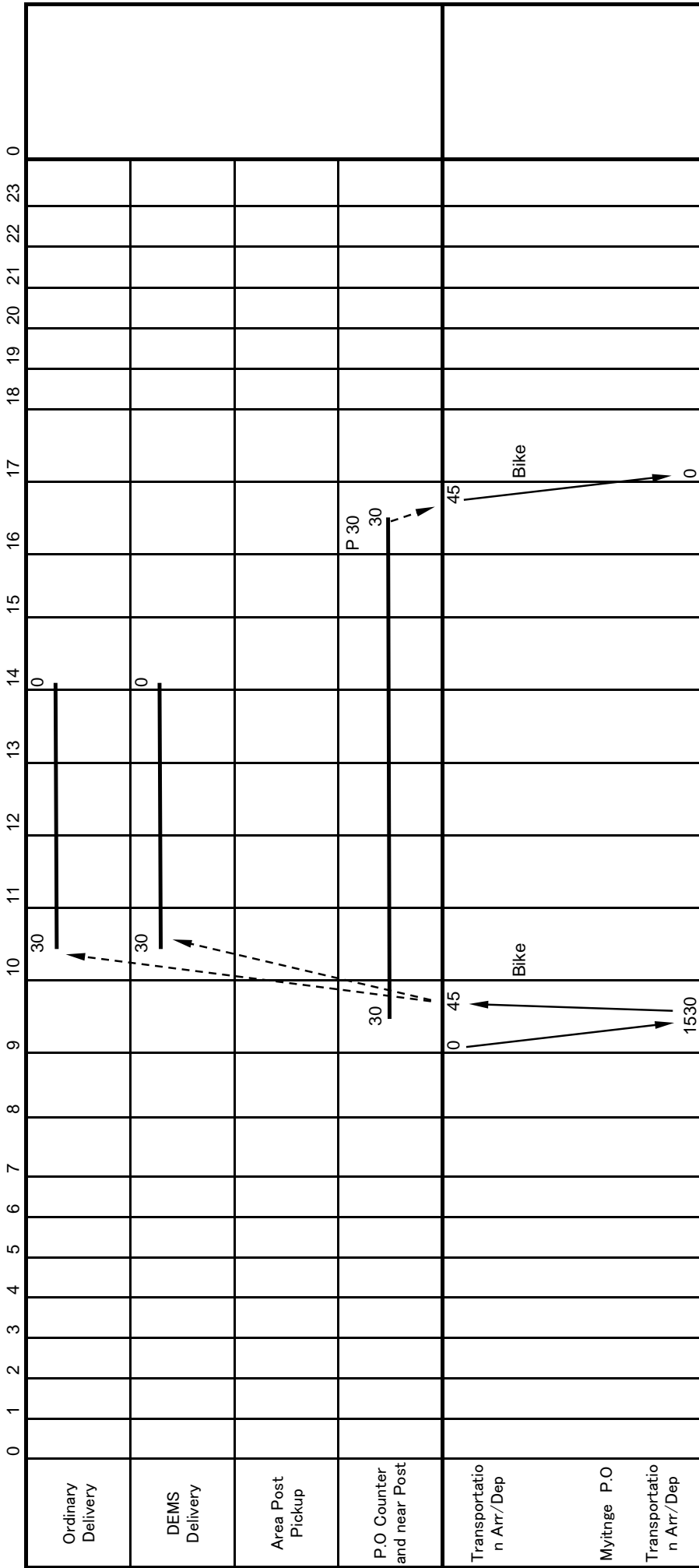

Bike→Daily

SintKaing POST OFFICE Kessoku Digram

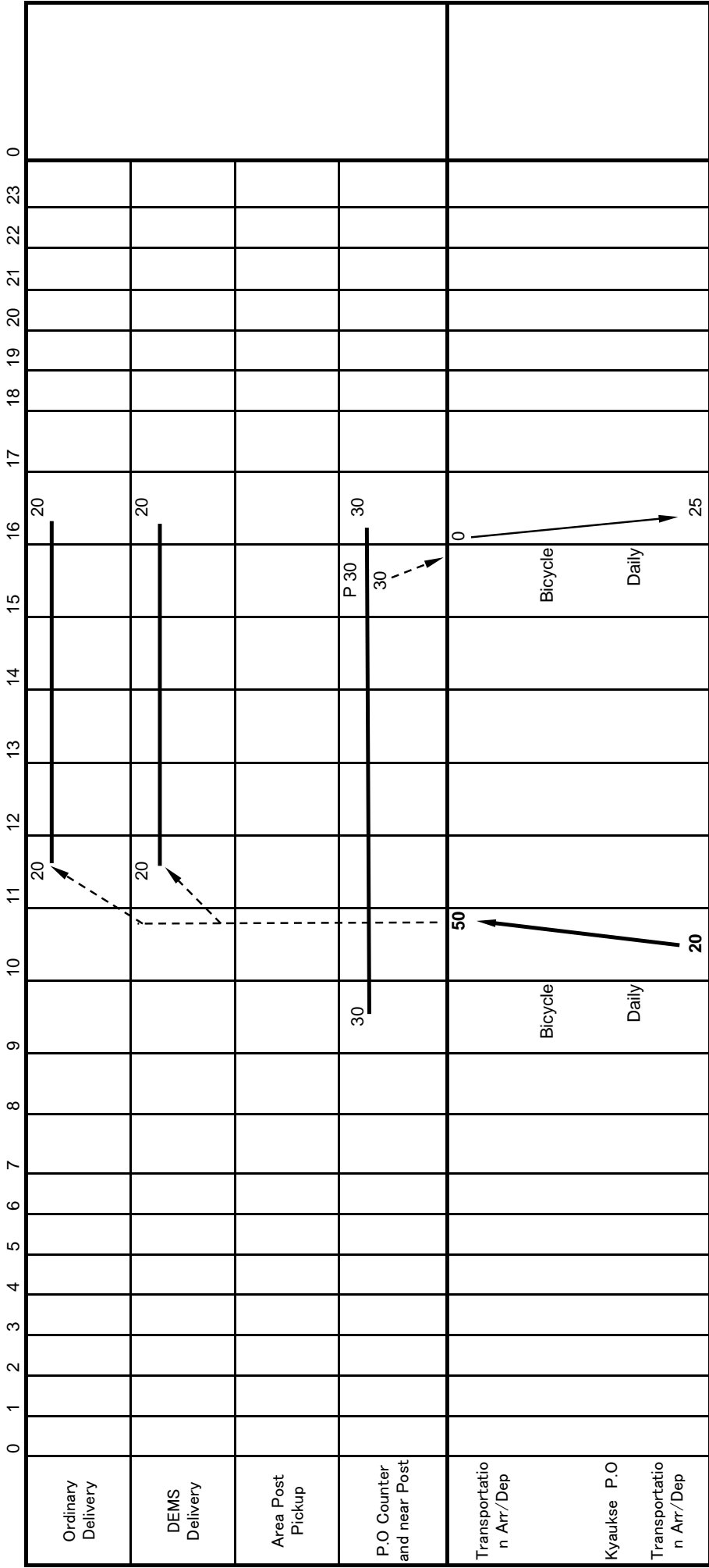

Kyaukse POST OFFICE Kessoku Diagram

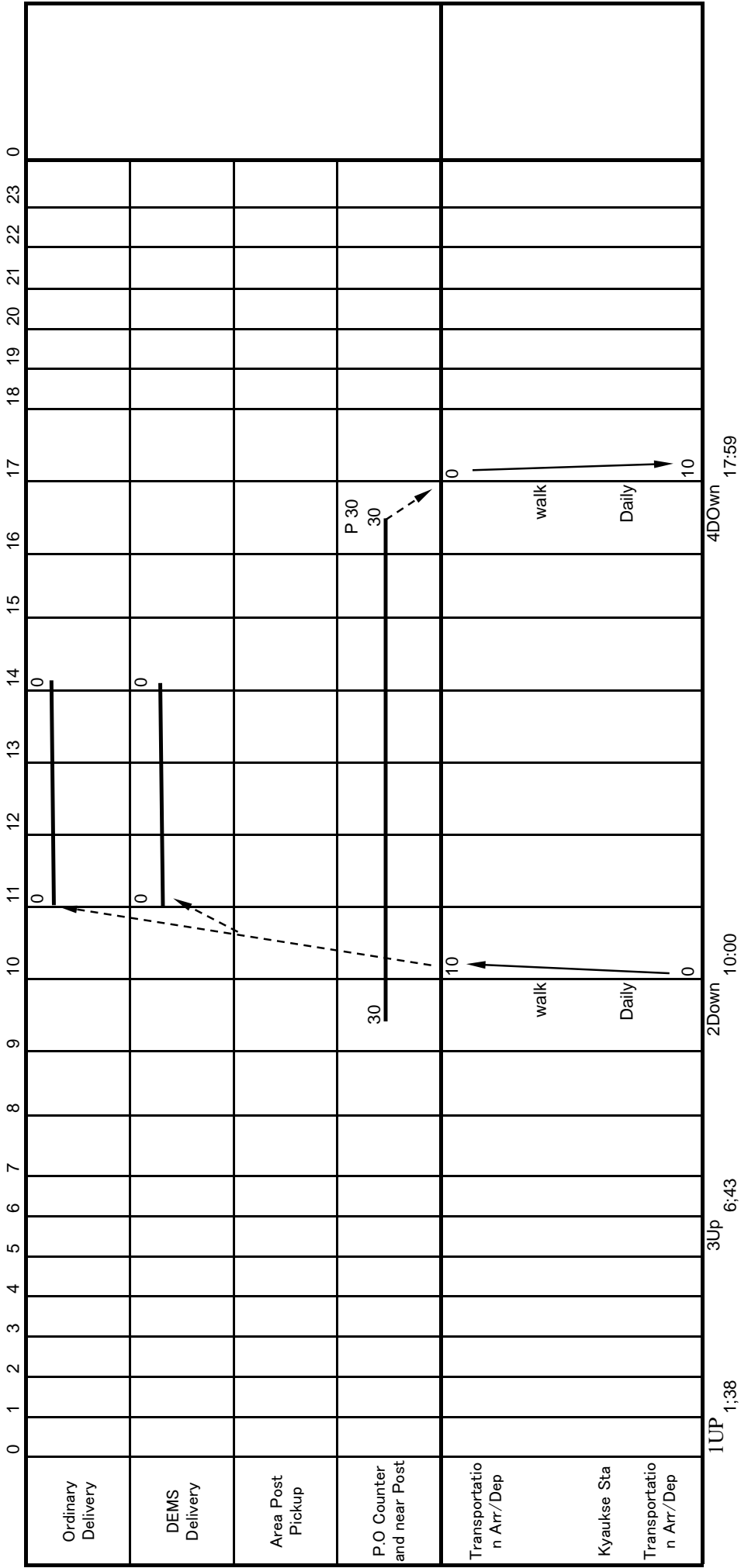

Mtyitthar POST OFFICE Kessoku Diagram

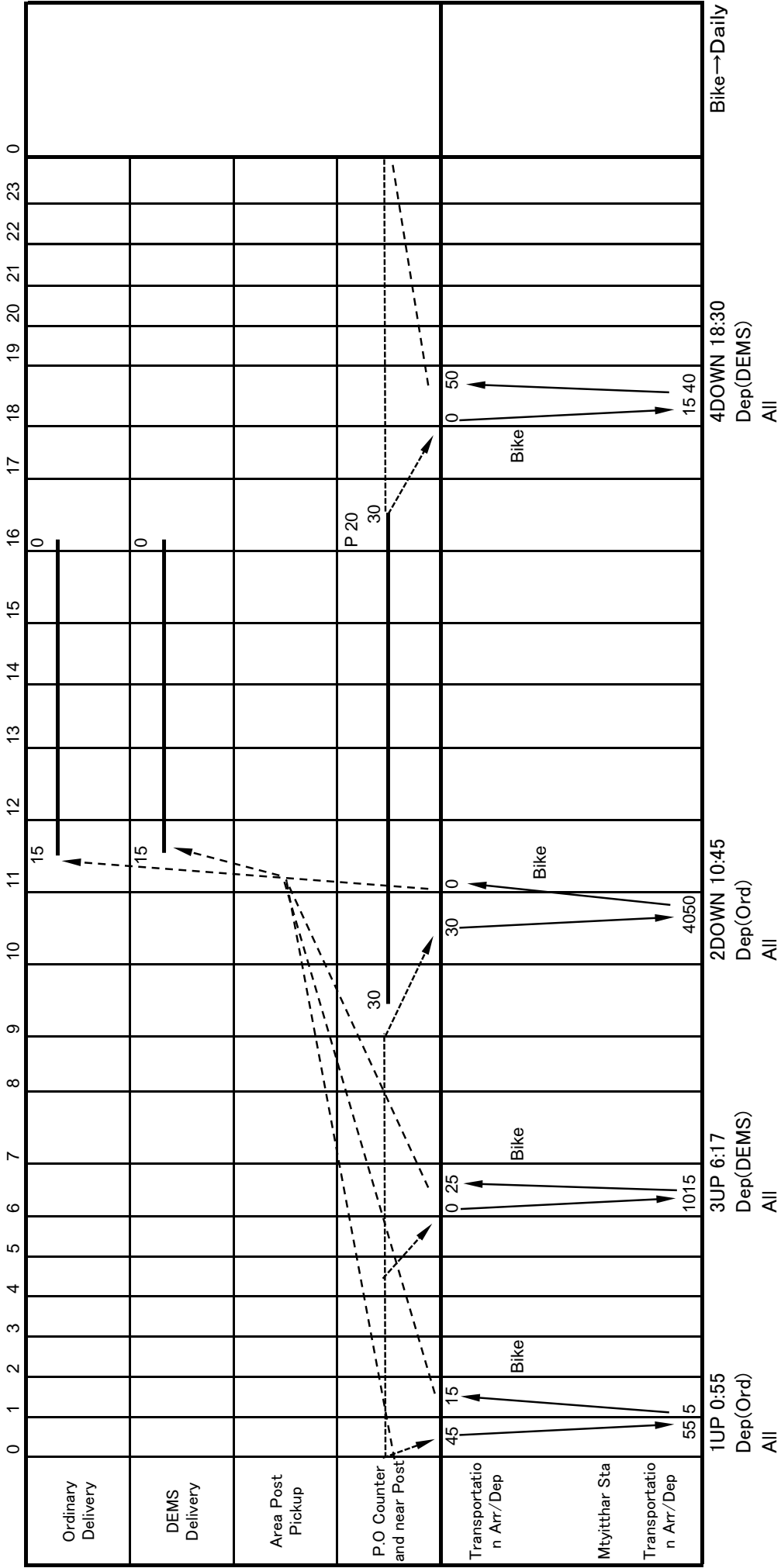



Kume POST OFFICE Kessoku Diagram

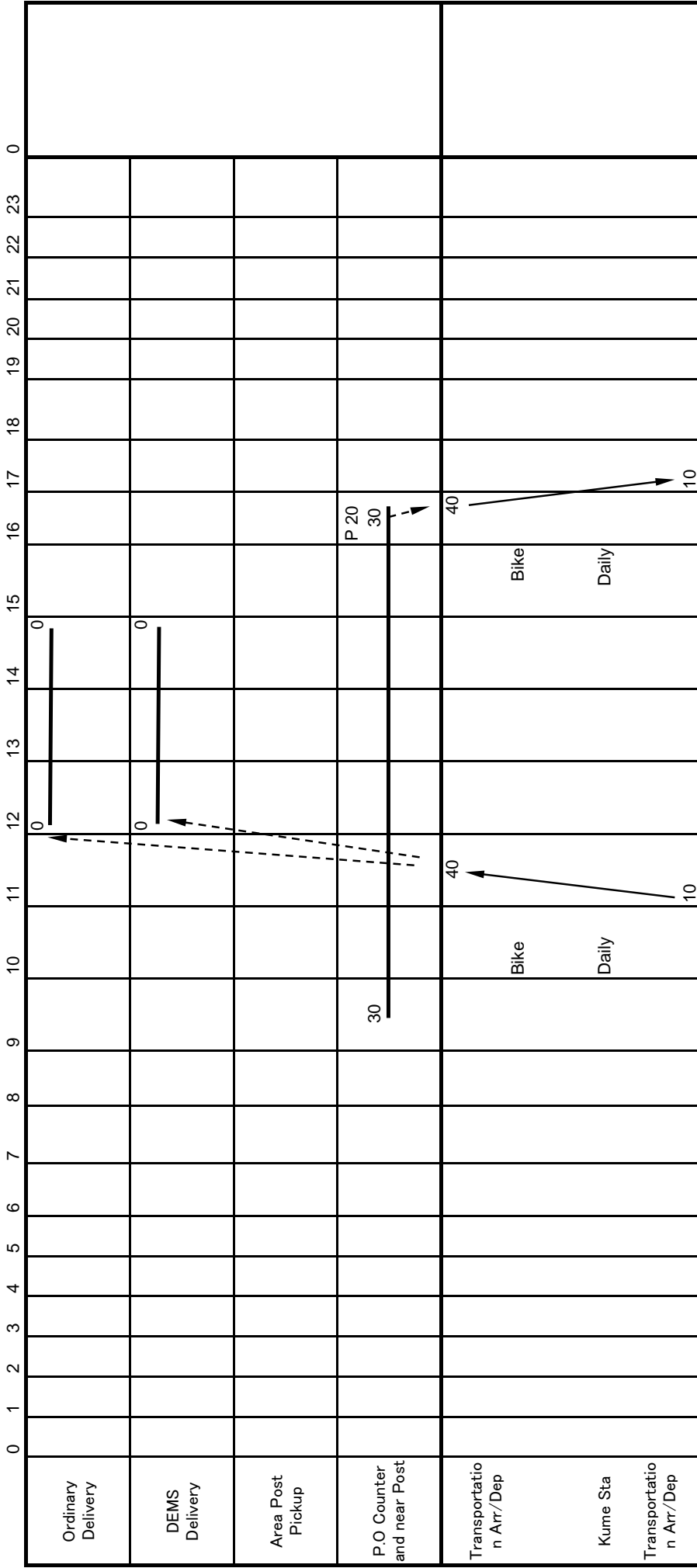

1up  
0:23

2Down  
11:10

Wundwin POST OFFICE Kessoku Diagram

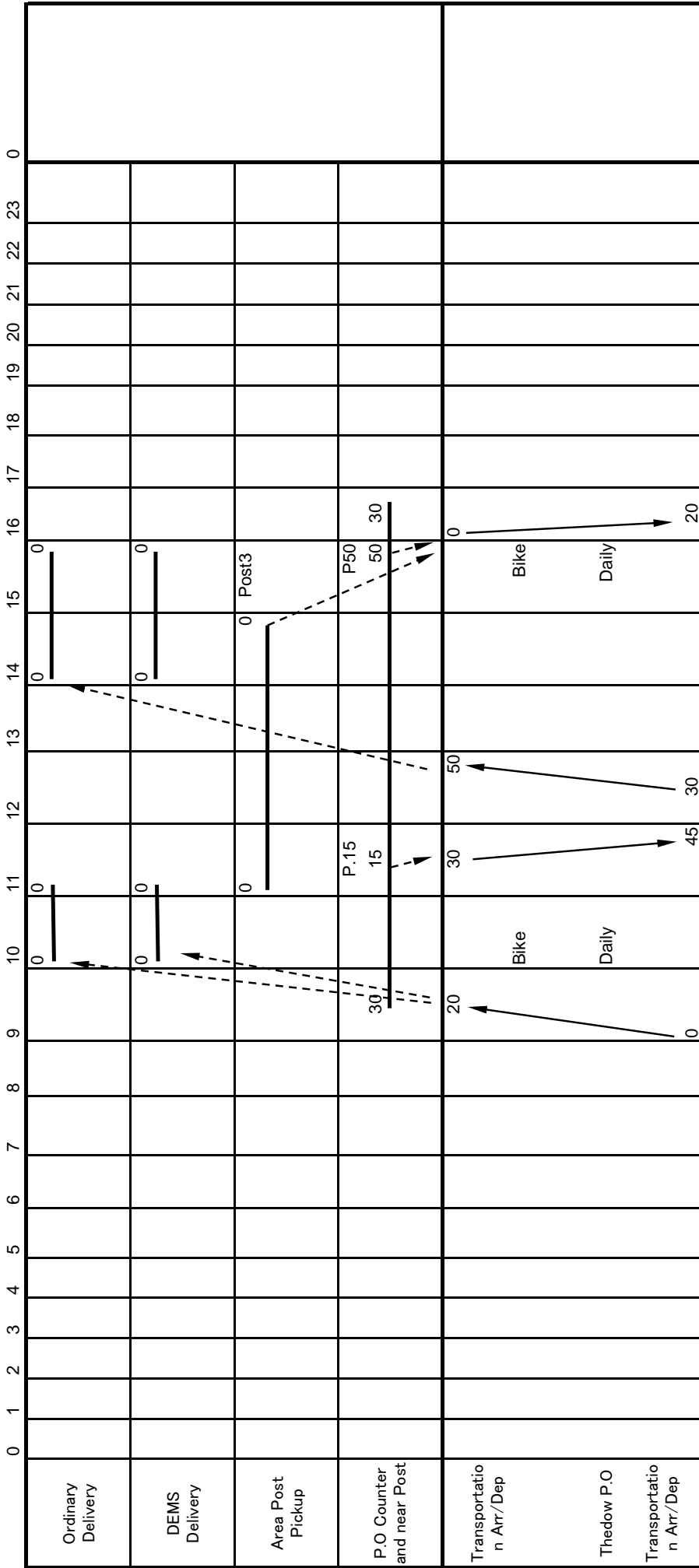

The Dow POST OFFICE Kessoku Diagram

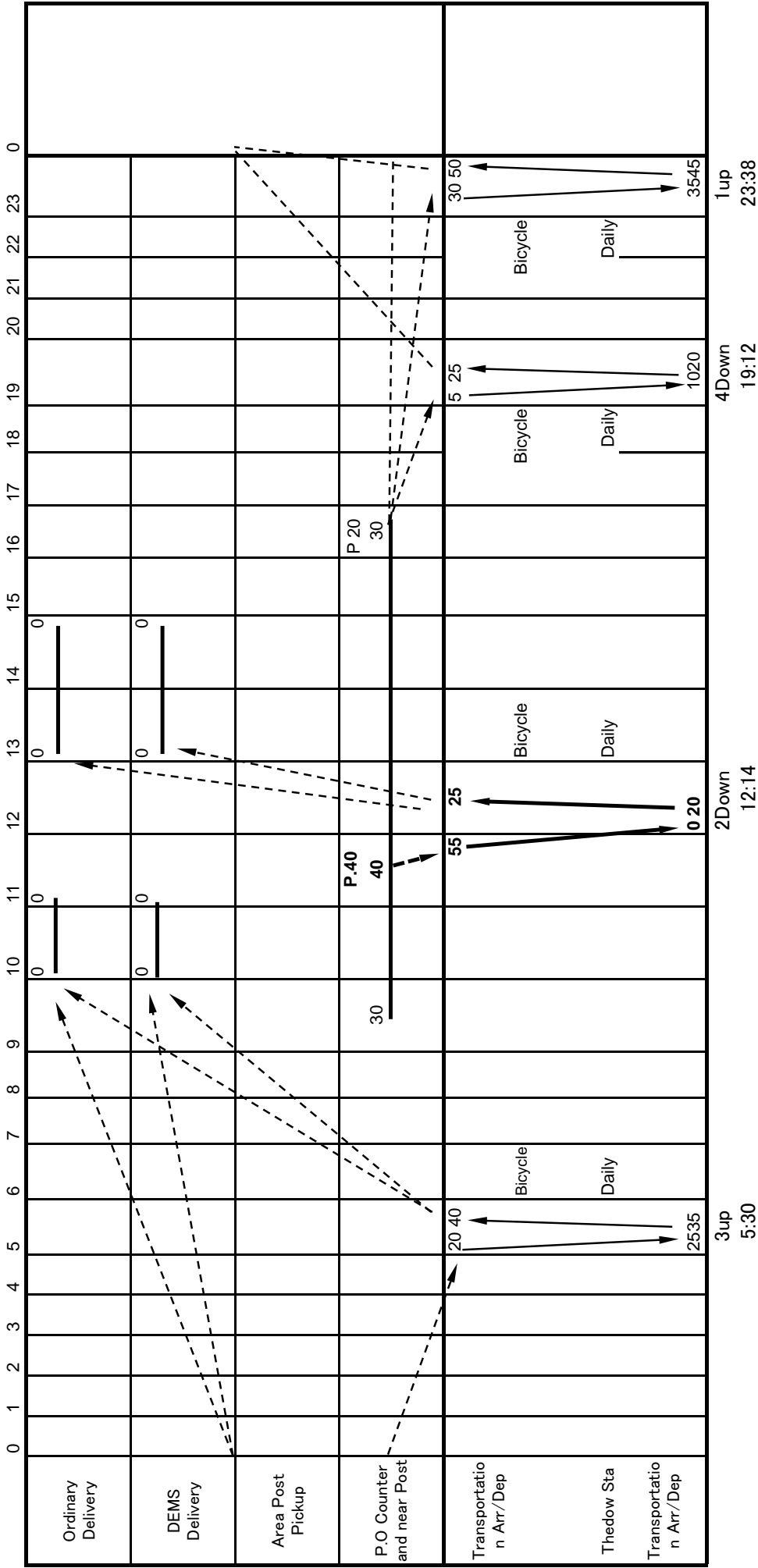

Hanza POST OFFICE Kessoku Diagram

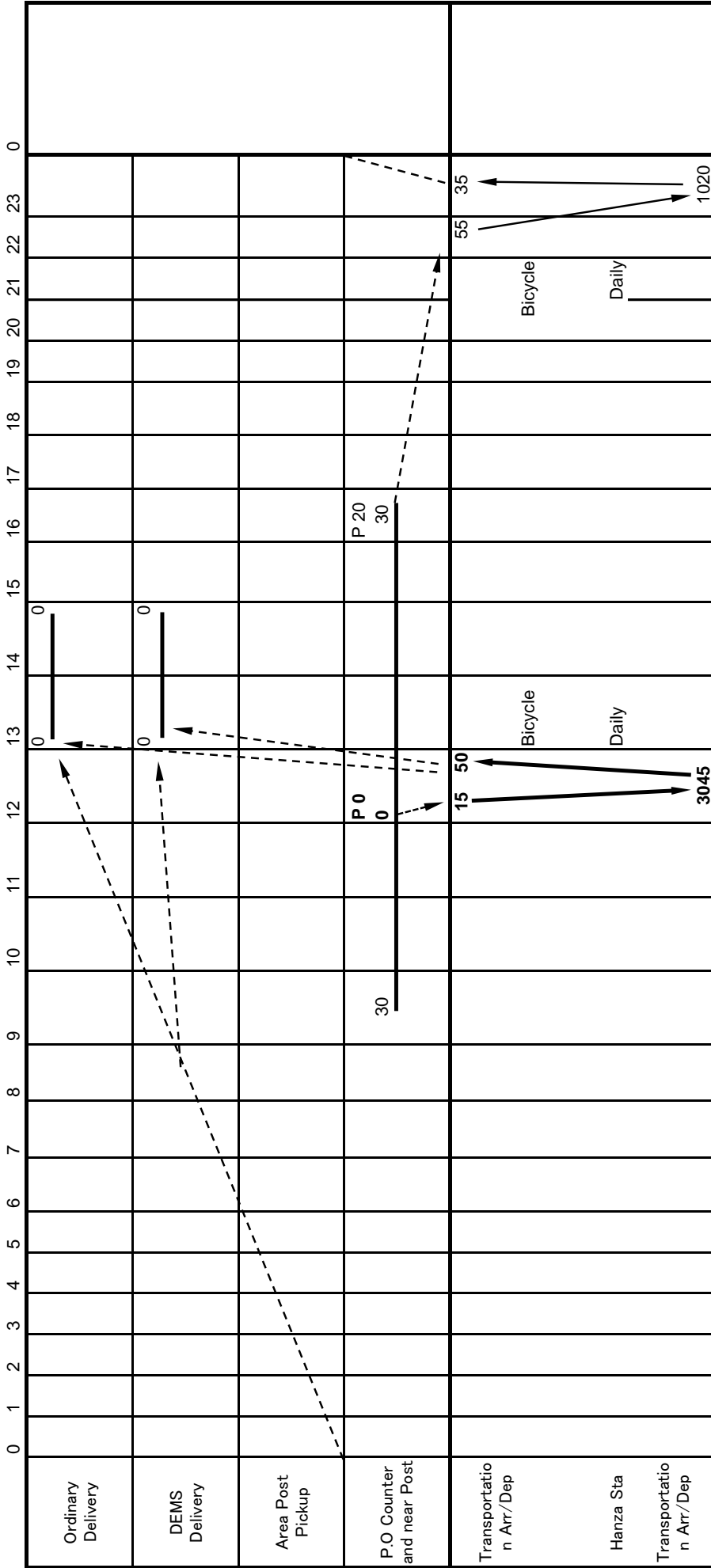

1up  
23:13

2Down  
12:45

Pyawbwe POST OFFICE Kessoku Diagram

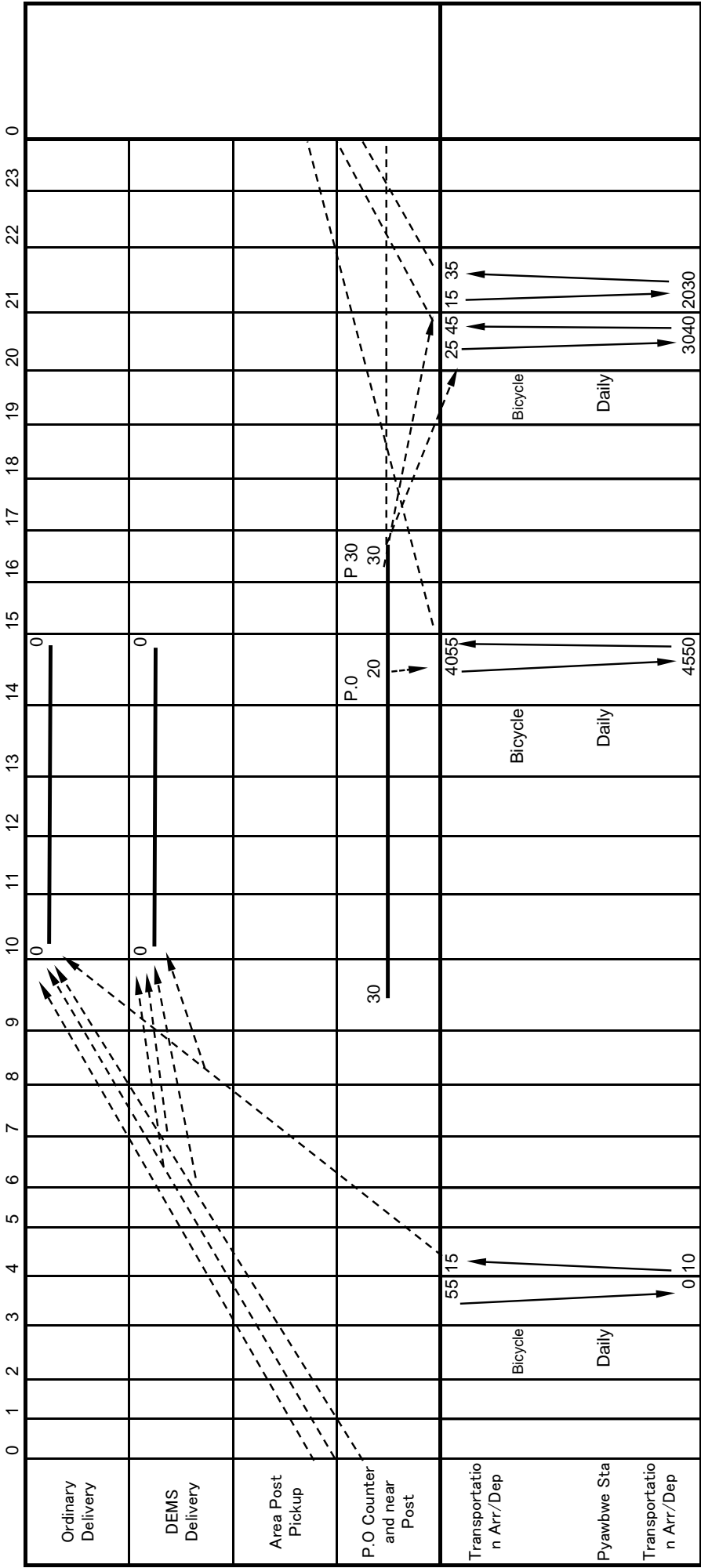

Theinkonegyi POST OFFICE Kessoku Diagram

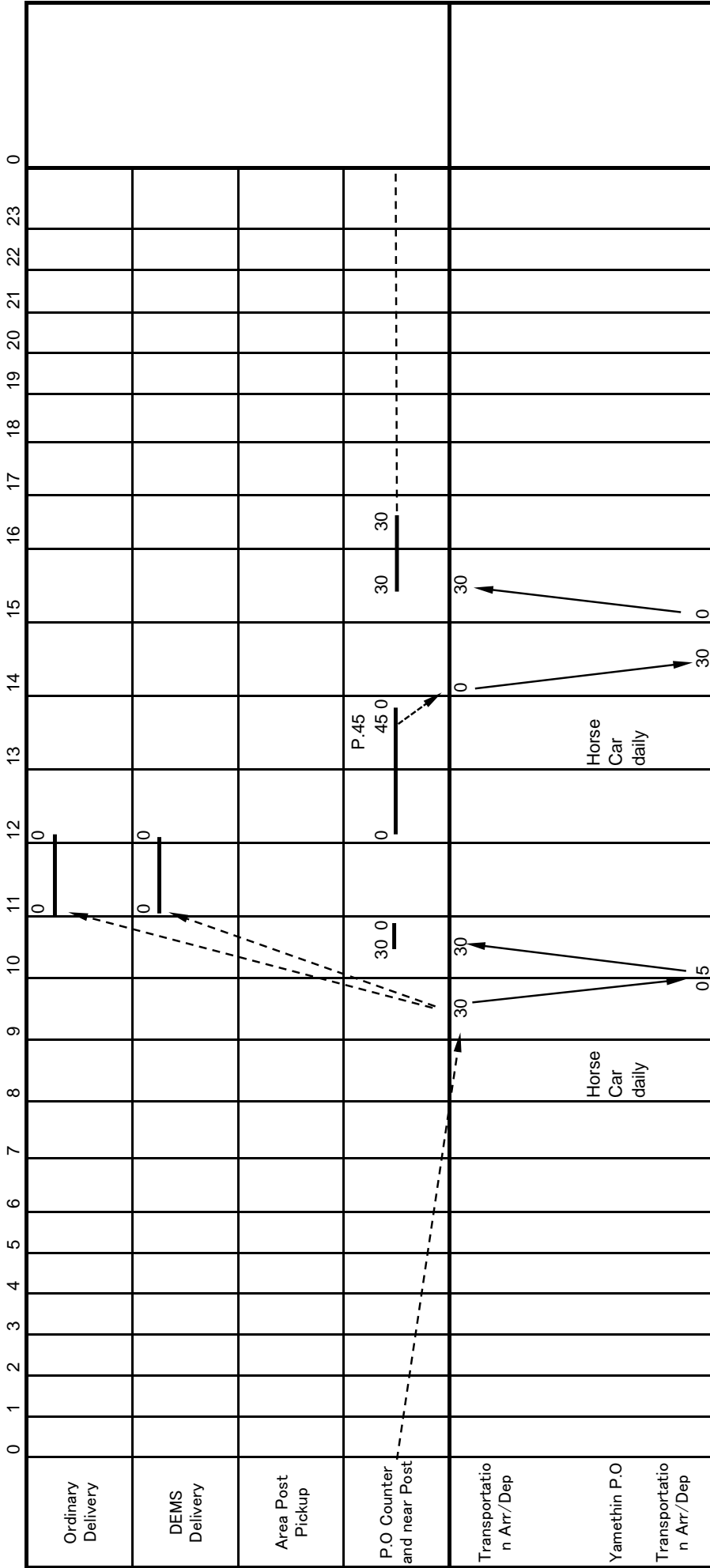

PostMaster 1 All Open (Transportation.Delivery.Counter)  
1 Day Delivery Mail 3~4

Yamethin POST OFFICE Kessoku Diagram

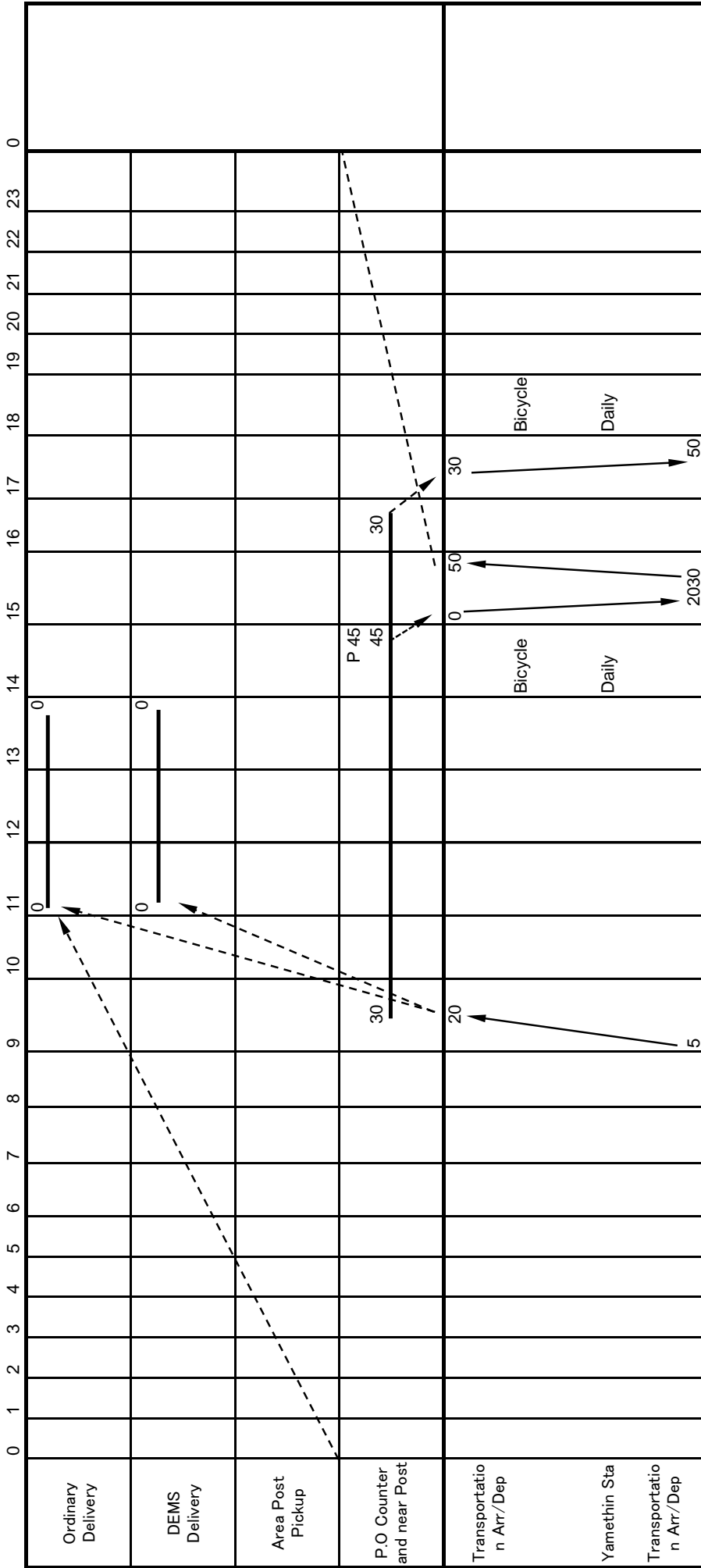

3up 3:34 (All 1up.4Down.3up)

2Down 15:37

1up 4Down 20:30 21:08 (Dep 1up.4Down.3up)

Myingyan POST OFFICE Kessoku Diagram

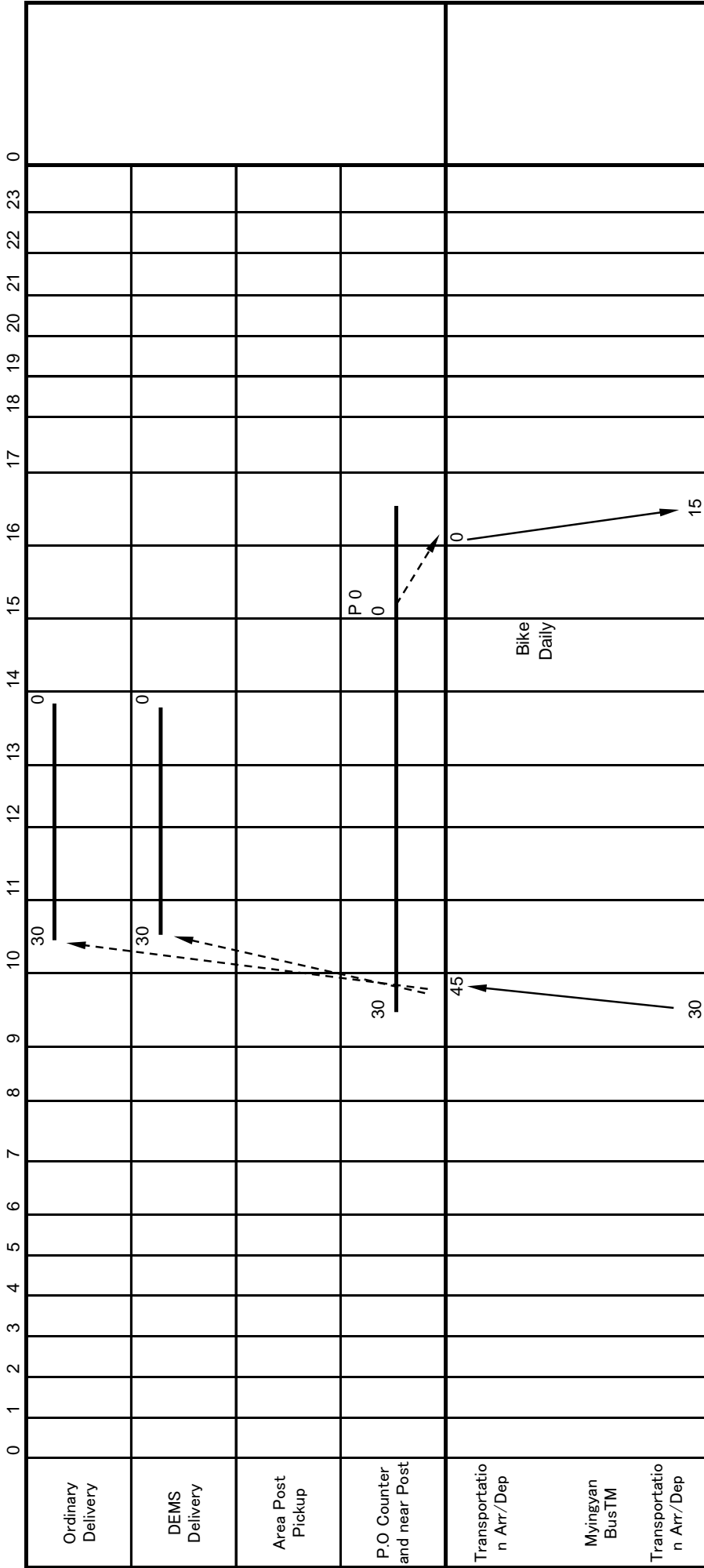



Nahtoegyí POST OFFICE Kessoku Diagram

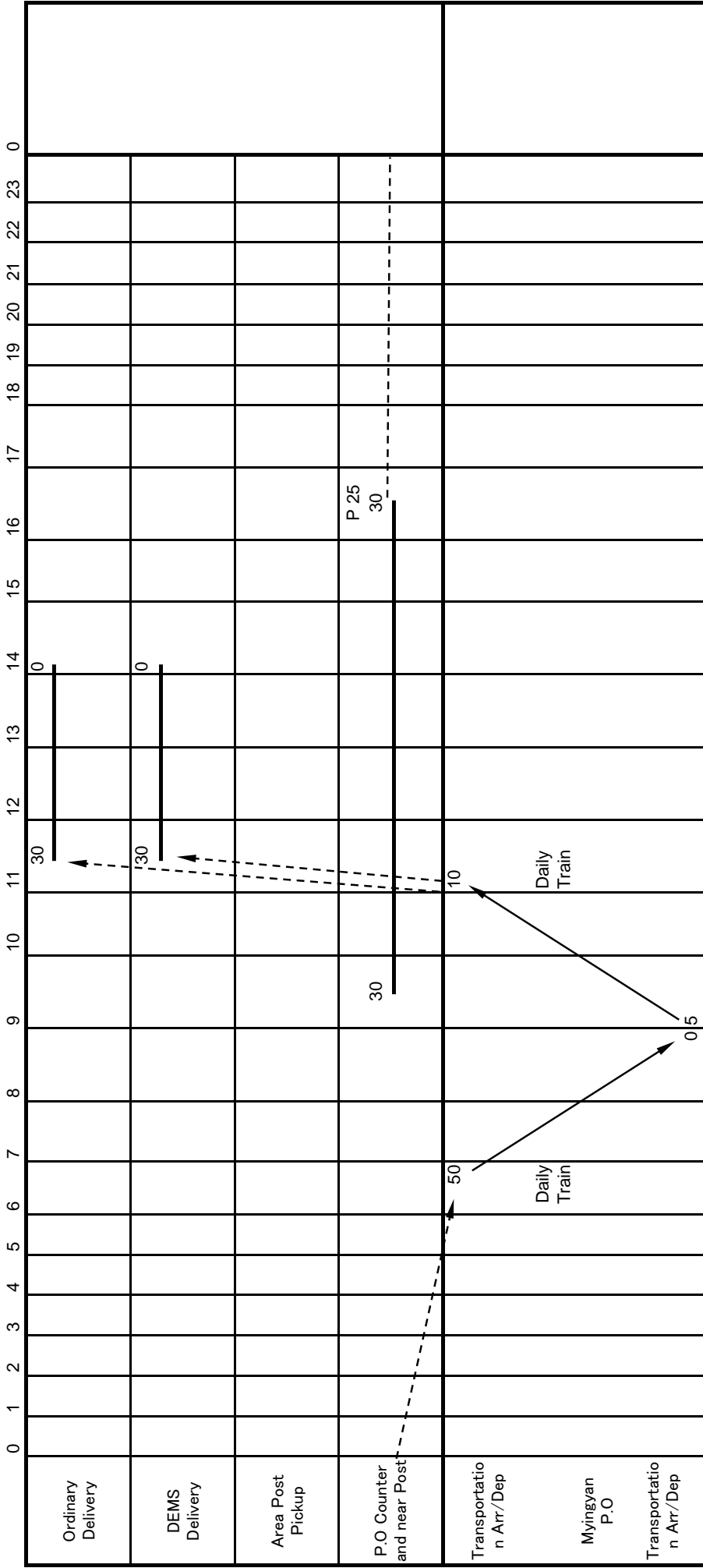

Postman Deliver mail Bag By Train

Nahtoegyí P.O	Nahtoegyí Sta	Myingyan Sta	Myingyan P.O
6:50 →	7:00	8:30 →	9:00
11:10 ←	11:00	9:30 ←	9:05

NyaungOo POST OFFICE Kessoku Diagram

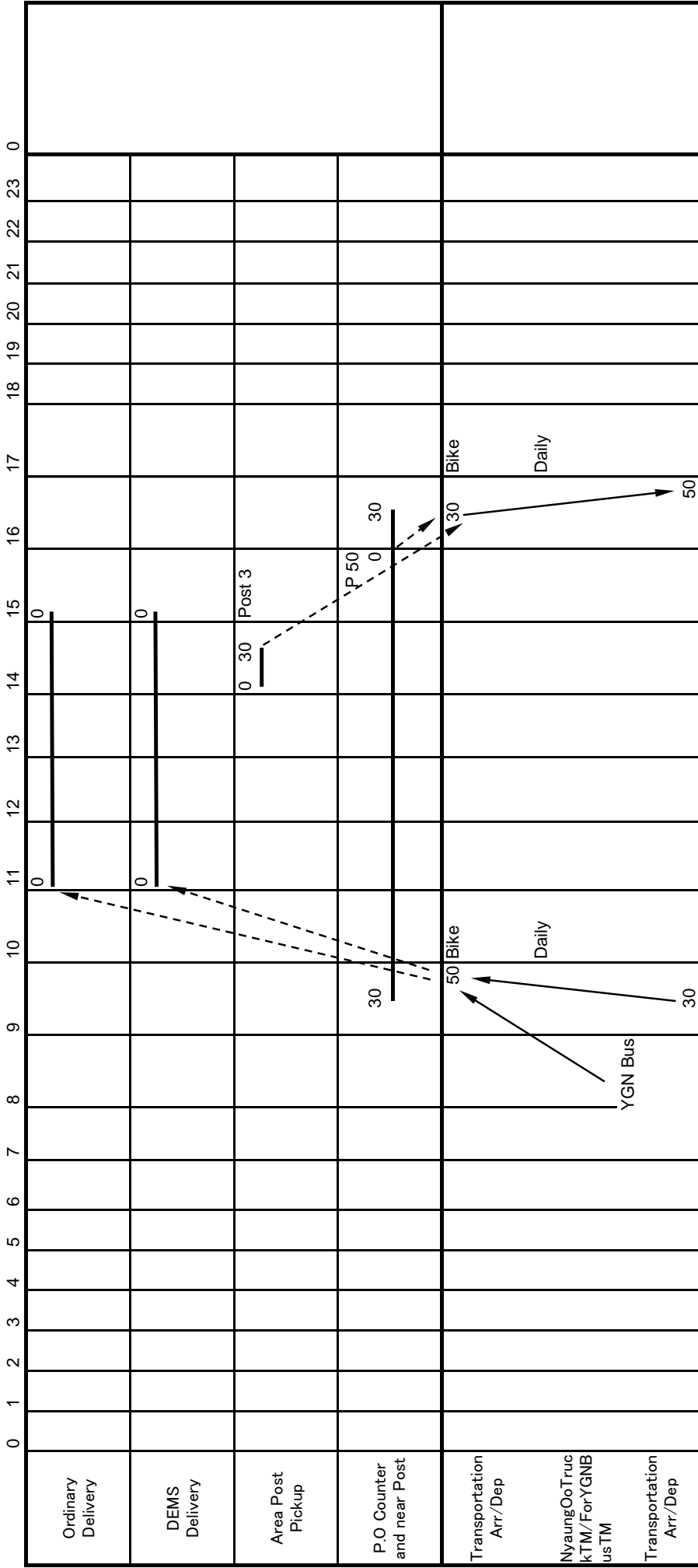



Kyaukpadaung POST OFFICE Kessoku Diagram

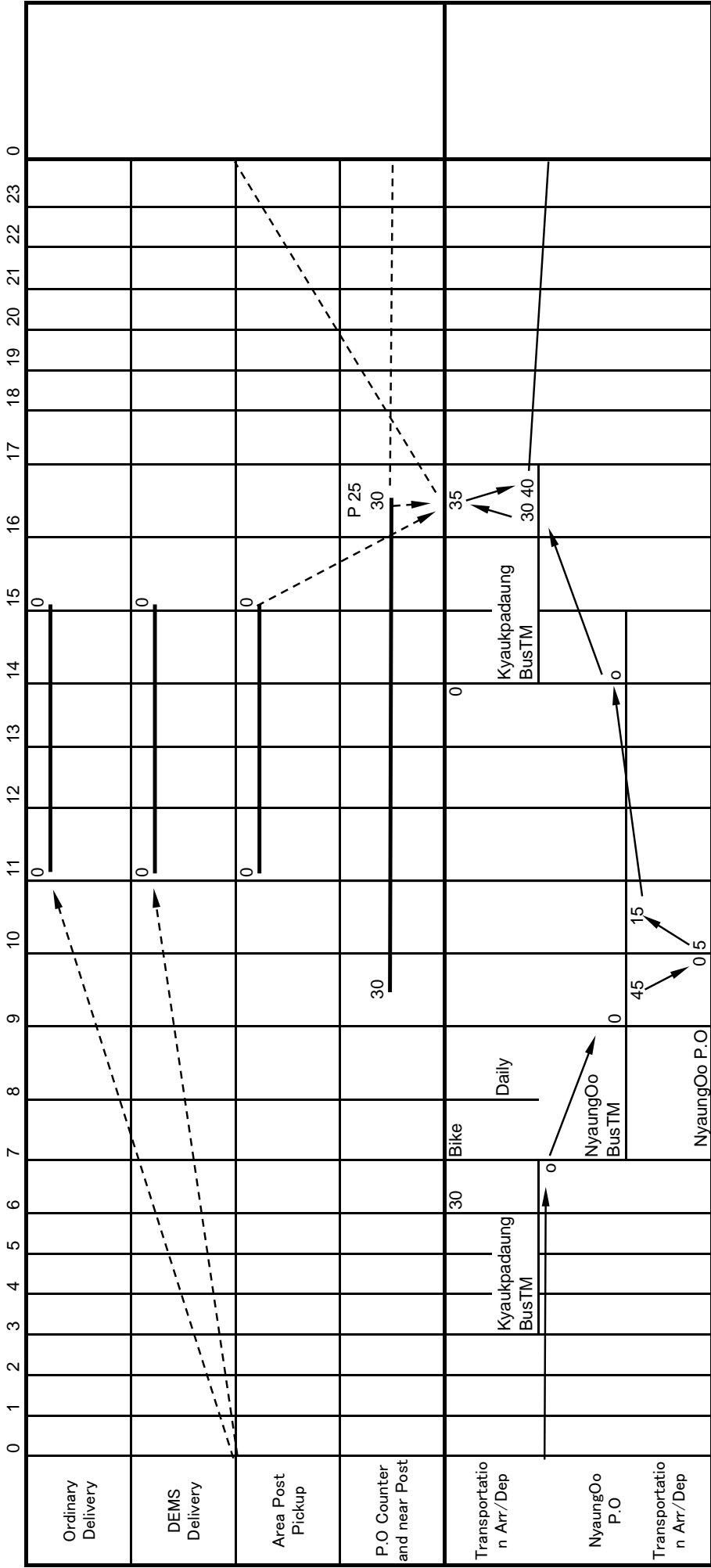

Taungtha POST OFFICE Kessoku Diagram

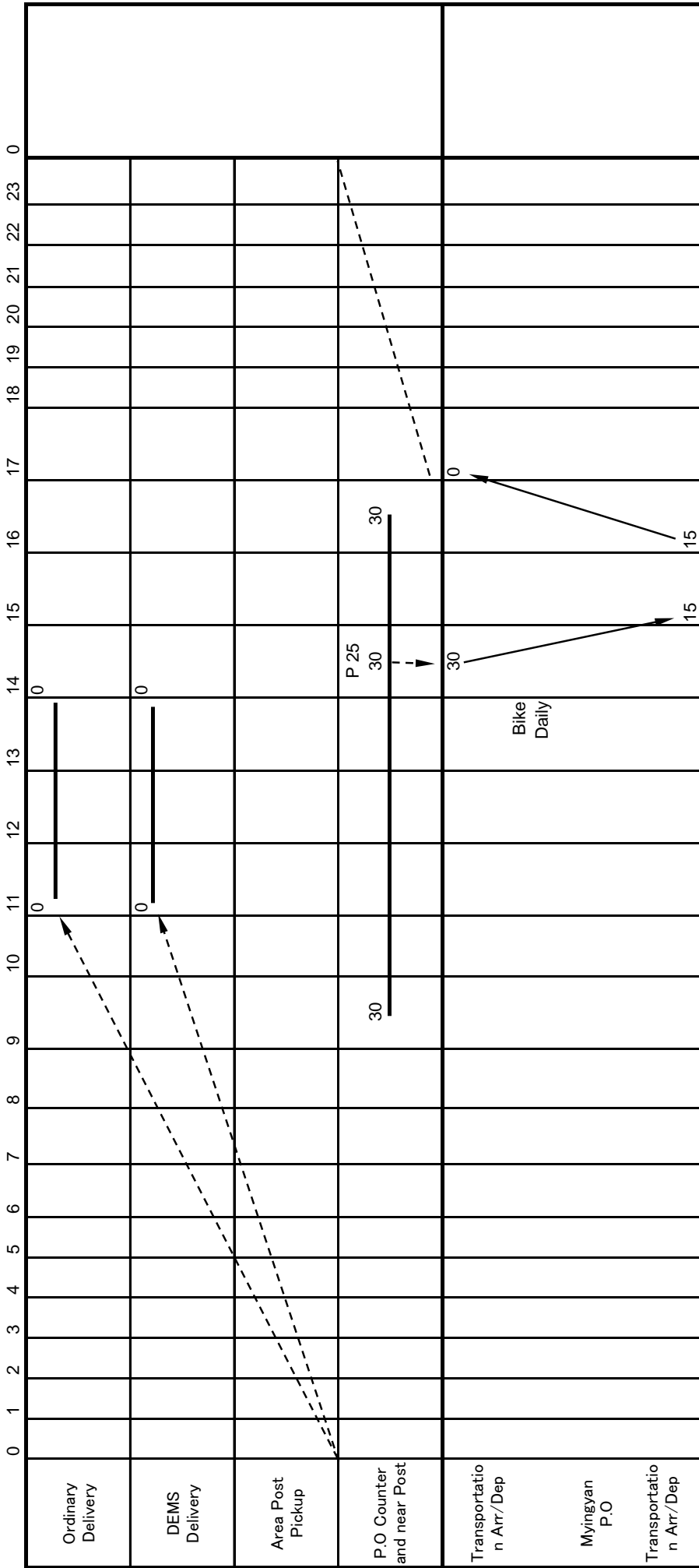

Myingyan Myoma POST OFFICE Diagram

	0	1	2	3	4	5	6	7	8	9	10	11	12	13	14	15	16	17	18	19	20	21	22	23	0
Ordinary Delivery																									
DEMS Delivery																									
Area Post Pickup																									
P.O Counter and near Post																									
Transportation Arr/Dep																									
Transportation Arr/Dep																									

All Ope Includina the Myingyan P.O

Welong POST OFFICE Kessoku Diagram

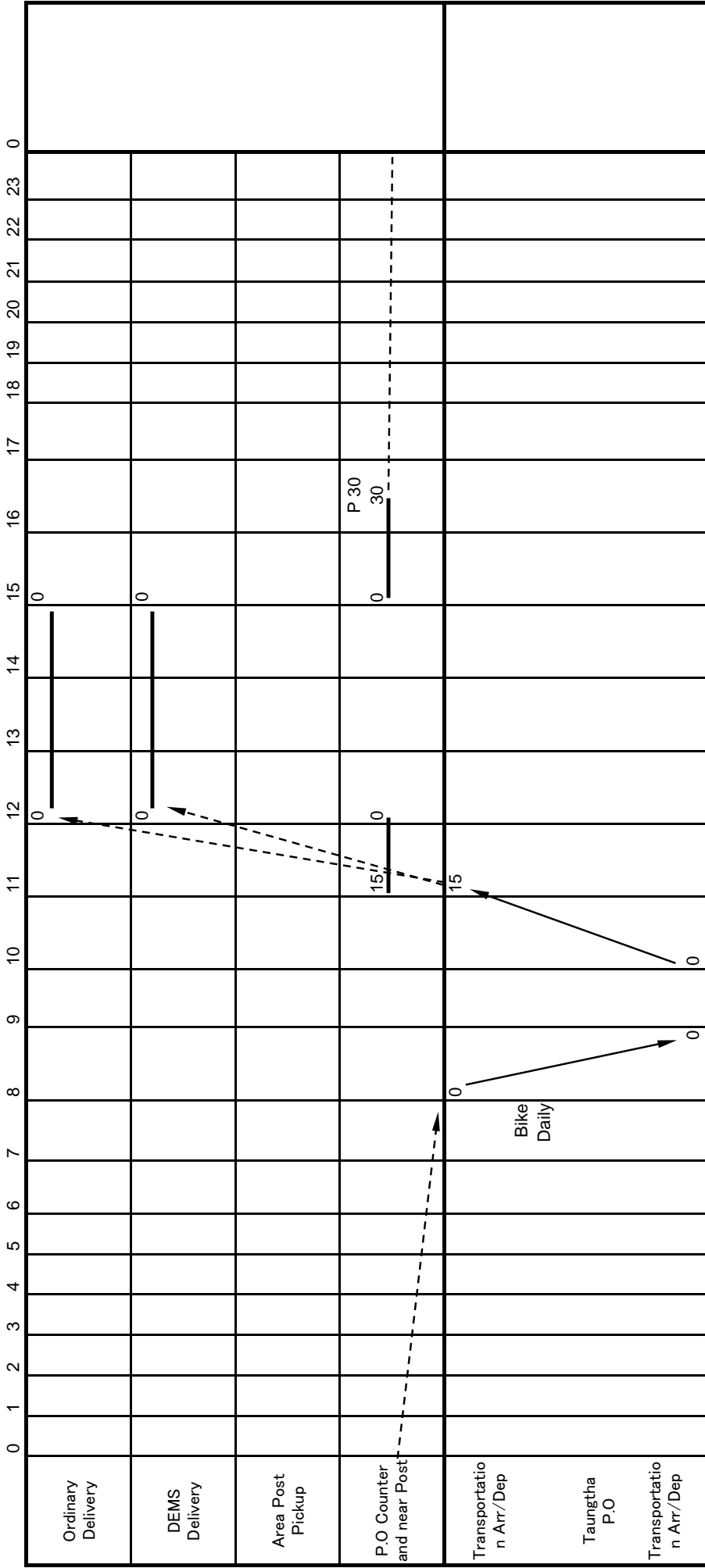

Postmaster Only 1 Operation(transportation.delivery.Counter)

Pyinsi POST OFFICE Kessoku Diagram

	0	1	2	3	4	5	6	7	8	9	10	11	12	13	14	15	16	17	18	19	20	21	22	23	0	
Ordinary Delivery													0	0												
DEMS Delivery													0	0												
Area Post Pickup																										
P.O Counter and near Post																										
Transportation Arr/Dep																										
Transportation Arr/Dep																										

Counter Open Including the Nahtoegy P.O  
 Delivery Mon Wed Fri (1 Week 3 Days)



Popa POST OFFICE Kessoku Diagram

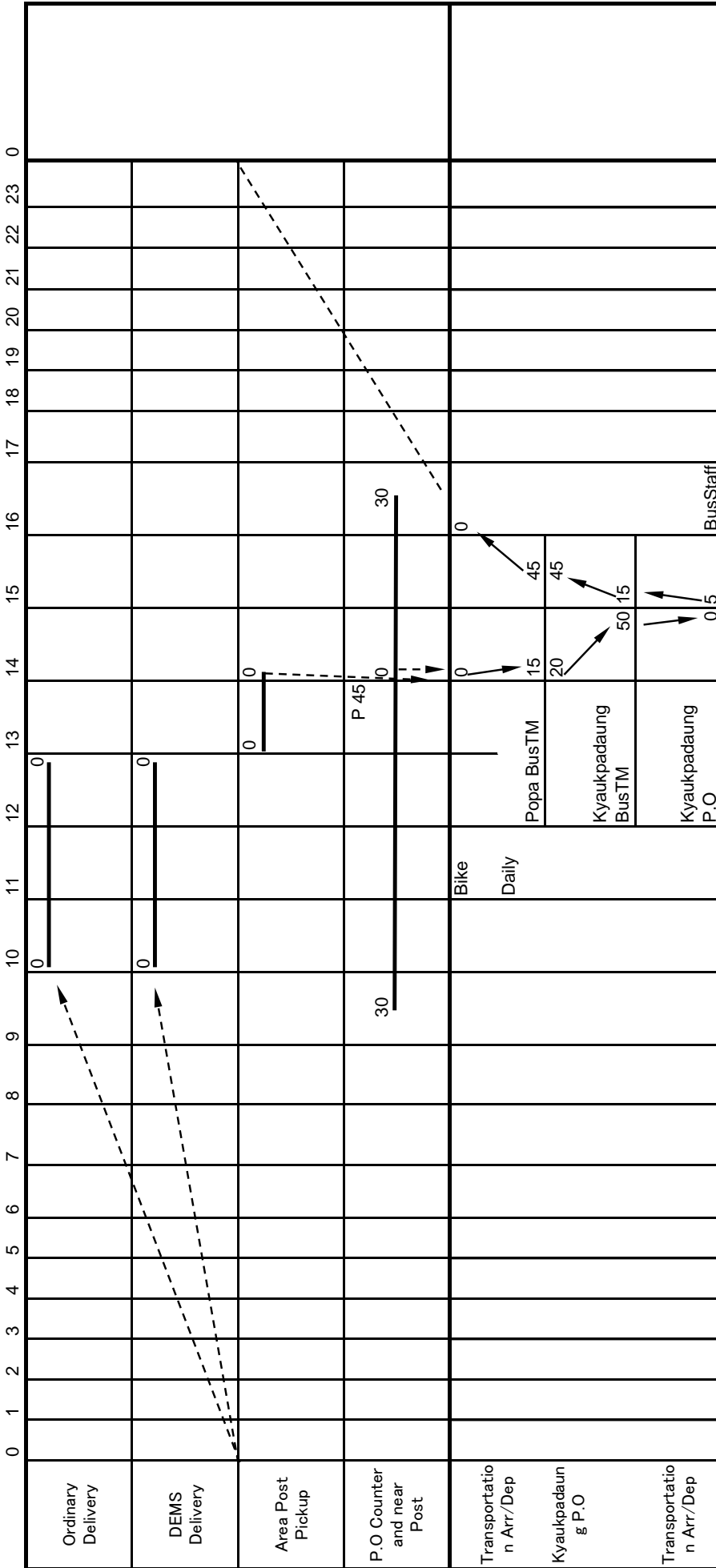

Singu POST OFFICE Kessoku Diagram

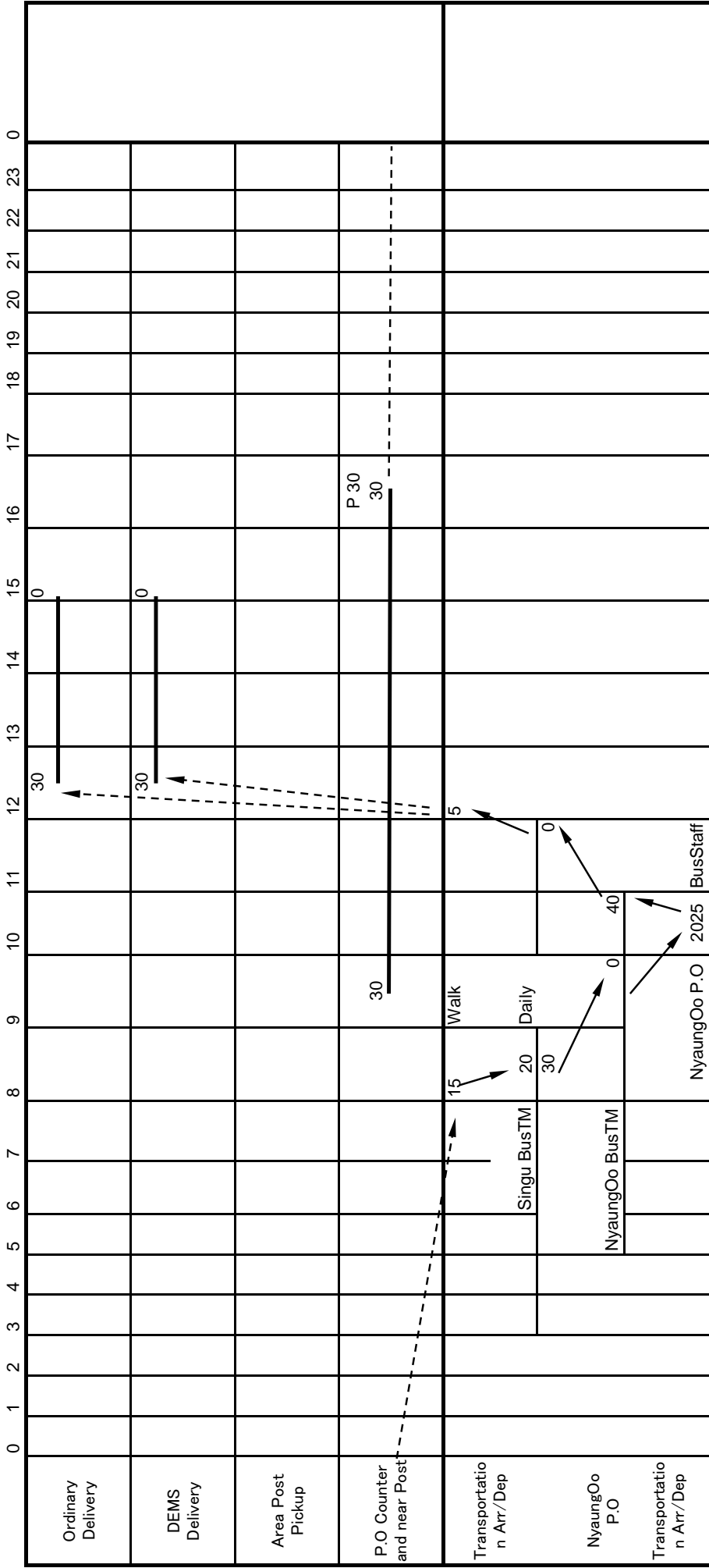

Postmaster Only 1 Operation



Mahlaing POST OFFICE Kessoku Diagram

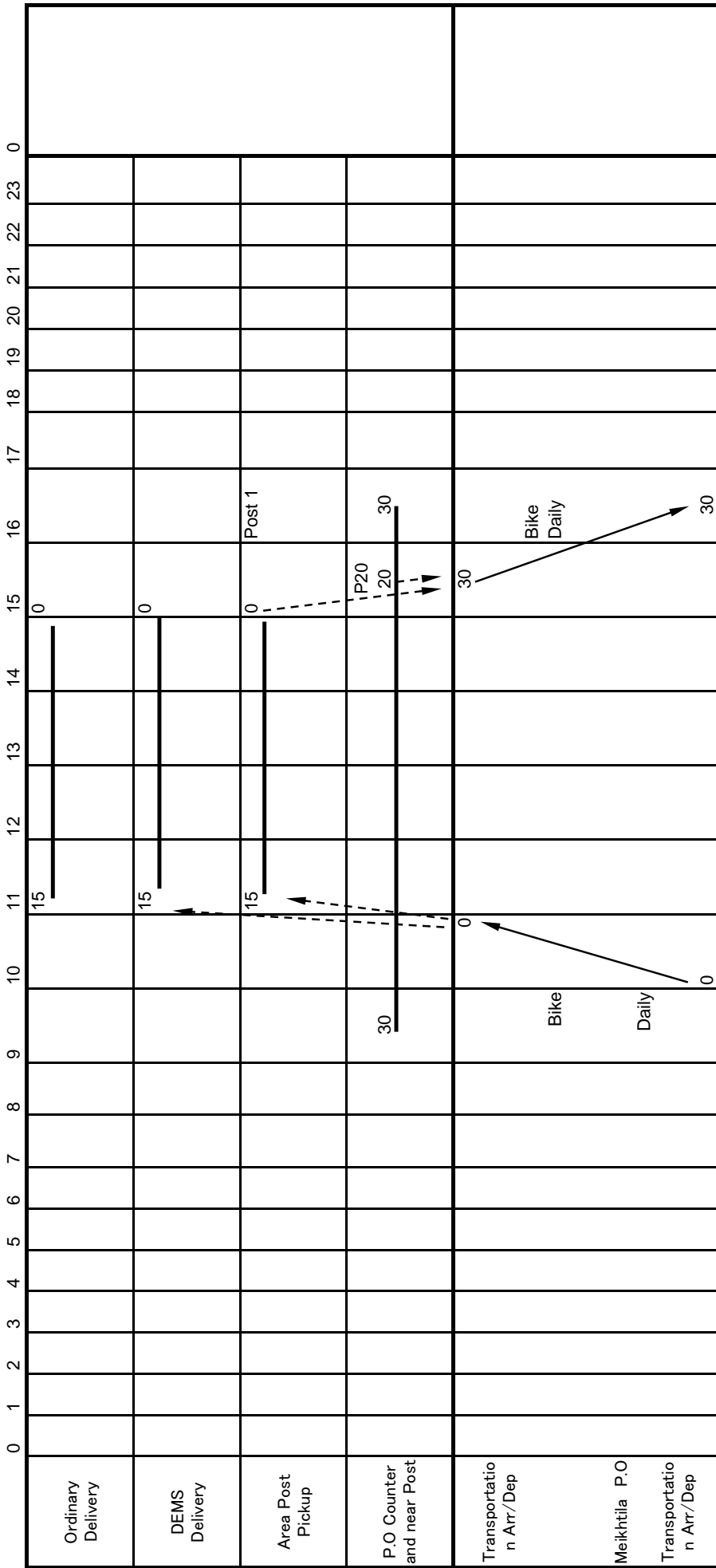

Meikhtila POST OFFICE Kessoku Diagram

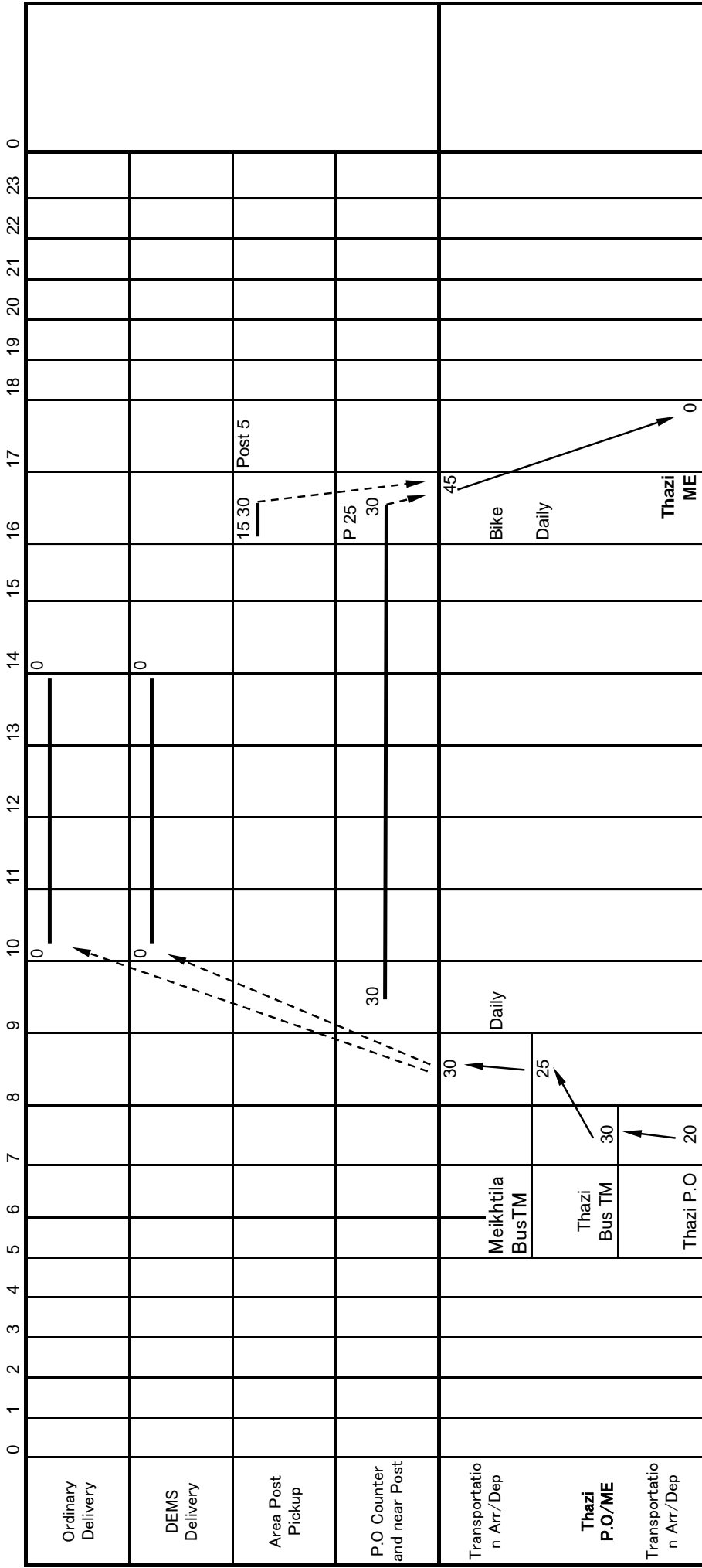

Meikhtila Cant; POST OFFICE Kessoku Diagram

	0	1	2	3	4	5	6	7	8	9	10	11	12	13	14	15	16	17	18	19	20	21	22	23	0
Ordinary Delivery																									
DEMS Delivery																									
Area Post Pickup																									
P.O Counter and near Post										30							P10 15 30								
Transportation Arr/Dep																	15								
Meikhtila P.O																	BIKE								
Transportation Arr/Dep																	Daily								30

Special Delivery Meikhtila OLD / DEMS

Meikhtila(Basaka) POST OFFICE Kessoku Diagram

	0	1	2	3	4	5	6	7	8	9	10	11	12	13	14	15	16	17	18	19	20	21	22	23	0	
Ordinary Delivery																										
DEMS Delivery																										
Area Post Pickup																										
P.O Counter and near Post										30							P10 15.30									
Transportation Arr/Dep																	15									
Meikhtila P.O																	BIKE									
Transportation Arr/Dep																	Daily									30

Special Delivery Meikhtila OLD/DEMS

Shante POST OFFICE Kessoku Diagram

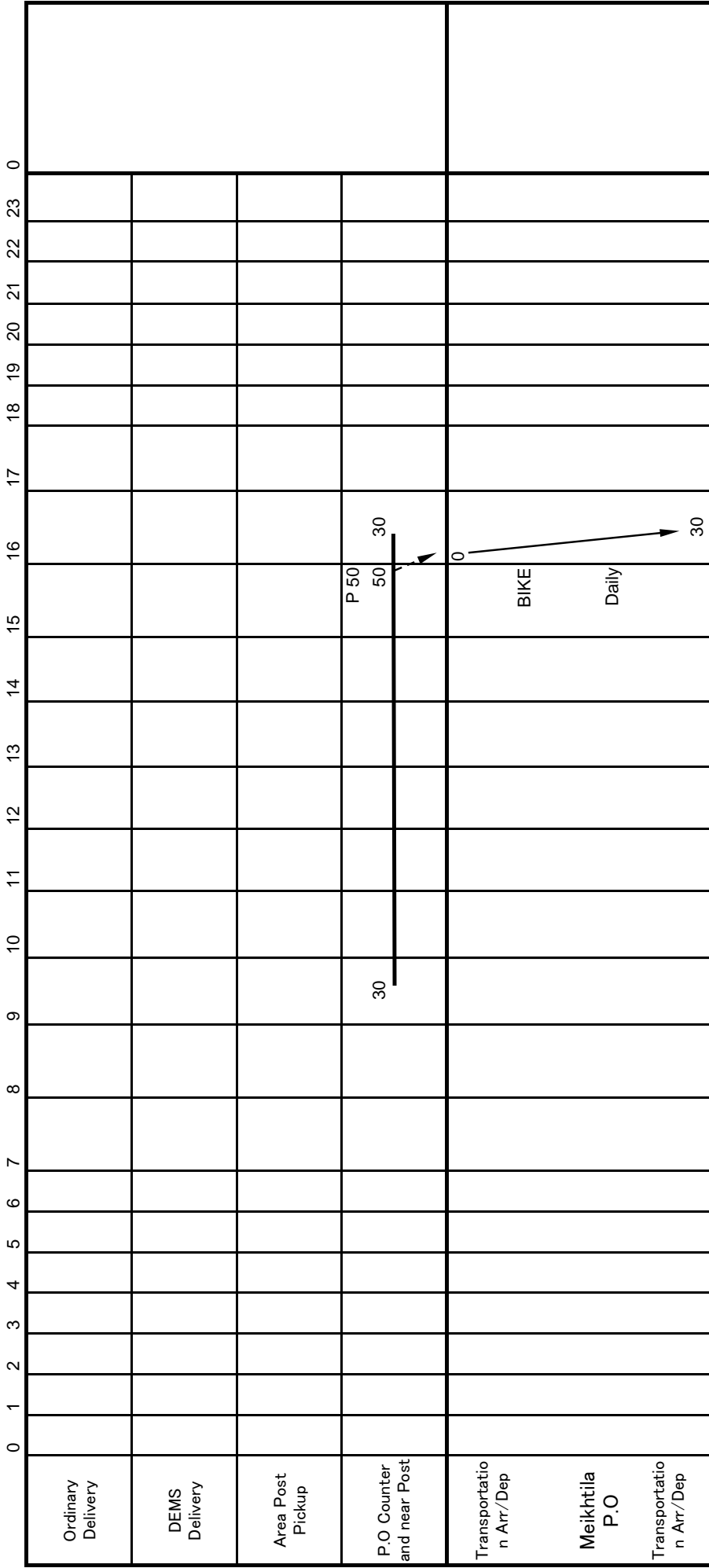

Special Delivery Meikhtila OLD / DEMS



Shanmange POST OFFICE Kessoku Diagram

	0	1	2	3	4	5	6	7	8	9	10	11	12	13	14	15	16	17	18	19	20	21	22	23	0
Ordinary Delivery																									
DEMS Delivery																									
Area Post Pickup																									
P.O Counter and near Post																									
Transportation Arr/Dep																									
Meikhtila P.O																									
Transportation Arr/Dep																									

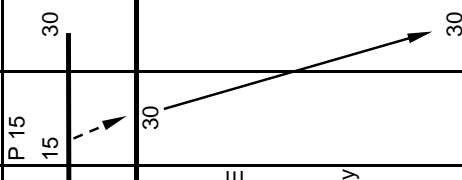

BIKE  
Daily

Special Delivery Meikhtila OLD / DEMS

PyinOoLwin POST OFFICE Kessoku Diagram

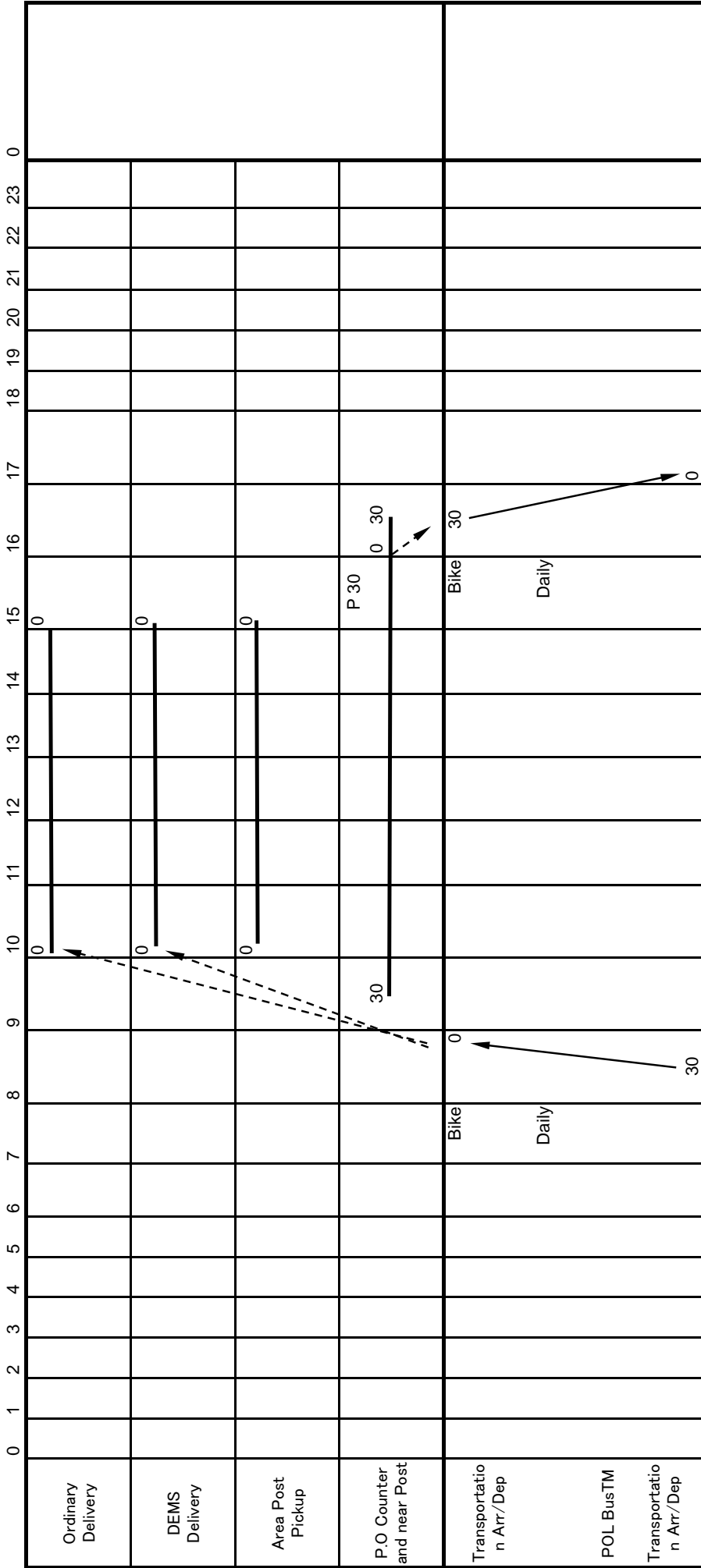

POL BusTM 6:00 → MDYBusTM 8:30  
 MDYBusTM 6:00 → POL BusTM 8:30  
 POL BusTM 18:00 → YGN(From POL)BusTM 6:00 For YGN DEMS Only  
 YGN(For POL)BusTM 21:00 → POL BusTM 6:00

PyinOolwin Cont; POST OFFICE Kessoku Diagram

	0	1	2	3	4	5	6	7	8	9	10	11	12	13	14	15	16	17	18	19	20	21	22	23	0
Ordinary Delivery																									
DEMS Delivery																									
Area Post Pickup																									
P.O Counter and near Post										30						P 45	0	30							
Transportation Arr/Dep																									
PyinOolwin P.O																									
Transportation Arr/Dep																									

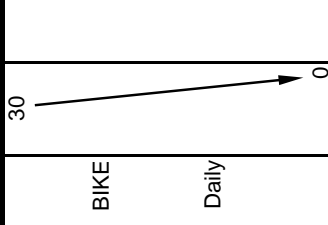

Special Delivery PyinOolwin OLD / DEMS

**Ahneesakhan POST OFFICE Kessoku Diagram**

	0	1	2	3	4	5	6	7	8	9	10	11	12	13	14	15	16	17	18	19	20	21	22	23	0
Ordinary Delivery																									
DEMS Delivery																									
Area Post Pickup																									
P.O Counter and near Post										30							P.O. 30								
Transportation Arr/Dep									5								30								
PyinOolwin P.O																									
Transportation Arr/Dep																									

Special Delivery PyinOolwin OLD / DEMS Money Order



CSTS(Zeebingyi) POST OFFICE Diagram

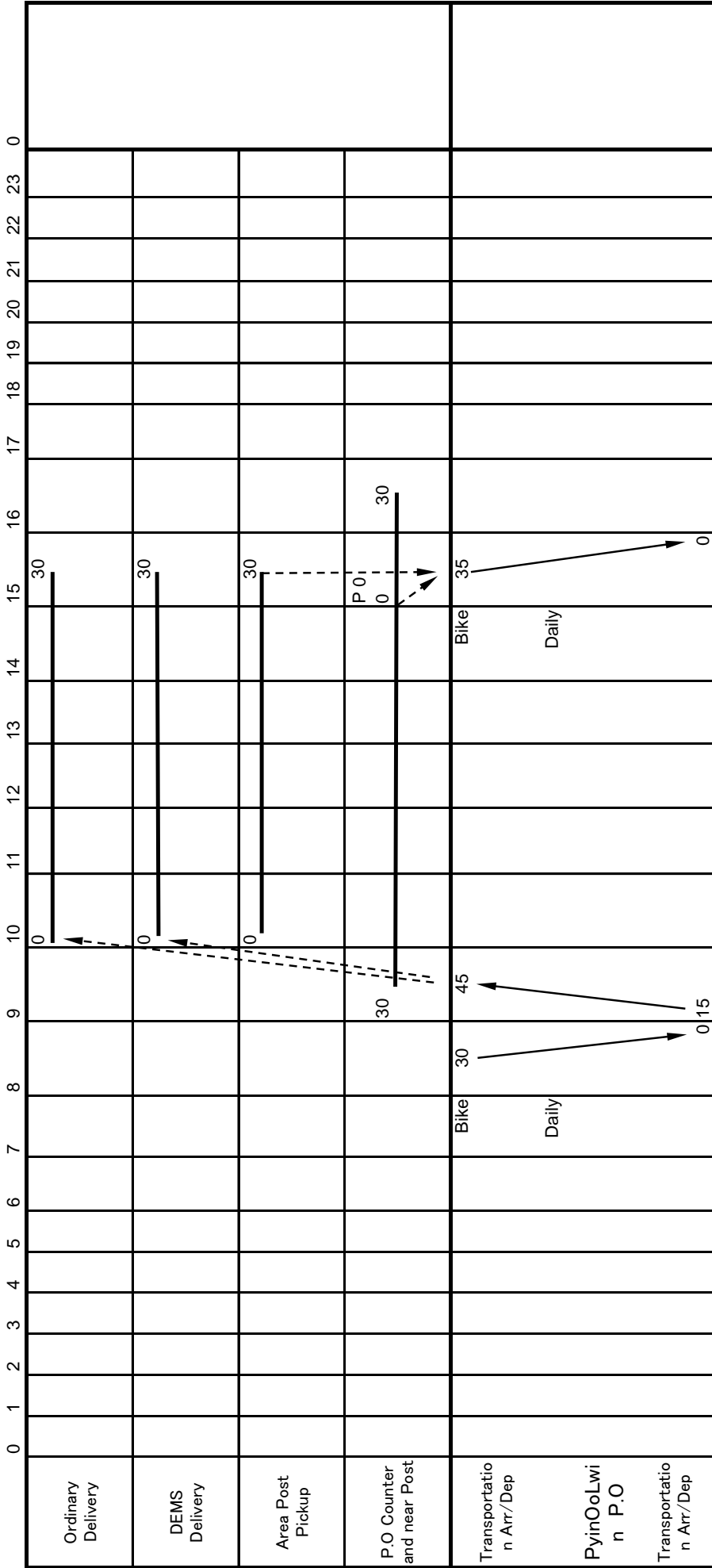

Yadanaponmyothit POST OFFICE Kessoku Diagram

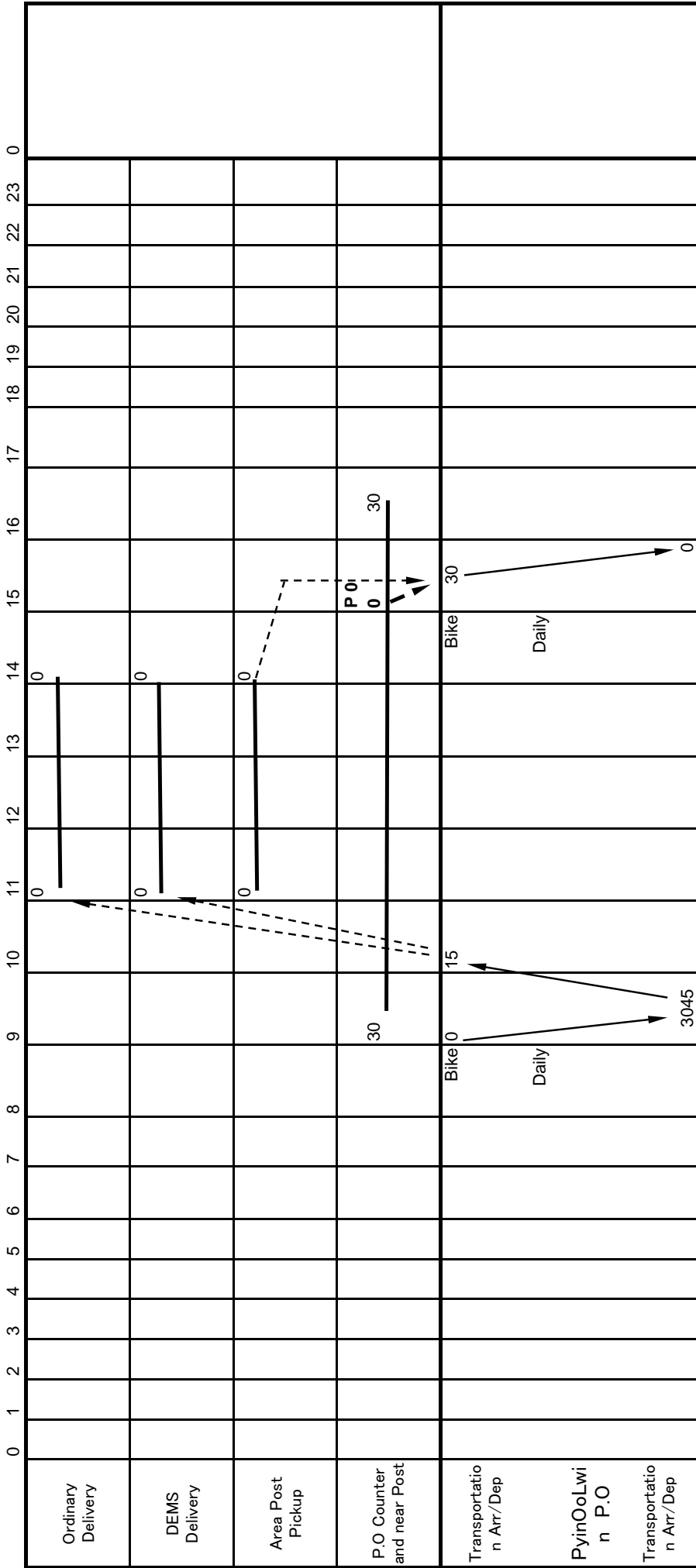

Mogoke POST OFFICE Kessoku Diagram

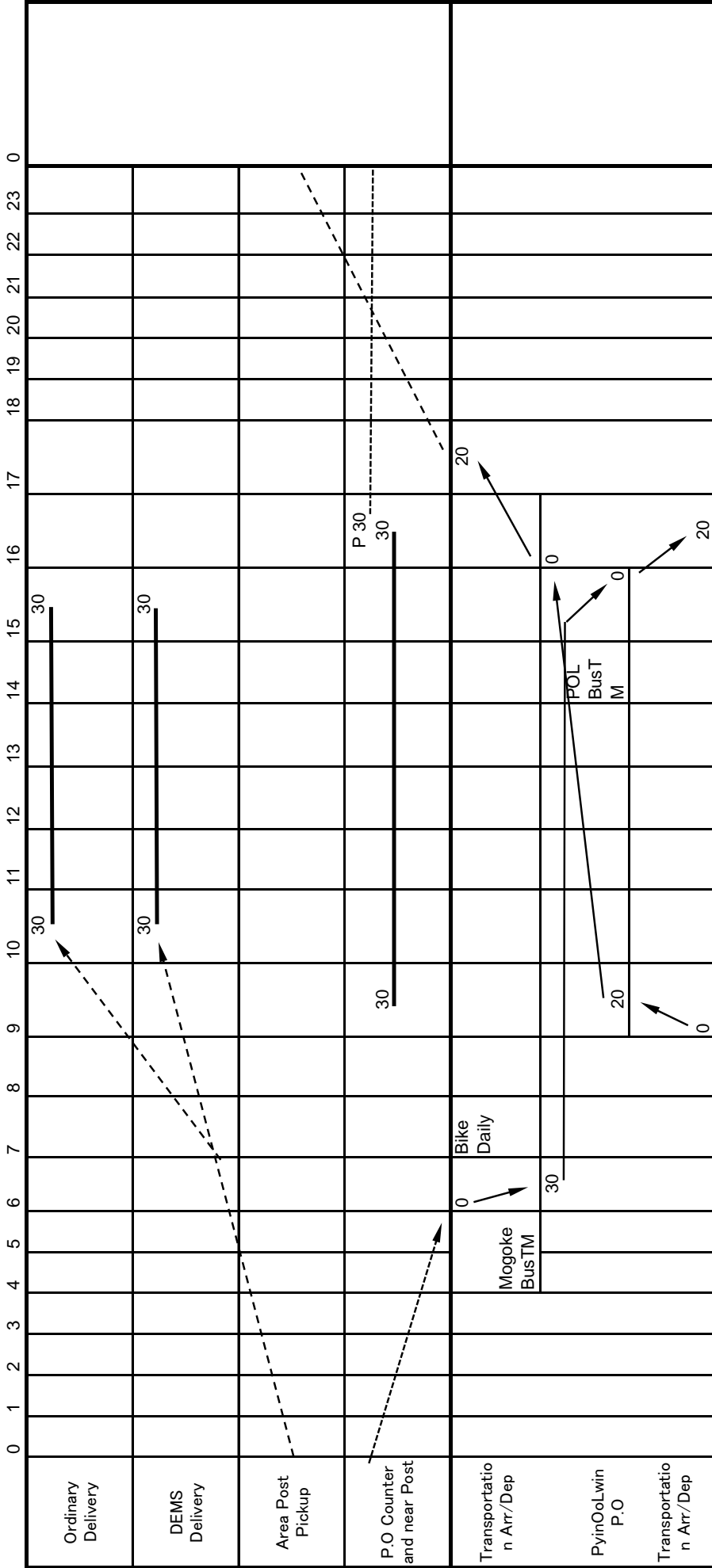

Mogoke BusTM 8:00~8:30 → PolBusTM 16:00~16:30  
 PolBusTM 9:20 → Mogoke BusTM 17:00  
 Bike → Daily



Kyatpyin POST OFFICE Kessoku Diagram

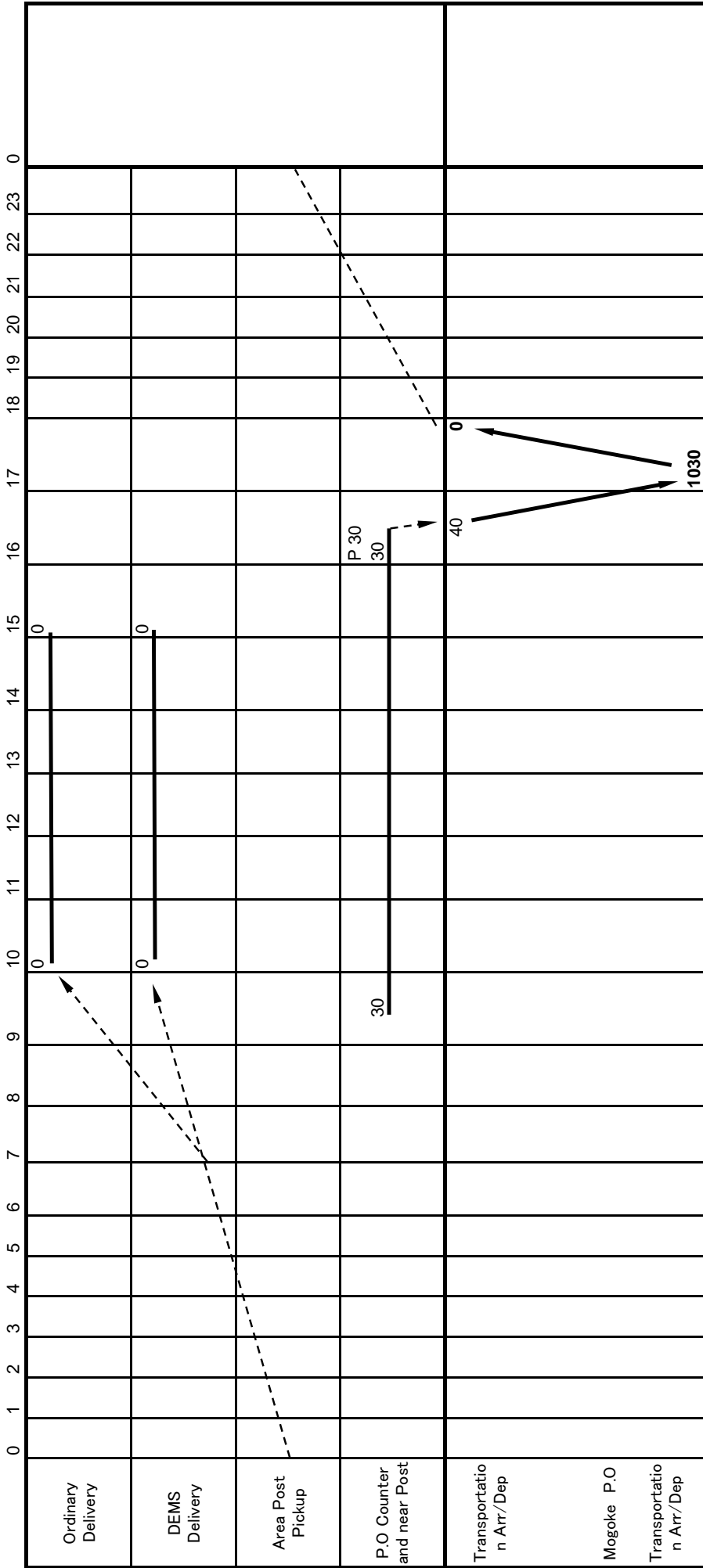

SuPaung(Yonepaungstone) POST OFFICE Kessoku Diagram

	0	1	2	3	4	5	6	7	8	9	10	11	12	13	14	15	16	17	18	19	20	21	22	23	0
Ordinary Delivery																									
DEMS Delivery																									
Area Post Pickup																									
P.O Counter and near Post										30						P 45	0	30							
Transportation Arr/Dep																									
PyinOoLwin P.O																									
Transportation Arr/Dep																									

Special Delivery PyinOoLwin OLD/DEMS

Madaya POST OFFICE Kessoku Diagram

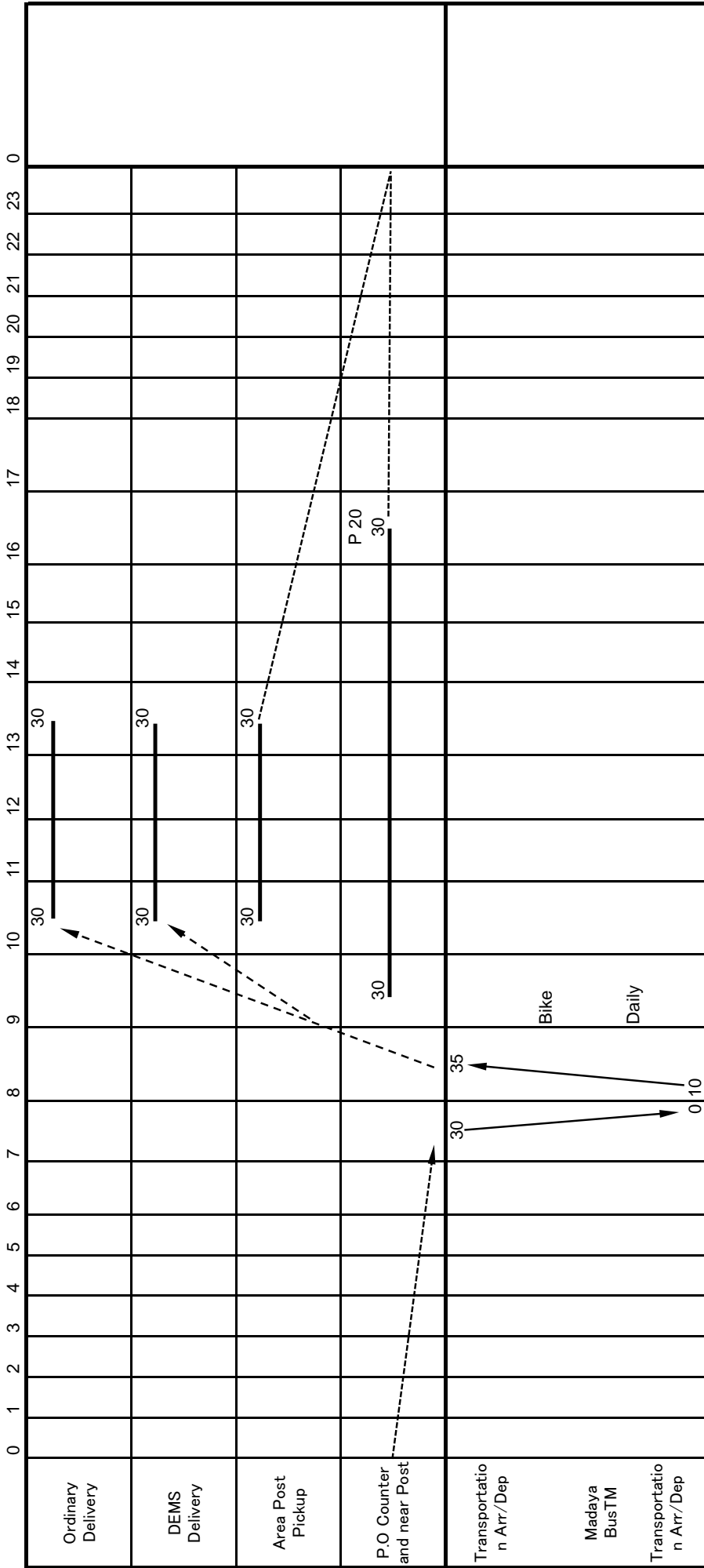

Madaya BusTM 10:00 → MDYBusTM 11:00  
MDYBusTM 14:00 → Madaya BusTM 15:00

Sintgu POST OFFICE Kessoku Diagram

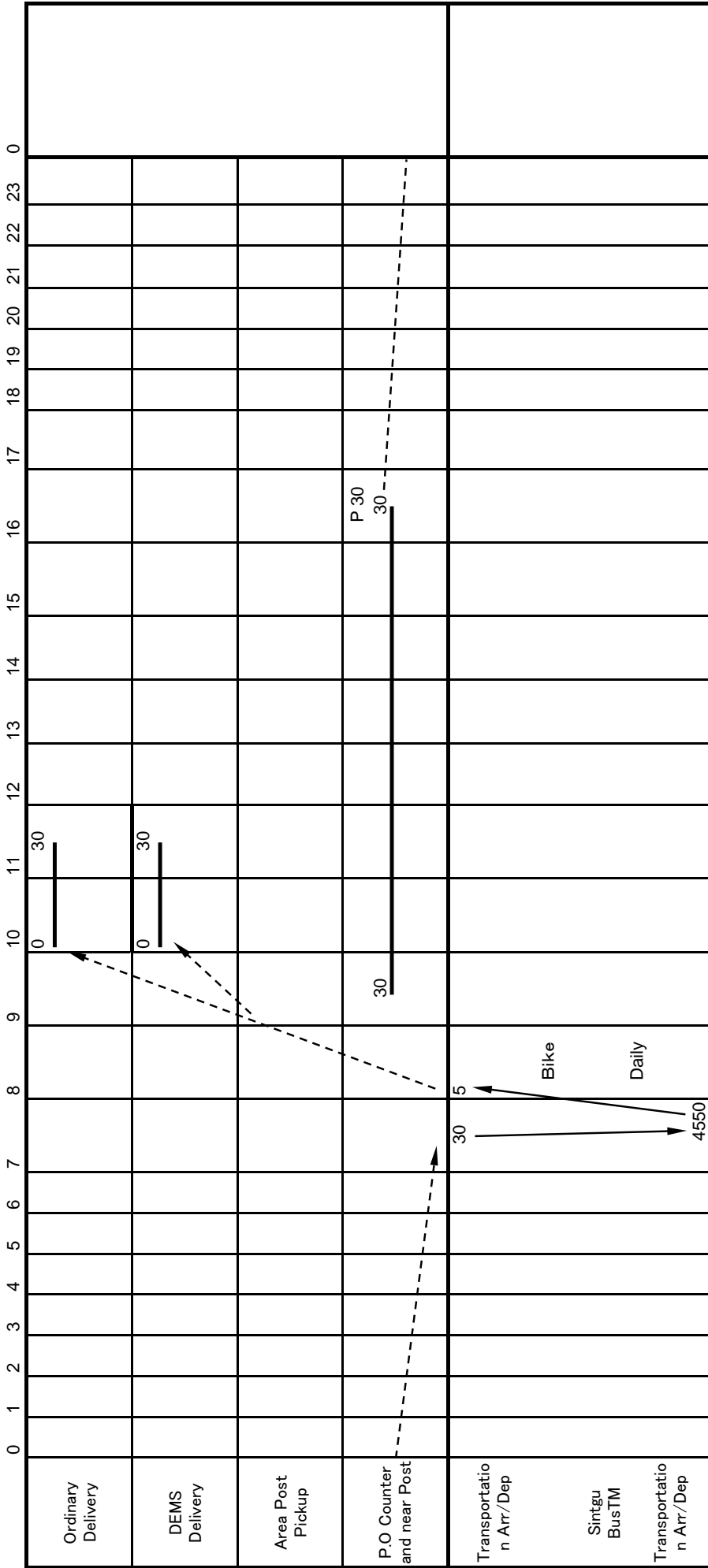

Sintgu BusTM 8:00 → MDYBusTM 12:00  
 MDYBusTM 15:30 → Sintgu BusTM 19:00

Thabeikkyin POST OFFICE Kessoku Diagram

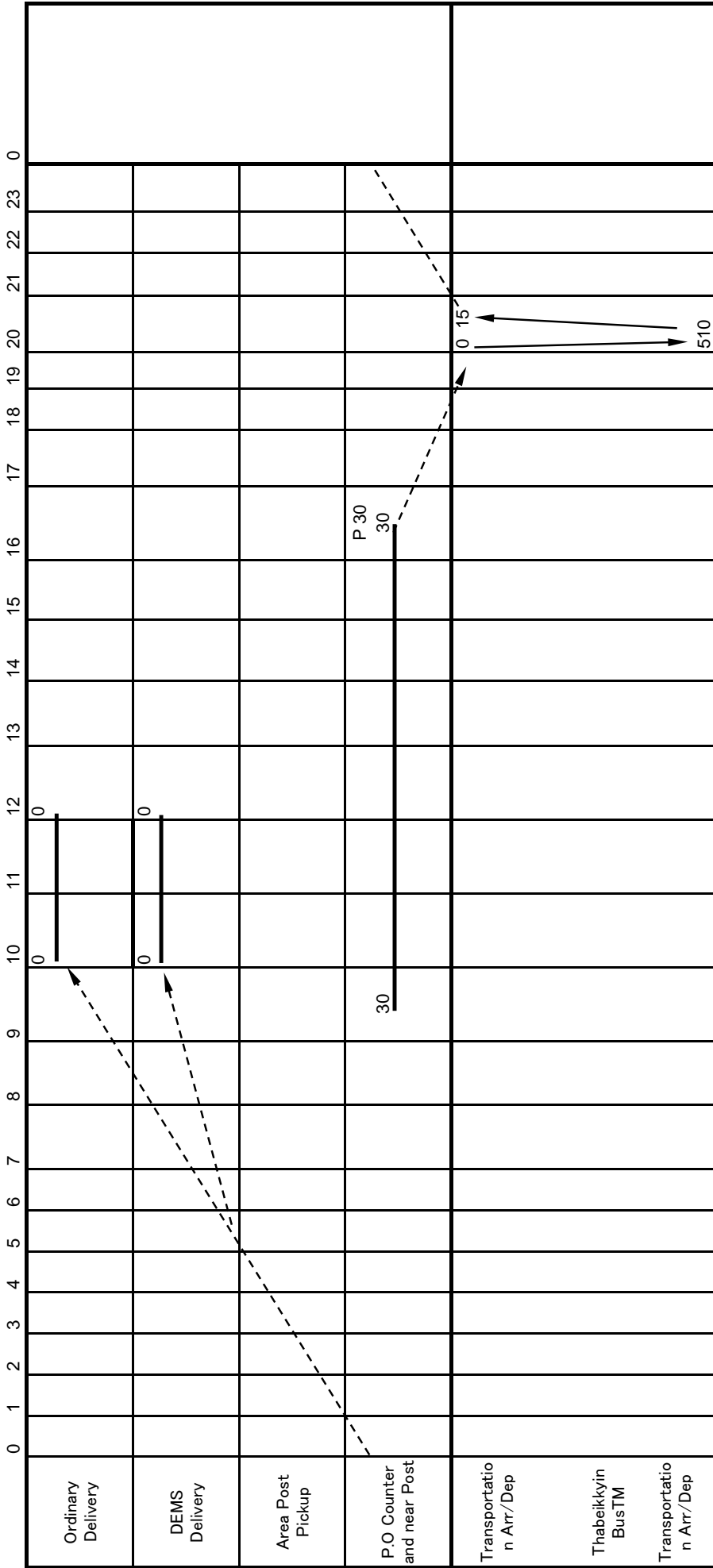

Thabeikkyin BusTM 5:00 → MDYBusTM 9:00  
MDYBusTM 16:00 → Thabeikkyin BusTM 20:00

Walk Daily

Ngazune POST OFFICE Kessoku Diagram

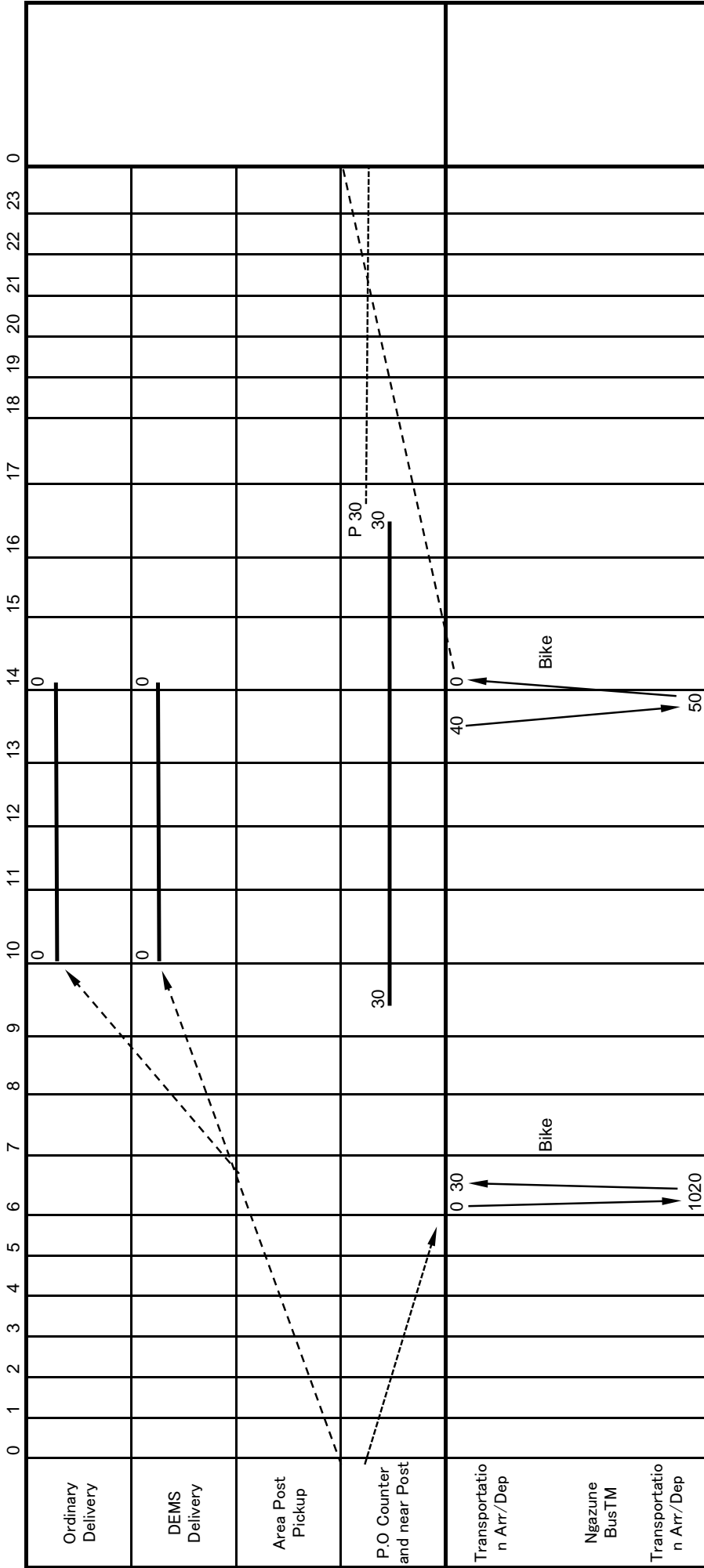

Bike → Daily

Ngazune Bus TM 6:15 → MDYBus TM 9:00  
MDYBus TM 9:30 → Ngazune Bus TM 13:30

Dagaung POST OFFICE Kessoku Diagram

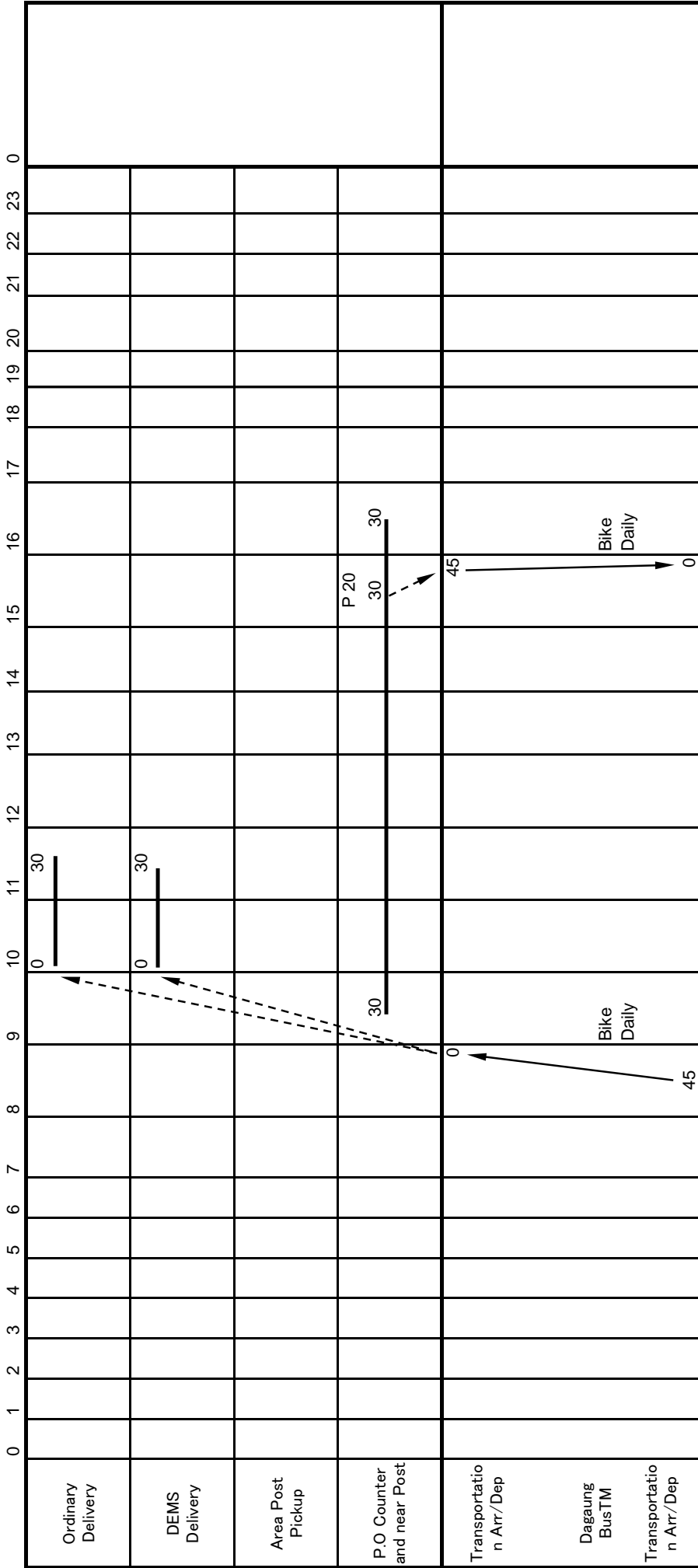

Dagaung BusTM 16:00 → MDYBusTM 23:00  
 MDYBusTM 16:00 → Dagaung BusTM 23:00

Myotha POST OFFICE Kessoku Diagram

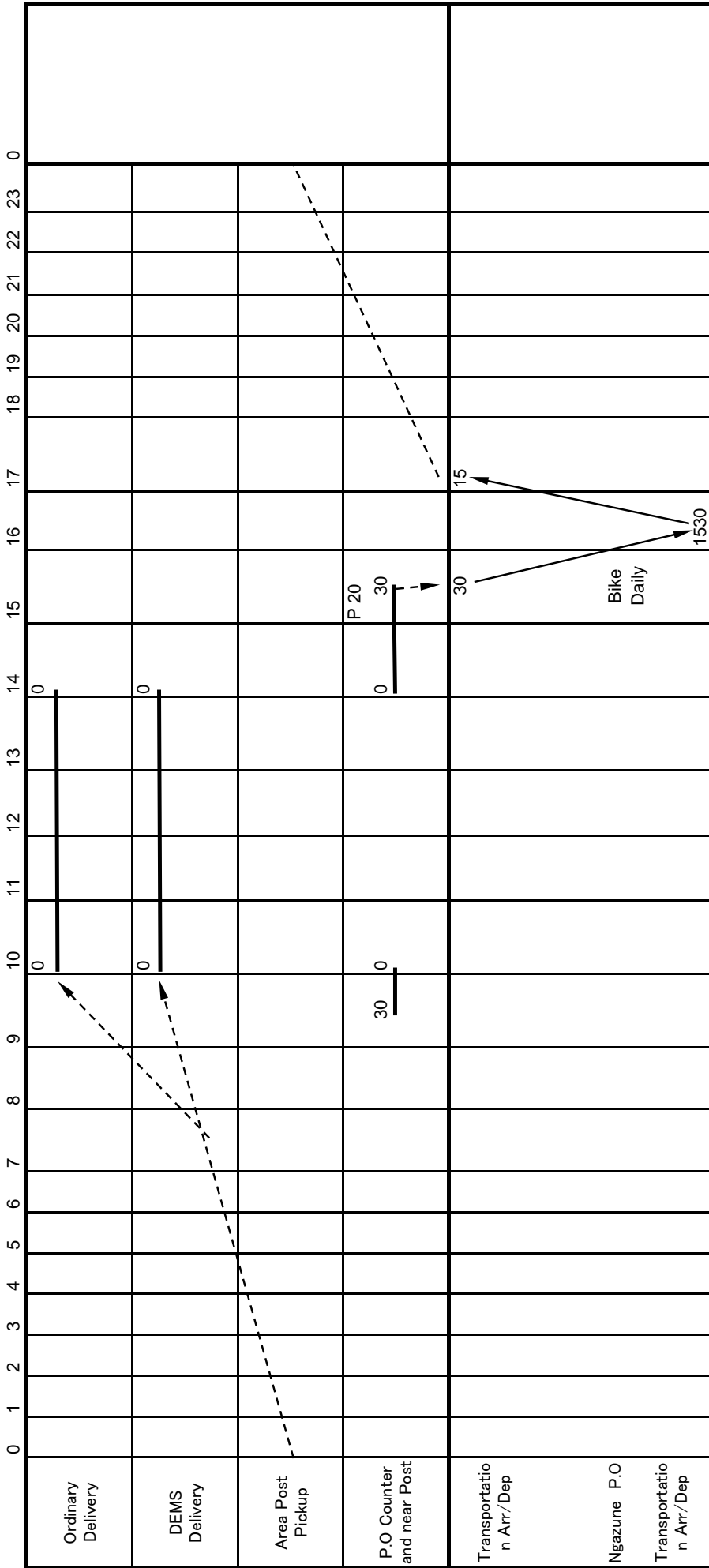

PostMaster 1 All Ope(TrunsPotartion.Delivery.Counter)



Latpanhla POST OFFICE Kessoku Diagram

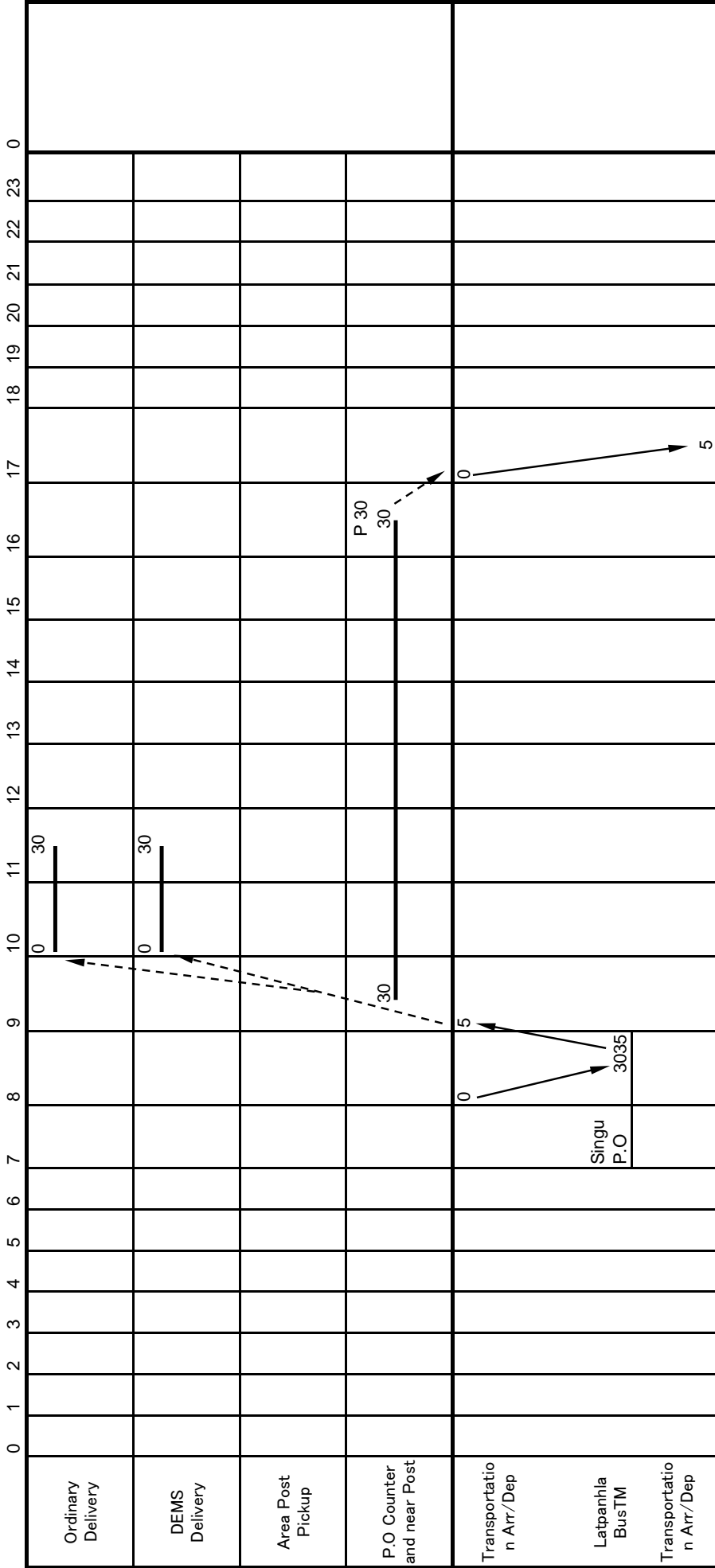

Latpanhla BusTM 8:30 → MDYBusTM 12:00  
MDYBusTM 15:30 → Sintgu BusTM 19:00

TadaU POST OFFICE Kessoku Diagram

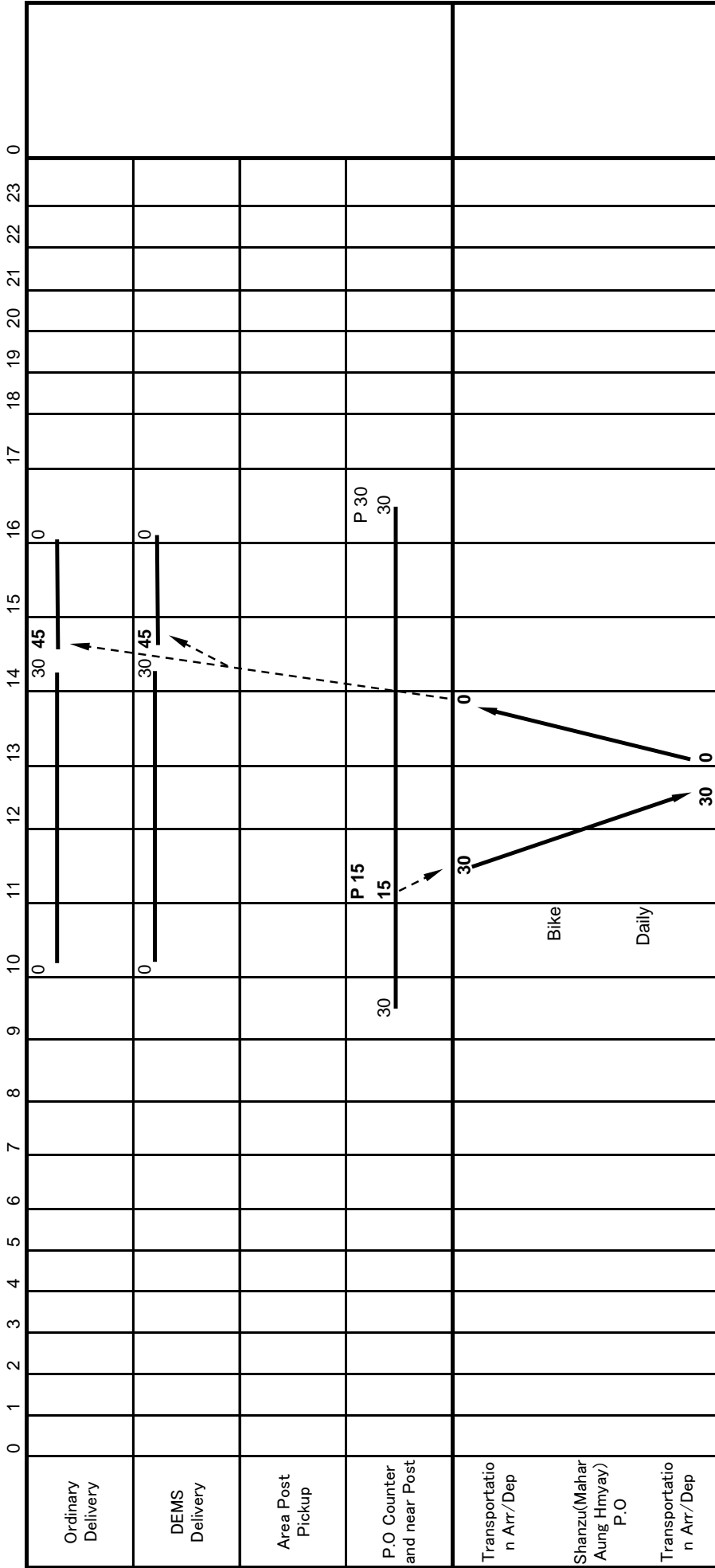

MDY Nantwin POST OFFICE Kessoku Diagram

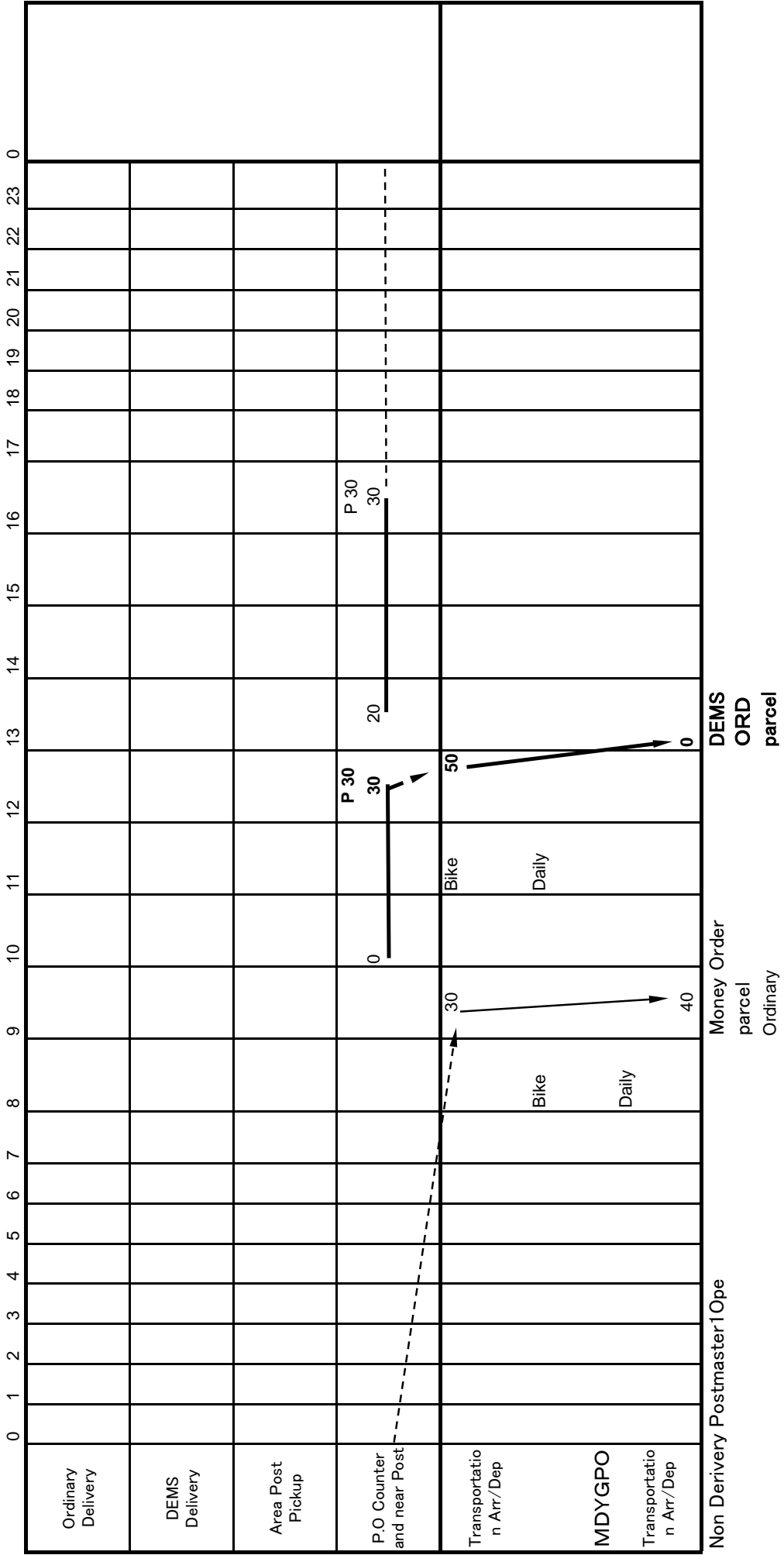

Man(Ashaepyin) POST OFFICE Kessoku Diagram

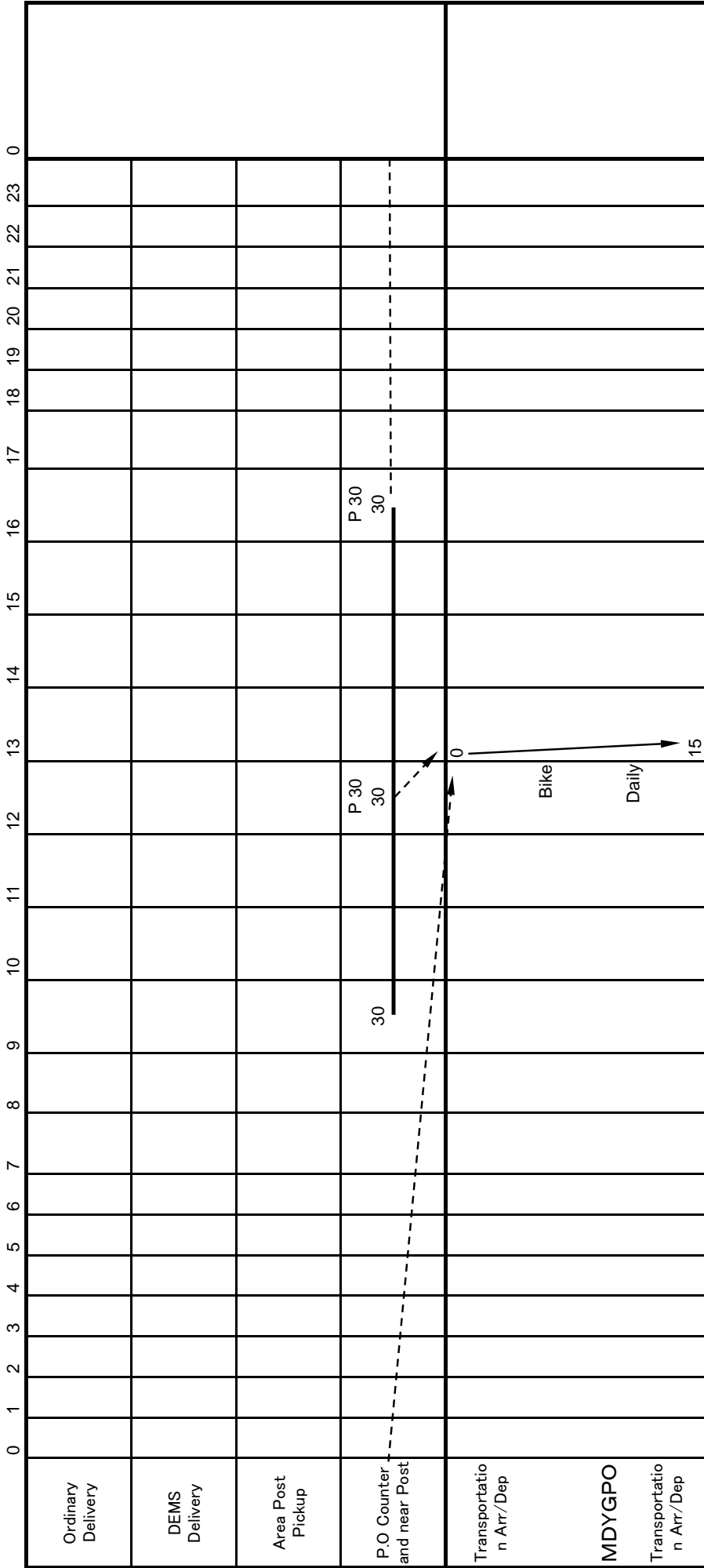

Man(myaukpyin) POST OFFICE Kessoku Diagram

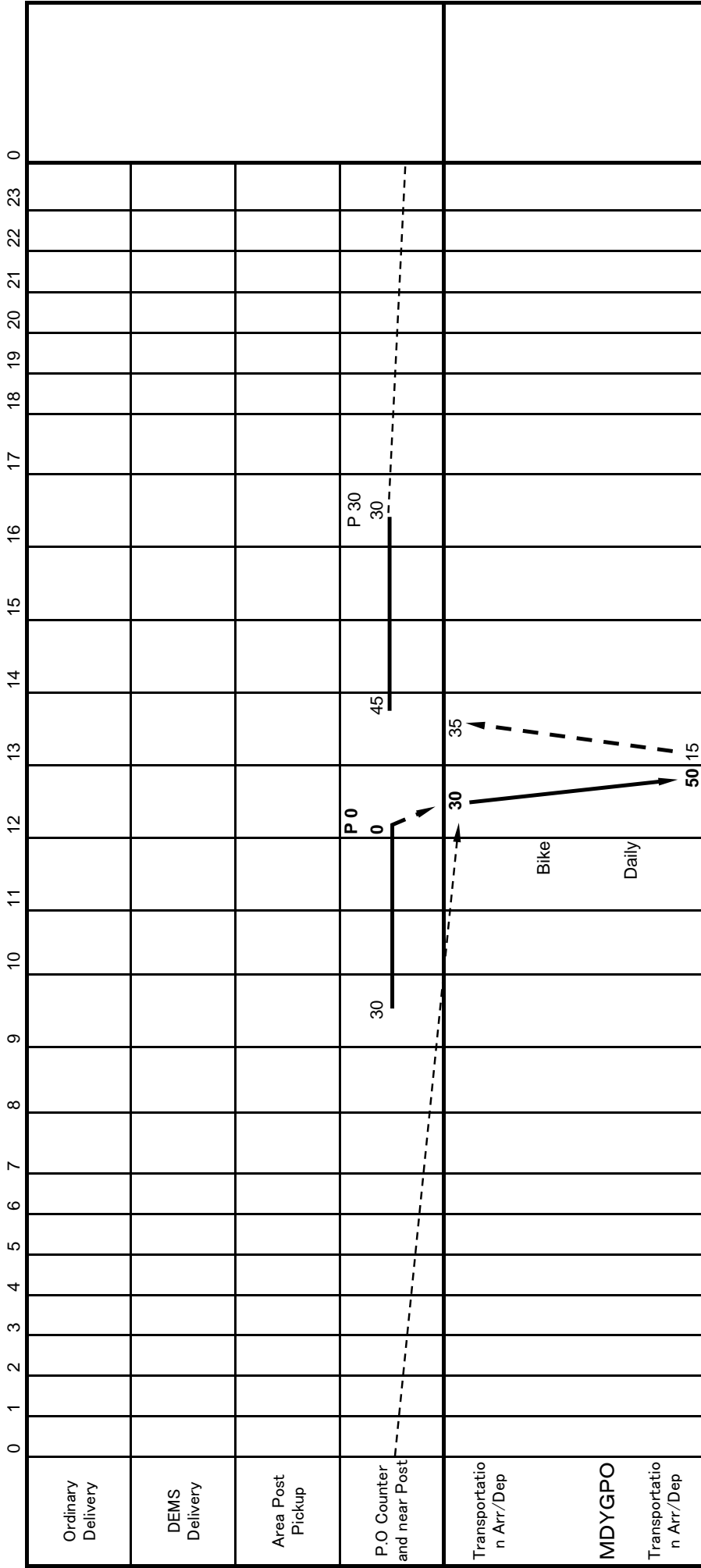

Non Delivery Postmaster Ope

HTONEBO(MTU) POST OFFICE Kessoku Diagram

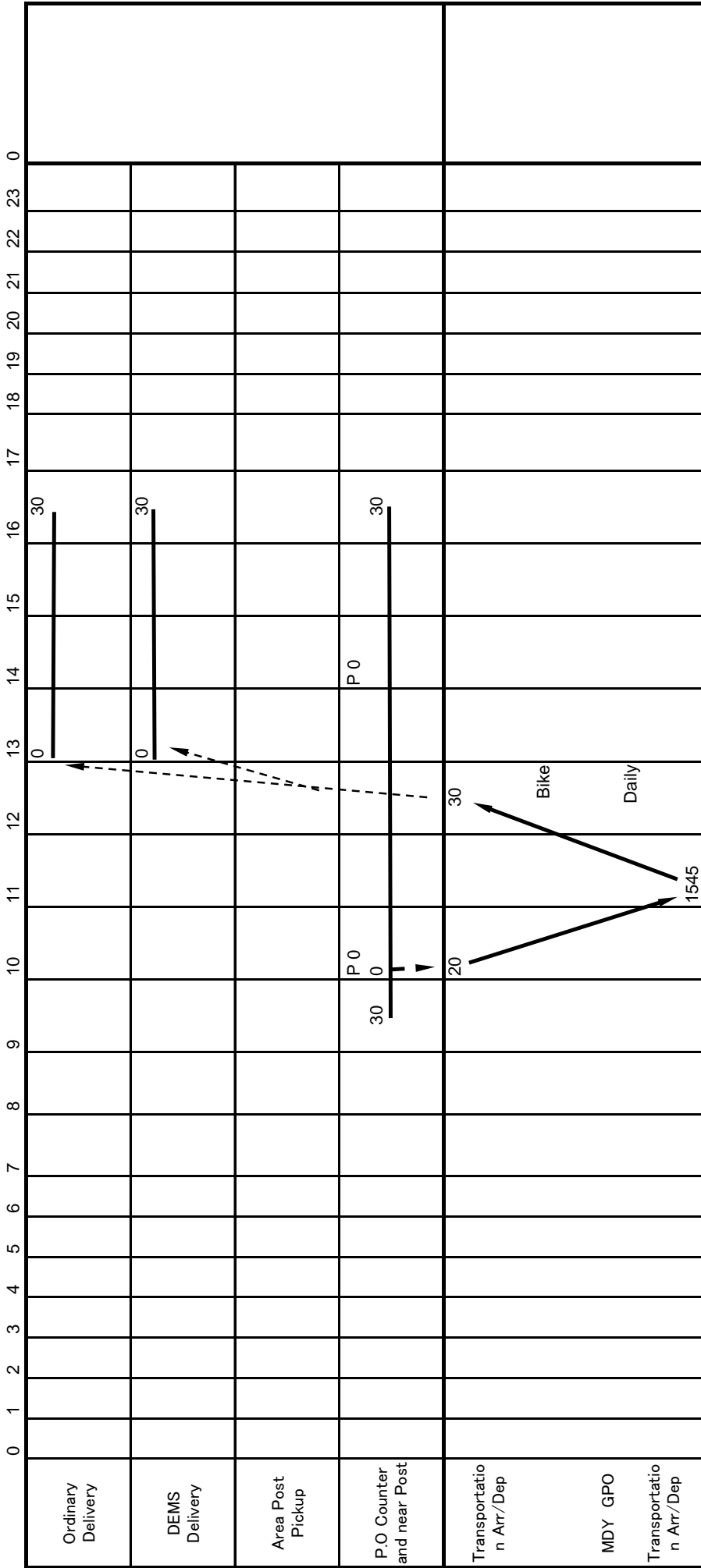

MIIT POST OFFICE Kessoku Diagram

	0	1	2	3	4	5	6	7	8	9	10	11	12	13	14	15	16	17	18	19	20	21	22	23	0	
Ordinary Delivery																										
DEMS Delivery																										
Area Post Pickup																										
P.O Counter and near Post																										
Transportation Arr/Dep																										
Chanmyathazi P.O																										
Transportation Arr/Dep																										

Non Delivery

DEMS

ORD

DEMS

ORD

DEMS

ORD

NPT CPO POST OFFICE Kessoku Diagram

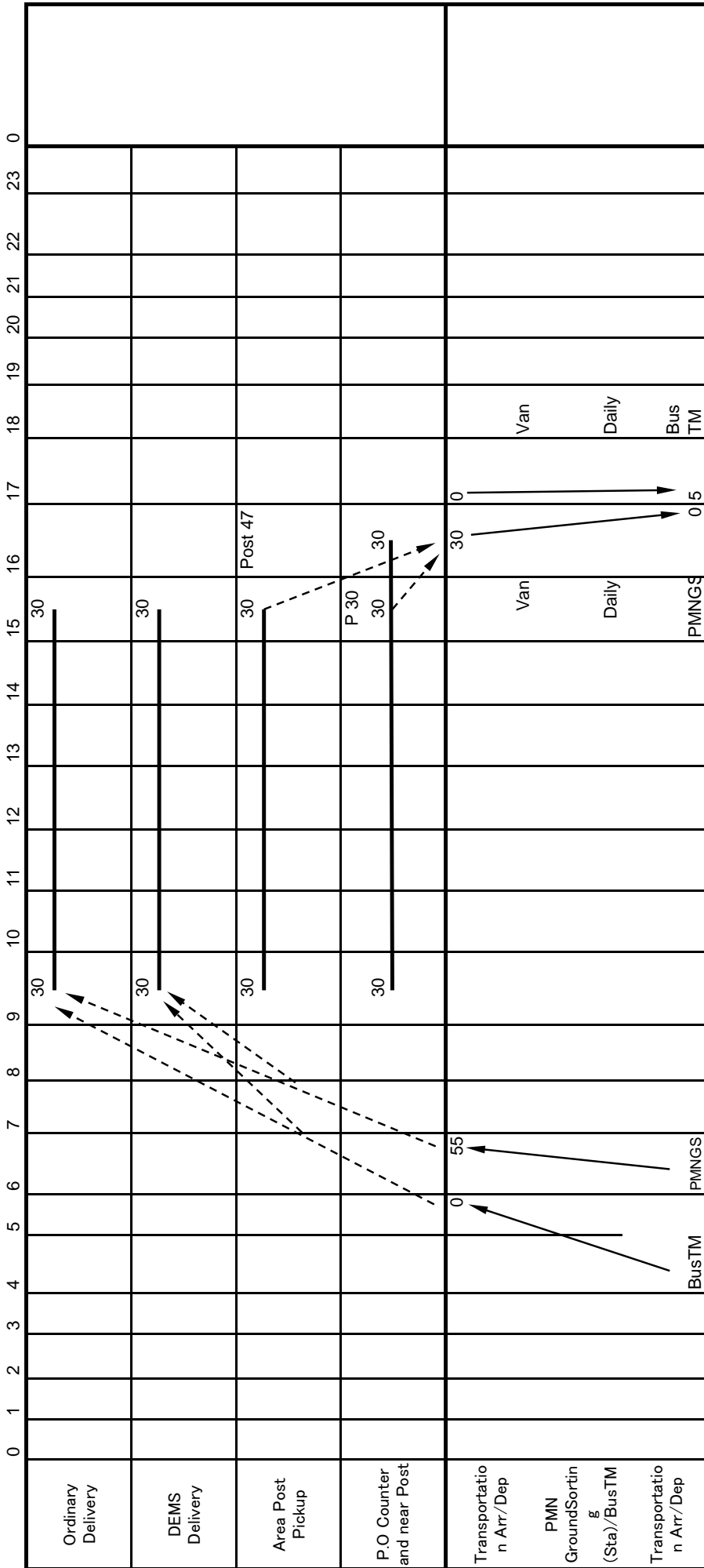

3up 1:27  
 1up 2Down 17:26 18:45  
 4Down 23:15



Pyinmana POST OFFICE Kessoku Diagram

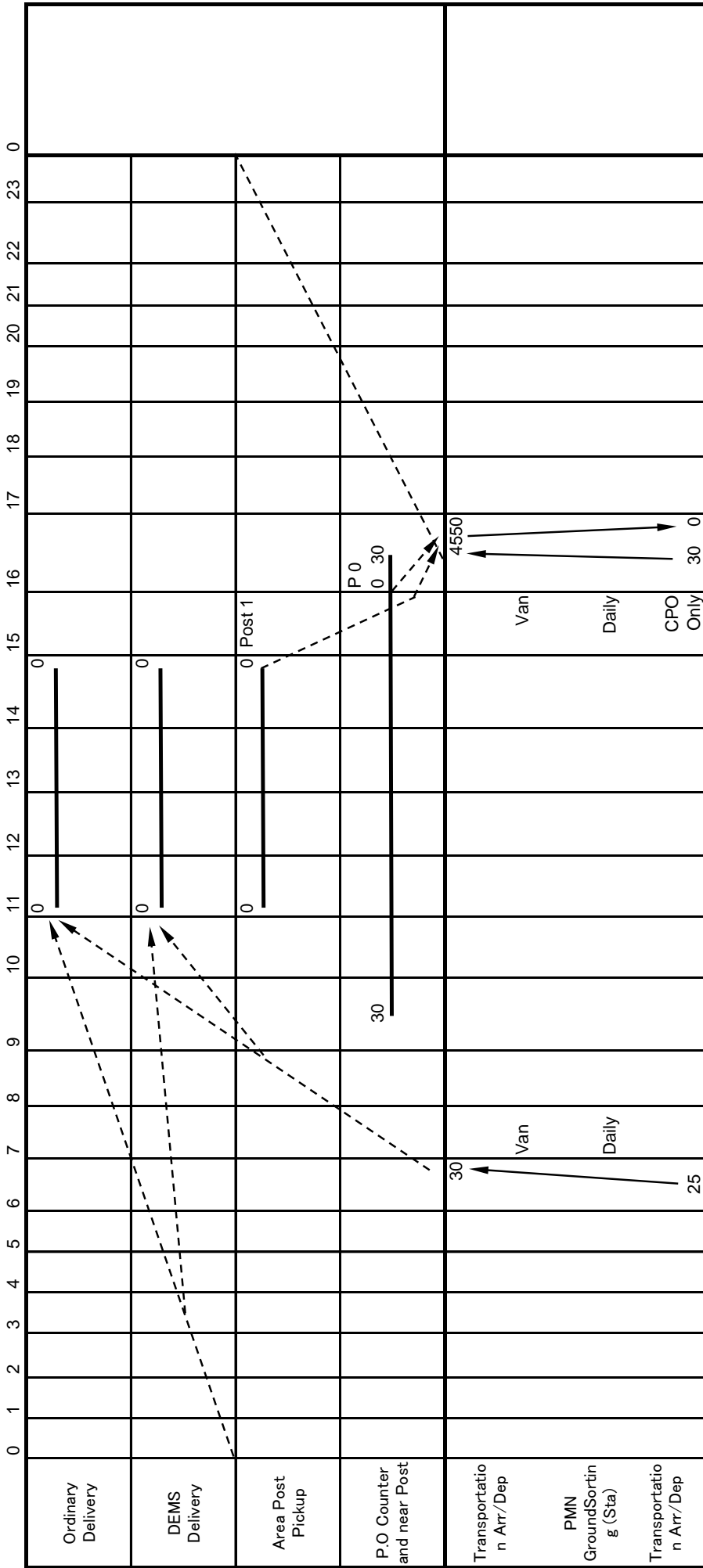

3up 1:27  
 1up 2Down 17:26 18:45  
 4Down 23:15

Yezin POST OFFICE Kessoku Diagram

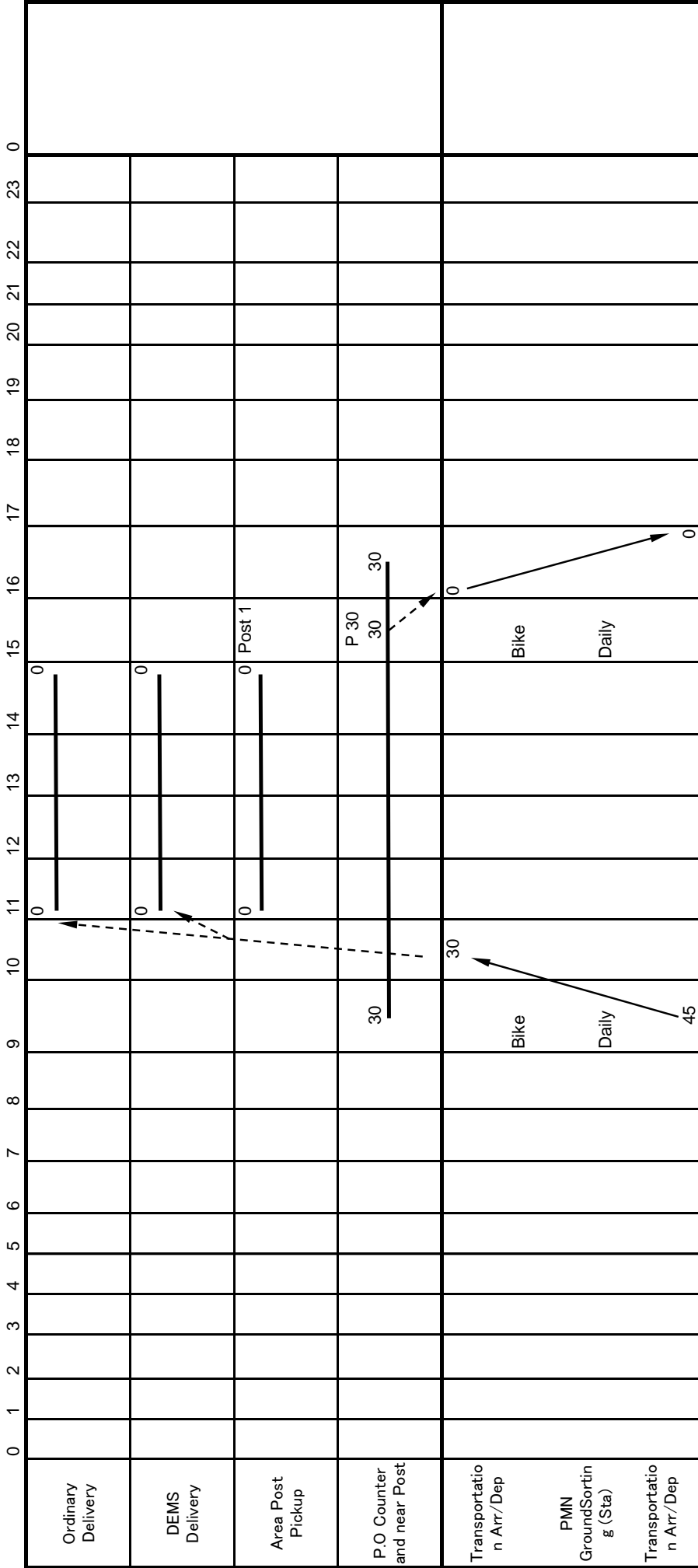

3up 1:27  
 1up 2Down 17:26 18:45  
 4Down 23:15

Lewe POST OFFICE Kessoku Diagram

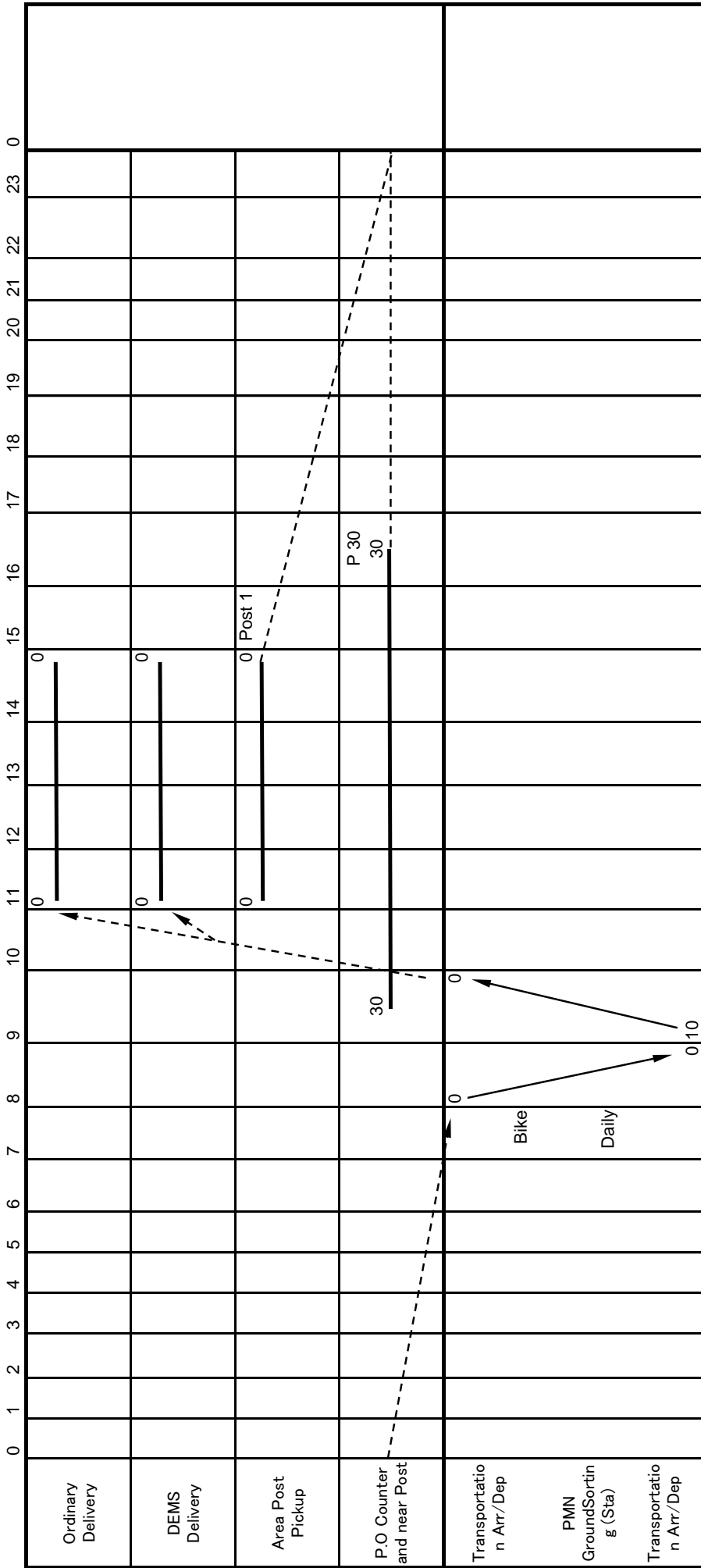

3up 1:27  
1up 2Down 17:26 18:45  
4Down 23:15

Tatkone POST OFFICE Kessoku Diagram

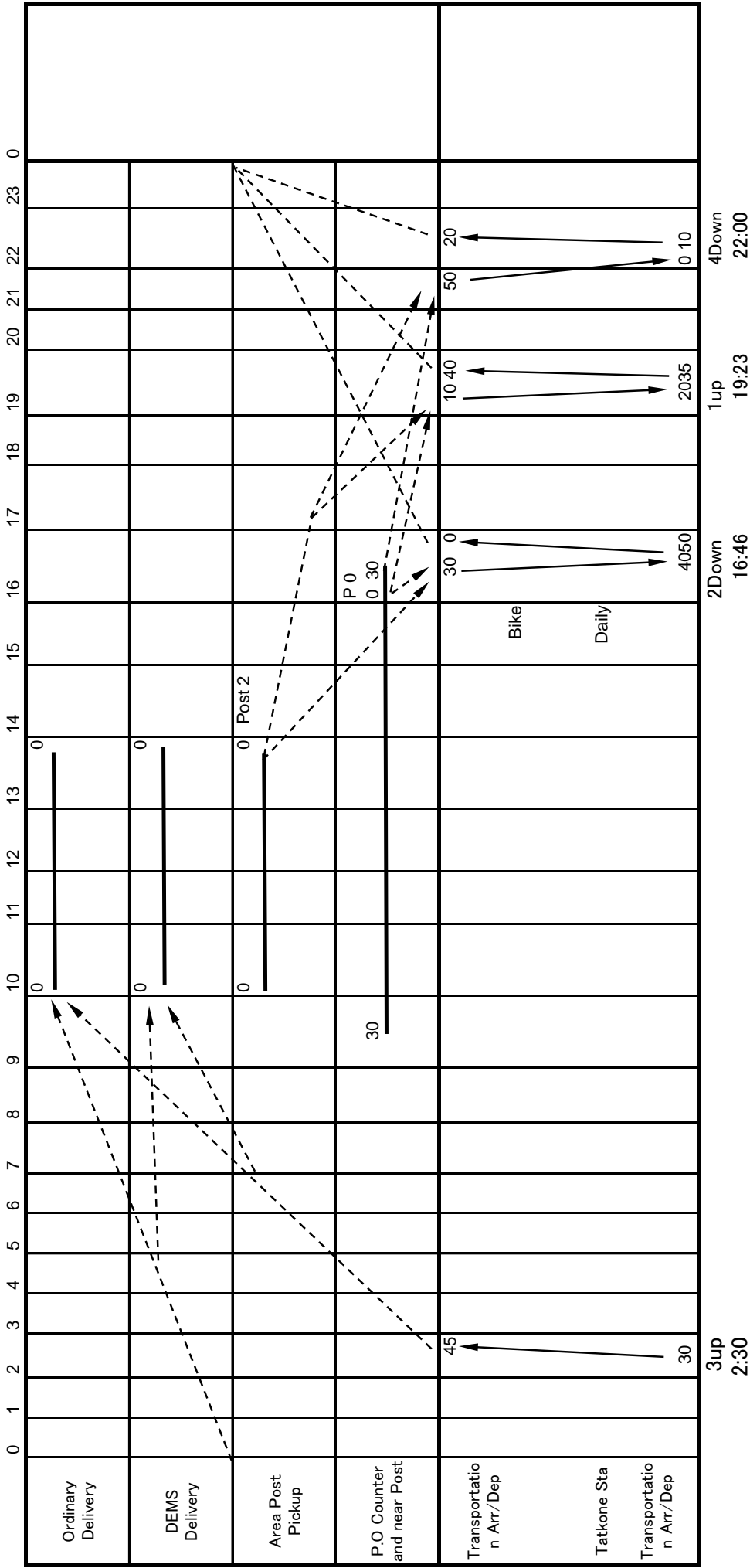

Kyitaunkkan POST OFFICE Kessoku Diagram

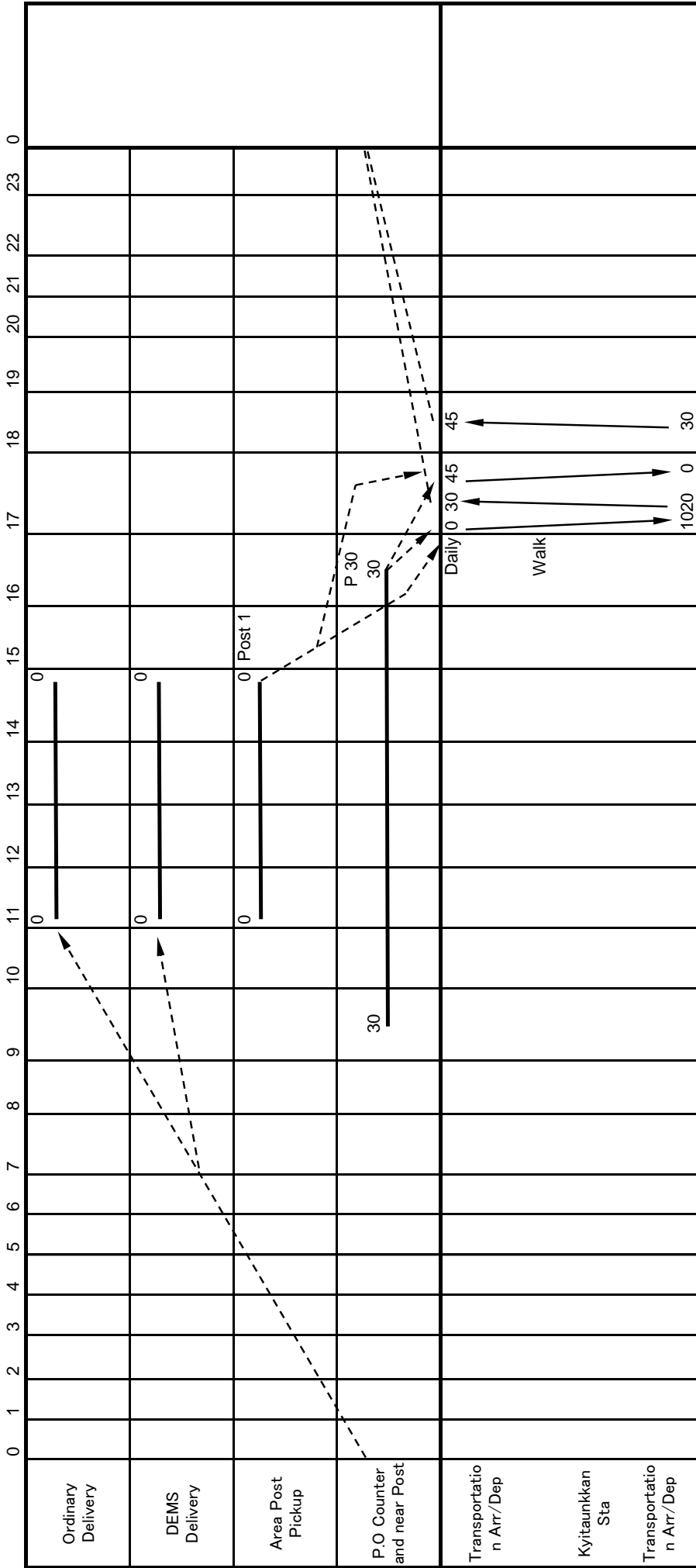

2Down 1up  
17:49 18:25

Elar POST OFFICE Kessoku Diagram

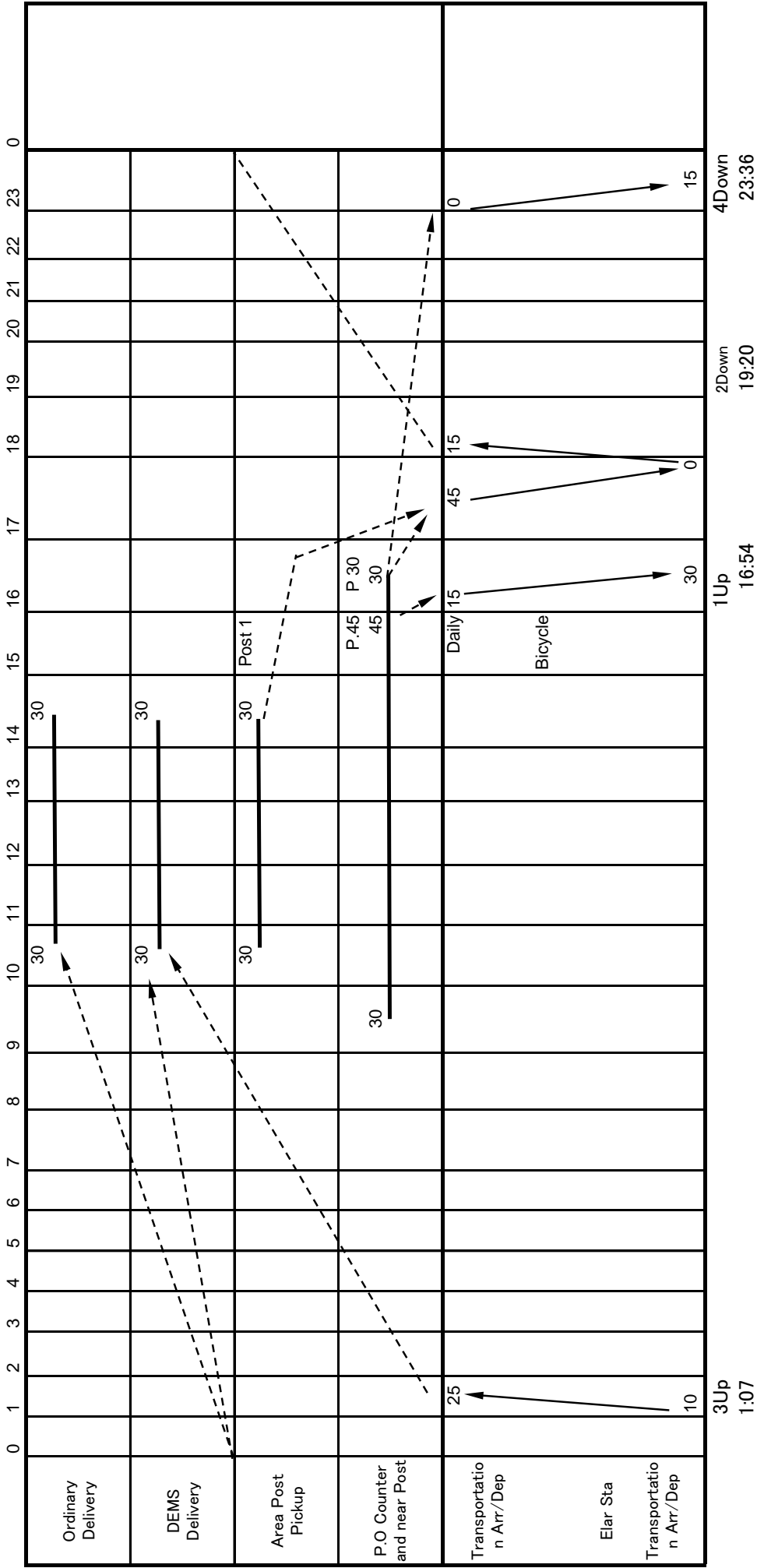

Tharwuthi POST OFFICE Kessoku Diagram

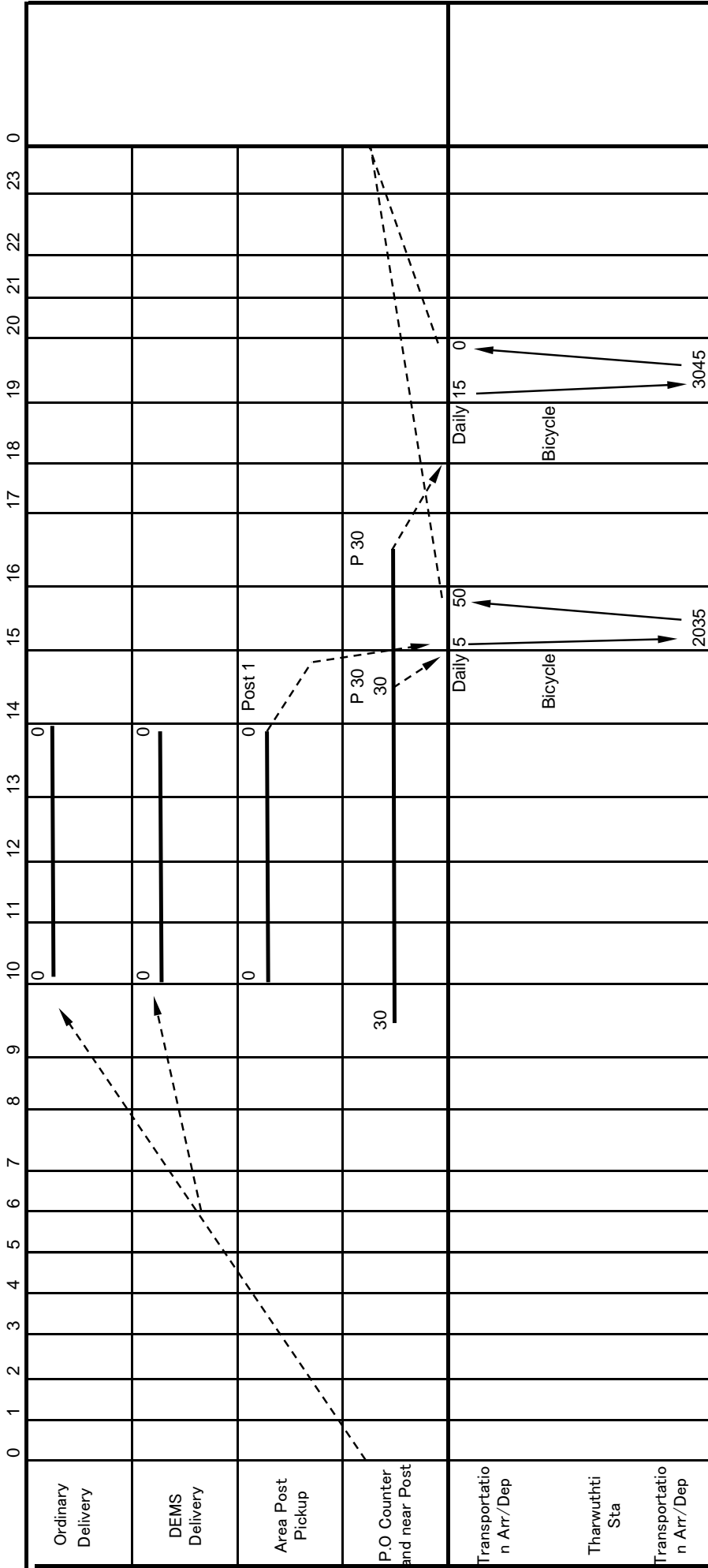

YGN CME Kessoku Time Table

ARRIVAL				Kessoku Line	DEPARTURE			
Hour	Minute	Day Of Operation	Transportation No.		Hour	Minute	Day Of Operation	Transportation No.
0					0			
1					1			
2					2			
3					3			
4					4			
5					5	30	Daily	Van-1(Parrami.Aungmingalar BusTM)
6					6	30	Daily	Van-3(TSO.4DownYGNSta)
7					7	0	Daily	Van-2(DagonAyar BusTM.TSO)
8	30	Daily	Van-3(TSO.4DownYGNSta)	ORD+DEMS	8			
9	0	Sat.Sun Off	MailCarrier②-1(Thanlyin)	1:00	9			
9	15	Tue~Fri	MP Bus(N/Dagon.ORD Only)		9			
9	15	Tue~Fri	MP Bus(Shwepyithar.ORD Only)		9			
9	30	Tue~Fri	MP Bus(Htaukkyaut.ORD Only)		9			
9	30	Sat.Sun Off	MailCarrier②(Kyauktan)		9			
9	30	Daily	Van-1(Parrami.Aungmingalar BusTM)	ORD+DEMS	9	30	Sat.Sun Off	MailCarrier②-1(Thanlyin)
10	0	Sat.Sun Off	MailCarrier③(Seikkyi)	1:30	10	5	Sat.Sun Off	MailCarrier③(Seikkyi)
10					10	10	Sat.Sun Off	MailCarrier②(Kyauktan)
10					10	0	Daily	Van-10(YGNSta.R-2In)
11					11	0	Daily	Van-4(TSO.DHL.R-1In)
11	0	Sun Off	MailCarrier①(Dala)		11	0	Daily	Van-5(TSO)
11					11	0	Daily	Van-6(TSO)
11					11	0	Daily	Van-7(TSO)
11					11	10	Sun Off	MailCarrier①(Dala)
12					12			
13					13			
14	0	Daily	Van-2(DagonAyar BusTM.TSO)		14			
14	0	Daily	MailCarrier②-2(Thanlyin)		14	5	Daily	MailCarrier②-2(Thanlyin)
14	30	Daily	Van-4(TSO.DHL.R-1In)		14			
14	30	Daily	Van-5(TSO)		14			
14	30	Daily	Van-6(TSO)	ORD+DEMS	14			
14	30	Daily	Van-7(TSO)	1:30	14			
15					15			
16					16	0	Daily	Van-8(YGNSta.3Up.)
16					16	0	Daily	Van-9(AirPort.AumBusTM.)
16					16	0	Tue~Fri	MP Bus(Shwepyithar.ORD Only)
16					16	30	Tue~Fri	MP Bus(N/Dagon.ORD Only)
16					16	30	Tue~Fri	MP Bus(Htaukkyaut.ORD Only)
17					17			
18					18			
19	0	Daily	Van-8(YGNSta.3Up.)		19			
19	0	Daily	Van-9(AirPort.AumBusTM.)		19			
20					20			
21					21			
22					22			
23					23			

DEMS ----->  
 ORD - - - - ->  
 DEMS+ORD =====>



PMN GS Kessoku Table

ARRIVAL			Kessoku Line	DEPARTURE		
Hour	Minute	Transportation No.		Hour	Minute	Transportation No.
0				0		
1	27	3Up Train(From YGN)	DEMS+ORD	1	27	3up Train(For MDL)
2			5:02	2		
3				3		
4				4		
5				5		
6	15	Van-1(CPO)		6	25	Van-1(PMN.CPO)
7				7		
8				8		
9	0	Bike(Luwe)		9	10	Bike(Luwe)
10				9	45	Bike(Yezin)
11				10		
12				11		
13				12		
14				13		
15				14		
16	30	PMNSta Post		15		
16	30	Bike(Luwe)		16		
17	0	Van-3(PMN.CPO)	DEMS+ORD			
17	0	Bike(Yezin)	0:26	17	20	Van-3(CPO)
17	26	1Up Train(From YGN)		17	26	1Up Train(For MDL)
18	45	2Down Train(From MDL)		18	45	2Down Train(For YGN)
19				19		
20				20		
21				21		
22				22		
23	15	4Down Train(From MDL)		23	15	4Down Train(For YGN)

DEMS      ----->  
 ORD        - - - - ->  
 DEMS+ORD    —————>

MDL GPO/ME Kessoku Table

ARRIVAL			Kessoku Line	DEPARTURE		
Hour	Minute	Transportation No.		Hour	Minute	Transportation No.
0				0		
1				1		
2				2		
3				3		
4				4		
5				5		
6				6		
7				7		
8				8		0 Van1-1①(Thiri Mandalar BT)
9		0 Van1-1①(Thiri Mandalar BT) 15 Van3-1(Train) 20 Van2-1(BusTM) 35 Bike(Zaycho P.O①) 40 Bike(Nantwin P.O①) 45 Van1-1②(Thiri Mandalar BT)		9		0 Van3-1(Train) 5 Van1-1②(Thiri Mandalar BT)
			DEMS+ORD 0:45			
11		0 Bike(Patheingyi P.O①) 0 Bike(MTU.Htonbo P.O①)  55 Van2-2(PyiGyiMyatShin BT)		10		30 Van1-2(TownPO)
			DEMS+ORD 1:05	11		0 Van2-2(PyiGyiMyatShin BT) 10 Bike(Patheingyi P.O①) 10 Bike(MTU.Htonbo P.O①) 30 Van4-2(MDL AirPort) 45 TSO Bike
12		0 15 Van※(Yonegyi) 35 Bike(Zaycho P.O②) 40 Bike(Eaindawya P.O) 45 Bike(Miit P.O①) 50 Bike(MyaukPyin P.O①)		12		
13		0 Bike(Nantwin P.O②) 15 Van1-2(TownPO) 15 Bike(Ashae Pyin P.O①) 30 Van4-2(MDL AirPort) 30 TSO Bike		13		0 Van2-3(ThiriMandalar BT)
14		0 Van2-3(ThiriMandalar BT)	ORD 1:00	14		
		5 Bike(Zaycho P.O③ DEMS Only) 40 Bike(Miit P.O②) 45 Bike(Yonegyi P.O DEMS Only)		15		0 Van1-3(Train)
15		15 Bike(Shanzu P.O DEMS Only)	DEMS 0:15	15		30 Van2-4(BusTM) 30 Van3-2(Train)
16				16		
17		10 Van2-4(BusTM) 10 Van3-2(Train)		17		
18				18		
19				19		
20				20		
21				21		
22				22		
23				23		

DEMS      - - - - ->  
 ORD        - - - - ->  
 DEMS+ORD   - - - - ->

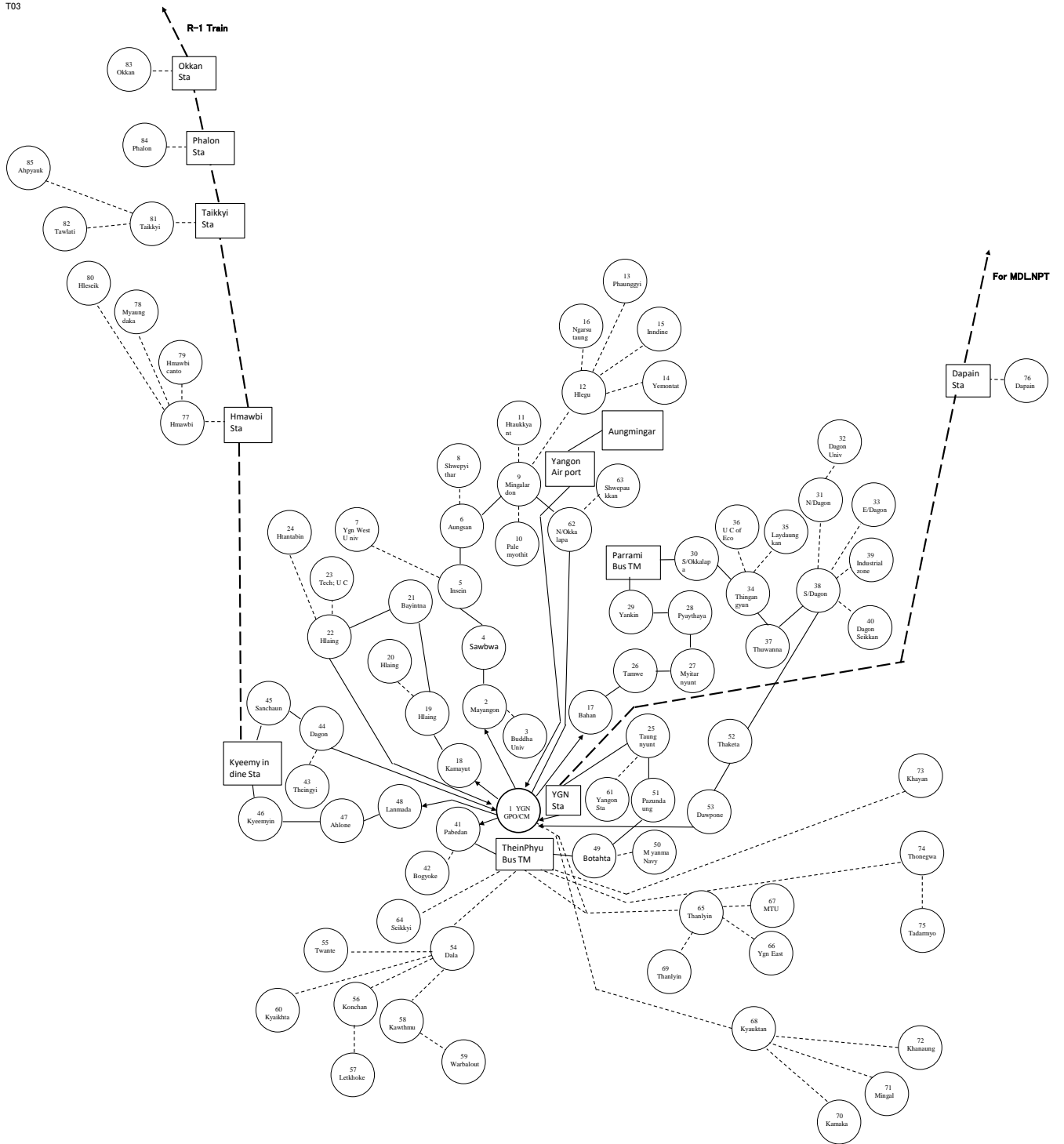

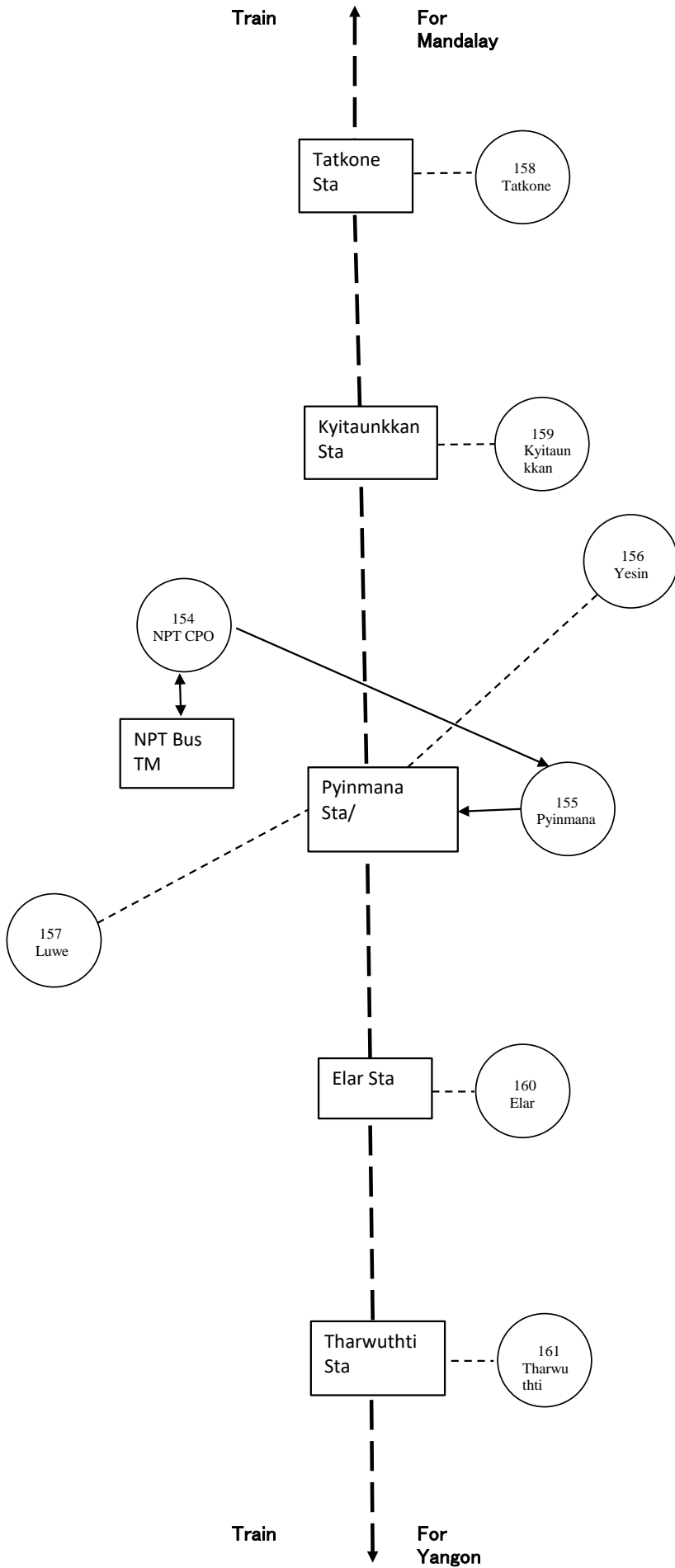

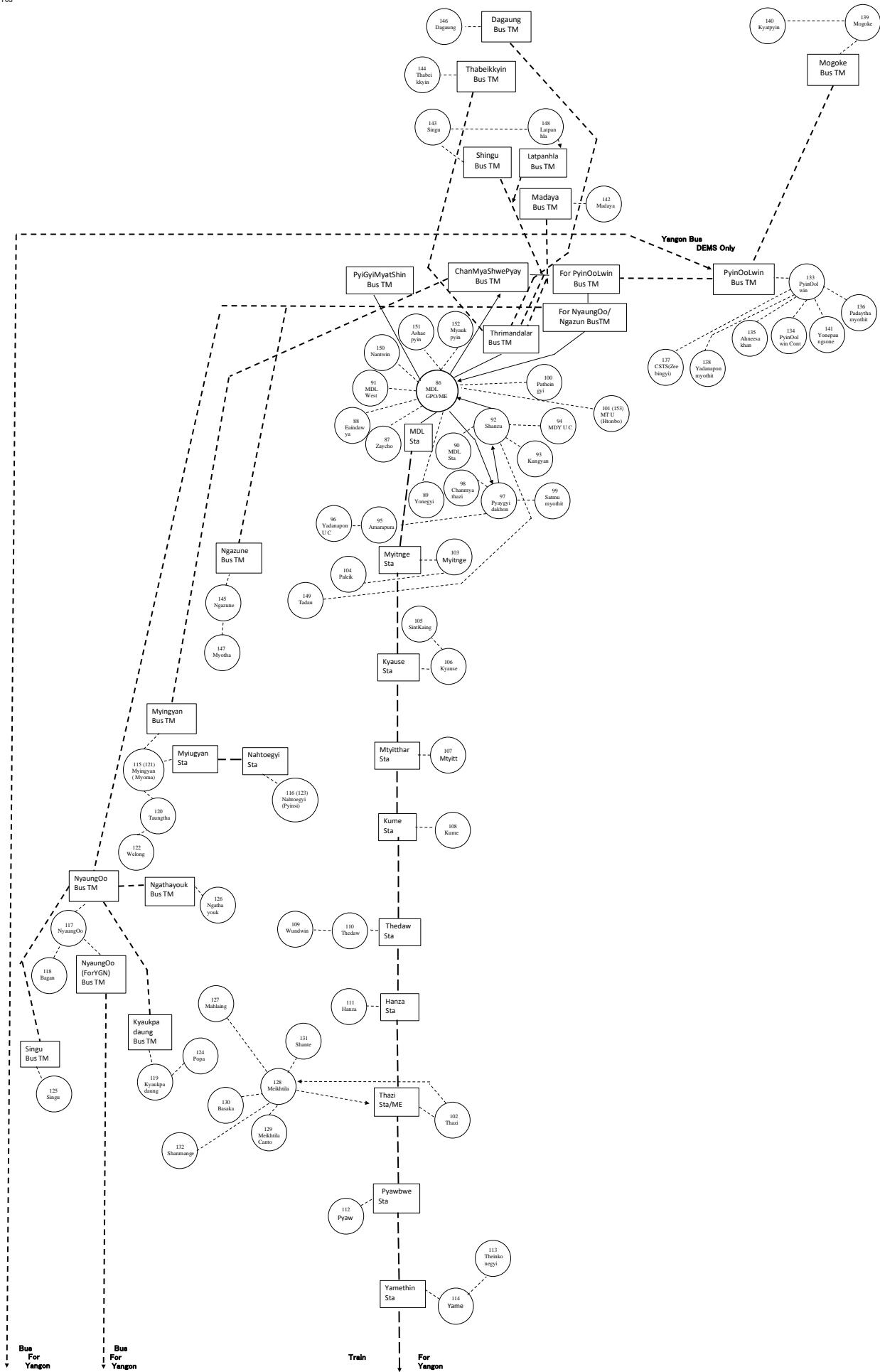

Materials relating to  
Delivery Date  
(T04-T05)

**T04 Delivery date table (Data)**

**T05 Kessoku list of 161 post office**













## Kessoku list for 161 delivery post offices

Arrival PO Yangon GPO/CME

Mail	ORD				DEMS		Remarks
	9:00	11:30	14:25	21:30	9:00	11:30	
YGN GPO	D	D	D+1	D+1	D	D	
Mayangone	D+1	D+1	D+1	D+1	D	D	
Buddha UC	D+1	D+1	D+1	D+1	D	D	DEMS SPDelivery
Sawbwaryigone	D+1	D+1	D+1	D+1	D	D	DEMS SPDelivery
Insein	D	D	D+1	D+1	D	D	
Aungsan	D+1	D+1	D+1	D+1	D	D	DEMS SPDelivery
Ygn West U C	D+1	D+1	D+1	D+1	D+1	D+1	
Shwepyithar	D+1	D+1	D+1	D+2	D	D	DEMS SPDelivery.Ferry
Mingalardon	D+1	D+1	D+1	D+1	D	D	DEMS SPDelivery
Palemyothit	D+1	D+1	D+1	D+2	D	D	DEMS SPDelivery.Ferry
Htaukkyant	D+1	D+1	D+1	D+2	D	D	DEMS SPDelivery.Ferry
Hlegu	D+1	D+1	D+1	D+2	D+1	D+1	Ferry
Phaunggyi	D+1	D+1	D+1	D+2	D+1	D+1	Ferry
Yemontat	D+1	D+1	D+1	D+2	D+1	D+1	Ferry
Inndine	D+1	D+1	D+1	D+2	D+1	D+1	Ferry
Ngarsutaung	D+1	D+1	D+1	D+2	D+1	D+1	Ferry
Bahan	D	D+1	D+1	D+1	D	D	DEMS SPDelivery
Kamayut	D+1	D+1	D+1	D+1	D	D	DEMS SPDelivery
Hlaing	D+1	D+1	D+1	D+1	D	D	DEMS SPDelivery
Hlaing U C	D+1	D+1	D+1	D+1	D	D	Non Derivery
Bayintnaungzay	D+1	D+1	D+1	D+1	D	D	DEMS SPDelivery
Hlaingtharyar	D+1	D+1	D+1	D+1	D	D	DEMS SPDelivery
Tech; U C	D+1	D+1	D+1	D+1	D+1	D+1	
Htantabin	D+1	D+1	D+1	D+1	D+1	D+1	
Taungnyunt	D	D+1	D+1	D+1	D	D	DEMS SPDelivery
Tamwe	D+1	D+1	D+1	D+1	D	D	DEMS SPDelivery
Myitarnyunt	D+1	D+1	D+1	D+1	D	D	DEMS SPDelivery
Pyaythaya	D	D	D+1	D+1	D	D	Non Derivery(Yankin)
Yankin	D	D	D+1	D+1	D	D	
S/Okkala	D	D	D+1	D+1	D	D	DEMS SPDelivery
N/Dagon	D+1	D+1	D+1	D+2	D	D	DEMS SPDelivery.Ferry
Dagon U C	D+1	D+1	D+1	D+2	D	D	DEMS SPDelivery.Ferry
E/Dagon	D+1	D+1	D+1	D+2	D	D	DEMS SPDelivery.Ferry
Thingangyun	D+1	D+1	D+1	D+1	D	D	DEMS SPDelivery
Laydaungkan	D+1	D+1	D+1	D+1	D+1	D+1	
U C of Eco	D+1	D+1	D+1	D+1	D+1	D+1	
Thuwunna	D+1	D+1	D+1	D+1	D	D	DEMS SPDelivery
S/Dagon	D+1	D+1	D+1	D+1	D	D	
Industrial Zone	D+1	D+1	D+1	D+1	D	D	DEMS SPDelivery
Dagon Seikkan	D+1	D+1	D+1	D+1	D	D	DEMS SPDelivery
Pabedan	D+1	D+1	D+1	D+1	D	D	DEMS SPDelivery
Bogyokezay	D+1	D+1	D+1	D+1	D	D	Non Derivery
Theingyizay	D+1	D+1	D+1	D+1	D	D	Non Derivery
Dagon	D	D+1	D+1	D+1	D	D	DEMS SPDelivery
Sanchaung	D	D+1	D+1	D+2	D	D	DEMS SPDelivery
Kyeemyindine	D	D+1	D+1	D+2	D	D	DEMS SPDelivery
Ahlon	D	D+1	D+1	D+2	D	D	DEMS SPDelivery
Lanmadaw	D	D+1	D+1	D+1	D	D	DEMS SPDelivery
Botataung	D+1	D+1	D+1	D+1	D	D	DEMS SPDelivery
Myanma Navy	D+1	D+1	D+1	D+1	D	D	Non Derivery
Pazundaung	D+1	D+1	D+1	D+1	D	D	Non Derivery
Thaketa	D+1	D+1	D+1	D+1	D	D	DEMS SPDelivery
Dawpone	D+1	D+1	D+1	D+1	D	D	DEMS SPDelivery
Yangon Station	D+1	D+1	D+1	D+1	D	D	Non Derivery
N/Okkalapa	D+1	D+1	D+1	D+1	D	D	DEMS SPDelivery
Shwepaukkan	D+1	D+1	D+1	D+1	D	D	DEMS SPDelivery

56

Arrival PO Dala BusTM

Mail	ORD	DEMS	Remarks
	12:25	12:25	
Dala	D	D	
Twante	D	D	
Kyaikhtaw	D+1	D	
Konchankone □	D	D	
Letkhokekone □	D+2	D+1	
Kawthmu	D	D	
Warbalouthaught □	D+1	D+1	

7

Arrival PO Seikkyi

Mail	ORD	DEMS	Remarks
	11:35	11:35	
Seikkyi	D	D	

1

Arrival PO Thanlyin

Mail	ORD	DEMS	Remarks
	10:30	10:30	
Thanlyin	D	D	
Thanlyin Cont	D	D	
MTU	D	D	
Ygn East U C	D	D	

4

Arrival PO Kyauktan

Mail	ORD	DEMS	Remarks
	11:40	11:40	
Kyauktan	D	D	
Kamakalote □	D+1	D+1	
Mingalane	D	D	
Khanaung	D	D	

4

Arrival PO Khayan

Mail	ORD	DEMS	Remarks
	11:15	11:15	
Khayan	D	D	

1

Arrival PO Thonegwa

Mail	ORD	DEMS	Remarks
	11:00	11:00	
Thonegwa	D	D	
Tadarmyo	D	D	

2

Arrival PO Kyause

Mail	ORD	DEMS	Remarks
Deadline	10:10	10:10	
Delivery PO			
Kyause	D	D	
SintKaing	D	D	

2

Arrival PO Mtyitthar

Mail	ORD	DEMS	Remarks
Deadline	11:00	11:00	
Delivery PO			
Mtyitthar	D	D	

1

Arrival PO Kume

Mail	ORD	DEMS	Remarks
Deadline	11:40	11:40	
Delivery PO			
Kume	D	D	

1

Arrival PO Thedaw

Mail	ORD	DEMS	Remarks
Deadline	12:25	12:25	
Delivery PO			
Thedaw	D	D	
Wundwin	D	D	

2

Arrival PO Hanza

Mail	ORD	DEMS	Remarks
Deadline	12:50	12:50	
Delivery PO			
Hanza	D	D	

1

Arrival PO Thazi ME

Mail	ORD	DEMS	Remarks
Deadline	4:55	4:55	
Delivery PO			
Thazi	D	D	
Meikhtila	D	D	
Meikhtila Canto <input type="checkbox"/>	D	D	SPDelivery
Basaka	D	D	SPDelivery
Shante	D	D	SPDelivery
Shanmange	D	D	SPDelivery
Mahlaing	D	D	

7

Arrival PO Pyawbwe

Mail	ORD	DEMS	Remarks
Deadline	4:15	4:15	
Delivery PO			
Pyawbwe	D	D	

1

Arrival PO Yamethin

Mail	ORD	DEMS	Remarks
Deadline	9:20	9:20	
Delivery PO			
Yamethin	D	D	
Theinkonegyi	D	D	

2

Arrival PO NyaungOo

Mail	ORD	DEMS	Remarks
Deadline	9:50	9:50	
Delivery PO			
NyaungOo	D	D	
Bagan	D	D	
Singu	D	D	
Kyaukpadaung	D+1	D+1	
Popa	D+2	D+2	
Ngathayouk	D	D	

6

Arrival PO Myingyan

Mail	ORD	DEMS	Remarks
Deadline	16:05	16:05	
Delivery PO			
Myingyan	D+1	D+1	
Myingyan Myoma	D+1	D+1	
Nahtoegy	D+1	D+1	
Pyinsi	D+1	D+1	
Taungtha	D+1	D+1	
Welong	D+1	D+1	

6

Arrival PO Ngazune

Mail	ORD	DEMS	Remarks
Deadline	14:00	14:00	
Delivery PO			
Ngazune	D+1	D+1	
Myohta	D+1	D+1	

2

Arrival PO PyinOolwin

Mail	ORD	DEMS	Remarks
Deadline	9:00	9:00	
Delivery PO			
PyinOolwin	D	D	
PyinOolwinCont	D	D	SPDelivery
Ahneesakhan <input type="checkbox"/>	D	D	SPDelivery
Padaythamyothit <input type="checkbox"/>	D	D	SPDelivery
CSTS(Zeebingyi) <input type="checkbox"/>	D	D	
Yadanaponmyothit <input type="checkbox"/>	D	D	
Yonepaungsone <input type="checkbox"/>	D	D	SPDelivery
Mogoke	D+1	D+1	
Kyatpyin	D+1	D+1	

9

T05

Arrival PO Dapain

Mail	ORD	DEMS	Remarks
Deadline	7:30	7:30	
Delivery PO			
Dapain	D	D	

1

Arrival PO Hmawbi

Mail	ORD	DEMS	Remarks
Deadline	5:55	5:55	
Delivery PO			
Hmawbi	D	D	
Hmawbicanto	D	D	Non Derivery
Myaungdaka	D	D	
Hleseik	D	D	

4

Arrival PO Taikkyi

Mail	ORD	DEMS	Remarks
Deadline	9:15	9:15	
Delivery PO			
Taikkyi	D	D	
Tawlati	D	D	
Ahpyauk	D	D	

3

Arrival PO Phalon

Mail	ORD	DEMS	Remarks
Deadline	8:00	8:00	
Delivery PO			
Phalon	D	D	

1

Arrival PO Okkan

Mail	ORD	DEMS	Remarks
Deadline	8:25	8:25	
Delivery PO			
Okkan	D	D	

1

YGN

85

Arrival PO Pyinmana GS(Sta)

Mail	ORD	DEMS	Remarks
Deadline	1:27	1:27	
Delivery PO			
NPT CPO	D	D	
Pyinmana	D	D	
Yesin	D	D	
Luwe	D	D	

4

Arrival PO Tharwuthti

Mail	ORD	DEMS	Remarks
Deadline	20:00	20:00	
Delivery PO			
Tharwuthti	D+1	D+1	

1

Arrival PO Elar

Mail	ORD	DEMS	Remarks
Deadline	1:25	1:25	
Delivery PO			
Elar	D	D	

1

Arrival PO Kyitaunkkan

Mail	ORD	DEMS	Remarks
Deadline	18:45	18:45	
Delivery PO			
Kyitaunkkan	D	D	

1

Arrival PO Tatfone

Mail	ORD	DEMS	Remarks
Deadline	2:45	2:45	
Delivery PO			
Tatfone	D	D	

1

NPT

8

Arrival PO MDY GPO/ME

Mail	ORD	DEMS	Remarks
Deadline	9:45	9:45	
Delivery PO			
MDY GPO/ME	D	D	
Zaycho	D	D	Non Derivery
Eaindawya	D	D	Non Derivery
Yonegyi	D	D	SPDelivery
MDL Sta	D	D	Non Derivery
MDLWest	D	D	Non Derivery
Shanzu	D	D	SPDelivery
Kungyan	D	D	Non Derivery
MDY UC	D	D	Non Derivery
Amarapura	D	D	SPDelivery
Yadanapon U C	D	D	
Pyaygyidakhon	D	D	
Chanmyathazi	D	D	SPDelivery
Satmumyothit	D	D	SPDelivery
Patheingyi	D	D	
MTU	D	D	
Nantwin	D	D	Non Derivery
Ashaepyin	D	D	Non Derivery
Myaukpyin	D	D	Non Derivery
TadaU	D	D	
Htonbo	D	D	

21

Arrival PO Myitnge

Mail	ORD	DEMS	Remarks
Deadline	9:15	9:15	
Delivery PO			
Myitnge	D	D	
Paleik	D	D	

2

Arrival PO Madaya

Mail	ORD	DEMS	Remarks
Deadline	8:35	8:35	
Delivery PO			
Madaya	D	D	

1

Arrival PO Sintgu

Mail	ORD	DEMS	Remarks
Deadline	8:05	8:05	
Delivery PO			
Sintgu	D	D	
Latpanhla <input type="checkbox"/>	D	D	

2

Arrival PO Thabeikkyin

Mail	ORD	DEMS	Remarks
Deadline	20:15	20:15	
Delivery PO			
Thabeikkyin <input type="checkbox"/>	D+1	D+1	

1

Arrival PO Dagaung

Mail	ORD	DEMS	Remarks
Deadline	9:00	9:00	
Delivery PO			
Dagaung	D	D	

1

MDL

68











Inter-city Diagram(Ordinary Mail)

Accept PO	Origin	①	②	③	④	⑤	⑥	⑦	⑧	⑨	⑩	⑪	⑫	⑬	⑭	⑮	⑯	⑰	⑱	⑲	⑳	㉑	㉒	㉓	㉔	㉕	㉖	㉗	㉘	㉙	㉚	㉛	㉜	㉝	㉞	㉟	㊱	㊲	㊳	㊴	㊵	㊶	㊷	㊸	㊹	㊺	㊻	㊼	㊽	㊾	㊿																																																																																																																																																																																																																																																																																																																																																																																																																																																																																																																																																																																																																																																																																																																																																																																																																																							
1600	2:20	1600	3:30	4:40	5:50	7:00	8:10	9:20	10:30	11:40	12:50	14:00	15:10	16:20	17:30	18:40	19:50	21:00	22:10	23:20	24:30	25:40	26:50	28:00	29:10	30:20	31:30	32:40	33:50	35:00	36:10	37:20	38:30	39:40	40:50	42:00	43:10	44:20	45:30	46:40	47:50	49:00	50:10	51:20	52:30	53:40	54:50	56:00	57:10	58:20	59:30	60:40	61:50	63:00	64:10	65:20	66:30	67:40	68:50	70:00	71:10	72:20	73:30	74:40	75:50	77:00	78:10	79:20	80:30	81:40	82:50	84:00	85:10	86:20	87:30	88:40	89:50	91:00	92:10	93:20	94:30	95:40	96:50	98:00	99:10	100:20	101:30	102:40	103:50	105:00	106:10	107:20	108:30	109:40	110:50	112:00	113:10	114:20	115:30	116:40	117:50	119:00	120:10	121:20	122:30	123:40	124:50	126:00	127:10	128:20	129:30	130:40	131:50	133:00	134:10	135:20	136:30	137:40	138:50	140:00	141:10	142:20	143:30	144:40	145:50	147:00	148:10	149:20	150:30	151:40	152:50	154:00	155:10	156:20	157:30	158:40	159:50	161:00	162:10	163:20	164:30	165:40	166:50	168:00	169:10	170:20	171:30	172:40	173:50	175:00	176:10	177:20	178:30	179:40	180:50	182:00	183:10	184:20	185:30	186:40	187:50	189:00	190:10	191:20	192:30	193:40	194:50	196:00	197:10	198:20	199:30	200:40	201:50	203:00	204:10	205:20	206:30	207:40	208:50	210:00	211:10	212:20	213:30	214:40	215:50	217:00	218:10	219:20	220:30	221:40	222:50	224:00	225:10	226:20	227:30	228:40	229:50	231:00	232:10	233:20	234:30	235:40	236:50	238:00	239:10	240:20	241:30	242:40	243:50	245:00	246:10	247:20	248:30	249:40	250:50	252:00	253:10	254:20	255:30	256:40	257:50	259:00	260:10	261:20	262:30	263:40	264:50	266:00	267:10	268:20	269:30	270:40	271:50	273:00	274:10	275:20	276:30	277:40	278:50	280:00	281:10	282:20	283:30	284:40	285:50	287:00	288:10	289:20	290:30	291:40	292:50	294:00	295:10	296:20	297:30	298:40	299:50	301:00	302:10	303:20	304:30	305:40	306:50	308:00	309:10	310:20	311:30	312:40	313:50	315:00	316:10	317:20	318:30	319:40	320:50	322:00	323:10	324:20	325:30	326:40	327:50	329:00	330:10	331:20	332:30	333:40	334:50	336:00	337:10	338:20	339:30	340:40	341:50	343:00	344:10	345:20	346:30	347:40	348:50	350:00	351:10	352:20	353:30	354:40	355:50	357:00	358:10	359:20	360:30	361:40	362:50	364:00	365:10	366:20	367:30	368:40	369:50	371:00	372:10	373:20	374:30	375:40	376:50	378:00	379:10	380:20	381:30	382:40	383:50	385:00	386:10	387:20	388:30	389:40	390:50	392:00	393:10	394:20	395:30	396:40	397:50	399:00	400:10	401:20	402:30	403:40	404:50	406:00	407:10	408:20	409:30	410:40	411:50	413:00	414:10	415:20	416:30	417:40	418:50	420:00	421:10	422:20	423:30	424:40	425:50	427:00	428:10	429:20	430:30	431:40	432:50	434:00	435:10	436:20	437:30	438:40	439:50	441:00	442:10	443:20	444:30	445:40	446:50	448:00	449:10	450:20	451:30	452:40	453:50	455:00	456:10	457:20	458:30	459:40	460:50	462:00	463:10	464:20	465:30	466:40	467:50	469:00	470:10	471:20	472:30	473:40	474:50	476:00	477:10	478:20	479:30	480:40	481:50	483:00	484:10	485:20	486:30	487:40	488:50	490:00	491:10	492:20	493:30	494:40	495:50	497:00	498:10	499:20	500:30	501:40	502:50	504:00	505:10	506:20	507:30	508:40	509:50	511:00	512:10	513:20	514:30	515:40	516:50	518:00	519:10	520:20	521:30	522:40	523:50	525:00	526:10	527:20	528:30	529:40	530:50	532:00	533:10	534:20	535:30	536:40	537:50	539:00	540:10	541:20	542:30	543:40	544:50	546:00	547:10	548:20	549:30	550:40	551:50	553:00	554:10	555:20	556:30	557:40	558:50	560:00	561:10	562:20	563:30	564:40	565:50	567:00	568:10	569:20	570:30	571:40	572:50	574:00	575:10	576:20	577:30	578:40	579:50	581:00	582:10	583:20	584:30	585:40	586:50	588:00	589:10	590:20	591:30	592:40	593:50	595:00	596:10	597:20	598:30	599:40	600:50	602:00	603:10	604:20	605:30	606:40	607:50	609:00	610:10	611:20	612:30	613:40	614:50	616:00	617:10	618:20	619:30	620:40	621:50	623:00	624:10	625:20	626:30	627:40	628:50	630:00	631:10	632:20	633:30	634:40	635:50	637:00	638:10	639:20	640:30	641:40	642:50	644:00	645:10	646:20	647:30	648:40	649:50	651:00	652:10	653:20	654:30	655:40	656:50	658:00	659:10	660:20	661:30	662:40	663:50	665:00	666:10	667:20	668:30	669:40	670:50	672:00	673:10	674:20	675:30	676:40	677:50	679:00	680:10	681:20	682:30	683:40	684:50	686:00	687:10	688:20	689:30	690:40	691:50	693:00	694:10	695:20	696:30	697:40	698:50	700:00	701:10	702:20	703:30	704:40	705:50	707:00	708:10	709:20	710:30	711:40	712:50	714:00	715:10	716:20	717:30	718:40	719:50	721:00	722:10	723:20	724:30	725:40	726:50	728:00	729:10	730:20	731:30	732:40	733:50	735:00	736:10	737:20	738:30	739:40	740:50	742:00	743:10	744:20	745:30	746:40	747:50	749:00	750:10	751:20	752:30	753:40	754:50	756:00	757:10	758:20	759:30	760:40	761:50	763:00	764:10	765:20	766:30	767:40	768:50	770:00	771:10	772:20	773:30	774:40	775:50	777:00	778:10	779:20	780:30	781:40	782:50	784:00	785:10	786:20	787:30	788:40	789:50	791:00	792:10	793:20	794:30	795:40	796:50	798:00	799:10	800:20	801:30	802:40	803:50	805:00	806:10	807:20	808:30	809:40	810:50	812:00	813:10	814:20	815:30	816:40	817:50	819:00	820:10	821:20	822:30	823:40	824:50	826:00	827:10	828:20	829:30	830:40	831:50	833:00	834:10	835:20	836:30	837:40	838:50	840:00	841:10	842:20	843:30	844:40	845:50	847:00	848:10	849:20	850:30	851:40	852:50	854:00	855:10	856:20	857:30	858:40	859:50	861:00	862:10	863:20	864:30	865:40	866:50	868:00	869:10	870:20	871:30	872:40	873:50	875:00	876:10	877:20	878:30	879:40	880:50	882:00	883:10	884:20	885:30	886:40	887:50	889:00	890:10	891:20	892:30	893:40	894:50	896:00	897:10	898:20	899:30	900:40	901:50	903:00	904:10	905:20	906:30	907:40	908:50	910:00	911:10	912:20	913:30	914:40	915:50	917:00	918:10	919:20	920:30	921:40	922:50	924:00	925:10	926:20	927:30	928:40	929:50	931:00	932:10	933:20	934:30	935:40	936:50	938:00	939:10	940:20	941:30	942:40	943:50	945:00	946:10	947:20	948:30	949:40	950:50	952:00	953:10	954:20	955:30	956:40	957:50	959:00	960:10	961:20	962:30	963:40	964:50	966:00	967:10	968:20	969:30	970:40	971:50	973:00	974:10	975:20	976:30	977:40	978:50	980:00	981:10	982:20	983:30	984:40	985:50	987:00	988:10	989:20	990:30	991:40	992:50	994:00	995:10	996:20	997:30	998:40	999:50	1000:00







Inter-city Diagram(Ordinary Mail)

100 Accept Area: 01, YCN 01, Train Group

Area/Station	Departure	Arrival	1	2	3	4	5	6	7	8	9	10	11	12	13	14	15	16	17	18	19	20	21	22	23	24	25	26	27	28	29	30	31	32	33	34	35	36	37	38	39	40	41	42	43	44	45	46	47	48	49	50	51	52	53	54	55	56	57	58	59	60	61	62	63	64	65	66	67	68	69	70	71	72	73	74	75	76	77	78	79	80	81	82	83	84	85	86	87	88	89	90	91	92	93	94	95	96	97	98	99	100																																																																																																																																																																																																																																																																																																																																																																																																																																																																																																																																																																																																																																																																																																																																																																																																																																																																																																																																									
1130	10:52	11:00	10:52	11:00	11:08	11:16	11:24	11:32	11:40	11:48	11:56	12:04	12:12	12:20	12:28	12:36	12:44	12:52	13:00	13:08	13:16	13:24	13:32	13:40	13:48	13:56	14:04	14:12	14:20	14:28	14:36	14:44	14:52	15:00	15:08	15:16	15:24	15:32	15:40	15:48	15:56	16:04	16:12	16:20	16:28	16:36	16:44	16:52	17:00	17:08	17:16	17:24	17:32	17:40	17:48	17:56	18:04	18:12	18:20	18:28	18:36	18:44	18:52	19:00	19:08	19:16	19:24	19:32	19:40	19:48	19:56	20:04	20:12	20:20	20:28	20:36	20:44	20:52	21:00	21:08	21:16	21:24	21:32	21:40	21:48	21:56	22:04	22:12	22:20	22:28	22:36	22:44	22:52	23:00	23:08	23:16	23:24	23:32	23:40	23:48	23:56	24:04	24:12	24:20	24:28	24:36	24:44	24:52	25:00	25:08	25:16	25:24	25:32	25:40	25:48	25:56	26:04	26:12	26:20	26:28	26:36	26:44	26:52	27:00	27:08	27:16	27:24	27:32	27:40	27:48	27:56	28:04	28:12	28:20	28:28	28:36	28:44	28:52	29:00	29:08	29:16	29:24	29:32	29:40	29:48	29:56	30:04	30:12	30:20	30:28	30:36	30:44	30:52	31:00	31:08	31:16	31:24	31:32	31:40	31:48	31:56	32:04	32:12	32:20	32:28	32:36	32:44	32:52	33:00	33:08	33:16	33:24	33:32	33:40	33:48	33:56	34:04	34:12	34:20	34:28	34:36	34:44	34:52	35:00	35:08	35:16	35:24	35:32	35:40	35:48	35:56	36:04	36:12	36:20	36:28	36:36	36:44	36:52	37:00	37:08	37:16	37:24	37:32	37:40	37:48	37:56	38:04	38:12	38:20	38:28	38:36	38:44	38:52	39:00	39:08	39:16	39:24	39:32	39:40	39:48	39:56	40:04	40:12	40:20	40:28	40:36	40:44	40:52	41:00	41:08	41:16	41:24	41:32	41:40	41:48	41:56	42:04	42:12	42:20	42:28	42:36	42:44	42:52	43:00	43:08	43:16	43:24	43:32	43:40	43:48	43:56	44:04	44:12	44:20	44:28	44:36	44:44	44:52	45:00	45:08	45:16	45:24	45:32	45:40	45:48	45:56	46:04	46:12	46:20	46:28	46:36	46:44	46:52	47:00	47:08	47:16	47:24	47:32	47:40	47:48	47:56	48:04	48:12	48:20	48:28	48:36	48:44	48:52	49:00	49:08	49:16	49:24	49:32	49:40	49:48	49:56	50:04	50:12	50:20	50:28	50:36	50:44	50:52	51:00	51:08	51:16	51:24	51:32	51:40	51:48	51:56	52:04	52:12	52:20	52:28	52:36	52:44	52:52	53:00	53:08	53:16	53:24	53:32	53:40	53:48	53:56	54:04	54:12	54:20	54:28	54:36	54:44	54:52	55:00	55:08	55:16	55:24	55:32	55:40	55:48	55:56	56:04	56:12	56:20	56:28	56:36	56:44	56:52	57:00	57:08	57:16	57:24	57:32	57:40	57:48	57:56	58:04	58:12	58:20	58:28	58:36	58:44	58:52	59:00	59:08	59:16	59:24	59:32	59:40	59:48	59:56	60:04	60:12	60:20	60:28	60:36	60:44	60:52	61:00	61:08	61:16	61:24	61:32	61:40	61:48	61:56	62:04	62:12	62:20	62:28	62:36	62:44	62:52	63:00	63:08	63:16	63:24	63:32	63:40	63:48	63:56	64:04	64:12	64:20	64:28	64:36	64:44	64:52	65:00	65:08	65:16	65:24	65:32	65:40	65:48	65:56	66:04	66:12	66:20	66:28	66:36	66:44	66:52	67:00	67:08	67:16	67:24	67:32	67:40	67:48	67:56	68:04	68:12	68:20	68:28	68:36	68:44	68:52	69:00	69:08	69:16	69:24	69:32	69:40	69:48	69:56	70:04	70:12	70:20	70:28	70:36	70:44	70:52	71:00	71:08	71:16	71:24	71:32	71:40	71:48	71:56	72:04	72:12	72:20	72:28	72:36	72:44	72:52	73:00	73:08	73:16	73:24	73:32	73:40	73:48	73:56	74:04	74:12	74:20	74:28	74:36	74:44	74:52	75:00	75:08	75:16	75:24	75:32	75:40	75:48	75:56	76:04	76:12	76:20	76:28	76:36	76:44	76:52	77:00	77:08	77:16	77:24	77:32	77:40	77:48	77:56	78:04	78:12	78:20	78:28	78:36	78:44	78:52	79:00	79:08	79:16	79:24	79:32	79:40	79:48	79:56	80:04	80:12	80:20	80:28	80:36	80:44	80:52	81:00	81:08	81:16	81:24	81:32	81:40	81:48	81:56	82:04	82:12	82:20	82:28	82:36	82:44	82:52	83:00	83:08	83:16	83:24	83:32	83:40	83:48	83:56	84:04	84:12	84:20	84:28	84:36	84:44	84:52	85:00	85:08	85:16	85:24	85:32	85:40	85:48	85:56	86:04	86:12	86:20	86:28	86:36	86:44	86:52	87:00	87:08	87:16	87:24	87:32	87:40	87:48	87:56	88:04	88:12	88:20	88:28	88:36	88:44	88:52	89:00	89:08	89:16	89:24	89:32	89:40	89:48	89:56	90:04	90:12	90:20	90:28	90:36	90:44	90:52	91:00	91:08	91:16	91:24	91:32	91:40	91:48	91:56	92:04	92:12	92:20	92:28	92:36	92:44	92:52	93:00	93:08	93:16	93:24	93:32	93:40	93:48	93:56	94:04	94:12	94:20	94:28	94:36	94:44	94:52	95:00	95:08	95:16	95:24	95:32	95:40	95:48	95:56	96:04	96:12	96:20	96:28	96:36	96:44	96:52	97:00	97:08	97:16	97:24	97:32	97:40	97:48	97:56	98:04	98:12	98:20	98:28	98:36	98:44	98:52	99:00	99:08	99:16	99:24	99:32	99:40	99:48	99:56	100:04	100:12	100:20	100:28	100:36	100:44	100:52	101:00	101:08	101:16	101:24	101:32	101:40	101:48	101:56	102:04	102:12	102:20	102:28	102:36	102:44	102:52	103:00	103:08	103:16	103:24	103:32	103:40	103:48	103:56	104:04	104:12	104:20	104:28	104:36	104:44	104:52	105:00	105:08	105:16	105:24	105:32	105:40	105:48	105:56	106:04	106:12	106:20	106:28	106:36	106:44	106:52	107:00	107:08	107:16	107:24	107:32	107:40	107:48	107:56	108:04	108:12	108:20	108:28	108:36	108:44	108:52	109:00	109:08	109:16	109:24	109:32	109:40	109:48	109:56	110:04	110:12	110:20	110:28	110:36	110:44	110:52	111:00	111:08	111:16	111:24	111:32	111:40	111:48	111:56	112:04	112:12	112:20	112:28	112:36	112:44	112:52	113:00	113:08	113:16	113:24	113:32	113:40	113:48	113:56	114:04	114:12	114:20	114:28	114:36	114:44	114:52	115:00	115:08	115:16	115:24	115:32	115:40	115:48	115:56	116:04	116:12	116:20	116:28	116:36	116:44	116:52	117:00	117:08	117:16	117:24	117:32	117:40	117:48	117:56	118:04	118:12	118:20	118:28	118:36	118:44	118:52	119:00	119:08	119:16	119:24	119:32	119:40	119:48	119:56	120:04	120:12	120:20	120:28	120:36	120:44	120:52	121:00	121:08	121:16	121:24	121:32	121:40	121:48	121:56	122:04	122:12	122:20	122:28	122:36	122:44	122:52	123:00	123:08	123:16	123:24	123:32	123:40	123:48	123:56	124:04	124:12	124:20	124:28	124:36	124:44	124:52	125:00	125:08	125:16	125:24	125:32	125:40	125:48	125:56	126:04	126:12	126:20	126:28	126:36	126:44	126:52	127:00	127:08	127:16	127:24	127:32	127:40	127:48	127:56	128:04	128:12	128:20	128:28	128:36	128:44	128:52	129:00	129:08	129:16	129:24	129:32	129:40	129:48	129:56	130:04	130:12	130:20	130:28	130:36	130:44	130:52	131:00	131:08	131:16	131:24	131:32	131:40	131:48	131:56	132:04	132:12	132:20	132:28	132:36	132:44	132:52	133:00	133:08	133:16	133:24	133:32	133:40	133:48	133:56	134:04	134:12	134:20	134:28	134:36	134:44	134:52	135:00	135:08	135:16	135:24	135:32	135:40	135:48	135:56	136:04	136:12	136:20	136:28	136:36	136:44	136:52	137:00	137:08	137:16	137:24	137:32	137:40	137:48	137:56	138:04	138:12	138:20	138:28	138:36	138:44	138:52	139:00	139:08	139:16	139:24	139:32	139:40	139:48	139:56	140:04	140:12	140:20	140:28	140:36	140:44	140:52	141:00	141:08	141:16	141:24	141:32	141:40	141:48	141:56	142:04	142:12	142:20	142:28	142:36	142:44	142:52	143:00	143:08	143:16	143:24	143:32	143:40	143:48	143:56	144:04	144:12	144:20	144:28	144:36	

















































































# Inter-city Diagram(DEMS)

Accept PO	MDY GPO/ME	1200	1230	1245	1250	1300	1315	1330	1345	1350	1355	1400	1415	1430	1445	1450	1500	1515	1530	1545	1550	1555	1600	1615	1630	1645	1650	1655	1700	1715	1730	1745	1750	1755	1800	1815	1830	1845	1850	1855	1900	1915	1930	1945	1950	1955	2000	2015	2030	2045	2050	2055	2100	2115	2130	2145	2150	2155	2200	2215	2230	2245	2250	2255	2300	2315	2330	2345	2350	2355	2400	2415	2430	2445	2450	2455	2500	2515	2530	2545	2550	2555	2600	2615	2630	2645	2650	2655	2700	2715	2730	2745	2750	2755	2800	2815	2830	2845	2850	2855	2900	2915	2930	2945	2950	2955	3000	3015	3030	3045	3050	3055	3100	3115	3130	3145	3150	3155	3200	3215	3230	3245	3250	3255	3300	3315	3330	3345	3350	3355	3400	3415	3430	3445	3450	3455	3500	3515	3530	3545	3550	3555	3600	3615	3630	3645	3650	3655	3700	3715	3730	3745	3750	3755	3800	3815	3830	3845	3850	3855	3900	3915	3930	3945	3950	3955	4000	4015	4030	4045	4050	4055	4100	4115	4130	4145	4150	4155	4200	4215	4230	4245	4250	4255	4300	4315	4330	4345	4350	4355	4400	4415	4430	4445	4450	4455	4500	4515	4530	4545	4550	4555	4600	4615	4630	4645	4650	4655	4700	4715	4730	4745	4750	4755	4800	4815	4830	4845	4850	4855	4900	4915	4930	4945	4950	4955	5000	5015	5030	5045	5050	5055	5100	5115	5130	5145	5150	5155	5200	5215	5230	5245	5250	5255	5300	5315	5330	5345	5350	5355	5400	5415	5430	5445	5450	5455	5500	5515	5530	5545	5550	5555	5600	5615	5630	5645	5650	5655	5700	5715	5730	5745	5750	5755	5800	5815	5830	5845	5850	5855	5900	5915	5930	5945	5950	5955	6000	6015	6030	6045	6050	6055	6100	6115	6130	6145	6150	6155	6200	6215	6230	6245	6250	6255	6300	6315	6330	6345	6350	6355	6400	6415	6430	6445	6450	6455	6500	6515	6530	6545	6550	6555	6600	6615	6630	6645	6650	6655	6700	6715	6730	6745	6750	6755	6800	6815	6830	6845	6850	6855	6900	6915	6930	6945	6950	6955	7000	7015	7030	7045	7050	7055	7100	7115	7130	7145	7150	7155	7200	7215	7230	7245	7250	7255	7300	7315	7330	7345	7350	7355	7400	7415	7430	7445	7450	7455	7500	7515	7530	7545	7550	7555	7600	7615	7630	7645	7650	7655	7700	7715	7730	7745	7750	7755	7800	7815	7830	7845	7850	7855	7900	7915	7930	7945	7950	7955	8000	8015	8030	8045	8050	8055	8100	8115	8130	8145	8150	8155	8200	8215	8230	8245	8250	8255	8300	8315	8330	8345	8350	8355	8400	8415	8430	8445	8450	8455	8500	8515	8530	8545	8550	8555	8600	8615	8630	8645	8650	8655	8700	8715	8730	8745	8750	8755	8800	8815	8830	8845	8850	8855	8900	8915	8930	8945	8950	8955	9000	9015	9030	9045	9050	9055	9100	9115	9130	9145	9150	9155	9200	9215	9230	9245	9250	9255	9300	9315	9330	9345	9350	9355	9400	9415	9430	9445	9450	9455	9500	9515	9530	9545	9550	9555	9600	9615	9630	9645	9650	9655	9700	9715	9730	9745	9750	9755	9800	9815	9830	9845	9850	9855	9900	9915	9930	9945	9950	9955	10000	10005	10010	10015	10020	10025	10030	10035	10040	10045	10050	10055	10060	10065	10070	10075	10080	10085	10090	10095	10100	10105	10110	10115	10120	10125	10130	10135	10140	10145	10150	10155	10160	10165	10170	10175	10180	10185	10190	10195	10200	10205	10210	10215	10220	10225	10230	10235	10240	10245	10250	10255	10260	10265	10270	10275	10280	10285	10290	10295	10300	10305	10310	10315	10320	10325	10330	10335	10340	10345	10350	10355	10360	10365	10370	10375	10380	10385	10390	10395	10400	10405	10410	10415	10420	10425	10430	10435	10440	10445	10450	10455	10460	10465	10470	10475	10480	10485	10490	10495	10500	10505	10510	10515	10520	10525	10530	10535	10540	10545	10550	10555	10560	10565	10570	10575	10580	10585	10590	10595	10600	10605	10610	10615	10620	10625	10630	10635	10640	10645	10650	10655	10660	10665	10670	10675	10680	10685	10690	10695	10700	10705	10710	10715	10720	10725	10730	10735	10740	10745	10750	10755	10760	10765	10770	10775	10780	10785	10790	10795	10800	10805	10810	10815	10820	10825	10830	10835	10840	10845	10850	10855	10860	10865	10870	10875	10880	10885	10890	10895	10900	10905	10910	10915	10920	10925	10930	10935	10940	10945	10950	10955	10960	10965	10970	10975	10980	10985	10990	10995	11000	11005	11010	11015	11020	11025	11030	11035	11040	11045	11050	11055	11060	11065	11070	11075	11080	11085	11090	11095	11100	11105	11110	11115	11120	11125	11130	11135	11140	11145	11150	11155	11160	11165	11170	11175	11180	11185	11190	11195	11200	11205	11210	11215	11220	11225	11230	11235	11240	11245	11250	11255	11260	11265	11270	11275	11280	11285	11290	11295	11300	11305	11310	11315	11320	11325	11330	11335	11340	11345	11350	11355	11360	11365	11370	11375	11380	11385	11390	11395	11400	11405	11410	11415	11420	11425	11430	11435	11440	11445	11450	11455	11460	11465	11470	11475	11480	11485	11490	11495	11500	11505	11510	11515	11520	11525	11530	11535	11540	11545	11550	11555	11560	11565	11570	11575	11580	11585	11590	11595	11600	11605	11610	11615	11620	11625	11630	11635	11640	11645	11650	11655	11660	11665	11670	11675	11680	11685	11690	11695	11700	11705	11710	11715	11720	11725	11730	11735	11740	11745	11750	11755	11760	11765	11770	11775	11780	11785	11790	11795	11800	11805	11810	11815	11820	11825	11830	11835	11840	11845	11850	11855	11860	11865	11870	11875	11880	11885	11890	11895	11900	11905	11910	11915	11920	11925	11930	11935	11940	11945	11950	11955	11960	11965	11970	11975	11980	11985	11990	11995	12000	12005	12010	12015	12020	12025	12030	12035	12040	12045	12050	12055	12060	12065	12070	12075	12080	12085	12090	12095	12100	12105	12110	12115	12120	12125	12130	12135	12140	12145	12150	12155	12160	12165	12170	12175	12180	12185	12190	12195	12200	12205	12210	12215	12220	12225	12230	12235	12240	12245	12250	12255	12260	12265	12270	12275	12280	12285	12290	12295	12300	12305	12310	12315	12320	12325	12330	12335	12340	12345	12350	12355	12360	12365	12370	12375	12380	12385	12390	12395	12400	12405	12410	12415	12420	12425	12430	12435	12440	12445	12450	12455	12460	12465	12470	12475	12480	12485	12490	12495	12500	12505	12510	12515	12520	12525	12530	12535	12540	12545	12550	12555	12560	12565	12570	12575	12580	12585	12590	12595	12600	12605	12610	12615	12620	12625	12630	12635	12640	12645	12650	12655	12660	12665	12670	12675	12680	12685	12690	12695	12700	12705	12710	12715	12720	12725	12730	12735	12740	12745	12750	12755	12760	12765	12770	12775	12780	12785	12790	12795	12800	12805	12810	12815	12820	12825	12830	12835	12840	12845	12850	12855	12860	12865	12870	12875	12880	12885	12890	12895	12900	12905	12910	12915	12920	12925	12930	12935	12940	12945	12950	12955	12960	12965	12970	12975	12980	12985	12990	12995	13000	13005	13010	13015	13020	13025	13030	13035	13040	13045	13050	13055	13060	13065	13070	13075	13080	13085	13090	13095	13100	13105	13110	13115	13120	13125	13130	13135	13140	13145	13150	13155	13160	13165	13170
-----------	------------	------	------	------	------	------	------	------	------	------	------	------	------	------	------	------	------	------	------	------	------	------	------	------	------	------	------	------	------	------	------	------	------	------	------	------	------	------	------	------	------	------	------	------	------	------	------	------	------	------	------	------	------	------	------	------	------	------	------	------	------	------	------	------	------	------	------	------	------	------	------	------	------	------	------	------	------	------	------	------	------	------	------	------	------	------	------	------	------	------	------	------	------	------	------	------	------	------	------	------	------	------	------	------	------	------	------	------	------	------	------	------	------	------	------	------	------	------	------	------	------	------	------	------	------	------	------	------	------	------	------	------	------	------	------	------	------	------	------	------	------	------	------	------	------	------	------	------	------	------	------	------	------	------	------	------	------	------	------	------	------	------	------	------	------	------	------	------	------	------	------	------	------	------	------	------	------	------	------	------	------	------	------	------	------	------	------	------	------	------	------	------	------	------	------	------	------	------	------	------	------	------	------	------	------	------	------	------	------	------	------	------	------	------	------	------	------	------	------	------	------	------	------	------	------	------	------	------	------	------	------	------	------	------	------	------	------	------	------	------	------	------	------	------	------	------	------	------	------	------	------	------	------	------	------	------	------	------	------	------	------	------	------	------	------	------	------	------	------	------	------	------	------	------	------	------	------	------	------	------	------	------	------	------	------	------	------	------	------	------	------	------	------	------	------	------	------	------	------	------	------	------	------	------	------	------	------	------	------	------	------	------	------	------	------	------	------	------	------	------	------	------	------	------	------	------	------	------	------	------	------	------	------	------	------	------	------	------	------	------	------	------	------	------	------	------	------	------	------	------	------	------	------	------	------	------	------	------	------	------	------	------	------	------	------	------	------	------	------	------	------	------	------	------	------	------	------	------	------	------	------	------	------	------	------	------	------	------	------	------	------	------	------	------	------	------	------	------	------	------	------	------	------	------	------	------	------	------	------	------	------	------	------	------	------	------	------	------	------	------	------	------	------	------	------	------	------	------	------	------	------	------	------	------	------	------	------	------	------	------	------	------	------	------	------	------	------	------	------	------	------	------	------	------	------	------	------	------	------	------	------	------	------	------	------	------	------	------	------	------	------	------	------	------	------	------	------	------	------	------	------	------	------	------	------	------	------	------	------	------	------	------	------	------	------	------	------	------	------	------	------	------	------	------	------	------	------	------	------	------	------	------	------	------	------	------	------	------	------	------	------	------	------	------	------	------	-------	-------	-------	-------	-------	-------	-------	-------	-------	-------	-------	-------	-------	-------	-------	-------	-------	-------	-------	-------	-------	-------	-------	-------	-------	-------	-------	-------	-------	-------	-------	-------	-------	-------	-------	-------	-------	-------	-------	-------	-------	-------	-------	-------	-------	-------	-------	-------	-------	-------	-------	-------	-------	-------	-------	-------	-------	-------	-------	-------	-------	-------	-------	-------	-------	-------	-------	-------	-------	-------	-------	-------	-------	-------	-------	-------	-------	-------	-------	-------	-------	-------	-------	-------	-------	-------	-------	-------	-------	-------	-------	-------	-------	-------	-------	-------	-------	-------	-------	-------	-------	-------	-------	-------	-------	-------	-------	-------	-------	-------	-------	-------	-------	-------	-------	-------	-------	-------	-------	-------	-------	-------	-------	-------	-------	-------	-------	-------	-------	-------	-------	-------	-------	-------	-------	-------	-------	-------	-------	-------	-------	-------	-------	-------	-------	-------	-------	-------	-------	-------	-------	-------	-------	-------	-------	-------	-------	-------	-------	-------	-------	-------	-------	-------	-------	-------	-------	-------	-------	-------	-------	-------	-------	-------	-------	-------	-------	-------	-------	-------	-------	-------	-------	-------	-------	-------	-------	-------	-------	-------	-------	-------	-------	-------	-------	-------	-------	-------	-------	-------	-------	-------	-------	-------	-------	-------	-------	-------	-------	-------	-------	-------	-------	-------	-------	-------	-------	-------	-------	-------	-------	-------	-------	-------	-------	-------	-------	-------	-------	-------	-------	-------	-------	-------	-------	-------	-------	-------	-------	-------	-------	-------	-------	-------	-------	-------	-------	-------	-------	-------	-------	-------	-------	-------	-------	-------	-------	-------	-------	-------	-------	-------	-------	-------	-------	-------	-------	-------	-------	-------	-------	-------	-------	-------	-------	-------	-------	-------	-------	-------	-------	-------	-------	-------	-------	-------	-------	-------	-------	-------	-------	-------	-------	-------	-------	-------	-------	-------	-------	-------	-------	-------	-------	-------	-------	-------	-------	-------	-------	-------	-------	-------	-------	-------	-------	-------	-------	-------	-------	-------	-------	-------	-------	-------	-------	-------	-------	-------	-------	-------	-------	-------	-------	-------	-------	-------	-------	-------	-------	-------	-------	-------	-------	-------	-------	-------	-------	-------	-------	-------	-------	-------	-------	-------	-------	-------	-------	-------	-------	-------	-------	-------	-------	-------	-------	-------	-------	-------	-------	-------	-------	-------	-------	-------	-------	-------	-------	-------	-------	-------	-------	-------	-------	-------	-------	-------	-------	-------	-------	-------	-------	-------	-------	-------	-------	-------	-------	-------	-------	-------	-------	-------	-------	-------	-------	-------	-------	-------	-------	-------	-------	-------	-------	-------	-------	-------	-------	-------	-------	-------	-------	-------	-------	-------	-------	-------	-------	-------	-------	-------	-------	-------	-------	-------	-------	-------	-------	-------	-------	-------	-------	-------	-------	-------	-------	-------	-------	-------	-------	-------	-------	-------	-------	-------	-------	-------	-------	-------	-------	-------	-------	-------	-------	-------	-------	-------	-------	-------	-------	-------	-------	-------	-------	-------	-------	-------	-------	-------	-------	-------	-------	-------	-------	-------	-------	-------	-------	-------	-------	-------	-------	-------	-------	-------	-------	-------	-------	-------	-------	-------	-------	-------	-------	-------	-------	-------	-------	-------	-------	-------	-------	-------	-------	-------	-------	-------	-------	-------	-------	-------	-------	-------	-------	-------	-------	-------	-------	-------	-------	-------	-------	-------	-------	-------	-------	-------	-------	-------	-------	-------	-------	-------	-------	-------	-------	-------	-------	-------	-------	-------	-------	-------	-------	-------	-------	-------	-------	-------	-------	-------	-------	-------	-------	-------	-------	-------	-------	-------	-------	-------	-------	-------	-------	-------	-------	-------	-------	-------	-------	-------	-------	-------	-------	-------	-------	-------	-------	-------	-------	-------	-------	-------	-------	-------	-------	-------	-------	-------	-------	-------	-------	-------	-------	-------	-------	-------	-------	-------	-------	-------	-------	-------	-------	-------	-------	-------	-------	-------	-------	-------	-------	-------	-------	-------	-------	-------	-------	-------	-------	-------	-------	-------	-------	-------	-------



























































# Materials relating to KESSOKU and Training documents (T06-T07)

## **T06 Kessoku 3 Articles. Training**

T06-1 Kessoku 3 Articles

T06-2 Documents of training for postal network

T06-3 Format of kessoku correlation diagram for  
ordinary Post Offices

T06-4 Time table of each operational process

T06-5 Check list of transportation monitoring

T06-6 Structure of transportation monitoring

## **T07 Kessoku rules for irregularity**

[ရှုံးခန်းတွင်ကပ်ရန်]

- Kessoku ဆိုတာ 「Customerကို ကတိပေးထားသော ချောကြာချိန်အတိုင်းပေးဝေနိုင်အောင် ကောင်တာလက်ခံနှင့် ချောယာဉ်၊ ချောယာဉ်နှင့်ချောယာဉ်၊ ချောယာဉ်နှင့်စာဝေများ ဆက်စပ်နေဖို့လိုသောကြောင့် အဲဒီအရာများကို ဆက်သွယ်ပေးခြင်းကို ဆိုလိုပါသည်။
- Kessoku Diagram တွင်ရေးထားသည့်အတိုင်း တိကျစွာလုပ်ငန်းဆောင်ရွက်ခြင်းဖြင့် 「Customer ကိုပေးထားသော ကတိရက်ကြာချိန်」 ကို လိုက်နာနိုင်မည်ဖြစ်သည်။
- ကျွန်တော်တို့မြန်မာ့စာတိုက်မှဝန်ထမ်းများသည် Kessoku diagram တွင်ရေးထားသောအချိန်အတိုင်း လုပ်ငန်းဆောင်ရွက်ပြီး Customer ၏ ယုံကြည်အားထားမှုရရှိကာ စာတိုက်ကိုအသုံးပြုသူ ပိုမိုများလာအောင် ကြိုးစားကြပါစို့။



# ချောလမ်းကြောင်းတာဝန်ခံသင်တန်း

— "Kessoku" ၏အရေးပါပုံကို လေ့လာအောင် —



JICA Project Team  
March 2018

I. ချောလမ်းကြောင်း၏အခြေခံသဘောတရားကို နားလည်ရန်

II. Kessoku daigram ကိုဆွဲကြည့်ရအောင်

III. ချောလှုပ်ငန်းဆောင်တာ စီမံခန့်ခွဲမှု/ စီစဉ်ဆောင်ရွက်ပုံနည်းလမ်းကို နားလည်ရန်

# I. ချောလမ်းကြောင်း၏အခြေခံသဘောတရားကို နားလည်ရန်

# I-1. ဦးစွာပထမ : စာတိုက်ချောလမ်းကြောင်းကွန်ယက်

ဥပမာ . . .  
ဂျပန်စာတိုက်၏ အကြီးဆုံးစာစုစာရွေးစုံက ရှင်းတိုကျို(Shin Tokyo)သို့ တစ်နေ့လျှင် ချောယာဉ် ၃၀၀၀ခန့် ရောက်ရှိပါသည်။ ၎င်းချောများသည် ဂျပန်တစ်နိုင်ငံလုံးမှ ရှင်းတိုကျိုသို့ ကား၊ လေယာဉ်၊ ရထား၊ သင်္ဘောများဖြင့် ရောက်ရှိခြင်းဖြစ်သည်။

၎င်းချောယာဉ်များသည် ခန့်မှန်းထားသောအလေးချိန် သတ်မှတ်ထားသောရက်ကြာချိန် နှင့် ဒေသအသီးသီးကြားရှိလမ်းအခြေအနေကို အခြေခံ၍ တိကျစွာ ထိရောက်စွာ ဆောင်ရွက်မောင်းနှင်နိုင်အောင် ချောလမ်းကြောင်းအချိန်ဇယားအသေးစိတ် (ကားအမျိုးအစား၊ မောင်းနှင်သောရက်၊ စာတိုက်သီးခြားစီဖြင့် ဝင်ချိန်ထွက်ချိန်ဇယား၊ လမ်းတွင်ဝင်သောစာတိုက်များ) ပါဝင်အောင်ရေးဆွဲထားသည်။  
၎င်းချောလမ်းကြောင်းအချိန်ဇယားနှင့်လိုက်၍ လုပ်ငန်းဆောင်တာအားလုံးနှင့် လိုအပ်သောဝန်ထမ်းဦးရေ ကိုစီမံထားရှိသည်။

ဂျပန်ပြည်တွင်းရှိ စာတိုက်များကြားအပြန်အလှန် ချောကြာချိန်ကို ဘယ်လောက်ပင်လေးလံသောနေရာဖြစ်ပါစေ ကောင်တာတွင်အပ်နှံပြီး ၂ရက်ကြာ (D+2) လျှင်ရောက်နိုင်အောင် ပြုလုပ်ထားပါသည် (အလွန်ပေးလဲသော ကျွန်းငယ်များမှအပ)။

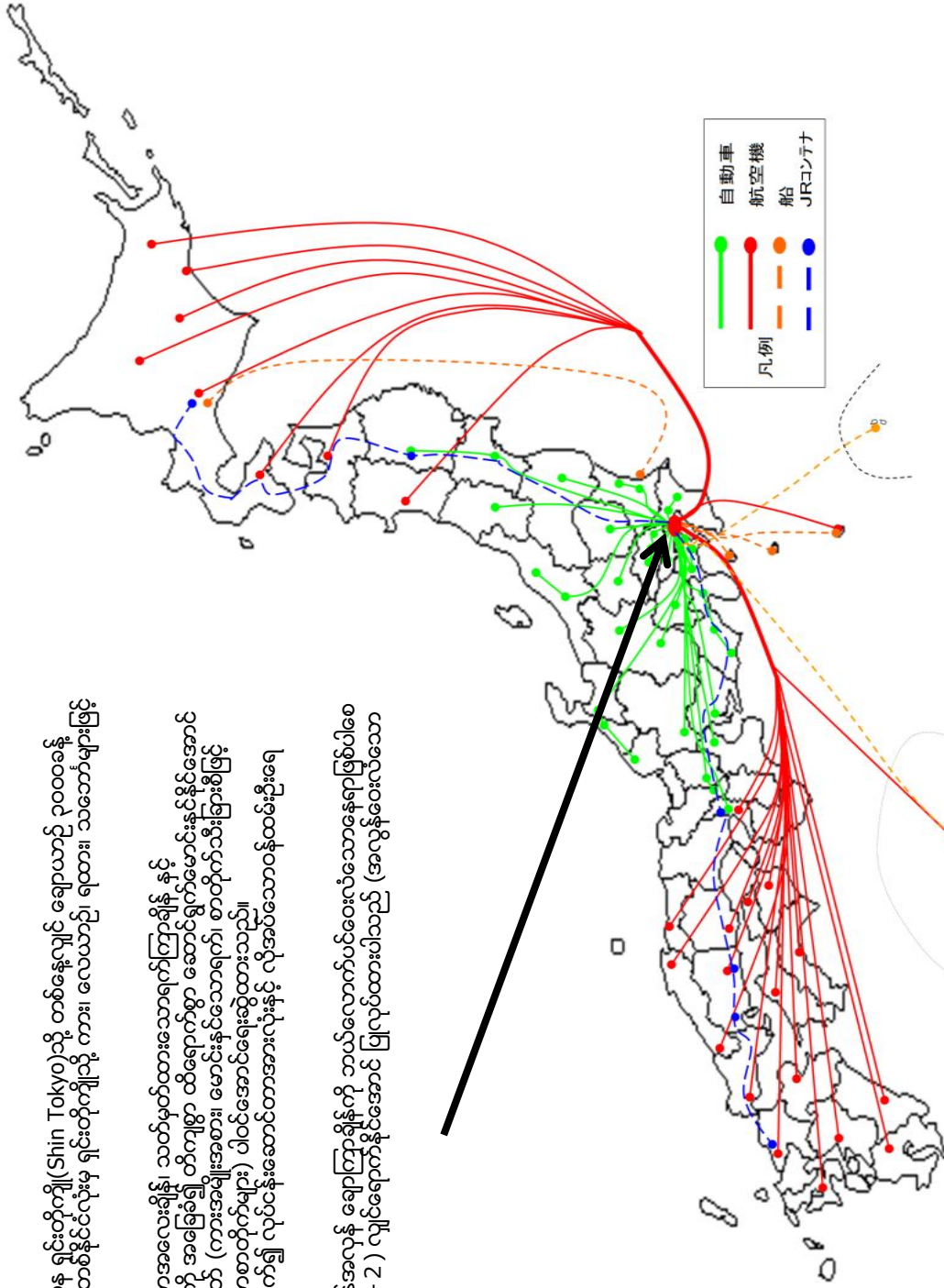

ထိရောက်ပြီး တည်ငြိမ်သောချောလမ်းကြောင်းက  
「တိကျ မှန်ကန် မြန်ဆန်」 သော စာတိုက်ဝန်ဆောင်မှုကို ထောက်ကူပံ့ပိုးသည်

# I -2. စာတိုက်၏ချောလုပ်ငန်းစဉ်

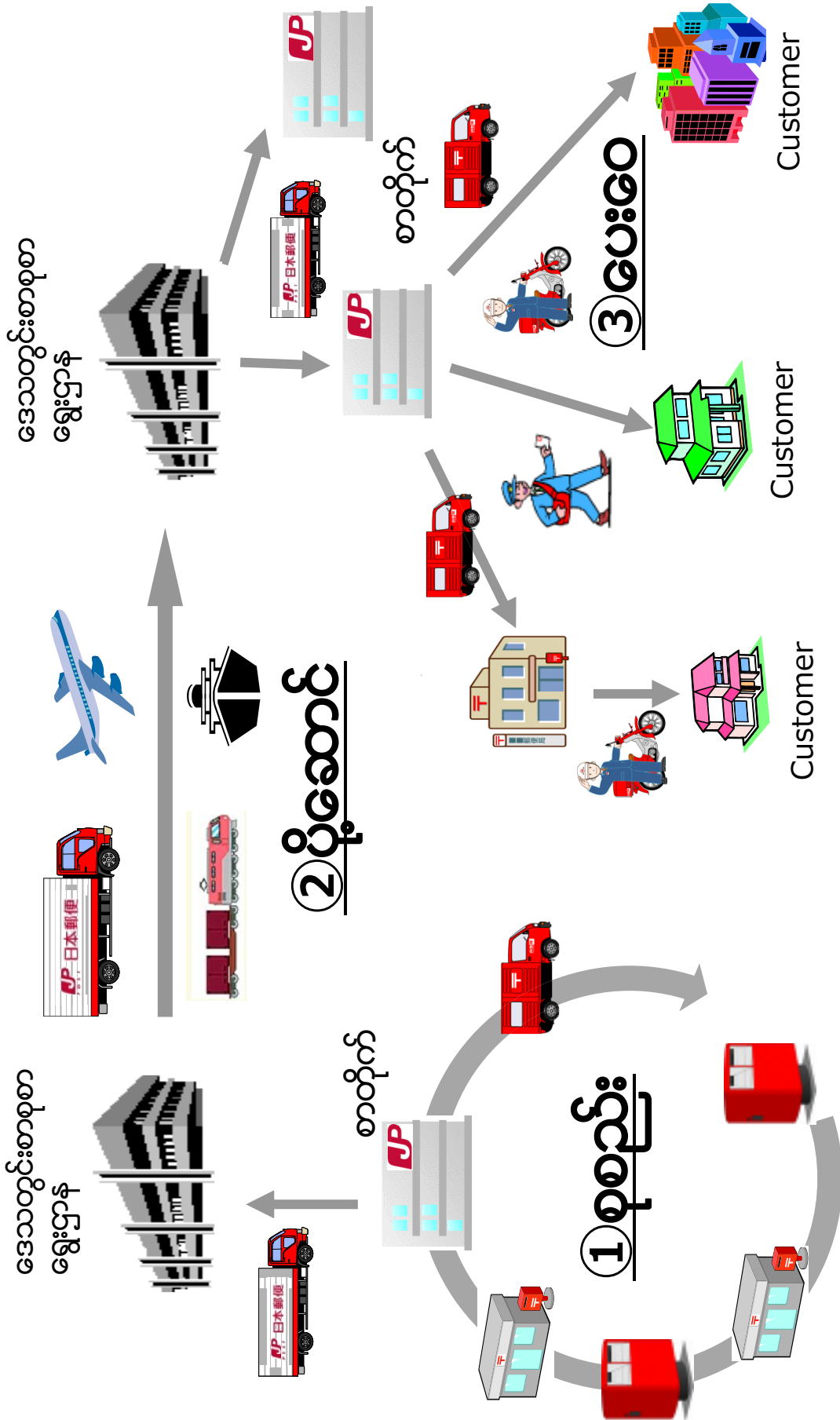

စာတိုက် မိမိစာတိုက်တာဝန်လူထားသောဖေယာဂို (စာတိုက်ပုံ၊ ကောင်တာရီစာတိုက်)များမှ စာသိမ်းခြင်းနှင့် ပေးဝေခြင်းကို ပြုလုပ်သည်။ ဒေသတွင်းစာစုစာရွေးဌာန အခြားဒေသ(တိုင်း)သို့ပို့ဆောင်ရန်နှင့် ၎င်းဒေသများမှ ရောက်ရှိလာသောချောများကို ရွေး/ခွဲခြားမှု ဆောင်ရွက်သည်။

# I -3. ချောလက်ခံမှုပေးဝေအထိ အဆင့်ဆင့်

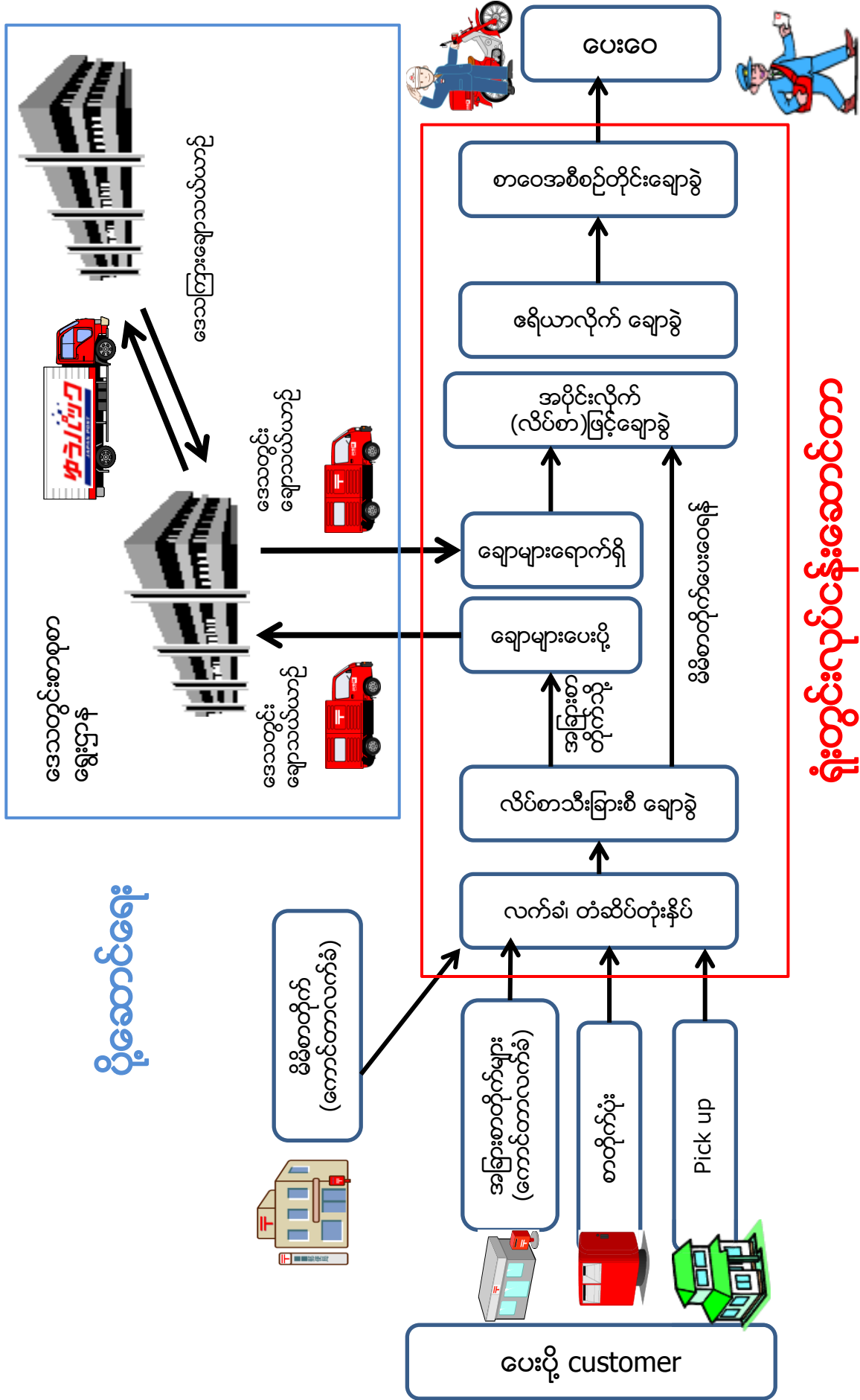

**ရုံးတွင်းလုပ်ငန်းဆောင်တာ**

I -4. မြန်မာ့စာတိုက်၏ ချောလမ်းစနစ် : မြန်မာနိုင်ငံ အခြေခံအချက်အလက်

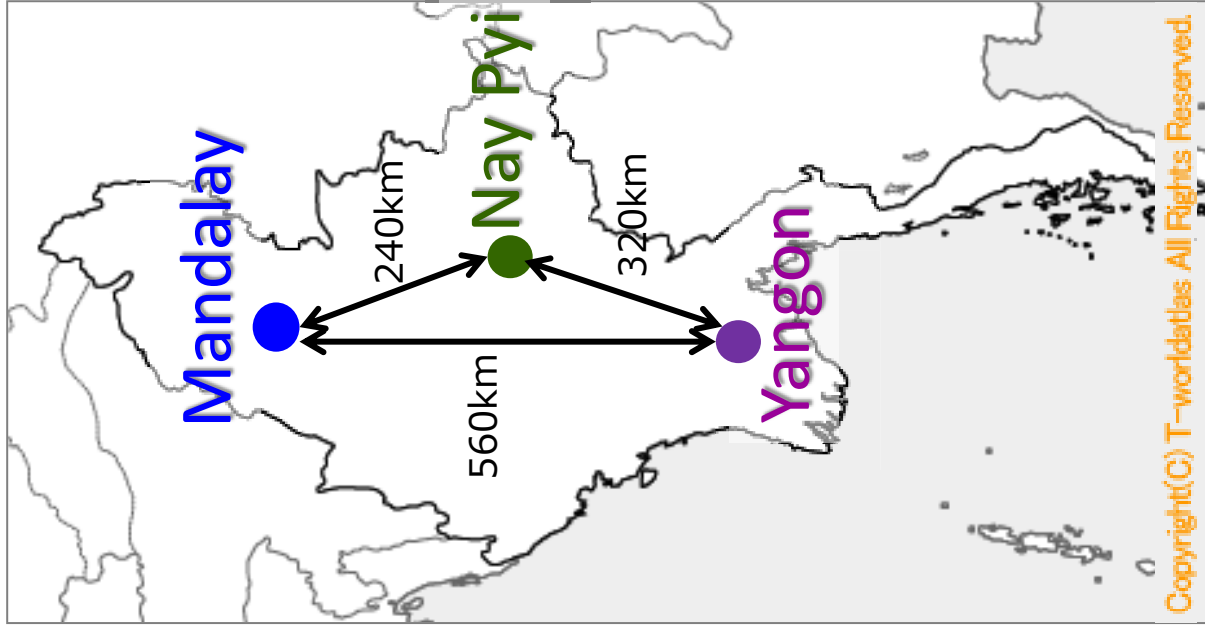

	မြန်မာ	ဂျပန်
အကျယ်အဝန်း	6.8သိန်းစတုရန်းကီလိုမီတာ	3.7သိန်းစတုရန်းကီလိုမီတာ
လူဦးရေ	51.41သန်းဦး	126.72သန်းဦး
စာတိုက်အရေအတွက်	1,381ရုံး	24,069ရုံး
ဆောင်ရွက်နေသောချောပမာဏ	3.812537million(စောင်)	17.7billion(စောင်)
ပါဆယ်အရေအတွက်	126,000(ခု)	630million(ခု)
ဝန်ထမ်းအရေအတွက်	5,153ဦး	195,242ဦး
စာတိုက်ပုံးအရေအတွက်	1,330ခု	181,523ခု
စာပို့သင်္ကေတ	ဂဏန်းဥလုံး Ex. 15-01-1 (State/region-Township-Post office)	ဂဏန်းဂုလုံး Ex. 272-0052 (ဒေသနံပါတ်-မြို့နံပါတ်)
တစ်ရက်ပေးဝေချောပမာဏ	၁သောင်းခန့်	၆သန်းခန့်
တစ်နှစ်လျှင် တစ်ဦးချင်း စာတိုက်အသုံးပြုမှု	ND	142စောင်
စာတိုက်တစ်ရုံးချင်းစီ၏ ပြည်သူအချိုး	38'294,88ဦး	5'230,02ဦး
စာတိုက်တစ်ရုံးချင်း၏ ပျမ်းမျှ အကျယ်အဝန်း	489,92km <sup>2</sup>	15,47km <sup>2</sup>



# I - 5 . မြန်မာ့စာတိုက်၏ ချောလမ်းစနစ် ①

## သယ်ယူပို့ဆောင်ပုံ

- တစ်နိုင်ငံလုံးရှိ စာစုစာရွေးဌာန ME ၄ခုကို ပို့ဆောင်သော ဒေသကြားချောသယ်ယာဉ်နှင့် ME နှင့် ဒေသတွင်းစာတိုက်များကိုပို့ဆောင်သော ဒေသတွင်းချောယာဉ်ဟူ၍ တွေ့ရ
- ဒေသကြားချောသယ်ယာဉ်သည် ရထား ဘတ်စ်ကား လေယာဉ်စသဖြင့် အများသုံးသယ်ယူပို့ဆောင်ယာဉ်
- ဒေသတွင်းချောသယ်ယာဉ်သည် MEအနီးနားရှိ စာတိုက်များသို့ ကိုယ်ပိုင်ချောယာဉ်ဖြင့်ပို့ဆောင်ခြင်း၊ MEမှ ဝေးလံသောစာတိုက်များသို့ ရထား၊ ဘတ်စ်ကားစသည့် အများသုံးသယ်ယူပို့ဆောင်ယာဉ်များဖြင့်ပို့ဆောင်ခြင်း။ ဒေသနှင့်လိုက်၍ နေ့စဉ်မပြေးဆွဲသောအခါလည်းရှိသည်။
- သယ်ယူပို့ဆောင်ရန် ချောအိတ်များကို အသုံးပြု

## ချောခွဲပုံနည်းလမ်း

- စာပို့သင်္ကေတရှိသော်လည်း ရေးသားမှုနည်းအလွန်နည်းနေသေးသောကြောင့် ချောခွဲခြင်းကို လိပ်စာကြည့်ပြီးဆောင်ရွက်
- ဒေသတွင်းမှ စာတိုက်များသည် ME (ရန်ကုန်မြို့တွင်း D E M S လက်ခံများက G P O သို့)သို့ ချောအိတ်ကိုပို့သည်အခါ အခြေခံအားဖြင့် sorting ပြုလုပ်ထားခြင်းမရှိပါ။ DEMSနှင့် အခြားဟူ၍ ၂မျိုးသာခွဲပြီးချောအိတ်ပိတ် (လက်ခံများသောစာတိုက်သည် ရိုးရိုးစာ၊ မှတ်ပုံတင်စာနှင့်ပေါ့ဆယ်ဟူ၍ ချောအိတ်ပိတ်)သည်
- MEမှ အခြား စာစုစာရွေးဌာန(M E နှင့်တဆင့်ခံစာတိုက်)သို့၊ (သို့မဟုတ်) စာဝေစာတိုက်အတွက် sorting ပြုလုပ်သည်



# I - 5. မြန်မာ့စာတိုက် ချောလမ်းစနစ် ②

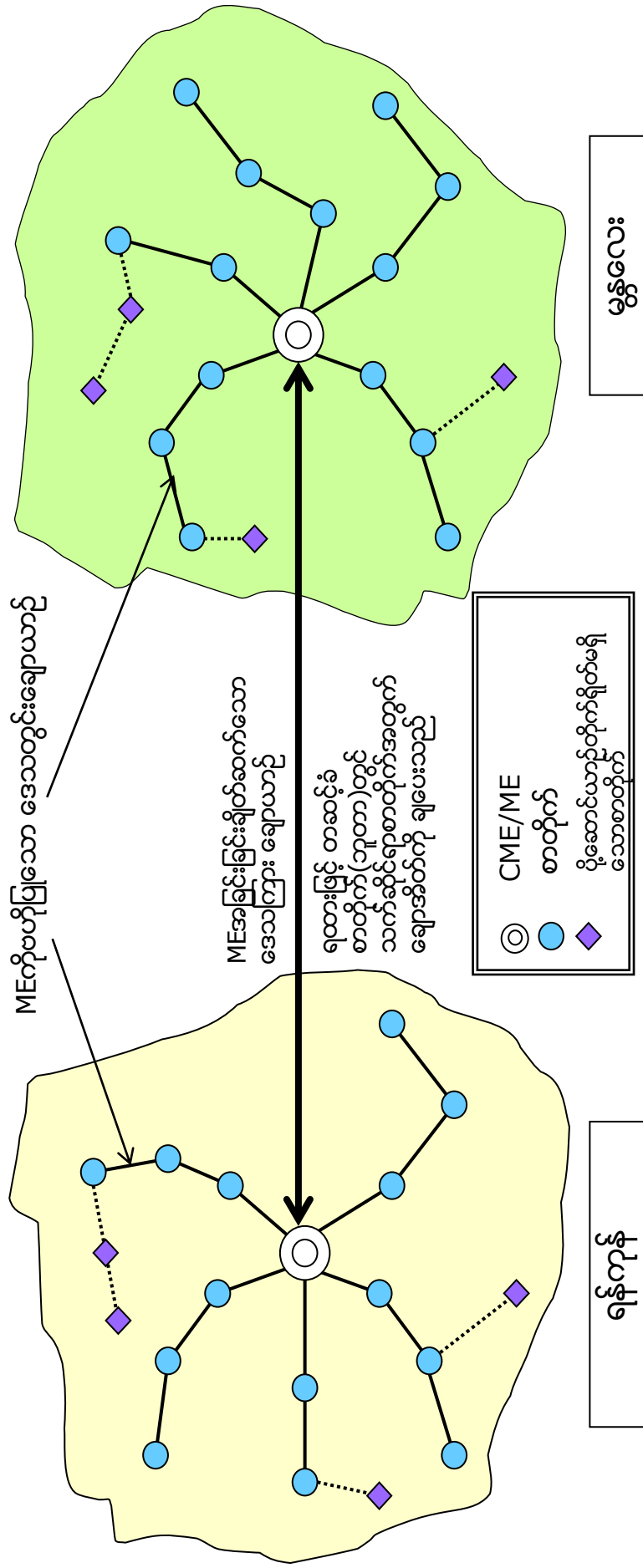

## I -6. 「KESSOKU」 ဆိုတာဘာလဲ①

Customerကို ကတိပေးထားသောရက်ကြာချိန်အတိုင်း အရောက်ပေးဝေနိုင်အောင် ကောင်တာလက်ခံ (စာတိုက်ပုံးသိမ်းအပေါ်)နှင့် ဒေသတွင်းချောယာဉ်၊ ဒေသတွင်းချောယာဉ်နှင့် ဒေသကြားချောယာဉ်၊ ဒေသတွင်းချောယာဉ်နှင့်စာဝေတို့သည် ဆက်စပ်မှုရှိစေရန်လိုအပ်ပြီး ၎င်းကို 「Kessoku」 ဟုခေါ်သည်။

သက်ဆိုင်ရာစာတိုက်အားလုံးတွင် ချောယာဉ်နှင့်စာဝေတို့၏ ထွက်ချိန်ဆိုက်ရောက်ချိန် ဇယားအတိုင်း အချိန်မှီအောင် စာတိုက်တွင်းလုပ်ဆောင်မှု၏ အစီအစဉ်၊ ပိတ်သိမ်းချိန်ကို တိကျစွာသတ်မှတ်ပြီး ၎င်းကိုလေးစားလိုက်နာရန်အလွန်အရေးကြီးပါသည်။

「Kessoku」 သည် ချောတစ်ခု၏ရက်ကြာချိန်ကို လေးစားလိုက်နာနိုင်ရန် အလွန်အရေးပါသော အတွေးအခေါ်ဖြစ်သည်။



# I -6. 「KESSOKU」 ဆိုတာဘာလဲ②

ဥပမာ ရန်ကုန်မြို့တွင်း၌လက်ခံထားသော ချောပစ္စည်းဆိုလျှင် . . .

ရန်ကုန် CME ၌ ရန်ကုန်မြို့တွင်းစာတိုက်အသီးသီးမှ ချောယာဉ်များဖြင့် ရောက်ရှိလာသောချောများကို မနက်ပိုင်းတွင် ခွဲခြမ်းပြီး ချောအိတ်ပိတ်ခြင်းကို ပြုလုပ်ပြီး ရန်ကုန်ဘူတာမှ 17:00နာရီ နေပြည်တော် မန္တလေးသို့သွားသော ရထားဖြင့် တင်ပို့ပါသည်



ချောအိတ်များကိုတင်ဆောင်ထားသော ချောကားသည် ရန်ကုန်ဘူတာသို့အချိန်မီရောက်ရန် ရန်ကုန် CMEကို 15:30တွင် ထွက်ရမည်ဖြစ်ပါသည်



ရန်ကုန် CMEတွင် ချောလုပ်ငန်းဆောင်တာ (sorting)ကို 15:30တွင် ပြီးစီးအောင် ဆောင်ရွက်ရန်လိုအပ်ပါသည်



**15:30အထိ ချောလုပ်ငန်းဆောင်တာများကို ပြီးစီးရန်သတ်မှတ်ပြီး ချောကားတွင် တင်ဆောင်ခြင်း = Kessoku စည်းကမ်း**

## II. Kessoku daigram ကိုဆွဲကြည့်ရအောင်

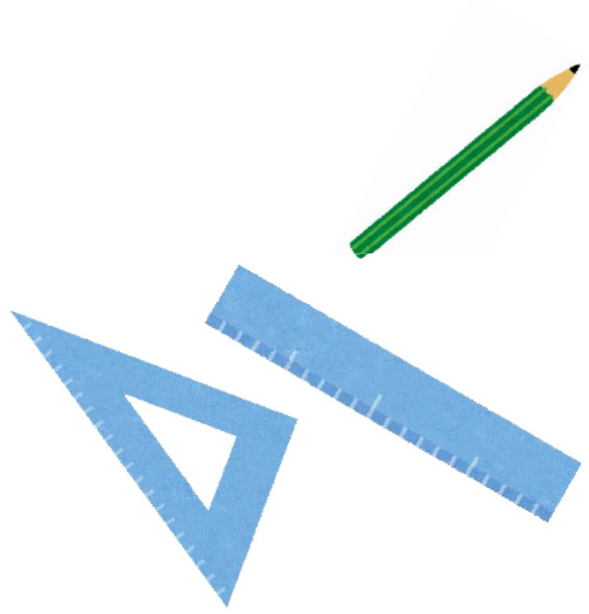

## II - 1 . Kessokuကိုလိုက်နာဆောင်ရွက်နိုင်ရန် လိုအပ်သော toolများ

- ①. Route Map (ချောယာဉ်များ၏ ထွက်/ရောက်ချိန်ဇယား)
 

စာတိုက်တစ်ခုချင်းစီ၏ ဘူတာနှင့်ကားဂိတ်များအကြား ချောများကို ဘယ်အချိန်ဘယ်လို အစီစဉ်/လမ်းကြောင်းဖြင့် သယ်ဆောင်နေသည်ကို ပြသောပုံ။ ထရပ်ကားတစ်ခုတည်းမဟုတ်ဘဲ ရထား၊ ဘတ်စ်ကား၊ ချောကန်ထရိုက်၊ စာတိုက်ဝန်ထမ်း(ဆိုင်ကယ်) စသဖြင့် ဒေသတွင်း၊ ဒေသကြားမရွဲခြားဘဲ ချောယာဉ်အကုန်လုံးအတွက် တစ်ခုချင်းစီ ဆွဲသွားရမည် (ပြုလုပ်ရန် : M E、 G P O、 ရထားစသဖြင့် အပေးအယူရှိသောစာတိုက်(ဌာန)အားလုံး၊ ချောယာဉ်(ထွက်/ရောက်) ရှိသောစာတိုက်အားလုံး)
- ②. Kessoku Diagram
 

စာတိုက်တစ်ခုချင်းစီ၏ 「ချောယာဉ်(ဝင်/ထွက်)ရှိသောစာတိုက်၏ ချောများကို sortingလုပ်ခြင်းမှ စာထွက်ချိန်အထိ」 နှင့် 「ကောင်တာလက်ခံချောများကို(ဧရိယာအတွင်းစာတိုက်ပုံးနှင့်ကောင်တာလက်ခံအပါအဝင်) ချောယာဉ်များသို့လွှဲပြောင်းခြင်းအထိ」 ၎င်းလုပ်ငန်းစဉ်တွင် ချောလုပ်ငန်းဆောင်ရွက်ပုံအဆင့်ဆင့်ကို အချိန်ကိုဝန်ရိုး(ဇယား၏)ဖြင့် ဖော်ပြသောပုံ (ပြုလုပ်ရန် : M E、 G P O、 အခြားတဆင့်ခံစာတိုက်များနှင့် ချောယာဉ်များဆိုင်ရောက်သော စာတိုက်အားလုံး)
- ③. ချောရက်ကြာချိန်ဇယား (CET)
 

အဓိကကျသောစာတိုက်များကြား ချောများကိုလက်ခံပြီးနောက် ပေးဝေအထိကြာမြင့်သော စုစုပေါင်းရက်ကိုပြသောဇယား။ နံပါတ်မှ Route Map နံပါတ် ၂မှ Kessoku Diagram နှစ်ခုပေါင်းပြီး စစ်ဆေးခြင်းဖြင့် တိကျသော ကြာချိန်ကိုသိနိုင်မည်။ (ပြုလုပ်ရန် : M E、 G P Oနှင့် အခြားတဆင့်ခံစာတိုက်)
- ④. Network Diagram
 

သယ်ယူပို့ဆောင်ရေးယာဉ်အမျိုးအစား (ရထား၊ ဘတ်စ်ကား၊ လေယာဉ်၊ သင်္ဘော) တစ်ခုချင်းစီ၏ ချောလမ်းကြောင်းကို ဖော်ပြသောပုံ။ နံပါတ်မှ Route Map ပြီးမှရေးဆွဲရန်။ နောက်ပိုင်းတွင် ချောလမ်းကြောင်းပြင်ဆင်ရန် စဉ်းစားရာတွင် အသုံးပြုရန်။ (ပြုလုပ်ရန် : M E、 G P Oနှင့် တဆင့်ခံစာတိုက်စသဖြင့် ချောယာဉ်များဆိုင်ရောက်သောစာတိုက်များ)

## II -2. Kessokuကိုလိုက်နာဆောင်ရွက်နိုင်ရန် လိုအပ်သော toolများ \_ Route Map

- ✓ Route Mapသည်စာတိုက်၊ ဘူတာ၊ ကားဂိတ်များအကြား ချောများကို ဘယ်လိုအစီအစဉ်ဖြင့် သယ်ဆောင်နေသည်ကို ဖော်ပြသည် (ချောယာဉ်တစ်စီးလျှင် တစ်ရွက်)။ ဒေသကြားယာဉ်များ (ရထား၊ ကား၊ လေယာဉ်)များအတွက်လည်း ရေဆွဲထားရမည်။
- ✓ စာတိုက်တစ်ခုချင်းစီ၏ ဘူတာ၊ ဘတ်စ်ကားဂိတ်များသို့ ချောများသယ်ယူသော ယာဉ်၏ဝင်ထွက်ချိန်များကိုလည်း ဖော်ပြရမည်။
- ✓ ဒီလမ်းကြောင်းပြပုံကို မှန်ကန်စွာ မရေးသားနိုင်ခဲ့လျှင် ၆ - ③တွင်ဆွဲရမည့် ကြားချိန်ဖယားကိုလည်း ရေးဆွဲနိုင်မည်မဟုတ်ပါ။

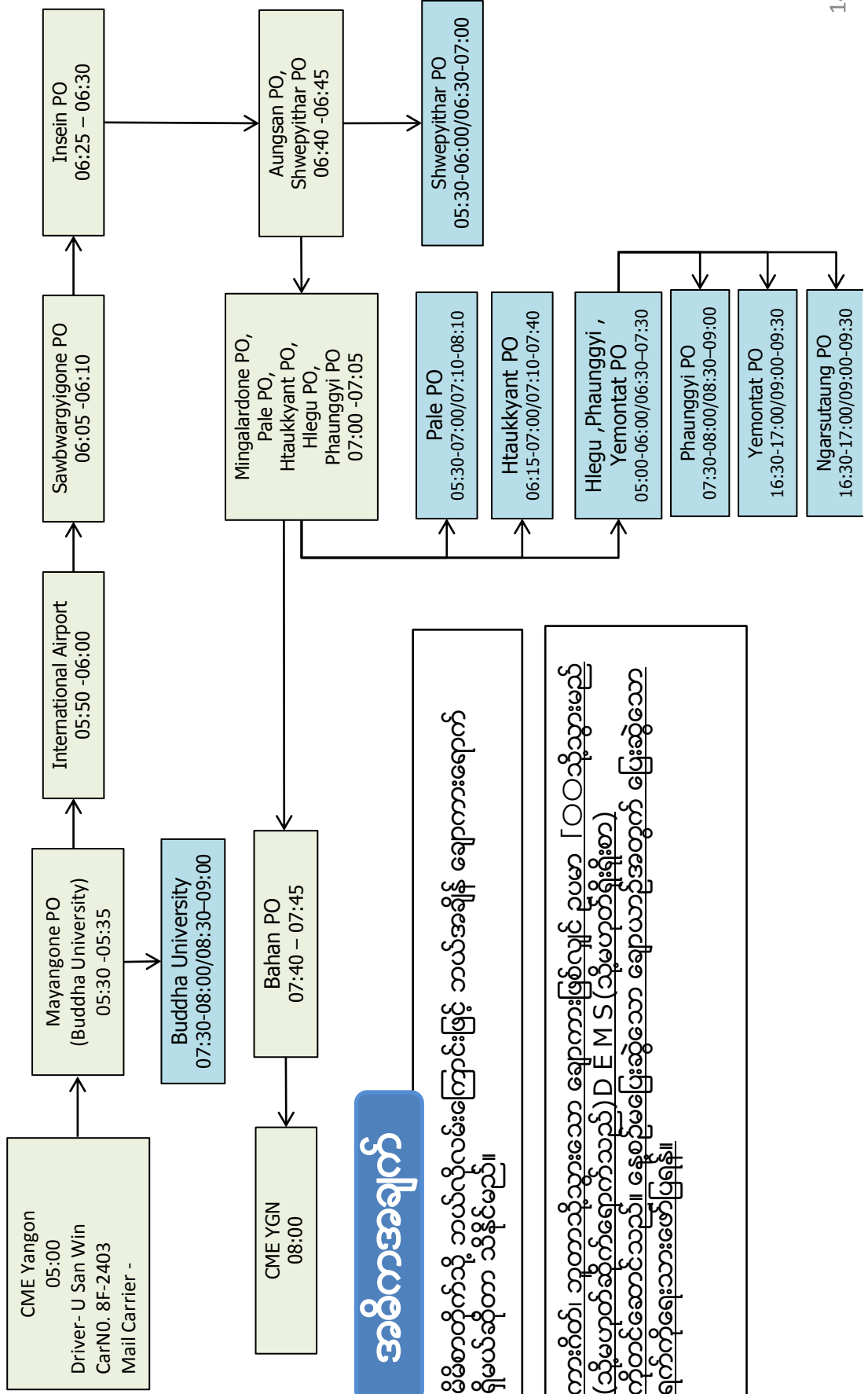



T06 II -3. Kessokuကိုလိုက်နာဆောင်ရွက်နိုင်ရန် လိုအပ်သော toolများ — Kessoku Diagram

- ✓ Kessoku Diagramသည် စာတိုက်တစ်ခုခြင်း၏ «ရောက်အိတ်ရောက်ပြီးနောက် sortingလုပ်ခြင်းမှ စာဝေအထိ» နှင့် «ကောင်တာတွင် ချောလက်ခံပြီး လွှဲပို့ရန်ချောကားပေါ်တင်သည်အထိ» ရှိ ချောများ၏လုပ်ဆောင်ပုံအဆင့်ဆင့်ကို အချိန်ဝန်ရှိဖြင့်ဖော်ပြသောဇယားဖြစ်သည်။ နေ့စဉ်မပြေးဆွဲသော ချောယာဉ်များအတွက် ပြေးဆွဲသောရက်ကိုဖော်ပြရန်။
- ✓ ရိုးတွင်းလုပ်ငန်းဆောင်တာများအတွက် အသုံးဝင်ပါသည်။

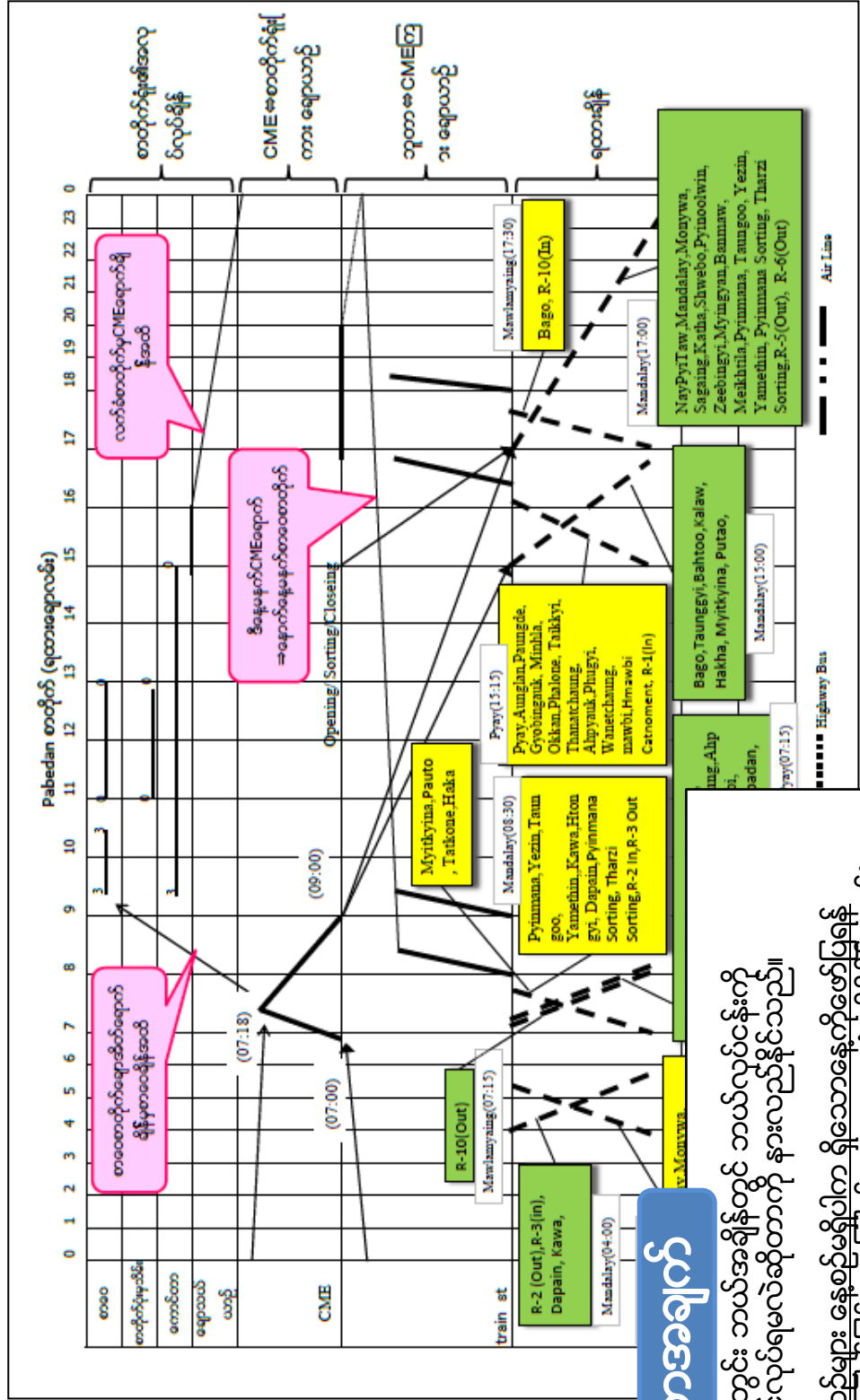

**အဓိကအချက်**

- စာတိုက်တွင်း ဘယ်အချိန်တွင် ဘယ်လုပ်ငန်းကို ပြီးစီးအောင်လုပ်ရမလဲဆိုတာကို နားလည်နိုင်သည်။
- ချောယာဉ်များ နေ့စဉ်မရှိပါက ရှိသောနေ့ကိုဖော်ပြရန် (ဇယားကိုကြည့်ခြင်းအကြောင်းအရာအားလုံးသိရှိနိုင်ရမည်)







## II -6. Kessoku Diagramကိုဆွဲကြည့်ရအောင်

### Kessoku Diagramရေးဆွဲရန် အဓိကအချက်များ

- ဒေါင်လိုက်ဝန်ရိုး = စာဝေချိန်၊ စာတိုက်ပုံးသိမ်းချိန်၊ ကောင်တာဖွင့်လှစ်ချိန်၊ သယ်ယူပို့ဆောင်ရေး၊ ME(G P O)၊ ဘူတာ၊ ရထားဝင်ထွက်အချိန်ဇယား၊ ကားဂိတ်၊ ကားဝင်ထွက်ချိန်ဇယားစသဖြင့်
- အလျားလိုက်ဝင်ရိုး = အချိန်
- ME(G P O)နှင့် အခြားစာတိုက်များမှ ချောကားများထွက်ချိန်
- မိမိစာတိုက်သို့ ချောကားဝင်ချိန်နှင့်ထွက်ချိန် (မိမိစာတိုက်မှသွားယူရသောအခါတွင်လည်းလိုအပ်သည်)
- ME(G P O)သို့ ချောကားများရောက်ချိန်
- များ (→) ၏အစမှ အဆုံးထိအချိန် = ရုံးတွင်းလုပ်ငန်းဆောင်တာ (sorting)အချိန်

II -7. Kessoku Diagram ရေးဆွဲရန် လိုအပ်သောခေါင်းစဉ်များကိုစစ်ဆေးခြင်း

လုပ်ငန်းစဉ်များ၏အချိန်ဇယား

ချောကားဆိုက်ရောက်ချိန်	(M Eစသော ချောကားရှိသောဌာန(စာတိုက်)များမှ ချောကားဆိုက်ရောက်ချိန်)
ချောကားထွက်ချိန်	(M Eစသော ချောကားရှိသောဌာန(စာတိုက်)များသို့ ချောကားထွက်ချိန်)
စာဝေထွက်ချိန်	(မနက်၊ နေခင်း၊ ညကြိမ်ရှိလျှင် ညကြိမ်စလုံးရေးရန်)
စာပို့လုလင်စာတိုက်ပြန်ရောက်ချိန်	(မနက်၊ နေခင်း၊ ညကြိမ်ရှိလျှင် ညကြိမ်စလုံးရေးရန်)
စာတိုက်ရှေ့ရှိစာတိုက်ပုံးမှစာသိမ်းချိန်	(တစ်ရက်အတွင်း သိမ်းသောအကြိမ်များကို အကုန်ရေးရန်)
ချောအိပ်ပိတ်သောအချိန်	(တစ်ရက်အတွင်း ချောကားသို့တင်ပို့ပေးသော အကြိမ်အားလုံးကိုရေးရန်)
ကောင်တာပိတ်သိမ်းချိန်	(M Eစသဖြင့် ချောကားဝင်ထွက်ချိန်နှင့် ချောအိတ်ပိတ်ချိန်များနှင့်ညှိနှိုင်း၍ ရေးရန်)

## II -8. Kessoku diagram ရေးဆွဲခြင်း

### 1. သင်၏စာတိုက်သို့ မနက် ငြောက်တွင် M E မှချောကားရောက်ခဲ့လျှင် Kessoku diagram က ဘယ်လိုဆွဲမလဲ

အခြေခံစဉ်းစားရမည့်အဓိကအချက်

- မိမိစာတိုက်ရှိ တစ်နေ့တာပေးဝေရသော ချောပမာဏသည် စာပို့လုလင်တစ်ယောက်ကို ဘယ်နှစ်ဆောင်(ခ)ရှိလဲ
- စာဝေထွက်ချိန်ကို ဘယ်အချိန်သတ်မှတ်ပြီး ပြန်ရောက်ချိန်ကို ဘယ်အချိန်သတ်မှတ်မလဲ

### 2. သင်၏စာတိုက်မှ မနက်၁၁နာရီ M E သို့သွားသော ချောကားထွက်ခဲ့လျှင် Kessoku diagram က ဘယ်လိုဆွဲမလဲ

အခြေခံစဉ်းစားရမည့်အဓိကအချက်

- သင့်စာတိုက်၏ တစ်ရက်လက်ခံရရှိသော ချောပမာဏက ဘယ်လောက်လဲ
- သင့်စာတိုက်၏ တစ်ရက်လက်ခံရရှိသော ချောများကို ချောကားထွက်တင်နိုင်ရန် ချောအိတ်ပိတ်သည်အထိ အချိန်ဘယ်လောက်လိုအပ်လဲ။ ဒါဆိုရင် ကောင်တာပိတ်သိမ်းချိန်ကို ဘယ်အချိန်ထားရင် ကောင်းမလဲ (ဥပမာ ချောကားမထွက်မှီ မိနစ် ၃၀)
- စာတိုက်ရှေ့ရှိစာတိုက်ပုံးမှ စာသိမ်းချိန်သည် ချောကားထွက်ချိန်နှင့် ကိုက်ညီထားပါသလား
- စာတိုက်ရှေ့စာတိုက်ပုံးအပြင်အခြားစာတိုက်ပုံးများမှ စာသိမ်းချိန်က ဘယ်အချိန်တွေပါလဲ

ခေါင်းစဉ် ①

စာတိုက်မှူးတစ်ယောက်အနေဖြင့်  
စာတိုက်လုပ်ငန်းဆောင်တာများကို ပုံမှန်ဆောင်ရွက်ခြင်းနှင့်  
သတ်မှတ်ထားသောရက်ကြာချိန်တွင်ပေးဝေနိုင်ရန်  
မည်သည့်အချက်များကို အစဉ်အမြဲ ကြိုးစားလိုက်နာနေပါသလဲ

ခေါင်းစဉ် ②

ချောများနှင့်ပက်သက်သော ရက်ကြာချိန်၊ ဝန်ဆောင်မှုအရည်အသွေး (ချောမရောက်ခြင်း)အပေါ် Customer ၏ထင်မြင်ချက်နှင့် တောင်းဆိုမှုများရှိပါသလား။ အဲဒါတွေဟာ ဘယ်လိုဖြစ်သင့်တယ်လို့ သင်စဉ်းစားပါသလဲ

III. ချောလှုပ်ငန်းဆောင်တာ စီမံခန့်ခွဲမှု/  
စီစဉ်ဆောင်ရွက်ပုံနည်းလမ်းကို နားလည်ရန်

### III-1. ချောလုပ်ငန်းဆောင်တာ စီမံခန့်ခွဲမှု/ စီစဉ်ဆောင်ရွက်ပုံနည်းလမ်းကို နားလည်ရန်

#### စာတိုက်မျိုး၏ လုပ်ငန်းဆောင်တာနှင့်တာဝန်

စာတိုက်လုပ်ငန်းဆောင်တာများ ပုံမှန်လည်ပတ်ပြီး Kessokuကို လိုက်နာနိုင်ရန်အတွက် အစဉ်အမြဲလုပ်ငန်းများ၏ အခြေအနေကို သိရှိထားရန်လိုအပ်သည်။ ၎င်းအပြင် Kessoku diagramအတိုင်း ဘယ်အချိန်အထိ လုပ်ငန်းများကို အပြီးသတ်လုပ်ဆောင်ရမည်ဆိုတာကို နားလည်သဘောပေါက်နေဖို့လိုအပ်သည်။

ရုတ်တရက်အကြောင်းအမျိုးမျိုးကြောင့် Kessokuမဖြစ်ခဲ့လျှင် (ကောင်တာပိတ်ချိန်အထိ လက်ခံထားသောချောများကို ချောကားသို့အချိန်မီတင်ပေးလိုက်နိုင်ခြင်း ချောကားဖြင့်ရောက်လာသော ချောများကို ၎င်းနေ့အတွင်းမပေးဝေနိုင်ခြင်း) အလျင်အမြန် ကိုင်တွယ်ဆောင်ရွက်ရန်လိုအပ်သည်။



စာတိုက်မျိုးကိုယ်တိုင် မိမိ၏တာဝန်ကို နားလည်ပြီး  
သယ်ယူပို့ဆောင်ရေးနှင့် စာတိုက်တွင်းလုပ်ငန်းစဉ်ကို  
လိုက်ဖက်ညီအောင် စီမံခန့်ခွဲလုပ်ဆောင်နိုင်ရန်လိုအပ်ပါသည်။



# III-2. Kessoku diagram ကို update လုပ်ခြင်း

## Kessoku diagram ကို update လုပ်နည်းအဆင့်ဆင့်

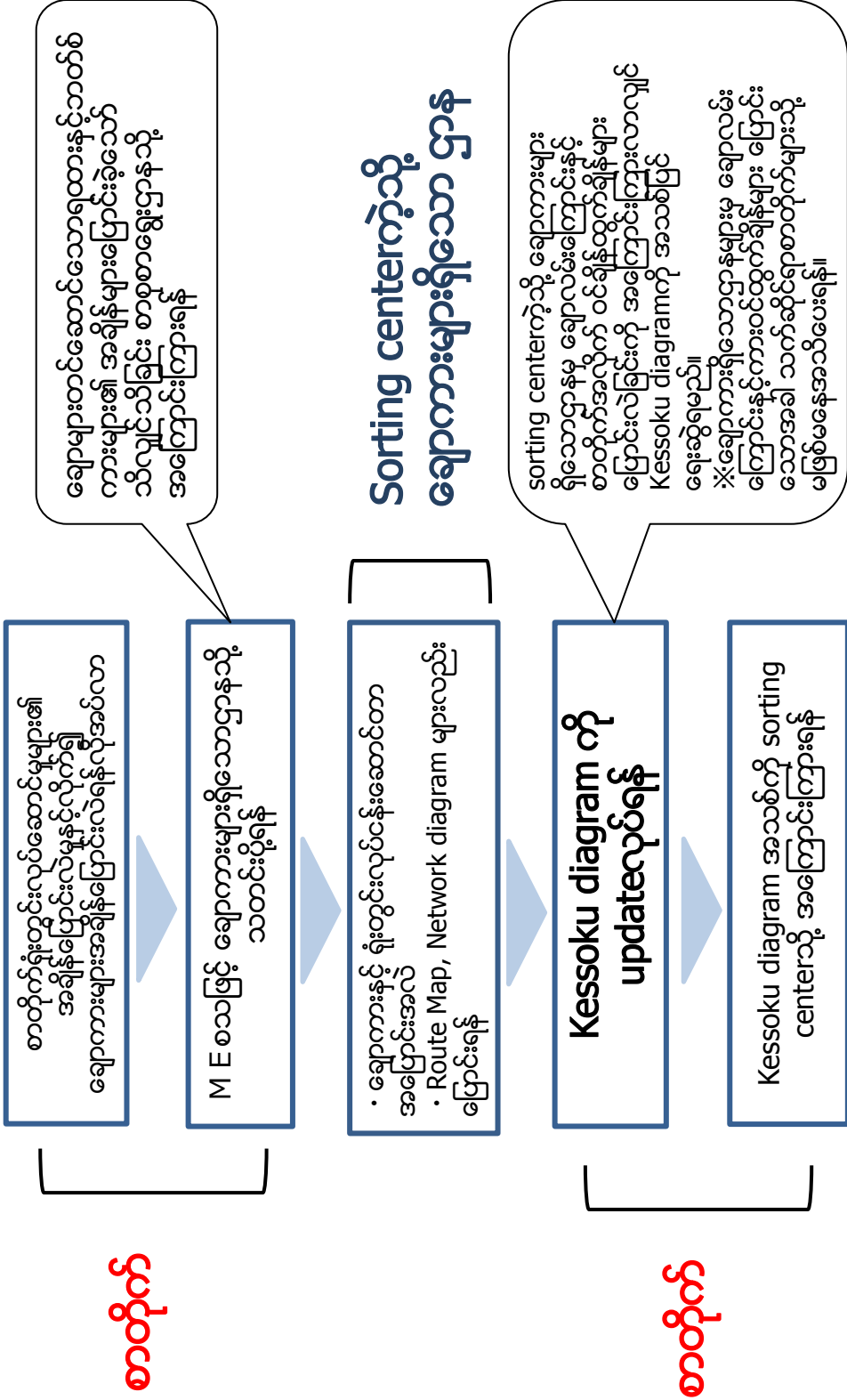

III-3. ဝန်ထမ်းများပြုစုပို့ဆောင်ခြင်း : On the Job Training (OJT)①

- ✓ စာတိုက်မှူးမှ သယ်ယူပို့ဆောင်ရေးနှင့် ရုံးတွင်းလုပ်ငန်းများကို နားလည်သဘောပေါက်ပြီး ဝန်ထမ်းများသို့အသိပေးပြောကြားကာ နားလည်သဘောပေါက်စေပြီးမှ လုပ်ငန်းများကိုဆောင်ရွက်ရန်လိုအပ်သည်။ Kessoku diagram ရဲ့ ကြည့်ပုံကြည့်နည်းနှင့်ရေးဆွဲပုံကို ဝန်ထမ်းများသို့ သင်ကြားပို့ချ၍ နားလည်သဘောပေါက်စေရန် လုပ်ဆောင်ရမည်။
- ✓ ၎င်းသို့သင်ကြားရာတွင် ရေးဆွဲပုံတစ်ခုတည်းသာမဟုတ်ဘဲ စာတိုက်တွင်ပုံမှန်ဆောင်ရွက်နေသော လုပ်ငန်းဆောင်တာများနှင့်အတူ လက်တွေ့ပြုလုပ်ရင်း ညွှန်ကြားမှုပေးရမည်။
- ✓ ၎င်းကဲ့သို့ညွှန်ကြားခြင်းပုံစံကို On the Job Training (OJT) ဟုခေါ်ပါသည်။

### III-3. ဝန်ထမ်းများပြုစုပို့ဆောင်ခြင်း : On the Job Training (OJT) ②

#### OJT၏အကျိုးကျေးဇူးများ

လက်တွေ့ အကောင်အထည်ဖော်နိုင်ခြင်း	လုပ်ငန်းခွင်၏လက်ရှိအခြေအနေ၊ လက်တွေ့ကျသော လုပ်ငန်းဆောင်တာများနှင့်ကိုက်ညီသော ညွှန်ကြားမှုကိုပြုလုပ်နိုင်သည်
တိကျသောချာခြင်း	ဝန်ထမ်းတစ်ဦးချင်းစီ၏ အရည်အသွေးနှင့်အမှုအကျင့်၊ အားသာချက်အားနည်းချက်များနှင့် ကိုက်ညီသော ညွှန်ကြားမှုကို ပြုလုပ်နိုင်သည်
အချိန်မရွေးလုပ်ဆောင်နိုင်ခြင်း	လိုအပ်သောအချိန်တွင် လက်တွေ့ကျသော ညွှန်ကြားမှုကို ဘယ်အချိန်မဆို လုပ်ဆောင်နိုင်သည်
ထပ်တလဲလဲလုပ်ဆောင်နိုင်ခြင်း	လုပ်နိုင်လာသည်အထိ အကြိမ်ကြိမ်ညွှန်ကြားမှုပုံစံကိုပြောင်းလဲရင်းဖြင့် သင်ကြားပေးနိုင်သည်

#### OJT၏အခြေခံ

ရှင်းပြ ⇒ လက်တွေ့လုပ်ပြ ⇒ ပြန်လည်ဆွေးနွေး ⇒ နောက်တစ်ကြိမ်လက်တွေ့လိုက်လုပ်

### III-3. ဝန်ထမ်းများပြုစုပို့ဆောင်ခြင်း : On the Job Training (OJT)③

① ခုနကရေးဆွဲပြီးသွားသော III-2. လုပ်ငန်းဆောင်တာအသီးသီး၏အချိန်ဇယားနှင့် Kessoku diagramကို စာတိုက်ရုံးတွင်းဝန်ထမ်းများမြင်နိုင်သောနေရာတွင်ချိတ်ဆွဲထားရန်။ ၎င်းဇယားသည် ရုံးတွင်းစာရွက်စာတန်းဖြစ်သည့်အတွက် customer မြင်အောင်ချိတ်ထားရန်မလိုအပ်ပါ။

② Kessoku diagramကို အသုံးပြုပြီး ချောယာဉ်နှင့်ရုံးတွင်းလုပ်ငန်းဆောင်တာ၊ လက်ခံ၊ ပေးစေသည်များ၏ လုပ်ဆောင်ပုံအဆင့်ဆင့်ကို ရုံးဝန်ထမ်းအားလုံးကို ရှင်းလင်းပြပြီး သဘောပေါက်နေစေရန် လုပ်ဆောင်ရမည်။

③ ချောကားများ ရောက်ရှိထွက်ခွာချိန်ကို သိရှိနေလျှင် ၎င်းအချိန်အတိုင်းမှီနိုင်ရန်အတွက် ရုံးတွင်းလုပ်ငန်းအားလုံးကို သေချာစွာလုပ်ဆောင်နိုင်ရန် ဝန်ထမ်းများအား လုပ်ငန်းဆောင်တာကို ညွှန်ကြားရမည်။

### III -4. ချောသယ်ပို့လုပ်ငန်းကို monitoring လုပ်ခြင်း①\_စာတိုက်မှူးစစ်ဆေးရမည့်အချက်များ

- ချောကားများ သတ်မှတ်ထားသော အချိန်နေ့ရက်တွင် ရောက်ရှိပါသလား
- ချောကားများနောက်ကျခဲ့လျှင် သယ်ဆောင်လာသောဝန်ထမ်းအား အကျိုးအကြောင်းမေးကာ ၎င်းကို ချောစာရင်းတွင် ရေးမှတ်ပြီး ကာယကံရှင်အားဆိုင်းထိုးခိုင်းပါသလား
- monitoring ကာလတွင် ချောအိတ်ဘယ်နှစ်အိတ် ရောက်ရှိသလဲ
- ပုံသဏ္ဍန်ပျက်ယွင်းခြင်း ပုံမှန်မဟုတ်သော ချောအိတ်ရှိမရှိကို စစ်ဆေးပါသလား
- ပုံသဏ္ဍန်ပျက်ယွင်းခြင်း ပုံမှန်မဟုတ်သော ချောအိတ်လက်ခံရရှိခဲ့ပါက သယ်ဆောင်လာသောဝန်ထမ်းအား အကြောင်းရင်းကိုမေးကာ ၎င်းကို ချောစာရင်းတွင် ရေးမှတ်ပြီး ကာယကံရှင်အားဆိုင်းထိုးခိုင်းပါသလား
- ရောက်ရှိလာသောချောအိတ်အတွင်းတွင် မိမိစာတိုက်ပေးဝေရန်မဟုတ်သော စာများရှိမရှိစစ်ဆေးပါသလား
- ချောစာရင်းတွင်ပါဝင်သော ချောများ၏အမျိုးအစား၊ အရေအတွက်၊ ချောအိတ်အလွတ်၏နံပါတ်များ ကိုက်ညီမှုရှိမရှိစစ်ဆေးပါသလား
- လွှဲပို့ရမည့်ချောများကို sortingပြုလုပ်၍ ချောအိတ်ပိတ်ပါသလား
- သတ်မှတ်ထားသောအချိန်အတိုင်း ချောအိတ်ပိတ်ပါသလား
- ချောကားသည် သတ်မှတ်ထားသောအချိန်အတိုင်း ထွက်ပါသလား
- လွှဲပို့ရန်ရှိသော ချောအိတ်များအားလုံး တင်ပေးလိုက်နိုင်ပါသလား

### III-4. ဧရာသယ်ပို့လုပ်ငန်းကို monitoring လုပ်ခြင်း ②\_Monitoring ကြီးကြပ်ရေးအဖွဲ့.

- ✓ Check sheet ကိုအသုံးပြုပြီး သယ်ယူပို့ဆောင်ရေး monitoringကြီးကြပ်ရေးအဖွဲ့ကို ဖွဲ့စည်းမည်။
- ✓ လိုအပ်ချက်ရှိခဲ့လျှင် IPO လည်း monitoring တွင်ပါဝင်မည်။

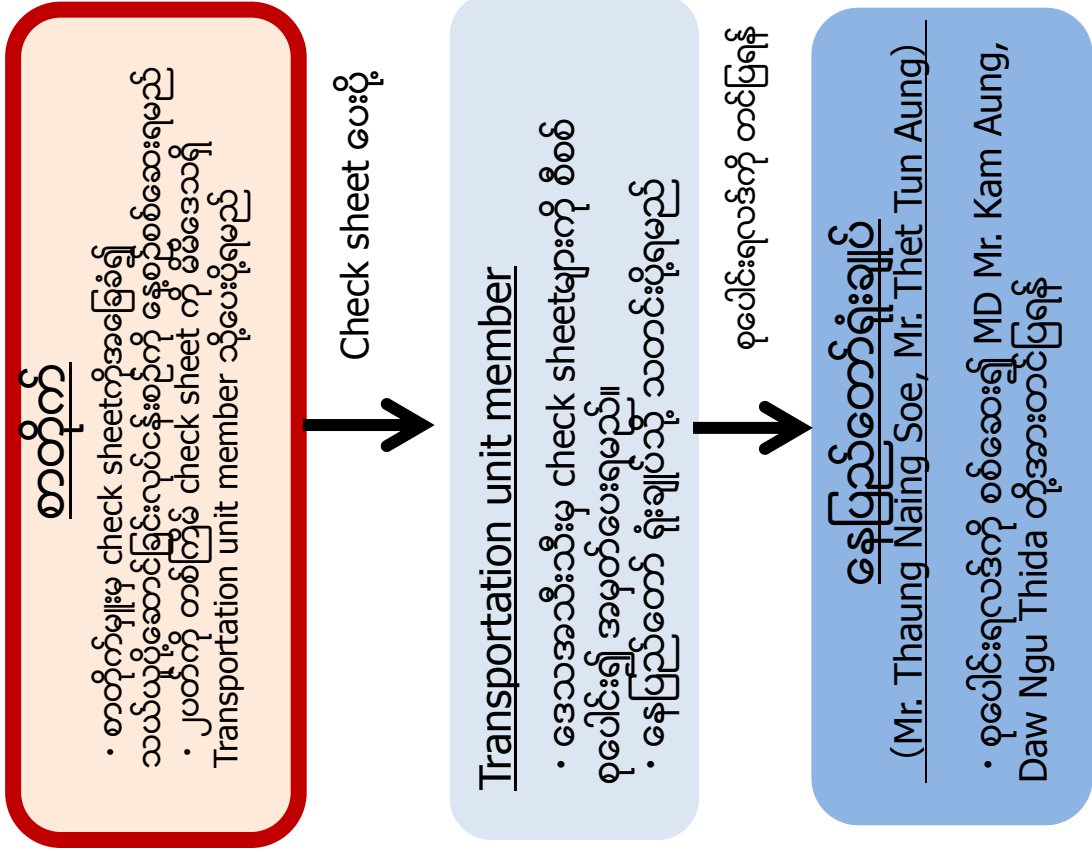

# III-4. ချောသယ်ပို့လုပ်ငန်းကို monitoring လုပ်ခြင်း ③\_\_Monitoring sheet

<b>輸送業務モニタリングチェック表</b>		郵便局名 局長名 モニタリング期間		運送便到着時間：XX:XX 運送便出発時間：XX:XX							【注意事項】 ・各項目について、できていたら1、できていなかったら0を記載。 ・項目1,4,6,10,11については、備考に併記記載。 ・項目1,3は、各局への評価点としては考慮しない			
区	項目	目	備考	月	日	月	日	月	日	月	日	月	日	合計
到着	1	輸送便は、定められた日時通りに到着したか	下段に、到着時間を記入	9:00										
	2	輸送便が遅れてきた場合、運んできたスタッフに理由を聞き、それを郵便物リストに書き、本人にサインをしても良かったか		0										0
	3	モニタリング時に到着した郵便物	到着した郵便物の数を記入	0										0
到着	4	形が崩れたり、異変だった郵便袋があったか否かを確認をしたか	あった場合、郵便数を記入	1	1	1	1	1	1					5
	5	形が崩れたり、異変だった郵便袋が届いた場合、運んできたスタッフに理由を聞き、それを郵便物リストに書き、本人にサインをしても良かったか		1										1
	6	到着郵便袋の中に、自局宛以外の郵便物は否かを確認をしたか	あった場合、通数を記入	0										0
区分	7	郵便物リストにある郵便物の種類、数、変更郵便物の番号が含まれていたか否かを確認をしたか		0										0
	8	差立てるべき郵便物は全て区分し、郵便物を作成したか		1										1
	9	決められている時間通りに郵便物を閉めたか		1										1
差立て	10	輸送便は、定められた日時通りに出発したか	下段に、運送便の出発時間を記入	1										
	11	差立てるべき郵便物はすべて積載できたか	下段に、積載数/全郵便数を記入	9:30										
				12:20										

特記事項(バスや鉄道時刻の変更など、その他報告すべき事項あれば記入)

- သတ်မှတ်ထားသောရက်ကြာချိန်အတိုင်း ချောများကိုအရောက်ပို့နိုင်ရန် 「Kessokuအတိုင်းလိုက်နာ」 ဆိုသည်မှာ အခြေခံလိုအပ်ချက်ဖြစ်သည်
- ချောလမ်းကြောင်းတာဝန်ခံများသည် Kessokuကိုသဘောပေါက်ပြီး Kessoku diagram, Route Map စသည့် စာရွက်စာတမ်းများကို တိကျစွာလုပ်ဆောင် ထားရှိပြီးနောက် တိကျသော ချောကြာချိန်ပြဇယား(CET)ကိုရေးဆွဲပြီး Customerကို အသိပေးနိုင်စေရန်ရည်ရွယ်ပါသည်။
- ချောသယ်ပို့လုပ်ငန်းကို monitoring လုပ်ခြင်းဖြင့် ဝန်ထမ်းများက Kessokuကို မည်မျှနားလည်သဘောပေါက်နေသည်ဆိုတာကို သိနိုင်နေမည်။



စာတိုက် Kessoku Diagram

	0	1	2	3	4	5	6	7	8	9	10	11	12	13	14	15	16	17	18	19	20	21	22	23	0		
ရိုးရိုးစာဝေ																											
DEMSစာဝေ																											
စာတိုက်ပုံသိမ်း																											
ကောင်းစားလက် နံ့စာတိုက်စာရ စာတိုက်ပုံ																											
ချောကားချောင်း/ ထွက်(ငွေပုံ)																											
CME/GPO																											

ပုံမှန်စာတိုက်၏ Kessoku Diagram (ရန်ကုန်ခရိုင်လက်ရှိ)

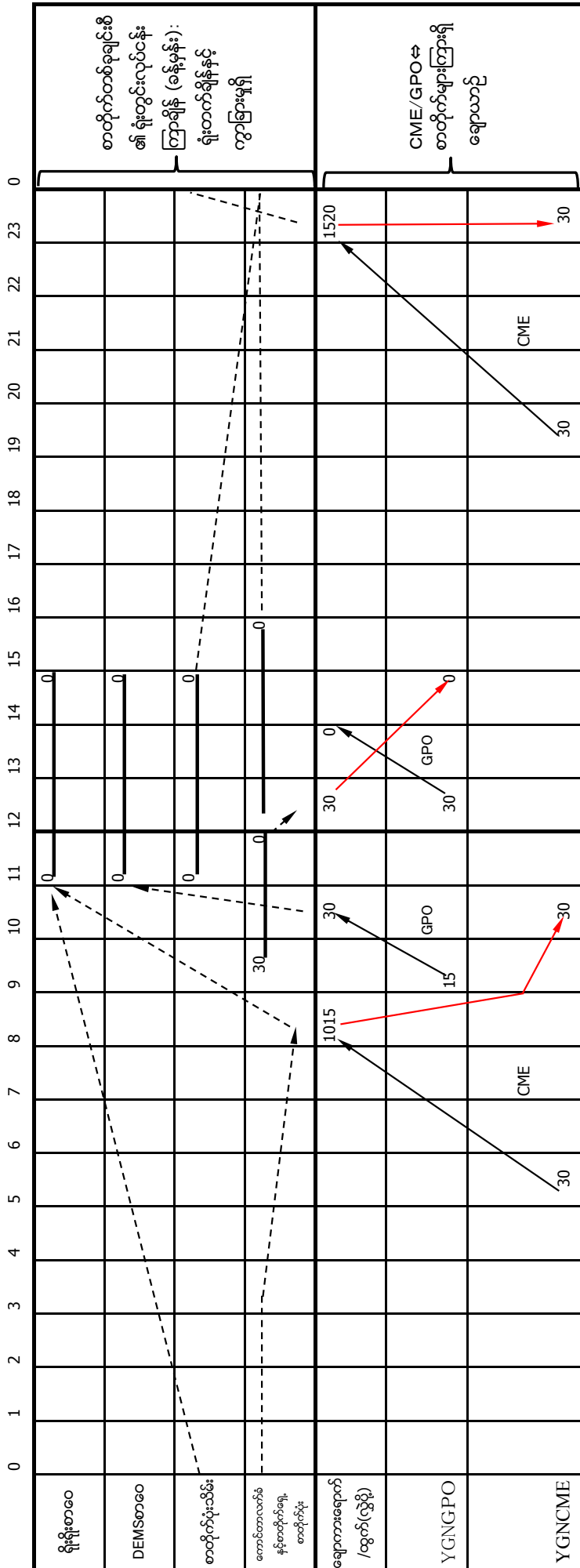

→ ရောက် (ဆိုက်ရောက်)      → ရောက် (လွှဲပို့)      - - - - - Kessoku line (ရောက်နေသောစာတိုက် ရှိတွင်း လုပ်ငန်းဆောင်တာများကို ဆက်သွယ်သောလမ်း)

T06-4

လုပ်ငန်းစဉ်များ၏အချိန်ဇယား

စာတိုက်  
အမည်

ချောကားဆိုက်ရောက်ချိန်	
ချောကားထွက်ချိန်	
စာဝေထွက်ချိန်	
စာပို့လှလင်စာတိုက်ပြန်ရောက်ချိန်	
စာတိုက်ရှေ့ရှိစာတိုက်ပုံးမှစာသိမ်းချိန်	
ချောအိပ်ပိတ်သောအချိန်	
ကောင်တာပိတ်သိမ်းချိန်	

ရောသယံပို့လုပ်ငန်း၏ Monitoring check sheet

စာတိုက်အမည်	
စာတိုက်မျိုးအမည်	
Monitoring period	

[သတိပြုရန်] အကြောင်းအရာအသိပေးရန် လုပ်ဆောင်နိုင်ပါက ✓ ကိုရေပါ။

ချောကားထိုက်ရက်ချိန် :  
ချောကားထွက်ခွာချိန် :

I ရောသယံပို့လုပ်ငန်း

နံပါတ်	အကြောင်းအရာ	Mon	Tue	Wed	Thu	Fri	Sat	Sun	စုစုပေါင်း
	မှတ်ချက်								
1	ချောကားများ သတ်မှတ်ထားသော အချိန်ဇယားတွင် ရောက်ရှိပါသလား								
2	ချောကားများအောက်ဖျားရှိသည့် သစ်ဆေးဆေးရုံများအား အချိန်အကြောင်းအရာ ဝန်ထုပ်ဝန်ပိုးများဖြင့် စစ်ဆေးပြီး ကာယကံရှင်အားစီမံကိန်းပြုပါသလား								
3	Monitoring ကာလတွင် ချောကားတပ်ဖွဲ့၏စီမံခန့်ခွဲမှု ရောက်ရှိပါသလဲ								
4	ပုံသေစွာနံရံကွဲယိုခြင်း ပုံမှန်မဟုတ်သော ချောကားပုံမှန်မှု စစ်ဆေးပါသလား								
5	ပုံသေစွာနံရံကွဲယိုခြင်း ပုံမှန်မဟုတ်သော ချောကားပုံမှန်မှု စစ်ဆေးပါသလား။ သစ်ဆေးဆေးရုံများအား ဝန်ထုပ်ဝန်ပိုးများဖြင့် စစ်ဆေးပြီး ကာယကံရှင်အားစီမံကိန်းပြုပါသလား								
6	ချောကားပုံမှန်မှုစစ်ဆေးရန်အတွက်တွင် မိမိတို့တပ်ဖွဲ့ဝင်များ၏အချိန်မဟုတ်သော စာများချိတ်ဆွဲဆောင်ရွက်ပါသလား								
7	ချောကားပုံမှန်မှုစစ်ဆေးရန်အတွက်တွင် ချောကားပုံမှန်မှုစစ်ဆေးမှုအား အချိန်အတွက် ချောကားအလုပ်အကိုင်များကို ကိုက်ညီပုံမှန်စီမံဆောင်ရွက်ပါသလား								
8	လွှဲပြောင်းချောကားကို sorting ပြုလုပ်၍ ချောကားပုံမှန်မှုစစ်ဆေးပါသလား								
9	သတ်မှတ်ထားသော အချိန်အတွင်း ချောကားပုံမှန်မှုစစ်ဆေးပါသလား								
10	ချောကားသည် သတ်မှတ်ထားသော အချိန်အတွင်း ထွက်ပါသလား								
11	လွှဲပြောင်းချောကား ချောကားပုံမှန်မှုစစ်ဆေးရန် တပ်ဖွဲ့ဝင်များ၏အချိန်စစ်ဆေးမှု								

အထူးအကြောင်းအရာ (သတ်မှတ်ထားသော အချိန်ပြင်ဆင်မှုများဖြင့် အသိပေးရန်လိုအပ်သော အကြောင်းအရာ)

T06-6 ချောသယ်ပို့လုပ်ငန်း၏ Monitoring ကို ကြီးကြပ်သောအဖွဲ့

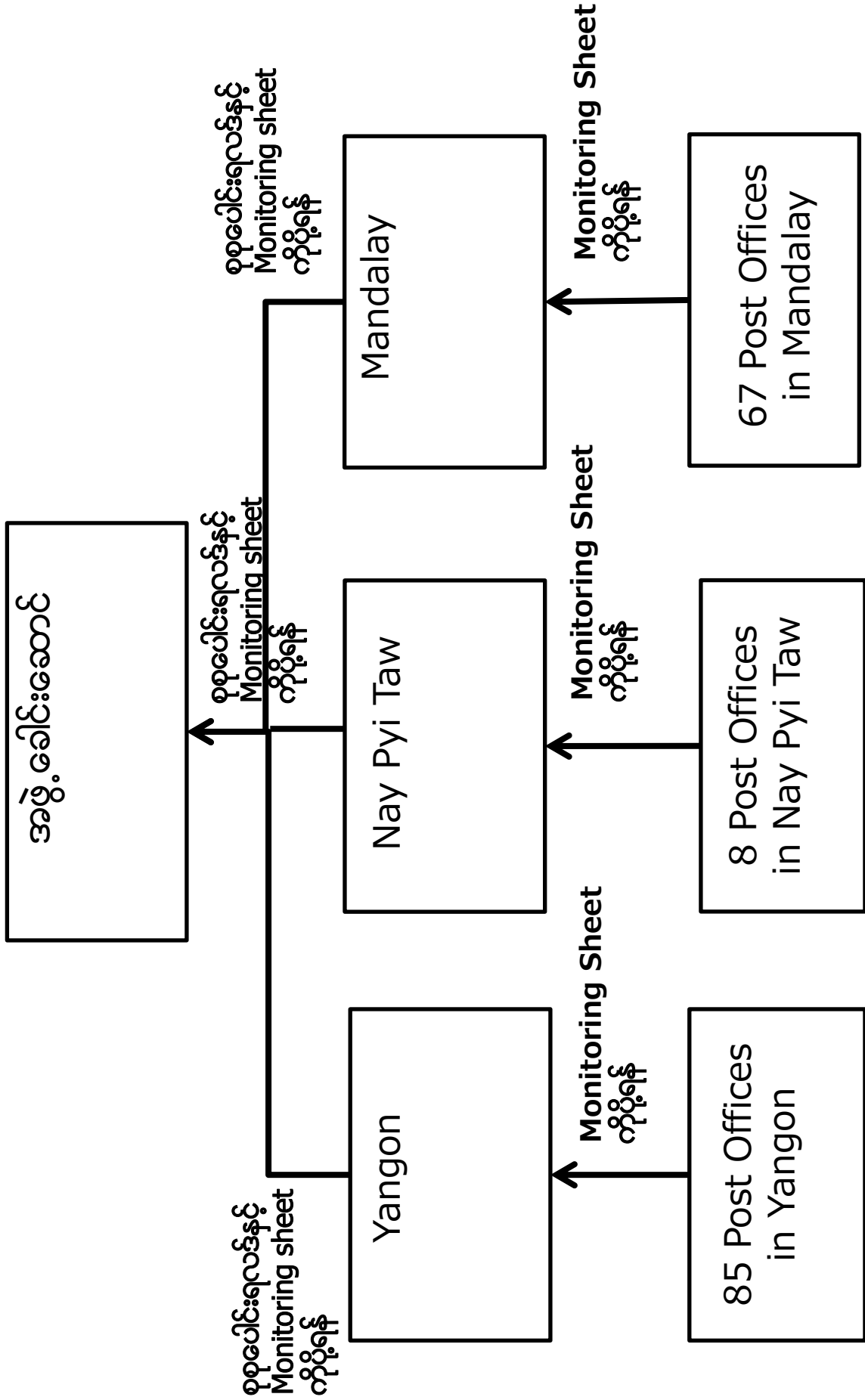

**ချောသယ်ပို့လုပ်ငန်း၏ Monitoring အဖွဲ့၏တာဝန်**

- ✓ စာတိုက်မှူးမှ Monitoring sheet ကိုနေ့စဉ်ဖြည့်စွက်ရန် (တနင်္လာမှ သောကြာအထိ)
- ✓ Monitoring sheet ကို ၂ပတ်လျှင် ၁ရွက်သုံးပါ။

#	Action	အချိန်	161 ရုံးမှ စာတိုက်မှူး	ဒေသအသီးသီးမှ ခေါင်းဆောင်	အဖွဲ့ ခေါင်းဆောင်	JICA Expert
1	Monitoring sheet ကိုနေ့စဉ်ဖြည့်စွက်ရန် (တနင်္လာမှ သောကြာအထိ)	① 3/19-30 ② 4/1-12	✓			
2	Monitoring sheet ကိုဒေသအသီးသီးမှ ခေါင်းဆောင်သို့ပို့ရန်	① 4/2 ② 4/13	✓			
3	Monitoring sheet ကိုတွက်ချက်အဖြေထုတ်ရန်	① -4/11 ② -4/26		✓		
4	Monitoring sheet နှင့်ရလဒ်အဖြေကို အဖွဲ့ ခေါင်းဆောင်သို့ပို့ရန်	① 4/12 ② 4/27		✓		
5	ရလဒ်အဖြေကိုစစ်ဆေးရန်နှင့် နောင်ဆောင်ရွက် (ဖြေရှင်း)ရမည့်ကိစ္စကို ဖော်ထုတ်ရန်	မေလ လဆန်း		✓	✓	✓
6	MP အထက်အရာရှိသို့ တင်ပြရန်	မေလ လကုန်			✓	✓
7	စာတိုက်များသို့ညွှန်ကြားရန်	ဇွန်လ		✓	✓	✓

[ရိုးခန်းတွင်ကပ်ထားရန်]

မီးရှုထား၊ ဘတ်စ်ကားနှင့် လေကြောင်းလှိုင်းများနောက်ကျခြင်းနှင့် ချောကားပျက်ခြင်း၊  
လမ်းပိတ်ခြင်းစသည့် ကြုံတင်မခန့်မှန်းနိုင်သော ကိစ္စများကြောင့် သူတို့ထူးထူးသော ချောကားသို့  
တင်(လွှဲ)ပို့မည့်ချောကား၏ ကန့်ကျားမှုကိုဖြစ်စေခံမည့်အလျှင် ဆိုက်ရောက်မည့်ချောကား မိနစ်  
၃၀ထက် နောက်ကျမည့်ဟု ခန့်မှန်းသိရှိနိုင်ခဲ့ပါက နောက်ကျနေသောကားကိုမစောင့်ဘဲ  
လွှဲပို့မည့်ချောကား တင်ဆောင်ထားသောချောကားကို ထွက်ခွင့်ပါ။

※ လွှဲပို့ရမည့်အချိန်လုံလောက်မှုရှိပါက ဆိုက်ရောက်မည့်ချောကားမိနစ်၃၀ထက် နောက်ကျသော်လည်း  
လွှဲပို့ရန်ပြဿနာမရှိပါက(အချိန်မှပါက) ၎င်းချောကားကိုတင်ဆောင်နိုင်ရန်ဆောင်ရွက်ပေးပါ။

