

**Republic of Uzbekistan  
Ministry of Investments and Foreign Trade,  
Uzbekistan Japan Center**

**Project for Capacity Development of  
Business Persons and Networking  
through Uzbekistan-Japan Center for  
Human Resource Development  
in the Republic of Uzbekistan**

**Final Report  
(Appendix – Volume 2)**

**March 2019**

**JAPAN INTERNATIONAL COOPERATION AGENCY**

**PADECO Co., Ltd.**

IL
JR
19-012

**Appendix 2**

**Technical Cooperation Materials**  
**(Cont.)**

Specialized Course (SC)  
(Owners and Managers)

2018

Strategic Marketing Planning Process

# マーケティング戦略立案プロセス

2016年2月  
株式会社戦略コンサルティング・ファーム  
代表取締役社長 藤田 忍



0

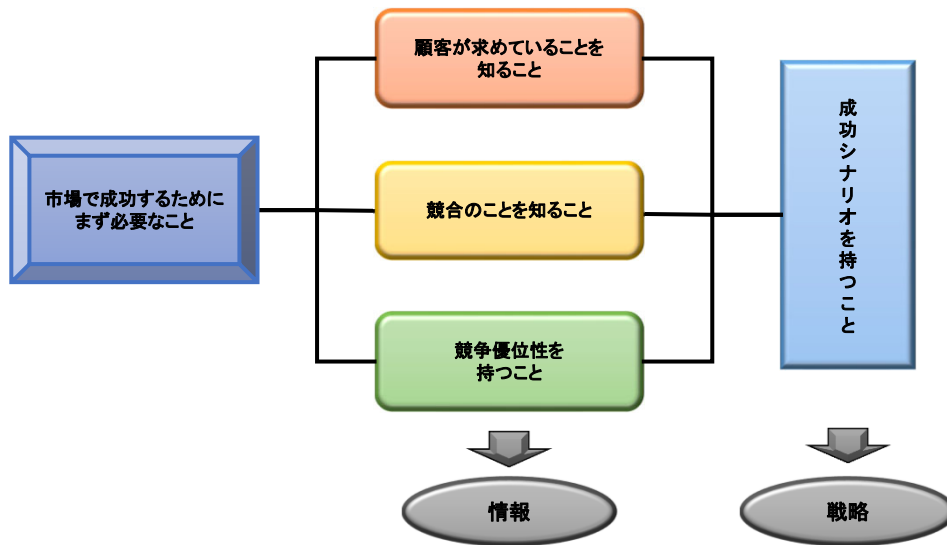

1

— マーケティングを論理的に展開すると成功シナリオになる —

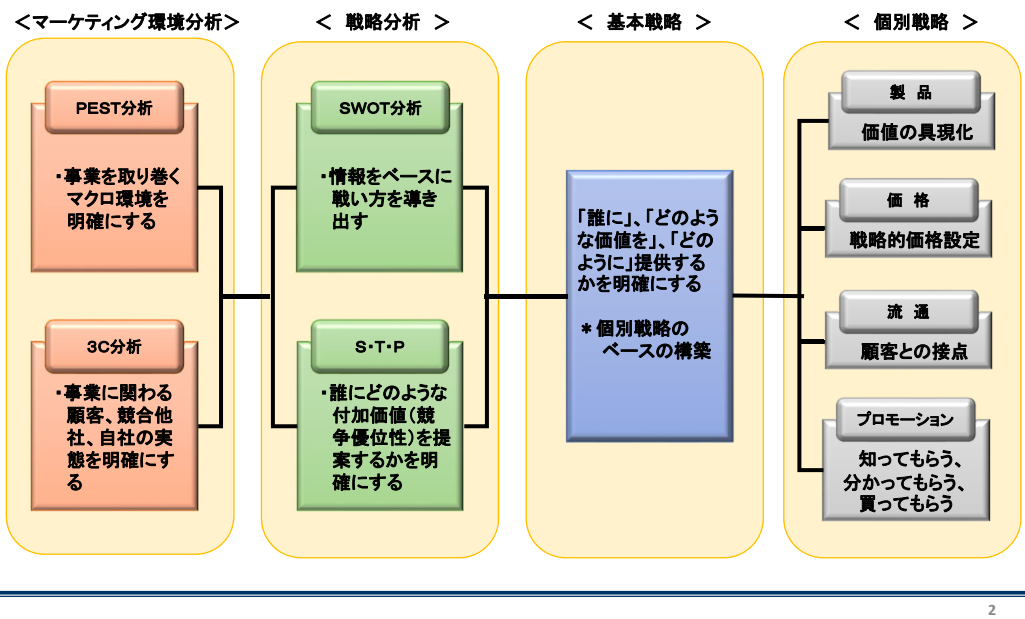

< 敵を知り、己を知らば百戦危うからず(孫子) >

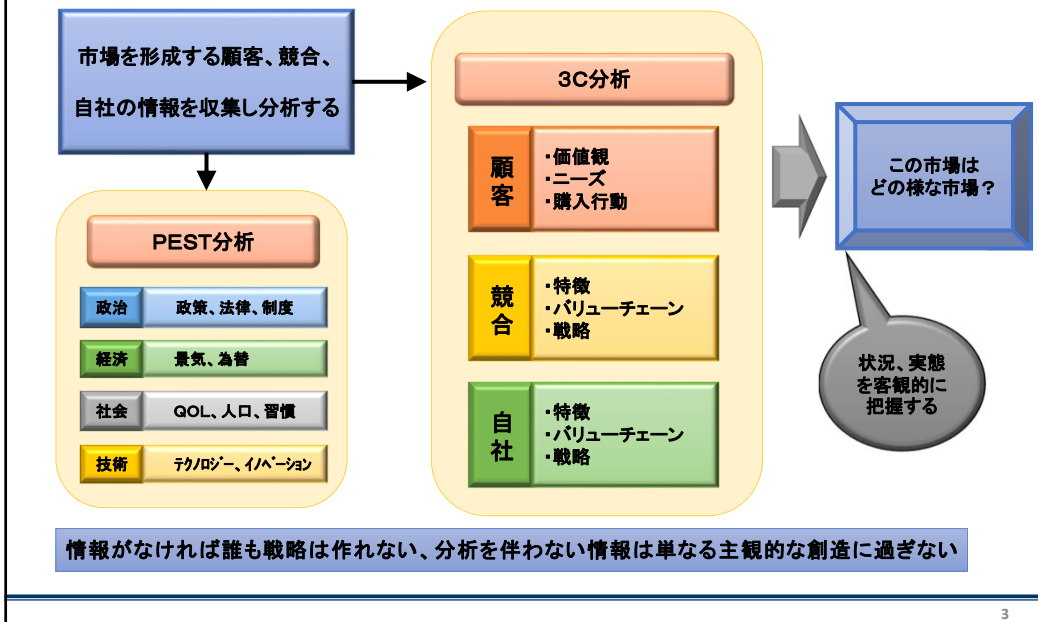

### < 成功のための市場競争のポイント探し >

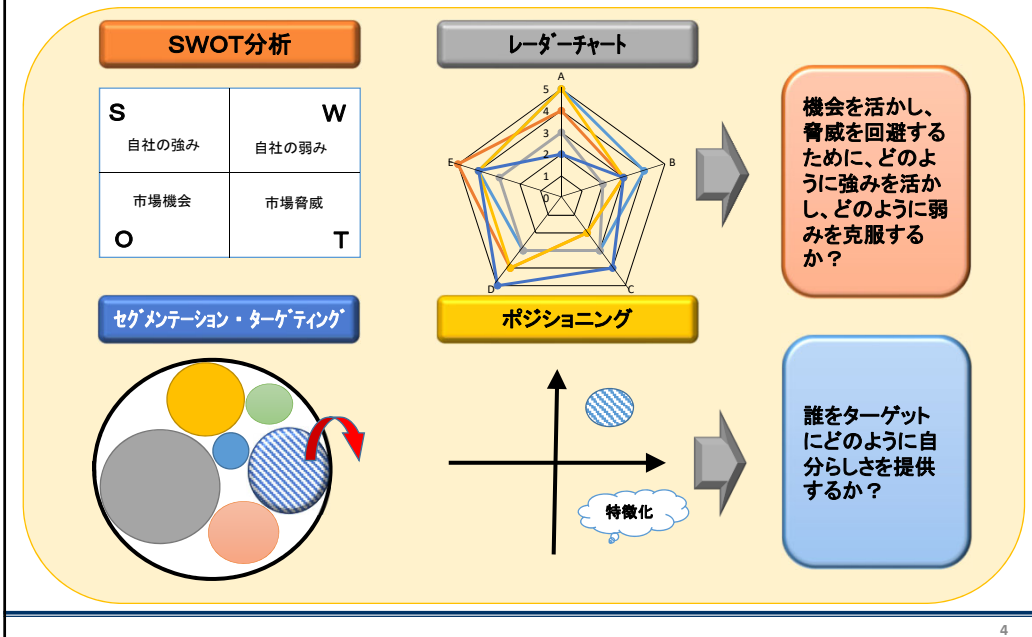

### < 基本戦略の方向性 >

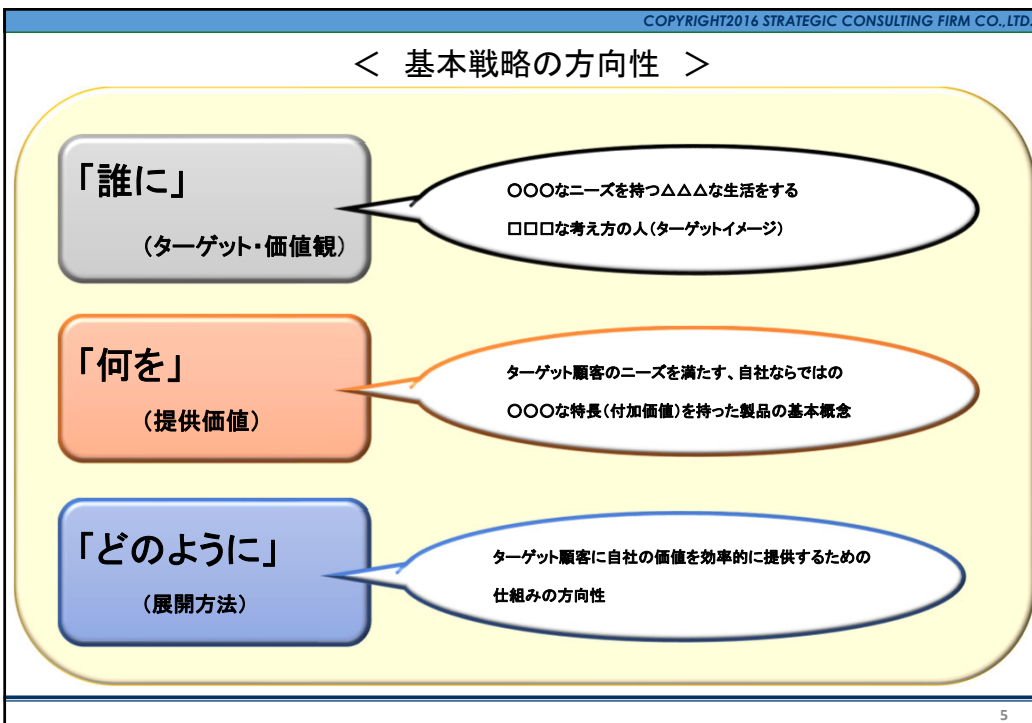

### < 具体的な戦略展開 >

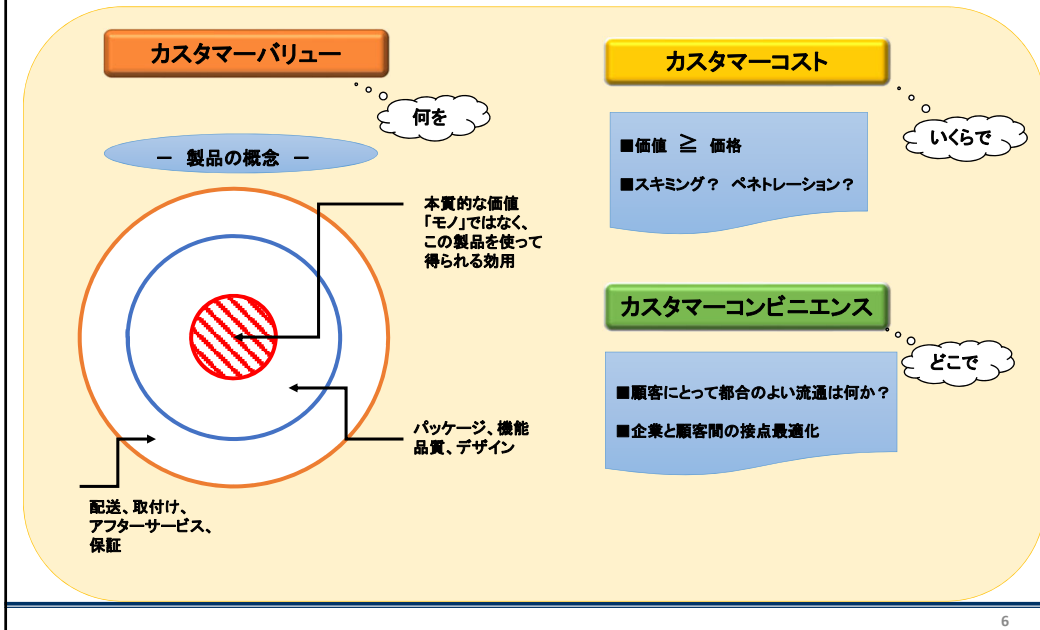

### < 具体的な戦略展開 >

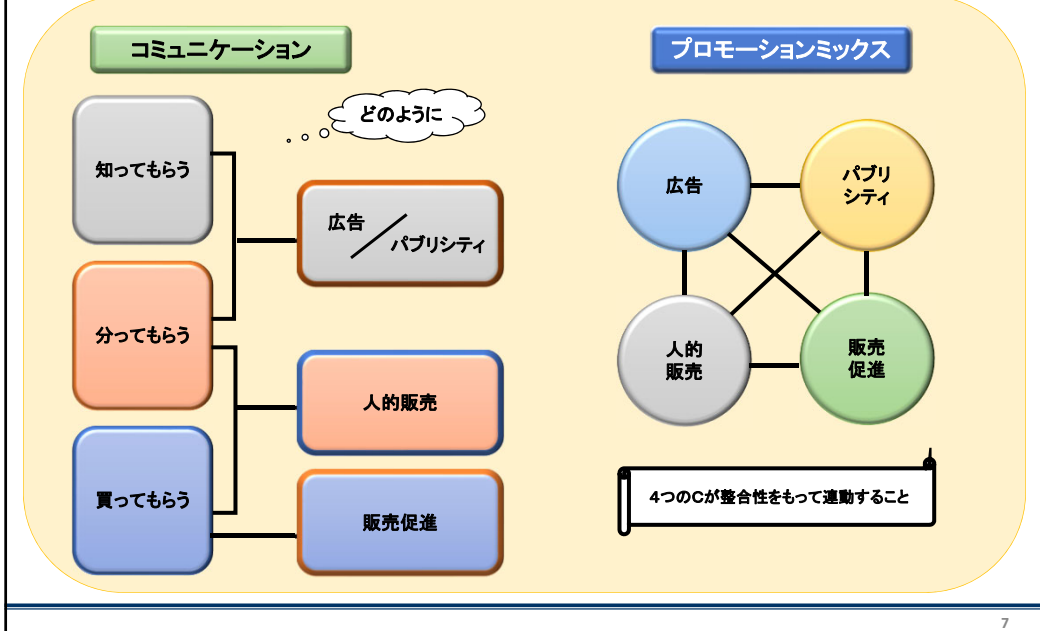

### < 戦略シナリオを作ることが成功の秘訣 >

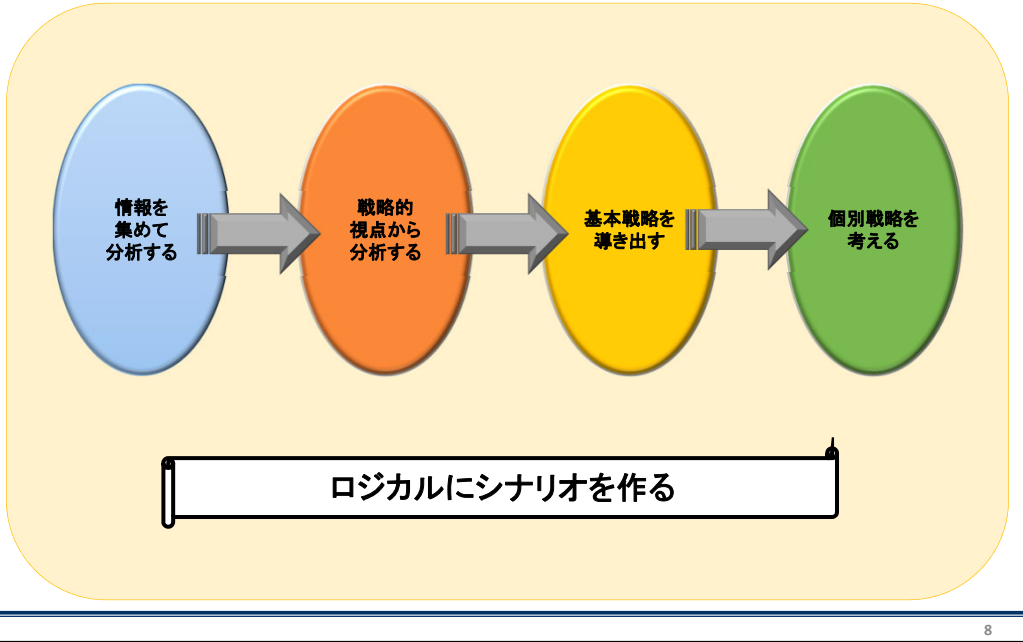

### < Outline of Marketing Strategy >

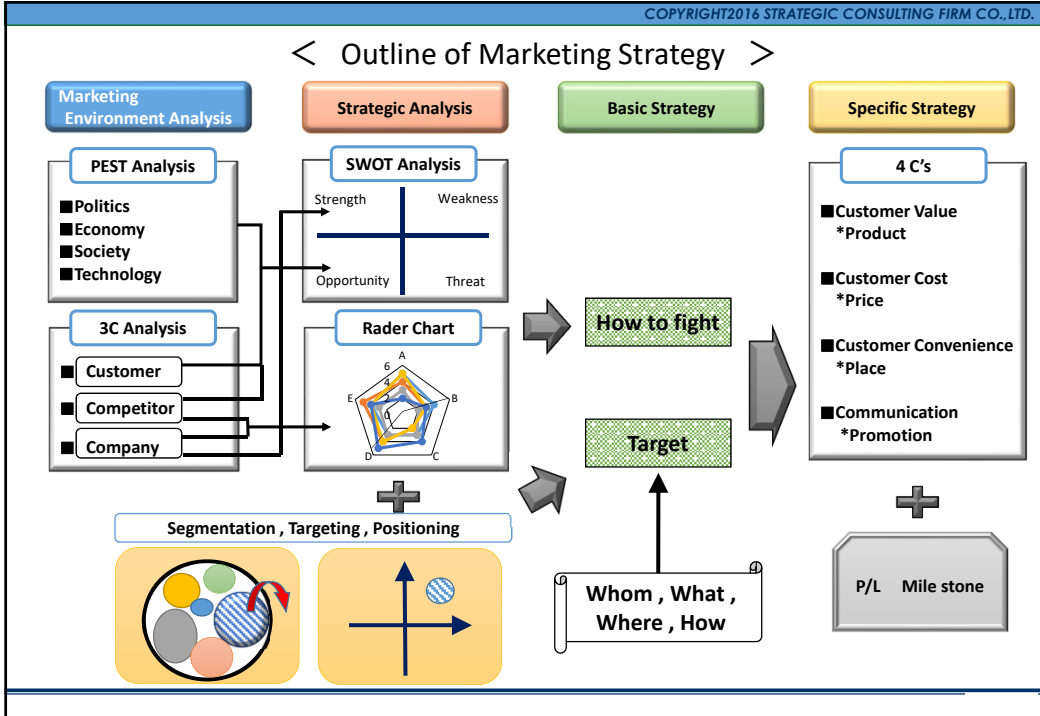



# マーケティング戦略の実践的立案手法

2017年6月

株式会社戦略コンサルティング・ファーム

代表取締役社長 藤田 忍



0

## I. 基本的考え方

### 1. マーケティング基本戦略の構成要素

■マーケティングの究極の目的は、顧客満足最大化にある。顧客の価値観に基づくニーズを満足させることが出来るソリューションを提供できれば顧客はその製品やサービスを必ず支持するであろう。

■では、どのように顧客が満足する最適ソリューションを開発すれば良いのだろうか？前段に示した通り「顧客の価値観とニーズ」を知ることが最重要ポイントとなるが、顧客は顧客の種類によって多種多様な価値観やニーズを持っていることから、全ての顧客の満足度を高めることは現実的でなく、ある程度絞る込む必要がある。従って、自社が対象とする「顧客はどのような人か」を設定することから全ては始まる。

■対象顧客が決まれば、その顧客が「何を求めているのか(価値観、ニーズ)」を分析し、把握する。こうすることで「誰に」「何を」提供すべきかが明確化し易くなる。

■もう一つ忘れてはならないことがある。通常、市場には必ず競争が存在するが、競争に勝つために「自社ならではの競争優位性」つまり、武器が必要となる。これが「特長化」である。

■これらの「対象顧客」「顧客価値観、ニーズ」「特長化」が明確化できればマーケティングの個別戦略構築が容易となり、市場競争に勝つ確率は一気に高まる。

### < マーケティング基本戦略における必須要件 >

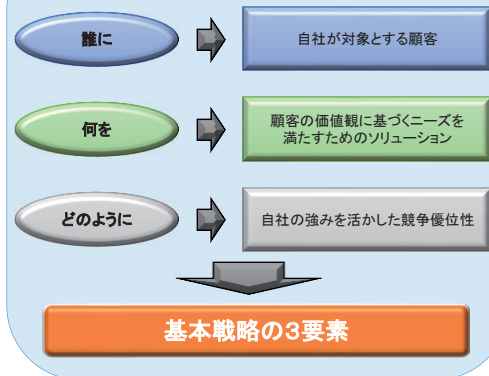

1

1

## Ⅱ. 基本的なマーケティング戦略立案手法

< マーケティング戦略の立案ステップ >

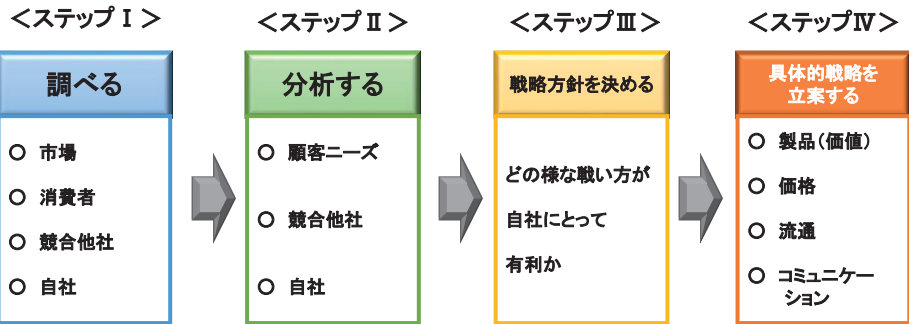

< 市場環境を把握・分析し、勝つための戦略を導き出すプロセス >  
これがマーケティングプロセス

## Ⅱ. 基本的なマーケティング戦略立案手法

< マーケティング戦略立案プロセス = 顧客価値開発プロセス >

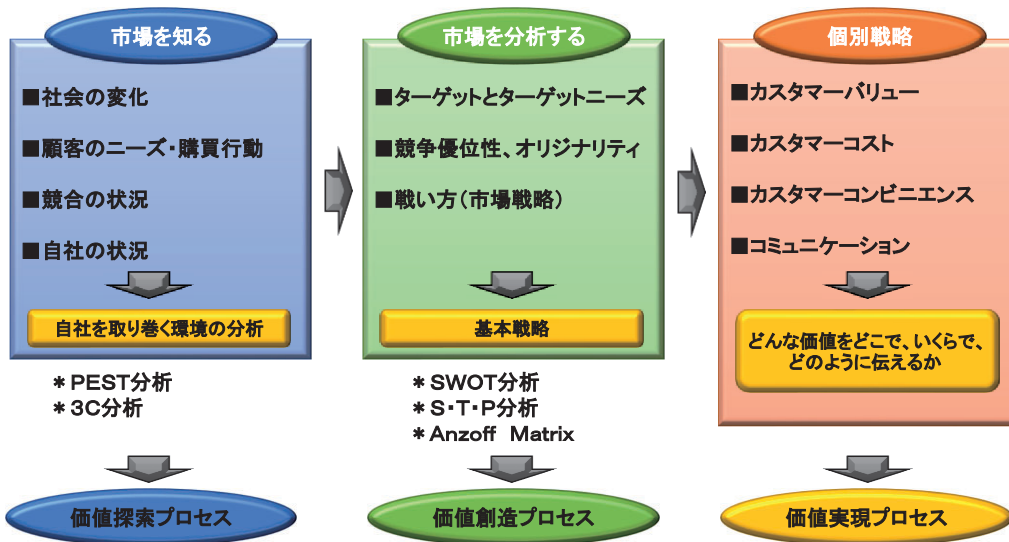

### Ⅲ. 簡易的なマーケティング戦略立案手法

#### 1. 問題、課題対応型

■売上低迷などマーケティング上の問題点が発生した場合には、マーケティング戦略の修正や見直しを基本的な立案プロセス手法に基づいて行うのが一般的である。

■しかしながら、継続して事業展開している場合において、「売上低迷」「顧客数減少」「クレーム増」など具体的な問題が顕在化した時に早期に問題点を明確にして対応方法を確立しなければならぬことがある。その時に使われるのが「WHYツリー」と「HOWツリー」である。

##### (1) WHYツリー

●売上が低迷した時戦略的に「値引き」や「宣伝」で対応する考え方があがるが、QOLが向上している市場或いは、マーケットインの市場においては多くが通用しない。何故ならば、売上低迷要因は、品質や機能はもとより、イメージ、デザイン、利便性、サービス、販売形態、応対、アフターサービス、価格、伝え方など様々な顧客価値の欠落によって形成されており、決して一つ二つの要因に起因するわけではないからである。

●従って、対応を考える場合、どのような問題が潜んでいるのかをまずは顧客の視点から考えられる全ての項目にわたって洗い出す方法（「何故WHY」を繰り返す）で、現象的な問題点を終局的な問題点として顕在化させることが重要である。その終局的な問題点を関連性を考慮してまとめたものが問題の本質となる。（次頁図参照）

●これが「WHYツリー」と呼ばれるもので、数回「WHY」を繰り返すことで、ひとつの事象から論理的に問題の本質を導き出すことが出来るのである。

##### (2) HOWツリー

●ソリューションを見つけ出すためには、まず、課題設定が必要となる。WHYツリーによって導き出された問題の本質への対応が自動的に対応すべき本質的課題となる。

●顧客の本質的課題を「どのように(HOW)」を繰り返すことで、より具体的な対応へと導くことが可能となる。こうして導き出された具体的な対応が問題を解決するためのソリューションになるのである。

●これが「HOWツリー」と呼ばれるもので、「HOW」の繰り返しによって、論理的且つ実態に即したソリューションに辿り着くことが出来る。（次頁図参照）

### Ⅲ. 簡易的なマーケティング戦略立案手法

#### < WHYツリー、HOWツリーの構造 >

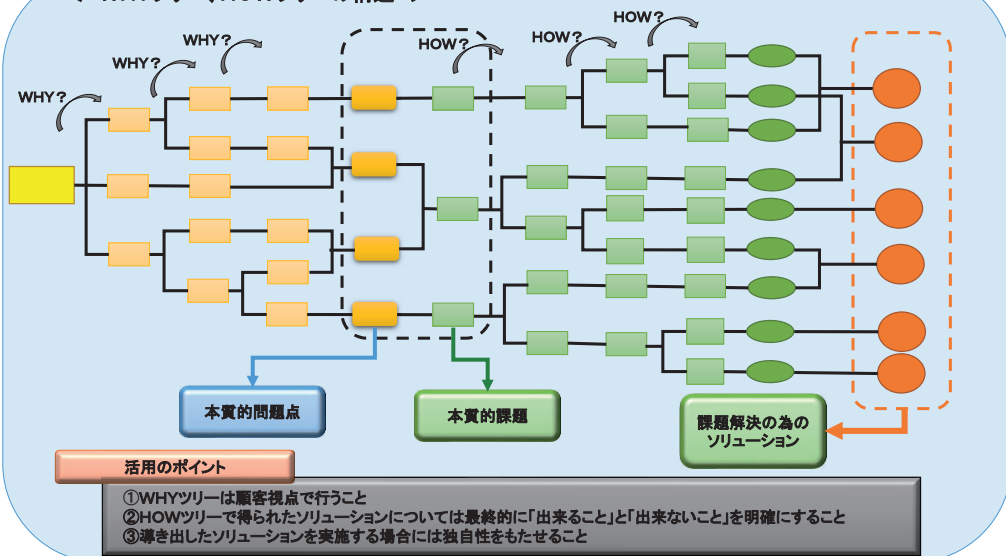

### Ⅲ. 簡易的なマーケティング戦略立案手法

#### 2. 競合対策型

■業績が低迷している局面では競合の存在に起因するケースが多いことから、競合する企業との差別化や競合する企業戦略の陳腐化を図ることが、自社活性化の有効な手段となる。

■競合企業への対応を検討するためには「競合企業の弱みを突く」、「競合企業の強みを弱体化させる」、「競合企業を上回る強みを作る」などの視点を持つことが必要となるが、そのためには以下の方法が考えられる。

■なお、以下に示すいくつかの分析手法を組み合わせることで、より有効な戦略立案が可能となる。

##### (1)レーダーチャート分析

●自社と競合他社について、業界の「KEY FACTOR FOR SUCCESS(その業界、市場で成功するための要素)」や「事業構成要素」などの要素を軸としたレーダーチャートを作成し比較する。

●両者の比較により、自社の強み、弱み、競合他社の強み、弱みが明確になることから、分析結果が競争に勝つための対応を検討する際の指針となり、戦略立案し易くなる。

●但し、この分析から導き出されるのは、あくまでも戦略レベルの方向性であるため、具体的対応(戦術)については別途検討しなければならない。

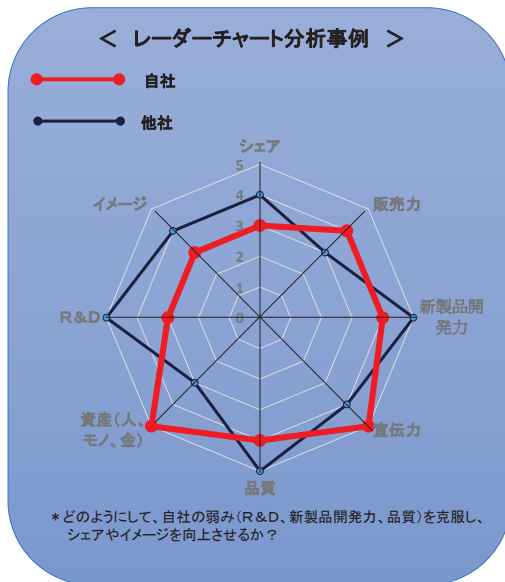

### Ⅲ. 簡易的なマーケティング戦略立案手法

#### (2)SWOT分析

●業績低迷企業の場合、多くは市場で勝つためのマーケティング戦略がない、或いは戦略が脆弱である場合が多い。このような状況においては自社の基本戦略構築時に用いられる「SWOT分析」を用いることが望ましい。

●「SWOT分析」は自社の強み(S)、弱み(W)と市場機会(O)、脅威(T)の4つの要素から「市場状況にどのように対応すれば良いか」を導き出す手法である。

●S、W、O、Tをマトリックス形式で作表し、それぞれを組み合わせることで以下の戦略を構築する。

- ・S×O : 強みで市場機会にどう対応するか (積極戦略)
- ・S×T : 強みでどのように市場脅威に対応するか (差別化戦略)
- ・W×O : 市場機会を活かすためにどのように弱みを克服するか (弱点克服戦略)
- ・W×T : 弱みと市場脅威が重なった時どう対応するか (防衛戦略)

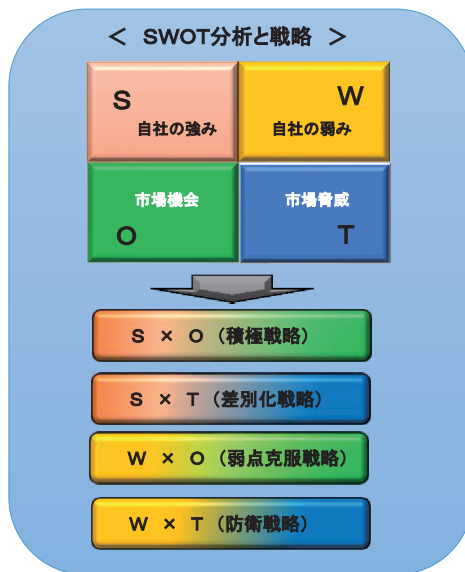

### Ⅲ. 簡易的なマーケティング戦略立案手法

(3) ポジショニング分析

- ポジショニングは、顧客ニーズに基づいて独自の競争優位性を構築し、競合他社との差別化を図ることである。つまり、他社が気が付いていない新たな顧客ニーズを見つけ出し、新しい価値観を確立して新たな市場を創造することに他ならない。
- 思い起こしてほしい。例えば家具を購入する時、購買ポイントは何か？ サイズ、デザイン、カラー、使用感、素材、アフターサービス、品揃え、保証、機能性、配送、新奇性、販売対応などターゲットにより多種多様である。また、品質は当然ながら必須であるが「価格は価値に見合っている」と言うまでもない。
- どのような製品でも顧客が「こだわり」を持って製品を選ぶ時、必ず顧客のニーズが潜在的に働いている。ということは、自社がターゲットとする顧客のニーズに合わせた提案が出来れば良いのである。
- ポジショニングの分析には2つの顧客ニーズ軸を用いる。これを2軸の座標軸で表示し、他社と比較し、自社だけが優位性を示すパターンを見つけ出すことで自社のポジショニングは確立できる。

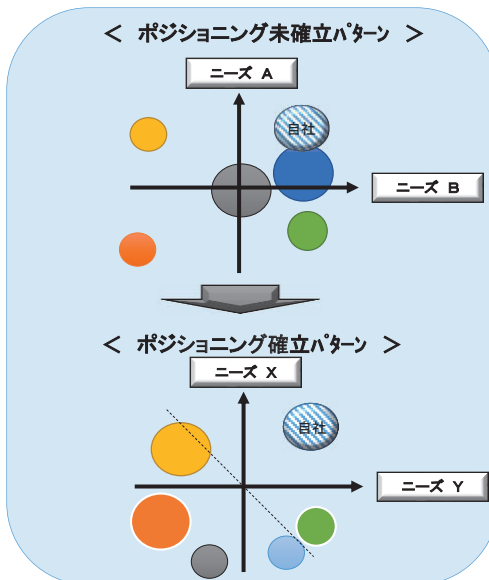

### Ⅳ. 各種手法の比較

■ マーケティング戦略には、その目的や事業状況や立案背景によって様々な種類や手法がある。従って、目的やその時点の状況に応じて最も効果的方法を選ばなければならない。

■ いずれにしても、売上低迷への対応は「宣伝や値引」が全てではないことを知る。その上で「顧客が自社を選ばない」理由をしっかりと把握し、「どうすれば自社製品を指名してもらえるか？」を顧客の立場（ニーズ）に立脚して対応することを肝に命じるべきである。

	ソリューションの内容	メリット	デメリット	コスト、時間	活用のタイミング
基本的なマーケティング戦略立案手法	<ul style="list-style-type: none"> <li>■ 全体を網羅したマーケティング戦略（市場環境、戦略分析、基本戦略、個別戦略）</li> <li>■ 市場実態に適合した内容</li> <li>■ 事業規模など自社の戦略方向と全ての具体的な対応</li> </ul>	<ul style="list-style-type: none"> <li>■ 市場（マクロ環境、自社、競合、消費者）が詳細に渡り把握できる</li> <li>■ 勝つための戦略が完全に網羅されている</li> </ul>	<ul style="list-style-type: none"> <li>■ 策定に時間とコストがかかる</li> <li>■ 場合によっては外部専門家が必要</li> <li>■ 大掛かりで全社対応となる</li> </ul>	<ul style="list-style-type: none"> <li>■ 3～5ヶ月の日数が必要</li> <li>■ 調査等に費用が必要</li> <li>■ 全社的な対応が必要</li> </ul>	<ul style="list-style-type: none"> <li>■ 新事業立上げ時</li> <li>■ 現行マーケティング戦略の抜本見直し時</li> <li>■ 市場構造の急変時</li> <li>■ 中期計画策定時</li> <li>■ 新製品開発時</li> </ul>
簡易的な戦略立案手法	<ul style="list-style-type: none"> <li>■ 問題、課題対応型</li> <li>* WHYツリー</li> <li>* HOWツリー</li> <li>■ 現在抱えている問題に対する解決策</li> <li>■ 問題の本質、解決すべき課題と具体的な対応方向</li> </ul>	<ul style="list-style-type: none"> <li>■ 自社の改善、補強すべきテーマと対応方向が分る</li> <li>■ 早期対応可能</li> <li>■ 関連する部署で対応可能</li> </ul>	<ul style="list-style-type: none"> <li>■ 競争の視点が弱い</li> <li>■ 抜本的な対応になりづらい</li> <li>■ 他分析必要</li> <li>■ 個別戦略が別途必要</li> </ul>	<ul style="list-style-type: none"> <li>■ 1～2ヶ月の日数が必要</li> <li>■ 少人数で或いは特定の部門で対応可能</li> <li>■ 費用がかからない</li> </ul>	<ul style="list-style-type: none"> <li>■ 市場競争激化時</li> <li>■ 強い競合の出現時</li> <li>■ 売上漸減時</li> <li>■ 緊急対応時</li> <li>■ 短期的売上成長鈍化時</li> </ul>
競合対応型	<ul style="list-style-type: none"> <li>■ 競合他社との比較と対応策（リーダーチャート）</li> <li>■ マーケティング基本戦略の方向性（SWOT分析）</li> <li>■ 特長化（ポジショニング）</li> </ul>	<ul style="list-style-type: none"> <li>■ 競争状況と競合への対応が分る</li> <li>■ 早期対応可能</li> <li>■ 凡その基本戦略立案可</li> <li>■ ポイント修正</li> </ul>	<ul style="list-style-type: none"> <li>■ 顧客の視点が弱い</li> <li>■ 抜本的な対応になりづらい</li> <li>■ 他分析必要</li> <li>■ 個別戦略が別途必要</li> </ul>		

Specialized Course (SC)  
(Owners and Managers)

2018

Advanced Kaizen



## **Advanced KAIZEN course (KAIZEN Management)**

---

**April 30 to May 3, 2018**

**Uzbekistan Japan Center  
JICA**

1



### **Vision and Mission of This Course**

---

#### **Vision**

**All participants become familiar with KAIZEN concept and methodologies, and apply them to their day to day operations in both factory shop floor and office in order to achieve business growth.**

#### **Mission**

**Identify the problems or challenges in the operation and come up with ideas for KAIZEN and apply them through team work approach.**

---

2



## Introduction of Lecturer

**Name** : Mitsuo Tamada, JICA Expert ,EBRD Senior Industrial Advisor

Email address: [mitsuo.tamada@truspire.com](mailto:mitsuo.tamada@truspire.com)

**Company** : Truspire Co., Ltd. ([www.truspire.com](http://www.truspire.com))

**Experience** : (1) 30 years Japanese textile company  
International Business, Marketing & Administration  
(2) 3 years in Textile/garment factory in Africa  
(3) 12 years consulting in Kaizen, Production/Operation,  
Sales Management, Marketing in various countries.



3



## Schedule/Table of Contents

Day	Session	Topics	Slide No.
1	1	- Introduction of KAIZEN (Continuous Improvement)	5
	2	- KAIZEN Case study	22
2	3	- Total Quality Management (TQM)	39
	4	- TQM Company-wide approach	50
3	5	- Quality Control (QC)	59
	6	- Quality Control (QC) Circle	72
4	7	- Shop Floor Improvement (IE), Visualization	100
	8	- 5S and 7 Wastes	134
5	9	- KAIZEN Master Plan	177
	10	- Rules of KAIZEN	182

4





## Introduction of KAIZEN (Continuous improvement)

---

5



## KAIZEN

---

KAIZEN is derived from the word "KAI" which means to "improve" and "ZEN" means to "make it better".

Kaizen is synonymous with "Continuous Improvement".

Kaizen is written in Japanese letters as below

改(KAI) 善(ZEN)

6



## Points in Kaizen

- **Bottom up, and Top down approach**
- **Management Acceptance/Commitment**
  - Implement any idea.
  
- **Tools/Methods are necessary to find improvement opportunities.**
  - **ECRS (Industrial Engineering: IE)**
    - Motion Economy, Time Study
  - **7 Tools in QC Circle Activities**
  - **5S**
  - **Elimination of 7 Wastes (One of TPS principles)**
  - **TPS (Toyota Production System) Principles**
- **Tools are from Production/Quality Management.**

7



## KAIZEN Organization in a Heavy Industry

- **KAIZEN Committee (5-6 people) in each section**
  - Evaluate proposals; Platinum, Gold, Silver, Bronze (Incentives)
    - Cost reduction,
    - Better safety,
    - Better working environments, etc.
  - Implement them and review periodically
  - Budget preparation
  - Publication
- **Proposals from all workers (Engineers, Staff, Workers)**
  - Group/Individual
  - Problem, How to improve, How much...
  - Current situation/Future situation (Before/After)
  - To suggestion box or Committee directly

8



## PDCA Kaizen

Kaizen is being implemented through PDCA cycle.

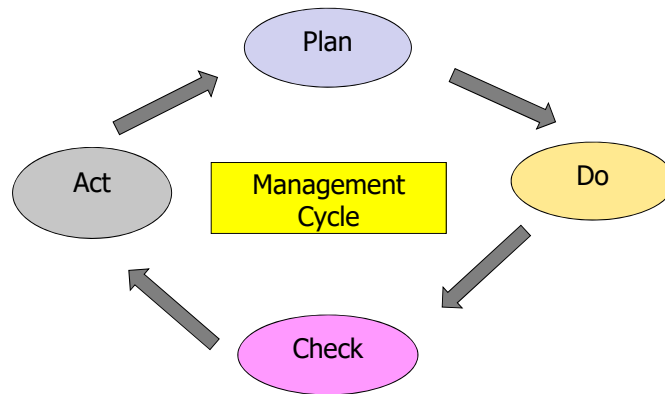

9



## SDCA cycle

S: Standardize, D: Do, C:Check, A:Action

- Problems: Production of defective goods, customers' complaints, etc.
- Management to find out root causes of such problems.
- Management to adjust procedures to rectify these problems.

10

10



## SDCA cycle

- SDCA cycle to standardize work procedures to avoid problems.
- PDCA cycle to raise standard level for further efficiency.

'Action' stage in both cycles is to aim to standardize and stabilize work procedures.

11

11



## SDCA and PDCA cycles

- Relation of SDCA and PDCA cycle

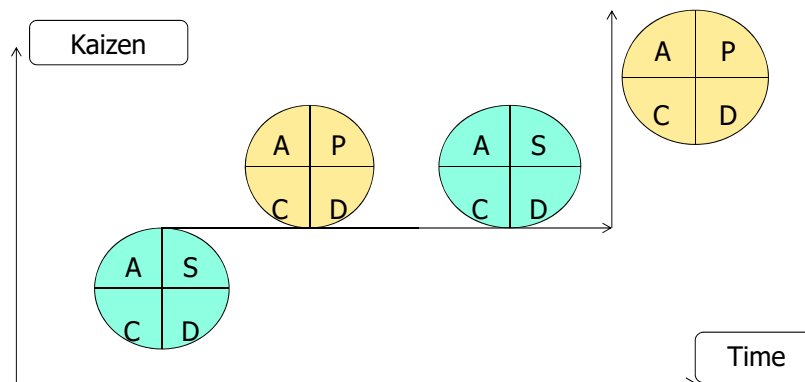

12

12



## Kaizen by PDCA

### 1. Plan - to identify and analyze the problem

The first step in the PDCA Kaizen event is to choose an area that offers the most return for the effort and will be the biggest bang for your buck – that “**Low-Hanging**” fruit.

Tools to be used :-

- Flow Chart ( or Process Map)
- Brainstorming
- **Fishbone analysis (cause and effect diagram)**
- Customer Survey
- Quarterly Reports etc.
- **5 Why analysis**

13

13



## Kaizen by PDCA

The following questions may also stimulate idea about the problems identified.

1. Is **TAKT** time ( i.e. customer demands and net available time ) known and understood?
2. Are the processes or process standardized so the process output is predictable?
3. Are the processes or process standardized to best practice ? And if so, is there a systematic process for improvement?
4. Are the processes or process simplified for easy cross-training or visual communications?

14

14



## Kaizen by PDCA

---

5. Is there a capacity issue with the process?
6. Is there a process throughput issue?
7. Will people, material,, and/or data flow more continuously ( i.e. without the waste of excess delays, motion, etc.)?
8. Can people, material, and/or access to data be located in a more efficient location?

15

15



## Kaizen by PDCA

---

### 2. Do – develop and implement a solution

Implement the change you decided on is the 'Plan' phase. Communicate to everyone affected by the change what is happening.

Tools to be used :-

- Countermeasure Kaizen Log
- Failure prevention analysis (Mistake proofing)
- Training plan
- Gantt chart

16

16



## Kaizen by PDCA

The following questions may also stimulate ideas about further developing a solution and/or implementing a trial.

1. Are the temporary resources available to ensure the customer ( i.e. client, patient, etc.) is not affected by the trial, similar to a doctor's credo of 'Do not harm' ?
2. Are standard methods being used and documented to ensure uniformity in the overall improvement project ?
3. Are the adequate visual controls to identify problems if they are still occurring ?
4. Is data being collected at the process level that is related directly to the improvement ( and made visible, if appropriate ) ?

17

17



## PDCA Kaizen

3. Check – to evaluate the results  
( What was learned and/or what went wrong? )

Once you have implemented the change for a short time, you must determine how well it is working.



Is it really improvement you had hoped ?

Monitoring to gauge the level of improvement

- Impact maps
- Run charts

18

18



## Kaizen by PDCA

The following questions may also stimulate ideas about what went well and what needs to improve ?

1. Did the visual controls work ? (Visualization: to share information among members)
2. Did the standard work procedures get documented to the appropriate level?
3. Has the data supported the improvement(s) ?

19

19



## Kaizen by PDCA

4. Act – to adopt and/or update the necessary standards, abandon the process change, or run through the cycle again.

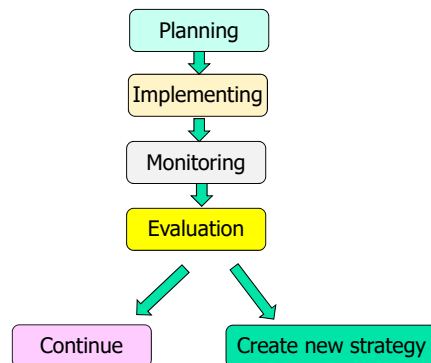

20

20





## **Kaizen by PDCA**

---

The following questions may also stimulate ideas about what more needs to be done.

1. Have Standard Work procedures been created for improved process ? Are they visual, easy-to-use?
2. Has a timeline been created to roll-out the improvements to other areas or departments (if appropriate)?
3. Is everyone being trained to the new process ?
4. Is data being collected and analyzed (i.e. control charts, etc.) with the improvements over a 7 – 30 – 60 days window to ensure the PDCA Kaizen Event improvements are sustained?

21

21



## **KAIZEN (Case study)**

---

22

22

## KAIZEN (Case study)

### Use of Air Balancer (Improvement of efficiency)



1. Process: Weighing liquid
2. 20kg can was handled by hands before. Air balancer helps bring up the can and pour liquid to weigh now. Woman handles the operation now.

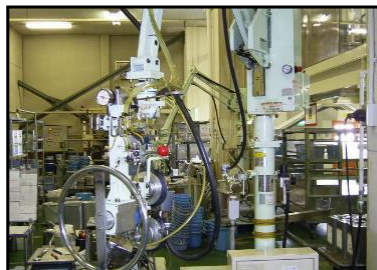

23

## KAIZEN (Case study)

### Air Balancer Sucker with Spike (To keep safety)

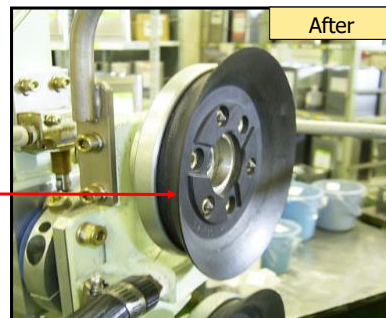

1. Process: Weighing liquid (Air Balancer)
2. With spikes in Sucker, accidents of dropping the can has been prevented.

24

24

## KAIZEN (Case study)

### Place of Container Cart (Improve efficiency)



1. Process: Weighing of raw materials
2. Big sign board to show which production tank uses the raw material is put up the container cart in order to eliminate mistakes.

25

25

## KAIZEN (Case study)

### Dissolution Tank Lid (Improve safety)



1. Process: Heat dissolution of raw materials
2. The lid of the tank is 80°C. When it is opened handle of the lid is used with help of balancer to reduce the heavy weight of the lid.

26

26

## KAIZEN (Case study)

Bar code checker (Improve efficiency and prevent contamination)



- 1.Process: Bulk transport out
2. Barcode label is put on the movable tank to filling process and checked by barcode reader before handling.

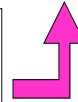

27

27

## KAIZEN (Case study)

Pipe integration (Improve efficiency)



- 1 Process: Transporting Lotion Bulk (Liquid)
- 2 Many pipes are integrated in one place and selection and set-up of which tank for which filling line is handled efficiently.



28

28



## KAIZEN (Case study)

Sign Board of Product (Improve efficiency)



1. Process: Forming and packaging
2. To reduce the careless mistakes color of current product producing and specification of the product is visually shown on many sign boards.

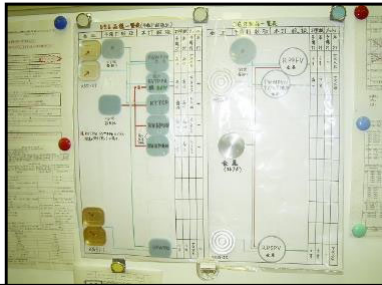

29

29

## KAIZEN (Case study)

(Hook for Hose to wash filling machine and parts (Improve sanitary conditions))



1. Process: Filling
2. Hose to wash filling machine and parts were on the shop floor ground. The hook to hang the hose in order to keep the edge of the hose from the ground was set.

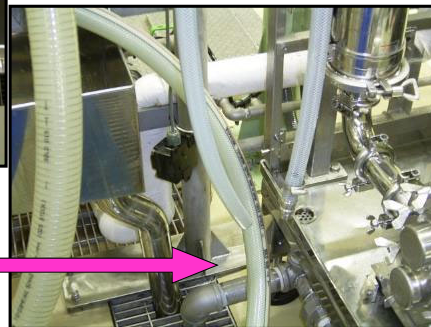

30

30

## KAIZEN (Case study)

Guide to turn the product (Improve efficiency)

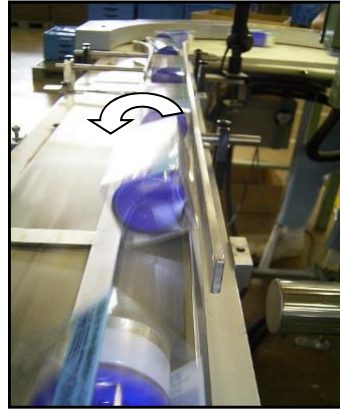
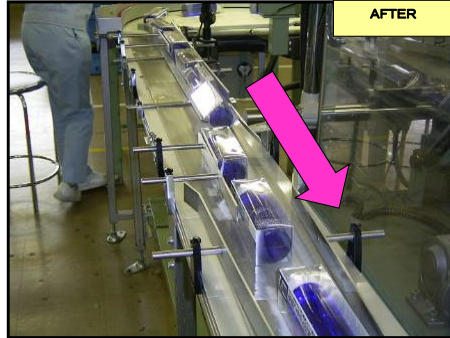

1. Process: Packaging
2. In packaging process product is turned by a simple guide without worker's involvement.

31

31

## KAIZEN (Case study)

Seal part cooling after filling into tube (Improve quality)

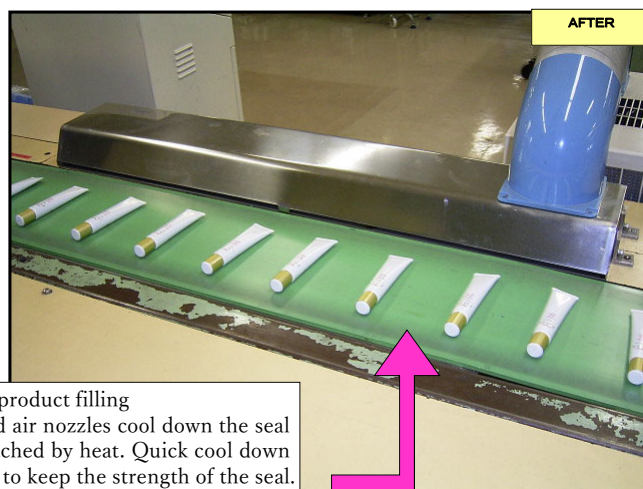

1. Process: Tube product filling
2. Spot cooler and air nozzles cool down the seal parts which is attached by heat. Quick cool down of the seal is good to keep the strength of the seal.

32

32

## KAIZEN (Case study)

Attachment of product filling line (HAKAMA) (Improve efficiency)



BEFORE

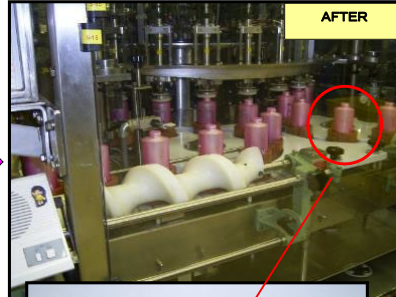

AFTER

1. Process Filling of liquid type product
2. Set-up and adjustment which required changes and adjustment of guide and parts, took a lot of time. Use of transporting jig eliminates such cumbersome set-up work.



33

33

## KAIZEN (Case study)

Cart for lipstick bulk transportation (Improve efficiency)

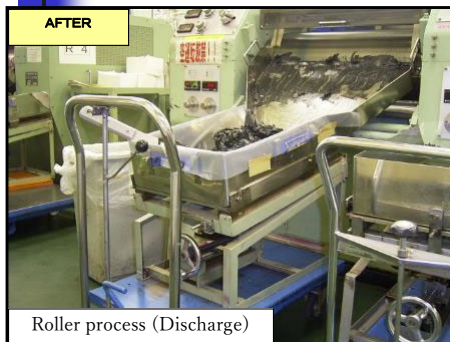

AFTER

Roller process (Discharge)

- 1 Process: Lipstick production
- 2 Cart is used for getting raw material discharged from roller and charging it to dissolving process for recycling. Efficiency is improved and work load is decreased.



34

34



## KAIZEN (Case study)

### Set-up of packaging (Improve efficiency)

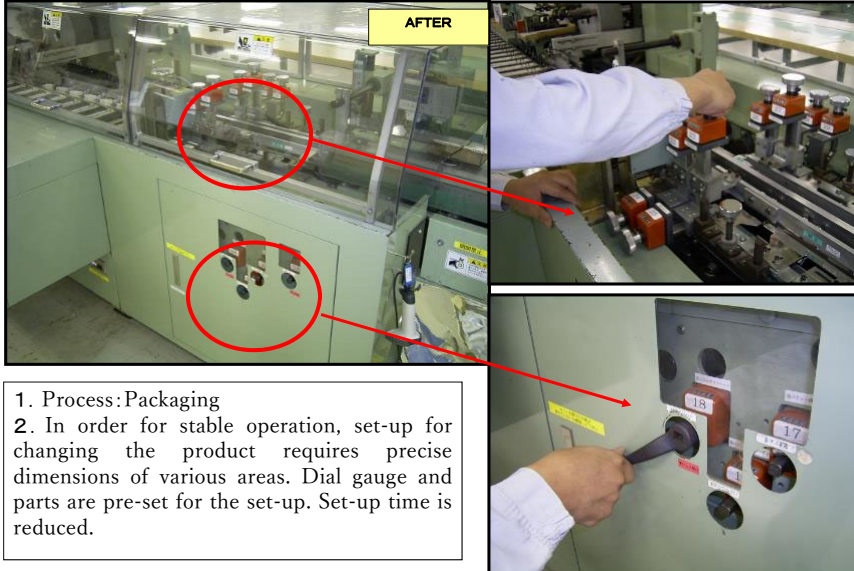

35

35

## KAIZEN (Case study)

### Sign board for sterilizing basin (Improve efficiency)

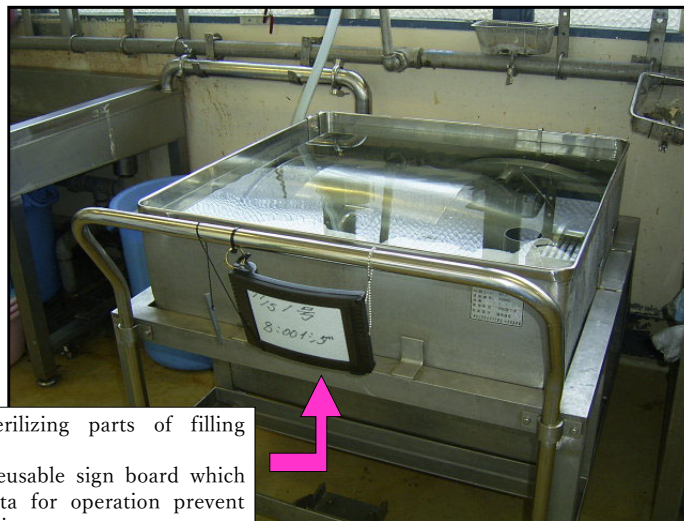

1. Process : Sterilizing parts of filling machine
2. Water-proof reusable sign board which has necessary data for operation prevent mistakes in operation.

36

36



## KAIZEN (Case study)

Color sheet for classifying products (Improve efficiency)



1. Process: Forming
2. Powder foundations and lipsticks are palletized and stored in warehouse after forming process for a while. Color sheet is used to identify the color of the products on the pallet to prevent contamination.

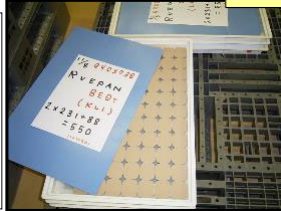

37

37

## KAIZEN (Case study)

Inventory control sheet (Improve efficiency)



手板票					
月日	入数	入出庫先	入庫	出庫	残高
		2004 6月度			0
6/1	5200	+	10300		10300
	(16,500)				
	5200	N1		10300	0
2/1	120X1	取L	120		120
			120X1		
		8月度			
8/4	2200X1	取L	2200		2320

1. Process: Warehouse of sub-materials (Label, Cap, etc.)
2. Control sheet is used to keep track of various sub-materials precisely. Each sheet is for one sub-material. Receipt and shipment of the material is recorded at the warehouse.

38

38

# Total Quality Management (TQM)

39

39

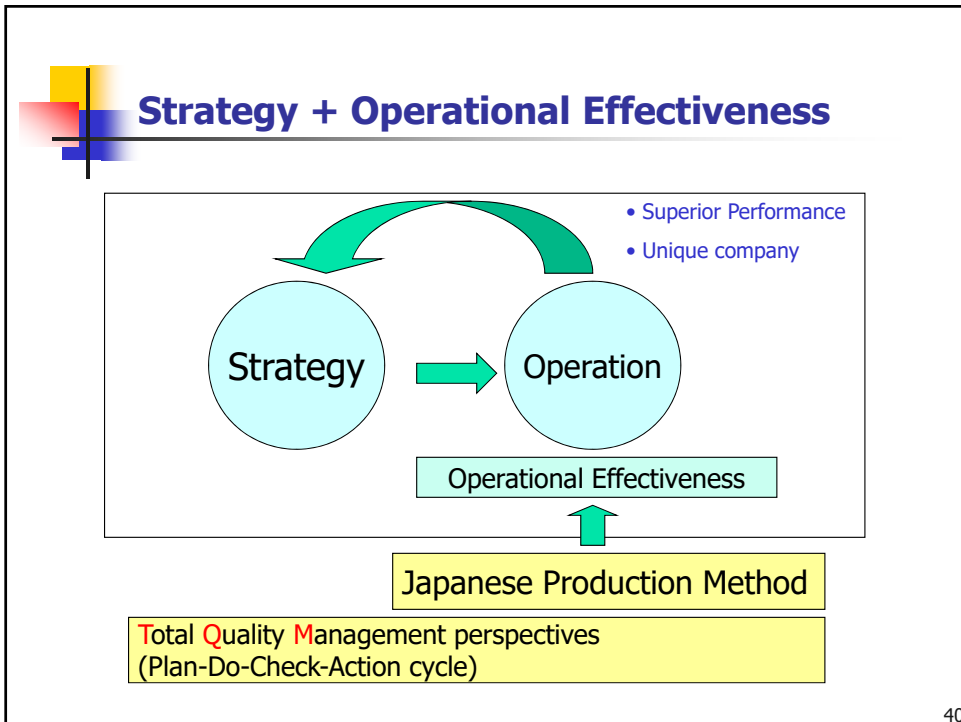

40

40



## Operational Effectiveness

- **Operational Effectiveness has been developed through Japanese Production Control Method.**
  - Toyota's way is known most.
  - Applicable not only for production sites but also for offices.
- **Team approach**
- **BPR (Business Process Reengineering) principles are all from Toyota's Method.**
- **Strategy with operational effectiveness really differentiates the company from the competitors.**
- **Production & Quality Management is the core of operational effectiveness.**

41

41



## Functions Related to Production

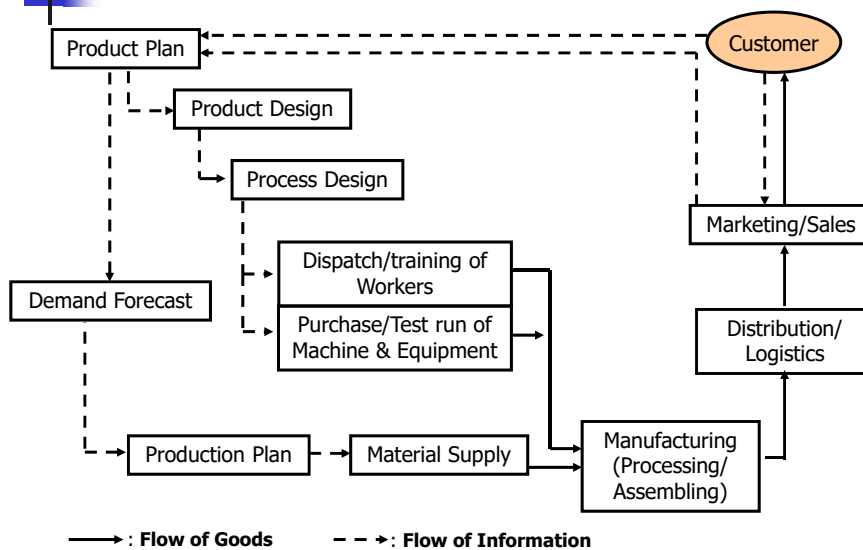

42

42

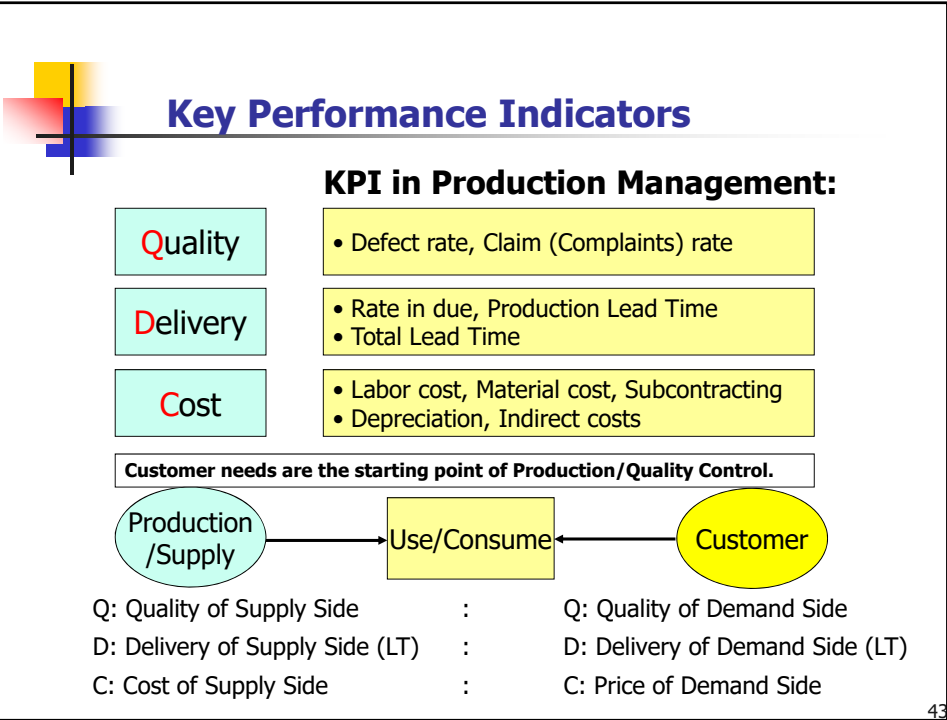

43

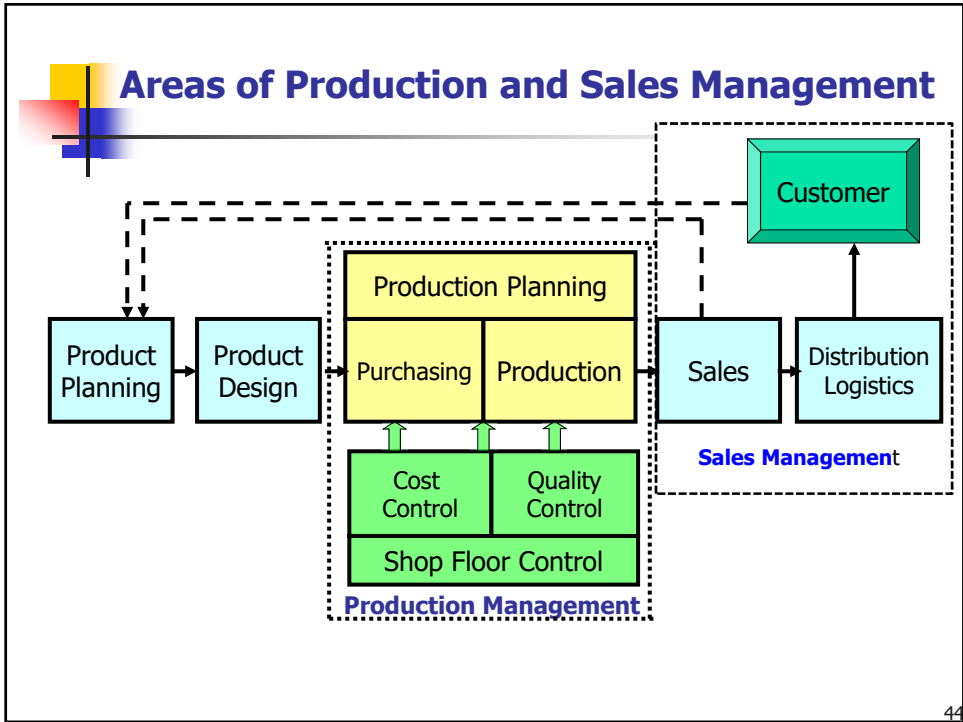

44

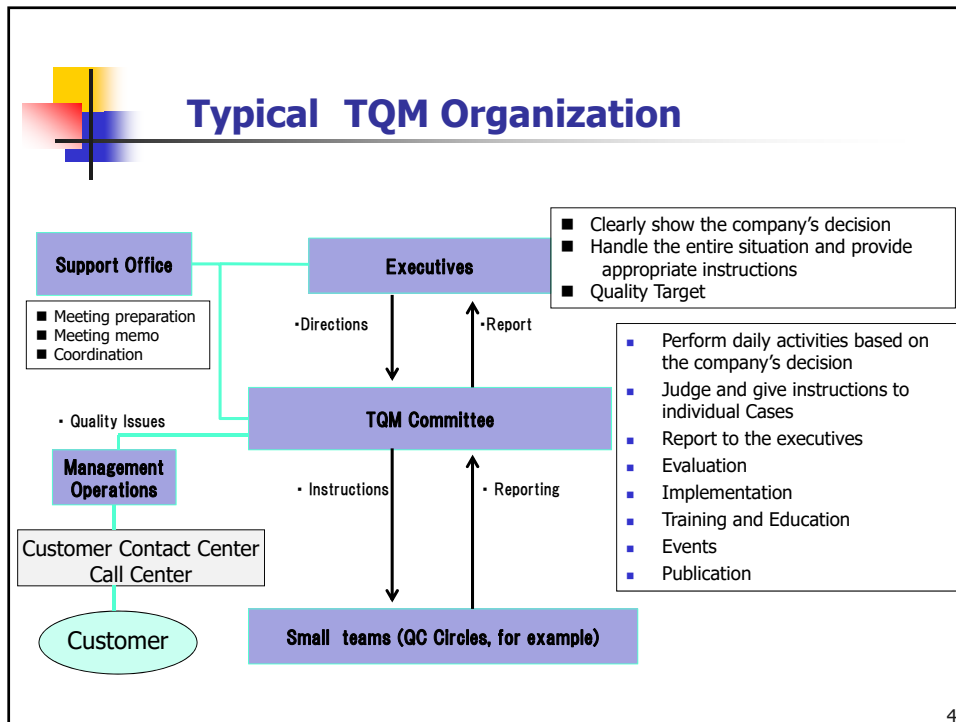

45

## Case: Iwakuni Medical Center

- TQC is not only for manufacturing but also for service industry.
- Iwakuni Medical Center: 160 beds, 18 doctors, 275 staff
- NDP (National Demonstration Project on TQM for Health)
- QC Circle
- Theme: Why so many nurse calls?
- Fish Bone Chart: Meals, Treatments, Nurses, Nurse call Position----- Major Causes
- Solution alternatives: Do not forget the time to treat  
Prepare meals quickly  
Fix nurse call position  
Improve staff motivation
- "Reduce nurse calls by frequent visits to the patients"
- 825 calls/week --→ 543 calls/week

46

## Case: Quality119 (A subsidiary of Panasonic)

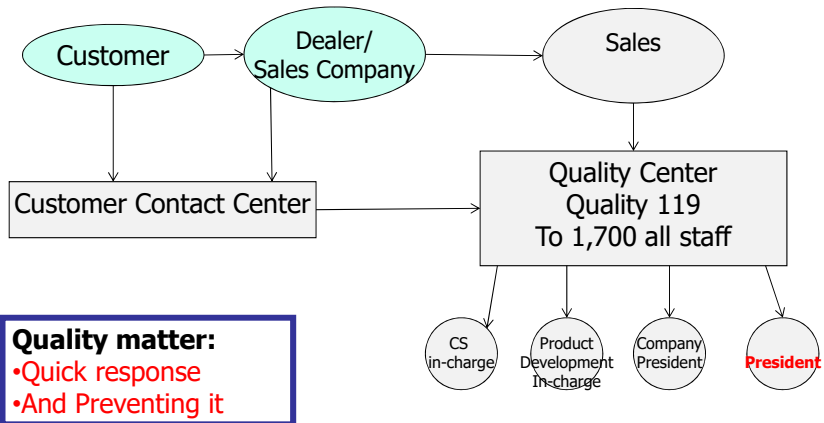

47

47

## Quality Management System (Clinical Laboratory)

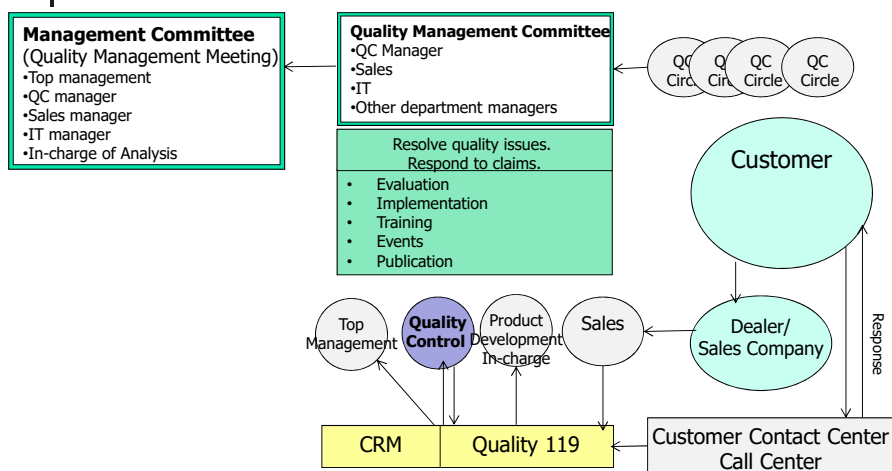

48

48



## PDCA: Quality Management

Management=Plan-Do-Check-Action (PDCA) Cycle → Improvement

e.g.

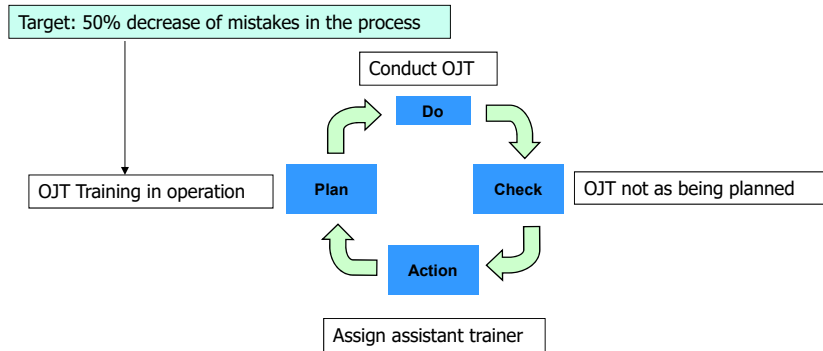

**QC start with education/training and end with education/training.**

49

49



## TQM- Company-wide approach

1. Product Planning
2. Product Design/Process Design
3. Production
4. Sales
5. After Sales

50

50



## TQM (Total Quality Management) Key Words

---

- **Company total**
  - Total employee involvement
  - All departments, Not only by production and Quality Management department
- **Integrated system**
- **Customer focused**
- **Brand means 'Quality'.**
- **Quality = Management quality**
- **PDCA (Plan-DO-Check-Action) cycle**
- **Continuous improvement efforts (KAIZEN)**
- **Top-down and bottom-up**
  - Policy by the top, commitment
  - Idea from people close to the operation
- **Manufacturing sector + adapted for use in almost every type of organization.**

51

51



## 1. Product Planning

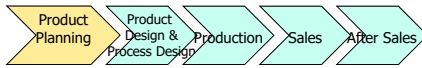

```

graph LR
    A[Product Planning] --> B[Product Design & Process Design]
    B --> C[Production]
    C --> D[Sales]
    D --> E[After Sales]
  
```

---

- **Market Needs Analysis**
- **Set/Define 'Quality'**
- **Basic Quality**
  - **Functionality**
    - Example: Universal design
    - Packaging is also quality.
  - **Effectiveness**
    - Cutting place to open (Additional process): Customer's view
    - Design to attract customers
  - **Product Life**
  - **Product Design**
- **Seeds Approach, too (Sony (Old days), Apple)**
  - **New product proposal to customers**

52

52



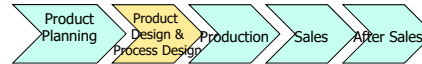

## 2. Product Design and Process Design

- Design to manufacture easy.
  - Assembly: From the bottom up and the inside out
  - Bad design:
    - Mistake in planning of a seminar
    - Project design in consulting -> Use of old proposals
    - System design phase
- Much of the costs of manufactured product are influenced during the design phase.
  - Specify standard materials, parts and processes.
  - Parts: Market standard: least expensive
- Industrial designer would be involved.
- Include elimination of wastes concept in process design.
  - ECRS principles
  - Fool-proof
  - Work with gravity

53

53

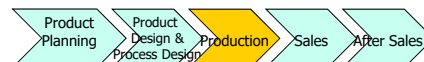

## 3. Production

- Put quality at the source.
  - Each process defect rate should be minimized(zero).
    - Purchasing, factory production shops, warehouse and shipping
    - Preventive maintenance
- QC process
  - Defects definition
  - QC Charts, Fish Bone Charts
  - QC Circle
- Standard Operation
  - Standard Operation Sheet
  - Stop-the-line in trouble
  - Education and training
- Process Capacity
- Mistake-proof

54

54



## 4. Sales

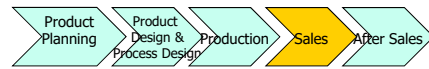

- Standard Operation
  - CRM standardizes the sales operations.
- Mistake-proof
  - CRM provides proper information to the sales
    - Inventory availability
    - Recent product information
    - Connection to the engineer/back office at the customer site

55

55



## Case: CRM (Customer Relationship Management)

### Develop long term relationship with the customers using IT

- Use integrated customer information (=Customer DB),
- Provide service which meets exactly to the needs of a customer (=One-to-One Marketing),
- Increase customer satisfaction by responding to the customer continuously and thoroughly.

— CRM definition by Gartner Group

CRM involved capturing customer data from across the enterprise, consolidating all internally and externally acquired customer related data in a central database, analyzing the consolidated data, distributing the results of that analysis to various **customer touch points** and using this information when dealing with customers via any touch point.

56

56

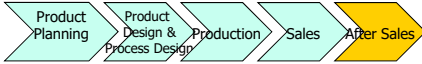



## 5. After Sales

- **Guarantee**
- **70% of the customers who have complaints will remain customers, if the complaints are resolved.**
- **Call Center (CRM) -> Communication Center**
  - **Claim is an important source for improvements and new products.**
- **Warehouse control and shipping control**

57

57



## After sales: Traceability

- **Claim**
  - **Product X**
  - **Lot Number Y**
  - **Defect Parts Z or Defects areas**
- **Traceability**
  - **Trace production record/history to identify the problems. (Date, Lot, Parts, Conditions)**
  - **Lot Number**
    - **Example: AX3=2010.12.03 production**
- **Recall = reliable maker (costly)**
  - **Identify other possibilities in other products.**
  - **Recall the other products, too.**

58

58



## Quality Control (QC)

---

59

59



### QC: Definition

---

- **Total Quality Control (TQC)** may be defined as “an effective system for integrating the quality development, quality maintenance, and quality improvement efforts of various groups in an organization so as to enable production and service at the most **economical levels** which allow for full **customer satisfaction**.” (A.V. Feigenbaum)
- **Statistical Quality Control (SQC)** is the application of **statistical techniques**, in all stages of manufacture, toward the most **economic** manufacture of a product that is maximally useful and has a **market**. (W.E. Deming)

60

60



## Quality: Definition

- **Quality = Quality of Management (not just quality of product)**
- **Quality = The level of quality at which customer is satisfied**
- **Design/Define Quality**
  - **Quality Characteristics**
    - Size/dimension, Purity, Strength, Appearance, Life span, etc.
  - **Unit**
    - Each, 10 cm, etc.
  - **Measure**
    - How to measure 'Quality', Sampling, Specimen, etc.
  - **Defect/Fault definition**
  - **Allowance ranges**
  - **Guarantee**
    - Service, Claim process, Warranty, etc.

61

61



## Quality Definition in a Company

Quality	For	To	Responsibility
Quality Standard	Control Process	Production Process	Production Manager
Quality Target	Improvement	<ul style="list-style-type: none"> <li>■ Research and Development</li> <li>■ All employees</li> </ul>	<ul style="list-style-type: none"> <li>■ Top Management</li> <li>■ R &amp; D Manager</li> </ul>
Quality Assured	Customer Satisfaction	Customer	Sales Manager + All others
Inspection Standard	No Defects to the customer	Inspection	Inspector

62

62

## Quality inspection at a textile company



Inspection for color



Inspection for size measurement

63

63

## Quality inspection at a textile company



Needle/metal detection



Inspection for stitching

64

64



## Quality inspection at a textile company

Quantity per style	Quantity to be checked	No. of defects tolerated
Less than 500 pieces	40	1
501 to 1000 pieces	80	3
1001 to 3000	100	4
3001 to 5000	120	5
Over 5001	140	6

In case the defective quantities are more than the above tolerated quantities, all the quantities of the item are to be inspected and delivered with final quality inspection sheet and report for quality improvement signed by the manager.

In case there is no quality improvement observed, business with such suppliers has to be terminated.

65

65



## Quality definition (Product Quality)

### Eight dimensions of quality

- **Performance:** main characteristics of the product or service.
- **Aesthetics:** appearance, feel, smell, taste.
- **Features:** extra characteristics (convenience, high tech., etc.)
- **Conformance:** how well a product or service corresponds to design specifications.
- **Reliability:** consistency of performance
- **Durability:** the useful life of the product or service
- **Perceived quality:** indirect evaluation of quality (e.g. reputation)
- **Serviceability:** handling of complaints or repairs.

66

66



## Quality definition (Service Quality)

### Seven dimensions of quality

- **Convenience:** the availability and accessibility of the service
- **Reliability:** the ability to perform a service dependably, consistently, and accurately.
- **Responsiveness:** the willingness of service providers to help customers in unusual situations and to deal with problems.
- **Time:** the speed with which service is delivered.
- **Assurance:** the knowledge exhibited by personnel who come into contact with a customer and their ability to convey trust and confidence.
- **Courtesy:** the way customers are treated by employees who come into contact with them.
- **Tangibles:** the physical appearance of facilities, equipment, personnel, and communication materials.

67

67



## Responsibility for Quality

All members of an organization have some responsibility for quality, but certain parts are key areas of responsibility.

### • **Top Management**

Top management has the ultimate responsibility for quality. While establishing strategies for quality, top management must institute programs to improve quality; guide, direct, and motivate managers and workers; and set an example by being involved in quality initiatives. Examples include taking training in quality, issuing periodic reports on quality, and attending meetings on quality.

### • **Design**

Quality products and services begin with design. This includes not only features of the product or service, but also it includes attention to the processes that will be required to produce the products and/or services that will be required to delivery the service to customers.

68

68





## Responsibility for Quality

---

- **Procurement**

The procurement department has responsibility for obtaining goods and services that will not detract from the quality of the organization's goods and services.

- **Production/operations**

Production/operations has responsibility to ensure that processes yield products and services that conform to design specifications. Monitoring processes, finding and correcting root causes of problems are important aspect of this responsibility.

- **Quality assurance**

Quality assurance is responsible for gathering and analyzing data on problems and working with operations to solve problems.

- **Packaging and shipping**

This department must ensure that goods are not damaged in transit, that packages are clearly labeled, that instructions are included, that all parts are included, and shipping occurs in a timely manner.

69

69



## Responsibility for Quality

---

- **Marketing and Sales**

This department has the responsibility to determine customer needs and communicate them to appropriate areas of the organization. In addition, it has the responsibility to report any problems with products or services.

- **Customer service**

Customer service is often the first department to learn of problems. It has the responsibility to communicate that information to appropriate departments, deal in a reasonable manner with customers, work to resolve problems and follow up to confirm that the situation has been effectively remedied.

70

70



## **Group discussion**

---

- What does 'Quality' mean ?
- State and evaluate your organization's policy for quality, and suggest improvements to the present approach.

71

71



## **Quality Control (QC) Circle**

---

72

72



## Quality Circle (1)

- Quality circles were originally associated with Japanese management and manufacturing techniques. The introduction of quality circles in Japan in the postwar years was inspired by the lectures of W. Edwards Deming (1900- 1993), a statistician for the U.S. government.
- Quality circle is one of the employee participation methods. It implies the development of skills, capabilities, confidence and creativity of the people through cumulative process of education, training, work experience and participation.

73

73



## Quality Circle (2)

- It also implies the creation of facilitative conditions and environment of work, which creates and sustains their motivation and commitment towards work excellence.
- Quality circles have emerged as a mechanism to develop and utilize the tremendous potential of people for improvement in product quality and productivity.

74

74



### Quality Circle (3)

---

- Quality circle is a small group of 6 to 12 employees doing similar work who voluntarily meet together on a regular basis to identify improvements in their respective work areas using proven techniques for analyzing and solving work related problems coming in the way of achieving and sustaining excellence leading to mutual development of employees as well as the organization.
- It is " a way of capturing the creative and innovative power that lies within the workforce."

75

75



### Quality Circle (4)

---

- Quality circle is a people – building philosophy, providing self-motivation and happiness in improving environment without any compulsion or monetary benefits.
- It represents a philosophy of managing people specially those at the grass root level as well as a clearly defined mechanism and methodology for translating this philosophy into practice and a required structure to make it a way of life.

76

76



## Quality Circle (5)

- The Quality circle philosophy calls for a progressive attitude on the part of the management and their willingness to make adjustments, if necessary, in their style and culture.
- It is bound to succeed where people are respected and are involved in decisions, concerning their work life, and in environments where peoples' capabilities are looked upon as assets to solve work-area problems.

77

77



## QC 7 Tools

- **QC circle uses tools and natural data.**
- **Seven Tools are:**
  - Histogram
  - QC Chart (Control Chart)
  - Cause Analysis (Fish Bone Chart)
  - Pareto Analysis (80/20 rules, ABC analysis)
  - Graph
  - Check Sheet
  - Scatter Chart
- **Number of QC Circle members: 5-6**
- **Themes:**
  - QC
  - Improvement in productivity, operation, delivery, safety, communications and morale.

78

78



## Data Class/Data Layer

By what data is collected?

- Time: e.g. AM, PM
- Worker
- Material
- Machine
- Method
- Condition

To find the real problem.

79

79



## QC 7 Tools

■ Powerful tools for quality activity by small group

■ 7 tools

1. Cause Effect Analysis (Fish Bone Chart)
2. Histogram
3. Pareto Analysis (80/20 rules, ABC analysis)
4. QC Chart (Control Chart)
5. Graph (Stratification)
6. Check Sheet
7. Scatter Chart

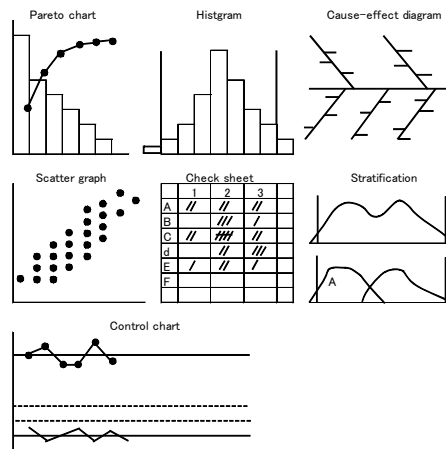

80

80



## No Intentional Data for QC

(1/3)

- **Experiment 1: The most favorable number in 0-10?**
- **Experiment 2: Flip a coin ten times and count the number of heads?**

Draw Histogram

- **Experiment 1: Intentional**
- **Experiment 2: Natural**

81

81



## No Intentional Data for QC

(3/3)

- **QC uses only natural data, which distributes.**
- **Processes in the factory provide distributed data, which are not intentional but natural.**
  - **Watching natural data which reflect the current situation of the process are the starting point of improvements.**
  - **Even if you follow the standard operation, the results are different. "Variability"**
- **If you get 10 heads in ten toss-ups, you may think that the coin is suspicious, although it could happen.**
- **In QC, if such a thing happens (probability like three out of 1,000), we think that something happens in the process. Such a situation is called 'Over Control Limit'.**

82

82

## Check sheet

Defect	Mon	Tue	Wed	Thu	Fri	Total
Head	### ##	### ###	### ###	### ###	### ###	50
Raw material	###	### /	### /	### /	### //	30
Screw		////	//	////		10
Wrong length	///	/	/			5
Scar		/	/	/		3
Other		/	/			2

83

83

## Pareto Analysis (80/20 rule)

Objective: Identify the most defect case and solve it one by one.

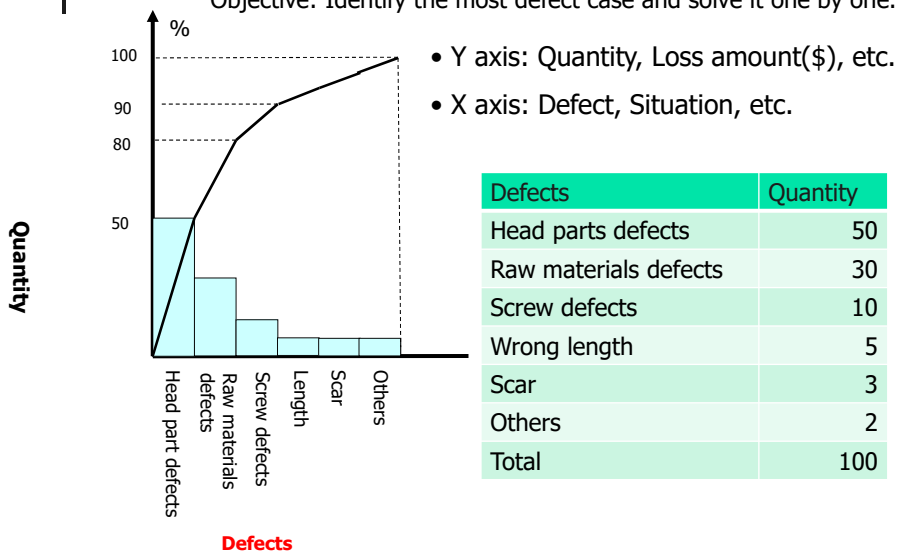

144

84



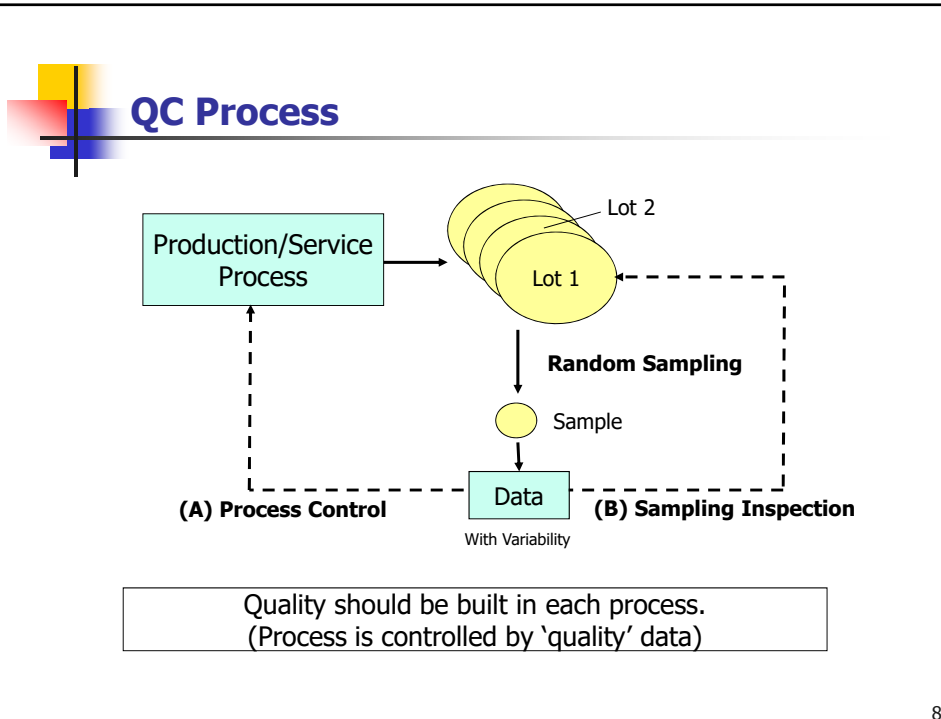

85

85

## QC Charts

(1/2)

**5 units from each lot were chosen to measure the length L ( $20 \pm 0.1$ ). The chart below shows  $\bar{X}$ -R Control, based on the recent data covering 20 lots.**

Lot	Measurement					$\bar{X}$	R
001	19.96	20.04	20.00	20.06	19.99	20.010	0.100
002	20.04	20.01	19.98	20.00	19.99	20.004	0.060
003	19.99	20.03	20.01	20.02	20.01	20.012	0.040
004	19.97	20.03	19.95	20.02	20.00	19.994	0.080
005	19.97	19.97	19.96	20.04	20.02	19.992	0.080
006	19.99	20.05	19.95	20.01	19.97	19.994	0.100
007	20.03	20.00	20.01	20.00	19.99	20.006	0.040
008	19.98	20.07	20.01	19.96	20.01	20.006	0.110
009	20.05	19.99	19.94	19.94	19.97	19.978	0.110
010	20.00	20.00	19.97	19.96	19.97	19.980	0.040
011	20.04	19.96	20.05	20.01	20.06	20.024	0.100
012	19.94	19.97	19.97	20.00	19.99	19.974	0.060
013	20.03	20.07	19.95	19.96	20.04	20.010	0.120
014	20.05	20.05	20.06	20.03	19.99	20.036	0.070
015	19.93	20.00	20.00	19.98	20.05	19.986	0.120
016	20.00	20.01	20.10	20.02	20.06	20.026	0.060
017	19.96	20.05	20.05	20.04	19.99	20.002	0.090
018	20.07	19.94	19.94	20.00	20.04	20.012	0.130
019	19.95	19.97	19.97	19.99	19.93	19.958	0.060
020	20.05	19.95	19.95	19.98	20.06	20.020	0.110

⊙  $\bar{X}$  Control Chart

$\bar{\bar{X}} = 20.001$

$UCL = \bar{\bar{X}} + A_2 \bar{R}$

$= 20.001 + 0.577 \times 0.084$

$= 20.049$

$LCL = \bar{\bar{X}} - A_2 \bar{R}$

$= 20.001 - 0.577 \times 0.084$

$= 19.953$

⊙ R Control Chart

$\bar{R} = 0.084$

$UCL = D_4 \bar{R}$

$= 2.114 \times 0.084 = 0.178$

86

86

## QC Charts (Control Chart)

### Shewhart X-bar and R & S control chart (2/2)

#### $\bar{X}$ QC Chart

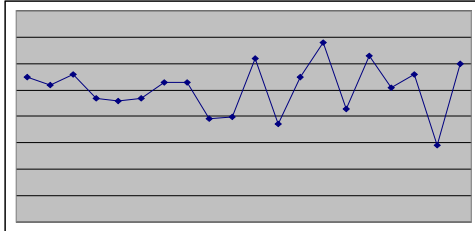

- With Control Limit Lines
  - Controlled State v.s. Out of Control
- ← limit UCL(20.049): Upper Control Limit
- CL(20.001): Center Line
- ← limit LCL(19.953): Lower Control Limit

© The number of Data and coefficient of each lot

The number of Data	A2	D4
2	1.880	3.268
3	1.023	2.574
4	0.729	2.282
5	0.577	2.114

#### R QC Chart

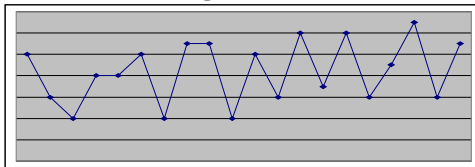

UCL(0.178)

0

87

87

## Scatter diagram

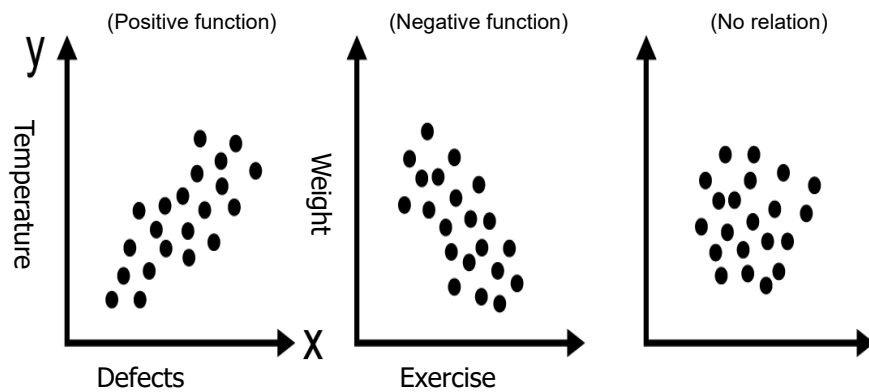

90

88

## Case: Chocolate Factory

Pin hole is the most serious problem.  
Data collection is the key.

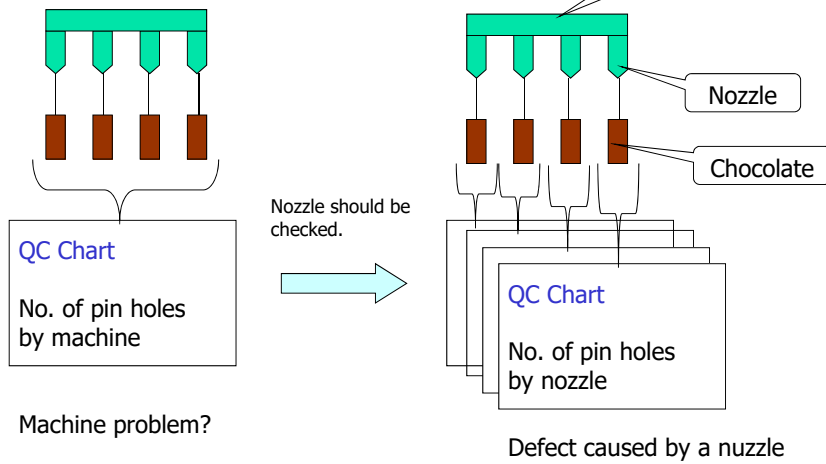

89

## Cause Analysis: Mind Map

### Brain Storming

Brainstorming is used to generate a high volume of ideas with team members' full participation.

It is FREE OF CRITICISM AND JUDGEMENT.

No idea is criticized !

90

90



## Cause Effect Analysis

### 5M (Man, Machine, Method, Measurement, Material)

5M = Input for production/services

5M	Description
Man	Cause Factor of In-charge, Management, Partner
Machine	Cause Factor of Machine, Equipment, Tool, Facility, Room, Chair or Table
Method	Cause Factor of Technology, Operation Procedure, How-to-do
Measurement	Cause Factor of Collecting information, Confirming process, Measurement of the result
Material	Cause Factor of Material to be processed

91

91



## Cause Effect Analysis

### 5M (Man, Machine, Method, Measurement, Material)

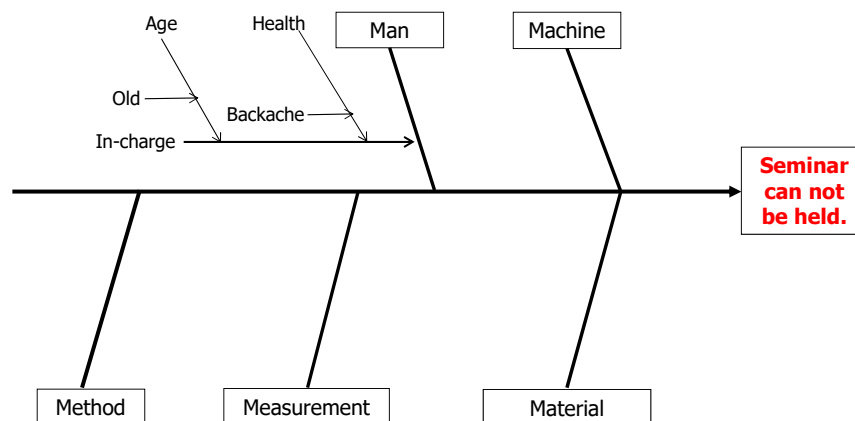

92

92

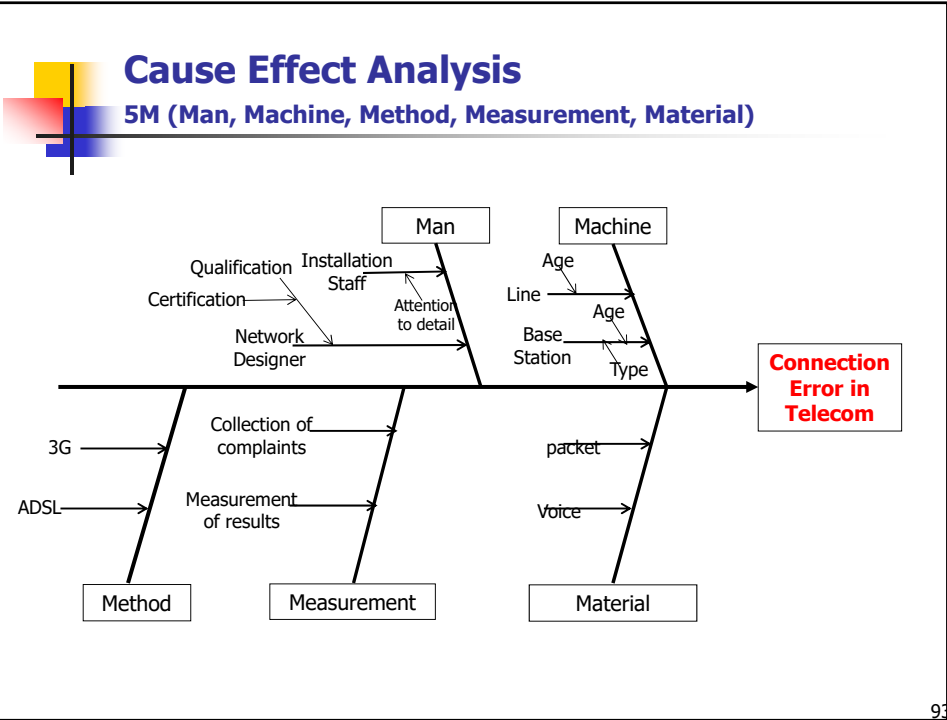

93

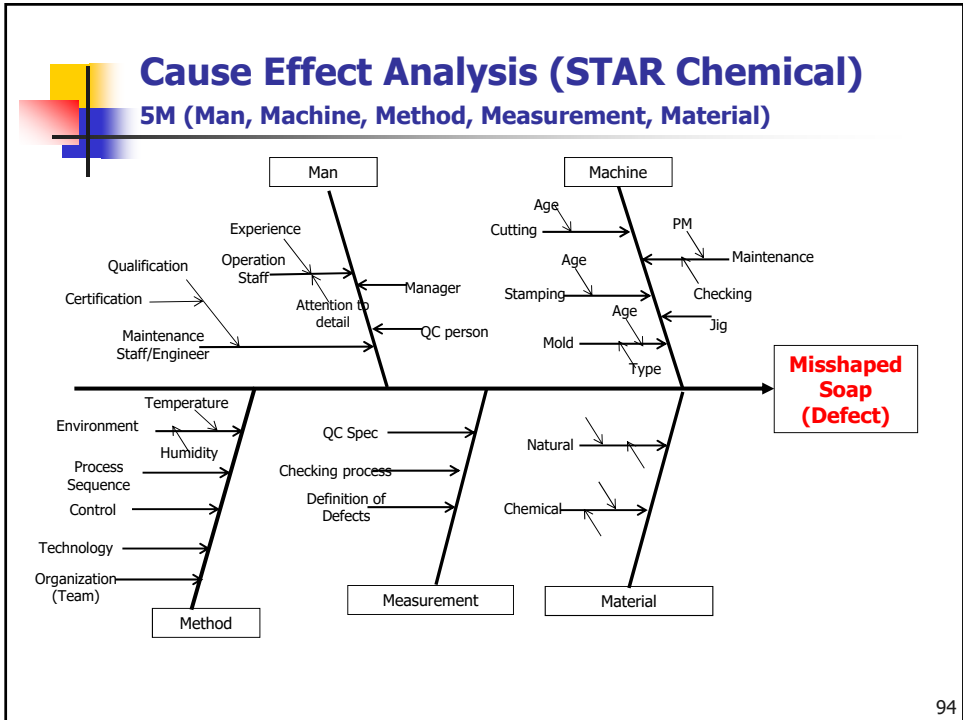

94

## Cause Effect Analysis

5M (Man, Machine, Method, Measurement, Material)

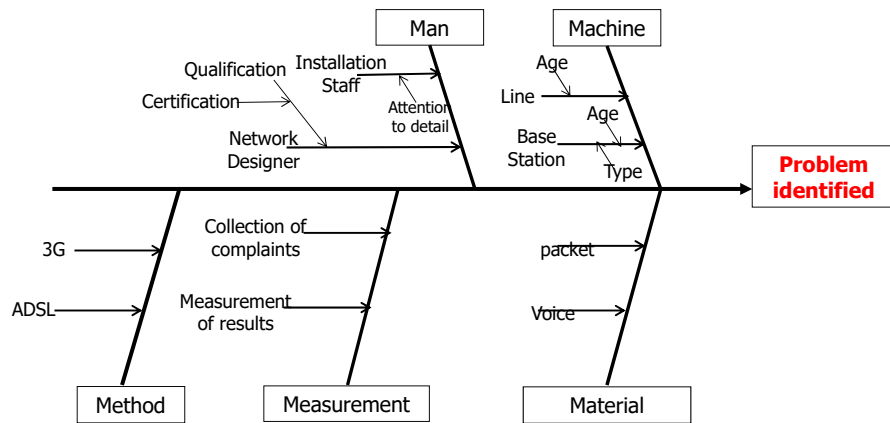

95

## Effectiveness of QC Circle

- Defects decrease
- Continuous Improvement
- Members capability up
- Leadership
- ? (Another important one)

96

96



## Case: Honda

- **1971: QC Contest was started.**
- **1972: NH Circle – ‘Now’, ‘Next’, ‘New’ Honda**
  - Focus on not only the results but also the processes
  - Develop teamwork/communication in working place
  - Improve morale
- **Now worldwide QC Convention**

97

97



## Case: Toyota

(1/2)

- **1965: TQC implementation was started.**
  - Production efficiency was increased
    - No. of employees 2 times more and production 7 times more than 1955 when Toyota Crown sales had started.
  - However, quality not so satisfactory
    - Lack of education and training
    - Manager's capability still premature
    - Less communication among the departments
    - Quality: competitive factor
- **QC Circle = Education & Training -> Develop employees**
- **Top management defines the quality target and makes all employees understand it.**
- **Functional cooperation is required among all the departments**
- **Improvement ideas in the shop floor are from QC Circles.**

Idea was from Peter Drucker

98

98



## Case: Toyota

(2/2)

- **QC Themes, for example:**
  - **Manual work improvement to eliminate wasteful hand movement.**
  - **Implementation of new machine/upgraded machine**
  - **Improvement of the way of using materials and consumables and saving money**

99

99



## Shop Floor Improvement

- Industrial Engineering (IE)
- 5S
- Elimination of 7 wastes

100

100





## Improvement in Process Design Phase

- ECRS Principles in IE (Industrial Engineering):
  - **E**liminate      Eliminate the operational steps.  
What happens if the process is eliminated?
  - **C**ombine      Conduct several operational steps concurrently.
  - **R**earrange      Change the order of operational steps
  - **S**implify      Simplify operational steps
  
- Factory and Processes are analyzed based on:
  - Operation and Flow Process Chart
  - Layout

101

101



## Kaizen by ECRS (5W1H)

Question		Action
1. What is the objective?	Why?	1. Eliminate unnecessary work.
2. Where should it be done?	Why?	2. Change the place or combine with other work.
3. When should it be done?	Why?	3. Change the time and order, or do it concurrently.
4. Who should do it?	Why?	4. Change the worker, or let the same worker do it.
5. How should it be done?	Why?	5. Simplify the process or improve the process

102

102



## Case: Industrialization of construction

- **Eliminate: No scaffold for painting**
  - Painting panel in the factory
  - No painting at the site
- **Simplify: No caulking between panels**
  - Substitute by silicone rubber
  - Speed
- **Eliminate/Simplify: No welding**
  - Using high-tension bolt
  - No welder (specialist), uniform in operation and low cost

103

103



## Case: Family restaurant chain in Japan (Saizeriya)

### ECRS

- No tray: bring plates by hands
  - ✓ **Eliminate** putting plates on the tray and removing them from the tray.
- No kitchen knife, no gas range in the kitchen
  - ✓ **Eliminate/simplify** cutting and heating (Use of Central Kitchen).
- No cap of salad dressing bottle in the kitchen: special bottle
  - ✓ **Eliminate** opening and fastening the cap
- Clean up not by vacuum cleaner but mop with corridor width and following the standard operation.

104

104

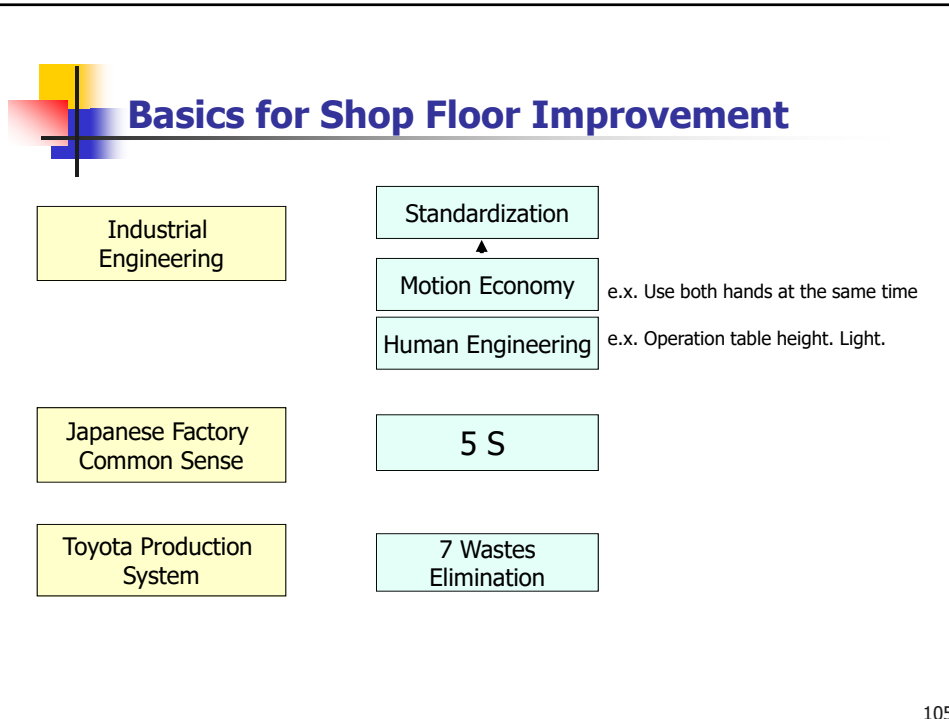

105

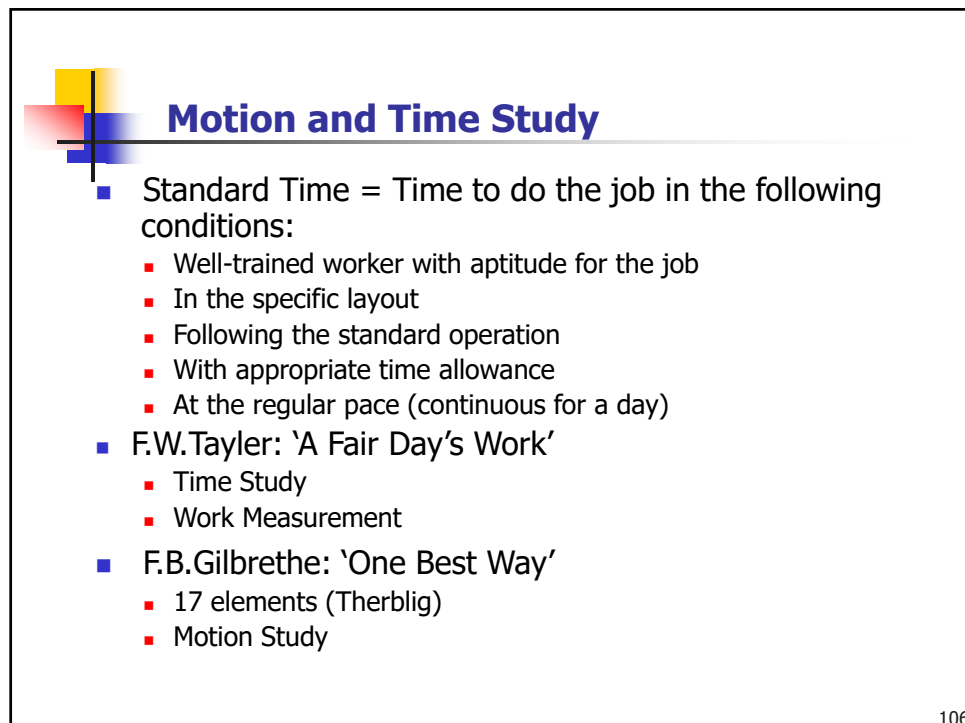

106

## Standard Time Setting

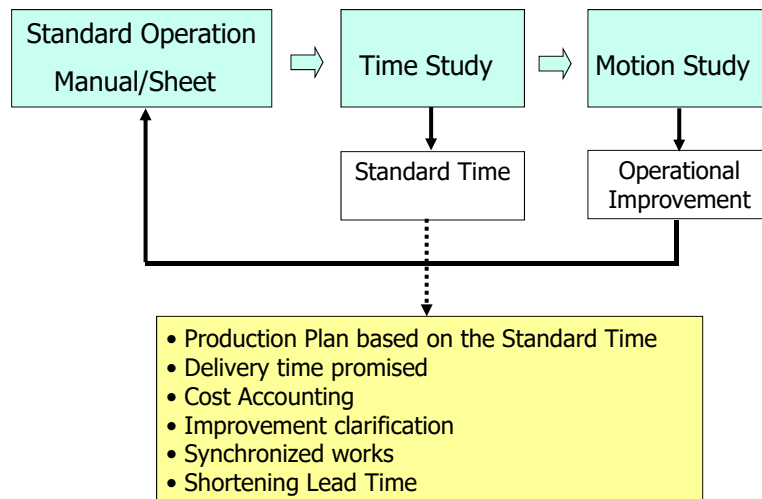

107

107

## Motion Study

### Therbligs

- According to Dr. Gilbreth, all jobs can be described as a sequence of the following actions, events, or movements called "Therbligs" or "Work Elements"
  - Search, Select, Grasp, Reach, Move, Hold, Position, Inspect, Assemble, Disassemble, Use,
  - Unavoidable Delay, Avoidable Delay, Plan, Rest to Overcome Fatigue
- In some cases, "Therbligs" or "Work Elements" may be grouped, e.g.,
  - "Get" = "Reach" + "Grasp"
  - "Put" = "Move" + "Position"

108

108

## Motion study : Therbligs Chart

Improve the motion of worker by eliminating wastes of motion → Analyze by using Therblig Chart

- Define 18 kinds of motion that are the smallest unit of manual labor that a human being performs
- Analyze the actual situation of these 18 kinds of motion

No.	Therblig name	Symbol
1	Transport empty	)
2	Grasp	c
3	Transport loaded	9
4	Assemble	#
5	Disassemble	t
6	Use	u
7	Release load	e
8	Position	s
9	Pre-position	∞
10	Inspect	o
11	Search	θ
12	Find	⊖
13	Select	↑
14	Plan	↓
15	Hold	d
16	Unavoidable delay	⊗
17	Avoidable delay	⊕
18	Rest	⊥

109

109

## Work Sampling

- Check how much workers spend their time for value-added tasks.
  - List tasks including others and develop check sheet.
    - Tasks and movements
    - Value-added and non-value-added
  - Visit the site randomly (Random Time Table), see what they are doing and check on the check sheet prepared.
  - The number of times in each task divided by the total number of visits would be the ratio of each task.
- Now, There are many software packages.

110

110



## Standard Operation Manual/Sheet

- Man, Machine and Materials (3M) combination
- Cycle Time (Takt)
  - =Working hours/No. of pieces necessary in a day
- Standard Operation Order
  - E.g. Cutting material
    - 1. Bring the raw material
    - 2. Set the material to the machine
    - 3. Cut the material
    - 4. Remove the material
    - 5. Put the material to the box beside the machine
- Standard Work-in-process
  - Minimum number of work-in –progress in the shop
- Standard Operation Manual/Sheet should be developed in the shop.
- In Toyota, just [three days](#) OJT using the sheet

111

111



## Time study

Improve the work by measuring the time of work element and set the standard time

→ Analyze by using Time Study Sheet

Work		Assembling			Improvement point
No.	Work element	Time(sec)			
		1st	2nd	3rd	
1	Search parts	180			Eliminate
2	Take one by one part A and part B	60			
3	Assembling	900			Simplify
4	Put finished goods in a box	180			

### ◆ Study on improvement plan

- Eliminate the Non-Value-Creating Work
- Improve the work of the long time required
- The work with much unevenness of the time analyzes a factor of the unevenness and is improved

112

112

## Layout Analysis

- Improve the layout of machine, worker and the warehouse to produce effectively.
- Reduce the distance and the number of times of transportation.

No.	Process	○	⇒	□	▽	Time (min)	Distance (m)
1	Go to material storage storage space		●			3	20
2	Carry material to the processing process	●	●			7	
3	Put material on the palette	●				5	
4	Processing	●				20/lot	
5	Carry parts to the assembly process	●	●			3	10
6	Put parts on the palette	●				2	
7	Go back to the processing process	●	●			3	10
8	Assembling	●				22/lot	
9	Carry finished goods to the inspection process	●	●			4	10
10	Put finished goods on the palette	●				5	
11	Go back to the assembly process	●	●			4	10

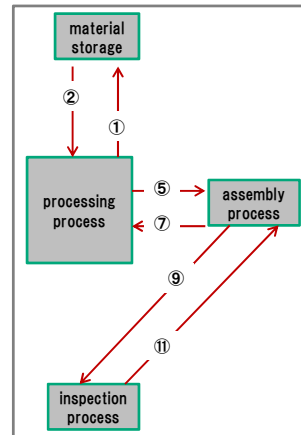

113

113

## Layout chart

Place	
Name	

114

114

## Standardization of Job

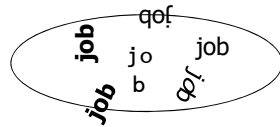

- Without models
- Without points of reference

= Full of Wastes



### Standardization

- Establish well-balanced jobs throughout manufacturing processes
- Fix working procedures for each job

Standardize individual job

Anybody can perform a given job in the same manner

Efficient combination of man, material and machine

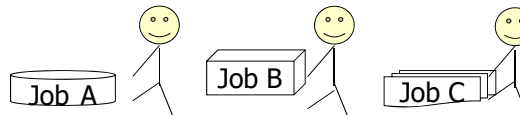

= Quality, Safety, Lower cost

115

## Standardization of Job

### Case: Fast food chain in Japan (Yoshinoya)

Man/Machine/Material (3M): IE technique

Best position of Tea machine, Rice cooker, Cooking equipment and Receipt. Used stopwatch to set up standard time.



116

116





## Operation Process Chart

### ■ Sample: Biscuit

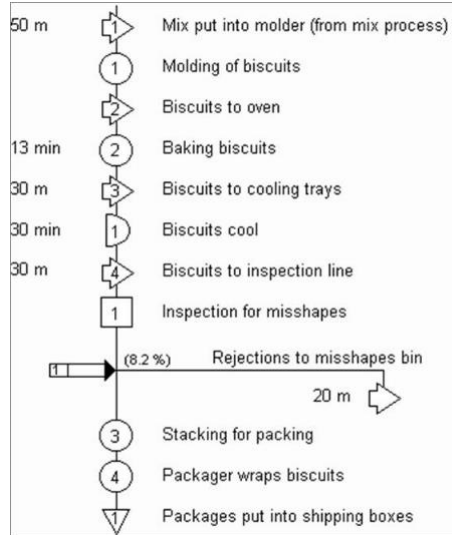

Source:  
[http://syque.com/quality\\_tools/toolbook/Flowproc/example.htm](http://syque.com/quality_tools/toolbook/Flowproc/example.htm)

117

117



## Visualization

118

118



## Visualization

---

Visualization means 'Visual control' or 'Mieruka' which is a Japanese terminology.

There are 3 basic rules for effective visual control.

- Make it easy to understand
- Make it big and easily visible
- Make it interactive and easy to change

119

119



## Visualization

---

### **Make it easy to understand**

An effective visual distills information to its essential core, so that people can immediately understand what the visual is trying to communicate.

A good visual allows all people, from management to employees, to immediately understand the current situation. The emphasis here is on speed and simplicity, as it will allow an issue to be understood, or a problem to be quickly spotted, analyzed and tended to, as opposed to be hidden away in an obscure report.

120

120



## Visualization

---

### **Make it big and easily visible**

A good visual is one placed in publicly visible areas, such as walls at high traffic areas, so that people don't need to go hunting for the information. Making the visual physically large is also important as it makes it easier to see, as you would want the message to be impossible to miss.

121

121



## Visualization

---

### **Make it interactive and easy to change**

It must be kept up-to-date with the latest information and should be easy to update. A Toyota whiteboard will often contain magnetic stickers which can be shuffled around in order to provide simple updates, with hand-written notes using a whiteboard marker if more detailed information is needed.

And finally...

When you put these rules together, you will be able to create visuals in no time.

122

122

## Visualization

All departments declare what kind of activity they will undertake every week by putting the board on the wall at the corridor of high traffic and share their progress company wide.



123

123

## Visualization

Date		03/52			
Part #	Box ID	Qty	No. of Defective	Iyoskanada	
1				Part 204F000-2110 < 204 >	
2				1 032545100005 100	
3				2 032545100005 100	
4				3 Suppl. 10000	
5				2 032545100005 100 (Out of box)	
6				0 032545100005 (Out of box)	
7				1 032545100005 - Box 100	
8					
9				204F000-2110 < 211 >	
10				1 032545100005 (Out of box)	
Cumulative of Defective Qty.					
Part #	204F000-2110	Defective Qty.	3	0	
Part #	204F000-2110	Defective Qty.	-	0	
Part #	204F000-2111	Defective Qty.	2	0	
Part #	204F000-2110	Defective Qty.	7.5	0	

124

124

## Visualization

Identification and classification of shelves and goods



125

125

## Visible Control System

**A picture is worth a thousand words.**

- Assignment Board
- Schedule Board
- Diary/Weekly reporting
  - Work load
- Signs, plates, notices



Inventory Control Label with color sticker  
Ex. 12 colors for 12 months for FIFO

126

126

## Cases: Control Processes Visually

- Daily schedule control

Machine X	Dec. 6	
Item YYY	20	###,###,
ITEM ZZZ	30	

Hand written on white board

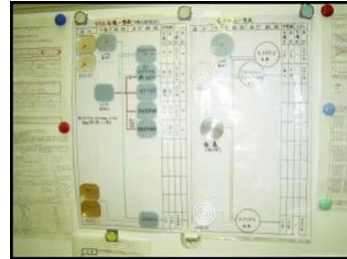

Standard operation chart on the wall

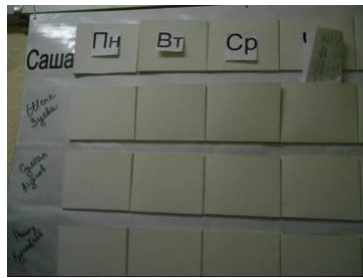

Simple schedule (Printing company)

127

127

## Case : Medical Clinical Laboratory & Testing

Use of bar code and different color (Sample, Container and Wall)



128

128

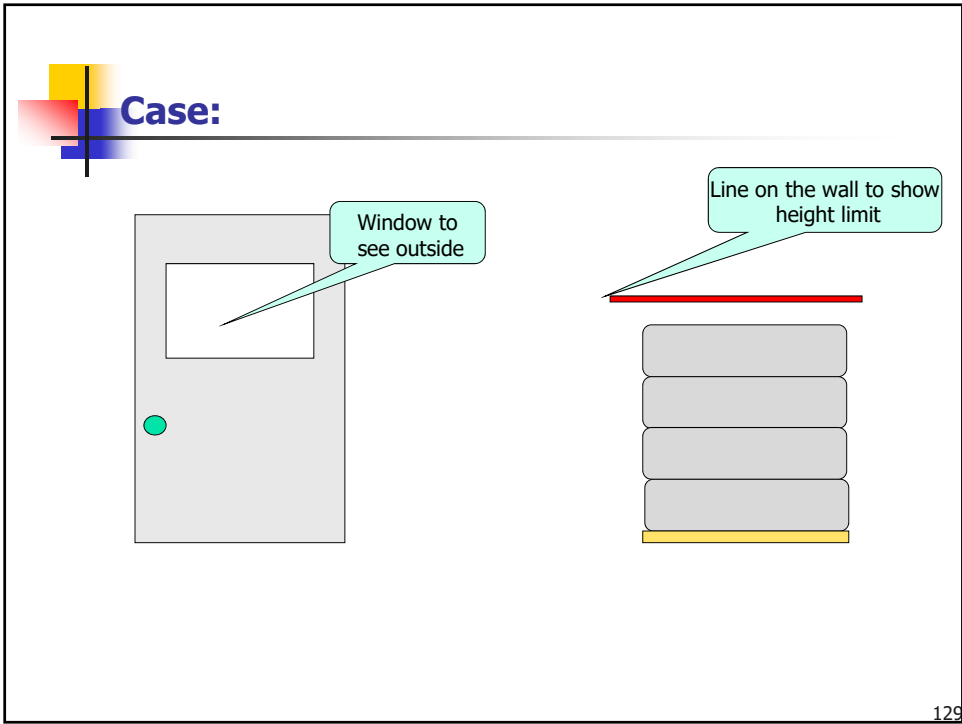

**Case: Gantt chart**  
 (Visualization of daily production planning)

Day	1	2	3	4	5	6	7	8	9	10
Line 1										
Line 2										
Line 3										
Total No. of workers										



## Visualization check list

No.	Check point	Score (1-5)
1	Sign to classify sections are large enough?	
2	Colored line on the floor indicating how a product is to be stacked?	
3	Signs are easy to understand?	
4	Are there freestanding whiteboard?	
5	Are there progress control board?	
6	Production plan is visible?	
7	Color is used, e.g. in inventory management? (FIFO)	
8	Traceability information is visualized? (Lot no., production date, internal code no. etc.)	
9	Bar code or QR code is used?	

131

131



## Visualization check list

No.	Check point	Score (1-5)
10	Defect cases are visualized?	
11	Follow-up of defects is visualized? (who, what, when, where)	
12	Defect graph by reason exists?	
13	In the storage area, each area is clearly marked to ensure that there are no mistakes when sorting and placing goods?	
14	The shelves are systematically organized and clearly labeled, while each individual product is also labeled with a sticker?	
15	Each label is designed to be both human and machine readable?	

132

132





---

**Exercise:** Please develop cases of applying ECRS in your life (business/private) .

133

133



## 5S and 7 Wastes

---

134

134



## 5 S's in both Japanese & English

### 5 Fundamental Principles

In Japanese

In English

<b>Seiri</b> (整理)	<b>S</b> orting: Remove unnecessary things. Separate out what is needed for the operations.
<b>Seiton</b> (整頓)	<b>S</b> et in order: Place things in order and make them visible
<b>Seiso</b> (清掃)	<b>S</b> weep: Tidy up and clean up
<b>Seiketsu</b> (清潔)	<b>S</b> tandardize: Keep/maintain your surroundings clean and comfortable
<b>Shitsuke</b> (躰)	<b>S</b> ustain: Make a custom of practicing the principles

135

135



## Case: Seiri, Seiton



Die Storage Shelf



Tool Shadow Board

- Seiri: Discarding Rules**
- Checking Cycle
  - Place
  - Term to keep



136

136

## Case: 2S (Seiri/Seiton) in Tool Cabinet



The 2S was implemented in the following procedure:

- \* Classify necessary and unnecessary items. And eliminate all unnecessary items ('Seiri');
- \* Identify and classify necessary item's location, amount, and how to store ('Seiton').

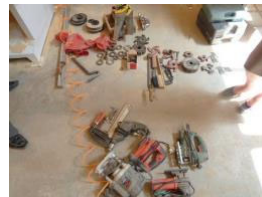

137

137

## Case: Seiton?



Putting things on the floor.



FIFO possible?

138

138

## Case: Seiton in Office



139

182

139

## Case: Seiton in Office



140

140

## SMEs in Higashi Osaka

This company is supplying aircraft parts to Boeing, U.S.A.  
Quality check at every production process and all quantities.



Storage system of spare parts/  
tools (size by size)



Utilizing the vertical space to  
store materials

141

141

## 5S in the warehouse (Packaging materials)



BEFORE KAIZEN



AFTER KAIZEN

142

142



## 5S in the warehouse (Packaging materials)



BEFORE KAIZEN

AFTER KAIZEN

143

143



## 5S at the shop floor



BEFORE KAIZEN

AFTER KAIZEN

144

144





## 5S check list

Score: 1 Not at all, 2: Need improvement, 3: Good

Area	No.	Description	Score (1-3)	Remark
Workshop	1	Materials, WIP, Tools are only for today?		
	2	Material and parts are in order?		
	3	Tools are close to handle by order of frequency? The more use, the closer.		
	4	No material, WIP, tools not necessary now are on operation table?		
	5	Unnecessary items under the operation table?		
	6	Documents, operation manuals are scattered?		
	7	Ashtray?		
	8	Food or beverage?		
	9	Personal belongings?		
	10	Pleasant atmosphere?		

145

145



## 5S check list

Score: 1 Not at all, 2: Need improvement, 3: Good

Area	No.	Description	Score (1-3)	Remark
Equipment/machine	1	Machines, equipment, old parts are left?		
	2	Tools are left?		
	3	Safety cover is set well?		
	4	Recorder and meter is correct?		
	5	Pipes and cables of electricity, oil, steam and air set with differentiation?		
	6	No leakage of oil, steam air?		
	7	Manual and electricity chart are well stored?		
	8	Machine and equipment are cleaned?		

146

146



## 5S check list

Score: 1 Not at all, 2: Need improvement, 3: Good

Area	No.	Description	Score (1-3)	Remark
Parts shelf	1	Unnecessary items?		
	2	Not parts like tools in the shelf?		
	3	Number of items is recorded and right?		
	4	Easy to take out?		
	5	Shelf is good place to use?		
	6	FIFO?		
	7	Can items be seen from outside?		
	8	Cleaned well including surrounding of shelf?		

147

147



## 5S check list

Score: 1 Not at all, 2: Need improvement, 3: Good

Area	No.	Description	Score (1-3)	Remark
Place of Materials	1	Any material not used long time?		
	2	Other items are in the place?		
	3	Well organized? By group, by product, by process or by supplier?		
	4	FIFO?		
	5	Cleaned well including surrounding areas?		
Place of finished products	1	Any product stays long time?		
	2	Anything which is not finished products in the place?		
	3	Any deteriorated product?		

148

148





## 5S check list

Score: 1 Not at all, 2: Need improvement, 3: Good

Area	No.	Description	Score (1-3)	Remark
Place of finished products	4	FIFO?		
	5	Cleaned well including surrounding areas?		
Pipes, cables	1	Any unnecessary pipes and electric cables?		
	2	Fixed well?		
	3	Disturbing walking?		
	4	Steam pipes well insulated?		
	5	Categorized and signed by directions to go?		
Corridor/ Floor	1	Unnecessary items?		

149

149



## 5S check list

Score: 1 Not at all, 2: Need improvement, 3: Good

Area	No.	Description	Score (1-3)	Remark
Corridor/ Floor	2	Lined to differentiate		
	3	Cleaned		

150

150



**Exercise (Homework):** Please show photo in your office or factory of "Before" and "After" implementing 5S.

151

151



## Waste Analysis (1/2)

**Seven Wastes**

Man	Waste of Motion
	Waste of Waiting
Machines	Waste of Overproduction
	Waste of Processing
	Waste of Defects
Materials	Waste of Transport
	Waste of Inventory

**Wastes/Futility = Cost Increase**

152

152



## Seven Wastes in Manufacturing (1/2)

Wastes of	Definition	Frequent phenomena
<b>Motion</b>	Motion within a local area that does not add value. <b>Difficult motion</b>	<ul style="list-style-type: none"> <li>• Searching for materials, components drawings or documents</li> <li>• Reaching for tools</li> <li>• Lifting boxes of components</li> <li>• Walking away to bring tools to area</li> </ul>
<b>Waiting</b>	Idle time created when people, materials, information, or equipment is not available when required	<ul style="list-style-type: none"> <li>• Waiting for parts or drawings</li> <li>• Waiting for information</li> <li>• Waiting for machine repaired</li> <li>• Waiting for people</li> </ul>
<b>Over production</b>	Generate more than the customer requires	<ul style="list-style-type: none"> <li>• Producing for stock/inventory</li> <li>• Working in large batches to avoid set ups</li> <li>• Adding 'scrap' allowances</li> </ul>
<b>Processing</b>	Efforts to create no added value from the customer's view such as <b>rework, reprocessing.</b>	<ul style="list-style-type: none"> <li>• Unnecessary operations</li> <li>• Over-tight tolerance</li> <li>• Bad design</li> <li>• Multiple cleaning</li> </ul>

153

153



## Seven Wastes in Manufacturing (2/2)

Wastes of	Definition	Frequent phenomena
<b>Defects</b>	Not perfect products <b>Processing due to defects, rework, repair or discard.</b>	<ul style="list-style-type: none"> <li>• Scrap</li> <li>• Rework</li> <li>• Defects</li> <li>• Corrective actions</li> <li>• Field failure</li> <li>• Variation</li> <li>• Missing parts</li> </ul>
<b>Transport</b>	Movement between plants or offices or areas that does not add to the value of the finished goods or service	<ul style="list-style-type: none"> <li>• Moving parts or equipment in and out of storage</li> <li>• Moving materials from one area to another</li> <li>• Moving parts between processes</li> </ul>
<b>Inventory</b>	More materials on hand than currently required	<ul style="list-style-type: none"> <li>• Raw materials</li> <li>• Work in progress</li> <li>• Finished goods</li> <li>• Consumable storage</li> <li>• Off site inventory</li> </ul>

154

154



## Seven Wastes in Office

Wastes	Office
Motion	Search, unnecessary motions without standard operation
Waiting	Waiting for signature, specification, document
Overproduction	Extra features
Processing	Paper work, Non-value added work
Defects	Error, mistake, bug Additional operation due to error
Transportation	Document, message switching, task switching By office layout, position of items
Inventory	Partially done work, documents waiting for being processed

155

155



## Waste 1: Motion

- Motion Economy Checklist
- 5S
- Study by Video
  - Pick up parts behind (0.6 seconds)
  - Difficult motion → Defects
  - Table height in the office



156

156



## Waste 2: Waiting

**Case: Team Coordinator is travelling abroad and consultants under the team coordinator sending invoices to the office. Invoices are waiting for his signature.**

**Before:** Invoices waiting for the signature while he is travelling abroad



**After:** On-line approval by email after checking invoices and evidences

**Further:** Electronic signature

**Case: Workflow automation**

**Case: Queuing Theory**

- More service counters
- Multi-skilled workers
- Reduction of service time dispersion

**Case: Reservation system (Barber shop, Hospital)**

**Case: Phone transfer/Voice warp**

**Case: Just-In-Time (Pull system)**

157

157



## Case : A Barber Shop

**Waiting is no value-added activity.**

1. Barbour shop is always crowded.
  - Many people are waiting.
  - They are losing time.
  - Potential customers leave due to the crowdedness.
  - Owner is not profitable but busy.
2. Copy the idea in production control!
  - Normally production plan is well organized to meet the demand and resources constraints.
  - Scheduling is the key.
3. New service
  - Reservation system.
  - No waiting of customers.
  - More profitable work for owner.

158

158

## Waste 3: Processing

### Bad design: Bottle of water

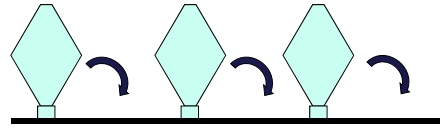

Unstable shape designed

Unnecessary process  
: Raise a fallen bottle

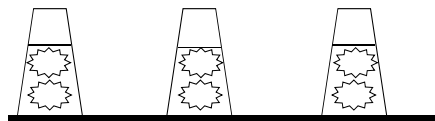

Too decorative surface designed

Unnecessary process  
: Refilling for water with gas  
To keep the level

### Bad design:

- Mistake in planning of a seminar
- Project design in consulting -> Use of old proposals
- System design phase

### Delegation

159

159

## Waste 4: Inventory

### Japanese Stance of Inventory Management

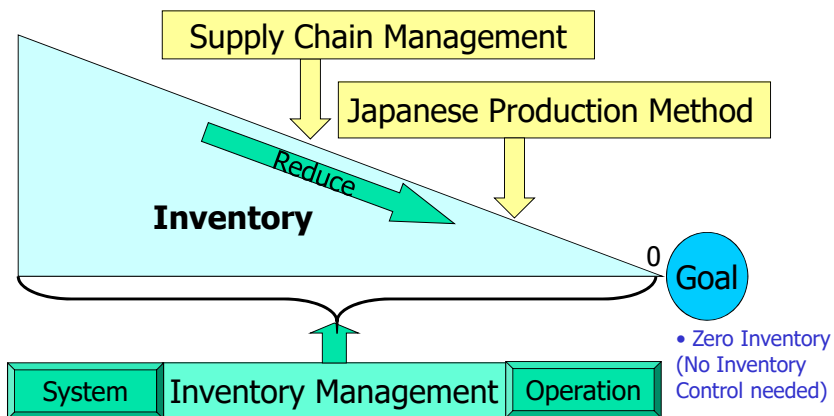

160

160

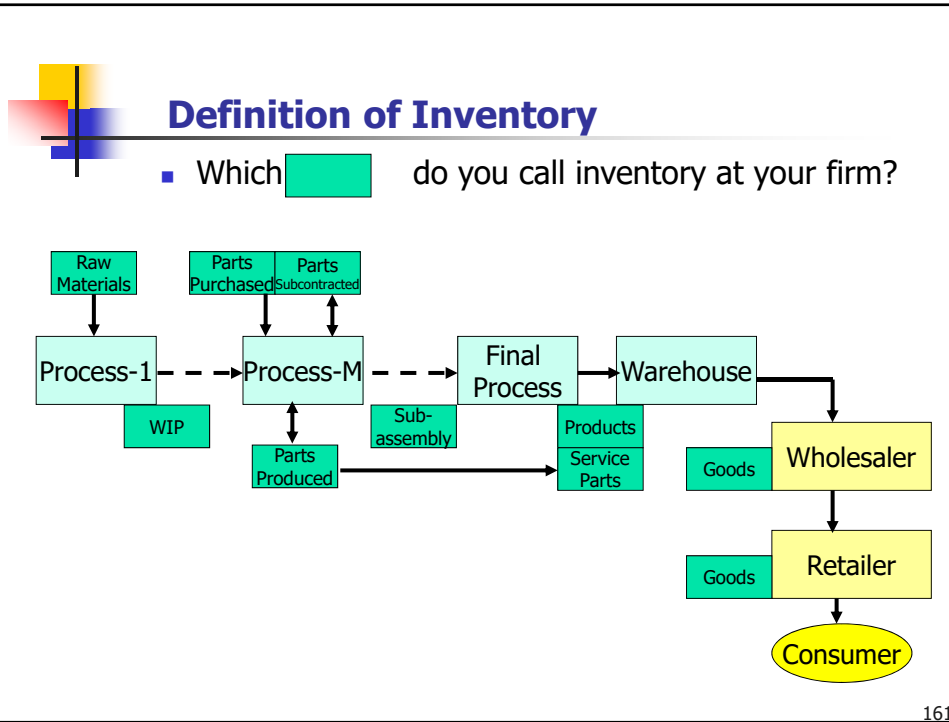

161

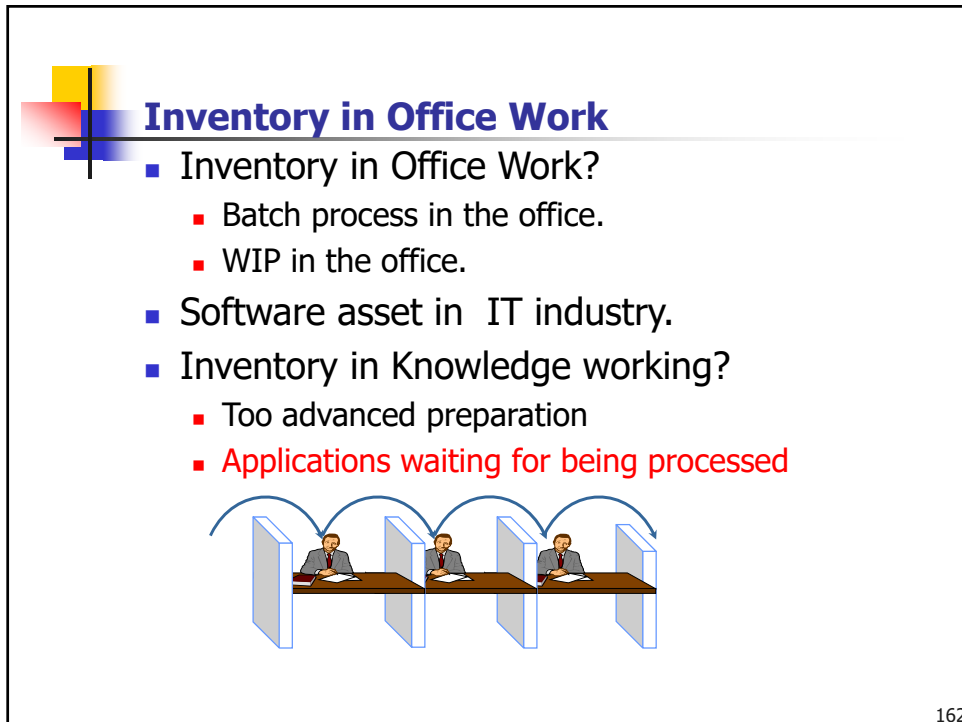

162



## Requirements of Inventory Management

- Principle: Inventory should be zero.
  - Many problems reside within inventory.
  - Difficult to identify real problems.
    - Defects
    - Machine down
    - Can not catch up the delivery time.
    - Can not follow the specification changes quickly.
  - Zero base approach is important.
  - Inventory is 'waste', 'wrong thing to have' or even 'evil'.
- Zero inventory means no need for inventory control.
- Inventory control is required en route to zero inventory.

163

163



## Why Is Inventory Bad?

### Inventory covers up the problems in the factory

- Schedule change not followed
- Many defect products
- Machine troubles
- Long setup time
- Shortage of parts
- Machine capacity ill-balanced
- Machine size too large

### Inventory causes:

- Increase of interest on a loan
- Occupation of additional space
  - Outside Warehouses
- Wasteful transportation
  - Transport it to the warehouses
  - Extra Workers, Forklifts
- Extra management cost
  - Additional Inventory Control Systems
- Unnecessary consumption of materials and parts
  - Stain remover, pallets
- Waste of energy

Shortage → More production → More inventory

164

164





## Ordering/Lead Time/Inventory

- Assume that:
  - Same shipment (sales) everyday
  - Same order quantity every time

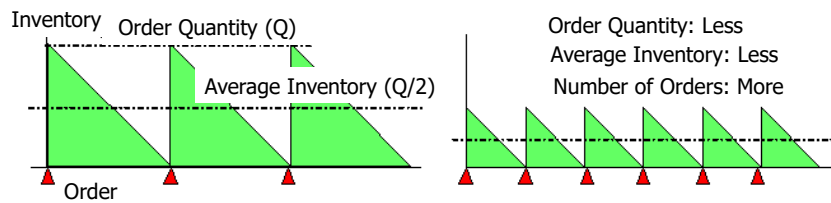

**The more frequent ordering, the less inventory.  
Less lead time is the key!**

165

165



## Waste: Inventory Case: Work in process

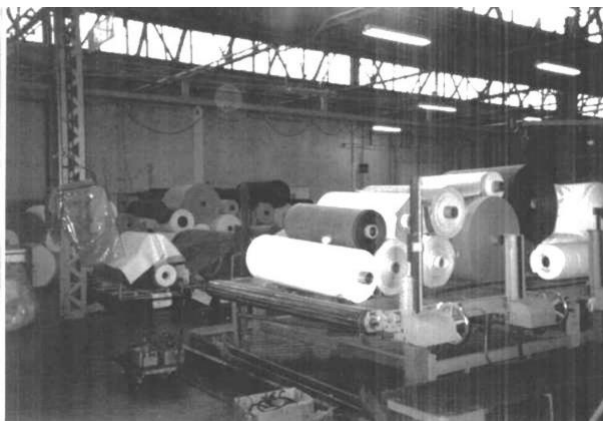

- Inventory
- Work in process
  - Not well organized

166

166



## Inventory Tag

### Important points in attaching inventory tags

1. Put one tag on each item. Fill in the number of receive/issue on each receive and issue of inventory.
2. In case the item belongs to the 'Ordering Point System' category, write the number of items at Reorder Point for further order,
3. At inventory check, put a mark (e.g. red line) on the tag and fill in the inventory check results. This makes it clear when the theoretical inventory met the physical inventory.

167

167



## Classification and Frequency of Inventory Check (Example)

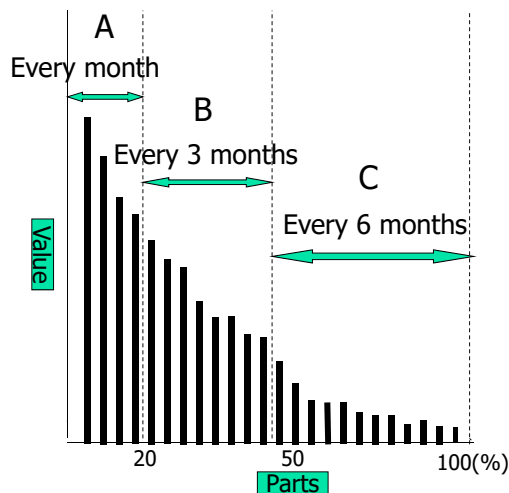

Classification	Month of inventory check
A	Every month
B1	1, 4, 7,10
B2	2, 5, 8,11
B3	3, 6, 9,12
C1	1, 7
C2	2, 8
C3	3, 9
C4	4, 10
C5	5, 11
C6	6, 12

168

168



## Inventory Control System

- Objectives
  - By having accurate inventory (including planned), it would be possible to:
    - Promises to delivery (to customers, to production)
    - Get appropriate ordering quantity
  - Find dead stock to discard or slow moving items.
  - **Quality** of slow moving items and dead stock is questionable.

169

169



## Inventory Control System

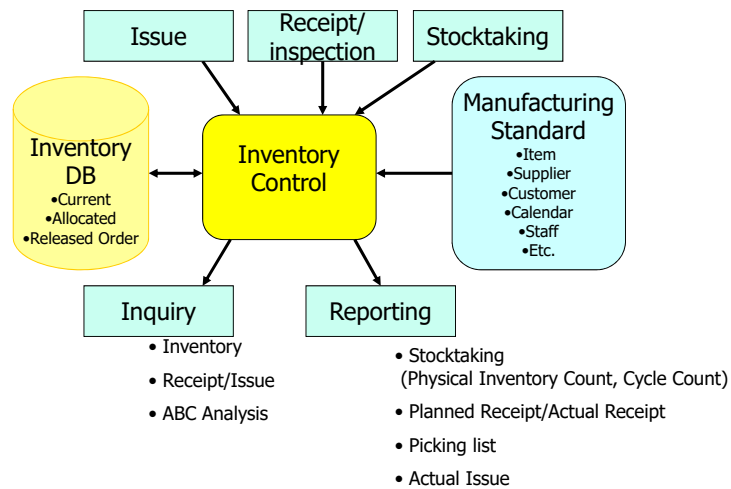

170

170

## Waste 5: Over Production

- Production before necessary timing
- Production more than necessary amount

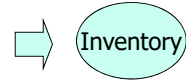

### ■ Hide wastes of:

- Waiting
- Motion

### ■ Create wastes of:

- Processing
- Transportation (material Handling)
  - More palette
  - More carts for transportation

171

171

## Case: Working in large batches

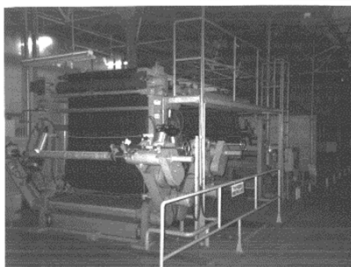

- Huge continuous line
- Huge lot size
- Not well used



### Case: Cell Method

Flexible production to meet with market needs/changes

### Case: Over-specification

### Case: Over-wrapping

### Case: Excess of report writing

172

172

## Waste 6: Transportation

### Example 1:

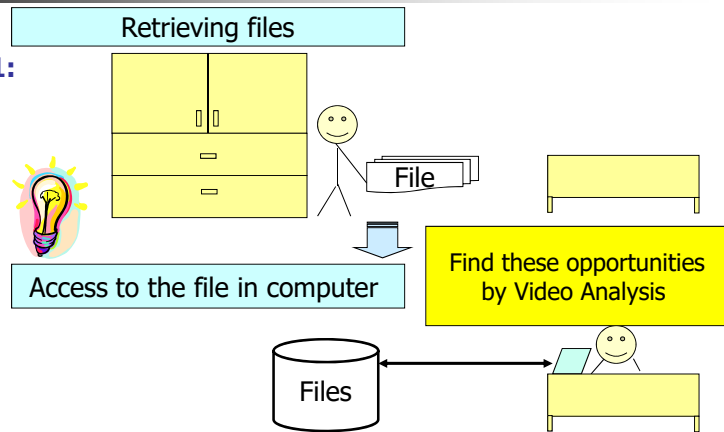

### Example 2:

Panasonic: 50 units/container -> 100 units/container by small size change of packaging, then half a number of transportation

173

173

## Waste 6: Transportation



- Bottle to dirty floor, then bag
- Transportation by bag
- Taking out bottle from bag in the next process

- New container to transport smoothly and for quick take-out
- No more putting bottle to the floor and putting it to the bag (small transportation)
- No more transportation by bag to the next process

Next step: Eliminate the transportation itself or shorten it!

174

174



## Waste 7: Defects

---

- Poka-Yoke (Mistake proof)
  - Use of checklists
- Standard operation
- QC circle
  - Use of 7 tools
- Quality at the source (TPS)
- Use of proven software

175

175



**Group discussion:**  
Please identify '7 Wastes' in your office or factory and make presentation.

176

176



## Kaizen Master Plan

---



177

177



## Steps of Kaizen master plan

---

- (1) Diagnose production management by standard questionnaire to grasp the client status briefly and identify the weak areas.**
- (2) Diagnose client's operations in the factory, using checklists or instruments including video, stopwatch, etc. to find the areas to improve.**
- (3) List up findings which are areas to have opportunities to improve.**
- (4) Discuss findings with the management and identify areas to challenge to improve.**
- (5) Prioritize the areas to improve (problems/challenges)**
- (6) Organize the project team(QC circle). Assign the persons responsible for each problem/challenge and consultants working together.**
- (7) Discuss with these persons and decide the time frame (man/days)**
- (8) Define detailed tasks including training of management.**
- (9) Draw Kaizen Master Plan after the above process (1) to (9)**
- (10) Explain the details of Kaizen Master Plan and obtain the commitment from both management and persons responsible.**

178

178



## Kaizen Master Plan (sample)

### Kaizen master plan

Category	Jan	Feb	Mar	Apr	May	June
Introduction	→					
Workshop						
Gemba WS	→					
Duration: 3-5 days 10 WS takes place						
Seminar	→					
Duration: 1-2 day 6 SM takes place						
<b>Objective:</b>						
To recognize and eliminate all kinds of waste						
To standardize and stabilize all improvement						
<b>Participants:</b>						
Cross-section of all employees, managers/department leaders/supervisors workers/production engineering staff 120 people to be trained in this step						

179

179



## Kaizen Planning sheet (sample)

### Kaizen plan for 5S

Category	Activity	Jan	Feb	Mar	Apr	May	June	July
Sorting	Project start	→						
	Planning/consensus for implementation	→						
	Selecting/Collecting unnecessary items	→						
	Making operational rule							
Shining	Planning/consensus for implementation		→					
	Planning for company-wide shining and implementation		→					
	Planning for daily shining rule and implementation			→				
Setting in order	Planning/consensus for implementation				→			
	Implementation of setting in order				→			
	Making operational rule					→		
Sustaining	Planning/consensus for implementation	→						
	5S Patrol							
Event	Monitoring by members	○	○	○	○	○	○	○
	Monitoring by chairperson	○	○	○	○	○	○	○
Event	5S meeting (weekly)	○	○	○	○	○	○	○
	5S competition						○	

180

180







## Rules of KAIZEN (Sample)

---

(Purpose)

Chapter 1

All employees are requested to positively participate in KAIZEN and propose their aggressive opinions to improve production works. Due to this activity, rationalization and improvement of production systems in the factory will be conquered and accordingly employees' participation spirit and motivation toward production efficiency will be the target of KAIZEN.

183

183



## Rules of KAIZEN (Sample)

---

(Proposers)

Chapter 2

Either individual or groups of the employees and its subcontractors are expected to make KAIZEN proposals.

(Contents of proposals)

Proposals shall be creative, inventive, constructive, applicable and achievable in the following categories.

- Improvement of working method
- Shortening of production lead time
- Improvement of working environment

184

184



## Rules of KAIZEN (Sample)

---

- Improvement of quality of the products
- Effective usage of work spaces
- Cost reduction of materials, labor, expenses, etc.
- Improvement of work safety
- Effective usage of disposed and/or used materials and tools.
- Others equivalent to the above.

185

185



## Rules of KAIZEN (Sample)

---

(Contents not be regarded as KAIZEN proposals)

Chapter 4

Following proposals shall not be regarded as KAIZEN proposals.

- Works instructed by the upper positions
- Same and/or very similar proposals which were already proposed and implemented.
- Simple hopes, desires, and/or claims which do not include factors of proposals.
- Matters of human affairs such as evaluation of works and/or movements in organization.

186

186



## Rules of KAIZEN (Sample)

(Organization to promote KAIZEN)

### Chapter 5

The below-mentioned organization shall be established in order to receive, evaluate and implement proposals.

#### A) KAIZEN office:

- Location: It should be established in the general affairs section of production department
- Duty of KAIZEN office: Receiving proposals, checking of contents, and confirmation, if there is not same or similar proposals ever made, deciding which section will be responsible go such proposals, reviewing KAIZEN system and related office works.

187

187



## Rules of KAIZEN (Sample)

#### B) KAIZEN committee

- KAIZEN committee: Each section shall appoint one KAIZEN committee member: valid one year, but extendable.
- Duty of KAIZEN committee: Promotion of KAIZEN system and support and indication to proposers.

#### C) Evaluation committee

- Forming of evaluation committee  
Chairperson: General Director of Production Division  
Deputy Chairperson: Factory Manager  
Committee members: Heads of each section and department
- Duty: Evaluation of proposals to judge whether such proposals are applicable or realizable.

188

188



## Rules of KAIZEN (Sample)

(How to propose and how to receive)

### Chapter 6

Proposals are to be written in the format paper and described in detail. If necessary, supplemental documents should be attached and sent to the KAIZEN office.

(KAIZEN office)

### Chapter 7

Once proposals are submitted, KAIZEN office shall confirm the contents and send the proposals to the head of related sections as well as to the evaluation committee.

189

189



## Rules of KAIZEN (Sample)

(Evaluation of proposals)

### Chapter 8

A) Evaluation committee shall be held from time to time depending on the contents and no. of proposals.

B) Evaluation committee shall review contents and classify them into A to D class in accordance with the followings;

- A class: Proposals fulfilling conditions in Chapter 3 and considered as excellent. Evaluation point is 90 -100.
- B class: Proposals fulfilling conditions in Chapter 3 and considered as good. Evaluation point is 70 – 89.
- C class: Proposals fulfilling conditions in Chapter 3. Evaluation point is 50 – 69.

190

190



## Rules of KAIZEN (Sample)

- D class: Proposals to be revised for reconsideration. Evaluation point is less than 49.

Evaluation factor	Evaluation items and points			
Efficiency (40 points)	More than ¥1.0million/year (40-31 points)	More than ¥0.5 million/year (30-21 points)	More than ¥0.1million/year (20-11 points)	Less efficiency (10-0 points)
Possibility of realization (20 points)	Easily possible (20-16 points)	Preparation is necessary (15-11 points)	Further improvement necessary (10-6 points)	Reconsideration Necessary ( 5-0 points)
Idea (20 points)	Excellent (20-16 points)	Very good (15 -11 points)	Good (10-6 points)	Not bad (5-0 points)
Effort (20 points)	Big effort (20-16 points)	Rather big effort (15-11 points)	Medium effort (10-6 points)	Less effort (5-0 points)

191

191



## Rules of KAIZEN (Sample)

- c) Proposals regarded as A and B classes are to be promptly realized and contents of proposals are to be made public on the board in the factory.
- d) Evaluation committee is to be held every 3 months. (June, September, December and March)

(Realization of proposals)

Chapter 9

Adopted proposals are to be promptly realized through meeting between the committee and responsible sections.

192

192



## Rules of KAIZEN (Sample)

(Award)

### Chapter 10

- The persons whose proposals meet conditions of Chapter 3 are to be awarded by prizes.
- Prizes are in accordance with the following table.

Award grade	Prize
A class	¥ 5,000.-
B class	¥ 2,000.-
C class	¥ 500.- (coupon for shop in the factory)
D class	¥ 200.- (coupon for shop in the factory)

193

193



## Rules of KAIZEN (Sample)

### Supplementary conditions

- A) Effectiveness: 1<sup>st</sup> January, 2012
- B) Approved by: General Director of Production
- C) Responsible section: General affairs section of Production Department (KAIZEN office)
- D) Remarks: This rule shall be reviewed and revised if necessary by KAIZEN committee.

194

194



## Rules of KAIZEN (Sample)

---

Group discussion

When you implement KAIZEN in your organization, what kind of committee is to be established and what kind of rules are to be set?

195

195



**Thank you very much for  
your participation to this  
course!**

196

196



Specialized Course (SC)  
(Owners and Managers)

2018

Business Process Reengineering



## **Special Course (BPR and SCM)**

---

**September,2018**  
**Uzbekistan Japan Center**  
**JICA**

1



### **Vision and Mission of This Course**

---

#### **Vision**

**All participants become familiar with BPR and SCM concept and methodologies, and apply them to their day to day operations in both factory shop floor and office in order to achieve business growth.**

#### **Mission**

**Identify the problems or challenges in the operation and come up with ideas for BPR and SCM and apply them through team work approach.**

---

2



## Introduction of Lecturer

**Name** : Mitsuo Tamada, JICA Expert ,EBRD Senior Industrial Advisor

Email address: [mitsuo.tamada@truspire.com](mailto:mitsuo.tamada@truspire.com)

**Company** : Truspire Co., Ltd. ([www.truspire.com](http://www.truspire.com))

**Experience** : (1) 30 years Japanese textile company  
International Business, Marketing & Administration  
(2) 3 years in Textile/garment factory in Africa  
(3) 12 years consulting in Kaizen, Production/Operation,  
Sales Management, Marketing in various countries.



3



## Schedule/Table of Contents

Day	Topics	Slide No.
1	BPR (Business Process Re-engineering)	5
2	SCM (Supply Chain Management)	61

4



# Business Process Re-engineering (BPR)

---

5



## Introduction

---

- The most charismatic figure in the reengineering movement is Mike Hammer, who popularized the term reengineering in the Harvard Business Review.

the fundamental rethinking and radical redesign of business processes to achieve dramatic improvements in critical contemporary measure of performance such as **cost, quality, service and speed.**

**KPI: Quality, Cost, Delivery**

6



## Introduction

BPR reviews all aspects of people, process, technology and organization in a single coordinated approach.

7

7



## Why reengineering?

Why companies need to implement reengineering?  
Why companies designed inefficient processes?



Many of their procedures were not designed at all, **they just happened.**

8

8



## Process of 'just happened'

---

1. The company founder recognized that he or she did not have time to handle a chore, so he or she delegated it to Smith.
2. Smith improvised. Time passed, the business grew, and Smith hired his entire clan to help him cope with the workload.
3. They all improvised.
4. Each day brought new challenges and special cases, and the staff adjusted its work accordingly.
5. The mixture of special cases and quick-fix was passed from one generation of workers to the next.

9

9



## Company continual success

---

A company's current success is usually based on changes made over the previous five to ten years, so success today does not guarantee success tomorrow unless a company is already thinking ahead.

10

10



## Three kinds of companies undertaking BPR

---

1. Companies finding themselves in deep trouble such as:
  - Uncompetitive price due to high production/operation cost.
  - Unsatisfactory or limited customer service level
  - High defective rate of products or services

Case study of 'Ford' in 1980 was a good example.

11

11



## Three kinds of companies undertaking BPR

---

2. Companies that are driving along very smoothly, but see something rushing forward them in their headlights
  - These companies are not yet in trouble, but have the foresight to see trouble coming. These companies have the vision to be reengineering in advance of running into adversity.

12

12

## Three kinds of companies undertaking BPR

3. The company undertaking reengineering is in peak condition.
  - They have no discernable difficulties, either now or on the horizon, but their managements are ambitious and aggressive. Reengineering is an opportunity to further their lead over their competitors.
  - By enhancing their performance, they seek to raise the competitive bar even higher and make life even tougher for everyone else.

13

13

## Key words of BPR

- Four key words that characterize BPR:

Fundamental, Radical, Dramatic, Process

Task-based thinking

Task-based thinking: Fragmentation of work into its simplest components and their assignment to special workers



Process-based thinking

Process-based thinking: Process to be reviewed whether such process adds value from the customer point of view.

14

14





## Improvement in Process Design Phase

- ECRS Principles in IE (Industrial Engineering):
  - **E**liminate      Eliminate the operational steps
  - **C**ombine      Conduct several operational steps concurrently
  - **R**earrange      Change the order of operational steps
  - **S**implify      Simplify operational steps

15

15



## Organizing for BPR

1. Identify the need for reengineering and business vision
2. Obtain the business unit leader's commitment
3. Identify process to be redesigned
4. Understand and measure existing processes
5. Identify the enabling role of IT and design new process
6. Specify the technical and social solutions
7. Transform the business processes

16

16

## BPR (Business Process Reengineering)

### Definition

- Reengineering Work: Don't Automate, Obliterate (Michael Hammer)
  - Harvard Business Review (July-August 1990)
- Review the flow of business process completely and restructure (re-engineer) it with IT supports.
- Target is office (paper factory: white collar operation).

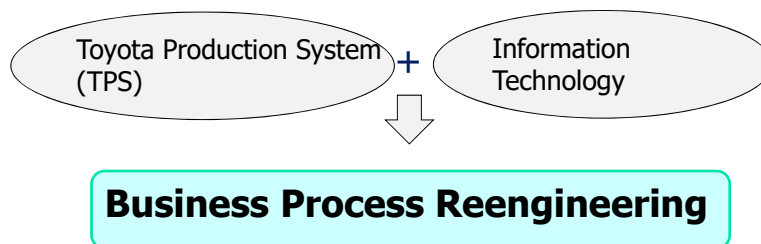

296

17

## TPS (Just In Time)

- **Just In Time: 'Just' is important.**
- **'In Time' still keeps wastes.**
- **Original idea was from Supermarket in the USA.**
  - **Customer = Succeeding Process**
  - **Supermarket = Preceding Process**
  - **Customer comes takes necessary amount of necessary items at necessary time.**

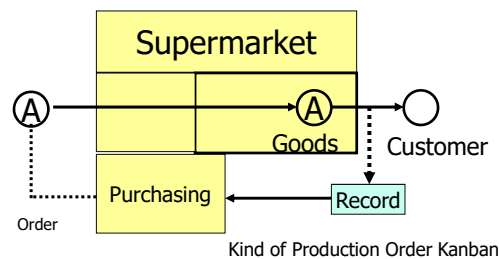

18

18

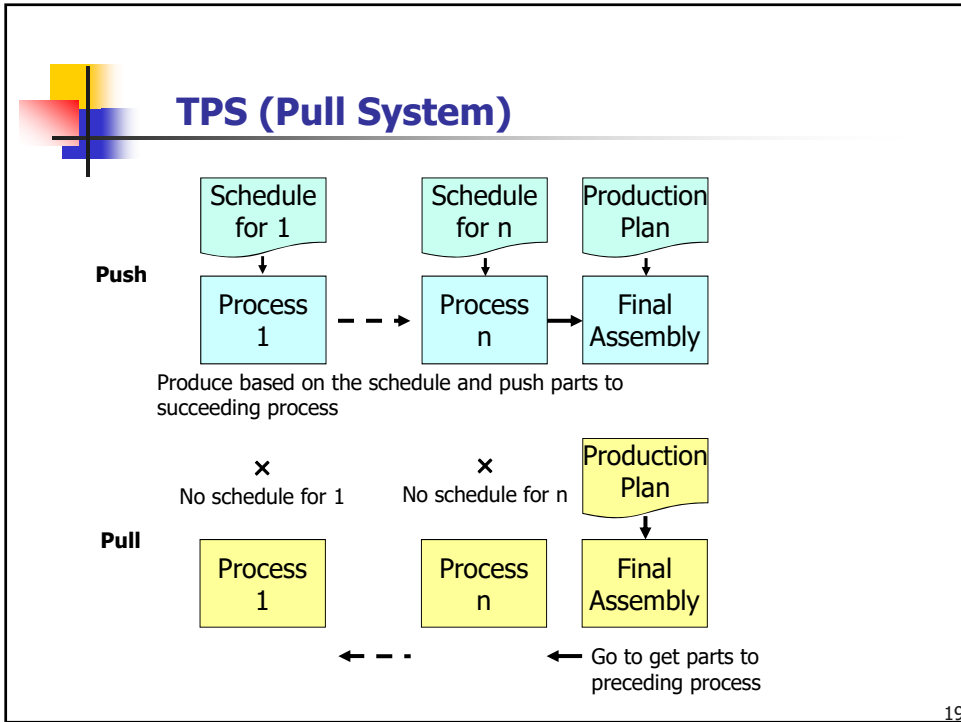

19

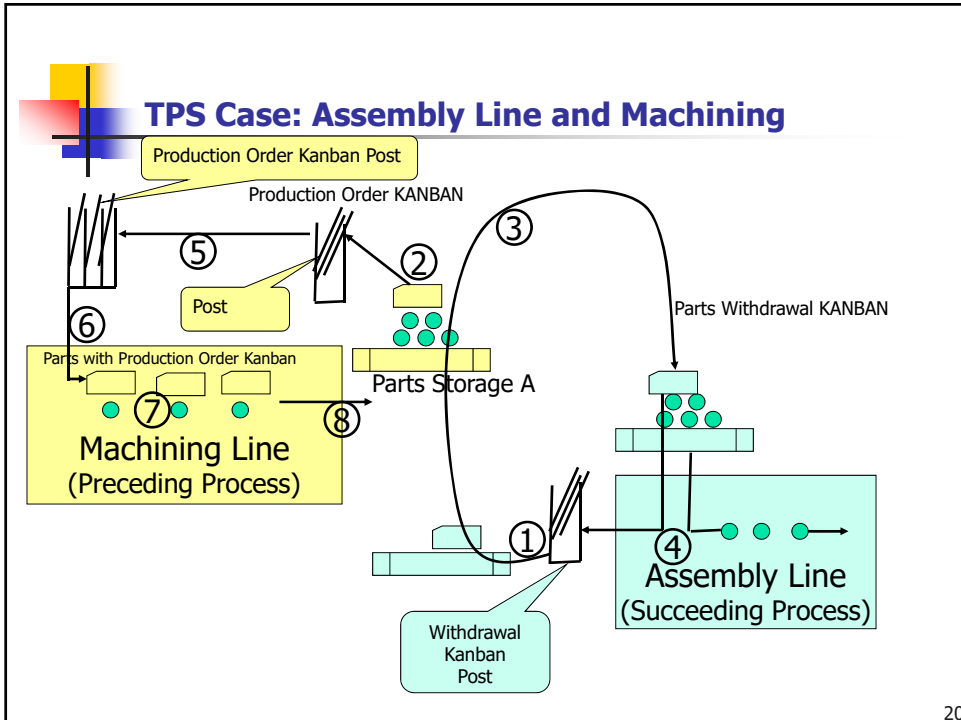

20

## TPS (Root Cause Analysis-5 Whys )

- Suppose the machine stopped.
  - 1st Why: Why did the machine stop?  
Fuse was cut due to overload.
  - 2nd Why: Why overloaded?  
Insufficient lubricant.
  - 3rd Why: Why insufficient?  
Lubricant pump did not draw the oil well.
  - 4th Why: Why did the pump draw the oil insufficiently?  
The shaft of the pump wore down and became shaky.
  - 5th Why: Why did it wear down?  
No strainer gave a chance of getting small metal scraps.
- Then, the resolution is to install a strainer.
- If only 1<sup>st</sup> Why, the answer is just changing the fuse.

## Waste Analysis (1/2)

Man

Machines

Materials

### Seven Wastes

Motion
Waiting
Overproduction
Processing
Defects
Transport
Inventory

**Wastes/Futility = Cost Increase**



## Seven Wastes in Manufacturing (1/2)

Wastes	Definition	Frequent phenomena
<b>Motion</b>	Motion within a local area that does not add value	<ul style="list-style-type: none"> <li>• Searching for materials, components drawings or documents</li> <li>• Reaching for tools</li> <li>• Lifting boxes of components</li> <li>• Walking away to bring tools to area</li> </ul>
<b>Waiting</b>	Idle time created when people, materials, information, or equipment is not available when required	<ul style="list-style-type: none"> <li>• Waiting for parts or drawings</li> <li>• Waiting for information</li> <li>• Waiting for machine repaired</li> <li>• Waiting for people</li> </ul>
<b>Over production</b>	Generate more than the customer requires	<ul style="list-style-type: none"> <li>• Producing for stock/inventory</li> <li>• Working in large batches to avoid set ups</li> <li>• Adding 'scrap' allowances</li> </ul>
<b>Processing</b>	Efforts to create no added value from the customer's view	<ul style="list-style-type: none"> <li>• Unnecessary operations</li> <li>• Over-tight tolerance</li> <li>• Bad design</li> <li>• Multiple cleaning</li> </ul>

23

23



## Seven Wastes in Manufacturing (2/2)

Wastes	Definition	Frequent phenomena
<b>Defects</b>	Not perfect products	<ul style="list-style-type: none"> <li>• Scrap</li> <li>• Rework</li> <li>• Defects</li> <li>• Corrective actions</li> </ul> <ul style="list-style-type: none"> <li>• Field failure</li> <li>• Variation</li> <li>• Missing parts</li> </ul>
<b>Transport</b>	Movement between plants or offices or areas that does not add to the value of the finished goods or service	<ul style="list-style-type: none"> <li>• Moving parts or equipment in and out of storage</li> <li>• Moving materials from one area to another</li> <li>• Moving parts between processes</li> </ul>
<b>Inventory</b>	More materials or information on hand than currently required	<ul style="list-style-type: none"> <li>• Raw materials</li> <li>• Work in process</li> <li>• Finished goods</li> <li>• Consumables</li> <li>• Off site inventory</li> </ul>

24

24

## BPR Principles

### Principle 1

- Treat geographically dispersed resources as though they were centralized.
  - Develop system where information always exist when a person who needs it.
- TPS: JIT (Just In Time)
  - Withdraw necessary number of necessary items from preceding process to succeeding process and produce what withdrawn in preceding process.
- TPS: Waiting is waste. (Elimination of 7 wastes) In-tray

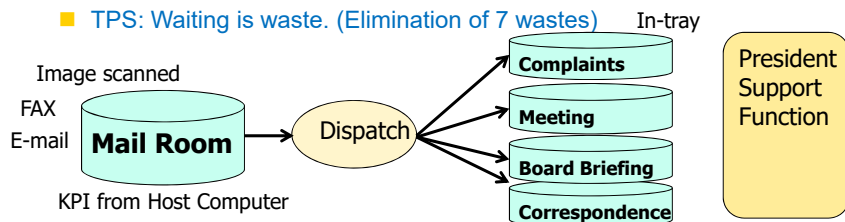

297

25

## Case of Principle 1 (Rental business)

IT (Information Technology) enables you new services.

Average utilization  
40%



Big Rental's utilization  
70%

Schedule  
Optimization

IT  
Internet

24hours  
Monitoring

Rental business of  
heavy construction  
machines

- Position information+GPS/Internet
- Available machines
- Transportation optimization
- Pricing information
- Sales staff access to the information

- 15 staff: 3,000 transactions/day
- 7,000 machines

298

26

## Case: KOMATSU: KOMTRAX

- GPS/Internet
- Machines are geographically dispersed resources.
- Centralized information.
- More than 300,000 in the world.
- Many machines were not moving in China. Then, decrease the production by changing the production plan.

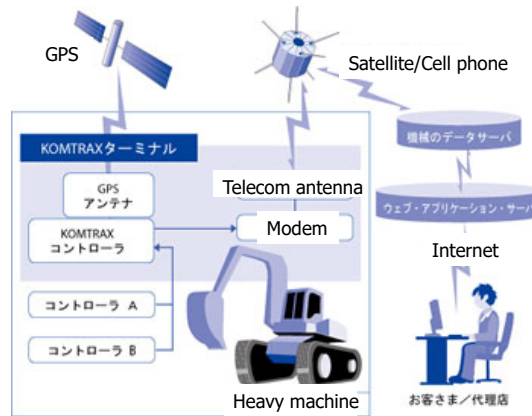

299

27

## Case: SPA

(Specialty store retailer of Private label Apparel)

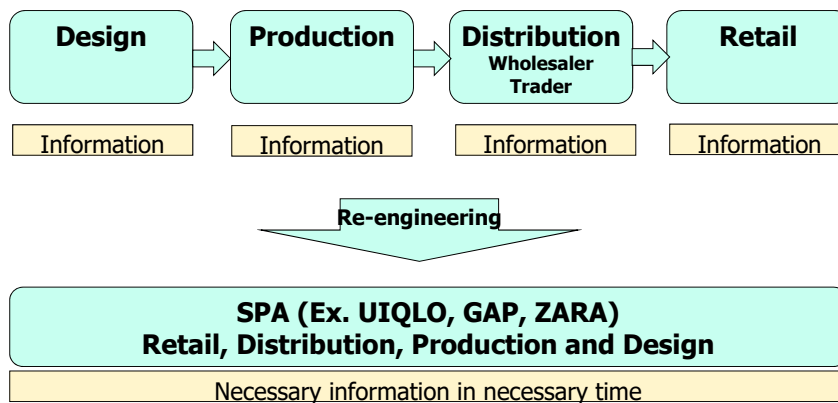

301

28

## BPR Principles

- Principle 2: Capture information once and at the source.
- Principle 3: Link parallel activities instead of integrating their results
- Principle 4: Have those who use the output of the process perform the process.

← TPS: Elimination of Wastes completely

Factory in Toyota	Knowledge-based activities
Waiting	No action due to waiting the information
Motion	Useless motion
Transport	Simple messaging, -bring file from cabinet.
Process	Meaningless business activity, -find the file.
Over production	Unnecessary much information
Inventory	Too advanced preparation
Defects	Mistakes, errors

302

29

## Case of Principle 2

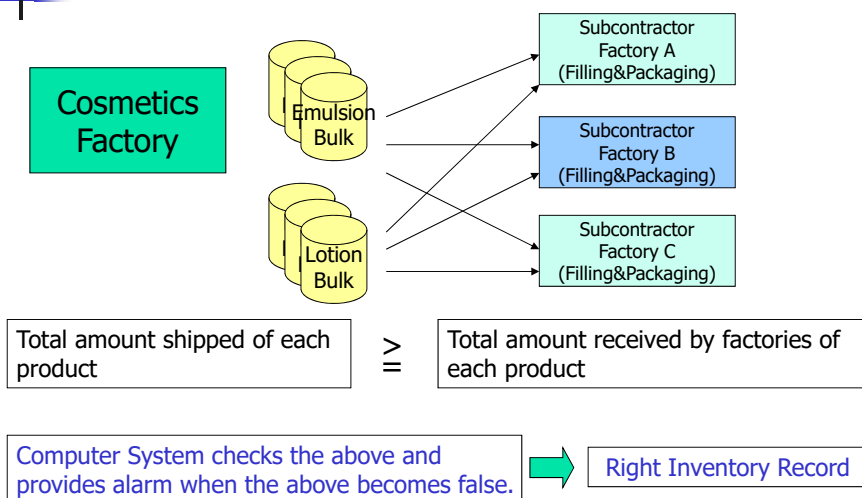

303

30



## Case of Principle 3

### Concurrent Engineering

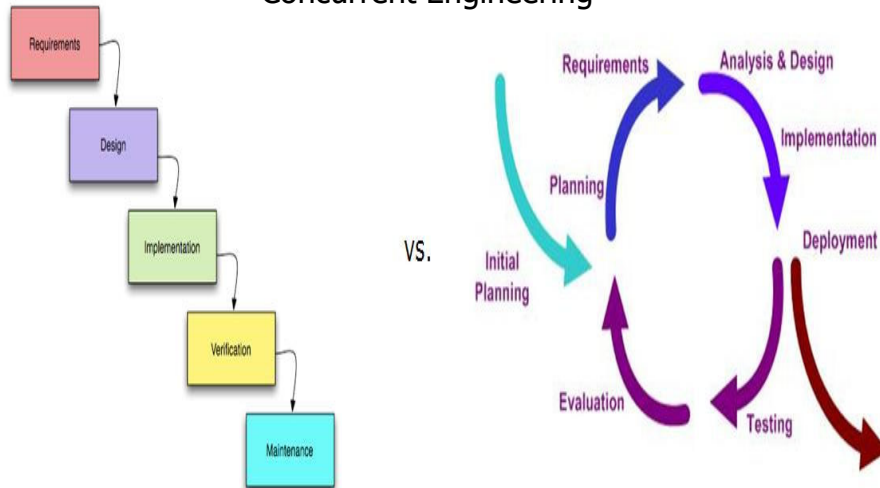

31

## Concurrent engineering (CE)

Concurrent engineering(CE) is a work methodology emphasizing the parallelization of tasks (i.e. performing tasks concurrently),which is sometimes called simultaneous engineering or integrated product development (IPD) using an integrated product team approach.

It refers to an approach used in product development in which functions of design engineering, manufacturing engineering, and other functions are integrated to reduce the time require to bring a new product to market.

32

32



## Concurrent engineering (CE)

Doing several things at once, such as designing various subsystems simultaneously, is critical to reducing design time and is at the heart of concurrent engineering.

33

33



## Case of Principle 4

Manager



Analyst



**Before:** Manager reads a report prepared by the analyst.



**After:** Manager uses IT to prepare a report by himself and analyze the report.

**Elimination of waiting for report preparation.**

34

34



## BPR Principles

### Principle 5

- Subsume information-processing work into the real work that produces the information.
- Integrate tasks of processing information with value-added work
- TPS: 5W1H (Root cause analysis)
  - Drill down approach (Executive Information System)
    - Online Analytical Processing/Multi-Dimensional Database
      - Slicing/Dicing/Drilling
    - Why: Human work, Processing: Computer work
- TPS: KANBAN system

304

35



## Case: Drill Down approach

Area	Distributor	Retail	Product X	Product Y	Product Z	
A	A1	A11				
		A12				
		A13				
	A2	A21				
		A22				
	A3	A31				
B	B1	B11				
		B12				
	B2	B21				
		B3	B31			
			B32		✓	
	B33					
C	C1	C11				
		C21				
	C2	C22				

Sales went down

Which area?: B

Which distributor in Area B?: B3

Which retail under B3?: B32

Which product?: Product Y

No segment for Product Y in B32 retail shop

36

36

## Case: Project Identification Project

### Use of Groupware or Dropbox

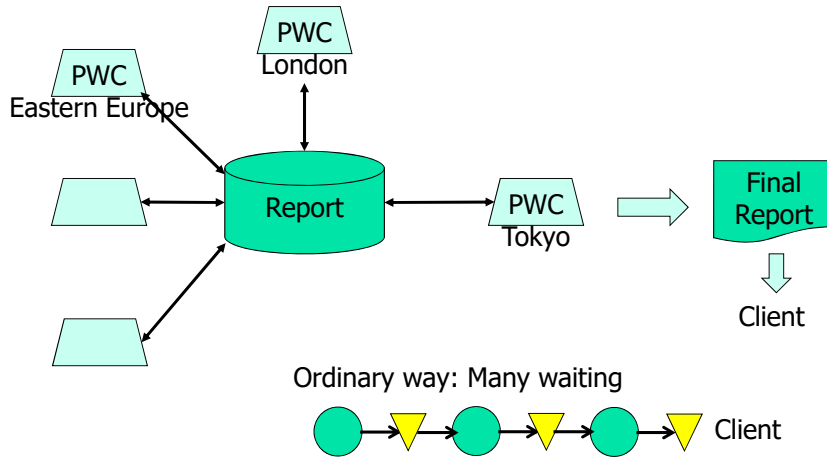

37

37

## BPR Principles

### Principle 6

- Put decision points where the work is performed and build controls into the process.
- Build-in management process into business process
  - Fool proof, Work load management, Due alarm, etc.
- TPS: "Fool proof/Mistake proofing" : Due alarm
- TPS: "Visual Control" : Visualize work load.

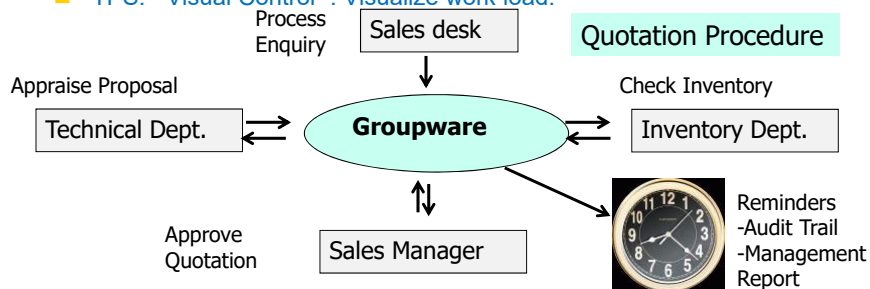

309

38

## BPR Principles

### Principle 7

- Organize around outcomes, not tasks.
- Restructure organization to output oriented one by implementing multi-skilled worker system.
- TPS: "Multi-skilled worker"
  - Multi-skilled teller at a bank
  - Multi-items salesman
- TPS: Through production (Prerequisite of JIT)
- Case: Workflow Automation

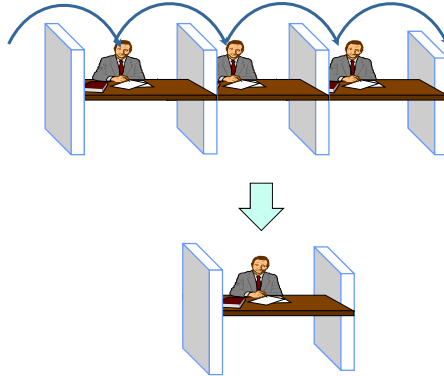

311

39

## Work Flow Automation

### Bank Loan Authorization Procedure

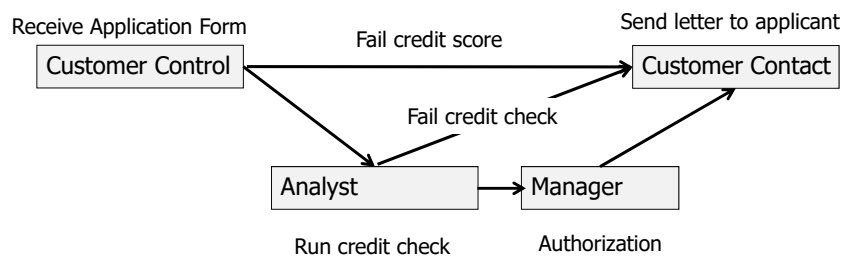

310

40



## Process reformation by IT

Pattern	Detailed case
Automation	Elimination of process by human beings (Automatic ordering system by EDI)
Information	Sales information data collection by POS system
Re-arrangement	Re-arrange process order, link parallel process (Concurrent engineering using 3D CAD)
Tracking	Monitoring process situation and process itself (Tracking system using GPS or IC tag)
Analysis	Data analysis and improvement of decision-making (Data mining)

41

41



## Process reformation by IT

Pattern	Detailed case
Geography	Arrangement of processes dispersed geographically (Production, Inventory and Sales data)
Integration	Arrangement of job and process (Integrated control by using ERP)
Knowledge	Sharing individual know-how and team's success story
Direct	Elimination of obstacles from the process (Direct sales via internet (on-line))

42

42

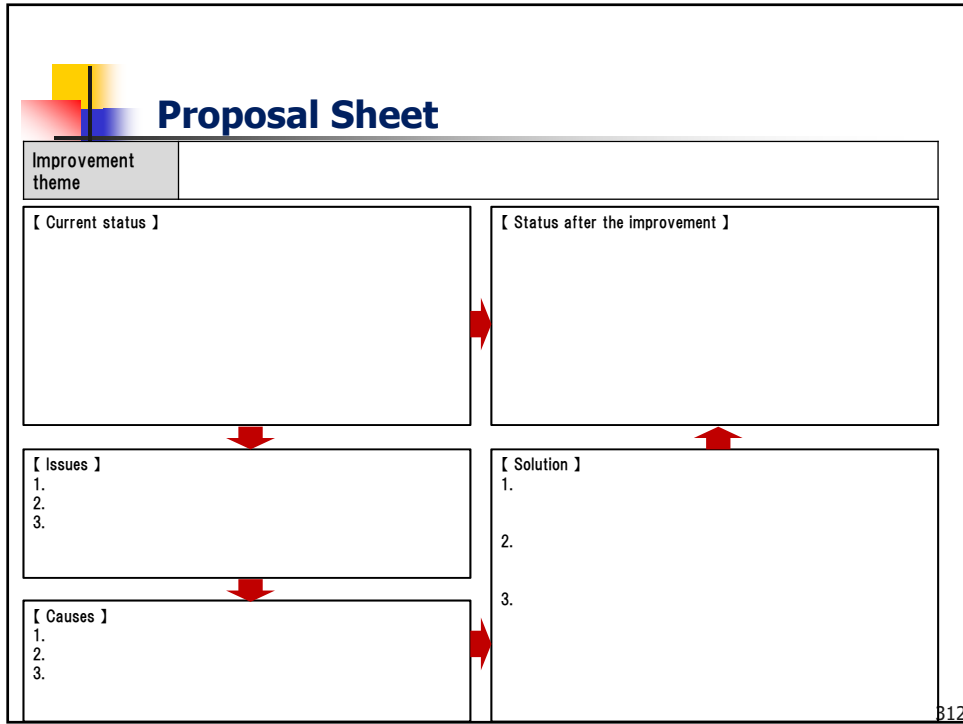

**Proposal Sheet**

Improvement theme			
[ Current status ]		[ Status after the improvement ]	
[ Issues ] 1. 2. 3.		[ Solution ] 1. 2. 3.	
[ Causes ] 1. 2. 3.			

B12

43

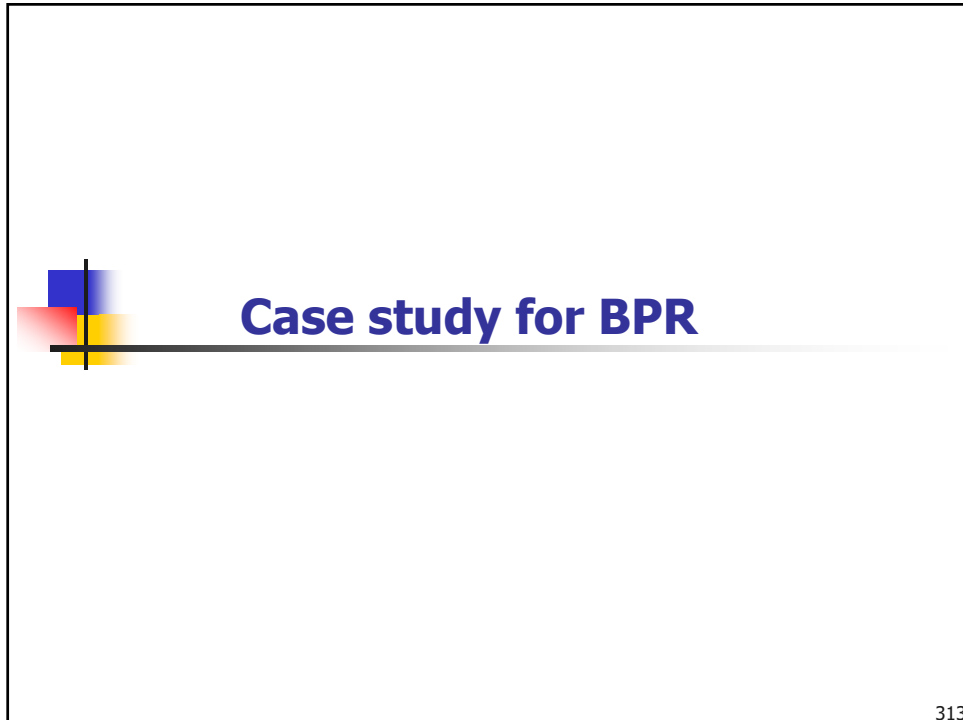

**Case study for BPR**

313

44



## BPR (FORD and MAZDA) case

### Group discussion

Please read the materials and discuss the following Issues.

- (1) Why did they implement BPR?
- (2) What were the results by BPR?
- (3) What principles of BPR were used?
  - Principles of TPS could be used.
- (4) What were their Critical Successful Factors?

314

45



## Major stages for BPR

- (1) Identify the need for reengineering and business vision
- (2) Obtain the business unit leader's commitment
- (3) Identify process to be redesigned
- (4) Understand and measure existing processes  
"AS-IS"
- (5) Identify the enabling role of IT and design new process  
"TO-BE"
- (6) Specify the technical and social solutions
- (7) Transform the business process
- (8) Continuous process improvement

315

46





## Key to success for BPR

- (1) Leadership  
Creating a vision, value and climate  
BPR fundamentally changes organizational culture.
- (2) Shared values  
No pain, no gain.
- (3) Teamwork at all levels
- (4) Constituency relationships, especially with shareholders, customers and suppliers
- (5) Change and the desire to dominate the market

316

47



## BPR case study (A Bank in Japan)

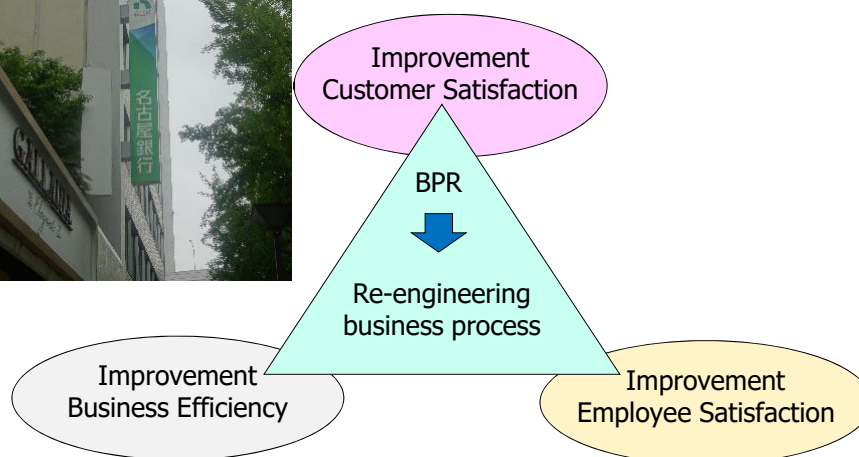

48

48



## Background for BPR

Get out of the downward trend of profit over the years and achieve sustainability and growth of the company

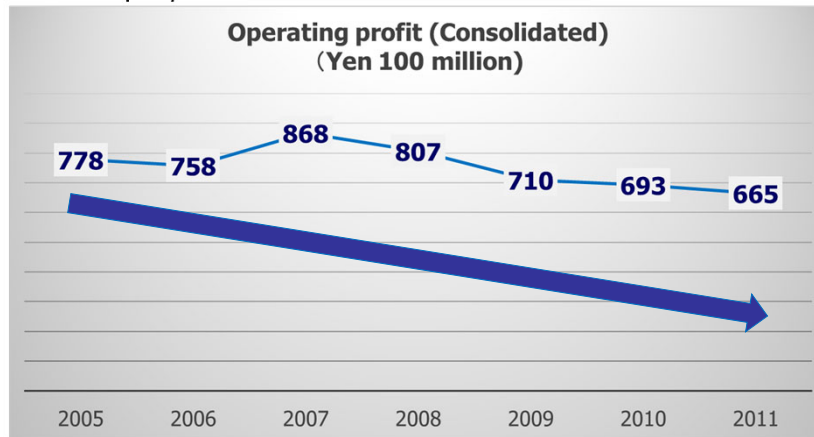

49

49



## Effect of BPR

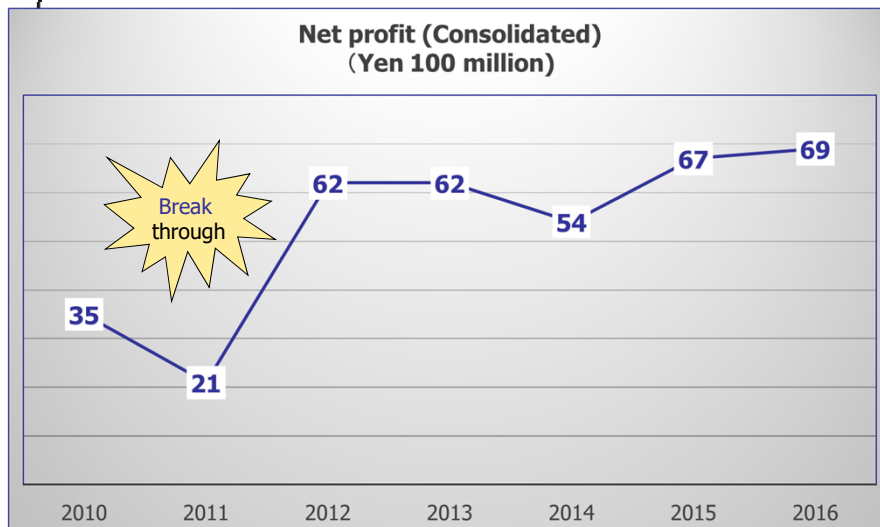

50

50

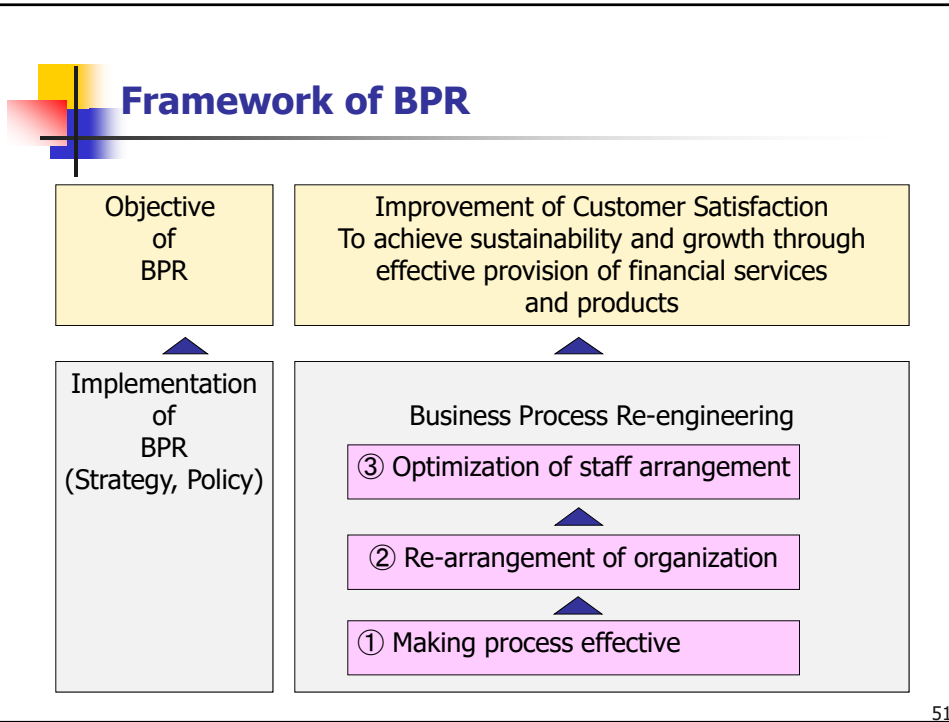

51

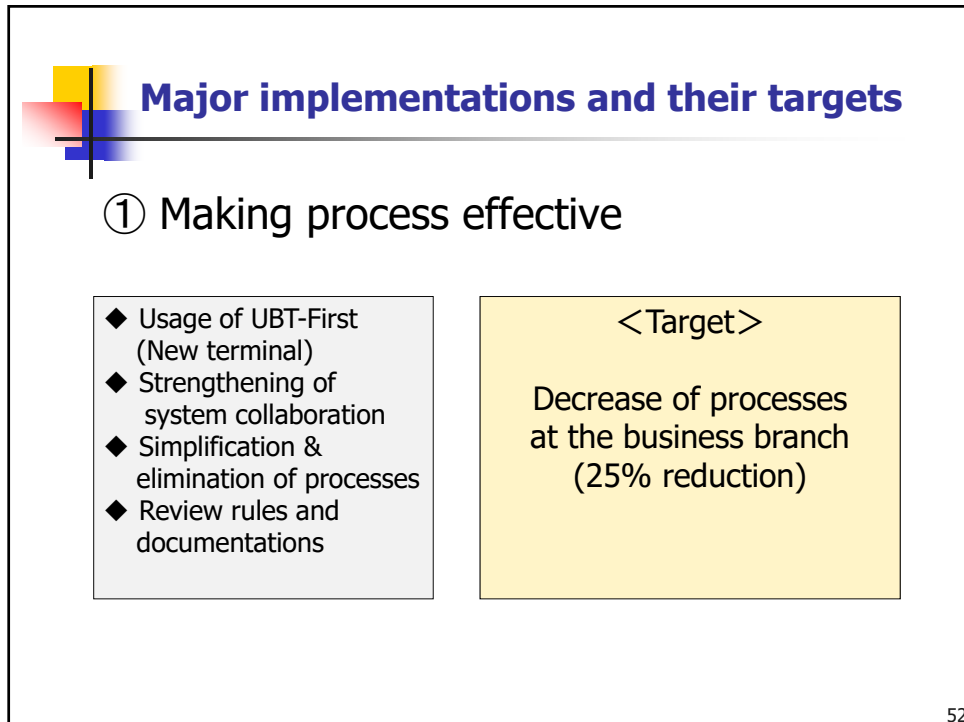

52

## Fujitsu UBT First



UBT First terminal



Administration



Promotion



Relation

53

53

## Major implementations and their targets

### ② Re-arrangement of organization

- ◆ Transfer of loan process to headquarters.
- ◆ Transfer of documents storage and checking processes.

<Target>

Concentration of business processes at headquarters

54

54



## Major implementations and their targets

### ③ Optimization of staff arrangement

- ◆ New establishment of Personal Concierge(PC).
- ◆ Communication enhancement with customers
- ◆ Support system at peak time.
- ◆ Flexible manpower arrangement with contract staff and part-time workers

<Target>

Strengthening of  
Customer Relationships  
(Personal Concierge: from  
550 to 700)

55

55



## Mission of PC

### Mission of Personal Concierge (PC)

- Strengthening relationship with individual customers.
- Developing business transactions with new customers and improving business share in the region.
- Developing business transactions by becoming Main Accounts with existing customers.
- Meeting customers demands for fund operation, investment, etc.

56

56

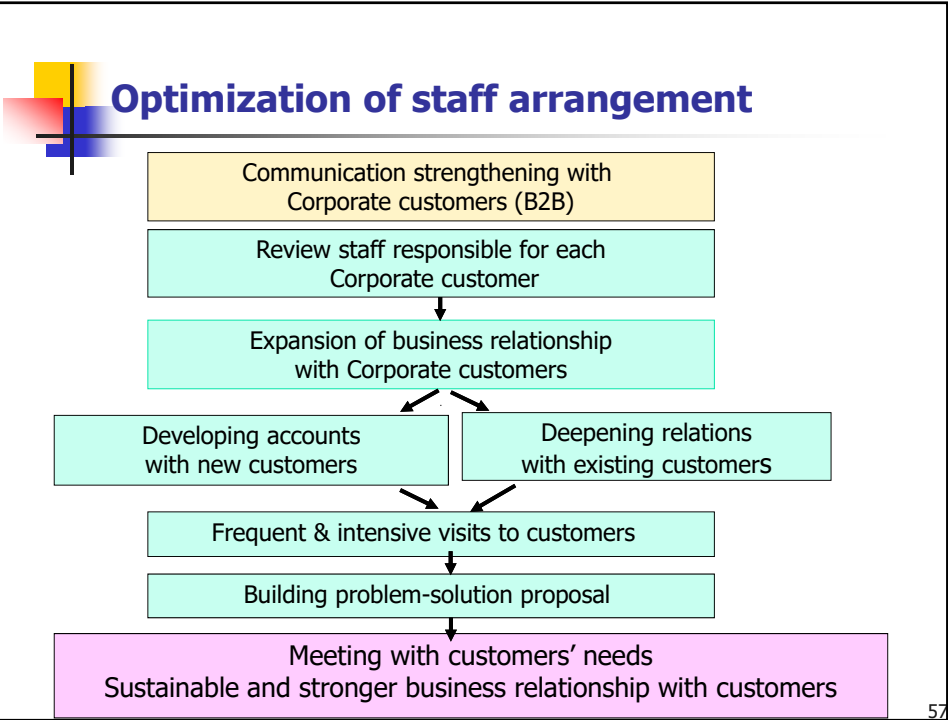

57

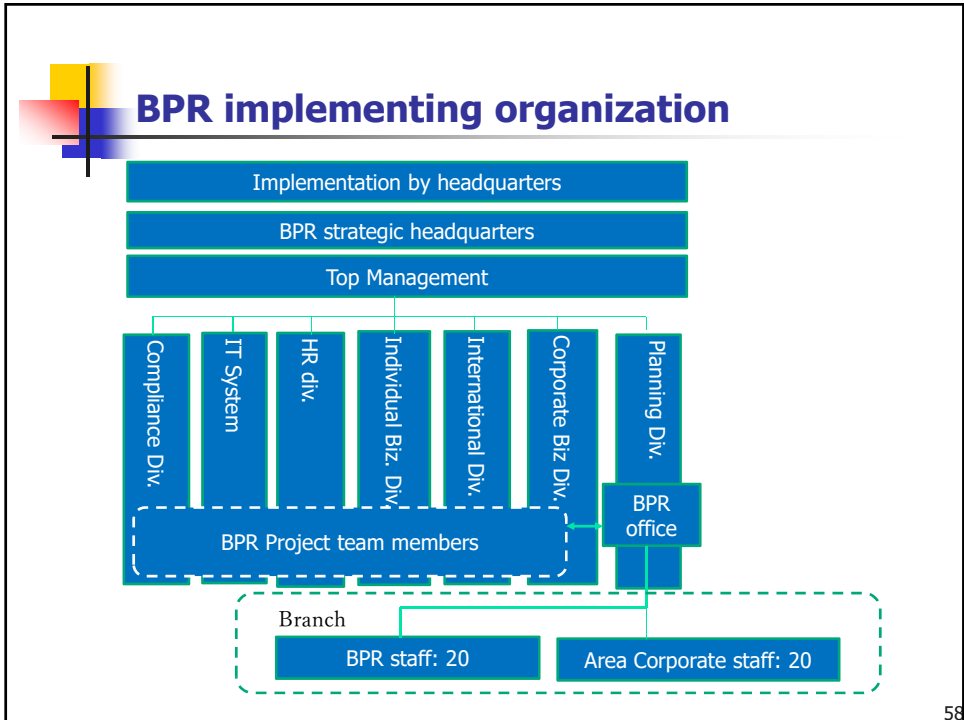

58

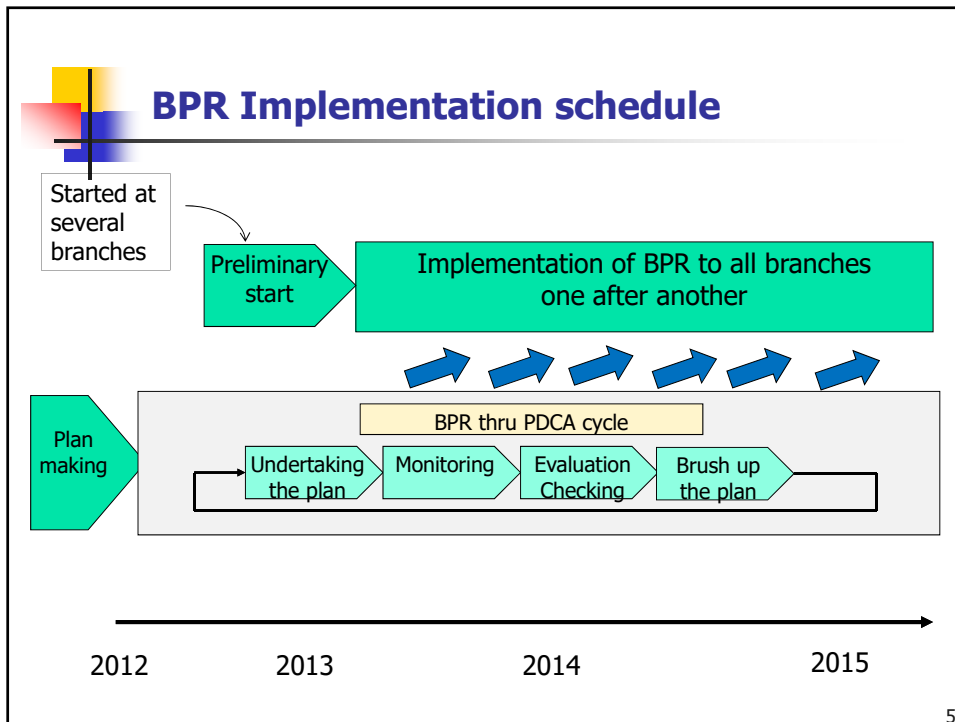

59

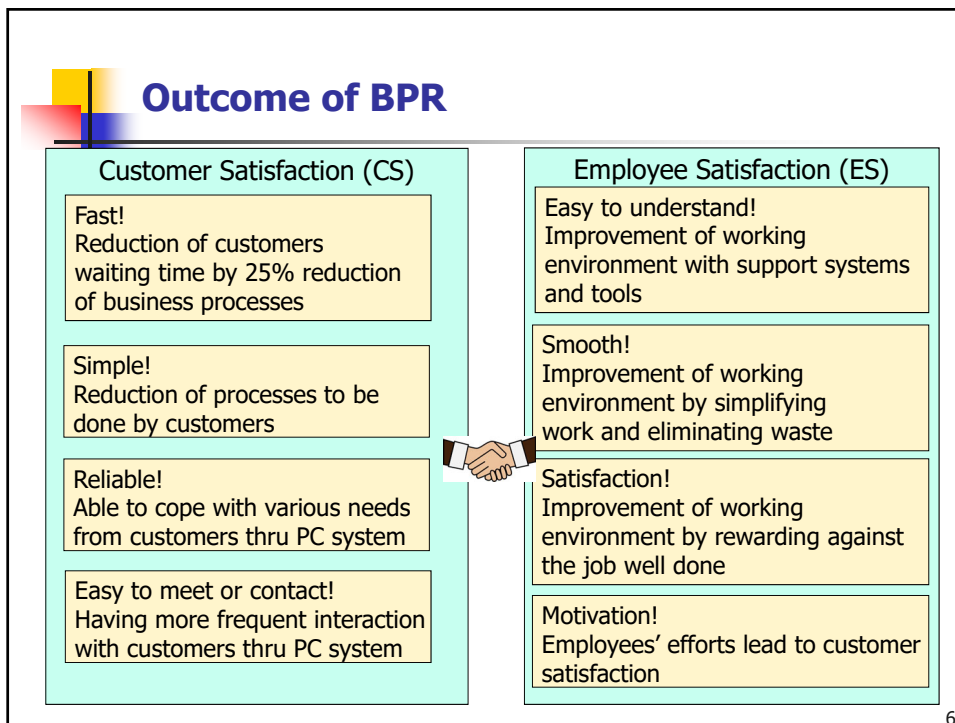

60



# Supply Chain Management (SCM)

**November, 2017**



## Background situation for SCM

Increased demand for SCM

```

    graph LR
      A[Slow economic growth and low demands] --> B[Increase of makers' inventories]
      C[Request for frequent deliveries of smaller lot by buyers] --> B
      B --> D[Review of production & logistic system]
      E[Wide variety of small lot production] --> D
      F[Diversification of consumption] --> E
      G[ICT development] --> H[Demands for SCM]
      I[Global competition] --> H
      D --> H
  
```

The diagram illustrates the background situation for SCM through a flowchart. It shows how factors like slow economic growth, diversification of consumption, and global competition lead to increased demands for SCM. Key elements include: Slow economic growth and low demands leading to an increase in makers' inventories; Request for frequent deliveries of smaller lot by buyers also leading to an increase in makers' inventories; Wide variety of small lot production leading to a review of production & logistic system; Diversification of consumption leading to wide variety of small lot production; ICT development and Global competition leading to demands for SCM; and a review of production & logistic system also leading to demands for SCM.



## Supply Chain Management

### Economic Value Added

Supply-side and demand-side competition in a global economy

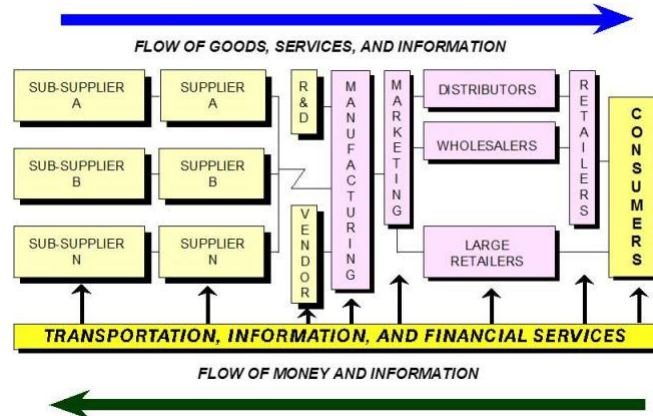

63

63

## Supply Chain Management

- Suppliers are partners (=working cooperatively)
  - Share information with partners
    - Production plan, Sales plan, Inventory and so on
  - Intel's BPR team for suppliers (Trading Partners)
  - Toyota's support to suppliers
    - Kanban method (JIT)
    - Production Control improvement
  - VMI (Vendor Managed Inventory)
    - Sony and suppliers
    - Fujitsu and suppliers
    - Wal-Mart/PG
- Reliable Suppliers are selected
  - Parts contents
    - Sony's inspection
- SCM with IT support
  - Global Standard for SCM: RosettaNet

BPR: Business Process Re-engineering

64

64

## SCM in an organization

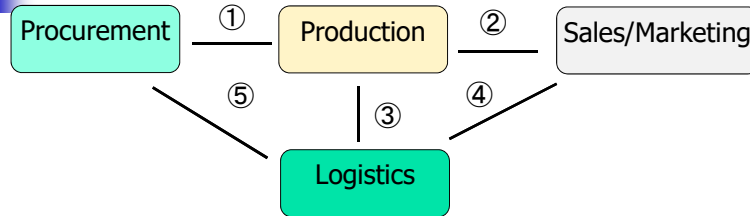

- ①: Procurement of raw materials depend on what and how many finished products are scheduled to be manufactured.
- ②: Production plan depends on what and how many finished products are scheduled to be sold.
- ③: What products are to be delivered to the warehouse?
- ④: What and how many finished products are to be stored to avoid stock-out and where?
- ⑤: Logistics are responsible for inventory management of both finished products and raw materials.

65

65

## SCM between organizations

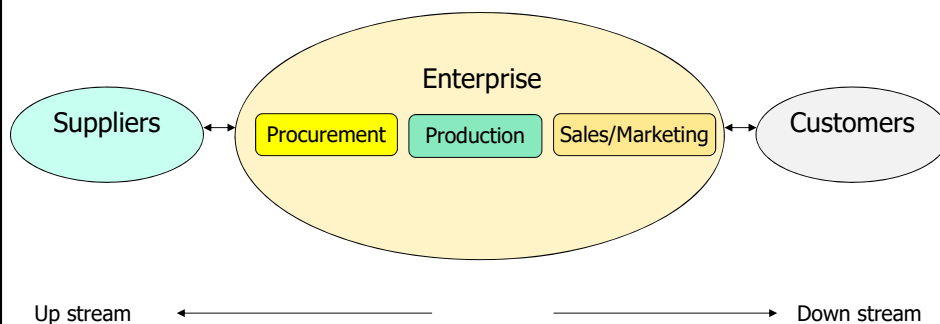

Suppliers would like to receive orders steadily and produce effectively, while customers would like to procure necessary items with necessary quantity and at necessary time.(JIT: Just in Time)

66

66

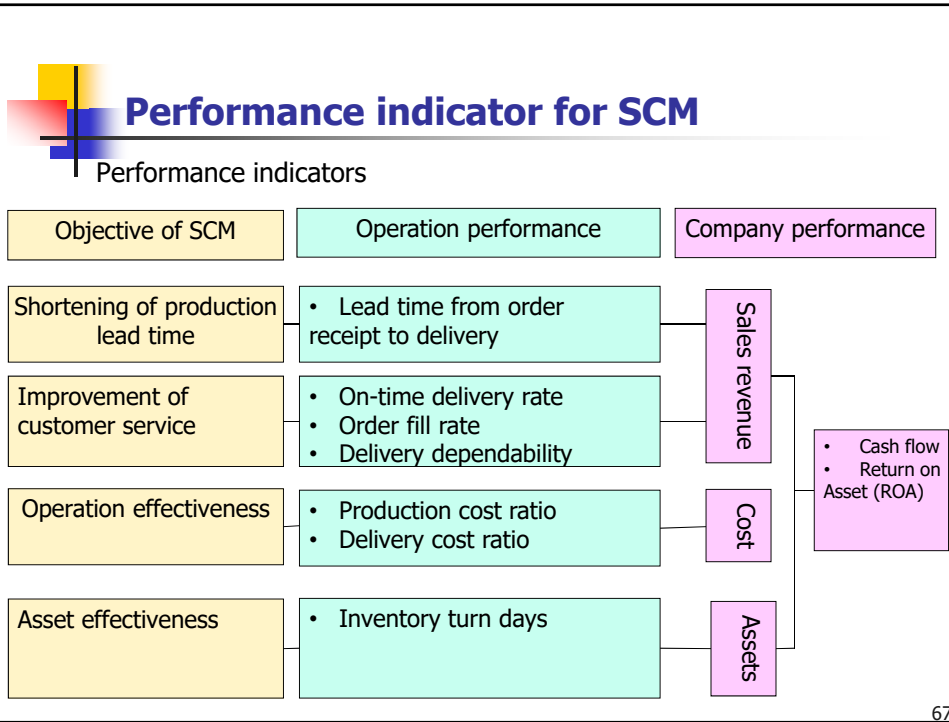

67

## Improvement of customer service

On-time delivery rate	$\frac{\text{No. of on – time deliveries}}{\text{Total no. of deliveries}}$
Order fill rate	$\frac{\text{No. of deliveries}}{\text{Total no. of orders received}}$
Delivery dependability	<ul style="list-style-type: none"> <li>• On-time delivery rate</li> <li>• Wrong delivery rate</li> <li>• Goods lost rate</li> <li>• Goods broken rate</li> </ul>

68



## Operation effectiveness

Production cost ratio (%)	$\frac{\text{Production cost}}{\text{Sales revenue}} \times 100$
Delivery cost ratio (%)	$\frac{\text{Delivery cost}}{\text{Sales revenue}} \times 100$

69

69



## Asset effectiveness

1. Inventory turn (days)	$\frac{\text{Inventories}}{\text{Cost of sales}} \times 365$
2. Return on assets	$\frac{\text{Net profit}}{\text{Total asset}}$

70

70



## Supplier management

Reliable and trustworthy suppliers are a vital link in an effective supply chain. Timely deliveries of goods or services and high quality are just two of the ways that suppliers can contribute to effective operations.

### **Vendor analysis**

Evaluating the sources of supply in terms of price, quality, Reputation, and service.

71

71



## Supplier Audits

### Typical questions for choosing a supplier

Factor	Typical Questions
Quality and quality assurance	What procedures does the supplier have for quality control and quality assurance? Are quality problems and corrective actions documented?
Flexibility	How flexible is the supplier in handling changes in delivery schedules, quantity, and product or service changes?
Location	Is the supplier nearby?
Price	Are prices reasonable given the entire package the supplier will provide? Is the supplier willing to negotiate prices? Is the supplier willing to cooperate to reduce costs?
Product or service changes	How much advance notification does the supplier require for product or service changes?
Reputation	What is the reputation of the supplier?

72

72



## Supplier Audits

### Typical questions for choosing a supplier

Factor	Typical Questions
Financial stability	How financially stable is the supplier?
Lead time	What lead time can the supplier provide?
On-time delivery	What procedures does the supplier have for assuring on-time deliveries? What procedures does the supplier have for documenting and correcting problems regarding the late delivery occurred?
Other accounts	Is the supplier heavily dependent on other customers, causing a risk of giving priority to those needs over ours?

73

73



## Supplier Relationships

- Purchasing has the ultimate responsibility for establishing and maintaining good supplier relationships.
- Keeping good relations with suppliers is increasingly recognized as an important factor in maintaining a competitive edge.
- Many companies are adopting a view of suppliers as partners. This viewpoint stresses a stable relationship with relatively few reliable suppliers who can provide high-quality supplies, maintain precise delivery schedules, and remain flexible relative to changes in productive specifications and delivery schedules.

74

74



## Supplier Relationships

Supplier as adversary versus supplier as partner

Aspect	Adversary	Partner
No. of suppliers	Many	One or a few
Length of relationship	May be brief	Long-term
Low price	Major consideration	Moderately important
Reliability	May not be high	High
Openness	Low	High
Quality	May be unreliable; Buyer inspects	At the source; vendor certified
Volume of business	May be low due to many suppliers	High
Flexibility	Relatively low	Relatively high
Location	Widely dispersed	Nearness is important for short lead time and quick service

75

75



## Demand forecast

76

76



## Steps in the forecasting process

---

1. Determine the purpose of the forecast
2. Establish a time horizon
3. Select a forecasting technique
4. Obtain, clean and analyze appropriate data
5. make the forecast
6. Monitor the forecast

77

77



## Forecast based on judgment and opinion

---

1. Executive opinions
  - A small group of upper-level managers (marketing, operations, and finance, etc.) may meet and collectively develop a forecast.
2. Sales force opinions
  - Members of the sales staff or the customer service staff are often good sources because of their direct contact with consumers.
3. Consumer surveys
  - Because it is the consumers who ultimately determine the demand, it seems natural to solicit input from them.

78

78





## Forecasts data on time-series data

1. **Trend** (Population shift, changing income, cultural trend, etc.): Long-term upward or downward movement in the data
2. **Seasonality** (Restaurant, supermarket, theatre, clothing, etc.): Short-term, fairly regular variations generally related to factors such as the calendar or time of day.
3. **Cycles** (Economic, political, agricultural conditions, etc.): Wavelike variations of more than one year's duration
4. **Irregular variations**  
Unusual circumstances such as severe weather conditions, strike or major changes in a product or service.

79

79



## Graph for irregular variations

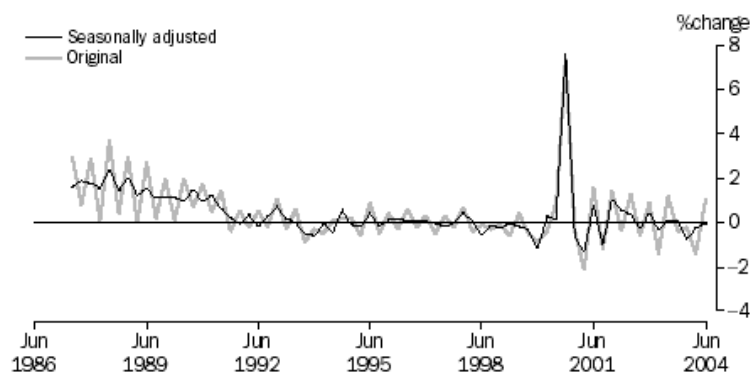

80

80



# Cycles

## THE BUSINESS CYCLE

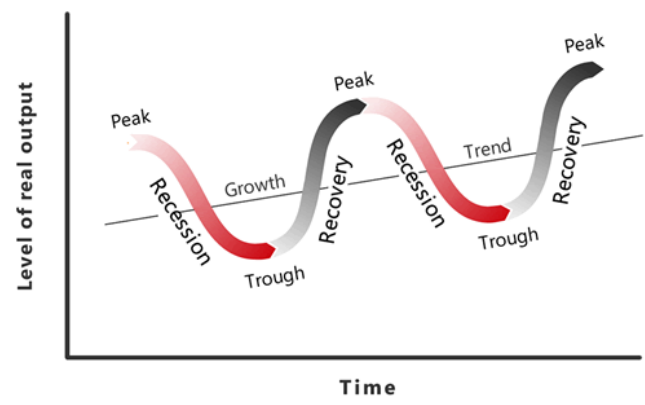

# Seasonality graph

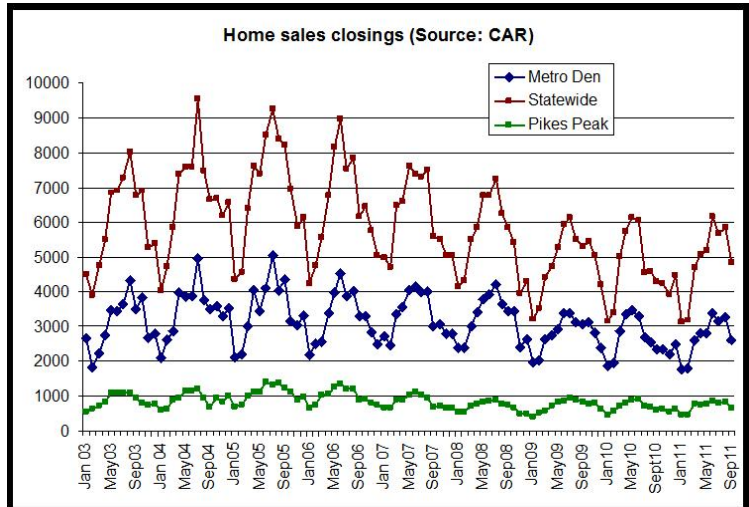

## Demand forecast

### Techniques for Averaging

- Moving average
- Weighted moving average
- Exponential smoothing

83

83

## Moving average

Moving average forecast uses a number of the most recent actual data values in generating a forecast.

$$\text{Formula: } F_t = MA_n = \frac{A_{t-n} + \dots + A_{t-2} + A_{t-1}}{n}$$

(Compute a **three-period moving average**)

Period	Demand
--------	--------

1	42
2	40
3	43
4	40
5	41

the 3 most recent demands

$F_t$  = Forecast for time period  $t$   
 $MA_n$  =  $n$  period moving average  
 $A_{t-1}$  = Actual value in period  $t-1$   
 $n$  = Number of periods in the moving average

$$F_6 = \frac{43+40+41}{3} = 41.33$$

84

84



## Weighted Moving Average

A weighted average is similar to a moving average, except that it assigns more weight to the most recent values in a time series.

<u>Period</u>	<u>Demand</u>	<u>Weight</u>
1	42	-
2	40	0.10
3	43	0.20
4	40	0.30
5	41	0.40

$$F_6 = .10(40) + .20(43) + .30(40) + .40(41) = 41.0$$

85

85



## Exponential smoothing

A weighted average method based on previous forecast plus a percentage of the forecast error

$$\text{Formula: } F_t = F_{t-1} + \alpha(A_{t-1} - F_{t-1})$$

$F_t$  = Forecast for period  $t$

$F_{t-1}$  = Forecast for the previous period

$\alpha$  = Smoothing constant

$A_{t-1}$  = Actual demand or sales for the previous period

Next forecast = Previous forecast +  $\alpha$  (Actual – previous forecast)

Smoothing constant  $\alpha$  represents a percentage of the forecast error.

86

86



## Exponential smoothing

For example:

Previous forecast: 42 units

Actual demand: 40 units

$\alpha = 0.10$

$$F_t = 42 + 0.10 (40 - 42) = 41.8$$

If the actual demand turns out to be 43, the next forecast would be

$$F_t = 41.8 + 0.10 (43 - 41.8) = 41.92$$

87

87



## Exponential smoothing

Period (t)	Actual demand	< $\alpha=0.10$ >		< $\alpha= 0.40$ >	
		Forecast	Error	Forecast	Error
1	42	-	-	-	-
2	40	42	-2	42	-2
3	43	41.8	1.2	41.2	1.8
4	40	41.92	-1.92	41.92	-1.92
5	41	41.73	-0.73	41.15	-0.15
6	39	41.66	-2.66	41.09	-2.09
7	46	41.39	4.61	40.25	5.75

Selecting a smoothing constant ( $\alpha$ ) is basically a matter of judgment or trial and error, using forecast errors to guide the decision.

Commonly used values of  $\alpha$  range from 0.05 to 0.50.

Low values of  $\alpha$  are used when the underlying average tends to be stable; higher values are used when the underlying average is susceptible to change

88

88

## VMI and CRP

89

89

## VMI (Vendor Managed Inventory)

Vendor (=Supplier) manage inventory.

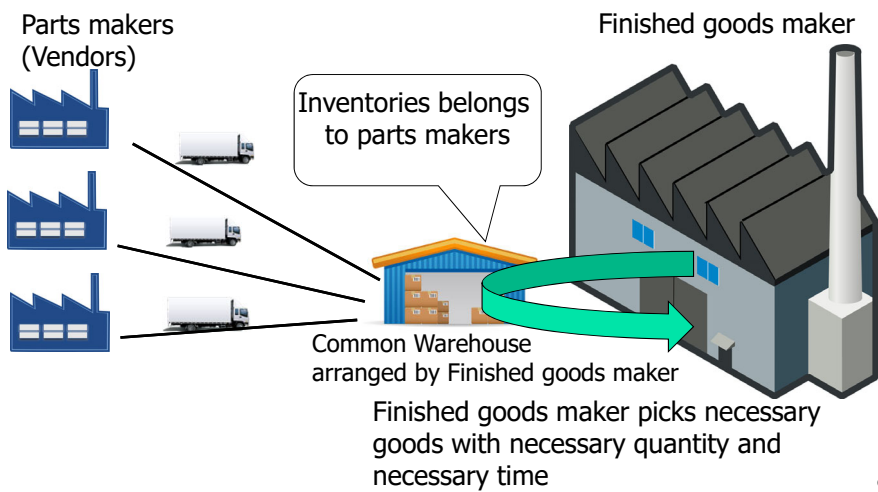

90

90

## CRP (Continuous Replenishment Program)

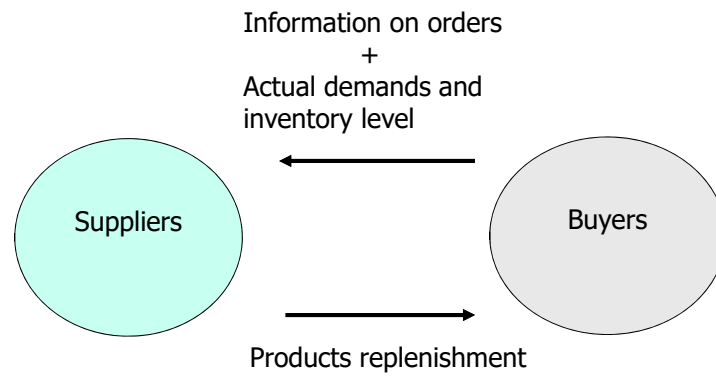

In case buyers are retailers, it is often the case that POS (Point of Sales) information is being shared with suppliers.

91

91

## CRP (2)

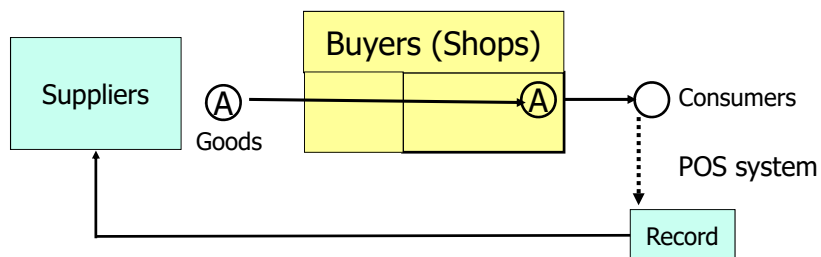

Buyers and suppliers have discussed and agreed the inventory level of the products: total quantity of the products to be manufactured and sold in a certain period of time.

1<sup>st</sup> shipment at the beginning of the season: 5,000pcs to the shops  
 another 3,000pcs. to be delivered to the shops immediately after the goods are being sold. (Continuous Replenishment Program)

Avoidance of Opportunity Loss

92

92

## Case: P&G and Wal-Mart

- Pampers (a disposable diaper) inventory
  - Require a lot of space, relative to its dollar value.
  - Inventory:
    - Too little – stock out causes opportunity loss
    - Too much- financing and storage cost
    - + Inventory Management cost

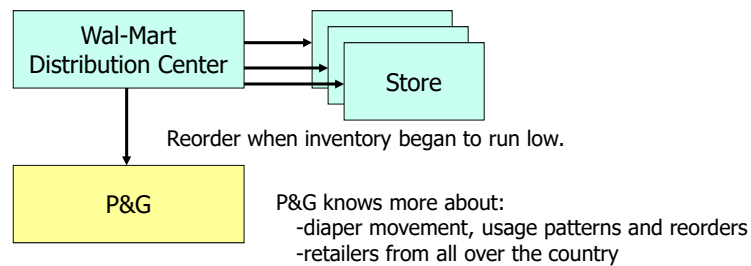

93

93

## Case: P&G and Wal-Mart

- Step 1:
  - P&G tells Wal-Mart when to order, in what quantity, which Wal-Mart approves. (purchase recommendation)
  - Wal-Mart tells P&G how much stock was moved from the DC to the stores
  - No inventory control by Wal-Mart
- Step 2:
  - Skip purchase recommendation
  - Inventory replenishment by supplier (P&G)
  - A/R control less (P&G)
  - Client retention (P&G)

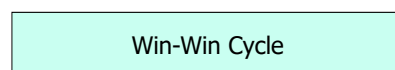

A/R = Accounts Receivable

94

94



## Wal-Mart & P&G SCM

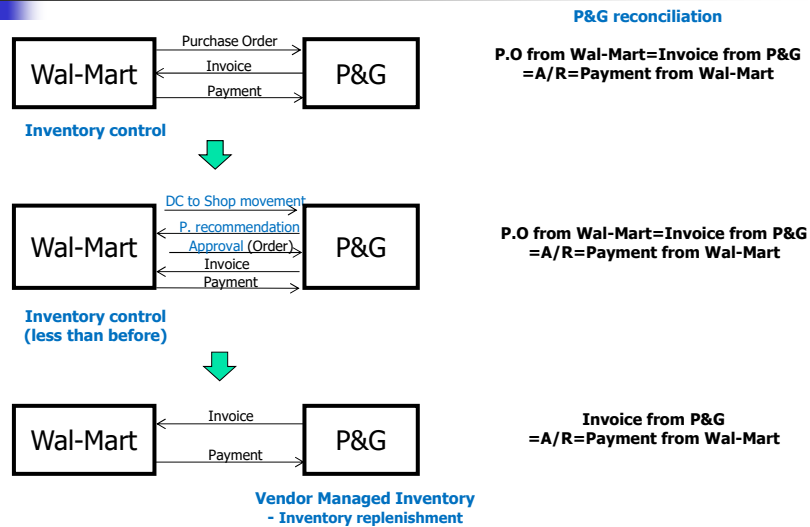

95

95

## Delayed differentiation

- Delayed differentiation is a postponement tactic
  - Producing but not quite completing a product or service until customer preferences or specifications are known.

96

96



## Delayed differentiation

- a concept in supply chain management where the manufacturing process starts by making a generic or family product which is later differentiated into a specific end-product.
- This is a widely used method, especially in industries with high demand uncertainty, and can be effectively used to address the final demand even if forecasts cannot be improved.

97

97



## Delayed differentiation

### Benetton (UNITED COLORS OF BENETTON)

Their knitted sweaters that are initially natural color, and then dyed into different colors only when the seasons customer color preference/demand is known.



98

98

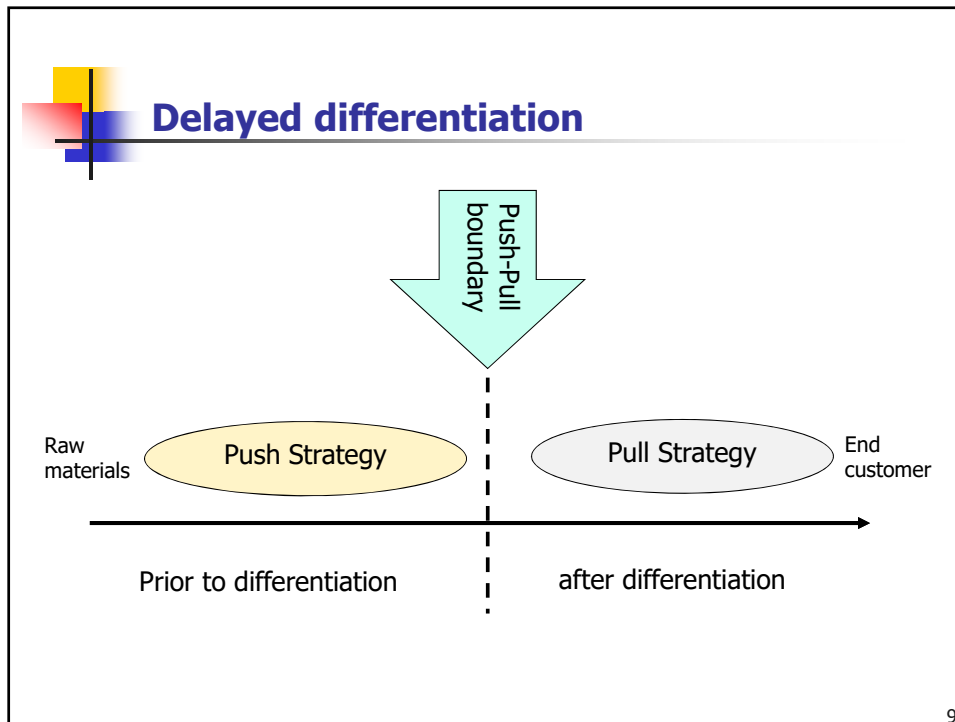

99

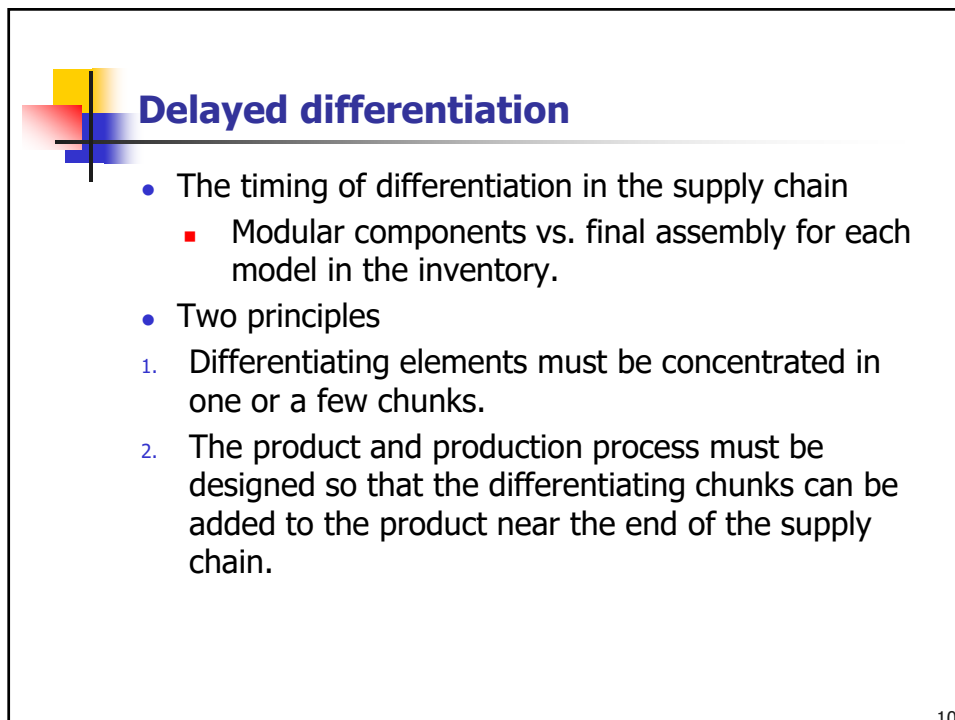

100

## Case Study for SCM (1)

K-Cosmetics Company  
Japan

101

101

## (POS-FMS)

### ■ K Cosmetics Approach Patented

- POS link and Flexible Manufacturing System

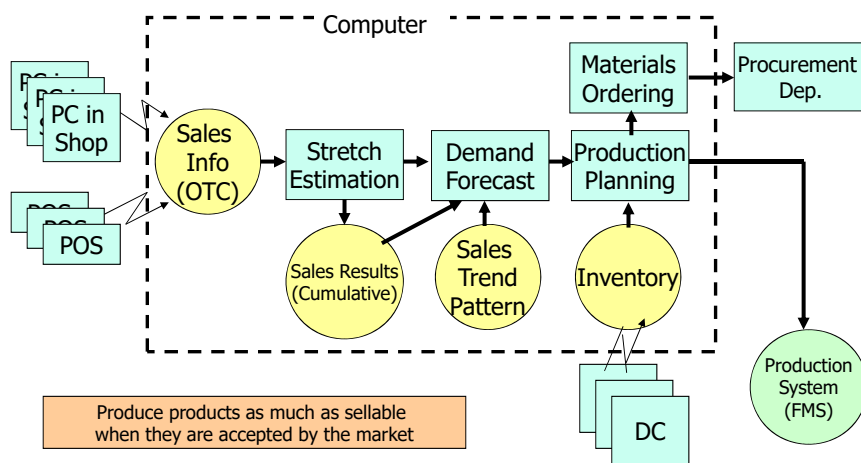

102

102

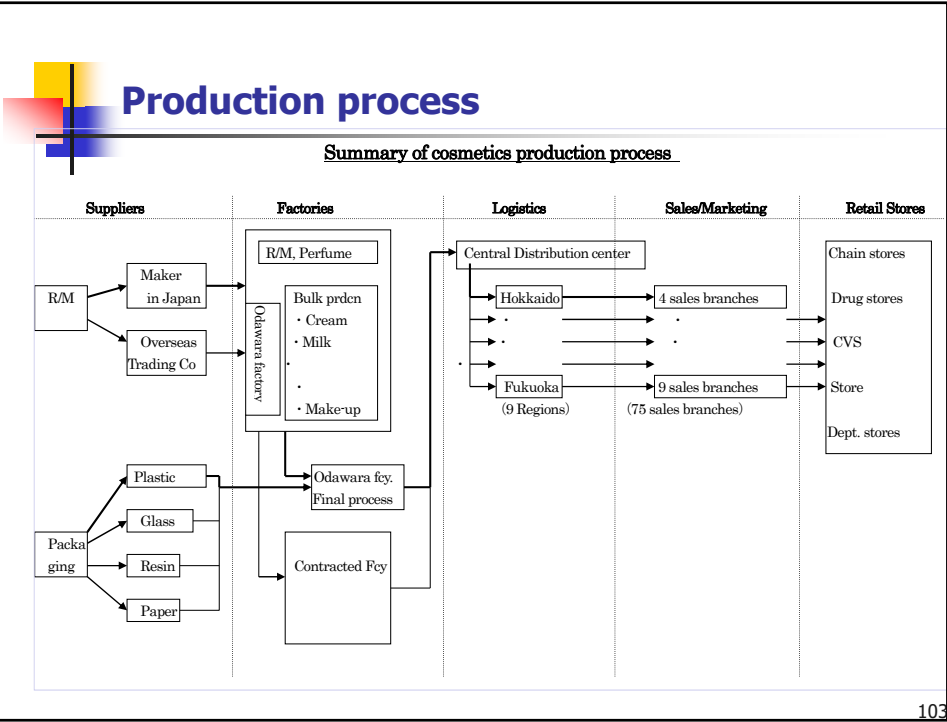

103

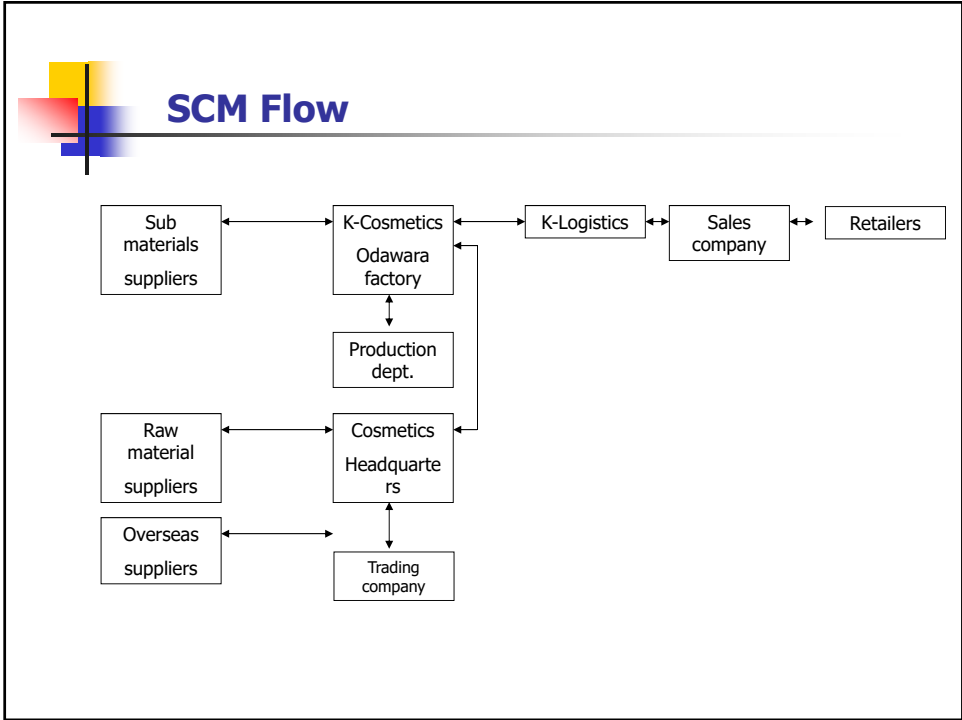

104

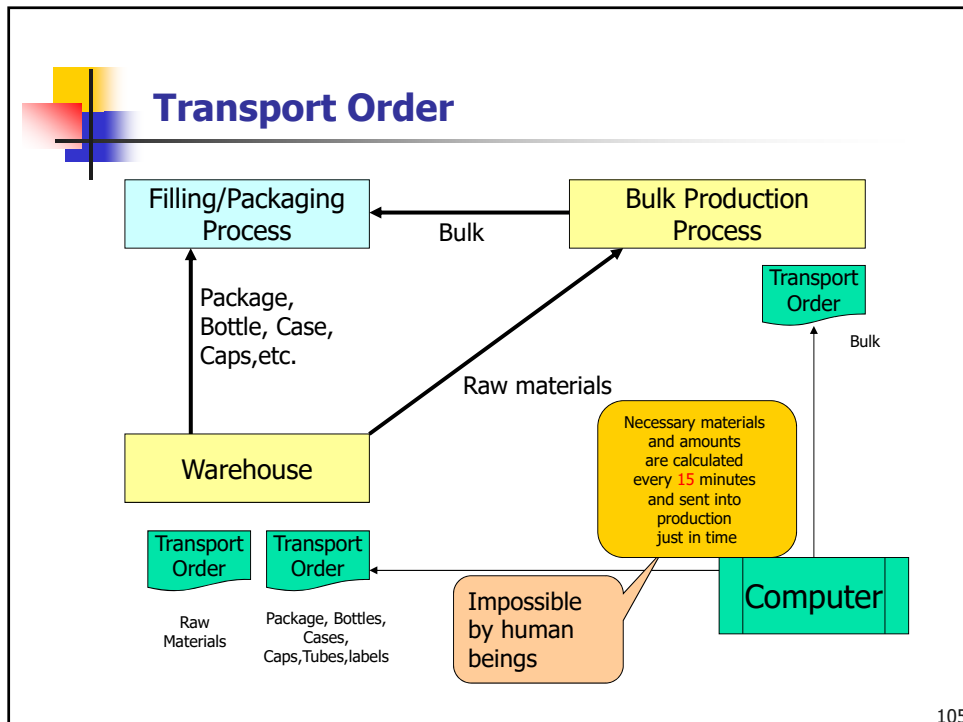

105

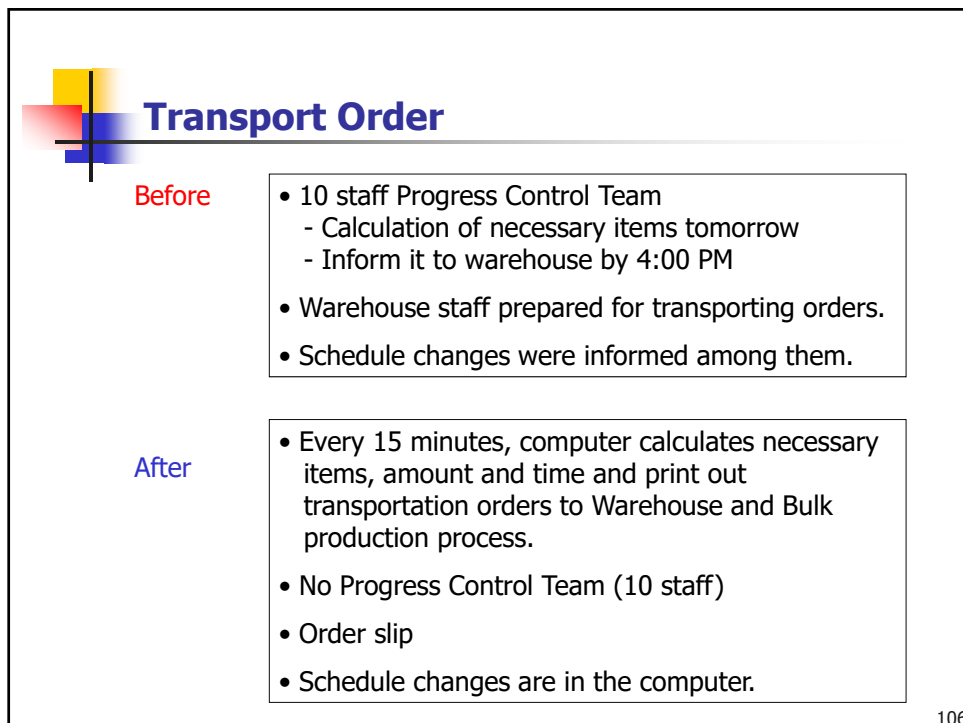

106



## Transport Order

### Transporting order slip

No. <u>Y-00048</u>		<u>Raw Material Transporting order</u>		99/01/29		
Name <u>TSLP</u>		Case <u>10E</u>				
Quantity	Contents	No. of Cases	To:	Time	Product Name	Remarks
1620	324	5	F1	09:41	TSLPLRS	No Fraction
Others						

107

107



## Case study for SCM (2)

Calbee, Inc.  
Japan

108

108

## Brief history of company

Manufacturer of snacks

- Established in Hiroshima, Japan in 1949.
- Company name changed to 'Calbee, Inc.' in 1955.
- Started sales of 'Kappa Ebisen' in 1964.



109

109

## Sales

Sales: Yen 179.4 billion (USD1.6billion)  
in FY2013



Worldwide sales:

U.K., Spain, Hongkong, Thailand, South Korea,  
Singapore, Taiwan, Philippines, Indonesia,  
Australia, U.S.A, Canada

110

110





## Calbee Potato, Inc. (A subsidiary company)

In order to procure quality potatoes from the contracted farmers in Japan, Calbee Potato, Inc. was established.

Mission of Calbee Potato, Inc. is:

- (1) Procurement of potato
- (2) Storage
- (3) Transport
- (4) Processing
- (5) Research and development
- (6) Planting/growing

111

111



## Procurement system of quality potato

30,000tons of potato  
required in 2018!



Target:  
Average output:  
40tons/ha per farmer  
(currently 35tons/ha per  
farmer)

Calbee 'Field man'  
• Data collection  
• Information  
provision  
• Technical advice  
on species, field,  
output, fertilizer,  
etc.



Supply of quality  
potato

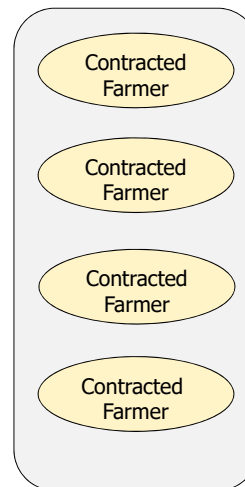

112

112



## Procurement system of quality potato

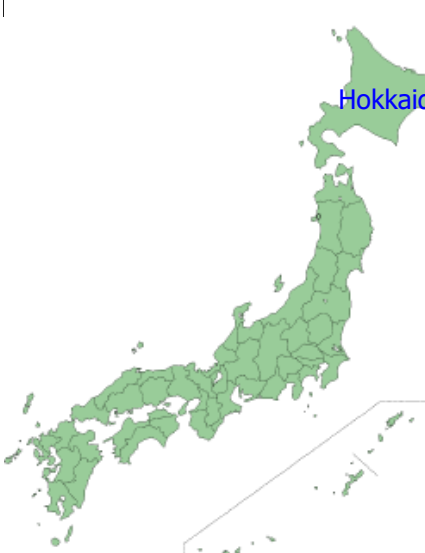

Hokkaido

Potato field in Hokkaido



113

113



## Case study for SCM (3)

Inditex, Spain  
(ZARA)

114

114



## Inditex, Spain

Sales: Euro 16.7 billion  
No. of ZARA shops: 6,340 in  
87 countries  
No. of total employees:  
128,313  
(Year 2013 annual report)



ZARA shop in Osaka

115

115



## ZARA Brand

Zara brand:  
No. of SKU (Stock Keeping Unit) in a year:  
**about 300,000**  
**(10,000 items x 5-6 colors x 5-7 sizes)**



ZARA TRAFALUC COLLECTION  
AW 2017

116

116

## Case: SPA

(Specialty store retailer of Private label Apparel)

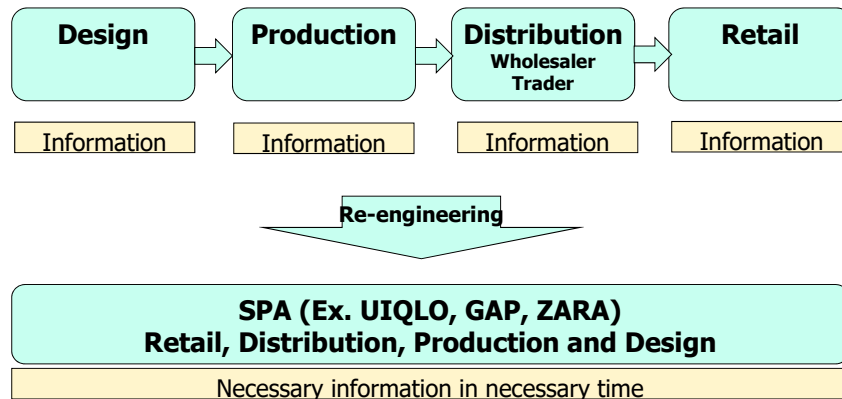

301

117

## Production and procurement outlook

### After season

- Designing and raw materials procurement: 35%
- Buying finished products from contracted factories: 40-50%
- Manufacturing at its own factories: 85%



Only 15% of total finished products to be manufactured at its own factories **before season** and remaining 85% to be manufactured **in season** while checking the sales of the finished products

118

118



## Supply Chain Process

- Making rough designs by about 200 designers.
- Discussing with marketers & buyers responsible for procurement in the same commercial team.
- Designing by computers
- Making prototype samples
- Final decision-making with prototype samples
  - Marketer to decide retail price
  - Buyer to do production costing and estimate production capacity

About 10,000 items out of 40,000 items are going to be manufactured in the above process and sold in their shops.

119

119



## Inventory management in the shops

Inventory control by headquarters

In principle, the shops are not allowed to carry much inventories; about 2-3 pieces per SKU.



Create atmosphere to make customers buy the items they prefer **NOW!**

120

120



## Production system

---

ZARA's strength:

**They have their own factories!**

- 20 own factories in Spain
- Comditel  
Fabric manufacturer, one of the subsidiaries
- Fabracolor  
Dyeing manufacturer, one of the subsidiaries

121

121



## 20 own factories

---

About 50% of ZARA products: mainly new and seasonal items

- Cutting fabrics by CAD,
- Delivering cut pieces to contracted sewing factories (about 500 companies)
- Receiving sewn products
- Finishing (Ironing, folding, labelling and packaging)

122

122

## ZARA Operation flow

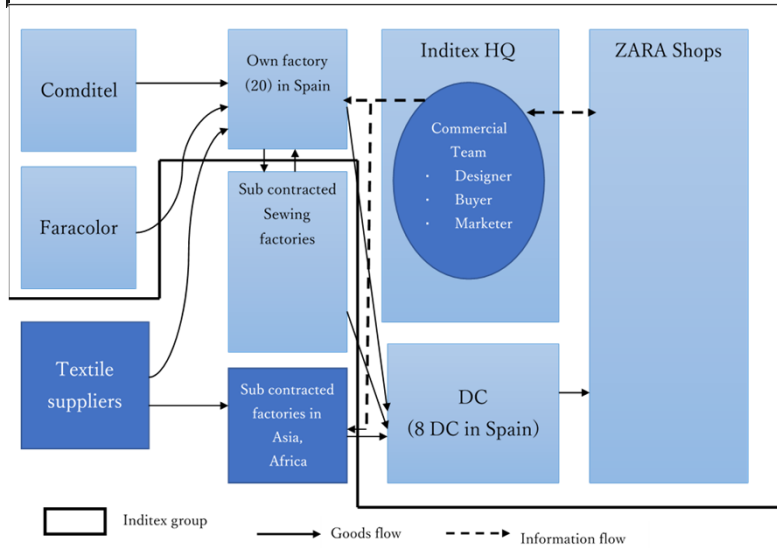

123

123

## Comditel

About 90% of its total sales from 'ZARA' brand.  
They supply about 40% of the total raw materials required for the production by own factories.

About 50% of the raw materials are 'before dyeing.'  
(Fabrics will be dyed at a later stage; in season.)

124

124



## Fabracolor

---

About 20% of its total sales from ZARA brand.

Fabrics will be dyed in season according to the fashion trend in the market.

(Piece dyed)

Benetton, Italian casual brand, is well known this system. (Delayed differentiation)

125

125



## Contracted factories

---

Contracted factories are located in Asia (China, Bangladesh) and North Africa (Morocco).

Mainly producing regular items such as T-shirts, Sweaters.

Inditex places orders with these factories 6 months before the season.

126

126





## Logistics

All finished products which are manufactured by their own factories or sub-contracted factories will be delivered to 8 distribution centers (DC) in Spain.  
(Space at one DC near the headquarters: 500,000 square meters)

The goods will be sorted out within 2 hours and ready for delivery to ZARA shops within 8 hours respectively, after the goods have arrived at DC.

Packaging: Carton boxes for air-lifting

Carton boxes or hanger for truck transport.



127

127



## Performance of SPA

Company name	Inventory turn rate (Day)	Operating profit Ratio (%)
Inditex (ZARA)	33.6	23.5
H & M	38.8	29.1
GAP	41.7	13.3
FR (UNIQLO)	42.4	11.6

SPA:

Specialty Store Retailer of Private Label Apparel

128

128

Training Courses for  
Women Owners and Entrepreneurs

Latest Version

Training Courses for  
Women Owners and Entrepreneurs

# Business model generation - Japanese women's examples

DEC 2018



Changed in red

Nahoko YANO  
President & CEO / Comfort Consulting Co.,Ltd

0

## Rule of this course



- Speak by one/Rule of a raised hand
- "Mobile" silence
- No speaking to each other
- Comply with time limit
- Be active
- To respect each participant's opinion
- Humor within boundaries and appropriate

1

## Table of Contents

### ➤ 1 Day - 2 Day

Strengths and weaknesses of women's entrepreneurs

Business model building blocks

Favorite thing × Ability × Strength

Business model patterns

Japanese women's examples

### ➤ 3 Day

Exchange opinions with Uzbekistan women's entrepreneurs

### ➤ 4 Day - 5 Day

Japanese women's examples

Business model design

Workshop – Creating business model

Presentation

## Profile : Nahoko YANO

### Profile



**Occupation** : President & CEO / Comfort Consulting Co.,Ltd

Representative / Yano Certified Public Accountants Office Certified Public Accountant

### Academic background:

Obtained Bachelor of politics in Waseda University, Department of Politics, Faculty of Politics and Economics

Obtained Juris Doctor in Seikei University Law School

**Career** : The Japan Research Institute, Limited Business Brain Showa/Ota Inc. Ernst & Young ShinNihon LLC

**Qualification** : Certified Public Accountant, Systems Auditor, Project Manager, Turn-Around Advisor

### Project Experience :

大手監査法人において一部上場の製造業社を中心に法定監査に従事。同時に、主に財務会計業務を対象とした経営改革コンサルティングの多数のプロジェクトに参加。

その後、民間企業の経営ノウハウや管理会計手法等を活用して、多数の公的機関の公会計改革、行財政改革プロジェクトに参加。同時に、引き続き民間企業に対して業務改革、事業形成、組織再編、事業再生、リスクマネジメント等のコンサルティングに参加。

### Uzbekistan Project:

The Study for Improvement of Management and Tariff Policy of Water Supply Services in the Republic of Uzbekistan (April 1999 – March 2000)

Project for Capacity Development of Business Persons and Networking through Uzbekistan-Japan Center Human Resources development(January 2016 - Now )

### 【女性が起業家にむく要因】

- ・時代が求めていることや消費ニーズを見極めるのが上手である。  
→衣食住に近いところにいる。
- ・小さな工夫をしたり、気配りをするのが上手である。  
→身の回りのちょっとした不便なことにこだわり、それを解決したがる。
- ・社会とのかかわりが円滑で他者の支援を取り付けるのが上手である。  
→おしゃべりであり、甘え上手である。
- ・苦痛に強くて仕事を楽しむことができる。  
→出産の痛みも忘れられる。

### 【女性の弱み】

- ・比較的數字に弱い。
- ・主観的になりがちである。→ロジカルシンキングを身に着ける。
- ・女性はけちなことが多い。→リターンがあるから投資するのではなく、投資するからリターンがあることを知るべき。

### 【女性の要素と男性の要素をうまく融合】

男は長距離、女は短距離ランナー  
男は持久力、女は瞬発力やばねの柔らかさ  
→男性と組むことでカバーできることもある。  
→女性の要素に男性の要素を付け加えるとより強くなれる。

### 【時代の変化と多様なライフスタイル】

キャリア選択において何が安全かという重大なポイントが変わってきた。  
コンピュータやインターネットなどで事業のスタートアップが可能な時代となってきた。  
ニッチ時間や短時間しかない女性でもビジネスをスタートできる。

今の自分のキャリアに「違和感」を感じたとき、自分らしく生きられる方法の一つが起業である。  
現状に強い不満があるわけではないが、もっと自由に色々なことをしたいということで起業する女性もいる。  
また、起業ではなくても、コミュニティ活動、NPO活動などに取り組む女性もいる。  
まだまだ男女不平等な面もあるが、昔に比べると、女性が自分らしく生きることを実現しやすくなってきた。

### 【自由と価値創造】

自由をはき違えてはいけない。  
目の前の仕事から逃げだすための起業ではない。  
現在会社員であれば、目の前にある仕事を極め、顧客である社長を満足させられてはじめてプロである。  
社長1人満足させられないのであれば、起業しても多数の人の役に立たず満足させられない。

女性は自由にはばたくべき、でも、お金をかせぐためにはそこに価値が必要である。  
そして、女性の感性や価値観をフルに活用して、価値をうむビジネスを起こすことができる。

**【起業のとき】**

女性が起業する経緯は人それぞれである。  
 まずはやれる範囲から小さくスタートし、それを軸に広げていく。  
 たしかにしっかり準備をすることは大事であるが、「やりたい」と思ったら即行動することも大事である。感性で行動を起こすことができる点も女性の強みである。  
 あれこれ悩むより、やってみて考える。行動から学ぶことが多い。ただし、最後にリスクヘッジを考えておく。  
 信念やビジョンを持つ。モチベーションを維持するためには夢とロマンを持つ。自分のやり方にこだわる。

**【好きな事×できる事×強み】**

起業して、それを継続するには好きな事をチョイスすべきである。  
 でも、好きな事、やりたい事とできる事のギャップをちゃんと把握して埋めていくことが大事である。  
 単に好きな事でできる事をやってるだけではボランティアにすぎない。利益を得て初めてビジネスと言える。  
 そのためには「強み」が必要となる。

日本人の女性経営者の先事例を分析するために、ビジネスモデルのコンセプトを9つのブロックとして整理する。

6

9 Business model building blocks :1

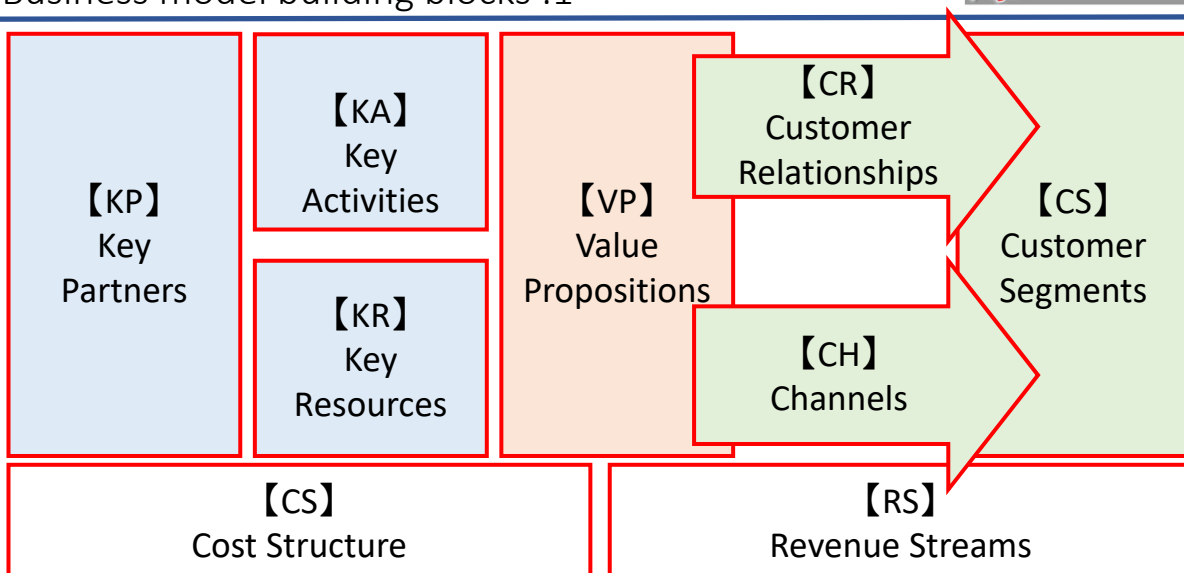

(References: Business Model Generation by Alexander Osterwalder & Yves Pigneur)

7

## 9 Business model building blocks :2

### ➤ 【CS】 Customer Segments

Define the different groups of people or organization an enterprise aims to reach and serve.

- Customers comprise the heart of any business model.
- In order to better satisfy customers, a company may group them into district segments with common needs, common behaviors, or other attributes.

### ➤ 【VP】 Value Propositions

Describe to bundle of products and services that create value for a specific Customer Segment.

- The Value Proposition is the reason why customers turn to one company over another.
- Each Value Proposition consists of a selected bundle of products and/or services that caters to the requirements of a specific Customer Segment.

### ➤ 【CH】 Channels

Describe how a company communicates with and reaches its Customer Segments to deliver a Value proposition.

- チャンネルの機能には、認知度をあげること、価値提案を評価してもらうことも含まれます。
- Channel types are Sales force, Web sales, Own stores, Partner stores, and Wholesaler etc.

## 9 Business model building blocks :3

### ➤ 【CR】 Customer Relationships

Describe the types of relationships a company establishes with specific Customer Segments.

- Relationships can range from personal to automated.
- Customer Relationships called for by a company's business model deeply influence overall customer experience.

### ➤ 【RS】 Revenue Streams

Represent the cash a company generates from each Customer Segment.

- If customers comprise the heart of a business model, Revenue Streams are its arteries.
- A company must ask itself "For what value is each Customer Segment truly Willing to pay?"

### ➤ 【KR】 Key Resources

Describe the most important assets required to make a business model work.

- Every business model requires Key Resources.
- Key Resources allow an enterprise to create and offer a Value Proposition, reach markets, maintain relationships with Customer Segments and earn revenues.

## 9 Business model building blocks :4

### ➤ 【KA】 Key Activities

Describe the most important things a company must do to make its business model work.

- Key Actions are the most important actions a company must take to operate successfully.
- Key Actions are required to create and offer a Value Propositions, reach markets, maintain Customer Relationships, and earn revenues.

### ➤ 【KP】 Key Partners

Describe the network of suppliers and partners that make the business model work.

- Companies create alliances to optimize their business models, reduce risk, or acquire resources.
- We can distinguish between four different types of partnerships:-Strategic alliances between non-competitors (including PR), -Strategic partnerships between competitors, -Joint ventures to develop new businesses, -Buyer-supplier relationships to assure reliable supplies.

### ➤ 【CS】 Cost Structure

Describe all costs incurred to operate a business model.

- Costs can be calculated relatively easily after defining Key Resources, Key Activities, and Key Partnerships.
- Some business models are more cost-driven than others. So-called “no frills” airlines, for instance, have built business models entirely around low Cost Structure.

## Japanese women's examples

No	Company	Business	Type of business
1	Home Design, Inc.	家具・カーテン・照明等のインテリアコーディネート・販売、内装・外装、リフォーム、オーダー家具製造など	サービス業
2	Herstory Co.,Ltd.	男女の購買行動の違いに着目した「女性特性マーケティング」などのマーケティングサービス	サービス業
3	Trenders Inc.	女性をターゲットにしたマーケティングからスタートし、ソーシャルメディアのビッグデータを抽出分析などのコンサルティングなど	サービス業
4	Waris, Inc.	人材サービス、有料職業紹介事業、各種セミナー等の企画・開催・運営 など	サービス業
5	Y's STAFF Corporation.	ホームページ制作、コンテンツ制作、ネットプロモーション、リサーチ/調査/コンサルティングなどIT関連サービス	IT関連事業
6	Galleria Collection, Inc. → Galleria, Inc.	欧米のウェディングドレス・メンズスーツ・小物類のレンタル・販売、ブライダル全般トータルプロデュースなど	サービス業 販売業
7	Chrysmela, Inc.	外れにくいピアスキッチの開発・製造、店頭販売・ネット通販など	製造・販売業
8	Poppins Corporation	高級ベビーシッターの派遣、ベビーシッター養成スクール、保育所・託児所、知育・幼児教育など	サービス業

Delete 3lines



**Home Design, Inc.**



**Company Profile**

会社名:株式会社 ホームデザイン                      社長名:久住博子(Hiroko KUSUMI)  
 設立:1999年                      資本金:300万円→500万円                      従業員数:2人  
 事業内容:家具・カーテン・照明等のインテリアコーディネート・販売、内装・外装、水回りの設備(キッチン・浴室・洗面台・トイレ)のリフォーム、オーダー家具製造など  
 URL: <http://www.home-d.co.jp/>

**Entrepreneurial history**

久住さんは、11年間のJALの客室乗務員の経験をもつ。機内という空間は、書斎であり、リビングであり、ダイニングであり、寝室となる。客室乗務員の経験から、お客様に、タイミングよく快適な空間を演出するのが最高のサービスだと学んだ。次第に、「住まい」を豊かにすることで、それが人の幸せにつながるという思いを抱くようになる。海外の有名な建築物、美術館やホテルなどのインテリアや建築様式に興味を持ち、「住まい」や「家」に関わりたいたいと思うようになる。JALを退職し、住宅業界に転職し実務経験を4年間積みながら、同時にインテリアコーディネーター、建築士やリフォームなどの資格を取得した。その後、ニューヨークに2年間留学し、海外の最先端の建築やインテリアの勉強をしながら、現地のインテリアデザイナー事務所でのインターンを経験した。帰国後、ユーザ(主として奥様)の希望やニーズをしっかりと聞いてデザインすることをポリシーに起業した。

**Home Design, Inc.**



**Business Model**

<p>KP 地元工務店 外部のデザイナーや コーディネーター</p>	<p>KA 誠実な仕事、実績の 積み重ね その広告宣伝</p>	<p>VP ライフスタイルや好み にマッチした住空間の 創造 家でのくつろぎや安ら ぎ</p>	<p>CR じっくりと住人の希望 やニーズを聞き出す 親密な人間関係</p>	<p>CS リフォームの時期とな る住宅を持ち快適な 住まいを求める人 自分好みのインテリア や住空間へのこだわ りが強い人 (女性が多い)</p>
<p>CS 事務所賃貸料、スタッフ人件費、外部委託料、広告宣伝料</p>		<p>RS 設計料、コーディネート料</p>		

**Home Design, Inc.**



Verification of the business model

<p><b>Strength</b>                  起業前の実務経験・留学による人脈                  生活空間に対するニーズの的確な理解</p>	<p>私が真似したい点、ヒントにする点                  高品質の仕事にじっくり取組み受注につなぐ点                  外部パートナーを活用する点</p>
<p><b>Weakness</b>                  顧客ニーズを掘り起こし人間関係を築くことができる人材不足</p>	<p>私だったらもっと工夫する点                  ニーズを聞き出すノウハウを整理し社員と共有する。</p>

Business evaluation

時間をかけクライアントのニーズを聞き出すことを強み、特徴としており、必ずしも規模を大きくすることが当該ビジネスの成功につながるとは言えない。専門家の外部パートナーを活用することや、あまり資源を使わずに事業を推進することは、このビジネスモデルにフィットしている。  
 しかし、事業継続のためには、人的リソースを投入せず、ある程度企画化されたサービスの提供をすることも必要ではないかと考えられる。

【強みをどうやって探すか】

好きな事で、できる事をするだけではなく、そこにどうやって強みを加えるのか。

- めざすのは、人が喜んでお金を払いたいくなる価値あるものを作り上げること。
  - ・人々が本当にほしがっているものを探す。
  - ・人がほしいと気が付いてないものを探り当てる。
  - ・人が欲しいと口にするのと本当に欲しいものが違うことがある。
  - ・人が大なり小なり大変だと思っていることを探す。
 →女性の感性をフル活用
- 日常生活のなかで、価値を創造するものを探し出す。
  - ・複雑な情報社会だからこそシンプルに情報提供する。
  - ・日常生活で実行するのが大変なことがビジネスチャンスにつながる。
  - ・「こうしたい」「こうあってほしい」「こうすべき」というこだわりを持つ。
  - ・革新ではなく、有用性を考えてみる。
  - ・多数の賛成者、多数の反対者がいることはビジネスになることがある。
 →女性は日常生活の工夫やちょっとした変更が上手  
 →自分の経験からビジネスのネタを見つける女性

**Herstory Co.,Ltd.**



Company Profile

会社名:株式会社ハー・ストーリー 社長名:日野 佳恵子 (Kaeko HINO)  
 設立:1990年 資本金:7960万円(2008年) 従業員数:-  
 事業内容:男女の購買行動の違いに着目した「女性特性マーケティング」、女性特有の思いと行動であるクチコミと井戸端会議をイメージした造語「クチコミコミュニティ・マーケティング」などのマーケティングサービス提供、コミュニティ運営など  
 URL: <http://herstory.co.jp/>

Entrepreneurial history

日野さんは、大学卒業後4年間、地元広告代理店でタウン誌の編集長として勤務した後、出産のため退社した。1年間専業主婦として、子供と公園にいき、ほかのママと話す毎日であった。  
 その際、女性の口こみ力、おしゃべり好きに強い衝撃を覚え、広告より口こみのパワーが購買に影響を及ぼしていることを認識した。女性はメディアであり、女性のコミュニティと男性のビジネス社会をつなぐことがビジネスになると思い起業した。また、女性が働きやすい雇用体制を作ることをもう一つの柱として起業した。  
 さらに、女性の声で社会を変えていきたいという思いから、企業と主婦が直接対話できる場を提供したりしている。

**Herstory Co.,Ltd.**



Business Model

KP 広告代理店 メディア 女性会員10万人	KA クチコミコミュニティ・マーケティングの執筆、講演、女性会員獲得活動、システム構築	VP 女性の率直な声、意見、消費行動パターンの分析情報(女性特有マーケティング&コンサルティング)	CR	CS
	KR 会員サイト等システム、情報分析スタッフ		CH	
CS システム運営費用、スタッフ人件費		RS		

**Herstory Co.,Ltd.**



Verification of the business model

<p>Strength 女性会員10万人 女性スタッフの感性による分析能力</p>	<p>私が真似したい点、ヒントにする点 女性の視点、感性や意見をビジネスに取り込んだ点</p>
<p>Weakness 女性社長のメディア露出に依存した広告宣伝</p>	<p>私だったらもっと工夫する点 女性の特性を分析しアンケート回答の質の向上を図る。</p>

Business evaluation

20年以上ビジネスを継続し、CSを特定しないビジネスモデルで、大手企業を含めて多数のクライアントを有しており、ビジネスとして成功を収めている。  
しかし、インターネットでのアンケート調査会社は、多数存在しており、女性を対象とするというだけでは特徴が出しにくくなっている。また、マーケティングの肝である、女性会員の質の高い「意見」「口コミ」を維持するために女性を引き付けておく魅力やアイデアがやや乏しいと思われる。

**Trenders Inc.**



Company Profile

会社名:トレンダーズ株式会社      社長名:経沢香保子(Kahoko TUNEZAWA)→会長(2014年就任)  
 設立:2000年→2012年株式公開      資本金:1000万円→5億4464万円      従業員数:3人→89人(2015年)  
 事業内容:女性をターゲットにしたマーケティングからスタートし、ソーシャルメディアのビッグデータを抽出分析、動画マーケティングコンサルティング、スマートフォンマーケティングコンサルティングなど  
 URL: <http://www.trenders.co.jp/>

Entrepreneurial history

経沢さんは、会社を変わりながら、営業、新規事業開発、社内体制整備という仕事につき、それぞれで成果をだし、充実感もあった。しかし、自分に足りないものは「留学経験とMBAの知識」だと思い退社したが、留学準備は進まなかった。  
 起業支援NPOでベンチャー企業の社長の人々と話をするうちに、「留学ではなく起業が私の新たな成長ステージだ」と思うに至り、起業を決意した。ところが、ビジネスのネタをもっていなかった。  
 あれこれ思考しているとき、「消費行動の8割は20歳から34歳までの女性が握る」というアメリカの女性サイト運営者の話をよみ、女性の消費行動に関する情報を男性経営者に届けるビジネスが成立すると考えた。  
 しかし、それだけだと既存のマーケティングサービスと差別化できないため、中心となる母集団を一定の女性の範囲に絞り、密度の高い情報を収集、提供するというビジネスで起業した。

**Trenders Inc.**



Business Model

KP	KA	VP	CR	CS
	KR		CH	
CS		RS		

**Waris, Inc.**



Company Profile

会社名:株式会社Waris 共同代表者名:米倉史夏(Fumika YONEKURA) 田中美和(Miya TANAKA) 河京子(Kyouko KAWA)

設立:2013年4月 資本金:646万円 従業員数:一

事業内容:人材サービス、有料職業紹介事業、各種セミナーやイベント等の企画・開催・運営 など

Entrepreneurial history

女性3名の共同代表者により経営されている。

米倉さんは、大学卒業後複数の会社で、企業の海外直接投資に関する調査、医療や製薬業界の調査・分析業務、さらに、医療領域やブライダル事業の事業企画業務に従事した。2011年に取得した、米国CCE,Inc.認定GCDF-Japan キャリアカウンセラーの資格を生かして女性のキャリア支援に携わりたいと考え起業に至る。

田中さんは、大学卒業後就職し、編集記者として、特に働く女性向け情報誌の企画・取材・編集・執筆に携わり、アンケート分析を通じて接した女性の声はのべ3万人以上になる。2009年に米国CCE,Inc.認定GCDF-Japan キャリアカウンセラーの資格を取得し、フリーランスのライター・キャリアカウンセラーとしての活動を経て起業に至る。

河さんは、大学卒業後就職し、外資系医療機器メーカーを始めとした医療業界の顧客企業と個人のマッチング事業、企業に対する事業拡大を人材の観点から支援する事業に従事したのち、株式会社Warisの起業に参画した。

ハイスキルな女性人材と企業ニーズのジョブマッチング、業務アウトソーシング受託により、女性が自分の能力を生かしてイキイキと働き続けられる社会の実現を目指している。

## Y's STAFF Corporation.



### Company Profile

会社名:株式会社 ワイズスタッフ 社長名:田澤由利 (Yuri TAZAWA) 設立年月:1998年  
 資本金:1000万円 従業員数:17名  
 事業内容:IT/インターネット事業(ホームページ制作、コンテンツ制作、ネットプロモーション等)、地域活性化関連事業(主にインターネットを利用した地域活性化事業の企画等) など  
<http://www.ysstaff.co.jp/>

### Entrepreneurial history

田澤さんは、東京の大学卒業後就職し、メーカーでパソコンの商品企画を担当していた。しかし、出産とご主人の転勤で仕方なく退職し北海道に引っ越した。  
 しかし、子育て中であっても、地方在住であっても、仕事をしたいと思い、3人の子供の子育てと夫の転勤による5回の引っ越しも乗り越えて、パソコン関連のフリーライターとして自宅で働き続けた。そして、「在宅でも女性がしっかり働ける会社を作りたい」と思い北海道で起業するにいたった。  
 様々なIT関連業務を受託し、「ネットオフィス」というコンセプトのもと、全国各地に在住する約150人のスタッフに業務委託して、チーム体制で業務を行っている。

## Galleria Collection, Inc. → Galleria, Inc.



### Company Profile

会社名:株式会社ギャザリアコレクション→株式会社ギャレリア  
 社長名:宮崎陽子 (Yoko MIYAZAKI) →山崎崇 (Takashi YAMAZAKI)  
 設立:2002年(96年「ギャレリアコレクション青山店」オープン) 資本金:1億6150万円 従業員数:70名(2010年)  
 事業内容:欧米のウェディングドレス・メンズスーツ・小物類のレンタル・販売、ブライダル全般トータルプロデュースなど  
 URL: <http://galleriacollection.jp/>

### Entrepreneurial history

宮崎さんは、アメリカの大学に留学し、卒業後は日本の三井銀行のニューヨーク支店に就職するが、コピーやファイリングをしていた。銀行が合併することになり、日本に戻ってやりたいことをやろうと退職する。日本では、親の勧めで外資系の会社に就職したが、次第に起業を意識するようになる。  
 ある日、友人が結婚することになり、レンタルドレスをさがすのに偶然付き合った。ところが、アメリカで見っていた美しく繊細なドレスとは比べ物にならないほど、全く洗練されていないものばかりだった。「本物のドレス」を伝えたい、女性の願望をかなえる美しい物に囲まれ、結婚する幸せな人たちに囲まれる仕事がしたいと思い、起業にいたった。  
 社員の99%は女性で、女性らしい、しなやかな物事の発想、女性らしい思いやりを大事にしている。また、ドレスには徹底したこだわりをもち、絶対妥協しないこと、100%お客様が満足することをポリシーとしている。

**Chrysmela, Inc.**



Company Profile

会社名:株式会社 Chrysmela                                  社長名:菊永英理 (Eri KIKUNAGA)  
 設立:2007年                                  資本金:—                                  従業員数:3名  
 事業内容:外れにくいピアスキャッチの開発・製造、店頭販売・ネット通販など  
 URL: <http://www.chrysmela.com/>

Entrepreneurial history

菊永さんは、キャリアと子育てを両立するためには起業しかないと、すでに16歳のときに起業を志した。銀行員の父に事業計画書を9年間出し続けるが、「使い物にならない」と言われ続ける。大学を卒業し、起業できずに就職した。  
 ある日、彼からもらったピアスをなくして怒られ、「私が悪いのではなく、外れてしまうピアスキャッチが悪い。」と彼とけんかになった。そのとき、「私が解決すべき問題はこれだ！」と思いつき、24歳から、外れにくいピアスの研究開発を開始する。2006年に「外れにくいピアスキャッチ」の特許を出願し、翌年会社を設立した。  
 長野県岡谷市 (Okaya-city Nagano Prefecture) の精密金型の設計・製作、切削加工技術を有する事業所数社と業務提携し、製品を提供している。

**Chrysmela, Inc.**



Business Model

KP ピアス製造事業者、販売取扱店、ネット販売店	KA (研究開発、製造業者探し) 良さを知ってもらうための公告宣伝	VP 外れにくいピアスキャッチにより大事なピアスをなくさなくてすむ安心感・満足感 大事なピアスをしまい込まずに身に着ける喜び	CR 自動的な関係	CS ピアスが外れやすくて困っている人
	KR 特許 スタッフ3名		CH 雑誌、マスコミ、口コミ、通販サイト、他社の店舗	
CS ピアスキャッチ製造費用、販売手数料、スタッフ費用		RS ピアスキャッチ販売料		



## Chrysmela, Inc.



### Difficulties and Conquest

- 【KR】 Key Resources
  - ・特許開発が成功するか否かわからない。→詳細は秘密にされているが、たまたま成功したのかもしれない。
- 【KP】 Key Partners
  - ・誰も製品を作ってくれない。→200社以上の会社にアポイントをとって会いに行く。→やっと長野県の精密金型工場（宝石製造ではない工場）が作ってくれることになる。
- 【CH】 Channels
  - ・誰も製品を売ってくれない。→宝石店を回って販売を依頼するが商売の邪魔だといわれる。→宝石関係ではない楽天の店長が取り扱ってくれることになる。発売開始から4年たってようやく販売が軌道にのる。

## Poppins Corporation



### Company Profile

会社名: 株式会社ポピンズ      社長名: 中村紀子(Noriko NAKAMURA)  
 設立: 1987年      資本金: 9,657万円      従業員数: 2,652名  
 事業内容: 高級ベビーシッター(Nanny、Poppins-sanと呼ぶ)の派遣、ベビーシッター養成スクール、保育所・託児所、知育・幼児教育、法人提携育児サービスなど  
 URL: <https://www.poppins.co.jp/english/index.html>

### Entrepreneurial history

中村さんは、1児の母親であり、当時テレビ局に勤務していた。子供をベビーシッターに預け、仕事に出かけていたが、母親として、子供を任せられる「プロ」のベビーシッターがいないことを痛感した。  
 ベビーシッターとはこうあるべきだということなど、気づいたことをノートにメモしていたら、3冊にもなった。  
 ベビーシッターの需要を感じて、テレビ局をやめ起業に至る。  
 自分でまとめた3冊のノートをもとにしてベビーシッター養成スクールのテキストを作り、そこで養成された修了生をPoppins-sanとして人材登録し、クライアントに派遣する事業の基盤を作った。



## Poppins Corporation



### Business Model

<b>KP</b> デパート、コンサートホール、美術館等 医療機関、安全サービスセンター	<b>KA</b> 高級ベビーシッター（ポピンズ）の育成 ポピンズのマーケティング  <b>KR</b> 高級ベビーシッターとなる人材 ポピンズのブランド	<b>VP</b> 愛する子供が受ける 幼児期に必要な、しつけ、教育、健康管理等の 高級ベビーシッター 幼児教育や健康管理に配慮する保育園 これらに子供を預けることができる満足感	<b>CR</b> ポピンズさんと子供と母親の親密な関係 保育園と母親達との信頼関係  <b>CH</b> ポピンズ、イベント会場、保育園、母親の口コミ、広告、マスコミ	<b>CS</b> キャリア・仕事をもち、育児に熱心な母親（父親）
<b>CS</b> ポピンズ育成プログラム開発費用、保育園開設費用、人件費、広告宣伝費		<b>RS</b> ベビーシッター料金、スクール授業料、保育園料		

## Meri Poppins & New Opportunity ← 比較しよう



### Company Profile

会社名：メリーポピンズ & ニューオポチュニティ      社長名：Valida Daminjanovna  
 設立：2006年      資本金：-      従業員数：11-50名  
 事業内容：ハウス・オフィス・スーパー・工場等の清掃スタッフの派遣、ベビーシッターの派遣など  
[http://meripoppins.gl.uz/5827-meri\\_poppins/](http://meripoppins.gl.uz/5827-meri_poppins/)

### Entrepreneurial history

Validaさんは、働きながら子供3人を育てていた時に、掃除やベビーシッターがいてくれるととても助かると感じていた。孫が生まれたときに、過去の苦勞を思い出しベビーシッターと清掃スタッフの派遣会社を設立した。その後、2010年に派遣スタッフのための教育センターを作成した。

**Meri Poppins & New Opportunity ← 比較しよう**



Business Model

KP	KA	VP	CR	CS
	KR		CH	
CS		RS		

30

Work shop : Business model generation

演習 : 9つのブロックを使ってビジネスモデルを完成する。

グループに分かれて、ビジネスモデルを作成する。

1. ビジネスモデルを作りたいビジネスアイデアがある人はそれを説明する。
2. 似たようなビジネスの人やほかの人の説明を聞いて一緒に検討したい人で同じグループを作る。
3. うまくグループを形成できない場合は、講師が調整する。

※講義とディスカッション

必要に応じて、演習の途中で講義や全員でのディスカッションを実施する。  
(9つのブロックを検討するときにも、必要であれば適宜ディスカッションを実施する。)

Changed in red

31

## Business Model Design :1

人が喜んでお金を払いたくなる価値あるもの、日常生活のなかで価値を創造するものを探し出し、ビジネスモデルを構築して起業する必要がある。

### 【より革新的なビジネスモデルの構築】

#### ➤ Customer Insight

- ・顧客の考えこそがイノベーションの源泉であるということではなく、ビジネスモデルを評価するのに顧客視点が含まれているべきだ。
- ・そのために、取巻く環境や日常生活、関心、願望といった、顧客に関する深い理解が欠かせない。
- ・しかし、何が欲しいかを顧客に聞くのではなく、顧客を深く理解することが大事である。
- ・What does she see? What does she hear? What does she really think and do? What does she say and do?  
What is her pain? What does she gain?

#### ➤ Ideation

- ・Mapping an existing business model is one thing; designing a new and innovative business model is another. What's needed is a creative process for generating a large number of business model ideas and successfully isolating the best ones. This process is called "Ideation".
- ・9つの構築ブロックのいずれもビジネスモデル構築の出発点となる。→リソース主導、価値提案主導、顧客主導、そして、ファイナンス主導。
- ・「もし～なら」という仮定の質問をぶつけてみる。

## Business Model Design :2

#### ➤ Visual thinking

- ・暗黙におかれた仮設が、目に見える情報へ置き換わる。
- ・議論が抽象的なものから具体的なものになり、ディベートの質を高める。

#### ➤ Prototyping

- ・抽象的な概念を具体化することができ、新しいアイデアの探索を可能にする。
- ・私たちのビジネスモデルがとることができる別の方向を探るのに役立つ思考ツールである。

#### ➤ Storytelling

- ・なじみのないモデルには抵抗を示すのが普通の反応である。そのため、抵抗を乗り越えるような方法で、新しいビジネスモデルを説明することが重要である。
- ・経営者を説得し、部下を巻き込み、顧客に物語を提供する。
- ・物語によって、顧客が何を受け取り、それが生活にどのように密着しており、どのように価値を生むのかを説明する。

#### ➤ Scenarios

- ・シナリオの第一の機能は、デザインをある文脈に特化させ、そのディテールを描くことで、ビジネスモデル開発プロセスへ情報提供することである。
- 異なる顧客設定によるシナリオ: 製品やサービスをどのように使い、利用する顧客や顧客の関心、欲求、目的は何かを考える。
- 未来の競争環境を説明するシナリオ: 未来の可能性について詳細にイメージする。未来の環境に対して適切なビジネスモデルを考えるのに役立つ。

(References: Business Model Generation by Alexander Osterwalder & Yves Pigneur)

Delete after sheets

## Japanese women's entrepreneurs example :3-2

### Trenders Inc.



#### Business Model

<b>KP</b> マスメディア 女性オピニオンリーダ 女性会員20万人弱 女性起業塾	<b>KA</b> オピニオンリーダーの ネットワーク構築 マスメディア等を活用した 広告宣伝  <b>KR</b> 会員サイト等システム 女性オピニオンリーダー	<b>VP</b> 自分のセンスや意見に自信をもつ有能な女性オピニオンリーダーを中心とした質の高いマーケットリサーチ情報 女性によるビックデータの分析	<b>CR</b> 女性オピニオンリーダーによる情報発信、アドバイス  <b>CH</b> 公告、メールマガジン、マスコミ、ロコミ、執筆・講演	<b>CS</b> 女性の意見を聞きたい各種商品・製品製造及び販売会社
<b>CS</b> システム運営費用、スタッフ人件費		<b>RS</b> マーケティング&コンサルティングフィー		

Построение бизнес-моделей: примеры японских женщин-предпринимателей

0

## Japanese women's entrepreneurs example :4-2

### Waris, Inc.



#### Business Model

<b>KP</b> ハイスキルマザー ハイスキルマザーのための 保育園	<b>KA</b> 人材スキルの的確な把握、 受託業務の的確な切り出し、 品質担保の仕組づくり  <b>KR</b> スタッフ、ハイスキルマザー登録・ 管理システム、マッチング ノウハウ	<b>VP</b> 退職したハイキャリア層の女性 (ハイスキルマザー)の的確で迅速な 人材配置サービス	<b>CR</b> 綿密なコンサルテーション、 ハイスキルマザーとの親密な関係  <b>CH</b> イベント、ホームページ、 広告、マスコミ、執筆・講演	<b>CS</b> マーケティング、人事、法務、 経理、広報などの人材ニーズが ある企業、特に中小企業やベンチャー 企業
<b>CS</b> 人件費、広告宣伝費、システム運用費、 ハイスキルマザーへの業務委託料		<b>RS</b> 企業からの業務受託料		

Построение бизнес-моделей: примеры японских женщин-предпринимателей

1

**Y's STAFF Corporation.**



Business Model

KP IT能力を有する女性 広告宣伝のための業 界サイト	KA ネットオフィスやクラウ ドの準備、スキル定義、 労働環境の定義、人 材確保、人材育成  KR ITシステム、テレビ会 議、事務スタッフ、事 務所	VP リーズナブルな価格で の高品質のホーム ページやコンテンツの 作成やIT関連コンサル ティング	CR チーム対応  CH ホームページ、業界サ イト、マスコミ	CS ホームページやコンテ ンツの作成を外注した い企業
CS システム運用費、業務委託費、スタッフ人件費		RS ホームページ等制作料、コンサルティングフィー		

2

**Galleria Collection, Inc. → Galleria, Inc.**



Business Model

KP ブライダルジュエリー ショップ 芸能人などの有名人 ホテル・結婚式会場 ドレスメーカー	KA こだわりのドレスの発 掘、買付 「本物」のドレスの公 告宣伝  KR 「本物」のドレス 極上のサービスを提供 できる女性社員	VP 繊細で美しいドレスを 身にまとった結婚式の 思い出 子どものころからのあ こがれの達成感や満 足度100%	CR 一人ひとりへのサポー ト専任体制  CH 結婚情報誌の広告、 口コミ、マスコミ	CS 結婚式、特にドレスに こだわりを持つ花嫁
CS 店舗開店費用、ドレス買付費用、人件費、広告宣伝費		RS ドレスレンタル・販売料		

3

**Trainer: Nahoko YANO**

**Title: Business model generation - Japanese women's examples**

**Target group: Women who have some business ideas and want to start their business, women who want to launch other new business**

**[Course description]**

- Learning objectives: To be able to create a Business Model and implement action plan independently upon completion of the training.
- Follow-up after implementation: To monitor the development of an independent Business Model and emphasize the importance of start-up implementation. This will involve: ① individual advice sessions and the individual coaching, ② priority participation opportunities for PMP and participation in specialized courses, ③ support for loan access for investors.

**Course objective:**

To support to inclusive growth and promote “a society where women can shine” as proposed by the Japanese government. This new business course is aimed at specializing in supporting the development of female managers and entrepreneurs. In this course, you can acquire the method of business model generation using nine blocks. And this course supports new business model generation by women's perspectives, the new services and product development taking advantage of women's sensibility, by using many Japanese women's entrepreneurs' cases. Moreover, this course gives the place sharing issues and experiences in the business of Uzbekistan women's entrepreneurs.

このコースでは、9つのブロックを使用したビジネスモデル生成の方法を取得できます。また、日本の女性起業家の多くの事例を通して、女性の視点による新しいビジネスモデルの生成、女性の感性を生かした新しいサービスや商品開発を支援します。さらに、このコースは、ウズベキスタンの女性起業家のビジネスにおける問題と経験を共有する場を提供します。

**Course requirements (maximum number of participants, position, etc.):**

Capacity: Approximately 10 to 15 participants per class.

Target: Women managers and entrepreneurs (eligibility requirements: submission of an expression of interest which details the applicant's motivation for participation).

**[Course schedule]****Date and time: 10/12/2018 – 14/12/2018, 10:00 – 13:00**

<b>D a y</b>	<b>Topic</b>	<b>Content</b>	<b>Methods</b>	<b>Equipment/ stationery to be used</b>	<b>Expected outcome</b>
<b>1</b>	Women's entrepreneurs Business model generation	<ul style="list-style-type: none"> <li>● Success factor of women's entrepreneurs</li> <li>● Business model building blocks</li> <li>● Japanese women's entrepreneurs models</li> <li>● Favorite thing × Ability × Strength</li> </ul>	Lecture/Discussion/Workshop	Projector PC,Text	To understand the business model building block
<b>2</b>	Japanese women's case study	<ul style="list-style-type: none"> <li>● Explanation Japanese women's entrepreneurs models using blocks</li> </ul>	Lecture/Discussion/Workshop	Projector PC,Text	To explain the Japanese women's business model
<b>3</b>	Exchange opinions with Uzbekistan women's entrepreneurs	<ul style="list-style-type: none"> <li>● Presentation by Uzbekistan women's entrepreneurs</li> <li>● Exchange opinions on issues and experiences of women entrepreneurs and managers in business</li> </ul>	Lecture/Discussion/Workshop	Projector PC	To build a network with women's entrepreneurs and managers
<b>4</b>	Japanese women's case study	<ul style="list-style-type: none"> <li>● Explanation Japanese women's entrepreneurs models using blocks</li> <li>● Comparison Japanese women's entrepreneurs models and Uzbekistan model</li> <li>● Business model design</li> </ul>	Lecture/Discussion/Workshop	Projector PC,Text	To reuse the Japanese women's business model
<b>5</b>	Business model generation and presentation	<ul style="list-style-type: none"> <li>● Creating new business Models</li> <li>● Presentation</li> </ul>	Work Shop Presentation	Projector PC,Text	To generate a business model

**Trainer: Nahoko YANO**

**Title: Business model generation - Japanese women's examples**

Contents draft	Min	
Day 1	Min	
The purpose of this course <Natalya>	5	指定席
Rule of this course and contents table	5	
Profile: Nahoko YANO	5	タシケント証券取引所 紙に自分の4点記載
Your name? Your business? What's your purpos of participation? New business idea? ★WS	20	
Strengths and weaknesses of women's entrepreneurs lecture and discussion	15	
Various life-style of women Free and Value lecture	10	
Favorite thing × Ability × Strength lecture	10	
9 Business model building blocks lecture	20	
Break	20	
Japanese women's examples	2	
Japanese women's entrepreneurs example 1 lecture and discussion(What can you learn as regards the business?)	33	
Strength of entrepreneurship(Favorite thing × Ability × Strength) lecture and ★WS	35	矢野の好きなこと、 できること、強味記載
Total	180	
Day 2	Min	指定席
Japanese women's entrepreneurs example 2 lecture and discussion(Create 9 blocks)	30	90年代携帯写真
Japanese women's entrepreneurs example 3 lecture and ★WS	40	ロシア語回答
Break	20	
Japanese women's entrepreneurs example 4 5 6 lecture	30	ワリスHP ワイススタッフHP
Japanese women's entrepreneurs example 4 5 6 ★WS	60	ロシア語回答
Total	180	
Day 3	Min	
Presentation and disucussion	80	ウズベキ女性2, 3名
Break	20	
Presentation and disucussion	80	テーマだし
Total	180	
Day 4	Min	指定席
Japanese women's entrepreneurs example 7 lecture	25	地下鉄図 ピアスのビデオ、HP
Japanese women's entrepreneurs example 8 lecture ★WS	45	ウズベキのHP
Expranetion theme and making team	15	
Break	20	
Business Model Design lectur	20	
Customer insight (and Storytelling) ★WS	45	女の子の絵
Creating business model ★WS	10	
Total	180	
Day 5	Min	
Creating business model ★WS	40	
Break	20	
Presentation	120	3チーム
Total	180	