

資料- 8 概略設計図

The Project
for
Upgrading of National Road Route 1
in the Republic of Djibouti

REFERENCE DRAWING

November-18

 YACHIYO ENGINEERING CO., LTD.

DRAWING LIST

No.	DRAWING TITLE
1	LOCATION MAP
2 • 3	TYPICAL CROSS SECTION (1), (2)
4 ~ 19	PLAN & PROFILE (1)~(16)
20 ~ 123	CROSS SECTION (1)~(104)
124 • 125	STANDARD DRAWING OF BOX CULVERT (1), (2)
126	GENERAL DRAWING OF BOX CULVERT(Box-36 at PK213+843)
127	STANDARD DRAWING OF GAURDRAIL
128	STANDARD DRAWING OF FOOT STRUCTURE OF SLOPE
129	STANDARD DRAWING OF PK POST

LOCATION MAP



 REPUBLIQUE DE DJIBOUTI MINISTRE DE L'EQUIPEMENT ET DES TRANSPORTS DIRECTION DE L'EQUIPEMENT	 JAPAN INTERNATIONAL COOPERATION AGENCY YACHIYO ENGINEERING CO., LTD.	THE PREPARATORY SURVEY FOR THE PROJECT FOR UPGRADING OF NATIONAL ROAD ROUTE 1 IN THE REPUBLIC OF DJIBOUTI		SCALE S=1:60,000
		SHEET CONTENTS LOCATION MAP		DATE NOV 2018

TYPICAL CROSS SECTION S=1:100

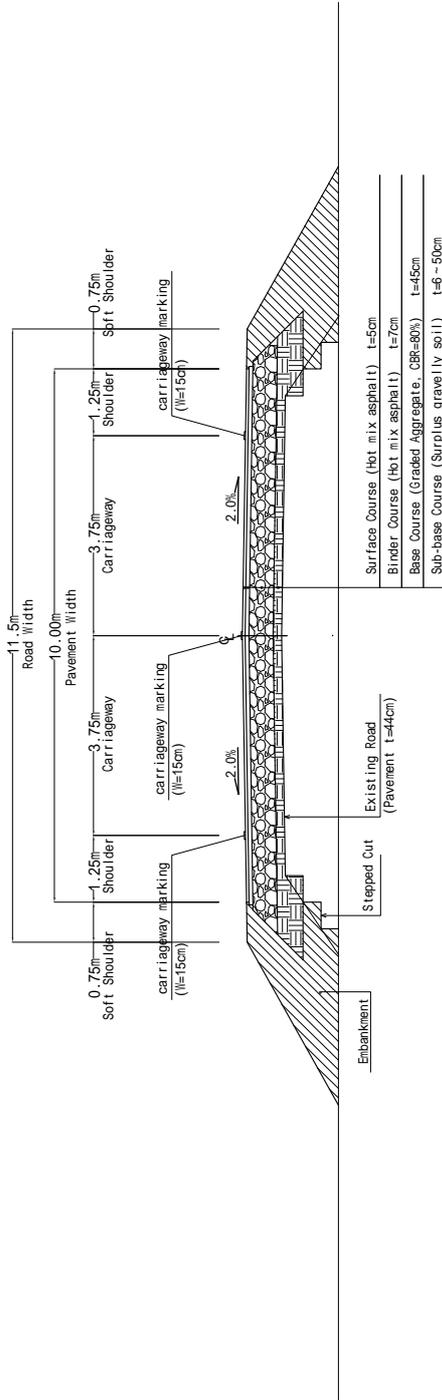

Type 1: Section of PK200 ~ PK 210

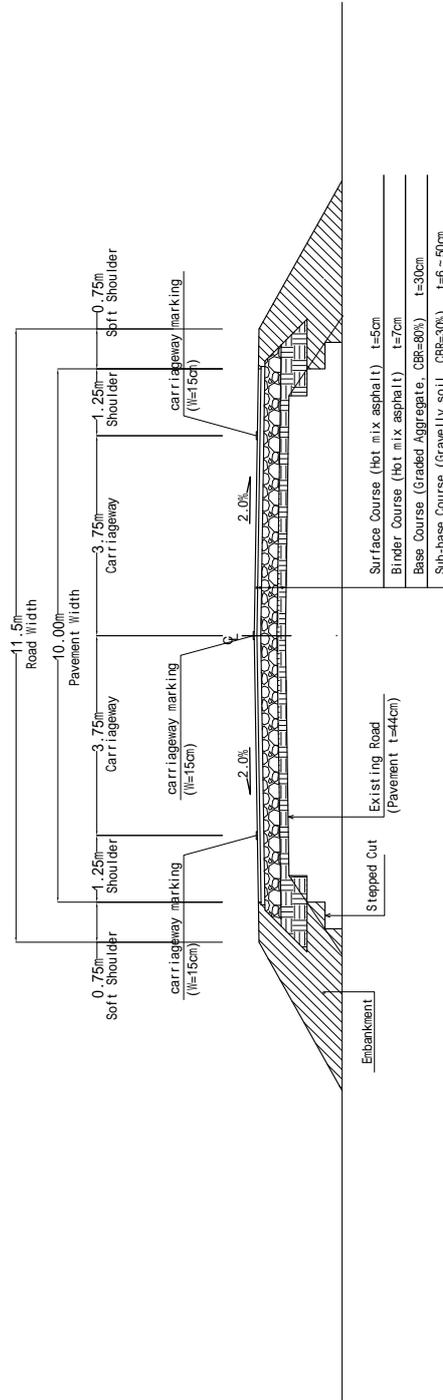

Type 2: Section of BP ~ PK 200, PK210 ~ EP

 REPUBLIQUE DE DJIBOUTI MINISTERE DE L'EQUIPEMENT ET DES TRANSPORTS DIRECTION DE L'EQUIPEMENT	 JAPAN INTERNATIONAL COOPERATION AGENCY YACHIO ENGINEERING CO., LTD.	THE PREPARATORY SURVEY FOR THE PROJECT FOR UPGRADING OF NATIONAL ROAD ROUTE 1 IN THE REPUBLIC OF DJIBOUTI		SHEET CONTENTS TYPICAL CROSS SECTION 1/2	SCALE S=1:100
		DATE NOV 2018	PAGE NO. 1 / 131		

TYPICAL CROSS SECTION S=1:100

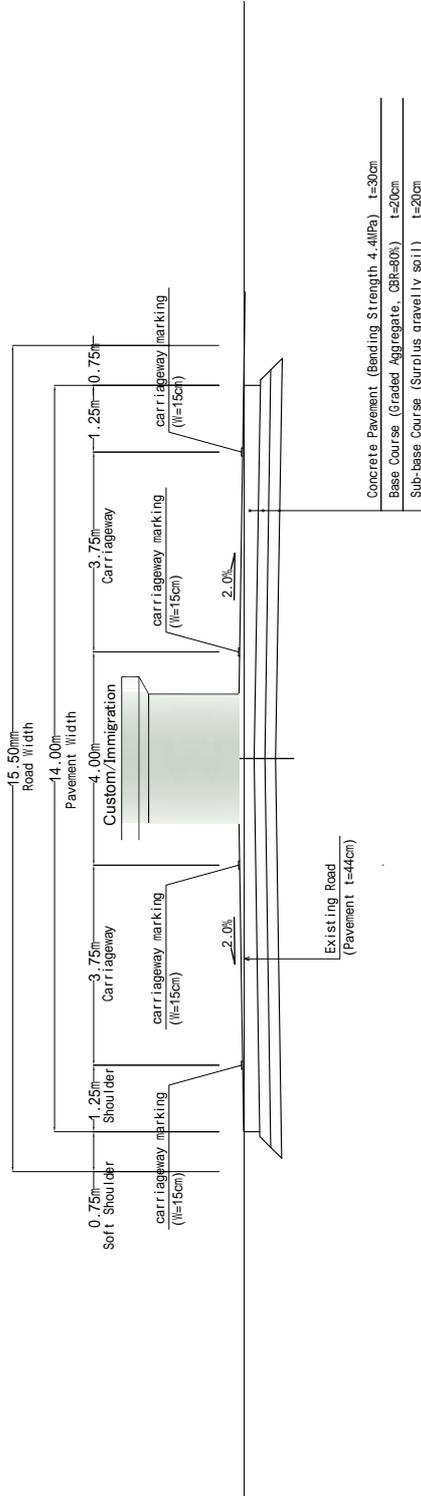

Type 3: Section of PK215+890 ~ PK 216+305

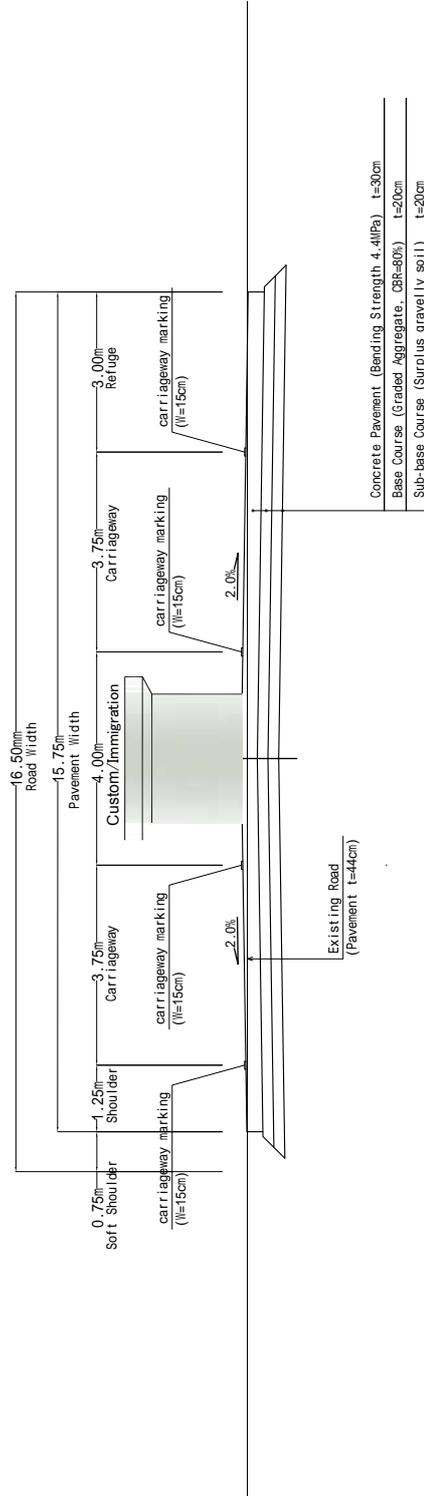

Type 4: Section of PK216+144 ~ PK216+206

 REPUBLIQUE DE DJIBOUTI MINISTERE DE L'EQUIPEMENT ET DES TRANSPORTS DIRECTION DE L'EQUIPEMENT	 JAPAN INTERNATIONAL COOPERATION AGENCY YACHIO ENGINEERING CO., LTD.	THE PREPARATORY SURVEY FOR THE PROJECT FOR UPGRADING OF NATIONAL ROAD ROUTE 1 IN THE REPUBLIC OF DJIBOUTI	SHEET CONTENTS	
			TYPICAL CROSS SECTION 2/2	SCALE S=1:100
			DATE	NOV 2018
			PAGE NO.	2 / 131

PLAN & PROFILE

PLAN S=1:4000

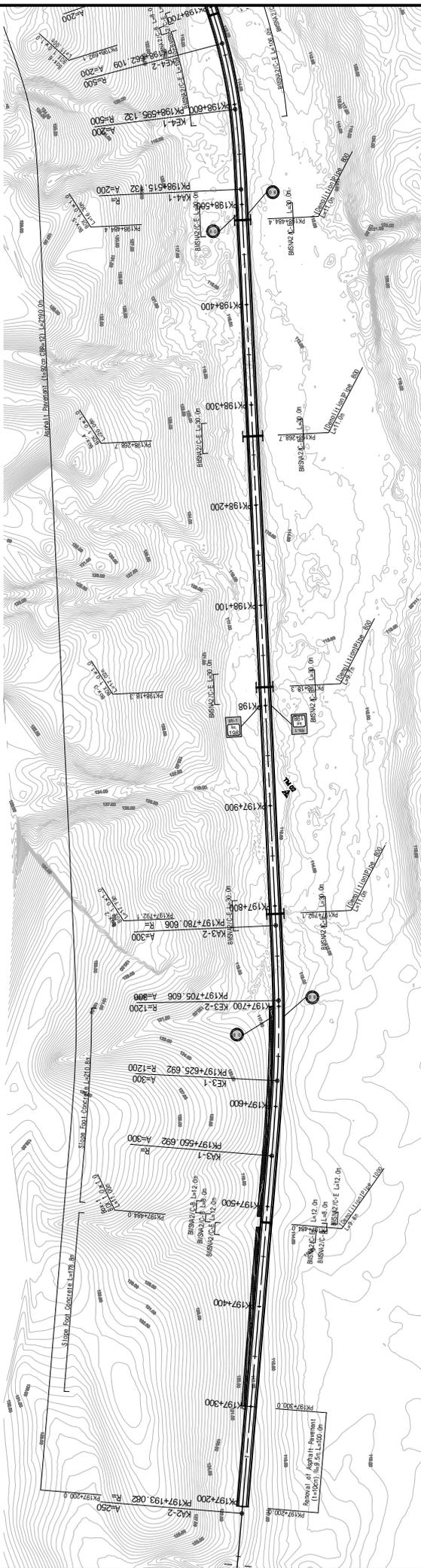

PROFILE V=1:1000 H=1:4000

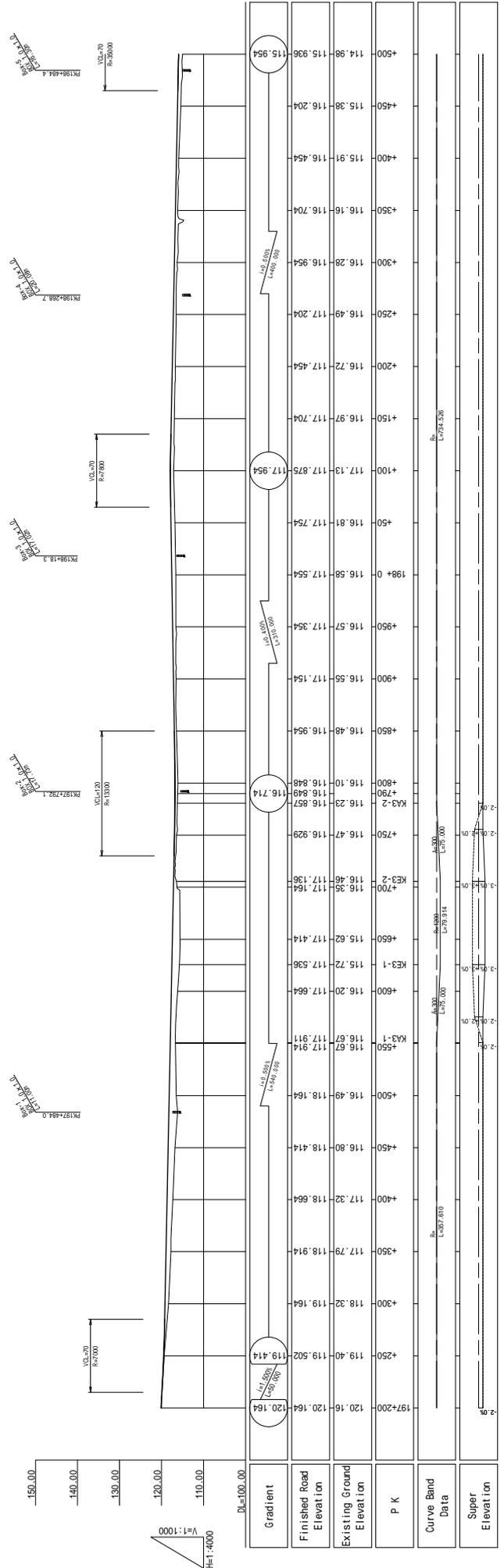

 <p>REPUBLIQUE DE DJIBOUTI MINISTERE DE L'EQUIPEMENT ET DES TRANSPORTS DIRECTION DE L'EQUIPEMENT</p>	 <p>JAPAN INTERNATIONAL COOPERATION AGENCY YACHIYO ENGINEERING CO., LTD.</p>	<p>SHEET CONTENTS</p> <p>THE PREPARATORY SURVEY FOR THE PROJECT FOR UPGRADING OF NATIONAL ROAD ROUTE 1 IN THE REPUBLIC OF DJIBOUTI</p>		<p>SCALE</p> <p>V=1:1000, H=1:4000</p>
		<p>DATE</p> <p>NOV 2018</p>	<p>PAGE NO.</p> <p>3 / 131</p>	

PLAN & PROFILE

PLAN S=1:4000

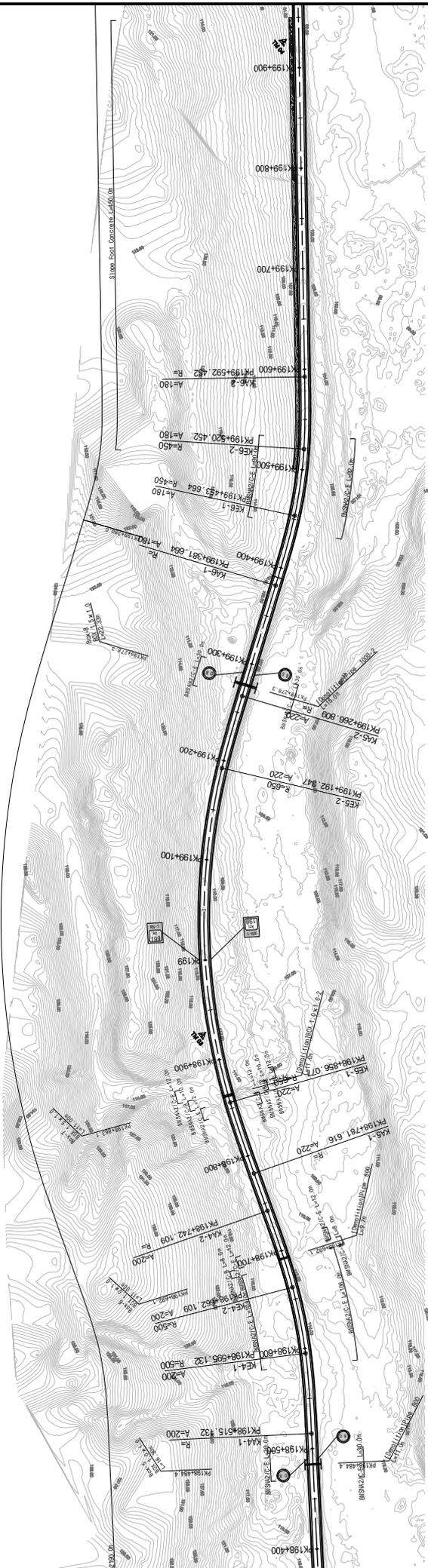

PROFILE V=1:1000 H=1:4000

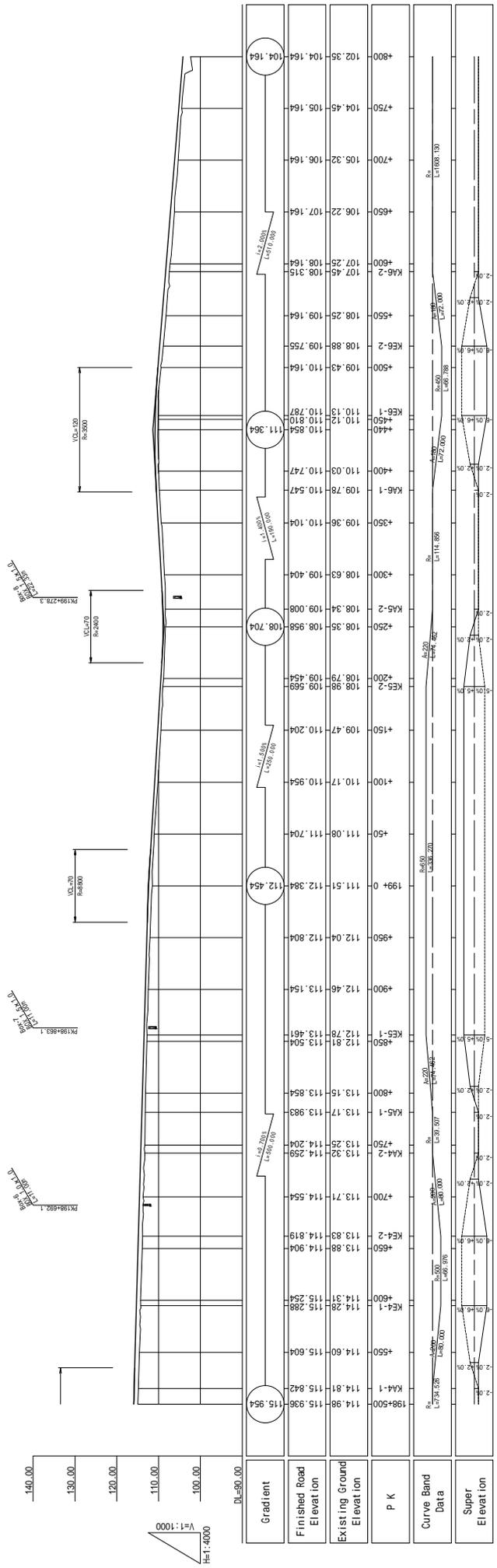

	REPUBLIQUE DE DJIBOUTI MINISTRE DE L'EQUIPEMENT ET DES TRANSPORTS DIRECTION DE L'EQUIPEMENT		JAPAN INTERNATIONAL COOPERATION AGENCY YACHIYO ENGINEERING CO., LTD.	SHEET CONTENTS PLAN & PROFILE PK198+500 ~ PK199+800	SCALE V=1:1000, H=1:4000
	THE PREPARATORY SURVEY FOR THE PROJECT FOR UPGRADING OF NATIONAL ROAD ROUTE 1 IN THE REPUBLIC OF DJIBOUTI		DATE NOV 2018	PAGE NO. 4 / 131	

PLAN & PROFILE

PLAN S=1:4000

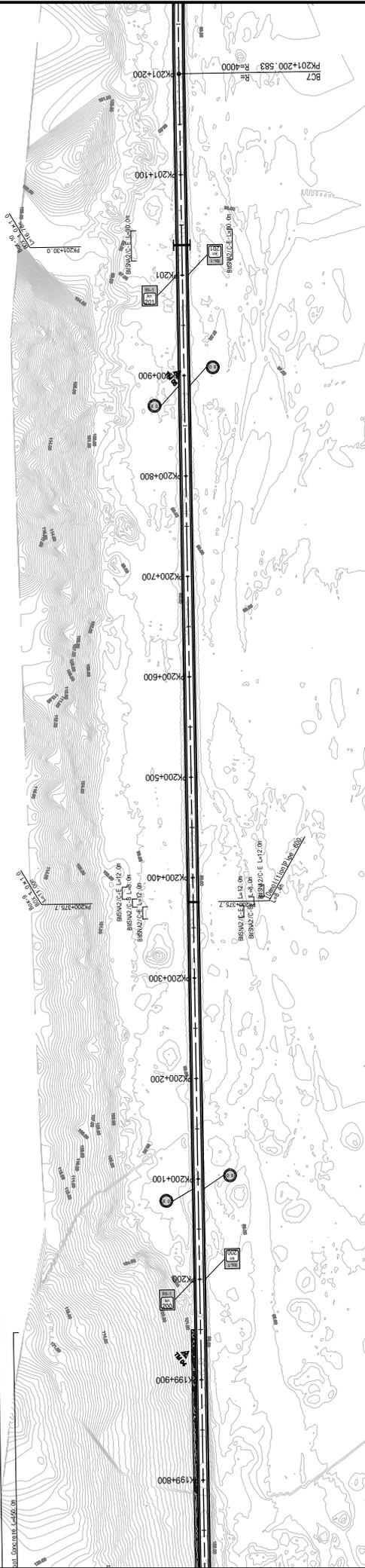

PROFILE V=1:1000 H=1:4000

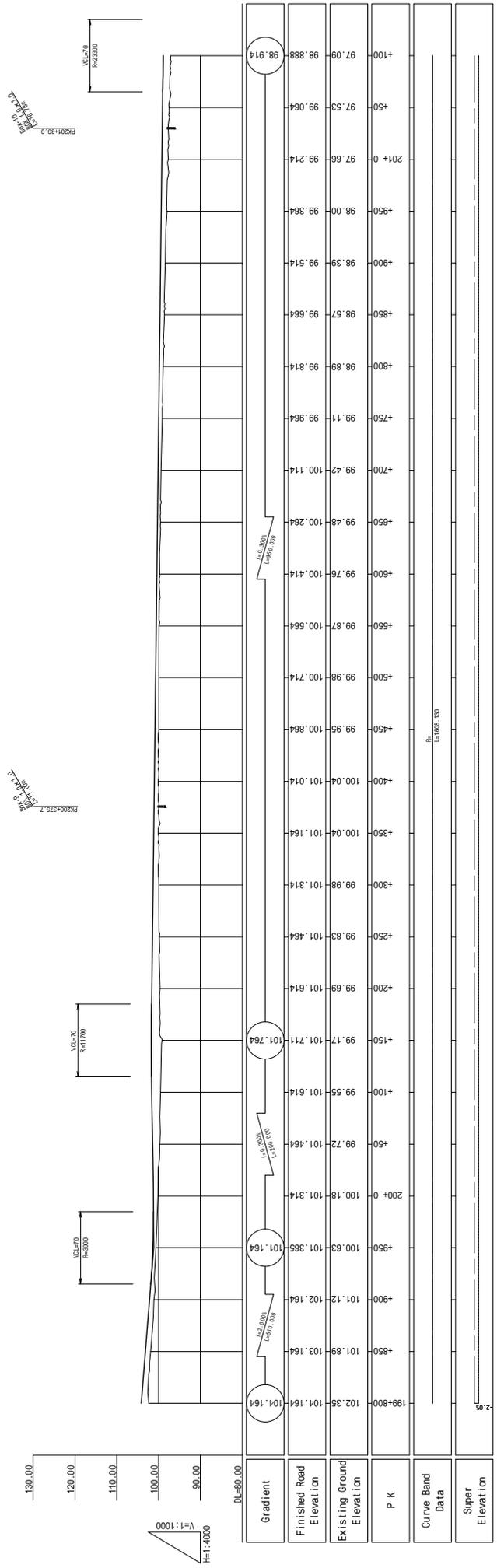

REPUBLICQUE DE DJIBOUTI MINISTRE DE L'EQUIPEMENT ET DES TRANSPORTS DIRECTION DE L'EQUIPEMENT		JAPAN INTERNATIONAL COOPERATION AGENCY YACHIYO ENGINEERING CO., LTD.		THE PREPARATORY SURVEY FOR THE PROJECT FOR UPGRADING OF NATIONAL ROAD ROUTE 1 IN THE REPUBLIC OF DJIBOUTI		SHEET CONTENTS PLAN & PROFILE PK199+800 ~ PK201+100		SCALE V=1:1000, H=1:4000
								DATE NOV 2018
								PAGE NO. 5 / 131

PLAN & PROFILE

PLAN S=1:4000

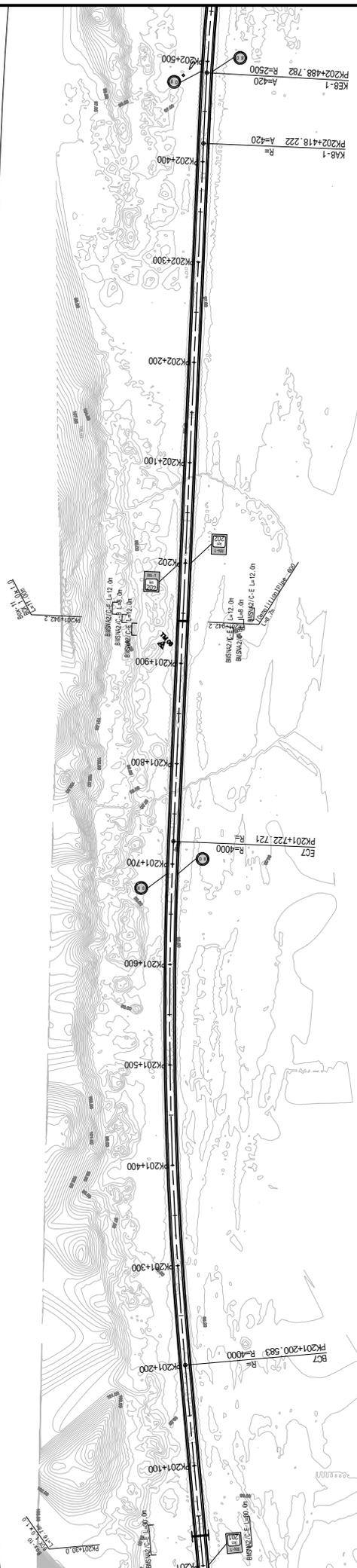

PROFILE

V=1:1000
H=1:4000

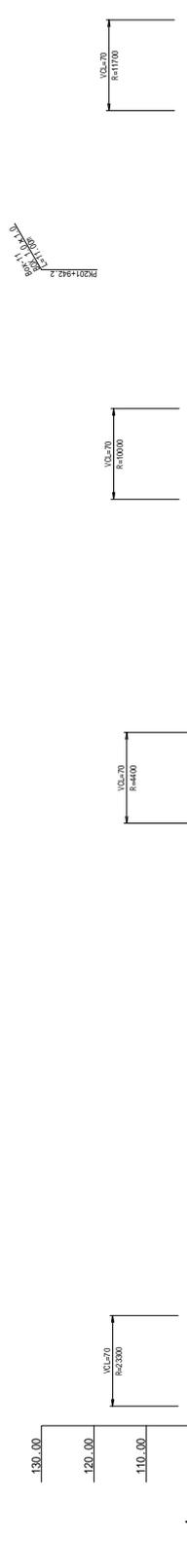

Station	Existing Ground Elevation	Finished Road Elevation	Gradient
201+100	97.09	98.888	98.914
201+150	96.94	98.614	98.314
201+200	97.01	98.314	98.214
201+250	96.29	98.014	97.714
201+300	95.91	97.714	97.414
201+350	95.83	97.414	97.114
201+400	95.65	97.114	96.814
201+450	95.65	96.814	96.514
201+500	95.51	96.514	96.354
201+550	95.60	96.354	96.214
201+600	95.57	96.214	96.074
201+650	95.96	97.214	96.853
201+700	96.29	97.714	97.941
201+750	96.50	97.941	98.214
201+800	97.80	98.653	98.714
201+850	98.02	98.864	98.914
201+900	98.15	99.014	99.164
201+950	98.30	99.164	99.314
202+000	98.46	99.314	99.464
202+050	98.72	99.464	99.561
202+100	97.74	99.561	99.614
202+150	97.56	99.464	99.314
202+200	97.65	99.314	99.164
202+250	97.58	99.164	99.014
202+300	97.59	99.014	98.864
202+350	97.67	98.864	98.714
202+400	97.67	98.864	98.714

REPUBLIQUE DE DJIBOUTI
MINISTRE DE L'EQUIPEMENT ET DES TRANSPORTS
DIRECTION DE L'EQUIPEMENT

JAPAN INTERNATIONAL COOPERATION AGENCY
YACHIYO ENGINEERING CO., LTD.

SHEET CONTENTS
PLAN & PROFILE
PK201+100 ~ PK202+400

SCALE V=1:1000, H=1:4000

DATE NOV 2018

PAGE NO. 6 / 131

PLAN & PROFILE

PLAN S=1:4000

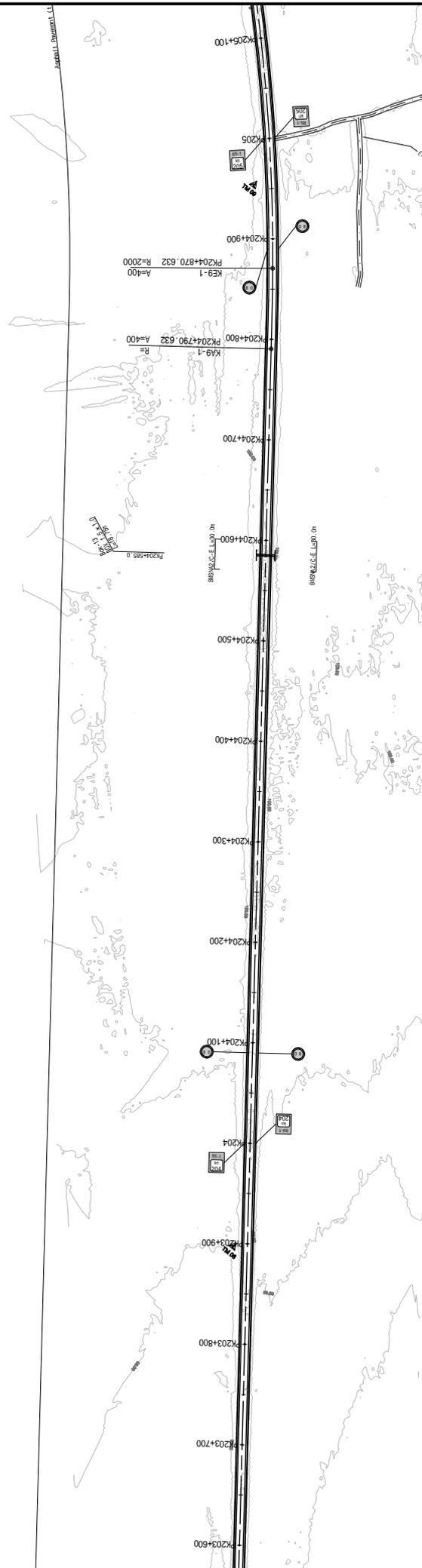

PROFILE V=1:1000 H=1:4000

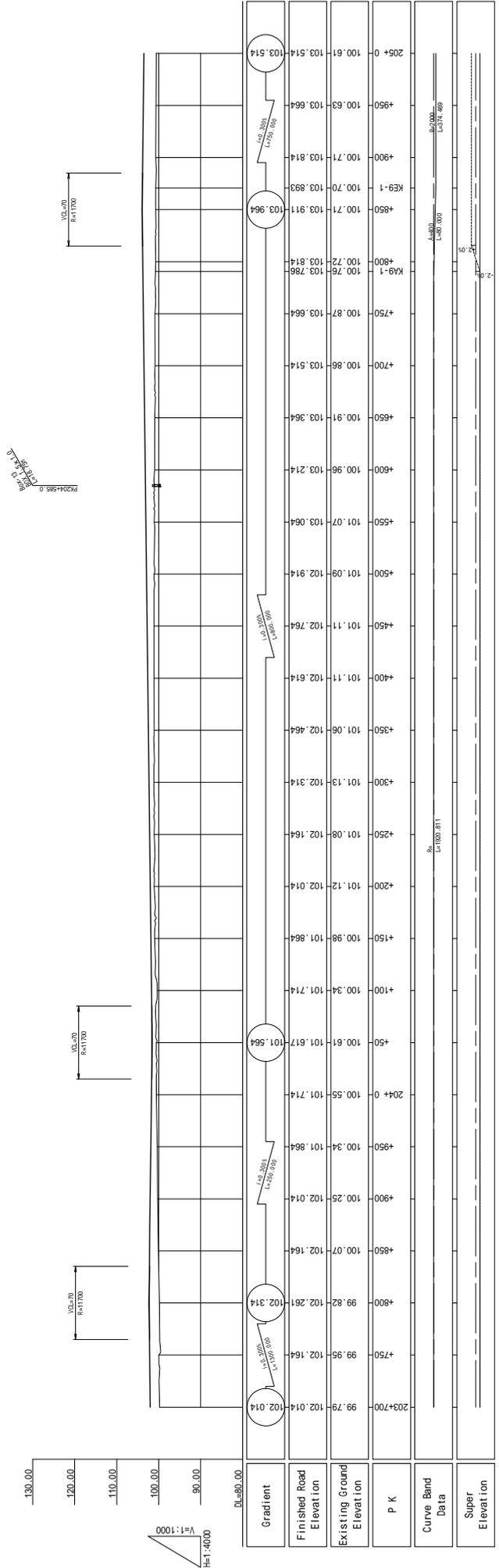

Gradient	Finished Road Elevation	Existing Ground Elevation	P K	Curve Bend Data	Super Elevation
0.00%	100.55	101.714	204+0		
0.50%	100.34	101.864	+950		
0.80%	100.25	102.014	+900		
0.80%	100.07	102.164	+850		
0.80%	99.82	102.261	+800		
0.80%	99.95	102.164	+750		
0.80%	99.79	102.014	203+700		
0.80%	101.13	102.314	+300		
0.80%	101.06	102.464	+350		
0.80%	101.11	102.614	+400		
0.80%	101.11	102.764	+450		
0.80%	101.09	102.914	+500		
0.80%	101.07	103.064	+550		
0.80%	100.96	103.214	+600		
0.80%	100.91	103.364	+650		
0.80%	100.86	103.514	+700		
0.80%	100.87	103.664	+750		
0.80%	100.72	103.766	+800		
0.80%	100.71	103.911	+850		
0.80%	100.71	103.911	+900		
0.80%	100.63	103.664	+950		
0.80%	100.61	103.514	205+0		

 <p>REPUBLIQUE DE DJIBOUTI MINISTRE DE L'EQUIPEMENT ET DES TRANSPORTS DIRECTION DE L'EQUIPEMENT</p>	 <p>JAPAN INTERNATIONAL COOPERATION AGENCY YACHIYO ENGINEERING CO., LTD.</p>	SHEET CONTENTS PLAN & PROFILE PK203+700 ~ PK205+000		SCALE V=1:1000, H=1:4000
		DATE NOV 2018	PAGE NO. 8 / 131	

PLAN & PROFILE

PLAN S=1:4000

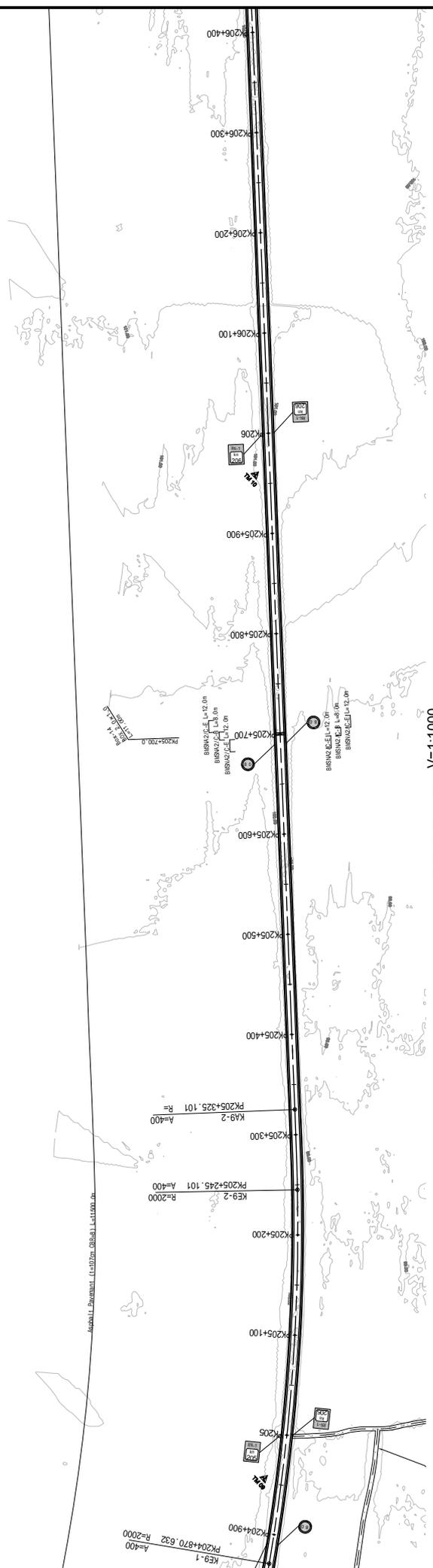

PROFILE V=1:1000 H=1:4000

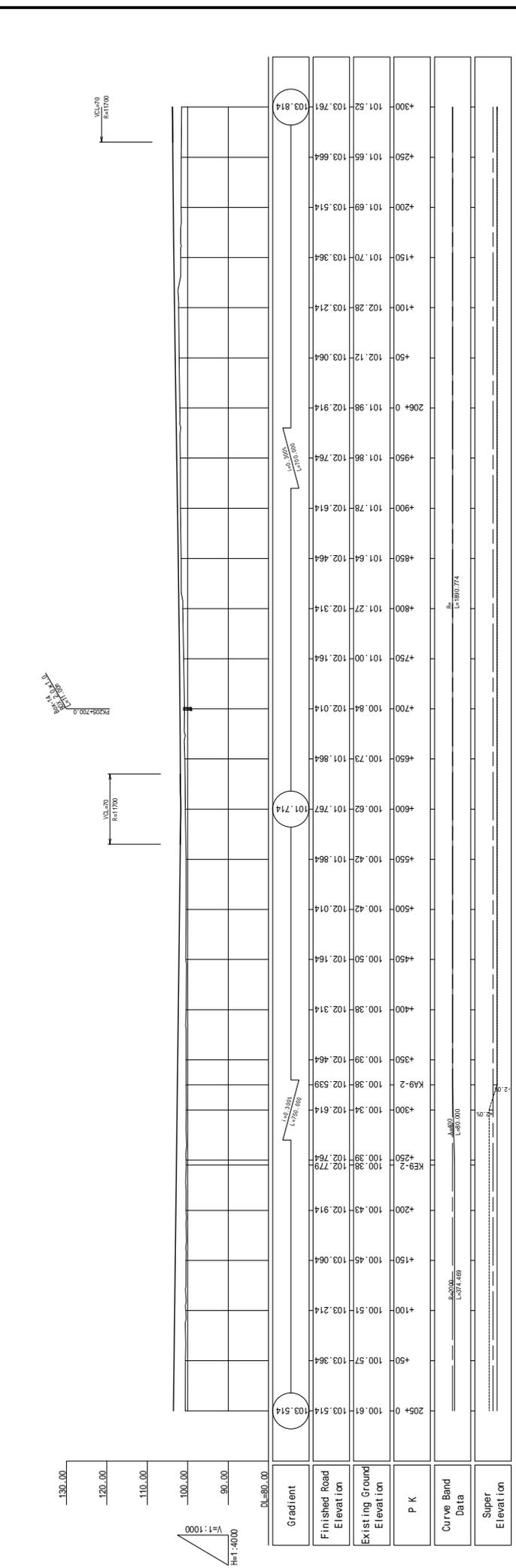

Gradient	Finished Road Elevation	Existing Ground Elevation	P K	Curve Band Data	Super Elevation
	103.814	103.814	205+0		
	101.65	103.664	+250		
	101.69	103.514	+200		
	101.70	103.364	+150		
	102.28	103.214	+100		
	102.12	103.064	+50		
	101.98	102.914	206+0		
	101.86	102.764	+950		
	101.78	102.614	+900		
	101.64	102.464	+850		
	101.27	102.314	+800		
	101.00	102.164	+750		
	100.84	102.014	+700		
	100.73	101.864	+650		
	100.62	101.767	+600		
	100.42	101.864	+550		
	100.42	102.014	+500		
	100.50	102.164	+450		
	100.38	102.314	+400		
	100.39	102.464	+350		
	100.38	102.539	+300	KA9-2	
	100.34	102.614	+250		
	100.38	102.719	+200	KE9-2	
	100.43	102.914	+150		
	100.45	103.064	+100		
	100.51	103.214	+50		
	100.57	103.364	205+0		
	100.61	103.514			



REPUBLIQUE DE DJIBOUTI
MINISTRE DE L'EQUIPEMENT ET DES TRANSPORTS
DIRECTION DE L'EQUIPEMENT

JAPAN INTERNATIONAL COOPERATION AGENCY
YACHIYO ENGINEERING CO., LTD.



SHEET CONTENTS
PLAN & PROFILE
PK205+000 ~ PK206+300

SCALE V=1:1000, H=1:4000
DATE NOV 2018
PAGE NO. 9 / 131

PLAN & PROFILE

PLAN S=1:4000

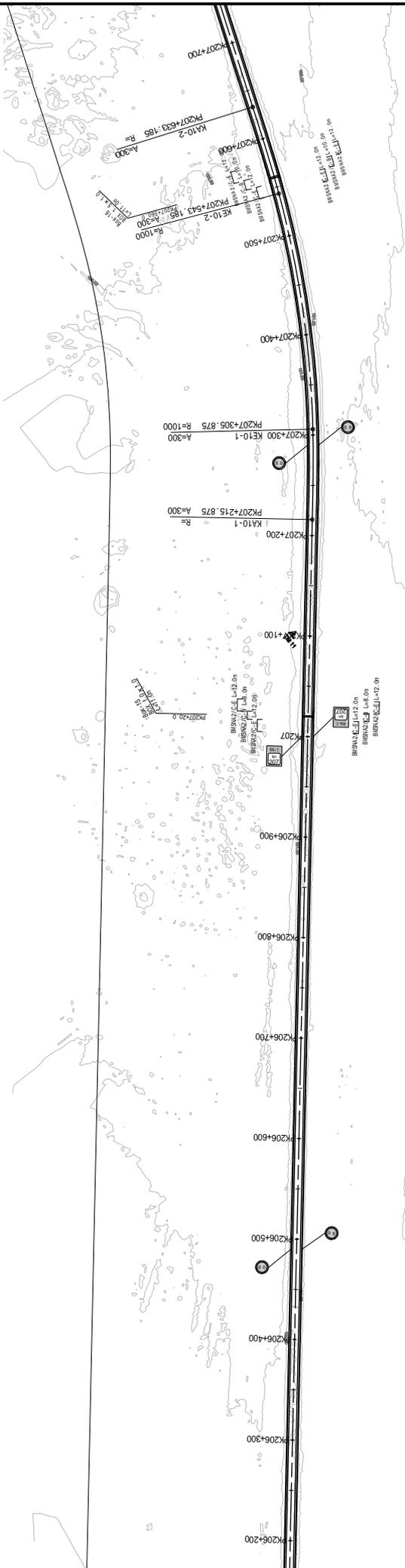

PROFILE V=1:1000
H=1:4000

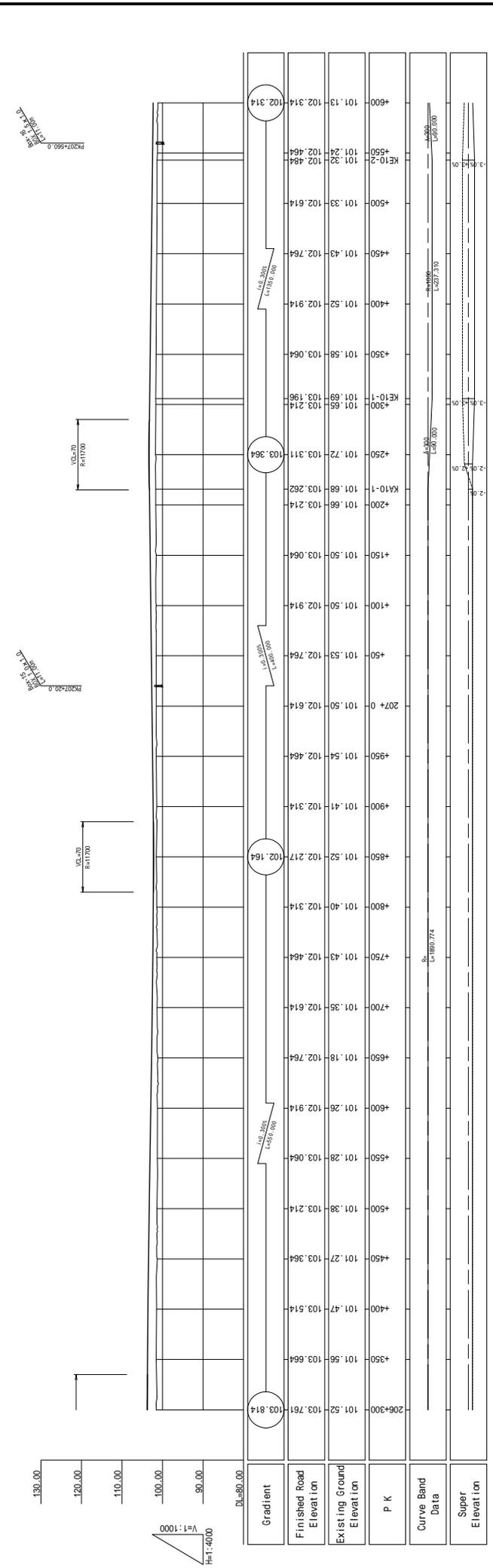

 <p>REPUBLIQUE DE DJIBOUTI MINISTRE DE L'EQUIPEMENT ET DES TRANSPORTS DIRECTION DE L'EQUIPEMENT</p>	 <p>JAPAN INTERNATIONAL COOPERATION AGENCY YACHIYO ENGINEERING CO., LTD.</p>	<p>SHEET CONTENTS</p> <p>PLAN & PROFILE PK206+300 ~ PK207+600</p>		<p>SCALE</p> <p>V=1:1000, H=1:4000</p>
		<p>DATE</p> <p>NOV 2018</p>	<p>PAGE NO.</p> <p>10 / 131</p>	

PLAN & PROFILE

PLAN S=1:4000

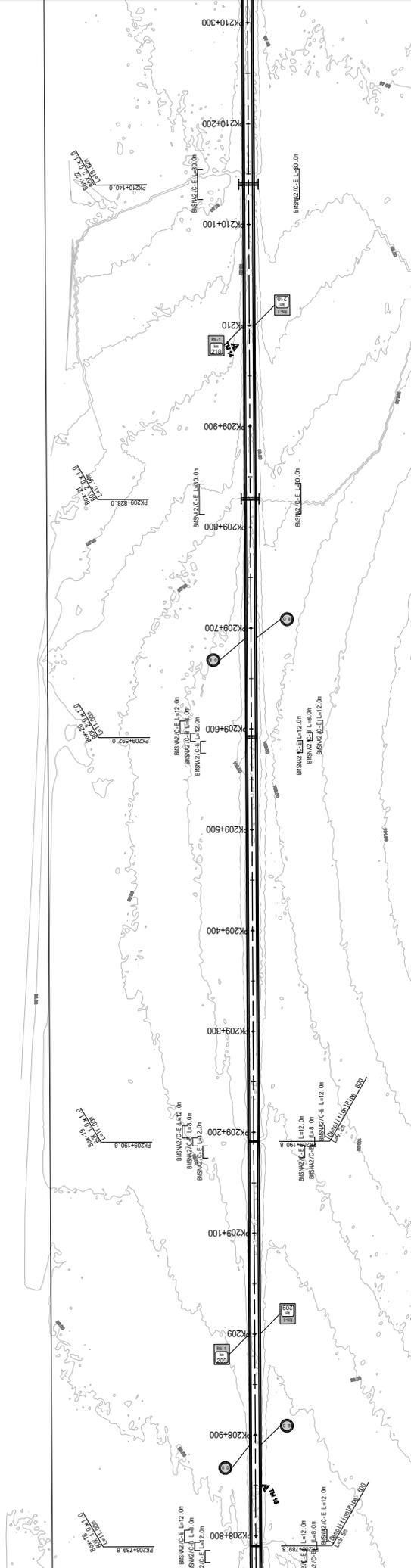

PROFILE V=1:1000 H=1:4000

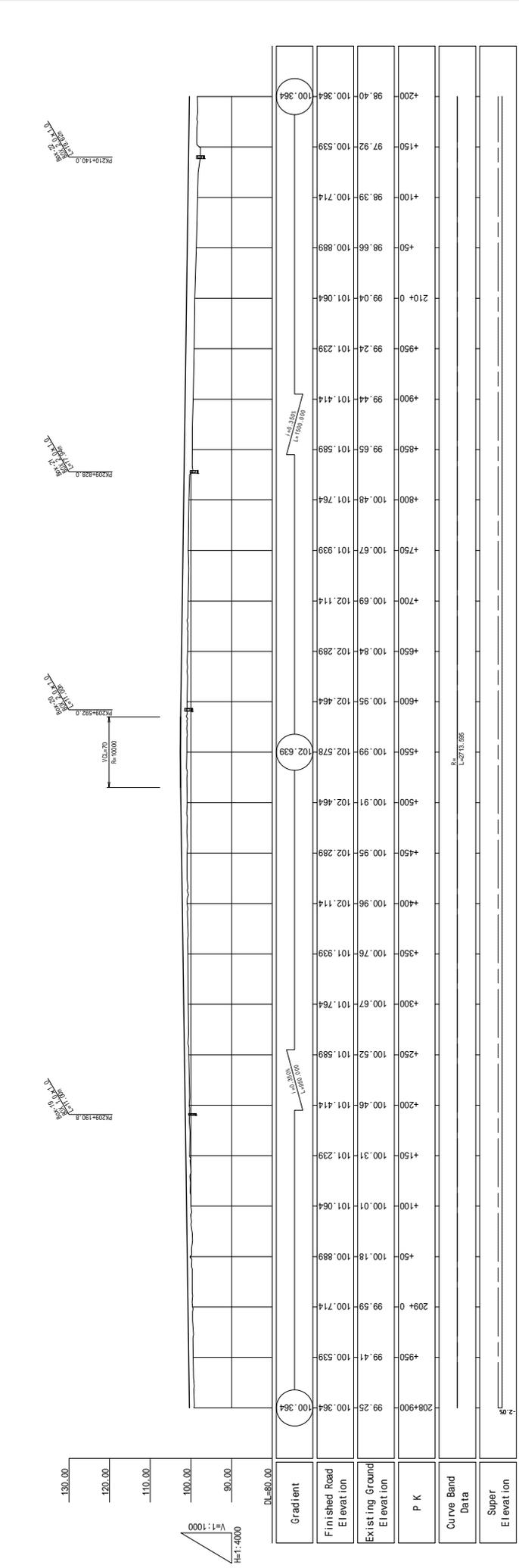

Gradient	Finished Road Elevation	Existing Ground Elevation	P K	Curve Band Data	Super Elevation
1.00%	100.364	100.364	208+900		
1.20%	100.539	100.539	+950		
1.00%	100.714	100.714	209+0		
1.20%	100.889	100.889	+50		
1.00%	101.064	101.064	100.01		
1.20%	101.239	101.239	+100		
1.00%	101.414	101.414	100.31		
1.20%	101.589	101.589	+150		
1.00%	101.764	101.764	100.67		
1.20%	101.939	101.939	+200		
1.00%	102.114	102.114	100.99		
1.20%	102.289	102.289	+250		
1.00%	102.464	102.464	101.31		
1.20%	102.639	102.639	+300		
1.00%	102.814	102.814	101.67		
1.20%	102.989	102.989	+350		
1.00%	103.164	103.164	102.03		
1.20%	103.339	103.339	+400		
1.00%	103.514	103.514	102.39		
1.20%	103.689	103.689	+450		
1.00%	103.864	103.864	102.75		
1.20%	104.039	104.039	+500		
1.00%	104.214	104.214	103.11		
1.20%	104.389	104.389	+550		
1.00%	104.564	104.564	103.47		
1.20%	104.739	104.739	+600		
1.00%	104.914	104.914	103.83		
1.20%	105.089	105.089	+650		
1.00%	105.264	105.264	104.19		
1.20%	105.439	105.439	+700		
1.00%	105.614	105.614	104.55		
1.20%	105.789	105.789	+750		
1.00%	105.964	105.964	104.91		
1.20%	106.139	106.139	+800		
1.00%	106.314	106.314	105.27		
1.20%	106.489	106.489	+850		
1.00%	106.664	106.664	105.63		
1.20%	106.839	106.839	+900		
1.00%	107.014	107.014	106.00		
1.20%	107.189	107.189	+950		
1.00%	107.364	107.364	106.36		
1.20%	107.539	107.539	+1000		
1.00%	107.714	107.714	106.72		
1.20%	107.889	107.889	+1050		
1.00%	108.064	108.064	107.08		
1.20%	108.239	108.239	+1100		
1.00%	108.414	108.414	107.44		
1.20%	108.589	108.589	+1150		
1.00%	108.764	108.764	107.80		
1.20%	108.939	108.939	+1200		
1.00%	109.114	109.114	108.16		
1.20%	109.289	109.289	+1250		
1.00%	109.464	109.464	108.52		
1.20%	109.639	109.639	+1300		
1.00%	109.814	109.814	108.88		
1.20%	109.989	109.989	+1350		
1.00%	110.164	110.164	109.24		
1.20%	110.339	110.339	+1400		
1.00%	110.514	110.514	109.60		
1.20%	110.689	110.689	+1450		
1.00%	110.864	110.864	109.96		
1.20%	111.039	111.039	+1500		
1.00%	111.214	111.214	110.32		
1.20%	111.389	111.389	+1550		
1.00%	111.564	111.564	110.68		
1.20%	111.739	111.739	+1600		
1.00%	111.914	111.914	111.04		
1.20%	112.089	112.089	+1650		
1.00%	112.264	112.264	111.40		
1.20%	112.439	112.439	+1700		
1.00%	112.614	112.614	111.76		
1.20%	112.789	112.789	+1750		
1.00%	112.964	112.964	112.12		
1.20%	113.139	113.139	+1800		
1.00%	113.314	113.314	112.48		
1.20%	113.489	113.489	+1850		
1.00%	113.664	113.664	112.84		
1.20%	113.839	113.839	+1900		
1.00%	114.014	114.014	113.20		
1.20%	114.189	114.189	+1950		
1.00%	114.364	114.364	113.56		
1.20%	114.539	114.539	+2000		
1.00%	114.714	114.714	113.92		
1.20%	114.889	114.889	+2050		
1.00%	115.064	115.064	114.28		
1.20%	115.239	115.239	+2100		
1.00%	115.414	115.414	114.64		
1.20%	115.589	115.589	+2150		
1.00%	115.764	115.764	115.00		
1.20%	115.939	115.939	+2200		
1.00%	116.114	116.114	115.36		
1.20%	116.289	116.289	+2250		
1.00%	116.464	116.464	115.72		
1.20%	116.639	116.639	+2300		
1.00%	116.814	116.814	116.08		
1.20%	116.989	116.989	+2350		
1.00%	117.164	117.164	116.44		
1.20%	117.339	117.339	+2400		
1.00%	117.514	117.514	116.80		
1.20%	117.689	117.689	+2450		
1.00%	117.864	117.864	117.16		
1.20%	118.039	118.039	+2500		
1.00%	118.214	118.214	117.52		
1.20%	118.389	118.389	+2550		
1.00%	118.564	118.564	117.88		
1.20%	118.739	118.739	+2600		
1.00%	118.914	118.914	118.24		
1.20%	119.089	119.089	+2650		
1.00%	119.264	119.264	118.60		
1.20%	119.439	119.439	+2700		
1.00%	119.614	119.614	118.96		
1.20%	119.789	119.789	+2750		
1.00%	119.964	119.964	119.32		
1.20%	120.139	120.139	+2800		
1.00%	120.314	120.314	119.68		
1.20%	120.489	120.489	+2850		
1.00%	120.664	120.664	120.04		
1.20%	120.839	120.839	+2900		
1.00%	121.014	121.014	120.40		
1.20%	121.189	121.189	+2950		
1.00%	121.364	121.364	120.76		
1.20%	121.539	121.539	+3000		
1.00%	121.714	121.714	121.12		
1.20%	121.889	121.889	+3050		
1.00%	122.064	122.064	121.48		
1.20%	122.239	122.239	+3100		
1.00%	122.414	122.414	121.84		
1.20%	122.589	122.589	+3150		
1.00%	122.764	122.764	122.20		
1.20%	122.939	122.939	+3200		
1.00%	123.114	123.114	122.56		
1.20%	123.289	123.289	+3250		
1.00%	123.464	123.464	122.92		
1.20%	123.639	123.639	+3300		
1.00%	123.814	123.814	123.28		
1.20%	123.989	123.989	+3350		
1.00%	124.164	124.164	123.64		
1.20%	124.339	124.339	+3400		
1.00%	124.514	124.514	124.00		
1.20%	124.689	124.689	+3450		
1.00%	124.864	124.864	124.36		
1.20%	125.039	125.039	+3500		
1.00%	125.214	125.214	124.72		
1.20%	125.389	125.389	+3550		
1.00%	125.564	125.564	125.08		
1.20%	125.739	125.739	+3600		
1.00%	125.914	125.914	125.44		
1.20%	126.089	126.089	+3650		
1.00%	126.264	126.264	125.80		
1.20%	126.439	126.439	+3700		
1.00%	126.614	126.614	126.16		
1.20%	126.789	126.789	+3750		
1.00%	126.964	126.964	126.52		
1.20%	127.139	127.139	+3800		
1.00%	127.314	127.314	126.88		
1.20%	127.489	127.489	+3850		
1.00%	127.664	127.664	127.24		
1.20%	127.839	127.839	+3900		
1.00%	128.014	128.014	127.60		
1.20%	128.189	128.189	+3950		
1.00%	128.364	128.364	127.96		
1.20%	128.539	128.539	+4000		
1.00%	128.714	128.714	128.32		
1.20%	128.889	128.889	+4050		
1.00%	129.064	129.064	128.68		
1.20%	129.239	129.239	+4100		
1.00%	129.414	129.414	129.04		
1.20%	129.589	129.589	+4150		
1.00%	129.764	129.764	129.40		
1.20%	129.939	129.939	+4200		
1.00%	130.114	130.114	129.76		
1.20%	130.289	130.289	+4250		
1.00%	130.464	130.464	130.12		
1.20%	130.639	130.639	+4300		
1.00%	130.814	130.814	130.48		
1.20%	130.989	130.989	+4350		
1.00%	131.164	131.164	130.84		
1.20%	131.339	131.339	+4400		
1.00%	131.514	131.514	131.20		
1.20%	131.689	131.689	+4450		
1.00%	131.864	131.864	131.56		
1.20%	132.039	132.039	+4500		
1.00%	132.214	132.214	131.92		
1.20%	132.389	132.389	+4550		
1.00%	132.564	132.564	132.28		
1.20%	132.739	132.739	+4600	</	

PLAN & PROFILE

PLAN S=1:4000

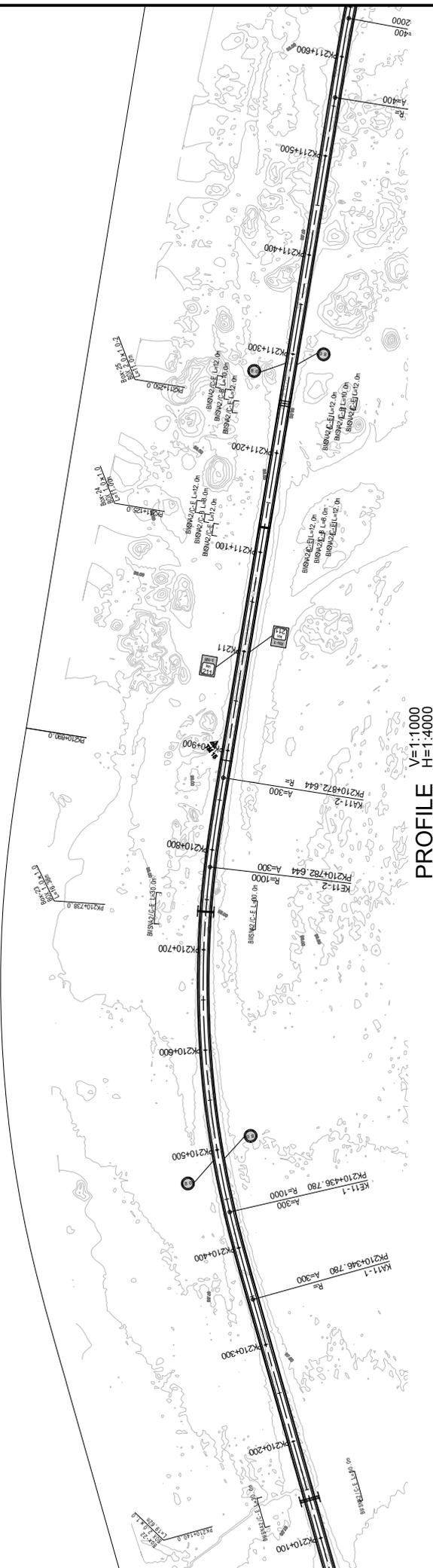

PROFILE V=1:1000 H=1:4000

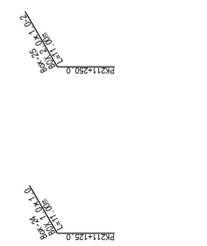

Gradient	Finished Road Elevation	Existing Ground Elevation	P K	Curve Band Data	Super Elevation
0.00	98.40	98.40	210+200		
0.00	100.364	100.364	100		
0.00	98.04	98.04	300		
0.00	98.04	98.04	100.199		
0.00	98.04	98.04	100.014		
0.00	97.66	97.66	350		
0.00	99.850	99.850	350		
0.00	97.70	97.70	350		
0.00	97.83	97.83	450		
0.00	97.71	97.71	450		
0.00	99.489	99.489	450		
0.00	97.53	97.53	400		
0.00	97.53	97.53	500		
0.00	97.37	97.37	500		
0.00	99.314	99.314	500		
0.00	97.53	97.53	550		
0.00	97.53	97.53	139		
0.00	98.964	98.964	600		
0.00	97.31	97.31	600		
0.00	98.789	98.789	650		
0.00	97.21	97.21	650		
0.00	98.789	98.789	700		
0.00	97.15	97.15	700		
0.00	98.614	98.614	750		
0.00	98.98	98.98	439		
0.00	98.264	98.264	800		
0.00	98.89	98.89	325		
0.00	98.90	98.90	325		
0.00	96.89	96.89	264		
0.00	96.77	96.77	850		
0.00	96.77	96.77	089		
0.00	96.69	96.69	1010		
0.00	96.59	96.59	914		
0.00	96.55	96.55	739		
0.00	96.65	96.65	564		
0.00	96.49	96.49	446		
0.00	96.49	96.49	539		
0.00	96.44	96.44	539		
0.00	96.38	96.38	699		
0.00	96.38	96.38	699		
0.00	96.36	96.36	839		
0.00	96.43	96.43	989		
0.00	96.56	96.56	139		
0.00	96.77	96.77	289		
0.00	96.49	96.49	439		
0.00	97.75	97.75	589		
0.00	98.739	98.739	739		

REPUBLIQUE DE DJIBOUTI
MINISTRE DE L'EQUIPEMENT ET DES TRANSPORTS
DIRECTION DE L'EQUIPEMENT

JAPAN INTERNATIONAL COOPERATION AGENCY
YACHIYO ENGINEERING CO., LTD.

SHEET CONTENTS
PLAN & PROFILE
PK210+200 ~ PK211+500

SCALE V=1:1000, H=1:4000

DATE NOV 2018

PAGE NO. 13 / 131

PLAN & PROFILE

PLAN S=1:4000

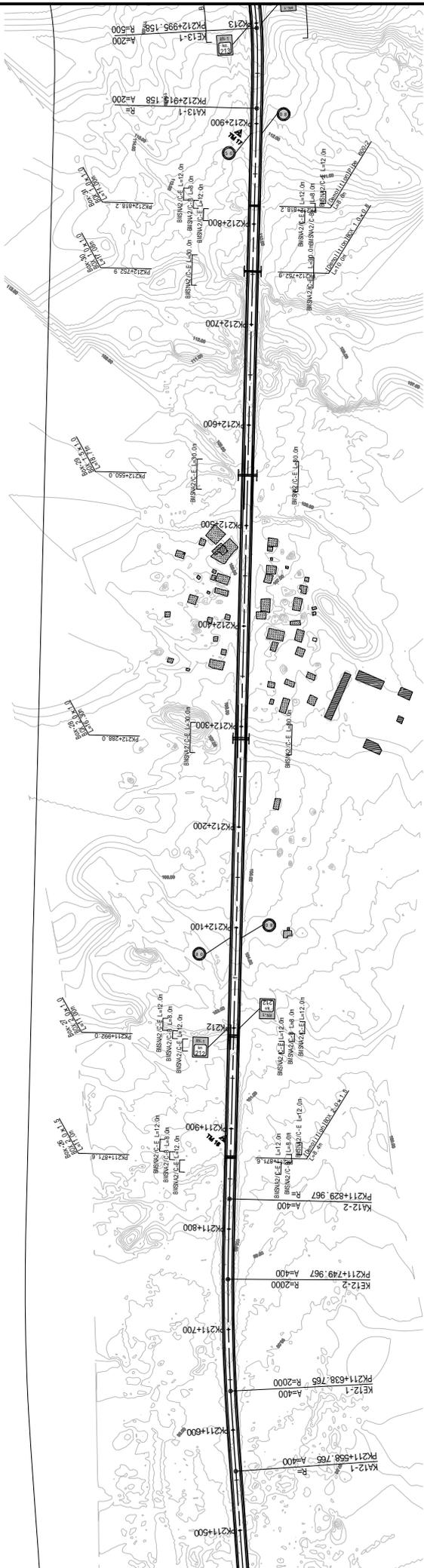

PROFILE V=1:1000 H=1:4000

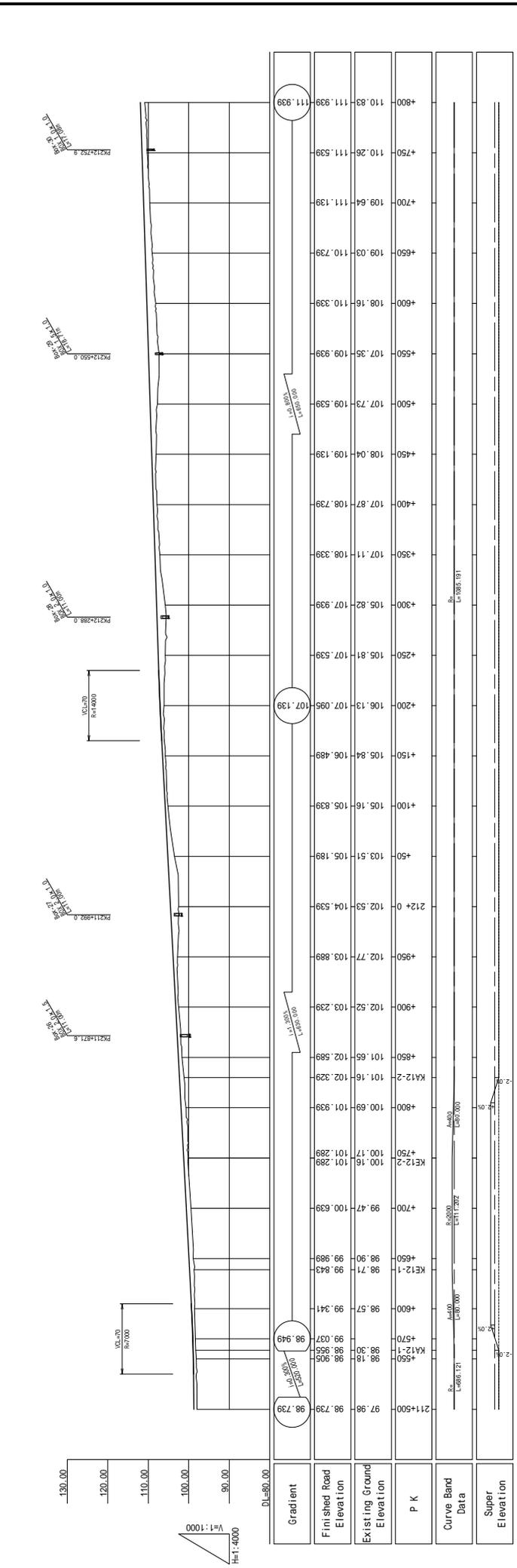

Gradient	Finished Road Elevation	Existing Ground Elevation	P K	Curve Band Data	Super Elevation
98.739	97.98	97.98	211+500		
98.949	98.30	98.30	KA12-1		
98.955	98.90	98.90	KE12-1		
98.983	98.71	98.71	KE12-1		
99.341	98.57	98.57	KE12-1		
99.843	98.90	98.90	KE12-1		
99.899	98.90	98.90	KE12-1		
100.639	98.47	98.47	KE12-2		
101.289	100.17	101.16	KE12-2		
102.293	101.99	101.99	KE12-2		
103.889	102.77	102.77	KE12-2		
104.539	102.53	102.53	KE12-2		
105.189	103.51	103.51	KE12-2		
106.839	105.16	105.16	KE12-2		
106.489	105.84	105.84	KE12-2		
107.095	106.13	106.13	KE12-2		
107.539	107.82	107.82	KE12-2		
108.339	107.11	107.11	KE12-2		
108.739	107.87	107.87	KE12-2		
109.139	108.04	108.04	KE12-2		
109.539	107.73	107.73	KE12-2		
109.939	107.35	107.35	KE12-2		
110.339	108.16	108.16	KE12-2		
111.139	109.64	109.64	KE12-2		
111.539	110.26	110.26	KE12-2		
111.939	110.83	110.83	KE12-2		

REPUBLICQUE DE DJIBOUTI
MINISTRE DE L'EQUIPEMENT ET DES TRANSPORTS
DIRECTION DE L'EQUIPEMENT

JAPAN INTERNATIONAL COOPERATION AGENCY
YACHIYO ENGINEERING CO., LTD.

THE PREPARATORY SURVEY FOR
THE PROJECT FOR
UPGRADING OF NATIONAL ROAD ROUTE 1
IN THE REPUBLIC OF DJIBOUTI

SHEET CONTENTS
PLAN & PROFILE
PK211+500 ~ PK212+800

SCALE V=1:1000, H=1:4000
DATE NOV 2018
PAGE NO. 14 / 131

PLAN & PROFILE

PLAN S=1:4000

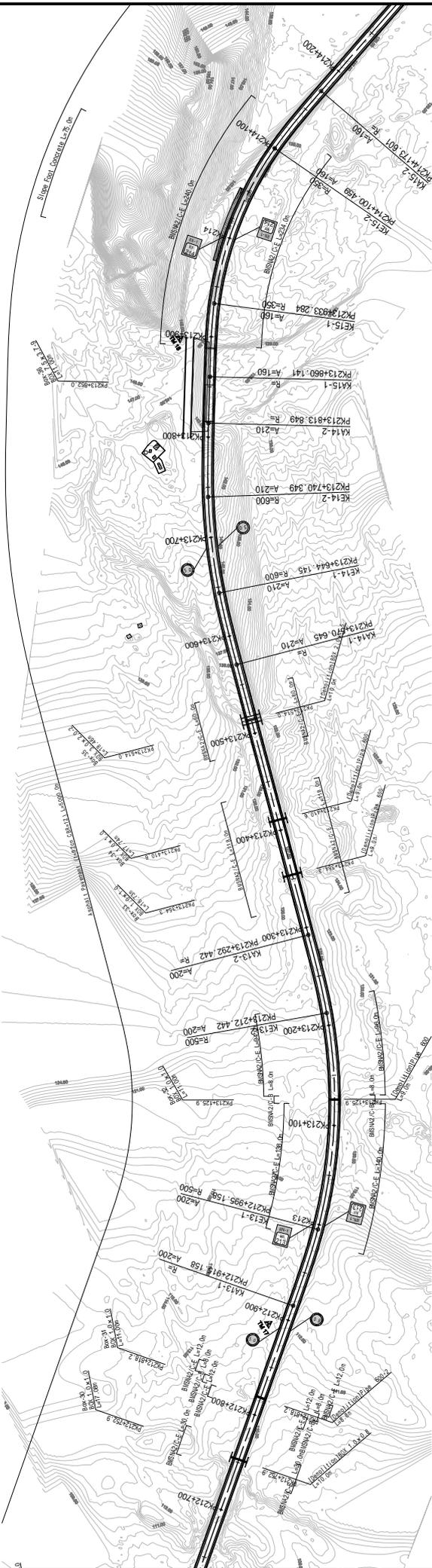

PROFILE V=1:1000 H=1:4000

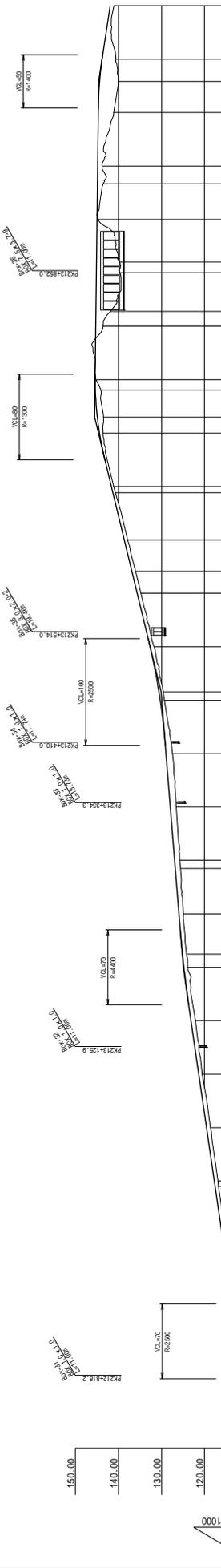

Gradient	Finished Road Elevation	Existing Ground Elevation	P K	Curve Band Data	Super Elevation
	111.939	111.939	212+800		
	111.84	111.84	+850		
	113.30	114.139	+900		
	113.84	114.685	+950		
	115.14	115.939	+950		
	116.78	117.565	KA13-1		
	116.89	117.739	KA13-1		
	118.68	119.539	+50		
	120.56	121.339	+100		
	122.15	123.139	+150		
	123.91	124.799	+200		
	124.20	125.130	KE13-2		
	124.93	125.939	+250		
	125.62	126.788	KA13-2		
	125.79	126.939	+300		
	126.57	127.939	+350		
	127.48	128.939	+400		
	128.32	130.297	+450		
	129.32	130.593	130.093		
	130.69	131.279	KE14-1		
	131.86	132.630	+600		
	133.03	133.869	KA14-1		
	134.77	135.630	+550		
	137.86	138.630	+600		
	140.69	141.279	KE14-1		
	141.09	141.630	+650		
	143.54	144.384	+700		
	144.11	145.389	KE14-2		
	144.23	145.415	+750		
	143.56	145.275	+800		
	143.63	144.975	+900		
	143.81	144.825	KA14-2		
	143.54	144.875	KA15-1		
	143.81	144.825	+950		
	141.0	144.675	214+0		
	140.58	143.789	+50		
	141.895	144.895	141.895		

REPUBLIQUE DE DJIBOUTI
MINISTRE DE L'EQUIPEMENT ET DES TRANSPORTS
DIRECTION DE L'EQUIPEMENT

JAPAN INTERNATIONAL COOPERATION AGENCY
YACHIOI ENGINEERING CO., LTD.

SHEET CONTENTS
PLAN & PROFILE
PK212+800 ~ PK214+100

SCALE V=1:1000, H=1:4000

DATE NOV 2018

PAGE NO. 15 / 131

PLAN & PROFILE

PLAN S=1:4000

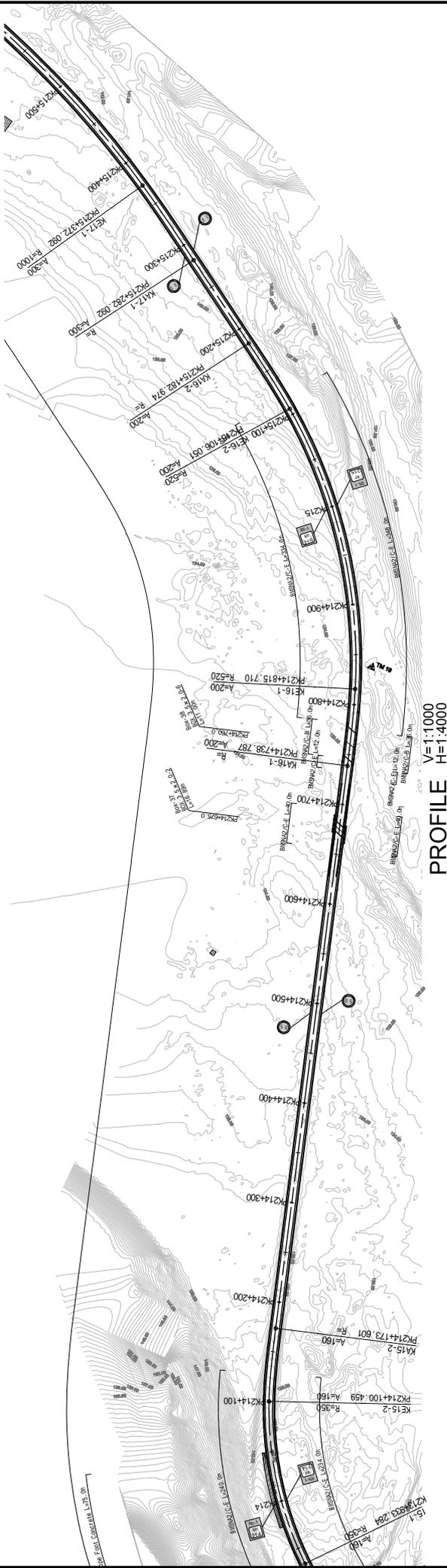

PROFILE V=1:1000 H=1:4000

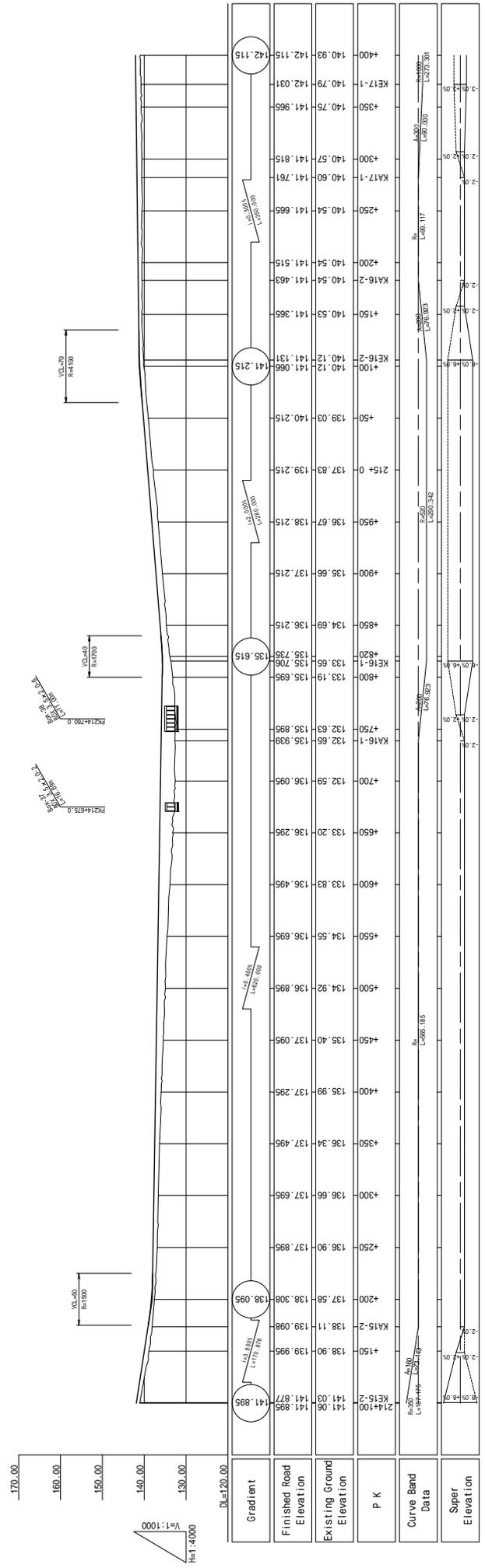

Gradient	Finished Road Elevation	Existing Ground Elevation	P K
	142.115	142.115	214+100
	140.75	141.06	ME15-2
	140.54	141.877	KA15-2
	140.57	137.295	KA15-2
	140.60	137.495	KA15-2
	140.54	137.695	KA15-2
	140.54	137.895	KA15-2
	140.53	138.095	KA15-2
	140.12	138.295	KA15-2
	141.066	138.495	KA15-2
	139.03	138.695	KA15-2
	137.83	138.895	KA15-2
	137.83	139.095	KA15-2
	136.67	139.295	KA15-2
	136.67	139.495	KA15-2
	135.66	139.695	KA15-2
	134.69	139.895	KA15-2
	134.69	140.095	KA15-2
	133.65	140.295	KA15-2
	133.65	140.495	KA15-2
	133.706	140.695	KA15-2
	133.65	140.895	KA15-2
	132.63	141.095	KA15-2
	132.63	141.295	KA15-2
	132.63	141.495	KA15-2
	132.59	141.695	KA15-2
	132.59	141.895	KA15-2
	132.65	142.095	KA15-2
	132.65	142.295	KA15-2
	133.19	142.495	KA15-2
	133.65	142.695	KA15-2
	135.706	142.895	KA15-2
	135.735	143.095	KA15-2
	135.735	143.295	KA15-2
	137.83	143.495	KA15-2
	137.83	143.695	KA15-2
	139.03	143.895	KA15-2
	140.12	144.095	KA15-2
	141.066	144.295	KA15-2
	141.066	144.495	KA15-2
	141.131	144.695	KA15-2
	141.131	144.895	KA15-2
	141.131	145.095	KA15-2
	141.131	145.295	KA15-2
	141.131	145.495	KA15-2
	141.131	145.695	KA15-2
	141.131	145.895	KA15-2
	141.131	146.095	KA15-2
	141.131	146.295	KA15-2
	141.131	146.495	KA15-2
	141.131	146.695	KA15-2
	141.131	146.895	KA15-2
	141.131	147.095	KA15-2
	141.131	147.295	KA15-2
	141.131	147.495	KA15-2
	141.131	147.695	KA15-2
	141.131	147.895	KA15-2
	141.131	148.095	KA15-2
	141.131	148.295	KA15-2
	141.131	148.495	KA15-2
	141.131	148.695	KA15-2
	141.131	148.895	KA15-2
	141.131	149.095	KA15-2
	141.131	149.295	KA15-2
	141.131	149.495	KA15-2
	141.131	149.695	KA15-2
	141.131	149.895	KA15-2
	141.131	150.095	KA15-2
	141.131	150.295	KA15-2
	141.131	150.495	KA15-2
	141.131	150.695	KA15-2
	141.131	150.895	KA15-2
	141.131	151.095	KA15-2
	141.131	151.295	KA15-2
	141.131	151.495	KA15-2
	141.131	151.695	KA15-2
	141.131	151.895	KA15-2
	141.131	152.095	KA15-2
	141.131	152.295	KA15-2
	141.131	152.495	KA15-2
	141.131	152.695	KA15-2
	141.131	152.895	KA15-2
	141.131	153.095	KA15-2
	141.131	153.295	KA15-2
	141.131	153.495	KA15-2
	141.131	153.695	KA15-2
	141.131	153.895	KA15-2
	141.131	154.095	KA15-2
	141.131	154.295	KA15-2
	141.131	154.495	KA15-2
	141.131	154.695	KA15-2
	141.131	154.895	KA15-2
	141.131	155.095	KA15-2
	141.131	155.295	KA15-2
	141.131	155.495	KA15-2
	141.131	155.695	KA15-2
	141.131	155.895	KA15-2
	141.131	156.095	KA15-2
	141.131	156.295	KA15-2
	141.131	156.495	KA15-2
	141.131	156.695	KA15-2
	141.131	156.895	KA15-2
	141.131	157.095	KA15-2
	141.131	157.295	KA15-2
	141.131	157.495	KA15-2
	141.131	157.695	KA15-2
	141.131	157.895	KA15-2
	141.131	158.095	KA15-2
	141.131	158.295	KA15-2
	141.131	158.495	KA15-2
	141.131	158.695	KA15-2
	141.131	158.895	KA15-2
	141.131	159.095	KA15-2
	141.131	159.295	KA15-2
	141.131	159.495	KA15-2
	141.131	159.695	KA15-2
	141.131	159.895	KA15-2
	141.131	160.095	KA15-2
	141.131	160.295	KA15-2
	141.131	160.495	KA15-2
	141.131	160.695	KA15-2
	141.131	160.895	KA15-2
	141.131	161.095	KA15-2
	141.131	161.295	KA15-2
	141.131	161.495	KA15-2
	141.131	161.695	KA15-2
	141.131	161.895	KA15-2
	141.131	162.095	KA15-2
	141.131	162.295	KA15-2
	141.131	162.495	KA15-2
	141.131	162.695	KA15-2
	141.131	162.895	KA15-2
	141.131	163.095	KA15-2
	141.131	163.295	KA15-2
	141.131	163.495	KA15-2
	141.131	163.695	KA15-2
	141.131	163.895	KA15-2
	141.131	164.095	KA15-2
	141.131	164.295	KA15-2
	141.131	164.495	KA15-2
	141.131	164.695	KA15-2
	141.131	164.895	KA15-2
	141.131	165.095	KA15-2
	141.131	165.295	KA15-2
	141.131	165.495	KA15-2
	141.131	165.695	KA15-2
	141.131	165.895	KA15-2
	141.131	166.095	KA15-2
	141.131	166.295	KA15-2
	141.131	166.495	KA15-2
	141.131	166.695	KA15-2
	141.131	166.895	KA15-2
	141.131	167.095	KA15-2
	141.131	167.295	KA15-2
	141.131	167.495	KA15-2
	141.131	167.695	KA15-2
	141.131	167.895	KA15-2
	141.131	168.095	KA15-2
	141.131	168.295	KA15-2
	141.131	168.495	KA15-2
	141.131	168.695	KA15-2
	141.131	168.895	KA15-2
	141.131	169.095	KA15-2
	141.131	169.295	KA15-2
	141.131	169.495	KA15-2
	141.131	169.695	KA15-2
	141.131	169.895	KA15-2
	141.131	170.095	KA15-2



REPUBLIQUE DE DJIBOUTI
MINISTRE DE L'EQUIPEMENT ET DES TRANSPORTS
DIRECTION DE L'EQUIPEMENT

JAPAN INTERNATIONAL COOPERATION AGENCY
YACHIYO ENGINEERING CO., LTD.

SHEET CONTENTS
PLAN & PROFILE
PK214+100 ~ PK215+400

SCALE V=1:1000, H=1:4000

DATE NOV 2018

PAGE NO. 16 / 131

PLAN & PROFILE

PLAN S=1:4000

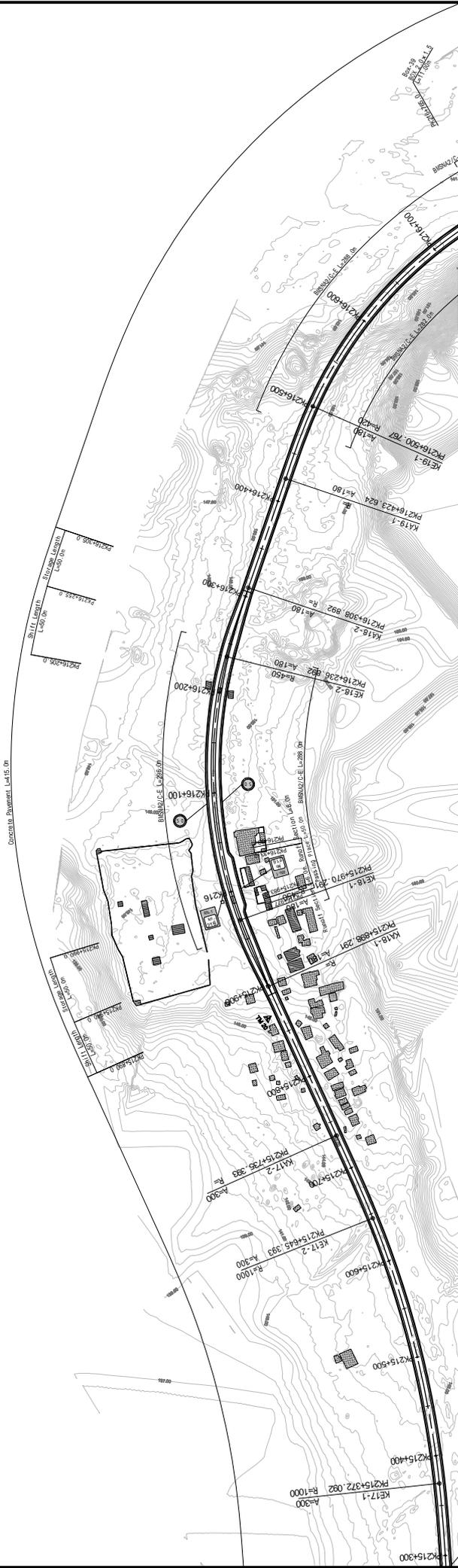

PROFILE

V=1:1000 H=1:4000

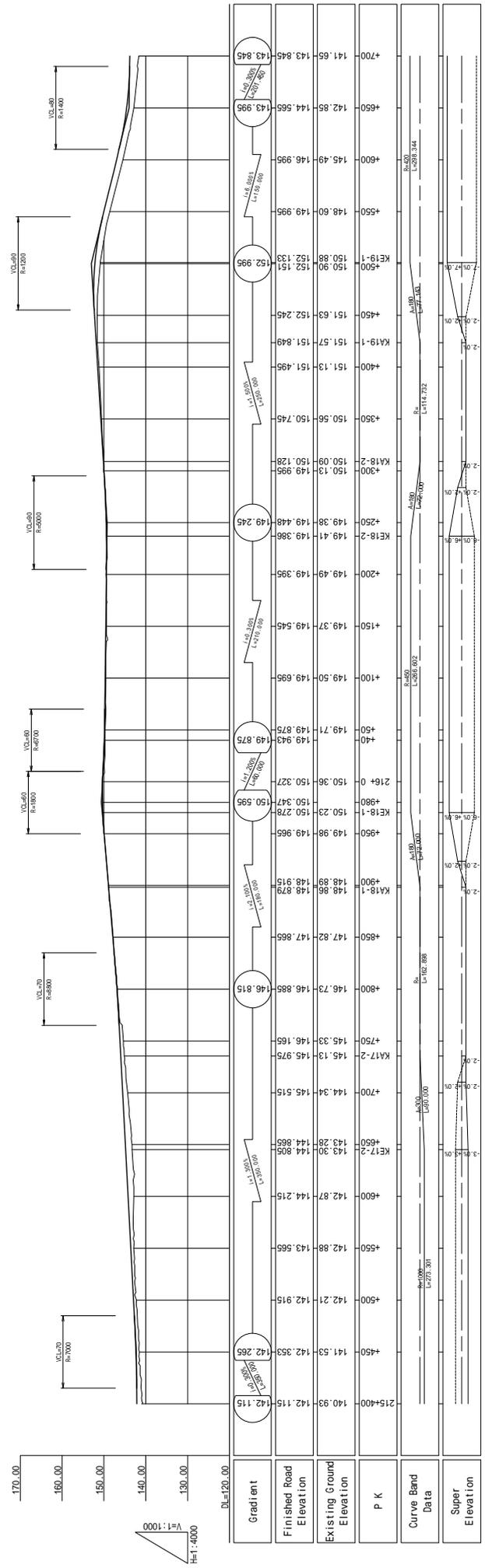

REPUBLICHE DE DJIBOUTI MINISTRE DE L'EQUIPEMENT ET DES TRANSPORTS DIRECTION DE L'EQUIPEMENT		JAPAN INTERNATIONAL COOPERATION AGENCY YACHIYO ENGINEERING CO., LTD.		SHEET CONTENTS PLAN & PROFILE PK215+400 ~ PK216+700		SCALE V=1:1000, H=1:4000
				DATE NOV 2018	PAGE NO. 17 / 131	

PK	197+350
Excavation Len	0.0 m
Spore Slope	0.7
Embankment	0.4 m
Spore Slope	0.2
Embankment	0.2 m
Length of Excavation Slope	0.0 m
Right Side	0.0 n
Length of Embankment Slope	0.0 m
Left Side	4.1 m
Right Side	3.7 m

PK197+350
 GH=117.79
 PH=118.914

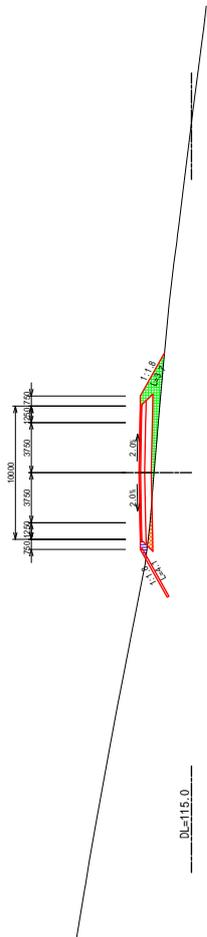

PK	197+300
Excavation Len	0.0 m
Spore Slope	1.8
Embankment	0.4 m
Spore Slope	2.0
Embankment	2.0 m
Length of Excavation Slope	0.0 m
Right Side	0.0 n
Length of Embankment Slope	0.0 m
Left Side	4.1 m
Right Side	2.7 m

PK197+300
 GH=118.32
 PH=119.164

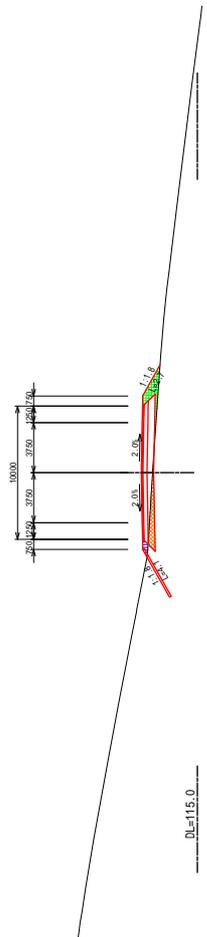

PK	197+250
Excavation Len	0.0 m
Spore Slope	8.7
Embankment	0.2 m
Spore Slope	0.0
Embankment	0.0 m
Length of Excavation Slope	0.0 m
Right Side	0.0 n
Length of Embankment Slope	0.0 m
Left Side	0.1 m
Right Side	1.2 m

PK197+250
 GH=119.40
 PH=119.502

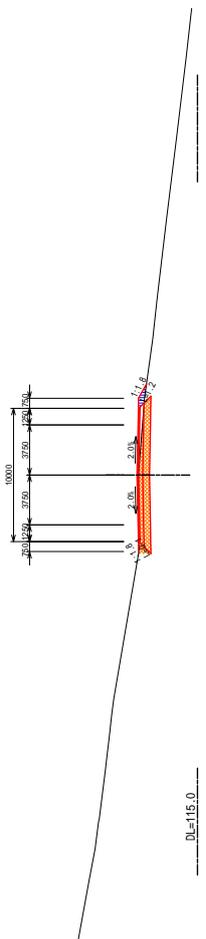

PK	197+200
Excavation Len	0.0 m
Spore Slope	10.4
Embankment	0.1 m
Spore Slope	0.0
Embankment	0.0 m
Length of Excavation Slope	0.0 m
Right Side	0.0 n
Length of Embankment Slope	0.0 m
Left Side	0.1 m
Right Side	1.3 m

PK197+200
 GH=120.16
 PH=120.164

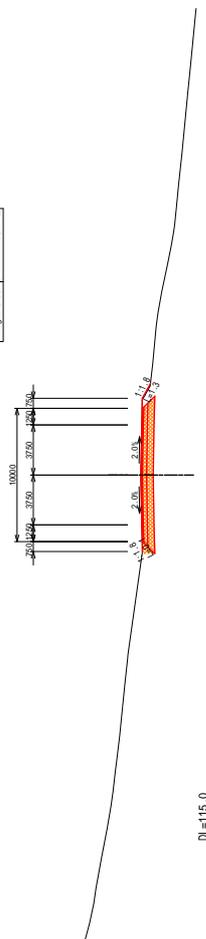

PK 197+450	
Excavation	
Subgrade	0.0 m
Shoulder	0.3 m
Embankment	
Subgrade	0.0 m
Shoulder	0.7 m
Subgrade	0.3 m
Shoulder	0.3 m
Length of Excavation Slope	
Left Side	0.0 m
Right Side	0.0 m
Length of Embankment Slope	
Left Side	4.1 m
Right Side	4.0 m

PK197+450
GH=116.80
PH=118.414

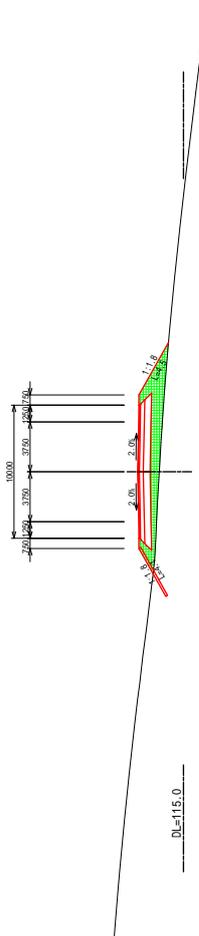

PK 197+550	
Excavation	
Subgrade	0.0 m
Shoulder	0.3 m
Embankment	
Subgrade	0.7 m
Shoulder	0.3 m
Subgrade	0.3 m
Shoulder	0.3 m
Length of Excavation Slope	
Left Side	0.0 m
Right Side	0.0 m
Length of Embankment Slope	
Left Side	4.1 m
Right Side	3.8 m

PK'197+550
GH=116.67
PH=117.914

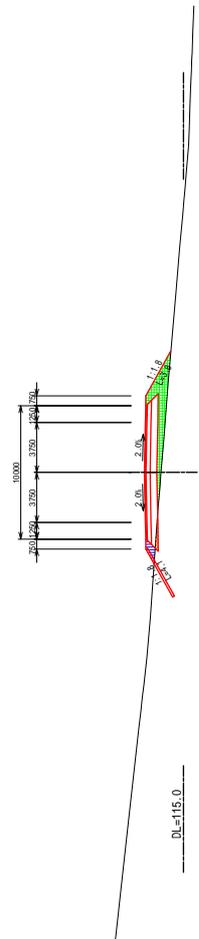

PK 197+400	
Excavation	
Subgrade	0.0 m
Shoulder	0.2 m
Embankment	
Subgrade	0.7 m
Shoulder	0.7 m
Subgrade	0.0 m
Shoulder	0.0 m
Length of Excavation Slope	
Left Side	0.0 m
Right Side	0.0 m
Length of Embankment Slope	
Left Side	4.1 m
Right Side	4.3 m

PK197+400
GH=117.32
PH=118.664

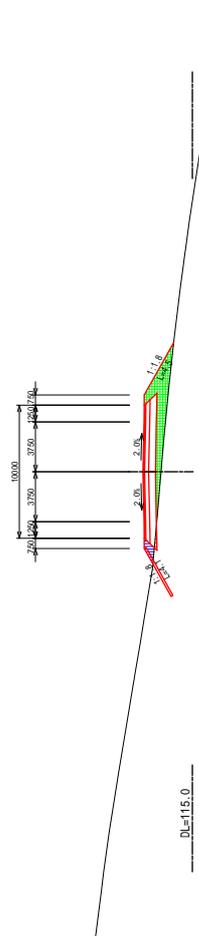

PK 197+500	
Excavation	
Subgrade	0.0 m
Shoulder	0.0 m
Embankment	
Subgrade	0.0 m
Shoulder	0.0 m
Subgrade	0.0 m
Shoulder	0.0 m
Length of Excavation Slope	
Left Side	0.0 m
Right Side	0.0 m
Length of Embankment Slope	
Left Side	4.1 m
Right Side	4.0 m

PK'197+500
GH=116.49
PH=118.164

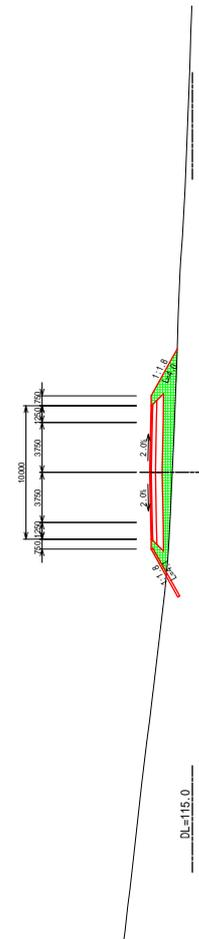

REPUBLIQUE DE DJIBOUTI
MINISTRE DE L'EQUIPEMENT ET DES TRANSPORTS
DIRECTION DE L'EQUIPEMENT



JAPAN INTERNATIONAL COOPERATION AGENCY
YACHIYO ENGINEERING CO., LTD.

THE PREPARATORY SURVEY FOR
THE PROJECT FOR
UPGRADING OF NATIONAL ROAD ROUTE 1
IN THE REPUBLIC OF DJIBOUTI

SHEET CONTENTS
CROSS SECTION
PK197+400 ~ PK197+550

SCALE S=1:400
DATE NOV 2018
PAGE NO. 20 / 131

PK 197+650	
Excavation	0.0 m
Subgrade	0.0 m
Shoulder	3.7 m
Enbankment	0.0 m
Left Slope	0.7 m
Right Slope	0.0 m
Length of Enbankment Slope	0.0 m
Left Slope	0.0 n
Right Slope	0.0 n
Length of Enbankment Slope	0.0 m
Left Slope	4.1 m
Right Slope	0.0 m

PK197+650
GH=115.62
PH=117.414

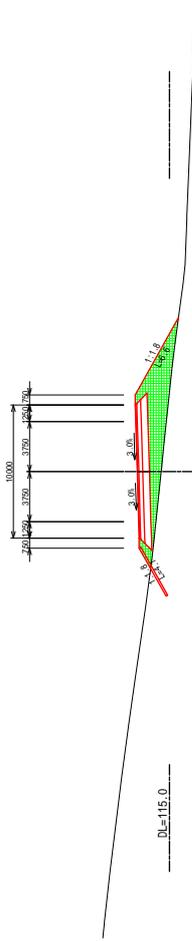

PK 197+750	
Excavation	0.0 m
Subgrade	0.0 m
Shoulder	3.7 m
Enbankment	0.0 m
Left Slope	0.7 m
Right Slope	0.0 m
Length of Enbankment Slope	0.0 m
Left Slope	0.0 n
Right Slope	0.0 n
Length of Enbankment Slope	0.0 m
Left Slope	1.8 m
Right Slope	4.3 m

PK197+750
GH=116.47
PH=116.929

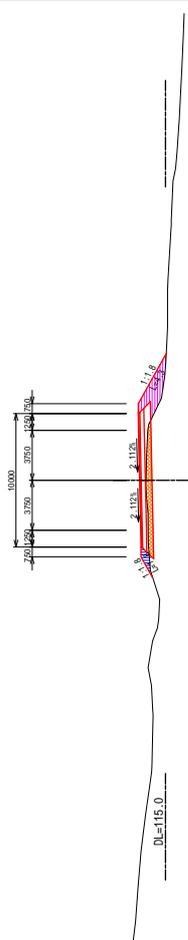

PK 197+600	
Excavation	0.0 m
Subgrade	0.1 m
Shoulder	0.8 m
Enbankment	0.0 m
Left Slope	1.1 m
Right Slope	1.3 m
Length of Enbankment Slope	0.0 m
Left Slope	0.0 n
Right Slope	0.0 n
Length of Enbankment Slope	0.0 m
Left Slope	4.1 m
Right Slope	5.3 m

PK197+600
GH=116.20
PH=117.664

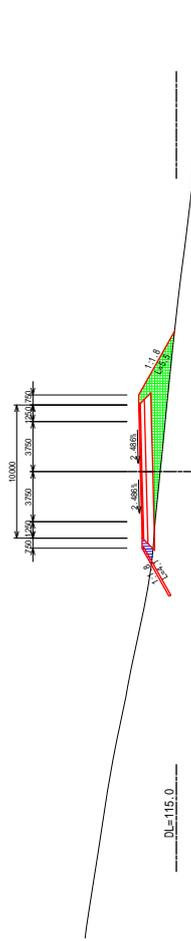

PK 197+700	
Excavation	0.0 m
Subgrade	1.6 m
Shoulder	0.5 m
Enbankment	0.0 m
Left Slope	2.8 m
Right Slope	3.9 m
Length of Enbankment Slope	0.0 m
Left Slope	0.0 n
Right Slope	0.0 n
Length of Enbankment Slope	0.0 m
Left Slope	4.1 m
Right Slope	3.8 m

PK197+700
GH=116.35
PH=117.164

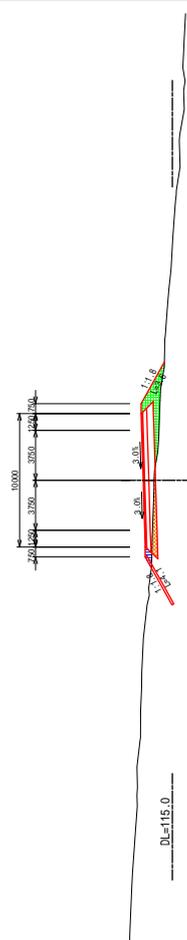

REPUBLIQUE DE DJIBOUTI
MINISTRE DE L'EQUIPEMENT ET DES TRANSPORTS
DIRECTION DE L'EQUIPEMENT



JAPAN INTERNATIONAL COOPERATION AGENCY
YACHIYO ENGINEERING CO., LTD.

THE PREPARATORY SURVEY FOR
THE PROJECT FOR
UPGRADING OF NATIONAL ROAD ROUTE 1
IN THE REPUBLIC OF DJIBOUTI

SHEET CONTENTS
CROSS SECTION
PK197+600 ~ PK197+750

SCALE S=1:400
DATE NOV 2018
PAGE NO. 21 / 131

PK 197+850	
Excavation	0.0 m
Spillway	4.2 m
Enbankment	1.5 m
Left Slope	0.0 n
Right Slope	0.0 n
Length of Embankment Slope	0.0 m
Left Slope	0.0 n
Right Slope	0.0 n
Length of Embankment Slope	0.0 m
Left Slope	1.5 n
Right Slope	1.0 n

PK197+850
GH=116.48
PH=116.954

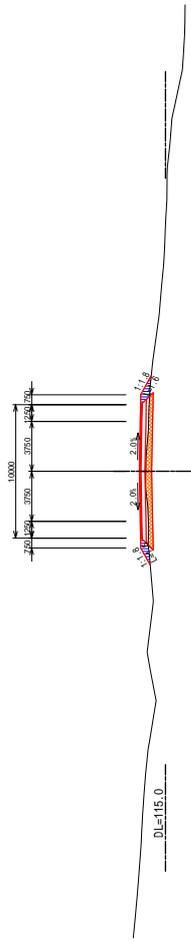

DL=115.0

PK 197+950	
Excavation	0.0 m
Spillway	1.1 m
Enbankment	2.4 m
Left Slope	0.0 n
Right Slope	0.0 n
Length of Embankment Slope	0.0 m
Left Slope	0.0 n
Right Slope	2.9 n

PK197+950
GH=116.57
PH=117.354

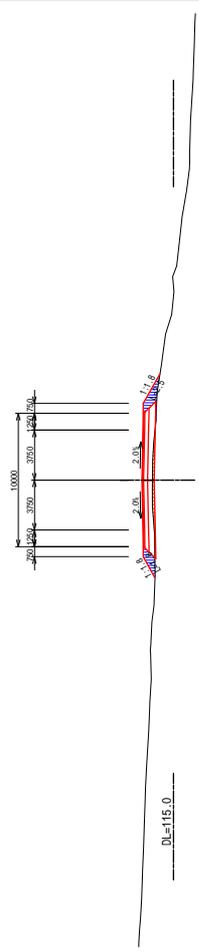

DL=115.0

PK 197+800	
Excavation	0.0 m
Spillway	2.2 m
Enbankment	1.0 m
Left Slope	0.0 n
Right Slope	0.0 n
Length of Embankment Slope	0.0 m
Left Slope	0.0 n
Right Slope	5.7 n

PK197+800
GH=116.10
PH=116.848

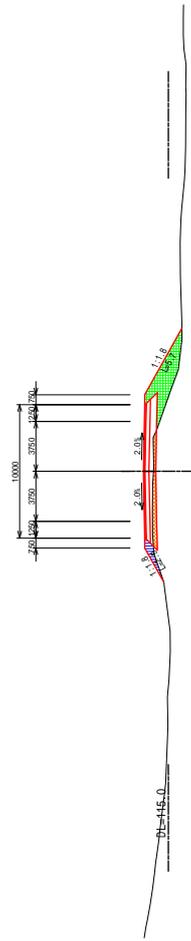

DL=115.0

PK 197+900	
Excavation	0.0 m
Spillway	3.6 m
Enbankment	1.3 m
Left Slope	0.0 n
Right Slope	0.0 n
Length of Embankment Slope	0.0 m
Left Slope	0.0 n
Right Slope	1.5 n

PK197+900
GH=116.55
PH=117.154

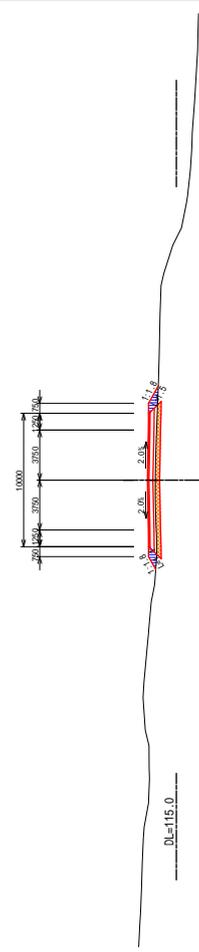

DL=115.0



REPUBLIQUE DE DJIBOUTI
MINISTRE DE L'EQUIPEMENT ET DES TRANSPORTS
DIRECTION DE L'EQUIPEMENT



JAPAN INTERNATIONAL COOPERATION AGENCY
YACHIYO ENGINEERING CO., LTD.

THE PREPARATORY SURVEY FOR
THE PROJECT FOR
UPGRADING OF NATIONAL ROAD ROUTE 1
IN THE REPUBLIC OF DJIBOUTI

SHEET CONTENTS
CROSS SECTION
PK197+800 ~ PK197+950

SCALE S=1:400
DATE NOV 2018
PAGE NO. 22 / 131

PK 198+150	
Excavation	0.0 m
Spillway	1.7 m
Enbankment	2.9 m
Length of Enbankment Slope	0.0 m
Left Side	0.0 m
Right Side	0.0 m
Length of Enbankment Slope	1.8 m
Left Side	3.1 m
Right Side	3.1 m

PK198+150
Gh=116.97
Ph=117.704

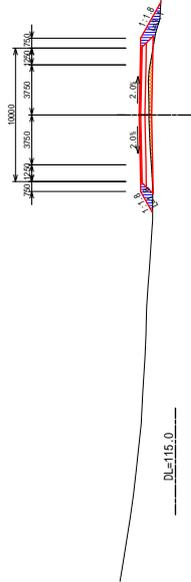

PK 198+100	
Excavation	0.0 m
Spillway	0.9 m
Enbankment	0.0 m
Length of Enbankment Slope	3.0 m
Left Side	0.0 m
Right Side	0.0 m
Length of Enbankment Slope	2.1 m
Left Side	2.1 m
Right Side	2.9 m

PK198+100
Gh=117.13
Ph=117.875

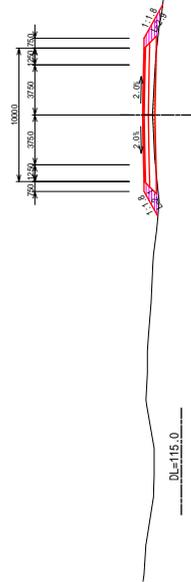

PK 198+50	
Excavation	0.0 m
Spillway	0.0 m
Enbankment	0.0 m
Length of Enbankment Slope	0.0 m
Left Side	0.0 m
Right Side	0.0 m
Length of Enbankment Slope	3.8 m
Left Side	3.7 m
Right Side	3.7 m

PK198+50
Gh=118.81
Ph=117.754

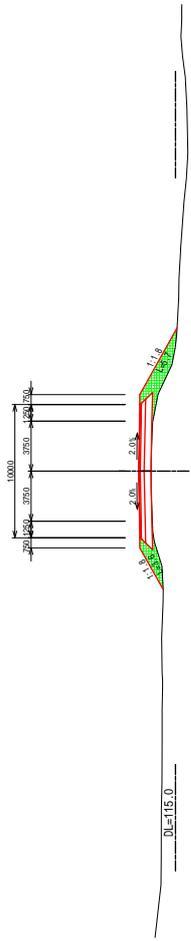

PK 198+0	
Excavation	0.0 m
Spillway	0.0 m
Enbankment	0.0 m
Length of Enbankment Slope	0.0 m
Left Side	0.0 m
Right Side	0.0 m
Length of Enbankment Slope	3.6 m
Left Side	6.0 m
Right Side	6.0 m

PK198
Gh=116.58
Ph=117.554

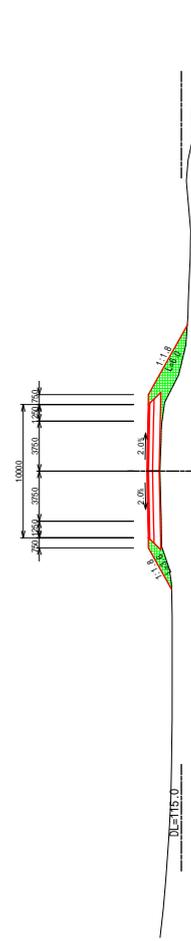

PK 198+250	
Excavation	0.0 m
Spillway	1.4 m
Enbankment	3.2 m
Left Slope	1.0 m
Right Slope	0.0 m
Length of Embankment Slope	0.0 m
Left Side	0.0 m
Right Side	0.0 m
Length of Embankment Slope	0.0 m
Left Side	0.0 m
Right Side	0.0 m

PK198+250
GH=116.49
PH=117.204

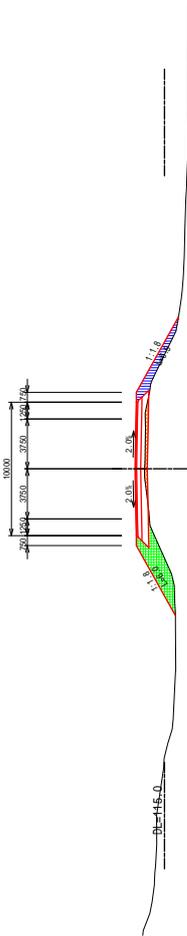

PK 198+350	
Excavation	0.0 m
Spillway	3.2 m
Enbankment	4.8 m
Left Slope	0.0 m
Right Slope	0.0 m
Length of Embankment Slope	0.0 m
Left Side	0.0 m
Right Side	0.0 m
Length of Embankment Slope	0.0 m
Left Side	0.0 m
Right Side	0.0 m

PK198+350
GH=116.16
PH=116.704

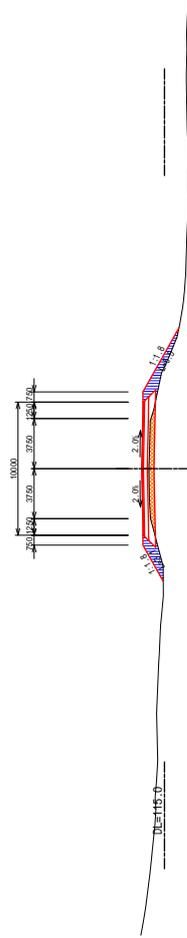

PK 198+200	
Excavation	0.0 m
Spillway	1.4 m
Enbankment	2.1 m
Left Slope	3.1 m
Right Slope	0.0 m
Length of Embankment Slope	0.0 m
Left Side	0.0 m
Right Side	0.0 m
Length of Embankment Slope	0.0 m
Left Side	4.1 m
Right Side	4.1 m

PK198+200
GH=116.72
PH=117.454

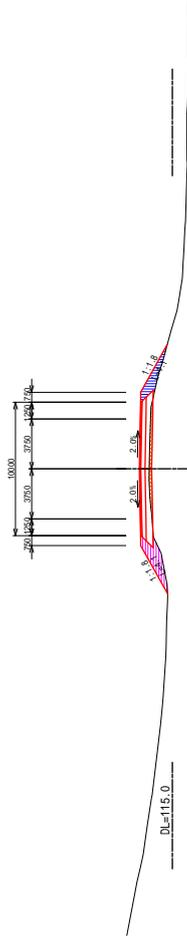

PK 198+300	
Excavation	0.0 m
Spillway	2.3 m
Enbankment	4.2 m
Left Slope	5.1 m
Right Slope	0.0 m
Length of Embankment Slope	0.0 m
Left Side	0.0 m
Right Side	0.0 m
Length of Embankment Slope	0.0 m
Left Side	5.1 m
Right Side	5.6 m

PK198+300
GH=116.28
PH=116.954

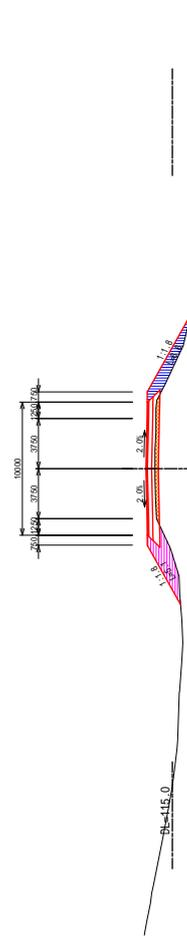

REPUBLIQUE DE DJIBOUTI
MINISTRE DE L'EQUIPEMENT ET DES TRANSPORTS
DIRECTION DE L'EQUIPEMENT



JAPAN INTERNATIONAL COOPERATION AGENCY
YACHIYO ENGINEERING CO., LTD.

THE PREPARATORY SURVEY FOR
THE PROJECT FOR
UPGRADING OF NATIONAL ROAD ROUTE 1
IN THE REPUBLIC OF DJIBOUTI

SHEET CONTENTS
CROSS SECTION
PK198+200 ~ PK198+350

SCALE S=1:400
DATE NOV 2018
PAGE NO. 24 / 131

PK 198+550	
Excavation	0.0 m
200% Slope Soil	0.0 m
300% Slope Soil	0.0 m
Embankment	0.0 m
2.5 m H E	0.0 m
3.0 m H E	0.0 m
Length of Embankment Slope	0.0 m
Left Side	0.0 m
Right Side	0.0 m
Length of Embankment Slope	0.0 m
Left Side	2.1 m
Right Side	3.1 m

PK198+550
GH=114.60
PH=115.604

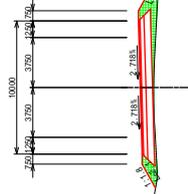

DL=110.0

PK 198+450	
Excavation	0.0 m
200% Slope Soil	1.0 m
300% Slope Soil	1.2 m
Embankment	0.0 m
2.5 m H E	0.0 m
3.0 m H E	0.0 m
Length of Embankment Slope	0.0 m
Left Side	0.0 m
Right Side	0.0 m
Length of Embankment Slope	2.8 m
Left Side	0.0 m
Right Side	0.0 m

PK198+450
GH=115.38
PH=116.204

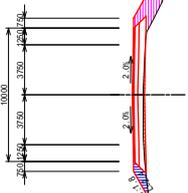

DL=110.0

PK 198+500	
Excavation	0.0 m
200% Slope Soil	0.0 m
300% Slope Soil	0.0 m
Embankment	0.0 m
2.5 m H E	3.1 m
3.0 m H E	2.1 m
Length of Embankment Slope	0.0 m
Left Side	0.0 m
Right Side	0.0 m
Length of Embankment Slope	3.0 m
Left Side	3.0 m
Right Side	5.0 m

PK198+500
GH=114.98
PH=115.936

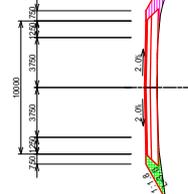

DL=110.0

PK 198+400	
Excavation	0.0 m
200% Slope Soil	3.1 m
300% Slope Soil	3.6 m
Embankment	0.0 m
2.5 m H E	0.0 m
3.0 m H E	0.0 m
Length of Embankment Slope	0.0 m
Left Side	0.0 m
Right Side	0.0 m
Length of Embankment Slope	2.0 m
Left Side	2.0 m
Right Side	4.8 m

PK198+400
GH=115.91
PH=116.454

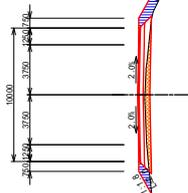

DL=110.0

PK 198+750	
Excavation	0.0 m
Top of Road	0.0 m
Subgrade	0.0 m
Enbankment	0.0 m
Left Slope	0.0 m
Right Slope	0.0 m
Length of Embankment Slope	0.0 m
Left Slope	0.0 n
Right Slope	0.0 n
Length of Embankment Slope	2.4 m
Left Slope	2.4 m
Right Slope	2.4 m

PK198+750
GH=113.25
PH=114.204

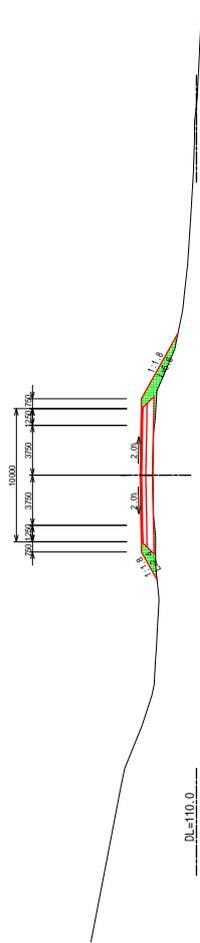

DL=110.0

PK 198+650	
Excavation	0.0 m
Top of Road	0.0 m
Subgrade	0.0 m
Enbankment	0.0 m
Left Slope	0.0 m
Right Slope	0.0 m
Length of Embankment Slope	4.3 m
Left Slope	0.0 n
Right Slope	0.0 n
Length of Embankment Slope	2.2 m
Left Slope	2.2 m
Right Slope	4.3 m

PK198+650
GH=113.88
PH=114.504

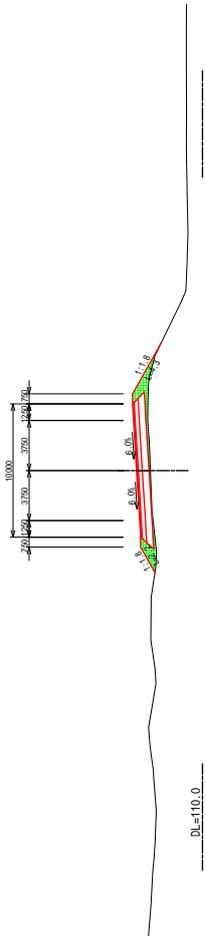

DL=110.0

PK 198+700	
Excavation	0.0 m
Top of Road	0.0 m
Subgrade	0.2 m
Enbankment	0.0 m
Left Slope	0.0 m
Right Slope	0.0 m
Length of Embankment Slope	3.8 m
Left Slope	0.0 n
Right Slope	0.0 n
Length of Embankment Slope	3.3 m
Left Slope	3.3 m
Right Slope	7.0 m

PK198+700
GH=113.71
PH=114.554

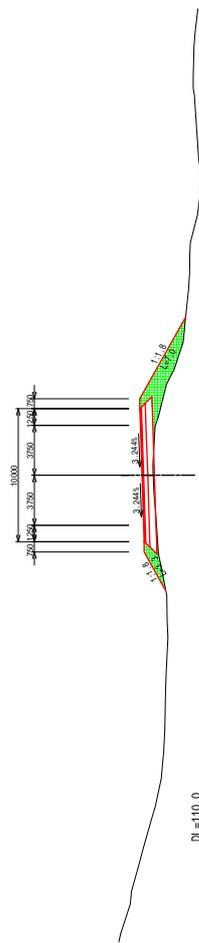

DL=110.0

PK 198+600	
Excavation	0.0 m
Top of Road	0.4 m
Subgrade	0.6 m
Enbankment	0.0 m
Left Slope	0.0 m
Right Slope	0.0 m
Length of Embankment Slope	3.0 m
Left Slope	0.0 n
Right Slope	0.0 n
Length of Embankment Slope	1.1 m
Left Slope	1.1 m
Right Slope	3.0 m

PK198+600
GH=114.31
PH=115.254

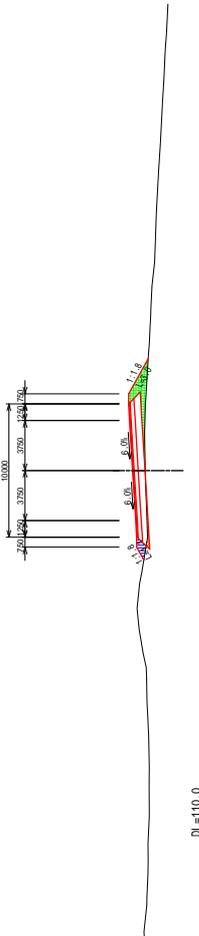

DL=110.0

PK 198+850	
Excavation	0.0 m
Shoulder	1.8 m
Enchantment	1.7 m
Shoulder	0.5 m
Enchantment	0.5 m
Length of Enchantment Slope	0.0 m
Left Slope	0.0 n
Right Slope	0.0 n
Length of Enchantment Slope	2.0 m
Left Slope	2.0 n
Right Slope	4.1 m

PK198+850
 GH=112.81
 PH=113.504

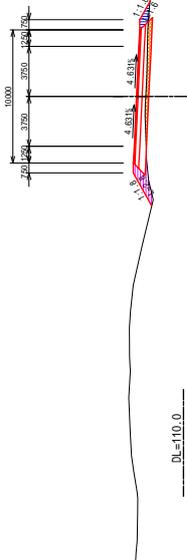

DL=110.0

PK 198+850	
Excavation	0.0 m
Shoulder	2.1 m
Enchantment	0.8 m
Shoulder	0.0 m
Enchantment	0.0 m
Length of Enchantment Slope	0.0 m
Left Slope	0.0 n
Right Slope	0.0 n
Length of Enchantment Slope	2.8 m
Left Slope	1.0 n
Right Slope	1.0 n

PK198+850
 GH=112.81
 PH=113.504

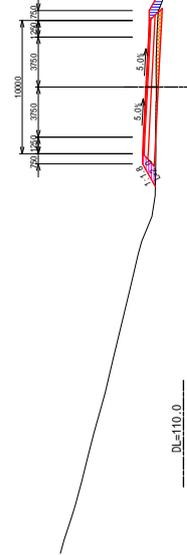

DL=110.0

PK 198+900	
Excavation	0.0 m
Shoulder	1.5 m
Enchantment	1.7 m
Shoulder	1.5 m
Enchantment	1.5 m
Length of Enchantment Slope	0.0 m
Left Slope	0.0 n
Right Slope	0.0 n
Length of Enchantment Slope	2.3 m
Left Slope	2.3 n
Right Slope	3.4 m

PK198+900
 GH=112.46
 PH=113.154

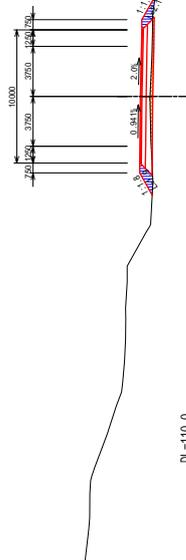

DL=110.0

PK 198+800	
Excavation	0.0 m
Shoulder	1.5 m
Enchantment	2.1 m
Shoulder	0.0 m
Enchantment	0.0 m
Length of Enchantment Slope	0.0 m
Left Slope	0.0 n
Right Slope	0.0 n
Length of Enchantment Slope	1.9 m
Left Slope	1.9 n
Right Slope	2.1 n

PK198+800
 GH=113.16
 PH=113.864

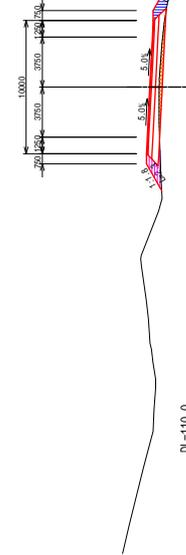

DL=110.0



REPUBLIQUE DE DJIBOUTI
 MINISTERE DE L'EQUIPEMENT ET DES TRANSPORTS
 DIRECTION DE L'EQUIPEMENT



JAPAN INTERNATIONAL COOPERATION AGENCY
 YACHIYO ENGINEERING CO., LTD.

THE PREPARATORY SURVEY FOR
 THE PROJECT FOR
 UPGRADING OF NATIONAL ROAD ROUTE 1
 IN THE REPUBLIC OF DJIBOUTI

SHEET CONTENTS
 CROSS SECTION
 PK198+800 ~ PK198+950

SCALE S=1:400
 DATE NOV 2018
 PAGE NO. 27 / 131

PK 199+50	
Excavation	0.0 m
Shoulder Slope	2.0 m
Shoulder Slope	1.7 m
Shoulder Slope	0.0 m
Shoulder Slope	0.0 m
Shoulder Slope	0.0 m
Length of Excavation Slope	0.0 m
Left Side	0.0 m
Right Side	0.0 m
Length of Embankment Slope	1.1 m
Left Side	1.1 m
Right Side	1.0 m

PK199+50
GH=111.08
PH=111.704

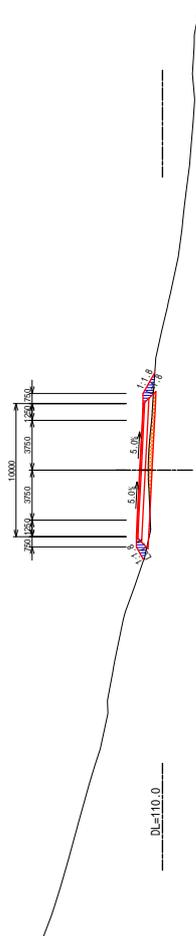

PK 199+150	
Excavation	0.0 m
Shoulder Slope	1.4 m
Shoulder Slope	3.1 m
Shoulder Slope	0.0 m
Shoulder Slope	0.0 m
Length of Excavation Slope	0.0 m
Left Side	0.0 m
Right Side	0.0 m
Length of Embankment Slope	2.1 m
Left Side	2.1 m
Right Side	3.9 m

PK199+150
GH=109.47
PH=110.204

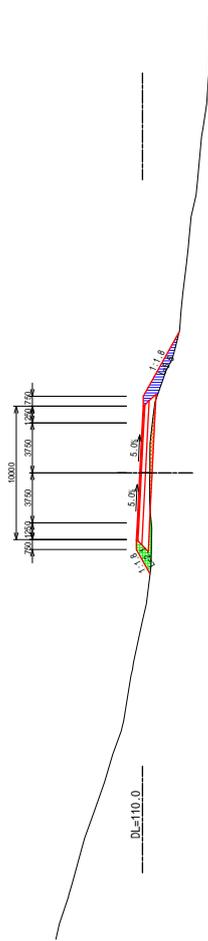

PK 199+0	
Excavation	0.0 m
Shoulder Slope	0.8 m
Shoulder Slope	0.9 m
Shoulder Slope	1.4 m
Shoulder Slope	0.0 m
Length of Excavation Slope	0.0 m
Left Side	0.0 m
Right Side	0.0 m
Length of Embankment Slope	1.4 m
Left Side	1.4 m
Right Side	1.7 m

PK199
GH=111.51
PH=112.384

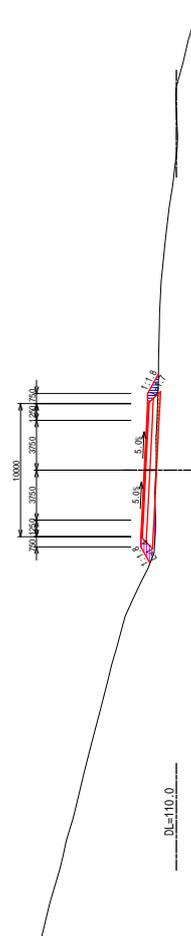

PK 199+100	
Excavation	0.0 m
Shoulder Slope	1.2 m
Shoulder Slope	2.4 m
Shoulder Slope	0.0 m
Length of Excavation Slope	0.0 m
Left Side	0.0 m
Right Side	0.0 m
Length of Embankment Slope	1.7 m
Left Side	1.7 m
Right Side	1.8 m

PK199+100
GH=110.17
PH=110.954

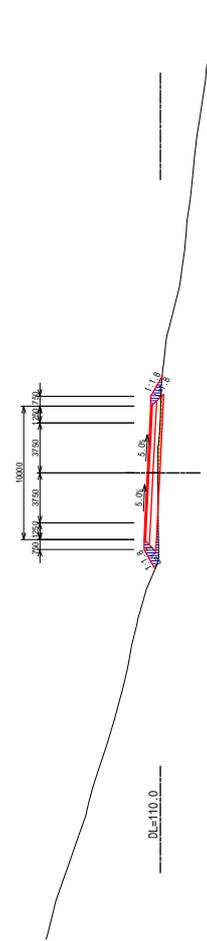

REPUBLIQUE DE DJIBOUTI
MINISTRE DE L'EQUIPEMENT ET DES TRANSPORTS
DIRECTION DE L'EQUIPEMENT



JAPAN INTERNATIONAL COOPERATION AGENCY
YACHIYO ENGINEERING CO., LTD.

THE PREPARATORY SURVEY FOR
THE PROJECT FOR
UPGRADING OF NATIONAL ROAD ROUTE 1
IN THE REPUBLIC OF DJIBOUTI

SHEET CONTENTS
CROSS SECTION
PK199+000 ~ PK199+150

SCALE S=1:400
DATE NOV 2018
PAGE NO. 28 / 131

PK 199+250	
Excavation	0.0 m
Slope Side Cut	3.1 m
Embankment	5.4 m
Length of Excavation Slope	0.0 m
Left Side	0.0 m
Right Side	6.1 m
Length of Embankment Slope	6.1 m
Left Side	6.1 m
Right Side	6.1 m

PK199+250
GH=108.35
PH=108.868

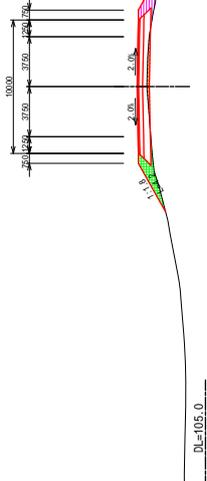

PK 199+350	
Excavation	0.0 m
Slope Side Cut	0.9 m
Embankment	0.0 m
Length of Excavation Slope	0.0 m
Left Side	0.0 m
Right Side	4.2 m
Length of Embankment Slope	4.2 m
Left Side	4.2 m
Right Side	4.2 m

PK199+350
GH=108.36
PH=110.104

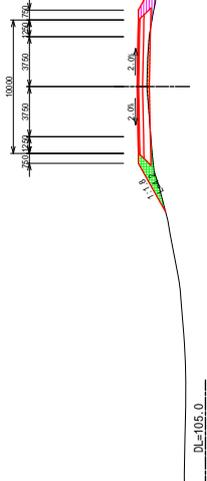

PK 199+200	
Excavation	0.0 m
Slope Side Cut	2.3 m
Embankment	6.3 m
Length of Excavation Slope	0.0 m
Left Side	0.0 m
Right Side	7.3 m
Length of Embankment Slope	7.3 m
Left Side	7.3 m
Right Side	7.3 m

PK199+200
GH=108.79
PH=109.454

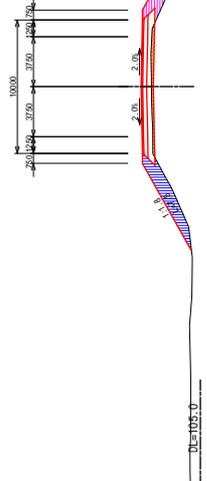

PK 199+300	
Excavation	0.0 m
Slope Side Cut	1.6 m
Embankment	6.0 m
Length of Excavation Slope	0.0 m
Left Side	0.0 m
Right Side	7.5 m
Length of Embankment Slope	7.5 m
Left Side	7.5 m
Right Side	7.5 m

PK199+300
GH=108.63
PH=109.404

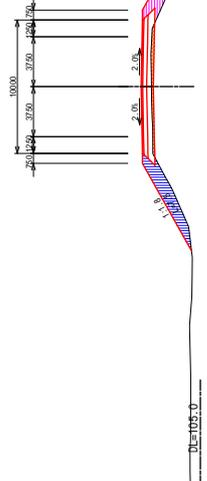

PK 199+550	
Excavation	0.0 m
Shoulder Slope	1.1 m
Embankment	1.1 m
Shoulder Slope	1.1 m
Excavation	0.0 m
Shoulder Slope	0.0 m
Embankment	0.0 m
Shoulder Slope	0.0 m
Length of Excavation Slope	0.0 m
Left Side	0.0 m
Right Side	0.0 m
Length of Embankment Slope	0.0 m
Left Side	0.0 m
Right Side	0.0 m

PK199+550
 GH=108.25
 PH=109.164

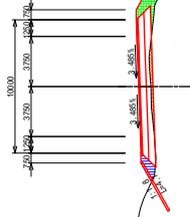

DL=105.0

PK 199+450	
Excavation	0.0 m
Shoulder Slope	4.0 m
Embankment	1.5 m
Shoulder Slope	0.0 m
Excavation	0.0 m
Shoulder Slope	0.0 m
Embankment	0.0 m
Shoulder Slope	0.0 m
Length of Excavation Slope	0.0 m
Left Side	0.0 m
Right Side	0.0 m
Length of Embankment Slope	1.0 m
Left Side	1.0 m
Right Side	1.0 m

PK199+450
 GH=110.12
 PH=110.810

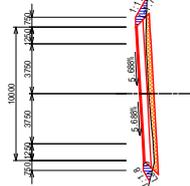

DL=105.0

PK 199+500	
Excavation	0.0 m
Shoulder Slope	3.3 m
Embankment	2.9 m
Shoulder Slope	0.0 m
Excavation	0.0 m
Shoulder Slope	0.0 m
Embankment	0.0 m
Shoulder Slope	0.0 m
Length of Excavation Slope	0.0 m
Left Side	0.0 m
Right Side	0.0 m
Length of Embankment Slope	0.0 m
Left Side	0.0 m
Right Side	0.0 m

PK199+500
 GH=109.43
 PH=110.164

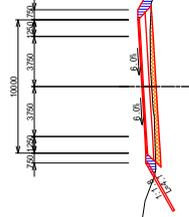

DL=105.0

PK 199+400	
Excavation	0.0 m
Shoulder Slope	4.3 m
Embankment	1.4 m
Shoulder Slope	0.0 m
Excavation	0.0 m
Shoulder Slope	0.0 m
Embankment	0.0 m
Shoulder Slope	0.0 m
Length of Excavation Slope	0.0 m
Left Side	0.0 m
Right Side	0.0 m
Length of Embankment Slope	0.6 m
Left Side	0.6 m
Right Side	0.6 m

PK199+400
 GH=110.03
 PH=110.747

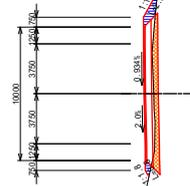

DL=105.0

PK	199+750
Excavation	0.0 m
Shoulder	3.3 m
Enbankment	7.1 m
Shoulder	0.0 m
Excavation	0.0 m
Length of Excavation Slope	0.0 m
Left Slope	0.0 n
Length of Enbankment Slope	0.0 m
Left Slope	3.8 n
Right Slope	7.2 n

PK199+750
GH=104.45
PH=105.164

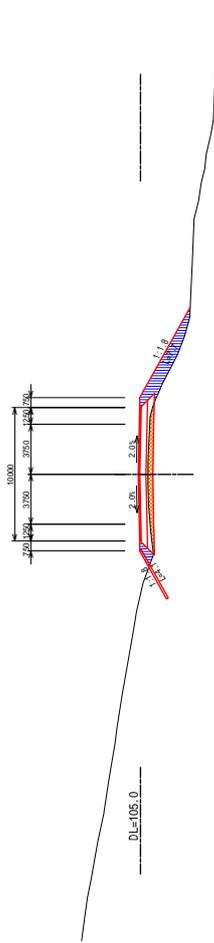

PK	199+700
Excavation	0.0 m
Shoulder	2.9 m
Enbankment	6.1 m
Shoulder	0.0 m
Excavation	0.0 m
Length of Excavation Slope	0.0 m
Left Slope	0.0 n
Length of Enbankment Slope	0.0 m
Left Slope	3.8 n
Right Slope	7.5 n

PK199+700
GH=105.32
PH=106.164

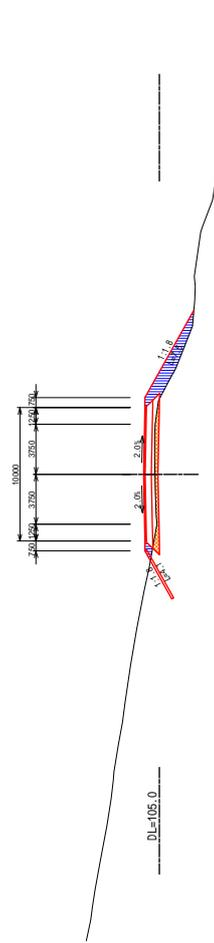

PK	199+650
Excavation	0.0 m
Shoulder	1.8 m
Enbankment	6.5 m
Shoulder	0.0 m
Excavation	0.0 m
Length of Excavation Slope	0.0 m
Left Slope	0.0 n
Length of Enbankment Slope	0.0 m
Left Slope	3.8 n
Right Slope	6.1 n

PK199+650
GH=106.22
PH=107.164

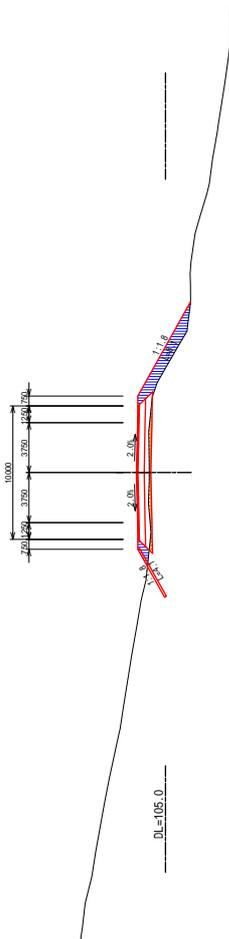

PK	199+600
Excavation	0.0 m
Shoulder	1.4 m
Enbankment	1.0 m
Shoulder	7.5 m
Excavation	0.0 m
Length of Excavation Slope	0.0 m
Left Slope	0.0 n
Length of Enbankment Slope	0.0 m
Left Slope	3.8 n
Right Slope	7.9 n

PK199+600
GH=107.25
PH=108.164

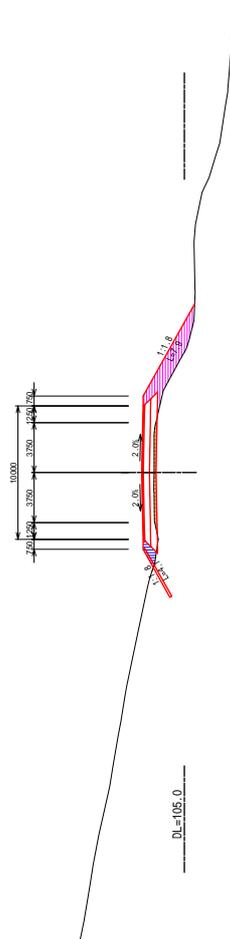

PK 199+850	
Excavation	0.0 m
Shoulder Cut	3.9 m
Enbankment	4.0 m
Length of Excavation Slope	0.0 m
Left Slope	0.0 n
Right Slope	0.0 n
Length of Enbankment Slope	0.0 m
Left Slope	4.1 n
Right Slope	4.8 n

PK199+850
GH=101.89
PH=103.164

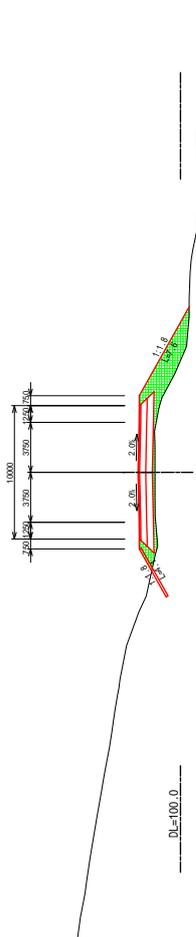

PK 199+850	
Excavation	0.0 m
Shoulder Cut	0.0 m
Enbankment	0.0 m
Length of Excavation Slope	0.0 m
Left Slope	0.0 n
Right Slope	0.0 n
Length of Enbankment Slope	0.0 m
Left Slope	3.7 n
Right Slope	7.6 n

PK199+850
GH=101.89
PH=103.164

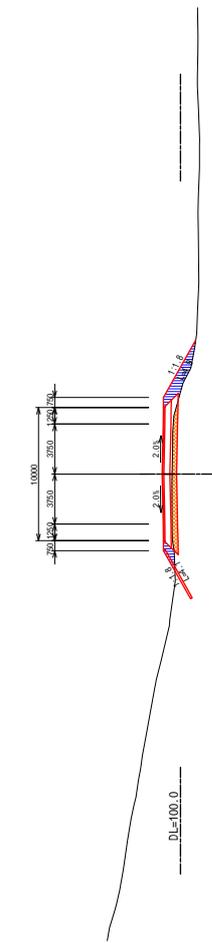

DL=100.0

PK 199+900	
Excavation	0.0 m
Shoulder Cut	0.6 m
Enbankment	1.3 m
Length of Excavation Slope	0.0 m
Left Slope	0.0 n
Right Slope	0.0 n
Length of Enbankment Slope	4.1 m
Left Slope	4.1 n
Right Slope	7.2 n

PK199+900
GH=101.12
PH=102.164

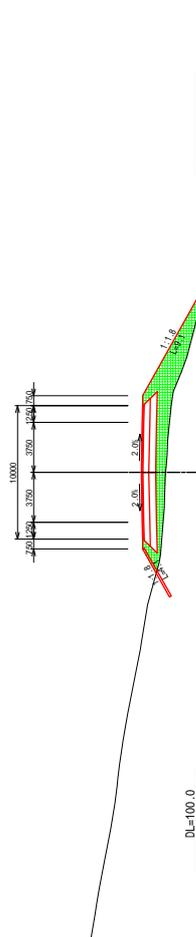

DL=100.0

PK 199+800	
Excavation	0.0 m
Shoulder Cut	0.0 m
Enbankment	0.0 m
Length of Excavation Slope	20.0 m
Left Slope	0.0 n
Right Slope	0.0 n
Length of Enbankment Slope	3.9 m
Left Slope	3.9 n
Right Slope	9.1 n

PK199+800
GH=102.35
PH=104.164

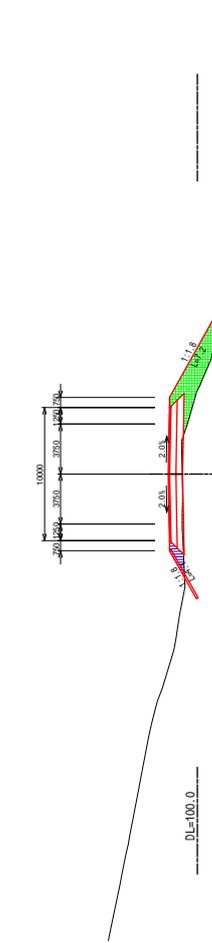

DL=100.0

PK 200+150	
Excavation	0.0 m
Open Cut	0.0 m
Enbankment	0.0 m
Length of Excavation Slope	0.0 m
Left Side	0.0 m
Right Side	0.0 m
Length of Enbankment Slope	6.0 m
Left Side	6.0 m
Right Side	6.0 m

PK200+150
GH=99.17
PH=101.711

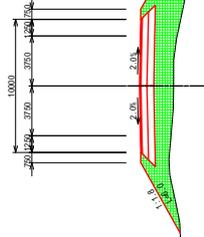

DL=95.0

PK 200+50	
Excavation	0.0 m
Open Cut	0.0 m
Enbankment	0.0 m
Length of Excavation Slope	20.0 m
Left Side	0.0 m
Right Side	0.0 m
Length of Enbankment Slope	6.2 m
Left Side	6.2 m
Right Side	6.7 m

PK200+50
GH=99.72
PH=101.464

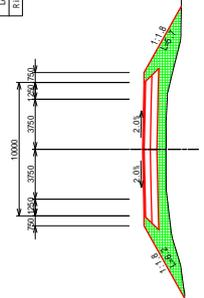

DL=95.0

PK 200+100	
Excavation	0.0 m
Open Cut	0.0 m
Enbankment	0.0 m
Length of Excavation Slope	2.9 m
Left Side	0.0 m
Right Side	0.0 m
Length of Enbankment Slope	6.4 m
Left Side	6.4 m
Right Side	7.1 m

PK200+100
GH=99.55
PH=101.614

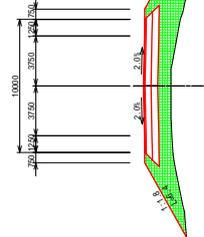

DL=95.0

PK 200+0	
Excavation	0.0 m
Open Cut	0.0 m
Enbankment	0.0 m
Length of Excavation Slope	10.0 m
Left Side	0.0 m
Right Side	0.0 m
Length of Enbankment Slope	4.1 m
Left Side	4.1 m
Right Side	5.9 m

PK200
GH=100.18
PH=101.314

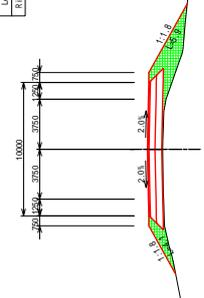

DL=95.0

PK 200+350	
Elevation (m)	
Top of Road	0.0
Subgrade	0.0
Shoulder	0.0
Left Side	0.0
Right Side	0.0
Length of Excavation Slope	0.0
Left Side	0.0
Right Side	0.0
Length of Embankment Slope	4.2
Left Side	4.2
Right Side	3.8

PK200+350
 GH=100.04
 PH=101.164

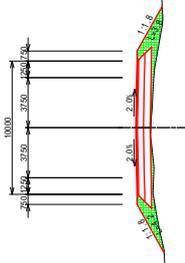

DL=95.0

PK 200+250	
Elevation (m)	
Top of Road	0.0
Subgrade	0.0
Shoulder	0.0
Left Side	0.0
Right Side	0.0
Length of Excavation Slope	0.0
Left Side	0.0
Right Side	0.0
Length of Embankment Slope	5.0
Left Side	5.0
Right Side	3.3

PK200+250
 GH=99.83
 PH=101.464

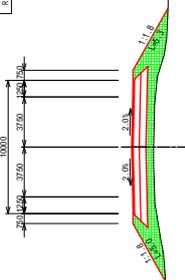

DL=95.0

PK 200+300	
Elevation (m)	
Top of Road	0.0
Subgrade	0.0
Shoulder	0.0
Left Side	0.0
Right Side	0.0
Length of Excavation Slope	0.0
Left Side	0.0
Right Side	0.0
Length of Embankment Slope	4.4
Left Side	4.4
Right Side	4.3

PK200+300
 GH=99.99
 PH=101.314

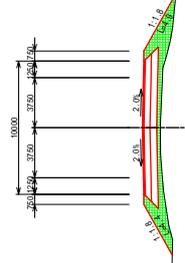

DL=95.0

PK 200+200	
Elevation (m)	
Top of Road	0.0
Subgrade	0.0
Shoulder	0.0
Left Side	0.0
Right Side	0.0
Length of Excavation Slope	0.0
Left Side	0.0
Right Side	0.0
Length of Embankment Slope	4.9
Left Side	4.9
Right Side	4.9

PK200+200
 GH=99.69
 PH=101.614

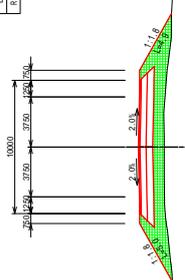

DL=95.0



REPUBLIQUE DE DJIBOUTI
 MINISTERE DE L'EQUIPEMENT ET DES TRANSPORTS
 DIRECTION DE L'EQUIPEMENT

JAPAN INTERNATIONAL COOPERATION AGENCY
 YACHIYO ENGINEERING CO., LTD.

THE PREPARATORY SURVEY FOR
 THE PROJECT FOR
 UPGRADING OF NATIONAL ROAD ROUTE 1
 IN THE REPUBLIC OF DJIBOUTI

SHEET CONTENTS
 CROSS SECTION
 PK200+200 ~ PK200+350

SCALE S=1:400
 DATE NOV 2018
 PAGE NO. 34 / 131

PK 200+450	
Elevation (m)	
Original Ground	0.0
Subgrade	1.9
Enhancement	1.5
Shoulder	2.0
Length of Excavation Slope	0.0
Left Slope	0.0
Right Slope	0.0
Length of Embankment Slope	2.9
Left Slope	3.0
Right Slope	3.0

PK200+450
GH=99.95
PH=100.864

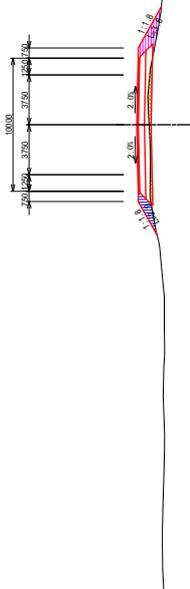

DL=95.0

PK 200+550	
Elevation (m)	
Original Ground	0.0
Subgrade	3.7
Enhancement	3.2
Shoulder	4.0
Length of Excavation Slope	0.0
Left Slope	0.0
Right Slope	0.0
Length of Embankment Slope	2.4
Left Slope	3.7
Right Slope	3.7

PK200+550
GH=99.87
PH=100.564

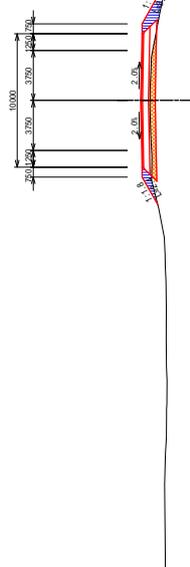

DL=95.0

PK 200+400	
Elevation (m)	
Original Ground	0.0
Subgrade	0.4
Enhancement	0.0
Shoulder	3.7
Length of Excavation Slope	0.0
Left Slope	0.0
Right Slope	0.0
Length of Embankment Slope	3.7
Left Slope	3.7
Right Slope	4.1

PK200+400
GH=100.04
PH=101.014

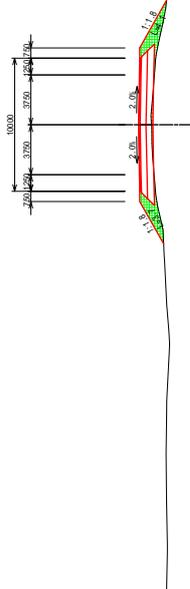

DL=95.0

PK 200+500	
Elevation (m)	
Original Ground	0.0
Subgrade	3.5
Enhancement	3.8
Shoulder	4.0
Length of Excavation Slope	0.0
Left Slope	0.0
Right Slope	0.0
Length of Embankment Slope	3.0
Left Slope	3.0
Right Slope	4.0

PK200+500
GH=99.98
PH=100.714

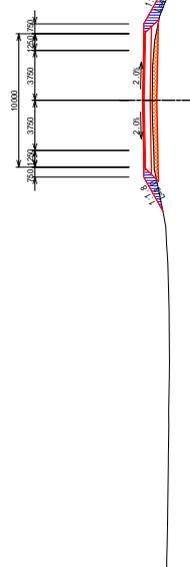

DL=95.0



REPUBLIQUE DE DJIBOUTI
MINISTRE DE L'EQUIPEMENT ET DES TRANSPORTS
DIRECTION DE L'EQUIPEMENT

JAPAN INTERNATIONAL COOPERATION AGENCY
YACHIYO ENGINEERING CO., LTD.

THE PREPARATORY SURVEY FOR
THE PROJECT FOR
UPGRADING OF NATIONAL ROAD ROUTE 1
IN THE REPUBLIC OF DJIBOUTI

SHEET CONTENTS
CROSS SECTION
PK200+400 ~ PK200+550

SCALE S=1:400
DATE NOV 2018
PAGE NO. 35 / 131

PK 200+750	
Elevation	
Subgrade	0.0 m
Shoulder	2.1 m
Enhancement	1.7 m
Subgrade	0.0 m
Shoulder	0.0 m
Enhancement	0.0 m
Length of Embankment Slope	0.0 m
Left Slope	0.0 n
Right Slope	0.0 n
Length of Embankment Slope	3.2 m
Left Slope	3.4 m
Right Slope	3.4 m

PK200+750
 CH=69.11
 PH=69.864

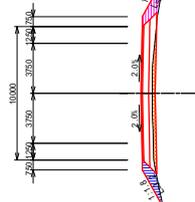

DL=95.0

PK 200+650	
Elevation	
Subgrade	0.0 m
Shoulder	3.4 m
Enhancement	2.9 m
Subgrade	0.0 m
Shoulder	0.0 m
Enhancement	0.0 m
Length of Embankment Slope	0.0 m
Left Slope	0.0 n
Right Slope	0.0 n
Length of Embankment Slope	2.8 m
Left Slope	3.3 m
Right Slope	3.3 m

PK200+650
 CH=69.48
 PH=100.264

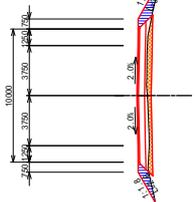

DL=95.0

PK 200+700	
Elevation	
Subgrade	0.0 m
Shoulder	3.8 m
Enhancement	2.5 m
Subgrade	0.0 m
Shoulder	0.0 m
Enhancement	0.0 m
Length of Embankment Slope	0.0 m
Left Slope	0.0 n
Right Slope	0.0 n
Length of Embankment Slope	1.9 m
Left Slope	3.2 m
Right Slope	3.2 m

PK200+700
 CH=69.42
 PH=100.114

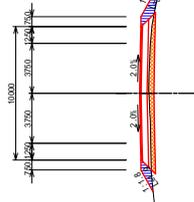

DL=95.0

PK 200+600	
Elevation	
Subgrade	0.0 m
Shoulder	4.2 m
Enhancement	2.8 m
Subgrade	0.0 m
Shoulder	0.0 m
Enhancement	0.0 m
Length of Embankment Slope	0.0 m
Left Slope	0.0 n
Right Slope	0.0 n
Length of Embankment Slope	2.5 m
Left Slope	3.4 m
Right Slope	3.4 m

PK200+600
 CH=69.76
 PH=100.414

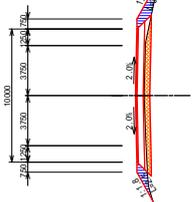

DL=95.0

PK	200+850
Excavation	0.0 m
200+844.500	0.0 m
200+849.500	0.3 m
Enchantment	0.0 m
200+854.500	0.0 m
200+859.500	0.2 m
200+864.500	0.0 m
Length of Excavation Slope	0.0 m
Left Slope	0.0 n
Right Slope	0.0 n
Length of Enchantment Slope	4.0 m
Left Slope	4.0 n
Right Slope	4.0 n

PK200+850
GH=88.57
PH=89.664

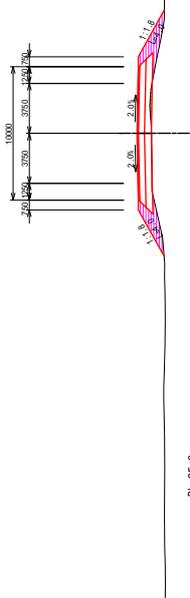

DL=95.0

PK	200+950
Excavation	0.0 m
200+944.500	0.0 m
200+949.500	0.0 m
Enchantment	0.0 m
200+954.500	0.0 m
200+959.500	1.0 m
200+964.500	0.0 m
Length of Excavation Slope	0.0 m
Left Slope	0.0 n
Right Slope	0.0 n
Length of Enchantment Slope	4.3 m
Left Slope	4.3 n
Right Slope	4.3 n

PK200+950
GH=88.00
PH=89.364

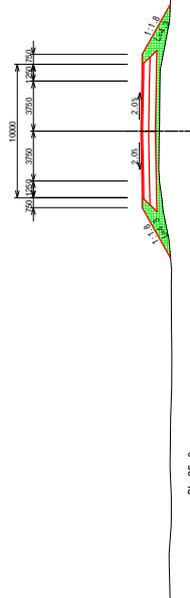

DL=95.0

PK	200+800
Excavation	0.0 m
200+794.500	1.3 m
200+804.500	1.8 m
Enchantment	2.8 m
200+814.500	0.0 m
200+819.500	0.0 m
Length of Excavation Slope	0.0 m
Left Slope	0.0 n
Right Slope	0.0 n
Length of Enchantment Slope	3.3 m
Left Slope	3.3 n
Right Slope	3.8 n

PK200+800
GH=89.89
PH=89.814

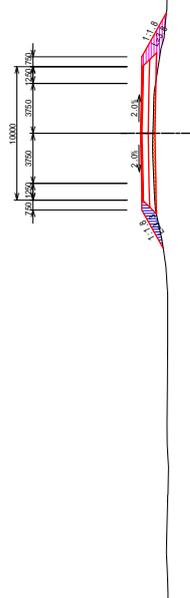

DL=95.0

PK	200+900
Excavation	0.0 m
200+894.500	0.0 m
200+904.500	0.0 m
Enchantment	0.0 m
200+914.500	2.8 m
200+919.500	0.0 m
Length of Excavation Slope	0.0 m
Left Slope	0.0 n
Right Slope	0.0 n
Length of Enchantment Slope	4.1 m
Left Slope	4.1 n
Right Slope	4.2 n

PK200+900
GH=88.39
PH=89.514

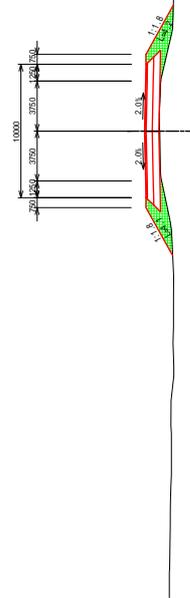

DL=95.0



REPUBLIQUE DE DJIBOUTI
MINISTRE DE L'EQUIPEMENT ET DES TRANSPORTS
DIRECTION DE L'EQUIPEMENT



JAPAN INTERNATIONAL COOPERATION AGENCY
YACHIYO ENGINEERING CO., LTD.

THE PREPARATORY SURVEY FOR
THE PROJECT FOR
UPGRADING OF NATIONAL ROAD ROUTE 1
IN THE REPUBLIC OF DJIBOUTI

SHEET CONTENTS
CROSS SECTION
PK200+800 ~ PK200+950

SCALE S=1:400
DATE NOV 2018
PAGE NO. 37 / 131

PK 201+150	
Excavation	0.0 m
Spill 0.0	0.0 m
Enlargement	0.0 m
Spill 1.0	0.0 m
Spill 2.0	0.0 m
Spill 3.0	0.0 m
Spill 4.0	0.0 m
Spill 5.0	0.0 m
Spill 6.0	0.0 m
Spill 7.0	0.0 m
Spill 8.0	0.0 m
Spill 9.0	0.0 m
Spill 10.0	0.0 m
Length of Excavation Slope	0.0 m
Left Side	0.0 m
Right Side	0.0 m
Length of Enlargement Slope	4.8 m
Left Side	4.8 m
Right Side	0.0 m

PK201+150

GH=86.94
PH=88.614

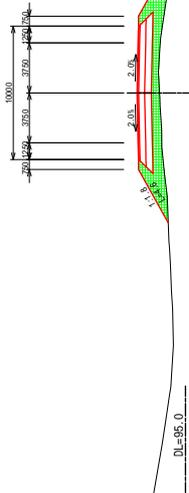

PK 201+100	
Excavation	0.0 m
Spill 0.0	0.0 m
Enlargement	0.0 m
Spill 1.0	0.0 m
Spill 2.0	0.0 m
Spill 3.0	0.0 m
Spill 4.0	0.0 m
Spill 5.0	0.0 m
Spill 6.0	0.0 m
Spill 7.0	0.0 m
Spill 8.0	0.0 m
Spill 9.0	0.0 m
Spill 10.0	0.0 m
Length of Excavation Slope	0.0 m
Left Side	0.0 m
Right Side	0.0 m
Length of Enlargement Slope	5.2 m
Left Side	5.2 m
Right Side	0.0 m

PK201+100

GH=87.498
PH=88.888

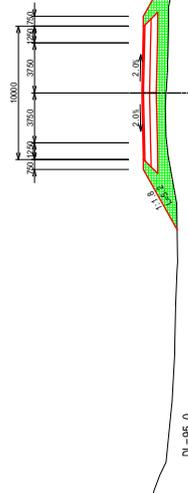

PK 201+50	
Excavation	0.0 m
Spill 0.0	0.0 m
Enlargement	0.0 m
Spill 1.0	0.0 m
Spill 2.0	0.0 m
Spill 3.0	0.0 m
Spill 4.0	0.0 m
Spill 5.0	0.0 m
Spill 6.0	0.0 m
Spill 7.0	0.0 m
Spill 8.0	0.0 m
Spill 9.0	0.0 m
Spill 10.0	0.0 m
Length of Excavation Slope	14.0 m
Left Side	0.0 m
Right Side	0.0 m
Length of Enlargement Slope	4.8 m
Left Side	4.8 m
Right Side	0.0 m

PK201+50

GH=97.63
PH=99.064

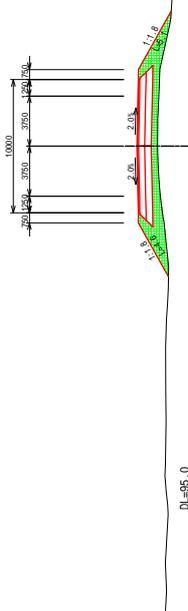

PK 201+0	
Excavation	0.0 m
Spill 0.0	0.0 m
Enlargement	0.0 m
Spill 1.0	0.0 m
Spill 2.0	0.0 m
Spill 3.0	0.0 m
Spill 4.0	0.0 m
Spill 5.0	0.0 m
Spill 6.0	0.0 m
Spill 7.0	0.0 m
Spill 8.0	0.0 m
Spill 9.0	0.0 m
Spill 10.0	0.0 m
Length of Excavation Slope	13.0 m
Left Side	0.0 m
Right Side	0.0 m
Length of Enlargement Slope	4.6 m
Left Side	4.6 m
Right Side	0.0 m

PK201

GH=97.66
PH=99.214

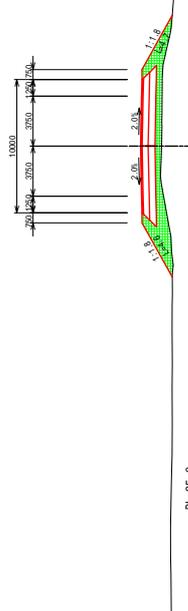

PK	201+250
Excavation	0.0 m
Shoulder Slope	0.0 m
Enchantment	0.0 m
Shoulder Slope	0.0 m
Length of Embankment Slope	0.0 m
Left Side	0.0 m
Right Side	0.0 m
Length of Embankment Slope	5.1 m
Left Side	5.1 m
Right Side	0.0 m

PK201+250
Gh=86.29
Ph=88.014

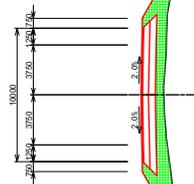

DL=80.0

PK	201+350
Excavation	0.0 m
Shoulder Slope	0.0 m
Enchantment	0.0 m
Shoulder Slope	0.0 m
Length of Embankment Slope	0.0 m
Left Side	0.0 m
Right Side	0.0 m
Length of Embankment Slope	5.0 m
Left Side	5.0 m
Right Side	5.2 m

PK201+350
Gh=95.83
Ph=97.414

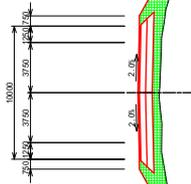

DL=80.0

PK	201+200
Excavation	0.0 m
Shoulder Slope	0.0 m
Enchantment	0.0 m
Shoulder Slope	0.0 m
Length of Embankment Slope	0.0 m
Left Side	0.0 m
Right Side	0.0 m
Length of Embankment Slope	5.0 m
Left Side	5.0 m
Right Side	5.2 m

PK201+200
Gh=87.01
Ph=88.314

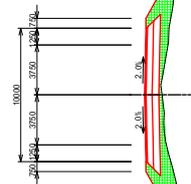

DL=80.0

PK	201+300
Excavation	0.0 m
Shoulder Slope	0.0 m
Enchantment	0.0 m
Shoulder Slope	0.0 m
Length of Embankment Slope	0.0 m
Left Side	0.0 m
Right Side	0.0 m
Length of Embankment Slope	4.7 m
Left Side	4.7 m
Right Side	5.4 m

PK201+300
Gh=95.81
Ph=97.714

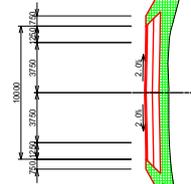

DL=80.0



REPUBLIQUE DE DJIBOUTI
MINISTRE DE L'EQUIPEMENT ET DES TRANSPORTS
DIRECTION DE L'EQUIPEMENT

JAPAN INTERNATIONAL COOPERATION AGENCY
YACHIYO ENGINEERING CO., LTD.

THE PREPARATORY SURVEY FOR
THE PROJECT FOR
UPGRADING OF NATIONAL ROAD ROUTE 1
IN THE REPUBLIC OF DJIBOUTI

SHEET CONTENTS
CROSS SECTION
PK201+200 ~ PK201+350

SCALE S=1:400
DATE NOV 2018
PAGE NO. 39 / 131

PK	201+750
Excavation	0.0 m
2003 Standard	0.0 m
Shoulder	0.0 m
Enbankment	0.0 m
2.5 m	0.0 m
3 m	0.0 m
Length of Embankment Slope	10.0 m
Left Slope	0.0 n
Right Slope	0.0 n
Length of Embankment Slope	4.8 m
Left Slope	4.2 n
Right Slope	4.8 n

PK201+750
GH=66.62
PH=68.214

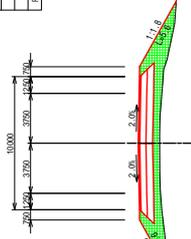

DL=90.0

PK	201+650
Excavation	0.0 m
2003 Standard	0.0 m
Shoulder	0.0 m
Enbankment	0.0 m
2.5 m	0.0 m
3 m	0.0 m
Length of Embankment Slope	8.0 m
Left Slope	0.0 n
Right Slope	0.0 n
Length of Embankment Slope	3.1 m
Left Slope	4.0 n
Right Slope	4.0 n

PK201+650
GH=65.96
PH=67.214

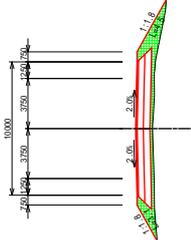

DL=90.0

PK	201+700
Excavation	0.0 m
2003 Standard	0.0 m
Shoulder	0.0 m
Enbankment	0.0 m
2.5 m	0.0 m
3 m	1.9 m
Length of Embankment Slope	10.0 m
Left Slope	0.0 n
Right Slope	0.0 n
Length of Embankment Slope	4.2 m
Left Slope	4.2 n
Right Slope	4.8 n

PK201+700
GH=66.23
PH=67.714

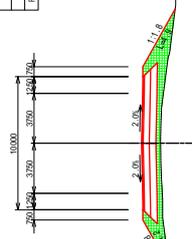

DL=90.0

PK	201+600
Excavation	0.0 m
2003 Standard	0.0 m
Shoulder	0.0 m
Enbankment	1.2 m
2.5 m	0.0 m
3 m	3.2 m
Length of Embankment Slope	10.0 m
Left Slope	0.0 n
Right Slope	0.0 n
Length of Embankment Slope	2.2 m
Left Slope	3.8 n
Right Slope	3.8 n

PK201+600
GH=65.57
PH=66.714

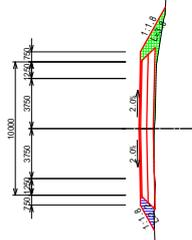

DL=90.0

PK 201+850	
Excavation	0.0 m
20m ³ of earth	2.1 m
Enlargement	1.9 m
20m ³ of earth	0.0 m
Length of Enlargement Slope	0.0 m
Left Slope	0.0 n
Right Slope	0.0 n
Left Slope	3.7 a
Right Slope	4.1 a

PK201+850
GH=68.02
PH=68.864

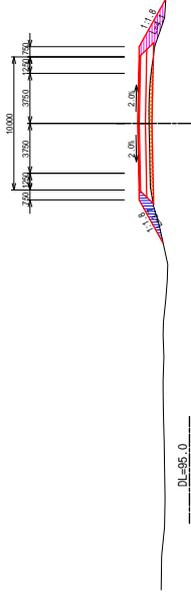

PK 201+950	
Excavation	0.0 m
20m ³ of earth	2.0 m
Enlargement	2.2 m
20m ³ of earth	0.0 m
Length of Enlargement Slope	0.0 m
Left Slope	0.0 n
Right Slope	0.0 n
Left Slope	3.8 a
Right Slope	3.7 a

PK201+950
GH=68.30
PH=69.164

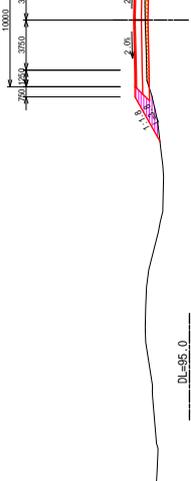

PK 201+800	
Excavation	0.0 m
20m ³ of earth	2.6 m
Enlargement	2.1 m
20m ³ of earth	2.6 m
Length of Enlargement Slope	0.0 m
Left Slope	0.0 n
Right Slope	0.0 n
Left Slope	4.1 a
Right Slope	3.8 a

PK201+800
GH=67.80
PH=68.653

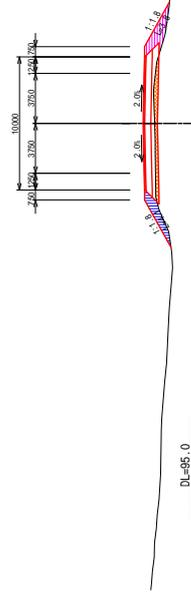

PK 201+900	
Excavation	0.0 m
20m ³ of earth	2.2 m
Enlargement	3.2 m
20m ³ of earth	0.0 m
Length of Enlargement Slope	0.0 m
Left Slope	0.0 n
Right Slope	0.0 n
Left Slope	3.3 a
Right Slope	2.8 a

PK201+900
GH=68.15
PH=69.014

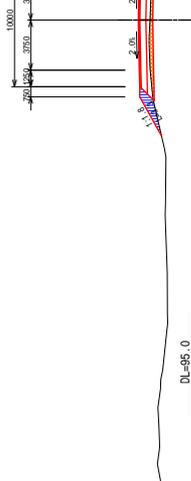

REPUBLIQUE DE DJIBOUTI
MINISTRE DE L'EQUIPEMENT ET DES TRANSPORTS
DIRECTION DE L'EQUIPEMENT



JAPAN INTERNATIONAL COOPERATION AGENCY
YACHIYO ENGINEERING CO., LTD.

THE PREPARATORY SURVEY FOR
THE PROJECT FOR
UPGRADING OF NATIONAL ROAD ROUTE 1
IN THE REPUBLIC OF DJIBOUTI

SHEET CONTENTS
CROSS SECTION
PK201+800 ~ PK201+950

SCALE S=1:400
DATE NOV 2018
PAGE NO. 42 / 131

PK 202+150	
Excavation	0.0 m
Shoulder Cut	0.0 m
Enbankment	0.0 m
Left Slope	0.0 m
Right Slope	0.0 m
Length of Excavation Slope	2.0 m
Left Slope	0.0 m
Right Slope	0.0 m
Length of Enbankment Slope	6.5 m
Left Slope	5.9 m
Right Slope	5.4 m

PK202+150
GH=97.56
PH=99.464

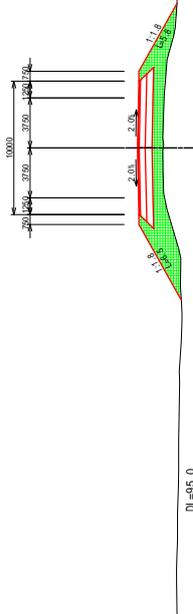

PK 202+100	
Excavation	0.0 m
Shoulder Cut	0.0 m
Enbankment	0.0 m
Left Slope	0.0 m
Right Slope	0.0 m
Length of Excavation Slope	2.15 m
Left Slope	0.0 m
Right Slope	0.0 m
Length of Enbankment Slope	5.9 m
Left Slope	5.9 m
Right Slope	5.4 m

PK202+100
GH=97.74
PH=99.461

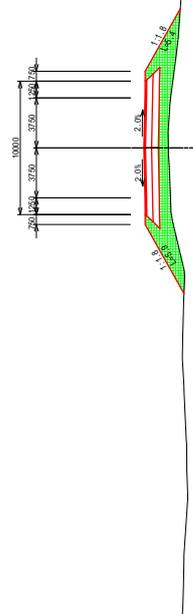

PK 202+50	
Excavation	0.0 m
Shoulder Cut	3.1 m
Enbankment	3.5 m
Left Slope	0.0 m
Right Slope	0.0 m
Length of Excavation Slope	0.0 m
Left Slope	0.0 m
Right Slope	0.0 m
Length of Enbankment Slope	3.7 m
Left Slope	2.8 m
Right Slope	2.8 m

PK202+50
GH=98.72
PH=99.464

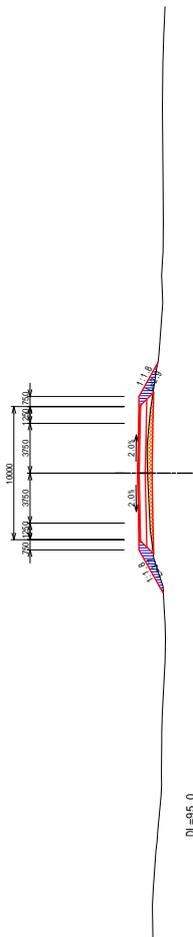

PK 202+0	
Excavation	0.0 m
Shoulder Cut	1.3 m
Enbankment	4.4 m
Left Slope	0.0 m
Right Slope	0.0 m
Length of Excavation Slope	0.0 m
Left Slope	0.0 m
Right Slope	0.0 m
Length of Enbankment Slope	4.0 m
Left Slope	3.4 m
Right Slope	3.4 m

PK202
GH=98.46
PH=99.314

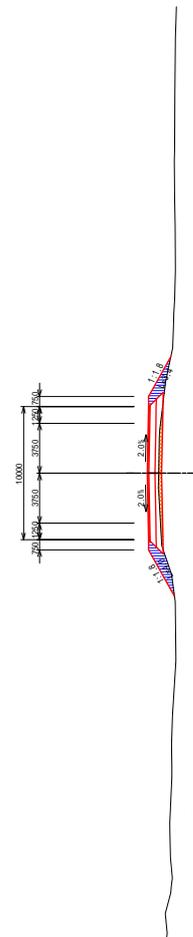

PK 202+350	
Excavation	0.0 m
Spore Side Cut	0.0 m
Embankment	0.0 m
Length of Excavation Slope	0.0 m
Left Side	0.0 m
Right Side	0.0 m
Length of Embankment Slope	5.6 m
Left Side	5.6 m
Right Side	3.8 m

PK202+350
 GH=97.67
 PH=98.864

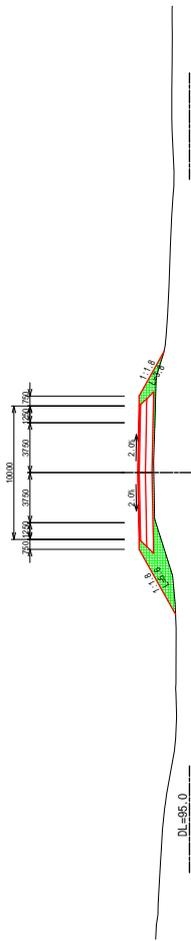

PK 202+300	
Excavation	0.0 m
Spore Side Cut	0.0 m
Embankment	0.0 m
Length of Excavation Slope	1.2 m
Left Side	0.0 m
Right Side	0.0 m
Length of Embankment Slope	5.9 m
Left Side	5.9 m
Right Side	4.5 m

PK202+300
 GH=97.69
 PH=99.014

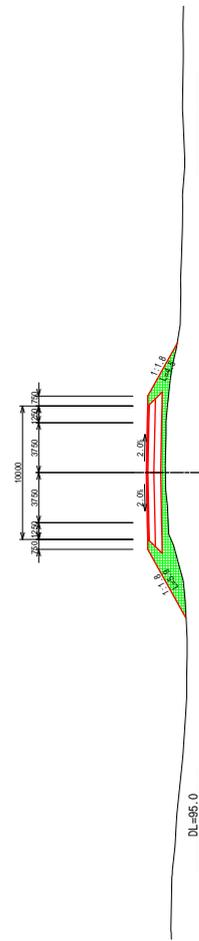

PK 202+250	
Excavation	0.0 m
Spore Side Cut	0.0 m
Embankment	0.0 m
Length of Excavation Slope	10.0 m
Left Side	0.0 m
Right Side	0.0 m
Length of Embankment Slope	6.2 m
Left Side	6.2 m
Right Side	4.0 m

PK202+250
 GH=97.58
 PH=99.164

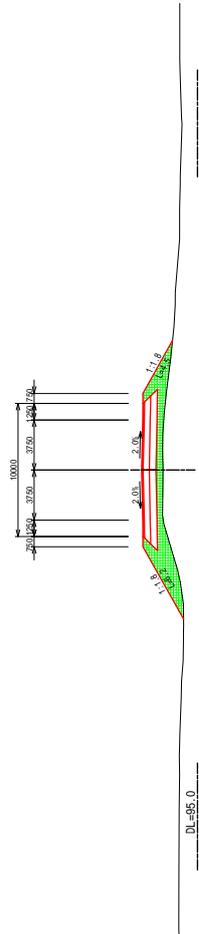

PK 202+200	
Excavation	0.0 m
Spore Side Cut	0.0 m
Embankment	0.0 m
Length of Excavation Slope	19.3 m
Left Side	0.0 m
Right Side	0.0 m
Length of Embankment Slope	6.1 m
Left Side	6.1 m
Right Side	5.7 m

PK202+200
 GH=97.65
 PH=99.314

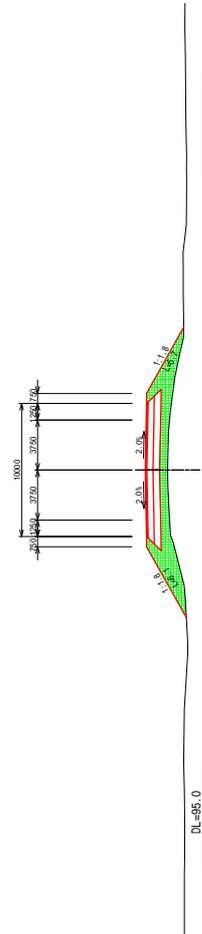

PK	202+450
Excavation	0.0 m
Shoulder Cut	1.0 m
Embankment	0.0 m
Shoulder	1.9 m
Length of Excavation Slope	0.0 m
Left Slope	0.0 m
Length of Embankment Slope	4.5 m
Right Slope	3.1 m

PK202+450
GH=97.73
PH=98.564

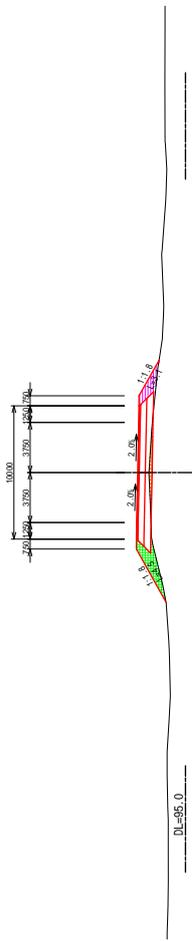

DL=95.0

PK	202+450
Excavation	0.0 m
Shoulder Cut	0.8 m
Embankment	1.6 m
Shoulder	0.0 m
Length of Excavation Slope	0.0 m
Left Slope	0.0 m
Length of Embankment Slope	5.2 m
Right Slope	2.8 m

PK202+450
GH=97.64
PH=98.564

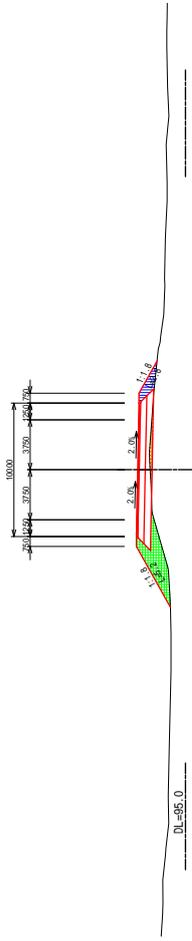

DL=95.0

PK	202+500
Excavation	0.0 m
Shoulder Cut	2.1 m
Embankment	1.2 m
Shoulder	0.0 m
Length of Excavation Slope	0.0 m
Left Slope	0.0 m
Length of Embankment Slope	6.2 m
Right Slope	2.4 m

PK202+500
GH=97.68
PH=98.467

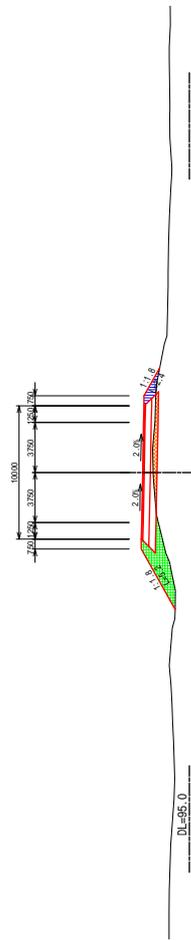

DL=95.0

PK	202+400
Excavation	0.0 m
Shoulder Cut	0.2 m
Embankment	0.0 m
Shoulder	0.0 m
Length of Excavation Slope	0.0 m
Left Slope	0.0 m
Length of Embankment Slope	5.2 m
Right Slope	2.7 m

PK202+400
GH=97.67
PH=98.714

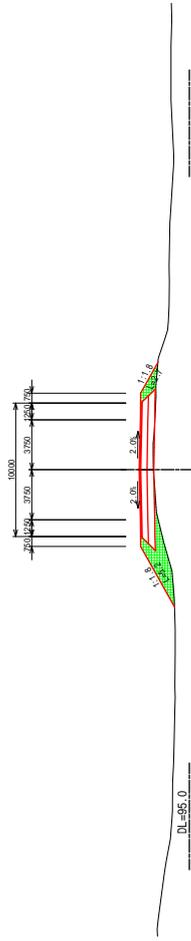

DL=95.0

PK	202+750
Excavation	0.0 m
200234467501	0.0 m
200234467502	0.1 m
Enchantment	0.0 m
200234467503	0.0 m
200234467504	0.0 m
200234467505	0.0 m
200234467506	0.0 m
200234467507	0.0 m
200234467508	0.0 m
Length of Excavation Slope	0.0 m
Left Slope	0.0 m
Right Slope	0.0 m
Length of Enchantment Slope	4.8 m
Left Slope	4.8 m
Right Slope	3.9 m

PK202+750
GH=98.07
PH=99.164

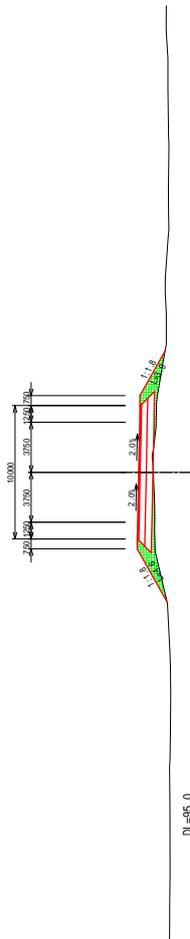

PK	202+700
Excavation	0.0 m
20023446701	0.0 m
20023446702	0.0 m
Enchantment	0.0 m
20023446703	0.0 m
20023446704	0.0 m
20023446705	0.0 m
20023446706	0.0 m
20023446707	0.0 m
20023446708	0.0 m
20023446709	0.0 m
20023446710	0.0 m
Length of Excavation Slope	0.0 m
Left Slope	0.0 m
Right Slope	0.0 m
Length of Enchantment Slope	4.7 m
Left Slope	4.7 m
Right Slope	4.2 m

PK202+700
GH=97.86
PH=99.014

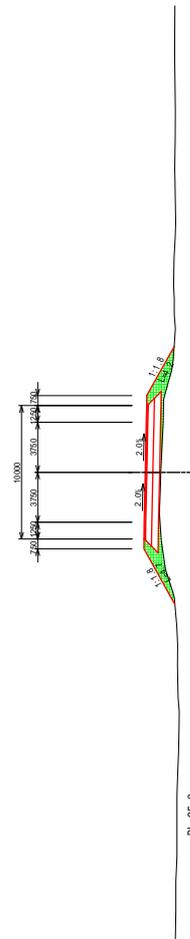

PK	202+650
Excavation	0.0 m
20023446651	0.0 m
20023446652	0.1 m
Enchantment	0.0 m
20023446653	0.0 m
20023446654	0.0 m
20023446655	0.0 m
20023446656	0.0 m
20023446657	0.0 m
20023446658	0.0 m
Length of Excavation Slope	0.0 m
Left Slope	0.0 m
Right Slope	0.0 m
Length of Enchantment Slope	4.8 m
Left Slope	4.8 m
Right Slope	3.2 m

PK202+650
GH=97.83
PH=98.864

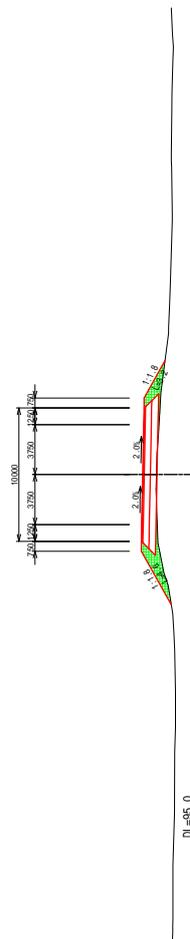

PK	202+600
Excavation	0.0 m
20023446601	0.0 m
20023446602	0.0 m
Enchantment	0.0 m
20023446603	0.0 m
20023446604	0.0 m
20023446605	0.0 m
20023446606	0.0 m
20023446607	0.0 m
20023446608	0.0 m
20023446609	0.0 m
20023446610	0.0 m
Length of Excavation Slope	0.0 m
Left Slope	0.0 m
Right Slope	0.0 m
Length of Enchantment Slope	4.9 m
Left Slope	4.9 m
Right Slope	3.9 m

PK202+600
GH=97.63
PH=98.714

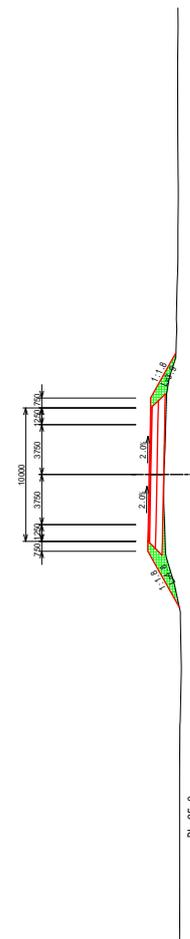

PK	202+850
Excavation	0.0 m
2002346F501	0.2 m
2002346F502	0.3 m
Enchantment	0.0 m
2002346F503	2.1 m
2002346F504	0.4 m
Length of Excavation Slope	0.0 m
Left Slope	0.0 n
Right Slope	0.0 n
Length of Embankment Slope	4.8 m
Left Slope	4.8 n
Right Slope	3.8 m

PK202+850
GH=98.44
PH=99.464

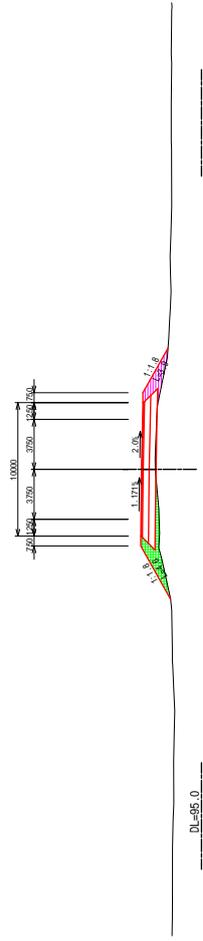

PK	202+950
Excavation	0.0 m
2002346F501	0.3 m
Enchantment	0.0 m
2002346F502	0.4 m
2002346F503	0.4 m
Length of Excavation Slope	0.0 m
Left Slope	0.0 n
Right Slope	0.0 n
Length of Embankment Slope	4.8 m
Left Slope	4.8 n
Right Slope	3.8 m

PK202+950
GH=98.75
PH=99.764

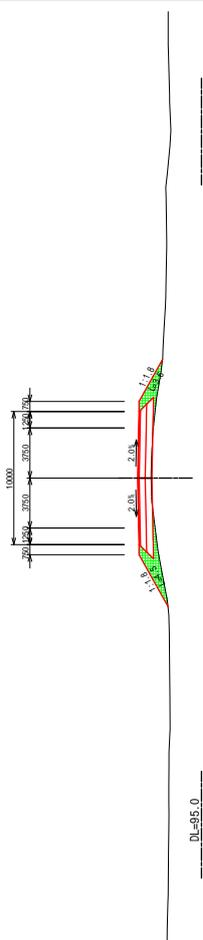

PK	202+800
Excavation	0.0 m
2002346F501	0.1 m
Enchantment	0.0 m
2002346F502	0.0 m
2002346F503	0.0 m
2002346F504	8.0 m
Length of Excavation Slope	0.0 m
Left Slope	0.0 n
Right Slope	0.0 n
Length of Embankment Slope	4.6 m
Left Slope	4.6 n
Right Slope	3.8 m

PK202+800
GH=98.32
PH=99.314

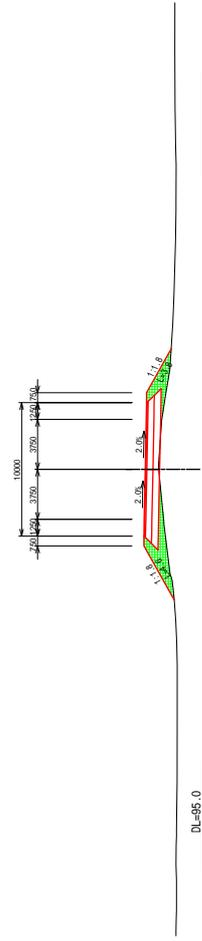

PK	202+900
Excavation	0.0 m
2002346F501	0.0 m
Enchantment	0.0 m
2002346F502	0.0 m
2002346F503	0.0 m
2002346F504	0.0 m
Length of Excavation Slope	0.0 m
Left Slope	0.0 n
Right Slope	0.0 n
Length of Embankment Slope	4.3 m
Left Slope	4.3 n
Right Slope	4.4 m

PK202+900
GH=98.40
PH=99.614

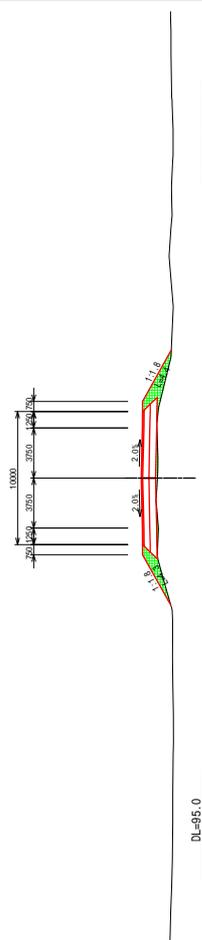

PK 203+150	
Excavation	0.0 m
Open Cut	0.0 m
Embankment	0.0 m
Length of Excavation Slope	0.0 m
Left Side	0.0 m
Right Side	0.0 m
Length of Embankment Slope	4.3 m
Left Side	4.3 m
Right Side	4.7 m

PK203+150
 GH=99.18
 PH=100.364

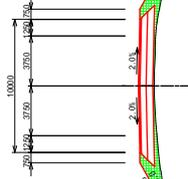

DL=95.0

PK 203+50	
Excavation	0.0 m
Open Cut	0.0 m
Embankment	0.0 m
Length of Excavation Slope	7.0 m
Left Side	0.0 m
Right Side	0.0 m
Length of Embankment Slope	3.9 m
Left Side	3.9 m
Right Side	4.2 m

PK203+50
 GH=98.98
 PH=100.064

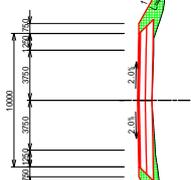

DL=95.0

PK 203+100	
Excavation	0.0 m
Open Cut	0.1 m
Embankment	0.0 m
Length of Excavation Slope	0.0 m
Left Side	0.0 m
Right Side	0.0 m
Length of Embankment Slope	3.9 m
Left Side	3.9 m
Right Side	4.5 m

PK203+100
 GH=99.17
 PH=100.214

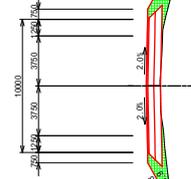

DL=95.0

PK 203+0	
Excavation	0.0 m
Open Cut	0.0 m
Embankment	0.0 m
Length of Excavation Slope	0.0 m
Left Side	0.0 m
Right Side	0.0 m
Length of Embankment Slope	3.3 m
Left Side	3.3 m
Right Side	4.2 m

PK203
 GH=98.78
 PH=99.914

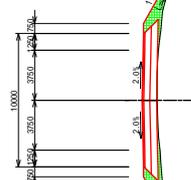

DL=95.0

PK 203+250	
Excavation	0.0 m
Shoulder	0.0 m
Embankment	0.0 m
Shoulder	0.0 m
Excavation	0.0 m
Shoulder	0.0 m
Embankment	11.5 m
Shoulder	11.5 m
Excavation	0.0 m
Shoulder	0.0 m
Embankment	0.0 m
Shoulder	4.8 m
Excavation	4.8 m
Shoulder	4.8 m

PK203+250
GH=99.22
PH=100.664

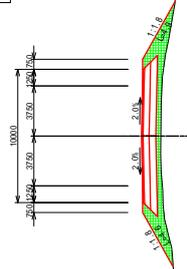

DL=95.0

PK 203+350	
Excavation	0.0 m
Shoulder	0.0 m
Embankment	0.0 m
Shoulder	0.0 m
Excavation	0.0 m
Shoulder	0.0 m
Embankment	11.5 m
Shoulder	11.5 m
Excavation	0.0 m
Shoulder	0.0 m
Embankment	0.0 m
Shoulder	4.7 m
Excavation	4.7 m
Shoulder	4.7 m

PK203+350
GH=99.41
PH=100.964

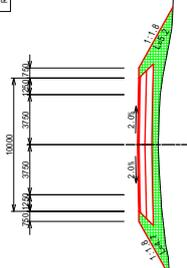

DL=95.0

PK 203+200	
Excavation	0.0 m
Shoulder	0.0 m
Embankment	0.0 m
Shoulder	0.0 m
Excavation	0.0 m
Shoulder	0.0 m
Embankment	11.5 m
Shoulder	11.5 m
Excavation	0.0 m
Shoulder	0.0 m
Embankment	0.0 m
Shoulder	4.2 m
Excavation	4.2 m
Shoulder	4.2 m

PK203+200
GH=99.22
PH=100.514

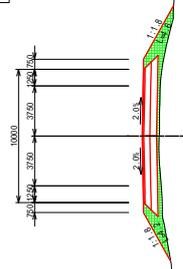

DL=95.0

PK 203+300	
Excavation	0.0 m
Shoulder	0.0 m
Embankment	0.0 m
Shoulder	0.0 m
Excavation	0.0 m
Shoulder	0.0 m
Embankment	11.5 m
Shoulder	11.5 m
Excavation	0.0 m
Shoulder	0.0 m
Embankment	0.0 m
Shoulder	4.6 m
Excavation	4.6 m
Shoulder	4.6 m

PK203+300
GH=99.30
PH=100.814

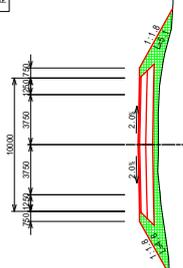

DL=95.0



REPUBLIQUE DE DJIBOUTI
MINISTRE DE L'EQUIPEMENT ET DES TRANSPORTS
DIRECTION DE L'EQUIPEMENT



JAPAN INTERNATIONAL COOPERATION AGENCY
YACHIYO ENGINEERING CO., LTD.

THE PREPARATORY SURVEY FOR
THE PROJECT FOR
UPGRADING OF NATIONAL ROAD ROUTE 1
IN THE REPUBLIC OF DJIBOUTI

SHEET CONTENTS
CROSS SECTION
PK203+200 ~ PK203+350

SCALE S=1:400
DATE NOV 2018
PAGE NO. 49 / 131

PK 203+750	
Excavation	
206.244-207.000	0.0 m
207.000-207.500	0.0 m
Embankment	
207.500-208.000	0.0 m
208.000-208.500	0.0 m
208.500-209.000	30.7 m
Length of Embankment Slope	
Left Slope	0.0 m
Right Slope	0.0 m
Length of Embankment Slope	
Left Slope	6.4 m
Right Slope	6.8 m

PK203+750
GH=99.95
PH=102.164

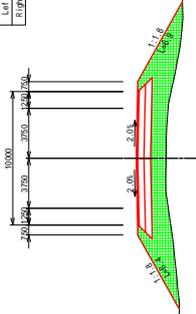

DL=95.0

PK 203+650	
Excavation	
206.244-207.000	0.0 m
207.000-207.500	0.0 m
Embankment	
207.500-208.000	0.0 m
208.000-208.500	30.7 m
Length of Embankment Slope	
Left Slope	0.0 m
Right Slope	0.0 m
Length of Embankment Slope	
Left Slope	6.0 m
Right Slope	6.4 m

PK203+650
GH=99.76
PH=101.864

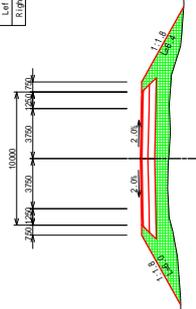

DL=95.0

PK 203+700	
Excavation	
206.244-207.000	0.0 m
207.000-207.500	0.0 m
Embankment	
207.500-208.000	0.0 m
208.000-208.500	26.3 m
Length of Embankment Slope	
Left Slope	0.0 m
Right Slope	0.0 m
Length of Embankment Slope	
Left Slope	6.1 m
Right Slope	6.6 m

PK203+700
GH=99.79
PH=102.014

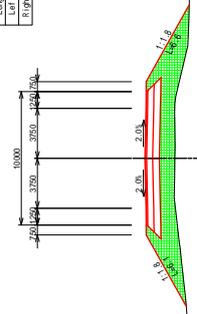

DL=95.0

PK 203+600	
Excavation	
206.244-207.000	0.0 m
207.000-207.500	0.0 m
Embankment	
207.500-208.000	0.0 m
208.000-208.500	22.8 m
Length of Embankment Slope	
Left Slope	0.0 m
Right Slope	0.0 m
Length of Embankment Slope	
Left Slope	5.6 m
Right Slope	6.1 m

PK203+600
GH=99.59
PH=101.714

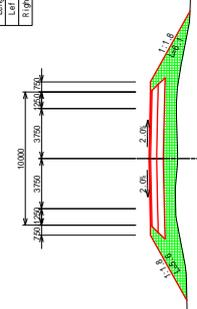

DL=95.0

PK	203+850	
Excavation	0.0	mf
200232644.501	0.0	mf
200232644.501	0.0	mf
Enchantment	0.0	mf
200232644.501	0.0	mf
200232644.501	0.0	mf
200232644.501	0.0	mf
Length of Excavation Slope	5.0	mf
Left Slope	0.0	n
Right Slope	0.0	n
Length of Enchantment Slope	4.7	n
Left Slope	5.0	n
Right Slope	5.0	n

PK203+850
GH=100.07
PH=102.164

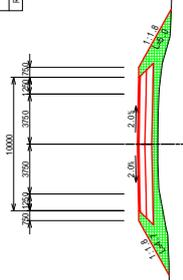

DL=95.0

PK	203+850	
Excavation	0.0	mf
200232644.501	0.0	mf
200232644.501	0.0	mf
Enchantment	0.0	mf
200232644.501	0.0	mf
200232644.501	0.0	mf
200232644.501	0.0	mf
Length of Excavation Slope	5.0	mf
Left Slope	0.0	n
Right Slope	0.0	n
Length of Enchantment Slope	6.1	n
Left Slope	6.4	n
Right Slope	6.4	n

PK203+850
GH=100.07
PH=102.164

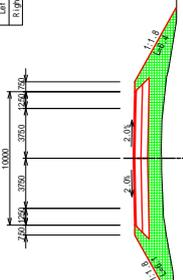

DL=95.0

PK	203+900	
Excavation	0.0	mf
200232644.501	0.0	mf
200232644.501	0.0	mf
Enchantment	0.0	mf
200232644.501	0.0	mf
200232644.501	0.0	mf
200232644.501	0.0	mf
Length of Excavation Slope	5.0	mf
Left Slope	0.0	n
Right Slope	0.0	n
Length of Enchantment Slope	5.2	n
Left Slope	5.7	n
Right Slope	5.7	n

PK203+900
GH=100.25
PH=102.014

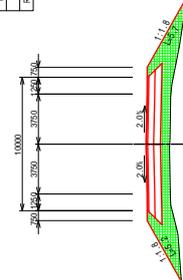

DL=95.0

PK	203+800	
Excavation	0.0	mf
200232644.501	0.0	mf
200232644.501	0.0	mf
Enchantment	0.0	mf
200232644.501	0.0	mf
200232644.501	0.0	mf
200232644.501	0.0	mf
Length of Excavation Slope	5.0	mf
Left Slope	0.0	n
Right Slope	0.0	n
Length of Enchantment Slope	6.5	n
Left Slope	7.1	n
Right Slope	7.1	n

PK203+800
GH=99.82
PH=102.261

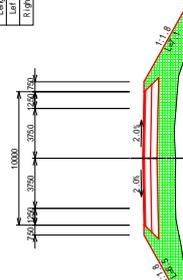

DL=95.0

PK	204+150
Excavation	0.0 m
Spillway	1.3 m
Enbankment	0.0 m
Length of Enbankment Slope	3.2 m
Left Side	0.0 m
Right Side	0.0 m
Length of Enbankment Slope	3.5 m
Left Side	3.5 m
Right Side	4.0 m

PK204+150
GH=100.98
PH=101.864

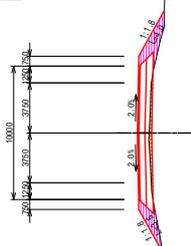

DL=95.0

PK	204+50
Excavation	0.0 m
Spillway	0.7 m
Enbankment	1.9 m
Length of Enbankment Slope	4.0 m
Left Side	0.0 m
Right Side	0.0 m
Length of Enbankment Slope	3.2 m
Left Side	3.2 m
Right Side	3.8 m

PK204+50
GH=100.61
PH=101.617

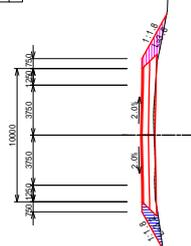

DL=95.0

PK	204+100
Excavation	0.0 m
Spillway	0.0 m
Enbankment	0.0 m
Length of Enbankment Slope	3.3 m
Left Side	0.0 m
Right Side	0.0 m
Length of Enbankment Slope	3.6 m
Left Side	3.6 m
Right Side	3.7 m

PK204+100
GH=100.34
PH=101.714

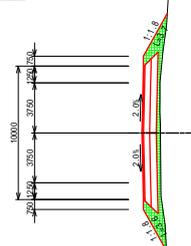

DL=95.0

PK	204+0
Excavation	0.0 m
Spillway	0.0 m
Enbankment	0.0 m
Length of Enbankment Slope	4.0 m
Left Side	0.0 m
Right Side	0.0 m
Length of Enbankment Slope	3.8 m
Left Side	3.8 m
Right Side	4.3 m

PK204
GH=100.55
PH=101.714

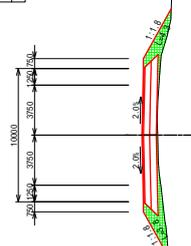

DL=95.0

PK	204+250
Excavation	0.0 m
Shoulder Slope	0.0 m
Enchantment	0.0 m
Shoulder Slope	0.0 m
Shoulder Slope	0.0 m
Shoulder Slope	0.0 m
Length of Enchantment Slope	2.0 m
Left Side	0.0 m
Right Side	0.0 m
Length of Enchantment Slope	4.3 m
Left Side	4.3 m
Right Side	4.3 m

PK204+250
 GH=101.08
 PH=102.164

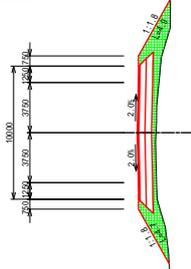

DL=95.0

PK	204+350
Excavation	0.0 m
Shoulder Slope	0.0 m
Enchantment	0.0 m
Shoulder Slope	0.0 m
Shoulder Slope	0.0 m
Shoulder Slope	0.0 m
Length of Enchantment Slope	2.0 m
Left Side	0.0 m
Right Side	0.0 m
Length of Enchantment Slope	4.7 m
Left Side	4.7 m
Right Side	4.7 m

PK204+350
 GH=101.08
 PH=102.464

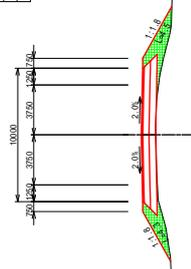

DL=95.0

PK	204+200
Excavation	0.0 m
Shoulder Slope	1.0 m
Enchantment	0.0 m
Shoulder Slope	5.8 m
Shoulder Slope	0.0 m
Shoulder Slope	0.0 m
Length of Enchantment Slope	2.0 m
Left Side	0.0 m
Right Side	0.0 m
Length of Enchantment Slope	3.8 m
Left Side	3.8 m
Right Side	4.1 m

PK204+200
 GH=101.12
 PH=102.014

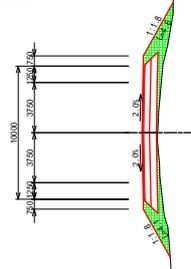

DL=95.0

PK	204+300
Excavation	0.0 m
Shoulder Slope	0.0 m
Enchantment	0.0 m
Shoulder Slope	2.8 m
Shoulder Slope	0.0 m
Shoulder Slope	0.0 m
Length of Enchantment Slope	2.0 m
Left Side	0.0 m
Right Side	0.0 m
Length of Enchantment Slope	4.1 m
Left Side	4.1 m
Right Side	4.6 m

PK204+300
 GH=101.13
 PH=102.314

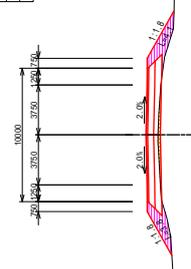

DL=95.0

PK 204+550	
Excavation	0.0 m ³
200% Slope Soil	0.0 m ³
300% Slope Soil	0.0 m ³
Embankment	0.0 m ³
2.5% Slope	0.0 m ³
5% Slope	26.2 m ³
Length of Embankment Slope	0.0 m
Left Side	0.0 m
Right Side	0.0 m
Length of Embankment Slope	0.0 m
Left Side	0.2 m
Right Side	0.9 m

PK204+550
 GH=101.07
 PH=103.064

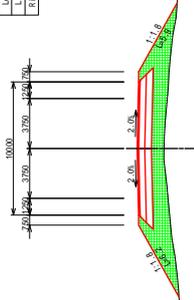

DL=95.0

PK 204+450	
Excavation	0.0 m ³
200% Slope Soil	0.0 m ³
300% Slope Soil	0.0 m ³
Embankment	0.0 m ³
2.5% Slope	0.0 m ³
5% Slope	17.0 m ³
Length of Embankment Slope	0.0 m
Left Side	0.0 m
Right Side	0.0 m
Length of Embankment Slope	5.1 m
Left Side	0.0 m
Right Side	0.0 m

PK204+450
 GH=101.11
 PH=102.764

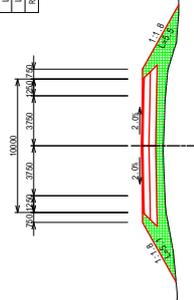

DL=95.0

PK 204+500	
Excavation	0.0 m ³
200% Slope Soil	0.0 m ³
300% Slope Soil	0.0 m ³
Embankment	0.0 m ³
2.5% Slope	0.0 m ³
5% Slope	26.2 m ³
Length of Embankment Slope	0.0 m
Left Side	0.0 m
Right Side	0.0 m
Length of Embankment Slope	0.0 m
Left Side	0.2 m
Right Side	0.9 m

PK204+500
 GH=101.09
 PH=102.914

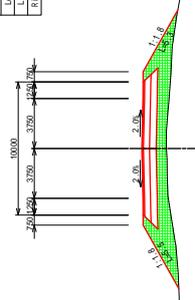

DL=95.0

PK 204+400	
Excavation	0.0 m ³
200% Slope Soil	0.0 m ³
300% Slope Soil	0.0 m ³
Embankment	0.0 m ³
2.5% Slope	0.0 m ³
5% Slope	16.8 m ³
Length of Embankment Slope	0.0 m
Left Side	0.0 m
Right Side	0.0 m
Length of Embankment Slope	4.8 m
Left Side	0.0 m
Right Side	5.1 m

PK204+400
 GH=101.11
 PH=102.614

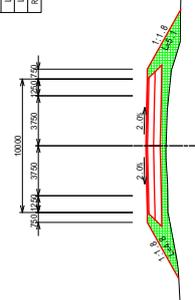

DL=95.0

PK	204+750
Excavation	0.0 m
Shoulder Slope	0.0 m
Enchantment	0.0 m
Shoulder Slope	0.0 m
Shoulder Slope	40.2 m
Length of Embankment Slope	0.0 m
Left Slope	0.0 m
Right Slope	0.0 m
Length of Embankment Slope	7.2 m
Left Slope	7.2 m
Right Slope	7.3 m

PK204+750
 GH=100.87
 PH=103.664

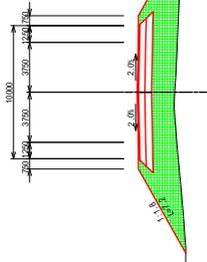

DL=95.0

PK	204+650
Excavation	0.0 m
Shoulder Slope	0.0 m
Enchantment	0.0 m
Shoulder Slope	0.0 m
Shoulder Slope	30.0 m
Length of Embankment Slope	0.0 m
Left Slope	0.0 m
Right Slope	0.0 m
Length of Embankment Slope	6.5 m
Left Slope	6.5 m
Right Slope	6.5 m

PK204+650
 GH=100.91
 PH=103.364

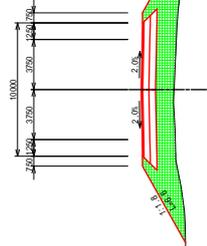

DL=95.0

PK	204+700
Excavation	0.0 m
Shoulder Slope	0.0 m
Enchantment	0.0 m
Shoulder Slope	0.0 m
Shoulder Slope	35.0 m
Length of Embankment Slope	0.0 m
Left Slope	0.0 m
Right Slope	0.0 m
Length of Embankment Slope	6.9 m
Left Slope	6.9 m
Right Slope	7.4 m

PK204+700
 GH=100.86
 PH=103.514

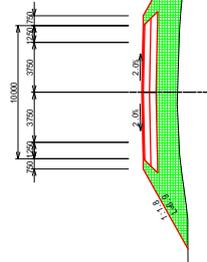

DL=95.0

PK	204+600
Excavation	0.0 m
Shoulder Slope	0.0 m
Enchantment	0.0 m
Shoulder Slope	0.0 m
Shoulder Slope	28.0 m
Length of Embankment Slope	0.0 m
Left Slope	0.0 m
Right Slope	0.0 m
Length of Embankment Slope	6.3 m
Left Slope	6.3 m
Right Slope	6.5 m

PK204+600
 GH=100.96
 PH=103.214

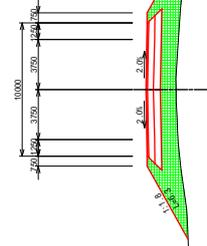

DL=95.0

PK	204+850
Excavation	0.0 m
Shoulder	0.0 m
Enchantment	0.0 m
Length of Excavation Slope	0.0 m
Left Slope	0.0 n
Right Slope	0.0 n
Length of Embankment Slope	7.7 m
Left Slope	8.2 n
Right Slope	8.8 n

PK204+850
Gh=100.71
Ph=103.911

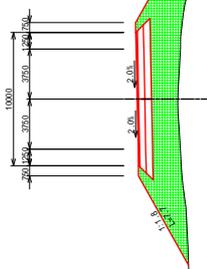

DL=95.0

PK	204+950
Excavation	0.0 m
Shoulder	0.0 m
Enchantment	0.0 m
Length of Excavation Slope	0.0 m
Left Slope	0.0 n
Right Slope	0.0 n
Length of Embankment Slope	7.7 m
Left Slope	8.2 n
Right Slope	8.8 n

PK204+950
Gh=100.63
Ph=103.664

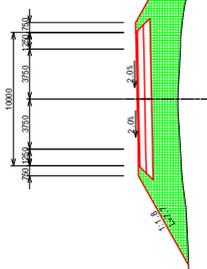

DL=95.0

PK	204+800
Excavation	0.0 m
Shoulder	0.0 m
Enchantment	0.0 m
Length of Excavation Slope	0.0 m
Left Slope	0.0 n
Right Slope	0.0 n
Length of Embankment Slope	7.8 m
Left Slope	8.5 n
Right Slope	8.5 n

PK204+800
Gh=100.72
Ph=103.814

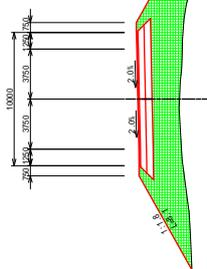

DL=95.0

PK	204+900
Excavation	0.0 m
Shoulder	0.0 m
Enchantment	0.0 m
Length of Excavation Slope	0.0 m
Left Slope	0.0 n
Right Slope	0.0 n
Length of Embankment Slope	9.1 m
Left Slope	9.1 n
Right Slope	9.8 n

PK204+900
Gh=100.71
Ph=103.814

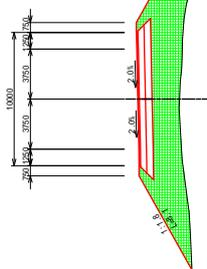

DL=95.0



REPUBLIQUE DE DJIBOUTI
MINISTRE DE L'EQUIPEMENT ET DES TRANSPORTS
DIRECTION DE L'EQUIPEMENT

JAPAN INTERNATIONAL COOPERATION AGENCY
YACHIYO ENGINEERING CO., LTD.

THE PREPARATORY SURVEY FOR
THE PROJECT FOR
UPGRADING OF NATIONAL ROAD ROUTE 1
IN THE REPUBLIC OF DJIBOUTI

SHEET CONTENTS
CROSS SECTION
PK204+800 ~ PK204+950

SCALE S=1:400
DATE NOV 2018
PAGE NO. 57 / 131

PK	205+150
Excavation	0.0 m
Shoulder	0.0 m
Enchantment	0.0 m
Length of Excavation Slope	4.2 m
Left Slope	0.0 n
Right Slope	0.0 n
Left Side	7.1 m
Right Side	8.4 m

PK205+150
 GH=100.45
 PH=103.064

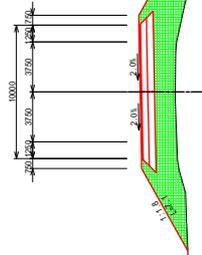

DL=95.0

PK	205+50
Excavation	0.0 m
Shoulder	0.0 m
Enchantment	0.0 m
Length of Excavation Slope	4.2 m
Left Slope	0.0 n
Right Slope	0.0 n
Left Side	7.8 m
Right Side	8.8 m

PK205+50
 GH=100.57
 PH=103.384

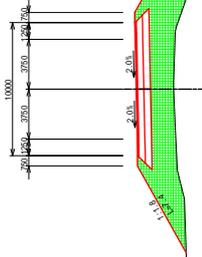

DL=95.0

PK	205+100
Excavation	0.0 m
Shoulder	0.0 m
Enchantment	0.0 m
Length of Excavation Slope	4.8 m
Left Slope	0.0 n
Right Slope	0.0 n
Left Side	7.0 m
Right Side	8.6 m

PK205+100
 GH=100.51
 PH=103.214

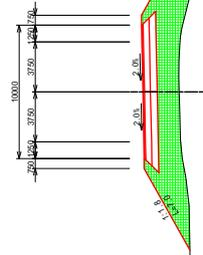

DL=95.0

PK	205+0
Excavation	0.0 m
Shoulder	0.0 m
Enchantment	0.0 m
Length of Excavation Slope	4.8 m
Left Slope	0.0 n
Right Slope	0.0 n
Left Side	7.0 m
Right Side	8.2 m

PK205
 GH=100.61
 PH=103.514

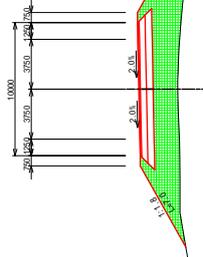

DL=95.0

PK	205+250
Excavation	0.0 m
Shoulder	0.0 m
Enbankment	0.0 m
Length of Excavation Slope	0.0 m
Length of Enbankment Slope	0.0 m
Left Side	0.0 m
Right Side	0.0 m

PK205+250
 GH=100.39
 PH=102.764

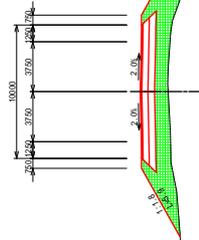

DL=95.0

PK	205+300
Excavation	0.0 m
Shoulder	0.0 m
Enbankment	0.0 m
Length of Excavation Slope	0.0 m
Length of Enbankment Slope	0.0 m
Left Side	0.0 m
Right Side	0.0 m

PK	205+300
Excavation	0.0 m
Shoulder	0.0 m
Enbankment	0.0 m
Length of Excavation Slope	0.0 m
Length of Enbankment Slope	0.0 m
Left Side	0.0 m
Right Side	0.0 m

PK205+300
 GH=100.34
 PH=102.614

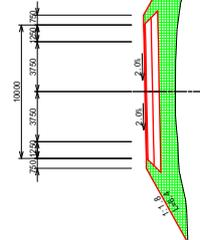

DL=95.0

PK	205+200
Excavation	0.0 m
Shoulder	0.0 m
Enbankment	0.0 m
Length of Excavation Slope	0.0 m
Length of Enbankment Slope	0.0 m
Left Side	0.0 m
Right Side	0.0 m

PK205+200
 GH=100.43
 PH=102.914

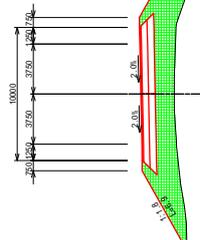

DL=95.0

PK	205+550
Excavation	0.0 m
Shoulder	0.0 m
Embankment	0.0 m
Length of Embankment Slope	0.0 m
Left Slope	0.0 n
Right Slope	0.0 n
Length of Embankment Slope	4.3 m
Left Slope	5.4 m
Right Slope	5.4 m

PK205+550
 GH=100.42
 PH=101.864

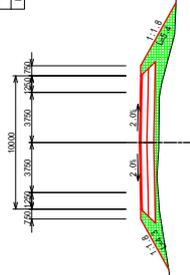

DL=95.0

PK	205+450
Excavation	0.0 m
Shoulder	0.0 m
Embankment	0.0 m
Length of Embankment Slope	20.0 m
Left Slope	0.0 n
Right Slope	0.0 n
Length of Embankment Slope	5.4 m
Left Slope	6.2 m
Right Slope	6.2 m

PK205+450
 GH=100.50
 PH=102.164

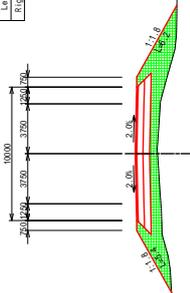

DL=95.0

PK	205+500
Excavation	0.0 m
Shoulder	0.0 m
Embankment	0.0 m
Length of Embankment Slope	0.0 m
Left Slope	0.0 n
Right Slope	0.0 n
Length of Embankment Slope	4.9 m
Left Slope	5.9 m
Right Slope	5.9 m

PK205+500
 GH=100.42
 PH=102.014

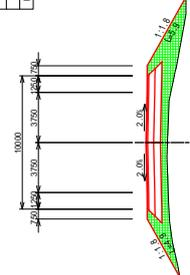

DL=95.0

PK	205+400
Excavation	0.0 m
Shoulder	0.0 m
Embankment	0.0 m
Length of Embankment Slope	20.0 m
Left Slope	0.0 n
Right Slope	0.0 n
Length of Embankment Slope	5.5 m
Left Slope	6.5 m
Right Slope	6.5 m

PK205+400
 GH=100.38
 PH=102.314

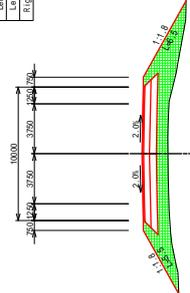

DL=95.0

PK	205+750
Excavation	0.0 m
Subgrade	0.0 m
Enchantment	0.0 m
Length of Excavation Slope	0.0 m
Left Slope	0.0 m
Right Slope	0.0 m
Length of Enchantment Slope	3.4 m
Left Slope	3.4 m
Right Slope	4.9 m

PK205+750
GH=101.00
PH=102.164

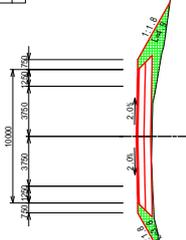

DL=95.0

PK	205+650
Excavation	0.0 m
Subgrade	0.0 m
Enchantment	0.0 m
Length of Excavation Slope	0.0 m
Left Slope	0.0 m
Right Slope	0.0 m
Length of Enchantment Slope	3.4 m
Left Slope	3.4 m
Right Slope	4.9 m

PK205+650
GH=100.73
PH=101.884

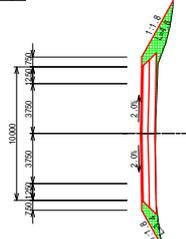

DL=95.0

PK	205+700
Excavation	0.0 m
Subgrade	0.0 m
Enchantment	0.0 m
Length of Excavation Slope	0.0 m
Left Slope	0.0 m
Right Slope	0.0 m
Length of Enchantment Slope	3.4 m
Left Slope	3.4 m
Right Slope	4.9 m

PK205+700
GH=100.84
PH=102.014

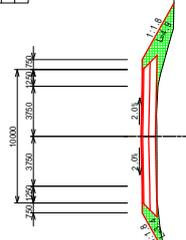

DL=95.0

PK	205+600
Excavation	0.0 m
Subgrade	0.0 m
Enchantment	0.0 m
Length of Excavation Slope	0.0 m
Left Slope	0.0 m
Right Slope	0.0 m
Length of Enchantment Slope	3.7 m
Left Slope	3.7 m
Right Slope	4.9 m

PK205+600
GH=100.62
PH=101.787

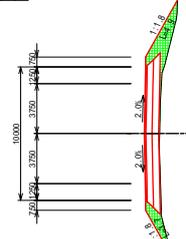

DL=95.0

PK 205+850	
Excavation	0.0 m
Shoulder	2.5 m
Enbankment	4.1 m
Length of Excavation Slope	0.0 m
Left Slope	0.0 n
Right Slope	0.0 n
Left Stop	2.9 m
Right Stop	4.2 m

PK205+850
 Gh=101.64
 Ph=102.464

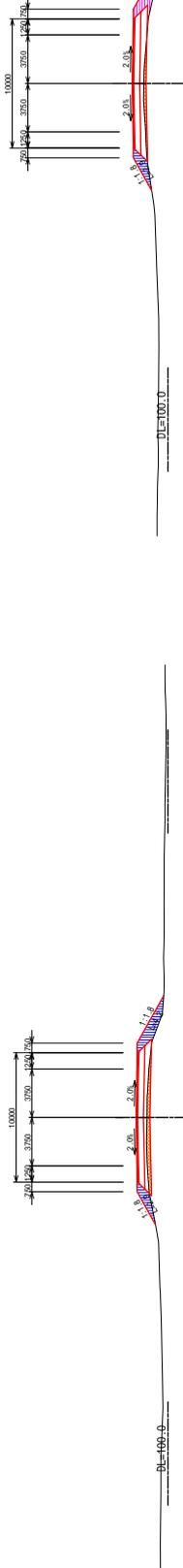

PK 205+850	
Excavation	0.0 m
Shoulder	2.5 m
Enbankment	4.1 m
Length of Excavation Slope	0.0 m
Left Slope	0.0 n
Right Slope	0.0 n
Left Stop	2.9 m
Right Stop	4.2 m

PK205+850
 Gh=101.64
 Ph=102.464

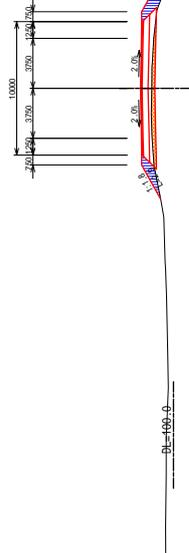

PK 205+900	
Excavation	0.0 m
Shoulder	1.6 m
Enbankment	1.7 m
Length of Excavation Slope	0.0 m
Left Slope	0.0 n
Right Slope	0.0 n
Left Stop	3.3 m
Right Stop	4.2 m

PK205+900
 Gh=101.78
 Ph=102.614

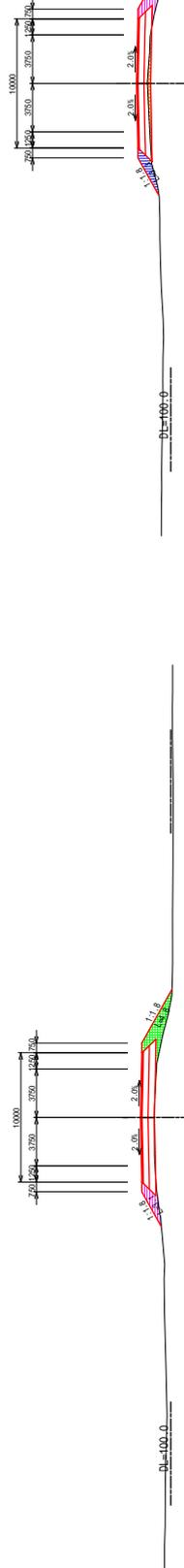

PK 205+800	
Excavation	0.0 m
Shoulder	0.2 m
Enbankment	0.0 m
Length of Excavation Slope	1.9 m
Left Slope	0.0 n
Right Slope	0.0 n
Left Stop	3.1 m
Right Stop	4.3 m

PK205+800
 Gh=101.27
 Ph=102.314

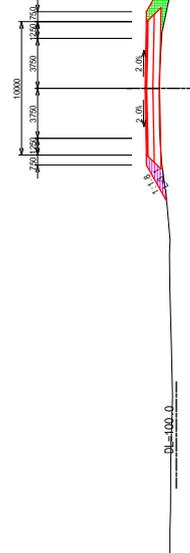

PK 206+150	
Excavation	0.0 m
Open Cut	0.0 m
Enbankment	0.0 m
Length of Excavation Slope	0.0 m
Left Side	0.0 m
Right Side	0.0 m
Length of Enbankment Slope	4.2 m
Left Side	2.1 m
Right Side	2.1 m

PK206+150
GH=101.70
PH=103.364

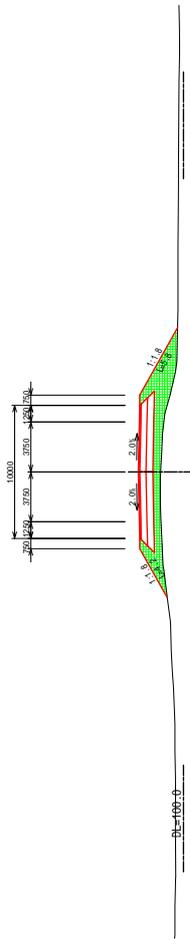

PK 206+50	
Excavation	0.0 m
Open Cut	0.9 m
Enbankment	1.7 m
Length of Excavation Slope	0.0 m
Left Side	0.0 m
Right Side	0.0 m
Length of Enbankment Slope	3.2 m
Left Side	1.6 m
Right Side	1.6 m

PK206+50
GH=102.12
PH=103.064

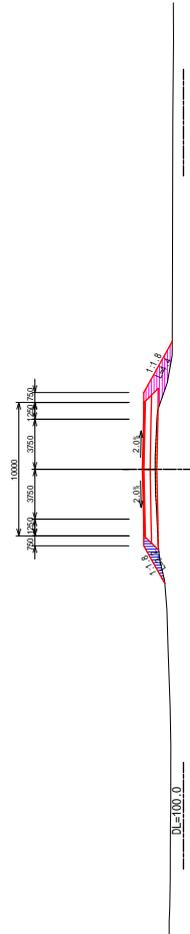

PK 206+100	
Excavation	0.0 m
Open Cut	1.1 m
Enbankment	1.7 m
Length of Excavation Slope	0.0 m
Left Side	0.0 m
Right Side	0.0 m
Length of Enbankment Slope	3.1 m
Left Side	1.55 m
Right Side	1.55 m

PK206+100
GH=102.28
PH=103.214

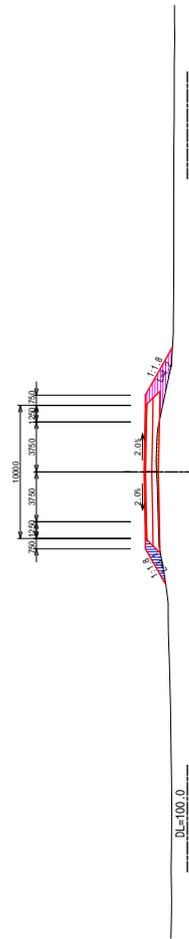

PK 206+0	
Excavation	0.0 m
Open Cut	1.0 m
Enbankment	1.7 m
Length of Excavation Slope	0.0 m
Left Side	0.0 m
Right Side	0.0 m
Length of Enbankment Slope	3.0 m
Left Side	1.5 m
Right Side	1.5 m

PK206
GH=101.98
PH=102.914

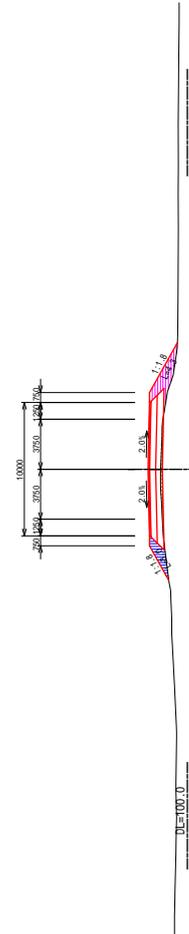

PK 206+350	
Excavation	
Span 206+350	0.0 m
Span 206+350	0.0 m
Enbankment	0.0 m
Span 206+350	0.0 m
Span 206+350	0.0 m
Span 206+350	27.2 m
Span 206+350	27.2 m
Length of Excavation Slope	0.0 m
Left Side	0.0 m
Right Side	0.0 m
Length of Enbankment Slope	5.9 m
Left Side	5.9 m
Right Side	6.8 m

PK206+350
 GH=101.36
 PH=103.664

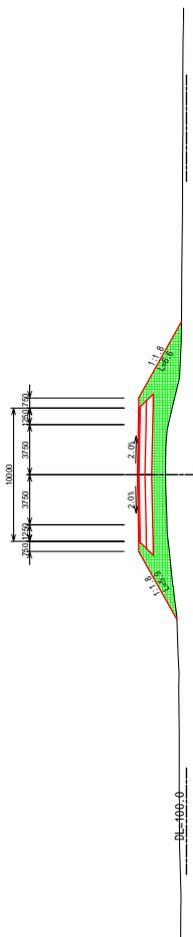

PK 206+300	
Excavation	
Span 206+300	0.0 m
Span 206+300	0.0 m
Enbankment	0.0 m
Span 206+300	0.0 m
Span 206+300	0.0 m
Span 206+300	27.2 m
Span 206+300	27.2 m
Length of Excavation Slope	0.0 m
Left Side	0.0 m
Right Side	0.0 m
Length of Enbankment Slope	6.0 m
Left Side	6.0 m
Right Side	6.8 m

PK206+300
 GH=101.32
 PH=103.761

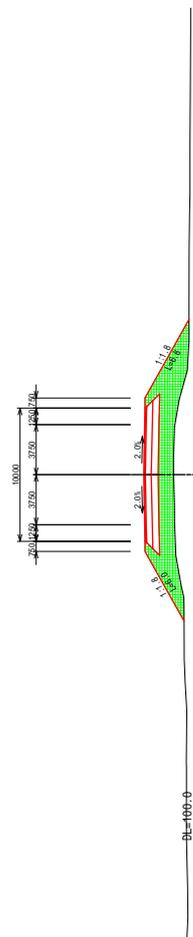

PK 206+250	
Excavation	
Span 206+250	0.0 m
Span 206+250	0.0 m
Enbankment	0.0 m
Span 206+250	0.0 m
Span 206+250	0.0 m
Span 206+250	26.0 m
Span 206+250	26.0 m
Length of Excavation Slope	0.0 m
Left Side	0.0 m
Right Side	0.0 m
Length of Enbankment Slope	5.3 m
Left Side	5.3 m
Right Side	6.0 m

PK206+250
 GH=101.65
 PH=103.664

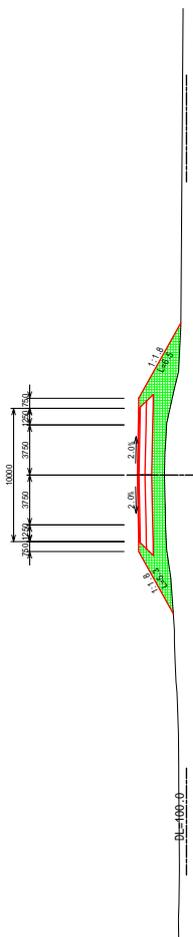

PK 206+200	
Excavation	
Span 206+200	0.0 m
Span 206+200	0.0 m
Enbankment	0.0 m
Span 206+200	0.0 m
Span 206+200	0.0 m
Span 206+200	27.2 m
Span 206+200	27.2 m
Length of Excavation Slope	0.0 m
Left Side	0.0 m
Right Side	0.0 m
Length of Enbankment Slope	5.2 m
Left Side	5.2 m
Right Side	6.2 m

PK206+200
 GH=101.69
 PH=103.514

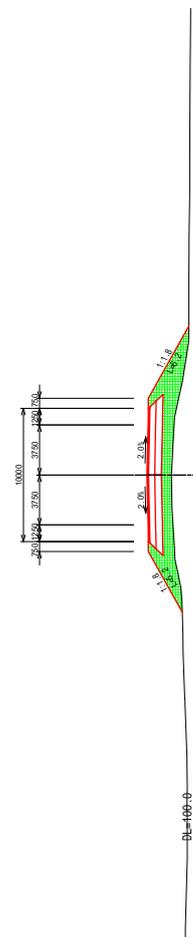

PK 206+750	
Elevation (m)	
206+750.00	0.0
206+750.00	0.3
206+750.00	0.0
206+750.00	0.0
206+750.00	3.3
206+750.00	3.3
206+750.00	0.0
206+750.00	0.0
206+750.00	3.2
206+750.00	4.4

PK206+750
 GH=101.43
 PH=102.464

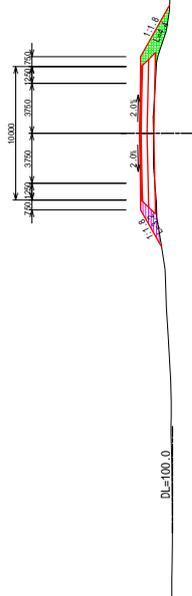

PK 206+700	
Elevation (m)	
206+700.00	0.0
206+700.00	0.0
206+700.00	0.0
206+700.00	0.0
206+700.00	0.2
206+700.00	0.0
206+700.00	0.0
206+700.00	0.0
206+700.00	4.2
206+700.00	4.3

PK206+700
 GH=101.35
 PH=102.614

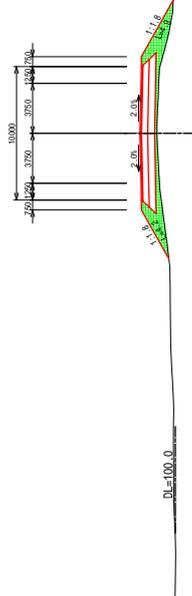

PK 206+650	
Elevation (m)	
206+650.00	0.0
206+650.00	0.0
206+650.00	0.0
206+650.00	0.0
206+650.00	3.2
206+650.00	3.2
206+650.00	0.0
206+650.00	0.0
206+650.00	4.4
206+650.00	5.4

PK206+650
 GH=101.18
 PH=102.764

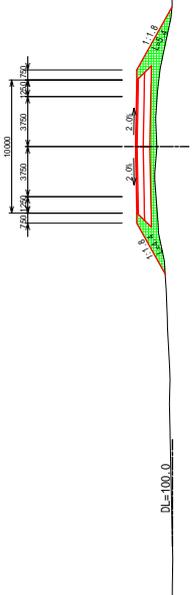

PK 206+600	
Elevation (m)	
206+600.00	0.0
206+600.00	0.0
206+600.00	0.0
206+600.00	0.0
206+600.00	4.0
206+600.00	0.0
206+600.00	0.0
206+600.00	0.0
206+600.00	4.8
206+600.00	5.4

PK206+600
 GH=101.26
 PH=102.914

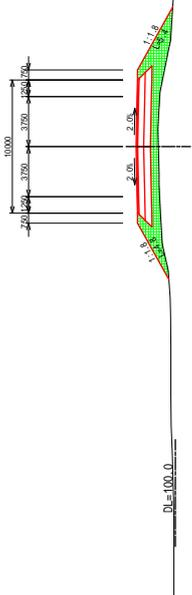

PK 206+850	
Excavation	0.0 m
206+844.500	3.5 m
206+849.500	3.4 m
Enchantment	0.0 m
206+854.500	0.0 m
206+859.500	0.0 m
Length of Excavation Slope	0.0 m
Left Slope	0.0 n
Right Slope	0.0 n
Length of Enchantment Slope	2.2 m
Left Slope	2.2 n
Right Slope	3.9 n

PK206+850
GH=101.52
PH=102.217

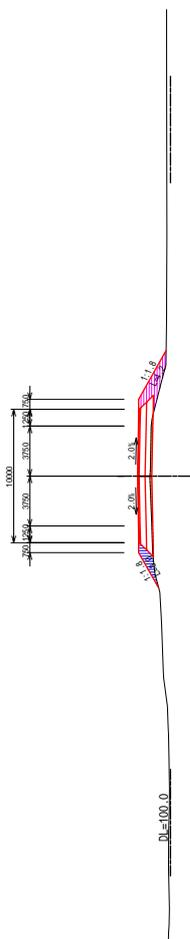

DL=100.0

PK 206+850	
Excavation	0.0 m
206+844.500	3.5 m
206+849.500	3.4 m
Enchantment	0.0 m
206+854.500	0.0 m
206+859.500	0.0 m
Length of Excavation Slope	0.0 m
Left Slope	0.0 n
Right Slope	0.0 n
Length of Enchantment Slope	2.2 m
Left Slope	2.2 n
Right Slope	3.9 n

PK206+850
GH=101.52
PH=102.217

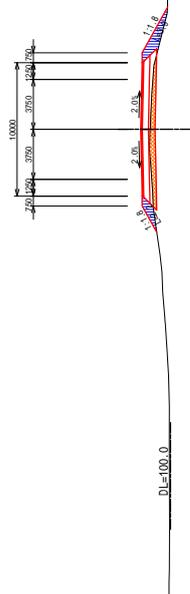

DL=100.0

PK 206+900	
Excavation	0.0 m
206+894.500	1.8 m
Enchantment	0.0 m
206+904.500	1.2 m
206+909.500	2.7 m
Length of Excavation Slope	0.0 m
Left Slope	0.0 n
Right Slope	0.0 n
Length of Enchantment Slope	2.4 m
Left Slope	2.4 n
Right Slope	3.8 n

PK206+900
GH=101.41
PH=102.314

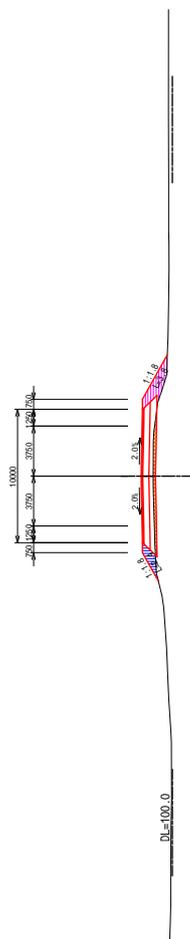

DL=100.0

PK 206+800	
Excavation	0.0 m
206+794.500	1.5 m
Enchantment	0.0 m
206+804.500	1.3 m
206+809.500	3.0 m
Length of Excavation Slope	0.0 m
Left Slope	0.0 n
Right Slope	0.0 n
Length of Enchantment Slope	2.7 m
Left Slope	2.7 n
Right Slope	4.0 n

PK206+800
GH=101.40
PH=102.314

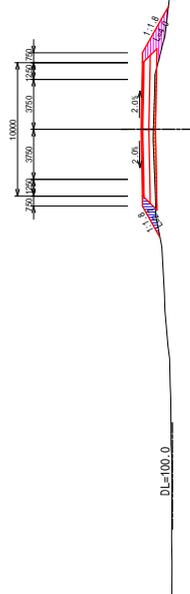

DL=100.0

PK 207+150	
Excavation	0.0 m
Spore Side	0.0 m
Enlargement	0.0 m
Length of Enlargement Slope	10.0 m
Left Side	0.0 m
Right Side	0.0 m
Length of Enlargement Slope	4.0 m
Left Side	3.2 m
Right Side	0.8 m

PK207+150
GH=101.50
PH=103.064

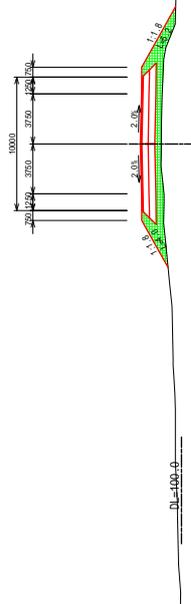

PK 207+50	
Excavation	0.0 m
Spore Side	0.0 m
Enlargement	0.0 m
Length of Enlargement Slope	9.0 m
Left Side	0.0 m
Right Side	0.0 m
Length of Enlargement Slope	3.7 m
Left Side	4.7 m
Right Side	0.0 m

PK207+50
GH=101.53
PH=102.764

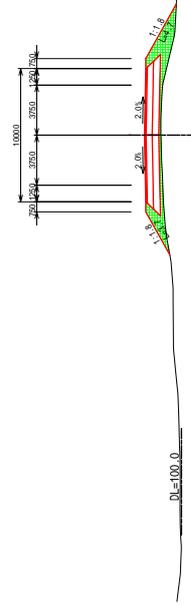

PK 207+100	
Excavation	0.0 m
Spore Side	0.0 m
Enlargement	0.0 m
Length of Enlargement Slope	10.3 m
Left Side	0.0 m
Right Side	0.0 m
Length of Enlargement Slope	3.8 m
Left Side	4.7 m
Right Side	0.0 m

PK207+100
GH=101.50
PH=102.914

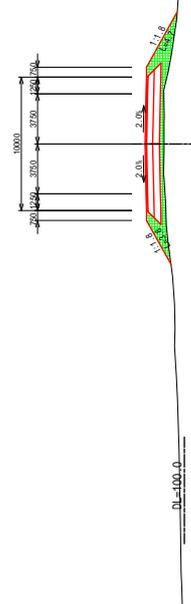

PK 207+0	
Excavation	0.0 m
Spore Side	0.0 m
Enlargement	0.0 m
Length of Enlargement Slope	3.0 m
Left Side	0.0 m
Right Side	0.0 m
Length of Enlargement Slope	2.9 m
Left Side	4.3 m
Right Side	0.0 m

PK207
GH=101.50
PH=102.614

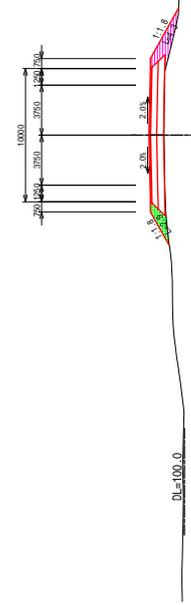

PK 207+450	
Excavation	0.0 m ³
200% Sand Gravel	0.0 m ³
Embankment	0.0 m ³
2.5% Gravel	0.0 m ³
3.0% Gravel	0.0 m ³
Length of Embankment Slope	0.0 m
Left Side	0.0 m
Right Side	0.0 m
Length of Embankment Slope	0.0 m
Left Side	3.5 m
Right Side	4.8 m

PK207+450
GH=101.43
PH=102.764

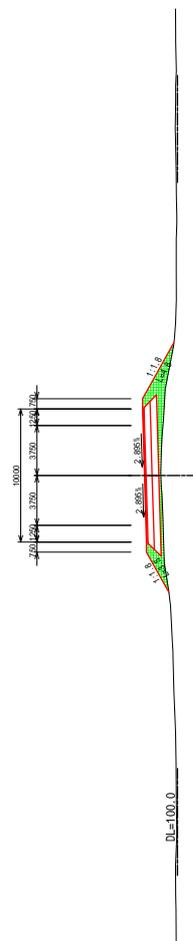

PK 207+450	
Excavation	0.0 m ³
200% Sand Gravel	0.0 m ³
Embankment	0.0 m ³
2.5% Gravel	0.0 m ³
3.0% Gravel	0.0 m ³
Length of Embankment Slope	0.0 m
Left Side	0.0 m
Right Side	0.0 m
Length of Embankment Slope	0.0 m
Left Side	4.0 m
Right Side	4.9 m

PK207+450
GH=101.43
PH=102.764

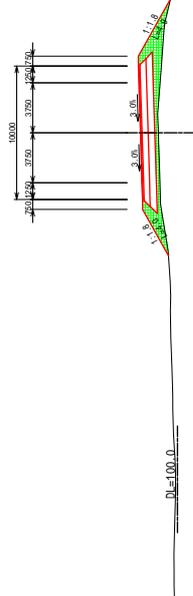

PK 207+500	
Excavation	0.0 m ³
200% Sand Gravel	0.0 m ³
Embankment	0.0 m ³
2.5% Gravel	0.0 m ³
3.0% Gravel	0.0 m ³
Length of Embankment Slope	0.0 m
Left Side	0.0 m
Right Side	0.0 m
Length of Embankment Slope	0.0 m
Left Side	3.3 m
Right Side	4.5 m

PK207+500
GH=101.33
PH=102.614

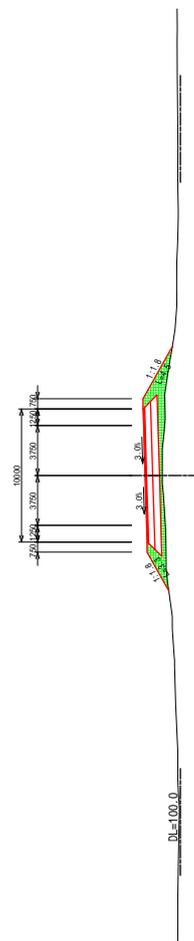

PK 207+400	
Excavation	0.0 m ³
200% Sand Gravel	0.0 m ³
Embankment	0.0 m ³
2.5% Gravel	0.0 m ³
3.0% Gravel	0.0 m ³
Length of Embankment Slope	0.0 m
Left Side	0.0 m
Right Side	0.0 m
Length of Embankment Slope	0.0 m
Left Side	3.9 m
Right Side	4.9 m

PK207+400
GH=101.52
PH=102.914

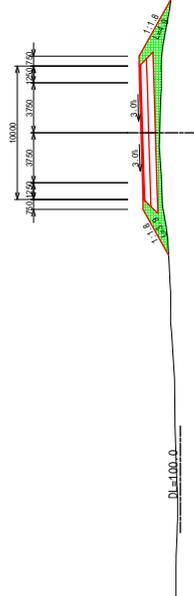

PK 207+750	
Excavation	0.0 m
200g Standard Soil	0.0 m
300g Standard Soil	0.0 m
Enbankment	0.0 m
Length of Enbankment Slope	0.0 m
Left Side	0.0 m
Right Side	0.0 m
Length of Enbankment Slope	0.0 m
Left Side	3.8 m
Right Side	3.2 m

PK207+750
GH=100.56
PH=101.864

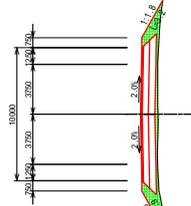

DL=100.0

PK 207+650	
Excavation	0.0 m
200g Standard Soil	0.0 m
300g Standard Soil	0.0 m
Enbankment	0.0 m
Length of Enbankment Slope	0.0 m
Left Side	0.0 m
Right Side	0.0 m
Length of Enbankment Slope	0.0 m
Left Side	3.7 m
Right Side	4.1 m

PK207+650
GH=100.83
PH=102.164

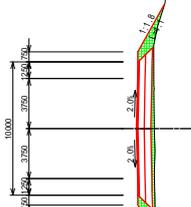

DL=100.0

PK 207+700	
Excavation	0.0 m
200g Standard Soil	0.0 m
300g Standard Soil	0.0 m
Enbankment	0.0 m
Length of Enbankment Slope	0.0 m
Left Side	3.8 m
Right Side	3.8 m
Length of Enbankment Slope	0.0 m
Left Side	3.8 m
Right Side	4.2 m

PK207+700
GH=100.74
PH=102.014

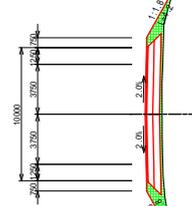

DL=100.0

PK 207+600	
Excavation	0.0 m
200g Standard Soil	0.0 m
300g Standard Soil	0.0 m
Enbankment	0.0 m
Length of Enbankment Slope	0.0 m
Left Side	3.7 m
Right Side	4.3 m
Length of Enbankment Slope	0.0 m
Left Side	3.7 m
Right Side	4.3 m

PK207+600
GH=101.13
PH=102.314

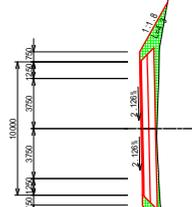

DL=100.0



REPUBLIQUE DE DJIBOUTI
MINISTRE DE L'EQUIPEMENT ET DES TRANSPORTS
DIRECTION DE L'EQUIPEMENT



JAPAN INTERNATIONAL COOPERATION AGENCY
YACHIYO ENGINEERING CO., LTD.

THE PREPARATORY SURVEY FOR
THE PROJECT FOR
UPGRADING OF NATIONAL ROAD ROUTE 1
IN THE REPUBLIC OF DJIBOUTI

SHEET CONTENTS
CROSS SECTION
PK207+600 ~ PK207+750

SCALE S=1:400
DATE NOV 2018
PAGE NO. 71 / 131

PK 207+850	
Excavation	0.0 m
Shoulder	0.0 m
Enchantment	0.0 m
Length of Excavation Slope	0.0 m
Left Slope	0.0 n
Right Slope	0.0 n
Length of Embankment Slope	3.4 m
Right Slope	3.0 m

PK207+850
GH=100.40
PH=101.564

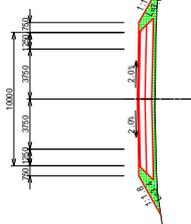

DL=95.0

PK 207+850	
Excavation	0.0 m
Shoulder	0.0 m
Enchantment	0.0 m
Length of Excavation Slope	0.0 m
Left Slope	0.0 n
Right Slope	0.0 n
Length of Embankment Slope	3.3 m
Right Slope	3.0 m

PK207+850
GH=100.40
PH=101.564

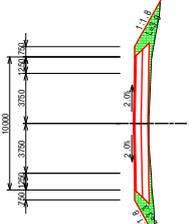

DL=95.0

PK 207+900	
Excavation	0.0 m
Shoulder	0.0 m
Enchantment	0.0 m
Length of Excavation Slope	0.0 m
Left Slope	0.0 n
Right Slope	0.0 n
Length of Embankment Slope	3.1 m
Right Slope	3.7 m

PK207+900
GH=100.18
PH=101.414

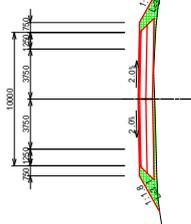

DL=95.0

PK 207+800	
Excavation	0.0 m
Shoulder	0.0 m
Enchantment	0.0 m
Length of Excavation Slope	0.0 m
Left Slope	0.0 n
Right Slope	0.0 n
Length of Embankment Slope	3.4 m
Right Slope	3.3 m

PK207+800
GH=100.53
PH=101.714

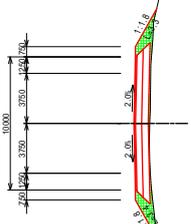

DL=95.0

PK	208+150	
Excavation	0.0	m
Shoulder	0.0	m
Enbankment	0.0	m
Length of Excavation Slope	0.0	m
Left Side	0.0	m
Right Side	0.0	m
Length of Enbankment Slope	0.0	m
Left Side	4.0	m
Right Side	4.1	m

PK208+150
 GH=99.24
 PH=100.664

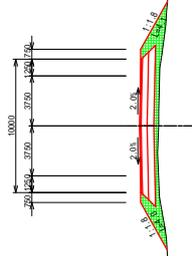

DL=95.0

PK	208+50	
Excavation	0.0	m
Shoulder	0.0	m
Enbankment	0.0	m
Length of Excavation Slope	0.0	m
Left Side	0.0	m
Right Side	0.0	m
Length of Enbankment Slope	0.0	m
Left Side	3.8	m
Right Side	3.9	m

PK208+50
 GH=99.57
 PH=100.964

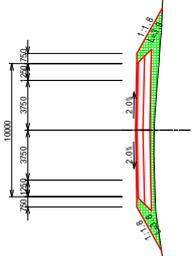

DL=95.0

PK	208+100	
Excavation	0.0	m
Shoulder	0.0	m
Enbankment	0.0	m
Length of Excavation Slope	0.0	m
Left Side	0.0	m
Right Side	0.0	m
Length of Enbankment Slope	0.0	m
Left Side	4.0	m
Right Side	4.1	m

PK208+100
 GH=99.49
 PH=100.814

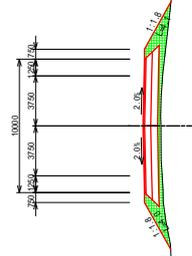

DL=95.0

PK	208+0	
Excavation	0.0	m
Shoulder	0.0	m
Enbankment	0.0	m
Length of Excavation Slope	0.0	m
Left Side	0.0	m
Right Side	0.0	m
Length of Enbankment Slope	0.0	m
Left Side	3.4	m
Right Side	3.2	m

PK208
 GH=99.84
 PH=101.114

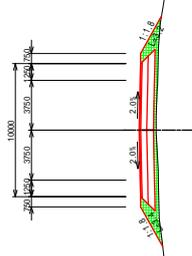

DL=95.0

PK	208+350
Excavation	0.0 m
Shoulder	0.0 m
Enbankment	0.0 m
Length of Excavation Slope	0.0 m
Left Side	0.0 m
Right Side	0.0 m
Length of Enbankment Slope	3.7 m
Right Side	3.9 m

PK208+350
GH=98.81
PH=100.064

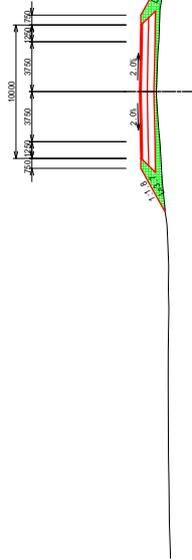

PK	208+300
Excavation	0.0 m
Shoulder	0.0 m
Enbankment	0.0 m
Length of Excavation Slope	0.0 m
Left Side	0.0 m
Right Side	0.0 m
Length of Enbankment Slope	4.0 m
Right Side	3.9 m

PK208+300
GH=98.79
PH=100.214

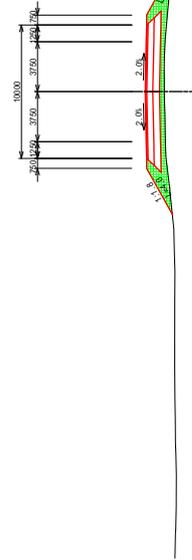

PK	208+250
Excavation	0.0 m
Shoulder	0.0 m
Enbankment	0.0 m
Length of Excavation Slope	0.0 m
Left Side	0.0 m
Right Side	0.0 m
Length of Enbankment Slope	4.2 m
Right Side	4.1 m

PK208+250
GH=98.95
PH=100.364

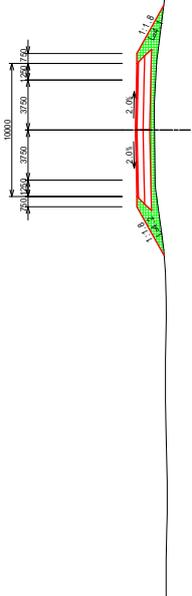

PK	208+200
Excavation	0.0 m
Shoulder	0.0 m
Enbankment	0.0 m
Length of Excavation Slope	0.0 m
Left Side	0.0 m
Right Side	0.0 m
Length of Enbankment Slope	3.9 m
Right Side	4.3 m

PK208+200
GH=99.09
PH=100.514

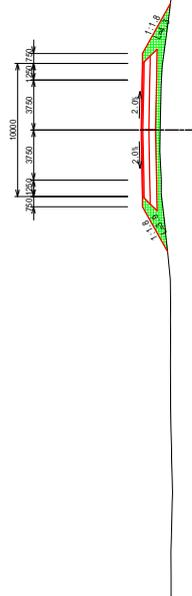

PK	208+550
Excavation	0.0 m
Shoulder Slope	2.3 m
Embankment	3.4 m
Shoulder Slope	2.3 m
Excavation	0.0 m
Length of Embankment Slope	0.0 m
Left Side	0.0 m
Right Side	0.0 m
Length of Embankment Slope	0.0 m
Left Side	3.0 m
Right Side	2.9 m

PK208+550
GH=98.65
PH=99.464

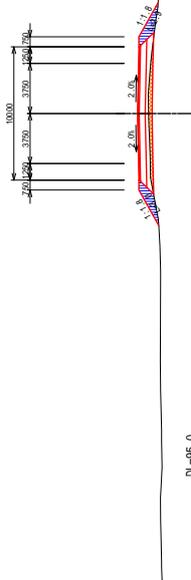

PK	208+500
Excavation	0.0 m
Shoulder Slope	1.0 m
Embankment	1.9 m
Shoulder Slope	2.1 m
Excavation	0.0 m
Length of Embankment Slope	0.0 m
Left Side	0.0 m
Right Side	0.0 m
Length of Embankment Slope	0.0 m
Left Side	3.3 m
Right Side	3.3 m

PK208+500
GH=98.61
PH=99.614

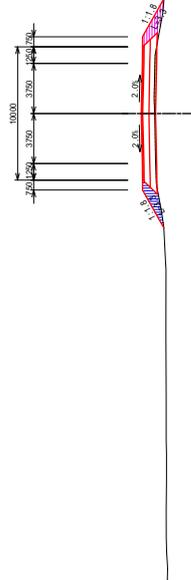

PK	208+450
Excavation	0.0 m
Shoulder Slope	0.0 m
Embankment	0.0 m
Shoulder Slope	0.0 m
Excavation	0.0 m
Length of Embankment Slope	0.0 m
Left Side	0.0 m
Right Side	0.0 m
Length of Embankment Slope	0.0 m
Left Side	3.8 m
Right Side	3.4 m

PK208+450
GH=98.64
PH=99.764

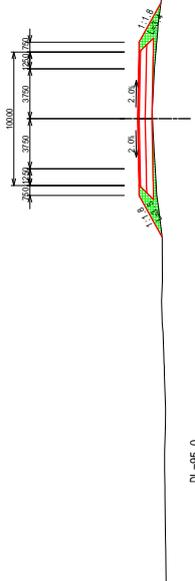

PK	208+400
Excavation	0.0 m
Shoulder Slope	0.0 m
Embankment	0.0 m
Shoulder Slope	0.0 m
Excavation	0.0 m
Length of Embankment Slope	0.0 m
Left Side	0.0 m
Right Side	0.0 m
Length of Embankment Slope	0.0 m
Left Side	3.6 m
Right Side	3.6 m

PK208+400
GH=98.70
PH=99.914

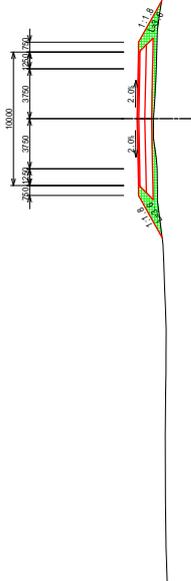

PK	208+850
Excavation	0.0 m
Subgrade	0.0 m
Shoulder	0.1 m
Enchantment	0.0 m
Length of Excavation Slope	2.0 m
Left Slope	0.0 m
Right Slope	0.0 m
Length of Embankment Slope	3.5 m
Left Slope	3.5 m
Right Slope	2.5 m

PK208+850
G=99.08
PH=100.189

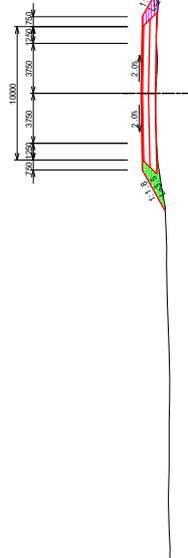

DL=95.0

PK	208+850
Excavation	0.0 m
Subgrade	0.0 m
Shoulder	0.1 m
Enchantment	0.0 m
Length of Excavation Slope	2.0 m
Left Slope	0.0 m
Right Slope	0.0 m
Length of Embankment Slope	3.5 m
Left Slope	3.5 m
Right Slope	2.5 m

PK	208+950
Excavation	0.0 m
Subgrade	0.0 m
Shoulder	0.1 m
Enchantment	0.0 m
Length of Excavation Slope	2.0 m
Left Slope	0.0 m
Right Slope	0.0 m
Length of Embankment Slope	3.8 m
Left Slope	3.8 m
Right Slope	2.2 m

PK208+950
G=99.41
PH=100.539

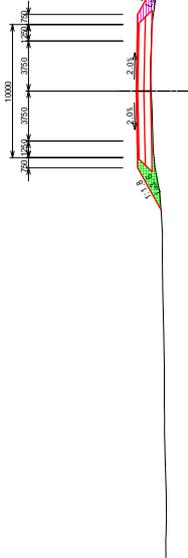

DL=95.0

PK	208+800
Excavation	0.0 m
Subgrade	0.2 m
Shoulder	0.0 m
Enchantment	2.0 m
Length of Excavation Slope	2.5 m
Left Slope	0.0 m
Right Slope	0.0 m
Length of Embankment Slope	3.4 m
Left Slope	3.4 m
Right Slope	3.1 m

PK208+800
G=96.97
PH=100.014

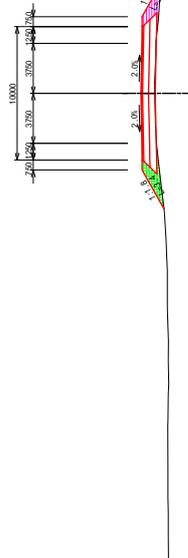

DL=95.0

PK	208+900
Excavation	0.0 m
Subgrade	0.0 m
Shoulder	0.0 m
Enchantment	2.0 m
Length of Excavation Slope	2.5 m
Left Slope	0.0 m
Right Slope	0.0 m
Length of Embankment Slope	3.7 m
Left Slope	3.7 m
Right Slope	3.0 m

PK208+900
G=99.25
PH=100.364

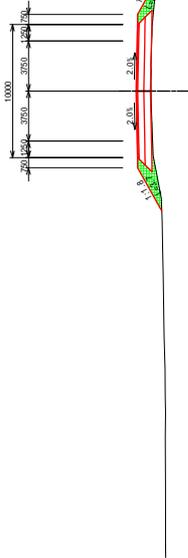

DL=95.0

PK	209+150
Excavation Len	0.0 m
Open Cut	0.7 m
Enbankment	1.6 m
Length of Excavation Slope	0.0 m
Left Side	0.0 m
Right Side	0.0 m
Length of Enbankment Slope	2.8 m
Left Side	2.8 m
Right Side	2.7 m

PK209+150
GH=100.31
PI=101.239

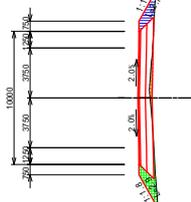

DL=95.0

PK	209+50
Excavation Len	0.0 m
Open Cut	1.4 m
Enbankment	0.0 m
Length of Excavation Slope	2.7 m
Left Side	0.0 m
Right Side	0.0 m
Length of Enbankment Slope	3.5 m
Left Side	3.5 m
Right Side	2.9 m

PK209+50
GH=100.18
PI=100.889

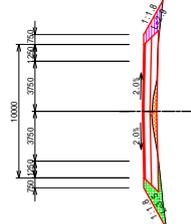

DL=95.0

PK	209+100
Excavation Len	0.0 m
Open Cut	0.2 m
Enbankment	0.0 m
Length of Excavation Slope	2.8 m
Left Side	0.0 m
Right Side	0.0 m
Length of Enbankment Slope	3.4 m
Left Side	3.4 m
Right Side	3.0 m

PK209+100
GH=100.01
PI=101.064

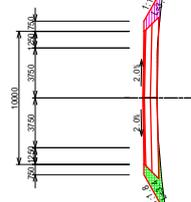

DL=95.0

PK	209+0
Excavation Len	0.0 m
Open Cut	0.2 m
Enbankment	0.0 m
Length of Excavation Slope	1.7 m
Left Side	0.0 m
Right Side	0.0 m
Length of Enbankment Slope	3.7 m
Left Side	3.7 m
Right Side	2.9 m

PK209
GH=99.59
PI=100.714

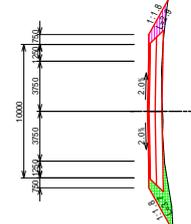

DL=95.0

PK	209+550
Excavation	
Subgrade	0.0 m
Shoulder	0.0 m
Embankment	
Subgrade	0.0 m
Shoulder	0.0 m
Slope	
Length of Excavation Slope	0.0 m
Left Slope	0.0 n
Right Slope	0.0 n
Length of Embankment Slope	5.0 m
Left Slope	4.7 n
Right Slope	4.2 n

PK209+550
GH=100.99
PH=102.578

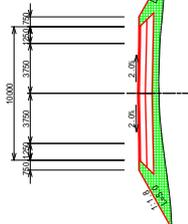

DL=95.0

PK	209+450
Excavation	
Subgrade	0.0 m
Shoulder	0.0 m
Embankment	
Subgrade	0.0 m
Shoulder	0.0 m
Slope	
Length of Excavation Slope	0.0 m
Left Slope	0.0 n
Right Slope	0.0 n
Length of Embankment Slope	4.1 m
Left Slope	3.4 n
Right Slope	3.4 n

PK209+450
GH=100.95
PH=102.289

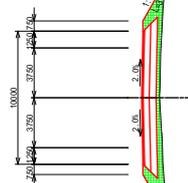

DL=95.0

PK	209+500
Excavation	
Subgrade	0.0 m
Shoulder	0.0 m
Embankment	
Subgrade	0.0 m
Shoulder	0.0 m
Slope	
Length of Excavation Slope	0.0 m
Left Slope	0.0 n
Right Slope	0.0 n
Length of Embankment Slope	4.7 m
Left Slope	4.7 n
Right Slope	3.9 n

PK209+500
GH=100.91
PH=102.464

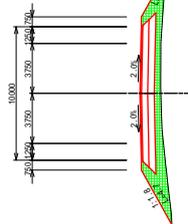

DL=95.0

PK	209+400
Excavation	
Subgrade	0.0 m
Shoulder	0.0 m
Embankment	
Subgrade	0.0 m
Shoulder	0.0 m
Slope	
Length of Excavation Slope	0.0 m
Left Slope	0.0 n
Right Slope	0.0 n
Length of Embankment Slope	3.9 m
Left Slope	3.9 n
Right Slope	3.2 n

PK209+400
GH=100.96
PH=102.114

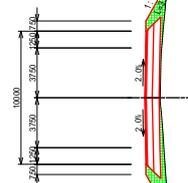

DL=95.0



REPUBLIQUE DE DJIBOUTI
MINISTRE DE L'EQUIPEMENT ET DES TRANSPORTS
DIRECTION DE L'EQUIPEMENT



JAPAN INTERNATIONAL COOPERATION AGENCY
YACHIYO ENGINEERING CO., LTD.

THE PREPARATORY SURVEY FOR
THE PROJECT FOR
UPGRADING OF NATIONAL ROAD ROUTE 1
IN THE REPUBLIC OF DJIBOUTI

SHEET CONTENTS
CROSS SECTION
PK209+400 ~ PK209+550

SCALE S=1:400
DATE NOV 2018
PAGE NO. 80 / 131

PK 209+750	
Excavation	0.0 m
Shoulder	0.0 m
Enchantment	0.0 m
Shoulder	0.0 m
Enchantment	0.0 m
Shoulder	0.0 m
Enchantment	0.0 m
Length of Embankment Slope	0.0 m
Left Slope	0.0 n
Length of Embankment Slope	4.4 m
Left Slope	3.2 m

PK209+750
GH=100.67
PH=101.939

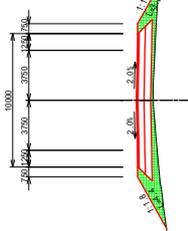

DL=95.0

PK 209+650	
Excavation	0.0 m
Shoulder	0.0 m
Enchantment	0.0 m
Shoulder	0.0 m
Enchantment	0.0 m
Shoulder	0.0 m
Enchantment	0.0 m
Length of Embankment Slope	0.0 m
Left Slope	0.0 n
Length of Embankment Slope	4.3 m
Left Slope	3.7 m

PK209+650
GH=100.94
PH=102.289

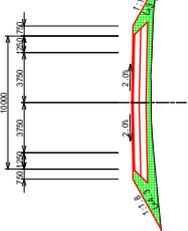

DL=95.0

PK 209+700	
Excavation	0.0 m
Shoulder	0.0 m
Enchantment	0.0 m
Shoulder	0.0 m
Enchantment	0.0 m
Shoulder	0.0 m
Enchantment	0.0 m
Length of Embankment Slope	0.0 m
Left Slope	0.0 n
Length of Embankment Slope	4.0 m
Left Slope	3.2 m

PK209+700
GH=100.69
PH=102.114

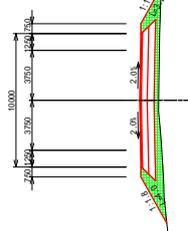

DL=95.0

PK 209+600	
Excavation	0.0 m
Shoulder	0.0 m
Enchantment	0.0 m
Shoulder	0.0 m
Enchantment	0.0 m
Shoulder	0.0 m
Enchantment	0.0 m
Length of Embankment Slope	0.0 m
Left Slope	0.0 n
Length of Embankment Slope	4.7 m
Left Slope	3.8 m

PK209+600
GH=100.96
PH=102.464

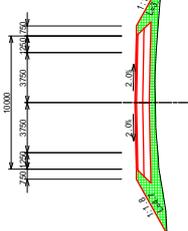

DL=95.0

PK	209+850
Excavation	0.0 m
Shoulder	0.0 m
Enchantment	0.0 m
Shoulder	0.0 m
Excavation	2.0 m
Length of Excavation Slope	2.0 m
Left Slope	0.0 n
Right Slope	0.0 n
Left Slope	6.1 n
Right Slope	5.4 n

PK209+850
GH=99.65
PH=101.588

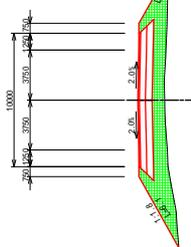

DL=95.0

PK	209+950
Excavation	0.0 m
Shoulder	0.0 m
Enchantment	0.0 m
Shoulder	0.0 m
Excavation	2.0 m
Length of Excavation Slope	2.0 m
Left Slope	0.0 n
Right Slope	0.0 n
Left Slope	6.1 n
Right Slope	5.4 n

PK209+950
GH=99.24
PH=101.239

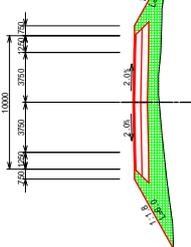

DL=95.0

PK	209+800
Excavation	0.0 m
Shoulder	0.0 m
Enchantment	0.0 m
Shoulder	0.0 m
Excavation	2.0 m
Length of Excavation Slope	2.0 m
Left Slope	0.0 n
Right Slope	0.0 n
Left Slope	4.8 n
Right Slope	3.4 n

PK209+800
GH=100.48
PH=101.764

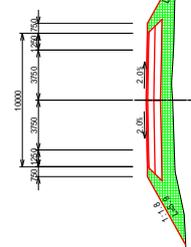

DL=95.0

PK	209+900
Excavation	0.0 m
Shoulder	0.0 m
Enchantment	0.0 m
Shoulder	0.0 m
Excavation	2.0 m
Length of Excavation Slope	2.0 m
Left Slope	0.0 n
Right Slope	0.0 n
Left Slope	5.9 n
Right Slope	5.4 n

PK209+900
GH=99.44
PH=101.414

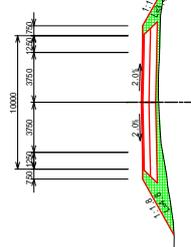

DL=95.0



REPUBLIQUE DE DJIBOUTI
MINISTRE DE L'EQUIPEMENT ET DES TRANSPORTS
DIRECTION DE L'EQUIPEMENT



JAPAN INTERNATIONAL COOPERATION AGENCY
YACHIYO ENGINEERING CO., LTD.

THE PREPARATORY SURVEY FOR
THE PROJECT FOR
UPGRADING OF NATIONAL ROAD ROUTE 1
IN THE REPUBLIC OF DJIBOUTI

SHEET CONTENTS
CROSS SECTION
PK209+800 ~ PK209+950

SCALE S=1:400
DATE NOV 2018
PAGE NO. 82 / 131

PK 210+50	
Excavation	0.0 m ³
Spill 0.0%	0.0 m ³
Embankment	0.0 m ³
Subgrade	0.0 m ³
Length of Excavation Slope	0.0 m
Left Side	0.0 n
Right Side	0.0 n
Length of Embankment Slope	6.3 m
Left Side	6.3 m
Right Side	6.4 m

PK210+50
GH=97.92
PH=100.539

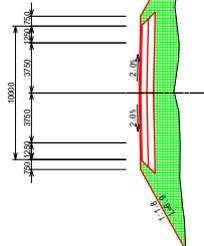

DL=95.0

PK 210+100	
Excavation	0.0 m ³
Spill 0.0%	0.0 m ³
Embankment	0.0 m ³
Subgrade	0.0 m ³
Length of Excavation Slope	0.0 m
Left Side	0.0 n
Right Side	0.0 n
Length of Embankment Slope	6.3 m
Left Side	6.3 m
Right Side	6.4 m

PK210+100
GH=98.04
PH=101.064

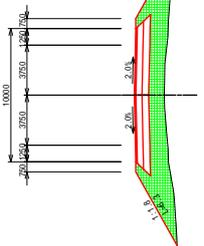

DL=95.0

PK 210+0	
Excavation	0.0 m ³
Spill 0.0%	0.0 m ³
Embankment	0.0 m ³
Subgrade	0.0 m ³
Length of Excavation Slope	0.0 m
Left Side	0.0 n
Right Side	0.0 n
Length of Embankment Slope	5.8 m
Left Side	5.8 m
Right Side	5.8 m

PK210+0
GH=99.04
PH=101.714

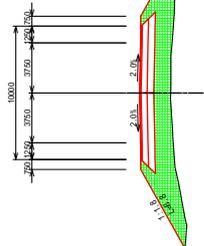

DL=95.0

PK 210+100	
Excavation	0.0 m ³
Spill 0.0%	0.0 m ³
Embankment	0.0 m ³
Subgrade	0.0 m ³
Length of Excavation Slope	0.0 m
Left Side	0.0 n
Right Side	0.0 n
Length of Embankment Slope	6.2 m
Left Side	6.2 m
Right Side	6.2 m

PK210+100
GH=98.39
PH=100.714

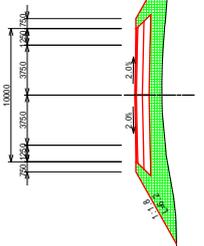

DL=95.0

PK	210+350
Excavation	0.0 m ³
Spill 0.5%	0.0 m ³
Enchantment	0.0 m ³
Spill 1.5%	0.0 m ³
Spill 2.5%	0.0 m ³
Spill 3.5%	0.0 m ³
Spill 4.5%	0.0 m ³
Spill 5.5%	0.0 m ³
Spill 6.5%	0.0 m ³
Spill 7.5%	0.0 m ³
Spill 8.5%	0.0 m ³
Spill 9.5%	0.0 m ³
Length of Embankment Slope	0.0 m
Left Side	0.0 m
Right Side	0.0 m
Length of Embankment Slope	0.0 m
Left Side	5.8 m
Right Side	4.8 m

PK210+350
GH=87.70
PH=89.439

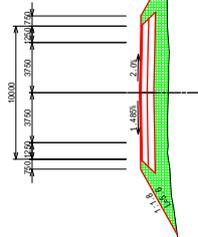

DL=95.0

PK	210+250
Excavation	0.0 m ³
Spill 0.5%	0.0 m ³
Enchantment	0.0 m ³
Spill 1.5%	0.0 m ³
Spill 2.5%	0.0 m ³
Spill 3.5%	0.0 m ³
Spill 4.5%	0.0 m ³
Spill 5.5%	0.0 m ³
Spill 6.5%	0.0 m ³
Spill 7.5%	0.0 m ³
Spill 8.5%	0.0 m ³
Spill 9.5%	0.0 m ³
Length of Embankment Slope	0.0 m
Left Side	0.0 m
Right Side	0.0 m
Length of Embankment Slope	0.0 m
Left Side	5.2 m
Right Side	5.4 m

PK210+250
GH=88.16
PH=100.189

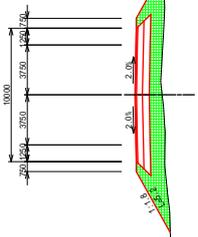

DL=95.0

PK	210+300
Excavation	0.0 m ³
Spill 0.5%	0.0 m ³
Enchantment	0.0 m ³
Spill 1.5%	0.0 m ³
Spill 2.5%	0.0 m ³
Spill 3.5%	0.0 m ³
Spill 4.5%	0.0 m ³
Spill 5.5%	0.0 m ³
Spill 6.5%	0.0 m ³
Spill 7.5%	0.0 m ³
Spill 8.5%	0.0 m ³
Spill 9.5%	0.0 m ³
Length of Embankment Slope	0.0 m
Left Side	0.0 m
Right Side	0.0 m
Length of Embankment Slope	5.2 m
Left Side	5.2 m
Right Side	5.0 m

PK210+300
GH=88.04
PH=100.014

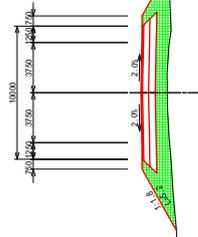

DL=95.0

PK	210+200
Excavation	0.0 m ³
Spill 0.5%	0.0 m ³
Enchantment	0.0 m ³
Spill 1.5%	0.0 m ³
Spill 2.5%	0.0 m ³
Spill 3.5%	0.0 m ³
Spill 4.5%	0.0 m ³
Spill 5.5%	0.0 m ³
Spill 6.5%	0.0 m ³
Spill 7.5%	0.0 m ³
Spill 8.5%	0.0 m ³
Spill 9.5%	0.0 m ³
Length of Embankment Slope	0.0 m
Left Side	0.0 m
Right Side	0.0 m
Length of Embankment Slope	5.4 m
Left Side	5.4 m
Right Side	5.3 m

PK210+200
GH=88.40
PH=100.384

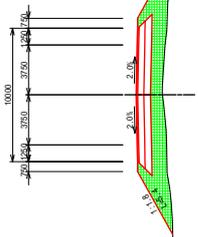

DL=95.0

PK 210+450	
Excavation	0.0 m ³
2000/2000/2000	0.0 m ³
2000/2000	0.0 m ³
Enbankment	0.0 m ³
2000/2000	12.0 m ³
2000/2000	12.0 m ³
Length of Embankment Slope	0.0 m
Left Side	0.0 m
Right Side	0.0 m
Length of Embankment Slope	0.0 m
Left Side	5.8 m
Right Side	4.8 m

PK210+450
GH=97.71
PH=99.489

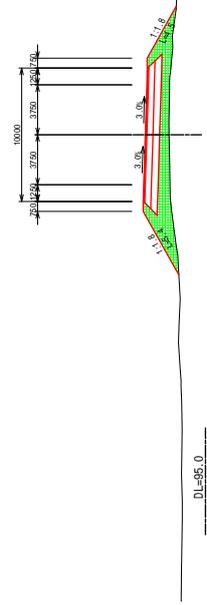

DL=95.0

PK 210+550	
Excavation	0.0 m ³
2000/2000/2000	0.0 m ³
2000/2000	0.0 m ³
Enbankment	0.0 m ³
2000/2000	12.0 m ³
2000/2000	12.0 m ³
Length of Embankment Slope	0.0 m
Left Side	0.0 m
Right Side	0.0 m
Length of Embankment Slope	0.0 m
Left Side	5.8 m
Right Side	4.8 m

PK210+550
GH=97.53
PH=99.139

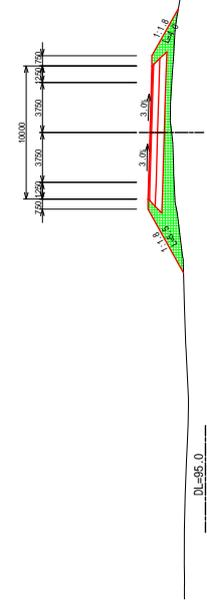

DL=95.0

PK 210+400	
Excavation	0.0 m ³
2000/2000/2000	0.0 m ³
2000/2000	0.0 m ³
Enbankment	0.0 m ³
2000/2000	7.8 m ³
2000/2000	7.8 m ³
Length of Embankment Slope	0.0 m
Left Side	0.0 m
Right Side	0.0 m
Length of Embankment Slope	0.0 m
Left Side	5.8 m
Right Side	4.8 m

PK210+400
GH=97.53
PH=99.664

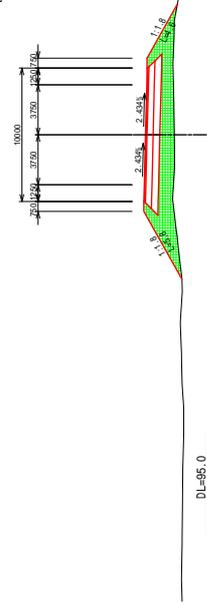

DL=95.0

PK 210+500	
Excavation	0.0 m ³
2000/2000/2000	0.0 m ³
2000/2000	0.0 m ³
Enbankment	0.0 m ³
2000/2000	12.0 m ³
2000/2000	12.0 m ³
Length of Embankment Slope	0.0 m
Left Side	0.0 m
Right Side	0.0 m
Length of Embankment Slope	0.0 m
Left Side	5.8 m
Right Side	4.8 m

PK210+500
GH=97.37
PH=99.314

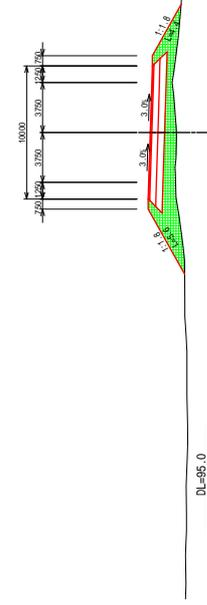

DL=95.0



REPUBLIQUE DE DJIBOUTI
MINISTRE DE L'EQUIPEMENT ET DES TRANSPORTS
DIRECTION DE L'EQUIPEMENT



JAPAN INTERNATIONAL COOPERATION AGENCY
YACHIYO ENGINEERING CO., LTD.

THE PREPARATORY SURVEY FOR
THE PROJECT FOR
UPGRADING OF NATIONAL ROAD ROUTE 1
IN THE REPUBLIC OF DJIBOUTI

SHEET CONTENTS
CROSS SECTION
PK210+400 ~ PK210+550

SCALE S=1:400
DATE NOV 2018
PAGE NO. 85 / 131

PK 210+750	
Excavation	0.0 m
200g Standard Soil	0.0 m
300g Standard Soil	0.0 m
Enbankment	0.0 m
Length of Embankment Slope	12.0 m
Left Slope	0.0 n
Right Slope	0.0 n
Length of Embankment Slope	4.8 m
Left Slope	4.0 m
Right Slope	4.0 m

PK210+750
GH=96.88
PH=98.439

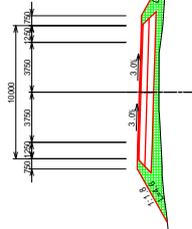

DL=95.0

PK 210+650	
Excavation	0.0 m
200g Standard Soil	0.0 m
300g Standard Soil	0.0 m
Enbankment	0.0 m
Length of Embankment Slope	10.0 m
Left Slope	0.0 n
Right Slope	0.0 n
Length of Embankment Slope	5.4 m
Left Slope	3.9 m
Right Slope	3.9 m

PK210+650
GH=97.21
PH=98.789

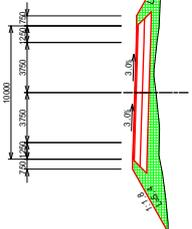

DL=95.0

PK 210+700	
Excavation	0.0 m
200g Standard Soil	0.0 m
300g Standard Soil	0.0 m
Enbankment	0.0 m
Length of Embankment Slope	11.3 m
Left Slope	0.0 n
Right Slope	0.0 n
Length of Embankment Slope	5.3 m
Left Slope	4.1 m
Right Slope	4.1 m

PK210+700
GH=97.15
PH=98.614

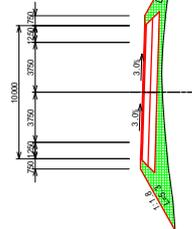

DL=95.0

PK 210+600	
Excavation	0.0 m
200g Standard Soil	0.0 m
300g Standard Soil	0.0 m
Enbankment	0.0 m
Length of Embankment Slope	7.0 m
Left Slope	0.0 n
Right Slope	0.0 n
Length of Embankment Slope	3.7 m
Left Slope	5.4 m
Right Slope	3.7 m

PK210+600
GH=97.31
PH=98.964

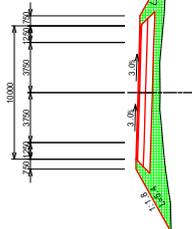

DL=95.0

PK 210+850	
Enlargement	0.0 m
Shoulder	0.0 m
Enlargement	0.0 m
Enlargement	0.0 m
Enlargement	0.0 m
Enlargement	0.0 m
Length of Enlargement Slope	0.0 m
Left Slope	0.0 n
Right Slope	0.0 n
Length of Enlargement Slope	0.0 m
Left Slope	3.3 n
Right Slope	3.0 n

PK210+850
 CH=66.55
 PH=67.79

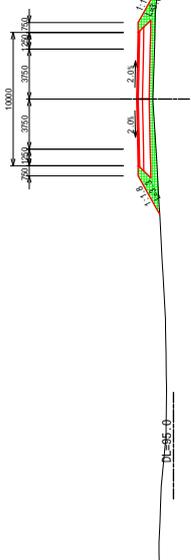

PK 210+850	
Enlargement	0.0 m
Shoulder	0.0 m
Enlargement	0.0 m
Enlargement	0.0 m
Enlargement	0.0 m
Enlargement	0.0 m
Length of Enlargement Slope	0.0 m
Left Slope	0.0 n
Right Slope	0.0 n
Length of Enlargement Slope	0.0 m
Left Slope	4.1 n
Right Slope	3.0 n

PK210+850
 CH=66.77
 PH=68.089

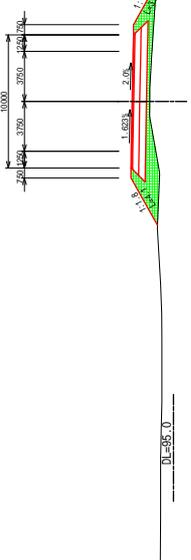

PK 210+900	
Enlargement	0.0 m
Shoulder	0.0 m
Enlargement	0.0 m
Enlargement	0.0 m
Enlargement	0.0 m
Enlargement	0.0 m
Length of Enlargement Slope	1.2 m
Left Slope	0.0 n
Right Slope	0.0 n
Length of Enlargement Slope	3.7 m
Left Slope	3.7 n
Right Slope	3.4 n

PK210+900
 CH=66.59
 PH=67.914

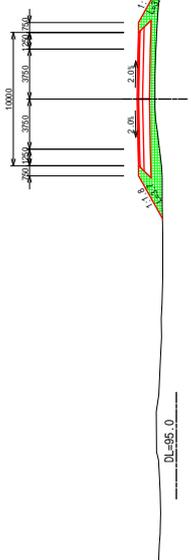

PK 210+800	
Enlargement	0.0 m
Shoulder	0.0 m
Enlargement	0.0 m
Enlargement	0.0 m
Enlargement	0.0 m
Enlargement	0.0 m
Length of Enlargement Slope	1.7 m
Left Slope	0.0 n
Right Slope	0.0 n
Length of Enlargement Slope	4.3 m
Left Slope	4.3 n
Right Slope	3.7 n

PK210+800
 CH=66.89
 PH=68.264

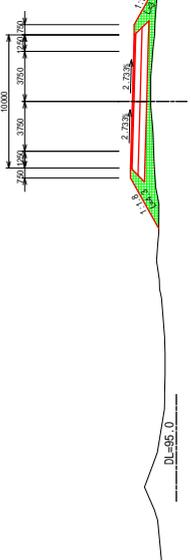

PK 211+50	
Excavation	0.0 m
Shoulder	0.0 m
Enbankment	0.0 m
Left Slope	0.0 m
Right Slope	0.0 m
Length of Excavation Slope	0.0 m
Length of Enbankment Slope	0.0 m
Left Side	2.7 m
Right Side	2.7 m

PK211+50
G=98.38
PI=97.689

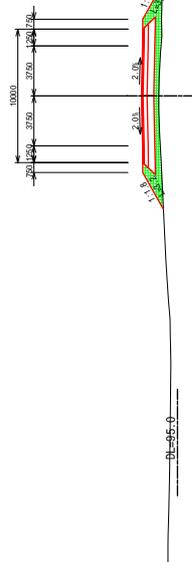

PK 211+50	
Excavation	0.0 m
Shoulder	0.0 m
Enbankment	0.0 m
Left Slope	0.0 m
Right Slope	0.0 m
Length of Excavation Slope	0.0 m
Length of Enbankment Slope	0.0 m
Left Side	2.7 m
Right Side	2.7 m

PK211+50
G=96.49
PI=97.446

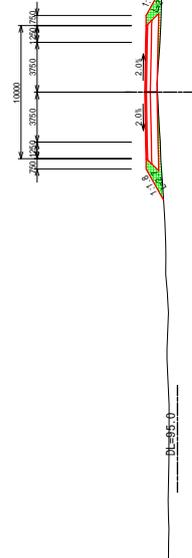

PK 211+100	
Excavation	0.0 m
Shoulder	0.0 m
Enbankment	0.0 m
Left Slope	0.0 m
Right Slope	0.0 m
Length of Excavation Slope	0.0 m
Length of Enbankment Slope	0.0 m
Left Side	2.7 m
Right Side	2.7 m

PK211+100
G=96.44
PI=97.539

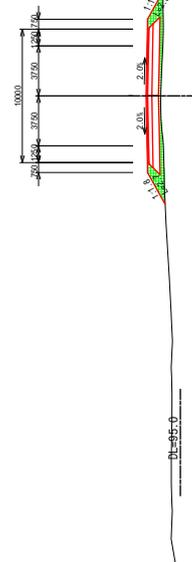

PK 211+0	
Excavation	0.0 m
Shoulder	0.0 m
Enbankment	0.0 m
Left Slope	0.0 m
Right Slope	0.0 m
Length of Excavation Slope	0.0 m
Length of Enbankment Slope	0.0 m
Left Side	2.7 m
Right Side	2.9 m

PK211
G=96.65
PI=97.564

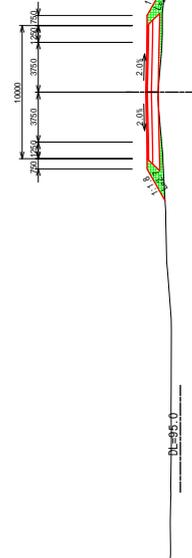

PK 211+350	
Excavation	0.0 m
Spill Slope	0.0 m
Embankment	0.0 m
Length of Excavation Slope	0.0 m
Left Side	0.0 m
Right Side	0.0 m
Length of Embankment Slope	3.2 m
Left Side	3.2 m
Right Side	4.0 m

PK211+350
GH=96.77
PH=98.289

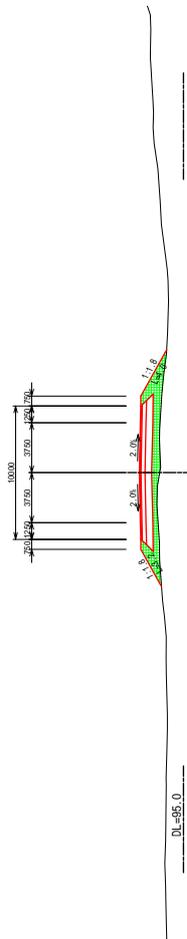

PK 211+300	
Excavation	0.0 m
Spill Slope	0.0 m
Embankment	0.0 m
Length of Excavation Slope	0.0 m
Left Side	0.0 m
Right Side	0.0 m
Length of Embankment Slope	3.3 m
Left Side	3.3 m
Right Side	3.9 m

PK211+300
GH=96.56
PH=98.139

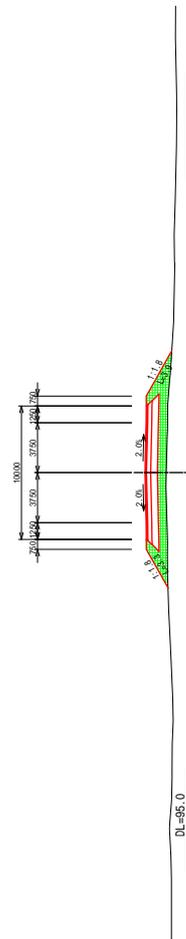

PK 211+250	
Excavation	0.0 m
Spill Slope	0.0 m
Embankment	0.0 m
Length of Excavation Slope	0.0 m
Left Side	0.0 m
Right Side	0.0 m
Length of Embankment Slope	3.5 m
Left Side	3.5 m
Right Side	4.1 m

PK211+250
GH=96.43
PH=97.989

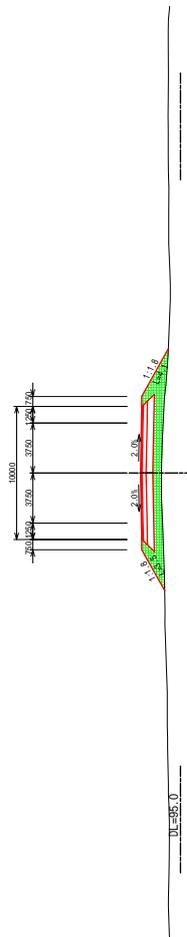

PK 211+200	
Excavation	0.0 m
Spill Slope	0.0 m
Embankment	0.0 m
Length of Excavation Slope	0.0 m
Left Side	0.0 m
Right Side	0.0 m
Length of Embankment Slope	3.5 m
Left Side	3.5 m
Right Side	3.8 m

PK211+200
GH=96.36
PH=97.839

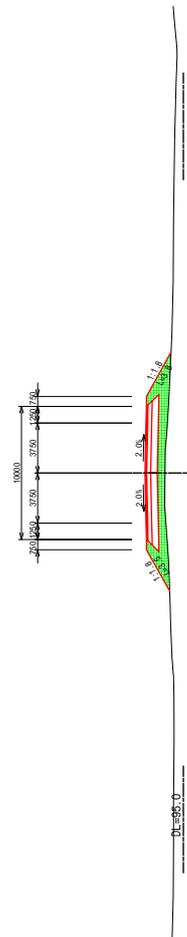

PK	211+750
Excavation	0.0 m
2000/3000/5000	0.0 m
Enbankment	0.0 m
2000/3000/5000	0.0 m
Length of Excavation Slope	0.0 m
Left Slope	0.0 n
Right Slope	0.0 n
Length of Enbankment Slope	4.3 m
Left Slope	4.3 n
Right Slope	3.8 m

PK211+750
GH=100.17
PH=101.289

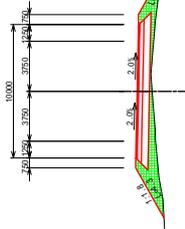

DL=95.0

PK	211+650
Excavation	0.0 m
2000/3000/5000	0.0 m
Enbankment	0.0 m
2000/3000/5000	0.0 m
Length of Excavation Slope	0.0 m
Left Slope	0.0 n
Right Slope	0.0 n
Length of Enbankment Slope	2.9 m
Left Slope	2.9 n
Right Slope	2.9 m

PK211+650
GH=98.90
PH=99.989

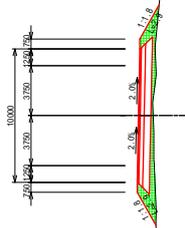

DL=95.0

PK	211+700
Excavation	0.0 m
2000/3000/5000	0.0 m
Enbankment	0.0 m
2000/3000/5000	0.0 m
Length of Excavation Slope	0.0 m
Left Slope	0.0 n
Right Slope	0.0 n
Length of Enbankment Slope	4.0 m
Left Slope	4.0 n
Right Slope	3.6 m

PK211+700
GH=99.47
PH=100.639

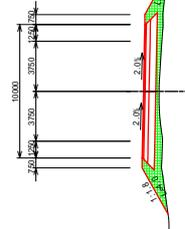

DL=95.0

PK	211+600
Excavation	0.0 m
2000/3000/5000	0.9 m
Enbankment	0.0 m
2000/3000/5000	3.0 m
Length of Excavation Slope	0.0 m
Left Slope	0.0 n
Right Slope	0.0 n
Length of Enbankment Slope	2.3 m
Left Slope	2.3 n
Right Slope	2.3 m

PK211+600
GH=98.57
PH=99.341

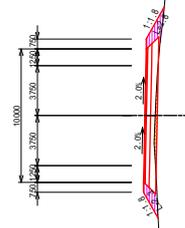

DL=95.0

PK	211+850
Excavation	0.0 m
Shoulder	0.0 m
Enlargement	0.0 m
Length of Excavation Slope	0.0 m
Left Slope	0.0 n
Right Slope	0.0 n
Length of Enlargement Slope	4.3 m
Left Slope	4.3 n
Right Slope	4.4 n

PK211+850
GH=102.65
PH=102.589

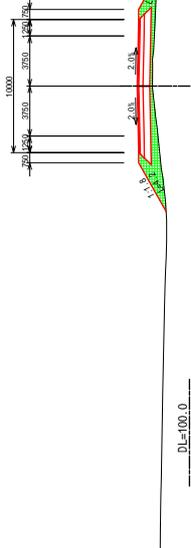

PK	211+850
Excavation	0.0 m
Shoulder	0.0 m
Enlargement	0.0 m
Length of Excavation Slope	0.0 m
Left Slope	0.0 n
Right Slope	0.0 n
Length of Enlargement Slope	4.3 m
Left Slope	4.3 n
Right Slope	4.4 n

PK211+850
GH=102.65
PH=102.589

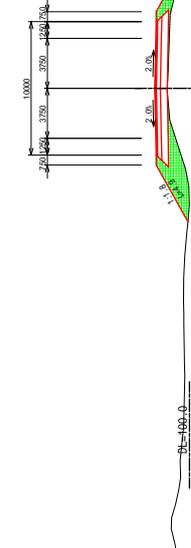

PK	211+900
Excavation	0.0 m
Shoulder	1.6 m
Enlargement	2.5 m
Length of Excavation Slope	0.0 m
Left Slope	0.0 n
Right Slope	0.0 n
Length of Enlargement Slope	4.5 m
Left Slope	4.5 n
Right Slope	4.8 n

PK211+900
GH=102.52
PH=103.239

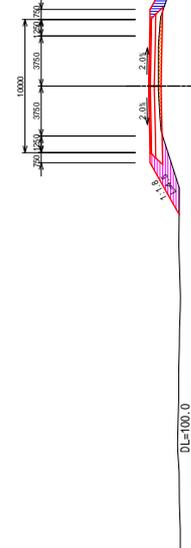

PK	211+800
Excavation	0.0 m
Shoulder	0.0 m
Enlargement	0.0 m
Length of Excavation Slope	0.0 m
Left Slope	0.0 n
Right Slope	0.0 n
Length of Enlargement Slope	6.1 m
Left Slope	6.1 n
Right Slope	3.4 n

PK211+800
GH=100.69
PH=101.939

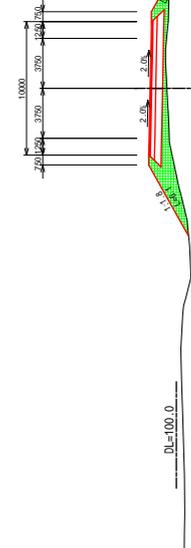

PK 212+150	
Excavation	0.0 m
Open Cut	1.9 m
Enbankment	2.0 m
Length of Excavation Slope	0.0 m
Left Side	0.0 m
Right Side	0.0 m
Length of Enbankment Slope	1.9 m
Left Side	1.9 m
Right Side	0.0 m

PK212+150
GH=105.84
PH=106.489

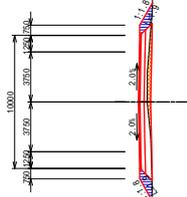

DL=100.0

PK 212+50	
Excavation	0.0 m
Open Cut	0.0 m
Enbankment	0.0 m
Length of Excavation Slope	0.0 m
Left Side	0.0 m
Right Side	0.0 m
Length of Enbankment Slope	2.8 m
Left Side	2.8 m
Right Side	0.0 m

PK212+50
GH=103.51
PH=105.189

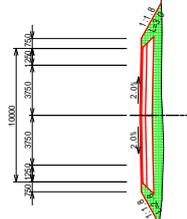

DL=100.0

PK 212+100	
Excavation	0.0 m
Open Cut	2.0 m
Enbankment	2.1 m
Length of Excavation Slope	0.0 m
Left Side	0.0 m
Right Side	0.0 m
Length of Enbankment Slope	1.9 m
Left Side	1.9 m
Right Side	0.0 m

PK212+100
GH=105.16
PH=105.839

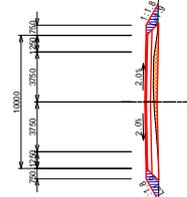

DL=100.0

PK 212+0	
Excavation	0.0 m
Open Cut	0.0 m
Enbankment	0.0 m
Length of Excavation Slope	0.0 m
Left Side	0.0 m
Right Side	0.0 m
Length of Enbankment Slope	2.6 m
Left Side	2.6 m
Right Side	4.7 m

PK212
GH=102.53
PH=104.539

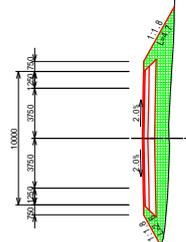

DL=100.0

PK	212+550
Excavation	0.0
Shoulder	0.0
Embankment	0.0
Length of Embankment Slope	0.0
Left Slope	0.0
Right Slope	0.3
Length of Embankment Slope	0.0
Left Slope	5.1
Right Slope	6.3

PK212+550
GH=107.85
PH=109.839

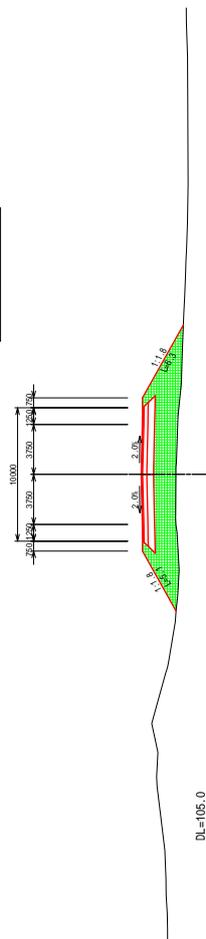

PK	212+500
Excavation	0.0
Shoulder	0.0
Embankment	0.0
Length of Embankment Slope	0.0
Left Slope	0.0
Right Slope	3.6
Length of Embankment Slope	3.2
Left Slope	3.2
Right Slope	3.6

PK212+500
GH=107.73
PH=109.539

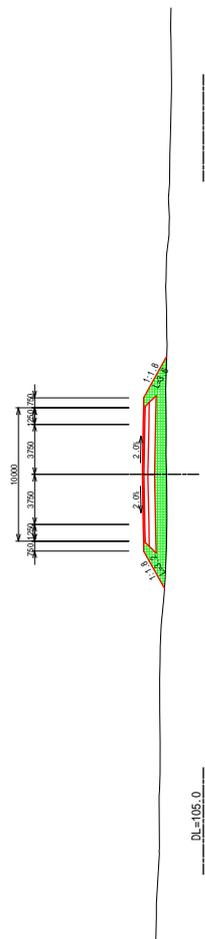

PK	212+450
Excavation	0.0
Shoulder	0.0
Embankment	0.0
Length of Embankment Slope	0.0
Left Slope	0.0
Right Slope	2.3
Length of Embankment Slope	2.3
Left Slope	2.3
Right Slope	2.3

PK212+450
GH=108.04
PH=109.139

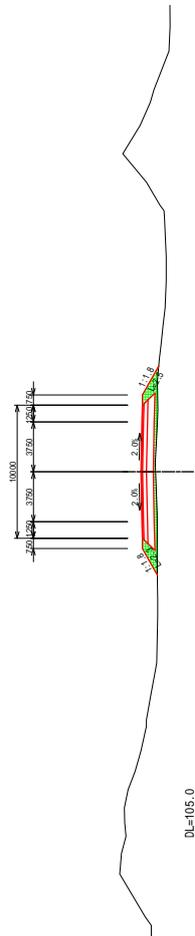

PK	212+400
Excavation	0.0
Shoulder	0.4
Embankment	0.0
Length of Embankment Slope	2.2
Left Slope	2.2
Right Slope	2.3
Length of Embankment Slope	2.2
Left Slope	2.2
Right Slope	2.3

PK212+400
GH=107.87
PH=108.739

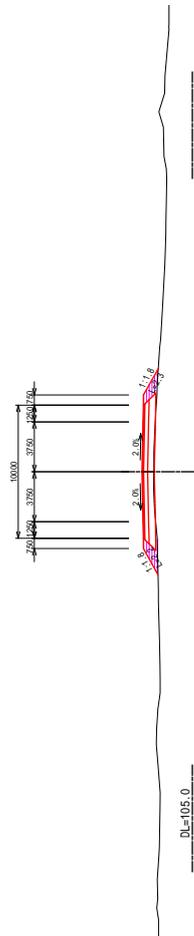

PK	212+650
Excavation	0.0 m
Shoulder	0.0 m
Enbankment	0.0 m
Length of Enbankment Slope	16.1 m
Left Slope	0.0 n
Right Slope	0.0 n
Length of Enbankment Slope	3.9 m
Left Slope	4.4 n
Right Slope	4.4 n

PK212+650
 GH=109.03
 PH=110.739

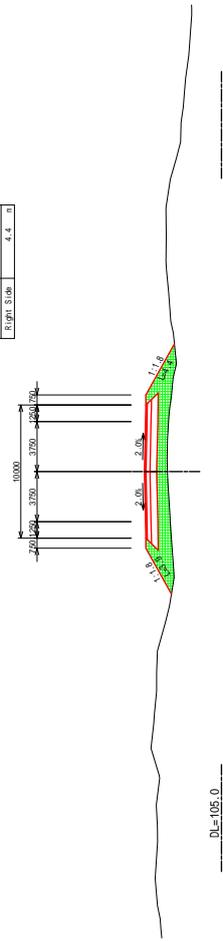

DL=105.0

PK	212+750
Excavation	0.0 m
Shoulder	0.0 m
Enbankment	0.0 m
Length of Enbankment Slope	17.2 m
Left Slope	0.0 n
Right Slope	0.0 n
Length of Enbankment Slope	4.7 m
Left Slope	6.7 n
Right Slope	6.7 n

PK212+750
 GH=110.28
 PH=111.539

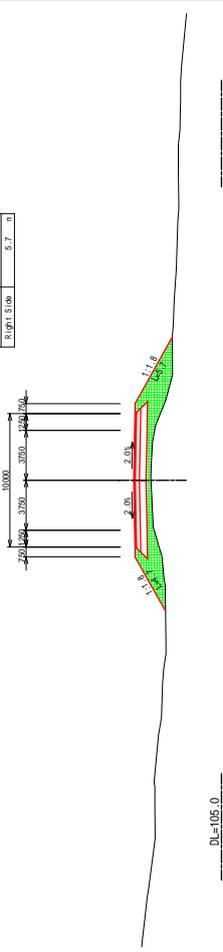

DL=105.0

PK	212+600
Excavation	0.0 m
Shoulder	0.0 m
Enbankment	0.0 m
Length of Enbankment Slope	28.1 m
Left Slope	0.0 n
Right Slope	0.0 n
Length of Enbankment Slope	5.4 m
Left Slope	7.1 n
Right Slope	7.1 n

PK212+600
 GH=108.16
 PH=110.339

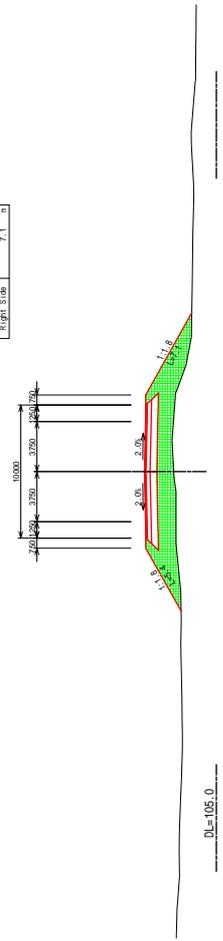

DL=105.0

PK	212+700
Excavation	0.0 m
Shoulder	0.0 m
Enbankment	0.0 m
Length of Enbankment Slope	17.8 m
Left Slope	0.0 n
Right Slope	0.0 n
Length of Enbankment Slope	1.7 m
Left Slope	1.7 n
Right Slope	2.5 n

PK212+700
 GH=109.64
 PH=111.139

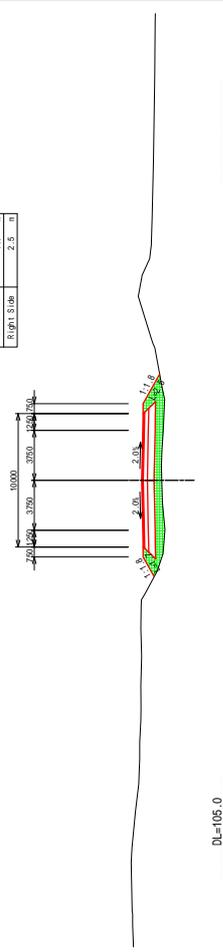

DL=105.0



REPUBLIQUE DE DJIBOUTI
 MINISTERE DE L'EQUIPEMENT ET DES TRANSPORTS
 DIRECTION DE L'EQUIPEMENT



JAPAN INTERNATIONAL COOPERATION AGENCY
 YACHIYO ENGINEERING CO., LTD.

THE PREPARATORY SURVEY FOR
 THE PROJECT FOR
 UPGRADING OF NATIONAL ROAD ROUTE 1
 IN THE REPUBLIC OF DJIBOUTI

SHEET CONTENTS
 CROSS SECTION
 PK212+600 ~ PK212+750

SCALE S=1:400
 DATE NOV 2018
 PAGE NO. 96 / 131

PK 212+850	
Excavation	0.0 m
2000/2000/2000	1.5 m
Enchantment	2.0 m
2000/2000/2000	0.0 m
Length of Excavation Slope	0.0 m
Left Slope	0.0 n
Right Slope	0.0 n
Length of Enchantment Slope	2.7 m
Left Slope	3.7 n

PK212+850
Gh=111.84
Ph=112.584

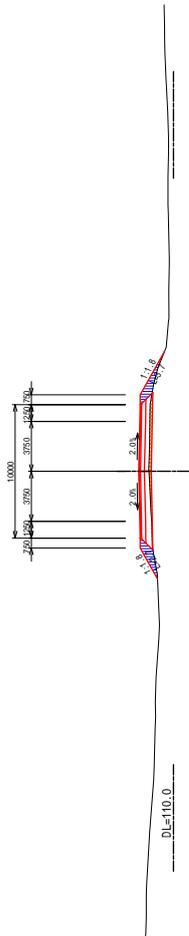

PK 212+950	
Excavation	0.0 m
2000/2000/2000	0.9 m
Enchantment	3.1 m
2000/2000/2000	0.0 m
Length of Excavation Slope	0.0 m
Left Slope	0.0 n
Right Slope	0.0 n
Length of Enchantment Slope	2.9 m
Left Slope	2.3 n

PK212+950
Gh=115.14
Ph=115.939

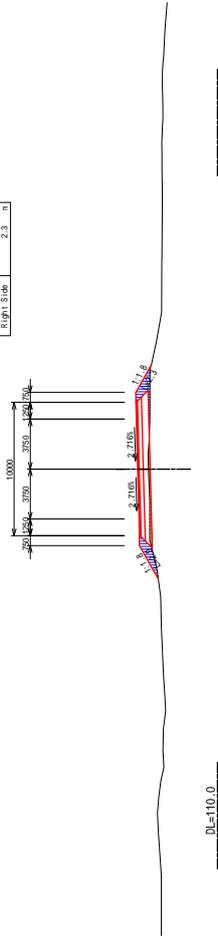

PK 212+800	
Excavation	0.0 m
2000/2000/2000	0.0 m
Enchantment	0.0 m
2000/2000/2000	0.0 m
Length of Excavation Slope	0.0 m
Left Slope	0.0 n
Right Slope	0.0 n
Length of Enchantment Slope	2.8 m
Left Slope	4.9 n

PK212+800
Gh=110.83
Ph=111.938

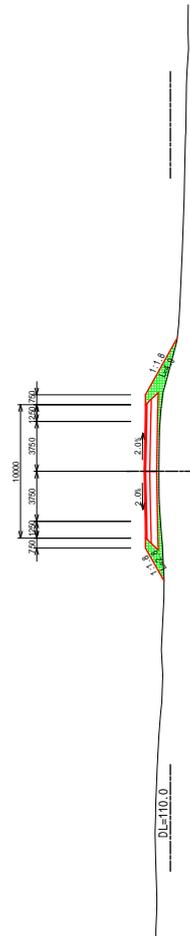

PK 212+900	
Excavation	0.0 m
2000/2000/2000	1.8 m
Enchantment	2.0 m
2000/2000/2000	0.0 m
Length of Excavation Slope	0.0 m
Left Slope	0.0 n
Right Slope	0.0 n
Length of Enchantment Slope	2.4 m
Left Slope	2.1 n

PK212+900
Gh=113.30
Ph=114.139

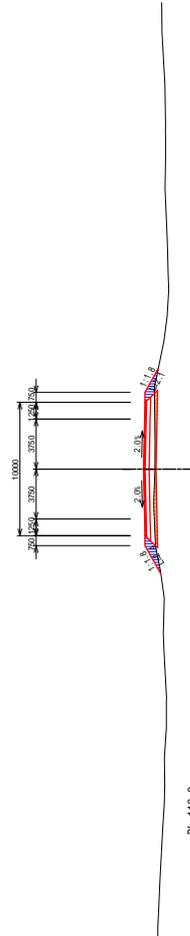

REPUBLIQUE DE DJIBOUTI
MINISTRE DE L'EQUIPEMENT ET DES TRANSPORTS
DIRECTION DE L'EQUIPEMENT



JAPAN INTERNATIONAL COOPERATION AGENCY
YACHIYO ENGINEERING CO., LTD.

THE PREPARATORY SURVEY FOR
THE PROJECT FOR
UPGRADING OF NATIONAL ROAD ROUTE 1
IN THE REPUBLIC OF DJIBOUTI

SHEET CONTENTS
CROSS SECTION
PK212+800 ~ PK212+950

SCALE S=1:400
DATE NOV 2018
PAGE NO. 97 / 131

PK 213+50	
Excavation	0.0 m
Spillway	0.0 m
Enbankment	1.8 m
Length of Enbankment Slope	3.1 m
Left Side	0.0 m
Right Side	3.1 m
Length of Enbankment Slope	3.1 m
Left Side	3.1 m
Right Side	3.4 m

PK213+50
 GH=122.15
 PH=123.139

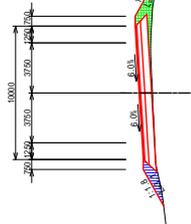

DL=115.0

PK 213+50	
Excavation	0.0 m
Spillway	0.5 m
Enbankment	0.9 m
Length of Enbankment Slope	2.0 m
Left Side	0.0 m
Right Side	1.5 m
Length of Enbankment Slope	2.1 m
Left Side	2.1 m
Right Side	4.3 m

PK213+50
 GH=118.68
 PH=119.539

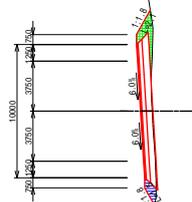

DL=115.0

PK 213+100	
Excavation	0.0 m
Spillway	1.1 m
Enbankment	0.7 m
Length of Enbankment Slope	2.3 m
Left Side	0.0 m
Right Side	1.4 m
Length of Enbankment Slope	1.4 m
Left Side	1.4 m
Right Side	3.1 m

PK213+100
 GH=120.66
 PH=121.339

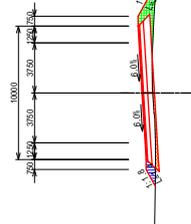

DL=115.0

PK 213+0	
Excavation	0.0 m
Spillway	0.8 m
Enbankment	1.1 m
Length of Enbankment Slope	3.0 m
Left Side	0.0 m
Right Side	2.1 m
Length of Enbankment Slope	2.1 m
Left Side	2.1 m
Right Side	4.3 m

PK213
 GH=118.89
 PH=117.739

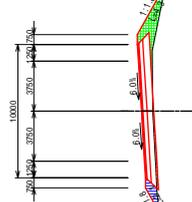

DL=115.0

PK 213+250		
Excavation	0.0	mf
Spill 0.0	0.0	mf
Enbankment	1.0	mf
Grass 0.0	0.0	mf
Length of Enbankment Slope	0.0	n
Left Side	0.0	n
Right Side	0.0	n
Length of Enbankment Slope	1.7	n
Left Side	1.7	n
Right Side	2.8	n

PK213+250
GH=124.93
PH=125.939

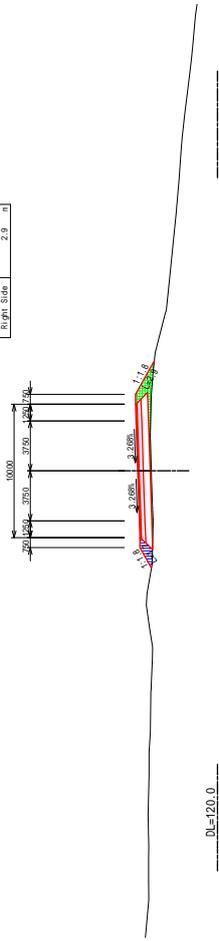

DL=120.0

PK 213+350		
Excavation	0.0	mf
Spill 0.0	0.0	mf
Enbankment	0.0	mf
Grass 0.0	0.0	mf
Length of Enbankment Slope	0.0	n
Left Side	0.0	n
Right Side	0.0	n
Length of Enbankment Slope	2.8	n
Left Side	2.8	n
Right Side	5.7	n

PK213+350
GH=126.57
PH=127.939

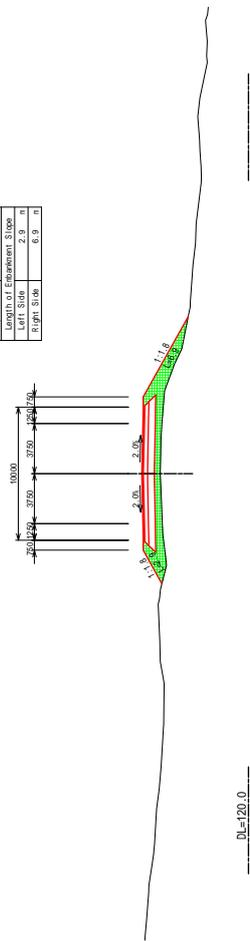

DL=120.0

PK 213+200		
Excavation	0.0	mf
Spill 0.0	0.2	mf
Enbankment	0.9	mf
Grass 2.0	2.0	mf
Length of Enbankment Slope	2.0	n
Left Side	0.0	n
Right Side	0.0	n
Length of Enbankment Slope	1.6	n
Left Side	1.6	n
Right Side	2.8	n

PK213+200
GH=123.91
PH=124.799

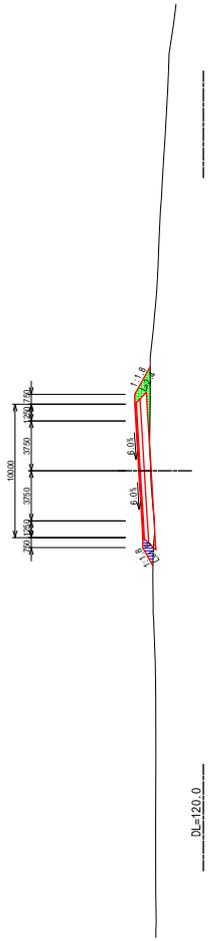

DL=120.0

PK 213+300		
Excavation	0.0	mf
Spill 0.0	0.0	mf
Enbankment	0.0	mf
Grass 2.8	2.8	mf
Length of Enbankment Slope	2.8	n
Left Side	0.0	n
Right Side	0.0	n
Length of Enbankment Slope	2.8	n
Left Side	2.8	n
Right Side	5.7	n

PK213+300
GH=125.79
PH=126.939

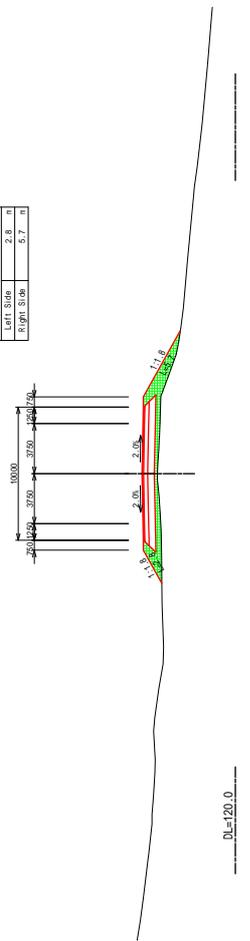

DL=120.0



REPUBLIQUE DE DJIBOUTI
MINISTRE DE L'EQUIPEMENT ET DES TRANSPORTS
DIRECTION DE L'EQUIPEMENT

JAPAN INTERNATIONAL COOPERATION AGENCY
YACHIYO ENGINEERING CO., LTD.

THE PREPARATORY SURVEY FOR
THE PROJECT FOR
UPGRADING OF NATIONAL ROAD ROUTE 1
IN THE REPUBLIC OF DJIBOUTI

SHEET CONTENTS
CROSS SECTION
PK213+200 ~ PK213+350

SCALE S=1:400
DATE NOV 2018
PAGE NO. 99 / 131

PK 213+450	
Excavation	0.0 m ³
200% Sand Fill	0.0 m ³
200% Sand	0.6 m ³
Embankment	0.0 m ³
1.5 m	5.1 m ²
2.0 m	0.0 m ²
3.0 m	0.0 m ²
Length of Embankment Slope	0.0 m
Left Side	0.0 m
Right Side	0.0 m
Length of Embankment Slope	0.0 m
Left Side	2.0 m
Right Side	6.3 m

PK213+450
GH=129.32
PH=130.297

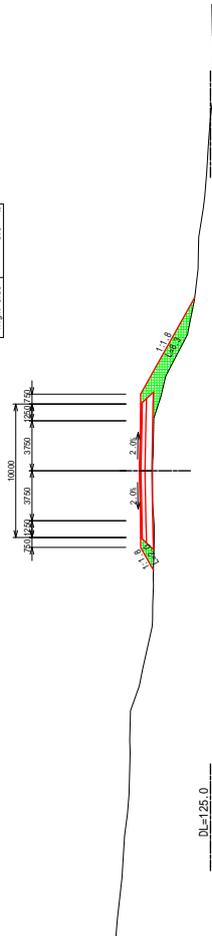

DL=125.0

PK 213+550	
Excavation	0.0 m ³
200% Sand Fill	0.0 m ³
200% Sand	0.6 m ³
Embankment	0.0 m ³
1.5 m	5.1 m ²
2.0 m	0.0 m ²
3.0 m	0.0 m ²
Length of Embankment Slope	0.0 m
Left Side	0.0 m
Right Side	0.0 m
Length of Embankment Slope	0.0 m
Left Side	2.3 m
Right Side	3.3 m

PK213+550
GH=134.77
PH=135.630

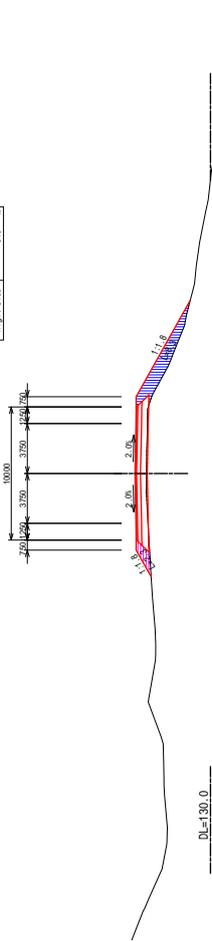

DL=130.0

PK 213+400	
Excavation	0.0 m ³
200% Sand Fill	0.0 m ³
200% Sand	0.0 m ³
Embankment	0.0 m ³
1.5 m	0.0 m ²
2.0 m	13.7 m ²
3.0 m	0.0 m ²
Length of Embankment Slope	0.0 m
Left Side	0.0 m
Right Side	0.0 m
Length of Embankment Slope	0.0 m
Left Side	2.6 m
Right Side	6.9 m

PK213+400
GH=127.48
PH=128.589

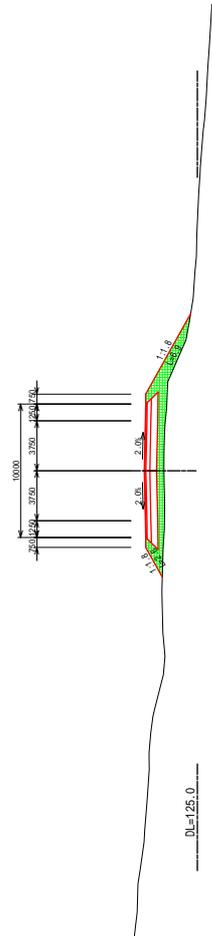

DL=125.0

PK 213+500	
Excavation	0.0 m ³
200% Sand Fill	0.0 m ³
200% Sand	0.2 m ³
Embankment	0.0 m ³
1.5 m	0.0 m ²
2.0 m	1.3 m ²
3.0 m	1.6 m ²
Length of Embankment Slope	0.0 m
Left Side	0.0 m
Right Side	0.0 m
Length of Embankment Slope	0.0 m
Left Side	2.4 m
Right Side	2.5 m

PK213+500
GH=131.74
PH=132.642

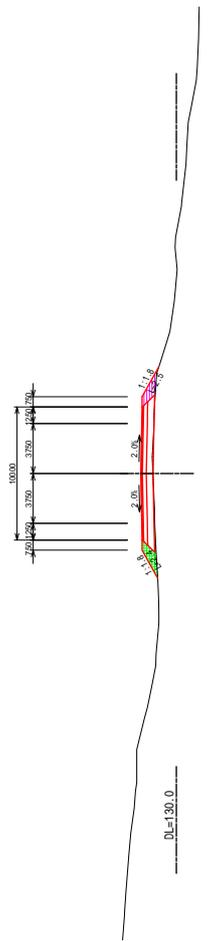

DL=130.0



REPUBLIQUE DE DJIBOUTI
MINISTRE DE L'EQUIPEMENT ET DES TRANSPORTS
DIRECTION DE L'EQUIPEMENT

JAPAN INTERNATIONAL COOPERATION AGENCY
YACHIYO ENGINEERING CO., LTD.

THE PREPARATORY SURVEY FOR
THE PROJECT FOR
UPGRADING OF NATIONAL ROAD ROUTE 1
IN THE REPUBLIC OF DJIBOUTI

SHEET CONTENTS
CROSS SECTION
PK213+400 ~ PK213+550

SCALE S=1:400
DATE NOV 2018
PAGE NO. 100 / 131

PK 213+650	
Excavation	0.0 m
200' Slope Soil	2.7 m
Embankment	5.8 m
2:5 Slope	0.0 m
3:1 Slope	0.0 m
Length of Embankment Slope	0.0 m
Left Side	0.0 m
Right Side	0.0 m
Length of Embankment Slope	1.7 m
Left Side	1.7 m
Right Side	0.0 m

PK213+650
GH=141.09
PH=141.630

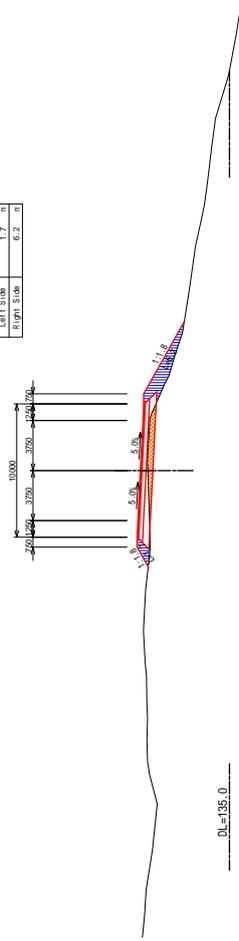

DL=135.0

PK 213+750	
Excavation	0.0 m
200' Slope Soil	6.1 m
Embankment	0.1 m
2:5 Slope	0.0 m
3:1 Slope	3.2 m
Length of Embankment Slope	0.0 m
Left Side	0.0 m
Right Side	0.0 m
Length of Embankment Slope	0.3 m
Left Side	0.3 m
Right Side	4.0 m

PK213+750
GH=145.23
PH=145.415

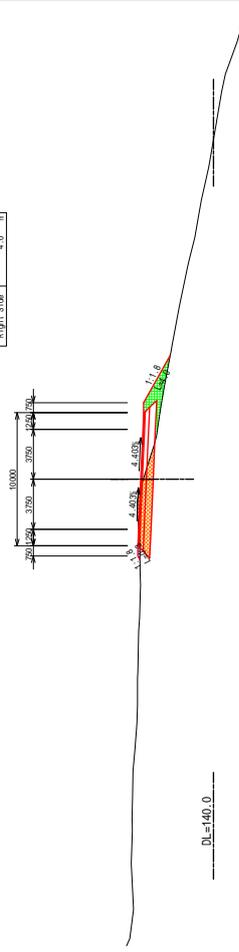

DL=140.0

PK 213+600	
Excavation	0.0 m
200' Slope Soil	1.2 m
Embankment	3.6 m
2:5 Slope	0.0 m
3:1 Slope	7.0 m
Length of Embankment Slope	0.0 m
Left Side	0.0 m
Right Side	0.0 m
Length of Embankment Slope	1.9 m
Left Side	1.9 m
Right Side	7.0 m

PK213+600
GH=137.86
PH=138.630

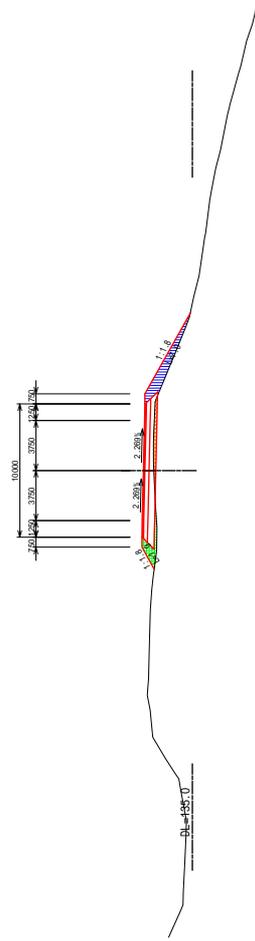

DL=135.0

213+700	
Excavation	0.0 m
200' Slope Soil	2.5 m
Embankment	0.4 m
2:5 Slope	0.0 m
3:1 Slope	1.3 m
Length of Embankment Slope	0.0 m
Left Side	0.0 m
Right Side	0.0 m
Length of Embankment Slope	1.0 m
Left Side	1.0 m
Right Side	6.4 m

PK213+700
GH=143.54
PH=144.384

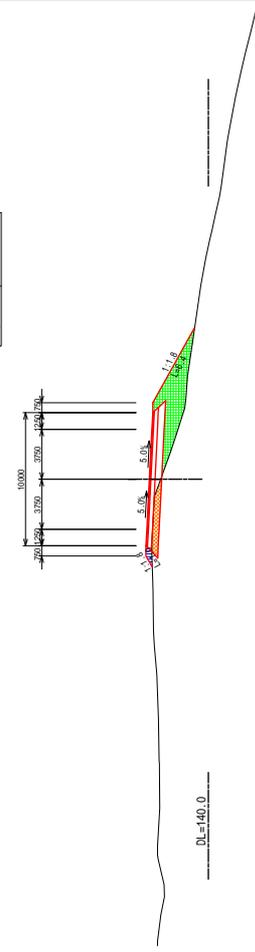

DL=140.0



REPUBLIQUE DE DJIBOUTI
MINISTRE DE L'EQUIPEMENT ET DES TRANSPORTS
DIRECTION DE L'EQUIPEMENT



JAPAN INTERNATIONAL COOPERATION AGENCY
YACHIYO ENGINEERING CO., LTD.

THE PREPARATORY SURVEY FOR
THE PROJECT FOR
UPGRADING OF NATIONAL ROAD ROUTE 1
IN THE REPUBLIC OF DJIBOUTI

SHEET CONTENTS
CROSS SECTION
PK213+600 ~ PK213+750

SCALE S=1:400
DATE NOV 2018
PAGE NO. 101 / 131

PK 214+150	
Excavation	0.0 m
Spill Out	0.0 m
Enlargement	0.0 m
Length of Excavation Slope	0.0 m
Left Slope	0.0 m
Right Slope	0.0 m
Left Stop	6.9 m
Right Stop	6.7 m

PK214+150
GH=141.80
PH=141.895

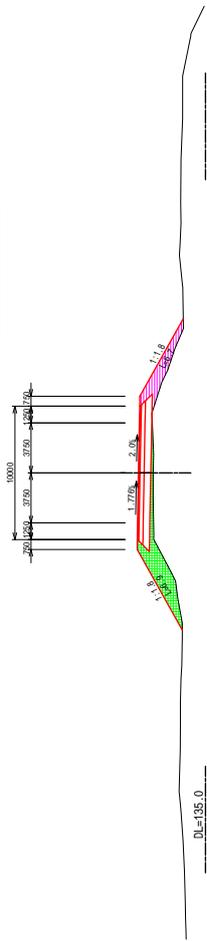

DL=135.0

PK 214+50	
Excavation	0.0 m
Spill Out	0.0 m
Enlargement	0.7 m
Length of Excavation Slope	3.7 m
Left Slope	0.0 m
Right Slope	0.0 m
Left Stop	4.1 m
Right Stop	6.2 m

PK214+50
GH=140.58
PH=143.789

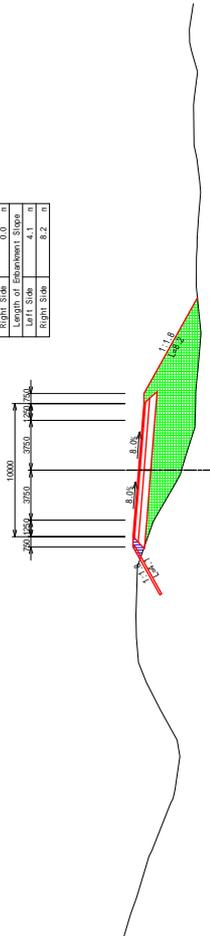

DL=135.0

PK 214+100	
Excavation	0.0 m
Spill Out	0.4 m
Enlargement	0.0 m
Length of Excavation Slope	0.0 m
Left Slope	0.0 m
Right Slope	0.0 m
Left Stop	8.1 m
Right Stop	8.4 m

PK214+100
GH=141.06
PH=141.895

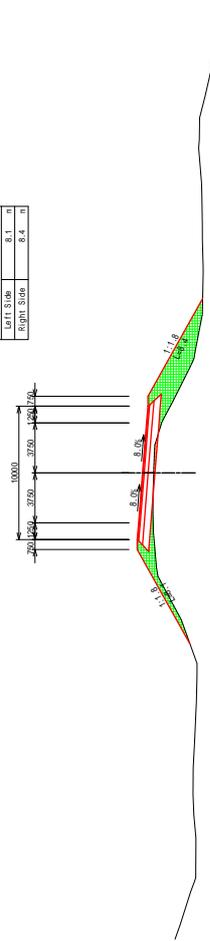

DL=135.0

PK 214+0	
Excavation	0.0 m
Spill Out	0.0 m
Enlargement	0.0 m
Length of Excavation Slope	0.0 m
Left Slope	0.0 m
Right Slope	0.0 m
Left Stop	5.2 m
Right Stop	6.7 m

PK214
GH=141.08
PH=144.675

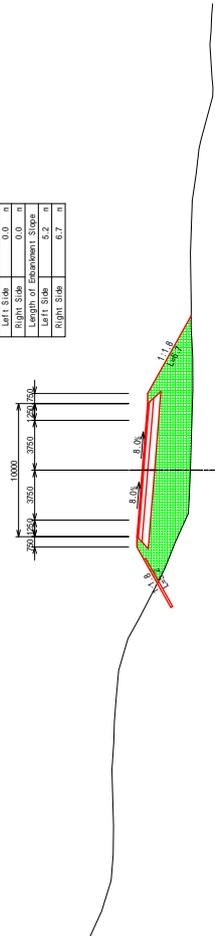

DL=135.0

PK 214+350	
Excavitation	0.0 m
Spore Slope	0.0 m
Enlargement	1.1 m
Length of Excavation Slope	0.0 m
Left Side	0.0 m
Right Side	0.0 m
Length of Enlargement Slope	2.1 m
Left Side	2.8 m
Right Side	2.8 m

PK214+350
 GH=136.34
 PH=137.495

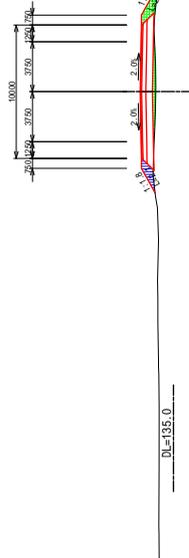

PK 214+300	
Excavitation	0.0 m
Spore Slope	0.1 m
Enlargement	2.4 m
Length of Excavation Slope	0.0 m
Left Side	0.0 m
Right Side	0.0 m
Length of Enlargement Slope	4.6 m
Left Side	4.0 m
Right Side	4.0 m

PK214+300
 GH=136.66
 PH=137.695

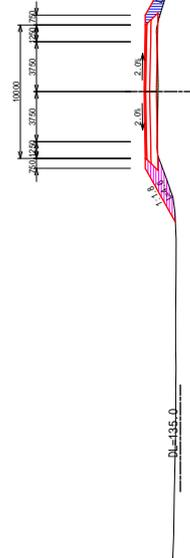

PK 214+250	
Excavitation	0.0 m
Spore Slope	0.9 m
Enlargement	6.0 m
Length of Excavation Slope	0.0 m
Left Side	0.0 m
Right Side	0.0 m
Length of Enlargement Slope	4.8 m
Left Side	4.0 m
Right Side	4.0 m

PK214+250
 GH=136.90
 PH=137.895

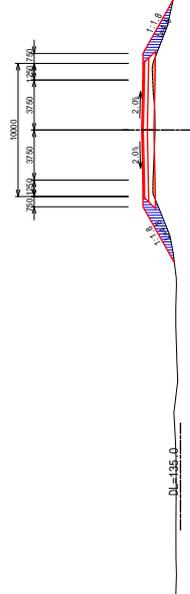

PK 214+200	
Excavitation	0.0 m
Spore Slope	3.0 m
Enlargement	4.0 m
Length of Excavation Slope	0.0 m
Left Side	0.0 m
Right Side	0.0 m
Length of Enlargement Slope	4.8 m
Left Side	2.2 m
Right Side	2.2 m

PK214+200
 GH=137.58
 PH=138.308

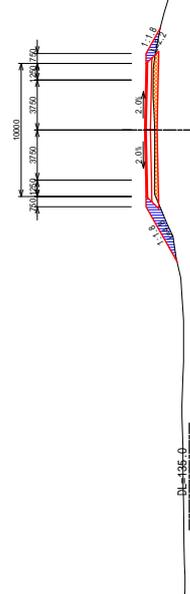

PK	214+550
Excavation	0.0 m
Shoulder Slope	0.0 m
Embankment	0.0 m
Length of Embankment Slope	0.0 m
Left Slope	2.0 m
Right Slope	2.0 m
Length of Embankment Slope	0.0 m
Left Slope	4.3 m
Right Slope	4.6 m

PK214+550
GH=134.55
PH=136.695

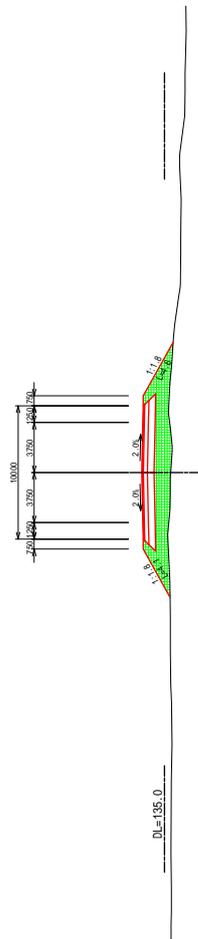

PK	214+500
Excavation	0.0 m
Shoulder Slope	0.0 m
Embankment	0.0 m
Length of Embankment Slope	0.0 m
Left Slope	2.3 m
Right Slope	2.3 m
Length of Embankment Slope	0.0 m
Left Slope	4.0 m
Right Slope	3.5 m

PK214+500
GH=134.92
PH=136.895

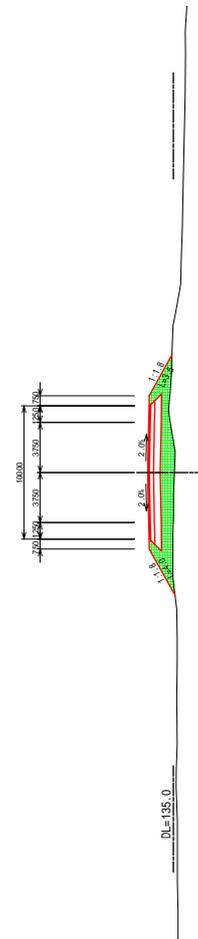

PK	214+450
Excavation	0.0 m
Shoulder Slope	0.0 m
Embankment	0.0 m
Length of Embankment Slope	0.0 m
Left Slope	3.1 m
Right Slope	2.8 m
Length of Embankment Slope	0.0 m
Left Slope	3.1 m
Right Slope	2.8 m

PK214+450
GH=135.40
PH=137.085

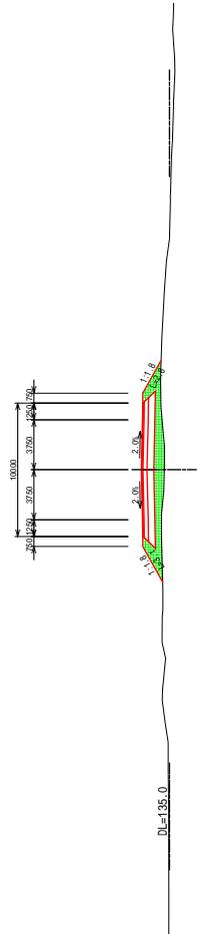

PK	214+400
Excavation	0.0 m
Shoulder Slope	0.0 m
Embankment	0.0 m
Length of Embankment Slope	0.0 m
Left Slope	2.3 m
Right Slope	2.3 m
Length of Embankment Slope	0.0 m
Left Slope	2.2 m
Right Slope	2.3 m

PK214+400
GH=135.99
PH=137.295

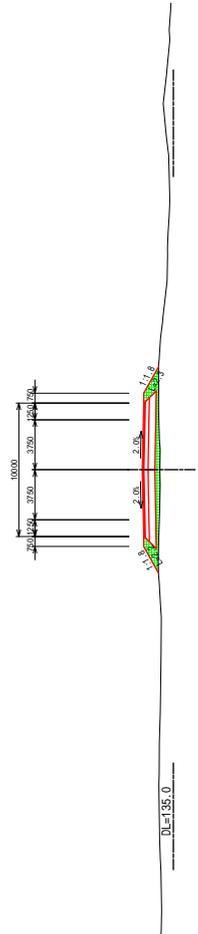

PK	214+750
Excavation	0.0 m
Shoulder	0.0 m
Enbankment	0.0 m
Length of Excavation Slope	0.0 m
Left Slope	0.0 m
Right Slope	0.0 m
Length of Enbankment Slope	0.0 m
Left Slope	5.8 m
Right Slope	7.8 m

PK214+750
 GH=132.63
 PH=135.885

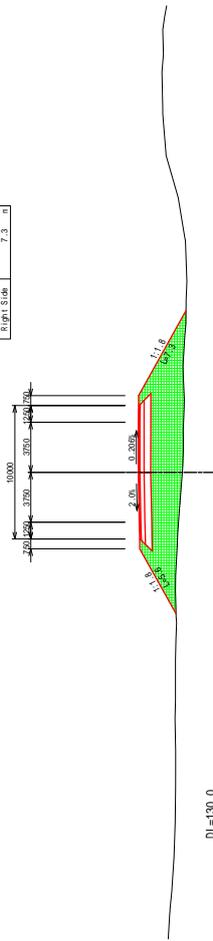

PK	214+700
Excavation	0.0 m
Shoulder	0.0 m
Enbankment	0.0 m
Length of Excavation Slope	0.0 m
Left Slope	0.0 m
Right Slope	0.0 m
Length of Enbankment Slope	0.0 m
Left Slope	6.1 m
Right Slope	7.8 m

PK214+700
 GH=132.59
 PH=136.085

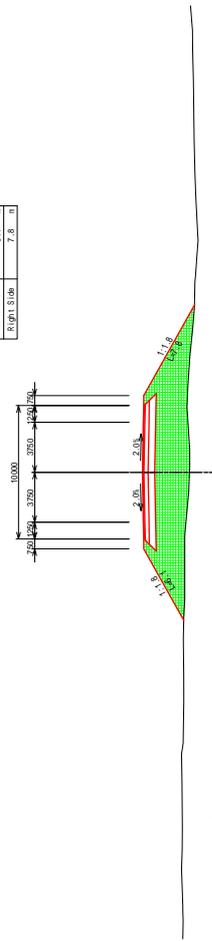

PK	214+650
Excavation	0.0 m
Shoulder	0.0 m
Enbankment	0.0 m
Length of Excavation Slope	0.0 m
Left Slope	0.0 m
Right Slope	0.0 m
Length of Enbankment Slope	0.0 m
Left Slope	5.9 m
Right Slope	7.8 m

PK214+650
 GH=133.20
 PH=136.285

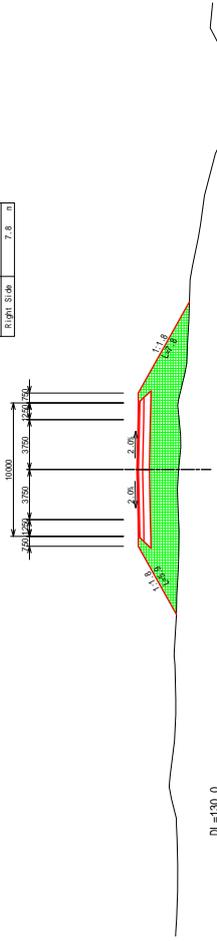

PK	214+600
Excavation	0.0 m
Shoulder	0.0 m
Enbankment	0.0 m
Length of Excavation Slope	0.0 m
Left Slope	0.0 m
Right Slope	0.0 m
Length of Enbankment Slope	0.0 m
Left Slope	4.6 m
Right Slope	4.8 m

PK214+600
 GH=133.83
 PH=136.685

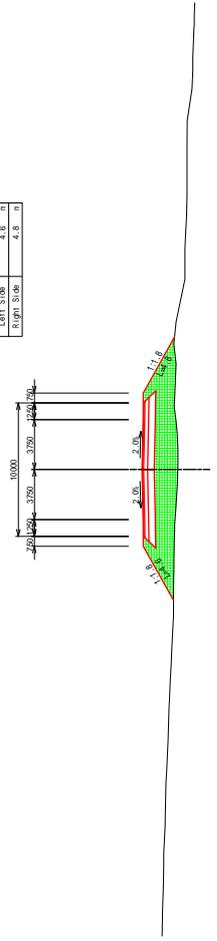

PK	214+850
Excavation	0.0 m
Shoulder	0.0 m
Enchantment	0.0 m
Length of Excavation Slope	0.0 m
Left Slope	0.0 n
Right Slope	0.0 n
Length of Embankment Slope	2.2 m
Left Slope	2.2 n
Right Slope	3.3 n

PK214+850
GH=134.69
PH=136.215

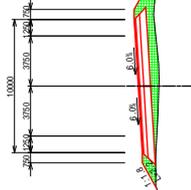

DL=130.0

PK	214+850
Excavation	0.0 m
Shoulder	0.0 m
Enchantment	0.0 m
Length of Excavation Slope	0.0 m
Left Slope	0.0 n
Right Slope	0.0 n
Length of Embankment Slope	2.2 m
Left Slope	2.2 n
Right Slope	3.3 n

PK214+850
GH=134.69
PH=136.215

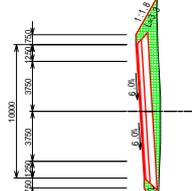

DL=130.0

PK	214+900
Excavation	0.0 m
Shoulder	0.0 m
Enchantment	0.0 m
Length of Excavation Slope	0.0 m
Left Slope	0.0 n
Right Slope	0.0 n
Length of Embankment Slope	5.0 m
Left Slope	5.0 n
Right Slope	5.4 n

PK214+900
GH=135.66
PH=137.215

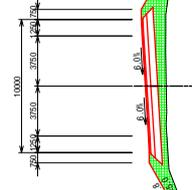

DL=130.0

PK	214+800
Excavation	0.0 m
Shoulder	0.0 m
Enchantment	0.0 m
Length of Excavation Slope	0.0 m
Left Slope	0.0 n
Right Slope	0.0 n
Length of Embankment Slope	3.9 m
Left Slope	3.9 n
Right Slope	5.2 n

PK214+800
GH=133.19
PH=135.695

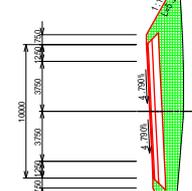

DL=130.0

PK	215+150	
Excavation	0.0	ft
Open Cut	1.2	ft
Enbankment	0.7	ft
Length of Excavation Slope	0.0	ft
Left Slope	0.0	n
Right Slope	0.0	n
Length of Enbankment Slope	1.8	n
Left Slope	1.5	n
Right Slope	2.7	n

PK215+150
 GH=140.53
 PH=141.365

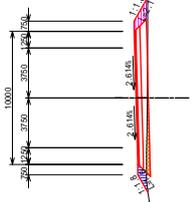

DL=135.0

PK	215+50	
Excavation	0.0	ft
Open Cut	0.1	ft
Enbankment	1.1	ft
Length of Excavation Slope	0.0	ft
Left Slope	0.0	n
Right Slope	0.0	n
Length of Enbankment Slope	2.2	n
Left Slope	3.2	n
Right Slope	3.1	n

PK215+50
 GH=139.03
 PH=140.215

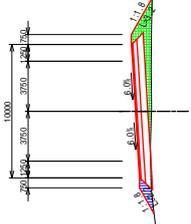

DL=135.0

PK	215+100	
Excavation	0.0	ft
Open Cut	0.9	ft
Enbankment	3.8	ft
Length of Excavation Slope	0.0	ft
Left Slope	0.0	n
Right Slope	0.0	n
Length of Enbankment Slope	1.5	n
Left Slope	1.5	n
Right Slope	2.7	n

PK215+100
 GH=140.12
 PH=141.066

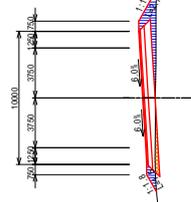

DL=135.0

PK	215+0	
Excavation	0.0	ft
Open Cut	0.0	ft
Enbankment	0.0	ft
Length of Excavation Slope	0.0	ft
Left Slope	0.0	n
Right Slope	0.0	n
Length of Enbankment Slope	2.6	n
Left Slope	2.6	n
Right Slope	3.1	n

PK215
 GH=137.83
 PH=139.215

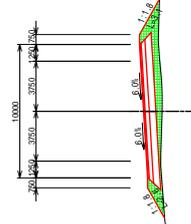

DL=135.0

PK	215+350
Excavation	0.0 m
Shoulder	0.0 m
Subgrade	0.0 m
Embankment	0.0 m
Length of Excavation Slope	0.0 m
Left Side	0.0 m
Right Side	0.0 m
Length of Embankment Slope	2.3 m
Left Side	2.3 m
Right Side	3.1 m

PK215+350
GH=140.75
PH=141.965

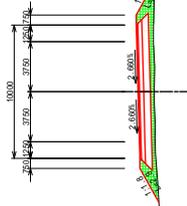

DL=135.0

PK	215+250
Excavation	0.0 m
Shoulder	0.0 m
Subgrade	0.0 m
Embankment	0.0 m
Length of Excavation Slope	0.0 m
Left Side	0.0 m
Right Side	0.0 m
Length of Embankment Slope	2.1 m
Left Side	2.1 m
Right Side	2.9 m

PK215+250
GH=140.54
PH=141.665

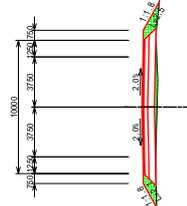

DL=135.0

PK	215+300
Excavation	0.0 m
Shoulder	0.0 m
Subgrade	0.0 m
Embankment	0.0 m
Length of Excavation Slope	2.4 m
Left Side	2.4 m
Right Side	0.0 m
Length of Embankment Slope	2.3 m
Left Side	2.3 m
Right Side	3.1 m

PK215+300
GH=140.57
PH=141.815

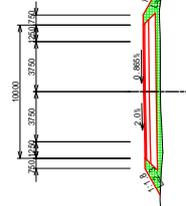

DL=135.0

PK	215+200
Excavation	0.0 m
Shoulder	0.4 m
Subgrade	0.4 m
Embankment	2.2 m
Length of Excavation Slope	0.2 m
Left Side	0.2 m
Right Side	0.0 m
Length of Embankment Slope	2.2 m
Left Side	2.2 m
Right Side	1.9 m

PK215+200
GH=140.54
PH=141.515

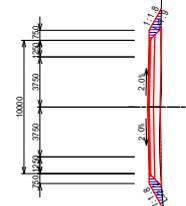

DL=135.0

PK 215+450	
Elevation (m)	
Proposed Road	0.0
Proposed Shoulder	1.3
Existing Road	0.7
Existing Shoulder	1.0
Left Side	0.0
Right Side	0.0
Length of Embankment Slope	0.0
Length of Embankment Slope	1.4
Left Side	2.1
Right Side	2.1

PK215+450
GH=141.53
PH=142.353

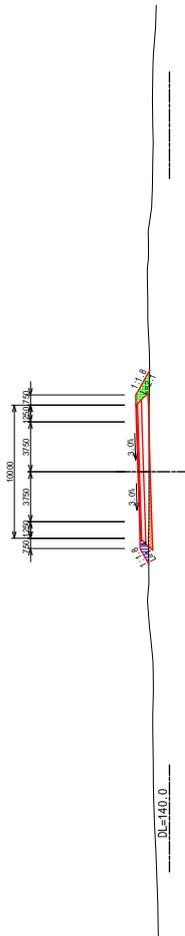

DL=140.0

PK 215+550	
Elevation (m)	
Proposed Road	0.0
Proposed Shoulder	2.1
Existing Road	1.9
Existing Shoulder	0.0
Left Side	0.0
Right Side	0.0
Length of Embankment Slope	0.0
Length of Embankment Slope	1.7
Left Side	1.9
Right Side	1.9

PK215+550
GH=142.88
PH=143.565

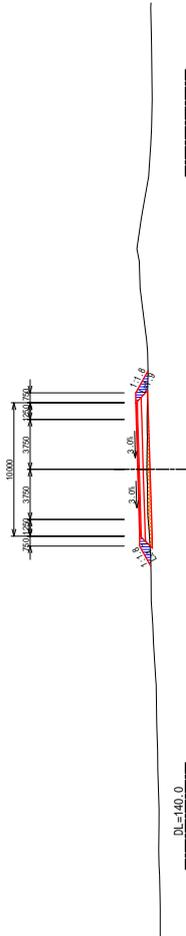

DL=140.0

PK 215+400	
Elevation (m)	
Proposed Road	0.0
Proposed Shoulder	0.0
Existing Road	0.0
Existing Shoulder	0.0
Left Side	0.0
Right Side	0.0
Length of Embankment Slope	0.0
Length of Embankment Slope	2.4
Left Side	2.4
Right Side	3.0

PK215+400
GH=140.93
PH=142.115

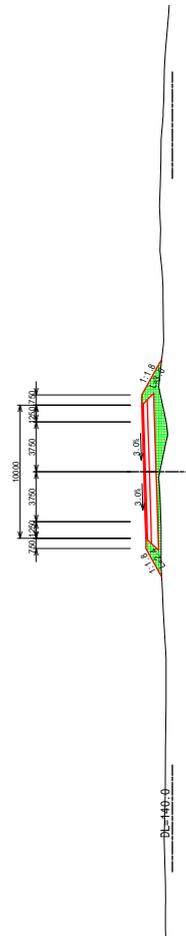

DL=140.0

PK 215+500	
Elevation (m)	
Proposed Road	0.0
Proposed Shoulder	3.6
Existing Road	1.1
Existing Shoulder	0.0
Left Side	0.0
Right Side	0.0
Length of Embankment Slope	0.0
Length of Embankment Slope	0.8
Left Side	0.8
Right Side	1.3

PK215+500
GH=142.21
PH=142.915

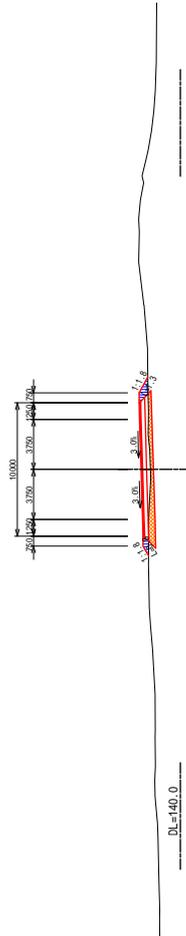

DL=140.0



REPUBLIQUE DE DJIBOUTI
MINISTRE DE L'EQUIPEMENT ET DES TRANSPORTS
DIRECTION DE L'EQUIPEMENT



JAPAN INTERNATIONAL COOPERATION AGENCY
YACHIYO ENGINEERING CO., LTD.

THE PREPARATORY SURVEY FOR
THE PROJECT FOR
UPGRADING OF NATIONAL ROAD ROUTE 1
IN THE REPUBLIC OF DJIBOUTI

SHEET CONTENTS
CROSS SECTION
PK215+400 ~ PK215+550

SCALE S=1:400
DATE NOV 2018
PAGE NO. 110 / 131

PK 215+750	
Excavation	0.0 m
Subgrade	0.0 m
Enbankment	1.4 m
Subgrade	1.7 m
Subgrade	0.0 m
Subgrade	0.0 m
Length of Enbankment Slope	0.0 m
Left Slope	0.0 n
Right Slope	0.0 n
Left Slope	1.8 n
Right Slope	1.8 n

PK215+750
 GH=145.33
 PH=146.165

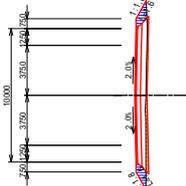

DL=140.0

PK 215+650	
Excavation	0.0 m
Subgrade	0.0 m
Enbankment	0.0 m
Subgrade	0.0 m
Subgrade	0.0 m
Length of Enbankment Slope	0.0 m
Left Slope	0.0 n
Right Slope	0.0 n
Left Slope	3.3 n
Right Slope	3.3 n

PK215+650
 GH=143.28
 PH=144.865

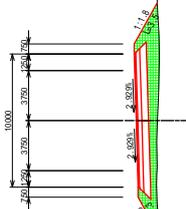

DL=140.0

PK 215+700	
Excavation	0.0 m
Subgrade	0.0 m
Enbankment	0.0 m
Subgrade	0.0 m
Subgrade	0.0 m
Length of Enbankment Slope	0.0 m
Left Slope	0.0 n
Right Slope	0.0 n
Left Slope	2.4 n
Right Slope	2.5 n

PK215+700
 GH=144.34
 PH=145.515

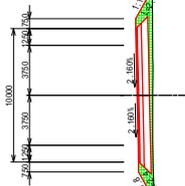

DL=140.0

PK 215+600	
Excavation	0.0 m
Subgrade	0.0 m
Enbankment	0.0 m
Subgrade	0.0 m
Subgrade	0.0 m
Length of Enbankment Slope	0.0 m
Left Slope	0.0 n
Right Slope	0.0 n
Left Slope	2.9 n
Right Slope	3.3 n

PK215+600
 GH=142.87
 PH=144.215

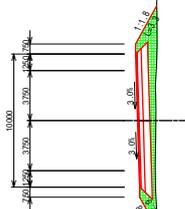

DL=140.0

PK 215+850	
Excavation	0.0 m
Shoulder Slope	8.8 m
Enbankment	0.3 m
Shoulder Slope	0.0 m
Shoulder Slope	0.0 m
Length of Enbankment Slope	0.0 m
Left Slope	0.0 n
Right Slope	0.1 n
Length of Enbankment Slope	0.9 m
Left Slope	0.0 n
Right Slope	0.0 n

PK215+850
 CH=147.82
 PH=147.865

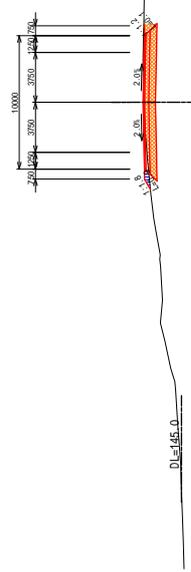

DL=145.0

PK 215+950	
Excavation	0.0 m
Shoulder Slope	10.2 m
Enbankment	0.1 m
Shoulder Slope	0.0 m
Shoulder Slope	0.0 m
Length of Enbankment Slope	0.0 m
Left Slope	0.0 n
Right Slope	0.3 n
Length of Enbankment Slope	0.1 m
Left Slope	0.0 n
Right Slope	0.0 n

PK215+950
 CH=149.88
 PH=149.865

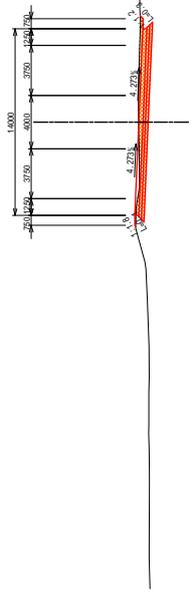

DL=145.0

PK 215+800	
Excavation	0.0 m
Shoulder Slope	9.4 m
Enbankment	0.2 m
Shoulder Slope	0.0 m
Shoulder Slope	0.0 m
Length of Enbankment Slope	0.0 m
Left Slope	0.0 n
Right Slope	0.1 n
Length of Enbankment Slope	0.5 m
Left Slope	0.0 n
Right Slope	0.0 n

PK215+800
 CH=146.73
 PH=146.865

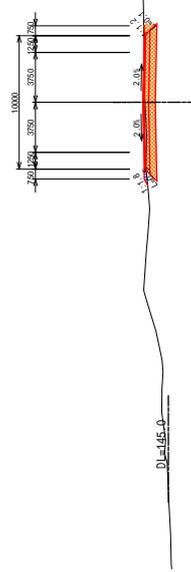

DL=145.0

PK 215+900	
Excavation	0.0 m
Shoulder Slope	7.9 m
Enbankment	0.0 m
Shoulder Slope	0.0 m
Shoulder Slope	0.0 m
Length of Enbankment Slope	0.0 m
Left Slope	0.0 n
Right Slope	0.2 n
Length of Enbankment Slope	0.1 m
Left Slope	0.0 n
Right Slope	0.0 n

PK215+900
 CH=148.88
 PH=148.915

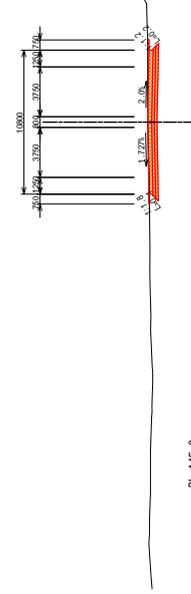

DL=145.0



REPUBLIQUE DE DJIBOUTI
 MINISTERE DE L'EQUIPEMENT ET DES TRANSPORTS
 DIRECTION DE L'EQUIPEMENT



JAPAN INTERNATIONAL COOPERATION AGENCY
 YACHIYO ENGINEERING CO., LTD.

THE PREPARATORY SURVEY FOR
 THE PROJECT FOR
 UPGRADING OF NATIONAL ROAD ROUTE 1
 IN THE REPUBLIC OF DJIBOUTI

SHEET CONTENTS
 CROSS SECTION
 PK215+800 ~ PK215+950

SCALE S=1:400
 DATE NOV 2018
 PAGE NO. 112 / 131

PK	216+150
Excavation	0.0 m
Spill Slope	6.7 m
Enbankment	0.0 m
Spill Slope	3.0 m
Enbankment	0.0 m
Spill Slope	3.0 m
Enbankment	0.0 m
Length of Excavation Slope	0.0 m
Left Side	0.2 m
Right Side	0.2 m
Length of Enbankment Slope	3.0 m
Left Side	0.0 m
Right Side	0.0 m

PK216+150
GH=149.37
PH=149.545

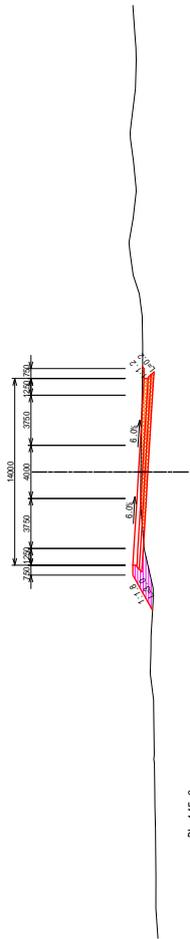

PK	216+50
Excavation	0.0 m
Spill Slope	7.2 m
Enbankment	1.1 m
Spill Slope	0.0 m
Enbankment	0.0 m
Spill Slope	0.0 m
Enbankment	0.0 m
Length of Excavation Slope	0.0 m
Left Side	0.0 m
Right Side	0.2 m
Length of Enbankment Slope	1.8 m
Left Side	0.0 m
Right Side	0.0 m

PK216+50
GH=148.77
PH=149.075

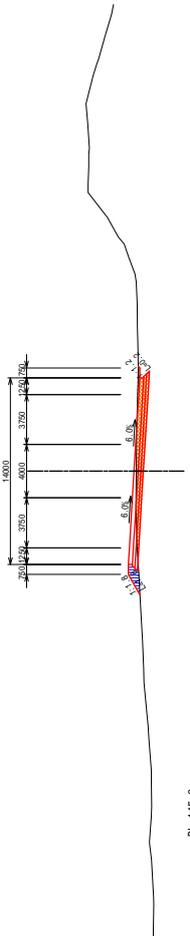

PK	216+100
Excavation	0.0 m
Spill Slope	5.9 m
Enbankment	0.0 m
Spill Slope	2.8 m
Enbankment	1.4 m
Spill Slope	1.4 m
Enbankment	0.0 m
Length of Excavation Slope	0.0 m
Left Side	0.0 m
Right Side	0.0 m
Length of Enbankment Slope	1.8 m
Left Side	0.1 m
Right Side	0.1 m

PK216+100
GH=149.50
PH=149.695

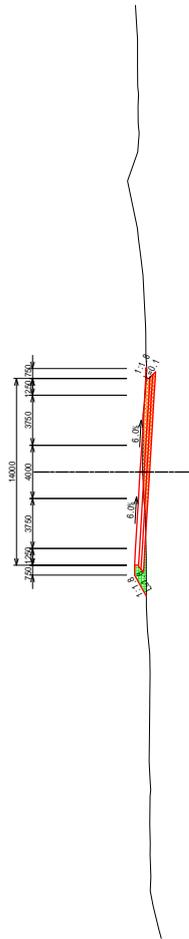

PK	216+0
Excavation	0.0 m
Spill Slope	14.0 m
Enbankment	0.8 m
Spill Slope	2.5 m
Enbankment	0.0 m
Spill Slope	0.0 m
Enbankment	0.0 m
Length of Excavation Slope	0.0 m
Left Side	0.0 m
Right Side	1.2 m
Length of Enbankment Slope	1.4 m
Left Side	0.0 m
Right Side	0.0 m

PK216
GH=150.36
PH=150.327

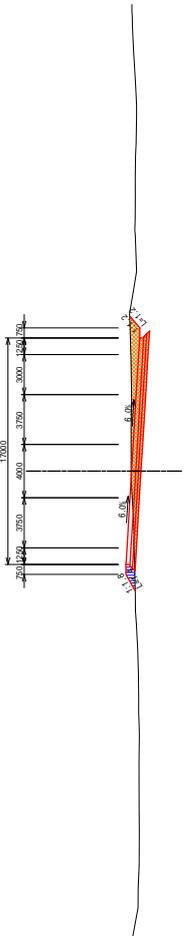

PK 216+350	
Excavation	0.0 m
Shoulder	8.6 m
Enbankment	0.3 m
Shoulder	0.0 m
Shoulder	0.0 m
Length of Embankment Slope	0.0 m
Left Side	0.0 m
Right Side	0.0 m
Left Side	0.5 m
Right Side	0.2 m

PK216+350
 GH=150.56
 PH=150.745

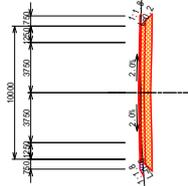

DL=145.0

PK 216+250	
Excavation	0.0 m
Shoulder	7.8 m
Enbankment	0.8 m
Shoulder	0.0 m
Shoulder	0.0 m
Length of Embankment Slope	0.0 m
Left Side	0.0 m
Right Side	0.2 m
Left Side	1.8 m
Right Side	0.0 m

PK216+250
 GH=149.38
 PH=149.448

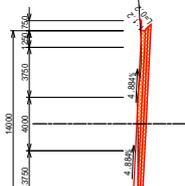

DL=145.0

PK 216+300	
Excavation	0.0 m
Shoulder	7.2 m
Enbankment	0.4 m
Shoulder	0.0 m
Shoulder	0.0 m
Length of Embankment Slope	0.0 m
Left Side	0.0 m
Right Side	0.0 m
Left Side	0.5 m
Right Side	0.5 m

PK216+300
 GH=150.13
 PH=149.985

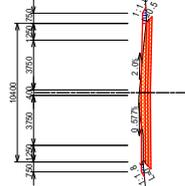

DL=145.0

PK 216+200	
Excavation	0.0 m
Shoulder	9.4 m
Enbankment	0.7 m
Shoulder	0.0 m
Shoulder	0.0 m
Length of Embankment Slope	0.0 m
Left Side	0.0 m
Right Side	1.3 m
Left Side	1.4 m
Right Side	0.0 m

PK216+200
 GH=149.49
 PH=149.395

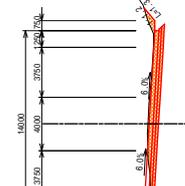

DL=145.0

PK 216+550	
Excavation	0.0 m ²
2000/2000/50/1	0.0 m ²
Embankment	0.0 m ²
2000/2000/50/1	0.0 m ²
Length of Embankment Slope	1.0 m
Left Side	0.0 m
Right Side	0.0 m
Length of Embankment Slope	4.5 m
Left Side	2.3 m
Right Side	2.3 m

PK216+550
GH=148.60
PH=149.995

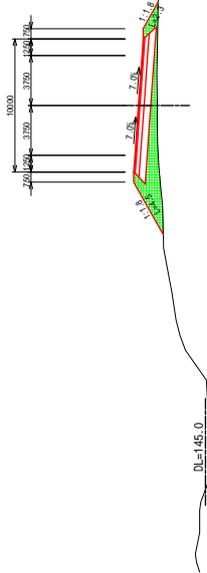

PK 216+500	
Excavation	0.0 m ²
2000/2000/50/1	0.0 m ²
Embankment	1.2 m ²
2000/2000/50/1	0.0 m ²
Length of Embankment Slope	2.3 m
Left Side	0.0 m
Right Side	0.0 m
Length of Embankment Slope	4.3 m
Left Side	2.1 m
Right Side	2.1 m

PK216+500
GH=150.90
PH=152.151

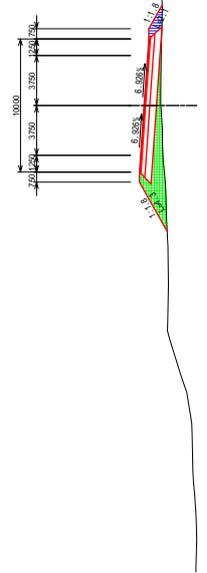

PK 216+450	
Excavation	0.0 m ²
2000/2000/50/1	3.8 m ²
Embankment	1.2 m ²
2000/2000/50/1	0.0 m ²
Length of Embankment Slope	0.0 m
Left Side	0.0 m
Right Side	0.0 m
Length of Embankment Slope	1.8 m
Left Side	0.9 m
Right Side	0.9 m

PK216+450
GH=151.53
PH=152.245

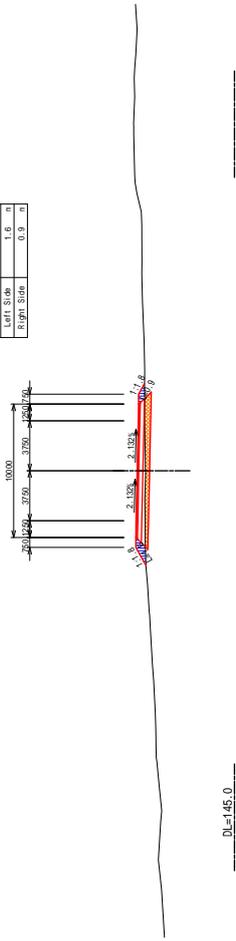

PK 216+400	
Excavation	0.0 m ²
2000/2000/50/1	6.8 m ²
Embankment	0.4 m ²
2000/2000/50/1	0.0 m ²
Length of Embankment Slope	0.0 m
Left Side	0.0 m
Right Side	0.0 m
Length of Embankment Slope	0.8 m
Left Side	0.3 m
Right Side	0.3 m

PK216+400
GH=151.13
PH=151.485

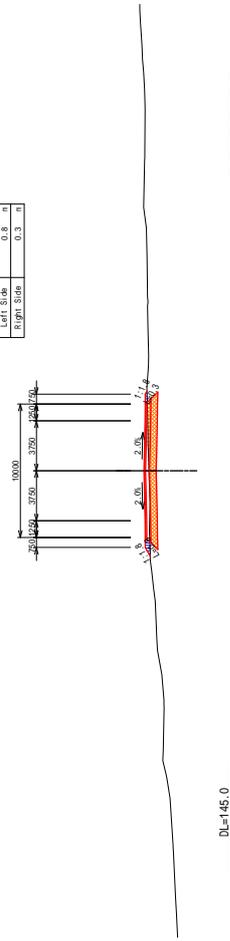

PK	216+750
Excavation	0.0 m
Shoulder	0.0 m
Enbankment	0.0 m
Length of Embankment Slope	20.2 m
Left Slope	0.0 n
Right Slope	0.0 n
Length of Embankment Slope	7.0 m
Left Slope	7.0 m
Right Slope	7.0 m

PK216+750
 GH=141.00
 PH=143.685

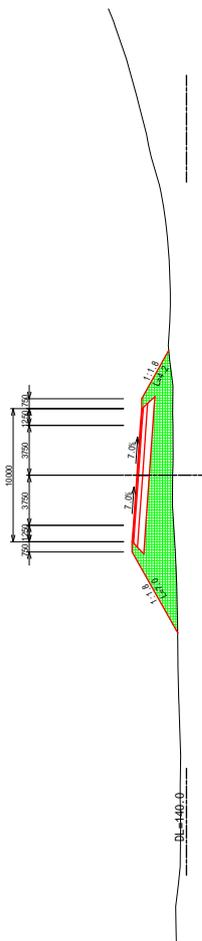

PK	216+700
Excavation	0.0 m
Shoulder	0.0 m
Enbankment	0.0 m
Length of Embankment Slope	20.8 m
Left Slope	0.0 n
Right Slope	0.0 n
Length of Embankment Slope	9.7 m
Left Slope	9.7 m
Right Slope	3.7 m

PK216+700
 GH=141.06
 PH=143.645

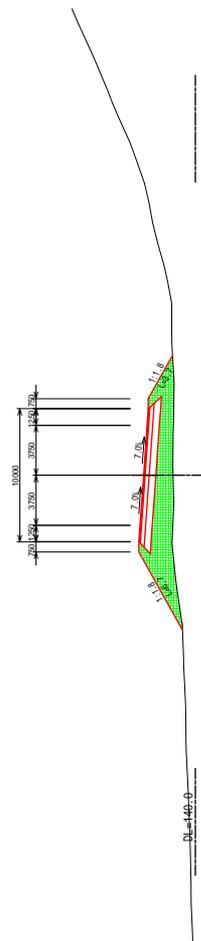

PK	216+650
Excavation	0.0 m
Shoulder	0.0 m
Enbankment	0.0 m
Length of Embankment Slope	20.0 m
Left Slope	0.0 n
Right Slope	0.0 n
Length of Embankment Slope	9.1 m
Left Slope	9.1 m
Right Slope	2.0 m

PK216+650
 GH=142.85
 PH=144.585

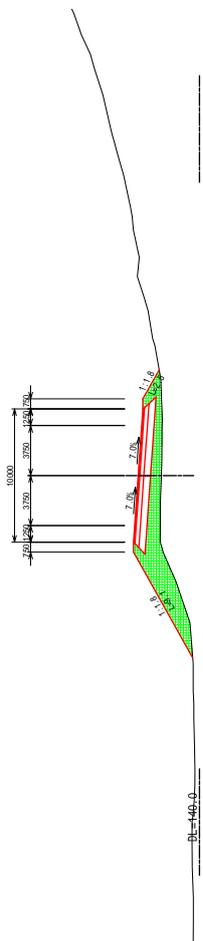

PK	216+600
Excavation	0.0 m
Shoulder	0.0 m
Enbankment	0.0 m
Length of Embankment Slope	29.7 m
Left Slope	0.0 n
Right Slope	0.0 n
Length of Embankment Slope	11.0 m
Left Slope	11.0 m
Right Slope	3.9 m

PK216+600
 GH=145.49
 PH=146.985

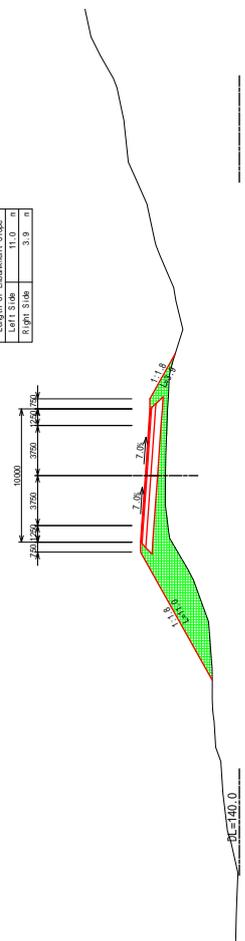

PK 216+850	
Excavation	0.0 m
Shoulder	0.0 m
Enbankment	0.0 m
Length of Separation Slope	1.0 m
Left Slope	0.0 n
Right Slope	0.0 n
Length of Enbankment Slope	4.1 m
Left Slope	4.1 n
Right Slope	4.3 n

PK216+850
 GH=142.06
 PH=143.438

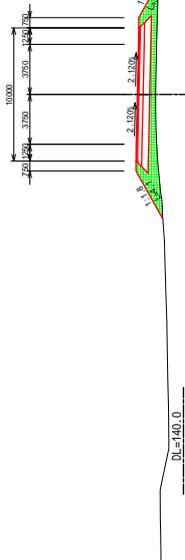

PK 216+950	
Excavation	0.0 m
Shoulder	0.0 m
Enbankment	0.0 m
Length of Separation Slope	0.0 m
Left Slope	0.0 n
Right Slope	0.0 n
Length of Enbankment Slope	2.7 m
Left Slope	2.7 n
Right Slope	2.8 n

PK216+950
 GH=143.05
 PH=144.080

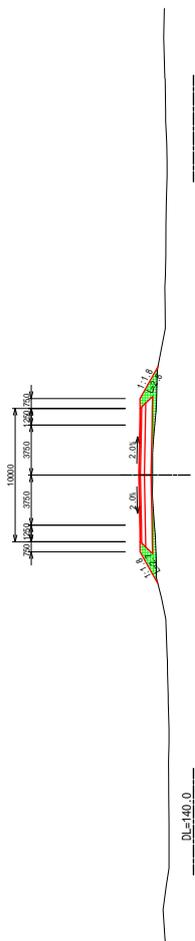

PK 216+800	
Excavation	0.0 m
Shoulder	0.0 m
Enbankment	0.0 m
Length of Separation Slope	2.6 m
Left Slope	0.0 n
Right Slope	0.0 n
Length of Enbankment Slope	6.1 m
Left Slope	6.1 n
Right Slope	4.3 n

PK216+800
 GH=141.43
 PH=143.545

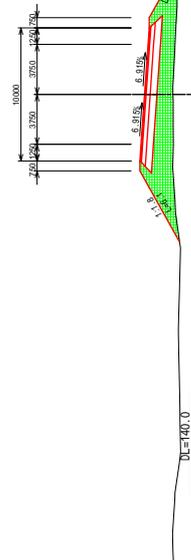

PK 216+900	
Excavation	0.0 m
Shoulder	0.0 m
Enbankment	0.0 m
Length of Separation Slope	3.1 m
Left Slope	0.0 n
Right Slope	0.0 n
Length of Enbankment Slope	4.1 m
Left Slope	4.1 n
Right Slope	3.0 n

PK216+900
 GH=142.70
 PH=143.720

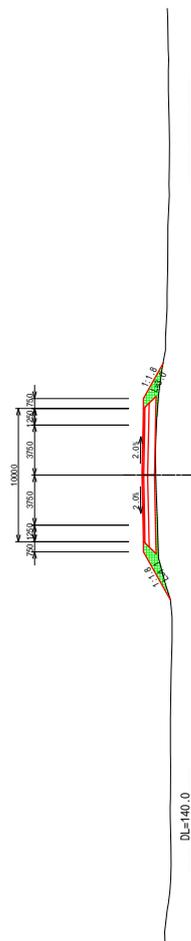

PK 217+150	
Excavation	0.0 m
Shoulder Slope	0.0 m
Enbankment	0.0 m
Length of Excavation Slope	0.0 m
Left Side	0.0 m
Right Side	0.0 m
Length of Enbankment Slope	2.7 m
Left Side	2.7 m
Right Side	3.1 m

PK217+150
GH=144.35
PH=145.480

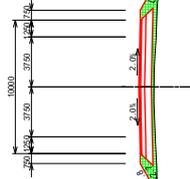

DL=140.0

PK 217+50	
Excavation	0.0 m
Shoulder Slope	0.0 m
Enbankment	0.0 m
Length of Excavation Slope	0.0 m
Left Side	0.0 m
Right Side	0.0 m
Length of Enbankment Slope	2.8 m
Left Side	2.8 m
Right Side	3.0 m

PK217+50
GH=143.64
PH=144.780

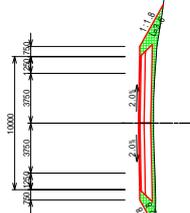

DL=140.0

PK 217+100	
Excavation	0.0 m
Shoulder Slope	0.0 m
Enbankment	0.0 m
Length of Excavation Slope	0.0 m
Left Side	0.0 m
Right Side	0.0 m
Length of Enbankment Slope	3.7 m
Left Side	3.7 m
Right Side	3.7 m

PK217+100
GH=144.08
PH=145.130

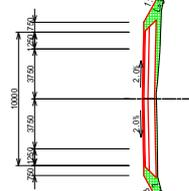

DL=140.0

PK 217+0	
Excavation	0.0 m
Shoulder Slope	0.0 m
Enbankment	0.0 m
Length of Excavation Slope	0.0 m
Left Side	0.0 m
Right Side	0.0 m
Length of Enbankment Slope	3.3 m
Left Side	3.3 m
Right Side	3.3 m

PK217
GH=143.28
PH=144.430

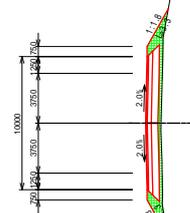

DL=140.0

PK	217+350
Excavation	0.0 m
Shoulder Slope	0.0 m
Shoulder Slope	0.9 m
Embankment	1.2 m
Shoulder Slope	0.0 m
Shoulder Slope	0.0 m
Length of Excavation Slope	0.0 m
Left Side	0.0 m
Right Side	0.0 m
Length of Embankment Slope	2.0 m
Left Side	2.0 m
Right Side	2.2 m

PK217+350
 GH=146.06
 PH=146.880

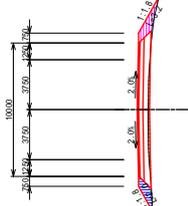

DL=140.0

PK	217+250
Excavation	0.0 m
Shoulder Slope	0.0 m
Shoulder Slope	1.1 m
Embankment	0.0 m
Shoulder Slope	0.0 m
Shoulder Slope	0.0 m
Length of Excavation Slope	0.0 m
Left Side	0.0 m
Right Side	0.0 m
Length of Embankment Slope	2.0 m
Left Side	2.0 m
Right Side	2.4 m

PK217+250
 GH=145.22
 PH=146.180

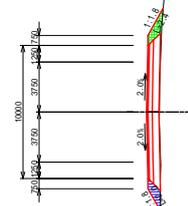

DL=140.0

PK	217+300
Excavation	0.0 m
Shoulder Slope	0.4 m
Shoulder Slope	0.4 m
Embankment	1.3 m
Shoulder Slope	1.5 m
Shoulder Slope	0.0 m
Length of Excavation Slope	0.0 m
Left Side	0.0 m
Right Side	0.0 m
Length of Embankment Slope	2.1 m
Left Side	2.1 m
Right Side	2.5 m

PK217+300
 GH=145.67
 PH=146.530

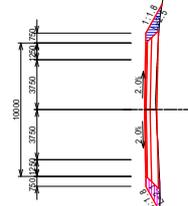

DL=140.0

PK	217+200
Excavation	0.0 m
Shoulder Slope	0.0 m
Shoulder Slope	0.0 m
Embankment	0.0 m
Shoulder Slope	2.5 m
Shoulder Slope	0.0 m
Length of Excavation Slope	0.0 m
Left Side	0.0 m
Right Side	0.0 m
Length of Embankment Slope	2.7 m
Left Side	2.7 m
Right Side	2.9 m

PK217+200
 GH=144.85
 PH=145.530

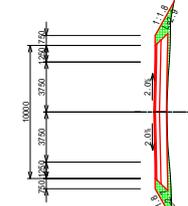

DL=140.0

PK	217+450
Excavation	0.0 m
Shoulder	3.3 m
Embankment	2.0 m
Shoulder	3.3 m
Excavation	0.0 m
Length of Embankment Slope	0.0 m
Left Slope	0.0 m
Right Slope	0.0 m
Length of Embankment Slope	0.0 m
Left Slope	1.8 m
Right Slope	2.8 m

PK217+450
GH=147.65
PH=148.280

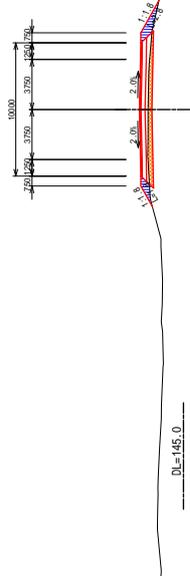

PK	217+450
Excavation	0.0 m
Shoulder	1.7 m
Embankment	2.0 m
Shoulder	1.7 m
Excavation	0.0 m
Length of Embankment Slope	0.0 m
Left Slope	0.0 m
Right Slope	0.0 m
Length of Embankment Slope	0.0 m
Left Slope	3.1 m
Right Slope	3.0 m

PK217+450
GH=146.82
PH=147.580

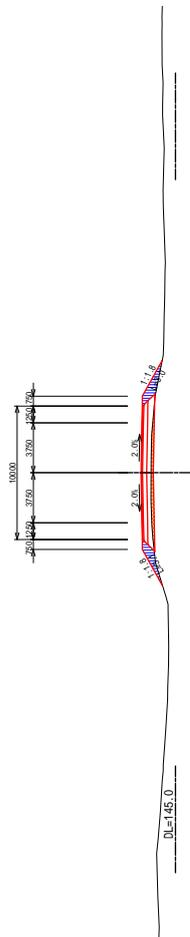

PK	217+500
Excavation	0.0 m
Shoulder	3.0 m
Embankment	2.2 m
Shoulder	3.0 m
Excavation	0.0 m
Length of Embankment Slope	0.0 m
Left Slope	0.0 m
Right Slope	0.0 m
Length of Embankment Slope	0.0 m
Left Slope	2.6 m
Right Slope	2.2 m

PK217+500
GH=147.27
PH=147.930

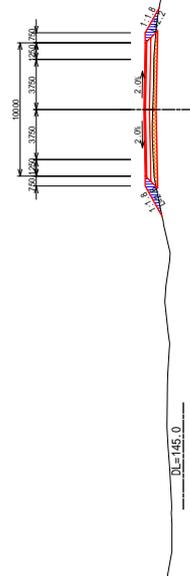

PK	217+400
Excavation	0.0 m
Shoulder	2.1 m
Embankment	2.4 m
Shoulder	2.5 m
Excavation	0.0 m
Length of Embankment Slope	0.0 m
Left Slope	0.0 m
Right Slope	0.0 m
Length of Embankment Slope	0.0 m
Left Slope	2.2 m
Right Slope	2.8 m

PK217+400
GH=146.55
PH=147.230

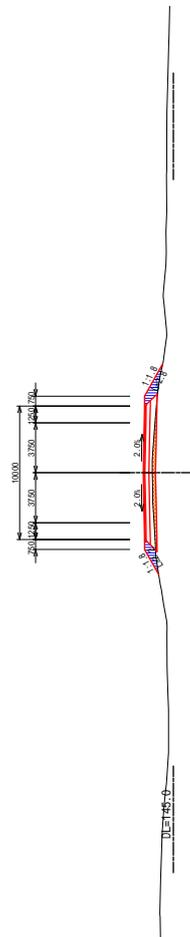

PK	217+750
Excavation	0.0 m
Shoulder	7.9 m
Enchantment	0.3 m
Length of Excavation Slope	0.0 m
Left Slope	0.0 n
Right Slope	0.1 n
Right Slope	0.3 n

PK217+750
GH=149.44
PH=149.680

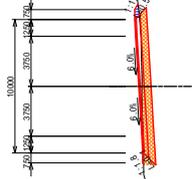

DL=145.0

PK	217+650
Excavation	0.0 m
Shoulder	3.9 m
Enchantment	0.5 m
Length of Excavation Slope	0.0 m
Left Slope	0.0 n
Right Slope	1.3 n
Right Slope	6.1 n

PK217+650
GH=148.45
PH=148.980

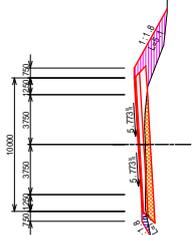

DL=145.0

PK	217+700
Excavation	0.0 m
Shoulder	4.3 m
Enchantment	0.3 m
Length of Excavation Slope	2.7 m
Left Slope	0.0 n
Right Slope	0.0 n
Right Slope	0.7 n
Right Slope	4.1 n

PK217+700
GH=148.86
PH=149.330

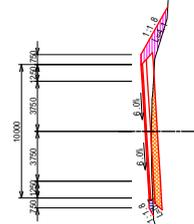

DL=145.0

PK	217+600
Excavation	0.0 m
Shoulder	3.5 m
Enchantment	0.7 m
Length of Excavation Slope	3.3 m
Left Slope	0.0 n
Right Slope	1.7 n
Right Slope	4.2 n

PK217+600
GH=148.10
PH=148.630

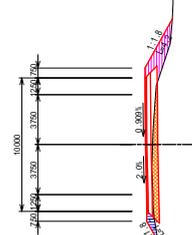

DL=145.0

PK 217+850	
Excavation	0.0 m
Shoulder	9.0 m
Enchantment	0.1 m
Shoulder	0.0 m
Shoulder	0.0 m
Length of Enchantment Slope	0.0 m
Left Slope	0.8 n
Right Slope	0.0 n
Length of Enchantment Slope	0.0 m
Left Slope	0.0 n
Right Slope	0.2 n

PK217+850

GH=150.23
PH=150.345

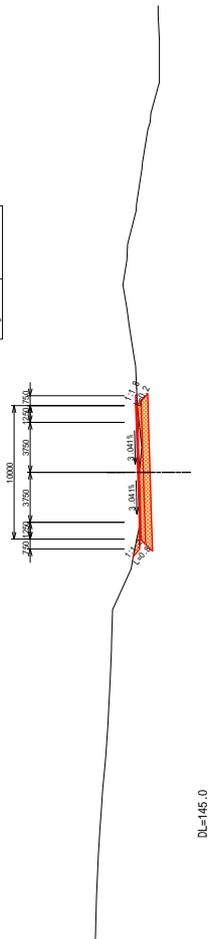

DL=145.0

PK 217+800	
Excavation	0.0 m
Shoulder	7.5 m
Enchantment	1.9 m
Shoulder	0.0 m
Shoulder	0.0 m
Length of Enchantment Slope	0.0 m
Left Slope	0.0 n
Right Slope	0.0 n
Length of Enchantment Slope	0.0 m
Left Slope	0.8 n
Right Slope	3.1 n

PK217+800

GH=149.81
PH=150.030

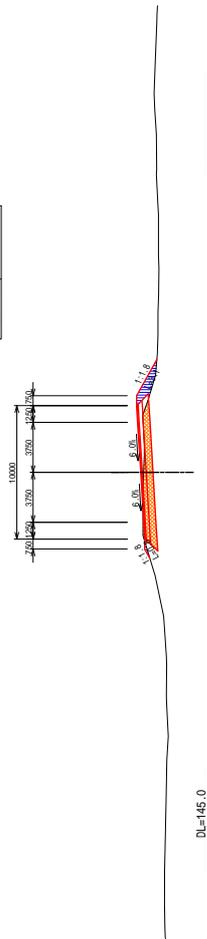

DL=145.0

PK 217+890	
Excavation	0.0 m
Shoulder	11.1 m
Enchantment	0.0 m
Shoulder	0.0 m
Shoulder	0.0 m
Length of Enchantment Slope	0.0 m
Left Slope	0.1 n
Right Slope	0.0 n
Length of Enchantment Slope	0.0 m
Left Slope	0.0 n
Right Slope	0.1 n

PK217+890

GH=150.51
PH=150.500

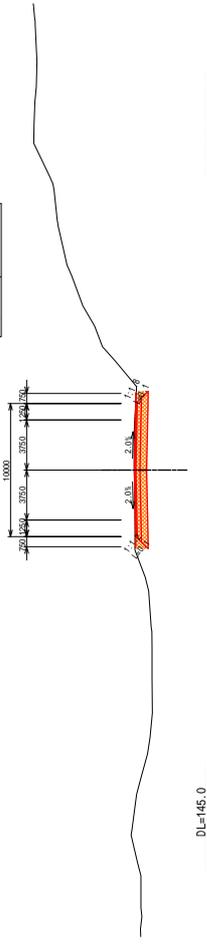

DL=145.0



REPUBLIQUE DE DJIBOUTI
MINISTRE DE L'EQUIPEMENT ET DES TRANSPORTS
DIRECTION DE L'EQUIPEMENT

JAPAN INTERNATIONAL COOPERATION AGENCY
YACHIYO ENGINEERING CO., LTD.

THE PREPARATORY SURVEY FOR
THE PROJECT FOR
UPGRADING OF NATIONAL ROAD ROUTE 1
IN THE REPUBLIC OF DJIBOUTI

SHEET CONTENTS
CROSS SECTION
PK217+800 ~ PK217+890

SCALE S=1:400
DATE NOV 2018
PAGE NO. 122 / 131

STANDARD DRAWING OF BOX CULVERT (1)

PLAN S=1:150

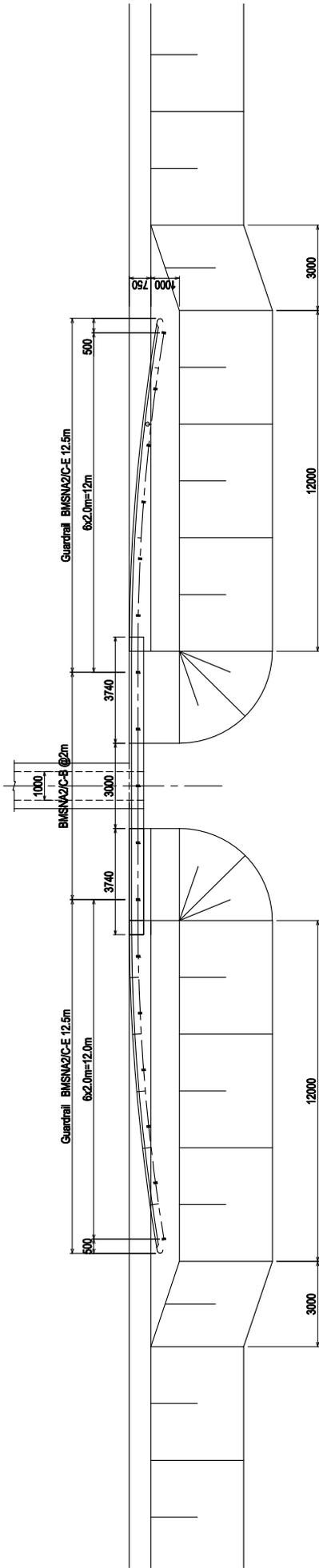

Type-A S=1:100
(Earth Cover Depth at Edge of Shoulder < 1000)

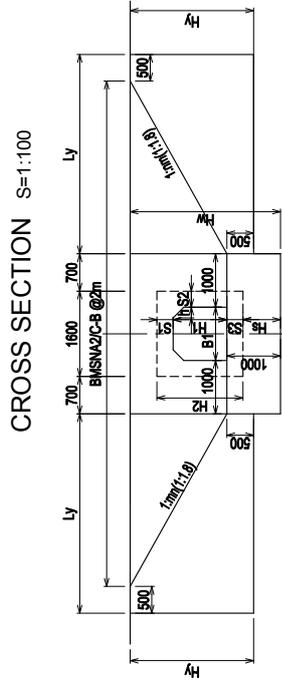
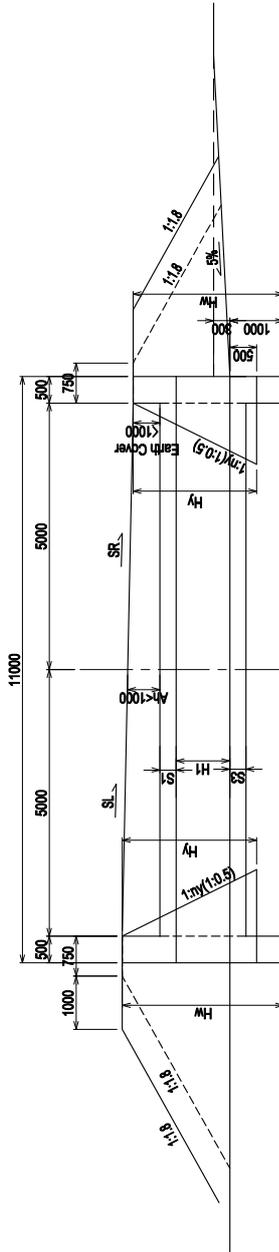

Type-B S=1:100
(Earth Cover Depth at Edge of Shoulder > 1000)

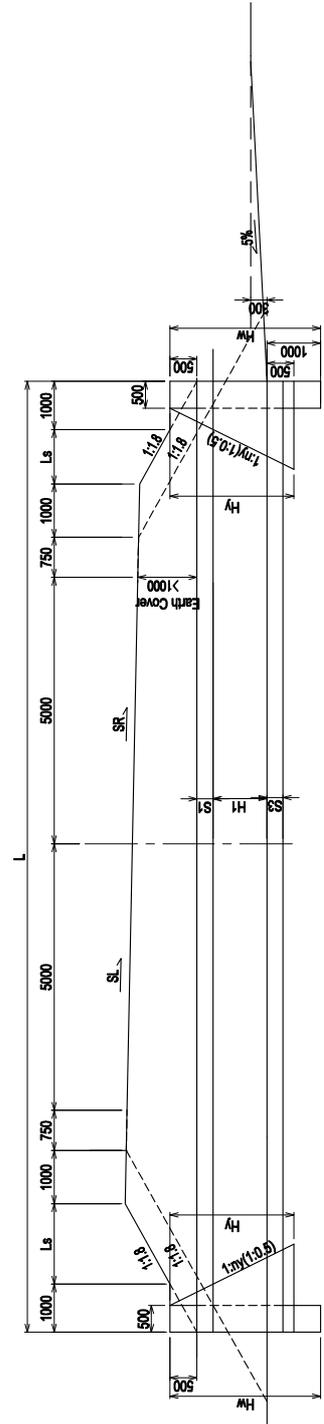

 <p>REPUBLIQUE DE DJIBOUTI MINISTERE DE L'EQUIPEMENT ET DES TRANSPORTS DIRECTION DE L'EQUIPEMENT</p>	 <p>JAPAN INTERNATIONAL COOPERATION AGENCY YACHIYO ENGINEERING CO., LTD.</p>	THE PREPARATORY SURVEY FOR THE PROJECT FOR UPGRADING OF NATIONAL ROAD ROUTE 1 IN THE REPUBLIC OF DJIBOUTI		SHEET CONTENTS STANDARD DRAWING OF BOX CULVERT (1)	SCALE DATE PAGE NO.	Shown NOV 2018 123 / 131

STANDARD DRAWING OF BOX CULVERT (2)

Mark	Unit	Box-1	Box-2	Box-3	Box-4	Box-5	Box-6	Box-7	Box-8	Box-9	Box-10	Box-11	Box-12	Box-13	Box-14	Box-15	Box-16	Box-17	Box-18	Box-19	
-	-	1.0x1.0	1.0x1.0	1.0x1.0	1.0x1.0	1.0x1.0	1.0x1.0	1.5x1.0	1.5x1.0	1.0x1.0	1.0x1.0	1.0x1.0	1.0x1.0	1.5x1.0	2.0x1.0	1.0x1.0	1.5x1.0	2.0x1.0	1.0x1.0	1.0x1.0	1.0x1.0
Sta.	-	197+484.0	197+792.1	198+018.3	198+268.7	198+484.4	198+692.1	198+863.1	199+278.3	200+375.7	201+030.0	201+942.2	202+800.0	204+585.0	205+700.0	207+020.0	207+560.0	208+156.0	208+789.8	209+190.8	
Type	-	A	B	B	B	A	A	A	B	A	A	A	A	B	A	A	A	A	A	A	A
Bx	Box	1	1	1	1	1	1	1	1	1	1	1	1	1	1	1	1	1	1	1	1
WL	m	5.00	5.00	5.00	5.00	5.00	5.00	5.00	5.00	5.00	5.00	5.00	5.00	5.00	5.00	5.00	5.00	5.00	5.00	5.00	5.00
WR	m	5.00	5.00	5.00	5.00	5.00	5.00	5.00	5.00	5.00	5.00	5.00	5.00	5.00	5.00	5.00	5.00	5.00	5.00	5.00	5.00
SL	%	2.00%	2.00%	2.00%	2.00%	2.00%	3.60%	2.00%	2.00%	2.00%	2.00%	2.00%	2.00%	2.00%	2.00%	2.00%	2.00%	2.00%	2.00%	2.00%	2.00%
SR	%	-2.00%	-2.00%	-2.00%	-2.00%	-2.00%	-2.00%	-2.00%	-2.00%	-2.00%	-2.00%	-2.00%	-2.00%	-2.00%	-2.00%	-2.00%	-2.00%	-2.00%	-2.00%	-2.00%	-2.00%
Ob	m	0.88	1.40	1.20	2.05	1.00	0.88	0.98	2.68	0.87	1.13	0.72	0.77	1.68	0.95	0.70	0.85	0.95	0.88	0.82	
L	m	11.00	17.73	17.02	20.08	16.30	11.00	11.00	22.33	11.00	16.78	11.00	11.00	18.75	11.00	11.00	11.00	11.00	11.00	11.00	11.00
B1	m	1.00	1.00	1.00	1.00	1.00	1.00	1.00	1.50	1.00	1.00	1.00	1.00	1.50	2.00	1.00	1.50	2.00	1.00	1.00	1.00
H1	m	1.00	1.00	1.00	1.00	1.00	1.00	1.00	1.00	1.00	1.00	1.00	1.00	1.00	1.00	1.00	1.00	1.00	1.00	1.00	1.00
B2	m	1.60	1.60	1.60	1.60	1.60	1.60	2.30	1.60	1.60	1.60	1.60	1.60	2.30	2.80	1.60	2.30	2.80	1.60	1.60	1.60
H2	m	1.60	1.60	1.60	1.60	1.60	1.60	1.70	1.70	1.60	1.60	1.60	1.60	1.70	1.70	1.60	1.70	1.70	1.60	1.60	1.60
S1	m	0.30	0.30	0.30	0.30	0.30	0.30	0.30	0.30	0.30	0.30	0.30	0.30	0.30	0.30	0.30	0.30	0.30	0.30	0.30	0.30
S2	m	0.30	0.30	0.30	0.30	0.30	0.30	0.30	0.40	0.30	0.30	0.30	0.30	0.40	0.40	0.30	0.40	0.40	0.30	0.30	0.30
S3	m	0.30	0.30	0.30	0.30	0.30	0.30	0.40	0.40	0.30	0.30	0.30	0.30	0.40	0.40	0.30	0.40	0.40	0.30	0.30	0.30
h	m	0.20	0.20	0.20	0.20	0.20	0.20	0.20	0.20	0.20	0.20	0.20	0.20	0.20	0.20	0.20	0.20	0.20	0.20	0.20	0.20
S4	m	0.500	0.500	0.500	0.500	0.500	0.500	0.500	0.500	0.500	0.500	0.500	0.500	0.500	0.500	0.500	0.500	0.500	0.500	0.500	0.500
Ah	m	0.875	0.850	0.850	0.850	0.875	0.875	0.878	0.850	0.868	0.850	0.720	0.765	0.850	0.850	0.698	0.850	0.850	0.850	0.878	0.823
Ls	m	0.000	1.616	1.260	2.790	0.900	0.000	0.000	3.915	0.000	1.139	0.000	0.000	2.124	0.000	0.000	0.000	0.000	0.000	0.000	0.000
Lw	m	0.70	0.70	0.70	0.70	0.70	0.70	0.70	0.70	0.70	0.70	0.70	0.70	0.70	0.70	0.70	0.70	0.70	0.70	0.70	0.70
Hs	m	0.70	0.70	0.70	0.70	0.70	0.70	0.60	0.60	0.70	0.70	0.70	0.70	0.60	0.60	0.70	0.60	0.60	0.70	0.70	0.70
B3	m	1.00	1.00	1.00	1.00	1.00	1.00	1.00	1.00	1.00	1.00	1.00	1.00	1.00	1.00	1.00	1.00	1.00	1.00	1.00	1.00
B4	m	0.50	0.50	0.50	0.50	0.50	0.50	0.50	0.50	0.50	0.50	0.50	0.50	0.50	0.50	0.50	0.50	0.50	0.50	0.50	0.50
nm	-	1.80	1.80	1.80	1.80	1.80	1.80	1.80	1.80	1.80	1.80	1.80	1.80	1.80	1.80	1.80	1.80	1.80	1.80	1.80	1.80
Hv0	m	0.50	0.50	0.50	0.50	0.50	0.50	0.50	0.50	0.50	0.50	0.50	0.50	0.50	0.50	0.50	0.50	0.50	0.50	0.50	0.50
Hv	m	2.68	2.30	2.30	2.68	2.78	2.30	2.67	2.30	2.67	2.30	2.52	2.57	2.30	2.75	2.50	2.65	2.75	2.68	2.82	2.82
Ly	m	4.42	3.74	3.74	4.42	4.40	3.74	4.40	3.74	4.40	4.14	4.22	3.74	4.45	4.10	4.37	4.55	4.42	4.42	4.32	4.32
ny	-	0.50	0.50	0.50	0.50	0.50	0.50	0.50	0.50	0.50	0.50	0.50	0.50	0.50	0.50	0.50	0.50	0.50	0.50	0.50	0.50
Hw	m	3.18	2.80	2.80	3.18	3.18	2.80	3.17	2.80	3.17	2.80	3.02	3.07	2.80	3.25	3.00	3.15	3.25	3.18	3.18	3.12

Mark	Unit	Box-20	Box-21	Box-22	Box-23	Box-24	Box-25	Box-26	Box-27	Box-28	Box-29	Box-30	Box-31	Box-32	Box-33	Box-34	Box-35	Box-36	Box-37	Box-38	Box-39	Box-40	
-	-	2.0x1.0	2.0x1.0	2.0x1.0	2.0x1.0	2.0x1.0	2.0x1.0	2.0x1.0	2.0x1.0	2.0x1.0	1.5x1.0	1.0x1.0	1.0x1.0	1.0x1.0	1.0x1.0	1.0x1.0	3.0x2.0	7.5x3.7	3.5x2.0	2.0x1.5	2.0x1.0	2.0x1.0	
Sta.	-	209+592.0	209+828.0	210+1400	210+738.0	211+125.0	211+250.0	211+871.6	211+992.0	212+288.0	212+550.0	212+752.9	212+818.2	213+125.9	213+354.3	213+410.6	213+514.0	213+652.0	214+675.0	214+760.0	216+765.0	217+875.4	
Type	-	A	B	B	B	A	A	A	A	B	B	B	A	A	A	B	B	B	B	A	A	A	
Bx	Box	1	1	1	1	1	2	1	1	1	1	1	1	1	1	2	2	2	2	6	1	1	
WL	m	5.00	5.00	5.00	5.00	5.00	5.00	5.00	5.00	5.00	5.00	5.00	5.00	5.00	5.00	5.00	5.00	5.00	5.00	5.00	5.00	5.00	
WR	m	5.00	5.00	5.00	5.00	5.00	5.00	5.00	5.00	5.00	5.00	5.00	5.00	5.00	5.00	5.00	5.00	5.00	5.00	5.00	5.00	5.00	
SL	%	2.00%	2.00%	2.00%	2.00%	2.00%	2.00%	2.00%	2.00%	2.00%	2.00%	2.00%	2.00%	2.00%	2.00%	2.00%	2.00%	2.00%	2.00%	3.08%	3.08%	2.00%	
SR	%	-2.00%	-2.00%	-2.00%	-2.00%	-2.00%	-2.00%	-2.00%	-2.00%	-2.00%	-2.00%	-2.00%	-2.00%	-2.00%	-2.00%	-2.00%	-2.00%	-2.00%	-2.00%	-2.00%	-2.00%	-2.00%	
Ob	m	0.92	1.46	1.92	1.02	0.88	0.74	0.77	0.83	1.00	1.67	1.22	0.93	0.94	1.68	1.40	1.88	1.16	0.80	0.80	0.96		
L	m	11.00	17.94	19.62	16.38	11.00	11.00	11.00	11.00	16.30	18.71	17.08	11.00	11.00	18.73	17.74	19.46	16.89	11.00	11.00	11.00	11.00	
B1	m	2.00	2.00	2.00	2.00	2.00	2.00	2.00	2.00	2.00	1.50	1.00	1.00	1.00	1.00	1.00	3.00	3.50	2.00	2.00	2.00	2.00	
H1	m	1.00	1.00	1.00	1.00	1.00	1.00	1.00	1.00	1.00	1.00	1.00	1.00	1.00	1.00	1.00	2.00	2.00	2.00	2.00	2.00	2.00	
B2	m	2.80	2.80	2.80	2.80	2.80	2.80	2.80	2.80	2.80	2.30	1.60	1.60	1.60	1.60	1.60	7.50	8.50	2.450	2.80	1.60	1.60	
H2	m	1.70	1.70	1.70	1.70	1.70	1.70	2.20	1.70	1.70	1.70	1.60	1.60	1.60	1.60	1.60	2.20	2.90	2.90	2.90	2.90	2.90	
S1	m	0.30	0.30	0.30	0.30	0.30	0.30	0.30	0.30	0.30	0.30	0.30	0.30	0.30	0.30	0.30	0.40	0.40	0.40	0.40	0.30	0.30	
S2	m	0.40	0.40	0.40	0.30	0.30	0.40	0.40	0.40	0.40	0.40	0.40	0.30	0.30	0.30	0.30	0.50	0.50	0.50	0.50	0.40	0.30	
S3	m	0.40	0.40	0.40	0.30	0.30	0.40	0.40	0.40	0.40	0.40	0.40	0.30	0.30	0.30	0.30	0.50	0.50	0.50	0.50	0.40	0.30	
h	m	0.20	0.20	0.20	0.20	0.20	0.20	0.20	0.20	0.20	0.20	0.20	0.20	0.20	0.20	0.20	0.20	0.20	0.20	0.20	0.20	0.20	
S4	m	0.500	0.500	0.500	0.500	0.500	0.500	0.500	0.500	0.500	0.500	0.500	0.500	0.500	0.500	0.500	0.500	0.500	0.500	0.500	0.500	0.500	
Ah	m	0.923	0.950	0.950	0.941	0.975	0.735	0.770	0.828	0.950	0.950	0.950	0.928	0.938	0.950	0.950	0.950	0.950	0.950	0.950	0.950	0.958	
Ls	m	0.000	1.719	2.561	0.000	0.000	0.000	0.000	0.000	0.900	2.106	1.292	0.000	0.000	2.115	1.620	2.480	1.193	0.0				

GENERAL DRAWING OF BOX CULVERT (Box-36 at PK213+843)

Side View S=1:500

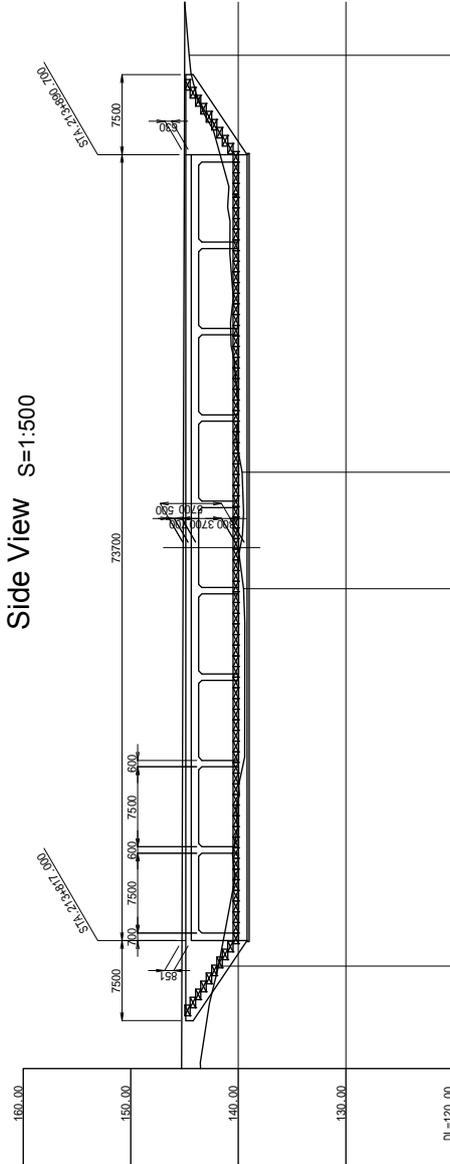

Cross Section S=1:150

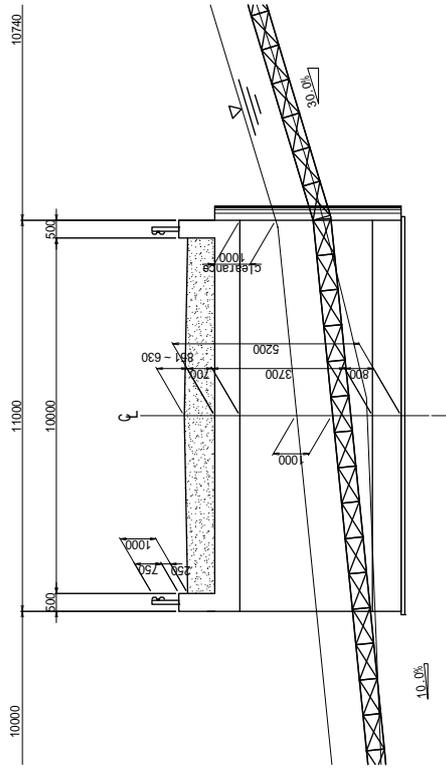

Pavement Details S=1:100

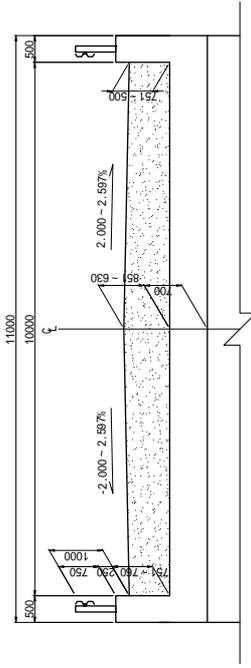

"A" Detail S=1:200

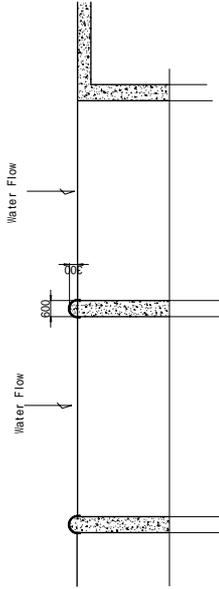

Plan S=1:500

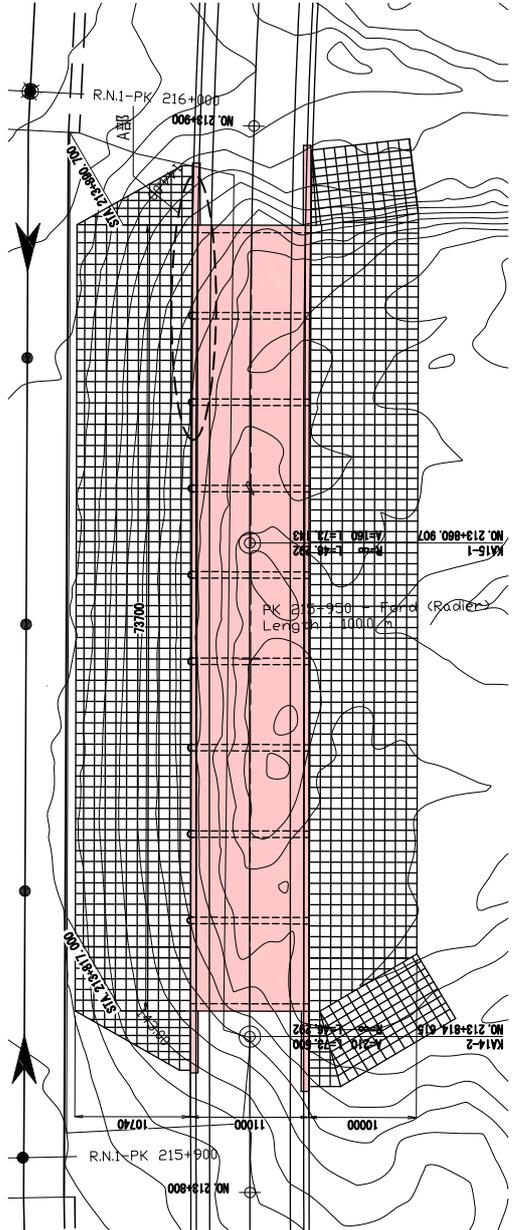

勾配	計画高	地面高	標点
1:50, 300%	145.102	145.133	K415-1
1:50, 300%	145.234	145.243	K414-2
1:50, 300%	145.234	145.243	STA.213
1:50, 300%	145.234	145.243	+817
1:50, 300%	145.234	145.243	141.85
1:50, 300%	145.234	145.243	141.406
1:50, 300%	145.234	145.243	139.52
1:50, 300%	145.234	145.243	145.133
1:50, 300%	145.234	145.243	145.102
1:50, 300%	145.234	145.243	145.013
1:50, 300%	145.234	145.243	144.985
1:50, 300%	145.234	145.243	141.703
1:50, 300%	145.234	145.243	+890.7
1:50, 300%	145.234	145.243	+900

STANDARD DRAWING OF GAURDRAIL

Plan S=1:200

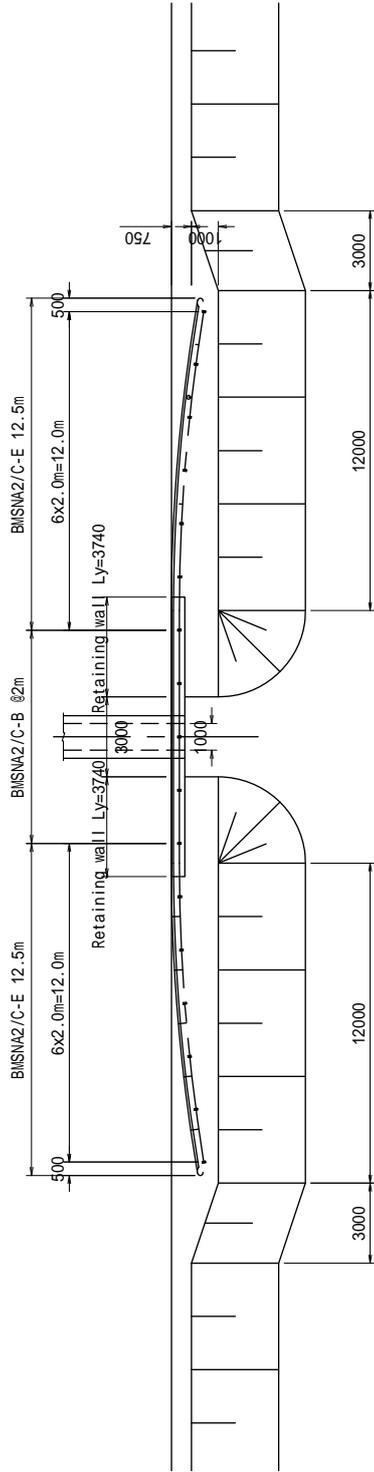

Structural Drawing S=1:40
(BMSNA2/C-E, BMSNA2/C-B)

Front View

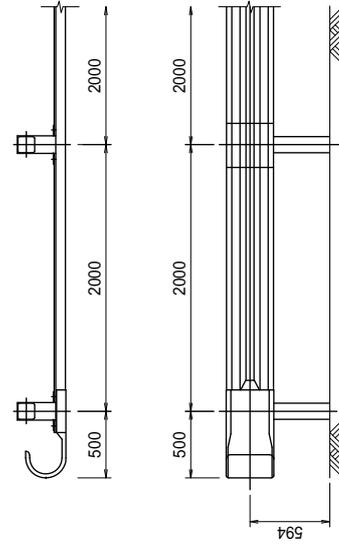

Side View

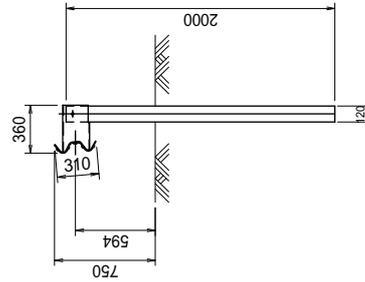

REPUBLIQUE DE DJIBOUTI
MINISTRE DE L'EQUIPEMENT ET DES TRANSPORTS
DIRECTION DE L'EQUIPEMENT



JAPAN INTERNATIONAL COOPERATION AGENCY
YACHIO ENGINEERING CO., LTD.

THE PREPARATORY SURVEY FOR
THE PROJECT FOR
UPGRADING OF NATIONAL ROAD ROUTE 1
IN THE REPUBLIC OF DJIBOUTI

SHEET CONTENTS
STANDARD DRAWING OF
GAURDRAIL

SCALE
DATE
PAGE NO.

As Shown
NOV/2018
126 / 131

STANDARD DRAWING OF FOOT STRUCTURE OF SLOPE

Typical Cross Section S=1:200

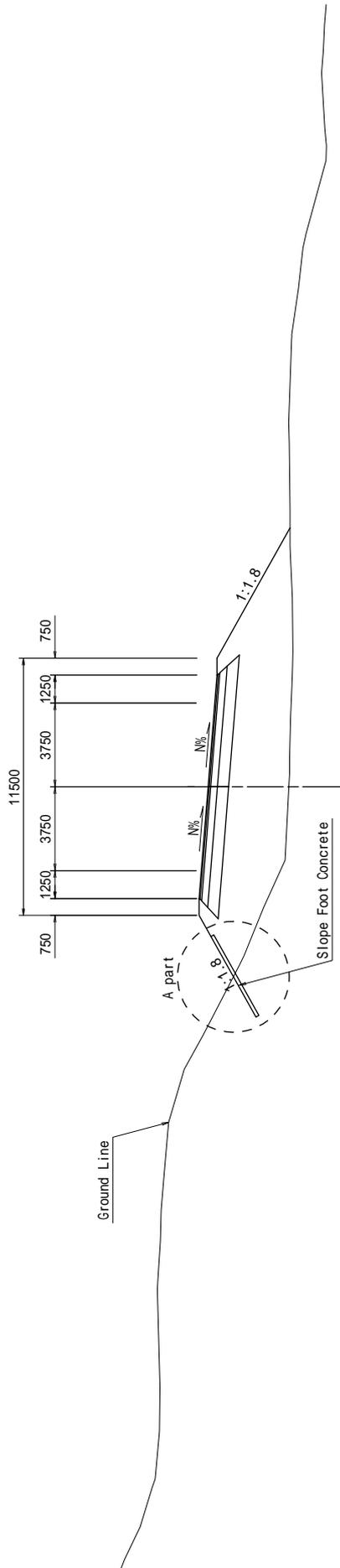

Detail of "A part" S=1:100

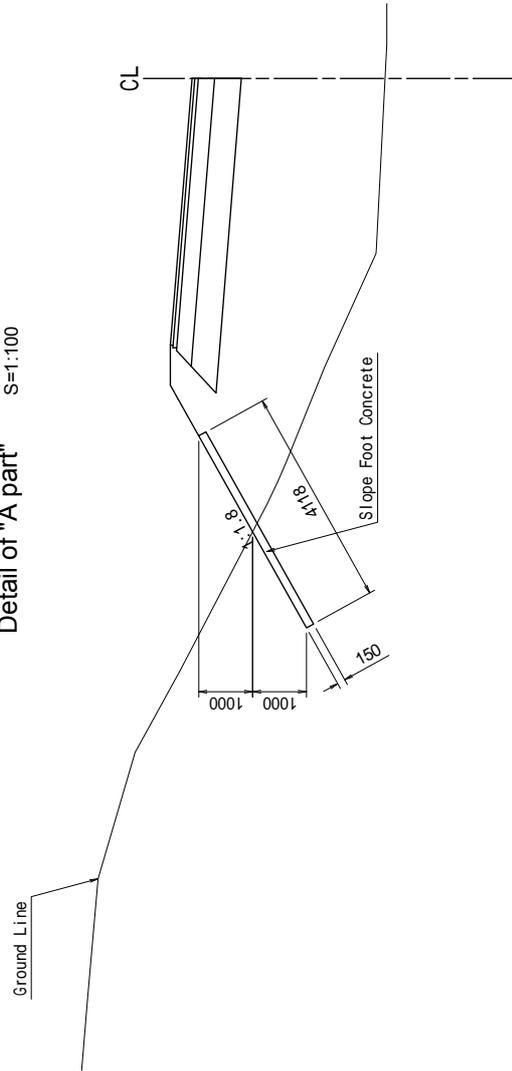

 REPUBLIQUE DE DJIBOUTI MINISTERE DE L'EQUIPEMENT ET DES TRANSPORTS DIRECTION DE L'EQUIPEMENT	 JAPAN INTERNATIONAL COOPERATION AGENCY YACHIYO ENGINEERING CO., LTD.	THE PREPARATORY SURVEY FOR THE PROJECT FOR UPGRADING OF NATIONAL ROAD ROUTE 1 IN THE REPUBLIC OF DJIBOUTI	SHEET CONTENTS	
			STANDARD DRAWING OF FOOT STRUCTURE OF SLOPE	SCALE DATE PAGE NO.

STANDARD DRAWING OF PK POST

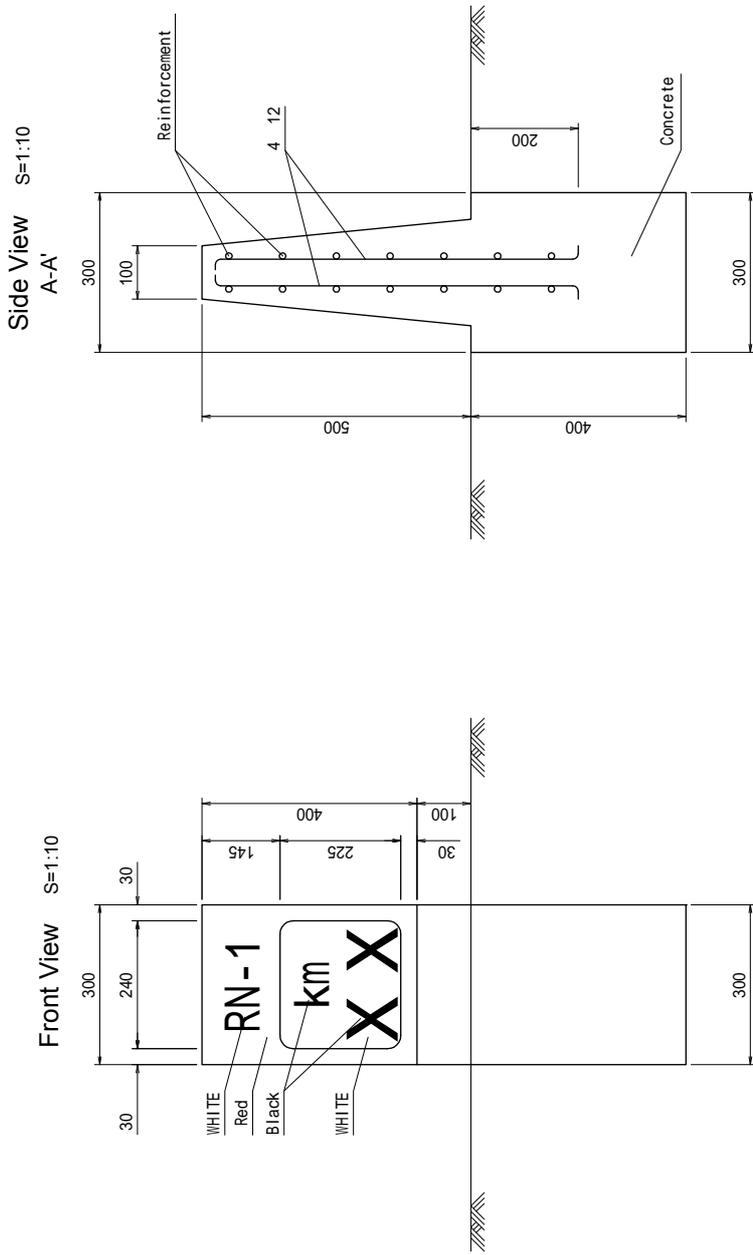

PLAN S=1:10

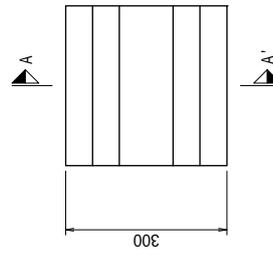

 REPUBLIQUE DE DJIBOUTI MINISTERE DE L'EQUIPEMENT ET DES TRANSPORTS DIRECTION DE L'EQUIPEMENT	 JAPAN INTERNATIONAL COOPERATION AGENCY YACHIO ENGINEERING CO., LTD.	THE PREPARATORY SURVEY FOR THE PROJECT FOR UPGRADING OF NATIONAL ROAD ROUTE 1 IN THE REPUBLIC OF DJIBOUTI	SHEET CONTENTS	
			DRAWING OF PK POST	
		SCALE	S=1:10	
		DATE	NOV 2018	
		PAGE NO.	128 / 131	