

**Minutes of Discussion  
on the Preparatory Survey for  
the Project for Provision of Agricultural Machinery and Construction Equipment  
in Rural Areas  
(Explanation on Draft Preparatory Survey Report)**

With reference to the minutes of discussions signed among Ministry of Agriculture, Livestock and Irrigation, Ministry of Construction and the Japan International Cooperation Agency (hereinafter referred to as "JICA") on 8<sup>th</sup> September, 2017 , JICA dispatched the Preparatory Survey Team (hereinafter referred to as "the Team") for the explanation of Draft Preparatory Survey Report (hereinafter referred to as "the Draft Report") for the Project for Provision of Agricultural Machinery and Construction Equipment in Rural Areas (hereinafter referred to as "the Project").

As a result of the discussions, both sides agreed on the main items described in the attached sheets.

Nay Pyi Taw, 7<sup>th</sup> March, 2018

上堂 蘭 明

Akira Kamidohzono

Leader

Preparatory Survey Team

Japan International Cooperation Agency

Japan



U Khant Zaw

Director General

Department of Rural Development

Ministry of Agriculture, Livestock and Irrigation

The Republic of the Union of Myanmar



for

U Kyaw Myint Hlaing

Director General

Irrigation and Water Utilization Management  
Department

Ministry of Agriculture, Livestock and Irrigation

The Republic of the Union of Myanmar





---

U Soe Hlaing *for*  
Director General  
Agricultural Mechanization Department  
Ministry of Agriculture, Livestock and Irrigation  
The Republic of the Union of Myanmar

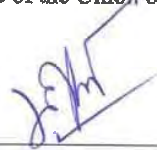

---

U Khin Thet  
Director General  
Department of Rural Road Development  
Ministry of Construction  
The Republic of the Union of Myanmar







## ATTACHEMENT

### 1. Objective of the Project

The objective of the Project is to improve income and living standard in rural areas by provision of equipment, thereby contributing to the balanced growth between rural and urban areas.

### 2. Title of the Preparatory Survey

Both sides confirmed the title of the Preparatory Survey as “the Preparatory Survey for the Project for Provision of Agricultural Machinery and Construction Equipment in Rural Areas”.

### 3. Project site

Both sides confirmed that the sites of the Project are in Chin State and Ayeyarwady Region, which is shown in Annex 1.

### 4. Responsible authority for the Project

Both sides confirmed the authorities responsible for the Project are as follows:

- 4-1. The line ministries of the Executing Agency are the Ministry of Agriculture, Livestock and Irrigation (hereinafter referred to as “MOALI”) and the Ministry of Construction (hereinafter referred to as “MOC”). The MOALI shall be responsible for supervising the Executing Agency on behalf of the Government of Myanmar.
- 4-2. Implementation structure of the Project is as shown in the Annex 2-1 and Coordination Agency who will sign the Grant Agreement is Department of Rural Development of MOALI. Executing Agencies of the Project are Agricultural Mechanization Department of MOALI and Department of Rural Road Development of MOC. The organization chart of agencies are shown as Annex 2-2, 2-3 and 2-4.

### 5. Contents of the Draft Report

After the explanation of the contents of the Draft Report by the Team, the Myanmar side agreed to its contents.

### 6. Cost estimate

Both sides confirmed that the cost estimate explained by the Team is provisional



and will be examined further by the Government of Japan for its approval.

7. Confidentiality of the cost estimate and technical specifications

Both sides confirmed that the cost estimate and technical specifications of the Project should never be disclosed to any third parties until all the contracts under the Project are concluded.

8. Timeline for the project implementation

The Team explained to the Myanmar side that the expected timeline for the project implementation is as attached in Annex 3.

9. Expected outcomes and indicators

Both sides agreed that key indicators for expected outcomes are as follows. The Myanmar side will be responsible for the achievement of agreed key indicators targeted in year 2023 and shall monitor the progress based on those indicators.

[Quantitative indicators]

1) Agricultural Machinery

Indicator	Baseline, 2015	Target, 2023
Available land area for new cultivable field development (Chin state) (Acre)	0 Acre	200 Acre
Available land for agricultural mechanization for field preparation and harvesting works for monsoon paddy (Chin State in total) (Acre) *Note1	288 Acre	1,360 Acre
Available land for agricultural mechanization for harvesting works for monsoon paddy and field preparation for dry season crop. (Ayeyarwady Region in total) (Acre) *Note2	0 Acre	6,158 Acre

\*Note1: Current agricultural cropping methods in Chin State are mainly by livestock and manpower, and available land for agricultural mechanization is evaluated as a quantitative effect regardless of type and size of machinery.

\*Note2: In Ayeyarwady Region, cropping has been already managed by using small-sized agricultural machinery, therefore using large-sized agricultural machinery would increase yield while reducing harvesting loss and reduce work load. Available land for large-sized agricultural mechanization is evaluated as a quantitative effect in Ayeyarwady Region.

## 2) Provision of Construction Equipment

Indicator	Baseline, 2015	Target, 2023
Number of available days of roads to pass through in one year (Chin State) (days/year)	315 days/year	358 days/year

### [Qualitative indicators]

#### 1) Agricultural Machinery

- By using of Combine Harvester, working time at harvesting would be reduced
- By using of Tractor and Combine Harvester, the efficiency of farm work could be improved. Moreover, farming time is shortened, and this would release farmers from heavy work load. Consequently, farmers may have opportunities to have additional income from non-farming activities.
- By using of versatile agricultural machines with both farming and transport functions, the efficiency of farm work could be improved, while shortening transportation time and reducing transportation expenses would be achieved and releasing farmers from carrying heavy products to transport.

#### 2) Construction Equipment

- Accessibility to schools and healthcare facilities would be improved throughout the year.
- By securing access to the market throughout the year, it could make possible to purchase and sale products by appropriate price.
- Safe traffic environment will be ensured.

## 10. Technical assistance (“Soft Component” of the Project)

Considering the sustainable operation and maintenance of the products and services granted through the Project, following technical assistance is planned under the Project. The Myanmar side confirmed to deploy necessary number of counterparts who are appropriate and competent in terms of its purpose of the technical assistance as described in the Draft Report.

## 11. Undertakings of the Project

Both sides confirmed the undertakings of the Project as described in Annex 4. With regard to exemption of customs duties, internal taxes and other fiscal levies as stipulated in (2)-5 of Annex 5, both sides confirmed that such customs duties, internal taxes and other fiscal levies, which shall be clarified in the bid documents



by MOALI (and MOC) during the implementation stage of the Project.

The Myanmar side assured to take the necessary measures and coordination including allocation of the necessary budget which are preconditions of implementation of the Project as Annex 4. It is further agreed that the costs are indicative, i.e. at Outline Design level. More accurate costs will be calculated at the Detailed Design stage.

Both sides also confirmed that the Annex 5 will be used as an attachment of G/A.

12. Monitoring during the implementation

The Project will be monitored by the Executing Agency and reported to JICA by using the form of Project Monitoring Report (PMR) attached as Annex 6. The timing of submission of the PMR is described in Annex 5.

13. Project completion

Both sides confirmed that the Project completes when all the facilities constructed and equipment procured by the grant are in operation. The completion of the Project will be reported to JICA promptly, but in any event not later than six months after completion of the Project.

14. Ex-Post Evaluation

JICA will conduct ex-post evaluation after three (3) years from the project completion, in principle, with respect to five evaluation criteria (Relevance, Effectiveness, Efficiency, Impact, Sustainability). The result of the evaluation will be publicized. The Myanmar side is required to provide necessary support for the data collection.

15. Items and measures to be considered for the smooth implementation of the Project

Both sides confirmed the items and measures to be considered for the smooth implementation of the Project as follows:

16. Schedule of the Study

JICA will finalize the Preparatory Survey Report based on the confirmed items. The report will be sent to the Myanmar side around end of April.

17. Environmental and Social Considerations

17-1 General Issues



#### 17-1-1 Environmental Guidelines and Environmental Category

The Team explained that 'JICA Guidelines for Environmental and Social Considerations (April 2010)' (hereinafter referred to as "the Guidelines") is applicable for the Project. The Project is categorized as C because the Project is likely to have minimal adverse impact on the environment under the Guidelines.

#### 18. Other Relevant Issues

##### 18-1. Disclosure of Information

Both sides confirmed that the Preparatory Survey Report from which project cost is excluded will be disclosed to the public after completion of the Preparatory Survey. The comprehensive report including the project cost will be disclosed to the public after all the contracts under the Project are concluded.

##### 18-2. Operation and Maintainance

Myanmar side agreed to provide the appropriate storage yard for the Equipment and its spare parts to operate and maintain them in proper manner.

##### 18-3. Safety Measures

Myanmar side understood the importance of safety measure in road maintenance and agricultural service stage. The Team explained "The Guidance for the Management of Safety for Construction Works in Japanese ODA Projects", and Myanmar side explained that they will respect and refer this Guidance in the use of the Equipment.

##### 18-4. Eligible source countries of the Equipment

Japanese side explained that eligible source countries of the Equipment, i.e. Japan and/or third countries, will be determined in terms of availability of Japanese product and securing a competitive tender.

##### 18-5. Travel Permission

Myanmar side agreed to arrange a permit necessary to travel around the Project sites.

Annex 1 Project Site(drafting by Consultant Team)

Annex 2 Implementation Structure of the Project and Organization Chart of related departments

Annex 3 Project Implementation Schedule (drafting by Consultant Team)

Annex 4 Table of Counterpart Cost

Annex 5 Major Undertakings to be taken by the Government of Myanmar

Annex 6 Project Monitoring Report (template)

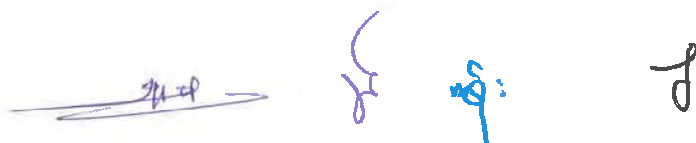
Handwritten signatures and marks at the bottom of the page, including a long horizontal line with a signature, and three distinct signatures in blue ink.

**【Annex 1】 Project Site**

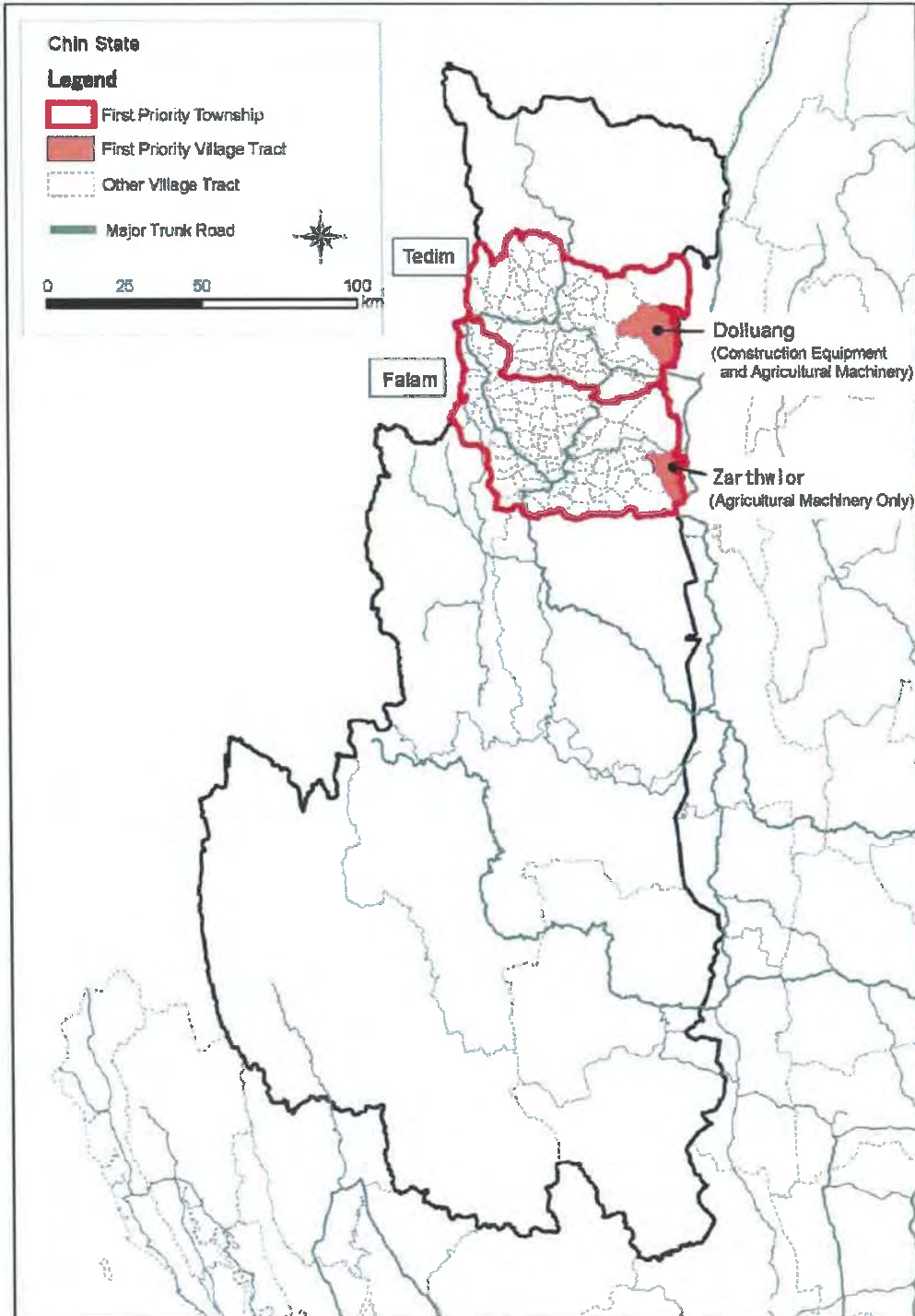

*(Handwritten signatures and marks)*



**Target areas in Chin State**

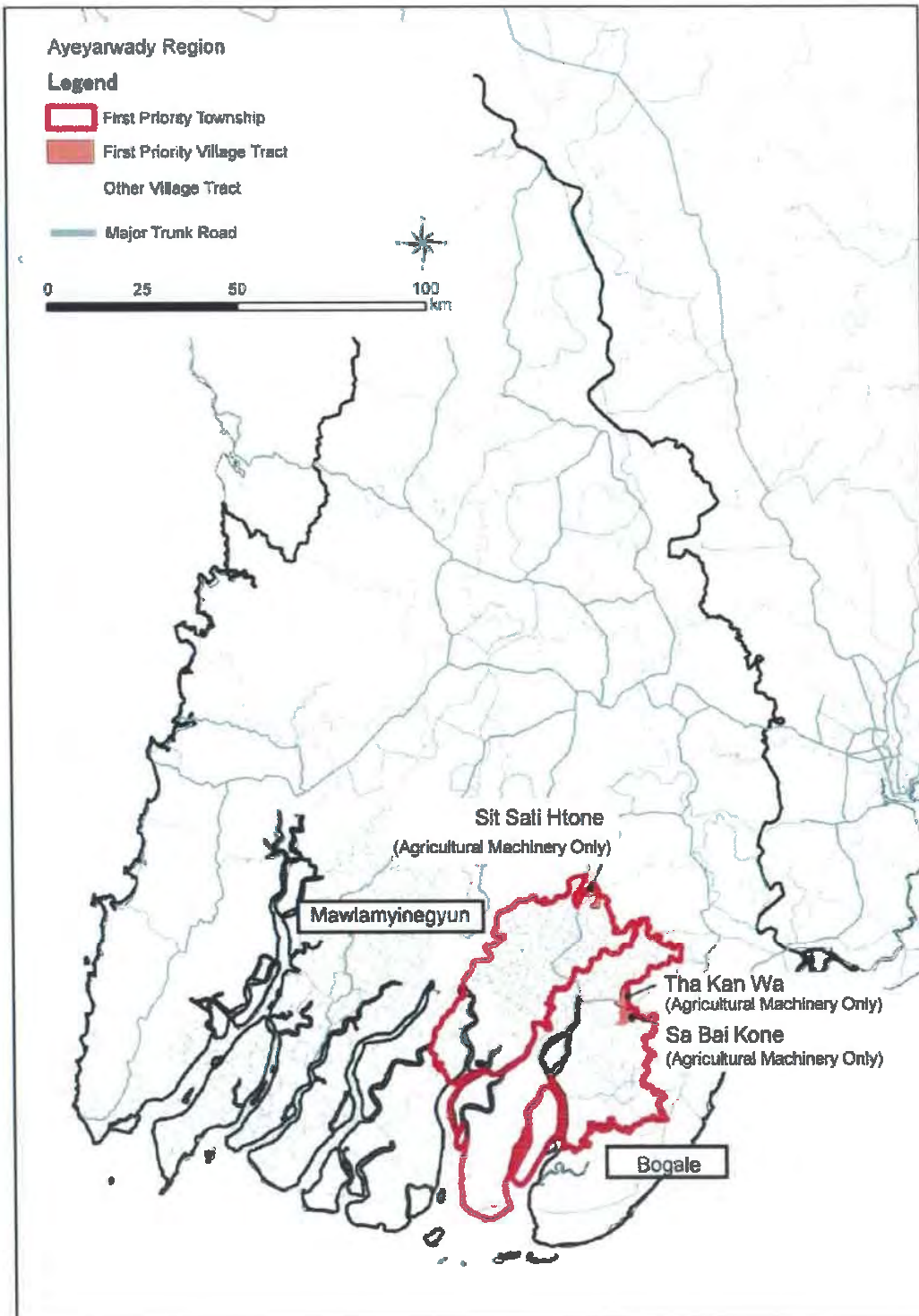

**Target areas in Ayevarwady Region**

Handwritten signatures and initials in blue ink.

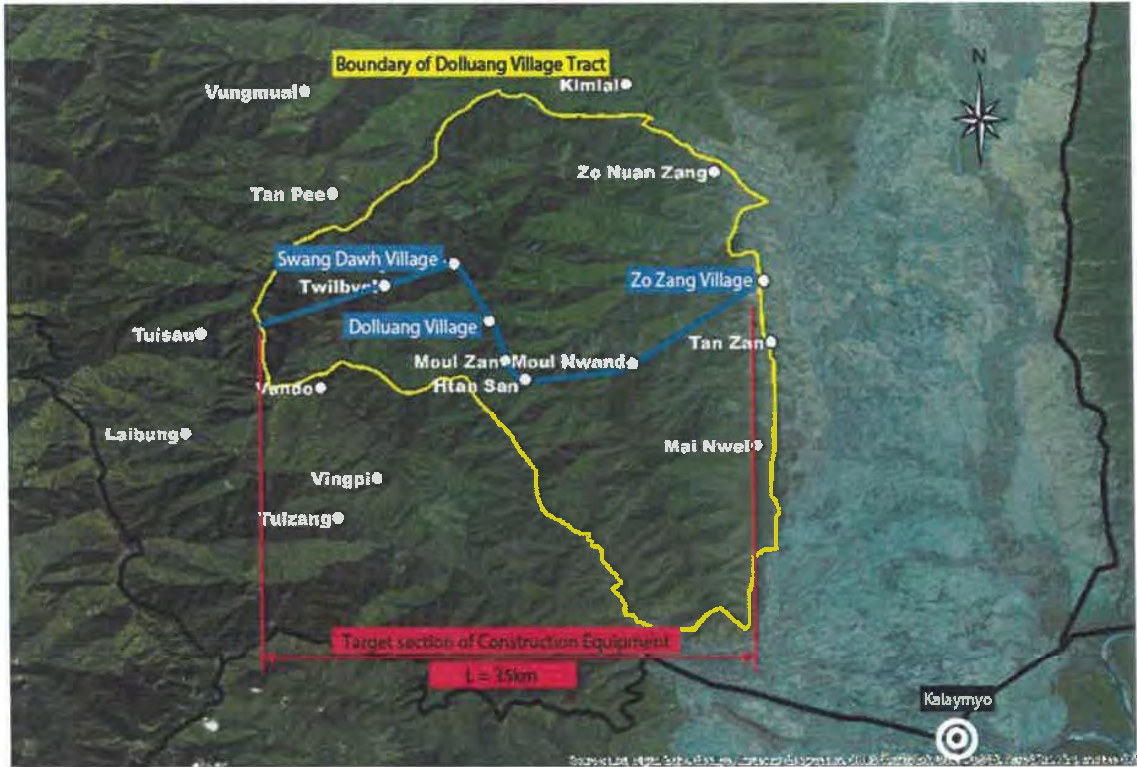

**Target section of Construction Equipment (Dolluang Village Tract, Chin State)**

Handwritten signatures and a stamp in blue ink, including a signature on the left, a signature in the middle, a signature on the right, and a circular stamp at the bottom right.

Implementation Structure of the Project

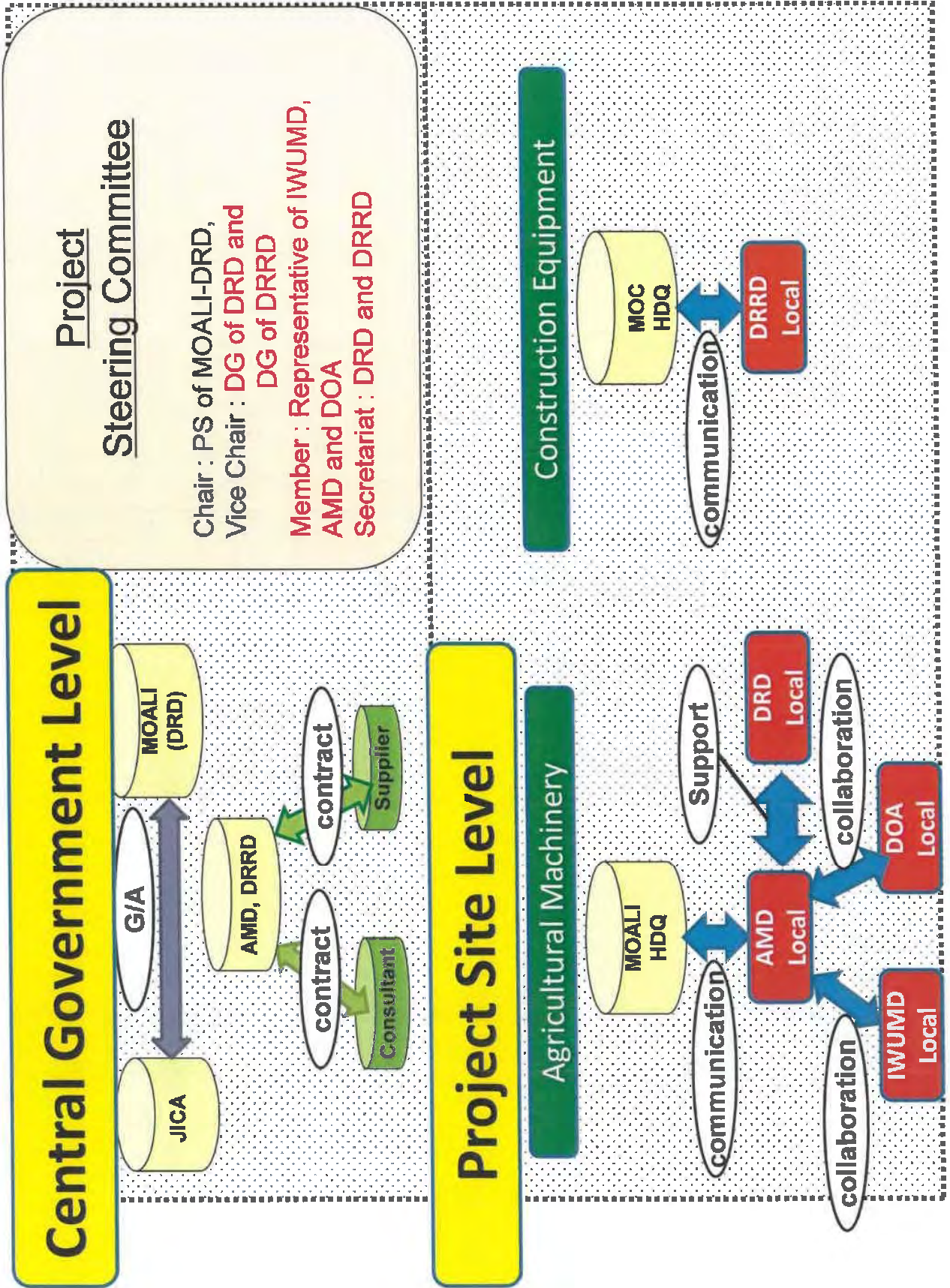

Handwritten signatures and initials in blue and black ink.

Handwritten number '21' in black ink.

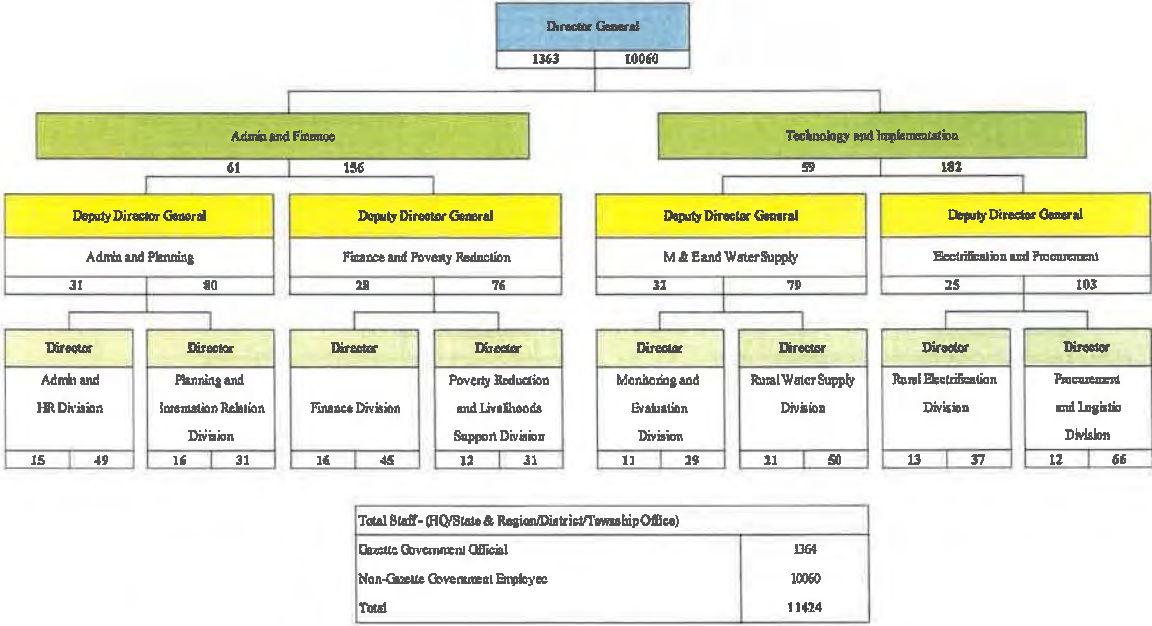

Organization Chart of DRD, MOALI

*[Handwritten signatures and initials in blue ink]*

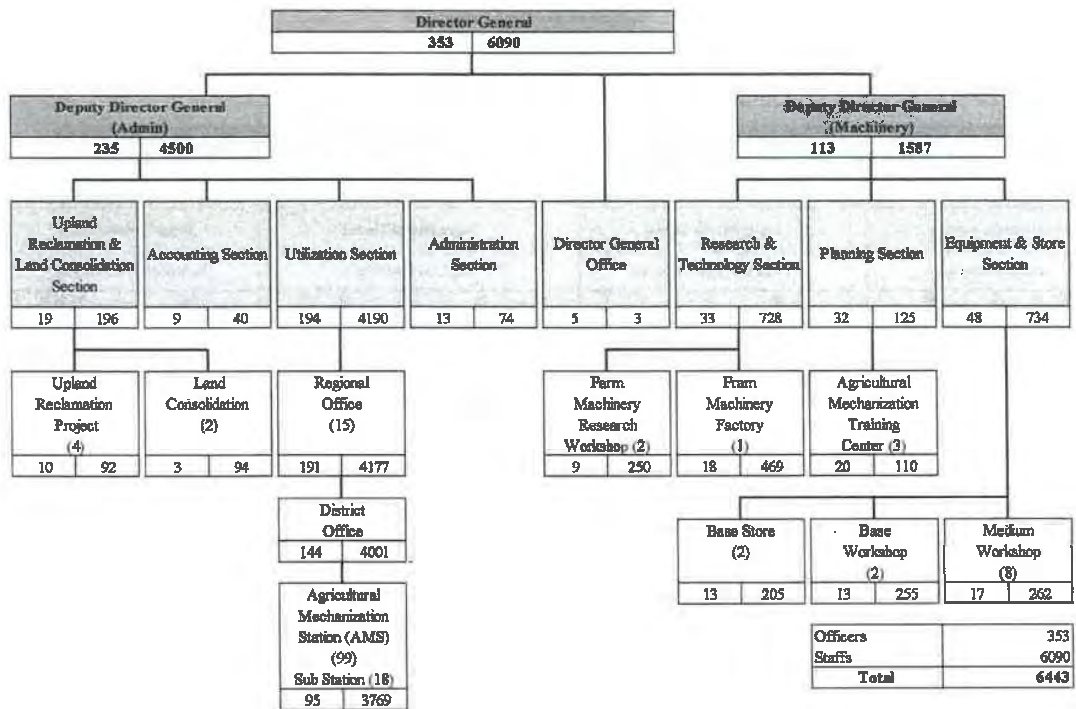

Organization Chart of AMD, MOALI

*[Handwritten signatures and initials in blue ink]*

Annex 2-4

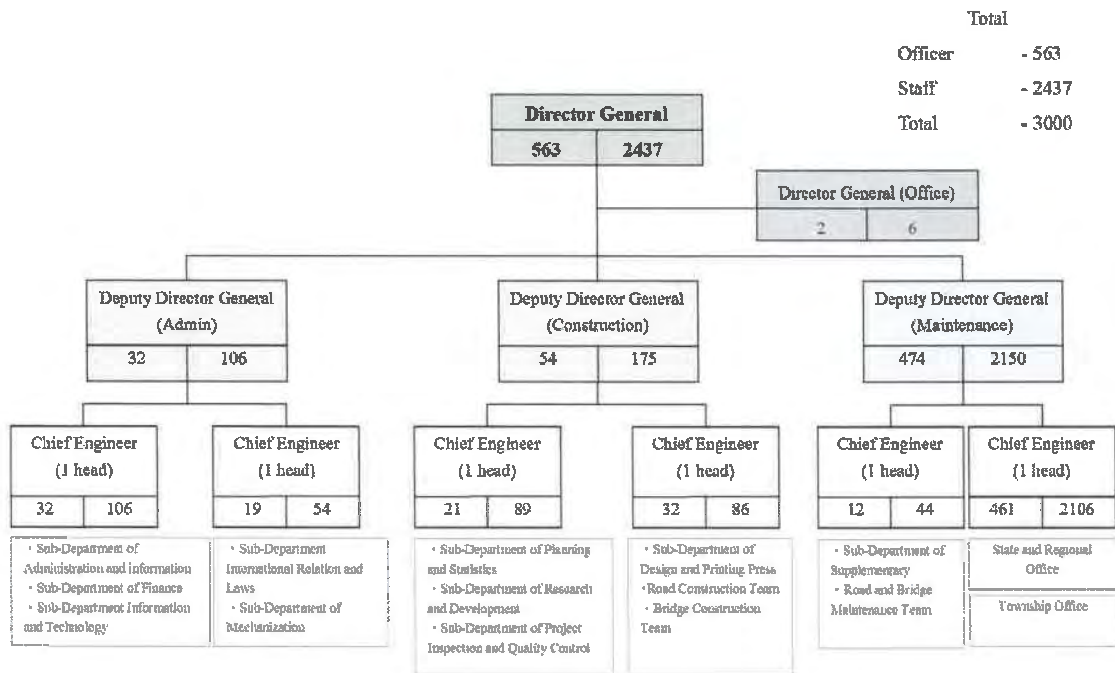

**Organization Chart of DRRD, MOC**

### Tentative Project Implementation Schedule

Month	1	2	3	4	5	6	7	8	9	10	11	12	13	14	15	16	
<b>TENDERING STAGE</b>	(4 months)																
- Preparation of Tender Documents	■																
- Obtaining of Approval for Tender Documents		■															
- Tender Opening (in Japan)			■														
- Tender Evaluation, Concluding the Contract with the Successful Tenderer				■													
- Soft Component by the Consultant			■	■	■												
<b>PROCUREMENT/MANUFACTURING AND TRANSPORTATION</b>	(15 months)																
- Preparation of Manufacturing Drawings by the Supplier	■																
- Procurement and Manufacturing of the Equipment		■															
- Transportation of the Equipment										■			■				
- Set-up of the Equipment at Delivery Points												■				■	
- Initial Operation Training												■				■	
- Soft Component by the Consultant		■	■										■	■			

■ : Works in Japan (including Transportation of the Equipment)

■ : Works in Myanmar



### Table of Counterpart Cost

The costs shown below must be borne by Myanmar side.

Approximately USD114,900

Items		Cost Amount (USD)
Preparation for the delivery of equipment	DRRD Note: Budget year 2019/2020	Securing a parking and storage, before the delivery of road maintenance equipment and spare parts to be procured under the Project 25,000
	AMD (Chin State) Note: Budget year 2019/2020	Securing a parking in Zo Zang Village, Tedim Township before the delivery of agricultural machinery to be procured under the Project 1,500
		Reinforcing operators of AMD and LRPO 2,200
		Procurement of trailer (7 units) and thresher (3 units) 7,000
		Implementation of terrace field development by LRPO 37,600
	AMD (Ayeyarwady Region) Note: Budget year 2019/2020	Securing a parking in targeted 3 Village Tracts before the delivery of agricultural machinery to be procured under the Project 3,300
		Reinforcing operators of AMD 800
Soft Component	AMD (Ayeyarwady Region) Note: Budget year 2019/2020	Materials and equipment for superstructure before November 2019 8,000 (4,000*2sets)
	IWUMD (Ayeyarwady Region) Note: Budget year 2018/2019	Materials and equipment for substructure* before February 2019 15,000 (1,500*10sites) Note*: The said USD15,000 is accumulated for 10 possible sites that are expected as sites of movable bridges, although the pilot works within the Soft Component will be conducted at only 1 site to be selected under the technical instructions by Japanese instructor at the implementation stage.
Commissions to the bank based on Banking Arrangement Note*: The arrangement will be made by DRD with necessary budget allocation from AMD and DRRD.		4,500

In addition, DRRD is required to provide costs from the yearly budget for urgent rehabilitation of the prioritized road section at Dolluang Village Tract, Tedim Township in Chin State without delay in a time of disaster.



## Major Undertakings to be taken by the Government of Myanmar

## 1. Specific obligations of the Government of Myanmar which will not be funded with the Grant

## (1) Before the Tender

NO	Items	Deadline	In charge	Estimated Cost	Ref.
1	To open bank account (B/A)	within 1 month after the signing of the G/A	MOALI	N/A	
2	To issue A/P to a bank in Japan (the Agent Bank) for the payment to the consultant	within 1 month after the signing of the contract	ditto	N/A	
3	To approve IEE/EIA(Conditions of approval should be fulfilled, if any) and secure the necessary budget for implementation.	N/A	N/A	N/A	
4	To secure the necessary budget and implement land acquisition and resettlement (including preparation of resettlement sites), and compensation with full replacement cost in accordance with RAP	N/A	N/A	N/A	
5	To implement social monitoring, and to submit the monitoring results to JICA, by using the monitoring form, on a quarterly basis as a part of Project Monitoring Report	N/A	N/A	N/A	
6	To secure and clear the following lands project sites	before notice of the bidding document	MOALI	N/A	
7	To obtain the planning, zoning, building permit	before notice of the bidding document	ditto	N/A	
8	To clear, level and reclaim the following sites 1) leveling and reclaiming the sites	before notice of the bidding document	ditto	N/A	
9	To submit Project Monitoring Report (with the result of Detail Design)	before preparation of bidding documents	ditto	N/A	

(B/A: Banking Arrangement, A/P: Authorization to pay, N/A: Not Applicable)

(2) During the Project Implementation

NO	Items	Deadline	In charge	Estimated Cost	Ref.
1	To issue A/P to a bank in Japan (the Agent Bank) for the payment to the Supplier(s)/ the Contractor(s)	within 1 month after the signing of the contract(s)	MOALI	USD 4,500	
2	To bear the following commissions to a bank in Japan for the banking services based upon the B/A				
	1) Advising commission of A/P	within 1 month after the signing of the contract(s)	ditto		
	2) Payment commission for A/P	every payment for consultant	ditto		
3	to ensure prompt unloading and customs clearance at ports of disembarkation in recipient country and to assist the Supplier(s) /the Contractor(s) with internal transportation therein	during the Project	ditto	N/A	
4	To accord Japanese nationals and/or physical persons of third countries whose services may be required in connection with the supply of the products and the services such facilities as may be necessary for their entry into the country of the Recipient and stay therein for the performance of their work	during the Project	ditto	N/A	
5	To ensure that customs duties, internal taxes and other fiscal levies which may be imposed in the country of the Recipient with respect to the purchase of the products and/or the services be exempted;	during the Project	ditto	N/A	
6	To bear all the expenses, other than those covered by the Grant, necessary for the implementation of the Project	during the Project	MOALI and MOC	USD 110,400	
7	To submit Project Monitoring Report after each work under the contract(s) such as shipping, hand over, installation and operational training	within one month after completion of each work	MOALI	N/A	
8	To submit Project Monitoring Report (final)	within one month after signing of Certificate of Completion for the works under the contract(s)	ditto	N/A	
	To submit a report concerning completion of the Project	within six months after completion of the Project	ditto	N/A	
9	To construct access roads	3 months before completion of the construction	ditto	N/A	
	1) Outside the site, if any				

10	To provide facilities for distribution of electricity, water supply and drainage and other incidental facilities necessary for the implementation of the Project outside the site(s), if any		MOALI and MOC	N/A	
	1) Electricity The distributing line to the site	before start of the construction	ditto	N/A	
	2) Drainage The city drainage main ( for storm, sewer and others ) to the site	6 months before completion of the construction	ditto	N/A	
11	To take necessary measure for safety construction - traffic control - rope off	during the construction	ditto	N/A	
12	To implement EMP and EMoP	N/A	N/A	N/A	
13	To submit results of environmental monitoring to JICA, by using the monitoring form, on a quarterly basis as a part of Project Monitoring Report	N/A	N/A	N/A	
14	To implement RAP (livelihood restoration program, if needed)	N/A	N/A	N/A	
15	To implement social monitoring, and to submit the monitoring results to JICA, by using the monitoring form, on a quarterly basis as a part of Project Monitoring Report - Period of the monitoring may be extended if affected persons' livelihoods are not sufficiently restored. Extension of the monitoring will be decided based on agreement between MOALI and JICA.	N/A	N/A	N/A	

(3) After the Project

NO	Items	Deadline	In charge	Estimated Cost	Ref.
1	To implement EMP and EMoP	N/A	N/A	N/A	
2	To submit results of environmental monitoring to JICA, by using the monitoring form, semiannually - The period of environmental monitoring may be extended if any significant negative impacts on the environment are found. The extension of environmental monitoring will be decided based on the agreement between MOALI and JICA.	N/A	N/A	N/A	
3	To maintain and use properly and effectively the equipment provided under the Grant Aid 1) Allocation of maintenance cost 2) Operation and maintenance structure 3) Routine check/Periodic inspection	After completion of the construction	MOALI and MOC	N/A	



**Project Monitoring Report**  
**on**  
**Project Name**  
**Grant Agreement No. XXXXXXXX**  
20XX, Month

**Organizational Information**

<b>Signer of the G/A (Recipient)</b>	<p>_____ Person in Charge (Designation)</p> <p>Contacts      _____                     Address:                     Phone/FAX:                     Email:</p>
<b>Executing Agency</b>	<p>_____ Person in Charge (Designation)</p> <p>Contacts      _____                     Address:                     Phone/FAX:                     Email:</p>
<b>Line Ministry</b>	<p>_____ Person in Charge (Designation)</p> <p>Contacts      _____                     Address:                     Phone/FAX:                     Email:</p>

**General Information:**

<b>Project Title</b>	
E/N	Signed date: Duration:
G/A	Signed date: Duration:
<b>Source of Finance</b>	Government of Japan: Not exceeding JPY _____ mil. Government of ( _____ ): _____



**1: Project Description**

**1-1 Project Objective**

--

**1-2 Project Rationale**

- Higher-level objectives to which the project contributes (national/regional/sectoral policies and strategies)
- Situation of the target groups to which the project addresses

--

**1-3 Indicators for measurement of "Effectiveness"**

Quantitative indicators to measure the attainment of project objectives		
Indicators	Original (Yr )	Target (Yr )
Qualitative indicators to measure the attainment of project objectives		

**2: Details of the Project**

**2-1 Location**

Components	Original <i>(proposed in the outline design)</i>	Actual
1.		

**2-2 Scope of the work**

Components	Original* <i>(proposed in the outline design)</i>	Actual*
1.		

Reasons for modification of scope (if any).

(PMR)
-------

**2-3 Implementation Schedule**

Items	Original		Actual
	<i>(proposed in the outline design)</i>	<i>(at the time of signing the Grant Agreement)</i>	

Reasons for any changes of the schedule, and their effects on the project (if any)

--

**2-4 Obligations by the Recipient**

**2-4-1 Progress of Specific Obligations**  
 See Attachment 2.

**2-4-2 Activities**  
 See Attachment 3.

**2-4-3 Report on RD**  
 See Attachment 11.

**2-5 Project Cost**

**2-5-1 Cost borne by the Grant (Confidential until the Bidding)**

Components	Original		Actual	
	<i>(proposed in the outline design)</i>	<i>(in case of any modification)</i>	<i>(proposed in the outline design)</i>	<i>(in case of any modification)</i>
1.				
Total				

Note: 1) Date of estimation:  
 2) Exchange rate: 1 US Dollar = Yen

**2-5-2 Cost borne by the Recipient**

Components	Original		Actual	
	<i>(proposed in the outline design)</i>	<i>(in case of any modification)</i>	<i>(proposed in the outline design)</i>	<i>(in case of any modification)</i>
1.				

*Handwritten signatures and marks*

- Note: 1) Date of estimation:  
2) Exchange rate: 1 US Dollar =

Reasons for the remarkable gaps between the original and actual cost, and the countermeasures (if any)

(PMR)

**2-6 Executing Agency**

- Organization's role, financial position, capacity, cost recovery etc,
- Organization Chart including the unit in charge of the implementation and number of employees.

**Original** (at the time of outline design)

name:

role:

financial situation:

institutional and organizational arrangement (organogram):

human resources (number and ability of staff):

**Actual** (PMR)

**2-7 Environmental and Social Impacts**

- The results of environmental monitoring based on Attachment 5 (in accordance with Schedule 4 of the Grant Agreement).
- The results of social monitoring based on in Attachment 5 (in accordance with Schedule 4 of the Grant Agreement).
- Disclosed information related to results of environmental and social monitoring to local stakeholders (whenever applicable).

**3: Operation and Maintenance (O&M)**

**3-1 Physical Arrangement**

- Plan for O&M (number and skills of the staff in the responsible division or section, availability of manuals and guidelines, availability of spareparts, etc.)

**Original** (at the time of outline design)

**Actual** (PMR)

**3-2 Budgetary Arrangement**

- Required O&M cost and actual budget allocation for O&M

**Original** (at the time of outline design)



Actual (PMR)

#### 4: Potential Risks and Mitigation Measures

- Potential risks which may affect the project implementation, attainment of objectives, sustainability
- Mitigation measures corresponding to the potential risks

##### Assessment of Potential Risks (at the time of outline design)

Potential Risks	Assessment
1. (Description of Risk)	Probability: High/Moderate/Low
	Impact: High/Moderate/Low
	Analysis of Probability and Impact:
	Mitigation Measures:
	Action required during the implementation stage:
2. (Description of Risk)	Probability: High/Moderate/Low
	Impact: High/Moderate/Low
	Analysis of Probability and Impact:
	Mitigation Measures:
	Action required during the implementation stage:
3. (Description of Risk)	Probability: High/Moderate/Low
	Impact: High/Moderate/Low
	Analysis of Probability and Impact:
	Mitigation Measures:
	Action required during the implementation stage:

	Contingency Plan (if applicable):
Actual Situation and Countermeasures (PMR)	

## 5: Evaluation and Monitoring Plan (after the work completion)

### 5-1 Overall evaluation

Please describe your overall evaluation on the project.

### 5-2 Lessons Learnt and Recommendations

Please raise any lessons learned from the project experience, which might be valuable for the future assistance or similar type of projects, as well as any recommendations, which might be beneficial for better realization of the project effect, impact and assurance of sustainability.

### 5-3 Monitoring Plan of the Indicators for Post-Evaluation

Please describe monitoring methods, section(s)/department(s) in charge of monitoring, frequency, the term to monitor the indicators stipulated in 1-3.



Attachment

1. Project Location Map
2. Specific obligations of the Recipient which will not be funded with the Grant
3. Monthly Report submitted by the Consultant
- Appendix - Photocopy of Contractor's Progress Report (if any)
  - Consultant Member List
  - Contractor's Main Staff List
4. Check list for the Contract (including Record of Amendment of the Contract/ Agreement and Schedule of Payment)
5. Environmental Monitoring Form / Social Monitoring Form
6. Monitoring sheet on price of specified materials (Quarterly)
7. Report on Proportion of Procurement (Recipient Country, Japan and Third Countries) (PMR (final) only)
8. Pictures (by JPEG style by CD-R) (PMR (final) only)
9. Equipment List (PMR (final) only)
10. Drawing (PMR (final) only)
11. Report on RD (After project)

Handwritten signature and initials in black ink, appearing to be a stylized signature followed by the initials 'JF' and 'J'.

Monitoring sheet on price of specified materials

1. Initial Conditions (Confirmed)

Items of Specified Materials	Initial Volume A	Initial Unit Price (₹) B	Initial total Price C=A×B	1% of Contract Price D	Condition of payment Price (Increased) E=C-D	Price (Increased) F=C+D
Item 1	●●t	●●	●●	●●	●●	●●
Item 2	●●t	●●	●●	●●		
Item 3						
Item 4						
Item 5						

2. Monitoring of the Unit Price of Specified Materials

(1) Method of Monitoring : ●●

(2) Result of the Monitoring Survey on Unit Price for each specified materials

Items of Specified Materials	1st month, 2015	2nd month, 2015	3rd month, 2015	4th	5th	6th
Item 1	●	●	●			
Item 2						
Item 3						
Item 4						
Item 5						

(3) Summary of Discussion with Contractor (if necessary)

.....

*Handwritten signature*

*Handwritten signature*

*Handwritten signature*

*Handwritten signature*

**Report on Proportion of Procurement (Recipient Country, Japan and Third Countries)  
(Actual Expenditure by Construction and Equipment each)**

	Domestic Procurement (Recipient Country) A	Foreign Procurement (Japan) B	Foreign Procurement (Third Countries) C	Total D
Construction Cost	(A/D%)	(B/D%)	(C/D%)	
Direct Construction	(A/D%)	(B/D%)	(C/D%)	
Cost others	(A/D%)	(B/D%)	(C/D%)	
Equipment Cost	(A/D%)	(B/D%)	(C/D%)	
Design and Supervision Cost	(A/D%)	(B/D%)	(C/D%)	
Total	(A/D%)	(B/D%)	(C/D%)	





## 資料-5 ソフトコンポーネント計画書

**ミャンマー一  
農村地域農機・建機整備計画  
準備調査**

**ソフトコンポーネント計画書  
(案)**

平成 30 年 3 月

**八千代エンジニアリング株式会社  
日本工営株式会社**

## 目 次

1. ソフトコンポーネントを計画する背景 .....	1
2. ソフトコンポーネントの目標 .....	2
3. ソフトコンポーネントの成果 .....	2
4. 成果達成度の確認方法 .....	2
5. ソフトコンポーネントの活動（投入計画） .....	3
6. ソフトコンポーネントの実施リソースの調達方法 .....	9
7. ソフトコンポーネントの実施工程 .....	9
8. ソフトコンポーネントの成果品 .....	9
9. ソフトコンポーネントの概略事業費 .....	10
10. 相手国側の責務 .....	10



## 1. ソフトコンポーネントを計画する背景

「ミャンマー国地方部農村インフラ整備計画準備調査」（以下、「本計画」という）は、ミャンマー連邦共和国（以下、「ミャンマー」という）の中で最も貧困率が高いチン州、ならびに貧困人口が多いエーヤワディー地域において、協力対象とする農村地域の所得向上及び生活改善を目標とし、農村開発の観点から道路維持管理機材及び農業機械を調達するものである。

本計画の実施調達機関として、道路維持管理機材を建設省農村道路開発局（以下、「DRRD」という）が担当し、農業機械を農業畜産灌漑省農業機械化局（以下、「AMD」という）がそれぞれ担当する。

本ソフトコンポーネントは、本計画により調達される農業機械(トラクターおよびコンバイン)が実施機関である AMD により迅速かつ適切に利用されるために必要な技術支援を行うことを目的とする。すなわち、調達機材の道路～圃場のアクセスを容易に可能とするための渡河構造物の導入支援を行うものであり、導入した技術を持続的に運営・維持管理する体制を構築することにより、もって本計画対象村落の農業生産の更なる効率化を図ることを基本方針とするものである。

本計画の対象村落であるエーヤワディー地域サバイコン、タカンワー、シッサリトン村落では、それぞれ水田耕作が主要であるが農業機械の圃場への搬入が容易でなく、結果として同地域において農業機械の導入・大型化の促進を妨げる一因となっている。この理由として、村落内の道路に隣接する圃場との間に舟運として使用されている水路(幅 5-10m 程度)が片側または両側にあり、水路を超えて圃場にアクセスするための渡河構造物が十分に整備されていないことから、農業機械の搬入が制約されていることが挙げられる。

現状では、農民は農業機械を渡すためヤシの木や木板を利用した仮橋をその都度設置しており、大人 3,4 人が 1 箇所の作業につき設置 3～4 日、撤去 1～2 日程度を要している。仮橋供用中(1 箇所あたり 1 週間程度)には舟運中断が生じ、農業活動への影響も大きい。また水路を走行してのコンバイン搬入も一部みられるものの、水路の利用は季節的に限定されるほか、地形条件により水路からの圃場アクセスができない地域も多く存在する。そのため、水路横断構造物の不足・未整備により圃場準備作業や収穫作業時期において適時適切な農業機械搬入が困難な状況にある。

かかる状況下、農村開発の観点から圃場アクセス未発達の状態を改善するためには、まず圃場整備（区画割を含む）を実施し、その上で農業機械を容易に搬入するため橋梁等構造物を整備するなど、包括的な圃場整備事業を計画的に進めることが重要である。一方、本計画対象村落を含む一帯では、実施機関である AMD や農業畜産灌漑省灌漑局（以下、「IWUMD」という）が協調して圃場整備事業（パイロット事業含む）に取り組んでいるものの、一帯の広大な圃場面積に対して限られた年次予算により事業を実施しているため、事業完了までは長期にわたる展望が必要となっている。

以上を踏まえ、本ソフトコンポーネントは、計画対象地域の村落レベルにおいて簡易かつ廉価な圃場アクセス手段を実現するため、AMD 及び IWUMD 職員を対象とし、①農業機械搬入

時期に安全かつ迅速に設置・撤去可能な仮橋の計画・施工に関する技術指導、ならびに②AMDとIWUMD 相互連携による持続的な運営・維持管理体制の確立支援を計画するものである。

## 2. ソフトコンポーネントの目標

上記の背景を踏まえ、プロジェクトの効果発現と持続可能性の観点から以下の目標を設定する。

**目標：仮設の圃場アクセス橋の建設・利用が計画通り実施され、農業機械の圃場搬出入が円滑に行われるようになり、農業生産効率が向上する。**

## 3. ソフトコンポーネントの成果

本計画によるソフトコンポーネント完了時の直接的成果を以下に記す。

成果： 現状では圃場準備作業や収穫作業時期において適時適切な農業機械搬入が困難な状況下、本ソフトコンポーネントによる技術支援により、IWUMD および AMD 職員が所定の位置に仮橋の設置・撤去を自力で実施し、仮橋を使用した圃場への農業機械の搬出入を円滑に行うと共に、仮橋部材のメンテナンスが適切に実施されるようになる。

そのため、IWUMD 職員は、仮橋設置箇所に応じた適切な下部工施工を実施する。AMD 職員は、仮橋上部工の架設・撤去、及び上部工資材のメンテナンスを適切に実施する。

## 4. 成果達成度の確認方法

本計画によるソフトコンポーネントの成果達成度を確認するため、成果毎の確認項目を以下の通り設定する。達成度の確認にあたっては、ソフトコンポーネント対象者への目視確認及び事後アンケート調査により評価を行う。

成果	達成度の確認項目
現状では圃場準備作業や収穫作業時期において適時適切な農業機械搬入が困難な状況下、本ソフトコンポーネントによる技術支援により、IWUMD および AMD 職員が所定の位置に仮橋の設置・撤去を自力で実施し、仮橋を使用した圃場への農業機械の搬出入を円滑に行うと共に、仮橋部材のメンテナンスが適切に実施されるようになる。	1. 習得した仮橋の施工ノウハウを活かし、下部工施工ができるようになる。(IWUMD 職員)
そのため、IWUMD 職員は、仮橋設置箇所に応じた適切な下部工施工を実施する。AMD 職員は、仮橋上部工の架設・撤去、及び上部工資材のメンテナンスを適切に実施する。	2. 作成したマニュアルに基づき、仮橋上部工の架設・撤去、及び仮橋上部工資材のメンテナンスが適切に出来るようになる。(AMD 職員)
	3. 仮橋の設置計画を自ら作成し、計画的な運用が出来るようになる。(IWUMD 及び AMD 職員)

## 5. ソフトコンポーネントの活動（投入計画）

### (1) 活動内容

本ソフトコンポーネントにおける活動内容を以下に示す。

活動項目	実施機関の対象組織	該当する成果
農業機械の圃場アクセス向上（エーヤワディー地域【シッサリトン村落、タカンワー村落、サバイコン村落】）	<ul style="list-style-type: none"> <li>● AMD 地方事務所（ボガレ、モラメアンジュン）</li> <li>● IWUMD 地方事務所（ボガレ、モラメアンジュン）</li> </ul>	成果 1

本計画のソフトコンポーネントは、上表に示す対象組織を対象とした受注コンサルタントによる直接支援型とし、ソフトコンポーネントの成果を達成するための活動内容を成果毎に以下に記す。

#### 1) 成果に対する活動

##### (a) 仮橋の概要

###### (ア) 架橋位置概要

ソフトコンポーネントで対象とする仮橋の架橋位置は、本計画対象村落内の道路沿いの水路である(詳細は本ソフトコンポーネント実施時に決定)。水路幅は5～10m程度で、河川ではなく干満以外の水位変動はない。常時は舟運として利用されており、手こぎや簡易エンジンを搭載した木製ボートの往来がある。



写真：現地の状況(タカンワー村落)

###### (イ) 構造概要

- **形式**：常時の舟運を阻害しないよう、橋梁は必要に応じ架設・撤去の繰返しができる仮橋タイプとする。構造形式は軽量の単純H鋼仮橋とする。
- **構造諸元**：仮橋の橋長は4mを想定する(ソフトコンポーネント実施時に、架橋位置の状況や確保すべき水路幅および本計画で調達されるキャブバッククレーン（クレーン付トラック）の稼働域により決定する。また、本計画で調達されるコンバインの車体幅および覆工板のサイズより幅員は4mとする。
- **設計荷重**：コンバインおよび農作物運搬用車両を想定する。諸元は下記の通りである。

➤ コンバイン

- ◇ 載荷荷重：機体重量 3t
- ◇ クローラ寸法：約 400mm×1500mm(片側)
- ◇ 接地圧：22.6kPa

➤ 運搬用車両：道路橋示方書・同解説(日本道路協会)の A 活荷重を想定する。

● **下部工(橋台)**

- 目的：橋台は安全性確保のため桁を所定位置に水平に設置し、車両通過時のずれ防止のために構築する。
- 構造形式：繰返し使用するが供用が短期間であるため仮設扱いとする。形式は鉄筋コンクリート橋台とする。
- 資機材：コンクリート打設量は少なく施工も容易なため現地調達とする。

(ウ) 水路の補強対策

仮橋は既設水路幅より短いため、設置位置の水路幅は現況より狭くなる。しかし、上記の通り河川では無く、流木等障害となる流下物もないため、河道閉塞による越流の恐れはない。ただし、潮目が替わる際に流速が発生するため、橋台保護の観点から護岸工を設置する。護岸工は現地で一般的な形式であるかご工とする。敷設延長は架橋地から左右に各 10m(河川施設等構造令 65 条を準用)とする。



図 5-1 仮橋イメージ図

(b) 必要な技術・業種

- IWUMD：測量技術、下部工および護岸工の施工技術
- AMD：仮橋設置計画および架橋位置の選定、仮橋上部工の架設および資材の維持管理

(c) 技術水準

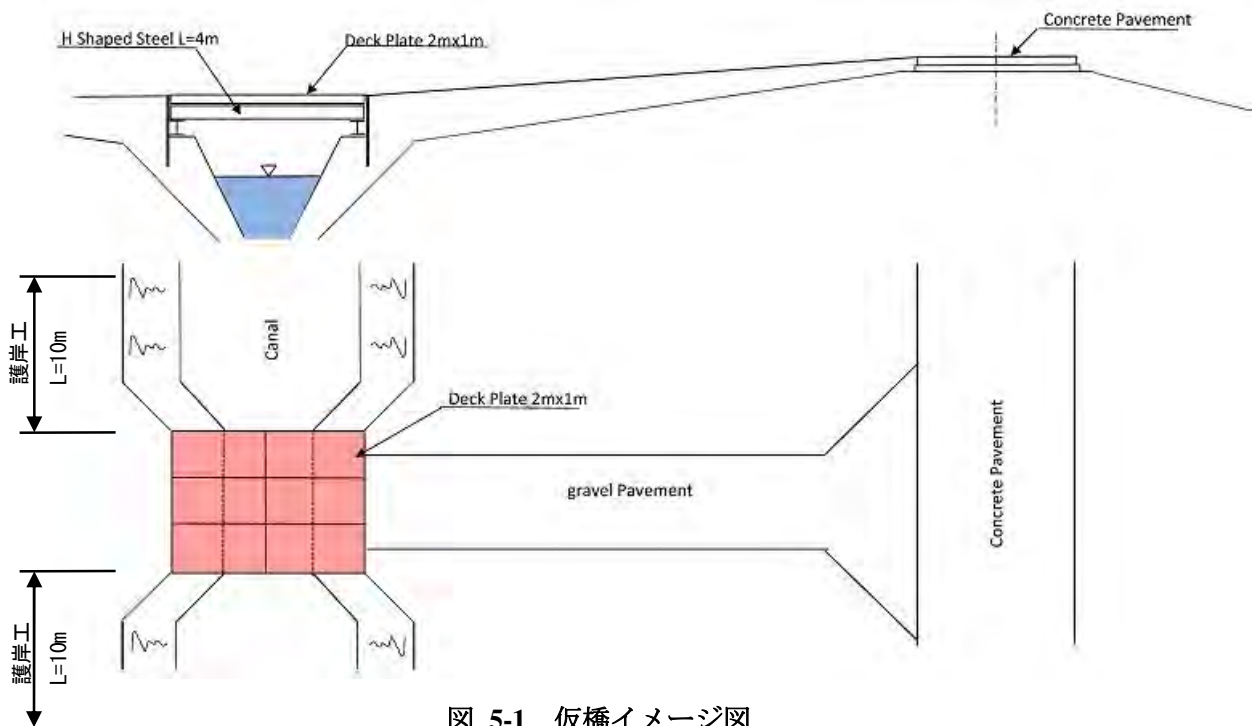
現状の技術水準	必要とされる技術水準
ヤシの木や木板を利用した仮橋をその都度建設し、圃場へ農業機械を搬入している。架設には大人3,4人が1箇所につき設置3～4日、撤去1～2日要する。	【IWUMD 地方事務所】 ① 護岸工(かご工)の施工が可能 ② 橋台の施工が可能 【AMD 地方事務所】 ① 現地条件を踏まえた仮橋設置計画の作成が可能 ② H鋼仮橋の架設・撤去が可能 ③ 仮橋資材のメンテナンスが可能

(d) 対象者

- IWUMD 地方事務所(ボガレおよびモラメアンジュンのタウンシップ)：約10名
- AMD 地方事務所(ボガレおよびモラメアンジュンのタウンシップ)：約10名

(e) 実施方法

実施場所	AMD 地方事務所 (ボガレタウンシップ) および現地架橋位置(タカンワー村落)
実施期間	● 国内作業：1.75ヶ月(全3回) 第1回：【0.25ヶ月】仮橋計画および架橋位置選定に関する技術指導書の準備 第2回：【1.00ヶ月】仮橋上下部工の設計および護岸工および下部工の施工に関する技術指導書準備 第3回：【0.5ヶ月】仮橋上部工の架設・撤去および維持管理に関する技術指導書の作成の準備 ● 現地作業：2.5ヶ月(全3回) 第1回：1.0ヶ月(以下、1名) (活動日21日、移動日3日、休日6日) 第2回：1.0ヶ月(以下、1名) 護岸工、橋台施工指導(活動日21日、移動日3日、休日6日) 第3回：0.5ヶ月(以下、1名) 仮橋上部工の仮設・撤去およびメンテナンス指導(活動日10日、移動日3日、休日2日)
活用教材	● 仮橋計画および架橋位置選定に関する技術指導書 ● 護岸工および橋台工施工に関する技術指導書 ● 仮橋上部工の架設・撤去に関する技術指導書 ● 仮橋のメンテナンスマニュアル
実習用機材	● キャブバッククレーン ● 仮橋用資材(H形鋼、覆工板)、橋台、護岸用資材、土のう等(現地調達)
活動内容	【第1回】仮橋計画および架橋位置決定として、各対象村落の現地調査を行い農業機械の使用、未使用範囲を確認する。結果を元に、仮橋の必要性を検討し、AMDおよびIWUMDが共同で将来も含む計画の策定を行えるよう支援する。併せてパイロット施工を実施する箇所を決定する。パイロット工事の対象村落は、現状で小型重機の搬入が可能なタカンワー村落とする。また、測量指導、材料条件・構造仕様に関する座学等を実施する。

【第2回】護岸工および橋台施工における施工指導を行う。護岸工は現地で自ら施工が可能な工法を基本とし、石積式護岸を想定する。

【第3回】仮橋上部工の仮設・撤去および維持管理指導を行い、運用およびメンテナンスの体制を自ら構築できるよう支援を行う。

なお、パイロット工事として施工する仮橋上下部工および護岸工は1箇所とする。活動内容の詳細は下記の通りとする。

● 国内作業

【第1回】5日間

国内準備作業として、「仮橋計画に関する技術指導書」を作成する。

活動内訳は以下の通り。

- オリエンテーション準備(1日)
- 座学①架橋位置選定(2日間)に向けた技術指導書作成(1.5日)
- 測量指導内容・指導方法の確認(0.5日)
- 現場確認指導の準備およびスケジュールの確認(0.5日)
- 座学②材料条件・構造仕様(5日間)に向けた準備(資料作成等)(1.5日)

【第2回】20日間

仮橋上下部工の設計および護岸工の設計を行い、図面数量を作成する。なお、図面は将来的な現地政府による整備に対応できるよう標準図とする。

併せて、護岸工および橋台工施工に関する技術指導書を作成する。

活動内訳は以下の通り。

- 測量結果の確認(0.5日)
- 仮橋上部工の設計・図面・数量作成(2日)
- 仮橋下部工の設計・図面・数量作成(3日)
- 護岸工の図面・数量作成(2日)
- 仮設工の設計・図面数量の作成(2日)
- 下部工施工計画(4日)
- 照査(0.5日)
- オリエンテーション準備(1日)
- 現地指導計画(2日)
- 座学準備(3日)

【第3回】10日間

仮橋上部工の架設・撤去に関する技術指導書および維持管理マニュアルを作成する。

活動内訳は以下の通り。

- オリエンテーション準備(0.5日)
- 現地指導計画(2.5日)
- 上部工架設・撤去マニュアル作成・座学準備(3日)
- 安全対策マニュアル作成・座学準備(2日)
- 維持管理マニュアル作成・座学準備(2日)

● 現地作業

【第1回】(活動21日間)

活動内訳は以下の通り。

- オリエンテーション：1日間
- 架橋位置選定に関する座学：2日間
  - 橋梁一般
  - 橋梁計画の流れ
  - 基本条件の整理
  - コントロール条件
  - 橋台位置の決定
  - 事例紹介

	<ul style="list-style-type: none"> <li>➤ 現場確認指導(シッサリトン村落、タカンワー村落、サバイコン村落)：9日間</li> <li>➤ 架橋位置選定およびパイロット工事位置選定：2日間</li> <li>➤ 測量指導：1日間</li> <li>➤ 材料条件・構造仕様に関する座学：5日間</li> <li>➤ 評価・フォローアップ：1日間</li> </ul> <p>第1回活動終了後、現地コンサルタントによる測量指導を行う（20日間）</p> <p><b>【第2回】(活動21日間)</b> 活動内訳は以下の通り。</p> <ul style="list-style-type: none"> <li>➤ オリエンテーション：1日間</li> <li>➤ 座学(護岸工および橋台工技術指導)：3日間 <ul style="list-style-type: none"> <li>- 施工計画の流れ</li> <li>- 施工条件の整理</li> <li>- 準備工</li> <li>- 仮設工</li> <li>- 護岸工</li> <li>- 橋台工</li> <li>- 施工工程</li> <li>- グループワーク(施工計画書作成)</li> </ul> </li> <li>➤ 準備工(現地)：2日</li> <li>➤ 実技指導(現地)：14日間</li> <li>➤ 評価・フォローアップ：1日間</li> </ul> <p><b>【第3回】(活動10日間)</b></p> <ul style="list-style-type: none"> <li>➤ オリエンテーション：0.5日間</li> <li>➤ 仮橋の架設・撤去に関する技術指導：1.5日間 <ul style="list-style-type: none"> <li>- 架設・撤去の流れ</li> <li>- 準備工</li> <li>- 運搬・クレーン操作</li> <li>- 架設・組立て</li> <li>- 組ばらし・撤去</li> <li>- 安全対策</li> </ul> </li> <li>➤ 仮橋の架設・撤去に関する実技指導(現地)：5日間</li> <li>➤ 仮橋のメンテナンスに関する技術指導：0.5日間 <ul style="list-style-type: none"> <li>- メンテナンス一般</li> <li>- 重点点検箇所の確認</li> <li>- 想定される損傷と損傷に応じたメンテナンス方法</li> </ul> </li> <li>➤ 仮橋のメンテナンスに関する実技指導：0.5日間</li> <li>➤ レビュー・マニュアル修正：1日間</li> <li>➤ 評価・フォローアップ：1日間</li> </ul>
--	---

(2) 実施リソース

1) 日本側

ソフトコンポーネントを実施するために派遣する日本人技術者の担当分野、人数、派遣期間、及び主な活動内容について以下に記す。

【日本人技術者】

担当分野	人数	期間 (M/M)	主な活動内容
技術・施工指導 (日本人技術者)	1名	国内：1.75M/M ・第1回：0.25M/M ・第2回：1.00M/M ・第3回：0.5M/M  現地：2.5M/M ・第1回：1.0M/M ・第2回：1.0M/M ・第3回：0.5M/M 合計：4.25M/M	第1回：仮橋計画技術指導書作成 第2回：設計、図面数量作成、指導書作成 第3回：上部工架設・撤去指導書、維持管理マニュアル作成  第1回：仮橋計画指導、位置選定等 第2回：護岸工・橋台施工指導 第3回：上部工架設・撤去、メンテナンス指導

また、現地備人として、通訳及び日本人技術者の作業補助要員を以下の通り備上する。

【現地備人】

担当分野	人数	期間 (M/M)	主な活動内容
通訳 (英緬) (現地備人)	1名	1回目：0.9M/M 2回目：0.9M/M 3回目：0.4M/M 合計：2.2M/M	- 日本人技術者の通訳 - 研修時の英緬通訳 - 教材等の翻訳

また、測量は現地コンサルタントの測量技術・機器を用いて指導を行うことで、測量の効率化、技術向上、および設計・施工品質の向上を図ることとする。

【現地コンサルタント】

担当分野	人数	期間 (M/M)	主な活動内容
測量 (現地コンサルタント)	3名	1回目：0.67M/M 合計：2.01M/M	- 測量技術指導

2) ミャンマー側

ソフトコンポーネントを実施するためにミャンマー側が投入すべき人材を以下に記す。

担当分野	投入人数	期間
農業機械管理担当者、測量担当者、工事担当者、機材オペレータ、作業員	20名程度	第1回：1.0ヶ月 測量：0.67ヶ月 第2回：1.0ヶ月 第3回：0.5ヶ月 合計：3.17ヶ月



## 6. ソフトコンポーネントの実施リソースの調達方法

本ソフトコンポーネントにおける各活動においては、以下に示す理由によりローカルリソースではなく日本人技術者が相応しいと考えられる。

活動項目	日本人技術者による実施の理由
農業機械の圃場アクセス向上 (エーヤワディー地域【シッサリトン村落、タカンワー村落、サバイコン村落】)	我が国の豊富な経験に基づく、仮橋に関する技術や知識は現地に根付いておらず、対応困難であり、メンテナンスと併せてノウハウは日本人技術者が指導する必要がある。
現地コンサルタント	日系コンサルや建設会社との経験が豊富な現地コンサルタントの測量技術・機器により効率的な指導が可能である。

以上の理由により、本ソフトコンポーネントにおいては、受注コンサルタントが直接実施することが適切である。

## 7. ソフトコンポーネントの実施工程

本ソフトコンポーネントの全体実施工程を以下に示す。

年	2018												2019												2020				
	月	4	5	6	7	8	9	10	11	12	1	2	3	4	5	6	7	8	9	10	11	12	1	2	3	4	5		
調達工程																													
ソフトコンポーネント	① 仮橋計画																												
	② 護岸・橋台施工																												
	③ 上部工の架設・撤去およびメンテナンス																												
	報告書提出																												

注) ミャンマーでは5月～10月が雨期にあたる。

## 8. ソフトコンポーネントの成果品

ソフトコンポーネントにより作成する成果品を以下に示す。

- 仮橋計画に関する講義資料
- 測量成果
- 護岸工、橋台工に関する講義資料
- 仮橋上部工の架設・撤去に関する技術資料
- 仮橋上部工のメンテナンスマニュアル
- ソフトコンポーネント完了報告書

完了報告書は以下の成果品を含む。

- 施工写真等の活動記録
- 施主に提出した Final Report

## 9. ソフトコンポーネントの概略事業費

ソフトコンポーネントの概略事業費を以下に示す。

費目	金額（千円）	備考
1. 直接人件費	3,867	
2. 直接経費	4,171	
3. 間接費	8,044	
合計	16,082	

※ 交換レート：1米ドル=112.05円

## 10. 相手国側の責務

ソフトコンポーネントの目標が達成されるためには、ソフトコンポーネントの実施による成果に加え相手側実施機関（農業機械化局、灌漑局）が果たすべき責務として以下のような項目が挙げられる。

- 農業機械化局及び灌漑局は、ソフトコンポーネントにより習得した仮橋の計画・施工・維持管理に関する知見を活用・共有することで、本計画対象地域の農業機械の圃場アクセス、および村落内農民の所得の向上に向けた支援を持続的に実施する。
- 農業機械化局及び灌漑局は、仮橋設置のニーズ拡大に対しては、上・下部工増設のための予算を確保し、現地ニーズに応じて複数箇所に展開する。
- 農業機械化局は、収穫及び圃場準備時期において仮橋の計画的な転用（設置・撤去）を継続する。また、民間保有の農業機械に対しても仮橋を活用して効率的に搬入・搬出を行えるよう支援を行う。

## 資料-6 その他資料・情報

## 6-1 フィールド・レポート

**PREPARATORY SURVEY  
FOR  
THE PROJECT  
FOR  
RURAL INFRASTRUCTURE DEVELOPMENT IN LOCAL AREAS**

**FIELD SURVEY REPORT**

**September 2017**

**JICA Survey Team**

**YACHIYO ENGINEERING CO., LTD., TOKYO, JAPAN  
NIPPON KOEI CO., LTD., TOKYO, JAPAN**

# THE PROJECT FOR RURAL INFRASTRUCTURE DEVELOPMENT IN LOCAL AREAS

## FIELD SURVEY REPORT

### **Preface**

Based on the Minutes of Meeting agreed between Ministry of Agriculture, Livestock (hereinafter referred to as “MOALI”) and Irrigation and JICA on 6<sup>th</sup> July, 2017 (hereinafter referred to as “the Minutes of Meeting”), the JICA Survey Team (hereinafter referred to as “the Team”) of the above captioned project conducted a field survey in Ayeyarwady Region and Chin State, respectively. Moreover, the Team discussed details of proposed project components with concerned officials of Department of Rural Development (hereinafter referred to as “DRD”), Department of Irrigation, Water Utilization and Management (hereinafter referred to as “IWUMD”) and Agricultural Mechanization Department (hereinafter referred to as “AMD”) from MOALI and Department of Rural Road Development (hereinafter referred to as “DRRD”) from Ministry of Construction (hereinafter referred to as “MOC”), which was newly established through reorganization between MOALI and MOC in August 2017.

As a result of the survey and discussion, the Team formulated details of following items.

- 1. Survey Areas**
- 2. Overview of Existing Infrastructure at surveyed Areas**
- 3. Progress on Road/ Bridge Project**
- 4. Progress on Irrigation Project**
- 5. Progress on Water Supply Project**
- 6. Progress on Agricultural Mechanization Project**

**However, all the items and components described in this report will be decided after further studies in Japan and consultations with the concerned officials of the Government of Japan.**

## 1. Survey Areas

In the selection of a target road for the Project, the Team conducted the field survey at following areas.

Table 1-1 Survey Area

State/Region	Township	Village Tract	Village
Chin State	Falam	Zarhwlor	- Pa Mum Chaung
	Tedim	Dolluang	- Zo Zang - Zo Nuan Zang - Tan Zan - Dolluang <sup>Note)</sup> - Swang Dawh
Ayeyarwady Region	Mawlamyinegyun	Sit Sali Htone	- Sit Sali Htone - Pat Taw - Ywar Ka Lay - Bon Taung Su
	Bogale	Sa Bai Kone	- Sa Bai Kone - Ba Wa Thit - Ywar Tan Shay - Mote So Chaung - Sa Kar Lon Kone - Dar Chaung - Nga Pi Tone Hle - U Do Kan Su
		Tha Kan Wa	- Tha Kan Wa - Tha Kan - Kyaung Su - Hin Oh Gyi - Kyon Pha - Ngwe Taung - Da None - Aung Mingalar - Tae Pin (1) - Tae Pin (2) - Tae Pin (3)

Note) Site survey for villages located in mountain area, Dolluang and Swang Dawh Village, will be conducted in dry season, December 2017, due to the difficulty of access in rainy season.

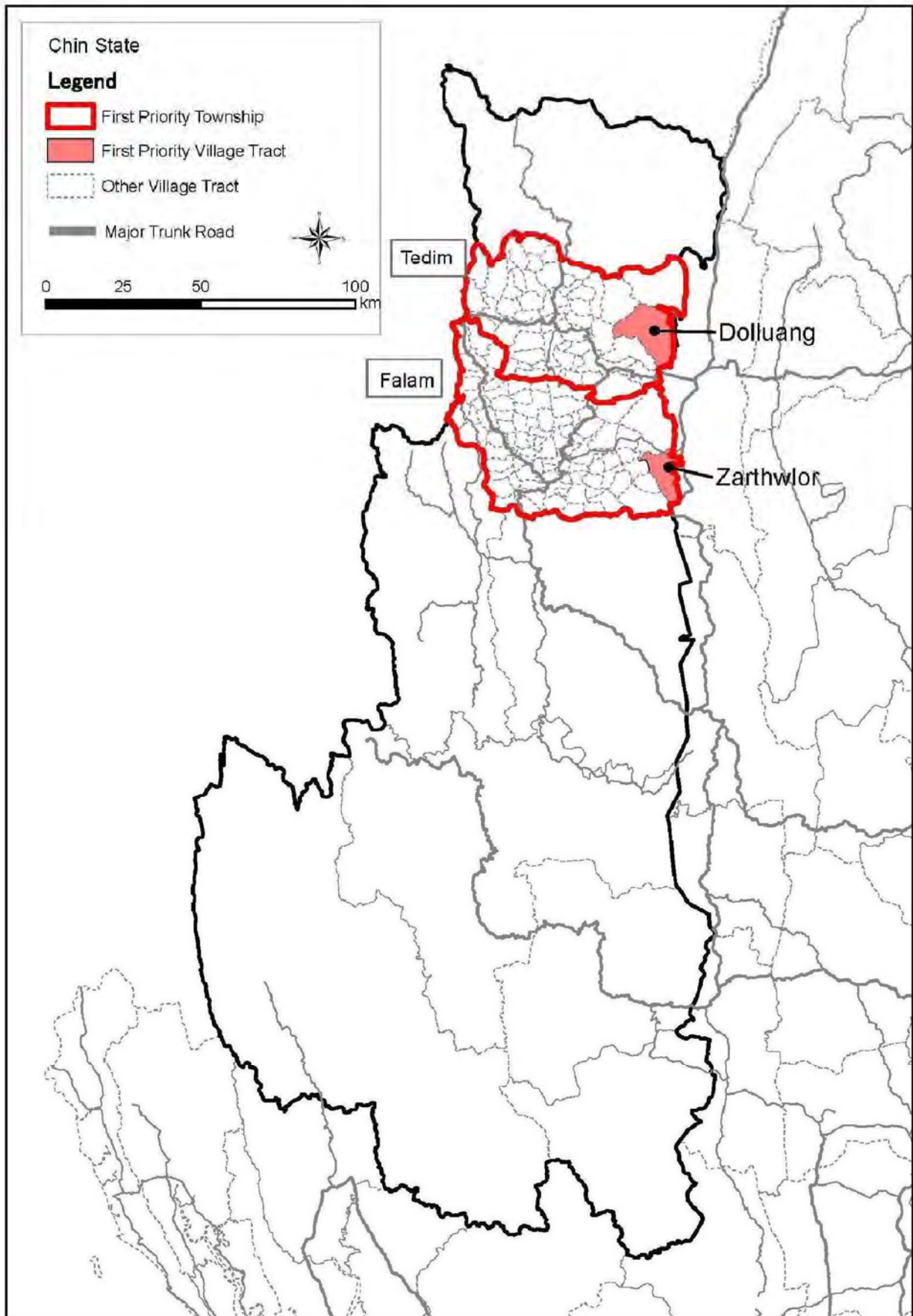

Figure1-1 Survey areas in Chin State



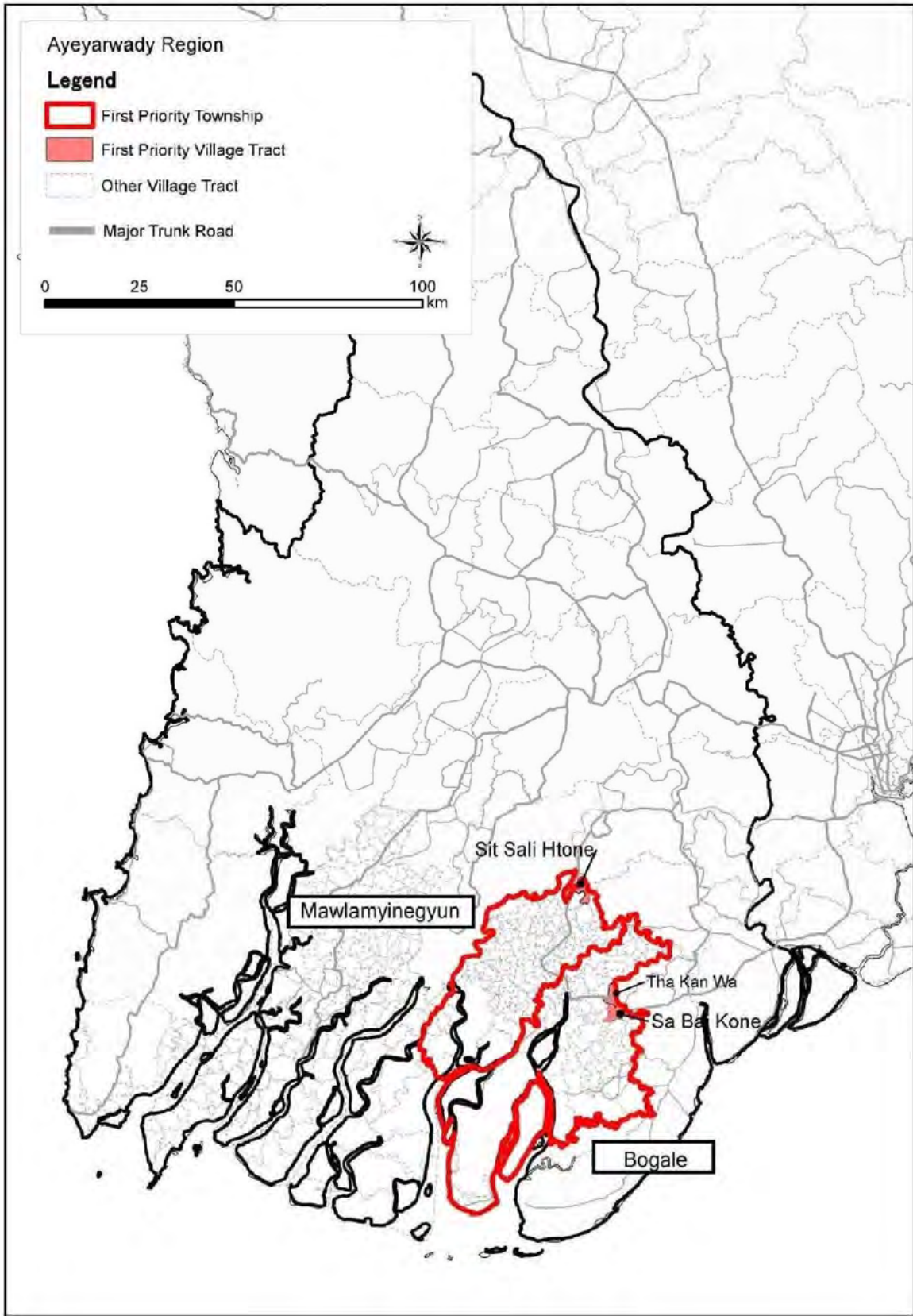

Figure 1-2 Survey areas in Ayeyarwady Region

## 2. Overview of Existing Infrastructure at Surveyed Areas

### 2-1. Road/Bridge

Current conditions at surveyed areas are observed as follows:

Table 2-1-1 Overview of existing road/bridge surveyed in Chin State

Area	Overview
<p>Dolluang Village Track, Tedim Township</p> <p>Village: Zo Zang, Tan Zan, ZoNuanZang, Mai Nwel, Dolluang, Swang Dawh</p>	<p>Zo Zang, Tan Zan , Mai Nwel, and Zo Nuan Zang village are located at plain area and others, Dolluang, Swang Dawh are located in the mountain. Zo Zang village is biggest village in Dolluang Village Track, and considered an entrance of the village. This village tract has major access problems. There is no bridge over a river named Pha La Tha River at present and the river becomes in impassable condition in rainy season. During several months in rainy season, Zo Zang village, Tan Zan village and other villages behind Zo Zang village are isolated from neighboring areas. A bridge construction over the river is in urgent needs for this village tract.</p> <p>About existing road/bridge of Mai Nwel village, there is an existing bridge to across Pha La Tha river, and the condition is still sound. However, road structures such as pipe culverts are used to be washed out in rainy season, road restoration is required every year.</p> <p>Zo Nuan Zang village is located over Pha La Tha river and close to Sagain Region. The road to connect to Sagain Region is available through the entire year. The road is paved with gravel, and mainly Zo Nuan Zang villagers and other 4 villages, which are located at north side of Zo Nuan Zang village, are using this road for economic activity.</p> <div data-bbox="392 952 1316 1294"> </div> <p style="text-align: center;">Existing road condition of Zo Zang village</p>
<p>Zarhwlor Village Track, Falam Township</p> <p>Village: Pa Mum Chaung</p>	<p>The existing timber suspension bridge for access to farm land in Pa Mum Chaung village is damaged around year 2013. Thus villagers cannot access to their farm land by any vehicle. When the rise of a river flooding, even access on foot is not available, and villagers cannot maintain their crops timely. The road condition for access to farm land after bridge is unpaved and muddy in rainy season, so that vehicle is hard to pass.</p> <p>For covering all agricultural area in Pa Mum Chaung village, not only replacement of existing timber suspension bridge, but also another available route to access farm land has to be considered.</p> <div data-bbox="392 1563 1316 1906"> </div> <p style="text-align: center;">Existing road condition of Pa Mum Chaung village</p>

Table 2-1-2 Overview of existing road/bridge surveyed in Ayeyarwady Region

Area	Overview
<p>Sit Sali Htone Village Tract, Mawlamyine gyun Township</p> <p>Village: Sit Sali Htone and surrounding villages in the tract</p>	<p>The existing road from local main road controlled by MOC to the village tract is 2.0m width and 11.8km length with unpaved surface. There are 3 existing bridges, but damaged due to inadequate load capacity, only motorcycle is able to pass in dry season. Road becomes muddy during the every rainy season, and hard to traffic to access to main market, Yone daunt where is located 2.5 km east of Sit Sali Htone village, and to administrative city, Mawgyun where is located around 25 km south of the village. In the rainy season, they are dependent on water transportation for economic and administrative activities. Paddy fields, approximately 1,000 acre, are formed along the road, and an agricultural machine is also hard to access their paddy field due to poor condition of the road and bridge.</p> <div data-bbox="517 607 1235 875"> </div> <p style="text-align: center;">Existing road condition of Sit Sali Htone village</p>
<p>Sa Bai Kone Village Tract, Bogale Township</p> <p>Village: Sa Bai Kone and surrounding villages in the tract</p>	<p>The existing road from Bogale – Pyapon highway controlled by MOC to Sa Bai Kone village is 2.6m width and 4.2km length with unpaved surface. Road becomes muddy during the every rainy season, and hard to traffic to access to main market, Bogale. In the rainy season, they are dependent on water transportation. It takes more than 2 hours to go to Bogale from Sa Bai Kone village using boat, whereas car only takes 20 min. Paddy fields, approximately 1,400 acre, are formed along the road, and an agricultural machine is also hard to access their paddy field due to poor condition of the road and bridge.</p> <div data-bbox="509 1135 1224 1404"> </div> <p style="text-align: center;">Existing road condition of Sa Bai Kone village</p>
<p>Tha Kan Wa Village Tract, Bogale Township</p> <p>Village: Tha Kan Wa and surrounding villages in the tract</p>	<p>The existing road from Bogale – Pyapon highway controlled by MOC to Tha Kan Wa village is 3.0m width and 4.8km length with gravel surface. Due to the poor construction quality of base course and harsh rain in rainy season, numerous potholes are confirmed on site. In dry season, 7-8 seater bus operates between Bogale and Tha Kan Wa village 5 times a day, but the bus is not available in rainy season due to poor road condition. There are 2 existing bridges on target road, but there is weight limitation, below 3 tons. Therefore, it is difficult to haul agricultural produce with truck. Paddy fiend has been spread along the road, but access of agricultural machine is not easy due to no existing of entering bridges. Farmer always make temporary timber bridges taking 2~3 days when access of agricultural machine is necessary.</p> <div data-bbox="497 1715 1219 1984"> </div> <p style="text-align: center;">Existing road condition of Tha Kan Wa village</p>

## 2-2. Irrigation

Current conditions at surveyed areas are observed as follows:

Table 2-2-1 Overview of existing irrigation surveyed in Chin State





Area	Overview
Zarthlor Village Track, Falam Township  Village: Pa Mum Chaung	<p>There are 2 small rural irrigation systems in the Pa Mun Chaung village, which were constructed in 1970 at upstream one and in 1969 at downstream one. Irrigation water is currently taken from a Pa Mun Chaung river directly without using intake gate facilities at the right side of the both headworks.</p> <p>Accordingly huge amount of sands and stones are always brought into the canals with flood flow whenever a flood occurs. Removal works of such sedimentation is one of severe burdens for farmers in the area. In addition, when the wooden fixed weir is flushed away by a flood, the farmers have to rebuild the weir with wood materials. According to the farmers, they had reconstructed them 3 times in a monsoon season in the past.</p> <div style="display: flex; justify-content: space-around;"> <div style="text-align: center;">  <p>Current condition of the upstream headworks</p> </div> <div style="text-align: center;">  <p>Sedimentation in the canal (upstream headworks)</p> </div> </div> <div style="display: flex; justify-content: space-around; margin-top: 20px;"> <div style="text-align: center;">  <p>Sedimentation in front of the intake (upstream headworks)</p> </div> <div style="text-align: center;">  <p>A current wooden fixed weir (downstream headworks)</p> </div> </div>

Table 2-2-2 Overview of existing irrigation surveyed in Ayeyarwady Region

Area	Overview
Tha Kan Wa Village Track, Bogale Township  Village: Tha Kan Wa and surrounding villages in the tract	<p>In the target area, water levels in the canal fluctuate with tidal movement through the Bogale river periodically.</p> <p>In the monsoon paddy cultivation period, canal water levels sometimes exceeded over the top level of bunds of paddy fields. Consequently canal water inundated periodically on paddy fields. When the paddy was in growing period, such inundation did not cause any serious damages on paddy. However, in harvest period, such inundation affected on quality of rice and workability of combine harvesters in the paddy field.</p> <p>On contrary, in summer paddy cultivation period, the canal water levels draw down till the bottom of the canal in low tide time, and canal water could not be supplied from the canal to the paddy fields sufficiently. It caused difficulty of growth of paddy.</p> <div style="text-align: right; margin-top: 20px;">  <p>Present inundation condition of the target paddy fields at high tide time</p> </div>

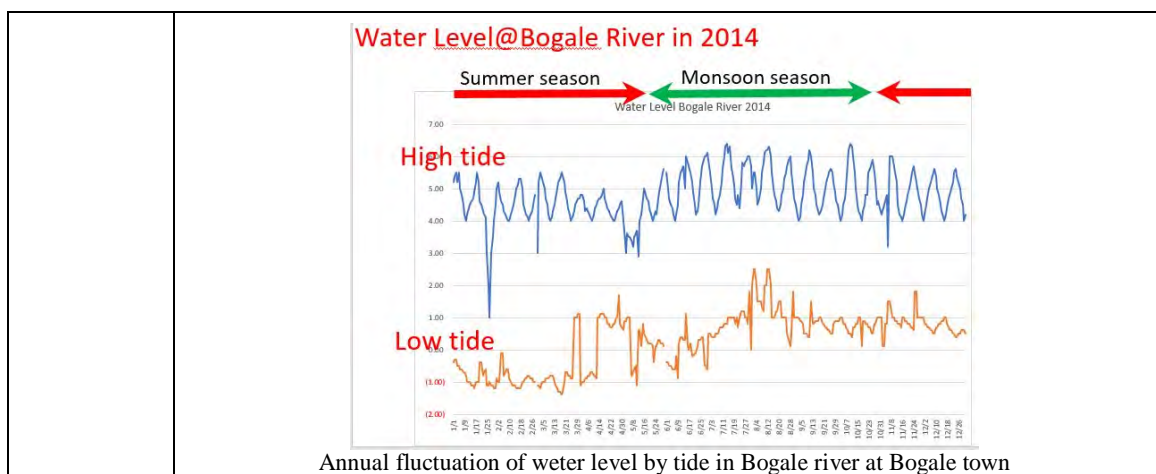

### 2-3. Water Supply

Current conditions at surveyed areas are observed as follows:

Table 2-3-1 Overview of existing water supply surveyed in Chin State

Area	Overview
<p>Dolluang Village Track, Tedim Township</p> <p>Village: Zo Zang, Tan Zan ZoNuanZang, Mai Nwel, Dolluang, Swang Dawh</p>	<p>In Zo Zang village, DRD constructed the public water system in 2016 and the source of water was stream near the village. After two months from the operation, the system was broke down and has not been repaired. People used only shallow wells and water quality is not good. Water in some shallow wells are dried up in dry season.</p> <p>In Tan Zan village, there are two water supplies in the village that constructed by UNDP and DRD. The present water facility was spring and steam water supply systems which is 4miles far from the village.</p> <ul style="list-style-type: none"> <li>➤ UNDP - Spring water supply system</li> <li>➤ DRD - Stream water supply system</li> </ul> <p>As per the village information, these systems can sustain enough amount of water in whole season but only small shortage for drinking water in dry season especially in April &amp; May.</p> <p>In Zo Nuan Zang village, there is one water supply system in the village that constructed by DRD at Feb, 2016. The present water facility was steam water supply system which is 4.8km far from the village. This system can sustain only small amount of water in dry season, water turbidity was higher and smells also not good in whole season. Villagers maintained over 10 times by themselves because of pipe line broken.</p> <p>In Mai Nwel village, there are two water supplies system in the village that constructed by Catholic Organization and Myanmar NGO at 2011. The present water facility was spring and steam water supply systems which is 1.5miles far from the village.</p> <ul style="list-style-type: none"> <li>➤ Catholic Organization - Spring water supply system</li> <li>➤ MNGO - Stream water supply system and Two public tube well</li> </ul> <p>As an amount of water is enough to supply all household in the village.</p>



Existing shallow well in Zo Zang village





<p>Zarhwlor Village Tract, Falam Township</p> <p>Village: Pa Mum Chaung</p>	<p>In Pa Mum Chaung village, there is a public water supply system using one spring water source which is established by UNDP in 2011, and spring water source is situated 4km from village. Discharge rate of spring intake was 60 L/min, but outflow to the tank in village was 40 L/min. Since an amount of spring water source is reduced and not enough to supply all villagers in dry season, they only supply at the limited time.</p>	 <p>Existing water supply facility (UNDP) in Pa Mum Chaung village</p>
---	---	--

Table 2-3-2 Overview of existing water supply surveyed in Ayeyarwady Region

Area	Overview	
<p>Sit Sali Htone Village Tract, Mawlamyine gyun Township</p> <p>Village: Sit Sali Htone and surrounding villages in the tract</p>	<p>In Sit Sali Htone Village Tract, for drinking water purpose, there are rain water storage tanks. Hand pumps borehole are also available but have water quality problem. Rain water tanks in accordance with DRD standard are constructed in Sit Sali Htone Village Tract. Its capacity is 5,000gallos (15'x9'x6') and rain water is collected from roof of other facilities such as private house and school. There are some rain water storage tanks including tanks established by NGO. Each household have several storage pots to collect water in rainy season, however, amount of stored water including rain water tanks is shortage during dry season. DRD support to supply water into rain water storage tank using water tank truck for dry season.</p>	 <p>Rain water tank (DRD standard) in Sit Sali Htone Village Tract</p>
<p>Sa Bai Kone Village Tract, Bogale Township</p> <p>Village: Sa Bai Kone and surrounding villages in the tract</p>	<p>In Sa Bai Kone Village Tract, water source in the tract is rain. There are rain water ponds in each village which are established by DRD and village. In addition to rain water ponds, there is rain water storage tank which collecting from roof system established by NGO as public water supply. Each household have several storage pots to collect water in rainy season, however, amount of stored water including rain water ponds is shortage during dry season.</p>	 <p>Rain water pond established by village in Sa Bai Kone</p>
<p>Tha Kan Wa Village Tract, Bogale Township</p> <p>Village: Tha Kan Wa and surrounding villages in the tract</p>	<p>In Tha Kan Wa Village Tract, villages use rain water ponds mainly and rain water tanks as public water supply. Some ponds are need to be repaired. There is deep well facility established by NGO, however it is no longer used due to water quality problem. Some rain water ponds in accordance with DRD standard are constructed. Their capacities are 300,000 gallons (100'x100'x5') and ponds are surrounded by fence. Hand pumps are installed outside fence in order to supply water. Each household have several storage pots to collect water in rainy season, however, amount of stored water including rain water ponds is shortage during dry season.</p>	 <p>DRD standard's pond in Tha Kan wa Village Tract</p>

## 2-4. Agricultural Mechanization

Current conditions at surveyed areas are observed as follows:

Table 2-4-1 Overview of existing agricultural machinery surveyed in Chin State

Village	Overview
<p>Zarthlor, Village Track, Falam Township</p> <p>Village: Pa Mum Chaung</p>	<p>Monsoon paddy is cultivated in 255 acres but summer crop is cultivated very little. Farm land are terraced on gentle slope in a valley where many rocks and stones are scattered and it obstacles to machine use. Farmers are making efforts to remove them. Farming practice relies on cows for land preparation and threshing. A powertiller donated by DOA is not used now in out of order.</p> <p>Distribution of stone on fields vary among areas, about a half of their sawn area can be used powertiller judging by observation and information given by farmers.</p> 
<p>Dolluang Village Track, Tedim Township</p> <p>Village: Zo Zang, Tan Zan ZoNuanZang, Mai Nwel, Dolluang, Swang Dawh</p>	<p>Zo Zang village: Monsoon paddy is cultivated in 840 acres. Farming by caws is major even 12 powertillers are also used for 100 acres approximately. Powertiller owners do not use them well by provision of lending service to other farmers. Summer crop is cultivated only on 70 acres.</p> <p>Service providers of thresher come from Kalaymyo side already. 30% of farm land is lowland where big machines like tractor and combine harvester cannot enter. Additionally, there are the areas of small farm plots of formless shape where big machines cannot use too. For the rest area, mechanization by big machine can be expected.</p> <p>About 200 acres of possible land to be a farmland was identified during the field survey, where locate on gentle slope of around 10 degrees extending to a mountain, and can be develop to terrace fields of enough width plots that big machines can be used.</p>  <p style="text-align: center;">Existing machinery                      Candidate area for land reclamation</p>
	<p>Zo Nuan Zang village : Among total 1,500 acres, 30 farm household in the village use only 120 acres, and the rest fields are owed by farmers out of the village. 5 powertillers are used in 35 acres.</p> <p>Even though need of farmers for using private mechanization services is high, but their fields scatter in 1,500 acres area and then they are facing difficulties to receive services due to less economic interest of the providers.</p> 
	<p>Tan Zan village: 20 farm households cultivate 200 acres mainly by cows. Among them, 4 farmers ask the service by powertillers for harrowing while they plow and rotavate by cows, the rest 16 farmers cultivate by cow. But 10 among 16 farmers borrow cows in the season. Thus, mechanization has been just started by using powertillers to harrow.</p>





	<p>Mai Nwel village : 2 farm households among 78 household are only cultivating on 8 acres. The other households work for animal breeding and raising of cows for meat, buffaloes and pigs by small scale, and some engage fish culture in a pond.</p>	
	<p>Dolluang village: 22 households engage tea leaves production in mountainous area. Road condition to the main road is a bad earth road and they carry the tea product in a bag on their shoulders and transport them to a market on foot or by a motorcycle.</p>	
	<p>Swang Dawh village: 36 households engage tea leaves production in mountainous area. Road condition to the main road is a bad earth road and they carry the tea product in a bag on their shoulders and transport them to a market on foot or by a motorcycle.</p>	

Table 2-4-2 Overview of existing agricultural machinery surveyed in Ayeyarwady Region

Village Tract	Overview	
<p>Sit Sali Htone Village Track, Mawlamyinegyun Township</p> <p>Village: Sit Sali Htone and surrounding villages in the tract</p>	<p>Monsoon paddy is cultivated in 2,461 acres by 423 farm households and paddy and upland crop such as beans and sunflower are cultivated in around 1,000 acres (43% of total fields). There are 2 farms who have a tractor and a combine harvester each but cultivation by 170 units of powertiller is major in the village. 132 heads of cow and 14 heads of buffalo are breed and used for cultivation in little fields.</p> <p>Farmers need to shorten the period from harvesting of monsoon paddy to land preparation of summer crops for sowing of summer crops earlier. Then, their needs for introduction of combine harvester and tractor in the time. However, it has not been introduced yet even about 50% of summer paddy is harvested by combine harvester.</p>	
<p>Sa Bai Kone Village Track, Bogale Township</p> <p>Village: Sa Bai Kone and surrounding villages in the tract</p>	<p>334 farm households cultivate rice by double cropping in 3,500 acres. A farm household cultivates 10 acres in an average. 125 units of powertillers owed by farmers are used for cultivation. Needs for using a combine harvester and a tractor for harvesting of monsoon paddy and land preparation of summer crops are very high but they are not introduced yet. In the last two years, the provision of harvesting service of summer paddy by private has been increased rapidly and occupied 90% of harvesting area in this year. Since farmland in the village locates on low land area, there are some areas where big machines such as a tractor and a combine harvester.</p>	
<p>Tha Kan Wa Village Track, Bogale Township</p> <p>Village: Tha Kan Wa and surrounding villages in the tract</p>	<p>352 farm households cultivate rice by double cropping in 1,942 acres. A farm household cultivates 5.5 acres in an average. 93 units of powertillers owed by farmers are used for cultivation.</p> <p>For harvesting of summer paddy, private machine service has been providing to farmers already and covered 700 acres in this year. But harvesting of monsoon paddy is still carried out by manpower and powertillers are used for land preparation for summer paddy yet.</p> <p>There is the lowland area where creek water flows over to fields in high tide time even in the dry season. In such area, big machines as a tractor and a combine harvester cannot enter.</p>	



### 3. Progress on Road/ Bridge Project

#### 3-1. Outline of Road/ Bridge Plan

As per survey result, road and bridge are planned by the Team. However, survey of “Environmental and Social Consideration” and study of “Rural Development” are still on going. Road/Bridge plan shall be finalized after completion of study of “Rural Development” and “Environmental and Social Consideration”. Outline of tentative road/bridge plan are shown as follows.

##### 3-1-1. Chin State

Target areas are Dolluang Village Tract of Tedim Township and Zarthwlor Village Tract of Falam Township. In Dolluang Village Tract, 6 numbers of roads are marked out as candidates. In Zarthwlor Village Tract, 2 numbers of roads are marked out as candidates. Target road and numbers of bridges and structures are shown in following.

##### (1) Dolluang Village Tract

Outline of tentative road/bridge plan are shown in Figure 3-1-1. There are 6 candidate roads. Road A, B, C, E, F are connected from village to village, and they are classified as “Class B” in accordance with national strategy for rural roads and access that defines the Core Rural Road Network (CRRN). Road D is interior village road. These candidate roads are still under evaluation, and proposed roads will be finalized after evaluation in terms of agricultural and rural development in around this areas. There is one major bridge on Road A, the bridge crossing river along to border line between Chin State and Sagaing Region. Zo Zang village, Tan Zang village and other 6 villages are isolated due to flood in monsoon season because there is no bridge on Road A.

Current situation of Road A and planned bridge location is shown in Figure 3-1-2.

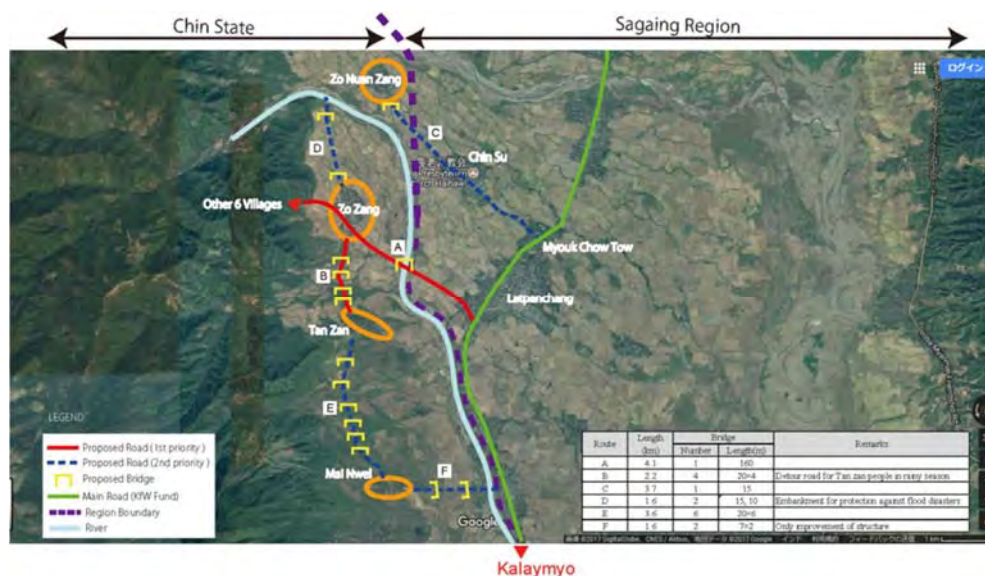

Figure 3-1-1 Planned roads and bridges in Dolluang Village Tract, Tedim Township



Figure 3-1-2 Current situation of Road A and planned bridge location

**(2) Zarthwlor Village Tract**

Outline of tentative road/bridge plan are shown in Figure 3-1-3. Residential area and paddy field are separated by the river. It is planned reconstruction of damaged bridge at Road A and construction of ford bridge for transportation of agricultural machine.

Existing bridge on Road A was damaged due to unexpected overload, villagers are going across river to agricultural work. There is no bridge at river crossing point on Road B, this road is used for transportation of agricultural machine.



Figure 3-1-3 Planned road and bridge in Zarthwlor Village Tract, Falam Township



Figure 3-1-4 Existing suspension bridge at Road A (Damaged) and river crossing point for agricultural machine at Road B

### 3-1-2. Ayeyarwady Region

Target areas are Sit Sali Htone Village Tract of Mawlamyinegyun Township and Sa Bai Kone Village Tract and Tha Kan Wa Village Tract of Bogale Township. Target road and bridge are shown in followings.

#### (1) Sit Sali Htone Village Tract

In Sit Sali Htone Village Tract, 11.8km length road is planned with concrete pavement. DRRD road classification Class 3 will be applied to this road due to the subsidence and land acquisition issue. Planned bridges are on existing road, existing bridges are three timber decked bridges. Those bridges are difficult to pass by vehicle and agricultural machine. It is required to improve road transportation for passengers, agricultural machine and product. It is recommended to reconstruct these 3 bridges as concrete bridge.

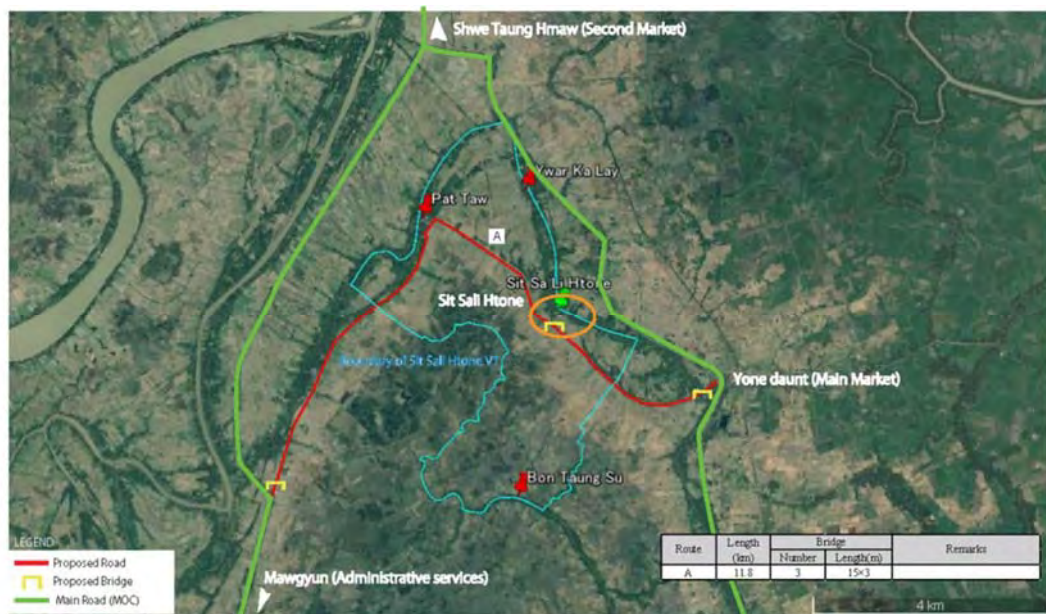

Figure 3-1-5 Planned road/bridge in Sit Sali Htone Village Tract, Mawlamyinegyun Township



Figure 3-1-6 Bamboo bridge



Figure 3-1-7 Timber decked bridge

## (2) Sa Bai Kone Village Tract

In Sa Bai Kone Village Tract, 4.2km length road is planned with concrete pavement. DRRD road classification Class 3, pavement within existing road width, will be applied to this road due to the subsidence and land acquisition issue. After improvement of this road, accessibility to their main markets, Bogale and Pyapon, will be sharply increased, also dependence on water transportation in rainy season will be moderated.

Planned bridges are on existing road, existing bridges are 3 bridges which are timber decked concrete bridge. These bridges are got older, it is recommended to reconstruct as steel and concrete bridge.



Figure 3-1-8 Planned road/bridge in Sa Bai Kone Village Tract, Bogale Township



Figure 3-1-9 Timber decked bridges at Sa Bai Kone Village Tract

### (3) Tha Kan Wa Village Tract

In Tha Kan Wa Village Tract, 4.8km length road is planned with concrete pavement. DRRD road classification Class 3, pavement within existing road width, will be applied to this road due to the subsidence and land acquisition issue. Space for car passing will be planned at regular intervals assumed about 300m. After improvement of this road, accessibility to their main markets, Bogale and Pyapon, will be sharply increased, also dependence on water transportation in rainy season will be moderated.

About the bridge plan, 2 bridges are subject to consider reconstruction due to the lack of load bearing capacity, only 3 tons.



Figure 3-1-10 Planned road/bridge in Tha Kan Wa Village Tract, Bogale Township



Figure 3-1-11 Existing concrete bridge in Tha Kan Wa Village Tract

**3-2. Design Condition**

**3-2-1. Road**

**(1) Applicable Standard**

Design of roads shall be followed standards/specifications which are used for the projects in Myanmar. Design standards, specifications and other relevant documents are shown as follows;

Table 3-2-1 Applicable Standards

No.	Standards/Specifications	Publisher	Published Date	Remarks
1	Typical Drawings of Rural Road and Bridge (2017-2018)	DRD	Dec.2016	
2	Road Design Criteria in Myanmar	MOC, Department of Highways	Dec.2015	
3	Road Note 29& 31: A Guide to the Structural Design of Bitumen Surfaced Roads in Tropical and Subtropical Countries	Transport and Road Research Laboratory, the UK	1993	If necessary
4	Road Design Standards	Japan Road Association	2015	If necessary

Source: JICA Survey Team

**(2) Design Condition**

**1) Road classification and crossing structure**

Road classification and cross structure of DRRD is shown as Figure3-2-1.

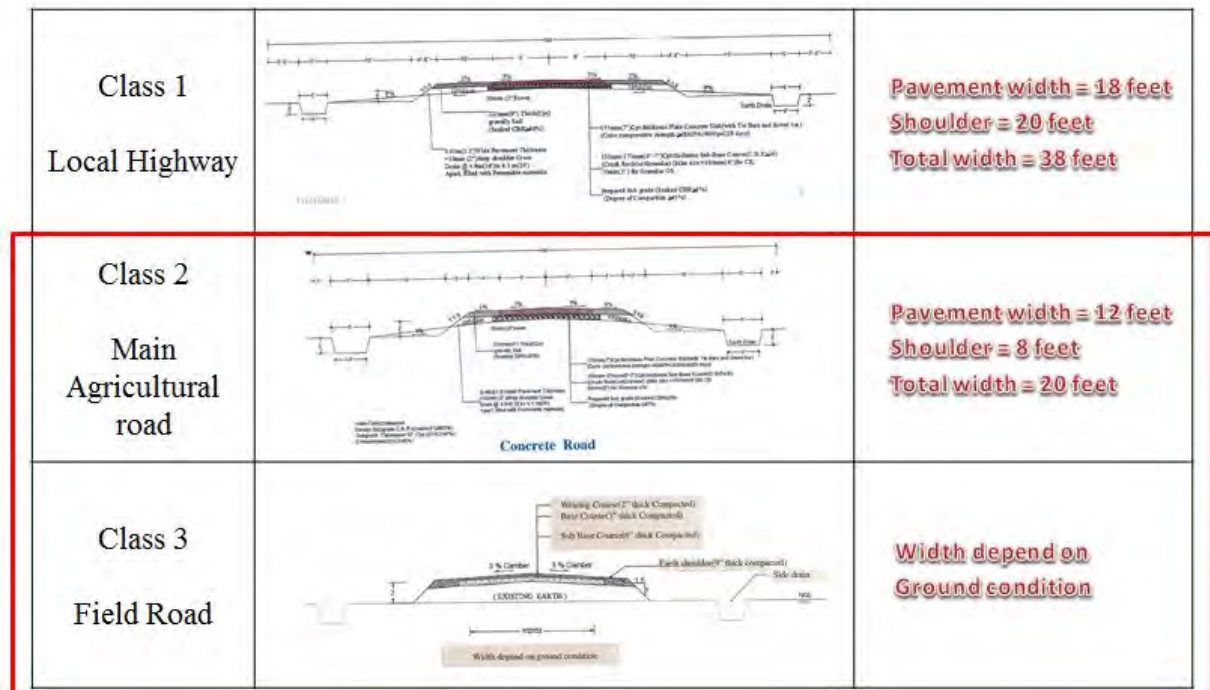

Source: Typical Drawings of Rural Road and Bridge (2017-2018)

Figure 3-2-1 Road classification of DRRD

At the meeting held on 4 September, 2017, DRRD and the Team has agreed to apply Class 2 or Class 3 considering existing situation and road function. Details of discussion are described as below.

- The road plan connecting village to village in Chin state, Class 2 road will be applied.
- Regarding the road plan in Ayeyarwady Region, it is difficult to apply Class 2 road due to following reasons.
  - Narrow existing road (refer to Figure 3-2-2)
  - Subsidence problem in Ayeyarwady Region, delta area
  - Land acquisition issue

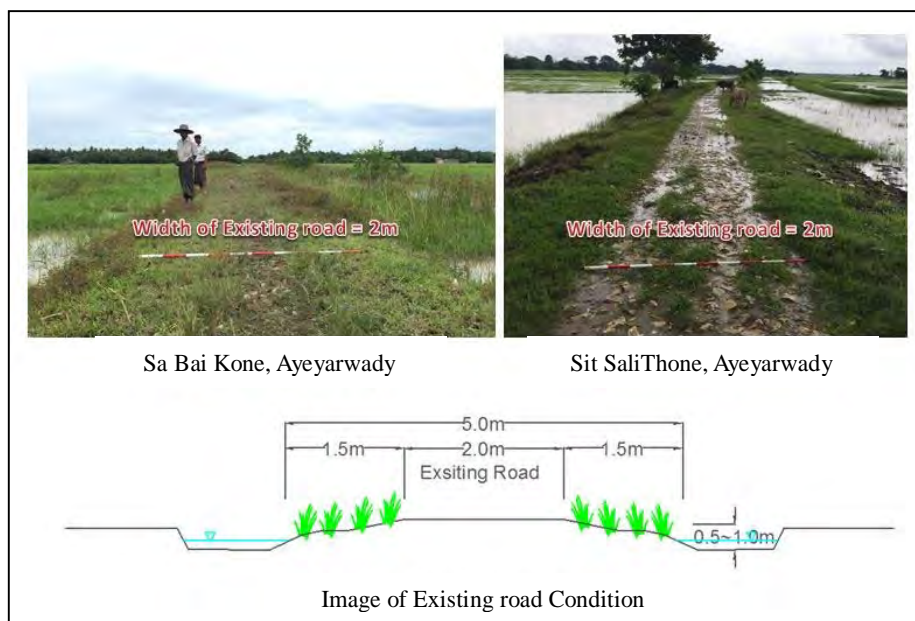

Source: JICA Survey Team

Figure 3-2-2 Existing road condition in Ayeyarwady Region

In consideration of above reasons, Class 3 road will be applied in Ayeyarwady. In typical drawing of DRRD, the Class 3 is described as “Width depends on ground condition”, however minimum width of road has to be reviewed in accordance with expected road functions.

A) Review for width of Class 3 road

a) Minimum width of carriageway = 2.0m (Vehicle width) + 0.6m (allowance) = 2.6m

Carriageway 車道幅員	Width height			
	名称	幅員 (m)		高さ (m)
Vehicle width 0.3   車両幅員   0.3	乗用車	1.7	2.0	Passenger car
	大型トラック (58.8kN以上)	2.5	3.8	Small truck
	小型トラック (19.6kN)	1.7	2.8	
	軽自動車 (軽トラック)	1.5	2.0	Power-tiller
	耕うん機 (3.7kW未満)	0.6		
	" (3.7kW以上)	0.8	2.0	
	乗用トラクタ (22.1kW未満)	1.3	2.0	Combine harvester
	" (22.1kW級)	1.7	2.8	
	" (36.8kWを超える)	2.3	2.0	
	コンバイン (2条)	1.6	2.0	
	" (3、4条)	1.7	2.7	
" (5条)	2.0	2.7		

Source: Agricultural road Design Standard by Ministry of Agriculture, Forestry and Fisheries, Japan.

Figure 3-2-3 Assumed vehicle on proposed road and minimum width of carriageway

b) Minimum width of road = 4.0m (Carriageway +Shoulder)

(During construction, proposed road will be used for construction road)

To consider the road function and construction plan, at least 4.0m width (pavement width 2.6m) is necessary. If the road is constructed to 4.0m width, space for car passing is required. The design conditions of car passing space are shown as below.

B) Design condition of car passing space

- Width: 6.0m
- Interval: Every 300m (This value is subjected to modify depends on sight distance)
- Length: 10m (Stop section) + 5m\*2 (Nose section)

Note) Above conditions are referred to Agricultural road Design Standard by Ministry of Agriculture, Forestry and Fisheries, Japan.

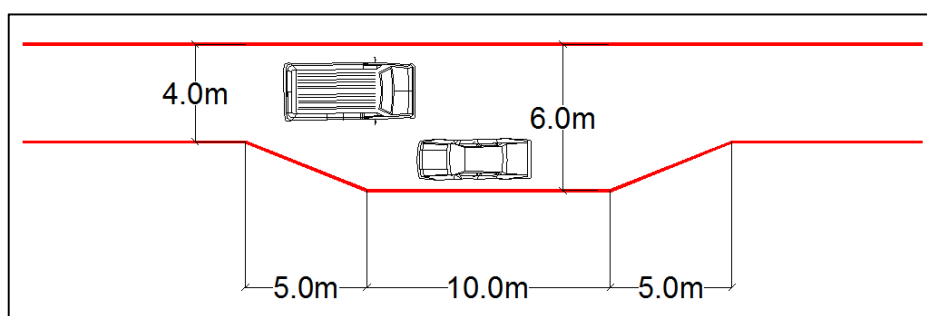

Source: JICA Survey Team

Figure 3-2-4 Image of car passing space

a) Geometric design

Geometric design shall be based on following parameters;

Table 3-2-2 Road geometric design

Item	Specific	Remarks
Classification of road	Class 2 and Class 3	



Design speed	30km/h	
Width of carriageway	3.6m for Class 2, 2.6m for Class 3.	
Width of shoulder	1.2m each direction for Class 2, 0.7m each direction for Class 2	
Minimum horizontal curve radius	20m	
Maximum vertical gradient	10%	
Superelevation	3%	
Stopping sight distance:	35m	

### 3-2-2. Bridge

#### (1) Applicable Standard

Design of bridges shall be followed standards/specifications which are used for the projects in Myanmar. Design standards, specifications and other relevant documents are shown as follows;

Table 3-2-3 Applicable Standards

No.	Standards/Specifications	Publisher	Published Date	Remarks
1	LRFD Bridge Design Specifications 4 <sup>th</sup> edition (SI units) <sup>1</sup>	AASHTO	2007	Latest 7 <sup>th</sup> edition
2	Typical Drawings of Rural Road and Bridge (2017-2018)	DRD	Dec.2016	

Source: JICA Survey Team

#### (2) Design Condition

##### 1) Geometric design

Geometric design shall be based on following parameters;

Table 3-2-4 Geometric Parameter

Item		Specific	Remarks
Design speed of vehicle		30km/h	
Bridge width <sup>2</sup>	L<100m	Carriageway	5.0m Incl. shoulder
		Kerb	1.0m
		Overall width	7.0m
	L≥100m	Carriageway	6.0m Incl. shoulder

<sup>1</sup> Per a decision by the AASHTO Subcommittee on Bridges and Structures, there will no further updates to the SI specification. On the other hand, SI unit will be applied for design works for bridges and structures as per MOC's decision. Therefore, design of bridges and structure depend on AASHTO LRFD Bridge Design Specifications 4<sup>th</sup> Edition (SI units).

<sup>2</sup> Bridge width has been discussed and concluded among DRRD and Survey Team as mentioned in table.

		Kerb	1.0m	
		Overall width	8.0m	
Clearance	Road	Vertical	4.5m	
		Horizontal	5.0m/6.0m	Depend on bridge length
	Navigation	Vertical	4.0m	
		Horizontal	6.0m	
Freeboard	For bridge		1.0m	Minimum requirement
	For box culvert			Depend on site condition
Pavement	Asphalt pavement		t=50mm	
	Concrete pavement		t=50mm	
Earth cover			0.6m	Foundations (footing, pile cap)

Source: JICA Survey Team

## 2) Materials

Materials to be used in the bridge construction work shall conform to following table.

Table 3-2-5 Materials

Item		Specific Value	Remarks	
Concrete	Specified compressive strength	Superstructure	28MPa	
		Substructure	24MPa	
		Pile foundation	31MPa	Bored pile
		Levelling concrete	18MPa	
Structural steel	Rolled steel	ASTM A36	fy=250MPa	Shapes
	Sheet pile	ASTM A572	fy=350MPa	Grade 50
	Steel pipe pile	ASTM A252	fy=205MPa	Grade1
			fy=240MPa	Grade2
			fy=310MPa	Grade3
Reinforcement	Yield strength		295MPa	Japan Road Association

Source: JICA Survey Team

### 3) Loadings

#### A) Dead load

Unit weight for calculation of self-weight of structural component shall be complied as follows;

Table 3-2-6 Unit weight

Item		Unit weight	Remarks
Concrete	Reinforced concrete	25.0kN/m <sup>3</sup>	
	Plain concrete	23.5kN/m <sup>3</sup>	
Pavement	Asphalt	22.5kN/m <sup>3</sup>	
	Concrete	23.5kN/m <sup>3</sup>	
Structural Steel		78.5kN/m <sup>3</sup>	

Source: JICA Survey Team

#### B) Live load

- Vehicular Live Load: HS20-44
- Pedestrian Live Load: 60lb/ft<sup>2</sup> (=3.0kN/m<sup>3</sup>)

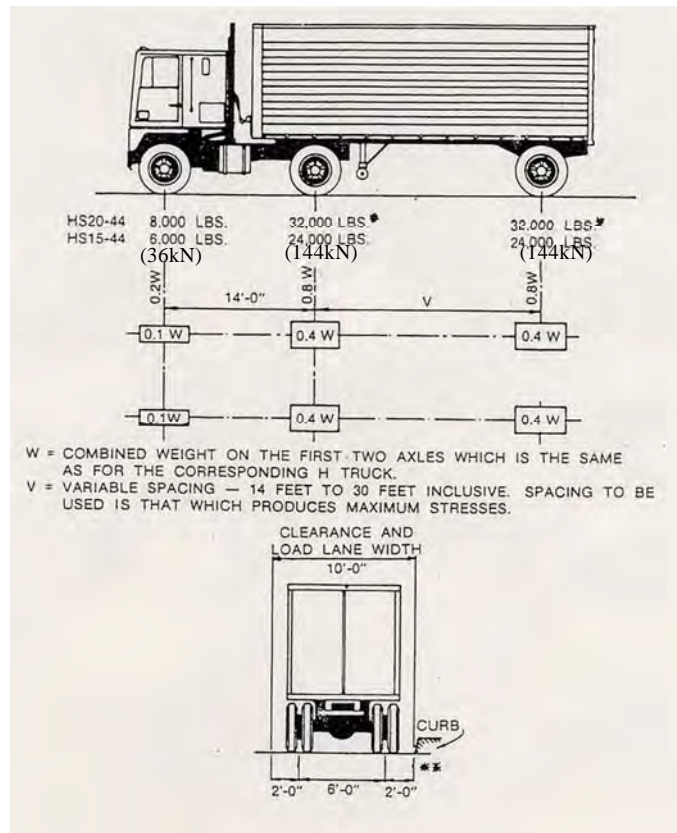

Source: AASHTO LRFD Bridge Design Specifications 2012

Figure 3-2-5 HS20-44 Design Track

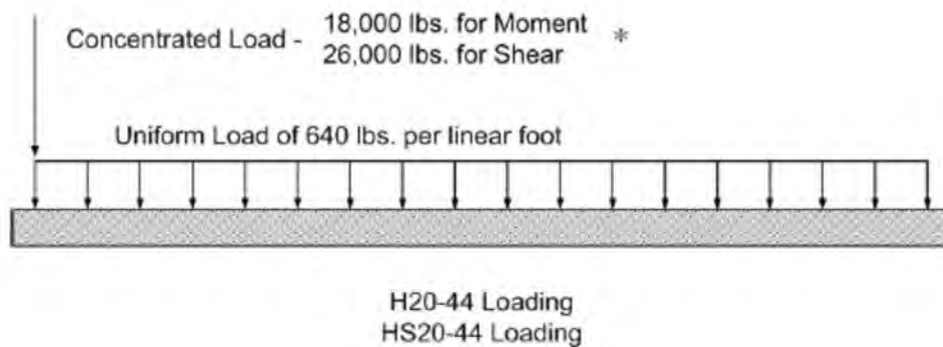

Source: Standard Specifications for Highway Bridges, AASHTO 1996

Figure 3-2-6 Lane Load

C) Thermal effect

Temperature range for bridge design shall be determined from meteorological observation record. Climate data are published on website by WMO<sup>3</sup>. Climate data of Kalaywa (Sagain Region) and Pathein (Ayeyarwady Region) are shown below. These two observation station are nearby project site.

Proposed temperature change and difference are shown in Table 3-2-7 and Table 3-2-8. However, it shall be reviewed specific temperature range and difference based on meteorological observation record.

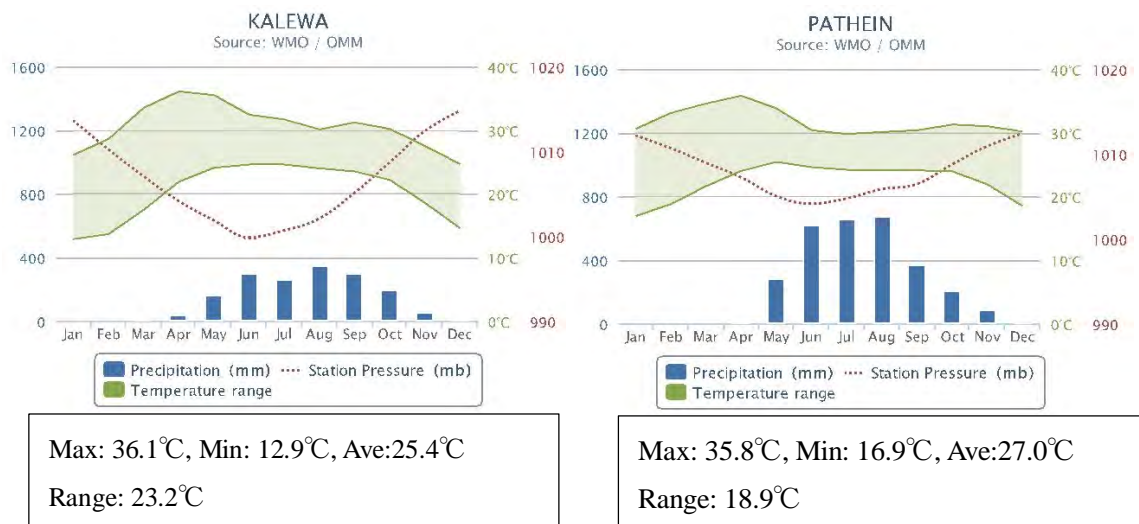

Source: World Meteorological Organization web site, Country Profile Database

Figure 3-2-7 Climate data at Kalaywa and Pathein

<sup>3</sup> WMO is abbreviation of World Meteorological Organization. As a specialized agency of the United Nations, WMO is dedicated to international cooperation and coordination on the state and behavior of the Earth's atmosphere, its interaction with the land and oceans, the weather and climate it produces, and the resulting distribution of water resources.

Table 3-2-7 Temperature change (rise/fall)

State/Region	Township	Village Tract	Temperature Range		Remarks
			Steel	Concrete	
Chin State	Falam	Zarhwlor	±30°C	±15°C	
	Tedim	Dolluang	±30°C	±15°C	
Ayeyarwady Region	Mawlamyinegyun	Sit Sali Htone	±30°C	±15°C	
	Bogale	Sa Bai Kone/Tha Kan Wa	±30°C	±15°C	

Source: JICA Survey Team

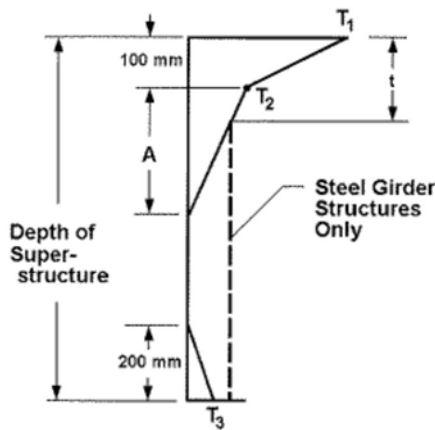

Figure 3.12.3-2 Positive Vertical Temperature Gradient in Concrete and Steel Superstructures.

Dimension "A" shall be taken as:

Concrete

Depth greater than 400mm

A=300mm

Depth less than 400mm

A=100mm less than actual depth

Steel

A=300mm

t: depth of the concrete deck

Source: AASHTO LRFD Bridge Design Specifications 2007 (Partly touch up)

Figure 3-2-8 Temperature gradient

Table 3-2-8 Temperature gradient

State/Region	Township	Village Tract	Temperature Gradient		Remarks
			T1	T2	
Chin State	Falam	Zarhwlor	30	7.8	
	Tedim	Dolluang	30	7.8	
Ayeyarwady Region	Mawlamyinegyun	Sit Sali Htone	30	7.8	
	Bogale	Sa Bai Kone/Tha Kan Wa	30	7.8	

Source: JICA Survey Team

D) Wind load

Design wind velocity shall be determined from the map as shown in. Figure3-2-9.

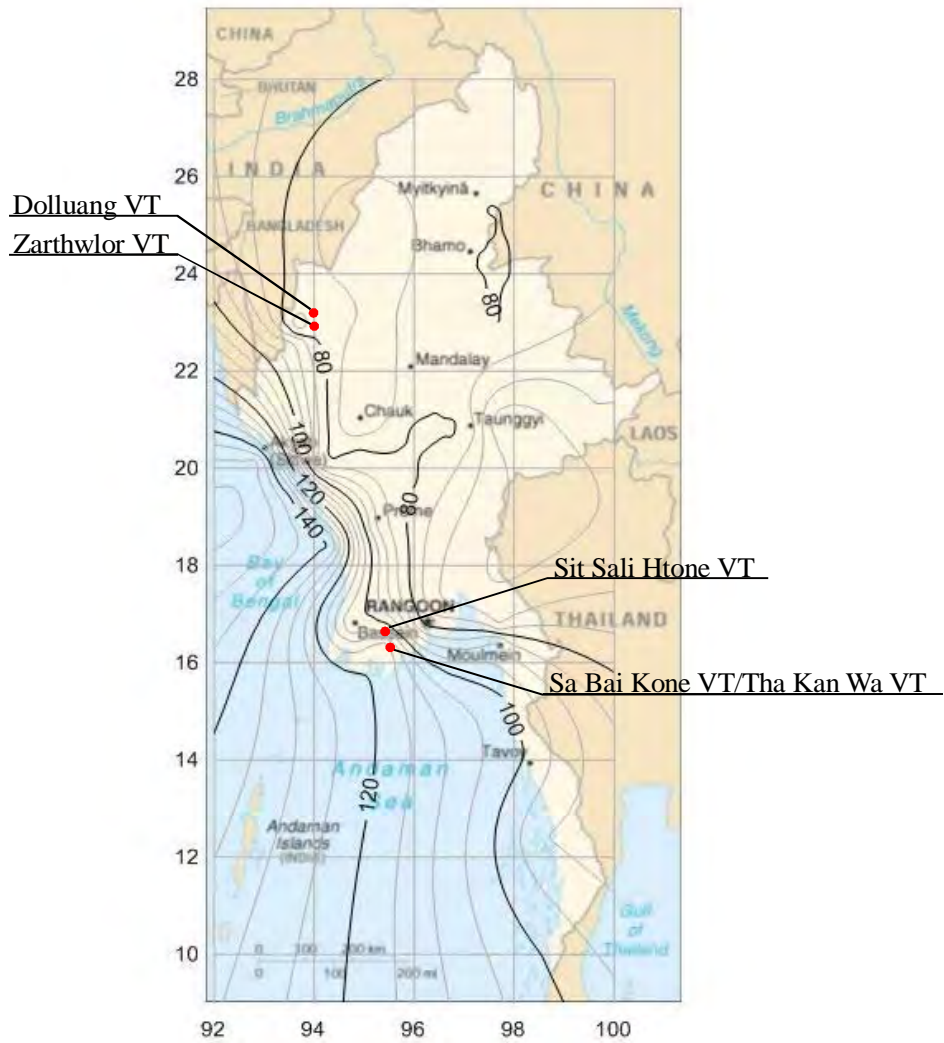

\*VT = Village Tract

Source: Ministry of Construction, Government of Myanmar

Figure 3-2-9 Map of maximum wind velocity

Table 3-2-9 Design wind velocity

State/Region	Township	Village Tract	Wind Load in mph (m/sec)	
			From Map	Specific Value
Chin State	Falam	Zarthwlor	75-80mph	80mph (35.8m/s)
	Tedim	Dolluang	75-80mph	80mph (35.8m/s)
Ayeyarwady Region	Mawlamyinegyun	Sit Sali Htone	100-105mph	105mph (46.9m/s)
	Bogale	Sa Bai Kone /Tha Kan Wa	110-115mph	115mph (51.4m/s)

Source: JICA Survey Team

E) Seismic force

Seismic force conform to AASHTO LRFD Bridge Design Specifications. However, Seismic zonation is not applicable for Myanmar. Therefore, seismic zonation is based on “Seismic Zone Map of Myanmar (Revised Version, 2005)”.

a) Seismic zone

Seismic zone map is shown in Figure 3-2-10. Peak Ground Acceleration (PGA) for target areas are taken as following table.

Table 3-2-10 Peak ground acceleration

State/Region	Township	Village Tract	Peak Ground Acceleration		Remarks
			Range of PGA	Specific Value	
Chin State	Falam	Zarthlor	0.21~0.3g	0.3g	Zone VIII
	Tedim	Dolluang	0.21~0.3g	0.3g	Zone VIII
Ayeyarwady Region	Mawlamyinegyun	Sit Sali Htone	0.11~0.2g	0.2g	Zone VII
	Bogale	Sa Bai Kone/ Tha Kan Wa	0.11~0.2g	0.2g	Zone VII

Source: JICA Survey Team

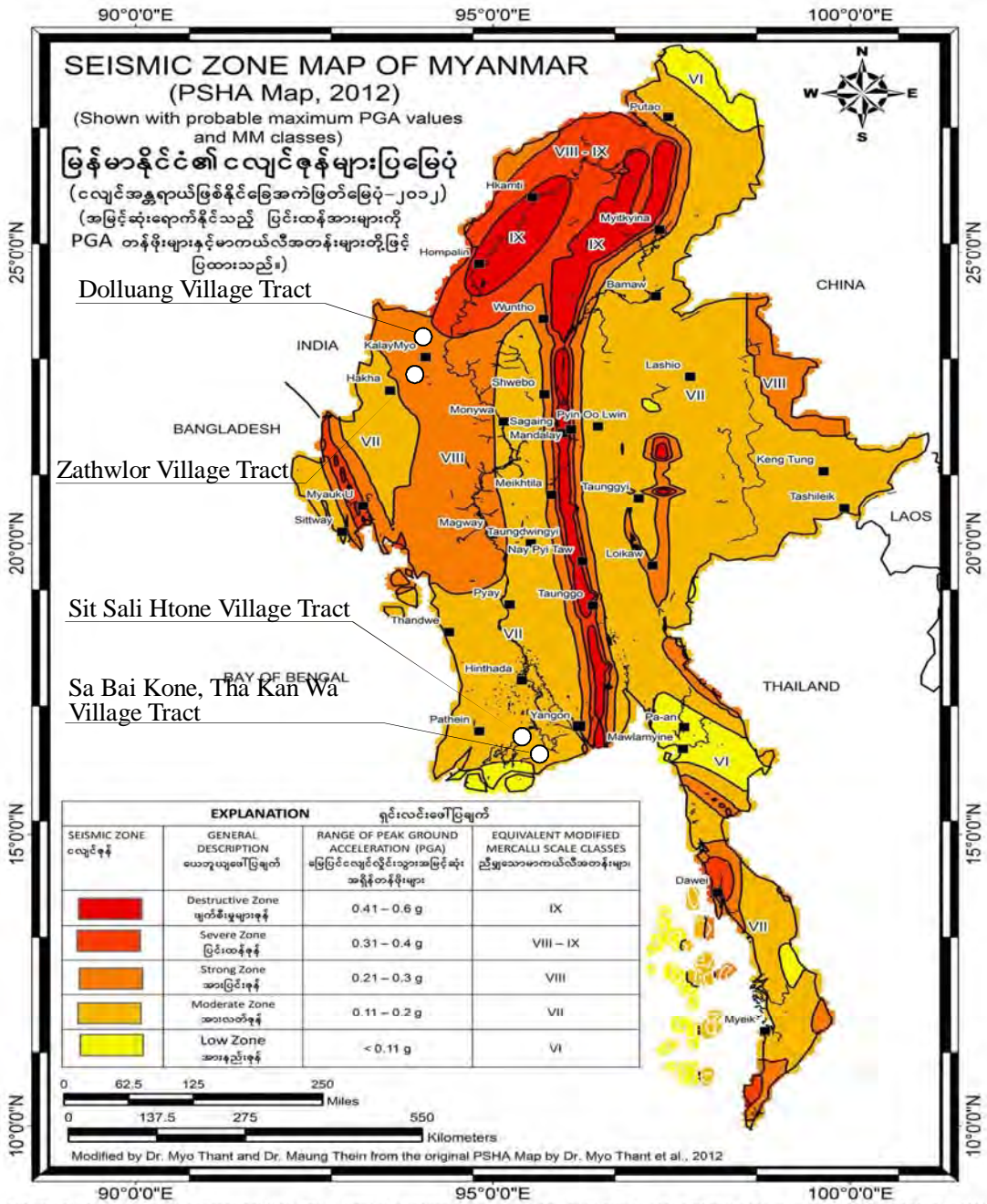

Probabilistic Seismic Hazard Assessment Map (PSHA Map) of Myanmar showing expected peak ground acceleration (PGA) values with 100% probability in 500 years.  
(Note: 0.21 - 0.3 g zone in the northern part of Shan State is taken from the Seismic Zone Map of Myanmar by Dr. Maung Thein et al., 2005)  
မြန်မာနိုင်ငံအတွက် ငလျင်ဖြစ်နိုင်ခြေ အကဲဖြတ်မြေပုံ၊ ၄၆၆၀၀၀ အနက် ၁၀၀၀၀၀ အတွင်း မြန်မာနိုင်ငံမြေ ဝန်ဆောင်မှုပြုသည့် မြေငလျင်လှိုင်းသွား အမြင့်ဆုံးအရှိန်တန်ဖိုးများ (၂ တန်ဖိုးများ) ပြင်ပြထားသည်။

Source: Seismic Zone Map of Myanmar (PSHA Map 2012)

Figure 3-2-10 Seismic zone map of Myanmar



Table 3-2-11 Site coefficient

Site Coefficient	Soil Profile Type			
	I	II	III	IV
S	1.0	1.2	1.5	2.0

Table 3-2-12 Soil profile type

Soil Profile Type	Description	Shear Wave Velocity
I	A profile shall be taken as Type I if composed of: <ul style="list-style-type: none"> <li>➤ Rock of any description, either shale-like or crystalline in nature, or</li> <li>➤ Stiff soils where the soil types overlying the rock are stable deposits of sands, gravels, or stiff clays.</li> </ul>	V>765m/sec
II	A profile with stiff cohesive or deep cohesionless soils where the soil depth exceeds 60 000mm and the soil types overlying the rock are stable deposits of sands, gravels, or stiff clays shall be taken as Type II.	
III	A profile with soft to medium-stiff clays and sands, characterized by 9000mm or more of soft to medium-stiff clays with or without intervening layers of sand or other cohesionless soils shall be taken as Type III.	
IV	A profile with soft clays or silts greater than 12 000mm in depth shall be taken as Type IV.	V<152m/sec

Source: AASHTO LRFD Bridge Design Specifications 2007

b) Elastic seismic response coefficient

<General>

Elastic seismic response coefficient shall be taken as following formula

$$C_{sm} = \frac{1.2AS}{T_m^{2/3}} \leq 2.5A$$

where:

$T_m$  = period of vibration of the  $m^{th}$  mode (sec.)

A = acceleration coefficient

S = site coefficient

<Exceptions>

For bridges on soil profile III or IV and in areas where the coefficient “A” is not less than 0.30,  $C_{sm}$  need not exceed 2.0A.

For soil profiles III and IV, and for modes other than the fundamental mode that have periods less than 0.3s,  $C_{sm}$  shall be taken as:

$$C_{sm} = A(0.8+4.0T_m)$$

If the period of vibration for any mode exceeds 4.0s, the value of  $C_{sm}$  for that mode shall

be taken as:

$$C_{sm} = \frac{3AS}{T_m^{4/3}}$$

c) Response modification factors

Seismic force effects shall be determined by dividing the force effects resulting from elastic analysis by the appropriate response modification factor, R, as specified in following tables.

Table 3-2-13 Response modification factors (Substructures)

Substructure	Importance Category		
	Critical	Essential	Other
Wall-type piers larger dimension	1.5	1.5	2.0
Reinforced concrete pile bents			
- Vertical piles only	1.5	2.0	3.0
- With batter piles	1.5	1.5	2.0
Single columns	1.5	2.0	3.0
Steel or composite steel and concrete pile bents			
- Vertical pile only	1.5	3.5	5.0
- With batter piles	1.5	2.0	3.0
Multiple column bents	1.5	3.5	5.0

Source: AASHTO LRFD Bridge Design Specifications 2007

Table 3-2-14 Response modification factors (Connections)

Connection	All Importance Categories
Superstructure to abutment	0.8
Expansion joints within a span of the superstructure	0.8
Columns, piers, or pile bents to cap beam or superstructure	1.0
Columns or piers to foundations	1.0

Source: AASHTO LRFD Bridge Design Specifications 2007

d) Combination of seismic force effects

The elastic seismic force effects on each of the principal axes of a component resulting from analysis in the two perpendicular directions shall be combined to form two load cases as follows:

- 100 percent of the absolute value of the force effects in one of the perpendicular directions combined with 30 percent of the absolute value of the force effects in the second perpendicular direction, and
- 100 percent of the absolute value of the force effects in the second perpendicular direction combined with 30 percent of the absolute value of the force effects in the first perpendicular direction.

Where foundation and/or column connection forces are determined from plastic hinging of the columns, the resulting force effects may be determined without consideration of combined load

cases herein.

### (3) Detailing

#### 1) Clear cover of reinforcement

Clear cover of reinforcing bar shall be complied with following requirement.

Table 3-2-15 Clear cover

Classification		Clear Cover in mm	Remarks
Superstructure		40	
Substructure	Exposed into atmosphere	50	
	Submerged portion	100	
Pile foundation		75	

Note) Values mentioned in table are based on “Typical Drawings of Rural Road and Bridge (2017-2018)”<sup>4</sup>.

#### 2) Splice of reinforcing bar

Length of lap splice of reinforcing bar shall be complied with AASHTO and JRA (Japan Road Association).

Lap splice of reinforcing bar shall be arranged as staggered to avoid strength degradation because at the point of overcrowded arrangement of reinforcement makes less quality of concrete structure due to honeycomb and cavity etc. Therefore, it is recommended distance between lap splices shall be taken as greater than 80% of embedment length of reinforcing bar and 20 times of diameter of reinforcing bar or more.

Table 3-2-16 Length of lap splice of reinforcing bar (reference)

Classification	Length of Splice	Remarks
Superstructure	44φ	
Substructure	50mm	
Pile foundation	1.0m	

Note) Lap length is mentioned in “Typical Drawings of Rural Road and Bridge (2017-2018)”.

### 3-3. Outline of Road Maintenance Equipment Plan

#### (1) General Plan of DRRD

- Construction of rural roads will be carried out under the direct management by DRRD-20%, and by contract with private company-80%
- Maintenance of rural roads will be carried out by DRRD (100%)
- Connect all rural roads to arterial roads by 2020
- Equipment for maintenance of rural roads is planned to allocate one motor grader per District, and one mini excavator and one road roller per Township
- Maintenance of the equipment will be carried out by DRRD (100%)

<sup>4</sup> “Typical Drawings of Rural Road and Bridges (2017-2018)” is provided from DRD.

- For the moment, until preparations for facilities and personnel of DRRD are complete, DOH provide assistance to DRRD

## (2) Equipment for Rural Road Maintenance in Chin State

After the series of discussions between the Teem and DRRD, both party agreed the followings;

- Prioritized project areas for provision of equipment for rural road maintenance in Chin State shall be Falam Township and Tedim Township.
- Project site for the provision of equipment for rural road maintenance in Chin State shall be Zarthwlor Village Tract in Falam Township, and Dollung Village Tract in Tedim Township.
- The delivery point of equipment in Chin State is planned at MOC compound (called as 9 miles store) located beside Thangmual Road (Kalay – Hakha Road) at near 9 miles point form Kalay, show in Figure 3-3-1..
- DRRD shall set up the regional station, parking lot and parts store at the delivery point for equipment.



Figure 3-3-1 Delivery point of equipment for rural road maintenance in Chin State

- Proposed equipment in Chin State shall be compact size, suitable to work on rural roads. See table 3-3-1 for the list of proposed equipment.
- Type and quantity of equipment for rural road maintenance in Chin State shall be determined in consideration of the road condition, total length of the road, and maintenance work volume in the prioritized project areas (Falam Township and Tedim

Township).

**(3) Transporting Construction Equipment by the Contractor of the Project**

- In case of the contractor of the project needs to carry the heavy equipment by road into the project site in Ayeyarwady Region and Chin State, DRRD will take measures to reinforce bridges in the transport route on request of the contractor, and if necessary.



Figure 3-3-2 Example of the reinforcement of the bridge

- In case of the contractor of the project needs to carry the heavy equipment by river/waterway into the project site, DRRD will allow the contractor of the project to use MOC landing place located beside the Nat Chaung Creek and 18<sup>th</sup> Street in the Bogale town, on request of the contractor, and if necessary.



Figure 3-3-3 MOC landing place in Bogale Town

Table 3-3-1 Tentative list of the equipment for the road maintenance

No.	Name of Equipment	Specification	Quantity	Priority
1.	Compact Size (Mini) Bulldozer	 Operation Weight: 6000~8000 kg Steel crawler Engine Output (approx.): 30 kW Power angle & Power tilt dozer FOPS/ROPS cab	3	A
2.	Compact Size (Mini) Excavator	 Bucket capacity (approx.): 0.1 m <sup>3</sup> Offset-boom Steel crawler Operation Weight: 4000 ~5000 kg Engine Output (approx.): 30 kW FOPS/ROPS cab	3	A
3.	Compact Size (Mini) Wheel Loader	 Engine output (approx.): 15 kW Bucket capacity (approx.): 0.3 m <sup>3</sup> Operation Weight:1900 ~ 3000 kg FOPS/ROPS cab	3	A
4.	Wheel Excavator	 Bucket capacity (approx.): 0.45 m <sup>3</sup> Operation Weight (approx.): 14000 kg Engine Output (approx.): 90 kW Max. Travel Speed (approx.): 35 km/h FOPS/ROPS cab	2	A
5.	Motor Grader	 Articulation frame type Blade length (approx.): 3000 mm Operation weight (approx.): 10000 kg Engine output (approx.): 100 kW FOPS cab	1	A
6.	Hand-guided Vibratory Roller	 Operation Weight: 500 – 600 kg Engine Output (approx.) 4 kW Compaction Width (approx.) 600 mm	3	A
7.	Plate Compactor	 Weight:40~60 kg Centrifugal force:6~10 kN Vibrating plate size (approx.): 550 × 350 (mm)	6	B
8.	Crawler Dump	 Operation Weight (approx.): 4000 kg Max. payload (approx.): 3500 kg Rubber crawler Engine Output (approx.): 35 kW Max. speed (approx.): 10 km/h	2	A
9.	Dump Truck	 Max payload: 2000 kg Forward control 4x4 drive system Left-hand steering, Engine output: (approx.) 100 kW	6	A
10.	Boom Truck (Cab-back Crane)	 Crane Max. Lifting capacity: 2000 kg Telescopic boom Carrier Max. payload (approx.): 3000 kg GVW (approx.): 6000 kg Forward control 4x2 cargo truck Engine output (approx.): 100 kW Left-hand steering	1	B
11.	Self-loading Truck (Equipment Carrier)	 Max. payload: 8000 kg, Rear loading type Forward control, 4 x4 drive system Engine output (approx.): 170 kW Left-hand steering	2	A
12.	Mobile Workshop	 4x4, cargo truck, with 2000 kg telescopic boom crane Equipped with tools and equipment necessary to carry out service for construction machines Max. payload (approx.): 3000 kg GVW (approx.): 6000 kg Engine output (approx.): 100 kW Left-hand steering	1	A

Priority : A = 1st, B=2nd, (A = If necessary, quantity to be adjusted, B = If necessary, quantity to be adjusted or omitted from the list)  
ROPS: Roll-Over Protective Structure, FOPS: Falling-Object Protective Structure

### **3-4. Other Issues**

#### **(1) Support for Heavy Equipment Mobilization**

During the construction stage, heavy equipment and construction materials will be mobilized by the contractor using MOC road. When it is necessary to reinforce existing bridges for heavy equipment and materials transit due to lack of load capacity, the DRRD will be fully responsible to undertake counter measures by reinforcement works and related procedures..

#### **(2) NATALA (Ministry of Border Affairs) Road plan in Chin State.**

NATALA has planned to road improvement around Dolluang Village Track in this year. The total length is around 16 km, connecting 7 villages, Mainwel – Tanzang – Zo Zang - Zo nang zang - Maun lang – Kimlai – Dain zan.

In this context, MOC has to coordinate with NATALA in order not to affect this project at all.

#### **4. Progress on Irrigation Project**

In Chin State and Ayeyarwady Region, there were 2 proposed irrigation facilities to be rehabilitated, improved and newly constructed in the Project. Basic plans for those facilities were summarized in the following table.

##### **4-1. Outline of Irrigation Plan**

###### **4-1-1. Chin State (Pa Mun Chaung village)**

###### **(1) Proposed Facilities**

In the project, the following facilities were proposed to be constructed in the target sites of Chin State:

###### **1) At the upstream headworks**

- Fixed weir improvement with concrete material
- Installation of the intake gate facility with steel sluice gate
- Installation of the sand flush gate facility with steel sluice gate

###### **2) At the downstream headworks**

- Fixed weir improvement with concrete material
- Installation of the intake gate facility with steel sluice gate
- Installation of the sand flush gate facility with steel sluice gate

###### **(2) Objectives and Effects of the Proposed Facilities**

Above 2 facilities were recommended in the Project in order to realize the following objectives.

###### **1) Alleviation of burden against damages by floods**

###### **A) Fixed weir**

Present rustic wooden fixed weir was frequently damaged and flushed out by flood flow in monsoon season. The improvement of strength of the weir using the rigid concrete material was recommended in the survey. Height of weir and intake water level should be kept as it were not so as to affect continuity of current agricultural activity.

###### **B) Canals**

Sedimentation phenomena had been observed in monsoon season, in particular during flood period. Installation of intake gate was highly recommended in order to prevent intrusion of sand and stones with flood flow into canal directly. Canal size, intake discharge, and any other conditions of the intake water should be kept as it were.

Aiming to discharge sands and stones in front of the intake gate, sand flushing gate was also recommended to install adjacent to the intake gate.

Those gates should be slide gate-type with manual operation, and ought to be anti-corrosion for less-maintenance works in future. Thus material of steel should be carefully selected. For the



gates ,it is recommended to use duplex stainless steel, which is high strength than normal stainless steel and high anti-corrosion even against sea water with less price.

## 2) Stabilization of intake water volume in order to increase agricultural productivity in paddy cultivation

By introduction of the rigid concrete fixed weir and the steel intake gate in the headworks, it is expected that the intake water would be stabilized after the Project.

It is also recommended that measuring device, such as broad crested weir, at the downstream side of intake gate to check intake discharge.

## 3) Securing safety against floods

When the wooden fixed weir was broken, a furious debris flow, containing sand and stones which were deposited at upstream of the wooden weir, occurred and attacked downstream area. If the fixed weir was improved with concrete material in the project, such dangerous flood flow phenomena would be avoided.

## (3) Basic Facility Plan

Particular plan including special remarks were summarized in the following table.

Table 4-1-1 Basic facility plan (Irrigation at Chin State)

Facilities	Facility Design Plan and Remarks
Fixed weir improvement with concrete material	<ul style="list-style-type: none"> <li>- Material: concrete or alternative rigid materials</li> <li>- Weir elevation and intake level: No change</li> </ul>
Installation of the intake gate facility with steel sluice gate	<ul style="list-style-type: none"> <li>- Material of gate and frame: Steel, preferably stainless steel for easy maintenance</li> <li>- Operation system: Manual operation</li> <li>- Measuring device, such as broad crested weir, should be constructed at downstream of the gate</li> <li>- Sand trap and sand discharging function is required preferably at the beginning point of the canal in order to sweep out sedimentation in the canal caused by human error.</li> </ul>
Installation of the sand flush gate facility with steel sluice gate	<ul style="list-style-type: none"> <li>- Material of gate and frame: Steel, preferably stainless steel for easy maintenance</li> <li>- Operation system: Manual operation</li> <li>- The facility should have steep slope for sweeping out sands and stones with jet flow.</li> <li>- The elevation of gate-sill should be low enough in comparison with the sill elevation of the intake gate in order to prevent from entering sedimentation into canal.</li> </ul>

### 4-1-2. Ayeyarwady Region (Tha Kan Wa village)

#### (1) Proposed Facilities

In the project, the following facilities were proposed to be constructed in the target sites of

Ayeyarwady Region:

- Installation of 2 numbers of regulation gate facilities at entrance/exit of the creek located at Tha Kan Wa and Tepin No.1 village.

## (2) Objectives and Effects of the Proposed Facilities

Above facilities were recommended in order to realize the following objectives.

- Alleviation of inundation of river water in paddy field at harvest period of the summer paddy  
If river water get into the paddy fields at harvest time and the ground become soft, combine harvesters cannot be used and quality of rice is drastically deteriorated.  
If the regulation gate is closed before river water enters in the creek at high tide time, the paddy field could be protected from intrusion and inundation of river water.
- Securing irrigation water in summer paddy cultivation  
When low tide time comes, a water level in the creek is drastically dropped to the bottom. Consequently the farmers cannot irrigate paddy field with river water even using a pump.  
If the regulation gate is closed at peak water level in the creek at high tide time and peak water level is maintained, water in the creek can be used for irrigation uninterruptedly.

## (3) Basic Facility Plan

Particular plan including special remarks were summarized in the following table.

Table 4-1-2 Basic facility plan (Irrigation at Ayeyarwady Region)

Facilities	Facility Design Plan and Remarks
Southern and Northern regulation gate facilities	<ul style="list-style-type: none"> <li>- The gates should be anti-corrosion and easy maintenance as much as possible.</li> <li>- Operation system of gates: Manual operation</li> <li>- Small boats, approximately 1.6m at maximum width, should pass the gate facility when it opens.</li> <li>- Since foundation at site is soft, foundation design of the structure should be conducted carefully. Based on the results, type of foundation should be determined.</li> <li>- Design conditions, in particular design water levels, of structures should be determined based on water levels at the construction sites. Water levels at the construction site should be derived from river water level records at the Bogale river gauging station.</li> </ul>

## 4-2. Design Conditions

### 4-2-1. Applicable Standard

In principle, the Design Criteria of Myanmar and Design Standard for Land Improvement Project of Japan are used for detail design of the headworks, gate and related facilities, roads and bridges, and river improvement works. In this chapter, major design conditions are given in hydraulic calculation

and structural design.

Table 4-2-1 Reference book of design

No.	Reference Book	Publisher	Published Date	Remarks
1	Design Criteria on Headworks	Union of Myanmar Ministry of Agriculture and Irrigation Irrigation Department	1997	
2	Design Criteria on Canal Works	"	"	
3	Some Notes for Reference	Union of Myanmar Ministry of Agriculture and Irrigation Irrigation Department Design Branch	November, 2011	Letter No. 3251/DB/am 13,2011
4	Design Standard for Land Improvement Project, JAPAN [Headworks]	Ministry of Agriculture, Forestry and Fisheries Rural Development Bureau	1995	
5	Design Standard for Land Improvement Project, JAPAN [Canal Works]	"	2001	

#### 4-2-2. Design Condition

The proposed design conditions for the basic design works for the irrigation facilities in the Project were summarized in Annex-2 "Design Criteria". Please refer to the above mentioned document.

#### 4-3. Other Issues

##### (1) Fish ladder

It was noted that there were several special species of fishes which moved from rivers to paddy fields in Tha Kan Wa village tract of Ayeyarwady Region. In particular, Climbing Fish climb up to paddy field when they lay eggs in spawning period. Thus it might be affected by the project facilities after the Project. Therefore in the further stage, the relations between gate operation and movement of fishes, changing water levels/accessibilities to paddy field should be carefully examined. Then necessary action, such as installation of the fish ladder, should be included if necessary.

##### (2) Soft Component

Irrigation facilities would function effectively only when those are operated and maintained properly. Consequently only construction works are not enough in the Project for sustainable utilization, and trainings on software components for the facilities are inevitable.

Contents of the trainings should be designed properly in the further design stage.

## 5. Progress on Water Supply Project

### 5-1. Outline of Basic Plan

As per survey result, water supply facilities are planned by Team. However, finalized confirmation of “Site Study for Installation of Rain Water Tank” is still on going. Water supply plan shall be finalized after completion of finalized confirmation of “Site Study for Installation of Rain Water Tank”. Outline of tentative water supply plan is shown as follows.

#### 5-1-1. Chin State

##### (1) Dolluang and Zarthwlor Village Tract

The targeted villages in this Project are Pa Mun Chaung village in Zarthwlor Village Tract and Zo Zang in Dolluang Village Tract.

##### 1) Current condition

As for current condition, in Pa Mun Chanung, there is a public water supply system using one spring water source, and spring water source is situated 4km from village. Discharge rate of spring intake was 60 L/min, but outflow to the tank in village was 40 L/min. Since an amount of water is not enough to supply all villagers, they only supply at the limited time. In Zo Zang village, DRD constructed the public water system in 2016 and the source of water was stream near the village. After two months from the operation, the system was broke down and has not been repaired. Gravitational water supply facility using spring and stream water is common.

##### 2) Tentative proposed water facility

From this kind of background, as a result of survey, the Team proposes gravitational water supply facility tentatively for each village. The following is a schematic drawing of tentative proposed water facility.

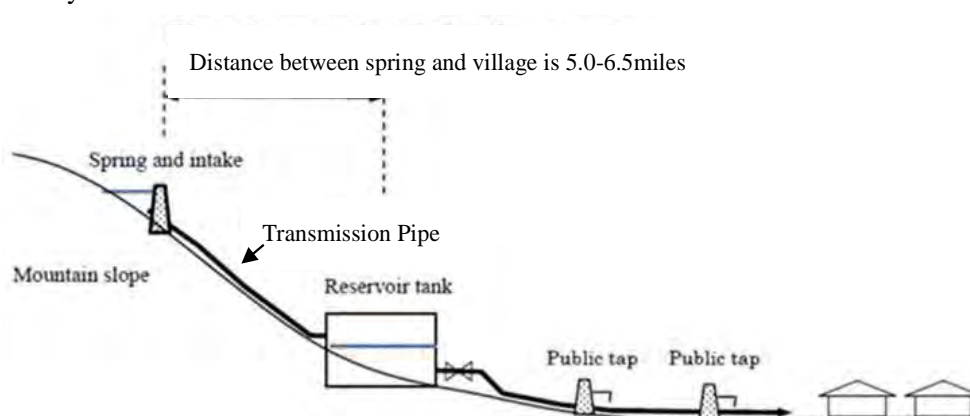

Source: JICA Survey Team

Figure 5-1-1 Tentative proposed water facility in Dolluang and Zarthwlor Village Tract

#### 5-1-2. Ayeyarwady Region

## **(1) Sit Sali Htone, Sa Bai Kone, and Tha Kan Wa Village Tract**

### **1) Current condition**

#### A) Sit Sali Htone Village Tract

For drinking water purpose, there are rain water storage tanks. Hand pumps borehole are also available but have water quality problem.

#### B) Sa Bai Kone Village Tract

Water source in the tract is rain. There are several rain water ponds. In addition to rain water ponds, there are rain water storage tanks which collecting from roof system.

#### C) Tha Kan Wa Village Tract

Villages use rain water ponds mainly and rain water tanks as public water supply. Some ponds are need to be repaired. There is deep well facility established by NGO, however it is no longer used due to water quality problem.

### **2) Tentative proposed water facility**

From this kind of background, as a result of survey, the Team propose rain water tanks tentatively for each village tract.

Existing rain water tanks in accordance with DRD standard are constructed in Sit Sali Htone Village Tract. Its capacity is 5,000gallons (15'x9'x6') and rain water is collected from roof of other facilities such as private house and school. The design photo is shown in Figure 5-1-2. The tentative proposed rain water tanks are for emergency use in dry season, therefore, proposed quantity and capacity are considered with condition of existing tanks and land acquisition.



Figure 5-1-2 Rain water tank (DRD Standard)

## 5-2. Design Condition

### 5-2-1. Applicable Standard

Design of rain water tanks should be followed DRD standard basically. DRD standard tank (5,000 gallon capacity) is shown in Appendix-1. In this project, roof system for collection of rain water will be modified.

### 5-2-2. Design Condition

#### (1) Water Supply Facility

##### 1) Pa Mun Chaung village (Zarthwlor Village Tract, Chin State)

There is new spring water source which distance is 10 km from the village. The new spring water source is planned to be used for construction of proposed water supply facility in this village. Webula village next to Pa Mun Chaung village is the owner of new spring water source and therefore it must be discussed between them. The location of water source and tentative proposed facilities are shown in Figure 5-2-1 and 5-2-2.

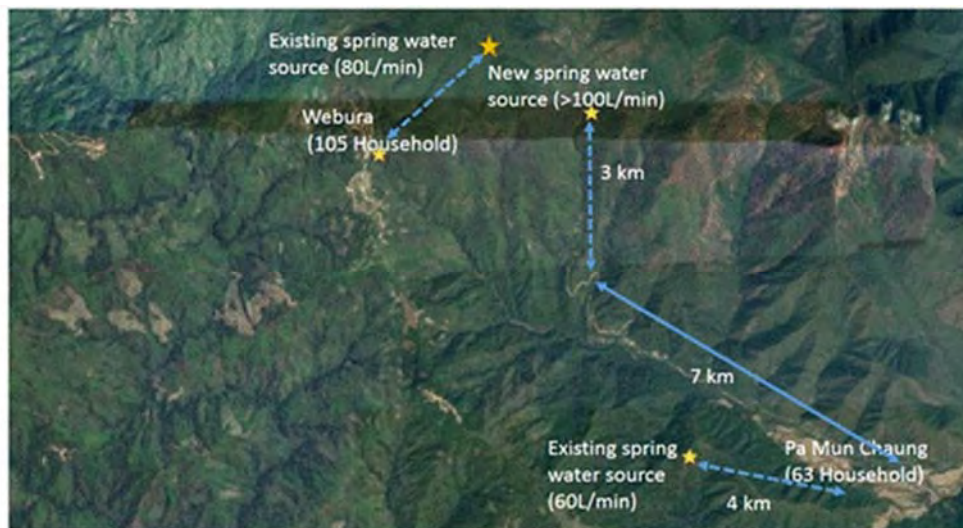

Figure 5-2-1 Location of water source in Pa Mun Chaung village and Webula village

Spring water is delivered by transmission pipe and stored in water tank which is located upper side of Pa Mun Chaung village. Then, spring water is distributed by distribution pipeline to public fountains (Figure 5-2-2).

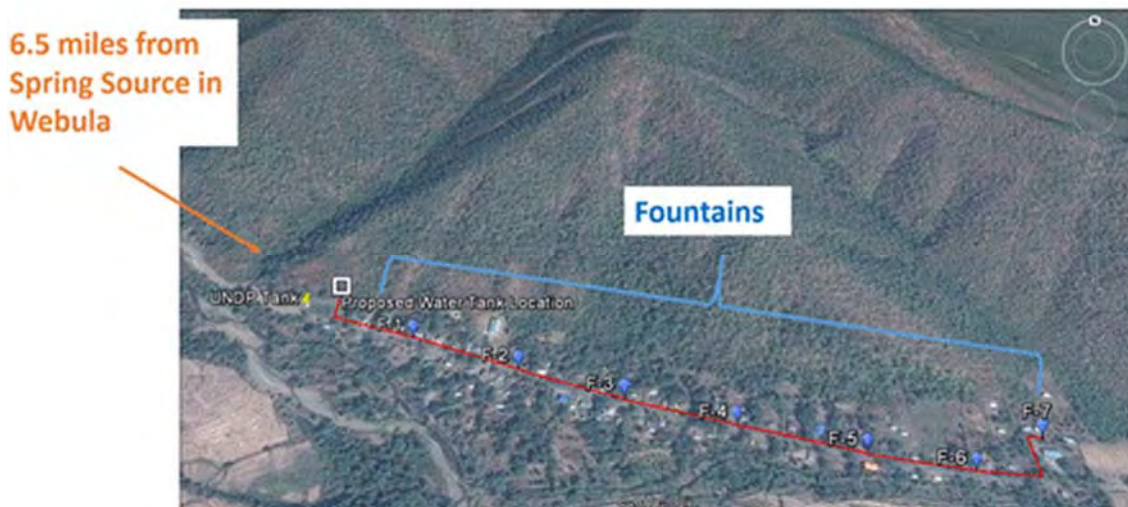

Figure 5-2-2 Tentative proposed water supply facilities in Pa Mun Chaung village

## 2) Zo Zang village (Dolluang Village Tract, Chin State)

There are several spring water sources which is situated at 8.5 km from the Mualunum village. Discharge rate of the first spring is 30L/min and the discharge rate of other springs have not confirmed yet and not known due to the severe weather condition. The location of water source and tentative proposed facilities are shown in Figure 5-2-3 and 5-2-4.

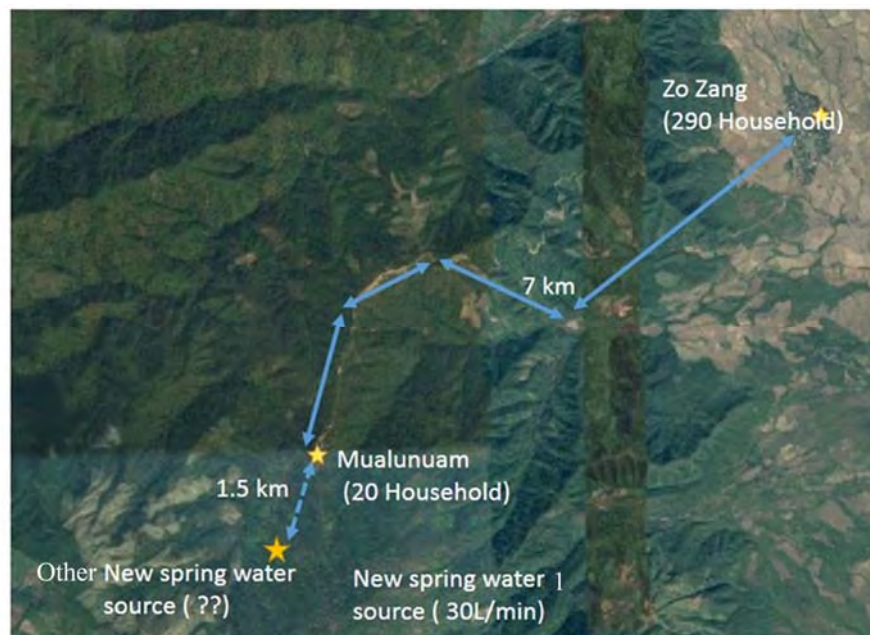

Figure 5-2-3 Location of water source in Mualunum

Spring water is delivered by transmission pipe and stored in water tank which is located upper side of Zo Zang village. Then, spring water is distributed by distribution pipeline to public fountains (Figure 5-2-4).

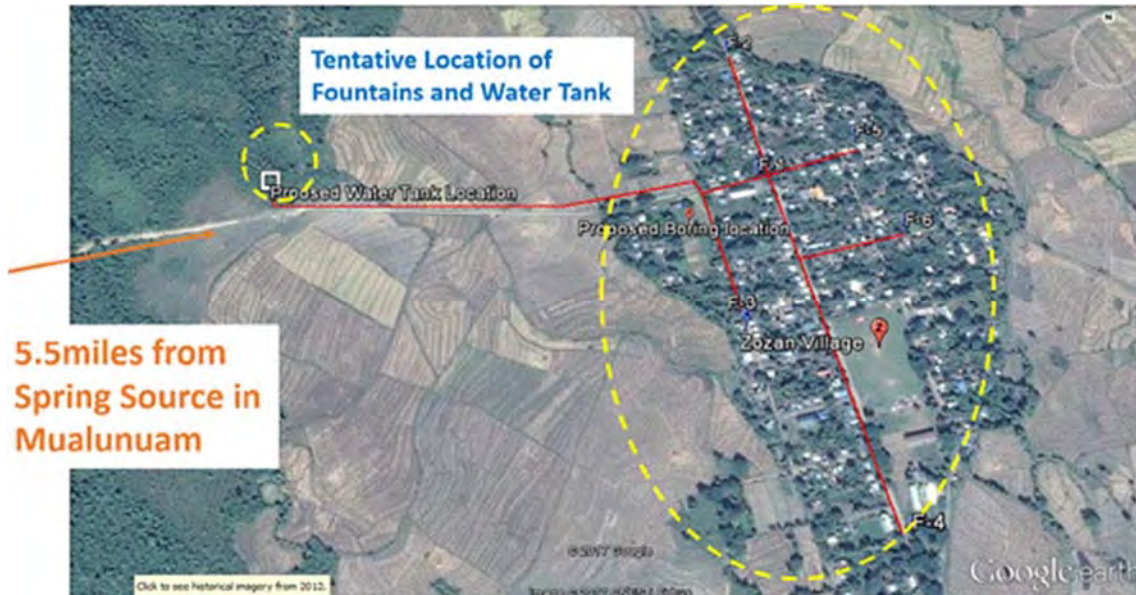

Figure 5-2-4 Tentative proposed water supply facilities in Zo Zang village

### 3) Ayeyarwady Region

The tentative proposed rain water tank is improved from DRD standard, in order to collect sufficient rain water during rainy season. Specially, collecting rain water from roof system is more efficient. The capacity of proposed rain water tanks should be considered to be more than 5,000 gallons as well. The following criteria is considered as much as possible for selection of construction sites.

- Not agricultural and paddy fields
- Outside of house garden
- Flat land

However, quantity and capacity of proposed rain water tanks are considered at the present. They will be finalized after completion of finalized confirmation of “Site Study for Installation of Rain Water Tank”. Ponds are not considered at the present due to difficulty of land acquisition. There are not enough land space to construct new ponds except for agricultural or paddy fields.

Regarding treatment system, any treatment systems is considered to install at proposed rain water tank, and treatment method will be introduced to WASHCOM and village organization as soft component.

#### (2) Grant Equipment for Water Quality Analysis

In this Project, equipment of water quality analysis must be granted to Mawlamyaingyun and Bogale DRD. The following 14 items must be annualized by grant equipment.

- Turbidity, pH, TDS, Sulphate, Nitrate, Manganese, Chloride, Hardness, Iron, Fluorite,



Arsenic, Lead, Total Coliform, Faecal Coliform

### **5-3. Construction materials and equipment**

Materials and equipment for design of water supply facilities shall be used standard and specification which are procured in following countries.

- The Republic of the Union of Myanmar
- Japan
- The third countries (ex. The Kingdom of Thailand)

### **5-4. Other Issues**

#### **(1) Chin State**

- Due to the raining in Chine State during survey period, the quantity of spring source cannot be estimated properly, and quantity of spring water should be clarified.
- Excavation for laying pipeline should be adjusted to planning of new road construction in Pa Mun Chaung village.
- Storage of spare pipes must be provided by DRD.

#### **(2) Ayeyarwady Region**

- Land for proposed rain water tanks is private property and land acquisition must be completed before the construction. Compensation should be considered for land acquisition as well.
- Leveling of access roads and construction sites must be conducted before the construction.
- Construction site must be cleaned before the construction.
- Proposed rain water tank is for emergency use during dry season.

## 6. Progress on Agricultural Mechanization Project

In Chin State and Ayeyarwady Region, there were 5 proposed target villages in 2 target village tracts in Chin State and 3 target village tracts in Ayeyarwady Region to be strengthened, improved, and promoted agricultural mechanization in the Project. Basic plans for those programs were summarized as follows.

### 6-1. Outline of Agricultural Mechanization Project

#### 6-1-1. Chin State

Target Village	Objectives of Program	Inputs Plan	Expected Effects
Zarhwlor Village Tract (Pa Mum Chaung)	Promotion of agricultural mechanization by provision of powertillers and threshers.	Provision of machines: - Powertillers with trailers - Threshers Support plan by AMD / AMS: - Training proper operation and daily maintenance way to villagers - Support and promote appropriate utilization way of machines among villagers - Monitoring operation, maintenance and utilizing condition of machines and give guidance for improvement if necessary - Provision of consumables and spare parts - Provision of repair works	- Improvement of productivity - Shortening farm work time and assigning the rest time for other economic activities - Reduction of hard farm work - Introduction of summer crops - Improvement of transportation of goods and moving of villagers
Dolluang Village Tract (Zo Zang, Tan Zan)	Promotion of agricultural mechanization by provision of mechanization service of tractor and combine harvester.	Support plan by AMD / AMS: - Provision of mechanization service by AMS, Kalay by allocation of machines and operators in the village continuously during the season. - Expansion of farmland to be mechanized by land reclamation work done by LRPO, Hakha	- Improvement of productivity - Reduction of post-harvest losses and cost - Shortening farm work time and assigning the rest time for other economic activities - Reduction of hard farm work - Expansion of summer crops cultivation area
Dolluang Village Tract (Dolluang Swang Dawh) *Note)	Improvement of transportation of goods and moving of villagers by using powertillers with trailers	Provision of machines: - Powertillers with trailers Support plan by AMD / AMS: - Training proper operation and daily maintenance way to villagers - Support and promote	- Reduction of transportation time and assigning the rest time for other economic activities - Improvement of transportation economy

		appropriate utilizing way of machines among villagers - Monitoring operation, maintenance and utilizing condition of machines and give guidance for improvement if necessary - Provision of consumables and spare parts - Provision of repair works	- Reduction of hard transportation work
--	--	--	---

\*Note) By the result of the field survey in this dry season, December 2017, the program is finally decided.

### 6-1-2 Ayeyarwady Region

Target Village Tract	Objectives of Program	Inputs Plan	Expected Effects
Sit Sali Htone, Sa Bai Kone, Tha Kan Wa Village Tract	Promotion of agricultural mechanization by provision of mechanization service of tractor and combine harvester specially to use the machines for demonstration of appropriate operation way in the season from harvesting of monsoon paddy to land preparation of summer crops.	Support plan by AMD / AMS: - Provision of mechanization service by AMS, Mawlamyinegyun by allocation of machines in the village continuously during the season. - Demonstration of proper operation way of using tractors and combine harvesters to villagers - Support and promotion of appropriate utilizing way of machines to farmers.	- Improvement of productivity - Reduction of post-harvest losses and cost - Shortening farm work time and assigning the rest time for other economic activities - Reduction of hard farm work

### 6.2 Design Plan

Since the machines to be considered for procurement by the Project have been used widely in Myanmar, the type and major specification of the machines were selected after discussion with AMD based on their experience data of using machines. Detailed specification and number of machines will be decided after further study in Japan

No.	Item	Type	Target area	Delivery point
1	Powertiller (with a trailer)	Ordinary (for lowland)	Zarhwlor Village Tract (Pa Mum Chaung)	AMS, Kalay
2	Powertiller (with a trailer)	Long handle (Shan Type)	Dolluang Village Tract (Dolluang Swang Dawh)	AMS, Kalay
3	Thresher	Movable (with wheel)	Zarhwlor Village Tract (Pa Mum Chaung)	AMS, Kalay
4	Tractor	50 hp class	Dolluang Village Tract (Zo Zang, Tan	AMS, Kalay, AMS,

			Zan), Sit Sali Htone Village Track, Sa Bai Kone Village Track, Tha Kan Wa Village Track	Mawlamyinegyun
5	Combine Harvester	70 hp class	Dolluang Village Track (Zo Zang, Tan Zan), Sit Sali Htone Village Track, Sa Bai Kone Village Track, Tha Kan Wa Village Track	AMS, Kalay AMS, Mawlamyinegyun
6	Dozer	Operation Weight: 6000~8000 kg,	Dolluang Village Track (Zo Zang)	Land reclamation project office, Hakha
7	Excavator	Operation Weight: 4000 ~5000 kg, Bucket capacity: (approx.) 0.1 m <sup>3</sup>	Dolluang Village Track (Zo Zang)	Land reclamation project office, Hakha
8	Tractor with front blade	50 hp class	Dolluang Village Track (Zo Zang)	Land reclamation project office, Hakha

## 6-2 ミャンマー免税情報シート

## ミャンマー国免税情報シート

更新日：2017年9月27日

**(1) 企業の所得に課される税金（法人税など）****【税の基礎情報（名称、税率、計算方法、根拠法）】**

- 名称：法人税
- 税率：居住法人・非居住法人とも25%。但し、キャピタルゲインは、別申告にて10%。
- 計算方法：課税所得に課税されるが、この所得が企業会計上の利益をベースとするのか、具体的な規定はないとみられる。このため、減価償却費以外は、会計上の利益と所得との関係が税法上明確となっていない。経費の損金算入基準についても、抽象的な基準が3つあるのみ。
- 根拠法：INCOME TAX LAW

**【免税に必要な情報（手順、申請先、所要期間）】**

免税には、ミャンマーの所得税法による免税と他国との条約による免税とがある。ミャンマーの所得税法に基づく免税に関しては、所得税法自体ではその手続き等に関する規定はない。

交換公文等による免税に関しては、別途の合意がない限り、案件ごとに課税当局に照会・協議する必要があると考えられる。

**【備考】**

備考：一般的には施設建設案件において法人税の免税手続きが必要となる。

**(2) 企業の従業員の所得に課される税金（個人所得税など）****【税の基礎情報（名称、税率、計算方法、根拠法）】**

- 名称：個人所得税
- 税率：原則、ミャンマー人及び外国人とも0%～25%の累進税率。但し、キャピタルゲインは、ミャンマー人及び外国人とも一律10%で別申告。
- 計算方法：給与、賞与、諸手当に課税。交通費等は非課税。
- 根拠法：INCOME TAX LAW

**【免税に必要な情報（手順、申請先、所要期間）】**

免税には、ミャンマーの所得税法による免税と他国との条約による免税とがある。ミャンマーの所得税法に基づく免税に関しては、所得税法自体ではその手続き等に関する規定はない。

交換公文等による免税に関しては、別途の合意がない限り、案件ごとに課税当局に照会・協議する必要があると考えられる。

**【備考】**

備考：一般的には施設建設案件において個人所得税の免税手続きが必要となる。

### (3) 付加価値税 (VAT)

#### 【税の基礎情報 (名称、税率、計算方法、根拠法)】

- 名称：商業税
- 税率：原則 5%。
- 計算方法：ミャンマー国内における財貨の販売、役務提供、及び財貨の輸入が課税対象。日本と異なり、輸出免税は財貨の輸出に限定され、サービスの輸出は非課税サービスに該当しない限り課税、また一部の物品輸出も課税。仕入れ控除には制限され、または取扱いが不明な点が多い。
- 根拠法：COMMERCIAL TAX LAW

#### 【免税に必要な情報 (手順、申請先、所要期間)】

免税には、ミャンマーの商業税法による免税と他国との条約による免税とがある。ミャンマーの商業税法に基づく免税に関しては、商業税法自体ではその手続き等に関する規定はない。

交換公文等による免税に関しては、別途の合意がない限り、案件ごとに課税当局に照会・協議する必要があると考えられる。

#### 【備考】

①ミャンマーにおける商業税の免税に関して、事前免税方式と事後還付方式の区分として、少なくとも商業税法上は、免税を二つの形態には区分した規定はないとみられる。したがって、両者の区分があるとすれば、それは交換公文等の解釈又は両国間の合意によるもの、あるいは単なる事実上の慣行によるものと考えられる。

②ミャンマーの有償・無償資金協力事業において、例えば本体工事代金部分は日本側負担で外貨支払い、一方、商業税部分はミャンマー政府負担でチャット払いといった契約事例もあるとのこと。その場合、工事本体は外貨支払い、商業税はチャット払いとなり、しかも工事本体部分の支払者と商業税の支払者とが異なることとなる。この結果として、工事請負業者は本来、工事本体の売上げ時レートによってミャンマー政府にチャット建て商業税を請求しているにも関わらず、ミャンマー政府は、商業税を業者への支払日レートで行なってしまう可能性もある。懸念事項として、場合によっては事後に、工事請負業者が追加納税、修正申告等を強いられる事態にもなりかねず、注意が必要と考えられる。

③商業税が免税扱いとなる場合は、単に売上げが免税扱いとなるだけか、あるいは仕入れ控除も取れるのかを明確にしておく必要があると考えられる。日本の消費税で免税扱いとなる場合、同時に仕入れ控除も取れる (すなわち輸出免税) との見解が有力であり、そのような日本の法制度を前提として締結される交換公文等については、その解釈にも影響してくる可能性があると考えられる。

備考：事前免税方式か事後還付方式かについて正確に記載すること。VATの免税／還付申請のために、当該国で法人登録や税務監査の受入れなどが必要になり、追加コストが必要となる場合もあるため、これら手続きやコストについても記載する。

#### (4) 資機材の輸入及び再輸出の際に課される税金や手数料

##### 【税の基礎情報（名称、税率、計算方法、根拠法）】

- 名称：関税
  - 税率：輸入品により異なる
  - 計算方法：-
- 根拠法：Control of Imports and Exports Act

##### 【免税に必要な情報（手順、申請先、所要期間）】

申請先：実施機関, Directorate of Investment and Company Administration (DICA) Office

手順：

- ① 調達業者より実施機関に、輸入許可取得のための Profoma Invoice を提出。
- ② Profoma Invoice に基づき、実施機関より経済・通産省に、Import License（輸入許可）を申請。
- ③ 経済・通産省より、実施機関に対して Import License 発行。
- ④ 実施機関より、計画・財務省に免税申請を提出。
- ⑤ 計画・財務省より、実施機関に対して免税承認。

時間：約2ヶ月

- 名称：輸出入前払法人税
- 税率：2%
- 計算方法：原則すべての貨物が対象とされ、輸出の際は、輸出貨物の課税価格の2%を通関時に納税し、輸入の場合は、輸入貨物の課税価格の2%を通関時に関税と一緒に納税する。納税義務者はミャンマーの輸出入業者であり、源泉税でなく自ら税として納税する。
- 根拠法：計画・財務省令 17/2016 (2016年2月4日付)

##### 【免税に必要な情報（手順、申請先、所要期間）】

原則2%の税金が課せられることから、免税手続き等の情報はなし。

##### 【備考】

上記の通り課税が原則であるが、有償・無償資金協力事業において、事前に免税証明書等が発行される実績があるとの情報を得ている。本件は引き続き「免税に必要な情報」等について情報収集を行う。

備考：事前に免税証明書等が発行され、通関時に免税が確保される方式と、通関後の事後申請により還付される方式とがありえるため明確に記載すること。

以下、JICA 内部情報（非公開）

在外事務所の担当者（部署、名前、連絡先）：

更新履歴：（更新日、更新者、更新内容）