



Republic of the Philippines
DEPARTMENT OF PUBLIC WORKS AND HIGHWAYS
CENTRAL OFFICE
Manila

April 17, 2018

HADJI KAHAL Q. KEDTAG

Regional Secretary
DENR-ARMM
Cotabato City

**SUBJECT : Proposed Urgent Rehabilitation of Damaged Trans-Central
Roads by the Conflict in Marawi City Project**

Dear Secretary Kedtag:

In connection with the requirement for the application for Environmental Compliance Certificate (ECC) for the above-mentioned subject, we wish to inform you that this Department will ensure submission of the necessary document/s as Proof of Authority over the Project Site prior to the implementation of the said project.

For the Regional Secretary's information and/or guidance.

Very truly yours,

SHARIF MADSMO H. HASIM

Project Director
RMC-II (Multilateral), UPMO





Initial Environmental Examination Checklist Report

Urgent Rehabilitation of Damaged Transcentral Roads by the Conflict in Marawi City

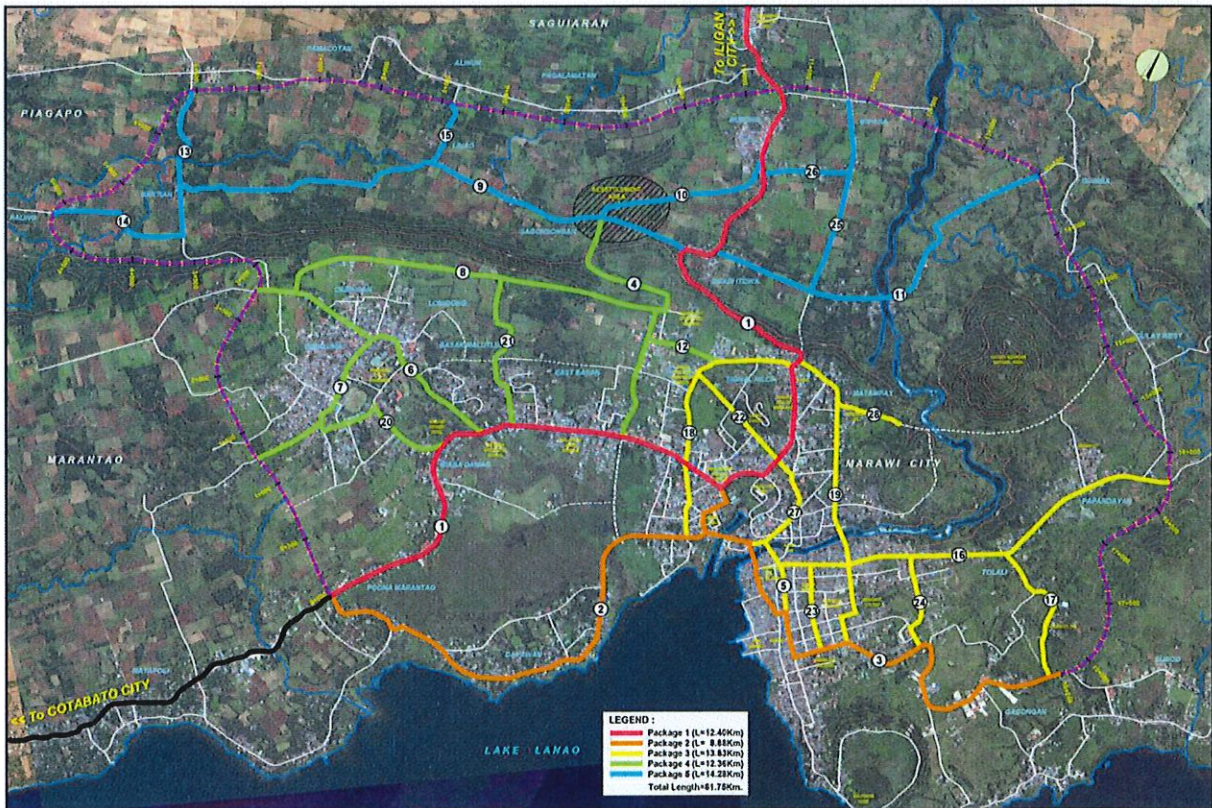

MARAWI TRANSCENTRAL ROAD PACKAGES

Package 3

PROJECT FACT SHEET

Name of the Project	Urgent Rehabilitation of Damaged Trans-central Roads by the Conflict in Marawi City	
Proponent Name	Department of Public Works and Highways	
Proponent Address	DPWH Central Office, Bonifacio Drive, Port Area, Manila, Philippines	
Authorized Representative	Name SHARIF MADSMO H. HASIM	Designation Project Director ,Roads Management Cluster II (Multilateral)
Proponent Means of Contact	Landline No.(02) 032-632-304-3779	Fax No.(02)304-3000 Email: hasim.sharif_madsmo@dpwh.gov.ph

Project Description

Project Type	Project Type Parameter	Project Size
Infrastructure Project: Rehabilitation/repair of existing road network (road reconstruction and pavement repair)	Package 3 Total Length: Road 5 - Gumising Ave. (0.73 km.) Road 16 - Marawi – Kapai Rd.(3.36 km) Road 17 – Kilala-Tuali Rd.(1.21 km) Road 18 - Marawi Cadre-New Capitol Rd. (2.15 km.) Road 22 - Marawi Landing Rd. (0.95 km.) Road 23 - Pangarungan Rd. (0.70 km) Road 24 – Dimusangcop Rd. (0.80 km.) Road 27 – Idarus Rd. (0.83 km.) Road 28 – Tampilong Rd. 0.55 km.)	13.83 km., no critical slope

	Width	6.5 meters (target/widest 7m)
<p>Other Description Details</p> <p>The project is to support the recovery and revitalization of socio-economic condition of Marawi City which was devastated by the conflict. Primarily, the project will repair and rehabilitate the road infrastructure. It covers the major roads which function as major distributor from urban areas to Marawi City Ring Road. The total length of the road to be covered by the project is about 61.75 km. Part of the Feasibility Study is the conduct of survey to capture the magnitude of damage on the road infrastructure: i) Road inventory and road surface condition survey, ii) Drainage inventory and condition survey and iii) Roughness survey using the DRIMS (Dynamic Response Intelligent Monitoring System). Information generated by these surveys are necessary to come up with road rehabilitation program/plan and its corresponding cost estimates and implementation strategy.</p> <p>The Japanese Government expressed interest to fund the project through JICA. The selection of roads for rehabilitation was in consultation with DPWH Central Office, DPWH ARMM, concerned LGU (Marawi City Government, Marantao, Saguiaran) and Task Force Bangon Marawi.</p> <p>Package 3 covers the city center of Marawi City. This also includes the so called "Ground Zero", the most devastated area as result of the recent armed conflict. The area is also host to most of the government centers including the provincial capitol, city hall and military camp.</p> <p>The objectives of the road rehabilitation project is to improve mobility and reduce travel time. In effect it can boost trade and economic dynamism with more efficient and lesser cost of transporting goods and local products.</p> <p>The road project will have impact on existing environment conditions but only during the construction phase. Mitigation measures will be put in place to manage impact both on air and water pollution. Efficiency and conservation measures will also be implemented vis a vis power and water consumption as well as other natural resource uses especially sand and gravel, key materials needed for road construction. The project will have no involuntary resettlement component as it will just rehabilitate the existing road way.</p>		

1.1. PROJECT LOCATION AND AREA

<p>Street/Sitio/Barangay:</p> <p>Package 3:</p> <p>Road 5:Gumisa Avenue Road 16: Marawi-Kapai Rd.(Macalilay Rd) Road 17: Kilala-Tuali Rd. Road 18a: Marawi Cadre Rd. Road 18b: New Capitol Road Road 19: Marcos Blvd Rd. Road 22:Marawi landing Road Road 23: Pangarungan Rd.</p>	<p>Zone Classification:</p> <p>Residential, Commercial, Institutional, Wasteland</p>
---	--

Road 24: Disumangcop Rd Road 27: Idarus Rd. Road 28: Tampilong Rd.		
Region: ARMM	City/Municipality: Marawi City	Province: Lanao del Sur
Total Project Land Area: 152.13 sq.km.(11m RROW x 13.83 km section length)	Total Project Building Footprint Area: 92.66 sq.km.(6.7m carriageway x 13.83 km section length)	

Geographic Coordinates of the Project Area (WGS84)

Road 5: (0.73 km) - Gumisa Avenue (Ground Zero/Marawi Conflict-Affected Areas)

Area/Section	Longitude	Latitude
NA		
NA		

Road 16: (3.36 km) - Marawi Kapai Road (Macalilay Road)

Area/Section	Longitude	Latitude
0 + 000	124.290833333333	8.001111111111
3 + 360	124.312222222222	8.020277777778

Road 17: (1.21 km) - Kilala-Tuali Road (Lasureco Road)

Area/Section	Longitude	Latitude
0 + 000	124.263611111111	7.982777777778
1 + 241	124.311666666667	8.003888888889

Road 18: (2.15 km) - Marawi Cadre - New Capitol Road

Area/Section	Longitude	Latitude
0 + 000	124.283611111111	8.000000000000
2 + 158	124.284166666667	8.013888888889

Road 19: (2.55 km) - Marcos Boulevard Road (Tampilong-Mapandi-Moncado Colony)

Area/Section	Longitude	Latitude
0 + 000	124.263611111111	7.982777777778
2 + 550	124.284444444444	8.003611111111

Road 22: (0.95 km) - Marawi Landing Road/Amai Pak Pak Capitol

Area/Section	Longitude	Latitude
0 + 000	124.278611111111	8.010000000000
0 + 950	124.284444444444	8.003611111111

Road 23: (0.70 km) – Pangarungan Road (Roxas Ave.) - Ground Zero/Marawi Conflict-Affected Area

Area/Section	Longitude	Latitude
NA		
NA		

Road 24: (0.80 km) - Disumangcop Road

Area/Section	Longitude	Latitude
0 + 000	124.298055555556	8.005833333333
0 + 844	124.284444444444	8.001111111111

Road 27: (0.83 km) – Idarus Road

Area/Section	Longitude	Latitude
NA	124.286666666667	8.007500000000
NA	124.289166666667	8.002777777778

Road 28: (0.55 km) - Tampilong Road

Area/Section	Longitude	Latitude
0 + 000	124.288611111111	8.013333333333
0 + 844	124.293611111111	8.014444444444

Location Map

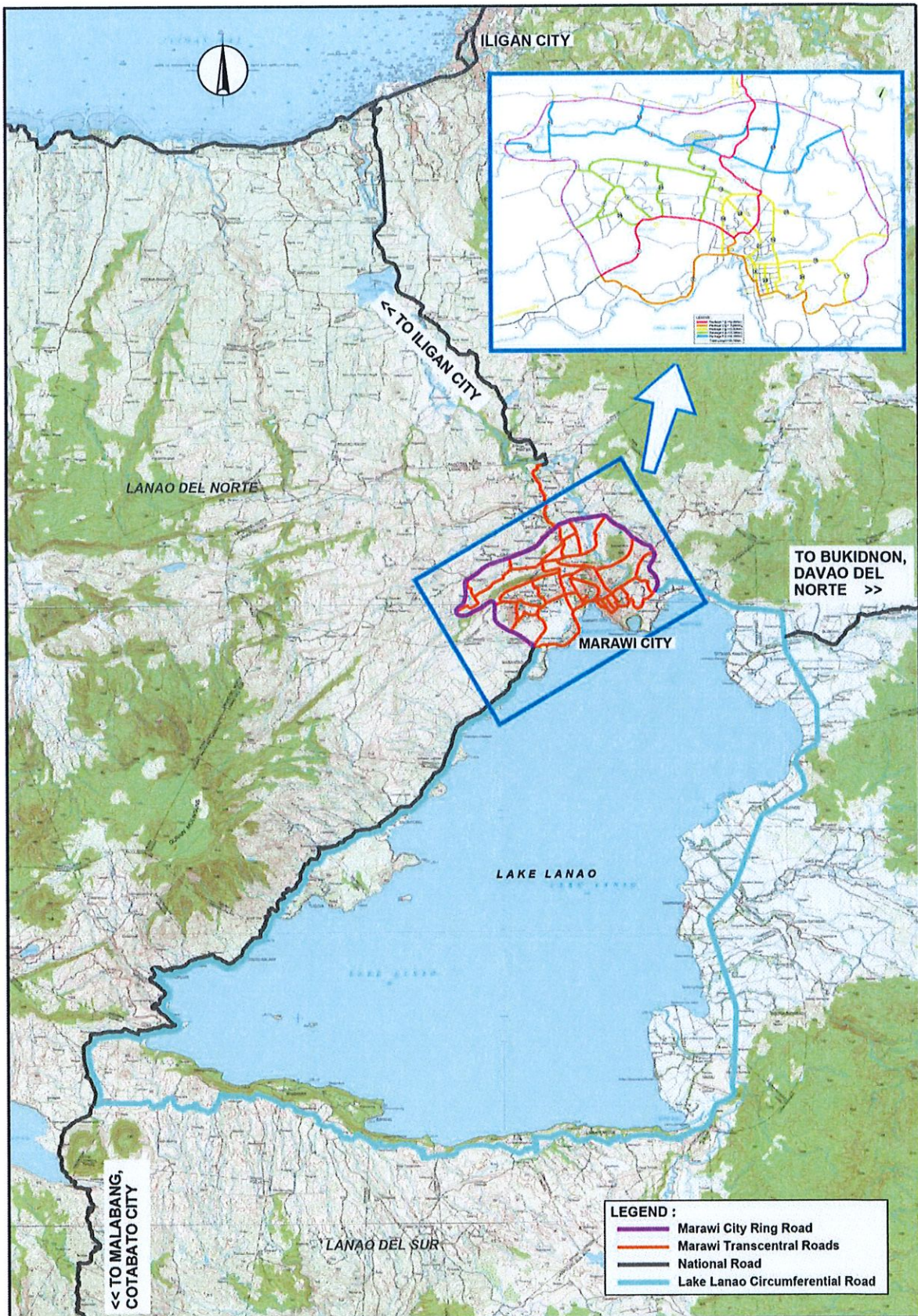

Land Cover Map Lanao del Sur

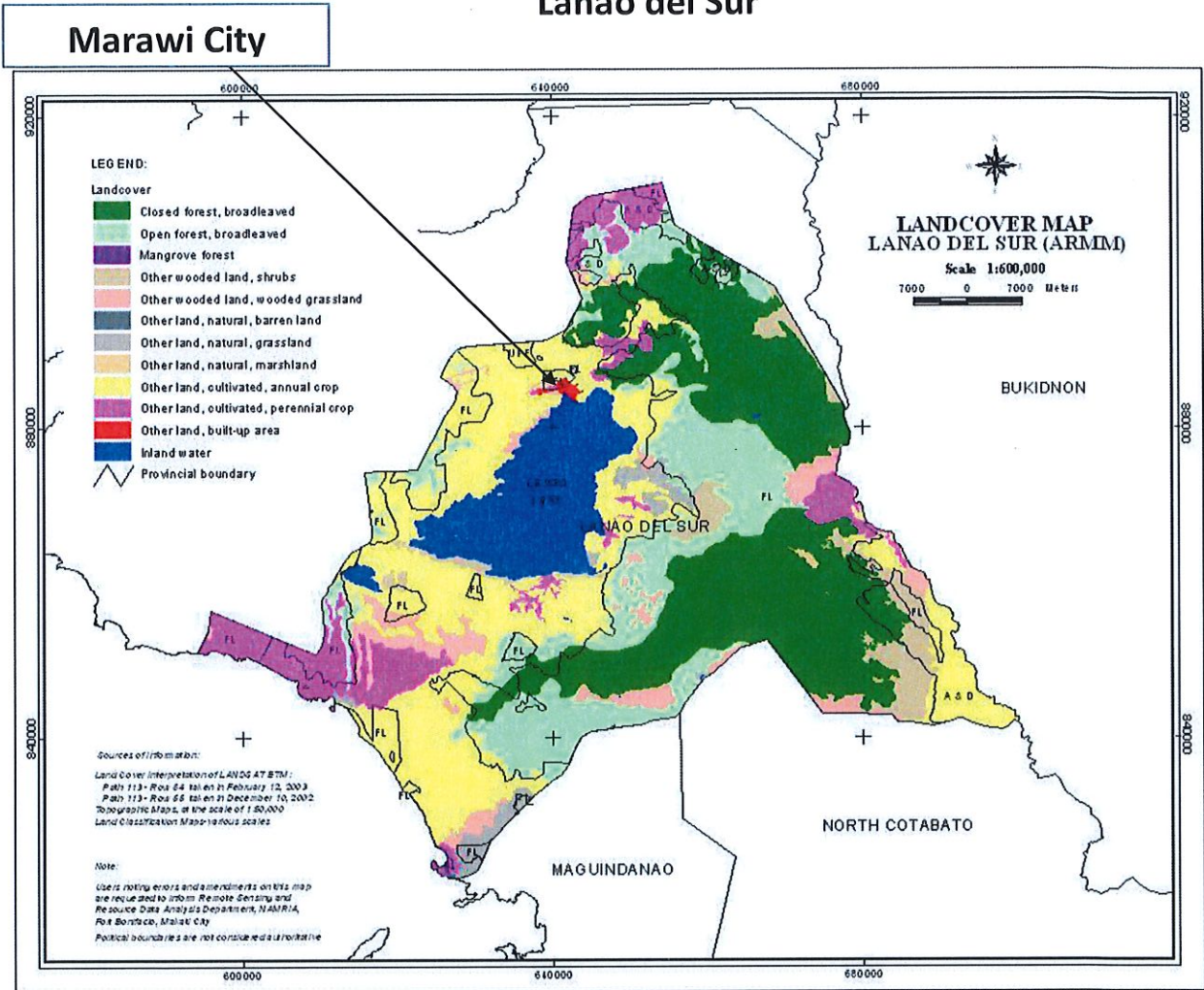

Marawi City and Lake Lanao

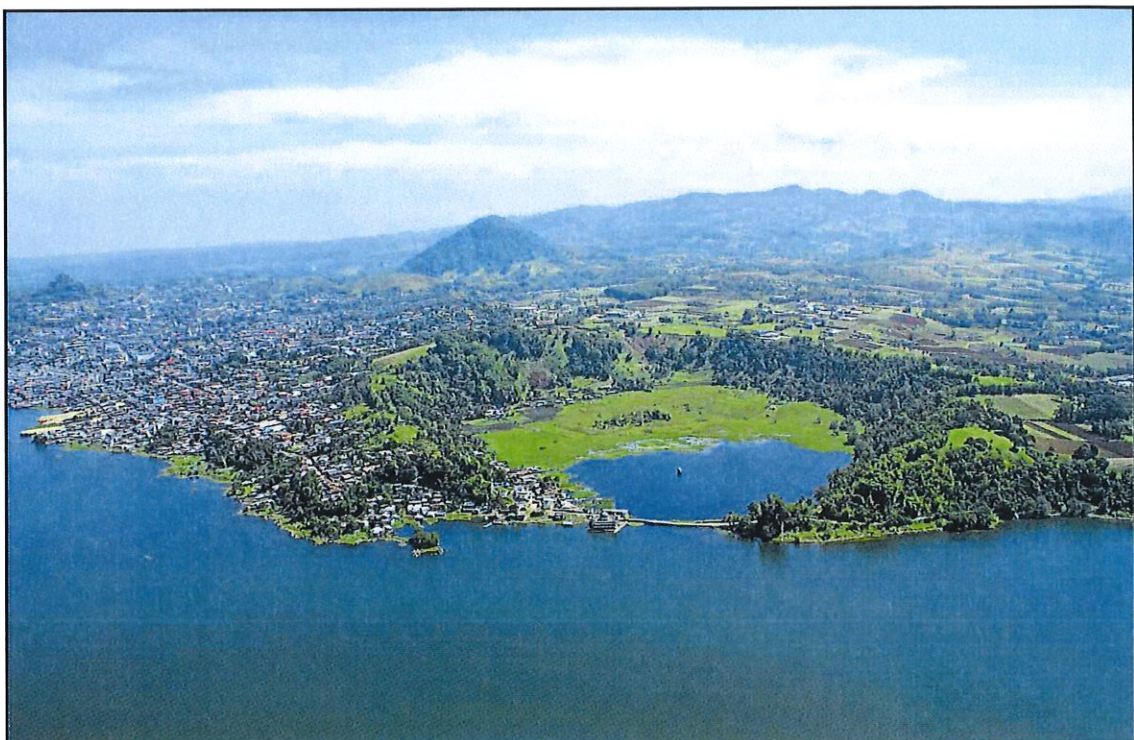

**Topographic Map
Package 3**

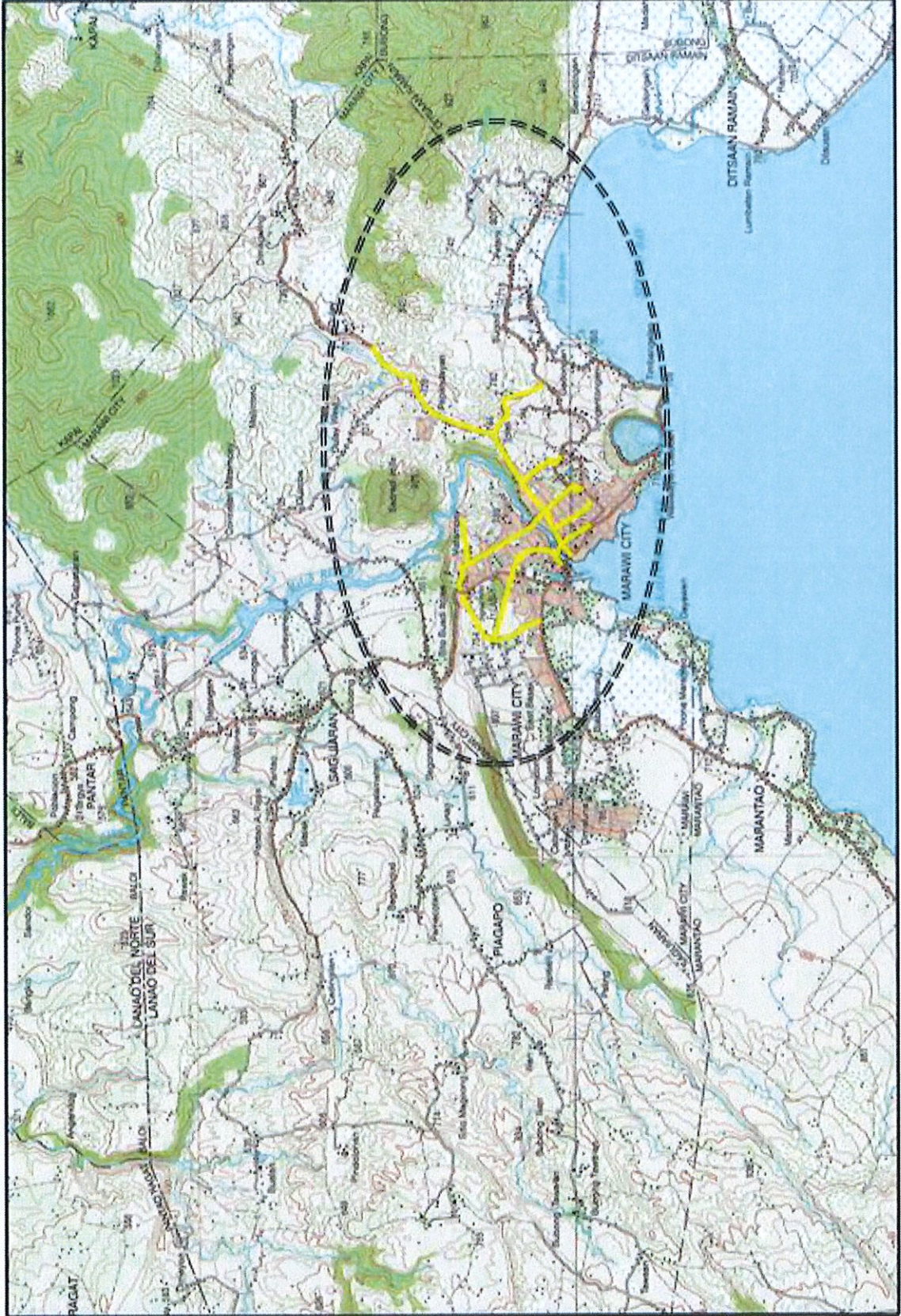

Site Plan: Package 3

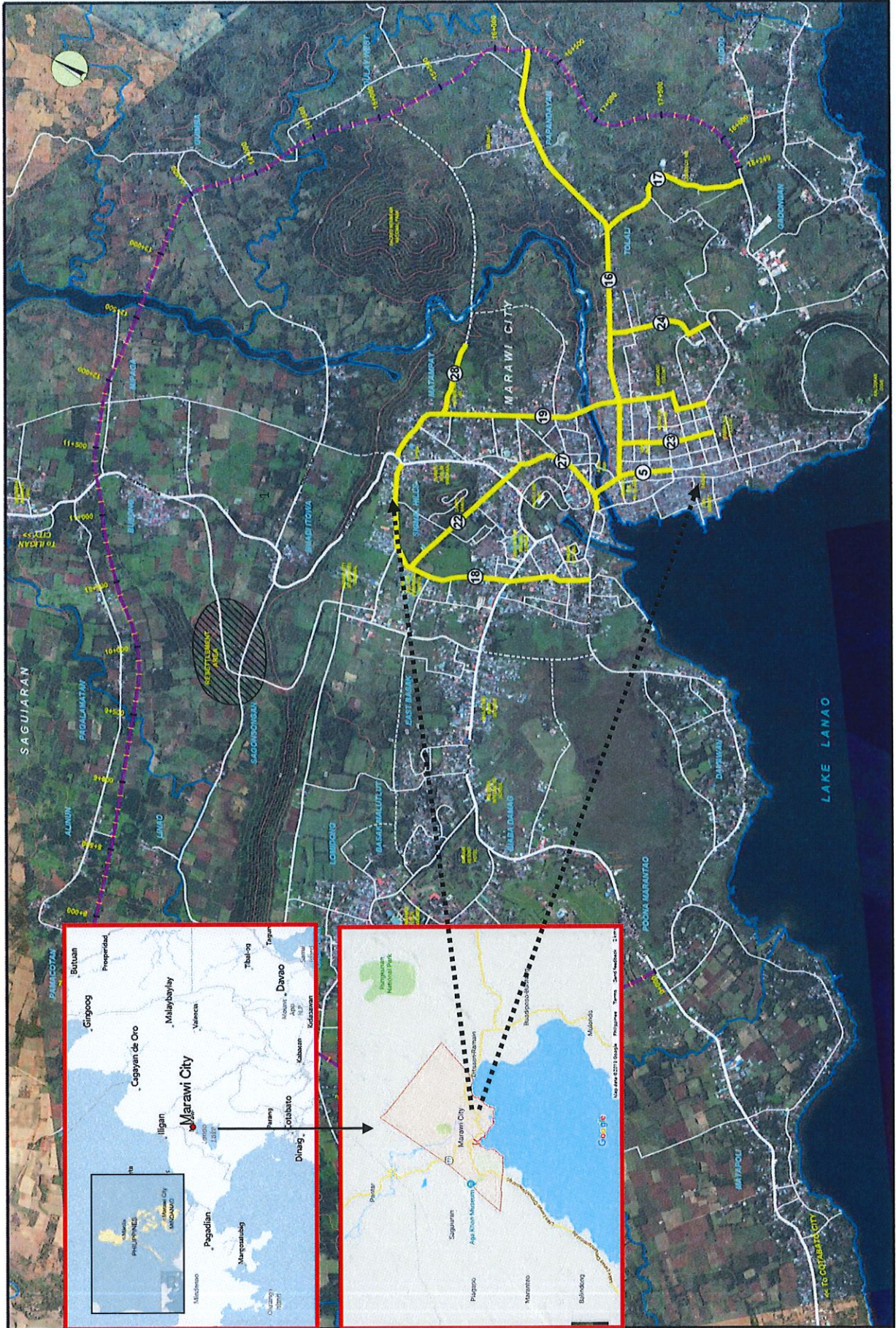

Road Packages and Numbering

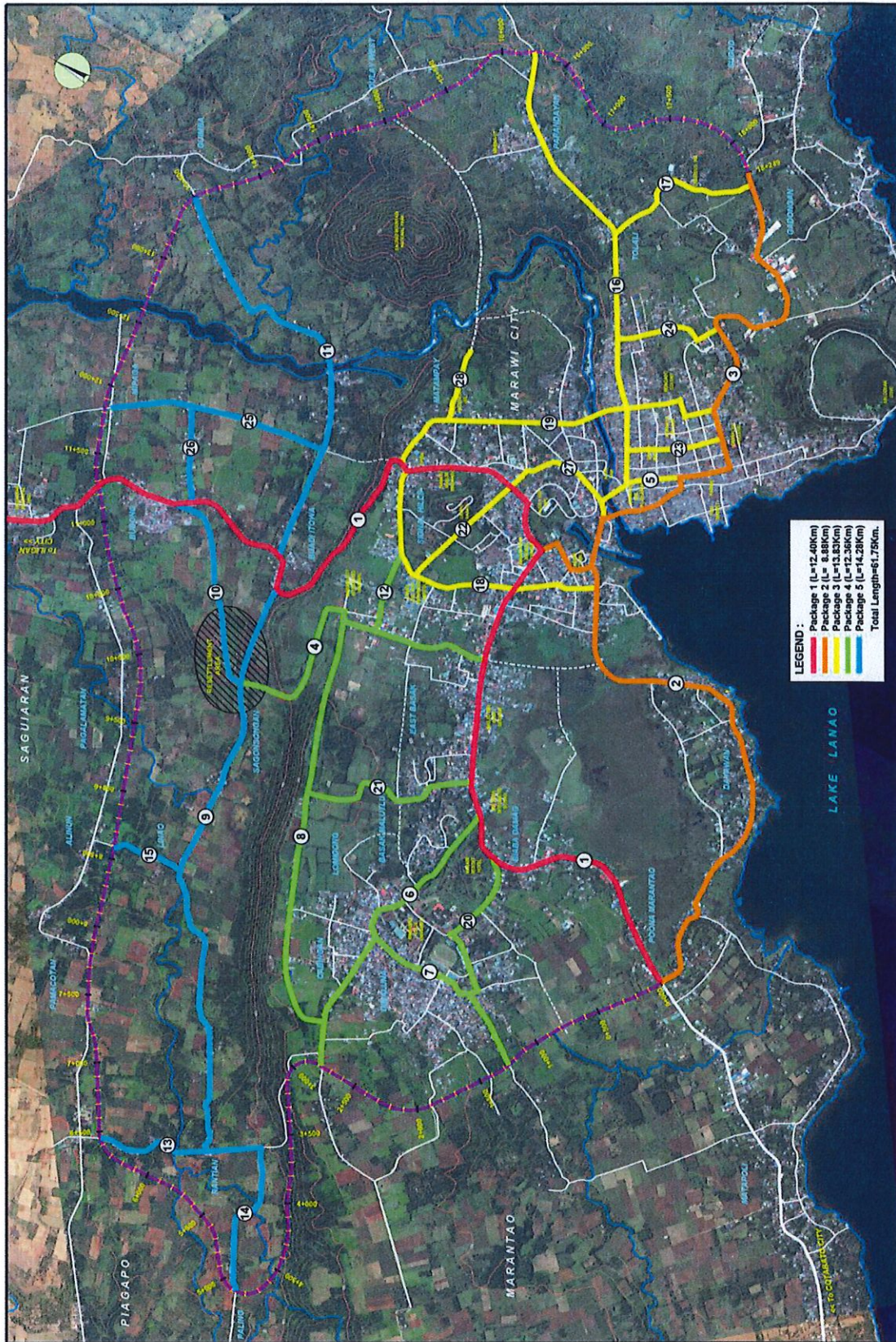

MARAWI TRANSCENTRAL ROADS NUMBERING

Package 3 Alignment of Roads

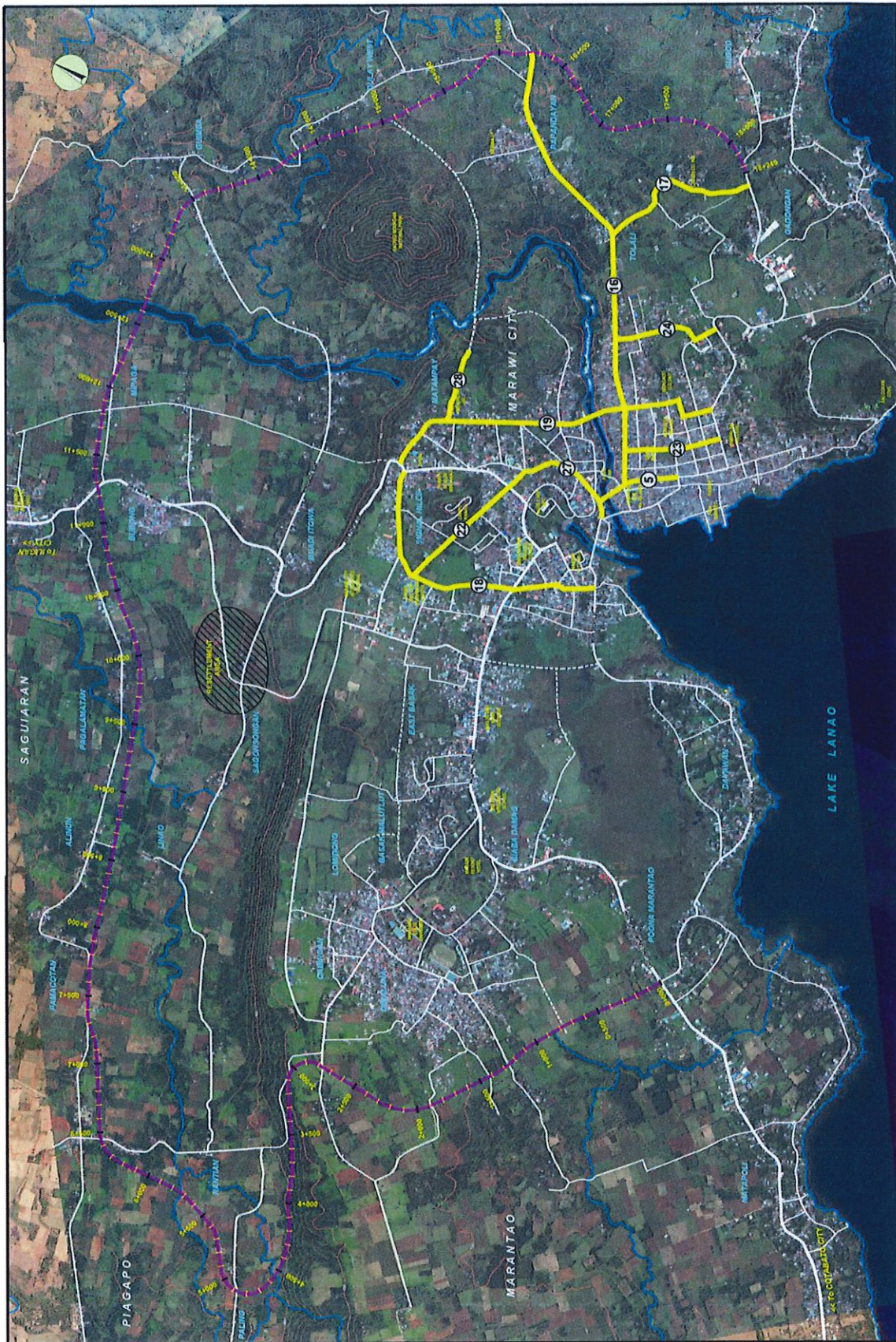

Geo-tagged Photos



Package 3:

Road 5 (Ground Zero/Marawi Conflict-affected Area)

Road Name: Gumising Ave (Pumping)

Length: 0.73 km

Barangay(s) Covered: Marawi City

Existing Land Use:

Residential and Commercial

Existing Carriageway Pavement Type

All concrete

Slope

Coordinates:

Longitude:

Latitude:

Coordinates:

Longitude:

Latitude:

Barangay(s):

Poblacion

Poblacion

City/Municipality:

Marawi

Marawi

NA

NA

Station Beginning:

0 + 000

Station Ending:

+

Road 16

Road Name: Marawi Kapai Road (Macallilay Road)

Length: 3.36 km

Barangay(s) Covered) Marawi City

Existing Land Use:

Existing Carriageway Pavement Type

Slope

Banggolo, Lilod Madaya, Lilod, Papandayan
Papandayan Kaniyogan

Residential and Commercial

All concrete

Coordinates:

Longitude:

Latitude:

124.290833333333

8.001111111111

Coordinates:

Longitude:

Latitude:

124.312222222222

8.020277777778

Barangay:

Banggolo

City/Municipality:

Marawi

Barangay: Papandayan Kaniyogan

City/Municipality: Marawi



Station Beginning:

0 + 000



Station Ending:

3 + 360

Road 17

Road Name: Kilala-Tuali Road (Lasureco Road)

Length: 1.21 km

Barangay(s) Covered: Marawi City

Existing Land Use:

Existing Carriageway Pavement Type

Slope

Kilala, Maliwanag, Pantaon, Papandayan

Minor:

Residential,commercial,institutional

Major: Wasteland

All concrete

Gently sloping

Coordinates:

Longitude: 124.263611111111

Latitude: 7.982777777780

Coordinates:

Longitude:

Latitude:

124.311666666667

8.0038888888889

Barangay:

Kilala

Papandayan

City/Municipality:

Marawi

City/Municipality:

Marawi

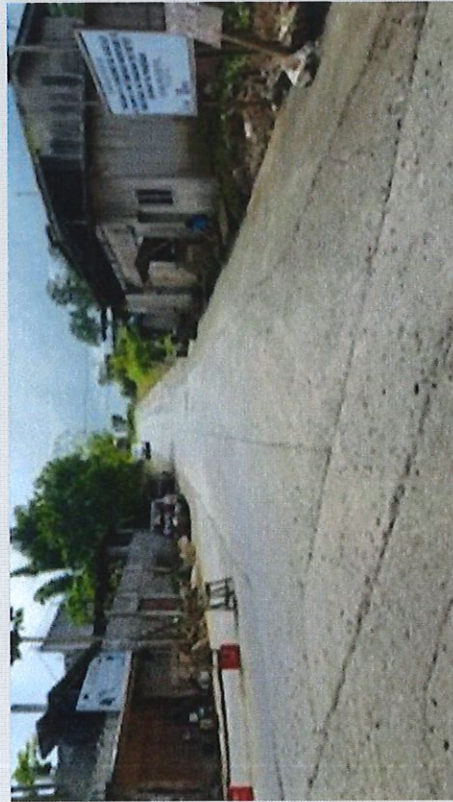

Station Beginning:

0 + 000

Station Ending:

1 + 241

Road 18

Road Name: Marawi Cadre - New Capitol Road

Length: 2.15 km

Barangay(s) Covered: Marawi City

Existing Land Use:

Existing Carriageway Pavement Type

Slope

Bangon, BO Green, New Capitol, Matampay
Major:

Residential/commercial

Minor: Institutional

All concrete

Generally flat, gently sloping

Coordinates:

Longitude: 124.283611111111

Latitude: 8.00000000000000

Coordinates:

Longitude: 124.284166666667

Latitude: 8.01388888888889

Barangay:

Bangon

Matampay

City/Municipality:

Marawi

Marawi



Station Beginning:

0 + 000

Station Ending:

2 + 158

Road 19

Road Name: Marcos Boulevard Road (Tampilong-Mapandi-Moncado Colony)

Length: 2.55 km

Barangay(s) Covered: Marawi City

Existing Land Use:

Existing Carriageway Pavement Type:

Slope:

Matampay, Tampilong, Mapandi

Coordinates:

Longitude: 124.284444444444

Latitude: 8.014444444444

Barangay: Matampay

City/Municipality: Marawi

Coordinates:

Longitude: 124.287777777778

Latitude: 7.015277777778

Barangay: Mapandi

City/Municipality: Marawi



Station Beginning:

0 + 000



Station Ending:

2 + 550

Road 22

Road Name: Marawi Landing Road/Amai Pak Pak Capitol

Length: 0.95 km

Barangay(s) Covered: Marawi City

Existing Land Uses:

Existing Carriageway Pavement Type

Slope

Poblacion, Pangao Saduc

Coordinates:

Longitude: 124.278611111111

Latitude: 8.010000000000

Barangay(s):

Poblacion

City/Municipality:

Marawi

Coordinates:

Longitude: 124.284444444444

Latitude: 8.003611111111

Barangay(s):

Pangao Saduc

City/Municipality:

Marawi



Station Beginning:

0 + 000



Station Ending:

0 + 950

Road 23 (Ground Zero/Marawi Conflict-affected Area)

Pangarungan Road (Roxas Ave.)

Road Name:

Length: 0.70 km

Barangay(s) covered

Existing Land Use:

Existing Carriageway Pavement Type

Slope

Station Beginning: 0 + 000

Coordinates:

Longitude:

Latitude:

Barangay(s):

City/Municipality:

Barangay(s):

City/Municipality:

NA

NA

Station Beginning:

0 + 000

Station Ending:

Road 24

Road Name: Disumangcop Road
Length: 0.80 km
Barangay(s) Covered: Marawi City
Existing Land Use: Wasteland
Existing Carriageway Pavement Type: All concrete
Slope: Generally flat

Coordinates:

Longitude: 124.298055555556
Latitude: 8.0058333333333

Barangay: Lilod
City/Municipality: Marawi



Station Beginning:

0 + 000

Lilod, Disumangcop, Kapantaran
Major: Residential, Commercial
Minor: Wasteland
All concrete
Generally flat

Coordinates:

Longitude: 124.284444444444
Latitude: 8.0011111111111

Barangay: Kapantaran
City/Municipality: Marawi



Station Ending:

0 + 800

Road 27

Road Name: Idarus Road
Length: 0.83 km
Barangay(s) Covered: Marawi City
Existing Land Use:
Existing Carriageway Pavement Type
Slope

Idarus
Major: Residential, Commercial **Minor:** Wasteland
All concrete
Generally flat, slightly sloping

Coordinates:

Longitude: 124.2866666666667
Latitude: 8.0027777777778

Coordinates:

Longitude: 124.2896666666667
Latitude: 8.0011000000000

Barangay:
City/Municipality:

Idarus
Marawi

Barangay
City/Municipality:

Idarus
Marawi



Station Beginning:

0 + 000

Station Ending:

0 + 830

Road 28

Road Name: Tampilong Road

Length: 0.55 km

Barangay(s) Covered: Marawi City

Existing Land Use:

Existing Carriageway Pavement Type

Slope

Tampilong

Major: Residential, Commercial

All concrete

Generally flat

Coordinates:

Longitude:

Latitude:

124.298055555556

8.0144444444444

124.284444444444

8.029361111111

Barangay:

City/Municipality:

Tampilong

Marawi

Tampilong

Marawi



Station Beginning:

0 + 000

Station Ending:

0 + 800

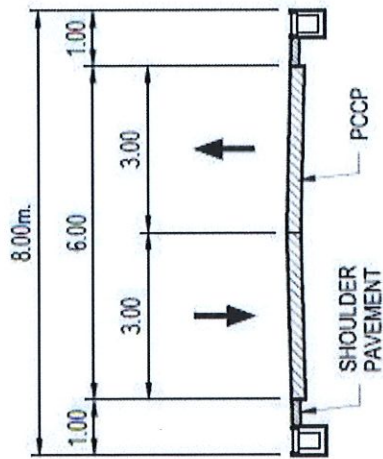

ROAD SECTION 3

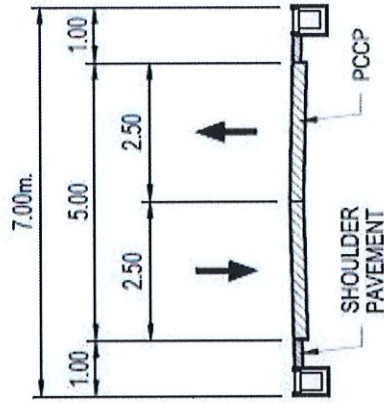

ROAD SECTION 4

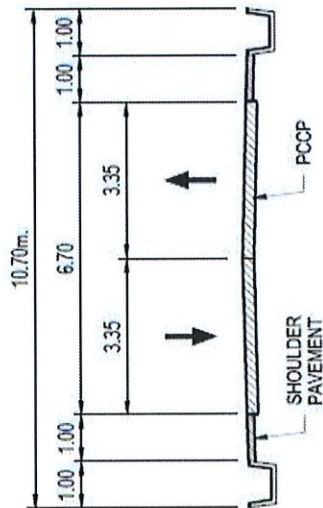

ROAD SECTION 1

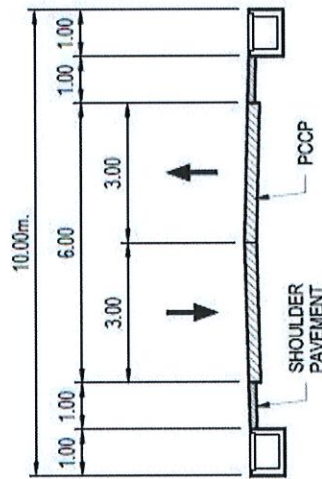

ROAD SECTION 2

Typical Cross Section Layout of Trans-central Roads

Institutional Plan (EIA)

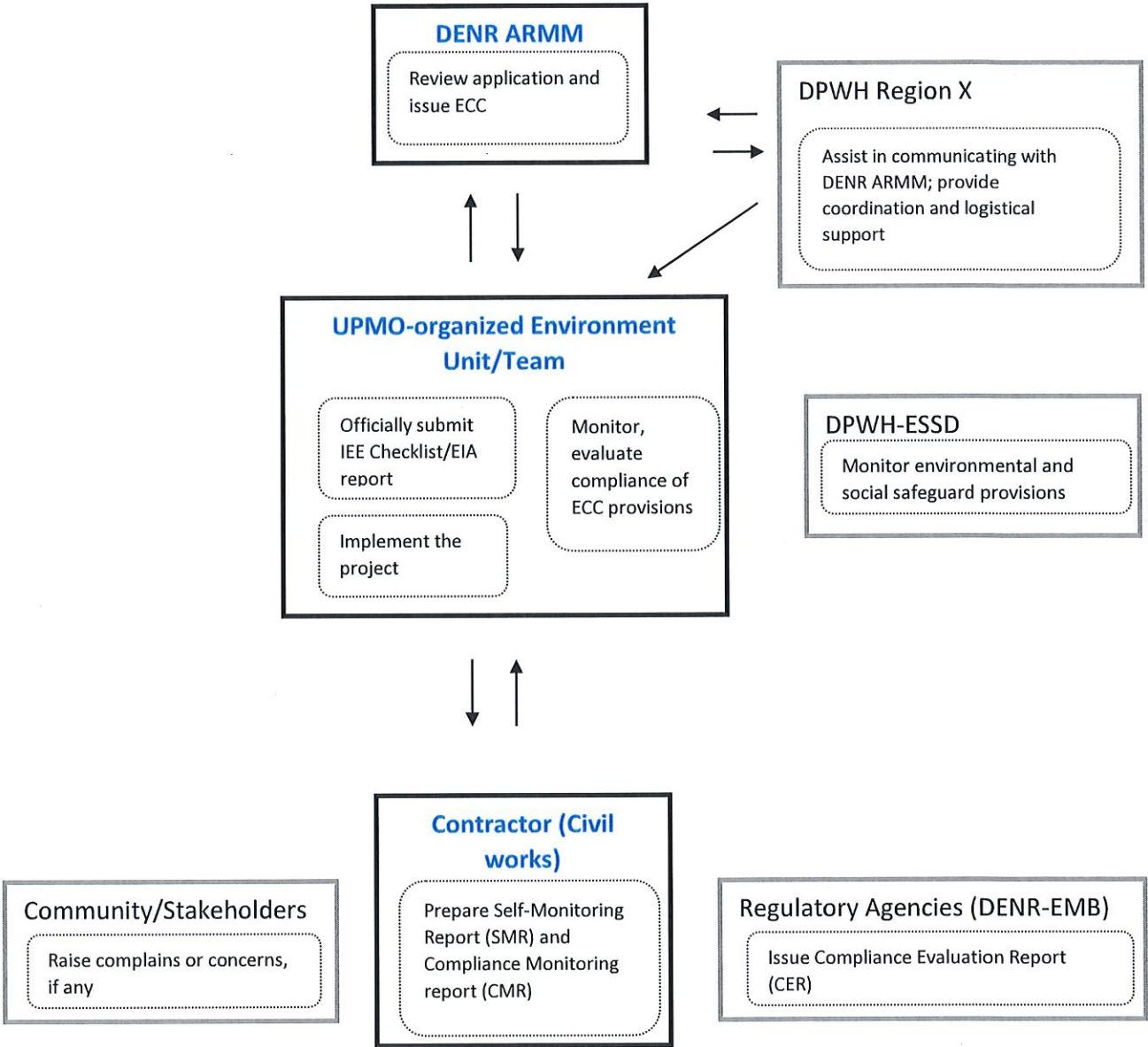

ROAD AND BRIDGE PROJECTS

I.2. PROJECT COMPONENTS

Facilities	No. of Units	Area (sq./M)/ Length (km)/ Capacity	Specification/Description
1. Road	10 (Package 3)	92.66 sq km (6.7m carriageway x 13.83 km section length) ⁺	Package 3 is 13.83 km in length
2. Intersections	67		Major intersections: Road 5 - 4 Road 16 - 8 Road 17 - 3 Road 18 - 12 ⁺
3. Bridge/s	NA		
4. Access roads/Ramp	NA		
5. Drainage facilities (i.e. Reinforced Concrete Box Culverts (RCBC); Reinforced Concrete Pipe Culverts (RCPC), others)	Reinforced Concrete Pipe Culverts or (RCPC)		Side ditches/pipe culverts are to be provided on both sides of the pavement
6. Associated facilities (i.e. Guardrails, Traffic signs, etc.)	NA		
7. Solid waste management facility	NA		
8. Others, specify ROW	The project will be implemented within the existing road-right-of-way		
9. Others, specify			
10. Others, specify			
11. Others, specify			
12. Others, specify			

Use additional sheets, if necessary

I.3. UTILITIES/REQUIREMENTS (Construction and Operation Phases):

Power/Energy, Water and other Requirements

Project Name: _____

Initial Environmental Examination (IEE) Checklist Report Form for Road and Bridge Projects

Utilities	Estimated Demand/Consumption (Total)	Source Breakdown	Projected breakdown from Source specified	
			Construction	Operation
Power/Electricity	Construction: 50,887.50	Grid		KWh
	KWh	Domestic consumption (office use and manpower line up)	50,887.50	0
		Generator Set		KWh
		Operation: NA		0
KWh	Others, please specify:		KWh	
	NA			
	Construction: NA	Local Water Utility Provider		m ³ /day
	NA	Well in: (specify location):		m ³ /day
		Spring in: (specify location):		m ³ /day
		108,000m ³ (200m ³ /day x 540 days) Note: 18 months construction x 30		
	Operation: NA	River, Lake or other surface water : (specify name & location)		m ³ /day
	m ³ /day	Tagaloan River, Cagayan de Oro City, Misamis Oriental		
		Others, please specify:		m ³ /day
Sand and Gravel	Construction: 22,954.36 MT	Source:		MT
	or 55,320.00 cubic meter	Tagaloan River, Cagayan de Oro City, Misamis Oriental	1,659.751 MT x 13.83 km per km road length	
Other materials and requirements ...		Source:		m ³ /day

Power/Energy and Water Efficiency Measures (if any)

Project Name: _____

Initial Environmental Examination (IEE) Checklist Report Form for Road and Bridge Projects

Utilities	Proposed Efficiency/Conservation Measures		Estimated Savings for each Project Phase	Estimated Total Savings
Power/ Electricity	Construction		KWh	KWh
	15,266	30% target - energy saving measures in construction site (office and worker's dormitory) - regulate use of equipment and appliances - use of alternative energy sources (solar power an	15,266 (estimated based on domestic power usage of project personnel)	15,266
	Operation		KWh	KWh
	NA			
Water	Construction		m ³ /day	m ³ /day
	32,400	Water Management System and component programs/activities (target reduction of 30% reduction on water use per total project package)	32,400 (entire construction period)	32,400 (entire construction period)
	Operation	Rainwater collection system Others, please specify:	m ³ /day	m ³ /day
	NA			

I.4. MANPOWER AND TIMELINES OF PROJECT PHASES

Target start of Construction	January 2019
Target Date of Ground-breaking	August 2020
Target Start of Operation	August 2020

Phase	Expertise/Skills	Requirement per Expertise/Skill	Total Requirement per project phase
a. Construction	Project Engineer, Pavement Engineer, Material Engineer	3 x 18 months	54 man-months
	Skilled laborers/workers	6 x 18 months	108 man-months
	Unskilled laborers/workers	8 x 18 months	144 man-months
b. Operation			

Project Name: _____

Initial Environmental Examination (IEE) Checklist Report Form for Road and Bridge Projects

I.5. INDICATIVE PROJECT COST (Initial Investment):

PHP US \$ (specify if with foreign investment)

Project Name: _____

II. ENVIRONMENTAL IMPACT MANAGEMENT AND MONITORING PLAN

ROAD AND BRIDGE PROJECTS		ROAD AND BRIDGE PROJECTS		Remarks
Possible Environmental/Social Impacts	Baseline Environment	Preventive/Mitigating Measures	Monitoring Parameters/Implementation	
<p>LAND</p> <p><input checked="" type="checkbox"/> Consistency with land use</p>				
<p>Current land use w/in 1km radius (as per zoning ordinance):</p> <p><input checked="" type="checkbox"/> Residential</p> <p><input checked="" type="checkbox"/> Commercial/ Institutional</p> <p><input type="checkbox"/> Industrial</p> <p><input checked="" type="checkbox"/> Agricultural/ Recreational</p> <p><input type="checkbox"/> Protected Areas</p> <p><input type="checkbox"/> Others, specify</p>	<p>Actual land uses w/in 1km radius:</p> <p><input checked="" type="checkbox"/> Residential</p> <p><input checked="" type="checkbox"/> Commercial/ Institutional</p> <p><input type="checkbox"/> Industrial</p> <p><input checked="" type="checkbox"/> Agricultural/ Recreational</p> <p><input type="checkbox"/> Protected Areas</p> <p><input type="checkbox"/> Others, specify</p>	<p><input checked="" type="checkbox"/> See attached proof of compatibility with land use</p> <p><input type="checkbox"/> Others, specify</p>	<p>Actual land uses w/in 1km radius:</p> <p><input checked="" type="checkbox"/> Residential</p> <p><input checked="" type="checkbox"/> Commercial/ Institutional</p> <p><input type="checkbox"/> Industrial</p> <p><input checked="" type="checkbox"/> Agricultural/ Recreational</p> <p><input type="checkbox"/> Protected Areas</p> <p><input type="checkbox"/> Others, specify</p>	

Project Name: _____

Initial Environmental Examination (IEE) Checklist Report Form for Road and Bridge Projects

Possible Environmental/Social Impacts	Baseline Environment	Preventive/Mitigating Measures	Monitoring Parameters/Implementation	Remarks
<input checked="" type="checkbox"/> Land tenure / compatibility issue	Identify tenure/ compatibility issues: <input type="checkbox"/> CARP <input type="checkbox"/> CADC/ CADT/ CALC/ CALT <input checked="" type="checkbox"/> ROW <input type="checkbox"/> Informal settlers <input type="checkbox"/> Ecologically sensitive or protected area <input type="checkbox"/> Others, specify <div style="border: 1px solid black; height: 20px; width: 100%;"></div>	<input checked="" type="checkbox"/> Obtain the following clearances/ permits from concerned agencies: <div style="border: 1px solid black; height: 40px; width: 100%;"></div> <input type="checkbox"/> Resettlement Plan prepared <input checked="" type="checkbox"/> Provide relocation/disturbance compensation packages <input type="checkbox"/> Ensure participation of IPs in consultations and dialogues <input type="checkbox"/> MOA prepared/signed <input type="checkbox"/> Provide adequate buffer <input type="checkbox"/> Others, specify <div style="border: 1px solid black; height: 20px; width: 100%;"></div>	<input checked="" type="checkbox"/> Regularly monitor presence/absence of complaints <input checked="" type="checkbox"/> Regular coordination with LGU or appropriate agencies <input type="checkbox"/> Others, specify <div style="border: 1px solid black; height: 20px; width: 100%;"></div>	
<input checked="" type="checkbox"/> Disturbance to wildlife due to vegetation clearing	Existing vegetation in the area: <input type="checkbox"/> Forestland <input type="checkbox"/> Marshland <input checked="" type="checkbox"/> Grassland <input type="checkbox"/> Mangrove <input type="checkbox"/> Wetland	<input checked="" type="checkbox"/> Comply with conditions of DENR/LGU SLUP, Tree Cutting Permit, ROW, PCA Permit <input checked="" type="checkbox"/> Limit land clearing as much as possible <input checked="" type="checkbox"/> Provide temporary fencing for vegetation that will be retained	<input checked="" type="checkbox"/> Annual inspection of area replanted/ re-vegetated <input type="checkbox"/> Others, specify	

Project Name: _____

Initial Environmental Examination (IEE) Checklist Report Form for Road and Bridge Projects

Possible Environmental/Social Impacts	Baseline Environment	Preventive/Mitigating Measures	Monitoring Parameters/Implementation		Remarks
			Cost of preventive/mitigating as well as monitoring integrated in the construction /operation cost		
<input type="checkbox"/> Change in surface landform/ topography/ terrain/slope <input type="checkbox"/> Soil Erosion	<input checked="" type="checkbox"/> Others, specify patches of trees and shrubs	<input checked="" type="checkbox"/> Promote restoration of damaged or destroyed vegetation where possible (e.g., tree planting) <input type="checkbox"/> Others, specify			
<input type="checkbox"/> Change in surface landform/ topography/ terrain/slope <input type="checkbox"/> Soil Erosion	Slope: <input type="checkbox"/> Flat (0-3%) <input type="checkbox"/> Gently sloping to rolling (3-18%) <input type="checkbox"/> Steep (>18%) Is the project site located in an area identified by MGB/ PAG-ASA/ PHIVOLCS as hazard prone? <input type="checkbox"/> Yes <input checked="" type="checkbox"/> No	Considering the natural hazards and climate projections in the area: <input type="checkbox"/> Employ erosion control and slope protection measures <input type="checkbox"/> Designate a spoils storage area, with topsoil set aside for later use and allow maximum re-use of spoils <input type="checkbox"/> Construct during dry season <input type="checkbox"/> Stabilize embankment with grasses or other soil cover <input type="checkbox"/> Conduct Engineering Geological and Geo-hazard Assessment (EGGA) and implement corresponding recommendation <input type="checkbox"/> Others, specify	<input type="checkbox"/> Regular inspection of slope protection measures in erosion-prone areas <input type="checkbox"/> Regular inspection for new eroded areas near the site <input type="checkbox"/> Others, specify	For the entire road package slope is flat with few gently sloping to rolling terrain	

Project Name: _____

Initial Environmental Examination (IEE) Checklist Report Form for Road and Bridge Projects

Possible Environmental/Social Impacts	Baseline Environment	Preventive/Mitigating Measures	Monitoring Parameters/Implementation	Remarks
Building of structure and improper solid waste disposal leading to: <ul style="list-style-type: none"> <input type="checkbox"/> Impairment of visual aesthetics <input type="checkbox"/> Devaluation of land values 	Solid Waste Management Scheme in the area: <ul style="list-style-type: none"> <input type="checkbox"/> SLF <input type="checkbox"/> MRF <input type="checkbox"/> Composting <input checked="" type="checkbox"/> Regular Collection of Solid Wastes Presence of visually significant landforms/landscape/structures? <ul style="list-style-type: none"> <input type="checkbox"/> Yes <input checked="" type="checkbox"/> No 	<input checked="" type="checkbox"/> Cost of preventive/mitigating as well as monitoring integrated in the construction /operation cost <ul style="list-style-type: none"> <input checked="" type="checkbox"/> Implement recovery re-use and recycling of waste materials <input checked="" type="checkbox"/> Provide receptacles / bins for solid wastes <input checked="" type="checkbox"/> Composting of Organic Wastes <input checked="" type="checkbox"/> Coordinate with the municipal / city waste collectors <input type="checkbox"/> Implement landscaping and other beautification measures <input checked="" type="checkbox"/> Provide adequate buffer <input type="checkbox"/> Compensate adjacent property owners <input type="checkbox"/> Others, specify 	<input type="checkbox"/> Daily inspection of waste handling including segregation in waste/recycling bins <ul style="list-style-type: none"> <input checked="" type="checkbox"/> Weekly inspection of waste accumulation and disposal <input type="checkbox"/> Regular inspection of landscaping and other beautification activities <input type="checkbox"/> Regular monitoring of buffer zones <input type="checkbox"/> Regular monitoring for presence/absence of complaints from adjacent property owners <input type="checkbox"/> Others, specify 	<input checked="" type="checkbox"/> Cost integrated in the construction/operation cost
WATER				
<input checked="" type="checkbox"/> Increased siltation due to project activities <ul style="list-style-type: none"> <input checked="" type="checkbox"/> Water quality degradation <input type="checkbox"/> Others, specify 	Specify nearest water body: Lanao Lake, Agus River Distance to nearest water body: <ul style="list-style-type: none"> <input checked="" type="checkbox"/> 0 to less than 0.5 km 	<input checked="" type="checkbox"/> Set up proper and adequate sanitary facilities <ul style="list-style-type: none"> <input checked="" type="checkbox"/> Ensure strict observance of proper waste handling and disposal and proper sanitation including by the contractor and its workers <input type="checkbox"/> Set up silt trap (Gabions, 	Regular (ocular) inspection of: <ul style="list-style-type: none"> <input checked="" type="checkbox"/> Drainage / canal systems <input checked="" type="checkbox"/> Sanitation facilities Monitoring of ambient water during construction for: <ul style="list-style-type: none"> <input checked="" type="checkbox"/> Turbidity and/or silted condition <input checked="" type="checkbox"/> Floating wastes or debris 	

Project Name: _____

Initial Environmental Examination (IEE) Checklist Report Form for Road and Bridge Projects

Possible Environmental/Social Impacts	Baseline Environment	Preventive/Mitigating Measures	Monitoring Parameters/Implementation	Remarks												
	<p><input checked="" type="checkbox"/> 0.5 to 1 km <input type="checkbox"/> More than 1 km</p> <p>Classification of nearest water body:</p> <table border="1"> <tr> <td><input checked="" type="checkbox"/> Freshwater</td> <td><input type="checkbox"/> Marine/ coastal water</td> </tr> <tr> <td><input type="checkbox"/> AA</td> <td><input type="checkbox"/> SA</td> </tr> <tr> <td><input checked="" type="checkbox"/> A</td> <td><input checked="" type="checkbox"/> SB</td> </tr> <tr> <td><input checked="" type="checkbox"/> B</td> <td><input checked="" type="checkbox"/> SC</td> </tr> <tr> <td><input checked="" type="checkbox"/> C</td> <td><input type="checkbox"/> SD</td> </tr> <tr> <td><input type="checkbox"/> D</td> <td></td> </tr> </table>	<input checked="" type="checkbox"/> Freshwater	<input type="checkbox"/> Marine/ coastal water	<input type="checkbox"/> AA	<input type="checkbox"/> SA	<input checked="" type="checkbox"/> A	<input checked="" type="checkbox"/> SB	<input checked="" type="checkbox"/> B	<input checked="" type="checkbox"/> SC	<input checked="" type="checkbox"/> C	<input type="checkbox"/> SD	<input type="checkbox"/> D		<p><input checked="" type="checkbox"/> Cost of preventive/mitigating as well as monitoring integrated in the construction /operation cost</p> <p>Fascines)/settling ponds to minimize downstream siltation <input type="checkbox"/> Others, specify</p>		
<input checked="" type="checkbox"/> Freshwater	<input type="checkbox"/> Marine/ coastal water															
<input type="checkbox"/> AA	<input type="checkbox"/> SA															
<input checked="" type="checkbox"/> A	<input checked="" type="checkbox"/> SB															
<input checked="" type="checkbox"/> B	<input checked="" type="checkbox"/> SC															
<input checked="" type="checkbox"/> C	<input type="checkbox"/> SD															
<input type="checkbox"/> D																
	<p>Current use of nearest/receiving water body:</p> <p><input checked="" type="checkbox"/> Fishery <input checked="" type="checkbox"/> Tourist Zone / Park <input checked="" type="checkbox"/> Recreational <input type="checkbox"/> Industrial <input checked="" type="checkbox"/> Agricultural <input type="checkbox"/> Others, specify:</p> <p>Distance of project area to the nearest well used: <input checked="" type="checkbox"/> 0 to less than 0.5 km</p>															

Project Name: _____

Initial Environmental Examination (IEE) Checklist Report Form for Road and Bridge Projects

Possible Environmental/Social Impacts	Baseline Environment	Preventive/Mitigating Measures	Monitoring Parameters/Implementation	Remarks
<input checked="" type="checkbox"/> Competition in water use <input type="checkbox"/> Depletion of water resources	<input checked="" type="checkbox"/> 0.5 to 1 km <input type="checkbox"/> More than 1 km Use of nearest well: <input checked="" type="checkbox"/> Drinking/Domestic <input type="checkbox"/> Industrial <input checked="" type="checkbox"/> Agricultural Size of population using water source: <input type="checkbox"/> ≤ 1,000 persons <input checked="" type="checkbox"/> >1,000 and ≤ 5,000 persons <input type="checkbox"/> >5,000 persons Available/nearest water source. <input checked="" type="checkbox"/> Deep well <input checked="" type="checkbox"/> Water district/LGU <input type="checkbox"/> Surface water <input type="checkbox"/> Others, specify <div style="border: 1px solid black; height: 40px; width: 100%;"></div> Current Use of water source : <input checked="" type="checkbox"/> Fishery <input type="checkbox"/> Tourist Zone / Park <input type="checkbox"/> Recreational <input type="checkbox"/> Industrial <input checked="" type="checkbox"/> Agricultural <input checked="" type="checkbox"/> Others, specify	<input checked="" type="checkbox"/> Cost of preventive/mitigating as well as monitoring integrated in the construction /operation cost <input checked="" type="checkbox"/> Implement rainwater harvesting and similar measures as an alternative source of water <input checked="" type="checkbox"/> Observe water conservation measures <input type="checkbox"/> Others, specify <div style="border: 1px solid black; height: 40px; width: 100%;"></div>	<input checked="" type="checkbox"/> Regular monitoring for presence/absence of complaints <input checked="" type="checkbox"/> Regular coordination with concerned agencies <input checked="" type="checkbox"/> Regular monitoring for occurrences of water shortages <input type="checkbox"/> Others, specify <div style="border: 1px solid black; height: 40px; width: 100%;"></div>	

Project Name: _____

Initial Environmental Examination (IEE) Checklist Report Form for Road and Bridge Projects

Possible Environmental/Social Impacts	Baseline Environment	Preventive/Mitigating Measures	Monitoring Parameters/Implementation		Remarks
			Cost of preventive/mitigating as well as monitoring integrated in the construction /operation cost		
	domestic				
<input type="checkbox"/> Increased occurrence of flooding	Is the project site located in an area identified by MGB/ PAG-ASA as flood prone? <input checked="" type="checkbox"/> Yes <input type="checkbox"/> No	<input checked="" type="checkbox"/> Use appropriate design for project facilities including appropriate drainage mechanism considering the existing local drainage system. <input checked="" type="checkbox"/> Regularly remove debris and other materials that may obstruct water flow <input type="checkbox"/> Others, specify	<input checked="" type="checkbox"/> Regular monitoring for presence/absence of complaints <input checked="" type="checkbox"/> Regular coordination with concerned agencies <input checked="" type="checkbox"/> Regular monitoring for increased frequency of flooding <input type="checkbox"/> Others, specify		
AIR / NOISE					
Air quality degradation	Distance to nearest community: <input checked="" type="checkbox"/> 0 to less than 0.5 km <input type="checkbox"/> 0.5 to 1 km <input type="checkbox"/> More than 1 km	<input checked="" type="checkbox"/> Properly operate and maintain all emission sources (e.g. vehicles, generator, etc) <input checked="" type="checkbox"/> Install appropriate air pollution control device/s <input checked="" type="checkbox"/> Strictly enforce good housekeeping practices <input checked="" type="checkbox"/> Control vehicle speed to lessen	<input checked="" type="checkbox"/> Regular monitoring for presence/absence of complaints Regular (ocular) inspection of: <input checked="" type="checkbox"/> Absence of white or black smoke from vehicles, generator, etc.		

Project Name: _____

Initial Environmental Examination (IEE) Checklist Report Form for Road and Bridge Projects

Possible Environmental/Social Impacts	Baseline Environment	Preventive/Mitigating Measures	Monitoring Parameters/Implementation	Remarks
<input checked="" type="checkbox"/> Nuisance due to noise generation	Distance to nearest community: <input checked="" type="checkbox"/> 0 to less than 0.5 km <input type="checkbox"/> 0.5 to 1 km <input type="checkbox"/> More than 1 km	<input checked="" type="checkbox"/> suspension of road dust <input checked="" type="checkbox"/> Conduct water spraying to suppress dust sources and minimize discomfort to nearby residents <input checked="" type="checkbox"/> Use covered vehicles to deliver materials that may generate dust <input type="checkbox"/> Others, specify <div style="border: 1px solid black; height: 20px; width: 100%;"></div>	<input checked="" type="checkbox"/> Presence of truck cover during deliveries	
<input checked="" type="checkbox"/> Nuisance due to noise generation	Distance to nearest community: <input checked="" type="checkbox"/> 0 to less than 0.5 km <input type="checkbox"/> 0.5 to 1 km <input type="checkbox"/> More than 1 km	<input checked="" type="checkbox"/> Properly operate and maintain all noise sources (e.g., vehicles, generator, etc.) <input checked="" type="checkbox"/> Install, when applicable, the appropriate noise control device/s (e.g., mufflers, silencer, sound barriers, etc.) <input checked="" type="checkbox"/> Implement appropriate operating hours <input type="checkbox"/> Provide adequate buffer and/or planting of trees <input type="checkbox"/> Others, specify	<input checked="" type="checkbox"/> Regular monitoring for presence/absence of complaints <input type="checkbox"/> Regular monitoring of buffer zones <input type="checkbox"/> Quarterly monitoring of noise level <input type="checkbox"/> Others, specify <div style="border: 1px solid black; height: 20px; width: 100%;"></div>	

Project Name: _____

Initial Environmental Examination (IEE) Checklist Report Form for Road and Bridge Projects

Possible Environmental/Social Impacts	Baseline Environment	Preventive/Mitigating Measures <input checked="" type="checkbox"/> Cost of preventive/mitigating as well as monitoring integrated in the construction /operation cost	Monitoring Parameters/ Implementation	Remarks
PEOPLE				
<input type="checkbox"/> Displacement of residents including indigenous people (if any) in the project site and within its vicinity <input checked="" type="checkbox"/> Enhanced employment and/or livelihood opportunities <input type="checkbox"/> Reduced employment and/or livelihood opportunities <input checked="" type="checkbox"/> Increased revenues for LGU <input type="checkbox"/> Disruption/Competition in delivery of public services (e.g., education, peace and order, etc.) <input checked="" type="checkbox"/> Enhanced delivery of public services (e.g., education, peace and order, etc.) <input checked="" type="checkbox"/> Increase in traffic volume and worsening of traffic flow	Size of population of host barangay: <input type="checkbox"/> ≤ 1,000 persons <input type="checkbox"/> >1,000 and ≤ 5,000 persons <input checked="" type="checkbox"/> >5,000 persons Classification of host barangay: <input checked="" type="checkbox"/> Urban <input checked="" type="checkbox"/> Rural Employment/Livelihood Opportunity Rate in the host Municipality: <input type="checkbox"/> High <input checked="" type="checkbox"/> Low Description: <div style="border: 1px solid black; height: 40px; width: 100%;"></div> Available services within/near the host barangay: <input checked="" type="checkbox"/> Schools (e.g., elementary, high school, college)	<div style="border: 1px solid black; height: 100px; width: 100%;"></div>	<div style="border: 1px solid black; height: 100px; width: 100%;"></div>	<div style="border: 1px solid black; height: 100px; width: 100%;"></div>
<input type="checkbox"/> Displacement of residents including indigenous people (if any) in the project site and within its vicinity <input checked="" type="checkbox"/> Enhanced employment and/or livelihood opportunities <input type="checkbox"/> Reduced employment and/or livelihood opportunities <input checked="" type="checkbox"/> Increased revenues for LGU <input type="checkbox"/> Disruption/Competition in delivery of public services (e.g., education, peace and order, etc.) <input checked="" type="checkbox"/> Enhanced delivery of public services (e.g., education, peace and order, etc.) <input checked="" type="checkbox"/> Increase in traffic volume and worsening of traffic flow	Size of population of host barangay: <input type="checkbox"/> ≤ 1,000 persons <input type="checkbox"/> >1,000 and ≤ 5,000 persons <input checked="" type="checkbox"/> >5,000 persons Classification of host barangay: <input checked="" type="checkbox"/> Urban <input checked="" type="checkbox"/> Rural Employment/Livelihood Opportunity Rate in the host Municipality: <input type="checkbox"/> High <input checked="" type="checkbox"/> Low Description: <div style="border: 1px solid black; height: 40px; width: 100%;"></div> Available services within/near the host barangay: <input checked="" type="checkbox"/> Schools (e.g., elementary, high school, college)	<input type="checkbox"/> Provide relocation/disturbance compensation packages <input checked="" type="checkbox"/> Prioritize local residents for employment <input checked="" type="checkbox"/> Promptly pay local taxes and other financial obligations <input checked="" type="checkbox"/> Regularly coordinate with LGU <input checked="" type="checkbox"/> Conduct prior consultation and coordination to minimize disruption of daily domestic activities <input type="checkbox"/> Ensure participation of IPs in consultations and dialogues and consider IP rights and cultural practices in the provision of relocation/disturbance compensation packages <input checked="" type="checkbox"/> Provide appropriate traffic/warning signs, lighting, etc. <input type="checkbox"/> Others, specify	<input checked="" type="checkbox"/> Regular monitoring for presence/absence of complaints <input checked="" type="checkbox"/> Regular coordination with LGU <input type="checkbox"/> Others, specify <div style="border: 1px solid black; height: 40px; width: 100%;"></div>	<input checked="" type="checkbox"/> Cost integrated in the construction/operation cost <div style="border: 1px solid black; height: 40px; width: 100%;"></div>

Initial Environmental Examination (IEE) Checklist Report Form for Road and Bridge Projects

Possible Environmental/Social Impacts	Baseline Environment	Preventive/Mitigating Measures	Monitoring Parameters/Implementation		Remarks
			Cost of preventive/mitigating as well as monitoring integrated in the construction /operation cost		
<p><input checked="" type="checkbox"/> Health facilities (e.g., clinics, hospitals, etc.)</p> <p><input checked="" type="checkbox"/> Peace and order (e.g., police outpost, Brgy. Tanod, etc.)</p> <p><input checked="" type="checkbox"/> Recreation and sports facilities</p> <p><input checked="" type="checkbox"/> Others, specify</p> <p>Mosque</p>	<p><input checked="" type="checkbox"/> Preparation of traffic management/re-routing plan in close coordination with the city government and barangay since an increase in traffic volume is anticipated</p> <p><input checked="" type="checkbox"/> Provide traffic diversion schemes and traffic management regulations for the project</p>	<p><input checked="" type="checkbox"/> Cost of preventive/mitigating as well as monitoring integrated in the construction /operation cost</p>			
<p><input type="checkbox"/> Destruction/disturbance of physical cultural resources. (✓ if project site has been identified to have such by NM, NHCP, NCAA and LGUs)</p>	<p>Physical Cultural resources within the vicinity of the project site:</p> <p>No</p>	<p><input type="checkbox"/> Implement appropriate protocols based on NM, NHCP, NCAA and LGU guidelines including those for chance finds (if any). Specify:</p>	<p><input type="checkbox"/> Regular coordination with NM, NHCP, NCAA and LGU</p>		
<p><input type="checkbox"/> Impacts on community safety</p>	<p><input type="checkbox"/> Structures posing safety risk to the community:</p>	<p><input checked="" type="checkbox"/> Regularly coordinate with LGU</p> <p><input checked="" type="checkbox"/> Provide appropriate warning signs, lighting and barricades, whenever practicable</p> <p><input checked="" type="checkbox"/> Observe proper housekeeping</p> <p><input type="checkbox"/> Provide on-site medical services for any emergency.</p> <p><input type="checkbox"/> Participate in public awareness programs on health and safety</p>	<p><input checked="" type="checkbox"/> Regular monitoring for presence/absence of complaints</p> <p><input checked="" type="checkbox"/> Regular coordination with LGU</p> <p><input checked="" type="checkbox"/> Regular submission of reports to concerned agency</p>		

Initial Environmental Examination (IEE) Checklist Report Form for Road and Bridge Projects

Possible Environmental/Social Impacts	Baseline Environment	Preventive/Mitigating Measures	Monitoring Parameters/Implementation	Remarks
		<input checked="" type="checkbox"/> Cost of preventive/mitigating as well as monitoring integrated in the construction /operation cost <input checked="" type="checkbox"/> Implement appropriate safety programs for both community and workers <input type="checkbox"/> Others, specify	<input type="checkbox"/> Others, specify	

Project Name: _____

ROAD AND BRIDGE PROJECTS

III. ABANDONMENT /DECOMMISSIONING/REHABILITATION INFORMATION
(If Applicable)

Project Life or Service: years

Alternatives for future use of the project area after abandonment:

Road rehabilitation program is a long term effort that impacts road network design and mobility of people. If deem relevant in overall transport network, a particular road can have along project/service life given the continued repair and improvement.

Abandonment Plan (general) to include management plan for the projected cumulative/long term project impacts such as:

- remediation of contaminated soil and water resources,
- land restoration
- proper dismantling/abandonment of facilities/ equipment
- others, please specify :

The proponent will ensure that construction will not pose any harm to the environment. It will observe its own environmental management system and adheres to government regulations and standards in terms of pollution or emission levels. It will coordinate and mobilize local stakeholders (community members) ensure management of potential sources of pollution and avoid environmental degradation during and after construction.

**PROJECT ENVIRONMENTAL MONITORING AND AUDIT PRIORITIZATION
SCHEME (PEMAPS) QUESTIONNAIRE**

Project Name: Urgent Rehabilitation of Damaged Trans-central Roads by the Conflict in Marawi City

Project Location: Marawi City, Lanao del Sur

ECC Reference No.:

Proponent: Department of Public Works and Highways-Unified Project Management Office (DPWH-UPMO)

Pollution Control Officer: Designated PCO

Tel. No./Fax No./E-mail: (+632) 304-3555

Project Type: Infrastructure Project: Road Reconstruction and Pavement Repair of Existing Road Network

Project Status: Feasibility Study

I. PROJECT CONSIDERATIONS

1.1 Size and Type

61.75 km

1.1.1 Size based on number of employees

Specify number of employees:

approximately ___ (construction stage)

1.1.2 Type:

ECP (in either ECA or Non-ECA)

Non-ECP but in ECA

Non-ECP and Non-ECA

1.2 Waste Generation and Management

1.2.1 Enumerate Waste Type and Specify Quantity of Wastes generated in your facility. (Identify /Enumerate)

Category	Waste	Type		Quantity
		Hazardous	Non-Hazardous	

PROJECT ENVIRONMENTAL MONITORING AND AUDIT PRIORITIZATION SCHEME (PEMAPS) QUESTIONNAIRE

Air	Waste 1 TSP/PM10	X		(units: MT/yr) minimal
	Waste 2 SOx	X		minimal
	Waste N NOx	X		minimal
Liquid	Used oil		X	(units: m ³ /yr)
Solid	Construction debris		X	(units: tons/yr)
	Garbage		X	

1.3 Pollution Control System (PCS)

1.3.1 Enumerate PCS or Waste Management Method Used in your facility.
(Identify /Enumerate)

Category	PCS/Waste Management Method Used	Remarks
Air	PCS 1 TSP/PM10 emission control measures (within emission guideline national values/standard/limit)	Water sprinkle to control dust Covering of trucks when transporting gravel or cements
	PCS 2 SOx emission control measures	Regular maintenance of heavy equipment

PROJECT ENVIRONMENTAL MONITORING AND AUDIT PRIORITIZATION SCHEME (PEMAPS) QUESTIONNAIRE

	PCS N NOx emission control measures	Regular maintenance of heavy equipment; check quality of fuel
Liquid	Primary Used oil management measures	Store in properly sealed and labeled containers Manage run-offs to avoid siltation/clogging of the +
	Secondary Management of pollutants (run-offs) washed from construction sites	Water pollution control measure (proper drainage and piling protection; enclosure of spoils)
	Tertiary	
Solid	Construction debris management measures	Haul by accredited haulers Built in the company's EMS +
	Garbage/solid waste management	Proper segregation and disposal.

II. PATHWAYS

2.1 Prevailing wind towards barrio or city? (mark the corresponding point) Yes No

2.2 Rainfall (impacts surface & groundwater pathways)

2.2.1 Average annual net rainfall:

Specify amount:

2791 mm (www.climate-data.org)

2.2.2 Maximum 24-hour rainfall:

Specify amount:

6.35 mm

2.3 Terrain (select one and mark) Flat Steep

2.4 Is the facility located in a flood-prone area? (select one and mark) Yes No

2.5 Ground Water

ANNEX 2-7d

**PROJECT ENVIRONMENTAL MONITORING AND AUDIT PRIORITIZATION
SCHEME (PEMAPS) QUESTIONNAIRE**

Depth of groundwater table (meter) (select one and mark)

0 to less than 3

3 to 10

Greater than 10

III. RECEIVING MEDIA/RECEPTORS

3.1 Air (Distance to nearest community) (select one and mark)

0 to less than 0.5 km

0.5 to 1 km

Greater than 1 km

3.2 Receiving Surface Water Body

3.2.1 Distance to receiving surface water: (select one and mark)

0 to less than 0.5 km

0.5 to 1 km

Greater than 1 km

3.2.2 Size of population using receiving surface water

Specify number:

>5,000 persons

3.2.3 Fresh Water

3.2.3.1 Classification of fresh water: (select one and mark)

**PROJECT ENVIRONMENTAL MONITORING AND AUDIT PRIORITIZATION
SCHEME (PEMAPS) QUESTIONNAIRE**

- AA
- A
- B
- C
- D

3.2.3.2 Size of fresh water body:

Specify size:

Agus River, 34 km (length); Lake Lanao, 340sq km (surface area)

3.2.3.3 Economic value of water use (may select more than one of the criteria below)

- Drinking
- Domestic
- Recreational
- Fishery
- Industrial
- Agricultural

3.2.4 Salt water

3.2.4.1 Classification of salt water (select one and mark)

- SA
- SB
- SC

**PROJECT ENVIRONMENTAL MONITORING AND AUDIT PRIORITIZATION
SCHEME (PEMAPS) QUESTIONNAIRE**

SD

3.2.4.2 Economic value of water use

(may select more than one of the criteria below)

Fishery

Tourist zone or park

Recreational

Industrial

3.3 Ground Water

3.3.1 Distance to nearest recharge area

(select one and mark)

0 to less than 0.5 km

0.5 to 1 km

Greater than 1 km

3.3.2 Distance to nearest well used

(select one and mark)

0 to less than 0.5 km

0.5 to 1 km

Greater than 1 km

3.3.3 Groundwater use within the nearest well

(may select more than one of the criteria below)

Drinking

**PROJECT ENVIRONMENTAL MONITORING AND AUDIT PRIORITIZATION
SCHEME (PEMAPS) QUESTIONNAIRE**

Industrial

Agricultural

3.4 Land

3.4.1 Indicate current/actual land uses within 0.5 km radius: (may select more than one of the criteria below)

Residential

Commercial/Institutional

Industrial

Agricultural/Recreational

Protected Area

3.4.2 Potential/proposed land uses within 0.5 km (may select more than one of the criteria below)

Residential

Commercial/Institutional

Industrial

Agricultural/Recreational

Protected Area

3.4.3 Number of affected Environmentally Critical Areas within 1 km:

ANNEX 2-7d

**PROJECT ENVIRONMENTAL MONITORING AND AUDIT PRIORITIZATION
SCHEME (PEMAPS) QUESTIONNAIRE**

Specify number:

2

3.4.4 Distance to nearest ECA

(select one and mark)

0 to less than 0.5km

0.5 to 1 km

Greater than 1 km

IV. ENVIRONMENTAL PERFORMANCE (FOR EXISTING PROJECTS FOR EXPANSION)

3.5 Compliance (pls. take note that this will be double-checked with PCD files)

Law	Violation (check if any)	Type (pls. specify number of times committed)				Type of Admin Violation	Additional Remarks/Status of Compliance
		STANDARD					
		Emission/Effluent/ Discharge	Ambient	Human Impact	Admin/ ECC		
RA 8749	<input type="checkbox"/>	N/A	N/A	N/A	N/A	N/A	N/A
RA 9275	<input type="checkbox"/>	N/A	N/A	N/A	N/A	N/A	N/A
RA 6969	<input type="checkbox"/>	N/A	N/A	N/A	N/A	N/A	N/A
PD 1586	<input type="checkbox"/>	N/A	N/A	N/A	N/A	N/A	N/A
RA 9003	<input type="checkbox"/>	N/A	N/A	N/A	N/A	N/A	N/A

3.6 Number of Valid Complaints

3.6.1 Citizen and NGOs

**PROJECT ENVIRONMENTAL MONITORING AND AUDIT PRIORITIZATION
SCHEME (PEMAPS) QUESTIONNAIRE**

Specify number:

N/A

3.6.2 Others (other Govt. Agencies, Private Institutions)

Specify number:

N/A



(To be filled up by EMB Personnel)

RECOMMENDATION/S:

[Empty rectangular box for recommendations]

Assessed By:

[Empty rectangular box for Assessed By]

Noted By:

[Empty rectangular box for Noted By]



Republic of the Philippines
 DEPARTMENT OF PUBLIC WORKS AND HIGHWAYS
 CENTRAL OFFICE
 Manila

ACCOUNTABILITY STATEMENT OF PROJECT PROPONENT

This is to certify that all the information in the submitted **Project Environmental Monitoring And Audit Prioritization Scheme (PEMAPS)** Questionnaire for the **Proposed Urgent Rehabilitation of damaged Trans-central Roads by the Conflict in Marawi City Sub-project (under the Road Network Development Plan in Conflict Affected Areas in Mindanao Project)** are accurate and complete to the best of our knowledge, and that an objective and thorough assessment of the Project was undertaken in accordance with the dictates of professional and reasonable judgments. Should I /we learn of any information, which would make this Initial Examination (IEE) Checklist Report inaccurate, I shall immediately bring the said information to the attention of DENR-EMB.

In witness whereof, I hereby set my hand this APR 18 2018 day of CITY OF MANILA.

SHARIF MADSMO H. HASIM
 Project Director
 Roads Management Cluster III (Multilateral)

APR 18 2018

SUBSCRIBED AND SWORN TO before me this ___ day of _____ 2018, affiant exhibiting his/her Community Tax Certificate No. _____ issued at _____ on _____.

Doc. No. 489
 Page No. 90
 Book No. V1
 Series No. 270

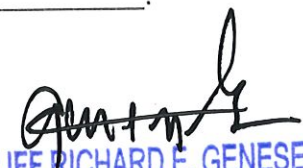
ATTY. CLIFF RICHARD E. GENESELA
 NOTARY PUBLIC CITY OF MANILA / ROLL NO. 49005
 Commission No. 2018-079 Issued on Feb. 28, 2018 Until Dec. 31, 2019 / Manila
 PTR No. 6990775 Issued on Dec. 27, 2017 until Dec. 31, 2018
 IBP No. 022177 Issued on Jan. 05, 2018 Until Dec. 31, 2018
 MCLE No. V-0017770 Valid From April 15, 2016 Until April 14, 2019
 Office Add: Rm. 305, NPC Building Magallanes Drive, Intramuros, Manila



Republic of the Philippines
 DEPARTMENT OF PUBLIC WORKS AND HIGHWAYS
 CENTRAL OFFICE
 Manila

SWORN STATEMENT OF ACCOUNTABILITY OF THE PROPONENT

This is to certify that all the information and commitments in this Initial Environmental Examination (IEE) Checklist Report for the **Proposed Urgent Rehabilitation of Damaged Trans-central Roads by the Conflict in Marawi City Project** are accurate and complete to the best of our knowledge, and that an objective and thorough assessment of the Project was undertaken in accordance with the dictates of professional and reasonable judgments. Should I /we learn of any information, which would make this Initial Examination (IEE) Checklist Report inaccurate, I shall immediately bring the said information to the attention of DENR-EMB.

I hereby certify that no DENR-EMB personnel was directly involved in the preparation of this Initial Environment Examination (IEE) Checklist Report other than to provide procedural and technical advise consistent with the guidelines in the DAO 03-30 Revised Procedural Manual.

I hereby bind myself to answer any penalty that may be imposed arising from any misrepresentation or failure to state material information in this Initial Examination (IEE) Checklist Report.

In witness whereof, I hereby set my hand this 18 day of APRIL at CITY OF MANILA.

[Signature]
 SHARIF MADSMO H. HASIM
 Project Director
 Roads Management Cluster III (Multilateral)

SUBSCRIBED AND SWORN TO before me this 18 day of APRIL 2018, affiant exhibiting his/her Community Tax Certificate No. _____ issued at _____ on _____.

Doc. No. 487
 Page No. 90
 Book No. VI
 Series No. 2018

[Signature]
 ATTY. CLIFF RICHARD E. GENESELA
 NOTARY PUBLIC CITY OF MANILA / ROLL NO. 49005
 Commission No. 2018-079 Issued on Feb. 28, 2018 Until Dec. 31, 2019 / Manila
 PTR No. 6990775 Issued on Dec. 27, 2017 until Dec. 31, 2018
 IBP No. 022177 Issued on Jan. 05, 2018 Until Dec. 31, 2018
 MCLE No. V-0017770 Valid From April 15, 2016 Until April 14, 2019
 Office Add: Rm. 305, NPC Building Magallanes Drive, Intramuros, Manila



Republic of the Philippines
 DEPARTMENT OF PUBLIC WORKS AND HIGHWAYS
 CENTRAL OFFICE
 Manila

REPUBLIC OF THE PHILIPPINES
 CITY OF _____

CITY OF MANILA

AFFIDAVIT OF NO COMPLAINT

That, I Sharif Madsmo H. Hasim, Project Director (RMC III – Multilateral), this Department, applying for an Environmental Compliance Certificate (ECC) for the **Proposed Urgent Rehabilitation of Damaged Trans-central Roads by the Conflict in Marawi City Sub-project (under the Road Network Development Plan in Conflict Affected Areas in Mindanao Project)**.

That I am executing this affidavit stating that there was/were no complaint/s which arise from the stakeholders to establish the aforementioned project. This Affidavit of No Complaint is one of the requirements of the on-line application of ECC.

IN WITNESS WHEREOF, I have hereunto affixed my signature for and on behalf of the DPWH on this _____ day of _____, 2018 at **CITY OF MANILA**.

APR 18 2018

[Handwritten Signature]

SHARIF MADSMO H. HASIM
 Project Director
 Roads Management Cluster III (Multilateral)

SUBSCRIBED AND SWORN TO before me this _____ day of _____ 2018, affiant exhibiting his/her Community Tax Certificate No. _____ issued at _____ on _____.

APR 18 2018

Doc. No. 408
 Page No. 98
 Book No. 1
 Series No. 2018

[Handwritten Signature]
ATTY. CLIFF RICHARD E. GENESELA
 NOTARY PUBLIC CITY OF MANILA / ROLL NO. 49005
 Commission No. 2018-079 Issued on Feb. 28, 2018 Until Dec. 31, 2019 / Manila
 PTR No. 6990775 Issued on Dec. 27, 2017 until Dec. 31, 2018
 IBP No. 022177 Issued on Jan. 05, 2018 Until Dec. 31, 2018
 MCLE No. V-0017770 Valid From April 15, 2016 Until April 14, 2019
 Office Add: Rm. 305, NPC Building Magallanes Drive, Intramuros, Manila



Republic of the Philippines
Autonomous Region in Muslim Mindanao
ISLAMIC CITY OF MARAWI
OFFICE OF THE CITY MAYOR

City Hall, Brgy. Bangon, Marawi City
E-mail: marawigovernment@gmail.com
Tel No. (063) 224-6415 or 0995 632 0858



C E R T I F I C A T I O N

This is to certify that the undersigned has understood the relevance of the **Proposed Urgent Post-conflict Rehabilitation of Damaged Trans-central Roads in Marawi City** to be undertaken by the Department of Public Works and Highways (DPWH).

Issued this 18th day of April 2018 at the Office of the City Mayor, City Hall, Marawi City.

CAMID C. GANDAMRA, SR.
City Administrator

LGU MARAWI
RELEASED
DATE: APRIL 18, 2018

SUBSCRIBED AND SWORN TO before me this 19th day of April 2018, affiant exhibiting his/her Community Tax Certificate No. 03859100 issued at Cotabato City on April 19, 2018.

Doc. No. 117
Page No. 24
Book No. XII
Series No. 2018

ATTY. OMAR YASSER C. SEMA
Notary Public

Commission No. 19
Until December 31, 2019
IBP No. 1071084 1/04/2018
PTR No. 7128037 1/03/2018
Roll No. 56191
TIN 914-058-024



Republic of the Philippines
 Autonomous Region in Muslim Mindanao
 Province of Lanao del Sur



Municipality of Saguiaran

CERTIFICATION FROM THE LOCAL GOVERNMENT UNIT

This is to certify that the undersigned has understood the implications of the **Proposed Urgent Rehabilitation of Damaged Trans-central Roads by the Conflict in Marawi City Project** to be undertaken by the Department of Public Works and Highways (DPWH).

Further, I certify that I have consulted my respective constituents and that they interpose no objection whatsoever to the project.

MONER R. MUTI

Municipal Administrator/OIC

SUBSCRIBED AND SWORN TO before me this ___ day of APR 12, 2018 2018,
 affiant exhibiting his/her Community Tax Certificate No.
03672319 issued at Saguiaran, Lanao Sur on
1-28-18.

Doc. No. 259
 Page No. 53
 Book No. IV
 Series No. 2018

ATTY. SHIDIK T. ABANTAS
 Notary Public, Until Dec 31, 2020
 for the Province of Lanao del Sur and Marawi City
 Roll No. 64031, PTR No. 02582260, Marawi City, 01/30/18
 IRP OR No. 32340, NC 434-18, TIN No. 943-971-856



AUTONOMOUS REGION IN MUSLIM MINDANAO
Province of Lanao del Sur
MUNICIPALITY OF PIAGAPO



Office of the Municipal Mayor

CERTIFICATION

This is to certify that the undersigned has understood the implications of the **Proposed Urgent Rehabilitation of Damaged Trans-central Roads by the Conflict in Marawi City Project** to be undertaken by the Department of Public Works and Highways (DPWH).

Further, I certify that I have consulted my constituents and that they interposed no objection whatsoever to the project.

BY THE AUTHORITY OF THE MUNICIPAL MAYOR:
Engr. Aji L. SUMANDAR

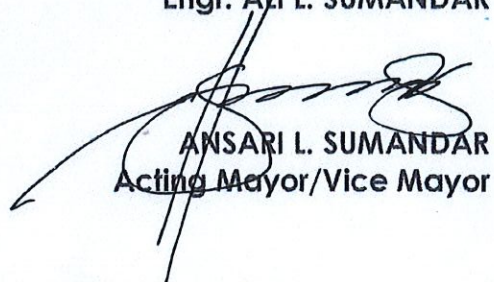
ANSARI L. SUMANDAR
Acting Mayor/Vice Mayor

April 12, 2018
Piagapo, Lanao del Sur

SUBSCRIBED AND SWORN to before me this 13th day of April 2018
2018, affiant exhibiting his/her Community Tax Certificate No.
Employee ID No: 002-2017 issued at Cotabato City on
April 11, 2018.

Doc. No. 210
Page No. 8
Book No. 1
Series No. 2018

ATTY. ASMIRA S. DIEGO
NOTARY PUBLIC FOR COTABATO CITY & MAGUINDANAO
NOTARIAL COMMISSION NO. 35
UNTIL DECEMBER 31, 2018
ROLL OF ATTORNEY NO. 67415
IBP NO. 1071096 • 08 JAN 2018 • COTABATO
MCLE COMPLIANCE NO. VI-000451 • 22 NOV 2017 • COTABATO CITY
PTR NO. 7136933 • 11 JAN 2018 • COTABATO CITY

Piagapo Municipal Complex, Brgy. Bubo, Piagapo, Lanao del Sur 9710
LGU-Piagapo, P.O. Box 45986, Phil. Postal Corp., Iligan City 9200

☎: +63 908.787.6888, +63 908.787.7999
e-Mail: orward_piagapo@yahoo.com URL: www.piagapo.gov.ph



Republic of the Philippines
 Autonomous Region in Muslim Mindanao
 PROVINCE OF LANA O DEL SUR
MUNICIPALITY OF MARANTAO



Office of the Municipal Mayor

CERTIFICATION FROM THE LOCAL GOVERNMENT UNIT

This is to certify that the undersigned has understood the implications of the **Proposed Urgent Rehabilitation of Damaged Trans-central Roads by the Conflict in Marawi City Project** to be undertaken by the Department of Public Works and Highways (DPWH).

Further, I certify that I have consulted my respective constituents and that they interpose no objection whatsoever to the project.

HON. RACMA B. KUDARAT-ABINAL
 MAYOR
 Municipality of Marantao

SUBSCRIBED AND SWORN TO before me this APR 16 2018 day of 2018, affiant exhibiting his/her Community Tax Certificate No. _____ issued at _____ on _____.

Doc. No. 101
 Page No. 19
 Book No. Y
 Series No. 2018

ATTY. SHIDIK T. ABANTAS
 Notary Public since Dec 31, 2020
 at the Province of Lanao del Sur and Marawi City
 Roll No. 64031 PTR No. 0252260, Marawi City, 01-30-17
 SJA OR No. 32340, NC 34-18, TIN No. 043 671 35