

Republic of the Philippines
DEPARTMENT OF PUBLIC WORKS AND HIGHWAYS
CENTRAL OFFICE
Manila

April 17, 2018

HADJI KAHAL Q. KEDTAG

Regional Secretary
DENR-ARMM
Cotabato City

**SUBJECT : Proposed Urgent Rehabilitation of Damaged Trans-Central
Roads by the Conflict in Marawi City Project**

Dear Secretary Kedtag:

In connection with the requirement for the application for Environmental Compliance Certificate (ECC) for the above-mentioned subject, we wish to inform you that this Department will ensure submission of the necessary document/s as Proof of Authority over the Project Site prior to the implementation of the said project.

For the Regional Secretary's information and/or guidance.

Very truly yours,

SHARIF MADSMO H. HASIM

Project Director
RMC-II (Multilateral), UPMO





Initial Environmental Examination Checklist Report

Urgent Rehabilitation of Damaged Transcentral Roads by the Conflict in Marawi City

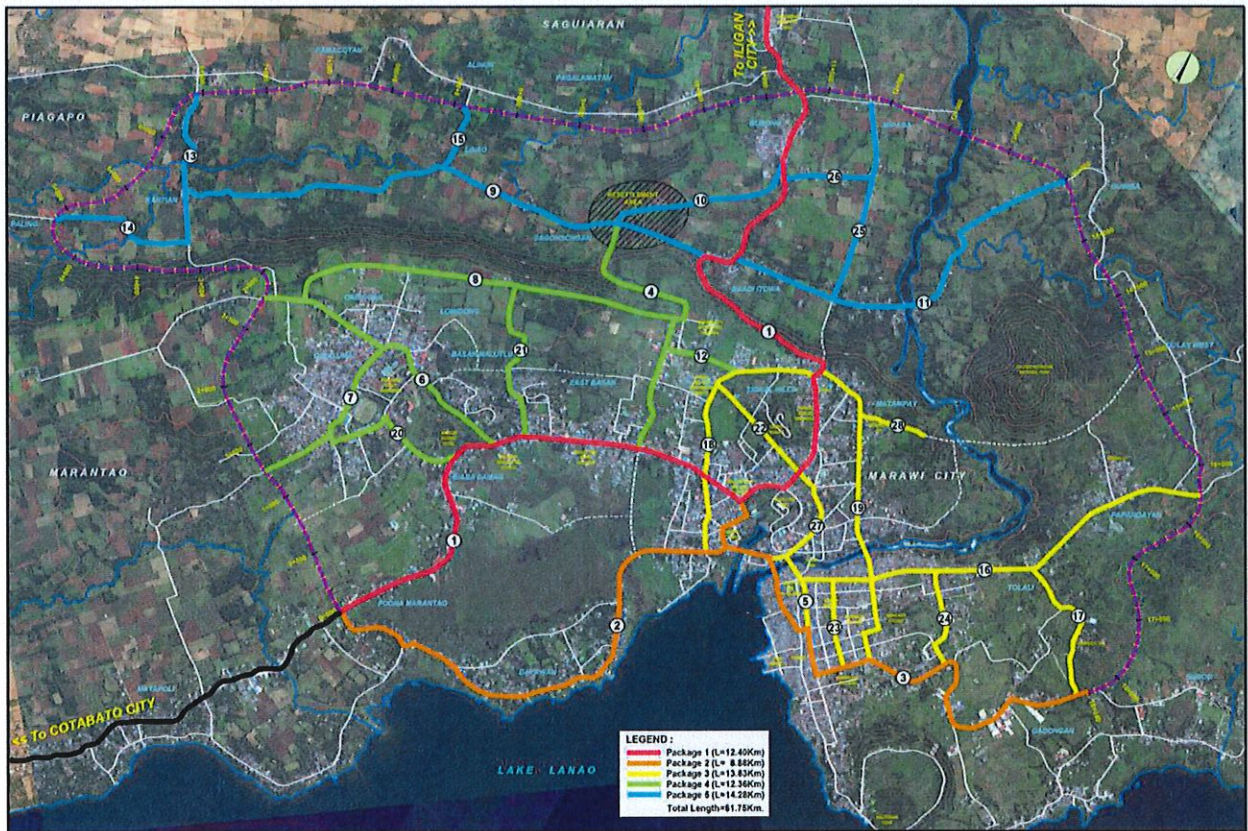

MARAWI TRANSCENTRAL ROAD PACKAGES

Package 2

PROJECT FACT SHEET

Name of the Project	Urgent Rehabilitation of Damaged Trans-central Roads by the Conflict in Marawi City	
Proponent Name	Department of Public Works and Highways	
Proponent Address	DPWH Central Office, Bonifacio Drive, Port Area, Manila, Philippines	
Authorized Representative	Name SHARIF MADSMO H. HASIM	Designation Project Director ,Roads Management Cluster II (Multilateral)
Proponent Means of Contact	Landline No.(02) 632-304-3779	Fax No.(02)304-3000 Email: hasim.sharif_madsmo@dpwh.gov.ph

Project Description

Project Type	Project Type Parameter	Project Size
Infrastructure Project: Rehabilitation/repair of existing road network (road reconstruction and pavement repair)	Length (Package 2) <i>Road 2 – Bangon-Poona Marantao Road (4.58 km)</i> <i>Road 3 – Raya Madaya-Gumisa-Alawiya-Gaunagn Road (4.30 km)</i> Width	Total Length = 8.88 km., no critical slope 6.5 meters (widest at 7m.)

Other Description Details

The project is to support the recovery and revitalization of socio-economic condition of Marawi City which was devastated by the conflict. Primarily, the project will repair and rehabilitate the road infrastructure. It covers the major roads which function as major distributor from urban areas to Marawi City Ring Road. The total length of the road to be covered by the project is about 61.75 km. Part of the Feasibility Study is the conduct of survey to capture the magnitude of damage on the road infrastructure: i) Road inventory and road surface condition survey, ii) Drainage inventory and condition survey and iii) Roughness survey using the DRIMS (Dynamic Response Intelligent Monitoring System). Information generated by these surveys are necessary to come up with road rehabilitation program/plan and its corresponding cost estimates and implementation strategy.

The Japanese Government expressed interest to fund the project through JICA. The selection of roads for rehabilitation was in consultation with DPWH Central Office, DPWH ARMM, concerned LGU (Marawi City Government, Marantao, Saguiaran) and Task Force Bangon Marawi.

Package 2 covers two roads. Road 2 (as defined by the Project) starts in Bacong, Marantao

to Datu Saber in Marawi City. Whereas Road 3 starts in Moncado Colony to Gadungan, both barangays are within Marawi City. The objectives of the road rehabilitation project is to improve mobility and reduce travel time. In effect it can boost trade and economic dynamism with more efficient and lesser cost of transporting goods and local products.

The road project will have impact on existing environment conditions but only during the construction phase. Mitigation measures will be put in place to manage impact both on air and water pollution. Efficiency and conservation measures will also be implemented vis a vis power and water consumption as well as other natural resource uses especially sand and gravel, key materials needed for road construction. The project will have no involuntary resettlement component as it will just rehabilitate the existing road way.

1.1. PROJECT LOCATION AND AREA

Street/Sitio/Barangay: Package 2: Road 2 Road 3	Zone Classification: Residential, Commercial, Institutional, Agricultural, Wasteland Start point (Bacong, Marantao) – End Point (Datu Saber, Marawi City) (4.58 km) Start Point (Moncado Colony, Marawi City) – End Point (Gadungan, Marawi City) (4.30 km)	
Region: ARMM	City/Municipality: Marawi City, Marantao	Province: Lanao del Sur
Total Project Land Area: 97.68 sq.km.(11m RROW x 8.88 km section length)	Total Project Building Footprint Area: 59.50 sq.km.(6.7m carriageway x 8.88 km section length)	

Geographic Coordinates of the Project Area (WGS84)

Package II:

Road 2: (4.58 km) - Bangon-Poona Marantao Road

Area/Section	Longitude	Latitude
(Start) 0 + 000	124.263611111111	7.982777777778
(End) 4 + 600	124.284444444444	8.003611111111

Road 3: (4.30 km) - Raya Madaya-Gumisa-Alawiya-Gadungan Road (Quezon Avenue)

Area/Section	Longitude	Latitude
0 + 000	NA	NA
2 + 475	124.31250000000	8.00444444444

Location Map

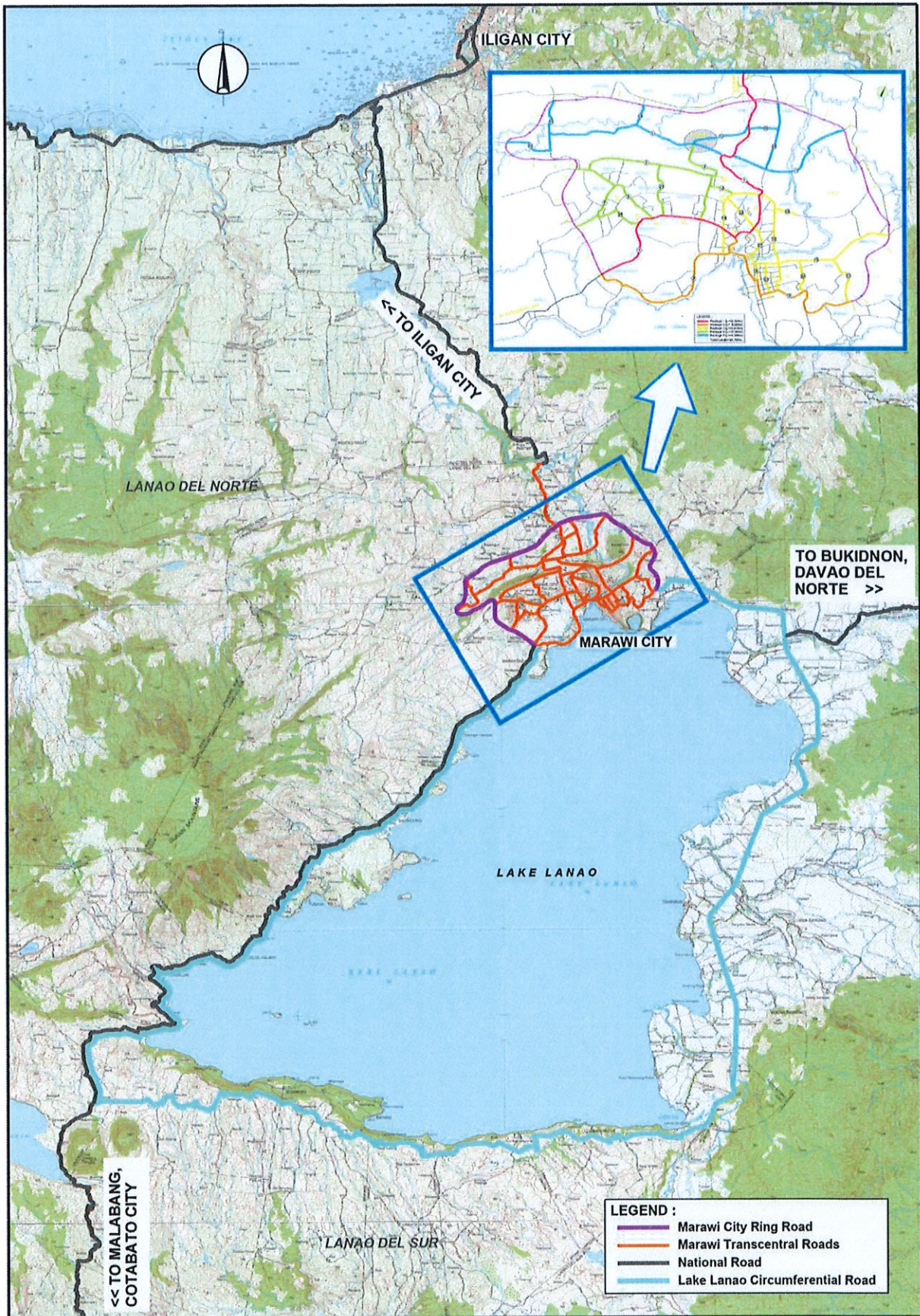

Land Cover Map Lanao del Sur

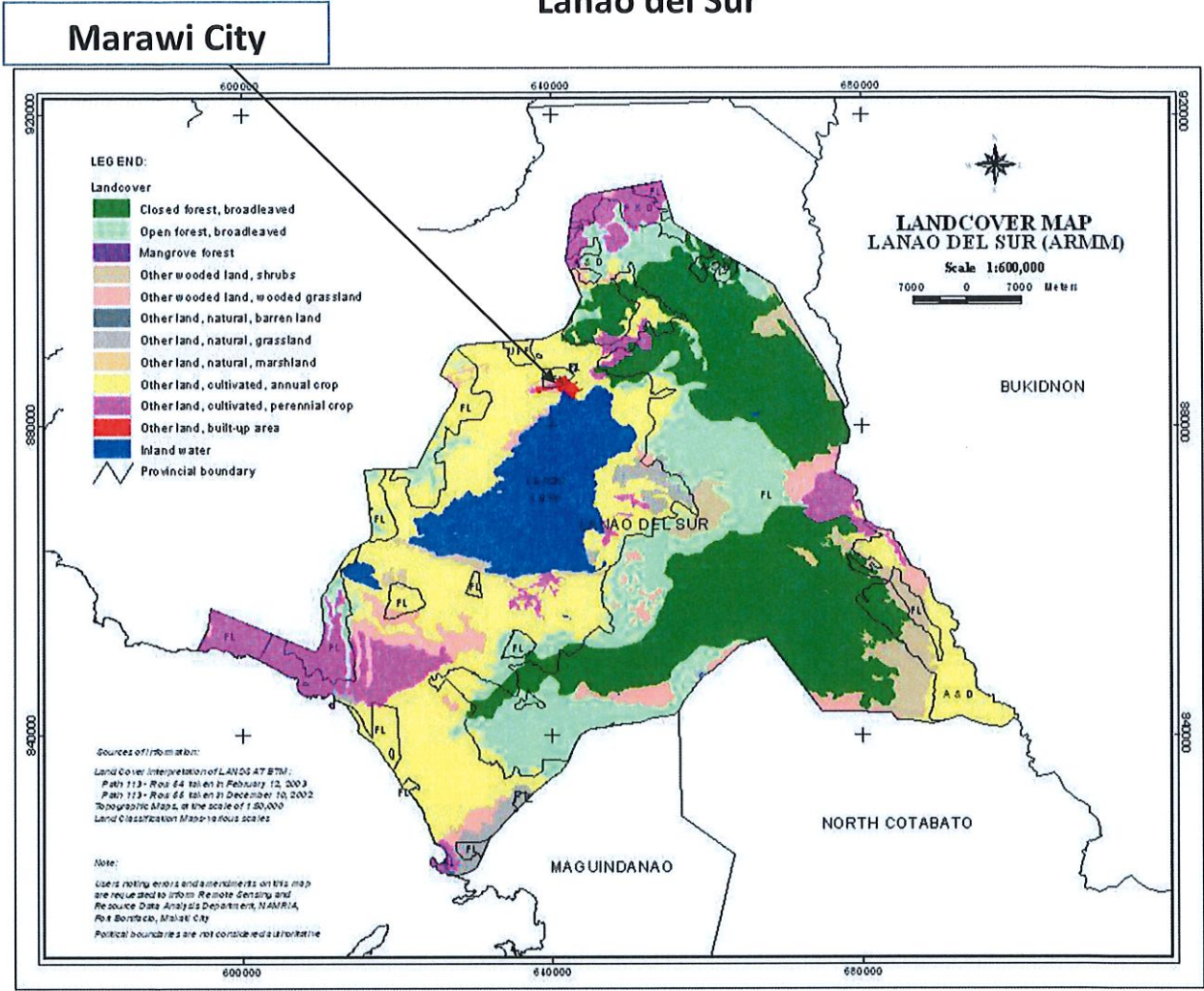

Marawi City and Lake Lanao

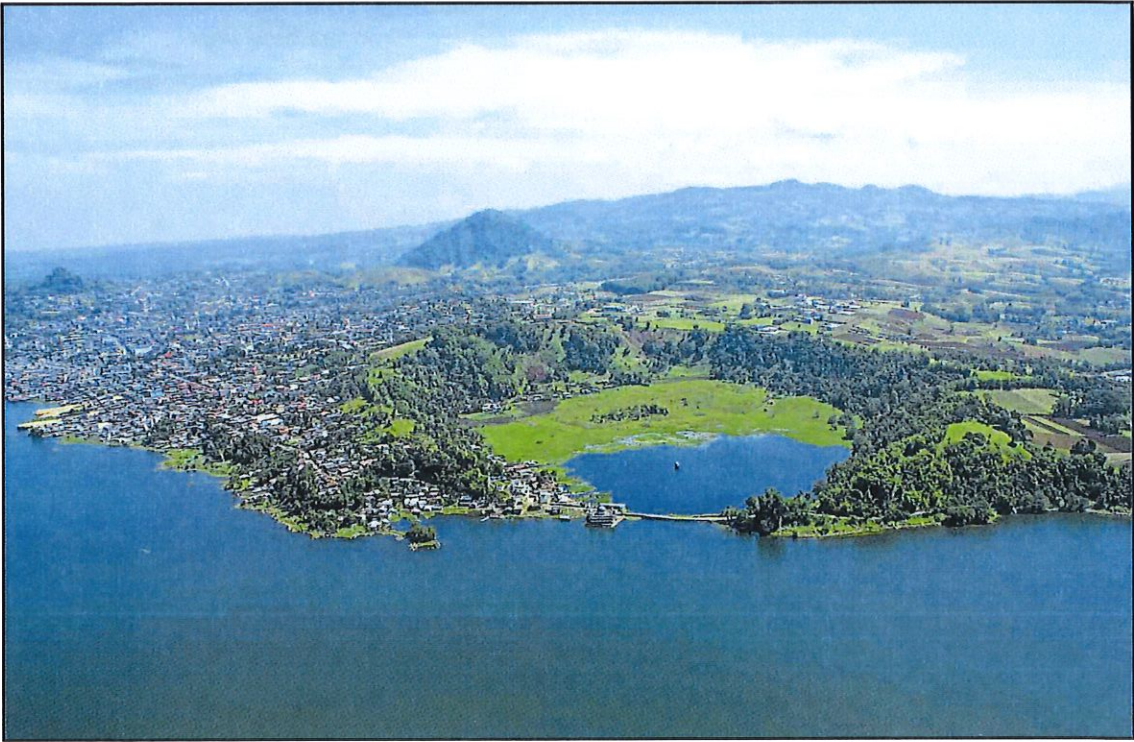

**Topographic Map
Package 2**



Site Plan: Package 2

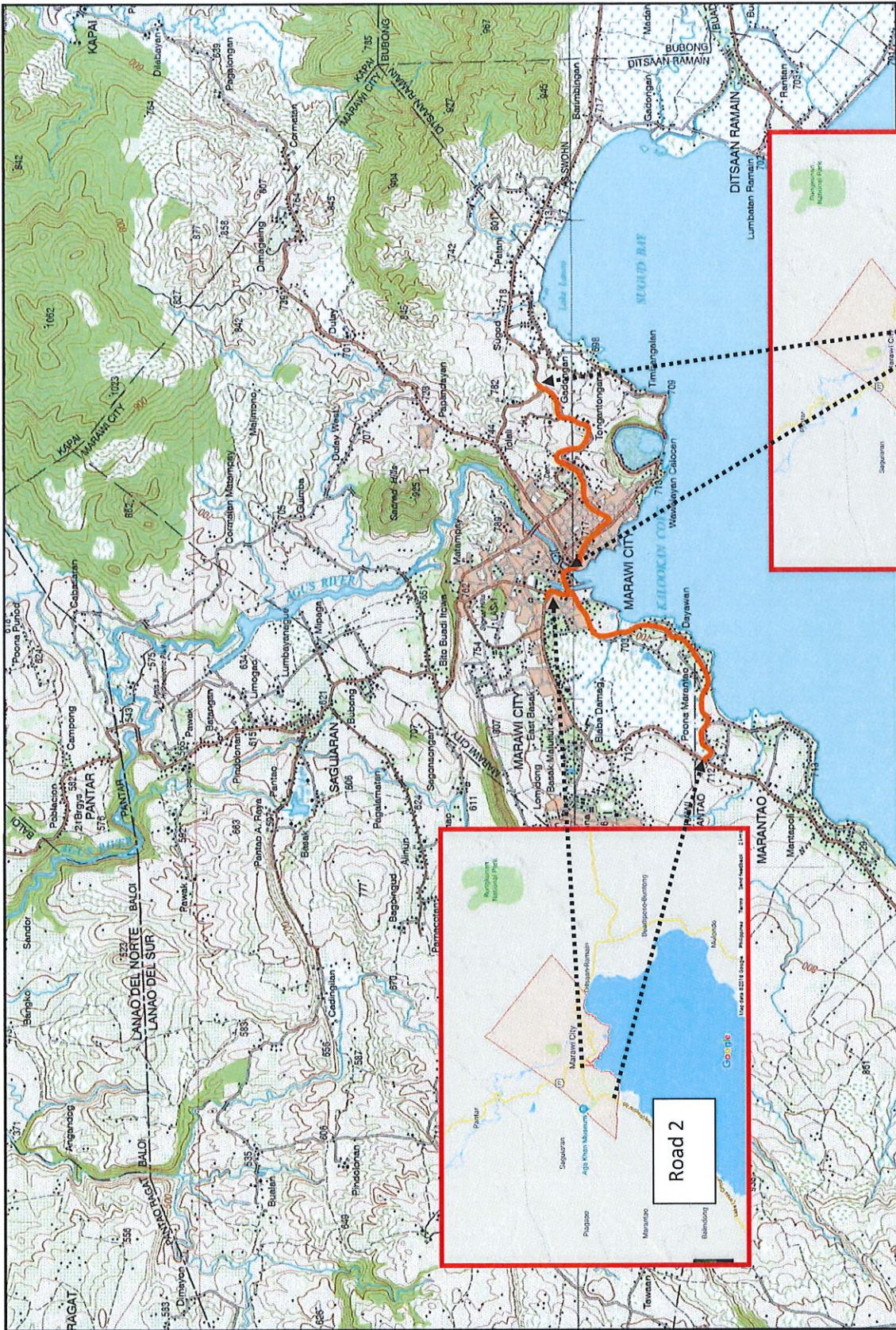

Road Packages and Numbering

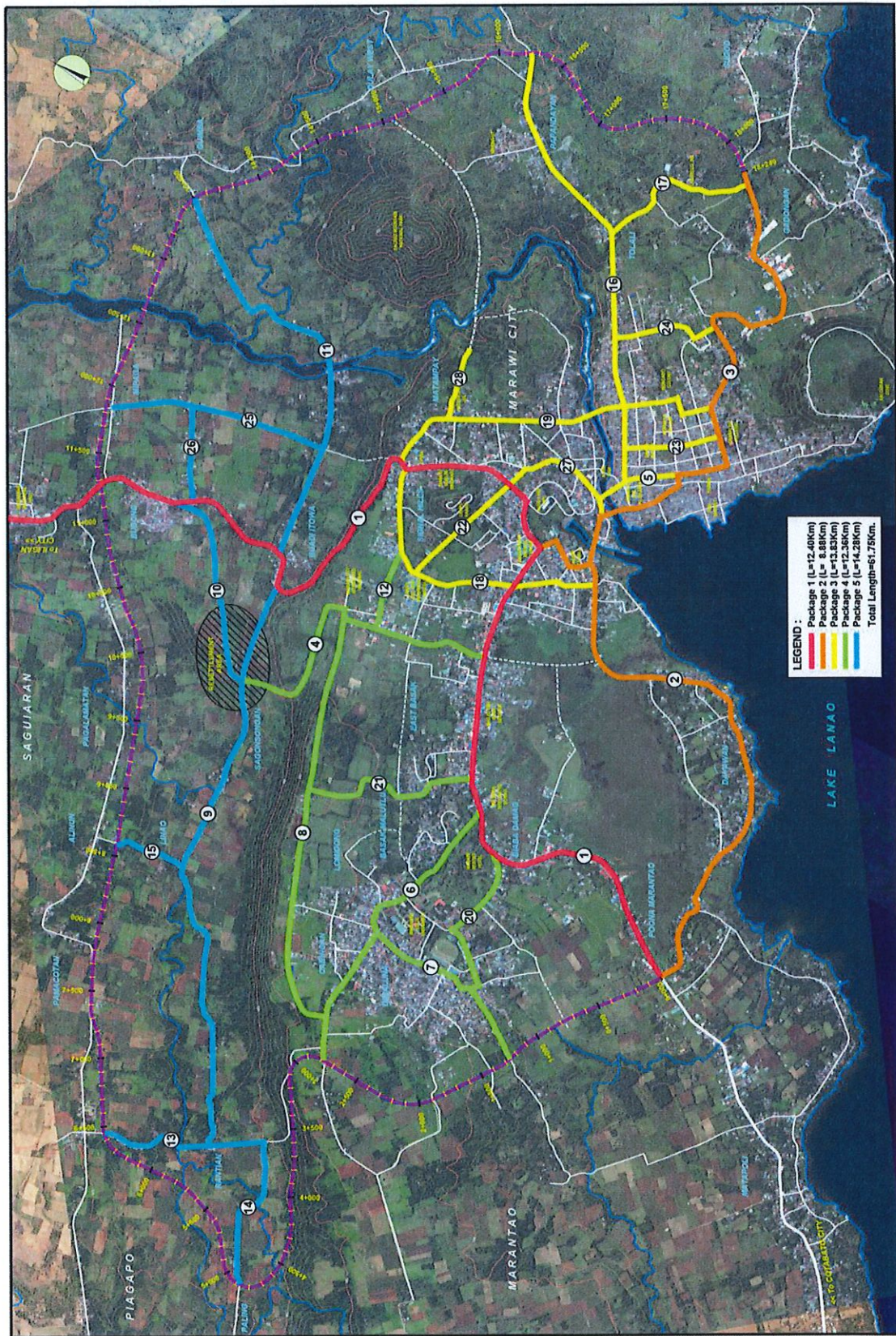

MARAWI TRANSCENTRAL ROADS NUMBERING

Package 2 (Road 2 and 3 Alignment)

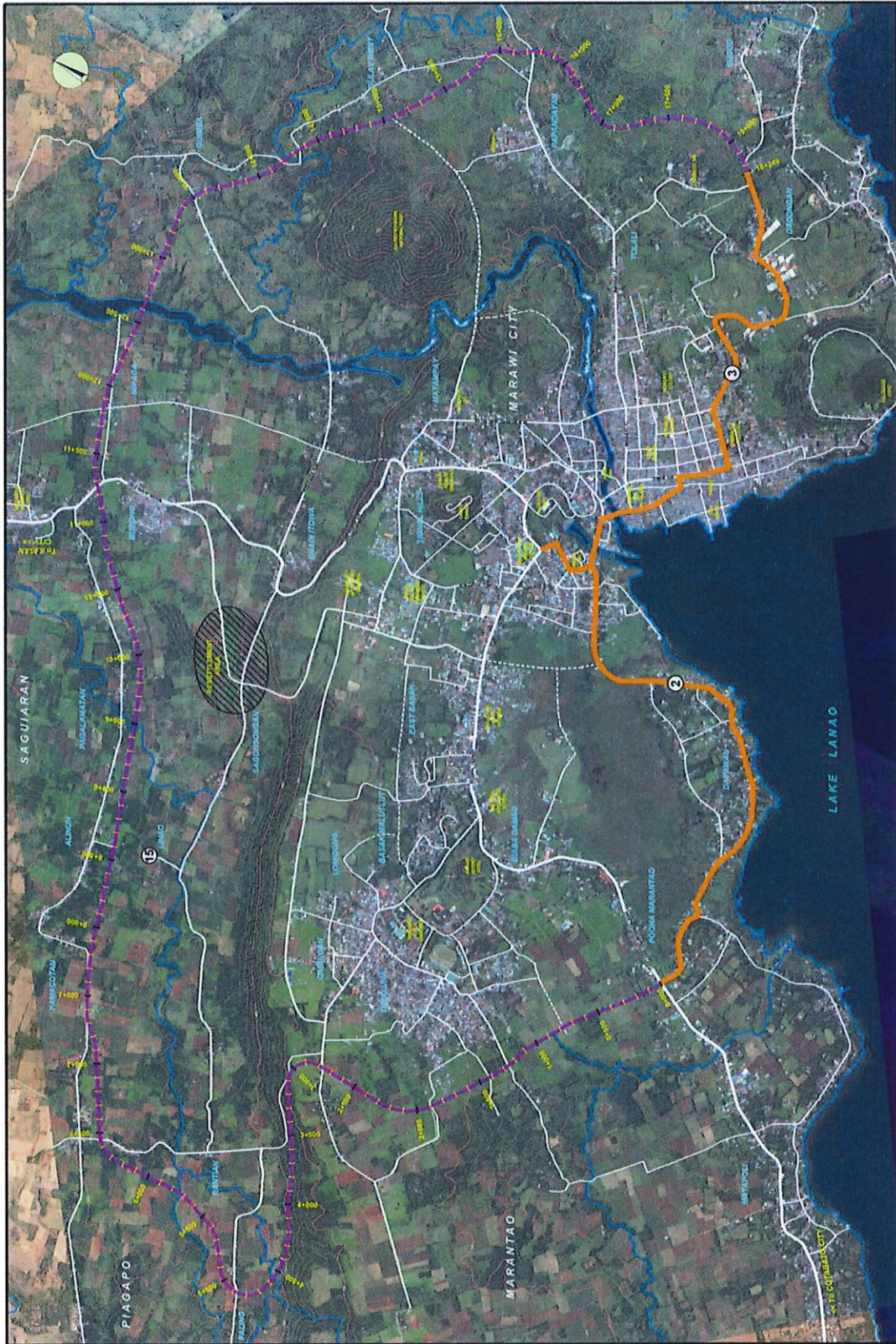

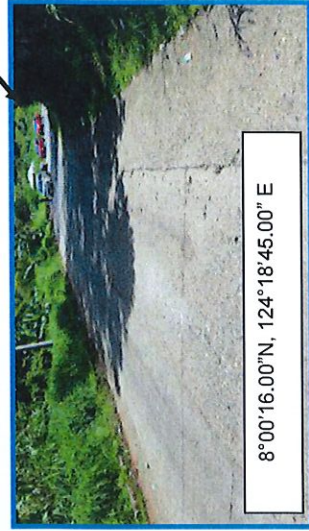
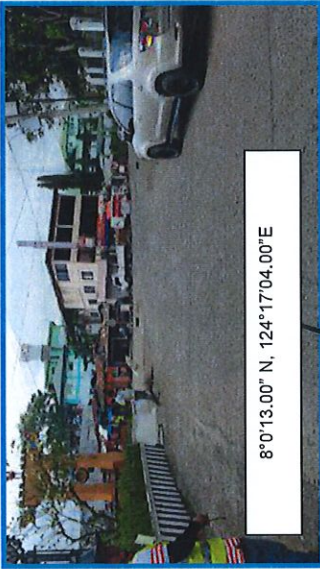
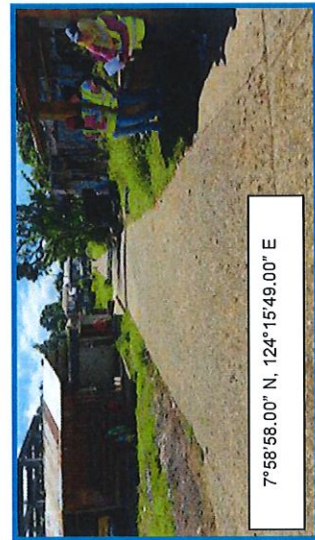

7°58'58.00" N, 124°15'48.00" E

Package 2:

Road 2

Road Name: Bangon-Poona Marantao Road
Length: 4.58 km
Barangay(s) Covered: Marantao
Marawi City

Existing Land Use:
Existing Carriageway Pavement Type:
Slope

Coordinates:
Longitude: 124.263611111111
Latitude: 7.982777777780

Barangay(s): Bacong
City/Municipality: Marantao



Station Beginning:

0 + 000

Bacong, Poona Marantao
Amito Marantao, Dayawan, Pandulohan, Tuca, Lumbaka
Turos
Bacolod Chico, Bangon, Datu Saber (Amai Pak Pak Avenue)
Major: Residential, Commercial **Minor:** Agricultural
Concrete, few Gravel
Generally Flat

Coordinates:
Longitude: 124.284444444444
Latitude: 8.003611111111

Barangay(s): Datu Saber
City/Municipality: Marawi



Station Ending:

4 + 600

Road 3

Road Name: Raya Madaya-Gumisa-Alawiya-Gadungan Road (Quezon Avenue)

Length: 4.30 km

Barangay(s) Covered: Marawi City

Existing Land Use:

Existing Carriageway Pavement Type

Slope:

Longitude:

Latitude:

Barangay:

City/Municipality:

Molondo Colony, Raya Madaya, Gumisa, Alawiya, Gadungan
Major: Residential, commercial **Minor:** Watershed, Institutional

All concrete

Generally flat; gently sloping

Longitude:

Latitude:

Barangay:

City/Municipality:

124.312500000000

8.00444444444444

Gadungan

Marawi

Moncado Colony

Marawi



Station Beginning:

0 + 000

Station Ending:

2 + 475

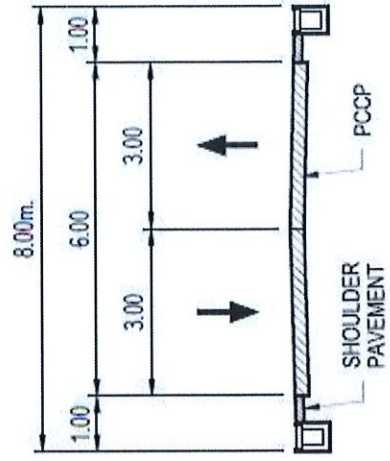

ROAD SECTION 3

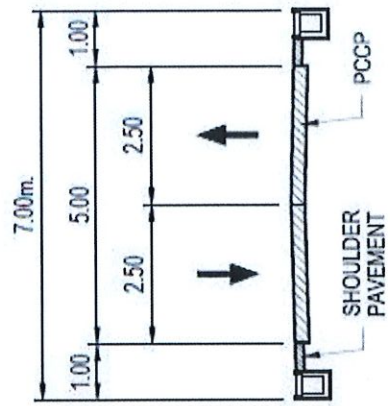

ROAD SECTION 4

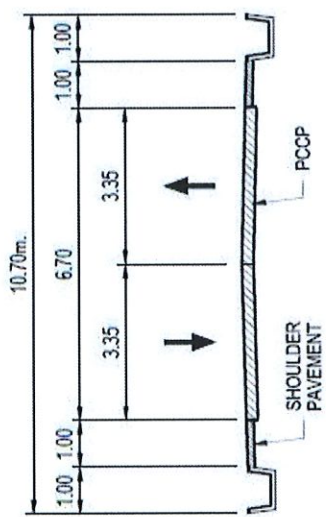

ROAD SECTION 1

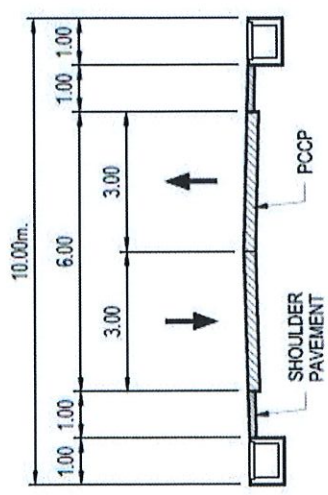

ROAD SECTION 2

Typical Cross Section Layout of Transcentral Roads

Institutional Plan (EIA)

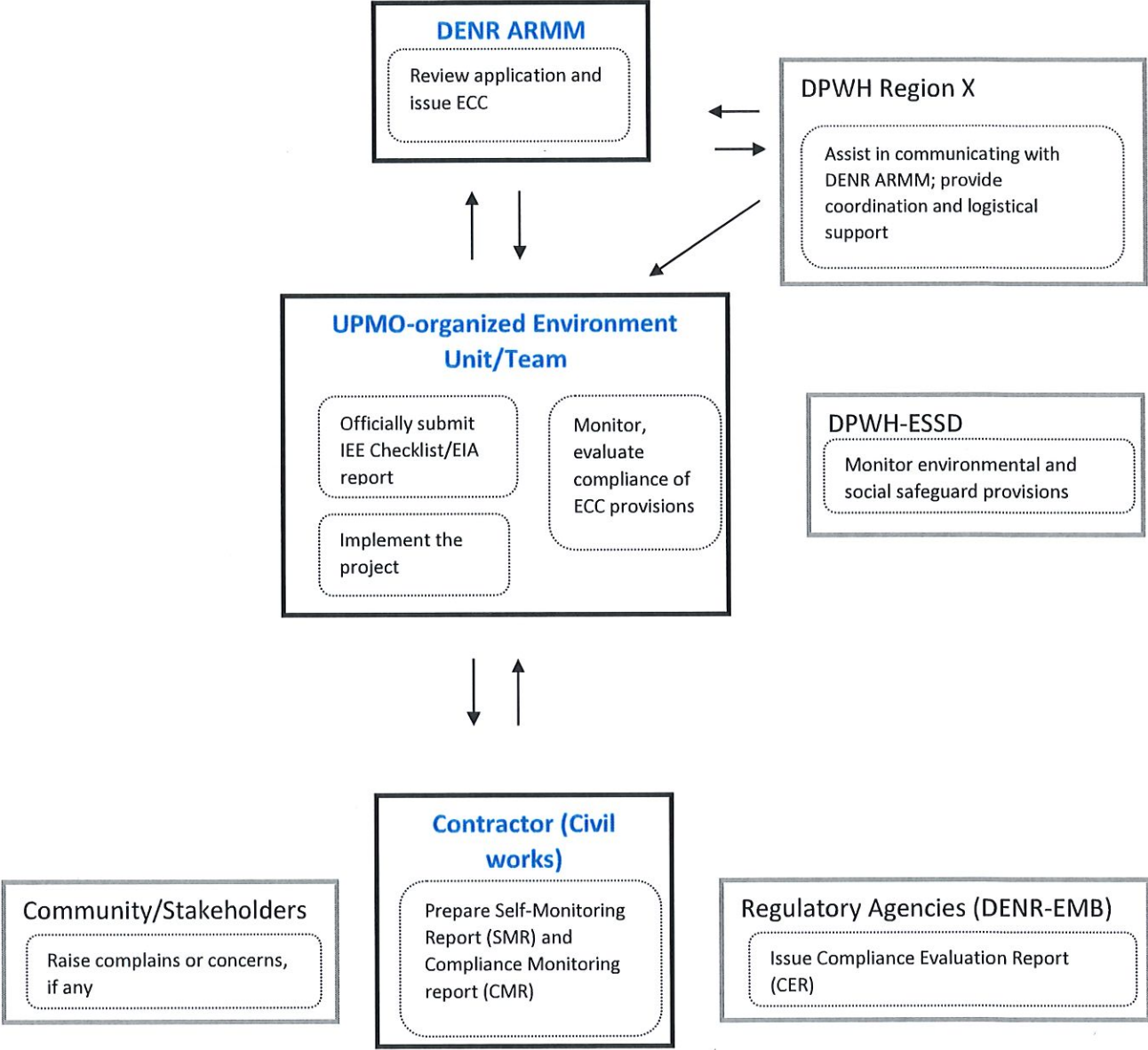

ROAD AND BRIDGE PROJECTS

I.2. PROJECT COMPONENTS

Facilities	No. of Units	Area (sq./M)/ Length (km)/ Capacity	Specification/Description
1. Road	2 (Package 2)	59.5 sq km (6.7m carriageway x 8.88 km section length)	Package 2 total length is 8.88 km
2. Intersections	Road 2: 7 major Road 3: 9 major	30.83 sq km	Road 2: Length: 4.6 km Intersection 1 - Bangon-Poona Marantao Rd cor Gomising St Intersection 2 - Borioogan St cor Gomising St
3. Bridge/s	NA		
4. Access roads/Ramp	NA		
5. Drainage facilities (i.e. Reinforced Concrete Box Culverts (RCBC); Reinforced Concrete Pipe Culverts (RCPC), others)	Reinforced Concrete Pipe Culverts or (RCPC)		Side ditches/pipe culverts are to be provided on both sides of the pavement
6. Associated facilities (i.e. Guardrails, Traffic signs, etc.)	NA		
7. Solid waste management facility	NA		
8. Others, specify ROW	The project will be implemented within the existing road-right-of-way		
9. Others, specify	NA		
10. Others, specify	NA		
11. Others, specify	NA		
12. Others, specify	NA		

Use additional sheets, if necessary

I.3. UTILITIES/REQUIREMENTS (Construction and Operation Phases):

Power/Energy, Water and other Requirements

Project Name: _____

Initial Environmental Examination (IEE) Checklist Report Form for Road and Bridge Projects

Utilities	Estimated Demand/ Consumption (Total)	Source Breakdown	Projected breakdown from Source specified	
			Construction	Operation
Power/Electricity	Construction: 50,887.50 KWh	Grid Domestic consumption (office use and manpower line up)	50,887.50	0 KWh
	Operation: NA KWh	Generator Set		0 KWh
	NA KWh	Others, please specify:		
	Construction: NA m ³ /day	Local Water Utility Provider		
	NA m ³ /day	Well in: (specify location):		
	108,000m ³ (200m ³ /day x 540 days) Note: 18 months construction x 30 m ³ /day	Spring in: (specify location):		
	Operation: NA m ³ /day	River, Lake or other surface water : (specify name & location)	200	
	14,738.59 MT or 35,520.00 m ³ m ³ /day	Others, please specify:		
Sand and Gravel	Construction: 25,580.91 MT or 49,600 m ³ MT	Source: Tagaloan Rver, Cagayan de Oro City, Misamis Oriental	1,659.751 MT x 8.88 km per km road length	MT
Other materials and requirements ...	NA	Source:		m ³ /day

Power/Energy and Water Efficiency Measures (if any)

Project Name: _____

Initial Environmental Examination (IEE) Checklist Report Form for Road and Bridge Projects

Utilities	Proposed Efficiency/Conservation Measures		Estimated Savings for each Project Phase	Estimated Total Savings
Power/ Electricity	Construction		KWh	KWh
	15,266	30% target - energy saving measures in construction site (office and worker's dormitory) - regulate use of equipment and appliances - use of alternative energy sources (solar power an+)	15,266 (estimated based on domestic power usage of project personnel)	15,266
Water	Operation		KWh	KWh
	NA			
Water	Construction		m ³ /day	m ³ /day
	32,400	Water Management System and component programs/activities (target reduction of 30% reduction on water use per total project package)	32,400 (entire construction period)	32,400 (entire construction period)
	Operation	Rainwater collection system Others, please specify:	m ³ /day	m ³ /day
	NA			

I.4. MANPOWER AND TIMELINES OF PROJECT PHASES

Target start of Construction	October 2018
Target Date of Ground-breaking	May 2020
Target Start of Operation	May 2020

Phase	Expertise/Skills	Requirement per Expertise/Skill	Total Requirement per project phase
a. Construction	Project Engineer, Pavement Engineer, Material Engineer	3 x 18 months	54 man-months
	Skilled laborers/workers	6 x 18 months	108 man-months
	Unskilled laborers/workers	8 x 18 months	144 man-months
b. Operation	NA		

Project Name: _____

Initial Environmental Examination (IEE) Checklist Report Form for Road and Bridge Projects

I.5. INDICATIVE PROJECT COST (Initial Investment):

Php US \$ (specify if with foreign investment)

Project Name: _____

II. ENVIRONMENTAL IMPACT MANAGEMENT AND MONITORING PLAN

ROAD AND BRIDGE PROJECTS		ROAD AND BRIDGE PROJECTS		Remarks
Possible Environmental/Social Impacts	Baseline Environment	Preventive/Mitigating Measures	Monitoring Parameters/Implementation	
<p>LAND</p> <p><input checked="" type="checkbox"/> Consistency with land use</p>				
<p>Current land use w/in 1km radius (as per zoning ordinance):</p> <p><input checked="" type="checkbox"/> Residential</p> <p><input checked="" type="checkbox"/> Commercial/ Institutional</p> <p><input type="checkbox"/> Industrial</p> <p><input checked="" type="checkbox"/> Agricultural/ Recreational</p> <p><input type="checkbox"/> Protected Areas</p> <p><input type="checkbox"/> Others, specify</p>	<p>Actual land uses w/in 1km radius:</p> <p><input checked="" type="checkbox"/> Residential</p> <p><input checked="" type="checkbox"/> Commercial/ Institutional</p> <p><input type="checkbox"/> Industrial</p> <p><input checked="" type="checkbox"/> Agricultural/ Recreational</p> <p><input type="checkbox"/> Protected Areas</p> <p><input type="checkbox"/> Others, specify</p>	<p><input checked="" type="checkbox"/> See attached proof of compatibility with land use</p> <p><input type="checkbox"/> Others, specify</p>	<p>Actual land uses w/in 1km radius:</p> <p><input checked="" type="checkbox"/> Residential</p> <p><input checked="" type="checkbox"/> Commercial/ Institutional</p> <p><input type="checkbox"/> Industrial</p> <p><input checked="" type="checkbox"/> Agricultural/ Recreational</p> <p><input type="checkbox"/> Protected Areas</p> <p><input type="checkbox"/> Others, specify</p>	

Initial Environmental Examination (IEE) Checklist Report Form for Road and Bridge Projects

Possible Environmental/Social Impacts	Baseline Environment	Preventive/Mitigating Measures	Monitoring Parameters/Implementation	Remarks
<input checked="" type="checkbox"/> Land tenure / compatibility issue	Identify tenure/ compatibility issues: <input type="checkbox"/> CARP <input type="checkbox"/> CADC/ CADT/ CALC/ CALT <input checked="" type="checkbox"/> ROW <input type="checkbox"/> Informal settlers <input type="checkbox"/> Ecologically sensitive or protected area <input type="checkbox"/> Others, specify	<input checked="" type="checkbox"/> Cost of preventive/mitigating as well as monitoring integrated in the construction /operation cost <input type="checkbox"/> Obtain the following clearances/ permits from concerned agencies: <input type="checkbox"/> Resettlement Plan prepared <input checked="" type="checkbox"/> Provide relocation/disturbance compensation packages <input type="checkbox"/> Ensure participation of IPs in consultations and dialogues <input type="checkbox"/> MOA prepared/signed <input type="checkbox"/> Provide adequate buffer <input type="checkbox"/> Others, specify	<input checked="" type="checkbox"/> Regularly monitor presence/absence of complaints <input checked="" type="checkbox"/> Regular coordination with LGU or appropriate agencies <input type="checkbox"/> Others, specify	
<input checked="" type="checkbox"/> Disturbance to wildlife due to vegetation clearing	Existing vegetation in the area: <input type="checkbox"/> Forestland <input type="checkbox"/> Marshland <input checked="" type="checkbox"/> Grassland <input type="checkbox"/> Mangrove <input type="checkbox"/> Wetland	<input checked="" type="checkbox"/> Comply with conditions of DENR/LGU SLUP, Tree Cutting Permit, ROW, PCA Permit <input checked="" type="checkbox"/> Limit land clearing as much as possible <input checked="" type="checkbox"/> Provide temporary fencing for vegetation that will be retained	<input checked="" type="checkbox"/> Annual inspection of area replanted/ re-vegetated <input type="checkbox"/> Others, specify	

Project Name: _____

Initial Environmental Examination (IEE) Checklist Report Form for Road and Bridge Projects

Possible Environmental/Social Impacts	Baseline Environment	Preventive/Mitigating Measures	Monitoring Parameters/Implementation	Remarks
<input type="checkbox"/> Change in surface landform/ topography/ terrain/slope <input type="checkbox"/> Soil Erosion	<input checked="" type="checkbox"/> Others, specify patches of trees and shrubs	<input checked="" type="checkbox"/> Cost of preventive/mitigating as well as monitoring integrated in the construction /operation cost <input checked="" type="checkbox"/> Promote restoration of damaged or destroyed vegetation where possible (e.g., tree planting) <input type="checkbox"/> Others, specify	<input type="checkbox"/> Regular inspection of slope protection measures in erosion-prone areas <input type="checkbox"/> Regular inspection for new eroded areas near the site <input type="checkbox"/> Others, specify	For the entire road package slope is flat with few gently sloping to rolling terrain
<input type="checkbox"/> Change in surface landform/ topography/ terrain/slope <input type="checkbox"/> Soil Erosion	Slope: <input type="checkbox"/> Flat (0-3%) <input type="checkbox"/> Gently sloping to rolling (3-18%) <input type="checkbox"/> Steep (>18%) Is the project site located in an area identified by MGB/ PAG-ASA/ PHIVOLCS as hazard prone? <input type="checkbox"/> Yes <input checked="" type="checkbox"/> No	Considering the natural hazards and climate projections in the area: <input type="checkbox"/> Employ erosion control and slope protection measures <input type="checkbox"/> Designate a spoils storage area, with topsoil set aside for later use and allow maximum re-use of spoils <input type="checkbox"/> Construct during dry season <input type="checkbox"/> Stabilize embankment with grasses or other soil cover <input type="checkbox"/> Conduct Engineering Geological and Geo-hazard Assessment (EGGA) and implement corresponding recommendation <input type="checkbox"/> Others, specify	<input type="checkbox"/> Regular inspection of slope protection measures in erosion-prone areas <input type="checkbox"/> Regular inspection for new eroded areas near the site <input type="checkbox"/> Others, specify	For the entire road package slope is flat with few gently sloping to rolling terrain

Project Name: _____

Initial Environmental Examination (IEE) Checklist Report Form for Road and Bridge Projects

Possible Environmental/Social Impacts	Baseline Environment	Preventive/Mitigating Measures	Monitoring Parameters/Implementation	Remarks
Building of structure and improper solid waste disposal leading to: <ul style="list-style-type: none"> <input type="checkbox"/> Impairment of visual aesthetics <input type="checkbox"/> Devaluation of land values 	Solid Waste Management Scheme in the area: <ul style="list-style-type: none"> <input type="checkbox"/> SLF <input type="checkbox"/> MRF <input type="checkbox"/> Composting <input checked="" type="checkbox"/> Regular Collection of Solid Wastes Presence of visually significant landforms/landscape/structures? <ul style="list-style-type: none"> <input type="checkbox"/> Yes <input checked="" type="checkbox"/> No 	<input checked="" type="checkbox"/> Cost of preventive/mitigating as well as monitoring integrated in the construction /operation cost <ul style="list-style-type: none"> <input checked="" type="checkbox"/> Implement recovery re-use and recycling of waste materials <input checked="" type="checkbox"/> Provide receptacles / bins for solid wastes <input checked="" type="checkbox"/> Composting of Organic Wastes <input checked="" type="checkbox"/> Coordinate with the municipal / city waste collectors <input type="checkbox"/> Implement landscaping and other beautification measures <input checked="" type="checkbox"/> Provide adequate buffer <input type="checkbox"/> Compensate adjacent property owners <input type="checkbox"/> Others, specify 	<input type="checkbox"/> Daily inspection of waste handling including segregation in waste/recycling bins <ul style="list-style-type: none"> <input checked="" type="checkbox"/> Weekly inspection of waste accumulation and disposal <input type="checkbox"/> Regular inspection of landscaping and other beautification activities <input type="checkbox"/> Regular monitoring of buffer zones <input type="checkbox"/> Regular monitoring for presence/absence of complaints from adjacent property owners <input type="checkbox"/> Others, specify 	<input checked="" type="checkbox"/> Cost integrated in the construction/ operation cost
WATER				
<input checked="" type="checkbox"/> Increased siltation due to project activities <ul style="list-style-type: none"> <input checked="" type="checkbox"/> Water quality degradation <input type="checkbox"/> Others, specify 	Specify nearest water body: Lanao Lake, Agus River Distance to nearest water body: <ul style="list-style-type: none"> <input checked="" type="checkbox"/> 0 to less than 0.5 km 	<input checked="" type="checkbox"/> Set up proper and adequate sanitary facilities <ul style="list-style-type: none"> <input checked="" type="checkbox"/> Ensure strict observance of proper waste handling and disposal and proper sanitation including by the contractor and its workers <input type="checkbox"/> Set up silt trap (Gabions, 	Regular (ocular) inspection of: <ul style="list-style-type: none"> <input checked="" type="checkbox"/> Drainage / canal systems <input checked="" type="checkbox"/> Sanitation facilities Monitoring of ambient water during construction for: <ul style="list-style-type: none"> <input checked="" type="checkbox"/> Turbidity and/or silted condition <input checked="" type="checkbox"/> Floating wastes or debris 	

Project Name: _____

Initial Environmental Examination (IEE) Checklist Report Form for Road and Bridge Projects

Possible Environmental/Social Impacts	Baseline Environment	Preventive/Mitigating Measures	Monitoring Parameters/Implementation	Remarks												
<div style="border: 1px solid black; height: 40px;"></div>	<input checked="" type="checkbox"/> 0.5 to 1 km <input type="checkbox"/> More than 1 km Classification of nearest water body: <table border="1" style="width: 100%; border-collapse: collapse;"> <tr> <td><input checked="" type="checkbox"/> Freshwater</td> <td><input type="checkbox"/> Marine/ coastal water</td> </tr> <tr> <td><input type="checkbox"/> AA</td> <td><input type="checkbox"/> SA</td> </tr> <tr> <td><input checked="" type="checkbox"/> A</td> <td><input checked="" type="checkbox"/> SB</td> </tr> <tr> <td><input checked="" type="checkbox"/> B</td> <td><input checked="" type="checkbox"/> SC</td> </tr> <tr> <td><input checked="" type="checkbox"/> C</td> <td><input type="checkbox"/> SD</td> </tr> <tr> <td><input type="checkbox"/> D</td> <td></td> </tr> </table>	<input checked="" type="checkbox"/> Freshwater	<input type="checkbox"/> Marine/ coastal water	<input type="checkbox"/> AA	<input type="checkbox"/> SA	<input checked="" type="checkbox"/> A	<input checked="" type="checkbox"/> SB	<input checked="" type="checkbox"/> B	<input checked="" type="checkbox"/> SC	<input checked="" type="checkbox"/> C	<input type="checkbox"/> SD	<input type="checkbox"/> D		<input checked="" type="checkbox"/> Cost of preventive/mitigating as well as monitoring integrated in the construction /operation cost Fascines)/settling ponds to minimize downstream siltation <input type="checkbox"/> Others, specify <div style="border: 1px solid black; height: 80px; width: 100%;"></div>		
<input checked="" type="checkbox"/> Freshwater	<input type="checkbox"/> Marine/ coastal water															
<input type="checkbox"/> AA	<input type="checkbox"/> SA															
<input checked="" type="checkbox"/> A	<input checked="" type="checkbox"/> SB															
<input checked="" type="checkbox"/> B	<input checked="" type="checkbox"/> SC															
<input checked="" type="checkbox"/> C	<input type="checkbox"/> SD															
<input type="checkbox"/> D																
	Current use of nearest/receiving water body: <input checked="" type="checkbox"/> Fishery <input checked="" type="checkbox"/> Tourist Zone / Park <input checked="" type="checkbox"/> Recreational <input type="checkbox"/> Industrial <input checked="" type="checkbox"/> Agricultural <input type="checkbox"/> Others, specify: <div style="border: 1px solid black; height: 40px; width: 100%;"></div>															
	Distance of project area to the nearest well used: <input checked="" type="checkbox"/> 0 to less than 0.5 km															

Project Name: _____

Initial Environmental Examination (IEE) Checklist Report Form for Road and Bridge Projects

Possible Environmental/Social Impacts	Baseline Environment	Preventive/Mitigating Measures	Monitoring Parameters/Implementation	Remarks
<input checked="" type="checkbox"/> Competition in water use <input type="checkbox"/> Depletion of water resources	<input checked="" type="checkbox"/> 0.5 to 1 km <input type="checkbox"/> More than 1 km Use of nearest well: <input checked="" type="checkbox"/> Drinking/Domestic <input type="checkbox"/> Industrial <input checked="" type="checkbox"/> Agricultural Size of population using water source: <input type="checkbox"/> ≤ 1,000 persons <input checked="" type="checkbox"/> >1,000 and ≤ 5,000 persons <input type="checkbox"/> >5,000 persons Available/nearest water source. <input checked="" type="checkbox"/> Deep well <input checked="" type="checkbox"/> Water district/LGU <input type="checkbox"/> Surface water <input type="checkbox"/> Others, specify <div style="border: 1px solid black; height: 40px; width: 100%;"></div> Current Use of water source : <input checked="" type="checkbox"/> Fishery <input type="checkbox"/> Tourist Zone / Park <input type="checkbox"/> Recreational <input type="checkbox"/> Industrial <input checked="" type="checkbox"/> Agricultural <input checked="" type="checkbox"/> Others, specify	<input checked="" type="checkbox"/> Cost of preventive/mitigating as well as monitoring integrated in the construction /operation cost <input checked="" type="checkbox"/> Implement rainwater harvesting and similar measures as an alternative source of water <input checked="" type="checkbox"/> Observe water conservation measures <input type="checkbox"/> Others, specify <div style="border: 1px solid black; height: 40px; width: 100%;"></div>	<input checked="" type="checkbox"/> Regular monitoring for presence/absence of complaints <input checked="" type="checkbox"/> Regular coordination with concerned agencies <input checked="" type="checkbox"/> Regular monitoring for occurrences of water shortages <input type="checkbox"/> Others, specify <div style="border: 1px solid black; height: 40px; width: 100%;"></div>	

Project Name: _____

Initial Environmental Examination (IEE) Checklist Report Form for Road and Bridge Projects

Possible Environmental/Social Impacts	Baseline Environment	Preventive/Mitigating Measures		Monitoring Parameters/Implementation		Remarks
		<input checked="" type="checkbox"/> Cost of preventive/mitigating as well as monitoring integrated in the construction /operation cost				
	domestic					
<input type="checkbox"/> Increased occurrence of flooding	Is the project site located in an area identified by MGB/ PAG-ASA as flood prone? <input checked="" type="checkbox"/> Yes <input type="checkbox"/> No	<input checked="" type="checkbox"/> Use appropriate design for project facilities including appropriate drainage mechanism considering the existing local drainage system. <input checked="" type="checkbox"/> Regularly remove debris and other materials that may obstruct water flow <input type="checkbox"/> Others, specify	<input checked="" type="checkbox"/> Regular monitoring for presence/absence of complaints <input checked="" type="checkbox"/> Regular coordination with concerned agencies <input checked="" type="checkbox"/> Regular monitoring for increased frequency of flooding <input type="checkbox"/> Others, specify			
AIR / NOISE						
Air quality degradation	Distance to nearest community: <input checked="" type="checkbox"/> 0 to less than 0.5 km <input type="checkbox"/> 0.5 to 1 km <input type="checkbox"/> More than 1 km	<input checked="" type="checkbox"/> Properly operate and maintain all emission sources (e.g. vehicles, generator, etc) <input checked="" type="checkbox"/> Install appropriate air pollution control device/s <input checked="" type="checkbox"/> Strictly enforce good housekeeping practices <input checked="" type="checkbox"/> Control vehicle speed to lessen	<input checked="" type="checkbox"/> Regular monitoring for presence/absence of complaints Regular (ocular) inspection of: <input checked="" type="checkbox"/> Absence of white or black smoke from vehicles, generator, etc.			

Project Name: _____

Initial Environmental Examination (IEE) Checklist Report Form for Road and Bridge Projects

Possible Environmental/Social Impacts	Baseline Environment	Preventive/Mitigating Measures	Monitoring Parameters/Implementation	Remarks
		<input checked="" type="checkbox"/> Cost of preventive/mitigating as well as monitoring integrated in the construction /operation cost suspension of road dust <input checked="" type="checkbox"/> Conduct water spraying to suppress dust sources and minimize discomfort to nearby residents <input checked="" type="checkbox"/> Use covered vehicles to deliver materials that may generate dust <input type="checkbox"/> Others, specify <div style="border: 1px solid black; height: 20px; width: 100%;"></div>	<input checked="" type="checkbox"/> Presence of truck cover during deliveries	
<input checked="" type="checkbox"/> Nuisance due to noise generation	Distance to nearest community: <input checked="" type="checkbox"/> 0 to less than 0.5 km <input type="checkbox"/> 0.5 to 1 km <input type="checkbox"/> More than 1 km	<input checked="" type="checkbox"/> Properly operate and maintain all noise sources (e.g., vehicles, generator, etc.) <input checked="" type="checkbox"/> Install, when applicable, the appropriate noise control device/s (e.g., mufflers, silencer, sound barriers, etc.) <input checked="" type="checkbox"/> Implement appropriate operating hours <input type="checkbox"/> Provide adequate buffer and/or planting of trees <input type="checkbox"/> Others, specify	<input checked="" type="checkbox"/> Regular monitoring for presence/absence of complaints <input type="checkbox"/> Regular monitoring of buffer zones <input type="checkbox"/> Quarterly monitoring of noise level <input type="checkbox"/> Others, specify <div style="border: 1px solid black; height: 40px; width: 100%;"></div>	

Project Name: _____

Initial Environmental Examination (IEE) Checklist Report Form for Road and Bridge Projects

Possible Environmental/Social Impacts	Baseline Environment	Preventive/Mitigating Measures <input checked="" type="checkbox"/> Cost of preventive/mitigating as well as monitoring integrated in the construction /operation cost	Monitoring Parameters/ Implementation	Remarks
PEOPLE				
<input type="checkbox"/> Displacement of residents including indigenous people (if any) in the project site and within its vicinity <input checked="" type="checkbox"/> Enhanced employment and/or livelihood opportunities <input type="checkbox"/> Reduced employment and/or livelihood opportunities <input checked="" type="checkbox"/> Increased revenues for LGU <input type="checkbox"/> Disruption/ Competition in delivery of public services (e.g., education, peace and order, etc.) <input checked="" type="checkbox"/> Enhanced delivery of public services (e.g., education, peace and order, etc.) <input checked="" type="checkbox"/> Increase in traffic volume and worsening of traffic flow	Size of population of host barangay: <input type="checkbox"/> ≤ 1,000 persons <input type="checkbox"/> >1,000 and ≤ 5,000 persons <input checked="" type="checkbox"/> >5,000 persons Classification of host barangay: <input checked="" type="checkbox"/> Urban <input checked="" type="checkbox"/> Rural Employment/Livelihood Opportunity Rate in the host Municipality: <input type="checkbox"/> High <input checked="" type="checkbox"/> Low Description: <div style="border: 1px solid black; height: 40px; width: 100%;"></div> Available services within/near the host barangay: <input checked="" type="checkbox"/> Schools (e.g., elementary, high school, college)	<div style="border: 1px solid black; height: 100px; width: 100%;"></div>	<div style="border: 1px solid black; height: 100px; width: 100%;"></div>	<div style="border: 1px solid black; height: 100px; width: 100%;"></div>
<input type="checkbox"/> Displacement of residents including indigenous people (if any) in the project site and within its vicinity <input checked="" type="checkbox"/> Enhanced employment and/or livelihood opportunities <input type="checkbox"/> Reduced employment and/or livelihood opportunities <input checked="" type="checkbox"/> Increased revenues for LGU <input type="checkbox"/> Disruption/ Competition in delivery of public services (e.g., education, peace and order, etc.) <input checked="" type="checkbox"/> Enhanced delivery of public services (e.g., education, peace and order, etc.) <input checked="" type="checkbox"/> Increase in traffic volume and worsening of traffic flow	Size of population of host barangay: <input type="checkbox"/> ≤ 1,000 persons <input type="checkbox"/> >1,000 and ≤ 5,000 persons <input checked="" type="checkbox"/> >5,000 persons Classification of host barangay: <input checked="" type="checkbox"/> Urban <input checked="" type="checkbox"/> Rural Employment/Livelihood Opportunity Rate in the host Municipality: <input type="checkbox"/> High <input checked="" type="checkbox"/> Low Description: <div style="border: 1px solid black; height: 40px; width: 100%;"></div> Available services within/near the host barangay: <input checked="" type="checkbox"/> Schools (e.g., elementary, high school, college)	<input type="checkbox"/> Provide relocation/disturbance compensation packages <input checked="" type="checkbox"/> Prioritize local residents for employment <input checked="" type="checkbox"/> Promptly pay local taxes and other financial obligations <input checked="" type="checkbox"/> Regularly coordinate with LGU <input checked="" type="checkbox"/> Conduct prior consultation and coordination to minimize disruption of daily domestic activities <input type="checkbox"/> Ensure participation of IPs in consultations and dialogues and consider IP rights and cultural practices in the provision of relocation/disturbance compensation packages <input checked="" type="checkbox"/> Provide appropriate traffic/warning signs, lighting, etc. <input type="checkbox"/> Others, specify	<input checked="" type="checkbox"/> Regular monitoring for presence/absence of complaints <input checked="" type="checkbox"/> Regular coordination with LGU <input type="checkbox"/> Others, specify <div style="border: 1px solid black; height: 40px; width: 100%;"></div>	<input checked="" type="checkbox"/> Cost integrated in the construction/ operation cost <div style="border: 1px solid black; height: 40px; width: 100%;"></div>

Initial Environmental Examination (IEE) Checklist Report Form for Road and Bridge Projects

Possible Environmental/Social Impacts	Baseline Environment	Preventive/Mitigating Measures	Monitoring Parameters/Implementation	Remarks
<p><input type="checkbox"/> Destruction/disturbance of physical cultural resources. <i>(✓ if project site has been identified to have such by NM, NHCP, NCAA and LGUs)</i></p> <p><input type="checkbox"/> Impacts on community safety</p>	<p><input checked="" type="checkbox"/> Health facilities (e.g., clinics, hospitals, etc.)</p> <p><input checked="" type="checkbox"/> Peace and order (e.g., police outpost, Brgy. Tanod, etc.)</p> <p><input checked="" type="checkbox"/> Recreation and sports facilities</p> <p><input checked="" type="checkbox"/> Others, specify</p> <p>Mosque</p>	<p><input checked="" type="checkbox"/> Cost of preventive/mitigating as well as monitoring integrated in the construction /operation cost</p> <p>Preparation of traffic management/re-routing plan in close coordination with the city government and barangay since an increase in traffic volume is anticipated</p> <p>Provide traffic diversion schemes and traffic management regulations for the project</p>	<p><input type="checkbox"/> Regular coordination with NM, NHCP, NCAA and LGU</p>	
<p><input type="checkbox"/> Impacts on community safety</p>	<p>Physical Cultural resources within the vicinity of the project site:</p> <p>No</p> <p>Structures posing safety risk to the community:</p>	<p><input type="checkbox"/> Implement appropriate protocols based on NM, NHCP, NCAA and LGU guidelines including those for chance finds (if any). Specify:</p> <p>Regularly coordinate with LGU</p> <p>Provide appropriate warning signs, lighting and barricades, whenever practicable</p> <p>Observe proper housekeeping</p> <p>Provide on-site medical services for any emergency.</p> <p>Participate in public awareness programs on health and safety</p>	<p><input checked="" type="checkbox"/> Regular monitoring for presence/absence of complaints</p> <p><input checked="" type="checkbox"/> Regular coordination with LGU</p> <p><input checked="" type="checkbox"/> Regular submission of reports to concerned agency</p>	

Project Name: _____

Initial Environmental Examination (IEE) Checklist Report Form for Road and Bridge Projects

Possible Environmental/Social Impacts	Baseline Environment	Preventive/Mitigating Measures	Monitoring Parameters/Implementation	Remarks
		<input checked="" type="checkbox"/> Cost of preventive/mitigating as well as monitoring integrated in the construction /operation cost <input checked="" type="checkbox"/> Implement appropriate safety programs for both community and workers <input type="checkbox"/> Others, specify	<input type="checkbox"/> Others, specify	

Project Name: _____

ROAD AND BRIDGE PROJECTS

III. ABANDONMENT /DECOMMISSIONING/REHABILITATION INFORMATION
(If Applicable)

Project Life or Service: years

Alternatives for future use of the project area after abandonment:

Road rehabilitation program is a long term effort that impacts road network design and mobility of people. If deem relevant in overall transport network, a particular road can have along project/service life given the continued repair and improvement.

Abandonment Plan (general) to include management plan for the projected cumulative/long term project impacts such as:

- remediation of contaminated soil and water resources,
- land restoration
- proper dismantling/abandonment of facilities/ equipment
- others, please specify :

The proponent will ensure that construction will not pose any harm to the environment. It will observe its own environmental management system and adheres to government regulations and standards in terms of pollution or emission levels. It will coordinate and mobilize local stakeholders (community members) ensure management of potential sources of pollution and avoid environmental degradation during and after construction.

**PROJECT ENVIRONMENTAL MONITORING AND AUDIT PRIORITIZATION
SCHEME (PEMAPS) QUESTIONNAIRE**

Project Name:	Urgent Rehabilitation of Damaged Trans-central Roads by the Conflict in Marawi City
Project Location:	Marawi City, Lanao del Sur
ECC Reference No.:	
Proponent:	Department of Public Works and Highways-Unified Project Management Office (DPWH-UPMO)
Pollution Control Officer:	Designated PCO
Tel. No./Fax No./E-mail:	(+632) 304-3555
Project Type:	Infrastructure Project: Road Reconstruction and Pavement Repair of Existing Road Network
Project Status:	Feasibility Study

I. PROJECT CONSIDERATIONS

1.1 Size and Type

61.75 km

1.1.1 Size based on number of employees

Specify number of employees:

approximately ____ (construction stage)

1.1.2 Type:

ECP (in either ECA or Non-ECA)

Non-ECP but in ECA

Non-ECP and Non-ECA

1.2 Waste Generation and Management

1.2.1 Enumerate Waste Type and Specify Quantity of Wastes generated in your facility. (Identify /Enumerate)

Category	Waste	Type		Quantity
		Hazardous	Non-Hazardous	

**PROJECT ENVIRONMENTAL MONITORING AND AUDIT PRIORITIZATION
SCHEME (PEMAPS) QUESTIONNAIRE**

Air	Waste 1 TSP/PM10	X		(units: MT/yr) minimal
	Waste 2 SOx	X		minimal
	Waste N NOx	X		minimal
Liquid	Used oil		X	(units: m ³ /yr)
Solid	Construction debris		X	(units: tons/yr)
	Garbage		X	

1.3 Pollution Control System (PCS)

1.3.1 Enumerate PCS or Waste Management Method Used in your facility.
(Identify /Enumerate)

Category	PCS/Waste Management Method Used	Remarks
Air	PCS 1 TSP/PM10 emission control measures (within emission guideline national values/standard/limit)	Water sprinkle to control dust Covering of trucks when transporting gravel or cements +
	PCS 2 SOx emission control measures	Regular maintenance of heavy equipment

ANNEX 2-7d

**PROJECT ENVIRONMENTAL MONITORING AND AUDIT PRIORITIZATION
SCHEME (PEMAPS) QUESTIONNAIRE**

	PCS N NOx emission control measures	Regular maintenance of heavy equipment; check quality of fuel
Liquid	Primary Used oil management measures	Store in properly sealed and labeled containers Manage run-offs to avoid siltation/clogging of the +
	Secondary Management of pollutants (run-offs) washed from construction sites	Water pollution control measure (proper drainage and piling protection; enclosure of spoils)
	Tertiary 	
Solid	Construction debris management measures	Haul by accredited haulers Built in the company's EMS +
	Garbage/solid waste management	Proper segregation and disposal.

II. PATHWAYS

2.1 Prevailing wind towards barrio or city? (mark the corresponding point) Yes No

2.2 Rainfall (impacts surface & groundwater pathways)

2.2.1 Average annual net rainfall:

Specify amount:

2791 mm (www.climate-data.org)

2.2.2 Maximum 24-hour rainfall:

Specify amount:

6.35 mm

2.3 Terrain (select one and mark) Flat Steep

2.4 Is the facility located in a flood-prone area? (select one and mark) Yes No

2.5 Ground Water

ANNEX 2-7d

**PROJECT ENVIRONMENTAL MONITORING AND AUDIT PRIORITIZATION
SCHEME (PEMAPS) QUESTIONNAIRE**

Depth of groundwater table (meter)

(select one and mark)

0 to less than 3

3 to 10

Greater than 10

III. RECEIVING MEDIA/RECEPTORS

3.1 Air (Distance to nearest community)

(select one and mark)

0 to less than 0.5 km

0.5 to 1 km

Greater than 1 km

3.2 Receiving Surface Water Body

3.2.1 Distance to receiving surface water:

(select one and mark)

0 to less than 0.5 km

0.5 to 1 km

Greater than 1 km

3.2.2 Size of population using receiving surface water

Specify number:

>5,000 persons

3.2.3 Fresh Water

3.2.3.1 Classification of fresh water:

(select one and mark)

**PROJECT ENVIRONMENTAL MONITORING AND AUDIT PRIORITIZATION
SCHEME (PEMAPS) QUESTIONNAIRE**

- AA
- A
- B
- C
- D

3.2.3.2 Size of fresh water body:

Specify size:

Agus River, 34 km (length); Lake Lanao, 340sq km (surface area)

3.2.3.3 Economic value of water use (may select more than one of the criteria below)

- Drinking
- Domestic
- Recreational
- Fishery
- Industrial
- Agricultural

3.2.4 Salt water

3.2.4.1 Classification of salt water (select one and mark)

- SA
- SB
- SC

**PROJECT ENVIRONMENTAL MONITORING AND AUDIT PRIORITIZATION
SCHEME (PEMAPS) QUESTIONNAIRE**

SD

3.2.4.2 Economic value of water use

(may select more than one of the criteria below)

Fishery

Tourist zone or park

Recreational

Industrial

3.3 Ground Water

3.3.1 Distance to nearest recharge area

(select one and mark)

0 to less than 0.5 km

0.5 to 1 km

Greater than 1 km

3.3.2 Distance to nearest well used

(select one and mark)

0 to less than 0.5 km

0.5 to 1 km

Greater than 1 km

3.3.3 Groundwater use within the nearest well

(may select more than one of the criteria below)

Drinking

**PROJECT ENVIRONMENTAL MONITORING AND AUDIT PRIORITIZATION
SCHEME (PEMAPS) QUESTIONNAIRE**

Industrial

Agricultural

3.4 Land

3.4.1 Indicate current/actual land uses within 0.5 km radius: (may select more than one of the criteria below)

Residential

Commercial/Institutional

Industrial

Agricultural/Recreational

Protected Area

3.4.2 Potential/proposed land uses within 0.5 km (may select more than one of the criteria below)

Residential

Commercial/Institutional

Industrial

Agricultural/Recreational

Protected Area

3.4.3 Number of affected Environmentally Critical Areas within 1 km:

ANNEX 2-7d

**PROJECT ENVIRONMENTAL MONITORING AND AUDIT PRIORITIZATION
SCHEME (PEMAPS) QUESTIONNAIRE**

Specify number:

2

3.4.4 Distance to nearest ECA

(select one and mark)

0 to less than 0.5km

0.5 to 1 km

Greater than 1 km

IV. ENVIRONMENTAL PERFORMANCE (FOR EXISTING PROJECTS FOR EXPANSION)

3.5 Compliance (pls. take note that this will be double-checked with PCD files)

Law	Violation (check if any)	Type (pls. specify number of times committed)				Type of Admin Violation	Additional Remarks/Status of Compliance
		STANDARD					
		Emission/Effluent/ Discharge	Ambient	Human Impact	Admin/ ECC		
RA 8749	<input type="checkbox"/>	N/A	N/A	N/A	N/A	N/A	N/A
RA 9275	<input type="checkbox"/>	N/A	N/A	N/A	N/A	N/A	N/A
RA 6969	<input type="checkbox"/>	N/A	N/A	N/A	N/A	N/A	N/A
PD 1586	<input type="checkbox"/>	N/A	N/A	N/A	N/A	N/A	N/A
RA 9003	<input type="checkbox"/>	N/A	N/A	N/A	N/A	N/A	N/A

3.6 Number of Valid Complaints

3.6.1 Citizen and NGOs

ANNEX 2-7d

**PROJECT ENVIRONMENTAL MONITORING AND AUDIT PRIORITIZATION
SCHEME (PEMAPS) QUESTIONNAIRE**

Specify number:

N/A

3.6.2 Others (other Govt. Agencies, Private Institutions)

Specify number:

N/A



(To be filled up by EMB Personnel)

RECOMMENDATION/S:

Assessed By:

Noted By:



Republic of the Philippines
 DEPARTMENT OF PUBLIC WORKS AND HIGHWAYS
 CENTRAL OFFICE
 Manila

ACCOUNTABILITY STATEMENT OF PROJECT PROPONENT

This is to certify that all the information in the submitted **Project Environmental Monitoring And Audit Prioritization Scheme (PEMAPS)** Questionnaire for the **Proposed Urgent Rehabilitation of damaged Trans-central Roads by the Conflict in Marawi City Sub-project (under the Road Network Development Plan in Conflict Affected Areas in Mindanao Project)** are accurate and complete to the best of our knowledge, and that an objective and thorough assessment of the Project was undertaken in accordance with the dictates of professional and reasonable judgments. Should I /we learn of any information, which would make this Initial Examination (IEE) Checklist Report inaccurate, I shall immediately bring the said information to the attention of DENR-EMB.

In witness whereof, I hereby set my hand this 18th day of April ²⁰¹⁸ at City of Manila.

 SHARIF MADSMO H. HASIM
 Project Director
 Roads Management Cluster III (Multilateral)

SUBSCRIBED AND SWORN TO before me this 18th day of April 2018, affiant exhibiting his/her Community Tax Certificate No. _____ issued at _____ on _____.

Doc. No. 409
 Page No. 90
 Book No. 1
 Series No. 2010

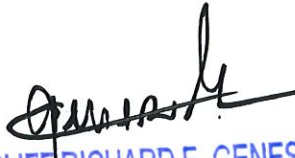
 ATTY. CLIFF RICHARD E. GENESELA
 NOTARY PUBLIC CITY OF MANILA / ROLL NO. 49005
 Commission No. 2018-079 Issued on Feb. 28, 2018 Until Dec. 31, 2019 / Manila
 PTR No. 6390775 Issued on Dec. 27, 2017 until Dec. 31, 2018
 IBP No. 022177 Issued on Jan. 05, 2018 Until Dec. 31, 2018
 MCLE No. V-0017770 Valid From April 15, 2016 Until April 14, 2019
 Office Add: Rm. 305, NPC Building Magallanes Drive, Intramuros, Manila



Republic of the Philippines
 DEPARTMENT OF PUBLIC WORKS AND HIGHWAYS
 CENTRAL OFFICE
 Manila

SWORN STATEMENT OF ACCOUNTABILITY OF THE PROPONENT

This is to certify that all the information and commitments in this Initial Environmental Examination (IEE) Checklist Report for the **Proposed Urgent Rehabilitation of Damaged Trans-central Roads by the Conflict in Marawi City Project** are accurate and complete to the best of our knowledge, and that an objective and thorough assessment of the Project was undertaken in accordance with the dictates of professional and reasonable judgments. Should I /we learn of any information, which would make this Initial Examination (IEE) Checklist Report inaccurate, I shall immediately bring the said information to the attention of DENR-EMB.

I hereby certify that no DENR-EMB personnel was directly involved in the preparation of this Initial Environment Examination (IEE) Checklist Report other than to provide procedural and technical advise consistent with the guidelines in the DAO 03-30 Revised Procedural Manual.

I hereby bind myself to answer any penalty that may be imposed arising from any misrepresentation or failure to state material information in this Initial Examination (IEE) Checklist Report.

In witness whereof, I hereby set my hand this 18 day of APR at CITY OF MANILA.

 SHARIE MADSIMO H. HASIM
 Project Director
 Roads Management Cluster III (Multilateral)

SUBSCRIBED AND SWORN TO before me this 18 day of APR 2018, affiant exhibiting his/her Community Tax Certificate No. _____ issued at _____ on _____.

Doc. No. 107
 Page No. 90
 Book No. 1
 Series No. 2018

 ATTY. CLIFF RICHARD E. GENESELA
 NOTARY PUBLIC CITY OF MANILA / ROLL NO. 49005
 Commission No. 2018-079 Issued on Feb. 28, 2018 Until Dec. 31, 2019 / Manila
 PTR No. 6990775 Issued on Dec. 27, 2017 until Dec. 31, 2018
 IBP No. 022177 Issued on Jan. 05, 2016 Until Dec. 31, 2018
 MCLE No. V-0017770 Valid From April 15, 2016 Until April 14, 2019
 Office Add: Rm. 303, NPC Building Magalhães Drive, Alabang, Manila



Republic of the Philippines
 DEPARTMENT OF PUBLIC WORKS AND HIGHWAYS
CENTRAL OFFICE
 Manila

REPUBLIC OF THE PHILIPPINES
 CITY OF Manila

AFFIDAVIT OF NO COMPLAINT

That, I Sharif Madsmo H. Hasim, Project Director (RMC III - Multilateral), this Department, applying for an Environmental Compliance Certificate (ECC) for the **Proposed Urgent Rehabilitation of Damaged Trans-central Roads by the Conflict in Marawi City Sub-project (under the Road Network Development Plan in Conflict Affected Areas in Mindanao Project)**.

That I am executing this affidavit stating that there was/were no complaint/s which arise from the stakeholders to establish the aforementioned project. This Affidavit of No Complaint is one of the requirements of the on-line application of ECC.

IN WITNESS WHEREOF, I have hereunto affixed my signature for and on behalf of the DPWH on this 18th day of April, 2018 at Manila.

SHARIF MADSMO H. HASIM
 Project Director
 Roads Management Cluster III (Multilateral)

SUBSCRIBED AND SWORN TO before me this 18th day of April 2018, affiant exhibiting his/her Community Tax Certificate No. _____ issued at _____ on _____.

Doc. No. 400
 Page No. 90
 Book No. V1
 Series No. 2710

ATTY. CLIFF RICHARD E. GENESELA
 NOTARY PUBLIC CITY OF MANILA / ROLL NO. 49005
 Commission No. 2018-079 Issued on Feb. 28, 2018 Until Dec. 31, 2019 / Manila
 PTR No. 6990775 Issued on Dec. 27, 2017 until Dec. 31, 2018
 IBP No. 022177 Issued on Jan. 05, 2018 Until Dec. 31, 2018
 MCLE No. V-0017770 Valid From April 15, 2016 Until April 14, 2019
 Office Add: Rm. 305, NPC Building Magallanes Drive, Intramuros, Manila



Republic of the Philippines
Autonomous Region in Muslim Mindanao
ISLAMIC CITY OF MARAWI
OFFICE OF THE CITY MAYOR

City Hall, Brgy. Bangon, Marawi City
E-mail: marawigovernment@gmail.com
Tel No. (063) 224-6415 or 0995 632 0858



C E R T I F I C A T I O N

This is to certify that the undersigned has understood the relevance of the **Proposed Urgent Post-conflict Rehabilitation of Damaged Trans-central Roads in Marawi City** to be undertaken by the Department of Public Works and Highways (DPWH).

Issued this 18th day of April 2018 at the Office of the City Mayor, City Hall, Marawi City.

CAMID C. GANDAMRA, SR.
City Administrator

LGU MARAWI
RELEASED
DATE: APRIL 18, 2018

SUBSCRIBED AND SWORN TO before me this 19th day of April 2018, affiant exhibiting his/her Community Tax Certificate No. 09859100 issued at Cotabato City on April 19, 2018.

Doc. No. 117
Page No. 24
Book No. XII
Series No. 2018

ATTY. OMAR YASSER C. SEMA
Notary Public
Commission No. 19
Until December 31, 2019
IBP No. 1071084 1/04/2018
PTR No. 7128037 1/03/2018
Roll No. 56191
TIN 914-058-024



Republic of the Philippines
 Autonomous Region in Muslim Mindanao
 Province of Lanao del Sur



Municipality of Saguiaran

CERTIFICATION FROM THE LOCAL GOVERNMENT UNIT

This is to certify that the undersigned has understood the implications of the **Proposed Urgent Rehabilitation of Damaged Trans-central Roads by the Conflict in Marawi City Project** to be undertaken by the Department of Public Works and Highways (DPWH).

Further, I certify that I have consulted my respective constituents and that they interpose no objection whatsoever to the project.

MONER R. MUTI

Municipal Administrator/OIC

SUBSCRIBED AND SWORN TO before me this ___ day of APR 12 2018 2018,
 affiant exhibiting his/her Community Tax Certificate No.
03672319 issued at Saguiaran, Lanao Sur on
1-28-18.

Doc. No. 259
 Page No. 53
 Book No. IV
 Series No. 2018

ATTY. SHIDIK T. ABANTAS
 Notary Public, Until Dec 31, 2020
 for the Province of Lanao del Sur and Marawi City
 Roll No. 64031, PTR No. 02582260, Marawi City, 01/30/18
 IRP OR No. 32340, NC 434-18, TIN No. 940-971-857



AUTONOMOUS REGION IN MUSLIM MINDANAO
 Province of Lanao del Sur
MUNICIPALITY OF PIAGAPO



Office of the Municipal Mayor

CERTIFICATION

This is to certify that the undersigned has understood the implications of the **Proposed Urgent Rehabilitation of Damaged Trans-central Roads by the Conflict in Marawi City Project** to be undertaken by the Department of Public Works and Highways (DPWH).

Further, I certify that I have consulted my constituents and that they interposed no objection whatsoever to the project.

**BY THE AUTHORITY OF THE MUNICIPAL MAYOR:
 Engr. Ayl L. SUMANDAR**

(Signature)
**ANSARI L. SUMANDAR
 Acting Mayor/Vice Mayor**

April 12, 2018
 Piagapo, Lanao del Sur

SUBSCRIBED AND SWORN to before me this 13th day of April 2018
 2018, affiant exhibiting his/her Community Tax Certificate No.
Employee ID No: 002-2017 issued at Cotabato City on
April 11, 2018

Doc. No. 210
 Page No. 8
 Book No. 1
 Series No. 2018

(Signature)
ATPY. ASMIRA S. DIEGO
 NOTARY PUBLIC FOR COTABATO CITY & MAGUINDANAO
 NOTARIAL COMMISSION NO. 35
 UNTIL DECEMBER 31, 2018
 ROLL OF ATTORNEY NO. 67415
 IBP NO. 1071096 • 08 JAN 2018 • COTABATO
 MCLE COMPLIANCE NO. VI-000451 • 22 NOV 2017 • COTABATO CITY
 PTR NO. 7136933 • 11 JAN 2018 • COTABATO CITY



Republic of the Philippines
 Autonomous Region in Muslim Mindanao
 PROVINCE OF LANA O DEL SUR
MUNICIPALITY OF MARANTAO



Office of the Municipal Mayor

CERTIFICATION FROM THE LOCAL GOVERNMENT UNIT

This is to certify that the undersigned has understood the implications of the **Proposed Urgent Rehabilitation of Damaged Trans-central Roads by the Conflict in Marawi City Project** to be undertaken by the Department of Public Works and Highways (DPWH).

Further, I certify that I have consulted my respective constituents and that they interpose no objection whatsoever to the project.

HON. RACMA B. KUDARAT-ABINAL
 MAYOR
 Municipality of Marantao

SUBSCRIBED AND SWORN TO before me this APR 16 2018 day of 2018, affiant exhibiting his/her **Community Tax Certificate** No. _____ issued at _____ on _____.

Doc. No. 101
 Page No. 19
 Book No. 5
 Series No. 2018

ATTY. SHIDK T. ABANTAS
 Notary Public, Commission No. 31, 2020
 in the Province of Lanao del Sur and Marawi City
 - a No. 24031 PTR No. 0294226Q, Marawi City, 6130
 - a No. 32140, NC 234-18, TIN No. 949-671-00