



**O & M of Mechanical and Electrical
Equipment
WSD 5231**

**Water Meter Introduction and
Selection**

Module 7



WSD 5321, Mod 7

1

Agenda

- ✓ Ice Breaker and Class Introduction
- ✓ Resources and handouts
- ✓ Importance of water meters
- ✓ Types of water meters



WSD 5321, Mod 7

2

Agenda

- ✓ Selection of water meters
- ✓ Installation of water meters
- ✓ Maintenance of water meters



Icebreaker and class introduction

- Importance of water meters in WASA operations
- What do we cover in this module?
- What to expect in this module?
- Goal and objectives of this module?



Icebreaker and Class Introduction

Now it is your turn...

- Degree and backgrounds?
- Share your work experience relative to water meter selection, installation & maintenance?



WSD 5321, Mod 7

5

Icebreaker and Class Introduction

Now it is your turn...

- Any prior experience related to water metering?
- Why interested in this module?
- What best skills do you bring to the class?



WSD 5321, Mod 7

6

Resources and Handouts

- Lecture notes
- Water meter installation guidelines
- Metering in municipalities - WRC report
- Water meters (various types)
- Water meter major components

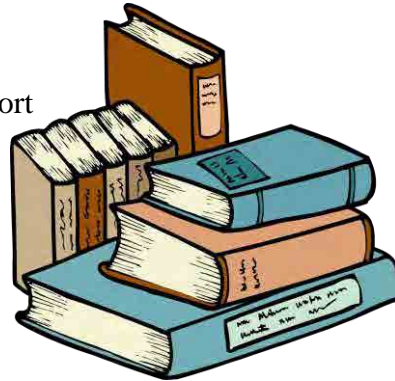

WSD 5321, Mod 7

7

Resources and Handouts

- Introduction to Integrated Water Meter Management, Zyl,J. (2011)
- Water meters, Vol.4, Satterfield, Z. (2004)



WSD 5321, Mod 7

8

Water meter overview

- ✓ Water metering is the process of measuring water use.
- ✓ And, the best way for a water utility to measure or account for the water produced and then sold is by using water meters.



WSD 5321, Mod 7

9

Importance of water meters

- ✓ Water meters are important to a utility for several reasons:
- ✓ Helps in monitoring the volume of finished water
- ✓ Help in water conservation
- ✓ allow the system to demonstrate accountability



WSD 5321, Mod 7

10

Importance of water meters

- ✓ fair for all customers because they record specific usage
- ✓ aid in the detection of leaks and waterline breaks in the distribution system.
- ✓ monitor the volume of consumed water



WSD 5321, Mod 7

11

Water Meter Selection Process Flow Chart

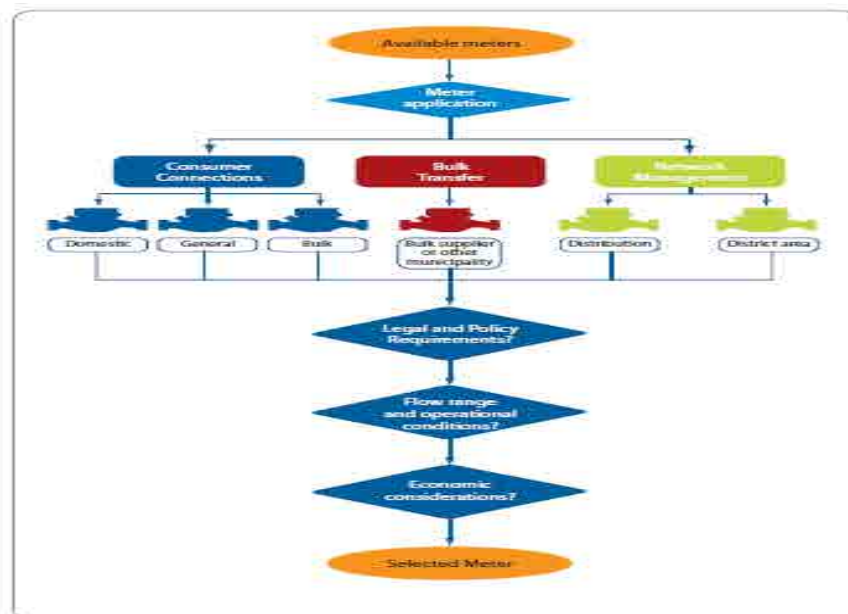

WSD 5321, Mod 7

12

Meter application

- ✓ Purpose
- ✓ There are three major applications of water meters:
 1. Consumer meters
 2. Bulk transfer meters
 3. Management meters



WSD 5321, Mod 7

13

Management meters

- ✓ Management meters measure the distribution of water to different parts of the network.
- ✓ They are essential for many technical and management functions.
- ✓ Management meters that are not district area meters are collectively called distribution meters.

WSD 5321, Mod 7

14

Major Type in WASA (Consumer Meters)

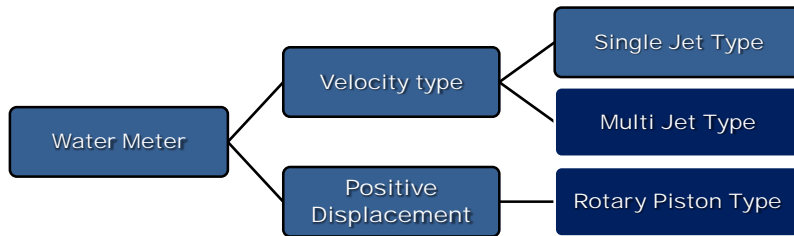

WSD 5321, Mod 7

15

Dry type & Wet type

- The dry type water meter has the reading mechanism hermetically separated from the water flow chamber.
- The transmission to the reading mechanism gears takes place via magnetic coupling between the turbine and the reading mechanism itself.
- The wet type water meters has the reading mechanism the reading mechanism completely immersed in the water and the transmission is direct from the turbine to the gears of the mechanism itself.

WSD 5321, Mod 7

16

Single Jet Type

- The principle of operation is given by the incidence of a single tangential stream of water with a turbine mounted in a radial position within the body of the meter.
- The rotation of the turbine transmits the motion to the reading mechanism allowing the measurement of the volume of water passing through the meter.

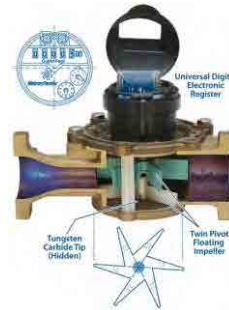

WSD 5321, Mod 7

17

Multi Jet Type

- The principle of operation is to force the passage of the inlet water flow through a series of ducts open in a capsule, called distributor, containing the turbine.
- The entrance of the water through the ducts generates a series of symmetrical jets that impact the turbine keeping it in perfect balance.



WSD 5321, Mod 7

18

Multi-jet meters

- ✓ They have tangential openings in a chamber to direct the water flow across a rotor with many vanes.

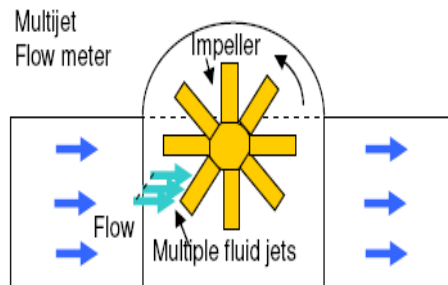

WSD 5321, Mod 7

19

Piston meters

- ✓ They have a piston that oscillates back and forth as water flows through the meter.

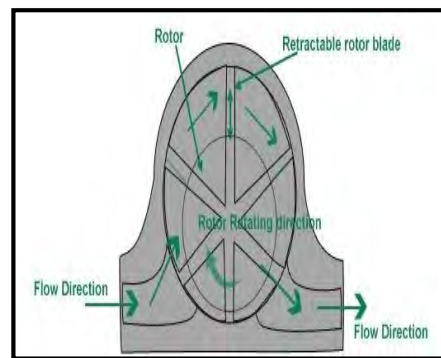

Oscillating piston meter

WSD 5321, Mod 7

20

Display of Water Meter

- ISO 4064: 1993

Q_n : Nominal Flow Rate
 PN : Nominal pressure
 ΔP : maximum pressure loss

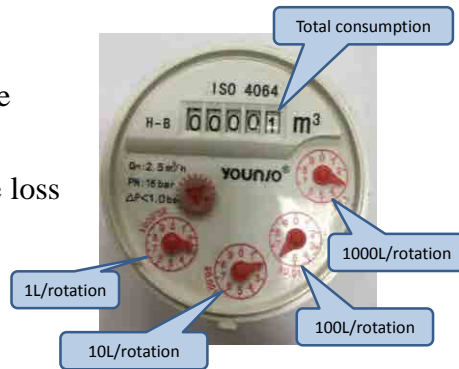

Selection Parameters (Consumer Meters)

ISO 4064 :1993

Type	Nominal Dia	Q_n [m ³ /h]	Q_{max} [m ³ /h]
Velocity type	13	1.5	3
	20	2.5	5
	25	3	6

Q_n : Nominal Flow Rate
 Q_t : Transitional Flow Rate
 Q_{min} : Minimum Flow Rate
 Q_{max} : Maximum Flow Rate

$R : Q_{max}/Q_{min}$
 Class B : $R=50$
 Class C : $R=100$

Class B $0.08 \times Q_n$ Class C $0.015 \times Q_n$
 Class B $0.02 \times Q_n$ Class C $0.01 \times Q_n$
 Class B $2 \times Q_n$ Class C $2 \times Q_n$

Other Selection Parameters

- **Material:**

e.g.: All materials in contact with the water passing through the water meter shall be made of materials which are harmless, non-contaminating and biologically inert.



- **Pressure test:**

e.g.: The water meter shall conform to the pressure resistance performance.

WSD 5321, Mod 7

23

Comparison of water meters

	Single jet (dry)	Multi jet (wet)	Rotary piston (wet)
Appearance			
Measuring method	Velocity	Velocity	Positive displacement
Structure	Simple structure	Complicated than Single jet	Complicated than others
Cost	Inexpensive	Inexpensive	More expensive than others
Others	Highly reliable operation	Small amount of water can be accumulated accurately	High accuracy than others

Turbine meter

- ✓ These meters have a rotating element that turns with the flow of water.
- ✓ Volume of water is measured by the number of revolutions by the rotor.

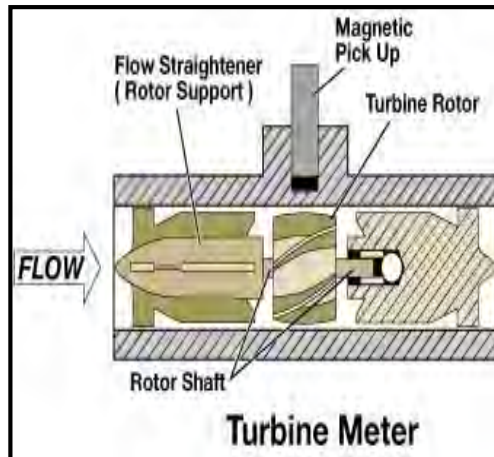

WSD 5321, Mod 7

25

Section through a flow meter showing the sensor, transducer, counter and indicator (meter supplied by Sensus)

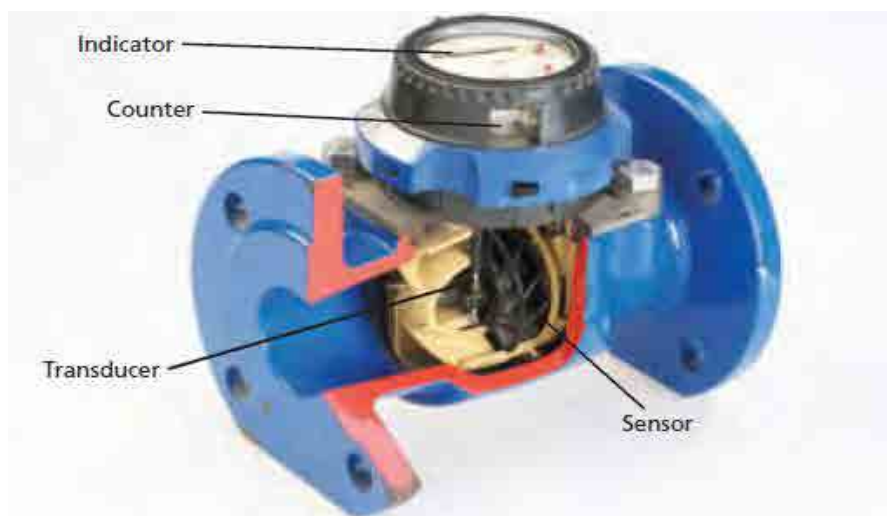

WSD 5321, Mod 7

26

Ultrasonic meters

- ✓ They work by sending sound waves diagonally across the flow of water in the pipe.
- ✓ Changes in the velocity of water are converted electronically to change in flow rate.

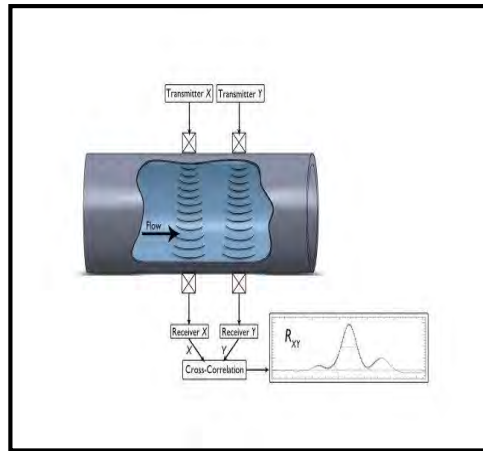

Ultrasonic meter

WSD 5321, Mod 7

27

Magnetic meter

- ✓ They have an insulated section through which water flows.
- ✓ The flow of water induces electrical current that is proportional to the velocity, hence the flow rate.





Magnetic water meter

WSD 5321, Mod 7

28

Comparison of Flow meters

	Ultra Sonic	Electromagnetic	Turbine
Appearance			
Accuracy	lower than Electromagnetic in small flow rate	High	lower than others in small flow rate
Installation condition (D:pipe dia)	Before meter:10D After meter:5D	Before meter:5D After meter:2D	Before meter:10D After meter:5D
Pressure loss	No pressure loss	Almost no pressure loss	Pressure loss due to around Impeller
Telecommunications	Available	Available	Available
Initial Cost	Expensive	Expensive	Inexpensive
Others	Proper installation skill is required	Susceptible to electrical noise	There is lifetime of rotation parts

Water meter installation

- ✓ Its important to install a meter in right spot
- ✓ In case of a private water service i.e.:
 - i. inside the front property boundary (inlet riser: b/w 300mm & 1000mm)
 - ii. from the left or right property boundary (inlet riser: b/w 300 & 600mm).
 - iii. and outlet riser are 300 mm from the ground
 - iv. and outlet riser are parallel to the closest side boundary

Water meter installation

- ✓ If you're installing meters close together, you must allow 300 mm between them.
- ✓ You must not install the meter more than 1.5 metres above the ground



WSD 5321, Mod 7

31

Spacing required in installation

20 mm to 50 mm light duty meters

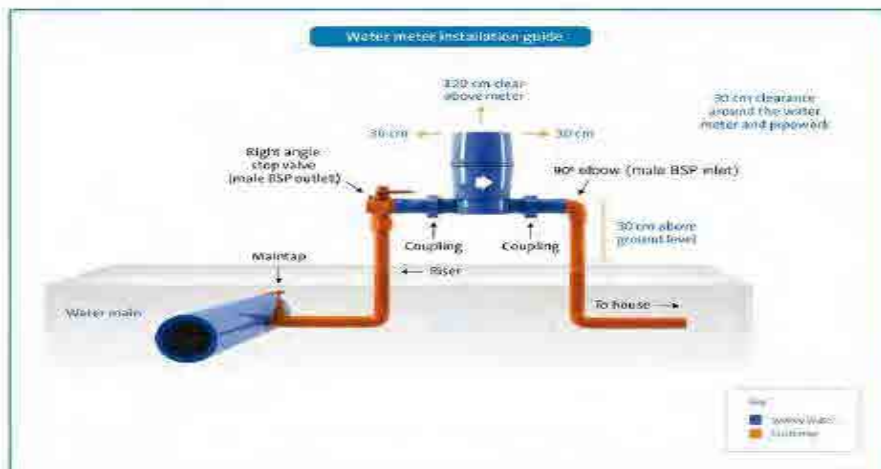

If you're installing a meter, doing it this way will help us access them.

WSD 5321, Mod 7

32

Water Meter Installation Schematic for cold environments (source: Lambton Shores municipality)

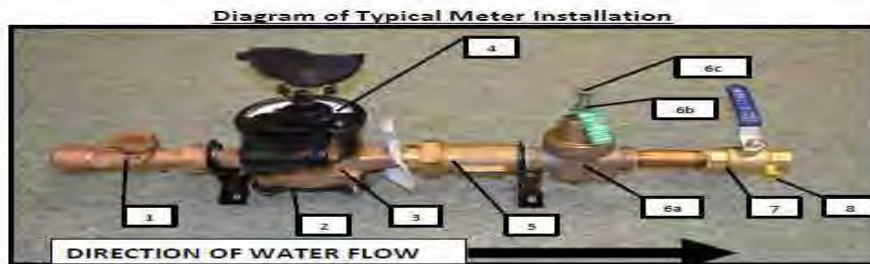

Meter Assembly Component

1. Isolation Valve (attached to waterline from street)
2. Water Meter Frost Plate (sacrificial black steel, under meter, will break if frozen)
3. Water Meter Base
4. Water Meter Register Head
5. Dual Check Backflow Preventer (DUC)
- 6a. Pressure Reducing Valve (PRV)
- 6b. Pressure Reducing Valve Lock Nut (hexagonal nut)
- 6c. Pressure Reducing Valve Operating Bolt (threaded bolt with hexagon head)
7. Residential Isolation Valve (connects to household plumbing)
8. Drain Port (for winterizing plumbing) (not included in a pit meter assembly)

These are the generic components to a water meter assembly in Lambton Shores. There are variations of older style valves but all operate similarly.

WSD 5321, Mod 7

33

Water meter maintenance

- ✓ Proper maintenance of metering device is essential for its operation.
- ✓ A municipality should develop a water meter maintenance programme.
- ✓ Water meter maintenance requires actions, such as cleaning of strainers, cleaning and repair of meter boxes, fixing leaks, register covers.



WSD 5321, Mod 7

34

Inspection Checklist

- ✓ A checklist should be developed for use by meter inspectors in the field. This checklist should include the following information:
 - ✓ Location and date.
 - ✓ Inspector's name.
 - ✓ Meter identification: make, model, size, serial number and current reading.
 - ✓ Condition of meter installation: meter body, meter register, pipe work, leakage, upstream valve, downstream valve, meter chamber, strainer, signs of unauthorised connections and other.
 - ✓ Actions taken: strainer cleaned/replaced, meter mechanism inspected and/or valve operation checked.
 - ✓ Action required: cleaning, chamber repairs, meter test and/or leak repairs.

WSD 5321, Mod 7

35

Problems related to metering

- ✓ Suspended solids get stuck in it & causes meters damaging.
- ✓ Meters buried under soil and vegetation
- ✓ Due to high TDS (total suspended solids) lime or metal oxide deposits in meters.
- ✓ Consumer complaints of suspected meter errors



Meter almost buried in the soil

WSD 5321, Mod 7

36

Problems related to metering

- ✓ Leakage from meter connections.
- ✓ Damage to meters due to high velocity air flow when drained pipes are refilled.
- ✓ Vandalism to meters for scrap metal or in anger, often in 'retaliation' when indigent consumers are cut off



Leakages from meter connections

WSD 5321, Mod 7

37

Problems related to monitoring

- ✓ Strainers to get clogged. These solids enter the system most often due to:
 - ✓ Large pipe bursts.
 - ✓ Mineral
 - ✓ Corrosion
 - ✓ Inadequate water treatment or malfunctioning treatment plants.



Pipe leakages causes the system to get clogged

WSD 5321, Mod 7

38



Operations and Maintenance of Heavy Machines

Application of 5S



Quality Tool for Operational Excellence

3/22

Objectives of Application of 5S

❖ *Application of 5S for enhancing:*

- Productivity
- Efficiency
- Quality
- Safety



4/30

Current Conditions



5/22

Current Conditions



6/22

Current Conditions



7/22

Current Conditions



8/22



What is 5S?

- Seiri (Sort)** Distinguish between necessary and unnecessary items.
- Seiton (Set in order)** Enforce the dictum 'a place for everything and everything in its place'.
- Seiso (Shine)** Clean up the demarcated area.
- Seiketsu (Standardize)** Maintain and monitor adherence to the first three Ss.
- Shitsuke (Sustain)** Follow the rule to keep the workplace 5S-right. Hold the gain.

5S – A Quality, Productivity, Efficiency and Safety Tool

- 5S is an approach to eliminate waste, organize work place to save time and effort to achieve operational efficiency.
- Implementation of 5S improves operational quality and efficiency.
- It enhances safety by reducing hazards, which may occur due to an unorganized work place.

11/22

1. Sort (Seiri)

- Necessary items are separated from unnecessary items and removed.
- Unnecessary items' accumulation makes it difficult to find and keep important items organized.
- Red tag campaign is conducted to evaluate items based on their usefulness and frequency of use.
- Items can include obsolete equipment and inventory, broken tools, scrap, old files, etc.
- Safety and productivity are improved as a result of an organized work place.

12/22

1. Sort (Seiri) For wavering items

- Place un-necessary items in the red tag area
- Allow course participants to re-evaluate the needed items
- At the end of evaluation, required items should be returned to proper area

PRIORITY	FREQUENCY OF USE	HOW TO USE
Low	Less than once per year Once per year	Discard Store away from the workplace
Average	Once per month Once per week	Store together
High	Once per day	Locate at the workplace

13/22

2. Set-in-order (Seiton)

- It involves setting of necessary items, which are always located in logically predetermined locations.
- Based on the inventory classification of the red tag campaign, items are placed in locations based on frequency of use.
- Frequently used items are placed at or near the work place.
- Infrequently used items are stored in store.
- Items in store would help employees save time, otherwise wasted in trying to locate scattered items.

14/22

3. Shine (Seiso)

- It is a regular cleaning activity at and near the work area.
- Removing unnecessary stickers, posters, pictures and other items.
- During operations and maintenance **ergonomically** establishing the positions for tools and equipment.
- Continuously achieve better level of organized and efficient work place through brainstorming.

15/22

3. Shine (Seiso)

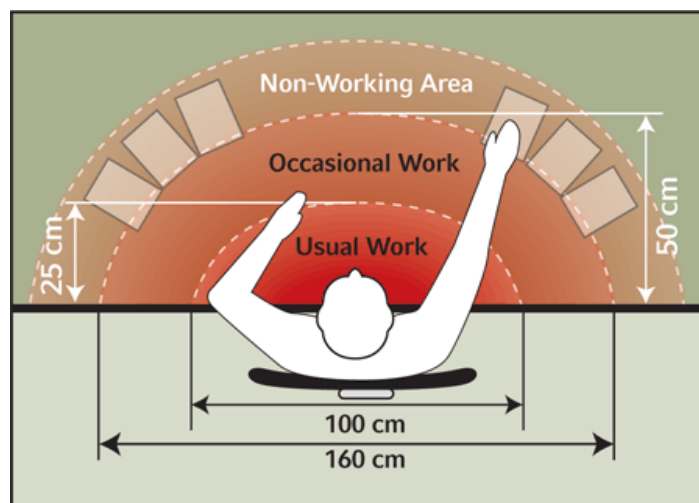

16/22

4. Standardize (Seiketsu)

- The goal of this step is to set a standard work place (organized)
- This is achieved by providing visual labels and signs
- Work place is marked and labeled so that organization is made simple and easy
- Organized and marked tool boards etc.

17/22

5. Sustain (Shitsuke)

- It involves developing habits to implement the 5S philosophy on an ongoing basis.
- If 5S is to be successful, a regular appraisal of the electrical panel is required.
- This ensures the focus remains on maintaining the electrical panel.
- It is a housekeeping and a structured program.
- **5S activity is conducted systematically and regularly.**
- **5S activity is tracked through a visual control board.**

18/22

5S- Red Tags

The form is titled "Red Tag" and includes the following sections:

- Item Information:** Fields for Date, Tagged By, Item Name, and Location.
- Category:** A grid of checkboxes for Equipment, Tools & Jigs, Finished Goods, Gauges & Instruments, Consumables, Machine Parts, Raw Materials, Work-in-Process, and Other.
- Reason for Red Tag:** A grid of checkboxes for Not Required, Defect, Scrap, Obsolete, and Unsound object.
- Suggested Action Required:** A grid of checkboxes for Return to Scrap, Relocate, and Sell.
- Comments:** A series of horizontal lines for text entry.
- Log No.:** A field at the bottom for logging the tag number.

5S- Red Tag Area

The sign features the jica and ALJAZARI ACADEMY logos at the top. The main text reads:

5S Red Tag Area

Please place your unwanted, unknown and broken items here

Contact area owner if you wish to remove items from this location:

Contact Information:



Before



After

21/22

WASA Outfall Workshop, Lahore



Before



After

22/22



Before



After

SCBA equipment was buried under this



5S- Monitoring Board

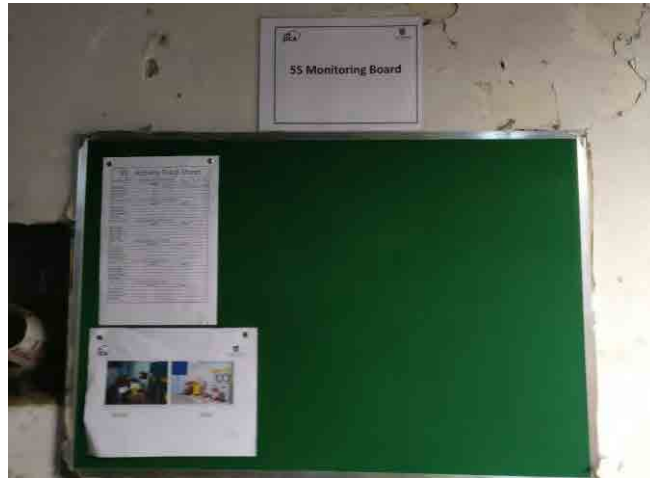



5S Red Tag Area

Please place your unwanted, unknown and broken items here

Contact area owner if you wish to remove items from this location:

Contact Information:



Red Tag

Item Information

Date: _____ Tagged By: _____
 Item Name: _____
 Location: _____

Category

- Equipment Raw Materials
- Tools & Jigs Work-in-Process
- Finished Goods Other
- Gauges & Instruments
- Consumables
- Machine Parts

Reason for Red Tag

- Not Required Obsolete
- Defect Unknown object
- Scrap

Suggested Action Required

- Return to _____
- Scrap
- Relocate
- Sell

Comments

Log No. _____



Red Tag

Item Information

Date: _____ Tagged By: _____
 Item Name: _____
 Location: _____

Category

- Equipment Raw Materials
- Tools & Jigs Work-in-Process
- Finished Goods Other
- Gauges & Instruments
- Consumables
- Machine Parts

Reason for Red Tag

- Not Required Obsolete
- Defect Unknown object
- Scrap

Suggested Action Required

- Return to _____
- Scrap
- Relocate
- Sell

Comments

Log No. _____



Red Tag

Item Information

Date: _____ Tagged By: _____
 Item Name: _____
 Location: _____

Category

- Equipment Raw Materials
- Tools & Jigs Work-in-Process
- Finished Goods Other
- Gauges & Instruments
- Consumables
- Machine Parts

Reason for Red Tag

- Not Required Obsolete
- Defect Unknown object
- Scrap

Suggested Action Required

- Return to _____
- Scrap
- Relocate
- Sell

Comments

Log No. _____

5S Activity Track Sheet

January, 2017		Date (activity performed):	
	<i>Quantity</i>	<i>Notes</i>	
<i>Items Sorted</i>			
<i>Items Stored</i>			
<i>Items Discarded</i>			
<i>Total Items</i>			
February, 2017		Date (activity performed):	
	<i>Quantity</i>	<i>Notes</i>	
<i>Items Sorted</i>			
<i>Items Stored</i>			
<i>Items Discarded</i>			
<i>Total Items</i>			
March, 2017		Date (activity performed):	
	<i>Quantity</i>	<i>Notes</i>	
<i>Items Sorted</i>			
<i>Items Stored</i>			
<i>Items Discarded</i>			
<i>Total Items</i>			
April, 2017		Date (activity performed):	
	<i>Quantity</i>	<i>Notes</i>	
<i>Items Sorted</i>			
<i>Items Stored</i>			
<i>Items Discarded</i>			
<i>Total Items</i>			
May, 2017		Date (activity performed):	
	<i>Quantity</i>	<i>Notes</i>	
<i>Items Sorted</i>			
<i>Items Stored</i>			
<i>Items Discarded</i>			
<i>Total Items</i>			
June, 2017		Date (activity performed):	
	<i>Quantity</i>	<i>Notes</i>	
<i>Items Sorted</i>			
<i>Items Stored</i>			
<i>Items Discarded</i>			
<i>Total Items</i>			



ALJAZARI
— ACADEMY —

Operations and Maintenance of Mechanical and Electrical Equipment WSD 5231

Module 1

Pumps, Induction Motors and Valves

Lecture 1

Pumps

Participant Lecture Notes

2016



ALJAZARI
— ACADEMY —

1. Lecture Information

<p>Lecture Topics</p> <ol style="list-style-type: none"> 1) Introduction to pumps types 2) Assembly parts of pumps 3) Pump operation 4) Preventive maintenance of pumps 5) Troubleshooting of pumps 6) Selection criteria of pumps 	<p>Lecture Duration: 2.30 Hours Parts Demonstration: 30 Minutes</p>
--	---

Liquids are typically moved by pumps. These use work to increase the mechanical energy of a fluid, which in turn can increase the flow rate (velocity), pressure, or elevation of the fluid.

Types of Pumps:

There are two main categories of pumps -- positive displacement and centrifugal. The choice is based on the liquid to be pumped and the desired head and capacity.

Centrifugal pumps are probably most common in industrial applications. They may be built in a very large number of materials. Capacity ranges up to 6000 gpm are common, as are heads to 600 feet, all without special drivers. Performance drops off significantly when handling viscous fluids or when air or vapor are present in the liquid.

For a given head and capacity, centrifugal pumps tend to be smaller and lighter than other types, hence costs are lower.

Positive Displacement Pumps:

Positive displacement pumps operate by trapping a fixed volume of liquid then releasing it to a higher pressure by means of a piston or rotary gear.

Reciprocating Pumps:

Reciprocating pumps use a piston, plunger, or diaphragm to raise the pressure of a liquid. The pumping chambers are surrounded by one-way valves so that liquid can only move in from the low pressure side and out from the high pressure side. They are classed as "single acting" if fluid



is moved only on the downstroke, or "double acting" if fluid is moved by both sides of the piston.

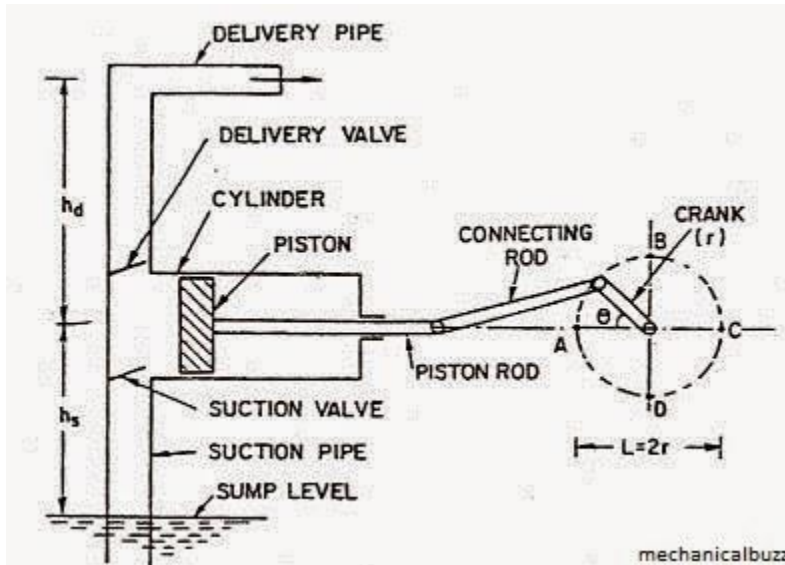

Single Acting Pumps

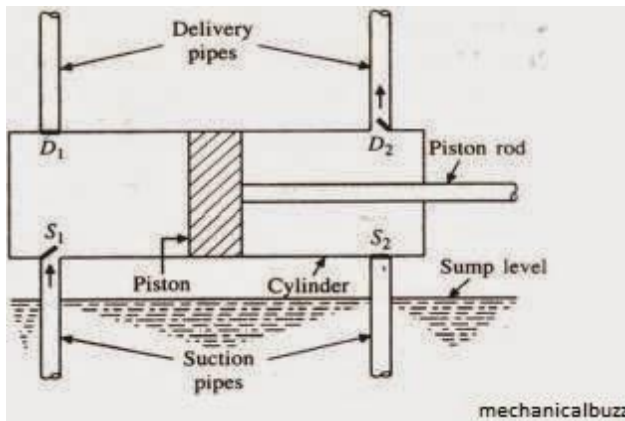

Double Acting Pumps



Rotary Pumps

Typically, rotary pumps are used in high head, low flow applications. They are good for high viscosity and low vapor pressure fluids. The fluid pumped must be "lubricating"; solids cannot be present. A key difference from centrifugal pumps is that discharge pressure variation has little effect on capacity.

2. Centrifugal Pump

Centrifugal pumps are used to transport fluids by conversion of rotational kinetic energy to the hydrodynamic energy of the fluid flow. The rotational energy typically comes from an engine or electric motor. The fluid enters the pump impeller along or near to the rotating axis and is accelerated by the impeller, flowing radially outward.

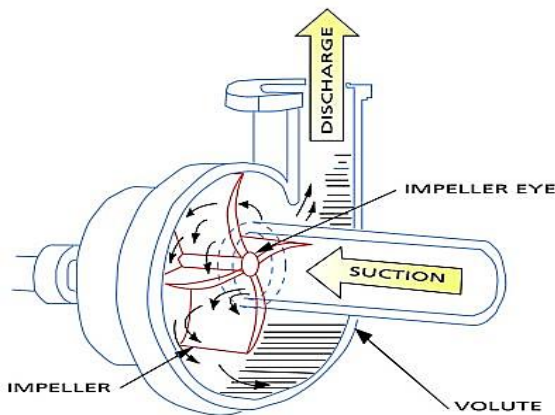
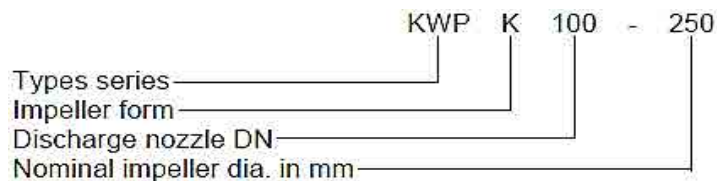

Figure 1 Centrifugal Pump

1.1. Designation

Impeller forms:

- K = channel-type impeller
- F = free-flow impeller (special)
- O = open multi-vane impeller



1.2. Design details

Horizontal, non-self-priming, radially split volute casing pump in back pull-out design, with impeller adapted to meet application requirements, single-flow, single-stage (other impeller forms and pump sizes on request).

1.2.1. Pump casing

Radially split, consisting of pump casing with integrally cast suction and discharge cover. The discharge cover includes an integrally cast stuffing box housing; the pump casing is fitted with a wear plate.

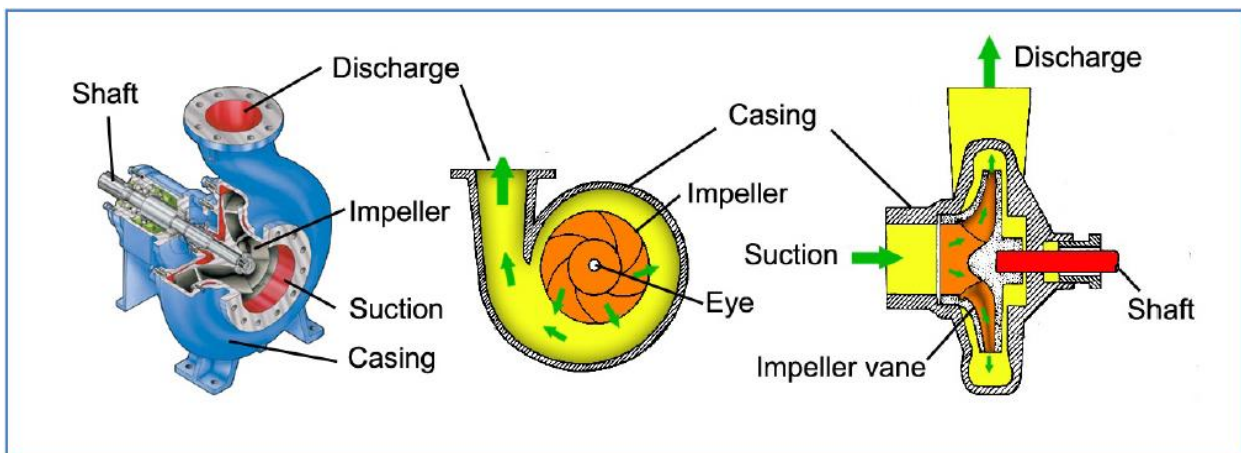
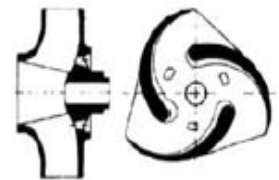

Figure 2 Centrifugal pump parts

1.2.2. Impeller form

K-impeller:

Closed channel-type impeller for contaminated, solids-laden, non-gaseous liquids not liable to plait. As closed multi-vane impeller for uncontaminated or slightly contaminated liquids containing no or very little gas.



F-impeller (special):

Open free-flow impeller for liquids containing large solids and matter liable to plait, as well as liquids with entrapped air and gas.

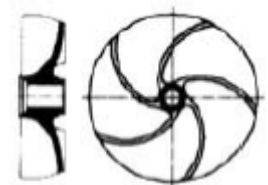

O-impeller:

Open multi-vane impeller for uncontaminated or slightly contaminated liquids as well as liquids liable to form deposits and bunch, with little entrapped gas.

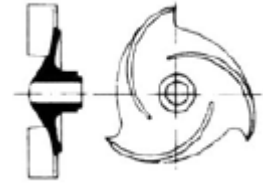
**1.3. Shaft seal**

A mechanical seal is simply a method of containing fluid within a vessel (typically pumps, mixers, etc.) where a rotating shaft passes through a stationary housing or occasionally, where the housing rotates around the shaft. When sealing a centrifugal pump, the challenge is to allow a rotating shaft to enter the ‘wet’ area of the pump, without allowing large volumes of pressurized fluid to escape.

Main elements of a mechanical seals

All mechanical seals are constructed with the following basic sets of parts:

- A set of (very flat) machined and lapped primary sealing faces: The very close (near) contact between these two flat mating surfaces, which are perpendicular to the shaft, minimizes leakage. Dissimilar materials are usually used for the faces, one hard and one softer, in order to prevent adhesion of the two faces. One of the faces is usually a non-galling material such as *carbon-graphite*. The other surface is usually a relatively hard material like *silicon-carbide*, or *ceramic*. However, when handling abrasive, two hard surfaces are normally used:
 - One face is held *stationary* in a housing
 - The other face is fixed to, and *rotates* with the shaft.
- A set of secondary static seals, typically O-rings, wedges and/or V-rings.
 - One static seal, seals stationary component(s) to the housing
 - The other seal, seals the rotating component(s) to the shaft (it normally moves axially on the shaft or shaft sleeve)
- A spring member to maintain face contact, such as a single spring, multiple springs or metal bellows.



- Other mechanical seal hardware, which includes shaft sleeves, gland rings, collars, compression rings, and/or pins.

Mechanical seals require clean water, or other compatible liquid, for the lubrication of the seal faces. The faces in a typical mechanical seal are lubricated with a boundary layer of gas or liquid between the faces. Lubrication can be provided from the pumped liquid itself or from an external source, depending on system requirements.

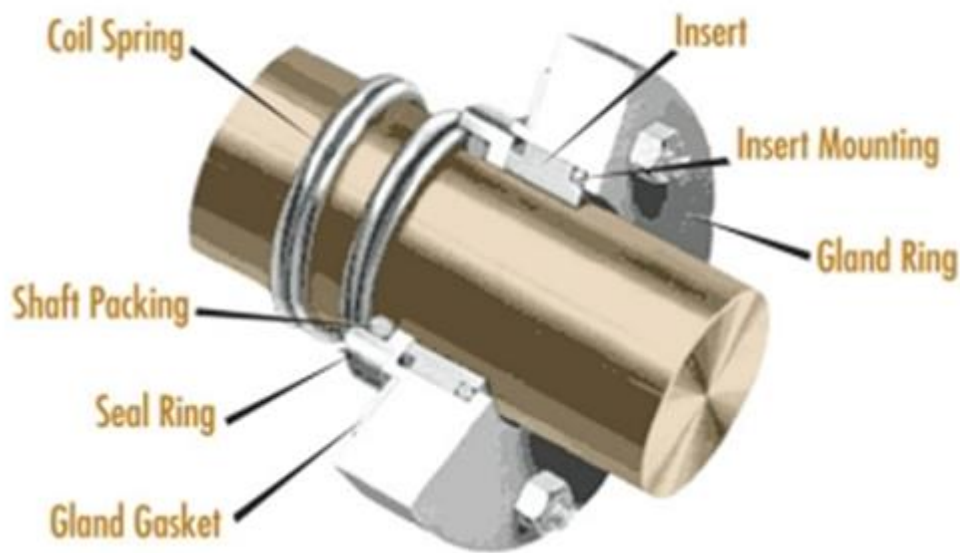

Figure: Typical Shaft Seal.

1.3.1. Priming the pump and checks to be carried out

The pump and suction lift line must be vented and primed with the fluid pumped before start-up. The isolating valve in the suction lift line must be fully open. All auxiliary connections provided on your pump (e.g. flushing liquid, sealing liquid, cooling liquid, etc.) must be opened fully and the



unimpeded flow of the fluid through these lines must line (if applicable to your installation) and close the vacuum-tight isolating valve.

1.3.2. Checking the direction of rotation

The direction of rotation must correspond to the arrow on the pump. This can be checked by switching on the pump for a short instant and switching it off again immediately. Mount the coupling guard.

1.4. Startup procedure

1.4.1. Switching on

Always make sure that the isolating valve in the discharge line is closed when the pump is switched on. Only after the pump has attained full operating speed should the discharge valve be opened gradually and the operating point conditions adjusted by means of this valve.

Caution:

After the operating temperature has been attained, and/or in the event of leakage, tighten the lantern/casing connecting bolts after switching off the pumping set.

1.4.2. Switching off

Close isolating valve in discharge line.

If a non-return valve or check valve has been incorporated in the discharge line, the isolating valve can remain open in so far as there is a back pressure present in the line.

Switch off driver. Observe the pumping set running down smoothly and quietly to a standstill. In the event of a prolonged shut-down, the isolating valve in the suction lift line should be closed. Close the auxiliary connections, and turn off the cooling liquid supply (if applicable to your installation) after the pump has cooled down. The shaft seal of pumps which are connected to a supply vessel under vacuum must be fed with sealing liquid even when the pump is switched off. In the event of frost and/or of prolonged shut-downs, the pump and the cooling compartments (if applicable) must be drained or otherwise protected against freezing.



1.5. Maintenance and lubrication

1.5.1. Supervision of operation

The pump should run quietly and free from vibration at all times. The pump must never be allowed to run dry. Avoid any prolonged running against a closed discharge valve. The bearing temperature may be allowed to attain up to 50°C above room temperature, but should not exceed + 90°C.

Make sure the oil level is adequate. The isolating valves in the auxiliary feed lines must always remain open while the pump is running.

The soft-packed stuffing box (if your pump is fitted with one) should drip slightly during operation. The stuffing box gland should only be tightened lightly.

Any standby pumps in the pumping installation should be operated once a week for a short instant., by switching on and switching off again so as to maintain them in good condition for instant start-up in an emergency. The correct functioning of the auxiliary connections should be kept under observation. When signs of wear become apparent on the flexible coupling elements in the course of time, these elements should be replaced by new ones in good time.

1.5.2. Lubrication and lubricant changes

Lubrication

The antifriction bearings are greased or oil-lubricated; for required lubricant fills.

Grease changes

The initial fill (grease packing) of grease-lubricated anti- friction bearings should last for 3000 operating hours approx., but should be renewed at least once every 2 years or after every 3000 hours of operation.

Grease quality:

Use a good quality ball and roller bearing grease with a lithium soap base, free of resin and acid, not liable to crumble, and possessing good rust-preventive characteristics. The grease should have a penetration number situated between 2 and 3, corresponding to a worked penetration situated between 220 and 295mm/10. Its drop point should not be less than 175°C.

Oil changes

The first oil change should be carried out after 300 hours of operation approx., and subsequent oil changes once every 3000 hours of operation approx.

Procedure:



Unscrew oil drain plug beneath the constant level oiler (or beneath the oil level indicator) and drain the old oil. When the bearing bracket is empty, replace the oil drain plug and fill in fresh oil.

1.6. Fault

Fault	Code number Cause – Remedy
Pump delivers insufficient liquid	1, 2, 3, 4, 5, 6, 7, 8, 9, 10,11, 28
Driver is overloaded	12, 13, 14, 15, 23, 27, 28
Excessively high pump discharge pressure	15
Excessively high bearing temperature	22, 23, 25, 26, 31
Leakage at the pump	29
Excessive leakage at shaft seal	17, 18, 20, 21, 22, 23
The pump runs rough	3, 6, 11, 12, 22, 23, 30, 31, 32
Excessive temperature rise inside the pump	3, 6, 32

Cause – Remedy

1. The pump delivers against an excessively high discharge pressure
 - Open discharge valve further until the duty point conditions have been attained (adjusted)
2. Excessively high back pressure
 - Fit an oversize impeller
 - Increase rotational speed (applies to turbine or I.C. engine driven pumps)
3. The pump and/or piping are incompletely vented or primed
 - Vent or prime the pump and system completely
4. Suction line or impeller clogged
 - Remove deposits in the pump and/or piping
5. Formation of air pockets in the piping
 - Alter piping layout
 - If necessary, fit a vent valve
6. NPSH available is too low (on positive suction head installations)
 - Check liquid level in suction vessel
 - Open isolating valve in suction line fully
 - Install a different suction line if necessary, if the friction losses in the suction line are excessive
 - Check suction line strained



7. Excessively high suction lift
 - Clean out suction strained basket and suction piping
 - Check liquid level in the pit
 - Alter the suction line
8. Entrainment of air through the stuffing box
 - Sealing liquid passages are clogged; clean them out. If necessary, arrange a sealing liquid supply from an outside source, or increase sealing liquid pressure
 - Fit a new shaft seal
9. Reverse rotation
 - Change over two of the phase leads of the power supply cable
10. Rotational speed is too low
 - Increase rotational speed
 - Increase voltage of power supply
11. Excessive wear of the pump internals
 - Replace worn components by new ones
12. Pump back pressure is lower than specified in the purchase order
 - Adjust duty point accurately by means of the isolating valve in the discharge line
 - In case of persistent overloading, trim the impeller if necessary
13. Specific gravity or viscosity of the fluid pumped is higher than that specified in the purchase order
14. Gland cover tightened excessively or askew
 - Adjust the gland as required
15. Excessive rotational speed
 - Reduce speed (applies to turbine or I. C. engine driven pump)
16. N/A
17. Worn shaft seal
 - Check condition of shaft seal and renew it if necessary
 - Check flushing liquid or sealing liquid pressure
18. Grooving, score marks or roughness on shaft protecting sleeve surface
 - Fit a new shaft protecting sleeve
19. N/A
20. Gland cover or seal incorrectly tightened, wrong type of packing material used
 - Remedy the fault
21. The pump runs rough



- Correct the suction conditions
 - Check alignment of pumping set and realign if necessary
 - Re-balance the pump rotor dynamically
 - Increase the suction pressure at pump suction nozzle
22. Pumping set misaligned
- Check piping connections and pump fixing bolts
23. The pump is warped
- Check piping connections and pump fixing bolts
24. N/A
25. Too much or too little lubricant, or unsuitable lubricant quality
- Top up lubricant, reduce quantity of lubricant , or change lubricant quality
26. The prescribed coupling gap has not been maintained
- Restore correct coupling gap in accordance with the data on the foundation drawing
27. Operating voltage is too low
28. The motor is running on two phases only
- Replace the defective fuses
 - Check the cable connections
29. The connecting bolts are slack
- Tighten the bolts
 - Fit new gaskets
30. The rotor is out of balance
- Clean the rotor
 - Re-balance the rotor dynamically
31. Defective bearings
- Fit new bearings
32. Insufficient rate of flow
- Increase the minimum rate of flow



2. Vertical Turbine Pumps

These pumps are commonly used in groundwater wells. These pumps are driven by a shaft rotated by a motor on the surface. The shaft turns the impellers within the pump housing while the water moves up the column. This type of pumping system is also called a line-shaft turbine. The rotating shaft in a line shaft turbine is actually housed within the column pipe that delivers the water to the surface.

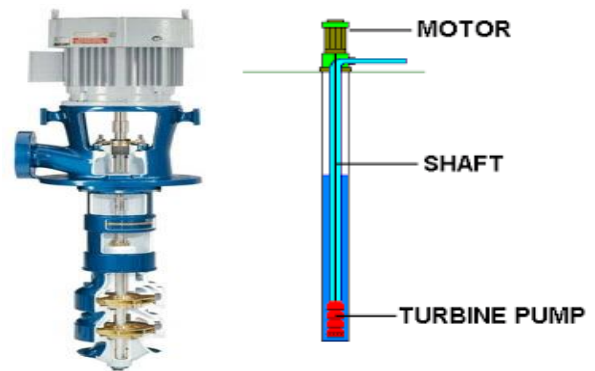

Figure 3 Vertical Turbine Pump

2.1. General B-types vertical pump

2.1.1. Application

B-Pumps are suitable for water supply schemes, irrigation schemes, lowering of ground water level and dewatering of mines, quarries, construction sites and sea water applications. These are particularly suitable for narrow bore holes. Minimum bore hole sizes required ranges from 150mm to 600mm.

2.1.2. Operating data

Capacity	up to 2600 m ³ /hr
Total head	up to 160 m
Speed	up to 3500 RPM
Temperature	up to 105°C
Suspended Depth	up to 120 m

2.1.3. Design Assembly Parts

Main pump parts are the Pump Bowl Assembly, Column Pipe Assembly, and Discharge Head Assembly. Bowl Assembly consists of single or multistage radially split, interchangeable intermediate bowls. Column Pipe Assembly consists of interchangeable lengths of the column pipes and variable setting depth. Discharge head assembly consists of discharge head with packed stuffing zone/mechanical seal and thrust bearing arrangement (in case of solid shaft drive only).



2.1.4. Designation

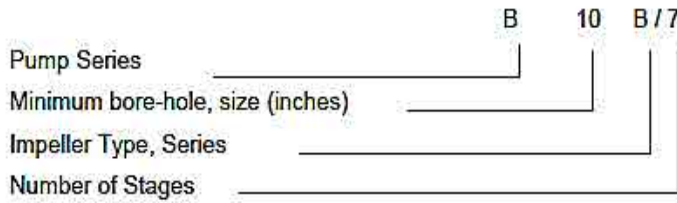

Figure 4 Vertical Turbine Pump

2.2. Description of the Pump (Set)

2.2.1. General description

- Deep-well turbine pump with mixed flow impeller.
- Electric motor or combustion engine.
- Discharge nozzle arranged above or below floor and variant for dry installation.
- Application: non-corrosive fluids, industry, water supply, fire-fighting systems, general industry, pressure boosting, irrigation
- Single-stage or multistage hydraulic system

Pump for use in water works, irrigation and drainage pumping systems, power stations and industrial water supply.

2.2.2. Designation

Example: B 16 B/2 VN / V1

Table: Key to the designation

Code	Description
B	Type Series
16	Well diameter in inches (16 = 16")
B	Hydraulic system (B impeller)
2	Number of stage of hydraulic system



VN	Type of installation (VN=Discharge nozzle above floor)
V1	Type of derive (V1= direct derive by vertical electric motor)

2.2.3. Name plate

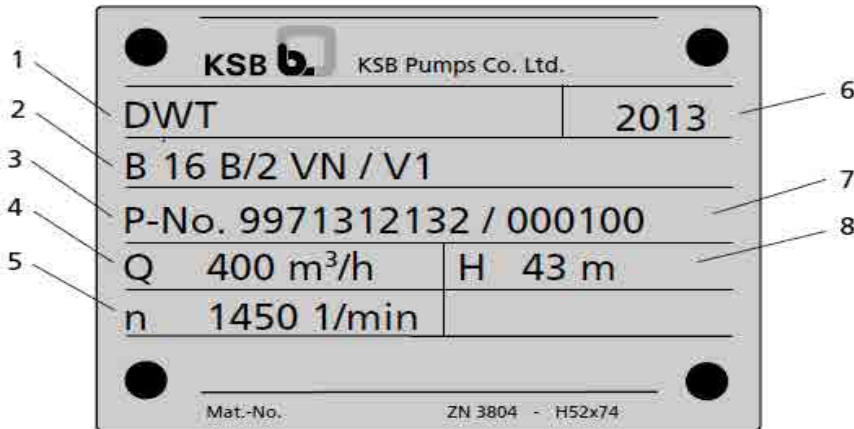

2.2.4. Name Plate Example

1	Pump type	2	Designation of the pump set
3	Order number	4	Flow rate
5	Speed	6	Year of supply
7	Order item number	8	Head

2.3. Design details

2.3.1. Vertical Turbine Shaft Design



- Vertical installation
- Single-stage or multi-stage
- Nominal diameter of the discharge nozzles: 80 mm to 500 mm
- Hole diameter: 6" to 24"

2.3.2. Pump Casing

- Radially split relative to the shaft
- Suction/discharge casing, 1 or more pump bowls
- Replaceable casing wear rings

2.3.3. Impeller

- Single-entry mixed flow impeller, hydraulically unbalanced
- Optionally with impeller wear rings
- Axially locked in position on the shaft via locking and stage sleeves

2.3.4. Pump coupling

- Connected via threaded, conical or split muff coupling
- Torque transmission from pump shaft to impeller/coupling(s) via locking sleeve(s) or key(s)

2.3.5. Shaft seal

- Gland packing
- Mechanical seal
- With or without shaft protecting sleeve

2.3.6. Shaft guide bearing

- Medium-lubricated plain bearings
- Pump shaft supported by bearing bush in each pump bowl (B series: additional support by bearing bushes in suction/discharge casing)
- Intermediate shaft supported by bearing spiders in bearing bushes installed between column pipes

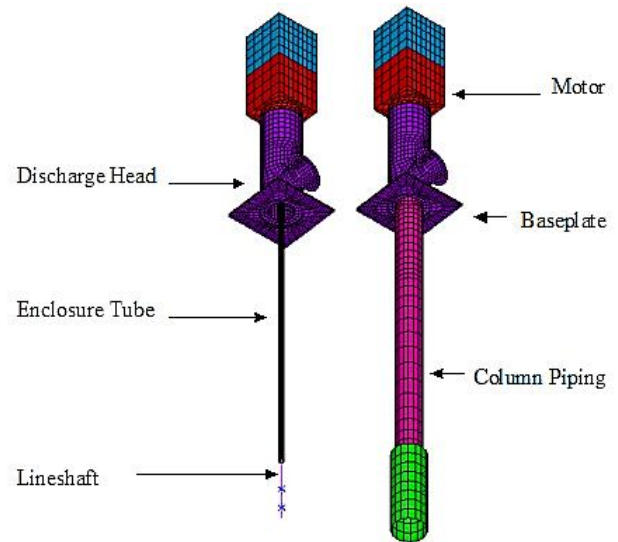

- Shaft protecting sleeves (stage sleeves) from size B14 in pump bowl and in all column pipe bearings

2.3.7. Thrust and radial bearing

- Grease-packed rolling element bearings
- Angular contact ball bearings in back-to-back arrangement
- Uncooled

2.3.8. Direction of rotation

The pump's direction of rotation is anti-clockwise, seen from the top shaft of the pump.

2.4. Configuration and function

2.4.1. Configuration

Refer to general assembly drawing.

2.4.2. Design

Pump and motor are connected by a coupling depending on the variant (see other applicable documents).

The stage casings, column pipes and distributor casings are centered via flange connections and bolted together. If necessary, a suction strainer with or without foot valve may be installed upstream of the pump to protect the pump against coarse particles and foreign objects.

2.4.3. Function

The fluid enters the suction casing via a suction strainer (if any) and flows to the suction impeller (connected to the rotating shaft) at a given pressure. In the impeller, the kinetic energy is imparted to the fluid handled and converted to pressure. The fluid flows from the impeller to the pump bowl where its pressure is further increased via further partial conversion of the kinetic energy.

This procedure is repeated from one stage to the next with the effect that the pressure increases at each stage by the same amount, i.e. by the discharge pressure per stage. After the last pump bowl, the fluid flows through the discharge casing into the column pipe. The clearance gap at the casing wear ring prevents any fluid from flowing back from the stage casing into the suction area of the previous impeller.



2.4.4. Importance of Sealing in pump operation

The pump is sealed by a shaft seal (mechanical seal or gland packing).

2.5. Commissioning/Startup/Shutdown

2.5.1. Prerequisite for commissioning/startup

Before commissioning/starting up the pump set, make sure that the following conditions are met:

- The pump set has been properly connected to the electric power supply and is equipped with all protection devices.
- The pump has been flooded up to the specified minimum water level. (See general arrangement drawing).
- The direction of rotation has been checked.
- All auxiliary connections required are connected and operational.
- The transport lock has been removed.
- The lubricants have been checked and filled in.
- After prolonged shutdown of the pump (set), the required activities have been carried out.
- The coupling alignment has been checked.

2.5.2. Priming and venting pumps

1. Close all drains and drain lines.
2. Flood the pump and the suction line, if any, up to the minimum water level specified. For suction lift operation, evacuate the pump.
3. Fully open the shut-off element in the suction line.
4. If the discharge line is equipped with a check valve, the shut-off element in the discharge line may remain open as long as there is some back pressure. If this is not the case, the shut-off element in the discharge line must be closed.
5. Fully open all auxiliary connections (barrier fluid, flushing fluid etc.).
If liquid is supplied from an external source, make sure the data indicated in the data sheet (pressure, flow rate, etc.) is observed.
6. Open the venting element/ensure proper venting.
The shut-off element in the discharge line opens as flow starts (e.g. swing check valve) or is opened immediately before pump start-up (e.g. gate valve already slightly open when pump is started).



2.5.3. Startup

1. Fully open the shut-off element in the suction head/suction lift line.
2. Close or slightly open the shut-off element in the discharge line.
3. Start up the motor.
4. Immediately after the pump has reached full rotational speed, slowly open the shut-off element in the discharge line and adjust it to comply with the duty point.

2.6. Checking Shaft Seal

2.6.1. Mechanical Seal

The mechanical seal only leaks slightly or invisibly (as vapour) during operation. Mechanical seals are maintenance-free.

2.6.2. Gland Packing

The gland packing must drip slightly during operation. (approx. 20 drops per minute)

The minimum leakage required depends on the fluid handled, pressure, sliding velocity and temperature. See data sheet for the leakage rates at the gland packing.

2.6.3. Adjusting the leakage

2.6.3.1. Prior to starting

1. Only lightly tighten the nuts of the gland follower by hand.
2. Use a feeler gauge to verify the gland follower is mounted centrally at right angle to the shaft.

The gland must leak after the pump has been primed. (Only applies to pumps with suction lift line and the respective excess inlet pressure.)

2.6.3.2. After five minutes of operation

The leakage can be reduced.

1. Tighten the nuts of the gland follower by 1/6 turn.
2. Monitor the leakage for another five minutes. Excessive leakage:

2.6.3.3. Excessive leakage



Repeat steps 1 and 2 until the minimum value has been reached.

2.6.3.4. Not enough leakage:

Slightly loosen the nuts at the gland follower.

2.6.3.5. No leakage:

Switch off the pump set immediately!

Loosen the gland follower and repeat start-up.

2.6.3.6. Checking for leakage

After the leakage has been adjusted, monitor the leakage for about two hours at maximum fluid temperature.

Check that enough leakage occurs at the gland seal at minimum fluid pressure.

2.6.4. Shutdown

1. Close the shut-off element in the discharge line slowly.
2. Switch off the motor immediately after closing the shut-off element and make sure the pump runs down smoothly to a standstill.

2.6.4.1. For prolonged shutdown periods:

1. Close the shut-off element in the suction line, if any.
2. Close the auxiliary connections.

2.7. Operating Limits

2.7.1. Maximum operating pressure

The maximum operating pressure depends on the pump size, pump material and nominal pressure of the flange design. Neither the material / size dependent maximum pressure nor the maximum nominal pressure of the flange must be exceeded. Maximum operating pressure: see data sheet.

2.7.2. Temperature of the fluid handled

If the values are not indicated in the data sheet, the following temperature limits apply. The temperatures must neither be below nor above these limits.



Table: Temperature limits of the fluid handled

Minimum fluid temperature	0°C
Maximum fluid temperature	+ 60 °C

2.7.3. Abrasive fluid/solid

Do not exceed the maximum permissible solid content limit specified in the data sheet. When pump handles fluid containing abrasive substance, increased wear of the hydraulic system and the shaft seal are to be expected. In this case, reduce the maintenance interval.

2.8. Maintenance/Inspection**2.8.1. Supervision of operation**

While the pump is in operation, observe and check the following:

- The pump must run quietly and free from vibrations at all times.
- In case of oil lubrication, ensure the oil level is correct.
- Check the shaft seal.
- Check the static seals for leakage.
- Check the rolling element bearings for running noises. Vibrations, noise and an increase in current input occurring during unchanged operating conditions indicate wear.
- Monitor the correct functioning of any auxiliary connections.
- Monitor the stand-by pump. To make sure that the stand-by pumps are ready for operation, start them once a month.
- Monitor the bearing temperature.
- Check the flexible or torsion-resistant elements of the coupling/Cardan shaft and replace if necessary.
- Check any pressure gauges.
- Check the drive as described in the manufacturer's product literature.
- Check that the fitted coupling guard make sure it doesn't interfere with the coupling.
- Make sure that the earth connection is fitted and marked.
- Cooling system (if any)



Take the pump out of service at least once a year to thoroughly service the cooling system.

2.8.2. Routine maintenance and inspection intervals

(Please revise the following table)

Interval	Number of persons	Time (?)	Maintenance job
Daily	1	6 min.	<ul style="list-style-type: none"> • Check shaft seal leakage.
	1	6 min.	<ul style="list-style-type: none"> • Check the oil level and top up the oil, if required (only for oil- lubricated bearings)
Weekly	1	15 min.	<ul style="list-style-type: none"> • Check pump operation (inlet pressure, head, bearing temperature, noise and vibrations).
	1	15 min.	<ul style="list-style-type: none"> • Check torsional play/condition of the coupling/Cardan shaft (see operating manual for the coupling/Cardan shaft).
	1	15 min.	<ul style="list-style-type: none"> • Switch to a stand-by pump, if any, or carry out a functional check run (5 minutes).
	1	15 min.	<ul style="list-style-type: none"> • Re-lubricate grease-packed rolling element bearings, re- lubrication quantity see data sheet
	1	15 min.	<ul style="list-style-type: none"> • Check oil-lubricated rolling element bearings
Every 4 years or if discharge head drop.	2		<ul style="list-style-type: none"> • Generally inspect and overhaul the pump in accordance with the operating instructions. • Check and replace, if necessary: <ul style="list-style-type: none"> ✓ Bearings, casing wear ring, impeller wear ring, shaft protecting sleeve ✓ Impeller and shaft ✓ Fit new seals and gaskets.



2.9. Vertical turbine pump troubleshooting

- A. Pump pressure is too low
- B. Excessive pump discharge pressure
- C. Excessive flow rate
- D. Pump delivers insufficient flow rate
- E. Excessive power consumption
- F. Pump is running but does not deliver
- G. Pump stops during operation
- H. Vibrations and noise during pump operation
- I. Impermissible rise of temperature inside the pump
- J. Excessive bearing temperature
- K. Excessive leakage at the shaft seal
- L. Motor is overloaded
- M. Leakage at the pump



A	B	C	D	E	F	G	H	I	J	K	L	M	Possible cause	Remedy ¹⁰
X	X	X	X	X	X	X	X	X	X	X	X	X	Operating point B does not match the Q and H performance data calculated in advance.	<ul style="list-style-type: none"> Re-adjust to duty point (e.g. close/open shut-off element accordingly).
X			X		X								Pump or piping are not completely vented.	<ul style="list-style-type: none"> Vent pump.
X			X		X	X	X	X					Inlet line or impeller clogged	<ul style="list-style-type: none"> Clean the impeller. Check system for impurities. Remove deposits in pump and/or piping. Check any strainers installed/ suction opening.
X			X		X	X	X						Formation of air pockets in the piping	<ul style="list-style-type: none"> Fit venting device. Alter piping layout.
X			X		X	X	X						NSPH available water level too low.	<ul style="list-style-type: none"> Check operating mode. Increase back pressure by throttling. Correct suction conditions. Increase suction head. Install pump at a lower level. Fully open the shut-off element in the inlet line, if any. Alter the inlet line if piping losses are too high, if any.



A	B	C	D	E	F	G	H	I	J	K	L	M	Possible cause	Remedy ¹⁹
										X			Shaft seal worn/Score marks or roughness on shaft protecting sleeve.	<ul style="list-style-type: none"> Check flushing liquid/barrier fluid pressure. Clean barrier fluid, supply external barrier fluid, if necessary, or increase barrier fluid pressure. Fit new shaft seal. Replace worn components by new ones. Replace shaft protecting sleeve.
X			X				X	X					Unfavourable flow to pump suction nozzle	<ul style="list-style-type: none"> Check the Inflow conditions of the intake reservoir and intake chamber. Check whether pipe routing results in swirling or irregular flow (e.g. downstream of elbow) and correct, if necessary.
			X				X	X					Gland follower, seal cover excessively tightened or tightened askew, incorrect packing material.	<ul style="list-style-type: none"> Correct. Replace. Correct. Replace gland packing. Replace worn components by new ones.
								X	X	X			Lack of cooling liquid or dirty cooling chamber.	<ul style="list-style-type: none"> Check flushing liquid/barrier fluid pressure. Clean barrier fluid, supply external barrier fluid, if necessary, or increase barrier fluid pressure. Increase cooling liquid quantity. Clean coolant/cooling chamber.
							X	X					Pump is warped or sympathetic vibrations in the piping.	<ul style="list-style-type: none"> Re-align pump/drive. Check piping connections and secure fixing of pump; improve fixing of piping, if necessary. Fix pipelines using anti-vibration material.
									X				Increased axial thrust	<ul style="list-style-type: none"> Check duty point/pump selection. Check operating mode. Check suction side flow conditions.
							X	X					Insufficient or excessive quantity of lubricant or unsuitable lubricant.	<ul style="list-style-type: none"> Clean the bearings. Top up, reduce or change lubricant.
									X				Non-compliance with specified coupling distance	<ul style="list-style-type: none"> Correct distance in accordance with the general arrangement drawing.



A	B	C	D	E	F	G	H	I	J	K	L	M	Possible cause	Remedy ¹⁰
X			X	X							X		Motor is running on 2 phases only.	<ul style="list-style-type: none"> Replace defective fuses. Check electrical connections. Check switchgear.
							X		X	X			Rotor out of balance	<ul style="list-style-type: none"> Clean the rotor. Check run-out; re-align, if necessary. Re-balance the rotor.
							X		X	X			Defective bearing(s)	<ul style="list-style-type: none"> Replace.
							X	X					Flow rate is too low.	<ul style="list-style-type: none"> Re-adjust to duty point. Fully open shut-off element in suction/inlet line. Fully open shut-off element in discharge line. Re-calculate or measure hydraulic losses H_v.
X			X										In star-delta operation, motor sticks at star stage	<ul style="list-style-type: none"> Check electrical connections. Check switchgear. Close or only slightly open the shut-off element in the discharge line during start-up.
X			X				X						Impermissible air or gas content in fluid handled	<ul style="list-style-type: none"> Check suction line for leakage, seal if necessary. Replace defective parts.
X			X		X	X	X						Air intake at pump inlet (e.g. air-entraining vortices)	<ul style="list-style-type: none"> Check intake area for air-entraining vortices. Correct suction conditions. Reduce flow velocity at suction line inlet. Increase suction head.
							X						Cavitation (rattling noise)	<ul style="list-style-type: none"> Correct suction conditions. Check operating mode. Increase suction head. Install pump at a lower level.
							X		X				Foundation not rigid enough.	<ul style="list-style-type: none"> Check. Correct.
X			X		X	X	X						Impermissible single-pump/parallel operation.	<ul style="list-style-type: none"> Re-adjust to duty point. Alter system conditions. Adjust pump characteristic H.
							X			X			Shaft is out of true.	<ul style="list-style-type: none"> Replace.
			X				X	X	X		X		Impeller rubs against casing components.	<ul style="list-style-type: none"> Check rotor. Check impeller position. Verify that piping has been connected without transmitting any stresses or strains.
											X		Operating voltage is too low.	<ul style="list-style-type: none"> Increase the operating voltage.
										X			Excessive surface pressure in the mechanical seal's sealing clearance, lack of lubricant/circulation liquid	<ul style="list-style-type: none"> Check installation dimensions.¹⁰



3. Submersible Pumps

Submersible pumps may be operated manually with a switch located above ground level or automatically with a pressure switch, electrodes or float control devices. Submersible pumps should always be operated below the water level. The pump should be installed at higher level than the well screen to prevent pump fluid suction break which leads to burnt motor.

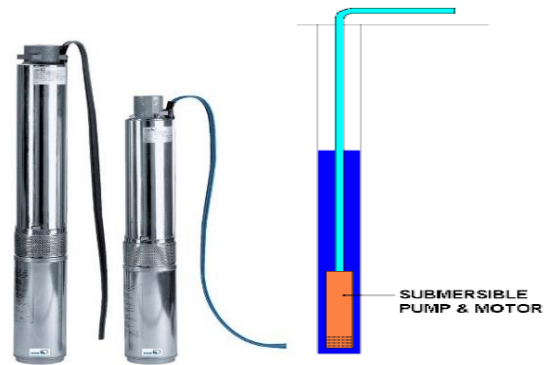



Figure 5 Submersible Pump

3.1. General Description

3.1.1. Name Plate

1	KSB 		KSB Aktiengesellschaft 67227 Frankenthal		16
2	Series No. 99720202635-000100-01		2013		17
3	MEI ≥ 0.70	η --- %	Mat. No.		
4	Pump		UPA 150C - 16 / 16		18
5	Q	6.92 m ³ /h	H	171.00 m	19
6	Q	21.77 m ³ /h	H	103.00 m	20
7	Q	18.5 m ³ /h	H	125.25 m	
8	Motor		3~ UMA-S 150E 37/22		21
9	37 kW	100 Hz	VFD		22
10	400 V	72 A	0.99 cos phi		23
11	Weight	272 kg			24
12	Temp.	20 °C max.	3,000 rpm		25
13	Min. flow velocity past the motor = 0.2 m/s				26
14	U _p = 338 V @ 3000 rpm				
15	EN 60034-1		IP 68		
Mat No.: 01 000 854		ZN 3823 - D 88			

3.1.2. Name Plate (Example)



1	Order number	2	Minimum efficiency index
3	Pump designation	4	Efficiency (see data sheet)
5	Minimum flow rate	6	Maximum flow rate
7	Flow rate at duty point	8	Motor designation
9	Rated power	10	Voltage
11	Frequency	12	Weight
13	Maximum fluid temperature	14	Minimum available flow velocity past the motor
15	Magnet wheel voltage ⁵⁾	16	Year of construction
17	Material number	18	Maximum head
19	Minimum head	20	Head at duty point
21	Configuration / starting method of the motor	22	Power factor
23	Amperage	24	Speed
25	VDE Standard	26	Motor enclosure

3.2. Design details

3.2.1. Design

- Centrifugal pump
- Single-stage or multi-stage
- Radial or mixed flow versions
- Single-entry
- Ring-section design
- Rigid connection between pump and motor Connections

3.2.2. Connection

- Pump end screw-ended or flanged
- With lift check valve or connection branch Impeller type

3.2.3. Impeller type

- Mixed flow hydraulic system with trim-able impellers Type of installation

3.2.4. Type of installation

- Vertical installation
- Horizontal installation



3.2.5. Drive

- Three-phase asynchronous motor
- Interior (buried) permanent magnet synchronous motor (IPMSM)
- Motor shaft protected by sealed sleeve coupling Shaft seal

3.2.6. Shaft Seal

- Mechanical seal

3.2.7. Bearings

- Radial plain bearings
- Pump bearings lubricated by fluid handled; motor bearings lubricated by water fill
- Axial thrust is balanced by a tilting-pad thrust bearing in the motor (lower end)

3.3. Configuration and function

3.3.1. Design

Pump and motor are connected by a rigid coupling. The stage casings are connected by means of studs. A suction strainer at the suction casing protects the pump from coarse particles in the fluid. The pump is connected to the piping via a lift check valve or connection branch with either internal thread or flanged end (optional).

3.3.2. Function

The fluid flows along the motor and enters the suction casing (2) through the suction strainer (1). It is accelerated outward by the suction impeller (3). In the flow passage of the stage casing (4) the kinetic energy of the fluid is converted into pressure energy, and the fluid is routed to the next impeller (5). This process is repeated in all stages until the fluid has passed the last impeller (5). It is then guided through the integrated lift check valve (6) to the connection branch (7), where it leaves the pump. The integrated lift check valve prevents uncontrolled backflow of the fluid.

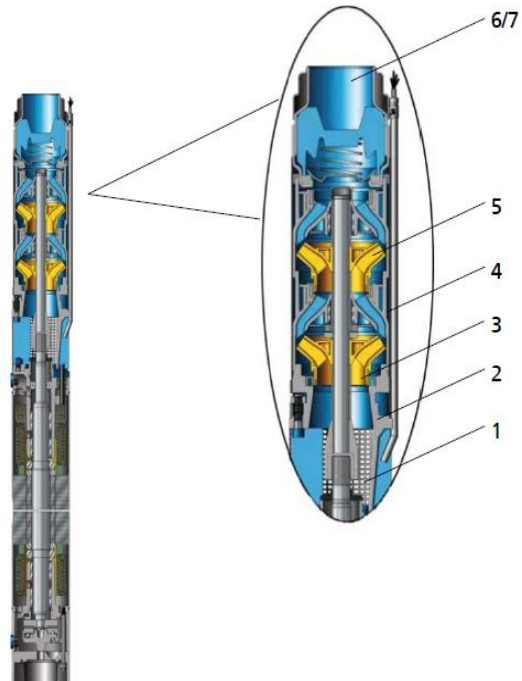

Figure 6 Cross Sectional drawing



3.4. Commissioning/start-up

3.4.1. Start-up

When commissioning pump in new borehole, initially only operate the pump for approximately 10 minutes with the shut-off element slightly open.

Check escaping water for any sand content.

- If the sand content equals 50 g/m³ or more, switch off the pump set and inform the well building company.
- If the sand content decreases, slowly open the shut-off element until the duty point is reached.

3.4.2. Checking the direction of rotation

1. Switch on the motor at the control cabinet.
2. As soon as the system reaches a steady state, note down the pressure and/or flow rate from the pressure gauges.
3. Verify the data against the name plate data.
 - If the values are almost identical, the direction of rotation is correct.
 - If the values are too low, the direction of rotation is incorrect.
4. If the direction of rotation is incorrect, switch off the motor from control cabinet.
5. Have a trained electrician correct the phase sequence (U, V, W) on the motor connection side in the control cabinet or, in case of frequency inverter operation, change the direction of rotation by adjusting the parameters.

3.5. Operating limits

3.5.1. Frequency of starts

To prevent inadmissible heat build-up in the motor, the following max. number of start-ups or minimum standstill periods must be complied

3.5.2. Supply voltage

Observe the permissible voltage and frequency fluctuations to; $UN \pm 5 \%$, $fN \pm 2 \%$. The limits may differ if specified in the order, see order confirmation.

3.5.3. Immersion depth

Do not exceed the maximum immersion depth of 250 m.

For submergence or larger immersion depths refer to the data sheet or the order documentation.



3.6. Trouble-shooting

If problems occurs which are not described in the following table, consultation with the KSB customer service is required.

- A. Pump is running but does not deliver
- B. Pump delivers insufficient flow rate
- C. Insufficient discharge head
- D. Vibrations and noise during pump operation
- E. Unit tripped by overcurrent relay
- F. Fuses have blown
- G. Pump set cannot be started up
- H. Pump set cannot be switched off

A	B	C	D	E	F	G	H	Possible cause	Remedy ²⁴⁾
-	X	-	-	-	-	-	-	Pump delivers against an excessively high pressure.	Open the shut-off valve to re-adjust to duty point.
-	-	X	-	-	-	-	-	Pump delivers against an excessively low discharge pressure.	Close the shut-off valve to re-adjust to duty point.
-	-	X	X	-	-	-	-	Deposits in the impellers	Remove deposits.
-	X	X	-	-	-	-	-	Wrong direction of rotation (three-phase units)	Interchange two of the phases of the power cable.
-	X	X	-	-	-	-	-	Wear of internal components	Replace worn components by new ones. Contact KSB.
-	X	-	-	X	-	-	-	Motor is running on 2 phases only.	Replace defective fuse. Check cable
X	-	-	-	-	-	X	-	No power supply	Check electrical installation. Inform electric utility
X	-	-	-	X	-	-	-	Pump clogged by sand	Clean suction casing, impellers, stage casings and lift check valve. Contact KSB.
X	-	-	-	X	X	X	-	Motor winding or power cable are defective.	Contact KSB.
X	X	X	-	-	-	-	-	Defective or clogged riser pipe (pipe and sealing elements)	Replace defective riser pipes. Replace sealing
-	X	-	-	-	-	-	-	Water level lowered too much during operation	Contact KSB.
X	-	X	X	-	-	-	-	Impermissible air/gas content in the fluid handled	Contact KSB.
-	-	-	X	-	-	-	-	Mechanical defect of pump or motor	Contact KSB.
-	-	-	X	-	-	-	-	System-induced vibrations	Contact KSB.
-	X	-	X	-	-	-	-	NPSH available (positive suction head) is too low.	Submerge pump deeper.
-	X	X	-	-	-	-	-	Speed is too low.	Check voltage and increase, if necessary. Contact KSB.
-	-	-	-	-	X	-	-	Wrong fuse size	Fit correct fuse size.
-	-	-	-	X	-	X	X	Defective overcurrent relay	Check and replace, if necessary.
-	-	-	-	X	-	-	-	Motor winding not suitable for operating voltage available	Replace the pump set. Contact KSB.



3.7. Inspection/Service

The submersible borehole pumps are generally maintenance-free. In order to detect indications of potential damage at an early stage, regular checks are required.

Possible indications of potential damage:

- Temperature rise in the fluid handled
- Increased sand content of the fluid handled
- Change in current consumption
- Change in discharge head / flow rate
- Change in rpm at startup
- Increase in noise and vibration levels

The submersible borehole pump need not be removed from the well/tank regularly for inspection. For any queries and repeat orders, particularly when ordering spare parts, specify the following information given on the name plate:

- Pump and/or motor type series and size
- Operating data
- Order number and/or material number

For information concerning repair jobs and spare parts please contact your nearest KSB service center.



3.8. Difference between Verticals Turbine Pump and Submersible Pump

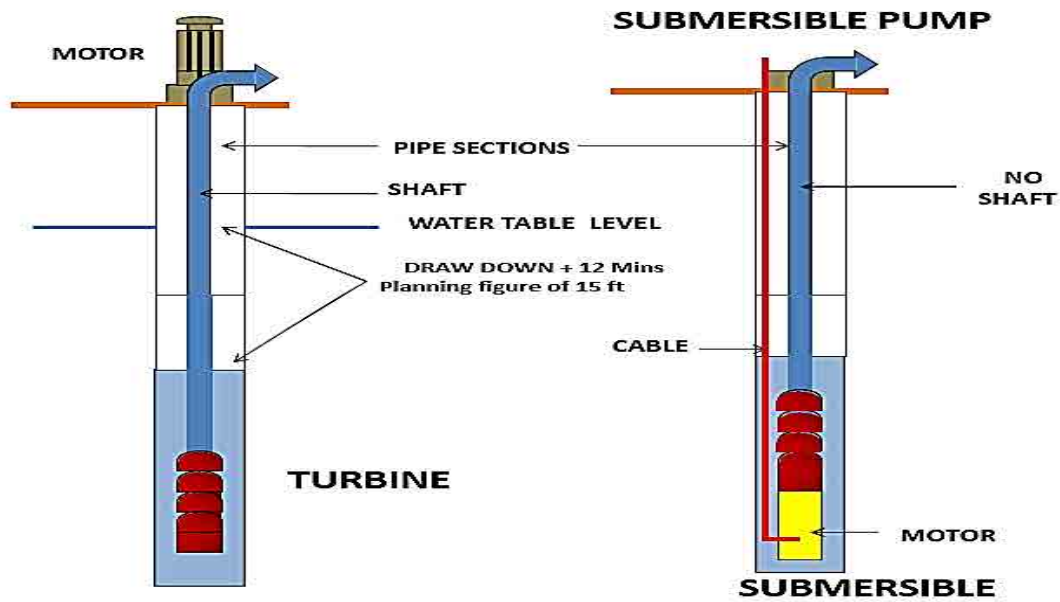

Figure 7 Difference between Vertical Turbine Shaft and Submersible Pump



4. Pumps performance and their issues during operation and maintenance

4.1. Pump characteristic curve

The pump characteristic curve shows the performance of a pump. It usually shows total dynamic head (TDH), power, efficiency and NPSHR plotted over flow rate at a given RPM. There are absolute or dimensional and relative or non - dimensional plots (fig.). The difference is that a dimensional diagram shows absolute values, while a non - dimensional plot shows the data in percent of their values at the pumps best efficiency point (BEP). The first line in the diagram shows the pumps TDH plotted over flow rate. Characteristic is the slightly decreasing TDH at increasing flow rate. The efficiency graph is typically increasing until it reaches its peak at the pumps BEP and drops as flow rate is further increasing. The bhp line is more or less a straight line as it increases with increasing flow rate. It is also possible to plot these functions for several speeds at a given diameter or at different diameters for a given speed in one diagram. Result is a set of pump characteristic curves as provided by most manufactures. In these diagrams you can estimate pump behavior at constant speeds and a range of impeller diameters. Constant horse power, efficiency, and NPSHR lines are plotted over the various head curves. The pump characteristic curve shown in fig.12 is an example for what information you can get out of such a diagram. In this example, we assume that we have this pump with an impeller diameter of 7" operating at 3540RPM and a flow rate of 48m³/h. Therefore we can read from the diagram the pump's current efficiency, head, required power as well as the NPSHR. In this case, our operating point is almost the pump's BEP and we get TDH of 60m, an efficiency of about 61%, required power of 13Hp and a NPSHR of 9ft.



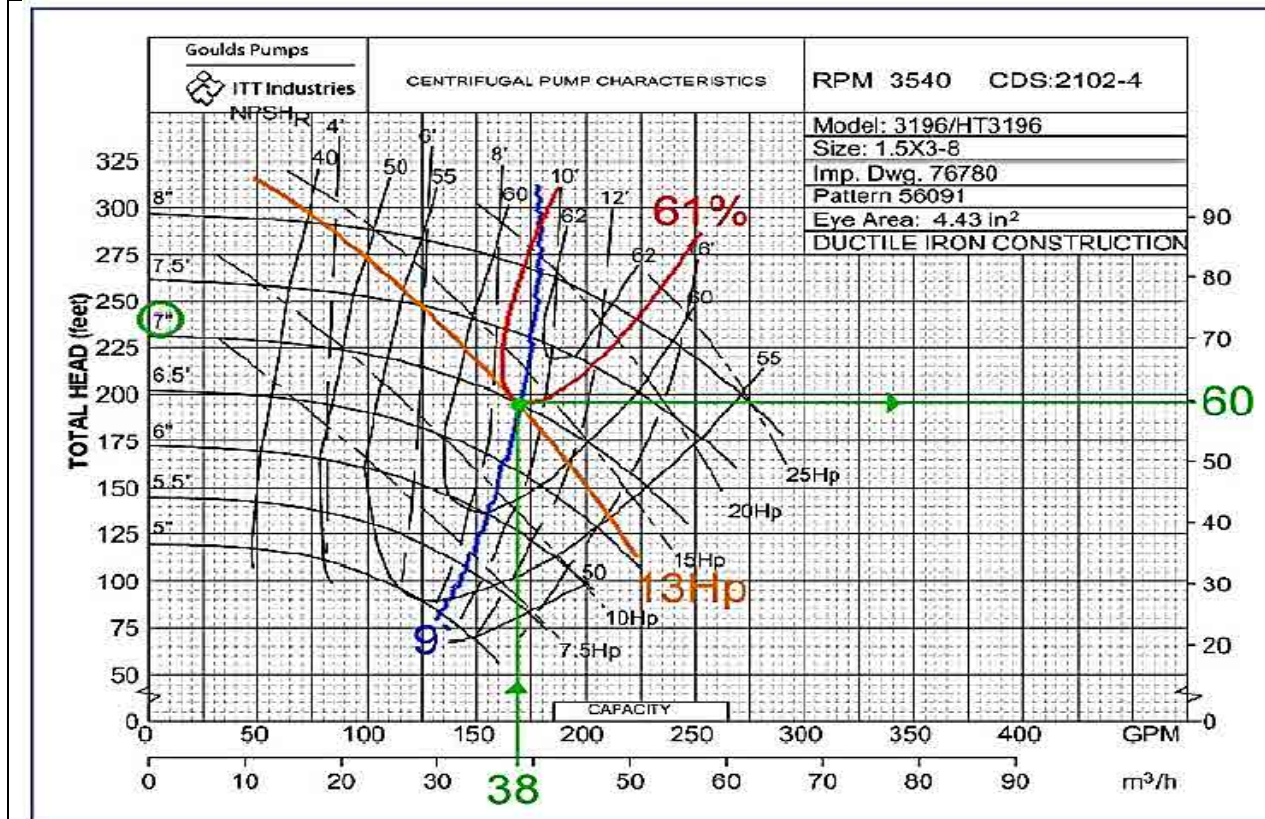

Figure 8 Centrifugal Pump Curve

4.2. Pump Selection

Double check with respect to design manual

A pump consists of the following basic elements:

- Bowl Assembly
- Motor
- Cable
- Drop Pipe
- Surface Plate (with)(without) discharge elbow

4.2.1. Data Required For Selection

- Capacity in GPM
- Static and Pumping Levels in Well
- Setting Required (drop pipe)



- Well I.D. Diameter
- Energy requirement
- System pressure required

4.2.2. Determination of Total Head

Total head = H + P + F where:

H = Distance from surface to water level when pumping P = Pressure (head) at pump discharge

F = Drop pipe friction (+) check valve(s) loss

4.2.3. Bowl Assembly Selection

Select impeller in exactly the same manner as for line shaft type pump. Note comments under Well Size.

4.2.4. Drop Pipe Selection

Size of drop pipe is selected based on the capacity to be pumped. Submersible pumps frequently require smaller drop pipe than do line shaft pumps since the full area of the pipe is used to deliver water to the surface.

Minimum velocity in drop pipe should not be less than 3.5Ft./Sec.

We recommend drop pipe size be selected to limit the maximum friction loss to 5' per 100' of pipe. Selection table is based upon this limitation. Smaller size drop pipe may be used when bowl assembly and motor are adequate for operation with the increased head and horsepower. Pipe furnished by others must be standard pipe with 3/4 taper NPT threading throughout and to connect to the bowl assembly and surface plate.

4.2.5. Check Valves

Where total head exceeds 200', the use of a drop pipe check valve is recommended. Check valve should be located approximately 20' above the bowl assembly. For settings over 600', the use of two check valves are recommended, with the first valve approximately 100' above bowl unit and the second located approximately 60% of the distance between the first valve and the surface plate.

4.2.6. Cable Selection



Select a drop cable designed for use in water. The insulation on the conductors should be RW, RUW, TW, or their equivalent. DO NOT compromise on drop cable quality. Paying a little more will save you money in the long run. Cable selection chart is based on horsepower, voltage, and length of cable required. Cable sizes and lengths are maximum allowable. Higher operating efficiency will be obtained by using the next larger cable size when lengths approach listed limits. All size and cable lengths shown are for copper wire only.

Note: Use of smaller cable than recommended will void warranty.

Select cable length equal to length of setting plus an additional 10' or more to connect to starter at the surface, plus 1 additional foot for each 50' of length in the well to compensate for unavoidable slack in the installation.

4.2.7. Surface Plate

Surface plate consists of flat steel plate with connection for drop pipe, hole for entrance of cable, vent hole, hole for air line or water level gauge. Surface plate is supplied (with)(without) elbow. If elbow is furnished, it can be flanged or female thread. Surface plate is selected to match drop pipe size.

4.2.8. Motor Selection

Motor selection is based upon horsepower required, pump RPM, thrust load, well diameter, and power supply. Also, see comments under WELL SIZE and WATER TEMPERATURE.

4.2.9. Starting Equipment

Selecting the proper overload protection is one of the most important factors in obtaining a successful submersible installation. Submersible motor starters should provide the following:

- Positive motor protection against single phasing.
- Positive motor protection against sustained overload in excess of 115% of motor rating.
- Motor protection if rotor is stalled.
- Tripping timers independent of ambient temperature; (Ambient Compensated Quick Trip Heaters).

Note: Failure to provide quick trip overload heaters will void warranty.



Also, note that under certain conditions of maximum load on the motor (use of the 1.15 service factor), a starter one size larger may be required.

4.2.10. Lightning Protection

Lightning and power surge damage are major causes of submersible motor failures, so a three-phase lightning arrestor is a must. The arrestor is mounted in the pump panel and grounded to both ground terminals onto pump panel and well head. If you use plastic pipe, the ground wire should also be connected to a stud on the motor to obtain good grounding and maximum benefit from the arrestor.

Warning: Failure to ground this unit may result in serious electrical shock. A faulty motor or wiring can be a serious electrical shock hazard if it is accessible to human contact. To avoid this danger, connect the motor frame to the power supply grounding terminal with copper conductor no smaller than the circuit conductors.



References

1. B-Pump installation/operating manual by KSB Pump. For vertical turbine shaft pump.
2. Selection criteria of pump, National Pump company manual
3. Submersible borehole pump, UPA with Motors up to 1000 V Operating Voltage 50 Hz, 60 Hz Installation/Operating Manual by KSB Pump.
4. Non-Clogging Centrifugal Pumps of process type construction standard bearing arrangement, casing construction 1 and 2 up to bearing bracket P65/160x operating instruction by KSB KWP.





ALJAZARI
— ACADEMY —

Operations and Maintenance of Mechanical and Electrical Equipment

WSD-5231

Module 1

Pumps, Induction Motors and Valves

Lecture 2

Induction Motors

Participant lecture notes

2016



1. Lecture Information

Topics 1) Introduction of motors 2) Basic design parameters of induction motors 3) Motor burnout and rewinding 4) Efficiency for re-wound motors	Lecture Duration: 1 Hour
--	--------------------------

2. Introduction of Topic

2.1 Brainstorming

The lecturer will evaluate course participants' prior knowledge of "Motors and especially AC motors" through brainstorming. The Lecturer will put a question to the class about "What is an AC motors and importance of AC motors in WASA operation?"

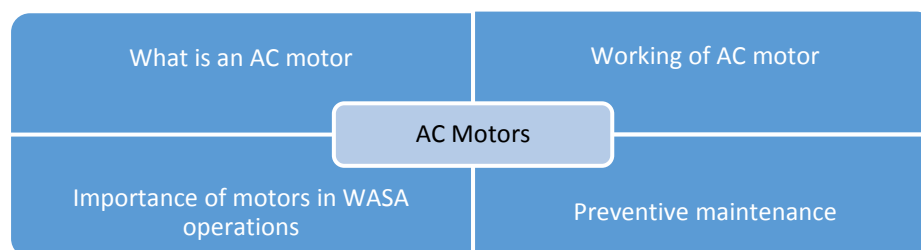

Figure 1

2.2 Definition of a Motor and its Kinds

"An electrical motor is an electromechanical device which converts electrical energy into a mechanical energy (in contrast an engine converts chemical energy into mechanical energy)". An electrical motor is essentially a reverse of electrical generator: a current through coils of wire causes some mechanical device to rotate. The core principle on which electrical motors work is



electromagnetic induction. By Ampere's law, the current induces magnetic field which can interact with another magnetic field to produce force that can cause mechanical motion. A motor is basically a generator run backwards as it uses current to produce motion whereas the motion will produce current in a generator.

Two broad categories of motors are; DC and AC motors. In a DC motor the input electrical power is in DC form whereas in AC motors the input power is AC. Like generators, electrical motors consist of a stator and rotor and the three ingredients; electrical current, magnetic field and something rotating.

- As a rule of thumb, in AC motors the electro-magnetic part is on the rotor and the current flows in the stator.
- In most DC motors, the electro-magnetic part is in the stator and the current is flowing in the rotor; hence, the need for brushes.
- A motor specifications include several quantities:
 - Voltage (or the range of voltage for DC motors) that the motor can be run at,
 - Rotor speed (or the range of speeds),
 - The (rated) mechanical power of the motor (in hp rather than in watts; 1 hp = 746 W). The input of a motor is in watts (W). The nameplate of a motor will always show its rated output (mechanical power), and a motor generally runs at different power (lower) than this one.
 - Torque or effective turning force of the motor, in Nm.
- Motors can range in power from few watts (small toy motor) to over 100 MW (used in large hydro power plants).
- The speed control of DC motors traditionally has been very flexible and easy compared to that of conventional AC motors. However, with the advancement in modern power electronics and devices AC motors are as easier to speed control as that of DC motors.
- In large power applications AC motors (three-phase AC motors) are used (no conversion from AC to DC if we would use a DC motor. DC generators are obsolete now and AC motor is more simple and rugged than that of a DC motor: it requires much less maintenance).
- Large AC motors are either three-phase synchronous motors or three-phase induction motors. The former are fixed speed whereas the later are variable speed (particularly in conjunction with modern power devices).

In case of three phase AC operation, most widely used motor is three-phase induction motor as this type of motor does not require any starting device (which is needed in case of a single-phase motor) or we can say they are self-starting induction motor.”



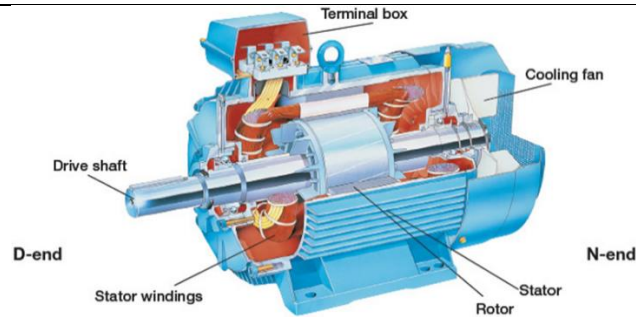

Figure 1 3-Phase induction motor

2.3 Introduction to induction motor

2.3.1 Common features of induction motor: Simple design, rugged, low-price, easy maintenance, wide range of power ratings (fractional horsepower to 10 MW), run essentially as constant speed from no-load to full load, manufactured with characteristics to suit most industrial requirements

2.3.2 Limitations of induction motor: It is essentially a constant speed motor and its speed cannot be changed easily, requires a variable-frequency power-electronic drive for optimal speed control.

2.4 Construction of Induction Motor

An induction motor has two main parts:

1. A Stationary Stator
2. A Revolving Rotor



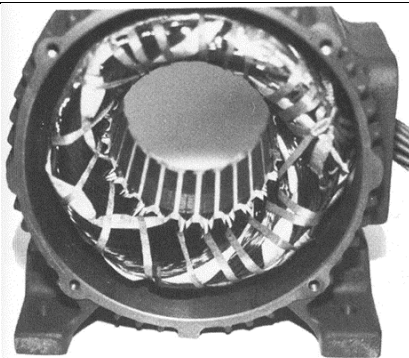

Figure 2 Stator for motor

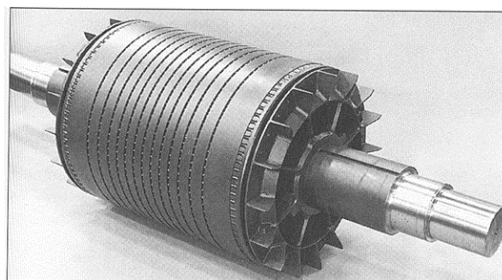

Figure 3 Rotor of motor

A stator is a stationary part of induction motor. A stator winding is placed in the stator of induction motor and the three phase supply is given to it. Stator is made up of number of stampings in which different slots are cut to receive 3-phase winding circuit which is connected to 3-phase AC supply. The three phase windings are arranged in such a manner in the slots that they produce a rotating magnetic field after AC supply is given to them.

2.4.1 How Does a Three-Phase Induction Motor Work?

- A rotating magnetic field is produced in the air when three-phase balanced AC voltages are applied to the three-phase stator windings in the induction motor. The speed of this revolving/rotating magnetic field, also called synchronous speed, is given by $120 \times \text{frequency of the supply voltage} / \text{number of poles in the windings}$.
- A simple construction of rotor in squirrel-cage type induction motors uses copper or aluminum bars in the rotor surface (placed in slots) which are connected at the ends (by end rings).
- The rotating magnetic field (meaning varying flux) cuts these short-circuited bars and thus emf is induced in these bars and as these are closed (or short-circuited) the current is produced in the bars.



- The current in the bars will produce its own magnetic field which will interact with the rotating field produced by the stator.
- As a result of the interaction of these two magnetic fields, a force (and thus torque) is produced which keeps on rotating the rotor.
- The rotor's physical speed, in RPM, is slightly lower than that of the rotating magnetic field's speed even if the motor is not loaded.
- Under load, the speed of an induction motor further decreases. For example, for a 4-pole, 50 Hz, system the synchronous speed will be 1500 RPM whereas the induction motor's rated speed could be 1450 RPM (or even lower).

2.5 Motor Preventive Maintenance

Motor preventive maintenance, especially for small induction motors, is more than just inspecting and maintaining the motor itself. If left running under rated conditions, an induction motor will provide many years of trouble-free service and may even outlast the building.

Preventive maintenance involves identifying potential problems and correcting them before the equipment fails. Due to their construction, induction motors are very reliable, so operators do not have effective preventive maintenance programs.

2.5.1 An Electric Motor's Bearing-Greasing Basics: General Procedure

- Lock and tag out the motor.
- Wipe grease from the pressure fitting, and clean dirt, debris and paint around the grease relief plug.
- Remove the grease relief plug and insert a brush into the grease relief as possible (to remove hardened grease). Remove the brush and wipe off any grease.
- Add the amount of grease as specified in the manufacturer's manual.
- Allow motor to run 30-40 minutes before replacing the grease relief plug.
- The frequency of greasing should be according to the manufacturer's recommendations.

2.6 Motor Failure and Re-winding

2.6.1 When do motors fail?

Motors tend to fail early in their service life due to

1. Manufacturing defects
2. Damage before or during installation
3. Improper installation
4. Misapplication.
5. Fluctuation in supply voltage



Similarly, motors have a high failure rate as they approach their rated life, which is typically determined by their insulation. In between these two endpoints, motors should experience low failure rates.

2.6.2 Testing for motor burnout

A typical 3-phase squirrel-cage motor has six connection leads in the electrical connection box for the three coils. If someone works with AC 3-phase motors, then it is important to know how to connect these motors in Star and Delta connection, and how to detect an electrical problem. There are basically 4 problems that the motor windings can suffer from:

1. Broken coil (infinite coil resistance)
 - Compared to a healthy coil its resistance will be extremely higher (in fact infinite) when measured with an ohm-meter.
2. Short-circuited coil (less than normal or zero coil resistance): A damaged coil can be identified easily with the help of an ohm-meter (should give here lower resistance than that of a healthy coil).
3. Leaking coil to ground (current leaking from one coil to ground/neutral): When measured with an ohm-meter, the resistance of damaged coil to ground should be much lower compared to that of a healthy coil (to ground).
4. Two or more coils short-circuited with each other (current leaking from one coil to another coil): This condition can also be identified quite easily. Two shorted coils will have much lower resistance when measured with an ohm-meter (in healthy condition there should be infinite resistance between the coils).
 - To identify the above faults it MUST be remembered that the coils should not be connected in either delta or wye, so there must be six terminals of the coils not connected with each other (two terminals for one coil).

2.6.3 Re-winding in case of motor burnout

In case a motor is damaged and needs overhaul following points should be taken care of:

1. Copper or aluminum inner wire should be used for rewinding the motor
2. Preferably the inside of the winding wire should be enameled copper wire (magnet wire).
3. The outside of winding wire should be of polyimide (PI) coating and should be manufactured to withstand high temperatures up to 250° C.
4. After re-winding the assembly should be coated with risen and baked.
5. Special care should be taken when inserting the rotor into the stator assembly.



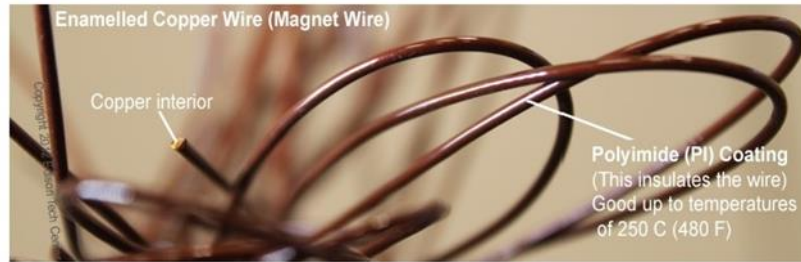

Figure 4 Copper wire for winding



Figure 5 Stator re-winding for Induction motor

2.6.4 Efficiency of re-wound motors

A test was carried out to study the efficiency of different re-wound motors from the same manufacturer. 24 new motors studied were divided into four groups to accommodate the different test variables. The test results summarized below show no significant change in the efficiency of



motors rewound using good practice repair procedures (within the range of accuracy of the IEEE 112B test method), and that in several cases efficiency actually increased.

Group A: Six low-voltage motors [100 - 150 hp (75 – 112 kW)] rewound once. No specific controls on stripping and rewind processes with burnout temperature of 660° F (350° C).

Effect of Repair/Rewinding On Motor Efficiency

Results: Initially showed average efficiency change of -0.6% after 1 rewind (range -0.3 to -1.0%).

Group B: Ten low-voltage motors [60 - 200 hp (45 – 150 kW)] rewound once. Controlled stripping and rewind processes with burnout temperature of 680° F - 700° F (360° C - 370° C).

Results: Average efficiency change of -0.1% (range +0.2 to -0.7%).

Group C: Low-voltage motors rewound more than once. Controlled stripping and rewind processes.

Group C1: Five low-voltage motors [100 – 200 hp (75 - 150 kW)] rewound two or three times. Controlled stripping and rewind processes with burnout temperature of 680° F - 700° F (360° C - 370° C).

Results: Average efficiency change of - 0.1% (range +0.6 to -0.4%) after 3 rewinds (3 machines) and 2 rewinds (2 machines).

Group C2: Two low-voltage motors [7.5 hp (5.5 kW)] processed in burnout oven three times and rewound once. Controlled stripping and rewind processes with burnout temperature of 680° F - 700° F (360° C - 370° C).

Results: Average efficiency change of +0.5% (range +0.2 to +0.8%).

Group D: One medium-voltage motor [300 hp (225 kW/ 3.3 kV)] with formed stator coils rewound once. Controlled stripping and rewind processes with burnout temperature of 680° F - 700° F (360° C - 370° C).

Results: Efficiency change of -0.2%.

(Reference: The Effect Of Repair/Rewinding On Motor Efficiency EASA/AEMT Rewind Study and Good Practice Guide To Maintain Motor Efficiency, Electrical Apparatus Service Association, Inc. 1331 Baur Boulevard St. Louis, Missouri 63132 U.S.A 2003)



This is the most important workflow diagram and the instructor should make every effort to make it thoroughly understandable to all attendees

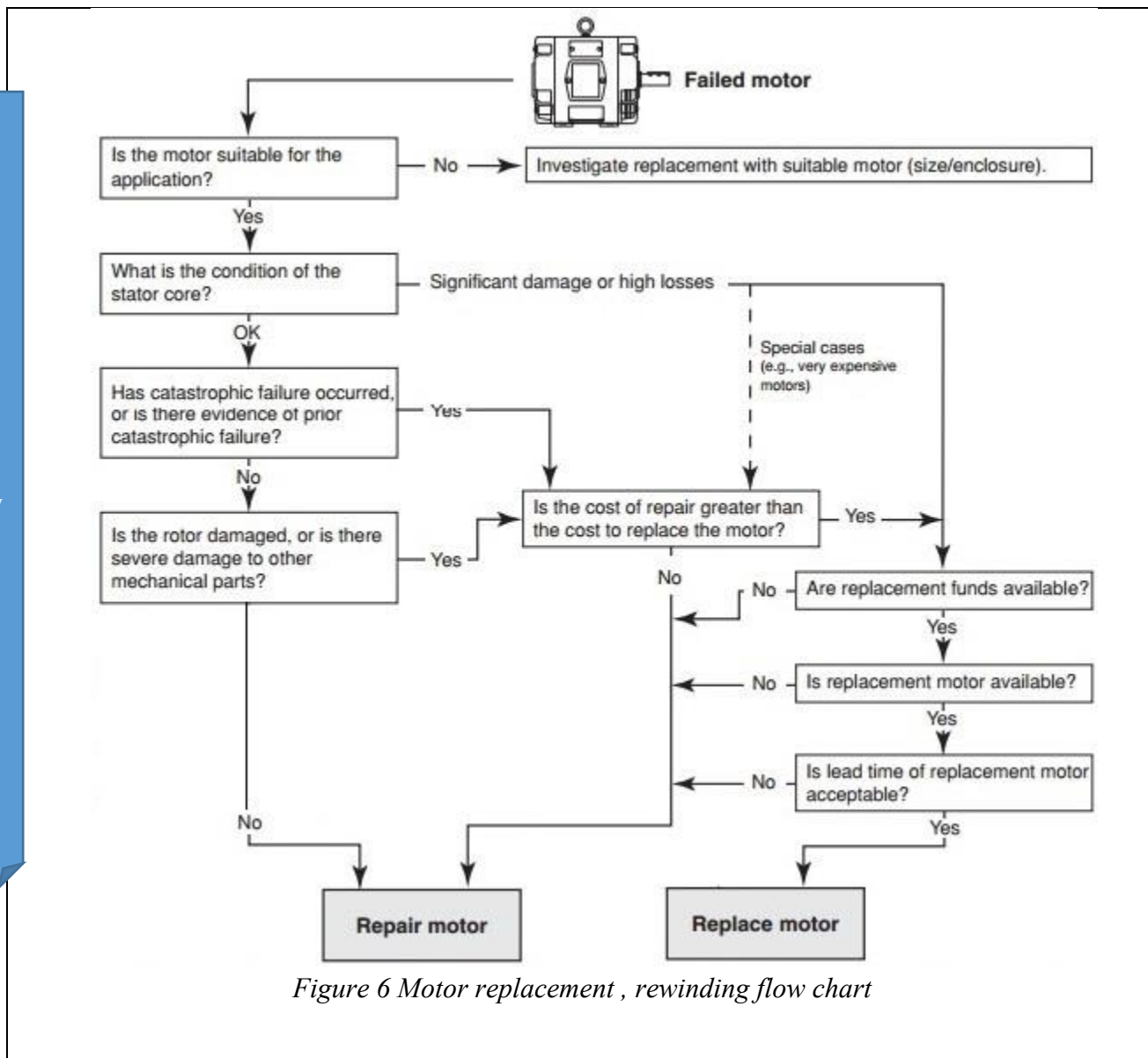

Figure 6 Motor replacement , rewinding flow chart

3. Conclusion

This lecture will provide insight about construction, operation and preventative maintenance of induction motors as well as basic knowledge of overhaul, requirement for overhaul, material required and efficiency of overhauled motor.



Trouble shooting checklist

S. NO.	Trouble	Cause	Remedy
1. ✓	Motor fails to start	<p>Blown fuse or open circuit breaker</p> <p>Motor overload relay on starter tripped</p> <p>Low voltage or no voltage applied to the motor</p> <p>Defective motor windings</p>	<p>Check the voltage at the input and output of the over current protection device. If voltage is measured at the input but not at the output, the fuse is blown or the circuit breaker is open. Check the rating of the fuse or circuit breaker. It should be at least 125 percent of the motor's full-load current.</p> <p>Allow overload relay to cool and reset it. If the motor causes the overload relay to open after a short period, check for motor short circuits and grounds. Check the full load current of the motor and compare it to the setting of the overload relay</p> <p>Check the voltage at the motor terminals. The voltage must be within 10 percent of the motor nameplate voltage. Determine the cause of the low voltage. Loose fuse clips and connections at the terminals of the disconnect switch or circuit breaker.</p> <p>Make resistance checks of the motor windings for</p>



		Burnt-out motor	<p>opens and shorts in coil windings and coils shorted to ground faults.</p> <p>If one or more of the motor windings looks blackened and smells burnt, it is most likely burnt out and needs to be replaced with rewinding process. Test the winding of motor with megger for short circuit to confirm.</p>
		Mechanical overload	<p>Rotate the motor shaft to see if load is the problem. Check for jammed bearings. Check the air gap between the stator and rotor. Reduce the load or try operating the motor with no load applied.</p>
2. ✓	Excessive motor noise and vibration	Insufficient cooling	<p>Remove any buildup of debris in or around the motor</p>
		Load	<p>Check ammeter reading against full load current rating of motor. For a higher-than-normal current reading, reduce the load or replace motor with a larger sized one.</p>
		Source voltage	<p>If the operating voltage is too high or too low, the</p>



			motor will operate at a higher temperature. Correct voltage to within +/- 10% of the motor's rating
3. ✓	Motor overload protector continually trips	Excessive load	Load too high. Verify that the impeller is not jammed. Remove the load from the motor and measure the no-load current Ensure that the relay is set correctly to about 140-150% of load current. Check whether dashpot is filled with correct quantity of lubricant
4. ✓	Heated up bearings	Bent or sprung shaft Electrical Damage (Fluting)	Straighten or replace shaft
5. ✓	Excessive belt pull		Decrease belt tension
6. ✓	Misalignment		Correct coupling alignment.
7. ✓	Bent or damaged oil rings	Oil leakage	Replace oil rings
8. ✓	Worn bearings	Life span completed Foreign Matter (Dust and dirt) Electrical Damage (Fluting) Improper Bearing Lubrication Bearing Fatigue High Temperatures	Replace bearings and rectify cause of failure
9. ✓	Motor Stalls	Motor overloaded	Check any excessive rubbing or clogging in pump Impeller stuck Faulty bearing
10. ✓	Mechanical locking in	Decreased air gap, jammed bearings or any foreign matter stuck	Dismantle and check bearings or at air gap. Check whether any foreign



			matter has entered air gap and clean
11. ✓	Wrong rotation	Wrong sequence of phases	Check the sequence of connections at the motor and electrical panel
12. ✓	Motor overheat	Overload	If overloaded, check and running rectify cause for over loading. Overloading may be due to system fault, e.g. if pipeline bursts, the pump may be operating at low head causing overload of motor Vortices in sump also may cause overload.
13. ✓	Starter or circuit breaker not operating	Non availability of power or faulty relay	Check and clean the relay contacts reset the relay if fault persists replace.
14. ✓	Overheating of cable	Cable size inadequate	Provide a cable in parallel to existing cable or higher size cable
15. ✓	Insulation burning at termination	Improper termination lug	Check size of lug and whether lug termination properly crimped and correct. Check whether only few strands of cable are inserted in lug. Insert all strands using a new or higher size lug if necessary
16. ✓	Overheating busbar	Bus bar capacity inadequate	Check and provide additional bars in combination with existing bus-bars or replace busbars.

Table 1. Trouble shooting checklist



References

1. THREE PHASE INDUCTION MOTOR DRIVE USING IGBTs AND CONSTANT V/F METHOD M.S.Aspalli.1 , Asha.R2 , P.V. Hunagund3 Dept of Electrical & Electronics Engg, P.D.A. College of Engineering, Gulbarga, Karnataka, India 1
2. Rotor Unbalance Detection in Electrical Induction Motors Using Orbital Analysis José Juan Carbajal-Hernández, Luis P. Sánchez-Fernández, Sergio Suárez-Guerra, Ignacio Hernández-Bautista
3. FAULT DIAGNOSTIC AND MONITORING METHODS OF INDUCTION MOTOR: A REVIEW Partha Sarathee Bhowmik1, Sourav Pradhan2 and Mangal Prakash3
4. Objective Electrical Technology By V. K. Mehta, Rohit Mehta (Writer on Electrical Engineering) Ch. 20 Three phase induction motors
5. MANUAL ON OPERATION AND MAINTENANCE OF WATER SUPPLY SYSTEMS CENTRAL PUBLIC HEALTH AND ENVIRONMENTAL ENGINEERING ORGANISATION World Health Organization (Ch.11)
6. <http://www.electrical4u.com/working-principle-of-three-phase-induction-motor/>
7. <http://www.electrical4u.com/single-phase-induction-motor/>
8. <http://www.uomisan.edu.iq/eng/ar/admin/pdf/93138541001.pdf>
9. <http://www.slideshare.net/vijaykumar0225/induction-machines-15543482>





ALJAZARI
— ACADEMY —

Operations and Maintenance of Mechanical and Electrical Equipment WSD 5231

Module 1

Pumps, Induction Motors and Valves

Lecture 3

Valves

Participant Lecture Notes

2016



Lecture Information

<p>Lecture Topics</p> <ol style="list-style-type: none"> 1) Introduction and selection of valves 2) Assembly parts of valves 3) Valve operation 4) Preventive maintenance of valves 5) Troubleshooting of valves 	<p>Lecture Duration: 1:25 Hours Parts Demonstration: 20 Minutes</p>
---	---

1. Introduction and Selection of valves

This introduces the major types of valves and the parameters that should be considered when selecting a valve. These parameters include the purpose of the valve, size, operation, and joint type.

Although certain valve types can be used for many different applications, operators should choose a valve that carefully balances efficiency and cost for the specific application. For example, butterfly valves in sizes 12 in. and larger are less costly than gate valves but have more flow resistance. Factors to be considered in the valve selection and specifying process include the requirement that the valve either control or shut off the flow in the manner demanded by service conditions;

Conformance to appropriate American Water Works Association (AWWA), American Society of Mechanical Engineers (ASME), American National Standards Institute (ANSI), and other product standards;

- Ability of the valve to withstand maximum working or test pressures
- The need for an unobstructed waterway to maximize flow or accommodate cleaning operations such as “pigging”
- Ability of the valve to resist attack by corrosion and erosion
- Actuator requirements (if any)
- Installation requirements such as weight and accessibility



1.1. Flow Control Elements

The many different types of valves have basic functions and elements that are similar. This section will discuss those basics.

1.1.1. Flow control

A valve controls flow through one of four basic closure methods:

- A disc or plug moves against or into an opening.
- A flat, cylindrical, or spherical surface slides across an opening.
- A disc or ellipse rotates across the diameter of a pipe or circular element.
- A flexible material moves into a flow passage.

The valve parts that control the flow element, or closure member, are the stem and the operating mechanism (generally a hand wheel, lever, or key that attaches to the operating nut).

1.1.2. Stems

Most valves employ a threaded stem to move the flow element. Although there are exceptions, such as safety valves and check valves, most valves have stems that extend to the outside of the valve. A rotating stem provides movement for non-rising-stem gate valves, ball valves, rotating-disc gate valves, butterfly valves, and most plug valves. Quick-opening gate valves, rising-stem gate valves, globe and diaphragm valves, and outside-spring safety and relief valves operate with a stem that moves axially but does not rotate. The factors that influence stem design and selection include torque, thrust, and valve size.

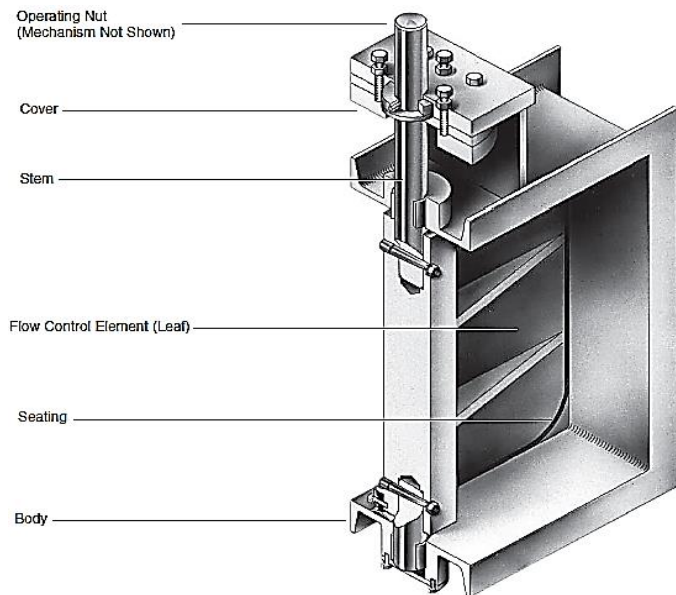

Figure 1 Valve elements (rectangular butterfly valve)



1.2. Valve operation mechanisms

Most valves are operated with a hand wheel, operating nut, or lever. Not every application lends itself to such a simple solution, so designers have devised a variety of methods for both manual and automatic valve operation. Special methods are usually needed when special conditions exist:

- The valve must be operated remotely. The valve is inoperable using normal methods.
- The size of the valve makes it impossible for one person to operate the valve.

The bury depth of valves may vary. Stem extensions or adjustable valve keys have been designed to operate most valves. Stem extensions usually consist of a steel rod and a coupling that attaches to the valve stem. If the extension must be very long to reach a valve, extra support is provided to keep the extension rigid and to prevent bending or breaking. Operators can use adjustable shafts or steel rods and universal joints to reach valves in difficult locations

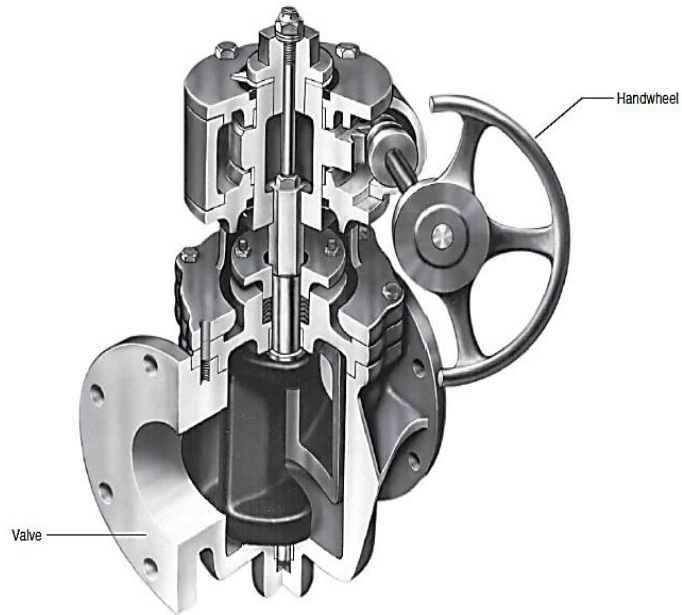

Figure 2 Eccentric plug valve with hand wheel actuator

Floor stands, gear operators, and wheel operators give personnel a mechanical advantage in opening or closing valves that are inconvenient to reach or are large and difficult to operate. Position indicators may be installed on non-rising stem valves to show how far the valve is open.

Accessories for automatic operation are also available. They can be used simply to open or close a valve or to throttle flows. Hydraulic or pneumatic operators, which operate with a diaphragm or piston construction, are common. In a piston type, two chambers in a cylinder are isolated from each other by a piston. The valve stem is connected to the piston. As hydraulic fluid or air is pumped to one side or the other of the piston, the piston is forced back and forth inside the cylinder, which operates the valve. Electric motors are also used to operate valves.



1.3. Sealing Mechanisms

Valves are employed to control the flow of fluid through a piping system. Valve seatings are the portions of the valve that contact the valve body to form a seal that stops or diminishes the flow of liquid. Because they undergo wear and tear during the sealing process, they will become less effective over time. Valve-sealing mechanisms used in water distribution systems are usually metal seating's or soft seating's. Another sealing mechanism involves using a sealant such as that used in a lubricated plug valve

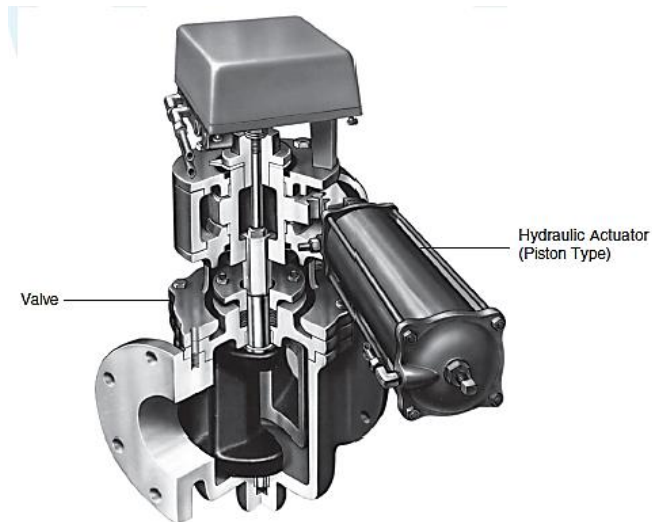

Figure 3 Eccentric plug valve with hydraulic actuator

1.3.1. Metal seatings

The material for metal seatings should be carefully chosen because the seatings are prone to damage by corrosion, erosion, abrasion, and deformation. The type of metal chosen for an application should be considered in relation to the types of fluids it will come in contact with, replacement capabilities, how often it will be operated, and other factors that may cause damage or wear to the sealing mechanism. Different metals offer various sealing abilities and resistance to damage. System designers should choose a valve that has seatings offering the best compromise between sealing ability and wear ability. Soft seatings (?)

Soft seatings are sealing mechanisms generally made from various natural or synthetic rubbers or plastics. The soft material readily conforms to the mating surface, creating an effective seal. This type of seating should be designed to prevent the seating material from being moved or deformed by fluid pressure. Presently there are limitations on the use of soft seatings on large valves.



1.3.2. Sealant

Valve passageways can be sealed by a substance (the sealant) injected into the space between the seatings after the valve is closed. The sealant fills any spaces that might be left open by the seatings and thus prevents leakage. Sealant is also used in emergencies to provide a seal when the original seal has failed.

1.4. Valves Used Primarily for On–Off Control

The valves discussed in this section are used primarily for on–off control of water, rather than for flow control.

1.4.1. Gate Valves

Advantages:

- clear waterway for low flow resistance
- ability to block flow in either direction

Disadvantage:

- some designs are not suitable for flow regulation

Description

Gate valves are the most commonly used type of valve for isolating portions of the distribution system. Gate valves block the passage of water with a disc sliding perpendicular to the flow. They are best used to completely isolate or open a section of piping, primarily for open or closed service; some designs are not recommended for flow regulation or for throttling because of the valve seat material. Gate valves are not well suited for precise flow control because flow reduction is not proportional to travel (the extent to which the valve is open); very little flow reduction occurs until the valve is about 75 percent closed. In the full open position,

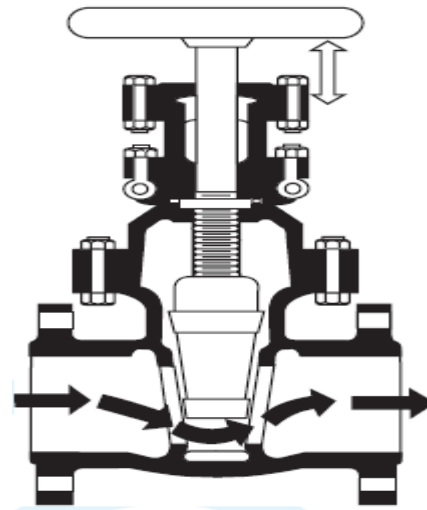
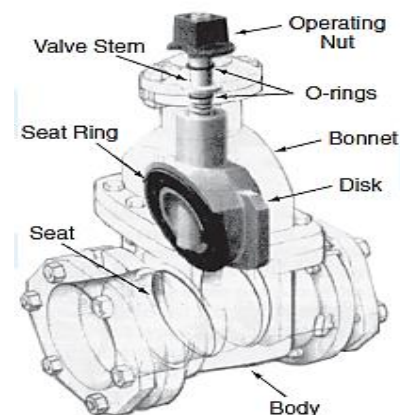

Figure 4 Gate Valve



1.4.2. Non-return Check Valves

The check valve is a single-direction valve that allows flow in one direction (forward) and stops reverse flow. See Figure 6. It opens under the influence of forward pressure and flow, and it closes automatically when flow ceases or reverses, making operation semi-automatic. In some check valve designs, an external lever with a weight or lever spring helps keep the valve closed. Check valves are also available with internal weights or internal springs to aid in closing. Because check valves cause significant pressure loss through flow restriction, applications where operational needs make them necessary.

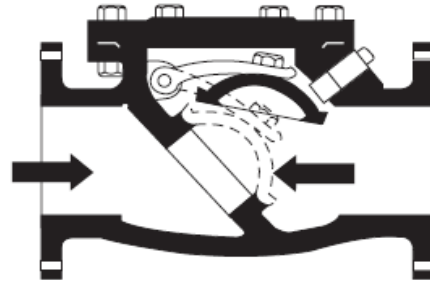

Figure 5 Swing type check valve

Many other types of check valves, such as swing-type check valves, ball check valves, and others, are available; but these are considered specialized valves and will not be discussed here.

1.4.3. Penstock Valve

A penstock is a sluice or gate or intake structure that controls water flow, or an enclosed pipe that delivers water to hydro turbines and sewerage systems

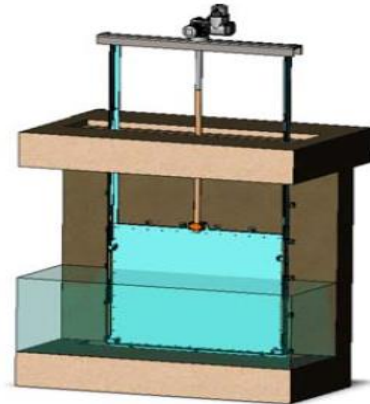

Figure 7 Penstock valve

1.4.4. Air Release Valves

An air release valve is generally a self-actuated valve that automatically vents small pockets of air that accumulate at the high point in a water distribution system when the system is operating under pressure.



Small-orifice air release valves.

After an air release valve is installed at the high point in a system, it fills with water and closes. During system operation, small amounts of air enter the valve from the system. As air displaces water within the valve, the water level drops. When the water level falls to the point where the float associated with the valve is no longer buoyant, the float drops. This action opens the valve orifice and allows the air that has accumulated in the upper portion of the valve body to be released into the atmosphere. As this air is released, the water level within the valve rises, lifting the float and closing the valve orifice. This cycle repeats itself whenever air accumulates in the valve.

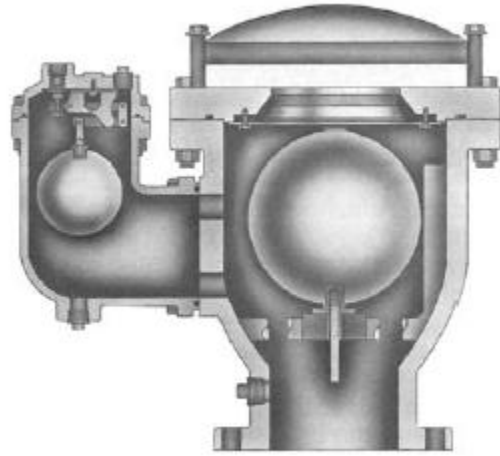

Figure 8 Air release valve

The ability of the valve to open and release accumulated air under pressure is achieved through the use of a leverage mechanism. As the water level and float drop, the weight of the float acting on the mechanism produces a greater force to open the valve than the system pressure exerts to hold the valve closed. Generally, the higher the system pressure, the smaller the orifice diameter needed in the air release valve.

Large-orifice air release valves

A large-orifice air release valve enables trapped air to escape more rapidly when a line is being filled, and if combined with a vacuum relief valve permits sufficient volumes of air to enter the pipe when the line is being emptied. A large orifice-valve will not permit any further escape of air at the pipe working pressure once the valve closes. Once closed, this type of valve will reopen only when the system pressure drops to near atmospheric pressure and the float is no longer buoyant.

An advantage of the large-orifice air release valve is that, because of its large diameter, relatively low pressure (either air or water) on the orifice is sufficient to support the internal float or buoyant element. However, during a high rate of discharge, the float or buoyant element may be caught up in the escaping air stream and slammed to its seat, sometimes resulting in a collapsed, hollow float, and possible water hammer effect.



1.4.5. Pressure Relief Valves

Pressure relief valves are used to protect against excess pressure in water lines. They lower the pressure by releasing water when the designated pressure safety limit is exceeded. They close again when the line pressure falls below the safety limit. See Figure. These types of valves are commonly used on water heaters to relieve high pressure conditions.

Pressure Reducing Valves

Pressure reducing valves are used to provide water to a pressure district or (zones) of lower elevation from a district of higher elevation. They are often globe valves equipped with hydraulic pilot systems similar to those of altitude valves. The valves do not close under normal flow conditions, unless doing so is required to shut off flow. Typically, a large volume and small volume valve are used in parallel.

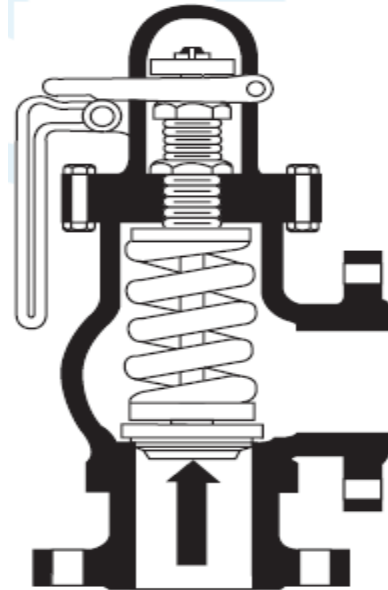

Figure 9 Pressure release valve

1.5. Valves used for On–Off operation and flow control

Some valves can be used for both on–off operation and flow control. Other valves are more efficient for throttling operations (butterfly, ball, cone, and globe valves). Still others, such as plug valves, are more effective for on–off operations but can also be used in some throttling operations. The following paragraphs describe the major types of valves and list their best applications. The advantages and disadvantages are somewhat subjective and may not strictly apply in all situations; the information should be used together with engineering data and operational judgment.

1.5.1. Globe Valves

Advantages:

- suitability for flow regulation
- high sealing capacity
- resistance to wear



Disadvantages:

- high flow resistance
- possibility of sediment being trapped by seating

Description.

Globe valves are closing-down valves where the closure member is moved directly on or off the seat, generally by a rotating threaded stem. The closure member is commonly referred to as a disc. This valve is well suited for flow regulation because of the short distance between the open and closed positions. It also has a high sealing capacity. Because there is little friction encountered in opening and closing the seats, it is resistant to friction wear. However, globe valves tend to trap particulates in the seat, and the flow resistance is high in these valves. See Figure

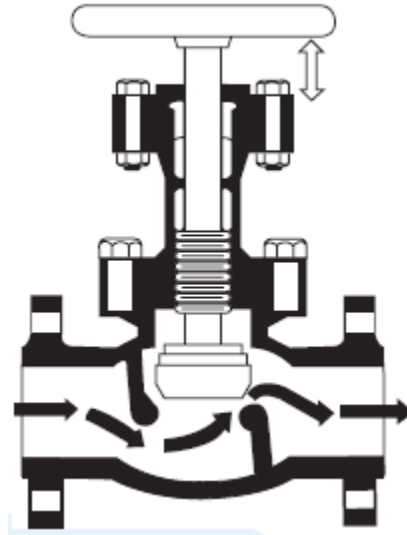

Figure 10 Globe Valve

1.5.2. Piston Valves**Advantages:**

- suitability for on–off operation
- suitability for some flow regulation

Disadvantage:

- high flow resistance

Description.

Piston valves use a piston-shaped closure member that intrudes into the seat bore. Sealing is achieved between the sides of the piston and the seat bore. Therefore, flow cannot start until the piston is completely withdrawn. This type of valve is effective for on–off operation and is somewhat useful for flow regulation. Solids that might be deposited on the seat tend to be wiped away during closing.

1.5.3. Butterfly Valves**Advantages:**

- suitability for both on–off and flow control



- ease of operation
- short face-to-face dimension
- light weight as compared to same size gate valves

Disadvantages:

- some flow resistance
- incompatibility with “pigging” (described in this section)
- high-velocity limitations

Description.

A popular type of valve for the distribution system, especially in larger sizes, the rubber-seated (sometimes called resilient-seated) butterfly valve (see Figure) has been used in distribution systems since the 1950s. In the butterfly valve, a circular disc or vane that has a diameter less than or equal to that of the pipe is fastened to a shaft running through the valve body and extending outside to an actuator. The disc or vane rotates 90° in the waterway. In the full open position, the disc is parallel to the flow. The flow, split by the disc, continues on either side of the disc. In a flow-through disc design, the flow is also directed through openings in the disc. In the closed position, the disc is perpendicular to the flow and stops the flow. The clearance between the disc and the valve body is sealed by a rubber seat.

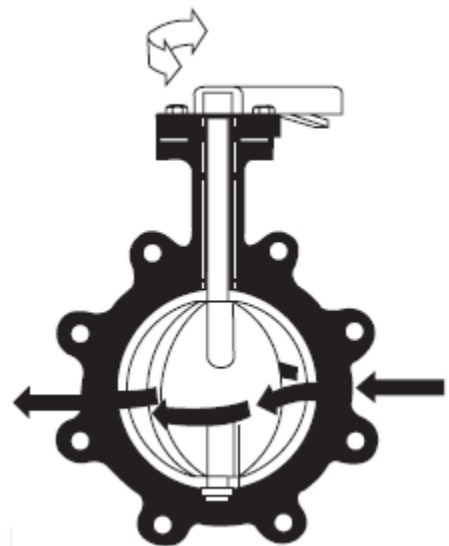

Figure 11 Butterfly Valve

The rubber seat may be attached to either the disc or the valve body. A butterfly valve shuts off pressure as though it were a gasket. The seat holds until the pressure exceeds the seal compression, after which the seal leaks. The valve is set at the factory to hold the rated working pressure (the pressure at which the valve is designed to operate) and should not be expected to seal at higher pressures. The reduction in flow of the butterfly valve is a function of the angle of the disc opening in the pipe. The valve is generally effective for flow control in the range of 20° to 70° open, depending on the difference in pressure across the valve and other characteristics of the valve. Butterfly valves may be used for throttling in some situations; however, they are not intended for long term throttling. The operator should consult the manufacturer before such applications.



Advantages to butterfly valves are that they provide shutoff capabilities, some throttling capabilities, and ease of operation, particularly in sizes 16 in. and larger. The actuators required by larger valves increase the mechanical advantage to allow for ease of operation. Additionally, butterfly valves that are 12 in. and larger are generally more economical than gate valves.

However, butterfly valves do not provide a clear waterway. Restriction of flow in a fully open butterfly valve is greater than in a fully open gate valve because the disc remains in the waterway. As the valve size increases, the proportion of the open flow area to the cross-sectional area of the disc increases. If a large number of butterfly valves are used, pressure loss in a distribution system can be significant. When flow resistance is critical, other types of valves may be required.

Another disadvantage is that butterfly valves prevent the use of “pigging,” which involves using line pressure to force a bullet-shaped plug through a water line to locate and clean flow restrictions.

1.5.4. Plug Valves

Advantage:

- suitability for both throttling and flow regulation

Disadvantage:

- cause some flow resistance

Description

Plug valves use a flow control mechanism consisting of a machined plug that has a waterway opening bored through it (see Figure). Plug valves are manufactured in three basic types: lubricated, non-lubricated, and eccentric. A lubricated plug uses grease to lubricate the plug motion and to seal the gap between the plug and valve body. Some plug valves use the lubricant to lift the plug before turning. For a non-lubricated plug, the valve is mechanically lifted up from, or pushed down to, the seat in a fully open or fully closed position.

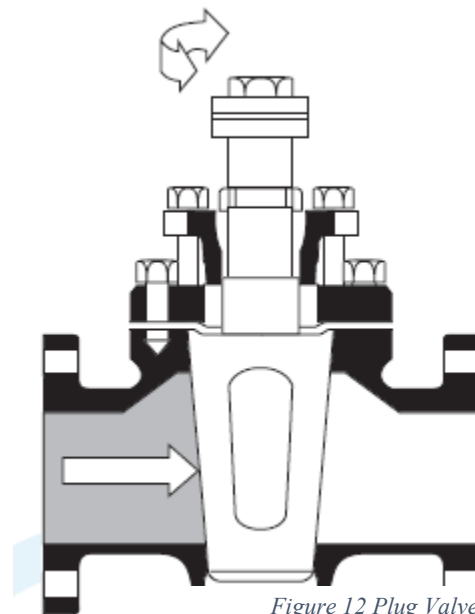

Figure 12 Plug Valves



An eccentric plug valve is also non-lubricated. This type of valve operates by rotating the plug 90° and pulling it away from the seat, thereby opening the valve. Some eccentric valves use a resilient-coated plug for tight shutoff.

Flow restriction in a plug valve depends on the size and shape of the plug opening. For example, some plug valves have tapered openings where the opening is smaller at the bottom than at the top. Tapered plugs cause more flow restriction than a rectangular design of the same size because there is more plug area blocking the flow. Flow resistance can range from that of a gate valve to more than that of a butterfly valve. An advantage of the plug valve is that it can be installed in any position without special consideration, and it can also be used in throttling applications.

Larger plug valves require an actuator for 90° rotation. Smaller plug valves may be operated with either a 90° rotating lever handle or actuator. Small rubber-seated plug valves are commonly used in consumer service connections as corporation stops, curb stops, and meter isolation valves.

1.5.5. Ball Valves

Advantages:

- low flow resistance
- suitability for throttling where pressure reduction is important
- high-pressure capability

Disadvantage:

- very heavy

Description.

The flow control mechanism in the ball valve is a sphere that has a waterway opening. The sphere is connected to shafts perpendicular to the waterway, and there is 90° of rotation from the closed to open positions. The seating surfaces are either resilient on a noncorrosive metal or noncorrosive metal to metal.

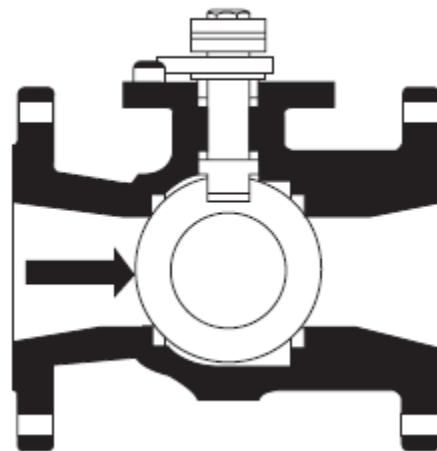

Figure 13 Ball Valve



When ball valves are furnished with port openings of the same size as the pipe opening, they have a very low head loss. See Figure.

Small rubber-seated ball valves are used in consumer service connections as corporation stops, curb stops, and meter isolation valves. Larger ball valves are generally installed in applications where the pressure or velocity exceeds the capability of a butterfly or gate valve. Ball valves are used extensively for control or throttling service where a moderate reduction in pressure is required. In such service, the actuator is constructed to provide a mechanical advantage so that the valve operates smoothly and easily.

1.5.6. Diaphragm Valves

Advantages:

- ease of operation
- resistance to corrosion

Disadvantage:

- only effective for flow control after 50 percent closed

Description.

Diaphragm valves contain a flexible diaphragm attached to a compressor. The diaphragm is lowered by a valve stem onto a weir, which seals and shuts off the flow. Diaphragm valves are easily maintained and are used to handle corrosive, erosive, or contaminated fluids, which should not be a consideration in water distribution systems. See Figure.

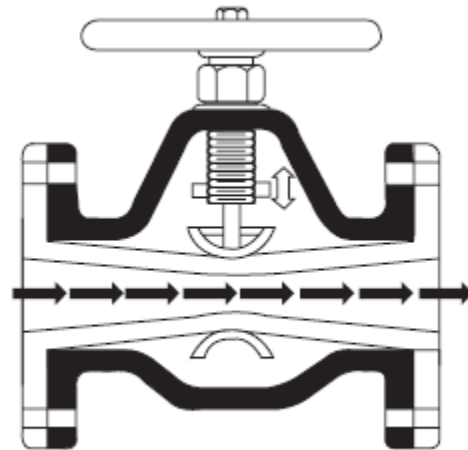

Figure 14 Pinch Valve

1.5.7. Control Valves

Advantage:

- accurate proportioning

Disadvantage:

- possible cavitation resulting in excessive wear if wrong type valve used



Description.

Control valves provide accurate proportioning control by automatically varying the rate of flow that passes through the valve according to signals received from sensing devices. Some valves are designed specifically as control units. Most types of valves, however, can be used as control valves when combined with actuators, positioners, and other accessory devices. Control valves function very similar to a globe valve.

1.6. Reactive Versus Preventative Maintenance of Valves

Reactive maintenance is typically referred to as the kind performed when a valve's usefulness has deteriorated or has experienced failure. The major difficulty with reactive maintenance is that one never knows when it will occur. This can be complicated to a greater degree if the parts necessary for repair/replacement are not available at the time they are needed. Reactive maintenance is the most expensive as well as the least efficient.

Preventive maintenance identifies the scheduling of required maintenance. It incorporates having the needed parts, identifying impacted customers, etc., to perform an efficient repair/replacement. Preventive maintenance (PM) is based on trying to repair/replace the valve that is due to fail before it fails. Another aspect is to regularly maintain the valves so that the ability to predict the failure is better enhanced.

One of the major problems in implementing a scheduled preventive maintenance program for valves is the apparent magnitude of the job. There may be hundreds of valves even in a small distribution system. However, if a systematic maintenance schedule is applied, the task becomes less daunting. In general, the following rules for operation, inspection, and maintenance apply:

- Inspections should be made of each valve on a regularly scheduled basis (annually if possible) and at more frequent intervals for valves with a 16-in. diameter and larger or valves deemed critical.

1.6.1. Operation and Maintenance

- Inspection should include examining the condition of the valve box or vault, operating the valve several times, and lubricating where required.
- Preventive maintenance should be performed as necessary or as suggested by the manufacturer.



- All gate valves should be cycled from full open to full close and back to open at least once every five years. Caution should be exercised when large valves in critical single-source transmission mains are cycled to the fully closed position. Some valves (such as butterfly valves that have a seating where a resilient coating meets stainless steel, or valves with actuators isolated from the contents of the line) may need less exercise. The manufacturers' guidelines should be followed.
- Repairs should be made promptly and correctly. Records of all operation and maintenance should be maintained. Computer programs are available for such record keeping.

1.6.2. Valve Maintenance Procedures

Operation and maintenance procedures for various types of valves are detailed in manufacturers' operation manuals and in the appropriate product standards. The following paragraphs provide guidelines for most situations.

A valve that has not been operated for a number of years needs to be closed by using a series of up and down motions. Crews attempting to close a difficult valve should never use a T-handle and extension to force the valve closed. Such over torque to obtain a positive shutoff can cause damage to the valve. Torque- limiting devices are available. Crews should follow the following guidelines to close a valve properly:

1. Begin with a steady amount of torque in the direction necessary to close the valve, moving through 5 to 10 rotations.
2. Reverse for two or three rotations.
3. Reverse again and rotate 5 to 10 more turns in the closing direction.
4. Repeat this procedure until full closure is attained.
5. Once the valve is fully closed, it should be opened a few turns so that high-velocity water flowing under the gates can move the remainder of the sediment downstream with more force and clear the bottom part of the valve body for seating.
6. Fully close the valve again.

The reason for this cautious approach is that debris and sediment often build up on the gates, stem, and slides. If this material is compacted while the valve is being closed, the torque required to close the valve continues to build as the material is loaded. If the procedure previously described is used, the stem and other parts are "scrubbed" by the



series of back-and-forth motions, and water in the system can flush the debris that has broken loose away from the stem gate and slides or guides.

1.6.3. Design of Valve Records

A utility using a manual card system should have two sets of cards. One set, in a master file, should be retained in the office at all times. A second file may be used by field crews for operation and inspection of the valves. The valve record card should contain information on valve condition, testing, and maintenance required. Figure shows a sample valve record card.

All information should be transferred from the field order to the permanent record as soon as possible after field inspection or maintenance of the valve. Computer programs are available for valve records and are capable of printing cards that can be used for field inspection or maintenance work orders. Computer-generated valve record cards should be designed for easy information entry in the field.

Technology within the industry has advanced to the point that hand-held devices are used to locate valves and report their status. Laptop computers can be installed in valve maintenance vehicles to upgrade the data from the field in a faster manner than before, and modeling programs are often employed to aid in determining their size and location within the system.

1.7. Valve records can include the following information:

- **Size of the valve:** 6 in., 8 in., etc.
- **Valve type:** identifies the valve design (gate, butterfly, resilient seat, check, or other design)
- **Function and purpose:** indicates whether the valve is a main line valve, hydrant branch valve, service line valve, bypass valve, division valve, or other such function. Current status should also be listed.
- **Manufacturer:** manufacturer's name, casting year, model number, and reference shop drawings, if available.
- **Type of access:** valve box or valve pit with lid size. The size of the access opening indicates what maintenance can be done from ground level through the pit or box opening and assists in identifying the casting.



- **Actuator:** indicates the torque required to operate the valve, whether the operating nut is direct to the valve stem or through a gear drive to the valve stem, or if it is a power-operated remote control valve.
- **Direction of operation:** indicates whether the valve opens right or left.
- **Position:** indicates normal position of the valve (open or closed) in the distribution system.
- **Date installed and maintained:** the installation date enables the valve maintenance crew to make the decision whether to repair or replace a broken valve, and it assists in identifying the parts required for repair. The date of the last preventive maintenance should also be listed.
- **Maximum turns:** the maximum number of revolutions required to close or open the valve completely. This information is very important to the field crew because it reduces the possibility of over torquing the valve and breaking the stem during operation.
- **Test turns:** the number of revolutions in turning the operating nut when the valve was exercised, last tested, or inspected. Test instructions and comments, such as notes indicating the number of revolutions recommended to exercise the valve, should be included.
- **Distribution map or map quadrant number:** intersection identification that will reference the valve to the distribution map.
- **Location:** the street name and intersection that indicates the location of the valve. The dimension for the valve to the center line of the street and from the center line of an intersecting street or other permanent reference points should be included. Measurements should always be taken from permanent points (not fire hydrants, building corners, or other points that may be lost or moved).

With current global positioning technology, X–Y coordinates should be captured for valve location. Because the X–Y coordinates never change, it is simple to identify the valve location using this equipment. This function is performed using GPS/GIS equipment.

- Pertinent information: soil conditions, installation difficulties, cost of installation, keyway material, etc.
- Other information: include valve number or asset number for identification purposes.



VALVE REPORT		VALVE NUMBER: _____
		CADASTRAL: _____
VALVE LOCATION		
STREET: _____		AVENUE: _____
VALVE ALIGNMENT: _____		
GPS COORDINATES: _____		
WATER MAIN <input type="checkbox"/> HYDRANT LEAD <input type="checkbox"/> SERVICE LEAD <input type="checkbox"/> INFORMATION <input type="checkbox"/> ALIGNMENT: _____		
SIZE: _____ mm TYPE: _____ MAKE: _____		
VALVE INFORMATION		
VALVE SIZE: _____ mm	TYPE: _____	MAKE: _____
	MODEL: _____	CLASS: _____
VALVE PURPOSE:	MAIN CONTROL <input type="checkbox"/>	GEARED: YES <input type="checkbox"/>
	HYDRANT CONTROL <input type="checkbox"/>	NO <input type="checkbox"/>
	SERVICE CONTROL <input type="checkbox"/>	OTHER <input type="checkbox"/> _____
TO OPEN TURN:	LEFT <input type="checkbox"/>	VALVE STATUS: OPEN <input type="checkbox"/>
	RIGHT <input type="checkbox"/>	CLOSE-STOP <input type="checkbox"/>
	OTHER <input type="checkbox"/> _____	OTHER <input type="checkbox"/> _____
KEYWAY:	CAST IRON <input type="checkbox"/>	VALVE INSTALLATION DATE: _____ 19____
	ENCASED IN P.V.C. <input type="checkbox"/>	
PROJECT NUMBER OR W.O. & ACCT.: _____		
FOREMAN OR CONTRACTOR: _____		YARD: _____
IN SERVICE DATE: _____ APPLICATION NO: _____		
REMARKS:		
FIELD SKETCH		
<div style="display: flex; align-items: center;"> <div style="border: 1px solid black; padding: 5px; margin-right: 10px;"> PLEASE INCLUDE COUPLINGS, FITTINGS CHAMBER, PROP. LINES CURBLINE, SIDEWALK ETC. </div> </div>		



1.8. Lists of Deficiencies and Repairs

Two other categories of information often included on valve records are deficiencies and repairs. Items found on a list of deficiencies can include the following:

- inability to locate casing
- incorrect casing measurement
- poor casing accessibility
- poor casing grade
- casing that requires cleanout
- spoils in casing
- water in casing
- frozen casing
- leaking valve
- valve found closed
- valve found open
- poor access to operating nut
- poor operation
- noisy operation
- broken top section
- obstruction
- broken plug
- missing plug

Some tasks found on a list of repairs include:

- inspect
- operate
- lower
- raise
- replace top section
- replace plug
- flush casing
- thaw casing
- pump out casing



Valve Selection:

The suitability of a valve for a particular application is decided by the materials used in relation to the conveyed fluid as well as its mechanical design. The table below can be used as a valve selection guide.

Conveyed Fluid	Nature of Fluid	Valve Function	Type of Disc
Liquid	Neutral (Water, Oil, etc.)	On/Off	Gate
			Rotary ball
			Plug
			Diaphragm
			Butterfly
			Plug gate
		Control valve, modulating	Globe
			Butterfly
			Plug gate
			Diaphragm
	Needle		
		On/Off	Gate



Conveyed Fluid	Nature of Fluid	Valve Function	Type of Disc	
	Corrosive (Acid, alkaline etc.)		Plug gate	
			Rotary ball	
			Plug	
			Diaphragm	
			Butterfly	
			Globe	
	Control valve, modulating	Diaphragm		
		Butterfly		
		Plug gate		
		Hygienic (Food, beverages, drugs etc.)	On/Off	Butterfly
				Diaphragm
			Control valve, modulating	Butterfly
Diaphragm				
Squeeze				



Conveyed Fluid	Nature of Fluid	Valve Function	Type of Disc
	Slurry	On/Off	Pinch
			Rotary ball
			Butterfly
			Diaphragm
			Plug
			Pinch
			Squeeze
	Control valve, modulating	Butterfly	
		Diaphragm	
		Squeeze	
		Pinch	
		Gate	
	Fibrous Suspensions	On/Off, Control valve, modulating	Gate
			Diaphragm



Conveyed Fluid	Nature of Fluid	Valve Function	Type of Disc
Gas	Neutral (Air, Steam etc.)	On/Off	Squeeze
			Pinch
			Gate
			Globe
			Rotary ball
	Control valve, modulating	Plug	
		Diaphragm	
		Globe	
		Needle	
		Butterfly	
Corrosive (Acid vapors, chlorine etc.)	On/Off	Diaphragm	
		Gate	
		Butterfly	
			Rotary ball



Conveyed Fluid	Nature of Fluid	Valve Function	Type of Disc	
			Diaphragm	
			Plug	
			Butterfly	
			Globe	
			Needle	
			Diaphragm	
	Vacuum		On/Off	Gate
				Globe
				Rotary ball
				Butterfly
Solids	Abrasive Powder (Silica, etc.)	On/Off, Control valve, modulating	Pinch	
			Squeeze	
			Spiral sock	
				Pinch



Conveyed Fluid	Nature of Fluid	Valve Function	Type of Disc
	Lubricating powder (graphite, talcum, etc.)	On/Off, Control valve, modulating	Gate
			Spiral sock
			Squeeze

Standard Operating Procedure:

The following SOP is recommended:

1. Locate valve.
2. Notify owner (if required).
3. Photograph the location, identifying the condition of the site.
4. Check the area for potential hazards and implement needed controls.
5. Pull cover.
6. Clean riser as necessary to inspect valve.
7. Exercise valve:
 - a. Verify the direction for turning the valve to the *Closed* and *Open* positions.
 - b. Assume valve is in the full *Open* position.
 - c. Begin *Closing Valve Slowly*, increasing torque as necessary to achieve movement (without exceeding the pre-determined *Maximum Torque*).
 - d. Count the number of turns necessary to achieve the full *Open Position*.
 - e. Begin *Opening Valve Slowly*, increasing torque as necessary to achieve movement (without exceeding the pre-determined *Maximum Torque*).
 - f. Count the number of turns necessary to achieve the full *Closed Position*.



- g. Repeat the Close/Open cycle a minimum of three (3) times, or until the number of turns necessary to open or close the valve does not change.
 - h. Record the number of Turns, Cycles, and Maximum Torque applied.
8. Photograph valve if possible.
 9. Record the valve dimensions, condition of the valve, and other pertinent information.
 10. Replace cover.
 11. Prior to departing, evaluate the location for hazards to people, property, or environment, record findings.
 12. Mitigate any hazards discovered and initiate the actions necessary to eliminate those hazards.
 13. Photograph the site.

Maintenance:

Valve maintenance is the best way of managing control valves, in order to control fluid flow. When making repairs on valve types, use the available manufacturer's technical manuals. As soon as a leak is detected quickly determine the cause, and then apply the corrective maintenance. Maintenance may be as simple as tightening a packing nut or gland. A leaking flange joint may need only to have the bolts tightened or to have a new gasket inserted. Scale if allowed to collect, will cause leakage. Loose hangers permit sections of a line to sag, and the weight of the pipe and the fluid in these sagging sections may strain joints to the point of leakage

Whenever a valve is to be installed, be sure to know the function the valve is going to perform, that is whether it will start flow, regulate flow, stop flow, prevent back flow, or regulate pressure. The valve body must be inserted according to the information that is stamped upon it by the manufacturer-like type of system (gas, oil, and water), direction of flow, operating pressure etc. The valve operating characteristics should be known, the type of end connections with which it is fitted, and the metal from which it is made. These operating characteristics and the material are the factors that determine the length and kind of service that a valve will give. Remember that end connections indicate whether or not a particular valve is suited to the installation. When a valve is installed, ensure it is readily accessible and allow enough headroom for operation.



Install valves with stems pointing upward if possible. Stem positions between straight up and horizontal is acceptable, but avoid the inverted position, because if allowed, sediment will collect in the bonnet and score the stem. Also, in a line that is subjected to freezing temperatures, liquid that is trapped in the valve bonnet will freeze and rupture it. Control valves, properly used and maintained can improve process efficiency and reduce costs. When a control valve is in use, an as-found test should be carried out on the valve. This is a diagnostic test that determines the performance of the valve in its current operation. It compares the transducers output and input signals, and also accesses the positioner input versus the air pressure applied by the actuators. It is wise to apply the basics of proper valve maintenance, in order to improve fluid flow control and operating efficiency. There are 5 basic control valve maintenance steps:

- **Understanding Control Valve Markings and Components:** Valves are identified by markings inscribed on the body, rims of the hand wheel, or to the adjacent piping. Examples of such markings are color codes, ratings, arrows etc. Arrows cast on the body of the valves is used to indicate the flow path through the valve. A code on the operating lever indicates the type of fluid flowing through it, like color code for hydraulic is orange. On the other hand, valves are made of different materials because flowing matter such as gases and liquids are often corrosive, or highly contaminated. For maximum efficiency and control, valve materials must fall into the same category of the fluid flowing through it.
- **Control Valve Connection:** Proper valve connection procedures should be taken into due consideration during installation on piping systems. In other words, the pipe should be properly aligned before the installation of a control valve. The valve must not be relied upon to pull the piping into alignment. If this is not adhered to, valves will not operate smoothly, because the misalignment stresses causes twisting of the valve body. Attention must be paid in particular to the installation and operation of diaphragm valves when they have to operate within specified time windows. This is to ensure no hang-ups due to valve body twisting caused by piping misalignment.
- **Ensure Valve is Clean Before Installation:** In good process operations, prior to installation, control valves must be free from all dirt, and foreign matter. In some cases, the valve and the line should be blown out with clean instrument air, steam, or clean water. This removes grit and dirt that might interfere with valve operation or shorten



control valve life. The type of blow out system applied is dependent on the type of fluid flowing through the piping system.

- **Proper Control Valve Storage:** Control valves should be kept in a safe place, away from weather, dirt etc. Valves must be in protective covers and kept in place until the time of installation. In some cases, control valves are shipped with the disc fully open, and others fully closed. In any case, the disc must be left in the shipping position if possible, until installation is completed. This is aimed at protecting the seating surfaces.

- **Control Valve Inspection upon Receipt:** Whenever a valve is received, thorough inspection should be carried out on it, because this is always the critical time in the management of the valve. Upon receipt, the control valves must be inspected for in-transit damage. And inspection should be focused on the valve actuator, valve stem, and valve ends etc. It is also advisable to dismantle the valve when received, for the inspection of its internals. This is done to remove any anti-movement restraints installed for protection during transit. Trouble shooting The first step to trouble shoot a control valve problem is to make sure it is installed properly.



The following Table provides guidance on troubleshooting three common control valve problems.

1. CONTROL VALVE SEVERE PLUGGING	
Possible cause	Remedy/Solution
a) Is flow rate higher than normal?	a) Adjust handle stem to achieve desired/normal output.
b) Is pressure gauge functioning?	b) Replace faulty gauge.
c) Is particle of debris caught in the port under the valve flap?	c) Check for obstruction. If so, duplicate the cam opening to flush the ports.
d) Is pump discharge filter installed?	d) Confirm filter is installed and without any fault.
e) Is piston/orifice blocked?	e) Perform back flush of orifice/piston until fluid flows freely and normal.
2. THERE IS EXCESSIVE NOISE.	
Possible cause	Remedy/Solution
a) Is valve seat faulty or worn out?	a) Replace the valve seat assembly



b) Is oil viscosity too high?	b) Check for oil purity, separator efficiency and status.
c) Is an improper spring installed behind the valve?	c) Ensure proper number, proper alignment and correct thickness of springs.
d) Is pressure setting too close to that of another valve in the circuit?	d) Adjust pressure gauge.
3. THERE IS IMPROPER FLOW	
Possible cause	Remedy/Solution
a) Is the fluid too hot?	a) Check the status and operation of fluid cooler.
b) Is valve not adjusted properly?	b) Check for proper installation. And adjust properly.
c) Is orifice restricted?	c) Clean the orifice.



References

(Will be organized in a proper bibliography format)

1. Distribution valves: Selection, installation, Field Testing and Maintenance
2. American Water Work Association (AWWA) Manual M44 Second Edition
2006





ALJAZARI
— ACADEMY —

Operations and Maintenance of Mechanical and Electrical Equipment WSD 5231

Module 4 Chlorination and Filtration System

Participant Lecture Notes

2016



1. Lecture Information

<p>Lecture Topics</p> <ol style="list-style-type: none"> 1) Introduction to chlorination and filtration systems and assembly parts. 2) Importance of chlorination and filtration systems. 3) Dosage calculation in chlorination systems and WHO guidelines. 4) Turbidity 5) Operation of chlorination and filtration system. 6) Preventive maintenance and troubleshooting of chlorination and filtration system 	<p>Lecture Duration: 5.15 Hours Parts Demonstration: 45 Minutes</p>
--	---

2. Introduction to chlorination and filtration system

2.1. Chlorination System

For continuous chlorination in smaller systems, hypo chlorinators are generally used; however, chlorinators are considered more economical when the supply source is greater than 8 liters per second, although those are used in smaller systems as well. Anticipated pumping periods and chlorine demand (based on the chlorine residual test) determine whether a hypo-chlorinator or chlorinator should be used in each situation.

2.1.1. Hypo-chlorinator

The hypo-chlorinator is a pump used to add hypochlorite solutions to water at a manually adjustable feeding rate. The setup shown in Figure 1 illustrates that pump draws the hypochlorite solution from a container and transfers it into the water for treatment. Due to the corrosive sodium hypo-chlorite solutions, the critical parts of the pump are made up with chemically resistant plastic and synthetic rubber.

It is recommended that hypo-chlorinator device should not be installed in the same area where equipment like switch board, pumps, meters, tools, because of corrosive nature of sodium hypo-chlorite. If placed in the same area with



other equipment, which is prone to corrosion, then adequate floor drains should be provided to carry away wastewater, spillage, sludge, and wash-down water.

2.1.2. Drip type chlorinator

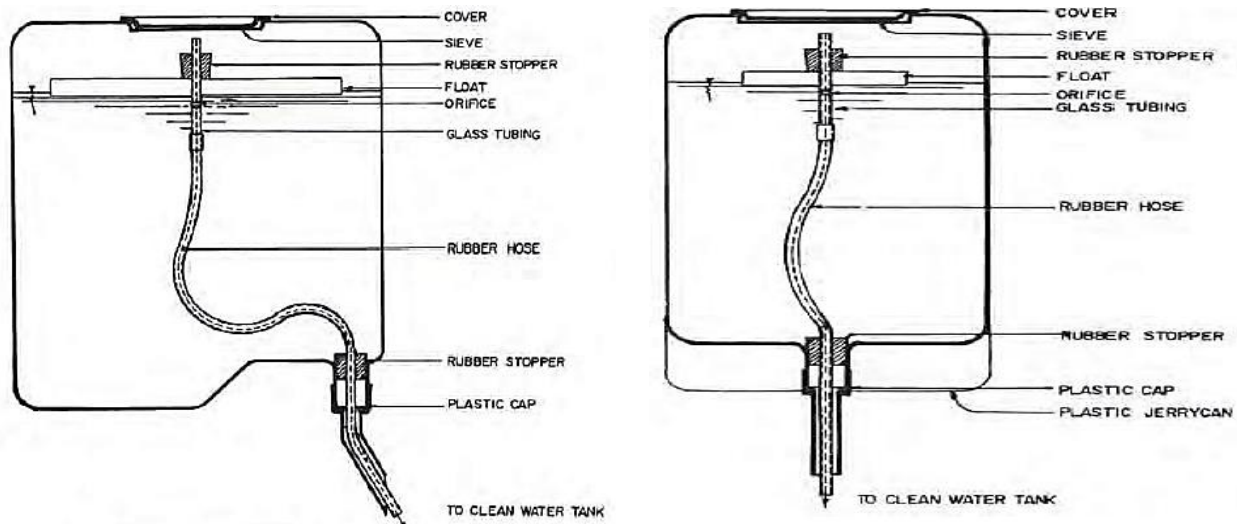

Drip-Type Chlorinator

A drip-type chlorinator can be used for disinfecting small reservoirs, wells and cisterns. To make a simple drip type chlorinator, follow the steps:

1. Use a plastic water container of about 6-18 liters' volume capacity with a spout. The spout of the container will act as the outlet for the chlorine solution.
2. Cut open the bottom of the container to provide a solution inlet and able to have access inside of the container.
3. Guided by Figure, prepare the required supplies like the tubing, hose, rubber stopper, and sieve, and prepare the chlorine feed equipment that will fit inside the container as follows:
 - Choose or cut out a piece of polystyrene (e.g., Styrofoam) or wood to act as the float.
 - In the center of the float, place a rubber stopper or cork and pass a piece of hard tubing through it. The tubing should be long enough to extend beyond the rubber stopper and below the float.
 - Make a small hole in the tubing below the float as inlet for the chlorine solution, which will fill the container.
4. Fill container with the chlorine compound and fill with water until the float reaches the top. Cover top of the container.
5. To control flow, use a small clamp. Place clamp around the hose and tighten it to clamp off all flow during installation. Loosen clamp to get the flow rate desired.



6. Install container over facility to be disinfected. The rubber outlet hose should reach into water



2.2. Filtration System

Filtration is applied to separate non-settle able solids from water and wastewater by passing it through a porous medium. The most common system is filtration through a layered bed of granular media, usually a coarse anthracite coal underlain by a finer sand.

2.2.1. Filter Media

Filters may be classified according to the types of media used as follows:

- **Single-media filters:** These have one type of media, usually sand or crushed anthracite coal.
- **Dual-media filters:** These have two types of media, usually crushed anthracite coal and sand.
- **Multi-media filters:** These have three types of media, usually crushed anthracite coal, sand, and garnet.

2.2.2. How does filtration work?

Let's examine the physical and chemical mechanisms of filtration

Larger particles may be removed by straining

- Particles may also be removed by sedimentation
- Others may be intercepted by and adhere to the surface of the medium due to inertia
- Filtration efficiency is greatly increased by destabilization or coagulation of the particles prior to filtration

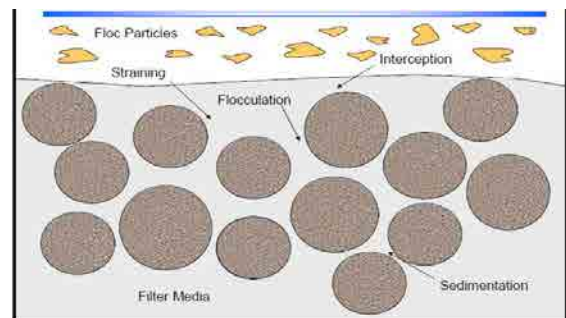

2.2.3. Types of filter media use in WASA

2.2.3.1. Sand filter

Suspended Solid will be removed by the vessel and inside the tank contains “Fine Sand”. Hydraulic flow will be controlled by Multi – Function Flow Control Valve which is operated automatically and divided into three modes.

- a) Service Mode: It control water to flow as downstream to filtrate. Water entrances Filtration Vessel at “Water Inlet” port and leaves at “Water Outlet” port.
- b) Back Wash Mode: It control water to flow as upstream to back wash particles on the surface of filter media. Water enters filtration tank at “Water Inlet” port and leaves at “Drain Outlet” port.
- c) Fast Rinse Mode: Control water to flow as downstream to rinse. Water entrances filtration Vessel at “Water Inlet” port and leaves at “Drain Outlet” port.



2.2.3.2. Activated Carbon, Sand and Arsenic Filtration

Heavy metals like arsenic etc., Color, taste, and odor will be removed by this part and inside the Vessel contains granular activated carbon. Hydraulic Flow will be controlled by Multi – Function Flow Control Valve which is operated automatically and also divided into three modes like the Pre Filtration Vessel.

- a) Activated Carbon
- b) Silica Sand
- c) Arsenic Removal Media
- d) Natural Gravel

2.2.3.3. Screen Filter.

Suspended Solid may be left from Pre Filtration Vessel and will be removed by Screen Filter. The screen can be taken off to wash and clean. 1/2"Mini Plastic filter double wired screen (H), 125 Micron



2.2.3.4. ULTRA-FILTRATION Membrane

For LDA – WASA Arsenic Removal Project, ULTRA-FILTRATION membrane is selected with a pore size of approximately 0.02 micron and the multi-bore fiber. The multi-bore membrane combines seven single hollow fibers into one fiber providing much greater mechanical strength than the conventional single hollow fiber through the foamy support structure in between the individual capillaries.

The multi-bore fiber is spun using polyethersulphone (PES) which is modified to make the membrane permanently hydrophilic. The hydrophilic modification reduces the fouling tendency by reducing the potential for organic adsorption on the membrane surface.

The pore size is approx. 0.02 μm . In spite of the very small pore size the permeability of the membrane in clean water is about 700 l/m²hbar.

The membrane is highly tolerant against chlorination allowing approx. 200,000 ppm- hours of free chlorine. In addition, it has a wide pH tolerance (pH1-13) in cleaning mode which is a precondition for efficient cleanings.



2.3. Chlorination system used in WASA tube well

WASA use different types feed pumps for chlorine supply, most common are

- a) EMEC V Pump



b) CHEM TECH Pump

2.3.1. EMEC V Pump

This pump is used in WASA Lahore mostly for chlorine supply in water supply system.

During their installation following should be followed:

- Suction and delivery hoses must be installed in vertical position!
- All hoses connections must be performed using only hands' force!
- No tongs required!
- Delivery hose must be firmly fixed to avoid suddenly movements that could damage near objects!
- Suction hose must be shorter as possible and installed in vertical position to avoid air bubbles suction!
- Use only hoses compatibles with product to dose! See chemical compatibility table. If dosing product is not listed, please consult full Compatibility Table or contact chemical's.

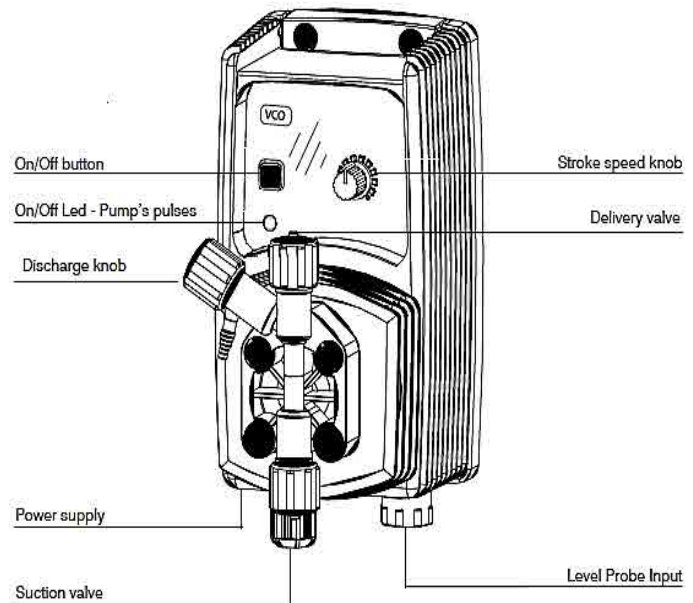
**2.3.1.1. Components used in Chlorinator**

1. Dosing Pump
2. Suction Hose
3. Delivery Hose
4. Injection Valve
5. Air Discharge
6. Level Probe
7. Foot Filter
8. Power Cable

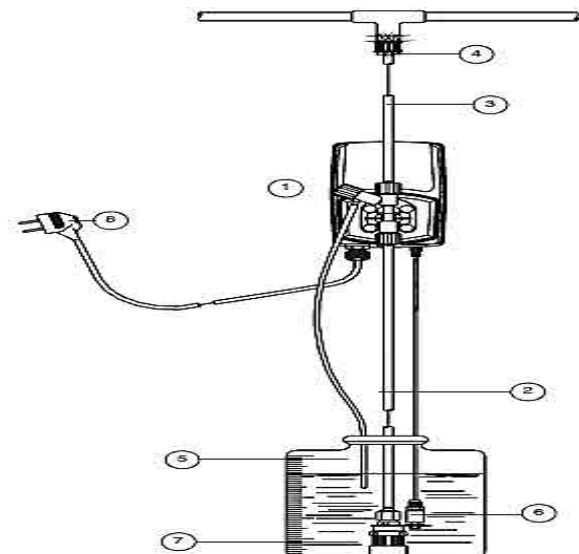

2.3.1.2. Injection Valve.

Injection valve must be installed on plant water's inlet. Injection valve will open at pressure greater than 0,3bar

2.3.1.3. Discharge hose.

Insert one side of discharge hose into discharge connector. Insert other side of discharge hose into chlorine tank. During priming procedure exceeding chlorine will flow into tank.

2.3.1.4. Important operation parameters for chlorinator pump

- Suction, delivery and purge valves are different! do not exchange them!
- Delivery and purge hoses are made of same material!
- It's allowed to lightly bend discharge hose!
- During calibration procedure ("TEST") insert discharge hose into test-tube!



2.3.2. CHEM TECH Pump

This pump is used in WASA Multan mostly for chlorine supply in water supply system

Series 100/150 are diaphragm-type metering pumps. A fluid is pumped from a chemical storage tank to the point of injection by the pulsing action of the diaphragm. The four check valves (top and bottom of pump head, strainer assembly, and injection assembly) keep the fluid flowing toward the point of discharge. To ensure the solution being pumped can only go forward, it is important that all check valves provide a positive, no leaking back flow prevention.

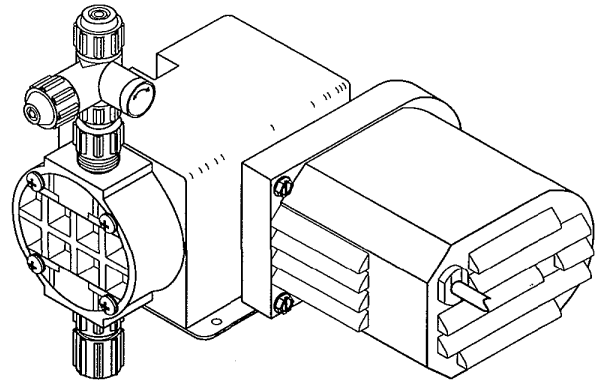

2.3.2.1. Assembly components

Chemical injection into an open tank: The discharge tubing can be placed in an open tank with or without the injection valve assembly. Each feeder is shipped with a spring loaded back check injection valve. This assists in a positive seal on the discharge side of the pump head preventing back flow.

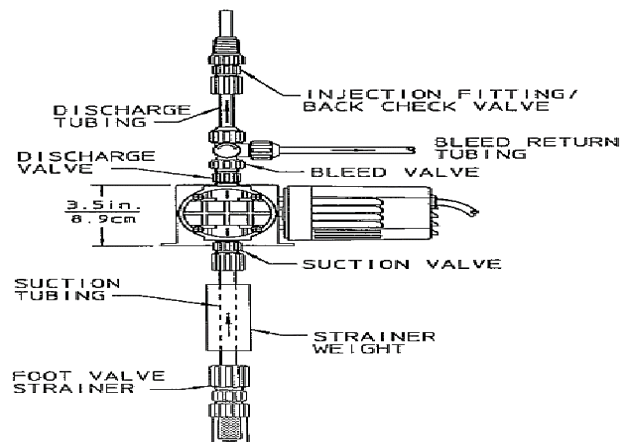

2.4. Components of filtration system

In project, the equipment's are divided into 3 main types according to their function.

2.4.1. Process and Back Wash

- Feed Pump
- Pre Filtration Vessel
- Activated Carbon Filtration Vessel
- Arsenic Filtration Vessel
- Screen Filter
- Production Solenoid Valve (SV1, SV2, and SV3)
- Back Wash Solenoid Valve (SV4 and SV5)
- Ultra- Filtration Membrane
- Back Wash Pump



2.4.2. Maintenance and Monitor

- Pressure Gauge (PI1, PI2, PI3, and PI4)
- Sample Cock (SC1 and SC2)
- Water Meter
- Filtrate Flow Meter
- Back Wash Flow Meter

2.4.3. Control Equipment

Control equipment is used for control over Ultra-Filtration System to operate, standby and shut down.

- Low Level Switch
- High Level Switch
- High Pressure Switch

3. Importance of Filtration and chlorination system at WASA tube well

3.1. Importance of Filtration system at WASA tube well

In LDA – WASA Lahore Project the water filtration process is designed to remove pollutants which are Turbidity, Bacteria, Arsenic and heavy metals. Each plant has capacity of 4000 LPH.



The water treatment process will start from raw water storage tank duly connected with the WASA tube-well or water supply line. Raw water will feed to Raw Water Storage Tank capacity 2,000 liter. Feed Pump will pump raw water from Storage Tank to Pre Filtration Tank to remove suspended solid followed by Activated Carbon Filtration Vessel removing color, taste, and odor. Then raw water containing high amount of Arsenic will be passed through the filtration vessel that was specified to remove these pollutants.



After treated by pre-filtration system including the Pre-Filtration Vessel, Activated Carbon Filtration Vessel and Arsenic removal filtration Vessel, Water will be passed through Screen Filter to remove suspended solid that is left from pre-filtration system. Then treated water flows through ultra-filtration membrane. The main purpose of Pre Filtration System and Screen Filter is to reduce load from ultra-filtration membrane and to expand life time of ULTRA-FILTRATION membrane while removing the contamination.

Pore size of ULTRA-FILTRATION membrane is approximately 0.02 micron. Therefore, suspended solid, colloid, bacteria, and virus will be removed from water. The filtrate water from ULTRA-FILTRATION will be stored in Filtrate Water Storage Tank where the water will be transferred to customer and used in Back Wash Process. Process flow diagrams below clearly illustrate the complete process.

3.2. Importance of Chlorination system at WASA tube well

Disinfection is necessary to ensure that drinking water is free from disease-causing microorganisms. Water disinfection means the removal, deactivation or killing of pathogenic microorganisms. Disinfection is often universally employed by water distribution systems, even when water at the source is deemed already potable – as a precautionary measure to control the spread of waterborne diseases. In Systems, this precaution is particularly important because of the risk of contamination due to breaks and other types of seepages anywhere throughout the extensive pipe network, and the magnified impact of this risk due to the number of users.



3.2.1. Chlorine Disinfection (Chlorination)

Chlorination is the process of adding the element chlorine to water to make it safe for human consumption as drinking water. Chlorine (and its compounds) is the most widely used disinfectant for water systems because of its effectiveness, cheap cost and availability.

Chlorination has the advantage of oxidizing bacteria and virus even after the point of application due to its residual action. Hence any bacteria introduced to the system after the point of chlorination can still be eliminated by the residual chlorine in the water.

Turbidity:

It is the cloudiness or haziness of a fluid caused by large numbers of individual particles that are generally invisible to the naked eye, similar to smoke in air. The measurement of turbidity is a key test of water quality.

Fluids can contain suspended solid matter consisting of particles of many different sizes. While some suspended material will be large enough and heavy enough to settle rapidly to the bottom of the container if a liquid sample is left to stand (the settleable solids), very small particles will settle only very slowly or not at all if the sample is regularly agitated or the particles are colloidal. These small solid particles cause the liquid to appear turbid. Turbidity (or haze) is also applied to transparent solids such as glass or plastic.

The most widely used measurement unit for turbidity is the Formazin Turbidity Unit (FTU). It is used to determine the concentration of suspended particles in a sample of water by measuring the incident light scattered at right angles from the sample. The scattered light is captured by a photodiode, which produces an electronic signal that is converted to a turbidity.

4. Chlorination dosage and system calibration

4.1. WHO chlorination standards

4.1.1. Identity

Element or compound	Case no.	Molecular formula
Chlorine	7782-50-5	Cl ₂
Hypo-chlorous acid	7790-92-3	HOCl
Sodium hypochlorite	7681-52-9	NaOCl

Physicochemical properties of chlorine [Conversion factor in air: 1 ppm = 2.9 mg/m³]



Property	Value
Boiling point	-34.6 °C
Melting point	-101 °C
Density	3.214 g/liter at 0 °C and 101.3 kPa
Vapor pressure	480 Pa at 0 °C
Water solubility	14.6 g/liter at 0 °C

4.1.2. Organoleptic properties

The taste and odor thresholds for chlorine in distilled water are 2 and 5 mg/liter, respectively. In air, chlorine has a pungent and disagreeable odor.

4.1.3. Major uses

Large amounts of chlorine are produced for use as disinfectants and bleach for both domestic and industrial purposes, and it is also widely used to disinfect drinking-water and swimming- pool water and to control bacteria and odors in the food industry.

4.1.4. Environmental fate

In water, chlorine reacts to form hypochlorous acid and hypochlorite. All three species exist in equilibrium with each other, the relative amounts varying with the pH. In dilute solutions and at pH levels above 4.0, very little molecular chlorine exists in solution. The concentrations of hypochlorous acid and the hypochlorite ion are approximately equal at pH 7.5 and 25 °C. Chlorine can react with ammonia or amines in water to form chloramines.

4.1.5. Analytical Methods

A colorimetric method can be used to determine free chlorine in water at concentrations of 0.1–10 mg/liter. Other methods allow for the determination of free chlorine, chloramines, other chlorine species, and total available chlorine, and are suitable for total chlorine concentrations up to 5 mg/liter. The minimum detectable concentration of chlorine is about 0.02 mg/liter (6).

4.1.6. WHO Environmental Levels and Human Exposure for Water

Chlorine is present in most disinfected drinking-water at concentrations of 1–2 mg/liter in all WASAs.



4.1.7. EPA Environmental Levels and Human Exposure for Water

Chlorine is present in most disinfected drinking-water at concentrations of 2 mg/liter in all WASAs.

4.2. Chlorine/Chlorine Compounds Used in Disinfection

Chlorine – Chlorine is a poisonous yellow-green gas with a penetrating, pungent odor. It is extracted from chlorides through oxidation and electrolysis. In water, chloride (chlorine compounds) hydrolyses to form hypochlorous acid and the hypochlorite ion (free available residual chlorine), which are very toxic to bacteria.

Bleaching Powder or Chloride of Lime – Bleaching powder or calcium hypochlorite is a yellow white solid which has a strong smell of chlorine. It is not highly soluble in water, and is preferably used in soft to medium-hard water. Bleaching powder loses strength rapidly whenever it is exposed to moist air so that it should be kept in closed containers.

High-Test Hypochlorite (HTH) – It is a more stable and stronger compound than bleaching powder.

Sodium Hypochlorite (NaOCl) – This is a highly corrosive, slightly yellow liquid. It is used extensively in many industries as a disinfectant, deodorizer, bleach, and to neutralize certain undesirable chemicals and compounds used or formed in productions processes. For households, it is supplied as the common households' bleach.

4.2.1. Percentage of Available Chlorine

Material	Available Chlorine	Quantity to Make a Liter of 1% Chlorine Solution
Chlorine gas	100%	-
Calcium Hypochlorite	70 – 74%	14 grams
Bleaching powder	34 – 37%	30 grams
Sodium Hypochlorite (HTH)	12 – 15%	80 grams

4.3. Chlorine Dosages

The commonly used dosages for various disinfection requirements are as follows:

1. For disinfection of water supplies:



- Dosage: 0.5 – 2.0 mg/l
 - Contact Time: 20 – 30 minutes
2. For disinfection of newly constructed/repared wells, storage tanks, pipelines, spring box, etc.:
- Dosage: 50 mg/l
 - Contact Time: 24 hours

or

- Dosage: 300 mg/l
- Contact Time: 1 hour

4.3.1. Sample Calculation

The examples on the following pages illustrate the mathematical methods applied in arriving at the disinfection dosages and rates of dosage using chlorine gas and some of the typical chlorine compounds used by water systems.

Example: Calculation of Dosage

Given:

Water Consumption: 10,000 liters per day (lpd)

Required Residual: 0.3 mg/l

Chlorine Demand: 0.5 mg/l

Required:

Dosage in mg/l

Dosage rate in gm/day

Using Chlorine gas

Using Bleaching powder

Analysis:

Dosage = Chlorine Demand + Chlorine Residual Dosage = 0.5 + 0.3 = 0.8 mg/l

Using Chlorine Gas:

Available chlorine = 100%



$$\text{Dosage Rate} = \frac{\text{Dosage}}{\text{Available}} \times \text{Volume of water to be treated}$$

$$\text{Dosage Rate} = \frac{0.8 \text{ mg/l}}{100\%} \times 10,000 \text{ lpd} = 8,000 \text{ mg / day} = \mathbf{8 \text{ g/day}}$$

Using Bleaching Powder:

Available chlorine = 35%

$$\text{Dosage Rate} = \frac{\text{Dosage}}{\text{Available}} \times \text{Volume of water to be treated}$$

$$\text{Dosage Rate} = \frac{0.8 \text{ mg/l}}{0.35} \times 10,000 \text{ lpd} = 22,857 \text{ mg / day} = \mathbf{22.9 \text{ g/day}}$$

Example: Dosage for Disinfection of Well

Given:

Well Diameter = 0.3 m

Static Water level = 6 m

Total Well Depth = 50 m

Required:

Amount of sodium hypochlorite required

Disinfection Specifications:

Dosage = 50 mg/l

Contact time = 24 hours

Analysis:

1. Calculate water volume in well

$$\text{Volume} = \pi \times 0.15^2 \times (50 - 6) = 3.11 \text{ m}^3 = 3110 \text{ liters}$$

2. Determine amount of chlorine compound using sodium hypochlorite (70% chlorine)

$$\text{Amount} = \frac{\text{dosage} \times \text{volume}}{\text{available Chlorine}}$$



$$\text{Amount} = \frac{50 \text{ mg/l} \times 3,110 \text{ l}}{0.70} = 222,142 \text{ mg} = 222 \text{ g}$$



4.4. WASA lab. Report

Sr. NO.	CHEMICAL & PHYSICAL TEST	GUIDELINE	RESULT
1	Temperature.	-----	
2	pH.	7.0-----9.2	
3	Adour.	Unobjectionable	
4	Colour.	5-----50 Units	
5	Taste.	Unobjectionable	
6	Turbidity	0-----5 NTU	
7	Clay/Sand/Rust.	Absent.	
8	Conductivity. $\mu\text{s}/\text{cm}$	-----	
9	Total Dissolved Solid. mg/L	500-----1000	
10	Total Hardness. mg/L	150-----500	
11	Calcium. mg/L	75-----200	
12	Magnesium. mg/L	30-----150	
13	Alkalinity. mg/L	-	
14	Chloride. mg/L	250	
15	Nitrites.	-	
16	Nitrates. mg/L	0-----45	
17	Carbonates. mg/L	-	
18	Bicarbonates. mg/L	-	
19	Fluorides. mg/L	0-----1.5	



4.5. Operation of chlorination system

4.5.1. EMEC V Pump

VCL type pump has constant dosing pump with level alarm.

A red LED indicates that the product's tank is empty. During this condition the pump does not dose. The pump has flow control (front panel knob may be set from 0% to 100% of pump nominal capacity). Flow control is electronically set and it operates on pump injections number. To avoid linearity problem, do not set the knob of pump flow between 0% and 10%.

VCL has a divider ($\times 0,1$) to reduce by ten times the pump capacity by dividing the pump stroke speed.

How to enable "divider mode":

- Set the pump into OFF* mode;
- Keeping pressed the on/off button, wait 3 flashes from the status LED. The pump will start the dosing activity with the stroke speed reduced ten times than the value set on stroke length knob.

To disable the "divider mode", power OFF the pump. Keeping pressed the on/off button, wait 3 flashes of the status led.



4.5.2. LED

The led on the frontal panel shows the pump's operating status through 5 flashing:

LED	PUMP'S STATUS
Three times per second blinking (RED)	Too low power supply
Two times per second blinking (RED)	Too high power supply



One time every 2 seconds blinking (GREEN) One time every 2 seconds blinking into DIVIDE mode (ORANGE)	OFF mode. Pump powered.
Always ON (GREEN), but off when pump strokes Always ON (ORANGE), but off when pump strokes into DIVIDE mode	ON mode. Pump powered.

4.5.3. CHEM TECH Pump

4.5.3.1. Output Adjusting Knob:

Sometimes the output adjusting knob can move on its shaft and cause a false output indication. This can happen if the knob set-screw slips or if the unit is disassembled for any reason. The unit can be reset to "0" as follows:

1. Remove the dial stop.
2. With the pump running, loosen the locking lever and turn the adjusting knob counter-clockwise until it is "loose" to touch.
3. SLOWLY re-screw the knob clockwise, using very light finger pressure. It will soon start to advance in pulses as the internal cam comes in and out of contact.
4. When light finger pressure will no longer allow movement of the knob between cam contacts, grasp the knob securely and tighten the locking lever (turning clockwise) making sure that the knob does not move. To check for zero point, turn on pump. There should be no liquid coming out of discharge fitting.
5. Replace dial stop.
6. If the pointer is not at "0", loosen the set-screw on the knob (use a 5/64" Allen key), and turn pointer to "0", then retighten the set-screw while holding the knob in place.
7. A setting of "0" will now give zero output. One full revolution of the knob counter clockwise will give maximum output. The knob should never be turned more than one full revolution.

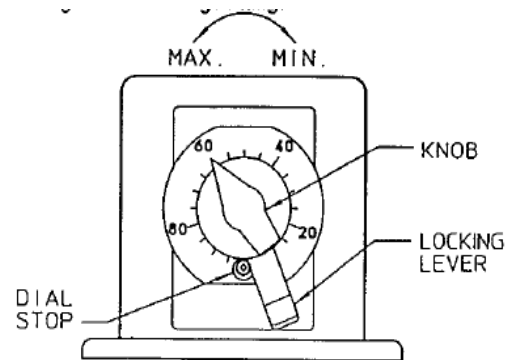

4.5.4. Water sampling

Water sampling needs identification of resources, preparation of sampling plan, location survey, preparation of list of preservatives and table of holding time for numerous parameters. Generally physical, chemical and biological parameters are required to be evaluated. Certain water quality



parameters are assessed in-situ like taste color, odor, temperature, turbidity, alkalinity, electrical conductivity, total dissolved solids at site. For such purpose mobile testing laboratory is vital important. Moreover, cation and anion, evaluation of heavy metal, microbial contamination may only be evaluated in the laboratory. The samples should reach the laboratory within specific time and in well preserved form. The data log should be properly filled and signed.

4.6. Operation of Filtration system

4.6.1. Feed Pump

Raw water is pumped from Raw Water Storage Tank through Pre filtration Tank and ULTRA-FILTRATION Membrane by Feed Pump. Flow rate and total head of feed pump need to meet the design criteria in order to function.



Model	Power	Ampere	Flow Q							
			(m ³ /h - l/min)							
KSB Pumps U5-180/6	KW	1 x 230 V x 50Hz)	0	1.8	2.4	3.6	4.8	6	7.2	8.4
			0	30	40	60	80	100	120	140
	Head (H)									
	1.7	7.7	69.3	64.4	62	55.6	48.2	39.6	28.8	12



4.6.2. Pre Filtration Vessel

Suspended Solid will be removed by this part and inside the tank contains “Fine Sand”. Hydraulic Flow will be controlled by Multi – Function Flow Control Valve which is operated automatically and divided into 3 modes.

- **Service Mode:** Control water to flow as Downstream to filtrate. Water entrances Filtration Vessel at “Water Inlet” port and leaves at “Water Outlet” port.
- **Back Wash Mode:** Control water to flow as Upstream to back wash particles on the surface of filter media. Water entrances Filtration Tank at “Water Inlet” port and leaves at “Drain Outlet” port.
- **Fast Rinse Mode:** Control water to flow as Downstream to rinse. Water entrances Filtration Vessel at “Water Inlet” port and leaves at “Drain Outlet” port.



4.6.3. Activated Carbon, Sand and Arsenic Filtration

Heavy metal especially Arsenic, Color, taste, and odor will be removed by this part and inside the Vessel contains Granular Activated Carbon. Hydraulic Flow will be controlled by Multi – Function Flow Control Valve which is operated automatically and also divided into 3 modes like the Pre Filtration Vessel.

- Activated Carbon
- Silica Sand
- Arsenic Removal Media
- Natural Gravel

4.6.4. Screen Filter.

Suspended Solid may be left from Pre Filtration Vessel will be removed by Screen Filter. The screen can be taken off to wash and clean. 1/2"Mini Plastic filter double wired screen (H), 125 Micron



4.6.5. Production Solenoid Valve (SV1, SV2, and SV3)

These valves function as normal ball valve but operated automatically by electrical control system. Filtration process needs 3 Solenoid valve to control flow direction passing through the



membrane in mode “Filtration Bottom” and “Filtration Top”. When the Feed Pump is running, these solenoid valves will also open as designed.

4.6.6. ULTRA-FILTRATION Membrane

For LDA – WASA Arsenic Removal Project, ULTRA-FILTRATION membrane is selected with a pore size of approximately 0.02 micron and the multi-bore fiber. The multi-bore membrane combines seven single hollows fibers into one fiber providing much greater mechanical strength than the conventional single hollow fiber through the foamy support structure in between the individual capillaries.

The multi-bore fiber is spun using polyethersulphone (PES) which is modified to make the membrane permanently hydrophilic. The hydrophilic modification reduces the fouling tendency by reducing the potential for organic adsorption on the membrane surface.



4.6.7. Back Wash Pump

Filtrate water will be pumped from Storage Tank to ULTRA-FILTRATION membrane by Back Wash Pump to back wash membrane. Capacity of Back Wash Pump is about two or three times of feed pump. The total head of back wash pump needs to meet the design criteria in order to function.



Model	Power	Ampere	Flow Q							
			(m3/h - l/min)							
KSB Pumps U7-180/4	KW	1 x 230 V x 50Hz)	0	2.4	3.6	4.8	6	7.2	8.4	9.6
			0	40	60	80	100	120	140	160
				Head (H)						
	1.83	8.3	49.5	47.4	45.3	42.5	39.2	34.8	29.4	22.6



4.6.8. Pressure Gauge

Pressure Gauge is used to measure pressure of the system. The pressures should be recorded as database for operating, maintenance, and analyzing future problems. In this system, there are four Pressure Gauges.



- PI1 measures pressure at entrance of Pre filtration Vessel
- PI2 measures pressure at exit of Pre filtration Vessel and entrance of Activated Carbon Vessel.
- PI3 measures pressure at exit of Screen filter and entrance of ULTRA-FILTRATION Membrane
- PI4 measures pressure at exit of ULTRA-FILTRATION Membrane and pressure of Back Wash

4.6.9. Sample Cock

Sample Cock is used to collect sample feed water and filtrate water of Ultra-filtration membrane. Sample water collected by Sample Cock can tell the efficiency of filtration and used as database for analyzing future problem. In this process, there are 2 Sample Cocks.

- SC1 collect sample at the entrance of ULTRA-FILTRATION Membrane to check the efficiency of Pre filtration, Activated Carbon, and Screen filter
- SC2 collect sample at the exit of ULTRA-FILTRATION Membrane to check the efficiency of ULTRA-FILTRATION membrane.

4.6.10. Water Meter

Water Meter records volume of filtrate water in required period.

Filtrate Flow Meter

Filtrate flow meter measures flow rate of filtrate water from Ultra-filtration membrane. This flow rate could be checked for fouling of ultra-filtration membrane.



Back Wash Flow Meter

Back Wash Flow Meter measures flow rate of back wash water which indicating the performance of Back Wash Process.



4.6.11. Low Level Switch

If the level of water in Raw Water Storage Tank reaches Low Level Switch, the system will be stopped in order to protect the damage from dry run of Feed Pump.

High Level Switch

If the level of filtrate water in Filtrate Water Storage Tank reaches High Level Switch, the system will be stopped to prevent from overflow and also to protect Feed Pump from operating without usage of drinking water. When the level of filtrate water decreases lower than High Level Switch, the system will be started again.

High Pressure Switch

High Pressure Switch will stop the system when the pressure in pipe reaches the maximum setting value. The high pressure in pipe is caused by following:

- Fouling in Any Filtration Tank, Screen Filter, or ultra-filtration membrane
- Closing ball valve by accident.
- Damaged Solenoid Valve

5. Preventive Maintenance Guideline for Filtration System

5.1. Pre filtration

System Automatically Backwash after 50m³ in ULTRA-FILTRATION plant for protecting pre filtration tank from fouling.

5.2. Carbon filter

After Pre Filtration Carbon Filter Automatically Backwash after 50m³ in ULTRA-FILTRATION plant for protecting Carbon filtration tank from fouling.

5.3. Micron Screen filter

Cleaning Screen Filter every 6 weeks by remove screen from housing then use water cleaning. The period of cleaning depends on suspended solid in the raw water.

5.4. Ultra-filtration system

Ultra-filtration System is cleaned periodically basis after each 60 minutes of operation. This cleaning is done automatically through the Programmable Logical Control system. Operators are



not required for the manual cleaning of the system. If required, a technical person can perform the manual cleaning.

5.5. Log sheet

Record all data as following the log sheet guideline and collect sampling water to check the quality of water.

5.6. Membrane Downtime Conditions

After use, the membrane must be stored wet at all times.

To avoid microbiological growth during shutdown, wet membranes must be treated with a compatible biocide/disinfection solution. Please follow the corresponding recommendations for different downtime conditions/periods:

a) Downtime up to 24 hours

In general, simply stop the system following a backwash at a flux-rate of $230 \text{ l/ (m}^2\text{·h)}$ for at least 60 seconds. No other action is necessary.

b) Downtime of longer than 24 hours

Perform a daily filtration sequence at a flux-rate of $50 \text{ L/ (m}^2\text{·h)}$ for at least 10 minutes.

Perform a daily backwash sequence at a flux-rate of $230 \text{ L/ (m}^2\text{·h)}$ with a NaOCl solution (2 mg/l as active chlorine) for at least 60 seconds. It is necessary to replace a minimum of twice the holdup volume of the module.

c) Downtime of longer than 7 days

Before the disinfection step is carried out it is absolutely necessary to clean the membranes from all organic and inorganic impurities (fouling, scaling layer). After the cleaning procedure, rinse with a 0.1% sodium bi-sulfite solution via backwash mode (Use ultra-filtration filtrate water quality compliant with the minimum water quality standard according to Drinking Water standards respectively).



6. Troubleshooting of filtration system

6.1. ULTRA-FILTRATION Troubleshooting

TROUBLE	CAUSE	SHOOTING
1. ULTRA-FILTRATION system does not work.	Electrical control equipment is out of order. (Low Level Switch, High Level Switch and High	Check the electrical control system and replace damaged electrical control equipment.
	A solenoid valve is damaged.	Check and change a coil of solenoid valve.
	A ball valve is totally closed.	Check and open the ball valve. (BV2and BV3)
	Any filtration tank, Screen Filter or ULTRA-FILTRATION membrane is clogged.	Check and Clean or Back wash it.
	Feed Pump is out of order.	Check and repair or replace one if necessary.
2. Bacteria are present.	An ULTRA-FILTRATION membrane is	Check by the Integrity Test. Repair a broken fiber.
3. Flood flow rate decreases.	An ULTRA-FILTRATION membrane is clogged.	1. Back wash. 2. CEB is necessary.
	A filtration Tank or Screen Filter is clogged.	Back wash or Clean.
4. ULTRA-FILTRATION drainage water flows at all times.	A solenoid valve has a problem.	Check and clean up inside a solenoid valve or replace one if necessary.



6.2. Filtration Tank Troubleshooting

TROUBLE	CAUSE	SHOOTING
1. Filtration Tank cannot regenerate or back wash.	Device power is off.	Check power supply whether normal or not (including fuse, plug switch etc.)
	Regeneration/Back Wash time set wrong.	Readjust time.
	Controller is damaged.	Check or change one.
2. Quality of Filtered Water is same as inlet water.	By pass ball valve opened	Close the bypass ball valve.
	No salt in brine tank. (In case of regeneration)	Make sure there is solid salt in tank.
	Ejection is blocked. (In case of regeneration)	Change or clean the ejection.
	No enough water is refilled in brine tank. (In case of regeneration)	Check time of refill water to brine tank.
	Leakage of riser pipe.	Check riser pipe not broken and check seal O- rings.
	Leakage in the valve body inside.	Check and repair or change valve body.
3. Cannot suck salt. (In case of regeneration)	Inlet pressure is too low.	Heighten inlet pressure.
	Brine pipe line is blocked.	Check the pipeline. Take out the stem.
	Leakage on brine pipeline.	Check the pipeline.
	Injector is damaged.	Change the injector.



	Leakage in the valve body inside	Check and repair or change valve body.
4. Too much water in brine tank. (In case of regeneration)	Brine Refill time is too long.	Readjusting Brine Refill Time.
	Too much water in brine tank after sucking salt	Check whether it is blocked or not in ejection or brine pipeline.
5. Water pressure damage	Pipeline leading to filtration tank blocked by some matter.	Clean up pipeline of filtration tank.
	Filtration tank blocked by some matter.	Clean up control valve. Add cleaning liquid to filtration tank in order to increase the regeneration/back wash efficiency.
6. Filter Media flow out from drainage pipe.	Air in system.	Make sure exhaust normally in system. Check it whether dry or not.
	Top strainer is damaged.	Change the top strainer.
7. Control valve continuously circulate.	Signal line be cut off.	Insert the signal line again.
	Fault on controller.	Change the controller.
	Wheel is locked by abnormal things.	Take out the abnormal things.
	Valve body inside leaking.	Check and repair or change valve body.



8. Water flow out from the drainage pipe continuously	Power off when backwash or fast rinse.	Switch by hand to service position or close by pass valve. Reopen when power is normal.
---	--	---

7. Troubleshooting for chlorination system

7.1. Troubleshooting for EMEC V Pump

PROBLEM	POSSIBLE CAUSE
Pump doesn't turn on.	<p>Pump isn't powered. Connect it to main supply. Pump's protection fuse is broken. Replace it.</p> <p>Pump's main board is broken. Replace it.</p>
Pump is not dosing and solenoid is operating.	<p>The foot filter is obstructed. Clean it.</p> <p>Suction hose is empty. Pump must be primed. Repeat priming procedure.</p> <p>Air bubbles inside hydraulic circuit. Check valves - hoses - fittings.</p> <p>Product to dose is generating gas. Turn discharge knob and let air flow away. Use a self-venting pump head.</p>
Pump is not dosing and solenoid isn't operating or slightly operating.	<p>Crystals presence inside valves. Check them and try to dose 2-3 liters of normal water.</p> <p>Change valves. Injection valve obstructed. Change it.</p>

7.2. Troubleshooting for CHEM TECH Pump

Problem	Probable Cause	Remedy



Leakage at Fitting	<ol style="list-style-type: none"> 1. Loose fittings 2. Broken or twisted gasket 3. Chemical attack 	<ol style="list-style-type: none"> 1. All fittings can be hand tightened to prevent leakage. Clean off chemicals which have spilled on feeder. 2. Check gaskets and replace if broken or damaged. 3. Consult your chemical supplier for compactable materials.
Feeder will not Prime	<ol style="list-style-type: none"> 1. Too much pressure at discharge 2. Check valves not sealing 3. Output dials not set at Maximum 	<ol style="list-style-type: none"> 1. Open bleed valve and circulate fluid until all air purged from pump head assembly: Close bleed valve. 2. Disassemble, loosen, clean and check for deterioration or swelling. Reassemble and wet the valve assembly, then prime. See INSTALLATION Section. 3. Always prime pump with output dial set at maximum rated capacity.
Anti-Siphon Valve Malfunction	<ol style="list-style-type: none"> 1. Scale or particles have plugged diaphragm 2. Ruptured valves 	<ol style="list-style-type: none"> 1. Remove, Clean and reassemble, being careful not to wrinkle the diaphragm. Check sequence and position of parts to be sure reassembly is correct. 2. Consult your distributor for replacement.
Pump Motor Stalls	<ol style="list-style-type: none"> 1. Pumping. Against excessive pressure 2. Low voltage to feeder 	<ol style="list-style-type: none"> 1. Test pressure to determine if it exceeds feeder specifications. If so, consult your distributor. 2. Make sure voltage of power source matches the voltage on the feeder specifications label. If not transformers are available.



Motor Running Very Hot	<ol style="list-style-type: none">1. Low voltage.2. If using a stepdown transformer, it may be undersized for the feeder	<ol style="list-style-type: none">1. Power supply voltage should match voltage on feeder specification label.2. Check the transformer to be sure it has at least 100 watts capacity.
------------------------	---	---

References

1. Instructional manual CHEM TECH series 100/150 pump for chlorination
2. Instructional manual EMEC V Pump for chlorination
3. Chlorine in Drinking-water WHO/SDE/WSH/03.04/45
4. UF Plant Manual for Installation, Testing & Commissioning and Operation & Maintenance Rev-01 on May, 2015 by KSB Pump





ALJAZARI
— ACADEMY —

Operations and Maintenance of Mechanical and Electrical Equipment

WSD 5231

Module 5

Heavy Machines

Participant Lecture Notes

2016



— ACADEMY —

Course Title: Operations and Maintenance of Mechanical and Electrical Equipment	Course Code: WSD 5231
Module Title: Heavy Machines	Module No: 7
Lecture Topics: <ol style="list-style-type: none"> 1. Equipment overview 2. Main assembly components 3. Standard operating procedures 4. Importance of preventative maintenance 5. Preventative maintenance of heavy machines 6. Planning for heavy equipment operations 7. Heavy equipment selection process 	Lecture Duration: 5 Hours Parts Demonstration: 60 Minutes

1 Equipment Overview

1.1 Velocity Cleaners (Jetting Units)

Jetting unit makes use of high velocity water jets to remove and dislodge obstructions, soluble grease, gut and other materials from sanitary, storm and combined sewerage systems. It combines the functions of a rodding machine and gully emptier machine.

Basically it includes a high pressure hydraulic pump capable of delivering water at variable pressure up to about 80 kg/cm² through a flexible hose to a sewer cleaning nozzle. The nozzle has one forward facing hole and a number of rear ward facing holes. The high pressure water coming out of the holes with a high velocity breaks up and dislodges the obstructions and flushes the materials down the sewer. Moreover by varying the pressure suitably, the nozzle itself acts as a jack hammer and breaks up stubborn obstructions. (A separate suction pump or air flow device may also be used to suck the dislodged material).

The entire equipment is usually mounted on a heavy truck chassis with either a separate prime mover or a power take off for the suction device. The high pressure hose reel is also hydraulically driven. The truck also carries fresh water tanks for the hydraulic jet and a tank for the removed sludge and the various controls grouped together for easy operation during sewer cleaning. The manufacturer's operating and servicing manuals should be carefully followed for best results in the use of the machine.





Figure 1 Jetting Unit (courtesy of Kisan Engineering)

1.2 Vacuum Cleaners (Suction Unit)

Suction units create the vacuum required for siphoning of mud, slurry, grit and other materials from sanitary, storm and combined sewerage systems. The vacuum elevated is such as to siphon the materials from the deep manholes catch-pits etc., having depth ranging from 1 m to 8 m in normal cases with an option to suck an additional 4 m with the help of special accessories for the purpose. The unit can be vehicle or trolley mounted.

Silt and heavy particles settled at the bottom can be agitated and loosened by pressurized air with the help of the pump and then sucked in a tank. Once the silt tank is full, the effluent is discharged in the nearby storm water drain or manhole and the operation is repeated until the silt is cleared off the manhole. The silt deposited in the tank is then emptied at the predetermined dumping spot.





Figure 2: Suction Unit (courtesy of Kisan Engineering)

1.3 Dump Trucks

Dump bodies, as the name implies, are equipped with underbody hoists and are used in any application where bulk product / Heavy load (such as soil, sand, stone, gravel, dirt or hot asphalt in construction, road building and surface mining applications etc) are to be transported & unloaded quickly, easily and cost effectively.

Dump Trucks are available in various capacities depending upon the base vehicle .Our Dump Truck has been trusted and praised by our customers for its advanced design, good performance, longevity, ease of unloading and versatility.

1.3.1 Features

- Available from 3 ton to 18 tons
- Control for Tipping & lowering located in driver's cabin
- Single/double acting Imported Hydraulic Cylinder
- Heavy duty steel body



- Automatic tail gate opening on lifting
- Closed coupled hydraulic pump to avoid mechanical complexity



Figure 3: Dump Truck

1.4 Water Tanker

Water is routinely transported from regions where it is plentiful to regions where it is scarce. Several water conveyance and distribution techniques are available, and are actively used in many parts of Pakistan.

Water Tankers (also known as water bowlers) can be a rapid means of transporting water to areas in need during the initial phase of an emergency. Water Tanker operations, however, are expensive and relatively time-consuming to administer.

In some cases, this involves the transfer of water from one part of the city (water source) to another area in the city or to a rural area. Tanker Trucks are common both in rural and urban areas primarily due to water scarcity and secondary due to lack permanent water transportation methods. Water tankers are fitted with a cistern or storage tank to transport and distribute water from a point of supply to the point of use, particularly to suburban and rural areas not served by a piped supply. If



water is not supplied from a central treatment facility, it is usually extracted from the closest natural source (rivers, canals, reservoirs, or groundwater sources), treated and transported by the trucks to the point of use. Water thus transported may be pumped into a storage cistern, dispensed directly into household or other containers, or discharged into a small-scale treatment facility for centralized distribution.

The tanks on the trucks are usually manufactured locally, and some trucks are equipped to carry portable pumps to extract the water from its source. Tanker trucks are used in most rural and urban areas Pakistan. This is true for large urban areas and remote hilly areas alike where water is not readily available or not easily accessible. Many of these water tankers are operated by the government services and some areas do have private owners providing similar service.



Figure 4: Water Tanker

1.5 Sewer Cleaning Bucket Machine

The bucket machine consists of two powered winches with cables in between. For cleaning a section of sewer; the winches are centered over two adjacent manholes. To get the cable from one winch to the other, it is necessary to thread the cable through the sewer line by means of sewer rods or flexible split bamboo rods. The cable from the drum of each winch is fastened to the barrel on each end of an expansion sewer bucket fitted with closing device, so that the bucket can be pulled in either direction by the machine on the appropriate end. The bucket is pulled into the loosened material in the sewer until the operator feels that it is loaded with debris. The winch is then thrown out of gear and the opposing winch is put into action. When the reverse pull is starts,



the bucket automatically closes and the dirt is deposited in a truck or a trailer. This operation is repeated until the sewer is cleared. Various bucket sizes are available for sewers of 150 mm to 900 mm in size. The machine is also used along with other scraping instruments for loosening sludge banks of detritus or cutting roots and dislodging obstructions

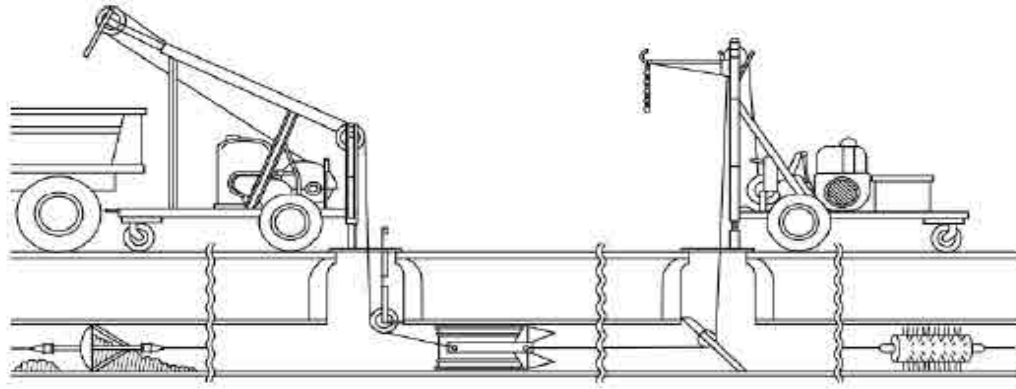

Source: EPA, 2003

Figure 5: Bucket Machine

Bucket machines hold many advantages: no water is required for operation and only solids are hauled by the bucket, which allows for large lines to be cleaned more quickly and effectively than with a combination truck. Bucket machines are also an excellent clean up tool in the event of a petroleum or chemical spill, as no water is added to the material during cleaning, thus saving a disposal costs.

General specification of a powered bucket machine

Length:	12'2"
Width:	5'11"
Height:	8'4"
Min HP:	25hp
Axle Configurations:	Single
Max Bucket Capacity:	36"
Max Cable Length:	1500'

1.6 Backhoe

A backhoe loader is a versatile earth-moving equipment, multipurpose machine that can be used as an excavator and as a loader and which allows you to quickly travel on the road to the jobsite. Backhoe loaders are available in various configurations, with the main difference being the



steering modes (e.g., four-wheel steering feature allows you to operate in narrow spaces, extending versatility of the machine). The optional telescopic arm extends the flexibility for attaining the maximum digging depth. Rear outriggers, which can be vertical or horizontal, increase machine stability while digging. A backhoe attachment can be mounted or adjusted to allow digging along the walls.

Backhoes have many uses

- a. Digging trenches and holes
- b. Demolition work
- c. General grading and landscaping
- d. Heavy lifting such as the lifting and placement of pipe



Figure 6: Backhoe with a front load

1.7 Dredger (Clam-shell)

The clamshell bucket is an attachment used with a crane for vertical digging belowground level and for placing materials at considerable height, depth, or distance. You can also use it for moving



bulk materials from stockpiles to plant bins, loading hoppers, and conveyors. It can be used to dig loose to medium compacted soil.

It consists of a grab bucket on a wire rope which is lowered into the manhole in the open condition with the help of a crane and pulley. On reaching the bottom of the manhole the segments are closed, and the accumulated silt is picked up. The bucket is then raised above ground level where the bucket opens and the silt is automatically dropped into a truck or a trailer.

The bucket can be closed by wire ropes or by a pneumatically operated cylinder. The disadvantage in this system is that it cannot clean the corners of the catch pits of manholes. Sometimes the deposits at tire corners may become so hard that the same may be required to be chiseled out.



Figure 7: Dredger (clam-shell)



2 Main Assembly Component

2.1 Baseline Trucks



Figure 8: Truck Baseline (ISUZU N-Series)

Generally diesel trucks such as ISUZU N-series, Hino and Mitsubishi are used to build jetting, suction, dumper and water tanker units. The truck such as shown in shown in *Fig 8* serves as the baseline driving unit for various water and sanitation service machines. These are 2771 CC, Diesel Engine, 4 Cylinder, OHV, Direct injection and water cooled trucks with manual 5 speed transmission. Maximum torque rating on this model is 175 N.m at 2000 rpm. The engine can be upgraded to a 2.8 turbo as an option.

They come both with long and short wheel base options. Long wheel base (LWB) and short wheel base (SWB) are measured as 3360 mm and 2460 mm respectively. Typical fuel consumption for ISUZU 4JB1 is about 10-13 km/l, heavily depending upon the driving style and delivers better mileage over long routes. These type of trucks come both in 2x4 and 4x4 wheel drive options.

These multipurpose trucks offer good options, ease of serviceability and reliable operations if maintained properly (as per owner's operator manual, provided in appendix A). Other alternate brands used in the service sector are, HINO and Mitsubishi with slight variance in the specifications.

Truck selection should be based upon the type of service (task), load capacity required, fuel consumption and overall reliability along with ease of service. Important factors of upfront capital investment and after sales support should be well analyzed during the selection decision, this is to



ensure spare parts availability and competitive (feasible) prices for frequently required consumable spare parts.

Table 1: Vehicle Specification

Vehicle Specification: Isuzu N-Series (courtesy RAVI Motors, Lahore)			
DIMENSION & WEIGHTS (Chassis only)		Short Wheel Base (SWB)	Long Wheel Base (LWB)
Wheel Base (WB)	mm	2460	3360
Overall Length (OAL)	mm	4610	5830
Overall Width (OW)	mm	1695	1695
Overall Height (OH)	mm	2120	2120
Tread Front (AW)	mm	1385	1385
Tread Rear (CW)	mm	1425	1425
Road Clearance	mm	190	190
Gross Vehicle Weight	Kg	5200	5200
Curb Weight	Kg	1670	1740
Pay Load	Kg	3530	3460
Fuel Tank	Litre	75	100
ENGINE			
Model	4JB1		
Type	Diesel Engine, 4 Cylinder, OHV, Direct injection, water cooled		
Displacement	2771 cc		
Max Output (ps)(kw) / rpm	(80 ps) (59kw) / 3600 rpm		
Torque (kgm)(N.m) / rpm	(17.8 Kgm) (175 N.m) / 2000 rpm		
CLUTCH			
Type	Dry single Plate with diaphragm spring, Hydraulic Control		
Size	240 mm		
TRANSMISSION			
	Manual (5+1) with Synchronizers		
AXLE			



Front Axle Type	Reverse Elliot, I-beam		
-----------------	------------------------	--	--

Vehicle Specification: Isuzu N-Series (courtesy RAVI Motors, Lahore)			
Rear Axle Type	Banjo fully floating type		
SUSPENSION			
Front & Rear	Semi-elliptical alloy steel leaf spring, hydraulic double acting telescopic shock absorber.		
BRAKE			
Service Brakes Type	Hydraulic, dual circuit front two leading and Rear two leading.		
Parking Brakes Type	Mechanical expanded type at rear of transmission		
STEERING			
Type	Recirculating ball with integral power assisted.		
WHEEL & TYRE			
Type	7.00 x 16 – 14 PR		
No. of Tyres	7 including one spare tyre		
ELECTRICAL SYSTEM			
Battery	1 x 12V – 80 AH		
Generator	12V / 50A		



2.2 Jetting and Suction Units (add component lists for all equipment, where missing)

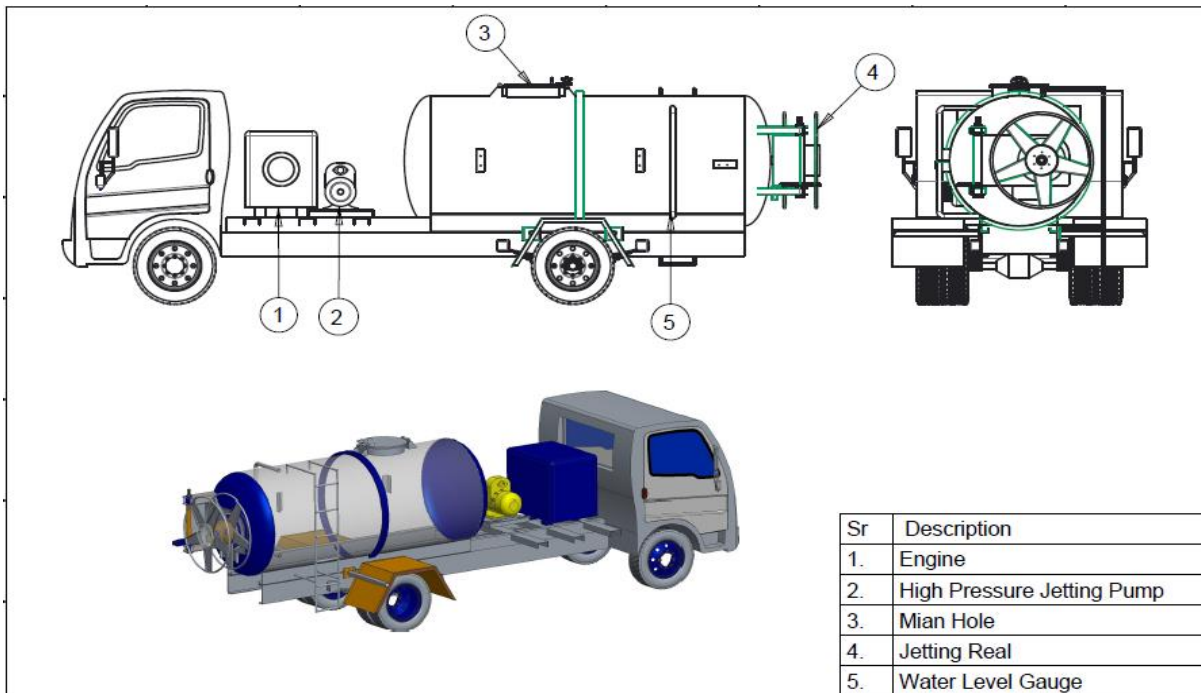

Figure 9: Jetting Unit (150-200bar)



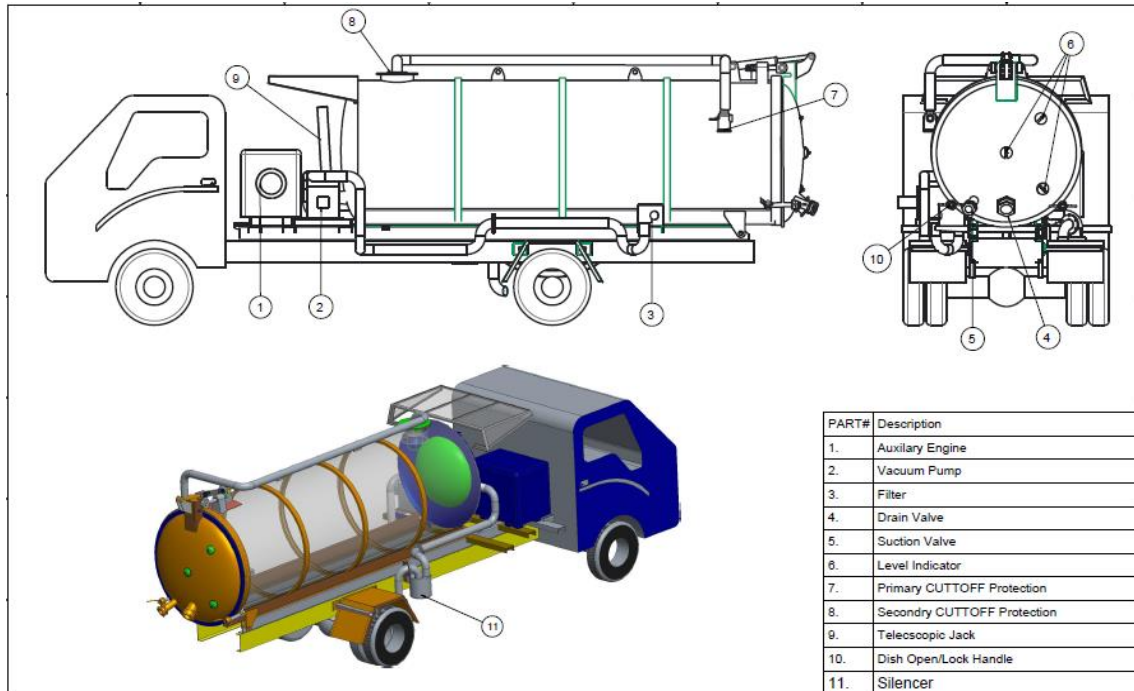

Figure 10: Suction Unit (Vacuum Pressure up to -1 Atmosphere)

2.3 Combined Jetting and Suction Unit



Figure 11: Combined Unit (suction off PTO Jetting with axillary pump 150 to 200 bar)



Combined Unit not only saves the user cost of a complete truck chassis but also gives enhanced sewer cleaning performance compared to independent Suction and Jetting Machines. Furthermore, it gives the user substantial saving on fuel and Maintenance Cost. Combine Units are the equipment of preference in Europe and North America.

2.4 Dump Truck

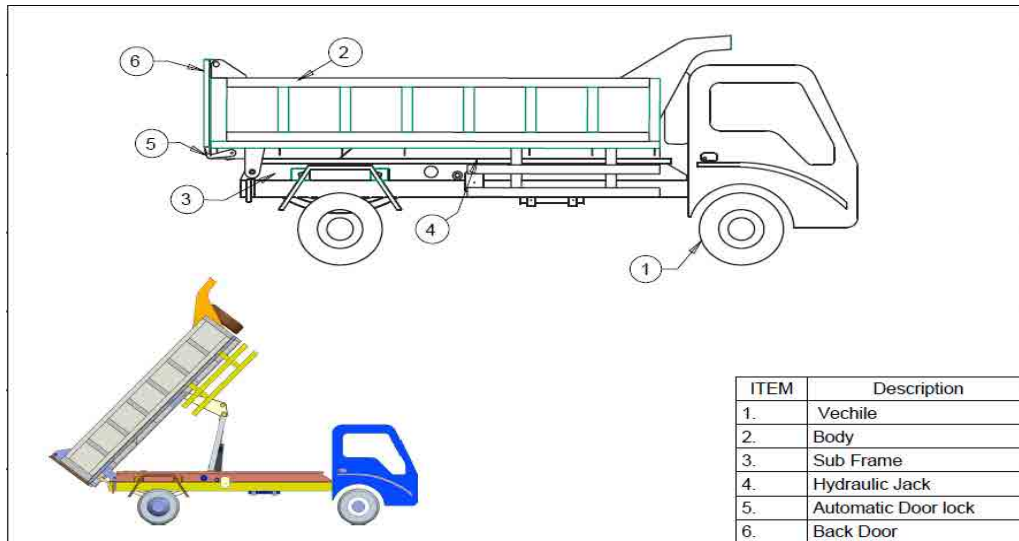

Figure 12: Dump Truck Components



Figure 13: Dump Truck (courtesy Kisaan Engineering)



2.4.1 Load Capacity:

4 Ton or 3.3 cubic yards of dirt

Dump trucks are rated by how many cubic yards they carry. The average commercial dump truck holds anywhere from **10 to 14 cubic yards** of dirt. The Dump Trucks used at local service facilities are much smaller with a capacity of 5 to 10 cubic yards of dirt.

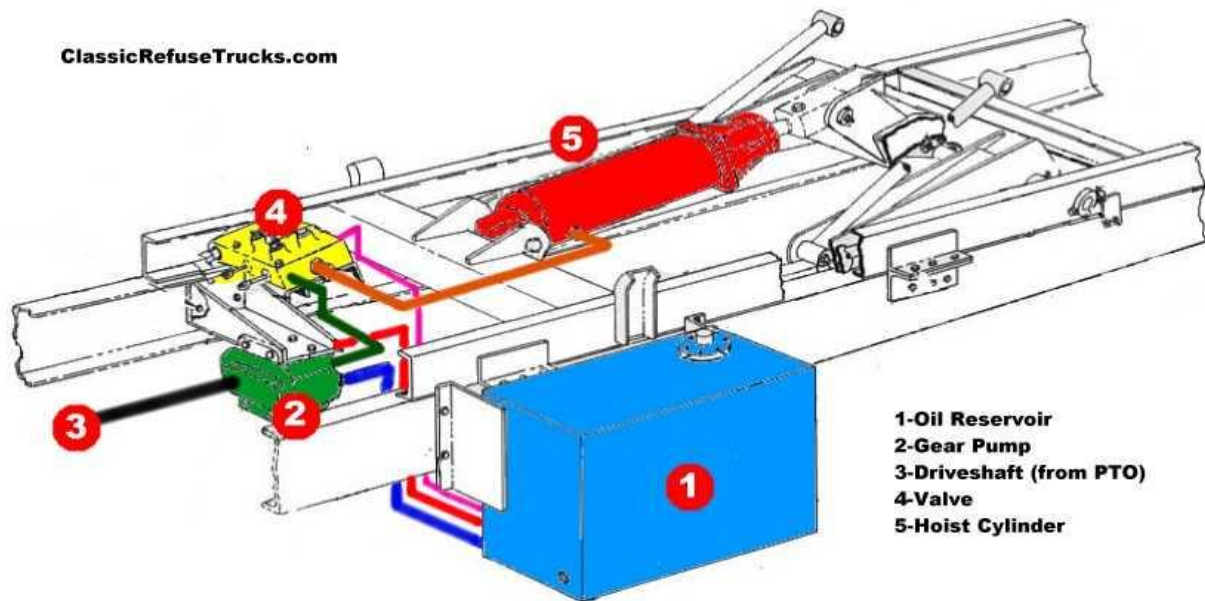

Figure 14: Dump Truck (courtesy Kisan Engineering)



2.5 Water Trucks

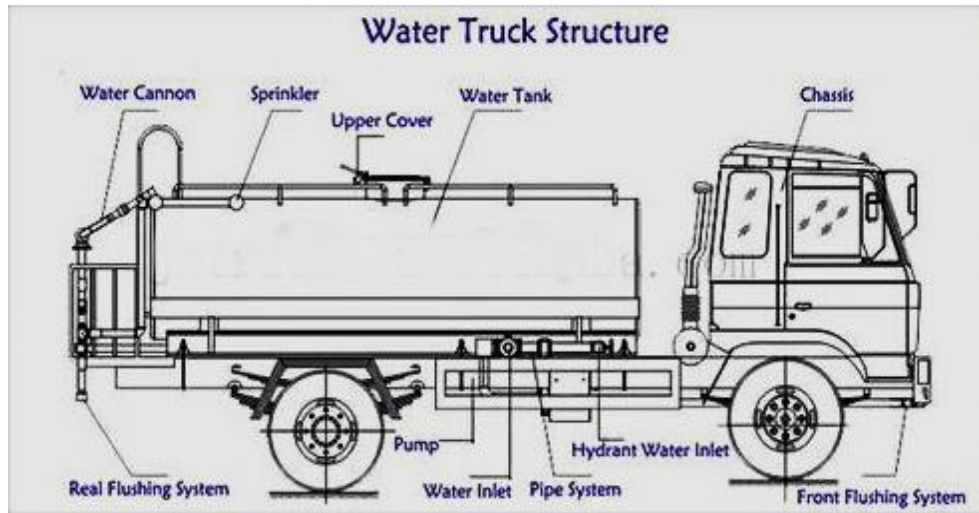

Figure 15: Water Tanker Components



Figure 16: Water Tanker Centrifugal Pumps (PTO and stand-alone engine driven)



2.6 Bucket Machine

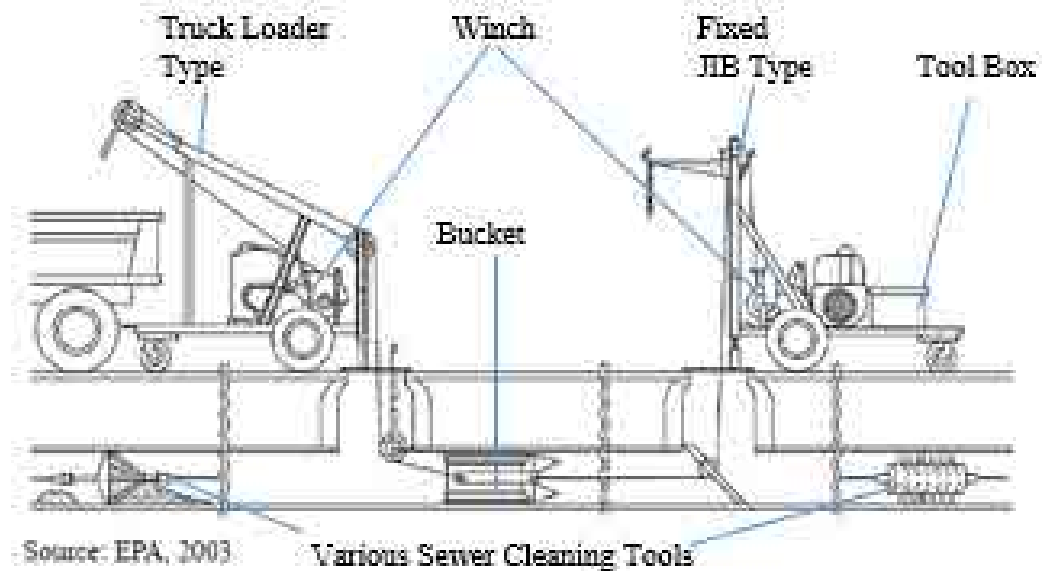

Figure 17: Bucket Machine Components





Figure 18: Bucket Machines

Solution to Problem	Emergency Stoppages	Type of Problem			
		Grease	Roots	Sand, Grit, Debris	Odors
Balling		●		●	●
High Velocity Cleaning	•	●		●	●
Flushing					●
Sewer Scooters		●		●	
Bucket Machines, Scrapers				●	
Power Rodders	●	•	●		
Hand Rods	●	•	●		
Chemicals		●	●		●

● = Most effective solution for a particular problem

• = Least effective solution for a particular problem

Figure 19: Bucket Machine effectiveness relative to sewer problems (source EPA)



2.7 Backhoe

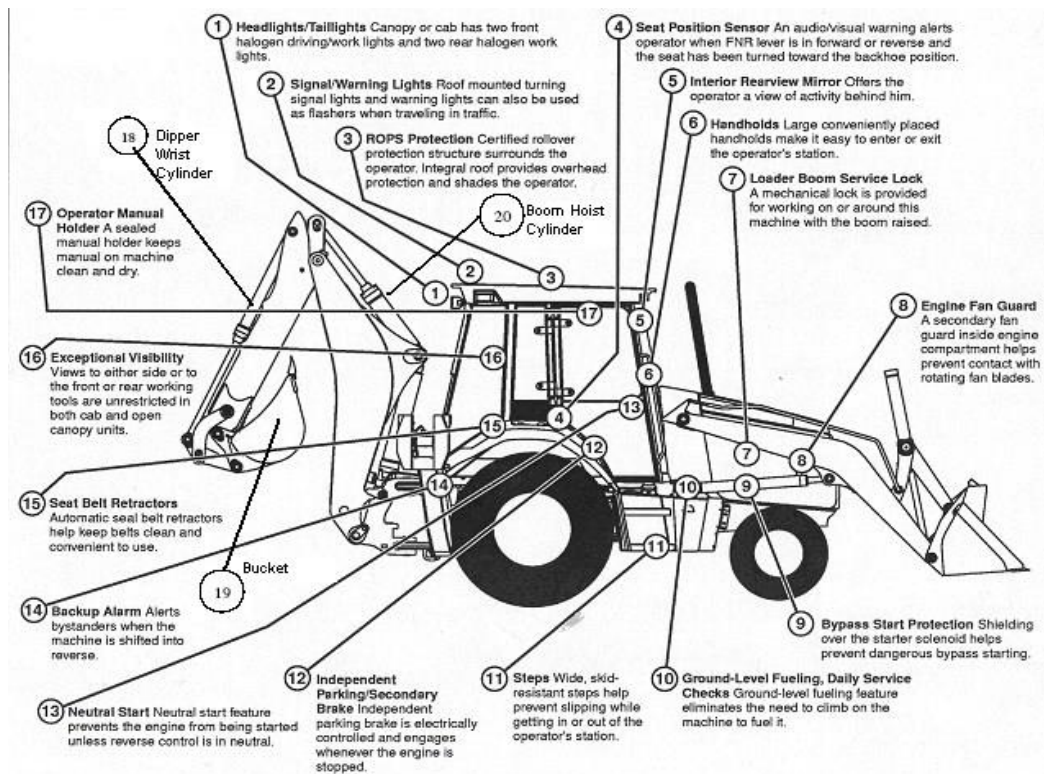

Figure 20: Backhoe with front loader (components)

2.7.1 Components of a Backhoe (see Figure 20)

1. Superstructure

- a. The main frame work of the equipment structure
- b. Also contains:
 - i. Power source (i.e., engine compartment)
 - ii. Main hydraulic pump and various hydraulic valves
 - iii. Cab house operator's compartment and controls

2. Undercarriage

- i. Axles front and rear



- ii. Drive train

3. Front end attachments

- i. Bucket standard or four-in-one clam

4. Rear attachments

- i. Dipper wrist cylinder
- ii. Bucket or dipper
- iii. Lift or hoist hook
- iv. Compactor
- v. Pavement breaker
- vi. Outriggers

2.8 Dredger (Clam-Shell)

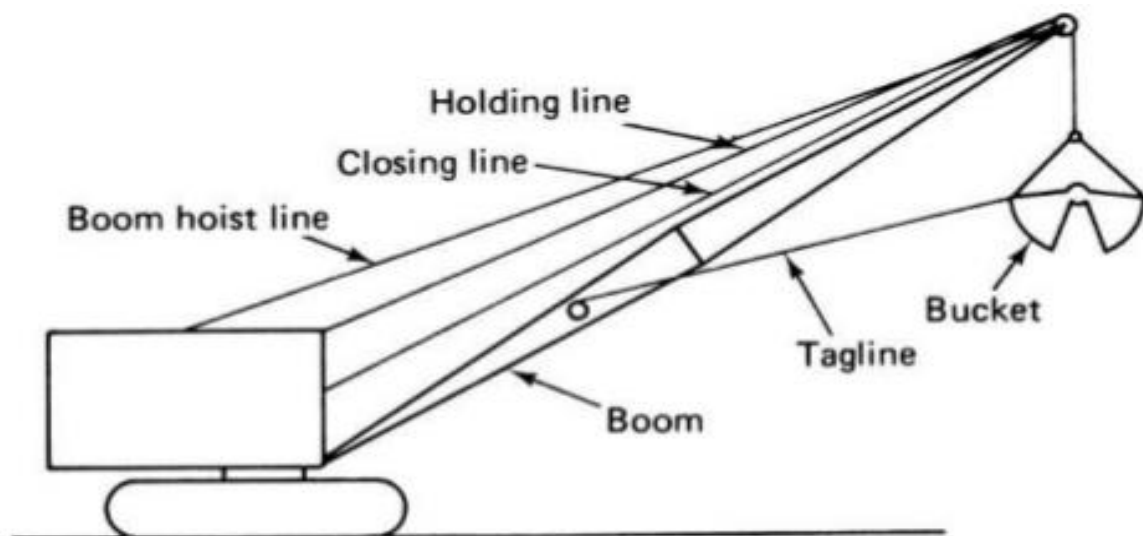

Figure 21: Dredger (Clam-Shell) Components



3 Standard Operating Procedures

3.1 Jetting Unit

1. Climb on to the truck and transport the truck to the work site.



2. Park the vehicle in such a way that the hose reel is as close as possible to the work area.



3. Start the auxiliary Engine by the panel provided on the side of engine. Unwind the pipe from the hose reel using a control valve provided on the hose reel and insert almost 3 feet of hose pipe in the line to be cleaned.



4. A throttle control is provided on the Auxiliary Engine. Increase the speed of the Engine until the pressure gauge shows a pressure of 150 bar or 2000PSI.



5. As the hose starts moving in the sewer line unwind the reel bit by bit so that the hose can move further in the sewer line. If the sewer line is not cleaned in one go, repeat the above mentioned operation.



6. After the work completion, wind the pipe on the hose reel again using the control valve that is provided on the hose reel. While pulling the pipe from the sewer line, keep the pump running so that any residual sludge may also be cleaned, but extensive care is needed during this operation because if the jetting nozzle suddenly pop out from the pit may cause serious injury to the operator. It is better to indicate a mark on the pipe near the end so that it may indicate the operator.



3.1.1 Preventive Maintenance*

Important Instructions before starting the Auxiliary Engine:

- a) Check the engine oil of the auxiliary engine daily before starting the work if the level of engine oil is below the mark, add more engine up to the required level. Only engine oil type CR-40 should be used.
- b) Check the condition of the pulleys and belts.
- c) Check the fuel filter after every 6 months, in case of blockage change the filter.
- d) Clean the air filter regularly depending on the usage of engine. If the engine is used with choked filter it may be harmful to engine.
- e) Use good grade of fuel for better performance of the engine and pump.

Important Instructions before starting the pump:

- a) Check the pump for any types of abnormal sounds, any abnormal sounds produced by the pump is a matter of concern. In case of any abnormal sound, stop the pump immediately and check for the reason of the sound.
- b) Check if the blades of the pump are worn out, replace if needed.
In this case contact the service department of the manufacturer.
- c) Clean pump on weekly basis, this increases the efficiency and life of the pump.
- d) The air intake can get clogged if dust particles get settled in it, so it needs to be cleaned at least once a week.
- e) Check for proper oil level
- f) Check for any leakages



3.2 Suction Unit

1. A suction inlet fitted with quick coupling and revolving boom is provided for ease of operation. Take out the suction hose from carrier and couple it with the quick coupling. Tighten clamps to ensure proper fitment. Put the hose in sewer or soaking pit ensuring there are no kinks or bend in the pipe.
2. **Select appropriate suction inlet position** according to location of sewer.



3. **Starting Truck Engine & Engaging P.T.O**
Start truck engine. Press clutch and pull P.T.O button located near Driver seat. Release clutch slowly to engage P.T.O.
A light is provided in the dash board to Indicate P.T.O. engage position. Never run the vehicle while the P.T.O. is in engaged Position.



4. Set PTO Speed

Set PTO speed by rotating accelerator knob located in truck dash board.

Truck Rpm should be 2000.



Accelerator knob

5. Vacuum Lever Position

The vacuum pump operating lever has three positions.

V =Vacuum

N=Neutral

P=Pressure

Turn lever to neutral position.

Caution: Check the level of disposable oil in the vacuum pump by means of dipstick.



6. Starting Suction

Tighten all clamps on rear door by mean of handles provided. Start sludge suction operation by pulling hydraulic lever up.

Vacuum pump will start. Push vacuum pump lever in vacuum position. When vacuum reaches -0.5 bar, tighten all clamps again. At -0.6 bar open ball valve of inlet suction hose to commence suction of sludge.



Note:

- a) Ensure Oil is dripping on the Bearing While the pump is operating.
- b) Pump consumes oil and should never run dry.



7. During suction operation keep observing the sight glass carefully. As soon as the top most sight glass is half full stop the pump.

Caution:

During suction be alert for abnormal sound & delays in filling which could be a result of blockage in suction line. In this case stop the pump immediately and remove blockage and restart the operation.



8. Disengage PTO

Push vacuum pump lever in neutral position and open suction boom ball valve. This removes residual vacuum from the tank. Remove suction hose and place into the hose carrier. The vehicle can now be transported to dumping site.



9. INLET/OUTLET VALVE

There is a 4” ball valve at the rear of tank for discharge. Connect the hose if required. Open it with valve handle for discharge operation.



10. Sludge Removal

Opening of dish end for removal of sludge .Under normal conditions the tank will be emptied by 4” outlet valve. However, to remove sludge which may deposit inside the tank after prolonged use, the rear dish can be opened. Loose tightening screws & completely disengage the screws as shown. Then open the dish through hydraulic jacks operating levers.



11. Important Safety Measures

Vacuum pump consumes oil. Check oil before starting pump. Also check level of disposable oil in the vacuum pump by means of dipstick. Ensure oil is dripping on to bearing while pump is operating .Continuously check vacuum pump oil and change vacuum pump oil after every two months.

Note: the pump consumes oil & should never run dry.

50 Work Hours are the running time of pump and engine, before maintenance is due.

Continuously check temperature of pump. In case of overheating, turn off the pump and wait for half an hour. During suction be alert for abnormal sound & abnormal delays in the filling which could be a result of blockage in suction line. In this case stop the pump immediately and remove blockage and restart the operation.



3.3 Dump Truck

Prior to start and start-up

1. Site hazards associated with dump truck operations are identified and safe operating techniques are used to minimize risk.
2. Engine power is managed to ensure efficiency of truck movements and to minimize damage to the engine and gears.
3. Engine power is coordinated with gear selection ensuring smooth transition and operation within torque range.



4. Dump truck is operated to work instructions under varied site and weather conditions in accordance with safe work practices and company operating procedures.
5. Road/traffic conditions are constantly monitored taking into account of road standards, traffic flow, distance and load, ensuring no injury to people or damage to property, equipment, loads and facilities.



Vehicle is brought to a halt without injury to personnel or damage to property, equipment and loads, through the use of engine retarder, gears and brakes using straight line braking techniques



Load, transport and tip materials

6. Vehicle is positioned at load and discharge points with a minimum of maneuver.
7. Dump truck movements including the raising and lowering of the tray are smooth and well controlled.
8. Weight and distribution of load is assessed for type of material and size of vehicle to ensure it is within vehicle capacity.
9. Safety and security of load, including load cover requirements, are maintained from loading site to discharge site
10. Load is discharged on slope and/or over face at fill site in accordance with company procedures.
11. Material is dumped/spread evenly in accordance with company procedures
12. Tray is cleared, lowered and secured before resuming travel in accordance with manufacturers' instructions

**Park and Maintenance**

13. Dump truck is safely parked, prepared for maintenance and shut down in accordance with manufacturers' manual and organizational requirements.
14. Inspection and fault finding are conducted in accordance with manufacturers' specifications.
15. Defective parts are removed and replaced safely and effectively according to manufacturers' manual and organizational requirements
16. Regular programmed maintenance tasks are carried out in accordance with manufacturers' and/or organizational requirements

**Clean up**

17. Work area is cleared and materials disposed of or recycled in accordance with project environmental management plan
18. Vehicle, tools and equipment are cleaned, checked, maintained and stored in accordance with manufacturers' recommendations and standard work practice



3.4 Water Tanker (Bowser, General Purpose)

1. Always perform pre-operational checks before putting a water truck in operation
2. Never operate a water truck without a thorough understanding of the rules at the construction site, as well as safe operating procedures of the truck
3. Make sure you allow sufficient time to warm the truck up (operating a “cold” truck can impact the vacuum braking system - you need to make sure you build a enough air pressure prior to operation)
4. Always wear your seat belt
5. Stay attentive - Watch for possible hazards (equipment and workers)
6. Adjust mirrors before your trip and use them often to monitor the activity around you
7. Confirm that regular maintenance is performed, making sure braking systems are maintained according to manufacturer specifications
8. Operate water trucks on safe haul roads (areas designed for vehicles)
9. Drive Smoothly - Because of the high center of gravity, and the surge of the liquid, you must start, slow, and stop, very smoothly. Make smooth turns and lane changes.
10. If you must make a quick stop, use controlled or stab braking. Remember - If you steer quickly while braking, your vehicle may roll over.
11. If you lose brake pressure during, pull the emergency brake and use the manual transmission to stop the truck



3.4.1 Inspecting Tanks:

12. On all tank vehicles, the most important item to check for is leaks. Check under and around the vehicle for signs of any leaking. Don't carry liquids or gases in a leaking tank.
In general, check the following:
13. The tank's body or shell for dents or leaks.
14. The intake, discharge, and cutoff valves - Make sure the valves are in the closed position except when loading or unloading.
15. The pipes, connections, and hoses for leaks, especially around joints.
16. The manhole covers and vents.



3.4.2 Liquid Surge:

17. Liquid surge results from movement of the liquid in partially filled tanks. For example, when coming to a stop, the liquid will surge back and forth. When the wave hits the end of the tank, it tends to push the truck in the direction the wave is moving.
18. If the truck is on a slippery surface, the wave can shove a stopped truck into an intersection. Remember: A half-full tank is more dangerous than a full tank!

3.4.3 Baffled Tanks:

19. Baffles allow the liquid flow through and helps control the forward and backward liquid surge. However, side to side surge can still occur which can cause a rollover. Drive slowly and be careful in taking curves or making sharp turns with a partially or fully loaded tanker.

3.4.4 Non-baffled Tanks:

Smooth bore tankers have nothing inside to slow down the flow of liquid. Therefore, forward and back surge is very strong. Be extremely cautious (slow and careful) when driving smooth bore tanks, especially when starting and stopping.

3.4.5 Special add on guidelines for Water Tankers on drinking clean water supply:

1. All water supplied in bulk form must originate from a regulated drinking water system, registered with the government according to Drinking-Water Systems Regulation.
2. At the time of filling, all water sources are currently potable (i.e., not under a boil water/drinking water advisory) and meet the **WHO requirements for the following:** Prevent the water tank, and any equipment and connections, from contamination during filling, storage, transportation, and delivery.
3. The water tank and any equipment used to supply water shall not have been previously used to transport a noxious, hazardous, or toxic substance or liquid. If the water tank was previously used to transport liquids for human consumption (i.e., milk, juice, etc.), it must be cleaned and sanitized before being used for haulage of drinking water.
4. The interior surface of water tanks used to supply potable water shall be constructed with a food-grade material that is non-corrosive (i.e., stainless steel, fiberglass, plastic) and shall not be used for any other purposes.



5. The inlet or opening of any container used for water haulage shall be constructed and maintained in a manner that will prevent the entry of insects, rodents, or any foreign material that may contaminate the water supply. With the exception of cleaning, emptying or filling of the tank, the inlet or opening must be covered and sealed at all times.
6. Hoses and nozzles used for water intake or discharge must be protected from possible contamination. They must be covered when not in use and disinfected before each use.
7. Food-grade lubricants shall be used for the operation of water pumps if the pumps are used for the transmission of drinking water to or from the water haulage vehicle.
8. Ensure the water tank and any removable equipment (i.e., hoses) are permanently labeled with the words “Drinking Water” or “Potable Water” in letters at least 15cm (6”) high on the water tank and in an appropriate size that can be easily read on the equipment.
9. The water tank shall be cleaned and disinfected in accordance with the Guidelines for Disinfecting a Water Haulage Tank Water Quality Standards.
10. Appropriate measures must be taken to protect the water from contamination

3.4.6 Guidelines for Disinfection a Water Haulage Tank

11. Disinfection of the water tank must be conducted on a monthly basis.

The following procedure requires the use of unscented household bleach (5.25% sodium hypochlorite)

12. Shut off valve to water tank distribution lines. Drain all water from the bulk tank.
13. Wash and remove dirt from the inside surfaces of the tank by using a high pressure hose.
14. Remove wash water and sediments from bottom of tank. These can be vacuumed out.
15. Rinse inside surfaces of tank with clean potable water. Remove wash water.
16. Disinfect the inside surfaces of the tank and distribution lines as follows:
17. Use 1 litre of household bleach for every 1000 litres of water. This provides 50 milligrams per litre chlorine solution. For example: a 3,500 gallon truck will have about 16,000 litres of water.
18. Add bleach while refilling the vehicle with water from the drinking water system. This will ensure thorough mixing of the bleach solution.
19. Ensure the tank is completely filled to allow interior surfaces to come in contact with the bleach solution.
20. Open valve to water tank distribution lines.
21. Run water out of water taps in the distribution lines until the smell of bleach is detected.
22. Shut off water faucets and valves to distribution lines. Ensure the tank is kept completely filled to allow a contact time of at least 12 hours
23. After 12 hours, drain all the water from the bulk tank into a municipal sanitary sewer or, if not available, a storm sewer. The tank can now be filled with fresh potable water.



24. Flush water tank by opening valves of distribution lines and running water until no smell of bleach is detected.
25. D. Disinfection of hose-end prior to each use
26. Hose end connections must be disinfected before each use.
27. A bleach solution for dipping hose ends can be made with unscented household bleach (5.25% sodium hypochlorite) as follows:
28. 100 ml. of bleach per 10 liters of water or
29. 1/2 cup of bleach per 3 gallons of water.

3.5 Bucket Machines

Bucket machines are very useful in cleaning medium to large size sewers.

The following steps are usually followed:

1: Make a Way

Before starting cleaning, connection between the two manholes has to be established. By floating an electrical lamp or if a blockage exists, Jetting or rodding should be done to establish this connection.



2: Preparation

A light steel wire or rope 5 mm in diameter is drawn through the sewer section. “Live winch” is positioned over the manhole on the downstream side of the sewer while the “dead winch” over the manhole on the upstream side. Wire or rope from the dead winch is tied to the smaller end of the bucket. Wire rope from the live winch is tied to the bigger end of the bucket. The bucket has a pivoted flap. Shake block, Snatch block, jacking screw and a manhole tube is used to support the wire or rope in the sewer.

3: Operation

The bucket is pulled through the sewer by the dead end winch. The bucket flap pivots to allow free passage of the silt through the bucket. Normally bucket should not travel more than 5 to 10 meters at a time. As the pull is reversed by the live winch, the bucket flap closes and full load of debris will be brought to the surface. The cycle is repeated, progressively drawing further through the sewer. Care should be taken not to damage the fabric of the sewer.



3.6 Backhoe

1. Set up the proper work zone control for the area where the work will be performed utilizing the Ohio Manual on Uniform Traffic Control Devices (OMUTCD)
2. Make sure the worksite footing has enough strength to support a backhoe firmly in order to prevent cave-ins
3. Watch for clearance height
 - Know what is above you at all times
4. Know your weight limitations for lifting capacity
5. Check underground utilities
 - Always call Ohio Utilities Protection Service (OUPS) prior to digging
6. Beware of power lines
 - Stay a minimum of 10 feet from power lines
7. Make sure that lights and warning signs are visible to everyone in the work area



3.6.1 Equipment Start-Up

8. The operator must be seated with the seat belt fastened to operate the controls
9. Start the engine with the throttle control lever set at idle
10. When the key switch is turned on, the buzzer will sound briefly



11. Buzzer Stop Alarm (if so equipped)

- a. The engine buzzer will sound whenever the engine oil pressure is low, the coolant overheats or the hydraulic oil overheats
- b. The alarm's location will vary depending on manufacturer
- c. The buzzer for low engine oil pressure will not stop until the equipment is turned off
- d. For high coolant temperature and high hydraulic oil temperature, reduce Load immediately and run the engine at reduced engine speed

12. Engine coolant temperature gauge

- a. The needle will point to the white zone until the engine is warm
 - Normal operating temperature is in the green zone
- b. Do not stop the engine when the needle enters the red zone or the temperature will farther
- c. Instead of stopping the equipment, stop digging immediately and place the equipment at the lower revolutions per minute (RPM) speed recommended by the manufacturer until the temperature drops
 - If the problem continues, inspect for a plugged radiator or coolant leakage

13. Alternator voltage indicator

- a. The indicator will light when there is low voltage output from the alternator
- b. Check the battery's charge and the electrical system

14. Engine oil pressure indicator

- a. If the engine oil pressure light (red indicator) comes on and the buzzer sounds while operating, stop the engine immediately
 - Cold oil, a low level of oil or operating the equipment at an extreme angle may cause the indicator to light

15. Air filter restriction indicator (if so equipped)

- a. The indicator will light when the air filter elements are plugged
- b. Stop operation of the equipment and clean or replace the elements



16. Hydraulic oil temperature indicator

- a. The indicator will light when hydraulic oil overheats
- b. The red indicator will light and the buzzer will sound if continue operation will cause damage to the hydraulic components
- c. Stop the engine immediately and consult with a mechanic to correct the problem before starting the equipment again

17. Hydraulic oil filter restriction indicator (if so equipped)

- a. The indicator will light when the hydraulic oil filters are plugged
- b. Immediately stop operation and have a mechanic replace the filters

18. Light indicator

- The indicator comes on when work lights (i.e., headlights, boom lights, etc.) are active

19. Levers

- a. Located on either side of the operator's seat
- b. Used to control the boom, dipper and bucket
- c. The horn button location depends on manufacturer
- d. The back-up alarm will sound when the FNR lever is placed in the R position

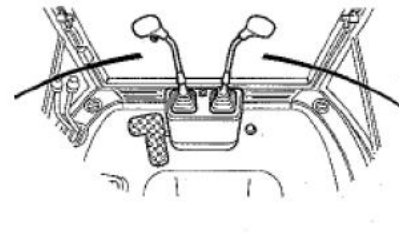
**20. Pedals**

- a. Accelerator and brake pedals are used by the operator to move the machine forward and reverse along with the FNR lever



- b. The dipper extension pedal if a backhoe is equipped with an extension rod



21. Operating lights (if equipped)

- a. Turn on all light switches for driving and to light up the instrument panel
- b. Turn on night time operating lights if so equipped

22. Warm weather warm-up for the engine

- a. Clear the area of all persons before running the machine through the warm-up procedure
- b. After the engine starts, run at 1/3 speed for 30 seconds
 - 1/3 speed can be achieved by raising the throttle lever to approximately 1/3 of traveling distance from the start position to full throttle
- c. Do not run the engine at fast or slow idle and do not accelerate rapidly during the warm up
- d. Operate a backhoe at less-than-normal loads and speeds until the engine is at normal operating temperature

23. Cold weather warm-up (below 32 degrees Fahrenheit)

- a. Clear the area of all persons before running the machine through the warm-up procedure
- b. Start the engine and run at half speed for 5 minutes
- c. Do not run at fast or slow idle and do not accelerate rapidly during the warm up
- d. Confirm that no one has entered the operating area
- e. Operate boom, arm and bucket functions by moving cylinders a short distance in each direction for the first time
- f. Continue cycling cylinders by increasing the traveling distance during each cycle until a full stroke is reached
- g. If hydraulic functions still move slowly, repeat the two steps immediately above
- h. Safety precautions specific to a cold weather warm-up
 - i. If hydraulic oil is cold, the hydraulic functions will move slowly
 - ii. Do not attempt normal backhoe operation until the hydraulic functions move at close to-normal cycle times.
 - iii. In cold conditions, an extended warm-up period will be necessary
 - iv. For faster warm-up, cover the radiator and oil cooler during the warming period
 - v. The hydraulic filter restriction indicator may flicker during warm up
 - vi. Operate functions slowly until the engine and hydraulic oil are thoroughly warmed
 - vii. Avoid sudden operations of all functions until the engine and until the engine and hydraulic oil are thoroughly warmed up

24. Moving a Backhoe

- a. Prior to traveling over long distances, be sure to lock boom in place and ensure the slow moving vehicle sign is on the back of the backhoe and visible to the public
- b. Insert swing lock pin
- c. Select gear for travel speed and place FNR lever in the F position
- d. If traveling a long distance put the transmission in 3rd or 4th gear (depending on the distance which will be traveled) then put the FNR lever in the F position



- e. If roading, LOCK brake pedals together; this ensures even braking power to each wheel
- f. Always drive the backhoe carefully
- g. During freezing weather, park the machine on a hard surface to prevent freezing to the ground
 - i. Clean debris from tires and frame daily
 - ii. If tires are frozen to the ground, raise the tires one at a time using the boom and move the machine carefully to prevent damage to the drive train and tires
- h. Do not drive a backhoe with the arm cylinder fully extended
 - Retract the arm cylinder slightly to prevent cylinder damage
 - i. Throttle control lever
 - ii. Use the engine speed control lever to set engine speed at desired RPMs
 - iii. To be used when digging only



25. Stopping the engine

- a. The turbocharger may be damaged if the engine is not properly shut down
- b. Before leaving the operator's seat, perform the following steps
 - i. Park the machine on a level surface
 - ii. Set parking brake
 - iii. Lower the front bucket to the ground
 - iv. Lower the boom and dipper to the ground
 - v. Lower the outriggers
 - vi. Run the engine at half speed without load for 2 minutes
 - vii. Push the speed control lever to the idle position
 - viii. Turn the key off
 - ix. Remove the key from the switch

26. Operating a Backhoe Digging Mechanism

- a. Pilot control shut-off lever (if equipped)
- b. This lever is the shut-off point for all hydraulic controls
 - i. Locking the switch in place will render a backhoe's lever inoperable
 - ii. Pull shut-off lever back to lock position to shut off hydraulic pressure to both right and left control levers and foot pedals

27. Control levers

- a. These levers are utilized to operate the boom, dipper, and bucket
- b. When the lever is released, it will return to neutral
- c. Read the operator's manual for directions on how the equipment controls are designed to work



- i. Cleaning
- ii. Keep the operator's cab clean

28. Operating in water or mud

Be careful not to operate the machine in water or mud above the swing pin. Causing the swing pin to be submerged will cause excessive wear.



29. Starting an excavation

- a. Prior to starting the excavation, ensure the proper bucket has been selected for the job to be completed
- b. Place the machine on level ground and use the stabilizers before digging
 - This creates a level-bearing stable surface for the tracks
- b. Position the arm slightly forward of the perpendicular position
- c. Place the bucket teeth on the ground with the bottom of the bucket at approximately a 45 degree angle to the ground
- d. Pull the bucket toward a backhoe using the dipper arm, boom and bucket functions until the bucket is full of material
 - Continue this procedure until the desired depth is reached



30. Straight line trenching

- a. The process by which a straight line dig is dug
 - i. Drive two stakes in at the beginning of the excavation process
 - ii. Drive the first stake in immediately behind the starting point and the second stake approximately 30 feet behind the first
 - iii. Positioning these stakes in a line extending from the centerline of the operator's position enables you to use them as a sight gauge
 - iv. This technique is especially useful where frequent repositioning of a backhoe is needed

31. Moving a backhoe off an embankment

- a. To move a backhoe off an embankment, position the bucket with the flat surface resting on the ground
 - The angle of the boom should be perpendicular to the operator



- b. The bucket must always be placed on the ground before beginning to move off the embankment; never move the machine and the bucket simultaneously off the embankment
 - If the machine and the bucket are moved simultaneously off the embankment, there is a great risk of the bucket absorbing the force of the fall, damaging the equipment
- c. The bucket must be on the ground before the machine begins to tip
- d. As the unit moves forward, raise the boom and retract the arm until the tires reach the lower ground level
- e. Raise the bucket off the ground
- f. Position the front bucket on the upper ground with the flat surface of the bucket resting on the ground
 - Keep the stabilizers up about 1 foot
- g. Place the FNR lever in R and slowly backup keeping pressure on the front bucket
- h. When the tires clear the embankment, raise the front bucket to lower the tires onto the lower ground level
- i. To move a backhoe onto an embankment, reverse the procedure

32. Craning/overhead lifting

- a. The process of using a sling attached to the bucket to move a heavy item (such as a catch basin) from one point to another
 - i. Secure sling/chain tightly to the load being lifted, always using grade 80 chain
 - a) Many buckets are equipped with a bucket loop through which the chain for the sling can be secured
 - b) If your equipment has a bucket loop, use when securing the sling/chain
 - ii. Coordinate hand signals with your designated ground guide before starting
 - iii. Know the location of all persons in the working area
 - iv. Attach a hand line to the load and make sure the person holding it is away from the load
 - v. Before starting the job, test your load by doing the following:
 - a) Park the machine close to the load
 - b) Attach the load to the machine
 - c) Raise the load 2 inches above the ground
 - d) Swing the load all the way to one side
 - e) While keeping the load close to the ground, move it away from the machine
 - f) If there is any indication of reduced machine stability (i.e., tipping starts to occur), lower the load to the ground to reposition boom and dipper
 - vi. Lift the load only as high as necessary when moving
- b. Safety precautions
 - i. Never move the load suddenly
 - ii. Never move a load over a person's head
 - iii. Do not allow anyone near a load
 - iv. Keep everyone away from a raised load until blocks are supporting it or the load is set on the ground
 - v. Fill the front bucket for more counterbalance and stability



- vi. Never attach a sling/chain to bucket teeth
- vii. Keep load as close to the machines as possible

33. Operating on a slope

- a. Level off a work area
- b. Avoid swinging the bucket farther than necessary in a downhill direction
- c. Do not lift the boom too high on the uphill side. A backhoe may tip backwards if the slope is too steep
- d. If at all possible, keep your spoil pile (dirt which is being dug out) on the uphill side of your excavation to make it easier to back fill and ensure the pile is a minimum of two feet from the excavation.

34. Hydraulic pavement breaker (manufacturer specific)

- a. An additional attachment available for the equipment which can be used in lieu of the bucket
- b. The pavement breaker functions by using a jack-hammer type effect on the object to be broken apart
- c. Refer to the operator's manual for specific instructions on how to use the attachment
- d. General operating tips
 - i. Perform the required checks and inspection daily before operation
 - ii. Avoid entry of contamination into the hydraulic system when switching the breaker with the bucket
- iii. Avoid blank hammering to prevent breaker damage
 - iv. Do not operate the breaker with hydraulic cylinder rods fully extended or fully retracted to prevent cylinder or machine damage
 - v. Do not operate the breaker in one position for over 1 minute
 - vi. Do not use the breaker as a lever or a ripper (extending the hammer fully in front of the operator and pulling the hammer toward the operator while hammering) to prevent damage to the chisel or its holder
 - vii. Do not use the breaker to move rocks
 - viii. Do not operate the breaker in water
 - ix. Operate the hydraulic pavement breaker carefully to avoid hitting it against the object to be broken
 - x. Upon completion of breaker operation, release the pressure from the lines by depressing the breaker control pedal/switch
 - xi. Failure to release the pressure will shorten the life of the breaker

35. Back blading utilizing the front bucket

- a. Place front bucket flat on the ground
- b. Tilt bucket slightly forward
- c. Backup length of area which needs to be leveled
- d. Just prior to the end, tilt bucket back up to feather out material being leveled



36. Operating tips

- a. Make sure you know the location and function of each control before operating
- b. Whenever possible, position the machine on a level surface
- c. Do not hit the stabilizers with the bucket when digging
- d. Do not use the bucket as a hammer or pile driver
Do not try to shift rocks and break walls using a swinging motion
- e. To avoid damaging the cylinders, do not strike the ground with the bucket or use the bucket for tamping (flattening a surface) when the bucket cylinder is fully extended (bucket completely curled under)
- f. Adjust the length and depth of each cut to produce a full bucket at every pass
- g. A full load should be the first objective, followed by speed, in order to increase productivity
- h. Do not try to break ledge rock by dropping the front of the bucket on the bucket teeth for penetration—serious damage could result
- i. Once a trench is open, ledge rock can be broken by pulling the bucket up under the layers
 - The top layers are pulled out first, with one or two layers being lifted at a time
- j. Never place any part of your body beyond the window frame
- k. When digging, avoid contacting stabilizers with the boom cylinders or the bucket

37. Parking a backhoe

- a. Before leaving the operator's seat, perform the following steps
 - i. Park the machine on a level surface
 - ii. Lower all attachments to the ground
 - iii. Follow procedure previously mentioned for shutting down the engine

38. Lock all compartments

- a. A backhoe is equipped with locks on the cab door and side shields
- b. Use these locks to safeguard the machine
- c. It is the operator's responsibility to lock the equipment to protect it from vandalism
- d. Shut off master switch, if so equipped. The switch will usually be found in one of the compartments.

3.7 Dredger (Calm-shell)**Clamshell operating procedures are as follows:**

1. Position and level the crane, ensuring the digging operation is as close to the radius as the dumping operation. This prevents you from having to boom up and down, resulting in a loss of production.
2. Select the correct size and type of bucket for the crane.



3. When lowering the clamshell bucket, if too much pressure is applied to the closing line brake, the bucket will close and an excess amount of wire rope will unwind from the holding line hoist drum. To avoid this, you should release the holding line and closing line brakes simultaneously when lowering the open clamshell into the material for the initial bite. Engage the closing line control lever to close the bucket. Control the digging depth by using the holding line control lever and brake.
4. If, during hoisting, the hoist line gets ahead of the closing line, the bucket will open and spill the material. (This could also be caused by having too much wire rope on the hoist drum.) The operator must hoist both the closing and holding lines at the same speed to keep the bucket from opening and spilling material.
5. When the clamshell bucket is raised enough to clear all obstacles, start the swing by engaging the swing control lever. Hoisting the bucket can be performed, as it is swung to the dumping site. The spring-loaded tag line will retard the twisting motion of the bucket if the swing is performed smoothly.
6. Dumping and unloading the clamshell is performed by keeping the holding line brake applied while the closing line brake is released. Apply the closing line brake quickly after the load is dumped to prevent the closing line from unwinding more wire rope than is needed to dump the material. After the bucket is emptied, swing the open clamshell back to the digging site. Then lower the open bucket and repeat the cycle.

The clamshell operating cycle has four steps:

- a) filling (closing) the bucket
- b) raising the loaded bucket
- c) swinging
- d) dumping

The boom angle for clamshell operations should be between 40 to 60 degrees. Be careful when working with higher boom angles, as the bucket could hit the boom. A clamshell attachment is not a positive digging tool. The height reached by the clamshell depends on the length of the boom used. The depth reached by the clamshell is limited by the length of wire rope that the hoist drum can handle. For the safe lifting capacity for the clamshell, refer to the operator's manual and the crane capacity load chart.



4 Why Preventive Maintenance is So Important

There are two types of maintenance strategies employed by companies that rely on equipment – reactive maintenance and preventive maintenance. Reactive maintenance goes by the “if it isn’t broke, don’t fix it” motto, a strategy that can sometimes save money short term but often ends up costing even more in the long run. Preventive maintenance, on the other hand, is a carefully designed maintenance program (often using CMMS software) where maintenance tasks are performed routinely in order to avoid larger, costly fixes down the line. Many maintenance professionals have recognized the benefits of preventive maintenance and are now turning to preventive maintenance software for ongoing equipment upkeep. Here is a look at 7 reasons why preventive maintenance is a much better alternative to reactive maintenance.

4.1 Cost Savings

Companies that rely solely on reactive maintenance are essentially waiting for a problem to happen, and this can often be a very costly move. Unplanned downtime can result in idle employees, halting the production line, missed deadlines, and – for property managers of hotels, resorts, school campuses and other consumer facing industries – long-term damage to their brand. An unexpected failure can also mean having to pay technicians overtime and having to pay out extra money for overnight delivery of parts. A preventive maintenance program is meant to avoid these problems through long-term maintenance tasks that are planned for using CMMS software.

A preventive maintenance plan can save a company money because efforts will be focused on preventing equipment failure rather than responding to emergencies, and preventive maintenance is usually much cheaper and faster than big fixes. Maintenance managers can use CMMS software to set up a maintenance program, which simplifies the transition from reactive to preventive maintenance and is also very cost effective.

4.2 Improved Safety

When equipment isn’t working in optimal condition, it creates many hazards, unsafe working conditions and even emergency situations where workers are injured. Preventive maintenance improves the safety of equipment and therefore the safety of company workers resulting in fewer on the job injuries and accidents.

4.3 Increased Equipment Efficiency

CMMS software can help plan routine maintenance such as inspections, oil and fluid changes, part replacements and more. These little fixes can help equipment to run much more efficiently. In turn, a company will benefit from fuel and energy savings because equipment will be running at peak performance.



4.4 Decreased Equipment Downtime

While almost all maintenance tasks require some equipment downtime, a preventive maintenance program can decrease and optimize that downtime. For example, a company doesn't experience unexpected downtime as much as if they were to rely solely on reactive maintenance. Companies can also use CMMS software to pre-plan maintenance tasks at optimal times so the downtime experienced is less troublesome. Decreasing equipment downtime is a benefit that saves time in maintenance and day-to-day operations.

4.5 Improved Reliability

Preventive maintenance can also help a company to be a more reliable business partner. Customers can count on a company to deliver products, materials, or service on time, without unnecessary delays. A resort with broken air conditioning will not succeed for long. By always offering a reliable product or service, a company can enhance its customer service and improve its reputation.

4.6 Conservation of Assets

Most equipment these days is certainly not cheap, but the better a company cares for its equipment, the longer it will last. Preventive maintenance will prolong the life of equipment so a company can get more hours out the equipment, resulting in reduced costs and increased profit.

The numerous benefits of preventive maintenance has caused many maintenance managers to shift from reactive maintenance to a regular, routine preventive maintenance plan meant to prevent problems and optimize equipment. Today's CMMS software helps facilitate preventive maintenance by helping schedule maintenance tasks and keep organized records of all inspections and fixes. Preventive maintenance is the best option for companies that want to succeed long term, and therefore understand that they need a long term plan for proper equipment upkeep.

5 Preventive Maintenance of Heavy Equipment

5.1 Record-keeping

Each Equipment should be provided with a log book to record its operation. This will help with the future planning of equipment work hours, efficient and reliable operations and for checking the efficiency of the vehicle and its drivers. Information below lists what should be recorded.

5.1.1 Equipment maintenance and operations log book

The log book should record:

- Date



- Operator's name
- Pre-task equipment inspection notes
- Task start and finish time
- Location, time and mileage
- Quantity of material used (if applicable)
- Rest periods (mandatory)
- Fuel quantity, time and date added (with mileage)
- Maintenance dates with part replacement records
- Signature of tasks completed
- Signature of any extra approvals for major repairs
- After-task equipment inspection notes

5.2 Proper maintenance

For the highest level of performance and safety, proper attention to equipment maintenance is crucial. It is recommended that all service and maintenance for the equipment be performed at an approved facility, where trained technicians are certified to work on specific heavy equipment and are most capable in determining the needs of your equipment. Always document all performed maintenance in a maintenance log or journal, and retain copies of service orders. Please refer to your owner's manual for maintenance requirements.

Within this section, you will find maintenance schedules and preventative care tips that are designed to help extend the life of your equipment even further.

5.3 Preventative Care

Preventive maintenance will prolong equipment life and guard against premature equipment wear, help keep major repairs to a minimum and ensure the continued safety of your equipment.

Below are some general tips for keeping your equipment in superior condition. Details and comprehensive preventative care instructions can be found in your equipment owner's or operator's manual.

5.4 Regular Checkups

The recommended service intervals of the equipment minimize overall operating costs and require less downtime for service and repairs. However, because mechanical or electrical problems can and do happen, it is recommend that you stay aware of your equipment's status between services and help keep it in excellent condition by attending to any problems or concerns as soon as possible. Follow these simple suggestions:



5.4.1 At each full stop

An equipment's engine and tires, tracks and crawlers are two of its most critical operating components. To help ensure they operate reliably, efficiently and safely, it's a good idea to check engine oil and wear levels of tires, tracks and crawlers at every fuel stop, or once per week. Refer to equipment owner's manual for specific information, including the recommended oil type for your vehicle and wear indicators.

5.4.2 Once a Month:

Maintaining other fluids at their proper levels and changing at recommended intervals is equally important to the equipment's ongoing good health. Consult the owner's manual for guidelines related to transmission or gearbox fluid, engine coolant, power steering fluid, windshield washer fluid, hydraulic fluid and clutch or brake fluid. Check all exterior lights and warning siren functions for operation as well, and maintain as required.

5.5 Maintaining Good Appearance:

Keeping your equipment clean and protected inside and out will help preserve its appearance and value over time. This owner's manual provides great guidance for cleaning and maintaining the various components and materials used in your equipment. Please always use recommended cleaning materials (chemicals) or tools.

5.6 Maintenance Schedule

The equipment is designed to perform and last under specific maintenance conditions. You can help preserve equipment's rugged dependability by following the maintenance schedule found in the owner's manual. This schedule is designed with the equipment's continued safety and top performance in mind and is one of the greatest assets to the long life of your vehicle.



Maintenance items	Service time				
	Daily	Weekly	Monthly	6 months	Yearly
Inspection	X				
Check coolant heater	X				
Check coolant level	X				
Check oil level	X				
Check fuel level	X				
Check charge-air piping	X				
Check/clean air cleaner		X			
Check battery charger		X			
Drain fuel filter		X			
Drain water from fuel tank		X			
Check coolant concentration			X		
Check drive belt tension			X		
Drain exhaust condensate			X		
Check starting batteries			X		
Change oil and filter				X	
Change coolant filter				X	
Clean crankcase breather				X	
Change air cleaner element				X	
Check radiator hoses				X	
Change fuel filters				X	
Clean cooling systems					X

Fig 22. Maintenance plan in a matrix format

Every 50 Service Hours or Weekly

Cab Filter (Fresh Air) - Clean/Inspect/Replace ...	150
Cab Filter (Recirculation) - Clean/Inspect/ Replace	151
Fuel Tank Water and Sediment - Drain	171
Parking Brake - Check/Adjust	178

Every 250 Service Hours

Engine Oil Sample - Obtain	162
----------------------------------	-----

Every 250 Service Hours or Monthly

Axle Breathers - Clean/Replace	145
Belts - Inspect/Adjust/Replace	147
Differential Oil Level (Front) - Check	156
Differential Oil Level (Rear) - Check	156
Extendable Stick Pads - Inspect/Adjust	163
Final Drive Oil Level (Front) - Check	168
Final Drive Oil Level (Rear) - Check	169
Power Sideshift Stabilizer Wear Pads - Inspect ..	179
Sideshift Stabilizer Wear Pads - Inspect/Adjust ..	182

Fig 23. Maintenance plan in descriptive format (source CAT)

Sample Maintenance Interval Schedule – Clam-Shell (Dredger)



Interval	Maintenance
As or When Required	Adjustable Gage Undercarriage Frame - Lubricate Air Conditioner/Cab Heater Filter (Recirculation) - Inspect/Replace Battery - Recycle Battery or Battery Cable - Inspect/Replace Boom Base Pins - Lubricate Bucket Linkage - Inspect/Adjust Bucket Tips - Inspect/Replace Cab Air Filter (Fresh Air) - Clean/Replace Circuit Breakers - Reset Counterweight Removal Chain - Inspect/Clean/Lubricate Engine Air Filter Primary Element - Clean/Replace Engine Air Filter Secondary Element - Replace Engine Air Pre-cleaner - Clean Ether Starting Aid Cylinder - Replace Fuses - Replace Oil Filter - Inspect Track Adjustment - Adjust Window Washer Reservoir - Fill Window Wiper - Inspect/Replace Windows – Clean
Every 10 Service Hours or Daily for First 100 Hours	Boom, Stick and Bucket Linkage – Lubricate
Every 10 Service Hours or Daily	Cooling System Coolant Level - Check Engine Oil Level - Check Fuel System Water Separator - Drain Fuel Tank Water and Sediment - Drain Hydraulic System Oil Level - Check Indicators and Gauges - Test Radiator Core - Clean Seat Belt - Inspect Track Adjustment - Inspect Travel Alarm - Test Undercarriage – Check



Interval	Maintenance
Every 10 Service Hours or Daily for Machines Used in Severe Applications	Boom, Stick and Bucket Linkage - Lubricate Every 50 Service Hours or Weekly Boom, Stick and Bucket Linkage – Lubricate
Every 100 Service Hours of Continuous Hammer Use	Hydraulic System Oil Filter (Case Drain) - Replace Hydraulic System Oil Filter (Pilot) – Replace
Initial 250 Service Hours	Engine Valve Lash and Fuel Injector Timing - Check Final Drive Oil - Change Hydraulic System Oil Filter (Case Drain) - Replace Hydraulic System Oil Filter (Pilot) - Replace Hydraulic System Oil Filter (Return) - Replace Swing Drive Oil – Change
Every 250 Service Hours	Cooling System Coolant Sample (Level 1) - Obtain Engine Oil Sample - Obtain Final Drive Oil Sample - Obtain Swing Bearing – Lubricate
Every 250 Service Hours or Monthly	Adjustable Gage Undercarriage Frame - Lubricate Belt - Inspect/Adjust/Replace Condenser (Refrigerant) - Clean Engine Oil and Filter - Change Final Drive Oil Level - Check Swing Drive Oil Level – Check
Every 250 Service Hours of Partial Hammer Use (50% of Service Hours)	Hydraulic System Oil Filter (Case Drain) - Replace Hydraulic System Oil Filter (Pilot) - Replace Every 250 Service Hours of Continuous Hammer Use Hydraulic System Oil Filter (Return) – Replace
Initial 500 Hours (for New Systems, Refilled Systems, and Converted Systems)	Cooling System Coolant Sample (Level 2) - Obtain
Every 500 Service Hours	Hydraulic System Oil Sample - Obtain Swing Drive Oil Sample – Obtain



Interval	Maintenance
Every 500 Service Hours or 3 Months	Engine Crankcase Breather - Clean Engine Oil and Filter - Change Fuel System - Prime Fuel System Primary Filter (Water Separator) Element - Replace Fuel System Secondary Filter - Replace Fuel Tank Cap and Strainer – Clean
Every 500 Service Hours of Partial Hammer Use (50% of Service Hours)	Hydraulic System Oil Filter (Return) – Replace
Every 600 Service Hours of Continuous Hammer Use	Hydraulic System Oil – Change
Every 1000 Service Hours or 6 Months	Battery - Clean Battery Hold-Down - Tighten Hydraulic System Oil Filter (Case Drain) - Replace Hydraulic System Oil Filter (Pilot) - Replace Hydraulic System Oil Filter (Return) - Replace Swing Drive Oil – Change
Every 1000 Service Hours of Partial Hammer Use (50% of Service Hours)	Hydraulic System Oil – Change
Every 2000 Service Hours or 1 Year	Engine Valve Lash and Fuel Injector Timing - Check Engine Valve Rotators - Inspect Final Drive Oil - Change Hydraulic System Oil - Change Refrigerant Dryer - Replace Swing Gear – Lubricate
Every Year	Cooling System Coolant Sample (Level 2) - Obtain
Every 3 Years After Date of Installation or Every 5 Years After Date of Manufacture	Seat Belt – Replace
Every 4000 Service Hours or 2 Years	Hydraulic System Oil – Change



Interval	Maintenance
Every 6000 Service Hours or 3 Years	Cooling System Coolant Extender (ELC) – Add
Every 12,000 Service Hours or 6 Years	Cooling System Coolant (ELC) – Change

5.7 Maintenance Log

The downloadable maintenance log provides a convenient and useful record of equipment's service history. With it, one can keep track of the equipment's service dates and all maintenance performed on the equipment.

Equipment Maintenance Log



Make:	Komatsu	
Model:	JK-XZ	
Year:	2004	
Vehicle ID Number:	XZDS_32456	
Engine:	TJ-SS	Total Cost: 155.12

Date of Service	Mileage at Service	Work Performed and Service Schedule	Performed By	Cost	Notes
18/06/2011	8,755	Oil Change, Replace Oil Filter	Jiffy Lube	74.89	
26/03/2012	17,339	Oil Change, Replace Oil Filter General Inspection & Tire Rotation	Jiffy Lube	80.23	
07/06/2012	20,611	A/C Discharge Hose Broken Recall fix: Replace Wiper Rod Arm	Dealer	-	Covered under warranty
	30,000	Oil Change, Replace Oil Filter Air, Cabin Air Filters Tire Rotation Inspect Drive Belts			
	40,000	Oil Change, Replace Oil Filter General Inspection & Tire Rotation			
	45,000	Flush/Replace Brake Fluid			
	50,000	Oil Change, Replace Oil Filter Rotate Tires			
	60,000	Oil Change, Replace Oil Filter			

Fig 24. Maintenance plan in descriptive format (source CAT)



5.8 Planning for heavy equipment operations

- Set up a preconstruction meeting inviting all contractors to discuss ways to coordinate work activities, identify potential hazards, and means to eliminate or reduce them
- Develop a process for reviewing incidents and close calls. Identify hazards and ways to correct them
- Develop diagrams to show how construction vehicles and heavy equipment will enter, move, and leave the work zone
- Design the workspace so that backing up and blind spots are minimal
- Establish ways to provide for well-lit work areas

5.9 Traffic Control

- Prevent unauthorized access to worksite.
- Establish parking areas for workers and visitors
- Install barricades or other barriers to clearly delineate traffic routes and prevent vehicles from coming into the work zone
- Designate a single traffic control person to authorize, monitor, and direct the movement of vehicles including backing up
- Provide alternate routes for workers on foot to access the work area, if possible
- Authorize the traffic control supervisor to temporarily stop work until traffic congestion is under control or eliminated

5.10 Pre-start / Walk Around Inspection

- a) Check for any warning lights, if any such lights on, refer to operator's manual
- b) Check for loose or worn parts and repair or replace immediately.
- c) Check all fluid/coolant levels.
Caution: Open the radiator cap only when the engine is cooled.
- d) Inspect hydraulic line connectors and hoses for leaks before applying pressure to the system. Use paper or cardboard, not your hands, to search for leaks.
Caution: Hydraulic fluid escaping under pressure can penetrate skin and cause serious bodily harm.
- e) Check tires for cuts, bulges, irregularities, abnormal wear and proper inflation.
- f) Mount a fire extinguisher and first aid kit in the cab.



5.11 Train students and young workers

- Review with them their information on What Can Happen to You and How to Keep Yourself Safe when working around heavy construction equipment
- Hold daily toolbox meetings at the job site to highlight potential dangers of today's tasks. Discuss close calls
- To recognize and avoid the hazards of working on foot around vehicles and heavy construction equipment by staying away and working at safe distances
- To recognize and stay away from the blind spots of heavy equipment and vehicles.



- To be alert to potential hazards that may be created by another contractor's employees
- To work within the line of sight of the equipment operator and maintain visual contact with the operator
- To wear high visibility safety clothing including retro reflective gloves, arm bands, and other accessories. This is critical under poor lighting and bad weather conditions

5.12 Work Safer

- Schedule work tasks to keep workers on foot out of areas where heavy equipment and construction vehicles are present whenever possible
- Use sensing units on heavy equipment to detect workers on foot
- Encourage communication, e.g., hand signals, two way radios for employees assigned to watch for safety in the work zone or employees on foot talking to the equipment operator
- Ensure backup alarms, horns on construction equipment are tested daily and function effectively. Instruct equipment operators to use these devices to call the attention of workers on foot

Encourage operators of heavy equipment and construction vehicles to:



- move equipment only after positive visual contact (seeing each other`s eyes) has been made and confirmed with workers on foot
- always observe jobsite speed limits and reduce speed when workers on foot are nearby



5.13 Shut Down and Parking

- Always Park at the designated place on a level ground.
- When parking on an inclined surface, position at right angles to the slope, block the wheels and set the parking brakes.
- When parking, lower all loader, buckets and hydraulics to the ground.

5.14 Housekeeping

- Ensure the cab area is clean and free of debris and tools.
- Clean windshield, mirrors and lights.
- Remove all oil, grease, mud or snow from grab irons, hand rails, steps, pedals and floor to prevent slips and falls.
- Remove or secure any loose items such as tools, chains or lunch boxes from the cab.

6 Heavy Equipment Selection Process

6.1 Methodology

Starting from the notion that heavy equipment should be selected by its performance on site, the first stage in this context is to choose the right method for measuring this performance. For each of the different types of equipment a specific method had to be selected.



The heavy equipment in water and sanitation can be divided in the following 6 groups:

1. Earth movement equipment
2. Material handling equipment
3. Elevation and rising equipment
4. Sewer and drainage cleaning machines
5. Suction and Pressure machines
6. Fluid transportation equipment

And for each type the methodology used to analyze the different criteria was based in:

1. Measuring the performance
2. Measuring the minimal risk
3. Measuring the minimal impact or environmental aspect

Table 2 Steps of the selection methodology (source irbnet.de)

CRITERIA	USED METHOD TO ANALYSE IT
Optimum performance	Minimal hourly cost Maximum hourly productivity
Minimal risk	The minimal risk criteria, will be the result from the sum of all the present risks. The valuation of these risks was made through the method proposed by the INSHT. (Instituto Nacional de Seguridad e Higiene del Trabajo).
Minimal impact or environmental aspect	The minimal impact or environmental aspect, will be the result from the sum of all the present impacts. The valuation of these impacts was made through the method of identification and evaluation of environmental impact and aspects based on the Environmental Management Systems contained in the ISO 14001 standard.



6.2 OPTIMUM PERFORMANCE

1. Measuring the productivity for each of the different types of equipment

The productivity is measured by several ways, for example, in earth moving equipment, established methods were used, as the Caterpillar method for their equipment, and for other types of equipment productivity can be measured on site under normal conditions of use.

2. Hourly costs

The hourly cost for each of the equipment's, as in the productivity is obtained either by established methods or by doing a market research on the price for renting that equipment for a established period of time and dividing it by the actual time of Usage. This also includes fuel cost, equipment fuel efficiency is critical to this aspect of the selection.

3. Factor the influence the performance of construction equipment

There are several factors that can affect or influence the performance of construction equipment and that can be gathered in the following groups:

a) Routine delays:

All those factors that are derived from the inevitable equipment use, no machine can function at maximum power continuously. Maintenance falls into these kind of delays.

b) Restrictions to optimal mechanic operation:

These originate a reduction effect on production, due exclusively to limitations to its optimal operation. Slopes, angles, heights, cutting depths, etc, are all restrictions of this kind.

c) Site conditions:

Once on site different kinds of factors can affect the performance of given equipment, some are:

- i. Physical conditions: topography and geology of the site, geotechnical characteristics of the ground or rocks, etc.
- ii. Climate: temperature, rain, wind, etc.
- iii. Localization of the site: how near is the site from urban centers or industrial sites for provisioning?
- iv. Adaptation conditions: degree of adaptation of the work team can sometimes hinder the performance of the equipment.

d) Direction and Supervision:



Organization of the workflow, planning and other management decisions can pose obstacles for maximum performance. All of these factors should be removed or mitigated in order to obtain real production of the equipment.

Table 3: Equipment Risk Valuation

		Severity		
		LIGHT	HAZARDOUS	EXTREMELY HAZARDOUS
		1	2	6
Low probability	1	Trivial risk 1	Tolerable risk 2	Moderate risk 6
Medium probability	2	Tolerable risk 2	Moderate risk 4 ≈ 6	Important risk 12
High probability	6	Moderate risk 6	Important risk 12	Intolerable risk 36

6.3 Minimum Risk Criteria

The minimal risk criteria is obtained as follows:

1. Identify and evaluate all the present risks of the equipment, according to the general process of risk evaluation.
2. Valuation of the found risks, by a numeric scale.
3. Finally all the values for each equipment are summed which gives the value of the minimal risk criteria

6.4 Minimal impact or Environmental Criteria

The minimal impact or environmental impact of construction equipment is obtained as follows:

1. Identification and evaluation of all impacts present on a given equipment applying a descriptive method based on the criteria of an environmental management system as the ISO standards.
2. Valuation of the encountered impacts according to their criticality.



3. The sum of all the values of specific equipment, this result gives the “minimal impact or environmental aspect”.



References

1. JICA MANUAL ON SEWERAGE AND SEWAGE TREATMENT PART B OPERATION AND MAINTENANCE
2. www.kissanengg.com.pk
3. Backhoe Manual OHIO department of transportation
4. Galion – Goldwin Dump Truck Operator Manual
5. VCSU SAFE OPERATING PROCEDURES: Heavy Equipment
6. North Dakota State University Heavy Equipment Operations
7. O&M Best Practices Guide, Release 3.0
8. FEMP. 2007. *Metering Best Practices Guide: A Guide to Achieving Utility Resource Efficiency*. DOE/EE- 0323. U.S. Department of Energy, Federal Energy Management Program, Washington, D.C.
9. NASA. 2000. Reliability Centered Maintenance Guide for Facilities and Collateral Equipment. National Aeronautics and Space Administration, Washington, D.C.
10. PEI. 1999. Portable Data Loggers Diagnostic Tools for Energy-Efficient Building Operations. Prepared for the U.S. EPA and U.S. DOE by Portland Energy Conservation, Incorporated, Portland, Oregon.
11. Owner’s Manual Hino PAK
12. Public Health Service Hamilton, Ontario, Canada: Water Hauler Services
13. GILLOTI Water Truck Safety Guidelines







ALJAZARI
— ACADEMY —

**Operations and Maintenance of
Mechanical and Electrical Equipment
WSD 5231**

Module 7

**Water Meter Selection, Installation and
Maintenance**

Participant Lecture Notes

2016



ALJAZARI
— ACADEMY —

1. Lecture Information

Course Title: Operations and Maintenance of Mechanical and Electrical Equipment	Course Code: WSD 5231
Module Title: Water Meter Selection, Installation and Maintenance	Module No: 7
Lecture Topics: 1) Importance of water meters 2) Types of water meters 3) Selection of water meters 4) Installation of water meters 5) Maintenance of water meters	Lecture Duration: 5 Hours Parts Demonstration: 60 Minutes

2. Water Meters Introduction

Any viable business must be able to determine how much product it is making and selling and if that product is profitable. Water is a business. And, the best way for a water utility to measure or account for the water produced and then sold is by using water meters. This Tech Brief, discusses the different types of meters, their applications, and their importance for a water utility business.

3. Importance of water meters

Why are meters important? Water meters are important to a utility for several reasons:

1. They make it possible to charge customers in proportion to the amount of water they use.
2. They allow the system to demonstrate accountability.
3. They are fair for all customers because they record specific usage.
4. They encourage customers to conserve water (especially as compared to flat rates).
5. They allow a utility system to monitor the volume of finished water it puts out.
6. They aid in the detection of leaks and waterline breaks in the distribution system.

A system without meters is like a taxi without a fare counter. Without a meter, it costs the same to drive the block as it does from Lahore to Karachi.



4. Types of Meters

Meters are classified into two basic types: positive displacement and velocity. Each of these meter types has variations, leading to the perception that there are several different kinds. Meters that feature both positive displacement and velocity are known as compound meters. The unit of measurement is usually in gallons but sometimes in cubic feet.

4.1 Positive Displacement Meters

Positive Displacement Meters In this type of meter, a known volume of liquid in a tiny compartment moves with the flow of water. Positive displacement flow meters operate by repeatedly filling and emptying these compartments.

The flow rate is calculated based on the number of times these compartments are filled and emptied. The movement of a disc or piston drives an arrangement of gears that registers and records the volume of liquid exiting the meter. There are two types of positive displacement meters: Nutating disc and piston.

Nutating Disc Meters have a round disc that is located inside a cylindrical chamber. The disc is mounted on a spindle. The disc nutates, or wobbles, as it passes a known volume of liquid through the cylindrical chamber. The rotating motion of the disc is then transmitted to the register that records the volume of water that went through the meter. (See Figure 1 below.)

Piston Meters have a piston that oscillates back and forth as water flows through the meter. A known volume of water is measured for each rotation, and the motion is transmitted to a register through an arrangement of magnetic drive and gear assembly.

Positive displacement meters are sensitive to low flow rates and have high accuracy over a wide range of flow rates. Positive displacement meters are used in homes, small businesses, hotels, and apartment complexes. They are available in sizes from 5/8" to two inches.

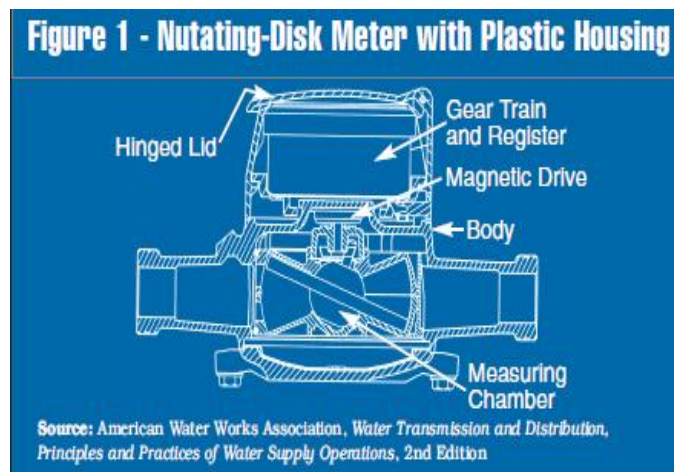

Velocity Meters operate on the principle that water passing through a known cross-sectional area with a measured velocity can be equated into a volume of flow. Velocity meters are good for high flow applications.

Velocity meters come in different types, including turbine, multi-jet, propeller, ultrasonic, venture, and orifice meters. These meters are available in sizes of two inches and larger with the exception of multi-jet meters, which are between 5/8” and two inches.

Turbine Meters have a rotating element that turns with the flow of water. Volume of water is measured by the number of revolutions by the rotor.

Venturi Meters have a section that has a smaller diameter than the pipe on the upstream side. Based on a principle of hydraulics, as water flows through the pipe, its velocity is increased as it flows through a reduced cross-sectional area. Difference in pressure before water enters the smaller diameter section and at the smaller diameter “throat” is measured.

The change in pressure is proportional to the square of velocity. Flow rate can be determined by measuring the difference in pressure. Venturi meters are suitable for large pipelines and do not require much maintenance.

Orifice Meters work on the same principle as venture meters, except that, instead of the decreasing cross sectional area, there is a circular disk with a concentric hole. Flow rate is calculated similarly to the venture meter by measuring the difference in pressures.

Ultrasonic Meters send sound waves diagonally across the flow of water in the pipe. Changes in the velocity of water are converted electronically to change in flow rate.

Magnetic Meters have an insulated section through which water flows. The flow of water induces an electrical current that is proportional to the velocity and hence the flow rate.

Propeller Meters have a fan-shaped rotor that spins with the flow of water. A recorder is attached to the rotor to register the readings.

Multi-jet Meters have tangential openings in a chamber to direct the water flow across a rotor with many vanes. Flow is measured proportional to the speed of the rotor. All water meters consist of **four basic components**:

a *sensor* to detect the flow, a *transducer* to transmit the flow signal, a *counter* to keep track of the total volume having passed

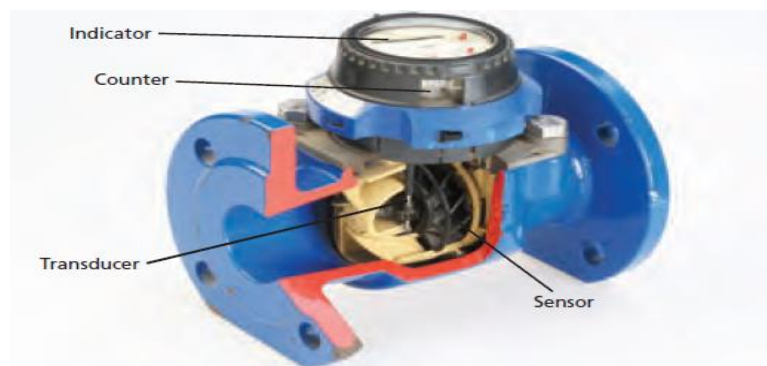

Figure 1-1 Section through a water meter showing the sensor, transducer, counter and indicator (meter supplied by Sensus)



through the meter, and an *indicator* to display the meter reading.

4.2 Compound Meters

In some cases, it is necessary to have a combination meter, both a positive displacement meter and velocity meter installed together, to be able to measure high and low flows. Low flows are measured through positive displacement while high flows are measured by velocity. A valve arrangement directs flows into each part of the meter. (See *Figure 2*.)

Figure 2 - Compound Meter

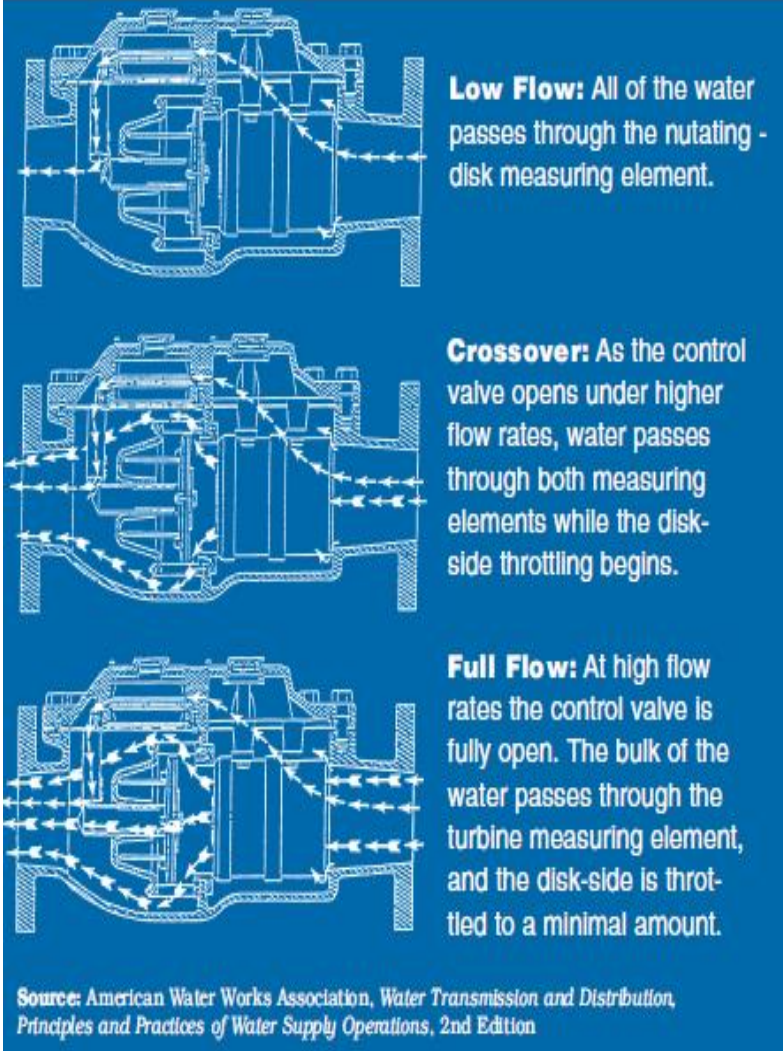

5. Selection of Water Meters

A municipality should have its own policy on water meter selection based on its experience with different meters in its distribution system. It is important to have a consistent policy on where water meters are installed in the system, and to select the most appropriate water meter for each installation. Selecting the right water meter model and size is very important. It is expensive to purchase and install a water meter, and thus the meter should perform well for an extended period of time before it has to be serviced or replaced.

Meters that are cheaper may have much shorter life spans or higher maintenance requirements, and thus may not be the most cost effective option overall. It is not easy to predict the long term performance of a water meter, as this will differ depending on the meter model, the system in which it is installed and the water consumption patterns of the consumer. Thus it is important that a municipality develops its own policy on water meter selection based on its own experience with different meters in its distribution system.

Larger water meters are more expensive than smaller meters. In addition, larger meters of the same class have higher starting, minimum and transitional flow rates. This means greater levels of meter under-registration, which translates directly into lower levels of income for a municipality. Thus it is important that meters are not over-sized, as is often the case in South Africa and many other countries¹. On the other hand, if a water meter is too small, the highest flows through the meter may exceed the meter's design parameters, causing permanent damage to the meter mechanism and rapid deterioration in meter accuracy. As a result, the meter will develop high levels of under-registration, and its service life may be substantially shortened. To get the greatest benefit from a water meter at the minimum cost, it is critical that the meter is correctly sized. Most water meters in a distribution system are small domestic meters that are quite standard and not very difficult to select.

It is critical that water meters are correctly sized. A meter that is either too small or too large will cost a municipality more over its lifetime.



However, correct meters for non-domestic consumers and bulk domestic consumers such as blocks of flats are more difficult to determine, and can't be selected without analysis and good judgement. It is necessary to follow a systematic procedure to select the best water meter for a given application. A meter should never be sized simply based on the size of the pipe it will be installed in. Such a selection does not consider the actual flow rate variations that can be expected to occur, and can thus easily result in an incorrectly sized meter. A good guide to selecting the right water meter is to base it on the following questions:

- What is the purpose of the meter?
- Does the meter comply with the required standards and policies?
- Is the meter rated for the expected flow rates and operating conditions?
- Which is the most economical meter to use?

The first three questions are used to eliminate meters that are not suitable for an application, and the last to select the best meter out of those that are left. This procedure is discussed in the rest of this section and is illustrated in the figure 3 on next page.

Note that most manufacturers are able to provide software to assist with meter sizing. Appendix B lists some manufacturers that have meter selection software available.

5.1 Meter Application

It is necessary to distinguish between the location of a meter in the distribution system, and the application and purpose of the meter. The location of meters is important to ensure that all consumer usage is metered, but also that water distributed to different parts of the system is measured to identify consumption patterns and leakage. Once it has been determined that a water meter should be installed at a given location, it is necessary to consider the application of the meter. Three major applications are identified and discussed: consumer, bulk transfer and management meters.

Where Should Meters be installed?

To get the greatest benefit from a water metering system, it is important that meters are installed at locations that will support the management of the system on technical, financial and management levels. It is generally considered good practice to install water meters at the following points in a distribution system:

- Raw water withdrawals from dams, boreholes or other sources.
- Clean water production at the outflow of water treatment plants.
- Connection points to bulk water suppliers or other municipalities.



- Points in the system where it is important to know how much water is distributed, such as reservoir outflows, pump stations and off-takes to different areas.
- Points of clean water tube-wells.
- Supply points to district metered areas (DMAs)
- Consumers.

Figure 4 below shows a typical water supply system with water meters at recommended locations

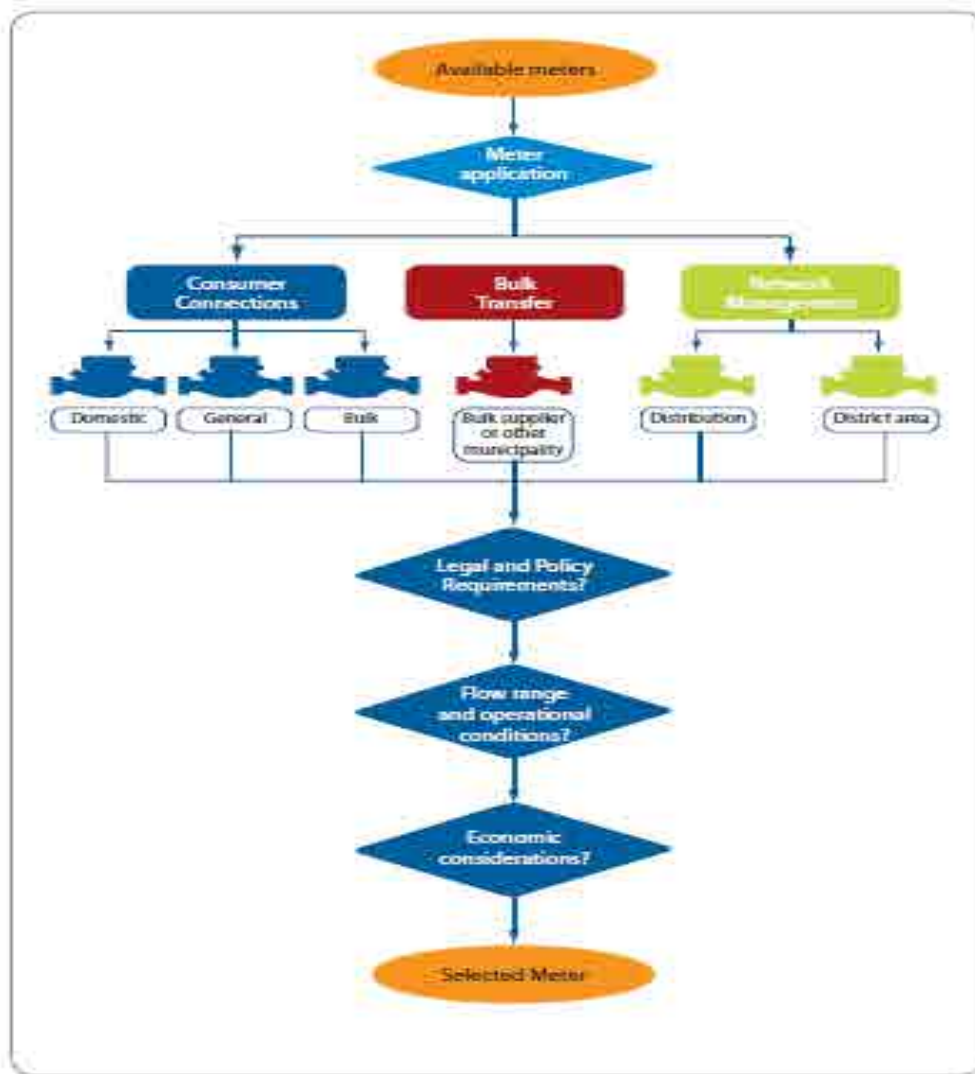

Figure 3. Water Meter Selection Process Flow Chart



District Metered Areas (DMAs) are commonly used to divide a water distribution system into smaller units that are easier to manage. DMAs are isolated from the rest of the system, except at one (or sometimes more) metered connection points. They typically consist of around 2 500 service connections². Ideally, all consumers should be metered. Even if the water meter is not used for billing purposes, it is still important to measure the supply to a consumer for equity and water management purposes. In many municipalities, fire hydrants on consumer properties have not been metered in the past. This is not recommended practice, since consumers can deliberately or unwittingly connect their consumption pipe work to the fire lines, resulting in significant levels of unmetered consumption in the system. If fire hydrants are not metered, it is possible to provide these connections with flow detection devices to identify illegitimate use. Other users that are often overlooked are public facilities such as parks, swimming pools and public toilets.

5.2 Consumer Meters

Consumer meters measure the water delivered to different types of consumers, and thus are like cash registers for a municipality. In most cases, these meters' readings are used to bill consumers for the quantity of water consumed, and thus it is important that they accurately register the consumption. Strict legislation and standards apply to consumer meters and have to be adhered to. For instance, class A meters may not be used as consumer meters. Even when consumers are not billed for consumption based on their metered consumption, it is still recommended that all consumers are supplied with a water meter. This will allow the municipality to identify consumers with excessive consumption, for instance due to on-site leakage, and then take corrective action.

5.3 Consumer meter connections may be placed in two categories

small (up to 25 mm) and large (> 25 mm) connections. Generally, most meters in a municipality are domestic meters supplying single households. On the other hand, most of the water consumption is likely to come from industrial, commercial and institutional consumers, which are often collectively referred to as ICI consumers. Commercial and industrial users typically account for 50% of the income from water sales in a municipality³. In most cases a few large consumers are responsible for a large portion of the consumption in the system. The water meters installed at these consumers are particularly important, since meter inaccuracies may result in much greater losses to the municipality than for other consumers.

5.3.1 Small Connections

Small connections are used for consumers that require water meters of 25 mm or less, including single housing units and ICI (institutional, commercial and industrial) users with low water consumption. The consumption behaviour of domestic users is similar in nature, and thus it is possible to have a simplified meter sizing procedure for estimating consumption or even



selecting the meter size. On-site leakage often occurs on domestic properties, and thus sensitivity at low flows is important. ICI users in this category are small and use water mainly for human activities such as toilet flushing, washing and cooking.

5.3.2 Large connections

Large connections are those that require meters larger than 25 mm. Bulk consumers have the largest consumption in the distribution system, and thus the sizing and maintenance of their meters are very important.

5.4 Bulk Transfer Meters

Bulk transfer meters (sometimes called custody transfer meters) are used when transferring water from a source or bulk supplier to a municipality or from one municipality to another. Payment for the water is based on the meter readings, and since bulk transfers normally involve very large quantities of water, the accuracy of these meters is critical. Higher accuracies are often required than for other meters. Bulk transfers are done based on a contract between the parties involved that should cover metering aspects of the transfer. Bulk suppliers are likely to have a metering policy in place, although municipalities sometimes install their own meters to verify measurements. Electromagnetic and three or five beam ultrasonic meters are commonly used in bulk transfers.

5.5 Management Meters

Management meters measure the distribution of water to different parts of the network. They are essential for many technical and management functions, including the estimation and management of water losses, pumping patterns, energy consumption, water demand patterns and hydraulic network calibration. Management meters are not used for bulk transfer or consumer billing, and thus the municipality has more freedom regarding the type and class of meter to use. District area meters are management meters that measure flows entering a district metering area (DMA), and are important for estimating the demand patterns, future demand and leakage of discrete areas of the DMA. Since these estimates are done for discrete, relatively small sections of the network, they allow the municipality to better understand demand and leakage trends at different points in the network. Management meters that are not district area meters are collectively called distribution meters.

5.6 Prepaid water meters

Meters can be prepaid or postpaid, depending on the payment method. Most mechanical type water meters are of the postpaid type, as are electromagnetic and ultrasonic meters. With prepaid water meters the user purchases and prepays for a given amount of water from a vending station. The amount of water credited is entered on media such as an IC (integrated circuit) or RF (radio



frequency) type card. The main difference is whether the card needs a contact with the processing part of the prepaid water meter. In some areas a prepaid water meter uses a keypad as the interface for inputting the water credit.

Register

There are several types of registers on water meters. A standard register normally has a dial similar to a clock, with gradations around the perimeter to indicate the measuring unit and the amount of water used, if less than the lowest digit in a display similar to the odometer wheels in a car, their sum being the total volume used. Modern registers are normally driven by a magnetic coupling between a magnet in the measuring chamber attached to the measuring element and another attached to the bottom of the register. Gears in the register convert the motion of the measuring element to the proper usage increment for display on the sweep hand and the odometer-style wheels. Many registers also have a leak detector. This is a small visible disk or hand that is geared closer to the rotation speed of the drive magnet, so that very small flows that would be visually undetectable on the regular sweep hand can be seen.

With Automatic Meter Reading, manufacturers have developed pulse or encoder registers to produce electronic output for radio transmitters, reading storage devices, and data logging devices. Pulse meters send a digital or analog electronic pulse to a recording device. Encoder registers have an electronic means permitting an external device to interrogate the register to obtain either the position of the wheels or a stored electronic reading. Frequent transmissions of consumption data can be used to give smart meter functionality.

There are also some specialized types of registers such as meters with an LCD instead of mechanical wheels, and registers to output data or pulses to a variety of recording and controller devices. For industrial applications, output is often 4-20 mA analog for recording or controlling different flow rates in addition to totalization.





A typical water meter register showing a meter reading of 8.3 gallons. Notice the black "1" on the odometer has not yet fully turned over, so only the red hand is read.



Water meters connected to remote reading devices through three-wire cables





Figure 4. Example Schematic of a Water Supply System

6. Installing a water meter

Where do you install the meter?

We need to access the meter to read it regularly so it's important that you install it in the right spot.

If you're laying a private water service, you should ensure the inlet riser:

- is between 300 mm and 1,000 mm inside the front property boundary
- is between 300 mm and 600 mm from the left or right property boundary
- and outlet riser are 300 mm from the ground (meters up to 50 mm light duty)
- and outlet riser are parallel to the closest side boundary.

- If you're installing meters close together, you must allow 300 mm between them.
- You must not install the meter:
 - more than 1.5 metres above the ground
 - in an area we cannot regularly access such as inside a house or unit, in a ceiling space or under a kitchen sink.

6.1 What spacing do you need to allow?

You'll need to allow a space for the meter by installing a bridging piece when you lay a private water service. The following diagrams and tables explain the distance you need to allow. This doesn't include the space for a separate backflow prevention device if the property needs one.



20 mm to 50 mm light duty meters

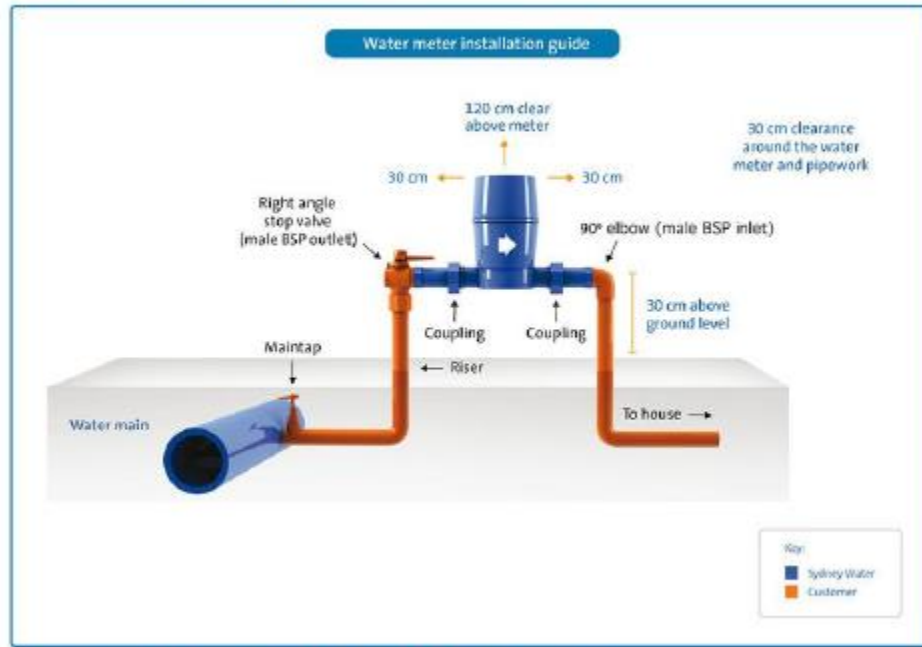

If you're installing a meter, doing it this way will help us access them.

Meter size DN	Right angle stop (ball) valve Install this on the water main side riser	Elbow Install this on the customer side riser	Meter space This is the distance between the stop valve and the elbow
Drinking water			
20 mm	Male BSP thread outlet	Male BSP thread inlet	244 mm
25 mm			283 mm
32 mm			336 mm *
40 mm			349 mm *
50 mm light			320 mm *
Recycled water			
20 mm recycled	Female BSP thread	Female BSP thread	244 mm
25 mm recycled			283 mm

* This doesn't include the distance for the backflow device.

Figure 5. Water Meter Installation Schematic light duty meters (source: Sydney Water)



50 mm to 300 mm heavy duty meters

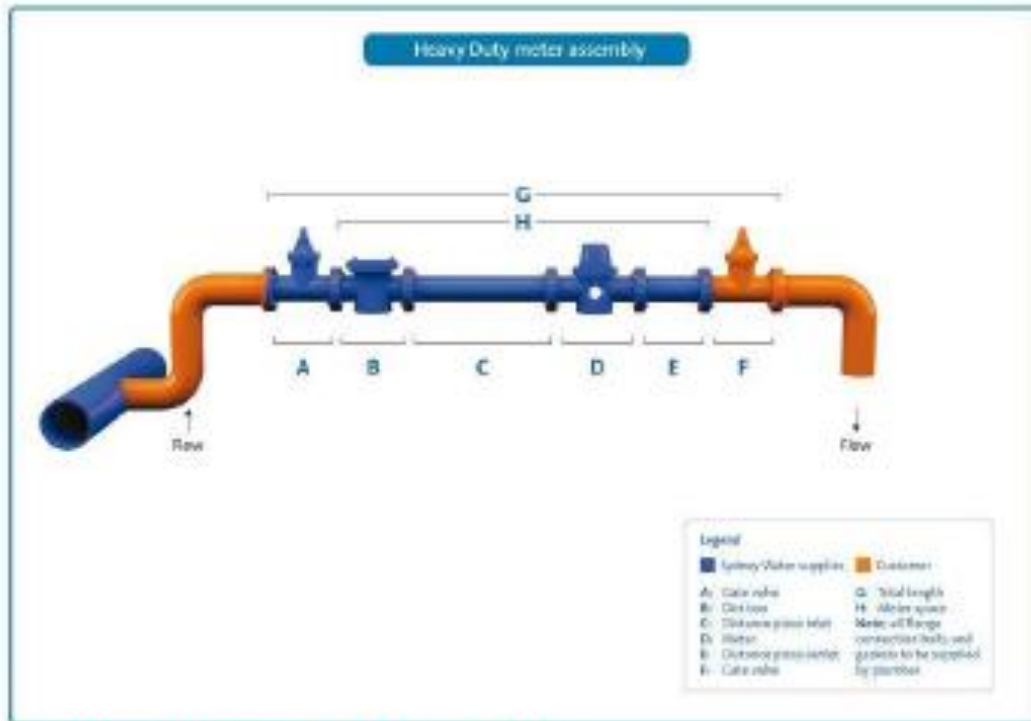

If you're installing a large meter, we'll give you more parts.



Meter size DN	A Gate valve PN16	B Dirt box	C Distance piece inlet	D Meter	E Distance piece outlet	F Gate valve	G Total length	H Meter space
50 mm heavy	175 mm	208 mm	372 mm	300 mm	150 mm	175 mm	1,380 mm	1,030 mm
80 mm	203 mm	252 mm	396 mm	413 mm	240 mm	203 mm	1,707 mm	1,301 mm
100 mm	229 mm	260 mm	476 mm	483 mm	300 mm	229 mm	1,977 mm	1,519 mm
150 mm	267 mm	406 mm	762 mm	500 mm	450 mm	267 mm	2,652 mm	2,118 mm
200 mm	292 mm	428 mm	1,000 mm	520 mm	600 mm	292 mm	3,132 mm	2,548 mm
250 mm	330 mm	522 mm	1,250 mm	450 mm	750 mm	330 mm	3,632 mm	2,972 mm
300 mm	356 mm	580 mm	1,500 mm	500 mm	900 mm	356 mm	4,192 mm	3,480 mm

Figure 6. Water Meter Installation Schematic heavy duty meters (source: Sydney Water)

If you're installing one of these meters, you'll need to allow a minimum of 500 mm clearance around it. This is so we can exchange it in future.

All new gate valves on 80 mm or 100 mm meters will have a flange with four holes. You may find old ones have six holes. If you're exchanging one of these meters, you may have to replace the gate valve.



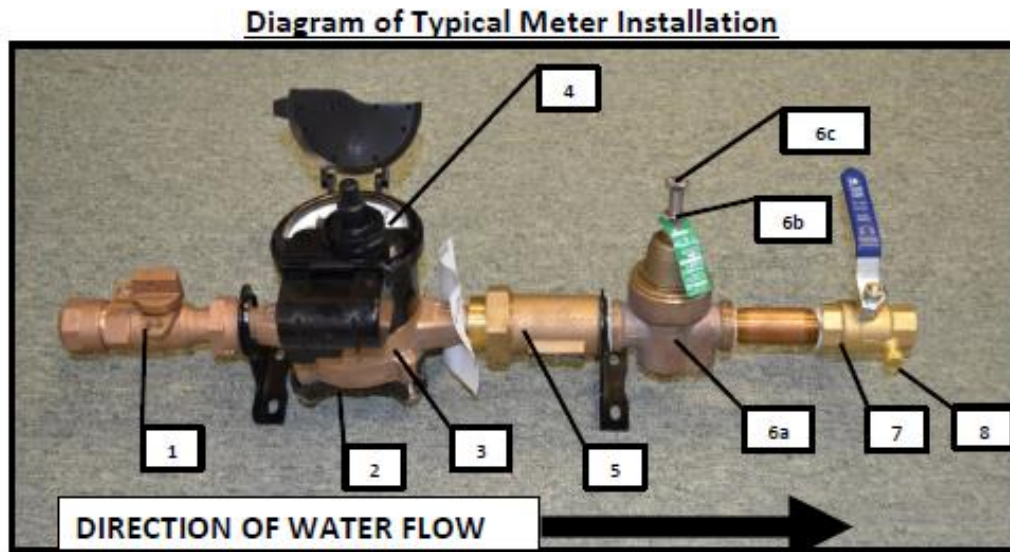

#	Meter Assembly Component
1.	Isolation Valve (attached to waterline from street)
2.	Water Meter Frost Plate (sacrificial black steel, under meter, will break if frozen)
3.	Water Meter Base
4.	Water Meter Register Head
5.	Dual Check Backflow Preventer (DuC)
6a.	Pressure Reducing Valve (PRV)
6b.	Pressure Reducing Valve Lock Nut (hexagonal nut)
6c.	Pressure Reducing Valve Operating Bolt (threaded bolt with hexagon head)
7.	Residential Isolation Valve (connects to household plumbing)
8.	Drain Port (for winterizing plumbing) (not included in a pit meter assembly)

These are the generic components to a water meter assembly in Lambton Shores. There are variations of older style valves but all operate similarly.

Figure 7. Water Meter Installation Schematic for cold environments

(source: Lambton Shores municipality)

7. Water Meter Maintenance

Maintenance is very important, especially for large meters, and thus manufacturers' maintenance requirements should be considered in the selection process. Meters with lower maintenance



requirements are desirable, but it is important to note that no meter will work indefinitely without the need for maintenance or replacement.

7.1 Maintenance

Flow meters are often forgotten when it comes to routine maintenance. The proper maintenance of any metering device is essential to ensure it operates at its specified accuracy, and is of even greater importance for bulk consumer and bulk transfer meters. All meters require maintenance, although some may have lower requirements than others.

Most meter manufacturers have a recommended maintenance and testing section in the operation manual for their meters. A municipality should develop a water meter maintenance programme to suit their particular needs, circumstances and resources. Always keep the potential cost of not doing proper maintenance in mind. Maintenance is an ongoing process that should be done at a suitable rate to ensure that backlogs don't develop. A system that has a large backlog of required maintenance will need to invest higher levels of funds into maintenance until the required standard is met. Lower levels of expenditure will then be required to maintain the system at that level.

A problem with a bulk transfer or bulk user meter has the potential to cause much greater losses to the municipality than domestic and other small meters. Thus it is good practice to concentrate on these meters. Water meter maintenance requires simple but important actions, such as cleaning of strainers, cleaning and repair of meter boxes, fixing leaks and replacing damaged registers and register covers. In certain cases meters have to be removed from site and serviced before being placed back in the system. Where possible, large meters should be opened and a careful visual inspection made of the meter mechanism for any signs of damage or wear.

A checklist should be developed for use by meter inspectors in the field. This checklist should include the following information:

- Location and date.
- Inspector's name.
- Meter identification: make, model, size, serial number and current reading.
- Condition of meter installation: meter body, meter register, pipe work, leakage, upstream valve, downstream valve, meter chamber, strainer, signs of unauthorised connections and other.
- Actions taken: strainer cleaned/replaced, meter mechanism inspected and/or valve operation checked.
- Action required: cleaning, chamber repairs, meter test and/or leak repairs.



The most common problems experienced with water meters in the field

1. Suspended solids in the water causing meter mechanisms to get stuck or damaged and meter
2. Strainers to get clogged. These solids enter the system most often due to:
 - a. Large pipe bursts.
 - b. Inadequate flushing of pipes after installations or repairs.
 - c. High velocities in the network stirring up sediments that had collected at the bottom of pipes.
 - d. Inadequate water treatment or malfunctioning treatment plants.
3. Service complaints after meter replacement or maintenance caused by:
 - a. Valve on the house connection not re-opened after work.
 - b. Network valve(s) not re-opened after work.
 - c. Installation errors such as a non-return valve fitted the wrong way around.
 - d. On-site leakage occurring, mostly on old and worn internal pipes and fittings.
4. Leakage from meter connections.
5. Vandalism to meters for scrap metal or in anger, often in ‘retaliation’ when indigent consumers are cut off.
6. Damage to meters due to high velocity air flow when drained pipes are refilled.
7. Consumer complaints of suspected meter errors.
8. Deposit of lime or metal oxides on the inside of meters due to high dissolved solid loads in the water.
9. Meters buried under soil and vegetation.

Scale of meter:

A water meter must be able to accurately read volumes of water extracted. The size of the meter must be compatible with flow rates described in the meter specifications. The meter must be able to record water volumes to a level that far exceeds expected use in any one year (10 times average annual use is appropriate) with no reset facility for total water volume. The meter’s unit of measurement must be sensitive enough to identify two percent of expected annual water use (for example, for annual use of 1 ML the meter should record use in units no greater than 0.02 ML). Before water is taken via a new or replacement meter, the manufacturers should certify that the meter functions is within $\pm 5\%$ of permissible error allowable for in-situ conditions. For water meters with electronic data storage, data must be retained in the event of power failure.

Different size meters indicate different resolutions of the reading. One rotation of the sweep hand may be equivalent to 10 gallons or to 1,000 gallons (1 to 100 ft.³, 0.1 to 10 m³). If one rotation of



the hand represents 10 gallons, the meter has a 10-gallon sweep. Sometimes the last number(s) of the wheel display are non-rotating or printed on the dial face. The fixed zero number(s) are represented by the position of the rotating sweep hand. For example, if one rotation of the hand is 10 gallons, the sweep hand is on 7, and the wheel display shows 123456 plus a fixed zero, the actual total usage would be 1,234,567 gallons.

In some countries, most utilities bill only to the nearest 100 or 1,000 gallons (10 to 100 ft.³, 1 to 10 m³), and often only read the leftmost 4 or 5 numbers on the display wheels. Using the above example, they would read and bill 1,234, rounding to 1,234,000 gallons based on a 1,000 gallon billing resolution. The most common rounding for a particular size meter is often indicated by differently colored number wheels, the ones ignored being black, and the ones used for billing being white.

Water metering is common for residential and commercial drinking water supply in many countries, as well as for industrial self-supply with water. However, it is less common in irrigated agriculture, which is the major water user worldwide. Water metering is also uncommon for piped drinking water supply in rural areas and small towns, although there are examples of successful metering in rural areas in developing countries, such as in El Salvador.

Metering of water supplied by utilities to residential, commercial and industrial users is common in most developed countries. In some developing countries metering is also common, such as in Chile where it stands at 96%. Nearly two-thirds of OECD countries meter more than 90% of single-family houses. A few are also expanding their metering of apartments (e.g., France and Germany).

Tamper proof devices:

A water meter must not be tampered with. Each meter must be fitted with tamper proof devices. The tamper proof devices must be fitted in a manner to demonstrate if any sealed component of a meter has been unsealed or attempted to be unsealed. Tamper with a water meter means to interfere with, damage or destroy a water meter. Tamper with a water meter includes unsealing any sealed components; blocking any part of the meter; attaching to the meter any device that is likely to affect the operation of the meter; or disconnect a meter from its power source for digital meters.



Metering Strategy:

It is important to realize that various consumer metering strategies may be adopted, and that the correct strategy depends on local needs and conditions. A number of different metering strategies, or a mix of them, may be used by a municipality, including conventional metering, pre-paid metering, demand restriction and no metering.

Conventional Metering:

The conventional metering strategy is to install water meters on all consumer connections and send monthly water bills based on the actual or projected consumption. The cost of providing a metered connection to new consumers is covered by a connection fee. When water meters are not read every month, the consumption for intermediate months is estimated based on factors such as historic consumption and seasonal patterns. The consumer is required to pay a deposit to ensure that any unpaid bills are covered. A conventional metering system is convenient for the consumer, since nothing is required except to pay the bill once it arrives. However, the consumer is expected to pay a deposit, and cover the installation costs of new meters through a connection fee. Errors in the meter reading process can cause excessive bills and severe inconvenience to the consumer. A large but hidden leak occurring on the consumer's property can also be responsible for a very large bill. The major disadvantage of a conventional metering system is the effort and cost required to manage the system. Meter readers have to be employed to read each meter every month (or at least every few months). Meter readers often have their own problems, such as getting access to water meters installed on consumers' properties. The water meter readings must then be entered into a computer system, checked for errors, and bills printed and mailed to consumers. Systems are required to handle errors that invariably occur when reading meters or transferring data. In addition, significant efforts are required to collect outstanding payments and disconnect users that do not pay their outstanding bills.

Pre-paid Metering:

Prepaid meters are water meters with built-in processing units and a mechanism that can automatically close a valve to shut off a consumer's supply. Consumers purchase water in advance, and the amount purchased is transferred through a token or electronic signal to the meter. Once the available credit on the meter has been used, the prepaid meter automatically shuts down the supply. In some cases the supply is shut down completely, while in others a small flow through the meter is maintained. Prepayment water metering provides solutions to some of the problems associated with conventional metering and revenue collection for both the utility and end-user. This technology has greatly advanced and today it is often used as an alternative to conventional metering for all types of users. To the municipality, the main advantage of prepaid water meters is that revenue is collected in advance, and the supply is automatically shut down



when the available credit runs out. This means that meter readings, an extensive billing system and

debt collecting systems are not required, reducing the financial risk to the municipality and saving the cost of an extensive meter reading and data management scheme. The built-in processor and shut-off valve make prepaid metering systems suitable for other and more advanced functions. They can, for instance, be used to automatically dispense the free basic allowance of water before requiring credit to operate. Alternatively the meter may revert to a small flow through the meter once credit runs out, instead of shutting down completely. Prepayment meters can also be programmed to allow users to provide some quantity of water past the point where the available credit has been depleted with a warning given to the consumer to recharge the meter credits. Another benefit is that consumers cannot ignore their water use, but is constantly reminded of it by virtue of having to purchase credit in advance, and when checking the credit remaining on the meter. It also gives consumers control over their own consumption and encourages them to manage their consumption appropriately. This often means that consumers use water more sparingly, thus saving money while helping to conserve the available water resources. Consumers benefit, since a good credit record is not needed in order to get a water connection. If a leak occurs on the consumer's property, the loss to the consumer is limited since the meter will automatically shut down once the available credit is depleted. The greatest disadvantage of prepaid water meters is the increased cost of the meter due to the additional components, the need for secure housing with tamper protection and stringent requirements for the meter's electrical components. Municipal staff working with prepaid meters require more skills to install, maintain and operate prepaid meters than conventional meters. Prepaid meters are also more sophisticated and have more components that can fail and cause problems. Thus regular inspection and maintenance of these meters is more important than for conventional meters. Prepaid meters also need an electrical supply via the network or a battery. A further disadvantage is that consumers might be more inclined to tamper with or bypass the meter when their water is shut off, causing an increase in apparent losses.

Supply restriction: An effective way to control water consumption in areas where it is uneconomical to provide conventional or prepaid metering systems, is to restrict the flow to consumers. This gives consumers access to as much water as the system will allow them without having to worry about the cost of the water. The consumers get a free or cheap supply, but in return the volumes provided are limited and thus wastage and leakage are controlled. Consumer that can afford to upgrade to a better system may apply and get an upgraded connection, thus allowing the community to improve their quality of life as their resources grow. It is also a cost effective system for municipalities, since no metering or billing system is required. Flow restrictors are devices that restrict either the flow rate or volume of water received by a consumer. This category includes trickle feed systems in which the supply is restricted to a



trickle collected by the user in a container such as a roof tank. Electronic flow limiters are devices that require a direct connection with a flow meter and can dispense a predetermined volume of water (typically programmed by the operator to allow 200 litres per day). It uses electronics and thus requires a power supply or battery. The typical battery life of these systems is 3 to 5 years. These systems are more sophisticated than mechanical systems, and also significantly more expensive.

No metering on unrestricted connections Systems without flow metering or restrictions exist in many areas. Users of these systems pay for their water through a fixed tariff, or may not pay at all. Since the cost to the user is not linked to the water consumption, there is no incentive to use water sparingly, or to fix leaks on their properties. The water consumption and leakage grows with time and the cost of the water supply through such a system to the municipality often becomes exorbitant. Thus it is important to ensure that all consumers in the system are managed through an appropriate metering or restriction system.

References



1. Municipality of Lambton Shores, Water Meter Installation guide
2. Introduction to integrated water meter management edition, Je van zyl, Water Research Commission Gezina, South Africa
3. Tech Briefs: Water Meters By Zane Satterfield, P. E. and Vipin Bhardwaj
4. Water meter installation guide What you need to know about installing water meters, Sydney Water, Australia
5. <https://www.portlandoregon.gov/water/article/383573>
6. <http://www.cambridge-water.co.uk/customers/water-meter-calculator>



添付資料 3.34

2016 年秋期研修「Asset Management」の教材



Module 1 : Introduction to Asset Management Day 1 Abid Hussainy



Course Title: Asset Management-M 4131 Lecture-01 Module 1: Introduction to Asset Management

Outline

- Introduction to Participants and Faculty
- Introduction to Assets
- Lists of assets of WASA
- Exercise-1
- Exercise-2
- Exercise-3
- Coding of Assets
- Assets condition Assessment
- **Assignment**

Introduction of Participants & Faculty

Name

City

What one thing you like to learn in this course –
Module 1

1. Assets and Asset Attributes
2. Condition Based Assessment of different asset types
3. Risk assessment
4. Application of asset attributes
5. Asset lifecycle and Asset Management Plan

What is an Asset & Why Asset Management ??

'What is an asset?' 'What can asset information used for?', 'How do we know when to replace equipment/assets?'

ASSET

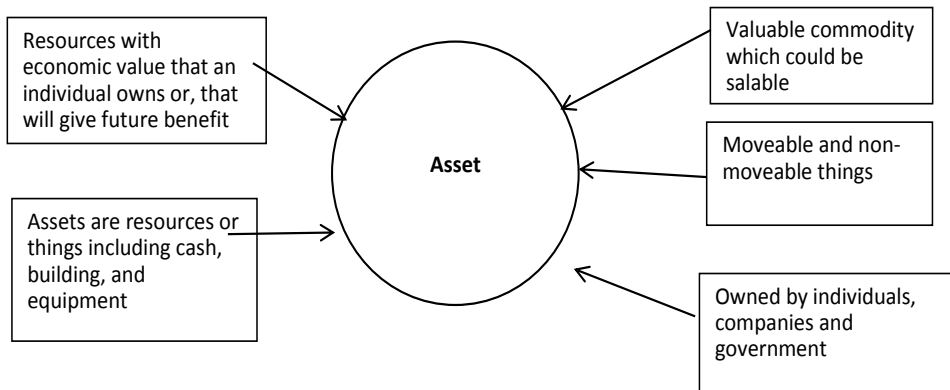

WASAs Assets & Impact

- **1435 PUMPS**
- **1,197 million m³ per annum of water**
- **131 MWs**
- **Rs 4.7 Billion Electricity Bills**
- **1.1 Million Connections**

Definition of Assets:

Assets are the physical resource of a business, such as plants, facilities, fleets or their parts and components (Campbell and Reyes-Picknell)

“Anything of value such as an area of land, or a building, or an item of plant or equipment or infrastructure that provides service potential or future economic benefits over a period longer than one year and has a cost which is not "immaterial" (typically defined as more than, say, Rs. 100,000). Assets are typically classified as either "financial" (cash, stocks, debt instruments), "intangible" (intellectual property, goodwill) or "physical".

Types of Assets:

❖ Physical assets :

It is an asset with useful life of over one year owned by individual or enterprise

❖ Financial assets :

It is a claim for future financial payment such as saving , account and banks

❖ Intangible assets :

Assets which are used in business which have no physical substance and non-current



Physical Assets of WASAs:

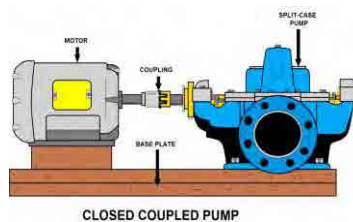

CLOSED COUPLED PUMP



List of Assets of WASAs

- ❖ Water Supply Pipelines
- ❖ Sewerage Pipelines
- ❖ Tube wells
- ❖ Disposal Stations
- ❖ Vehicles
- ❖ Transformers
- ❖ Electrical & Mechanical Works
- ❖ Buildings
- ❖ Any other

Exercise 1:



Pump, Motor, Flow meter, Non return valve, Pressure gauge, Chlorine dosing pump

Exercise 2:



Control panel, Motor, Non return valve, Pump, Crane, Pressure gauge

Exercise 3:



A: _____ B: _____ C: _____ D: _____

Water level censer, Penstock valve, Exhaust duct, Screen facility

Coding of Asset

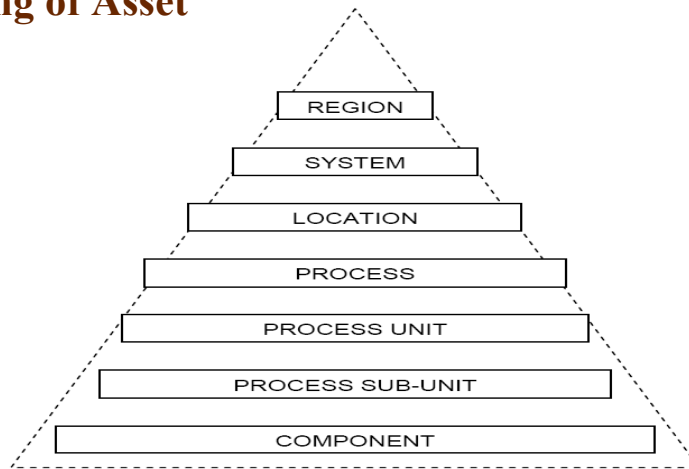

WASA Lahore example of Asset Register by JICA

Table 10.4 Information to Be Input in Ledger (Example)

Facilities	Data to be input
Pipe line	Diameter, Length, Invert level, Flow direction, Material, Installation year, Construction cost
Well, Pumping station	Construction year, Construction cost, Specifications of Equipment, Equipment installation year, Equipment procurement cost
Water/Wastewater treatment plant	Treatment capacity, Treatment method, Construction year, Construction cost, Specifications of Equipment, Equipment installation year, Equipment procurement cost

Asset Code system in Punjab WASAs

1. District- lahore - 180
2. City- lahore - 1850
3. Town – Gulberg - 104
4. UC – 000
5. Organization WASA – 20
6. Asset auto Generated Code by AMIS - 110

Asset Condition Assessment

Category	Asset Condition	Actions Required
A	Excellent	Only Normal Maintenance Required
B	Good	Minor Maintenance And Rehabilitation Required
C	Fair	Significant Maintenance And Minor Rehabilitation Required
D	Poor	Significant Renewal/ Upgrade Required
F	Failing	Major Renewal/Replacement Required

Following factors contribute to the overall condition of an asset:

- > Its age
- > Its operating environment (what weather etc. it is exposed to)
- > Its apparent wear and tear
- > How well it is treated by the community
- > How much use it gets

According to USEPA GHD; Asset condition can be analyzed by using the following methodology. A score from 5-1 shall be awarded by the O&M department for each factor. Asset condition can be specified using the following scales:

1. Physical Condition

Physical Condition	New/Excellent Condition	Minor Defects Only	Moderate Deterioration	Significant Deterioration	Unserviceable
Score	1	2	3	4	5

2. Asset Performance (KPIs)

Performance (KPIs)	Meets Performance Targets	Minor Performance Deficiencies	Considerable Performance Deficiencies	Major Performance Deficiencies	Doesn't Meet Performance Targets
Score	1	2	3	4	5

3. Asset reliability

Reliability	As Specified by Manufacturer	Random Breakdown	Occasional Breakdown	Periodic Breakdown	Continuous Breakdown
Score	1	2	3	4	5

Asset Condition Rating

An average score shall then be calculated by the O&M department and final score shall be awarded on the basis of average score of all the factors.

Average Score	1	2	3	4	5
Asset Condition	Excellent	Good	Fair	Poor	Failing
Category	A	B	C	D	F

Average figures may be rounded off to the nearest whole number for convenience

Use the Tool to Determine following from the Report of Energy Audit

1. Asset Condition based on A , B , C , D , E
2. Discharge
3. Pumping Efficiency
4. Also rate the physical condition and asset performance

Table-2 Detail of Quid-e-Azam Industrial Estate Subdivision

#	WASA Station	No. of Water Supply Pumps Installed	Installed Capacity (Cusec)	Actual Discharge (Cusec)
1	Block 6 A2	01	4.0	2.94
2	Block 4 A2 (Town Ship)	01	4.0	2.54
3	Block 2 A2 (Town Ship)	01	2.0	1.27
4	Irrigation Colony	01	4.0	3.94
5	Baba Fareed	01	4.0	2.45
6	Baba Fareed (Jail)	01	4.0	1.47
7	Bank Stop	01	4.0	2.90
8	General Hospital	01	4.0	4.80
9	Awami Colony	01	4.0	2.84
10	Qainchi Stop	01	4.0	3.94
11	Sitara Colony	01	4.0	4.90
12	Chungi Amer Sadu	01	2.0	2.69
13	Nishter Colony (Police Station)	01	2.0	2.79
14	Nishter Colony (Tank)	01	2.0	2.30
15	Ghulam Bhatti	01	4.0	2.45
16	Ittefaq Colony	01	2.0	0.34
	Total	16	54.0	44.56
Wastewater Disposal Pumps				
17	Bostan Colony	01	6.0	5.94
18	Chandrai Road	01	2.0	2.10
19	Kahna	01	4.0	3.38
20	Nishter-01	01	13.0	14.13
21	Nishter-02	01	25.0	17.36
22	Nishter-04	01	25.0	9.07
23	Nishter-06	01	12.0	15.29
24	Usama-01	01	6.0	5.78
25	Usama-02	01	8.0	4.23
26	Town Ship Disposal	01	5.0	4.90
	Total	10	106.0	82.18

Table-3 Typical Overall Pumping System Efficiency Classification

Motor HP	Low	Fair	Good	Excellent
3-7.5	<44.0	44-49.9	50-54.9	>54.9
10	<46.0	46-52.9	53-57.9	>57.9
15	<47.1	48-53.9	54-59.9	>59.9
20-25	<48.0	50-56.9	57-60.9	>60.9
30-50	<52.1	52.1-58.9	59-61.9	>61.9
60-75	<56.0	56-60.9	61-65.9	>65.9
100	<57.3	57.3-62.9	63-66.9	>66.9
150	<58.1	58.1-63.4	63.5-68.9	>68.9
200	<59.1	59.1-63.8	63.9-69.4	>69.4
250	<59.1	59.1-63.8	63.9-69.4	>69.4
300	<60	60-64.0	64.1-69.9	>69.9

Table-7A Interventions & Investment Required in WASA Stations Quid-e-Azam Industrial Estate Subdivision

Intervention	WASA Stations												
	Block 6 A2	Block 4 A2	Block 2 A2	Irrijat Colony	Baba Fareed	Baba Fareed Jail	Bank Stop	General Hospital	Awami	Qainchi	Sitara	Chungi	Nishtar
Electrical													
Install VFD	x	x	x	x	x	x	x	x	x	x	x	x	x
Install hour meter	x	x	x	x	x	x	x	x	x	x	x	x	x
Replace ampere meter			x		x								x
Replace volt meter		x			x		x						x
Replace over current relays													
Replace over voltage relay										x			
Install/maintain PFI plant	x	x	x	x	x	x	x				x	x	x
Install/connect capacitors at PFI plant													
Install PFI control/relay													
Install/replace motor terminal box /Improve open and loose motor connection	x		x				x						x
Improve panel condition	x	x	x		x								
Improve wiring condition		x			x								
Replace de-rated capacitors													
Relocate panel away from bore hole	x	x		x						x			
Replace electrical motor													
Install fan in the panel													
Replace PFI HRC fuses													
Replace PFI display meter													
Correct date & time of electrical meter													
Replace/correct electrical meter													
Replace change over													
Replace main circuit breaker													
Mechanical													
Replace damaged/install new flow	x	x	x	x	x	x	x	x	x	x	x	x	x

Table-2 Detail of Water Works Subdivision

#	WASA Station	No. of Water Supply Pumps Installed	Installed Capacity (Cusec)	Actual Discharge (Cusec)
1	Al-Jillan	01	4.0	2.71
2	Al-Sana Hotel	01	4.0	2.62
3	Ansar Colony-I	01	4.0	4.02
4	B. C. G Chowk (PM Package)	01	4.0	4.02
5	Board Office-Gulgasht Colony (PM Package)	01	4.0	3.76
6	Bagh Langey Khan-I	01	4.0	4.34
7	Baghchi Mirza Jan	01	4.0	4.33
8	Basti Khudadad (Phase-VI)	01	4.0	4.72
9	Bodla Town (Phase-VI)	01	4.0	4.66
10	Bosan Road PTCL Exchange	01	4.0	3.09
11	Chain Mari Farooq Pura	01	4.0	4.02
12	Chowk Shaheedan-I	01	4.0	3.43
13	Chowk Shaheedan-II (PM Package)	01	4.0	4.28
14	Circuit House	01	4.0	3.68
15	D-Block SRA-I	01	4.0	4.53
16	D-Block SRA-II	01	4.0	4.51
17	Dhobi Ghat-I	01	4.0	4.71
18	E-Block SRA (Phase-VI)	01	4.0	4.17
19	Eid Gah-I	01	4.0	4.51
20	G-Block SRAI	01	4.0	4.31
21	Grass Mandi	01	2.0	1.94
22	Gujjar Plot	01	4.0	4.22
23	Gulberg Colony	01	4.0	3.72
24	Gulshan Market-I	01	4.0	4.07
25	Hassan Parwana-II	01	4.0	3.61
26	Hassan Parwana-I	01	4.0	3.81
27	Kabootar Mandi	01	4.0	4.02
28	K-Block SRAI	01	4.0	3.43
29	Khar Pur	01	4.0	3.94
30	Kiri Daud Khan	01	4.0	3.82
31	Lodhi Colony-I	01	4.0	3.69
32	Lodhi colony-II (PM Package)	01	4.0	4.46
33	Lohari Gate-I	01	4.0	3.58

Table-2 Detail of Motor Loading & Pumping System Efficiency

WASA Station	Motor Load (%)	Pumping System Efficiency (%)	Pumping System Efficiency Rating
D-Block SRA-I	84	69	EXCELLENT
Eid Gah-I	74	70	EXCELLENT
Gulberg Colony	58	72	EXCELLENT
Hassan Parwana-I	50	89	EXCELLENT
Naqshband Colony	96	70	EXCELLENT
Shah Shamas Park (PM Package)	94	77	EXCELLENT
Timber Market Ground (PM Package)	98	72	EXCELLENT
Tughlaq Town	74	72	EXCELLENT
Bosan Road PTCL Exchange	75	66	GOOD
G-Block SRAI	86	68	GOOD
Gulshan Market-I	78	65	GOOD
Kiri Daud Khan	71	65	GOOD
Sameeja Abad	55	66	GOOD
Board Office-Gulgasht Colony (PM Package)	81	51	FAIR
D-Block SRA-II	97	61	FAIR
Khar Pur	101	58	FAIR
Lodhi Colony-II (PM Package)	82	60	FAIR
Madina Colony-I	85	63	FAIR
Mohammadi Ground Shah Shams	70	62	FAIR
Mumtazabad-II	79	60	FAIR
Muzaffarabad (Phase-VI)	78	62	FAIR
Sameejabad	55	66	FAIR
Al-Jillan	79	39	LOW
Al-Sana Hotel	93	31	LOW
Ansar Colony-I	94	55	LOW
B. C. G Chowk (PM Package)	100	44	LOW
Bagh Langey Khan-I	96	51	LOW
Baghchi Mirza Jan	84	56	LOW

Lab Work – Assignment 1

Based on today lectures and reference in library – write two pages or 500 words on following points

Discuss the asset management system in WASA/KWSB/NSUSC where you belong to

1. How asset are recoded in WASAs?
2. How they are Coded?
3. How do they monitor (frequency & observation manner)?
4. Who is responsible for maintaining Record?
5. Strength and weakness of AM of WASA
6. Propose an asset register and coding system for Water supply assets

Assessment

Assessment	Marks	Remark
Attendance	25	5 each day
Task 1 WASA Asset Management Report – 300 words	10	Individual
Task 2 Asset Risk Report- 300 words	10	Individual
Task 3 – asset Management Plan	10	Group work
Task 4 Fixed asset Register	10	Individual
Task 5 AMIS	10	Individual
Preparation of the Asset Management Plan of 5-10 Tube wells or any area of utility service	25	Individual assignment to Prepare the Asset Management Plan and input Risk, Condition, etc. in AMIS by the end of November.



Contact

Engr. Abid Hussainy,

BE (Civil), MEMD (ANU, Australia), MEID (IOE, UoL, UK)
Senior Capacity Building Specialist

The Urban Unit,
Phone: 042-99205316-22
Fax: [042-99205323](tel:042-99205323)



Module 1 : Introduction to Asset Management Day 2 Abid Hussainy



Outline

- Risk of Assets
- Application of Asset Attributes for Decision making
- Exercise-1
- Exercise-2
- Exercise-3

What is a risk ?

- ❖ It can be defined as, “a situation involving exposure to danger or possibility of loss”.
- ❖ The risk related to physical assets is called Asset Failure risk.
- ❖ Simply put, it means that assets have inherent risks or the potential for failure.

Extent of the Risk

❖ The following scale is used worldwide to determine risk of an asset;

- I) Significant
- II) High
- III) Medium
- IV) Low



Condition of WS Pipes- WASA Multan

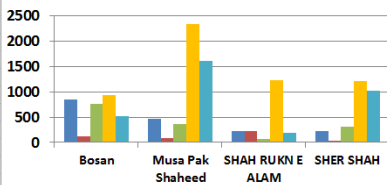

Condition of WS Pipes- WASA Lahore

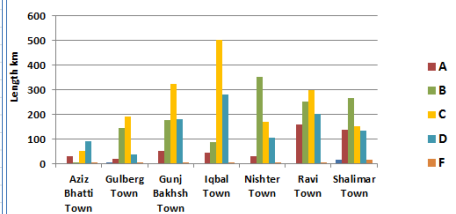

Risk of WS Pipes- WASA Multan

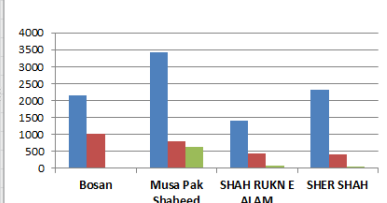

Risk of WS Pipes Wasa Lahore

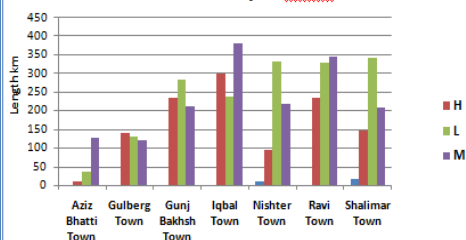

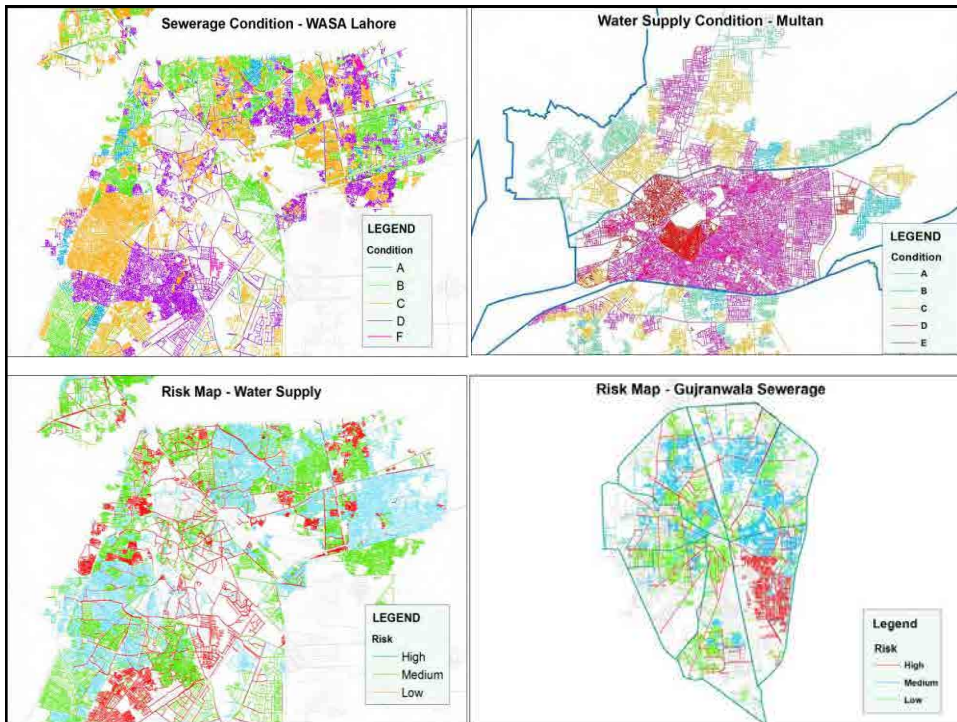

Asset Risk Management

- ❖ The risks must be clearly understood and managed to assure cost-effective service delivery.
- ❖ ISO 55002 states that “the organization should determine the actions that are necessary for addressing risks when planning for its asset management system. The overall purpose is to understand the cause, effect and likelihood of adverse events occurring, to manage such risks to an acceptable level, and to provide an audit trail for the management of risks”.

Asset Risk Management (Contd.)

a) Probability of Asset Failure

- Following factors can be analyzed to predict the probability of Asset Failure:
 - Asset Condition
 - Asset Effective Age
 - Past Failure history
- Asset probability of failure can be calculated according to the following scales:

Condition	A	B	C	D	F
Probability of Failure Rating	1	2	3	4	5

Asset Risk Management (Contd.)

b) Impact of Asset Failure

- **Scale showing the Extent of Impact of an Asset**
 - ⋮
 - Based on the already potential impacts/ consequences associated with the failure of asset, Impact of an asset to the service delivery can be assigned using the following scale :

Impact	Total System Failure	Facility/ Sub-Division Failure	Asset Failure	Major Component Failure	Minor Component Failure
Scale Value	5	4	3	2	1

Asset Risk Management (Contd.)

❖ Risk Rating

- The overall risk depends on both the likelihood and consequence of the event.

Asset Risk Management (Contd.)

❖ Risk Rating

- Calculation steps for the product of probability rating and impact rating are shown in the following table :

Probability	Impact (criticality assessment)				
	1	2	3	4	5
A	Low Risk	Low Risk	Low Risk	Moderate Risk	High Risk
B	Low Risk	Low Risk	Moderate Risk	High Risk	High Risk
C	Low Risk	Moderate Risk	High Risk	High Risk	Significant Risk
D	Moderate Risk	High Risk	High Risk	Significant Risk	Significant Risk
F	High Risk	High Risk	Significant Risk	Significant Risk	Significant Risk

Asset Risk Management (Contd.)

❖ Risk Rating

EXERCISE

Asset Risk Management (Contd.)

- ❖ Combining Condition, Risk and Residual life to plan
- In order to plan asset management in light of the *Physical Condition* and assessed *Asset Failure Risks* the following matrix may be used to identify action plan for asset management :

Condition	Failure Risk State			
	<i>Low</i>	<i>Moderate</i>	<i>High</i>	<i>Significant</i>
<i>A</i>	Regular Maintenance	Regular Maintenance	Preventive Maintenance	Priority Maintenance
<i>B</i>	Regular Maintenance	Preventive Maintenance	Priority Maintenance	Priority Rehabilitation
<i>C</i>	Preventive Maintenance	Priority Maintenance	Priority Rehabilitation	Immediate Rehabilitation
<i>D</i>	Priority Maintenance	Priority Rehabilitation	Immediate Rehabilitation	Immediate Replacement
<i>F</i>	Priority Maintenance	Immediate Rehabilitation	Immediate Replacement	Immediate Replacement

Asset Risk Management (Contd.)

❖ Combining Condition, Risk and Residual life to plan

EXERCISE

Asset Risk Management (Contd.)

❖ Combining Condition, Risk and Residual life to plan

- Assets that require “immediate Replacement/ Rehabilitation” should be top priority
- Assets that require “ Priority Rehabilitation” should be accommodated if resources allow
- Assets that require “Preventive/ Priority maintenance” should be carefully monitored to prevent the need for their replacement
- Note that the assets that require regular maintenance does not pose a risk and can be operated with regular maintenance schedule.

Asset Risk Management (Contd.)

- ❖ Application of risk , condition and other attributes to make decision

EXERCISE

Group Exercise – all WASA / KWSB/NSUSC



Data on tube well with its condition

Exercise

Your managing director has asked you to prepare a risk report of tube wells data based on the consultant report as attached.

1. You will use the risk table to determine the risk and its impacts
2. Use condition table
3. Impact table





Write a report to MD - 3 paragraph recommendation what to do with asset along with table of condition and impact marks



Module 1 : Introduction to Asset Management Day 2 Abid Hussainy



Course Title: Asset Management-M4131 Lecture-03 Module 1 Introduction to Asset Management



Lecture Outline

- Asset Life Cycle
- Asset Management
- Preventive Maintenance of Assets
- Frequencies of Preventive Maintenance
- Asset Management Plan
- **Exercise-1**



Course Title: Asset Management-M 4131 Lecture-03 Module 1: Introduction to Asset Management



Asset Life Cycle

The Asset Life Cycle consists of following four stages

- Planning
- Acquisition
- Operation & Maintenance
- Disposal

Asset Management

Asset Management is organizing, planning and controlling the acquisition, use, care, refurbishment and/or disposal of physical assets to:

- Optimize their service delivery potential
- Minimize related risks and costs over their entire life through development and application of intangible assets such as business processes and decision supporting systems

Preventive Maintenance

- Preventative maintenance is maintenance that is regularly performed on a piece of equipment to lessen the likelihood of it failing.
- Preventative maintenance is performed while the equipment is still working, so that it does not break down unexpectedly.
- Preventative maintenance is planned so that any required resources are available.

Frequencies of Preventive Maintenance

International best practices regarding frequencies of preventive maintenance for different assets of WASA;

- Instrumentation Maintenance Frequencies
- M&E Maintenance Frequencies
- Pumping Station M&E Maintenance Frequencies
- Pumping Station Instrumentation Maintenance Frequencies

Instrumentation Maintenance Frequencies

Asset type	Monthly	3 monthly	6monthly	Annual
Control panel meters			•	
Level sensors/transmitters	•			
SCADA control panels				•
Soft starters		•		
Bearing sensors			•	
Chemical dosing	•			
Bulk Flow meters				•
pH Calibration (RO) Plants	• weekly			

M&E Maintenance Frequencies

Asset Type	Monthly	3 Monthly	6 Monthly	Annual	Two yearly	Overhaul Period (yrs)
Pumps (dw/ww)	•			•		•5
Motors		•	•		•	•5
Sub pumps			•			•5
Gear boxes	•		•			•5
Transformers		•	•	•		
Control panels	•					
Control valves	•					
Bulk meters	•					
Compressors	•		•			•3
Generators	•	•		•		•5
Chlorinators	•			•		•3
A/sc blowers	•	•				•3
Bk/w pumps	•		•			•5
Lime handling	•	•				•2-3
Chemical handling	•	•				•3
Tank stirrers			•			•5
Cooling fans	•	•		•		•3
RO plants	•	•				
Lifting equip				•		
Site security	•					
Safety inspections				•		

Pumping Station M&E Maintenance Frequencies

Asset Type	Monthly	3 Monthly	6 Monthly	Annual	Two Yearly	Overall Period (yrs)
Pumps (dw/ww)	•			•		•5
Motors		•	•		•	•5
Sub pumps			•			•5
Gear boxes	•		•			•5
Transformers		•	•	•		
Control panels	•					
Control valves	•					
Generators	•	•		•		•5
Lifting Equipment				•		

Pumping Station Instrumentation Maintenance Frequencies

Asset type	Monthly	3 Monthly	6 Monthly	Annual
Control panel meters			•	
Level sensors/transmitters	•			
SCADA control panels				•
Soft starters		•		
Bearing sensors			•	
Chemical dosing	•			
pH Meters (RO) Plants	• weekly			

Asset Management Plan

An **asset management plan (AMP)** is a tactical **plan** for **managing** an organization's infrastructure and other **assets** to deliver an agreed standard of service.

Asset Management Plan- template For Tube well

180 1850 104 000 20 110

Name of Asset	Asset code	Condition	Maintenance Frequency /Checking	Remaining Life	Improvement required to extend life of asset	budget
Pump	1					
Motor	2					
Electrical	3					
Chlorinator	4					
Meter	5					
Transformer	6					

Exercise

Prepare Asset Management Plan for
the Asset you have been shared



Contact

Engr. Abid Hussainy,

BE (Civil), MEMD (ANU, Australia), MEID (IOE, UoL, UK)
Senior Capacity Building Specialist

The Urban Unit,
Phone: 042-99205316-22
Fax: [042-99205323](tel:042-99205323)

Assessment	Marks	Remark
Attendance	25	5 each day
Task 1 WASA Asset Management Report – 300 words	10	Individual
Task 2 Asset Risk Report- 300 words	10	Individual
Task 3 – asset Management Plan	10	Group work
Task 4 Fixed asset Register	10	Individual
Task 5 AMIS	10	Individual
Preparation of the Asset Management Plan of 5 to 10 Tube wells/dispal or any area of utility service delivery	25	Individual assignment to Prepare the Asset Management Plan and input Risk, Condition, etc. in AMIS by the end of November.

Module 1 : Introduction to Asset Management Day 2 Abid Hussainy



Course Title: Asset Management-M4131 Lecture-01 Module 1 Introduction to Asset Management



JICA

ALJAZARI ACADEMY

LECTURE # 2
Day 2

- Risk of Assets Failure
- Application of Asset Attributes for decision making

Course Title: Asset Management-M4131 Lecture-01 Module 6: Use of GIS Application in Asset Management

ALJAZARI ACADEMY 3

RISK.....





What is Risk

Example of Risk ? At home or work

Why risk is important



Do we carry out risk assessment in WASA or NSUSC



What is a risk ?

- ❖ It can be defined as, “a situation involving exposure to danger or possibility of loss”.
- ❖ The risk related to physical assets is called Asset Failure risk.
- ❖ Simply put, it means that assets have inherent risks or the potential for failure.

Course Title: Asset Management-M4131 Lecture-01 Module 6: Use of GIS Application in Asset Management 04

Risk Management and Security Level

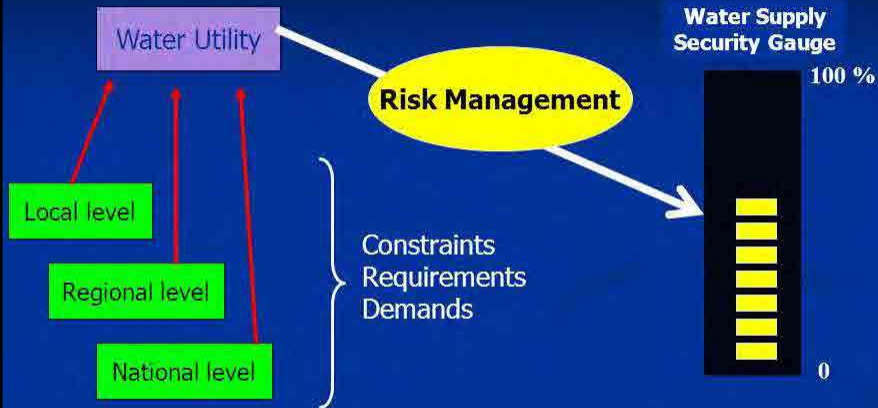

Risk management never leads to 100% security or zero risks.
It just helps water suppliers to know at what level they are and if this level fits with their goals.

11/16



Extent of the Risk

- ❖ The following scale is used worldwide to determine risk of an asset;
 - Significant
 - High
 - Medium
 - Low



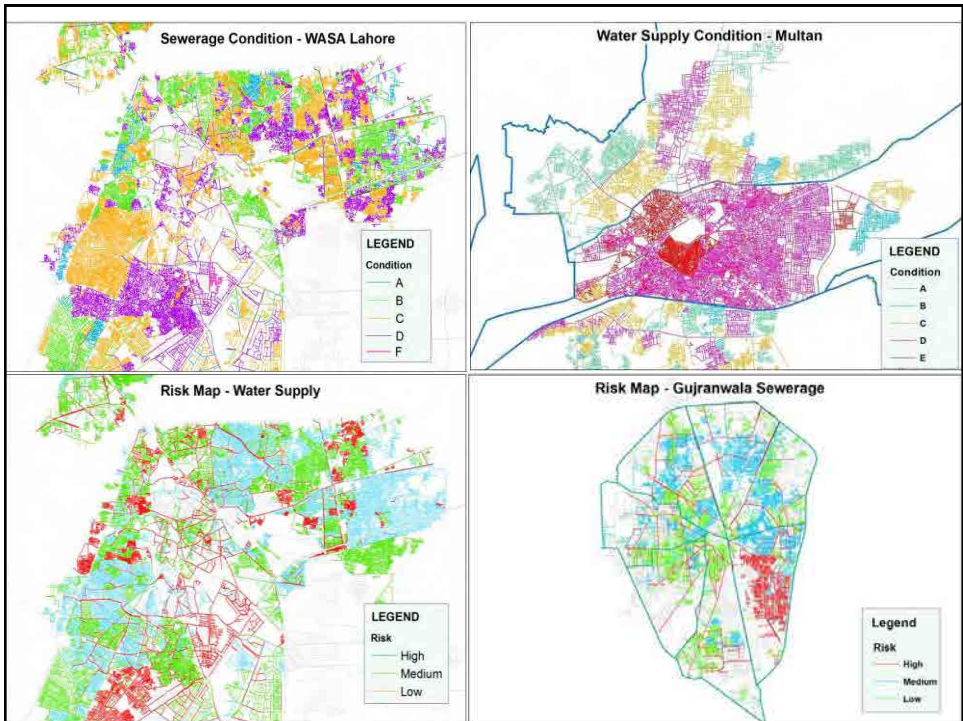

Asset Risk Management

- ❖ The risks must be clearly understood and managed to assure cost-effective service delivery.
- ❖ ISO 55002 states that “the organization should determine the actions that are necessary for addressing risks when planning for its asset management system. The overall purpose is to understand the cause, effect and likelihood of adverse events occurring, to manage such risks to an acceptable level, and to provide an audit trail for the management of risks”.

Asset Risk Management (Contd.)

a) Probability of Asset Failure

- Following factors can be analyzed to predict the probability of Asset Failure:
 - Asset Condition
 - Asset Effective Age
 - Past Failure history
- Asset probability of failure can be calculated according to the following scales:

Condition	A	B	C	D	F
Probability of Failure Rating	1	2	3	4	5

Asset Risk Management (Contd.)

b) Impact of Asset Failure

- **Scale showing the Extent of Impact of an Asset :**
Based on the already potential impacts/ consequences associated with the failure of asset, Impact of an asset to the service delivery can be assigned using the following scale :

<i>Impact</i>	Total System Failure	Facility/ Sub-Division Failure	Asset Failure	Major Component Failure	Minor Component Failure
<i>Scale Value</i>	5	4	3	2	1

Asset Risk Management (Contd.)

❖ Risk Rating

- The overall risk depends on both the likelihood and consequence of the event.

Asset Risk Management (Contd.)

❖ Risk Rating

➤ Calculation steps for the product of probability rating and impact rating are shown in the following table :

Probability	Impact (criticality assessment)				
	1	2	3	4	5
A	Low Risk	Low Risk	Low Risk	Moderate Risk	High Risk
B	Low Risk	Low Risk	Moderate Risk	High Risk	High Risk
C	Low Risk	Moderate Risk	High Risk	High Risk	Significant Risk
D	Moderate Risk	High Risk	High Risk	Significant Risk	Significant Risk
F	High Risk	High Risk	Significant Risk	Significant Risk	Significant Risk



Asset Risk Management (Contd.)

❖ Risk Rating

EXERCISE



Asset Risk Management (Contd.)

- ❖ **Combining Condition, Risk and Residual life to plan**
- In order to plan asset management in light of the *Physical Condition* and assessed *Asset Failure Risks* the following matrix may be used to identify action plan for asset management :

Condition	Failure Risk State			
	Low	Moderate	High	Significant
A	Regular Maintenance	Regular Maintenance	Preventive Maintenance	Priority Maintenance
B	Regular Maintenance	Preventive Maintenance	Priority Maintenance	Priority Rehabilitation
C	Preventive Maintenance	Priority Maintenance	Priority Rehabilitation	Immediate Rehabilitation
D	Priority Maintenance	Priority Rehabilitation	Immediate Rehabilitation	Immediate Replacement
F	Priority Maintenance	Immediate Rehabilitation	Immediate Replacement	Immediate Replacement

Asset Risk Management (Contd.)

- ❖ **Combining Condition, Risk and Residual life to plan**

EXERCISE

Asset Risk Management (Contd.)

- ❖ **Combining Condition, Risk and Residual life to plan**
- Assets that require “immediate Replacement/ Rehabilitation” should be top priority
- Assets that require “ Priority Rehabilitation” should be accommodated if resources allow
- Assets that require “Preventive/ Priority maintenance” should be carefully monitored to prevent the need for their replacement
- Note that the assets that require regular maintenance does not pose a risk and can be operated with regular maintenance schedule.

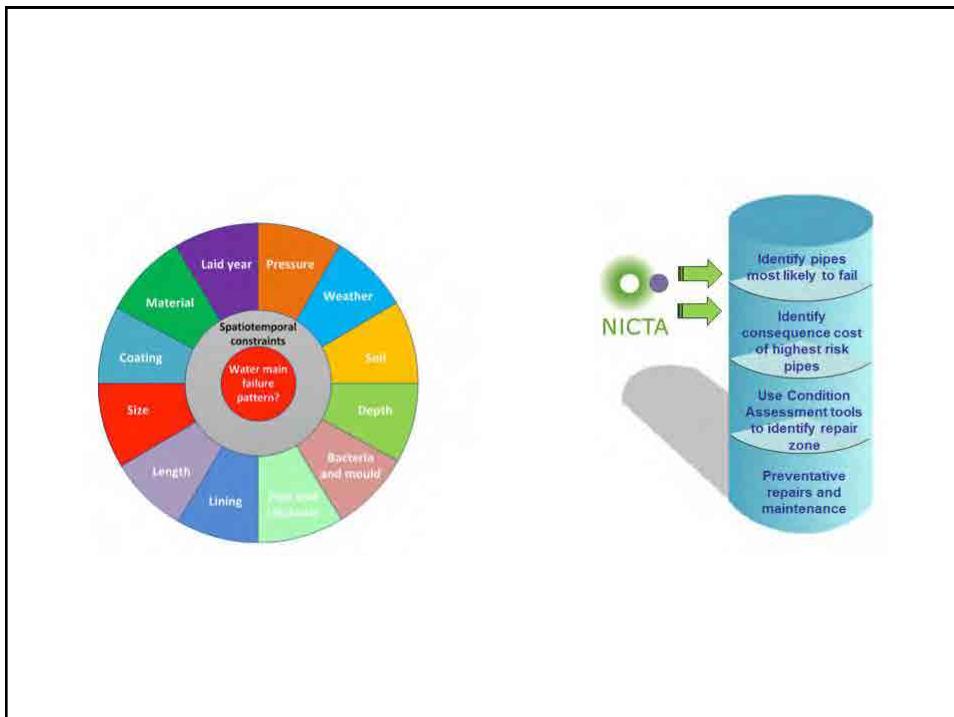

Asset Risk Management (Contd.)

- ❖ Application of risk , condition and other attributes to make decision

EXERCISE

Group Exercise – all WASA /NSUSC



Data on tube well with its condition

Exercise

Your managing director has asked you to prepare a risk report of tube wells based on the consultant report as attached.

1. Calculate probability of asset failure
2. Calculate Impact of Asset Failure
3. Calculate Risk Rating
4. You will use the risk table to determine the risk and its impacts

Write a short report to MD with recommendation with table as per serial 1 , 2 and 3



LECTURE # 3

- Asset Lifecycle
- Preventive Maintenance of Assets
- Asset Management Plan



Abid Hussainy



Course Title: Asset Management-M4131 Lecture-01 Module 6: Use of GIS Application in Asset Management



1



Lecture Outline

- Asset Life Cycle
- Asset Management
- Preventive Maintenance of Assets
- Frequencies of Preventive Maintenance
- Asset Management Plan



Course Title: Asset Management-M4131 Lecture-01 Module 6: Use of GIS Application in Asset Management



2

Asset Life Cycle

The Asset Life Cycle consists of following four stages

- Planning
- Acquisition
- Operation & Maintenance
- Disposal

Asset Management

Asset Management is organizing, planning and controlling the acquisition, use, care, refurbishment and/or disposal of physical assets to:

- Optimize their service delivery potential
- Minimize related risks and costs over their entire life through development and application of intangible assets such as business processes and decision supporting systems



Preventive Maintenance

- Preventative maintenance is maintenance that is regularly performed on a piece of equipment to lessen the likelihood of it failing.
- Preventative maintenance is performed while the equipment is still working, so that it does not break down unexpectedly.
- Preventative maintenance is planned so that any required resources are available.

Why we do preventive maintenance





List down – exercise

Preventive maintenance activities

1. Tube well
2. Disposals
3. Vehicles





Frequencies of Preventive Maintenance

International best practices regarding frequencies of preventive maintenance for different assets of WASA;

- Instrumentation Maintenance Frequencies
- M&E Maintenance Frequencies
- Pumping Station M&E Maintenance Frequencies
- Pumping Station Instrumentation Maintenance Frequencies

Course Title: Asset Management-M4131
Lecture-01
Module 6: Use of GIS Application in Asset Management
2

Instrumentation Maintenance Frequencies

Asset type	Monthly	3 monthly	6monthly	Annual
Control panel meters			•	
Level sensors/transmitters	•			
SCADA control panels				•
Soft starters		•		
Bearing sensors			•	
Chemical dosing	•			
Bulk Flow meters				•
pH Calibration (RO) Plants	• weekly			

M&E Maintenance Frequencies

Asset Type	Monthly	3 Monthly	6 Monthly	Annual	Two yearly	Overhaul Period (yrs)
Pumps (dw/ww)	•			•		•5
Motors		•	•		•	•5
Sub pumps			•			•5
Gear boxes	•		•			•5
Transformers		•	•	•		
Control panels	•					
Control valves	•					
Bulk meters	•					
Compressors			•			•3
Generators		•		•		•5
Chlorinators	•			•		•3
A/sc blowers	•	•				•3
Bk/w pumps	•		•			•5
Lime handling	•	•				•2-3
Chemical handling	•	•				•3
Tank stirrers			•			•5
Cooling fans	•	•		•		•3
RO plants	•	•				
Lifting equip				•		
Site security	•					
Safety inspections				•		

Pumping Station M&E Maintenance Frequencies

Asset Type	Monthly	3 Monthly	6 Monthly	Annual	Two Yearly	Overhaul Period (years)
Pumps (dw/ww)	•			•		•5
Motors		•	•		•	•5
Sub pumps			•			•5
Gear boxes	•		•			•5
Transformers		•	•	•		
Control panels	•					
Control valves	•					
Generators	•	•		•		•5
Lifting equipment				•		
Security	•					
Safety inspections				•		

Pumping Station Instrumentation Maintenance Frequencies

Asset type	Monthly	3 Monthly	6 Monthly	Annual
Control panel meters			•	
Level sensors/transmitters	•			
SCADA control panels				•
Soft starters		•		
Bearing sensors			•	
Chemical dosing	•			
pH Meters (RO) Plants	• weekly			

Asset Management Plan

An **asset management plan** (AMP) is a tactical **plan** for **managing** an organization's infrastructure and other **assets** to deliver an agreed standard of service.

Asset Management Plan- template For Tube well 180 1850 10 40 20110

Name of Asset	Asset code	Condition	Maintenance Frequency /Checking	Remaining Life	Improve ment required to extend life of asset	budget
Pump	1					
Motor	2					
Electrical	3					
Chlorinator	4					
Meter	5					
Transformer	6					

Level	Description	Description	AMIS
I	District	Lahore	180
		Faisalabad	090
		Rawalpindi	020
		Gujranwala	120
		Multan	260
II	City	Lahore	1850
		Faisalabad	1490
		Rawalpindi	1100
		Gujranwala	1630
		Multan	2120
III	Town (WASA Lahore)	Allama Iqbal	106
		Gunj Buksh	109
		Ravi	101
IV	Union Council	Gulberg	097
		Mozang	079

Exercise

Prepare Asset Management Plan for the Asset you have been shared

Evaluation & Reflection

1. What did I learn

Level	Description	Description	AMIS
V	Organization	CDG	10
		WASA	20
VI	Category	Tube wells	110
		Disposal Stations	030
		Water treatment plants	130
		Overhead reservoirs	070
		Machinery & Equipment	060
		Vehicles	120
		Land	050
		Buildings	020
		Pipelines	090



In the name of Allah, the most Gracious and ever Merciful

- Role of Accounts and Finance in Asset Life Cycle Management.
- What is Residual Life?
- Introduction of Accounting Manners.
- Fixed Asset Policy in WASAs of Punjab.
- Depreciation & Ways to use information.
- Fixed Asset Register.

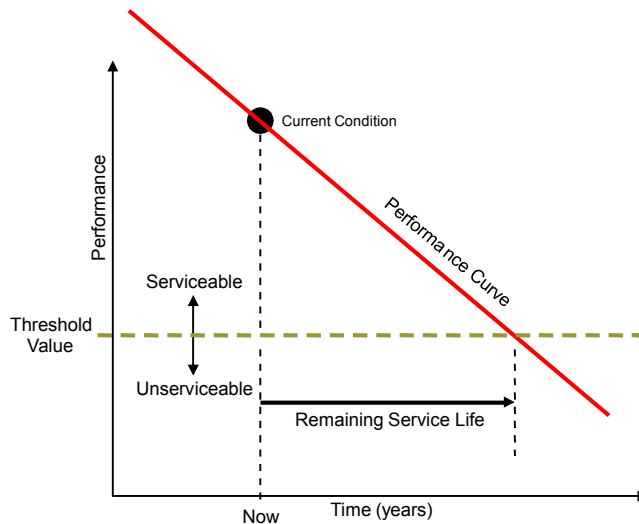
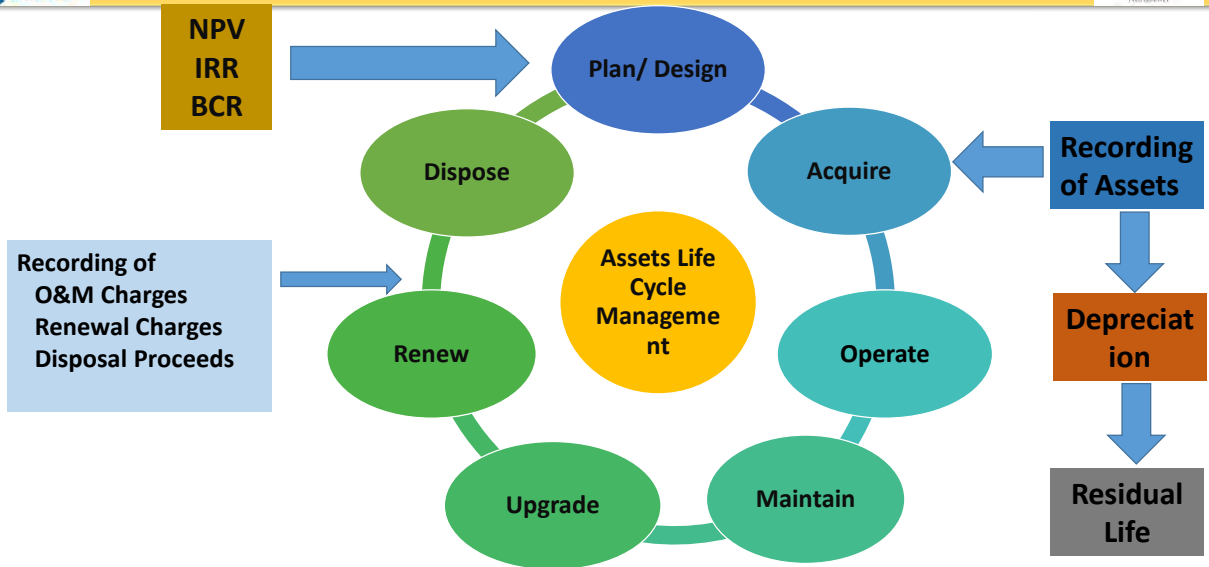

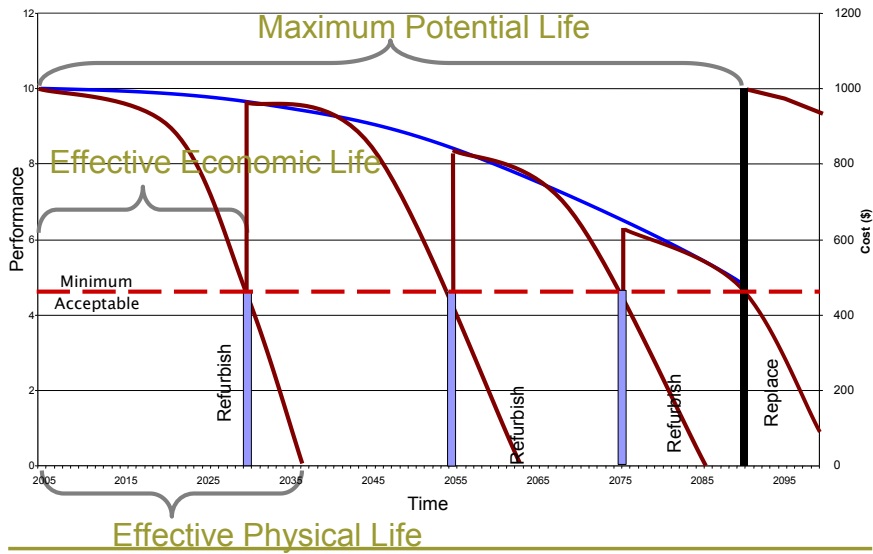

➤ Modified Cash Basis of Accounting:

➤ International Public Sector Accounting Standards (IPSAS)

- Accounting Policies and Procedure Manual (APPM) by Auditor General of Pakistan
- New Accounting Manual

➤ Accrual Basis of Accounting:

- International Accounting Standards (IAS) & International Financial Reporting Standards (IFRS)

Accounting Manners are implemented through Accounting Manual which includes Policies

- **What is Fixed Asset Policy or practice in your Organization?**

Fixed Assets shall be classified into following categories:

- Land & building
- Machinery and Equipment
- Water Supply Pipelines
- Sewerage Pipelines
- Tube wells
- Vehicles
- Computer equipment
- Furniture & fitting
- Office equipment

- **Fixed Assets with**
 - Value / Initial cost > Rs. 100,000/-
 - Economic Life > 1 year
- **Major Improvement cost is also to Capitalize/ record as addition in Assets.**
- **Economic life estimates to be reviewed once a year.**
- **Depreciation to be charged at rates mentioned below.**
- **Impairment loss shall be recognized if the carrying amount exceeds its estimated recoverable amount.**

Assume a utility has a policy to record assets if its acquisition cost is more than 100,000/- and expected life of more than one (1) year. Please identify the following transactions may or may not be recorded into fixed assets:

- | | |
|---|------------|
| Purchase of a table in Rs. 120,000/- | (Yes / No) |
| Purchase of UPS in Rs. 80,000/- | (Yes / No) |
| Purchase of stationery of Rs. 110,000/- | (Yes / No) |

➤ **Depreciation**

Depreciation is the systematic allocation of the depreciable amount of an asset over its useful life.

➤ **Residual Value**

The residual value of an asset is the estimated amount that an entity would currently obtain from disposal of the asset, after deducting the estimated costs of disposal, if the asset were already of the age and in the condition expected at the end of its useful life

➤ **Depreciable Amount**

Depreciable amount during usable period is the cost of an asset less its residual value.

- **Straight Line Method**
- **Declining Balance Method**
- **Average Balance Method**

Straight Line Method is being used in WASAs of Punjab as per FM Manual

$$\text{Annual Depreciation} = \frac{(\text{Acquisition Cost} - \text{Residual Value})}{\text{Economic Life}}$$

Description	Depreciation %age	Tax Depreciation %age
Freehold land	0%	0
Building	2%	10
Plant and Machinery		
• Tube-wells and water supply	7%	10
• Sewerage and disposal station	7%	10
Pipelines		
• Water supply	3%	10
• Sewerage	3%	10
Office equipment	10%	30
Furniture and fixture	10%	10
Vehicles	20%	20
Computer equipment	20%	30

- **Average Depreciable Life = Investment/ Annual Depreciation Expense**

- **Average Age (Years used) = Accumulated Depreciation/ Annual Depreciation Expense**

- **Remaining Useful Life = Net investment/ Annual Depreciation Expense (Average Depreciable Life – Average Age)**

Fixed asset register is a compulsory accounting record. Accounting Policies and Procedural Manual (APPM) requires to record following attributes into the Fixed Asset Register at minimum (Section 13.4):

- Description
- Classification of asset
- Year of Purchase or completion
- Original Cost in PKR
- Cost in foreign currency (if applicable)
- Asset Identification Number
- Current Location
- Ownership / Responsibility of Asset

International Accounting standard requires following additional information into the Fixed Asset Register (TS 6):

- Addition / Deletion of assets
- Depreciation
- Accumulated Depreciation
- Revaluation
- Date of Revaluation

Suppose you are an Asset Manager of XYZ Subdivision of WASA-A. The fixed asset register for Financial Year 2014-15 is attached at annexure-A. In July 2015, you extended services in liberty area and installed water supply pipelines in 50 million and a Tubewell in Rs. 13 million. Please do the following;

1. Prepare Fixed Asset Register for FY 2015-16.

Questions?



In the name of Allah, the most Gracious and ever Merciful

- Why do we need Asset Registry/ Database?
- Introduction of Asset Management Information System.
- Basic Functions of AMIS.
- Overview of complete AMIS.

Why Do we need Asset Database?

What is the current state of my assets?

- *What* do I own?
- *Where* is it?
- What *Condition* is it in?
- What is its *remaining useful life*?

Decision Support System

Asset Management Information System is the Answer

A Web System integrated with Geographic Information System (GIS)

Automate processes related to asset management

Asset Management Information System

THE URBAN UNIT

Activate Windows
Go to PC settings to activate Windows.

Copyright © 2016, All Rights Reserved - Government of the Punjab.

4:00 PM
10/26/2016

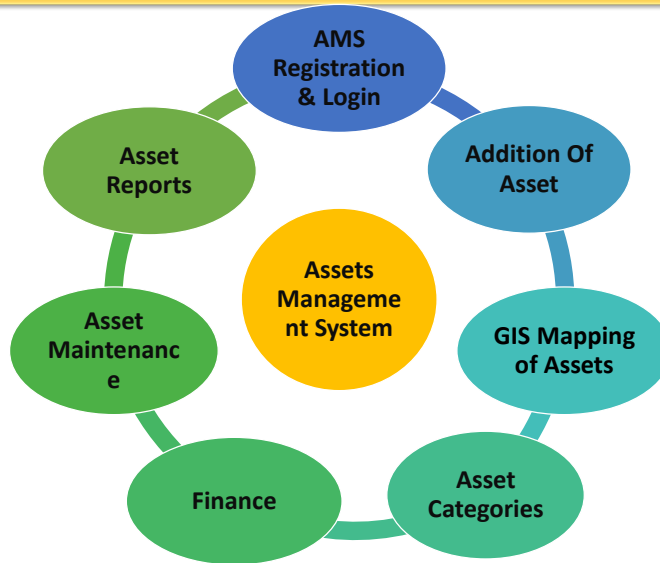

AMIS includes following information regarding Assets:

- Asset Code
- Asset Category & Subcategory
- Asset Ownership details
- Asset Location including information of town, UCs and specific address
- Capacity, technical specification and installation details
- Accounting information like purchasing cost, book value, estimated life, R&M cost, HR cost etc.
- Engineering details like Condition, Risk etc



GIS Based Asset Inventory



Microsoft Excel interface showing a spreadsheet titled "IDAM DATA PF (Autosaved) - Excel". The spreadsheet contains columns for Asset Code, Location, Name, Status, and various technical specifications. The bottom status bar shows "Module-2 Lecture-2" and the number "6".

Module-2 Lecture-2

6



Dashboard (1/3)



Total Number of Assets in all Districts

District Wise Number of Assets

District	Assets
Faisalabad	5496
Gujranwala	3993
Lahore	5408
Multan	4570
Rawalpindi	5160
Total	24627

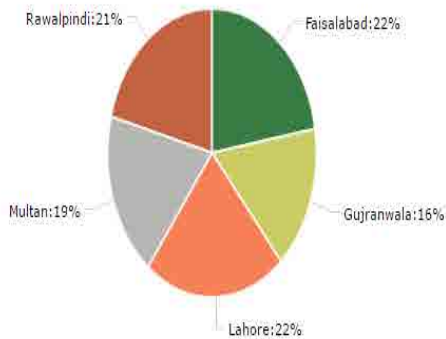

Module-2 Lecture-2

7

Category Wise Number of Assets

Category Wise Number of Assets

Assets Type	Assets
Bridge	14
Building	12430
Disposal Station	177
Ground Reservoir	35
Land	4110
Machinery Equipment	3462
OverheadWaterTanks	132
Parking Stand	18
Pipes	250
Road	1764
Tubewell	994
Vehicle	1241
Total	24627

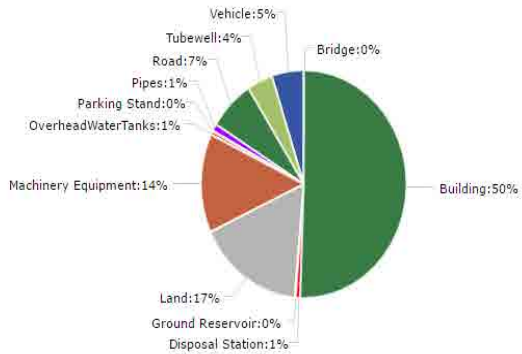

Organization Wise Number of Assets

Assets of Wasa's

Asset Name	WASA-LHR	WASA-GUJ	WASA-RWP	WASA-MUL	WASA-FSD
Machinery Equipment	256	44	0	13	127
Parking Stand	0	0	0	0	0
Pipes	61	3	178	0	9
Road	0	0	0	0	0
Vehicle	204	25	133	43	74
Land	14	0	0	26	166
Disposal Station	94	30	0	11	35
Water Treatment Plant	1	0	0	0	0
Tubewell	424	69	339	106	49
Building	46	14	6	6	17
Ground Reservoir	0	0	8	0	27
Bridge	0	0	0	0	0
OverheadWaterTanks	18	12	31	18	42

Add Building

Form No.	1800113592	Organization	Select Organization
Department/Office		Sub Department	
Asset Name	Building	Sub Department Ext	

Basic Information

Name of the building	
District	Lahore
City	Select a City
Town	
Union Council	
Roads	
Locality	
Type of building	<input type="radio"/> Educational <input type="radio"/> Health <input type="radio"/> Commercial <input type="radio"/> Residential <input type="radio"/> Administrative
Ownership of the building	<input type="radio"/> Primary School <input type="radio"/> Elementary School <input type="radio"/> Higher Secondary School <input type="radio"/> Other
Property Type	<input type="radio"/> Government property <input type="radio"/> Donated Property <input type="radio"/> Rented Property <input type="radio"/> Facilities
Add Property Detail	

Module-2 Lecture-2

10

Add Tubewell

Form No.	180 1 12 03	Organization	
Department/Office		Asset Name	Tube Wells
Sub Department		Related Service Delivery	Sewerage System
Depty Sub Department			

Basic Information

Name/ no. of the tube well		District	Lahore
City	Select a City	Town	
Union Council		Sub Division	Select SubDivision
Road / Street		Locality / Mohalla	

Module-2 Lecture-2

11

Assets Report

Assets of All Departments, All Organizations in All Districts

Asset Type	Count
Bridge	14
Building	12359
Disposal Station	173
Ground Reservoir	35
Land	4092
Machinery Equipment	3350
OverheadWaterTanks	121
Parking Stand	18
Pipes	250
Road	1885
Tubewell	987
Vehicle	1205
Total	24300

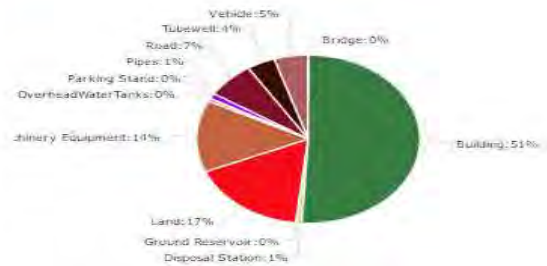

Module-2 Lecture-2

12

Assets Report

Select Building Filters

Building Type

Ageing Analysis

Buildings of All Departments, CDG in Lahore

Asset Type	Count
Elementary School	18
Higher Secondary School	36
Primary School	52
Any other	47
Total	123

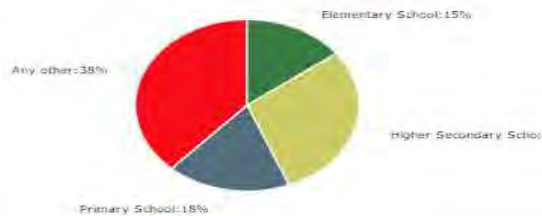

Module-2 Lecture-2

13

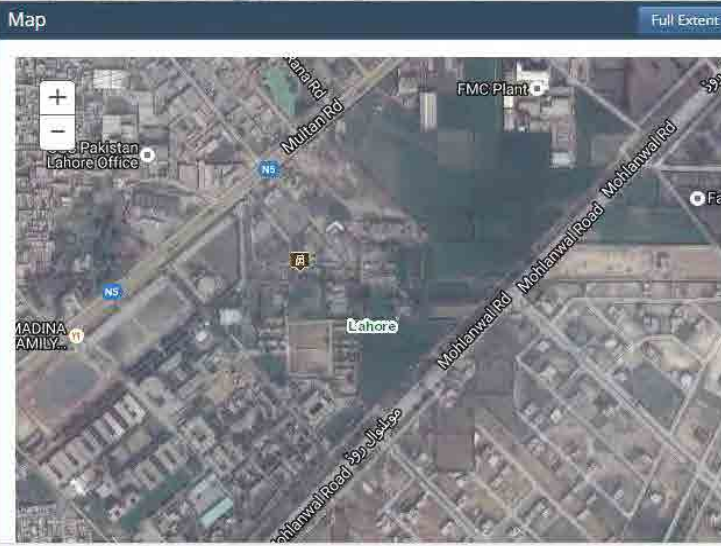



Survey Information

Name	RHC Chung
Town	Iqbal Town
UC No	Chung
Road	Multan Road
Locality	RHC Chung Multan Road Lahore
Condition Rating	3
IMEI	359651045552889
Date	2015-04-05 00:58:46.677



Questions?





  

MODULE # 3

Asset Database Analysis

Aneeqa Azeem
Research Analyst,
The Urban Unit



Course Title: Asset Management-M 4131 Lecture-01 Module 3: Asset Database Analysis  01

Lecture Outline

- Data Description
- Summary of WASA Lahore Assets
- Steps of creating pivot table
- Analysis
 - Asset Condition Analysis
 - Pipeline Diameter Base Analysis



Database Description



Data Available

ID	Street Name	Sub_Division	Town	Diameter	Material	Installation	Condition	placement_Dia	Replacement_Y	Level	Risk	Aspe_Length (m)
1	main pecco road	Township	Multan Town	50"	AC	2000 B	10"	11 P	M	1896.633919	L	1915.904832
2	Main pecco road	Township	Multan Town	50"	AC	2011 B	10"	25 P	L	850.8450429	L	213.4052514
3		Township	Multan Town	8"	AC	2000 B	8"	12 S	L	444.3776578	L	97.2420231
4		Township	Multan Town	18"	AC	2010 B	10"	20 S	L	329.7542212	L	193.2733465
5	model town link road	Township	Multan Town	8"	AC	2009 B	8"	20 S	L	133.3156498	L	150.4298999
6	R Block Model town	Township	Multan Town	4"	AC	1984 B	4"	15 S	L	282.9811067	L	105.5030352
7	R Block Model town	Township	Multan Town	4"	AC	1986 B	4"	15 T	L	46.6978441	L	107.4636598
8	Karnal water Block	Township	Multan Town	12"	AC	1987 B	12"	15 T	L	277.9007926	L	73.82368128
9		Township	Multan Town	8"	AC	1987 B	8"	15 P	L	245.8732027	L	502.1487785
10	substation	Township	Multan Town	12"	AC	1987 B	12"	15 S	L	215.0459667	L	121.0487651
11	Extension	Township	Multan Town	4"	AC	1992 B	4"	12 T	L	190.2874521	L	282.9811067
12	Extension	Township	Multan Town	4"	AC	1992 B	4"	12 T	L	105.5030352	L	46.6978441
13	KHADAM PAIRC	Township	Multan Town	4"	AC	1992 B	4"	12 T	L	107.4636598	L	277.9007926
14	R Block Model Town	Township	Multan Town	4"	PVC	1992 B	4"	12 T	L	190.2874521	L	282.9811067
15	Extension	Township	Multan Town	4"	AC	1992 B	4"	12 T	L	105.5030352	L	46.6978441
16	R Block Model Town	Township	Multan Town	4"	AC	1992 B	4"	12 T	L	107.4636598	L	277.9007926
17	R Block Model Town	Township	Multan Town	4"	AC	1992 B	4"	12 T	L	190.2874521	L	282.9811067
18	R Block Model Town	Township	Multan Town	4"	AC	1992 B	4"	12 T	L	105.5030352	L	46.6978441
19	Extension	Township	Multan Town	4"	AC	1992 B	4"	12 T	L	107.4636598	L	277.9007926
20	Extension	Township	Multan Town	4"	PVC	1992 B	4"	12 T	L	190.2874521	L	282.9811067
21	Chakral Park near Refco	Township	Multan Town	4"	AC	1992 B	4"	12 T	L	105.5030352	L	46.6978441
22	Cricket Ground	Township	Multan Town	8"	AC	2000 B	8"	16 P	L	277.9007926	L	73.82368128
23	R Block Model Town	Township	Multan Town	4"	AC	1992 B	4"	12 T	L	245.8732027	L	502.1487785
24	Q Block Model Colony	Township	Multan Town	4"	AC	1974 B	4"	20 T	L	215.0459667	L	240.9520377
25	Q Block Model Colony	Township	Multan Town	4"	AC	1974 B	4"	20 T	L	116.8837542	L	219.8930662
26	Q Block Model Colony	Township	Multan Town	4"	AC	1974 B	4"	20 T	L	219.8930662	L	71.49516675
27	Q Block Model Colony	Township	Multan Town	4"	AC	1974 B	4"	20 T	L	219.8930662	L	219.8930662
28	Q Block Model Colony	Township	Multan Town	4"	AC	1974 B	4"	20 T	L	219.8930662	L	219.8930662
29	Q Block Model Colony	Township	Multan Town	4"	AC	1974 B	4"	20 T	L	219.8930662	L	219.8930662
30	Q Block Model Colony	Township	Multan Town	4"	AC	1974 B	4"	20 T	L	219.8930662	L	219.8930662
31	Q Block Model Colony	Township	Multan Town	4"	AC	1974 B	4"	20 T	L	219.8930662	L	219.8930662
32	Q Block Model Colony	Township	Multan Town	4"	AC	1974 B	4"	20 T	L	219.8930662	L	219.8930662
33	Q Block Model Colony	Township	Multan Town	4"	AC	1974 B	4"	20 T	L	219.8930662	L	219.8930662
34	Q Block Model Colony	Township	Multan Town	4"	AC	1974 B	4"	20 T	L	219.8930662	L	219.8930662
35	Q Block Model Colony	Township	Multan Town	4"	AC	1974 B	4"	20 T	L	219.8930662	L	219.8930662
36	Q Block Model Colony	Township	Multan Town	4"	AC	1974 B	4"	20 T	L	219.8930662	L	219.8930662
37	Q Block Model Colony	Township	Multan Town	4"	AC	1974 B	4"	20 T	L	219.8930662	L	219.8930662
38	Q Block Model Colony	Township	Multan Town	4"	AC	1974 B	4"	20 T	L	219.8930662	L	219.8930662
39	Q Block Model Colony	Township	Multan Town	4"	AC	1974 B	4"	20 T	L	219.8930662	L	219.8930662
40	Q Block Model Colony	Township	Multan Town	4"	AC	1974 B	4"	20 T	L	219.8930662	L	219.8930662

Figure 1: Water supply pipes data of Lahore



Asset attribute/information

Asset parameters include :

1	Diameter (inch)
2	Material (pipe material)
3	Year of Installation
4	Level (P,S,T)
5	Condition (A,B,C,D,F)
6	Risk (H,M,L)
7	Replacement Year
8	Replacement dia
9	Town Name
10	Subdivision/Zone Name



➤ Asset Condition

Asset condition explains its state in term of defined ranking. For example

A =	Excellent: No noticeable defects. Some aging or wear may be visible.
B =	Good: Only minor deterioration or defects are evident.
C =	Fair: Some deterioration or defects are evident, but function is not significantly affected.
D =	Poor: Serious deterioration in at least some portion of the structure. Function is inadequate.
F =	Failed: No longer functional. General failure or complete failure of a major structural component.

➤ Asset Risk

Risk is the probability of failure of the asset and defined in term of High, Medium and Low:

H → High

M → Medium

L → low

Cont.

➤ Level

Level is classified in three classes; Primary level, secondary level and tertiary level. In the attribute table they will be shown as:

P → Primary,
S → Secondary,
T → Tertiary



Cont.

➤ Replacement Year

Replacement year indicates the remaining life of an asset and provide information on when an asset should be replaced.

➤ Replacement diameter

Replacement diameter means when a pipe has to be replaced, what should be its future diameter and also diameter reveals the information that whether it should be changed or should remain same.



Summary of WASA Lahore Assets

Summary of WASA assets with help of pivot tables

- ✓ 519 tube wells
- ✓ 4,500 kilometer Pipelines
- ✓ 150 water purification plants
- ✓ Disposal stations
- ✓ 8,500 valves
- ✓ 50 overhead reservoirs



What is Pivot Table?

Pivot tables are one of Excel's most powerful features.

✓ A pivot table allows you to extract , summarize and explore data interactively from detailed data set.

✓ Building a pivot table is the process of answering questions you have about the data e.g.,:

- ✓ What is total length of Pipes by Subdivision?
- ✓ What is the length of pipelines with 6" diameter?

✓ Once you create a pivot table, you can quickly transform huge numbers of rows and columns into a meaningful, nicely formatted report.



Open your MS Excel file.
Our data set consists of 35865 rows and 12 fields.

Street Name	Sub Division	Town	Diameter	Material	Installation	Count	Placement Dis	Segmentation	Level	Risk	Pipe Length (m)
1 Main peeco road	Township	Nishtar Town	10"	AC	2011 B	10"	25 P	M	1836.633918		
2 Main peeco road	Township	Nishtar Town	10"	AC	2011 B	10"	25 P	L	1935.843432		
3 Main peeco road	Township	Nishtar Town	8"	AC	2000 B	8"	12 S	L	850.840478		
4 Model town link road	Township	Nishtar Town	10"	AC	2010 B	10"	20 S	L	211.4002514		
5 Model town link road	Township	Nishtar Town	8"	AC	2009 B	8"	20 S	L	444.2776538		
6 R Block Model Town	Township	Nishtar Town	4"	AC	1984 B	4"	12 S	L	97.2420231		
7 R Block Model Town	Township	Nishtar Town	4"	AC	1986 B	4"	15 T	L	329.7344242		
8 R Block Model Town	Township	Nishtar Town	32"	AC	1987 B	32"	16 T	L	478.6977832		
9 R Block Model Town	Township	Nishtar Town	8"	AC	1987 B	8"	16 P	L	1943.073846		
10 Karmia wala Race	Township	Nishtar Town	12"	AC	1987 B	12"	16 S	L	133.926488		
11 Extension	Township	Nishtar Town	8"	AC	2000 B	8"	20 T	L	253.8459687		
12 Extension	Township	Nishtar Town	4"	AC	1992 B	4"	12 T	L	123.0407651		
13 HOUSING PARK	Township	Nishtar Town	4"	AC	1992 B	4"	12 T	L	110.4998996		
14 R Block Model Town	Township	Nishtar Town	4"	PVC	1992 B	4"	12 T	L	199.2874624		
15 R Block Model Town	Township	Nishtar Town	4"	AC	1992 B	4"	12 T	L	282.9811167		
16 R Block Model Town	Township	Nishtar Town	4"	AC	1992 B	4"	12 T	L	105.5633852		
17 R Block Model Town	Township	Nishtar Town	4"	AC	1992 B	4"	12 T	L	66.6875841		
18 R Block Model Town	Township	Nishtar Town	4"	PVC	1992 B	4"	12 T	L	107.4836588		
19 Extension	Township	Nishtar Town	8"	AC	2000 B	8"	16 P	L	277.9007928		
20 Cocher Ground	Township	Nishtar Town	4"	AC	1992 B	4"	12 T	L	77.82381018		
21 R Block Model Colony	Township	Nishtar Town	4"	AC	1987 B	4"	20 T	L	245.8719207		
22 R Block Model Colony	Township	Nishtar Town	4"	AC	1974 B	4"	20 T	L	103.1487786		
23 R Block Model Colony	Township	Nishtar Town	4"	AC	1974 B	4"	20 T	L	213.0720968		
24 R Block Model Colony	Township	Nishtar Town	4"	AC	1974 B	4"	20 T	L	240.9520937		
25 R Block Model Colony	Township	Nishtar Town	4"	AC	1974 B	4"	20 T	L	118.8817662		
26 R Block Model Colony	Township	Nishtar Town	4"	AC	1974 B	4"	20 T	L	210.3920903		
27 R Block Model Colony	Township	Nishtar Town	4"	AC	1974 B	4"	20 T	L	219.8930662		
28 R Block Model Colony	Township	Nishtar Town	4"	AC	1974 B	4"	20 T	L	71.49516675		

Figure 1: Water supply pipes data of Lahore

Steps for creating pivot tables

Steps for creating **pivot tables**:

- Select the data you want to analyze,
- Then go to Insert and click on "Pivot Table"
- Choose "New Work Sheet" for the Pivot table to be placed

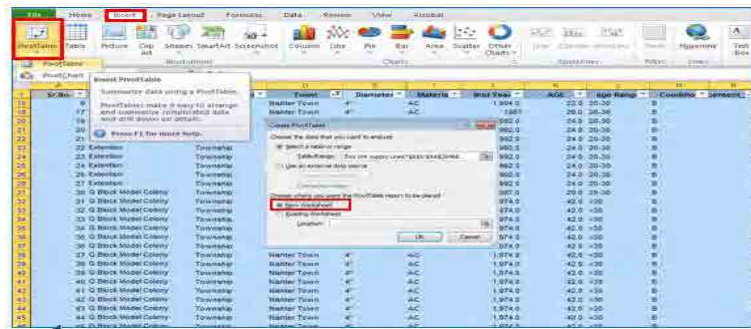
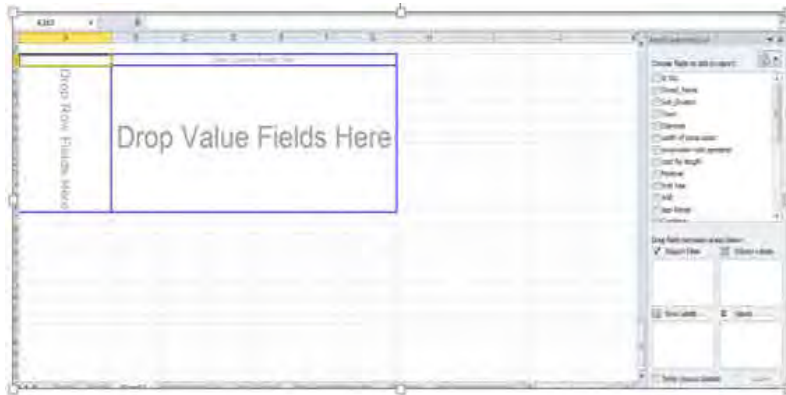

Figure 2: Creating Pivot Table

Cont.



Asset Condition Analysis



Assignment

Please prepare the following in steps;

1. Table and graph showing %age of pipe length in terms of condition on subdivision level.
2. The D condition lines will be then categorized according diameter. (3" to 6")
3. Write a brief report on findings



Assignment

Please prepare the following in steps;



1. Categories the pipeline data age wise and select a subdivision which has oldest pipes.
2. Rank the lines as per their condition.
3. Calculate the Total replacement cost for D & F condition pipes. (Relevant WASA)
4. Write brief paragraph on findings.





Thank you





Introduction to Asset
Management (Replacement)



Course Title: Asset Management-M 4131 Lecture-01 Module 4: Asset Replacement Plan

Asset Replacement Plan (Module 4)

Major topics included in the asset replacement module are:

- Current asset monitoring practices at WASA Lahore
- Repair/ replacement cost comparison
- Asset database analysis
- Exercises of asset database analysis
- Asset Replacement Plan Preparation



Asset Replacement Plan (Lecture 01)



Current practices of asset monitoring

- Visual check of the assets
- Check whether the asset is working properly or not
- Find an asset being out of order
- Request for replacement
- Recording on the Log book.



Example

Replacement of main building of Ise Shrine every twenty years in JAPAN for about thousand years.



Requirement For replacement in Ise Shrine

The replacement needs three requirements:

➤ **Human resources**

Who are able to plan and rebuild a wholly building with high skills

➤ **Good materials**

Wood for the building which are grown in the forest.

➤ **A fund**

For the construction work.



Case Study

**Current Asset monitoring and
Procurement
at WASA, Lahore**



Over view of Lahore WASAs Assets

- Water production: 435 million gallons per day
- Tube wells: 519



- Pipelines: 4,500 kilometers



Over view of Lahore WASAs Assets

- Water purification plants : 150
- Valves: 8,500

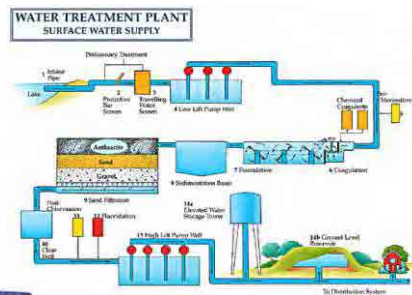

Over view of Lahore WASAs Assets

➤ **Overhead reservoirs: 50**



➤ **Water connections:
636,338**



Over view of Lahore WASAs Assets

➤ **Disposal stations:
12 (2,299cfs)**



➤ **Lift stations: 93 (826cfs)**



Over view of Lahore WASAs Assets

➤ **Drainage network: 461km**



➤ **Drainage stations:
4 (663cfs)**



Honda Philosophy: Three (3) real

1. Go to the real sites
2. Face the real issues
with your eyes
3. Implement really
workable solutions



Monitoring of existing Assets

Logbooks of machinery/ equipment maintenance recording are maintained by;

- mechanical engineers
- sub engineers
- pipe fitters
- mechanical helpers
- mechanical supervisors
- electricians
- operators of the Operation and Maintenance department (O & M)



Current monitoring and repair at Lahore

	Monitoring of the existing assets	Keeping records of the monitoring results	if they find a breakdown	Repair/ replacement	Request for replacement
Department in charge	O &M department implements a everyday monitoring of the assets (according to SOP).	O &M department keeps records of the monitoring results in their log books.	O &M department staffs report to their executive engineers.	O &M department makes a decision: repair/ replacement	(repair) O &M department requests for suppliers to repair. (replacement) O &M department requests for Procurement and Store Dep. (P &S) to procure a new one.
Staff in charge	mechanical engineers, sub engineers, pipe fitters, mechanical helpers, mechanical supervisors, electricians, operators				executive engineers

Procurement process in WASA

- Procurement process in WASA is done by PEPPRA rules prepared by government.
- The Procurement & Store Department (P&S) is in charge of routine and non-routine purchase requested by other departments and prepares estimates.
- Non-development-budget is prepared by the P&S as well
- On the other hand, the Planning and Design division (P&D) is in charge of on-site survey, design, cost estimation, scheduling and procurement in their PCIs to formulate the development budget.



Repair/replacement based on monitoring

- The P&S/ P&D would estimate the procurement costs to obtain an approval from DMD.
- If the estimation cost is less than Rs.100,000, P&S/ P&D would obtain cost offers from more than three (3) suppliers, then placing an order to the supplier which offers the best one.
- The suppliers would deliver the products within one (1) week from the award if they have a stock.
- It would take three (3) to four (4) weeks from the date of procurement request for P&S/ P&D to the delivery.



Repair/replacement based on monitoring

- At the estimation cost of Rs.100,000- 2 million, P&S/ P&D make a bid announcement on PPRA web site, thereby conducting a tender.
- At more than Rs. 2 million, P&S/ P&D make a bid announcement on newspaper as well as on PPRA web site.
- Then, P&S/ P&D obtain quotations from more than three (3) suppliers.
- Those suppliers put their offers in the “Quotation Box”.
- P&S/ P&D, Finance department, departments requesting for the procurement would jointly formulate an “Appraisal Committee”, to evaluate those quotations, thereby placing an order to a bidder offering the best one. .

Repair/replacement based on monitoring

Procurement and its finance source (budget) at Lahore WASA

Departments in charge	Actual works	Finance source (budget)	Actual expenditures	Process of procurement
Procurement and Store division (P&S) is in charge of routine/ non-routine purchases requested by various departments.	Cost estimation, tender, selection of bidders, awarding, inspection upon delivery, request for payment to Finance Division.	"Repair & maintenance", non-development budget (formulated by P&S, every year May 15- June 15)	Repair & maintenance (Million Rs.) (year 2012-13) 785 (year 2013-14) 615 (year 2014-15) 1,146	(estimation costs: less than Rs. 100,000) Obtaining offers more than three (3) companies (estimation costs: Rs. 100,000- 2 million) Bid announcement on PPRA website
Planning and Design division (P&D)	on-site survey, design, cost estimation, scheduling and procurement	development budget (formulated by P&D, every year May 15- June 15)	Annual dev. program (year 2012-13) 701 (year 2013-14) 1,745 (year 2014-15) 6,918	(estimation costs: more than Rs. 2 million) Bid announcement on PPRA website and newspaper The estimations shall be authorized upon DMD

Note: Procurement process in WASA shall be done by PEPR.A rules prepared by government.

Inspection and payment to suppliers

Inspection and payment to suppliers;

- P&S/ P&D conduct an inspection upon delivery, examining whether the product quality meets the requirement.
- Upon acceptance of the product, Departments in charge would request for the Finance department for payment of the contract amount.
- The Finance department would issue a check which would be converted into cash in a bank by the supplier.



Procurement process at Lahore WASA

Cost estimation	Selection of bidders	Order placement	Inspection upon delivery	Payment to suppliers
P&S/ P&D The cost estimations shall be authorized upon DMD approval	Appraisal committee including Finance department	P&S/ P&D	P&S/ P&D	Finance department upon request by the P&S/ P&D



Monitoring and Procurement (graphical view)

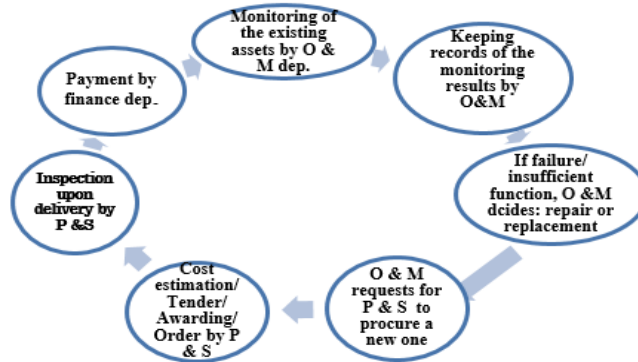

Whole process of monitoring and procurement at Lahore WASA

Cost Comparison of Repair/Replacement (Lecture 02)

Introduction of Topic

- ❖ Financial report and Budget formulation
- ❖ Values of fixed assets and budgeting
- ❖ Fixed asset list
- ❖ GIS
- ❖ Group Discussion and Presentation



Financial report and Budget formulation

Lecture 2 will be related to values of fixed assets, budgeting, and GIS at Lahore and other WASAs.



Values of fixed assets and budgeting

The lecture will highlight that it is difficult to know current asset values of Lahore or other WASAs.

On the other hand, P&S/ P&D formulate a new fiscal budget of procurement from May 15 to June 15.



Fixed asset list

The WASAs have prepared fixed asset lists with support of the Urban Unit, however, current use of the lists is limited. The Asset management course will assist WASAs to more efficiently take advantage of those lists.

GIS

The GIS unit was established in 2013 and has currently three (3) assistant directors and one (1) CAD operator. They conduct a data input of tube wells, disposal stations, water supply/ sewerage pipe line network in GIS. The unit has completed those works in five (5) sub divisions of Lahore WASA. The work in remaining 27 sub divisions is on-going.



If other information is required to be input, it is necessary for the Unit to obtain a DGPS (Differential Global Position System) and others. The Unit recommended that Lahore WASA establish a MIS (Management Information System) section in charge of programming for data input and reporting with information from various departments, for example:

- Fixed asset location and its values including tube wells, pipelines and others
- Consumer address, tariff, payment situation, illegal connections
- Water production and distribution



Exercise # 1

Group 1 and 2 will discuss :

- 1) when the assets should be inspected
- 2) how inspection should be conducted
- 3) how asset condition should be measured
- 4) what actions should be taken based on the inspection.
- 5) who would input data of new assets in the asset list.



Group 3 and 4 will discuss:

- 1) how to share the asset monitoring results with GIS department.



Cost Comparison of Repair/Replacement (Lecture 03)

Introduction of Topic

- ❖ Cost comparison of repair/ replacement
- ❖ Net present values (NPV)
- ❖ Internal rate of return
- ❖ Conclusion
- ❖ Review Questions

Cost comparison of repair/ replacement

When failure or insufficient function is found in an asset, managers at the O & M department would make a decision: repair or replacement. The repair would reduce an initial cost of the recovery while maintenance costs afterward might be increasing. By contrast, the initial purchasing cost of a substitute one would be much higher than that of repair, while maintenance costs afterward might be less than those of the repair. The quantitative manner of cost comparison in described below might help the managers to appraise the options

	Year 0	Year 1	Year 2	Year 3	Year 4	Year 5	Total costs
Repair	130	40	40	40	40	40	330
replacement	250	10	10	10	10	10	300



Conclusion

The lecturer will conclude day 1 by reviewing current monitoring practices and will invite questions from course participants for further clarifications. Lastly it will be highlighted that WASA staff could prepare replacement plans to incorporate these plans in an annual non-development/ development budgets, as well as recognize the importance of daily monitoring and its recording.



Review Questions

- 1) If you find a generator out of order, which do you recommend, repair or replacement?
- How do you judge?
- If you have a budget limitation in your replacement plan, which do you give a priority to, business area or school area?



Asset Replacement Plan & Asset Database Analysis by the Participants (Lecture 04)



Lecture Outline

- ❖ **Asset Replacement Plan**
 - Introduction
 - Case Study: Pipeline replacement of Yokohama river
- ❖ **Asset Database Analysis**
 - Exercises 1 and 2
 - Presentation of analysis by Participants

Introduction of the Topic

- ❖ **Review of day 1**
 - Current Asset Monitoring/ Replacement Practices
 - Importance of Checklist Preparation
 - Quantitative Evaluation for new asset procurement
- ❖ **Reflection of day 1**
 - Presentation by each participant

Case Study

Pipeline replacement of Yokohama Water

- ❖ In recent hundred years, local governments of Japan has implemented a huge investment to increase water resources, water purification plants, pipelines to cope with growing demand.
- ❖ Policy is to supply enough quantity and quality water at reasonable prices
- ❖ Yokohama city government is one of the typical local governments

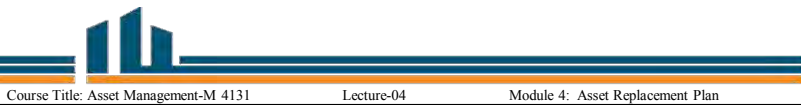

Pipeline replacement of Yokohama Water (Contd.)

- ❖ **Yokohama Water Works**
 - Established in the year 1887
 - The Yokohama city population then was 140 thousand, and increased to 1 million in 1942, 2 million in 1968, 3 million in 1985, and 3.7 million now.
 - Yokohama water works was merged in Yokohama city government to become “Yokohama Water Works Bureau (YWWB)”.
 - The YWWB has implemented a new pipeline installation every year to meet the increasing demand.
 - Current length of the pipeline has reached to 9,100 km.

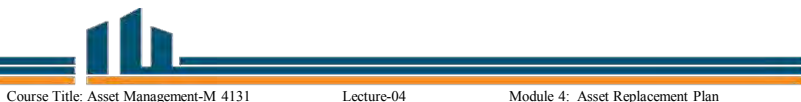

Pipeline replacement of Yokohama Water (Contd.)

❖ Yokohama Water Works

- The increase in the accumulated length of the pipeline in the Yokohama river is shown in the following bar-chart.

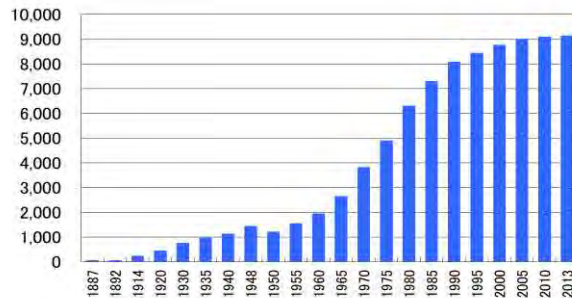

Pipeline replacement of Yokohama Water (Contd.)

❖ Yokohama Water Works

- The following graph shows annual installation of new pipelines in Yokohama City.
- In Japan, life span of pipelines stipulated by law is forty (40) years.
- Japan used to achieve a rapid economic growth in 1960's and early 1970's until 1972, so called "Nixon shock".
- Annual installation then was 350 km, accumulating to 2,400 km. in this era, 1/4 of the total length, 9100 km.

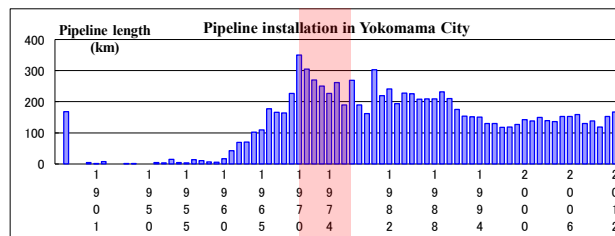

Pipeline replacement of Yokohama Water (Contd.)

❖ Yokohama Water Works

- Many water leakages were found in old pipes installed in early era of Yokohama Water Works.
- The City has, thus, implemented a replacement of old pipes since the year 1970, reaching to 3,900 km.
- The replacement has reduced numbers of leakage, from 30,000 in 1970 to 2,000 in 2011 and ratio of leakage from 20% to 5 %.

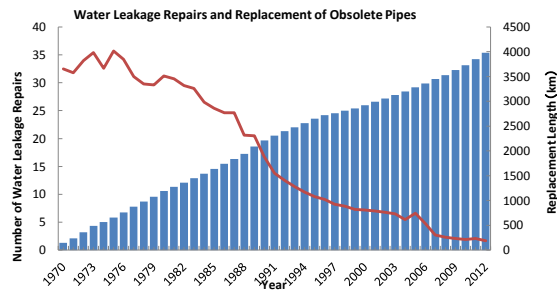

Pipeline replacement of Yokohama Water (Contd.)

❖ Group Discussion

- YWWB has achieved 24-hour water supply, daily water quality analysis to meet consumers' demand.
- On the other hand, Lahore WASA carries out limited time of water supply.
- It might not meet growing demand of Lahore residents, as well as might generate contamination of water.
- *In your point of view, what good practices of YWWB could be implemented in your WASA and how ?*

Asset Database Analysis ; Exercise 1

- ❖ The following table shows tube wells in Iqbal Town of Lahore.
- ❖ Please conduct your database analysis in a table and graph, using Pivot Table in the Excel.

Asset Database Analysis ; Exercise 1 (Contd.)

Sr. No.	Name	Installation Year	Status	Town	Generator	Design Capacity	Actual Capacity	Condition	Replacement	Motor Size	Sub Division
1	Chenab Block	2009	Functional	Iqbal Town	NILL	4 CFS	4 CFS	C	8	150 HP	Allama Iqbal Town
2	Pak Block	1986	Functional	Iqbal Town	YES	4 CFS	1.75 CFS	D	4	150 HP	Allama Iqbal Town
3	Asif Block	2014	Functional	Iqbal Town	NILL	4 CFS	4 CFS	A	14	150 HP	Allama Iqbal Town
4	Clifton Colony	2014	Functional	Iqbal Town	NILL	4 CFS	4 CFS	A	14	150 HP	Allama Iqbal Town
5	Nasium Block	2008	Functional	Iqbal Town	NILL	4 CFS	2 CFS	D	5	150 HP	Allama Iqbal Town
6	Hunza Block	2009	Functional	Iqbal Town	YES	2 CFS	2 CFS	C	7	80 HP	Allama Iqbal Town
7	College Block	1993	Functional	Iqbal Town	NILL	4 CFS	2 CFS	C	7	150 HP	Allama Iqbal Town
8	Raza Block	2009	Functional	Iqbal Town	NILL	4 CFS	4 CFS	C	9	150 HP	Allama Iqbal Town
9	Kareem Block	1996	Functional	Iqbal Town	NILL	4 CFS	1.75 CFS	D	4	150 HP	Allama Iqbal Town
10	Kareem Block Graveyard	2004	Functional	Iqbal Town	YES	2 CFS	2 CFS	C	8	80 HP	Allama Iqbal Town
11	Nishtar Block	2009	Functional	Iqbal Town	NILL	2 CFS	1.90 CFS	D	6	80 HP	Allama Iqbal Town
12	F&V Market 2 Wadhat Road										
12	Multan Chungi	2009	Functional	Iqbal Town	NILL	4 CFS	4 CFS	B	8	150 HP	Allama Iqbal Town
13	F&V Market 1 Main Multan Road	2010	Functional	Iqbal Town	NILL	4 CFS	3.75 CFS	C	10	150 HP	Allama Iqbal Town
14	Ravi Block	2011	Functional	Iqbal Town	NILL	4 CFS	3.90 CFS	C	12	150 HP	Allama Iqbal Town
15	Nargis Block	2008	Functional	Iqbal Town	NILL	4 CFS	4 CFS	C	7	150 HP	Allama Iqbal Town
16	Huma Block	1999	Functional	Iqbal Town	NILL	4 CFS	3.25 CFS	C	8	150 HP	Allama Iqbal Town
17	Jahanzaib Block	1986	Functional	Iqbal Town	NILL	4 CFS	2 CFS	D	2	150 HP	Allama Iqbal Town
18	Kmaran Block	2010	Functional	Iqbal Town	NILL	4 CFS	3.75 CFS	C	10	150 HP	Allama Iqbal Town

Example 1-1: Installation year and actual capacity of tube wells

Installation Y	1.75 CFS	1.90 CFS	2 CFS	3.25 CFS	3.75 CFS	3.90 CFS	4 CFS	Total
1986	1							2
1993			1					1
1996	1							1
1999				1				1
2004			1		1			2
2008			2				1	3
2009		1	2				3	4
2010					2			2
2011						1		1
2014							2	2
Total	2	1	5	1	2	1	6	18

Asset Database Analysis : Exercise 1 (Contd.)

Installation	A	B	C	D	Total
1986				2	2
1993			1		1
1996				1	1
1999			1		1
2004			1		1
2008			2	1	3
2009		1	2	1	4
2010			2		2
2011			1		1
2014	2				2
Total	2	1	10	5	18

Example 1-2: Installation year and conditions (A, B, C, D) of tube wells (table)

- ❖ The above table shows more than half of the tube wells in Iqbal Town are in C condition. A graph might help visual understanding.



Presentation of Asset Database Analysis

- ❖ Each participant will present his/ her own database analysis results in the class, explaining observations with tables/ graphs.
- ❖ Some might say a large difference is found between design and actual capacity of many tube wells.
- ❖ Others might insist AC pipes should be replaced because many water leakages have been found in these pipes in Lahore.



Asset Database Analysis ; Exercise 2

- ❖ The following table shows a part of pipelines in Lahore.
- ❖ Please conduct your database analysis in a table and graph, using Pivot Table in the Excel.



Asset Database Analysis : Exercise 2 (Contd.)

Sr.No.	Street_Name	Sub_Division	Town	Diameter	Material	Installation year	Condition	Replacement_Diameter	Replacement_Year	Level	Risk	Shape_Length (m)
1	main pecco road	Township	Nishter Town	10"	AC	2,000.0	B	10"	11	P	M	1897
2	Main pecco road	Township	Nishter Town	10"	AC	2,011.0	B	10"	25	P	L	1316
3	Asghar MPA Road	Township	Nishter Town	8"	AC	2000	C	8"	1	T	H	579
4		Township	Nishter Town	8"	AC	2,000.0	B	8"	12	S	L	601
5	main pindi rajputa	Township	Nishter Town	6"	AC	1994	C	8"	2	S	M	425
6		Township	Nishter Town	10"	AC	2,010.0	B	10"	20	S	L	213
7		Township	Nishter Town	8"	AC	1995	B	8"	1	S	L	918
8	model town link road	Township	Nishter Town	8"	AC	2,009.0	B	8"	20	S	L	445
9	R Block Model town	Township	Nishter Town	4"	AC	1,994.0	B	4"	12	S	L	97
10	Karma_wala Bazar	Township	Nishter Town	6"	AC	1,986.0	B	6"	15	T	L	330
11	School road pindi rajputan	Township	Nishter Town	10"	AC	1994	B	10"	10	T	M	902
12	main bazar liaqatbad	Township	Nishter Town	10"	AC	1994	B	10"	10	T	M	1021
13	Nasrat Road Behar Colony	Township	Nishter Town	8"	AC	2000	B	10"	5	P	M	648
14		Township	Nishter Town	12"	AC	1,987.0	B	12"	15	T	L	479
15		Township	Nishter Town	8"	AC	1,987.0	B	8"	15	P	L	1943
16	extension	Township	Nishter Town	12"	AC	1,987.0	B	12"	15	S	L	139
17	extension	Township	Nishter Town	4"	AC	1987	B	4"	10	T	L	175
18	Extension	Township	Nishter Town	8"	AC	2,000.0	B	8"	20	T	L	254
19	Extension	Township	Nishter Town	4"	AC	1,992.0	B	4"	12	T	L	123
20	KHADAM PARK	Township	Nishter Town	4"	AC	1,992.0	B	4"	12	T	L	110
21	R Block Model Town	Township	Nishter Town	4"	PVC	1,992.0	B	4"	12	T	L	199
22	Extension	Township	Nishter Town	4"	AC	1,992.0	B	4"	12	T	L	283
23	R Block Model Town	Township	Nishter Town	4"	AC	1,992.0	B	4"	12	T	L	106
24	Extension	Township	Nishter Town	4"	AC	1,992.0	B	4"	12	T	L	67
25	R Block Model Town	Township	Nishter Town	4"	PVC	1,992.0	B	4"	12	T	L	107
26	Cricket Ground	Township	Nishter Town	8"	AC	2,000.0	B	8"	16	P	L	278
27	R Block Model Town	Township	Nishter Town	4"	AC	1,992.0	B	4"	12	T	L	74
28	Extension	Township	Nishter Town	4"	AC	1987	B	6"	10	S	M	446
29	Q Block Model Town	Township	Nishter Town	4"	AC	1987	B	6"	3	T	L	291
30	Q Block Model Colony	Township	Nishter Town	4"	AC	1,987.0	B	4"	20	T	L	246
31	Q Block Model Colony	Township	Nishter Town	4"	AC	1,974.0	B	4"	20	T	L	102



Asset Database Analysis : Exercise 2 (Contd.)

Example 2-1: Diameter (inch), length (meter) of pipelines

Example 2-2: Pipeline replacement plan

Total / Shape	L	Diameter					total
		10"	12"	4"	6"	8"	
Replacement	Y						
	1					1,498	1,498
	2				426		426
	3			291			291
	5					648	648
	10	1,923		621			2,544
	11	1,897					1,897
	12			1,167		601	1,767
	15		618		330	1,943	2,891
	16					278	278
	20	213		348		699	1,260
	25	1,916					1,916
total		5,949	618	2,426	756	5,666	15,416

Presentation of Asset Database Analysis

- ❖ Course participants will present their own database analysis results in the class.
- ❖ Some participants might show a graph with replacement year and pipe diameters/ length.
- ❖ The presentation must include :
 - i) How many meters of pipes should be replaced in short/ medium/ long term?
 - ii) How much would be replacement costs in each year?

Asset Database Analysis : Exercise 2 (Contd.)

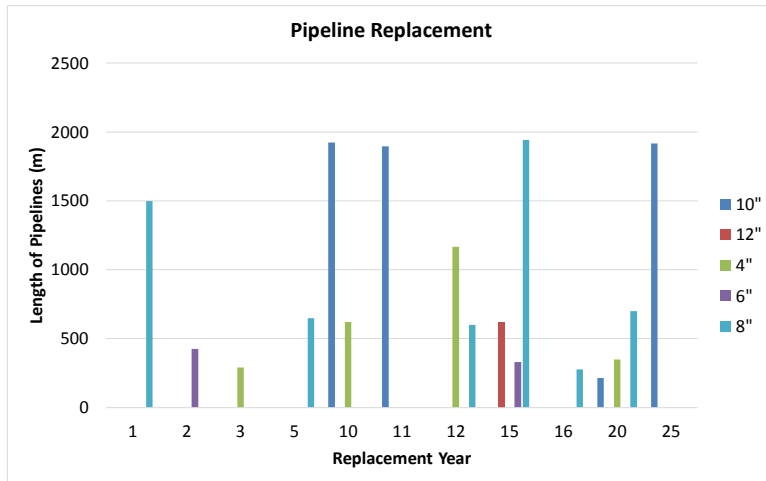

Conclusion

- ❖ Review of an example of actual and prospective pipeline replacement in Yokohama and database analysis manners with actual data of tube wells and pipelines in Lahore.
- ❖ Emphasis on the importance of both the daily practices described in day 1 and replacement planning and on their correlation with each other.
- ❖ Any questions for clarification ?

Review Questions

- ❖ Many leakages have been found in AC pipes. Do you hear many customer complaints in AC pipe areas?
- ❖ Would AC pipe replacement reduce customer complaints?
- ❖ Would AC pipe replacement increase collection rates of water/ sewerage charges?

Presentation of Replacement Plans by the Participants & Replacement Cost (Lecture 05)

Outline

- Presentation of Replacement Plans By Participants
- Replacement Cost

Introduction of Topic

- Actual and Prospective Pipeline Replacement in Yokohama
- Database Analysis Manners
- Reflection of Previous Lectures
- Brain Storming

Exercise 1

First please input a formula “=2016 - installation year” to get how many years from installation. Then If you input

=IF(K3<6,"0-5",IF(K3<11,"6-10",IF(K3<16,"11-15",>15)))

Or

=IF(K5<=5,"0-5",IF(K5<=10,"6-10",IF(K5<=15,"11-15",IF(K5>15,">15"))))

you can get a range of years from the installation.



Sr.No.	Street Name	Sub_Division	Town	Diameter	Material	Installation year	How many years from installation	a range of years from installation	Condition	Replacement Diameter	Replacement Year	a range of replacement years	Level	Risk	Shape Length (m)
1	main pecco road	Township	Nishtar Town	10"	AC	2,000.0	16	15-29 B	10"	11	5-14 P	M	1997		
2	Main pecco road	Township	Nishtar Town	10"	AC	2,011.0	5	5-14 B	10"	25	15-29 P	L	1916		
3	Asghar MPA Road	Township	Nishtar Town	8"	AC	2000	16	15-29 C	8"	1	0-4 T	H	579		
4		Township	Nishtar Town	8"	AC	2,000.0	16	15-29 B	8"	12	5-14 S	L	601		
5	main pindi rajputa	Township	Nishtar Town	8"	AC	1994	22	15-29 C	8"	2	0-4 S	M	426		
6		Township	Nishtar Town	10"	AC	2,010.0	6	5-14 B	10"	20	15-29 S	L	213		
7		Township	Nishtar Town	8"	AC	1995	21	15-29 B	8"	1	0-4 S	L	918		
8	model town link road	Township	Nishtar Town	8"	AC	2,009.0	7	5-14 B	8"	20	15-29 S	L	445		
9	R Block Model town	Township	Nishtar Town	4"	AC	1,994.0	22	15-29 B	4"	12	5-14 S	L	97		
10	Kanna, wala Bazar	Township	Nishtar Town	8"	AC	1,986.0	30	30-50 B	6"	15	15-29 T	L	300		
11	School road pindi rajputan	Township	Nishtar Town	10"	AC	1994	22	15-29 B	10"	10	5-14 T	M	902		
12	main bazar laqatabad	Township	Nishtar Town	10"	AC	1994	22	15-29 B	10"	10	5-14 T	M	1021		
13	Nasrat Road Behar Colony	Township	Nishtar Town	8"	AC	2000	16	15-29 B	10"	5	5-14 P	M	648		
14		Township	Nishtar Town	12"	AC	1,987.0	29	15-29 B	12"	15	15-29 T	L	479		
15		Township	Nishtar Town	8"	AC	1,987.0	29	15-29 B	8"	15	15-29 P	L	1943		
16	extension	Township	Nishtar Town	12"	AC	1,987.0	29	15-29 B	12"	15	15-29 S	L	139		
17	Extension	Township	Nishtar Town	4"	AC	1987	29	15-29 B	4"	10	5-14 T	L	175		
18	Extension	Township	Nishtar Town	8"	AC	2,000.0	16	15-29 B	8"	20	15-29 T	L	254		
19	Extension	Township	Nishtar Town	4"	AC	1,992.0	24	15-29 B	4"	12	5-14 T	L	123		
20	KHADAM PARK	Township	Nishtar Town	4"	AC	1,992.0	24	15-29 B	4"	12	5-14 T	L	110		
21	Extension	Township	Nishtar Town	4"	PVC	1,992.0	24	15-29 B	4"	12	5-14 T	L	199		
22	Extension	Township	Nishtar Town	4"	AC	1,992.0	24	15-29 B	4"	12	5-14 T	L	283		
23	Extension	Township	Nishtar Town	4"	AC	1,992.0	24	15-29 B	4"	12	5-14 T	L	106		
24	Extension	Township	Nishtar Town	4"	AC	1,992.0	24	15-29 B	4"	12	5-14 T	L	67		
25	Extension	Township	Nishtar Town	4"	PVC	1,992.0	24	15-29 B	4"	12	5-14 T	L	107		
26	Cricket Ground	Township	Nishtar Town	8"	AC	2,000.0	16	15-29 B	8"	16	15-29 P	L	278		
27	Extension	Township	Nishtar Town	4"	AC	1,992.0	24	15-29 B	4"	12	5-14 T	L	74		
28	Q Block Model Town	Township	Nishtar Town	4"	AC	1987	29	15-29 B	6"	10	5-14 S	M	446		
29	Extension	Township	Nishtar Town	4"	AC	1987	29	15-29 B	6"	3	0-4 T	L	291		
30	Q Block Model Colony	Township	Nishtar Town	4"	AC	1,987.0	29	15-29 B	4"	20	15-29 T	L	246		
31	Q Block Model Colony	Township	Nishtar Town	4"	AC	1,974.0	42	30-50 B	4"	20	T	L	102		

Example 1-1

Age, Condition, Materials (AC/ PVC) And Length Of Pipelines (Table)

Shape_Length (m)	Material Condition		AC Total	PVC	PVC Total	Ttotal
	AC					
How many years from installation	B	C		B		
5	1,916		1,916			1,916
6	213		213			213
7	445		445			445
16	3,677	579	4,257			4,257
21	918		918			918
22	2,020	426	2,447			2,447
24	763		763	307	307	1,069
29	3,719		3,719			3,719
30	330		330			330
(空白)	102		102			102
Ttotal	14,103	1,006	15,109	307	307	15,416



Example 1-2

Age, Condition, Materials (AC/ PVC) And Length Of Pipelines (Graph)

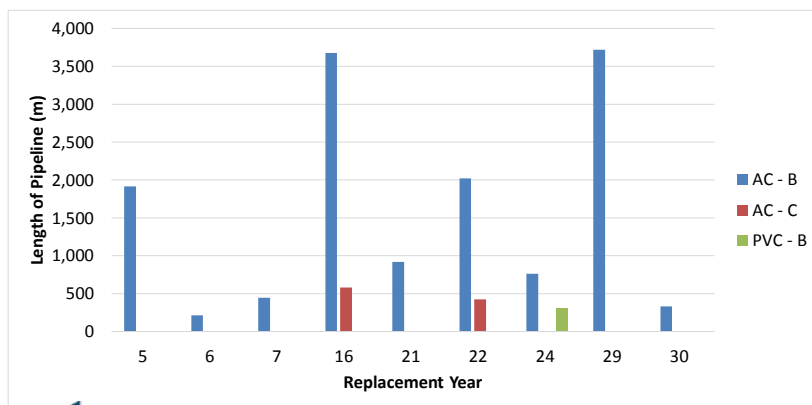

Example 1-3

Pipeline Replacement In Each Town Of Lahore (Table) Unit: Meter

Town	0-5	6-10	11-15	>15	Total
Aziz Bhatti Town	135324	10072	2717	26556	174669
Gulberg Town	125692	77557	42284	148704	394237
Gunj Bakhsh Town	446671	163515	39951	80041	730178
Iqbal Town	230795	308241	306631	71165	916832
Nishter Town	486552	72078	44200	54950	657779
Ravi Town	443878	204613	83309	179622	911422
Shalimar Town	372534	208761	61809	75268	718371
Total	2241445	1044837	580901	636306	4503490

Example 1-4

Pipeline Replacement In Each Town of Lahore (Graph)

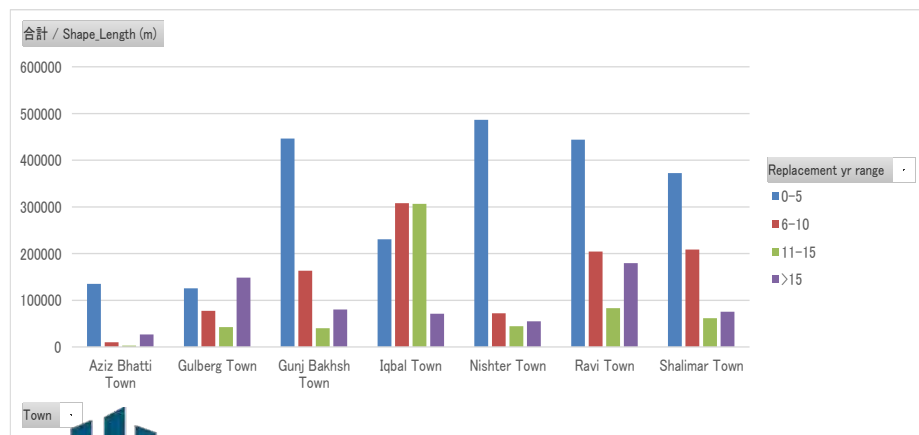

Example 2

Please make your short/ medium/ long term replacement plans, using Pivot Table in the Excel.

The following table and graph shows a data analysis of all tube wells in Lahore.



Example 2-1

Tube Well Replacement From The Year 2016 In Each Town Of Lahore

Town	0	1	2	3	4	5	6	7	8	9	10	11	12	13	14	15	16	17	18	20	22	23	24	25	30	35	Nil	Total
Aziz Bhatti Town		9	1	3	1	8					4		1															27
Gulberg Town	4	7	4		1	8		4		14		3	1		9			2	6				2	1	2			68
Gunj Bakhsh Town	1	24	9	8	1	5	3	1	4	5	3		1	2	3	6				15				4			1	96
Iqbal Town		13	7	1	4	13		1	4	6	1	21		1	2	4				7					1			86
Nishtar Town		10	6	8	2	6		5	6	1	8	1	4		2	5		1		3	2							70
Ravi Town		24	2			5		1	2		12		2			18	9	5	1	15		2	1	9		1		109
Shalimar Town	4	13	2	2		6						2				18				16								63
Total	9	100	31	22	9	51	4	11	22	7	64	1	11	4	7	60	9	6	3	62	2	2	1	15	2	2	1	519



Example 2-2

Tube well replacement from the year 2016 in each town of Lahore (graph)

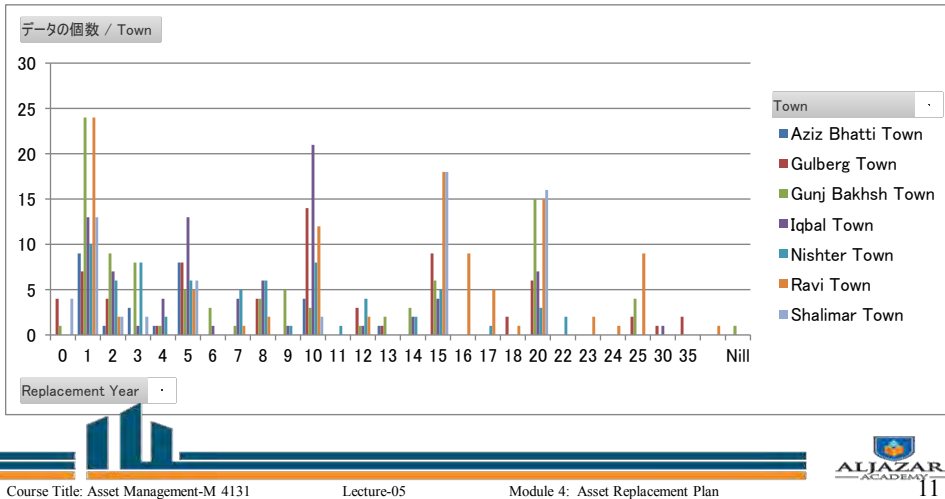

Replacement cost

Replacement cost is the actual **cost** to **replace** an item or structure at its pre-loss condition. This may not be the "market value" of the item, and is typically distinguished from the "book value" which includes a deduction for depreciation.



Replacement cost

The following table shows a replacement cost of old water supply pipes

	A	B	C	D	E	F	G	H
1	Diameter		Material	Cost of Different Pressure Rated Pipes/m				Construction Cost/ m
2	(mm)	(Inch)		PN 8	PN 10	PN 12.5	PN 16	
3	50	2"	HDPE	97	120	148	181	244
4	110	4"	HDPE	473	582	713	864	529
5	160	6"	HDPE	1000	1220	1512	1835	1001
6	200	8"	HDPE	1560	1910	2355	2860	1539
7	250	10"	HDPE	2310	2836	3475	4461	2385
8	315	12"	HDPE	4095	4916	6161	7455	3321
9	The cost is in Pak Rupee.							

Replacement cost

We'll need to add fields in "Existing Water supply lines" sheet as follows;

- Material Cost Per Meter
- Total Material Cost
- Construction Cost Per Meter
- Total Construction Cost
- Total Material And Construction Cost

Replacement cost

	R	S	T	U	V	W
1						
2	Cummulative Length	Material Cost/m	Total Material Cost	Const. Cost /m	Total Const. Cost	Total material & Const.
3	226.2397776					
4	630.9364019					
5	1179.331479					
6	1933.648482					
7	2375.146592					
8	2786.024012					
9	1896.653919					
10	3812.603351					
11	4026.008609					
12	4927.69519					
13	5949.189951					
14	6596.933937					
15	7152.397213					
16	7190.042472					
17	7194.756608					
18	7235.08102					
19	7415.415614					
20	8780.826129					
21	8790.551909					
22	8806.643802					

Sub Divisions Pivot Table **Exs Wtr supply Lines** Costing Table Exs Tubewell Exs Water Filtration Plant Exs Valves

Course Title: Asset Management-M 4131 Lecture-05 Module 4: Asset Replacement Plan

Replacement cost

Now look if the following columns represent the mentioned fields in “Exs Wtr supply lines” sheet;

L= Replacement Diameter
Q= Length of Pipe

Now look in the costing table if these columns represent the mentioned fields;

B= Diameter (inch)
D= PN8 Cost/m
H= Construction Cost/m

Replacement cost

Now in “Existing Water Supply line” sheet, select ‘S3’ cell to get the cost per meter for corresponding diameter in row # 3.

Input the following formula;

```
=IF(L3='Costing Table'!B$3,'Costing Table'!D$3,IF(L3='Costing Table'!B$4,'Costing Table'!D$4,IF(L3='Costing Table'!B$5,'Costing Table'!D$5,IF(L3='Costing Table'!B$6,'Costing Table'!D$6,IF(L3='Costing Table'!B$7,'Costing Table'!D$7,IF(L3='Costing Table'!B$8,'Costing Table'!D$8))))))
```



Replacement cost

Or simply do the following;

- Type “=IF(L3=”
- Then go to “costing table” sheet and select ‘B3’
- Type comma, and then select “D3” and type a comma. The formula should look like this;

```
=IF(L3='Costing Table'!B3,'Costing Table'!D3,
```

- Now continue the formula, type “=IF(L3=”
- Then stay in “costing table” sheet and select ‘B4’
- Type comma, and then select “D4” and type a comma. The formula should look like this;

```
=IF(L3='Costing Table'!B3,'Costing Table'!D3,IF(L3='Costing Table'!B4,'Costing Table'!D4,
```



Replacement cost

You will continue this till “B8” and “D8” and at the insert)))))).
Also The formula should look like this

```
=IF(L3='Costing Table'!B3,'Costing Table'!D3,IF(L3='Costing Table'!B4,'Costing Table'!D4,IF(L3='Costing Table'!B5,'Costing Table'!D5,IF(L3='Costing Table'!B6,'Costing Table'!D6,IF(L3='Costing Table'!B7,'Costing Table'!D7,IF(L3='Costing Table'!B8,'Costing Table'!D8)))))))))
```



Replacement cost

Now put the '\$' sign between 'B' and 'D' values to fix the cells.

```
=IF(L3='Costing Table'!B$3,'Costing Table'!D$3,IF(L3='Costing Table'!B$4,'Costing Table'!D$4,IF(L3='Costing Table'!B$5,'Costing Table'!D$5,IF(L3='Costing Table'!B$6,'Costing Table'!D$6,IF(L3='Costing Table'!B$7,'Costing Table'!D$7,IF(L3='Costing Table'!B$8,'Costing Table'!D$8)))))))))
```



Replacement cost

Now press enter, you will get “2310” if you have done it correctly.

R	S	T	U	V	
mulative	Material Cost/m	Total Material Cost	Const. Cost /m	Total Const. Cost	Total mate
226.2397776	2310				
630.9364019					
1179.331479					
1933.648482					
2375.146592					
2786.024012					

Replacement cost

- If you double click on the bottom right corner, it will expand and apply the same formula till the last row.
- Now in the “Total Material cost” go to ‘T3’ and type the following formula to get the Total material cost.

$$=Q3*S3$$
- You will get the total material cost. Expand it by double clicking on bottom right corner of ‘T3’ cell and the formula will be applied till the last row.
- Now calculate the construction costs/m and total construction costs using the procedure you just learnt.
- You can get the total material and construction costs by adding the two already calculated material and construction costs.

Replacement cost

P	Q	R	S	T	U	V	W
Risk	Length of pipe (m)	cumulative	Material Cost/m	Total Material Cost	Const. Cost/m	Total Const. Cost	Total material & Const.
M	226.2397776	226.2397776	2310	522614	2385	539581.8697	1062196
M	404.6966243	630.9364019	2310	934849	2385	965201.4489	1900051
M	548.3950768	1179.331479	2310	1266793	2385	1307922.258	2574715
M	754.3170036	1933.648482	2310	1742472	2385	1799046.054	3541518
M	441.4981101	2375.146592	2310	1019861	2385	1052972.992	2072834
M	410.8774195	2786.024012	2310	949127	2385	979942.6455	1929069
M	1896.653919	1896.653919	2310	4381271	2385	4523519.597	8904790
L	1915.949432	3812.603351	2310	4425843	2385	4569539.396	8995383
L	213.4052574	4026.008609	2310	492966	2385	508971.5388	1001938
M	901.6865813	4927.69519	2310	2082896	2385	2150522.496	4233418
M	1021.494761	5949.189951	2310	2359653	2385	2436265.006	4795918
M	647.7439854	6596.933937	2310	1496289	2385	1544869.405	3041158
M	555.4632768	7152.397213	2310	1283120	2385	1324779.915	2607900
L	37.64525845	7190.042472	2310	86961	2385	89783.9414	176744
L	4.714136618	7194.756608	2310	10890	2385	11243.21583	22133
L	40.32441192	7235.08102	2310	93149	2385	96173.72242	189323
M	180.3345934	7415.415614	2310	416573	2385	430098.0053	846671
M	1365.410515	8780.826129	2310	3154098	2385	3256604.079	6410602
M	9.725779647	8790.551909	2310	22467	2385	23195.98446	45663

Replacement cost

	A	B	C	D	E	F	G
1	Town	Ravi Town					
2							
3	Sum of Total material & Const.	Replacement yr range					
4	Replacement Diameter	0.5	6-10	11-15	>15	Grand Total	
5	2"	1,594,526	56,207	25,242	1,675,976		
6	4"	304,268,975	142,324,273	52,623,364	594,534,093		
7	6"	113,123,792	45,521,709	18,242,543	41,689,470	218,577,513	
8	8"	65,602,295	48,152,862	25,815,526	40,753,929	180,324,613	
9	10"	122,451,292	48,296,708	23,953,163	58,568,723	253,269,886	
10	12"	120,574,234	94,328,497	12,143,869	125,830,220	352,876,820	
11	Grand Total	727,615,114	378,680,256	132,803,707	362,159,823	1,601,258,900	

Replacement cost

Then let's calculate the replacement cost of all water supply lines in Lahore over range of years.

Town	0-5	6-10	11-15	>15	Grand Total
Aziz Bhatti Town	185,403,496	19,756,561	9,588,960	63,813,814	278,562,832
Gulberg Town	297,436,638	155,803,822	83,009,541	331,050,800	867,300,802
Gunj Bakhsh Town	1,086,468,286	415,525,725	103,628,531	202,211,284	1,807,833,826
Iqbal Town	425,919,353	648,808,775	517,205,448	200,829,247	1,792,762,822
Nishtar Town	888,594,127	183,652,234	92,780,167	108,259,202	1,273,285,729
Ravi Town	727,615,114	378,680,256	132,803,707	362,159,823	1,601,258,900
Shalimar Town	656,215,937	344,278,292	125,817,497	143,879,672	1,270,191,397
Grand Total	4,267,652,951	2,146,505,665	1,064,833,851	1,412,203,841	8,891,196,308

If you don't get the diameters or year range in proper order, then you can manually drag the rows or columns to desired position.

For the desired number format, you can just select the values and right click to go to "Number Format".



Case studies of replacement priorities

1. Pipelines with much leakages
2. Pipelines providing water/ sewerage for wider area
3. Pipe lines near schools or hospitals
4. Pipelines near pumps
5. AC pipelines
6. Pipelines supplying areas with higher rates of water/ sewerage charge collection
7. Pipelines without substitute lines (no backup)
8. Leakage of the pipelines might lead another accident



Conclusion

- Carry out a daily monitoring of assets with check sheets
- Evaluate repair or replacement of the existing assets, especially those with values of more than two (2) million Rs.
- Formulate of an annual “repair and maintenance” budget in non-development/ development, every year, May 15- June 15



Contact



Yasuyuki Kuroda

JICA Business & Finance Expert

Al-Jazari Water & Sanitation Academy

Fax: 042-35118573







Module 5 : Asset Condition Survey

Day 1



Engr. Ali Raza



Course Title: Asset Management-M4131 Lecture-01 Module 5 Asset Condition Survey



1



Introduction of Participants & Faculty

Name
City
**What one thing you like to learn in this course –
Module 5**

- 1. Type of Assets and Asset Attributes**
- 2. Condition Based Assessment of different
asset types**
- 3. Asset condition Rating**



Course Title: Asset Management-M4131 Lecture-01 Module 1: Asset Condition Survey



2

Introduction to Asset Condition Survey

“It is the practical exercise through which the condition of the asset is determined by doing the physical inspection and some performance parameters most importantly discharge, pressure and electrical are measured by instruments in the field.”

WASAs Asset Types

- Water Supply Assets
- Disposal Station Assets
- Vehicle, Mechanical Machinery & Other Assets

Water Supply System

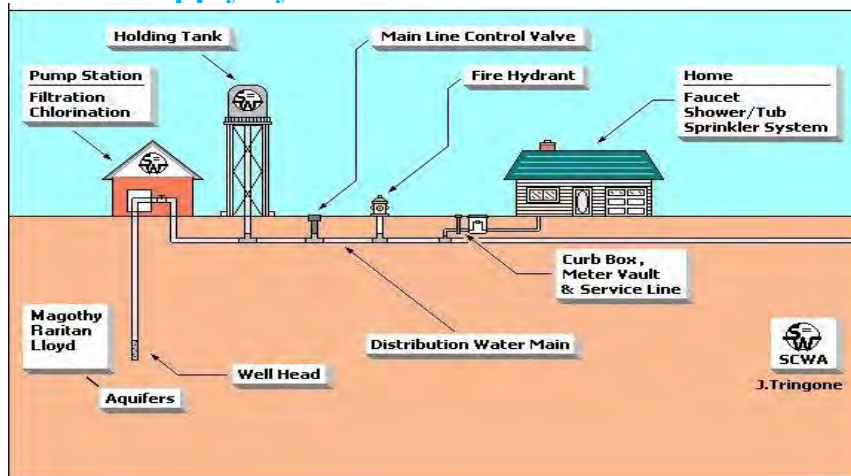

Sewerage System

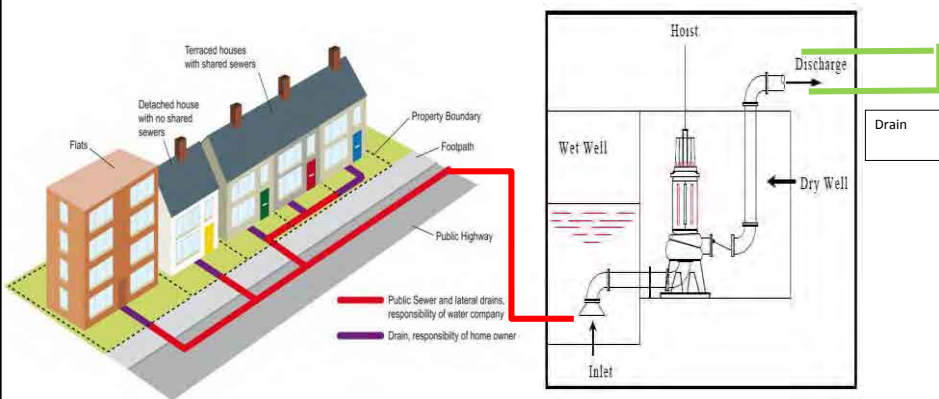

Exercise

What are assets used in your water Supply?

What are the assets used in your disposal station and sewer system?

Asset Condition Parameters

Physical Condition of Pump	Lubricant Leakage	Water Leakage	Cable Insulation	Cable Sizing	Chlorinator	Transformer Condition
Energy Meter Condition	Performance of Starter	Pump Vibration	Pump Noise	Motor Temperature Control	Cooling Fan Condition	Piping Condition
Condition of Return Valve	Return Valve Condition	Air Release Valve	OHR	Wet Well	Pressure Gauge Condition	Ventilation
Civil Structure	Generator Condition	Power Factor Improvement Capacitor	Safety Equipment	Chlorinator Condition	Bulk Flow meter	Log Book
Earthing Condition	Screening Chamber Condition	Screens	Lighting Condition	Human Signaling Signs	SoPs	

Asset Condition Performance Parameters

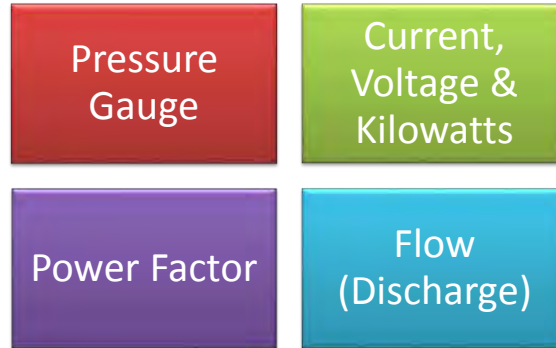

Asset Condition Rating

- A = No noticeable defects. Some aging or wear may be visible.**
- B = only minor deterioration or defects are evident.**
- C = some deterioration or defects are evident, but function is not significantly affected.**
- D = Serious deterioration in at least some portion of the structure. Function is inadequate.**
- F = No longer functional. General failure or complete failure of a major structural component.**

Average Score	1	2	3	4	5
Asset Condition	Excellent	Good	Fair	Poor	Failing
Category	A	B	C	D	F

Exercise

What is condition rating of Terminal Box and cabling of Motor?



Exercise

What is condition rating of Terminal Box and cabling of Motor?



Exercise

What is condition rating of Priming Box?



Exercise

What is condition of equipment?

1. 4.
2. 5.
3. 6.



View of motor & pump-Shahdin Park



Panel and cabling condition-Shalimar Scheme



Cabling condition-Faten Garh Dispensary



Out of order water flow meter-Maskeen Pura



Motor and pump without any shade-Gawalla Colony



Condition of motor terminal-Gawalla Colony



Tools to measure performance parameters at tube well & disposal Station.



Pressure Gauge:
Used to measure Suction & Discharge Head

Power Analyzer:
Used to Measure Amps, Voltage, Power Factor, Kvars & kilowatts

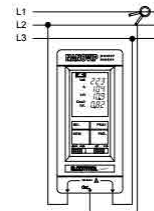

Tools to measure performance parameters at tube well & disposal Station.



Flow Meter:
Used to measure discharge and discharge velocity in the pipe.



Inputs:
Pipe Perimeter (mm)
Pipe Thickness (mm)
Liquid Type W/WW
Pipe Material (CS/PVC)
Sensors Distance (mm)
Method (V/Z)

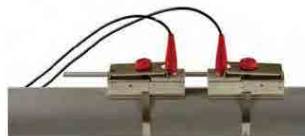

Outputs:
Flow (m3/hr)
Disc Velocity (m/s)

Rotational Speed Measurement: Tachometers



Temperature Measurement: IR Gun





Exercise

Watch Video and Rate the overall condition of Tube well station?

OJT Assignment

- **List down all the components within the tube well station**
- **Briefly explain the application of each component**
- **Measure the performance parameters of the tube well station- Performa given in Lecture Notes**
- **Perform a condition survey of the tube well station**
- **Prepare Asset Replacement Plan or O/M requirement at the tube well station**
- **Prepare a budget sheet to improve the condition of the tube well station**



Module 5 : Asset Condition Survey

Day 2



Engr. Ali Raza



Course Title: Asset Management-M4131 Lecture-01 Module 5 Asset Condition Survey



21



Review of Day 1

- 1. Present the condition survey and their results of tube well station – Group Activity**
- 2. Being in charge of the utility, prepare a basic asset management plan based on the condition survey**



Course Title: Asset Management-M4131 Lecture-01 Module 1: Asset Condition Survey



22

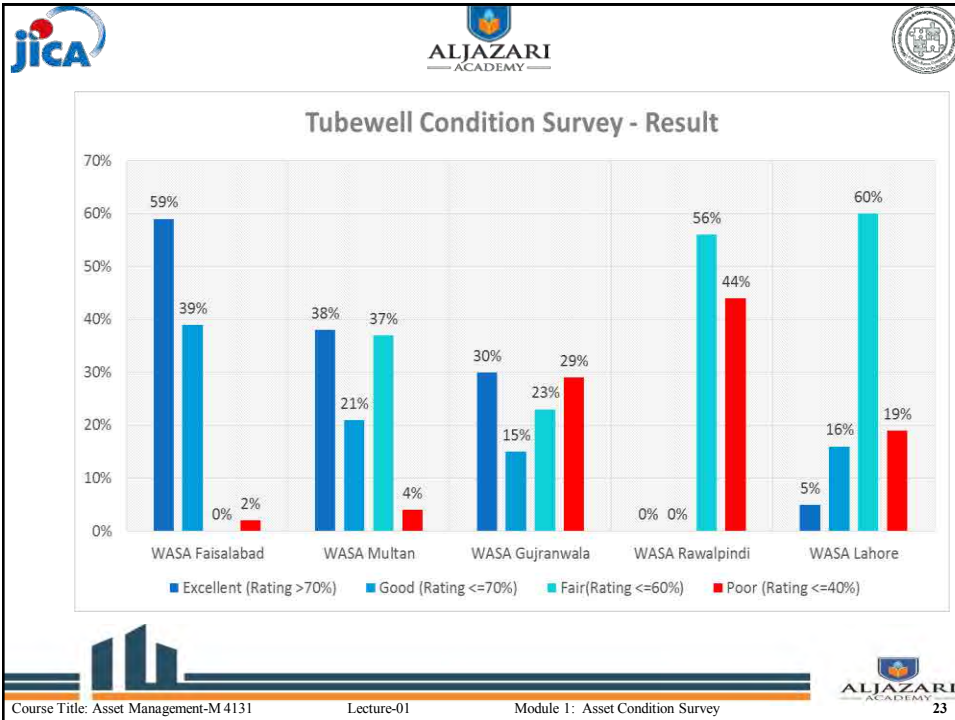

OJT Assignment- 2

- **List down all the components within the disposal station**
- **Briefly explain the application of each component**
- **Measure the performance parameters of the disposal station- Performa given in Lecture Notes**
- **Perform condition survey of the disposal station**
- **Prepare Asset Replacement Plan or O/M requirement at the tube well station**
- **Prepare a budget sheet to improve the condition of the disposal station**

Course Title: Asset Management-M4131 Lecture-01 Module 1: Asset Condition Survey



Thank You

Engr. Rao Ali Raza





Introduction to GIS & its applications in asset mapping

Nizam-ud-Din

GIS Manager, The Urban Unit

Outline

- ❖ Introduction to GIS
- ❖ GIS Data Types
- ❖ Referencing System
- ❖ Map Scale
- ❖ Introduction to Remote Sensing
- ❖ GIS applications in context to AMIS & WASA
- ❖ Case Study of All 5 WASA's & International

Introduction to GIS

What is GIS?

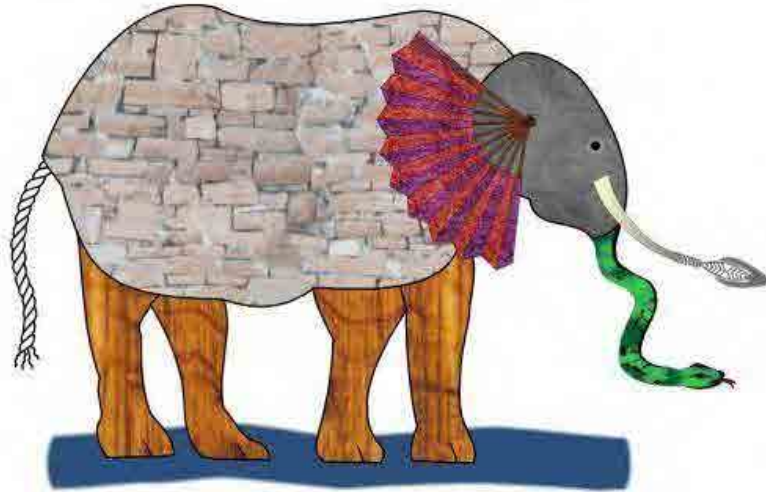

GIS for Asset Management

- ❖ GIS is a tool that can provide information regarding the asset to help answers questions.
- ❖ GIS solutions for asset management include the process for storing, managing and accessing spatial data.



Decision Maker's Problem?

- ❖ Getting the right information to make the correct decision.
- ❖ Integrating information from a variety of sources.
- ❖ Assimilating voluminous information for analysis.

Yet...

We tolerate long delays in getting the right information
and...
we are prepared to accept poor decisions made because of
lack of good information.

Governance vs Decision Making

The quality of **Governance** is directly dependent upon the quality of **Decision making** by the Government

Good Governance = **Good Decision making**

Decision Making vs Information

The Quality of **Decision Making** is directly dependent upon the quality of **Information** available with the Decision Maker

Qualities of Information

- ❖ Accurate: As far as possible
- ❖ Reliable: If shared by everyone
- ❖ Timely: when decision is being made
- ❖ Integrated: Health & Sanitation?
- ❖ Optimum level; The Pyramid model
- ❖ Adequately disseminated: Field to Policy level
- ❖ Geographically Based: The real power of GIS



Information Flow ..



How information flows in a typical government organization and how policies & decisions are made. Delay or inaccuracy in the information leads to poor policies and decisions.



Statistics have shown

Over 80% of information used by government has a spatial component i.e. information about where something is located or where something is happening.

Importance of GIS

GIS is used as **tool** for the mapping of asset because; it gives **answers** the following;

- ❖ Location: Where specific asset (pipelines, tube well etc.) is?
- ❖ Condition: Status of assets (pipelines, tube well etc.)?
- ❖ Trends: What has changed since...?
- ❖ Patterns: What spatial patterns exist?
- ❖ Modeling: What if...?

GIS Concept

- ❖ **Geographic** – 80% of government data collected is associated with some location in space
- ❖ **Information** - attributes, or the characteristics (data), can be used to symbolize and provide further insight into a given location
- ❖ **System** – a seamless operation linking the information to the geography – which requires hardware, networks, software, data, and operational procedures
 - ...not just software!
 - ...not just for making maps!

GIS-Definitions

- ❖ The common ground between information processing and the many fields using spatial analysis techniques. (Tomlinson, 1972)
- ❖ A powerful set of tools for collecting, storing, retrieving, transforming, and displaying spatial data from the real world. (Burroughs, 1986)
- ❖ A computerized database management system for the capture, storage, retrieval, analysis and display of spatial (locationally defined) data. (NCGIA, 1987)
- ❖ A decision support system involving the integration of spatially referenced data in a problem solving environment. (Cowen, 1988)

jica **ALJAZARI ACADEMY**

Components of GIS

People, organizational setting

Data, information

Procedures, rules, quality control

Tools & hardware

Software

GIS

Course Title: Asset Management-M 4131 Lecture-01 Module 6: Use of GIS Application in Asset Management **ALJAZARI ACADEMY** 15

jica **ALJAZARI ACADEMY**

GIS Process includes a complete exercise

Capture Data → **Register Map Base** → **Interpret Data** → **Convert Data to Digital Format** → **Process Data** → **Display Results**

Store Data in Computer → **Process Data**

DATA COLLECTION → **REAL WORLDS** → **DATA SOURCES** → **DATA INPUT** → **DATA STORAGE** → **DATA RETRIEVAL AND ANALYSIS** → **ANALYSIS** → **PRESENTATION FOR DECISION MAKING** → **USERS** → **DATA MANIPULATION** → **DATA COLLECTION**

1. Stand straight and extend both arms horizontally (90° angle) to shoulder height (10° forward or 10° backward) and rotate.
2. Stand with feet shoulder width apart, knees slightly bent.
3. Place right arm on right shoulder blade and rotate.
4. Stand with feet shoulder width apart and rotate trunk.
5. Stand with feet shoulder width apart and rotate trunk.
6. Stand with feet shoulder width apart and rotate trunk.
7. Stand with feet shoulder width apart and rotate trunk.
8. Stand with feet shoulder width apart and rotate trunk.
9. Stand with feet shoulder width apart and rotate trunk.
10. Stand with feet shoulder width apart and rotate trunk.
11. Stand with feet shoulder width apart and rotate trunk.
12. Stand with feet shoulder width apart and rotate trunk.
13. Stand with feet shoulder width apart and rotate trunk.
14. Stand with feet shoulder width apart and rotate trunk.
15. Stand with feet shoulder width apart and rotate trunk.

Course Title: Asset Management-M 4131 Lecture-01 Module 6: Use of GIS Application in Asset Management **ALJAZARI ACADEMY** 16

Data Sources

Remote Sensing- data from satellite sensors.

Digital Data- data from other than GIS sources for example; CAD data.

Field Survey Data- Data from GPS devices.

Maps and plans- data from conversion of hard maps and building plans

Paper files- conversion of non-spatial data from hard papers into database and linkage with spatial

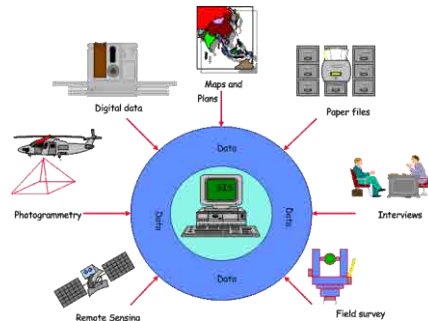

GIS Capabilities

- ❖ **Integration of data-** Non-spatial data (statistical, texts data) is integrated with spatial data features.
- ❖ **Data capture/input-** by digitizing, scanning, or direct coordinate entry, edition of data, labelling of data in the output map.
- ❖ **Management-** Linking of attribute with spatial features, linking of external databases, import and export from other than GIS format.
- ❖ **Manipulation-** make maps from different sources compatible so that they can be drawn on top of each other.
- ❖ **Spatial analysis-** deals with spatial queries and proximity analysis, geocoding and network operations.
- ❖ **Modelling-** identify or predict a process that has created or will create a certain spatial pattern, diffusion (how is the epidemic spreading in the province?), interaction (where do people migrate to?), what if scenarios (if the dam is built, how many people will be displaced?).
- ❖ **Display/output-** visualization of pattern and identification anomalies to compare information in map space and data space.

GIS Elements

- ❖ **Data Acquisition-** It consists of analog data (base maps, aerial photo, reports, etc. and digital data (satellite images, GPS data, existing database, etc.)
- ❖ **Pre-processing-** data processing before the data management.
- ❖ **Data Management-** cataloging of data in a refine format.
- ❖ **Manipulation and Analysis-** the conversion of data from different sources into GIS environment for analysis.
- ❖ **Product Generation-** final output for presentation or displaying to decision makers.

GIS Data Types

GIS Data Types

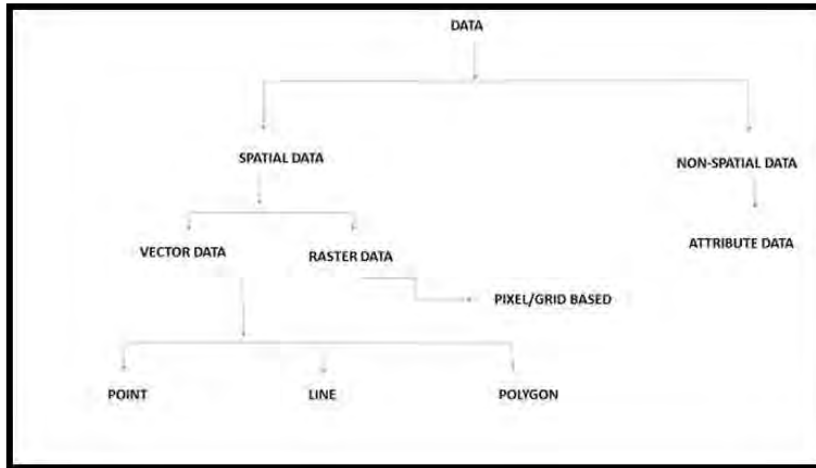

Data vs. Information

Data, by itself, generally differs from information.

- ❖ **Data** is of little use unless it is transformed into information.
- ❖ **Information** is an answer to a question based on raw data.



Vector Data

- ❖ **Point Data-** A point is a combination of two numbers (X, Y), and some time in three (x, Y, Z), z represents hieght value. The examples are; disposal station, filtration plant, mainhole, OHR, etc.
- ❖ **Line/polyline Data-** A line is the shortest distance between two points. It consists of begining and an ending point. The examples are; sewerge line, water supply line, road, stream, etc.
- ❖ **Polygon Data-** A polygon is a set of points connected by line segments that close back to the first vertex. The examples are; WASA town boundary, sub-division boundary, etc.

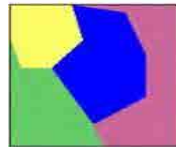
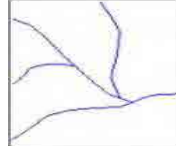
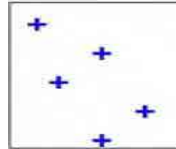

How maps portray the world?

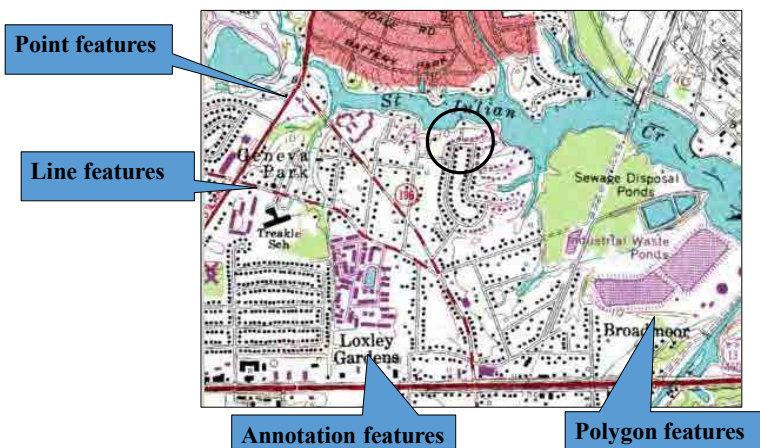

Raster Data

Raster data is comprised of discrete pixels with a value. The examples of raster data are cell based/pixel based data such as aerial photographs and Digital Elevation Model (DEM).

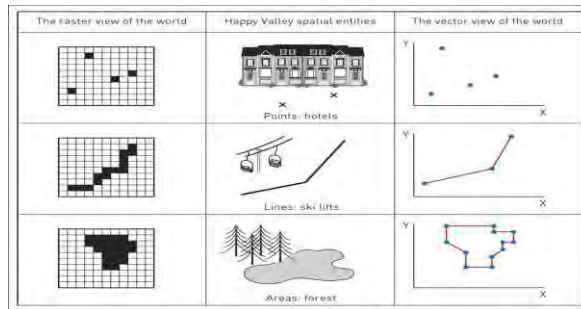

Concept of Vector and Raster

Real World

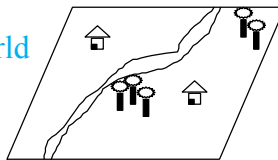

Raster Representation

	0	1	2	3	4	5	6	7	8	9
0								R	T	
1								R		T
2	H							R		
3								R		
4					R	R				
5			R							
6		R		T	T		H			
7		R		T	T					
8	R									
9	R									

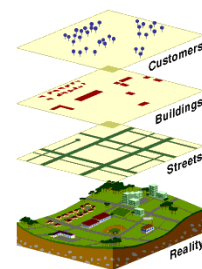
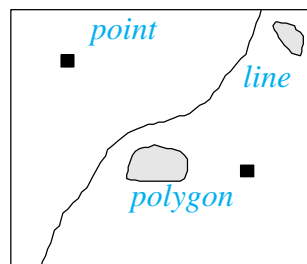

Vector Representation

Non-Spatial Data

Non-Spatial- relates to attribute data/tabular data.

Attribute values in a GIS are stated as relational database tables.

Shape *	Street Nam	Sub_Divisi	Town	Material	Age	Cond	Repl_Di	Repl	Ris
Polyline ZM	Zubair Road	Krisnan Nagar	Gunj Bakhsh To	AC	1985	C	4"x6"	3	L
Polyline ZM	Zaman Park to Nich	Shimia Hill	Gulberg Town	AC	1990	B	12"	15	H
Polyline ZM	Zatoon colony	Fateh Garh	Shalimar Town	AC	2000	B	4"	5	L
Polyline ZM	Zatoon colony	Fateh Garh	Shalimar Town	AC	2000	B	4"	5	L
Polyline ZM	Zatoon colony	Fateh Garh	Shalimar Town	AC	2000	B	8"	5	L
Polyline ZM	Zatoon colony	Fateh Garh	Shalimar Town	AC	2000	B	4"	5	L
Polyline ZM	Zatoon colony	Fateh Garh	Shalimar Town	AC	2000	B	4"	5	L
Polyline ZM	Zatoon colony	Fateh Garh	Shalimar Town	AC	2000	B	4"	5	L
Polyline ZM	Zatoon colony	Fateh Garh	Shalimar Town	AC	2000	B	4"	5	L
Polyline ZM	Zatoon colony	Fateh Garh	Shalimar Town	AC	2000	B	4"	5	L
Polyline ZM	Zatoon colony	Fateh Garh	Shalimar Town	AC	2000	B	4"	5	L
Polyline ZM	Zatoon colony	Fateh Garh	Shalimar Town	AC	2000	B	4"	5	L
Polyline ZM	Zatoon colony	Fateh Garh	Shalimar Town	AC	2000	B	4"	5	L

(0 out of 35865 Selected)

The GIS Data Model

- ❖ Data is organized by layers, coverages or themes (synonymous concepts), with each layer representing a common feature.
- ❖ Layers are integrated using explicit location on the earth's surface, thus geographic location is the organizing principal.

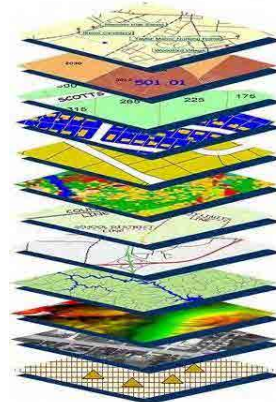

Reference System



Reference System

- ❖ a system that uses coordinates to establish position
- ❖ A **spatial reference system (SRS)** or coordinate reference system(CRS) is a coordinate-based
 - local,
 - regional or
 - global system
 - used to locate geographical entities.
- ❖ it defines a specific map projection, as well as transformations between different spatial reference systems.



Map Projection

A map projection is a **set of rules for transforming features** from the **three-dimensional** earth onto a **two-dimensional** display. No flat representation of the earth can be completely accurate, so many different projections have been developed, each suited to a particular purpose. Map projections differ in the way they handle four properties:

Area, Angles, Distance and Direction.

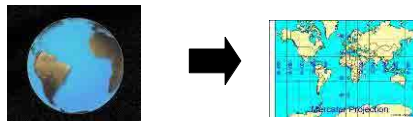

Reasons for Projection

There are many reasons for wanting to project the Earth's surface onto a plane, rather than deal with the curved surface

- ❖ The paper used to output GIS maps is flat
- ❖ Flat maps are scanned and digitized to create GIS databases
- ❖ Rasters are flat, it's impossible to create a raster on a curved surface
- ❖ The Earth has to be projected to see all of it at once
- ❖ It's much easier to measure distance on a plane

Applying a projection to a data frame is like putting on a pair of glasses



You see the map differently, but the data have not changed



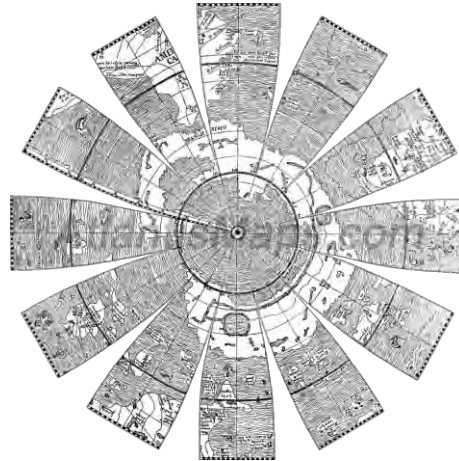

Examples of Several Projections

True Shape
(Mollweide Projection)

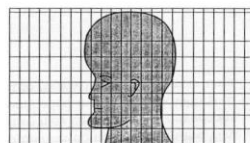
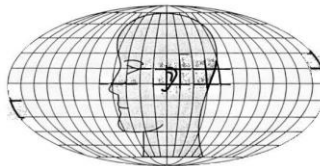

True Area
(Cylindrical equal-area Projection)

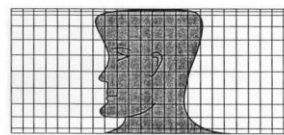

True Direction
(Mercator Projection)

Depending on the projection, a certain amount of distortion occurs when portraying the earth on paper.

Types of Coordinate Systems

Many different coordinate systems, based on a variety of datums, units, projections, and reference systems in use today

Two major different types of coordinate systems

- ❖ Geographic coordinate systems – Latitude & Longitude
- ❖ Projected coordinate systems – Metric System

Concept of Geographic Coordinate system

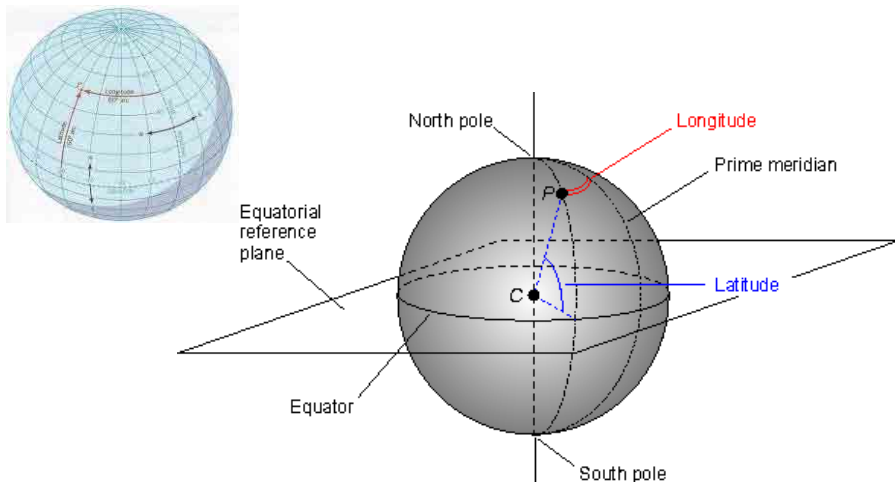

Projected Coordinate System

- ❖ **Cylindrical** - analogous to wrapping a cylinder of paper around the Earth, projecting the Earth's features onto it, and then unwrapping the cylinder
- ❖ **Conical** – analogous to wrapping a sheet of paper around the Earth in a cone
- ❖ **Azimuthal or planar** - analogous to touching the Earth with a sheet of flat paper

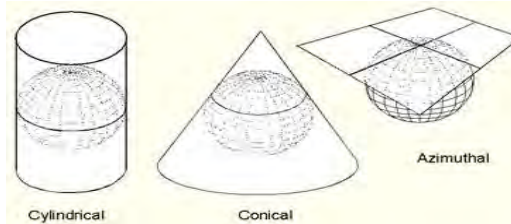

Map projections *always* introduce error and distortion

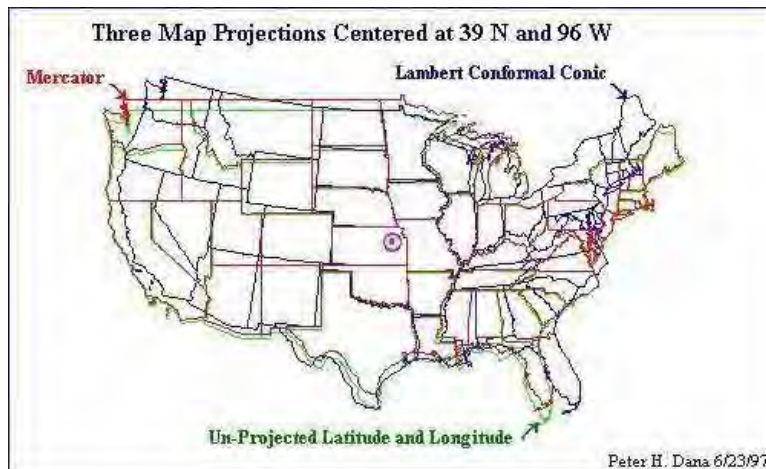

Map Scale



What is Scale?

The representative fraction is the **map distance** divided by the **ground distance** in the same units.

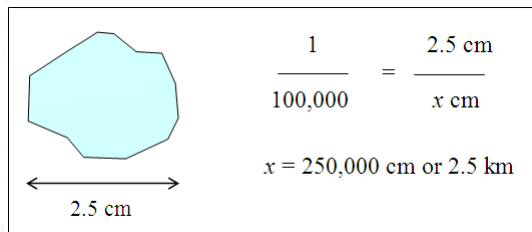
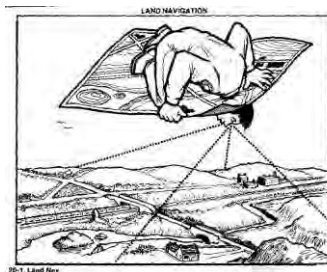

1 cm on map = 100,000 cm on ground

Types of Scales

- ❖ Representative fraction or ratio:
1:100,000 or 1/100,000

- ❖ Graphical scale:

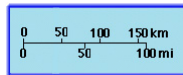

- ❖ Verbal-style scale:
1 inch in map equal to 2000 feet on the ground or
1 inch = 2000 feet

Large Scale & Small Scale

- ❖ **Large scale:**
Large representative fraction
(1:50,000 or Larger)
 - More detail
 - Covers smaller spatial area of Earth's surface
- ❖ **Intermediate Scale:**
1:50,000 to 1:250,000
- ❖ **Small Scale:**
1:250,000 to 1:7,500,000
 - Less detail
 - Covers larger spatial area of the Earth's surface

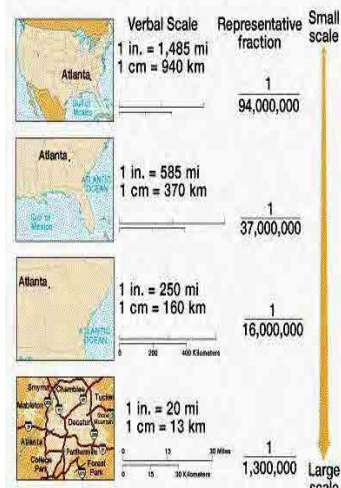

Introduction to Remote Sensing



Remote + Sensing

- ❖ Remote means; Far, inaccessible, without contact
- ❖ Sensing means; to sense, to take picture or acquire image



© CCRS / CCT

Of our five senses (sight, hearing, taste, smell, touch), three may be considered forms of "remote sensing", where the source of information is at some distance. The other two rely on direct contact with the source of information - which are they?

Definition of Remote Sensing

- ❖ Remote Sensing (RS) is a general term which describes the action of obtaining information about an object with a sensor from a distance .
- ❖ Remote Sensing is the science of **acquiring**, **processing** and **interpreting** images of the earth's surface from aircraft or satellites.
- ❖ Satellite Remote Sensing is based on the detection of reflected energy from objects on ground through different kind of sensors onboard satellites.

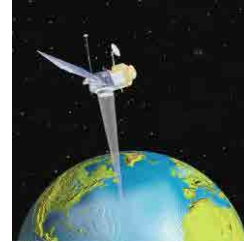

History of Remote Sensing

- ❖ Balloon photography (1858)
- ❖ Pigeon cameras (1903)
- ❖ Kite photography (1890)
- ❖ Aircraft (WWI and WWII)
- ❖ Space (1947)

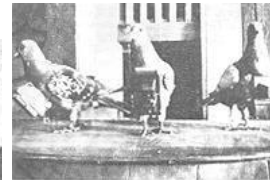

jica **ALJAZARI ACADEMY**

How it works?

Passive RS systems → A
Active RS systems → B

Receiving stations → E
Final product Application → G
Interpretation → F

A. Energy source: Passive/Active
 B. Atmosphere
 C. Target
 D. Recording devices/Sensor
 E. Transmission/reception/processing
 F. Interpretation/Analysis
 G. Application

Course Title: Asset Management-M 4131 Lecture-01 Module 6: Use of GIS Application in Asset Management **ALJAZARI ACADEMY** 49

jica **ALJAZARI ACADEMY**

Remote Sensing System

Energy Source or Illumination (A) – the first requirement for remote sensing is to have an energy source which illuminates or provides electromagnetic energy to the target of interest.

Radiation and the Atmosphere (B) – as the energy travels from its source to the target, it will come in contact with and interact with the atmosphere it passes through. This interaction may take place a second time as the energy travels.

Interaction with the Target (C) – once the energy makes its way to the target through the atmosphere, it interacts with the target depending on the properties of both the target and the radiation.

Recording of Energy by the Sensor (D) – after the energy has been scattered by, or emitted from the target, we require a sensor (remote – not in contact with the target) to collect and record the electromagnetic radiation.

Transmission, Reception, and Processing (E) – the energy recorded by the sensor has to be transmitted, often in electronic form, to a receiving and processing station where the data are processed into an image (hardcopy and/or digital).

Interpretation and Analysis (F) – the processed image is interpreted, visually and/or digitally or electronically, to extract information about the target which was illuminated.

Application (G) – the final element of the remote sensing process is achieved when we apply the information we have been able to extract from the imagery about the target in order to better understand it, reveal some new information, or assist in solving a particular problem.

© CCRS / CCT

Course Title: Asset Management-M 4131 Lecture-01 Module 6: Use of GIS Application in Asset Management **ALJAZARI ACADEMY** 50

What are Satellites?

Satellites are objects which revolve around another object - in this case, the Earth.

For example,

- ❖ the moon is a natural satellite,
- ❖ whereas man-made satellites include those platforms launched for remote sensing, communication, and telemetry (location and navigation) purposes.



Satellites' Major Types

- ❖ Anti-Satellite weapons/Killer Satellites
- ❖ Astronomical satellites
- ❖ Biosatellites satellites
- ❖ Communications satellites
- ❖ Navigational satellites
- ❖ Earth observation satellites
- ❖ Weather satellites

Remote Sensing Sensor

Sensor is the remote sensing device recording **wavelengths of energy**.

e.g. Aerial photography - the plane and the camera

Types:

There are two of Types of Sensor

- ❖ Active Sensor
- ❖ Passive Sensor

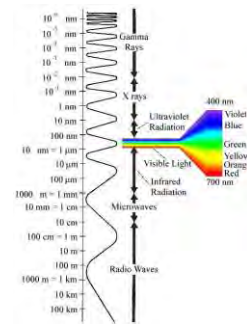
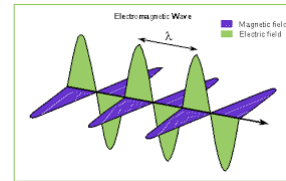

Active Sensor

- ❖ Active sensors provide their **own energy** source for illumination.
- ❖ The sensor emits radiation which is directed toward the target to be investigated.
- ❖ The radiation reflected from that target is detected and measured by the sensor

Examples of active remoter sensors:

- Radar (Radio Detection and Ranging)
- Scatter meter
- Lidar (Light Detection and Ranging)
- Laser Altimeter

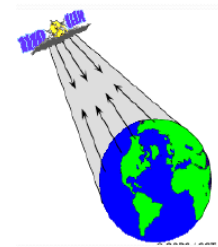

Passive Sensors

- ❖ Passive sensors detect **natural energy** that is reflected or emitted from the observed scene.
- ❖ Passive instruments sense only radiation emitted by the object being viewed or reflected by the object from a source other than the instrument

Examples of active remoter sensors:

- Radiometer
- Imaging Radiometer
- Spectrometer
- Spectroradiometer

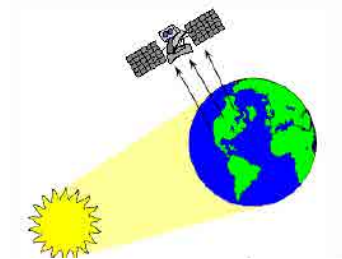

Image Resolution

Finest Information related to object.



What do you think about information?



What do you think about information?

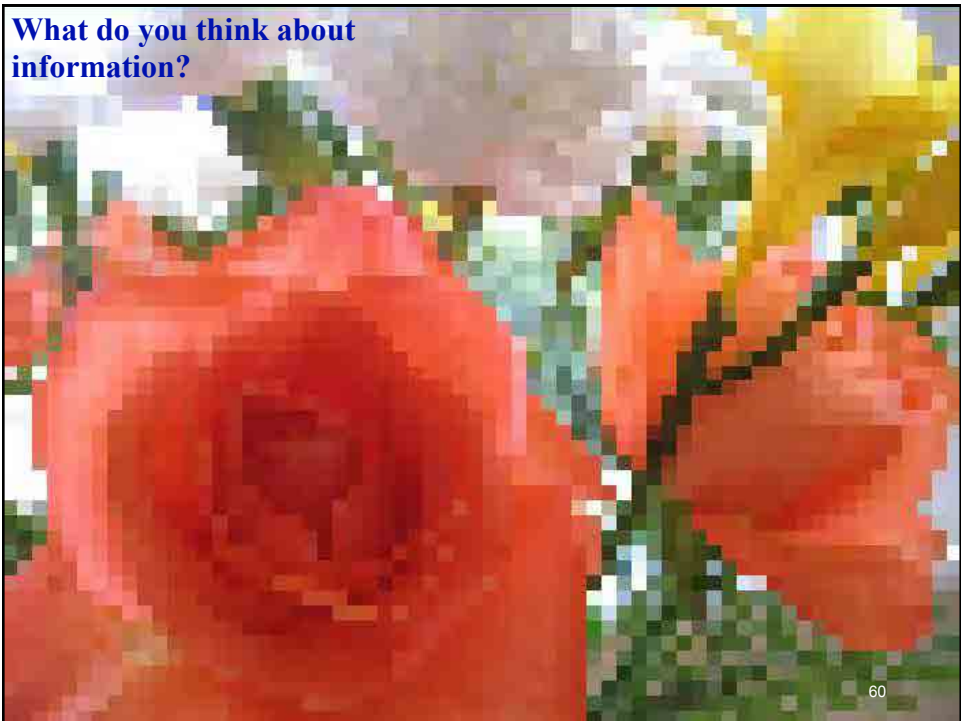

What do you think about information?



61

What do you think about information?



62

Image Resolution Types

- ❖ Spatial Resolution
- ❖ Temporal Resolution
- ❖ Spectral Resolution
- ❖ Radiometric Resolution

Spatial Resolution

The **spatial resolution** of a satellite image is based on the pixel size or picture element

Can only identify objects which are larger than the pixel size?

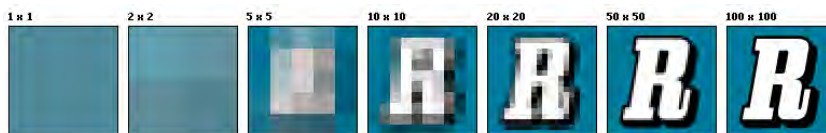

Effects of Spatial Resolution

Spatial resolution (20 m)

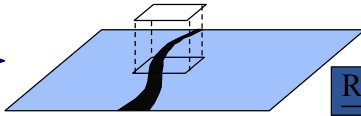
Feature detection →  **Road (8 m)**

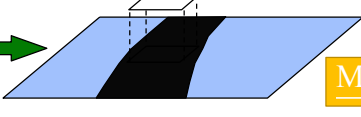
Feature identification →  **Motorway (25 m)**

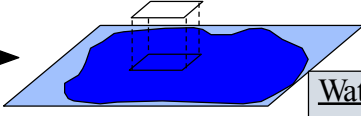
Feature analysis →  **Water body (80-200 m)**

Course Title: Asset Management-M 4131 Lecture-01 Module 6: Use of GIS Application in Asset Management ALJAZARI ACADEMY 63

A little clearer?

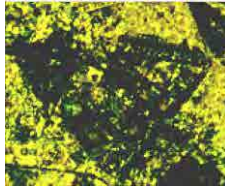
 (20 meter resolution SPOT Image)

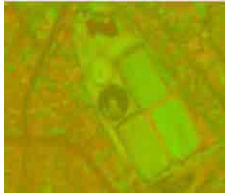
 (10 meter resolution SPOT Image)

More Clear Information

 (0.6 meter Resolution Quick-Bird Image)

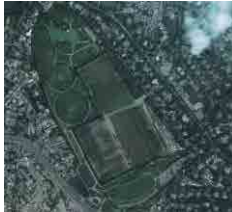
 (0.45 meter Resolution Geo-Eye Image)

Course Title: Asset Management-M 4131 Lecture-01 Module 6: Use of GIS Application in Asset Management ALJAZARI ACADEMY 64

Temporal Resolution

The time period after which the sensor revisits the same place.

Examples:

SPOT	: from 2,5 up to 26 days
IRS-1C	: from 5 up to 24 days
Landsat-7 ETM	: 16 days
NOAA	: 4 times a day

MISR has a swath width of 360 km. and images the earth once every 9 days.



MODIS has a swath width of 2,330 km. and images the earth once every 1 to 2 days.

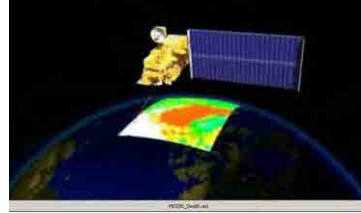

Spectral Resolution

- ❖ The number, wavelength position and width of spectral bands a sensor has.
- ❖ A **band** is a region of the EMR to which a set of detectors are sensitive.

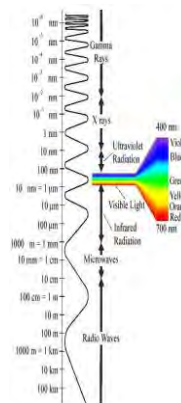
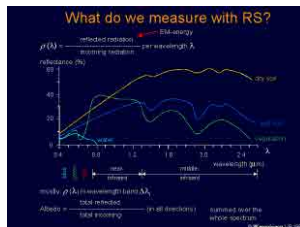

Electromagnetic Spectrum

Modes of Sensor

❖ **Panchromatic**(Black and white)- consist of single spectral bands.



❖ **Multispectral**(Colors)- consists of more than one spectral bands.



Use of Multispectral Data-True color composite

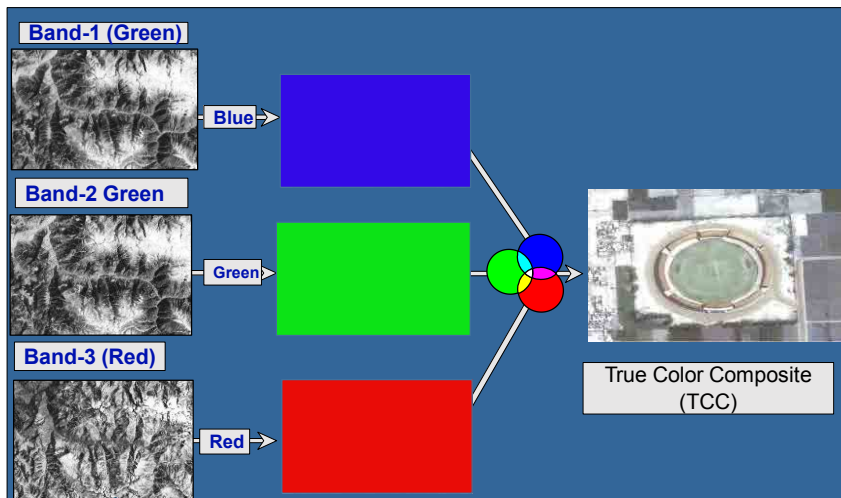

jica **ALJAZARI ACADEMY**

Use of Multispectral Data-False color composite

Band-2 (Green) → Blue → [Blue Channel]

Band-3 (Green) → Green → [Green Channel]

Band-4 (Red) → Red → [Red Channel]

False Color Composite (FCC)

Course Title: Asset Management-M 4131 Lecture-01 Module 6: Use of GIS Application in Asset Management **ALJAZARI ACADEMY** 68

jica **ALJAZARI ACADEMY**

Radiometric Resolution

It gives the **number of grey levels** within a single band data.

Reported in terms of **bits**: $n\text{-bits} = 2^n \text{ grey levels}$.

A 6-bit sensor can record 2^6 levels of brightness, or 64 levels.

A 12-bit sensor can record 2^{12} levels of brightness, or 4096 levels.

Example: Quick Bird = 11 bit data

Course Title: Asset Management-M 4131 Lecture-01 Module 6: Use of GIS Application in Asset Management **ALJAZARI ACADEMY** 69

jica **ALJAZARI ACADEMY**

Radiometric Resolution

1-bit

Course Title: Asset Management-M 4131 Lecture-01 Module 6: Use of GIS Application in Asset Management 70

ALJAZARI ACADEMY

jica **ALJAZARI ACADEMY**

Elements of Image Interpretation

Shape Size Tone Site

Texture Shadow Association Pattern

Course Title: Asset Management-M 4131 Lecture-01 Module 6: Use of GIS Application in Asset Management 71

ALJAZARI ACADEMY

Advantages & Disadvantages

Advantages of GIS

- ❖ Exploring both geographical and thematic components of data in a holistic way.
- ❖ Stresses geographical aspects of a research question.
- ❖ Allows handling and exploration of large volumes of data.
- ❖ Allows integration of data from widely disparate sources.
- ❖ Allows analysis of data to explicitly incorporate location.
- ❖ Allows a wide variety of forms of visualisation.

Limitations of GIS

- ❖ Data are expensive.
- ❖ Learning curve on GIS software can be long.
- ❖ Shows spatial relationships but does not provide absolute solutions.
- ❖ Origins in the Earth sciences and computer science. Solutions may not be appropriate for humanities research.



Thought of the day:

GIS, GPS and Remote Sensing
bring sense to censuses!

