

**REPUBLIC OF THE UNION OF MYANMAR
MINISTRY OF CONSTRUCTION
DEPARTMENT OF BRIDGE**

**DETAILED DESIGN STUDY ON
THE BAGO RIVER BRIDGE
CONSTRUCTION PROJECT**

FINAL REPORT ATTACHMENTS

VOLUME V DRAFT TENDER DOCUMENT

PACKAGE 2

Volume - III

SPECIFICATIONS

DECEMBER 2017

JAPAN INTERNATIONAL COOPERATION AGENCY (JICA)

NIPPON KOEI CO., LTD.

ORIENTAL CONSULTANTS GLOBAL CO., LTD.

METROPOLITAN EXPRESSWAY COMPANY LIMITED.

CHODAI CO., LTD.

NIPPON ENGINEERING CONSULTANTS CO., LTD.

EI
CR(3)
17-136

**REPUBLIC OF THE UNION OF MYANMAR
MINISTRY OF CONSTRUCTION
DEPARTMENT OF BRIDGE**

**DETAILED DESIGN STUDY ON
THE BAGO RIVER BRIDGE
CONSTRUCTION PROJECT**

FINAL REPORT ATTACHMENTS

VOLUME V DRAFT TENDER DOCUMENT

PACKAGE 2

Volume - III

SPECIFICATIONS

DECEMBER 2017

JAPAN INTERNATIONAL COOPERATION AGENCY (JICA)

NIPPON KOEI CO., LTD.

ORIENTAL CONSULTANTS GLOBAL CO., LTD.

METROPOLITAN EXPRESSWAY COMPANY LIMITED.

CHODAI CO., LTD.

NIPPON ENGINEERING CONSULTANTS CO., LTD.

SPECIFICATIONS

DIVISION 01	General Specification	
DIVISION 02	Site Works	
DIVISION 03	Earthworks	
DIVISION 04	Waterway Works	
DIVISION 05	Pavements	
DIVISION 06	Concrete Works	
DIVISION 07	Steelworks	
DIVISION 08	Miscellaneous	
DIVISION 09	Lighting and Electrical Works	
DIVISION 10	Toll Collection Facility	(For Package 2 Only)
DIVISION 11	Supply of Equipment	(For Package 1 Only)

Division 1
General Specifications

Table of Contents

Section 01000 - General Provisions.....	1
Section 01050 - General Works.....	4
Section 01100 – Contractor’s Mobilisation	10
Section 01110 – Temporary Facilities.....	17
Section 01150 – Contractor’s Submittals	29
Section 01200 – Contractor’s Drawings	33
Section 01300 – Programme of the Works.....	40
Section 01400 – Monthly Progress Reports	43
Section 01500 – Project Safety	46
Section 01600 – Maintenance and Control of Traffic	57
Section 01650 – Navigation Control and Safety Works on River (Package 1 and Package 2 only).....	67
Section 01700 - Environmental Management.....	76
Section 01750 - Laboratory and Equipment.....	85
Section 01800 – Contractor’s Quality Control	90
Section 01900 - Control of Materials	100
Section 01920 –Prevention of HIV/AIDS	106
Section 01950 – Soil Investigation.....	109
Section 01960 – Control of Material.....	111

Section 01000 - General Provisions

1. Description

The “General Specifications” shall be applied complementarily to the Conditions of Contract and other Contract Documents.

Notwithstanding any approval, consent, agreement, acceptance, assent, concurrence or similar act by the Engineer (including absence of disapproval) as may be given in these Specifications shall not relieve the Contractor from any responsibility he has under the Contract, including responsibility for errors, omissions, discrepancies and non-compliances. Oral approval, consent, agreement, acceptance, assent, concurrence, instructions or similar act of the Engineer shall be authorized only through a written document.

1.1 Abbreviations

In addition to the “Definitions and Interpretations” shown in Clause 1 of the Conditions of Contract, the following abbreviations used in the Specifications shall be interpreted as follows:

AASHTO	American Association of State Highway and Transportation Officials
ACI	American Concrete Institute
ANSI	American National Standards Institute
ASME	American Society of Mechanical Engineers
ASTM	American Society for Testing and Materials
AC or A/C	Asphalt Concrete
AWS	American Welding Society
BS	British Standard
BOQ or BQ	Bill of Quantities
CBR	California Bearing Ratio
CPM	Critical Path Method
CSI	Construction Standards Institute
Dia. dia. or Ø	Diameter
FHWA	Federal Highway Administration, USA
HV	High Voltage
IRI	International Roughness Index
ISO	International Organization for Standardization
JIS	Japan Industrial Standards
JRA	Japan Road Association
LV	Low Voltage
Max., max.	Maximum
Min., min.	Minimum
MOECAF	Ministry of Environmental Conservation and Forestry, Myanmar
MUTCD	Manual on Uniform Traffic Control Devices, FHWA
No.	Number
OSHA	Occupational Safety and Health Administration
PC or PrsC	Prestressed Concrete
PCC	Portland Cement Concrete
PCI	Precast/Prestressed Concrete Institute, USA
PrcC	Precast Concrete
PTI	Post-Tensioning Institute, USA

PVC	Polyvinyl Chloride
QA	Quality Assurance
QC	Quality Control
QCP	Quality Control Plan
RC	Reinforced Concrete
SI	International System of Units

1.2 Units of Measurement

Unless otherwise stated in these Specifications, all units of measurement used herein and in the Bill of Quantities and Rates and Unit Prices are expressed in the standard metric system. Abbreviations of Units used in the Specifications are as follows:

°C	degrees Celsius
°F	degrees Fahrenheit
cm	Centimetre(s)
Gr	Gram
G/m ³	Grams per cubic meter
Ha	Hectare
HP or Hp	Horsepower
Hz	Hertz (Cycles per Second)
Kg	Kilogram
Kg/cm ²	Kilogram per square centimetre
Kg/cm ³	Kilogram per cubic centimetre
Kg/m ²	Kilogram per square meter
Kg/m ³	Kilogram per cubic meter
Km	Kilometre
Km/h	Kilometre per hour
L or lt	Litter
lm or m	Linear Meter
m ² or sq. m	Square meter
m ³ or cu.m	Cubic meter
Mm	Millimetre(s)
mm ²	Square millimetre
MPa	Mega Pascal
m/s	Meter per second
Mg/L	Milligram per litre
N	Newton
N/mm ²	Newton per square millimetre
rpm	Revolutions per minute
ppm	Percent per million
sq. cm or cm ²	Square centimetre(s)
sq. m or m ²	Square meter(s)
T, t or ton	Metric ton (1000 kg)
USD, US\$ or \$	United States Dollar
MMK	Myanmar Kyat
JPY or ¥	Japanese Yen

2. Requirements

2.1 Applicable Standards

- (a) The latest, at the date of the contract signed, versions of AASHTO, ACI, ANSI, ASTM, FHWA, AWS, BS JIS and JRA etc. are applied and codes used in technical matters shall prevail in the Specifications. If there are any discrepancies in the requirements and statements in the Specifications, the clarifications and/or the decisions made by the Engineer in accordance with Sub-Clause 3.5 of the Conditions of Contract shall prevail in any case of discrepancy, ambiguity, or contradiction.
- (b) Unless otherwise stipulated in the Specifications or the Drawings, the standards, codes described in the materials, acceptance tolerance, measurement, or payment methods, etc. as provided by or on behalf of the Employer, the Engineer shall advise the Contractor the appropriate measures to arrive at solutions in light of the duties set out in Sub-Clause 3.5 of the Conditions of Contract.
- (c) If the Contractor's proposed materials are produced in compliance with standards other than those specified above, then the Contractor shall submit, not less than 28 days before the intended use, for the Engineer's review and prior approval, a detailed construction statement including drawings and engineering data, documentation including cross reference that the proposed standards of his materials are at least comparable to those specified in the Specifications, and in compliance with equivalent standards which are internationally recognized.

2.2 Requirements Classification

Work is paid either directly or indirectly according to each respective section of Work as specified in Subsection "Measurement and Payment" of the respective section.

The requirements established in this Specification Section are classified into the following payment modes:

Indirectly Paid Work:	The items or requirements established or described in these Specifications but not listed as specified pay items in the Bill of Quantities, are deemed inherently included in or distributed among rates and prices in the Bill of Quantities. Separate payment shall not be made for these items and claims by the Contractor shall not be considered.
Directly Paid Work:	The requirements for those items for which a separate payment will be made based on the quantities measured and accepted in accordance with this Specification Section.

Section 01050 - General Works

1. Description

This section consists of the Works classified as “Indirectly Paid Works”.

2. Requirements

2.1 Materials, Equipment, and Plants

2.1.1 Delivery Schedule

- (a) No later than thirty (30) days after issuance of the Letter of Acceptance, the Contractor shall prepare and submit to the Engineer the list of delivery schedules for each essential material/equipment, whether of a temporary or permanent nature, required in execution, completion and remedying of defects of the Works. The list shall show the target order dates, shipping, and receiving dates and quantities of each required material/equipment.
- (b) The Contractor shall update the list as necessary when preparing the programme, or as may be instructed by the Engineer.

2.1.2. Receiving, Handling, and Delivery

- (a) All equipment, component parts, tools, and spare parts shall be suitably protected and/or packaged against damage or deterioration during transit to, and storage in, the construction site and/or temporary storage yard in Myanmar.
- (b) Painted surfaces of steel products shall be protected against impact, abrasion, discoloration, and other damages.
- (c) Grease and lubricating oil shall be applied to all bearings and similar items.
- (d) Articles subject to damage or deterioration shall be repaired or replaced by the Contractor at no expense to the Employer.
- (e) The Contractor shall provide required information concerning the shipment and delivery. This requirement also applies to any sub-supplier making direct shipments to the Site or to any port of entry in Myanmar.
- (f) The project name, name of the Contractor, and the name of the Employer must be clearly indicated on the air waybill or bill of lading.

2.1.3. Storage

- (a) Storage Facilities: The Contractor shall provide and maintain storage facilities within the limits of the Site. The Contractor shall submit to the Engineer for review the complete details of the type of temporary storage facilities proposed in his mobilisation schedule.
- (b) Storage Procedure:
 - Stacked items shall be suitably protected from damage by using spacers or load distributing supports that are safely arranged.

- No metal materials (steel plates, steel sheet piling, reinforcing steel bars, etc.) shall be stored directly on the ground.
- Bulk cement shall be stored in silos or bulk cement container cars shutting out moisture.
- Packed cement shall be stored in container boxes to keep it from moisture, and the Contractor shall check the quality of cement before usage.
- Pipe fittings and valves may be stored outdoors but must be placed on wooden blocking and be protected from weather.
- PC tendons, sheath, and related parts shall be kept in a warehouse in the manner specified by the manufacturers.
- PVC pipe, geotextile membranes, plastic liner, and other plastic materials shall be stored off the ground on pallets and protected from direct sunlight.
- Pumps, motors, electrical equipment, and all equipment with antifriction or sleeve bearings shall be stored in weather-tight structures. Electrical equipment controls, and insulation shall be protected against moisture and water damage.
- Equipment with moving parts, such as gears, bearings, and seals, shall be stored and fully lubricated with oil, grease, etc., unless otherwise instructed by the manufacturer. The Contractor shall carefully follow the manufacturer's storage instructions.
- Off-site storage arrangements shall be notified to the Engineer for all materials and equipment. Such off-site storage arrangements shall be presented in writing, and shall provide an adequate and satisfactory security and protection.

2.1.4. Loads Restriction

- (a) Comply with legal load restrictions when hauling material and equipment on public roads and bridges to and from the project. A special permit does not relieve the Contractor of liability for damage resulting from the moving of material or equipment.

Unless otherwise permitted, do not operate equipment or vehicles that exceed the legal load limits over new or existing structures, or pavements within the project; except those pavements to be removed during the same construction season.

- (b) Special Loads

In the preparation of the "Traffic Control Plan" specified in Section 01600, where special loads necessitate the strengthening, altering, protecting, and/or improving of any bridge, culvert or road, the Contractor shall provide the Engineer the complete details of the Contractor's intended procedure.

- (c) The abovementioned details shall include the following:

- Details of the Construction Plant, Plant and/or Temporary Works to be moved, including the total weight of load;
- The proposed date and time of such movement;
- The starting location and destination;

- The proposed route;
- The bridge(s), culvert(s) and/or road(s) which require(s) strengthening, altering, protecting, and/or improving;
- Full details of any such strengthening, altering, protecting and/or improving, including all necessary design calculations;
- Traffic safety measures while the load is in transit; and
- Evidence that the Contractor has liaised with, and obtained all necessary permissions, permits, licence and the like from, all appropriate authorities.

2.2 Project Meetings

The Engineer shall chair all project meetings and take minutes of meetings. He shall deliver copy of the minutes to the Employer and the Contractor after obtaining ratifications from both the parties.

2.2.1. Pre-construction Conference

- (a) A Pre-construction Conference shall be held at a time and place designated by the Employer, prior to the Commencement Date.
- (b) The conference shall be attended by:
 - Employer's representative
 - Engineer's representative
 - Contractor's project manager
 - Contractor's general superintendent
 - Contractor's project engineer
 - Contractor's quality control manager
 - Contractor's safety representative
 - Government representatives, as appropriate
 - Stakeholders or others, as requested by the Employer, the Engineer, or the Contractor
- (c) The Contractor shall provide and explain the following in the meeting:
 - Contractor's organization.
 - The construction programme and respective schedule by CPM.
 - The schedule of values for progress and disbursement schedule for payment purposes
 - The schedule of Contractor's Documents and other submittals
 - The Safety and Health Management Plan
- (d) The Engineer will, in advance, advise the full agenda of the conference meeting, will preside it, and will arrange the keeping and distribution of the minutes of meeting to all attendants.

2.2.2. Regular Meetings

- (a) The Engineer shall schedule and hold meetings regularly, monthly, weekly and at any time as required by the Engineer or the Contractor. The Contractor shall provide sufficient documents and/or materials listed below to the Engineer for organizing such meetings.

Meetings	Documents to be provided by the Contractor
Monthly Progress Meeting	<ul style="list-style-type: none"> - Monthly and accumulated progress of the Works - Planned schedule until the completion of the Works - Quality issues, if any - Safety issues, if any - Environmental issues, if any - Countermeasures, if any - Minutes of Meeting
Weekly Quality Meeting	<ul style="list-style-type: none"> - Quality Test Results of last week - Planned Quality Test of this week and next week - Quality issues, if any - Minutes of Meeting
Monthly Safety Meeting (after Safety Patrol by the Employer, Engineer and Contractor)	<ul style="list-style-type: none"> - Safety Patrol (monthly) results - Safety issues, if any - Countermeasures, if any - Minutes of Meeting

- (b) The purpose of the meeting is to improve aspects related to coordination, and to review the progress of the Works, monitor all programmes, plans, and schedules for the Works, submittals, quality control, etc.
- (c) The meetings shall be held also to prepare, update, and monitor the problems, or potential problems, that are affecting or could affect the Project.
- (d) The Engineer will preside in the meetings and take care of keeping and distributing the respective minutes.
- (e) The Contractor's Project Manager, Quality Control Manager, Safety Officer, Scheduler, and other key personnel as required by the Engineer, or as necessary for the presentation of relevant information and data, shall attend the progress meetings.

2.2.3. Meetings with Institutions and Entities Concerned

- (a) The Contractor shall provide sufficient support to the Engineer for preparing and holding periodic meetings as well as coordination and reporting to all the Project's stakeholders concerned.
- (b) The pertinence and necessity of these meetings will be determined by the Engineer at his own discretion.

2.3 Insurance and warranty

- (a) These requirements shall be read and applied accordingly, and without detriment, to the requirements and provisions of Clause 18 "Insurance" of the Conditions of Contract.
- (b) The Contractor shall provide an evidence of insurance policies prior to the start of the Works.
- (c) With each application for Interim Payment Certificate under Sub-Clause 14.3 of the Conditions of Contract, the Contractor shall submit evidence consisting of receipts of payment or other verification as approved by the Employer that insurance policies are in effect.

- (d) The Contractor shall be responsible for all the costs for the warranty period of the Works in accordance with the related provisions of the Conditions of Contract.

2.4 Protection of Works

- (a) The Contractor shall carefully protect all works and materials from injury caused by the weather, or by other external action. In the event work defects or injuries are detected, these shall be repaired in a manner acceptable to the Engineer or replaced at the Contractor's expense, unless such costs of repair or replacement is not recoverable through the insurance policy referred to in Sub-Clause 18.2 of the Conditions of Contract.
- (b) Prior to placing facilities in any area, all clearing and grubbing operations shall be done to the satisfaction of the Engineer. The ground elevation of all temporary facilities shall be 20 cm at a minimum above the adjacent existing ground. The surface shall be sloped to allow rainwater to drain completely.

2.5 Protection of Utilities and Existing Structures

- (a) Before commencing the construction work, the Contractor shall undertake a survey to establish the detailed location of all utilities affected by the Works. Survey results shall be recorded in the plan form to the satisfaction of the Engineer and surface pegs fixed on the Site shall be required to indicate the location of all underground utilities. These pegs shall remain for the duration of the Contract.
- (b) Where Works are to be undertaken by the Contractor in the vicinity of the utilities, the Contractor shall provide adequate protective devices and take precautionary measures.
- (c) The Contractor shall be responsible for locating all existing structures prior to the start of construction.
- (d) The Contractor shall maintain all existing fences until completion of the Works. They shall not be relocated or dismantled, until written permission is obtained from the fence owner.
- (e) Damage to Existing Property:

The Contractor shall be responsible for damage caused by any construction activities of the Works to public and private properties such as the streets, roads, railroads, curbs, sidewalks, highways, shoulders, ditches, embankments, culverts, bridges, or other public or private facilities.

Unless the Contractor could otherwise show reasonable justification, any damage to such properties shall be deemed to be caused by the transport of Contractor's equipment, materials, or people to or from the Site.

The Contractor shall repair or replace any damaged structures, works, materials, or equipment to the satisfaction of the Engineer, and at no additional cost to the Employer.

2.6 Maintenance of Existing Waterway

- (a) The Contractor shall take all necessary measures to remove water, including ground water flows from the area of his work when necessary, and/or as required by the Engineer, to allow satisfactory execution of the works in progress or for the protection of completed works.
- (b) The Contractor shall maintain all the existing drainage and irrigation channels entering, crossing, or affecting the works that should be relocated or protected. This shall include

the cleaning of upstream and downstream to an extent of 100 m beyond the construction limits and the Right-of-Way, and other works as may be required by the Engineer,.

2.7 Temporary Installations

(a) Temporary Power: Temporary power consists of the following:

Construction Operations:

- The Contractor shall provide installations of power supply from approved and available power sub-stations.
- The Contractor shall provide all electrical power needed for the operation of the plant and equipment, or for any other use.
- If the power source is available, the Contractor shall arrange with the utility company to use such source and pay for the services required for power supply and lighting.

(b) Other Temporary Installations:

- External Lighting: Suitable external lighting shall be provided at the entrance of all buildings.
- Maintenance: During the performance of the Works, the Contractor shall maintain all temporary facilities in a suitable manner to the satisfaction of the Engineer.
- Removal: Upon completion of the Works, or as otherwise directed by the Engineer, all plant, temporary facilities, and encumbrances used for the Works shall be removed, the area has to be properly cleaned and repaired and, if necessary, the property owner shall be paid.

(c) Removal: Upon completion of the Works, the Contractor shall remove from the Site all construction plant and equipment provided by the Contractor, any subcontractor, or supplier.

(d) Employer not Liable for Damage to the Plant: The Employer shall not at any time be liable for the loss or damage to any of the construction plants and equipment provided by the Contractor or any subcontractor or supplier.

3. Measurement and Payment

The work herein defined as “Indirectly Paid Work” shall neither be measured nor paid separately, and shall be deemed included in the rates and prices of other main items, or distributed among all pay items listed in the Bill of Quantities.

Section 01100 – Contractor’s Mobilisation

1. Description

This work consists of moving personnel, equipment, material, and incidentals to the project and performing work necessary before beginning work at the project site. This work also includes obtaining permits, insurance, and bonds.

2. Requirements

2.1 Mobilisation schedule

- (a) The Contractor shall submit to the Engineer, for his review and comments, a detailed mobilisation schedule.
- (b) The mobilisation schedule shall include a schedule noting the anticipated arrival of all construction equipment and facilities as well as the arrival of all key personnel of the Contractor and subcontractors.
- (c) The mobilisation schedule shall include a layout plan noting the location, size, and arrangement of all temporary facilities, including security fencing, entrance and exit gates, sewage and water lines and systems, electrical supply, and access and facility roads.
- (d) The Contractor shall complete the construction of all temporary facilities and the mobilisation of all key personnel, equipment, and plant not later than one hundred twenty (120) days after the Commencement Date. This 120 days period will be referred to as the mobilisation period which will be established as a milestone specified in Specification Section 01300.

2.2 Mobilisation of Employer’s Professionals and General Staffs

- (a) The Contractor is required to enter into an agreement with the Employer in respect of a technology transfer programme in compliance with Sub-Clause 4.25 of the Conditions of Contract.
- (b) Upon entering into the agreement, the Contractor is required to work in harmonious manner with the Employer’s professionals and general staffs with the main aim to promote transfer of the bridge construction technology, except for patent-protected technology.

2.3 Superintendents and Assistants

- (a) The Contractor shall mobilize and deploy all the key staff as required in the Bidding Documents, Conditions of Contract, and the Specifications.
- (b) The Contractor shall not remove his staff, such as Project Manager, Deputy Project Manager and other key position, from the Site without the express written permission of the Engineer. Within fourteen (14) days of any such removal, or notice of intent of removal, the Contractor shall nominate a replacement staff for the Engineer’s prior consent.

2.4 Land for Construction Purposes, Detours, Plant, and Other Uses

- (a) The Employer provides effective access to and possession of the Site including Right of Way mentioned in the reference drawings in the Bidding Documents and temporary yard for construction mentioned in the supplementary information in the Volume V of the Bidding Documents shall be provided by the Employer prior to commencement of the site works.

- (b) In case that the Contractor acquires additional working areas or any additional areas required for construction purposes and access or other uses, as stipulated in the Specifications, the Contractor shall follow below procedures:
- 1) Before entering the work site, the Contractor shall give a written notice to the Engineer. The Contractor shall give separate notices to each owner and occupier or authority having jurisdiction over the work sites.
 - 2) Before entering any additional work areas, the Contractor shall obtain, and forward to the Engineer, a copy of the written consent of the owner and occupier or authority having jurisdiction over the land, and shall state the purposes for which such land is to be used. The Contractor shall define the extent and period of occupation for which such consent is granted.
 - 3) The Contractor shall select, arrange for and, if necessary, pay for the use of sites for construction purposes, detours, plant, and other uses necessary for the execution of the Works.
 - 4) Before using any land belonging to the government or to a private landowner for any purpose in connection with the execution of the Works, the Contractor shall obtain the Engineer's prior consent for such use.
 - 5) If any utility passing through the temporary site is affected by the Works, the Contractor, at his own expense, shall provide an appropriate plan for re-alignment or relocation of such utility in full working order to the satisfaction of the owner of the utility and the Engineer, before cutting or removing or relocating the existing utility.
- (c) Upon completion of the Contract, or earlier if so directed by the Engineer, all plant, temporary facilities and any other encumbrances shall be removed, the site and land use areas shall be properly cleaned, all damages shall be repaired, and, if necessary, the landowner shall be paid for the use of land.

2.5 Construction Equipment and Plant

All construction plant and equipment provided by the Contractor shall, when brought to the Site, be deemed to be exclusively intended for the construction and completion of the Works, and the Contractor shall not remove the same or any part thereof without the consent of the Engineer.

2.6 Contractor's Site Office, Sheds, Stores, and Living Quarters

Unless otherwise provided by the Employer within the Site, the Contractor shall obtain, at his risk and cost, any additional rights of way or facilities outside the Site which he may require for the purpose of the Works.

2.7 Contractor's Workshop and Warehouse

The Contractor shall have a suitable workshop in the Site, adequately equipped and provided with utilities, to allow for repairs of the equipment employed to carry out the Works. He shall also provide a warehouse for the equipment spare parts, mainly for the parts that frequently fail or are difficult to procure. A chief foreman qualified for mechanical repairs, with an adequate labour force shall be assigned for management and operation of the workshop.

2.8 Subsidiary Requirements for Contractor's Facilities

2.8.1. Access Roads

The Contractor shall construct and maintain suitable entry and exit roads to, from, and around all temporary installations.

2.8.2. Project Information Signs

Within the mobilisation period, the Contractor shall erect project information signs at locations as required by the Engineer. The size and material of the project information signs and the message thereon, and style of lettering and colour, shall be determined by the Engineer. The Contractor shall maintain the signs and remove them upon completion of the Works.

2.8.3. Security Fencing

The Contractor shall obtain a written permission to install Security Fencing from the related person and/or authorities prior to installation of security fencing. Security fencing with at least three (3) strands of barbed wire shall be constructed around all temporary facilities. Fencing shall be at least 1.8 meters high and provided with lockable gates at each entry and exit point.

2.8.4. Temporary Lighting for all Buildings at Site

- (a) The Contractor shall provide temporary lighting for all buildings at the Site, to protect the Works and maintain suitable working conditions. Temporary lighting shall be maintained until the Employer has accepted the Works.
- (b) The Contractor shall provide and install circuit and branch wiring with area distribution boxes so that power and lighting are available throughout the construction site.
- (c) Generators with suitable capacity shall be furnished by the Contractor in cases of power supply cut-off.

2.8.5. Sanitary Facilities

The Contractor shall furnish temporary sanitary facilities at the Site, as provided herein, for the needs of all construction workers and others performing works or furnishing services to the Project. Sanitary facilities shall have reasonable capacity, be properly maintained until it receives the Taking-Over Certificate, and obscured from public view to the greatest practical extent. If chemically treated-type toilets are used, at least one such toilet shall be furnished for every twenty (20) people. The Contractor shall enforce the use of such sanitary facilities by all personnel at the Site.

2.8.6. Water

- (a) All water required for and in connection with the equipment and plant, devices, dust control, for settling of backfill material or for any other use as may be required for proper completion of the Works, shall be provided by, and at the expense of, the Contractor.
- (b) The Contractor shall provide sufficient supply of bottled drinking water from an acceptable source to all of the Contractor's employees, including all necessary devices for keeping the water in good condition (hot and cold water).

2.8.7. Sewage system

All sanitary facilities shall be connected to a suitable sewage system.

2.8.8. Communication System

The Contractor shall provide internet, wireless phone, or landline telephone services of the latest available technology to the Contractor's office. Pay bills from the service provider by the payment due date. Make all necessary arrangements and pay all installation and usage charges for the communication system in his office at the Site.

2.8.9. Contractor's Weigh-House and Scale

- (a) The Contractor shall provide a weigh-house and acceptable scales or other weighing devices for weighing a truck axle, which shall be part of the Construction Plant.
- (b) Scale platform shall have a sufficient length to permit simultaneous weighing of all axle loads of each hauling vehicle.
- (c) Each weighing device shall be calibrated every six (6) months.
- (d) Calibrated results shall be submitted to the Engineer as per the Engineer's request.
- (e) Standard scales, certified or owned by a responsible local authority, may be used subject to consent of the Engineer.
- (f) Truck platform scales for weighing bituminous products shall be equipped with automatic printing devices to record time and weight, and one copy of each weight ticket shall be kept by the Engineer after each weight measurement.

2.9 Filling-In Holes and Trenches

The Contractor, upon completion of any part of the Works, shall immediately, at no additional cost, fill up all holes and trenches that he may have dug or excavated and are no longer required for the Project, or shall carry out such relevant work as required by the Engineer, and he shall clear away all rubbish and materials that are no longer required for the execution of the Works. All costs related to this requirement shall be deemed included in the Contractor's Unit Prices for the applicable work.

2.10 Engineer's Inspection Boats (only Package 1 and Package 2)

The work shall cover providing inspection boats for exclusive use by the Engineer. The Contractor shall provide new boats as required below:

- Package 1 Contractor: Two (2) Speed Boats for 6 passengers (outboard engine 85 HP)
- Package 2 Contractor: Two (2) Speed Boats for 6 passengers (outboard engine 85 HP)

2.10.1 Conditions for Requirements

The provision of boats shall include the following conditions:

- (a) The provision of boats (deck shall be covered by non-slip sheets) shall include life-jackets and other items required under relevant regulations and a full-time boatman for each boat, having license.
- (b) All registrations and license plates shall be obtained and provided by the Contractor.
- (c) The Contractor shall take out an insurance policy to cover full personnel compensation of death and medical for boatmen, passengers and third parties to the accidents in respect to the boats supplied by the Contractor, which shall be maintained until issue of the Taking-over Certificate.

- (d) The makers and models of the boats as well as boatmen and insurance policy shall be approved by the Engineer before providing the boats.
- (e) The two (2) boats shall be mobilized prior to commencement of the works on the Bago River.

2.10.2 Maintenance and Management

The boats provided as above shall be maintained day and night in smooth running condition as required by the Engineer until the issue of the Taking-over Certificate. All expenses required for maintenance and management such as fuel, lubricant and other consumables, necessary services, repairs, replacement and mooring facilities, etc. shall be borne by the Contractor.

2.10.4 Own-ship during construction and after Taking-over Certificate

All the boats provided by the Contractor under the Contract shall be the property of the Contractor during construction and after the issue of the Taking-over Certificate.

2.10.5 Measurement and Payment

The measurement for the payment for the provision of the boats shall be made on lump sum, which shall be inclusive of Section 01100 –Contractor’s Mobilization.

2.11 Engineer’s Personnel Protective Equipment (PPE)

2.11.1 Description

With understanding of the Engineer’s responsibility as well as the Employer’s in relation to the management of safety of construction site, the Contractor shall provide the Personnel Protective Equipment (PPE) for exclusive use of the Engineer and the Employer.

2.11.2 Requirements

The Contractor shall provide the PPE to the Engineer as well as the Employer as requested. The PPE will protect the user’s health and safety risks at work. It includes items such as safety helmets, gloves, eye protection, high-visibility clothing, safety foot wear and safety harnesses. Required quantities to be provided by the Contractor are as follows:

Items to be provided by the Contractor	unit	Quantities
Safety Helmet	Each	30
Gloves	Sets	30
Safety Foot Wear (Shoes)	Pairs	30
Eye Protection	Sets	30
High-Visibility Clothing	Each	30
Safety Harnesses	Each	30
Raincoat	Each	30

Note: PPE mentioned above shall be provided prior to commencement of the site works.

2.11.3 Measurement and Payment

The measurement for the payment for the provision of the PPE items above shall be inclusive of lump sum of Section 01100- Contractor’s Mobilization.

3. Measurement and Payment for Contractor’s Mobilisation

3.1 Method of Measurement for Mobilisation

Mobilisation shall not be measured, but shall be paid in a lump sum. All items shall be deemed to be included in the Contractor's tendered prices and no separate payment will be made thereof.

However, payment to the Contractor for an amount payable to a nominated Subcontractor will be made in accordance with Sub-Clauses 5.3, 5.4 and 13.5 of the Conditions of Contract.

3.2 Basis of Payment

Payment for mobilisation shall include:

- (a) Transport of construction plant or any additional equipment or plant required, from the port of entry in Myanmar to the sites and their installation;
- (b) The supply, installation, and maintenance of the Contractor's vehicles, living quarters, offices, laboratories, workshops, stores, communication system, facilities and Engineer's laboratory and equipment.
- (c) Such other items as expressly stated in this Specification;
- (d) Dismantling of the work site by the Contractor, with the removal of all the installations, constructional plant and equipment, so that the site is restored to its original state before the installations or placing of equipment; and
- (e) Protection and restoration of land acquisition marks and right-of-way (ROW), which were already handed over to the Contractor.
- (f) All Works including the costs of all incidental works necessary to comply satisfactorily with the requirements of this Specification Section.

Payment shall be made on a lump sum basis with the following instalments:

Twenty percent (20%) upon completion of the Contractor's Site offices, laboratory and Engineer's equipment and mobilisation schedule and acceptance by the Engineer.

Fifty percent (50%) during the execution of the Works split in partial payments in proportion to the work progress subject to certification of achievement issued by the Engineer.

Thirty percent (30%) upon issuance of the Taking-Over Certificate.

No additional payment shall be made for any additional mobilisation of personnel, plant, equipment, and materials.

The Pay Items and Pay Unites shall be as follows;

<u>Pay Item</u>	<u>Description</u>	<u>Unit</u>
01100-01	Mobilisation	Lump Sum

4. Measurement and Payment for Project Information Signs

4.1 Method of Measurement for Project Information Signs

Project Information Signs shall be measured as the number of signs, satisfactorily provided and installed and accepted by the Engineer and maintained throughout the Contract period, and the removal satisfactorily carried out and accepted by the Engineer.

4.2 Basis of Payment

Payment for Project Information Signs shall be made at the stated unit per sign. The price shall be full compensation for all materials and labour required to perform the work described.

The Pay Items and Pay Unites shall be as follows;

<u>Pay Item</u>	<u>Description</u>	<u>Unit</u>
01100-02	Project Information Signs	Number

5. Payment for the Employer's Professionals and General Staffs

5.1 Basis of Payment

Unless a method of payment to the Employer is specifically provided otherwise, payment to the Employer's general staffs will be made on a monthly per capita basis in accordance with the schedule of rate agreed between the Contractor and the Employer.

The Employer shall be responsible for payment to its professionals. However, the Contractor shall be responsible for payment of any overtime payment and related charges arising from overtime payment.

The pay Items and Pay Unites shall be as follows;

<u>Pay Item</u>	<u>Description</u>	<u>Unit</u>
01100-03	Payment to the Employer's General Staffs	Provisional Sum

Section 01110 – Temporary Facilities

1. Description

1.1 General

This work shall consist of all labour, materials, equipment, delivery, construction and removal of temporary facilities that are generally designed and constructed by the Contractor in the execution of the Works, and whose failure to perform properly could adversely affect the character of the Contract Works or endanger the safety of adjacent facilities, properties, or the public.

Unless otherwise specified, the furnished information, Plans and Drawings in the Contract Documents are for general information only.

The Contractor shall constitute the acknowledgement that he is relying on his own examination of (a) the site of the Works, (b) the access to the Site, and (c) all other data necessary for the fulfilment of the Works.

1.2 Scope of work

This section describes requirement for temporary facilities as follows:

- (a) Temporary roads
 - Entrance access roads
 - Site access roads
- (b) Temporary site compounds
 - Filling for Site compounds,
 - Contractor's office and temporary facilities such as warehouse, motor-pool, repair shop, re-assembling yard and etc.
- (c) Temporary Dredging Work
 - Dredged temporary access to the construction site in the river and hauling
 - Dumping areas
- (d) Temporary jetties
 - Temporary jetties for loading and unloading
- (e) Temporary navigation marker buoys for the existing navigation channel
- (f) Water connection and power connection
- (g) Temporary cutoff wall for temporary site compound or road construction
 - Temporary cutoff wall for Thaketa side
 - Temporary cutoff wall for Thanlyin side

The other temporary facilities related to the structures such as formwork and falsework for concrete structure, erection girders, and span-by-span short line equipment, are described in Division 6.

The Works shall consist of:

Design, supply, fabrication, installation, maintenance, and removal of temporary works, including, but not limited to: access roads, site access roads, temporary bridges, site compounds, dredging temporary channel, steel jetty, navigation and marker buoys;

Mobilization and demobilization of equipment and materials required for the said Works; and Site restoration.

2. Requirements

2.1 Reference Standard

Temporary works shall comply with these related Specifications and referenced standards of latest issues.

2.2 Submittals

The Contractor shall submit the followings to the Engineer for his review

- (a) Detailed design notes and Shop Drawings for captioned temporary works shall be submitted. Specific temporary works requiring Shop Drawings will be identified in the Specifications. The design shall be in accordance with the requirements of this Specification and the requirements shown in the Drawings.
- (b) Proof that the above noted temporary works have been constructed in accordance with the Specifications.
- (c) Proposed supplier(s) and location of quarry(ies) and borrow area intended for supplying rockfill and/or soil materials for access roads, site work roads, and site yards.

2.3 Materials

The Contractor shall be responsible for the supply, safe storage, and handling of all materials associated with these Works.

2.4 General requirements

- (a) Temporary works, as described above, shall be designed to support all anticipated loads. The temporary works shall be designed and constructed such that the Works can be properly constructed as required by the Specifications, Drawings and Special Provisions. Sufficient clearances shall be provided by the temporary works to permit all required construction activities to proceed without any hindrance.
- (b) The Contractor shall construct the temporary works in accordance with the Shop Drawings. Variations in the construction will not be permitted, unless such variations are accepted by the Engineer, and the Contractor provides revised Shop Drawings.
- (c) Care shall be taken not to damage any portion of the permanent work. Damage to the permanent work during installation or removal of the temporary works shall be repaired by the Contractor at his own cost to the satisfaction of the Engineer.
- (d) Temporary works shall be in accordance with the environmental and regulatory requirements, and to the satisfaction of the Engineer.

3. Temporary Road and Site Compound

3.1 General

- (a) The temporary roads such as entrance access roads, site access roads, and temporary site compounds are to be re-designed by the Contractor, considering that the project site consists of various conditions of soil strengths, roughly estimated as very soft to soft, medium, stiff and very stiff to hard, including wet land and the location of bridges over the seashore. A sample option is shown in the Drawings for information.
- (b) The temporary roads shall be maintained by the Contractor's own cost.
- (c) If temporary roads and site compounds are proposed to be changed or added, the Contractor shall submit proposed alternative locations as part of the Site Plan submission.
- (d) Public roads shall not be used as site access roads. These roads can be used as haul roads in accordance with the General Conditions.
- (e) The Contractor shall not disturb the channel and embankment slopes beyond the limits (right-of-way) shown in the Drawings unless he has obtained a written permission from the Engineer. Such written permission shall be granted only if it can be shown conclusively that there is no alternative to cutting the banks or slopes beyond the limits shown in the Drawings. If permission is granted, the Contractor shall be responsible for restoring the banks and slopes to the profile and compaction shown in the Drawings or as directed by the Engineer at his own expense.
- (f) Temporary filling material required for embankment of the site compound at level of 4.300m and site work roads may be permitted, subject to the approval of the Engineer. Any erosion and sedimentation control devices (for example, silt fence or sand bag) deemed necessary by the Engineer to protect the temporary stockpile area shall be supplied, installed, maintained, and removed at the Contractor's own expense.
- (g) The Contractor is responsible for all topsoil removal within the limits of the work. Temporary stockpiling of cleared soil may be permitted at locations and to dimensions acceptable to the Engineer. All procedures for temporary stockpiling of soil shall consider the requirements for temporary sediment and erosion control measures, sightlines for the travelling public, and embankment slope stability, if applicable.
- (h) The Contractor shall return all entrance access roads, site access roads, and site compounds outside the ROW to pre-construction conditions upon or before completion of the Works to the satisfaction of the Engineer. If the Engineer issues instruction to the Contractor to retain the temporary facilities, the facilities should be left in good and stable condition.

3.2 Payment

Temporary road and site compound are treated as part of temporary facility, so payment shall be made in lump sum basis as shown in the BOQ.

4. Temporary Water Cutoff

4.1 General

- (a) This section specifies the materials and workmanship required for temporary water cutoff comprised of sheet piles, struts, and walls. These temporary works are required in order to accomplish the site compounds or temporary roads. The sheet piles shall be driven up to a sufficient depth for the stabilization.

- (b) The Contractor shall be fully responsible for the stability of the soil during construction and shall provide his own measures to establish stability. These works shall only commence once the method statement, drawings, and calculations have been accepted by the Engineer.
- (c) If other temporary water cutoff other than sheet pile is proposed, the Contractor shall submit the proposed water cutoff system in accordance with the authorized standards, for the Engineer's approval.

4.2 Method Statement For temporary water cutoff with sheet piles and others

The Contractor shall submit a detailed method statement for sheet piles and support system. It shall include details of the following:

- Design calculations for sheet piles and support system;
- Method of installation for sheet piles and support system;
- Equipment to be used;
- Sequence of embankment; and
- Drawings with details of the proposed support system.

4.3 Sheet Piling

- (a) Sheet piles shall be of the interlocking type and of a suitable class for the particular location.
- (b) Each pile shall be in one length throughout but if required, may be extended by welding on an additional length subject to the acceptance of the Engineer. All welding shall be done by a certified welder.
- (c) The Contractor shall minimize noise and vibration during installation of sheet piles.
- (d) The packing between the sheet piles and walls shall be made of concrete or steel.

4.4 Payments

Sheet piles are treated as parts of the temporary site access road, so payment shall be made in lump sum basis as shown in the Bill of Quantities (BOQ).

5. Temporary Dredging Work

5.1 General

- (a) The Works consists of the excavation of the riverbed to open a temporary access channel to construction sites in case that marine equipment could not approach due to shallow riverbed or as may be planned by the Contractor.

5.2 Dumping Area

- (a) Prior to the commencement of the Works, the Contractor shall confirm the availability and right of use of the dumping areas to the Engineer.
- (b) The Contractor shall minimize the dumping area used; this means that the second dumping area shall be used only if the first dumping area will be occupied.

5.3 Construction Programme

Prior to commencement of the dredging works, the Contractor shall submit to the Engineer, his detailed sequence and method of dredging the area, and provision for traffic maintenance. In preparing the methodology, focus shall be given on the manner and sequence of dredging the channel and disposing of dredge spoil without unnecessary obstructions of waterborne traffic along the dredging and disposal areas.

5.4 Survey and Setting Out

Prior to commencing dredging work, the Contractor shall carry out sounding of the mandatory areas to be dredged. Sounding shall be carried out jointly with the Engineer using proper equipment.

5.5 Safety of Work

- (a) As safety precaution, the area to be dredged shall be marked with buoys which shall light at night to identify the limits of the dredging operation and to preclude vessel/ship intrusion into the area.
- (b) The Contractor shall maintain waterborne traffic along the dredged channel as part of the dredging works at all times to avoid obstruction to traffic.
- (c) The Contractor shall be deemed to have satisfied himself as to the nature and location of the Works, general and local conditions particularly those pertaining to traffic and the sub-soil conditions along the area.
- (d) The Contractor shall comply with all local and national safety regulations particularly on navigation and operation of Contractor's vessels and floating equipment.

5.6 Equipment Required

5.6.1 Operating Condition

- (a) The Contractor shall, at all times during the progress of the Works, provide, operate, and maintain in proper working condition all floating and other equipment of adequate capacities and amounts required for the expeditious and proper execution.
- (b) The equipment shall include, but not be limited to, dredgers, hoppers, barges, tugs, launches, boats, buoys, moorings, surveying and sounding instruments, tools, implements, and tackles. The Contractor, without the written approval of the Engineer, shall not demobilize the Contractor's Equipment.

5.6.2 Contractor's Responsibility for his Equipment

- (a) The Contractor shall be solely responsible for the suitability, safety, and security of all Contractor's Equipment and shall take all precautions to ensure that the same is fully secured and maintained in safe condition as long as may be necessary to protect it against risks of damage by wind or wave action or other causes.
- (b) Approval by the Engineer of the Contractor's Equipment shall not relieve the Contractor from any of his responsibilities for the sufficiency of the same or from any of his other responsibilities and obligations under the Contract.
- (c) If any of the equipment provided by the Contractor is found to be unfit for the execution of the Works, the Contractor shall provide replacement equipment which is appropriate and necessary for the Works when directed by the Engineer.

5.7 Execution

- (a) Dredging shall be conducted by trailing suction hopper dredge or any approved dredge equipment. For trimming work, mounted grab on barge may be used or any other approved equipment.
- (b) Dredging shall commence from upstream going downstream.
- (c) Dredged spoils shall be disposed into the offing at a location as proposed area by the Contractors. The Contractor is however required to obtain properly any permit, licences or approvals in compliance with the requirements under Sub-Clause 2.2 of the Conditions of Contract.
- (d) The Contractor shall keep a record of dumping time and dumping point with GPS in every disposal of dredged spoil at the Site.
- (e) The Contractor shall maintain the elevation of the disposed spoil until the Taking-Over of the Works.

5.8 Materials Removed from the Riverbed

Everything dredged from the Site of the Works or removed from the riverbed of the Works shall remain the property of the Employer, but shall remain in the custody of the Contractor until it is discharged or dumped at the approved dumping site or otherwise placed as directed by the Engineer. The Contractor shall obtain necessary permit, licences or approvals in accordance with Sub-Clause 2.2 of the Conditions of Contract.

5.9 Pollution control measures

- (a) The Contractor shall undertake the necessary measurements to determine the occurrence of any adverse environmental consequences. In case any of the above is encountered, anti-pollution control measures including the provision of net to contain the dispersion shall be provided by the Contractor at his own cost as part of incidental expenses to the dredging activities.

5.10 Payments

- (a) Dredging is treated as part of the temporary site access road, so payment shall be made in lump sum base as shown in the BOQ.

6. Steel Temporary Jetty

6.1 Description

The work includes furnishing of all labour, materials, and equipment required for performing all operations in the fabrication, installation, dismantle and removal of structural steel jetty, steel coping and portal, bolts and other miscellaneous connection works as designed by the Contractor. A typical example is shown in the Drawings for information.

6.2 Material requirements

6.2.1 Reference Standards

Materials for steel structure, unless otherwise required by other Specification sections or the Drawings, shall be in accordance with the following standards:

- Japan Industrial Standards (JIS) Publication

- Japan Steel Structural Association (JSS) Publication
- AASHTO
- ASTM
- SSPC - Steel Structures Painting Council (U.S.A)

6.2.2 Materials

(a) General

All materials shall be of free from surface imperfections and shall conform to the applicable JIS standard or approved equal. Unless otherwise specified, steel materials shall conform to JIS or JRA standards.

(b) Structural Steel

Materials shall conform to the requirements hereinafter specified. Connections in which details are not indicated shall be designed in accordance with the JIS or approved equivalent latest edition, and shall be welded or bolted, except as shown otherwise.

Materials and parts necessary to complete each item, even though such work is not definitely shown or specified, shall be included. Miscellaneous bolts and anchors, supports, braces and connections necessary for completion of the works shall be provided.

Structural steel shall be furnished according to the following specifications. The grades of steel to be furnished shall be as specified in the Drawings.

All steel shall conform to the following standards or approved equivalent and shall be supplied in the grades as shown in the Drawings.

SS400 : JIS G3101

SM400A, SM400B, SM400C: JIS G3106

SM490YA, SM490YB: JIS G3106

SM520C : JIS G3106

SMA570W: JIS G3114

SPA-H: JIS G3125

SM400C-H : JRA Part II

SMA570W-H : JRA Part II

(c) Other metal works

Fabrication of other metalwork shall conform to the material sizes and dimensions shown in the Drawings, and installation thereof shall be as indicated in the said Drawings and these Specifications, or as directed by the Engineer.

Tests are required under the JIS for steel to be used in the Works and shall be carried out in the presence of the Engineer.

(d) High Strength Bolts

High strength bolts for structural steel shall conform to JIS B 1186 and JRA Standard, Sets of Torque-Shear Type High Strength Hexagon Bolt, Hexagon Nut and Plain Washers for Friction Grip Joint or shall conform to JIS B 1186 and JRA standard (corrosion resistant).

Sets of high strength bolt, hexagon bolt, hexagon nut and plain washers for friction grip joint shall conform to JIS B 1186 (corrosion resistant).

(e) Torque Control Bolts

Torque control bolts for structural steel shall conform to JSS II 09-1981 and JRA.

(f) Shear Studs

The steel grade, type, size, and tolerance of shear studs shall conform to JIS B 1198, Headed Stud or its equivalent.

6.3 Tolerances

- (a) The Contractor shall, through appropriate planning and continuous measurements in the workshop and at the construction site ensure that the tolerances given in the Specifications are strictly observed. The Engineer will require any specific working procedure changed in case such procedure appears to have no sufficient security against exceeding the tolerances.
- (b) The Contractor shall be fully responsible for the calculation and provision of the necessary camber in the pre-assembled elements to obtain the correct levels in the completed bridge, duly considering the applied erection procedure and the sequence in the installation of the various dead load components.

6.4 Submittal

6.4.1 Working Drawings

- (a) The Contractor shall submit working drawings, including structure calculation sheet relating to the actual site conditions, for the whole of the steelwork to the Engineer for his review. All working drawings shall show full detailed dimensions, sizes, and cambers for all component parts of the structure. The size and extent of all welds shall be clearly shown in the shop drawings such that the work can be fabricated from these drawings without reference to the design drawings.
- (b) The required grade of steel for each individual fabrication shall be clearly indicated. All working drawings shall show the method of construction, spacing of bolts, welding, sectional areas, and other details necessary for the Works. Bolted or welded construction may be employed subject to approval, soundness, and neatness of design. Where welds are used, either at the shop or on site, it shall wherever possible, be continuous around the joint to ensure that the joints are completely sealed against corrosion.
- (c) The details of connections in the working drawings shall be such as to minimize formation of pockets to hold condensation, water or dirt and a minimum gap between abutting angles and the like shall be provided wherever possible to eliminate any traps and facilitate maintenance painting.
- (d) The Contractor shall be responsible for all errors of detailing, fabrications and correct fitting for all structural members.

6.4.2 Erection Procedures

- (a) The Contractor shall submit a program of work and methodology to illustrate steel erection and temporary staying and bracing, and to give clarification on data submitted. These submittals shall include details of storage and handling of steel materials, camber control, geometric control, site connections, cutting, welding, bolted connection, site assembly, test, erection equipment, crane way, and assembling yard preparation.
- (b) The Contractor shall also submit the details of welding equipment and the welder's license for the approval of the Engineer. Whatever erection method is proposed, the Contractor shall provide, for prior approval of the Engineer, a detailed statement of his proposed methods for assembly, movement, and erection of girder units. The statement shall include, but not be limited to, the following:

Program for assembly of the main beam and cross beam units for jetty

Details of the proposed assembly methods

Layout and details of the assembly yard and its equipment

Methods for fabricating, including temporary supports (or bracing) to steelworks

6.4.3 Proof for Materials

Manufacturer's certificates shall always be submitted to the Engineer for his approval. The Contractor shall also submit the following test results as a proof that the materials to be used will comply with the requirements of these Specifications.

- (a) Reports of Ladle Analysis for Steel

Mill test reports for main members

Fabricator's certificate for secondary members

- (b) Certificate of Conformance on the following items:

Structural steel tubing

Steel bar grating

Filler metals for welding

- (c) Reports of Mechanical Tests for High Strength Bolts and Standard Bolts

6.4.4 Manufacturer's Literature

The Contractor shall provide to the Engineer copies of the manufacturer's literature describing the structural steel and type of welding and/or arc shields used.

6.5 Construction requirements

6.5.1 Organization

To ensure consistent high quality, the Contractor shall employ only qualified engineers and personnel experienced in the techniques of steel jetty construction to supervise these works. The Contractor shall submit to the Engineer full details of qualifications of the personnel he proposes

to supervise these works, together with the description of their duties down to the level of the foremen.

6.5.2 Handling and Storing Material

- (a) Material to be stored at the job site shall be placed on skids above the ground. The underlying ground shall be kept free from vegetation and shall be properly drained. The material shall be kept clean and shall be properly drained. Beams and decks shall be placed upright and shall be shored.
- (b) The Contractor shall be responsible for the loss of any material, for which he has been paid, while it is in his care, or for any damage, resulting from his work. The loading, transporting and unloading of structural steelwork shall be so conducted that the steel will be kept free from injury and rough handling.

6.5.3 Qualification

(a) Steel Fabricator

The steel fabricator shall have experience in fabrication of structural steel for projects of similar type. A fabricator's shop shall have suitable space for temporary shop assembly. The Contractor shall submit a written description of fabrication capability including facilities, personnel, and list of similar completed projects, including testing and quality control capability and specifically the type and extent of quality control procedure, which the fabricator intends to employ on this Project.

(b) Steel Erector

The steel erector shall have experience in the erection of structural steel structures of similar size to the proposed structure. The Contractor shall submit a written description of its structural steel erection capability including equipment, personnel, geometric control applications, and a list of completed projects.

(c) Qualified Welder and Welding Procedures

The Contractor shall submit for Engineer's approval the welding procedure, welder's qualification, and the test results of each type of welding to be performed.

Procedures shall be developed for welding all metals included in the works. The Contractor shall not start welding works until procedures, welders and trackers have been qualified as specified herein. The Contractor shall perform qualification testing by an approved testing laboratory, or by the Contractor's laboratory, if approved by the Engineer. Cost of such testing shall be borne by the Contractor.

The Contractor shall qualify each welder and tracker assigned to work on this Project by test using equipment, positions, procedures, base metal and electrodes that will be encountered in his assignment. The Contractor shall furnish to the Engineer for approval a certification that each welder is qualified in accordance with the requirements of JIS Z 3801 and/or JIS Z3841 or approved standard. The welder shall have successful past experience with similar weld types or approved equal.

6.5.4 Welding

(a) General

Unless otherwise specified in this Specification, welded components shall comply with JRA Part II or approved equivalent.

Before the work is started, the welding procedure for each type of joint shall be approved by the Engineer. The welding procedure prepared by the Contractor shall include such welds and tests to satisfy the requirement of JRA Part II.

(b) Welding Plan

Prior to the start of fabrication, a Welding Plan shall be prepared and submitted to the Engineer for review. The plan shall be prepared, signed by a suitably qualified professional engineer, having significant past experience with similar projects, and shall include the following information:

(c) Equipment

The welding machine shall be of modern type and with ample capacity to provide the required current to each welding point without appreciable fluctuations. Welding machine to be used shall be Carbon Gas Arc Semi-automatic Welding Machine, and Alternating Current Arc Welding Machine, or approved equal machine. All shop/site welds shall be carried out by qualified welders under proper supervision. The work shall be properly prepared for welding and the correct sequence shall be adhered to at all times.

(d) Welding Material

All arc-welding electrodes shall conform to the requirements of JIS Standards or approved equivalent.

6.5.5 Fabrication

(a) General

The Contractor shall fabricate the structural steel in the shop to the greatest extent possible for the appropriate transportation purpose, taking into consideration the requirements in the Drawings.

Bolted or welded connection shall be provided whether constructed at the shop or in the field as shown in the Drawings, or as approved by the Engineer. High strength bolts for all bolted connections shall be used unless otherwise shown in the Drawings or approved by the Engineer.

Connections shall be as shown in the Drawings or as approved by the Engineer. Holes except bolt holes shall be cut, drilled or punched at right angles to the surface of the metal and shall not be made or enlarged by burning.

The tolerance shall not exceed those shown in the Drawings and each unit assembled shall be closely checked to ensure that all necessary clearances have been provided and that binding does not occur in any moving part.

In order to maintain accurate finished dimensions and shape, appropriate reverse strain or restraints shall be provided as required.

Assembly and disassembly work shall be performed in the presence of the Supervisor of the Contractor, unless waived in writing by the Engineer. Any error or defect disclosed shall be immediately remedied by the Contractor.

Before disassembly for shipment, each piece of the structure shall be match-marked to facilitate erection in the field.

(b) Straightening

All material before being assembled, shall be straightened or conformed to the specified configuration by methods specified below.

Straightening or bending of either fabricated or un-fabricated steel, if necessary, shall be done by means of steady pressure applied by roll or press. Straightening and bending shall not be done by hammering or, unless the Engineer's approval has been obtained by heating. If straightening by heating is allowed, the steel shall in no case be heated to a higher temperature than 9000 e as measured by indicating crayons, liquids, or bimetal thermometers. After heating, the metal shall be cooled slowly in air without any forced cooling.

(c) Holes of Bolts

All holes shall be drilled. Punching of holes shall not be permitted. Reamed and fitted holes shall be sub-drilled 3 mm less in diameter than that of the finished holes and reamed to size.

Reamed and fitted holes and drilled holes shall be made through steel templates or after assembly or by other approved means, to ensure complete matching between the plies of the joints.

6.5.6 Payment

- (a) Temporary jetty is treated as part of temporary facility, so payment shall be made in lump sum basis as shown in the BOQ.

7. Water Connection and Power Connection

7.1 General

The work consists of commission to Yangon City Development Committee (YCDC) for water supply and Yangon Electricity Supply Corporation (YESC) for providing connection of water (300 m³/day) and electric power (500 kVA) for the construction works.

Electricity back-up system by generator with fuel or other appropriate devices (voltage stabilizer etc.) shall be provided taking into consideration the occurrences of electricity power failure and unstable voltage in Yangon.

Water and power connections are treated as part of temporary site compound, so payment shall be included in pay item 01110-02 Temporary Site Compound as shown in the BOQ.

8. Measurement and Payment

8.1 Basic of payment

Payment shall be made in Lump Sum Basis. The Contractor shall submit the breakdown of each lump sum showing quantities and amount for the Engineer's justification.

The payment shall be inclusive of all necessary labour, equipment, and materials needed to complete specified works. The payment shall also include coordination with local authorities and all necessary requirements, permits and fees required by authorities.

The Pay Items and Pay Unites shall be as follows;

<u>Pay Item</u>	<u>Description</u>	<u>Unit</u>
01110-01	Temporary Site Compounds	Lump Sum

Section 01150 – Contractor’s Submittals

1. Description

This Specification Section prescribes the form and contents of the documents or materials for the Works that shall be submitted to the Engineer for review and comments, or for testing in accordance with the requirements in the Specifications.

2. Requirements

2.1 Submittals Classification and List

The submittals established are classified, and listed up, into the following types:

(a) Directly Paid Submittals, including all related submittals, are listed below:

Item	Specified Section in the Specifications
As-Built-Drawings	01200 “Contractor’s Drawings”

A separate payment for the submittals shall be made in accordance with this Specification Section.

(b) Indirectly Paid Submittals, including all related documents, records and reports, and materials, are listed below:

Item	Specified Section in the Specifications
Contractor’s mobilisation schedule	01100 “Contractor’s Mobilisation”
Maintenance and Protection Programme of Traffic	01600 “Maintenance and Protection of Traffic”

A separate payment shall not be made for submittals. They shall be included in the rates and prices for the relevant main items, or distributed among all the pay items listed in the Bill of Quantities.

(c) Inherently Paid Work:

Item	Specified Section in the Specifications
Programme, Schedule, Cash Flow	01300 “Programme of Works”
Construction Photographs and Video Recording	01150 “Contractor’s Submittals”
Contractor’s Safety Plan	01500 “Project Safety”
Monthly Progress Report	01400 “Monthly Progress Reports”
Traffic Control Plan	01400 “Monthly Progress Reports”
Environmental Control Plan	01700 “Environmental Control and Protection”
Environmental Monitoring Report	01700 “Environmental Control and Protection”
All the forms, records and reports, technical documents, instruments and equipment’s catalogues and reference guides (when required by the Engineer), lists and inventories	01750 “Laboratory and Engineer’s Equipment”
Quality Control Plan	01800 “Contractor’s Quality Control”
Quality Control Reports	01800 “Contractor’s Quality Control”

Monitoring Schedule for Work Acceptance	01850 "Acceptance of Work"
Schedule of Materials	01900 "Control of Materials"

The prices for the submittals that may be essentially required under the Contract, but are not specifically described in the Specifications or in the Bill of Quantities, shall be deemed included in or distributed among the rates and prices of the pay items in the Bill of Quantities; Separate payment shall not be made for these submittals, and claims based on the same shall be rejected.

2.2 Requirements for the Contractor' Submittals

These requirements shall be applied complementarily to the submittals specified in the Conditions of Contract.

All the submittals specified in each Section of these Specifications to be made by the Contractor shall be submitted at the specified time.

All submittals specified in these Specifications shall be provided in hard copies with editable electronic files recorded on the software or applications acceptable to the Engineer and the Employer. The standard submission requirements are:

Latest edition of all standards, regulations, guidelines, specifications, technical papers, monographs, catalogues, and other technical documents required	1 copy
Drawings (Size A3)	3copies
Technical Documents (Size A4 or A3)	3 copies
Schedule of Works (Size A4 or A3)	3 copies
Technical Manuals and/or Guidelines (If required)	3 copies
Technical Manuals – CD ROM (If required)	1 copy

2.3 Construction Photographs and Video Recording

2.3.1. Photographs

The Contractor shall take construction photographs by using digital cameras with an automatic setting on the records of the date-month-year, as described below:

Items	Time To Shoot a Photo	Submission Time
Photographs at intervals of no more than 50 meters or other intervals as agreed by the Engineer along the route of the Works	Each month throughout the Works before the commencement of the work	With monthly report or as otherwise required by the Engineer
Photographs of each entire site, all the structure sites, or pertinent features		
The same views from same points as above	Upon completion of all construction activities	With the Contractor's application for final payment

- (a) Photographs shall be consistent with the number of photographs to be specified by the Engineer.
- (b) The Contractor shall supply both "hard" and computerized copies of photographs as required by the Engineer. The Contractor shall provide the necessary software to the Engineer for computerized storage, editing, and reproduction of photographs.

- (c) Each photograph shall have suitable captions.

2.3.2 Video Recording

- (a) The Contractor shall keep a video recording of the construction progress and salient features of the Project. Upon completion of the Works, the record shall be edited and compiled, based on the following specifications:

Video System:	DVD
Recording Time	90 minutes
Language:	Both in Myanmar and English versions
Copies:	Five (5) for each version
Subjects:	<ul style="list-style-type: none"> ① Preconstruction conditions of the Project area ② Mobilisation and site preparation ③ Installation of equipment and facilities ④ Installation of plant and plant under operation ⑤ Earthworks ⑥ Soft soil treatment ⑦ Pavement works ⑧ Construction of bridges and other major structures ⑨ Electrical and telecommunication utilities ⑩ Laboratory and testing for quality control ⑪ Commencement and completion ceremonies ⑫ Testing and inspection for acceptance of the Works ⑬ Others as required by the Engineer

- (b) The Contractor shall submit the outline of the narration process prior to the compilation of the video record, for the acceptance of the Employer. The final video record shall be produced by a specialized company acceptable to the Employer, and submitted to the Employer and the Engineer within thirty (30) days after the issuance of the Taking-Over Certificate

3. Measurement and Payment

3.1. Measurement

The supply of the Contractor's drawings shall be paid on the basis of the split distribution of a lump sum.

3.2. Basis of Payment

- (a) Payment shall include:

All costs necessary and required for preparation and submittal of the documents in accordance with the requirements and stipulations of this Specification Section.

All the supplemental documents, corrections, materials, expertise staff, computer applications, and any other incidentals applied for the purpose.

- (b) Payments shall be made in the following three steps:

1. Twenty percent (20%) upon the issuance of the Engineer's certification of the documents or materials prepared for each respective item as required herein and submitted by the Contractor for the first time after commencement of the Works;
2. Fifty percent (50%) during the execution of the Works split in partial payments in proportion to the work progress, upon the Engineer's certification of the submitted items to be paid for, and on the condition that no delays in the submittals were reported by the Engineer; and
3. Thirty percent (30%) upon the issuance of the Engineer's certification of the completed item prepared and submitted by the Contractor after completion of the Works, and for the last time in the Contract.

The Pay Items and Pay Unites shall be as follows;

<u>Pay Item</u>	<u>Description</u>	<u>Unit</u>
01150-01	Contractor's Submittals including As-Built Drawings of all the Permanent Works Executed by the Contractor	Lump Sum

Section 01200 – Contractor’s Drawings

1. Description

This section consists of the requirements for preparation of drawings by the Contractor.

Without detriment to the stipulations shown in the Conditions of Contract, and Technical Specifications, The Contractor shall prepare and submit the following documents:

Shop Drawings:	<p>These drawings shall show all necessary details required for execution of the Works including (but not limited to) the following:</p> <p>(a) Details as per site conditions for construction of the Works based on the Drawings comprised in Part 2: “Works Requirements”, Section VI-C of the Bidding Documents, and in accordance with all pertinent stipulations of the General Conditions of Contract and Particular Conditions of Contract.</p> <p>(b) Fabrication details, including materials used for fabrication or workshops to use in fabrication of components necessary for the Works, Plant or other equipment to be installed. The Contractor shall submit to the Engineer for his check and approval shop drawings of relevant components at least 28 days before the intended start of fabrication.</p>
Construction Drawings Working Drawings:	<p>Those Shop Drawings approved by the Engineer as the Drawings “good for construction”</p> <p>(c) Detailed design calculations and drawings for all Temporary Works (such as from-work, staging, centring, specialized constructional handling and launching equipment and the like);</p> <p>(d) Detailed drawings for templates, support and end anchorage, details for per- stressing cable profiles, bar bending and cutting schedules for reinforcement, material lists for fabrication of structural steel, works for tunnelling construction, etc.</p>
As-Built Drawings:	<p>(e) Detailed drawings prepared based on the approved Shop Drawings and Working Drawings used for performing the Works, showing in detail all the works as actually constructed</p>

Shop Drawings	<p>These drawings shall show all necessary details required for execution of the Works including (but not limited to) the following:</p> <p>(a) Details as per site conditions for construction of the Works based on the Drawings comprised in the Contract Documents, and in accordance with all pertinent stipulations of the General Conditions of Contract and Particular Conditions of Contract.</p> <p>(b) Fabrication details, including materials used for fabrication or workshops to use in fabrication of components necessary for the Works, Plant or other equipment to be installed. The Contractor shall submit to the Engineer for his check and approval shop drawings of relevant components at least 28 days before the intended start of fabrication.</p> <p>Those Shop Drawings approved by the Engineer as the Drawings “good for construction”</p>
---------------	--

Working Drawings	(a) Detailed design calculations and drawings for all Temporary Works (such as from-work, staging, jetty, centring, specialized constructional handling lifting materials, and erecting equipment and the like); (b) Detailed drawings for templates, support and end anchorage, details for prestressing cable profiles, bar bending and cutting schedules for reinforcement, material lists for fabrication of structural steel, works for tunnelling construction, etc.
As-Built Drawings	Detailed drawings prepared based on the approved Shop Drawings and Working Drawings used for performing the Works, showing in detail all the works as actually constructed.

2 Requirements

2.1 General

- (a) The Contractor shall be responsible for the following:
- Confirmation and correlation of all incorporated information;
 - Accuracy of all dimensions and quantities;
 - Information pertaining to the fabrication and construction method;
 - Handling and conservation of all the drawings in good condition; and
 - Delays in the submittals
- (b) The Contractor shall provide all the necessary information to substantiate that all materials, plants, construction site conditions and construction works incorporated into the Works, conform to and meet or exceed the requirements of the Specifications and/or the Drawings.
- (c) The Contractor shall provide all necessary and/or required drawings, calculations, and certifications for all permanent works and temporary works as required or described in the Specifications.

2.2 Requirements for the Contractor's Drawings Preparation

- (a) All the Contractor's Drawings shall be prepared using Auto-CAD 2016 or a latest version, in a sheet format previously approved by the Engineer.
- (b) Notes shall be written in English.
- (c) All dimensions shall be in the metric system.
- (d) The format of the Contractor's Drawings shall be as approved previously by the Engineer.
- (e) The Contractor's Drawings shall be stamped "Submitted for Approval for Construction" and shall be signed by the Contractor's Expert as the Quality Control Manager.
- (f) Design notes, calculations, lists, reports, descriptions, catalogue cuts, and other non-drawing submittals shall be submitted in A4 size sheets, in lieu of the size mentioned above.

- (g) Unless otherwise specified, each submittal of the Contractor's Drawings shall consist of three (3) copies and shall be submitted to the Engineer, one (1) set of which will be returned to the Contractor with revisions, if needed, noted thereon.
- (h) Editable electronic files, in the approved application form for the Project, of the Contractor's Drawings subject to the Engineer's approval, shall be provided to the Engineer after issuance of the respective approval.
- (i) Submittals without the required signatures and seal will not be accepted and will be returned to the Contractor without action.

Sample of the Format of the Drawings

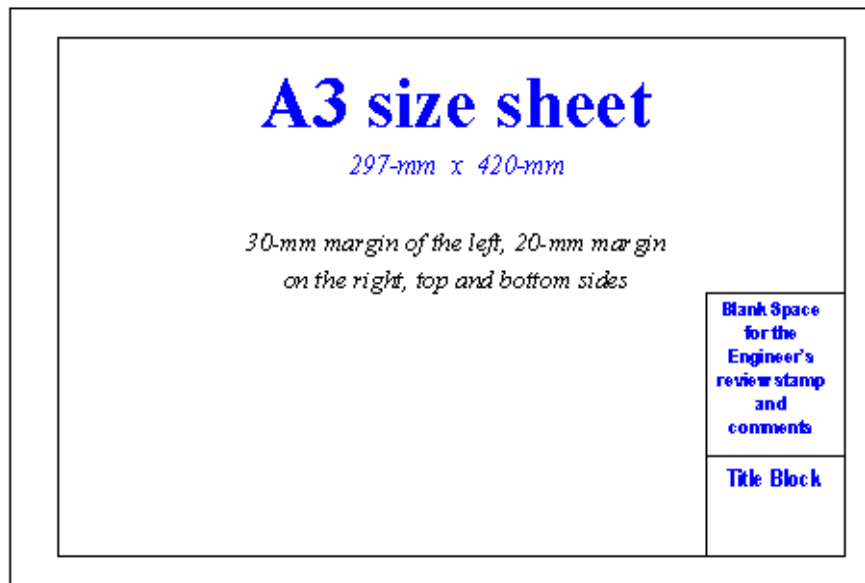

Format of the Contractor's Drawings

Figure - 1

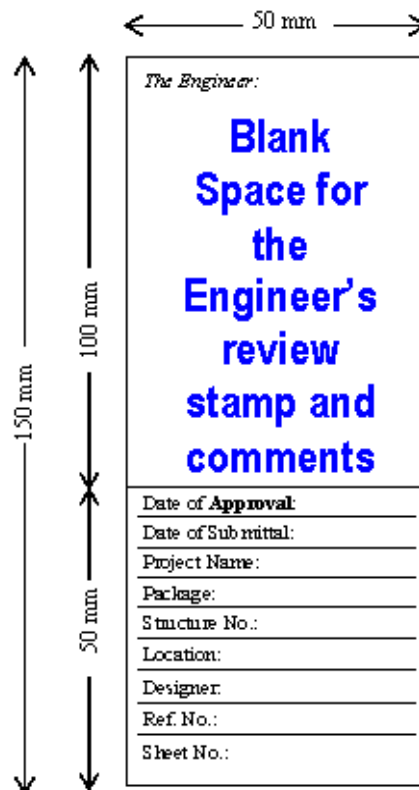

Details on the Blank Space for the Engineer's Review Stamp

Figure - 2

2.3 Requirements for Submittal and Approval

2.3.1. Submittal Schedule (the Drawings' Schedule)

- (a) The Drawings' Schedule shall be prepared in close relation, and showing solid consistency with a programme specified under Sub-Clause 8.3 of the Conditions of Contract.
- (b) Incorporating in a programme, the Contractor shall prepare and submit a submittal schedule (hereafter referred as the Drawings' Schedule), noting all required information and data required for the Contractor's Drawings.
- (c) The Drawings' Schedule shall be used as the document for monitoring the submittals, and to register the approvals, throughout the Contract.
- (d) The Drawings' Schedule shall contain, but not be limited to, the following:
 - A list of the Contractor's Drawings to be submitted well in advance of the construction activities shown on a programme. Such drawings shall be classified by type (i.e., shop drawings, working drawings, other drawings, or as-built drawings);
 - A bar schedule of the main submittals showing the main work items of the critical path as the milestone of each submittal; and
 - A list and schedule of the main tests for materials and trials to be subject to approval by the Engineer for the main work items. This list shall include also the submittals of certifications from the suppliers.
 - ◆ A list of the Contractor's Drawings to be submitted well in advance of the construction activities shown on a program. Such drawings shall be classified by type (i.e., shop drawings, working drawings, as-built drawings or unclassified drawings);
 - ◆ A bar schedule of the main submittals showing the main work items of the critical path as the milestone of each submittal; and
 - ◆ A list and schedule of the main tests for materials and trials to be subject to approval by the Engineer for the main work items. This list shall include also the submittals of certifications from the suppliers.
- (e) The registry of each submittal shall contain the following:
 - A description of each submittal and its contents, including applicable specification identification;
 - Statement if the submittal is for information, or to receive the Engineer's consent or approval;
 - The dates of the submittal: date of submittal to the Engineer and the expected date for return of the submittal;
 - In the event that a re-submittal is required, besides the new dates, it shall contain the status of the returned submittal (i.e., approved as noted, the comments, or rejected); and

- In the event that a deviation regarding the requirements shown in the Drawings and the Specifications is detected, it shall be clearly stated by the Contractor in the respective submittal.

- (f) The Drawings' Schedule shall be updated monthly or when required by the Engineer.
- (g) The Contractor shall include in his monthly report, a summary describing the existing conditions and the progress of his Drawings' Schedule.

2.3.2. Requirements and Procedure for the Approval

- (a) Submittals of the Contractor's Drawings shall be made in complete packages according to the approved Drawings' Schedule, and shall include all necessary information to allow a verification of conformity with the requirements of the Contract, the Drawings and the Specifications.
- (b) Upon receipt by the Engineer of a submittal package, it will be evaluated for completeness and the Contractor will be notified of any deficiencies therein.
- (c) The Engineer will review the submitted drawings to determine that general conformity with the design concept and general compliance with the information given in the Contract Drawings and the Specifications have been accomplished.
- (d) Any work done by the Contractor prior to the Engineer's review of the submitted drawings shall be at the Contractor's sole risk.
- (e) The Engineer may request additional details and require the Contractor to make changes in the submitted drawings which are necessary to conform to the provisions shown in the Contract Drawings and the Specifications (without additional cost to the Employer).
- (f) After review, the Engineer will return one (1) set of submitted drawings to the Contractor. Returned drawings will be stamped with the Engineer's review stamp to indicate the following:

Approved:	The submitted Contractor's Drawings have been reviewed and do not require re-submittal
Approved as Noted:	The submitted Contractor's Drawings have been reviewed and the Contractor shall incorporate the comments as noted in the drawings. The reviewed Contractor's Drawings do not require re-submittal.
Reviewed and Resubmit:	The submitted Contractor's Drawings require correction or redrawing and shall be resubmitted for further review. If the submitted drawings are returned for correction or redrawing, corrections shall be made and the Contractor shall resubmit them in the same manner as the first submittal. Specific notation shall be made on the resubmitted drawings to indicate the revisions made.

- (g) The Contractor's Drawings that have been evaluated by the Engineer as "*Approved as Noted*" shall be registered for the update of the Drawings' Schedule and shall form part of the Construction Drawings that shall be available at the Site at all times.
- (h) Any approval, check, certificate, consent, examination, inspection, instruction, notice, proposal, request, test, or similar act by the Engineer (including absence of disapproval) shall not relieve the Contractor from any responsibility he has under the Contract, including responsibility for errors, omissions, discrepancies and non-compliances.

2.4 Particular Requirements for the As-Built-Drawings

- (a) The requirements established in Sub-Clause for completion of the Construction Drawings shall first be satisfied by the Contractor, and approved by the Engineer.
- (b) Based on the above condition, the Contractor shall prepare in consultation with the Engineer, the final format to be used for preparation of the as-built drawings (including relevant documents such as drawings, completed quantities, and backup data).
- (c) The completion and submittal of the “As-Built Drawings” is a mandatory condition for the issuance of the Taking Over Certificate. Therefore, it shall be made in accordance with these Specifications and Sub-Clause 4.1: “Contractor’s General Obligations” Sub-Clause(d) and all related procedures and stipulations of the Conditions of Contract.
- (d) The “As-Built Drawings” shall be submitted, for review and approval by the Engineer, 28 days before the commencement of Test on Completion (Clause 9: “Test on Completion” of the Conditions of Contract).
- (e) The procedure specified in Sub-Clause 10.1 of the Conditions of Contract for the issuance of the “Taking-Over Certificate”, may be suspended if As-Built Drawings are not prepared as specified herein.
- (f) The Contractor shall initially submit two (2) sets of quality prints of the as-built drawings to the Engineer for review, comments, and approval. As-built drawings shall be submitted in turn according to the completed schedule.
- (g) After all corrections or comments as required by the Engineer have been addressed, and the as-built drawings have been approved, the Contractor shall submit to the Engineer the following:
 - One (1) original and six (6) clear photocopies, and
 - One (1) computer disk copy containing the electronic files of all drawings in an editable version by the approved application for the Project.

2.5 Drawing Copyrights

The rights for using, copying, or reproducing, partly or entirely, all or any of the drawings prepared by the Contractor as herein specified, are reserved and belong to the Employer at any time or in any situation.

3 Measurement and Payment

The submittal in this Specification Section shall be paid in accordance with the requirements for measurement and payment established in Specification Section 01150 “Contractor’s Submittals”.

Section 01300 – Programme of the Works

1. Description

This Specification Section prescribes the form and contents of the Programme of Work (hereafter referred to as “the Programme”). The Programme referred to herein shall also be interpreted as a programme referred to in Sub-Clause 8.3 [Programme] of the Conditions of Contract.

The following definitions shall be referred to for proper interpretation of this Specification Section:

Programme:	The Programme shall govern the execution of the whole Works, and shall consist of all the plans, schedules, statements on the methods and procedures for construction, assignments of equipment and personnel, testing and trials, drawings, submittals, and the like required or mentioned in the Specifications, or required by any other part of the Contract.
Time Schedule:	The time schedule that shall be incorporated in the Programme to show, describe, and monitor the progress, using the Critical Path Method (CPM) presented in the form of bar chart and showing other data herein specified.
Cash Flow:	The cash flow schedule, in accordance with the requirements of Sub-Clause 14.4 “Schedule of Payment” of the Conditions of Contract, shall consist of non-binding estimate of the payment which the Contractor expects to become due during each quarterly period.

2. Requirements

2.1. General

- (a) Failure of the Contractor to comply with the requirements of the Contract shall be considered as a serious default of the Contractor in meeting his contractual obligations, resulting in a delay in the commencement of the activities for execution of the Works.
- (b) Unless otherwise specified in the Contract, the delay caused by the Contractor and its effect on the work progress will be estimated by the Engineer and settled in accordance with the stipulations of Sub-Clause 8.7 “Delay Damages” of the Conditions of Contract, at the time of taking-over of the Works.

2.2. Requirements for the Programme’s Composition and Contents

2.2.1. The Programme’s Composition and Contents

- (a) The Programme shall incorporate in detail all activities related to the Works from their commencement to their completion, taking into account all the main items introduced in the Bill of Quantities for each component of the Works.
- (b) The Programme shall include, but not be limited to, the following:
 - Schedule (showing the critical path);
 - Contractor’s mobilization and demobilization plan;
 - All submittals and drawings;
 - All plans and schedules;
 - All activities for site investigation;

- All surveys and laying out;
 - All key and milestone dates (such as the dates for submittals of schedule, the dates for mobilization, the commencement/completion dates for the works of soft soil treatment, bridge construction, sub-base, Engineers' accommodation, etc.);
 - All interface dates between the Contractor and sub-contractors for the Works;
 - All activities associated with the procurement, purchase, fabrication and shipment of goods, materials, and equipment to be incorporated into the Works;
 - All public and site holidays; and
 - Other activities that the Engineer may require for monitoring.
- (c) The construction schedule (the Programme) prepared by the Contractor and progress by the charts, Critical Path Method (CPM) and S-curve shall be made using the latest version of software (tools) "Primavera P6: Professional Project Management". For this purpose the Contractor shall provide the required software and licenses at least for 3 users selected by the Engineer.

2.2.2. The Schedule's Contents

- (a) The schedule shall include a narrative statement and a logical breakdown of major activities. The narrative statement shall comprehensively describe the work execution plan, the achievement of milestones and any intermediate dates, the outline method statements for the major work items, temporary works, and the like. It shall fully explain the reasons for the main logic links in the schedule, and shall include particulars on how activity durations are established.
- (b) The details and number of activities incorporated in the schedule shall be sufficient to manage the total Works and to identify restraints, delays, and effects on the Works by dependent activities.
- (c) All the activities shall be organized in a logical work breakdown structure, indicating work stages and phases, and shall have a code number for identification related to the work breakdown structure as well as a unique description.
- (d) The schedule shall show activity durations, activity descriptions, early and late start and finish dates (all of them expressed in calendar days), and activity float and activity dependencies, applying the critical path method (CPM) of scheduling with all activities tied to only one start date and only one end date.
- (e) All activities shall be cost-loaded (as appropriate) with schedule costs equivalent to the "Cash Flow".
- All activities shall be resource-loaded (as appropriate), indicating all manpower and/or equipment necessary to accomplish the activity within the given time duration.
 - Any activity having or creating an imposed constraint to the schedule shall be clearly defined and fully described.
 - The schedule shall be prepared by using a computer application approved by the Engineer for programming, and that has been provided in software by the Contractor for each package of the Project, with relevant licenses for both the Contractor and the Engineer.

2.3. Requirements for Submittal and Approval of the Programme

- (a) The Contractor shall comply satisfactorily and without delay to the requirements herein specified regarding the composition and contents of the Programme.
- (b) After the Programme has been reviewed by the Engineer, the Contractor shall, within fourteen (14) days after receiving the Engineer's comments on the Programme, incorporate the required corrections or modifications into the Programme and re-submit it to the Engineer for approval.
- (c) No more than two (2) submittals of the Programme are required for the Engineer's review, provided however that:
 - If additional submittals are required by actions of the Contractor, any delays shall be the Contractor's responsibility.
 - The Employer may, at any time, after advising the Contractor of such additional costs for submittal review, recover such costs from money due or will be due to the Contractor.

3. Requirements for Updating the Schedule and Cash Flow

The Work Programme and Cash Flow shall be updated on a monthly basis to reflect the actual work accomplished by the end of each month, and to facilitate the monitoring of payments.

In addition, an activity report, generated by the schedule computer programme, shall be attached as an appendix to the Contractor's monthly report.

The above referred report shall include the following information and data for each activity:

- Activity identification number and description;
- Activity duration expressed in calendar days;
- Early and late start and finish dates for each activity, as well as planned start and finish dates;
- Calculated total and free float for each activity;
- Predecessors(s) and successor(s), accompanying relationships and lag/lead duration(s) for each activity;
- Imposed time or date constraints on each activity;
- An activity calendar;
- Critical path delay; and
- All activities that have a negative float shall be identified and analysed to identify the impact on the timely completion of the Works.

4. Measurement and Payment

The submittal of the Programme of Works in accordance with the provisions of this Specification Section shall be paid in accordance with the requirements for measurement and payment established in Specification Section 01150 "Contractor's Submittals"

Section 01400 – Monthly Progress Reports

1. Description

This section consists of the requirements for the preparation and submittal procedure for the Monthly Progress Report (hereinafter referred to as “the Report”) prepared by the Contractor.

2 Requirements

2.1. General

- (a) The requirements established in this Specification Section shall supplement the requirements and provisions stated in the Specification Sections 01000 “General Provisions”, 01200 “Contractor’s Drawings”, 01300 “Programme of Work” and the like included in the Contract regarding reporting requirements.
- (b) The Reports shall be prepared and submitted as established in Sub-Clause 4.21 “Progress Reports” of the Conditions of Contract. The Report shall describe all works performed up to and including, the last day of the preceding month.
- (c) The Report constitutes the fundamental document for the procedure of each progress payment; therefore, the reviewed and approved Report shall be attached to each certificate for progress payment as established in Sub-Clause 14.3 “Application for Interim Payment Certificates” of the Conditions of Contract.

2.2. Requirements for the Report’s Contents

The Report shall contain, but not be limited to, the following:

Descriptions	Pages
(a) Cover (or title sheet) showing Project Location Map (Figure)	1
(b) Table of Contents and Signature of Contractor’s Representative	1
(c) Project Outline (Table)	1
(d) Summary of Monthly Certificate and Price Escalation (Table)	1
(e) Scheduled and Actual Progress (Chart) as specified in Section 01300 “Programme of Work “showing the approved bar chart format with the progress of payments as per the updated cash flow curve (“S” curve)	1
(f) Activity list (Table)	1
<ul style="list-style-type: none"> • Completed activity in a month, including the actual start and completion dates 	
<ul style="list-style-type: none"> • Activity currently under progress, with the time required to complete (Current and anticipated delay reasons shall be attached on the column of remarks) ate 	
(g) 6-8 Photographs with brief explanation of works as specified in Section 01150 “Contractor’s Submittals”	2
(h) Safety Summary: prepared by the Contractor’s Safety Manager and Traffic Supervisor including a summary of related activities performed in the month, addressing problems on safety, traffic and environmental control, other	2

Descriptions	Pages
constraints and any accident as specified in Section 01500 "Project Safety" and Section 01600 "Maintenance and Protection of Traffic"	
(i) Environmental Activity summary: prepared by the Contractor's Environmental Manager including a summary of related activities performed in the month, addressing problems on environmental monitoring and control, other constraints and any accident as specified in Section 01700 "Environmental Control and Protection"	2
(j) Quality Control Summary: prepared by the Contractor's Quality Control Manager including a summary of related activities performed in the month, addressing quality control problems, outstanding deficiencies, and shall include a summary of all quality control tests, and test results. Section 01750 "Laboratory and Engineer's Equipment", Section 01800 "Contractor's Quality Control" and Section 01900 "Control of Materials"	2
(k) Acceptance Control Summary: prepared by the Contractor's Quantity Surveyor including accepted works or not accepted works accumulated summary table in the month (with satisfactory evidence list and applicable payment factors, if specified), outstanding deficiencies as specified in Section 01850 "Acceptance of Work"	2
(l) List of the materials on Site as specified in Section 01900 "Control of Materials" (Table)	2-1
(m) List of the mobilisation and demobilisation of contractor's staff (Table with name, company affiliation, their position, and nationality) in the commencement of work up to the end of the report period, including subcontractors and suppliers. The listing shall include the names of all personnel)	1
(n) Major Construction Equipment List on Site (Table): The tabulation shall identify the type, maker, model, and capacity (if applicable) of equipment, in operation or not operating and shall indicate the date the equipment arrived on Site and the date the equipment left the Site	1
(o) Labour numbers related to each work (Table)	1
(p) List of submittals (Table) as specified in Section 01150 "Contractor's Submittals" and Section 01200 "Contractor's Drawings"	1
(q) List of photographs and video taken in the month (Table)	1
(r) Status of variation order (Table)	1
(s) Summary of Contractor's Claim (Table)	1
(t) List of correspondence with the Client and the Engineer (Table)	1

3. Measurement and Payment

The submittal of the Monthly Progress Reports in compliance with the provisions of this Specification Section shall be paid in accordance with the requirements for measurement and payment established in Specification Section 01150 "Contractor's Submittals".

Sample Form of the Monthly Certificate and Price Escalation

(Project Name)

Summary of Monthly Certificate

No	Description of Major Work Items	Percent (%) to date	Local Component	Foreign Component	Combined Total
1					
2					
3					
4					
5					
6					
7					
8					
9					
10					
11					
	A: Total Sum of Work Completed to Date				
	B: Material on Site				
	C: Gross Sum of Monthly Certificate	A+B			
Deduction	D: Previous Monthly Certificate				
	E: XX % for Retention Money				
	F: YY % for Advance Payment				
	G: Tax				
	H: (Liquidated Damage)				
	I: Total Sum of Reduction	SUM(D:H)			
	J: Net Value of Monthly Certificate	C-I			
	K: Price Escalation				
	L: Total Payment in this Month	J+K			

Section 01500 – Project Safety

1. Description

This section consists of the requirements for planning, implementing, and maintaining the safety measures to be applied by the Contractor for the Project during the execution of the Works.

The following definitions shall be referred to, for proper interpretation of Specification Section:

Contractor`s Health and Safety Plan: The Contractor shall prepare the Contractor`s “Safety Plan” in accordance with “The Guidance for the Management of Safety for Construction Works in Japanese ODA Projects, JICA, Sep. 2014”.

It shall consist of a complete plan for implementation and monitoring of safety measures applied in the project inclusive of the site and all the related areas such as the construction plant, quarries, roads for materials transportation, etc.

2. Requirements

2.1. Scope of Work

The Contractor shall, throughout the execution and completion of the Works and the remedying of any defects therein, take full responsibility for the protection of the Works, the health and safety of all persons entitled to be upon the Site and the public or others concerned to the Works, and the security of the Site. Lighting at night and underground sites including installation of floodlights shall be covered as a part of Safety.

The requirements established in this Specification Section shall also supplement the requirements and provisions stated in the following sections of the General Specifications:

Section 01600: Maintenance and Control of Traffic.

Section 01700: Environmental Control and Protection.

Section 08400: Road signs.

All sections regarding safety that are included in the Contract.

2.2. Relevant Statutes

The Contractor shall at all the time comply with all the existing statutes in the Myanmar concerning Safety, Security and Health for the implementation of the works. Such statutes include, but are not limited to the following.

- MOTC: The Highway Law-No,24/2015
- MOTC: The First Amended Highway Law-No, 60/2015
- MOTC: The Second Amended HighwayLaw-No,62/2015
- MOTC: The Amended Utilization of Roads and Bridge Law-No,25/2014
- YCDC: The YCDC Rules and Regulations-No, 3/2001
- YCDC: The YCDC Law-No,6/2013
- MHS : The Law Relating to Private Health Care Services-No,5/2007
- MHS : Accidents and Injury Prevention Law-53/2014
- MLI : The Amended Law for Leave and Holiday Act 1951-No,30/2014

- MLI : The Amended Settlement of Labour Dispute law-No,40/2014
- MLI : The Social Security Law-No,15/2012
- MLI : The Amended Law for Factories Act 1951-No,12/2016
- MFSD : The Myanmar Fire Brigade Law-No,11/2015
- Myanmar National Building Code 2016.
- Reference: The Traffic Regulations, standards the ASEAN countries are referenced

2.3 Occupational Safety and Health Administration (OSHA)

In addition to JICA's safety guidance and Myanmar's safety regulations, the Contractor shall refer to and follow regulations of:

Occupational Safety and Health Administration (OSHA), U.S. Department of Labour.

2.4 Safety Plan and Security.

2.4.1. Planning of Safety and Security

The Contractor shall within fifty-six (56) calendar days after the date of the letter of Acceptance submit to the Engineer for his approval a health and safety plan or similar plan in order to comply with the requirements set out in Sub-Clause 4.8 [Safety Procedures] of the Conditions of Contract.

The so-called safety plan shall be developed with utmost care and vigilance in compliance with the requirements referred in previous Subsection 2.2. Relevant Statutes: laws, regulations and authorities in the Myanmar, and Subsection 2.3. OSHA.

The construction work shall not begin until the safety plan has been approved by the Engineer. The Safety Plan shall cover the following aspects:

- a) Statement of Contractor's Safety and Security policy.
- b) Senior management responsibility for Safety and Security.
- c) Appointment, duties and responsibilities of Safety staff.
- d) Policy for identifying Hazards.
- e) Risk assessment and management plan for Safety and Security.
- f) Promotion, awareness and training for Safety and Security.
- g) Equipment for Safety and Security.
- h) Safety and Security of the Contractor's construction and office equipment.
- i) Safety and Security of the staff and workers at Site
- j) Safety and Security of the public and third parties at Site.
- k) Safety and Security procedures for Subcontractors.
- l) Measures to avoid traffic accident on public roads.
- m) Disciplinary procedures.
- n) Accident reporting.
- o) Medical check-up to all project staff
- p) First aid system.
- q) Emergency evacuations plan
- r) Others.

The safety and security plan for each section or installation shall be submitted in the Method Statement specified.

The approval of Health and Safety Plan by the Engineer shall not relieve the Contractor of any of his responsibility for Health and Safety at the Site. Furthermore, the Engineer shall have the

right to request the Contractor to improve the approved Safety Plan whenever it is deemed necessary in the opinion of the Engineer.

2.4.2. Implementation of Health and Safety Plan

The Contractor shall develop and implement a site-specific Health and Safety Plan which includes, but not limited to, a statement of health and safety policy organization and lines of responsibilities including Subcontractors and suppliers, training, methods for enduring health and safety incentive programs and compliance monitoring, accident reporting and record-keeping, medical support, and operating procedures. The Contractor shall be responsible and accountable for the actions and activities of his Subcontractors and suppliers, and for their compliance with the Safety Plan.

2.4.3 Notice of Contravention

The Engineer will notify the Contractor in writing as Notice of Contravention of any observed noncompliance with relevant laws, regulations, permits and other elements of the Contractor's Safety Plan.

The Contractor shall, after receipt of such notice, inform the Engineer of proposed corrective actions and take such actions, at his own cost, immediately when approved. If the Contractor fails to comply promptly, the Engineer may issue and order stopping, all or part of the work until satisfactory corrective action has been taken. No time extension therefore shall be granted to the Contractor for any such suspensions.

The Contractor may appeal to the Engineer for modification of the terms of any Notice of Contravention before the expiry of the notice. Upon such appeal the Engineer in his sole discretion may modify, withdrawal or confirm the notice.

2.5 Safety Management Committee (SMC)

For implementing the SMC, the Contractor shall constitute a duly empowered SMC which shall convene monthly under the chairmanship of the Occupational Health and Safety Manager.

The Committee is comprised of the following members at least and shall be subjected to the approval of the Engineer, who may, if in his opinion the committee is not carrying out its duties with due diligence, order that a new committee be reconstituted.

1. The Employer
2. The Engineer
3. The Contractor (project manager, Site managers, Safety manager and officers and so on)
4. Representatives of Subcontractors

The Committee shall execute the site inspection regarding the health and safety at the Site before the Committee meeting.

The Committee shall have authority to cease work if unacceptable health and safety conditions exists, and instruct the Contractor to take necessary action to re-establish and maintain safe working conditions.

2.6 Health & Safety Manager (SM)

The SM shall be a graduate with at least a bachelor course of environmental or civil engineering and have experiences of more than 15 years in health and safety works in construction.

The SM or his deputy or representative shall be available at Site on a 24H/ day basic and his or her deputies shall carry out regular and random checks of all parts of the Site where work is taking place.

The duties of the SM and his deputy are as follows, but not limited:

1. Management and implementation of safety plan,
2. Notification, investigation and recording of accidents,
3. Ensuring healthy and safe working conditions and management of hazardous conditions in accordance with Subsection 2.3 in this Section,
4. Arrangement for frequency and occasions of routine and special meetings,
5. Arrangement for disseminating information, training and supervision to ensure the Subsection 2.3 of this Section,
6. Participation in internal weekly inspection and auditing on safety measures at Site by the Contractor and Subcontractors,
7. Participation in monthly safety inspection by the Employer and /or Engineer, and
8. Other required duties in SM.

3. Special Requirements for Safety

3.1 Rules and Responsibilities of Project Stakeholders

3.1.1 Precedence

The rules and responsibilities of Project Stakeholders specified in the contract documents shall take precedence over this safety specification.

3.1.2 Employer

The rules and responsibilities of the Employer relating to the management of safety on construction sites are as follows:

- a) The Employer shall endeavour to strictly comply with the relevant laws and regulations of Myanmar to ensure the safety of the Project Stakeholders during construction works at site and protect nearby local residents, and any other third parties, from every potential accidental risk foreseen to arise from the construction works at site.
- b) The Employer shall, in collaboration with the Engineer, make sure the works carried out in accordance with the Safety Plan and the Method Statements on Safety prepared by the Contractor and provide notice, suggestion or guidance for improvement.
- c) The Employer shall endeavour to create an environment where all the project Stakeholders positively participate in activities to promote safety on construction sites.
- d) When two or more Contractors carry out work at the same construction site, the Employer shall establish an environment for mutual cooperation and coordination on safety management.
- e) The Employer shall notify the Contractor of natural conditions, social conditions or any other factors that may affect the management of safety for construction works at site.

3.1.3 Engineer

The rules and responsibilities of the Engineer relating to the management of safety on construction sites are as follows:

- a) The Engineer shall have a full understanding of the roles and responsibilities of the Employer on the management of safety for construction works at site and, together with the Employer, appropriately implement activities to manage safety, including these obligations specified in the contract documents.
- b) The Engineer shall, in collaboration with the Employer, review the Safety plan and the Method Statements on Safety prepared by the Contractor and provide notice, suggestion or guidance for improvement to the Contractor if there are any risks to safety.
- c) The Engineer shall, in collaboration with the Employer, make sure the work is carried out as per the Safety Plan and the Method Statements on Safety prepared by the Contractor and provide notice, suggestion or guidance for improvement.

3.1.4 Contractor

The rules and responsibilities of the Contractor relating to the management of safety on construction sites are as follows:

- a) The Contractor shall be responsible for the operation and management of safety on construction sites.
- b) The Contractor shall appropriately prepare the Safety Plan at the appropriate time in the pre-construction stage in accordance with the relevant laws and regulations of the Myanmar and Health and Safety Plan. In the construction stage, the Contractor shall appropriately prepare the Method Statement on Safety, which shall specify the details of safe methods to implement safety measures prior to the start of each item of work and submit the document to the Employer and Consultant for review and approval must be obtained.
- c) The Contractor shall make appropriate revision or correction whenever any insufficiency or suggestion for improvement relating to safety is raised following the review of the Safety Plan and the Method Statements on Safety.
- d) The Contractor shall undertake work according to the Health and Safety Plan and the method Statement on Safety they prepared.
- e) The Contractor shall take into account the safety of nearly local residents and any other parties, as well as all Project Stakeholders of the construction project.
- f) The Contractor shall carry out construction works for the safety of nearly local residents and any other third parties, as well as Project Stakeholders of the project.

3.1.5 Subcontractor

The rules and responsibilities of the Subcontractor relating to the management of safety on construction sites are as follows:

- a) Each Subcontractors shall carry out construction works in compliance with the relevant laws and regulations of the recipient country applicable to the construction work and these Guidance's.

- b) Each Subcontractors shall establish and maintain safe and sanitary site conditions according to the instructions of the Contractor.
- c) Each Subcontractors shall cooperate with other Subcontractors engaged on the construction site in accordance with the instructions of the Contractor.
- d) Each Subcontractors shall receive from the Contractor an explanation on the Safety Plan and the Method Statements on Safety prepared by the Contractor. Each Subcontractors shall pass on the explanation received from the Contractor to their Employees and have them fully comply with those explanations to ensure safety.

3.2 Safety of Public

The Contractor shall be responsible for the safety of the public passing through the Site. All excavations, plant or items of potential danger to the public must be barricaded and sign-posted to the satisfaction of the Engineer, and the Contractor must provide sufficient watchmen to ensure the safety of the public at all times. All existing pedestrian routes shall be maintained in a safe condition unless an alternative route is provided to the satisfaction of the Engineer.

3.3 Safety Barricade and Signboard

The Contractor shall provide and maintain adequate safety barricade and signboard around the dangerous area such as opening, excavate trench, heavy equipment, lifting work area, etc.

3.4 Handrail, Safety Belt and Safety Net

The Contractor shall provide and maintain adequate handrail and safety net.

Handrail shall be installed for all the working places higher than 2.0 m. Handrail shall be strong, enough with adequate height. When working at higher than 2.0 m without handrail, safety belt and safety rope shall be used. The contractor shall use adequate safety belt and safety rope.

In case there is a risk of materials or tools falling down, the Contractor shall provide and maintain safety net around the stage. Type of the handrail, Safety Harness and Safety Net shall be subjected to the approval of the Engineer.

3.5 Evacuation Route and Place of Refuge

The Contractor shall provide and maintain the Evacuation route and place of the refuge in the site which can access to any location of the site by vehicle in case of emergency. Safety path for workers to access to their working location shall be provided in the site. The Contractor shall maintain safety path with safety condition. Emergency evacuation route and place of refuge shall be indicated by signboard.

3.6 Temporary Roads/Construction Yard in the Site

Traffic lanes shall be clearly marked by safety cone, barricade and guide signs to prevent accidents and to ensure quality control of constructing roads.

The contractor shall provide and maintain security fences around the site. Purpose of the fence is to prevent residence especially children from entering the site without any permission. Therefore, security fence shall be at least 2.4m high, dense and strong enough so that children cannot break it or slip through the fence. Type of the fence shall be approved by the Engineer prior to construction.

The contractor shall check the fence condition every day and if any damage or opening is found, repair them immediately on his own responsibility.

3.7 Diversion roads/Widening Road.

Traffic lanes shall be clearly marked by safety cone, barricade and guide signs to prevent accident and to ensure quality control of Diversion roads.

Contractor shall install a detour information board to inform public vehicles and pedestrians of the need for diversions, and deploy flagmen as appropriate.

Notify local residents of the plan to work on public roads, so as to obtain their understanding and cooperation.

3.8 Workers Rest House.

Labour's rest house with first aid facility shall be provided and maintained by the contractor to prevent from lightening accident and sunstroke. Toilets, smoking corner and drinking water shall be set up in the worker's rest house.

3.9 Prevention of Fall (scaffolding)

Where works are undertaken at a place more than two (2) meters above ground level, the Contractor shall construct scaffolding prior to the commencement of work. Where it is impossible to construct scaffolding, workers use protective gear to prevent themselves from falling, such as safety belts or fall arrestors. Where safety belts are used, the Contractor shall ensure that equipment is affixed.

3.10 Prevention of Public Accidents and Traffic Accidents

1. When work is undertaken on a public road, the Contractor shall adopt appropriate measures, such as barricading the work site and stationing the watch-personnel or traffic-control personnel, to prevent the entry of unauthorized personnel including third parties into the work area,.
2. Where buried utilities or facilities are located under the ground of a work site or where excavation is undertaken in the ground near a structure, then if damage to those utilities, facilities or structures by overturning or collapsing is likely, the Contractor shall take appropriate measures prior to the commencement of work, so as to prevent the risk, such as the relocation or reinforcement of the utilities, facilities or structures.
3. When earth and sand is backfilled over buried utilities or facilities, the Contractor shall undertake backfilling according to the predetermined specifications, without applying unsymmetrical pressure or damaging the buried utilities or facilities.

3.11 Availability of Safety-related Documents

The Contractor shall comply with the Engineer's requirements in so far as displaying in each of its site offices, workshops, and canteens a copy of such safety and industrial health posters, and keeping on Site copies of safety and industrial health regulations and documents. The minimum regulations and most important documents (selected by the Engineer from the approved Safety Plan) shall be translated into languages which are understood by the operators engaged by the Contractor or Subcontractors, and such translations shall be displayed or kept alongside with those in Myanmar and English languages.

3.12 Safety Reports

The Contractor shall submit regular safety reports to the Engineer as a requirement of the Safety Plan. A summary of this report shall be included in each Monthly Progress Report. Safety reports shall comprehensively address all relevant aspects of site safety and industrial health regulations and, in particular, shall report on all site safety audits undertaken during the period covered by the report.

3.13 Safety Information

The Contractor shall ensure that safety, rescue, and industrial health matters are given a high degree of publicity to all persons, regularly or occasionally, at the Site. Posters, in both Myanmar and English, drawing attention to site safety, rescue and industrial health regulations shall be made or obtained from the appropriate sources and shall be displayed prominently in relevant areas of the Site.

3.14 Safety Meeting and Patrol

The Safety Manager of the Contractor shall perform regular safety meetings and patrol in accordance with the Health and Safety Plan, with the participation of the Employer and Engineer (or a representative delegated by him for the purpose), and representatives of Subcontractors if so requested by the Engineer. All safety meetings shall be notified to the Engineer at least three (3) days in advance. Minutes of all safety meetings shall be taken and sent to the Engineer within three (3) days after the meeting.

3.15 Fire Extinguishers

In supplement to the safety equipment stated in the Safety Plan, the Contractor shall provide in particular wall-mounted hand-held fire extinguishers of multi-purpose, nitrogen-pressured, or dry chemical type at the Employer's and Engineer's facilities and the Contractor's facilities as suitable in conformity of the law or the safety standard of the country. Individual fire extinguishers shall also be provided in all the vehicles being used in the Project. Fire extinguishers shall be replaced before the expiry period.

3.16 First Aid Base

The Contractor shall, at his own expenses, establish and maintain a fully equipped first aid base as described in the approved Safety Plan, one per each package of Contract, and satisfying the following conditions:

The first aid base shall be located at the Contractor's principal work area and shall consist of a treatment room fitted with a hand wash basin, two treatment couches and sterilizing equipment, and lockable cupboards to contain sufficient medical supplies for the Contractor's workforce, the Engineer's site supervisory staff and any visitors to the Site. In addition, three (3) stretchers shall be stored, available for instant use.

A qualified nurse and nurse aid shall be in attendance at the first aid base during all times when work is being undertaken at the Site, including work by any Subcontractor, and during periods when only emergency activities are being undertaken, such as periods of inclement weather.

All the costs for first aid shall be considered as a part of the unit price of the bid, and no additional payment will be made for it.

3.17 Notification of Accidents

The Contractor shall notify the Engineer immediately when any accident occurs whether on site or off site in which the Contractor, his personnel or construction plant, or those of his Subcontractors are directly or indirectly involved and which results in any injuries to any persons. Such initial notification may be verbal and shall be followed by a written comprehensive report within 24 hours after the occurrence of the accident.

4. Measures for Safety

4.1 General

The Contractor shall take the measures for health and safety at the Site listed below but not limited in accordance with 2.2 Relevant Statutes and 2.3 Code of Practice.

4.2 Personal Protective Equipment (PPE)

The Contractor shall ensure his and his Subcontractor's personnel to wear appropriate PPE at the Site at all times and supply the Employer and the Engineer at his own cost with such safety equipment as requested.

No body without PPE is allowed to enter the Site.

Every person entering the Site in open air and underground shall wear PPE. A sufficient number of electric lamps shall be equipped to the workers working underground and supplied by the Contractor to the Employer's and Engineer's persons entering underground.

The Contractor ensures that appropriate safety-toe footwear is worn by all persons engaged in work with an inherent danger to the foot. Light footwear such as sandals, canvas shoes or the like shall not be permitted at any construction work site.

The Contractor shall ensure that ear protectors are worn by the workers engaged in the drilling work or in the work site where workers are exposed to harmful noise levels.

The Contractor shall ensure that protection glasses, goggles or masks are worn by the workers engaged in work with an inherent danger of eye or face injury. Likewise, protective clothing shall be worn by the workers where irritant or toxic substances can come in contact with the skin or clothing.

The Contractor shall ensure that safety harnesses and lifelines are used by the workers working on steep slopes with an inherent danger of falls not protected by fixed guardrails or safety nets.

4.3 Sanitary Arrangement

The Contractor shall keep the Site in a clean and sanitary condition and shall provide and maintain sanitary conveniences for the use of persons working at the Site to the extent and in the manner and at such places as approved by relevant local authorities concerned and the Engineer. All persons concerned with the Works shall be obliged to use these conveniences when being at the Site.

4.4 Sewerage and Sanitation

The Contractor shall supply, install, operate, maintain and subsequently remove the adequate treatment process for disposal of sewerage from all temporary buildings including houses, offices, camps, etc. to be constructed by the Contractor. The Contractor shall construct, operate and maintain at the Site temporary toilet facilities complete with adequate water closets, urinals and hand-basins, septic tanks, absorption trenches or other sewerage disposal installation for all of his personnel. The temporary toilet facilities shall meet the requirements of the Government health authority. The location of these facilities and their construction shall be as approved by the Engineer. Sewerage from temporary facilities shall be disposed of in hygienic manner as approved by the Engineer.

The Contractor shall remove all rubbish and shall provide an adequate number of covered garbage bins/containers placed at convenient points around his camp quarters and work sites. The Contractor shall establish, operate and maintain a regular garbage collection and disposal system, utilizing a covered vehicle for collection and transport of garbage to the place of disposal. Garbage shall be disposed of by burning, by burial or by other means approved by the Engineer. No waste of any kind shall be deposited in any watercourse

4.5 Epidemics and Hazardous Substances

In the event of any outbreak of illness of a highly contagious or epidemic nature the Contractor shall comply with and carry out such regulations, orders and requirements as may be made by the Country, or the local medical or sanitation authorities for the purpose of dealing with and overcoming the same.

The Contractor shall identify and keep records of all hazardous equipment, materials, or other substances and any other health hazards in his undertaking of the Contract. Newly created hazards or new hazardous equipment, materials or other substances brought on to Site shall be added to the record. The Contractor shall draft new, or adapt and modify existing codes of practice appropriate to the said hazards.

The Engineer shall be granted access to such records at all times.

The Contractor shall conduct and document at least weekly inspections of the storage areas for equipment, transport vehicles and hazardous materials and substances, especially for spillages and leaks. The Contractor shall take adequate precautions and make adequate provisions, to the satisfaction of the Engineer, to prevent such spillages of toxic materials and substances from entering natural stream or areas outside the Site.

4.6 Other Measures for Safety

Safety measures shall be taken for the following items but not limited in accordance with 2.2 Relevant Statutes and Subsection 2.3 in this Section.

- 1) Training
- 2) Reporting
- 3) Medical check-up and First Aid
- 4) Emergency Plans
- 5) Signs, Signals and Barricades
- 6) Fire Prevention and Protection
- 7) Material Handling, Storage, and Disposal
- 8) Electrical Safety
- 9) Walking and Working Surfaces
- 10) Confined Spaces
- 11) Control of Hazardous Energy (Lockout/Tag out)
- 12) Fall Protection and Rope Supported Work
- 13) Hand Tools, Power Tools, Pressure Vessels, Compressors, and Welding
- 14) Slings and Rigging Hardware
- 15) Hoisting and Pile Driving Equipment
- 16) Mobile and Stationary Mechanized Equipment
- 17) Hazardous Waste Site Operations
- 18) Excavation Operations
- 19) Blasting Operations
- 20) Concrete, Masonry Construction and Formwork
- 21) Steel Erection
- 22) Reclamation Drilling Standards

5. Safety of Site against Unexploded Ordnance (UXO)

5.1 Certificates for Safety of Site against UXO

The Contractor shall be informed that the whole area of the construction Site within the right-of-way including the camp yards had been certified safe against unexploded ordnance (UXO) through conducting ordnance survey on the said area pursuant to the Regulation “Specification for Detection and Treatment of Bombs, Mines and other Unexploded Matters” promulgated by the Supreme Commander for Army Engineering – Ministry of Defence.

5.2 Measures against UXO

Notwithstanding the certificate for safety against UXO as mentioned above, if and when the Contractor encounters UXO or accident thereof at the Site during the execution of the Works, the work shall be immediately stopped, evacuate all people from the accident spot, administer first aid if wounded, and report to the Engineer and the Employer.

Investigation and treatment of UXO will be carried out by the Surveyor of the Ministry of Defence through the request and at the expense of the Employer. The Contractor is strictly instructed not to detect nor touch UXO. The construction works on the spot and its vicinity should not be resumed until the Surveyor has completed investigation and treatment of UXO and issued a safety certificate on such area again.

5.3 Compensation for UXO Accident

The UXO accident, if befallen inside the right-of-way to the Contractor’s personnel, materials, equipment or works, shall be deemed to be an Employer’s risk as stipulated in the Conditions of Contract. In the event of loss or damage occurring inside the Site due to UXO, the Contractor shall, if and to the extent required by the Engineer, rectify the loss or damage of the works and will accordingly be paid for compensation thereof, as an addition to the Contract price. In such event, the Contractor will be entitled to an extension of the time for completion in accordance with the Conditions of Contract.

The UXO accident, if befallen outside the right-of-way but inside the Employer’s country to the Contractor’s personnel, materials, equipment, or works which are on transportation to/from the Site, shall be deemed to be a combined risk of the Contractor and the Employer. In the event of loss or damage occurring outside of the Site due to UXO, the Engineer will determine the proportion of the responsibility between the Contractor and the Employer pursuant to the Conditions of Contract. The Contractor shall have no obligation for the insurances to include the loss and damage caused by UXO in accordance with the Conditions of Contract.

6. Measurement and Payment

All requirements associated with the Contractor’s Safety organization and program, including providing all necessary equipment and personnel for compliance with the requirements of the Contract Documents shall be included in related pay item.

Section 01600 – Maintenance and Control of Traffic

1. Description

1.1 General

This section consists of the requirements for planning, implementing, and monitoring the necessary measures to maintain, control, and protect the traffic in and adjacent to the Project area during the execution of the Works.

This section also consists of the requirements for furnishing, maintaining, relocating, and removing temporary traffic control devices and services as ordered for the control and protection of public traffic through the Project Site.

The following definitions shall be referred to for proper interpretation of this Specification Section:

Traffic Control Plan:	<p>The plan shall be prepared and submitted by the Contractor in compliance with the Contract (hereafter referred to as “the Traffic Control Plan”).</p> <p>The plan shall consist of a complete plan for implementation and monitoring of necessary measures that the Contractor shall perform for the maintenance and protection of public traffic, including traffic due to the construction, in the Project area and adjacent area that is being affected by the execution of the Works.</p> <p>The Project area shall be understood as the area encompassing the Site and all the Project’s related areas such as the plants, quarries, roads for material transportation, etc.</p>
Temporary Roads Plan:	<p>The plan for all the temporary roads to be used by the Contractor for executing the Works.</p> <p>Temporary roads shall include not only new tentative roads related to the construction, but also existing roads to be used for the transportation of materials and equipment.</p> <p>This plan shall be considered as a key component of the main “Traffic Control Plan”. Moreover, the Contractor shall also take into account the special loads referred to in Specification Section 01050 “General Works”.</p>
Program and the Schedule:	As defined in Specification Section 01300 “Program of Work”
Safety Plan:	As defined in Specification Section 01500 “Project Safety”
Environmental Control Plan:	As defined in Specification Section 01700 “Environmental Control and Protection”

1.2 Relevant Statutes

The Contractor shall at all times comply with all existing statutes in the Myanmar concerning Traffic Safety for the implementation of the Works. Such statutes include, but are not limited to, the following:

- MOTC: The Highway Law-No,24/2015

- MOTC: The First Amended Highway Law-No, 60/2015
- MOTC: The Second Amended Highway Law-No,62/2015
- MOTC: The Amended Utilization of Roads and Bridge Law-No,25/2014
- YCDC: The YCDC Rules and Regulations-No, 3/2001
- YCDC: The YCDC Law-No,6/2013
- Myanmar National Building Code 2016.
- In accordance with JICA Guidance for the Management of Safety for Construction Works Sep 2014.
- Reference: The Traffic Regulations, standards the ASEAN countries are referenced.

2. Requirements

2.1 General

- 1) The “Traffic Control Plan” shall be considered as one of the key plans as described in Specification Section 01300 “Programme of Work”.
- 2) The Contractor shall thoroughly acquaint himself with existing traffic conditions and understand the importance of maintaining traffic safety and avoiding excessive traffic delay. The Contractor shall cooperate with the pertinent agencies regarding traffic control and all details will be subject to the Engineer’s approval.
- 3) The Contractor shall take necessary care at all times during the execution of the Works to ensure convenience, environmental protection and safety of residents along and adjacent to the roads, and any public highways or other facilities that may be affected by the Works.
- 4) The Contractor shall be responsible for carrying out the necessary investigations and obtaining approvals, licenses, escorts, and any other necessary facilities in order to enable extraordinary traffic to be moved on the roads in the Project area.
- 5) Before the application of the measures for traffic maintenance and safety contained in the “Traffic Control Plan” described below, the Contractor shall sufficiently investigate and clarify the details and regulations established by local authorities and pertinent divisions of the Ministry of Transport and Communications (MOTC), Ministry of Construction (MOC), YCDC and Traffic Police Office.
- 6) The technical requirements specified in the Myanmar Standards “Road Signs and Signalling Regulations” shall be applied as the specifications for the work items contained in this Specification Section. Supplementing these Myanmar Standards, the specifications stated in other international standards such as AASHTO, ASTM, MUTCD (of the FHWA), or other standards that may be recommended by the Engineer as applicable, shall be used.
- 7) The requirements established in this Specification Section shall supplement, without detriment to, the requirements and provisions stated in the following Specifications:
 - Specification Section 01500 “Project Safety”
 - Specification Section 01700 “Environmental Control and Protection”
- 8) In the event that the Contractor’s failure to meet these requirements persists, it will entitle the Engineer to carry out such works as he deems necessary, and to charge the Contractor with the full cost thereof, plus the respective incidental and administrative costs, of which amount shall be deducted from any money due, or which may become due, to the Contractor under the Contract.

2.2. Traffic Control Plan (TCP)

2.2.1. Description

There is an important and dense population area in Thaketa flyover construction site. Hence, construction of the flyover while maintaining the existing transportation of Thanlyin chin kat road, Yadanar intersection, Shukhinthar intersection has high potential safety risks.

2.2.2. Planning of TCP

Incorporating in the Programme, and supplementing the Safety Plan, the Contractor shall prepare and submit to the Engineer for review and approval, the “Traffic Control Plan” that shall be implemented during the work execution, and shall be monitored on a daily basis.

The Traffic Control Plan shall be in accordance with the Myanmar Standards.

The Traffic Control Plan shall include, but not be limited to, the following:

Traffic Control Organizational Structure: The organization shall be classified into subdivisions that can be technically and effectively managed, and described in a “Traffic Control Organizational Chart” identifying the subdivisions, responsibilities, and tasks of the personnel and supporting staff, all of them engaged solely and specifically for traffic control issues (including the Contractor’s Traffic Supervisor who will be responsible for all traffic control issues in the Site). Moreover, the criteria for appointment of principal staff shall also be described.

Interaction and Communication Procedures: Procedures defining the communication system between the Contractor’s construction personnel working in areas where the traffic is being affected, and the traffic control staff, including radio communication facilities, regular communication, and reporting system. Moreover, the frequency, coverage, and intent of site meetings for traffic coordination shall also be clarified.

Subcontractors’ Traffic Control Plan: The means by which the Traffic Control Plan will be communicated to subcontractors (if any), including also the procedure for reviewing the plan for traffic control proposed by subcontractors, and the method to incorporate the subcontractors’ traffic control plans into the Project’s Traffic Control Plan.

Inventory of the Affected Traffic: A detailed inventory of the road sections on which traffic will be affected by the Works, in accordance with the Programme prepared by the Contractor.

Temporary/Diversion Roads Plan: A consistent plan for construction, maintenance, and removal including all the necessary temporary roads to be used at all stages of construction in accordance with the Programme. This plan shall include a detailed time schedule for the use of all the temporary roads until their respective removal. In the event that a local road is planned to be used as a temporary road, the Contractor shall supplement the plan with a construction method and statement (referring the description in, and a detailed schedule well linked with the construction schedule of the affected local road), for review and approved by the Engineer.

Drawings for Temporary Roads: Full detailed drawings of the planned temporary roads (if any). These drawings shall include details on the alignment, profile, pavement construction, installation of traffic signs, lighting, and the period of use for each temporary road.

Methods, Equipment, and Supporting Staff for Traffic Control: A detailed and consistent description of the methods, equipment, and supporting staff to be applied for traffic control, including details for each stage considered during the construction of the Works. The methodology described in the Traffic Control Plan shall cover all the items herein specified, and all applicable requirements of the Myanmar standards or the like for traffic control.

Traffic Control Schedules: Time-bar schedules prepared for each case of traffic control necessity identified in the abovementioned inventory, including a description of all the main activities for traffic control, dates for commencement and completion of each activity, critical items of the schedule, all means for traffic control, etc.

Traffic Control Inspections: The procedure and schedule for inspection of the traffic control equipment, instruments, and devices.

Supervision and Auditing: The means by which the established traffic control system will be supervised, monitored, and audited by the Traffic Supervisor to ensure its due compliance with the principles and objectives of the Traffic Control Plan. This shall also include the procedure for updating the Traffic Control Plan.

Records: To be prepared and maintained by the Traffic Supervisor and the staff for traffic control, and the communication procedures to be adopted by the Traffic Supervisor such that the Engineer, and others associated with the Works, are kept fully informed throughout the period of the Contract on matters relating to traffic regulations.

2.2. Measures for Prevention of Traffic Accidents

2.3.1. General

When undertaking work with a risk of traffic accidents, the Contractor shall review following measures taking into account the particular work conditions:

- a) Installation of temporary enclosures and gates and related measures.
- b) Measures relating to the area around gates to construction sites.
- c) Installation of temporary pedestrian passages.
- d) Communication with local residents in the vicinity of the construction sites.
- e) Decluttering and cleanliness.
- f) Measures relating to work on public roads.
- g) Prevention of flying or falling object accidents to third parties.
- h) Prevention of dust generation.
- i) Provision of sufficient lighting.
- j) Prevention of noise and vibration.
- k) Site patrol Installation of temporary enclosures and gates.

2.3.2. Measures Relating to Temporary Enclosures and Gates

The Contractor shall construct temporary enclosures on the perimeter of the construction site to prevent third parties accessing the site at any given time. The Contractor shall review the structural measure designed to prevent children accessing the work area, taking into account the following requirements:

- (1) Temporary enclosures shall be of a height that is difficult for children to climb over.

- (2) The mesh-size used for the temporary enclosure shall be sufficiently small to prevent children from putting their limbs or heads through.
- (3) Temporary enclosures shall have no open underside, so that children cannot slip through.
- (4) Temporary enclosures shall be made of materials that would withstand strong wind or external forces and be durable enough to persist during the planned installation period.
- (5) When installing temporary enclosures, the work shall be undertaken taking third parties into consideration.
- (6) Temporary enclosures shall be regularly inspected and maintained to ensure they prevent intrusions.
- (7) Gates shall be constructed on the temporary enclosures. The locations of the gates shall not disturb traffic of general vehicles and pedestrians.
- (8) Gates shall be lockable. When the gates are open, the Contractor shall take appropriate measures including the stationing of watch-personnel or flagmen for work vehicles.
- (9) Gates of temporary enclosures shall be indicated as such, and warning signs prohibiting entry of unauthorized personnel into the site shall be put up.
- (10) No third parties or general vehicles shall be allowed to enter the construction area without prior permission, regardless of whether or not work is being conducted.

2.3.3. Measures Relating to Area Around Gates to Construction Sites

- (1) The Contractor shall provide entry and exit areas for work vehicles at the construction site and install appropriate guidance signboards or other similar measures to inform third parties including pedestrians of the entry and exit of work vehicles.
- (2) The Contractor shall ensure that the traffic of third parties is a top priority at the gates, and extend efforts to prevent public accidents associated with entry and exit of work vehicles. Traffic-control personnel or flagmen shall be stationed as needed taking into account the frequency of work vehicles accessing the gate and the general volume of traffic.

2.3.4. General Rules on Public Roads

When there is a risk of traffic accidents on public roads in connection with the construction work, the Contractor adopt the following measures as appropriate for the particular work conditions:

2.3.5. Measures Relating to work on Public Roads and Diversion Roads.

The Contractor shall:

- (1) Obtain the relevant permission when it is necessary to conduct work on public roads and diversion roads, through the relevant procedures in accordance with the provisions of the relevant laws and regulations of the recipient country prior to the commencement of work.
- (2) Clearly indicate work area on public roads and take measures to prevent unauthorized access by third parties to the area. Relevant watch-personnel shall be stationed as needed.
- (3) Maintain the travelling areas for pedestrians and public vehicles so as to prevent road traffic issues, and station flagmen at appropriate spots to guide public vehicles.
- (4) Maintain safe pedestrian passages for the smooth passages of children and the elderly.

- (5) Take measures to allow drivers of public vehicles to be able to identify the work area from a distance and drive in a safe and secure manner by;
 - Installing road signs at work areas.
 - Installing notice boards to give advance notice of work on public roads.
 - Providing lighting that increases the visibility of road signs and noticeboards, when working after nightfall.
- (6) Firmly affix road signs and notice boards, so as to ensure they do not overturn owing to strong wind or rainfalls.
- (7) Provide appropriate lighting during night time, and take care to prevent the dazzling light of the installed lighting fixture from disturbing drivers of public vehicles.
- (8) Install a detour information board to inform public vehicles and pedestrians of the need for diversions of public vehicles, and deploy flagmen as appropriate.
- (9) Notify local residents of the plan to work on public roads, so as to obtain their understanding and cooperation.

2.4 Traffic Supervisor

- 1) The Contractor shall appoint a Traffic Supervisor, whose duties throughout the period of the Contract shall be entirely connected with the traffic control activities at the Site.
- 2) The Traffic Supervisor shall be a suitably qualified and experienced person who shall prepare, supervise, and monitor the Traffic Control Plan, and shall, in particular but without limitation, carry out auditing of the operation of the Traffic Control Plan in accordance with a rolling program to be submitted, from time to time, to the Engineer for his consent.
- 3) If so requested by the Contractor, the duties designated for the “Traffic Supervisor” could be covered by the Safety Manager designated as established in Specification Section 01500 “Project Safety” and upon the Engineer’s acknowledgement on the curriculum vitae and records of the proposed person for this item. The evaluation of the proposed staff shall include an interview performed by the Engineer.
- 4) Unless specifically agreed in writing by the Engineer, the Contractor shall not undertake any work at the Site, which may affect the traffic, until the Traffic Supervisor has commenced duties on site and the Traffic Control Plan has been approved by the Engineer.
- 5) The Contractor shall not remove the Traffic Supervisor from the Site without the expressed written permission of the Engineer. Within fourteen (14) days of any such removal, or notice of intent of removal, the Contractor shall nominate a replacement Traffic Supervisor for the Engineer’s acknowledgement.
- 6) The Contractor shall provide the Traffic Supervisor with enough supporting staff in accordance with the staffing levels set out in the Traffic Control Plan. The supporting staff shall include at least one (1) Deputy Traffic Supervisor (per each package of Contract) whose appointment shall be subject to information to the Engineer. The Deputy Traffic Supervisor shall be capable of assuming the duties and functions of the Traffic Supervisor as contained in the Traffic Control Plan, whenever necessary.
- 7) The Contractor shall ensure that the Traffic Supervisor maintains a daily site diary, comprehensively recording all relevant matters concerning traffic safety inspections and audits,

related incidents and the like. The site diary shall be available at all times for inspection by the Engineer.

2.5 Special Requirements for Traffic Control

The requirements for the Contractor for maintenance and protection of traffic shall include, but not be limited to, construction of detours, temporary works, traffic control devices, and services for the control and protection of traffic through the construction areas. These include:

2.5.1. Works for Traffic Control

- 1) Prior to the start of construction operations, based on his approved Traffic Control Plan, the Contractor shall furnish, erect, and maintain (at prescribed points) warning and guide signs, barricades or barriers, temporary fences (2.0m height), and other traffic control devices as established in the approved Traffic Control Plan, the Myanmar Standards, these Specifications or as directed by the Engineer.
- 2) As necessary for proper control of traffic, or when/where directed by the Engineer, the Contractor shall furnish and station competent flagmen whose sole duty shall consist of directing the movement of traffic through or around the Works.

2.5.2. Materials for Traffic Control Devices

Retro-reflective Material: Unless otherwise specified in the Contract, sign panels, barricades, cones, vertical panels, and flagged paddles shall have retro-reflective sheeting to meet the minimum requirements for retro-reflective material.

2.5.3. Maintenance of Equipment and Devices.

- 1) The equipment and devices provided to satisfy the requirements of this Specification Section shall be maintained and kept in good working condition all the time.
- 2) Any equipment or devices that are lost, stolen, destroyed, or deemed unacceptable while their use is required on the Project shall be replaced at the Contractor's own expense. Devices for traffic control shall be operated only when necessary.

During non-working hours and following the completion of a particular construction operation, all warning signs, except those necessary for the safety of the public, shall be removed or entirely covered with either metal or plywood sheeting so that the sign panel will not be visible.

2.5.4. Traffic Control during Hours of Darkness

- 1) Night time operation shall be illuminated by a lighting system approved by the Engineer.
- 2) The lighting system shall be positioned and operated to preclude glare.
- 3) Incandescent lights will not be permitted.
- 4) Retro-reflective sheeting on signs, barricades, and other devices shall be kept clean and in good condition. The Contractor shall promptly correct stretches, rips, and tears in the sheeting. Retro-reflective sheeting shall have a maintained retro-reflection.
- 5) When applicable, street lighting shall be relocated as necessary to maintain the same standard of lighting in the course of the Works until new lighting facilities are put into operation.

2.5.5. Traffic Control Conserving Existing Traffic

- 1) When the construction is going to affect an existing road (feeder roads or others) where traffic closure is not permissible, the Contractor shall keep the road open to traffic during the execution of the Works, provided that when approved by the Engineer, the Contractor may divert the traffic over a detour.
- 2) The Contractor shall, at all times, keep roads and footpaths that are affected by his operations free from soil and material spillage, and properly repaired at his own expense if the road is damaged by the operations.
- 3) The Contractor shall keep the length of the Project construction areas in such condition that traffic will be accommodated safely. Traffic control devices and services shall be provided and maintained both inside and outside the Project limits to facilitate traffic guidance as necessary.

2.5.6. Temporary Road Works

In accordance with his Temporary Roads Plan (reviewed and approved by the Engineer), the Contractor shall:

- 1) Furnish, maintain, and remove, upon completion of the Works for which they are required, all temporary roads and road works such as staging over roads, access and service roads, temporary crossing structures, to maintain the existing traffic. Such temporary road works shall be constructed to the satisfaction of the Engineer in accordance with the actual traffic, and shall be maintained in practical condition all the time. The Contractor shall pay special attention to the initial pavement of unpaved local road, if they are included in the Temporary Roads Plan, to protect the local people from the dust and vibration caused by the transportation track.
- 2) Make all necessary arrangements, including payment if required, with public authorities or landowners concerned, for the use of the land, (before constructing the works for temporary roads, and obtaining the Engineer's prior approval). The Engineer's approval shall depend upon the Engineer's satisfaction with the Contractor's proposals for items such as paving, signs installation, lighting, and riding quality of the temporary road, together with the proposed maintenance arrangements. Such approval will not, however, relieve the Contractor of his responsibilities under the Contract. Upon completion of the Works, the Contractor shall clean up and restore the land to the satisfaction of the Engineer.

2.5.7. Temporary Traffic Ramps

Where temporary traffic ramps are required, or if so requested by the Engineer, the Contractor shall furnish all the labour and materials, construct and maintain such temporary traffic ramps to the satisfaction of the Engineer.

2.5.8. Passing of Other Contractors

- 1) When applicable, the Contractor shall make all the necessary arrangements to permit the passage along the road section relating to this Contract of the construction plant, materials, and employees belonging to other contractors engaged in the construction of contiguous stretches of the road.

For this purpose the Contractor and the contractors engaged in the construction of the stretches contiguous to the road through which they must pass shall, when necessary and with at least 15-day notice, request the Engineer for permission to pass and submit a schedule for such passage.

- 2) After the Engineer has granted such permission and approved the schedule submitted, both the Contractor permitting the passage and those requesting it shall undertake to observe the schedule approved by the Engineer for the passage along the site without having any right to extra pay in consequence of the restrictions on passage or the necessary temporary suspension of work due to the aforesaid schedule.

2.5.9. Number of Lanes for Traffic Control

- 1) The existing number of traffic lanes of the roads that may be affected by the Project must be maintained at all times during the work execution, and if diversions are provided, these must be of the same traffic capacity as the original road.
- 2) Notwithstanding the above, the Engineer may give approval to reduce the traffic capacity if the Contractor can show that these will not cause excessive delay to traffic. If such approval is given, the Engineer may specify the hours during the day when the reduction in capacity may be applied, and it should be anticipated that these hours may not include the peak period for the traffic movement under consideration.

2.5.10. Half-Width Construction

- 1) The Contractor shall include in his Traffic Control Plan and proposed method for construction described in the Programme, pertinent details of the construction method to be applied where a detour is not feasible and the construction on existing public roads should be undertaken only over a half of the full width of the roadway.
- 2) The following aspects shall be considered for this purpose:

The length of such half-width construction shall be kept as short as possible.

Work on culverts must be commenced and completed in the dry season and the embankments adjacent to them must be restored so that at least half the full width will be available for use by the public throughout the next rainy season.

A single lane of at least 3.5m wide shall be kept open to traffic.

The Contractor shall conduct his operations in such a manner as to cause the least possible obstruction, inconvenience, and delay to traffic, and shall be responsible for adequate control of the traffic using such lengths of single lane.

2.5.11. Vertical Clearance

In general, any temporary work placed over roads or diversions used by public traffic should have a vertical clearance specified by the Myanmar Standards, as follows:

Where required by the Engineer, the Contractor shall erect and maintain suitable approved check-gates, fitted with warning signs indicating the vertical clearance.

3. Measurement and Payment

3.1 Method of Measurement

All costs related to the implementation and execution of the “Maintenance and Control of Traffic” shall be measured monthly for the duration of construction period.

3.2 Basis of Payment

- 1) Payment shall include all costs necessary and required for the implementation of this work in accordance with these specifications. The Engineer may any time withhold payments if in his opinion this work is not being provided, in due compliance with the requirements and procedures of this specification.
- 2) The Engineer may, at any time, deduct the amount of any uncertain/unsatisfied part of the Works if, in his opinion, the maintenance and protection of traffic have not been provided in due compliance with the requirements and procedures of this Specification Section.

The Pay Items and Pay Unites shall be as follows;

<u>Pay Item</u>	<u>Description</u>	<u>Unit</u>
01600-01	Maintenance and Control of Traffic on Land	Month

Section 01650 – Navigation Control and Safety Works on River (Package 1 and Package 2 only)

1. Description

1.1 General

This section consists of the requirements for planning, implementing, and monitoring the necessary measures to maintain, control, and protect the navigation in and adjacent to the construction area in the BAGO river during the execution of the Works.

The Package 1 Contractor shall have fully responsible for navigation control, safety management and maintenance for Package 1 side (from Pier P6 to Pier P13 (boundary between Package 1 and Package2)).

The Package 2 Contractor shall have fully responsible for navigation control, safety management and maintenance for Package 2 side (from Pier P13 (boundary between Package 1 and Package2) to Pier P23).

Both of the Package 1 Contractor and the Package 2 Contractor are requested to cooperate with navigation control, safety management, construction programme, work plan and so on each other.

This section also consists of the requirements for furnishing, maintaining, and control of navigation and safety control devices and protection of public ship through the Project Site.

The following definitions shall be referred to proper interpretation of this Specification Section:

Navigation Control Plan:	<p>The plan shall be prepared and submitted by the Contractor in compliance with the Contract (hereafter referred to as “the Navigation Control Plan”).</p> <p>The plan shall consist of a complete plan for implementation and monitoring of necessary measures that the Contractor shall perform for the maintenance and protection of public ships, including navigation vessels due to the construction, the construction area in the BAGO river and adjacent area that is being affected by the execution of the Works.</p> <p>The construction area in the BAGO river shall be understood as the area encompassing the Site and all the Project’s related areas such as the construction yard, temporary navigational fairways, Jetty for material transportation, etc.</p>
Safety Plan of Works over River:	<p>The plan for work in the BAGO river shall be used by the Contractor for executing the Works.</p> <p>This plan shall be considered as a key component of the main “Navigation Control Plan”.</p>
Program and the Schedule:	As defined in Specification Section 01300 “Program of Work”
Safety Plan:	As defined in Specification Section 01500 “Project Safety”

Environmental Control Plan: As defined in Specification Section 01700 “Environmental Control and Protection”

1.2 Relevant Statutes

The Contractor shall at all times comply with all existing statutes in Myanmar concerning river laws for implementation of the Works. Such statutes include, but are not limited to, the following:

- Directorate of Water Resources and Improvement of River Systems (DWIR)
- Inland Water Transport (IWT)
- Myanmar Port Authority (MPA)

Table1.1 –Status of River Laws and Regulations

No.	Enacted Laws	Available Version	Law No.	Notification No.
1	The Conservation of Water Resources and Rivers Law	MM/EN	8/2006	
2	The Conservation of Water Resources and Rivers Rule	MM		14/2013
3	The Law of Inland Water Transport Board	MM	51/2014	
4	The Rule of Inland Water Transport	MM		158/2015
5	The Law regarding the Inland Water Vessels	MM	29/2015	
6	The Law Amending the Water Blockade Act	MM	26/2013	
7	The Myanmar Port Authority Law	MM	21/2015	
8	The Law Amending the Light House Act	MM&EN	1/2016	

- JICA Guidance for the Management of Safety for Construction Works Sep 2014

2. Requirements

2.1 General

- (1) The “Navigation Control Plan” shall be considered as one of the key plans as described in Specification Section 01300 “Program of Work”.
- (2) The Contractor shall thoroughly acquaint himself with existing navigation conditions and understand the importance of maintaining safety works in the river. The Contractor shall cooperate with the pertinent agencies regarding navigation control. All details will be subject to the Engineer’s approval.
- (3) The Contractor shall take necessary care at all times during the execution of the Works to ensure convenience, environmental protection and safety of the residents along and adjacent to the Navigational Fairways, and any public vessels or other facilities that may be affected by the Works.

- (4) The Contractor shall be responsible for carrying out the necessary investigations and obtaining approvals, licenses, escorts (ship), and any other necessary facilities in order to enable extraordinary ships to be moved on the rivers in the Project area.
- (5) Before application of the measures for navigation control and safety contained in the “Navigation Control Plan” described below, the Contractor shall sufficiently investigate and clarify the details and regulations established by local authorities and pertinent divisions of the Directorate of Water Resources and Improvement of River Systems (DWIR), Inland Waterway Transport (IWT), Myanmar Ports Authority (MPA) and Police Office.
- (6) The requirements established in this Specification Section shall supplement, without detriment to, the requirements and provisions stated in the following clauses of the Specifications:
 - Specification Section 01500 “Project Safety”
 - Specification Section 01700 “Environmental Control and Protection”
- (7) In the event that the Contractor’s failure to meet these requirements persists, it will entitle the Engineer to carry out such works as he deems necessary, and to charge the Contractor with the full cost thereof, plus the respective incidental and administrative costs, of which amount shall be deducted from any money due, or which may become due, to the Contractor under the Contract.

2.2 Navigation Control Plan (NCP)

2.2.1 Description

The Contractor shall be compliance with the River Law of Myanmar in BAGO river area and establishes the prevention measures of ship accidents, and the safety measures of the Bridge construction on the river, and submits to the Employer and Engineer before construction according to the contract documents.

2.2.2 Planning of NCP

Incorporating in the Program, and supplementing the Safety Plan, the Contractor shall prepare and submit to the Engineer the “Navigation Control Plan” that shall be implemented during the work execution and shall be monitored on a daily basis for review and approval by the relevant authorities and the Employer/Engineer.

The Contractor shall undertake the work according to the Navigation Control Plan on Safety they prepared. Whenever the Navigation Control Plan on Safety need to be amended in consideration of the latest site conditions, social and environmental conditions and/or any other relevant particulars, the Contractor shall update and maintain the documents for review and approval by the Employer and Engineer.

The Navigation Control Plan shall include, but not be limited to, the following:

The Contractor shall:

- (1) Key Points for the Preparation Stage for Navigation Control Plan: The Contractor shall understand the following conditions for construction in advance:
 - Water depth, topography, and geology
 - Local characteristics mainly concerning maritime phenomena and meteorology
 - Traffic conditions in the work area, including traffic routes on the waterway or Temporary Navigational Fairways
 - The presence of underwater obstacles such as sunken ships
 - Aerial lines and other similar utilities around the work area

- (2) Organizational Navigation Control Structure: Appoint appropriate personnel, including a supervisor to be responsible for safety management and safety officers within the internal organizational structure and clarify their respective roles, responsibilities and relevant authorities.
- (3) Navigation Control Safety Committee: In accordance with any requirements under the contract documents, consider establishing an appropriate organization to manage safety, such as a safety committee.
- (4) Response to Emergencies: The Contractor shall determine the policies for responding to the establishment of an emergency communication network.
- (5) Planning Temporary Navigational Fairways: Planning temporary navigational fairways and signal system for leading channels to obtain permission by the relevant authorities before the implementation.
- (6) Planning Construction Area in the BAGO River: Planning construction area and signal system for leading channels to obtain permission by the relevant authorities before the implementation.
- (7) Temporary Navigational Fairways between Pier P11 and Pier P12, and Pier P16 and Pier P18 (refer to the reference drawings of Volume IV of the Bidding Documents) shall be managed and controlled below requirements:

Temporary Navigational Fairways	Construction Period	
	From 1 st month to 21 st month	Form 22 nd month to the end of the Project
Between Pier P11 and Pier P12	Between P11 and P12 shall be opened.	Between P11 and P12 shall be closed. (superstructure works of this area shall be constructed this period)
Between Pier P16 and Pier P18	Between P16 and P18 shall be closed (superstructure works of this area shall be completed within this period)	Between P16 and P18 shall be opened.

- (8) Arrangement of Special Purpose Buoy System: Indicate the Temporary Navigational Fairways and construction areas within the river for arrangement of the buoy system and prevention of the trespassing areas and carry out measures to prevent public accidents such as ship collisions.
- (9) Supporting Staff for Navigation Control: A detailed and consistent description of the methods, equipment's, and supporting staff to be applied for navigation control, including the details for each stage considered during the construction of the Works. The methodology described in the Navigation Control Plan shall cover all the items herein specified, and all applicable requirements of Myanmar standards or the like for navigation control.
- (10) Lighting System at Night time: Draw particular attention to lighting during night time sailing and the station watch-personnel as appropriate.
- (11) Safety Signboard of Temporary Navigational Fairways: Setting place of fairway signboards shall be permitted by relevant authorities and according to the waterway regulations.
- (12) Navigation Control Schedules: Time-bar schedules shall be prepared for each case of navigation control necessarily identified in the above-mentioned inventory, including a

description of all the main activities for navigation control, commencement and completion dates of each activity, critical items of the schedule, all means for navigation control, etc.

- (13) Supervision and Auditing: The means by which the established navigation control system will be supervised, monitored, and audited by the waterway traffic Supervisor to ensure its due compliance with the principles and objectives of the Navigation Control Plan. This shall also include the procedure for updating the Navigation Control Plan.
- (14) Records: To be prepared and maintained by the waterway traffic Supervisor and the staff for waterway traffic control, and the communication procedures to be adopted by the waterway traffic Supervisor such that the Engineer, and others associated with the Works, are kept fully informed throughout the period of the Contract on matters relating to River regulations.

2.3 Works Over River on Safety

2.3.1 Description

The Contractor shall be compliance with the River Law of Myanmar in BAGO river area and establishes the prevention measures of accidents when working over water, and the safety measures of Bridge construction on the river, and submits to the Employer and Engineer before construction according to the contract documents.

2.3.1 Planning of works over river on safety

When undertaking the activities with risks of working over river, the Contractor shall review the following measures taking into account the particular work conditions.

The safety plan of working over river shall include, but not be limited to, the following:

The Contractor shall:

- (1) Development of systems to rescue workers if they fall into water.
- (2) Ensure that workers do not undertake work over water and diving works alone.
- (3) Implement measures to ensure safety against floods, rainstorms, or waves during work over water.
- (4) Collect information on water levels or tide levels in conjunction with the work.
- (5) Prescribe and communicate emergency response measures to all relevant workers in advance.
- (6) Put in place protective gear for ready use, including life preservers and ropes.
- (7) Draw particular attention to lighting during night work and station watch-personnel as appropriate.
- (8) Prohibit from over boarding and overloading of any vessel.
- (9) Diving works, inspection of equipment for diving and diver licenses, and health state of divers are determined in advance
- (10) Install and regularly maintain lifesaving appliances at the appropriate positions in the construction vessel.

2.4 Measures for Prevention of River Accidents

2.4.1 Measures Relating to the Temporary Navigational Fairways

- (1) Periodical Survey on Temporary Navigational Fairways: Periodically observe the depth and flow velocity of the temporary navigational fairways to ensure safe navigation. In particular, water depth measurement at the dry season and low tide is an indispensable item.
- (2) The Contractor shall survey the depth of water in the temporary navigational fairways and shall always secure the lowest at 5 m depth and width at 140m.

- (3) Arrangements of Navigation Control Station and Leading Ship: When obtaining information about a case that ships, construction facilities and other waterway means are not possible to follow the right itinerary, operate exceeding the allowed speed or enter the warned Temporary Navigational Fairways and construction area; timely use high speed boats for instruction and prevention. Communication equipment and facilities VHF are required to use to navigate them as well as inform control stations to mobilize, to instruct and handle in case of deliberate violation.

2.4.2 Measures relating to the works over water

- (1) The Contractor shall establish work suspension rules and communication systems. For example, in case of heavy rain and strong winds, the Contractor shall implement evacuation plan on a regular basis.
- (2) Workers shall use life jackets when undertaking work. They shall use safety belts when working in areas where they may fall and be injured by flying or falling objects or collide with permanent or temporary structures.
- (3) The Contractor shall declare the danger zones to be off-limits to unauthorized personnel in order to prevent from the occurrence of accidents, such as an injury caused by collision with construction machinery. Where it is impossible (on the Barge) to restrict access for unavoidable reasons, the Contractor shall station flagmen's or other appropriate personnel.

2.5 Special Requirements for Navigation Control

The Contractor shall specially require to maintain and protect waterway traffic including, but not limited to, construction of navigation control devices and services for the control and protection of waterway traffic through the construction areas. These include:

2.5.1 Temporary Navigation Buoys System

- (1) As a part of the navigation control measures, light buoys system shall be installed along the temporary navigational fairways and construction area in the BAGO River as specified in the Drawings, or as directed by the Engineer.
- (2) The buoys system of the navigation aids shall be in accordance with the waterway regulations in Myanmar, and then permitted by the relevant authorities.
- (3) Temporary navigational fairways and construction area in the BAGO River shall be agreed by the relevant authorities and the Employer. Provided that, Contractors shall obtain permission from the relevant authorities and the Employer before construction.

2.5.2 Control of Navigational Fairway during Construction

- (1) The Contractor shall ensure that the speed boats shall lead all ships in order to pass the temporary navigational fairways during launching Girder in the BAGO River.
- (2) Inform timely about the emergency cases happening on the Temporary Navigational Fairways and the construction area of the BAGO River such as collision, sink, fire, explosion, pollution, or oil spill inform to the relevant authorities and the Employer/Engineer.

2.5.3 Navigation Control Station

- (1) The Contractor shall place the navigation control station based on safety in the river construction works.
- (2) Suspension work of navigation control station must be informed to all the construction parties. Moreover, the emergency measures and 24-hour monitored sailing ships in the

construction area shall be stationed. A practicable Tugboat shall tow uncontrolled ships and ensure all safety control in the river construction area.

- (3) The Contractor shall rescue and cope with any emergency of waterway means as well as any latent risk of accidents and waterway problems. Therefore, the rescue work and emergency countermeasure must be specially focused. In case of any situation of river rescue or emergency, all forces at site should promptly implement the followings:

The Contractor should base on information of the weather forecast. All means and equipment's must be moved to the safe place when it is whirlwind, low pressure or storm.

Manpower and means must be timely mobilized at site in order to settle the problems as well as notify to other control stations and the relevant authorities at the same time.

Table 2.5.1 Arrangement of Minimum Required Facilities and Equipment

Name of Equipment's	Unit	Navigation Control Station		Remarks
		Control base Tugboat	Assign Speed boat	
Tugboat with capacity equal to 190CV	Number	1	-	Control Station
Speedboat with capacity equal to 50CV	Number	-	1	Upstream Look out for all ships
Speedboat with capacity equal to 50CV	Number	-	1	Downstream Look out for all ships
ICOM MR 1000	Number	1	-	Watch Radar
VHF M72 hand-held device	Number	2	2	Communication
ICOM M402 communication device	Number	1	2	Emergency contact
1000w headlight	Number	1	-	Warning, watch
Binoculars	set	2	4	Watch of vessels
Sign fire gun	set	2	4	Warning, leading ships
Pennant	set	2	4	Warning, leading ships
Electric loud speaker	set	2	2	Warning, leading ships
Life jacket	set	5	4	Prevention drown
First- aid kits	set	1	2	First –aid treatment
Fire extinguisher	set	3	2	Early stage extinguishes

2.5.4 Maintenance of Equipment and Devices

The equipment and devices provided to satisfy the requirements of this Specification Section shall be maintained and kept in good working condition all the time.

Any equipment or devices that are lost, stolen, destroyed, or deemed unacceptable while their use is required on the Project shall be replaced at the Contractor's own expense. Devices for navigation control shall be operated only when necessary.

2.5.5 Personal Protection Equipment (PPE)

Workers shall use life jackets when undertaking work. They shall use safety belts when working in the areas where they may fall and be injured by flying or falling objects or collide with permanent or temporary structures.

2.5.6 Fixed Heavy Machines on the Barge

The Contractor shall fix cranes or heavy machines on the barges for the prevention of turning over due to high waves and rolling barges.

2.5.7 Stability analysis of construction barge

The Contractor shall consider/analyse loading in the construction barges such as loading materials with a crane in order to ensure stability of barges.

2.5.8 Provision of education on safety

The Contractor shall provide necessary training for the operators and workers using construction machines including training for deployment of the construction machines, the work area, the work scope, the work method over river, and the work procedures prior to the commencement of works over river.

2.6 Measurement and Payment

2.6.1 Method of Measurement

All costs related to the implementation and execution of the “Navigation Control and Safety Works on River” shall be measured monthly for the duration of construction period.

(1) Temporary Navigation Buoy

Measurement of this work item is calculated by the number of sets of light buoys which are installed and accepted in the completed works.

Measurement of this item of work shall be in number of sets of light buoys installed and accepted in the completed Works.

Separate payment will not be made for chains, sinkers, batteries, consumables items and accessories necessary to complete the works as such it shall be deemed as part an incidental to the works.

Required quantities of temporary Buoys are mentioned on the Reference Drawings in the Bidding Documents.

(2) Navigation Control

All navigation control devices prepared by the Contractor shall remain the property of the Contractor, and shall be removed upon the completion of the Works. However, the usage of the Navigation Control shall be planned by the contractor.

All the costs related to the implementation of the Navigation Control Plan shall be measured for payment as lump sum.

2.6.2 Basis of Payment

Payment shall include all cost necessary and required for the proper implementation of the navigation control plan, fully in accordance with the requirements of this specification section, including all updates and submittals supervision, materials, equipment, apparatuses and devices, labour, and any incidental costs.

The safety control of works over river shall be deemed included or distributed among all the rates and prices entered for the unit prices in the Bill Quantities. Separate payment shall not be made for these submittals. Claims based on those shall not be considered.

The Engineer may, at any time, deduct the amount of any uncertain/unsatisfied part of the Works if, in his opinion, the maintenance and protection of traffic have not been provided in due compliance with the requirements and procedures of this Specification Section.

<u>Pay Item</u>	<u>Description</u>	<u>Unit</u>
01600-01	Maintenance and Control of Navigation on River	Month

Section 01700 - Environmental Management

1. Scope of Work

The Contractor shall take full responsibility for performing the work minimizing environmental pollution and damage that can occur pursuant to his construction operations.

The Contractor shall develop and implement a site-specific Environment Management Plan (EMP) in complying with all applicable government/ local laws and regulations in the Country as well as the Environmental Impact Assessment (EIA) report which is in the process of approval by Ministry of Natural Resources and Environmental Conservation (MONREC), of this Project, which described the requirement of environmental protection during the entire duration of this contract. The Contractor shall be primarily responsible and accountable for the actions and activities of his subcontractors and suppliers, and for their compliance with the EMP.

The Contractor shall assume the responsibility of securing all the necessary licenses, permits, clearances and their attendant costs and fees prior to start of any construction activities. The Contractor may request the assistance of the Employer/ Engineer thereon on a best endeavour basis.

The Engineer will notify the Contractor in writing of any observed noncompliance with relevant laws, regulations, permits and other elements of the Contractor's EMP. The Contractor shall, after receipt of such notice, inform the Engineer of proposed corrective actions and take such actions, at his own cost, immediately when approved. If the Contractor fails to comply promptly, the Engineer may issue an order stopping all or part of the work until satisfactory corrective action has been taken. No time extension therefore shall be granted to the Contractor for any such suspensions.

The Contractor shall provide and maintain at his own cost the personnel, equipment and facilities necessary for a fulfilment of the requirements of the Environment Protection.

2. Submittals

2.1 Environment Management Plan (EMP)

The Contractor shall submit the own EMP to the Engineer for his approval within twenty-eight (28) calendar days after the date of the Letter of Acceptance. Any construction operation shall not begin until the EMP has been approved by the Engineer. The EMP shall include a series of management plans as below:

- Sediment and erosion control plan for each Site;
- Camps management plan for each camp;
- Waste management plan;
- Pollution control (water, air, noise) plan for each Site;
- Traffic management plan;
- Standard Operating Procedures for pollution spills, and management of fuels and hazardous substances.

These plans above shall be compiled by using information below:

- a) Organization and lines of responsibilities including subcontractors and suppliers

- b) Methods of protection of features to be preserved such as trees/vegetation, soil, landscape features, air and surface/ ground water, fish and wildlife, historical, archaeological and cultural resources.
- c) Procedures to be implemented to provide the required environmental management, to comply with the applicable laws and regulations, and to correct pollution due to accident, natural causes, or failure to follow the procedures of the EMP
- d) Drawings showing locations of any proposed temporary excavations or embankments for haul roads, stream crossings, material storage areas, stockpiles of excess or spoil materials and sanitary facilities and solid waste disposal areas
- e) Training for Contractor's personnel during the construction period

The approval by the Engineer shall not relieve the Contractor of any of his responsibility for the Environment Protection pursuant to his construction operations. Furthermore, the Engineer shall have the right to require the Contractor to improve the approved EMP whenever it is deemed necessary in the opinion of the Engineer.

2.2 Environment Monitoring Report

The Contractor shall submit the Environmental Monitoring Report to the Engineer for his review monthly thereafter, each within 7 days after the last day of the period to which it relates.

Reporting shall continue until the Contractor has completed all work which is known to be outstanding at the completion date stated in the Taking-Over Certificate for the Works.

The Report shall include the items of environmental monitoring requested in this Section.

3. Relevant Statutes

The Contractor shall at all times comply with all existing statutes in the Country concerning environmental protection, pollution control and abatement that are applicable to his construction operations. Such statutes include, but are not limited to, the following;

Table 1 Main Laws and Regulations with Relation to Environmental Protection

Issuance Date	Code / Number	Title
2012/03/30	The Pyidaungsu Hluttaw Law No. 9 / 2012	Environmental Conservation Law
2014/06/05	Notification No. 50 / 2014	Environmental Conservation Rules
2015/12/29	Notification No. 615 / 2015	National Environmental Quality (Emission) Guidelines
2015/12/29	Notification No. 616 / 2015	Environmental Impact Assessment (EIA) Procedure

Note: Official Pdf formatted files of the law and regulation related to environment are available in government webpage of Environmental Conservation Department in MONREC

Table 2 Regulations on Solid Waste

Issuance Date	Code/Number	Title
2013/08/26	2013, Pyidaungsu Hluttaw Law No. 28	Prevention of Hazard from Chemical and Related Substances Law

Issuance Date	Code/Number	Title
2015/12/29	Notification No. 615 / 2015	National Environmental Quality (Emission) Guidelines (Page – 99, Chapter 2: Industrial-specific Guidelines, 2.4: Waste Management)

Table 3 Myanmar Regulations on Standards/Technical Regulations, and Major Environmental Standards/Technical Regulations

Issuance date	Code/Number	Title
2015/12/29	Notification No. 615 / 2015	National Environmental Quality (Emission) Guidelines (Chapter 1: General Guidelines, Air quality for 1.1: Air Emission and Noise for 1.3: Noise, Wastewater discharge for 1.2: Wastewater and Chapter 2: Industrial-specific Guidelines)

Guidelines of the Donor Government:

JICA Guidelines for Confirmation of Environmental and Social Considerations (2010).

4. Assignment of Environment Protection Manager (EPM)

The Contractor shall designate an environment protection manager (EPM) with his staff. The name and qualifications including education and work experiences of the EPM shall be submitted for approval of the Engineer prior to the appointment.

5. Baseline Survey

Prior to any onsite construction activity, the Contractor, together with the Employer and the Engineer, shall make a baseline survey jointly to confirm the ground condition within the whole Site before start of construction, after which the Contractor shall prepare a brief report indicating on a layout plan the condition of trees, shrubs and grassed areas at the Site, immediately adjacent to the Site and adjacent to the assigned storage area and access routes as applicable. This report will be signed by the Employer/ Engineer and the Contractor upon agreement as to its accuracy and completeness.

6. Terrestrial Environment

(a) Vegetation and Wildlife

The Contractor shall minimize interference with, disturbance to, and damage of vegetation and wildlife. The Contractor shall take appropriate measures as may be necessary to prevent his personnel from hunting, disturbing, capturing, or destroying wildlife specified by the relevant laws and regulations. The tree removal in the Site designated by the Employer is handled by the Employer. However, in the case that additional tree removal will be required for the construction work within the Site designated by the Employer, the Contractor shall follow instructions by the Engineer for necessary process.

(b) Landscape

The Contractor shall define all activities at the Site defined by the drawings and specifications. Except in areas indicated on the drawings or specified to be cleared, the Contractor shall not destroy topsoil and land forms without the permission of the Engineer.

Any unpermitted destruction, scarring, damage, or defacing of the landscape pursuant to the construction operations shall be corrected to the satisfaction of the Engineer at the Contractor's expense.

Pay attention to keep construction materials, machines, vehicles, workers' camps and many more not to disturb the landscape of the project area, keeping clean storage sites for the construction equipment.

(c) Soil erosion

The Contractor shall effectively prevent erosion and control sedimentation through approved methods including, but not limited to, the following:

- Retardation and control of runoff
- Erosion and sedimentation control devices
- Sediment basins

7. Water Resources

The Contractor shall keep construction activities under surveillance, management, and control to avoid pollution of surface and ground waters. Toxic or hazardous chemicals shall not be applied to soil or vegetation when such application may cause contamination of the fresh water reserve.

Proper treatment of water pollutants generated from construction works for example settling ponds or a simple water treatment system to comply with effluent level in National Environmental Quality (Emission) Guidelines (EQG). Also, adequate preventive following measures shall be taken as necessary;

- Install cover sheet on bare lands, cut and fill areas and waste soil disposal sites if necessary.
- Surface runoff from the Site shall be directed to silt traps or sedimentation basin with the help of channels before discharge.
- To shelter scattering of soil mud from excavation work by applying preventive measure such as submerged fence in order to avoid increase in turbidity.
- Monitoring water quality during construction.

8. Air, Noise and Vibration

The Contractor shall keep construction activities under surveillance and control to minimize environment damage by air contamination, noise, vibration, odours and/or other disturbances.

Dust particles pursuant to production and preparation of materials shall be controlled at all times. The Contractor shall maintain excavations, stockpiles, haul roads, permanent and temporary access roads, spoil areas, and other work areas within or outside the Site free from particulate which would cause a hazard or a nuisance to persons and/or damage crops, orchards, cultivated field and dwellings. A discharge of dust into the atmosphere shall be controlled during processing, handling and storing cement and cementitious materials.

Night-time operations producing a high level of noise and/or vibration shall be performed only at time and places approved by the Engineer. Temporary noise barriers, or acoustic screens or enclosures shall be used at the Site close to the residential houses to shield residences from the noise as necessary. The Contractor shall indemnify the Engineer from any liability for damages due to noise, vibration and/or other disturbances caused by his construction operations and also from all claims relating to such liability.

Equipment and vehicles shall be maintained and operated at all times in such a condition as not discharge excessive exhaust gases due to poor engine adjustments or other inefficient operating

conditions. The Contractor shall likewise ensure that all equipment and machinery are in proper working condition so as to minimize the amount of noise and vibration generated. The Engineer may require, at his discretion, the Contractor to replace any equipment, machinery or vehicles emitting excessive exhaust gases, noise and/or vibration.

9. Waste Disposal

The Contractor shall dispose any kind of wastes pursuant to his construction operations in compliance with the relevant laws and regulations. Any fees or charges required shall be paid by the Contractor.

The Contractor shall treat the vegetative wastes and construction wastes separately at the dumps approved by the relevant local authorities and the Engineer. The Contractor shall be responsible for making necessary arrangements with private parties and with the relevant local authorities for the location of such dumps.

Solid wastes shall be placed in containers which can be emptied on a regular schedule. Handling and disposal shall be conducted to prevent contamination. Segregation measures shall be employed so that no hazardous or toxic waste will become co-mingled with solid waste.

Chemicals shall be dispensed ensuring no spillage to ground or water. Periodic inspections of dispensing areas to identify leakage and initiate corrective action shall be performed and documented by the Contractor. Chemical waste shall be collected in corrosion resistant, compatible containers.

The Contractor shall take sufficient measures to prevent spillage of hazardous and toxic materials during dispensing and shall collect waste in suitable containers observing compatibility. Spills of hazardous or toxic materials shall be immediately reported to the Engineer. Clean-up and the costs arising there from due to spills shall be the Contractor's responsibility.

10. Historical, Archaeological, and Cultural Resources

Although legally protected historical, archaeological and cultural resources have not been identified within the Site, the Contractor shall pay attention not to damage any other cultural values around the Site. If any historical, archaeological, and cultural resources are newly identified in the Site, the Contractor shall take precautions to preserve all such resources as they existed at the time they were first pointed out.

11. Social Considerations

The Contractor shall pay attention to the public morality of his staff and labourers including his subcontractors both on and off the Site.

In the interest of good community relations, the Contractor and his subcontractors shall be circumspect in dealings with people residing in the neighbourhood of the Site and take adequate efforts to avoid any disturbance to them. The Contractor shall, in his responsibility, arbitrate any dispute arising between his personnel and persons in the neighbourhood of the Site. Unskilled labour shall preferably be employed from the towns/villages affected by the Works. Also, the Contractor shall distribute prior information of construction works as following but not limited through installation of signboards informing the residents who live in and around the construction area.

- Starting and completion date of construction works
- Location of construction work (dredging and disposal work)
- Notices of the construction work etc.
- Method of grievance (contact person and contact number, etc.)

12. Environmental Monitoring

The Contractor shall perform environmental monitoring for the duration of this contract and submit results to the Engineer. The minimum requirements for items, frequency and number of locations of sampling or measurement for Packages 1 to 3 shall be as indicated in the table and figures below, and the detail shall be confirmed in the latest EIA report to be approved by MONREC.

Table 4 Frequency and Locations of Environmental Monitoring during the Construction Phase

Item	Monitoring Item	Monitoring Method	Monitoring Place*	Frequency*	Package	Responsibility
1. Social Environment						
Existing Social Infrastructure and Service	Complaint from surrounding communities	- Check complaint records	Project sites	As necessary	All package	Contractor
Water Use	- Complaint from vessels using navigation channels, - People doing fishing near the project area	- Check complaint records	Project sites	As necessary	PKG 1 & 2	Contractor
Cultural Heritage	Complaint from surrounding communities	- Check complaint records	Project sites	As necessary	PKG 3	Contractor
Landscape	Condition of storing construction machines and materials	- Check the site condition - Check the record of storing construction machines and materials	Project site	Once	All package	Contractor
Children's Right	Complaints from surrounding communities	Check complaint records	Project site	As necessary	PKG 3	Contractor
2. Health and Safety						
Infectious Disease	- Awareness of infectious disease	- Check records of awareness activities on infectious disease	Project site	As necessary	All package	Contractor
Occupational Health	- Record of accidents in the construction site	- Check record of accidents in the construction site	Project site	As necessary	All package	Contractor
Community Health and Safety	- Records of traffic accidents in the surrounding communities	- Check records of traffic accidents in the surrounding communities	Project site	As necessary	All package	Contractor
3. Emergency Risk						
Flood	Condition of flood	Check the site conditions	Project site	As necessary	All package	Contractor
Fire	Condition of fire	Check the site conditions	Project site	As necessary	All package	Contractor
4. Natural Environment						
Flora, Fauna and Ecosystem	Condition of vegetation	Visual check of vegetation condition	Project site	As necessary	PKG 1 and 2	Contractor

Item	Monitoring Item	Monitoring Method	Monitoring Place*	Frequency*	Package	Responsibility
5. Pollution						
Air Quality	i) Record of watering ii) Level of NO ₂ , PM10, PM2.5, SO ₂	i) Check the site conditions ii) Site measurement	i) Project site ii) Total 4 points in the project site (shown in Figures below)	i) Weekly ii) Once a year in the dry season	All package	Contractor
Water Quality	i) Visual observation ii) Level of BOD5, COD, Oil and Grease, pH, Total coliform bacteria, Total suspended solids (TSS)	i) Check the site condition ii) Site measurement	i) Project site ii) Total 4 points in the project site (shown in Figures below)	i) As per construction activity ii) Once a year in the dry season	All package	Contractor
Waste	Record of waste disposal and site condition	[Construction Yard] Check records of amount and type of waste, and disposal method [Worker's Camp] Check solid waste	Project site	As per disposal of waste	All package	Contractor
Noise and Vibration	i) Complaint from surrounding communities ii) Sound level	i) Check records of complaint (for noise and vibration) ii) Site measurement (for noise)	i) Project site ii) 4 points in the project site (shown in Figures below)	i) As necessary ii) Once a year in the dry season	All package	Contractor

* The number and frequency show the minimum requirement.



Note: PK-1AN is for n air quality and noise monitoring point. PK1-W is for a water quality point.

Figure 1 Candidate monitoring points for Package 1 (noise, air quality and water quality)



Note: PK-2AN-1 and PK-2AN-2 are air quality and noise monitoring points. PK2-2W-1 and PK2-2W-2 are water monitoring points.

Figure 2 Candidate monitoring points for Package 2 (noise, air quality and water quality)



Note: PK-3_AN is for an air quality and noise monitoring point. PK-3_W is for a water quality monitoring point.

Figure 3 Candidate monitoring points for Package 3 (noise, air quality and water quality)

13. Measurements and Payments

All cost related to the implementation and execution of “Environmental Management” shall be measured and paid in a lump sum in the following three steps:

1. Twenty percent (20%) upon the issuance of the Engineer’s certification on the EMP, documents or materials prepared by the Contractor as required herein and submitted by the Contractor for the first time after commencement of the Works;
2. Fifty percent (50%) during the execution of the Works split in partial payments in proportion to the work progress, upon the Engineer’s certification on the performed activities herein specified; and
3. Thirty percent (30%) upon the issuance of the Engineer’s certification of the completed item prepared and submitted by the Contractor after completion of the Works, and for the last time in the Contract.

The Pay Items and Pay Unites shall be as follows;

<u>Pay Item</u>	<u>Description</u>	<u>Unit</u>
01700-01	Environmental Management	Lump Sum

Section 01750 - Laboratory and Equipment

1. Description

This section consists of the requirements and procedures to establish, furnish, staff, and maintain the Contractor's Laboratory and the equipment that the Contractor shall provide under the Contract.

The following definitions shall be referred to for proper interpretation of this Specification Section:

Laboratory:	<p>The services of an Independent Testing Laboratory (the Laboratory) that the Contractor shall procure and provide for performing all the necessary testing for quality control.</p> <p>The Laboratory shall have fully furnished and equipped facilities installed and operated by the Contractor, and shall consist of a Central laboratory and/or a Site laboratory or others as may be requested by the Engineer for quality control during the execution of the Works. All the equipment provided for the Laboratory shall be the Contractor's property.</p>
Quality Control Plan (QCP):	As defined in Specification Section 01800 "Contractor's Quality Control"
Quality Control Manager (QC Manager):	As defined in Specification Section 01800 "Contractor's Quality Control"
Programme and the Schedule:	As defined in Specification Section 01300 "Programme of Work"
Certificate of Satisfactory Laboratory Operation:	The certificate that the Engineer may issue to certify his acceptance of the Contractor's compliance with the requirements of this Specification Section during the period of services of the laboratory, to be considered for the payment certificate

2. Requirements

2.1. Reference Standards

The following standards in their latest edition shall be particularly referred to, whenever applicable (but not limited to):

- ASTM C1077-06 Standard Practice for Laboratories Testing Concrete and Concrete Aggregates for Use in Construction and Criteria for Laboratory Evaluation.
- ASTM D3666-05a Standard Specification for Minimum Requirements for Agencies Testing and Inspecting Roads and Paving Materials.
- ASTM D3740-04a Standard Practice for Minimum Requirements for Agencies Engaged in the Testing and/or Inspection of Soil and Rock as Used in Engineering Design and Construction.
- ASTM D4561-96(2001) Standard Practice for Quality Control Systems for Organizations Producing and Applying Bituminous Paving Materials.

- ASTM E329 Standard Specification for Agencies Engaged in Construction Inspection and/or Testing.
- ASTM E542-01 Standard Practice for Calibration of Laboratory Volumetric Apparatus.
- ASTM E543-06 Standard Specification for Agencies Performing Non-destructive Testing.
- ASTM E617-97 (2003) Standard Specification for Laboratory Weights and Precision Mass.
- Other international standards such as AASHTO, ASTM, JIS, and others that may be recommended by the Engineer as applicable.

2.2. General

- (a) The provision of the Laboratory and equipment shall be considered as a primordial condition for due compliance with the requirements of the following Specification Sections:

Section 01800 “Contractor’s Quality Control”,

Section 01000 “General Provisions” (Mobilization),

Section 01300 “Programme of Work”.

- (b) The requirements established in this Specification Section shall also supplement the requirements and provisions stated in the following sections of the General Specifications:

Section 01850 “Acceptance of Work”,

Section 01900 “Control of Materials”

and similar sections regarding the laboratory and equipment in the Contract.

- (c) Failure of the Contractor to comply with the requirements of this Specification Section shall be considered as a serious default of the Contractor in meeting his contractual obligations. In this case, the Engineer shall take note and record the default, and notify the Contractor for applying pertinent measures to secure normality in compliance with the requirements for the Laboratory and Equipment.

- (d) In the event that the Contractor’s failure to meet these requirements persists, the Engineer will be entitled to proceed with the following countermeasures:

1. To establish the revised total amount that shall be applied for calculation of the remaining payment stated deducting proportionally the amount due in the respective default period (i.e., the period for which a deducting adjustment factor is applied in accordance with the above referred paragraph (c) of Subsection 2.2, or in which the Contractor does not obtain the “Certificate of Satisfactory Laboratory Operation” from the Engineer), from the original total amount introduced in the respective Interim Payment Certificate. This deduction will be made in accordance with the procedures established in Sub-Clauses 7.4 “Testing”, 2.5 “Employer’s Claims” and 3.5 “Determinations” of the Conditions of Contract.

2. To carry out such works as he deems necessary and charge the full cost thereof to the Contractor (including related incidentals and administrative costs), which amount shall be deducted from any money due, or which may become due, to the Contractor under the Contract.

- (e) The Engineer reserves the right to require the Contractor to provide additional laboratory testing materials or instruments, as necessary or adequate, to provide necessary technical support for quality control specified in the Contract.

2.3. Special Requirements

2.3.1. Special Requirements for the Laboratory

- (a) The Contractor shall procure, provide and maintain the services of an Independent Testing Laboratory complete with all utility services, furniture, equipment, apparatuses and fittings for performing all the necessary testing for quality control in the Project.
- (b) The Laboratory proposed by the Contractor shall be noted in the QCP described in Specification Section 01800 "Contractor's Quality Control", including all information and data necessary to evaluate its qualifications and adequacy.
- (c) Moreover, a list of the tests that the Contractor proposes to be accomplished off-site by the Laboratory, or by other laboratories, shall also be described.
- (d) The Laboratory shall consist of fully furnished and equipped facilities, fittings and equipment installed and operated by the Contractor all the times throughout the Contract period until the issuance of the Taking-Over Certificate.
- (e) Incorporating in the Programme to be submitted as described in Specification Section 01300 "Programme of Work", the Contractor shall prepare and submit to the Engineer, for review and comments, the following:

Design drawings of the Laboratory facilities prepared by experienced professional staff and reviewed by the QC Manager in accordance with the QCP.

Detailed list of the Laboratory's equipment, instruments, materials and devices for testing that shall be mobilized, installed, and maintained during the Contract period.

A detailed list of equipment that shall be mobilized and maintained during the Contract period.

- (f) The requirements specified in Specification Section 01800 "Contractor's Quality Control" regarding the Quality Control Plan shall also govern the Laboratory's operation, organization, management and administration, etc.
- (g) The Laboratory shall be properly installed and in operation to the Engineer's satisfaction, at least twenty-eight (28) calendar days from the date of issuance of the Engineer's notification, in accordance with Sub-Clause 8.1 of the Conditions of Contract, which instructs the Contractor to commence the Work, or before the start of any work requiring its use, whichever is earlier.
- (h) Materials, equipment, and instruments in the Laboratory, and those used for field testing shall be maintained by the Contractor and kept ready in good operating condition at all times.
- (i) The Contractor shall provide all technicians, supporting staff, labour, etc., in the number deemed necessary to operate the Laboratory as required by the approved QCP, to work under the supervision of each QC Manager.
- (j) Personnel once assigned to the Laboratory shall not be removed without the prior written acceptance by the Engineer.

2.3.2. Equipment and Instruments for the Laboratory

The Laboratory shall be furnished and maintained with all equipment, apparatuses, and supplies necessary to permit the proper execution of all standard tests required by these Specifications under the Contract and relevant to the materials and construction methods to be used on the Works.

The Contractor shall provide all the equipment needed for the correct execution of tests according to the Contract and the equipment shall be of an acceptable quality, new and of

models and brands approved by the Engineer, and calibrated in accordance with the requirements of international standards and testing specifications.

The Laboratory equipment shall be maintained properly, calibrated periodically and/or replaced in order not to interrupt implementation of the Works.

Since the Contractor is solely and fully responsible for implementing and assuring the quality control for the Works, all the activities related to the implementation, furnishing, maintenance and operation of the Laboratory, as well as all the provision and administration of all testing results shall also be the full responsibility of the Contractor.

At the completion of the Contract, all furniture, equipment, apparatuses and supplies provided by the Contractor shall be delivered to the Employer. Prior to deliver all furniture, equipment, apparatuses and supplies provided by the Contractor to the Employer, the Contractor shall provide the list of the delivered all furniture, equipment apparatuses and supplies provided by the Contractor and their manuals for operation.

Moreover, at least within two (2) months before the taking over of the Works, the Contractor shall coordinate a program for training the Laboratory operation of the Employer's technical staff.

2.3.3. Laboratory Check by the Engineer

- (a) *Rights to Check Testing Laboratories:* The Engineer shall at all times have full right and power to check the Laboratory equipment for verifying their due compliance with the Specifications, and to confirm the adequacy of the Laboratory technicians' testing procedures and techniques.
- (b) *Engineer's Access and Use of Laboratory Facilities:* The Engineer shall at all times have full right and power to access the Laboratory and the respective laboratory records related to the Project. The Engineer may, at any time, use the Laboratory facilities to conduct independent testing, or require the Laboratory personnel employed by the Contractor, to conduct such testing.

2.3.4. Survey and Testing Equipment and Personnel Supplied to the Engineer

- (a) Equipment and Supporting Staff for Staking and Survey Works

The Contractor shall, as a requirement of the Contract and without extra charge, furnish for the exclusive use of the Engineer all necessary instruments, appliances, surveyor personnel, and labour, and any material that the Engineer may at any time require for checking the setting out, survey or for any other relevant work to be done.

- (b) All survey and testing equipment shall be supplied with miscellaneous tools, necessary tripods, extra batteries and battery chargers (for electrically operated equipment), mountings, carrying and storage cases, and all necessary accessories.
- (c) Survey and testing equipment will be utilized by the Engineer and will be repaired or replaced by the Contractor as required by the Engineer; however, the equipment will remain the property of the Contractor at the completion of the Contract.
- (d) Any marks or survey staking made by the Engineer, or by the Contractor if so required by the Engineer, shall be carefully preserved and, if disturbed or destroyed, shall be immediately replaced by the Contractor at his own expense and to the satisfaction of the Engineer. No work shall be carried out in any section until the Engineer has approved the necessary setting out.

2.3.5. Certificate of Satisfactory Laboratory Operation

This certificate will be issued by the Engineer, on a monthly basis, upon due compliance of the Contractor with the following conditions:

- a) The tests required by the Specifications have been satisfactorily performed by the Laboratory,
- b) The operation and maintenance of Laboratory's offices for Engineers has been fully provided as specified in this Specification Section.

3. Measurement and Payment

3.1. Basis of Payment

The Laboratory and Engineer's equipment shall be deemed included in or distributed among all the rates and prices entered for the unit prices of the Bill of Quantities. Therefore, separate payment shall not be made under this Section and will not be listed in the BOQ. Claims based on the same shall not be considered.

Section 01800 – Contractor’s Quality Control

1. Description

This Specification Section consists of the requirements and procedures to establish, implement, and maintain the Quality Control Programme by the Contractor.

Quality control procedures and acceptance test procedures have different purposes in principle. Quality control shall be conducted by the Contractor to produce good Works as his tasks under his responsibility. Acceptance test shall be conducted to receive the acceptance of the Work. However, the data of quality control procedures will be used also as the data for the acceptance of the Work.

The following definitions shall be referred to for proper interpretation of this Specification Section:

Quality Control Plan (QCP):	The Contractors’ plan for quality control that shall be prepared and submitted by the Contractor in compliance with the Contract. It shall consist of a complete plan for implementation and monitoring of necessary measures to be performed by the Contractor to control the Works’ quality, assuring that the services and work supplied comply satisfactorily with the standards and the requirements of the Contract.
Programme and the Schedule:	As defined in Specification Section 01300 “Programme of Work”
Laboratory:	As defined in Specification Section 01750 “Laboratory and Engineer’s Equipment”
Certificate of Satisfactory Quality Control:	The certificate which the Engineer may issue, for the purpose of issuing the payment certificate for the corresponding interim payment, to certify that the relevant activities for quality control (QC) have been performed by the Contractor in compliance with the requirements of this Specification Section for Quality Control (QC).
Certificate of Satisfactory Laboratory Operation:	As defined in Specification Section 01750 “Laboratory and Engineer’s Equipment”
Certificate of Satisfactory Control of Materials:	As defined in Specification Section 01900 “Control of Materials”

2. Requirements

2.0. Reference Standards

Supplementing the currently applicable Myanmar regulations for quality control, the following standards in their latest edition shall be particularly used as applicable;

- AASHTO and ASTM Standards for Quality Control and Quality Assurance for Construction of Civil Works;
- Japan Industrial Standards (JIS)
- Nippon Expressway Company (Japan Highway): Manual for Supervision of Civil Works;
- Japan Road Association: Manual for Asphalt and Concrete Pavements;

- Japan Society of Civil Engineering: Standard Specifications for Concrete structures; and
- U.S. Department of Transportation, Federal Highways Administration; Standard Specifications for Construction of Roads and Bridges on Federal Highway Projects: FP-14.

2.1. General

- (a) Myanmar National Building Code 2016 for quality control on construction of civil works, shall govern the basic procedure for establishing and monitoring the QCP for the Project.
- (b) In the event of any discrepancy or ambiguity between the above referred regulations and these Specifications, the Contractor shall timely request for a clarification to be made by the Engineer in consultation with pertinent regulating local authorities.
- (c) The Contractor shall be solely and fully responsible for the application of measures, methods and procedures for testing and handling the testing results, for correction of defects on the Works, and for any eventual work performed to assure the quality of the Works. However, the respective analysis and application of the results obtained by the activities for quality control will be performed by the Engineer in accordance with the Specification Section 01850 “Acceptance of Work”.
- (d) The Quality Control Plan shall be considered as one of the key plans composing the Programme to be prepared, submitted, and monitored as described in Specification Section 01300 “Programme of Work”.
- (e) The requirements established in this Specification Section shall also supplement the requirements and provisions stated in the following sections of the General Specifications:
 - Section 01200 “Contractor Drawings”;
 - Section 01750 “Laboratory and Engineer’s Equipment”;
 - Section 01850 “Acceptance of Work”;
 - Section 01900 “Control of Materials”.

and similar sections regarding quality control in the Contract.

- (f) Failure of the Contractor to comply with the requirements of this Specification Section shall be considered as a serious default of the Contractor in meeting his contractual obligations. In this case, the Engineer will take note and record the default, and notify the Contractor for applying pertinent measures to secure normality in compliance with the requirements for quality control.
Moreover, the payment factor for deduction to be applied to some defined items under Specification Section 01850 “Acceptance of Work”, for preparing the payment certificate, shall be determined at the Engineer’s discretion based on the actual work performed by the Contractor for QC.
- (g) In the event that the Contractor’s failure to meet these requirements persists, the Engineer will be entitled to proceed with the following countermeasures:
 1. To determine the revised total amount that shall be applied for calculation of the remaining payment instalments under Subsection 3.2 (e) by deducting proportionally the amount due in the corresponding default period (i.e., the period for which a deducting adjustment factor is applied in accordance with the above referred paragraph (f) of Subsection 2.1 hereof, or during which the Contractor did not obtain the “Certificate of Satisfactory Quality Control” from the Engineer), from the original total amount introduced in the respective Interim Payment Certificate. This deduction will be made

in accordance with the procedures established in Sub-Clauses 2.5, 3.5 and 7.4 of the Conditions of Contract.

2. To carry out such works as he deems necessary and charge the full cost thereof to the Contractor (including relevant incidentals and administrative costs), which amount shall be deducted from any money due, or which may become due, to the Contractor under the Contract.

2.3. Contractor's Quality Control Plan (QCP)

- (a) Incorporating in the Programme, the Contractor shall prepare and submit to the Engineer for review and comments, the QCP that shall be implemented during the work execution, and shall be monitored on a daily basis. Thereafter, the Contractor shall revise his QCP by introducing the Engineer's comments and review as necessary, and shall re-submit it to the Engineer for its use in the Project as the Revised QCP.

- (b) The Quality Control Plan shall include, but not be limited to, the following:

Quality Control Organizational Structure:

The organization shall be classified into subdivisions that can be technically and effectively managed, and described in the "Quality Control Organizational Chart" identifying the subdivisions, responsibilities and tasks of the personnel and supporting staff, all of whom are engaged solely and specifically for quality control issues (including the Contractor's Quality Control Manager who will be responsible for all quality control issues in the Site). Moreover, the criteria for appointment of principal staff shall also be described.

Lines of Communication:

The organizational structure shall show direct lines of communication and reporting among the Quality Control Manager, Contractor's Project Manager, and the Contractor's Director responsible for the Contract execution.

Interaction and Communication Procedures:

The procedures defining the communication system between the Contractor's Personnel working where quality control is required, and the quality control staff, including regular communication and reporting system. Moreover, the frequency, coverage, and intent of site meetings for coordination shall also be specified.

Subcontractors' Quality Control Plan:

The means by which the QCP will be communicated to the subcontractors (if any), including also the procedure for reviewing the plan for quality control proposed by subcontractors, and the method to incorporate the subcontractors' quality control plans into the Project's QCP.

Methods, Equipment, and Supporting Staff for Quality Control:

- A detailed and consistent description of the methodology, techniques to be applied and equipment (including laboratory), and supporting staff to be provided for quality control, including details for each stage considered during the construction of the Works.
- A consistent cross-reference among the methods applied in the QCP, these Specifications, and all applicable requirements of the Myanmar standards or the like regarding quality control.

Testing List:

A list of tests to be performed throughout the Contract period. The list shall give the test name, frequency, specification section and paragraph containing the test requirements, the personnel and laboratory responsible for each type of test, and an estimate of the number of tests required.

On-Site and Off-Site Testing:

A list and brief description of all on-site and off-site testing to be performed by the Laboratory. Moreover, a list of other testing procedures that the Contractor proposes to be accomplished by other laboratories.

Quality Control Schedules:

Time-bar schedules prepared for each case of quality control necessity identified in the above-mentioned inventory, including a description of all the main activities for quality control, dates for commencement and completion of each activity, critical items of the schedule, certification, management submittals, etc.

Quality Control Inspections: The procedure and schedule for:

- Quality control inspections;
- Verification of due compliance of the methods and materials; and
- Supervision of the performance of the supporting staff.

A complete set of the forms to be used for the inspections shall also be included.

- *Forms for Testing, Reporting and Other Submittals:* All the forms to be used for testing, testing summary reports, quality control monthly report, and other submittals.
- *Tracking of Defects:* The procedure for tracking construction deficiencies from its identification through acceptable corrective actions. This shall also include the method to verify that the identified deficiencies have been properly corrected.
- *Supervision and Auditing:* The means by which the established Quality Control System is supervised, monitored and audited by the Quality Control Manager to ensure due compliance with the principles and objectives of the QCP. This shall also include the procedure for updating the QCP.
- *Records:* To be prepared and maintained by the Quality Control Manager and the staff for quality control, and the communication procedures to be adopted by the Quality Control Manager such that the Engineer and others associated with the Works are kept fully informed throughout the period of the Contract on matters relating to quality control.

Before the start of construction, and prior to the consent of the Engineer on the QCP, the Contractor shall make a full and detailed presentation of the QCP and his proposed quality control system prescribed therein. Minutes of the meeting shall be prepared by the Contractor, and shall be signed by the Contractor and the Engineer. The minutes shall become part of the contractual documents.

Modifications to the Revised QCP shall not be allowed without previous consultation with the Engineer, unless otherwise requested by the Engineer based on the actual necessities for improving the quality control in the Project, or in the event new items are introduced due to the application of some variation orders.

2.4. Quality Control Manager (the QC Manager)

- (a) The Contractor shall appoint a Quality Control Manager (hereafter referred to as “the QC Manager”), whose duties throughout the period of the Contract shall be solely and entirely connected with the quality control activities on Site.
- (b) The QC Manager shall be a suitably qualified and experienced person who shall prepare, supervise, and monitor the QCP, and shall, in particular but without limitation, carry out auditing of the operation of the QCP in accordance with a rolling programme to be submitted, from time to time, to the Engineer for his consent.

- (c) Unless specifically agreed in writing by the Engineer, the Contractor shall not undertake any work at the Site, which may require quality control for his work acceptance, until the QC Manager has commenced duties on Site and the Revised QCP has been received and consent is given by the Engineer.
- (d) The Contractor shall not remove the QC Manager from the Site without the expressed written permission of the Engineer. Within fourteen (14) days of any such removal, or notice of intent of removal, the Contractor shall nominate a replacement QC Manager for the Engineer's consent.
- (e) The Contractor shall provide the QC Manager with enough authority on all aspects relating to quality control within the Contractor's main organization.
- (f) The Contractor shall provide the QC Manager with at least one (1) Deputy Quality Control Manager (for each Contract Package) whose appointment shall be subject to the Engineer's consent. The Deputy Quality Control Manager shall be capable of assuming the duties and functions of the QC Manager as contained in the QCP whenever necessary.
- (g) The Contractor shall provide the QC Manager with enough supporting staff in accordance with the staffing levels set out in the QCP. The supporting staff shall be fully qualified in terms of experience and technical training to perform their responsibilities for quality control, and shall have excellent understanding regarding the contents and objectives of the QCP.
- (h) The Contractor shall ensure that the QC Manager maintains a daily site diary, comprehensively recording all relevant matters concerning quality control inspections and audits, related incidents, and the like. The site diary shall be available at all times for inspection by the Engineer.

2.5. Special Requirements for Quality Control

2.5.1. Laboratory, Testing Inspection, Sampling and Testing Procedures

(a) Laboratory

General: The Contractor shall procure and provide the services of the Laboratory in accordance with the requirements and provisions of Specification Section 01750 "Laboratory and Engineer's Equipment".

Administration: The Laboratory shall work independently, but under the jurisdiction of the QC Manager (for each Contract Package).

Laboratory Check by the Engineer: The rights and power of the Engineer to check the Laboratory are as described in Specification Section 01750 "Laboratory and Engineer's Equipment".

(b) Inspections and Testing

Categories: Testing inspections to be performed regularly by the Contractor, in the presence of the Engineer, are divided into the following two categories:

Job-Site Testing Inspection: The inspection of all "on-site" testing, including its respective procedures, facilities and results to confirm complete and due compliance with the Contract.

Off-Site Testing Inspection: Off-site or factory inspection consisting of:

- Inspection at the point of manufacture or production of various products or materials to be shipped to the Site; and
- Inspection of equipment and materials identified in the Specifications.

Notice to the Engineer: The Contractor shall give appropriate written notice to the Engineer not less than twenty-eight (28) days before off-site inspection services are required, and shall provide for the producer, manufacturer, or fabricator to furnish safe access and proper facilities, and to cooperate with the inspecting personnel in the performance of their duties.

- If the Engineer does not attend on the date agreed, the Contractor may, unless otherwise instructed by the Engineer, proceed with the tests. The absence of the Engineer at the tests does not relieve the Contractor from his obligations.
- The acceptance of the tests results, or the respective work, shall be made only by the Engineer in accordance with Specification Section 01850 "Acceptance of Work".

Expenses: The Contractor shall pay all the expenses required for the inspection, testing, and attendance of the Engineer.

Off-Site Testing and Inspections by Specialized Laboratory:

- In the case of foreign equipment and materials, an independent specialized laboratory approved by the Engineer shall certify the off-site testing and inspections. Related expenses shall be borne by the Contractor.
- All off-site testing and inspections shall be completed to the satisfaction of the Engineer prior to the shipment of the products concerned from the factory to the Site.

Final Inspection:

- Prior to the commencement of the procedure for taking-over of the Works, or any increment thereof, and before inspection by the Engineer, the QC Manager shall conduct an inspection of the Works and shall prepare a list of items which do not conform to the plans and specifications.
- The list of deficiencies shall be included as part of the quality control documentation, and shall include the estimated date by which the deficiencies will be corrected.
- Further, the QC Manager shall make a second inspection to ascertain that all deficiencies have been corrected, and notify the Engineer of such.
- After completion of the deficiency correction as identified by the quality control inspection, the Contractor may proceed with his application for Taking-Over of the Works as stated in Sub-Clause 10.1 of the Conditions of Contract.

(c) Sampling

Standards: Where required by the Specifications (General and Technical), for any work item, sampling shall be made in due accordance with the current Myanmar standards for sampling, supplemented by the likes of AASHTO, ASTM, JIS or other standards recommended by the Engineer as applicable.

Samples: Any material that appears defective or inconsistent with similar material being produced shall be sampled, unless such material is voluntarily removed and replaced or corrected by the Contractor at his own expense.

Procedure: The procedure for sampling shall be defined and scheduled in the QCP, by using random number methods, and defining sets, lots or sections for monitoring the tests procedure until the issuance of the respective acceptance of Work. Splits of samples shall be performed when required, and they shall be delivered to the Engineer in an acceptable container.

Witness by the Engineer: The sampling procedure shall provide the Engineer the opportunity to witness all sampling, immediately perform splits when required, and instruct the Contractor to deliver the government's portion of the sample or split sample in an acceptable container suitable for shipment.

Labelling of Samples: Labels of samples shall contain the following information:

- Project name;
- Source of material;
- Pay item number;
- Sample number;
- Date sampled;
- Time sampled;
- Location where sample taken;
- Name of person sampling;
- Name of person witnessing sampling; and
- Type of test required on sample.

(d) Testing Procedures

Scope of Tests: The Contractor shall perform the tests specified or required to verify that control measures are adequate to provide a product that conforms to the requirements of the Contract and/or Specifications. Testing includes operation and/or acceptance tests when specified or required.

Required Data: The QC Manager shall perform the following activities, and shall provide the following data for the Engineer's approval:

- Verify that the testing procedures comply with the standards referred to in the Specifications.
- Verify that the facilities and testing equipment are available and comply with testing standards.
- Check the test instrument calibration data against certified standards.
- Verify that the recording forms and test identification control number system, including all of the test documentation requirements, have been prepared.

Results Report:

- Results of all tests taken, both passing and failing tests, shall be recorded on the quality control report for the date taken. Specification paragraph reference, location where tests were taken, and the sequential control number identifying the test shall be given. Actual test reports may be submitted later, if allowed by the Engineer, with a reference to the test number and date taken.
- The Contractor shall provide directly to the Engineer an information copy of tests performed by an off-site or commercial test facility.
- Failure to submit timely test reports, as stated, and/or disapproval of the test facility, may result in non-payment for the related work performed.

2.5.2. Certified Laboratory Tests and Manufacturer's Certification

(a) Certified Laboratory Tests:

Laboratory tests may consist also of certified tests made by an authorized agency for testing of materials and equipment that will be incorporated into the Works under the Contract.

Certified tests on materials to be incorporated into the structures will be accepted provided that the tests are performed by the manufacturer or by authorized agencies or laboratories and show that the materials conform to the Specifications.

(b) Manufacturer's Certification:

Manufacturer's certification may be furnished by the Contractor on items of materials and equipment to be provided only when this method will assure, to the satisfaction of the Engineer, their full compliance with the provisions of the Contract. Pre-printed certifications will not be accepted.

All certifications shall be submitted to the Engineer. All certifications by manufacturers or independent laboratories shall name the appropriate item of equipment and material, specifications, standards or other document specified as controlling the quality of that item, and shall be accompanied by certified copies of test reports upon which the certifications are based.

2.5.3. Quality Control Records and Reports

(a) Quality Control Records

Current records of all quality control operations, activities, and tests performed, including those performed by subcontractors and/or suppliers, shall be maintained in the way and format prescribed in the QCP.

The abovementioned records shall be made on a daily report form reviewed by the Engineer, and shall include actual evidences that specified quality control activities and/or tests have been properly performed in accordance with the standards referred to in the Specifications.

The records shall include, but not be limited to, the following:

- Work performed, giving location, description, and the names of technical staff in charge of the control
- Type and number of control activities and tests involved
- Results of control activities or tests
- Deficiencies noted, including in a first instance, the proposed remedial or corrective action.
- Quality control activities performed with results and references to specifications and/or drawings requirements.

(b) Quality Control Reports

Written reports of tests and engineering data furnished by the Contractor for the Engineer's review of materials and equipment proposed to be used in the Works shall be submitted as specified and detailed in the QCP.

The Laboratory shall furnish three (3) copies of a written report on each test performed by the Contractor's QC staff, or by the Engineer when necessary. (Two (2) copies shall be distributed to the Engineer and one (1) copy to the Contractor).

The submittal shall be done within three (3) days after a test is completed.

Laboratory submittal procedures and requirements shall be detailed in the QCP.

(c) Monthly Summary

Complying with the requirements of Specification Section 01400 “Monthly Progress Report”, the Contractor shall summarize all the main activities, and all relevant tests and results obtained in the activities performed during the month.

Moreover, all the problems occurred in the course of execution of the activities for quality control, and outstanding deficiencies, shall also be included in the summary. Tabulated and graphic form should preferably be applied.

2.6. Acceptance and Notification of Non-Compliance

The procedures and stipulations of this section shall apply without detriment to Clause 7: “Plant, Materials and Workmanship” and Clause 9: “Test on Completion” of the Conditions of Contract.

2.6.1. Acceptance

If the Engineer determines that the testing and quality control implemented by the Contractor in executing the Works for the Project is ineffective or contains defects, the Contractor shall make immediate improvements to correct these inadequacies. The results obtained by the application of the system established by the QCP of this Specification Section shall be evaluated for specified pay items under Specification Section 01850 “Acceptance of Work” based on the criteria for acceptance established for the Project.

2.6.2. Notification of Non-compliance

- (a) The Contractor shall, immediately after receipt of a notice regarding any non-compliance with the foregoing requirements, detected by the Engineer or by his staff, take prompt corrective actions.
- (b) Such notice, when delivered to the Contractor at the Site of the Work, shall be deemed sufficient for the purpose of notification.
- (c) If the Contractor fails or refuses to comply promptly with this requirement, the Engineer will be entitled to issue an order for stopping all or part of the Works until satisfactory corrective actions are taken. No part of the time lost due to such stop-orders will be accepted as the subject of a claim by the Contractor for extension of time or for additional costs or damages. Instead, the procedures established and referred in paragraphs (f) and (g) of Subsection 2.1 hereof shall apply.

2.6.3. Certificate of Satisfactory Quality Control

This certificate will be issued by the Engineer, on a monthly basis, upon the Contractor’s due compliance with the following conditions:

- (a) No failures in the compliance with the requirements of this Specification Section have been observed by the Engineer, and the QCP has been properly implemented to the Engineer’s satisfaction in accordance with the consented QC schedules and contents;
- (b) The *Certificate of Satisfactory Laboratory Operation* required in Specification Section 01750 “Laboratory and Engineer’s Equipment” has been issued by the Engineer;
- (c) The *Certificate of Satisfactory Control of Materials* required in Specification Section 01900 “Control of Materials” has been issued by the Engineer; and
- (d) The QC Records and Reports, including the monthly summary have been timely submitted to the Engineer.

3. Measurement and Payment

The Contractor's quality control work shall be deemed included in or distributed among all the rates and prices entered for the unit prices of the Bill of Quantities. Therefore, separate payment shall not be made for these Section. Claims based on the same will not be considered.

Section 01900 - Control of Materials

1. Description

This Section consists of the requirements and procedures to establish, implement, and maintain a systematic procedure for control of materials by the Contractor.

The following definitions shall be referred to for proper interpretation of this Specification Section:

Schedule of Materials:	The schedule prepared for the Programme to show, describe and monitor the proper, adequate, and well-balanced use of materials for construction of the Works, illustrated by shop/working Drawings, summary bar-schedules, quantity tables or diagrams and others, as required and in accordance with the Programme.
Programme and the Schedule:	As defined in Specification Section 01300 "Programme of Work"
Shop Drawings and Working Drawings:	As defined in Specification Section 01200 "Contractor's Drawings"
Laboratory:	As defined in Specification Section 01750 "Laboratory and Engineer's Equipment"
Quality Control Plan (QCP):	As defined in Specification Section 01800 "Contractor's Quality Control"
Certificate of Satisfactory Control of Materials:	The certificate which the Engineer may issue, for the purpose of issuing the Payment Certificate for the corresponding interim payment, to certify that the relevant activities for control of materials have been performed by the Contractor in compliance with the requirements of this Specification Section.

2 Requirements

2.1. Reference Standards

- (a) Supplementing the currently applicable Myanmar regulations referred to in Specification Sections 01750 and 01800, the following standards in their latest edition shall particularly be used as applicable.
- Guide Specifications for Highway Construction, AASHTO, 1998.
 - Nippon Expressway Company (Japan Highway), Manual for Supervision of Civil Works.
 - U.S. Department of Transportation, Federal Highways Administration; Standard Specifications for Construction of Roads and Bridges on Federal Highway Projects - FP-14.
- (b) Unless otherwise designated, when reference is made in the Specifications to standards or test methods such as AASHTO, ASTM, or others, the reference shall mean the specification,

standard or test method which is in effect until twenty-eight (28) days before the date of submission of bids.

2.2. General

- (a) The Contractor shall be fully responsible for all located sources, including established commercial sources, which are related to the Project. The sources listed in the Bidding Document, Part 2 – Works Requirements, Scope of Work – Materials are given only as information to help the Contractor in locating material sources. The decision to use an identified source is entirely that of the Contractor.
- (b) Regardless the origin of the source, all materials to be incorporated into the Works shall comply satisfactorily with all the requirements herein specified, and shall have the Engineer's acceptance issued based on quality control and testing results submitted by the Contractor.
- (c) All materials shall be subject to inspection, sampling, testing, re-testing, and rejection at any time prior to the acceptance of the Works.
- (d) The stipulated Myanmar regulations for quality control and for the Laboratory referred to in Specification Sections 01750 and 01800 shall also govern the basic procedures for establishment, implementation, and maintenance for control of materials for the Project, as applicable.
- (e) The requirements established in this Specification Section shall also supplement the requirements and provisions stated in the following sections of the General Specifications and other Contract Documents:
 - Section 01000 “General Provisions”;
 - Section 01300 “Programme of Work”;
 - Section 01750 “Laboratory and Engineer's Equipment”;
 - Section 01800 “Contractor's Quality Control”; and
 - Section 01850 “Acceptance of Work”.
- (f) Failure of the Contractor to comply with the requirements of this Specification Section will be considered as part of the default to be regulated as specified in Specification Section 01800 “Contractor's Quality Control”, Subsection 2.1 paragraphs (f) and (g).

2.3. Schedule of Materials

- (a) The Schedule of Materials shall incorporate in detail all activities related to the Control of Materials to be implemented in the Project taking into account all the requirements described in the Specifications, the schedules in the Programme, the material sources/delivery to the Project, the procedures for testing and acceptance, and other aspects that the Contractor plans to introduce in the Programme, or as the Engineer may instruct.
- (b) The general schedule of materials shall be submitted along with the Programme, and shall be considered as one of the key schedules for the Project.
- (c) Revisions during the construction period will be allowed if required by the Engineer, or if proposed by the Contractor based on the actual conditions, provided that a plan be properly prepared and submitted to the Engineer for his review and approval, at least twenty-eight (28) days prior to its application in the work execution.
- (d) The schedule of materials shall include, but not be limited to, the following:

- List of materials to be controlled by the Schedule of Materials;
- Sources (location, capacity, technical properties and characteristics, testing results, providers or suppliers references, etc.);
- Contractor's material inspection system (supplementing the QCP specified in Specification Section 01800 "Contractor's Quality Control");
- All the details, working drawings, etc., describing the location or item where the material is intended to be used;
- All the supplementary schedules required for proper monitoring (time schedule, manning schedule, testing and quality control schedules, equipment, etc.);
- All activities associated with the procurement, purchase, fabrication, and shipment of materials provided from local or international sources; and
- Others that the Engineer may require for monitoring.

2.4. Special Requirements for the Control of Materials

2.4.1. Source of Supply and Quality Requirements

- (a) The Contractor shall:
- Perform all the requirements and procedures for quality control, testing, and approval of materials as stipulated in the Specifications;
 - Select sources and provide acceptable materials;
 - Notify the Engineer of all proposed sources before delivery of materials to the Site, to expedite material inspection and testing; and
 - Not incorporate material requiring submittal into the work until approved.
- (b) The material may be approved at the source of supply before delivery to the Project.
- (c) Achieving satisfactory testing results does not constitute acceptance by the Engineer. The Engineer reserves the right to issue his acceptance based on the test results, actual conditions, and actual necessities or requirements for the Works.
- (d) If an approved source does not continue to supply acceptable materials during the Project's execution, further use of that source will be denied, and the Contractor shall furnish materials from other sources.

2.4.2. Material Sources

- (a) Local Material Sources: Except for commercially operated sources, no work shall be performed within a source until the Engineer approves the Schedule of Materials which shall include a detailed plan of operations for development of the source.
- (b) Contractor-located Sources: For the use of this kind of source, the Contractor shall:
- Be fully responsible for all matters related to the source;
 - Use sources that fulfil entirely and satisfactorily the contract requirements with regards to quantity and quality;
 - Determine the quantity and type of equipment and work necessary to select and produce acceptable materials;
 - Secure all permits and clearances for use of the source and provide copies of the documents to the Engineer;
 - Bear all costs related thereto, including those needed for development, exploitation, erosion control, restoration, hauling and any other incidental cost;

- Provide laboratory test reports and available historical performance data indicating that acceptable material is available from the source;
- Not use materials from a source that is unacceptable to the Engineer; and
- Dispose of unacceptable materials and locate other sources at his expense, and without having right to time extension to recover delays due to this matter.

2.4.3. Material Source Management

The Contractor shall:

- (a) Notify the Engineer at least twenty-eight (28) days before starting pit operations;
- (b) Develop and operate within a material source according to the plan of operation included in the accepted Schedule of Materials or the Engineer's written acceptance for developing the source;
- (c) If any or if applicable, before developing a material source;
 - Measure the sediment content of water bodies adjacent to the work area that will receive drainage;
 - Control erosion so that the sediment levels in the water bodies within the drainage area will not increase; and
 - Control erosion so that sediment will not leave the work area.

2.4.4. Storage and Handling of Materials

- (a) All materials shall be handled in such a manner as to preserve their quality and fitness for the Works. Aggregates shall be transported from the storage site to the Works in tight vehicles so constructed as to prevent loss or segregation of materials after loading and measurement.
- (b) The Contractor shall:
 - Store and handle materials to preserve their quality and suitability for the Works. Upon the Engineer's decision, stored material approved before storage may again be inspected before use in the Works;
 - Locate stored materials in such a way that prompt inspection is facilitated;
 - Place the stored materials on a hard and clean surface and, when required, place them under cover;
 - Use only approved portions of the right-of-way for storing materials and placing plant and equipment;
 - Provide all additional space needed;
 - Not use private property for storage without written permission of the owner or lessee; furnish the Engineer with copies of all agreements for such use;
 - Restore all the provided storage sites to their original condition, after completion of the Works, in a manner acceptable to the Engineer, and at no cost to the Employer; and
 - Be responsible for the security of all stored materials.

2.4.5. Stockpiling

- (a) Material stockpiles shall be prepared by clearing and levelling as directed by the Engineer.
- (b) The centre of all aggregate stockpile areas shall be raised and sloped to the sides as required so as to provide proper drainage of excess moisture.

- (c) The materials shall be stored in such a manner as to prevent segregation and to ensure proper gradation and moisture content.

2.4.6. Use of Materials Found in the Work

- (a) Materials such as rock, stone, gravel or sand found in the excavation for the roadway, structures, or channel relocation may be used for another pay item when acceptable.
- (b) When there is an acceptable material found in the Works, which is suitable for another item, the Contractor shall prepare a plan for the use of such material and it shall be included in the Schedule for Materials herein described.
- (c) If the Contractor produces or processes materials found in the Site in excess of the quantities required in the Contract, the Engineer may:
 - Determine and direct the use of the excess material, and determine the amount of payment to the Contractor, including the cost of production; or
 - Direct the removal of the material and restoration of the land to a satisfactory condition, at no cost to the Employer.

2.4.7. Condition of Materials

Unless otherwise specifically provided in the Contract, all items incorporated in the completed Works, such as equipment, materials and other articles shall be new and of the most suitable grade for the purpose intended.

2.4.8. Control of Materials Records and Reports

The records, reports, and monthly summary for the control of materials shall be prepared in accordance with Specification Section 01800 "Contractor's Quality Control", Subsection 2.5.3 "Quality Control's Records and Reports", and shall be incorporated into the QC reports.

- (a) Certification of Compliance
- (b) When a certification is required under the Contract and/or the Specifications, a "Certificate of Compliance" in which the lot is clearly identified shall accompany each lot of such materials delivered to the Works (Refer to the definitions included in Specification Section 01850 "Acceptance of Work").
- (c) When sampling and testing of materials are required under the Contract, the Engineer may permit such materials to be incorporated into the Works prior to sampling and testing, provided that they are accompanied by the "Certificate of Compliance" stating that the materials fully comply with the requirements of the Contract.
- (d) Certificates initiated by the manufacturer and, when required, supported by tests performed by the manufacturer, shall accompany commercially manufactured materials. Copies of such test results shall be furnished to the Engineer.
- (e) A Production Certificate shall be provided for each material to be transported to the Site and shall identify the date and place of manufacture, as well as the lot number or other means of cross referencing in the inspection and testing system. The Contractor shall furnish specific test results on materials from the same lot upon request by the Engineer.

2.5 Acceptance and Notification of Non-Compliance

2.5.1. Acceptance

- (a) The results obtained by the application of the system established in this Specification Section for the Control of Materials shall be evaluated under the Specification Section

01850 “Acceptance of Work” based on the criteria for acceptance established for the Project.

- (b) If the Engineer determines that the control of materials implemented by the Contractor in executing the Works is ineffective or contains defects, the Contractor shall make immediate improvements to correct these inadequacies.

2.5.2. Notification of Non-compliance

The notification of non-compliance with the requirements for control of materials herein specified shall be made in accordance with the procedure established in Specification Section 01800 “Contractor’s Quality Control”, Subsection 2.6.2 “Notification of Non-Compliance”.

2.5.3. Certificate of Satisfactory Control of Materials

This certificate will be issued by the Engineer, on a monthly basis, upon due compliance by the Contractor with the following conditions:

- (a) No failures in complying with the requirements for this Specification Section have been reported by the Engineer, and the Schedule of Materials has been properly implemented to the Engineer’s satisfaction; and
- (b) The Control of Material’s Records and Reports, including the monthly summary have been timely submitted to the Engineer.

3 Measurement and Payment

All the costs related to the control of materials shall neither be measured nor paid separately.

All the Contractor’s unit prices shall include the cost associated with the control of materials. No payment will be made in this regard and no claims will be permitted in connection with any such cost or costs.

Section 01920 –Prevention of HIV/AIDS

1. Description

1.1. General

This section deals with the prevention of HIV/AIDS at workplace and surrounding local communities during the execution of the project.

Regarding the HIV/AIDS as the workplace issue (like any other serious illness/condition in the workplaces), the Contractor shall conduct an HIV/AIDS awareness program via an approved and elite service provider, and shall undertake to reduce the risk of the transfer of the HIV virus between and among the Contractor's Personnel and the surrounding local community, to promote early diagnosis and to assist the affected individuals.

The requirements established in this section shall be minimum requirements, without detriment to, the responsibilities of the Contractor. However, it is not a requirement of this Section for the contractor to undertake or pay for treatment or medication for personnel found to be suffering from HIV/AIDS. Such personnel, however, shall not be discriminated in any situations but shall be referred to National AIDS Programme of the respective township or to other International NGOs (INGOs) which provide further testing and treatment.

1.2. Scope of work

The Contractor shall prepare a detailed HIV/AIDS Prevention Plan (the Plan) indicating how he shall comply with the Contract requirements as well as requirements in the IEE report, for the Engineer's Approval. The Plan shall contain the contents, methods, frequency and cost of the activities for HIV/AIDS prevention targeting all staff related to construction works as well as communities surrounding the Site.

The Contractor shall undertake to implement activities indicating in the Plan, including all necessary facilitation. The approved Plan shall be properly implemented by the Contractor throughout the contract period including the defects liability period, and the activity record with attendee lists shall be submitted to the Engineer within ten (10) working days.

The Contractor shall assign a manager and appropriate number of staff who will work for preparation and implementation of the Plan.

The Contractor shall, within fifty six (56) calendar days, after the date of the letter of Acceptance, submit to the Engineer for his approval of the Plan. In case the Contractor sublets any of his obligation under the Contract, it is required that the sub-contractor shall comply with the Plan as mandatory.

The Plan shall cover the following aspects but not limited to the following:

(1) HIV/AIDS Awareness and Education Program

- (a) HIV/AIDS awareness and education program indicates the risks, danger and impact, and appropriate avoidance behaviour with respect to Sexually Transmitted Diseases (STD) – or Sexually Transmitted Infections (STI) in general and HIV/AIDS in particular. The Contractor shall provide the program addressed to all the Site staffs and labours (including all the Contractor's employees, all Sub-Contractors and Consultants' employees and all truck drivers and crews to Site for construction

activities). The HIV/AIDS awareness and education program shall be provided at least one time for all workers before commencement of their works.

- (b) HIV/AIDS awareness and education program to the surrounding local communities, at least every three months, concerning the risks, danger and impact, and appropriate avoidance behaviour with respect to Sexually Transmitted Diseases (STD) – or Sexually Transmitted Infections (STI) in general and HIV/AIDS in particular.
 - (c) Arrangement for the providing of condoms for all Site staffs and labours on Site as appropriate place or other approved method of distribution throughout the contract period.
 - (d) Arrangement for the hanging of the HIV/AIDS awareness posters in (A0 and A3 size) vinyl at the appropriate place of offices, work place and labour camps.
 - (e) Arrangement of place, keeping and submission of record for the implementation of HIV/AIDS awareness and education program to the Engineer.
- (2) Peer Educators Program
- (a) Selection sufficient number of the Peer Educators from all Site staffs and labours to be more effective in HIV/AIDS prevention program.
 - (b) Implementation schedule of the peer educator program.
 - (c) Arrangement for providing the necessary support to the peer educators.
- (3) HIV Testing
- (a) Arrangement of STI and HIV/AIDS screening, diagnosis, voluntarily counselling/testing referral to a dedicated national STI and HIV/AIDS program, (Unless otherwise agreed) of all Site staffs and labours.
 - (b) Confidentially keeping system of the testing results not to discriminate in working area.
 - (c) Referring the staffs and labours found HIV positive in testing results to the National AIDS Programme (NAP) of the relevant township or to other INGOs which provide further testing and treatment.

1.3 Relevant Statutes

The Contractor shall at all the time comply with the existing statutes in the Country concerning Public Health Law for the implementation of the Works.

- The Public Health Law (1972)
- The Prevention and Control of Communicable Diseases Law (1995, revised in 2011)

If the requirements stated in this document are less stringent than or in conflict with the country's applicable legislation, the latter shall apply.

1.4 Code of Practice

The Code of Practise shall be in accordance with the Contract, based on a recognized standard and not less standards than those prescribed in the following code and standards:

- The ILO Codes of Practise on HIV/AIDS and the world of work (Guidelines for the Construction Sectors)

1.5 Notice of Contravention

The Engineer will notify the Contractor in writing as Notice of Contravention of any observed noncompliance with the responsibilities of Contractors' HIV/AIDS prevention plan. The Contractor shall, after receipt of such notice, inform the Engineer of proposed corrective actions and take such actions immediately.

1.6 Payment for HIV/AIDS Prevention Plan

The payment for HIV/AIDS Prevention plan shall include full compensation for equipment, labours and materials, including procurement and distribution of both male and female condoms, required for the provision of the services. The payment shall be done by provisional sum, split proportionally, at completion of each awareness and education program.

The Pay Items and Pay Unites shall be as follows;

<u>Pay Item</u>	<u>Description</u>	<u>Unit</u>
01920-01	Prevention of HIV/AIDS	Provisional Sum

Section 01950 – Soil Investigation

4. Description

This Specification Section describes the requirements and procedures to establish, implement, and maintain a procedure for soil investigations at locations as may be directed by the Engineer or required by the Contractor for pile driving, foundation bearing capacity information.

5. Requirements

The Contractor shall carry out soil investigations at the locations designated by the Engineer. Locations shall include each pier and abutments at bridge foundation sites that has not been surveyed.

The Contractor shall establish a site store for all soil samples. Each sample shall be given a unique number. Samples shall not be disposed of unless ordered by the Engineer.

The Contractor shall employ a Geologist or Soils Engineer and shall provide an interpretive full report of all investigations and test results to the Engineer.

Prior to commencing of the soil investigation, the Contractor shall submit a scheme of the works for the approval of the Engineer.

The minimum requirements of the soil investigation shall be as follows;

- (i) One or more boring at each pier and abutments.
- (ii) The hole diameter of the borehole shall be $\phi 64$ mm. When the undisturbed sampling is required, the hole diameter of the borehole is 112 mm. Although the hole diameter of the borehole is in principle these, please use the engineer's approval when using other specifications.
- (iii) Depth of borehole to be instructed by the Engineer.
- (iv) Tests by Standard Penetration Test (ASTM D 1586-99).
- (v) The number of samples of the laboratory soil test (disturbed samples) is directed by the Engineer. The method of Laboratory tests is as follows.

(The physical properties tests)

- Natural Moisture Content Test (ASTM D 2216-10)
- Specific Gravity Test (ASTM D 854-14)
- Particle Size Analysis Test (ASTM D 422-63(2007)e2)
 - Grain Size Distribution Test
 - Hydrometer Test
- Atterberg Limits Test (ASTM D 4318-10e1)
 - Liquid Limit Test
 - Plastic Limit Test

- (vi) Boreholes are to be filled with cement grout to the approval of the Engineer
- (vii) Upon completion of the soil investigation, the Contractor shall submit a full detailed report, including all test results, to the Engineer for his consideration.
- (viii) All boring logs shall contain, but not be limited to, the following information and data:

- Structure name
- Bore position and code number
- Reduced level of top of the bore
- Date and time of boring
- Diameter of bore
- Type of plant used
- Depth to which bore was cased
- Depth to base of each stratum from the surface
- Description of strata
- Depth and results of standard penetration testing tests (if required)
- Depth of any split-spoon sampling (if required)
- Static water level
- Remarks

- (ix) All descriptions and classifications of soils shall be in accordance with ASTM D2487 “Classification of Soils for Engineering Purpose (Unified Soil Classification System)”

The Engineer will call for more elaborate testing than described above at any site should he find that the information obtained by the Contractor is not adequate to determine the necessary parameters to allow the intents of the design to proceed.

6. Reference Standards

- (a) The field investigation works and laboratory tests are carried out in accordance with ASTM, and the units are applied with SI.
- (b) Unless otherwise designated, when reference is made in the Specifications to the standards or test methods such as AASHTO, ASTM, or others, the reference shall mean the specification, standard or test method in the latest version or as instructed in these Specifications.

7. Measurement and Payment

A Provisional Sum is designated in the Bid of Quantity Sheet for Geotechnical Investigations. All the costs related to the site (Geotechnical) investigation shall be measured in accordance with the detailed quotation and schedule provided by the Contractor before commencement of this work.

<u>Pay Item</u>	<u>Description</u>	<u>Unit</u>
01950-01	Soil Investigation for Bridge Foundation	Number
01950-02	Soil Investigation for Soft Soil Improvement	Number

Section 01960 – Control of Material

1. Description

This Section consists of the requirements and procedures to establish, implement, and maintain a systematic procedure for control of materials by the Contractor.

The following definitions shall be referred to for proper interpretation of this Specification Section:

Schedule of Materials:	The schedule prepared for the Programme to show, describe and monitor the proper, adequate, and well-balanced use of materials for construction of the Works, illustrated by shop/working Drawings, summary bar-schedules, quantity tables or diagrams and others, as required and in accordance with the Programme.
Programme and the Schedule:	As defined in Specification Section 01300 “Programme of Work”
Shop Drawings and Working Drawings:	As defined in Specification Section 01200 “Contractor’s Drawings”
Laboratory:	As defined in Specification Section 01750 “Laboratory and Engineer’s Equipment”
Quality Control Plan (QCP):	As defined in Specification Section 01800 “Contractor’s Quality Control”
Certificate of Satisfactory Control of Materials:	The certificate which the Engineer may issue, for the purpose of issuing the Payment Certificate for the corresponding interim payment, to certify that the relevant activities for control of materials have been performed by the Contractor in compliance with the requirements of this Specification Section.

2. Requirements

2.1. Reference Standards

- (a) Supplementing the currently applicable Myanmar regulations referred to in Specification Sections 01750 and 01800, the following standards in their latest edition shall particularly be used as applicable.
- Guide Specifications for Highway Construction, AASHTO, 1998.
 - Nippon Expressway Company (Japan Highway), Manual for Supervision of Civil Works.
 - U.S. Department of Transportation, Federal Highways Administration; Standard Specifications for Construction of Roads and Bridges on Federal Highway Projects - FP-14.
- (b) Unless otherwise designated, when reference is made in the Specifications to standards or test methods such as AASHTO, ASTM, or others, the reference shall mean the specification, standard or test method which is in effect until twenty-eight (28) days before the date of submission of bids.

2.2. General

- (a) The Contractor shall be fully responsible for all located sources, including established commercial sources, which are related to the Project. The sources listed in the Bidding Document, Part 2 – Works Requirements, Scope of Work – Materials are given only as information to help the Contractor in locating material sources. The decision to use an identified source is entirely that of the Contractor.
- (b) Regardless the origin of the source, all materials to be incorporated into the Works shall comply satisfactorily with all the requirements herein specified, and shall have the Engineer's acceptance issued based on quality control and testing results submitted by the Contractor.
- (c) All materials shall be subject to inspection, sampling, testing, re-testing, and rejection at any time prior to the acceptance of the Works.
- (d) The stipulated Myanmar regulations for quality control and for the Laboratory referred to in Specification Sections 01750 and 01800 shall also govern the basic procedures for establishment, implementation, and maintenance for control of materials for the Project, as applicable.
- (e) The requirements established in this Specification Section shall also supplement the requirements and provisions stated in the following sections of the General Specifications and other Contract Documents:
 - Section 01000 “General Provisions”;
 - Section 01300 “Programme of Work”;
 - Section 01750 “Laboratory and Engineer's Equipment”;
 - Section 01800 “Contractor's Quality Control”; and
 - Section 01850 “Acceptance of Work”.
- (f) Failure of the Contractor to comply with the requirements of this Specification Section will be considered as part of the default to be regulated as specified in Specification Section 01800 “Contractor's Quality Control”, Subsection 2.2 paragraphs (f) and (g).

2.3. Schedule of Materials

- (a) The Schedule of Materials shall incorporate in detail all activities related to the Control of Materials to be implemented in the Project taking into account all the requirements described in the Specifications, the schedules in the Programme, the material sources/delivery to the Project, the procedures for testing and acceptance, and other aspects that the Contractor plans to introduce in the Programme, or as the Engineer may instruct.
- (b) The general schedule of materials shall be submitted along with the Programme, and shall be considered as one of the key schedules for the Project.
- (c) Revisions during the construction period will be allowed if required by the Engineer, or if proposed by the Contractor based on the actual conditions, provided that a plan be properly prepared and submitted to the Engineer for his review and approval, at least twenty-eight (28) days prior to its application in the work execution.
- (d) The schedule of materials shall include, but not be limited to, the following:
 - List of materials to be controlled by the Schedule of Materials;
 - Sources (location, capacity, technical properties and characteristics, testing results,

- providers or suppliers references, etc.);
- Contractor's material inspection system (supplementing the QCP specified in Specification Section 01800 "Contractor's Quality Control");
- All the details, working drawings, etc., describing the location or item where the material is intended to be used;
- All the supplementary schedules required for proper monitoring (time schedule, manning schedule, testing and quality control schedules, equipment, etc.);
- All activities associated with the procurement, purchase, fabrication, and shipment of materials provided from local or international sources; and
- Others that the Engineer may require for monitoring.

2.4. Special Requirements for the Control of Materials

2.4.1. Source of Supply and Quality Requirements

- (a) The Contractor shall:
 - Perform all the requirements and procedures for quality control, testing, and approval of materials as stipulated in the Specifications;
 - Select sources and provide acceptable materials;
 - Notify the Engineer of all proposed sources before delivery of materials to the Site, to expedite material inspection and testing; and
 - Not incorporate material requiring submittal into the work until approved.
- (b) The material may be approved at the source of supply before delivery to the Project.
- (c) Achieving satisfactory testing results does not constitute acceptance by the Engineer. The Engineer reserves the right to issue his acceptance based on the test results, actual conditions, and actual necessities or requirements for the Works.
- (d) If an approved source does not continue to supply acceptable materials during the Project's execution, further use of that source will be denied, and the Contractor shall furnish materials from other sources.

2.4.2. Material Sources

- (a) Local Material Sources: Except for commercially operated sources, no work shall be performed within a source until the Engineer approves the Schedule of Materials which shall include a detailed plan of operations for development of the source.
- (b) Contractor-located Sources: For the use of this kind of source, the Contractor shall:
 - Be fully responsible for all matters related to the source;
 - Use sources that fulfil entirely and satisfactorily the contract requirements with regards to quantity and quality;
 - Determine the quantity and type of equipment and work necessary to select and produce acceptable materials;
 - Secure all permits and clearances for use of the source and provide copies of the documents to the Engineer;
 - Bear all costs related thereto, including those needed for development, exploitation, erosion control, restoration, hauling and any other incidental cost;
 - Provide laboratory test reports and available historical performance data indicating that acceptable material is available from the source;

- Not use materials from a source that is unacceptable to the Engineer; and
- Dispose of unacceptable materials and locate other sources at his expense, and without having right to time extension to recover delays due to this matter.

2.4.3. Material Source Management

The Contractor shall:

- (a) Notify the Engineer at least twenty-eight (28) days before starting pit operations;
- (b) Develop and operate within a material source according to the plan of operation included in the accepted Schedule of Materials or the Engineer's written acceptance for developing the source;
- (c) If any or if applicable, before developing a material source;
 - Measure the sediment content of water bodies adjacent to the work area that will receive drainage;
 - Control erosion so that the sediment levels in the water bodies within the drainage area will not increase; and
 - Control erosion so that sediment will not leave the work area.

2.4.4. Storage and Handling of Materials

- (a) All materials shall be handled in such a manner as to preserve their quality and fitness for the Works. Aggregates shall be transported from the storage site to the Works in tight vehicles so constructed as to prevent loss or segregation of materials after loading and measurement.
- (b) The Contractor shall:
 - Store and handle materials to preserve their quality and suitability for the Works. Upon the Engineer's decision, stored material approved before storage may again be inspected before use in the Works;
 - Locate stored materials in such a way that prompt inspection is facilitated;
 - Place the stored materials on a hard and clean surface and, when required, place them under cover;
 - Use only approved portions of the right-of-way for storing materials and placing plant and equipment;
 - Provide all additional space needed;
 - Not use private property for storage without written permission of the owner or lessee; furnish the Engineer with copies of all agreements for such use;
 - Restore all the provided storage sites to their original condition, after completion of the Works, in a manner acceptable to the Engineer, and at no cost to the Employer; and
 - Be responsible for the security of all stored materials.

2.4.5. Stockpiling

- (a) Material stockpiles shall be prepared by clearing and levelling as directed by the Engineer.
- (b) The centre of all aggregate stockpile areas shall be raised and sloped to the sides as required so as to provide proper drainage of excess moisture.
- (c) The materials shall be stored in such a manner as to prevent segregation and to ensure proper gradation and moisture content.

2.4.6. Use of Materials Found in the Work

- (a) Materials such as rock, stone, gravel or sand found in the excavation for the roadway, structures, or channel relocation may be used for another pay item when acceptable.
- (b) When there is an acceptable material found in the Works, which is suitable for another item, the Contractor shall prepare a plan for the use of such material and it shall be included in the Schedule for Materials herein described.
- (c) If the Contractor produces or processes materials found in the Site in excess of the quantities required in the Contract, the Engineer may:
 - Determine and direct the use of the excess material, and determine the amount of payment to the Contractor, including the cost of production; or
 - Direct the removal of the material and restoration of the land to a satisfactory condition, at no cost to the Employer.

2.4.7. Condition of Materials

Unless otherwise specifically provided in the Contract, all items incorporated in the completed Works, such as equipment, materials and other articles shall be new and of the most suitable grade for the purpose intended.

2.4.8. Control of Materials Records and Reports

The records, reports, and monthly summary for the control of materials shall be prepared in accordance with Specification Section 01800 "Contractor's Quality Control", Subsection 2.5.3 "Quality Control's Records and Reports", and shall be incorporated into the QC reports.

- (a) Certification of Compliance
- (b) When a certification is required under the Contract and/or the Specifications, a "Certificate of Compliance" in which the lot is clearly identified shall accompany each lot of such materials delivered to the Works (Refer to the definitions included in Specification Section 01850 "Acceptance of Work").
- (c) When sampling and testing of materials are required under the Contract, the Engineer may permit such materials to be incorporated into the Works prior to sampling and testing, provided that they are accompanied by the "Certificate of Compliance" stating that the materials fully comply with the requirements of the Contract.
- (d) Certificates initiated by the manufacturer and, when required, supported by tests performed by the manufacturer, shall accompany commercially manufactured materials. Copies of such test results shall be furnished to the Engineer.
- (e) A Production Certificate shall be provided for each material to be transported to the Site and shall identify the date and place of manufacture, as well as the lot number or other means of cross referencing in the inspection and testing system. The Contractor shall furnish specific test results on materials from the same lot upon request by the Engineer.

2.5 Acceptance and Notification of Non-Compliance

2.5.1. Acceptance

- (b) The results obtained by the application of the system established in this Specification Section for the Control of Materials shall be evaluated under the Specification Section 01850 "Acceptance of Work" based on the criteria for acceptance established for the Project.

- (c) If the Engineer determines that the control of materials implemented by the Contractor in executing the Works is ineffective or contains defects, the Contractor shall make immediate improvements to correct these inadequacies.

2.5.2. Notification of Non-compliance

The notification of non-compliance with the requirements for control of materials herein specified shall be made in accordance with the procedure established in Specification Section 01800 "Contractor's Quality Control", Subsection 2.6.2 "Notification of Non-Compliance".

2.5.3. Certificate of Satisfactory Control of Materials

This certificate will be issued by the Engineer, on a monthly basis, upon due compliance by the Contractor with the following conditions:

- (a) No failures in complying with the requirements for this Specification Section have been reported by the Engineer, and the Schedule of Materials has been properly implemented to the Engineer's satisfaction; and
- (b) The Control of Material's Records and Reports, including the monthly summary have been timely submitted to the Engineer.

4 Measurement and Payment

All the costs related to the control of materials shall neither be measured nor paid separately.

All the Contractor's unit prices shall include the cost associated with the control of materials. No payment will be made in this regard and no claims will be permitted in connection with any such cost or costs.

**Division 2
Site Works**

Table of Contents

Section 02100 – Site Clearing1

Section 02200 - Demolition & Removal of Existing Structures & Obstructions.....4

Section 02300 - Diversion and Protection of Existing Utilities8

Section 02100 – Site Clearing

1. Description

This work consists of clearing, grubbing, removal of top soil, all vegetation including shrubs and debris, tree felling and uprooting the stumps within the Project limits, except those objects designated to remain in place or to be removed in accordance with other sections of these Specification Section. All removed materials shall be disposed of in the disposal areas established in accordance with Section 02200 unless otherwise specified herein.

This work shall also include the preservation from damage or defacement of all vegetation and objects designated to remain.

2. Construction Requirements

2.1. General

The Engineer will establish the limits of work and designate all trees, shrubs, plants and other things to remain. The Contractor shall protect and preserve all items designated to remain.

2.2. Clearing and Grubbing

- (a) All surface objects including trees, timber, rotten wood, stumps, roots, snags, brush, other vegetation, rubbish, and other protruding obstructions, not designated to remain, shall be cleared and grubbed, including its disposal as required.
- (b) In areas under roadway embankments, from which top soil or unsuitable materials are to be removed or which are designated to be compacted, all stumps and roots shall be removed to a depth of at least 50 cm below the original ground level and at least 50 cm below the bottom of the designed lowest pavement layer.
- (c) In roadway cut areas, all stumps and roots shall be removed to a depth of not less than 50 cm below the finished subgrade level.
- (d) Clearing and grubbing of pits, channel changes, and ditches shall be made only to the depth required by the excavation within such areas.
- (e) Voids left after removal of stumps and roots shall be backfilled with suitable materials, and compacted to an approved level.

2.3. Topsoil Stripping

- (a) In areas under roadway embankments or where designated by the Engineer, the Contractor shall remove the topsoil and dispose it off as directed by the Engineer.
- (b) In general, the removal of topsoil shall include only the removal of soil which is sufficiently fertile to contribute to or sustain the growth of vegetation.
- (c) Removal of topsoil over any designated area shall be to the depth directed by the Engineer, and the topsoil that in the opinion of the Engineer can be re-used shall be stockpiled separately from other excavated materials.
- (d) Where topsoil is to be used for dressing of the slopes of embankment or other areas as directed by the Engineer or as indicated in the Drawings, the work of topsoil stripping will be deemed to include stockpiling of topsoil when necessary as well as removal, placing, and spreading of topsoil in areas designated by the Engineer. In which case, the work shall be measured and paid only under Specification Section 08200 "Top". After spreading, the topsoil shall be raked to form a smooth surface free from weeds, roots, sods, and large stones.

2.4. Protection of Areas Designated to Remain

In areas designated by the Engineer, the Contractor shall be responsible for the protection and routine maintenance of existing shrubs, trees, and grassed areas. Upon completion of Works, these areas shall be returned to the Employer in the same condition as the existing, and any damage due directly or indirectly by the Contractor's operations shall be made good at the Contractor's own expense.

2.5. Disposal of Cleared Material

- (a) The Contractor shall have the right to use unsaleable timber (or saleable timber when permission is granted in writing by the appropriate government agency or authority) for his own purposes in connection with the Contract, provided that he has ascertained and complied with the requirements of the relevant government agency or authority.
- (b) Saleable timber shall be neatly stored in an approved accessible place within or near the right-of-way as directed and shall be trimmed and stacked in accordance with the requirements of the relevant government agency.
- (c) All other timber, except timber to be used, and all brush, stumps, roots, logs, and other refuse from the clearing and grubbing operation shall be disposed of at locations provided by the Contractor.
- (d) The roadway and adjacent areas shall be left with a neat and finished appearance. No accumulation of debris shall remain on or adjacent to the right-of-way.

3. Measurement and Payment

3.1. Method of Measurement

Cleaning and grubbing will be measured on Plan area basis in square meter, as indicated in the Bill of Quantities. The work of cleaning and grubbing at disposal sites, material sites, and borrow pit sites shall not be paid for when such are outside the areas disposal sites or borrow pit sites.

Any areas occupied by an existing gravel, macadam, and asphalt concrete, concrete or sealed roadway surfaces or otherwise maintained areas are excluded from the designated areas and shall not be included in measurement.

Any areas designated as soft ground and for bridge construction shall not be included in measurement.

Felling of trees, the trunks of which are less than 300 mm at 1 m above ground, and uprooting the stumps shall be considered as included in clearing and grubbing.

Felling of trees, the trunks of which are greater than 300 mm at 1 m above, ground and uprooting the stumps shall be separately measured for payment at Provisional Sum herein.

3.2. Basis of Payment

(a) Clearing and Grubbing

This work measured as provided above shall be paid for at the Contract unit as detailed below per square meter. The rates shall be full compensation for furnishing all labour, material, tools, equipment and incidentals necessary to do the work and for doing all the cleaning and grubbing in the designated areas and as specified in the Specification and as directed by the Engineer including the removal and disposal of all the resulting material.

(b) Tree Felling and Uprooting Sumps

Payment for tree felling and uprooting the stumps shall be made at Provisional Sum and shall be the payment in full for carrying out the required operations including full compensation for all labour, materials, tools, equipment and incidentals necessary to complete the work. These will include felling, excavation, backfilling the holes after uprooting with suitable materials in layers and compacting, handling, transporting and disposal.

The Pay Items and Pay Units shall be as follows;

Pay Items	Descriptions	Units
02100-01	Clearing and Grubbing	m ²
02100-02	Removal of trees (girth greater than 300mm at 1 m above ground)	Provisional Sum

Section 02200 - Demolition & Removal of Existing Structures & Obstructions

1. Description

Demolition and removal of existing structures shall consist of the removal, wholly or in part, and satisfactory disposal of blocks of masonry of an individual size greater than 1 cubic meter, of all buildings, hedges, fences, structures, pavements regardless of their nature (asphalt, concrete, etc.), curbs, and any other obstructions which are not designated or permitted to remain. Demolition includes the salvaging of designated materials and proper backfilling (in accordance with specification requirements) of any and all trenches, holes, and pits resulting from demolition and removal work.

Right-of-way acquisition may not be completed in all areas at the start-up of the construction period, and the Contractor shall schedule the work associated with this Specification Section, accordingly.

Obstructions or other items that are designated for removal and disposal elsewhere as indicated in the Contract Documents shall be dealt with in accordance with the relevant stipulated requirements.

2. Submittals

The Contractor, prior to the commencement of any work, shall prepare and submit to the Engineer, for respective approval, the following:

- (a) Shop Drawings in accordance with the provisions of Specification Section 01200 "Contractor's Drawings", including detailed information regarding the drainage structures, curbs, pavements, etc. to be demolished and removed in accordance with the provisions and indications of this Specification Section.
- (b) Complete details of the method, equipment, and schedule to perform the demolition and removal work pertinent to this item.
- (c) Inventory of the materials that could be recovered from demolition work and stockpiling of suitable materials from stripping that the Contractor intend to use for other items.
- (d) Detailed drawings showing disposal areas for non-reusable materials arising within the Site, or areas for stockpiling of the recovered materials planned to be used for other items.

3. Construction Requirements

3.1. General

Demolition and removal of existing structures shall be executed by the Contractor within and adjacent to roadways and on the right-of-ways, as shown in the Drawings or as directed by the Engineer. The demolition and removal work shall comply with the following conditions:

- (a) The Engineer may instruct that the materials recovered from demolition work shall remain the property of the Employer, unless otherwise specifically stipulated in the Contract Documents.
- (b) All designated salvageable materials shall be removed, without unnecessary damage, in sections or pieces which may be readily transported, and shall be stored by the Contractor at specified locations within the Project Site as directed by the Engineer.
- (c) Basements or cavities left by any structure removal shall be backfilled with an acceptable material to the level of the surrounding ground, and if within the prism of construction, shall be compacted in accordance with Specification Section 03400 "Embankment Construction". There will be no separate payment for backfilling and compaction of the resulting cavities.
- (d) Demolition and removal of existing structures includes salvage of materials removed, their custody, preservation, and storage on the right-of-way or any other locations as may be designated by the Engineer or the Employer, or disposal as provided herein.

- (e) All the materials resulting from the demolition of existing structures, or obstructions, shall be removed from the Site in accordance with the requirements for “Unsuitable Material” stipulated in Specification Section 03100 “Common Excavation”.

In the case that the material to be removed is, in the Engineer’s opinion, usable for other items, the volume of the reusable materials shall be measured and paid only for the items for which it will be used.

3.2. Removal of Drainage Structures

- (a) Bridges, asphalt or concrete pavements, culverts, and other drainage structures in use by traffic shall not be removed until satisfactory arrangements have been made to accommodate the traffic.
- (b) The removal of existing culverts within embankment areas shall be required only as necessary for the installation of new structures. Abandoned culverts shall be broken down, crushed, and sealed or plugged.
- (c) All culvert sections removed, which are not designated for stockpiling or relaying, shall become the property of the Contractor and shall be removed from the Project or disposed of in a manner approved by the Engineer.
- (d) Unless otherwise directed, the substructures of existing structures shall be removed down to the natural stream bottom and those parts outside the stream shall be removed down to at least 300 mm below the natural ground surface.
- (e) Where such portions of the existing structures lie wholly or in part within the limits of a new structure, they shall be removed if necessary to accommodate the construction of the proposed structure. Where only a section of the existing structure is to be demolished, the Contractor shall execute the work in such a manner as to avoid damage to the section designated to remain. All details of the Contractor's proposed working methods shall be submitted to the Engineer for approval.
- (f) Any structures designated to become the property of the Contractor shall be removed from the right-of-way.
- (g) Blasting or other operations necessary for the removal of an existing structure or obstruction, which may damage new construction, shall be completed prior to placing the new work, unless otherwise approved by the Engineer.
- (h) Existing bridges or other structures, when specified by the Engineer to be salvaged, shall be carefully dismantled without damage. Salvaged members shall be match-marked before dismantling, unless the Engineer waives such match marking. All salvaged materials shall be stored as requested by the Engineer.
- (i) Unless waived in writing by the Engineer, all concrete removed that is of a suitable size for rip-rap and not needed for such use on the Project, shall be stockpiled at locations designated by the Engineer, for use by the Employer.

4. Removal of Curbs

- (a) Existing curbs designated for removal, including their bases, shall be broken into pieces, the size of which shall not exceed 300 mm in any dimension.
- (b) Removal of existing curbs shall be undertaken in such a manner as to avoid damage to existing pavements and curbs which are designated to remain.

4.1. Removal of Pavements, Footpaths, etc.

- (a) Irrespective of their thickness or nature, all asphalt or concrete pavements, footpaths, or other hard surfaces designated for removal, shall be broken into pieces, the size of which shall not exceed 300 mm in any dimension.
- (b) Removal of pavements shall be carefully undertaken to avoid damage to abutting sections of pavement or structures designated to remain.

4.2. Removal of Buildings and Structures

- (a) Upon receipt of notification by the Engineer, the Contractor shall take over all responsibility for the vacant buildings or buildings previously acquired, and shall proceed with the removal thereof as specified.
- (b) Unless otherwise indicated in the Drawings or directed by the Engineer, the Contractor shall complete the demolition and removal of buildings and structures together with all foundations and retaining walls, piers, partitions, and columns down to a plane 30 cm below the ultimate grade in the area.
- (c) Walls shall be broken into pieces not exceeding 60 cm² for any area of surface, mixed with previous backfill materials and placed in basement areas.
- (d) Basement floor slabs shall be broken and displaced into pieces not exceeding 60 cm² for any area of surface and shall be left in place. Excess debris shall be removed and disposed of. All other foundations, concrete floor slabs, sidewalks, signs, sheds, garages, and fences and all other incidental and collateral work necessary to fully complete the removal of buildings and appurtenances shall be removed and disposed of as directed.
- (e) The Contractor shall inspect each building to be removed and determine for himself the work involved and the equipment and materials required for such demolition work.
- (f) The Contractor shall arrange for the disconnection of all utility services that serve the building or buildings in accordance with the respective requirements and regulations of the relevant government authorities and utility agencies involved.
- (g) The Contractor shall disconnect and properly seal, in a manner approved by the relevant local government agency or agencies responsible and the Engineer, all sewer outlets that serve any building or buildings that the Contractor is directed to remove.
- (h) The Contractor shall keep the Engineer informed of his plans for the performance of any work in connection with the sealing off of such outlets in order that proper inspection may be provided at the time the work is performed.
- (i) The Contractor shall conduct his operations in such a manner as to avoid potential hazards to persons and vehicles. Once a work on any building has commenced, the work shall be continued promptly and expeditiously until completion.
- (j) All debris shall be removed from basement areas and concrete floors shall be broken. The area shall then be filled with previous backfill material simultaneously with the breaking of the foundation walls so that the previous backfill material will be well integrated with the pieces of broken concrete.
- (k) Concrete slabs resting on earth and forming walks, driveways, or the first floor slabs of buildings without basements, except as indicated in the Drawings, shall be broken up and removed from the Site.
- (l) The Contractor shall be responsible for the removal of any additional small buildings or miscellaneous structures which have not been indicated in the Drawings.
- (m) Existing underground storage tanks on the Site or within the buildings shall be removed and disposed of by the Contractor. The Contractor shall take all necessary measures and precautions during the removal and disposal of the liquid, sludge or other waste materials from the tanks as well as the removal of the existing tanks. The Contractor shall backfill with fine aggregate the areas where the tanks are removed. This backfill shall be in accordance with the specifications for "Granular Backfill".
- (n) Structures designated to become the property of the Contractor shall be removed from the right-of-way.
- (o) Operations necessary for the removal of an existing structure or obstruction, which may damage new construction, shall be completed prior to placing the new work, unless otherwise stipulated in the Contract Documents.

5. Measurement and Payment

5.1 Measurement

The required and accepted work of removal of the structures etc. shall be measured as cubic meter of structures in place before demolition.

5.2 Payment

Payment for removal of structures shall be made after the successful disposal of cleared materials. Payment shall include full compensation for carrying out the operations described including but limited to excavation, backfilling of excavations using approved materials, preparing and shaping, handling, sorting out, salvaging, stockpiling, disposing etc. of material.

The Pay Items and Pay Units shall be as follows;

Pay Items	Descriptions	Units
02200 - 01	Removal of Unreinforced Concrete Structures	m3
02200 - 02	Removal of Reinforced Concrete Structures	m3
02200 – 03	Removal of Pavement and Footpath	m3

Section 02300 - Diversion and Protection of Existing Utilities

1. Description

Any work involved in moving, reinstating existing utilities and laying of new utilities that may be affected by the construction of the works shall be undertaken by the appropriate authority or by the Contractor under the supervision of the appropriate authority.

2. Construction Requirements

The Contractor may be required to carry out certain works for and on behalf of various utility authorities and he shall also provide, with the prior approval of the Engineer, such assistance to the various bodies as may be authorized by the Engineer.

No removal of or alternations to any public utility shall be carried out unless directed by the Engineer.

The Contractor shall take all reasonable precautions to protect, and shall provide temporary support to, existing utilities during construction and during relocation of such utilities.

Whenever utilities are encountered that interfere with the execution of the works and require moving or relocation, the Contractor shall inform the Engineer who will determine the extent of the work involved.

Any pipe, cable, conduit or other utilities of any nature whatsoever, which has been damaged as a result of the Contractor’s operations shall be repaired and reinstated forthwith by the Contractor or by the authority concerned, all at the expense of the Contractor and to the satisfaction of the Engineer.

The Employer will not be held liable of responsible for any delay in completion of the works under the contract which may occur due to any damage occurring to such utilities in consequence of the Contractor’s operations.

Where utility relocation is required for the execution of the works, it shall be executed by

- (a) The utility authorities by themselves, or
- (b) The Contractor under the co-supervision of the Engineer and the utility authority with the consent of the utility authority.

3. Measurement and Payment

The works of temporarily supporting and protecting public utilities during execution of the works shall not be paid separately.

Where utility relocation is executed by the utility authorities themselves, the Contractor shall assist the authorities to their relocation works.

Pay-Item	Description	Unit
02300-01	Assist Utility Authority for the Relocation Works	Provisional Sum
02300-02	Relocation of Utilities as Per Requirements of the Utility Authority and the Employer	Provisional Sum
02300-03	Reinstatement of Road as Directed by the Engineer	Provisional Sum

Division 3
Earthworks

Table of Contents

Section 03100 – Common Excavation1
Section 03200 - Structural Excavation.....6
Section 03300 - Borrow Material.....13
Section 03400 -Embankment Construction.....16
Section 03500 – Mechanically-Stabilised Earth Wall.....31
Section 03600 – Reinforced Concrete Retaining Wall38
Section 03800 – Aggregate Subbase and Base40
Section 03900 - Soft Soil Improvement by Soil Cement Columns.....50
Section 03910 – Soft Soil Improvement by Shallow Improvement.....57
Section 03950 – Soft Soil Improvement by Preloading61

Section 03100 – Common Excavation

1. Description

Common excavation consists of all types of excavation within the limits of the right-of-way, except for structural excavation, which are specified in Specification Section 03200 “Structural Excavation”.

Common excavation shall be applicable for all Works that may be required and/or directed by the Engineer.

Common excavation shall include the removal, handling, and proper utilization or disposal of all excavated materials, regardless of their nature or existing condition, and shaping of excavation and preparation of the exposed surface of excavation in accordance with these Specifications and in conformity with the lines, levels, grades, dimensions, and cross-sections shown in the Drawings and/or as required by the Engineer.

2. Classification of Excavation

Common excavation will be categorized into three types: (1) Soil excavation, (2) Rock excavation, and (3) Excavation of unsuitable materials

(1) Soil Excavation: Common excavation will be classified as “Soil Excavation” when it consists of the removal of the following materials:

- Soil: Roadway excavation classified as Soil which include all soil and soft rock (except for hard rock and boulders herein defined) regardless of its nature or existing condition; and
- Soft Rock: Soft rock comprising of weathered rock, sandstone, limestone, and such materials which, in the opinion of the Engineer, can be excavated by picking, ripping or other similar means without resorting to blasting.

However, excavation of unsuitable materials is treated as different payment item in this Specification Section as shown below (c).

(2) Rock Excavation: Common excavation will be classified as “Rock Excavation” when it consists of the removal of the following materials:

- Hard Rock: Roadway excavation classified as Hard rock shall include hard igneous, metamorphic, and/or sedimentary rock that, in the opinion of the Engineer, cannot be removed without the use of pneumatic tools or drilling and blasting operations (blasting operations are described in Specification Section 03150). Hard rock shall not include material which, in the opinion of the Engineer, can be loosened or excavated with standard equipment (tractor or backhoe).
- Boulders: Boulders shall comprise solid pieces of rock that are weathered on all faces and are between 0.25 m³ and 1.0 m³ in volume. Boulders will be measured by the maximum length of the longest axis of the boulder multiplied by the area of the circle with a circumference measured at the widest point of the boulder. Boulders with a dimension exceeding the above-stated volume and that cannot be pulverized without the use of pneumatic tools, drilling and blasting operations, or by standard tractor or backhoe, shall be classified as hard rock. However, boulders which are larger than the above-stated volume, but can be disposed of

outside the Project area using common equipment for transportation without the necessity of blasting or pulverization, shall not be considered as hard rock. Boulders that are smaller than the above-stated volume shall be classified as soil.

- (3) Excavation of Unsuitable Material: Common excavation will be classified as “Excavation of Unsuitable Material” when it consists of the removal of the following materials:
- Materials resulting from the Work performed in accordance with Specification Section 02100 “Site Clearing” and Section 02200 “Demolition and Removal of Existing Structures and Obstructions”.
 - Materials below the natural ground surface in embankment areas below the grading plane or other limits shown in the Drawings, or as designated by the Engineer, that are unsuitable for the planned use.
 - Surplus materials over the amount required for the construction of the embankment, provided however, that it is not rendered surplus by reason of the Contractor having opened borrow pits solely for his own convenience.
 - Materials such as highly organic clays and silts, peat, muck, soil containing a large number of roots, grass, and other vegetal matters, domestic or industrial waste, which might be classified as “unsuitable” under this Specification Section.
 - Soils with a liquid limit exceeding 55% and a plasticity index exceeding 27%.
 - Soils with natural water content exceeding 50%.
 - Soil with a very low natural density of 800 kg/m³ or lower.
 - Highly expansive soil having an Activity Value greater than 1.0 or a degree of expansion classified by AASHTO T258 “Standard Method of Test for Determining Expansive Soils” as “Very High” or “Extra High”. The Activity Value shall be measured by the Plasticity Index/Percent Clay Size ratio. The application of equivalent ASTM standards is also allowed depending upon the Engineer’s approval regarding its proper interpretation and application.
 - Materials having hazardous chemical or physical properties.
 - Soil that cannot be properly compacted in accordance with Specification requirements or as determined by the Engineer.
 - Suitable materials that in the opinion of the Engineer were contaminated by unsuitable materials during excavation operations.

3. Construction Requirements

3.1. Preparation Work

- (a) The Contractor shall, before and after clearing and grubbing and excavation, under the supervision of the Engineer, shall make a topographical survey of the area and submit the surveyed cross-section and profile maps to the Engineer for his consideration and approval, to be used as a basis for the computation of the actual volume of the excavated materials.

- (b) Prior to excavation, all necessary clearing and grubbing in the area shall have been performed in accordance with Specification Section 02100 "Site Clearing".
- (c) The Contractor shall include in the "Schedule of Materials", required by Specification Section 01900 "Control of Materials", a detailed plan and schedule for the use of "suitable material" in the Project including details related to the location (of excavation and placement), construction method, time schedule, testing, etc. This plan shall be continuously updated on a weekly basis and in accordance with the progress of the Works until completion of the roadway excavation. On the revision of the Plan, the Contractor shall try to use better materials for the surface or upper course, and comparatively poor materials for the lower places.

3.2. Use of Excavated Materials

- (a) The Contractor may opt at his discretion to use materials from roadway excavation and/or borrow excavation in the formation of the road embankment, subgrade, shoulders, slopes, bedding, surcharge and/or counterweight, backfill for structures, structures, subbase and/or base courses, production of aggregates for concrete or asphalt pavements, or for other purposes shown in the Drawings, specified in the Specifications or as directed by the Engineer.
- (b) In accordance with the provisions of Specification Section 02100: "Site Clearing", suitable topsoil (for slope protection or other uses decided by the Engineer) encountered in excavation and on areas where embankment is to be placed, shall be removed to such extent and depth as described in this Specification Section or as directed by the Engineer. The topsoil shall be completely removed to the required depth from any designated area prior to the beginning of regular excavation or embankment works in the area and shall be kept separate from other excavated materials for later use. The removed topsoil shall be transported and deposited in stockpiles at locations previously prepared by the Contractor and approved by the Engineer. The Contractor may select some of the site compounds which may be provided by the Employer as temporary stockpiles, subject to approval by the Engineer. The Contractor shall take full responsibility for clearing and returning the temporary site compounds.
- (c) All excavations shall be finished to reasonably smooth and uniform levels. Excavation operations shall be conducted so that material outside the limits of slopes will not be disturbed.

3.3. Removal of Unsuitable Material

- (a) No materials shall be wasted without previous quantification by the Contractor and approval by the Engineer.
- (b) When unsuitable materials below sub-grade level in cut or below embankment foundation level is ordered by the Engineer to be removed, the soil left in place (after the removal of the unsuitable materials) shall be compacted to a depth of 20 cm and with 95% maximum dry density determined in accordance to AASHTO T180. Payment for such compaction shall be deemed included in the unit rate for excavation.
- (c) All unsuitable materials shall be removed and disposed of in approved waste areas provided by the Contractor in such a manner as to present a neat and orderly appearance and not to obstruct drainage to any highway nor to cause injury to highway works or property. If it becomes necessary for the Contractor to locate or relocate any waste areas, the Contractor shall obtain prior approval of the Engineer to commence the operation for spreading any waste.

- (d) Waste areas shall be left in a smooth, neat, and drainable condition, as required by the Engineer, and all waste material shall be placed in such a manner that adjacent properties will not be damaged or endangered.
- (e) The relevant provisions of Specification Section 01700 “Environmental Control and Protection” shall be adhered to for the hauling and disposal of unsuitable materials.

3.4. Dimensional Tolerances

- (a) Finished grades, lines, and formations after excavation shall not vary from those specified by more than 20 mm at any point.
- (b) Finished excavated surfaces that are exposed to surface runoff water shall be adequately smooth and uniform, and have sufficient slope, to ensure free drainage of the surface with no ponding.

4. Measurement and Payment

4.1 Method of Measurement

- (a) The quantities of excavated unsuitable materials that were not previously approved by the Engineer (as a part of the “Schedule of Materials”) shall not be paid and claims based on this respect shall be rejected.
- (b) No payment shall be made for the excavation from unapproved design changes. But the measurement shall include unavoidable over-breakage due to slides when not attributable to the carelessness of the Contractor.
- (c) The actual excavation volume shall be computed from the average cross-section areas bounded by ground lines after clearing and grubbing, and ground lines after excavation or a plane defined by the Engineer. The volume for excavation of temporary embankment shall not be measured for payment.
- (d) The soil excavation volume shall be measured for payment as the resultant volume by deducting the excavation volume of unsuitable material and rock from the total excavation volume and shall be suitable to site condition and Drawings approved by the Engineer.
- (e) The materials, with the exclusion of unsuitable materials, excavated from the roadway excavation shall be measured for payment in accordance with Specification Section 03400 “Embankment Construction” if such excavated materials are incorporated in the Works and accepted by the Engineer.
- (f) The entire excavation schedule, transport of materials to the appropriate location, and arrangement of stock pile shall be set up by the Contractor. Omitting of suitable material or re-use of unsuitable material from the excavation shall be proposed by the Contractor in the Working Schedule and accepted by the Engineer. The costs for equipment, labours spent for excavation, transportation and protection of these materials were included in the unit price of this Section and therefore shall be deducted in unit prices of sections where these materials are used.
- (g) Material excavated for temporary diversion roads constructed by the Contractor shall not be measured for payment but shall be considered as included in the rates and prices of Specification Section 01600 “Maintenance and Control of Traffic”.

4.2 Basis of Payment

The accepted quantities measured as provided above, shall be paid at the contract price per unit of measurement in the pay items of the Bill of Quantities listed below.

Payment shall be for full compensation for the work prescribed in this Specification Section including all preparation, assembly, installation, excavation, removal, ripping, blasting, haulage, compaction of road bed or satisfactory disposal (waste) of site excavation, for shaping and completion of all surfaces, works for planning and updating, and for furnishing all labour, materials, tools, equipment, and any incidentals necessary to complete the work as shown in the Drawings and as required, in accordance with this Specification Section and/or as directed by the Engineer.

Pay Item	Description	Unit
03100-01	Soil Excavation	m3
03100-02	Unsuitable Material Excavation (Waste Excavation)	m3

Section 03200 - Structural Excavation

1. Description

1.1 General

- (a) Structural excavation shall consist of excavation of earth for foundations of bridges, culverts, sub-drains and other structures not otherwise provided for in the Specification Section and except as otherwise provided for pipe culverts as shown in the Drawings, which are made for structures.
- (b) The use and disposal of all excavated materials shall be in accordance with this Specification Section and in conformity with the Drawings, or as directed by the Engineer. Any excavation that can be defined under any other Specification Sections will not be considered as structural excavation.
- (c) All excavated materials, so far as suitable and approved by the Engineer, shall be utilized as backfill or embankment, or shall be removed from the Site, if exceeding requirements.
- (d) All surplus materials over the requirements shall, if instructed by the Engineer, be considered as waste and treated in accordance with the requirements for “Unsuitable Material Excavation (Waste Excavation)” of Specification Section 03100 “Common Excavation” Subsection 2 (3).
- (e) Structural excavation shall include backfilling in accordance with relevant Specification Sections and approved by the Engineer, incorporating surplus materials in the fill areas in accordance with the requirements of Specification Section 03400 “Embankment Construction”, hauling and disposing of waste materials, and all necessary materials and equipment for keeping the excavation free of surface run-off and groundwater.
- (f) This Specification Section addresses supplying, placing, and compacting granular backfill adjacent to structures. The areas in which this material is to be placed shall be as indicated in the Drawings or as required by the Engineer.
- (g) It shall also include the supply and placing of approved foundation fill material to replace unsuitable materials encountered below the foundation level of structures.
- (h) This work shall include necessary diversion of live streams, bailing, pumping, draining, sheeting, bracing, the necessary construction of cribs and cofferdams, and supply of the materials therefore, and subsequent removal of cribs, cofferdams, and remaining unsuitable materials, and placing of all necessary backfill.
- (i) Removal or diversion of existing water flows shall be addressed in accordance with the requirements and stipulations of Specification Section 01050 “General Works” Subsection 2.6 Maintenance of Existing Waterway.

1.2 Structural Excavation Classification

Structural excavation is classified for measurement and payment as follows:–

(a) Structural Excavation with Cofferdam for Suitable/Unsuitable Soil

Payment under this item will only be allowed in cases where the excavation is carried out within a complete and sealed cofferdam or a method as approved by the Engineer. Payment will not be allowed in cases where the Contractor has merely carried out intermittent soil support. Prior to starting the work, the Contractor shall submit working drawing and design calculation for Engineer's approval. This item shall be divided into "Structural Excavation with Cofferdam for Suitable Soil" and "Structural Excavation with Cofferdam for Unsuitable Soil" in conformity with Specification Section 03100 "Common Excavation".

(b) Structural Excavation for Suitable/Unsuitable Soil

This will comprise structure excavation which is not covered under items (a) above. This item shall be divided into "Structural Excavation for Suitable Soil" and "Structural Excavation for Unsuitable Soil" in conformity with Specification Section 03100 "Common Excavation".

(c) The rate per cubic meter for these items shall be deemed including all required equipment, labour, incidentals, temporary materials, works, and costs associated and necessary including, but not necessarily limited to:

- All expenses involved in providing pumps, cofferdams (regardless of their type or material), braced sheet piling, or any other methods proposed by the Contractor and approved by the Engineer;
- All expenses resulting from the Contractor's observance of all rules and regulations of competent authorities regarding the interference or maintenance of flow in the relevant canals, water courses, channels, or pipes;
- Provisions for and driving and removal of sheet piles including provision of certification by an independent engineer;
- Provisions for placement and removal of temporary jetty/guide frames;
- Provisions for underwater works;
- Provisions for underwater concrete, Class G or blinding concrete;
- Provisions for pumps and dewatering by submersible pumps;
- Provisions for all necessary barges; and
- Provisions for all necessary tug boats and auxiliary river craft.

2. Construction Requirements

2.1 Groundwater

Whenever groundwater is encountered or the excavation is taking place adjacent to free-surface water during structural excavation, the Contractor shall take such measures as necessary under the provisions of Specification Section 01050 "General Works" Subsection 2.6 Maintenance of Existing Waterway

to ensure that the excavation and footing are kept free of water.

2.2 Cofferdams

- (a) The Contractor shall use cofferdams when excavating under water or when the excavation is affected by groundwater.
- (b) The Contractor shall submit drawings and calculations based on water level for construction which specified in General Notes, an allowance for local and general scour of the river bed and the minimum ship impact requirements as noted in the Drawings, showing his proposed method of cofferdam construction to the Engineer for his review, in accordance with the requirements and stipulations of Specification Section 01200 "Contractor's Drawings". All designs shall be checked by an independent professional engineer, at the Contractor's expense, who shall furnish a certification as to the adequacy and safety of the proposed details.
- (c) Cofferdams or cribs for foundation construction shall be carried out well below the bottom of the footings and shall be well braced to withstand pressure without buckling and as nearly water-tight as practicable.
- (d) The interior dimensions of cofferdams shall be such as to give sufficient clearance for the construction of forms and the inspection of their exteriors, and to permit pumping outside the forms.
- (e) Cofferdams or cribs that are tilted or moved laterally during the process of sinking shall be corrected or enlarged to provide the necessary clearance.
- (f) When conditions are encountered which, as determined by the Engineer, render it impractical to dewater the foundation before placing the footing, the Engineer may require the construction of a concrete foundation seal of such dimensions as shown in the approved shop drawings. The foundation shall then be dewatered and the footing placed. When weighted cribs are employed and the weight is utilized to partially overcome the hydrostatic pressure acting against the bottom of the foundation seal, special anchorage such as dowels or keys shall be provided to transfer the entire weight of the crib into the foundation seal. Where a foundation seal is placed under water, the cofferdam shall be vented or ported at low water level as directed.
- (g) Cofferdams shall be constructed to protect green concrete against damage from sudden rising of water levels and to prevent damage to the foundation by erosion. No timber or bracing shall be left in cofferdams or cribs, without the approval of the Engineer.
- (h) Any pumping that may be permitted from the interior of any foundation enclosure shall be done in such a manner as to preclude the possibility of any portion of the concrete materials being carried away. Any pumping required during concrete placing, or for a period of at least 24 hours thereafter, shall be done from a suitable pump located outside the concrete forms. Pumping for dewatering shall not commence until the seal has set sufficiently to withstand the hydrostatic pressure.
- (i) Unless otherwise provided, the Contractor shall remove cofferdams and cribs after completion of the substructure. Removal shall be executed in such a manner that will not disturb or damage any finished work.

2.3 Preservation of Channels

The Contractor shall perform work in or next to a running waterway as follows:

- a) Excavate and conserve material inside cofferdams, sheeting, or other separations (such as dikes or sandbags). Unless otherwise permitted, no excavation shall be made outside caissons, cribs,

cofferdams, or sheet piles.

- b) Do not disturb the natural stream bed of the waterway adjacent to the structure without the approval of the Engineer.

Backfill the excavation to original ground-line with materials satisfactory to the Engineer after the foundation base has been in place, if any excavation or dredging is made at the site of the structure before caissons, cribs, or cofferdams are sunk in place.

- c) Materials deposited within the stream area from foundation or other excavation or from the filling of cofferdams shall be removed to free the stream area from obstruction.

2.4 Excavation

- (a) Prior to commencement of excavation operations in any area, the Contractor shall:
- Take steps on his own initiative to regulate the natural drainage of the water flowing on the surface of the ground, to prevent the flooding of excavations;
 - Ensure that all necessary site clearance and demolition in the area have been performed in accordance with these Specifications; and
 - Notify the Engineer sufficiently in advance at the beginning of any excavation works so that cross-sectional elevations and measurements can be taken off the undisturbed ground under the Engineer's supervision. The existing ground adjacent to the structures shall not be disturbed without the approval of the Engineer.
- (b) Trenches or foundation pits for structures or structure's footings shall be of sufficient size to permit the placing of structures or footings of the full width and length shown in the Drawings. The sides of trenches or pits shall be adequately supported always. The elevations of the bottoms of footings as shown in the Drawings shall be considered approximate only and the Engineer may order, in writing, such changes in dimensions or elevations of footings as may be deemed necessary to secure a satisfactory foundation.
- (c) Boulders, logs, and any other unsuitable materials encountered in excavation shall be removed from the Site and shall not be used for backfilling purposes.
- (d) Upon completion of excavation has been completed, the Contractor shall notify the Engineer to that effect, and no footing or bedding material shall be placed until the Engineer has approved the depth of excavation and the character of the foundation material.
- (e) All rocks or other hard foundation materials shall be cleaned of all loose materials and cut to a firm surface, either level, stepped or serrated as directed by the Engineer. All seams or crevices shall be cleaned out and grouted. All loose and disintegrated rocks and thin strata shall be removed.
- (f) Where the footing is to rest on materials other than rock, excavation to final grade shall not be made until just before the footing is to be placed. Where the foundation material is soft or mucky or otherwise unsuitable, in the opinion of the Engineer, the Contractor shall remove the unsuitable material and replace it with granular backfill as required by the Engineer. This foundation fill shall be placed and properly compacted in 15 cm layers up to the foundation level.
- (g) If, in the opinion of the Engineer, the foundation material is unsuitable solely because of the Contractor's failure to fulfil his obligations under Specification Section 01050 "General Works" Subsection 2.6 Maintenance of Existing Waterway , then the Contractor may either:

- Carry out at his own expense the removal and replacement described above; or
 - Suspend works in that excavation, at his own expenses (without time extension), until the foundation material becomes suitable.
- (h) Where foundation piles are used, the excavation of each pit shall be completed before pile driving and any placing of blinding stone shall be done after the piles have been driven. However, if for any reason, it is impossible to drive the piles after excavation, piles shall be driven from the natural ground level, as directed by the Engineer. Surplus length of piles in this case will not be measured for payment.
- (i) After both the driving and the excavation have been completed, all loose and displaced material shall be removed, leaving a smooth, solid bed to receive the footing.
- (j) Where a box culvert is to be in embankment, the Engineer may instruct the Contractor that the excavation shall be performed after the embankment has been constructed to the proposed subgrade level and compacted sufficiently.

2.5 Backfilling

On completion of the structure, excavated areas shall be backfilled with approved material to the level of the finished ground surface.

(a) Soil Backfilling and Compacting

- Soil Backfill shall be placed in layers not exceeding 15 cm and compacted to 95% of the maximum dry density determined in accordance with AASHTO T180.

(b) Granular Backfilling and Compacting

- Granular backfilling is especially required for specific structures such as box culverts, abutment and others shown in the Drawings, or as indicated by the Engineer.
- Granular backfill shall be placed in layers not exceeding 15 cm and compacted to 95% of the maximum dry density determined in accordance with AASHTO T180.
- The material shall be well-graded crushed or uncrushed gravel, stone, rock-fill, or natural sand or a well-mixed combination of any of these. Grading requirements for granular backfill are as follows:

Maximum size	5 cm
Passing 4.75 mm sieve	25% to 90%
Passing 0.075 mm sieve	0% to 10%
Liquid limit AASHTO T89	30% max.

2.6 Blinding Stones

- (a) Blinding stones for use as foundation base for structures shall be provided as shown in the Drawings or as instructed by the Engineer.
- (b) The main component of the blinding stone shall be approved cobble stones or crushed rocks, with maximum size compatible with the thickness of the blinding stone as shown in the Drawings. The minimum thickness of any stone as placed shall be 7 cm. Stone shall be closely packed by hand

placing, to the dimensions as shown in the Drawings, and then thoroughly rammed by a mechanical rammer. Smaller stone pieces of a minimum size of 3 cm shall then be placed between the larger stones and the upper surface brought up to the finished level as shown in the Drawings or as instructed by the Engineer. The complete surface shall then be thoroughly compacted to the satisfaction of the Engineer using a mechanical rammer or a vibrating roller.

- (c) The Contractor may propose an alternative to the above process, based on the use of graded, and crushed stone with a maximum size of less than 5 cm. The Engineer's acceptance of this alternative and the maximum thickness to be laid in one layer will depend on the proposed compacting plan and its suitability to the available restricted working area.

3. Measurement and Payment

3.1 Method of Measurement

- (a) Structural Excavation and Blinding Stone will not be measured for payment under any item in which the Basis of Payment states that such work is included in the pay item.
- (b) The quantity of structural excavation to be paid for shall be the number of cubic meters of material measured in its original position, and shall be computed as described herein.
- (c) When specific detail is not shown in the Drawings or this specification, the volume of earth to be measured for structural excavation shall consist of a prism bounded by the following planes:
- Upper plane: the plane reproduced by the projection of the perimeter of the base of the structural member and passing through the cleared ground along the perimeter above which plane excavation shall be considered as site clearing, and below which excavation shall be considered as structure and shall be measured and paid for accordingly;
 - Lower plane: the horizontal plane at the base of the foundation, which shall be taken as the lower surface of the structural concrete, levelling concrete or blinding stone as shown in the Drawings or instructed by the Engineer; and
 - Vertical plane: the plane that coincides with the perimeter of the base of the structural member. Any additional width of excavation necessary for the installation of blinding stone or levelling concrete or structural concrete exceeding the area of the lower plane shall not be measured for payment and the cost of this excavation shall be deemed included in the unit price for the measured quantity as described above.
 - Excavation for cofferdam seal to be excluded from the measurement.
 - Upper plane, lower plane and vertical plans for structural excavation shall be referred to the following tables unless otherwise instructed by the Engineer:
- (d) The above method of measurement shall be used irrespective of whether the structural excavation is carried out with or without the use of a cofferdam. Measurement for structural excavation shall not include material removed to suit the Contractor's working method, or material below the footing grade and beyond the specified limits of the excavation, or to compensate for anticipated swell or as a result of effective swell during pile driving or additional material
- (e) If the Engineer requires excavation after the embankment has been placed, this excavation in the embankment shall be measured for payment as structural excavation, unless otherwise provided in these Specifications.

- (f) The volume of blinding stone measured for payment shall be the number of cubic meters of stone completed in accordance with these Specifications and calculated using the nominal dimensions as shown in the Drawings or as instructed by the Engineer.
- (g) Regardless of its quantity or nature, removal of the remaining soil or materials after completion of the Works measured by this section, shall not be measured for separate payment and the cost of this removal shall be deemed included in the unit price for the measured quantity as described hereto.
- (h) Structural excavation and blinding stone for pipe and box culverts shall neither be measured nor paid under this Specification Section and shall be deemed included in the rates and prices for Specification Section 04310 “Concrete Pipe Culverts” and/or Section 04320 “Concrete Box Culverts”.

3.2 Basis of Payment

The accepted quantities, measured as provided above, shall be paid at the contract price per unit of measurement for the pay items of the Bill of Quantities listed below.

Payment shall be for full compensation for the work prescribed in this Section including all preparation, assembly, installation, excavation, cofferdam installation, removal, ripping, blasting, haulage, placing and compaction for backfilling and reuse or satisfactory disposal (waste) of site excavation, for shaping and completion of all surfaces, works for planning and updating, and for furnishing all labour, materials, tools, equipment and any incidentals necessary to complete the work as shown in the Drawings and as required in accordance with these Specifications and/or as directed by the Engineer.

Pay Item	Description	Unit
03200-01	Structural Excavation for Suitable Soil	m3
03200-02	Structural Excavation with Cofferdam for Suitable Soil	m3
03200-03	Structural Excavation for Unsuitable Soil	m3
03200-04	Structural Excavation with Cofferdam for Unsuitable Soil	m3
03200-05	Structural Excavation (Inside Cofferdam (Steel Pipe Sheet Piles))	m3
03200-06	Backfill with Borrow Material	m3
03200-07	Blinding Stone	m3

Section 03300 - Borrow Material

1. Description

This Specification Section describes the requirements and procedures for the clearing of borrow area and the excavation and hauling of material. Borrow areas include the area legally obtained by the Contractor and approved by the Engineer.

Borrow material is categorized as follows:

- Borrow material for capping layers
- Borrow material for sub-grade
- Borrow material for road and counterweight embankment
- Borrow material for cohesive slope

The Contractor opts at his discretion to use materials from roadway excavation and/or borrow excavation in the formation of the road embankment, subgrade, shoulders, slopes, bedding, surcharge and/or counterweight, backfill for structures, structures, subbase and/or base courses, production of aggregates for concrete or asphalt pavements, or for other purposes shown in the Drawings, specified in the Specifications or as directed by the Engineer.

2. Material Requirements

2.1 Submittals for Materials

2.1.1 Shop and Working Drawings and Schedules

- (a) In accordance with the requirements stipulated in Specification Sections 01150 "Contractor's Submittals" and 01900 "Control of Materials", the Contractor shall submit Engineer for review and approval, the complete sets of drawings and schedules for the use of borrow materials to the Engineer for review and approval.
- (b) The Contractor's plan of earthwork operation using borrow material shall be in accordance with the requirements for the "Schedule of Materials" established in Specification Section 01900. The schedule shall be closely related to the construction programmer submitted by the Contractor.
- (c) The plan of earthwork operation using borrow material shall include, but not be limited to, the following:
 - The intended section of the Project where the borrow material will be used, including a time schedule and construction plan;
 - Material sources, routes, and the procedures for delivery to the Project;
 - The lots and procedures for testing and acceptance;
 - The approximate dimensions and depths of anticipated borrow pit excavations;
 - Drainage details;
 - Pits and slopes that will remain when the excavation has been completed;

- The excavation methods, limits, volume, and depths for each stage;
 - The construction of detours and temporary or permanent drainage facilities, retaining walls, and soil-water conservation; and
 - The establishment of safety measures and the proposed progress of excavation.
- (d) The Contractor shall obtain the Engineer's approval of the submitted drawings and schedules at least twenty-eight (28) days before commencement of the corresponding works.

2.1.2 Samples and Testing

- (a) In supplement to the above referred "Schedule of Materials", the Contractor shall submit samples of materials corresponding to the lots for testing.
- (b) The Contractor shall permanently monitor the schedule for quality control, testing, and acceptance, providing to the Engineer with consistent reports as required in Specification Section 01800 "Contractor's Quality Control".

2.2 Borrow Material for Embankment Construction

The borrow materials to be used for embankment construction shall be in accordance with the requirements for materials stated in Subsection 2.3 "Materials" of Specification Section 03400 "Embankment Construction".

3. Construction Requirements

- (a) All suitable materials removed from borrow sources shall be used, as indicated in the Drawings or as directed by the Engineer, and the placing work shall conform to the grades and cross-sections established by the Engineer.
- (b) During construction, the drainage at the borrow area shall be kept functioning in a good condition as practicable. Payment will not be allowed for excavation of any material which is used for purposes other than those designated.
- (c) Sites of the borrow operations shall be left in a suitable condition as directed by the Engineer.
- (d) The sides and/or ends of borrow pits shall be sloped to the dimensions determined in consultation with the Engineer.
- (e) If the Engineer determines that the proposed pit operation will create an unsightly appearance or other damaging effect, the Contractor's plan and/or the borrow area will be rejected.
- (f) During excavation and hauling, the Contractor shall dig temporary ditches for intercepting or draining out rainstorm water to avoid irregular flowing or flooding.
- (g) Before any borrow is excavated, the Contractor shall clear the ground surface of the borrow area and notify the Engineer to jointly make an area survey of the topography and provide necessary cross-sections.
- (h) The excavation operation shall be performed from up to down in layers. Excavation of the toe of slopes will not be allowed. The depth of layers shall be about 3 m to 5 m; and after the excavation

- of each stage has been completed, the pit slopes shall be shaped and vegetated to prevent soil erosion, to green the environment, and to improve the landscape.
- (i) In the borrow operation, the excavation face of each layer shall always be kept at a proper downward slope and temporary interception ditches shall be constructed to divert the surface runoff into the existing drainage ditches. Such measures shall be provided to prevent surface runoff from directly or irregularly flowing over the hill slope surfaces and causing the flowing of massive soil and stones that could endanger the safety of the nearby public or private properties and lives.
 - (j) The Contractor shall take full responsibility and pay for compensation for damages and losses caused by improper construction and inadequate safety and protection measures or by improper operation methods or mistakes.
 - (k) During borrow operations, haul roads shall be maintained. Where necessary water spraying shall be provided to prevent the rising of dust. Haul road surfaces shall always be kept in a neat and clean condition.
 - (l) All construction plant, trucks, and transportation facilities shall, before entering public paved roads, have the body and the tires washed and cleaned.
 - (m) Trucks used for hauling borrow materials shall not be overloaded.
 - (n) Trucks used for hauling borrow materials shall be covered with canvas tarps to prevent hauled materials from being inadvertently blown or dropped.
 - (o) Before hauling the borrow material through public roads, the wheels of trucks used for hauling shall be washed of mud stuck when working at borrow pit or at construction site.
 - (p) Anything related to the control of noise, pollution, dust, and public nuisance, and to the environment protection and hygiene shall conform to the laws or regulations issued by the competent government agencies concerned and appropriate requirements of Specification Section 01700 “Environmental Management”.
 - (q) After the use of a borrow area is completed, the Contractor shall take the responsibility for the recovery of damaged facilities, and for the implementation of measures for mitigation of impacts on landscape and ecology. No separate payment shall be made for complying with this requirement.
 - (r) The Contractor shall not obtain borrow material from locations other than the borrow areas approved by the Engineer for the Project. Failure of the Contractor to comply with this requirement may be considered as grounds for default.
 - (s) In accordance with the conditions for removal of “Embankment for Settlement” (EfS) indicated in Specification Section 03950 “Soft Soil Improvement by Pre-consolidation”, the Contractor shall include in his construction programmer the highest rate for the reuse of the removed EfS material.
4. Measurement and Payment

Performance of this work shall not be paid for separately, but shall be considered as a subsidiary obligation of the Contractor for which full payment is in accordance with applicable unit prices in Specification Section 03400 for the work items in which it is called for or required.

Section 03400 -Embankment Construction

1. Description

1.1 Embankment Construction

This Specification Section describes requirements and procedures for the construction of the roadway embankment and subgrade, including the requirements for setting out the work, staking, and surveying.

1.2 Setting Out the Work, Staking, and Surveying

This Specification Section also describes the requirements and procedures for setting out the work, staking, and surveying. This work consists of furnishing qualified personnel and necessary equipment and material to survey, stake, calculate, and record data for the control of work.

Surveying and staking shall be performed in accordance with these Specifications to obtain close conformity with the lines, grades, and details indicated in the Drawings or as instructed by the Engineer. These works shall be performed from the stage of "Site Clearing" until the completion of the Works as required.

Personnel, equipment, and material shall conform to the following:

- (a) Personnel: Furnish technically qualified survey crews capable of performing in a timely and accurate manner.
- (b) Equipment: Furnish survey instruments and supporting equipment capable of achieving the specified tolerances.
- (c) Material: Furnish acceptable tools, supplies, and stakes of the type and quality normally used in highway survey work and suitable for the intended use.

2. Material Requirements

2.1 Reference Standards

The following Standards in their latest editions shall be particularly applied to the works covered by this Specification Section in principle. However, the Contractor may propose another reference standards if so required or methodology during construction, to ensure that the target contract period of construction is met.

- AASHTO M145 Classification of Soils and Soil-Aggregate Mixtures for Highway Construction Purposes
- AASHTOT11 Materials Finer Than 75- μ m (No. 200) Sieve in Mineral Aggregates by Washing
- AASHTO T27 Sieve Analysis of Fine and Coarse Aggregates
- AASHTO T87 Dry Preparation of Disturbed Soil and Soil Aggregate Samples for Test

- AASHTO T88 Particle Size Analysis of Soils
- AASHTO T89 Determining Limit Liquid of Soils
- AASHTO T90 Determining Plastic Limit and Plasticity Index of Soils
- AASHTO T99 The Moisture-Density Relations of Soils Using a 2.5 kg Rammer and 305 mm Drop
- AASHTO T146 Wet Preparation of Disturbed Soil Samples for Test
- AASHTO T180 The Moisture-Density Relations of Soils Using a 4.54 kg Rammer and 457 mm Drop
- AASHTO T191 Density of Soil In-place by Sand-cone Method
- AASHTO T205 Density of Soil In-place by the Rubber-balloon Method
- AASHTO T224 Correction for Coarse Particles in the Soil Compaction Test
- ASTM D1140 Amount of Material in Soils Finer Than the No. 200 (75- μ m) Sieve

2.2 Submittals

2.2.1 Shop and Working Drawings and Schedules

- (a) In accordance with the requirements of Specification Sections 01150 “Contractor’s Submittals” and 01900 “Control of Materials”, the Contractor shall submit to the Engineer for review and approval, complete sets of drawings and schedules for embankment construction.
- (b) The Contractor’s plan for embankment construction shall be in accordance with the requirements for the “Schedule of Materials” stated in Specification Section 01900 “Control of Materials”. The schedule shall be closely related to the construction programme and the plans for the use of borrow material stipulated in Specification Section 03300 “Borrow Materials”.
- (c) The plan of earthwork operation for embankment construction shall also include the following:
 - A plan for embankment construction by reusing the remaining materials. This plan shall include an approximate time schedule, the location (KM station or road section) of the material to be reused, the location where it is intended to be placed, detailed schedule of quantities, etc.
 - A plan for embankment construction by using the suitable material obtained from common excavation within the Project limits or from excavation for channel relocation. This plan shall include an approximate time schedule, the location where the material will be excavated, the location where it is intended to be placed, detailed schedule of quantities, etc.
- (d) The approved plan shall be used for monitoring of quantities and shall be updated continuously on a weekly basis by the Contractor in coordination with the Engineer.

2.2.2 Schedule for Setting the Work, Staking, and Surveying

Submittals shall include a detailed plan and schedule for setting the work, staking, and surveying. The schedule shall be in the form of a progress chart, including the dates and sequence of staking requirements; and the plan shall include, but not be limited to, the following:

- Surveying and staking methods
- Stake marking
- Referencing
- Structure control
- Maintenance of stakes and references
- Any other procedures and controls necessary for the work

2.3 Materials

The Contractor may opt at his discretion to use materials from roadway excavation and/or borrow excavation in the formation of the road embankment, subgrade, shoulders, slopes, bedding, surcharge and/or counterweight, backfill for structures, structures, subbase and/or base courses, production of aggregates for concrete or asphalt pavements, or for other purposes shown in the Drawings, specified in the Specifications or as directed by the Engineer.

Materials shall be tested according to the requirements of AASHTO T11, T27, T87, T88, T89, T90 and T146, and ASTM D1140 as applicable or as instructed by the Engineer.

2.3.1 Top 30 cm Layer (Subgrade)

The material that will be used for embankment construction of top 30 cm layer as subgrade shall be hill soil with a minimum CBR value (saturated sampling for 96 hours) of more than 10% or equivalent, according to AASHTO T193:90, Liquid Limit (LL) \leq 40% according to AASHTO T89, Plasticity Index (PI) \leq 20% according to AASHTO T90 and maximum nominal size of aggregate of 7.5cm.

2.3.2 Layers below Subgrade

- (a) A layer of 50 cm below subgrade (embankment) shall follow the requirements for each item according to Table 1 shown below.
In case the material is "hill soil", Liquid Limit (LL) \leq 55% according to AASHTO T89, Plasticity Index \leq 27% according to AASHTO T90 shall be required.
- (b) The minimum CBR of layers less than 100 cm below subgrade level shall be 8% according to AASHTO T193:90.
- (c) The minimum CBR of layers more than 100 cm below subgrade level shall be 6% according to AASHTO T193:90.

Table 1 Classification of Materials Suitable for Embankment (AASHT M145)

General Classification:	Granular Materials (35% or less passing sieve 0.075 mm)				
Group Classification:	A-1		A-3	A-2(*)	
	A-1-a	A-1-b		A-2-4	A-2-6

Sieve Analysis, Percent Passing: sieve					
2.00 mm (Sieve No. 10)	50 max	---	---	---	---
0.425 mm (Sieve No. 40)	30 max	50 max	51 max	---	---
0.075 mm (Sieve No. 200)	15 max	25 max	10 max	35 max	35 max
Characteristics of fraction passing 0.425 (Sieve No. 40):					
Liquid Limit:	---	---	---	40 max	40 max
Plasticity Index:	6 max	6 max	N.P.	10 max	11 min
Types of Significant Constituent Materials	Stone fragments, gravel, and sand		Fine sand	Silty or clayey gravel and sand	
General Rating	Excellent to good				

(*) A-2 can be used for embankment construction upon the Engineer's consent based on the actual conditions, laboratory test results, and testing on trial sections performed with the proposed material.

2.3.3 Rock Fragments and Boulders

- (a) Rock fragments and boulders with a largest dimension of 10 cm (within the scope of 80 cm, counting from the bottom of pavement and 15 cm for the layers below) could be used for embankment construction depending on the proposed plan of the Contractor, as reviewed and approved by the Engineer.
- (b) In case the use of rock fragments and boulders is allowed by the Engineer, the filling material between the large rock fragments and boulders shall be finer materials, composed of rock fragments, gravel, sand or soil, in accordance with the requirements of Subsection 2.3 of this Specification Section.
- (c) Soil lumps will be considered as soil and will not be treated as an aggregate unit.

2.3.4 Cohesive Slope Material

Materials to be used on the slope surface shall receive prior approval of the Engineer which will satisfy the following characteristics:

- Soil with size gradation containing clay size particles (i.e. less than 0.002) in more than 25%. The material may be graded gravel or sandy clay;
- Plasticity Index: $17\% \leq PI \leq 27\%$ according to AASHTO T90;
- Limit Liquid: $LL \leq 55\%$ according to AASHTO T89;
- Maximum dry density: $\gamma_c \text{ max} \geq 1.7 \text{ g/cm}^3$;
- Uniform Density at appropriate moisture $K \geq 95\%$ according to AASHTO T180, CBR value $\geq 6\%$ according to AASHTO T193:90, suitable thickness of compacted material is 30 cm.

2.4 Utilization of Site Materials for Embankment or Sub-grade

Construction of embankment and/or subgrade with reused materials shall receive prior approval of the Engineer based on the plan by the Contractor.

2.4.1 Reuse

The plan for material reuse shall show in detail the following: 1) the stages of construction, 2) the road sections where reuse material will be applied, 3) quantity calculation, and 4) time schedule.

2.4.2 Use of Suitable Materials from Site Excavation

The plan for material use shall show in detail the following: 1) the location where site excavation will be performed, 2) the lines surveyed for quantity control, 3) the road sections where embankment will be constructed with the said material, 4) quantity calculation, and 5) time schedule.

3. Construction Requirements

3.1 General

(a) Embankment construction shall consist of:

- Constructing roadway embankments, including preparation of the area upon which they are to be placed;
- Installation of coarse sand blanket;
- Construction of dykes within or adjacent to the roadway;
- Placing and compaction of approved material within roadway areas where unsuitable material has been removed; and
- Placing and compaction of embankment material in holes, pits, and other depressions within the roadway area

(b) Embankments and backfills shall contain no muck, peat, sod, roots, or other deleterious matter. Rocks, broken concrete or other solid, bulky materials shall not be placed in embankment areas where piling is to be placed or driven.

(c) Prior to the construction of roadway embankments, all necessary surface drainage, clearing, and grubbing in that area shall have been performed in conformity with Specification Section 02100 "Site Clearing". After topsoil stripping, cohesive materials can be excavated underneath and deposited aside as a protection dyke or the stockpile for slope protection as directed by the Engineer.

(d) At locations indicated in the Drawings, the embankment slopes shall be covered with cohesive materials to prevent slope erosion. Erosion control fence and/or silt basin shall be installed as directed by the Engineer.

3.2 Setting Out the Work, Staking, and Surveying

(a) Fundamental Conditions for Construction: Construction operation shall not commence on any section of the Work until surveying and staking works are completed, and the Engineer has approved all the controls established by the Contractor.

- (b) Notice for the Commencement of Work: The Contractor shall give the Engineer not less than forty-eight (48) hours' notice of his intention to stake out or establish levels for any part of the Work in order that arrangements may be made for checking. The survey and staking shall be established not only for initial layout and control, but also for intermediate and additional one to take responsibilities for the accuracy of all surveys or measurements made by his employees. The survey shall be repeated at the Contractor's expense until the specified tolerances are satisfied. Approval of the construction staking does not relieve the Contractor of his responsibility for correcting errors discovered during the work.
- (c) Control Points: Initial horizontal and vertical control points in conflict with construction shall be relocated to areas that will not be disturbed by construction operations, and the Contractor shall furnish the coordinates and elevations for the relocated points before the initial points are disturbed.
- (d) Centreline Establishment: The Contractor shall establish the centreline stake from control points by 20 m intervals.
- (e) Lines and Grades: The Contractor shall set construction stakes establishing lines and grades in accordance with the Drawings and shall secure the approval of the Engineer before commencing the construction works. The Engineer will, if he deems it necessary, revise the lines and grades and require the Contractor to adjust the stakes accordingly.
- (f) Roadway Cross-Sections: The Contractor shall take roadway cross-sections at interval of 20 m, and additional cross-sections at significant breaks in topography and at changes in the typical section. The Contractor shall prepare and submit cross-section drawings for the Engineer's approval.
- (g) Slope Stakes and References: The Contractor shall establish slope stakes at the intersection points of the design roadway slope with the natural ground line, and references stakes on both sides at the cross-section locations.
- (h) Clearing and Grubbing Limits: The Contractor shall set up the limits for clearing and grubbing on both sides.
- (i) Grade Finishing Stakes: The Contractor shall set stakes at the top of subgrade and at the top of the final aggregate course for grade elevations and horizontal alignment on the centre line and on each shoulder.
- (j) Staking for Drainage Structures: The locations of the drainage structures shown in the Drawings are not definitive, and could be modified depending on the actual conditions found at the Site and by the recommendation of the Engineer.
- (k) The Contractor shall perform the following surveys and staking works without claims either for price adjustment or time extension on any modifications required:

Ground profile	Along the centre line of the structure
Information record	To determine structure length and end treatments
Determination of	Catch points at the inlet and outlet
Plot the profile of the structure	With the natural ground, the flow line, the roadway section
Setting of reference points	
Submit the documents	For approval of final alignment

- (l) Bridges and other Structures: The Contractor shall:

Set out adequate horizontal and vertical controls and reference points
Establish and reference the structure chord or the structure's tangent
Establish and reference the centre line of foundations
Verify any discrepancy in the Drawings
Submit documents for the approval of the Engineer

- (m) Permanent Monuments and Markers: All existing land survey monuments and property markers shall be protected. The Contractor shall perform all necessary survey and staking to establish new permanent monuments and markers, if directed by the Engineer.
- (n) Tolerances: Survey and establishment of controls shall be within the tolerances shown in Table 2 below.

Table 2 Construction Surveying and Staking Tolerances

Staking Phase	Horizontal	Vertical
Control points	± 5 mm	± 3 mm
Centreline points (a) - (PoC), (PoT), (PoT), and (PoC) including references thereto	± 5 mm	± 3 mm
Other centre line points	± 10 mm	± 10 mm
Cross-section points, slope stakes, and slope stake references (b)	± 20 mm	± 10 mm
Culverts, ditches, and minor drainage structures	± 10 mm	± 10 mm
Retaining walls	± 10 mm	± 10 mm
Railroad crossing structures	± 3 mm	± 3 mm
Bridge substructure	± 5 mm	± 5 mm
Bridge superstructure	± 3 mm	± 3 mm
Clearing and grubbing limits	± 200 mm	-
Roadway subgrade finish stakes	± 10 mm	± 10 mm
Roadway finish grade stakes	± 3 mm	± 3 mm

Note: (a) Centreline points are point of curve (PoC), point of tangent (PoT), and point on curve (PoC).
 (b) Take the cross-sections normal to the centreline within ± 1 degree (0.02 rad).

- (o) Errors: The Contractor shall be responsible for the supervision of the surveying and staking personnel. Any errors resulting from the operations of the surveying personnel shall be corrected at the Contractor's expense.
- (p) Check and Conservation: The construction surveying and staking work may be spot-checked for accuracy, and the unacceptable portions of the work will be rejected.
- (q) Equipment and Personnel: In accordance with the requirements and procedures of Specification Section 01750 "Laboratory and Engineer's Equipment", the Contractor shall provide the Engineer with all the survey and testing equipment and personnel.
- (r) Payment for Surveying and Staking: All cost of surveying and staking shall be included in the unit prices of the related pay items; no direct or separate payment will be made for these works.

3.3 Method of Construction

- (a) Where embankments are to be widened, slopes of the existing embankment steeper than 1 to 5 shall be prepared by removing all surface vegetation and stepped so that the new embankment is keyed in to the existing embankment to the satisfaction of the Engineer. Stepping shall be done by cutting horizontal benches in the existing slope to a sufficient width to accommodate placement and compaction operations and equipment; cutting of benches shall begin at the intersection of the original

ground and the vertical cut of the previous bench. The widened embankment shall then be built up in horizontal layers to the subgrade level where it shall be covered as soon as practical with base so that the widened area can be used by traffic as soon as possible, enabling construction to proceed on the other side of the road, if required.

- (b) Embankment materials, generally, shall be transferred directly from the borrow area to the prepared surface in dry weather and spread. Stockpiling of embankment materials shall generally not be permitted, especially during the wet season.
- (c) Roadway embankment materials shall be placed in horizontal layers not exceeding the thickness of 25 cm, in loose measurement, and shall be compacted as specified, tested for density and accepted by the Engineer, before the next layer is placed. Effective spreading equipment shall be used on each lift to obtain uniform thickness prior to compacting. As the compaction of each layer progresses, continuous levelling and manipulating will be required to assure uniform density. Water shall be added or removed, if necessary, to obtain the required density. Removal of water shall be accomplished through aeration by ploughing, balding, disking, or other methods satisfactory to the Engineer. In placing embankment over or against coarse sand blanket or other porous drainage material, care shall be taken to avoid intermingling of the two (2) materials. In the case of forming vertical chimney drains, a sharply defined interface between the two (2) materials shall be ensured using temporary forms of thin steel sheeting which shall be gradually withdrawn as placing of the fill and porous drainage is carried out.
- (d) Where embankment is to be constructed across low swampy ground that will not support the mass of trucks or other hauling equipment, the lower part of the fill may be constructed, when approved by the Engineer, by dumping successive loads in uniformly distributed layers of thickness not greater than necessary to support the hauling equipment while placing subsequent layers.
- (e) Where placing and/or compaction of material under saturated or flooded conditions cannot be avoided, the Contractor shall submit to the Engineer for approval his proposed methods to ensure adequate compaction.
- (f) All rock fills shall be covered with one or more 20 cm thick layers of well-graded material containing no stones larger than 5 cm and capable of filling all the interstices on the top of the rock fill. These capping layers shall be constructed to the density requirements for embankment given in this Specification Section.
- (g) Dumping and rolling areas shall be kept separate, and another shall cover no lift until compaction complies with the requirements of this Specification Section.
- (h) Hauling and levelling equipment shall be routed and distributed over each layer of the fill in such manner as to make use of compaction effort afforded thereby and to minimize rutting and uneven compaction.
- (i) Embankment layers shall be compacted and shaped to a 4% grade from the centre to both sides for drainage of rainwater during construction. The grade of the last two (2) layers shall be gradually modified to obtain a 2% grade below the pavement structure.

3.4 Compaction of Embankment Material

- (a) Subgrade Layer: Unless otherwise specified, the Contractor shall compact the materials placed in all embankment layers and the material scarified to the designated depth below the subgrade level in cut section, at a moisture content approved by the Engineer to be suitable for the required density.

Acceptance of compaction, including slope, may be based on adherence to an approved roller pattern.

- (b) Layers of Below Subgrade Level: Embankment layers 50 cm or less below the subgrade level shall be placed at a maximum of 30 cm thickness and compacted to a uniform density at moisture content within the range of 3% less than optimum moisture content to 1% more than optimum moisture content.
- (c) Optional Compaction Method for Layers More than 50 cm Below Subgrade Level: Alternatives on the compaction method will be allowed in case that the Contractor intends to apply thicker layers for embankment compaction based on the availability of modern and high capacity equipment for compaction.
- (d) The following options can be considered, if the Contractor decides to apply them for the Project:

Up to 50 cm of one layer thickness compaction may be allowed, on the submission and approval of the Engineer on the plan, schedule, construction method, and quality control procedure with the road sections or/and lots be applied. This proposal shall be confirmed first at a trial section on the premise that uniform compaction degree is also obtained at the bottom of the tested layer. However, the Engineer's approval does not apply to the entire roadway of the Project. The procedure for approval shall be repeated case by case.

The above construction methods proposed shall include the construction and compaction method for the embankment slopes. Additional payment for the surplus material for slope formation, or time extension for correction of defects on the slopes, will not be allowed.

If the required compaction degree is not successfully obtained, the definition of Subsection 01850 "Acceptance of Works" will be applied.

- (e) Alternative Construction and Compaction Method for Layer below Coarse Sand Blanket: Alternative construction and compaction method will be allowed if the Contractor can ensure that the required compaction degree for embankment is based on the availability of modern and high capacity equipment for compaction.
- (f) Testing Method: The Contractor shall, during the progress of the Works, carry out density tests of compacted material in accordance with AASHTO T191, T205, or other approved field density tests, including the use of properly calibrated nuclear testing devices. Such calibration shall include comparison with direct measurement of in-situ density in the field in accordance with AASHTO T191 and, if the result of any test shows that the density is less than the required density, the Contractor shall rectify the work. The test shall be made to the full depth of the layer at locations directed by the Engineer, but which shall not be more than 200 m apart. For backfill around structures or in culvert trenches, at least one (1) test per complete layer of backfill placed shall be carried out. In embankments, at least one (1) test shall be performed for every 500 m³ of materials placed.
- (g) Corrections: A correction for coarse particles may be made in accordance with AASHTO T224. If by such tests, the Engineer determines that the specified density and moisture conditions have not

been attained, the Contractor shall perform additional works as may be necessary to attain the specified conditions.

- (h) Testing Frequency: At least one (1) group of three (3) in-situ density tests shall be carried out for every 1000 m² of each layer of compacted fill. Tests shall be made to the full depth of the layer. For backfill around structures or in culvert trenches, at least one (1) test per complete layer of backfill placed shall be carried out.

3.5 Compaction Equipment

Compaction equipment shall satisfy compaction requirements of this Specification Section without detrimentally affecting the compacted material. The equipment shall be of modern, standard, and has efficient compacting capabilities as approved by the Engineer. The compacting units may be of any type, if they are capable to compact each lift of material as specified, and shall meet the minimum requirements as contained herein.

Minimum requirements for rollers are as follows:

- Sheep's foot, tamping, or grid rollers shall can exert a force of 45 Newton per mm of length of roller drum.
- Steel wheel rollers other than vibratory rollers shall can exert a force of not less than 45 N/mm² of width of the compression roll or rolls.
- Vibratory steel wheel rollers shall have a minimum mass of 6 tons. The compactor shall be equipped with amplitude and frequency controls and specifically designed to compact the material to which it is used.
- Pneumatic tire rollers shall have smooth tread tires of equal size that will provide a uniform compacting pressure for the full width of the roller and capable of exerting a ground pressure of at least 550 kPa.
- Heavier compacting units may be required to achieve the specified density of the embankment.

3.6 Compaction Trials

- (a) Before commencing the formation of embankments, the Contractor shall submit, in writing to the Engineer for approval, his proposals for the compaction of each type of fill material to be used in the Works. The proposals shall include the relation between the types of compaction equipment, and the number of passes required and the method of adjusting moisture content. The Contractor shall carry out full scale compaction trials on areas not less than 10 m wide and 60 m long as required by the Engineer and using his proposed procedures, or such amendments thereto as may be found necessary to satisfy the Engineer that all the specified requirements regarding compaction can be consistently achieved. Compaction trials with the main types of fill materials to be used in the Works shall be completed before working with subsequent materials can commence.
- (b) If during construction of the Works, the character and properties of the fill materials change, the Contractor shall carry out further full scale compaction trials and submit the results to the Engineer for approval.

- (c) Throughout the periods when compaction of earthwork is in progress, the Contractor shall adhere to the compaction procedures found from compaction trials for each type of material being compacted, each type of compaction equipment employed and each degree of compaction specified.

3.7 Construction of Control Strips and Determination of Target Density

- (a) To determine the target density, a control strip shall be constructed at the commencement of work on each course of material to be compacted. Each control strip, constructed to acceptable density and surface tolerances, shall remain in place and become a section of the completed roadway. Unacceptable control strips shall be corrected or removed and replaced at the Contractor's expense and without allowing time extension for these corrective works. A control strip shall have an area of approximately 350 m² and shall be of the same depth as specified for the construction of the course that it represents.
- (b) The materials used in the construction of the control strip shall conform to the Specification requirements. They shall be obtained from the same source and shall be of the same type to be used in the remainder of the course represented by the control strip. The underlying grade or pavement structure upon which a control strip is to be constructed shall have the prior approval of the Engineer.
- (c) The equipment used in the construction of the control strip shall be approved by the Engineer and shall be of the same type and mass to be used on the remainder of the course represented by the control strip.
- (d) Compaction of control strips shall commence immediately after the course has been placed to the specified thickness, and shall be continuous and uniform over the entire surface. Compaction of the control strip shall be continued until no discernible increase in density can be obtained by additional compaction effort.
- (e) Upon completion of the compaction, the mean density of the control strip will be determined by averaging the results of ten (10) in place density tests taken at randomly selected sites within the control strip. The mean density of the control strip shall be the target density for the remainder of the course which it represents.
- (f) If the mean density of the control strip is less than the specified density required in this Specification Section, the Engineer may order the construction of another control strip.
- (g) A new control strip may also be ordered by the Engineer or requested by the Contractor when:
- A change in the material or job-mix formula is made;
 - Ten (10) days of production have been accepted without construction of a new control strip; and
 - There is a reason to believe that a control strip density is not representative of the material being placed.

3.8 Protection of Roadbed and Slope during Construction

During the construction of the roadway, the embankment shall have sufficient camber to provide drainage from the road of any rainfall; and the roadbed shall be maintained in such condition that it will be well drained always. Drainage for seepage water, if any, shall be taken into consideration.

Side ditches or gutters shall be so constructed as to avoid damage to embankments by erosion. Slope shall be checked carefully before, during, and after raining, and covered by protection sheets based on the site conditions.

3.9 Protection of Structures

If embankment can be placed on only one side of abutments, wing walls, piers or culvert headwalls, care shall be taken to ensure that the area immediately adjacent to the structure is not compacted to the extent that it will cause overturning of, or excessive pressure against the structure. When noted in the Drawings, the fill adjacent to the end bent of a bridge shall not be placed higher than the bottom of the back wall of the bent until the superstructure is in place. When embankment is to be placed on both sides of a concrete wall or box type structure, operations shall be so conducted that the embankment is always at approximately the same elevation on both sides of the structure.

3.10 Rounding and Warping Slopes

- (a) Except on solid rock, the tops and bottoms of all slopes, including the slopes of drainage ditches, shall be rounded by 1 m tangent length from shoulder edge. A layer of earth overlaying rock shall be rounded above the rock as done on earth slopes.
- (b) Adjustments in slopes shall be made to avoid injury to standing trees or marring of weathered rock, or to harmonize with existing landscape features, and the transition to such adjusted slopes shall be gradual.

3.11 Finishing Roadbed and Slopes

- (a) After the roadbed has been substantially completed, its full width shall be conditioned by removing any soft or other unsuitable material that will not compact properly or serve the intended purpose. The resulting area and all other low sections, holes, or depressions shall be brought to grade with suitable selected materials. Scarifying, blending, scraping, dragging, rolling, or other methods of work shall be performed or used as necessary to provide a thoroughly compacted roadbed shaped to the grades and cross-sections shown in the Drawings or as directed by the Engineer.
- (b) All earth slopes shall be reasonably uniform, without any noticeable break, and in reasonably close conformity with the Drawings or other surfaces indicated in the Drawings, or as directed by the Engineer, with no variations readily discernible as viewed from the road.

3.12 Complementary Requirements for Subgrade Construction

- (a) Requirement for Compaction Completion of Drainage System: After completion of embankment construction and before the placement of any base material for pavement, all culverts, transversal drains, ducts, and the like (including their fully compacted backfill), ditches, drains, and drainage outlets shall be completed.
- (b) Subgrade on Fill Embankment Sections: After the top layer of embankment (i.e. the subgrade) has been completed, its full width shall be carefully conditioned and any soft, unstable material or materials that are not approved by the Engineer shall be removed. The resulting areas and all other low sections, holes, or depressions shall be brought to grade with suitable material. Scarifying in accordance with the Drawing requirements, blending, dragging, rolling, or other method of work shall be performed or used as necessary to provide a thoroughly compacted roadbed to the cross-sections shown in the Drawings.

- (c) Subgrade on Cut Excavation Sections: Common excavation shall be performed suitable depth from the designed subgrade level, or as determined by the Engineer based on the actual conditions and materials encountered during the execution of work. The surface for subgrade construction, composed of natural ground material after excavation, shall be scarified and made uniform, and unsuitable materials shall be removed, then it shall be levelled and compacted as required in this Specification Section. Thereafter, the subgrade layer shall be constructed following the normal procedure herein specified.
- (d) Protection of Completed Work: The Contractor shall protect and maintain at his own expense the entire work within the limits of this Contract in good condition satisfactory to the Engineer from the time he first commenced work until all works have been completed. Maintenance shall include repairing and recompacting ruts, ridges, soft spots, and deteriorated sections of the subgrade due to traffic caused by Contractor's vehicle/equipment or that of the public.
- (e) Proof rolling shall be conducted after finishing by more than 25 tons weight roller on the place directed by the Engineer. If the deflection is more than 5 mm, the place shall be checked and replaced, if necessary, as instructed by the Engineer.

3.13 Requirement for Compaction

Layers of Embankment	Compaction Degree *	Lot Size
Top 30 cm Layer (subgrade)	95% (AASHTO T180)	1000 m ²
Layers below Subgrade	95% (AASHTO T180)	1000 m ³
Backfill Below Course Sand Blanket	95% (AASHTO T180)	1000 m ³
Cohesive Material Slope	95% (AASHTO T180)	500 m ²
Embankment at Berm	90% (AASHTO T180)	1000 m ³

The compaction degrees used for embankment construction can be revised by the Engineer based on the results from the trial compaction performed by the Contractor, to ensure the CBRs specified in Subsection 2.3 for each layer of the embankment.

3.14 Dimensional Tolerances after compaction

All exposed finished fill surfaces shall be sufficiently smooth and uniform, and shall have sufficient slope, to ensure the free runoff of surface water.

	Items	Tolerance	Lot Size
Embankment	Centre line	±15 mm	1000 m ³
	Thickness of one layer	±40 mm	
	Final grades levels	±30 mm	
	Width on top	±40 mm	
Slope	Thickness by cohesive soil	±50 mm	5500 m ²
	Surface irregularity from the specified profile line	±20 mm	
Subgrade	Centre-side location	±10 mm	1000 m ²
	Width	±30 mm	
	Thickness	±15 mm	

	Level	±15 mm	
	Surface irregularity by 3 m straight edge	±10 mm	
	Cross-fall or camber	± 0.5%	
	Longitudinal grade over 25 m length	± 0.1%	

4. Measurement and Payment

4.1 Method of Measurement

- (a) The quantities for embankment construction shall be measured in cubic meters and computed (by cross-sections surveying immediately before/after work completion of a part or whole) in compacted volume after compaction has been completed (in its final position) and approved by the Engineer.
- (b) The cleared ground shall be surveyed by the Contractor, supervised by the Engineer, and the surveyed cross-sections and profile maps shall be submitted by the Contractor and signed after verification by the Engineer.
- (c) The actual embankment volume shall be computed from the average cross-section areas bounded by ground lines after excavation, the designed slope lines, and bottom planes of the subgrade or a plane defined by the Engineer.
- (d) For embankments placed over excavated hillsides, the measurement shall be the volume between the ground lines after excavation and the planned finished slopes and grades. The excavation and backfill for benches on hillsides shall be deemed as incidental to roadway excavation and embankment construction. No separate measurement and payment shall be made.
- (e) For embankments placed over unconsolidated ground identified in the Drawings as per “soft soil improvement”, the following procedure shall be made for measurement:
 - Survey: The cleared ground shall be surveyed immediately before and after soil replacement. Moreover, top level of embankment, shall be surveyed periodically based on the Contractor’s submittal as described in Subsection 2.2.
 - Computation: The volume of embankment shall be computed from the average cross-section areas bounded by the ground lines after soil replacement, the designed slope lines and bottom planes of the subgrade or a plane defined by the Engineer after deduction of all quantities included (for example: Coarse sand blanket; Dry rip-rap; etc.).
- (f) The measured soil replacement shall be paid at the unit price by Specification Section 03100 “Common Excavation”
- (g) For embankments placed over a ground which was not identified in the Drawings as per soft soil improvement, but were sensible to settlements due to differential consolidation, separate payment shall not be considered and shall be deemed considered by the Contractor as an incidental cost included in the prices and rates for embankment construction.
- (h) The quantities for cohesive slope construction shall be measured in cubic meters and computed in actual compacted volume and in accordance with the Drawings.

- (i) Deduction for Structures: The volume of pipe culverts, box culverts, bridges, and the volume of backfill around such structure and fillings which have been paid under other items of work, shall be deducted from the volume of embankment placed.

4.2 Basis of Payment

- (a) Payment for embankment will be full compensation for the entire work prescribed in this Section including preparation of foundations for embankment (over unconsolidated ground or other ground approved by the Engineer), classified soil material (from borrow or excavation from the project Site), layering, blending (if required), watering, construction and removal of dykes within or adjacent to the roadway, temporary drainage, hauling, compacting, shaping, trimming, finishing and maintaining embankments, and for furnishing all labour, materials, tools, equipment, and any incidentals necessary to complete the work as shown in the Drawings and as required in accordance with these Specifications and/or as directed by the Engineer.
- (b) The cost of equipment, labour, shaping and compacting of material classified as “suitable excavation” provided from common or structural excavation which usage has been ordered by the Engineer, under the strict condition of confirmation that the used volume has not been certified under other section, and it is in accordance with the approved ”Schedule of Materials”, shall be paid at the contract price per unit of measured cubic meters and computed in compacted volume of embankment after compaction has been completed and approved by the Engineer.

The Pay Items and Pay Units shall be as follows;

Pay Item	Description	Unit
03400-01	Subgrade Construction	m3
03400-02	Embankment Construction	m3

Section 03500 – Mechanically-Stabilised Earth Wall

1. Description

This work shall consist of furnishing all materials as shown in the Drawings including reinforcing strips or grids, constructing, erecting and finishing mechanically-stabilised earth wall.

Systems for construction of reinforced earth structures may involve the use of geosynthetic reinforcing strips and tie and the Contractor shall be responsible for making his own arrangements to secure the supplies and services needed in respect of the system proposed for use in the work from the patentee or his licenses through suitable legal agreement. A full copy of such agreement shall be submitted to the Engineer.

The items not specified herein shall conform to the provisions in the Standard Specifications for “Construction of Roads and Bridges on Federal Highway Projects FP-14” of the FHWA; or the latest version of Design and Construction of Mechanically Stabilized Earth Walls and Reinforced Soil Slopes edited by FHWA-NHI, or Manual for Design and Construction for Mechanically-Stabilised Earth Wall Method forth (4) edition revision, August.

2. Materials

2.1 Reinforcement (Strip)

The reinforcement shall be the one that is zinc coated exceeding HDZ35 (minimum zinc coating mass on either surface of 350g/m²) specified in JIS H 8641 or SM490A specified in JIS G 3106.

- (1) The standard strip shall be the width of 80mm, board thickness of 4mm and the projection height on the rib of 3mm.
- (2) The dimensional deviations of the strip shall be as in Table 1: Dimensional deviation of strip.

Table 1: Dimensional deviation of strip (unit : mm)

Item	Symbol	Deviation	Remark
Thickness	t	± 0.3	
Width	W	± 1.5	
Length	L 3.5~7.0m	+50 -5	
	L 7.5~9.0m	+60 -5	
Rib i n t e r v a l	P_1	43~52	
	P_2	103~118	
	P_3	Over 16	
	H	+0.3 -0.6	

Rib h e i g h t	H_1	Over 2.0	
Lateral b e n t	C	Overall of 2 0 or le ss 5 p er ar bi tr ar y le n g t h of 1 m *	

Note *: Lateral bentness refers to a large curve to the direction of board width for the total length.

2.2 Concrete skin

- (a) The concrete quality shall be $f'_{ck}=35N/mm^2$ or more with little variability.
- (b) For the concrete skin, required components including but not limited to the connective strip to mount a strip, the hanging anchor to hoist a member and the dowel to maintain wall unity must be buried in their proper positions.
- (c) The standard concrete skin shall be cross-shaped with the central interval of 1.5m between the right and left dowels and the dowel holes; the basic height of 1.5m; and the board thickness of 14cm. However, those including the standard shape halved; the edge-processed shape that has been created by cutting either right or left projection; or the columnar corner skin shall also be used as required by the place to be used.
- (d) The shape and dimension of the concrete skin shall conform to the production drawing of the concrete skin, and its deviation shall be as shown in Table 2: Dimensional deviations of concrete skin.

Table 2: Dimensional deviations of concrete skin (unit : mm)

	Item	Symbol	Size ¹	Tolerance	Remark
--	------	--------	-------------------	-----------	--------

Full size	Basic		1,	±5	
	Height		1,		
	Width		1,		
			1,		
Half	Basic		1,		
	Height		7		
	Width		1,		
			1,		
Thickness			1		

2.3 Embankment material (Back Fill)

The embankment materials within the range where the effect of Mechanically-Stabilised Wall is anticipated shall conform to the following paragraphs:

(a) The embankment shall in principle adopt either material of [A1] or [A2] shown below:

- [A1] Soil material that contains 25 % or less of fine-grained fractions.

- [A2] Hard rock muck that excludes large grains exceeding 250mm, with the content of 25% or less of fine-grained fractions sifted through a 75mm sifter, and moderate mixture of large and small grains facilitating compaction.

However, the following embankment materials are also available for use if performing an additional test or countermeasures conforming to the manual described previously:

- [B] Soil material that contains 25% to 35% or less of fine-grained fractions.
- [C] Rock material that excludes large grains exceeding 250mm, with the content of 25% or less of fine-grained fractions sifted through a 75mm sifter.

- (b) If unexpected defective soil emerges in construction of the embankment, the contractor must immediately report this issue to the supervising personnel to process such soil in accordance with the instruction given by such personnel.

3. Construction

3.1 Preparatory work and foundation work

- (a) Preparation work includes survey work, selection, delivery and maintenance of construction machines to be used, preparation of members or materials/tools to assemble members, to consider smooth achievement of the main work.
- (b) Prior to work commencement, the contractor must survey the current state of a work spot to check that there is no difference with the design. Now if such differences exist to the extent they interfere with the construction, the contractor must immediately report this issue to the supervising personnel to deal with it in accordance with the instruction given by such personnel.
- (c) If the following situations occur in excavating the natural ground at the bottom of the Reinforced Earth and in excavating ground mass behind the strip, the contractor must immediately report this issue to the supervising personnel to deal with it in accordance with the instruction given by such personnel:
- When the soil characteristic of the natural ground is more defective than the initial prediction.
 - When the reclaimed surface has unexpected spring, groundwater level or buried structures.
 - When the excavated slop is collapsed.
 - When other indication like those above, which may damage stability of the Reinforced Earth or the surrounding ground is detected.
- (d) For construction of the foundation of the Reinforced Earth, horizontality of the top face of the foundation work must particularly be ensured because its finish largely affects stability and appearance of the Reinforced Earth itself.

3.2 Skin panel assembly

- (a) The standard pile pitching of the concrete skin shall adopt a truck crane or crawler crane of the 10t class.
- (b) For assembling a skin panel, constant attention must be paid to ensuring wall flatness as an upright wall to check verticality, horizontality, linearity to the extended direction of the wall, and the degrees of the shear of adjacent skin panels.

- (c) In case batter or distortion exceeding your prediction arises on part of the wall during construction, other works must immediately be stopped to investigate its cause, remove it, and repair the defective part of the finished work quality.
- (d) Each skin panel must be aligned to the proper position shown in the design, and the tools and materials for required assembly must be used appropriately for proper installation.

3.3 Embankment construction

- (a) The standard construction machine used for spreading and laying the embankment shall be around 15t class, and use of a model exceeding such level requires permission by the supervising personnel.
- (b) The following five items (five principles for travelling) must be complied with to travel a construction machine for spreading, laying and compacting the embankment:
 - Travel parallel to the wall.
 - Travel 1.0m away from the wall.
 - Work shall progress in order from the wall to the embankment.
 - Never suddenly change direction of the machine in the area where a strip has been embedded.
 - Do not travel directly on the strip of which no embankment material has been spread.
- (c) The standard layer of the embankment shall be 25cm thick after compaction, and the compaction face must be finished evenly in order not to interfere with strip laying.
- (d) The degree of embankment compaction shall be 90% or more of the maximum dry density specified in either A or B method, or 85% or more of the maximum dry density of one of C, D or E methods in JIS A 1210.
- (e) Construction moisture content of the embankment shall be 90% of the maximum dry density (A and B methods), or shall be the range between the optimum moisture content that 85% (C, D and E methods) of compaction degree is retainable and the moisture content of lubricant.
- (f) Areas close to the wall where a large compaction machine cannot enter, corners, and combination parts with existing structures must be carefully compacted using a small machine.
- (g) To avoid water influx into the embankment (especially in the strip laying) or high moisture content, perform the following:
 - The embankment materials spread in the embankment of the Reinforced Earth shall always be compacted, and the work left loose shall not be called a day (to avoid higher moisture content due to rainfall during night time).
 - Take measures for spring adequately as well as planned measures for drainage.
 - When rainfall is expected, set up a drainage slope (around 5%) on the embankment towards the opposite side of the wall, or waterproof the embankment with a sheet or others.
 - Embankment materials placed temporarily shall be cured with a sheet, or after rainfall they shall not be used until moisture content is lowered.
 - If no gutter is laid at the toe of the slope of the uploaded embankment, sufficiently compact the embankment or waterproof it with vegetation or concrete to avoid water influx from the slope.

- Items for construction control and their reference values shall be as shown in Table 3: Reference values for control.
- If there is a sufficient reason to conclude that the reference values for construction control cannot be based on Table 3: Reference values for control, then the contractor shall submit to the supervising personnel prior to work commencement to determine appropriate reference values upon discussion by both parties.

Table 3: Reference values for control

Target	Item for control	Reference values for control	Frequency	Remark
Foundation concrete	Height of installation	+5.0cm -0 cm	Every wall extension of 30m	Measured before building up a concrete skin
	Relative difference for each station	1.0cm	Every wall extension of 1.5m	
Concrete skin	Verticality when completed	$\pm 0.03H$ and 30cm	Every wall extension of 30m	Front laid (+), Back laid (-)
Earth work	Degree of compaction	90% or more of the maximum dry density specified in either A or B method, or 85% or more of the maximum dry density of one of C, D or E methods in JIS A 1210	Once every embankment of 500m ³	By volume and weight test (replaced by sand) at the site
	Construction moisture content	Range between the optimum moisture content and the moisture content that required density is retainable	After heavy rain, long rain or spring	

4. Measurement and Payment

4.1 Measurement

Measurement for the items shall be the number of square meters of concrete panel areas completed and accepted by the Engineer in accordance with the Drawings. Payment shall be the full compensation for furnishing and placing all materials, embankment, backfill aggregate with geo-textile sheet, coping concrete, foundation concrete, levelling materials, structural excavation and back fill, labour, equipment, strips testing on site, tools and other incidentals to complete the work in accordance with the Drawings and this Specifications and/or as directed by the Engineer.

4.2 Payment

The measured quantities for Mechanically-Stabilized Earth Wall shall be paid at the Contract unit price which shall be full compensation for the work prescribed in this Specification Section.

The Pay Items and Pay Units shall be as follows;

Pay Item	Description	Unit
03500-01	Mechanically-Stabilised Earth Wall	m2

Section 03600 – Reinforced Concrete Retaining Wall

1. Description

This work consists of constructing reinforced concrete (L type) retaining walls.

2. Survey and Drawings

To assist the Engineer in his review of the Engineering Drawings, the Contractor shall undertake a survey of the sites to determine the location, structure size and formation level.

3. Sequence of Works

Before the L type retaining walls construction, soft soil improvement shall be completed as indicated in the Drawings, specified in these Specification Sections or as directed by the Engineer. The Contractor shall consider the construction schedule in relation with the soft soil improvement works.

4. Materials

The L type retaining wall materials shall conform to the requirements of Division 3 Earthworks and Division 6 Concrete works.

5. Construction Requirements

5.1 General

The Contractor shall verify the limits of the wall installation, prepare and submit forms, falsework drawings and drainage provisions. After excavation is complete, the Contractor shall request Engineer's approval as to the character and suitability of the foundation material. The Contractor shall allow the Engineer 24 hours to review and approve the foundation before constructing the footing.

5.2 Submittals

At least 90 days before starting construction, submit the following for the Engineer's approval:

- 1) Plan of the wall structure,
- 2) Elevation of the wall structure,
- 3) Typical cross-section,
- 4) Dimensions and schedule of reinforcing steel,
- 5) Details and dimensions for foundations, and
- 6) Detail for the installation of drainage, utilities, lighting foundations, construction joints and traffic safety.

5.3 Structure Excavation

Prior to starting excavation, the Contractor shall take all necessary measures to keep the excavation free from ground and surface water.

Excavated materials not suitable for back-filling shall be disposed of. Any suitable material below the level of the retaining wall bed, which is removed unnecessarily by the Contractor, shall be replaced at no additional cost to the Employer.

5.4 Bedding Finishing

Excavation shall be executed after soft soil improvement until the true line and level as shown in the Drawings or as directed by the Engineer. After the excavation and the compaction, foundation by crusher runs and lean concrete shall be constructed. Then the Contractor shall place the reinforcement bars and the forms for casting concrete.

5.5 Backfilling

Backfilling shall not commence until, in the opinion of the Engineer, the concrete has achieved sufficient strength. Backfilling shall be carried out around the wall areas. Compaction for each layer shall conform to Division 03 Earthworks.

6. Measurement and Payment

6.1 Method of Measurement

L type retaining walls shall be measured by linear metres shown on the Drawings regardless of the height. Excavation, foundation, backfilling, formwork, scaffolding, reinforcing steel, concrete and other incidental works to the retaining walls shall not be measured separately for payment because they are deemed to be included in the works.

6.2 Basis of Payment

The payment shall include all works, features, fittings, joints and components required and shown on the Drawings for completion of the retaining wall structures including all excavation in any materials and supports, backfilling with appropriate materials, granular drainage layer, disposal of excavated materials, all Temporary Works, necessary traffic diversion, etc. Any other requirements described in this Sub-clause or shown on the L type retaining wall Drawings are considered as a subsidiary obligation of the Contractor and shall not be paid separately.

<u>Pay Item</u>	<u>Description</u>	<u>Unit</u>
03600-01	L Type Retaining Wall	lm

Section 03800 – Aggregate Subbase and Base

1. Description

This work consists of supplying, processing, hauling, spreading, watering, and compacting graded aggregates on a prepared and accepted surface, in accordance with details shown in the Drawings or as directed by the Engineer. Processing shall include, where necessary, crushing, screening, separation, blending, and any other operation necessary to produce a material conforming to the requirements of this Specification Section.

2. Material Requirements

2.1 Reference Standards

The most recent editions of the following Standards shall apply to the materials covered in this Specification Section:

- AASHTO T89 Determining the Liquid Limit of Soils
- AASHTO T90 Determining the Plastic Limit and Plasticity Index of Soils
- AASHTO T180 Moisture Density Relations of Soils using a 4.54 kg Rammer and a 457 mm Drop
- AASHTO T104 Soundness of Aggregate by use of Sodium or Magnesium Sulphate

2.2 Material Sources

All materials shall be tested by the Contractor and approved by the Engineer before use. Prior to delivery of materials to the Site, the Contractor shall notify the Engineer of the sources of the materials proposed for the Works, and shall obtain the approval of the Engineer based on the requirements of this Specification Section. If the proposed source of a material does not comply with this Specification Section, the Contractor shall furnish material from other sources for the Engineer's approval. Delivery of materials produced from commercial manufacturing processes shall be accompanied by the manufacturer's certification and test report showing that the materials comply with the Specification requirements. The Engineer's approval of a source does not imply that all the materials from that source are approved.

2.3 Storage, Mixing, and Handling of Materials

- (a) Materials shall be so stored and handled as to ensure the preservation of their quality and fitness for construction. Materials, even though approved before storage or handling, may again be inspected and tested prior to use. Stored materials shall be located to facilitate prompt inspection.
- (b) Handling and stockpiling of aggregates shall be to the approval of the Engineer, and always be as such to eliminate segregation of the various sizes and contamination.

- (c) Aggregate stockpiles for base course shall be protected from rain to prevent saturation of the aggregates, which would result in a reduction in the quality of the placed material or adversely affect the placement of the material.
- (d) Where materials of different sizes are to be blended to meet the gradation, such blending shall be as directed by the Engineer and shall be accomplished prior to delivery to the roadway. Mixing of separate materials on the roadway by motor grader will not be permitted by the Engineer.

2.4 Unacceptable Materials

Unless otherwise instructed by the Engineer, all materials that do not comply with the requirements of this Specification Section will be rejected and shall be removed immediately from the site of the Works, and replaced if necessary, at the Contractor's expense and without allowing any time extension to recover the delay due to this fault. Unacceptable materials of which defects can be corrected shall not be used until positive results of testing are obtained, and approval thereof is issued by the Engineer.

2.5 Aggregate Material Requirements

- (a) The aggregate subbase and base shall consist of hard, durable particles of fragments of stone crushed to the size and of the quality requirements of this Specification Section. The aggregate subbase and base shall be cleaned and free from vegetable matters, lumps or balls of clay and other deleterious substances. The materials shall be of such nature that it can be compacted readily to form a firm, and stable subbase or base.

The material for subbase and base shall conform to the grading requirements shown in Table 1:

Table 1 Grading Requirements for Aggregate

Sieve Designation	Mass Percent Passing ^(*)		
	Base	Subbase	
	Grading AD _{max} = 25mm	Gradi D _{max} = 50mm	Gradi D _{max} = 25cm
50	100	100	-
25	-	75-95	100
9.5	30-65	40-75	50-85
4.75	25-55	30-60	35-65
2.00	15-40	20-45	25-50
0.425	8-20	15-30	15-30
0.075	2-8	5-20	5-15

(*): Standard specification for materials for aggregate and soil-aggregate subbase, base and surface courses; AASHTO M147-65.

The Engineer will determine the application of Grading B or C for subbase considering the existing conditions found in the Site and materials

The fraction passing the 0.075 mm (No. 200) sieve shall not be greater than 0.66 (two thirds) of the fraction passing the 0.425 mm (No.40) sieve.

If filler, in addition to that naturally present, is necessary for aggregate base for meeting the grading requirements or for satisfactory bonding, it shall be uniformly blended with the crushed base course material as approved by the Engineer. Filler shall be obtained from sources approved by the Engineer, free from hard lumps and shall not contain more than 15 percent of material retained on the 4.75 mm (No.4) sieve according to AASHTO T112.

The aggregate subbase and base shall conform, through wet sieve testing, to the properties given in Table 2.

Table 2 Aggregate Subbase and Base Properties

Properties	Subbase	Base
Abrasion of Aggregate retained on 2.00 mm (No.10) sieve (AASHTO T96)	50% max	45% max
Plasticity Index of Aggregate passing 0.425 mm (No. 40) sieve (AASHTO T90)	6 max	6 max
Percent by weight of Aggregate retained on 2mm (No.10) sieve with one fractured face	-	-
Liquid Limit of Aggregate passing 0.425 (No. 40) sieve (AASHTO T89)	35 max	25 max
Soaked CBR (AASHTO T193) at maximum dry density according to AASHTO T180 Method D	30% min	for material passing 19 mm sieve 80% min.

3. Construction Requirements

3.1 Provision on the Commencement of the Works

The works for construction of the base courses, as well as all the works for pavement construction, shall not commence if the works for slope formation (in cutting and/or embankment sections) and slope protection have not been properly completed by the Contractor, and accepted by the Engineer.

3.2 Submittals

At least twenty-one (21) days prior to the proposed date of first use of any materials proposed to be used as aggregate subbase and base, the Contractor shall submit to the Engineer the following:

- (a) Three (3) samples of 50 kg weight each of the material, one of which shall be retained by the Engineer for reference throughout the Contract Period;
- (b) A statement of the origin and composition of any material proposed for use as aggregate subbase and base, together with laboratory test data verifying that the material properties specified in this Specification Section are met.
- (c) The Contractor shall submit the following in written form to the Engineer immediately following the completion of each section of the work and before any approval is granted for placing other materials on top of the aggregate subbase and base:
 - The results of testing as specified in Subsection 3.8 of this Specification Section.
 - The results of surface measurement tests and survey data verifying that the surface and thickness tolerances shown in Table 3 are met.

3.3 Trial Sections

- (a) Before commencement of base construction, the Contractor shall spread and compact trial sections as directed by the Engineer. The purpose of the trial section is to check the suitability of the materials and the efficiency of the equipment and construction method proposed to be used by the Contractor. Therefore, the Contractor shall use the same materials, equipment, and procedures which he proposes to use for the main work. One trial section about 500 m² shall be made for every type of material and/or construction equipment/procedure proposed for use.

- (b) Density tests and other tests required as directed by the Engineer.
- (c) If the materials are, in the Engineer's opinion, not suitable for base as observed through the trial, the materials shall be removed at the Contractor's expense, and a new trial section shall be constructed without consideration of time extension due to this delay.
- (d) If the basic conditions regarding the type of material or procedure change during the execution of the work, new trial sections shall be constructed.

3.4 Rectification of Unsatisfactory Aggregate subbase and base

- (a) Areas with a thickness or surface uniformity not satisfying the tolerances herein specified, or which develop irregularities in the surface during or after construction, shall be rectified by loosening the surface and removing or adding material as required, followed by reshaping and recompacting.
- (b) The aggregate subbase and base which is too dry for compaction, in terms of moisture content specified in this Specification Section or as directed by the Engineer, shall be corrected by scarifying the material followed by sprinkling with an adequate quantity of water and thoroughly mixing by means of equipment approved by the Engineer, and recompacting.
- (c) The aggregate subbase and base which is too wet for compaction as defined by the moisture content specified in this Specification Section or as directed by the Engineer, shall be rectified by scarifying the material followed by intermittently working using motor grader or other approved equipment to air-dry the material under dry weather conditions. Alternatively, or if sufficient drying cannot be achieved by reworking the loose material, the Engineer may direct that the material be removed from the work and replaced with a suitably dry material.
- (d) The aggregate subbase and base which becomes saturated by rain or flooding or otherwise after it has already been satisfactorily compacted according to this Specification Section will generally require no rectification work provided its material properties and surface uniformity meet the requirements of this Specification Section.
- (e) Rectification of the aggregate subbase and base which does not meet the density or material property requirements of this Specification Section, shall be as directed by the Engineer and may include additional compaction, loosening followed by moisture content adjustment and recompacting, removal, and replacement of the material, or the application of an additional thickness of material.

3.5 Equipment used for Aggregate Subbase and Base

- (a) Equipment and method used shall place the aggregate subbase and base to the lines, levels, grades, dimensions, and cross-section shown in the Drawings and as directed by the Engineer.
- (b) The Engineer has the right to stop the use of any equipment or plant which he deems to be inferior to the quality required, and to instruct the removal of such equipment and to have it replaced by suitable equipment or to alter the method of operation at any time.
- (c) The Contractor shall immediately comply with such instructions without being entitled to any indemnities or time extensions as a result of such instructions. The Contractor shall not use, except after obtaining the prior approval of the Engineer, any equipment or plant, and shall follow sound technical methods in operation and engage skilled and trained operators, mechanics and labour to carry out the Works. The Engineer has the right to expel any operators, mechanics or labour and to instruct suitable replacement thereof at any time he deems necessary.

3.6 Placing, Spreading, and Compacting Aggregate Subbase and Base

The aggregate subbase and base shall not be placed, spread or compacted while rain is falling, and no compaction shall be carried out when the moisture content of the material falls outside the specified range

3.6.1 Placing

- (a) The aggregate subbase and base material shall be placed in accordance with the drawing requirements as a uniform mixture in a quantity which will provide the required compacted thickness.
- (b) When more than one layer is required, each layer shall be compacted as specified in Subsection 3.6.3 of this Specification Section, before the succeeding layer is placed.
- (c) The placing of material shall begin at the point designated by the Engineer.
- (d) The area being prepared for laying the base material shall be completed and the approval of the Engineer obtained for at least 200 m ahead of the placing of the base always.
- (e) Hauling equipment may be routed over completed portions of the courses if no damage results and that such equipment is routed over the full width of the course to avoid rutting or uneven compaction. The Engineer has the right to stop all hauling over completed or partially completed subbase or base courses when in his opinion such hauling is causing damage

3.6.2 Spreading

- (a) Where the required thickness is 150 mm or less, the material may be spread and compacted in one layer of subbase or base, respectively. Where the required thickness is more than the foresaid requirement, the aggregate subbase and base shall be spread and compacted into two (2) or more layers of approximately equal thickness, and the maximum compacted thickness of any one (1) layer shall not exceed for said requirement unless otherwise directed by the Engineer. All subsequent layers shall be spread and compacted in a similar manner. All aggregate subbase and bases shall be placed by a spreader.
- (b) The aggregate subbase and base shall be delivered to the roadbed as a uniform mix and shall be spread at moisture content within the range specified in this Specification Section. The moisture shall be uniformly distributed throughout the material.
- (c) The aggregate subbase and base shall be spread and shaped by any approved method, which does not cause segregation of the fine and coarse aggregate particles. Segregated materials shall be corrected or removed and replaced with a graded material.
- (d) Immediately following final spreading and smoothening, each layer shall be compacted to the full width by means of approved compaction equipment. Rolling operations shall begin along the edges and progress gradually towards the centre, in a longitudinal direction. On super-elevated sections rolling shall begin at the low side and progress towards the high side. The rolling operation shall continue until all roller marks are eliminated and the layer is uniformly compacted and the aggregates firmly keyed. Any irregularities or depressions that develop shall be corrected by loosening the material at these places and adding or removing material until the surface is smooth and uniform. Along kerbs, headers, and walls, and at all places not accessible to the roller, the base material shall be compacted thoroughly with approved tampers or compactors. At the end at each shift, the surface of the base shall be shaped and sloped to prevent ponding of rain water.

- (e) The aggregate subbase and base surfaces which are to receive a prime coat shall then be further compacted to produce a stable, tightly locked surface, without open pores, suitable for priming. All coarse aggregates shall be tightly locked in place. Under no circumstances shall any form of soil or fine aggregates be added to the surface to assist the locking process, which shall be achieved by compaction only. Vibration shall not be used in the final stages of the compaction of the surface. The Engineer may direct that pneumatic rollers be used for the final surface compaction, if static steel wheeled rollers are considered likely to cause excessive breakdown or degradation of the aggregate subbase and base.

3.6.3 Compaction

- (a) Compaction shall be carried out only when the moisture content of the material is within the range of 3% less than the optimum moisture content to 2% more than the optimum moisture content, where the optimum moisture content is as defined by the maximum modified dry density determined by AASHTO T180, Method D.
- (b) When the underlying material is soft or yielding the base course, compaction shall be stopped and the underlying materials rectified as directed by the Engineer.
- (c) During all the operations of spreading, compacting, and levelling of course material, care shall be taken so that the layers already compacted under the layer being executed are not affected, or that the finished subgrade, subbase or base surface is also not affected. Special attention shall be given in places where equipment makes turns in going back and forth. Any such damage resulting in mixing the various layers constituting the different subgrades, subbase and base courses shall be carefully made good by the Contractor and at his expense and to the satisfaction of the Engineer.
- (d) If the layer of subbase or base material, or part thereof, does not conform to the required finish, the Contractor shall, at his own expense, make the necessary corrections.
- (e) Compaction of each layer shall continue until a field density has been achieved. In-place density determination shall be made in accordance with AASHTO T191. When aggregate subbase and base divides into layers for construction, the subsequent layers shall be placed only after execution of inspection and acceptance for compacted density of previous layer is done.
- (f) Proof rolling shall be conducted after finishing by more than 25 tons weight roller on the place directed by the Engineer. If the deflection is more than 3 mm, the place shall be replaced as instructed by the Engineer.

3.7 Control of Traffic on Base Surfaces

- (a) Construction traffic or other traffic shall not be permitted to travel on any aggregate layers, prior to the construction of the final surfacing, except where directed or permitted by the Engineer.
- (b) The aggregate subbase and base shall not be opened to traffic until shaping and compaction are substantially completed.
- (c) Pending the construction of the final surfacing, the aggregate subbase and base shall be maintained as follows:
- The aggregate subbase and base shall be maintained always by drag blooming. The traffic shall be controlled by temporary speed restrictions and, during working hours, it shall be

channelled by suitably defined traffic lanes, with frequent transverse shift of the defined lanes to obtain an even spread of traffic over the entire surface.

- Where the pavement course is too dry, so that surface stability does not or is unlikely to improve under the effect of traffic and/or rolling and where rain is not imminent or has been insufficient, a uniform application of water shall be applied to the entire surface. Up to 4 L/sq.m shall be applied in gradual increments to avoid flooding or scouring the surface.

3.8 Testing

- (a) The amount of supporting test data required for initial approval of the quality of the material shall be as directed by the Engineer, and shall include all the tests specified in this Section on at least three (3) representative samples from the proposed material source, selected to represent the range of material quality likely to be obtained from the source.
- (b) Following approval of the quality of a proposed material, the full range of material quality tests performed shall be repeated subsequently, at the discretion of the Engineer, in the event of observed changes in the material or in its source or in its method of production.
- (c) A programme of routine material quality control testing shall be carried out to control variability of the material being brought on site. The extent of the testing shall be as directed by the Engineer, but following test shall be conducted for every 3000 m³:

Five (5) plasticity index tests

Five (5) particle grading tests

One (1) maximum dry density determination (AASHTO T180 Method D)

CBR Tests

- The density and moisture content of the compacted material shall be routinely determined, using AASHTO T191. The test shall be made to the full depth of the layer at locations as directed by the Engineer, but not more than 200 m apart.
 - All holes in the finished work made by density testing or otherwise shall be backfilled with the specified material by the Contractor without delay and compacted to the density and surface tolerance requirements of this Specification Section.
 - Examination stage for acceptance of aggregate quality which was gathered at the Site for construction: tested sample is taken from material at the site and shall be conducted for every 1000 m³ from each material supply source or when material quality is extraordinary. Material shall meet all physical properties specified in Tables 1 and 2 and compacting test conducted inside the Laboratory.
- (d) Examination during construction period: During construction period, the contractor shall regularly conduct tests and check the following contents:
 - Moisture, aggregate material separation (observed by eyes and by checking sieve particle): Test on moisture and sieve particles shall be conducted for every 200 m³ aggregate or every shift;
 - Compacted density: test shall be conducted for every finished aggregate foundation layer, according to the testing process; base aggregate's compacted density shall be certified by sand cone test according to equivalent process as required by the Engineer. At the final stage of compaction, test for checking compacted density shall be frequently performed

and taken as basis for completion of compaction works; test for compactness shall be conducted for every 800 m² at each random position; and

- Flatness, geometric factors: shall be checked according to the requirements specified in Table 3. These testing data will be the basis for acceptance of works.

(e) Checking and acceptance of construction works

- As for compacted density, test shall be conducted for every 7000 m² at two (2) random positions;
- For flatness, geometric factors: checking density shall account for 20% of quantity regulated in Table 3.

(f) During conducting of finishing works, all holes made by density testing shall be backfilled with the specified material by the Contractor without delay, and compacted to the density and surface tolerance requirements of this Specification Section.

3.9 Tolerances for Acceptance

The aggregate subbase and base shall be spread with the equipment that will provide a uniform layer which when compacted will conform to the designed thickness, level, and longitudinal grade and cross fall or camber as shown in the Drawings. The allowable tolerances after compaction shall be as shown in Table 3.

- (a) The surface of all aggregate subbase and base layers shall not have any irregularities which can hold moisture and the camber of all such surfaces shall comply with that shown in the Drawings.
- (b) When testing the irregularity of aggregate subbase and base surfaces to be treated with bituminous surfacing, all loose material shall be removed by hard blooming.

Note: The following table shows the tolerances for two (2) layers since the materials of both layers are the same in the Bill of Quantities. However, the second layer shall conform to the tolerances as “Subbase” from functional view point.

Table 3: Tolerances for Aggregate Subbase and Base

Item Checking	Permitted Variation comparing with the Drawings		
	Subbase	Base	Description
Layer Thickness	+ 10 mm	+ 5 mm	Measurement of cross-section shall be conducted for every 40-50 m for straight section and 20 – 25 m for horizontal or vertical curves
Surface Level	+10 mm	+5 mm	
Width on Top	+100 mm	+50 mm	
Cross Fall or Camber	+ 0.3%	+ 0.2%	
Surface Irregularity by 3 m straight edge	< 20 mm	< 5 mm	One position for every 100 m along the route

4. Measurement and Payment

4.1 Method of Measurement

- (a) The aggregate subbase and base shall be measured in cubic meters of compacted material required, complete in place and accepted. The volumes to be measured shall be based on the cross-sections shown in the Drawings where the required thickness is uniform and on the cross-sections approved by the Engineer, where the required thickness is not uniform, and the lengths measured horizontally along the road centreline. No allowance shall be given for materials placed outside the design limits shown on the cross-sections. Trial sections shall not be measured separately but shall be included in the quantity of base herein measured.
- (b) The work for preparing and maintaining the subgrade on which the aggregate subbase and base is to be placed shall not be measured or paid.
- (c) No separate measurement for payment shall be made for any running course gravel used for temporary protection of the surface of aggregate subbase and base exposed to traffic.
- (d) No additional measurement for payment shall be made for repairs to layers caused by traffic or natural conditions.
- (e) No additional measurement for payment shall be made for extra material provided in the next course due to deficiency of the base course.
- (f) Measurement of rectified work:
 - When rectification of unsatisfactory base is directed by the Engineer, the quantities to be measured for payment shall be those which would have been paid if the original work had been acceptable. No additional payment shall be made for the extra work or quantities necessitated by the rectification.
 - Where adjustment of moisture content has been directed by the Engineer prior to compaction, no additional payments shall be made for adding water or drying out the material or for any other work required to obtain satisfactory moisture content.

4.2 Basis of Payment

Payment shall be for full compensation for the work prescribed in this Specification Section including hauling, supplying, placing, compacting, finishing and testing the materials, the supply and placing of running course, and maintenance of the surface under traffic, and for furnishing all labour, materials, tools, equipment, and any incidentals necessary to complete the work shown in the Drawings and as required in accordance with these Specifications and/or as directed by the Engineer.

The Pay Items and Pay Units shall be as follows;

Pay Item	Description	Unit
03800-01	Aggregate Subbase Course	m ³
03800-02	Aggregate Base Course	m ³

Section 03900 - Soft Soil Improvement by Soil Cement Columns

1. Description

This work consists of supply of materials and instruments, and implementation deep mixing method as necessary measures to improve the existing mechanical conditions of the underground soft soil layers, in accordance with the requirements for stabilization and pre-consolidation determined in the Drawings.

The requirements herein specified refer to applied for improving the underground soft soil layers on which the roadway embankment will be constructed.

1.1 Deep Mixing Method (Soil Cement Column)

Deep mixing method is the process of improving properties of existing soils by mixing stabilizing material, i.e. cement, with existing soils. Soil cement columns can be installed by mechanical mixing method by means of wet mixing (slurry type). The mixing of stabilizing material to the existing soils at various levels shall create soil columns with a predetermined strength, depth and diameter.

Soil cement columns shall be installed using special equipment designed and manufactured specifically for this purpose and the operator shall have at least 3 years' experience in installing deep soil cement columns using the relevant special equipment. Details of the equipment to be used and the personnel carrying out the work shall be submitted to the Engineer for approval before the equipment or the personnel are mobilized to the site. The equipment shall include the devices for monitoring the cement volume and mixing process. This data will be automatically included in a printout with data at one meter interval which the Contractor shall submit at the end of every column installation to serve as a record for the satisfactory completion of the work. The depth, minimum finished diameter, spacing and pattern of the installed columns shall be shown on the Drawings or instructed by the Engineer and the Contractor shall take these into consideration when preparing his proposed equipment and construction method.

2. Material Requirements

2.1 Reference Standards

The most recent editions of the following Standards shall apply to the materials covered in this Specification Section:

- Guideline for Road Earth Work, Measure of Soft Soil Ground, issued by Japan Road Association, 2012
- Manual for Design and Construction of Deep Mixing Method on Land, issued by Public Works Research Centre, Japan, 2004

2.2 Submittals

2.2.1 Shop and Working Drawings and Schedules

- (a) The Contractor shall submit complete sets of drawings and schedules for the soft soil improvement, to the Engineer for review and approval. Moreover, the Contractor shall update the geological survey data and actual stabilizing material, and compute the soft soil

improvement requirements to be submitted to the Engineer and Employer for their approval. The Contractor shall update the data of the geological survey and the actual stabilizing material, computing the soft soil improvement to submit to the Engineer for review and the Employer for acceptance.

- (b) The Contractor shall obtain the Engineer's approval of the submitted drawings and schedules at least twenty-eight (28) days before commencement of the corresponding works.

2.2.2 Other Submittals

Other submittals shall include, but not be limited to, the following:

- General: Samples and all the information related to the materials requiring approval. This information might include all the pertinent certificates, testing results, and any other document that could prove that the material is suitable for the respective work.
- Documents from Manufacturers: All the information related to instruments, method of installation, etc. provided by the manufacturers proposed by the Contractor.
- Submittals for deep mixing method: All the information related to the type of deep mixing method that the Contractor proposes to use, the properties, and relevant experience records.
- Deep mixing method Installation: All the information related to the sequence and construction and installation method for deep mixing method.
- Layouts of deep mixing method Locations: Detailed and dimensioned layouts of locations in duplicate for the approval of the Engineer at least two (2) weeks prior to installing the deep mixing method at any section.

2.3 General Requirement for Materials

- (a) Materials used for the soft soil improvement shall comply with the minimum requirements described in this Specification Section.
- (b) The Contractor shall use the instruments previously approved by the Engineer for the soft soil improvement.

3. Tests Requirements

3.1 Stabilizing Material

Cement shall be Cement according to Manual for Design and Construction of Deep Mixing Method on Land, issued by Public Works Research Center, Japan, 2004.

The materials shall be stored in containers to prevent damage from moisture before application.

The required amount of stabilizing material to achieve the design compressive strength in the field shall be determined by the Contractor through laboratory tests and field tests specified in this Specification Section and shall be approved by the Engineer.

3.2 Soil Investigation and Trial Mix Tests

The contractor shall perform soil investigations and trial mix tests to determine the soil profile and the appropriate cement content for the soil cement column in accordance with requirements stated in the following sections.

At a ratio of two (2) % of cement soil columns improved by deep mixing method, a set of undisturbed soil samples shall be collected at the appropriate depth to the lower end of cement soil columns through rotary wash boring, and the following laboratory tests shall be performed on each sample:

- Determination of natural moisture content, unit weight, Atterberg Limits and sieve analysis for all samples.
- Unconfined compression tests on all samples.
- Determination of pH of suspended soil, ignition loss of soil and organic carbon content of soil for all samples.

The soil investigation report shall include tables summarizing test results and boring logs in graphical form.

3.3 Laboratory Trial Mix and Tests

For the soil collected at the appropriate depth to the lower end of cement soil columns, trial mixes shall be prepared to determine the unconfined compressive strength and modulus of the mixture of existing soft soil with cement through unconfined compression tests. The test shall be performed with at least 15 samples for each mixture proportion as given in the table below. Unconfined compression tests shall be made when the test samples are cured at 7 days, 14 days and 28 days. At least three samples shall be tested for each different curing time. If volume of sample soil is insufficient to conduct the above trial mix, additional borehole shall be installed nearby area. The mixing, making and curing method for laboratory trial mix shall be in accordance with “Summary of the Practice for Making and Curing Stabilized Soil Specimens without Compaction (JGS 0821)” or as directed by the Engineer.

The water cement ratio (W/C) shall range between 0.8 and 1.2. The Contractor, based on the results from the trials, shall determine a suitable ratio that will be subject to the Engineer’s approval.

The design unconfined compressive strength is shown in the Drawings or shall be directed by the Engineer.

However, the actual quantity of stabilizing materials to be used in the field shall not be less than minimum values shown in Section 3.1.

Unconfined compression test shall be made in accordance with ASTM D 2166-13. The test sample shall have minimum diameter of 50 mm and a height of 2 times the diameter. The casing shall be the type that can be removed without disturbing of the sample. The sample shall be cured by covering with plastic sheet to prevent dehydration of water.

In the mixture test, the stabilizing materials shall be of the same type and characteristics as to be used in the field as shown below:

Field Soil Cement Column	Mixture Test
Wet Mixing	Mix stabilizing material slurry of same water proportion to be used in the field with existing soft soil.

The report shall describe the mixing method, storage and curing procedure and the test results. The report shall also include:

- Tables summarizing unconfined compressive strength, modulus and unit weight of mixed samples at different curing times.
- Graph showing unconfined compressive strength of mixture against quantity of stabilizing material and graph showing unconfined compressive strength against curing time.

4. Construction Requirements

Soil cement columns shall be made with suitable machines, tools, and equipment to create columns as specified in the Drawings and Specifications. The construction shall have computer printout for each column. The printout for each column shall be made immediately upon completion of each column and shall show the depth of the column; quantity of stabilizing material used or remained in the container and graph showing quantities of stabilizing material used at various levels.

The Contractor shall submit the list of machines, tools, and equipment with explanation to the Engineer for approval prior to commencement of work.

Upon approval, the Contractor shall construct a set of three preliminary test columns (trial columns which are non-working piles) for verification. Two test columns shall have a diameter of 1.2 m and a depth shown in the Drawings or as directed by the Engineer and one test column shall have a diameter of 1.2 m and a half depth of the other test columns to demonstrate ability of machines, tools and equipment. The quantities and types of stabilizing materials shall be first approved by the Engineer, which may be determined by mixture test. The unconfined compressive strength of each column at various levels shall be tested at 28 days. The test columns shall be checked to confirm that it has diameter of not less than 95 % of diameter specified on the Drawings in accordance with the method described in Subsection 4.5. One test column shall be used for the static load test as specified in Subsection 4.3 and 4.6.

3.2 Wet Mixing (Slurry Type)

For soil cement columns made by wet mixing, the Contractor shall provide a container for stabilizing material, a container for water, water pump, mixture agitator, mixture machine with steel shaft and vane at the end, and measuring device for determining the quantities of materials, pressure of slurry being injected, and a device to measure speed of rotation and lifting of shaft.

Mixture of material and water shall be continuously agitated to remain uniformity. Proportion of stabilizing material and water shall be of the proportion as tested and approved by the Engineer. The Engineer shall have the right to inspect the proportion of slurry at any time. The slurry shall be used within two hours. The expired slurry shall not be used unless admixture is used to retard the setting of mixture with the approval from the Engineer.

Mixture machine shall be able to rotate and lift the shaft during wet mixing with existing soils at approved speed to produce uniform column. The speed for rotation and lifting of shaft and mixing shall be determined in the actual field test. Mixing vane shall be able to thoroughly mix soil and stabilizing material. Shaft shall have the length of not less than the depth of soil cement column. Mixing vane shall have diameter of not less than diameter of column as specified in the Drawing.

Pump to inject slurry into soil shall have adequate pressure to continuously inject slurry into soil.

Measuring device for materials and slurry shall have accuracy of reading to 2 kg.

In addition to the above, the construction equipment shall satisfy the following requirements.

- The equipment for mixing shall be provided with blades, storage tanks for cement, mixing blade rotation and facility to control withdrawal speeds.
- The equipment shall be durable to rotate the mixing blade at a required speed.
- The withdrawal speed during mixing shall be established in the field after the experience gained from the construction of the trial cement column.
- The number of blade rotation, which is defined as the number of rotation of the mixing blades in a soil-stabilizer mixture in a given 1-m-long section while the blades are raised and lowered, shall be computed as follows.

$$T = \sum M \times \{ (Nd/Vd) + (Nu/Vu) \}$$

Where:

T: number of blade rotation (n/m)

$\sum M$: total number of mixing blades

Nd: rotation speed of the blades during penetration (rpm)

Vd: mixing blade penetration velocity (m/min)

Nu: rotational speed of the blades during withdrawal (rpm)

Vu: mixing blade withdrawal velocity (m/min)

- The number of blade rotation as defined shall not be less than 350. The mixing blade shall be designed to ensure homogeneous mixture of the soil and the stabilizing agent. Tolerance of deviation of the mixing blade diameter shall not be more than 5%.
- The control of the mixing process shall be computerized to assure the best quality of mixture. After the placement of each of the column, one printout result shall be generated from the computer showing the column number, time, depth of the column, content of cement slurry used in the mixing process and the number of rotation. The process shall be recorded and submitted for all the columns to be installed for the checking of the integrity and quality of the end products.

4.2 Dry Mixing

Not used.

4.3 Field Tests

The test column in the field shall be tested as follows:

- Unconfined compressive strength on cored samples from one column
- Verification of column dimensions and uniformity of column by pulling-out an entire test column (preliminary test column of 10m length) from the ground. The column shall be inspected for size, shape and uniformity of the stabilization along the entire length of the

column. The Contractor shall submit the pulling method to the Engineer for approval before operation.

- Pile static load test on test column using kentledge, tension pile or ground anchorage system.

Prior to the start of construction the Contractor shall submit to the Engineer for approval the test procedures for determining unconfined compressive strengths and the diameter and depth of columns. The cost of these tests shall be borne by the Contractor.

The unconfined compressive strengths of column at various levels including diameter and depth of column shall be determined. However, in case that the test for unconfined compressive strength cannot be satisfactorily attained, pile load test may be required to determine the capacity of column. The pile load test of column shall be conducted at 28 days of curing time.

Any pile which fails the above tests shall be replaced by one or more piles by the Contractor or as directed by the Engineer and an additional test shall be conducted for the replaced piles. If, in the opinion of the Engineer, it is impractical or inadvisable to install substitute piles in place of a failed pile, the Contractor shall submit proposals to rectify the defect. The proposal is subject to the acceptance of the Engineer.

In addition, the Contractor shall at his expense carry out two more additional working load tests. The piles for these tests shall be selected by the Engineer.

4.4 Unconfined Compression Test

Unconfined compressive strength of column by the cored sample on site shall be made at interval not more than 1 m with age of 28 days old having a value of no less than the design unconfined compressive strength. If the requirements are not met, judgment shall be made by the Engineer. Testing frequency shall be in accordance with Subsection 4.7 below.

4.5 Verification of Column Dimensions

Verification of column dimensions shall be made as specified herein.

Column dimensions can be checked by exposing a top 2m portion of completed column improved by deep mixing method. The column shall be inspected for size, shape and uniformity of the stabilization. The Contractor shall submit the proposed method on the exposure of column top portion for inspection to the Engineer for approval before operation.

4.6 Pile Load Test on Column

Pile load test shall be performed in according to ASTM D1143-81 on a soil cement column of age over 28 days applying 1.5 times of design working load shown in the drawing or as directed by the Engineer. The pile top shall be properly prepared for the test. The method of testing shall be approved by the engineer prior to execution of the work. Testing frequency shall be in accordance with Subsection 4.7 below.

4.7 Frequency of Testing

The number of columns to be tested shall be as follows:

- Frequency of coring for determination of unconfined compressive strength shall be performed at a ratio of two (2) % of total number of columns improved by deep mixing method.
- Frequency of verification of column size and uniformity of column by pulling-out test shall be conducted one preliminary test column (non-working column prior to the commencement of working columns).

- Frequency of verification of column size at a top 2m portion shall be conducted at a ratio of one (1) % of total number of columns improved by deep mixing method. If the Contractor changes a part of his construction method, additional test shall be conducted in accordance with clause 4.3.
- Frequency of pile static load test shall be conducted for one preliminary test column (non-working column prior to the commencement of working columns) and one (1) % of total number of working columns improved by deep mixing method. If the Contractor changes a part of his construction method, additional preliminary test column shall be conducted in accordance with clause 4.3 and pile load test shall follow.

4.8 Allowable Deviation

The Contractor shall construct each column to the depth, spacing, vertical alignment, location and with unconfined compressive strength as specified in the Drawing and/or these Specifications. In such case that any column constructed with smaller diameter or specified strength, the Engineer shall have the right to order construction of additional column or reconstruct the defective column at the expense of the Contractor.

Allowable deviation shall be as follows:

- Vertical Deviation of column shall not be more than 1%.
- Position of each column and spacing between columns shall not be deviated more than 100 mm in any direction.
- Diameter of column shall not be less than 95% of specified diameter.
- Unconfined compressive strength shall not be less than the design unconfined compressive strength at 28 days.

5. Measurement and Payment

5.1 Method of Measurement

Cement columns shall be measured in linear meters from the tip of the column to the cut-off level. The length of cement columns shall be in accordance with the dimensions shown on the Drawings and accepted by the Engineer. Cut-off lengths will not be measured for payment.

5.2 Basis of Payment

The work measured as provided above will be paid for at the Contract unit price per linear meter of cement columns. The payment shall be full compensation for furnishing and placing all materials, including labour, tools, equipment, all kinds of tests as specified herein or in the Drawings and incidentals necessary for the satisfactory completion of the work.

<u>Pay Item</u>	<u>Description</u>	<u>Unit</u>
03900-01	Soil Cement Columns (Working Pile) including Field Test	lm
03900-02	Soil Cement Columns (Preliminary Test Column; Non-working Pile) including Field Test	lm

Section 03910 – Soft Soil Improvement by Shallow Improvement

1. Description

This work consists of supply of materials and instruments, and shallow improvement method as necessary measures to improve the existing mechanical conditions of the underground soft soil layers, in accordance with the requirements for stabilisation determined in the Drawings.

The requirements herein specified refer to applied for improving the underground soft soil layers on which the roadway embankment will be constructed.

1.1 Shallow Improvement

This work shall consist of a stabilized soil improvement body composed of soil mixed with Portland cement and water, constructed in multi-layers on a prepared and accepted subgrade in accordance with these Specifications and the lines, levels, grades, dimensions and cross sections shown on the Drawings and subject to approval by the Engineer.

2. Material Requirements

2.1. Reference Standards

The most recent editions of the following Standards shall apply to the materials covered in this Specification Section:

- Guideline for Road Earth Work, Measure of Soft Soil Ground, issued by Japan Road Association, 2012
- Manual for Design and Contraction of Deep Mixing Method on Land, issued by Public Works Research Centre, Japan, 2004

2.2. Submittals

2.2.1. Shop and Working Drawings and Schedules

- (a) The Contractor shall submit complete sets of drawings and schedules for the soft soil improvement, to the Engineer for review and approval. Moreover, the Contractor shall update the geological survey data and actual stabilizing material, and compute the soft soil improvement requirements to be submitted to the Engineer and Employer for their approval. The Contractor shall update the data of the geological survey and the actual stabilizing material, computing the soft soil improvement to submit to the Engineer for review and the Employer for acceptance.
- (b) The Contractor shall obtain the Engineer's approval of the submitted drawings and schedules at least twenty-eight (28) days before commencement of the corresponding works.

2.2.2. Other Submittals

Other submittals shall include, but not be limited to, the following:

- General: Samples and all the information related to the materials requiring approval. This information might include all the pertinent certificates, testing results, and any other document that could prove that the material is suitable for the respective work.
- Documents from Manufacturers: All the information related to instruments, method of installation, etc. provided by the manufacturers proposed by the Contractor.
- Shallow improvement installation: All the information related to the sequence and construction and installation method for shallow improvement method.
- Layouts of shallow improvement locations: Detailed and dimensioned layouts of locations in duplicate for the approval of the Engineer at least two (2) weeks prior to installing the shallow improvement at any section.

2.3. General Requirement for Materials

- (a) Materials used for the soft soil improvement shall comply with the minimum requirements described in this Specification Section.
- (b) The Contractor shall use the instruments previously approved by the Engineer for the soft soil improvement .

3. Material Requirements

3.1. Soil

Soil shall be sand with a fines content of less than 25%. The soil shall conform to the requirements and shall be free from contamination by topsoil, vegetation and other organic matter, and any deleterious materials of a different nature from the soil required.

3.2. Cement

Cement shall conform to the requirements for Cement in accordance with Manual for Design and Contraction of Deep Mixing Method on Land, issued by Public Works Research Centre, Japan, 2004. The materials shall be stored in containers to prevent damage from moisture before application.

The design unconfined compressive strength is shown in the Drawings or shall be directed by the Engineer.

3.3. Water

Water shall be clean and free from harmful matter. Any indication of unsoundness, marked change in time of setting or a reduction of more than 10% in strength of mortar mixtures made with the water; as compared with mixtures made with distilled water shall be cause for rejection.

4. Construction method

4.1 Mix Design

The Contractor shall submit to the Engineer for his approval samples of materials to be used in the Mat together with the Contractor's proposed mix design. The proportions of cement and moisture

content required will be determined by means of cylinder tests. Cylinders tests will be carried out in accordance with AASHTO test method T134 for cement stabilized mixes subject to modification to use the compaction effort defined in AASHTO test method T180. The mix will be so selected that the strength shall be at least equal to the design strength as indicated in this specification section or as shown on the Drawings.

4.2 Equipment

Equipment shall be suitable for the work specified, and shall have met with the approval of the Engineer as to type, capacity, design and manufacture before construction is permitted. The equipment shall be capable of constructing the improvement body to meet the requirements specified and to permit the measurements required.

4.3 Initial Testing

The Contractor shall make and test trial mixes using different proportions of stabilizer and will select mix proportions that give strengths of test cylinders made and cured in the laboratory of not less than 105% of the required strength. This mix will be the Approved Mix for use in the Works.

4.4 Mix Control

The entire operation of mixing of shallow improvement shall be subject to close control and frequent testing will be required as the work proceeds to ensure that the strength and density requirements are being maintained.

To evaluate the quality of the improvement body, the Contractor shall conducting unconfined compression tests as directed by the Engineer. The test results shall be not less than the required design strength.

The Contractor shall provide to the Engineer samples of soil for stabilizing at least 10 days in advance of its use so that any necessary adjustments to the mix design may be made and approved. Failure to do so will make the Contractor responsible for replacing at his own expense any sections of work that are unsatisfactory on account of an unsuitable mix.

4.5 Mixing

The materials shall be dry mixed before addition of water so that cement balls are not formed when water is added. The water content shall be within two percentage points of the optimum moisture content for the compaction required. Placing and mixing shall be completed and compaction started within 30 minutes of the addition of water in the case of cement stabilized mixes.

The Contractor shall give the Engineer every facility for checking the actual quantities of cement used in the construction.

4.6 Spreading and Compaction

Except in the case where the existing subgrade is to be stabilized in place, the mixed material shall be placed and compacted between robust forms secured against movement. Adjoining sections of previously completed mat shall be neat, clean and treated at the interface with slurry of cement, sand and water. Construction joints shall be trimmed to be vertical before adjoining sections are constructed.

The layer shall be compacted throughout its depth to 95% of the maximum dry density obtained from the test method used in mix design. Compaction shall be uniform over the whole area and shall be done in such a way that no ruts are formed. The use of both steel tired rollers and pneumatic tired rollers will be required. Compaction shall be completed to the required standard within 3 hours of mixing for cement stabilized mixes.

4.7 determination of thickness

After final compaction, test cores shall be taken from the mat to determine the thickness at intervals not greater than 100 meters. Any part of the mat which fails to meet the Specifications or which originally having met the Specifications subsequently suffers damage or deformation shall be rebuilt to the Specifications to the full depth of the mat at the Contractor's expense.

4.8 Acceptance

The Engineer may test by generally recognized methods not mentioned herein and any test result which shows that the work does not comply with these Specifications may be grounds for rejection of the work.

5. Measurement and Payment

5.1 Method of Measurement

Shallow improvement body shall be measured in cubic meters of material complete in place and approved by the Engineer. Measurement will be based on the cross-section area of the mat shown on the Drawings and accepted by the Engineer.

5.2 Basis of Payment

The work measured as provided above will be paid at the Contract unit price per cubic meter of shallow improvement body. The payment shall be full compensation for furnishing all materials complete in place including handling, placing, mixing, compacting and for all labour, tools, equipment, all kind of tests as specified herein or in the Drawings and incidentals necessary for the satisfactory completion of the work.

No payment will be made for unauthorized, defective, unsound or unsatisfactory shallow improvement body of any cost incurred by the Contractor for such cement stabilized mat.

Item No.	Description	Unit
03910-01	Shallow Improvement	m3.

Section 03950 – Soft Soil Improvement by Preloading

1. Description

This work consists of supplying the materials and instruments, installation of devices for monitoring of settlements, and implementation of all necessary measures to improve the existing mechanical conditions of the underground soft soil layers, in accordance with the requirements for stabilization and pre-consolidation determined in the Drawings.

The requirements herein specified refer specifically to the improvement of underground soft soil layers, on which the roadway embankment will be constructed, by pre-consolidation of the soft soil layer only by the effect of a preloading embankment weight.

1.1 Preloading System

- (a) This Specification Section addresses the implementation of construction methods and practices, and supply and installation of specific materials shown in the Drawings and herein specified to stabilize by pre-consolidation the soft soil layers underlying some sections of the roadway embankment.
- (b) These items include the removal of ground material (organic or/and unsuitable material), construction of sand mat (SM), construction of surcharge embankment (SE) and monitoring of settlements during several months prior to roadway embankment and subgrade preparation.
- (c) At the locations shown in the Drawings, the settlement treatment for stabilisation by pre-consolidation shall include:
 - Staged construction of embankment; and
 - Waiting up after embankment construction to the time specified in the Drawings before the final and permanent embankment is permitted based on the Reference Section (refer to Subsection 3.8) test results and the Engineer's approval.

1.2 Surcharge Embankment (SE)

The roadway embankment shall be constructed in two (2) stages to prevent the final settlement estimated in the detailed design.

- 1st Stage: The surcharge embankment (SE) shall be constructed to its total height including an over-height approximately equal to the foreseen height of settlement of embankment at the end of the period considered for stabilization,
- 2ndStage: Once the embankment has reached the scheduled stability, or after the Engineer has authorized the construction of the final and permanent embankment, embankment formation shall be prepared to the lines and levels specified in the Drawings for the final embankment foundation.

1.3 Embankment Instrumentation and Monitoring

This section mainly describes the specifications and methods for supplying instruments, installation, data recording/monitoring of embankment settlements, and horizontal deformations related to the applied soft soil improvement.

1.4 Subsoil Investigation

- (b) The Contractor shall obtain the Engineer's approval of the submitted drawings and schedules at least twenty-eight (28) days before commencement of the corresponding works.

2.2.2. Other Submittals

Other submittals shall include, but not be limited to, the following:

- General: Samples and all the information related to the materials requiring approval. This information might include all the pertinent certificates, testing results, and any other document that could prove that the material is suitable for the respective work.
- Documents from Manufacturers: All the information related to instruments, method of installation, etc. provided by the manufacturers proposed by the Contractor.
- Surface Settlement Plates: The Contractor shall submit a detailed construction statement of the Settlement Monitoring System to be applied. The statement shall include details of the materials, the installation of gauges (considering the works for embankment and other layers of the pavement foundation), the measurement procedure, as well as the results recording system.
- Observation Wells: One set of observation well devices composed of PVC pipe piles and caps.
- Equipment for monitoring: Piezometer and Inclinator.

2.3. General Requirement for Materials

- (a) Materials used for the soft soil improvement shall comply with the minimum requirements described in this Specification Section.
- (b) The Contractor shall use the instruments previously approved by the Engineer for the soft soil improvement.

2.4. Materials for the Drainage System

2.4.1. Sand Mat (SM)

- (a) The sand material to be used for SM shall be coarse sand, free from clay, wood, bark, or other extraneous material.
- (b) The material for SM shall meet the following requirements:

- General Requirement:

Content of organic materials:	<5%
Particles with a diameter	> 0.25 mm; >50%
Particles with a diameter	< 0.075 mm; <5%
Modulus for sand	> 2.5

and, it shall satisfy one of the following conditions as follows:

$$\frac{D_{60}}{D_{10}} > 6$$

and

$$1 < \frac{(D_{30})^2}{D_{10} \times D_{60}} < 3$$

In which,

D60 – Grain size, content of its smaller grains obtain 60%

D30 – Grain size, content of its smaller grains obtain 30%

D10 – Grain size, content of its smaller grains obtain 10%

- (c) During implementation of improvement, water tends to get cantred at the middle of embankment because the settlement at the middle portion is the greatest. To treat the water properly, the underground drainages and temporary catch basins shall be placed in the coarse sand layer at the middle of the embankment. The water shall be forced out by using pumping system proposed by the Contractor and accepted by the Engineer.
- (d) The underground drainages shall be made from blinding stone, as specified in Specification Section 3200, Subsection 2.6. The temporary catch basin shall be made from R.C. pipe, as specified in Specification Section 4310, Subsection 2.5. Detailed dimensions and arrangement of the underground drainages and temporary catch basins shall be as shown in the related Drawings, approved by the Engineer.
- (e) The Contractor shall use the instruments that are previously approved by the Engineer for the soft soil improvement.

2.4.2. Geotextile Filter Fabric for Separation (Non-woven)

- (a) Where required, as directed by the Engineer, the geotextile filter fabric for separating the "Sand mat" material from the existing soils shall conform to AASHTO M288 for high survivability fabric specifically used for highway separation applications.
- (b) The fabric shall be non-woven, needle punched, of continuous filament type, and manufactured from durable synthetic polymer. It shall have a permeability rate greater than surrounding soils and have the minimum physical properties as shown in Table 2.

Table 2: Minimum Requirements Geotextile Filter Fabric for Separation (Non-woven)

Property	Required Values	Test Method
Min. Weight g/m ²	130	ASTM D3776
Min. Strip Tensile Strength kN/m	12	ASTM D4595
Max. Elongation at Failure %	65	ASTM D4595
Min. CBR Puncture Strength N	1,000	ASTM D4833

- (c) The filter fabric shall be procured from a reputable manufacturer and shall be approved by the Engineer.
- (d) The Contractor shall present relevant certified test results and justify that the filter fabric is suitable for the intended use.
- (e) The apparent opening size (AOS) shall be in accordance with the requirements of Table 1 of AASHTO M288.

2.4.3. Geotextile fabric for Reinforcement (woven)

- (a) This item shall consist of supplying and installing approved geotextile material as part of the road earthworks.
- (b) Unless otherwise shown in the Drawings or instructed by the Engineer, the materials to be used shall be as follows:
 - The geotextile sheets shall be UV-stabilized and made of polyester yarns woven in the strength of 200 kN/m and 40 kN/m for warp and weft directions respectively (ASTM D4595). Tensile elongation at break for both direction (ASTM D4595) $\leq 15\%$. The permittivity (ASTM D4491): ≥ 0.05 s-1. UV resistance (ASTM D4355): $> 70\%$ strength retention after three (3) months UV light exposed. It shall have the minimum physical properties shown in Table 3.

Table 3. Minimum Requirements for Geotextile Fabric for Reinforcement (Woven)

Property	Required Values	Test Method
Min. Permittivity s-1	0.05	ASTM D4491
Min. Strip Tensile Strength kN/m	200	ASTM D4595
Max. Elongation at Failure %	15	ASTM D4595
Min. UV Resistance %	70	ASTM D4355

- (c) Geotextile sheet shall be measured in square meters for the net area of measurement that will be made for joints or for surplus material laid outside the requirement of the Engineer.

2.5. Embankment Instrumentation

The instrument types, installation methods, and monitoring procedures shall initially be tested in the reference section (RS), as specified in this Specification Section. The Contractor shall immediately amend or rectify any instrument, which is not functioning adequately in the RS. Installation methods shall be modified as directed by the Engineer.

2.6. Observation Wells

1. Pipes for observation wells shall be perforated 20 cm diameter PVC pipes as shown in the Drawings.
2. Perforated PVC pipes shall have a wall thickness of at least 10 mm and shall be wrapped with two (2) layers of geotextile filter fabric as shown in the Drawings.

3. Construction Requirements

3.1 Sand mat

- (a) Prior to the placing and compaction of embankment material and prior to the installation of vertical drains, a SM shall be placed on the prepared ground surface to ensure adequate drainage of pore water during consolidation of the underlying soils.
- (b) The drainage blanket shall conform to the location and dimensional requirements of the typical cross-sections and details shown in the Drawings.
- (c) Surface depressions around the installations shall be filled with the same material (as for SM) before commencing the works over the treated area.
- (d) The underground drainages and temporary catch basins shall conform to the location and dimensional requirements of the typical cross-sections and details shown in the Drawings and compacted to a density of 95% of the maximum dry density determined according to AASHTO T180.
- (e) Frequency of tests for SM material shall be at the interval of 5000m³ sand placing at the designed position or as directed by the Engineer.

3.2 Geotextile Filter Fabric for Separation (non-woven)

- (a) Where required, filter fabric shall be supplied in rolls, marked to show the length, width, type and weight of the material. Each roll shall be packed in such a way that will protect the geotextile from direct sunlight during transport and storage in accordance with the supplier's recommendation and as directed by the Engineer.
- (b) One layer of separation for geotextile filter fabric shall be placed, as directed by the Engineer, over the prepared ground surface in areas that remain soft, unstable, and muddy due to their proximity to the ground water table, before installing the SM. It shall be stretched out on properly levelled surfaces to obtain a continuous filter layer, without kinks and creases. Overlap for joints shall be not less than 0.50 m for transverse joints, and not less than 0.25 m for longitudinal joints.

- (c) Borings and holes for pipes and rods of instruments shall be made as small as possible and without damaging the filter fabric on the sides.
- (d) Vehicles or construction equipment shall not be allowed on the filter fabric unless a sufficiently thick layer of fill shall be placed carefully so as not to damage the fabric.
- (e) Any damage to the filter fabric shall be repaired or replaced to the satisfaction of the Engineer by the Contractor at his expense.
- (f) The Contractor shall provide all information and data applicable for the geotextile filter fabric noting all physical and chemical properties to the Engineer for approval, prior to purchasing the same.

3.3 Geotextile Filter Fabric for Reinforcement (woven)

- (a) Geotextile filter fabric sheets (woven) shall be installed at specified locations in the arrangement shown in the Drawings. Prior to the laying of the geotextile, all preceding works shall have been completed and the ground surface shall be cleared of all sharp materials that could puncture or tear the fabric. The ground surface shall be flat and level, and any unevenness shall not exceed 100 mm, and the inclination shall be less than 5%.
- (b) Laps in the geotextile material sheets shall be made by either overlapping each sheet by a minimum of 300 mm or by stitching using a 30 mm double over locking seam.

3.4 Surcharge Embankment (SE)

- (a) The embankment shall be placed on the lines and levels shown in the Drawings, and in accordance with requirements and procedures of Specification Section 03400 "Embankment Construction".
- (b) The SE shall be kept until the specified settlement criteria have been satisfied and approved by the Engineer.

3.5 Removal of Surcharge Embankment (SE)

- (a) The removal of SE shall be subject to the following criteria:
 - The estimated minimum time for settlement indicated in the Drawings has passed (this criterion can be modified by the Engineer, based on the results of the Reference Section test).
 - The ratio between the measured settlement during the previous month divided by the total measured settlement is less than or equal to 4% (subject to the results of the Reference Section test).
 - The Contractor shall provide porous water pressure data before removal of SE to determine the consolidation.
 - After the settlement criteria, have been satisfied, the SE shall be excavated and moved to other fill areas or stockpiled as directed by the Engineer; and the embankment surface shall be prepared for the roadway subgrade.
- (b) The SE, after the approval for its removal has been issued by the Engineer, shall be excavated to the specified elevations within a tolerance of ± 5 cm. This material shall be removed and may be reused if so determined by the Engineer.
- (c) Payment for the reused material from the removed SE will be in accordance with the procedure described in Subsection 4.1 of this Specification Section.

3.6 Reference Section (RS)

The initial section of ground improvement is designated as a reference section (RS), as shown in the Drawings. The purpose of this Specification Section is to test the Contractor's working methods, observe embankment stability, confirm staged loading sequences and design of vertical drain lengths and spacing, evaluate the rates of settlement for the various embankment heights and

vertical drain design, establish best monitoring procedures and proposed instruments, and check the tentative criteria for acceptance of improved ground.

RS shall have a length of approximately 50 m or as instructed by the Engineer, and shall be located as shown in the approved shop drawings prepared by the Contractor.

The main construction requirements for RS are as follows:

- (a) RS shall be constructed based on the typical cross-sections shown in the Drawings and the Specifications for the roadway embankment.
- (b) Work requirements shall be the same as specified for the relevant work items mentioned elsewhere in this Specification Section.
- (c) The Contractor shall drill and obtain disturbed samples to a maximum depth as shown in the Drawings or as directed by the Engineer. If required by the Engineer, samples shall be obtained and tested at a laboratory, for comparative analysis with the observation and instrumentation results obtained from RS.
- (d) RS shall have more instrumentation than other parts of the Works and shall be monitored on the same basis as the SE. This monitoring will be a guide in judging the stability, staged loading, consolidation periods, and modifications to surcharge embankment removal criteria. Only the Engineer may adjust these requirements. In addition, from the results of the RS test, the Engineer and Contractor may together discuss changes to optimize the work procedure of the Contractor.
- (e) In addition to the settlement monitoring plates and stakes required for embankment monitoring throughout the alignment, observation wells will be installed at the locations and depths shown in the Drawings, or as directed by the Engineer.

3.7 Embankment Instrumentation and Monitoring

- (a) The Contractor shall throughout the Works supply, install, and monitor the instruments and observation points for monitoring settlements, and horizontal deformations of the embankment.
- (b) The instruments shall be placed as shown in the Drawings or as directed by the Engineer. Instrument monitoring and maintenance will be required throughout the Contract period or as directed by the Engineer.
- (c) The Contractor shall take utmost care to ensure that the instrumentation is not damaged or disturbed in any way, and is kept in good working condition if it is required. The Contractor shall erect warning markers where necessary to protect them. For all those instruments, which project through and above the fill, special precautions shall be taken to provide protection from vehicles and construction plant by provision of suitable barriers at a minimum distance of 0.75 m around each instrument. Heavy construction equipment shall not be used within 1.00 m distance from projecting instruments. Any instrumentation damaged or disturbed by construction operations shall be replaced or repaired by the Contractor at his own expense. At the end of the observation period, the instrumentation shall be cut off below subgrade level and preserved where necessary.
- (d) All instruments shall be labelled with their reference number at the location where the readings or measurements are taken. The labelling shall be in accordance with the system and method to be agreed with the Engineer.
- (e) The installation of all instrumentation and observation points shall be as specified in the Drawings. All instruments shall comply with the requirements under item (c) above for each type.
- (f) Where required, boreholes for instruments shall be drilled by a suitable method to provide a clean and stable hole of required diameter to the correct depth. Boreholes shall be cased as required. Boreholes shall be drilled using clean water. Drilling mud or polymer additives shall only be used with the approval of the Engineer.
- (g) During drilling, care shall be taken to ensure that material loss from outside the casing is kept to a minimum. Surging of casing will not be allowed, and flushing of drilling water up the outside of the casing shall be kept to a minimum.
- (h) For any borehole or part thereof that requires grouting during the installation of instruments, the grout shall be poured into the boreholes using a tremie pipe.

3.7.1 Surface Settlement Plates (SSP)

- (a) SSP shall consist of a base plate of 800 mm x 800 mm connected to steel extension rods and protection pipes as shown in the Drawings. The length of each extension rod shall be exactly as shown in the Drawings.
- (b) SSP shall be installed at bottom on top of the SM platform, on the separation geotextile (in case of non-application of SM, the SSP shall be installed at 30 cm higher than the soil replacement level), in such a way that the top of the base plate rests horizontally. Before the placing of any embankment material, the Engineer shall inspect the complete installation and check the initial elevations on top of the base plate and on top of the rod. The rod and pipe shall be extended as the embankment construction advances.

3.7.2 Alignment Wood Stakes

- (a) Alignment stakes shall consist of five (5) wood stakes, each 1.5 m long, penetrating to a depth of 1.0 m, and placed at 4.0 m intervals on each side of the embankment.
- (b) The wood stakes shall be as vertical as possible and driven on the same line.
- (c) Alignment nails shall be placed on the top surface of the stakes, exactly on an alignment perpendicular to the roadway alignment.

3.7.3 Inclinerometers

- (a) The Contractor shall engage experienced personnel to install inclinometer tubes in the pre-drilled investigation boreholes, as shown in the drawing. The depths of the inclinometers will be determined by the Engineer, but generally they shall be installed at least 2m into the underlying hard stratum. Details of a typical inclinometer installation in a drill hole are shown in the Drawing. The Contractor shall submit details of the installation including surface protection to the Engineer for approval.
- (b) Since Inclinerometers or similar approved instruments shall be used for determining the horizontal deformation of the ground. The Engineer's approval for the material and method of installation of the inclinometer tubing shall be indispensable prior the commencement of installation.
- (c) Drill holes shall be sunk in appropriate size subject to be approved by the Engineer.
- (d) The backfilling grout shall be a bentonite cement mix with a strength comparable to that of the surrounding soil or concrete. The Contractor shall submit full details of the proposed grout mix for the approval of the Engineer.
- (e) Prior to installation, the end edges and the keyways of the inclinometer tubes shall be examined and the contractor shall remove any damaged tubing and provide replacements when required to do so by the Engineer. The inclinometer tubing shall be inserted into the drill hole inside the temporary casing. The top and bottom of the inclinometer tubing shall be fitted with an end cap and all tubing couplings shall be riveted connections. While connecting the tubes, the inserted section shall be securely clamped at ground level and the section connected to it. All completed connections shall be sufficiently wrapped with sealing tape to prevent the ingress of grout. The tube shall be filled with water to overcome buoyancy.
- (f) After insertion of the inclinometer tubing, the hole shall be backfilled by pumping grout through a tremie pipe. The grout shall be pumped initially to fill the hole to the top of the temporary casing. The casing shall then be extracted in such a manner that the level of the grout inside the hole shall be always higher than the bottom of the casing.

- (g) The Contractor shall flush the tubes after installation to remove all solids and flush again after two days.
- (h) The Contractor's licensed surveyor shall determine the level of the top of the inclinometer tubing after final trimming and the level shall be recorded on the installation record.
- (i) The Contractor shall keep full details of the drilling and installation and submit a complete record to the Engineer within two working days after installation. The format of the record sheet shall be approved by the Engineer prior to commencement of work.

3.7.4 Electric Piezometers

- (a) Electric piezometers to be installed in the Embankment shall be vibrating wire or vibrating strip piezometers, supplied from a reputed manufacturer. They may be either the borehole installation type, or the push-in type, and shall be complete with all necessary readout and data-logging equipment. Information on the proposed type, brand, and specifications for the proposed piezometers shall be submitted with the tender together with any other technical documentation. Lightning protection shall be provided as required.
- (b) Piezometers shall be installed from the natural ground ("free-field" piezometers), or from the top of the Sand mat, before proceeding with the embankment fill.
- (c) Piezometers shall be installed in boreholes as shown on the Drawings, or carefully pushed to the tip elevation indicated. The installation method shall be as specified by the supplier and approved by the Engineer.
- (d) Piezometer leads above ground shall be protected as required by the manufacturer.

3.7.5 Recording and Monitoring

(a) Commissioning and Base Reading

- After installation, the function of each instrument or observation/monitoring point shall be checked. As part of the commissioning, three (3) sets of readings shall be taken and compared. If significant differences or anomalies are found, further readings shall be averaged to form the base readings representing conditions prior to start of the earthworks.
- The instrumentation records shall contain the following information:
 - Instrument reference number and type
 - Chainage and coordinates
 - Dates of installation
 - Initial readings

(b) Installation Records

Installation records of each instrument shall be prepared containing the following additional information as appropriate for each instrument type:

- Existing ground level at the time of installation;
- Weather conditions;
- Length, width, diameter, orientation, and depth;
- Plant and equipment used, and diameter and depth of any drill casing used;

- Readings required during installation to ensure that all previous steps have been followed correctly, including acceptance tests;
- Simplified log of ground conditions (in drill holes);
- Type of backfill used;
- Problems encountered, delays, unusual features of installation, and any events that may have a bearing on instrument behaviour; and
- A record of commissioning information and readings

(c) Installation Report

An installation report for each instrument section shall be prepared incorporating the following items and submitted to the Engineer for his review and approval:

- Text describing the work carried out and the types of instruments installed
- All installation record sheets
- Plan and cross-section drawings at a scale of 1:200 showing the locations, elevations, and details of all instruments
- Values of all base readings taken together with any subsequent readings until the time of submission

(d) Monitoring

- Frequency of Measurements
 - Each SSP or observation well shall be measured/inspected immediately before and after each change in loading (i.e. each layer of embankment or structural fill etc.), daily during filling operations, then at twice-weekly intervals during the first month. Thereafter, until the end of the settlement period, each of them shall be measured/inspected at intervals not greater than once a week. Monthly readings shall then be made through the end of the Contract period. Any SSP or observation well found to be faulty shall promptly be brought to the Engineer's attention and replaced by the Contractor at no additional cost.
 - The Contractor shall monitor the SSP and observation wells once daily for the first seven (7) days after the installation, and during the RS construction. Thereafter, water levels shall be monitored twice weekly during the first month, and subsequently at weekly intervals until the end of the settlement period, or as directed by the Engineer. Monthly readings shall then be made through the end of the Contract period. During periods of continuous rainfall, water levels shall be monitored daily for the duration to be directed by the Engineer.
 - Whenever sets of data are measured, they shall be compared to previous sets of data. If defective readings are identified which may differ from the expected value or trend, then further readings shall be taken immediately and the Engineer shall be kept informed. If anomalous values persist, the Engineer shall be informed and an investigation shall be carried out to ascertain the reasons for such anomalous readings.
- General Information on All Records: The records of instrumentation readings shall include the following information:
 - Instrument or observation point reference number and type;
 - Location by chainage/offset or by coordinates;
 - Dates of installation;

- Initial readings;
- Personnel responsible; and
- Relevant comments or remarks.

(e) Monitoring Report

- The Contractor shall submit a graphical plot of all monitoring instrumentation readings to the Engineer daily;
- The Contractor shall submit to the Engineer a formal monitoring report at the end of each calendar month, in written, electronic digital and graphical format. A sample monitoring report shall be submitted to the Engineer (including all graphical presentations) for approval at least two (2) weeks before the submission of the first monthly report;
- Each monthly report shall include:
 - A description of monitoring work performed during the previous month;
 - Information on reading anomalies or corrections, and factors which may have influenced the measured data;
 - Observations and remarks;
 - Drawings showing installed locations of instruments (taken from installation report);
 - Data tabulations or plots of instrument readings as described hereafter; and
 - Computer disk file copies of all records.
- Data tabulation or plots of instrument readings
- The Contractor shall have suitable software for generation of the required plots and tabulations. The zero time to be used in all the plots and tabulations shall be agreed with the Engineer. The time axis shall be marked in days from "day zero" and an indication of date or month shall be included in the axis. The plots and tabulations, thereby giving a complete record starting from the time of installation, shall contain the following:

Instrument	Required Plots and Summaries
Settlement Plate	Settlement versus Time (tabulation and plot)
Alignment Stakes	Horizontal and vertical movements of each stake with reference to a baseline survey. Position shall be plotted versus time and date from beginning of embankment filling operations.
Observation Well	Draining conditions of the Sand mat
Inclinometer	Horizontal movement versus settlement at centre.
Piezometer	Piezometric pressure showing excess Piezometric pressure versus time for each piezometer and versus depth for latest set of readings (plots).

- All plots, where time forms the horizontal axis, shall have the same scale as the time axis. Where fill thickness, settlement and excess water head are all available at the same location, the plots shall be combined on the same sheet where possible. Final layouts, scales, and details shall be agreed with the Engineer at the time of submitting the format.

3.8 Stability and Settlement Monitoring Surveys

The Contractor shall provide all personnel and equipment necessary to initiate, modify design, install and monitor instrumentation for the RS and for the overall project embankment stability and settlement in accordance with these Specifications.

3.8.1 Geotechnical Engineering Specialists

(a) Requirements

- The Contractor shall provide experienced Geotechnical Engineering Specialists, an assistant Geotechnical Engineering Specialist, and a Senior Soil Technician to conduct detailed investigation of the embankment behaviour, including additional explorations, testing, evaluations, and modifications required, and evaluation of results for reference section; review of design, installation and monitoring of ground improvement measures, piles and pile testing; confirmation of the settlement period completion; and all other geotechnical support as requested by the Engineer.
- The Assistant Geotechnical Engineering Specialist shall be a graduate engineer with at least five (5) years' experience, including at least one year experience on soft ground improvement projects.
- A Senior Soil Technician with at least five (5) years' experience in geotechnical field investigations shall also be provided in full time during the field explorations.
- Prior approval for the Geotechnical Specialists is required. The Contractor shall submit names and curriculum vitae of the personnel who will carry out the additional geotechnical engineering services as well as a programme of their attendance for approval by the Engineer. Any deviation from the approved programme of attendance or the requirements given in this Specification Section shall only be permitted with the approval of the Engineer.

(b) Work Tasks of the Geotechnical Engineering Specialists

Specific work tasks to be undertaken by the geotechnical engineering specialists shall include, but not be limited, to the following:

- Evaluate adequacy of subsurface information along the alignment;
- Define and conduct additional field explorations along/across alignment;
- Define and conduct additional laboratory tests;
- Review/revise design and instrumentation of RS;
- Monitor construction and assist with installation of instrumentation for the reference section;
- Direct and coordinate monitoring of instrumentation in the RS during the settlement period;
- Evaluate information obtained from RS:
 - Embankment stability and staged loading sequences;
 - SE height;
 - SCP length and width;
 - SCP transition design; and

- Time for completion of settlement period.
- Re-assess/revise engineering soil properties for design;
- Re-evaluate embankment stability and slope design;
- Re-evaluate embankment settlement estimates;
- Review/modify soft soil improvement design;
- Review/modify embankment subdrain design;
- Review/modify overbuild design:
 - Embankment;
 - Underpasses;
 - Box culverts; and
 - Pipe culverts.
- Re-evaluate instrumentation/monitoring requirements for embankment construction;
- Confirm/modify criteria for completion of removal of SE;
- Re-evaluate pile foundation design for structures;
- Re-evaluate pile load test requirements and driving criteria; and
- Re-evaluate design/modify criteria for installation of embankment relief piles.

3.8.2 Soil Investigation

The Contractor shall also provide all labour, equipment, and materials necessary to carry out additional soil borings, field and laboratory tests, and reports as instructed by the Engineer. These are required for the Contractor to conduct detailed evaluation of soil conditions along the alignment, and for determination of material borrow sites and other routine operations in carrying out the Works.

(a) Field Equipment for Soil Investigation

- The Contractor shall provide at the Site and maintain during the entire Contract period, a suitable and well-maintained boring rig, or rigs, and other necessary supporting equipment and spare parts. The rig(s) and equipment shall be equipped for carrying out the following types of investigation to the required depths, or as directed by the Engineer.
- The Contractor shall have all equipment ready to start the subsoil investigations one (1) month after the issuance of the Notice to Proceed.
- The equipment shall always be available for subsoil investigations. It can be used for other purposes such as installation of instruments only when approved by the Engineer.
- The Contractor shall present along with his bid, detailed information of the type and brand of the boring equipment he proposes to provide. The equipment shall be subject to the Engineer's approval.
- At the end of the Contract the equipment will revert to the Contractor.

(b) Subsoil Investigation and Testing

- Borings:
 - The Contractor shall investigate the subsoil by performing borings along the embankment centreline and cross-section in a quantity specified in Table 1, and as directed by the Engineer. Borings of hydraulic driven rotary-type methods, shall be in accordance with ASTM Guide D420-87, or equivalent methods approved by the Engineer.
- Standard Penetration Tests (SPT):
 - (1) SPT shall be carried out in accordance with ASTM D 1586.
 - (2) SPT shall be performed at every 1.0 m intervals except for the depth of undisturbed sampling.
 - (3) The load of hammer shall be 63.5 kg, and shall be allowed to freely fall under gravity from height of 75 cm, to act a blow on a split-barrel sampler.
 - (4) Prior to the SPT, the bottom of hole shall be washed as clean as reasonably possible to be free of cuttings.
 - (5) The Contractor shall drive the sampler with blows from the hammer and count the number of blows in each 15-cm increment. The first set of count of blows is regarded as test and not applied to estimate the N-value. The next two successive blow counts shall be recorded as the N-value of the SPT (Thus, the N-value is equal to N_2+N_3 , while N_1 is not recorded).
 - (6) The sample obtained from the SPT shall be put into a polyethylene bag for use in the physical test in such a way that water content does not change. SPT sample shall be put into a plastic container and then stored in the laboratory.
- Field Vane Shear Test:
 - Field Vane Shear Test shall be conducted at 2.0 m intervals in accordance with ASTM D2573
 - The depth of measurement shall be 20 m or as directed by the Engineer
- Undisturbed Sampling during Drilling Works
 - (1) Undisturbed sampling shall be conducted using stationary piston sampler in accordance with ASTM D1587 and ASTM D6519.
 - (2) A Thin-wall tube sampler, 75 mm in diameter, shall be used for soft soil having N-value of less than 8. In case of soil having N-value of more than 8, the other type shall be used for sampling, which the Contractor shall obtain of the approval of the Engineer.
 - (3) The sampler shall be pushed-in at a constant speed without stopping during sampler push-in.
 - (4) The sampler shall be sealed with a rubber packing or paraffin immediately after the characteristics of the soil are observed and recorded.
 - (5) The collected sample shall be designed with hole no., sample no., location, and depth of sample.
- Laboratory Tests

- The laboratory tests are necessary to verify classification and determine engineering properties. The following tests shall be carried out using some SPT sample (disturbed), and all thin-wall tube samples (undisturbed)
 - Natural Water Content ASTM D2216
 - Specific Gravity ASTM D854
 - Atterberg Limits ASTM D4318
 - Grain Size Analysis ASTM D422
 - Unit Weight Test ASTM D4718
 - Unconfined Compression ASTM D2850
 - Consolidation ASTM D2435
- Submittals
 - (1) The Contractor shall submit the report, including the following information to the Engineer for approval at the appropriate time.
 - (2) Objectives
 - (3) Organization of the staff assigned
 - (4) Time schedule performed
 - (5) Standards applied
 - (6) List of equipment used
 - (7) Data of boring log
 - (8) Coordinates of boreholes, according topographic survey
 - (9) Boring method and size of casing used
 - (10) Information on the ground water levels in the borehole during test
 - (11) The soil type and description as identified from the sample with a soil profile of borehole
 - (12) Result of SPT
 - (13) Soil profiles on the alignment of approach road area
 - (14) Location and methods of undisturbed sampling
 - (15) Result of Field Vane Shear Test
 - (16) Results of laboratory tests
 - (17) Laboratory test data sheets
 - (18) Photographs

Table 1. Additional Geotechnical Investigation in Construction Stage

	Package 1		Package 2		Total
	Centre Line	Cross	Centre Line	Cross	
Number of Boring Location	20	2	20	2	40
Drilling Length	20 m x 20 = 40 0 m	20 m x	20 m x 20 = 40 0 m	20 m x	88
Standard Penetration Test 1)	20 nos x 20 =4 00 no s	20 nos	20 nos x 20 =4 00 no s	20 nos	80

Undisturbed Sampling	2 depths x 20 loc ati on s = 40 sa mp les	-	2 depths x 20 loc ati on s = 40 sa mp les	-	80
Physical Tests of Soil 2) (Specific Gravity, Natural Water Content, Grain Size Analysis, Atterberg Limits)	3 x 20 (di stu rbe d) + 30 (u ndi stu rbe d) = 90	-	3 x 20 (di stu rbe d) + 30 (u ndi stu rbe d) = 90	-	18
Unit Weight Test of Soil 3)	40	-	40	-	80
Unconfined Compression Test of Soil 3)	40	-	40	-	80

Triaxial Compression Test of Soil (UU) 3)	40	-	40	-	80
Consolidation Test 3)	40	-	40	-	80
Number of Field Vane Shear Test Location 4)	20	2	20	2	44
Accumulated Depth of Field Vane Shear Test 4)	20 m x 20 = 40 0 m	20 m x	20 m x 20 = 40 0 m	20 m x	88

- Note
- 1) It shall be performed at every 1.0 m intervals except for the depth of undisturbed sampling and FVST.
 - 2) Disturbed means the SPT samples, while undisturbed means the undisturbed samples by undisturbed sampling.
 - 3) Unit Weight Test, Unconfined Compression Test, Triaxial Compression Test (UU), and Consolidation Test shall be carried out using the undisturbed samples.
 - 4) Field Vane Shear Test will be carried out up to the depth of 20 m at every 2.0 m intervals.

3.8.3 Grouting of Pipes for SSP and Observation Wells

- (a) After completion of the soft soil improvement, and upon the approval of the Engineer for construction of the subgrade layer, all the pipes used for SSP and observation wells shall be grouted following the procedure shown in this Subsection.
- (b) Grout at the top of SSP and observation wells shall be a pumpable cement possible to the strength or consistency of the natural soils present.
 - One (1) month prior to commencement of this work item, trials shall be conducted with different mixes to ascertain the relationship with strength.
 - Specimens shall first be cured and stored, and then tested in unconfined compression at seven (7) days.
 - On the basis of these trials, the mix design for the cement mortar grout shall be decided.
- (c) The Contractor shall obtain the Engineer's approval for the grouting procedure.

4. Measurement and Payment

4.1 Method of Measurement

- (a) Temporary earth dykes, if required, shall not be measured but shall be deemed included in the unit prices.
- (b) SM shall be paid in cubic meters for compacted material in place. The measured volume shall be based on the nominal thickness shown in the Drawings and as approved by the Engineer. Any excess volume shall be paid as embankment construction.
- (c) Geotextiles shall be measured and paid in square meters of ground covered by the fabric.
- (d) Embankment instrumentation and monitoring.
- (e) Field and office engineering works required for the RS instrumentation and stability and settlement monitoring shall not be paid separately but shall be deemed included in the unit prices.
- (f) The settlement plates shall be measured for payment by the actual number of instruments installed.
- (g) Stability and settlement monitoring surveys
- (h) Subsoil investigations shall be measured by the length of boring or cone penetration test probe from the surface elevation to the tip elevations at termination, all as specified and approved by the Engineer.
- (i) Standard penetration tests, undisturbed samples and vane shear tests shall be paid for at the Contract unit price for each test, which shall include all sample tubes, special test equipment, reporting, and summarizing results as required.
- (j) Surcharge embankment (SE)
 - SE material and construction shall be measured and paid in accordance with the requirements and stipulations of Specification Section 03400 "Embankment Construction".
 - The SE volume includes any additional volume required caused by embankment settlement. The means and methods of measuring the additional volume caused by embankment settlement shall be based on settlement plate measurements and as approved by the Engineer.
 - The Contractor shall prepare and submit to the Engineer a plan for the reuse of

material remaining from the SE after the settlement period. Accordingly, it is deemed that the volume of reused material from SE removal has been considered in determining the unit price here below defined. Therefore, separate or additional payment for the reuse of SE shall not be considered.

- If the reuse of the SE material is neither planned by the Contractor nor instructed by the Engineer, the actual volume of removed SE shall be surveyed and paid as “Excavation of Unsuitable Material” specified in Section 03100 “Common Excavation”.

4.2 Basis of Payment

The accepted quantities, measured as provided above, shall be paid at the Contract price per unit of measurement for the pay items of the Bill of Quantities listed below. Payment shall be full compensation for the works prescribed in this Specification Section including all the soil improvement measures required in these Specifications, and for furnishing all labour, materials, tools, equipment, and any incidentals necessary to complete the works as shown in the Drawings and as required in accordance with these Specifications and/or as directed by the Engineer.

- (a) The underground drainages and temporary catch basins, as specified in Subsection 2.4.1 (c) shall not be paid separately, but shall be deemed included and distributed in all the rates and unit prices for SM.

The works for “Embankment Instrumentation and Monitoring”, and “Stability and Settlement Monitoring Surveys” shall not be paid separately, but shall be deemed included and distributed in all the rates and unit prices for soft soil improvement.

Surcharge embankment shall be paid for as provided in Specification Section 03400 “Embankment Construction” (03400-02) .

Pay Item	Description	Unit
03950-01	Sand Mat	m3

Division 4

Waterway Works

Table of Contents

Section 04100 – Open Ditches 1

Section 04200 - Mortared Stonework and Rip-Rap 4

Section 04310 – Concrete Pipe Culverts..... 8

Section 04320 - Concrete Box Culverts 13

Section 04330 - Catchpits/Pits, Inlets, Outlets, Manholes..... 18

Section 04400 – Vertical Drain 21

Section 04500 - Porous Backfill and BeddingError! Bookmark not defined.

Section 04600 – Drainage Outlet..... 24

Section 04100 – Open Ditches

1. Description

The work in this section consists of constructing road side ditches using mortared stonework, reinforced concrete, or pre-cast concrete as shown in the Drawings, unless otherwise directed by the Engineer.

2. Material Requirements

2.1. Materials

Within the period stipulated in the General Specifications, the Contractor shall submit samples of materials he intends to use for waterway lining to obtain the Engineer's approval.

- (a) Fill shall conform to the requirements for material properties, placing, compacting, and quality assurance specified in Specification Section 03400 "Embankment Construction". Erosion resistant material shall be approved by the Engineer.
- (b) Mortared stone lining shall conform to the requirements for material properties, placing, compacting, and quality assurance specified in Specification Section 04200 "Mortared Stonework and Rip-rap".
- (c) Reinforced concrete work shall conform to the requirements for material properties, placing, curing, and quality assurance specified in Specification Section 06100 "Structural Concrete".
- (d) Materials for base of the open ditches consist of levelling concrete and foundation. Levelling concrete shall be Class EI plain concrete with 100mm thickness. Material of foundation such as crusher run stones and gravels shall be appropriately selected with taking into consideration of construction site condition and workability, procurement availability and so on. Thickness of the foundation shall be 200mm.

2.2. Submittals

2.2.1. Shop and Working Drawings and Schedules

In accordance with the requirements stipulated in Specification Section 01150 "Contractor's Submittals", and Section 01200 "Contractor's Drawings" the Contractor shall submit complete sets of shop drawings for the ditches works, to the Engineer for review and approval.

2.2.2. Other Submittals

The Contractor shall submit samples of materials he intends to use for waterway lining subject to the Engineer's approval.

3. Construction Requirements

3.1. Setting Out Ditches

The Contractor shall set out the required locations, lengths, direction of fall, and grades of all ditches, whether lined or unlined. Setting out shall include locating all associated catchpits and out falls.

3.2. Roadside Construction

- (a) The Contractor shall construct the stone lining for ditches as specified in this Specification Section after the Engineer approves the prepared roadside.
- (b) The Contractor shall excavate, fill, and shape the realigned or new ditches to the grades shown in the Drawings.

- (c) The Contractor shall remove and dispose of all excavated materials to at least 10 m away from the waterway area to prevent any surplus materials from falling into the excavated waterway.
- (d) The finish shall be sufficiently smooth and uniform to ensure the free flow of water without ponding during periods of low flow.

3.3. Tolerances, Rectifying defects

3.3.1. Dimensional Tolerances

Grades on new roadside and median ditches inverts against those specified or approved	±5 mm at any point
Ditches alignments and the shape of cross-sections as specified in the Drawings	±2 cm at any point.

3.3.2. Rectifying Unsatisfactory Work

- (a) The Contractor shall rectify all waterway construction works that do not meet the above-mentioned tolerance criteria or works found unacceptable to the Engineer. The Contractor shall rectify unacceptable work as directed by the Engineer.
- (b) The Contractor shall perform resurvey works defining existing or constructed surface profiles as often as necessary to obtain an accurate record of the physical conditions.
- (c) Rectification work may include:
- Additional excavation or fill, which could include backfilling new work and re-excavating it to the specified dimensions, lines, and grades; and
 - Repairing or replacing defective mortared stonework or reinforced concrete work.
- (d) No additional payment shall be made for the extra work or quantities used for the rectification.

4. Measurement and Payment

4.1. Method of Measurement

Ditches shall be measured in linear metres (lm) of completed ditch according to the shop drawings submitted by the Contractor. Concrete covers for “Side Ditch Type U-1000 x 1500”, “Side Ditch Type U-1500 x 1500” and “Side Ditch Type U-1500 x 1700” shall be measured as the number of covers satisfactorily installed by the Contractor and accepted by the Engineer.

4.2. Basis of Payment

- (a) Payment shall be full compensation for the work prescribed in this Section including all preparatory works, supplying and transportation of materials, placing and compaction of filling material, and for furnishing all labour, materials, tests, tools, equipment, and any incidentals to complete the work as shown in the Drawings and as required in accordance with these Specifications and/or as directed by the Engineer.
- (b) No separate payment shall be made for excavation, backfill, stone foundation, levelling, bedding, lean concrete, and lining for ditches or ditch relocation.

The Pay Items and Pay Unites shall be as follows;

<u>Pay Item</u>	<u>Description</u>	<u>Unit</u>
04100-01	Side Ditch Type U-500 x 500 with Concrete Cover	lm
04100-02	Side Ditch Type U-500 x 850 with Concrete Cover	lm

<u>Pay Item</u>	<u>Description</u>	<u>Unit</u>
04100-03	Side Ditch Type U-800 x 800 with Concrete Cover	lm
04100-04	Side Ditch Type U-1000 x 1500	lm
04100-05	Side Ditch Type U-1500 x 1500	lm
04100-06	Side Ditch Type U-1500 x 1700	lm
04100-07	Concrete Cover Type A	Number
04100-08	Concrete Cover Type B	Number
04100-09	U-Ditch Type A	lm
04100-10	U-Ditch Type B	lm
04100-11	U-Ditch Type C	lm
04100-12	Side Ditch Type U-300 x 300	lm
04100-13	Side Ditch Type U-300 x 300 TYPE V	lm
04100-14	Side Ditch Type U-500 x 500	lm
04100-15	Side Ditch Type U-800 x 800	lm
04100-16	Side Ditch Type U-1000 x 1000	lm
04100-17	Side Ditch Type U-800 x 1000 with concrete cover	lm
04100-18	Side Ditch Type U-1000 x 1200 with concrete cover	lm
04100-19	Side Ditch Type U-1000 x 1500 with concrete cover	lm
04100-20	Side Ditch Type U-1500 x 1500 with concrete cover	lm
04100-21	Side Ditch Type U-1500 x 2500 with Concrete Cover	lm

Section 04200 - Mortared Stonework and Rip-Rap

1. Description

This Specification Section describes the requirements and procedures for furnishing and placing mortared stonework and mortared rip-rap.

Mortared Stonework	This work consists of lining of roadside drains and waterways, as well as constructing aprons, catchpits, and other similar small water control structures with mortared stone
Mortared Rip-Rap	This work consists of furnishing and placing riprap for bank protection, slope protection, and erosion control.

2. Material Requirements

2.1 Reference Standards

The following standard in its latest edition shall be applied to the works covered by this Specification Section:

- ASTM C33 Concrete Aggregates

2.2 Stone

Stones shall consist of field stone or quarry stone. They shall be sound, tough, durable, dense, resistant to the action of air and water, and suitable in all respects for the purpose intended.

- (a) Mortared Stonework: Unless otherwise indicated in the Drawings or directed by the Engineer, the stone shall meet the gradation requirements shown in Table 1.
- (b) The quality and dimensions of the stones shall be approved by the Engineer prior to their use. Stones shall be as nearly rectangular in shape as practicable.
- (c) Mortared Rip-Rap: The Engineer shall approve the quality and dimensions of the stones prior to their use. Stones for paving roadside drains shall be as nearly rectangular in shape as practicable.
 - * Riprap should be well-graded mixture of stones with at least 50% of the stones weighing more than 15 kg for 150 mm thick riprap and 45 kg for 250 mm thick riprap.

Table Gradation Requirement for Stones (*)

Nominal Thickness (mm)	Approximate Given Size		Equivalent Cubic Dimension (mm)	Total Size Smaller than Given Size (%)
	Weight (kg)	Volume (cu.m.)		
150	15	0.006	150	100
	10	0.004	125	80
	5	0.002	75	50
	0.5	0.0003	50	10*
250	45	0.018	250	100
	27	0.011	225	80
	11	0.005	165	50
	2	0.0003	75	10*

* Material shall consist of spills and rock fragments graded to provide a stable compact mass.

2.3 Cement Mortar

All cement mortar shall be in accordance with the provisions of Specification Section 08010 “Mortar and Grout” or as directed by the Engineer.

2.4 Sand Bedding for Mortared Stonework

Materials for forming bedding, weep holes, or filter pockets for mortared stonework shall conform to the gradation requirements of ASTM C33.

2.5 Submittals

Within the period specified in the General Specifications for submittals, the Contractor shall submit to the Engineer two (2) representative 50 kg samples of each class of stone that he intends to use for mortared stonework and mortared rip-rap, subject to the Engineer’s approval. The Engineer may retain one of these samples for reference until the expiry date of the Defect Notification Period. The Contractor shall use for the works only the stone classes that the Engineer approves.

3. Construction Requirements

3.1 Shop Drawings and Schedule

3.1.1 Shop Drawings

The Contractor shall furnish shop drawings containing the construction details for mortared stonework and mortared rip-rap indicated in the Drawings. Shop drawings shall be submitted to the Engineer within the period specified in the General Specifications for submittals by the Contractor, for respective approval prior to the start of the construction of mortared stonework or mortared rip-rap. Construction of the works shall begin only after the Engineer’s approval of the shop drawings submitted by the Contractor for the respective work item.

3.1.2 Work Scheduling

The Contractor shall schedule the works based on the following main criteria:

- Mortared stonework and rip-rap shall be executed in such a way as to ensure that stones are placed only in fresh mortar at any time that such work is being performed; and
- Mortared stonework and rip-rap paving are to be constructed on slopes or as roadside drain lining. The Contractor shall first form the slopes as if they are not to be paved. The Contractor shall shape the work to the final lines only immediately before placing the stonework.

3.2 Tolerances, Rectification and Maintenance

3.2.1 Dimensional Tolerances

- (a) The surface of each stone face shall not vary from the average profile of the surrounding stonework by more than 3 cm.
- (b) The average surface profile for waterway lining formed by placed stonework or rip-rap shall not vary from the specified or approved channel invert profile by more than 2 cm.
- (c) The minimum thickness of any mortared stonework and mortared rip-rap lining shall be 10 cm and 20 cm, respectively.
- (d) The finished profiles for minor, non-load bearing structures such as catchpits and spillway aprons shall not vary from the specified or approved profiles by more than 2 cm.

3.2.2 Rectifying Unsatisfactory Work

- (a) The Contractor shall rectify, at his own expense, any mortared stonework or mortared rip-rap that does not meet the tolerances given in this Specification Section, or that was not completed as directed by the Engineer.
- (b) The Contractor shall be responsible for the stability and integrity of all finished work. Unless otherwise determined by the Engineer, the Contractor shall replace at his own expense any damaged or displaced portions throughout the Contract Period and the Defects Notification Period. No separate measurement or payment will be made for rectifying unsatisfactory work.

3.3 Work Preparation

3.3.1 Preparing Formations or Foundations

- (a) Mortared Stonework:
 - The Contractor shall prepare formations for mortared stonework paving in accordance with the provisions of Specification Section 04100 “Open Ditches”.
 - The Contractor shall prepare foundations and trenches for cut-off walls or other structures made of mortared stonework in accordance with the provisions of Specification Section 03200 “Structural Excavation” and Specification Section 03400 “Embankment Construction”.
- (b) Mortared Rip-Rap:
 - The Contractor shall prepare foundations in accordance with the provisions of Specification Section 03400 “Embankment Construction”.

3.3.2 Preparing Stone

- (a) The Contractor shall clean the stones and remove all defects that may impair the bond with the mortar.
- (b) The Contractor shall thoroughly wet the stones long enough until the stones absorb water to near saturation prior to laying.

3.5 Placing Stone Lining

- (a) Surfaces to receive mortar shall be cleaned from oil or clay or other contaminants and thoroughly saturated before the mortar is applied. Free surface water shall be removed before application of the mortar.
- (b) The Contractor shall place a bedding of fresh mortar at least 3 cm thick on the prepared formation. The Contractor shall construct this mortar bedding progressively by laying the surface stones in such a manner that the stones are always securely bedded in the mortar before it hardens.
- (c) The Contractor shall place the stones firmly against each other to provide the required paving thickness measured perpendicular to the slope. The Contractor shall then place additional mortar to completely fill all spaces between the stones. The finish shall be almost flush with the surface of the lining but the mortar shall not cover the stones.
- (d) The work shall progress from the bottom of the slopes towards the top. The Contractor shall finish the surface immediately following the initial set of the mortar by sweeping the surface with a stiff broom.
- (e) The Contractor shall cure the finished surfaces as specified for concrete work in Specification Section 06100 “Structural Concrete”.

- (f) The Contractor shall trim and finish adjacent slopes and shoulders to ensure a tight and smooth interface with the mortared stonework. The interfaces shall allow unobstructed drainage and prevent scour at the edges of the work.

3.6 Constructing Mortared Stonework Structures

- (a) The Contractor shall construct the cut-off walls by filling the trench or forms with mortar to a depth of 60% of the maximum dimension of the stones. The Contractor shall then place the stones in the unset mortar immediately. The Contractor shall add additional mortar and repeat the process until the form is filled. The Contractor shall then add mortar to the top of the cut-off until he obtains a screened level top surface.
- (b) The Contractor may construct mortared stonework or mortared rip-rap structures without forms if the stone can interlock sufficiently and if he uses stiff mortar.
- (c) The Contractor shall finish and cure exposed surfaces of mortared stonework structures as specified in Specification Section 06100 "Structural Concrete".
- (d) The Contractor shall perform backfill around the finished and cured mortared stonework or mortared rip-rap structures in accordance with related Specification Sections.

4. Measurement and Payment

4.1 Method of Measurement

4.1.1 Mortared Stonework

- (a) Mortared stone shall not be measured for payment in this Section. Instead, the cost shall be incorporated in the unit price of paved ditches as provided for in Specification Section 04100 "Open Ditches".
- (b) Excavations for aprons and catchpits lined with mortared stonework shall be measured and paid in accordance with the provisions of Specification Section 03200 "Structural Excavation".

4.1.2 Mortared Rip-Rap

- (a) Mortared rip-rap, when used in drainage outlet, shall not be measured for payment in this Section. Instead, the cost shall be incorporated in the unit price of drainage outlet as provided for in Specification Section 04600 "Drainage Outlet".
- (b) Any material placed in excess of the approved theoretical volume shall not be measured, and no payment shall be made therefore;
- (c) Excavation for roadside drains lined with mortared rip-rap shall be measured in accordance with Specification Section 03100 "Common Excavation".

4.2 Basis of Payment

All works carried out in accordance with the requirements herein will not be paid for separately, but will be deemed as a subsidiary obligation of the Contractor for which full payment is included in the unit prices in the Bill of Quantities for the work items in which it is called for or required as described hereinbefore.

Section 04310 – Concrete Pipe Culverts

1. Description

This Section covers the works of constructing new reinforced concrete pipe culverts including construction of inlet and outlet structures, headwalls and incidental structures works such as erosion and scour protection works.

2. Material Requirements

2.1 Reference Standards

The following Standards in their latest editions shall be applied to works covered by this Specification Section:

- AASHTO M170 Reinforced Concrete Culvert, Storm Drain, and Sewer Pipe
- AASHTO T11 Materials Finer than 75- μ m (No. 200) Sieve in Mineral Aggregates by Washing
- AASHTO T27 Sieve Analysis of Fine and Coarse Aggregates
- AASHTO T89 Determining the Liquid Limit of Soils
- AASHTO T90 Determining the Plastic Limit and Plasticity Index of Soils
- ASTM C990 Joints for Concrete Pipe, Manholes, and Pre-cast Box Sections Using Preformed Flexible Joint Sealants

2.2 Bedding

- (a) Sand bedding shall be a porous, free-draining granular material free of excess moisture, muck, roots, sod, or other deleterious material and uniformly graded from coarse to fine, meeting the gradation as shown below.

- Sand Bedding Gradation

Sieve Size	Percent by Weight Passing Designated Sieve (AASHTO T27 and T11)
12.5 mm	100
No. 200	0 – 75

- The material shall also conform to the following:
 - Plasticity Index, AASHTO T90 6 max.
 - Liquid Limit, AASTTO T89 30 max.

- (b) Lean concrete bedding or blinding shall be in accordance with the requirements of Specification Section 06100 “Structural Concrete”.

2.3 Concrete

Concrete used for all structural work described in this Specification Section shall conform to the requirements specified in Specification Section 06100 “Structural Concrete”.

2.4 Reinforcing Steel for Concrete

All reinforcing steel used in the works shall conform to the requirements specified in Specification Section 06200 “Reinforcement Bar”.

2.5 Reinforced Concrete Culvert Pipes

- (a) Reinforced concrete pipes shall be of pre-cast reinforced concrete and shall conform to the

specification of AASHTO M170. Unless otherwise approved by the Engineer or indicated in the Drawings, the Contractor shall use pipes with tongue and groove joints. Reinforcement in all pipes shall consist of circular bars as shown in the Drawings.

- (b) The Engineer will periodically inspect the pipe manufacturing plants to ensure compliance with approved manufacturing methods. The Contractor shall supply material samples for laboratory testing to ensure quality compliance, and shall do all the necessary arrangements to facilitate the inspection by the Engineer; the inspection will also cover all the reinforced concrete pipes. Depending upon the results obtained by the inspection, the Engineer will issue the approval for permitting the Contractor to lay any pipe.
- (c) Unless otherwise indicated in the Drawings or required by the Engineer, all joints for reinforced concrete culvert pipes shall be flexible joints in accordance with ASTM C990.

2.6 Mortar

Mortared joints shall only be used if required by the Engineer, or so indicated on the Drawings. If and/or when required, mortar for pipe joints and collars shall be composed of 1 part Portland cement and 3 parts fine aggregate by volume, to which hydrated lime may be added in an amount equal to 10% of the cement by weight.

2.7 Porous Backfill or Filter Material

Porous backfill or filter material shall be in accordance with the provisions of Specification Section 03200 "Structural Excavation" or as directed by the Engineer.

2.8 Backfill

Backfill material used in the works shall conform to the requirements specified in Specification Section 03400, "Embankment Construction".

2.9 Rip-Rap

Stone used in the works for riprap shall conform to the requirements specified in Specification Section 04200, "Mortared Stonework and Rip-Rap".

2.10 Base Structure

Materials for base of concrete pipe culverts consist of levelling concrete and foundation. Levelling concrete shall be Class EI plain concrete with 100mm thickness. Material of foundation such as crusher run stones and gravels shall be appropriately selected with taking into consideration of construction site condition and workability, procurement availability and so on. Thickness of the foundation shall be 200mm.

3. Construction Requirements

3.1 Shop Drawings and Schedule

3.1.1 Shop Drawings

The Contractor shall furnish shop drawings containing the construction details for culverts and concrete drains indicated in the Drawings and as directed by the Engineer. Shop drawings shall be submitted to the Engineer, within the period stipulated in Specification Section 01200 "Contractor's Drawings" for submittals of the Contractor, for respective approval prior to the start of the construction of culverts and concrete drains. Construction of the culverts and drains shall begin only after the Engineer's approval to the shop drawings submitted by the Contractor.

3.1.2 Work Scheduling

- (a) The Contractor shall submit the schedule and construction method he proposes for the

Engineer's review. Temporary drainage work shall be in place and operational before commencement of embankment construction, or as directed by the Engineer.

- (b) No sub-grade preparation or pavement overlay work (either on the road or the shoulder areas) shall commence until the culverts, headwalls, and other minor structures below the subgrade level along that particular section of the project are complete.

3.2 Installation of Pipe

3.2.1 Site Preparation

The Contractor shall excavate and prepare trenches and foundations in accordance with the provisions of Specification Section 03200 "Structural Excavation" and Section 03400 "Embankment Construction". The Contractor shall be responsible for all dewatering of the trenches during construction. The Contractor shall place supports and/or bedding material in accordance with the drawing requirements or as required by the Engineer in conformance with applicable Specification Sections.

Preparation work for subgrade shall comply with the clause for bedding materials under Section 04500, "Porous Backfill and Bedding".

3.2.2 Pipe laying

- (a) Each pipe will be carefully inspected by the Engineer before it is laid, and any defective or damaged pipe will be rejected. The Contractor shall replace at his own expense any pipe that was not approved by the Engineer. No pipe shall be laid when the trench conditions are unsuitable for such work.
- (b) The Contractor shall excavate culvert trenches to the required depth. The bed shall provide a uniform and continuous support under the entire length of the pipe.
- (c) The trench width shall be a plane 500 mm measured from the outer walls of the pipe. The Engineer, at his discretion, may allow extra trench widths, but the Contractor shall receive no additional payment for the wider trench excavation.
- (d) The side slopes of the trenches shall be adopted to suit the soil stability. If the Contractor over-excavates the culvert trench, he shall fill the void to the proper level with material approved by the Engineer at the Contractor's own expense.
- (e) Water shall be removed from trenches by sump pumping or other approved methods.
- (f) The pipe shall be laid to the grades and alignment indicated in the Drawings or as directed by the Engineer.
- (g) Before laying succeeding sections of reinforced concrete pipe which do not require cambering, the Contractor shall plaster the lower half of the hub of the preceding sections on the inside with Portland cement mortar. The mortar shall be sufficiently thick to bring the inner surface of the abutting pipes flush and even. The Contractor shall plaster the upper half of the spigot of the succeeding pipe with mortar at the same time.
- (h) After laying the reinforced concrete pipe, the Contractor shall fill the remainder of the joint with sufficient mortar to form a bead around the joint. The Contractor shall wipe the inside of the joint and finish it to a smooth and even surface. The mortar on the outside shall be cured and remain damp for two days or until the Engineer allows backfilling to proceed.
- (i) All pipes in place shall be approved before covering up.
- (j) The Contractor shall backfill and compact the soil around and over the reinforced concrete culvert pipes using material of selected granular embankment. The material shall consist of soil or gravel free of clay lumps and organic matter. The backfill material shall not contain stones that would be retained on a 25 mm sieve. Oversized

materials shall be removed at the source.

- (k) The Contractor shall take the fill to a minimum height of 50 cm above the top of the pipe.
- (l) Unless in a trench, the fill shall extend to a minimum distance of one and a half diameters from the centreline of the pipe on each side of the pipe.
- (m) The backfill shall be brought up evenly on both sides of the haunches for the entire pipe length. The Contractor shall take special care to compact the backfill under the haunches of the pipe properly.
- (n) Heavy earth moving and compacting equipment shall not operate closer than 1.5 metres from the culvert until the cover above the pipe is at least 50 cm. Light weight equipment may operate within the limitation mentioned above provided the backfill is placed and compacted to least 30 cm above the top of the pipe. Notwithstanding these conditions, the Contractor shall be responsible for and shall rectify any damage resulting from such operations.

3.3 Culvert Headwalls, Inlets, and Outlets

Unless otherwise shown in the Drawings, the Contractor shall construct all culvert aprons, wing walls, and headwalls using class of reinforced concrete as indicated in the Drawings, and in accordance with requirements and provisions of Specification Section 06100 "Structural Concrete". Scour protection works will normally be mortared rip-rap unless indicated in the Drawings.

3.4 Joints, Fittings and Connections

Pipe shall be laid with necessary openings between the ends of the pipe or as required by spacing lugs constructed in the pipe. Mortar shall be placed in the joint between pipes and with inlet, etc. and pressed firmly into place to hold the pipe securely in line. The mortar shall be for full depth and shall be located around the joint. The inside of the pipe shall be free of excess mortar.

3.5 Tests

Strength tests for pipes shall conform to field service test requirements of the ASTM specification, covering the product.

3.6 Cleaning Culverts

The Contractor shall clean all culverts until they are free of loose debris, soil, and all foreign materials. The Contractor shall keep the culverts clean and maintain them in an operating condition throughout the Contract Period. The Contractor shall only permit water to flow through the cleaned culvert after the Engineer inspects and approves the culvert.

3.7 Rectification of Defects

Any defects or damage as identified by the Employer or by the Engineer on behalf of the Employer shall be rectified by the Contractor within a reasonable time before covering up. Defects or damage identified on or before the expiry date of the Defects Notification Period shall be made good by the Contractor by the expiry date of the Defects Notification Period or as soon as practical thereafter.

4. Measurement and Payment

4.1 Method of Measurement

- (a) The reinforced concrete pipe culvert quantities shall be measured for payment in linear metres (lm) of the placed new structure. This quantity shall be measured as the actual placed length of reinforced concrete pipe of a specified diameter, including all excavation, backfill, bedding (sand, stones, lean concrete and/or mortared), cradles, cement mortar, two

layers of bituminous coating, and joints.

- (b) The cost of other work is deemed incidental to constructing the culvert or drain work. Such cost is included in the prices tendered for the culvert pipes and for the various construction materials used.

4.2 Basis of Payment

The accepted quantities, measured as provided above, shall be paid at the contract price per unit of measurement for the pay items listed below that are shown in the Bill of Quantities. Payment shall be full compensation for the work prescribed in this Section including furnishing and placing of all the materials, all necessary joint materials for concrete pipes and for furnishing all labour, materials, tests, tools, equipment and any incidentals to complete the work as shown in the Drawings and as required in accordance with these Specifications and/or as directed by the Engineer.

The Pay Items and Pay Unites shall be as follows;

<u>Pay Item</u>	<u>Description</u>	<u>Unit</u>
04310-01	Concrete Pipe Culvert ϕ 300 (CON. 360°) TYPE A	lm
04310-02	Concrete Pipe Culvert ϕ 300 (CON. 360°) TYPE B	lm
04310-03	Concrete Pipe Culvert ϕ 900 (CON. 360°)	lm

Section 04320 - Concrete Box Culverts

1. Description

The works described herein consist of constructing new reinforced concrete box culverts for waterway, which also include construction of incidental works such as inlet/outlet structures, headwalls, as well as associated erosion and scour protection works.

2. Material Requirements

2.1 Reference Standards

The following Standards in their latest editions shall be particularly applied to the works covered by this Specification:

- AASHTO M259 Precast Reinforced Concrete Box Sections for Culverts, Storm Drains, and Sewers
- AASHTO T11 Materials Finer than 75- μ m (No.200) Sieve in Mineral Aggregates by Washing
- AASHTO T27 Sieve Analysis of Fine and Coarse Aggregates
- AASHTO T89 Determining the Liquid Limit of Soils
- AASHTO T90 Determining the Plastic Limit and Plasticity Index of Soils
- ASTM D543 Evaluating the Resistance of Plastics to Chemical Reagents
- ASTM D570 Water Absorption of Plastics
- ASTM D638 Tensile Properties of Plastics
- ASTM D2240 Rubber Property—Durometer Hardness

2.2 Materials for Box Culverts

2.2.1 Bedding

- (a) Sand bedding shall be a porous, free-draining granular material free of excess moisture, muck, roots, sod, or other deleterious materials, uniformly graded from coarse to fine, meeting the gradation as shown below. The material shall also conform to the following:

Plasticity Index, AASHTO T90	6 max.
Liquid Limit, AASTTO T89	30 max.
Gradation	
Sieve Size	Percent by Weight Passing Designated Sieve (AASHTO T27 and T11)
12.5 mm	100
No. 200	0 – 75

- (b) Lean concrete bedding shall be bedding or blinding in accordance with the requirements of Specification Section 06100 “Structural Concrete”.

2.2.2 Cut off Plates (Water Stop)

- (a) Cut off plates shall be furnished and installed in accordance with the details indicated in the Drawings, the provisions in this Specification Section, and as directed by the Engineer.
- (b) Cut off plates shall be manufactured either from neoprene or from polyvinyl chloride (PVC), at the option of the Contractor.
- (c) Field splices for neoprene cut off plates shall be either vulcanized, mechanical, using stainless steel parts; or made with a splicing union of the same stock as the cut off plate, at the option of the Contractor.
- (d) Fabricated plastic cut off plates with a uniform cross section that are free from porosity and other defects shall be used. If approved, an equivalent standard shape may be furnished.
- (e) Cut off plates shall be fabricated from a homogeneous, elastomeric, plastic compound of basic PVC and other material. The use of any reclaimed material shall not be permitted.
- (f) Certification from the manufacturer showing test values for the following properties shall be provided:

Tensile strength, ASTM D638:	9.65 MPa
Elongation at breaking, ASTM D638:	250% min
Hardness (shore), ASTM D2240:	60 – 75
Resistance to alkali, ASTM D543 - Max. % change:	-0.10 to +0.25
Max. change in hardness:	+/-5 shore
Min. decrease in tensile strength:	- 15%
Water absorption, ASTM D570:	- 0.50% max.

2.2.3 Concrete, Reinforcement Bar and Others

The materials used for all structural work described in this Specification Section shall be in conformity with the requirements of the Specification Sections shown in Table 1.

Table 1 - Requirements for Concrete, Reinforcement Bar and Other Materials

Material	Relevant Specification Section
Concrete	Section 06100: "Structural Concrete"
Reinforcement Bar for Concrete	Section 06400: "Reinforcement Bar"
Porous Backfill or Filter Material	Section 03200: "Structural Excavation"
Backfill	Section 03400: "Embankment Construction"

Materials for base of concrete box culverts consist of levelling concrete and foundation. Levelling concrete shall be Class EI plain concrete with 100mm thickness. Material of foundation such as crusher run stones and gravels shall be appropriately selected with taking into consideration of construction site condition and workability, procurement availability and so on. Thickness of the foundation shall be 200mm.

3. Construction Requirements

3.1 Shop Drawings and Schedule

3.1.1 Shop Drawings

- (a) The Contractor shall furnish the Engineer with shop drawings showing construction details for culverts indicated in the Drawings, and as directed by the Engineer. Shop drawings shall be submitted to the Engineer, within the period established in Specification Section 01200 "Contractor's Drawings" for respective approval by the Engineer.
- (b) Construction of the box culverts shall commence only after the Engineer's approval of the shop drawings submitted by the Contractor.

3.1.2 Work Schedule

- (a) The Contractor shall submit the schedule and method statement he proposes to adopt in the box culvert construction or concrete drain works for the Engineer's review. Temporary drainage works and/or temporary detours shall be in place and operating before commencement of embankment works, or as directed by the Engineer.
- (b) No subgrade preparation or pavement overlay works (either on the road or shoulder areas) shall commence until the culverts, headwalls, and other minor structures below the subgrade level along that particular section of the project are completed.

3.2 Rectification of Defects

Any defects or damage as identified by the Employer or by the Engineer on behalf of the Employer shall be rectified by the Contractor within a reasonable time before covering up. Defects or damage identified on or before the expiry date of the Defects Notification Period shall be made good by the Contractor by the expiry date of the Defects Notification Period or as soon as practical thereafter.

3.3 Site Preparation

- (a) The Contractor shall excavate and prepare trenches and foundations for concrete and mortared stone-lined drains, as well as, for culverts in accordance with the provisions of Specification Section 03200 "Structural Excavation" and Specification Section 03400 "Embankment Construction".
- (b) The Contractor shall be responsible for all dewatering of the trenches (if needed), detours, temporary works, and any other incidental works that might be necessary during construction.
- (c) The Contractor shall place supports and/or bedding material in accordance with the requirements of the Drawings or as instructed by the Engineer in conformity with applicable Specification Sections.

3.4 Construction of Box Culverts

- (a) The Contractor shall construct box culverts to the lines and dimensions given in the Drawings or as indicated by the Engineer.
- (b) Unless otherwise required, all works shall be in accordance with requirements of AASHTO M259.
- (c) All reinforced concrete works shall conform to the requirements of Specification Section 06100 "Structural Concrete". All excavation and backfill works shall comply with the provisions of Specification Section 03200 "Structural Excavation" and Specification

Section 03400 “Embankment Construction”

- (d) Cut off plates shall conform to the cross section and to the minimum dimensions indicated in the Drawings.
- (e) If after placing concrete, cut off plates are materially out of position or shape, the surrounding concrete shall be removed, the cut off plates reset, and the concrete replaced, all at the Contractor’s expense.
- (f) Field splices for PVC cut off plates shall be performed by heat sealing the adjacent surfaces in accordance with the manufacturer’s recommendations. A thermostatically controlled electric source of heat shall be used to make all splices. The heat shall be sufficient to melt but not deform the plastic.
- (g) Cut off plates when being installed shall be cut and spliced at changes in direction as may be necessary to avoid buckling or distortion of the web or flange.
- (h) Field splices shall develop water-tightness equal to that of the unspliced material, and have a tensile strength of not less than 50% of the unspliced material.

3.5 Cleaning Culverts

- (a) Unless otherwise shown in the Drawings or indicated by the Engineer, the Contractor shall construct all culvert aprons, wingwalls, headwalls, inlets and outlets, and approach slabs using reinforced concrete of the class indicated in the Drawings, and in accordance with requirements and provisions of Specification Section 06100 “Structural Concrete”.
- (b) Scour protection works shall normally be mortared rip-rap unless indicated in the Drawings.

3.6 Placing Water Stops

- (a) Water stops shall be carefully placed and properly supported. If splicing of water stop is done, heat splices shall be heated according to the manufacturer’s instructions to make them watertight. Splices should have a tensile strength of at least 80% of the reported tensile strength of the unspliced water stop. Water stops shall be prevented from being displaced or damaged by construction operations and other activities.
- (b) All surfaces of water stops shall be kept free from oil, grease, dried mortar, or any other deleterious materials embedded in the concrete. It shall be ensured that embedded portions of the water stop are completely enclosed in dense concrete.

3.7 Acceptance Criteria

- (a) The finished dimensions of box culverts shall be as shown on Table 2.

Table 2 - Dimension Tolerances

	Box Culvert	Wing wall	Apron	Approach Slab
Centre Position	±5 mm	-	-	-
Top Level	±5 mm	-	-	-
Invert Level	±5 mm	-	-	-
Dimension Inner & Outer	- 10 to +20 mm*	-	-	-
Verticality	1 in 300	-	-	-
Top Grade Irregularities	±2.5 mm	-	-	-

Note: Dimensions are width, length, thickness, height etc. and they shall be checked by the inspection results of formwork, if final measurement is difficult.

- (b) Wingwalls, apron and approach slab for inlet and outlet concrete structure shall conform to Specification Section 06100, “Structural Concrete”.

- (c) If the water stop work is unacceptable, the Contractor shall submit the proposed remedial works to the Engineer’s approval.

4. Measurement and Payment

4.1 Method of Measurement

- (a) Reinforced concrete box culverts shall be measured for payment in linear metres (lm) of the actually placed new structures of the specified section. This quantity shall be measured as the actual placed length of reinforced concrete box culvert of a specified size and cross section, including all excavation, backfill, bedding (sand, stones, lean concrete and/or mortared), blinding, cradles, cement mortar, concrete and reinforcement bar, and all the incidentals to complete the works.
- (b) Excavation and backfill for the box culverts, bedding (sand, stones, mortar or lean concrete), blinding shall neither be measured nor paid separately, and shall deemed included as incidentals required to complete the works for box culverts.
- (c) The cost of any other incidental works necessary to complete the box culvert is deemed included in the rates and prices for incidental items for the construction of the box culvert.

4.2 Basis of Payment

- (a) The accepted quantities, measured as provided above, shall be paid at the contract price per unit of measurement for the pay items of the Bill of Quantities listed below.
- (b) Payment shall be full compensation for the work prescribed in this Section including furnishing and placing all the materials, excavation, backfill, reinforcement, all necessary joint materials for concrete box culverts and for furnishing all labour, materials, tests, tools, equipment and any incidentals to complete the work as shown in the Drawings and as required by this Specification Section, and/or as directed by the Engineer.

<u>Pay Item</u>	<u>Description</u>	<u>Unit</u>
04320-01	Box Culvert Type 1500 x 1500	lm
04320-02	Box Culvert Type 1500 x 1000	lm
04320-03	Box Culvert Type 1000 x 1000	lm

Section 04330 - Catchpits, Inlets, Outlets, Manholes

1. Description

This Specification Section describes the requirements for construction of catchpits, inlets, outlets and manholes.

2. Material Requirements

2.1 Reference Standards

The following Standards in their latest edition shall be particularly applied to Works covered under this Specification Section.

- ASTM A48 Gary Iron Castings
- ASTM D994 Preformed Expansion Joint Filler for Concrete (Bituminous Type)

2.2 Materials

- (a) Sand bedding, porous backfill, and backfill shall be in accordance with the requirements of Specification Section 04310 "Concrete Pipe Culverts". The sand material shall be high quality, free of any debris or organic materials.
- (b) Reinforcement shall conform to the requirements of Specification Section 06200 "Reinforcement Bar". Class of concrete shall be as indicated in the Drawings or as required by the Engineer. Concrete shall be in accordance with Specification Section 06100 "Structural Concrete".
- (c) Expansion-joint filler material, or asphalt sealant shall conform to ASTM D994 with a nominal thickness of 13 mm.
- (d) Mortar for pipe joints and connections to other drainage structures and mortar pipe bedding shall be in accordance with requirements of Specification Section 08010 "Mortar and Grout".
- (e) Covers, frames, and gratings shall be cast iron, which meet the requirements of ASTM A48 Class 50, classified as "Heavy Duty", with shape, sizes, and connection requirements as indicated in the Drawings.
- (f) Materials for base of catch basins/pits, inlets, outlets, manholes consist of levelling concrete and foundation. Levelling concrete shall be Class EI plain concrete with 100mm thickness. Material of foundation such as crusher run stones and gravels shall be appropriately selected with taking into consideration of construction site condition and workability, procurement availability and so on. Thickness of the foundation shall be 200mm.

2.3 Submittals

Certifications from the manufacturers attesting that the materials meet specification requirements shall be submitted to the Engineer for approval no later than 60 days prior to the intended commencement of work. Certificates are required for all drainpipes, fittings, manhole covers and frames, and drainage grates and frames.

3. Construction Requirements

3.1 Shop Drawings and Schedule

3.1.1 Shop Drawings

The Contractor shall furnish shop drawings containing the construction details of drainage structures and piping indicated in the Drawings, and as directed by the Engineer. Shop drawings shall be submitted to the Engineer, within the period stipulated in Specification Section 01200 "Contractor's Drawings", for respective approval prior to the start of the construction of drainage structures and piping. Construction of the drainage structures and piping shall commence only after the Engineer's approval to the shop drawings submitted by the Contractor.

3.1.2 Work Scheduling

The Contractor shall submit the schedule and method statement he proposes to adopt in the construction for the Engineer's review.

3.2 Delivery, Storage and Handling

Materials delivered to site shall be inspected for damage, unloaded, and stored with minimum handling. Materials shall not be stored directly on the ground. The inside of pipes and fittings shall be kept free of dirt and debris.

Materials shall be handled in such a manner as to insure delivery to the point of installation in a sound undamaged condition.

3.3 Manhole Covers, Catchpits and Frames

Manhole covers and catchpits shall be supplied and installed complete with frames and covers as indicated in the Drawings.

4. Measurement and Payment T

4.1 Method of Measurement

Catchpit quantities shall be measured for payment by the number of units placed in site with grates and frames completed and installed including concrete, reinforcement, bedding and bedding materials, excavation, backfill and all incidentals, such as gabions and any other supplementary work necessary for a completed and acceptable work.

Do not measure metal frames and grates when included as part of the original inlet, manhole or Catchpit construction.

4.2 Basis of Payment

The accepted quantities, measured as provided above, shall be paid at the contract price per unit of measurement for the pay items of the Bill of Quantities listed below. Payment shall be for full compensation for the work prescribed in this Section including all preparatory works, supplying, transporting and placing all materials, and for furnishing of all labour, materials, tests, tools, equipment and any incidentals to complete the work as shown in the Drawings and as required in accordance with these Specification Sections and/or as directed by the Engineer.

<u>Pay Item</u>	<u>Description</u>	<u>Unit</u>
04330 -01	Catchpit (C=DITCH) Type A	Number
04330 -02	Catchpit (C=DITCH) Type B	Number
04330 -03	Catchpit 600 x 600 x 1100	Number
04330 -04	Catch Pit 500 x 500 x 500	Number
04330 -05	Catchpit (C=DITCH) Type C	Number
04330 -06	Catchpit (C=DITCH) Type D	Number

<u>Pay Item</u>	<u>Description</u>	<u>Unit</u>
04330-07	Catchpit 700 x 700 x 1050	Number
04330-08	Catchpit 700 x 700 x 1850	Number
04330 -09	Catchpit 700 x 700 x 2250	Number
04330 -10	Catchpit 1000 x 1000 x 1350	Number
04330 -11	Catchpit 1200 x 1200 x 1600	Number

Section 04400 – Vertical Drain

1. Description

The Contractor shall construct roadside ditches using mortared stonework, reinforced concrete, or pre-cast concrete as shown in the Drawings, unless otherwise directed by the Engineer.

2. Material Requirements

2.1. Materials

Within the period stipulated in the General Specifications, the Contractor shall submit samples of materials he intends to use for waterway lining to obtain the Engineer's approval.

- (a) Fill shall conform to the requirements for material properties, placing, compacting, and quality assurance specified in Specification Section 03400 "Embankment Construction". Erosion resistant material shall be approved by the Engineer.
- (b) Mortared stone lining shall conform to the requirements for material properties, placing, compacting, and quality assurance specified in Specification Section 04200 "Mortared Stonework and Rip-rap".
- (c) Reinforced concrete work shall conform to the requirements for material properties, placing, curing, and quality assurance specified in Specification Section 06100 "Structural Concrete".
- (d) Pipes and pipe fittings for drains shall be as shown in the Drawings, complying with the requirements for types and sizes, and conforming to the standards of JIS K 6741 or equivalent for Un-plasticised Polyvinyl Chloride (UPVC) pipes (VP pipes).
- (e) Materials delivered to site shall be inspected for damage, unloaded, and stored with minimum handling. Materials shall not be stored directly on the ground. The inside of pipes and fittings shall be kept free of dirt and debris. Plastic pipes shall be installed within six (6) months from the date of manufacture unless otherwise approved.
- (f) Materials shall be handled in such a manner as to ensure delivery to the point of installation in sound, undamaged condition. Pipes shall be carried and not dragged along the ground to the installation location.
- (g) Materials for base of open ditch structure consist of only foundation. Material of foundation such as crusher run stones and gravels shall be appropriately selected with taking into consideration of construction site condition and workability, procurement availability and so on. Thickness of the foundation shall be 150mm.

2.2. Submittals

2.2.1. Shop and Working Drawings and Schedules

- (a) In accordance with the requirements stipulated in Specification Section 01150 "Contractor's Submittals", and Section 01200 "Contractor's Drawings" the Contractor shall submit complete sets of Drawings and Schedules for the ditches works, to the Engineer for review and approval.
- (b) The Contractor shall obtain the Engineer's approval of the submitted shop drawings at least twenty-eight (28) days before commencement of the corresponding works.

2.2.2. Other Submittals

The Contractor shall submit samples of materials he intends to use for waterway lining subject to the Engineer's approval.

3. Construction Requirements

3.1. Setting-Out of Ditches

The Contractor shall set out the required locations, lengths, direction of fall, and grades of all ditches, whether lined or unlined. Setting out shall include locating all associated catchpits and out falls.

3.2. Setting-Out of Pipes

Each pipe shall be carefully inspected before it is placed. Any defective or damaged items shall be rejected. The adhesive for securing piping and fittings shall be suitable for the application and approved by the Engineer.

3.3. Roadside Construction

- (a) The Contractor shall construct the stone lining for ditches as specified in this Specification Section after the Engineer approves the prepared roadside.
- (b) The Contractor shall excavate, fill, and shape the realigned or new ditches to the grades shown in the Drawings.
- (c) The Contractor shall remove and dispose of all excavated materials to at least 10 m away from the waterway area to prevent any surplus materials from falling into the excavated waterway.
- (d) The finish shall be sufficiently smooth and uniform to ensure the free flow of water without ponding during periods of low flow.

3.4. Tolerances, Rectifying and Maintenance

3.4.1. Dimensional Tolerances

Grades on new roadside and median ditches inverts against those specified or approved	±5 mm at any point
Ditches alignments and the shape of cross-sections as specified in the Drawings	±2 cm at any point.

3.4.2. Rectifying Unsatisfactory Work

- (a) The Contractor shall rectify all waterway construction works that do not meet the above-mentioned tolerance criteria or works found unacceptable to the Engineer. The Contractor shall rectify unacceptable work as directed by the Engineer.
- (b) The Contractor shall perform resurvey works defining existing or constructed surface profiles as often as necessary to obtain an accurate record of the physical conditions.
- (c) Rectification work may include:
 - Additional excavation or fill, which could include backfilling new work and re-excavating it to the specified dimensions, lines, and grades; and
 - Repairing or replacing defective mortared stonework or reinforced concrete work.
- (d) No additional payment shall be made for the extra work or quantities used for the rectification.

4. Measurement and Payment

4.1. Method of Measurement

4.1.1. Ditches

Ditches shall be measured in linear metres (lm) of completed ditch according to the shop drawings submitted by the Contractor. Concrete covers for “Side Ditch Type U-1000 x 1500”, “Side Ditch Type U-1500 x 1500” and “Side Ditch Type U-1500 x 1700” shall be measured as the number of covers satisfactorily installed by the Contractor and accepted by the Engineer.

4.1.2. Drainage Pipe

Drainage piping shall be measured for payment by the actual length (in linear metres) of the UPVC drain piping in the diameter and type required in the Drawings. These include straight pipe and accessories, protective coatings, constructed and installed in accordance with the requirements of the Drawings, these Specifications and instructions by the Engineer.

4.1.3. Drainage Pipe for Joint (Elbow)

The drain pipe joints (Elbow) shall be measure for payment according to the diameter and type of joints required in the Drawing. These include pipes processed for connection, flexible joints, protective coatings, constructed and installed in accordance with the requirements of the Drawings, these Specifications and instructions by the Engineer.

4.1.4. Drainage Pipe for Pipe Brace

The drain pipe brace shall be measure for payment according to the size and type required in the Drawing. These include parts of pipe braces such as flat bars, bolts, nuts and anchor installed in accordance with the requirements of the Drawings, these Specifications and instructions by the Engineer.

4.2. Basis of Payment

- (a) Payment shall be full compensation for the work prescribed in this Section including all preparatory works, supplying and transportation of materials, placing and compaction of filling material, and for furnishing all labour, materials, tests, tools, equipment, and any incidentals to complete the work as shown in the Drawings and as required in accordance with these Specifications and/or as directed by the Engineer.
- (b) No separate payment shall be made for excavation, backfill, bedding, stones, and lining for ditches or ditch relocation.

The Pay Items and Pay Unites shall be as follows;

<u>Pay Item</u>	<u>Description</u>	<u>Unit</u>
04400-01	Vertical Drain Type A UPVC Pipe ϕ 200mm	lm
04400-02	Vertical Drain Type A Joint (90°) ϕ 200mm	Number
04400-03	Vertical Drain Type B U-Ditch Section A-A	lm
04400-04	Vertical Drain Type B U-Ditch Section B-B	lm
04400-05	Vertical Drain Type B U-Ditch Section C-C	lm
04400-06	Vertical Drain Type C UPVC Pipe ϕ 150mm	lm

Section 04500 – Drainage Outlet

1. Description

This work consists of constructing new flap gates at the end of the waterway. Requirements of structures to which the flap gates are fixed are described in Section 04320. Incidental structures of waterway works are also described in Section 04330.

2. Material Requirements

2.1 Reference Standards

The following Standards in their latest editions shall be particularly applied to the works covered by this Specification:

- AASHTO M259 Precast Reinforced Concrete Box Sections for Culverts, Storm Drains, and Sewers
- AASHTO T11 Materials Finer than 75- μ m (No.200) Sieve in Mineral Aggregates by Washing
- AASHTO T27 Sieve Analysis of Fine and Coarse Aggregates
- AASHTO T89 Determining the Liquid Limit of Soils
- AASHTO T90 Determining the Plastic Limit and Plasticity Index of Soils
- ASTM D543 Evaluating the Resistance of Plastics to Chemical Reagents
- ASTM D570 Water Absorption of Plastics
- ASTM D638 Tensile Properties of Plastics
- ASTM D2240 Rubber Property—Durometer Hardness
- JIS G 4305 Cold-rolled Stainless Steel Plate, Sheet and Strip

2.2 Materials for Flap Gates

The Contractor shall provide a flap gate at the end of each drainage outlet. The flap gates shall be used for preventing reverse-flow of the water from river side to upstream of each discharging drainage. Requirements for the flap gates materials are designed in accordance with Japanese Technical Standard for Dam and Weir Structure (MLIT) as mentioned in below 2.2.1. The shutter plate and gate stopper shall be made of stainless steel (SUS323L) or equivalent as shown in the Drawings.

2.2.1 Requirements for Flap Gates Materials

- (a) Type of Flap Gate: Stainless Steel Flap Gate (JIS G 4305, SUS323L or equivalent)
- (b) Bore of Flap Gate: 1000mm x 1000mm for Type A, 2000mm x 1500mm for Type B
- (c) Number of Flap Gate: 4 gates (2 gates for Type A and 2gates for Type B)
- (d) Design High Water Level: 4.22m
- (e) System of Water-tight: Rear 4 Faces Rubber Water-tight System or equivalent
- (f) Primary Materials: Shutter Plate (SUS323L or equivalent), Gate Stopper (SUS323L or equivalent)

3. Construction Requirements

3.1 Shop Drawings and Schedule

3.1.1 Shop Drawings

- (a) The Contractor shall furnish the Engineer with shop drawings showing construction details for flap gates and culverts indicated in the Drawings, and as directed by the Engineer. Shop drawings shall be submitted to the Engineer, within the period established in Specification Section 01200 "Contractor's Drawings" for respective approval by the Engineer.
- (b) Construction of the flap gates and box culverts shall commence only after the Engineer's approval of the shop drawings submitted by the Contractor.

3.1.2 Work Schedule

- (a) The Contractor shall submit the schedule and method statement he proposes to adopt in the box culvert construction or concrete drain works for the Engineer's review. Temporary drainage works and/or temporary detours shall be in place and operating before commencement of embankment works, or as directed by the Engineer.
- (b) No subgrade preparation or pavement overlay works (either on the road or shoulder areas) shall commence until the culverts, headwalls, and other minor structures below the subgrade level along that particular section of the project are completed.

3.2 Rectification of Defects

Any defects or damage as identified by the Employer or by the Engineer on behalf of the Employer shall be rectified by the Contractor within a reasonable time before covering up. Defects or damage identified on or before the expiry date of the Defects Notification Period shall be made good by the Contractor by the expiry date of the Defects Notification Period or as soon as practical thereafter.

3.3 Site Preparation

- (a) The Contractor shall excavate and prepare trenches and foundations for concrete and mortared stone-lined drains, as well as, for culverts in accordance with the provisions of Specification Section 03200 "Structural Excavation" and Specification Section 03400 "Embankment Construction".
- (b) The Contractor shall be responsible for all dewatering of the trenches (if needed), detours, temporary works, and any other incidental works that might be necessary during construction.
- (c) The Contractor shall place supports and/or bedding material in accordance with the requirements of the Drawings or as instructed by the Engineer in conformity with applicable Specification Sections.

3.4 Setting of Flap Gates

- (a) Each flap gates shall be carefully inspected before it is placed in position. Any defective or damaged items shall be rejected. When the flap gates consisting of shutter plates and gate stoppers with anchor bolt are fixed on box culvers, water-tightness shall be properly secured as shown in the Drawings.

4. Measurement and Payment

4.1 Method of Measurement

- (a) Drainage outlet consisting of flap gates and reinforced concrete box culverts shall be measured for payment by number of units placed in site with grates and frames completed and installed including flap gate, concrete, reinforcement, rip-rap, bedding and bedding materials and all incidentals, such as gabions and any other supplementary work necessary for a completed and acceptable work.
- (b) Excavation and backfill for the main section of the concrete box culverts, and bedding (of sand, stone, mortar or lean concrete) shall neither be measured nor paid separately, and shall deemed included as incidentals required to complete the works for box culverts.
- (c) The cost of any other incidental works necessary to complete the drainage outlet is deemed included in the rates and prices for incidental items for the construction of the drainage outlet consisting of flap gate and box culvert.

4.2 Basis of Payment

- (a) The accepted quantities, measured as provided above, shall be paid at the contract price per unit of measurement for the pay items of the Bill of Quantities listed below. Payment shall be for full compensation for the work prescribed in this Section including all preparatory works, supplying, transporting and placing all materials, and for furnishing of all labour, materials, tests, tools, equipment and any incidentals to complete the work as shown in the Drawings and as required in accordance with these Specification Sections and/or as directed by the Engineer.

<u>Pay Item</u>	<u>Description</u>	<u>Unit</u>
04500-01	Drainage Outlet Type A (Left Side)	Number
04500-02	Drainage Outlet Type A (Right Side Side)	Number
04500-03	Drainage Outlet Type A Flap Gate 1000 x 1000	Number
04500-04	Drainage Outlet Type B (Left Side)	Number
04500-05	Drainage Outlet Type B (Right Side)	Number
04500-06	Drainage Outlet Type B Flap Gate 200 x 1500	Number

**Division 5
Pavements**

Table of Contents

Section 05100 - Prime Coat and Tack Coat1

Section 05300 - Asphalt Concrete Binder and Surface Courses7

Section 05700 - Cement Concrete Pavement30

Note: Subbase and Base Course are specified in Section 03800

Section 05100 - Prime Coat and Tack Coat

1. Description

The prime coat works consist of supply and application of emulsified or cut back asphalt to previously prepared and approved absorbent surfaces (subgrade, granular subbase, or aggregate base course) prior to placing superimposed layers. The prime coat shall be applied to the full width indicated in the Drawings, or as required by field conditions.

The tack coat works consist of furnishing and applying emulsified or cut back asphalt to a previously placed asphaltic base or binder course with this Specification and on entire width shown in the Drawings or by Engineer's instruction.

2. Material Requirements

2.1. REFERENCE STANDARDS

The following Standards in their latest editions shall be particularly applied to the works covered by this Specification Section:

- AASHTO M82 Cut-back Asphalt Medium Curing Type
- AASHTO M226 Viscosity Graded Asphalt Cement
- AASHTO T179 Effect of Heat and Air on Asphalt Materials (Thin-film Oven Test)

2.2. MATERIALS

- Materials for prime coat shall be either asphalt cement (A/C) AC-20 grade asphalt cement (which is approximately equivalent to 60/70 Pen.) diluted with kerosene. AC-20 shall be in accordance with AASHTO M226 which is classified by viscosity. Proportion of diluted kerosene to be used shall follow the instruction of the Engineer.
- Materials for tack coat to be used on the prepared A/C binder course for rough surface courses shall satisfy the requirements for liquid bitumen RC-70 (ASTM D2028-97) with proportion (volume of bitumen or emulsified asphalt shall be in litre/m²) that depends on the covering layer's exploration time.
- When AC-20 is to be diluted with kerosene, the proportion of kerosene diluents to be used shall be as previously approved by the Engineer.

2.3. SUBMITTALS

The Contractor shall submit the following to the Engineer:

- A 5-litre sample of any bitumen that the Contractor proposes to use in the work, together with a certificate from the manufacturer, to be submitted before construction begins. The certificate must state that the binder complies with all the specifications and grade requirements for the prime coat, given in this Specification Section.
- A satisfactory record of the calibration certificates of all instruments, gauges, and dipstick for the bitumen distributor, to be submitted not less than thirty (30) days before construction begins.
- Spray chart, meeting the requirement of this Specification Section, to be submitted before construction begins, so that equipment checks can be carried out.
- Samples of materials used in each day's work shall be submitted in accordance with this Specification Section.

- Daily records of sealing works done and material application rates shall be submitted in accordance with this Specification Section, the Drawings or as directed by the Engineer.
- In case of pavements on steel deck for bridges, using an “adhesive layer” and “water proofing layer” as shown in the Drawings, the Contractor shall submit to the Engineer detailed information regarding to the material and application method statement, for review and approval.

3. Construction Requirements

3.1. WEATHER LIMITATION

Prime coat and tack coat shall be applied only on dry surfaces, and shall not be applied during high winds, rain, foggy weather, or if rain threatens.

3.2. EQUIPMENT

3.2.1. GENERAL

The equipment to be used by the Contractor shall include a power broom and/or a power blower, a pressurized bitumen distributor, equipment for heating bitumen. Use of gravity distributors shall not be permitted.

3.2.2. DISTRIBUTOR

- The distributor shall have a minimum capacity of 1000 litres.
- The distributor shall be so designed, equipped, maintained and operated in such a way that the bitumen at even heat may be applied uniformly on variable widths of surface, at a controlled rate of transverse and longitudinal spread within $\pm 10\%$ of the required rate of application.
- The distributor equipment shall include a tachometer, pressure gauges, calibrated tank dipstick, thermometer for measuring the temperature of the tank contents, and an instrument for measuring the speed of travel at low speed. All measuring equipment on the distributor shall have been recently calibrated, and an accurate and satisfactory record of such calibration shall be submitted to the Engineer.
- When so directed by the Engineer, the Contractor shall make equipment and operators available for field testing, and shall supply any other assistance required for this purpose.

3.2.3. INSTRUMENTATION/CALIBRATION

- The distributor shall be equipped with a spray chart and operation manual to be utilized for operating the sprayer and distributor, which shall be in good condition at all times.
- The operation manual shall include pipe flow diagrams and full instructions for all operations of the distributor.
- The spray chart shall show the relationship between speed and application rate for the bitumen distributor being used as well as the relationship between pump speed and the number of nozzles in use, based on a constant bitumen output per nozzle. The constant nozzle output (litres/min), as well as the spraying pressure, shall be noted on the spray chart.
- The spray chart shall also show the height of the spray bar from the surface, and the correct horizontal angle of the spray nozzles to ensure triple overlap of the nozzle fans (i.e., the width of road coated by each nozzle is exactly three times the spacing between nozzles).

3.2.4. UNACCEPTABLE EQUIPMENT

- The Engineer shall have the right to stop the use of any equipment or plant which he deems to be of inferior quality, and to instruct the removal of such equipment and have it replaced with suitable equipment or to alter the method of operation at any time.

- The Contractor shall immediately comply with such instructions without being entitled to any indemnities or extensions as a result of such instructions. The Contractor shall not use any equipment or plant before obtaining the approval of the Engineer, and shall follow sound technical methods in operation and employ skilled and trained operators, mechanics and labour to carry out the works. The Engineer shall have the right to expel any operators, mechanics or labour, and to instruct suitable replacement thereof at any time he deems such action is necessary.

3.3. APPLICATION METHODS

3.3.1. SITE PREPARATION

- Prior to the application of the bitumen, loose dirt and other objectionable materials shall be removed from the surface by means of power broom or blower or both. If this does not provide a uniformly clean surface, additional sweeping shall be done by hand using stiff brooms. Sweeping shall extend at least 20 cm (centimetres) beyond each edge of the area to be sprayed.
- The surfaces of structures or trees or property adjacent to the areas shall be protected against marring and spattering.
- Adherent patches of objectionable materials shall be removed from the surface using steel scraper or other approved method, and where the Engineer so directs, the scraped area shall be washed down with water and hand brooms.
- The Contractor shall provide and maintain at the heating site, adequate fire prevention and control measures, and also first aid supplies and facilities.
- The work method to be carried out shall offer the least inconvenience to traffic and without damage to the work.
- The Contractor shall be responsible for all the consequences of traffic being allowed to pass to the newly laid prime coat, and he shall prohibit such traffic when necessary by providing a detour or half-lane width construction.
- Application of bitumen shall not be made until the pavement has been prepared to the satisfaction of the Engineer. The Engineer will not permit the application when there is free water present on the surface.
- Bituminous material shall not be discharged into any side ditch or drain.

Other requirements shall be as follows:

- The length of surface that is sprayed in each time of passage of distributor shall be measured and marked on the ground. For the prime coat and tack coat, stripping shall be made to limit the area of spraying (painting...).
- The distributor shall be operated according to the approved spray chart. Speed of pumping, velocity of vehicle, height of spraying bar, and position of sprayer shall be suitable with the charts of pre- or during each spraying.
- Asphalt material shall be spread to create an overlap of 20 cm strip along the interface edge of lanes. Width of spray shall be more than that stipulated for treatment measure for road edge or shoulder edge in order to consider spray reduction at edge, which has no overlap portion.
- Average proportion of spray for each time of passage shall be calculated according to used bitumen capacity divided by spreading area, which shall be within the range of $\pm 5\%$ of that directed by the Engineer. Reference rate of spray shall be determined for each subsequent passage, which may be adjusted if necessary to secure a constant rate of consecutive spraying.

3.3.2. SPRAYING TEMPERATURES

Spraying temperatures shall comply with Table 1.

Table 1: Spraying Temperatures (Prime Coat)

Type of Material	Spraying Temperature Range
Cutback, 50 pph kerosene (MC-70 grade cutback)	70 ± 10 0C
Cutback, 75 pph kerosene (MC-30 grade cutback)	45 ± 10 0C
Cutback, 100 pph kerosene	30 ± 10 0C
Cutback, more than 100 pph kerosene	Not heated

Spraying Temperatures (Tack Coat)

Type of Material	Spraying Temperature Range
Cutback, 25 pph kerosene	110 ± 10 0C

Note: The abbreviation pph shown in Table 1 means parts of kerosene per 100 parts of asphalt cement by volume.

3.3.3. EXCESSIVE HEATING

Heating in excess of the requirements or prolonged heating at high temperatures shall be avoided. Any material, which in the opinion of the Engineer has been damaged by overheating, shall be rejected and shall be replaced at the Contractor's expense.

3.3.4. PRECAUTIONS

Extreme care shall be taken when heating any cut-back asphalt cement. Open flames or sparks shall not be permitted close to these materials. Controlled heat shall be applied in heating kettles, mixers, distributors, or other equipment designed and approved for such purpose. Open flames shall not be used to inspect or examine drums, tank cars or other containers in which these materials are stored. All vehicles transporting these materials shall be properly vented. Only experienced personnel shall be permitted to supervise the handling of these materials.

3.3.5. RATE OF APPLICATION

- The Contractor shall carry out field trials under the supervision of the Engineer to establish the appropriate application rate and such trials shall be repeated, as directed by the Engineer, whenever the type of bitumen or the type of surface changes.
- The transverse distribution of bitumen application rates produced by the distributor shall be tested by passing the spray bar over a test area laid with 25 cm x 25 cm sheets of absorbent material with a binder-proof backing, which are weighed before and after the spray application. The difference in weight shall be used in determining the spraying rate actually applied to each sheet, and the variation from the mean rate for any sheet across the full width sprayed shall not exceed 15%.Maintenance of Prime Coat.
- The Contractor shall maintain the coated surface to the specified standard until it is overlaid by the subsequent course.
- Traffic shall not be permitted on the coated surface until the bitumen has penetrated and dried and, in the opinion of the Engineer, will not pick up under traffic.
- In exceptional circumstances where it becomes necessary to permit traffic on prime coat prior to that time, but in no case sooner than four (4) hours after the application of the prime coat, clean cover aggregate shall be applied as directed by the Engineer, and traffic may be permitted to use the lanes so treated.
- Cover aggregate shall be spread from trucks in such a manner that no wheel will travel on uncovered wet bitumen. When applying cover aggregate to a treated lane that adjoins a lane yet to be treated, a strip at least 20 cm wide along the adjoining edge shall be left

uncovered or if covered, shall be uncovered when the second lane is being prepared for treatment, in order to permit an overlap of bitumen as required above. The cover aggregate shall be used to the minimum extent possible.

3.4. QUALITY OF WORK AND RECTIFICATION OF UNSATISFACTORY WORK

- The finished coat shall completely cover the area treated and have a uniform appearance, without missed areas or streaks or “rich” areas of accumulated bitumen.
- After curing for 4 to 6 hours, the binder shall be soaked into the course where it was applied, leaving behind only sufficient binder to ensure that the surface is uniformly black or dark grey in colour, and non-porous.
- Rectification of unsatisfactory prime coat or tack coat shall be conducted as directed by the Engineer. Minor potholing shall be promptly patched.

3.4.1. FIELD QUALITY CONTROL AND TESTING

- A bitumen sample and certificate shall be provided for each delivery of bitumen to the Site of the works.
- Samples of the prime coat shall be taken from the distributor as directed by the Engineer.
- The bitumen distributor shall be inspected and tested as follows:
 - Prior to the commencement of spraying works under the Contract;
 - Every six (6) months or every 150,000 litres of binder sprayed by the distributor, whichever is the more frequent;
 - Following any accident or modification to the distributor that, in the opinion of the Engineer, warrants rechecking the distributor.
- The result of the wet sieve testing of the proposed cover aggregate shall be submitted to the Engineer for approval prior to any use of that aggregate.
- A detailed written record of daily surfacing operations, including the location, binder used on each sprayer run, application rates achieved, and area covered shall be prepared and submitted to the Engineer.

4. Measurement and Payment

4.1. METHOD OF MEASUREMENT

The surface application shall be measured in square meters of work completed and accepted by the Engineer. Surface measurements shall be based on the width and length of the surface area approved by the Engineer.

4.2. BASIS OF PAYMENT

- Payment shall be for full compensation for the work prescribed in this Section including furnishing, producing, mixing and placing all materials, testing and trial sections, and for furnishing all labour, materials, tests, tools, equipment and any incidentals to complete the work as shown in the Drawings and as required by these Specification Sections, and/or as directed by the Engineer.
- Payment for the Prime Coat will be made at the Contract unit rates and shall include full compensation for providing all materials, mixing where required, placement, labour equipment and incidentals to complete the prime coat as specified in this Section.
- Payment for Tack Coat will be made at the Contract unit rate for the completed work as measured which shall include full compensation for cleaning of the surface, providing all materials, labour, equipment tools and incidental necessary to complete the work as specified in this Section.
- The “adhesive layer” and “water proofing layer” shall be measured and paid under Specification Section 06530 “Bridge Floor Waterproofing”. The payment for these layers

used for bridges, or other structures as shown in the Drawings, shall be deemed to include all the works and materials for installation, and all the incidental works that could be required for such installation.

The Pay Items and Pay Units will be as follows;

<u>Pay Item</u>	<u>Descriptions</u>	<u>Units</u>
05100-01	Prime Coat	m ²
05100-02	Tack Coat	m ²

Section 05300 - Asphalt Concrete Binder and Surface Courses

1. Description

The work under this Specification Section consists of the supply of hot asphalt mixtures mixed in a central plant for dense durable binder course and surface course, hot bituminous plant-mix crush stone, spreading and compaction of the mixtures

2. Reference Standards

The following standards in their latest editions shall be particularly applied to the works covered by this Specification:

- AASHTO M17 Mineral Filler for Bituminous Paving Mixtures
- AASHTO M20 Penetration Graded Asphalt Cement
- AASHTO M226 Viscosity Graded Asphalt Cement
- AASHTO M316 Polymer Modified Cationic Emulsified Asphalt
- AASHTO R 15 Asphalt Additives and Modifiers
- AASHTO PP37 Determination of International Roughness Index (IRI) to Quantify Roughness of Pavements
- AASHTO T11-05 Materials Finer Than 75- μm (No. 200) Sieve in Mineral Aggregates by Washing. ASTM C117-03
- AASHTO T27-99 Sieve Analysis of Fine and Coarse Aggregates. ASTM C 136-96
- AASHTO T49 Penetration of Bitumen
- AASHTO T50 Float Test for Bitumen
- AASHTO T51 Ductility of Bitumen
- AASHTO T 53-96 (2004) Softening Point of Bitumen (Ring-and-Ball Apparatus). ASTM D36-95 (2000)
- AASHTO T96 Resistance to Degrading of Small-Size Coarse Aggregate by Abrasion and Impact in the Los Angeles Machine
- AASHTO T104 Soundness of Aggregate by Use of Sodium Sulfate or Magnesium Sulfate
- AASHTO T164 Quantitative Extraction of Bitumen from Bituminous Paving Mixtures
- AASHTO T165 Effect of Water on Cohesion of Compacted Bituminous Mixtures
- AASHTO T166 Bulk Specific Gravity of Compacted Bituminous Mixtures Using Saturated Surface-Dry Specimens
- AASHTO T168 Sampling Bituminous Paving Mixtures
- AASHTO T170 Recovery of Asphalt from Solution by Abson Method
- AASHTO T176 Plastic Fines in Graded Aggregates and Soils by Use of the Sand Equivalent Test
- AASHTO T179 Effect of Heat and Air on Asphalt Materials (Thin Film Oven Test)

- AASHTO T182 Coating and Stripping of Bitumen-Aggregate Mixtures
- AASHTO T209 Theoretical Maximum Specific Gravity and Density of Bituminous Paving Mixtures
- AASHTO T230 Method B. Standard Method of Test for Determining Degree of Pavement Compaction of Bituminous Aggregate Mixtures
- AASHTO T245 Resistance to Plastic Flow of Bituminous Mixtures using Marshall Apparatus
- ASTM E950 Standard Test Method for Measuring the Longitudinal Profile of Travelled Surfaces with an Accelerometer Established Inertial Profiling Reference
- American Asphalt Institute Manual MS-2
- Manual for Asphalt Pavement, Japan Road Association (JRA), 1989

3. Materials for Asphalt Mixtures

3.1. AGGREGATES

- The aggregates to be used in the work shall have a retained strength of not less than 75% when tested for loss of cohesion resulting from the action of water in accordance with AASHTO T165 and AASHTO T245.
- No aggregate shall be used if not previously approved by the Engineer. Materials shall be stockpiled in accordance with the requirements for storage stated in Specification Section 03800 “Aggregate Subbase and Base”.
- The Engineer may approve, or direct the use of, aggregates not meeting the requirements of this Specification Section provided that it can be demonstrated to his satisfaction.
- Aggregates shall be stocked by separating each size, to avoid mixing, on the floor or ground with good drainage facilities. Fine aggregates shall be stored under a roof for protection against rain.
- Aggregate of each type shall be delivered into the mixing plant via separate cold feed bin. Pre-blending of aggregates of different types or from different sources shall not be permitted.
- Approval of sources of supply of aggregates and mineral fillers shall be obtained from the Engineer prior to delivery of the materials. Samples of each material shall be submitted as directed by the Engineer.
- In selecting sources of aggregate, the Contractor shall take into account the bitumen that could be lost due to absorption into the aggregate.

3.1.1. COARSE AGGREGATES FOR ASPHALT MIXTURES

- Coarse aggregates shall consist of clean, tough, durable crushed stone free from dirt or other objectionable matter.
- When subjected to five cycles of sodium sulphate soundness test, referring to AASHTO T104, the coarse aggregate shall have a weighted loss of not greater than 12%.
- When subjected to coating and stripping tests, referring to AASHTO T182, the aggregate shall have a coated area of not less than 95%.

3.1.2. FINE AGGREGATES FOR ASPHALT MIXTURES

- Fine aggregates shall be composed of clean, tough particles, free from lumps or balls of clay, or of other objectionable natural sands, or crushed stone screenings, or suitable combinations thereof. If some crushed stone screenings (“crusher dust”) are required to produce an economical mix meeting the mix properties specified in this Specification Section, the crusher dust shall be produced by crushing clean stone having no clay or silt content, and shall be stockpiled separately from any natural sand to be used in the mix.

The crusher dust and natural sand components shall also be fed into the mixing plant using separate cold bin feeds so that the ratio of sand to crusher dust can always be carefully controlled.

- In no case shall dirty or dusty natural sands having more than 8% fines passing the No.200 sieve nor having a sand equivalent value of less than 50% as determined by AASHTO T176 be permitted to be used in the mix.

3.1.3. FILLER FOR ASPHALT MIXTURES

- Filler for asphalt mixtures shall fully conform to the requirements and specifications AASHTO M17, and the particular provisions herein specified.
- Filler shall consist of limestone dust, dolomite dust, Portland cement, fly ash, cement kiln dust, or other non-plastic mineral matter from sources approved by the Engineer. It shall be free from foreign or other objectionable materials.
- It shall be dry and free from lumps and when tested by wet sieving shall contain not less than 75% (preferably not less than 85%) by weight of particles passing a 75-micron sieve.

3.2. BITUMEN FOR ASPHALT MIXTURES

- Asphalt cement (bitumen) shall be homogeneous, free from water shall conform to the requirements given in Table 1. Other asphalts will be permitted only upon prior approval of the Engineer.

TABLE 1. Requirements for Specification for Asphalt Cement (Bitumen)
(AASHTO M 20, JIS K 2207-1996, Penetration-Graded Asphalt Cement)

No.	Properties	Unit	AASHTO Grade 60/70	JIS K 2207-1996
1	Penetration at 25 °C, 100 g, 5 s	-	60–70	60-80
2	Flash point	°C	Min. 232	Min. 260
3	Solubility in Trichloroethylene	%	Min. 99	Min. 99
4	Ductility at 25 °C, 5 cm/min, cm	cm	Min. 100	Min 100 (15°C)
5	Thin-film oven test, 3.2 mm, 163°C, 5 hour, Loss on heating	%	Max. 0.8	Max. 0.6
6	Penetration of residue, % of original	%	Min. 54	Min. 55
8	Spot test (when and as specified with):	-	Negative for all grades	-

3.3. POLYMER MODIFIED BINDER (PMB) (ON STEEL DECK BRIDGES):

- Asphalt concrete mixture to be used for thin asphalt concrete covering layer with high roughness shall be produced by hot mixing and spaying method with interrupted aggregate and cohesive substance, which is a polymer asphalt.
- Polymer asphalt to be used for thin asphalt concrete covering layer with high roughness shall be “Polymer Modified Bitumen” PMB-I, PMB-II or PMB-III-WF meeting the technical requirements as specified in Table No.2A
- The test of No.5 in Table No.2A shows test according to “Pavement Survey and Test Handbook (Japan Road Association)”.

TABLE 2A: PMB Requirements

No.	Binder Properties	Unit	Polymer Modified Binder			Reference
			PMB-I	PMB-II	PMB-III-WF	
1	Softening Point (Ring and Ball Method)	°C	Min. 50	Min. 56	Min. 70	JIS K 2207
2	Ductility at 7 °C	cm	Min 30	-	-	JIS K 2207
3	Ductility at 15°C	cm	-	Min. 30	Min. 50	JIS K 2207
4	Stripping area percentage of coarse aggregates	%	-	-	Max. 5	Pavement Survey and Test Manual (JRA)
5	Fraass Breaking Point	°C	-	-	Max. -12	JIS K 2207
6	Penetration at 25°C	1/10mm	Min. 40			JIS K 2207
7	Mass change percentage of TFOT	%	Max. 0.6			JIS K 2207
8	Remaining Percentage of Penetration after TFOT	%	Min. 65			JIS K 2207
9	Flashing Point	°C	Min. 260			JIS K 2265
10	Density	g/cm ³	should be reported			JIS K 2207

- Application of PMB:
 - PMB-II and PMB-III-WF shall be applied on the steel deck of bridges, or other structures, as shown in the Drawings or as instructed by the Engineer

3.4. BONDING COAT (ON STEEL DECK BRIDGES):

The bonding coat on Steel Deck Bridges shall be a bituminous/Rubberized Asphalt Primer meeting the requirements specified in Table No. 2B

Table 2B: Property Bonding Coat / Solvent-Type Rubberized Asphalt Primer

Property	Requirement	Specification
Non-Volatile Content (%)	min. 50	JIS K 6833
Viscosity at 25°C (poise)	max. 5	JIS K 6833
Set to touch drying Time (minutes)	max. 90	JIS K 5600-1-1
Low Temperature Flexural Resistant, -10°C, 3mm deformation	No breaking	JIS K 5600-5-1
Cross Cut Test (points)	10	JIS H 4001
Cross Cut Test after submerged (points)	min. 8	JIS K 5664
Salty Water Spray Resistance (points)	min. 8	JIS K 5600-7-1

3.5. WATERPROOFING (ON STEEL DECK BRIDGES):

The waterproofing shall be a rubberized asphalt coat (hot applied type), meeting the requirements specified in Table No. 2C

Table 2C: Property Waterproofing / Hot- Applied Asphalt Membrane Waterproofing

Property	Requirement	Specification
Cone Penetration (mm)	1 to 5	JIS K 2207
Softening point (°C)	more than 80	JIS K 2207
Tensile Strength at 23°C	more than 0.35	JIS A 6021

(Mpa)		
Elongation Rate at	more than 300	JIS A 6021
Durability against Alkalinity	No abnormal change during/after 15 days soaked in Ca(OH) ₂ solution.	JIS K 5600-6-1
Durability against Salt Water	No abnormal change during/after 15 days soaked in 3 % salty water.	JIS K 5600-6-1

3.6. SURFACE PREPARATION (ON STEEL DECK BRIDGES, AND WHEN REQUIRED OR INSTRUCTED BY THE ENGINEER):

Steel Deck surface shall be prepared, before applying Bonding Coat, free from oil, dead paint, dust, zinc-rich paint and rust conforming. These ones on Steel Deck should be removed more than 99% as approved by the Engineer. The removal level is Sa 2-1/2 (SVENSK STANDARD SIS 05 5900 or ISO 8501) or more.

After surface preparation, Bonding Coat shall be applied and Waterproofing be applied immediately. Bonding Coat is applied normally at 0.4 l/m² and Waterproof at 1.2 kg/m² depending on the manufacture's instruction. To protect applied Waterproofing from damage by traffic, dry, screened sand approximately at 0.7 kg/m² shall be spread uniformly over it.

3.7. ASPHALT ADDITIVE FOR BITUMEN

If required in the Drawings, or directed and approved by the Engineer, an adhesion and anti-stripping agent shall be added to the bitumen. The additive shall be of a type approved by the Engineer, and the required percentage of additive shall be thoroughly mixed with the bitumen in accordance with manufacturer's instruction and as directed by the Engineer for such time necessary to produce a homogeneous mixture.

3.8. MATERIAL TESTING

- All acceptance and testing, necessary to determine conformity with the requirements herein specified, shall be performed in accordance with Subsection 4.10 "Quality Control and Testing" under this Specification Section.
- A one litre sample of any bitumen that the Contractor proposes to use, a statement as to its source, together with test data showing its properties, both before and after the Thin Film Oven Test (AASHTO T179), shall include:
 - Penetration at 25 °C
 - Penetration at 35 °C
 - Ring and ball softening point
 - Viscosity at 60 °C
 - Viscosity at 135 °C

3.9. SUBMITTALS

The Contractor shall provide the Engineer with the following:

- Detailed plan and schedule for testing and performing the trial Sections for the job-mix design of each type of asphalt concrete layer; This plan and schedule shall be submitted at least twenty-eight (28) calendar days before commencing the activities for asphalt mix design;
- Samples of all materials approved for use, which shall be retained by the Engineer throughout the Contract period for reference purposes;

- A bitumen sample and certificate for each delivery of bitumen or as directed by the Engineer;
- Written reports containing all the test results for each material, satisfying the requirements of relevant Specification Sections;
- Job-mix formula and all the supporting test data, satisfying the requirements of relevant Specification Sections, in written report form;
- Surface test measurements as specified in Subsection 4.10 “Quality Control and Testing” of this Specification Section, in written form;
- Written reports on the density of the placed mixtures, as specified in Subsection 4.10 “Quality Control and Testing” of this Specification Section;
- Checking the calibration and accuracy of the weigh scales and of the laboratory testing equipment and procedures;
- Laboratory and field test data as specified in Subsection 4.10 “Quality Control and Testing” of this Specification Section, for daily control of mix batching and mix quality, in written report form;
- Written records of layer thickness and pavement dimensions as specified in Subsection 4.11 “Asphalt Mixture Tolerances for Acceptance” of this Specification Section;
- In addition, when changing the job-mix formula, or in any event from time to time as directed by the Engineer, additional samples of (i) to (iv) shall be taken to enable determination of the bulk specific gravity of the hot bin aggregates, and the maximum theoretical density of the bituminous mixture (AASHTO T209).

4. Equipment Used for Asphalt Mix Work

- The Contractor shall not use any equipment or plant before obtaining the approval of the Engineer. The Contractor shall follow sound technical methods in operation and engage skilled and trained operators, mechanics and labour to carry out the works. The Engineer has the right to expel any operators, mechanics or labour and to instruct suitable replacement thereof at any time he deems such action is necessary.
- The Engineer has the right to stop the use of any equipment or plant which he deems to be of inferior quality, and to instruct the removal of such equipment and have it replaced by suitable equipment, or to alter the method of operation at any time.
- The Contractor shall immediately comply with such instructions without being entitled to any indemnities or extensions as a result of such instructions.

4.1. PLANT GENERAL

- The mixing plant shall be of weigh-batching type (the use of a continuous drum-mixing plant requires the Engineer’s approval) and shall have a capacity sufficient to supply the finisher(s) on the road continuously when spreading the asphalt mix at a normal speed and required thickness. The plant shall be so designed, coordinated, and operated so as to produce a mixture within the job mix tolerances.
- The plant shall be provided with automatic or computer controlled batching systems with batch print out records. The plant must meet the applicable environmental requirements of Vietnam and shall be in accordance with applicable provisions of Specification Section 01700 “Environmental Control and Protection”.

4.1.1. PLANT SCALES

- Scales for any weigh box or hopper should be of the springless dial type, load cell, or as approved by the Engineer, and shall be of standard make and design accurate to within one-half of 1% of the maximum load that will be required.

- When springless dial scales are used, the end of the pointer shall be set close to the face of the dial, and shall be of a type that shall be free from excessive parallax.
- The scale shall be provided with adjustable pointers for marking the weight of each material to be weighed into the batch. The scales shall be substantially constructed, and those that easily get out of adjustment shall be replaced. All dials shall be so located in such a way that they are in plain view of the operator at all times.
- Scales for weighing the bitumen shall conform to the specifications for scales for aggregate. The value of the minimum graduation in any case shall not be greater than one (1) kg.
- Scales shall be approved by the Engineer and shall be checked as often as the Engineer may deem necessary to assure their continued accuracy. The Contractor shall provide and have at hand sufficient standard weights for frequent testing of all scales to their full capacity.

4.1.2. EQUIPMENT FOR STORAGE OF BITUMEN

- Tanks for storage of bitumen shall be equipped for heating the material under effective and positive control at all times, to a temperature within the range specified.
- The circulating system for the bitumen shall be of adequate size to ensure proper and continuous circulation during the entire operating period. Suitable means shall be provided, either by steam jackets or other insulation, for maintaining the specified temperature of the bitumen in the pipe lines, meters, weight buckets, spray bars, and other containers of the flow lines. Upon approval of the Engineer, bitumen may be partially heated in the tanks and brought to a specified temperature by means of booster heating equipment between the tanks and the mixer.
- The total storage capacity of the tanks shall be sufficient to provide ten (10) hours of full operation of the asphalt mixing plant. If more than one (1) storage tank is used, they shall be so connected to the circulatory system that each tank can be separately isolated without interference to the circulation of bitumen to the mixer.

4.1.3. BINS

The plant shall include storage bins of sufficient capacity to supply the mixer when it is operating at full capacity.

- Bins shall be divided into at least four (4) compartments, and shall be arranged to ensure separate and adequate storage of appropriate fractions of the aggregate, not including mineral filler.
- Each compartment shall be provided with an overflow pipe that shall be of such size and at location that will prevent any backing up of material into other bins.
- Bins shall be so constructed that the gates do not leak and samples can be readily obtained.

4.1.4. FEEDER FOR DRIER

- A separate feeder shall be provided for each aggregate batch to be used in the mix.
- The cold feed bins shall have walls high and wide enough depending on the loading equipment used, to prevent intermingling of materials from adjacent bins.
- All feeders shall be calibrated, with the gate opening and speed settings for each approved job mix clearly indicated on the gates and on the plant control panel. Once established, the feeder settings shall not be altered without the approval of the Engineer.

4.1.5. DRIER

A rotary drier of any satisfactory design for drying and heating the mineral aggregate shall be provided.

4.1.6. SCREEN

Screen shall have an operating efficiency such that the aggregate deposited in any bin shall not contain more than 1% of oversize or undersize material.

4.1.7. WEIGH BOX OR HOPPER

- The equipment shall include a means to weigh accurately each bin size of aggregate in a weigh box or hopper, suspended on scales, ample in size to hold a full batch without hand raking or running over.
- There shall also be sufficient clearance between hoppers and supporting devices to prevent accumulations of foreign materials.
- The discharge gate of the weigh box shall be hung so that the aggregate will not be segregated when dumped into the mixer, and shall be closed tightly when the hopper is empty so that no material is allowed to leak into the batch in the mixer during the process of weighing the next batch.

4.1.8. MIXER

- The batch mixer shall be of twin pug mill type.
- The mixer shall be heat-jacketed with steam, hot oil, or other means approved by the Engineer.
- The mixer shall be of such design so as to permit visual inspection of the mix.
- The mixer capacity shall be not less than a one-ton batch and shall be so constructed so as to prevent leakage of contents. If not enclosed, the mixer box shall be equipped with a dust hood to prevent loss of dust by dispersion.
- The mixer shall have an accurate time clock to control the operation of a complete mixing cycle by locking the weigh box gate after charging the mixer, until the closing of the mixer gate at the completion of the cycle.
- Control of timing shall be flexible and capable of being set at intervals of not more than 5 seconds throughout cycles of up to 3 minutes. A mechanical batch counter shall be installed as part of the timing device.
- The clearance of blades of mixer from all fixed and moving parts shall not exceed 2 cm except in the case of aggregates having a nominal maximum size of over 2.5 cm.

4.1.9. BITUMINOUS CONTROL UNIT

- The metering device shall be designed and constructed to measure automatically the required amount of liquid asphalt into each batch within a tolerance of 0.4%.
- The meter shall have a capacity of at least 10% in excess of the volume of bitumen used in any batch.
- If an automatic volumetric meter is used, it shall be constructed so that any dial setting may be locked and will automatically reset after the addition of bitumen into each batch.

4.1.10. THERMOMETRIC EQUIPMENT

- An armoured thermometer reading from 100 °C to 200 °C shall be fixed in the bituminous feed line at a suitable location near the discharge valve at the mixer unit.

- The plant shall be further equipped with either an approved dial scale mercury-actuated thermometer, and an electric pyrometer, or other approved thermometric instrument at the discharge chute of the drier so as to register automatically or indicate the temperature of the heated aggregates.
- A thermocouple or resistance bulb shall be mounted near the bottom of the bin to measure the temperature of the fine aggregates before entering the mixer. The thermocouple used for discharge and for the fine aggregate bin shall be wired to a temperature recording apparatus. Charts showing time and temperature from the temperature recording device shall be provided to the Engineer daily.
- Unless approved by the Engineer, automatic temperature controls for the plant's drier burner shall be used.
- Replacement of any thermometer by an approved temperature recording apparatus may be required by the Engineer, and he may further require that the daily temperature charts be filed under his direct supervision.

4.1.11. DUST COLLECTOR

The plant shall be equipped with a dust collector constructed to waste or return uniformly to the elevator, all or any part of the material collected, as directed by the Engineer.

4.1.12. CONTROL OF MIXING TIME

- General
 - The asphalt plant shall be equipped with electronic weighing systems capable of automatically printing a delivery ticket, which include the following:
 - * Automatic batch plant with print-out; and
 - * Electronic weighing system on the truck scales.
 - The printed delivery ticket shall contain the following information, or as required by the Engineer, as a minimum:
 - * Sequential load number,
 - * Date and time,
 - * Name or location of plant,
 - * Type of mix,
 - * Truck number,
 - * Gross, tare, net weight or batch weight (as applicable),
 - * Accumulated total of mix (for that day, the year to date or total for job, as directed by the Engineer),
 - * Temperature of mix (may be hand recorded) at plant and site,
 - * Pavement layer where applied,
 - * Places for location (chainage or station) of where mix was placed, and
 - * Spaces for signatures (as directed by the Engineer).
 - The ticket shall be printed in one (1) original and at least 2 (two) copies, one of which shall be submitted to the Engineer.
- Automatic Printer System for Batching Plant

- The batching plant's automatic printer system shall print the individual weight of aggregate and bitumen delivered to the pug mill and the total weight of batches contained in a truckload.
- The automatic printer system shall be used only in conjunction with automatic batching and mixing control systems, which have been approved by the Engineer.
- In the event of a printer or other equipment failure, hot mix shall not be shipped unless the Engineer provides approval in writing, but in no case shall this continue for more than 12 hours.
- Truck Scales Weighing Station
 - The weighing station shall have minimum dimensions of 2 m in width, 3 m in length and 2.5 m in height. The structure shall be completely enclosed, weatherproof and equipped with air conditioner/heater. It shall be provided with sufficient number of windows as directed by the Engineer.

4.1.13. ACCESSIBILITY AND SAFETY REQUIREMENTS

- Accessibility to the top of truck bodies shall be provided by means of a platform built to the length and height of the truck's dump body, to enable the Engineer to obtain sampling and mixture temperature data.
- To facilitate handling scale calibration equipment, sampling equipment, etc., a hoist or pulley system shall be provided to raise or lower the equipment from the ground to the platform, or vice versa.
- All gears, pulleys, chains, sprockets, and other dangerous moving parts shall be thoroughly guarded and protected.
- Ample and unobstructed passage shall be maintained at all times in and around the truck loading space. This space shall be kept free from drippings from the mixing platform.

4.2. HAULING EQUIPMENT

- Trucks for hauling bituminous mixtures shall have tight, clean, and smooth metal beds that have been sprayed with a minimum amount of soapy water, vegetable oil, or lime solution to prevent the mixture from adhering to the beds. Fuel or oil shall not be used for application to such metal beds.
- Any truck causing excessive segregation of material by its spring suspension or other contributing factors, or that shows oil leaks in detrimental amounts, shall, upon direction of the Engineer, be removed from the work until such conditions are corrected.
- Each load shall be covered with a canvas or other suitable material of such size so as to protect the mixture from the weather. The cover shall have no clearance with the mixture.

4.3. SPREADING AND FINISHING EQUIPMENT

- The equipment for spreading and finishing shall be of approved mechanical, self-powered pavers, capable of spreading and finishing the mixture true to the lines, grades, and cross Sections required in the Drawings or as directed by the Engineer.
- The pavers shall be equipped with screed controls, which can be adjusted for manual, semi-automatic, and fully automatic operation, to ensure that a smooth asphalt mat can be placed regardless of irregularities in the surface being paved. The automatic screed control device must be able to sense the required grade from either a taut piano wire guideline or a long (length as required by Engineer) sliding ski.
- Pavers shall be equipped with activated screeds, of either the tamping or vibrating type, and devices for heating the screeds to the temperature required for the laying of the mixture without pulling or marring.

- If, during construction, it is found that the spreading and finishing equipment are not satisfactorily operated, the use of such equipment shall be discontinued, and other satisfactory spreading and finishing equipment shall be provided by the Contractor.

4.4. COMPACTING EQUIPMENT

- The equipment provided by the Contractor for bituminous layer compaction shall be equipped with the following features:
 - One tandem steel wheel roller for breakdown rolling, weighing between 4.5 tons to 11 tons
 - One pneumatic tired roller for secondary rolling with the weight of 5 tons to 11 tons. This roller shall have at least seven (7) smooth tread tires of equal size and diameter.
 - One tandem steel wheel roller for finish rolling, weighing between 7 tons and 11 tons
 - All rollers shall be equipped with a water system which prevents sticking of the asphalt mixture to the pneumatic or steel-tired wheels.
 - All rollers shall be self-propelled.
 - The Contractor may use less compaction equipment or other types, subject to the approval of the Engineer. Such approval shall not relieve the Contractor from achieving the compaction requirements of Subsection 4.10 “Quality Control and Testing” of this Specification Section.
 - Application of the following methods for compaction of the surface course for A/C draining pavement shall be determined based on the results of compaction obtained in the trial Sections:
 - Two or three passes of only tandem steel wheel rollers weighing 6 tons to 10 tons;
 - Two-stage compaction method specified in “The Policy for Draining A/C Surface Courses”, Japan Road Association (JRA). First stage: steel wheel rollers weighing 8 tons to 11 tons; and Second stage: tandem pneumatic tired rollers of 7 tons to 11 tons.

4.5. MANUFACTURE AND PRODUCTION OF THE MIXTURE

4.5.1. ASPHALT MIXTURE TYPES

The type of hot asphalt mixture shall be as indicated in the Drawings or as directed by the Engineer, and shall consist of the following:

Drainage asphalt concrete surface course	Draining asphalt concrete surface course is intended as the top layer of pavement that comes into contact with the traffic. It is placed on a binder course, the surface of which has been overlaid with a tack coat.
Fine aggregate asphalt concrete (surface course)	This layer lies between drainage AC layer and binder AC course. There is a tack coat between surface and binder courses.
Coarse aggregate asphalt concrete (binder course)	The binder course lies directly under the surface course. This layer is placed on the crushed aggregate base course which is sprayed with a prime coat. In case there is no binder course placed after applying prime coat for three (3) days, the Contractor shall spray additional prime coat at his own cost prior to placing the binder at site

4.5.2. REQUIRED MIX PROPERTIES

- The bituminous mixture shall conform to the requirements given in Table 3.

Table 3 Properties of Bituminous Mixture

Properties		Medium Aggregate Mixture	Fine Aggregate Mixture
Percent asphalt cement of total mix by weight (%)	Min.	5.0%	5.5%
	Max.	6.0%	6.5%
Asphalt cement to be absorbed	Max.	1.7%	1.7%
Marshall specimen			
Number of compaction blow on specimen's surface	Min.	75	75
Stability	Min.	8.0 KN	8.0 KN
Flow	Min.	2 mm	2 mm
	Max.	4 mm	4 mm
Air voids	Min	3%	3%
	Max	6%	6%
Retained Marshall Strength (AASHTO-T165)	Min.	75%	75%

- Marshall specimen shall have flow value equal to 70% of its asphalt cement, and shall have a minimum elongation of 40 cm in accordance with AASHTO-T149 and T51.
- Asphalt cement shall be separated from mixture according to AASHTO T-164. Fine fraction shall be separated from centrifugal machine from condensed volume of 200 mm. The separation of fine fraction shall be considered acceptable when dust content (by burning) of total collected asphalt cement by weight is less than 1%. Asphalt cement shall be collected in accordance with AASHTO-T170.

4.6. JOB-MIX FORMULA

- Before starting work, the Contractor shall submit in writing to the Engineer a proposed job-mix formula for the mixture to be supplied under the Contract.
- The formula so submitted shall stipulate the mixture of the aggregate source, a combined grading showing the percentage of each material to be used in the mix, expressed as percentages by weight of the total mix, temperature at which the mixture is to be emptied from the mixer, and definite temperature at which the mixture is to be delivered on the road, all of which shall fall within the specified ranges of the general composition and temperature limits.
- The proposed formula shall be supported by a laboratory trial mix data and graphs. In approving the job mix, the Engineer may request the Contractor to perform additional trial mix tests or to investigate alternative aggregates.
- When approving the job-mix formula, the Engineer will nominate the particular aggregates, and their sources, to which the job-mix formula applies.
- Before its application on the work, the approved job-mix formula shall subsequently be confirmed by testing and procedures described in the approved plan and schedule for job-mix design, including the preparation and testing of "Trial Sections" as specified in this Specification Section.

4.6.1. AGGREGATE COMPONENT PROPORTIONS

Aggregates for hot asphalt mixtures shall conform to Table 4A and Table 4B, unless otherwise instructed by the Engineer.

Table No.4A: Aggregate Proportion for Asphalt

Standard Sieve (std. No.)	Sieve Size (mm)	Percent Passing by Weight			
		Surface Course		Binder Course	
		MIN.	MAX.	MIN.	MAX.
0,25	31.500	-	-	-	-
1	25.000	-	-	100	100
0,75	19.000	100	100	95	100
5/8	16.000	95	100	-	-
0,5	12.500	81	89	76	84
5/16	8.000	65	75	60	70
No. 5	4.000	43	57	43	57
No. 10	2.000	31	44	31	44
No.18	1.000	22	33	22	33
No. 35	0.500	16	24	16	24
No. 50	0.300	12	18	12	18
No. 100	0.160	8	13	8	13
No. 200	0.075	5	10	5	10
Reference asphalt content (calculated by aggregate percentage)		5.0–6.0		5.0–6.0	

Table No.4B Aggregate Proportion for High Roughness Asphalt

Square Mesh Sieve Size	Roughness Asphalt Concrete
25	
19	
12.5	100
9.5	80–100
6.3	35–60
4.75	22–40
2.36	20–36
1.18	12–27
0.6	8–17
0.3	6–13
0.15	
0.075	4–8
Reference asphalt content (calculated by asphalt concrete mixture quantity's percentage)	4.8–6.2

4.6.2. FILLER CONTENT

- Filler (particles passing the sieve No.200) may be added to the nominal mix to meet the criteria contained in this Specification Section or as directed by the Engineer.
- On no account shall the ratio of filler to total bitumen exceed 1.1 for asphalt concrete surface course and 1.4 for asphalt concrete binder course.
- If the mix strength does not meet the specified requirements with a filler/bitumen ratio within these ranges, the strength is to be altered by using different aggregates.

4.6.3. BITUMEN CONTENT OF THE MIX

- The laboratory trial mixes shall be prepared according to the Marshall Mix Design procedures.
- For each mix variant to be tried, at least three samples shall be prepared and tested using the Marshall testing method, and the mix properties of each trial shall be calculated on forms approved by the Engineer.
- For economical reasons, the mix proportions may be optimized, and the bitumen content is minimized within the allowable limits specified in Table 4 of Subsection 4.5.2.
- The percentage of bitumen to be actually added to the mix will depend on the absorption of the used aggregates, and will be fixed by the Engineer using the approved job-mix formula. The value so fixed will be based on the test data supplied by the Contractor in full accordance with this Specification Section.
- The laboratory values of water absorption for the proposed aggregates shall be used to estimate the amount of bitumen to be absorbed by the combined aggregates in the nominal mix. The total bitumen content shall be not less than the minimum value specified in Table 2.
- The estimated bitumen absorption will be assumed at 50% of the measured water absorption. The absorbed bitumen so calculated shall be taken into consideration in establishing the bitumen content for the trial mixes.

4.6.4. APPLICATION OF JOB-MIX

- Formula and Allowable Tolerance:
 - All mixtures furnished shall conform to the job-mix formula approved by the Engineer, within the ranges of tolerances specified below:

Passing aggregate mixture 4,75 mm	+/- 7% according to mixture weight
Passing aggregate mixture 0,15 mm	+/- 2% according to mixture weight
Passing aggregate mixture 0,075 mm	+/- 2% according to mixture weight
Asphalt content tolerance	0.1% according to total mixture quantity
Temperature tolerance of mixture outside the plant	+/- 10 °C
Temperature tolerance of mixture when laying on the road	+/- 10 °C

- Continuous Control:
 - Each daily sample shall be taken for the materials and mixtures as outlined in Subsection 4.10 “Quality Control and Testing” or any further samples, as the Engineer considers necessary for checking the required uniformity of the mixtures.
- Approval on Variations:

- Should a change in a material be encountered or should a change in a source of material be made, a new job-mix formula shall be submitted and approved before the mixture containing the new material is produced and delivered. Job materials will be rejected if they are found to have voids, or other characteristics, requiring greater bitumen content or less than the specified range.

4.6.5. ADJUSTING MIX PROPORTIONS BY TRIAL MIXES

- The Contractor shall demonstrate the suitability of all proposed aggregates and proposed mix component proportions by making and testing trial mixes in the laboratory, and also by testing trial mixes made in the mixing plant immediately prior to laying of the mix.
- The tests required will include grading, specific gravity and water absorption on the aggregates to be used, as well as other aggregate property tests that may be requested by the Engineer.
- Laboratory trial mix testing shall be carried out in accordance with the Marshall Mix Design Method defined by AASHTO or in the Asphalt Institute Manual MS-2.
- Before the laboratory trials are commenced, a nominal mix recipe appropriate to the proposed mix materials shall be estimated on the basis of theoretical mix design considerations. The nominal aggregate blending proportions, bitumen content and added filler content shall be used as the starting point and reference datum for the mix variations investigated in the laboratory trials and, if accurately estimated, shall simplify and improve the accuracy of the trial-and-error testing process required in the laboratory.
- The calculation of the nominal mix-batching recipe from the design mix components shall be recorded as directed by the Engineer.
- Trial mixes shall then be made in the same condition as applied in the mixing plant immediately prior to batching. For weigh batching plants, this means using aggregate samples taken from the plant hot bins.
- Before its application on the work, the final results obtained by performing the trial mix shall further be confirmed by testing and procedures mentioned in the approved plan and schedule for job-mix design, and these Specification Sections.

4.7. TRIAL SECTION

- Following approval of the proposed job-mix formula by the Engineer, the Contractor shall place a trial Section at a location approved by the Engineer.
- The test Section shall have a length of at least 300 m and cover the full width and full depth of the pavement structure, unless otherwise agreed with the Engineer.
- The trial Section shall be tested in detail and in accordance with the approved plan and schedule for job-mix design.
- If the trial Section fails to conform to the specifications in any respect, necessary adjustments shall be made and the trial repeated. Permanent paving work shall not commence until a satisfactory trial has been made and the Engineer has approved the final job-mix formula.
- Testing for acceptance of the trial Sections shall include measurements of the IRI along several Sections in order to determine the representative average index of the entire trial Section.
- Moreover, testing for acceptance of A/C draining surface course shall include testing of permeability of the completed surface course of the trial Section.

4.8. PRODUCTION OF MIXTURE

4.8.1. MINIMUM RATE FOR MIXING PLANT CAPACITY

No mix batching shall be performed when there is insufficient hauling, spreading, or finishing equipment, or labour, to assure progress at a rate of not less than 60% of the capacity of the mixing plant.

4.8.2. PREPARATION OF BITUMEN

- The following temperatures shall be kept as standard:

	60/70 Bitumen	PMB (Polymer Modified Bitumen)
Bulk Storage	120 °C – 130 °C	Specified temperature shall be based on data provided by the polymer asphalt manufacturer and approved by the Engineer
Mixing Temperature	150 °C – 160 °C	
Laying Temperature	130 °C – 140 °C	

Notes: Bitumen shall not be stored over 30 days from manufacturing to paving.

- In general, local overheating shall be avoided and the bitumen shall be continuously provided to the mixer at a uniform temperature at all times.
- Before any mixing operation is made each day, there shall be at least one full day's requirement of heated bitumen ready for supply to the mixer.

4.8.3. PREPARATION OF MINERAL AGGREGATES

- The mineral aggregates for the mixture shall be dried and heated. Burner flames used for drying and heating shall be adjusted properly to avoid injury to the aggregate and to avoid forming of a heavy coating of soot on the aggregate.
- When combined with bitumen, the aggregate shall be dry and at a temperature within the range specified for the bitumen, but not more than 14 °C above the temperature of the bitumen.
- Additional filler, if required to meet the grading requirements, may be proportioned separately from a small hopper mounted directly over the mixer.

4.8.4. PREPARATION OF MIXTURE

- The combined mineral aggregate shall be thoroughly mixed, after which the bitumen shall be measured and placed into the mixer.
- The mixing time of “dry” and “wet” aggregates shall be agreed with the Engineer and regulated by a suitable clocking means.
- The mixture when emptied from the mixer shall be at a temperature within the absolute limits indicated in Table 5, even allowing for tolerances.

Table 5: Specified Limits for Bitumen Asphalt Mix Temperatures

Construction Procedures	Asphalt Mix Temperature (°C)	
	Mixes Using AC-20 Bit. (Approx. equiv. to 60/70 Pen)	Mixes Using PMB. (Approx. range 40 to 70 Pen)
Mixing Marshall Mix Specimen	155	160
Compacting Marshall Mix Specimen	140	150
Maximum Mixing Temperature in AMP	< 165	< 170
Emptying AMP Mixer into Truck	> 135	> 140

Construction Procedures	Asphalt Mix Temperature (°C)	
	Mixes Using AC-20 Bit. (Approx. equiv. to 60/70 Pen)	Mixes Using PMB. (Approx. range 40 to 70 Pen)
Delivery to Paver	150-120	155-130
Breakdown Rolling (Steel Drum)	125-110	135-90
Secondary Rolling (Rubber Tire)	110-95	135-90
Finishing Rolling (Steel Drum)	95-80	100-85

4.8.5. TRANSPORTATION AND DELIVERY TO SITE

- The mixture shall be delivered to the paver at a temperature within the absolute limits indicated in Table 5 of Subsection 4.8.4.
- No load shall be sent out so late in the day so as to prevent completion of the spreading and compaction of the mixture during daylight hours, unless satisfactory illumination is provided and approved by the Engineer.

4.9. PLACING AND COMPACTION OF THE MIXTURE

4.9.1. PREPARATION OF SURFACE TO BE COVERED

- Immediately before placing the bituminous mixture, the surface shall be cleaned of loose or deleterious material by sweeping with a power broom, supplemented by the use of hand broom, if necessary.
- If rain commences during the paving operation, the batching plant shall be shut down until the rain stops at the location of paving. The mixture already loaded into the trucks may be placed, subject to the Engineer's approval, provided that freestanding water is not stagnant in the surface to be paved. All freestanding water shall be cleaned using a broom, or blown off the paving surface using a compressor, prior to placing the bituminous mixture.
- Where the surface to be covered does not meet the requirements of Specification Section 05100 "Prime Coat and Tack Coat", as applicable, it shall be rectified as directed by the Engineer in accordance with respective provisions of both of these Specification Sections, as applicable.

4.9.2. SIDE SCREEDS

I-shaped steel or other approved formwork may be fixed to the required line and level at the edges of the area where the hot asphalt mixture is to be placed.

4.9.3. SPREADING AND FINISHING

- Before the start of paving operations, the screed of the paver shall be heated.
- The paver shall be operated at a speed which does not cause surface cracks, tearing, or any other irregularities in the surface.
- The maximum depth of a single layer of asphalt binder or surface course shall not be greater than 8 cm, unless otherwise approved by the Engineer.

- If any segregation, tearing or gouging of the surface occurs, the paver shall be stopped and shall not be restarted until the cause has been determined and remedied. Patches of rough or segregated material may be corrected by spreading fines and gently raking. Raking however shall be avoided as far as possible. Coarse particles shall not be spread (casting) over the paved surface.
- Care should be taken to prevent the mixture from collecting and cooling at the sides of the hopper or elsewhere on the paver.
- Where the road is to be paved half width at a time, the paving sequence shall be organized in such a way that the length of half width paving remaining at the end of each daywork is minimized.
- The weight of asphalt mixture actually placed shall be monitored by the Contractor using the approved weighing system. In the event that the actual placed weight determined from the approved weighing system is 5% greater or less than the weight calculated from the average volume and density of the material placed, the Engineer will institute a detailed investigation to determine the cause of the discrepancy before approving the placed material for payment.

4.9.4. COMPACTION

- A/C Courses:
 - Immediately after the mixture has been spread and struck off, the surface shall be checked and any inequalities adjusted. The temperature of the loose laid mix shall be monitored and rolling shall be carried out within the temperature limits given in this Specification Section or as directed by the Engineer.
 - Rolling of the mix shall consist of three separate operations as follows, or as directed by the Engineer:

	<u>Time after laying</u>
Initial or breakdown rolling	0 min- 10 min
Secondary or intermediate rolling	10 min- 20 min
Final or finish rolling	20 min- 45 min

- The initial or breakdown rolling and the final or finish rolling shall all be done with steel-wheeled rollers. The secondary or intermediate rolling shall be done with a pneumatic tired roller. The breakdown roller shall operate with the drive roll nearest to the paver.
- The secondary or intermediate rolling shall follow as closely as practical behind the breakdown rolling, and shall be done while the mixture is still at a temperature that will result in maximum compaction.
- Transverse joints shall be rolled first and the initial rolling shall be rolled transversely using boards of the required thickness at the edge of the pavement to provide for off-the-pavement movement of the roller. Where the transverse joint is to be made next to a previously paved lane, the first pass shall be made along the longitudinal joint for a short distance.
- Rolling shall start longitudinally at the joint and then at the outside edge, and shall proceed parallel to the road centreline towards the centre of the pavement, except that on super-elevated curves, rolling shall begin at the low side and progress toward the high side. Successive passes of the roller shall overlap by at least one half of the width of the roller, and passes shall not terminate at points within 1 m of the endpoints of

previous passes. Rolling effort shall be concentrated towards the outside edges of the laid width.

- The speed of the rollers shall not exceed 4 km/hr. for steel wheeled rollers and 15 km/hr. for pneumatic tired rollers. The line of rolling shall not be suddenly changed, and the direction of rolling shall not be suddenly reversed to avoid displacing the mix.
- Rolling shall progress continuously as may be necessary to obtain a uniform compaction while the mixture is in workable condition and until all roller marks and other irregularities are eliminated.
- To prevent adhesion of the mixture to the roller, the wheels shall be kept properly moistened, but excess water shall not be permitted.
- Heavy equipment or rollers shall not be permitted to stand on the finished surface until it has thoroughly cooled or set.
- Dropping or spilling of any petroleum products from the vehicles or equipment employed by the Contractor on any portion of the pavement under construction and after the completion shall be cause for the removal and replacement of the contaminated pavement by the Contractor.
- The surface of the mixture after compaction shall be smooth and true to the established crown and grade within the tolerance specified. Any mixture that becomes loose and broken, mixed with dirt, or which is defective in any way, shall be removed and replaced with fresh hot mixture, which shall be compacted immediately to conform to the surrounding area. Placed mix in any area of 1,000 cm² or more showing an excess or deficiency of asphalt material shall be removed and replaced. All high spots, high joints, depressions, and honeycombs shall be adjusted as directed by the Engineer.
- While the surface is being compacted and finished, the Contractor shall trim the edges neatly in line. Any excess material shall be cut off square after final rolling, and disposed of by the Contractor off the right-of-way and out of sight from the road.
- Monitoring of compaction shall be complemented by nuclear density gauges (provided by the Contractor), calibrated to the control strip core density test results. The compaction degree shall be not less than 97% of the density of laboratory compacted specimens composed of the same materials in same proportions.
- 150 mm diameter core samples shall be taken from the compacted pavement in accordance with AASHTO T230, Method B. Core holes shall be filled with asphalt concrete and duly compacted immediately after core extraction is completed. Testing of the cores for monitoring the specific gravity and thickness shall be regularly performed and registered in the daily book.

4.9.5. JOINTS

- Both longitudinal and lateral joints in successive courses shall be staggered so as not to be one above the other.
- Longitudinal joints shall be arranged so that the longitudinal joints on the top courses shall be at the location of the line dividing the traffic lanes.
- Lateral joints shall be staggered at a minimum of 25 cm and shall be straight.
- No mixture shall be placed against previously rolled material unless the edge is vertical or has been cut back to a vertical face. A brush coat of the asphalt used for contact surfaces shall be applied just before additional mixture is placed against the previously rolled material.

4.9.6. A/C SURFACE COURSE FOR BRIDGES

The A/C surface course for bridges shall be placed in one or two layers based on the finishing conditions of the concrete slab and subject to approval of the Engineer.

4.10. QUALITY CONTROL AND TESTING

4.10.1. MIXTURE SAMPLING AND QUALITY CONTROL

Samples of the following shall be taken at the mixing plant for daily testing under the supervision of the Engineer. The Contractor shall keep daily records of all the tests, and these records shall be sent to the Engineer the following day:

Samples from		Frequency / Lot Size
Each cold bin	with the combined belt mix	twice a day
Hot bin aggregates	Grading by wash method	
Combined aggregate		
Loose bituminous mixture	Temperature	once per hour
	Extraction of bitumen (AASHTO T164)	every 500 tons
	Grading	
Compacted sample at Plant laboratory	Marshall Stability	
	Density	
Mixture from the mixer	Temperature	once per hour/truck

Note: Bitumen contents percentage is one of the most important and sensible factors of unit price of asphalt mixtures. Samples from the plant before the compaction shall be used for the measurement of the bitumen contents, not by core samples from site. For the confirmation of accuracy of extraction test, the Contractor shall demonstrate the calibration of the loss of fine particles through the filter paper etc., from time to time. The marshal stability test shall be conducted by using the samples taken from the plant and compacted at the laboratory, not by core samples from the site.

4.10.2. SURFACE TEST OF THE PAVEMENT

- During and after final rolling, the smoothness of the course shall be checked, and any irregularity of the surface exceeding the limits and any area defective in texture, compaction or composition shall be corrected.
- Within 14 days after completion of paving work for the surface course, the roughness of the surface shall be measured. For this purpose, the Contractor shall provide a full set of portable rough meter similar or equivalent to a Multi-purpose Profiling System (including all the necessary devices, hardware, and software) for calculation of the IRI (AASHTO PP37 or ASTM E950).
- Permeability of the draining A/C surface course shall be verified.

4.10.3. CORE SAMPLING OF THE PAVEMENT AT THE SITE

- The Contractor shall take core samples at the Site after the compaction of A/C. The spacing and location of the cores at any Section shall be as directed by the Engineer, and in accordance with requirements noted under Subsection 2.4.2 “Acceptance Sampling and Testing” of this Specification Section. The method of sampling the mixture shall be in accordance with AASHTO T168.
- The cost of any additional or more frequent coring, additional geometric surveys or laboratory testing, instituting tally systems, or any other measures which the Engineer may deem necessary to ascertain the reason for the volume tolerances being exceeded, shall be borne by the Contractor at his own expense.

4.11. ASPHALT CONCRETE TOLERANCES FOR ACCEPTANCE

Acceptance of surface course and binder course shall be based on the total evaluation results of the items shown in Table 6, which shall be certified through quality control and acceptance test process.

Lot size shall be proposed by the Contractor's QC Plan.

Table 6: Tolerances of Items to be applied to Decide Payment Factors

	Binder Course	Normal Surface	Drainage Surface
Centre-side location	± 10 mm	± 5 mm	
Surface levels	± 5 mm	± 5 mm	
Width	± 20 mm	± 10 mm	
Thickness by site core sample	± 8 mm	± 5 mm	± 5 mm
Density by site core samples** (AASHTO T166)	Min. 96%	Min. 97%	Min. 95%
Density by plant samples**	100%±4%	100%±3%	100%±5%
Marshal stability by plant sample**	100%± 8%		
Bitumen contents by plant sample **	± 0.3%	± 0.3%	± 0.3%
Surface irregularity by 3 m straight edge	± 5 mm	± 3 mm	
IRI values (m/km)		Max. 2.00	
Permeability (cm/sec)			Min. 0.01

Note ** means the basic value shall be taken from the proposal of the Contractor through trial mixing subject to the inspection and approval of the Engineer.

4.11.1. RECTIFICATION OF UNSATISFACTORY ASPHALT MIXTURES

- Areas with unsatisfactory defect will not be paid for until rectified by the Contractor, as directed by the Engineer. Rectification may include removal and replacement, adding of a supplementary layer of asphalt mixture and/or any other measure, which the Engineer deems necessary. No additional payment will be made for the extra work or quantities necessitated by the rectification.
- All test holes made by the taking of pavement cores or otherwise shall be filled with asphalt mixture material by the Contractor's cost without delay, and compacted to the density and surface tolerance requirements specified in this Specification Section.

5. Measurement and Payment

5.1. METHOD OF MEASUREMENT

- A/C course areas shall be measured for payment in square meters (m²) of the shop drawing against the compacted asphalt mix required, complete in place and accepted by the Engineer.
- The width of asphalt mixture areas to be used for quantity checking shall be taken as the roadway width actually placed (as determined by tape survey carried out by the Contractor under the supervision of the Engineer). The tape survey measurements shall be taken at right angles to the road centreline, and shall exclude any thin or otherwise unsatisfactory material along the edges of the laid asphalt mixture. The longitudinal spacing of the measurements shall be regularly one every 20 m or as directed by the Engineer.
- The longitudinal length of asphalt mixture to be used for quantity checking shall be the length measured along the road centreline, using standard engineering surveying procedures, and excluding any Sections containing unsatisfactory material.

5.2. BASIS OF PAYMENT

- Payment shall be for full compensation for the work prescribed in this Section including furnishing, producing, mixing and placing all materials, testing and trial Sections, and for furnishing all labour, materials, tests, tools, equipment and any incidentals to complete the work as shown in the Drawings and as required by these Specification Sections, and/or as directed by the Engineer.
- Payment of waterproofing membrane for steel deck shall include bonding coat described in Article 3.4 of Section 05300, waterproofing membrane described in Article 3.5 of Section 05300 and surface preparation described in Article 3.6 of Section 05300 as specified and shall be for full compensation for furnishing, producing, mixing and placing all materials, testing and trial Sections, and for furnishing all labour, materials, tests, tools, equipment and any incidentals to complete the work as shown in the Drawings and as required by these Specification Sections, and/or as directed by the Engine

The Pay Items and Pay Unites shall be as follows;

Pay Item	Descriptions	Units
05300-01	Asphalt Concrete Surface Course (t=4cm)	m ²
05300-02	Asphalt Concrete Surface Course (t=5cm)	m ²
05300-03	Asphalt Concrete Binder Course (t=4cm)	m ²
05300-04	Asphalt Concrete Binder Course (t=5cm)	m ²
05300-05	A/C Surface Course for Bridge using PMB Type II (t=4cm)	m ²
05300-06	A/C Binder Course for Bridge using PMB Type III (t=4cm)	m ²
05300-07	Waterproofing Membrane for Steel Deck	m ²

Section 05700 - Cement Concrete Pavement

1. Description

This Specification Section describes the requirements and procedures for the placement of pavement composed of Portland cement concrete, constructed on a prepared base surface in conformance with the lines, grades, thickness, and typical cross Sections shown in the Drawings.

2. Material Requirements

2.1. Reference Standards

The following standards in their latest editions shall be particularly applied to the works covered by this Specification:

- | | |
|--------------------------|--|
| • AASHTO M254 | Corrosion Resistant Coated Dowel Bars |
| • ASTM E950 | Standard Test Method for Measuring the Longitudinal Profile of Travelled Surfaces with an Accelerometer Established Inertial Profiling Reference |
| • ASTM C31 (/C31M-03a) | Standard Practice for Making and Curing Concrete Test Specimens in the Field |
| • ASTM C78 | Flexural Strength of Concrete (Using Simple Beam with Third-Point Loading) |
| • ASTM C94 (/C94M-05) | Standard Specification for Ready-Mixed Concrete |
| • ASTM-C143 (/C143M-05a) | Standard Test Method for Slump of Hydraulic Cement Concrete |
| • ASTM-C172-04 | Standard Practice for Sampling Freshly Mixed Concrete |
| • ASTM-C174 (/C174M-06) | Standard Test Method for Measuring Thickness of Concrete Elements Using Drilled Concrete Cores |
| • ASTM C494 (/C494M-05a) | Standard Specification for Chemical Admixtures for Concrete |
| • ASTM C881 (/C881M-02) | Standard Specification for Epoxy-Resin-Base Bonding Systems for Concrete |
| • ASTM C1077-06 | Standard Practice for Laboratories Testing Concrete and Concrete Aggregates for Use in Construction and Criteria for Laboratory Evaluation |
| • ASTM D994-98 (2003) | Preformed Expansion Joint Filler for Concrete (Bituminous Type) |
| • ASTM D3665-06 | Standard Practice for Random Sampling of Construction Materials |
| • ASTM D6690-06 | Joint and Crack Sealants, Hot Applied, for Concrete and Asphalt Pavements |

2.2. Water

Water shall be in accordance with requirements of Specification Section 06100 Concrete and Concrete Structures.

2.3. Aggregates

Aggregates shall be in accordance with requirements for Type P Class concrete under Specification Section 06100 "Structural Concrete".

2.4. Cement

Cement shall be in accordance with requirements of Specification Section 06100 "Structural Concrete".

2.5. Pre-moulded Joint Filler

- (a) Pre-moulded joint filler for expansion joints shall thickness Joint filler must be compatible with joint sealant and shall be punched to admit dowels.
- (b) The filler for each joint shall be furnished in a single piece for the full depth and width required for the joint. When the use of more than one piece is required for a joint, the abutting ends shall be fastened securely and held accurately to shape by stapling or other positive fastening means.

2.6. Joint Sealer

- Joint sealer shall be in accordance with ASTM D6690-06 - Joint and Crack Sealants, Hot Applied, for Concrete and Asphalt Pavements.
- Each lot or batch of sealing compound shall be delivered to the job Site in the manufacturer's original sealed container. Each container shall be marked with the manufacturer's name, batch or lot number, and the safe heating temperature, and shall be accompanied by the manufacturer's certification stating that the compound meets the requirements of this Specification Section.

2.7. Steel Reinforcement

Steel reinforcement shall be placed as shown in the Drawings, in accordance with Specification Section 06200 - Reinforcement Bar

2.8. Welded Steel Wire Fabric

Welded steel wire fabric shall be as shown in the Drawings and in accordance with Specification Section 06200 - Reinforcement Bar. Wire fabric for concrete pavement works shall be furnished in flat sheets only.

2.9. Dowels

- Dowels shall be as shown in the Drawings and in accordance with Specification Section 06200 - Reinforcement Bar. Dowel bars shall be plain and shall be free from burring or other deformation restricting slippage in the concrete. Before delivery to the construction site, each dowel bar shall be painted on all surfaces with one coat of rust preventive paint approved by the Engineer. If plastic or epoxy coated steel dowels are used, no paint coating is required, except when specified for a particular situation in the Drawings. Coated dowels shall conform to the requirements of AASHTO-M254.
- Where called for in the Drawings, painted or coated dowels shall be lubricated. The sleeves (expansion cap) for dowel bars used in expansion joints shall be metal or other type of an approved design to cover 50 mm to 75 mm of the dowel. Sleeves shall be of such design that they will not collapse during construction.

2.10. Curing

Materials used for curing shall conform to the requirements for materials of Specification Section 06100 "Structural Concrete" and Subsection 3.12 "Curing" described herein.

2.11. Admixtures

Admixtures shall conform to the requirements of Specification Section 06100 "Structural Concrete"

2.12. Epoxy-Resin

Epoxy-resin used for anchor dowels and tie bars in pavements shall conform to the requirements of ASTM C881, Type I, Grade 3, Class C.

2.13. Material Acceptance

Prior to the use of materials, the Contractor shall submit certified test reports to the Engineer for those materials proposed for use during construction. The certification shall show the appropriate ASTM test(s) for each material, the test results, and a statement that the material passed or failed. The Engineer may request samples for testing, prior to and during production, to verify the quality of the materials and to ensure conformity with specifications.

2.14. Concrete Mixes

- Concrete shall be of Class-P in accordance with requirements of Specification Section 06100 "Structural Concrete".
- Prior to the start of paving operations and after approval of all materials to be used in the concrete, the Contractor shall submit a mix design to the Engineer, for review and approval, showing the proportions and flexural strength of concrete tested at seven (7) days and twenty-eight (28) days.
- The mix design shall include copies of test reports, including test dates, and a complete list of materials including type, brand, source, and amount of cement, coarse aggregate, fine aggregate, water, and admixtures. The fineness modulus of the fine aggregate shall also be shown. Copies of the mix design shall be submitted to the Engineer at least thirty (30) days prior to the start of operations.
- Production shall not begin until the Engineer approves the mix design in writing.
- Should a change in sources be made, or admixtures added or deleted from the mix, copies of a new mix design must be submitted to the Engineer for consent.
- Flexural strength test specimens shall be prepared in accordance with ASTM-C31 and tested in accordance with ASTM-C78. The mix determined shall be for a workable concrete having a slump for side-form concrete between 25 mm and 50 mm as determined by ASTM C143. For vibrated slipform concrete, the slump shall be between 13 mm and 38 mm.
- Admixtures: Water-reducing, set-controlling, and other approved admixtures can be added to the mix in the manner recommended by the manufacturer and in the amount necessary to comply with the Specification requirements. Tests shall be conducted on trial mixes, with the materials to be used in the work, in accordance with ASTM C494.
- Testing Laboratory: The laboratory used to develop the mix design shall meet the requirements of ASTM C1077.

3. Construction requirements

3.1. Equipment

- Batching Plant and Equipment: The batching plant and equipment shall conform to the requirements of ASTM C94. If slip-form paving methods are used, a central plant mixer shall be used.
- The Contractor shall furnish all equipment and tools necessary for handling materials and performing all parts of the work.
- Mixers and Transportation Equipment:
 - General
 - Concrete may be mixed at a central plant, or wholly or in part in truck mixers. Each mixer shall be attached, in a prominent place, with a manufacturer's nameplate showing the capacity of the drum in terms of volume of mixed concrete and the speed of rotation of the mixing drum or blades.
 - Central Plant Mixer

- Central plant mixers shall conform to the requirements of ASTM C94. The mixer shall be examined daily for changes in condition due to accumulation of hard concrete or mortar or wear of blades. The pickup and throw over blades shall be replaced when they have worn down 19 mm or more. The Contractor shall have a copy of the manufacturer's design on hand showing dimensions and arrangement of blades in reference to original height and depth.
- Truck Mixers and Truck Agitators
 - Truck mixers used for mixing and hauling concrete and truck agitators used for hauling central mixed concrete shall conform to the requirements of ASTM C94.
- Non-agitating Trucks
 - Non-agitating hauling equipment shall conform to the requirements of ASTM C94.

3.1.2. FINISHING EQUIPMENT

The finishing equipment shall be of sufficient weight and power for proper finishing of the concrete. The finishing machine shall be designed and operated to strike off, screed and consolidate the concrete such that laitance on the surface is less than 3 mm thick.

3.1.3. VIBRATORS

- Vibrator shall be of either internal type with immersed tube or multiple spuds, or surface type vibrating pan or screed. For pavement thickness of 20 cm or more, thick internal vibrators shall be used. These may be attached to the spreader or the finishing machine, or may be mounted on a separate carriage. Operating frequency for internal vibrators shall be between 8,000 and 12,000 vibrations per minute. Average amplitude for internal vibrators shall be 0.06 cm- 0.13 cm.
- For pavements less than 20 cm thick, vibrating surface pans or screeds will be allowed. Operating frequencies for surface vibrators shall be between 3,000 and 6,000 vibrations per minute. The number, spacing, and frequency shall be as necessary to provide a dense and homogeneous pavement. Adequate power to operate all vibrators shall be available on the paver. The vibrators shall be automatically controlled so that they shall be stopped as forward motion ceases. Hand held vibrators may be used in irregular areas.

3.1.4. CONCRETE SAWS

- The Contractor shall provide sawing equipment adequate in number of units and power to complete the sawing to the required dimensions.
- The Contractor shall provide at least one standby saw in good working order and a supply of saw blades at the Site of the work at all times during sawing operations

3.1.5. SIDE FORMS

- Straight side forms shall be made of steel and shall be furnished in Sections not less than 3 m in length. Forms shall have a depth equal to the pavement thickness at the edge. Flexible or curved forms of proper radius shall be used for curves of 31 meters radius or less. Forms shall be provided with adequate devices to secure settings so that when in place, they will withstand, without visible spring or settlement, the impact and vibration of the consolidating and finishing equipment.
- Forms with battered top surfaces and bent, twisted or broken forms shall not be used. Built-up forms shall not be used. The top face of the form shall not vary from a true plane more than 3 mm in 3 meters, and the upstanding leg shall not vary more than 6 mm. The forms shall contain provisions for locking the ends of abutting Sections together tightly for secure setting.

3.1.6. PAVERS

Pavers shall be fully energized, self-propelled, and designed for the specific purpose of placing, consolidating, and finishing the concrete pavement, true to grade, tolerances, and cross Section.

They shall be of sufficient weight and power to construct the maximum specified concrete paving lane width as shown in the Drawings, at an adequate forward speed, without transverse, longitudinal or vertical instability or without displacement. Pavers shall be equipped with electronic or hydraulic horizontal and vertical control devices.

3.2. Preparation of Base surface

- After the base surface has been placed and compacted to the required density, the areas shall be trimmed or graded to the plan grade elevation and profile by means of a properly designed machine. The grade of the base surface shall be controlled by a positive grade control system using lasers, string lines, or guide wires.
- If the density of the base surface is disturbed by the trimming operations, it shall be corrected by additional compaction and retested at the option of the Engineer before the concrete is placed. If traffic is allowed to use the prepared grade, the grade shall be checked and corrected immediately before the placement of concrete.
- The prepared grade shall be moistened with water, without saturating, immediately ahead of concrete placement to prevent rapid loss of moisture from concrete.
- Damage caused by hauling or usage of other equipment shall be corrected and retested. If damage occurs to the base and or subbase, the Contractor shall correct it to the full depth.
- A template shall be provided and operated on the forms immediately in advance of the placing of all concrete. The template shall be propelled only by hand and not attached to a tractor or other power unit. All excess materials shall be removed and wasted. Low areas shall be filled and compacted to a condition similar to that of the surrounding grade.
- The template shall be maintained in an accurate adjustment, at all times by the Contractor, and shall be checked daily.

3.3. Form Setting

- Forms shall be set sufficiently in advance of the concrete placement to ensure continuous paving operation. Before setting forms, the base surface shall be thoroughly tamped, either mechanically or by hand, at both the inside and outside of the forms. After the forms have been set to the correct grade, forms shall be staked into place sufficiently to maintain the form in position for the method of placement. Form Sections shall be tightly locked and shall be free from play or movement in any direction.
- The forms shall not deviate from true line by more than 3 mm at any joint. Forms shall be so set that they will withstand, without visible spring or settlement, the impact and vibration of the consolidating and finishing equipment. Forms shall be cleaned and oiled prior to the placing of concrete. The alignment and grade elevations of the forms shall be checked and corrections made by the Contractor, immediately before placing the concrete.

3.4. Handling, Measuring, and Batching Material

- The batching plant site, layout, equipment, and provisions for transporting material shall assure a continuous supply of material to the work. Stockpiles shall be constructed in such a manner that prevents segregation and intermixing of deleterious materials.
- Aggregates that have become segregated or mixed with soil or foreign materials shall not be used. All aggregates produced or handled by hydraulic methods, and washed aggregates, shall be stockpiled or binned for draining at least 12 hours before being batched. Rail shipments requiring more than 12 hours will be accepted as adequate binning only if the car bodies permit free drainage.
- Batching plants shall be equipped to proportion aggregates and bulk cement, by weight, automatically using interlocked proportioning devices of an approved type. When bulk cement is used, the Contractor shall use a suitable method of handling the cement from weighing hopper to transporting container, or into the batch itself for transportation to the

mixer, such as a chute, boot, or other device, to prevent loss of cement. The device shall be arranged to provide positive assurance that the cement content specified is present in each batch.

3.5. Mixing Concrete

- Concrete may be mixed at the work site, in a central mix plant or in truck mixers. The mixer shall be of an acceptable type and capacity. Mixing time shall be measured from the time all materials, except water, are emptied into the drum. All concrete shall be mixed and delivered to the site in accordance with the requirements of ASTM C94.
- Mixed concrete from the central mixing plant shall be transported in truck mixers, truck agitators, or non-agitating trucks. The elapsed time from the addition of cement material to the mix until the concrete is deposited in place at the work site, shall not exceed 60 minutes.

3.6. Limitations on Mixing and Placing

When the concrete is hauled in non-agitating trucks, or 90 minutes when the concrete is hauled in truck mixers or truck agitators, re-tempering concrete by adding water or by other means will not be permitted, except when concrete is delivered in transit mixers. With transit mixers, additional water may be added to the batch materials and additional mixing performed to increase the slump to meet the specified requirements, provided that the addition of water is performed within 45 minutes after the initial mixing operations, and provided that the water/cement ratio specified in the mix design is not exceeded.

3.6.1. VISIBILITY

Concrete shall not be mixed, placed, or finished when the natural light is insufficient, unless an adequate artificial lighting system approved by the Engineer is operated.

3.6.2. HOT WEATHER

- During periods of hot weather when the maximum daily air temperature exceeds 30 °C, the following precautions shall be taken:
- The forms and/or the base surface shall be sprinkled with water immediately before placing the concrete. The concrete shall be placed at the coolest temperature practicable, and in no case shall the temperature of the concrete when placed exceed 35°C.
- The aggregates and/or mixing water shall be cooled as necessary to maintain the concrete temperature at or not more than the specified maximum. This can be done by covering the materials with wet burlap or cotton mats, fog spraying with water, covering with protective housing, or by other approved methods. Moreover, during placement, the concrete temperature can be maintained using any combination of the following:
 - Shading the material storage areas or production equipment;
 - Cooling the aggregate by sprinkling; and
 - Cooling the aggregate and water by refrigeration or replacing a portion or all of the mix water with flaked or crushed ice to the extent that the ice completely melts during mixing of the concrete.
- The finished surfaces of the newly laid pavement shall be kept damp by applying a water-fog or mist with approved spraying equipment, until the pavement is covered by the curing medium. If necessary, wind screens shall be provided to protect the concrete from an evaporation rate in excess of 0.2 psf per hour as determined in accordance with Figure 2.1.5 of ACI 305R, Hot Weather Concreting, which takes into consideration relative humidity, wind velocity, and air temperature.
- When conditions are such that problems with plastic cracking can be expected, and particularly if any plastic cracking begins to occur, the Contractor shall immediately take such additional measures as necessary to protect the concrete surface. Such measures

shall consist of windscreens, more effective fog sprays, and similar measures commencing immediately behind the paver. If these measures are not effective in preventing plastic cracking, paving operations shall be immediately stopped.

3.7. Placing Concrete

- The prepared base surface shall be moistened with water, without saturating, immediately ahead of concrete placement to prevent rapid loss of moisture from the concrete.
- The Contractor has the option of placing the concrete with either side (fixed) forms or slipforms. At any point in concrete conveyance, the free vertical drop of the concrete from one point to another or to the base surface shall not exceed 1 m.
- Hauling equipment or other mechanical equipment can be permitted on adjoining previously constructed pavement when the concrete strength reaches a flexural strength of 3800 kPa. Also, subgrade and subbase planers, concrete pavers, and concrete finishing equipment may be permitted to ride upon the edges of previously constructed pavement when the concrete has attained a minimum flexural strength of 2750 kPa.

3.7.1. SIDE-FORM METHOD

- For the side-form method, the concrete shall be deposited on the moistened grade to require as little re-handling as possible. Unless truck mixers, truck agitators, or non-agitating hauling equipment are equipped with means for discharging concrete without segregation of the materials, the concrete shall be placed and spread using an approved mechanical spreading device that prevents segregation of the materials. Placing shall be continuous between transverse joints without the use of intermediate bulkheads. Necessary hand spreading shall be done with shovels, not rakes. Workmen shall not be allowed to walk in the freshly mixed concrete with boots or shoes coated with earth or foreign substances.
- Concrete shall be deposited as near as possible to expansion and contraction joints without disturbing them, but shall not be dumped from the discharge bucket or hopper onto a joint assembly unless the hopper is cantered above the joint assembly.
- Concrete shall be thoroughly consolidated against and along the faces of all forms and previously placed concrete, and along the full length and on both sides of all joint assemblies by means of vibrators inserted in the concrete. Vibrators shall not be permitted to come in contact with a joint assembly, the grade, or a side form. In no case shall the vibrator be operated longer than 20 seconds at any location, nor shall the vibrators be used to move the concrete.

3.7.2. SLIPFORM METHOD

- For the slipform method, the concrete shall be placed with an approved crawler-mounted, slipform paver designed to spread, consolidate and shape the freshly placed concrete in one complete pass of the machine, so that a minimum of hand finishing will be necessary to provide a dense and homogeneous pavement in conformity with requirements of the Drawings and Specifications. The concrete shall be placed directly on top of the joint assemblies to prevent them from moving when the paver moves over them. Side forms and finishing screeds shall be adjustable to the extent required to produce the specified pavement edge and surface tolerance. The side forms shall be of dimensions, shape, and strength to support the concrete laterally for a sufficient length of time so that no edge slumping exceeds the requirements of Subsection 3.16.5(f) hereof. Final finishing shall be accomplished while the concrete is still in the plastic state.
- In the event that slumping or sloughing occurs behind the paver or if there are any other structural or surface defects which cannot be corrected within the permissible tolerances, paving operations shall be immediately stopped until proper adjustment of the equipment or procedures have been made. In the event that satisfactory procedures and pavement are not achieved after 600 lm of single lane paving, the Contractor shall complete the balance of the work with the use of standard metal forms and the formed method of placing and

curing. Any concrete not corrected to permissible tolerances shall be removed and replaced at the Contractor's expense.

3.8. Striking Off Concrete and Placement of Reinforcement

- After being placed, the concrete shall be struck off to conform to the cross Section shown in the Drawings and to an elevation such that when the concrete is properly consolidated and finished, the surface of the pavement shall be at the elevation shown in the Drawings.
- When reinforced concrete pavement is placed in two layers, the bottom layer shall be struck off to such length and depth that the sheet of reinforcing steel fabric or bar mat may be laid in full length on the concrete in its final position without further manipulation. The reinforcement shall then be placed directly on the concrete, after which the top layer of the concrete shall be placed, struck off, and screened.
- If any portion of the bottom layer of concrete has been placed more than 30 minutes without being covered with the top layer, or if initial set has taken place, it shall be removed and replaced with freshly mixed concrete at the Contractor's expense. When reinforced concrete is placed in one layer, the reinforcement may be positioned in advance of concrete placement or it may be placed in plastic concrete by mechanical or vibratory means after spreading.
- Reinforcing steel, at the time concrete is placed, shall be free of mud, oil, or other organic matter that may adversely affect or reduce bond. Reinforcing steel with rust, mill scale or a combination of both will be considered satisfactory, provided that the minimum dimensions, weight, and tensile properties of a hand wire-brushed test specimen are not less than the applicable ASTM specification requirements.

3.9. Joints

- Joints shall be constructed as shown in the Drawings and in accordance with the requirements specified herein. All joints shall be constructed with their faces perpendicular to the surface of the pavement, and finished or edged as shown in the Drawings. Joints shall not vary by more than 13 mm from their designated position and shall be true to line with not more than 6 mm variation in 3 m.
- The surface across the joints shall be tested with a 3-meter straightedge and any irregularities in excess of 6 mm shall be corrected before the concrete has hardened. All joints shall be so prepared, finished, or cut to provide a groove of uniform width and depth as shown in the Drawings.

3.9.1. JOINT CONSTRUCTION

- Longitudinal construction joints shall be slip formed or formed against side forms with or without keys, as shown in the Drawings.
- Transverse construction joints shall be installed at the end of each day's placing operations and at any other points within a paving lane, when concrete placement is interrupted for more than 30 minutes, or it appears that the concrete will obtain its initial set before fresh concrete arrives. The installation of the joint shall be located at a planned contraction or expansion joint. If placing of concrete is stopped, the Contractor shall remove the excess concrete back to the previous planned joint.

3.9.2. CONTRACTION JOINTS

- Contraction joints shall be installed at locations and spacing shown in the Drawings. Contraction joints shall be installed to the dimensions required by forming a groove or cleft in the top of the slab while the concrete is still plastic or by sawing a groove into the concrete surface after the concrete has hardened.
- When the groove is formed in plastic concrete, the sides of the grooves shall be finished evenly and smoothly with an edging tool. If an insert material is used, the installation and edge finish shall be in accordance with the manufacturer's instructions. The groove shall

be finished or cut clean so that spalling will be avoided at intersections with other joints. Grooving or sawing shall produce a slot at least 3 mm wide and to the depth shown in the Drawings.

3.9.3. EXPANSION JOINTS

- Expansion joints shall be installed as shown in the Drawings. The remoulded filler of the thickness as shown in the Drawings, shall extend for the full depth and width of the slab at the joint, except for the space for sealant on top of the slab. The filler shall be securely staked or fastened into position perpendicular to the proposed finished surface.
- A cap shall be provided to protect the top edge of the filler and to permit the concrete to be placed and finished. After the concrete has been placed and struck off, the cap shall be carefully withdrawn leaving the space over the remoulded filler. The edges of the joint shall be finished and tooled while the concrete is still plastic. Any concrete bridging the joint space shall be removed for the full width and depth of the joint.

3.9.4. KEY FOR JOINT

- Key for joints shall be formed in the plastic concrete by means of side forms or the use of key liners, which are inserted during the slipform operations. The key shall be formed to a tolerance of 6 mm in any dimension, and shall be of sufficient stiffness to support the upper key flange without distortion or slumping of the top of the flange.
- The dimensions of the key forms shall not vary by more than plus or minus 6 mm from the mid-depth of the pavement. Liners that remain in place permanently and become part of the keyed joint shall be made of galvanized, copper clad, or of similar rust-resistant material compatible with plastic and hardened concrete, and shall not interfere with joint reservoir sawing and sealing.

3.9.5. TIE BARS

- Tie bars shall consist of deformed bars installed in joints as shown in the Drawings. Tie bars shall be placed at right angles to the centreline of the concrete slab and shall be spaced at intervals shown in the Drawings. They shall be held in position parallel to the pavement surface and in the middle of the slab depth.
- When tie bars extend into an unpaved lane, they may be bent against the form at longitudinal construction joints, unless threaded bolt or other assembled tie bars are specified. These bars shall not be painted, greased, or enclosed in sleeves.
- When slipform operations call for tie bars, two-piece hook bolts can be installed in the female side of the keyed joint provided that the installation is made without distorting the keyed dimensions or causing edge slump. If a bent tie bar installation is used, the tie bars shall be inserted through the key liner only on the female side of the joint. In no case shall a bent tie bar installation for male keys be permitted.

3.9.6. DOWEL BARS

- Dowel bars or other load-transfer units of a specified type shall be placed across joints in the manner as shown in the Drawings. They shall be of the dimensions and spacing as shown and held rigidly in the middle of the slab depth in the proper horizontal and vertical alignments by an approved assembly device to be left permanently in place.
- The dowel or load-transfer and joint devices shall be rigid enough to permit complete assembly as a unit ready to be lifted and placed into position. A metal dowel expansion cap or sleeve shall be furnished for each dowel bar used with expansion joints.
- These caps shall be substantial enough to prevent collapse and shall be placed on the ends of the dowels as shown in the Drawings. The caps or sleeves shall fit the dowel bar tightly, and the closed end shall be watertight.

- Dowel bars shall be painted with rust preventative paint. The expansion caps at half of the bar shall be thoroughly coated to prevent the concrete from bonding to that portion of the dowel.

3.9.7. INSTALLATION OF JOINTS

All devices used for the installation of expansion joints shall be as specified below:

- The top of an assembled joint device shall be set at the proper distance below the pavement surface and the elevation shall be checked. Such devices shall be set to the required position and line, and shall be securely held in place by stakes or other means to the maximum permissible tolerances during the pouring and finishing of the concrete. The remoulded joint material shall be placed and held in a vertical position; if constructed in Sections, there shall be no offsets between adjacent units.
- Dowel bars and assemblies shall be checked for position and alignment. During the concrete placement operation, it is advisable to place plastic concrete directly on dowel assemblies immediately prior to the passage of the paver, to help maintain dowel position and alignment within maximum permissible tolerances.
- When concrete is placed using slip-form pavers, dowels and tie bars shall be placed in longitudinal construction joints by bonding the dowels or tie bars into holes drilled into the hardened concrete. Holes approximately 3 mm to 6 mm greater in diameter than the dowel or tie bar shall be drilled with rotary-type core drills that must be held securely in place to drill perpendicularly into the vertical face of the pavement slab. Rotary-type percussion drills may be used provided that spalling of concrete does not occur. The Contractor shall repair any damage caused to the concrete. Dowels or tie bars shall be bonded in the drilled holes using an epoxy resin material. Installation procedures shall be adequate to insure that the area around dowels is completely filled with epoxy grout. Epoxy shall be injected into the back of the hole and displaced by the insertion of the dowel bar. Bars shall be completely inserted into the hole and shall not be withdrawn and reinserted creating air pockets in the epoxy around the bar.
- The Contractor shall furnish a template for checking the position and alignment of the dowels. Dowel bars shall not be less than 10 inches (25 cm) from a transverse joint, and shall not interfere with dowels in the transverse direction.

3.9.8. SAWING OF JOINTS

- Joints shall be cut as shown in the Drawings. Equipment shall be as described in Subsection 3.1. The circular cutter shall be capable of cutting a groove in a straight line and shall produce a slot of at least 3 mm wide and to the depth shown in the Drawings.
- The top portion of the slot shall be widened by sawing to provide adequate space for joint sealers. Sawing shall commence as soon as the concrete has hardened sufficiently to permit cutting without chipping, spalling, or tearing, and before uncontrolled shrinkage cracking of the pavement occurs. Sawing shall be carried out both during the day and night as required.
- The joints shall be sawed at the required spacing, consecutively in sequence of the concrete placement.

3.10. Final Strike-Off, Consolidation, and Finishing

3.10.1. SEQUENCE

The sequence of operations shall be the strike-off, floating and removal of latency, straight edging, and final surface finish. The addition of superficial water to the surface of the concrete to assist in finishing operations will not be permitted.

3.10.2. FINISHING AT JOINTS

- The concrete adjacent to joints shall be compacted or firmly placed without voids or segregation against the joint material; it shall be firmly placed without voids or

segregation under and around all load-transfer devices, joint assembly units, and other features designed to extend into the pavement. Concrete adjacent to joints shall be mechanically vibrated.

- After the concrete has been placed and vibrated adjacent to the joints, the finishing machine shall be operated in a manner that will avoid damage or misalignment of joints. If uninterrupted operations of the finishing machine to, over, and beyond the joints, cause segregation of concrete, damage to, or misalignment of the joints, the finishing machine shall be stopped when the screed is approximately 20 cm from the joint. Segregated concrete shall be removed from the front of and off the joint; and the forward motion of the finishing machine shall be resumed. Thereafter, the finishing machine may be run over the joint without lifting the screed, provided that there is no segregated concrete immediately between the joint and the screed, or on top of the joint.

3.10.3. MACHINE FINISHING

- The concrete shall be spread as soon as it is placed, and it shall be struck off and screened by a finishing machine. The machine shall go over each area as many times as necessary, and at such intervals as necessary to give proper consolidation and to leave a surface of uniform texture.
- Excessive operation over a given area shall be avoided. When side forms are used, the tops of the forms shall be kept clean using an effective device attached to the machine, and the travel of the machine on the forms shall be maintained true without lift, wobbling, or other variation tending to affect the precision finish.
- During the first pass of the finishing machine, a uniform ridge of concrete shall be maintained ahead of the front screed for its entire length. When in operation, the screed shall be moved forward with a combined longitudinal and transverse shearing motion, always moving in the direction in which the work is progressing, and so manipulated that neither end is raised from the side forms during the striking-off process. If necessary, this shall be repeated until the surface is of uniform texture, true to grade and cross Section, and free from porous areas.

3.10.4. HAND FINISHING

Hand finishing methods will not be permitted, except under the following conditions:

- In the event of breakdown of the mechanical equipment, hand methods may be used to finish the concrete already deposited on the grade;
- In areas of narrow widths or of irregular dimensions where operation of the mechanical equipment is impractical; and
- Concrete, as soon as placed shall be struck off and screened. An approved portable screed shall be used. A second screed shall be provided for striking off the bottom layer of concrete when reinforcement is used. The screed for the surface shall be at least 0.6 meters longer than the maximum width of the slab to be struck off. It shall be of approved design, sufficiently rigid to retain its shape, and shall be constructed either of metal or of other suitable material covered with metal. Consolidation shall be attained by the use of suitable vibrators.

3.10.5. FLOATING

After the concrete has been struck off and consolidated, it shall be further smoothed and trued by means of a longitudinal float using one of the following methods:

- Hand Method
 - Long-handled floats shall not be less than 3.6 meters in length and 15 cm in width, stiffened to prevent flexibility and warping. The float shall be operated from footbridges spanning but not touching the concrete or from the edge of the pavement. Floating shall pass gradually from one side of the pavement to the other. Forward movement along

the centreline of the pavement shall be in successive advances of not more than one-half the length of the float. Any excess water or latency in excess of 3 mm thick shall be removed and wasted.

- Mechanical Method
 - The Contractor may use a machine composed of a cutting and smoothing float(s), suspended from and guided by a rigid frame and constantly in contact with the side forms or base surface. If necessary, long-handled floats having blades of not less than 1.5 meters in length and 15 cm in width may be used to smooth and fill in open-textured areas in the pavement. When the crown of the pavement does not permit the use of the mechanical float, the surface shall be floated transversely by means of a long-handled float. Care shall be taken not to work the crown out of the pavement during the operation. After floating, any excess water and latency in excess of 3 mm thick shall be removed and wasted. Successive drags shall be lapped one-half the length of the blade.

3.10.6. STRAIGHT-EDGE TESTING AND SURFACE CORRECTION

- After the pavement has been struck off and while the concrete is still plastic, it shall be tested for trueness with a 3-meter straightedge.
- The straightedge shall be held in contact with the surface in successive positions parallel to the centreline and the whole area gone over from one side of the slab to the other, as necessary.
- Any depressions shall be immediately filled with freshly mixed concrete, struck off, consolidated, and refinished. High areas shall be cut down and refinished. Special attention shall be given to assure that the surface across joints meets the smoothness requirements of Subsection 3.16.5
- Straightedge testing and surface corrections shall continue until the entire surface is found to be free from observable departures from the straightedge, and until the slab conforms to the required grade and cross Section.
- Where the departure from correct cross Section exceeds 13 mm, the pavement shall be removed and replaced at the expense of the Contractor when so directed by the Engineer.

3.11. Surface Texture

- The surface of the pavement shall be finished with either a brush or broom finish applied when the water sheen has practically disappeared.
- The equipment shall operate transversely across the pavement surface, providing corrugations that are uniform in appearance and approximately 2 mm in depth.
- It is important that the texturing equipment does not tear or unduly roughen the pavement surface during the operation. Any imperfections resulting from the texturing operation shall be corrected.

3.12. Curing

- The construction requirements for curing shall conform to the requirements of Specification Section 06100 "Structural Concrete" and this subsection.
- Immediately after finishing operations are completed and marring of the concrete does not occur, the entire area of the newly placed concrete shall be cured in accordance with the methods described below. Failure to provide sufficient cover material of whatever kind the Contractor may elect to use, or lack of water to adequately take care of both curing and other requirements, shall be cause for immediate suspension of concreting operations. The concrete shall not be left exposed for more than an hour during the curing period.
- The Contractor shall utilize one of the following types of curing methods:

3.12.1. IMPERVIOUS MEMBRANE METHOD

- The entire surface of the pavement shall be sprayed uniformly with white pigmented curing compound immediately after the finishing of the surface and before the concrete has set.
- The curing compound shall not be applied during rainfall. Curing compound shall be applied using mechanical sprayers under pressure at the rate of 4 litres to not more than 14 m². The spraying equipment shall be of the fully atomizing type equipped with a tank agitator. At the time of use, the compound shall be in a thoroughly mixed condition with the pigment uniformly dispersed throughout.
- During application, the compound shall be stirred continuously by mechanical means. Hand spraying of odd widths or shapes and concrete surfaces exposed by the removal of forms will be permitted.
- The curing compound shall be of such character that the film will harden within 30 minutes after application. Should the film become damaged from any cause, including sawing operations, within the required curing period, the damaged portions shall be repaired immediately with additional compound or by other approved means.
- Upon removal of side forms, the sides of the exposed slabs shall be protected immediately to provide a curing treatment equal to that provided for the surface.

3.12.2. WATER METHOD

The concrete surface shall be kept continuously wet by ponding, spraying, or covering. Covering material may consist of cotton mats, multiple layers of burlap, or others that does not discolour or otherwise damage the concrete. Entirely cover the surface of the pavement and the edges of the slab with water saturated mats. Extend mats to at least twice the thickness of the pavement beyond the edges of the slab. Place the mats in complete contact with the surface. Use weights or other approved methods to maintain contact.

3.12.3. WATERPROOF COVER METHOD

Thoroughly wet the surface using a fog mist applicator. Entirely cover the surface with a waterproof cover. Lap the cover by at least 18 inches (460 mm). Extend the cover beyond the edges of the slab to at least twice the thickness of the pavement. Place the cover in complete contact with the surface.

3.13. Sealing Joints

3.13.1. TIME OF APPLICATION

Joints shall be sealed as soon after completion of the curing period as feasible and before the pavement is opened to traffic, including construction equipment.

3.13.2. PREPARATION OF JOINTS

Immediately before sealing, the joints shall be thoroughly cleaned of all latency, curing compound, and other foreign materials. Sandblasting and/or wire brushing shall accomplish cleaning. Upon completion of cleaning, the joints shall be blown out with compressed air. The joint faces shall be surface dry when the seal is applied. Prior to resealing joints, any existing joint material shall be removed.

3.13.3. INSTALLATION OF SEALANT

- Joints shall be inspected and approved for proper width, depth, alignment, and preparation by the Engineer before sealing is allowed. Sealant shall be installed in accordance with the following requirements:
- Hot poured sealant shall be applied as uniformly solid from bottom to top, and shall be filled without formation of entrapped air or voids.
- The heating kettle shall be of an indirect heating type, constructed as a double boiler. A positive temperature control and mechanical agitation shall be provided.
- The sealant shall not be heated below the safe heating temperature.

- The allowable heating temperature shall be obtained from the manufacturer's catalogues.
- A direct connecting pressure-type extruding device with nozzles shaped for insertion into the joint shall be provided.
- Any sealant spilled on the surface of the pavement shall be removed immediately.
 - * Protection of Pavement
- The Contractor shall protect the pavement and its appurtenances against both public traffic and traffic caused by the Contractor's employees and agents. This shall include watchmen to direct traffic and the erection and maintenance of warning signs, lights, pavement bridges, crossovers, and protection of unsealed joints from intrusion of foreign materials, etc.
- Any damage to the pavement occurring prior to final acceptance shall be repaired, or the pavement replaced, at the Contractor's expense.
- For any pavement areas that are uncovered, the Contractor shall have available at all times, materials for the protection of the edges and surface of the unhardened concrete.
- Such protective materials shall consist of rolled polyethylene sheeting of at least 0.1 mm thick, with sufficient length and width to cover the plastic concrete slab and any edges.
- The sheeting may be mounted on either the paver or a separate movable bridge from which it can be unrolled without dragging over the plastic concrete surface.
- In any uncovered areas, when rain appears imminent, all paving operations shall stop and all available personnel shall begin covering the surface of the unhardened concrete with the protective covering.

3.14. Opening to Traffic

The pavement shall not be opened to traffic until test specimens moulded and cured in accordance with ASTM C31 have attained a flexural strength of 3790 kPa when tested in accordance with ASTM C78. If such tests are not conducted, the pavement shall not be opened to traffic until fourteen (14) days after the concrete was placed. Prior to opening to traffic, the pavement shall be cleaned.

3.15. Rejection of Concrete Batches

The Engineer may at any time, notwithstanding previous plant acceptance, reject and require the Contractor to dispose of any batch of concrete mixture which is rendered unfit for use due to contamination, segregation, or improper slump. Such rejection may be based only on visual inspection. In the event of such rejection, the Contractor may take a representative sample of the rejected material in the presence of the Engineer, and if it can be demonstrated in the laboratory, in the presence of the Engineer, that such material was erroneously rejected, payment will be made for the material at the contract unit price.

3.16. Acceptance of the Pavement

3.16.1. ACCEPTANCE SAMPLING AND TESTING

- The Contractor's testing laboratory shall perform all acceptance sampling and testing necessary to determine conformity with the requirements specified in this Specification Section. The Engineer will have the authority to direct locations for sampling and testing and will at all times have access to the Contractor's laboratory and testing equipment for observing and checking results.
- Acceptance sampling and testing shall be conducted for each lot. A lot size shall be proposed by the Contractor and approved by the Engineer before the commencement of the Work. Normally, the desirable size is 1500 m² of pavement or one day's placement (whichever is less).

- Testing organizations performing these tests shall meet the requirements of ASTM-C1077. The Contractor shall bear the cost of providing curing facilities for the strength specimens and coring and filling operations.

3.16.2. FLEXURAL STRENGTH

- Minimum of two times a day sampling shall be taken at the batching plant. The concrete shall be sampled in accordance with ASTM C172.
- Specimens shall be made in accordance with ASTM-C31, and the flexural strength shall be determined in accordance with ASTM-C78. The Contractor shall provide adequate facilities for the initial curing of beams.
- The Contractor may request the Engineer for the approval of the specimen test by the compression test instead of flexural test, by submitting the calibration test results about the relationship between two strengths, before the work. The Engineer has the authority to order the Contractor to carry out a re-calibration test according to the site and material conditions.
- During the 24 hours after moulding, the temperature immediately adjacent to the specimens must be maintained in the range of 16 oC to 27 oC, and loss of moisture from the specimens must be prevented.

3.16.3. PAVEMENT THICKNESS

- Each lot shall be divided into four equal sublots and the Contractor shall take one core from each sub lot. Sampling locations shall be in accordance with random sampling procedures contained in ASTM D3665. The Contractor shall fill core holes with a non-shrink grout approved by the Engineer within one (1) day after sampling. The Contractor shall furnish all tools, labour, and materials for cutting samples and filling the cored hole.
- Testing: The thickness of the cores shall be determined by the average caliper measurement in accordance with ASTM C174.

3.16.4. PAVEMENT ROUGHNESS

At least twenty-one (21) days before use, the roughness of the pavement surface shall be measured. For this purpose, the Contractor shall provide a full set of portable rough meter similar or equivalent to a Multi-purpose Profiling System (including all the necessary devices, hardware and software) for calculation of the International Roughness Index (IRI) (AASHTO PP37 or ASTM E950).

3.16.5. ACCEPTANCE CRITERIA FOR CONCRETE PAVEMENT

Acceptance will be based on the following characteristics of the completed pavement:

Table 1: Tolerances of Items to be applied to decide payment factors

Items	Tolerance
Surface Levels	± 5 mm
Width	± 10 mm
Thickness by Site Core Sample	± 8 mm
Flexural Strength (Class P, in Specification Section 06100)	Min. 98%
Surface Irregularity by 3 m Straight Edge	± 5 mm

4. Measurement and Payment

4.1. Method of Measurement

Portland cement concrete pavement will be measured for payment in square meters (m²) completed

to the neat lines shown in the Drawings.

4.2. Basis of Payment

- The accepted quantities, measured as provided above, will be paid at the contract price per unit of measurement for the pay items of the Bill of Quantities listed below, for each pavement lot, adjusted by the payment factors determined according to Specification Section 01850 “Acceptance of Work” for the acceptance criteria based on Subsection 3.16.5.
- Payment shall be for full compensation for the work described in this Specification Section including all joints, joint sealant and filler materials, all labour, materials, tools, equipment and appurtenances to complete the concrete pavement, concrete placing and finishing, dowels (including smooth and tie bars and dowel lubrication and painting), epoxy grouting of dowels, dowel supports, expansion caps, formwork, joint sawing, pavement curing, surveying, testing and sampling.

Pay Item	Descriptions	Units
05700-01	Concrete Pavement, Type C thickness 25 cm	m ²
05700-02	Concrete Pavement, Type CS thickness 20 cm	m ²

DIVISION 6

Concrete Works

Table of Contents

Section 06100 – Structural Concrete 1

Section 06200 - Reinforcement Bar 26

Section 06300 - Cast-in-Place Concrete Piles 31

Section 06400 – Prestressing for Concrete 44

Section 06410 – Prestressed Concrete I Girder 55

Section 06420 – Precast Concrete Plate 60

Section 06430 – Precast Segment Concrete..... 63

Section 06500 - Bridge Bearings 69

Section 06510 – Anchor Bar 81

Section 06520 – Bridge Expansion Joints..... 84

Section 06530 – Bridge Floor Waterproofing 92

Section 06100 – Structural Concrete

1. Description

This Specification Section consists of furnishing, placing, finishing and curing concrete in bridges, culverts and other structures in conformity with the lines, grades and cross sections shown in the Drawings, or required by the Engineer, in accordance with this and other related Specification Section.

2. Material Requirements

2.1. Reference Standards

The following Standard Specifications in their latest editions shall be applied to the works covered by this Specification.

- AASHTO M6 Fine Aggregate for Hydraulic Cement Concrete;
- AASHTO M33 Preformed Expansion Joint Filler for Concrete (Bituminous Type);
- AASHTO M43 Size of Aggregate for Road and Bridge Construction;
- AASHTO M80 Coarse Aggregate for Hydraulic Cement Concrete;
- AASHTO M85 Portland Cement;
- AASHTO M115 Asphalt Used in Damp-Proofing and Waterproofing;
- AASHTO M116 Asphalt Primer Used in Roofing, Damp-Proofing, and Waterproofing;
- AASHTO M118 Coal-Tar Bitumen Used in Roofing, Damp-Proofing, and Waterproofing;
- AASHTO M148 Liquid Membrane-Forming Compounds for Curing Concrete;
- AASHTO M153 Preformed Sponge Rubber and Cork Expansion Joint Fillers for Concrete Paving and Structural Construction;
- AASHTO M182 Burlap Cloth Made from Jute or Kenaf and Cotton Mats;
- AASHTO T11 Materials Finer Than 75- μ m Sieve in Mineral Aggregates by Washing;
- AASHTO T21 Organic Impurities in Fine Aggregates for Concrete;
- AASHTO T22 Compressive Strength of Cylindrical Concrete Specimens;
- AASHTO T23 Making and Curing Concrete Test Specimens in the Field;
- AASHTO T27 Sieve Analysis of Fine and Coarse Aggregates;
- AASHTO T71 Effect of Organic Impurities in Fine Aggregate on Strength of Mortar;
- AASHTO T96 Resistance to Degradation of Small-Size Coarse Aggregate by Abrasion and Impact in the Los Angeles Machine;
- AASHTO T97 Flexural Strength of Concrete;
- AASHTO T119 Slump of Hydraulic Cement Concrete;
- AASHTO T121 Mass per Cubic Meter (Cubic Foot), Yield, and Air Content (Gravimetric) of Concrete;
- AASHTO T134 Moisture-Density Relations of Soil-Cement Mixtures;
- AASHTO T141 Sampling Freshly Mixed Concrete;
- AASHTO T224 Correction for Coarse Particles in the Soil Compaction Test;
- ASTM C31 Making and Curing Concrete Test Specimens in the Field;
- ASTM C33 Concrete Aggregates;
- ASTM C39 Compressive Strength of Cylindrical Concrete Specimens;

- ASTM C40 Organic Impurities in Fine Aggregates for Concrete;
- ASTM C87 Effect of Organic Impurities in Fine Aggregate on Strength of Mortar;
- ASTM C88 Soundness of Aggregates by Use of Sodium Sulfate or Magnesium Sulfate;
- ASTM C91 Masonry Cement;
- ASTM C94 Ready-Mixed Concrete;
- ASTM C109 Compressive Strength of Hydraulic Cement Mortars (Using 2-in. or 50-mm Cube Specimens);
- ASTM C123 Lightweight Pieces in Aggregate;
- ASTM C136 Sieve Analysis of Fine and Coarse Aggregates;
- ASTM C138 Unit Weight, Yield, and Air Content (Gravimetric) of Concrete;
- ASTM C143 Slump of Hydraulic-Cement Concrete;
- ASTM C144 Aggregate for Masonry Mortar;
- ASTM C150 Portland Cement;
- ASTM C227 Potential Alkali Reactivity of Cement-Aggregate Combinations (Mortar-Bar Method);
- ASTM C287 Chemical-Resistant Sulfur Mortar;
- ASTM C294 Constituents of Concrete Aggregates;
- ASTM C295 Petrographic Examination of Aggregates for Concrete;
- ASTM C494 Chemical Admixtures for Concrete;
- ASTM C827 Change in Height at Early Ages of Cylindrical Specimens of Cementations Mixtures;
- ASTM C1017 Chemical Admixtures for Use in Producing Flowing Concrete;
- ASTM C1074 Standard Practice for Estimating Concrete Strength by the Maturity Method;
- ASTM C1077 Agencies Testing Concrete and Concrete Aggregates for Use in Construction and Criteria for Testing Agency Evaluation;
- ACI 347 Guide to Formwork for Concrete (American Concrete Institute)

2.2. Materials for Concrete

2.2.1. General

Materials that do not comply with the requirements of this Specification Section shall be rejected by the Engineer and shall be removed immediately from the Site of the Works, unless otherwise instructed by the Engineer.

Samples of all materials to be used in the mix shall be submitted to the Engineer for testing, and such samples shall be tested in the site laboratories as directed by the Engineer.

No materials forming any part of this mix shall be delivered to the Site before the Contractor receives prior approval from the Engineer for such materials.

Verification of mix designs with trial mixes prepared from the same source(s) shall be done to receive the approval of the Engineer.

All storage sites shall be restored to their original condition at the Contractor's expense prior to the acceptance of Work.

2.2.2. Portland Cement

Cement shall be Portland cement Type I, complying in all respects with ASTM C150 (AASHTO M85). However, the Contractor may propose using other types subject to the approval of the Engineer. All cement shall be manufacturer's standard grey cement unless otherwise specified in the Drawings.

Only one brand of cement as approved by the Engineer shall be used for all concrete works throughout the Project, unless otherwise authorized by the Engineer.

Cement shall be delivered to the Site in sealed bags or watertight cement bulk trailer bearing the manufacturer's name, cement type and the date of manufacture. The source of supply of cement shall be subject to the Engineer's approval and the Contractor shall at all times furnish the manufacturer's test certificates and proof that the specifications have been complied with, certified by an independent agency in the country of origin. The Engineer has the power to reject a part or the whole of any consignment of cement if he considers it unsuitable for use in the Works.

Bagged cement shall be stored in waterproof sheds or other such temporary buildings approved by the Engineer. Storage areas shall be perfectly dry with the floors raised well above the ground. The storage capacity shall correspond to the amount of concrete required for the largest units to be cast. Bags of cement shall not be piled more than 8 bags high. These buildings shall be used exclusively for the storage of cement, and at the completion of the Works, the buildings shall remain the property of the Contractor and shall be dismantled and removed, the foundations broken up, and the site restored to its original condition by the Contractor.

Cement delivered by bulk carriers shall be stored in silos made for cement storage. All operations for handling of bulk cement shall be by methods that prevent contamination of the cement. The cement storage silos shall be provided with interior moisture control devices that keep the cement dry and prevent premature hydration in the silos. The silos shall be provided with access ladders and openings so that samples can be extracted from various levels of each silo for testing purposes.

A free passage of at least 1 meter shall be left between the cement and the side walls of the sheds. Access ways shall also be left between the stored containers of cement such that every container is visible. Each consignment of cement shall be stored apart from earlier consignments, and consignments shall be used in the order in which they are delivered. Any consignment which has become caked or otherwise adversely affected shall be removed from the Site completely at the Contractor's own expense.

The Contractor shall provide weighing machines which shall be kept permanently in each shed for checking the weight of the bags or barrels of cement. The Engineer shall have access at all times to the cement storage sheds.

2.2.3. Water for Concrete Mixing and Curing

Water used in mixing and curing of concrete shall be subject to approval and shall be reasonably clean and free of oil, salt, acid, alkali, sugar, vegetable, or other injurious substances. Water shall be tested in accordance with, and shall meet the suggested requirements of AASHTO T 26. Water known to be of potable quality may be used without test. Where the source of water is relatively shallow, the intake shall be so enclosed as to exclude silt, mud, grass, or other foreign materials.

Mixing water for concrete in which steel is embedded shall not contain a chloride ion concentration in excess of 1,000 ppm or sulfates as SO_4 in excess of 1,300 ppm.

Quality of water shall be tested to conform to the requirements of this Specifications every month and when source of water is changed.

2.2.4. Aggregates

Aggregates shall be free of substances that react deleteriously with alkali in the cement in an amount sufficient to cause excessive expansion of the concrete. Acceptance of aggregate will be based on satisfactory evidence furnished by the Contractor that the aggregate is free from such materials. This evidence shall include service records of concrete of comparable properties under similar conditions of exposure and/or certified records of tests by a testing laboratory that meets the requirements of ASTM C1077. Tests shall be made in accordance with ASTM C227, ASTM C287 and ASTM C295.

All aggregates shall consist of tough, hard, durable and uncoated particles. The Contractor shall be responsible for satisfactorily processing the materials to meet the requirements of these Specification Sections. Thirty calendar days before commencement of Work, the Contractor shall advise the

Engineer of the sources of aggregates to be used to permit samples to be taken in the presence of a representative of the Engineer and the Contractor, for testing before being brought to the Site. Approval of the aggregate quality and/or gradation shall not waive the responsibility of the Contractor to fabricate concrete of the strength specified.

Aggregates shall be stored in such a way as to prevent segregation and contamination. The center of the storage area shall be free of excess moisture. Aggregates, which have become segregated or contaminated with foreign matter during storage or handling, shall be rejected and shall be removed and reprocessed and/or replaced with materials of acceptable quality. Aggregates shall be stored in sufficient quantity to ensure that there is no interruption of concreting work at any time.

Both fine and coarse aggregates shall be tested in accordance with the following standards:

- ASTM C39 Compressive Strength of Cylindrical Concrete Specimens
- ASTM C40 Organic Impurities in Fine Aggregates for Concrete
- ASTM C87 Effect of Organic Impurities in Fine Aggregate on Strength of Mortar
- ASTM C88 Soundness of Aggregates by Use of Sodium Sulfate or Magnesium Sulfate
- ASTM C117 Standard Test Method for Materials Finer than 75- μ m (No. 200) Sieve in Mineral Aggregates by Washing
- ASTM C123 Lightweight Pieces in Aggregate
- ASTM C136 Sieve Analysis of Fine and Coarse Aggregates
- ASTM C142 Standard Test Method for Clay Lumps and Friable Particles in Aggregates

Approval of aggregates will not prevent later rejection of the same, if results of subsequent tests do not reflect their compliance with the requirements of the specified standards.

(a) Fine Aggregates

Fine aggregate for concrete shall conform to the requirements of AASHTO M6.

The maximum combined quantity of soluble chloride and sulphate in fine aggregates shall not exceed 1,000 ppm.

Quality of fine aggregates shall be tested to conform to the requirements of this Specifications every month and when a source of fine aggregates is changed.

(b) Coarse Aggregate

Coarse aggregate for concrete shall conform to the requirements of AASHTO M80.

Coarse aggregates shall be crushed and shall be homogeneous, clean, free from extraneous materials, clay lumps, organic matter, and alkaline and detrimental materials.

The Engineer may order that coarse aggregate be washed if it is unclean, or may reject any material that does not comply with this Specification Section.

The quarry from which coarse aggregates are to be obtained shall be approved by the Engineer before the material is delivered to the Site.

Coarse aggregates shall withstand at least five cycles of immersion and drying in both sodium sulphate and magnesium sulphate solutions, as prescribed in the sodium sulfate soundness test, and shall show an average weight loss of not more than 12 %.

Quality of coarse aggregates shall be tested to conform to the requirements of this Specifications every month and when a source of coarse aggregates is changed.

2.2.5. Admixtures

On use of admixture, the Contractor shall obtain approval from the Engineer for the design of the mixture.

The use of any or all admixtures according to their type, amount and the place where they shall be

used shall be subject to the approval of the Engineer.

2.3. Concrete Classes

Concrete to be used shall be as shown in Table 2.3.1. Method for Testing Concrete, AASHTO T22 and T23 (ASTM C39 and C31 respectively) shall govern the manufacture of compressive strength test cylinders for all classes of concrete.

The class of concrete to be used in each part of the Contract Works shall be as called for in the Drawings or as directed by the Engineer.

The approximate weights or volumes of the components for each class of concrete and any other data given in any table of this Specification Section serve as aid for suggested trial mixes, and may be of value to Contractors in determining the approximate quantities of components required. However, the minimum crushing strength of the work test cylinders at 7 days and 28 days shall be strictly adhered. The acceptance of work by the Engineer shall be based on 28 day cylinders strength as determined in accordance with requirements and procedures stated in this Specification Section.

Table 2.3.1 Composition and Strength of Concrete for Use in Structures

Requirements	Class of Concrete										
	A	BI	BII	CI	CII	DI	DII	DE	EI	EII	P
Minimum Strength at 28 days (MPa)	50	40		30		24		21	18		5
	Minimum Compressive Strength of 150 mm x 300 mm Concrete Cylinder										Minimum Flexural Strength
Maximum Size of Course Aggregate	25	25	20	25		25	20	20	20	40	25
Minimum Cement Content (kg/m ³)	450	420		350		310		280	270		350
Water /Cement Ratio (Max.)	0.375	0.40		0.475		0.55		0.63	0.60		0.40
Slump (mm)	80±25	80±25		80±25	180±25	80±25		150 or slump flow 500	80±25		Min25 Max50

Concrete class to be used shall be based on the location and classification of structure as shown in Table 2.3.2 (expressed in terms of required strength):

Table 2.3.2 Usage of Concrete Classes

Component	Item	Prestressed Concrete	Reinforced Concrete	Non-Reinforced
Deck Slab	RC Deck Slab in Composite Deck Slab for PC-I Girder Bridge		CI-2	
	PC Deck Slab in Composite Deck Slab for PC-I Girder Bridge	BII		
	RC Deck Slab of Steel Bridge		DI-1	
Main Girder	Key Segment (CIP) for PC Box Girder Bridge	A		
	PC-I Girder Bridge	BI		
Cross Beam	Pier Table (CIP Portion) for PC Box Girder Bridge	A		
	PC-I Girder Bridge	CI-1		

Coupling Concrete of Main Girder			CI-1	
Pier	Column (T-type)		DI-2	
	Pile Cap		DI-2	
Abutment	Column (Inverted T-type)		DI-2	
	Pile Cap		DI-2	
Approach Slab			DI-3	
Pile	Cast-in-place Pile		CII (Subsection 06300)	
SPSP	Top Slab Concrete		DII-1	
	Bottom Slab Concrete			DE-1
	Concrete for filling into steel pipe			DE-2
Retaining Wall	L-type Wall, Retaining Wall, Gravity Retaining Wall		DI-4	
Concrete kerb, Concrete Barrier, Median, Foundation of Lighting Pole			DI-5	
Side Ditch, Box Culvert, U-ditch			DII-2 (Division 3)	
Leveling Concrete on Deck Slab				EI
Lean Concrete on Pile Cap and Approach Slab				EII
Pavement			P	

Ranges for concrete slump values shall be decided through the mixture design subject to approval of the Engineer. Slump shall be measured in accordance with AASHTO T119.

2.3.1. Approved Mix Design

The Contractor shall submit in writing to the Engineer a proposed mix design based on trial mixes conducted with the approved materials for each specified class of concrete for the Project. A target mean strength for quality control shall be proposed by the Contractor.

The Contractor shall make arrangements for mix design to allow the Engineer sufficient time to review the design(s) and, if necessary, to conduct and/or require additional strength testing.

No concrete work shall be allowed to commence before the Contractor receives the Engineer's approval of the Contractor's proposed mix design.

In the event of any changes in characteristics or source of supply for any of the component parts, a new mix design must be submitted for approval of the Engineer. Any delay due to such changes shall be the entire responsibility of the Contractor and no claims for delay or compensation shall be considered. During the Contract execution period, the Engineer can direct the Contractor, at any time, to take samples of the work mix, in order to check compliance with the approved mix design.

2.3.2. Water - Cement Ratio

The quantity of water used in mixing shall be subject to approval of the Engineer on the basis of preliminary tests and trial mixes, and shall be the least amount that shall produce a workable homogeneous plastic mixture. Excess water shall not be permitted, and any batch containing such excess shall be rejected.

In measuring water for each batch of concrete, allowance shall be made for the water contained in

the aggregates. The total water in the batch shall be deemed to consist of the water in the aggregates plus the water added.

Frequent tests including slump tests shall be carried out to ensure that consistent water content is maintained.

2.3.3. Adjustments during Progress of Work

(a) Adjustments for Variation in Workability

After a mix design has been approved, as prescribed above, the proportions of the constituents of the designed mix shall not be changed during the progress of the work except as follows:

If it is found impossible to obtain concrete of the desired workability with the proportions originally determined, the Engineer may allow changes in aggregate weights as he may deem appropriate.

(b) Adjustment for Minimum Strength

If it is found impossible to produce concrete having the minimum allowable strength specified, the cement content shall be increased as directed by the Engineer.

(c) Adjustment for New Materials

No change in the source or character of the materials shall be made without due notice to the Engineer.

No new materials shall be used until the Engineer has approved in writing such materials, and new proportions based on the tests of trial mixes have been determined.

2.3.4. Contents of Chloride and Sulphate

The amount of chloride in the concrete mass shall not exceed below amount:

- Reinforced concrete, Post-tensioning prestressed concrete: 0.3 kg/m³
- Pre-tensioning prestressed concrete, grouting for ducts: 0.3 kg/m³

The amount of sulphate in the concrete shall not exceed 1000 ppm when calculated on the total concrete mass, or 5,000 ppm when calculated on the amount of cement in the actual mix. For the above-mentioned calculations, the amounts of sulphate shall be determined by laboratory analysis of the cement, aggregates, water and admixtures. The analysis shall be carried out by acceptable and approved methods.

2.4. Submittals

The Contractor shall submit, in writing, concrete mix designs to the Engineer for approval, 60 days before production (covering two possible trials for sampling and testing of concrete at 28 days), or at least within a period of time enough to allow the Engineer to check the proposed mix design twice before approval, according to the procedure specified herewith.

Each mix design submittal shall include, but not be limited to, the following:

- Project identification;
- Name and address of the Contractor and concrete producer;
- Mix design designation;
- Class of concrete and intended use;
- Material proportions;
- Name and location of material sources for aggregate, cement, admixtures, and water;
- Type of cement and type of cement replacement if used.
- Fly ash, ground iron blast-furnace slag, or silica fume may partially replace cement if complying with pertinent specifications, and if approved by the Engineer.
- Cement content in kilogram per cubic meter of concrete;
- The saturated surface dry batch mass of the coarse and fine aggregates in kilogram per

- cubic meter of concrete;
- Water content (including free moisture in the aggregate plus water in the drum, exclusive of absorbed moisture in the aggregate) in kilogram per cubic meter of concrete;
- Target water/cement ratio;
- The water/cement ratio for modified concrete is the ratio of the mass of water to the combined mass of Portland cement and cement substitute;
- Dosage of admixtures;
- Fine and coarse Aggregate quality;
- Sieve analysis of fine and coarse aggregates;
- Absorption of fine and coarse aggregates;
- Bulk specific gravity (dry and saturated surface dry) of fine and coarse aggregates;
- Dry-rodded unit mass of coarse aggregate in kilogram per cubic meter;
- Fineness modulus (FM) of fine aggregate;
- Material certifications for cement, admixtures, and aggregate (if applicable);
- Target values for concrete slump
 - with and without high-range water reducers;
- Target values for concrete air content;
- Concrete unit mass; and
- Compressive strengths of 7- and 28-day concrete.

3. Requirements for Construction

3.1. Formwork

3.1.1. Design

All formworks shall be fabricated in accordance with one or other types that meet the requirements under Subsection 3.4 “Concrete Finishing”, unless otherwise required in the Drawings or other Specification Sections.

The Contractor shall submit shop and working drawings, calculations, materials and manufactured goods, to the Engineer for approval, at least 2 months before fabrication of the forms.

The Contractor shall indicate the proposed sequence, rate of placement, direction of placement, and location of construction joints when concrete placement is involved. Show anticipated total settlements and deflections of the falsework and forms. Include falsework footing settlements, joint take-up, and deflection of beams or girders.

The Contractor shall be responsible for the design and the strutting and bracing of the formworks, which shall have no harmful deformation under the weight of the concrete, or due to methods adopted for the placing and compaction thereof, or due to any incidental loading. No accessory for supporting the formwork or staging shall be built into the permanent structure except with the Engineer’s approval.

Formworks shall be designed for vertical loads and lateral pressures in accordance with ACI347 (American Concrete Institute) In addition, the formwork shall be constructed to provide completed concrete surfaces complying with the tolerances specified herein.

In the event retarding admixtures are to be employed, their effect shall be duly considered during the calculation of the lateral pressures due to fresh concrete.

The shop and working drawings shall show the proposed details of construction of members, and the manufacturer’s recommended safe working capacity of all form ties and column clasps. All assumptions, dimensions, material properties and other data used in the structural analysis shall be

noted on the shop drawings. Upon the Engineer's request, the Contractor shall furnish copies of the design calculations to the Engineer for examination, as a condition for approval.

When prefabricated formwork, shoring or scaffolding units are used, the manufacturer's recommendations for allowable loads may be followed if supported by test reports or successful experience records. For materials to be substantially re-used, reduced allowable load values may be required.

Forms shall be treated with a non-staining material or shall be saturated with water before concrete is placed. For all exposed surfaces, the forms shall be treated with a non-staining material, as approved by the Engineer, to prevent adherence to the concrete. The forms shall be free from any material that shall adhere to or discolor the concrete.

3.1.2. Construction of Formwork

The formwork shall be constructed accurately to represent the shape of the concrete as detailed in the Drawings. It shall be of suitable design and appropriate construction, and shall be approved by the Engineer. The Contractor shall make any necessary adjustments to allow for shrinkage, settlement or deflection which may occur during construction, so that the finished concrete sections conform accurately to the specified dimensions true to line, level and camber.

Wooden boards shall be fixed with such openings between the individual boards that they will close completely after the wetting, which will precede the concreting work.

Unless otherwise required by the Engineer, Class E-II blinding concrete shall be placed to a minimum depth of 10 cm below the foundation of pile caps of structures to provide a working platform and to ensure stability of the foundation soils. The area shall be sufficient to provide support for the formwork.

Forms for all surfaces which shall not be completely enclosed or hidden below the permanent surfaces of the ground or for surfaces where plywood forms are not specified, shall be made of surfaced lumber or material which shall provide a surface at least equally satisfactory. Any lumber or material which becomes warped prior to concrete placing shall be rejected.

Forms for all exposed surfaces shall be constructed with suitable plywood or metal on the face of the form that shall be in contact with the concrete. The surfaces of these forms shall be maintained equal to the new surfaces at all times as needed to produce the desired concrete surface. The Engineer will be the sole judge as to when the form faces are to be replaced.

All exposed sharp edges shall be chamfered with triangular fillets of not less than 2 cm by 2 cm in size, unless otherwise directed by the Engineer. The triangular fillets or chamfer strips shall be milled from clear, straight grain lumber and shall be surfaced on all sides. Curved surfaces shall be formed by plywood, metal, or other suitable material.

Bolts or form clamps for fastening forms shall provide a positive action and shall have sufficient strength and quantity to prevent movement of the forms. Lifting anchors maybe installed in precast members. Bolts, form clamps and lifting anchors shall be entirely removed or cut back, leaving no metal within 3 cm from the concrete surface. All forms for the outside surfaces shall be constructed with stiff wales (separator) at right angles to the studs, and all form clamps shall extend through and fasten such wales.

Drainage holes and weep holes shall be constructed as detailed in the Drawings or method statement provided by the Contractor. Forms for weep holes shall be as approved by the Engineer.

The Contractor shall install in the formwork required inserts, anchors, expansion joint elements, sleeves, and other items specified under relevant Subsections of this Specification Section, and shall coordinate installation with other trades for the proper location of such items. Ends of piping and sleeves embedded in concrete shall be closed with caps or plugs.

No concrete shall be deposited in the forms until all works related to constructing the forms and placing all reinforcement bar, ducts, anchorages, or pre-stressing steel strand have been completed for the unit to be poured, and until the Engineer has given written approval of said forms, reinforcement bar, ducts, anchorages, or pre-stressing steel strand.

The inside surfaces of forms shall, except for permanent formworks, or unless otherwise agreed with the Engineer, be thoroughly cleaned out and coated with a release agent approved by the Engineer. Release agents shall be applied strictly in accordance with the manufacturer's instructions and shall not come into contact with the reinforcement bar or pre-stressing steel strand and anchorages. Different release agents shall not be used in formwork for the concrete that will be visible in the finished Works.

The strength of concrete before the removal of falsework shall be as indicated in following table, unless otherwise approved by the Engineer:

Table 3.1.2 Removable Time of Bottom Form/Falsework

Formwork/Falsework	Minimum Period	Minimum Concrete Strength
Precast Segments for PC Box Girder Bridge	—	*1
Precast Girders for PC-I Girder Bridge		85% of specified characteristic strength
Precast Deck Slab		85% of specified characteristic strength
Cast-in-place PC Girder	After Prestressing	85% of specified characteristic strength
Other PC members		85% of specified characteristic strength
Other RC members	*2	

*1: Precast segments for PC box girder bridges at the time of removal of form/falsework shall have sufficient strength to support self weight and temporary construction loads, as well as not to induce harmful deformation due to creep and shrinkage. The Contractor shall conduct studies on this required strength prior to fabrication of precast segments for the Engineers approval.

*2: To facilitate finishing, forms used for parapets, barriers, and exposed vertical surfaces shall not be removed in less than 24 hours and not more than 72 hours, depending on weather conditions.

3.2. Concreting

3.2.1. General

Concrete may be mixed at the site of construction, at a central point or by a combination of central point and truck mixing or by a combination of central point mixing and truck agitating.

All concrete shall be batched by weight unless otherwise directed by the Engineer. The weight-batching machines used shall be of a type approved by the Engineer and shall be kept accurate and in good condition while in use for the Works. Checks shall be made as required by the Engineer to ensure that the weighing devices are registering correctly. Each mixer shall be fitted with a water measuring device having accuracy within one percent of the quantity of water required for the batch. The measuring device shall be such that its accuracy is not affected by variations in the water supply pressure.

In the event aggregate batching is by volume, cement shall be batched by weight, and water by weight or volume. Each size of aggregate shall be measured in a metallic container, the depth of which shall be at least equal to its greatest width. The containers shall be of such shape that their volume can be easily checked by measurement.

3.2.2. Batching

Measurement and batching of materials shall be done at a batching plant.

All concrete shall be machine mixed (wet mixing). The location of the batching and mixing plant shall be agreed with the Engineer, and the Contractor must submit to the Engineer for approval, before erection of any mixing plant, his proposed arrangements for the storage of aggregates and the batching and mixing of concrete. He must also submit details of the type or types of mixers and machines to be used, and his proposals for conveying the mixed concrete from the mixer to the points of deposit.

The approved type of mixer shall have a drum rotating about a horizontal or inclined axis and must be kept in good condition at all times. The drum shall rotate at an appropriate speed approved by the Engineer. The use of continuous mixers will not be permitted.

The batching plant shall be computerized of weighing (cement, aggregates, water, admixture) and mixing. All data for mixing (date, mixed volume, mixing time, weight of each materials, temperature) shall be recorded by computer hard disk and/or hard drive and be printed everyday to keep those documents. The Contractor shall, any time, provide mixing data to the Engineer when the Engineer requests the Contractor to submit data of mixing.

The batching plant shall include separate bins for the bulk cement, fine aggregate and for each size of coarse aggregate, a weighing hopper, and scales capable of accurately determining the weight of each component of the batch.

Scales shall be accurate to one percent throughout the range of use.

If there is no prior experience with the approved mix design or if special handling procedures, such as pumping, change one or more of the characteristics between discharge of the load and placement in the forms, the Contractor shall correlate the discharge tests with the placement tests to define these changes.

The Contractor shall also provide documentation and repeat the correlations as often as necessary, or as directed by The Engineer.

(a) Portland Cement

Either sacked or bulk cement may be used. No fraction of a sack of cement shall be used in a batch of concrete.

All bulk cement shall be weighed on an approved weighing device. The bulk cement weighing hopper shall be properly sealed and vented to preclude dusting during operation. The discharge chute shall not be suspended from the weighing hopper and shall be so arranged that cement will not lodge in it nor leak from it.

Accuracy of batching shall be within plus or minus 1 percent of the required weight.

(b) Water

Water may be measured either by volume or by weight. The accuracy of water measurement shall be within plus or minus one percent of the required weight or volume.

About 10% of the water required for the batch shall be poured into the drum before the cement and aggregates, and the remainder of the water shall be added gradually while the drum is in action, and all the water shall be in the drum by the end of the first quarter of the mixing time.

(c) Aggregates

All aggregates produced or handled by hydraulic methods, and washed aggregates shall be stockpiled or binned for draining at least 12 hours before being batched. In case the aggregates contain high or non-uniform moisture content, a storage or stockpile period in excess of 12 hours may be required by the Engineer.

The accuracy of measurement of aggregates shall be within plus or minus 2% of the required weights.

3.2.3. Mixing and Delivery

When batches are hauled to the mixer, bulk cement shall be transported either in waterproof compartments or between the fine and coarse aggregates. When cement is placed in contact with the moist aggregates, batches will be rejected unless mixed within 1.5 hours of such contact. Sacked cement may be transported on top of the aggregates.

The concrete shall be mixed until a mixture of uniform color and consistency is obtained. Mixers less than 0.5 m³ capacity shall not be used to batch structural concrete.

Mixing and delivery of concrete shall be in accordance with the appropriate requirements of ASTM C94 except as modified in the following paragraphs of this Subsection for truck mixing or a combination of central point and truck mixing or truck agitating. Delivery of concrete shall be so regulated that placing is at a continuous rate unless delayed by the placing operations. The intervals between deliveries of batches shall not be so great so as to allow the concrete in place to harden partially, and in no case shall such an interval exceed 45 minutes.

Arrangements for the cooling of the mixing water as well as the handling of admixtures shall be approved by the Engineer.

Additional mixing water and/or admixture may not be added to the Work Site unless specifically authorized by the Engineer and if the water/cement ratio in the approved job mix is not exceeded, and the truck mixer is loaded to no more than 70% of its rated capacity.

The volume of concrete mixed per batch shall not exceed the mixer's nominal capacity as shown on the manufacturer's standard rating plate on the mixer.

Minimum mixing time shown below shall continue after all the water has been added.

Mixers having a capacity of 1.5 m ³ or less	minimum 60 seconds
Mixers having a capacity greater than 1.5 m ³	minimum 90 seconds
Mixer with a capacity of 750 liters or less	minimum 1.5 minutes
Each additional 500 liter capacity or fraction	be increased by 15 seconds
Double-drum high performance mixer	minimum 70 seconds

Mixing time shall be measured from the time all materials, except water, are in the drum. Any concrete mixed in less than the specified time shall be discarded and disposed of by the Contractor.

The timing device on stationary mixers shall be equipped with a bell or other suitable warning device, adjusted to give a clearly audible signal each time the lock is released. In case of failure of the timing device, the Contractor will be permitted to continue operations while it is being repaired, provided he furnishes an approved timepiece equipped with minute and second hands. If the timing device is not placed in good working order within 24 hours, further use of the mixer shall be prohibited until repairs are made.

On cessation of work, including all stoppages exceeding 20 minutes, the mixers and all handling plant shall be washed with clean water. Any deposits of old concrete in the drum shall be cleaned out by rotating clean aggregate and water in the drum before any fresh concrete is mixed.

Concrete that is not in place within one hour, counted since the time when ingredients were charged into the mixing drum, or concrete that had developed initial set, shall be rejected.

3.2.4. Concrete Consistency

Concrete slump shall be decided through trial mixing by the Contractor. Slump shall be measured in accordance with AASHTO T119.

3.2.5. Pumping

Placement of concrete by pumping may be authorized by the Engineer.

Where concrete is conveyed and placed by mechanically applied pressure, the equipment shall be suitable in kind and adequate in capacity for the work.

The operation of the pump shall be such that a continuous stream of concrete without air pockets is produced.

When pumping is completed, the concrete remaining in the pipeline, if it is to be used, shall be ejected in such a manner that there shall be no contamination of the concrete or separation of the ingredients.

3.2.6. Placing and Compacting

Concrete shall not be placed until forms and reinforcement bar have been inspected and approved by the Engineer. The method and sequence of placing concrete shall be as approved by the Engineer.

Concrete shall be placed gently in position and shall not have a free fall of more than 1.5 m, so as to avoid segregation of the materials and displacement of the reinforcement bar.

Any method involving the use of pipes or chutes for transporting concrete shall not be permitted, except with the written approval of the Engineer.

Use of drop chutes made of rubber or metal shall be allowed for small sections and bottom dump buckets or other suitable vessels for large sections to convey the concrete as near as possible to its final position.

Where steep slopes are required, the chutes shall be equipped with baffle boards or be in short lengths that reverse the direction of movement.

The use of aluminum chutes, tremie, troughs, and pipes will not be permitted.

Concrete shall be placed so as to prevent water from collecting at the ends, corners or along the faces of the forms, and water shall not be placed in large quantities at a given point and allowed to run or be worked over a long distance in the form.

All concrete shall be placed and compacted in even layers with each batch adjoining the previous one.

The thickness of concrete layers shall be between 40-cm and 50-cm for concrete structures.

Concrete shall be compacted by mechanical or electromechanical poker vibrators, of a type approved by the Engineer. Over-vibration of concrete in the formwork by means of vibrators will not be permitted. When required, vibrating shall be supplemented by hand spading with suitable tools to assure proper and adequate compaction.

Vibrators shall not be attached to the reinforcement in any circumstances. Each immersion shall continue until shortly after air bubbles cease to appear on the surface of the concrete, but shall not last more than 30 seconds. Vibrators shall be withdrawn gradually and vertically to ensure that no air pockets are formed.

The Contractor shall provide stand-by (extra) vibrators during all concrete pours. In all cases, at least two vibrators shall be available at the site of the structure in which more than 25 m³ of concrete are to be placed.

All vibration, compaction and finishing operations shall be completed immediately after the placing of concrete in its final position.

Concreting in any one part or section of the work shall be carried out in one continuous operation, and no interruption of concreting work will be allowed.

Where beams and slabs together form an integral part of the structure, they shall be poured in one operation, unless otherwise specified, or an approved provision is made to form a construction joint.

After a beam, wall or column has been cast, an interval of one hour shall be allowed before casting the continuous slab. The same applies for all abrupt changes in sections.

The external surface of all concrete shall be thoroughly worked during the placing by means of tools of an approved type. Such work shall force all coarse aggregate from the surface and bring mortar against the forms to produce a smooth finish, substantially free from water and air pockets, or honeycombs.

Freshly placed concrete shall be adequately protected from rain, dust storms, chemical attack and the harmful effects of sun, heat, wind, flowing water, vibrations and shocks. It shall also be fenced off or otherwise protected to prevent persons from walking thereon or articles being placed or thrown thereon. This protection shall continue until the concrete is sufficiently set such that it can no longer be damaged by these factors.

The Contractor shall take all necessary precautions to prevent differential temperatures between the

core part and the surface part from exceeding 20 °C during concrete placing and curing.

3.2.7. Placing of Concrete in or Under Water

For all work requiring concrete placement in or under water, or if the Engineer specifically approves the placement of concrete in or under water, the Contractor shall submit to the Engineer, for approval, his proposed construction procedure for the placing of concrete in or under water before proceeding with the work.

Tremie pipes shall be smooth bored watertight fitted with quick release joints and have an adequate cross-section for the size of aggregate to be used. Aluminum pipes shall not be used.

Tremie pipes: Seal the discharge end and fill the tremie tube with concrete at the start of concrete placement. Keep the tremie tube full of concrete to the bottom during placement. If water enters the tube, withdraw the tremie and reseal the discharge end. Maintain continuous concrete flow until the placement is completed.

Bottom opening skips shall be straight sided, perfectly smooth and fitted with externally operated bottom opening double doors and overlapping canvas flaps.

Concrete pumps: Use pumps with a device at the end of the discharge tube to seal out water while the tube is first being filled with concrete. When concrete flow is started, keep the end of the discharge tube full of concrete and below the surface of the deposited concrete until placement has been completed.

Place underwater concrete continuously from start to finish in a dense mass. Place each succeeding layer of concrete before the preceding layer has taken initial set. Keep the concrete surface as horizontal as practical. Do not disturb after placement. Maintain still water at the point of deposit. Dewater after test specimens cured under similar conditions indicate that the concrete has sufficient strength to resist the expected loads. Remove laitance or other unsatisfactory material from the exposed concrete.

The Contractor shall submit and obtain the approval of the Engineer for his detailed proposals for concreting.

Where concrete is to be placed in or under water, the actual mix proportions and selection of aggregates shall be in such a manner that will ensure a resulting concrete with good flow and cohesion characteristics.

The cement content shall be 25% greater than for a comparable mix for use in dry conditions. The minimum cylinder strength for all concrete shall be approved by the Engineer for the comparable mixes for use in dry conditions.

3.2.8. Hot Weather Concreting

Hot weather is defined as any time during the concrete placement when the ambient temperature at the work site is above 35 °C.

The surfaces that come in contact with the concrete mix shall be cooled below 35 °C by covering with wet burlap or cotton mats, fog spraying with water, covering with protective housing, or by other approved methods.

During concrete placement, maintain concrete temperature by using any combination of the following:

- Shade the material storage areas or production equipment;
- Cool aggregate by sprinkling; and
- Cool aggregate and water by refrigeration or replacing a portion or all of the mix water with flaked or crushed ice to the extent that the ice completely melts during mixing of the concrete.

The concrete mixing plant shall be screened and covered as protection from wind, rain and sun, and adequate similar precautions shall be taken throughout the transit, placing and curing of the concrete

whenever such conditions arise.

When the shade air temperature is 35 °C and rising, special precautions shall be taken during all concrete operations so that the temperature of the concrete does not exceed 35 °C when placed.

Fresh concrete placed at air temperatures of 35 °C or higher shall be shaded from the direct rays of the sun, to the satisfaction of the Engineer.

Evaporation: When placing concrete in bridge decks or other exposed slabs, limit expected evaporation rate within the reasonable rate. When necessary, take one or more of the following action:

- Construct windbreaks or enclosures to effectively reduce the wind velocity throughout the area of placement.
- Use fog sprayers upwind of the placement operation to effectively increase the relative humidity; and
- Reduce the temperature of the concrete according to above measures.
- Rain: Protect the concrete from rain during and after placement.

3.2.9. Continuity of Concrete Work

Whenever instructed by the Engineer, the Contractor shall carry out the work in such a manner that the placing of concrete in any particular section of the structure shall be executed without any interruption whatsoever from the beginning to the end of the operation. If interruptions are permitted, no fresh concrete shall be deposited on or against the concrete placed before the interruption until the latter is sufficiently set to resist damage.

Particular care shall be taken to ensure that partially set concrete shall not be damaged by shock or any other cause whatsoever.

Casting of concrete shall not commence until a sufficient quantity of approved material is at hand to ensure continuity of operation.

Concrete work shall not commence until there is sufficient equipment reserved for use in case of breakdown.

3.3. Joints

3.3.1. General

Joints shall, as a rule, be limited to the positions indicated in the Drawings and shall be of the type specified.

The Contractor shall provide adequate protection to expansion joints against the entry of debris or other materials that may interfere with the closing of the joints.

Construction joints shall be as detailed in the Drawings, and concreting shall be carried out continuously at these joints, which shall as a rule be formed at right angles to the axis of the members.

3.3.2. Construction Joints

Construction joints shall be made only at locations indicated in the Drawings, as specified herein, or as approved by the Engineer, except in cases of breakdowns or other unforeseen and unavoidable delays, in which case the Engineer shall define if the joint is to be bonded.

Construction joints in abutment walls, wing-walls, and barrels of box culverts shall not be placed at intervals exceeding 10 m except as otherwise indicated in the Drawings or approved by the Engineer.

The face edges of all joints, which are exposed to view, shall be carefully finished true to line and elevation. Shear keys, formed into or out from the surface of the previously placed concrete or steel dowels, shall be used where required. Shear keys formed into the concrete shall be formed by the insertion and subsequent removal of beveled wood strips which shall be thoroughly saturated with water prior to insertion. Steel dowels may be used in lieu of keys at the discretion of the Engineer.

The size and spacing of the keys and dowels shall be as determined by the Engineer.

Care shall be exercised not to injure the concrete or break the concrete-steel bond at any time. In the construction of bridge floors where longitudinal joints are specified, a platform shall be constructed outside the longitudinal joints and supported on the lower slab form, and workmen shall not be permitted to stand or walk on the projecting reinforcement bars until the concrete has hardened.

3.3.3. Bonded Construction Joints

Except where otherwise specified, bonded construction joints where required shall be made using any of the following procedures, as appropriate:

- After the header board has been removed, the cement paste shall be removed from the surface by washing with water under pressure or by sandblasting to expose clean and well bonded aggregate.
- After the surface has been prepared, the concrete shall be left saturated with water until the new concrete is placed, or it shall be saturated for a period of 4 hours before placing the new concrete.
- After the header board or form is removed and the concrete has been cured for the normal period, the second pour shall be bonded to the first pour by the application of a two-component liquid polysulphide polymer epoxy resin concrete adhesive to the concrete joint surface. The epoxy concrete adhesive shall meet the requirements specified by the Engineer.
- The surface on which the adhesive is to be applied shall be free of oil, dirt, and loose concrete. All unsound concrete shall be removed until a base of strong, undamaged concrete on which to apply the adhesive is exposed. Heavy deposits of dirt or oil products shall be removed by wire brushing or sandblasting. The surface shall be free of moisture and dry before application of the adhesive. The adhesive shall not be applied to newly placed concrete before the normal curing period has elapsed.
- Immediately before application, the two adhesive components shall be combined in the proportions specified by the adhesive manufacturer. The components shall be intimately blended by hand or with a slow speed motor-driven mixing device. The mixture of adhesive shall then be thinned by adding and blending a solvent into the adhesive. The amount of adhesive mixed at a time shall be limited to that quantity which can be conveniently applied within the life indicated in the adhesive's pot.
- The two components and solvent shall not be mixed for more than 30 minutes prior to use. The resulting adhesive shall be brushed onto the concrete in a 1 to 2 mm thick layer. After the adhesive has been applied, concrete shall not be placed against it until the solvent has evaporated. This period shall be between 30 to 60 minutes depending on weather conditions. The adhesive must be tacky and not dry at the time of concrete application. Areas that have been allowed to become dry shall be re-coated before concrete is placed.
- Because of toxicity of the materials, including the solvents, the handling and use of the same present some safety and health hazards, and may cause serious skin rash or other allergic reactions in persons sensitive to them. Furthermore, the use of solvents as cleaning aids presents some fire and flash hazards. Hence, the Contractor shall obtain complete instructions from the producers of the materials regarding the safety, health and handling precautions that must be exercised with respect to the materials to be used, and the procedures that shall be followed in the event that workmen come in contact with such materials. Before they are permitted to proceed with the work, the workmen shall be instructed on the hazards to which they will be exposed, the necessary safety precautions and the procedure to be followed in the event of accidental contact with the materials.

3.3.4. Non-Bonded Construction Joints

Non-bonded construction joints shall be made by forcing or striking off the previously placed concrete to a true and even surface and allowing it to set. After the concrete has set, the new concrete shall be placed in contact with it, and thoroughly compacted to secure a close contact between the old and new concrete at all points, with no attempt to secure a bonding of the new to the old work.

3.4. Concrete Finishing

3.4.1. Finishing Concrete Surfaces

All concrete shall be given a surface finish, as indicated in the Drawings or as otherwise required by the Engineer. Finishing-type of concrete shall be as indicated in following table.

Permanently exposed concrete surfaces to Class F4, F3 and F2 finish shall be protected from rust marks and stains of all kinds.

Unless otherwise described in the Specification, all formwork joints for exposed surfaces of concrete to Class F2, F3 and F4 finish shall form a regular pattern with horizontal and vertical lines continuous throughout each structure, and all construction joints shall coincide with these horizontal or vertical lines.

The types of surface finishes and necessary form works are as follows:

Table 3.4.1 Finishing Type of Concrete

	Finishing	Description	Formworks
Formed Finish	Class F1	No particular requirements for finishing	Sawn Formwork for unexposed concrete surfaces
	Class F2	With specified regularities on the finish	Wrought Formwork of steel or plywood or timber.
	Class F3	With accurate finishing to provide a smooth finish of uniform texture and appearance	Lined Formwork by material approved by the Engineer
	Class F4	With accurate finishing on the use of internal ties and embedded metal parts	It shall be of the same type and obtained from only one source throughout any one structure.
Unformed Finish	Class U1	Leveled by wooden float etc.	-
	Class U2	Steel float finishing	
	Class U3	Finishing by steel-trowel	

3.4.2. Remedial Treatment of Finished Surfaces

Any remedial treatment to finished surfaces shall be agreed with the Engineer following inspection immediately after removing the formwork, and shall be carried out without delay.

Any concrete surface which has been treated before being inspected by the Engineer may be subject to rejection.

3.4.3. Fixing of Ironwork

All brackets, lag-bolts and other ironwork for which holes have been boxed out or left in the concrete of a structure shall be carefully grouted into their correct positions.

3.4.4. Reconstruction of Faulty Work

In the event any members or portion of the work proves, to be of inferior workmanship or to be in any way whatsoever defective after removal of the formwork, or should crushing tests on samples taken from the work show that the concrete used therein is of inferior quality, such work shall, at the

discretion of the Engineer, be cut out and replaced.

3.5. Curing

All newly placed concrete shall be cured, and curing shall begin immediately after finishing, and continue for at least 7 days by water. Curing shall be done so as to maintain moisture continuously, and shall be an integral part of the concreting operations.

Improperly cured concrete will be considered defective, and the Engineer will stop all of the Contractor's placing operations until proper procedures are put into effect.

The method for supplying additional moisture as described below shall be used for curing exposed concrete surfaces unless otherwise required and/or approved by the Engineer.

When permitted in writing by the Engineer, the Contractor may use one of the following methods or a combination thereof as specified below for curing exposed concrete surfaces.

3.5.1. Supplying Additional Moisture

This method consists of supplying additional moisture by ponding, sprinkling, or fogging. Coverings such as burlap shall be used to retain water so supplied. The use of sawdust will not be allowed, and coverings that cause unsightly discoloration of concrete shall not be used. Any method that results in the concrete being alternately wet and dry will be considered an improper curing procedure. Coverings shall be placed as soon as possible after finishing operations have been completed and there is no danger of surface damage. The coverings shall be kept continuously moist.

3.5.2. Preventing Moisture Loss

This method consists of preventing concrete moisture loss. It may be done with the use of approved waterproof paper, plastic sheets, or liquid membrane curing compound except where other requirements prohibit the use of these compounds. If a formed surface is to be rubbed, the concrete shall be kept moist before and during the rubbing, and the curing shall be initiated immediately following the first rub while the concrete surface is still moist. Bridge decks, approach slabs, parapets shall be covered with burlap or approved equal material as soon as the concrete is sufficiently set to support this material without damage to finish. This moisture-retaining material shall then be saturated with water and the entire area covered with waterproof paper or plastic sheeting.

3.5.3. Waterproof Paper

The paper shall have the widest practicable width, and adjacent sheets shall overlap a minimum of 15 cm, and shall be tightly sealed with a pressure sensitive tape, mastic, glue or other approved methods to form a complete waterproof cover of the entire concrete surface. The paper shall be secured so as not to be displaced by wind. If any portion of the sheets is broken or damaged before expiration of the curing period, the broken or damaged portion shall be immediately repaired. Sections that have lost their waterproof qualities shall not be used.

3.5.4. Plastic Sheets

The sheets shall be used in the same manner as required above for waterproof paper.

3.5.5. Curing Compounds

Only Type 2 liquid membrane curing compound complying with AASHTO M148 may be used when approved by the Engineer as the initial and final curing agents on structural concrete. If the membrane film is broken or damaged at any time during the curing period, the broken or damaged area(s) shall be re-coated according to the original requirements. Curing compounds shall be applied to unformed areas as soon as the water sheen has practically disappeared from the concrete, or as soon as the forms have been removed from surfaces not to be rubbed. Curing compounds shall not be used on areas receiving a rubbed finish. If there is any expected delay in applying curing compound, the surface shall receive moist curing until the compound can be applied.

Curing compound shall be applied using equipment that will produce a fine spray, and all compounds shall be thoroughly agitated just prior to use. The surface shall be sprayed again immediately at a right angle to the first application. The rate of each application shall not be less than 1 liter for each

3.6 m² of surface. Care shall be taken to prevent application to joints where concrete bond is required to reinforcement steel, and to joints where joint sealer is to be placed.

Timber formwork covering the concrete shall be moistened with water at frequent intervals to keep it from drying during the curing period. Metal formwork exposed to the sun must be shaded from its direct rays, painted white, or otherwise protected during the curing period.

When forms are removed before the end of the 7-day curing period, specified curing procedures shall be implemented by the Contractor and continued until the end of the 7-day period as specified.

3.6. Precast Concrete

Precast concrete members are including Subsection 06400 "Prestressed Concrete".

3.7. Quality Control of Concrete

3.7.1. General

The Contractor shall submit and implement his quality control plan for the entire Project. Especially, the target mean strength shall be described clearly.

All quality control tests must be carried out in a manner acceptable to the Engineer and shall be conducted by the Contractor's independent laboratory or at Site.

3.7.2. Technicians at Mixing Plant

The Contractor shall designate a competent and experienced concrete technician to be in charge of the mixing operations at the mixing plant, and to be responsible for the overall quality control including, but not limited to, the following:

- The proper storage and handling of all components of the mix
- The proper maintenance and cleanliness of plant, trucks, and other equipment
- The gradation testing of fine and coarse aggregates
- The determination of the fineness modulus of fine aggregate
- The measurement of moisture content of the aggregates and adjustment of the mix proportions as required before each day's production or more often if necessary to maintain the required water/cement ratio
- The computation of the batch masses for each day's production and the checking of the plant's calibration as necessary

Compliance to specifications of the furnishing of all equipment and the performance of temperature, unit mass, slump, and other tests shall be verified before and during each placement operation.

One slump test, or more as directed by the Engineer, shall be carried out. The test will not be deemed to have been carried out unless witnessed by the Engineer or his representative. The method of making the slump test shall conform to ASTM C143.

After mixing concrete, before delivering to the site, unit mass of the concrete shall be measured and recorded by the Contractor.

The verification of adjustments to the mix before discharge shall comply with the specifications.

The completion of the batch ticket, the apparent water/cement ratio, and the time discharge are completed shall be recorded; furnishing a copy of each batch ticket at the time of placement.

The completion of batch tickets, including the following information, shall be indicated:

- Concrete supplier
- Ticket serial number
- Date and truck number
- Contractor

- Structure or location of placement
- Mix-design and concrete class
- Component quantities and concrete total volume
- Moisture corrections for aggregate moisture
- Total water in mix at plant
- Time of batching and time at which discharge must be completed

The Contractor shall provide equipment necessary for the above tests and controls, and furnish copies of work sheets as they are completed.

Testing shall be done to determine the unit mass, slump, and temperature according to this Specification Section.

3.7.3. Technician at Site

The Contractor shall designate at least one competent and experienced concrete technician to be at the project site who shall be responsible for concrete placing, and sampling.

Samples, to be tested according to AASHTO T121 during construction, shall be taken (1 per lorry or 1 agitator) at the point of placement.

Measurement of temperature of concrete, slump test and chloride test shall be conducted for each agitator or lorry.

3.7.4. Sampling of Mixed Concrete

Samples shall be taken from the specified lot as per approved quality control plan prepared by the Contractor in accordance with AASHTO T141 standard procedure.

Sampling frequency shall be proposed by the Contractor and shall be approved by the Engineer prior to commencement of concrete works.

Sampling of every after at least 0.2 m³ shall be discharged before placing any of the batch in the forms.

Initial testing frequency shall be resumed if a test shows a failing temperature, slump or when directed by the Engineer.

The Contractor shall bear all expenses for obtaining, cutting out or sampling all specimens and/or component parts for testing.

The quantity of the specimens for sampling shall be, at least, taken as follows:

Compressive Test	Quantity
7 days strength	3 specimens
28 days strength	3 specimens
Spare	3 specimens
Total	9 specimens

Above specimens shall be cured into water properly.

In addition to above, one concrete specimen shall be taken everyday. The volume of this specimen shall be 0.008 m³ (20 cm x 20 cm x 20 cm) or an equivalent bucket. This may not be cured into water. The purpose of this specimen is for taking cored sample from it in case that quality of concrete is troubled.

All specimens shall put below information side of each specimen, but not limited to:

Required information:

- Name of the Project, the Employer and Contractor
- Pouring date and time
- Outside and concrete temperature
- Slump
- Pouring location
- Structure's name
- Name of the person in charge by the Contractor

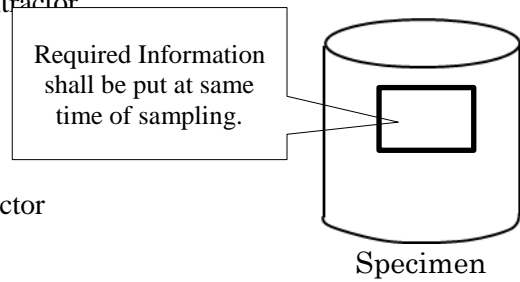

3.7.5. Compressive Strength Testing

Testing to determine the compressive strength of in-situ concrete may be used for the following purposes:

- Determination of concrete compressive strength to allow early stripping of forms
- Determination of concrete compressive strength prior to application of post tensioning force
- Determination of concrete compressive strength prior to launching of traveler
- Determination of acceptance of the lot completed

The procedure for strength testing shall be in accordance with ASTM C1074, or equivalent procedure approved by the Engineer.

The Contractor shall indicate details of his proposed procedure for strength testing for the determination of early concrete strength. This procedure shall address the use of conventional test cylinder results to substantiate strength testing predictions and the proposed locations within the concrete pour. The figure below shows an example of the procedure which may be modified by the Contractor's proposal with the approval of the Engineer.

The Contractor shall carry out the compressive test by an authorized agency once a month by using spared specimens as directed by the Engineer. The full expenses of the compressive test by an authorized agency shall be borne by the Contractor.

Example of Concrete Strength Quality Control Flow Chart

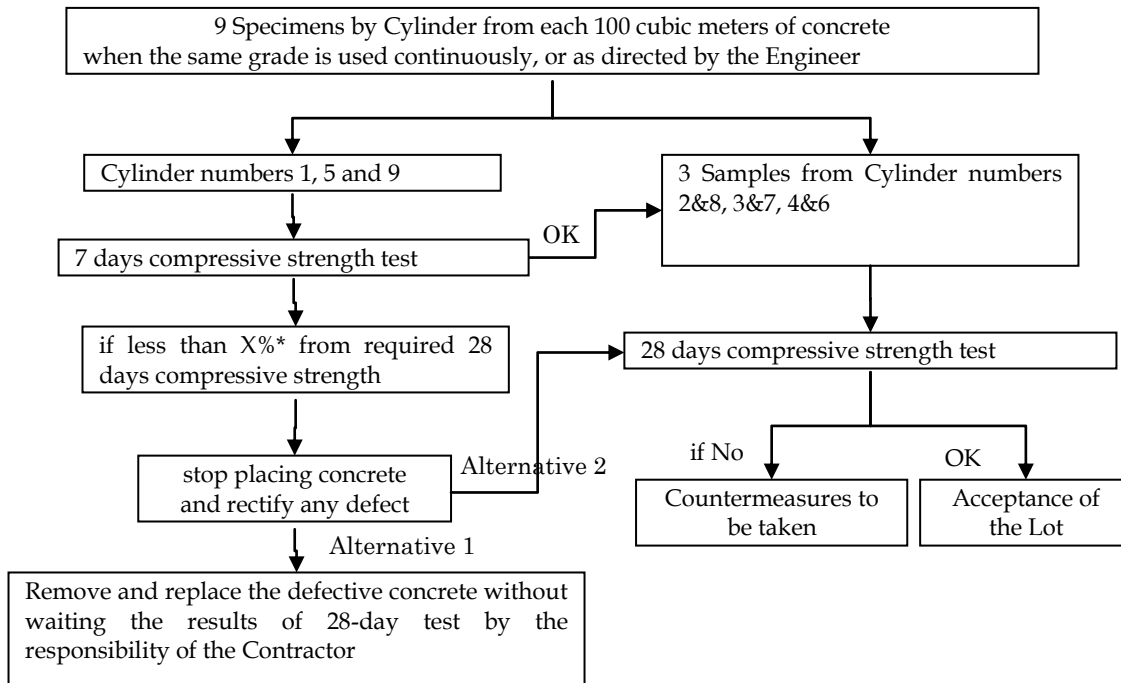

*Note: This percentage or strength shall be decided in accordance with the test results of trial mixing as mentioned in sub-section 3.1 Concrete Mix Design and with the proposal by the Contractor.

3.8. Acceptance Tests and Tolerances

3.8.1. Strengths

Final acceptance of the concrete work will be based on 28-day strength testing and the final dimension of the each lot.

The work is considered in compliance if the average of the samples is equal to or exceeds the minimum specified for the class of concrete being placed.

If the results of the 28-day testing do not satisfy the minimum technical requirements, the Contractor, in accordance with the instructions of the Engineer, shall conduct tests in the parts of the structure which are suspected to be of inferior quality.

The Engineer shall, any time, be entitled to take a cored sample from the constructed structures by the Contactor.

3.8.2. Dimensions

The tolerances of finished dimensions of concrete structures shall be as shown in following tables.

Table 3.8.1 General Tolerances

Item	Tolerances
Placing of reinforcement	5 mm controlled by cover; half bar diameter otherwise
Placing of post-tensioning sheathing	5 mm
Concrete cover	0 to +5 mm

Table 3.8.2 Dimension Tolerances

Item		Tolerance (mm unless shown otherwise)
(i) Footings		
Plan dimensions	Formed footings and Plan dimensions pile caps	-15 to +50
	Unformed footings (when approved by the Superintendent)	0 to +150
Thickness	< 300 mm	-5 to +25
	> 300 mm	-10 to +50
Top of footing or pile cap reduced level		-25 to +25
Departure from the plan position in any direction		50
(ii) Cylinders		
	Variation from the vertical	25 mm in 3m
	Departure from the plan position in any direction	75
(iii) Variation in Cross Section of Columns, Piers, Crossheads, Slabs, Walls, Beams and Similar Parts (excluding deck slabs and end posts)		
	< 3 m	-5 to +15
	> 3 m	-10 to +25
(iv) Variation of Cross Section of End Posts		-5 to +5
(v) Deck		
	Thickness of deck slabs (excluding allowance for correction of camber or hog)	0 to +10
	Deck surface reduced level	-10 to +10
(vi) Deck Joints		
	Width of slot	-3 to +3
(vii) Variation from Vertical or Specified Batter of Columns, Piers, Walls, Handrail Posts and Arises		
	Unexposed concrete	10 mm in 2.5m (1/250)
	Exposed concrete	5 mm in 2.5m (1/500)
(viii) Reduced Level of Tops of Crossheads and Piers		
	With pedestals	-10 to +10
	Without pedestals	-5 to +5
	Difference in level across the width of crosshead	5
(ix) Bearing pedestals		
	Reduced level	-2.5 to +2.5
	Variation from grade across the width of individual pedestals shall not exceed	1 in 200
	Deviation from flat surface	+1.0 to -1.0
(x) Departure from Plan Position at any Level		
	Columns, piers, walls, crossheads, beams, slabs, kerbs, railing and other similar parts	25
	Relative displacement of adjoining components shall not exceed	10

(xi) Departure from Alignment		
	Rows of columns, faces of piers or walls	10
	Handrails, faces of hand rail posts, kerbs	5
(xii) Maximum Allowance for Irregularities in Exposed Concrete Surfaces		
	Sections less than 1 m in dimension when measured with a straightedge across the dimension of the section	2.5
	Sections greater than 1m in dimension when measured with a straightedge across the dimension of the section, except that when sections are greater than 2.5 m in dimension, a 2.5 m straightedge shall be used	5
xiii) Irregularities in Railings		2.5 mm in 2.5m
(xiv) Slab Surface Finish		5 mm in 2.5m

4. Measurement and Payment

4.1. Method of Measurement

Measurement shall be made to the neat lines of the structures as indicated in the Drawings. Temporary works (e.g. from and false work) and bedding stones underneath of lean concrete shall not be measured for payment.

No deduction shall be made for the volume of outside chamfer and occupied volume by reinforcement bars or other small items embedded in concrete.

Measurement for the various classes of concrete and at the various locations shall be made in cubic meters (m³) of concrete in place, indicated in the Drawings and described in the Bill of Quantities, and approval by the Engineer.

All costs associated with this work shall be considered as a subsidiary obligation and requirement under the applicable pay items in the Bill of Quantities.

Acceptance and allowance of the following concrete components shall be referred to each relevant Specification Subsection as shown below:

Cast-in-place Concrete Piles	Subsection 06300
Prestressed Concrete I girder	Subsection 06410
Precast Concrete Plate	Subsection 06420
Precast Segment Concrete	Subsection 06430

4.2. Basis of Payment

The accepted quantities, measured as provided above, shall be paid at the contract price per unit of measurement for the pay items of the Bill of Quantities listed below.

No separate payment shall be made for the formwork and falsework. They shall be included in the applicable items of the Bill of Quantities.

Items in the Bill of Quantities also include, but are not limited to, the following:

- All expenses involved in providing, pumps, cofferdams, braced sheet piling or any other methods approved by the Engineer;
- Provisions for placement and removal of temporary guide frames;

- Provisions for travelers and traveler testing;
- Provisions for Subsidiary measure and monitoring;
- Furnishing all labour, materials, tests, tools, equipment and any incidentals to complete the work as shown in the Drawings and as required by these Specification Sections, and/or as directed by the Engineer
- Bedding stones underneath of lean concrete shall be included in the Pay Item 06100-14.

<u>Pay Item</u>	<u>Description</u>	<u>Unit</u>
06100-01	Concrete Class A for Cross Beam in Pier Table (CIP) and Key Segment (CIP) of PC Box Girder	m3
06100-02	Concrete Class CI-1 (30 MPa) for Cross Beam and Connection of Main Girder (PC-I Girder)	m3
06100-03	Concrete Class CI-2 (30 MPa) for RC Deck Slab in Composite Deck Slab (PC-I Girder)	m3
06100-04	Concrete Class CI-3 (30 MPa) for Pier (Column)	m3
06100-05	Concrete Class DI-1 (24 MPa) for RC Deck Slab of Steel Bridge	m3
06100-06	Concrete Class DI-2 (24 MPa) for Pier and Abutment (Column, Pile Cap)	m3
06100-07	Concrete Class DI-3 (24 MPa) for Approach Slab	m3
06100-08	Concrete Class DI-4 (24 MPa) for Mechanically-Stabilised Earth Wall, L-type Wall and Gravity Retaining Wall	m3
06100-09	Concrete Class DI-5 (24 MPa) for Concrete Kerb, Concrete Barrier, Median and Foundation of Lighting Pole	m3
06100-10	Concrete Class DII-1 (24 MPa) for SPSP: Top slab concrete	m3
06100-11	Concrete Class DE-1 (21 MPa) for SPSP: Bottom slab concrete	m3
06100-12	Concrete Class DE-2 (18 MPa) for SPSP: Concrete Filling to Steel Pipe	m3
06100-13	Concrete Class EI (18 MPa) for Leveling Concrete on Deck Slab	m3
06100-14	Concrete Class EII (18 MPa) for Lean Concrete on Pile Cap and Approach Slab	m3
06100-15	Concrete Class P (min. flexural strength = 5 MPa) for reinforced Concrete Pavement	m3

Section 06200 - Reinforcement Bar

1. Description

This Specification Section consists of the supply, bending, fabrication and placing of reinforcement bar of the type, size, shape and grade shown in the Drawings, or required by the Engineer.

2. Material Requirements

2.1. Reference Standards

The following Standards in their latest editions shall be particularly applied to the works covered by this Specification Section.

- Specifications for Highway Bridges:

- Part I, Common (Materials), Chapter 3, Material, Japan Road Association (JRA), 2012

- JIS G3112 Steel bar for concrete reinforcement

2.2. Material for Reinforcement Bar

Reinforcement bars shall meet the requirements of Japanese Standard JIS G 3112 or appropriate international standards. No reinforcement bar shall be applied to the Work without a certificate guaranteeing the yield stress and the tensile strength. Reinforcement bars shall be stored above the surface of the ground on platforms, skids or other supports and shall be protected as far as practicable from mechanical injury and surface deterioration caused by exposure to conditions producing rust.

If it is necessary for the Engineer to ascertain the quality of reinforcement bars, the Contractor shall test them at his own expense by means directed by the Engineer.

2.3. Submittals

The Contractor shall submit to the Engineer, for his approval, complete shop drawings of all reinforcement bars.

The Contractor shall provide to the Engineer for review and approval, manufacturer's literature confirming that all materials to be supplied conform to the requirements of this Specification Section.

The Engineer may request the Contractor to furnish whatever samples which may be required and to perform any of the tests specified as necessary for approval of the material. Reinforcement bars to be used in the work shall be subject to written approval of the Engineer.

3. Requirements for Construction of Reinforcement Bars

3.1. Handling and Placing of Reinforcement Bar

All reinforcement bars shall be protected as far as practicable from mechanical injury or surface deterioration, from rusting, or other causes from the time of shipment until it is placed. Reinforcement bars stored at the site shall be laid on wood floors or pillows suitably spaced so that no reinforcement bars shall be laid upon or come in contact with the ground. When the weather is dry and the time for storage before installation is limited, housing may be omitted, but if rainy or exceptionally humid weather occurs or is anticipated, reinforcement bars shall be stored under cover.

3.2. Quality and Supply of Reinforcement Bar

Representative samples of all reinforcement bars that the Contractor proposes to use in the Works must be submitted to the Engineer for his written approval before commencement of Works. Samples

shall be submitted with the manufacturer's certificates stating clearly, for each sample, the place of manufacture, expected date and size of deliveries to the Site, and all relevant details of composition, manufacture, strengths and other qualities of the reinforcement bars.

In the event a reinforcement bars sample under test fails to meet the specification requirements at any time, or the Engineer considers that samples which were presented to him for test were not truly representative, or if it becomes apparent that reinforcement bars which has not been approved has been used for the Works, the Engineer may instruct the Contractor to break out and remove completely all such sections of the work already constructed using such defective reinforcement bars.

All testing of reinforcement bars shall meet the requirements and specification limits of the JIS designation for the particular size, grade and any additional requirements.

3.3. Reinforcement Bar Lists and Bending Diagrams

The Contractor shall provide detailed reinforcement bar lists and bending diagrams to the Engineer for review and approval. Fabrication of material shall not begin until such lists have been approved. The approval of reinforcement bar lists and bending diagrams shall in no way relieve the Contractor of responsibility for the correctness of such lists and diagrams. Any expense incidental to the revision of material furnished in accordance with such lists and diagrams to make it comply with the design drawings shall be borne by the Contractor.

In case that the Contractor is willing to use reinforcement bars which are different from the ones specified in the contract drawings in terms of unit weight, sizes, lengths and number of bars, he shall propose, for the Engineer's authorization, in detailed with comparative explanation table separating from relevant working drawings.

3.4. Fabrication of Reinforcement Bar

3.4.1. Hooks and Bend Dimensions

The dimensions of hooks and the diameters of bends measured on the inside of the reinforcement bar shall be as shown in the Drawings. When the dimensions of hooks or the diameter of bends are not shown, they shall be in accordance with the Specification for Highway Bridges (JRA).

3.4.2. Bending and Anchorage

Each reinforcement bar shall be cut and bent to the dimensions specified in the Drawings. For some structures, the number and length of reinforcement bars may need measuring on site to be in accordance with the dimensions of the structure.

For bending of reinforcement bars, the recommendations of the manufacturer shall be adhered to in each case. All reinforcement bars shall be bent cold. All reinforcement bars requiring bending shall be bent in accordance with the Specification for Highway Bridges (JRA) procedures unless otherwise detailed. Reinforcement bars partially embedded in concrete shall not be bent except as indicated in the Drawings or otherwise permitted. Only qualified workers shall be employed for cutting and bending, and proper appliances shall be provided for such work.

3.5. Fixing of Reinforcement Bar

Reinforcement bars shall be assembled to the shapes and dimensions as indicated in the Drawings. The rods shall be of the cross-sectional areas indicated and shall be fixed rigidly and accurately in the forms in the positions indicated in the Drawings. The rods shall be firmly bound together at intersections of rods to ensure that the reinforcement bar framework as a whole shall retain its shape, and the framework shall be so temporarily supported as to retain its correct position in the forms during the process of depositing and consolidating the concrete. The end of all tying wires shall be turned into the main body of the concrete and not be allowed to project towards the surface. Spacer blocks shall be of precast concrete or mortar of strength at least equal to that of concrete being placed. They shall be as small as practicable and shall be securely fixed in position. They shall be soaked with water immediately prior to concreting.

No temporary metal supports to the reinforcement bar will be allowed to be incorporated in the finished concrete, and metal clips or supports shall not be placed in contact with forms for exposed

surfaces. Use of plastic supports will not be allowed.

Clear cover of 50 mm for all reinforcement bars shall be provided unless otherwise indicated in the Drawings, or approved by the Engineer.

At the time of concreting, all reinforcement bars shall have been thoroughly cleaned and freed from all loose rust, scale, mud, oil or any other coatings that might destroy or reduce the bond, and it shall also have been cleaned of all set or partially set concrete which may have been deposited thereon during the placing of a previous lift of concrete.

The placing of all reinforcement bars shall be checked by the Engineer and in no case shall concrete be placed around any reinforcement bars that have not been approved by the Engineer. The insertion of reinforcement bars into, or the removal of reinforcement bars from concrete already placed, will not be permitted. Reinforcement bars temporarily left projecting from the concrete at the joints shall not be bent without the prior approval of the Engineer.

Dowels shall project to a minimum reinforcement bar of 40mm diameters unless otherwise indicated in the Drawings. Metal supports, which extend to the surface, shall not be used. Placing reinforcement bars on layers of fresh concrete as the work progresses, and adjusting reinforcement bars during the placing of concrete will not be permitted.

Main reinforcement bar carrying determinate stresses shall be spliced only where indicated in the Drawings or on approved shop drawings.

The minimum center to center spacing of parallel reinforcement bars shall be 40mm, but in no case shall the clear distance between the reinforcement bars be less than 4/3 times the maximum size of the coarse aggregate. Also, the spacing of reinforcement bars shall be larger than 1.5 times the bar diameter.

Bundled reinforcement bars shall be tied together at not more than 1.80 m between centers.

All reinforcement bars shall have a clear coverage as indicated in the Drawings or specified herein.

Cover, reinforcement bar sizes and spacing shall be inspected and approved by the Engineer before placing of concrete.

Cover to reinforcement bar, general limits on bar sizes, and spacing of reinforcement bars shall be as indicated in the Drawings.

3.6. Splicing of Reinforcement Bars

All reinforcement bars shall be furnished in full lengths indicated in the Drawings, unless otherwise approved by the Engineer. Except for splices shown in the Drawings, splicing of reinforcement bars will not be permitted without approval. Splices shall be staggered as far as possible.

3.6.1. Lapped Splices

Lapped splices shall be of the lengths shown in the Drawings. If not shown in the Drawings, the length of lapped splices shall be the following equation.

$$l_a = \sigma_{sa} / (4\tau_{0a}) * \phi$$

where;

l_a: Length of lapped splice (mm)

σ_{sa}: Allowable stress for calculating length of lapped splice (N/mm²)

(SD345: 200 N/mm², SD390: 230 N/mm²)

τ_{0a}: Allowable adhesion stress for calculating length of lapped splice (N/mm²)

Design Strength of Concrete (N/mm ²)	24	30	40	50
--	----	----	----	----

Allowable adhesion stress (N/mm ²)	1.60	1.80	2.00	2.00
--	------	------	------	------

ϕ : Diameter of reinforcement bar (mm)

In lapped splices, the reinforcement bars shall be placed and wired in such as manner as to maintain the minimum distance to the surface of the concrete shown in the Drawings.

3.6.2. Mechanical Splices

Mechanical splices shall have a sufficient strength required in the design and equal or more than the material strength of reinforcing steel bars.

Minimum clear distance between adjacent reinforcing steel bars shall be required for the installation and procedure of equipment for mechanical splices.

3.7. Splicing of Mesh or Mats

Sheets of mesh or reinforcement bar mat shall be spliced by overlapping each other sufficiently to maintain a uniform strength, and shall be securely fastened at the ends and edges. The edge lap shall not be less than one mesh in width plus 50 mm.

4. Measurement and Payment

4.1. Method of Measurement

Reinforcement bar incorporated in the concrete will be measured in weight (ton) based on the total computed weight (mass) for the sizes and lengths of bars shown in the contract documents or authorized by the Engineer for use in the work.

The weight (mass) of reinforcement bars will be computed using the weights (masses) in Table "Unit Mass and Standard Dimensions of Deformed Steel Bars (JIS G 3112)" listed in this Specifications unless otherwise altered by the Engineer.

No measurement shall be made for reinforcement bars if it is applied at incorrect places.

The weight (mass) of reinforcement used in item such as railings and precast members and Cast-in-Place pile, where payment for the reinforcement is included in the contract price for the item, shall not be included. Threaded bars or dowels placed after the installation of precast members in the work and used to attach such members to cast-in-place concrete shall be included.

No allowance shall be made for clips, wire, separators, wire chairs, and other material used in fastening the reinforcement in place. If bars are substituted upon the Contractor's request and as a result more reinforcing steel is used than specified in the contract documents, only the amount specified in the contract documents shall be included.

The additional reinforcing bar required for splices that are not shown in the contract documents, but are authorized as provided herein, shall not be included.

Mechanical splices for reinforcing bar will be measured in numbers of each class shown in BOQ and the contract documents or authorized by the Engineer for use in the work. No allowance shall be made for splice which is determined as defective in the opinion of the Engineer.

4.2. Basis of Payment

Payment for the accepted quantity of reinforcement determined under measurement for each class of reinforcing bars shown in the contract documents shall be made at the contract price per ton. Payment shall be full compensation for supply, transport, furnishing, fabricating, splicing, and placing of the reinforcing steel, including all incidental work and materials required.

Payment for the accepted quantity of mechanical splice under measurement for each class shall be made at the contract price per number. Payment shall be full compensation for supply, transport, furnishing, fabricating, splicing, and placing of the reinforcement bar, including all incidental work and materials required.

Table of Unit Mass and Standard Dimensions of Deformed Steel Bars (JIS G 3112) (For reference)

<u>Designation</u>	<u>Unit mass</u> (kg/m)	<u>Nominal diameter (d)</u> (mm)	<u>Nominal cross-sectional area (S)</u> (mm ²)
D 6	0.249	6.35	31.67
D 10	0.560	9.53	71.33
D 13	0.995	12.7	126.7
D 16	1.56	15.9	198.6
D 19	2.25	19.1	286.5
D 22	3.04	22.2	387.1
D 25	3.98	25.4	506.7
D 29	5.04	28.6	642.4
D 32	6.23	31.8	794.2
D 35	7.51	34.9	956.6
D 38	8.95	38.1	1,140
D 41	10.5	41.3	1,340
D 51	15.9	50.8	2,027

<u>Pay Item</u>	<u>Description</u>	<u>Unit</u>
06200-01	Reinforcement Bar (D ≤ 13mm), SD345	ton
06200-02	Reinforcement Bar (13mm < D ≤ 25mm) , SD345	ton
06200-03	Reinforcement Bar (25mm < D ≤ 32mm) , SD345	ton
06200-04	Reinforcement Bar (D = 35mm) , SD345	ton
06200-05	Reinforcement Bar (D = 38mm) , SD345	ton
06200-06	Reinforcement Bar (D = 51mm) , SD345	ton
06200-07	Reinforcement Bar (13mm < D ≤ 25mm) , SD390	ton
06200-08	Reinforcement Bar (25mm < D ≤ 32mm) , SD390	ton
06200-09	Reinforcement Bar (D = 35mm) , SD390	ton
06200-10	Reinforcement Bar (D = 38mm) , SD390	ton
06200-11	Mechanical Splice for D32mm	nos
06200-12	Mechanical Splice for D35mm	nos
06200-13	Mechanical Splice for D38mm	nos
06200-14	Mechanical Splice for D51mm	nos

Section 06300 - Cast-in-Place Concrete Piles

1. Description

This Specification Section consist of the furnishing and constructing reinforced cast-in-place piles using the reverse circulation drilling method, (benoto) hammer-grab, and steel casing or any other earth drill method, in conformity with the lines, grades, design and dimensions shown in the Drawings, or required by the Engineer, in accordance with this and other related Specification Section.

The work to be performed as specified in this Specification Section shall be carried out after sub-soil investigations have been completed by the Contractor, all in accordance with this Specification Section, the Drawings, or required by the Engineer.

2. Material Requirements

2.1. Reference Standards

The Specifications for Highway Bridge (JRA) shall be particularly applied to the works covered by this Specification Section referring to following specifications in their latest editions:

- ASTM A36 Carbon Structural Steel
 - ASTM A53 Standard Specification for Pipe, Steel, Black and Hot-Dipped, Zinc-Coated, Welded and Seamless
 - ASTM A252 Welded and Seamless Steel Pipe Piles
 - ASTM D1143 Standard Test Method for Deep Foundations Under Static Axial Compressive Load
 - ASTM D6760 Standard Test Method for Integrity Testing of Concrete Deep Foundations by Ultrasonic Crosshole Testing
 - OCMA DFCP4 Drilling Fluid Materials Bentonite (OCMA: Oil Companies Materials Association)
 - APIS 13A Specification for Oil Well Drilling Fluid Materials (APIS: American Petroleum Institute Standard)
- Handbook for Design of Pile Foundation (JRA)
Handbook for Construction of Pile Foundation (JRA)

2.2. Materials for Piling

2.2.1. Concrete

Cast-in-place piles shall be constructed, in accordance with the details shown in the Drawings using the class of concrete noted in the Drawings and defined under Specification Section 06100 "Structural Concrete".

Concrete shall be mixed and placed in accordance with the applicable provisions of Specification Section 06100 "Structural Concrete".

2.2.2. Reinforcement Bar

Reinforcement bar shall comply with the provisions of Specification Section 06200 "Reinforcement Bar".

2.2.3. Temporary Casings

Temporary casings shall be used to maintain the stability of pile excavation to avoid possible collapse. Temporary casings shall be free from significant distortion. They shall have a uniform cross-section

throughout each continuous length. During concreting, they shall be free from internal projections and encrusted concrete, which might prevent the proper formation of piles.

If in case of using the earth drilling method diameter of temporary casing should be more 5 cm from the diameter of original piles.

2.2.4. Bentonite and Bentonite Slurry (Drilling Fluid)

(a) Supply of Material

Bentonite, immediately prior to mixing, shall be in accordance with the OCMA DFCP4 (Drilling Fluid Materials Bentonite), or the APIS 13A (Oil Well Drilling Fluid Material).

(b) Mixing

Bentonite shall be mixed thoroughly with clean fresh water to make a suspension, which will maintain the stability of the pile excavation for the period necessary to place concrete and complete construction.

Where chemically contaminated groundwater occurs, special precautions shall be taken to modify the bentonite in all respects for the construction of piles.

2.3. Submittals

Prior to commencement of the Works, in complement to the investigation performed in accordance with Specification Section 01950 – Soil Investigation, the Contractor shall submit to the Engineer, for approval, a complete schedule for investigation of the site and underground conditions in order to confirm the presence or absence of obstructions (e.g. existing piles, sheet piles, remaining structures or structural elements, cables, etc.).

Time extension and relevant payment for the implementation of countermeasures due to the presence of obstructions, including the works partially performed until the interruption, shall be definitively rejected if the above-mentioned requirement is not timely and duly complied with by the Contractor.

Prior to the commencement of piling operations, the Contractor shall submit to the Engineer, for his approval, a method statement giving details of proposed piling methods including:

- Construction Schedule;
- Materials including concrete, reinforcement bars, bentonite slurry or other agents;
- Construction Method;
- Test Method for pile capacity and
- Environmental and Safety measures

2.3.1. General

(a) Details of Construction Plant

Method, schedule and sequence of pile installation, including methods of avoiding damage to adjacent piles, utilities and structures, and method to clear the base of cast-in Place piles;

(b) Methods of Controlling Groundwater

Anticipated ground vibration, ground movement and groundwater drawdown and methods of instrumentation and monitoring;

Methods of Quality control, sampling, testing, mixing, storing, recalculation, removal of silt and sand, prevention of spillage and disposal from the site;

(c) Proposal about Location of Test Pile on Working Pile

Arrangements for pile testing on working pile including static loading test and integrity tests (Sonic Test, Ultrasonic Drilling integrity tests and Coring Test as specified in this Specification) program and method;

2.3.2. Drilling

Borehole shall be excavated to the required depth as shown in the Drawing or as directed by the Engineer. Once the excavation operation has been started, the excavation shall be conducted in a continuous operation until the excavation of the borehole is completed, except for pauses and stops as noted, using approved equipment capable for excavating through the type of material expected. Pauses during this excavation operation, except for casing splicing and removal of obstructions, shall not be allowed.

If the borehole excavation is not complete at the end of the shift of continuous shifts, the borehole excavation operation may be stopped, provided the Contractor, before the end of the work day, protects the borehole by means of full depth of casing or slurry.

Proposed drilled pile excavation and construction methods used to ensure shaft stability during construction and reinforcement/concrete placement;

Proposed drilling procedures for maintaining required horizontal and vertical borehole alignment and a disposal plan for excavated material. If casing is required, provide casing dimensions and detailed procedures for temporary casing installation and removal;

If in case of the drilling by earth drilling method the diameter of drilling should be expanded more 5 cm from diameter of original piles;

2.3.3. Slurry

Proposed method for mixing, testing, circulating, using, maintaining, and disposing of slurry, if used. Provide a detailed slurry mix design and its suitability to the subsurface conditions;

A certificate from the manufacturer of the bentonite powder showing the type, the manufacturer's name, the date and place of manufacture, including details of the apparent viscosity range in centipoises and strength range for solids in water in N/mm²;

Characteristics of the bentonite slurry in a freshly mixed condition and in the excavation immediately before concreting;

Head of bentonite slurry, including calculations.

2.3.4. Concreting and Reinforcement Bar

Details of reinforcement bar placement including bracing, centering, centralizers, and lifting and support methods;

Proposed structural concrete mix design according to Subsection 2.3 "Concrete Classes" of Section 06100 "Structural Concrete";

Concrete placement methods including proposed operational procedures for free-fall, tremie, or pumping methods;

3. Requirements for Construction of Cast-in Place Pile

3.1. Boring

3.1.1. Boring Near Recently Cast Piles

Piles shall not be bored so close to other piles which have recently been cast and which contain workable or unset concrete that a flow of concrete could be induced from, or cause damage to any of the piles.

In case the Contractor intends to bore a new pile that is located close to a recently bored one, do not drill new piles, allow wheel loads, vibration-inducing equipment, or other construction activities within 3 shaft diameters of a newly constructed shaft for at least 20 hours and until the compressive strength of the recently casted borehole concrete has reached 70 % of its designed strength unless otherwise accepted by the Engineer.

3.1.2. Stability of Pile Excavation using Drilling Fluid

Where the use of drilling fluid is approved for maintaining the stability of a bore, the level of the

fluid in the excavation shall be maintained so that the fluid pressure always exceeds the pressures exerted by the soils and external groundwater, and an adequate temporary casing shall be used in conjunction with the method to ensure stability of the strata near ground level until concrete has been placed. The fluid level shall be maintained at not less than 1 m above the level of the external groundwater.

In the event of a rapid loss of bentonite suspension from the pile excavation, the excavation shall be backfilled without delay and the instructions of the Engineer or Engineer's representative shall be obtained before excavation at that location is resumed.

3.1.3. Spillage and Disposal

All reasonable steps shall be taken to prevent spillage of bentonite suspension at the site and in areas outside the immediate vicinity of a bore. Discarded bentonite shall be removed from the site without delay, and shall not be thrown into the waterway. Any disposal of excess bentonite shall comply with the regulations of the local authority.

3.1.4. Temporary Casing

Subsurface casings are to be considered temporary unless designated as permanent casing. Remove temporary casing concurrent with concrete placement. Maintain the concrete within the casing so fluid trapped behind the casing is displaced upward and discharged at the ground surface without contaminating or displacing the pile concrete.

Temporary casings that have become bound or fouled during pile construction and cannot be practically removed are considered to be a defect in the drilled pile. Correct defective shafts using methods approved by the Engineer. Corrective action may consist of, but is not limited to, the following:

- Removing the pile concrete and extending the pile deeper to compensate for loss of frictional capacity in the cased zone;
- Providing straddle piles to compensate for capacity loss; or
- Providing a replacement pile.

3.1.5. Pumping from Bored Holes

Pumping from a bored hole will not be permitted unless a casing has been placed into a stable stratum which prevents the flow of water from other strata in a significant quantity into the bore, or unless it can be shown that pumping will not have a detrimental effect on the surrounding soil or adjacent property.

3.1.6. Cleanliness of Pile Bases

On completion of boring, loose, disturbed or remolded soil shall be removed from the base of the pile, using appropriate and approved methods, which may include airlifting, and which shall be designed to clean while at the same time minimizing ground disturbance below the pile base.

3.1.7. Inspection

For a boring without casing, the diameter of the boring hole for a representative number of piles will be measured by measuring scale prior to the placing of concrete into it. The Contractor's quality control personnel shall do the measurement using approved equipment.

The Contractor shall provide an approved means by which inspection of the verticality of cast-in-place piles and reinforcement cages can be performed.

3.2. Final Pile Toe Level

The Engineer will determine the final pile toe level after his inspection of the earth layers penetrated by the pile.

During pile boring, the Contractor shall produce a boring log indicating approximate depths and types of the various earth layers found therein. Based on the existing conditions of boring, the

Engineer may require the Contractor to provide disturbed samples for visual analysis.

If it is observed that the ground conditions are deemed different from those observed in available information, the Contractor shall immediately notify the Engineer.

The Contractor shall prepare for carrying out sampling to check bottom soils and excavation geometry, but will not be reimbursed for possible delays.

Prior to the commencement of pile borings of On-ramp bridge foundation (AO1 and PO3) (Package-1) and flyover bridge (Package-3), the Contractor shall carry out soil investigations at the locations of directed by the Engineer for review of the design pile length by the Engineer. The soil investigation shall be in accordance with requirements and procedures as specified in Section 01950 – Soil Investigation and/or as required by the Engineer. The Contractor shall submit all required data of the soil investigation results at least 4 weeks before commencement of the pile works.

3.3. Reinforcement Bar and Sonic Logging Tubes

Reinforcement bar shall be fabricated in accordance with the sizes and dimensions shown in the Drawings, and shall be placed, centered and braced in the pile hole to the approval of the Engineer.

Particular care shall be taken in locating projecting "column dowel bars", with a tolerance not exceeding 10 mm in any direction, and pouring will not be permitted until the Engineer is satisfied that adequate provisions have been made.

Adequate "shoes" or spacers shall be firmly anchored to the reinforcement bar to ensure that the reinforcement bar is kept centered in the concrete.

Along with the construction method for pile construction, the Contractor shall submit to the Engineer, for approval, the working drawings and details related to the placing of the reinforcement cage and respective splicing procedures, equipment and measures to prevent damage to the bored hole, and maintain the stability of the bore while the cage is being placed, procedure to control the verticality and consistency of the cage during placing operations, etc.

Sonic Logging Tubes: Install steel Cross-hole Sonic Logging access tubes for each pile at locations specified and according to ASTM D6760. Extend the access tubes at least 300 mm above pile top and a maximum of 75 mm above pile bottom. Use D60.5mm and D114.3mm nominal diameter steel standard black pipe conforming to ASTM A53. Provide a watertight end plug at the lower end of the pipe and make joints watertight. Fill the Sonic Logging access tubes with potable water before placing concrete in the drilled shaft. Temporarily cap the top of the tubes to prevent debris or concrete from entering the tubes.

3.4. Concreting

Immediately after the activities for boring excavation, placement of reinforcement cage and cleaning of the borehole have been completed, the Contractor shall request the Engineer's approval for the commencement of concreting.

Once the Engineer's approval for the commencement of concreting has been obtained, concreting shall start forthwith and continue without interruption. In a boring which contains water or drilling fluid, the concrete shall be placed by using a tremie.

Before placing concrete, measures shall be taken to ensure that there is no accumulation of silt or other materials at the base of the bore.

Concrete shall be a rich coherent mix of high workability having a maximum measured slump of 180±25 mm.

Concrete shall be placed in such a manner that segregation does not occur.

During and after concreting, care shall be taken to avoid damage to the concrete by pumping and dewatering operations.

The hopper and pipe of the tremie shall be clean and watertight throughout. The pipe shall extend to

the base of the pile and a sliding plug or barrier shall be placed on the pipe to prevent direct contact between the first charge of concrete in the pipe of the tremie and the water. The pipe shall at all times penetrate the concrete that has previously been placed and shall not be withdrawn from the concrete until completion of concreting. At all times a sufficient quantity of concrete shall be maintained within the pipe to ensure that the pressure from it exceeds that from the water, and the tremie pipe is under the concrete level by at least 2.0 m deep but never more than 5.0 m. The internal diameter of the tremie pipe should be 200 mm. It should be so designed that external projections are minimized, allowing the tremie to pass through reinforcing cages without causing damage. The internal face of the pipe of the tremie shall be free from projections.

Measurement of the level of concrete surface shall be taken immediately before and after any vertical movement of the tremie pipe.

The Contractor shall ensure that heavily contaminated bentonite suspension, which could impair the free flow of concrete from the pipe of the tremie, has not been accumulated in the bottom of the hole.

A sample of the bentonite suspension shall be taken from the base of the bore using an approved sampling device. If the specific gravity of the suspension exceeds 1.25, the placing of concrete shall not proceed. In such an event, the Contractor shall modify or replace the bentonite as approved to meet the specification.

Remove the top portion of the pile concrete before continuing with column construction when it is determined the concrete has been affected by underwater placement.

Adjust approved admixtures for project conditions to ensure that the concrete has the minimum required slump for at least 2 hours. Submit trial mix and slump loss test results for concrete at ambient temperatures appropriate for site conditions. Place each load of concrete within 2 hours of batching. Longer placement time may be permitted if the concrete mix maintains the minimum required slump for longer than 2 hours. Do not re-temper concrete that has developed its initial set.

Continue placing concrete until the pile hole is full and until acceptable quality concrete is evident at the top of pile.

3.5. Extraction of Casing

3.5.1. Workability of Concrete

Temporary casings shall be extracted while the concrete within them remains sufficiently workable to ensure that the concrete is not lifted. Should a semi-dry mix have been approved, the means of ensuring that the semi-dry concrete does not lift during extraction of the casing shall be subject to approval of the Engineer.

3.5.2. Concrete level

When the casing is being extracted, a sufficient quantity of concrete shall be maintained within it to ensure that pressure from external water or soil is exceeded and that the pile is neither reduced in section nor contaminated.

No concrete shall be placed in the bore once the bottom of the casing has been lifted above the top of the concrete. Concrete shall be placed continuously as the casing is extracted until the desired head of concrete is obtained. The pile shall be settled with an over-height approved by the Engineer to allow for chiseling back to the required cutoff level and to ensure sound, uncontaminated concrete in the head of the pile.

Adequate precautions shall be taken in all cases where excess hydraulic heads could occur as the casing is withdrawn because of the displacement of water by the concrete as it flows into its final position against the walls of the shaft.

The use of vibrating casing extractors shall be subject to the approval of the Engineer.

3.5.3. Water Level

In the event that the groundwater level becomes higher than the required pile head casting level shown in the Drawings, the Contractor shall submit his proposals to the Engineer for approval prior

to placing concrete. The pile head shall not be left below the groundwater level unless approved precautions are taken.

3.6. Quality Control of Piling

3.6.1. General

The Contractor shall submit and follow his quality control plan for the entire Project.

3.6.2. Testing of Materials for Drilling Fluid

The Contractor, based on the referred standards for drilling fluids and prior to the commencement of the work, shall propose the frequency of testing drilling fluid and the method and procedure of sampling. The frequency may subsequently be varied as required depending on the consistency of the results obtained.

Quality control tests shall be carried out on the bentonite suspension, using suitable apparatus. The density of freshly mixed bentonite suspension shall be measured daily as a check on the quality of the suspension being formed. The measuring device shall be calibrated to read to within 0.01 g/ml. Tests to determine density, viscosity, shear strength and pH value shall be applied for the bentonite supplied to the pile bore. For average soil conditions, the results shall generally be within the ranges stated in the table shown in this Subsection. The tests shall be carried out until a consistent working manner has been established, account being taken of the mixing process, any blending of freshly mixed bentonite suspension and previously used bentonite suspension and any process which may be used to remove impurities from previously used bentonite suspension. When the results show consistent behavior, the tests for shear strength and pH value may be discontinued, and tests to determine density and viscosity shall be carried out as approved by the Engineer.

The Contractor shall submit to the Engineer for his approval the method proposed for sampling and checking of contaminated bentonite and for the cleaning of the base of the bore. In the event of a change in the established working manner, tests for shear strength and pH values shall be reintroduced for a period if required.

Table 3.6.1 Acceptable Range of Values for Slurry

Property to be Measured	Range of Results at 20 °C	Test Method
Density	Less than 1.10 g/ml	Mud density balance
Viscosity	30-90 second or Less than 20 cP (centi- poise)	Marsh Funnel Cone method or Fann viscometer *
Shear strength(10 minute gel strength)	1.4-10 N/m ² or 4-40 N/m ²	Shearometer or Fann viscometer
PH	7 - 9	pH indicator strips or electrical pH meter

* Where the Fann viscometer is specified, the fluid sample should be screened by a # 52 sieve (300 µm) prior to testing

3.6.3. Piling Inspection

The Contractor shall designate a competent and experienced technician to be at the site for piling, in charge of the operations and to be responsible for the overall quality control including, but not limited to, the following:

- Proper storage and handling of all the materials for pile fabrication
- Proper maintenance and cleanliness of plant (including that for bentonite preparation), cranes, trucks, and other equipment
- Coordinating closely with the responsible staff of the Contractor designated for the quality control of the works specified in Specification Section 06100 "Structural Concrete"

- Continuous monitoring of the quality of bentonite and other materials used for piling
- Proper preparation of the work before, during and after concrete pouring
- Proper preparation and performance for piles (including the test piles if required according to the Drawings or as instructed by the Engineer) as stated in this Specification Section
- Proper preparation and timely submittal of the data and reports specified in this Specification Section
- Preparation of working drawings, details, and equipment related to the measures to prevent, or to correct, defective piles, which shall be carried out in the event that a borehole collapses during or before concreting work.

3.6.4. Static Loading Test on Working Piles

(a) Testing

Unless otherwise directed by the Engineer, the test load shall be applied in the following sequence:

- Remove load and set recording instruments to zero.
- Increase load to the required pile working load, as shown in the Drawings, in four equal increments.
- Deflection shall be read just after each load increment or decrement is applied and at 15-minute intervals thereafter. The next increment or decrement shall not be applied until the rate of settlement has decreased to 0.05 cm/hour and the load has been sustained for at least one hour.
- The pile working load shall be maintained for at least 12 hours.
- Reduce load to zero by similar equal decrements.
- Increase load to 1.5 times the required pile working load in six equal increments, and maintain at this load for at least 24 hours.
- Reduce load to zero by similar equal decrements.
- For acceptance, the total pile top displacement under 1.5 times the pile working load and after its subsequent removal shall not exceed the following values:

Loading Condition:	Tolerance (% of the pile diameter)	
	Loaded	Unloaded (only dead load of pile)
For bored cast-in-place piles:	1.50%	0.75%

- Instrumentation shall be installed as directed by the Engineer and readings taken at each increment, all in accordance with the manufacturer's recommended procedures.
- In case that signs of yield of bearing resistance is found, the Contractor shall immediately notice the Engineer requesting for his instruction.
- Test loads;

	Package-1	Package-2
Location	A1 Abutment (Diameter: 1.5m)	A2 Abutment (Diameter: 1.5m)
Test Load (1.5 times of required pile working load)	3,600 kN	5,400 kN

	Package-3
Location	PF2 (Diameter: 1.5m)
Test Load (1.5 times of required pile working load)	6,000 kN

(b) Test Results on Pilot and Working Piles

The Contractors shall submit to the Engineer within 48 hours of the completion of the pile test for each pile tested, a detailed record of testing and, in addition, graphs showing:

- Load and pile top displacement plotted above and below a common base line of time for static load tests.
- Pile top displacement plotted vertically against a base line of load for static load tests.

A full comprehensive written report shall be submitted to the Engineer within 10 working days for approval.

After the completion of load tests, all equipment and means of loads used shall be removed from the site.

If the results of the load tests on working piles are considered as non-compliant with the criteria specified or required, piles shall be further tested. If the succeeding pile tests also do not comply with specifications or requirements in the opinion of the Engineer, the Engineer may order changes to the pile group as he considers necessary. New pile or piles shall be installed to replace the defective pile in a position or positions instructed by the Engineer.

3.6.5. Sonic Test in Working Piles

Cast-in-place concrete shall be subject to non-destructive sonic testing. These non-destructive tests shall be carried out by a specialized firm approved in advance by the Engineer. Before commencement of the work, the Contractor shall submit a detailed method statement of the procedures to be undertaken and calibration certificates of all testing apparatus for the Engineer's approval.

The interpretation of the testing results shall be carried out by a competent person and an indication of the result of all testing shall be submitted to the Engineer immediately on completion of the testing for each pile. A full written report shall be submitted directly to the Engineer within 10 days of the test being carried out.

For the purposes of sonic testing, 3 number of D60.5mm and 1 number of D114.3mm steel tubes shall be provided at every pile and these are to be equally spaced around the perimeter of the inner reinforcing steel spacer hoops. Four tubes shall be arranged provided for cast-in-place piles.

The bottom of the tube shall be permanently sealed while the top shall be provided with a screwed plug to prevent the ingress of any undesirable material.

It will be incumbent upon the Contractor to select carefully suitable tubes for straightness and to arrange his method of assembly of the tubes during placing of the pile reinforcements and concrete to avoid any possibility of introducing undesirable material into the tubes and to maintain the straightness after concrete casting. Care must also be taken to protect the tube assembly during extraction of the temporary casing and thereafter.

If it is found that for any reason it is not possible to lower the test probe down a tube, the Contractor shall be responsible for making the tube good or for its replacement at his own expense.

Ultra-sonic tests shall be carried out on every pile (unless otherwise instructed by the Engineer) after confirmation of a 7-day concrete compression strength and within 56 days of concreting for the approval of the Engineer.

Upon completion of tests or whenever instructed by the Engineer, all the tubes shall be filled with an

approved non-shrinkage grout capable of displacing the water contained within each tubes while grout is progressively introduced starting from the bottom of the tube and working upwards. The non-shrinkage grout shall have at least the same strength as the concrete in the pile body.

The cost of providing, installing, and grouting all the steel tubes shall be included as part of the cost per linear meter of the bored pile.

If the sonic tests results indicate signs of defects such as discontinuity or lack of homogeneity in the concrete in the opinion of the Engineer, the Contractor shall conduct core drillings for sampling and laboratory testing to determine whether the quality and bearing capacity of the concrete pile is impaired. The program for any such core drilling and testing shall be approved by the Engineer and all associated costs including grouting the core holes on completion shall be at the Contractor's expense. In case, core sampling test result shows the concrete doesn't have enough strength or homogeneous, the Contractor shall propose countermeasures and repairs at his own expense.

3.6.6. Ultrasonic Drilling Monitor Test

Ultrasonic drilling monitor test shall conduct for assurance of borehole accuracy. Drilled borehole shall be within the limitations of the internal diameter, drilling length and inclination. The Contractor shall verify these geometry for all boreholes and obtain approval of the Engineer after drilling and before the installation of the rebar cage.

(a) Purpose of Ultrasonic Drilling Monitor Test

Determine the geometry of the bored hole, check the inclination and deficit of the drilling hole.

(b) Testing Method

Using a bi-directions of ultrasonic emitting and receiving equipment running along the borehole, the data collector will draw the profile of the borehole.

(c) Testing Procedure

According to the procedure of each equipment manufacturer or according to the specifications instructed by the Engineer.

(d) Steps of Implementation

- Install the probe and roller on top of the bored hole so that the probe is in the center of the hole
- Connect the reading control unit and display
- Turn on the machine to the necessary parameters
- Run the test, checking signal receiver
- Control the roller to drop the probe down and start receiving the signal, drawing the profile.
- Check the results and re-measure the disability potential point if instructed by the Engineer.

(e) Report on Test Results:

The Contractor shall report the records for approval of the Engineer. The contents of report shall include, but not limited to, as below:

Results of the test will be printed out at the site by the ultrasonic drilling monitoring equipment

- Drilling hole mark
- Wall face
- Depth mark (in 10meter intervals)
- Comments and recommendations (Where abnormalities such as decreasing diameter points, collapsing walls)

3.6.7. Core Testing

As required by the Engineer, core drilling shall be provided for completed piles from the bottom of the D114.3mm tube to at least 600 mm below the bottom of the pile. The cores obtained shall be placed in core boxes, and the drill hole identification shall be clearly marked on each respective core and box.

Upon satisfactory completion of tests, all voids formed by core drills shall be pressure grouted with non-shrink grout in accordance with Subsection 3.6.5.

3.7. Positional Tolerance

The center of the completed pile at the cut off level shall not deviate by more than 80 mm from the theoretically correct position shown in the Drawings. The inclination of the pile shall not deviate by more than 1:100 from the vertical.

3.8. Reporting

3.8.1. Daily Piling Records

The Contractor shall furnish the Engineer daily with a detailed record of soils encountered during excavation and construction of the piles.

The Contractor shall keep records, as indicated in the following table, of the installation of each pile, and shall submit two signed copies of these records to the Engineer not later than noon of the next working day after the pile was installed. The signed records shall form a record of the work in accordance with the following:

Table 3.8.1 Record of Pile Borings

(a)	Contract Name and Date
(b)	Pile reference number (location)
(c)	Pile type
(d)	Nominal cross-sectional dimensions or diameter
(e)	Nominal diameter of under-ream
(f)	Length of performed pile
(g)	Standing groundwater level
(h)	Date and time of boring
(i)	Date of concreting
(j)	Ground level at commencement
(k)	Working level
(l)	Depth from working level to pile toe
(m)	Toe level
(n)	Depth from working level to pile head level
(o)	Length of temporary casing
(p)	Length of permanent casing
(q)	Vertical of borehole
(r)	Set of pile or pile tube in mm per 10 blows or number of blows per 25 mm of penetration
(s)	Soil samples taken and in-place tests carried out
(t)	Length and details of reinforcement
(u)	Concrete mix
(v)	Volume of concrete supplied to pile where this can be measured in practice and corresponding levels of concrete and casing
(w)	All information regarding obstructions, delays and other interruptions in the sequence of work
(x)	Strength of corresponding concrete cylinders

(y)	If grouting was done, mix and quantity of grout used.
-----	---

4. Measurement and Payment

4.1. Method of Measurement

(a) Cast-In-Place Pile

Construction of Cast-in-Place pile shall be measured by the lineal meter (lm) of pile constructed for each diameter. The lineal meter shall be computed using the top of pile elevation as defined below, and the bottom elevation shown in the Drawings, unless adjusted by the Engineer.

Except as otherwise specified, the top of CIP pile shall be defined as the bottom surface elevation of pile cap (footing) concrete pile for cast-in-place piles in place, indicated in the Drawings and described in the Bill of Quantities, and approval by the Engineer.

This item is combining item for excavation, concrete placement, and reinforcement bar placement including materials.

(b) Static Loading Test (D 1.500m)

Load test shall be measured per each for tests carried out successfully to the test load specified.

(c) Sonic Test

Sonic test shall be measured per number of CIP piles tested successfully. Re-test for CIP pile that had tested shall not be measured duplicate.

(d) Ultrasonic Drilling Monitor Test

Ultrasonic Drilling Monitor Test shall be measured per number of CIP piles tested successfully. Re-test for CIP pile that had tested shall not be measured duplicate.

(e) Core Testing

Core Testing shall be measured per number of CIP piles tested successfully. Multiple number of core testing in one CIP pile is measured as one (1) number.

4.2. Basis of Payment

The accepted quantities, measured as provided above, shall be paid at the contract price per unit of measurement for the pay items of the Bill of Quantities listed below.

(a) Cast-In-Place Concrete Pile

Payment for the item "Cast-In-Pile Concrete Pile" per lineal meter for each diameter, include all costs in connection with furnishing, mixing, placing, maintaining, containing, collecting, and disposing of all mineral, synthetic, and water slurry and disposal of all excavated materials. Temporary casing required to complete borehole excavation shall be included in this BOQ item. No other separate payment shall be made for the construction of CIP pile.

All costs related to concrete works and reinforcing steel works necessary for completion of CIP pile construction shall also be included in this BOQ item.

All costs related to arrangement of sonic testing tubing are included in this BOQ item.

No payment shall be made for cast-in-place pile if it is applied at incorrect places.

(b) Static Loading Test (D 1.500m)

Load test shall be paid per test installed successfully to specified test load. Payment shall include all costs necessary for completion of the static loading test.

(c) Sonic Test

Sonic Test shall be paid per number of CIP piles tested successfully. Payment shall include all costs

necessary for completion of the Sonic Test. Payment shall include all expenses for furnishing all materials (except sonic testing tubing), equipment and instruments, technicians and experts for completion of the sonic test.

(d) Ultrasonic Drilling Monitor Test

Ultrasonic Drilling Monitor Test shall be paid per number of CIP piles tested successfully. Re-test for CIP pile that had tested shall not be measured delicately. Payment shall include all expenses for furnishing all materials, equipment and instruments, technicians and experts for completion of the ultrasonic drilling monitor test.

(e) Core Testing

As required by the Contractor and approved by the Engineer or directed by the Engineer, payment shall be made at Provisional Sum.

<u>Pay Item</u>	<u>Description</u>	<u>Unit</u>
06300 – 01	Cast-In-Place Concrete Pile (D 1.500m)	lm
06300 – 02	Cast-In-Place Concrete Pile (D 2.000m)	lm
06300 – 03	Static Loading Test (D 1.500m)	Number
06300 – 04	Sonic Test	Number
06300 – 05	Ultrasonic Drilling Monitor Test	Number
06300 – 06	Core Testing	Provisional Sum

Section 06400 – Prestressed Concrete

1. Description

This Specification Section consists of the supply, transport and installation of internal prestressing steel strand, external prestressing steel strand and internal prestressing steel bar in prestressed concrete in conformity with the lines, grades, design and dimensions shown in the Drawings, or as required by the Engineer, and in accordance with this and other related Specification Sections.

The Work shall include the supply, transport, installation, construction, manufacture and placement of any items necessary for the prestressing system to be used, including but not limited to ducts, anchorage devices, jack for prestressing and grout in the ducts.

Post-tensioning is defined as any method of prestressing concrete in which the tensioned reinforcement is tensioned after the concrete has hardened to the required strength.

The Work of Prestressed Concrete I Girder, Precast Concrete Plate and Precast Segment Concrete is referred in Section 06410, Section 06420 and Section 06430, respectively

2. Material Requirements

2.1. Reference Standards

The following Standards in their latest editions shall be particularly applied to the works covered by this Specification. For those not covered by this specification, “Handbook for Construction of Concrete Highway Bridges” by Japan Roadway Association shall also be basically applied:

- JIS G3536: Steel Wires and Strands for Prestressed Concrete
- JIS G3109: Steel Bars for Prestressed Concrete
- “Handbook for Construction of Concrete Highway Bridges” by Japan Roadway Association
- “Precast Segmental & External Cable Construction Method” by Japan Prestressed Concrete Institute: External Cable
- AASHTO M235: Epoxy Resin Adhesives

2.2. Material for Prestressed Concrete

2.2.1. General Requirement

All materials to be furnished and used, but not covered in this Specification Section, shall conform to the requirements stipulated in other applicable sections.

2.2.2. Prestressing Steel Strand

High tensile strength steel strand with low-relaxation shall be weld free and stress relieved after stranding, and shall conform to the requirements of JIS G3536 or equivalent steel strand, uncoated wire stress relieved strand for prestressed concrete.

Testing of prestressing steel strand shall be in accordance with the requirements of the specifications or as instructed by the Engineer.

Manufacturer’s test certificate for breaking strength shall be obtained for each delivered coil or bundle, and a stress/strain diagram shall be obtained for every fifth coil or bundle. Copies of these shall be transmitted to the Engineer.

2.2.3. External Cable

External cable shall be “Epoxy Coated and Filled Strand (ECF)” specified by “Recommendation for Design and Construction of Prestressed Concrete Structures Using Advanced Prestressing Steel Coated by Epoxy Resin” by Japan Society of Civil Engineering (Concrete Library 133) July 2010 or

equivalent approved by the Engineer. Basic properties of strand shall be in compliance with JIS G 3536, while other coatings shall conform to JSCE-E-141 (Japan Society of Civil Engineering) or equivalent approved by the Engineer.

2.2.4. Anchorages

All anchorage assemblies shall be subject to the approval of the Engineer.

All post-tensioned prestressing steel strand shall be secured at the ends by means of approved permanent type anchoring devices. The Contractor shall submit information and details, including test certifications for approval of the Engineer.

End anchorage devices (stress and dead anchorages) shall be designed and manufactured for the types of prestressing steel strand to be used. They shall have a previous service record of performance and durability when used on similar type work.

All anchorage devices for post-tensioning shall be capable of holding the prestressing steel strand at a load producing a stress of not less than 95 percentage (%) of guaranteed minimum tensile strength of the prestressing steel strand or stress instructed by the Engineer.

It shall be the responsibility of the Contractor to determine the required bursting reinforcements in the local zone for the particular shape, and design of the anchorage devices proposed.

It shall be the responsibility of the Contractor to determine the required temporary supports or frames for installation of anchorages.

All externally exposed steel parts shall be protected from corrosion. All threaded parts and fittings shall be protected by greased wrappings or plugs until used. Anchorages shall be kept free from dirt, mortar, loose rust or other deleterious materials. Damaged anchorage parts shall not be used.

2.2.5. Ducts

Ducting for internal prestressing steel strand shall be fully compatible with the proposed prestressing system. The ducts shall be fabricated from corrugated galvanized steel sheet or semi-rigid conduit.

The Contractor shall use mortar-tight duct that are sufficiently-rigid to maintain their shape and alignment during concrete placement and grout installation. Use ducts conforming to the following minimum wall thicknesses or approval of the Engineer:

- | | |
|-------------------------------------|---------|
| • Metal duct, 65 mm diameter | 0.55 mm |
| • Metal duct, >65 mm diameter | 0.70 mm |
| • High density polyethylene (HPDE) | 2.0 mm |
| • High density polypropylene (HDPP) | 2.0 mm |

Ducts shall have grouting connections at each end and shall have vent/drains at all intermediate high and low points, subject to the approval of the Engineer.

2.2.6. Grout for Ducts and Sheaths

Grout shall be an approved, flowable, non-shrink, non-metallic grout containing sulfate-resistant cement. The grout shall have a minimum compressive strength of 20 MPa in 28 days when tested using applicable portions of ASTM C109. The grout shall show no expansion after the final set takes place when tested in accordance with ASTM C827 or equivalent test method approved by the Engineer. The grout shall have an initial setting time of not less than 45 minutes.

Unless otherwise specified in other prevailing sections, or directed or approved by the Engineer as a result of grouting trials, the grout shall:

- consist only of ordinary portland cement, water and expansive admixtures approved by the Engineer, and shall be applied in accordance with the manufacturer's instructions;
- have a water/cement ratio as low as possible, consistent with the necessary workability, and under no circumstances shall the water/cement ratio exceed 0.40;

- not contain admixtures containing chlorides, nitrates or similar electrolytic conducting materials.

2.2.7. Concrete

Material requirements of concrete and concrete classes shall be referred to Subsection 2 “Material Requirements” of Specification Section 06100 “Structural Concrete” or indicated by the Engineer.

Concrete shall be of the class indicated in the Drawings.

2.2.8. Reinforcement Bars

Material requirements of reinforcement bars shall be referred to Subsection 2 “Material Requirements” of Specification Section 06200 “Reinforcement Bar”.

Reinforcement bar shall be of the size indicated in the Drawings.

2.3. Submittals

The Contractor shall prepare, check and submit to the Engineer, for review and approval, the following:

Complete detailed shop drawings, working drawings and schedules together with calculations as required by the Engineer, showing, but not limited to, the following:

- Contractor’s details of proposed manufacture and construction;
- Method and timing of the insertion of the prestressing steel strands;
- A method statement for grouting of ducting;
- Sequence of operation proposed, complete with structural analysis at each stage of construction, with consideration for deformations due to effects of prestressing forces, dead loads, temperature range, creep and shrinkage of concrete and the like, if so required by the Engineer;
- Dimensions and complete descriptions of all devices, joints, bearings, and anchorage's not specified or detailed in the Contract Documents;
- Vertical alignment and deflection control measures including calculations of pre-camber in consideration with prestressing forces, loads, temperature range and effects of creep and shrinkage of concrete and the like;
- Details and design of traveling forms, suspended falsework or scaffolding and the like;
- Temporary fixing/stabilizing method of the supports at the pier tables and closures during erection operations;

Geometry control plan including detailed procedure and method for controlling the geometry at every stage of construction.

Detailed casting manual describing all the activities for casting and curing, including also details of the step-by-step procedure for concrete placement, stressing and advancing the form support system.

The Contractor’s drawings, geometric control calculations, concrete mixtures, formwork and falsework, application methods of prestressing forces, methods for placing, curing, protecting and handling. Particular statement shall be made to emphasize that concrete shall not be cast prior to the Engineer’s approval of these requirements.

The Contractor shall submit the documents required above to the Engineer for his review and approval, at least not less than 7 days, prior to commencement of the concrete works.

3. Requirements for Construction

3.1. Prestressing Steel Strand

The Contractor shall use prestressing steel strand that is bright and free of corrosion, dirt, grease, wax, scale, rust, oil, or other foreign material that may prevent bond between the steel strand and the concrete. Do not use prestressing steel strand that has sustained physical damage or is pitted.

When multi-strand jacking is used, splice all the strands or no more than 10 % of the strands. Use strands having similar properties, from the same source, and having the same "twist" or "lay". Locate splices outside the casting bed and between members.

Do not weld or ground welding equipment on forms or other steel in the member after the prestressing steel strand is installed.

Pack prestressing steel strand to protect it from physical damage and corrosion during shipping and storage. Place a corrosion inhibitor in the package. Use a corrosion inhibitor that has no deleterious effect on the prestressing steel strand, concrete, or bond strength of prestressing steel strand to concrete. Replace or restore damaged packaging.

Mark the shipping package with a statement that the package contains high-strength prestressing steel strand and a warning to use care in handling. Identify the type, kind, and quantity of corrosion inhibitor used, including the date when placed, safety regulations, and instructions for use. Assign a lot number and tag for identification purposes to prestressing steel strand, anchorage assemblies, or bars shipped to the site.

Use hydraulic jacks to tension prestressing steel strand. Use a pressure gauge or load cell for measuring jacking force.

Calibrate measuring devices at least once every 6 months or if they appear to be giving erratic results. Calibrate the jack and gauge as a unit with the cylinder extension in the approximate position that it will be at final jacking force. Keep a certified calibration chart with each gauge.

If a pressure gauge is used, do not gauge loads less than $\frac{1}{4}$ nor more than $\frac{3}{4}$ of the total graduated capacity of the gauge, unless calibration data clearly establishes consistent accuracy over a wider range. Use a pressure gauge with an accurate reading dial at least 150 mm in diameter.

Measure the force induced in the prestressing steel strand using calibrated jacking gauges, load cells, or a calibrated dynamometer. Take elongation measurements of the prestressing steel strand. Determine the required elongation from average load-elongation curves for the prestressing steel strand used.

3.2. Concrete

Make at least one set release strength test cylinders according to AASHTO T23 in addition to those required to determine the 28-day compressive strength. Cure the release strength test cylinders with the concrete member they represent.

Requirements for construction of formwork, concreting, finishing, curing and quality control shall be referred to Subsection 3 "Requirements for Construction" of Specification Section 06100 "Structural Concrete" or indicated by the Engineer.

3.3. Reinforcement Bar

Requirements for construction of reinforcement bar shall be referred to Subsection 3 "Requirements for Construction" of Specification Section 06200 "Reinforcement Bar" or indicated by the Engineer.

3.4. Sampling and Testing

3.4.1. Grouting Trials

Where full scale trials are to be carried out, or when instructed by the Engineer, these shall commence at least 21 days before the planned commencement of duct fixing for prestressing for the permanent works unless otherwise specified in the Contract.

The trials shall incorporate all relevant details of ducts, vents, duct supports and prestressing anchorages, prestressing steel strands, grout inlets and outlets. All systems, methods and materials shall be those proposed for the permanent works and shall have been submitted to the Engineer as part of the detailed method statement required.

Grouting shall be carried out in accordance with the requirements of this Specification Section, and the following information shall be recorded:

- Fluidity of the grouting using a flow cone;
- Results of bleeding tests;
- Compressive strength of the grout;
- Temperature of the grout at the point of injection;
- Shade temperature;
- Grouting pressure close to the point of injection;
- Type of any admixture and results of control tests carried out by the manufacturer to demonstrate its properties including those at appropriate hydration temperatures; and
- Results of a visual inspection for detection of leakage

The arrangement of ducting, end plates injection and outlet connections shown in the Drawings shall be rigidly supported, and an actual or simulated prestressing steel strand inserted but not stressed.

After the grout strength has reached 17 MPa, at least three samples, each 1 m long, shall be cut from the grouted duct at the locations chosen by the Engineer. Each of the samples shall be sectioned longitudinally by cutting with a high speed abrasive cutting wheel, friction saw or similar. The sectioned samples shall be delivered to the Engineer, who will assess the acceptability of the grouting trials particularly with respect to the presence and location of voids in the samples.

If the presence and location of voids are deemed to be unacceptable, the Contractor shall amend the properties of the grout and/or grouting procedures and carry out further trials, until an acceptable result is obtained.

Before commencing grouting trials the Contractor shall submit to the Engineer details of the proposed ducting, method of support and calculations substantiating that the ducting and any surrounding supporting material, which will withstand the grouting pressure used during the trials.

3.4.2. Site Flow Tests

Fluidity of the grout shall be tested on site at the time of mixing using the Marsh Cone Test to ensure practicality of pumping and minimize the risk of blockage during grouting operation. A target flow time of 10-15 seconds shall be achieved.

3.5. Placing Prestressing Steel Strand and Reinforcement Bar

All prestressing steel strands and reinforcement bars shall be accurately placed in the position shown in the Drawings and rigidly held during placing and setting of the concrete. Distance from the forms shall be maintained by stays, formwork spacers, ties, hangers, or other approved support. Formwork spacers for holding units from having contact with the forms shall be of approved material, shape and dimensions. Layers of prestressing steel bars and reinforcement bars shall be separated by suitable wire spacers. Wooden blocks shall not be used as spacers.

3.6. Post-tensioning Method

Post-tensioning shall be carried out in accordance with an approved method and in the presence of the Engineer, unless permission has been obtained to the contrary.

Unless otherwise agreed with the Engineer, prestressing stress shall not be transferred to the concrete, nor end anchors be released, until the concrete has attained a compressive strength of not less than 85 % of the specified 28-day strength as shown by standard specimens made and cured cured identically with the members.

Make positive joints between duct sections. Use waterproof tape at the joints. Use ferrous metal or polyethylene couplings to connect ducts to anchoring devices. Protect ducts, against crushing, excessive bending, dirt contamination and corrosive elements during transport, handling and storing.

In case of duct damage, seal duct with tape, or splice a duct coupler over the damaged section to form a seal that prevent cement paste from entering the duct during the placement of concrete and to prevent leakage during grouting operations.

Immediately before tensioning, the Contractor shall prove that all prestressing steel strands are free to move in the ducts.

Each anchorage device shall be set square to the line of action of the corresponding prestressing steel strand and shall be securely fixed in position and gradient to prevent movement during the placing and compaction of concrete.

Except where dead-end anchorages are cast in the concrete, prestressing steel strands shall not be installed until just prior to stressing. Prestressing steel strands shall be pulled or pushed through the duct in such a manner that will avoid damage to either the prestressing steel strands or the duct.

Before placing concrete, demonstrate that ducts are unobstructed. Immediately after concrete placement, blow out the metal conduit with compressed, oil-free air to break-up and remove mortar in the conduit before it hardens. Approximately 24 hours after the concrete placement, flush the metal conduits with water containing lime (calcium oxide) or slaked lime (calcium hydroxide) in the quantity of 12 grams per liter. Blow the water out with compressed, oil-free air.

Where members consist of jointed elements, the strength of transfer of the jointing material shall be at least equivalent to the specified transfer strength of the members.

The Contractor shall establish the datum point for measuring extension and jack pressure to the satisfaction of the Engineer. Allowance shall be made for the friction in the jack and anchorage for pull-in of the prestressing steel strand during anchorage.

The prestressing steel strand shall be stressed at a gradual and steady rate until the required extension and prestressing steel strand load are reached, or are approved by the Engineer. The sequence of stressing shall be as shown in the Drawings or directed by the Engineer.

The force in the prestressing steel strands shall be obtained from readings on a load cell or pressure gauge incorporated in the equipment and the extension of the prestressing steel strands measured. The extension of the prestressing steel strands under the approved total forces shall be within the limits given 5% of prestressing steel strand for the agreed calculated extension.

If the measured extensions are not within the specified tolerance, the Contractor shall submit to the Engineer his method for rectifying the discrepancy.

When the prestressing force has been applied to the satisfaction of the Engineer, the prestressing steel strands shall be anchored. The force exerted by the tensioning apparatus shall then be decreased gradually and steadily so as to avoid shock to the prestressing steel strand or anchorage.

Full records shall be kept of all tensioning operations including measured extensions, pressure gauge or load cell readings and draw-in at anchorage. Copies of records shall be supplied to the Engineer within 24 hours of each tensioning operation.

Unless otherwise agreed with the Engineer, prestressing steel strands shall not be cut in less than 2 days after stressing.

3.7. Grouting

3.7.1. Plant for Grouting

The grout mixer shall produce a grout of colloidal consistency. The grout injector shall be capable of continuous operation with a sensibly constant pressure of up to 0.70 N/mm² and shall include a system of circulating or agitating the grout while actual grouting is not in progress. All baffles to the pump shall be fitted with 1.18 mm sieve strainers.

The equipment shall be capable of maintaining pressure on completely grouted ducts and shall be fitted with a nozzle that can be locked off without loss of pressure in the duct.

The pressure gauges shall be calibrated before they are first used in the Works, and thereafter as required by the Engineer. All equipment shall be thoroughly cleaned and washed with clean water at

least once every 3 hours during the grouting operations and at the end of use for each day.

During the grouting operation, the Contractor shall provide adequate flushing-out equipment to facilitate the complete removal of the grout in the event of a breakdown of the grouting equipment or other disruption before the grouting operation has been completed.

3.7.2. Grouting of Ducts and Sheaths

Grouting trials shall be undertaken when directed by the Engineer. Prior to using the grout in any trial or in the works covering proposed materials, sheathing, anchorage and vent alignment equipment, the Contractor shall submit a detailed method statement, grouting procedures and quality control plan for the approval of the Engineer.

All ducts shall be thoroughly cleaned out by means of flushing with water and/or compressed air.

Grouting of ducts shall be carried out as soon as it is technically practicable, after the prestressing steel strands inside the ducts have been stressed, and the Engineer's permission to commence grouting has been obtained. If due to the requirements of the stressing procedure, prestressing steel strands cannot be grouted, the sheathing shall be sealed to protect the prestressing steel strands from corrosion.

Injection shall be continuous and slow enough to avoid producing segregation of the grout. The method of injecting grout shall ensure complete filling of the ducts and complete surrounding of the prestressing steel strands. Grout shall be allowed to flow from the free end of the duct until its consistency is equivalent to that of the grout injected. The opening shall then be firmly closed. Any air vents shall be closed in a similar manner one after the other in the direction of flow. The injection tubes shall then be sealed off under pressure until the grout has set.

The filled ducts shall not be subjected to shock or vibration within 1 day of grouting. Not less than 2 days after grouting the level of grout in the injection and vent tubes shall be inspected and made good as necessary.

The Contractor shall keep full records of grouting including quality test of the grouting at site, the date when each duct was grouted, the proportion of the grout and any admixtures used, the pressure, details of any interruptions and topping up required. Copies of these records shall be supplied to the Engineer within 3 days of grouting.

3.8. Protection of Prestressing Anchorages

As soon as possible after tensioning and grouting are completed, exposed end anchorages, prestressing steel strands and other metal accessories shall be cleaned of rust, misplaced mortar, grout and other such materials.

Anchor post-tensioned prestressing steel strand at the ends by permanent type anchoring devices capable of developing not less than 95 % of the ultimate tensile strength of the prestressing steel strand. Enclose loop tendon anchorage in ducts for their entire length.

Immediately following the cleaning operation, the entire surface of the anchorage recess and all exposed metals shall be thoroughly dried and uniformly coated with an epoxy bonding agent conforming to AASHTO M235 Class III in accordance with the manufacturer's recommendations or Japanese Standards.

The anchorage recess shall then be filled with an approved non-shrinkage mortar (refer to Specification Section 08010 "Mortar and Grout"). The mortar shall not contain aluminum powder, iron particles, chlorides, sulfates, fluorides or nitrates.

Where the protection will form part of the exposed works, the anchorage recess shall be filled with concrete of the same quality and color as that of the adjacent concrete and shall be applied and cured in accordance with this Specification Section or as directed by the Engineer.

Exposed surfaces of anchorages not in an anchorage recess shall be coated for corrosion protection with a coal tar epoxy or equivalent approved by the Engineer. Prior to coating, all surfaces shall be wire brushed to remove all loose rust, mill scale or other deleterious substances, and the surfaces cleaned with a suitable solvent to remove oil and grease.

3.9. Curing

3.9.1. GENERAL

Except as specified herein or otherwise approved, wet (water) curing shall be provided in compliance with the requirements in Specification Section 06100 "Structural Concrete". If the Contractor selects to cure by any other method, such method and details shall be subject to the approval of the Engineer.

3.9.2. STEAM CURING

A steam curing process complying with the following conditions may be used, if timely proposed by the Contractor and subsequently approved by the Engineer, as an alternative to water curing:

The casting bed for any unit cured with steam shall be completely enclosed to prevent steam from escaping and exclude the outside atmosphere.

Two to four hours after placing concrete and after the concrete has undergone initial set, the first application of steam shall be made. If retarding admixtures have been used, the duration before application of the steam shall be increased to four to six hours.

Water curing methods shall be used from the time the concrete is placed until steam is first applied.

The steam shall have a relative humidity of 100% to prevent loss of moisture and to provide moisture for proper hydration of the cement.

Application of the steam shall not be directly on the concrete. During the application of the steam, the ambient air temperature shall increase at a rate not exceeding 22°C per hour until the maximum temperature is reached, and shall be held until the concrete has reached the desired strength.

In discontinuing the steam application, the ambient air temperature shall not decrease at a rate exceeding 22°C per hour until the temperature has reached 10°C above the temperature of the air to which the concrete will be exposed.

The maximum curing temperature shall be from 60°C to 67°C.

3.10. HANDLING, TRANSPORT AND STORAGE

Precast prestressed concrete shall not be transported until the concrete has attained a compressive strength of 90% of the specified 28-day strength.

Extreme care shall be exercised in handling and moving concrete members.

Precast girders and slabs shall be transported in an upright position. Shock shall be avoided, and the points of support and directions of the reactions with respect to the members shall be approximately the same during transport and storage as when the member is in its final position. If the Contractor deems it expedient to transport or store precast prestressed units in other than this position, it shall be done at his own risk after notifying the Engineer of his intention to do so. Any unit considered by the Engineer to have become substandard shall be rejected and replaced by an acceptable unit at the Contractor's expense.

3.11. Tolerances for Prestressed Concrete Structures

The tolerances listed in the following table are the allowable deviations for prestressed concrete structures. These tolerances will be the basis for the acceptance of work.

Table 3.11.1 Acceptance Tolerances for Prestressed Concrete Structures

Item	Tolerance
Center Location	± 5 mm
Width & Depth	0mm to +10 mm
Compression Strength	Refer to Subsection 06100
Surface Irregularity by 3m straight edge	± 5 mm

3.12. SPECIAL PROVISIONS FOR EXTERNAL TENDONS

3.12.1. ANCHORAGES

Anchorage to be used for external tendons shall be a product of which the satisfactory performance has been confirmed in the past application. The Contractor shall submit a performance report of the anchorage to the Engineer for his approval.

3.12.2. DEVIATORS

(a) Material

Deviators shall have sufficient capability to deviate a tendon having a required pressing force. Deviators shall not cause any damage to prestressing tendons and have sufficient durability. The Contractor shall submit a performance report of the deviator to the Engineer for his approval.

(b) Installation Tolerance

Installation tolerance of the deviator shall satisfy the following requirements:

Longitudinal Direction:	not more than $L/200$ mm
Transverse Direction:	not more than the smallest of $L/200$, $T/80$ and 30 mm
Vertical Direction:	not more than the smallest of $L/200$, $V/80$ and 30 mm
Angle:	not more than $5/100$ radian
<i>where,</i> $L = \text{Free length of the cable (mm)}$ $T = \text{Width of bottom slab (mm)}$ $V = \text{Height of box girder (mm)}$	

(c) Diablo

The following tolerances apply to the diablo cast in deviators:

- In the vertical direction, $t/50$ or 5 mm;
- In the transverse direction $t/50$ or 10 mm;
- For angular difference in the plane of diablo, 0.05 radian.

(d) Galvanizing

- Deviators shall be galvanized in accordance with Specification Section 07100, or equivalent. Galvanizing shall be applied after the deviator is bent as required for the cable.

3.12.3. DUCTS AND FILL MATERIALS

Ducts shall have sufficient strength for inserting of cables and injection of fill materials. The Contractor shall submit a performance report of the ducts and fill materials to the Engineer for his approval.

3.12.4. MINIMUM RADIUS OF AN EXTERNAL TENDON

<u>Pay Item</u>	<u>Description</u>	<u>Unit</u>
06400-01	External Prestressing Steel Strand (Seven-wire, ECF) – SWPR7BL 19S15.2mm (Grade 1850MPa) for longitudinal prestressing of PC Box Girder	ton
06400-02	Internal Prestressing Steel Strand (Seven-wire) – SWPR7BL 12S15.2mm (Grade 1850MPa) for longitudinal prestressing of PC Box Girder	ton
06400-03	Internal Prestressing Steel Strand (Seven-wire) – SWPR7BL 4S15.2mm (Grade 1850MPa) for Crossbeams of PC Box Girder	ton
06400-04	Internal Prestressing Steel Strand (Seven-wire) – SWPR7BL 4S15.2mm (Grade 1850MPa) for Crossbeams of PC-I Girder	ton
06400-05	Internal Prestressing Steel Strand (Seven-wire) – SWPR7BL 3S12.7mm (Grade 180MPa) for deck slab of PC Box Girder	ton
06400-06	Prestressing Steel Bar - SBPR930/1080 Dia. 32mm for Crossbeams of PC Box Girder	ton
06400-07	Prestressing Steel Bar - SBPR930/1080 Dia. 32mm for Crossbeams of PC-I Girder	ton

Section 06410 – Prestressed Concrete I Girder

1. Description

1.1. General

This Specification Section consists of manufacture, transport and erection of post-tensioning Prestressed Concrete I Girders in conformity with the lines, grades, design and dimensions shown in the Drawings, or as required by the Engineer, and in accordance with this and other related Specification Sections.

The Work shall include the manufacture, supply, transport, installation and construction of any items necessary for the manufacture of Prestressed Concrete I Girder to be used, including but not limited to reinforcement bars, prestressing steel strands, anchorage devices, ducts, concrete and grout used in the ducts.

Post-tensioning is defined as any method of prestressing concrete in which the tensioned reinforcement is tensioned after the concrete has hardened to the required strength.

2. Material Requirements

2.1. Reference Standards

The following Standards in their latest editions shall be particularly applied to the works covered by this Specification:

- JIS G3536 Steel Wires and Strands for Prestressed Concrete
- AASHTO M235 Epoxy Resin Adhesives

2.2. Materials for Prestressed Concrete I Girder

2.2.1. General Requirement

All materials to be furnished and used, but not covered in this Specification Section, shall conform to the requirements stipulated in other applicable sections.

2.2.2. Prestressing Steel Strand

Material requirements of prestressing steel strands shall be referred to Subsection 2 “Material Requirements” of Specification Section 06400 “Prestressed Concrete” or indicated by the Engineer.

Prestressing steel strand shall be of the size indicated in the Drawings.

2.2.3. Anchorages

Material requirements of anchorages shall be referred to Subsection 2 “Material Requirements” of Specification Section 06400 “Prestressed Concrete” or indicated by the Engineer.

2.2.4. Ducts and Sheaths

Material requirements of ducts and sheaths shall be referred to Subsection 2 “Material Requirements” of Specification Section 06400 “Prestressed Concrete” or indicated by the Engineer.

2.2.5. Grout for Ducts

Material requirements of grout for ducts shall be referred to Subsection 2 “Material Requirements” of Specification Section 06400 “Prestressed Concrete” or indicated by the Engineer.

2.2.6. Concrete

Material requirements of concrete and concrete classes shall be referred to Subsection 2 “Material Requirements” of Specification Section 06100 “Structural Concrete” or indicated by the Engineer.

Concrete shall be of the class indicated in the Drawings.

2.2.7. Reinforcement Bars

Material requirements of reinforcement bar shall be referred to Subsection 2 “Material Requirements” of Specification Section 06200 “Reinforcement Bar”.

Reinforcement bar shall be of the size indicated in the Drawings.

2.3. Submittals

The Contractor shall prepare, check and submit to the Engineer, for review and approval, the following:

Complete detailed shop drawings, working drawings and schedules together with calculations as required by the Engineer, showing, but not limited to, the following:

- Contractor’s details of proposed manufacture and construction;
- Method and timing of the insertion of the prestressing steel strands;
- A method statement for grouting of ducting;
- Sequence of operation proposed, complete with structural analysis at each stage of construction, with consideration for deformations due to effects of prestressing forces, dead loads, temperature range, creep and shrinkage of concrete and the like, if so required by the Engineer;
- Dimensions and complete descriptions of all devices, joints, bearings, and anchorage’s not specified or detailed in the Contract Documents;
- Vertical alignment and deflection control measures including calculations of pre-camber in consideration with prestressing forces, loads, temperature range and effects of creep and shrinkage of concrete and the like;
- Details and design of traveling forms, suspended falsework or scaffolding and the like;

Geometry control plan including detailed procedure and method for controlling the geometry at every stage of construction.

Detailed casting manual describing all the activities for casting and curing, including also details of the step-by-step procedure for concrete placement, stressing and advancing the form support system and adjusting the system for calculated deflection.

The Contractor’s drawings, geometric control calculations, concrete mixtures, formwork and falsework, application methods of pre-stressing forces, methods for placing, curing, protecting, handling and erection of members. Particular statement shall be made to emphasize that concrete shall not be cast prior to the Engineer’s approval of these requirements.

The Contractor shall submit the documents required above to the Engineer for his review and approval, at least not less than 7 days, prior to commencement of the concrete works of this Section.

3. Requirements for Construction

3.1. Prestressing Steel Strands

Requirements for construction of prestressing steel strands shall be referred to Subsection 3 “Requirements for Construction” of Specification Section 06400 “Prestressed Concrete” or indicated by the Engineer.

3.2. Concrete

Make at least one set release strength test cylinders according to AASHTO T23 in addition to those required to determine the 28-day compressive strength. Cure the release strength test cylinders with the concrete member they represent.

Requirements for construction of formwork, concreting, finishing, curing and quality control shall be referred to Subsection 3 “Requirements for Construction” of Specification Section 06100 “Structural Concrete” or indicated by the Engineer.

3.3. Reinforcement Bar

Requirements for construction of reinforcement bar shall be referred to Subsection 3 “Requirements for Construction” of Specification Section 06200 “Reinforcement Bar” or indicated by the Engineer.

3.4. Sampling and Testing

3.4.1. Grouting Trials

Requirements for grouting trials shall be referred to Subsection 3 “Requirements for Construction” of Specification Section 06400 “Prestressed Concrete” or indicated by the Engineer.

3.4.2. Site Flow Tests

Requirements for site flow tests shall be referred to Subsection 3 “Requirements for Construction” of Specification Section 06400 “Prestressed Concrete” or indicated by the Engineer.

3.4.3. Testing of Precast Prestressed Members

When directed by the Engineer, one or more Prestressed Concrete I Girders shall be subjected to a loading test. The Contractor shall obtain the prior approval of the Engineer for the detailed arrangements for testing. The cost of tests and records shall be included in the unit prices.

3.5. Placing Prestressing Steel Strands and Reinforcement Bars

Requirements for placing prestressing steel strands and reinforcement bars shall be referred to Subsection 3 “Requirements for Construction” of Specification Section 06400 “Prestressed Concrete” or indicated by the Engineer.

3.6. Post-tensioning Method

Requirements for post-tensioning method shall be referred to Subsection 3 “Requirements for Construction” of Specification Section 06400 “Prestressed Concrete” or indicated by the Engineer.

3.7. Grouting

Requirements for grouting shall be referred to Subsection 3 “Requirements for Construction” of Specification Section 06400 “Prestressed Concrete” or indicated by the Engineer.

3.8. Protection of Prestressing Anchorages

Requirements for protection of prestressing anchorages shall be referred to Subsection 3 “Requirements for Construction” of Specification Section 06400 “Prestressed Concrete” or indicated by the Engineer.

3.9. Fabrication

Girders shall be cast horizontally.

The dimensional length of beams shown in the Drawings shall be the required length without allowances for elastic shortening, creep or shrinkage.

To ensure proper bond to the deck slab, the top surface of girders in contact with deck slabs shall be given a rough exposed aggregate finish. At approximately the time of initial set, all laitance shall be removed to a depth of not less than 3 mm, with a coarse wire to expose the concrete aggregate.

Precast elements that are manufactured off-site shall not be transported from the fabrication area until the concrete compressive strength has attained 90 % of the specified 28-day strength.

All precast members shall be lifted and supported only at the points indicated in the Drawings or otherwise approved by the Engineer.

Precast items shall be lifted and otherwise handled to prevent damage. Any damage to precast items that occurs during transportation or placement shall be inspected by the Engineer. The Engineer may

reject damaged precast items if, in his opinion, such damage will adversely affect the strength and/or the appearance of precast items.

GROUT PADS:

Girder bearings shall be placed on grouted pads as indicated on the Drawings. The concrete bearing area shall be constructed to a plane surface which shall not vary perceptibly from a straightedge placed in any direction across the area. The finished plane shall not vary more than 3 mm from the elevations indicated on the Drawings.

Before placing the grout pad, the concrete areas to be in contact with the grout shall be thoroughly cleaned of all loose and foreign material that could in any way prevent bond between the grout and the concrete surfaces, and shall be kept thoroughly moistened with water for a period of not less than 24 hours immediately prior to placing the grout.

3.10. Handling, Transport and Storage

Prestressed Concrete I Girder shall not be moved from the casting position, or transported, until the concrete compressive strength has attained 90 % of the specified 28-day strength, respectively.

Extreme care shall be exercised in handling and moving concrete members.

Prestressed Concrete I Girder shall be transported in an upright position. Shock shall be avoided, and the points of support and directions of the reactions with respect to the members shall be approximately the same during transport and storage as when the member is in its final position. If the Contractor deems it expedient to transport or store Prestressed Concrete I Girders in other than this position, it shall be done at his own risk after notifying the Engineer of his intention to do so. Any unit considered by the Engineer to have become substandard shall be rejected and replaced by an acceptable unit at the Contractor's expense.

3.11. Tolerances for Prestressed Concrete I Girders

The tolerances listed in the following table are the allowable deviations for Prestressed Concrete I Girders. These tolerances will be the basis for the acceptance of work.

Table 3.11.1 Acceptance Tolerances for Prestressed Concrete I Girders

Item	Tolerance
Center Location	± 5 mm
Surface levels of main girder	± 10 mm
Width & Depth	0mm to +10 mm
Compression Strength	Refer to Subsection 06100
Surface Irregularity by 3m straight edge	± 5 mm

3.12. Marking of Prestressed Concrete I Girder

Each Prestressed Concrete I Girder is to be uniquely and permanently marked so as to show its type, date of casting and reinforcement by using templates.

3.13. Erection

The Contractor shall be responsible for the safety of Prestressed Concrete I Girders during all stages of construction. Lifting devices shall be used in a manner that does not cause damaging, bending, or tensional forces. After a member has been erected and until it is secured to the structure, temporary braces shall be provided as necessary to resist wind or other loads.

4. Measurement and Payment

4.1. Method of Measurement

Measurement shall be made to the neat lines of the structures as indicated in the Drawings.

Measurement for Prestressed Concrete I Girders shall be made in number (Number) of Prestressed Concrete I Girders in place, indicated in the Drawings and described in the Bill of Quantities, approval by the Engineer.

Concrete, reinforcement bars, prestressing steel strands, form, false work, prestressing and grouting shall not be separately measured for payment of the Prestressed Concrete I Girders because they are included in the PC-I girder pay items.

4.2. Basis of Payment

The accepted quantities, measured as provided above, shall be paid at the contract price per unit of measurement for the pay items of the Bill of Quantities listed below.

Payment shall be full compensation for the work prescribed in this Section for the manufacture, transport and erection of all the required Prestressed Concrete I Girder including all labour, materials, tests, tools, equipment and any incidentals to complete the work as shown in the Drawings, and as required by this Specification, and/or as directed by the Engineer and excluding prestressing works at construction site (crossbeam prestressing work). All fees and expenses for the works of the prestressing work at construction site shall be deemed to be included in pay items described in the Section 06400 Prestressed Concrete.

Payment for fabrication and transportation of Prestressed Concrete I Girder shall include the work of materials and installation of concrete, reinforcement bars, prestressing steel strands, prestressing, grouting material and grouting. Payment for erection of Prestressed Concrete I Girders shall include hauling to construction site and erection.

<u>Pay Item</u>	<u>Description</u>	<u>Unit</u>
06410-01	Fabrication and Transportation of PC-I Girder (L=28.6m, H=2.1m)	Number
06410-02	Erection of PC-I Girder (L=28.6m, H=2.1m)	Number
06410-03	Fabrication and Transportation of PC-I Girder (L=29.1 to 30.6m, H=1.9m)	Number
06410-04	Erection of PC-I Girder (L=29.1 to 30.6m, H=1.9m)	Number
06410-05	Fabrication and Transportation of PC-I Girder (L=29.8m, H=2.0m)	Number
06410-06	Erection of PC-I Girder (L=29.8m, H=2.0m)	Number

Section 06420 – Precast Concrete Plate

1. Description

1.1. General

This Specification Section consists of manufacture, transport and erection of pre-tensioning Precast Concrete Plates in conformity with the lines, grades, design and dimensions shown in the Drawings, or as required by the Engineer, and in accordance with this and other related Specification Sections.

The Work shall include the manufacture, supply, transport, installation and construction of any items necessary for the manufacture of Precast Concrete Plates to be used, including but not limited to reinforcement bars, prestressing steel strands and concrete.

2. Material Requirements

2.1. Reference Standards

The following Standards in their latest editions shall be particularly applied to the works covered by this Specification:

- JIS G3536 Steel Wires and Strands for Prestressed Concrete
- AASHTO M235 Epoxy Resin Adhesives

2.2. Materials for Precast Concrete Plate

2.2.1. General Requirement

All materials to be furnished and used, but not covered in this Specification Section, shall conform to the requirements stipulated in other applicable sections.

2.2.2. Prestressing Steel Strand

Material requirements of prestressing steel strands shall be referred to Subsection 2 “Material Requirements” of Specification Section 06400 “Prestressed Concrete” or indicated by the Engineer.

Prestressing steel strand shall be of the size indicated in the Drawings.

2.2.3. Concrete

Material requirements of concrete and concrete classes shall be referred to Subsection 2 “Material Requirements” of Specification Section 06100 “Structural Concrete” or indicated by the Engineer.

Concrete shall be of the class indicated in the Drawings.

2.2.4. Reinforcement Bars

Material requirements of reinforcement bar shall be referred to Subsection 2 “Material Requirements” of Specification Section 06200 “Reinforcement Bar”.

Reinforcement bar shall be of the size indicated in the Drawings.

2.3. Submittals

The Contractor shall prepare, check and submit to the Engineer, for review and approval, the following:

Complete detailed shop drawings, working drawings and schedules together with calculations as required by the Engineer, showing, but not limited to, the following:

- Contractor’s details of proposed manufacture and construction;

Detailed casting manual describing all the activities for casting and curing, including also details of the step-by-step procedure for concrete placement, stressing and advancing the form support system.

The Contractor's drawings, concrete mixtures, formwork and falsework, application methods of prestressing forces, methods for placing, curing, protecting, handling and erection of members. Particular statement shall be made to emphasize that concrete shall not be cast prior to the Engineer's approval of these requirements.

3. Requirements for Construction of Precast Concrete Plate

3.1. Prestressing Steel Strand

Requirements for construction of prestressing steel strand shall be referred to Subsection 3 "Requirements for Construction" of Specification Section 06400 "Prestressed Concrete" or indicated by the Engineer.

3.2. Concrete

Make at least one set release strength test cylinders according to AASHTO T23 in addition to those required to determine the 28-day compressive strength. Cure the release strength test cylinders with the concrete member they represent.

Requirements for construction of formwork, concreting, finishing, curing and quality control shall be referred to Subsection 3 "Requirements for Construction" of Specification Section 06100 "Structural Concrete" or indicated by the Engineer.

3.3. Reinforcement Bar

Requirements for construction of reinforcement bar shall be referred to Subsection 3 "Requirements for Construction" of Specification Section 06200 "Reinforcement Bar" or indicated by the Engineer.

3.4. Placing Prestressing Steel Strands and Reinforcement Bars

Requirements for placing prestressing steel strands and reinforcement bars shall be referred to Subsection 3 "Requirements for Construction" of Specification Section 06400 "Prestressed Concrete" or indicated by the Engineer.

3.5. Pre-tensioning Method

The prestressing elements shall be accurately held in position and stressed by jacks. Stressing shall be applied to produce the stresses required in the strands immediately after the anchorage as shown in the Drawings or as directed by the Engineer. Suitable allowances shall be made for friction in the jacks and for slip and yield in the grips or anchorages.

A record of the items, namely, jacking forces and the elongations produced thereby; and the minimum age in hours of the concrete in the unit at the time the prestressing steel strands were released, shall be kept.

No bond stress shall be transferred to the concrete, nor shall end anchors be released, until the concrete has attained a compressive strength of not less than 85% of the specified 28-day strength as shown by standard specimens made and cured identically with the members. The elements shall be cut or released in such an order that eccentricity of prestressing steel strand is minimized.

3.6. Handling, Transport and Storage

Precast Concrete Plate shall not be moved from the casting position, or transported, until the concrete compressive strength has attained 90 % of the specified 28-day strength, respectively.

Extreme care shall be exercised in handling and moving Precast Concrete Plates.

Precast Concrete Plates shall be transported horizontal position. Shock shall be avoided, and the points of support and directions of the reactions with respect to the members shall be approximately the same during transport and storage as when the member is in its final position. If the Contractor deems it expedient to transport or store Precast Concrete Plate in other than this position, it shall be

done at his own risk after notifying the Engineer of his intention to do so. Any unit considered by the Engineer to have become substandard shall be rejected and replaced by an acceptable unit at the Contractor's expense.

3.7. Marking of Precast Concrete Plates

Each Precast Concrete Plates are to be uniquely and permanently marked so as to show its type, date of casting and reinforcement by using templates.

3.8. Erection

The Contractor shall be responsible for the safety of Precast Concrete Plates during all stages of construction. Lifting devices shall be used in a manner that does not cause damaging, bending, or tensional forces. After a member has been erected.

4. Measurement and Payment

4.1. Method of Measurement

Measurement for Precast Concrete Plates shall be made in number (Number) of Precast Concrete Plates in place, indicated in the Drawings and described in the Bill of Quantities, approval by the Engineer.

Concrete, reinforcement bars, prestressing steel strands for prestressing, form, false work, equipment, jacks and other devices for prestressing work shall not be separately measured for payment of the Precast Concrete Plate.

4.2. Basis of Payment

The accepted quantities, measured as provided above, shall be paid at the contract price per unit of measurement for the pay items of the Bill of Quantities listed below.

Payment shall be full compensation for the work prescribed in this Section for the manufacture, transport and construction of all the required Precast Concrete Plate including all labour, materials, tests, tools, equipment and any incidentals to complete the work as shown in the Drawings, and as required by this Specification, and/or as directed by the Engineer. Payment for Precast Concrete Plate shall include the work of concrete, reinforcement bars and prestressing steel bars, prestressing and hauling to construction site and erection of Precast Concrete Plates.

<u>Pay Item</u>	<u>Description</u>	<u>Unit</u>
06420-01	Fabrication, Transportation and Erection of PC Plate (Standard Part, w=2680mm, L=998mm)	Number.
06420-02	Fabrication, Transportation and Erection of PC Plate (Adjustment Part, w= 2680mm, L=770mm to 970mm)	Number.
06420-03	Fabrication, Transportation and Erection of PC Plate (Standard Part, w=2380mm, L=998mm)	Number.
06420-04	Fabrication, Transportation and Erection of PC Plate (Adjustment Part, w=2380mm, L=616mm to 950mm)	Number.

Section 06430 – Precast Segment Concrete

1. Description

1.1. General

This Specification Section consists of preparation, fabrication, transportation and erection of precast segment concrete for the approach bridges, prepared and constructed in accordance with this Specification Section and Drawings.

Bridges constructed for segmentally placed superstructures shall conform to the requirements specified in these Specification Section, based on the concrete placement method and the erection method to be used as follows:

(a) Span-by-span construction

- Span-by-span (SBS) construction is defined as construction where the precast segments are assembled using a steel erection girder on the entire span between permanent piers. The erection girder is removed after application of post tensioning to make the span capable of supporting its own weight and any construction loads.

2. MATERIAL REQUIREMENTS

2.1. REFERENCE STANDARDS

The following Standard in its latest edition shall be applied to Works covered by this Specification Section.

Prestressed Concrete Technical Standards in Japan:

- “Specification for Design and Construction of Precast Segmental & External Cable Construction Method” by Japan Prestressed Concrete Institute

Besides the above, in general, all materials shall comply with the requirements of the relevant Standard of the Japanese Industrial Standards (JIS) in their latest editions, or other local and/or international standard specifications approved by the Engineer.

2.2. MATERIALS FOR SEGMENT

2.2.1. CONCRETE

The concrete class to be used for pre-cast segments shall be as indicated in the Drawings, and shall comply with the requirements of Specification Section 06100 “Structural Concrete”.

2.2.2. PRESTRESSING STEEL AND GROUTING

Material requirements of prestressing steel strands / bars, duct and grouting to be used for pre-cast segments shall be referred to Subsection 2 “Material Requirements” of Specification Section 06400 “Prestressed Concrete” or indicated by the Engineer.

Prestressing steel strands / bars shall be of the size indicated in the Drawings.

2.2.3. REINFORCEMENT BAR

Material requirements of reinforcement bar to be used for pre-cast segments shall be referred to Subsection 2 “Material Requirements” of Specification Section 06200 “Reinforcement Bar”.

Reinforcement bar shall be of the size indicated in the Drawings.

2.2.4. SUPPLY OF MATERIALS

The Contractor shall submit to the Engineer, for approval, samples of the materials to be provided, and the names of the respective manufacturers and suppliers from whom he proposes to provide the materials required for precast construction. The quality of the provided material shall be certified

by the suppliers, and by testing of the submitted samples under the supervision of the Engineer, at the Contractor's expense.

3. CONSTRUCTION REQUIREMENTS

3.1. GENERAL

All precast segments shall be constructed by short-line match-casting method at a fabrication yard in the presence of the Engineer or his representative.

The segments shall be fabricated at the bed for the short-line match-casting method. In order to secure the proper fabrication procedure, the existing ground condition shall be adequately improved. After the completion of the fabrication, the segments shall be shifted to the temporary storage area by a transfer crane of sufficient capacity. All segments shall be carefully stocked to the lines and spacing and shall be transported to the erection site.

3.2. DESIGN CONSTRUCTION SEQUENCE OF APPROACH BRIDGES

The design sequence of a phased construction of a bridge superstructure is hereby specified. The Contractor shall design, execute and complete the work in accordance with the relevant Specification Sections and the Engineer's instructions. The Contractor shall take full responsibility for the adequacy, stability and safety of all site operations and a method of construction which is developed by the Contractor. Any failure of the Contractor to adopt the method described and acknowledged in this Specification Section shall not relieve the Contractor from responsibility for executing the work.

The Contractor shall consider the requirements for erection of girders as described below based on the Project conditions. However, the Contractor shall be responsible in making his own plan to implement the works. Such plan shall not relieve the Contractor's responsibility to accomplish the work, when it is adopted.

- The PC box girders will be erected from abutment side toward river side (from A1 toward P5 for Thilawa side, and from A2 toward P20 for Thanlyin side). The construction schedule of the PC box girders shall be considered the construction schedule of adjacent Steel Box Girders.
- The longitudinal tendons (external and internal) will be stressed in accordance with the order shown in the design drawings.
- The transverse tendons for deck slab of standard segments will be stressed in the construction yard prior to transportation to the site, while those for deck slab of pier table segments will be stressed on site.
- The outline of erection girder shall be designed as indicated in the Drawings.

3.3. SUBMITTALS

Prior to the commencement of segment operations, the Contractor shall submit to the Engineer, for approval, a method statement giving details of proposed segment casting methods, including, but not limited to,:

- Plan of fabrication yard including casting bed for short line match casting method, soil improvement plan, lifting facility and temporary storage yard;
- Fabrication procedure for segments, including the segment fabrication flow, rebar work, prestressed concrete tendons works, formworks, concrete works, removal of the forms and separation of the segments, prestressing works for deck slab, and transportation for segment;
- Geometry control plan for segment production including the principle of manufacturing segment, geometry control methodology flow for segment, and survey method;
- Method of support for segments during storage (including method of stacking of segments, if necessary) with study and necessary countermeasures for bearing capacity of soil and safety of members (both precast segments and temporary works)

- Summary of all design load assumptions for erection of girders;
- Step-by-step confirmation of the strength and serviceability of the structure at each stage of construction;
- Calculation of required cambers taking into account the effects of creep, shrinkage of concrete and temperature;
- Full design details of temporary structures such as erection girder and temporary bracing;
- Proposed type of epoxy resin adhesive and construction plan;
- Proposed methods for calculation of the jacking forces and extensions for the external cables, if necessary, including stressing of tendons for segment connection;
- Sufficient details to allow a review of effects of the proposed erection procedure for the structure.

3.4. FORMWORK

Formworks for precast segment shall conform to the general requirements for concrete formworks as described under Specification Section for structural concrete. Such forms shall consist of edge forms, side forms, inner forms and bottom forms.

The edge forms will be equipped with a sliding mechanism in order to satisfy the change in length of segments. The side forms will be equipped with the open and close mechanism. The inner forms will be equipped with a shifting mechanism. The side forms will be supported by the temporary platform arranged under the slab of the cantilever and opened or closed using a jack equipment as the supporting points are of pinned mechanism. The inner forms will be set on the main beams of the temporary platform equipped with the sliding mechanism. During the placing of concrete, the main beam will be supported by a suspension system from the top slab of the old segment. The side and inner forms will be connected with the tie bar in order to resist concrete pressure.

The bottom forms of the old segment will be adjusted by putting on and taking off in order to satisfy the change in length of segments. The bottom forms of new segment will be supported by the beam of bottom slab and the vertical jack. The old segment will be supported by the mobile platform equipped with a vertical hydraulic jack.

3.5. CASTING OF CONCRETE

The sheaths for prestressing tendons shall be supported at the interval of 1.0m or shorter, in order to avoid unfavorable displacement of the sheaths due to casting of concrete. Drop or adverse deviation of sheaths at joints shall be avoided by countermeasures such as use of sheaths with sufficient stiffness, insertion of flexible pipes into sheaths across the joints etc.

To obtain match-cast joint, the new segment shall be cast against the previously cast segment before transverse prestressing of the deck slab, in order to avoid adverse deformation of the new segment due to the transverse prestressing of old segment.

3.6. CONSTRUCTION TOLERANCES

The construction tolerance shall be as specified in Specification Sections 06100 and 06400 unless a particular requirement is stipulated below:

<u>No.</u>	<u>Item</u>	<u>Restricted Value</u>
(1)	Segment length	0.01mm/mm
(2)	Web thickness	0 to +10 mm
(3)	Bottom slab thickness	0 to +10 mm
(4)	Deck slab thickness	0 to +10 mm
(5)	Deck slab width	5mm/m, Max 25 mm

(6)	Rib thickness	0 to +12 mm
(7)	Gradient of formwork	1 mm/m
(8)	Position of sheath	±3 mm
(9)	Position of shear key	±6 mm

3.7. LIFTING FACILITY

The Contractor shall allocate a fabrication yard which will consist of a facility for a transfer crane to shift and move segments, and a gantry crane of sufficient capacity to install rebar and form of segments. The proposed details at the lifting points of the segments and the proposed method of lifting and supporting the segment shall be submitted to the Engineer for approval at least 7 days prior to manufacture of segments.

3.8. HANDLING AND TEMPORARY STORAGE YARD

The position and mode of attachment of slings or other tackle for guiding and controlling the movement of the segments during lifting and transport shall be approved by the Engineer. Special care shall be taken to protect the segments from damage due to slings and other tackle.

No superimposed loads or secondary load components resulting from handling, storage or transport shall be placed on any segment.

At all means all segments shall be secured in an upright position by suitable means.

During storage of segments, the tip of tendon sheaths at the joints of segments shall be covered by caps etc. against penetration of rainwater and other fluids, in order to protect the sheaths from corrosion.

The types of temporary supports, position of supports at box girder soffits, method of supporting of segments etc. shall be described in the method statements. The segment shall be kept in stockyard until the erection period. The structure of temporary stock yard, improvement of soft soil (if necessary) etc. shall also be described in the method statement.

3.9. TRANSPORTATION

Segment shall not be transported to the bridge site until concrete test cylinders representing the concrete in the segments have reached strength of not less than the specified 28 days strength as indicated Specification Section 06100.

During transportation, segments shall be handled and supported properly to avoid damage. Segments shall be securely fixed to the transporter to the satisfaction of the Engineer.

3.10. ERECTION OF SEGMENTS

The Contractor shall submit to the Engineer, a detailed proposal outlining the proposed construction sequence. The submission shall incorporate detailed methodology, shop and erection drawings based on the proposed construction sequence, together with the corresponding complete and checked erection design calculations. The package shall be submitted at least 12 weeks prior to the commencement of construction of the SBS segments.

The Contractor shall be responsible for the detailed design of the erection plant, equipment and temporary works, as well as for ensuring the structural adequacy and stability of all such items when used based on proposed construction sequence or the construction sequence shown in the Drawings.

The Contractor shall be responsible for the static and dynamic stability of the structure during all stages of construction. In the development of the Design, detailed computation for construction stage had been conducted. However, the Contractor shall conduct its own assessment of the data and materials contained therein. The Contractor shall confirm with their erection method statement and ensure that their erection scheme will adequately provide stability of the structure at all stages of the construction.

The Contractor shall take account of all loads and material effects. It shall prescribe theoretical

vertical deck profiles for all stages of construction, and the application of superimposed dead loads such as bridge furniture and deck wearing surfaces. Vertical profiles beyond completion shall also be predicted, and at which time, all time-dependent rheological effects can be assumed to have taken place.

The bridge geometry given in the Drawings is based on a mean deck temperature described in the detailed design report/calculations. The Contractor shall achieve this bridge geometry in accordance with the contract documents. The Contractor shall be aware of the fact that direct exposure to the sun on the sides or parts of the bridge will have a significant effect on the deflections, which might be far greater than the specified construction tolerances. The Contractor shall therefore in general conduct global profile surveys and associated measurements at times when solar irradiation has negligible effects, and also provide values of the influence coefficients for critical deflections due to the temperature gradients, which might be anticipated.

3.11. PASTING MATERIAL FOR JOINTING

Epoxy resin adhesives to be used for jointing precast segments shall meet the requirements of Japan Society of Civil Engineers (JSCE) H 101-2013 "Specification for Epoxy Resin Adhesive for Precast Concrete (for Bridge Beam)". According to type of material, mixing types of two liquids or one liquid type, as required, shall be adopted.

Epoxy resin adhesives shall be applied to the whole area of joint surface.

During re-matching period, proper control of adhesive shall be conducted so that there will be no adhesive leaking into the sheath.

3.12. JOINTING SEGMENT

Jointing segment shall be conducted during available usage time of epoxy resin adhesive.

For the joint surfaces, all necessary plans for temporary prestressed concrete tendons shall be prepared in advance and submitted to the Engineer for approval.

Any uneven surface at the deck between each segment may cause obstruction for smooth waterproof construction. In such cases, proper remedy shall be provided by the Contractor.

Treatment of epoxy resin adhesive after re-matching segment shall be carefully conducted.

During jointing work, the joint surfaces of segments shall be kept in uniform compression of 0.3 N/mm² or greater by temporary PC bars until epoxy resin adhesive at joint surfaces is hardened to develops required strength. The time required for hardening of epoxy resin adhesive shall be confirmed by the study and testing prior to the jointing work.

During jointing work, leakage of epoxy resin adhesive into tendon sheaths shall be avoided by appropriate countermeasures such as placing sponge sealing around the tip of sheath etc. The thickness of sealing shall be determined so as not to disturb jointing work or required adhesion area.

4. MEASUREMENT AND PAYMENT

4.1. METHOD OF MEASUREMENT

The quantity of precast segments to be paid shall be the actual number of segments in place of the completed and accepted work. Measurements shall be made in accordance with the Drawings.

4.2. BASIS OF PAYMENT

Payment for Precast Segment Concrete approved by the Engineer shall be conducted in accordance with applicable Unit Prices as indicated on the Bid Price Schedule, wherein payment shall be considered as full compensation for furnishing all labor, materials, equipment and performing all work to complete the fabrication, transportation and erection of segments. The item includes, but not limited to, the following:

- 1) Fabrication and transportation

- All costs of construction of the segment(s) including all materials, fabrication, prestressing work in the fabrication yard, transportation to the stock yard at site, assembling and any kind of incidental work

2) Erection

- Erection of segments includes transportation from stock yard at site to the designated location (construction), lifting, applying epoxy resin adhesive, erection, dismantling the all tools and equipment for erection, and excluding prestressing works at construction site. All fees and expenses for the works of the prestressing work at construction site shall be deemed to be included in pay items described in the **Section 06400 Prestressed Concrete**.
- The price and payment shall be full compensation for all labor, tools, equipment, safety measures, incidentals necessary to complete the work prescribed.

The pay item for concrete and any related activities for segmental concrete are covered under other sections. This section covers only items mentioned in paragraph (a) above.

Payment for fabrication and transportation of Precast Concrete Segment shall include the work of materials and installation of concrete, reinforcement bars. Payment for erection of Precast Concrete Segment shall include hauling to construction site and erection.

<u>Pay Item</u>	<u>Description</u>	<u>Unit</u>
06430-01	Fabrication and Transportation of Precast Segment (Standard Segment, L= 2.5 to 3.0m, H = 2.7m, W = 9.8m)	Number
06430-02	Fabrication and Transportation of Precast Segment (Pier Table, L= 2.6 to 3.3m, H = 2.7m, W = 9.8m)	Number
06430-03	Erection of Precast Segment (Standard Segment, L= 2.5 to 3.0m, H = 2.7m, W = 9.8m)	Number
06430-04	Erection of Precast Segment (Pier Table, L= 2.6 to 3.3m, H = 2.7m, W = 9.8m)	Number

Section 06500 - Bridge Bearings

1. Description

This Specification Section consists of supply, transport and installation of bridge bearings in conformity with the lines, grades, type, and dimensions shown in the Drawings, or as required by the Engineer, and in accordance with this and other related Specification Sections.

The Work shall include the manufacture, placement and finishing of any items necessary for the bed mortar and filling mortar regarding bridge bearing to be used.

The work shall include the manufacture, placement and finishing of any items necessary for the bed mortar, filling mortar, anchor bolt, anchor frame, pedestal frame and tie bar for steel bearings to be used.

2. Material Requirements

2.1. Reference Standards

The following Standard Specifications in their latest editions shall be applied to Works covered by this Specification.

- Specifications for Highway Bridges:

- Part I, Common (Materials), Chapter 4, Bearing and Expansion Joint, Japan Road Association (JRA), 2012

- Part II, Steel Bridges, Japan Road Association (JRA), 2012

- Road Bridge Bearing Manual (in Japanese only):

- Japan Road Association (JRA), 2004

- JIS B0601 Geometrical Product Specifications (GPS) - Surface texture: Profile method - Terms, definitions and surface texture parameters
- JIS B1176 Hexagon Socket Head Cap Screws
- JIS B1180 Hexagon Bolt
- JIS B1181 Hexagon Nuts
- JIS B1256 Plain Washer
- JIS B1351 Split Pins
- JIS G0701 Symbols of forming ratio for steel forging
- JIS G1257 Iron and Steel - Atomic Absorption Spectrometric Method
- JIS G3101 Rolled Steel for General Structure
- JIS G3106 Rolled Steel for Welded Structure
- JIS G3112 Steel Bars for Concrete Reinforcement
- JIS G4051 Carbon Steels for Machine Structural Use
- JIS G4303 Stainless Steel Bars
- JIS G4305 Cold-rolled stainless steel plate, sheet and strip
- JIS G5102 Steel Casting for Welded Structure
- JIS H0401 Test Methods for Hot Dip Galvanized Coatings
- JIS H5120 Copper and copper alloy castings
- JIS H8641 Hot Dip Galvanized Coatings
- JIS K6226 Rubber and rubber products:
Determination of the composition of vulcanizates and uncured compounds by thermogravimetry

- JIS K6227 Rubber:
Determination of carbon black content - Pyrolytic and chemical degradation methods
- JIS K6228 Rubber:
Determination of ash
- JIS K6230 Rubber:
Identification - Infrared spectrometric method
- JIS K6231 Rubber:
Identification of polymers (single polymers and blends) - Pyrolytic gas chromatographic method
- JIS K6251 Rubber, vulcanized or thermoplastic:
Determination of tensile stress - strain properties
- JIS K6256 Rubber, vulcanized or thermoplastic:
Determination of adhesion test
- JIS K6257 Rubber, vulcanized or thermoplastic:
Determination of heat ageing properties
- JIS K6258 Testing methods of the effect of liquids for vulcanized rubber
- JIS K6259 Rubber, vulcanized or thermoplastic:
Determination of ozone resistance
- JIS K6261 Rubber, vulcanized or thermoplastic:
Determination of low temperature properties
- JIS K6262 Rubber, vulcanized or thermoplastic:
Determination of compression set at ambient, elevated or low temperatures
- JIS K6411 Elastomeric Seismic-protection Isolators for Road Bridges – Test Methods
- JIS K6896 Polytetrafluoroethylene powder for molding and extrusion materials
- ASTM C1107 Packaged Dry, Hydraulic-Cement Grout (Non shrink)
- AASHTO M111 Zinc (Hot-Dip Galvanized) Coatings on Iron and Steel Products

2.2. Materials for Bearings

2.2.1. General

All materials used in the manufacture of the bearing assemblies shall be new and unused with no reclaimed material incorporated into the finished assembly.

The bearings are composed in the elastomer, steel plates and steel bars.

The bearings shall consist of assemblies of laminated elastomeric pads as indicated in the Drawings and as specified herein.

The materials for the bearings and assemblies shall fully comply with the requirements shown in this Specification Section, or as indicated by the Engineer

2.2.2. Requirements for Elastomer

The elastomeric materials of the compounds shall be 100% virgin chloroprene rubber and/or neoprene rubber meeting the requirements of following table. The properties of the elastomeric compounds shall be determined from test specimens complying with JIS as follows:

Table 2.2.1 Applied Specifications for Chloroprene Rubber and Neoprene Rubber

Item		Specification	Test Method
Basic	Elongation	$\geq 450\%$ (CR), $\geq 550\%$ (NR)	JIS K6251

	Item	Specification	Test Method
Properties		G10)	
	Tensile Strength (N/mm ²)	≥ 10 N/mm ² (HDR) ≥ 15 N/mm ² (NR,CR)	JIS K6251
Deterioration Test	25% Elongation Stress variation Rate	-10~+100 % (70 °C x 72 hr)	JIS K6257
	Elongation Variation Rate	≥ -50 % (70 °C x 72 hr)	JIS K6257
Durability Test	Permanent Compression Strain Ratio	≤ 35 % (70 °C x 24 hr)	JIS K6262
	Ozone resistance *	No cracks 40 °C x 96 hr, 50 pphm, 50 % elongation)	JIS K6259
	Durability to Water * (Volume variation rate)	≤ 10 % (55 °C x 72 hr)	JIS K6258
	Proof against the cold	≤ - 30 °C	JIS K6261
Bond Strength of Rubber and Steel		≥ 7 N/mm	JIS K6256-2

*Applicable if the elastomer and the cover are the same. If different, not applicable.

Table 2.2.2 Chemical Properties of Chloroprene Rubber and Neoprene Rubber

Item	Specification	Test Method
Polymer qualitative	CR, NR	JIS K 6231, JIS K 6230
Total polymer quantity	≥ 50%	JIS K 6226-1
Quantity of reinforcer	10~35%	JIS K 6226-1, JIS K 6227
Quantity of ash	≤ 10%	JIS K 6226-1, JIS K 6228

2.2.3. Requirements for Steel Plate and Steel Bar

The steel plate and steel bar composing the elastic bearing shall be complying with JIS listed in the following table or equivalent.

Table 2.2.3 Applied Specifications for Steel Plate and Steel Bar

Material	Applied Specification	Material's Correspondence Sign
Rolled steel for structures	JIS G 3101: Rolled steels for general structure	SS400 and others
	JIS G 3106: Rolled steels for welded structure	SM490A and others
Alloy steel for structures	JIS G 4051: Carbon steels for machine structure use	S35CN and others
Hexagon head bolts & hexagon head nuts	JIS B 1180: Hexagon bolt JIS B 1181: Hexagon nuts	
Plain washers	JIS B 1256: Plain washer	
Hexagon Socket Head Cap Screws	JIS B 1176: Hexagon Socket Head Cap Screws	
Deformed bars	JIS G 3112: Steel bars for concrete reinforcement	SR235 and others

For protection for corrosion of steel plates, in general, galvanizing shall conform to the requirements of AASHTO M111 or JIS H 8641 and JIS H 0401.

All welded areas shall be thoroughly cleaned prior to galvanizing to remove all slag or other material that would interfere with the adherence of the zinc. When it is necessary to straighten any sections after galvanizing, such work shall be performed without damage to the zinc coating.

Galvanizing surfaces that are abraded or damaged at any time after the application of the zinc coating shall be repaired by thoroughly wire brushing the damaged areas and removing all loose and cracked coating, after which the cleaned areas shall be painted with three applications of zinc anticorrosive paint as agreed by the Engineer.

2.2.4. Requirements for Lead Plug

Purity of lead shall be confirmed by chemical analysis from a sample of lead used in the Rubber Bearings with lead purity. This test shall be carried out to confirm a minimum of 99.9% purity of the lead by JIS G 1257 and submit the test reports to the Engineer.

2.2.5. Requirements for Bed Mortar and Filling Mortar regarding Bearings

The bed mortar under the steel plates and filling mortar on the steel anchor bars shall be used with an approved non-shrinkage mortar (refer to Specification Section 08010 “Mortar and Grout”). The mortar shall not contain aluminum powder, iron particles, chlorides, sulfates, fluorides or nitrates.

Required characteristic strength of mortars regarding bearings are shown below:

	Characteristic Strength of Mortar [N/mm ²]
Bed mortar under bearings	45
Filling mortar on the steel anchor bars	45
Pedestal layer mortar above bearings (for PC box girder)	50

2.2.6. Requirements for Reinforcement Bar

Material requirements of reinforcement bar in the bed mortar shall be referred to Subsection 2 “Material Requirements” of Specification Section 06200 “Reinforcement Bar”.

Reinforcement bar shall be of the size indicated in the Drawings.

2.3. Materials for Steel Bearings

2.3.1. General

All materials used in the manufacture of the steel bearing (steel pivot bearings, steel pin roller bearings, steel horizontal bearings and steel rocking bearings) assemblies shall be new and unused with no reclaimed material incorporated into the finished assembly.

The steel bearings are composed in the top bearing, bottom bearing and other items as shown in the Drawings.

The materials for the steel bearings and assemblies shall fully comply with the requirements shown in this Specification Section, or as indicated by the Engineer

2.3.2. Bearing Materials

The Bearing materials composing the steel bearing shall comply with JIS or equivalents.

Steel casting used for the steel bearings shall comply with JIS G 5102 (SCW480N, SCW480) or equivalents.

Copper alloy casting used for the steel rocking bearings shall comply with JIS H 5120 (CAC304+SL) or equivalents.

Steel materials used for the steel bearings shall comply with JIS G 3101(SS400), JIS G 3106(SM400 and others), JIS G 4051(S35CN), JIS G 4303(SUS420J2, SUS431), JIS G 4305(SUS316) or equivalents.

Hexagon head bolt, hexagon nut, hexagon hole bolt and plane washer used for the steel bearings shall comply with JIS B 1180, JIS B 1181, JIS B 1176, JIS B 1256 or equivalents respectively.

Some solid lubricant shall be installed at rotation mechanism member of the steel rocking bearing. The materials of solid lubricant shall comply with JIS K 6896 (I-1 grade) or equivalents or other alternative materials consented by the Engineer.

2.3.3. Anchor Frame, Pedestal Frame and Tie Bar Materials

The anchor frame, pedestal frame and tie bar materials for the steel bearings shall comply with JIS or equivalents.

Steel materials used for the anchor frame, pedestal frame and tie bar shall comply with JIS G 3101(SS400), JIS G 3106(SM400 and others), JIS G 4051(S35C) or equivalents.

Torque sheared high strength bolts for the tie bar shall comply with “Specifications for Highway Bridges, Part II, Steel Bridges, Japan Road Association” (S10T) or equivalents.

2.3.4. Galvanizing and Painting

Exposed surface of the top and bottom bearings and other items shown in the Drawings shall be galvanized with adhesion volume of not less than 550 g/m². The bolts, ring, washer and nuts shall be galvanized with adhesion volume of 350 g/m². The galvanizing shall comply with JIS H 8641 and JIS H 0401 or equivalents.

Exposed surface of the pedestal frame shall be painted by C-5 and F-13 coating system. The requirements of the painting shall be referred to Section 07100 in this technical Specifications.

Exposed surface of the anchor frame and tie bar for the steel rocking bearings shall be painted by C-5, F-11 and J coating system with additional painting (same with additional painting for girder ends). The requirements of the painting shall be referred to Section 07100 in this technical Specifications.

2.4. Submittals

The Contractor shall prepare and submit the followings to the Engineer for his approval:

- Certification from the manufacturer that the elastomer, steel plate and steel bar, in the elastomeric bearings to be furnished, conform to all of the requirements indicated in this Specification Section. The certification shall be supported by a certified copy of the results of tests performed by the manufacturer on the samples of that material to be used as elastomeric bearings.
- Certification from the manufacturer that the steel casting, steel materials and other materials, in the steel pivot bearings, steel pin roller bearings, steel horizontal bearings and steel rocking bearings to be furnished, conform to all of the requirements indicated in this Specification Section. The certification shall be supported by a certified copy of the results of tests performed by the manufacturer on the samples of that material to be used as these bearings.
- The Contractor shall submit the detail of mortar following the Specification Section 08010 “Mortar and Grout”.

- Certification from the manufacturer that the bearing devices to be furnished have been widely applied in other projects, listing the project name, country and bearing codes and properties.
- The drawings herein requested shall show all details of the bearings including the material proposed for use. The Contractor shall obtain the approval of the Engineer before commencing fabrication of the bearings.
- Shop drawings and calculations demonstrating the compliance of all bearings with the schedule shown in the Drawings.
- Detailed statement describing the procedures for packaging, handling and storage of the bearing devices to be used for the Project.
- Detailed schedule for all the required testing of materials or bearing devices to be used for the Project.
- Detailed statement of the method for construction and installation of the bearing devices to be used for the Project
- Detailed statement with respect to the methods for installation of the bearings; Once the Engineer has approved these methods, they shall not be changed without prior approval by the Engineer.

3. Construction Requirements

3.1. Construction Requirements for Rubber Bearings

3.1.1. Testing and sampling

The testing of selected bearings shall be arranged with the Engineer prior to their inclusion in the Works. The testing shall be done at an independent testing facility approved by the Engineer.

3.1.2. Elastomeric Bearings

The testing of selected bearings shall be arranged with the Engineer prior to their inclusion in the Works. The testing shall be done at a testing facility or factory of rubber bearing approved by the Engineer.

(a) Compression test

Compression test is a method of checking if a rubber bearing supports the load up to the maximum compressive force, and that there is no trouble in swelling based on the appearance of the rubber bearing. It shall also be ensured that the compression displacement due to live load does not become excessive, based on the compression test performed. Compression test method is shown in (a) and (b).

Middle fulcrum

Maximum compressive force ($R_{max}=R$) shall be loaded 3 times on the rubber bearing. Such test shall ensure that there is no trouble in swelling based on the appearance of the rubber bearing. The 3rd compression displacement is a characteristic value, for checking if the compression displacement (δ_1) at the maximum compressive force based on the rotation (R_1) is more than the rotation displacement (δ_r).

$$\delta_1 \geq \delta_r$$

Ends fulcrum

Maximum compressive force ($R_{max}=R$) shall be loaded 3 times on the rubber bearing. Such test shall ensure that there is no trouble in swelling based on the appearance of the rubber bearing. The 3rd compression displacement is a characteristic value. It checks that ① the compression displacement (δ_1) at the maximum compressive force based on rotation (R_1), is more than the

rotation displacement (δr), and that ② the compression displacement ($\delta c l$) at the check load ($R1 l = 1/2$ of live load) is less than “Design value + 1 mm”.

- ① $\delta l \geq \delta r$
- ② $\delta r \leq \text{Design Value} + 1 \text{ mm}$.

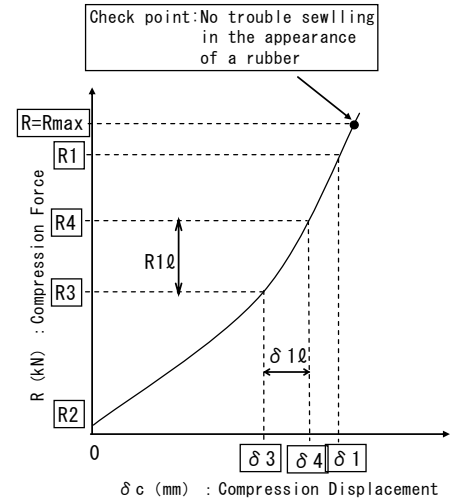
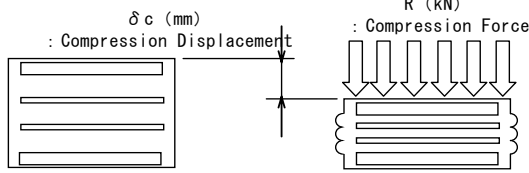

(b) Shearing Test

Shearing test checks if the rubber bearing has required shear stiffness to the horizontal force due to an earthquake. Shearing test method applies rubber bearing horizontal displacement ($\pm 175\%$ of the total rubber thickness) of 3 cycles, in the state where dead load is applied on the rubber bearing. The 3rd shear stiffness is a characteristic value. It checks if test results are less than $\pm 10\%$ of the design values of the measured shear stiffness. Moreover, it checks if there are no defects in the appearance of a rubber bearing.

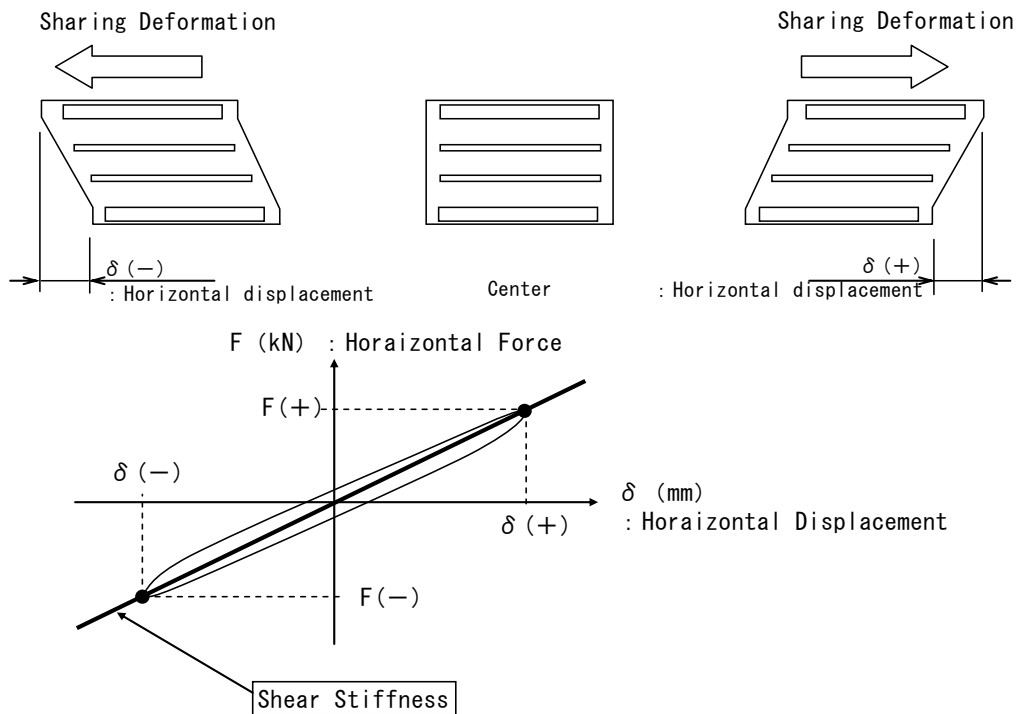

3.1.3. Tolerances

The characteristics of the elastomeric bearing shall be within the following listed tolerances:

The testing of selected bearings shall be arranged with the Engineer prior to their inclusion in the Works. The testing shall be done at a testing facility or factory of rubber bearing approved by the Engineer.

Table 3.2.1 Requirements for Elastomeric Bearing Pads

Standard	Physical Properties	Categories	Value
Rubber bearing main body	Length(a) Width (b) Diameter (D)	$a, b, D \leq 500 \text{ mm}$	0~+5 mm
		$500 \text{ mm} < a, b, D \leq 1500 \text{ mm}$	0~+1%
		$1500 \text{ mm} < a, b, D$	0~+15 mm
	Thickness (t)	$t \leq 20 \text{ mm}$	$\pm 0.5 \text{ mm}$
		$20 \text{ mm} < t \leq 160 \text{ mm}$	$\pm 2.5\%$
		$160 \text{ mm} < t$	$\pm 4 \text{ mm}$
	Flatness *1)	$a, b, D \leq 1000 \text{ mm}$	1 mm
$1000 \text{ mm} < a, b, D$		$(a, b, D)/1000 \text{ mm}$	

*1) Relative error shall be 1 mm between each corner of rubber.

3.2. Construction Requirements for Steel Bearings

3.2.1. Surface Roughness

The surface roughness for steel casting of steel pivot bearing, steel pin roller bearing and steel rocking bearing shall comply with JIS B 0601 (surface roughness: less than 200S) or equivalents.

3.2.2. Forging Ratio

The forging ratio for the pin and spherical bush bearing of the steel rocking bearing shall comply with JIS G 0701 (for pin: more than 3S, for spherical bush bearing: more than 3M) or equivalents.

3.2.3. Tolerances

The characteristics of the bearings shall be within the following listed tolerances:

Table 3.2.2 Fabrication Tolerance for Assembly Height

Items		Tolerance	
Assembly Height of Bearings	Upper/Lower Surface Finish	$\pm 3 \text{ mm}$	
	For Concrete Structure	$H \leq 300$	$\pm 3 \text{ mm}$
		$H > 300$	$\pm(H/200+3) \text{ mm}$

Table 3.2.3 Fabrication Tolerance for Machining Dimension

Size Classification	Tolerance
3 – 6	$\pm 0.3 \text{ mm}$
6 – 30	$\pm 0.5 \text{ mm}$

30 – 120	± 0.8 mm
120 – 400	± 1.2 mm
400 – 1000	± 2 mm
1000 – 2000	± 3 mm
2000 - 4000	± 4 mm

Table 3.2.4 Fabrication Tolerance for Steel Casting Dimension

Size Classification	Tolerance		
	Raw Casting Length of Upper Bearing (CT 13)	Length of Steel Casting Products (CT 14)	Thickness of Raw Casting (CT15)
16 – 25	± 3 mm	± 4 mm	± 5 mm
25 – 40	± 3.5 mm	± 4.5 mm	± 5.5 mm
40 – 63	± 4 mm	± 5 mm	± 6 mm
63 – 100	± 4.5 mm	± 5.5 mm	± 7 mm
100 – 160	± 5 mm	± 6 mm	± 8 mm
160 – 250	± 5.5 mm	± 7 mm	± 9 mm
250 – 400	± 6 mm	± 8 mm	± 10 mm
400 – 630	± 7 mm	± 9 mm	± 11 mm
630 – 1000	± 8 mm	± 10 mm	± 12.5 mm
1000 - 1600	± 9 mm	± 11.5 mm	± 14.5 mm

Table 3.2.5 Fabrication Tolerance for Gas Cutting Dimension

Cutting Width	Thickness	Tolerance		
		6 -27	27 - 50	50 - 100
Less than 1000		± 2 mm	± 2.5 mm	± 3.5 mm
1000 – 3150		± 2.5 mm	± 3 mm	± 4 mm
3150 – 6000		± 3 mm	± 3.5 mm	± 4.5 mm

Table 3.2.6 Fabrication Tolerance for Shear Key

Items	Tolerance
Diameter	-1 to + 0mm
Height	-0 to +1mm

Table 3.2.6 Fabrication Tolerance for Bolt Hole

Items	Tolerance	Remarks
-------	-----------	---------

Connection bolt hole – Superstructure and Substructure	Hole Diameter	+2 to -0 mm	Deviation measured from shear key
	Distance between Hole Centers \leq 1000mm	\leq 1mm	
	Distance between Hole Centers $>$ 1000mm	\leq 1.5mm	

Table 3.2.6 Fabrication Tolerance for Anchor Bolt Length

Items	Tolerance
Anchor Bolt	\pm 2%

Table 3.2.6 Fabrication Tolerance for Roller and Anchor Plate

Items		Tolerance
Anchor Plate	Straightness of rolling surface (roller axial direction)	0.05mm per Length 1000mm
	Flatness of rolling surface after installation	Roller Diameter x (2/1000) mm
Roller	Straightness of rolling surface (axial direction)	0.05mm per Length 1000mm
	Diameter inequality of rolling surface (Roundness, Cylindricity)	Less than 0.05mm

Table 3.2.7 Fabrication Tolerance for Steel Rocking Bearing

Items		Condition	Tolerance (mm)
Anchor Plate	Hole Diameter	H8	+0.165 0
Spherical Bush	Outer Diameter (Sphere)		\pm 0.2
	Inner Diameter		\pm 0.2
	Inner Roundness	---	0.1
	Inner Cylindricity	---	0.1
Spherical Bush Bearing	Outer Diameter	r8	+0.425 +0.260
	Inner Diameter (Sphere)		\pm 0.2
Pin	Outer Diameter	---	\pm 0.2
	Outer Roundness	---	0.1
	Outer Cylindricity	---	0.1

4. Requirements for Installation

The bearings shall be clearly marked with their longitudinal and transverse axes, their type number

and their intended locations in the Works.

Unless otherwise approved by the Engineer, the bed mortar under the steel plates and filling mortar on the steel bars shall be used with an approved non-shrinkage mortar (refer to Specification Section 08010 "Mortar and Grout"). Proposals for the thickness and type of bearing plinths and beds shall be submitted by the Contractor and approved by the Engineer in advance of bearing installation.

Bearings shall not be dismantled. Any transit bolts, straps or other temporary fixing shall not be removed until the bearing is fixed to its final position, and the structure immediately above the bearing is in place. Care shall be taken to ensure that all transit bolts, straps or other temporary fixings are finally removed.

All bearings shall be set horizontal in both directions, and shall be positioned so that the inscribed longitudinal axis is parallel to the structure axis at the point of support, unless otherwise noted in the Drawings.

Immediately prior to directly placing each beam and segment on elastomeric bearings, the top of the bearing shall be coated with a sufficient thickness of approved mortar as indicated in the Drawings to take up any irregularities between the surface of the beams and segment, and the bearings.

Tolerances for bearing installation shall be within the following table.

Table 3.1 Tolerance for Bearing Installation

Item	Concrete bridge	Steel bridge
Elevation	± 5 mm	
Span	\geq Design movement + 10 mm	
Deviation in the bridge direction	5 mm	
Distance among bearings (traverse direction)	± 5 mm	$\pm (4+0.5(B-2))$ mm
Inclination in longitudinal and transverse direction	1/300	

B: Distance among bearings (m)

5. Measurement and Payment

5.1. Method of Measurement

Measurement shall be made to the neat lines of the structures as indicated in the Drawings.

Measurement for bridge bearings shall be made in number (Number.) of bridge bearings in place, indicated in the Drawings and described in the Bill of Quantities, approval by the Engineer.

No measurement and payment shall be made for bridge bearings if it is applied at incorrect places. All costs associated with this work shall be considered as a subsidiary obligation and requirement under the applicable pay items in the Bill of Quantities.

Payment of bridge bearings is including bed mortar, filling mortar and pedestal layer mortar above bearings regarding bearings, and the reinforcement bar in the bed mortar and in the pedestal layer mortar above bearings.

Payment of steel bearings is including bed mortar, filling mortar, anchor bar, anchor frame, pedestal frame and tie bar and necessary galvanizing and painting.

5.2. Basis of Payment

The accepted quantities, measured as provided above, shall be paid at the contract price per unit of measurement for the pay items of the Bill of Quantities listed below.

Payment shall be full compensation for the work prescribed in this Section for the supply, transport and installation of all the required bridge bearings including all labour, materials, tests, tools,

equipment and any incidentals to complete the work as shown in the Drawings, and as required by this Specification, and/or as directed by the Engineer. Payment for bridge bearings shall include the work for placement of bed mortar and filling mortar. Payment for steel bearings shall include the work for placement of bed mortar, filling mortar and installation of anchor bar, anchor frame, pedestal frame and tie bar.

<u>Pay Item</u>	<u>Description</u>	<u>Unit</u>
06500-01	Elastomeric Rubber Bearing 920 x 920 x 224 (G10) for PC Box Girder	Number
06500-02	Elastomeric Rubber Bearing 920 x 920 x 210 (G10) for PC Box Girder	Number
06500-03	Elastomeric Rubber Bearing 920 x 920 x 180 (G10) for PC Box Girder	Number
06500-04	Elastomeric Rubber Bearing 1220 x 1220 x 210 (G10) for PC Box Girder	Number
06500-05	Elastomeric Rubber Bearing 1220 x 1220 x 180 (G10) for PC Box Girder	Number
06500-06	Elastomeric Rubber Bearing 1220 x 1220 x 150 (G10) for PC Box Girder	Number
06500-07	Elastomeric Rubber Bearing 600 x 400 x 100 (Pad Type, G10) for On-ramp Bridge	Number
06500-08	Elastomeric Rubber Bearing 600 x 400 x 80 (Pad Type, G10) for On-ramp Bridge	Number
06500-09	Elastomeric Rubber Bearing 600 x 400 x 60 (Pad Type, G10) for On-ramp Bridge	Number
06500-11	Rubber Bearing 970x970x354 for Steel Box Girder	Number
06500-12	Rubber Bearing 920x920x274 for Steel Box Girder	Number
06500-13	Rubber Bearing 920x970x342 for Steel Box Girder	Number
06500-21	Steel Pivot Bearing for P11 and P12	Number
06500-22	Steel Pin Roller Bearing for P11 and P12	Number
06500-23	Steel Horizontal Bearing for P10 and P13	Number
06500-24	Steel Rocking Bearing for P10 and P13	Number
06500-31	Steel Bearing (Movable type) for Steel Box Girder at P13	Number
06500-32	Rubber Bearing 920x920x184	Number
06500-33	Rubber Bearing 920x920x188	Number
06500-34	Steel Bearing (Movable type) for Steel Box Girder at P20	Number
06500-41	Rubber Bearing 520x470x92	Number
06500-42	Rubber Bearing 520x520x112	Number
06500-43	Rubber Bearing 520x520x142	Number
06500-44	Rubber Bearing 510x510x238	Number
06500-45	Rubber Bearing 710x710x305	Number
06500-46	Rubber Bearing 810x760x356	Number
06500-47	Rubber Bearing 1210x1210x524	Number

Section 06510 – Anchor Bar

1. Description

This Specification Section consists of supply, transport and installation of anchor bars between superstructures and substructures in conformity with the lines, grades, type and dimensions shown in the Drawings, or as required by the Engineer, and in accordance with this and other related Specification Sections.

The Work shall include the manufacture, placement and finishing of any items necessary for the filling mortar regarding anchor bars to be used.

2. Material Requirements

2.1. Reference Standards

The following Standard Specifications in their latest editions shall be applied to Works covered by this Specification Section.

- Specifications for Highway Bridges:

Part I, Common (Materials), Chapter 3, Material, Japan Road Association (JRA), 2012

- JIS G4051 Carbon Steels for Machine Structural Use
- JIS H0401 Test Methods for Hot Dip Galvanized Coatings
- JIS H8641 Hot Dip Galvanized Coatings
- AASHTO M111 Zinc (Hot-Dip Galvanized) Coatings on Iron and Steel Products

2.2. Materials for Anchor Bars

2.2.1. Requirements for Anchor Bars

Anchor bars (S35CN) shall meet the requirements of Japanese Standard JIS G4051 or appropriate international standards. No anchor bar shall be applied to the Work without a certificate guaranteeing the yield stress and the tensile strength. Anchor bars shall be stored above the surface of the ground on platforms, skids or other supports and shall be protected as far as practicable from mechanical injury and surface deterioration caused by exposure to conditions producing rust.

If it is necessary for the Engineer to ascertain the quality of anchor bars, the Contractor shall test them at his own expense by means directed by the Engineer.

For protection for corrosion of anchor bars, in general, galvanizing shall conform to the requirements of AASHTO M111 or JIS H 8641 and JIS H 0401.

Galvanizing surfaces that are abraded or damaged at any time after the application of the zinc coating shall be repaired by thoroughly wire brushing the damaged areas and removing all loose and cracked coating, after which the cleaned areas shall be painted with three applications of zinc anticorrosive paint as agreed by the Engineer.

2.2.2. Spiral bars

The material of spiral bars is SS400. Material requirements of SS400 shall be referred to JIS G3101 in Division 7 “Steelworks”.

2.2.3. Requirements for Filling Mortar for Anchor Bars

The filling mortar on anchor bars shall be used with an approved non-shrinkage mortar (refer to Specification Section 08010 “Mortar and Grout”). The mortar shall not contain aluminum powder, iron particles, chlorides, sulfates, fluorides or nitrates.

2.2.4. Accessory for anchor bars

The anchor bars have some accessories, Anchor Cap and CR Sponge, to prevent from corrosion. The

anchor caps are made from SS400 and CR sponges are made from chloroprene rubber.

Material requirements of SS400 shall be referred to JIS G3101 in Division 7 “Steelworks” and the chloroprene rubber shall be referred to JIS standards in Subsection 06500 “Bridge Bearings”.

2.3. Submittals

The Contractor shall prepare and submit to the Engineer for his approval;

- Certification from the manufacturer that the anchor bar to all of the requirements indicated in this Specification Section.
- The Contractor shall submit the detail of mortar following the Specification Section 08010 “Mortar and Grout”.
- Certification from the manufacturer that the anchor bars to be furnished have been widely applied in other projects, listing the project name, country and bearing codes and properties.
- The drawings herein requested shall show all details of the anchor bars including the material proposed for use. The Contractor shall obtain the approval of the Engineer before commencing fabrication of the anchor bars.
- Detailed statement describing the procedures for packaging, handling and storage of the anchor bars to be used for the Project.
- Detailed statement of the method for installation of the anchor bars to be used for the Project.

3. Requirements for Installation

3.1. Handling and Placing

All anchor bars shall be protected as far as practicable from mechanical injury or surface deterioration, from rusting, or other causes from the time of shipment until it is placed. Anchor bar stored at the site shall be laid on wood floors or pillows suitably spaced so that no anchor bar shall be laid upon or come in contact with the ground. When the weather is dry and the time for storage before installation is limited, housing may be omitted, but if rainy or exceptionally humid weather occurs or is anticipated, anchor bars shall be stored under cover.

3.2. Quality and Supply

Representative samples of all anchor bars that the Contractor proposes to use in the Works must be submitted to the Engineer for his written approval before commencement of Works. Samples shall be submitted with the manufacturer’s certificates stating clearly, for each sample, the place of manufacture, expected date and size of deliveries to the Site, and all relevant details of composition, manufacture, strengths and other qualities of the steel.

In the event a anchor bar sample under test fails to meet the specification requirements at any time, or the Engineer considers that samples which were presented to him for test were not truly representative, or if it becomes apparent that anchor bar which has not been approved has been used for the Works, the Engineer may instruct the Contractor to break out and remove completely all such sections of the work already constructed using such defective anchor bar.

All testing of anchor bar shall meet the requirements and specification limits of the JIS designation for the particular size, grade and any additional requirements.

3.3. Installation of Anchor Bar

All anchor bars shall be accurately placed in the position shown in the Drawings and rigidly held during placing and setting.

Unless otherwise approved by the Engineer, the filling mortar on anchor bars shall be used with an approved non-shrinkage mortar (refer to Specification Section 08010 “Mortar and Grout”).

4. Measurement and Payment

4.1. Method of Measurement

Measurement shall be made to the neat lines of the structures as indicated in the Drawings.

Measurement for anchor bars shall be made in number (Number.) of anchor bars in place, indicated in the Drawings and described in the Bill of Quantities, approval by the Engineer.

No measurement and payment shall be made for anchor bars if it is applied at incorrect places. All costs associated with this work shall be considered as a subsidiary obligation and requirement under the applicable pay items in the Bill of Quantities.

Payment of anchor bars is including filling mortar regarding anchor bars.

4.2. Basis of Payment

The accepted quantities, measured as provided above, shall be paid at the contract price per unit of measurement for the pay items of the Bill of Quantities listed below.

Payment shall be full compensation for the work prescribed in this Section for the supply, transport and installation of all the required anchor bars including all labour, materials, tests, tools, equipment and any incidentals to complete the work as shown in the Drawings, and as required by this Specification, and/or as directed by the Engineer. Payment for anchor bars shall include the work for placement of filling mortar.

<u>Pay Item</u>	<u>Description</u>	<u>Unit</u>
06510-01	Anchor Bar (S35CN) (Dia. 25mm ~ 100mm)	kg

Section 06520 – Bridge Expansion Joints

1. Description

This Specification Section consists of supply, installation and construction of expansion joints in conformity with the lines, grades, design and dimensions shown in the Drawings, or as required by the Engineer, and in accordance with this and other related Specification Sections.

This Work shall include the supply, transport and installation of any items necessary for cover of concrete to be used.

2. Material Requirements

2.1. Reference Standards

The following Standard Specifications in their latest editions shall be applied to Works covered by this Specification Section.

- Specifications for Highway Bridges:
 - Part I, Common (Materials), Chapter 4, Bearing and Expansion Joint, Japan Road Association (JRA), 2012
- Road Bridge Bearing Design Manual for Expansion Joint (in Japanese only):
 - Nippon Dohro Joint Association, 2010
- JIS B1186 High Strength Hexagon Bolt, Hexagon Nut and Plain Washers for Friction Grip Joints
- JIS G3101 Rolled Steel for General Structure
- JIS G3106 Rolled Steel for Welded Structure
- JIS G3112 Steel Bars for Concrete Reinforcement
- JIS G4304 Hot-rolled Stainless Steel Plate, Sheet and Strip
- JIS G4305 Cold-rolled Stainless Steel Plate, Sheet and Strip
- JIS G5502 Spheroidal Graphite Iron Castings
- JIS H5202 Aluminium Alloy Castings
- JIS H8641 Hot Dip Galvanized Coatings
- JIS K6251 Rubber, vulcanized or thermoplastic:
Determination of tensile stress - strain properties
- JIS K6252 Rubber, vulcanized or thermoplastic:
Determination of tear strength
- JIS K6253 Rubber, vulcanized or thermoplastic:
Determination of hardness
- JIS K6257 Rubber, vulcanized or thermoplastic:
Determination of heat ageing properties

2.2. Materials for Aluminum Expansion Joint

(a) General

All materials used in the manufacture of the expansion joint assemblies shall be new and unused with no reclaimed material incorporated into the finished assembly.

The expansion joints are composed in the aluminum casting alloy and ethylene propylene rubber.

The materials for the expansion joints and assemblies shall fully comply with the requirements shown

in this Specification Section, or as indicated by the Engineer

No materials shall be used or installed until the Contractor has been notified by the Engineer of their approval.

(b) Requirements for Aluminum Expansion Joint

Materials used for expansion joints shall be as shown in following tables, or equivalent.

Table 2.2.1 Requirements for Main Materials of Expansion Joints

Material	Character	Grade	Property	Standard No.
Joint body	Aluminum casting alloy	AC4CH-T6	Tensile strength	JIS H5202
			Elongation	
			Hardness	
Waterproofing rubber	Ethylene Propylene rubber (EPDM)	-	Tensile strength	JIS K6251
			Elongation	JIS K6253
			Hardness	
			Deterioration of tear strength	JIS K6252

Table 2.2.2 Requirements for Accessories of Expansion Joints

Material	Character	Grade	Standard No.
Cover for kerb and median	Steel	SS400	JIS G3101
Cover for concrete barrier	Steel	SUS304	JIS G4304
Reinforcement bar	Steel	SD345	JIS G3112

2.2.2. Concrete

Material requirements of concrete and concrete classes shall be referred to Subsection 2 “Material Requirements” of Specification Section 06100 “Structural Concrete” or indicated by the Engineer.

Concrete shall be of the class indicated in the Drawings.

2.2.3. Reinforcement Bars

Material requirements of reinforcement bars shall be referred to Subsection 2 “Material Requirements” of Specification Section 06200 “Reinforcement Bar”.

Reinforcement bar shall be of the size indicated in the Drawings.

2.3. Materials for Modular-type Bridge Expansion Joint (MBEJ) System

The Modular-type Bridge Expansion Joint (hereinafter called as “MBEJ”) shall conform to the specifications provided by the Manufacturer at the time of approval.

2.4. Materials for Steel Finger Joint

2.4.1. General

All joint material and assemblies stored at the job site shall be protected from damage and assemblies shall be supported so as to maintain their true shape and alignment. Deck expansion joint shall be constructed and installed to provide a smooth ride. Bridge deck joint shall be covers over by

protective material after installation until final clean-up of the bridge deck.

The materials for the expansion joints and assemblies shall fully comply with the requirements shown in this Specification Section, or as indicated by the Engineer

2.4.2. Requirements for Steel Finger Joint

Materials used for expansion joints shall conform to JIS standards shown in “2.1 Reference Standards” or equivalent, or as indicated by the Engineer.

No materials shall be used or installed until the Contractor has been notified by the Engineer of their approval.

2.5. Manufacture and Fabrication for MBEJ

2.5.1. General

The following requirements apply to both shop welds and field welds unless specifically noted otherwise. The MBEJ shall be fabricated in accordance with the dimensions, shapes, details, material specifications, and procedures shown in the approved shop plans. Fillet welds shall be welded continuously. Intermittent fillet welds are not permitted.

Field-splice details shall be fatigue-tested and shall be approved by the Engineer.

Care must be taken to avoid weld metal getting into the seal retainer grooves, which can lead to seal pullout and leaking. Lifting devices shall be provided, and devices to maintain the preset opening of the joint shall be provided at a uniform spacing not greater than 4500 mm along the length of the MBEJ. At least three devices shall be used per segment of MBEJ.

When the fabrication is completed, the Manufacturer shall perform the pre-installation inspection described in Article 3.2 to assure that the MBEJ will pass this inspection.

2.5.2. Center-beam and Support Bar

The center-beams, support bars, and connection details shall be the same type as were used in the prequalification tests. Shop splices in the center-beam profile shall be two-sided, complete-joint-penetration groove welds. In welded multiple-support-bar MBEJ, the weld joint between the center-beam and support bar shall be a full-penetration groove weld.

After welding, the center-beam/support bar assembly shall be placed on a flat surface and it shall be verified that the support bars lie in a single plane, with no part of the bottom of any support bars exceeding 6 mm off the surface. The subassembly may be straightened. No more than three attempts may be made to heat-straighten the subassembly.

2.5.3. Seals

Seals shall be installed by the Manufacturer before shipping unless center-beam field splices are used. If field splices are necessary, continuous seals (without splices) shall be installed in the field after the construction is complete. In either case, the same lubricant-adhesive that was used in the prequalification tests shall be used when installing the seals. The seals shall extend out from the ends of the edge-beams and center-beams by at least 50 mm.

2.5.4. Support Boxes

Support boxes shall be made from steel plate or tubes at least 9 mm thick continuously welded. If the support boxes are more than 400 mm wide, the thickness of the top plate shall increase so that the width-to-thickness ratio does not exceed 45 or stiffening must be used. If the support box is made of nested tubes, the diameter or width-to-thickness ratio of each tube shall not exceed 45.

2.5.5. PTFE Sliding Surface

The PTFE shall be bonded under controlled conditions and in accordance with the instructions of either the PTFE Manufacturer or the adhesive Manufacturer. After completion of the bonding operation, the PTFE surface shall be smooth and free underlying bubbles.

2.5.6. Stainless Steel Sliding Surface for MBEJ

The stainless steel shall be polished to an 0.20 μm mirror finish.

2.5.7. Corrosion Protection

All steel surfaces, except the surfaces under stainless steel or those to be bonded to PTFE, shall be protected against corrosion.

2.6. Submittals

2.6.1. Aluminum Expansion Joint and Steel Finger Joint

The Contractor shall submit to the Engineer, for his approval, complete shop drawings of all expansion joints. The shop drawings shall include a movement chart showing the total anticipated movement of the structure and the required setting width of the joint assembly at various temperatures. All movements due to shrinkage, creep, mid-slab deflection, and similar data, may not be incorporated into this chart but shall be considered by the Contractor and approved by the Engineer prior to final installation and adjustments.

The Contractor shall provide to the Engineer for review and approval, manufacturer's literature confirming that all materials to be supplied conform to the requirements of this Specification Section.

The Engineer may request the Contractor to furnish whatever samples which may be required and to perform any of the tests specified as necessary for approval of the material. Joints to be used in the work shall be subject to written approval of the Engineer.

2.6.2. Modular-type Bridge Expansion Joint

The MBEJ axis is defined as any axis paralleled to the axes of the edge-beams and seals of the MBEJ. The skew angle is the angle between the longitudinal axis of the support bars and a line perpendicular to the MBEJ axis. Movements parallel to the longitudinal axis of the support bars will be referred to as longitudinal movements. The longitudinal axis of the support bars is typically coincident with the direction of the net expected thermal movement. Movement's perpendicular to the longitudinal axis of the support bars will be referred to as transverse movements.

The Contractor shall submit details of the MBEJ to be used together with installation and waterproofing plans to the Engineer for approval prior to fabrication of the MBEJ. The shop plans shall include, but not be limited to the following:

- Plan and section views of the MBEJ for each movement rating and roadway width, showing dimensions and tolerances.
- All welded and bolted center-beam/support bar joints and all shop and field splices shall be shown.
- Complete details of all components and sections showing all material incorporated into the MBEJ.
- All ASTM, AASHTO, or other material designations.
- Corrosion protection system.
- Lifting locations and lifting mechanisms shall be shown as part of an integral installation plan.
- Temperature adjustment devices and opening dimensions relative to temperature.

3. Requirements for Installation

3.1. Aluminum Expansion Joint and Steel Finger Joint

3.1.1. Handling and Placing

All expansion joints shall be protected as far as practicable from mechanical injury or surface deterioration, from rusting, or other causes from the time of shipment until it is placed. Expansion joint stored at the site shall be laid on wood floors or pillows suitably spaced so that no expansion joint shall be laid upon or come in contact with the ground.

3.1.2. Quality and Supply

Representative samples of all expansion joints that the Contractor proposes to use in the Works must be submitted to the Engineer for his written approval before commencement of Works. Samples shall be submitted with the manufacturer's certificates stating clearly, for each sample, the place of manufacture, expected date and size of deliveries to the Site, and all relevant details of composition, manufacture, strengths and other qualities of the expansion joint.

If a sample of expansion joint under test fails to meet the specification requirements at any time, and if it becomes apparent that expansion joint which has not been approved has been used for the Works, the Engineer may instruct the Contractor to break out and remove completely all such sections of the work already constructed using such defective expansion joint.

3.1.3. Installation of Expansion Joint

All expansion joints shall be accurately placed in the position shown in the Drawings and rigidly held during placing and setting.

The Contractor shall follow the Manufacturer's written installation guidelines and the following guidelines.

3.1.4. Tolerance of Expansion Joint

Expansion joints shall be installed so as not to cause any unnecessary stress, torsion, strain or damage. Tolerances of expansion joints before installation shall be as given in following table.

Table 3.1 Tolerances of Bridge Expansion Joints

Item		Tolerance
Length		-5 ~ +5 mm
Elevation finger to finger		-2 ~ +2 mm
Space between fingers	Longitudinal	+2 mm
	Transverse	0 ~ +2 mm

3.2. Modular-type Bridge Expansion Joint

3.2.1. General

All joint material and assemblies stored at the job site shall be protected from damage and assemblies shall be supported so as to maintain their true shape and alignment. Deck expansion joint shall be constructed and installed to provide a smooth ride. Bridge deck joint shall be covers over by protective material after installation until final clean-up of the bridge deck.

After installation and prior to final acceptance, deck expansion joint shall be tested in the presence of the Engineer for leakage of water through the joint. Any leakage of the expansion joint shall be cause for rejection.

The Contractor shall follow the Manufacturer's written installation guidelines and the following guidelines.

For the MBEJs for the main bridge, the Contractor shall check their bolt hole spacing with these for the end floorbeam top flanges and confirm that both fit together.

3.2.2. Shipping and Handling

The MBEJ shall be delivered to the job site and stored in accordance with the Manufacturer's written recommendations as approved by the Engineer. Damage to the corrosion protection system shall

be repaired to the satisfaction of the Engineer. Seals shall not be damaged or cut.

3.2.3. Pre-installation Inspection

Immediately prior to installation, the MBEJ and the block-out shall be inspected by the Engineer for:

- Proper alignment
- Complete bond between the seals and the steel.
- Proper placement and effectiveness of studs or other anchorage devices.
- Proper placement of elastomeric springs and bearings.
- The proper placement of waterproofing membranes shall be verified, if utilized.
- The clearance specified on the drawings 75 mm is recommended between the bottoms of the support boxes of MBEJ and the surface of the block-out should be verified.

Cutting of bridge deck reinforcing steel can compromise the structural integrity of the block-out and requires approval of the Engineer. The Engineer shall verify that reinforcing mesh or bars are at least 50 mm from the edge-beam or anchorages and do not prevent the flow of concrete around the MBEJ.

No bends or kinks in the MBEJ steel shall be allowed (except as required to follow the roadway crown and grades). Any MBEJ exhibiting bends or kinks shall be repaired to the Engineer's satisfaction or replaced at the expense of the Contractor.

Seals not fully connected to the steel shall be fully connected at the expense of the Contractor. Headed concrete anchors shall be inspected visually and shall be given a light blow with a hammer. Any headed concrete anchor that does not have a complete end weld or does not emit a ringing sound when struck a light blow with a hammer shall be replaced. Headed concrete anchors located more than 25 mm along the length of the edge-beam from the location shown on the shop drawings and headed concrete anchors located more than 6 mm too high in elevation (reducing cover) shall be carefully removed and a new anchor welded in the proper location. All anchor replacement shall be at the expense of the Contractor.

3.2.4. Installation

Prior to installation of the joint, the block-out and supporting system shall be protected from damage and construction traffic.

(a) Setting Gap Opening

The MBEJ shall be installed at the proper gap opening corresponding to the installation temperature, as shown on the approved shop plans. The opening devices should be removed immediately after the concrete is placed.

(b) Formwork

The Contractor shall ensure that formwork excludes concrete entry into support boxes or in any way impeding free movement of the MBEJ.

(c) Supporting MBEJ during Placing of Concrete.

The MBEJ shall be fully supported during the placement of the concrete. Welds for temporary attachments to the center-beams or support bars for erection purposes must be removed and the surface ground smooth. The corrosion protection system shall be repaired to the satisfaction of the Engineer using a method approved by the Engineer. To reduce corrosion of the MBEJ, it should be electrically isolated by not connecting the bridge deck reinforcement to the MBEJ.

(d) Placing the Concrete

The concrete shall be controlled, mixed and handed as specified in Section 5 "Concrete Structures" of these Specifications. Very-high-slump concrete shall not be used in the block-out. Concrete shall not be deposited in the forms until the Engineer has inspected and approved the placement of the

reinforcements, conduits, anchorages, and prestressing steel.

If there is a vertical grade, concrete shall be placed on the downhill side of the block-out first. The concrete shall be vibrated thoroughly so as to adequately consolidate concrete underneath the support boxes and edge-beams. Care should be taken to avoid displacement of the forms and reinforcing steel. The concrete shall not be placed during extremely cold weather or during heavy rain.

(e) Finished MBEJ Tolerances

The MBEJ shall be inspected after installation to verify the following:

- The top surfaces of the MBEJ shall be recessed from the finished roadway profile 0 to 6mm.
- There shall be no more than 3mm difference in elevation among the tops of any of the center-beams or edge-beams. This variation shall be measured vertically from a straight line connecting the top of the deck profile on each side of the MBEJ.
- There shall be no more than 12 mm difference among gap widths at either end of a seal or among the multiple gaps of MBEJ

(f) Bridging MBEJ After Installation

Construction loads shall not be allowed on the MBEJ for at least 72 h after installation is completed. If it is necessary to cross the MBEJ, the Contractor shall bridge over the MBEJ in a manner approved by the Engineer.

(g) Removal of Forms and Debris

All forms and debris shall be removed after installation.

(h) Water-tightness Test

If specified in the Contract Documents, the water-tightness test shall be conducted. After the MBEJ has been installed and completed, the MJBS shall be flooded for a minimum of 1 h to a minimum depth of 75 mm. If leakage is observed, the MJBS shall be repaired to the Engineer's satisfaction and retested at the Contractor's expense. The repair procedure shall be recommended by the Manufacturer and approved by the Engineer.

(i) Acceptance

An MBEJ that fails inspection or testing shall be replaced or repaired to the satisfaction of the Engineer at the Contractor's expense. Any proposed corrective procedure shall be submitted to the Engineer for approval before corrective work is begun.

4. Measurement and Payment

4.1. Method of Measurement

Measurement shall be made to the neat lines of the structures as indicated in the Drawings.

Measurement for expansion joints shall be made in liner meter (lm) along the center line of expansion joint in place, indicated in the Drawings and described in the Bill of Quantities, and approval by the Engineer.

No measurement and payment shall be made for expansion joint if it is applied at incorrect places. All costs associated with this work shall be considered as a subsidiary obligation and requirement under the applicable pay items in the Bill of Quantities.

Payment of expansion joints shall include concrete, reinforcement bars and bolts. However, materials for connection with deck or girder embedded or installed in advance at girder ends such as reinforcement bars, plate and bolts etc. shall be included in scope of deck or girder work. For concrete, reference is made to Specification Section 06100 "Structural Concrete" and for reinforcement bar, reference is made to Specification Section 06200 "Reinforcement Bar".

4.2. Basis of Payment

The accepted quantities, measured as provided above, shall be paid at the contract price per unit of measurement for the pay items of the Bill of Quantities listed below.

Payment shall be full compensation for the work prescribed in this Section for the supply, installation and construction of all the required bridge expansion joints including all labour, materials, tests, tools, equipment and any incidentals to complete the work as shown in the Drawings, and as required by this Specification, and/or as directed by the Engineer.

<u>Pay Item</u>	<u>Description</u>	<u>Unit</u>
06520-01	Modular-type Bridge Expansion Joint at P5	lm
06520-02	Modular-type Bridge Expansion Joint at P10	lm
06520-03	Modular-type Bridge Expansion Joint at P13	lm
06520-04	Modular-type Bridge Expansion Joint at P20	lm
06520-05	Modular-type Bridge Expansion Joint at A1	lm
06520-06	Modular-type Bridge Expansion Joint at A2	lm
06520-07	Steel Finger Joint at AO1	lm
06520-08	Aluminum Expansion Joint Type 80	lm
06520-09	Aluminum Expansion Joint Type 110	lm
06520-10	Aluminum Expansion Joint Type 160	lm
06520-11	Aluminum Expansion Joint Type 230	lm
06520-12	Aluminum Expansion Joint Type 320	lm

Section 06530 – Bridge Floor Waterproofing

1. Description

This Specification Section consist of the supply, transport and construction of waterproofing membranes on deck slab, drain pipe, flexible tube and slab drain on concrete deck slab, in conformity with the lines, grades, design and dimensions shown in the Drawings, or required by the Engineer, in accordance with this and other related Specification Section.

Waterproofing on the steel deck shall be referred to 3.5 Waterproofing of Section 05300 Asphalt Concrete Binder and Surface Courses.

2. Material Requirements

2.1. Reference Standards

The following Standards in their latest editions shall be particularly applied to the works covered by this Specification Section. Those not specified in this Specification Section shall basically refer to “Handbook for deck waterproofing for highway bridges” by Japan Road Association:

- “Handbook for deck waterproofing for highway bridges” by Japan Road Association
- AASHTO TP50-95 Water absorption test
- AASHTO T259 Crack sealing capabilities

2.2. Requirements for Materials

2.2.1. Waterproofing Membrane on Deck Slab

All the materials to be used for furnishing and installing waterproofing membrane on deck slab shall be certified by the manufacturer, and the Contractor shall obtain the approval of the Engineer before using such materials in the Project.

The waterproofing membrane on deck slab shall be liquid type waterproofing (hot melt bituminous type), which shall be non-flammable, and non-toxic, subject to the Engineer’s approval.

2.2.2. Drain Pipe and Flexible Tube on Deck Slab

All the materials to be used for furnishing and installing drain pipe and flexible tube on deck slab shall be certified by the manufacturer, and the Contractor shall obtain the approval of the Engineer before using such materials in the Project.

Drain pipe and flexible tube on deck slab shall be of various parts with the shape, size, and connection requirements as indicated in the Drawings.

2.3. Submittals

The Contractor shall submit to the Engineer the sample of materials in accordance with pertinent requirements of this Specification Section.

The Contractor shall submit to the Engineer, certification that materials to be furnished comply with specification requirements for materials herein specified.

3. Requirements for Construction

3.1. Product Delivery, Storage and Handling

The Contractor shall deliver products to the construction site in their original unopened containers clearly labeled with the manufacturer's name, brand designation, type and class, as applicable.

The Contractor shall store products in an approved dry area and shall protect them from contact with soil and from exposure to the elements. Products shall be kept dry at all times.

Products shall be handled in a manner that will prevent breakage of containers and damage to products.

Surfaces of deck slab to which the waterproofing materials will be applied shall be surface dry, smooth and free of dirt, grease or oil.

3.2. Preparation of Surface of Deck Slab

The surface of deck slab to which the waterproofing is to be applied shall be cleaned of all loose and foreign materials and dirt, and shall be dry. When necessary, the Engineer may require the surface to be scrubbed with water and a stiff brush, after which the surface of deck slab shall be allowed to dry before application of the material.

Deck slab to which the deck waterproofing membrane is to be applied shall be prepared in accordance with the manufacturer's recommendations.

3.3. Construction

3.3.1. Surface of Deck Slab

Surfaces of deck slab, which are to be protected by waterproofing membrane, shall be thoroughly cleaned before the material is applied.

3.3.2. Waterproofing Membrane on Deck Slab

The waterproofing membrane on deck slab shall be a proprietary waterproofing system of the thickness indicated in the Drawings, and as approved by the Engineer, and shall be applied in accordance with the manufacturer's recommendations. The Contractor shall apply liquid type waterproofing, which is a proprietary material to be approved by the Engineer, with all installation details in accordance with the manufacturer's recommendations. The Contractor shall pay special attention to smoothen the surface prior to spraying of the waterproofing material. The waterproofing material shall not be applied to the deck slab if the temperature is over 32 °C. The Contractor shall conduct the performance test prior to the permanent application work. The quantity control of installation of the waterproofing material shall be checked for every 300 m².

Primer shall be applied to the surface of deck slab prior to the application of bituminous waterproofing, in order to ensure adhesion between deck slab surface and waterproofing layer. In case of rain, primer work shall be halted immediately and countermeasures shall be taken against spilling out of the primer.

After applying the bituminous waterproofing, silicate sand shall be applied on the surface prior to the application of pavement work.

3.3.3. Drain Pipe on Deck Slab

Drain pipe on deck slab shall be installed completing at the locations indicated in the Drawings.

4. Measurement and Payment

4.1. Method of Measurement

Measurement shall be made to the neat lines of the structures as indicated in the Drawings.

Measurement for waterproofing membranes on deck slab shall be made in square meters (m²) of waterproofing membranes in place, indicated in the Drawings and described in the Bill of Quantities, and approval by the Engineer.

No measurement and payment shall be made for slab drain and membranes applied on other concrete structures. All costs associated with this work shall be considered as a subsidiary obligation and

requirement under the applicable pay items in the Bill of Quantities.

Payment of waterproofing membranes is including drain pipe on bridge deck slab.

4.2. Basis of Payment

The accepted quantities, measured as provided above, shall be paid at the contract price per unit of measurement for the pay items of the Bill of Quantities listed below.

Payment shall be full compensation for the work prescribed in this Section for the supply, transport and construction of all the required waterproofing membranes and bonding coat including all labour, materials, tests, tools, equipment and any incidentals to complete the work as shown in the Drawings, and as required by this Specification, and/or as directed by the Engineer. Payment for waterproofing membrane on deck slab shall include the work of materials and installation of drain pipe on bridge deck slab.

<u>Pay Item</u>	<u>Description</u>	<u>Unit</u>
06530 - 01	Waterproofing Membrane for Bridge Deck	m2

Division 7

Steelworks

Table of Contents

	Page
Section 07100 - Steel Structures.....	1
Section 07210 - Bridge Rail, Wheel Guard and Median.....	43
Section 07220 – Miscellaneous Metals	45
Section 07400 - Bridge Drainage	47
Section 07550 –Steel Pipe Sheet Pile Foundation.....	50
Section 07700 –Cable-Stayed Bridge Construction (For Package 1 Only)	68
Section 07750 – Stay Cable (For Package 1 Only)	71

Section 07100 - Steel Structures

1 General

1.1 Description

The work under this Section shall consist of the materials supply, fabrication, delivery to the site and erection of all steel structures of the Project, in accordance with the Specifications and Drawings and/or as established and directed by the Engineer.

Technical specifications of expansion joints and bearings shall conform to Division 6 "Concrete Works".

1.2 Standards and Specifications

Unless otherwise indicated on the Drawings or elsewhere in this Specification, the fabrication and erection of the steel superstructure shall generally conform to the requirements "Specifications for Highway Bridges, Part II", March 2012, by Japan Road Association.

In case of any conflict between the above referenced specifications and these Specifications, these Specifications shall prevail.

1.3 Manufacturer's Fabrication Shop(s)

- (1) The Engineer has the authority to inspect, test and examine materials, workmanship, quality control and performance of any part of the works at the manufacturer's works and the site of fabrication.
- (2) Manufacturer's fabrication shop(s) shall be inspected and approved by the Engineer prior to commencement of the steel fabrication works. The Contractor shall submit an inspection request of the fabrication shop(s) proposed to the Engineer, not less than 28 days before inspection date, for his inspection (capacity, capability, organization, workmanship, quality control, stock yard and delivery route to the Site) and approval. This inspection shall be carried out by an inspection team consisting of the Engineer's representatives and the Employer's representatives. The inspection team will be a 6-person tentatively. The inspection shall typically be for a period of 3 working days at a manufacturer's fabrication shop.
- (3) In case that the Contractor proposes the fabrication shop(s) outside of Yangon City of Myanmar, costs of any inspections by the Engineer's representatives and the Employer's representatives including transportation (Air tickets: normal economy class fair, Trains, Taxis and others), accommodation and per diem for the Engineer's representatives and the Employer's representatives shall be paid by the Contractor and shall be deemed to be included in the unit prices for relevant pay items in Bill of Quantities (BOQ).
- (4) The Contractor shall furnish all facilities for the inspection of material, quality and workmanship at the place of fabrication and the Engineer, his representatives or their delegate shall be allowed free access to all parts of the premises upon request.
- (5) The Contractor shall take instructions from the Engineer and his representatives and shall submit monthly reports (progress, quality control, test results and others directed by the Engineer) to the Engineer.
- (6) The Engineer's inspection shall carry out all fabrication works performed by the Contractor up to the stage of fabrication, trial assembling and shop painting in accordance with this

Specification and the approved shop drawings. Certain authority of the Engineer will be delegated to the Engineer's Representative(s) (hereinafter the "Inspectors") for the purpose of quality control and testing. The powers delegated to this Inspectors by the Engineer will be notified to the Contractor in writing when the Inspectors are appointed.

- (7) The Inspectors' certificates shall not relieve the Contractor of any of his obligations under the Contract.
- (8) During fabrication, the minimum number of inspections by the Engineer and/or the Inspectors shall be as shown in the table below, however, the Engineer may require additional inspections at any time in the opinion of the Engineer. All costs for inspections as specified in Subsection 1.3 (3) shall be born by the Contractor.

Table 1-1 Type of Inspection and Minimum Frequencies

Type of Inspection	Tentative Composition of Inspectors	Tentative Number of Trips
Manufacturer's fabrication Shop Inspection prior to fabrication	6-person	1
Welding test for fabrication of steel deck with U-trough rib	3-person	1
Fabrication of steel girder and pylon		2
Trial assemblage of steel box girder, pylon and steel I-girder		2
Shop painting of steel girder and pylon		1

1.4 Inspection by the Contractor

- (1) Irrespective of the appointment of the Inspector(s) by the Engineer, the Contractor shall, by himself, inspect or have inspected quality of all materials, shop works and field works in accordance with the Contract and the requirements of the Drawings and Specifications.
- (2) The Contractor shall provide the necessary assistances, labour, materials, electricity, fuel, stores, apparatus and instruments and any other materials required to ensure that all testing and inspection by the Engineer, the Inspectors, the Employer and the Employer's representatives.
- (3) The Contractor shall appoint **an independent Inspection Agency** (hereinafter the "Independent Inspector"). The Independent Inspector shall be accepted by the Engineer and be responsible for non-destructive test of welds at the manufacturer's works and/or the site of fabrication. The Inspection Inspector shall be experienced and qualified. All fees and expenses for the works of the Independent Inspectors shall be paid by the Contractor and shall be deemed to be included in the unit price for relevant pay items in BOQ.
- (4) The Independent Inspector shall admit the instructions from the Engineer and shall submit inspection reports to the Engineer. The Independent Inspector shall certify that all welds have been satisfied in accordance with the Specification and the approved drawings. However, the Independent Inspector's certificates shall not relieve the Contractor from his obligations under the Contract.

1.5 Subcontractor

The Contractor shall not sublet the fabrication of structural steelwork(s) or any part thereof without prior consent of the Engineer in writing. Only those workshops that have been specifically consented by the Engineer to carry out the work will be authorized to perform the work on the structural steel. The Contractor's attention is drawn to the conditions on

subcontracting stated in the relevant Clauses of Contract Documents and shall comply with all provisions.

1.6 Submittals

(1) Work schedule for steel fabrication and site erection

Prior to fabrication, the Contractor shall submit the work schedule for steel fabrication and site erection to the Engineer for his review and consent. The work schedule shall include fabrication shop(s) information, organization, and shall include schedule of shop drawings, material procurement, fabrication, trial assembling, painting, delivery to the Site, site erection and reporting to the Engineer.

(2) QC (Quality control) / QA (Quality Assurance) plan and Welding Plan

Prior to fabrication, the Contractor shall submit the QC/QA Plan and welding plan of the Contractor's fabrication workshop for the Engineer's information in accordance with the Contract and the Specifications.

The Contractor shall not proceed with any welding until the Engineer has reviewed the method statement and notified that there was no inconsistency between the information and the Contractor's obligation under the Contract. The welding plan shall include the following information.

- Welding procedures including welding procedure test, procedure, equipment, additives and preheating during the welding operations.
- Precautions with regard to welding shrinkage.
- Possible treatment of completed welds by grinding with indication of grinding direction, etc.
- Welding sequence for each component and for welding to assemble the components together.

(3) The information of the material Supplier(s) and Manufacturer(s)

Prior to procurement of materials for steel structure fabrication and erection works, the information of all materials for steel structures fabrication and erection works to be used in the Contract except for temporary works shall be submitted to the Engineer for his review and approval.

(4) Material Certificate(s)

Prior to the use of any materials, the Contractor shall submit for the Engineer's consent, two (2) copies of the Suppliers' and Manufacture's Certificates for:

- bolts, nuts, washers,
- filler for welding,
- Painting, and
- mill test certificates for structural steel.

These shall include the names and locations of steel mills, analysis results of chemical, mechanical and physical properties, and shall be properly correlated to the various grades and delivery batches of structural steel to be used in the project.

(5) Shop Drawings

The Contractor shall submit, at least 28 days before commencement of the fabrication, 3-copy of the shop drawings to the Engineer for his review and approval. The Contractor shall not proceed with fabrication until the relevant Shop Drawings have been approved by the Engineer.

(6) Camber for steel structures

The geometric dimensions of the bridge in the plan show the elevation at the bridge completion at a reference temperature. The Contractor shall determine the appropriate camber in vertical and horizontal directions for the steel girders and pylons to have the geometric dimension of the bridge to be achieved within a range of tolerances specified hereafter.

The Contractor shall obtain “no objection” from the Engineer, 28 days before the commencement of the fabrication of girders and pylons, for the calculation and the control of camber.

(7) Method Statement for fabrication and erection works

(8) QC/QA Records

Based on the QC/QA plan, the Contractor shall maintain records of QC/QA, such as material test, welding, painting, fabricated steel structure’s dimensions, trial assembly and site erection, and shall submit to the Engineer, before completion of the site erection works, for his review and approval.

Welding shall include welding procedure test results, procedures, the Independent Inspector’s inspection results, the Contractor’s inspection results, welders employed with date of qualification and identification symbol. These records shall be made freely available for the use of the Independent Inspector.

Records shall also be maintained of all bolts tested and the corresponding torque values if torque control method is employed.

(9) As-built Drawings

The Contractor shall submit the As-built drawings for steel structure works in accordance with the Contract. These drawings shall include details of actual camber achieved, details of temporary bracing left in the works, etc.

1.7 Matters to be Considered by the Contractor

In the preparation of shop drawings and in all his fabrication works the Contractor shall give careful consideration to the following:

- The trial assembling at the fabrication shop.
- The weight and size of elements for transportation between fabrication yard and the construction site.
- Temperature variation between the fabrication yard and the site assumed for the purposes of the Contract.

- The need for certain dimensions of structural steel work to be verified by actual measurement at site.
- Prohibition of the use of site welding, unless otherwise permitted by the Engineer or specified in other relevant part of the Contract Document.

2. Materials

2.1 Material and Workmanship

- (1) Steel materials shall be ordered at the earliest possible time in consultation with the suppliers and manufacturers, and according to the fabrication priorities. The Contractor shall inform to the supplier the name of the project and the place to be used. Prior to the purchase order being made, the Contractor shall furnish the Engineer with a copy of the order.
- (2) Steel materials shall be of brand new without any defects and shall conform to the requirements of the following specifications.

2.2 Structural Steel

- (1) Plate and shape shall comply with JIS or equivalent standard as shown in Table 2-1 and shall be of the grades shown on the Drawings.

Table 2-1 Materials and Standards

Items	Standards		Symbol
Structural Steel	JIS G 3101	Rolled Steel for General Structure	SS400
	JIS G 3106	Rolled Steel for Welded Structure	SM400, SM490, SM490Y, SM520, SM570,
	JIS G 3444	Carbon steel tubes for general structural purposes	STK400, STK490 STKR400,STKR490
Anchor Bolt	JIS G 4051	Carbon Steel for Machine Structure	S35CN
Steel fasteners	JISB 1186	Sets of a high strength hexagon bolt, hexagon nut and plain washers for friction grip joints	F10T
Welding materials	JISZ3211	Covered electrodes for mild steel high strength steel and low temperature service steel	
	JISZ3312	MAG or MIG welding solid wires for mild steel, high strength steel, and low temperature service steel	
	JISZ3312	Submerged arc welding solid wire for carbon steel and low alloy steel	
	JISZ3352	Submerged Arc Welding Fluxes	
	JIS G4304	Stainless Steel Plate	SUS304
Stud	JIS B 1198	Stud with button Head	

Source: JRA's Specifications for Highway Bridges, Part I, Common, 2012

- (2) All steel materials shall be delivered with certificates and delivery shall be in accordance with the requirement of the current edition of JIS G 3191, G 3192, G 3193 and G 3194 including the requirements to produce analysis, carbon equivalent, tolerances, inspection and testing, and marking.
- (3) When the shape steels of SS400 which used for secondary members are to be welded, they must be used after verifying by examining their chemical constituents beforehand or a welding test or the like that there is no problem concerning their weldability.

- (4) The steel materials of SM490C-H, SM520C-H, SM570-H shall comply with “Specifications for Highway Bridges, Part II” , March 2012, by Japan Road Association.
 - (5) In case that screwed studs will be used, those material shall comply with the requirement so that the yield stress is over 315 N/mm² and the ultimate stress is over 400 N/mm².
- (6) Bolts
- 1) Except for the torque sheared type, High Strength Bolts with associated nuts and end washers shall comply with JIS B 1186 and shall incorporate load indicating devices acceptable to the Engineer.
 - 2) Bolts, except High Strength Bolts, shall comply with JIS B 1180 “High Tensioning Hexangular Bolts, Nuts and Washers”. The shape of bolt which has screws shall comply with JIS B 0205. Nuts shall comply with JIS B 1181, washer shall comply with JIS 1256.
 - 3) Torque sheared high strength tension bolts shall conform to “Torque Shear (control) Type High Strength Bolts, Nuts and Washers” designated as S10T by Japan Road Association.
- (7) Filler Metal Requirements
- (1) The Contractor shall in this respect submit his proposal for the Engineer’s consent.
 - (2) All materials to be used for welding shall be of a recognized manufacture, and the Contractor shall when requested by the Engineer furnish manufacturer’s certification that the electrodes and other products used for welding meet the requirement of this Specification.
 - (3) The division of usage for welding consumables shall generally be as stipulated in Table 2-2.

Table 2-2 Division of Welding Consumables

	Division of Usage
Welding steels of the same strength	Welding consumables possessing mechanical properties equal to or greater than the specification values of the base material
Welding steels of different strengths	Welding consumables possessing mechanical properties equal to or greater than the specification values of a base material on the low side with respect to strength
Welding steels of the same toughness	Welding consumables possessing toughness equal to or greater than the required values of the base material
Welding steels of different toughness	Welding consumables possessing toughness equal to or greater than the required values of a base material on the low side with respect to toughness

- (4) When a steel of SM490 or more high strength steel is welded, low hydrogen type welding consumables shall be used.
- (5) Co₂ gas which used for Co₂ gas shielded arc welding shall comply with III specified in JIS K 1106 (Liquefied Carbon Dioxide Gas).

3. Fabrication and Assembly

3.1. Storage Materials

- (1) All steel whether fabricated or not shall be stored above the ground on platforms, skids, or other supports. It shall be kept free from dirt, grease and other foreign matter, and shall be properly protected in order to prevent the material from corrosion. Excessively rusted, bent or damaged steel will be rejected.
- (2) Protected or painted steel surfaces shall not be stored or stacked with the faces in contact but shall be separated by spacers.

3.2. Workmanship

- (1) Except as otherwise denoted herein or on the Drawings, all work shall be executed in accordance with the relevant sections of this Specification.
- (2) The Contractor shall be responsible for any damage caused to other components of the structure including the substructures, by his operations for the duration of this Contract. In particular, he shall take all necessary precautions to minimize concrete splash onto completed steel work or rust staining of concrete due to erected steel work. The Contractor shall clean and/or repair all stains and other damage to completed work, before acceptance and taking over.

3.3. Cutting; Straightening; Bending & Welding

- (1) The Contractor shall, through appropriate planning and continuous measurements in the workshop and at the erection site, ensure that the tolerances given in the Specifications are strictly observed. The Engineer shall require any specific working procedure to be changed in case such procedure appears not to afford sufficient security against exceeding the tolerances.
- (2) The Contractor is fully responsible for the calculation and provision of the necessary camber in the preassembled elements to obtain the correct levels in the completed bridge, duly considering the applied erection procedure and the sequence in the installation of the various dead load components.
- (3) The roadway levels given on the Drawings or defined by the given inclination and curvature are the required roadway levels at top of asphalt surfacing along bridge axis of the completed bridge, when loaded only with the dead loads of the installed and completed structure. In fixing the geometry of the superstructure, the Contractor shall make compensation for the difference between ambient temperature and temperature of the bridge at a reference temperature.

(4) Template and Measurements

The Contractor shall supply all templates, jigs and other appliances necessary to ensure the accuracy of the work.

(5) Cutting of Steel

1) Cutting Plan

The stress of direction of members including cross beams shall be same as direction of roll.

2) Marking

In performing marking, flaws by chisel or punch shall not generally be given to the location that remains after completion.

3) Dissection/Cutting

- a) The dissection of a main member shall generally be performed by automatic gas cutting. However, when the qualities of next item ii) are ensured, the automatic cutting such as the plasma-arc cutting method and the laser cutting method may be used.
- b) The qualities of the groove face that has undergone dissection/cutting and working shall be superior to those shown in Table 3-1.

Table 3-1 Quality of Dissection/Cutting Surface

Type of member	Main member	Secondary member
Maximum surface roughness ⁱ⁾	50 μmRy or less	100 μmRy or less ⁱⁱⁱ⁾
Notch depth ⁱⁱ⁾	There shall be no notch.	1 mm or less
Slag	Although slag clumps are dotted around and attached, they should be easily exfoliated without leaving any marks.	
Upper-edge melt	The one that is slightly rounded but in a smooth state	

Source: JRA's Specifications

Note:

- i) The maximum surface roughness shall be the maximum height of the surface roughness stipulated in JIS B 0601.
- ii) The notch depth is referred to as the depth from the upper edge of the notch to the valley.
- iii) In case of cutting, it shall be 50 μmRy or less.

- c) The filler, tie-plate, shaped steel, gusset plate with its plate thickness of 10 mm or less, stiffener, etc., may be cut by shear. However, when there are extreme shoulder losses, burrs or irregularities, etc., on the line of the cutting plane, a smooth finish shall be achieved by performing edge planning or grinder finishing until these are removed. The quality of the finished surface in this regard shall be superior to the qualities shown in Table3-1.

- d) The chamfer shall be applied to the corner of the cross-section that will be free edges after assembly in a main member that will be coated.

(6) Flatness of Steel Plates

- 1) All material before being assembled shall be flatted or formed to the specified configuration by methods specified below.
- 2) The surface smoothness of the steel plate shall be such that it poses no hindrance to cutting plan, marking, joint work, etc.
- 3) It is desirable to use the steel plate whose upper limit target for surface smoothness is approximately 2/3 of JIS standard (JIS G 3193) (Table 3-2)

Table 3-2 Upper Limit Target for Surface Flatness of Steel Plates

Thickness	Width	Less than 2,000 mm	2,000 mm and above, less than 3,000 mm	3,000 mm above
		6.00 and above, less than 10.0 mm	9 mm	14 mm
10.0 and above, less than 25.0 mm		8	11	12
25.0 and above, less than 40.0 mm		6	9	10
40.0 and above, less than 63.0 mm		6	8	8
63.0 and above, less than 100 mm		5	7	7

Source: JRA's Specifications

- 4) The Engineer shall have the right to reject the steel material in case that the defect(s) has been found or to direct that the defect(s) be repaired in a manner that shall be consented by the Engineer. The cost of replacement of repair shall be borne by the Contractor.
- 5) The deformation of a member generated by welding shall be remedied by press or the gas-flame heating method, etc.
- 6) The surface temperature of the steel when remedied by the gas flame heating method and cooling methods shall be in accordance with Table 3-3.

Table 3-3 Surface Temperature of Steel during Linear Heating by Gas-Flame Heating Method and Cooling Method

Steel type	Surface temperature of steel	Cooling method
Quenched and tempered steel (Q)	750°C or less	Air-cooling (or water-cooling at 600°C or less after air-cooling)
Thermo-mechanical control process steel (TMC)	$Ceq > 0.38$	Air-cooling (or water-cooling at 500°C or less after air-cooling)
	$Ceq < 0.38$	Water-cooling or air-cooling immediately after heating
Other steel	900°C or less	Avoiding water cooling from the red heat state

$$Ceq = C + Mn/6 + Si/24 + Ni/40 + Cr/5 + Mo/4 + V/14 + (Cu/13)(\%)$$

In this regard, the item in () shall be included in the case of Cu > 0.5 percent.

(7) Bending

- 1) When performing cold bending work on a primary member, the inner diameter shall be at least 15 times the plate thickness.
- 2) Quenched and Tempered Steel and Thermo-Mechanical Control Processed Steel shall not be applied heat bending.

(8) Drilling Holes

- 1) All holes for bolts shall be drilled. Punching of holes shall not be permitted.
- 2) Reamed and fitted holes and drilled holes shall be made through steel templates or after assembly or by other accepted methods, to ensure complete matching between the ply of the joints.
- 3) All steel templates shall have hardened steel bushings in holes accurately dimensioned from the centrelines of the connection. The centrelines shall be used to accurately locate the template.

- 4) Reaming of drilling full-size holes for field connections through templates shall be done after the templates have been located with the utmost care as to position and angle, and firmly bolted. Template used for the reaming of holes in matching members, or of opposite faces of one member, shall be exact duplicates. Templates for connections which duplicate shall be so accurately located that like members are duplicates.
- 5) All finishes holes shall be cylindrical and perpendicular to the member unless otherwise specified. All burrs and other defects shall be removed.
- 6) If the Contractor proposes other method than specified herein, the details of the method including accuracy control shall be submitted for the Engineer's approval.
- 7) Burrs, fins and other defects shall be removed. Drifting to align holes shall be done in a manner that will not distort the metal or enlarge the hole.
- 8) The diameter of a bolt hole shall be as shown in Table 3-4
- 9) The diameter of a bolt hole for longitudinal ribs may be 2mm larger than the shown in Table 3-4.

Table 3-4 Diameter of Bolt Hole

Nominal Designation of Bolt	Diameter of Bolt Holes Friction/tension connection
M22	24.5 mm
M24	26.5mm

- 10) The permissible variation of the diameter of bolt hole shall be as shown in Table 3-5

Table 3-5 Permissible Variation of the Diameter of Bolt Hole

Nominal designation of bolt	Permissible Variation of the Diameter of Bolt Hole	
	Friction/tension connection	For 20% of Bolts for 1 joint
M22	+0.5 mm	+1.0 mm
M24	+0.5mm	+1.0 mm

- 11) In making a hole into the prescribed diameter, it shall be performed by a drill or through the combined use of a drill and reamer. However, the hole making of a material piece of a secondary member with the plate thickness of 16 mm or less may be conducted by punching.
- 12) In making a hole with a prescribed diameter in a main member before assembly, the template shall generally be used. However, when using an NC drill, this provision shall not be applicable.
- 13) The burr generated around the hole by the hole making shall be chipped off.
- 14) In a bolt hole, the penetration rate of a penetration gauge and the stop rate of a stop gauge shall satisfy the values shown in Table 3-6.

Table 3-6 Penetration Rate and Stop Rate of Bolt Hole

	Nominal designation of screw	Diameter of penetration gauge (mm)	Penetration rate (%)	Diameter of stop gauge(mm)	Stop rate (%)
Friction	M22	23.0	100	25.0	80 or more
	M24	25.0	100	27.0	80 or more

- 15) Generally, use of enlarged holes shall not be permitted. However, where enlarged holes are necessary for erection of closure segments for example, the Contractor shall submit a proof report on friction coefficient measurement data and effect to geometry of permanent structure by use of enlarged holes for Engineer's consent. Friction coefficient shall satisfy the design requirement of 0.4 or more. Any incurred cost due to application of enlarged holes is born to the Contractor.

(9) Welding

- 1) All welding shall be planned and executed using the most suitable materials and working methods for the particular purpose of the work.
- 2) For notation on welding, shall be referred to the provision in JIS Z 3021 for weld mark.
- 3) The Contractor shall propose weld details to fit the purpose of the permanent structure for review and comments by the Engineer prior to commencement of the fabrication.
- 4) All welding shall be executed by skilled, experienced welders holding valid welder examination qualifications based on the qualification tests specified in JIS Z 3801 or similar internationally recognized qualification tests. A welder shall be qualified for each process used.
- 5) A welding procedure test shall be conducted under any of the items below:
 - a) When the heat input per pass exceeds 7,000 J/mm in SM570, SM520;
 - b) When the heat input per pas exceeds 10,000 J/mm in SM490 and SM490Y;
 - c) When conducting welding other than the shield metal arc welding method (manual welding only), gas-shield arc welding method (CO₂ gas or mixed gas of Argon and CO₂) and submerged arc welding method;
 - d) When there is no record in regard to the fabrication of steel bridges;
 - e) Which the supply of materials is received from those with no usage records;
 - f) When there are no work records of the welding procedure being adopted.
- 6) The welding procedure test shall generally be conducted by selecting appropriate items from among the test items stipulated in Table 3-7, and the following provisions shall generally be applied to the selection of test steels, welding conditions, etc.

Table 3-7 Welding Procedure Test

Test type	Test item	Welding procedure	Shape of test piece	Number of test piece	Test procedure	Criterion
Groove welding test	Tensile test	See Figure 17.4.1	JIS Z 3121 No. 1	2	JIS Z 2241	The tensile strength is equal to or greater than the standard value of the base material.
	Guided bend test (Root bend for less than 19 mm) (Side bend for 19 mm or more)		JIS Z 3122	2	JIS Z 3122	Cracking shall not generally be generated.
	Impact test		JIS Z 2202 No.4	Three for each site	JIS Z 2242	Equal to or greater than the standard of the base material at welded metal and in the portion affected by welding heat (average of three for each)
			(The location for collection of the test piece is as shown in Figure 17.4.2.)			
	Macroscopic test		-		JIS G 0553 correspondingly	No defect
Non-destructive test	-	Test piece Joint Overall length	JIS Z*) 3104	Category 2 or more (on tensile side) *) Category 3 or more (on compressive)		
Fillet welding test	Macroscopic test	See Figure 17.4.3	See Figure 17.4.3	1	JIS G 0553 correspondingly	No defect
Stud welding test	Tensile test	JIS B 1198	JIS B 1198	3	JIS Z 2241	235 N/mm ² or more at yield point, 400 to 550 N/mm ² for tensile strength and 20% or more for elongation. However, it must not break during the welding process.
	Bend test	JIS Z 3145	JIS Z 3145	3	JIS Z 3145	No cracking shall occur in the welded part.

*) By radiographic testing

1. The steel plate under the worst condition among those under similar conditions shall be used for a test plate.
2. The welding shall be conducted under the same conditions as the actual work, and the most disadvantageous welding position among the actual welding positions shall be adopted.
3. The groove welding test on dissimilar steels shall be performed in the same combination as that of the actual work. For joints of the same steel with different plate thicknesses, the test may be conducted on the one with a thinner plate thickness.
4. The retest shall use twice as many test pieces as the first test.

1) Assembly welding

- a) The assembly welding shall be worked with the same control as regular welding.
- b) The leg of fillet weld of an assembly welding shall be 4 mm or more, and its length shall be 80 mm or more. However, when the thickness of the thicker plate is 12 mm or less, or when the weld cracking sensitivity composition PCM obtained after calculating by the following formula is 0.22 % or less, it can be stipulated as 50 mm or more.

$$\text{PCM} = \text{C} + \text{Mn}/20 + \text{Si}/30 + \text{Ni}/60 + \text{Cr}/20 + \text{Mo}/15 + \text{V}/10 + \text{Cu}/20 + 5\text{B} \text{ (\%)}$$

- c) In the assembly welding, slag shall be removed by the end of assembly, and it must be confirmed that no cracking has occurred on the surface of the weld zone. When a crack is found, an appropriate measure must be taken after its cause is investigated.

2) Preheating

Depending on the steel type and welding procedure, the 100 mm on both sides of a weld line and the range of 100 mm ahead of the arc of the base material shall generally be preheated in accordance with Table 3-8.

Table 3-8 Preheating Temperature Standard

Steel Type	Welding Procedure	Preheating Temperature (oC)			
		Plate Thickness Division (mm)			
		25 or less	Over 25 and 40 or less	Over 40 and 50 or less	Over 50 and 100 or less
SM400	Covered arc welding by electrode other than low hydrogen type	No preheating	50		
	Covered arc welding by low hydrogen type electrode	No preheating	No preheating	50	50
	Submerged arc welding Gas shield arc welding	No preheating	No preheating	No preheating	No preheating
SMA400W	Covered arc welding by low-hydrogen type electrode	No preheating	No preheating	50	50
	Submerged arc welding Gas shield arc welding	No preheating	No preheating	No preheating	No preheating
SM490 SM490Y SM490YC-H	Covered arc welding by low hydrogen type electrode	No preheating	No preheating	80	80
	Submerged arc welding Gas shield arc welding	No preheating	No preheating	50	50
SM520 SM520C-H SM570 SM570C-H	Covered arc welding by low hydrogen type electrode	No preheating	80	80	100
	Submerged arc welding Gas shield arc welding	No preheating	50	50	80
SMA490W SMA570W	Covered arc welding by low hydrogen type electrode	No preheating	80	80	100
	Submerged arc welding Gas shield arc welding	No preheating	50	50	80

Under conditions of "no preheating," when the air temperature (room temperature in the case of indoor) is 5°C or less, heating to approximately 20°C is performed.

7) Heat gain restriction

- a) The heat gain per pass shall generally be controlled at 7,000 J/mm or less for SM570, SM520, and 10,000 J/mm or less for SM490 and SM490Y.
- b) When the heat gain of item a) is exceeded, it is necessary to conduct a welding procedure test and confirm that the prescribed quality is obtained at the weld zone.

8) Note for welding works

- a) There shall be no harmful mill scale, rust, paint, oil, etc., on the part where welding is to be conducted. Before the welding is conducted, the part near the welding line must be sufficiently dried.
- b) In the work of the groove welding and fillet welding, etc., of the flange and web plate of the main girder, the weld tab that possesses the same groove as a member shall generally be installed so that the start point and end point of the weld may not interfere with the member to be welded.
- c) The weld tab shall be removed by the gas cutting method after welding, and shall be finished with a grinder.
- d) When working on continuous weld lines by two welding methods in the work of the partial penetration groove welding, the next welding shall be performed once it is confirmed that there is no chipping or defect in the end portion of the previous weld bead. However, this provision shall not be applicable when a crater treatment is conducted in the manual welding or semi-automatic welding.
- e) The fillet welding that ends at the corner portion of a material piece must be performed in a continuous manner by rotating the corner portion.
- f) For a Stress transfer filler weld by a primary member, the weld size shall be 6mm or more and when a drawing does not have instructions, it shall satisfy Equation (3.1) as standard.

$$t_1 > S \text{ and } S \geq \sqrt{2}t_2 \quad \text{--- (3.1)}$$

where:

S: size (mm)

t1: Thickness of thinner base material (mm)

t2: Thickness of thicker base material (mm)

- g) When using the submerged arc welding method or other welding method, it is advisable not to cut the arc in the middle of a joint.
- h) The welding used to install a suspender, temporary member, etc., to be used for transportation, erection, etc., shall generally be performed within a factory, and its condition must be equal to or greater than the condition for shop welding. When installation is conducted on site out of necessity, it must be done carefully under sufficient control.
- i) During the assembly work, the components shall be held in position and supported in such a manner that no unfavourable inherent stresses or deformation shall develop. Drilling of holes for temporary assembly or for welding purposes shall not be accepted.

- j) Minimum preheating and inter-pass temperature shall comply with the welding procedure in question and shall be subject to no objection of the Engineer.
 - k) When temporary attachments including lifting lugs welded on the permanent structure for fabrication, and/or site assembly and erection, the fillet radius details and welding, details of welding conditions, removal method, and non-destructive testing method shall be submitted for review and consent by the Engineer. The welding requirements for the attachments shall be same as those for the permanent structure. After removal of the attachments used for fabrication, the steel surface shall be reconditioned by grinding level with the surrounding material. Scars in the surface shall be filled by welding and ground flush. Magnetic particle testing shall be performed to ensure that the surface is free from cracks.
 - l) When using the site welding, effect of the site welding (shrinkage, deformation, restraint, etc.) to overall and detailed structure shall be studied in advance.
 - m) When using the site welding, the cleanness and dry condition of the welding area and welding materials shall be paid attention. And necessary equipment shall be prepared at the site.
 - n) Prior to the site welding, the condition of groove and material restraint shall be paid attention.
 - o) Notes for the site welding (material, inspection, etc.) shall conformed to the notes for shop welding.
 - p) When the site welding is influenced by wind, necessary wind-resistance equipment shall be installed.
- 9) Note for Steel Deck Slab
- a) The work of a full penetration butt welded joint that uses the backing strip of a closed section rib shall generally be performed in such a way that the joint prevents a crack in the gap portion between the backing strip and the base material of the closed section rib, and so it possesses the prescribed fatigue strength against the generation of a fatigue crack from the root.
 - b) The backing strip shall be tightly adhered to the closed section rib, and the assembly welding shall be administered only to the groove portion before the welding of the first layer is conducted.
 - c) The material that can ensure the prescribed welding quality shall be used for the backing strip.
 - d) The work shall be performed in such a manner that a sufficient penetration amount is secured.
 - e) In the welding between a closed section rib or corner plate and a deck plate, it shall generally be confirmed that the prescribed throat and penetration is secured.
 - f) The welding work test shall be performed, and after it is confirmed that the prescribed throat and penetration amount have been secured, the welding shall be conducted under the welding condition confirmed there. Moreover, the groove shall generally be taken when necessary for the purpose of securing the penetration amount.

- g) In the welding between a closed section rib or corner plate and a deck plate, it shall generally be confirmed that the prescribed throat and penetration is secured.
- h) The welding work test shall be performed, and after it is confirmed that the prescribed throat and penetration amount have been secured, the welding shall be conducted under the welding condition confirmed there. Moreover, the groove shall generally be taken when necessary for the purpose of securing the penetration amount.
- i) The non-destructive inspection at the location of the scallop that is used in the welded portion of closed-section rib, cross rib, crossbeam, longitudinal beam and the like of a deck plate shall be in accordance with the Section 3.4 in this Specification, and it shall generally be performed in an appropriate manner in consideration of the size of the scallop.
- j) In the crossover portion of the longitudinal rib and cross rib or crossbeam, the welding work shall generally be performed in such a way that the prescribed fatigue strength at the site where the weld lines of three directions from the welding of the closed section rib and deck plate in the longitudinal direction, the welding of the deck plate and cross rib or crossbeam and the welding of the closed section rib and cross rib or crossbeam intersect with one another can be secured.
- k) In the location where the weld lines of three directions from the welding of the longitudinal rib and deck plate in the longitudinal direction, the welding of the longitudinal rib web and cross-rib web and the welding of cross-rib web and deck plate intersect with one another, the cross-rib web shall be corner cut and the welding work shall be performed in such a way that excessive space does not remain.
- l) The start-and-end point of welding shall not be located in the corner portion.

10) Qualification of Welder

- a) The welder shall have passed the tests corresponding to particular operation or the tests equivalent to those tests or more) from among the tests stipulated in JIS Z 3801, "Standard Qualification Procedure for Manual Welding Technique." However, in the case where semi-automatic welding will be performed, the operator shall have passed the tests corresponding to particular operations (or test equivalent to these tests or more) from among the tests stipulated in JIS Z 3841, "Standard Qualification Procedure for Semi-Automatic Welding Technique."
- b) The welder engaged in shop welding must be someone who has been engaged in the welding work for six months or more and has been engaged in the welding work in the factory for two or more months continuously prior to the construction.
- c) The welder engaged in site welding must someone who has been engaged in the welding work for six months or more and possesses experience in the welding procedure being adopted, or shall have received sufficient training.

11) Welding Tolerances

- a) The members to be connected by welding shall be so prepared that they fit exactly together, without being forced into position.

- b) The assembly tolerance of material pieces shall generally be as the values below. However, when the allowable values of error are confirmed by a welding procedure test, they may be followed.
- c) Groove weld
 - i) Error in route distance: stipulated values ± 1.0 mm or less.
 - ii) Eccentricity of material piece in direction of plate thickness
 - iii) $t \leq 50$ 10 % or less of thickness of thinner plate
 $50 < t \leq 100$ 5 mm or less
t: Thickness of thinner plate
 - iv) Adhesion degree in the case of using backing strip: 0.5 mm or less
 - v) Groove angle: Stipulated values $\pm 10^\circ$
- d) Fillet weld
 - Adhesion degree of material piece: 1.0 mm or less

3.4. Welding Inspection

The Contractor shall appoint an Independent Inspector to perform inspection for welding according to work schedule to be accepted with the Engineer.

The Independent Inspector shall carry out:

(1) Welding Inspection

- 1) The inspection for the internal flaw of a full penetration butt welding joint must be conducted by an appropriate non-destructive inspection after the welding is completed, and it must be checked that the required weld quality is satisfied. The non-destructive inspection is performed through radiographic testing and ultrasonic testing.
- 2) The Contractor shall prepare a detailed timetable for Quality Control of welds in consultation with the Engineer and the established timetable must not be deviated from without the Engineer's consent.
- 3) The Contractor shall perform test welds of the types of welding seams to be applied in the structure, according to a program to be agreed upon with the Engineer. The quality of the test welds shall be approved by the Engineer prior to execution of the welding work in question. The test welding shall be made from working positions corresponding to the actual working positions during construction.
- 4) Moreover, the Contractor shall perform test weld of the partial groove weld between U-Rib and Deck plate by the visual and the ultrasonic inspection for the confirming 75% Penetration. If it is difficult to ensure the accuracy of flaw detection necessary to ensure that the required amount of intrusion is secured, the penetration amount of a weld section shall generally be verified by conducting a procedure test in advance under the same condition as the actual work.

(2) Surface flaw inspection

- 1) There must be no cracking whatsoever in the weld bead or its vicinity. While the crack inspection shall generally be conducted with the naked eye, it shall be performed the magnetic particle method or liquid penetrant method if any flaw is suspected.

- 2) Visual Inspection before and after Welding includes inspection of edge preparation and surface conditions by use of penetrative dyes for cracks, gaps and other items that may cause any defect of welding.
- 3) All welds shall be visually inspected including the use of penetrative dyes in accordance with JIS Z 2343.
- 4) There must be no pitting on the surface of a bead in a T-joint and corner joint constituting the butt joint and cross section of a primary member. Up to three pits per joint or per meter of the joint's length shall be allowed for the fillet welding and partial penetration groove welding in others. However, when the size of the pit is 1 mm or less, three pits shall be regarded as one pit in calculation.
- 5) The unevenness on the surface of a bead shall be shown by the difference of elevation within 25 mm of the length of the bead, and there must be no unevenness exceeding 3 mm.
- 6) The depth of an undercut shall conform to JRA's Specification.
- 7) There must be no overlap.
- 8) The size and throat thickness of a fillet welding must not under-run the size and throat thickness of a designated fillet. However, in the portion excluding 50 mm of both ends of a weld line within the range of up to 10 % of the weld length, an error margin of - 1.0 mm shall be allowed for both the size and throat thickness.
- 9) In the groove weld having no particular specification regarding finish in design, reinforcement within the range shown in Table 3-9 need not undergo finishing. When the reinforcement height exceeds the values shown in Table 3-9, the bead form, particularly its toe portion, must be finished smoothly.

Table 3-9 Groove Weld Reinforcement (mm)

Bead width (B)	Weld reinforcement height (h)
$B < 15$	$h \leq 3$
$15 \leq B < 25$	$h \leq 4$
$25 \leq B$	$h \leq (4/25) \cdot B$

- 10) The repair of a defective portion must be carried out carefully in consideration of the effect of the repair on the base material. The methods to repair defects shall be conform to JRA's Specification.
 - 11) Those conducting the magnetic particle flaw detection test and penetrant flaw examination must have the level 2 or higher certification specified in JIS Z 2305.
- (3) Internal flaw inspection

The inspection for the internal flaw of a full penetration butt welding joint must be conducted by an appropriate non-destructive inspection after the welding is completed, and it must be checked that the required weld quality is satisfied. When the inspection

for the internal flaw of a full penetration butt welding joint is conducted in accordance with the method shown below.

- 1) The non-destructive inspection is performed through radiographic testing and ultrasonic testing.
- 2) Sampling inspection rate, acceptance criteria and judgment of acceptance
 - a) Sampling inspection rate

For a primary member, a sampling inspection of picking one joint per group shown in Table 3-8 shall be performed. However, of the full penetration butt welding joints that undergo site welding, for the welded portion of the beam and column of a steel bridge pier, the flange and web plate of a main girder and the steel deck plate, the inspection shall be conducted in accordance with Table3-10.

Additionally, when the allowable stress in other member is set to be the same value as the joint of the same type that undergoes shop welding, an inspection shall be carried out by a non-destructive inspection for the entire length of the joint

Table 3-10 Non-destructive Inspection Rate of Full Penetration Butt Welding Joint of Primary Member

Member		Maximum number of joints per group in grouping 1 inspection lot	Number of photoshoots in radiographic testing	Number of joints to be inspected in ultrasonic testing
Tensile member		1	One shoot(including end part)	1
Compressive member		5	One shoot	1
Bending member	Tensile flange	1	One shoot	1
	Compressive flange	5	One shoot	1
	Web plate Joint in direction perpendicular to stress	1	One shoot (on the side of tension)	1
	Web plate Joint in parallel direction to stress	1	One shoot (including end part)	1
Steel floor deck		1	One shoot (including end part)	1

Table 3-11 Non-destructive Inspection Rate of Full Penetration Butt Welding Joint that Undergoes Site Welding

Member	Radiographic testing	Ultrasonic testing
	Location to shoot	Inspection length
Beam and column of steel bridge pier	Entire length of joint in general	
Flange of main girder (excluding steel floor deck) and web plate		
Orthotropic steel deck	50 cm continuously at the start point and end point of joint (two shoots), one location per meter in middle part (one shoot) and one location at wire joint portion (one shoot) in general	Entire length of joint in general

- b) Acceptance criteria

The size of the flaw detected in the inspection must be the size allowed in design or less. However, there must be no sheet flaws such as open cracks on the surface, irrespective of size. On the other hand, regarding the results of the test by the radiographic testing with the plate thickness of 25 mm or less, it may be deemed as having passed when the following provisions are satisfied:

- i) The welded portion receiving tensile stress shall be in Class 2, as shown in Appendix 4 of JIS Z 3104 "Method for Classification of Flaw Image by Radiographic Photos," or more.
 - ii) The welded portion receiving compressive stress shall be in Class 3, as shown in Appendix 4 of JIS Z 3104 "Method for Classification of Flaw Image by Radiographic Photos," or more.
- c) Qualification of inspector
- i) It is advisable to conduct the radiographic testing in accordance with JIS Z 3104, and the manual flaw detecting in accordance with JIS Z 3060.
 - ii) The non-destructive inspection shall be conducted by the inspector who shall be certification stipulated in JIS Z 2305 or equivalent certification.
 - iii) The radiographic testing shall be conducted by the inspector who shall have level 2 or equivalent qualifications.
 - iv) The manual flaw detecting inspection shall be conducted by inspector who shall have Level 2 or equivalent qualifications, and auto flaw detecting inspector shall have Level 3 or equivalent qualifications.

3.5. Tightening Bolt

(1) Bolted Connection

- 1) Contact surfaces in bolted joints shall be painted by System No. J (Inorganic zinc rich) as specified in subsection 6.4 painting System of the Specifications. When assembled in the field, the rust on joint surfaces, including those adjacent to bolt head, nut and washer, shall be removed by wire brushing. The separation between fraying surfaces of bolted connections shall be not greater than 1 mm. If the separation is between 1 mm and 3 mm, the surface shall be tapered to eliminate the separation. Over 3 mm separation shall be filled with filler plate as required.
- 2) In the case that contact surfaces in bolted joints shall be painted by Inorganic zinc rich, the design allowable capacity shall be the value shown below.

Table 3-11 Allowable force (kN)

Bolt size	F10T	S10T
M22	54	54
M24	63	63

- 3) High strength bolts shall not be reused. Retightening of previously tightened bolts which may have been loosened by the tightening of adjacent bolts, shall not be considered as re-use.
- 4) The bolt to be used for the friction grip connection, bearing connection and tensile connection shall be tightened in such a way that the design bolt axial force shown in Table 3-12.

Table 3-12 Minimum Bolt Tension

Grade	Bolt size	Design bolt axial force (kN)
S10T	M22	205
	M24	238

- 5) The tightening bolt axial force in the case of tightening by means of the torque control method shall generally be 10 percent greater than the design bolt axial force.

Concerning the tightening bolt axial force of the torque shear type high strength bolt at normal temperature (10°C – 30°C), the average value of testing five sampling sets randomly selected from one production lot must fall within the range of the bolt axial force shown in Table 3-13.

When the test is conducted outside the range of the normal temperature (0 to 10 °C, 30 to 60 °C), the range of the bolt axial force shown in Table 3-13 shall be applied.

Table 3-13 Average Value of Tightening Bolt Axial Force

Grade	Bolt size	Conditions	Average Bolt Tightening Axial Force in the Lot
S10T	M22	normal temperature 10 to 30 °C	212 to 249 (kN)
		outside of normal temperature 0 to 10 °C, 30 to 60 °C	207 to 261 (kN)
	M24	normal temperature 10 to 30 °C	247 to 290 (kN)
		outside of normal temperature 0 to 10 °C, 30 to 60 °C	241 to 304 (kN)
Remarks: Five (5) sets of bolt shall be tested to measure bolt tension randomly in one fabricated			

- 6) The introduction of the bolt axial force is generally performed by rotating the nut.
- When the head rotation is conducted out of necessity, the change of the torque coefficient shall be checked.
- 7) When the tightening of bolts is performed through the torque control method, the tightening torque shall be adjusted in such a way that the axial force of bolt tightening is introduced uniformly to each bolt.
- 8) When the torque shear type high strength bolts are used, a special tightener shall be employed for the final tightening.
- 9) When the tightening of bolts is performed through the torque gradient control method, the high strength bolts stipulated in item“2 materials” shall be used and the final tightening shall be conducted by means of the special tightener.
- 10) Tightening bolts shall be performed by starting from the bolt at the centre of the splice plate and making for the bolts at the end portion, and the second tightening shall be conducted accordingly.
- 11) Additionally, marking shall generally be applied to bolts, nuts and washers so that failed tightening and dragged rotation can be readily identified after the preliminary

tightening. The member and splice plate or t connected material pieces shall be fixed each other by means of tightening, leaving no room for the lap joint.

Galvanizing bolts shall be tightened by turn-of-nut method. The initial tightening of nut shall be achieved by introducing a torque of approximately 20 kgf.m. The marking shall be made after the initial tightening. The final tightening of the nuts shall be made up to 120 degrees turns with ± 15 degrees deviation after the initial tightening.

- 12) The calibration of bolt tighteners and measuring instruments shall be conducted at appropriate periods, and their precision shall be checked.
- 13) Concerning the tightening bolt axial force in the case of tightening by the torque gradient control method, the average value of testing five sampling sets randomly selected from one production lot for the tightener to be used must fall within the range of the bolts axial force shown in Table 3-14

Table 3-14 Average value of tightening bolt axial force by Torque Gradient Control Method

Set	Nominal designation of thread	Average value of tightening bolt axial force of the set of one production lot (kN)
F10T	M22	$0.242\sigma_y \sim 0.273\sigma_y$

3.6. Marking for Trial Assembling

Each part shall be carefully marked to facilitate erection. Such marking shall be durable but shall not injure the material, be defaced or removed by any person. The marking of components shall be in accordance with that shown on the workshop drawings submitted.





(1) Trial Assembling

- 1) The Contractor shall carry out trial assembling at the Contractor's fabrication shop(s) in principle. Trial assembling shall be understood as placing of prefabricated elements together to control the fitting. The Contractor shall submit his proposed trial assembling to the Engineer for inspection by the Engineer and/or his representatives. The trial assembling shall verify that the individual elements have the shape to fit exactly into adjoining elements. Also, the trial assembling shall verify that the camber aimed at, or prescribed, actually exists, and that the geometry is generally correct.
- 2) The Contractor shall perform measurement of the structural members, and the results shall be recorded and submitted to the Engineer. The Contractor shall inform the Engineer that the trial assembling of major components have been completed and measured, and the structure shall not be dismantled until the Engineer and/or his representatives have witnessed the trial assembling.

3.7. Tolerances for Steel Structures

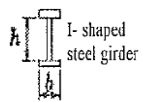
- (1) All fabrication shall be executed accurately to the shapes and dimensions shown on the Drawings, and, unless otherwise indicated on the Drawings, shall be within the tolerances listed below. Where, in the opinion of the Engineer, there is evidence that the application of the following tolerances would adversely affect the serviceability of the structure, the Engineer shall have the right to reduce the tolerances.
- (2) The allowable variations shown on Table 3-15 acceptable in fabricating a member of girder and pylon.

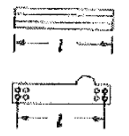
Table 3-15 Precision of Member

No.	Item	Allowable variation (mm)	Remark	Measurement method
1	Flange width b (m) Web plate height h (m) Web plate distance b' (m)	± 2 ---- $b \leq 0.5$ ± 3 ---- $0.5 < b \leq 1.0$ ± 4 ---- $1.0 < b \leq 2.0$ $\pm(3+b/2)$ $2.0 < b$	The b in the left column represents b, h and b'	
2	Plate deviation from flatness	Web plate of member such as a bridge girder, truss, etc.	h/250	h: Web plate height (mm)
		Flange of box girder, truss, etc., and deck plate of steel floor system	w/150	w: Distance of web plate or rib (mm)
3	Flange squareness δ (mm)	b/200	b: Flange width (mm)	
4	Member length l (m)	Steel girder, pylon	± 3 $l \leq 10$ ± 4 $l > 10$	 
		Truss, arch, etc.	± 2 $l \leq 10$ ± 3 $l > 10$	
		Expansion joint	0 to 30	
5	Bend of compressed member δ (mm)	l/1,000	l: Member length (mm)	

Concerning the member precision, the allowable values corresponding to the provisions on design are shown and the measurement methods are clearly described.

It is preferable to refer to Table 3-16 for the measurement points and quantities,

Table 3-16 Measurement Point or Quantity of Member

No.	Item	Steel girder, Pylon	Truss, arch, etc.
1	Flange width b (m) Web plate height h (m) Web plate distance b' (m)	Main girder, pylon, main structure	Near each support and each middle span
		Floor system, etc.	Near the centre of one member picked up per five members for each structure
2	Plate Deviation from flatness δ (mm)	Web plate of member such as a bridge girder, truss, etc.	Main girder Pylon
		Flange of box girder, truss, etc., and deck plate of steel floor system	
3	Flange squareness S (mm)		Near each support and each middle span
4	Member length l (m)	Steel girder, Pylon	Total number of primary members in general that for temporary assembly
		Truss, arch, etc.	
		Expansion joint	
5	Bend of compressed member δ (mm)	-	Total number of primary members

(3) Deviation of web from flange connection line

The maximum deviation of the centreline of the web from the flange connection line of the box girder and the flange centreline of the cross beams shall not exceed 6 mm.

(4) Assembly precision

- 1) After the completion of erection, the assembly precision of the combined members satisfies the allowable values of Table 3-15. Additionally, for the location at which to measure the various types of precision shown in Table 3-17, Table 3-18 can be used as a standard.

Table 3-17 Tolerance for Assembly precision







	Item	Condition	Tolerance (mm)	
Trial Assembly	Bridge length, L (m)	-	$\pm (10+L/10)$	
	Distance between CL girders, B (m)	$B \leq 2$	± 4	
		$B > 2$	$\pm (3+B/2)$	
	Main structure height, H (m)	$H \leq 5$	± 5	
		$H > 5$	$\pm (2.5+H/2)$	
	Horizontal alignment, L (m)	$L \leq 100$	$5 + L/5$	
		$100 < L$	25	
	Warping of main girder, structure, L (m)	$L \leq 20$	-5 to +5	
$20 < L \leq 40$		-5 to +10		
$40 < L \leq 80$		-5 to +15		
Verticality of main girder, main structure,		$3+H/1000$		
Cross point difference at bridge edge of min girder		10		
Verticality of Pylon δ (mm)		$H/1000$		
Field Erection	Gap at field joints		5	
	Span length, L (m)	-	$\pm(20+L/5)$	
	Camber, L (m)	-	$\pm(25+L/2)$	
	Horizontal alignment, L (m)	-	$\pm(10+2L/5)$	

Table 3-18 Location or Number to Measure of Assembly precision

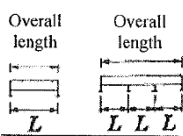
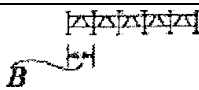
Item		Steel girder, Pylon
Overall length, span length	L (m)	Total number of main girder, main structures
Distance between centres of main girder, main structure	B (m)	Near each support and each middle span
Alignment of main girder, main structure	H (m)	One support and one middle span concerning outermost main girder or main structure
Warping of main girder	δ (mm)	Distance of 10 to 12m for each main girder
Cross point difference at bridge edge of main girder	δ (mm)	Either end of main girder (main structure)
Verticality of main girder	δ (mm)	Both end portion of each main girder
Verticality of Pylon	δ (mm)	Each pylon Each cable anchor point of pylons

4. Transport, Handling and Storage

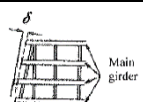
- (1) Before shop assembly is dismantled, all adjacent sections shall be marked with paint. The Contractor shall submit to the Engineer drawings of the finished structure showing all parts and match marks.
- (2) Steel segments and materials to be transported over ocean shall be kept by appropriate protective cover from splashing sea water.
- (3) During delivery, all component materials shall be adequately protected from damage, and the Contractor shall be responsible for any damage which may occur, including damages due to repetitive loading during shipping. In particular, the Contractor shall adequately brace the box girders, cross beams and steel pylons. All straps and chains used in lifting shall be adequately padded to prevent damage to the steel work and its protective coating.
- (4) All materials shall be delivered to the Site at such time or times as they are required for incorporation in the Works. Stacking of steel segments for box girders and pylons may be permitted, however, the Contractor shall submit a report to Engineer for information for assuring no damage to the permanent structure and its coating, and no harmful settlement of supporting soil. The Contractor shall notify the Engineer prior to the transport of major items from the shop, temporary storage yard or other place.
- (5) Bolts and small or loose pieces shall be bagged and close crated. Bolts, nuts and washers shall be separately bundled for each size and each bundle clearly marked with the size and purpose of the bolts. The batch number of each bag of bolts shall be clearly marked to facilitate reference to the test certificates.
- (6) No fabricated steel shall leave the Contractor's workshop without being inspected and passed by the Engineer at the place of fabrication or be placed in the Works without being inspected and passed by the Engineer after delivery.
- (7) The methods of transporting and handling shall be subject to the consent of the Engineer. Special care shall be taken in the packing, methods of supporting, lifting during handling and transporting of structural steel work which is shop assembled before delivery, to ensure protection from damage.
- (8) Immediately following delivery to the site, the Contractor shall check the material and bring immediately to the notice of the Engineer or his representative any damage or defects therein. He shall also report in writing to the Engineer any such damage or defects, and give his proposals for the rectification or replacement of damaged sections.
- (9) Material to be stored shall be placed on skids above the ground and shall be kept clean and properly drained. Girders, beams and pylons shall be placed upright and shored. Long

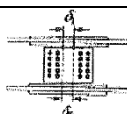
members shall be supported on skids places closely enough together to prevent injury from deflection.

- (10) Any structural steel materials regardless of painted or unpainted shipped to the site by sea transport, which expose to salt water spray, shall be thoroughly washed with clean fresh water, using pressure hoses and stiff bristle brushes, prior to erection or application of finish coats of paint.

5. Erection

5.1 Erection Procedures and Working Plan

- (1) The Contractor shall submit method statements of the steel structures erection works at the site to the Engineer. The submission shall incorporate detailed methodology, erection drawings of the proposed construction sequence, together with the corresponding complete and checked erection design calculation in every erection step to obtain the correct elevation in the completed bridges. The proposed documents shall be submitted at least twelve (12) weeks prior to the commencement of construction of the superstructure for the Engineer's information.
- (2) The Contractor shall submit, in addition to the requirements under "Section 01500 – Project Safety" of the General Specifications, the detailed safety measures for the erection work including the following:
 - Specifying work zone and safety zone
 - Working conditions for each erection work (wind speed, rain intensity, etc.)
 - Preventive measures from falling of workers, materials and equipment
 - Preventive measures against unstable operation of equipment including but not limited to, unbalanced load transfer, excessive loading, excessive movement, and settlement of soil supporting the equipment
 - Safety measures for existing traffic and surrounding
 - Method of traffic control, partial lane closure and traffic diversion if necessary
- (3) If the Contractor plans to execute night time work for their part of erection works, the details of the work items, hourly working schedule, and additional safety measures shall be submitted for the Engineer's consent. Prior to commence the night work, at least 7 days before, the Contractor shall submit the night work schedule to the Engineer.
- (4) The erection drawings shall show all temporary works necessary, the bearings, supports and incidentals, and include full method statements for each stage of the erection.
- (5) The Contractor shall be responsible for the detailed design of the erection plan, equipment and temporary works and be responsible for ensuring the structural adequacy and stability of all items when used in its chosen construction sequence or in the construction sequence depicted in the Drawings.
- (6) In the Working Plan for the erection works, the Contractor shall submit for the Engineer's information a full description of his proposed erection method and means including:
 - A summary of all design loads and the assumptions in deriving them, design calculation, detailed erection drawings, including full details of the construction equipment, falsework and temporary bent and girder. The layout and position of major equipment including cranes shall be detailed.

- A step-by-step verification of the strength, stability and serviceability of the permanent structure for all loading including gravity, effect of temperature, erection loading, and effect of settlement of temporary bents. The verification shall include the detailed calculation of stress, deformation and buckling in the permanent structure during every erection step including during fresh concrete by the Contractor's proposed erection method and prove no such overstress or unfavourable stresses and deformations in the permanent structure.
 - Calculation of the required cambers on the permanent structure at each stage of erection process taking into account the effect of temperature.
 - Analysis of errors of fabrication, erection and tolerance shall be presented for the Engineer's information.
 - Design details of temporary structures such as temporary bent and girder, scaffolding and their connections and foundations. Design shall include details of stability design of the temporary structure and their foundations in accordance with the site geological conditions. Unbalanced loadings during construction shall be considered in their design. Settlement of soil supporting temporary bent shall be calculated and the necessary preventive measures shall be employed. The Contractor shall submit design conditions for the temporary structures and their foundation for the Engineer's consent.
 - Proposed method for the calculation of jacking forces, jacking up and down.
 - Proposed method of setting and adjustments of bridge bearings.
 - Calculation sheet and detailed drawings of lifting lug on permanent structure and method of removal, if any.
 - Proposed sequence and method of casting deck concrete
- (7) Proposed method of installation of expansion joints and casting concrete fill. Proposed sequence and method of pavement including waterproofing (requirements see Article 3.4, 3.5, 3.6 of Section 05300). Method of demolition of temporary structure.
- (8) The Engineer's consent on the above details shall not relieve the Contractor of his contractual obligations or of his responsibility for providing proper method, equipment, workmanship and safety precautions.
- (9) Steel structures shall be stored on timber bearers, clear of the ground and in such a way as to permit checking and to avoid excessive handling and damage to the steel work or its protective coating.
- (10) Unless otherwise directed by the Engineer, all surfaces to be brought together to form a joint or splice shall be free of paint or any other applied finish, oil, dirt, loose rust and scale, burrs and other defects which would prevent solid seating of the parts or would interfere with the development of friction between them.

5.2 Field Erection

- (1) The position of field splices as shown on the drawings is for information only and the Contractor may propose alternative procedures providing they comply with all the relevant requirements of these Specifications. The preparation of the calculations and detailed design to support the proposed alternative shall be at the Contractor's responsibility and cost, including any additional cost incurred by the change.

- (2) The Contractor shall provide setting drawings, templates, and directions for the installation of anchor bolts or other items to be embedded in concrete.
- (3) During erection, the parts shall be accurately assembled as shown on the approved Shop Drawings and any match marks shall be followed.
- (4) The material shall be carefully handled so that no parts shall be bent, broken or otherwise damaged.
- (5) Hammering which will injure or distort the members shall not be done. Bearing surfaces and surfaces to be in permanent contact shall be cleaned before the members are assembled. Splices and field connections shall have sufficient number of bolts and cylindrical erection pins (drifts) before bolting with high-strength bolts. The Contractor shall provide calculations of required number of bolts and drifts according to his construction plan for the Engineer's review and consent. Fitting-up bolts shall be of the same nominal diameter as the high-strength bolts, and cylindrical erection pins shall be 1 mm larger.
- (6) The correction of minor misfits involving harmless amounts of reaming, cutting and chipping shall be considered a legitimate part of the erection. However, any error in the shop fabrication or deformation resulting from handling and transportation which prevents the proper assembling and fitting up of parts by the moderate use of drift pins or by a moderate amount of reaming and slight chipping or cutting, shall be reported immediately to the Engineer and his consent of the method of correction obtained. The correction shall be made in his presence. The Contractor shall be responsible for all misfits, errors and injuries and shall make the necessary corrections and replacements.
- (7) The straightening of plates, angles, other shapes and built-up members, then permitted by the Engineer, shall be done by methods that shall not produce fracture or other injury. Distorted members shall be straightened by mechanical means or, if consented by the Engineer, by the carefully planned and supervised application of a limited amount of localized heat, each application subject to the consent of the Engineer.
- (8) Each joint shall be bolted up with service bolts and/or parallel drifts so that the various sections and plates are in close contact throughout. Service bolts shall not remain in the completed structure.
- (9) Drifts shall be parallel barrel drifts. The length of the barrels shall not be less than the combined thickness of the material, plus one diameter. The ends of the drifts, for a length of 1.5 barrel diameters, shall be tapered down to an end diameter equal to half the barrel diameter. Heavy drifting that would distort the holes shall not be carried out.
- (10) High tensile strength bolts shall be assembled with one hardened washer under the turned element (nut or bolt head). The washer shall be assembled with any convexity outwards. The inserting and tensioning of the high tensile strength bolts shall be so arranged that the close contact established by the service bolts is maintained at all times. The tensioning of high tensile strength bolts shall not commence until the joint has been inspected by the Engineer.
- (11) The slope of surfaces of bolts parts in contact with the bolt head and nut shall not exceed 1:20 with respect to a plane normal to the bolt axis; in cases where the shape of the member is such that this slope is exceeded, taper washers shall be used.
- (12) Unless otherwise agreed by the Engineer, the lifting lugs used for site assembly and erection work shall be cut to the remaining height be less than 10 mm and cutting edge be ground to be smoothed.

6. Painting and Galvanising

6.1 Description

This work shall consist of the painting of surfaces specified in the Contract Documents to be painted. The work shall be taken to include the preparation of surfaces to be painted; application and curing of the paint; protection of the work; protection of existing facilities, vehicles, and the public from damage due to this work; and the furnishing of all labour, equipment, and materials needed to perform the work.

Waterproofing on the steel deck shall be referred to 3.4, 3.5 and 3.6 Waterproofing of Section 05300 Asphalt Concrete Binder and Surface Courses.

This work consists of both Shop and Field Painting, and galvanizing.

6.2 Material Requirements

(1) Reference Standards

The painting of the steel superstructure shall conform to the requirements of "Painting Manual for Steel Highway Bridges" by Japan Road Association (JRA), March 2014 or approved equivalent.

(2) Materials for Surface Treatment of Steel

- 1) The specified paints shall be procured only from recognized manufacturers.
- 2) Samples and technical data shall be submitted to the Engineer for his consent.
- 3) In any paint system (primer, undercoats, intermediate coat, and finishing coats) each coat of paint must be compatible with all the others.
- 4) To ensure this, all paints must be obtained from the same manufacturer with a guarantee of compatibility.
- 5) Galvanizing shall, in general, conform to the requirements of AASHTO M-111 or JIS H 8641 HDZ 35-55 (or equivalent of ASTM A53 or ASTM A123 approved by the Engineer), and JIS H 0401. Any material thinner than 3.2 mm may be galvanized before fabrication in accordance with the requirements of ASTM A924. Galvanizing of iron and steel hardware and nuts and bolts shall conform to the specifications of AASHTO M-232 or similar specifications approved by the Engineer.

6.3 Construction Requirements

(1) General

1) Submittals

The Contractor shall submit a written plan for information at least 14 days before beginning work that details the measures to be used for protecting the environment, public, adjacent property, and workers. Include the following:

- (a) Manufacturer's product data sheets for cleaning and painting products.
- (b) Design and construct safe containment structures that will support the loads imposed. Do not apply loads to the existing structure in excess of the load carrying capacity of any part of the structure. Include details of attachment. Make connections that do not require welding or drilling holes in the existing structure. Make connections with clamps or other approved devices. Submit working drawings and construction details.

- (c) A detailed disposal plan for used cleaning products, and paint debris.
- (d) Specific safety measures to protect workers from site hazards including falls, fumes, fires, or explosions.
- (e) Emergency spill procedures.
- (f) Person's experience.

2) Protection of Public and Property

The Contractor shall comply with all applicable environmental protection and occupational safety and health standards, rules, regulations, and orders. Failure to comply with these standards, rules, regulations, and orders shall be sufficient cause for suspension of work.

All reasonable precautions shall be taken to contain waste materials (used blasting material and old paint) classified as hazardous. Disposal of hazardous waste material shall be performed in accordance with all applicable Laws and Regulations.

The Contractor shall provide protective devices such as tarps, screens, or covers as necessary to prevent damage to the work and to other property or persons from all cleaning and painting operations. The Contractor shall be responsible for all damage caused by the painting work to vehicles, persons, or property.

Paint or paint stains that result in an unsightly appearance on surfaces not designated to be painted shall be removed or obliterated by the Contractor with no additional costs to the Employer.

3) Protection of the Work

The Contractor shall take all precautions necessary to protect the surface from contamination prior to or during the application process. The Contractor shall use screens, paper, cloth or other suitable means to protect adjacent surfaces that are not to be painted.

The Contractor shall protect all parts of the work against disfigurement by splatters, splashes, and smirches of paint materials.

All painted surfaces that are marred or damaged as a result of operations of the Contractor shall be repaired by the Contractor, no additional costs to the Employer, with materials and to a condition equal to that of the coating specified herein.

If traffic causes an objectionable amount of dust, the Contractor, when directed by the Engineer, shall sprinkle the adjacent roadbed and shoulders with water or dust palliative for a sufficient distance on each side of the location where painting is being done.

Upon completion of all painting operations and of any other work that would cause dust, grease, or other foreign materials to be deposited on the painted surfaces, the painted surfaces shall be thoroughly cleaned. At the time of opening any structures to public traffic, the painting shall be completed and the surfaces shall be undamaged and clean.

4) Thickness and Paint Colour

The dry film thickness of each coat and total thickness of the finished product shall be in accordance with the Contract Documents.

Each coat of paint should be separately coloured to ensure complete coverage, and such that the previous coat can be hidden by a single coat of the next application.

Painting colour of the finishing coat for the exterior surface of steel structure shall be as instructed by the Engineer.

The Contractor shall submit colour samples for the finishing coat before starting the work for the consent of the Engineer.

As for the inside of the pylons, considering maintenance work of pylon, the paint colour shall be selected as follows;

Table 6-1 Painting Colour for Inside of Pylons

Painting System	1st Coating	2nd Coating
D-5	N 7.5	N 8.5

6.4 Painting System

(1) Coating Systems and Paints

The Contractor shall perform painting work according to the accepted plan in Subsection 3.1.1. Stop work and take corrective action if measures to fail to perform as intended.

(2) Coating System

- 1) The coating system to be applied is described in these Specifications.
- 2) The conditions for painting inorganic zinc paint on the bolt contact surface are shown in Table 6-2.

Table 6-2 Required thickness of paint on the bolt contact surface

Item	Conditions
Minimum dry coating film thickness per side of contact surface	more than 50 μm
Total dry coating film thickness of contact surface	100 μm ~200 μm
The amount of zinc in the dried coating film	more than 80%
Particle size Zinc	more than 10 μm

- 3) The inside surfaces of bolt holes shall be cleaned and visible rust shall be removed, and then coated with one application of zinc rich primer.
- 4) The coating system and application are described in Table 6-3. The process of painting including surface preparation, type of paint, quantity of painting, required thickness and painting interval are specified in Tables 6-4 to 6-10 respectively.
- 5) The end of the girder and lower flange shall be applied with two layers of C-5 3rd coating.
- 6) The exposed surface of anchor frame and tie bar for rocking bearing at cable stayed bridge shall be applied with two layers of C-5 3rd coating.

Table 6-3 Coating System and Application

System No.	C-5	D-5	F-11	F-12	F-13	F-14	J	E
Applied Parts	Exterior surface of girders, cross beams	Interior surface of box girders and pylons.	Exterior surface of bolted connection for girders, cross beam	Interior surface of bolted connection for box girders and steel piers	Exterior surface of site welded connection for girders and pylons	Interior surface of site welded connection for girders and pylons	Contact surface of bolted connection incl. filler plate Exterior	Interior surface of steel deck in contact with concrete

	and pylons.						surface of top flange of girders.	
Total film thickness (µm)	250	240	430	375	250	375	One side more than 50	75

Table 6-4 Coating Specifications on C-5

Process		Type of Painting	Standard quantity by spray (g/m ²)	Required thickness (µm)	Painting interval
Steel mill	Fist surface preparation	Blast cleaned (ISO Sa2.5)			Within 4 hrs.
	Primer coating	Inorganic zinc rich primer	160	(15)	
Shop Painting	Second surface Preparation	Blast cleaned (ISO Sa2.5)			Within 6 months
	1st coating	Inorganic zinc rich paint	600	75	Within 4 hrs.
	2nd coating – mist coat	Epoxy resin	160	-	2 days - 10days
	3rd coating	Epoxy resin	540	120	1 day - 10days
	4th coating	Fluorescent resin	170	30	1 day - 10days
	5th coating	Fluorescent resin	140	25	1 day - 10days

Table 6-5 Coating Specifications on D-5

Process		Type of Painting	Standard quantity by spray (g/m ²)	Required thickness (µm)	Painting interval
Steel mill	Fist surface preparation	Blast cleaned (ISO Sa2.5)			Within 4 hrs.
	Primer coating	Inorganic zinc rich primer	160	(15)	
Shop Painting	Second surface preparation	Power tool cleaned (ISO Sa3)			Within 6 months
	1st coating	Formulated epoxy resin	410	120	Within 4 hrs.
	2nd coating	Formulated epoxy resin	410	120	1 day – 10 days

Table 6-6 Coating Specifications on F-11

Process		Type of Painting	Standard quantity by spray (g/m ²)	Required thickness (μm)	Painting interval
Steel mill	Fist surface preparation	Blast cleaned (ISO Sa2.5)			Within 4 hrs.
	Primer coating	Inorganic zinc rich primer	160	(15)	
Shop Painting	Second surface preparation	Blast cleaned (ISO Sa2 1/2)			Within 6 months
	1st coating	Inorganic zinc rich paint	600	75	Within 4 hrs.
Field Painting	Third surface preparation	Power tool cleaned (ISO St 3)			Within 1 year.
	2nd coating – mist coat	Formulated epoxy resin	160	-	Within 4 hrs.
	3rd coating	Ultra-thick epoxy resin	1,100	300	1 day - 10days
	4th coating	Fluorescent resin	170 (140 by brush)	30	1 day - 10days
	5th coating	Fluorescent resin	140 (120 by brush)	25	1 day - 10days

Table 6-7 Coating Specifications on F-12

Process		Type of Painting	Standard quantity by spray (g/m ²)	Required thickness (μm)	Painting interval
Steel mill	Fist surface preparation	Blast cleaned (ISO Sa2.5)			Within 4 hrs.
	Primer coating	Inorganic zinc rich primer	160	(15)	
Shop Painting	Second surface preparation	Blast cleaned (ISO Sa2 1/2)			Within 6 months
	1st coating	Inorganic zinc rich paint	600	75	Within 4 hrs.
Field Painting	Third surface preparation	Power tool cleaned (ISO St 3)			Within 1 year.
	2nd coating – mist coat	Formulated epoxy resin	160	-	Within 4 hrs.
	3rd coating	Ultra-thick epoxy resin	1,100	300	1 day - 10days

Table 6-8 Coating Specifications on F-13

Process		Type of Painting	Standard quantity by spray (g/m ²)	Required thickness (µm)	Painting interval
Shop Painting	First surface Preparation	Blast cleaned (ISO Sa2.5)			Within 4 hrs.
	1st coating	Organic zinc rich paint	600	75	
	2nd coating	Formulated Epoxy resin	240	60	1 days - 10days
	3rd coating	Formulated Epoxy resin	240	60	1 day - 10days
	4th coating	Fluorescent resin	170	30	1 day - 10days
	5th coating	Fluorescent resin	140	25	1 day - 10days

Table 6-9 Coating Specifications on F-14

Process		Type of Painting	Standard quantity by spray (g/m ²)	Required thickness (µm)	Painting interval
Field Painting	First surface preparation	Blast cleaned (ISO Sa2.5)			Within 4 hrs.
	1st coating	Organic zinc rich paint	600	75	
	2nd coating	Ultra thick epoxy resin	1,100	300	1 day - 10days

Table 6-10 Coating Specifications on J, E (Shop painting)

Process		Type of Painting	Standard quantity by spray (g/m ²)	Required thickness (µm)	Painting interval
Steel mill	Fist surface preparation	Blast cleaned (ISO Sa2.5)			Within 4 hrs.
	Primer coating	Inorganic zinc rich primer	160	(15)	
Shop Painting	Second surface preparation	Blast cleaned (ISO Sa2.5)			Within 6 months
	1st coating	Inorganic zinc rich paint	600	75	Within 4 hrs.

1) The application of painting materials shall comply with manufacturer's instruction.

- 2) Unless otherwise indicated, the Contractor shall use adequate paints conforming to relevant JIS.
- 3) Using mix type paint, the Contractor shall comply with instructions prepared by the supplier in the mixing procedure, mixing ratio and recommended use by time.
- 4) The Contractor shall not use expired paints, and term of validity as specified in a manufacturer's instruction.
- 5) The Contractor shall maintain labels on sealed containers of paint and carry in the painting yard for the work. The Contractor shall submit shipping certificate and test certificate including date of manufacture, lot number, colour and quantity, to the Engineer for verification before the commencement of the work.

(3) Paint Materials

Materials used in painting of steel structures shall be as shown on the Drawings or specified elsewhere and shall conform to the requirements of Standard of Painting Materials for Steel Highway Bridges in "Painting Manual for Steel Highway Bridges", March 2014, or equivalent standards.

Handling and storing material. Use safe handling practices conforming to the manufacturer's product data sheets. Store paint in original unopened containers with labels intact and in weather-tight spaces where temperature is maintained between 4 and 38 °C. Do not open paint containers until required for application that day. Do not use paint from a punctured container or from a container with its lid seal broken. Do not use paint with an expired shelf life.

(4) Weather Conditions

Paint shall be applied only on thoroughly dry surfaces. If no information is provided, apply paint when:

- (a) The surface temperature is between 10 and 40 °C;
- (b) The surface temperature is 3 °C or more above the dew point;
- (c) The humidity is 85 % or less, unless specified otherwise on the manufacturer's product data sheets; and
- (d) Provide a controlled environment to meet requirements when necessary.

(5) Surface Preparation

All exposed surfaces of structural steel, except galvanized or metalized surfaces, shall be cleaned and painted.

All surfaces of new structural steel shall be cleaned by the blast-cleaning method unless otherwise specified in other relevant clauses of the Contract Documents or approved in writing by the Engineer.

Any damage to sound paint, on areas not designated for treatment, resulting from the Contractor's operations shall be repaired by the Contractor with no additional costs to the Employer to the satisfaction of the Engineer.

The methods used in the cleaning of metal surfaces shall conform to the specifications herein.

- If fabricated members to be painted will be suspected adhering sodium due to ocean transportation or others, the Contractor shall inspect salinity determination.
- Resulting that adhesion of sodium chloride exceeds 100 mg/m², the Contractor shall clear away by utilizing adequate cleaning method.
- The areas for splices by high tensile strength bolts shall be protected by masking at the time of the fabrication shop undercoats. Immediately prior to final erection, any rust in the joint area shall be removed by power wire brushing to the "Painting Manual for Steel Highway Bridges", Japan Road Association, March 2014, or equivalent standard.
- The edges and corners of plates exposed outside shall be rounded off from a 2-mm radius to a 3-mm. The other edges shall be made chamfer from 0.5 mm to 1.0 mm.

(6) Blast Cleaning

Abrasives used for blast cleaning shall be clean dry sand, mineral grit, steel shot, or steel grit, at the option of the Contractor, and shall have a suitable grading to produce satisfactory results. The use of other abrasives shall not be permitted unless approved in writing by the Engineer.

Unwashed beach sand containing salt or excessive amounts of silt will not be allowed.

All dirt, mill scale, rust, paint, and other foreign material shall be removed from exposed steel surfaces in accordance with the requirements of the Steel Structures Painting Council Surface Preparation Specification No.10, SSPC-SP 10, Near-White Blast Cleaning. Blast cleaning shall leave all surfaces with a dense and uniform anchor pattern of not less than 25.4 μ m or more than 76.2 μ m as measured with an approved surface profile comparator.

When blast cleaning is being performed near machinery, all journals, bearings, motors, and moving parts shall be sealed against entry of abrasive dust before blast cleaning begins.

Blast-cleaned surfaces shall be primed or treated the same day blast cleaning is done, unless otherwise authorized by the Engineer. If cleaned surfaces rust or are contaminated with foreign material before painting is accomplished, they shall be re-blast-cleaned by the Contractor at the Contractor's expense.

(7) Steam Cleaning

All dirt, grease, loose chalky paint, or other foreign material that has accumulated on the previously painted or galvanized surfaces shall be removed with a steam cleaning apparatus which shall precede all other phases of cleaning. It is not intended that sound paint be removed by this process. Any paint which becomes loose, curled, lifted, or loses its bond with the preceding coat or coats after steam cleaning shall be removed as directed by the Engineer to sound paint or metal surface by the Contractor at the Contractor's expense.

A biodegradable detergent shall be added to the feed water of the steam generator or applied to the surface to be cleaned. The detergent shall be of such composition and shall be added or applied in such quantity that the cleaning as described in the above paragraph is accomplished.

Any residue, detergent, or other foreign material that may accumulate on cleaned surfaces shall be removed by flushing with fresh water.

Steam cleaning shall not be performed more than two weeks prior to painting or other phases of cleaning.

Subsequent painting shall not be performed until the cleaned surfaces are thoroughly dry and in no case in less than 24 hours after cleaning and flushing.

(8) Solvent Cleaning

Unless otherwise prohibited by the Contract Documents, solvents shall be used to remove oil, grease and other soluble contaminants in accordance with the requirements of Painting Council, SSPC-SP 1, Solvent Cleaning, November 1982. Solvent cleaning shall be performed prior to blast cleaning. If contamination remains after blasting, the area shall be re-cleaned with solvent.

(9) Hand Cleaning

Wire brushes either hand or powered, hand scraping tools, power grinders, or sandpaper shall be used to remove all dirt, loose rust and mill scale, or paint which is not firmly bonded to the metal surfaces.

Pneumatic chipping hammers shall not be used unless authorized in writing by the Engineer.

(10) Power Washing

Power washing shall utilize water at a pressure between 5.5 MPa to 10.3 MPa, applied with the nozzle no further than 300 mm from the surface of the steel.

(11) Application of Painting

- 1) The Contractor shall notify the Engineer, in writing, at least four weeks in advance of the date that cleaning and painting operations are to begin.
- 2) The Contractor shall apply paint according to the manufacturer's recommendations. Apply paint by brush, spray, roller, or combination of methods permitted by the manufacturer's product data sheet.

a) Brushes.

Use brushes with sufficient bristle body and length to spread the paint in a uniform film. Use round, oval shaped brushes, or flat brushes no wider than 120 mm. Evenly spread and thoroughly brush out the paint as it is applied.

b) Sprayers.

Use airless or conventional spray equipment with suitable traps, filters, or separators to exclude oil and water from the compressed air. Use compressed air that does not show black or wet spots. Use the spray gun tip sizes and pressures recommended by the manufacturer.

c) Rollers.

Select rollers and covers suitable for the surface and paint to be applied. Use rollers only on flat, even surfaces. Do not use rollers that leave a stippled texture in the paint film.

- 3) Use sheepskin daubers, bottle brushes, or other acceptable methods to paint surfaces where painting by regular means is not achievable.
- 4) Paint in a neat and workmanlike manner that does not produce excessive paint build-up, runs, sags, skips, holidays, or thin areas in the paint film. Correct thin areas, skips, holidays, and other deficiencies before the next application of paint.

- 5) Tint succeeding applications of paint to contrast with the paint being covered. Obtain colour approval for the finish coat before application.
- 6) Paint surfaces that will be inaccessible after erection with the full number of undercoats required before erection. After erection, thoroughly clean areas where the undercoating is damaged or deteriorated, and spot coat these with the specified undercoats to the required thickness before applying the final coat.
- 7) Measure the wet film thickness during application and adjust the application rate to obtain the required dry film thickness.
- 8) Cure each coat of paint according to the manufacturer's recommendations.
- 9) Application of painting on the girders shall be covered as indicated in the drawings.

(12) Application of Zinc-Rich Primers

Zinc-rich primers, which include organic and inorganic zinc primers, shall be applied by spray methods. On areas inaccessible to spray application, the paint may be applied by brush or daubers.

Mechanical mixers shall be used in mixing the primer. After mixing, zinc-rich primers shall be strained through a metal 250 to 600 µm mesh screen or a double layer of cheesecloth immediately prior to or during pouring into the spray pot.

An agitating spray pot shall be used in all spray application of zinc-rich primers. The agitator or stirring rod shall reach to within 50 mm of the bottom of the spray pot and shall be in motion at all times during primer application. Such motion shall be sufficient to keep the primer well mixed.

Spray equipment shall provide the proper pot pressure and atomization pressure to produce a coating, the composition of which shall comply in all respects with the specifications for zinc paint. The hose from pot to nozzle shall not be more than 23 m long, nor be used more than 4,600 mm above or below the pot.

Cured, zinc-rich primer shall be free from dust, dirt, salt, or other deleterious deposits and thoroughly dry before applying vinyl wash primer. In addition, the application of inorganic zinc paints shall conform to the following:

- Succeeding applications of inorganic zinc paints shall be applied within 24 hrs, but not less than 30 minutes after prior application of such paint.
- In areas where mud-cracking occurs in the inorganic zinc paint, it shall be blast-cleaned back to soundly bonded paint and recoated to the same thickness by the same methods specified for the original coat.
- Paint shall be cured for 48 hrs at a relative humidity of at least 45 % before the application of vinyl wash primer. The cured inorganic zinc paint shall be hosed down with water and be in a surface dry condition before the application of vinyl wash primer if the vinyl wash primer is not applied within three weeks after the inorganic zinc paint is applied, or if there is evidence of dust, dirt, salt, or other deleterious deposits on the inorganic zinc paint.

(13) Galvanizing

In general, galvanizing shall conform to the requirements of AASHTO M-111 or JIS H 8641 and JIS H 0401.

All welded areas shall be thoroughly cleaned prior to galvanizing to remove all slag or other material that would interfere with the adherence of the zinc. When it is necessary to straighten any sections after galvanizing, such work shall be performed without damage to the zinc coating.

Galvanizing surfaces that are abraded or damaged at any time after the application of the zinc coating shall be repaired by thoroughly wire brushing the damaged areas and removing all loose and cracked coating, after which the cleaned areas shall be painted with three applications of zinc anticorrosive paint as agreed by the Engineer. The specifications of zinc plating are shown in Table 6-11.

Table 6-11 Galvanizing Specifications

Members	Specifications	Adhesion of zinc
Steel plate (8mm or more) Shaped Steel	HDZ 55 or equivalent	600 g/m ² or more
Steel plate (6 mm or more and less than 8mm) Bearing	HDZ 55 or equivalent	550 g/m ² or more
Steel plate (3.2 mm or more and less than 6 mm)	HDZ45 or equivalent	450 g/m ² or more
Steel plate (less than 3.2 mm) Bolts	HDZ35 or equivalent	350 g/m ² or more

7. Measurement and Payment

7.1 Measurement

- (1) Steel structures such as steel girders, crossbeams, pylons, steel decks and other steel structures complied with this Section 07100 shall be measured by computed weight (ton) of the net finished dimensions (the dimensions after erection completed) and delivered members comprising of permanent materials such as plate, shaped steel, bolts, nuts, washers, rolled sections, shear connectors, stiffeners, splice plates, studs, fittings and other members welded on the permanent steel structures without allowance for tolerances for permissible deviations from standard weight or nominal dimensions. The computed weight shall exclude the weight of welds, bolt holes, lug holes (i.e., subtracting the weight for such holes), temporary members for erection and protective paintings.
- (2) No weight for temporary lugs nor reinforcements for shop fabrication, transportation, site assembly and site erection shall be measured.
- (3) No deductions shall be made for chamfer (a 2-mm radius and 1-mm cut) of edge of the plates and cope holes.
- (4) The computed weight of rolled and cast steel shall be determined from the dimensions shown on the Drawings assuming a weight of 7.850 ton/m³.
- (5) The weight of the structural steel for “Steel I-Girders”, “Steel Box Girders”, Steel Box-Girders for Cable Stayed Bridge” and “Steel Pylons” shall be computed separately.
- (6) Pay Item: 07100-01 and 07100-07, the weight of Steel I-Girders shall include I-girders, cross beams, stringers, brackets and other permanent members welded on the permanent steel structures.
- (7) Pay Item: 07100-02 and 07100-08, the weight of Steel Box Girders shall include box girders, cross beams, lateral bracing, sway bracing, manhole and other permanent members welded on the permanent steel structures.

- (8) Pay Item: 07100-03 and 07100-09, the weight of Steel Box Girders shall include box girders, steel deck slab, cross beams, stringer, brackets, inspection walkway, manhole and other permanent members welded on the permanent steel structures.
- (9) Pay Item: 07100-04 and 07100-10, the weight of Steel Box Girders for Cable Stayed Bridge shall include box girders, stringer, bracket, guide tube for stay cable at girder side, girder anchorage of stay cables, inspection walkway, water pipe support, fairings, cable racks, manhole and other permanent members welded on the permanent steel structures.
- (10) Pay Item: 07100-05 and 07100-11, the weight of Steel Pylons shall include pylons, guide tube for stay cable at pylon side, pylon anchor of stay cables, aerodynamic devices, manhole, ladders and other permanent members welded on the permanent steel structures.
- (11) Pay Item: 07100-06 and 07100-12, the weight of Steel Box Girders shall include box girders, deck slab, cross beams, stringer, brackets, inspection walkway, manhole and other permanent members welded on the permanent steel structures

7.2 Payment

- (1) The Payment of steel structures is divided into two main groups such as “fabrication and transportation” and “erection”. Payment shall be made on a ton-unit-price basis.
- (2) The weight (ton) of each class of steel in each such member shall not be separately computed nor paid.
- (3) Members which fail to meet the Contract requirements and members rejected as a result of tests and/or inspections will not be paid for by the Employer.
- (4) Pay item of “Shop Fabrication and Transportation”

The unit rate of each Pay Item 07100-01, 07100-02, 07100-03, 07100-04, 07100-05, 07100-06 shall be full compensation for the cost of preparation of shop fabrication including materials supplying, fabricating, cutting, shop and stock yard welding, assembling, any tests, any inspections, steel mill’s paintings, shop and stock yard paintings, rubber for manholes, delivering from fabrication shop to the site storage yards, furnishing all labour, equipment, facilities, materials, tools and other items necessary for the proper completion of the fabrication and transportation works.

- (5) Pay item of “Erection”

The unit rate of each Pay Item 07100-07, 07100-08, 07100-09, 07100-10, 07100-11, 07100-12 shall be full compensation for the cost of erection including delivery from the site stock yard to the erection site, site assembling, joint connection, bolts tightening, site welding, any tests, any inspections, site paintings, installing and removing temporary staging, scaffoldings and other structures for erection, furnishing all labour, equipment, facilities, materials, scaffoldings, tools and other items necessary for the proper completion of the erection works.

- (6) The partial amount in accordance with the progress will be paid with following principle;
 - The structural steel for girder and pylon will be measured when the delivery of material to the site stock yard is completed and accepted by the Engineer. The partial amount will be paid equivalent to 70 percent of amount calculated at the unit rate per ton for the items in Bill of Quantities.
 - The remaining 30 percent will be paid when all structural steel for girders and pylons are completed and accepted by the Engineer.

Pay Item	Description	Unit
07100 -01	Shop Fabrication & Transport of Steel I-Girders (Package3)	ton
07100 -02	Shop Fabrication & Transport of Steel Box Girders (Package3)	ton
07100 -03	Shop Fabrication & Transport of Steel Box Girders (Package1)	ton
07100 -04	Shop Fabrication & Transport of Steel Box Girders for Cable Stayed Bridge (Package1)	ton
07100 -05	Shop Fabrication & Transport of Steel Pylons (Package1)	ton
07100 -06	Shop Fabrication & Transport of Steel Box Girders (Package2)	ton
07100 -07	Erection of Steel I-Girders (Package3)	ton
07100 -08	Erection of Steel Box Girders (Package3)	ton
07100 -09	Erection of Steel Box Girders (Package1)	ton
07100-10	Erection of Steel Box Girders for Cable Stayed Bridge (Package1)	ton
07100-11	Erection of Steel Pylons (Package1)	ton
07100 -12	Erection of Steel Box Girders (Package2)	ton

Section 07210 - Bridge Rail, Wheel Guard and Median

1. Description

This Specification Section describes the requirements for the provision, coating, and installation of steel Bridge Rail as indicated in the Drawings. Wheel Guard and Median on which the steel Bridge Rail will be placed are described in this Specification Section.

2. Material Requirements

2.1 Reference Standards of Bridge Rail

The following Standards in their latest edition shall be applied to the Works covered by this Specification Section.

“Specifications for Design of Guard Fences” by Japan Road Association (Japanese only)

JIS G3101	Rolled Steel for General Structure
JIS G3466	Carbon Steel Square and Rectangular Tubes for General Structure
JIS B1180	Hexagon Head Bolts
JIS G3112	Steel Bars for Concrete Reinforcement
JIS G3141	Cold-rolled Carbon Steel Sheets and Strips
JIS H0401	Test Methods for Hot Dip Galvanized Coatings
JIS H8641	Hot Dip Galvanized Coatings

2.2 Steel Rails, Posts, Grids and Other Parts

Steel tubular rails which compose horizontal steel rails and posts of Bridge Rail shall comply with Grade A in “Specifications for Design of Guard Fences” by Japan Road Association. The size of pipes, fall prevention grid and other related details shall be as shown in the Drawings.

2.3 Coating of Steel Rails, Posts, Grids and Other Parts

All parts of Bridge Rail shall be zinc-coated (galvanized) in accordance with JIS H8641 and H0401. The amount of zinc deposition shall be JIS H8641 type 2 HDZ55, while bolts, nuts and members with a thickness of less than 3.2mm shall be HDZ35.

2.4 Wheel Guard

Concrete of wheel guard shall conform to Section 061000 – Structural Concrete of this Technical Specification. Reinforcing steel shall conform to Section 06200 - Reinforcement Bar of this Technical Specifications.

Reinforcing bar stud, designated as SD345 to be used for connection between steel deck slab and wheel guard, shall conform to JIS 3112 for shape, dimensions, and tolerances or equivalent steel.

2.5 Median at Cable Stayed Bridge

Median at cable stayed bridge consists of thin concrete layer with stud, grid of steel reinforcing bars, waterproofing layer and drainage pipe to prevent the steel deck plate from corrosion as shown in the Drawings. Median at cable stayed bridge shall be in compliance with applicable portions of this Technical Specification.

2.6 Median at Steel Box Girder Bridge

Median at steel box girder bridge consists of thick layer as same height as wheel guard with waterproofing layer, formed polystyrene and concrete surface as shown in the Drawings. Median at steel box girder bridge shall be in compliance with applicable portions of this Technical Specification.

2.7 Submittals

The Contractor shall submit the following for review and approval of the Engineer:

- Steel rails submittals shall include method statements, schedule, the manufacturer's certification of compliance of the materials and coating; and
- Wheel guard submittals shall include the Section 06200 – Reinforcement Bar of this Technical Specifications.

3. Installation

Railings shall be installed as shown in the Drawings and in compliance with this Specification Section.

Unless otherwise approved by the Engineer, the mortar around the base of the post shall be used with an approved mortar (refer to Specification Section 08010 "Mortar and Grout").

4. Measurement and Payment

4.1 Method of Measurement

Measurement for bridge rail shall be made in linear meter (lm) along the horizontal railing length for the satisfactorily installed to correct location which is shown in the Drawings. Payment of bridge rail shall include the mortar around the base of the post. Measurement and payment for the wheel guard shall be included in the scope of concrete and steel work. For concrete, reference is made to Specification Section 06100 "Structural Concrete", for reinforcement bar, reference is made to Specification Section 06200 "Reinforcement Bar" and for stud, reference is made to Specification section 07100 "Steel Structures".

Measurement of median at cable stayed bridge shall be made in square meters (m²) of planar area of the median as indicated in the Drawings. Payment of median at cable stayed bridge shall include grid of steel reinforcing bars, waterproofing layer and drainage pipe, while concrete and stud shall be included in the scope of concrete and steel work respectively.

Measurement of median at steel box girder bridge shall be made in square meters (m²) of planar area of the median as indicated in the Drawings. Payment of median at steel box girder bridge shall include waterproofing layer and formed polystyrene, while concrete shall be included in the scope of concrete work.

4.2 Basis of Payment

Payment shall be made at the above stated unit. The price shall be full compensation for all materials, installation, equipment, tools and labour required to perform the work described in this Specification Section.

Pay Item	Description	Unit
07210-01	Bridge Rail	lm
07210-02	Median at Cable Stayed Bridge	m ²
07210-03	Median at Steel Box Girder Bridge	m ²

Section 07220 – Miscellaneous Metals

1. Description

This Specification Section describes the requirements for the provision, coating, and installation of miscellaneous metals such as:

- bridge name plaque
 - bridge record plaque
 - ODA symbol mark plaque
 - entrance hatch of the PC box girder
 - inspection facility
- as indicated in the Drawings or as required by the Engineer.

2. Material Requirements

2.1 Reference Standards

The Contractor shall provide the types and grades for the miscellaneous metals listed in this Specification Section unless otherwise shown in the Drawings or as instructed by the Engineer.

2.2 Bridge Name Plaque, Bridge Record Plaque and ODA Symbol Mark Plaque

Bridge name plaques, bridge record plaques and ODA symbol mark plaques shall be made from brass plates meeting the requirements of JIS H3100 and in accordance with the design, wording, and fabrication as indicated in the Drawings or as required by the Engineer.

2.3 Entrance Hatch of the PC Box Girder

The bulkhead of the PC box girder is designed to provide the aperture for inspection purpose. The function of the entrance hatch is to access the inspector inside the box girder while limiting the unintended person to come inside. High air-tightness and water-tightness is not required for the hatch, but it shall be designed to prevent rainfall and humid air from coming inside.

Entrance hatch of the PC box girder shall be made with steel plate, formed steel and other steel products in compliance with applicable portions of Section 7 “Steelworks”

2.4 Inspection Facilities

Inspection facilities including inspection ladder from the deck to pier, inspection ladder from manhole of cable stayed bridge to pier and fall prevention fence on the pier shall be made with the shaped steels meeting the requirements of:

- JIS G 3192 Dimensions, mass and permissible variations of hot rolled steel sections
- JIS G 3193 Dimensions, mass and permissible variations of hot rolled steel plates, sheets and strips
- JIS G 3194 Dimensions, mass and permissible variations of hot rolled flat steel
- JIS G 3351 Expand metal
- Other materials approved by the Engineer.

2.5 Coating of Entrance Hatch and Inspection Facilities

Entrance hatch, inspection facilities, metal accessories, and fastening devices shall be zinc-coated (galvanized) in accordance with JIS H8641 and H0401. The amount of zinc deposition shall be JIS H8641 type 2 HDZ55, while bolts, nuts and members with a thickness of less than 3.2mm shall be HDZ35.

2.6 Submittals

The Contractor shall submit the following for review and approval of the Engineer:

- Product data: Provide manufacturer's product data for all materials in this Specification Section.
- Shop Drawings: Show profiles, accessories, location, and dimensions. Shop drawings of bridge name plaque, bridge record plaque and ODA symbol mark plaque shall be submitted noting in full scale the wording and phrasing to be used. The Engineer will issue the approval for these drawings prior to plaque fabrication.

3. Fabrication and Installation

Miscellaneous metals shall be supplied, fabricated, placed and erected by the Contractor as shown on the drawings or as specified in the Specification Section and applicable portions of Section 7 "Steelworks".

4. Measurement and Payment

4.1 Method of Measurement

Bridge name plaques, bridge record plaque and ODA symbol mark plaques shall be measured as a Provisional Sum for the satisfactorily installed to correct location which may be directed by the Engineer.

Entrance hatch shall be measured as Number of Pieces (Nos) for the satisfactory installed to correct location which may be directed by the Engineer.

Inspection facilities shall be measured as Lump Sum for the satisfactory installed to correct location which may be directed by the Engineer.

4.2 Basis of Payment

Payment shall be made at the above stated unit. The price shall be full compensation for all materials and labour required to perform the work described in this Specification Section.

Pay Item	Description	Unit
07220-01	Bridge's Name Plaque	Provisional Sum
07220-02	Bridge Record Plaque	Provisional Sum
07220-03	ODA Symbol Mark Plaque	Provisional Sum
07220-04	Entrance Hatch of the PC Box Girder	Nos
07220-05	Inspection Facilities	Lump Sum

Section 07400 - Bridge Drainage

1. Description

This work consists of the construction of bridge drainage including slab drain (installed to drain residence water on the deck), drainage pipes, catch pit with grating and strainer.

2. Material Requirements

2.1 Reference Standards

The following standards or equivalent shall be applied to the works covered by this Specification Section. For those that are not listed below, shall be refer to the Drawings.

JIS G 3101	Rolled steels for general structure
JISG 3106	Rolled steels for welded structure
JIS B 1180	Hexagon head bolts and hexagon head screws
JIS B 1181	Hexagon nuts and hexagon thin nuts
JIS B 1256	Plain Washers
JIS H 8641	Zinc Hot Dip Galvanizing
JIS K 6741	Un-plasticized poly (vinyl chloride) (PVC-U) pipes (VP pipes)

2.2 Catchpit with Grating and strainers

Catch Pit with gratings, strainers and chains shall be as shown in the Drawings, complying with the requirements for types, shape, sizes, galvanizing and connections.

2.3 Drain Pipes

Pipes and pipe fittings for drains shall be as shown in the Drawings, complying with the requirements for types and sizes, and conforming to the standards of JIS K 6741 or equivalent for Polyvinyl Chloride (PVC) pipes (VP pipes).

2.4 Delivery, Storage and Handling

(a) Delivery and Storage

Materials delivered to site shall be inspected for damage, unloaded, and stored with minimum handling. Materials shall not be stored directly on the ground. The inside of pipes and fittings shall be kept free of dirt and debris. Plastic pipes shall be installed within six (6) months from the date of manufacture unless otherwise approved.

(b) Handling

Materials shall be handled in such a manner as to ensure delivery to the point of installation in sound, undamaged condition. Pipes shall be carried and not dragged along the ground to the installation location.

2.5 Submittals

The Contractor shall submit for the approval of the Engineer method statements, schedule, materials, all certifications from the manufacturers, attesting that materials

meet the specification requirements. Certificates are required for all drain pipes, fittings, catch pit and slab drain.

3. Construction Requirements

(a) Installation of Catch Pit

Catchpit shall be installed completing with gratings, strainers, chains and connections at the locations indicated in the Drawings. The catchpit shall be firmly fixed with deck slab reinforcement before concreting, so as not to be moved during the concreting.

(b) Pipe Placement

Each pipe shall be carefully inspected before it is placed. Any defective or damaged items shall be rejected. The pipes shall be jointed fully with leak-resistant seals using gasket, bell and spigot joints. The adhesive for securing piping and fittings shall be suitable for the application and approved by the Engineer.

The pipes shall be firmly fixed with the bridge structures using metal accessories and appropriate gradient. After completion of the catch pit and the drain pipe installation, water leak test shall be carried out and any defects shall be corrected and repaired.

4. Measurement and Payment

4.1 Method of Measurement

(a) Catch Pit

Catch Pit is classified into three (3) types (Types 1, 2, and 3), each including all the materials described in the Drawings. Catch Pit shall be measured for payment by the actual quantity of drainage devices of each type, constructed and installed in accordance with the requirements of the Drawings, these Specifications and instructions by the Engineer.

(b) Drainage Pipe

Drainage piping shall be measured for payment by the actual length (in linear meters) of the straight PVC drain piping in the diameter and type required in the Drawings.

No separate measurement shall be made for the bolts, nuts, washers, accessories, protective coatings and metal supports for PVC Pipes except welded members on the steel bridges.

Metal supports for PVC pipes welded on the steel bridges shall be measured in the Section 07100.

(c) Drainage Pipe for Elbows and Branch connections

Elbows and Branch connections shall be measured by the number. These include pipes processed for connection, flexible joints, protective coatings, constructed and installed in accordance with the requirements of the Drawings, these Specifications and instructions by the Engineer.

4.2 Basis of Payment

Payment shall be made in accordance with the applicable unit prices of the pay items of the Bill of Quantities listed below, and shall be full compensation of materials, fabrication, installation, all labour, equipment, tools and incidentals necessary to install drainage grates, frames shoots, and piping.

Pay Item	Description	Unit
07400-01	Catch Pit Type 1 (400 x320, L=360mm)	Number
07400-02	Catch Pit Type 2 (400 x320, L=200mm)	Number
07400-03	Catch Pit Type 3 (400 x320, L=260mm)	Number
07400-04	Catch Pit Type 4 (400 x320, L=530mm)	Number
07400-05	Catch Pit Type 5 (400 x320, L=360mm) for PC Box Girder Bridge	Number
07400-06	Catch Pit Type 6 (420 x300, L=400mm) for On-ramp Bridge	Number
07400-07	PVC Pipe (VP) ϕ 200mm	lm
07400-08	PVC Pipe (VP) ϕ 200mm for Elbow and Branch Connections	Number

Section 07550 –Steel Pipe Sheet Pile Foundation

1. Description

- (a) This Section specifies materials and workmanship for fabrication, installation, and testing of steel pipe sheet pile foundations by the driven method. Load tests will be required to confirm the load-bearing capacity of the piles and to determine the quantity and lengths of piles to be executed, and to obtain necessary information for establishing driving criteria.
- (b) The type of piling to be used shall be as indicated in the Drawings. The Engineer may give his approval, subject to the Employer's approval, for the use of alternative types of piling. The Contractor, in submitting an alternative type of pile, shall provide the design data, piling experience records, and calculations supporting the pile design.

2. Material Requirements

2.1. Reference Standards

The following standards in their latest edition shall be applied to Works covered by this Specification.

- Specification for Highway Bridge, IV Substructure Section- Japan Road Association (for design)
- Guideline for Design and Construction of Steel Sheet Pile Foundation—Japan Road Association (for design and construction)
- AASHTO LRFD Bridge Construction Specifications (for construction)
- JGS 1816-2002 “Method for Dynamic Load Test of Single Piles” - Japan Geotechnical Society (for load test)

In general, all materials shall comply with the requirements of Japanese Industrial Standards (JIS A 5525, JIS A 5530 and JIS G 3444), or the relevant Standards of the American Society for Testing and Materials (ASTM) in its latest edition subject to the Engineer's approval.

2.2. Materials for Piling

- (1) Steel Pipe Sheet Piles
 - (a) Steel pipe sheet piles and steel joint pipes (interlocking pipes) for exterior (outer) and bulkhead (diaphragm) sheet piles shall conform to the requirements of JIS A 5530, designated as SKY400 and SKY490 and the requirements of JIS G 3444, designated as STK400 or equivalent, respectively.
 - (b) The Contractor shall submit to the Engineer for his consent, the manufacturer's Quality Control Program, method of manufacturing including joint pipe welding

detail, testing, and experience of supplying steel pipe sheet piles for permanent structures.

- (c) The Contractor may splice pile segments with welds ahead of pile driving if this suits his construction method.
- (d) The Contractor may, subject to the Engineer's consent, extend the steel pipe piles more than the top elevation, which is suggested in the Contract documents, to facilitate the construction of a temporary cofferdam during construction. However, the Contractor should note that this change will require changes in the permanent structure design based on the Engineer's suggested plan, which will be shown in the Contract documents. In such case, the Contractor shall submit the detailed calculation sheets for the Engineer's approval. The additional cost incurred by the change for his own convenience shall be borne solely by the Contractor.

(2) Joint Pipe Mortar

The joint pipe mortar filling for permanent steel pipe well shall conform to the following proportion and strength requirements. Admixture may be used at the Contractor's opinion subject to the Engineer's consent.

Table-3.1.2-1 Proportion for Cement Mortar Filling (for permanent steel pipe well)

Minimum Cement Content per m ³ (kg)	Maximum Water/Cement Ratio	Minimum Fine Aggregate Content per m ³ (kg)	Minimum Compressive Strength-28days (MPa)
600	0.64	850	21

Minimum Compressive Strength of the joint pipe mortar filling for temporary steel pipe well shall be 0.1 ~ 3.0 MPa at 28 days and admixture may be used at the Contractor's opinion subject to the Engineer's consent.

(3) Concrete for Steel Pile Filling

Concrete for steel pipe filling shall be DE21 conforming to the relevant section in this Specifications. Concrete filling of the steel piles shall be completed at least three (3) days in advance of the excavation work inside the cofferdam.

(4) Bottom Slab Concrete

Bottom slab concrete shall be seal concrete, DE21 conforming to the relevant section in this Specifications. The concrete shall have sufficient fluidity and non-segregation of mortar and aggregates in mixed concrete.

(5) Top Slab Concrete

Top slab concrete shall be DII24 concrete conforming to the relevant section in this Specifications.

(6) Reinforcing steel

Reinforcing steel shall conform to Section 06200 - Reinforcement Bar of this Technical Specifications.

(7) Reinforcing Bar Stud

Reinforcing bar stud, designated as SD345 to be used for connection between top slab and steel pipe sheet pile, shall conform to JIS 3112 for shape, dimensions, and tolerances or equivalent steel.

3. Construction requirements

3.1. General

- (a) The Contractor shall comply with all applicable environmental protection and occupational safety and health standards, rules, regulations, and orders. Failure to comply with these standards, rules, regulations, and orders shall be sufficient cause for suspension of work.
- (b) All piles shall be driven in the presence of the Engineer or his assistants. All piling shall be carefully located on the lines and spacing indicated in the Drawings and shall be vertically driven.
- (c) If during driving of piles, conditions indicate that a pile is hitting an obstruction before reaching proper bearing stratum, the Contractor shall drive through the obstruction or shall use whatever means necessary to remove the obstruction, without additional cost to the Employer.
- (d) Prior to proceeding with any pile work under this Contract, the Contractor shall complete the survey of existing riverbed elevation and pile load tests consisting of driving test piles and completing load tests on it at the locations specified by the Engineer.

3.2. Submittals

Prior to the commencement of piling operations, the Contractor shall submit to the Engineer, for review and consent, a method statement giving details of proposed piling methods including, but not limited to:

- Details of construction plan;
- Method and sequence of pile installation;
- Calculations of driving stresses;
- Methods of pile test and driving criteria for steel pipe piles;
- Methods of jointing for steel pipe piles;
- Methods of groundwater control;
- Methods of concrete and earth work;

- Anticipated ground vibration, ground movement, and groundwater drawdown and methods of instrumentation and monitoring;
- Methods and sequence for temporary cofferdam; and
- Methods of concreting for the steel pipe sheet piles and pile cap.

3.3. Storage and Handling

- (a) The units of steel piles shall be stored clear of the ground on timber supports placed on firm ground which is not liable to subside, whether wet or dry, under the weight of the units. Where units are stacked in layers, they shall not be stacked more than three (3) high with timber supports placed between each layer. If they are stacked more than three (3) high, the method of stacking shall be accepted by the Engineer prior to the stacking. Supports for each layer shall be placed above those of the preceding layer and shall be placed not more than 20% of the length of the unit from each end.
- (b) The Contractor shall attach lifting points to the steel pile segments to allow both horizontal and vertical lifting of the segment. A minimum of two (2) lifting points is required for both horizontal and vertical lifting. The method of attachment shall not cause damage to the steel pile segment during attachment, segment lifting and removal of attachment. The method of attachment and location of the attachment points shall be consented by the Engineer prior to the attachment of lifting points. Only the consented lifting points shall be used during lifting, and steel piles shall be stored and transported on adequate supports located under these lifting points of the piles. Steel piles within a stack shall be in groups of the same length. Packing of uniform thickness shall be provided between piles at the lifting points.
- (c) Piles damaged during handling or driving shall be replaced by the Contractor's expense.

3.4. Load Test

- (1) General
 - (a) The Contractor shall execute the Pile Dynamic Analysis (hereinafter referred as PDA) test in accordance with JGS 1816-2002 "Method for Dynamic Load Test of Single Piles" by the Japan Geotechnical Society with referring to ASTM D4945 "Standard Test Method for High-Strain Dynamic Testing of Pile" and AASHTO LRFD Bridge Construction Specification.
 - (b) Objectives of the test are to obtain general information of the vertical static pile capacity of a single pile under the impact loading and to ensure the predetermined design capacity of a pile. For driven piles, information on the end of driving, stresses in the pile, hammer efficiency etc. shall be evaluated for the management of pile installation.

- (c) The Contractor shall submit the detailed test plan including method of testing, equipment, reaction piles, impact energy to be applied, sensors and their attachment, measuring items and method of measurement, measuring time duration and sampling time interval, method of analysis and evaluation, reporting, and test schedule to the Engineer's approval.

(2) Number and Location of Test Piles

The test shall be done at one pile each foundation. The test pile shall be the first working pile, which it will act also as the base positioning pile for the following piles, in the pile groups of each foundation. Therefore, the Contractor shall decide the piling sequence (driving order) by minimizing the influence of the river water flow force against the pile group to ensure the pile group closure at the required positioning accuracy.

(3) Testing Time

The Contractor shall perform PDA test twice for each test pile. The first test shall be done when the pile driving reaches the target depth and the second one will be executed in principal at a time not earlier than 5 days for the pile driven into the layers mainly consisting of sand and 14 days for clay layers. The Contractor may propose to shorten the interval with supporting data/information and carry out at earlier time subject to the Engineer's approval.

(4) Planned Maximum Impact Energy

The maximum impact energy shall be large enough to produce a sufficient pile displacement so that the soil resistance is mobilized for achieving the test purpose. For reference, the target value to calculate the maximum impact energy is specified in Table 4.7.2-1.

Table 4.7.2-1. Target Value of Static Resistance for Dynamic Loading (reference)

Static Resistance	Package-1 (P6-P13)	Package-2 (P14-P22)	Note
Target Value	21,000 kN	13,800 kN	Equivalent to Ultimate Bearing Capacity as Single Pile

(5) Test Equipment

- (a) The driving devices shall have a sufficient margin of safety and capability for the planned maximum impact energy.
- (b) The driving devices shall be set up correctly on the center of the test pile without eccentricity. Pipe cap and cushion shall be used adequately for the protection of the pile head and for avoiding the influence of eccentric loading.
- (c) All measurement devices shall be inspected and shall have an adequate accuracy and a proper dynamic response to achieve the test objectives.

- (d) The sensors shall be firmly set in their appropriate positions and proper directions. When sensors are attached near the pile head, the sensors shall be attached at distances more than 1.5 times the pile diameter from the pile head. The sensors shall be attached at the same level of the pilesymmetrically.
- (6) Loading and Measuring Methods
- (a) Loading methods
- The driving shall be performed until suitable signals are measured.
 - In the re-driving test (the second one), signals of the first driving shall be measured carefully, because succeeding continuous driving may result in reduction of the soil resistance.
- (b) Items to be measured
- The following items shall be measured but not limited to:
- Axial strains along the pile
 - Accelerations along the pile
 - Displacement along the pile
 - Others
- (c) Measurement duration and sampling intervals
- Signal measurement for each driving shall be continued until the full stop of the pile movement. Generally, measurement duration shall be 2 to 3 times the time necessary for the wave to travel back and forth along the pile.
 - The sapling interval shall be less than 0.1 ms.
- (d) Record of the test conditions
- During the test, the following items but not limited to shall be recorded:
- Number of blows
 - Total number of tests
 - Rebound and penetration per blow during the test and construction
 - Others
- (7) Commencement, Interruption and Completion of The Test
- (e) The Contractor shall commence the test after ensuring the conditions surrounding the site, preparations of all equipment, and the suitability of the weather conditions with attendance of the Engineer or his assistants.
- (f) If any abnormal conditions are noticed during the test, the test shall be interrupted promptly. The Contractor can resume the test only when the cause

of the abnormal condition has been detected and remedied subject to the Engineer's approval.

- (g) The test shall be completed when the objectives of the test have been achieved, or when it is judged that abnormal conditions make it impossible to continue the test.
- (8) Test Report and Analysing
- (h) The Contractor shall employ competent and experienced Pile Driving Analyzer Consultants, subject to the Engineer's approval, to perform the bearing capacity determinations of steel pipe sheet piles.
 - (i) The characteristics of the vertical static pile capacity shall be evaluated using Signal Matching Analysis or other method proposed by the Contractor subject to the Engineer's approval.
 - (j) The Contractor shall submit a test report to the Engineer for his acceptance within three (3) days after the test at each foundation is completed.
 - (k) The report shall include the following items, but not limited to this.
 - ✓ The purpose of the test
 - ✓ The test site conditions, and soil profile
 - ✓ The test procedure
 - ✓ The pile dimensions and the test pile installation method
 - ✓ The test equipment
 - ✓ The loading and measuring methods
 - ✓ The test results
 - ✓ The results of the analysis of the test including bearing capacity
 - ✓ Proposal of driving criteria
 - ✓ Others
 - (l) The Contractor shall allow three (3) days after a sufficient report is submitted by the Contractor for the Engineer's review of the load test result before specified tip elevations will be provided by the Engineer for execution of driving piles.

3.5. Driving Criteria

- (a) Driving of piles other than test piles shall not be allowed until the Engineer has approved the driving criteria for a group of piles for each foundation.
- (b) The driving criteria to be submitted by the Contractor shall specify the final setting conditions of pile driving at the site. The driving criteria shall be established by considering the load test results, dynamic bearing capacity estimated from rebounds, penetration depth by a single blow measured at the final setting depth, and all other information obtained during pile driving.

3.6. Pile Driving

(1) Pile Driving

- (m) During driving, steel piles shall be adequately supported and restrained by means of leaders, trestles, or other guide arrangements to maintain position and alignment and to prevent buckling. The Contractor shall satisfy the Engineer regarding the suitability, efficiency, and energy of the driving equipment.
- (n) Steel piles shall be driven continuously until the prescribed set or approved depth has been reached. The minimum length of steel piles shall be the length as shown in the Drawings. In case of hard driving, the Contractor may propose partial excavation of the piles or other methods. In this case, the Contractor shall submit the bearing strength calculation for the Engineer's approval.
- (o) Steel piles shall be driven in a sequence consented by the Engineer. If accepted, steel piles shall be lengthened by full penetration butt welding. Longitudinal and spiral seam welding of cylindrical piles shall be staggered.
- (p) Steel pipe piles shall be driven in a consented sequence to minimize the detrimental effect of heave and lateral displacement of the ground. When a pile has risen because of adjacent piles being driven, the Contractor shall submit to the Engineer his proposals for correcting this and the measures to avoid this in subsequent work.

(2) Tolerance of Steel Pipe Pile

Tolerance of manufactured steel pipe sheet piles shall comply with JIS A 5530 as specified in Table 4.7.2-2.

Table 4.7.2-2. Shape and Dimensional Tolerances

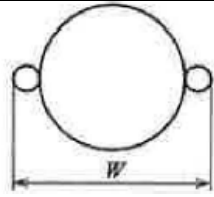
Division		Tolerance	Remarks
Outside diameter (D)	End part of pile	±0.5%	The outside diameter tolerance shall be based on the circumferential length measurement. The mutual conversion of outside diameter (D) and circumferential length (l) shall use the following formula: $D = l/\pi$ where, D: outside diameter (mm) l: circumferential length(mm) $\pi=3.1416$
Width (W)	l/D 1.1% to and excl. 1.5%	±2.0%	
	l/D 1.5% or over	±1.5%	
Thickness ¹⁾ (t)	Thickness under 16mm	Outside diameter 500 mm or over to and excl. 800 mm	+ Not specified - 0.7 mm

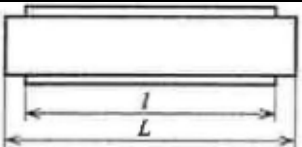
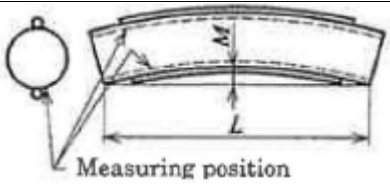
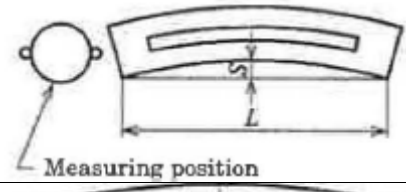
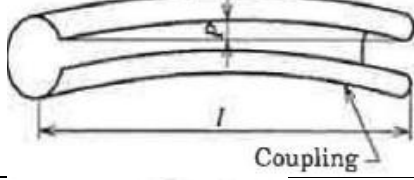
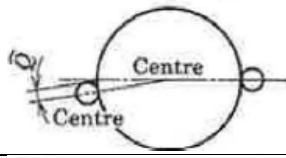
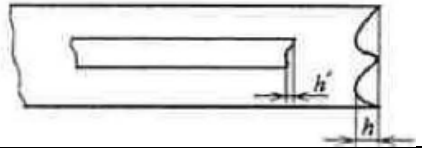
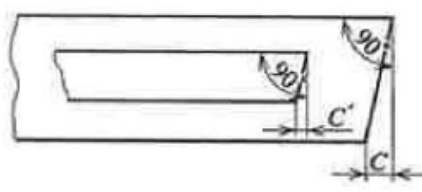
Division			Tolerance	Remarks	
	Thickness 16mm or over	Outside diameter 800 mm or over to and incl. 2,000 mm	+ Not specified - 0.8 mm		
		Outside diameter 500 mm or over to and excl. 800mm	+ Not specified - 0.8 mm		
		Outside diameter 800 mm or over to and incl. 2,000 mm	+ Not specified - 1.0 mm		
Length ⁱⁱ⁾ (L), (l)	Steel pipe body (L)		+ Not specified 0		
	Coupling (l)				
Flexure ⁱⁱⁱ⁾ (M)			0.1 % or under of length of steel pipe body (L). However, 6 mm or under for steel pipes under 6 m in body length		
Camber ^{iv)} (S)			0.1 % or under of length of steel pipe body (L). However, 6 mm or under for steel pipes less than 6 m in body length.		
Straightness ^{iv)} (P) of the opening of coupling	Length of coupling (l) 15 m or under		10 mm max.		
	Length of coupling (l) over 15 m		Within 1/1,500 of the length (l) of coupling		
Attaching position of coupling (Q)	Pipe end part		5mm max.		
Flatness of the end face to form the site circumferential weld	Steel pipe body (h)		2mm max		
	Coupling (h')				
Perpendicular ity of the end face to form the site circumferenti al weld	Steel Pipe Body (C)	Outside diameter 1,000 mm or under	18 m or under in length of steel pipe body	Within 0.5 % of outside diameter, with the max, being 3 mm	
			Over 18 m in length of steel pipe body	Within 0.5 % of outside diameter, with the max. being 4 mm	
		Over 1,000 mm in outside diameter			
Coupling (C')			2 mm max		

NOTE: Although figures in the remarks are illustrated by the P-P type interlocking type, the same principle applies to other types of couplings.

Division	Tolerance	Remarks
Notes		
i)	The outside diameter and the thickness shall be measured of the steel pipe body.	
ii)	The length tolerance may be decided, by the agreement between the manufacturer and the purchaser, as +not specified, -50 mm.	
iii)	The measuring point of flexure shall be close to the coupling and either convex or concave.	
iv)	The measuring points of camber and straightness of the opening of coupling shall be either convex or concave.	

Steel pipe piles shall be installed at the tolerances given in Table 4.7.2-3 below.

Table 4.7.2-3. Tolerances of Placing Steel Pipe Sheet Piles

	Tolerance
Position	75 mm in any direction at the pile head
Verticality	1 in 500 deviation
Plan dimensions	+/- 100 mm
Deviation from specified cut-off level	25 mm

3.7. Cutting of Steel Pile

The cutting of steel pipe piles shall be executed from inside the piles using an automatic cutting machine consented by the Engineer. The method of steel pipe pile cutting shall be set out by the Contractor in a method statement and consented by the Engineer prior to the commencement of any pile cutting work.

Cut-offs of steel pipe piles shall be made at right angles to the axis of the steel pile. The cut-offs shall be made in clear, straight lines and any irregularity due to cutting or burning shall be leveled off to within a tolerance of ± 2 mm.

Steel piles shall not be cut until the backfill to the existing ground level and pour water to the river water level in the cofferdam has been done.

3.8. Welding

(1) Site Welded Joint for Steel Pipe Pile

- (q) A welding administration engineer with experience and thorough capabilities shall be designated at the site and he shall be responsible for all quality of welding works. The Contractor shall submit his qualifications for the Engineer's approval.
- (r) Welders hired for this purpose shall be successful passers of an examination necessary for site welding of piles or other licensing examinations equivalent or superior to it as provided in AWS D1.1 or JIS Z 3801 and have already been engaged in welding operations for six (6) months or longer.

- (s) Welded joints of the steel pipe piles shall be welded in accordance with AWS D1.1 or JIS A 7201, but allowance for dislocation between both joints shall be as provided in the JIS A 5525.
- (2) Stud Welding of Bar Stud
- (a) The Contractor shall submit the welding plan for rebar stud for the Engineer's consent. The welding plan shall include welding method, welding equipment and monitoring system, welders and administering engineer, surface treatment, welding environment, quality control, inspection, safety, and all other necessary information necessary for stud welding of bar stud.
- (b) Stud welding of bar stud on steel pipe exterior surface shall be administered by an experienced engineer from similar projects. The Contractor shall submit his qualifications for the Engineer's approval.
- (c) Welding equipment shall be automatic type and capable of horizontal welding of long deformed rebar and is provided with the monitoring of amperage, arc time, movement of stud, and short circuit.
- (3) Inspection of welding
- (t) Inspection of Internal Flaws in Butt Joint
- Butt welded joints made in-situ shall be inspected using radiograph test method throughout the whole length of the joint. Alternately, ultrasonic testing may be used instead of radiographic testing, provided enough information is available;
 - Radiographic testing shall be carried out in accordance with JIS Z 3104 Method of Radiographic Test and Classification of Radiographic for Steel Welds, and the test results shall satisfy the following criteria; and
 - Welding parts shall be Grade 2 or higher as specified in JIS Z 3104.
- (u) Inspection of Weld Cracks
- There shall be no cracks appearing in or near the weld beads. The inspection shall be carried out by visually, but in uncertain cases, inspection may be carried out using either magnetic particle testing or penetrative dyes.
- (v) Inspection of Weld Profile
- Butt joints shall be free of weld pits on the bead surface. There shall be no height difference exceeding 3 mm within 25 mm length of a bead. The depth of undercut shall not exceed 0.3 mm. There shall be no overlap.

3.9. Concrete Work

- (1) Mortar Filling of Steel Joint Pipes

- (a) Mortar filling of the steel joint pipes shall be made after all steel pipe piles at a group within a pier have been driven to final depth to the satisfaction of the Engineer.
- (b) Immediately prior to the mortar filling of joint pipes, the joint pipes shall be flushed clean of soil over their full depth with water jets using a turbine pump of a suitable capacity and to the satisfaction of the Engineer.
- (2) Concrete Filling of Steel Pipe Piles
 - (w) After joint pipe mortar filling for the steel pipe piles are completed, the steel pipe piles shall be excavated by hammer grab or other common equipment over the depth to be filled with concrete as shown in the Drawings.
 - (x) The excavated depth shall be cleaned by flushing with potable water or other consented method by the Engineer and pumped dry prior to placing the concrete filling to the satisfaction of the Engineer.
- (3) Underwater Concrete and Drawing

The underwater concreting work shall follow the stipulations of Section 06100 Structural Concrete, subsection 3.2.7 "Placing of Concrete in or Under Water" of this Technical Specifications and the followings:

- (y) The bottom slab concrete shall be placed underwater by tremie pipes using the "dry-pipe" method or other method. The Contractor shall provide the Engineer with an underwater concreting work plan prior to the commencement of this work for his consent.
- (z) The underwater concreting work plan shall adequately describe all constituent materials, the concrete mix, the tremie equipment, the placement procedure plan, and the concrete sampling and testing plan and the inspection plan.
- (aa) All areas where bonded, either for water-tightness or structural purposes, between the steel pipe sheet piles and the fresh concrete placed underwater, shall be thoroughly cleaned immediately prior to initiating the casting. Cleaning shall remove mud, silt, or sand from the placement areas.
- (bb) The concreting of the bottom slab shall be done in one continuous operation. Casting shall be continued uninterrupted until the entire casting is completed. Interruption of casting through a single tremie shall not exceed thirty (30) minutes without removal of the tremie and carrying out the restarting process.
- (cc) The cofferdam shall be dewatered after the bottom slab concrete has achieved a compressive strength of 21 MPa. The top surface of the bottom slab concrete and the inner faces of the steel pipe sheet piles adjacent to the concrete top slab of the foundations shall be cleaned with water jets or other method consented by the Engineer. The top surface of the bottom slab concrete shall be scabbled to expose the aggregate and shall be blown clean to the satisfaction of the Engineer. Any contaminated areas of concrete shall be cut out and replaced with fresh concrete.

- (dd) Any concrete surface which has been treated before being inspected by the Engineer may be subject to rejection.
 - (ee) The reinforcing bar stud shall not be connected to the steel pipe piles until the concerned areas have been thoroughly cleaned and pumped dry, the top surface of the bottom slab concrete has been scabbled and any contaminated concrete areas have been replaced to the satisfaction of the Engineer.
- (4) Top Slab Concrete

Top slab concrete work shall follow the stipulations of Section 06100 Structural Concrete of this Technical Specifications.

3.10. Earth work and Temporary Works

(1) Excavation Inside Cofferdam

- (ff) Excavation of the cofferdam shall commence not earlier than one (1) day after the concrete filling of all steel pipe piles is completed.
- (gg) The excavated material shall not be dumped into the riverbed and shall be removed by barge, dump truck, or other method consented by the Engineer.
- (hh) Regular soundings shall be made to monitor the depth and progress of the excavation.

(2) Spread Sand

Place uncompacted bedding material over the inside cofferdam in a layer of uniform level. Before placing bottom slab concrete, the surface smoothness of the spread sand shall be checked and improved to the satisfaction of the Engineer.

(3) Backfill

The cofferdam shall be backfilled with excavated material or suitable material consented by the Engineer, placed up to the existing ground level prior to the cutting of steel pipe piles used as temporary works for the construction of the steel pipe sheet pile foundation.

(4) Temporary works and Method of Construction

- (ii) The Contractor shall submit working drawings illustrating fully the proposed method of erection of temporary works and construction of the steel pipe sheet pile foundation.
- (jj) The Contractor shall submit calculations of stresses and deformations for steel/timber-bracing and steel pipe sheet piles for all stages of construction including excavation and backfilling for the Engineer's consent.

- (kk) The Contractor shall not commence the construction of any temporary work for which working drawings and working plans are required, until they have been consented by the Engineer.

3.11. Defective Piles

- (ll) Any pile delivered with defects, or damaged in driving due to internal defects or by improper driving, or driven out of its proper location shall be corrected at the Contractor's expense by one of the following methods approved by the Engineer for the pile in question:
- The pile shall be withdrawn and replaced by a new and longer pile, when necessary;
 - A second pile shall be driven or cast adjacent to the defective pile; and
 - The pile shall be spliced or built-up as otherwise provided herein or the underside of the footing lowered to properly embed the pile.
- (mm) When a new pile is driven to replace a rejected one, the Contractor, at his own expense, shall enlarge the footing as deemed necessary by the Engineer.

4. Measurement and Payment

4.1. Method of Measurement

- (nn) Measurement for steel pipe sheet pile (permanent part) shall be made in weight (ton) of steel pipe sheet pile of outer and bulkhead piles, exclusive of a weight of steel joint pipes (permanent part), in place and indicated in the Drawings, and described in the Bill of Quantities, and approved by the Engineer.
- (oo) Measurement for steel pipe sheet pile (cutting part) shall be made in weight (ton) of steel pipe sheet pile of outer and bulkhead piles, exclusive of a weight of steel joint pipes (cutting part), in place and indicated in the Drawings, and described in the Bill of Quantities, and approved by the Engineer.
- (pp) Measurement for mortar filling of steel joint pipes shall be made in cubic meters (m³) of mortal filling of permanent joint pipes in place, indicated in the Drawings and described in the Bill of Quantities, and approved by the Engineer.

Measurement shall be made to the neat lines of the structures as indicated in the Drawings.

No deduction shall be made for the volume of occupied volume by reinforcement bars or other small items embedded in concrete.

- (qq) Measurement for reinforcement stud bars shall be made in weight (ton) of reinforcement bars in place, indicated in the Drawings and described in the

Bill of Quantities, and approved by the Engineer. No measurement and payment shall be made for reinforcement stud bars if it is applied at incorrect places.

- (rr) Measurement for dynamic load tests shall be made in the actual number (nos.) of pile load tests completed and accepted.

All costs associated with the above works shall be considered as a subsidiary obligation and requirement under the applicable pay items in the Bill of Quantities.

4.2. Basis of Payment

The accepted quantities, measured as provided above, shall be paid at the contract price per unit of measurement for the pay items of the Bill of Quantities listed below.

- (ss) Steel Pipe Sheet Pile (Permanent Part)

Payment for the item shall be full compensation for furnishing, handling and driving the piles, welding at site and its test as shown in the Drawings.

Items in the Bill of Quantities also include, but are not limited to, the following:

- Steel Joint Pipes in permanent part
- Provisions for Subsidiary measure and monitoring;
- Furnishing all labour, transport, materials, tests, tools, equipment and any incidentals to complete the work as shown in the Drawings and as required by these Specification Sections, and/or as directed by the Engineer

For computing the weight of steel pipe sheet pile for payment, the standard unit weight table by the supplier shall be used after getting approval of the Engineer. For reference, the following table is used during the design stage:

Table of Weights and Area (For reference)

Diameter D (mm)	Thickness t (mm)	Unit Weight W (kgf/m)	Area A ₀ (cm ²)
1,200	14	409	521.6
1,200	15	438	558.4
1,200	16	467	595.1

The Steel Pipe Sheet Pile (Permanent Part) will be measured when the delivery of material to the stock yard is completed and accepted by the Engineer. The partial amount for above will be equivalent to 30 percent of amount calculated at the unit rate per ton for the items in Bill of Quantities. The remaining 70 percent will be paid when all Steel Pipe Sheet Piles are driven and accepted by the Engineer.

The price adjustment shall be calculated by using the price indices on the day of the delivery of material to the stock yard being completed and accepted by the Engineer.

(tt) Steel Pipe Sheet Pile (Cutting Part)

Payment for the item shall be full compensation for furnishing, handling and driving the piles, cutting of the piles to the required levels, welding at site and its test, provisions for placement and removal of temporary guide frames, strut, waling with filling concrete, drainage control etc. as shown in the Drawings.

Items in the Bill of Quantities also include, but are not limited to, the following:

- Steel Joint Pipes in cutting part
- Backfill inside cofferdam of SPSP
- Pile head treatment, which connect between footing (top slab) and bulkhead piles, including excavation, cleaning, reinforcing bar arrangement and placing concrete.
- Provisions for Subsidiary measure and monitoring;
- Furnishing all labour, transport, materials, tests, tools, equipment and any incidentals to complete the work as shown in the Drawings and as required by these Specification Sections, and/or as directed by the Engineer

The Steel Pipe Sheet Pile (Cutting Part) will be measured when the delivery of material to the stock yard is completed and accepted by the Engineer. The partial amount for above will be equivalent to 30 percent of amount calculated at the unit rate per ton for the items in Bill of Quantities. The remaining 70 percent will be paid when all Steel Pipe Sheet Piles are cut and accepted by the Engineer.

The price adjustment shall be calculated by using the price indices on the day of the delivery of material to the stock yard being completed and accepted by the Engineer.

(uu) Mortar Filling of Steel Joint Pipes

No separate measurement and payment shall be made for the formwork and falsework. They shall include in applicable items of the Bill of Quantities.

Items in the Bill of Quantities also include, but are not limited to, the following:

- Mortar filling of steel joint pipes including permanent and temporary parts
- Excavation inside steel joint pipes including permanent and temporary parts

- Provisions for Subsidiary measure and monitoring;
- Furnishing all labour, materials, tests, tools, equipment and any incidentals to complete the work as shown in the Drawings and as required by these Specification Sections, and/or as directed by the Engineer

(vv) Reinforcing Bar Stud

Payment shall be full compensation for the supply, transport and installation of all the required reinforcing stud bars including all labour, materials, tests, tools, equipment and any incidentals to complete the work as shown in the Drawings, and as required by this Specification, and/or as directed by the Engineer.

For computing the weight of reinforcing stud bars for payment, the standard unit weight table by the supplier shall be used after getting approval of the Engineer.

(ww) Dynamic Load test

Payment for the item of Dynamic Load Test on working piles shall be at the lump sum rate per actual quantity as included in the Bid Price Schedule, for which payment shall be full compensation for furnishing all labors, transport, materials, analysis and reports, and equipment and performing all work to fully complete the load test.

(xx) Top Slab Concrete

Payment shall be made by Pay Item No.06100-10 of the Bill of Quantities.

(yy) Bottom Slab Concrete

Payment shall be made by Pay Item No.06100-11 of the Bill of Quantities.

(zz) Concrete Filling of Steel Pipe Piles

Payment shall be made by Pay Item No.06100-12 of the Bill of Quantities.

No separate measurement and payment shall be made for the excavation inside steel pipe piles. This shall include in applicable items of the Bill of Quantities.

(aaa) Excavation inside cofferdam

Payment shall be made by Pay Item No.3200-07 of the Bill of Quantities.

No separate measurement and payment shall be made for the spread sand which will be laid under the bottom slab concrete. This shall include in applicable items of the Bill of Quantities.

Pay Item	Description	Unit
07550-01	Steel Pipe Sheet Pile (Permanent Part)	ton
07550-02	Steel Pipe Sheet Pile (Cutting Part)	ton
07550-03	Mortar Filling of Steel Joint Pipes	m3
07550-04	Reinforcing Bar Stud	ton
07550-05	Dynamic Load test on D1.2 m Steel Pipe Sheet Pile	Nos.

Section 07700 –Cable-Stayed Bridge Construction (*For Package 1 Only*)

1. Girder Camber and Pylon Horizontal Adjustment

The geometric dimensions of the bridge in the Plan shows the elevations after 10 years from the bridge completion at a reference mean air temperature of 25° C. The Contractor shall determine the appropriate camber for the girders as well as appropriate horizontal and vertical adjustments for the pylons to have the geometric dimension of the bridge to be achieved within a range of tolerances specified hereinafter.

The Contractor shall obtain the approval from the Engineer, eight (8) weeks before the commencement of construction of the cable-stayed bridge superstructure, for the calculation, the plan, and the control programme of the camber and the additional horizontal adjustment prepared, considering any possible deformation of the girders and pylons during the construction and after completion of the bridge.

2. General Quality Requirements for Bridge Construction

The measurements and other characteristics of the completed structure shall be in accordance with the shop drawings approved by the Engineer. Each quality requirement against theoretical shape/position of the bridge at its completion shall be met separately.

- The location of pylon top in horizontal level in both longitudinal and transverse directions shall be +60/-60 mm.
- The allowable deviations in the elevation of the main spans after the prestressing of the stay cables, and all other superimposed dead loads is +70/-70 mm for the main spans and +40/-40 mm for side spans.
- The allowable error for tension of stay cables at completion state (Dead Load + Prestressed condition) shall be +10%/-10% of design cable tension at completion state.

3. Measurement in the Course of Work

During the pylon construction and the girder erection phases of the superstructure, the Contractor has to present to the Engineer the measurements of previously constructed and just erected stages of construction. The measurements are inspected by the Engineer before the construction proceeds.

Plans/methods for measurement of stay cable tensions during the erection stages should be presented in the installation and stressing schedule. During and after installation of the stay cables, the stay cable tensions should be measured with natural frequency method or equivalent method.

A setting points situated at support lines is presented in the Drawings. These points are acting as coordinate points for the bridge structures.

When surveying the structures, the required tolerances are to be taken into consideration. In order to find out the standard error and deviation, each survey is to be carried out from another different base point.

Positioning surveys and inspection surveys of the completed structure shall be documented.

The positioning survey, the standard error and deviation in the measurements of the structure shall be documented.

4. Verification Measurements

Possible deviations in measurements are found out in inspection surveys. In order to ensure reliable results, the inspection surveys should be carried out by separate organization. Inspection survey can be carried out by sampling.

5. Deformation and Displacement Measurements

Deformation and displacement of both the substructure and superstructure shall be surveyed during the following stages of construction.

- After pylon foundations and end piers are completed.
- After pylons are completed.
- After final tensioning of all stay cables is completed.
- After paved and completion of the bridge.

The Contractor shall submit the survey plan including method of survey, establishment of measuring points for the Engineer's consent. After performing each survey, the Contractor shall present the survey report and theoretical values after one (1) week from the survey.

6. Erection Method Statement

The Contractor shall submit to the Engineer a proposal detailing the construction sequence. The submission shall incorporate detailed methodology, shop and erection drawings of the proposed construction sequence, together with the corresponding complete and checked erection design calculations in every erection step to obtain the correct elevation in the completed bridge. The package shall be submitted at least eight (8) weeks prior to the commencement of construction of the cable-stayed bridge superstructure for the Engineer's consent.

The erection drawings shall show all temporary works necessary for the launching including bearings, supports and incidentals, and include detailed method statements for each stage of the erection.

The Contractor shall be responsible for the detailed design of the erection plan, equipment and temporary works and be responsible for ensuring the structural adequacy and stability of all items when used in its chosen construction sequence or in the construction sequence depicted on the Drawings.

The Contractor shall submit for the Engineer's prior consent a full description of his proposed erection method and means including:

- A summary of all design loads and the assumptions made in deriving them, design calculations, detailed shop and erection drawings, including full details of the erection cranes (travellers) and all other construction equipment, falsework, temporary bent, temporary bracing against lateral buckling for edge girders and floor beams but not limited to as necessary, cable tensions in each cable at all construction stages and details of the proposed cable lengths and allowance for shims.
- A step-by-step verification of the strength, stability and serviceability of the permanent structure for gravity, and wind loads and the effects of creep, shrinkage and temperature changes. The verification shall include the detailed calculation of stress and deformation in the permanent structure and the temporary structures by the Contractor's proposed erection method and prove no such overstress or unfavourable stresses and deformations including settlements in the permanent and temporary structures.
- Calculations of the required cambers on the permanent structure at each stage of erection process taking into account the effects of creep, shrinkage and temperature changes.

- Analysis of errors of fabrication and erection and their tolerances shall be presented for the Engineer's consent.
- Design details of temporary structures such as temporary bent and bracing, scaffolding and their connections. The design shall include details of stability of the temporary structures and their foundations in accordance with the site conditions such as geological conditions, stream flows and wind. Unbalanced loadings during construction shall be considered in their design. The Contractor shall submit design criteria for the temporary structures and their foundations including bearing, settlement and sliding for the Engineer's review and comments.
- Proposed methods for the calculation of the jacking forces.
- Ongoing participation during the construction of stay cable system.
- Proposed method of setting and adjustment of bearings.
- Proposed method of installation of expansion joints and casting concrete fill.
- Proposed method of wind fairing installation and the erection stage.
- Countermeasures for cable vibration during erection stages.
- Calculation sheets and detail drawings of lifting lug on permanent structure and method of removal and smooth grinding if necessary.
- Details of lifting lugs, lifting locations and lifting mechanisms of all steel segments.
- Method of load transfer and demolition of temporary structures.
- Protection method of temporary structures/equipment and permanent structure from stream flow, floating debris and boats.

The Contractor's construction engineering shall take account of all load and material effects. It shall prescribe the theoretical vertical deck profiles for all stages of the construction, and application of superimposed dead loads such as bridge appurtenances and deck wearing surface. Vertical profiles shall also be predicted beyond the bridge completion and at one-year intervals up to ten (10) years after completion at which all time-dependent effects can be assumed to have taken place.

The Engineer's approval or consent of the above details shall not relieve the Contractor of his contractual obligations or of his responsibility for providing proper methods, equipment, and workmanship and safety precautions.

No direct payment is made in this Section 07700.

Section 07750 – Stay Cable (For Package 1 Only)

1. General

The Specification covers the supply, fabrication, delivery, testing, installation, stressing and permanent protection of the stay cables and associated components.

The stay cables and the anchorages shown in the Drawings are based on a parallel strand type of cables. However, the Contractor may propose to use prefabricated parallel wire strand type stay cable. In case that the Contractor wishes to use prefabricated parallel wire strand type of cables for the bridge, prior to the execution of stay cable works, the Contractor shall design with his own expense and responsibility stay cable system, cable anchorages at edge girders and pylons, as well as overall bridge design to be influenced by changing cable system and submit to the Engineer for reviewing and approval of drawings, detailed calculation, quantities, method of statement and construction schedule. The Contractor's proposal of different type of stay cable from original designed one (bid drawings) shall not be the reason for deceleration of project progress as stipulated in the Contract and any additional payments by changing the type of stay cable shall not be made.

Stay cables, anchorage and all necessary and associated materials and devices shall have a past service record of previous use on cable stayed bridges.

Stay cables shall be comprised of galvanized mono-strands encapsulated in individual polyethylene sleeves in an outer HDPE pipe. Each stay cable shall consist of seven wire strands protected by at least three levels of corrosion - protection with conical wedge anchorage and an additional corrosion protection system consisting of an outer polyethylene pipe. The corrosion protection system to be provided shall be submitted to and consented by the Engineer. Cement grouting of the free length part of any stay cable shall not be permitted.

The stay cable system shall be such that the re-tension or replacement of any cable can be accomplished strand by strand at any time during the life of the bridge. Strands shall be protected in the anchorage zone, to avoid damage due to any protection defect. Blocking of strands with a hardening material will not be permitted.

Stay cable installation and bridge construction procedures shall incorporate requirements and provisions for the assessment and adjustment of stay cable tension. Such shall include stipulations for stay cable geometric control in accordance with applicable provisions of this Technical Specifications.

Tensioning operations shall be accomplished strand by strand during the phases of construction with full consideration for geometric control of stay cables in accordance with applicable provisions of this Technical Specifications.

Final adjustments of stay cables shall be done in accordance with a method(s) proposed by the Contractor. To accomplish final adjustments, stay cable anchorage shall be constructed to allow the use multi-strand jacks capable of pulling the complete anchorage.

Prior to commencement of pylon construction, the Contractor shall verify all details of the stay cable system and provide design calculations and working drawings to define the reinforcement details and dimensions to accommodate the cable stay system.

Prior to delivery of any stay cable to site, the Contractor shall submit to the Engineer records of the number of strands from each coil that are installed in each stay cable, together with the calculated elongation of each stay.

2. Submittals

2.1 Cable Stay System

The Contractor shall submit full details, including field survey data of the proposed cable stay system, supported by all applicable calculations for the parallel strand stay cable system in accordance with the type, size, strength, geometry and arrangement depicted on the Drawings.

2.2 Stay Cables and Corrosion Protection System

Prior to ordering stay cables or any associated equipment or devices, the Contractor shall submit to the Engineer for consent full details of the proposed stay cables including cable protection systems and devices.

2.3 Final Stay Cable Adjustment Systems

Prior to final adjustment of stay cables, the Contractor shall submit to the Engineer for review full details and procedures for all final cable adjustments. Such details shall include all calculations and data necessary to accomplish final adjustments, as well as equipment and devices proposed for use.

2.4 Cable Stay System Materials

It should be noted that the Contractor may be allowed to submit documentation of previous tests of the proposed stay cable system which comply with the requirements, for the purpose of replacing the execution of project-specific tests described in this Specifications, only when the Engineer and the Employer can be satisfied with such documentation.

2.5 Past Service Records

The Contractor shall provide complete information and documentation detailing the past service record of previous use on cable stayed bridges of all materials.

2.6 Material Data, Certifications and Test Reports

(1) Stay Cable Strands

- The Contractor shall submit to the Engineer complete manufacturer's data, information and documentation verifying that the material meets requirements in accordance with this Technical Specifications.
- The Contractor shall submit to the Engineer reports on test as follows:
 - Load-strain tests
 - Ductility test results
 - Fatigue tests

(2) HDPE Coating

- The Contractor shall submit to the Engineer complete manufacturer's data, information and documentation verifying that the material meets requirements in accordance with this Technical Specifications.
- The Contractor shall submit to the Engineer reports on the tests shown below:
 - Chemical Resistance tests

- Chloride permeability test results
- Impact test
- Abrasion resistance tests
- Salt spray test results

(3) Stay Cable Protective Filler Material

- The Contractor shall submit to the Engineer complete manufacturer's data, information and documentation verifying that the protective filler compound/material meets requirements of this Technical Specifications.
- The Contractor shall submit to the Engineer reports of filler material tests in accordance with this Technical Specifications.

(4) Stay Cable Sheathing

- The Contractor shall submit to the Engineer complete manufacturer's data, information and documentation verifying that the material meets requirements in accordance with this Technical Specifications.
- Prior to the start of sheathing manufacturing the Contractor shall submit to the Engineer for review and approval proposed sheathing colouring and verification of requirements of this Technical Specifications, along with manufacturer's certification and certified tests results.
- The Contractor shall submit to the Engineer reports on tests in accordance with this Technical Specifications.

(5) Buffer for Angular Deviations

- The Contractor shall submit to the Engineer complete manufacturer's data, information and documentation verifying that the material meets requirements in accordance with this Technical Specifications.

(6) Damping Devices

- The Contractor shall submit to the Engineer complete manufacturer's data, design information and documentation verifying that damping devices to be permanently installed meet requirements in accordance with this Technical Specifications.

2.7 Stay Cable Anchorage Specifications

Prior to the commencement of stay cable work and before the ordering of any stay cable materials, the Contractor shall submit to the Engineer for review and approval complete stay cable anchorage specifications in accordance with this Technical Specifications.

2.8 Stay Cable Drawings and Calculations

Prior to the commencement of stay cable work, the Contractor shall submit to the Engineer for check and approval design calculations and anchorage assembly drawings in accordance with requirements of this Technical Specifications.

2.9 Stay Cable Testing Timetable

Prior to commencing any stay cable work, the Contractor shall submit a complete test timetable to verify the design and performance of the cable system with anchorage devices in accordance with requirements of this Technical Specifications.

2.10 Stay Cable Method Statement, Shop and Working Drawings

Prior to starting work, the Contractor shall prepare and submit to the Engineer a stay cable installation method statement and working drawings in accordance with the requirements of this Technical Specifications. And the Contractor shall prepare and submit to the Engineer for check and approval a shop drawings in accordance with the requirements of this Technical Specifications.

2.11 Damping Device Shop Drawings

The Contractor shall submit detailed damping device shop drawings in accordance with requirements of this Technical Specifications.

2.12 Electro-Fusion System

The Contractor shall submit details of the Electro-fusion system for welding of HDPE sheathing joints, along with welded joint samples in accordance with requirements of this Technical Specifications.

3. Materials

3.1. Strands for Stay Cables

(1) General Requirements

- Strand materials for the stay cables shall be in accordance with Drawings, these specifications and Section 3 of "Recommendations for Stay Cable Design, Testing and Installation", American Post-Tensioning Institute Committee on Cable-Stayed Bridges (PTI), Fifth Edition, 2007.
- They shall be seven wire strands conforming to the requirements of ASTM A 416 or equivalent, low-relaxation grade, except where the requirements below differ from those of ASTM A 416.
- All cable stay strands shall be:
 - Factory-galvanised with a zinc coating (applied before the last wire drawing operation) that is of uniform thickness (without drops or local thickenings) – the weight of galvanizing shall be measured in accordance with requirements of ASTM A90.
 - Coated with high density polyethylene (HDPE) and
 - Provided with a protective filler inside the interstices between the core wire and the outer wires and around the outer wires.
- Prestressing strands shall comply with the following material requirements:

Material Characteristics	Value
--------------------------	-------

Nominal Diameter	15.2 or 15.7mm
Minimum Ultimate Tensile Strength	$F_{pu} = 1,860 \text{ Mpa}$
Nominal Section	140 or 150mm ²
Modulus of Elasticity (tolerance)	$E = 195\text{kN/mm}^2 \pm 5\%$
Ductility	One Pin Test
Minimum Elongation at Rupture	3.5%
Maximum relaxation after 1000h and load 70% GUTS	2.5%
Fatigue Strength Test:	
No of Cycles	2×10^6
Upper Stress	$0.45f_s'$
Stress Range	300 N/mm^2
Galvanizing	Min 190g/m ² Max 350g/m ²
Curvature of Strand	15mm

f_s' = design value of guaranteed ultimate strength (GUTS)

Test frequency- for every unit of production or every 10 tons of strands

- In addition to the material requirement as noted above, strands shall be in accordance with all test requirements of this specifications section.

(2) Testing and Quality Control

- Prior to ordering stay cables, the Contractor shall submit documentation of previous use of the same materials in cable stayed bridges for review and comment by the Engineer.
- The Contractor shall furnish to the Engineer for review and consent, complete mill test reports and certificates for the strands from each heat, including stress-strain curves and modulus of elasticity.
- All strands and strand specimens derived for testing shall be clearly identifiable to ensure tractability during manufacture, delivery, storage, testing and installation.
- All testing shall be performed by a recognized independent testing laboratory approved by the Engineer.
- The Engineer shall be advised in writing at least 4 working days prior to the commencement of any strand testing. Unless otherwise being advised by the Engineer, a representative of the Engineer shall witness the followings tests:
 - Testing of fully assembled cables for fatigue, ultimate strength and acceptance.
 - Testing of individual strands for fatigue, ultimate strength and acceptance.
 - Strand anchorage acceptance tests.
- All testing data and testing results shall be submitted to the Engineer.
- Fabrication of anchor systems and stay cable strands shall not be begun until the tests as indicated below are successfully completed and the Engineer gives written approval of the material(s).

1) Load-Strain Test

- Stay cable strands shall be subjected to a tension test, conducted at a laboratory approved by the Engineer. Test acceptance criteria is as follows:
 - the minimum Ultimate Tensile Strength shall be as specified by the Engineer
 - the modulus of elasticity shall be as specified by the Engineer with a tolerance of 5%
- The test specimens shall be representative pieces selected by the Contractor from each continuous manufactured length of strand to be used, on the basis of one sample for each ten (10) tons or part thereof. The free length of test piece shall be 5.0m.
 - If a sample fails to meet any of the test criteria, the strands represented by that sample shall be rejected.
 - If any specimen fails within the anchorage zone, the test shall be discarded and another specimen shall be tested from the same sample.

2) Ductility Test

- "One Pin" testing in accordance with "Recommendations for Stay Cable Design, Testing and Installation" by the American Post Tensioning Institute Committee on Cable Stayed Bridges, Fifth Edition, 2007 of "Recommendations for Stay Cable Design, Testing and Installation", shall be conducted on a sample taken from each manufactured length or 10 tons or portion thereof to be used on the works. Acceptance criteria shall be as follows:
- The tensile force in the sample during the One Pin Test shall equal at least 0.8 times the actual ultimate tensile stress. The sample taken for the One Pin Test shall be long enough for two ultimate strength tests and three one pin tests. If the first specimen fails the One Pin Test, two additional samples shall be tested. If both samples pass, the material is acceptable. If either sample fails, the manufactured length represented by that sample shall be rejected.
- The Contractor shall submit to the Engineer all above noted test results prior to delivery of any stay cable to the site.

3) Fatigue Testing of Strands

- From every twenty (20) tons or part thereof, of strands manufactured from each heat of steel, a test sample 5.0m in length shall be obtained. Test specimens with a minimum length of one (1) meter shall be obtained from the sample and subjected to cycle loading in accordance with the testing and acceptance criteria in Section 3.2 quality control of stay cable materials in "Recommendations for Stay Cable Design, Testing and Installation", American Post-Tensioning Institute Committee on Cable-Stayed Bridges (PTI), Fifth Edition, 2007.
- The testing shall be carried out in accordance with "Recommendations for Stay Cable Design, Testing and Installation", American Post-Tensioning Institute Committee on Cable-Stayed Bridges (PTI), Fifth Edition, 2007.
- If an initial test specimen fails the fatigue test, two additional tests shall be conducted from the same sample. If further failures occur, the material represented by the sample shall be rejected.

- The Contractor shall submit to the Engineer all above test results to demonstrate acceptance in accordance with requirements of the above noted fatigue test.

3.2. HDPE Coating

(1) General Requirements

Cable sheathing for each individual parallel strand cable shall be high density polyethylene (HDPE) plastic pipe conforming to ASTM D4976 and to "Recommendations for Stay Cable Design, Testing and Installation", American Post-Tensioning Institute Committee on Cable-Stayed Bridges (PTI), Fifth Edition, 2007.

Property	ASTM Test Method	Value
Density, g/cm ³	D1505	0.941 – 0.965
Melt Index, g/10 min	D1238	Max of 1.0
Flexural modulus, N/mm ²	D790	550 – 1100
Tensile Strength at Yield, N/mm ²	D638	21 – 28
Elongation at Rupture	D638	500% - 700%
Hardness	D2240	64 – 65
Low Temperature Brittleness	D746	-40 °C at 50% flexibility (min)

The HDPE coating shall be extruded around the strand and the protective filler. It shall tightly follow the outer contour of the strand, and have a minimum thickness of 1.5 mm (-0, +0.25). The final thickness of the HDPE strand coating will be such that the outer diameter of the coated strand does not exceed 19.7 mm.

The stay cable supplier shall demonstrate that no cracking of the HDPE coating shall occur due to stress variations.

(2) Testing and Quality Control

At least one of each of the following noted test shall be carried out per each unit of production.

1) Chemical Resistance

The chemical resistance of the sheathing shall be evaluated in accordance with ASTM standard G20 by immersing coated strands in each of the following:

- a 3M aqueous solution of CaCl₂,
- a 3M aqueous solution of NaOH, and
- a solution saturated with Ca(OH)₂.
- Tests with specimens without damage to the sheathing and specimens with intentional 6mm diameter holes drilled through the sheathing, shall be performed at 24 ± 2°C .
- Minimum test time shall be 45 days.
- Acceptance criterion is that the polyethylene must not soften, crack, or be visually deteriorated and that intentionally made holes shall exhibit no undercutting during the 45-day period.

2) Chloride Permeability Test

The chloride permeability characteristics of the films of cured coating having the minimum thickness as proposed for use shall be measured by the methods outlined in FHW A-RD-74-018.

- The test shall be performed at 24 ± 2 °C for 45 days.
- The accumulative concentration of chloride ion permeating through the film shall be less than 1×10^{-4} M.

3) Impact Test

The resistance of a strand sheathing to mechanical damage shall be determined by the falling weight test.

- A test apparatus similar to that described in ASTM G14 shall be used along with a 1.8 kg tup.
- Impact shall occur on the crown areas of the sheathed strand.
- The test shall be performed at room temperature.
- With an impact of 9N-m, no shattering, cracking, of sheathing shall occur except at the impact area, that is, the area permanently deformed by the tup.

4) Abrasion Resistance Test

The resistance of the strand sheathing to abrasion shall be determined by the falling sand method of ASTM D968 adopted for testing sheathed strand. The net loss of sheathing shall not exceed 0.25mm per 1,000 L.

5) Salt Spray (fog) Test

Sheathed strand specimens shall be tensioned to 70 percent of the minimum ultimate tensile strength and exposed to salt fog for 3,000 hours in accordance with ASTM B117. Care shall be taken to protect the end anchorage used from salt fog or corrosion so as not to influence the test results. Observations for signs of corrosion shall be made and recorded every 250 hours. After 3,000 hours of exposure, no evidence of corrosion shall be present, and the specimen shall be holiday free. After the salt spray (fog) test is completed, the specimen shall undergo a tensile test, in conformance with ASTM A416. No cracks visible to the unaided eye shall occur in the HDPE up to an elongation of 1 percent (yield point).

6) Water tightness Test

The stay cable supplier shall propose a water tightness test to the consent of the Engineer. One test of the void filling manufacturing process of the sheathed strand as per the approved test procedure, shall be carried out per production run or portion thereof.

3.3. Protective Filler

(1) General Requirements

The protective filler compound shall be corrosion inhibiting grease, a petroleum wax or an approved equivalent. Suitable measures shall be taken to ensure that the protective filler (with provided spacers) shall fill the inter-wire voids, and the voids between the outer wires and the strand sheathing. The weight of grease or wax per unit length of strand shall be within the maximum and minimum values specified by the stay cable supplier. The minimum value shall ensure that any possible water flow or passage is prevented, and the maximum value shall provide for sufficient bond between the wires and the strand sheathing.

(2) Testing and Quality Control

For each unit of production, the weight of the filler shall be confirmed by testing a known length of strand.

The test procedure shall consist of weighing a length of strand, which has been cut longitudinally and measured to the nearest millimetre, and weighing the cleaned and degreased wires and HDPE sheath.

3.4. Stay Cable Sheathing

(1) General Requirements

- Stay cable outer sheathing shall consist of polyethylene (HDPE) pipe conforming to the requirements as noted herein.
- Procedures for packaging, handling and shipping the pipe shall ensure the pipe will not be damaged when delivered to the site.

(2) Sheath Colouring

Prior to commencing with initial manufacturing of sheathing, the Contractor shall submit details of the proposed sheathing colouring to the Engineer for approval. These shall be submitted along with test evidence of the coloured sheathing's resistance against ultraviolet degradation and colour change for a minimum of 15 years.

(3) Testing and Quality Control

HDPE pipe sheathing shall meet specific cell category requirements for class PE 324433 and class PE 335534 materials as defined by Table 1 of ASTM D3350. The acceptable criteria for the primary properties for the PE materials shall be as follows.

Property	ASTM Test Method	Value
Density, g/cm ³	D1505	0.941 – 0.965
Melt Index, g/10 min	D1238	Max of 1.0
Flexural modulus, N/mm ²	D790	550 – 1100
Tensile Strength at Yield, N/mm ²	D638	21 – 28
Environmental Stress (F ₂₀ , hrs)	D1639 (Condition C)	192
Hydrostatic Design Basis, N/mm ²	D2837	0.86 – 1.10
Ultraviolet Radiation Stability	D3350	Condition E

A manufacturer's certification clearly stating that the material meets specification requirements along with certified results of tests required in accordance with this specifications section shall be furnished for each shipment of sheathing.

Verification tests shall be performed on each size of pipe used. Samples for verification testing shall consist of one 2-metre length of pipe per size thickness per 1000 meter.

(4) Sheathing Joints

The required length of the HDPE pipe shall be obtained by continuous extrusion or by fusion welding. Fusion welding of the HDPE pipe shall be performed in accordance with ASTM D 2657. The Contractor shall submit samples to qualify the fusion welding procedure. The samples shall consist of 2-meter lengths of pipe per each pipe size thickness.

Stay cable sheath joints, at the ends of the stay cable shall be permanently sealed on site by an Electro-fusion welding procedure, incorporating electric welding of bands within the joint. The details of the Electro-fusion system shall be submitted to the Engineer for review and approval.

Welded joints shall be capable of developing the full yield strength of the pipe cross section.

4. Stay Cable Anchorage

4.1 General

Prior to the commencement of stay cable work and before the ordering of any stay cable materials, the Contractor shall furnish to the Engineer for review and consent complete stay cable anchorage specifications to supplement requirements noted herein and on drawings. Materials, accessory and assembly requirements of these Specifications shall be in accordance with and make reference to relevant AASHTO and ASTM, or equivalent requirements and clearly indicate such reference by standard designation number(s).

The stay cable anchorage system shall be a parallel strand system.

Stay cable anchorage shall be in accordance with acceptance criteria specified in Section 3, 4 and 6 of "Recommendations for Stay Cable Design, Testing and Installation", American Post-Tensioning Institute Committee on Cable-Stayed Bridges (PTI), Fifth Edition, 2007.

The level of protection within the anchorage assembly devices shall be consistent with the level of protection required in the stay cables.

Anchorage and fixings shall be capable of providing minimum tensile force equal to 92% of the actual ultimate tensile strength of the cable or 95% of the minimum ultimate tensile strength of the cable, whichever is greater. All other components such as bearing plates shown on the Drawings shall be of suitable type and sufficient strength for the intended use.

The stay anchorage system and devices shall be such that strand-by-strand replacement of stay cables may be accomplished.

All exposed steel parts of the cable stay system shall receive a minimum protection in accordance with as shown on the Drawings.

To prevent any fretting corrosion, the anchoring system and system components shall be such that the steel strands of the stay cables are not in contact with any other steel elements, except in the jaws of anchoring devices.

Stay cable anchorage shall be designed to individually anchor each strand reversible means.

4.2 Drawings, Calculations and Testing

Prior to commencing any stay cable work, the Contractor shall submit to the Engineer for review and approval complete design calculations for the cable anchorage systems, devices and components.

Prior to commencing any stay cable work, the Contractor shall submit to the Engineer for review and approval complete anchorage assembly drawings clearly detailing the sizes and types of anchorage used in the construction, with all dimensions and details of all components.

Prior to commencing any stay cable work the Contractor shall propose a complete test timetable to verify the design and performance of the cable system with anchorage devices. The test timetable shall detail full instrument, testing and monitoring requirements. The timetable shall be submitted to the Engineer for review and approval.

4.3 Buffer for Angular Deviations

The anchorage shall comprise cable guide systems in order to prevent angular deviations of the strand extending to the anchorage head or wedges. The design of the cable guide system must take account of transverse and flexural forces resulting from:

- Cable deformations caused by centenary effects and wind oscillations at service and maximum wind speed
- Deck and pylon anchorage rotation under live loads
- Inaccuracy of anchorage placing
- Permanent angles due to the fanning out of the strands
- Bending of strand in the anchorage head due to manufacturing, tolerance of anchorage parts

Detail plan and calculation sheet of buffers including materials, properties, testing for materials, manufacturer's recommendations for installation shall be proposed by the Contractor for the Engineer's consent.

4.4 Cable Vibration and Damping Devices

During all stages of construction, restraints such as secondary ropes tied around individual stays and anchored to the deck shall be employed at necessary locations to control stay cable vibration.

Permanent damping devices (vibration control device) shall be installed as specified in the contract drawings. Damping devices shall consist of high damping rubbers, supporting plates, damping clamps, bolts and nuts, rubber liners and rubber plates stipulated in the Drawings.

The Logarithmic damping frequency of installed dampers shall not be less than 0.03, with full consideration for rain, wind, bridge design criteria, ambient temperatures and other subjective conditions.

In addition to above noted criteria, permanent damping device shall comply with the following:

- they shall not be insensitive to the frequency and the amplitude of vibrations;
- they shall not be temperature dependent;
- they shall not be subject to vibration caused by rain;
- they shall be adjustable during the life of the bridge and
- they and the components they are comprised of shall give full consideration for future maintenance, access, inspection, and replacement.

The Contractor shall submit design calculations and shop drawings with full details of proposed damping devices to the Engineer for check and approval. The drawings and design shall fully describe the damping devices proposed and how they will be damped to and incorporated in the stay cable system.

5. Fatigue Resting of Anchorage System

Acceptance of the anchorage system shall be based on fatigue and ultimate strength of fully assembled cables. Test parameters and acceptance criteria shall be as detailed in Section 4.2 of the 2007 Edition of the Post-Tensioning Institute (PTI) "Recommendations for Stay Cable Design, Testing and

Installation" carried out at a laboratory approved by the Engineer and in accordance with the following:

- Unless otherwise accepted by the Engineer, two (2) complete fully assembled stay cable specimen shall be fabricated for testing, one specimen shall representing the smallest stay cable and largest stay cable in the bridge. The specimen shall be fully representative of all details and procedures for anchorage production. The required number of the specimens has been reduced from Section 4.2 of the PTI Recommendations above.
- Stay cables shall be tested with complete load bearing appurtenances and assemblies including protective sheathing and strand deviators.
- The method of construction and assembly of the cable and socket to be tested shall be the same as that used in the structure. Active anchorage and a passive anchorage shall be included.
- The number of tests to be conducted shall be as instructed by the Engineer with consideration for past stay cable test results on the material. If, in the opinion of the Engineer, past testing does not establish satisfactory results, the tests shall be conducted at the Contractor's expense.

6. Arrangement and Handling of Materials

The Contractor shall adopt procedures to ensure that stay cable components are not damaged during handling. All stay cables, cable sheathing, anchorage devices and associated materials and apparatus shall be arranged, transported and stored in such a manner so as to prevent any damage or deterioration of the material(s). They shall be protected from corrosion, heat, abrasion and other harmful effects during fabrication, transportation, storage and installation.

Damaged strands and/or damaged load carrying components shall be replaced. Damaged non-load carrying components shall (subject to the Engineer's consent) be repaired prior to installation. When directed by the Engineer, damaged components shall be replaced.

All damage to stay cables or components thereof shall be remedied prior to installation.

The HDPE shall be warmed to a minimum temperature of 24 °C to 50 °C prior to coiling or uncoiling pipe material. The HDPE pipe shall be slowly coiled or uncoiled so as not to damage the pipe. HDPE shall not stored at a temperature greater than 50 °C. The reel diameter shall be at least 17 times the outside diameter of the HDPE pipe.

The Contractor shall assure that all material orders clearly convey necessary requirements for arrangement and packaging to assure preservation of materials, protection from damage and specific requirements as stated herein.

7. Stay Cable Installation

7.1 General

At all times the Contractor shall conduct his activities with due regard to the safety and stability of the Works.

The installation of all stay cables, including necessary anchorage and associated requirements and procedures shall be the responsibility of the Contractor. Construction shall be in accordance with these specifications and the latest internationally recognized references and procedures for stay cable construction by a Contractor and sub-contractors that have recent experience with similar work.

Stay cables installation shall be in accordance with detailed engineered installation procedures prepared by the Contractor. Installation procedures shall be prepared with full consideration of

construction loads and static conditions during the course of construction and the segmental construction procedures and requirements as given under Specifications Section 7700.

7.2 Method Statement, Shop and Working Drawings

Prior to starting work, the Contractor shall prepare a Method Statement that fully describes in detail all stay cable installation operations and procedures. The Method Statement shall include a description and documentation of the main items of the equipment the Contractor proposes to use as well as a detailed engineered cable installation timetable prescribing cable forces and the elongation of each stay cable.

The Method Statement shall fully detail the construction sequence together with complete corresponding erection design calculations. In the Method Statement, the Contractor shall confirm and certify that the proposed erection scheme shall adequately provide for structure stability during all stages of construction.

With full consideration for procedures and requirements of the Contractor's Method Statement, the Contractor shall provide complete detailed shop and working drawings noting all materials, dimensions, calculations and procedures for stay cable installation to the Engineer for review, consent and approval.

The Contractor's Method Statement, shop drawings, working drawings as well as all erection and design calculations shall be prepared under the direction of and be certified by a Registered Professional Engineer with past experience in the design and construction of cable stay bridges.

The Contractor's Method Statement, with due consideration to the construction requirements noted in this Specifications section, shall include the following:

- A summary of all design loads and assumptions.
- A step-by-step confirmation of the strength and serviceability of the structure at each stage of construction.
- Full calculation details of temporary structures such as erection carries and temporary bracing.
- Proposed methods for calculation of jacking forces and extensions for the stay cables.
- Sufficient detail to allow a review of the effects of the proposed erection procedures on the structure.

Consent and approval of the Contractor's Method Statement, shop drawings, working drawings and erection and design calculations shall not relieve the Contractor from his responsibility for performing the work required by the Contract Documents.

7.3 Construction Requirements

Stay cable construction procedures shall be compatible with the bridge construction sequence and erection procedures.

The Contractor shall provide the determination of forces and deflections together with the verification of all the elements in the permanent structure at all erection stages.

A package tensioning, as a final adjustment, shall be done after completion of bridge surfacing works.

Jacks and gauges for stay cable installation shall be calibrated using a load cell or a static load machine calibrated not more than one month prior to the beginning of cable installation. All jacks and gauges shall be calibrated every 6 months thereafter, for the duration of cable installation.

The 6-month re-calibration may be performed using a master gauge, provided that the master gauge is calibrated with the field gauges at the time of initial jack calibration.

In-situ erected stay cable strands may be tensioned one by one provided that it can be demonstrated to the satisfaction of the Engineer that the final tension and elongation of each strand is equalized within a range of $\pm 2.5\%$. The stay cable system must be compatible with the strand by strand tensioning procedure. Fully trained specialists who have had relevant past experience on similar type projects shall accomplish the strand by strand tensioning and installation.

Stay cables shall be capable of being tensioned, de-tensioned or re-tensioned more than once during the construction of the structure. These operations may be carried out either by full jacking of the live anchorage and adjustable ring setting, or strand by strand.

Maximum cable tension during construction shall not exceed the prescribed percentage of the cable's minimum ultimate tensile strength.

Stay cable shall be installed with sufficient adjustment devices to permit de-tensioning without relaxing stay anchorage component devices. If de-tensioning the cables strand by strand in such way that the gripping zone is incorporated in the stressed portion of the stay, no gripped zone shall permanently be left on the stressed portion of the stay.

All permanent corrosion protection inside the anchorage shall be suitable approved type.

8. Measurement and Payment

8.1 General

In case of the Contractor propose to use prefabricated parallel wire strand stay cable, the Contractor shall recalculate quantity and re-propose unit price of stay cable, anchor system and other items. But the total amount shall not be higher than total amount of each items in the Contract.

8.2 Measurement

(a) Stay Cables

Cable stay work including all anchorage, and associated items shall be paid based on the theoretical weight of installed and accepted stay cables measured from the theoretical final position of the outer surface of the steel anchor plate at the lower end to the theoretical final position of the outer surface of the steel anchor plate at the upper end.

(b) Damping Device

Measurement for stay cable damping devices shall be made by sets of dampers installed.

8.3 Payment

(a) Payment for Stay Cable

Payment for stay cable shall cover all necessary works for stay cables cited in this specifications section including all fabricating furnishing, installing, and adjusting of stay cables, complete with anchorage components, positioning and guide tube, split shims (if used), wedges, bearing plates, drainage plates, buffer devices, polyethylene pipes including painting and sealing, bolts, support ring, corrosion protection, erection devices and all incidental materials, tests, quality control and labour and equipment necessary to construct the stay cables, and all inspection, testing and safety provisions.

The pay items shall include material supply costs for stay cables such as stay cable materials, anchorage materials, and protection pipe materials for stay cables. The stay cable material means PC strand, and lost materials of the PC strands. The anchorage material means anchorage devices with cap on pylons and box girders and their transportation costs etc. The protection pipe materials means high density polyethylene pipe (HDPE), protection tubes, sliding tubes, buffer devices, water proofing protection covers, bands for hanging, and their transportation and storage costs.

The pay items shall include costs for installation works of stay cables which works include fabrication and installation of HDPE pipes, fabrication and installation of stay cables, stress installation of the stay cables by strand-by-strand including stress adjusting works, machinery/equipment costs for installation.

The partial amount in accordance with the progress will be paid with following principle;

- The stay cable will be measured when the installation and initial tensioning is completed and accepted by the Engineer.
- The partial amount for above will be equivalent to 80 percent of amount calculated at the unit rate per ton for the items in Bill of Quantities.
- The remaining 20 percent will be paid when all stay cables and dumpers are completed and accepted by the Engineer.
- The price adjustment shall be calculated by using the price indices on the day of the installation and initial tension being completed and accepted by the Engineer.

(b) Payment for Stay Cable Damping Device

The amount of completed and accepted stay cable damping devices, measured in sets for the pay items in the Bill of Quantities, which rate shall be full compensation for design, material, installation, furnishing labour, equipment, tools and other items necessary for the proper completion of the work for supplying, fabricating, erecting, inspection, adjusting and testing.

Pay Item	Description	Unit
07750-01	Stay Cables	ton
07750-02	Stay Cable Damping Devices	set

Division 8
Miscellaneous

Table of Contents

	Page
Section 08010 - Mortar and Grout.....	1
Section 08150 – Sodding and Planting.....	4
Section 08200 - Topsoil	8
Section 08300 - Monuments, Markers, Guide and Guard Posts	11
Section 08400 –Signboard.....	13
Section 08500 - Guardrail	17
Section 08600 – Road Markings	20
Section 08700 – Painting	23
Section 08800 - Fences and Gates	31
Section 08910 - Sidewalks	34
Section 08920 - Concrete Kerb	36
Section 08950 – Installation of Measuring Devices for Simplified Monitoring	39

Section 08010 - Mortar and Grout

1. Description

This work consists of the preparation and supply of cement mortar in accordance with all the requirements of the Specification Sections for masonry and other incidental works.

This work also consists of the preparation and placing of non-shrink mortar and grout for use in concrete structures other than in prestressing ducts. Such uses include for filling to box-out under bridge bearings and bridge railings and for filling keyways between precast members where shown in the contract documents, mortar used to fill voids and repair surface defects, grout used to fill sleeves for anchor bolts, and mortar and grout for other such uses where required or approved.

2. Material Requirements

2.1 Reference Standards

The following Standards in their latest editions shall be particularly applied to the works covered by this Specification Section:

- AASHTO M45 Aggregate for Masonry Mortar
- AASHTO M85 Portland Cement
- ASTM C207 Hydrated Lime for Masonry Purposes
- JSCE^{*1/} F541 Test Method for Flowability of Filling Mortar (Non-shrink)
- JSCE^{*1/} F542 Test for Bleeding and Expansibility Filling Mortar (Non-shrink)
- JSCE^{*1/} G541 Test for Compressive Strength of Filling Mortar (Non-shrink)

*1/Standard Specifications for Concrete Structures by Japan Society of Civil Engineers

2.2 Cement Mortar

The materials to be used for preparation of cement mortar shall meet the following requirements:

- (a) Cement shall conform to the requirements of AASHTO M85.
- (b) Fine aggregate shall conform to the requirements of AASHTO M45.
- (c) Hydrated lime shall meet the requirements for residue, popping and pitting, and water retention specified for Type N lime in ASTM C207.
- (d) Water shall conform to the requirements for concrete under Specification Section 06100 "Structural Concrete".
- (e) Unless otherwise directed by the Engineer, masonry mortar shall be composed of one part Portland cement and three parts fine aggregate by volume, to which hydrated lime may be added in an amount equal to 10% of the cement by weight.

2.3 Non-shrink Mortar

The materials to be used for preparation of non-shrink mortar shall meet the following requirements:

- (a) Premixed type for the material of non-shrink mortar shall be used.
- (b) Water shall conform to the requirements for concrete under Specification Section 06100 "Structural Concrete".
- (c) The quantity of water shall be such as to produce mortar of the required consistency.
- (d) Non-shrink mortar shall meet the following requirements. As for the items of bleeding, and swelling and contraction, mill sheet shall be acceptable for the Engineer's approval.

Table Requirements for Non-shrink Mortar Properties

Item	Requirement	Standard for the Test
Consistency	8±2 seconds (within 3 minutes after mixing)	JSCE-F541 or equivalent
Bleeding	Less than 2% (At 2 hours after mixing)	JSCE-F542 or equivalent
Swelling and Contraction	No shrinkage at 7 days age	JSCE-F542 or equivalent
Compressive Strength	<p>Unless otherwise specified in the drawing or other sections of the technical specifications, following compressive strength shall be applied.</p> <ul style="list-style-type: none"> i) Filling bearing anchor over 25N/mm² at 3 days age over 45N/mm² at 28 days age ii) Pedestal layer mortar above bearing (PC box girder) over 28N/mm² at 3 days age over 50N/mm² at 28 days age iii) Filling bridge rail anchor over 18N/mm² at 3 days age over 30N/mm² at 28 days age iv) Others <p>It shall be higher compressive strength than that of concrete in contact.</p>	JSCE-G541 or equivalent

- (e) The Contractor shall prove the filling performance into the anchor of bearing by model test at one case of the largest size of bearing pad.

3. Construction Requirements

- (a) Concrete areas to be in contact with the mortar or grout shall be cleaned of all loose or foreign material that would in any way prevent bond, and the concrete surfaces shall be flushed with water and allowed to dry to a surface dry condition immediately prior to placing the mortar or grout.
- (b) The mortar or grout shall completely fill and shall be tightly packed into recesses and holes, on surfaces, under structural members, and at other locations specified. After placing, all surfaces of mortar or grout shall be cured by the water method as provided in 3.(c) of this section for a period of not less than three days.
- (c) Concrete surface shall be kept continuously wet by ponding, spraying, or covering with materials that are kept continuously and thoroughly wet. Such materials may consist of cotton mats, multiple layers of burlap, or other approved materials that do not discolour or otherwise damage the concrete.

- (d) Keyways, spaces between structural members, holes, spaces under structural members, and other locations where mortar could escape shall be mortar-tight before placing mortar.
- (e) No load shall be allowed on mortar that has been in place less than 72 h unless otherwise permitted by the Engineer.
- (f) All improperly cured or otherwise defective mortar or grout shall be removed and replaced by the Contractor at the Contractor's expense.

4. Measurement and Payment

The mortar or grout shall not be measured for direct payment.

This work shall not be paid for separately, but will be deemed as a subsidiary obligation of the Contractor for which full payment is included in the unit prices in the Bill of Quantities for the work items in which it is called for or required.

Section 08150 – Sodding and Planting

1 Description

This work consists of the provision of sods and planting of trees at locations shown in the Drawings, or as indicated by the Engineer.

2. Material Requirements

2.1 Reference Standards

The following Standard in its latest edition shall be particularly applied:

- ASTM C602 Agricultural Liming Materials

2.2 Sod Shrubs and Trees for Planting

Sods, shrubs and trees for planting shall be healthy living stems (stolons or rhizomes) with attached roots or perennial turf-forming grass, harvested without adhering soil, and obtained from approved sources in the locality of the work, and grounds are of optimal conditions. The presence of objectionable grass, weeds, or other detrimental materials will be cause for rejection.

2.3 Fertilisers

- (a) Fertilizer shall be standard commercial fertilizer supplied separately or in mixtures containing percentages of total nitrogen, available phosphoric acid, and water-soluble potash based on the soil composition and shall meet Myanmar Standards and applicable local laws. They shall be furnished in standard containers with name, weight, and guaranteed analysis of contents clearly marked thereon.
- (b) No cyanamide compounds or hydrated lime shall be permitted in mixed fertilizers.
- (c) The Contractor shall have his proposed sod planting beds tested by an acceptable agricultural laboratory for available nutrients. Based on results of tests, the type, contents and application rates of fertilizer, and the need and application rates for lime shall be established by the laboratory.
- (d) Fertilizers may be supplied in one of the following forms:
 - As dry, free flowing fertilizer suitable for application by a common fertilizer spreader;
 - As finely ground fertilizer soluble in water, suitable for application by power sprayers;
or
 - In granular or pellet form suitable for application by blower equipment.

2.4 Lime

If the use of lime is required, it shall be ground limestone containing not less than 85% of total carbonates, and shall be ground to such fineness that 90% shall pass through a 250 µm mesh sieve and 50% shall pass through a 150 µm mesh sieve. Dolomitic lime or a high magnesium lime shall contain at least 10% of magnesium oxide. All liming materials shall conform to the requirements of ASTM C602.

2.5 Topsoil

Materials for top soiling shall be provided in accordance with the provisions of Specification Section 08200 "Topsoil"

2.6 Submittals

Prior to the commencement of the work for this item, the Contractor shall submit the following to the Engineer for approval:

- (a) Details of his proposed sources for sod, evidencing that the sod is heavy and thickly matted and does not contain any objectionable grass, weeds, or other detrimental material;
- (b) Details of his proposed sources for shrubs and trees, evidencing that all the shrubs and trees are in optimal conditions to be planted as indicated in the Drawings;
- (c) Detailed description of the sod, shrubs and trees including the name, type, size and major characteristics regarding the environment and their maintenance;
- (d) Details regarding the fertilizer suppliers proposed by the Contractor for the Project;
- (e) Test results, and the laboratory's proposed fertilizer contents and application rates; and
- (f) Test results of lime, if its use is allowed by the Engineer, confirming that the quality of the proposed lime sources comply with this Specification Section and providing enough information to the Engineer regarding the lime properties for respective approval.

3. Construction Requirements

3.1. Harvesting

- (a) The Contractor shall notify the Engineer at least five (5) days before sods are to be harvested, and the source shall be approved by the Engineer before harvesting begins.
- (b) To begin harvesting, grass and woods shall be mowed to a height of 50 to 75 mm and all clippings removed. Sods shall then be loosened by cross-disking, shallow plowing or other acceptable methods. After being loosened from the soil, sods shall be gathered in small piles or windrows, watered and kept moist until planted.
- (c) Not more than 24 hours shall elapse between harvesting and planting, except that when weather or other uncontrollable condition interrupts the work, in which case a time extension may be granted, provided that the sods are still moist and viable. Sod, shrubs and trees that have heated in stockpiles, permitted to dry out or otherwise seriously damaged during harvesting or delivery shall be immediately rejected and disposed of as directed by the Engineer/

3.2. Advanced Preparation and Cleanup

After grading and before applying fertilizer and ground limestone, the areas to be sodded shall be raked or otherwise cleared of stone larger than 50 mm in diameter, sticks, stumps and other debris which might interfere with sodding, growth of grass, or subsequent maintenance of grass-covered areas. If any damage by erosion or other causes has occurred after grading of areas and before the application of fertilizer and ground limestone, the Contractor shall repair such damage. This may include filling gullies, smoothing irregularities, and repairing other incidental damage.

3.3. Topsoil Placement

Placement of topsoil shall be carried out in accordance with the provisions of Specification Section 08200 "Topsoil"

3.4. Applying Fertiliser and Ground Limestone

- (a) Following advance preparation and cleanup, fertilizer shall be uniformly spread at a rate approved by the Engineer.
- (b) If the use of ground limestone is required, it shall be spread at a rate approved by the Engineer.
- (c) Materials shall be incorporated into the soil to a depth of not less than 50 mm by disking, racking, or other methods acceptable to the Engineer. Stones larger than 50 mm in diameter, large clods, roots, and other litter brought to the surface by this operation shall be removed.
- (d) On steep slopes where fertilizer and ground limestone cannot be incorporated effectively by mechanical equipment, they may be applied with power sprayers, blower equipment or other approved method, and need not be incorporated into the soil.

3.5. Planting

- (a) Sodding shall not be done during windy weather, or when the ground is dry, excessively wet, or otherwise non-tillable.
- (b) Sods shall be planted on topsoil. If the soil is not moist when the sods are being set, water shall be applied until the soil is moist and in a workable condition.
- (c) One or more of the following methods shall be used, whichever is directed by the Engineer:

3.5.1. Broadcasting

- (a) Sods shall be spread by hand or by suitable equipment in a uniform layer over the prepared surface with spacing between sods not to exceed 150 mm.
- (b) Sprigs shall then be forced into the soil to a depth of 50 mm to 100 mm with a straight spade or similar tool, or with a disk harrow or other equipment set to cover the sods to the required depth

3.5.2. Row Planting

- (a) Furrows shall be opened along the approximate contour of slopes at a spacing and depth approved by the Engineer.
- (b) Sods shall be placed without delay in continuous rows in open furrow with successive sods touching and shall be covered immediately.

3.5.3. Spot Planting

Spot sodding shall be performed as specified under row sodding, except that, instead of planting in continuous rows, groups of four sods or more shall be spaced 450 mm apart in the rows.

3.6. Compacting

- (a) After planting of sods has been completed, and prior to compacting, the surface shall be cleared of stones larger than 50 mm in diameter, large clods, roots and other litter brought to the surface during sodding.
- (b) The sodden area shall be compacted within 24 hours from the time sodding has been completed, weather and soil conditions permitting, by cultipackers, rollers or other

appropriate equipment operated at right angles to the slopes. Compaction shall not be done when the soil is in such condition that the equipment cannot practically be operated. Clay shall not be compacted if so directed by the Engineer.

3.7. Maintenance of Planted Areas

The Contractor shall protect sodden areas against traffic by warning signs or barricades approved by the Engineer. Surfaces gullied or otherwise damaged following sodding shall be repaired by re-grading and re-sodding as directed by the Engineer. The Contractor shall mow water as directed and otherwise maintain sodden areas in a satisfactory condition until final inspection and Acceptance of the Work.

4. Measurement and Payment

4.1 Method of Measurement

Sodding will be measured for payment by the number of units of 100 square meters each, measured on the ground surface, completed and accepted. Areas covered by shrubs or trees planting work shall be excluded from the area calculated for payment of sodding.

4.2 Basis of Payment

Payment shall be made in accordance with the applicable unit prices of the pay items of the Bill of Quantities listed below. Payment shall be for full compensation for the completed and approved work, including furnishing and placing all materials, any required mulching of sodden areas, labour, equipment, tools and any other incidentals to complete the work in accordance with the Drawings and Specifications, and as directed by the Engineer.

Topsoil placement shall be paid for as provided in Specification Section 08200 "Topsoil".

Pay Item	Description	Unit
08150-01	Sodding	m ²
08150-02	Shrubs/Trees	each

Section 08200 - Topsoil

1. Description

This work consists of the preparation of the ground surface for topsoil application, removal of topsoil from areas to be stripped on the site or from approved sources off the site, and placing and spreading of the topsoil on prepared areas.

2. Material Requirements

2.1. Reference Standards

The following Standard in its latest edition shall be particularly applied to the works:

- ASTM C117 Materials Finer than 75- μ m (No. 200) Sieve in Mineral Aggregates by Washing.

2.2. Material for Topsoil

- Topsoil shall be the surface layer of soil with no admixture of refuse or any material toxic to plant growth, and it shall be reasonably free from subsoil and stumps, roots, brush, stones (50 mm or more in diameter), clay lumps or similar objects.
- Brush and other vegetation that will not be mixed into the soil during handling operations shall be cut and removed.
- Ordinary sods and herbaceous growth such as grass and weeds are not to be removed but shall be thoroughly broken up and intermixed with the soil during handling operations.
- Topsoil or soil mixture, unless otherwise specified or approved, shall have a pH range of approximately 5.5 to 7.6.
- The organic content shall not be less than 3% but not higher than 20%.
- The material passing the 0.075 mm sieve, as determined by the wash test in accordance with ASTM C117, shall not be less than 20% and not higher than 80%.
- The Contractor may change the natural topsoil with approved materials and methods to meet the above specifications.

2.3. Obtaining Topsoil

- Prior to the stripping of topsoil, briars, stumps and large roots, rubbish or stones found in such areas, which may interfere with subsequent operations, shall be removed.
- Heavy sod or other cover, which cannot be added into the topsoil by disking or other means, shall be removed.
- When suitable topsoil is available on the site, the Contractor shall remove this material from the areas. The topsoil shall be spread on areas already tilled and smooth graded, or stockpiled in approved areas. Any topsoil stockpiled by the Contractor shall be re-handled and placed without additional compensation. Any topsoil that has been stockpiled on the site by others, and is required for top soiling purposes, shall be removed and placed by the Contractor. The sites of all stockpiles and areas adjacent thereto which the Contractor has disturbed, shall be graded if required, and put into a condition acceptable for seeding.
- When suitable topsoil is secured off site, the Contractor shall locate and obtain the supply, subject to the approval of the Engineer. Topsoil shall be hauled to the site of the work and

placed for spreading, or spread as required. Any topsoil hauled to the site of the work and stockpiled shall be re-handled and placed without additional compensation.

2.4. Filling Material for Topsoil

The filling material, when required for those areas to be covered with topsoil but requiring some filling materials to be in accordance with the designed levels, shall be, as described for embankment construction, reasonably compacted as instructed by the Engineer.

3. Construction Requirements

3.1. General

- (a) The areas to be covered with topsoil are as shown in the Drawings or as indicated by the Engineer. If topsoil is available on site, the Engineer will approve the location of the stockpiles or areas to be stripped of topsoil and the stripping depths.
- (b) Suitable equipment necessary for proper preparation and treatment of the ground surface, stripping of topsoil, and for the handling and placing of all required materials shall be on hand and in good condition.

3.2. Preparing Ground Surface

- (a) Immediately prior to dumping and spreading the topsoil on any area (except directly on a rock surface), the surface shall be loosened by discs or spike tooth harrows, or by other approved means, to a minimum depth of 50 mm to facilitate bonding of the topsoil to the covered subgrade soil. The surface of the area to be covered with topsoil shall be cleared of all stones larger than 50 mm in any diameter and all litter or other materials which may be detrimental to proper bonding, the rise of capillary moisture, or the proper growth of the desired planting. Limited areas as shown in the Drawings, which are too compact to respond to these operations, shall receive special scarification.
- (b) Grades on the area to be covered with topsoil, which have been established by others as shown in the Drawings, shall be maintained in a true and even condition. Where grades have not been established, the areas shall be smooth graded and the surface left at the prescribed grades in an even and properly compacted condition to prevent, insofar as practical, the formation of low places or pockets where water will stand.
- (c) Areas to be covered with topsoil that require filling material to reach the lines and levels described in the Drawings, shall be filled up to a level that topsoil can be applied properly as specified in this Specification Section.

3.3. Placing Topsoil

- (a) Topsoil shall be evenly spread on the prepared areas to a uniform depth of 50 mm after compaction, unless otherwise shown in the Drawings. Spreading shall not be done when the ground or topsoil is excessively wet, or otherwise in a condition detrimental to the work. Spreading shall be carried out so that seeding operations can proceed with a minimum of soil preparation or tilling.
- (b) After spreading, any large, stiff clods and hard lumps shall be broken with a pulverizer or by other effective means, and all stones or rocks (50 mm or more in diameter), roots, litter, or any foreign matter shall be raked up and disposed of by the Contractor. After spreading is completed, topsoil shall be satisfactorily compacted by rolling or by other approved means. The compacted topsoil surface shall conform to the required lines, grades, and cross

sections. Any topsoil or other dirt falling upon pavements as a result of hauling or handling of topsoil shall be promptly removed.

4. Measurement and Payment

4.1 Method of Measurement

Topsoil shall be evaluated and measured for payment in square meters (m²) of topsoil placement to the depth required and in accordance with requirements of this Specification Section, and as approved by the Engineer.

4.2 Basis of Payment

Payment shall be made in accordance with the applicable unit prices of the pay items of the Bill of Quantities listed below. Payment shall be for full compensation for the completed and approved work, including furnishing and placing all materials, hauling, pre-preparation to meet specification requirements, ground surface preparation, placing, spreading and preparing final topsoil surface and all necessary clean-up and remedial work, labour, equipment, tools and any other incidentals to complete the work in accordance with the Drawings and Specifications, and as directed by the Engineer.

Pay Item	Description	Unit
08200-01	Furnishing and Placing Top Soil	m ²
08200-02	Filling for Topsoil	m ³

Section 08300 - Monuments, Markers, Guide and Guard Posts

1. Description

This work consists of the supply and installation of kilometer posts and/or concrete guard posts in conformity with the sizes, dimensions and design shown in the Drawings, or as required by the Engineer.

2. Material Requirements

2.1. Materials

2.2.1. Concrete

Concrete shall be of the class indicated in the Drawings and in accordance with the requirements of Specification Section 06100 "Structural Concrete".

2.2.2. Reinforcing Steels

Reinforcing steel shall conform to the requirements of Specification Section 06400 "Prestressed Concrete".

2.2.3. Reflective Sheeting

Reflective sheeting shall conform to the requirements of Specification Section 08400 "Road Signs". Where the sheeting is to be applied directly to the surface of the post, it shall be of a type that is suitable for application to this material.

2.2.4. Flexible Post

Flexible Guide Posts shall be made of a material such as urethane elastomer that will enable the post to bend on impact with a vehicle and return to its original position after the vehicle has released it. The Contractor shall submit to the Engineer for approval a sample post together with a report from a reputable testing agency, giving details of its strength, durability, and flexural properties.

2.2.5. Paint

- (a) Paints, as required, shall conform to the requirements shown in the Drawings.
- (b) All coatings, paints and enamels used in the preparation of the posts and fittings shall be of the best quality, specially made for the purpose they serve, and of types and brands approved by the Engineer.
- (c) Depending on the required function of the paint and the type and surface condition of the material to be painted, the paint used for each item of road furniture shall comply with the provisions of Specification Section 08700 "Painting".
- (d) To ensure compatibility, primers, undercoats and finishing coats shall be from the same manufacturer. All materials shall be used within the time limits specified by the manufacturer.

3. Construction Requirements

- (a) Construction or fabrication and installation of monuments and posts shall be as shown in the Drawings and shall include the painting of posts, as required.
- (b) Each monument and post shall be set accurately at the required location and elevation and in such manner as to ensure its being held firmly in place.
- (c) Flexible Guide Posts shall be fixed to the pavement or other surface using anchor bolts in accordance with the manufacturer’s instructions.
- (d) Reflective sheeting shall be attached to the post in the manner shown in the Drawings, or as otherwise approved by the Engineer.
- (e) In constructing precast monuments, the forms shall not be removed until after the concrete has hardened. Monuments that are warped shall be rejected. The exposed surface of the finished monuments shall be uniform, of even texture, and free from holes, cracks and chipped edges.
- (f) Precast monuments shall not be transported to the work until the concrete has been cured.

4. Measurement and Payment

4.1 Method of Measurement

The kilometre posts, guideposts and concrete guard posts shall be measured for payment by the actual number furnished, placed and accepted by the Engineer, and painting shall be measured for payment by the actual area per square meter completed and accepted by the Engineer.

4.2 Basis of Payment

The accepted quantities, measured as provided above, shall be paid at the contract price per unit of measurement for the pay items of the Bill of Quantities listed below. Payment shall be for full compensation for the work prescribed in this Section including the following:

- (a) Furnishing and placing all right-of-way monuments, kilometer posts, guideposts and concrete guard posts.
- (b) All paints of required colours and quality, labour, tools, preformed expansion joint filler, and for furnishing all labor, materials, tests, tools, equipment and any incidentals to complete the work as shown in the Drawings and as required by these Specifications, and/or as directed by the Engineer.

Pay Item	Description	Unit
08300-02	Kilometer Posts	each
08300-05	Concrete Guard Posts	each

Section 08400 –Signboard

1. Descriptions

This item consists of the supply and installation of signboards in accordance with the Drawings, or as required by the Engineer.

The signboards shall comply in all respects with the applicable Myanmar's signage standards. The categories of signboards are designated as warning signs, regulation signs, and informatory signs.

Signboards shall be classified as standard or non-standard. Standard signs have a standard shape and a fixed range of sizes. All other signs are classified as non-standard signs.

The size is the length of the side of triangular signs (measured from the points of intersection of the extension of the edges), the horizontal width of octagonal signs and the diameter of circular signs.

All signboards shall be made retroreflective by the application of retroreflective sheeting, fixed over aluminium sheeting as per these specifications.

2. Material Requirements

2.1. Reference Standards

The following Standards in their latest editions shall be particularly applied to the works covered by this Specification Section:

- AASHTO M111 Zinc (Hot-Dip Galvanized) Coatings on Iron and Steel Products
- ASTM A57 Pipe, Steel, Black and Hot-Dipped, Zinc-Coated, Welded and Seamless
- ASTM B209 Aluminium and Aluminium-Alloy Sheet and Plate
- ASTM D4956-01a Standard Specification for Retroreflective Sheeting for Traffic Control
- ASTM E810 Standard Test Method for Coefficient of Retroreflection of Retroreflective Sheeting

2.2. Materials for Signboards

2.2.1. Sign Panels

Sign panels for warning, regulation, and informatory signs shall be flat sheet aluminium, complying with the requirements specified by ASTM B209 for hard alloy, 5052 for chemical composition, and H34 for mechanical properties, and having a minimum thickness of 2.5 mm. Such sheets shall be degreased, etched, neutralized and processed prior to use as traffic sign panels.

2.2.2. Reflective Sheeting

The retroreflective sheeting used on the signs shall consist of white or coloured sheeting having a smooth outer surface, which has the property of retroreflection over its entire surface. The sheeting shall conform to the requirements of ASTM D4956 in respect of outdoor weathering, colour-fastness, shrinkage, flexibility, liner removal, adhesion, impact resistance, and specular gloss. It shall be weather-resistant and show colour-fastness. It shall be new and unused and shall show no evidence of cracking, scaling, pitting, blistering, edge lifting, or curling, and shall have negligible shrinkage or expansion. The sheeting shall be part of a family of matched component products required for the manufacture and imaging of permanent traffic signs. The

material (sheeting, inks, and overlay films) for use in the production of finished traffic control devices shall all be from the same manufacturer.

Retroreflective sheeting type VIII of very high reflection shall be used for expressways. This sheeting type has retroreflective beads of non-plated micro-prism. Minimum service life of sheeting type VIII is ten (10) years.

(a) Coefficient of retroreflection:

Table 1. Minimum Coefficient of Retroreflection (RA) of Sheeting Type VIII (cd.lx-1.m-2)

Observation Angle	Entrance Angle	White	Yellow	Orange	Green	Red	Blue	Brown	Fluorescent Yellow-Green	Fluorescent Yellow	Fluorescent Orange
0.1° ^a	-4°	1000	750	375	100	150	60	30	800	600	300
0.1° ^a	+30°	460	345	175	46	69	28	14	370	280	135
0.2°	-4°	700	525	265	70	105	42	21	560	420	210
0.2°	+30°	325	245	120	33	49	20	10	260	200	95
0.5°	-4°	250	190	94	25	38	15	7.5	200	150	75
0.5°	+30°	115	86	43	12	17	7	3.5	92	69	35

a Measured values at observation angle 0.1° are provided upon additional request only, which should be clearly stated in the contract or order.

Table 2. Minimum Coefficient of Retroreflection (RA) for Sheeting Type IX (cd.lx-1.m-2)

Observation Angle	Entrance Angle	White	Yellow	Orange	Green	Red	Blue	Fluorescent Yellow-Green	Fluorescent Yellow	Fluorescent Orange
0.1° ^a	-4°	660	500	250	66	130	30	530	400	200
0.1° ^a	+30°	370	280	140	37	74	17	500	220	110
0.2°	-4°	380	285	145	38	76	17	300	230	115
0.2°	+30°	215	162	82	22	43	10	170	130	65
0.5°	-4°	240	180	90	24	48	11	190	145	72
0.5°	+30°	135	100	50	14	27	6	110	81	41
1.0°	-4°	80	60	30	8	16	3.6	64	48	24
1.0°	+30°	45	34	17	4.5	9	2	36	27	14

a Measured values at observation angle 0.1° are provided upon additional request only, which should be clearly stated in the contract or order.

(b) Outdoor Weathering:

Outdoor Weathering: All retroreflective sheeting samples exposed to outdoor weathering do not show any crack, blistering or cavitation. There is neither remarkable curling on edges nor shrinkage/expansion of more than 0.8 mm. After outdoor weathering, reflection at observation angle 0.2° and entrance angles -4° and +30° are measured. Required duration for outdoor weathering test for minimum reflection coefficient of sheeting type VIII is 36 months; RA = 80% of the values stated in Table 1.

Accelerated Outdoor Weathering: In case there is not enough time for outdoor weathering test, accelerated outdoor weathering method can be applied. All the sheeting samples exposed to accelerated outdoor weathering test do not show any crack, blistering or cavitation. There is neither remarkable curling on edges nor shrinkage/expansion of more than 0.8 mm. Required duration for accelerated outdoor weathering test for minimum reflection coefficient of sheeting type IX is 2,200 hours; RA = 80% of the values stated in Table 2.

2.2.3. Signboard Posts

Signboard posts shall be constructed of steel pipe, hot-dip galvanized, complying with ASTM A120 and having a minimum external diameter of 60.3 mm. All open ends shall be capped to

prevent water entry. A steel bar of 16 mm diameter x 450 mm long shall be welded in the middle horizontally to the foot of the post to prevent the rotation of the post in its foundation. The length of the post and the depth of embedment shall be as shown in the Drawings but the post shall be at least 0.80 m into the ground when the sign is at its correct height.

2.2.4. Frames and Fastening

Sheet metal sign plates exceeding 500 mm in any dimension shall be stiffened through the attachment of a frame or stiffening member(s) to the back of the sign plate, as shown in the Drawings. Where details for construction of the frame and the attachment thereof to the sign plate are not shown in the Drawings, the Contractor shall design it himself and submit the details to the Engineer for approval before manufacture.

The method of fixing sign plates, frames and brackets to posts shall be such that it will facilitate removal for replacement or maintenance purposes and permit adjustment in the position of a sign without detaching it from its post or posts, but the sign and any framing shall be held firmly enough to withstand the load to which it will be subjected.

All components of signs and their supports (other than the sign face) shall be prepared and painted in accordance with Specification Section 08700 "Painting".

2.2.5. Nuts and Bolts

Nuts, bolts, washers and other metal parts shall be hot-dip galvanized after fabrication in accordance with the requirements of AASHTO M111.

2.2.6. Concrete Foundation Block

The concrete for foundation blocks shall be the class of concrete indicated in the Drawings and in accordance with Specification Section 06100 "Structural Concrete". Foundations shall be of the size shown in the Drawings.

3. Construction Requirements

3.1. Confirmation of Design

The designs shown in the Drawings shall be subject to amendment, and confirmation of the details shall be obtained from the Engineer before any signs are made.

3.2. Application of Sheeting to Sign Plate

The preparation of the sign plate, and the application of the sheeting to the plate, shall be done in accordance with the sheeting manufacturer's instructions. The material shall cover the sign surface evenly and shall be free from twists, blisters, cracks and folds. Cut-outs to produce legends and borders shall be bonded with the sheeting in the manner specified by the sheeting manufacturer.

3.3. Warranty

The Contractor shall obtain the following from the sheeting manufacturer and then submit the same to the Engineer:

- (a) A Lot Certificate stating that the sheeting material lot being supplied to the sign supplier under the purchase order conforms to the Standards specified herein for retroreflective sheeting, and

- (b) A seven-year warranty for satisfactory field performance, including the stipulated retroreflectance of the retroreflective sheeting.

In addition, a seven-year warranty for satisfactory in-field performance of the finished sign inclusive of the letters/legends and their bonding to the sheeting shall be obtained from the sign supplier and passed on to the Engineer, who shall keep it until the expiration of the Defects Notification Period of the Contract (the time when the warranty will be transferred to the Client). The warranty shall place the obligation on the sheeting manufacturer, as well as the sign supplier, to replace, repair, or restore the retroreflective efficiency in any case of defects. All signs shall be dated during fabrication with an indelible marking to indicate the type of sheeting used, the name of the manufacturer, and the start date for the warranty. Warranty shall be provided in the original and shall have legal jurisdiction in Myanmar.

3.4. Erection of Posts

The posts shall be erected vertically in position inside the formwork of the foundation block prior to the placing of the concrete and shall be adequately supported by bracing to prevent movement of the post during the placing and setting of concrete. The foundations shall be as shown in the Drawings or as directed by the Engineer. After the concrete has set sufficiently, the spaces around the concrete foundation shall be refilled to the required elevation with suitable material, which shall be thoroughly tamped in layers of not more than 150 mm thickness. Surplus excavated material shall be disposed of by the Contractor as directed by the Engineer.

3.5. Sign Panel Installation

Any chipping or bending of the sign panels will be considered as sufficient cause to require replacement of the panels at the Contractor's expense.

The exposed portion of the fastening hardware on the face of the signs shall be painted with enamels matching the background colour.

4. Measurement and Payment

4.3 Method of Measurements

Standard warning, regulation and informatory signs shall be measured for payment by the number of such signs of the size specified, and shall include the necessary posts and supports erected and accepted.

4.4 Basis of Payment

Payment shall be made in accordance with the applicable unit prices of the pay items of the Bill of Quantities listed below. Payment shall be full compensation for furnishing and installing signboards, for excavation, backfilling and construction of foundation blocks, and all materials, labour, equipment, tests, tools and any incidentals to complete the work as shown in the Drawings and as required by this Specification Section, and/or as directed by the Engineer.

Pay Item	Description	Unit
08400-01	Regulatory Signs	Number
08400-02	Warning Signs	Number
08400-03	Informatory Signboards – Type A (Arm 2.5 m)	Number
08400-04	Informatory Signboards – Type B (Arm 1.0 m)	Number
08400-05	Informatory Signboards – Type C	Number

Section 08500 - Guardrail

1. Description

This work consists of the supply and construction of posts and guardrails of the following types:

- Box Beam
- Guard Fence
- Metal Type Guardrail (Type GR-A, GR-Am, GR-B)
- Guard Pipe (Type GP-A)

2. Material Requirements

2.1. Reference Standards

The following Standards in their latest editions shall be applied to the works:

- AASHTO M111 Zinc (Hot-Dip Galvanized) Coatings on Iron and Steel Products
- ASTM A36 Carbon Structural Steel
- AASHTO M232 Zinc Coating (Hot-Dip) on Iron and Steel Hardware

2.2. Guardrails

The rail shall be corrugated sheet steel beams of the type, section and thickness indicated in the Drawings. All rails shall be free from abrasions, rough or sharp edges and shall not be kinked, twisted or bent.

Guardrails shall be made of steel with a thickness of no less than 12 gauges (3 mm) and shall:

- (a) be elongated not less than 12% in a 5 cm long specimen under tensile test;
- (b) have an ultimate tensile strength of not less than 5,600 kg/cm²;
- (c) have a beam strength including joints of 680 kg at a deflection of 5 cm when tested on a clear span of 365 cm with a load applied through an 8 cm wide flat surface at the centre;
- (d) have joints capable of withstanding a side pull of 2,200 kg; and
- (e) be galvanized in accordance with AASHTO M111. All galvanizing shall be done after fabrication.

Where applicable, and if approved by the Engineer, the use of materials for guardrail complying with the standards of Myanmar will be accepted.

2.3. Guardrail Hardware

- (a) Offset blocks shall be steel sections of the type, dimensions, and thickness shown in the Drawings.
- (b) Splices and terminal pieces shall be of the type, dimensions and thickness shown in the Drawings, and shall be of such strength as to develop the full design strength of the rail elements.
- (c) Unless otherwise specified, all fittings, bolts, washers and other accessories shall be galvanized in accordance with the requirements of AASHTO M232. All galvanizing shall be done after fabrication.
- (d) Reflector tabs shall be made of 2 mm thick aluminium, covered with high-intensity retroreflective sheeting in accordance with Specification Section 08400 "Road Signs", and shall be attached to the rail at the spacing shown in the Drawings using a secure,

corrosion- and theft-resistant fastening. Other types of reflectors that are of at least equivalent luminosity may be used, if approved by the Engineer.

2.4. Guardrail Posts

- (a) Posts shall be steel sections of the type, dimensions, and thickness shown in the Drawings.
- (b) They shall be of a copper-bearing steel. Steel shall conform to the requirements of ASTM A36 for the grade specified.
- (c) Posts shall be galvanized in accordance with requirements of AASHTO M111. All galvanizing shall be done after fabrication.

2.5. Galvanising Repair

- (a) In the event that minor damage to the galvanized coating of the guardrail of guardrail hardware occurs, the Engineer may, rather than require removal and replacement, allow the Contractor to make repairs by three applications of zinc anticorrosive paint as approved by the Engineer. The Contractor shall provide all details and information, including the manufacturer's application and surface preparation requirements, for the approval of the Engineer of the repair application coating that he may propose to use.
- (b) Repair of the coating application shall not proceed until such information and data have been approved by the Engineer.

3. Construction Requirements

3.1. Posts

- (a) Holes shall be dug or drilled to the depth indicated in the Drawings, or the posts may be driven by approved methods and equipment provided that they are erected in proper position and do not become distorted, burred or otherwise damaged.
- (b) Posts shall be set vertically in the position shown in the Drawings and, where embedded in a concrete foundation block, shall remain undisturbed for a minimum of 48 hours.
- (c) The space around the post shall be backfilled to the ground line with approved material in layers not exceeding 100 mm and each layer shall be moistened and thoroughly compacted. When backfilling and tamping are completed, the posts shall be held securely in place.
- (d) Posts for guardrails on bridges and culverts may be bolted to the structure as detailed in the Drawings. The anchor bolts shall be set to the proper location and elevation with templates, and carefully checked.

3.2. Rail Elements

- (a) Rail elements shall be erected in a manner resulting in a smooth, continuous beam that is true to line and grade. The height of the rail above ground level must be within ± 10 mm of the height shown in the Drawings. All bolts, except adjustment bolts, shall be drawn tight. Bolts shall be of sufficient length to extend beyond the nuts by at least 5 mm but not more than 100 mm.
- (b) Where galvanized surfaces have been abraded so that the base material is exposed, the threaded portions of all fittings and fasteners and cut ends of bolts shall be protected in a manner as using a zinc-based coating in accordance with the above referred Subsection 2.5.
- (c) All rails shall be erected and adjusted so that the longitudinal tension shall be uniform throughout the entire length of the rail.

4. Measurement and Payment

4.1 Method of Measurement

Unless otherwise specified, guardrails (Box Beam, Guard Fence) shall be measured by the length in linear metres of each type.

4.2 Basis of Payment

The unit rate of payment for each item of work shall be full compensation for all labour, equipment, tools, materials and incidentals necessary to complete the work including painting as specified.

Pay Item	Description	Unit
08500-01	Box Beam	lm
08500-02	Guard Fence	lm
08500-03	Metal type (GR-A)	lm
08500-04	Metal type (GR-Am)	lm
08500-05	Metal type (GR-B)	lm
08500-06	Guard Pipe (GP-A)	lm

Section 08600 – Road Markings

1. Descriptions

This work consists of the provision and placing of markings on the finished pavement.

The thermoplastic compound shall be screened or sprayed onto the pavement surface in a molten state by a suitable machine capable of controlled preparation and laying together with the surface application of glass beads at a specific rate. Upon cooling to ambient pavement temperature, it shall produce an adherent road marking of specified thickness and width and capable of resisting deformation due to traffic.

The thermoplastic compound shall be applied to the size, shape and location of the markings shown in the Drawings, or as required by the Engineer.

2. Material requirements

2.1. Reference Standards

The following Standards in their latest editions shall be particularly applied to the works covered by this Specification Section:

- AASHTO M247 Glass Beads Used in Road Markings
- AASHTO M248 Ready-Mixed White and Yellow Traffic Paints
- AASHTO M249 White and Yellow Reflective Thermoplastic Striping Material (Solid Form)

2.2. Paint for Road Markings

The thermoplastic material shall be homogeneously composed of aggregate, pigment, resins and reflectorizing glass beads. The thermoplastic material shall be factory-mixed, from an approved manufacturer, and shall be of a tropical grade suitable for application, by the means proposed, to the specified road surfaces.

The thermoplastic material shall be sampled and tested in accordance with the appropriate ASTM method. The Contractor shall furnish to the Engineer a copy of certified test reports from the manufacturer of the thermoplastic material showing results of all tests specified herein and shall certify that the material meets all requirements of this Specification Section.

2.3. Glass Beads for Reflective Road Markings

The marking shall be reflectorized by incorporation of Type I glass beads into the mix and by application of Type II glass beads to the surface of the marking. Both types of glass beads shall conform to the requirements of AASHTO M247.

Glass beads shall be of good quality, optically clear, lead-free glass and not less than 90% shall be reasonably spherical and free from flaws. The beads shall contain no more than one percent of sharp angular particles and not more than one half percent of foreign matter and shall be free-flowing under normal atmospheric conditions. The grading of the glass beads shall be as follows:

US Standard Sieve		Percentage Passing
mm	Alternative	By Weight
1.180	No.16	100
0.850	No.20	65 ~ 75
0.600	No.30	45 ~ 55
0.300	No.50	15 ~ 25
0.180	No.80	0

The glass beads shall make up not less than 30 ~ 40% of the thermoplastic compound by weight.

2.4. Defective Materials or Workmanship

Materials which are defective or have been applied in an unsatisfactory manner or to incorrect dimensions or in a wrong location, and do not have a uniform satisfactory appearance both in daytime and night-time shall be removed, the road pavement made good and materials replaced, reconstructed and/or properly located, all at the Contractor's expense and to the satisfaction of the Engineer.

3. Construction Requirements

3.1. Preparation of Road Surfaces

The works for road markings shall include the following:

- (a) Cleaning of the pavement surfaces to remove all dust, dirt, grease, oil and other foreign matters;
- (b) Application, protection and drying of paint coatings;
- (c) Protection of pedestrian, vehicular or other traffic;
- (d) Protection of all parts of the road structure and its appurtenances against disfigurement by spatters, splashes or smirches of marking material; and
- (e) Supply of all tools, labour and marking materials necessary for the entire work.

Thermoplastic shall not be applied during rain or wet weather or when air is misty, or when in the opinion of the Engineer, conditions are unfavourable for the work. Thermoplastic shall not be applied on damp pavement surfaces, or on pavement which has absorbed heat sufficient to inhibit the thermoplastic from setting properly.

3.2. Application of Thermoplastic Materials

- (a) Thermoplastic shall not be placed on a sealed surface sooner than three (3) days after application of the final seal coat or asphaltic concrete surfacing.
- (b) The precise dimensions and positions of all road markings shall be set out and marked on the pavement before the thermoplastic is applied.
- (c) The thermoplastic material shall be melted in a heater fitted with a mechanical stirrer to give a smooth consistency to the material and to avoid local overheating. The temperature of the mass shall be maintained within the range specified by the manufacturer.
- (d) Road markings shall be carried out by suitable machines and equipment approved by the Engineer. Hot plastic materials shall be thermal painted by glazing, pressing and spraying methods. Materials that are already put in spreading machine must be maintained at a temperature stipulated by manufacturer for specific spreading methods. For road marking by machine, only one layer of painting with thickness of more than 2.5 mm shall be placed. Before being used for a designated works, road marking machines must be tested at a suitable location outside the work site. Calibration of the machine/equipment shall be carried out in the next test. Only when it is properly calibrated by the Contractor, and approved by the Engineer will the equipment be used for the designated works. Capable and experienced workers shall be assigned to operate the road marking machines. Number of machines shall be considered and properly adjusted, if necessary, before

putting into operation in a large-scale work site. Daily checking and adjustment is also necessary throughout the work.

- (e) For locations or markings which are awkward to do by machine, approved manual methods may be used with the prior approval of the Engineer.
- (f) Thermoplastic shall be applied in uniform thickness of at least 2.5 mm (exclusive of the glass beads applied to the surface) unless otherwise specified.
- (g) Type II glass beads shall be applied uniformly to the surface of the marking whilst it is still molten. The glass beads shall be applied by pressure or spray application at a rate of 450 gm/m².
- (h) The markings shall not deviate from the specified dimensions by more than 20 mm. The edges shall be smooth and distinct.
- (i) The upper surface of the markings shall be level, uniform and free from streaks. The surface must not be slippery when wet.
- (j) All markings shall be protected from traffic until the markings have hardened sufficiently so that there is neither pick-up of the material on tires nor any imprint of tire marks.
- (k) The markings shall show no appreciable deformation, discoloration, cracking, lifting or peeling under traffic and under road temperatures of up to 60°C.

4. Measurement and Payment

4.1 Method of Payment

The road markings shall be measured for payment by the length in linear meters of different type and width of line markings as shown in the Drawings (centre lines, edge lines, etc.), or the number of standard items (arrows, symbols, etc.).

4.2 Basis of Payment

Payment shall be full compensation for the completed and approved work, including furnishing and placing of all materials, labour, equipment, tools and any other incidentals to complete the work in accordance with the Drawings and these Specifications, and as directed by the Engineer.

Pay Item	Description	Unit
08600-01	Road Markings Solid Line (W = 80 mm)	lm
08600-02	Road Markings Solid Line (W = 100 mm)	lm
08600-03	Road Markings Solid Line (W = 150 mm)	lm
08600-04	Road Markings Solid Line (W = 300 mm)	lm
08600-05	Road Markings Solid Line (W = 450 mm)	lm
08600-06	Road Markings Broken Line (W = 80 mm)	lm
08600-07	Road Markings Broken Line (W = 100 mm)	lm
08600-08	Speed Limit Marks	Number
08600-09	Toll Ahead Marks	Number
08600-10	Arrow Marks	Number

Section 08700 – Painting

1. General

This work consists of the removal of coatings and application of protective coatings to metal (including galvanizing), timber, or concrete surfaces to control corrosion or deterioration.

2. Material Requirements

2.1. Reference Standards

The following Standards in their latest editions shall be applied to the works:

- AASHTO M111 Zinc (Hot-Dip Galvanized) Coatings on Iron and Steel Products
- AASHTO M232 Zinc Coating (Hot-Dip) on Iron and Steel Hardware HM-22. ASTM A153/A153M-00
- ASTM A653/A653M-06 Steel Sheet, Zinc-Coated (Galvanized) or Zinc-Iron Alloy-Coated (Galvanized) by the Hot-Dip Process
- ASTM D3359-02 (Method A) Measuring Adhesion by Tape Test
- ASTM D4138-94 Measurement of Dry Film Thickness of Protective Coating Systems by Destructive Means
- ASTM D4285-83 Indicating Oil or Water in Compressed Air
- ASTM D4417-03 Field Measurement of Surface Profile of Blast Cleaned Steel
- ASTM E337-02 Measuring Humidity with a Psychrometer (the Measurement of Wet- and Dry-Bulb Temperatures)
- Outline of Recommendation for Concrete Repair and Surface Protection of Concrete Structure by JSCE

2.2. Materials for Painting

- (a) Only certified manufacturers approved by the Engineer shall be allowed to supply paints for the Works.
- (b) All paints shall be obtained from the same approved manufacturer, and any variation on the paint material (type, date, etc.) for a commenced work will be rejected.
- (c) In case of multiple coats painting system, each coat of paint shall be compatible with the previous one.
- (d) Galvanization of metallic elements shall, in general, conform to the requirements of AASHTO M111. A material thinner than 3.2 mm may be galvanized before fabrication, in conformity with the requirements of ASTM A653. Galvanization of iron and steel hardware and nuts and bolts shall conform to the specifications of AASHTO M232.

2.3. Submittals

2.3.1. Samples and Data

The Contractor shall provide the Engineer with technical data, and the manufacturer's specifications for his review and approval.

2.3.2. Plan for Protection of Public, Property, and Workers

At least 28 days before commencement of surface preparation for painting, the Contractor shall submit a written plan for the Engineer's approval on the measures to be used for protecting the environment, public, adjacent property, and workers. The plan shall include the following:

- (a) Manufacturer's material safety data sheets and product data sheets for all cleaning and painting products
- (b) A detailed containment plan for removed materials, cleaning products, and paint debris, including details of attachment that do not require welding or drilling holes in the existing structure; details of connections with clamps or other approved devices
- (c) A detailed disposal plan for removed materials, cleaning products, and paint debris
- (d) Specific safety measures to protect workers from site hazards including falls, fumes, fires, or explosions
- (e) If the paint being removed is a hazardous material, specific safety measures to comply with applicable environmental regulations shall be included
- (f) Emergency spill procedures
- (g) To perform quality control functions, a competent personnel with the following qualifications shall be employed by the Contractor:
 - Minimum 2 years of industrial field painting experience;
 - Minimum 90 days of field supervisory or management experience in paint removal work; and
 - Documentation of the individual's qualifications including records of training and experience.

3. Construction Requirements

The procedures described herein are for guidance only. The Contractor is required to follow the manufacturer's instructions and recommended procedures at the actual work. Any non-conformant work shall be removed and collected and properly dispose of all materials including wastewater that is used in preparations, cleaning, or painting.

3.1. Protection of the Works

The Contractor shall perform the following to protect the Works:

- Protect adjacent surfaces that are not to be painted by using tarps, screens, paper, cloth, or other suitable means; and
- Prevent contamination of freshly painted surfaces by dust, oil, grease, or other harmful or deleterious material.

3.2. Surface Preparation

The Contractor shall notify the Engineer in writing at least seven (7) days before beginning operations, shall prepare the surface, immediately before painting, according to the following:

- Clean the surface to the specified cleanliness level;
- Remove dirt, dust, and other contaminants from the surface using methods recommended by the paint manufacturer and approved by the Engineer;
- Thoroughly dry the surface;
- Determine that the surface temperature is between 10 °C and 40 °C;
- Determine that the surface temperature is 3°C or more above the dew point according to ASTM E337;
- Determine that the humidity is 85% or less, unless specified otherwise on the manufacturer's product data sheet; and
- Suitable engineering controls such as enclosures and dehumidification shall be used to provide the above required conditions.

3.3. Paint Application

The Contractor shall apply the paint according to the following:

- Use safe handling practices that conform to the manufacturer's safety data sheet and instructions. Mix and apply paint according to the product instructions. Mix paint with mechanical mixers for a sufficient length of time to thoroughly blend the pigment and vehicle together. Continue the mixing during application. Do not thin paint that is formulated ready for application.
- Paint in a neat and workmanlike manner that does not produce excessive paint buildup, runs, sags, skips, holidays, or thin areas in the paint film. Measure the wet film thickness during application and adjust the application rate.
- Use brushes that have sufficient bristle body and length to spread the paint in a uniform film.
- Use airless or conventional spray equipment with suitable traps, filters, or separators to exclude oil and water from the compressed air. Use compressed air that does not show black or wet spots when tested according to ASTM D4285. Use the spray gun tip sizes and pressures recommended by the manufacturer.
- Use rollers only on flat, even surfaces. Do not use rollers that leave a stippled texture in the paint film.
- Use sheepskin daubers, bottle brushes, or other acceptable methods to paint surfaces that are inaccessible for painting by regular means.
- Cure each coat of paint according to the manufacturer's recommendations. Correct all thin areas, skips, holidays, and other deficiencies before the next application of paint. Tint succeeding applications of paint to contrast with the paint being covered. The colour for the finish coat shall be approved by the Engineer before its application.
- Coat surfaces that will be inaccessible after erection with the full number of undercoats required before erection. After erection, thoroughly clean all areas where the undercoating is damaged or deteriorated, and spot coat these with the specified undercoats to the required thickness before applying the final coat.

3.4. Painting of Structural Iron and Steel

3.4.1. Painting Systems

- (a) New surfaces or surfaces with all existing paint removed: The paint system shown in Table 1 shall be furnished except concrete curb.
- (b) Surfaces with existing sound paint: The paint system compatible with the existing paint shall be furnished. The system shown in Table 2 or a system approved by the Engineer shall be applied.

Table 1. Structural Iron and Steel Coating Systems for New Surfaces and Surfaces with All Existing Paint Removed

Coat	Paint System (1)				
	1	2	3	4	5
	Aggressive Environments (Salt)	Aggressive Environments (Salt)	Aggressive Environments (Salt)	Less Aggressive Environments (No Salt)	Less Aggressive Environments (No Salt)
Primer	Inorganic zinc type I 75-100µm dry	Zinc rich epoxy 75-100µm dry	Moisture-cured urethane 50-75µm dry	Acrylic latex 50-75µm dry	Low VOC alkyd 50-75µm dry
Intermediate	Epoxy 75-100µm dry	Epoxy 75-100µm dry	Moisture-cured urethane 50-75µm dry	Acrylic latex 50-75µm dry	Low VOC alkyd 50-75µm dry
Top	Aliphatic urethane 50-75µm dry	Aliphatic urethane 50-75µm dry	Moisture-cured urethane 50-75µm dry	Acrylic latex 50-75µm dry	Low VOC alkyd 50-75µm dry
Total Thickness	200-275 µm dry	200-275 µm dry	150-225 µm dry	150-225 µm dry	150-225 µm dry

- (1) System 1, 2, or 3 is for corrosion protection of iron and steel in aggressively corrosive atmospheric environments such as marine, industrial, high humidity, or structures exposed to deicing salts. System 4 or 5 is for use in those environments free from high concentrations of salts or pollutants that cause aggressive corrosion environments.

VOC: Volatile Organic Compound

Table 2. Structural Iron and Steel Coating Systems for Surfaces with Existing Sound Paint

	Paint System (1)		
	6	7	8
	Aggressive Environments (Salt)	Less Aggressive Environments (No Salt)	Less Aggressive Environments (No Salt)
Primer	Moisture-cured urethane 50-75µm dry	Low VOC alkyd 50-75µm dry	Low viscosity epoxy Sealer 25-50µm dry
Intermediate	Moisture-cured urethane 50-75µm dry	Low VOC alkyd 50-75µm dry	Epoxy 75-100µm dry
Top	Moisture-cured urethane or aliphatic urethane 50-75µm dry	Low VOC alkyd 50-75µm dry	Aliphatic urethane 50-75µm dry
Total Thickness	150-225 µm dry	150-225 µm dry	150-225 µm dry

- (1) System 6 is for the corrosion protection of iron and steel in aggressively corrosive atmospheric environments such as marine, industrial, high humidity, or structures exposed to deicing salts. System 7 or 8 is for use in environments free from high concentrations of salts or pollutants that cause aggressive corrosion environments.

VOC: Volatile Organic Compound

At least 14 days before ordering paint, the Contractor shall verify compatibility of the proposed system with the existing system, as follows:

- Select a test area of at least 3 m² in a condition representative of the condition of the structure. Perform the specified level of surface preparation, and apply the proposed system to the existing topcoat and to the existing primer. Observe for lifting, bleeding, blistering, wrinkling, cracking, flaking, or other evidence of incompatibility.
- Verify that no indication of incompatibility exists at least 14 days after the application of each product. Perform adhesion tests according to ASTM D3359, method A. Notify the Engineer immediately if adhesion testing fails at the interface of the existing system and substrate or between the existing finish coat and primer. An adhesion failure indicates incompatibility. Choose a more compatible paint system.

3.4.2. Surface Preparation

The Contractor shall not remove sound paint unless specifically required by the Engineer or indicated in the Drawings.

The Contractor shall prepare the surface to be painted according to the following process:

(a) New surfaces or surfaces with all existing paint removed

- Remove all dirt, mill scale, rust, paint, and other foreign material from exposed surfaces by blast cleaning to near white metal.
- Use compressed air that is free from oil or moisture and does not show black or wet spots when tested according to ASTM D4285. Do not use unwashed sand or abrasives that contain salts, dirt, oil, or other foreign matter. Before blast cleaning near machinery, seal bearings, journals, motors, and moving parts against entry of abrasive dust.
- Blast clean with clean dry slag, mineral grit, steel shot, or steel grit. Use a suitable gradation to produce a dense, uniform anchor pattern. Produce an anchor profile height of 25 to 50 micrometers, but not less than that recommended by the paint system manufacturer's product data sheet. Measure anchor profile height using the tape method according to ASTM D4417
- On the same day when cleaning is performed, remove dirt, dust, and other debris from the surface by brushing, blowing with clean dry air, or vacuuming and apply the first coat of paint to the blast cleaned surfaces. If the cleaned surfaces rust or become contaminated before painting, blast cleaning shall be repeated.

(b) Surfaces with existing sound paint

- Wash all areas to be painted with pressurized water to remove dirt, surface chalking, loose rust, and contaminants such as chlorides. Maintain a wash water pressure of at least 3.5 MPa. Collect all wash water and remove/dispose waste according to appropriate regulations.
- Clean by an Engineer's approved method (e.g. hand tool cleaning, power tool cleaning, or commercial blast cleaning) to remove dirt, loose mill scale, loose rust, or paint that is not firmly bonded to the underlying surface. Clean small areas that show pinhole corrosion, stone damage from traffic, or minor scratches. Clean at least 50 millimeters beyond the damaged areas. Feather off edges of remaining old paint to achieve a reasonably smooth surface.
- On the same day when hand- or power-tool cleaning is performed, remove dirt, dust, and other contaminants from the surface with solvent-cleaning methods

according to SSPC-SP 1, and spot paint all bare steel areas with the first coat of paint. If the cleaned surfaces rust or become contaminated before painting, repeat solvent cleaning. Repair all damages to sound paint by applying the entire system.

3.4.3. Application of Paints

Apply each coat to the wet film thickness as recommended by the paint manufacturer to obtain the specified dry film thickness. Verify the application rate of each coat with a wet film paint thickness gauge immediately after applying paint to the surface. Confirm the application rate by measuring the dry film thickness after the solvent has evaporated from the surface.

3.5. Painting of Galvanized Surfaces

The Contractor shall apply the following process in the painting of galvanized surfaces:

- Remove all oil, grease, or other contaminants on the surface by washing with a mineral spirit solvent; and
- Apply the coating system shown in Table 3(a), under items for “Other Metals”.

3.6. Painting Timber Structures

Where painting of timber structures is required by the Engineer or is shown in the Drawings, the Contractor shall apply the following process:

- Dry timber to a moisture content of 20% or less. On previously painted timber, remove all cracked or peeled paint, loose chalky paint, dirt, and other foreign materials by wire brushing, scraping, or other approved methods. On timber treated with creosote or oil-borne pentachlorophenol preservative, wash and brush away visible salt crystals on the wood surface and allow drying. Remove all dust or other foreign materials from the surface to be painted.
- Apply the coating system shown in Table 3(a). The primer may be applied before erection. After the primer dries and the timber is in place, fill all cracks, checks, nail holes, or other depressions flush with the surface using approved putty. Evenly spread and thoroughly work the paint into all corners and recesses. Allow the full thickness of the applied coat of paint to dry before applying the next coat.

3.7. Painting Concrete Structures

Where painting of concrete structures is required by the Engineer or is shown in the Drawings, the Contractor shall apply the following process:

- Remove all laitance, dust, foreign material, curing compound, form oil, grease or other deleterious materials from the concrete surface. Remove form oil, grease, or curing compound by washing with a 5% solution of trisodium phosphate and rinsing with clean water. Allow the surface to dry completely.
- Give the cleaned surface a light abrasive sweep to remove mortar wash or other contaminants. Remove all residues and dust by hand, broom, compressed air or other approved methods.
- Apply the coating systems shown in Table 3(a). Evenly spread and thoroughly work the paint into all corners and recesses. Allow the full thickness of the applied coat of paint to dry before applying the next coat.

Table 3 (a) Coating Systems for Other Structures

Substrate	Paint Coatings			
	Primer	Intermediate	Finish	Total Thickness
Smooth Wood	Exterior wood primer (1) 60-70 μ m dry	Exterior latex or alkyd 35-50 μ m dry	Exterior latex or alkyd 35-50 μ m dry	130-170 μ m dry
Rough Lumber	Exterior latex or alkyd(1) 35-50 μ m dry	Exterior latex or alkyd 35-50 μ m dry	Exterior latex or Alkyd 35-50 μ m dry	105-150 μ m dry
Concrete	Refer to Table 3 (b)			Refer to Table 3 (b)
Masonry Block	Masonry block filler 50-60 μ m dry	Exterior latex or alkyd 35-50 μ m dry	Exterior latex or alkyd 35-50 μ m dry	120-160 μ m dry
Aluminum	Metal primer 30-40 μ m dry	Exterior latex or alkyd 35-50 μ m dry	Exterior latex or alkyd 35-50 μ m dry	100-140 μ m dry
Other Metals	Metal primer (2) 35-45 μ m dry	Exterior latex or alkyd 35-50 μ m dry	Exterior latex or alkyd 35-50 μ m dry	105-145 μ m dry

- (1) For untreated wood, thin the primer with up to 0.1 liter of turpentine and 0.1 liter of linseed oil per liter of paint.
- (2) For galvanized surfaces, use an epoxy primer (35-45 micrometers dry thickness) or a vinyl wash primer (7-13 micrometers dry thickness).

Table 3 (b) Specification of Water System Acrylic Rubber for Concrete Curb

Layer	Material	Usage (kg/m ²)	Thickness (μ m)		Coating Tool
			Wet	Dry	
Primer	Water system epoxy resin	0.1	-	-	Roller
Main coat 1	Water system acrylic rubber	0.5	340	161	Roller
Main coat 2	Water system acrylic rubber	1.5	1020	484	Roller
Top coat	Water system acrylic silicon resin	0.2	160	59	Roller

Layer	Painting Interval		Pot Life		Interval
	35 $^{\circ}$ C	5 $^{\circ}$ C	35 $^{\circ}$ C	5 $^{\circ}$ C	
Primer	12Hr -	24Hr-	About 1Hr	About 2Hr	Each process within 7 days
Main coat 1	2Hr-	6Hr-	About 0.5Hr	About 0.5Hr	
Main coat 2	6Hr-	24Hr-	About 0.5Hr	About 0.5Hr	
Top coat	—	—	No pot life	No pot life	

3.8. Acceptance of Painting

The dry paint thickness on steel structures will be determined according to ASTM D4138. Test locations used for testing for acceptance shall be repaired in an approved manner.

3.9. Galvanization

3.9.1. Surface Preparation for Galvanization

The specifications, requirements and procedures for surface preparation described above for painting shall apply also for galvanizing works.

3.9.2. Galvanizing Procedure

- (a) Except for pre-galvanized standard pipe, galvanization of material 3.2 mm thick or thicker shall be performed after fabrication into the largest practical sections.

- (b) All welded areas shall be thoroughly cleaned prior to galvanizing to remove all slag or other materials that would interfere with the adherence of the zinc. When it is necessary to straighten any sections after galvanizing, such work shall be performed without damage to the zinc coating.
- (c) Galvanizing surfaces that are abraded or damaged at any time after the application of the zinc coating shall be repaired by thoroughly wire brushing the damaged areas and removing all loose and cracked coating, after which the cleaned areas shall be painted with three applications of zinc anticorrosive paint as approved by the Engineer.

4. Measurement and Payment

- (a) Painting and galvanization shall not be measured for direct payment.
- (b) Performance of this work shall not be paid for separately, but shall be deemed as a subsidiary obligation of the Contractor for which full payment is included in the applicable unit prices indicated on the Bill of Quantities for the work items in which it is called for or required.

Section 08800 - Fences and Gates

1. Description

This work consists of constructing permanent fences and gates and removing and resetting fences.

2. Material

Specification for materials shall be AASHTO or equivalent specification approved by the Engineer.

The materials shall conform to the followings:

1) Chain Link Fence

Furnish fabric, posts, rails, ties, bands, bars, rods and other fittings, and hardware conforming to AASHTO M 181. Furnish 4.5-mm coiled spring steel tension wire conforming to ASTM A641 hard temper with a Class 3 galvanized coating. Use the same coating on the tension wire as used on the rest of the chain link fence.

2) Fence Gates

For frame gates using chain link fabric, conform to AASHTO M 181. Use the same chain link fabric in the gate as in the fence.

3) Fence Posts (steel)

For line fence posts, conform to AASHTO M 281. For chain link fence, conform to AASHTO M 181.

4) Minor concrete (Refer to Division 06 Concrete Works)

3. Construction Requirements

3.1 General

Clear along the fence line. Remove and dispose of trees, brush, logs, upturned stumps, roots of downed trees, rubbish, and debris according to Section 02100 Site Clearing. Clear a 1 m width for chain link fence.

Grubbing is not required, except where short and abrupt changes in the ground contour require removal of stumps to properly grade the fence line. Remove or cut stumps according to Section 02100 Site Clearing.

Perform clearing and leveling with minimum disturbance to the terrain outside the fence line.

Schedule the fence installation, provide temporary fence, or other adequate means to prevent outside people from entering the project right-of-way, easements, or adjoining properties.

At bridges, connect new fence to structure to permit maintenance people to enter the bridge areas.

3.2 Chain Link Fence and Gates

1) Posts

Space posts at not more than 3 m intervals. Measure the post spacing interval horizontally. Set posts vertically. Set posts in concrete according to Division 06 Structural Concrete.

2) Top Rail

Install top rails through the loop caps of the line posts, forming a continuous brace from end-to-end of each stretch of fence. Join lengths of top rail with sleeve-type couplings. Securely

fasten top rails to terminal posts by pressed steel fittings or other appropriate means.

3) Tension Wire

Attach tension wire to end, gate, corner, or pull posts by bands and clamps. Either thread the top tension wire through the line post loop caps or hold in open slots in a manner to limit vertical movement. Tie or attach the bottom tension wire to the bottom of the line posts by ties or clamps in a manner that prevents vertical movement. Apply sufficient tension to avoid excess sag between posts. On the top tension wire, provide one turnbuckle or ratchet take-up in each run of fence.

4) Fence Fabric

For fences placed on the right-of-way, place fence fabric on the post face away from the highway. On curved alignment, place the fence fabric on the post face on the outside of the curve. For residential fences and fences off the right-of-way, place fence fabric on the post face designated by the Engineer.

Place the fabric approximately 25 mm above the ground and on a straight line between posts. Excavate high points of the ground to maintain grade. Do not fill in depressions without prior approval.

Stretch the fabric taut and securely fasten the fabric to the posts. Do not stretch using a motor vehicle. Use stretcher bars and fabric bands to fasten to end, gate, corner, and pull posts or weave the fabric into the fastening loops of roll-formed posts.

Fasten fabric to line posts using wire ties, metal bands, or other approved method. Fasten the top and bottom edge of the fabric with tie wires or hog rings to the top rail or tension wires as applicable.

Join rolls of fabric by weaving a single strand into the ends of the rolls to form a continuous mesh.

5) Gates

Fasten fabric to the end bars of the gate frame by stretcher bars and fabric bands. Fasten fabric to the top and bottom bars of the gate frame by tie wires similar to the method specified for fence fabric or by other approved standard methods.

Thoroughly clean welded connections on gate frames where the smelter coating has been burned with a wire brush. Remove traces of the welding flux and loose or cracked smelter. Paint the cleaned areas with two coats of zinc-oxide paint.

Provide a concrete footing for the drop-bar locking device on double metal gates. Make a hole to receive the locking bar to the depth specified by the manufacturer of the locking device.

Hinge each single gate to prevent removal of the gate without tools. Set the gate in an approximately horizontal plane. Set the gate so it swings freely inward and outward and fastens securely in its latch holder, or in the case of double gates, in its latch holder and gate stops. Set double gates on their respective hinge pintles to provide a common horizontal plane in which each single gate swings. Set gates to swing open at least 90 degrees in each direction.

3.3 Chain Link Remove and Reset Fence

At required locations, remove existing fence and reset to approximately the same condition as the original fence. Salvage material in the existing fence and incorporate the material into the reset fence. When posts are set in concrete, remove concrete from old post and reset in new concrete. Replace fence material damaged beyond reuse. Firmly reset posts on new alignment. Space posts and attach the horizontal members or wires to posts the same as the original fence. Furnish and use new material to fasten members or wires to posts.

4. Measurement

Unless otherwise specified, fences shall be measured by the length in meters of each type of fence and gates by the number of each type and as accepted by the Engineer.

5. Payment

The unit rate of payment for each item of work shall be full compensation for all labour, equipment, tools, materials, and incidentals necessary to complete the work including painting.

The Pay Items and Pay Units shall be as follows;

Pay Item	Description	Unit
08800-01	Boundary Fence	Lm
08800-02	Fence Gate	Number

Section 08910 - Sidewalks

1. Description

This work consists of constructing sidewalks with aggregate, sand and precast concrete paving blocks.

2. Materials

2.1 Soil Aggregate

The Contractor shall furnish a suitable, well-graded, free draining material conforming to the following:

- (a) Maximum particle size 30 mm
- (b) Material passing 75- μ m sieve 10.0 % max.

AASHTO T 27 and AASHTO T 11

2.2 Sand, Sand Compacted

The Contractor shall furnish a suitable, well-graded, free draining material conforming to the following:

- (a) Maximum particle size 10 mm, 300 mm
- (b) Material passing 75- μ m sieve, 10.0 % max.

AASHTO T 27 and AASHTO T 11

2.3 Precast Concrete Paving Block

The precast concrete block shall conform to:

ASTM C 1319, Concrete Grid Paving Units.

Dimensions will be 300x300 mm, with nominal thickness of 60 mm.

2.4 Hardcore with compacted sand

The Contractor shall furnish a suitable, well-graded, free draining material conforming to the following:

- (a) Maximum particle size 200 mm
- (b) Material passing 75- μ m sieve 10.0 % max.

AASHTO T 27 and AASHTO T 11

2.5 Exposed aggregate of footpath

This material shall follow the drawing, or shall be approved by engineer.

3. Construction Requirements

3.1 General

The Contractor shall excavate and backfill according to Division 03 Earthworks. Place and compact soil aggregate in layers to the thickness indicated in the Drawings. Place and compact sand accordingly. Compact each layer with at least three passes of a light weight mechanical tamper, roller or vibratory system.

3.2 Precast Concrete Paving Blocks

Lay the concrete blocks in successive courses on a prepared surface. Lay each course to grade. Sweep and inspect the surface before the bed sets. Remove and replace imperfect blocks.

3.3 Exposed aggregate of footpath

The sidewalk surface shall be uniform. After construction, the surface shall be kept continuously wet by ponding, spraying, or covering.

4. Measurement and Payment

4.1 Measurement

This work shall be measured in a square meter basis, complete and accepted in place, based on neat lines shown in the Drawings.

4.2 Payment

Precast concrete blocks for sidewalks and Exposed aggregate of footpath shall be in accordance with the applicable Unit Prices as indicated on the Bill of Quantities for work measured as prescribed above and approved by the Engineer, which price shall include precast concrete paving blocks, soil aggregate, sand, equipment, tools, labor and all incidentals necessary to complete the work.

Excavation, backfilling, disposal of surplus materials and other miscellaneous items for this work are considered as incidental to the cost of the work.

Pay Item	Description	Unit
08910-01	Precast Concrete Sidewalk	m ²
08910-02	Exposed aggregate of footpath	m ²

Section 08920 - Concrete Kerb

1. Description

This work consists of the construction of concrete kerbs.

Moreover, this work shall also include kerb markings of red and white paint where shown on the Drawings or where indicated by the Engineer.

2. Material Requirements

2.1. Reference Standards

The following Standards in their latest editions shall be applied to the works covered by this Specification.

AASHTO M033 Preformed Expansion Joint Filler for Concrete (Bituminous Type)

AASHTO M248 Ready-Mixed White and Yellow Traffic Paints

2.2. Bedding

The thickness of bedding material shall be in accordance with the requirements shown in the Drawings or as indicated by the Engineer.

2.3. Concrete

Concrete shall be as shown in the Drawings and shall be in accordance with the provisions and requirements of Specification Section 06100 "Structural Concrete".

2.4. Cement Mortar

Cement mortar, shall be in accordance with the provisions and requirements of Specification Section 08010 "Mortar and Grout".

2.5. Kerb Paint

Unless otherwise indicated in the Drawings, or by the Engineer, paint for kerbs shall be in accordance with the specifications of AASHTO M248 and Specification Section 08700.

3. Construction Requirements

3.1. Concrete Kerbs

- a. Excavation shall be made to the required depth, and the base shall be compacted to a firm even surface.
- b. All soft and unsuitable materials shall be removed and replaced with material that complies with the provisions and requirements of its respective specifications, and as approved by the Engineer.
- c. If so indicated in the Drawings, the bed course material shall be placed and compacted to form a uniform bed course of the required thickness.
- d. Mortar joints shall be filled for the whole cross section, and the joint shall be of 10 mm width.

- e. The finished work shall be true to line, grade and level to within 3 millimetres and shall present a smooth appearance free from kinks and distortions visible to the eye.
- f. Concrete shall be in accordance with the provisions and requirements of Specification Section 06100 “Structural Concrete”

3.2. Kerb Markings

- a. Paint shall be applied on the surface that is thoroughly clean and dry as indicated in the Drawings or required by the Engineer. All loose and detritus matter shall be removed prior to paint application.
- b. Applications shall not be made over old paint markings that are incompatible with the new paint being applied.
- c. If a primer or undercoat is necessary to ensure proper adhesion or discolouring, it shall be fully compatible with the concrete surfaces and the paint being applied.
- d. Paint shall be applied at the rate of application recommended by the manufacturer and approved by the Engineer.
- e. All paint shall be thoroughly mixed in the field to keep pigments in uniform suspension.
- f. The use of thinners or other additives will not be permitted unless otherwise approved by the Engineer.

4. Measurement and payment

4.1. Method of Measurement

a. Concrete Kerbs

Concrete Kerb Type A-1, Type A-3 and Type C shall be measured for payment by the length in linear meters of the structures of each type completed in place and accepted by the Engineer. Measurement shall be made along the centre of the kerb. No deduction shall be made for drainage structures installed in the kerbs, or for flattening of kerbs for entrances, or for kerb drainage inlets, or for flanged-end sections.

b. Concrete Kerb Type A-2

Concrete Kerb Type A-2 shall be measured for payment by the actual number installed and accepted by the Engineer.

c. Concrete Seal

Concrete Seal shall be measured for payment by the actual area per square meter completed and accepted by the Engineer.

d. Medians

Medians shall be measured for payment by the length in linear meters of the structures of each type completed in place and accepted by the Engineer.

4.2. Basis of Payment

Payment shall be full compensation for the completed and approved work, including:

- a. All excavation, backfilling, tamping, and bedding (in case of Concrete Kerb, Seal under Flyover Bridge and Median),

- b. All paints of required colours and quality, preformed expansion joint filler (in case of Kerb Marking), and
- c. Furnishing and placing all materials, and bedding, mortar, labour, equipment, tools, and any other incidentals to complete the work in accordance with the Drawings and Specifications, and as directed by the Engineer.

The Pay Items and Pay Units shall be as follows;

Pay Item	Description	Unit
08920-01	Concrete Kerb Type A-1	lm
08920-02	Concrete Kerb Type A-2	Nos.
08920-03	Concrete Kerb Type A-3	lm
08920-04	Concrete Kerb Type A-4	Nos.
08920-05	Concrete Kerb Type A-5	lm
08920-06	Concrete Kerb Type B-1	lm
08920-07	Concrete Kerb Type B-2	Nos.
08920-08	Concrete Kerb Type B-3	lm
08920-09	Concrete Kerb Type C	lm
08920-10	Concrete Kerb Type D	lm
08920-11	Concrete Kerb Type E	lm
08920-12	Concrete Seal (t = 100 mm, with Wire Net)	m ²
08920-13	Concrete Seal (t = 70 mm)	m ²
08920-14	Median Type A	lm
08920-15	Median Type B	lm
08920-16	Median Type C	lm

Section 08950 – Installation of Measuring Devices for Simplified Monitoring

1. Description

1.1 General

The Contractors shall arrange measuring devices in order to obtain historical data of deformations and configure measurement system for simplified monitoring. Furthermore, they shall perform calibration of arranged measuring devices and validation of the entire system, then hand over them for operations/maintenance with their operation manuals.

1.2 Specifications of measuring devices

Figure-1 and Figure-2 show the specifications of measuring devices and measurement system respectively, or device provision and measurement system shall be fully equivalent or more than to the specific requirements below. At the installation of measuring devices, measurement range also shall be arranged in view of the behaviors of target structures for measurement. Moreover, anti-thief measures should be taken.



Item	Inclinometer (type A)	Inclinometer (type B)	Displacement Sensor	
Installation place	Main tower 2 locations	Abutment	2 locations	
Device	Range	$\pm 5^\circ$	$\pm 1^\circ$	100mm
	Direction	2 directions(xy axis)	2 directions(xy axis)	1 direction(x axis)
	Accuracy	0.025°	0.005°	0.5mm
	Others	With temperature sensor	With temperature sensor	Optional temperature sensor is required
	Reference diagram	 KB-5EBT	 KB-1ACT	 FDP-100A
Data Logger	Specifica tion	2 data recorders ※Standard Output $1 \times 10^{-6} \text{ } \epsilon$	2 data recorders ※Standard Output $1 \times 10^{-6} \text{ } \epsilon$	
	Reference diagram	 Switch box CSW-5B Hand type data logger TC-32K	 Switch box CSW-5B Hand type data logger TC-32K	

Figure-1: Reference Specification of Measuring Devices

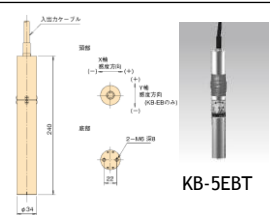
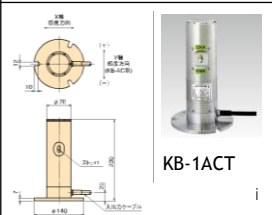
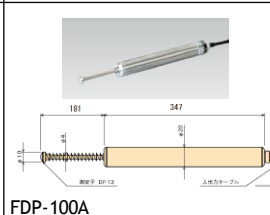

Sample of Measurement Data (Excel)

	A	B	C	D	E	F
1	Date Time	CH00	CH01	CH02	CH03	CH04
2	2017/7/5 11.32.10	2	2	2	2	2
3	2017/7/5 11.32.13	1001	1001	1001	1001	1001
4	2017/7/5 11.32.16	1999	1999	2000	2000	2000
5	2017/7/5 11.32.19	2998	2999	2999	2999	2999
6	2017/7/5 11.32.20	3997	3997	3998	3998	3998
7	2017/7/5 11.32.23	4996	4996	4997	4997	4997
8	2017/7/5 11.32.27	9989	9990	9991	9992	9993
9						
10						

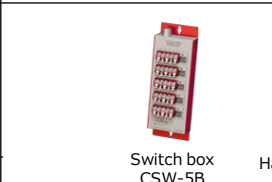
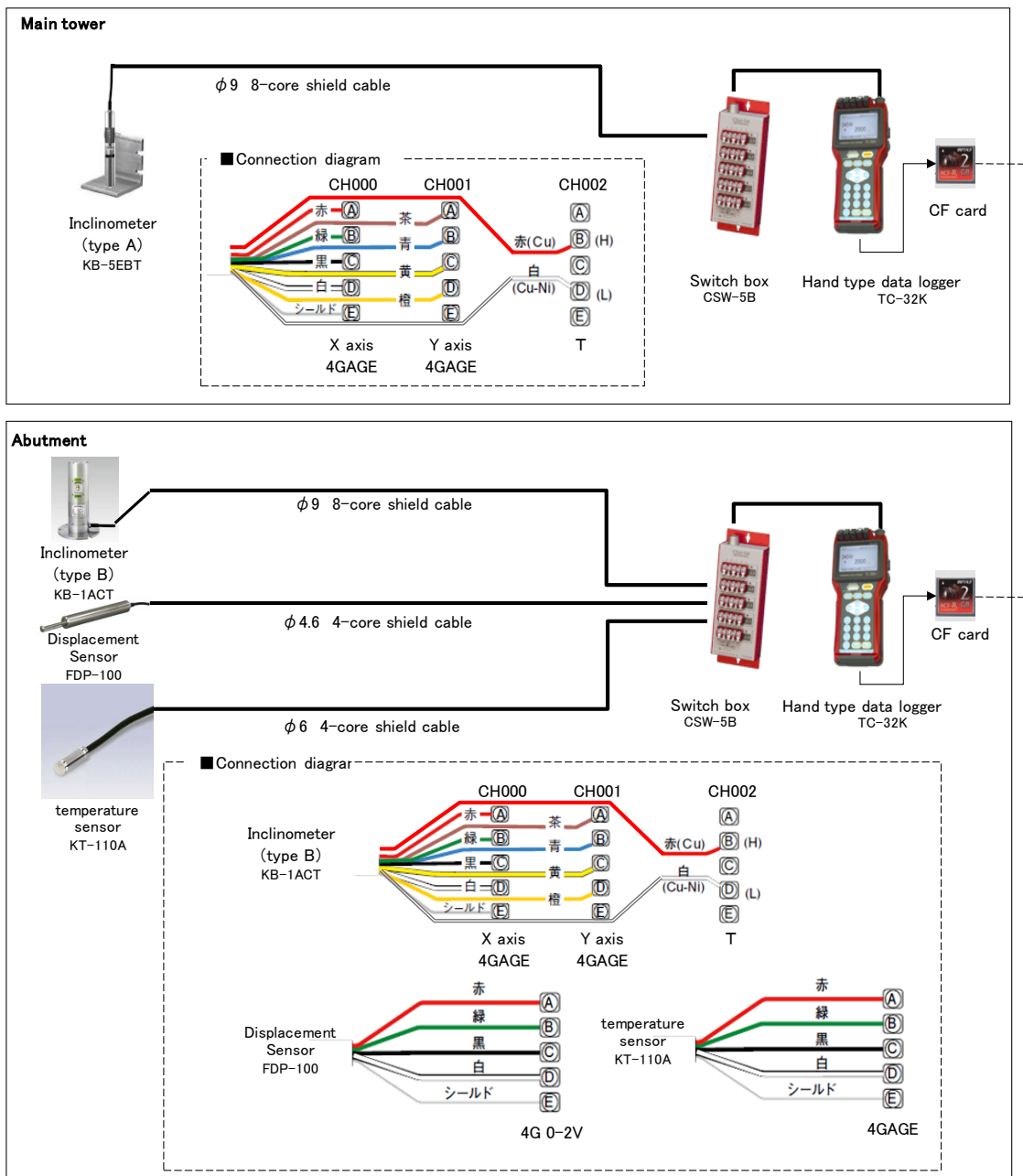

PC
Odata editing using Excel etc.

Figure-2: Measurement System Diagram

2. Requirements of device installation

2.1 Installation of Devices

The Contractors shall arrange measuring devices in order to obtain historical data of deformations and configure measurement system for simplified monitoring. Furthermore, they shall perform calibration of arranged measuring devices and validation of the entire system, then hand over them for operations/maintenance with their operation manuals.

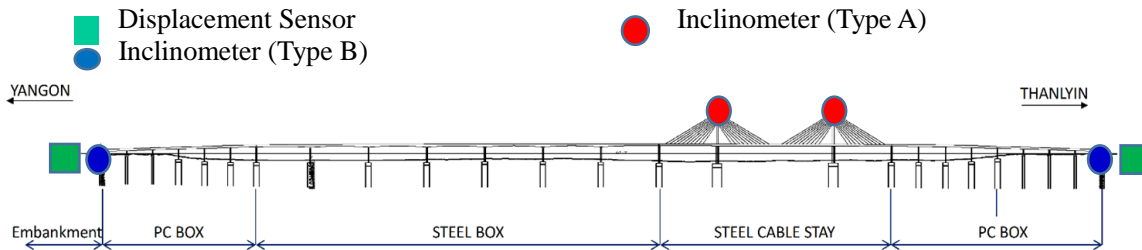

Note: Exact locations for device installation and setting shall be confirmed at the Site by the Engineer, referring to the Contractor’s proposal.

The installation of devices and quantities are summarized as below:

Device Installation	Package-1		Package-2
	Main Tower	Abutment	Abutment
1) Inclinometer	2 sets: Type A	1 set: Type B	1 set: Type B
2) Temperature sensor	2 sets: Sensor	1 set: Sensor	1 set: Sensor
3) Displacement sensor	N/A	1 set: Sensor	1 set: Sensor
4) Temperature sensor	N/A	1 set: Sensor	1 set: Sensor
5) Switch box	2 sets: box	1 set: box	1 set: box
6) Hand type data logger	2 sets: Data logger	1 set: Data logger	1 set: Data logger
7) Compact flash	2 sets: each	1 set: each	1 set: each
8) Metal fittings	as required	as required	as required
9) Connecting cables	as required	as required	as required

2.2 Other Requirements

The installation shall include the following works and items:

1) Validation of system

The Contractor, while calibrating arranged measuring devices, shall perform validation of the entire system before handing-over of entire system to the Employer, in order to verify if all the measuring devices operate normally or not.

2) Formulation of operation manuals

The Contractor shall prepare and supply operation manuals, which enable the ordering party to operate measurement system independently.

3) The Contractor shall provide the facilities for anti-theft.

3. Measurement and payment

3.1. Method of Measurement

Monitoring devices installed shall not be measured separatory, but shall be paid in a lump sum.

d. Concrete Seal

3.2. Basis of Payment

Payment shall be full compensation for the completed and approved work, including:

- a. Procurement and installation of all devices required,
- b. Furnishing and placing all materials, and labour, equipment, tools, and any other incidentals to complete the work in accordance with the Specifications, and as directed by the Engineer.

The Pay Items and Pay Units shall be as follows;

<u>Pay Item</u>	<u>Description</u>	<u>Unit</u>
08950-01	Simplified Monitoring for Package 1	Lump Sum
08950-02	Simplified Monitoring for Package 2	Lump Sum

Division 9
Lighting and Electrical Works

Table of Contents

Section 09100 – Road Lighting System.....1

Section 09200 – Traffic Signal Control System.....26

Section 09100 – Road Lighting System

1. General

1.1 General

The work shall consist of furnishing, installing, modifying, relocating, or removing all materials and equipment necessary to complete in place lighting systems, aviation obstruction lights, lightning protection system, substation, emergency generator set, conduits, and electrical systems or provisions for future systems, when so specified, all in accordance with the Engineer. Unless otherwise noted, civil construction works necessary for this work shall comply with the following clauses.

Regarding the locations of lighting, distribution panels, and appurtenances shown in the Drawings, their final locations will be established by the Engineer in the field with the support by the survey team and survey data provided by the Contractor.

The electrical works for roadway lighting shall be executed in accordance with the Specifications.

Payment under this Clause for lighting cables will terminate at the distribution panel and connected in the hand-hole of the each pole

1.2 Scope of Works

The scope of work shall cover the supply, delivery to site, erection, test and commissioning of all material and equipment in connection with the electrical installation to the extent described and shown in the Drawings or other relevant documents and includes but is not necessarily limited to:

- (a) Preparation and submission of shop drawings
- (b) Submission of detailed material supply lists
- (c) All work associated with the removal of section of existing systems and the incorporation of the remaining section in the permanent works.
- (d) Site measurement of ambient brightness of natural daylight at site each section to assist the Engineer in his review of the lighting details shown in the Drawings or other relevant documents

All other electrical equipment and services needed to complete a usable and operable facility in accordance with the relevant standards of International Electrotechnical Commission (IEC) or equivalent standards for electrical installation.

The Contractor shall take countermeasures against phenomenal of Karman Vortex to the bridge lighting poles. The Contractor shall prepare and submit the related data and its remedy, as required by the Engineer.

Power capacity listed in the Drawings, the Specifications or other relevant documents for reference only. The Contractor shall provide the necessary capacity based on the Contractor's design and submit these related data to the Engineer for approval.

The Contractor shall owe the works of all equipment and devices for power factor correction to feed power to motors, necessary equipment or facilities to compensate power factor at the incoming point from Yangon City Electricity Supply Board (YESB) for targeted power factor.

And the Contractor shall owe the related all costs. The Contractor shall negotiate with YESB and decide the targeted power factor between both parties.

1.3 Quality Assurance

For the actual fabrication, installation, and testing of the work described in this Clause, the Contractor shall use only thoroughly trained and experienced personnel who are completely familiar with the requirements for the work and with the installation recommendations of the manufacturers of the specified items. In acceptance or rejection of the installed electrical system, no allowance will be made for lack of skill on the part of installers.

Installers shall hold the relevant veiled certificates complying with the regulations of all concerned YESB.

All work shall comply with the Drawings and this Specification, in addition to complying with the requirements of YESB, exploitation units and local government authority

1.4 Drawings and Documents

- 1) The Contractor shall refer to all relevant drawings to ascertain for himself the location and routes of all other utility services so as to maintain adequate clearance between electrical and other services.

The drawings supplied are to indicate generally the arrangement of the work. The Contractor shall therefore require to all underground or under bridge cables and conduits or ducts, the exact run of all conduits and trunking, the location of manholes, handholds, draw-in and junction boxes, the number and size of wires in each conduit or trunking, the final connection arrangements at distribution boards, the detail of ducts and the method of fixing main and sub-main distribution boards, for the approval of the Engineer before commencing any portion of the work.

All such working drawings shall be submitted in duplicate and within the periods established in the Programme, or accepted by the Engineer.

Details of duct, conduit and method of fixing main and sub-main distribution boards and cable entry into any places.

The Contractor shall submit a program indicating the dates on which concreting in different sections will take place, together with the submission of the working drawings.

- 2) After the Test on Completion is duly performed in accordance with Clause 9 of the Conditions of Contract, the Contractor shall prepare and submit to the Engineer the "as built" drawings of plans and circuit diagrams in accordance with the specifications Section 01200 Contractor's Drawings and all related clauses of the Conditions of Contract.
- 3) Upon completion of the work, and as a condition of its acceptance, the Contractor shall supply to the Engineer three copies of a manual for the maintenance and operation of all electrical installations and a parts list sufficient for the ordering of parts.

1.5 Standards and Regulations

- 1) The work covered by this Contract shall be carried out in accordance with the latest version of standards issued by IEC60364 series and IEC61200 series, or equivalent standards. They are the following:

- Proceedings of IEC60364-1 and IEC61200 series;

- The latest version of IEC60364-7-714;
- The latest version of the Road Laws;
- The latest version of the River Laws; and
- The latest version of the Park Laws.

- 2) Before submitting his Bid, the Contractor must carefully examine at his own expense all of the regulations and selected materials and method of installation shall be in accordance with these regulations.

The Tenderer shall include in his unit price for any changes or modification of contract documents to ensure conformance with the Engineer.

1.6 General Requirements

- 1) The requirements for quality control of materials and workmanship that are obligatory for the satisfactory completion by a Contractor of the electrical works and other defined work items required for arterial or roadway of the project, shall be defined in accordance with the plans and specifications herein described.
- 2) All work hereunder shall comply with the latest Building codes, Electrical codes, and other relative codes, in case of the absence of any code in the locally.

All work shall be done under the administrative supervision of the Engineer.

Any changes made thereof shall be with the approval in writing of the Engineer.

- 3) The Requirements shall be as follows:

All electrical installation shall be done in accordance with the applicable ordinances, rules and regulations of YESB. The electrical work shall be under the supervision of a licensed Electrical Engineer.

Cables and wires conductors shall be 2.5 mm² minimum and stranded types used and all cable shall be conforming applied specification to IEC 60502-1-am (2009) or JIS C3667-1 (2008) or both.

Total voltage Drop shall be 5 % maximum, including:

- Between of the supply point / SS panel and MDP panel or LP panel shall be less than 2 % any type of feeders;
- Between LP panel and the end of lighting circuit shall be less than 3 % maximum, any type of cables;

Necessary wiring devices such as pull boxes, junction boxes, and utility boxes of correct dimensions shall be provided.

2. 6.6kV Power Line and Substation

An electrical power supply system to suite the project's scope and substation system requirements has been planned using branch connections from the 6.6 kV overhead distribution lines.

The system shall also include the materials supply, installation, and commissioning by the Contractor to a performance specification.

Payment for the Section of the Works will be by lump sum incorporating the following items of equipment and work:

2.1 General

- 1) A substation electrical system, as shown in the Contract Documents, shall consist of lightning arresters, 6.6 KV based switches, transformer, high tension overhead cables, grounding system, isolators, protection devices, service metering panel and termination materials.
- 2) Primary 6.6kv Overhead Line System shall be the followings:

A set of 6.6kV power cable shall be connected to a terminal located at a 12 m high concrete pole of the 6.6 kV distribution lines of YESB to the project area whence it will be terminated as shown in the Contract Documents.

The pole mounted substation will contain lightning arresters, 6.6KV based 6.6kv fuse disconnection switches, splicing, isolator materials and watt-hour meter (low voltage) as shown in the Contract Documents.

All materials shall be shown in the Contract Documents or equivalent or both as approved by the Engineer.

2.2 Transformer

An oil-cooled transformer installed on the incoming concrete pole shall be shown in the Contract Documents or equivalent as approved by the Engineer.

2.3 Secondary Low Voltage 415/240 Volts, 50HZ Distribution System

- 1) Secondary voltage system, AC 415/240 volts, 3-phase, 4 wires system and 50 Hz, shall feed the power to the MDP of the distribution system, as shown in the Contract Documents.
- 2) The distribution system at the secondary transformer switching gear shall be point of metering measure interface with YESB at the substation.
- 3) The cabling of distribution power system from the secondary low voltage switching gear to MDP for the bridge and roadway facilities equipment will be installed as shown in the Contract Documents.

All distribution power system will be shown in the Contract Documents, unless otherwise of the equivalent method as approved by the Engineer.

3. Lighting Units

3.1 General

Lighting units as shown in the Contract Documents shall consist of luminary housing, light bulb, electrical control ballast(s), and mounting accessories.

The Contractor shall submit for approval, detailed light distribution diagrams such as Illuminating Engineering Society (IES) type II or equivalent type for each type of lantern he proposes to install. Furthermore, calculations shall be submitted showing the horizontal luminance at arterial street and roadway, level and the luminance distribution in candela per square-meter (cd/m²) for every two (2) m in arterial street and roadway direction and every 1.5 m across the roadway.

- 1) The type of lighting unit for roadway lighting shall be shown in Table 5.3.1 and shall be detailed in the Contract Documents.

Table 1. Type of Lightning Unit

Type of luminary housing	Applied lighting pole	Installation location of foundation	Type of foundation
Type -L11	Mounted on 11m	Bridge section	Pre-constructed
Type -L12	Mounted on 11m	Subgrade section	Site constructed
Type -L13	Mounted on 12m	Main Bridge section	Pre-constructed
Type -L10	Mounted on ceiling	Under bridge	Not applied

The Luminary housing for Light Emitting Diodes (LED) lamp 150 watts shall be made of anodized extruded aluminum and each optical compartment shall be a protector made of hardened glass sealed onto a refractor made of deep drawn, polished and anodized aluminum. The control gear shall be removable. The lantern shall be installed directly on a pole.

The minimum required characteristics of lantern shall be the following:

- Optical compartment tightness level: IP 65 (/1)
 - Control gear tightness level: IP 43 (/1)
 - Aerodynamic resistance: Proposed by the Contractor by design
 - Impact resistance (Glass): IK08 (/2)
 - Electrical Insulation Class: I of II (/1)
- 2) Notes:
- a) IEC60589 Luminaries, General Requirements and Tests
 - b) IEC62262 Degree of Protection Provided by Enclosures for Electrical Equipment against External Mechanical Impacts (IK Code)

The outline dimensions of lighting lantern shall be shown in the Contract Documents.

- 3) The Contractor shall submit the all data of lantern to be required as shown in the following below, or for approval by the Engineer.

The calculation factors for luminance calculation on the roadway shall be the following.

- a) Road Condition: Dark (Road Surrounds at a Collector Road)
- b) Average Luminance: 1.0 cd/m²
- c) Overall Luminance Uniformity U_0 : Shall not be smaller than 0.4
- d) Required Luminance Uniformity on lane axis U_1 (L_{min} / L_{mas}): Shall not be smaller than 0.5
- e) Required Disability Glare (TI): Shall not be bigger than 15%
- f) Type of road surface: Asphalt

4. Electrical Power Distribution

1) Main Distribution Panel (MDP) and Lighting Panel (LP)

The Main distribution panels (MDP) shall be included as feeders of the power source fed each to the Lighting panel (LP), circuits of the roadway lighting and street lighting. The panels shall be as shown in the Contract Documents or equivalent as approved by the Engineer.

The panels shall be ventilated and shall be substantial, free-standing structures mounted on a concrete foundation a minimum of 40 cm above ground level, or as approved by the Engineer.

The roof of Panel house shall be double pitched, the apex being central to the panel.

The panel and door shall be made from fully- finished steel sheet not less than 3.2 millimeters in thickness with the necessary steel frames. The welding for all outside joints shall be smooth finished.

The panel shall have a bottom design that will permit tack welding to channels that shall be set on the raised concrete foundation as shown in the Contract Documents.

The panel shall be completely assembled and wired at the factory. Main and small wiring shall be easily accessible for maintenance and inspection, and small wiring shall be effectively isolated from the main wiring. The wiring diagram, engraved or etched on an aluminum plate, shall be permanently fixed to the inner door of the panel. Each panel shall have one or more nameplates for identification. Nameplates shall be made of laminated plastic with white characters to show through a black top layer when cut or engraved.

Panel housing shall be fitted with a mastered pad lock.

2) Components of devices

The Main distribution panel (MDP) and lighting panels (LP) shall be as shown in the Contract Documents. The components shall be designed for 3-phase, 50 Hertz operation volts at AC 380/220 volts.

3) Circuit Breakers

The circuit breakers shall be molded case, air break type, rated for 460volt A.C service. The circuit breakers shall have 3-poles unless otherwise noted. Each phase shall be provided with independent circuit breakers in order to prevent total failure in the event that a single phase fails.

The circuit breakers shall be provided inverse time tripping for overloads and instantaneous action and overload ten times of the normal rating.

The circuit breakers shall be arc resisting contact type and be provided with trip-free operating handles and arc quenchers.

The circuit breakers interrupting capacity shall be 15,000 amperes based in IEC 60947-2:2003, JIS C8201:2004, standard duty cycles, except that breakers large than 100 amperes shall have 25,000 amperes interrupting capacity, or as approved by the Engineer.

The breakers for the main power feeders shall be provided with auxiliary contact that will close when the breakers are closed and 380 volts shunt trip coil. They shall be wired to prevent either breaker being closed while the other is closed.

4) Control Equipment

Multiple lighting circuits shall be controlled by a combination of time switch and remote control relays which shall be installed in the distribution panel (MDP).

5) Timer Switch

Timer switch unit shall have two control elements, one of switch shall be for "on" control at evening and "off" at early morning, and the other which shall be for reduced current control at midnight for saving energy, all as shown in the Contract Documents.

Both "on" and "off" time setting shall be available for any of the 24 hours, and the minimum setting increment shall be one minute.

Timer switches shall be operated on single phase, 220 volts, 50 Hz. Timer switches installed in the Main Distribution Panel (MDP) shall have an emergency driving device for 48 hours when the incoming power source fails.

MDP panels shall be fitted with a manual switch-over circuit to by-pass the timing switch.

6) Remote Control Device

Remote control relays shall have contacts related to switch the specified IEC60947-4-1:2000, JIS C8201-4-1:2007 or equal rating, and shall be normally opened unless otherwise specified.

Relays shall be the mechanical armature type with the number of poles specified in the Contract Documents.

The mechanical armature type shall consist of an opening coil (250 volts), a laminated core, a laminated armature, and contact terminals, the contacts shall be silver alloy.

7) Control Device for Illuminations

Additional control devices for illuminations comprise an auto controller and photo sensor. The former is to be attached to the MDP and the latter is to be installed at the roadway and street.

The automatic controller shall be a panel mounted type provided with a built-in timer switches for automatic or manual control. Power source requirement shall be AC single phase 220V + 10 % 50Hz and 40VA at maximum.

Setting of timer for basic lighting shall be 100% turn on between 06:00 hours and 24:00 hours and 50% turn on between 24:00 hours and 06:00 hours.

The timer switch shall have an emergency driving device for 48 hours or more when the incoming power source fails.

The photo sensor shall consist of a light receiving window and cadmium sulphide detecting device and relay unit.

5. Road Lighting Poles

5.1 Lighting poles

- 1) 12 m and 11 meter high steel round type lighting poles shall be hot dip galvanized in accordance with the details shown in the Contract Documents, as outlined herein and in accordance with the requirements of the lighting units of the Specifications.

All materials shall be in natural color and shall not be painted or coated with any other material.

All pole items shall be hot dip galvanized steel and all hardware shall be galvanized steel. Scratches, marks, dents or other damages to poles and fittings will be cause for rejection.

Any marks or stains resulting from wrapping materials shall be removed.

All poles and arms shall be individually spiral wrapped and, in addition, shall be packed for shipping in groups with suitable form fitting wood damage between all poles and completely around each group at a minimum of 4 locations, and held with suitable metal strapping.

Arms shall be wrapped, packed, and shipped to the job site with a minimum of reloading between points of origin and destination. Packing not in conformance with this provision shall be cause for rejection of poles or arms or both.

All loading and unloading of poles and arms shall be under the supervision of the manufacturer or the Contractor or both.

All miscellaneous pole line hardware required to complete the project should be standard material manufactured for pole line construction. All metal parts shall be hot-dip galvanized.

All poles supplied shall be of the anchor base type, and shall have a cast steel anchor base fitted over the shaft and secured with two circumferential welds.

The handhole and cover place for the terminal connection shall be 1.0 meter above the anchor base plate level.

For the roadway and the arterial street, each lighting pole shall be fitted with a standard identification plate.

2) Foundations

Concrete for foundations for lighting poles and pedestals of cabinets shall be of class E-3 or as shown in the Contract Documents. The Contractor shall submit for the Engineer's approval, construction drawings of the footings and calculations showing that the footings and the anchor bolts are sufficient for their intended application under any conditions of loading.

All details of concrete and reinforcement for foundations shall conform to the applicable requirements of this Specification.

6. Cable, Grounding Splices and Conduit

6.1 Wiring for Lighting

- 1) Main cables to be installed in the ground under arterial streets and roadway by pulling shall be of the type and size shown in the Contract Documents or given in the Specification.

Cables shall be pulled into the pole directly from underground ducts or from the bridge hand hole through conduit prepared in the foundation of the pole, and shall be terminated at a circuit breaker installed in the pole.

For this purpose all poles shall include an approved molded case 2-pole circuit breaker rated at 15 amperes, 250 volts, installed in the base of each pole and accessible through the hand hole of the pole.

The circuit breaker shall protect both the pole cables and electrical control ballast.

Cables installed from the circuit breaker in the pole shall have two conductors of 2.5 mm² as prescribed in "Cable and Wire" herein. Cables shall be adequately attached to the lantern so that lantern terminals shall be free from carrying their weights.

Street and highway lighting cables shall be used four (4) cores through to the last pole.

2) Cable and Wire

All cables shall be suitable for operation at the specified voltage in open, duct or conduit, under the connection of the maximum conductor operating temperature which at rated current shall be less than 70°C.

Cable colors shall comply with color code standards of YESB.

Cables shall be delivered to the Site on substantial non-returnable wooden drums, each bearing a securely fixed label stating gross weight, serial number, and length of cable and other description.

Covers shall be provided around the periphery of the drum in order to protect the cable in transit and the inner cable end shall be adequately protected by a metal guard or other approved means.

Both ends of the cable shall be sealed by a suitable method to prevent the entrance of moisture.

All cables inside of the lighting pole shall have two conductors per lantern. Cables shall be 600v /1Kv grade "Polyvinyl Chloride Insulated and Sheathed Cable" (X-LPE /PVC type) or shall be of the type approved by the Engineer.

All cables for the roadway and street lighting system to be installed in cabling duct/ conduit at underground shall be X-LPE /PVC type, or PVC insulated, galvanized flat steel wire 1.6 mm armoring, and PVC sheeting type (600v/1Kv XLPE-SWA-PVC type) for direct-buried cabling or equivalent approved by the Engineer.

Conductor shall have a minimum cross-sectional area of 6 mm² for in the cabling duct/ conduit or 10 mm² for direct-buried installation.

All cables to be used shall be certified as tested, and approved by the Engineer before installation.

6.2 Grounding

Conduit, steel poles and cabinets (Electrical panels) shall be made mechanically and electrically secure to form a continuous system, and shall be effectively grounded.

Bonding and grounding jumpers shall be copper wire of the same cross-sectional area for all systems. Bonding jumpers shall be used in all non-metallic boxes.

Metallic boxes shall employ hubs of double lock nuts and bushes. The bonding of all conduits, lighting poles and panels to form a continuous ground system shall be in accordance with applicable code standards.

If directed by the Engineer, each lighting pole shall be individually grounded.

Grounding conductor shall be the 35mm² standardized copper-wire for Class B shown in the Design Standard and 16mm² copper-wire for the others, or as approved by the Engineer.

Electrode shall be copper sheathed steel (16-18mm), is buried 0.8m depth from ground or approval by the Engineer. The Electrode shall be buried at not less than 1m from the pole. The installation distance of additional electrode (s) shall not be less than 1m from each other for connecting to grounding conductor (s).

Before the grounding construction works, the Contractor shall be required for approval of land owner for investigation of each site and measure the grounding resistance of the sites, and also be required the reporting for approval by the Engineer.

After taking the data, the Contractor shall obtain the Engineer's approval of the site.

The grounding resistance shall be 5 ohms or less, or as approved by the Engineer.

Details of all grounding points shall be submitted to the Engineer for approval.

6.3 Electrical Splice Materials

Splices and taps shall be made with pressure-type solder-less connectors to securely join the wires both mechanically and electrically.

An epoxy resin, cast type insulation shall be formed in clear plastic molds. The material used shall be compatible with the insulation specified in the Contract Drawings or the Specifications. Materials to be used for the work shall conform to the requirements of IEC 60587:2007 or JIS C 2804:1995, JIS C 2805:2003 and JIS C 2806:2003 or shall have the quality approved by the Engineer.

Insulating tape when specified for use in splice formation shall conform to IEC 60454-3-1:1998 or JIS C 2336-1999. Un-fused quick-disconnect connectors such as In-line connectors or Tee connectors shall be of the quality approved by the Engineer.

6.4 Conduit and Electrical Pipe

- 1) Material for conduit to be installed below a bridge, above ground, in a concrete parapet or on the surface of structures shall be steel or PVC or specified in the Contract Documents.
- 2) Conduit crossings of the direct burial system shall be constructed at a minimum depth of 1.2 m beneath the finished surface from steel pipe under intersections or streets and roads or both, a minimum depth of 0.6 m or more for the other place, that has been uniformly and adequately zinc-coated by a hot-dip galvanizing process, or concrete encased PVC conduit meeting the requirements of IEC 61084-2-1:1996 or JIS C8430:1977.
- 3) Electric pipe shall be High density polyethylene (HDPE) specified in the regulations, IEC61386-2:2000, JISC3653:2004 or Perfluoro Ethylene Propylene (FEP) conduit, IEC61386:2002 or JIS C3653:2004. The HDPE pipes and FEP pipes shall be installed the roadway closing, rising to panels or poles as shown in the Contract Documents.

6.5 Cable Trays

All details regarding material and installation of cable trays shall be as shown in the Contract Documents.

6.6 Pull Boxes

Type - A of pull boxes of appropriate dimensions shall be installed in the inner parapet of the main bridge section and also type -D of pull boxes shall be installed embed slab concrete of the approach bridge sections and main bridge section as and where shown in the Contract Documents.

The body of the pull box shall be fabricated from 3.2 mm mild steel sheet and hot-dip-galvanized.

The cover shall be made either from 3mm type SUS 304 stainless steel or from 3.2 mm mild steel sheet and hot-dip-galvanized.

No sharp projections from screws or other objects shall be permitted within the pull box. The covers shall be watertight by rubber gasket.

Details of dimensions and pull box type will be shown in the Contract Documents.

7. Modification of Existing System

7.1 Removing

The Contractor shall remove existing materials, which will obstruct the construction of the works, in accordance with the Drawings and these Specifications, or as established or both by the Engineer.

A detailed work method and timing schedule shall be submitted for the Engineer's approval prior to commencing any work of removal.

On completion of removal works, all holes shall be filled and the area left clean and tidy, all to the satisfaction of the Engineer.

It shall be the Contractor's responsibility to remove all useless materials which shall be dumped or stored as specified or required by the Engineer.

7.2 Relocation

Part of the existing materials removed shall be relocated in accordance with the Drawings or as established or both by the Engineer.

All relocation shall be carried out by the same means of construction as additional furnished materials in the works as required in the Specifications.

Prior to fixing any lighting pole or control panel, accessible surfaces shall be rubbed or brushed clean of all rust, etc. and painted with 3 coats of a zinc based rust-preventing paint as specified by the Engineer.

If there are any dents or other damage to materials during the relocation, the material shall be replaced with the same kind, or repaired to the satisfaction of the Engineer.

8. Construction

8.1 General

All workmanship shall be complete and in accordance with the latest accepted standards of the industry, as determined by the Engineer. Installation of duct, construction of manholes, and excavation for cable or duct track, shall be in accordance the Specifications.

8.2 Excavation and Backfilling

Excavating and Backfilling required for the installation of foundations, poles and other appliances shall be performance in accordance with the requirement of these Specifications but will not be measured for payment.

The cost of such extra work shall be deemed to be included in the unit price of the pay item being installed.

8.3 Foundations

Foundation shall be constructed of Portland cement concrete Class DI shown in Section 06100 Structural Concrete, unless otherwise specified in the Drawings or other relevant document and all details shall meet the applicable requirements of these Specifications.

The bottom of concrete foundations shall rest on firm ground.

Foundations shall be poured in one pour where practicable. The exposed portions shall be formed to present a neat appearance.

The footing shown in the Contract Documents shall be extended if conditions require additional depth, and such additional work, if ordered by the Engineer, will be paid for under the applicable provision of the Specifications.

Forms shall be true to line and grade. Tops of footings for poles, except special foundations, shall be finished to ground line or sidewalk grade, unless otherwise noted in the Contract Documents or directed by the Engineer.

Forms shall be rigid and securely braced in place. Conduit ends and anchor bolts shall be placed in proper position and to proper height, and shall be held in place by means of a template until concrete sets.

Plumbing of poles shall be accomplished by adjusting leveling nuts. Shims or other similar devices for plumbing or raking will not be permitted.

Both forms and ground which will be in contact with the concrete shall be thoroughly moistened before placing concrete. Forms shall not be removed until the concrete has set at least 3 days.

A "rubbed surface finish" shall be applied to exposed surface of concrete in accordance with the requirements of the Specifications.

Where obstructions prevent construction of planned foundations, the Contractor shall construct an effective foundation, satisfactory to the Engineer.

1) Conduit and Electric Pipe

Installation of electric pipe shall be performed in accordance with the Specifications and in reasonably close conformity with the location as specified in the Contract Documents or as directed by the Engineer.

The size of pipe used shall be as shown in the Contract Documents. Conduit smaller than 50mm diameter electrical trade size, shall not be used unless otherwise specified.

It shall be the option of the Contractor, at his own expense, to use larger size pipe if desired, and where larger size pipe is used, it shall be for the entire length of the run from outlet to outlet.

No reducing coupling will be permitted.

The ends of conduit shall be well reamed to remove burrs and rough edges. Field cuts shall be made square and true so that the ends will butt or come together for the full circumference thereof. Slip joints or running threads will not be permitted for coupling pipe.

When a standard coupling cannot be used, an approved threaded union coupling shall be used.

The threads of all steel conduits shall be well painted with a good quality of lead or rust-preventative paint before couplings are made up.

All steel couplings shall be screwed up until the ends of the conduits are brought together, so that a good electrical connection will be made throughout the entire length of the conduit run.

Where coating on steel conduit has been damaged in handling or installing, such places shall be thoroughly painted with rust- preventative paint.

All conduit ends shall be threaded and capped with standard conduit couplings capped with until wiring is started.

When couplings and push Penney's are removed the threaded ends shall be provided with approved conduit bushing.

The use of any plugs, even though temporary, in lieu of the aforementioned conduit couplings and push Penney's is expressly prohibited.

Conduit stubs from bases shall extend at least 15 cm from the face of foundations and at least 80 cm below the top of foundations.

Conduit bends, except factory bends, shall have a radius of not less than six times the inside diameter of the conduit.

Where factory bends are not used, conduit shall be bent, using an approved conduit bending tools employing correctly sized dies, without crimping or flattening, using the longest radius practicable. All PVC conduit bends shall be pre-formed.

Conduit terminating in poles or pedestals shall extend approximately 15 cm above the foundation vertically and shall be sloped towards the handhold opening.

Conduit entering through the bottom of a pull box shall be located near the end walls to leave the major portion of the box clear.

At all outlets, conduit shall enter from the direction of the run, terminate 15 to 20 cm below the pull box lid and within 9 cm of the box wall nearest its entry location.

Suitable markers shall be set at the ends of conduits which are covered so that they may be easily located.

A galvanized pull wire shall be installed in all conduits which are to receive future conductors. At least 60 cm of pull wire shall be doubled back into the conduit at each termination.

2) Pull Boxes

Pull boxes shall be installed at the locations shown in the Contract Documents, and at such additional points as ordered by the Engineer.

The Contractor may install, at his own expense, such additional boxes may be desired to facilitate the work.

3) Wires

Wiring shall conform to appropriate code requirements. Wiring within cabinets, manholes, etc. shall be neatly arranged and within cabinets shall be laced.

Powdered soapstone, talc, or lubricant shall be used in placing conductors in conduit.

Splicing in conductors will be permitted only at manholes, transformer leads, in pole bases, or at control equipment.

Sufficient signal light conductors shall be provided to conform to the functional operation of the signal system as shown. Spare conductors shall be provided when noted in the Contract Documents.

4) Service Point

Service points are located within or close to the Site, normally, but not necessarily always, at the substation transformer nearest the project main panel designated of the drawings by the symbol "SS" substation.

The cable work from the SS to the Main Distribution Panel (MDP) shall be installed by the Contractor.

The work will not be paid for directly but considered a subsidiary obligation of the Contractor provided for under the unit rate for the "MDP" service switch.

Unless otherwise noted in the Contract Documents, each service point shall include a meter base installed in accordance with serving utility requirements, a three wire service breaker of size noted in the Contract Documents, the necessary conduit risers and grounding assembly.

Service breakers shall be a standard thermal circuit breaker encased in rain-tight enclosure that can be pad locked.

Documentation for the application for the service connection, which shall be submitted for the Engineer.

The Engineer shall then, upon request of the Contractor, make arrangements with the serving utility to complete the service connections.

The serving utility connection costs, but not the electrical, energy consumption, will be charged to the Contractor.

5) Field Test

Prior to completion of the work, the Contractor shall cause the following tests to be made on all traffic signal and lighting circuits, in the presence of the Engineer.

Test for continuity of each circuit.

Test for grounds in each circuit.

A megger test on each circuit between the conductor and ground with all switchboards, panel boards, fuse holders, switches, sockets, and over current devices in place and all readings recorded.

The Contractor shall furnish the Engineer with three copies of the test results identifying observed readings with their respective circuits.

Any change in the above stated minimum readings must be approved by the Engineer. Such approval must be in writing, following written application by the Contractor.

A functional test to be demonstrated each part of the system function and every part shall be as specified or intended herein.

Any fault in any material or in any part of the installation revealed by these tests shall be replaced or repaired by the Contractor in a manner approved by the Engineer, and the same test shall be repeated until no fault appears.

6) Painting

All painting required shall be in conformance with applicable portions of the Specifications.

If the enclosure of any electrical equipment (less signal heads) located above ground does not have an exterior surface of either aluminum or galvanizing, then it shall be finished with two coats of an approved zinc based paints, plus such finishing coat as the Engineer may direct.

Controller cabinets shall be finished in accordance with the above requirements for electrical equipment.

Galvanized steel lighting poles and lighting lanterns shall not be painted.

7) Lighting Poles

Lighting poles shall be handled in loading, unloading and erecting in such a manner that they will not be damaged.

Any parts that are damaged due to the Contractor's operation shall be repaired or replaced at the Contractor's expense, to the satisfaction of the Engineer.

Lighting poles shall not be erected on concrete foundations until the concrete of foundations has set at the time to achieve the minimum strength specified in Section 06100 Structural Concrete, and shall be raked sufficiently to be plumb after all load has been placed, or as otherwise directed by the Engineer.

8) Control Equipment

Where specifically detailed in the Contract Documents, for service locations where two or more lighting circuits are operated from one time switch control device, the relays, service breakers and any other necessary control equipment shall be grouped together and installed in a suitable rain tight enclosure of a sufficient size to accommodate all of the equipment installed therein.

Each electrical control ballast assembly shall be protected by molded circuit breakers.

9) Guarantee

The Contractor shall furnish to the Client any guarantee or warranty required as a normal trade practice in connection with the purchase of any materials or items used in the construction of the illumination or traffic signal system or system included in this Contract.

9. Aviation Obstruction Light (AOL)

9.1 General

The AOL unit of medium intensity strobe warning systems shall consist of a complete electrical mechanism for controlling the operations of aircraft traffic and warning, including the following:

- 1) The number of AOL for each pylon shall be installed on the top of pylon as shown in the Contract Documents. The type of AOL and locations of installation shall be the following table.

Table 2. Type of AOL and Locations

Type	Intensity of Lamp	Type of Signal	No. of Lamps	AOL Location on Pylon
A	Medium White	Flashing Strobe 360°horizontal	One (One/Shaft)	Top of Pylon

Note: Refer to note below.

Medium Intensity White Flashing Strobe Obstruction Light shall be complied with the International Civil Aviation Organization (ICAO) Annex 14 Vol.1, Fourth Edition – July 2004, Chapter 6 Type A medium intensity obstruct light.

- 2) The medium intensity white flushing strobe obstruction light shall be the following, however not limited to:
- Control: Internal microprocessor based controller for power management, flash character, daylight on/ off and failure alarm control,
 - Alarms: volt free contact shall be provided for system failed alarm to the further alarm & status information via control unit.
 - Photocell: Two internal photocells fitted in the light fixture for automatic day and night control light.
 - Source and Life expectancy: Xenon flash tube, over 2 year's life with safe plug fitting,
 - Lenz diameter and color: Precision injunction moulded 300 mm diameters Fresnel lens. UV resistant with hinged opening.
 - Divergence (Beam angle):
 - Type -A ; 360 degrees horizontal, 3 degrees vertical at 50% peak,
 - Effective intensity: 20,000cd., white $\pm 25\%$ in daytime/twilight mode, 2000cd white $\pm 25\%$ in night time mode,
 - Flash character: 40fpm, 20 - 40 (FAA) or 20 -60 fpm (ICAO),
 - Operation temperature: -30 °C to +45 °C,
 - Ingress protection: IP65

10. Lateral Marks and Signal Light (LMSL)

- 1) The Standards for the navigation lights shall be complied with IALA O-113 for Signal light. The signal lights shall be installed them at the adequate locations on the bridge together with lateral marks. However instructions or requests or both by Myanmar related Organization(s) shall be high priority on the agenda.
- 2) Two of shipping water ways (SWW) will be provide under the Bago Bridge, between pylons by information from the Authorities. However the Contractor shall decide the exact locations of SWW under the Bridges to be instructed by the Authorities.

- 3) The Contractor shall supply and install six (6) navigation lights per SWW, three (3) on the upstream side of the SWW and others three (3) on the downstream side. The colour signal system of the lights shall be followed the Standards
 - Port for the direction of ship: Red on her left and Green on right,
 - Center: White flash on left and White on right,
 - Starboard: Green on left and Red on right
- 4) The LMSL shall be the following, however not limited to:
 - Specifications of signal light: RL-123
 - Organic Optics Lens: Diameter D = 123mm
 - Lens material: Polycarbonate, weather resistant
 - Flashing mode: 15 rates according to navigation signal rule
 - Light on/off switch: 300 / 350Lux
 - Power source: AC240V
 - Self- operating time of combustion: 8 days
 - Lamp: light source 32 or 40 LED lamps with high emission color dependent
 - Working temperature -22~ +55°C

Signal lights RL-123 shall be suspended below the bridge deck and supported on a hinged swing arm with retrieval chain and locking rod to allow the light to be swung up to deck level for maintenance, or proposal by the Contractor for the Engineer's approval.

11. Nightscape Lighting System

11.1 General Requirements

Nightscape lighting presentation of bridge may stage the daintiness, understandability, friendliness, and optimization in city. The light-up secure safety and comfortability and afford more time and place in civilian life and peace of mind.

It is important for Nightscape lighting to create the shadow, light and shade well. Generally, the impression of nightscape lighting depends on a change of the small light and shadow occurs well.

The value of object lighted-up is decided to consider the balance of whole city. The lighting should be designed based on the view of location, direction, distance, background brightness, etc. The brightness on the surface of the object should be not less than 12cd/m² according to CIE94 1994.

The objects for the nightscape lighting should be two (2) sets of the pylon and pier.

11.2 Flood Light to Pylons

The flood lights to the pylons for the purpose that the lighting makes pylon to be high visibility shall be carried out the lighting by the floodlights from the bottom of pylons and from road level as shown in the Contract Documents. The lamp of the floodlights is a 2000w High Intensity

Discharge (HID) Lamp. The Contractor shall propose the color combination of flood lighting to the Engineer for approval. Arrangement of floodlights for a pylon shall be shown in Contract Documents. The Contractor shall submit his proposal, drawings, specifications, quantities, construction cost estimate, and other necessary documents for the alternative to the Engineer for his approval.

12. Lightning Protection System (LPS) for Bridge Pylon

12.1 General Requirements

The Lightning Protection System (LPS) shall comprise air terminations, down conductors and earth terminations and performing the necessary inspection, testing, records and maintenance upon completion of the system installation. The materials used in the system shall select themselves to avoid corrosion problems.

The system shall use all means necessary to protect materials before, during and after installations and to protect the works and materials of all other trades. In the event of damage, repairs and replacement shall be made to the approved of the Engineer and at no additional cost.

Upon completion of work, the Contractor shall internal test all parts of the functional system.

In the presence of the Engineer, measurement of the grounding resistance will be carried out on the various parts of the system and should the installation or any component fail to pass any test the Contractor shall be responsible for corrective action and subsequent test and bear any associated costs until the installation or component is accepted by the Engineer.

The lightning protection system components shall be manufactured to suit the use in tropical climatic area and shall be suitable in the service conditions mentioned below:

12.2 Air Terminal

Air termination shall be solid copper 10 mm diameter of the point, length minimum 400mm long, or equivalent.

12.3 Down Conductor

The down conductor shall be connected to the air terminal.

Main down-conductor cable shall be stranded, bare soft-drawn copper 38 mm² minimum sizes cross sectional area.

Down conductor shall install from the top of pylon down to the Copper plate Electrode embedded in the ground.

12.4 Installation Requirements

A distinction shall be made between top of pylon and on the bridge section lightning protection system.

1) Top of pylon

Comprise all devices provided and top of pylon device at and in the protected installation for the purpose of intercepting and diverting the lightning stroke current to the grounding system.

2) On the bridge section

Comprise the measure taken to counteract the effects of the lightning stroke current and its electrical and magnetic fields on metal assemblies and electrical apparatus included in the bridge metal structures of the installation.

12.5 Applicable International Standards and codes

The materials and equipment shall be designed, constructed and tested minimum in conformance with following the latest standards and codes.

- JIS A4201:2003 (IEC 61024-1)
- IEC 364-5-54/1980; IEC 479-1/1984

13. Facilities in Pylon

The facilities in Pylon shall comprise lighting system and socket power supply system Lighting System in Pylon.

Lighting units as shown in the Contract Documents shall consist of lighting lantern, lamps, electrical control ballast(s), and mounting accessories.

The Contractor shall submit for approval, detailed light distribution diagrams for each type of lantern he proposes to install. Furthermore, calculations shall be submitted showing the average Luminance (Lx) at a few points of staircase landing.

The type of lighting fixture for lighting system in pylon and pier shall be the following, however not limited to:

- Type of lighting source: Fluorescent lamp 1x 32w,
- Power supply: 220volts ac, 50Hz
- Housing of lighting fixture: ABS Housing with stainless steel clips,
- Lighting Diffuser: Prismatic diffuser with good dazzle-proof,
- Control Ballast: Electromagnetic ballast, and
- Ballast Holder: Nylon ballast holder.

13.1 Socket Power Supply System

The Socket Power Supply System as shown in the Contract Documents shall consist of socket, waterproof box and mounting accessories.

The Contractor shall submit date of related materials for approval

14. Civil Works for Electrical Items

14.1 Description

The work under this clause will include anchor bolts in concrete structure, installation of pull boxes and conducting in bridge structures or medium voltage cable ducts under the bridge, if required in the Contract Documents, as necessary for the installation of the Bridge electrical facility as described in the Specifications.

14.2 Materials

All used materials shall conform to the details given in the Contract Documents. In the absence of any details in the Drawings, the work shall be carried out in accordance with the relevant sections of these Specifications and the instruction of the Engineer. The materials for Conduit and fittings shall be given for the Specifications.

14.3 Construction

1) Anchor Bolts in Concrete Structures

All details of anchor bolts shall be in accordance with the Drawings and the relevant parts of in the Specifications. Anchor bolts shall be fixed in the concrete structure positions and held in place by means of templates until the concrete has set.

2) High Density Polyethylene (HDPE) Pipe in Concrete Structure

The installation of the required pipe shall be performed in accordance with the Specifications and in reasonably close conformity with the locations as specified in the Drawings or as directed by the Engineer.

The size of HDPE pipe used shall be as shown in the Drawings. Pipe which smaller than 50 mm diameter electrical trade size shall not be used, unless otherwise specified. It shall be the option of the Contractor, at his own expense, to use larger size conduit if desired, and where larger size conduit is used, it shall be for the entire length of the run from pull box to pull box. No reducing coupling will be permitted.

3) Pull Box in Concrete Structure

Pull boxes shall be installed in concrete structure at the location shown in the Drawings, and, at such additional point as ordered by the Engineer. The Contractor may install, at his own expense, such additional boxes as may be desired to facilitate the works.

4) Electrical Manhole/ Handhole

All details of manhole or handhole or both shall be in accordance with the Drawings and the relevant requirements of the Specifications.

Conduit or duct endings shall be fixed in the proper position and held in place by means of templates until the concrete has set.

A rubbed surface finish shall be applied to exposed concrete surface in accordance with the Specifications.

Excavation for cable installation shall be of the width necessary for satisfactory lying of the cable and shall ensure that cables are at least 600 mm below finished level as shown in the Design Standard of YESB.

The bottom of the cable track shall be level and free from stones or other sharp objects. The depth of the cable may be increased if this is necessary to avoid existing obstructions.

5) Underground Duct

After cable has been laid they shall be protected by concrete-made cable marker or cable protector tile of a design or approved by YESB.

The location of duct will be as shown in Drawings or as instructed by the Engineer.

Unless the Contractor elects at his own expense to install duct by jacking or drilling, all work on ducts shall be completed before work is started on the sub-base course.

Full details of any ducts to be installed by jacking or drilling must be submitted to the Engineer for his approval.

Unless otherwise instructed, all ducts shall extend at least 600 mm beyond the edge of the pavement.

Suitable marker stakes shall be set at the ends of ducts which are buried so that they may be easily located. Existing underground ducts to be incorporated into a new system shall be blown out with compressed air and checked with a mandrel.

A galvanized pull wire shall be installed in all ducts which are to receive future cables.

At least 600 mm of pull wire shall be doubled back into the duct at each termination.

All ducts shall be laid in straight lines only, with a minimum number of joints throughout the lengths of each duct run.

Where joints must be provided the ends of all ducts shall be well reamed to remove burrs and rough edge.

Where metallic conduits have been specified field cuts shall be made square and true so that the ends will butt or come together for the full circumference thereof. Slip joints or running threads will not be permitted for coupling metallic ducts. When a standard coupling cannot be used an approved threaded union coupling shall be used.

The threads on all ducts shall be well painted with a good quality of lead or rust preventive paint before couplings are made up. All ducts shall be checked with a mandrel after completion of each installation.

Unless otherwise approved by the Engineer the ducts shall be laid to a depth of not less than 600 mm below the curb grade in the sidewalk and all other areas and to a depth of not less than 800 mm below the finished grade in road-crossing areas.

6) Duct Bank

Underground duct line shall be constructed of pipe encased in concrete. Except where rigid galvanized steel conduit is indicated or specified, the pipe shall be of High Density Polyethylene (HDPE) pipe or Perfluoro Ethylene Propylene (FEP) conduit.

The kind of conduit used shall not be mixed in anyone duct bank. Ducts shall not be smaller than 100mm in diameter unless otherwise indicated.

The top of the concrete envelope shall not be less than 450 mm below grade except that under roads and pavement, it shall be not less than 600 mm below grade.

Duct lines shall have a continuous slope downward toward underground structures and away from building with a pitch of not less than 76 mm in 30 meters.

Except at conduit risers, changes in direction of runs exceeding a total of 10 degrees, either vertical or horizontal, shall be accomplished by a long sweep bends having a minimum radius of curvature of 7.6 meters, sweep brands may be made up of one or more curved or straight sections or combinations thereof.

Trenches shall be excavated along straight lines from structure to structure before ducts are laid or structure constructed so the elevation can be adjusted, if necessary, to avoid unseen obstruction.

7) Termination of Duct

Pipes shall terminate in end-bells where duct lines enter underground structures. The joints of the pipes shall be staggered by rows and layers so as to provide a duct line having the maximum strength. During construction, partially completed duct lines shall be protected from the entrance of debris such as mud, sand dirt by means of suitable conduits plugs.

As each section of duct line is completed from structure to structure, a testing mandrel not less than 300 mm long with a diameter of 6 mm less than the size of the conduit, shall be drawn through each conduits, after which a brush having the diameter of the duct, and having stiff bristles shall be drawn through until the conduit is clear of all particles of earth, sand and gravel, conduit plugs shall then be immediately installed.

Provide a plastic pull rope, having 1 meter or spare at each end of the ducts.

For duct line connections to concrete pads, break an opening on the pad out to the dimensions required and preserve the steel in the pad.

Cut the steel and bend it out to the ties into the reinforcing of the duct line envelope. Chip out the opening in the pad to form a key for the duct line envelope.

During construction, wherever a construction joints is necessary in a duct line, debris such as mud, sand and dirt shall be prevented from entering into the ducts by providing suitable pipes plugs etc.

Fit concrete envelope of a partially completed duct line with reinforcing steel for a minimum of 600 mm beyond the end of the envelope. Reinforcing bars shall be provided as shown in the plans.

8) Underground Pipe for Branch Circuits

Underground pipes for branch circuits shall be HDPE pipe from the panel board and lighting pole and projections thereof, the ends of the pipes shall be protected by caps. Pipes shall be cleaned and plugged until conductors are installed.

The underground portion of the pipe shall be encased in a concrete envelope and shall be buried as specified for underground ducting with concrete encasement.

9) Excavation and Backfilling

All excavation for hand holes, ducts, and cable installation shall be carried out so as to minimize damage to existing surfaces.

The Contractor will reinstate all surfaces on completion of back-filling to the original condition and in accordance with the Engineer's instruction.

To facilities reinstatement the outline of all areas to be removed in Portland cement concrete and asphalt concrete sidewalks and pavements shall be cut to a minimum depth of 50 mm with a saw, prior to removing the sidewalk and pavement materials.

Cut for remainder of the required depth may be made by a method satisfactory to the Engineer. Cuts shall be neat and true and surfaces outside the removal area shall not be damaged.

The Engineer may waive or modify the above requirements for excavation and reinstatement when the excavation lies within an area to be overlaid or reconstructed under other clause of the Specifications.

All backfill for manholes, duct banks, and ducts shall comply with the requirements of the Specifications.

15. Measurement

Each accepted installed item relating to road lighting, obstruction lights, nightscape lighting, lightning protection and facilities in pylon installation shall be measured as described herein. Items which are incidental construction required for the installation of those lighting shall not be measured and shall be considered incidental to the work.

Any other item for installation not measured herein shall not be measured and shall be considered incidental to the work.

15.1 Lighting Poles

Accepted pole of each type, size, section, and mounting arrangement specified shall be measured as the number furnished and installed complete in place.

15.2 Lighting Panel

Accepted lighting panel (MCCB, magnet contactors, photo sensor, timer switch) of each rating, size, section, and mounting arrangement specified shall be measured as the number furnished and installed complete in place.

15.3 Pull Box

Accepted pull box of each rating, size, section, and mounting arrangement specified shall be measured as the number furnished and installed complete in place.

15.4 Grounding System

Accepted grounding system shall be measured as the number furnished and installed complete in place.

15.5 Electric Wire Cable

Accepted electric wire cable of each rating, size, section, and mounting arrangement specified shall be measured as the linear meter furnished and installed complete in place.

15.6 Pipes

Accepted pipes (HDPE Pipe, FEP Pipe) of each rating, size, section, and mounting arrangement specified shall be measured as the linear meter furnished and installed complete in place.

15.7 Steel Conduit

Accepted steel conduit of each rating, size, section, and mounting arrangement specified shall be measured as the linear meter furnished and installed complete in place.

15.8 Handhole

Accepted handhole of each rating, size, section, and mounting arrangement specified shall be measured as the number furnished and installed complete in place, per each

15.9 MV Site Substation

Accepted substation (concrete pole, lightning arrester, 11kv and/or 6.6kV based switches, transformer, high tension cable, grounding, isolator, protection devices, service metering panel, termination materials) of each rating, size, section, and mounting arrangement specified shall be measured as a lump sum item furnished and installed complete in place.

16. Payment

The work measured as provided above shall be paid for at the Contract unit price as detailed below. The payment shall be full compensation for furnishing, hauling, installing, commissioning and testing for all labour, tools, equipment, material, plants and incidentals necessary to complete the work.

The Pay Items and Pay Units shall be as follows;

Pay Items	Descriptions	Unit
09100-01	Lighting Pole Type A (Mounted Type, H=11m)	Number
09100-02	Lighting Pole Type B (H=12m,)	Number
09100-03	Lighting Pole Type C (H=9m)	Number
09100-04	Flood Light Pole (H=25m)	Number
09100-05	LED Lamp (51W)	Number
09100-06	LED Lamp (140W)	Number
09100-07	LED Lamp (150W)	Number
09100-08	LED Lamp (380W)	Number
09100-09	HID Lamp (360W)	Number
09100-10	Lighting Panel Type A (17 lines)	Number
09100-11	Lighting Panel Type B (4 lines)	Number
09100-12	Pull Box Type A (450 x 350 x 250)	Number
09100-13	Pull Box Type B (550 x 200 x 600)	Number
09100-14	Pull Box Type C (400 x 300 x 200)	Number
09100-15	Pull Box Type D (300 x 350 x 175)	Number
09100-16	Grounding Plate	Number
09100-17	4 Core/XLPE 80 sq. mm Electric Wire Cable	lm
09100-18	4 Core/XLPE 35 sq. mm Electric Wire Cable	lm
09100-19	4 Core/XLPE 25 sq. mm Electric Wire Cable	lm
09100-20	4 Core/XLPE 16 sq. mm Electric Wire Cable	lm
09100-21	4 Core/XLPE 10 sq. mm Electric Wire Cable	lm
09100-22	4 Core/XLPE 8 sq. mm Electric Wire Cable	lm
09100-23	4 Core/XLPE 6 sq. mm Electric Wire Cable	lm
09100-24	4 Core/XLPE 4 sq. mm Electric Wire Cable	lm
09100-25	HDPE Pipe (25mm dia.)	lm
09100-26	HDPE Pipe (50mm dia.)	lm

09100-27	HDPE Pipe (100mm dia.)	lm
09100-28	FEP Pipe (25mm dia.)	lm
09100-29	FEP Pipe (50mm dia.)	lm
09100-30	FEP Pipe (100mm dia.)	lm
09100-31	Steel Conduit (100mm dia.)	lm
09100-32	Handhole (600 x 600 x 1200)	Number
09100-33	Handhole (600 x 600 x 600)	Number
09100-34	Incoming Power Receiving Pole (H=15m)	Number
09100-35	Power Receiving Panel (100kva)	Number
09100-36	Power Receiving Panel (200kva)	Number
09100-37	Emergency Engine Generator (50kva)	Number
09100-38	Emergency Engine Generator (200kva)	Number
09100-39	Main Power Distribution Panel (300AF/ 50AF)	Number
09100-40	Boundary Fence (H=1.2m)	lm
09100-41	Warning Light	Number
09100-42	Aviation Obstruction Lights (LED 25W White)	Number
09100-43	Control Panel for Aviation Obstruction Lights	Number
09100-44	CV 0.75sq.mm x 2c	lm
09100-45	CV 2.0sq.mm x 2c	lm
09100-46	CV 5.5sq.mm x 1c	lm
09100-47	CV 6.6sq.mm x 2c	lm
09100-48	CV 16sq.mm x 2c	lm
09100-49	CVV 2.0sq.mm x 4c x 3	lm
09100-50	CVV 2.0sq.mm x 6c	lm
09100-51	Navigation Lateral Marks (Left) with LED Signal Light	Number
09100-52	Navigation Lateral Marks (Right) with LED Signal Light	Number
09100-53	Navigation Lateral Marks (Centre) with LED Signal Light	Number
09100-54	Control Panel for Navigation Lateral Marks	Number
09100-55	Joint Box (200 x 200 x 150)	Number
09100-56	Lightning Rod	Number
09100-57	Copper Wire (30 sq.mm)	lm
09100-58	Conductor Drawn Terminal	Number
09100-59	Conductor Water Stopper Terminal	Number
09100-60	Conductor Connector	Number

Section 09200 – Traffic Signal Control System

1. General Requirements

This work shall consist of furnishing and installing all necessary materials and equipment to provide new traffic signal systems, traffic detector, conduits and computers complete.

The work includes earthwork and concrete placement for pole foundations, installation of conduit with required earthwork, erection of signal support poles and span wires or mast arms, installation of signal heads and a controller for each signal system, and installation of all wiring, appurtenances, and auxiliary equipment necessary for the complete installation of the traffic signal system as shown on the tender documents and as specified herein or as directed by the Engineer.

2. MATERIAL REQUIREMENTS

All material shall be new unless otherwise indicated in the Drawings , in the Specifications or other relevant document. The signals, controllers, and appurtenances shall be located as shown in the Drawings or as directed by the Engineer.

All systems shall be complete and in operation to the satisfaction of the Engineer at the time of completion of the work

1) Regulations and Codes

- IEC62061/JIS B9961 (Functional Safety: Programmable electronic control system)
- IEC61508 series/JIS C0508 series (Functional Safety:Electrical/Electronic/Programmable electronic system)
- IEC/TR 62513 (Communication System)
- IEC 60947/JIS C 8201 (LV Switchgear and Control gear)
- IEC61200-52 (Wiring system)

2) Materials General

- a. All materials furnished shall conform to the requirements provided herein, the tender documents.
- b. If the Contractor proposes to furnish materials or supplies other than those specified, he shall furnish complete descriptive data, including performance capabilities, specifications.
- c. Throughout the entire project, all units of any one pay item shall be of the same manufacture and model unless otherwise approved by the Engineer.

3. TRAFFIC SIGNAL FIELD EQUIPMENT AND MATERIAL

3.1 SIGNAL HEADS

Vehicle and pedestrian signals complete with mounting devices as shown on the tender documents shall be provided by the Contractor. Each signal face shall consist of one or more signal sections, each containing an optical unit, lens, main housing, door and visor designed and constructed so as to fit rigidly and securely together, one above the other to present a clean appearance and provide a weathertight enclosure for the optical and electrical equipment.

Each signal head assembly shall be supplied complete with a traffic signal illuminating device of the required size and ready for operation with the connection of field wiring and installation of LED optical system.

1) Materials Requirements

- a. The housing and door of each signal section shall be fabricated from corrosion resistant U.V. stabilized Polycarbonate resin material
- b. Visors and backplates shall be fabricated from corrosion resistant U.V. stabilized Polycarbonate resin material.
- c. Side of pole signal mounting brackets and shims shall be fabricated from glass impregnated polycarbonate material
- d. Materials used for the lens and LED module construction shall conform to the specifications where applicable.
- e. The housing of each section shall be a one-piece, corrosion resistant, Polycarbonate resin molding with integral sides, top, and bottom and free of voids, cracks, inclusions, or blow holes. Each vehicle signal shall be furnished with provisions for mounting of a backplate.
- f. The housing door of each signal section shall be a one-piece, corrosion resistant polycarbonate resin molding free of voids, cracks, inclusions, or blow holes. The door shall be designed to allow proper visor and lens mounting of either "right" or "left" hinge opening.
- g. The LED module shall be a single, self-contained device. The assembly and manufacturing process for the LED assembly shall be designed to assure all internal LED and electronic components are adequately supported to withstand mechanical shock and vibration from high winds and other sources.

2) Optical System Structure

- a. The vehicular signal lens, signal lamp socket, and reflector or vehicular signal LED module shall form a sealed module with a molded neoprene gasket
- b. The pedestrian signal shall provide a sealed optical unit by installing the pedestrian signal LED module against the gasket on the inner surface of the door employing neoprene gaskets and 4 plated screws with each.

3) LED optical system

- a. The LED optical system shall consist of an LED traffic signal module for each display.
- b. The multiple LED light source should be the latest technology available on the market.
- c. The LEDs utilized shall be AlInGaP technology for red, Portland Orange, and yellow indications, or InGaN technology for green or white indications.
- d. LEDs shall be the ultra-bright type rated for 100,000 hours of continuous operation from -40C to +74C.
- e. Pedestrian LED traffic signal modules shall be designed as a retrofit replacement for the message bearing surface of a 300mm x 300mm pedestrian traffic signal housing built

- f. The message-bearing surface of the module shall be supplied with “HAND” and “MAN” outline and overlapping symbols. This message-bearing surface shall be designed so that it can be removed from the sealed unit for replacement without further damage to the module.
- g. The lens shall be tinted or colored to match the wavelength (chromaticity) of the LED
- h. The LED module shall be constructed to allow the replacement of the outer lens and/or the light engine as needed. The configuration of the arrow icon for the LED arrow lens is illustrated in Figure below.

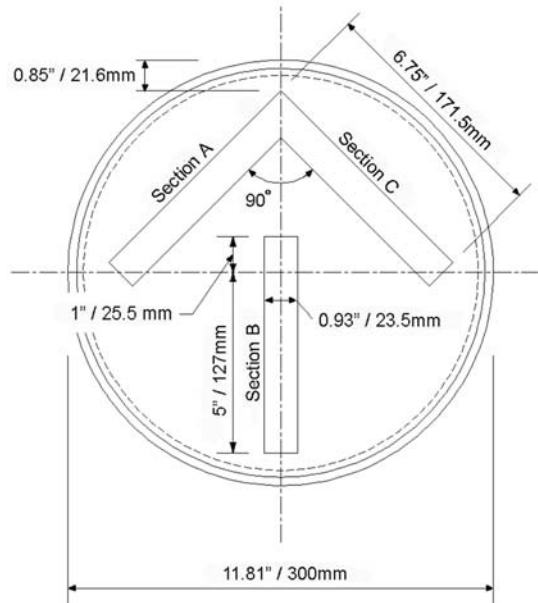

4) Environmental Requirements

- a. The LED module shall be rated for use in the ambient operating temperature range of -40°C to +74°C.
- b. The LED module shall be protected against dust and moisture intrusion
- c. The lens shall be smooth on the outside to prevent excessive dirt/dust buildup, and be specifically designed to reduce sun reflections (Sun Phantom). The LED module must be supplied with an installed gasket.

5) Luminous Intensity and Distribution

- a. The maintained minimum luminous intensity values for red, yellow, and green LED modules throughout the warranty period, under the operating conditions and at the end of the warranty period, shall not be less than the values shown in Table below and are required to meet initial luminous values that are 115 percent of the required minimum values.

Table 4. Maintained Minimum Luminous Intensity for 300mm Expanded View LED Signal Modules Candlepower Values

Vertical Angle	Horizontal Angle (Left & right)	300mm Signal		
		Red	Yellow	Green

2.5° up	17.5°	58	115	115
	2.5°	220	441	441
-2.5° down	2.5°	396	678	678
	7.5°	251	501	501
	12.5	141	283	283
	17.5	77	154	154
-7.5° down	2.5	226	452	252
	7.5	202	404	404
	12.5	145	291	291
	17.5	89	178	178

- b. Pedestrian module shall provide an average luminous of at least 3750 candela per square meter of lighting surface for the “HAND”, and 5300 candela per square meter for the “WALKING PERSON” symbol throughout the warranty period over the operating temperature range.
- c. Chromaticity: The measured chromaticity coordinates of LED modules shall be between 500 nm and 650 nm,

6) Electrical system

- a. Voltage Range: LED modules shall operate from a 50 ± 3 cycle AC line power over a voltage range from 80 VAC RMS to 135VAC RMS. The current draw shall be sufficient to ensure compatibility and proper triggering and operation of load current switches and conflict monitors in the signal controller
- b. Low Voltage Turn Off: There shall be no illumination from the module when the applied voltage is less than 45 volts AC.
- c. Turn-On and Turn-Off Time: The modules shall reach 90% of their full illumination (turn-on) within 100 m sec ($\pm 10\%$) after the application of the nominal operating voltage.
- d. Transient Voltage Protection: The LED module on-board circuitry shall include voltage surge protection to withstand high-repetition noise transients and low-repetition, high-energy transients
- e. LED Drive Circuitry: The individual LED light sources shall be wired so that the catastrophic failure of one LED will result in the loss of the light from only that one LED.

The power supply must be current regulated.

7) Quality Assurance:

- a. Quality Assurance Program: LED modules shall be manufactured in accordance with a vendor quality assurance (QA) program.
- b. Record Keeping: QA process and test result documentation shall be kept on file for a minimum period of seven years.
- c. Manufacturers' Serial Numbers: Each LED module shall be identified by a manufacturer's serial number for warranty purposes.
- d. Production Quality Assurance (QA) Testing: All new LED modules shall undergo the following Production Quality Assurance testing prior to shipment. Failure of any LED module to meet requirements of these QA tests shall be cause for rejection. QA test results shall be maintained per the requirement above.
- e. Connected Wattage: Wattage and power savings are critical. The maximum acceptable wattage for the individual modules is listed in the Table below. LED modules shall provide a wattage maximum less than or equal to the maximum wattage shown below

Table 5. Maximum Acceptable Wattage for Individual Modules

Modules	Wattage
300mm Red Ball	10 or less
300mm Yellow Ball	22 or less
300mm Green Ball	12 or less
300mm Yellow Arrow	11 or less
300mm Green Arrow	5 or less

8) Mounting Hardware.

- a. Pole: The Polycarbonate Side of Pole Bracket, where required, shall be one-piece molding with internal wiring raceway for banding or lag screw attachment to steel poles. Brackets shall be designed to withstand 100 mph wind loading on the bracket and the signal head.
- b. Mast arm: Signal displays shall be mounted to the mast arms using an astrobrac assembly with a 1 ½" gusseted aluminum tube. The tube shall have a vinyl insert to conceal the wiring that will allow wire to enter the gusseted tube at any point and be routed from the mast arm to the signal display.
- c. Post: The Slip Fitter Collar, where required, shall be malleable iron,

9) Color, Finish, and Painting.

Polycarbonate resin hardware shall have color impregnated throughout the material. The finish shall be smooth and unflawed. Signal head parts shall be colored as follows:

- a. Vehicle Head:
 - Housing - Yellow
 - Door - Flat Black
 - Tunnel Visor - Flat Black inside and out
 - Backplate - Flat Black front and back
 - Pole Bracket - Yellow
- b. Pedestrian Head:
 - Housing - Yellow
 - Door – Black
 - Tunnel Visor - Flat Black inside and out
 - Pole Bracket - Yellow

3.2 CONTROLLERS AND CABINETS

1) General

This subsection describes the general and specific construction and operating requirements of new controllers, cabinets, and related equipment to be furnished by the Contractor. As called for on the Plans, controllers shall either be local intersection traffic signal controllers or reversible lane controllers.

This subsection contains design requirements for controllers, controller interfaces, physical standards, functional standards, and coordination standards.

The control equipment described herein is to be capable of being used in operating traffic signals as part of a coordinated system. The local control equipment shall be fully compatible with the signal system and central software, which as called for shall either be existing or to be supplied under other specifications.

The Contractor shall install all local controller databases, including coordination timing and scheduling, using data furnished by the Engineer in standard traffic engineering terminology

The controller shall consist of an electrically operated traffic control device, which shall function continuously and unattended at the locations shown in the Plans, to assign vehicle and pedestrian right-of-way by illuminating standard signals in accordance with a prescribed timing program. The signal display operation shall conform to the sequence charts and the phase diagrams included on the tender documents.

- a. Components: The traffic control assembly, referred to as the controller, shall include the timer, (control unit) load relay switches, signal conflict monitor, line filters, and necessary auxiliary equipment mounted in a cabinet. The controller shall be installed at the location shown on the tender documents or as directed by the Engineer. Each controller shall be wired complete with the specified auxiliary equipment and ready for operation by making field connections to the signal display equipment, detectors, and electric service line

- b. Solid State Construction: All controllers shall employ high quality, solid-state modular electronic construction designed for continuous unattended operation. No camshafts, rotary stepping line switches, lighting discharge tubes, or vacuum or gaseous tubes, shall be used for internal or external auxiliary circuitry, except incandescent or gaseous tube indicator lamps are acceptable devices.
- c. Training: The Contractor shall provide (with manufacturer personnel), as part of the contract for the controller, a minimum of twenty-four hours of classroom and laboratory instruction on the operation and maintenance of each separate type of controller supplied for three technicians. Instructions shall be on a highly technical level, describing the design and operation of electronic circuitry in detail as well as demonstrating troubleshooting and repair techniques.

2) Controllers Requirements

a. General

New traffic signal controller shall be a fully actuated, two-through-eight phase, four-ring solid-state, digitally-timed traffic signal controller.

The model of new controller furnished by the Contractor shall be a proven controller and not a pre-production prototype.

The controller shall be of modular design with an internal power supply all mounted in a suitable sheet metal enclosure. The metal chassis shall be designed for easy access to the printed circuit boards. All pin connectors shall be front mounted.

- b. The traffic signal controller shall meet or exceed all requirements of the specification.
- c. Central Processor Unit (CPU): The CPU shall provide the following:
 - Operating System with runtime license
 - Microprocessor, 25 MHz version
 - 4 Megabytes minimum dynamic random-access memory (DRAM)
 - 8 Megabytes minimum FLASH memory organized as a disk drive
 - 512 Kilobytes minimum static random-access memory (SRAM)
 - Time of Day (TOD) clock with hours, minutes, seconds, month, year, and automatic daylight savings time adjustment. TOD may be implemented in the CPU via electronic circuitry, operating system software, or a combination.
 - During power failures, the SRAM and TOD shall be powered by STANDBY voltage from the power supply.
- d. Line Frequency: Reference signal shall be generated by a crystal oscillator.
- e. Standby Voltage via a super capacitor for backup power during loss of service voltage shall be provided. The super capacitor shall have a minimum of 15-farad nominal size. No batteries of any type are allowed
- f. Keyboard and Display shall provide the following:
 - Keyboard shall be removable by pulling off, installed by pushing on, without use of

- tools
- Stowed extension cord to allow remote use of keyboard and display
 - Emulation of terminal per Joint Standard
 - Key quantity and function per Joint Standard
 - Liquid Crystal Display (LCD) with 8 lines of 40 characters
 - LCD contrast adjustment accomplished via the keypad, no contrast knob allowed.
 - Light-emitting diode backlight for the LCD.
 - Audible electronic bell.
 - Connector compatible with Joint Standard.
- g. Communications: The controller shall provide the following:
- Built-in 10 Base-T Ethernet with RJ-45 connector on controller front panel
 - Built-in Internet Protocol (IP) address assigned
 - Built-in Infrared (IR) wireless port compatible with Microsoft Windows for Pocket PC Infrared RAW mode.
 - Built-in 1200 bps Frequency Shift Keying (FSK) modem.
 - Built-in EIA-232 port for uploading and downloading applications software, as well as to update the operating system.
 - Built-in connector for use with removable Keyboard and Display, Personal Computer COM1 or Personal Digital Assistant (PDA).
- h. Required Phase Sequences: The Contractor shall be fully capable of providing, as a minimum, all phase sequences shown on the Plans.
- i. Controller Housing: The controller housing shall provide the following:
- Seven slots with card guides for expansion modules. The expansion modules and mating back plane board in controller are optional.
 - Two slots with card guides for standard modems. The modems and mating back plane board in the controller are optional.
 - Polycarbonate construction, except that the back panel, rear mounting tabs and power supply mounting plate shall be aluminum for electrical grounding.
 - Built-in carrying handle.
 - Two adjustable front mounting feet, used to raise the front cables and vary the display viewing-angle.
- j. Controller Expansion/Modification Capability: Controller shall be provided to operate as a two (2) through eight (8) phase controller. The controller design shall permit the mode of operation to be changed and the vehicle and pedestrian phasing capacity to be increased

without requiring that the controller case be internally modified or rewired. The motherboard and power supply shall be of adequate design to service the maximum configuration of the controller

k. The phase features shall provide the following capabilities:

- 16 Vehicle Phases
- 20 Pedestrian Phases
- Timing Rings
- 16 Overlaps
- 20 Detectors

l. The per-phase features shall be provided:

- Extended flashing pedestrian. Clearance
- Actuated rest in walk
- Soft vehicle recall
- Selective phase omit
- Selective phase yellow omit
- Conditional service
- Detector (stretch, delay and switching)

m. The per-unit features shall be provided:

- Programmed (remote) flash
- Exclusive pedestrian service
- Ring configurations (to 4 rings)
- Start-up flash or all red
- Remote sequence modifiers (16)
- Timed trailing overlaps
- Overlap green/yellow omit
- Auto timing of pedestrian clear
- Resident diagnostics
- Parameter printout
- Unit-to-unit transfer

n. The coordination features shall be provided:

- 4 Dial/4 Split/3 Offset
 - 24 traffic patterns
 - 3 offset correction mode
 - Transition cycles
 - Auto permissives (vehicle and pedestrian)
 - Sync monitoring
 - Manual control
 - Input monitor (walk rest modifier, manual control enable, stop time, remote flash)
 - Dial/split to dial/split copy
 - Coordination Modes: Permissive Mode, Yield Mode, Permissive Yield Mode, Permissive Omit Mode, Sequential Omit Mode, Full Actuated Mode.
- o. The time base scheduler features shall be provided:
- 10 week programs
 - 50 day programs
 - 120 event capacity
 - Dimming (per phase by phase output)
 - Auxiliary special function outputs, minimum of four (4)
 - Automatic or user-programmable daylight savings time and leap-year adjustment
- p. Whether or not preemption is required by the intersection's initial operation as called for on the Plans, each new local intersection controller shall provide a minimum of six (6) preemption sequences.
- q. The controller shall have the ability to assign, modify, and view detector operational parameters of all detector inputs to the controller.

Detector operations shall be assigned as follows:

- A standard vehicle detector
- A standard pedestrian detector
- A standard ultrasonic vehicle detector
- A 1-calling vehicle detector where the input shall operate as a vehicle detector that is operational while the phase is not green and the phase is on locking detection.
- A stop bar detector that shall operate as a vehicle detector which operates normally until it is in its phase green. In the green, the detector is disconnected and does not input to the phase. This feature is to operate in either lock or non-lock operation.

- A stop bar detector whose input shall operate as a vehicle detector that operates normally when the assigned phase is not green. When a call is detected, it shall be held in green until a gap greater than the Extend Timer setting occurs. The Extend Timer shall begin with the green. If a call is received before the Extend Timer times out, it shall be reset. Timer reset shall continue to occur until a gap is large enough to allow the Extend Timer to time out. Once a time out occurs, the detector shall be disconnected until the green terminates. When the extend time setting is zero, a call shall be held in green until a gap occurs. Delay time is to function normally
 - Ability to switch detector actuations to another phase when the assigned phase cannot be serviced normally or is red or yellow and the entered phase is green.
 - Delayed actuations, selectable from 0-99.9 sec. in 1/10th sec. increments.
 - Extended actuations, selectable from 0-99.9 sec. in 1/10th sec. increments.
- r. The special features shall be provided:
- Eight (8) system detector/coordination inputs
 - 6 Priority Routines
 - Detector diagnosis
 - Detector assignments and special detector allocation
 - Speed report
 - Standard reports
 - Built-In Diagnostics
 - Measurements of effectiveness
 - Green utilization
 - Time waiting
 - Cars waiting
 - Volume
 - Controller local alarm log: The log shall be accessible from the keyboard. It shall have the ability to store up to 80 alarms, of the following types, and showing the date and time of occurrences.
 - On-line/off-line
 - Power on/off-interrupt
 - Preemptions and user definable alarms
 - Low battery check/replace
 - Watchdog timeout
 - EPROM write/failure counts

- RTC chip failure/fault/adjust
- Alarm/Comm/TrafResp./Speed/Detector fault log
- Communication Faults
- Diagnostics
- Coordination status and Local/Free
- Software clock adjust
- Time change remote/keypad

Alarms shall appear in the order in which they occur. It shall be able to store up to 80 of the latest alarms with any additional alarms replacing the oldest.

- Minimum of four (4) special functions
- Remote "Manual" overrides
- TBC on loss of communications
- Upload and download data
- Communications
- Adaptive Traffic Control:
 - Adaptive Maximum Routines
 - Adaptive Protected / Permissive Routines
 - Conditional Virtual Split Routines
 - Coordinated Adaptive Split Routines.
- Status: Ring Timers, Coordination Timers, Preempt Timers, Time Base, Communication, Detector Diagnostics, Intersection, Input / Output

3) Miscellaneous Requirements

- a. Keyboard: All input data shall be user-programmable by means of the keyboard and LCD display.
- b. Coordination: Any phase of a multi-phase controller shall be capable of being the coordinated phase with any or all 16 timing Plans
- c. Clocks: The controller shall have one and only one set of master digital clocks to time all intervals of all phases.
- d. I/O Component Design: All controller unit input and output integrated circuit components shall be socket mounted to facilitate repair and maintenance of input/output boards. Also, all CPU board integrated circuit components with 14 or more leads shall be socket mounted
- e. Dual Maximum: The controller shall be furnished with at least two maximum time

settings for all phases.

- f. Power Supply: The control unit shall have a self-contained power supply to operate the controller and all auxiliary equipment.
- g. I/O Logic Levels: All controller input and output logic levels shall be a nominal zero volts (logic ground) for the true state and nominal +24 volts for the false state.
- h. Software and Software Updates: The Contractor shall furnish a certification from the controller manufacturer that the controller software shall be updated as revisions are available.
- i. Internal Communications Transceiver: Each new local controller furnished by the Contractor shall have an internal communications transceiver which shall receive system commands and data from the central system and transmit local intersection status data, database, and system detector data to the central system.

4) Controller Cabinets

- a. Type of Cabinet Required: Base mounted cabinets shall be furnished for multi-phase controllers which have a frame capable of providing five to twelve phases. All other controllers shall be furnished in pole mounted cabinets.
- b. Submission of Shop Drawings: Before fabrication of the cabinets is begun, the Contractor shall submit for approval three copies of complete shop drawing of the cabinet to be provided for each type of controller to be furnished.
- c. Cabinet Material: Pole-mounted cabinets (required for four phase cabinet) and pedestal mounted cabinets shall be fabricated from cast aluminum or welded sheet aluminum or a combination of both. All welds shall occur on the inside surface of the cabinet to maintain a clean appearance. Base-mounted controller cabinets shall be fabricated from cast aluminum or welded sheet aluminum. All welds shall occur on the inside surfaces of the cabinet to maintain a clean appearance. All new controller cabinets shall have an unpainted natural aluminum finish.
- d. Doors: Cabinets shall have a right-hinged front opening door, which shall include, substantially, the full area of the cabinet front and one (1) auxiliary police door-in-door for access to emergency controls. The main cabinet door shall have a switch wired to activate "door-open" alarm input into the controller. This alarm shall be active whenever the main door is open.
- e. Locks and Keys: The auxiliary police door shall be furnished with a standard police sub-treasury lock. Two (2) keys for each lock shall be provided with each controller cabinet.

5) Mounting Hardware

- a. Base-mounted cabinets shall be installed on a concrete foundation using Contractor-furnished hot dip galvanized bolts, nuts, washers, and template.
- b. Pole-mounted cabinets shall be equipped with brackets (two each) for stainless steel banding
- c. Pedestal-mounted cabinets shall be furnished with a galvanized slip-fitter sized appropriately for the pedestal post.

6) Fans and Ventilation.

- a. Cabinets shall be furnished with a thermostatically operated roof-mounted electric exhaust fan. All cabinets shall have fans rates at 34 m³/h at 37.8 C.
- b. Inlet ventilation openings shall be located in the lower part of the cabinet door, shall be screened and fitted with a fiberglass, furnace type replaceable air filter of adequate size and capacity to pass a volume of air equal to or greater than the rated capacity of the fan.

7) Surge Protection

The cabinet AC service shall be provided with the following surge protection:

- Unit must be a two stage hybrid type.
- The protector shall be provided with terminals as defined below:
 - Main line (AC line first stage terminal)
 - Main neutral (AC neutral input terminal)
 - Equip line in (AC line second stage input terminal, 10 amps)
 - Equip line out (AC line second stage output terminal, 10 amps)
 - Equip neutral out (neutral terminal to protected equipment)
 - GND (earth connection)

8) Solid-State Load Switches

Each AC+ signal display terminal shall withstand a 10 kA, (8 x 20 microsecond surge) 5 times without damage.

- Unit response time shall be less than 50 nanoseconds.
- Maximum clamping voltage shall be 395 volts (at 1 mA).
- Unit shall return to a high impedance state following surge.
- Unit shall be epoxy encapsulated in flame retardant material.

9) Colors of Signals During Flashing Operation

During flashing operation, the colors of the signals shall be as follows unless otherwise called for on the Plans:

a. Single-ring sequences:

The signals for phase 2 shall flash yellow;

- If phase 1 is a protected-permitted left-turn (i.e., has a 5-section signal head), the circular yellow section in its 5-section head shall flash yellow; otherwise, the signals for phase 1 shall flash red; and
- All other signals shall flash red.

b. Dual-ring sequences:

The signals for phase 2 and 6 shall flash yellow;

- If phase 1 is a protected-permitted left-turn, the circular yellow section in its 5-section head shall flash yellow; otherwise, the signals for phase 1 shall flash red;
- If phase 5 is a protected-permitted left-turn, the circular yellow section in its 5-section head shall flash yellow; otherwise, the signals for phase 5 shall flash red; and
- All other signals shall flash red.

10) Switches Inside Main Door

Automatic/Flashing switch: Mounted on the inside of the main cabinet door. Switch shall preempt the normal signal display and initiate the specified flashing display. The controller shall continue to operate during this flashing mode.

11) Police Panel.

All cabinets shall be furnished with 2 police compartment accessible through the door-in-door. The back side of the compartment extending into the cabinet shall have all exposed electrical facilities enclosed in a protective housing.

The police compartment shall be equipped as follows:

- a. Signal Power Switch: This switch will remove power from the signal Buss.
- b. Automatic/Flashing switches: In flashing position, the normal red, yellow, and green signal display shall be preempted for the flashing operation. Upon resuming automatic operation, the controller display shall be in the pre-programmed start-up orientation.
- c. Normal/Manual switch: When in manual, this switch shall stop the automatic sequence of the controller and hold the existing display until manually advanced into the next interval. When in normal, the automatic control sequence shall continue.
- d. Push Button and Cord: A miniature panel connector shall be installed for connecting a detachable hand held push button for manual operation.

12) Detector Amplifiers

Controller cabinet shall be supplied with harnesses for four-channel shelf-mounted detector amplifiers. The number of harnesses shall be as follows:

- a. One or more harnesses to accommodate the number of local detector amplifier channels called for in the Plans plus a minimum of two (2) spare channels.
- b. One or more harnesses to accommodate the number of system amplifier channels called for in the Plans.

13) Fiber Optic Communications Interface

Unless otherwise called for, Controller cabinet shall be supplied with a Fiber Optic Communications Interface

14) Miscellaneous Required Facilities

Detector push button switches shall be provided for placing vehicular and pedestrian calls on each individual phase separately. A sufficient number of switches shall be provided to serve the maximum phase capability of the controller unit supplied in case of future expansion.

15) Malfunction Management Unit (Conflict Monitor)

All cabinets provided by the Contractor shall have a (16) sixteen channel MMU. Each conflict monitor shall provide the following features:

- a. Dual Indication Monitoring. This monitoring function shall be required to detect simultaneous indications of active green, yellow, walk and red field signal outputs on the same channel.
- b. Conflict/Voltage Monitor Operations. One of three different groups of prohibited dual combinations shall be selected via front panel "dual select" switches to be provided on the front panel for all channels which have been enabled for dual indication monitoring.
- c. Green-Yellow Dual Indication Monitoring. This monitoring function shall be provided to detect a simultaneous indication of active green and yellow field signal outputs on the same channel.
- d. Clearance (Short or Absent Yellow) Monitoring. This function shall be provided to detect the absence of a minimum 2.8 second period of an active yellow field signal output during a red to green to yellow to red sequence.
- e. Controller Watchdog Monitoring. This function shall be provided to monitor an optional watchdog output from the cabinet controller circuitry.
- f. Walk Disable (Red Monitoring). This option shall be provided to modify the operation of red monitoring.
- g. Non-Volatile Fault Memory. The loss of AC+ power to the monitor shall not reset a fault condition (conflict, dual indication, red failure, clearance, or a voltage monitor latch option is enabled).
- h. Real-Time Clock/Calendar. A real-time clock shall be provided in the monitor to identify each fault occurrence with the time of day and date.
- i. Fault Data Logging: the monitor shall automatically update and maintain a complete record of the last nine faults which caused the unit to trigger.
- j. Program Card Readback. the channels programmed as "permissive" on the program card are to be displayed on the field output status display, if desired.
- k. Program Card Absent. the monitor shall enter the fault mode and cause the output relay contacts to transfer.
- l. Internal Watchdog. The monitor shall generate an internal watchdog pulse from the microprocessor.
- m. Reset Input Detection. This function shall be provided to prevent the cabinet controller from being operated with the monitor disabled due to a faulty reset button or external test reset input.
- n. Voltage Monitor Fault Latch. When the voltage monitor fault option is enabled by the front panel switch labeled "VM latch"

- o. Display LCD & LED Test. The monitor shall display all front panel LCD indicators and illuminate all front panel LED indicators
- p. Memory Test. The monitor is to verify the proper option of the memory (RAM& EPROM) devices required to operate the monitor.
- q. Fault Timing and Configuration Display. The fault timing specifications for conflict, red fail, voltage monitoring, dual indication, clearance fail, and controller watchdog fail (if enabled) as set by the factory shall be reviewed on the fault status display using the Mode and Inc. buttons on the front panel.
- r. BND (Blinking/Noise/Dimming) Error Detection. This error detection shall be provided to supplement the unique firmware sampling and digital filtering method for the field input signals which are to provide limited noise immunity.

16) Front Panel Description

- a. Field Output Status Display.
- b. Fault Status Display.
- c. Voltage Monitor Indicators
- d. Conflict Indicator.
- e. Dual Indicator.
- f. Red Fail Indicator.
- g. Clearance Indicator.
- h. BND Indicator
- i. Program Card Indicator.
- j. Previous Failure Indicator
- k. Time and Date Display.
- l. DC Voltage Monitor
- m. Logic Inputs.
- n. Timing Functions. Dual indication, Watchdog, AC+ interruption, Minimum flash after disable, Start delay relay timer.

17) LED Displays

- a. Power Indicator
- b. Fault Indicator
- c. Monitor Fail Indicator

3.3 VEHICLE DETECTOR AMPLIFIERS

1) General

This defines the minimum acceptable design, operational and functional performance requirements for high performance, multiple channel, inductive loop vehicle detection systems.

- a. The detector shall be microprocessor controlled, self-tuning and fully digital
- b. Detector units shall have optical outputs for interface with new solid state controllers and computer systems
- c. All connectors and channel indicators shall be mounted on the front panel; controls for selection of sensitivity, mode of operation, reset/circuit breakers
- d. All component part and test points shall be clearly identified by permanent marking of circuit references on the P.C. Board.
- e. Integrated circuit devices having 16 or more leads shall be socket mounted to facilitate repair and maintenance of units

3.4 PEDESTRIAN PUCH BUTTON DETECTOR

Pedestrian Push Button Assembly shall be actuated by pushing a neoprene surface area at least 5cm in diameter. Each push button assembly shall comply with applicable requirements of the Specifications. The internal button shall be of the spring return type and cause the closure of a set of internal contacts. The push button/contact assembly shall be screwed into a one-piece, Yellow painted aluminum die cast, cylindrical housing suitable for mounting on a steel pole in conformance with the tender documents.

The push button assembly shall be constructed and gasketed to prevent accidental shock and provide weatherproof and freeze-proof operation.

3.5 ULTRASONIC VEHICLE DETECTOR

Ultrasonic vehicle detector shall provide the following:

- Detectable Object: Mini passenger vehicles or larger
- Detectable Vehicle Velocity: 0 ~ 120km/h
- Ultrasonic Frequency: 26±1kHz
- Pulse Repeating Cycle: Possible to select the types either automatic synchronized to road reflected wave (standard) or fixed time with 85±5msec
- Detection Output Holding Time Pulse repeating cycle: 115msec±10%.
- Detection Distance: Detection distance range is 1.5m to 8m from the transmitter front face. Setting of distance is selective either automatic synchronized to road reflected wave or manual setting with PC.
- Detection Field: Detection diameter of noted below at the point of 5m from transmitter' s front side. N Type: 0.75m±10%, M Type: 1.2m±10%
- Output Contact Capacity Voltage: 25V (max.), Current 25 mA (max.) Open collector output, detection: off
- Power Supply: DC12V±1V, UPS
- Power Consumption: 3VA (max.)

- Ambient Temperature: -20°C ~ +60°C
- Relative Humidity: 40 ~ 90%
- Weight: 2 kg or lighter (cables and fitting metal parts are excluded)
- Attachment Cable Length: 15m or 30m

3.6 SIGN AND SIGNAL SUPPORT POLES

1) General

These Specifications apply to the manufacture of poles for the support of traffic signals and signs. The height of poles, shaft dimensions, and wall thickness shall meet the design requirements and mounting height of traffic signals and signs as set forth in these Specifications and on the Plans. Bracket arm lengths are indicated on the tender documents.

2) Common Requirements for Galvanized Steel Mast Arm Poles, and Galvanized Steel Mast Arms

(1) General

Materials: The materials used shall meet or exceed the standards of American Society of Testing and Materials and the Society of Automotive Engineers as noted. Poles shall be galvanized inside and outside to ASTM A123.

Structure: The poles covered under these specifications shall be tapered, upright circular steel with uniformly tapered shaft and round cross section.

Welding: All welding shall be performed by welders qualified in accordance with "American Welding Bridges."

Design Drawing: The Contractor shall submit four copies of design drawings unless otherwise specified. Contractor's estimated weights of the various units shall appear in the design drawings. The successful Contractor shall be required to submit shop drawing for approval.

(2) Galvanized Steel Mast Arm Poles

The Mast arm poles shall be galvanized steel with a uniformly tapered shaft. The shaft shall be fitted with a removable pole cap, a J hook wire support welded inside near the mast arm connection, a welded frame handhole opposite the mast arm (of like design and installation to lower handhole), and a flange plate assembly to match that welded to the butt end of the mast arm.

Mast arm poles shall have a cast anchor base or welded plate base of adequate strength, shape, and size and shall be secured to the lower end of the shaft. The base shall be fabricated from drop forged or cast steel of sufficient cross section to develop the ultimate strength of the pole.

A grounding lug for no. 4mm dia. ground wire shall be welded to inside of pole at a point readily accessible from the handhole for wiring. Where required, mast poles shall be of sufficient height and equipped with proper mounting plates for street light attachments as required in the pole dimensions.

(3) Galvanized Steel Mast Arms.

Mast Arms shall be fabricated in the same manner as the upright shafts and with the same physical characteristics. The mast arms shall meet the design requirements necessary to support rigidly mounted traffic signals and signs, as designated in the Plans.

All arms shall include a removable cap at the tip, signal attachment method of the type and number shown in the Plans, and a signal arm clamp flange plate welded to the butt end to provide a rigid connection to the mast. The assembly shall be constructed so that all wiring can be concealed internally.

(4) Pedestal Poles.

The pedestal poles shall consist of one upright pole with suitable base and any other accessories or hardware as required to make a complete installation.

All poles shall be made of one continuous piece from top of base connection for the entire height of the pole. The cross-section shall be cylindrical and uniformly tapered from butt to tip.

Bases shall be round, octagonal, or square in shape and of an ornamental fabricated cast material of a transformer type base. A handhole shall be provided in the base or 18 inches above the base in the pole. Bases shall be furnished with four steel anchor bolts of sufficient size and length to securely anchor the base to the concrete footing.

3.7 CONDUIT AND RISERS

Metal conduit and fittings shall be rigid heavy-walled, hot dipped galvanized steel and shall comply with the Specifications.

Each conduit riser which brings aerial copper cable into a pole-mounted cabinet shall be fitted with a pair of elbow condulets and enter the cabinet through the bottom.

The exposed top of each conduit riser shall be fitted with either a weatherhead or a sealing bushing.

3.8 PULL BOXES

Standard traffic pull boxes shall be constructed of Class A concrete reinforced in accordance with the details as shown on the tender documents.

The cast iron cover shall have a roughened top surface. Notches shall be provided for removing the cover. The words "Traffic Signal" shall be inscribed on the top of the cover.

3.9 ELECTRICAL CABLES AND CONDUCTORS

Traffic signal conductors, power service drops, detector conductors shall be stranded copper with insulation rated at 600 volts.

The cable or conductors shall be suitable for use in conduit, duct, aerial, or direct burial installation.

The cable size shall be as required by the tender documents or as directed by the Engineer. The Contractor may install larger cable than required without extra compensation.

Signal Cable:

All multi-conductor control cables (3 or more conductors) shall have individual conductor size no.1.6mm dia., high molecular weight polyethylene color-coded insulation, suitable fillers and binder tape with a PE overall jacket and be rated at 600 volts. These cables shall be suitable for use in conduit, duct, aerial, or direct burial installations.

4. CONSTRUCTION REQUIREMENTS

4.1 GENERAL

All construction and equipment installations shall comply with the requirements provided herein and with the details shown on the tender documents for the type work involved.

4.2 ELECTRICAL INSTALLATION

All electrical installations shall comply with all laws, codes, and regulations. All metallic conduit and the installed electrical equipment shall be grounded in accordance with these Specifications and the tender documents.

The effectiveness of the grounding shall be determined by measuring the resistance from the point of attachment of the grounding wire to the equipment with an approved 0 to 50 ohm megger.

4.3 BONDING AND GROUNDING

All metallic cable sheaths, cable shields, conduit (both metal and PVC), transformer cases, span wires, cabinets, and metal poles and pedestals shall be made mechanically and electrically secure to form a continuous system and shall be effectively grounded.

Grounding of conduit and neutral shall be accomplished as required under the Specification, except that grounding conductors shall be 38mm² or approved equal, as shown in the tender documents. Exposed grounding conductors shall be enclosed in 15mm diameter rigid galvanized steel conduit riser and shall be bonded to the ground rod with a copper clad ground clamp.

Bonding and grounding jumpers shall be 2.9mm dia. solid copper wire with green insulation. Grounding conductors which ground electrodes to the signal system or the utility system neutral shall be bare stranded or braided copper wire of not less than the same cross-sectional areas as 4mm dia. Ground electrodes shall be one-piece lengths of copper weld ground rod not less than 1.5m in length and 1.6 in diameter, installed in accordance with the tender documents.

4.4 EXCAVATION, CONSTRUCTION AND IMPROVEMENT

The excavations required for the installation of conduit, foundations, and other items shall be coordinated with other improvements and performed in such a manner as to cause the least possible damage to the existing streets, sidewalks, and other improvements.

The trenches shall not be excavated wider than necessary for the proper installation of the electrical equipment and foundations. Excavating shall not be performed until immediately before installation of conduit and other items. The material from the excavation shall be placed in a position where the least disruption and obstruction to vehicular and pedestrian traffic shall be realized and the least interference with the surface drainage will occur.

The excavations shall be backfilled and compacted to at least the density of the surrounding material. All surplus excavation material shall be removed and disposed of by the Contractor outside of the highway right-of-way, in accordance with as directed by the Engineer.

Excavations, after backfilling, shall be kept well filled and maintained in a smooth and well drained condition until permanent repairs can be made. At the end of each day's work and at all other times when construction operations are suspended, all equipment and other obstructions shall be removed from the portion of the roadway.

Excavation in the street or highway shall be performed in such a manner that not more than one traffic lane shall be restricted in either direction at anytime. Traffic signal installation work shall be scheduled so no part of the roadway is closed to traffic between the hours of 7-9 a.m. and 4-6

p.m., Monday through Friday unless approved otherwise by the Engineer. Construction signing shall be incorporated in accordance with the provisions of road construction.

4.5 REPLACING, REMOVED, BROKEN OR DAMAGED IMPROVEMENTS

Improvements such as sidewalks, driveways, curbs, gutters, Portland cement concrete and asphalt concrete pavement, bituminous surfacing, base material, and any other improvements removed, broken, or damaged by the Contractor and not a part of the installation shall be replaced or reconstructed in kind. Whenever a part of a square of slab of existing concrete sidewalk or driveway is broken or damaged, the entire square or slab shall be removed and reconstructed as specified above.

4.6 CONCRETE PLACEMENT

Concrete operations (foundations, sidewalks, curb, and gutter, and pavement) shall not be permitted when in the opinion of the Engineer the weather or other conditions are in any way unsuitable. Concrete placement and curing shall conform to the requirements.

4.7 TRAFFIC CONTROL FACILITIES

New controllers and associated equipment shall be timed per the signal timing sheets provided by the Engineer. Signal timing shall be requested a minimum of ten (10) days prior to actual signal turn on. The actual setting of the dials on the traffic signal controller and all associated equipment is to be accomplished by the Contractor.

New pedestrian and vehicular signals shall be hooded with tied canvas or opaque plastic bags until all work at the intersection has been completed, accepted by the Engineer, and the signals are being turned on for traffic use. Hooded shall mean that the entire signal head shall be covered. At the time of turn-on of the new signal, any previously used signal taken out of service shall be hooded with tied canvas or opaque plastic bags or immediately removed.

Any damage due to negligence on the part of the Contractor because of lack of proper care of equipment shall be cause for the Engineer to order its replacement. The cost of such replacement shall be borne fully by the Contractor without extra compensation.

4.8 POWER SUPPLY

The Contractor shall provide an electrical secondary service drop for each cabinet. The Contractor shall coordinate with YESB for the service drop and make the connection from the drop to the cabinet panel terminal as specified herein.

4.9 MAINTENANCE OF TRAFFIC

Traffic disruption and delay shall be kept to a minimum, and traffic operations shall be maintained through the project area for the length of the Contract.

The Engineer may direct special efforts during certain phases of work to insure compliance with the approved construction schedule.

The Contractor shall be responsible for providing and maintaining adequate safety lights and barricades to protect the public and must maintain access to abutting property. The Contractor shall be required to have police personnel present to direct traffic during signal turn-on if so directed by the Engineer.

4.10 INSTALLATION OF TRAFFIC CONTROL EQUIPMENT AND MATERIAL

1) Signal Heads.

The Contractor shall install the signal heads as required by the tender documents. The Contractor shall wire all signal heads complete for operation in accordance with the tender documents, and shall provide a complete circuit from the signal head terminal, to the controller cabinet terminal. Labels shall be attached to the controller terminal identifying all signal functions. All signal field circuits shall be tested for continuity, "flashed out" to verify identification, and measured for amperage load with an approved clamp-on ammeter.

2) Controllers and Cabinets

The Contractor shall install the controller cabinet as required by the tender documents, providing all other miscellaneous installation materials including grounding wire, copper clad grounding rod, secondary service drop, brackets and banding (if required), and foundations with anchor bolts, nuts, and washers (if required). The controller cabinet shall be completely wired for service.

Following the Field Tests indicated in the Specifications, the Contractor shall install the controller in the cabinet, making the necessary connections between the controller and the terminal blocks in the cabinet. The Contractor shall also install the detector amplifiers, flasher, monitor, load switches, and make the necessary wiring connections to the terminal blocks.

Foundations (if required) and topping shall be poured monolithically according to the requirements of the Specifications. Anchor bolts and reinforcing steel shall be placed in accordance with the tender documents.

The bottom shall rest on firm, undisturbed ground and the top shall be formed to present a neat appearance.

3) Pedestrian Detector Sensor Units

The Contractor shall install pedestrian push buttons according to the pole locations and orientation shown in the tender documents. The push buttons shall be wired to the controller in accordance with the tender documents. The pedestrian actuated signal sign given in the tender documents shall be installed on the pole with each push button.

4) Ultrasonic Vehicle Detector

The Contractor shall install ultrasonic vehicle detector according to the mast arm of pole locations and orientation shown in the tender documents. The detector shall be wired to the controller in accordance with the tender documents.

4.11 SIGN AND SIGNAL SUPPORT POLES

1) Foundations.

Foundations for posts, standards, and pedestals, shall be Class A Portland cement concrete as specified in these Specifications. Anchor bolts, conduits, and reinforcing steel shall be placed in accordance with the tender documents.

Foundations for posts, standards, and pedestals shall be poured monolithically to final grade. The exposed portions shall be formed to present a neat appearance.

The bottom of concrete foundations shall rest on firm, undisturbed ground. A vibrator shall be used in the pouring of all foundations to remove voids and air entrapment.

Forms shall be true to line and grade. Tops of foundations for posts and standards, except special foundations, shall be finished at sidewalk grade or as ordered by the Engineer.

Conduit entries in addition to those required for the installation shall be placed in each foundation, oriented as shown on the Plans or as directed by the Engineer, and capped according to these Specifications.

Where obstructions prevent construction of planned foundations, the Contractor shall construct a foundation satisfactory to the Engineer.

Steel poles shall be bolted as shown in the tender documents. Poles shall be fitted with all necessary hardware to make the installation complete. Steel poles shall be oriented such that the handholes are facing away from the street and oncoming traffic in the near curbs at approximately 90° or more from the curbs, unless otherwise directed by the Engineer.

2) Underground Conduits.

Conduit under existing pavement shall be placed by an approved method. Existing pavement shall not be disturbed unless otherwise directed by the Plans or by the Engineer.

3) Conduit Risers.

Each conduit riser which brings aerial copper cable into a pole-mounted cabinet shall be fitted with a pair of elbow condulets and enter the cabinet through the bottom.

4) Pull Boxes.

Pull boxes shall be installed at locations shown on the Plans or where directed by the Engineer. Covers shall be flush with the curb or sidewalk grade or with the surrounding ground, as required. No pull boxes shall be placed in the roadway area.

4.12 ELECTRICAL CABLES AND CONDUCTORS

1) Signal Cable.

All splices in the signal wiring shall be made with solderless connectors of a copper sleeve compressed type, crimped with a suitable crimping tool, and covered with a screw-on, removable, reusable plastic cap. All splices shall be made in the pole bases and condulet. A cover kit shall be placed over splices as shown in the tender documents or when directed by the Engineer.

4.13 CLEARANCE FROM UTILITY FACILITIES

Traffic signal foundations shall maintain a minimum 60cm of separation between the foundation and any underground electric, gas, or water distribution facilities.

4.14 COMPUTER APPARATUS

The Contractor shall furnish notebook computers as called for in the Plans.

4.15 TEST EQUIPMENT

If called for in the tender documents or other Contract Documents, the Contractor shall furnish one or more items of the following test and support equipment.

4.16 PAINTING

- a. Standards, posts, pedestals, and any other galvanized surface to be painted shall be cleaned and coated with the approved primer best suited for the surface.
- b. If an approved prime coat has been applied by the manufacturer and is in good condition,

additional primer application by the Contractor, other than for repairs, shall not be required.

- c. When specified to be painted, standards and posts shall have at least two coats of Traffic Paint applied as follows:
 - (1) Mast arms and standards with bracket mounted signals shall be painted in their entirety, except that polycarbonate signals and brackets shall be omitted and only the standards painted.
 - (2) Pedestrian push-button posts, steel pedestals for cabinets, and standards with top mounted signals, including left turn signals, shall be painted from the base to the top of the post.
- d. Steel controller cabinets shall have a finish on all surfaces, both interior and exterior, consisting of a minimum of one coat of zinc chromate primer on all surfaces and two coats of a high grade aluminum paint, unless otherwise shown on the tender documents.
- e. All signal heads, signal head mountings, and pedestrian push-button housings shall have one or more coats of primer followed by two coats of traffic Signal Yellow except polycarbonate type which shall present the equivalent color.
- f. Louvers as specified, interior and exterior of signal hoods, and fronts and backs of back plates shall have one or more coats of primer followed by two coats of Lusterless Black enamel, except polycarbonate type. All factory enameled equipment and materials shall be examined for damaged paint after installation, and such damaged surfaces shall be repainted to the satisfaction of the Engineer.

4.17 TEST, SERVICE CHECKS, INSPECTION AND DOCUMENTATION

1) General

The Contractor shall be responsible for the installation tests, demonstration of the functioning system, and checks of all hardware.

The Engineer reserves the right to examine and test any and all materials furnished and/or installed by the Contractor for this project to determine if they meet the requirements of the tender documents and of the specifications. If any material used in the construction of this project does not meet these requirements, the Contractor shall replace such defective parts and material at no cost to the Project. Rejected equipment may be offered again by the Contractor for re-testing provided all non-compliance has been corrected and the equipment has been pre-tested by the Contractor.

Testing of Contractor-furnished and installed hardware and equipment shall be conducted as described below. All tests specified herein shall be successfully conducted prior to Final Acceptance of the Project. All test equipment shall be provided by the Contractor unless otherwise provided herein. The Contractor shall perform the tests and document the test results.

When the tests are completed, whether successfully or not, the test results shall be furnished to the Engineer. All test documentation forms shall be submitted to the Engineer for approval.

No separate payment shall be made for any testing or documentation, all costs of which shall be included in the amount bid for other pay items.

The times and dates of tests shall be approved by the Engineer. The Contractor shall conduct all tests in the presence of the Engineer or his authorized representative. Unless otherwise approved by the Engineer, testing shall take place only on weekdays which are official working days and during normal working hours.

2) Circuit Tests

Prior to completion of the work, the Contractor shall cause the following tests to be made on all traffic signal circuits in the presence of the Engineer. Any fault in any material or in any part of the installation revealed by these tests shall be replaced or repaired by the Contractor in a manner approved by the Engineer, and the same test shall be repeated until no fault appears.

3) Cabinet/Controller Tests

Initial Testing by Contractor

Each new controller and cabinet assembly (including both intersection controllers and reversible lane controllers) shall be tested by the Contractor prior to shipment to the project. For the purposes of the test, the timing intervals shall be programmed in a manner that will exercise each phase and overlap color indication (up to the maximum capacity of the cabinet) throughout the test.

This 48-hour burn-in test shall, as a minimum, exercise the following equipment: controller; cabinet auxiliary devices; conflict monitor; power supply; and all load switches, and (if applicable) flasher, flash transfer relays, and preemption isolation relays. Such tests shall demonstrate that the equipment has been fabricated, constructed, and wired in a thoroughly workmanlike manner.

Cabinet/controller assemblies which fail the 48-hour burn-in shall be repaired and/or replaced and then re-tested.

Pre-Installation Programming

- a. The Contractor shall provide one (1) or more controller cabinets, which shall be set up by the Contractor in the Signal Shop. The number to be provided, which shall be a function of the number of new controllers to be furnished in conjunction with the project, shall be one (1) cabinet per twenty(20) controllers up to a maximum of five (5) cabinets.
- b. After successful completion of the required initial testing to be performed by the Contractor any required controller and cabinet assembly training required to be performed by the Contractor, the Contractor shall deliver to the Project Signal Shop lots of not more than ten (10) controllers and conflict monitors, each labeled as to the intersection or lane control gantry for which it is intended.
- c. The Contractor shall allow at least five (5) working days (excluding per delivered lot of controllers and monitors for the Project to perform the required programming and database entry, after which the Contractor shall pick up the controllers and monitors and install them at the locations for which they have been programmed.

5. MEASUREMENT

Each accepted installed item relating to traffic signal installation shall be measured as described herein. Items which are incidental construction required for the installation of a traffic signal shall not be measured and shall be considered incidental to the work.

Any other item for installation not measured herein shall not be measured and shall be considered incidental to the work.

5.1 Poles

Accepted poles (traffic signal pole, pedestrian signal pole) of each size, section, and mounting arrangement specified shall be measured as the number furnished and installed complete in place.

5.2 Signal Heads / Push Button

Accepted signal heads and push button (traffic signal head, arrow signal head, pedestrian signal head) of each size, section, and mounting arrangement specified shall be measured as the number furnished and installed complete in place.

5.3 Handhole

Accepted handholes shall be measured as the number furnished and installed complete in place.

5.4 Traffic Signal Controller

Accepted traffic signal controller shall be measured as the number furnished and installed completed in place.

5.5 HDPE Pipe

Accepted HDPE Pipe of each size shall be measured as the linear meter furnished and installed complete in place.

5.6 Electric Wire Cables

Accepted electric wire cables (SVV, SVV-SS cables) of each size shall be measured as the linear meter furnished and installed complete in place.

6. PAYMENT

The work measured as provided above shall be paid for at the Contract unit price as detailed below. The payment shall be full compensation for furnishing, hauling, installing, commissioning and testing for all labour, tools, equipment, material, and plants and incidentals necessary to complete the work.

The Pay Items and Pay Units shall be as follows;

Pay Item	Descriptions	Pay Unit
09200-01	Traffic Signal Pole	Number
09200-02	Pedestrian Signal Pole	Number
09200-03	Traffic Signal Head	Number
09200-04	Arrow Signal Head	Number
09200-05	Pedestrian Signal Head and Push Button	Number
09200-06	Handhole (600 x 600 x 800)	Number
09200-07	Traffic Signal Controller	Number
09200-08	Distribution Panel (3 branches)	Number
09200-09	HDPE Pipe (50mm dia.)	lm
09200-10	HDPE Pipe (25mm dia.)	lm
09200-11	SVV-SS 2.0sq.mm x 15c	lm
09200-12	SVV-SS 2.0sq.mm x 18c	lm
09200-13	SVV-SS 2.0sq.mm x 21c	lm
09200-14	SVV-SS 2.0sq.mm x 33c	lm

09200-15	SVV-SS 2.0sq.mm x 36c	lm
09200-16	SVV-2.0sq.mm x 4c	lm
09200-17	SVV-2.0sq.mm x 8c	lm
09200-18	Joint Box (36 Terminal)	Number

Section 10100 – Toll Collection Facility

Table of Contents

1. DESCRIPTION..... 1

1.1 GENERAL..... 1

1.2. ABBREVIATIONS..... 1

1.3. SCOPE OF WORK..... 1

1.4. QUALITY ASSURANCE..... 2

1.5. DRAWINGS AND DOCUMENTS 2

2. MATERIAL REQUIREMENTS2

2.1. STANDARDS AND REGULATIONS 2

2.2. GENERAL REQUIREMENTS 3

3. REQUIREMENTS FOR CONSTRUCTION4

3.1. GENERAL 4

3.2. CONSTRUCTION WORKS 4

3.3. INSPECTION OF CONSTRUCTION WORKS..... 4

3.4. PROPOSAL FOR CONSTRUCTION METHOD 4

3.5. EQUIPMENT INSTALLATION WORKS..... 4

3.6. MANAGEMENT OF CONSTRUCTION SITE 5

4. TOLL PLAZA FACILITY5

4.1. REBAR WORKS..... 5

4.2. CONCRETE WORKS..... 5

4.3. STEEL FRAME WORKS 5

4.4. ELECTRICAL FACILITY WORKS 6

4.5. MACHINE FACILITY WORKS..... 7

5. ADMINISTRATIVE OFFICE8

5.1. FOUNDATION CONSTRUCTION WORKS..... 8

5.2. REBAR WORKS..... 8

5.3. CONCRETE WORKS..... 8

5.4. ALC PANEL WORKS..... 9

5.5. STEEL FRAME WORKS 9

5.6. ELECTRICAL FACILITY WORKS 9

5.7. MACHINE FACILITY WORKS..... 10

6. MEASUREMENT AND PAYMENT..... 10

6.1. METHOD OF MEASUREMENT 10

6.2. BASIS OF PAYMENT 11

Section 10100 – Toll Collection Facility

1. Description

1.1 General

- (a) This work consists of furnishing and installing all materials and equipment necessary to complete in place toll collection facilities and weighbridges (the term truck scale may be used interchangeably) all in accordance with the requirements of this Specification Section, manufacturer's manual/instructions and the Drawings, or as directed by the Engineer.
- (b) The locations of toll collection facilities and weighbridges shown in the Drawings are approximate, and the exact locations may be modified to fit in with surrounding structures. Any such modifications shall be made in accordance with the Engineer's instructions.

1.2. Abbreviations

The abbreviations in this Specification Section are the following:

Abbreviation	Description
JIS	Japanese Industrial Standards
IEC	International Electrotechnical Commission
JEAC	Japan Electric Association Code
JEM	Standards of the Japan Electrical Manufactures' Association
AOQL	Average Outgoing Quality Limit
Lx	Lux
BTU	British Thermal Unit
ALC	Autoclaved Lightweight aerated Concrete

1.3. Scope of Work

The scope of this work consists of supply and delivery to the site, installation, testing and commissioning as required of all materials, equipment and labor for the works of the following:

(a) Toll Plaza Facility:

Large Roof, Toll Island, Toll Booth, Related Equipment

(b) Administrative Office:

Administrative Office Building which has Manager's Room, Administrative Room, Control Room, Resting Room, and Air Conditioning and other equipment, etc.

1.4. Quality Assurance

- (a) For the actual fabrication, installation, and testing of the work described in this Specification Section, the Contractor shall use only thoroughly trained and experienced personnel who are completely familiar with the requirements for this work and with the installation recommendations of the manufacturers of the specified items. In acceptance or rejection of the installed electrical system, no allowance will be made for lack of skill on the part of the installers.
- (b) Installers shall hold the relevant valid certificates complying with the regulations of the concerned Myanmar's authorities.

1.5. Drawings and Documents

The Contractor shall refer to all relevant Drawings and ascertain for himself the location and routes of all other utility services so as to maintain adequate clearance between the services. The Drawings issued for construction indicate the general arrangement of the works, and the Contractor shall provide working drawings showing the exact routes of all pipes, overhead and underground installations, the exact run of conduits and trunk-connection, the location of manholes or control holes, draw-in and junction units, the number and size of cables in each conduit, etc.

The Contractor shall submit a schedule showing lists of intended events and times such as the date on which concreting in different sections will take place, together with the submission of the working drawings.

Upon completion of the work, and as a condition of its acceptance, the Contractor shall provide to the Employer copy of instructions/manuals for the operation and maintenance of all equipment and a parts list sufficient for the ordering of parts.

2. Material Requirements

2.1. Standards and Regulations

- (a) The work covered by this Contract shall be carried out in accordance with the regulations issued by the local authority and with the following applicable standards and codes:
- IEC (International Electrotechnical Commission)
 - JIS (Japanese Industrial Standards Committee)
 - JEAC (Japan Electric Association Code)
 - JEM (Standards of the Japan Electrical Manufactures' Association)
- (b) The Contractor shall carefully examine at his own expense all the regulations issued by the local power company, and ensure that selected materials and method of installation are in accordance with such regulations.

The Contractor shall include in his unit price for any reasonable minor changes, modification, or supplementation of engineering drawings and specifications to ensure conformance with local regulations.

2.2. General Requirements

All works shall be done under the supervision of the Engineer and in accordance with the Drawings and the requirements herein described. Any changes made thereof shall only be made upon obtaining consent from the Engineer.

All electrical installations shall be done in accordance with the applicable ordinances, rules and regulations or standards of the local power company and with requirements of the relevant authority. The construction works shall be carried out under the supervision of a licensed engineer of the Contractor.

The materials shall comply with the following general requirements:

- (a) All the materials used in the works must be brand-new which satisfies the requirements of quality and performance denoted in the drawings. However, this does not apply to the case of temporal construction.
- (b) The Contractor must submit the documents certifying the quality and performance of the materials to the Engineer. However, in case of using materials which has been specified to use JIS in the drawings and approved by the Engineer in advance to use the materials marked “JIS”, submission of this documents can be omitted.
- (c) The Contractor must report to the Engineer in each time of carrying materials into the site. However, this does not apply to the case where the Contractor obtains approval from the Engineer.
- (d) Material Inspection
 - Material inspection shall be carried out by each type of materials when these materials are carried into the site. However, this does not apply to the case where the Contractor obtains approval from the Engineer.
 - As the result of above inspection, the same types of material which passed the inspection can generally change to sampling inspection. However, this does not apply to the case where the Engineer gives instructions.
 - Carrying material into the site which is designated as an inappropriate material due to the deterioration, etc. by the Engineer must be conveyed out from the site immediately.

(e) Testing Associated with Material Inspection

Without detriment to the requirements of Sub-Clause 7.4 “Testing”, the Contractor shall perform the following:

- In case of conducting material testing to certificate its quality or performance, test shall be performed based on the designated method in the drawings. If there is no designation in the drawings, the test shall be performed based on the method which is approved by the Engineer.
- The Contractor shall submit the testing plan to the Engineer before the testing.

- The test shall be performed at the appropriate site such as Examination Institution, construction site, etc. For the selection of testing site, approval by the Engineer shall be required.
- Generally, the test shall be performed in the presence of the Engineer. However, this does not apply to the case where the Contractor obtains approval from the Engineer.

(f) Material Storing

- Material which is carried into the site shall be stored not to be deteriorated till the time to use in the construction work.

3. Requirements for Construction

3.1. General

All workmanship shall be complete and in compliance with the latest accepted standards of the industry, as determined by the Engineer.

3.2. Construction Works

- (a) Construction works shall be conducted according to the Drawings, work plan, method statement, working drawings.
- (b) In case of the work which shall make a hidden area such as Concrete placing work, the Contractor must not conduct the work till required inspection is completed. However, this does not apply to the case where the Contractor obtains approval from the Engineer.

3.3. Inspection of Construction Works

- (a) When the instruction from the Engineer received, the inspection of the construction work shall be conducted.
- (b) As the results of the above inspection, the same types of material and work method which passed the inspection of construction work can generally change to sampling inspection. However, this does not apply to the case where the Engineer gives instructions.

3.4. Proposal for Construction Method

- (a) If there is the proposal to adopt the different construction method from the designated in the drawings with which required quality and performance have been satisfied and environmental condition has been preserved adequately, consultation with the Engineer shall be conducted in advance.

3.5. Equipment Installation Works

- (a) Equipment installation work must be carefully performed in terms of horizontal and vertical position so as not to interfere with its performance after the installation of the equipment due to strain, etc.

- (b) Used ironmongery shall be manufactured after the adequate site survey.

3.6. Management of Construction Site

- (a) Appropriate curing shall be performed not to deface existing facilities, already completed or installed facilities, etc.
- (b) When construction works are completed, the Contractor shall conduct clean up the site both inside and outside of the architecture.

4. Toll Plaza Facility

4.1. Rebar Works

(a) Type of Rebar

D10: SD295A (JIS or equivalents)

D13: SD295A (JIS or equivalents)

(b) Joint of rebar

Gas pressure welding (D19 or above) must be applied to the joint of main reinforcement of column and beam.

4.2. Concrete Works

(a) Strength

Ordinary Concrete: $F_c = 24\text{N/mm}^2$, JIS or equivalents

Lightweight Concrete: $F_c = 18\text{N/mm}^2$, JIS or equivalents

(b) Air Dried Weight of Unit Volume

2.3t/m³

(c) Type of Cement

Ordinary Portland Cement

(d) Formwork

Thickness of the Plywood: 12mm

4.3. Steel Frame Works

(a) Capacity of Steel Frame Manufacturing Factory

To decide the manufacturing factory of steel frame, approval from the Engineer must be obtained.

(b) Steel Material

SS400, SN400B, SN400C, STKR400: JIS or equivalents

SSC400: JIS or equivalents

(c) High Strength Bolt

JIS Torshear type high strength bolt or equivalents

(d) Testing of Welding Section

UT (Ultrasonic Test)

	AOQL
Shop Welding	4.0%
Field Welding	4.0%

(e) Anchor Bolt

Anchor bolt for structure: JIS SNR400 or equivalents

(f) Field Welding

When members are attached on the structures by field welding, the Contractor shall conduct carefully so as not to occur the strain on the existing structures due to the effects of heat.

4.4. Electrical Facility Works

(a) Lighting Facility

Specified illuminance must be secured.

Object Location	Average Illuminance (Lx)	Remarks
Under the Large Roof	150	Illuminance of road surface
Inside of the Toll Booth	500	Height from the floor: 85cm
Inside of the Machine Room	150	Illuminance on the floor

(b) Conduit and Wiring Works

- Terminal processing must be performed to the cable termination in a conformable manner and be jointed perfectly.
- All cables must be marked manufacture's name, year and month of manufacture and testing laboratory on outer surface of the cable or wire. Name plate, which indicates connected place from/to, must be attached on the cable.
- Prior to the construction work, the Contractor shall conduct the calculation of conduit and wiring and obtain the approval by the Engineer.
- Cable in handhole and manhole must secure the extra length.

(c) Distribution Panel

- Work space for repairing and maintenance must be secured sufficiently.
- The wiring diagram must be provided on the inside of panel door.

- Prior to the construction work, the Contractor shall conduct the calculation of piping and wiring and obtain the approval by the Engineer.

4.5. Machine Facility Works

(a) Drainage Facility

The large roof drainage shall be treated by connecting directly to the drain pipe for pavement.

(b) Air Conditioning Facility

Air conditioning facility must be installed in all of toll booth as instructed in the drawings and secure the specified capacity in the following table.

Object Room	Type	Number of Machines	Cooling Capacity
Toll Booth (1.2m x 3.9mm)	Ceiling Suspended Type	9	More than 12,000BTU
Toll Booth (1.4m x 6.0mm)	Hooked on the Wall Type	2 (Including a standby machine)	More than 13,500BTU

(c) Ventilation Facility

Ventilation facility must be installed as instructed in the drawings and secure the specified capacity in the following table.

Object Room	Type	Number of Machines	Capacity
Toll Booth (1.2m x 3.9mm)	Air-conditioning Ventilator	9	More than 100φ×30m ³ /h

(d) Truck Scale Facility

- Track scale facilities shall be installed as shown in the Drawings, on the 1st lane and 10th lane of the toll collection booth.

Configuration	Specification	Quantity
Weighbridge/Truck Scale	<ul style="list-style-type: none"> • Pit type (If the loading surface becomes higher than the road surface, the Contractor shall measure the height of clearance and obtain the approval by the Engineer.) • Maximum measurable weight: 60t • Width: 3,000mm • Length: 15,000mm 	2
Meter and Recorder	Indoor installation type with a printer	2
Display Panel	Rainproof type	2
Foundation (Concrete)	<ul style="list-style-type: none"> • Type of Rebar : D13: SD295A (JIS or equivalent) • Ordinary Concrete: F_c = 24N/mm², JIS or equivalent 	2

5. Administrative Office

5.1. Foundation Construction Works

(a) Load Testing

Flat Plate Load Test: one place

Maximum Load: 35 KN/m²

Depth of Testing: GL-1.55 m

(b) Gravel and Sand Foundation

Crusher-run: Thickness 60mm

(c) Concrete Sub-slab

Concrete Sub-slab: Thickness 50mm

5.2. Rebar Works

(a) Type of Rebar

D16 or less: SD295A (JIS or equivalents)

D19 or above: SD345 (JIS or equivalents)

(b) Joint of rebar

Gas pressure welding (D19 or above) must be applied to the joint of main reinforcement of column and beam.

5.3. Concrete Works

(a) Strength

Design Strength Fc(N/mm ²)	Scope of Application
24	Foundation, Standing wall on ground floor
21	Building Skelton (Including the floor concrete inside of the building)

(b) Air Dried Weight of Unit Volume

2.3t/m³

(c) Type of Cement

Ordinary Portland Cement

(d) Formwork

Thickness of the Plywood: 12mm

(e) Plain Concrete

Design Strength: 18N/mm² (Ordinary Concrete)

5.4. ALC Panel Works

Type	Design Load (N/ m ²)	
	Positive Load	Negative Load
Exterior Wall Panel	1400	900

5.5. Steel Frame Works

(a) Capacity of Steel Frame Manufacturing Factory

To decide the manufacturing factory of steel frame, approval from the Engineer must be obtained.

(b) Steel Material

SS400, STKR400: (JIS or equivalents)

SSC400: (JIS or equivalents)

(c) High Strength Bolt

JIS Torshear type high strength bolt or equivalents.

(d) Testing of Welding Section

UT (Ultrasonic Test)

	AOQL
Shop Welding	4.0%
Field Welding	4.0%

(e) Fireproof Covering

Fireproof board must be applied for the column and beam.

(f) Anchor Bolt

Anchor bolt for structure: JIS SNR400 or equivalents

(g) Field Welding

When members are attached on the structures by field welding, the Contractor shall conduct carefully so as not to occur the strain on the existing structures due to the effects of heat.

5.6. Electrical Facility Works

(a) Lighting Facility

Specified illuminance must be secured.

Object Location	Average Illuminance	Remarks
-----------------	---------------------	---------

	(Lx)	
Office Room	750	Height from the floor: 80cm
Entrance Hall	350	
Server Room	300	
Resting Room	200~500	
Dressing Room	200	
Water Supply Room	200	
Toilet	200	
Corridor	200	Illuminance on the floor

(b) Conduit and Wiring Works

- Terminal processing must be performed to the cable termination in a conformable manner and be jointed perfectly.
- All cables must be marked manufacture's name, year and month of manufacture and testing laboratory on outer surface of the cable or wire. Name plate, which indicates connected place from/to, must be attached on the cable.
- Prior to the construction work, the Contractor shall conduct the calculation of piping and wiring and obtain the approval by the Engineer.
- Cable in handhole and manhole must secure the extra length.

(c) Distribution Panel

- Work space for repairing and maintenance must be secured sufficiently.
- The wiring diagram must be provided on the inside of panel door.
- Prior to the construction work, the Contractor shall conduct the calculation of piping and wiring and obtain the approval by the Engineer.

5.7. Machine Facility Works

(a) Sanitary Facility

Toilet bowl must have washing tank and urinal must have flush valve.

(b) Drainage Facility

Sewage and miscellaneous drainage shall release into a septic tank. In addition, including the rainwater, sewage shall connect to the drain pipe for pavement.

(c) Air Conditioning Facility

The Contractor shall install package type air conditioner facilities and room air conditioning facilities, as illustrated in the drawings.

6. Measurement and Payment

6.1. Method of Measurement

The quantity of each item paid for under this clause will be the number of each, set, linear meters, and lump sums of individual items as detailed below, which are furnished and installed in accordance with this Specification Section, the Drawings, and the instructions of the Engineer.

(a) Toll Island (unit – set)

- The work covered in this work items are toll plaza reinforced concrete work covering conduit for water on piled slab, lane mark (zebra in front and behind of toll island) and installation of truck scale for the wider toll islands (2.2m x 25.0m).

(b) Steel large roof (unit – set)

- Tollgate shall be installed at the location where tolls are collected. The work covers fabrication and installation of – structural frame including connection bolt and nuts for tollgate, installation of lighting, wiring and cabling in electrical work, drainage work for treatment of rainfall and other miscellaneous works to complete and acceptable the work.

(c) Steel Booth (unit – set)

- The work covered in this work items includes fabrication and installation of framework for booth, installation of outer and inner panel including door and tempered glass for booth, equipped wiring and cabling for lamp and air conditioner in electrical work, and other miscellaneous works to complete and acceptable the work including provision of various apparatus stated in the drawing.

(d) Steel Staircase (unit –lump sum)

- The work covered in this work items are building of steel staircase which is a part of passage of the access connecting the toll plaza and administrative office.

(e) Administrative Office (unit –lump sum)

- The works covered in this work items are building, fabrication and installation of equipment for the administrative office.

(f) Other Works

- Payment for related works, which is not specifically described in any other pay items, such as excavation and backfilling, markers for underground cables, buried cable protectors shall be included in the rates of pay items specified hereunder. The payment shall be full for compensation for all necessary equipment, materials, labor, transportation, installation, and testing to ensure that the finished work is in operation and fully functional.

6.2. Basis of Payment

The quantity of each item measured as described above paid for at the contract rates and unit prices as shown on the Bill of Quantities. The payment will be full compensation for the works as described above furnished and installed in compliance with the Specification, the Drawings and the instructions of the Engineer.

<u>Pay Item</u>	<u>Description</u>	<u>Unit</u>
10100-01	Toll Plaza Facility, Toll Island (1.8m x 25.0m)	Set
10100-02	Toll Plaza Facility, Toll Island (2.2m x 25.0m)	Set
10100-03	Toll Plaza Facility, Steel Large Roof (12.0m x 50.8m)	Set
10100-04	Toll Plaza Facility, Steel Booth (1.2m x 3.9m)	Set
10100-05	Toll Plaza Facility, Steel Booth (1.4m x 6.0m)	Set
10100-06	Toll Plaza Facility, Steel Staircase (Height: 3.6m)	LS
10100-07	Administrative Office, Building / Equipment	LS