

**Cargo Handling Operation Manual
in Juba River Port
(Mechanized Cargo Handling)**

May 2017

**The Project
on
Monitoring Support and Improvement
for the Operation and Management
of Juba River Port
in the Republic of South Sudan**

It is hoped this booklet will contribute to safe cargo handling operations at the port.

Contents

- 1. General Rule**
- 2. List of Cargo Handling Equipment**
- 3. Cargo Handling Work in the Yard**
 - 3.1 Yard Layout**
 - 3.2 Cargo Handling Work in the Yard**
 - 3.2.1 Work in the Yard**
 - 3.2.2 Cargo Handling Work at the Jetty**
 - 3.2.3 Cargo Handling Work for Storage and Payout of Cargo
in Outdoor Yard**
 - 3.2.4 Cargo Handling Work in Warehouse**
- 4. Cargo Handling with Crawler Crane**
- 5. Cargo Handling with Truck-Trailer**
- 6. Cargo Handling with Fork Lift**
- 7. Cargo Handling with Belt Conveyer**
- 8. Incidental work in the Yard**
- 9. Safety Meeting before the Start of Cargo Handling**

Appendix (Relevant Rules, Standards and Manuals)

- 1) Manual for Safe Cargo Handling Operations (February 2012)**

1 General Rule

This mechanized cargo handling manual describes specific cargo handling methods, safety work and safety standards, when handling general cargo, containers and fuel (mainly diesel) using a cargo handling equipment in Juba River Port.

Cargo handling equipment shown in the table below will be introduced as part of the Grant Aid project.

It should be noted that this manual should be revised whenever new cargo handling techniques are introduced as it may be necessary to enhance safety and work standards. Cargo handling workers need to receive revised versions of the manual and may need to undergo supplementary training.

2 List of Cargo Handling Equipment

Cargo handling equipment, which will be introduced at Juba River Port in the Grant Aid project, is shown in the Table 1.

Table 1 List of Cargo Handling Equipment

* This cargo handling equipment will be introduced by the Grant Aid project of JICA.

| Item No. | Component No. | Name of Equipment | Quantity | Reference Figure |
|----------|---------------|--|----------|------------------|
| 1 | | 120t Crawler Crane | 1 | A |
| 2 | | Fork Lift (Engine type) | 1 | B |
| 3 | | Fork Lift (Battery type) | 1 | C |
| 4 | | Towing tractor | 1 | D |
| 5 | | Trailer for Yard | 2 | E |
| 6 | | Truck with Crane | 1 | F |
| 7-1 | | Belt Conveyer (5m Length) | 1 | G |
| 7-2 | | Belt Conveyer (10m Length) | 1 | H |
| 8-1 | | Pallet Rack (Standard Type) | 20sets | I |
| 8-2 | | Pallet Rack (Standard with Shelf Panel Type) | 15sets | J |

The Project for Enhancement of Management and Operation Capacity of Inland Waterway in South Sudan (Phase I)

| | | | | |
|----|--|-----------------------------|---|---|
| 9 | | Harbor Communication System | 1 | K |
| 10 | | Oil Pump with | 1 | L |



Fig. A 120t Crawler Crane



Fig. B Fork Lift (Engine Type)



Fig. C Fork Lift (Engine Type)



Fig. D Towing Tractor



Fig. E Trailer for Yard



Fig. F Truck with Crane



Fig. G Belt Conveyer (5m Length)

Fig. H Belt Conveyer (10m Length)

The Project for Enhancement of Management and Operation Capacity of Inland Waterway in South Sudan (Phase I)



Fig. I Pallet Rack (Standard Type)

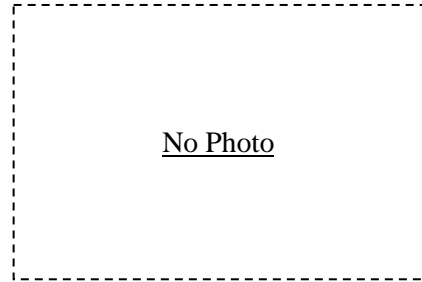

Fig. J Pallet Rack (Standard with Shelf Panel)



Fig. K Harbor Communication System



Fig. L Oil Pump

The Project for Enhancement of Management and Operation Capacity of Inland Waterway in South Sudan (Phase I)

3 Cargo Handling Work in Yard

3.1 Yard Layout

3.1.1 General Arrangement of Yard

An aerial view of the new Juba River Port planned in the Grant Aid project is shown in the following figure.



The yard layout of new Juba River Port is shown in the following figure.

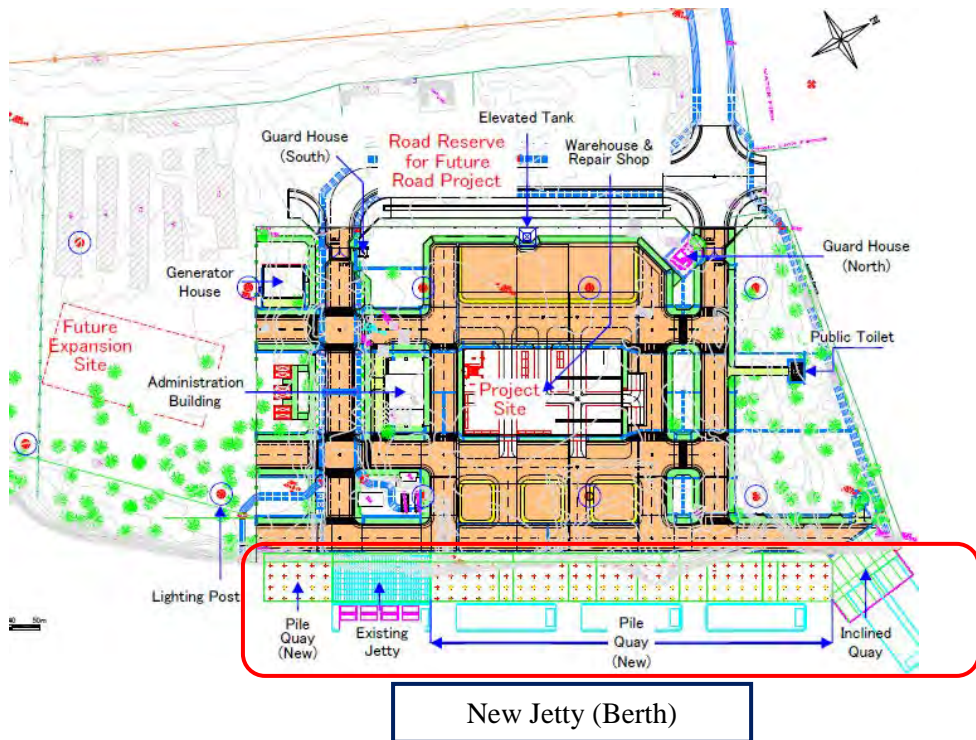

3.1.2 Berth Allocation of Jetty

Berth allocation of the jetty for cargo handling is shown in following figure.

This layout of the jetty consists of three areas based on the type of cargo to be handled.

JRPA should adopt a flexible berth allocation system to cope with increases in the cargo handling volume which are expected in future.

Furthermore, the berth allocation method for handling cargo at the jetty should be stipulated in the "JRPA Standard Regulations" as "Procedures of Cargo Handling Work".

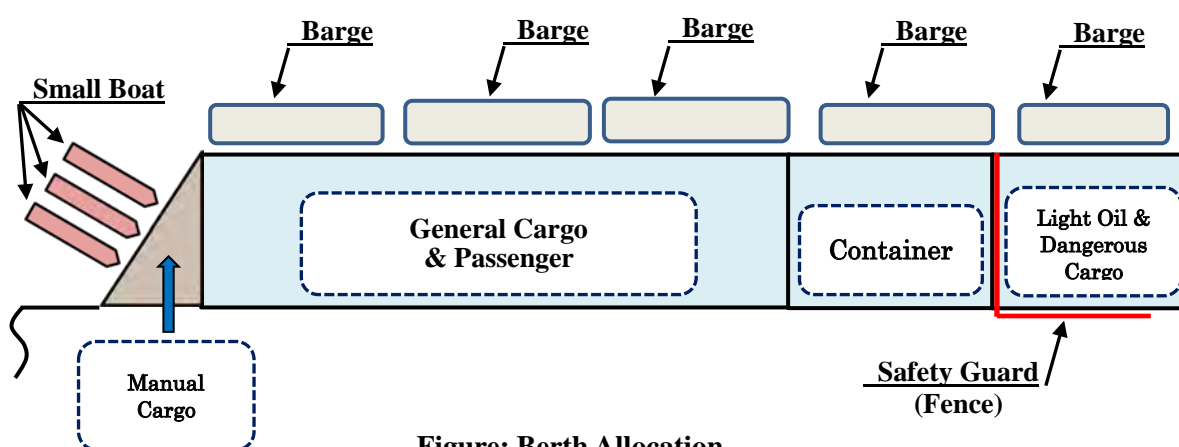

Figure: Berth Allocation

(Regulations for performing safe cargo handling work)

- 1) When handling dangerous cargo such as fuel at the "Dangerous Cargo Handling Berth", the relevant party has to submit the "Cargo Handling Application" in prescribed form before starting handling operation and obtain the approval for cargo handling from JRPA.

In addition, cargo handling company has to install a "safety guard (or fence)" around the border line between "Dangerous Cargo Handling Berth" and Container Handling Berth and also along the center road of the yard. A caution sign warning that dangerous cargo is being handled also needs to be placed near the cargo handling area.

- 2) When the cargo handling is carried out simultaneously at separate berths, the stevedoring company of each berth has to appoint one or more observers.

The main task of an observer is to manage the "entry and exit" of trucks, workers and barge crew during cargo handling operations.

3.2 Cargo Handling Work in the Yard

The Project for Enhancement of Management and Operation Capacity of Inland Waterway in South Sudan (Phase I)

Cargo handling work in the yard is roughly divided into three categories as follows;

- 1) Wharf-cargo handling by using a crawler crane, etc.
- 2) Storage and discharging work in the yard
- 3) Storage and discharging work in the warehouse

3.2.1 Work in the Yard

3.2.1.1 Work plan, Work method and Placement

- 1) Regarding the cargo handling work performed in the yard, the person in charge shall draft the "Work Plan" in consideration of the type of cargo, handling equipment and the work area. He must also inform relevant workers of the contents of the plan and ensure that they understand it thoroughly.
- 2) The distance between stored containers should be properly secured, and the working method and storage plan should ensure containers being handled do not contact other stacked containers.
- 3) The number of containers to be stacked at the temporary storage area face the aisle side of chassis road shall be up to one-stage as a general rule.
- 4) General cargo can be loaded from road chassis to barge, unloaded from barge (or small boat) to the jetty and directly on to truck on the jetty loaded/unloaded to/from barge after being temporarily place on the Jetty. Packing style and volume of cargo to be handled needs to be confirmed before work commences and the work method needs to be determined.

In addition, work plan to ensure that work progresses in a safe and efficient manner needs to be established.

Handling work of general cargo shall be carried out in accordance with the procedure mentioned above.

3.2.1.2 Work Instructor

- 1) A work conductor shall be appointed to facilitate the smooth conduct of yard work.
- 2) When the work plan is changed or special work will be carried out, safety measures must be informed to the relevant workers and work parties.
- 3) The work conductor shall hold the "Safety meeting before the start of work" to "ensure all relevant workers and work officials to have a thorough understanding of safety requirements.

3.2.1.3 Special Work in Yard

Signs should be erected at locations which can clearly be seen by drivers of crawler cranes, fork-lifts and trailer-trucks when special work is being carried out in the yard.

The Project for Enhancement of Management and Operation Capacity of Inland Waterway in South Sudan (Phase I)

3.2.1.4 Work instructor

- 1) The work instructor is responsible for ensuring that drivers can carry out their tasks seamlessly which requires paying close attention to the presence of pedestrians and other vehicles and giving the driver the necessary signals.
- 2) Work instruction person must immediately evacuate all vehicles, pedestrians and special work parties to the determined location, when they enter a dangerous or unauthorized area.
- 3) Work Instructor shall comply with all instructions received by the work responsible person.
- 4) In particular, work instruction person must remove any obstacles that could affect the movement of crawler crane and give the crane operator the safety necessary signals and safety instructions.

3.2.1.5 Gate check

- 1) The area around of the gate needs to be clean and barrier-free so that truck trailers can pass through safely following inspection.
- 2) After confirming that the engine of the truck has been turned off, the gate staff checks the contents of the container.
- 3) After completing the inspection of the truck, the gate attendant gives the driver the departure signal by means of Lamp and Buzzer, Loudspeaker, etc.

3.2.2 Cargo Handling Work at the Jetty

3.2.2.1 Name of handling operation foreman

The name of cargo handling foreman at barge side shall be informed to relevant work parties using an armband which should display his name and the name of the barge name.

3.2.2.2 Matters requiring caution during barge cargo handling work

- 1) Mooring condition of the barge always needs to be checked. When an abnormality is observed, must be informed and efforts should be made to correct the abnormality. .
- 2) During cargo handling at the barge side, necessary safety measures should be taken to protect the crew of barge and other relevant workers when the other work such a repair work is being carried out.
- 3) Before loading and unloading work on the barge, it is necessary to confirm that there are no abnormalities related to the barge and cargo. When abnormalities are discovered, the relevant persons should be informed immediately and measures to ensure safety should be taken.

The Project for Enhancement of Management and Operation Capacity
of Inland Waterway in South Sudan (Phase I)

- 4) Attention must be paid to the Jetty side, the deck of barge, the condition of each portion of crane and the surrounding states. When abnormalities are discovered, the responsible parties must be informed immediately and measures to ensure safety should be taken.
- 5) The work instructor from the port management's side has to supervise the work, and ensure the workers and relevant work parties complying with the safety regulations.
- 6) When opening the hatch of a barge, measures must be taken to prevent equipment from crashing to the ground.

3.2.2.3 Matters requiring caution when getting on and off the ceiling of containers on a barge

When getting on and off the ceiling of containers on the barge, a removable ladder or a lift machine equipped with cage must be used.

- 1) Protective cap shall be worn.

If the protective cap is not available, the old type helmet should be worn.

- 2) Sliding-protection measures shall be provided for "Removable ladders", etc.
- 3) To ensure lighting at night, lighting equipment, head-lamps and flashlights should be used as necessary.
- 4) Handrails should be erected for elevated areas of over 2 m in height. In case it is difficult to install handrails, a safety belt, protection net, etc. must be used. When a safety belt is used, attachment instrument shall be provided.
- 5) In opening end of the hatch such as hatch combing etc., fall prevention measures such as handrail must be adopted.
- 6) Work on the container should only be carried out when absolutely necessary and a safety belt must be worn. Mounting equipment for safety belts must be provided.
- 7) If the work environment is changed due to wind and the work instructor and field officials determine that it is dangerous to handle general cargo and containers, work must be suspended until the necessary safety measures are taken.
- 8) When the lashing equipment, etc. are lifted up or down, it is sure to use the rope, etc. to lift up or down every time and it must be prohibited to throw up or throw down.
- 9) After completion of lashing work, the lashing equipment must be cleaned and stored in a place that will not obstruct cargo handling work. During lashing work, only authorized personnel may enter the area. Cargo handling machinery, tools or pallet, etc. must be cleaned and stored in appropriate place.
- 10) Protecting workers against the risk of pile collapse or the fall of load, ropes and tension nets should be fastened to piles to lower the risk of collapse.
- 11) When storing cargo into a container, it is necessary to ensure that there is no eccentric load.
- 12) When lifting general cargo by the lifting beam, it is necessary to ensure that there is no offset of the

The Project for Enhancement of Management and Operation Capacity of Inland Waterway in South Sudan (Phase I)

center of gravity.

3.2.2.4 Compliance matters on the jetty

(Work in the same or adjacent areas)

When different types work are being performed in the same or adjacent area, a work plan which considers safety measures must be created in advance among responsible persons.

(Temporary fence and access control)

A temporary fence such as rope, etc., must be installed at prescribed areas and access control must be carried out to ensure only authorized personnel enter such areas.

3.2.3 Storage and Cargo handling work in the Yard

3.2.3.1 Determining the responsible person for cargo handling work and storage

For storage and cargo handling work in the yard, the person responsible must be determined, and his name and the type and duration of handling work should be displayed in a visible place.

3.2.3.2 Matters requiring caution regarding storage and cargo handling works

(1) The responsible person must understand the purpose of the cargo handling, the contents of work and the type, specification and quantity of handling equipment. He should also be familiar with the names and number of workers and make sure that they attend the safety meeting each morning.

(2) If he observes a worker engaging in unsafe work, he must stop the work immediately and teach the worker how to carry out the task in a safe manner.

3.2.4 Cargo Handling Work in Warehouse

3.2.4.1 Display of the responsible person of Cargo handling work in the warehouse

Regarding the cargo handling work performed in the warehouse, the responsible person in cargo handling work in the warehouse must be determined and displayed in the visible place around inside or near the inlet of warehouse to inform the relevant work parties.

3.2.4.2 Matters requiring caution during of cargo handling work in the warehouse

(1) The person responsible must understand the purpose of the cargo handling works, the contents of work and the type, specification and quantity of handling equipment. He should also be familiar with the names and number of workers and make sure that they attend the safety meeting each morning.

The Project for Enhancement of Management and Operation Capacity
of Inland Waterway in South Sudan (Phase I)

(2) If he observes a worker engaging in unsafe work, he must stop the work immediately and teach the worker how to carry out the task in a safe manner.

The Project for Enhancement of Management and Operation Capacity of Inland Waterway in South Sudan (Phase I)

4 Cargo Handling with Crawler Crane

4.1 Crawler crane operation criteria

Regarding "Operating instructions of crawler crane", and "Maintenance Management of Inspection", refer to the "Operation Instruction Manual", which will be provided by the "Grant aid project".

4.1.1 Crawler crane driver qualification requirements and obligations

- 1) To satisfy the internal regulations of JRPA, a driver must hold the necessary license during operation work. He also has to be approved as a qualified crawler crane operator by the port administrator (JRPA).

<The definition of Crawler crane driver qualified personnel and the registration requirements (draft)>

| Qualification | Definition | Registration requirements |
|----------------------|---|--|
| Primary (Grade 1) | Owns the driver's mobile crane Can operate crawler crane and perform the handling work by oneself | Person who has operated the crawler crane for more than 30 hours under Grade 2 status, and who is approved as Primary by JRPA. |
| Grade 2 | A person with Grade status can operate a crawler crane provided a person with Primary qualification is in the vehicle | Must hold a mobile crane driver's license and receive technical training on the operation of a crane and be approved by JRPA. |

- 2) The driver is qualified to operate the machine as stipulated in the internal regulations of JRPA, and he has to have the necessary license during operation work.
- 3) The driver must fully aware the surrounding circumstances to ensure that he operates the crawler crane safely.
- 4) The driver must follow the instructions of his superiors.
- 5) The driver must strive to keep his mind and body in optimum condition.

If a driver is judged to be mentally or physically unfit to safely perform the work, the responsible person must relieve him of duty.

- 6) A driver who fails to wear proper safety attire and deviates from safety standards can be stripped of his qualifications to operate the crane.

The Project for Enhancement of Management and Operation Capacity of Inland Waterway in South Sudan (Phase I)

The registration procedure (draft) for crawler crane drivers in JRPA is shown below.

< The registration procedure (draft) for Crawler crane driver >

| Crawler crane driver (Grade 2) Application | |
|--|-----------------------------|
| Necessary information | Authorizing Body |
| <ul style="list-style-type: none"> ✧ Crawler crane driver registration criteria ✧ <input type="checkbox"/> Fill out the required items and attach a copy of mobile crane operators license ✧ Attach a copy of crane technological credential ✧ "Sign and submit application. | Port Management Body (JRPA) |
| <ul style="list-style-type: none"> ✧ Necessary license: The license stipulated by JRPA (Type: mobile crane driver's license) ✧ Necessary qualifications: Completion of training certificate | |



After documents are reviewed by the port administrator, the driver code (with registration number) is issued from the cargo handling division



| Crawler crane primary driver (Grade 1) <Application> | |
|--|-----------------------------|
| Necessary information | Authorizing Body |
| <ul style="list-style-type: none"> * Applicant must have accumulated more than 40 hours of operation time under the guidance of a driver with a Grade 1 qualification. * A third party must verify that the applicant has met the necessary requirements and sign his application form. * After completion of stipulated operation time by a guiding driver, the responsible person of group which the applicant belong to, must confirm the application form and make a signature.(???) * The applicant submits the completed application form to the port administrator. | Port Management Body (JRPA) |



The Project for Enhancement of Management and Operation Capacity
of Inland Waterway in South Sudan (Phase I)

After documents are reviewed by the port administrator, the license of "Grade 1" is issued from the cargo handling division.

The Project for Enhancement of Management and Operation Capacity
of Inland Waterway in South Sudan (Phase I)

< Crawler crane driver registration application >

Crawler Crane Driver Registration Application

[Submission to] Juba River Port Administration

Address:
Name/ Company:
The person In charge:

| | | | |
|--|------------------|-----|--|
| Name of registered person | | Age | |
| Employed date | | | |
| Driver's license | License number | | |
| | Acquisition date | | |
| Date of Training session | | | |
| Driver license code of other heavy equipment | | | |
| Driver's license of Crane (Copy) | | | |
| | | | |

Juba River Port Administration
Cargo Handling Group

<Note>:

Unregistered person cannot operate cargo handling equipment in the Juba River Port Administration.

| | | |
|----------|-----------------|---------|
| | General Manager | Manager |
| Approved | | |

4.1.2 Crawler crane inspection standards

- 1) When operating a crawler crane, the following items must be confirmed;

The lighting status of lamps for operation and condition confirmation of Gantry travelling, Boom rotating/telescoping and Hoisting operations must be confirmed, and also actuation of normal stop and emergency stop limit switches must be confirmed, along with performing the inspection before starting the work based on the "crawler crane daily work report", which is to be stipulated separately.

- 2) When operating the crane, the appearance inspection of lifting beam/spreader and underbody of the crane, etc. must be performed. If an abnormal part, etc. is found, it must be quickly reported to the port administrator (JRPA) or the maintenance division. Identifying and reporting abnormal parts is the responsibility of the driver who operated the crane.
- 3) After completion of the work, the operator must perform the inspection in accordance of the "Inspection records", and confirm that there is no abnormal part.

< Crawler crane Daily work reports >

The status of crawler crane before use, during use and after use, must be recorded in the Work Daily Reports" every day. The "Daily work reports", which informs the status of the crane parts to the next operator, is an important tool for preventing accident and ensure safety.

The "Daily work reports" of crawler crane are shown in the following figures.

This daily report must be stored for at least one year as a management document by the cargo handling division of JRPA.

Daily Work Reports of Crawler Crane

TO: Juba River Port Administration
The Director of Operation Department
Mr. aaaaaa xxxxx bbbbbb

Date: 18/11/2015
Operation Department
Operator's Name: xxxxxx xxxxx xxxxxx

| Date (dd/mm/yy) | Contents of Work | Operation time of Crawler crane (Hours) | Person confirmed work | Signature |
|--------------------------|------------------|--|-----------------------------|-----------|
| From: 07:45 To: 11:55 | | | | |
| From: 13:10 To: 16:58 | | | | |
| From: To: | | | | |
| From: To: | | | | |
| From: To: | | | | |
| From: To: | | | | |
| From: To: | | | | |

Check List (A)
(Before work)

Check List (B)
(During work)

Check List (C)
(After work)

Juba River Port Administration
Cargo Handling Group

<Note>:
Unregistered person cannot operate cargo handling equipment
in the Juba River Port Administration.

| | | |
|----------|--------------------|---------|
| | General Manager | Manager |
| Approved | | |

The Project for Enhancement of Management and Operation Capacity
of Inland Waterway in South Sudan (Phase I)

Check List (A) < Before work >

1) Before work

| | | |
|------------------|-------------------|--|
| Spreader | A-1 | Is the spreader appropriately and safely attached to the crane hook? |
| Twist Lock | A-2 | Does latch stopper of crane hook achieve its purpose completely? |
| | A-3 | Is the spreader equipped in horizontal? |
| | A-4 | Does the lock / unlock of "Twist-locks" function properly? |
| | A-5 | Are any abnormalities in each part of Twist-locks observed? |
| | A-6 | Are abnormal phenomena such as scratches, cleft, etc. present? |
| | Gantry Travelling | B-1 |
| B-2 | | Are any abnormalities in chains or the drive and driven rollers of the crawler portion observed? |
| B-3 | | Is there any leakage from pipes? Is the level of oil in hydraulic unit sufficient? |
| B-4 | | |
| Hoisting | C-1 | Does the emergency stop switch of hoist upper limit operate properly? |
| | C-2 | Are any abnormalities such as kink, wire breakage, etc. observed in hoisting ropes? |
| | C-3 | Is there abnormal winding to the hoist drum? |
| | C-4 | Are there any abnormalities observed in the fixed part of the hoisting rope end? Is there slack in the drum cotter? |
| | C-5 | Is the brake function operating properly? Is there any change in set value of brake? |
| Boom Hoisting | D-1 | Is there any leakage of oil from boom hoist cylinders? Is there any damage to the cylinder rod? |
| | D-2 | Can boom-hoisting be performed smoothly during the boom up / down operation? |
| | D-3 | Do the limit switches of "Boom-upper and lower end" detect and function appropriately? |
| Boom Telescoping | E-1 | Is the telescopic boom functioning normally? |
| | E-2 | Are there any abnormalities such as oil-leakage, etc. from boom-telescoping cylinders? |
| | E-3 | Is safety device at the maximum extend-position or the retract-position of boom-telescoping in good working order? |
| Boom Rotating | F-1 | Is the movement of lock / unlock of Lock Pins of Jib-rotating appropriate? |
| | F-2 | Is the mating state of Jib-rotating Pinion and Gear smooth? |
| | F-3 | Is the rotating-movement by "Boom-rotating Slewing Ring" smooth? |
| | F-4 | Are there any abnormalities in the portion of Slip-Ring of Boom-rotating? (e.g. bending of brush or lack of brush) |
| | F-5 | Is there interference between Upper-side body and Lower-side body by boom-rotating? |
| Common | G-1 | Are staffs prevented from entering the working range of boom-hoisting or rotating of the crane? |

The Project for Enhancement of Management and Operation Capacity
of Inland Waterway in South Sudan (Phase I)

| | | |
|---|--------|---|
| Boom Hoist, Telescoping, Hoisting | G-2 | During cargo handling in nighttime, is there sufficient light?. |
| | G-3 | |
| Operation Testing | H-1 | Do you confirm that Gantry-travelling single operation before starting work is carried out? |
| | H-2 | Are boom-rotating, boom-telescoping and main-hoisting operation in good working order? |
| | H-3 | Are there any problems with Gantry-travelling operation? |
| | H-4 | Are the safety devices (Limit switches, etc.) for "Gantry-travelling, Boom-hoisting/telescoping, Main hoisting and Boom-rotating operation" functioning properly? |
| | H-5 | Is each instrument such as warning device and loudspeaker and telephone functioning properly? |
| | Others | |

Check List (B) < During work >

2) During work

| | | |
|----------------|-----|--|
| During work | P-1 | Is there any abnormal noise emanating from the hydraulic motor, reducer, brake, coupling, etc. of each device? |
| | P-2 | Are there any abnormalities in the safety device of each motion? |
| | P-3 | Are there any abnormalities in the lifting equipment (Spreader, etc.)? |
| | P-4 | Any problems identified by the driver during crane operation must be recorded in "Daily Work Reports of Crawler Crane" |

Check List (C) < After work >

3) After work

| | | |
|------------|-----|--|
| After work | Q-1 | Are the boom-rotating lock pins inserted? |
| | Q-2 | Is boom hoisting or telescopic position stopped at the correct position? |
| | Q-3 | Is the stowed position of Hook correct? |
| | Q-4 | Is each safety device functioning properly? |
| | Q-5 | Are any parts cracked or damaged? |
| | Q-6 | Have all parts been pointer-lubricated? |
| | Q-7 | Is the power switch turned off? |
| | Q-8 | Are any parts of the Spreader cracked or damaged? |
| | Q-9 | |

4.2 Cargo handling work by the Crawler crane

4.2.1 In case of Container handling

In container handling by the Crawler crane, there are three kinds of handling patterns below;

- 1) Loading of containers from the jetty to the barge
- 2) Unloading of containers from the barge to the jetty
- 3) Re-handling of containers from the jetty onto trucks or from trucks to the jetty

When performing these operations, it is necessary to follow the procedure below from the viewpoint of safety.

1) Confirmation of installation position

As shown in the figure below, the installation position of crawler crane must be determined by taking into consideration the condition of the pavement on the jetty.

If the pavement surface is severely uneven, plates have to be laid and the Crane will be installed on them (see figure A below).

Also, as shown in figure B below, the installation position of the Crawler crane must be determined from the relative position of the barge and position of truck or container taking into account the crane working radius and "Moment Diagram".

(Note):

Regarding "Moment Diagram" in figure C, refer to the Specification of Crawler crane.

In addition, when changing the position of the crane, the boom angle should be in the upper top position (that is, the condition in which the crane hook is stowed in the minimum working radius position) in order to avoid interference with other equipment.

The gantry travelling operation for changing the position of the crane must not be carried out when the boom angle is in the lower position.

When the position of the crane is determined, the gantry-travelling controller must be changed over to the neutral position, and then the parking brakes must be applied.

The installation of the crane for cargo handling operation must be completed in accordance with the procedure mentioned above.

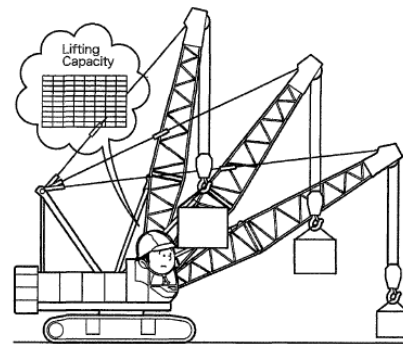
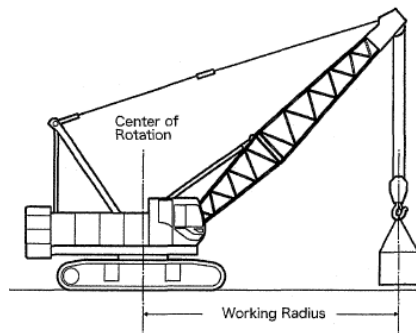
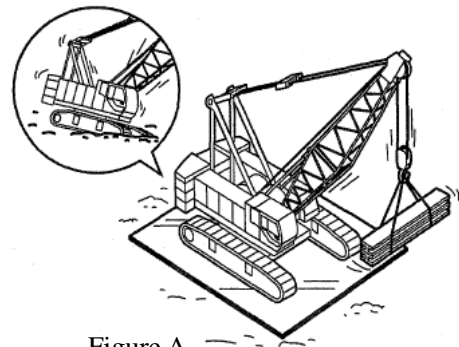

2) Attaching the spreader (20ft Spreader, 40ft Spreader)

Then, the spreader must be attached when handling a 20ft container, a spreader 20ft in length is fitted, and when handling a 40ft container, a spreader 40ft in length is fitted.

JRPA will need to create a work plan for container handling in the yard if both 20ft and 40ft containers arrive randomly.

Also, the Cargo Handling Division of JRPA must draft plans to cope with yard, loading and unloading management works,

The following figures show the main hook of the crawler crane is attached to the spreader in order to handle a container.

The Project for Enhancement of Management and Operation Capacity of Inland Waterway in South Sudan (Phase I)

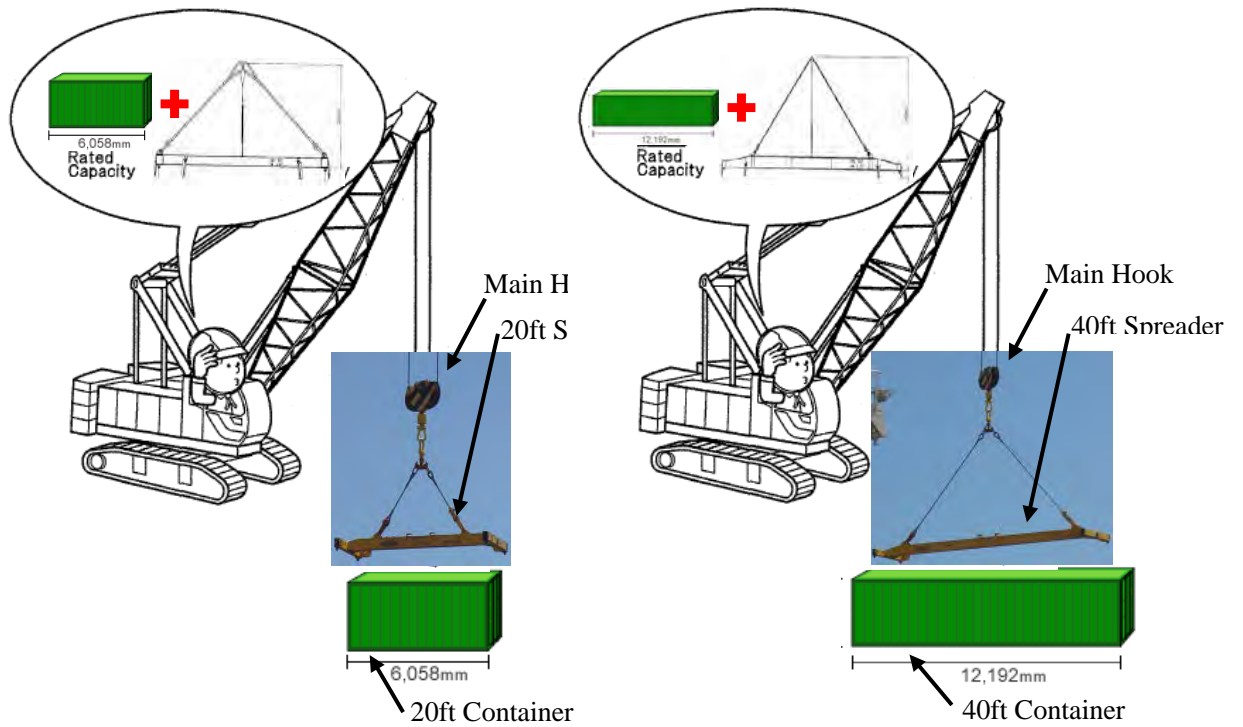
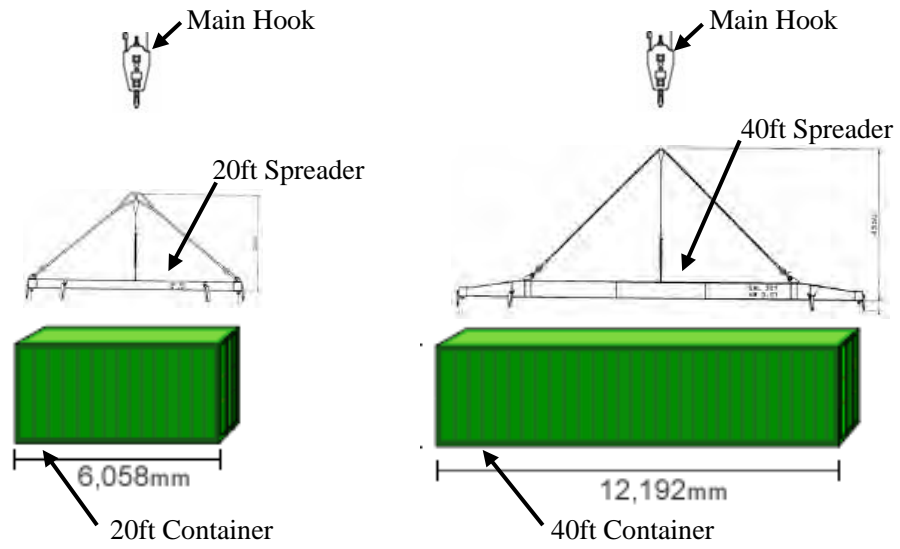

Crawler crane with 20ft Spreader

Crawler crane with 40ft Spreader

3) Relationship between Load and Working radius

When performing container handling operation, the driver and relevant working persons must understand the relationship between "Lifting load" and "Working Radius" of the Crawler crane.

If the driver does not understand this relationship, serious accidents such as the crane falling to the ground could occur.

In general, if the crane lifts a load less than the load area shown in "Moment Diagram" (which shows the relationship between "Lifting load" and "Working Radius" of the Crawler crane), the crane will not tip over even if the crane upper portion (including Boom and Cab) is rotated 360 degrees (called "Full Rotation") in the same working radius.

Accordingly, the driver must always be conscious of the "Moment Diagram" while operating the crane.

When the crane lifts the load at each Working Radius in the "Moment Diagram", the Boom can be rotated 360 degrees ("Full Rotation") and the crane can transport the load to any position, if the working radius is either same radius or less than it.

Weight of container: W_{cu} (Max. weight which can be lifted at "a" m radius)

Weight of lifting lug (Hook block + Spreader): W_{hs}

1) At working radius = a (m)

Tilting moment by lifting weight: $M_a = (W_{cu} + W_{hs}) \times a$ [Ton-m]

2) At working radius = b (m)

Tilting moment by lifting weight: $M_b = (W_{cu} + W_{hs}) \times b$ [Ton-m]

3) At working radius = c (m)

Tilting moment by lifting weight: $M_c = (W_{cu} + W_{hs}) \times c$ [Ton-m]

Here, $b < a < c$, then $M_b < M_a < M_c$

The crane operator can handle the container from the location "O" (at shore side) to the location "A" and "B" (on Barge), but cannot handle a container from O to the location "C" (on Barge) because of excess of maximum tilting moment.

The crane operator should understand the "Moment Diagram" and also drive the crane watching the moment annunciator panel.

The operator can handle a container from "O" to "C" in case of lighter weight than W_{cu} (Max. weight which can be lifted at "a" m radius).

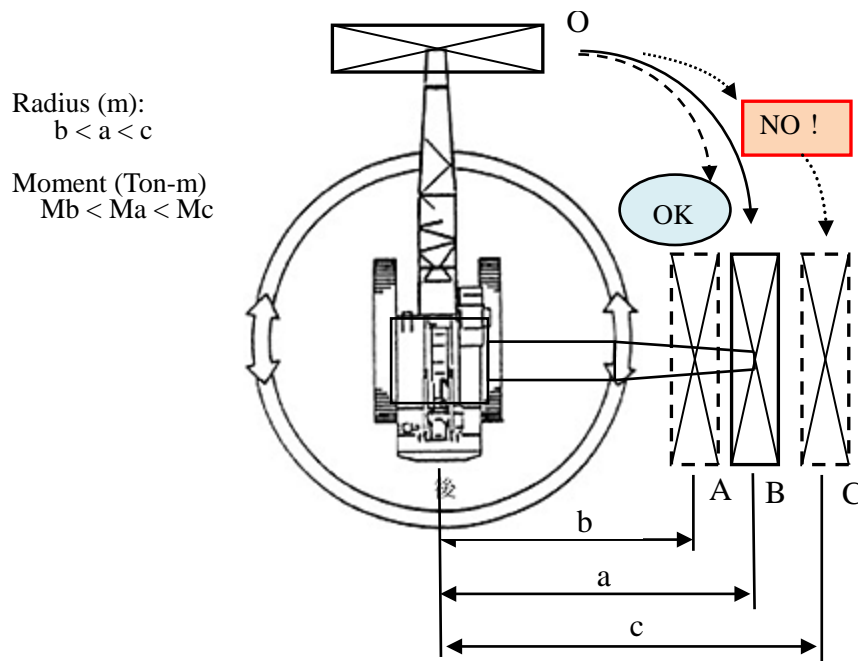

4.2.1-1 Safety Meeting prior to carrying out handling work by the Crawler crane

A “Work Plan” must be drafted in advance by the responsible person and details of the plan must be explained to the relevant workers at the safety meeting.

[Holding of meeting on safe practices prior to work commencement]

The meeting on safe practices must be held prior to the start of cargo handling work in accordance with the procedure below.

- 1) The chief of the cargo handling division must nominate the responsible person for each work.
- 2) The responsible person must understand the work and create the "work plan".

In the "Work plan", at least 3 targets to perform the work safely must be listed by assuming unsafe work practices and expected accidents.

- 3) The responsible person must explain the details of work (i.e., container handling volume, contents of container, handling procedure, responsibilities of each worker, the waiting area at cargo handling, chain of command of cargo handling work, etc.), prior to work commencement and then make efforts to ensure that the work is performed safely.

The Project for Enhancement of Management and Operation Capacity
of Inland Waterway in South Sudan (Phase I)

- 4) The responsible person must make a record of the contents of the handling work, including cargo handling start time, end time, the workers in charge and their breakdown, instances of unsafe work practices etc. in the "Cargo Handling Work Report" (i.e., "Cargo-handling Work Diary"), and then submit it to the director of the Cargo handling division..
- 5) The contents of the meeting for safe practices and the report recording details of the work, mentioned above, must be reflected in the next cargo handling plan.

< Safety Meeting of container handling operation >

Safety meeting should be held before starting container handling operation.

It is extremely important to ensure there is sufficient communication and cooperation between Slinging persons, Signal person and Crane driver.

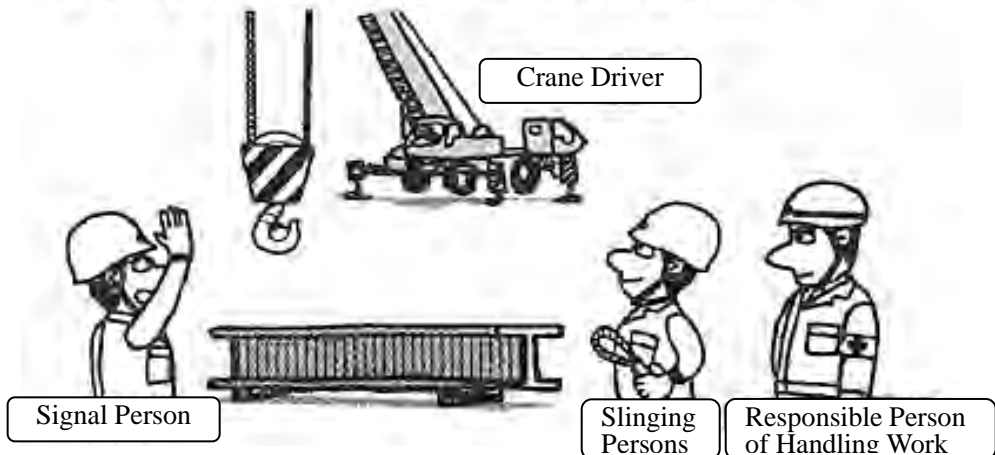

The overview and procedure of work should be thoroughly explained to all workers at the pre-meeting before starting work.

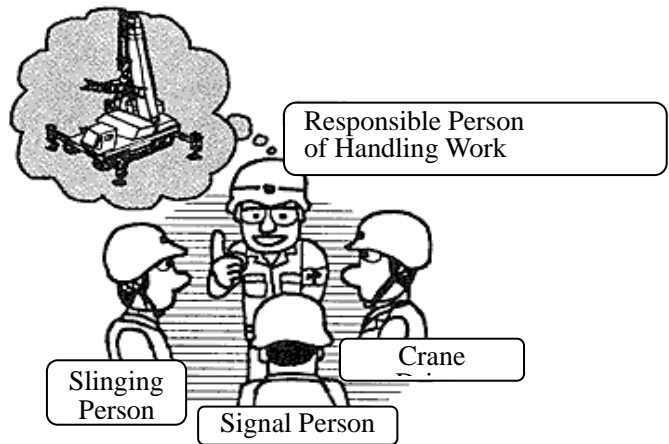

Safety work meeting of Persons in charge of Container handling work

1) In case of loading a container from the jetty to a barge

When loading a container from the jetty to a barge, the container handling must be carried out in accordance with the following procedure

Before starting the work, the safety meeting on the cargo handling work must be held, and the fundamental matters requiring caution in regards to container handling and contents of handling work of the subject day (i.e. container handling volume, contents of container, handling procedure, work contents of each workers, the waiting area at container handling, chain of command of cargo handling work, etc.) must be confirmed.

Cargo handling work must be carried out in accordance with instructions of the person responsible for handling operations and safety.

The cargo handling form from the jetty to a barge is shown in Figure 4.2-1.

- 1) The person responsible the cargo handling from the jetty to a barge must confirm the contents and procedure of work in accordance with the work plan.
- 2) The berthing location "A" of a barge must be determined and confirmed.
- 3) The installation position "B" of Crawler crane must be determined, and the then crane must be moved to the correct position. In this case, the 20ft and 40ft Spreaders must be move the opposite side "C" of the working area of crane.
- 4) The work responsible person must instruct the driver of Crawler crane to confirm that a container to be loaded, the position of a chassis and the loading position on a barge must be in the working area of crane, by means of equipping the spreader and rotating the Boom without a container with performance of the Boom hoisting/lowering and retracting/extending.
- 5) The positions "D1, D2 - - -" of containers to load onto a barge must be determined, and their positions must be marked by paint. (The temporary positions of containers to be loaded onto a barge must be marked on the ground of the jetty.)
- 6) The waiting position "E" of Yard chassis and Road chassis (i.e., the waiting positions of chassis conveying a container to be loaded) must be determined.
- 7) The responsible person on the barge side and the positions (F1, F2 - - -) of container to be loaded on a barge must be determined.
- 8) The area surrounding the working area must be isolated as a No Trespassing Zone "Z" by color-cones and ropes.
- 9) The operator of crane, driver of tractor-chassis, the signal person, slinging persons and workers on the jetty and a barge assume their positions in accordance with the instructions by the cargo handling from

The Project for Enhancement of Management and Operation Capacity
of Inland Waterway in South Sudan (Phase I)

the jetty to a barge.

- 10) After confirmation of the above 9), the responsible person gives a start- signal to commence cargo handling works.

Personnel in charge and their roles in container handling work

Personnel in charge and the number of workers involved in handling works by the Crawler crane are shown in the following table as for reference.

The number of workers and their roles are to be determined on a case-by-case basis.

| Personnel in charge | Number of person | Major roles |
|---|------------------|--|
| Responsible person | 1 | Responsible person of the subject handling work |
| Signalman | 1 | To inform workers of the cue from the work responsible person, and enforce the cue. |
| Operator of Crawler crane | 1 | To operate a crawler crane The operator of Crawler crane must follow the instructions of signalman or the slinging persons. |
| Driver of Yard-tractor | 1 | Driver of Yard tractor to transport a container in the yard |
| Slinging person Under crane | 4 | Slinging work on the jetty side |
| Barge side | 4 | Slinging work on the Barge side |
| Driver of truck crane in the stacking area in the yard | 1 | Driver of yard tractor to transport a container in the yard |
| In the stacking area in the yard, The signalman who can do slinging work | 1 | To perform slinging work in the container stacking area in the yard |
| Slinging person | 3 | |
| Total persons | 15 | |

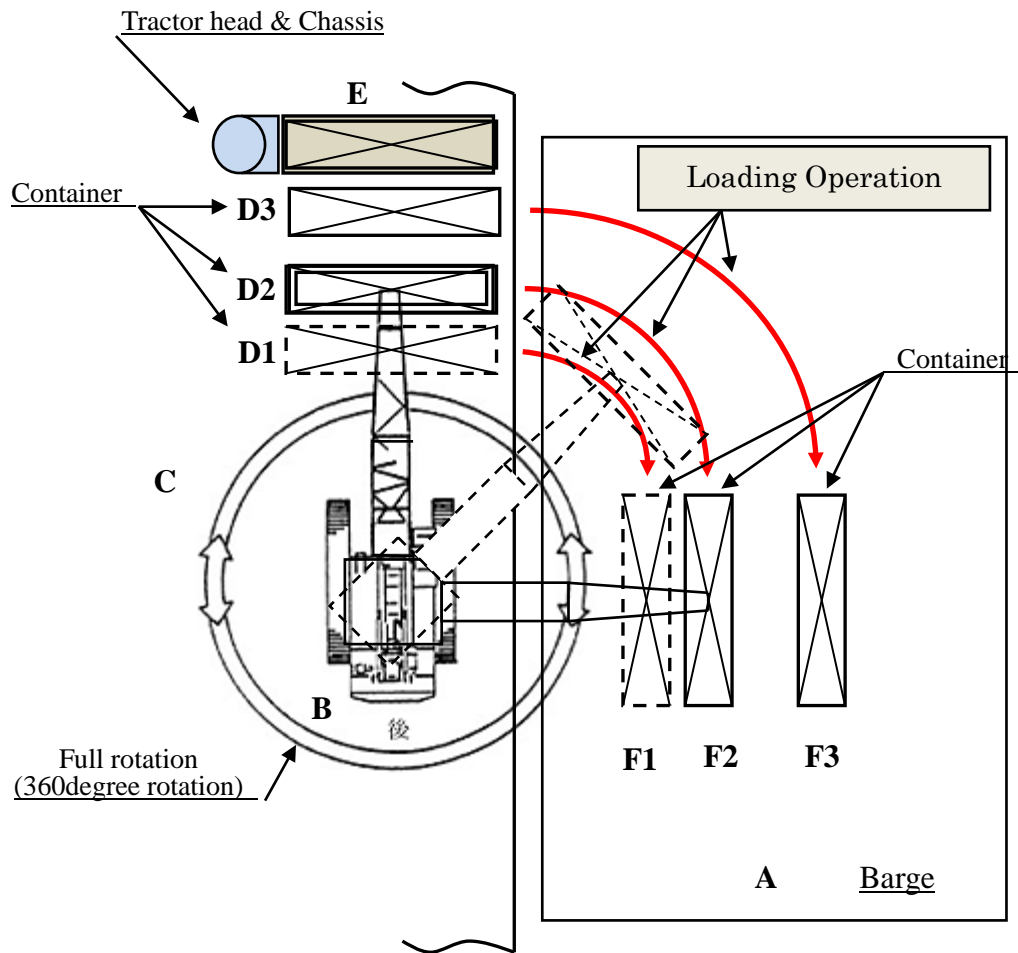

Figure 4.2-1 Loading containers from the quay to a barge

2) In case of unloading containers from a barge to the jetty

When unloading of containers which have been transported by barge to the jetty, unloading work is basically the same as the manner shown in the above 1), with only the direction of the work flow changing.

Cargo handling work from a barge to the jetty is shown in Figure 4.2-2.

- 1) The responsible person must confirm the contents and procedure of cargo handling work in accordance with the work plan.
- 2) The berthing location "A" of a barge must be determined and confirmed.
- 3) The installation position "B" of Crawler crane must be determined, and the then crane must be moved to the correct position. In this case, the 20ft and 40ft Spreaders must be moved the opposite side "C" of the working area of crane.
- 4) The work responsible person must instruct the driver of Crawler crane to confirm that a container to be loaded, the position of a chassis and the loading position on a barge must be in the working area of crane, by means of equipping the spreader and rotating the Boom without a container with performance of the Boom hoisting/lowering and retracting/extending.
- 5) The positions "D1, D2 - - -" of containers to be loaded on a barge must be determined, and their positions must be marked by paint. (The temporary positions of containers to be loaded onto a barge must be marked on the ground of the jetty.)
- 6) The waiting position "E" of Yard chassis and Road chassis (i.e., the waiting positions of chassis conveying a container to be loaded) must be determined.
- 7) The responsible person on the barge side and the positions (F1, F2 - - -) of container to be loaded on a barge must be determined.
- 8) The area surrounding the working area must be isolated as a No Trespassing Zone "Z" by color-cones and ropes.
- 9) The operator of crane, driver of tractor-chassis, the signal person, slinging persons and workers of the jetty and a barge assume their positions in accordance with the instruction by the work responsible person.
- 10) After confirmation of the above 9), the responsible person gives a start-signal to commence handling works.

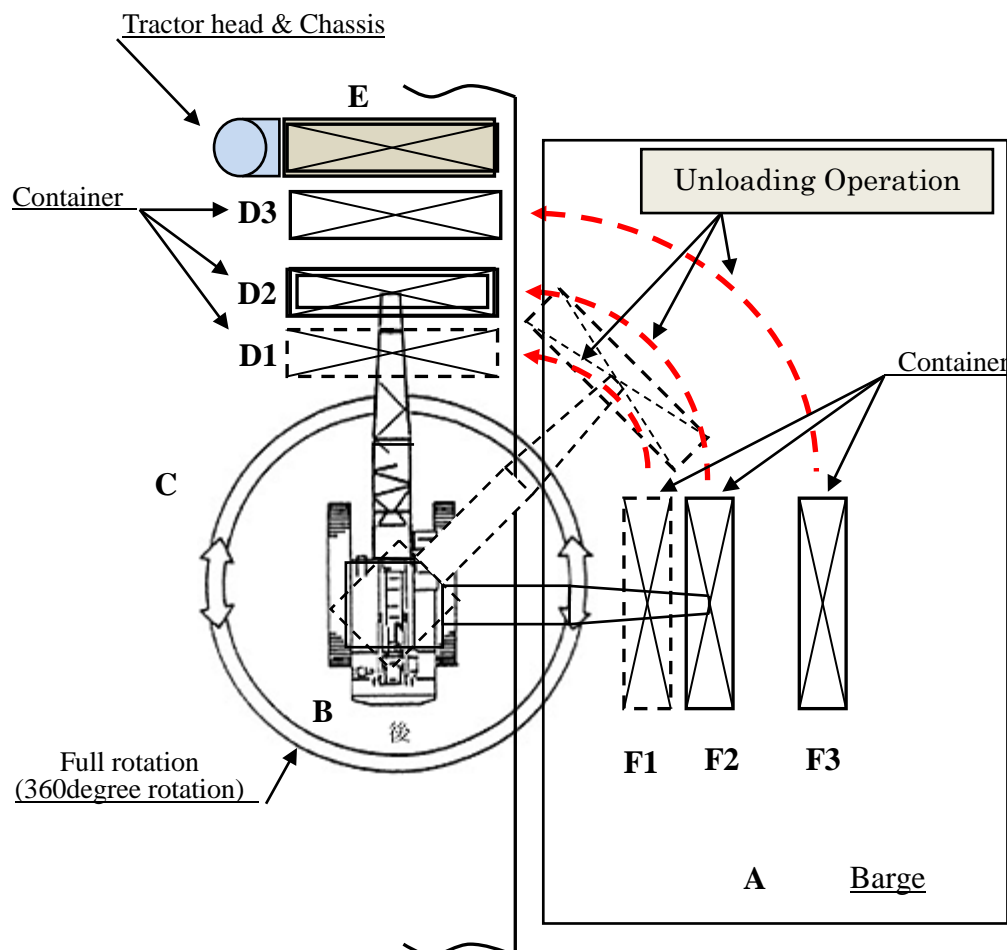

Figure 4.2-2 Unloading containers from a barge to the quay

3) In case of moving containers from the jetty onto a truck, or from a truck to the jetty

In this type of cargo handling operation, a container is unloaded from the jetty onto a yard chassis or a road chassis or loaded from a yard chassis or a road chassis to designated positions on the jetty.

The cargo handling method for the above operation is shown in Figure 4.2-3.

a) Loading a container from a truck to a temporary place

The bold continuous lines show the route of container handling operation from a truck to a temporary place on the jetty.

b) Container handling operation to a container from temporary places to a track

The bold dotted lines show the root of container handling operation from temporary places to a truck on the jetty.

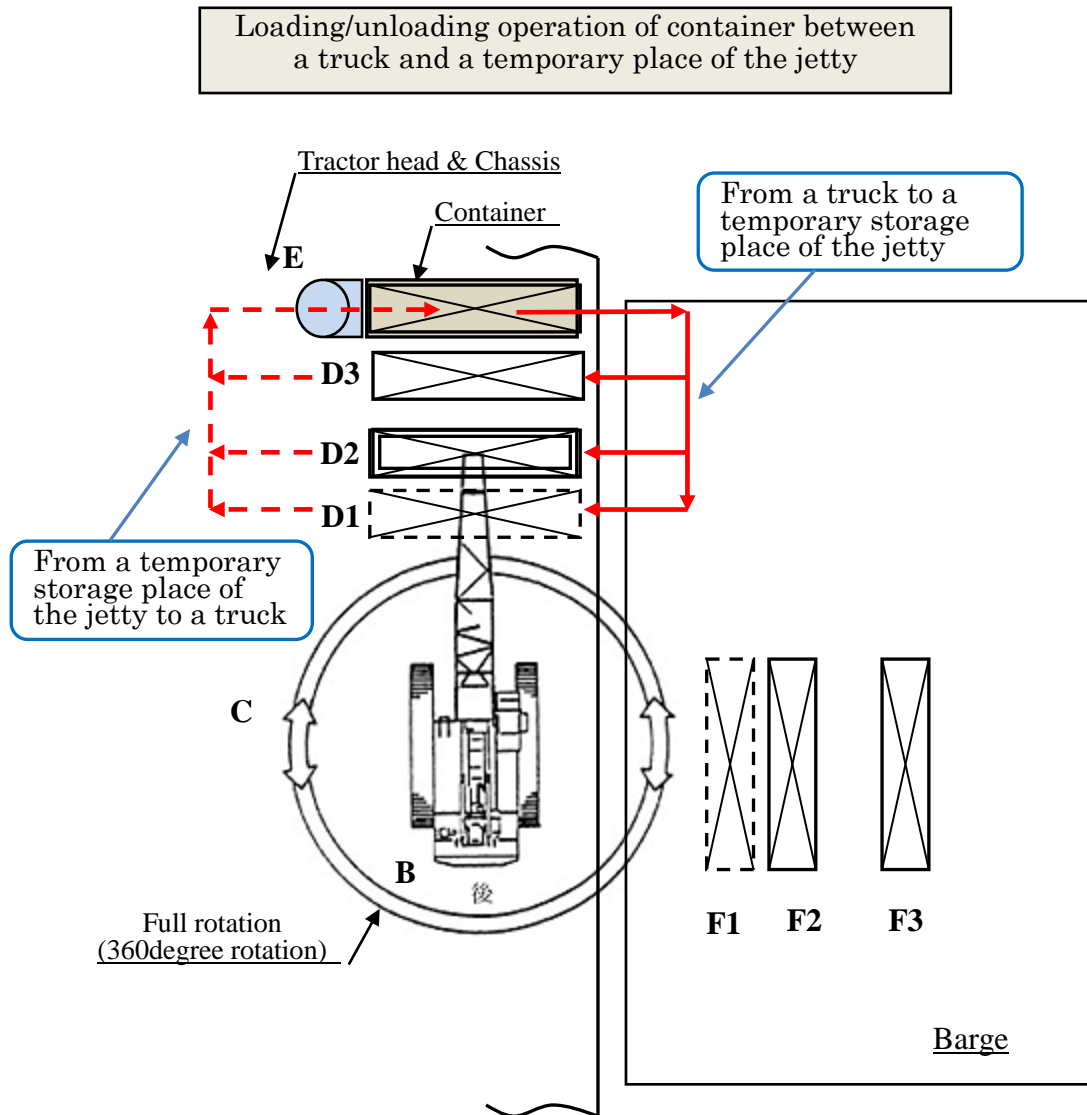

Figure 4.2-3 Container handling operation between truck and temporary storage area

4.2.2 In case of General cargo handling

When handling of general cargo (grain, fertilizer, miscellaneous goods and others such as daily necessities packed in paper bags), they must be loaded from the jetty to a barge and unloaded from a barge to the jetty using the following procedure to ensure safety.

1) Confirmation of the installation position of Crawler crane

The installation position of the crawler crane must be confirmed in accordance with the procedure mentioned above.

2) Installation of spreader, such as Cargo net and Cargo net with sheet

Next, the dedicated spreader (Cargo net, etc.) to handle general cargo must be mounted to the crane hook.

Several types of cargo net while are used in cargo handling of general cargo are shown below.

JRPA should purchase two or three sets two different cargo nets (nets which are easy to use and obtain should be sought) shown below in order to minimize the damage to package goods during operations.



Figure 4.2-4 Examples of Cargo nets (with sheet)

Examples of handling cargo using nets are shown in the following figure.

The Project for Enhancement of Management and Operation Capacity of Inland Waterway in South Sudan (Phase I)



Figure 4.2-5 Examples of handling Cargo using nets

Mounting states of Cargo-net attached to the main hook of the crawler crane are shown in the figure below while the open plan view of cargo-net with sheet is shown in Figure 4.2-7.

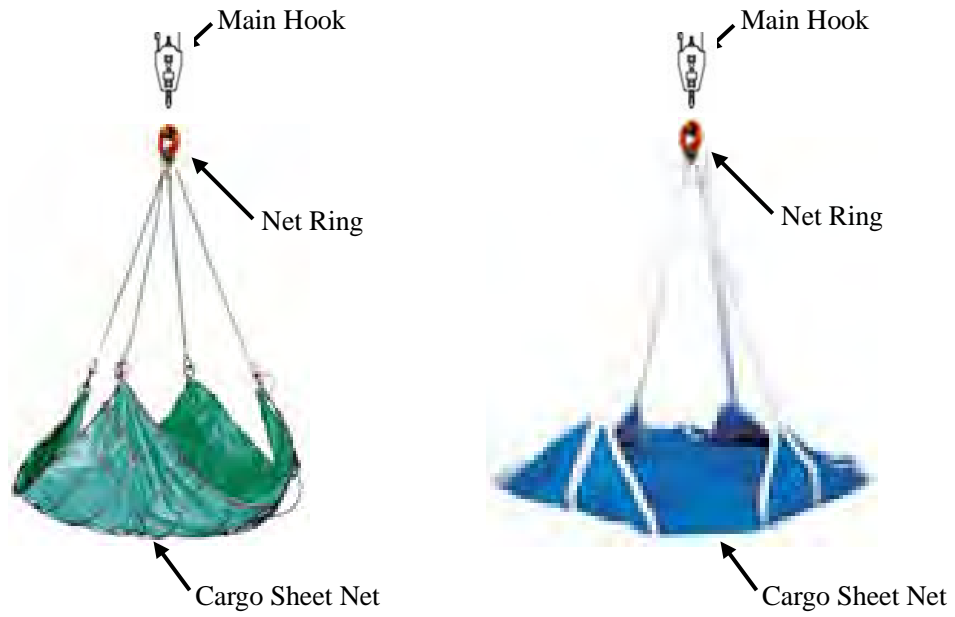

Figure 4.2-6 Fitting condition of Cargo-net with sheet

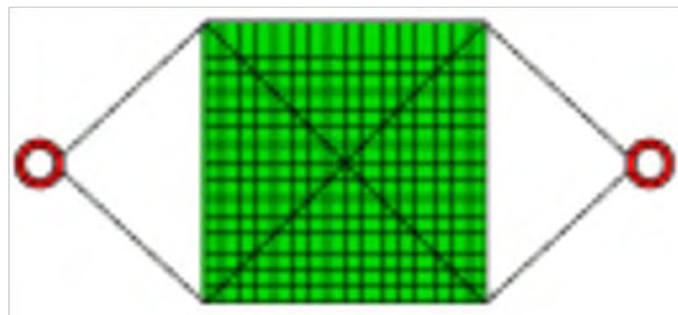

Figure 4.2-7 Plan view of Cargo-net with sheet (Example figure)

3) Relationship between Lifting load and Working radius

When cargo handling of general cargo, the operator must understand the relationship between Lifting load and Working radius, and then perform the work while being aware of Moment diagram of crane.

4.2.2-1 General cargo handling work by Crawler crane

1. Holding of meeting on Safe work practices prior to cargo handling work

As in the case container handling works, the responsible person must draft the "Work plan" based on a thorough understanding of the cargo handling work in advance, and explain the work details to the relevant workers at the meeting to ensure that the work is performed safely..

The contents of the meeting report after cargo handling works are completed should be reflected in subsequent cargo handling plans.

2. In case of loading general cargo from the jetty to a barge, or from a barge to the jetty

- 1) The work responsible person must confirm the contents and procedure of work in accordance with the work plan.
- 2) The berthing location "A" of a barge must be determined and confirmed.
- 3) The installation position "B" of Crawler crane must be determined, and the then crane must be moved to the designated position. In this case, the proper lifting device such as Cargo-net must be moved to the opposite side "C" of the working area of crane.
- 4) The work responsible person must instruct the driver of Crawler crane to confirm that General cargo to be loaded, the position of a chassis and the loading position on a barge must be in the working area of crane, by means of equipping Cargo-net and rotating the Boom without a container with performance of the Boom hoisting/lowering and retracting/extending.
- 5) The positions of general cargo to be loaded onto a barge must be determined, and their positions must be marked by paint. (The temporary positions of cargo to be loaded onto a barge must be marked onto the ground of the jetty.)
- 6) The waiting position of Yard chassis and Road chassis (i.e., the waiting positions of chassis conveying a container to be loaded) must be determined.

The Project for Enhancement of Management and Operation Capacity
of Inland Waterway in South Sudan (Phase I)

- 7) The responsible person on the barge side and the positions of general cargo to be loaded on a barge must be determined.
- 8) The area surrounding the working area must be isolated as a No Trespassing Zone by color-cones and ropes.
- 9) The operator of crane, driver of tractor-chassis, the signal person, slinging persons and workers of the jetty and a barge must assume their positions in accordance with the instruction by the work responsible person.
- 10) After confirmation of the above 9), the responsible person gives a start-signal to commence handling work.

<Note>:

When unloading general cargo which has been transported by barge to the jetty, unloading operation is basically the same as the manner shown, with only direction of the work flow changing.

If poor or un-safe work practices are observed, the worker in charge must stop the work and inform the work responsible person immediately.

Personnel in charge and their roles in general cargo handling work

Personnel in charge and the number of workers engaged in handling works by the Crawler crane are shown in the following table as for reference.

The number of workers and their roles are to be determined on a case-by-case basis.

| Personnel in charge | Number of person | Major roles |
|---|------------------|---|
| Responsible person | 1 | Responsible person of the subject handling work |
| Signalman | 1 | To inform and the workers in charge of the cue from the work responsible person, and enforce the cue. |
| Operator of Crawler crane | 1 | To operate a crawler crane The operator of Crawler crane must follow the instruction by the Signalman or the slinging persons. |
| Driver of Yard-tractor | 1 | Driver of Yard tractor to transport General cargo in the yard |
| Slinging person Under crane Barge side | 4 4 | Slinging work in the jetty side Slinging work in Barge side |
| Worker to charge/discharge cargo into Cargo-net | 3 - 6 | Charging/discharging of General cargo into/from Cargo-net |

The Project for Enhancement of Management and Operation Capacity
of Inland Waterway in South Sudan (Phase I)

| | | |
|--|---------|---|
| Driver of truck crane in the stacking area in the yard | 1 | Driver of yard tractor to transport General cargo in the yard |
| In the stacking area in the yard, The signalman who can do slinging work Slinging person | 1 4 | To perform slinging work in the cargo stacking area in the yard |
| Total persons | 24 - 30 | |

5 Cargo Handling with Truck-Trailer

5.1 Truck-Trailer operation criteria

- 1) A driver of a tractor-trailer must have the proper license and satisfy the requirements stipulated in the internal regulations of JRPA.
- 2) When driving the tractor-chassis, the driver must perform inspections before and after work in accordance with the Inspection Tables and confirm that the Truck-chassis is in normal and safe condition.

5.1.1 Truck-Trailer driver qualification requirements and obligations

<The definition of Truck-Trailer driver qualified personnel and the registration requirements (draft)>

| Qualification | Definition | Registration requirements |
|---------------|--|--|
| Grade 1 | Can drive Truck-Trailer and perform the handling work by oneself | Must possess driver's license of ordinary passenger car. Must have completed Truck-Trailer Driver Education Course by JRPA. |

- 1) The driver satisfies the requirements stipulated in the internal regulations of JRPA and possesses a valid driver's license.
- 2) The driver must follow the instruction of his superiors.
- 3) The driver must strive to keep the mind and body in the best condition.
- 4) If a driver is judged to be mentally or physically unfit to safely perform the work, the responsible person must relieve him of duty.
- 5) A driver who fails to wear proper safety attire or deviates from safety standards can be stripped of his qualifications to operate the truck-trailer.

< The registration procedure (draft) of the Truck-Trailer driver >

| |
|--|
| Application for Truck-Trailer driver (Grade 1) |
|--|

The Project for Enhancement of Management and Operation Capacity
of Inland Waterway in South Sudan (Phase I)

| Necessary information | Authorizing Body |
|--|-----------------------------|
| <ul style="list-style-type: none"> ✧ Truck-Trailer driver registration procedure ✧ Complete application form and attach a copy of driver's license ✧ Submit signed application form to JRPA | Port Management Body (JRPA) |
| <ul style="list-style-type: none"> ✧ Required license: Driver's license for ordinary car ✧ Necessary qualifications: Trainer certificate (after completion of training on tractor-trailer) | |



- * The completion of four (4) hours operation training to be carried out by the port administrator
- * After documents are reviewed, the driver code is issued from the port administrator.

< Truck-Trailer driver's registration application >

Truck-Trailer Driver's Registration Application

[Submission to] Juba River Port Administration

Address:
Name/ Company:
The person In charge:

| | | | |
|--|------------------|-----|--|
| Name of registered person | | Age | |
| Employed date | | | |
| Driver's license | License number | | |
| | Acquisition date | | |
| Date of Training session | | | |
| Driver license code of other heavy equipment | | | |
| Driver's license (Copy) | | | |
| | | | |

Juba River Port Administration
Cargo Handling Group

<Note>:

Unregistered person cannot operate cargo handling equipment in the Juba River Port Administration.

| | | |
|----------|-----------------|---------|
| | General Manager | Manager |
| Approved | | |

5.1.2 Truck-Trailer inspection procedure

- 1) When operating a Truck-Trailer, the inspection of each part in accordance with the “Inspection Items of Track-Trailer”, which will be submitted by the maker, must be carried out.
- 2) When abnormality is found prior to operation or problem occurs during operation, the driver must immediately inform the person in charge of maintenance and wait for instructions.
- 3) The driver must inspect the appearance of the truck-trailer after use. When finding abnormality, the driver must inform the maintenance division or responsible person.
In addition, if the driver is not aware of abnormality, it is responsible to the driver who has operated the truck-trailer.
- 4) When the driver operates a tractor-trailer, he must remove the bollard prior to operation paying due attention to his surroundings.

< Inspection items of truck-trailer >

1. Inspection items before operation

The following matters must be inspected before operation.

* Engine portion

Confirmation of amount of oil and cooling water

Confirmation of any oil leakage

* Each gauge

Operation verification of Fuel gauge and other gauges

* Gantry portion

Confirmation of steering wheel and chassis connecting portion

Confirmation of tire puncture, wear of tire, and tire pressure

Confirmation of Falling off of wheel nut,

Confirmation of the clutch pedal operation

* Braking device

Check the operation of the parking brake and brake pedal

* Display lights and horn

Lighting test for each lamp

Warning sound check

* Container fixing device

Check the operation of lock / unlock of the twist lock

2. Matters requiring during work

When a tire is punctured, Truck-Trailer must not be moved without instruction.

The driver must comply with the stipulated speed in the yard. (25Km/h or less)

Unsafe driving practices such as sudden acceleration, sudden deceleration, sudden turning, etc. are prohibited.

Cleaning of the vehicle

<Note>:

When abnormalities are found during inspection or operation, they must be informed to the relevant party immediately.

5.1.3 Matters requiring in operation of Truck-Trailer

5.1.3.1 Response to when Yard-Trailer is in failure

- 1) When an abnormality is found during operation, the driver must immediately stop the vehicle in a safe place and inform maintenance personnel. He must also inform drivers of other vehicles of his status and take care not to interfere with their operations.

5.1.3.2 Safe driving practices

- 1) A safety helmet must be worn in the yard
- 2) When the driver operates a tractor-trailer, he must remove the bollard prior to start, paying due attention to his surroundings.
- 3) The driver must comply with the speed limit of 25Km/hour or less in the yard.
- 4) Unsafe driving practices such as sudden acceleration, sudden deceleration, sudden turning, etc. are prohibited.
- 5) In the yard, travelling direction of vehicles must be one-way, i.e. "counter-clockwise". Operator must drive a vehicle along the "Defined running path" in compliance with "Direction of travel" and "Stop Sign or Line".
- 6) The driver must keep a sufficient inter-vehicle distance in the yard.
- 7) The driver must not park a vehicle on the defined running path of Crawler crane and Fork-Lift.
- 8) As the crawler crane is given top priority in the yard, drivers of vehicles must give way to crawler crane not obstruct the passage of a crawler cranes.
- 9) Running a truck-trailer in reverse is basically prohibited. When a slight retraction is avoidable, the driver must pay attention to his surroundings to ensure safety is maintained.
- 10) When a vehicle is operated by manual, Driver must principally start a vehicle by means of 1st

speed (Low gear) to prevent the failure of Gear and Clutch.

- 11) A vehicle must be parked at the designated positions in the yard.
- 12) The driver must use the "Turn-signal light (Blinker)" when entering or exiting a lane.
- 13) The driver must clean the front windshield and the inside of the Cab to ensure visibility and safety. The driver must also remove any articles he brought into the cab when exiting the vehicle.
- 14) The driver must confirm that the Gear is in the "Neutral" position and Side-brake is in the "ON" position, and he must switch off the power of "Vehicle Terminal" and stop the Engine before getting out of the vehicle. Finally, the driver must lock tires by bollard.
- 15) Before getting into a Tractor-Trailer and/or in case of the crew's changing, the connection between Tractor and Trailer must be confirmed every time.

5.1.3.3 Matters requiring caution when connecting and disconnecting the "Connection Pin" of Truck and Trailer

- 1) The driver of Tractor must move the Tractor straight backward to Chassis, guide Connection Pin to the center of the connecting device and connect it. When connecting, the driver must operate the Truck at the lowest speed.
- 2) When disconnecting the Truck and Trailer, the lock of Connection Pin must be released, and then the driver must move the Tractor gradually forward and disconnect the Trailer.

5.1.3.4 Matters requiring caution in case of cargo handling work of a barge, shifting work of cargo and other miscellaneous work

- 1) When temporarily putting the unloaded cargo on the jetty in case of barge work, the intrusion of Track-Trailers and containers into the waterside area from the red line (which is drawn by paint at 3 m landside position from the quay line) on the jetty, and also temporary stacking of containers must be prohibited, because the relevant persons of the barge (i.e., the work responsible person, the agent of the barge owner, etc.) and the work related person (the mooring workers, etc.) frequently enter this area.
- 2) When unloading containers, the operator of a crawler crane may proceed to the next action only after confirming visually that a container has been completely unlocked from the spreader.
- 3) The positioning of spreader to land on to a container at the storage yard must be performed in accordance with the cue of the signalman of crawler crane, and It should not be to move the chassis in dogmatism.
- 4) A container must not be loaded onto a chassis because the maximum load capacity of a trailer is 3 tons.
- 5) When loading or unloading two 20ft containers onto/from a 40ft chassis, the following work

The Project for Enhancement of Management and Operation Capacity
of Inland Waterway in South Sudan (Phase I)

procedure must be adopted.

When loading two 20ft containers onto a 40ft chassis, 1) load first container on to the front side of chassis, 2) load second container on to the back side of chassis.

When unloading two 20ft containers from a 40ft chassis, 3) unload a container of the front side of chassis and 4) unload a container of the back side of chassis.

When unloading a container from the back side of chassis, close attention must be paid to the surroundings.

- 6) When loading the 20ft over-height adjuster onto a chassis, it must be loaded onto the front side.
- 7) In case of unloading of cargo from a barge directly to the storage yard, the handling of cargo must be carried out after confirming the safety of surroundings by means of communicating with the cargo handling division via a wireless or other method.
- 8) When loading a laden container, only one container must be loaded onto a chassis.
- 9) In case of loading a container with special cargo, the driver must confirm the safety after hoisting the container locked by the spreader from the chassis, and then immediately move the chassis from there in accordance with the instruction from the responsible person and the lead vehicle.
- 10) During cargo handling on a barge, yard chassis and road chassis must be prohibited from travelling on the jetty.
- 11) When a Truck-Trailer is passing under a lifting device or the spreader of crawler crane, it must stop once before entering under the crane.

5.2 Cargo Handling with Tractor and Trailer

General cargo handling work, i.e. loading and unloading work, is described below.

5.2.1 Unloading work of cargo from a truck, and Safety

1. Lashing of cargo on the truck

1.1) Basics of Rope Lashing work

Basic rope hanging work may be described with reference to Figure 5.2-1.

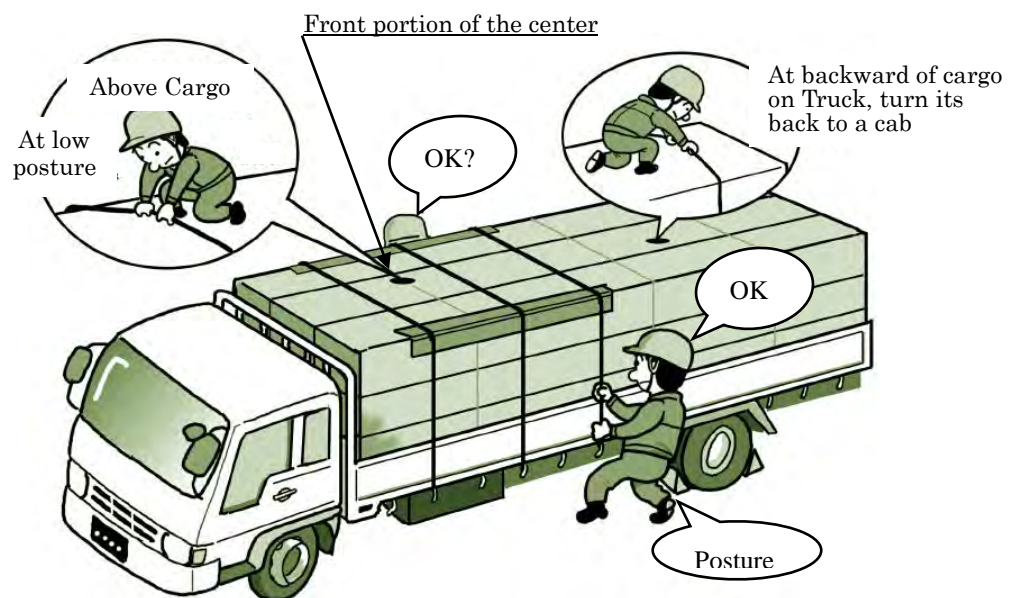

Figure 5.2-1 Fundamental Rope-Reeving Method

- 1) Inspect the ropes before use. Do not use ropes which appear damaged or weak.
- 2) Confirm that the ropes are dry.
- 3) When working with two persons, confirm the work procedure so as to work in unison.
- 4) When tightening the ropes, make the body towards a vehicle, make the legs open in the front-rear diagonal direction, and then strongly pull the rope in a vertical direction.

In the work on the cargo, at the forward portion than the center of the cargo bed, to lower the posture and take the position to make the body towards the driver's seat. And, at the backward portion than the center of the cargo bed, to lower the posture and take the position to make the back of body towards the driver's seat.

- 5) Place pads at corner sections of the cargo where the rope makes contact to prevent damage. Tighten the rope according to the nature of cargo.

- 6) Rope reeving must be made crossed over from the front to the rear, so as to connect the opposite rope hooks of both sides in one straight line, i.e. to be perpendicular to the traveling direction of the vehicle.

1.2) Basic rope tightening method

The method of hanging the middle of the rope on the rope hooks and tightening the rope is shown using the following figures.

- 1) Bend the hanging rope into two around the waist and lift it up to eye height.
- 2) Pass (2) of the following figure from the other side of (1).
- 3) Twist (3) by 1 turn.
- 4) Hang it on the rope hook of the truck bed after passing (4) through a hoop (3).
- 5) Pull (5) strongly in vertical direction.

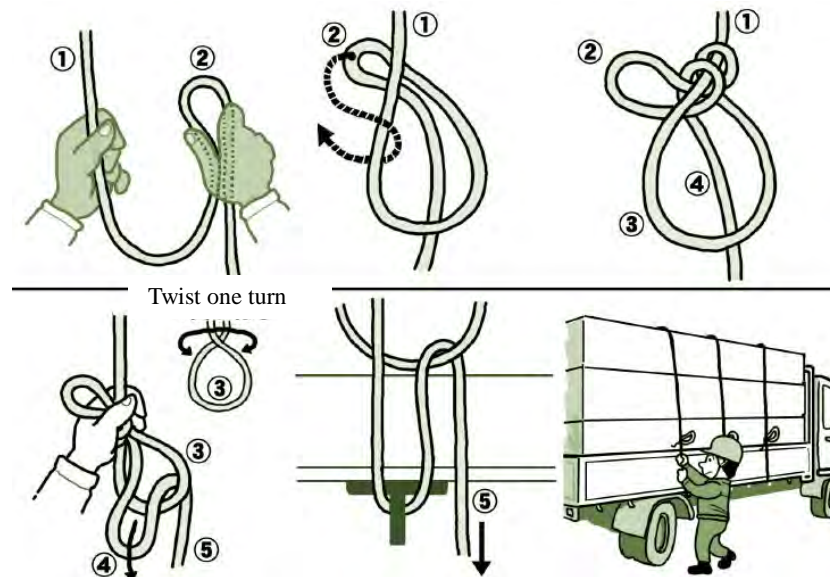

Figure 5.2-2 Fundamental Rope Fastening Method

1.3) Basic rope fastening method

The basic method of rope fastening is shown using the following figures.

- 1) Hang the rope on Rope hook of Truck.
- 2) While holding the portion which the rope hung on the rope hook by hand, make a rope loop after passing the rope over behind the rope pulled.
- 3) Twist the tip of loop by 1 turn and hang it on the rope hoop.
- 4) Pull the rope strongly at the same time release the holding hand. If it is not done quickly, the rope tighten may be loose.

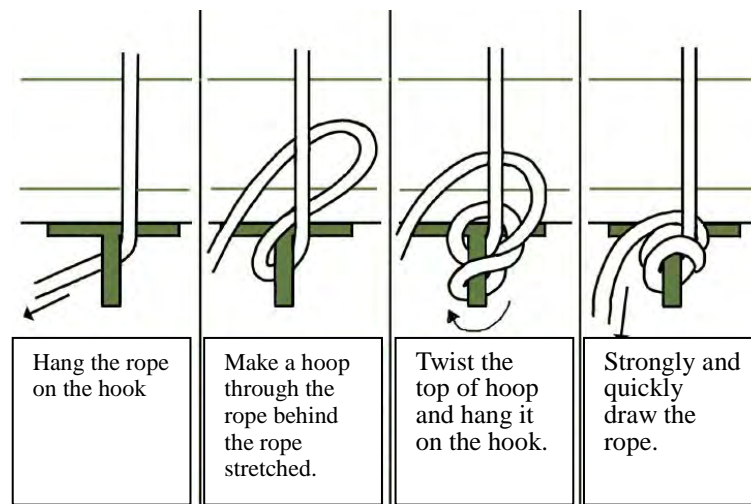

Figure 5.2-3 Fundamental Rope Fixing Method

1.4) Basic rope releasing work

The following must be borne in mind during rope releasing work.

- 1) Rope releasing work must be carried out in a flat area. The engine of the truck should be turned off and wheel chocks should be used to prevent the truck from moving.
- 2) The rope releasing work can be started after confirming that there is no danger of cargo falling from the truck.
- 3) During the rope releasing work, workers must not climb on top of the cargo.

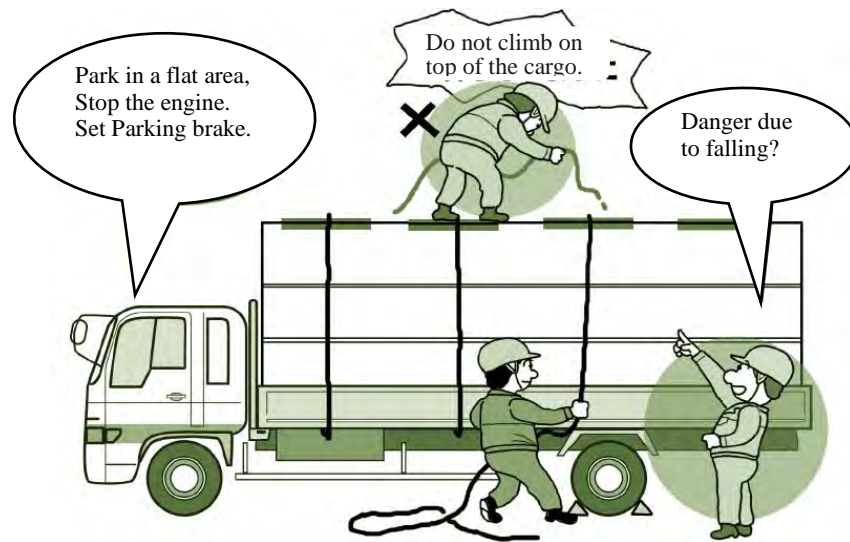

Figure 5.2-4 Fundamental Action When Rope-Reeving

1.5) Matters requiring caution during cargo unloading/discharging work

When manual labor is employed, unsafe practices which could cause accidents or injury need to be avoided.

- 1) Adopt the correct posture when lifting heavy objects. (It is safer to kneel down when lifting heavy objects.)
- 2) Use a stand when placing cargo in high positions.
- 3) Do not attempt to handle cargo above your head.
- 4) Do not walk backwards.
- 5) Do not work such as wielding a long object.
- 6) Objects should be handled in short time as possible.
- 7) Loads in excess of 55kg, must be handled by two persons.

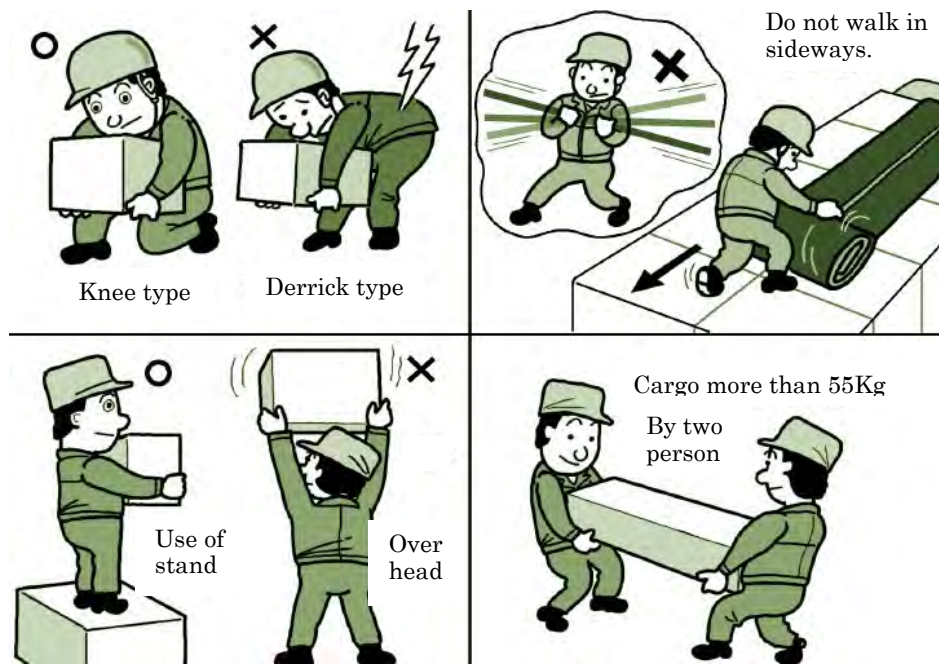

Figure 5.2-6 General Cautions When Human-handling Cargo

6 Cargo Handling with Fork Lift

6.1 Fork Lift operation criteria

In this section, the criterion for the operation of Fork Lift is described.

Regarding the explanation on operation of Fork Lift, refer to the "Operation and Instruction Manual of Fork Lift". Regarding the Maintenance Management such as Inspection before work and Periodical Inspection, refer to the "Maintenance Manual of Fork Lift".

- 1) The driver of a Fork Lift must have a driver's license or an ordinary passenger car and satisfy the registration requirements in JRPA. He must also obtain the proper certification to be qualified as a forklift primary (Grade 1) driver.

<The definition of Fork Lift driver qualified personnel and the registration requirements (draft)>

| Qualification | Definition | Registration requirements |
|---------------|--|---|
| Grade 1 | Can drive a Folk Lift and perform the handling work by oneself | Must possess a driver's license for an ordinary passenger car. Must have completed "JRPA's Driver Education Course" by JRPA. Be approved as Primary driver by JRPA. |

- 2) The driver must satisfy JRPA's internal requirements and carry the necessary license while driving.
- 3) The driver must be aware of his the surroundings while operating the fork lift to ensure safety.
- 4) The driver must strive to maintain his mind and body in optimum condition. If it is judged that he is mentally or physically unfit to operate the vehicle, he must be relieved of duty immediately.
- 5) A driver who fails to wear proper safety attire or violates safety regulations can be stripped of his qualifications to operate the vehicle.

The Project for Enhancement of Management and Operation Capacity
of Inland Waterway in South Sudan (Phase I)

< Fork Lift driver registration application >

Fork Lift Driver Registration Application (Draft)

[Submission to] Juba River Port Administration

Address:
Name/ Company:
The person In charge:

| | | | |
|--|------------------|-----|--|
| Name of registered person | | Age | |
| Employed date | | | |
| Driver's license | License number | | |
| | Acquisition date | | |
| Date of Training session | | | |
| Driver license code of other heavy equipment | | | |
| Driver's license (Copy) | | | |
| | | | |

Juba River Port Administration
Cargo Handling Group

<Note>:

Unregistered person cannot operate cargo handling equipment in the Juba River Port Administration.

| | | |
|----------|-----------------|---------|
| | General Manager | Manager |
| Approved | | |

The Project for Enhancement of Management and Operation Capacity of Inland Waterway in South Sudan (Phase I)

6.1.1 Fork Lift driver qualification requirements and obligations

< The registration procedure (draft) of the Fork Lift driver >

| Application for Fork Lift driver (Grade 1) (Draft) | |
|--|-----------------------------|
| Necessary information | Authorizing Body |
| <ul style="list-style-type: none"> ✧ Fork Lift driver registration procedure ✧ Complete application form and attach a copy of Fork Lift driver's license ✧ Also attach a copy of completion certificate of crane technology training-course ✧ Submit signed application form to JRPA | Port Management Body (JRPA) |
| <ul style="list-style-type: none"> ✧ Required license: The license stipulated by JRPA (Type: Fork Lift driver's license) ✧ Necessary qualifications: Completion certificate of training on mobile crane | |



After documents are reviewed by the port administrator, the driver code (with registration number) is issued from the cargo handling group.

6.1.2 Fork Lift inspection procedure

- 1) When operating a Fork Lift, each part must be inspected in accordance with "Instruction manual of Fork Lift" based on "Fork Lift daily Work Report".
Brake, steering handle, alarm horn, each confirmation lamp, fuel, etc. must be confirmed.
- 2) If any abnormalities were found prior to the start of work or if a problem occurred during work, the driver must inform the responsible person and await instructions.
- 3) Prior to engaging to a fork lift, an appearance inspection must be always carried out. If an abnormality is found, it must be reported to the maintenance division and the port administrator. In addition, if inspection and report of the abnormal part were failed, keep in mind that it is the responsibility of the driver who was riding in the fork lift.
- 4) When getting on a Fork Lift, wheel chocks must be removed in advance and pay attention must be paid to the surroundings.

Daily Work Report of Fork Lift

TO: Juba River Port Administration
The Director of Operation Department
Mr. aaaaaa xxxxx bbbbbb

Date: 18/11/2015
Operation Department
Operator's Name: xxxxxx xxxxx xxxxxx

| Date (dd/mm/yy) | Contents of Work | Operation time of Fork-Lift (Hours) | Person confirmed work | Signature |
|--------------------------|------------------|--|-----------------------------|-----------|
| From: 07:45 To: 11:55 | | | | |
| From: 13:10 To: 16:58 | | | | |
| From: To: | | | | |
| From: To: | | | | |
| From: To: | | | | |
| From: To: | | | | |
| From: To: | | | | |

Abnormal Condition
(Before work)

Abnormal Condition
(During work)

Abnormal Condition
(After work)

Juba River Port Administration
Cargo Handling Group

<Note>:

Unregistered person cannot operate cargo handling equipment
in the Juba River Port Administration.

| | | |
|----------|--------------------|---------|
| Approved | General Manager | Manager |
| | | |

6.1.3 Matters requiring caution when operating a Fork Lift

In case of performing cargo handling by using a fork lift, safety issues are illustrated below.

In addition, each work instruction must be given to the operator in advance based on the "Work Plan".

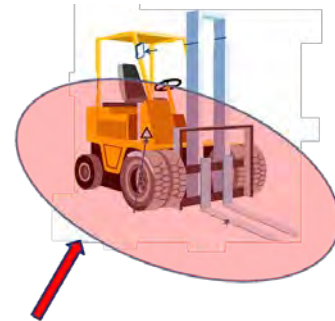
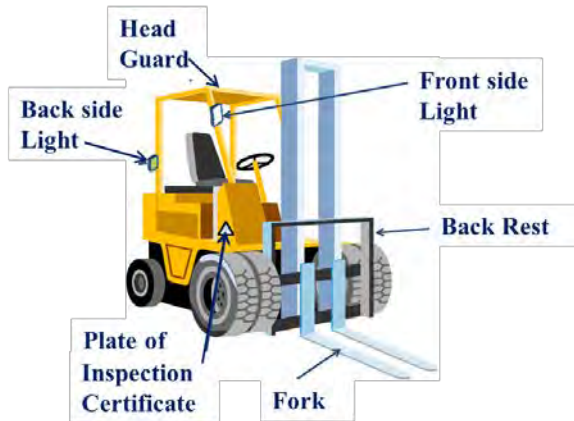

Do not allow workers to enter areas where it is possible to come into contact with Forklift.

Only authorized personnel can enter work area.

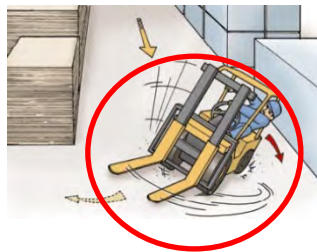

Workers are prohibited from entering areas where they may come into contact with handling machines.

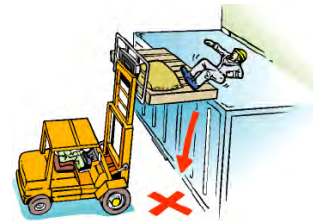

Workers are prohibited from entering areas where they may come into contact with handling machines.



Workers are strictly prohibited from climbing on the lifted load of the fork of Forklift.



It is strictly prohibited to walk under a lifted load.

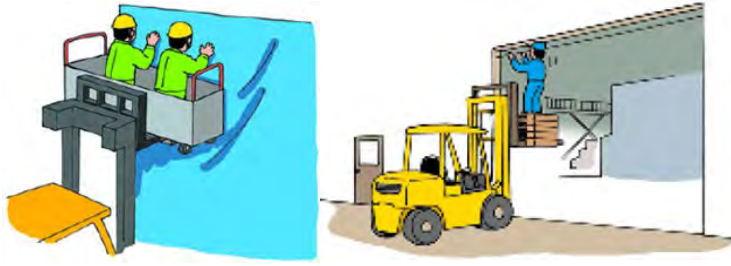

It is strictly prohibited to use the Forklift as a stand to clean a wall, or to attach something to a higher position like a ceiling.



Never touch the cargo on the fork when a Forklift is in operation.



Operator should check his surrounding when operating a fork lift.

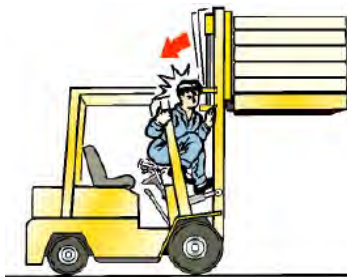

Do not get off the Forklift when holding the cargo.

Do not leave the Forklift when the engine is running.

Do not allow workers to enter areas where it is possible to come into contact with a Forklift.

The Project for Enhancement of Management and Operation Capacity of Inland Waterway in South Sudan (Phase I)

6.2 Cargo handling work by Fork Lift

6.2.1 Usage of Fork Lift

The cargo handling division has one battery-powered forklift and one engine-powered forklift. The battery-powered fork lift, is used for "loading and unloading work" of general cargo, and also for transportation and re-handling work of cargo in the warehouse.

The engine-powered forklift is used in the outdoor yard of JRPA, and used for handling work of general cargo in the yard.

6.2.2 Loading method of general cargo

Fork Lifts are used in conjunction with plastic pallets as pictured below.

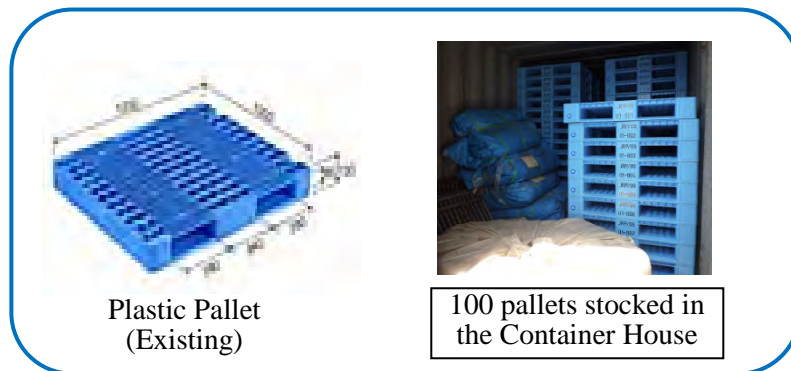

General cargo which is bagged in Nylon bags or paper bags is stacked on a pallet. Speed of the fork lift must not exceed 10 km/hour. or there is a risk the cargo will fall off.

In the case of general cargo packed in a cardboard box, it must be stacked carefully to ensure there are no imbalances.

Examples of "Stacking state" of general cargo are shown in the figure below.

The Project for Enhancement of Management and Operation Capacity of Inland Waterway in South Sudan (Phase I)

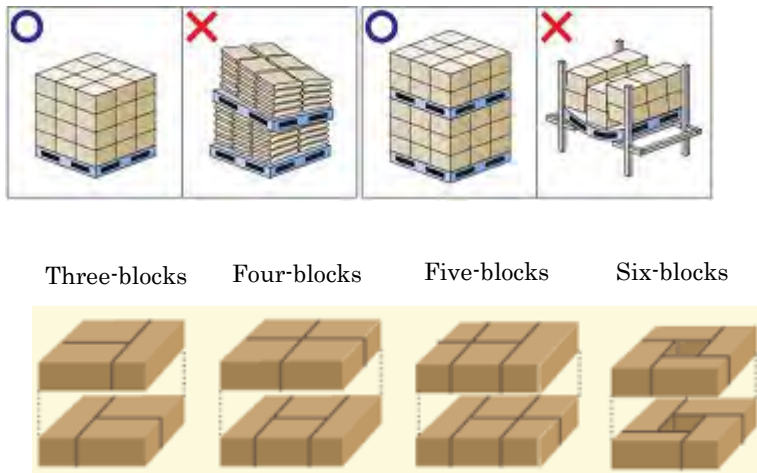

When stacking, stack the boxes in changing the direction by 90 degrees.

Actual “Stacking state” on a pallet is shown in the following figures.



Figure 5.2-7 Palletizing patterns (Continued)

The Project for Enhancement of Management and Operation Capacity of Inland Waterway in South Sudan (Phase I)



Figure 5.2-7 Palletizing patterns

Examples of “Pallet handling” are shown in the figure below.

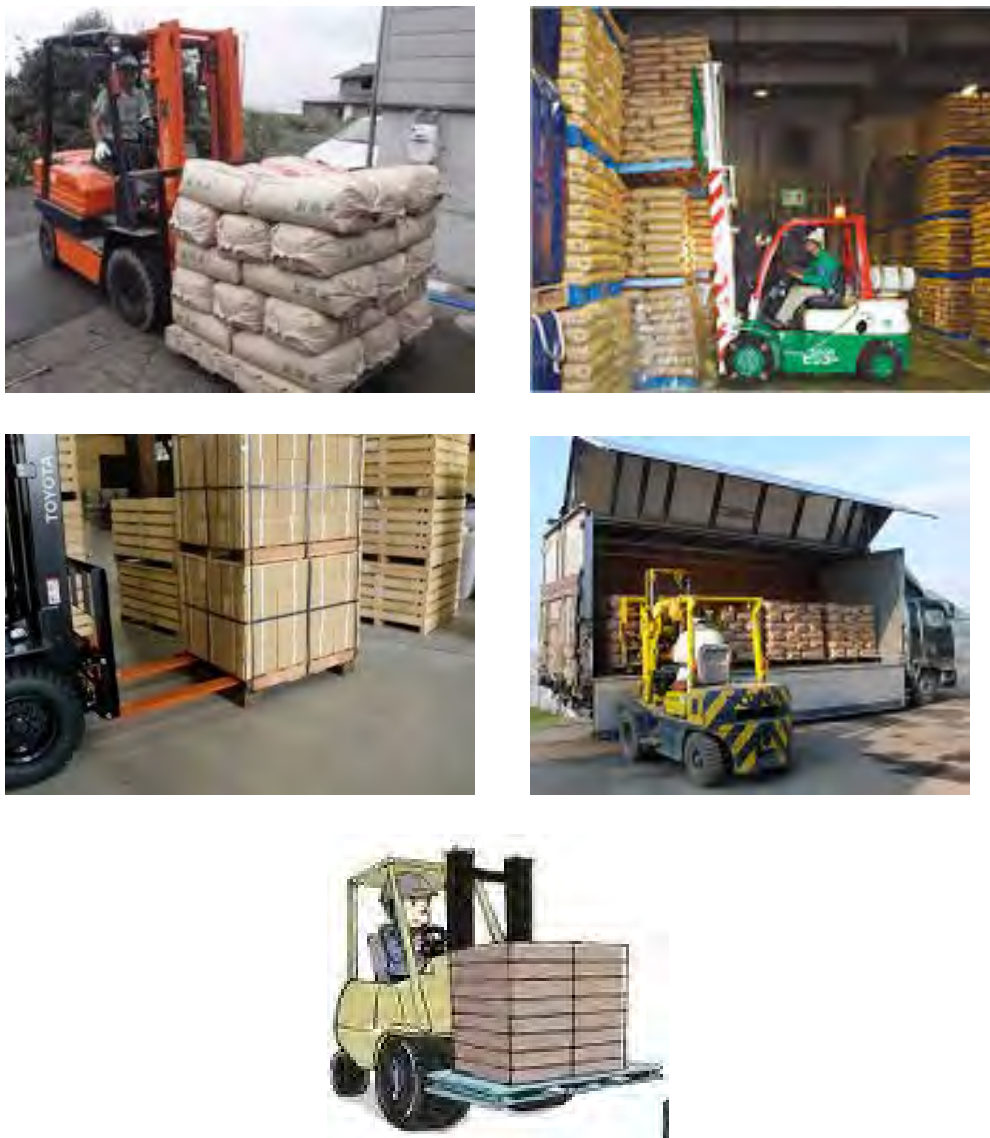

7 Cargo Handling with Belt Conveyor

7.1 Belt conveyor operation procedure

In this section, the the operation procedure of Belt Conveyor is described.

For a detailed explanation on the operation of belt-conveyors, refer to "Operation and Instruction Manual of Belt conveyor". Regarding maintenance, refer to "Maintenance Manual of Belt conveyor".



Figure: Belt-Conveyor

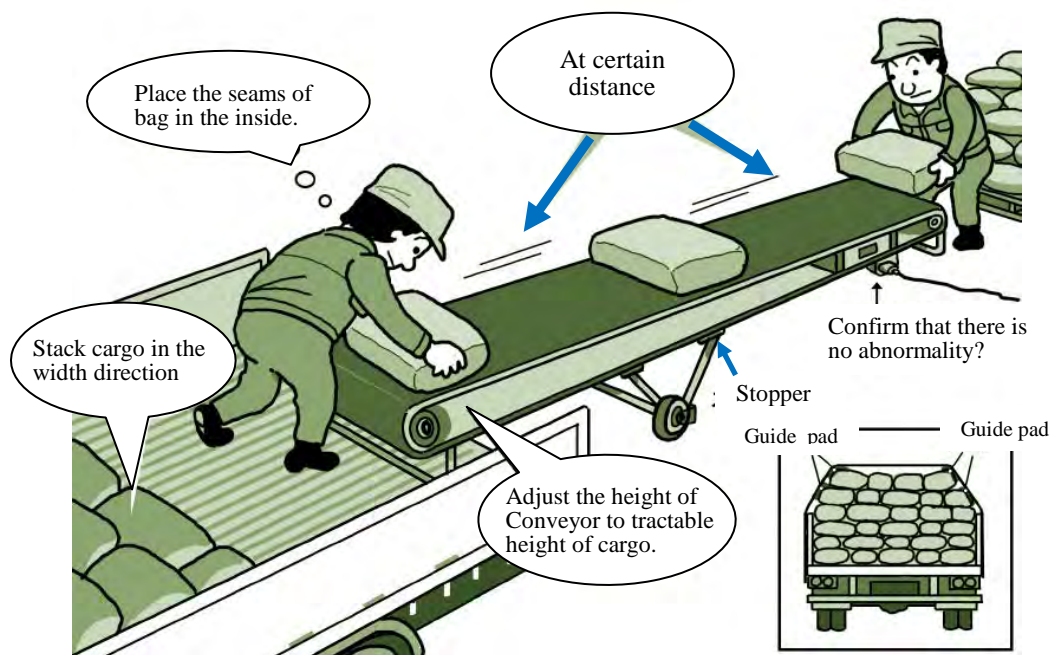

Figure: Example of Works on Belt-Conveyor

The Project for Enhancement of Management and Operation Capacity of Inland Waterway in South Sudan (Phase I)

7.1.1 Basic loading work by belt-conveyor

Loading bags (paper bags, etc.) to the truck bed with a belt-conveyor is done in the following manner.

- 1) First, confirm that there is no abnormality in the handling equipment used and instrument.
- 2) Confirm the stacking (such as quantity, stowage state, etc.) state of cargo.
- 3) Park the truck in the predetermined position.
- 4) Set the flat conveyor or the inclined belt-conveyor in the place instructed. In this case, the stopper of the moving wheels must be locked by the stopper.

In addition, the tip of the inclined belt conveyor must be set at proper height to easily handle cargo.

- 5) The workers engaged in loading work must put cargo on the conveyor while observing the workers at the truck bed.
- 6) Cargo must be placed horizontally on the truck.

Workers must consider proper stacking manner based the characteristics of the cargo. For example, it is necessary to consider, such as directing the sewing opening on the inside when stacking paper bags.

- 7) When repeating bag-stacking work, the end portions of top of the cargo must be made slightly inward by means of reducing the number of stacking stowage. However, the guide pads must be applied not only to the top, but also to the second layer from the top.
- 8) The belt-conveyor must be returned to the proper location after work is completed.

7.1.2 Belt-conveyor operator qualification requirements and obligations

Loading bags (paper bags, etc.) to the truck bed with belt-conveyor may be done in the following manner.

"Belt-conveyor operator qualification requirements and obligations" should be created and issued as an internal rule, by the cargo handling division of JRPA, in a similar fashion to the "Driver qualification requirements and obligations" of Crawler crane and Fork Lift.

In addition, workers engaged in actual operation of a belt conveyor should have to undergo mandatory training.

7.1.3 Belt-conveyor inspection procedures

Regarding the Maintenance Management such as Inspection before work and Periodical Inspection, refer to "Maintenance Manual of Belt-conveyor"

7.2 Cargo handling work with Belt-conveyor

The "Operation Manual" and the "Instruction Manual" of belt-conveyor should be read by all relevant workers in order for them to thoroughly understand all aspects of belt conveyor operation.

In addition, the cargo handling division of JRPA must create the "Working Procedure of Belt-conveyor" and offer training to workers engaged in such work based on the procedures.

8. Incidental Work in Yard

- 1) In case of operating cargo handling equipment and vehicles in the yard for activities not planned in advance, the approval of the Port administrator is required.
- 2) In case any failure occurs or abnormalities are observed during operation of cargo handling equipment and vehicles, etc., it must be immediately reported to the port administrator. No further work is to be done until instructions are received.
- 3) If obstacles are found in the yard, work must be temporarily interrupted and the obstacles promptly removed.
- 4) Permission from the port manager is required for all those who wish to enter the yard.
- 5) Proper safety attire must be worn when entering the yard. (helmet, safety belt and safety shoes)
- 6) If the need to perform incidental work arises, the operator and port administrator must be consulted each time.

9. Safety Meeting before the start of cargo handling operations

For all cargo handling work, the person responsible of overseeing the work must be appointed and the "Guidance Manual of Cargo Handling Work" must be created. Then the "Safety Meeting" must be held to explain the details of the handling works and safety requirements to all workers prior to the commencement of work.

At least 3 targets to perform the work safely should be set by assuming unsafe work practices and possible accidents.

If an accident occurs during the work, the status of the accident, regardless of the size, must be reported, and then appropriate action must be taken in accordance with instructions from the responsible person.

The Project for Enhancement of Management and Operation Capacity
of Inland Waterway in South Sudan (Phase I)

In addition, an "Accident Report" must be promptly be submitted to the port administrator.

Appendix (Relevant Rules, Standards and Manuals)

1) Manual for Safe Cargo Handling Operations (February 2012)

Manual for Safe Cargo Handling Operations

May 2017

**The Project
on
Monitoring Support and Improvement
for the Operation and Management
of Juba River Port
in the Republic of South Sudan**

This booklet is to compile the materials which were used and distributed at the Task Force 3, the Working Group 2 (namely cargo handling and safety section, and port operation section) and the study sessions from April 2011 to February 2012.

It is hoped this booklet will contribute to safe cargo handling operations at the port.

This booklet was produced through the collaboration of the counterparts of the WG 2 and the JICA expert team.

Contents

| | |
|---|-----------------------|
| 1. Manual for Oil Cargo Handling | • • • • • 5-5 |
| 2. Manual for Slings Technology | • • • • • 5-9 |
| 3. Key Points of Container Handling | • • • • • 5-26 |
| 4. Check Points for Using Crane | • • • • • 5-30 |
| 5. Check List for the Efficiency of Cargo Handling | • • • • • 5-33 |
| 6. Key Points of Safe Docking | • • • • • 5-35 |
| 7. Basic Concept for Berth Allocation | • • • • • 5-57 |
| 8. Documentation for Port Entrance and Departure | • • • • • 5-42 |

1. Manual for Oil Cargo Handling

Volume of dangerous cargo, specifically fuel oil, handled at Juba River Port is increasing day by day. There is a possibility that a large accident such as a fire, oil spill and so on could occur if no efforts are made to handle oil safely.

The most important point is to prepare necessary measures for safe handling of oil cargo. Furthermore, the place for handling of oil cargo must be designated and separated from other cargoes if possible.

In this part, check points for safety handling of oil cargo are introduced in the stage of before and during cargo loading/unloading.

(1) Check Points in the stage of “Before Loading/Unloading”

| No. | Check Point | Check | Remarks |
|------------|--|--------------|----------------|
| 1 | To fasten bonding cables between a vessel and shore side or a tank truck to secure the same level | | |
| 2 | To take off any electrostatic items from your own body, hoses and so on | | |
| 3 | To prepare fire extinguisher nearby | | |
| 4 | To prepare oil mats, sawdust and other materials in case of leakage of oil | | |
| 5 | To prepare the gas tight pump for loading/unloading cargo | | |
| 6 | To make the area off-limits to unauthorized personnel | | |
| 7 | To prepare wire ropes on the opposite site of the shore for towing a vessel in the event of fire | | |
| 8 | To prepare a signboard that reads “Handling dangerous cargo, use of flammable materials or fire strictly prohibited” | | |

(2) Check Points in the Stage of “During Loading/Unloading”

| No. | Check Point | Check | Remarks |
|------------|---|--------------|----------------|
| 1 | To close the hatch of cargo tank during loading/unloading of dangerous cargo | | |
| 2 | To assign some persons on the deck for monitoring the situation during loading/unloading of dangerous cargo | | |
| 3 | To always pay attention to oil leakage | | |
| 4 | To immediately stop cargo handling in case of lightening | | |
| 5 | To always pay attention to fire nearby | | |
| 6 | To always pay attention to overflow of oil from the tank or the tank truck | | |

(3) Place for Handling Dangerous Cargo

JRPA should designate the place for oil cargo handling and separate it from other handling areas if possible.

For reference

Three (3) elements of ignition and/or explosion are air (oxygen), inflammable items (oil, gas, etc.) and heat (fire, spark). If these three elements would come together, an ignition and/or explosion occur. You should control one of three elements to prevent an explosive accident caused by oil. It is said that causes of an explosive accident by an oil tanker are mostly sparks brought by static electricity.

(Petroleum gas)

- [1] Dangerous nature of petroleum gas Human body (poisoning)
 Fire & Explosion
 Environmental disruption (Oil spill accident)

[2] Combustibility

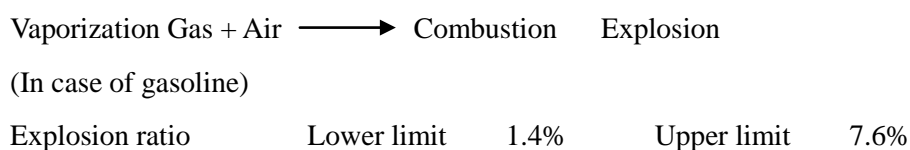

[3] Vaporization point

The temperature that enough gas produces to catch fire.

- Gasoline -40 C below
Kerosene +30 - 60 C
Gas oil +50 - 70 C

[4] Ignition point (Flash point)

- Gasoline 300 C
Kerosene 250 C
Gas oil 250 C

[5] Specific gravity of petroleum gas.

Heavier than air (Without Methane)

(Nature of Gasoline)

- Gravity: 0.65-0.85 g/cm³
Vaporization point : -40 C below
Ignition point: 300 C
Explosion density: 1.4-7.6%
Gas gravity: 3-4
Boiling point: 40-220 C
*Extremely flammable

*Specific gravity is heavier than air. It is easy to stay in low place.

*It is easy to accumulate static electricity by the flow.

(Nature of Kerosene)

Gravity: 0.79-0.85g/cm³

Vaporize point: 30-60 C

Ignition point : 250 C

Explosion density: 1.1-6.0%

Gas gravity: 4.5

*The vaporize point is higher than normal temperature but as for the danger of ignition, abbreviation becomes same as gasoline when temperature becomes it than vaporize point by heating.

*Danger increases in the condition that kerosene floating with form of fog or kerosene soaked into cloth

(Nature of Gas oil) ---Diesel oil

Gravity: 0.83-0.88b/cm³

Vaporize point: 50-70 C

Ignition point : 250 C

Explosion density: 1.6-6.0%

Gas gravity: 4.5

*The danger is same as kerosene.

2. Manual for Slings Technology

Slings work and its related technology is important for safe handling of cargo. Slings technology allows to be prevented during cargo handling and is absolutely necessary for smooth and safe operation of the river port.

The following manual for slings technology is used by some Japanese maritime contracting companies.

Practical Guide for Slings

1 . General Instructions

(1) Slinger's Work Rules

① Wear a working outfit suitable for slinging.



- Carry your slinger's license – a certificate stating that you have finished the prescribed skill training course in slinging.
- Wear a hard hat – a protective helmet.
- Wear working gloves.
- Wear specified work shoes.

② Check the details and process of the lifting job with other members of the group.

- Check the details and process of the job
- Arrange a uniform method of signaling



(2) Check up on the Rated Load of the Crane

- Check the rated load of the crane

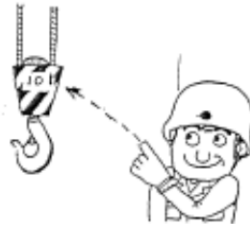

(3) Estimation of Load Weight and COG

- ① Estimate by the eye the weight of the load to be lifted/

- Be sure to add 20 percent to the estimated weight.
- Brush up your estimating skill by daily practice.



- ② Locate the COG of the load by calculations

- Do not try to locate the COG of the load by a single calculation. Divide the load into as many parts as necessary and begin your calculations with both ends of the loads, generally proceeding toward the center.
- Improve your COG-finding skill by daily practice in calculating the COG of material bodies in different shapes.

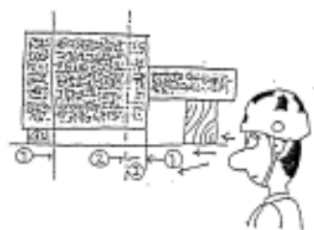

(4) Selection of Sling Gears

- Look at all available types of sling gear.
- Study them with all other members of your group.
- Fully understand their functions and features.
- Choose the best sling gear and best slinging method for each lifting job based on the above knowledge and consultation with all other members of the group.

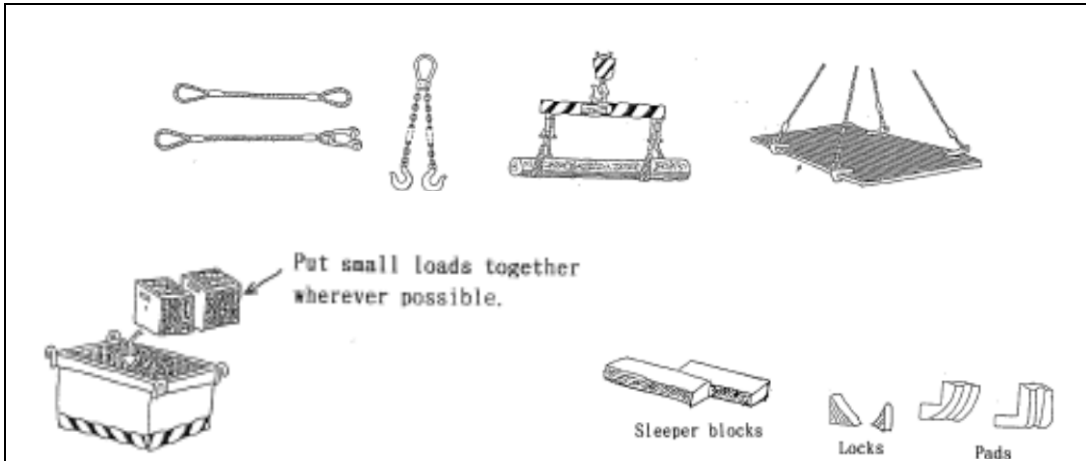

(5) Sling Gear Checkups

- Examine the labeling of the last periodic inspection.
- Check the sling gear for any damage, deformation or wear and tear.
- Don not use any defective sling gear.

(6) Essential Consideration in Slinging

- Take the COG location into account.
- Take care to preclude the wire ropes from slipping.

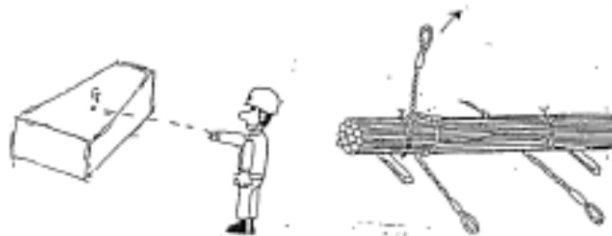

- Sling the load properly, so it will not fall off the slings.
- Pad the edges of an angular or squarish load.
- Protect the sling wire ropes against damage.

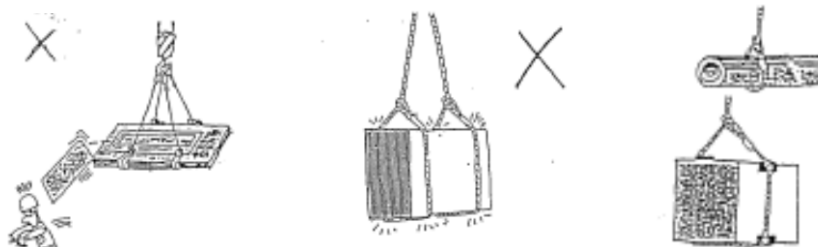

(7) Calling the Crane

- The signaler takes his or her position at a safe place within full view of the crane operator.
- Give signals by clear, unmistakable motions.
- Guide the operator to bring the hook right above the COG of the load.



(8) Putting the Sling Gear on the Hook

- Check the safety tongue of the hook to make sure it is in order.
- Put the sling wire ropes on the hook in the order mentioned below.
- Begin with the ends of the wire ropes on the side nearer the back of the hook and proceed in the order indicated, i.e., ①, ②, ③ and ④.
- Set the sling angle properly within the permissible limit of 60 degree.



(9) Inching up (with a Brief Stop Right Before the Load Leaves the Ground)

- The signaler takes his or her position at a safe place within full view of the crane operator.
- Do not take your position right behind the hook which obstructs the operator's view.
- When slinging is done by more than one worker, keep vocal communication with one another.



● When the slinging wire ropes become taut, stop the crane for a moment to make sure that:

- All wire ropes are stretched evenly;
- The hook is right above the COG of the load;
- The load is not liable to shift in the slings; and
- None of the slings is apt to slip not of its position.
- During the load-lifting process, never grasp any of the wire ropes. To find their tension, press them inward by the palms or push them outward by the thumbs.
- Push the ropes outward by the thumbs of both hands.

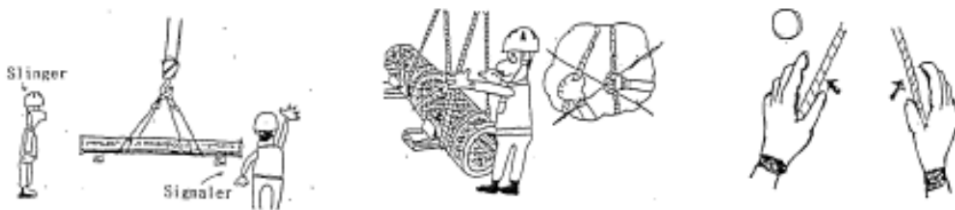

(10) Correction of Sling Positions

- IF you feel the load is slung precariously, sling it anew.
- The signaler will check whether the hoisting accessories of the crane are aligned with the COG of the load and whether the load will stay level and well-balance during lifting.
- IF the center of the hoisting accessories is off the COG of the load, an accident may occur as shown in the sketch.



(11) Inching Up (with a brief stop right after the load leaves the ground)

When the load is inched up to somewhere between 10 cm to 30 cm, stop the crane for a moment to check:

- IF the load remains stable;
- If there is anything wrong with the slinging; and
- If the load is swinging.

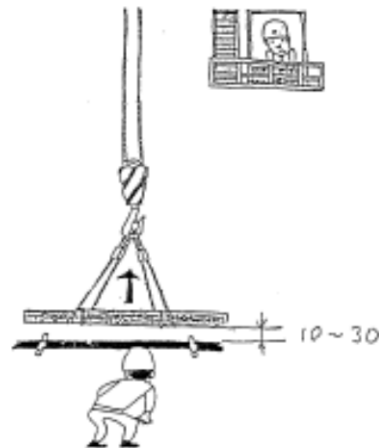

(12) Lifting

- Usually lift the load to 2 meters above the ground.
- An important consideration here is to keep the load at proper height to ensure safety, depending on the conditions of the load itself and the path of its conveyance.

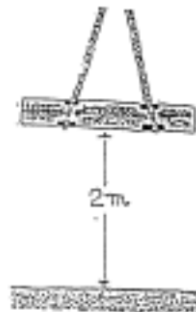

(13) Guidance to Unloading Place

● Slings' Position

- During load lifting by an overhead traveling or portal bridge crane, stay 45 degrees away from either the traversing or traveling path of the crane.
- When a jib-crane is used, stay outside its operating radius and at 45 degrees to its derricking and slewing paths.

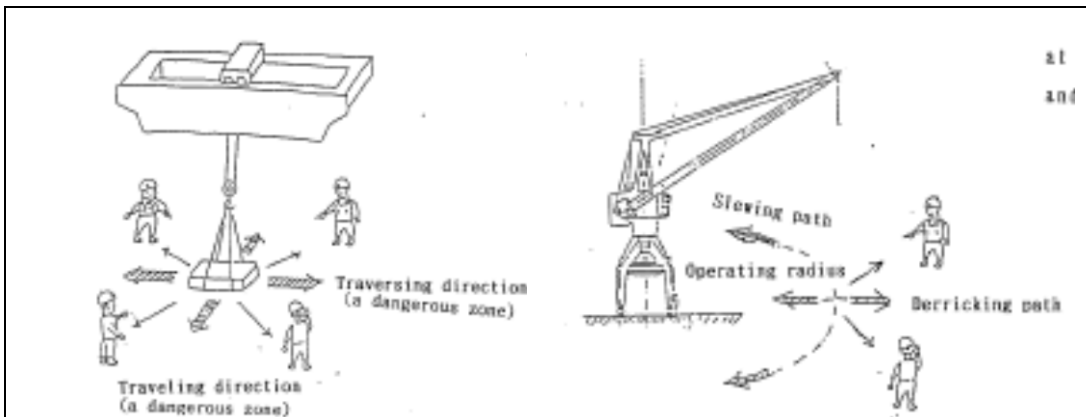

● Signaler's Position

- The signaler will move ahead of the load, indicating the place it is to be carried to.
- Be sure to use a guide rope when the load is a bundle of goods or a long object.

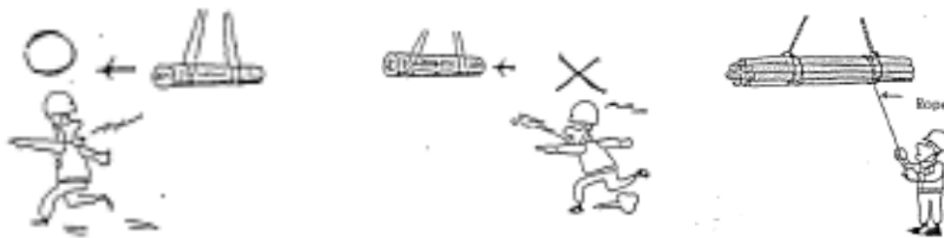

(14) Lowering (with a brief stop right before grounding)

Stop the load between 10 cm to 30 cm above the top of the sleeper blocks or any other type of rests for a moment to make sure that everything is in order.

- Check where and how the sleeper blocks are set.
- Get locks ready when the load of a cylindrical object.
- Stop the load from swinging.
- Correct the relative positions of the load and blocks, of necessary.

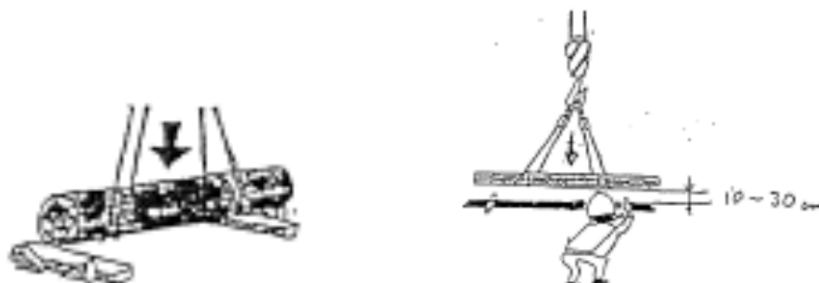

(15) Inching Down (with a brief stop upon grounding)

- When the load reaches the ground but the sling wire ropes are still taut, stop the crane for a moment to make another checkup.
- Take care not to slacken the sling wire ropes too much.
- Check if the load rests stable on the blocks.

- Check if the load is apt to shift on the blocks.
- Examine if the sling gear can be removed easily.

(16) Inching Down and Stopping (at the un-slinging position)

Inch the hook down continuously to the level where the load can be unslung easily.

(17) Un-slinging

- Never pull out the sling wire ropes from under the load by the hook of the crane or any other lifting equipment.



(18) Lifting the Crane Hook

- Remove the sling gear from the hook.
- Lift the hook to at least 2 meters above the ground.

(19) End of the Lifting Job

- Check with the crane operator to confirm that lifting job has been finished.

(20) Storage of Sling Gear

- Return the sling gear and attachments to their respective places of storage.
- Be sure to straighten the wire ropes, if bent in any part, before stowing them away.

2. Method of Slinging with Wire Ropes

2.1 General Instructions

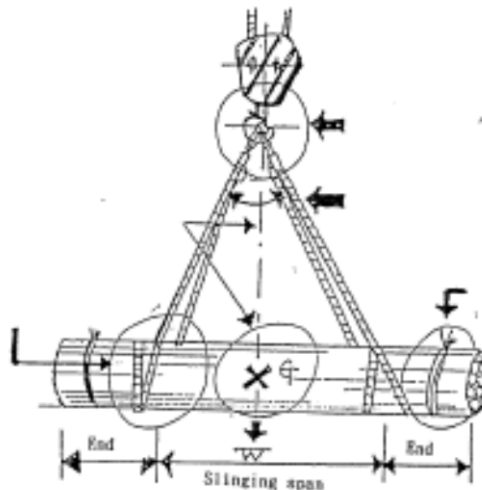

- Check if safety tongue of the hook is in order.
- Make sure the sling wire ropes do not cross in any part.
- Check if the wire ropes are properly set in the middle of the hook.
- Be sure to keep the sling angle within 60 degrees usually and within 90 degrees at the most.
- Check if the COG of the load and the center of the hoisting accessories are aligned accurately.
- When multiple goods are to be lifted as one load, make sure they are bundled tight.
- Put the sling wire ropes properly on the middle of the hook in due order.
- Keep the sling angle within 60 degrees usually and within 90 degrees at the most.
- Make sure that no sling wire rope will be twisted.
- Take care to avoid crossing any two wire ropes on the hook or the load.



2.2 Methods of Securing Wire Ropes to Hook

① Fastening Wire Ropes by the Eye

The method of slinging with the eyes of wire ropes on the crane hook includes one-rope, two-rope, four-rope slinging and so on, depending on the number of wire ropes used.



② Single-Turn Slinging

This is a method of hanging a sling wire rope on the hook by simply putting its bight or middle part on the hook.



③ Slinging with One Round Turn on the Hook

The one-round-turn slinging is a method of securing a wire rope on the crane hook by winding its bight around the hook once in a single round turn.

- The method is used to preclude the sling wire rope from slipping on the hook.
- Care should be taken to avoid passing any part of the rope over another on the hook.



④ Blackwall Hitch

The blackwall hitch means winding a wire rope around the crane hook shoulder in one round turn.

- This method uses the same single loop in the wire rope bight as the one-round-turn sling but the location of the loop is moved up to the shoulder of the hook.
- Form a loop in the bight of the sling wire rope, taking care to avoid twisting the rope against its lay, and then put the loop around the shoulder of the crane hook.



2.3 Methods of Securing Wire Ropes to Load

(1) Fastening Methods

① Fastening Wire Ropes by the Eye

This is a method of securing sling wire ropes to the load by putting their eyes on the hangers, especially hooks, of the load.

- In using this method, bear it in mind that the eyes of the wire ropes may come off the hooks of the load when the ropes are slack.



② Single-Turn Slings

This method supports the load from the bottom by passing the bight of the sling wire ropes under it.

- The method may let the wire ropes slip on the load toward the center.

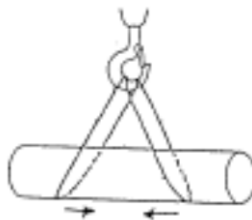

③ Noosing by the Eye

This method secures the load by putting the eye of the wire rope at one end through that at the other end so as to form a noose around the load.

- A disadvantage of the method is that the wire rope declines in strength because it is bent sharply at the eye.

(a) One-rope slinging

- The load may turn during conveyance.
- The turning of the load may untwist the wire rope, leading to a decrease in its

strength.



(b) Two-rope slinging

- Use of shackles is recommended to protect the sling wire ropes from damage.
- Noosing both wire ropes in the same direction may let the load roll in the loops.
- Noosing the wire ropes in opposite directions applies a twisting force to the load.
- This helps the load rest stable in the loops.

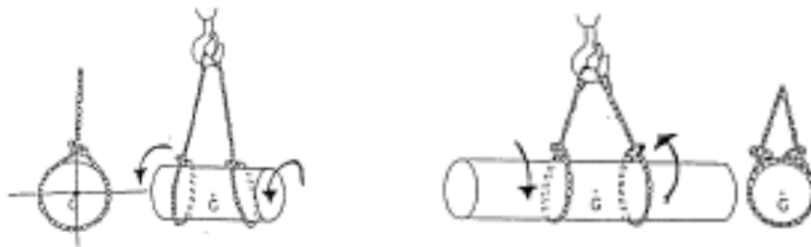

● How to use shackles.

Fasten the shackle in such a way that the inside of the U-bend comes in contact with the section of the wire rope on which a greater tensile force works.

If the shackle is fastened this way, the belt may be pulled loose by the wire rope.

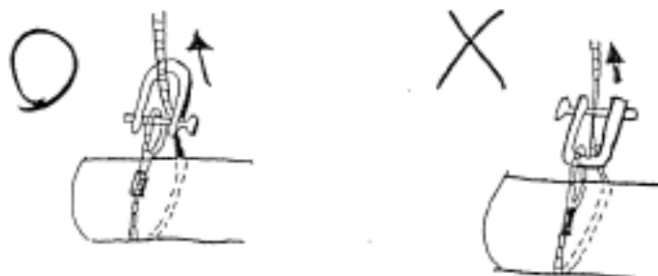

④ Bale Sling Hitch

This method secures the load with a sling wire rope or wire ropes doubled over and usually fastened in a ring hitch.

- Slings method A in the left sketch is used generally.
- Method B is used when different tensile forces work on the two wire ropes.
- The sketch below shows a variation of method B in which the two end of the wire rope are looped around the load in opposite directions.

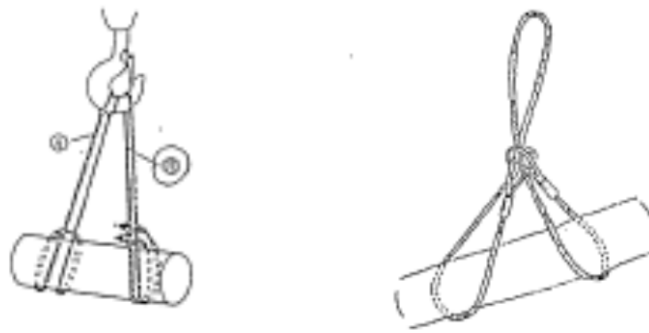

⑤ One-Round-Turn Slinging

This is a method of securing the load by winding a sling wire rope or wire ropes around it in a single round turn.

- When right-handed wire ropes are used, you can loop them around the load easily without damaging them if they are wound in an S shape.
- When slinging round bars or other similar materials by this method be sure to build them with wire a both ends.
- Take care to avoid crossing any two sections of the wire rope on the underside of the load.



⑥ Slinging with Single Hitch on Bottom

This method, used for slinging relatively tall loads with a small plane area, ensure the load by crossing two wire ropes in a single hitch on its underside as shown in the left sketches.

- Sling the load in such a way that the single hitch, i.e., the intersection of the two wire rope on its base will be right under its COG.
- Make sure that the wire ropes will have equal length and will be located at equal intervals.
- When slinging a load with a square base, take care to pass the wire rope right at the center of each side of the base.

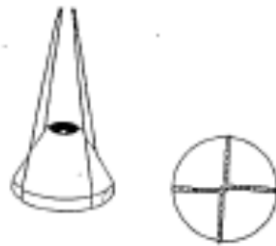

(2) Examples of Slings

① Slings Long Goods (including unbound bars)

- Ensure that the wire ropes will not slip on the load.
- When slinging two or more goods together, be sure to build them tightly.

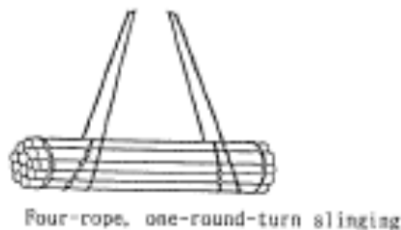

② Slings Steel Plates, etc.

- Be sure to apply pads to angular or squarish loads.
- When slinging two or more sheets or plates together, laying one on top of another, take care to preclude them from shifting in the slings during conveyance.

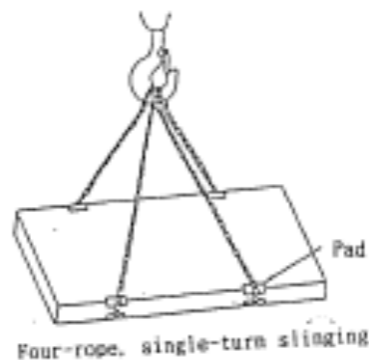

③ Slings T-Shaped Goods

- Slings the load with wire ropes of equal length in such a way that all three points on the load at which it is fastened with the wire ropes will be on the circumference of a circle drawn with the COG of the load at the center.
- If the sling wire ropes are fastened by the eye, use of shackles is recommended as they serve to protect the wire ropes against damage.

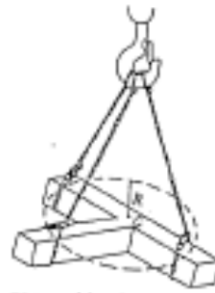

Three-rope slinging with the wireropes fastened on the load by the eye

④ Slinging Frustum-Shaped Goods

- Use a proper slinging method applicable to loads of slippery shape.
- It is recommended that a shackle be used for the intersection of the sling wire ropes on the underside of the load.

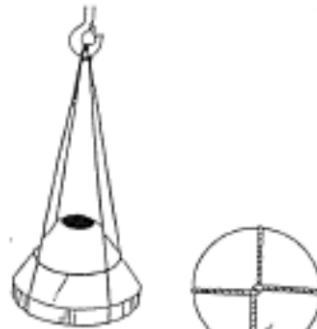

Four-rope, single-hitch slinging

⑤ Slinging Wheel-Shaped Goods

- Sling the load properly with the wire ropes located at equal intervals.
- Be sure to pad an angular load.
- If the wire ropes are fastened on the load by the eye, use of shackles is recommended as they protect the wire ropes against damage.



Six-rope, single-turn slinging



Four-rope, one-round-turn and through-the-eye slinging

3. Slinging with Special Sling Gear

3.1 Clamps

Take care to avoid mixing up vertical and horizontal clamps.

- Be sure to use clamps within the allowable limits of plate thickness.
- Put clamps on the load firmly until the edges of the load reach the deepest end of their openings.
- Never use one-point slinging.
- When slinging the load with more than one clamp, make sure that the COGs of the load and slinging point will be aligned accurately.
- Keep the sling angle within 60 degrees.
- Take care to identify the top and bottom of vertical clamps.

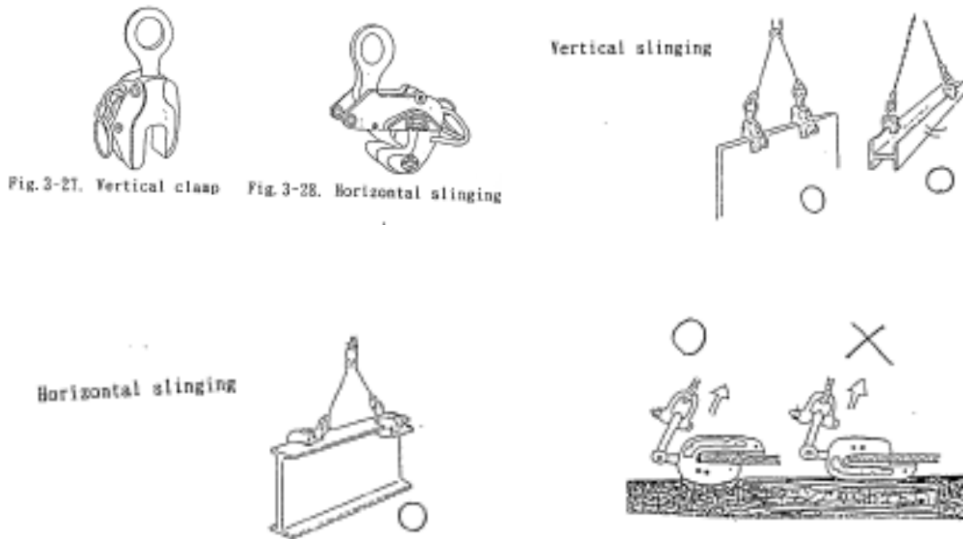

3.2 Hackers

- Do not use hooking hackers for draw-stringer slinging.
- Always use hackers within the allowable limits of plate thickness.
- Keep the sling angle within 60 degrees.
- In principle, sling the load with two or more hackers.

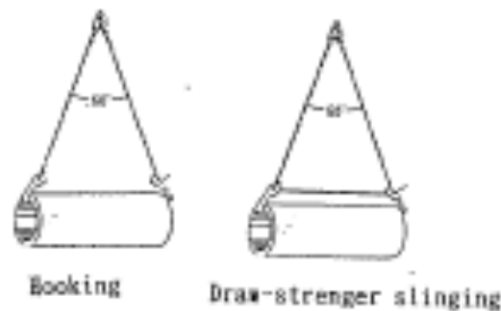

3.3 Sling Beams

- When a two-hook sling beam is used, make sure that an equal load will work on the hook at each end of the beam.
- In using a multipoint sling beam, take into account that loads on the individual hooks differ from one another.

3.4 Wire Netting

- Use wire nets carefully because their meshes may break and let small goods fall through the opening.

3. Key Points of Container Handling

3.1 Container Specification

This section is to explain the container specification based on regulations of ISO (International Standardization Organization).

Size of Container

- 20 feet container: width 8' x height 8'6" x length 20'
- 40 feet container: width 8' x height 8'6" x length 40'
- High cube container: width 8' x height 9'6" x length 40'

Maximum Payload (including Tare weight)

- 20 feet container: 24,000 kg
- 40 feet container: 30,480 kg

Material of container

- Aluminum container
- Steel container

Type of container

- ①. Dry container: This container is a regular type of container and the most widely used for cargo transportation.
- ②. Reefer container: This container is used to carry refrigerated cargoes such as fruits, vegetables, meats, perishable foods, films and so on. Reefer function is attached in a container and is also needed to be equipped in a port to maintain a prescribed temperature.
- ③. Open top container: This container is used to carry high curb and/or heavy cargoes. It is possible to handle cargo from the top of the container.
- ④. Side open container: This container is used to mainly carry length cargo. Cargo can be handled from the side of a container and it is easier to load/unload cargo into/out of a container.
- ⑤. Flat rack container: This container is used to carry length and heavy cargoes. Large scale cargo which can not be accommodated with an ordinary container is also carried with this container.
- ⑥. Flat bed container: this container has no pillars and can accommodate a large scale cargo.
- ⑦. Tank container: This container installs a tank in a container and is used to carry liquid cargoes such as liquid chemicals, malts, food, soy source and son on.



Dry Container



Reefer Container



Open Top Container



Side Open Container



Flat Rack Container



Tank Container

Slings used for loading

There are several kinds of equipment for handling containers.

However, in the case that there are no folk-lift, top lifters and other machines for handling a container, a container is handled and lifted up by sling.

There are several kinds of slings, namely wire hook sling, chain hook sling, fiber sling and so on.



Chain hook sling

A Spreader device is sometimes used instead of sling.

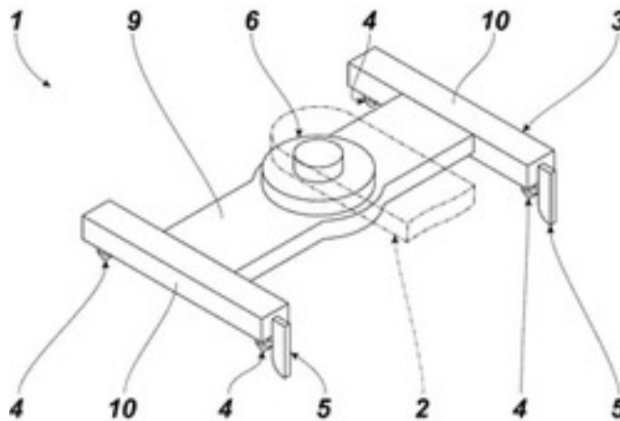

3.2 Procedure for container loading

① Container loading application

JRPA shall prepare the application form and a shipping company/handling company has to fill out necessary information in the application form.

② Submission and Approval

A shipping company/handling company has to submit the application form to handle containers to JRPA, and then JRPA has to approve the application in case there is any specific issues and problems.

Conditions for approval are;

The Project for Enhancement of Operation and Management Capacity of Inland Waterway in South Sudan

- Confirmation of handling place for container cargo
 - Confirmation of container volume
 - Confirmation of cargo type in a container (dangerous and/or explosive items, etc.), and
 - Confirmation of using a crane
- ③ Condition of site condition before handling containers
- Setting a crane
 - Condition of cargo handling gears
 - Safety measures for crane works
- ④ Report of the completion of cargo handling to JRPA
- Confirmation of jetty conditions after handling containers
 - Conditions of a jetty crane and others

4. Check Points for Using Jetty Crane

Check points for using a jetty crane are as follows.

(1) Check Points before using a jetty crane

| No. | Check Point | Check | Remarks |
|-----|---|-------|---------|
| 1 | To check engine oil | | |
| 2 | To check diesel oil | | |
| 3 | To check cooling liquid | | |
| 4 | To check fan belt | | |
| 5 | To check the outside of diesel engine and generator to determine whether there is an unusual situation or not | | |
| 6 | To check the condition of wire cable | | |
| 7 | To check the condition of cargo hook and tackle | | |
| 8 | To check the surroundings of the jetty crane whether there is an unusual situation or not | | |
| 9 | To check engine noise | | |

(2) Check Points before handling cargo

| No. | Check Point | Check | Remarks |
|-----|---|-------|---------|
| 1 | Communication: Foreman, crane operator, signal man and workers have to fully communicate amongst themselves | | |
| 2 | Crane Operator: Crane operator has to be qualified | | |
| 3 | Signal man: Foreman has to decide signals of crane handling and appoint a signal man | | |
| 4 | Safety area: Safety area has to be decided and only authorized personnel can be allowed inside | | |
| 5 | To check every part of cargo gear before handling | | |

| | | | |
|---|--|--|--|
| | cargo, such as hooking wire, hooks, shackles, wire slings, wire net, and dram hook, etc. | | |
| 6 | To use guide ropes effectively | | |
| 7 | To maintain the hooking angle with less than 60 degrees | | |

(3) Check Point for Setting Mobile Crane

| No. | Check Point | Check | Remarks |
|-----|---|-------|---------|
| 1 | To confirm all setting points | | |
| 2 | To secure the bearing power of ground | | |
| 3 | To use planked board | | |
| 4 | Do not enter the space during loading/unloading cargo | | |

(4) Inspection Points of Wire Rope, Cargo Hook and Shackles

Hooking Wire Rope

| | Inspection Point | Check | Remarks |
|---|---|-------|---------|
| a | Steel yarn: Broken ratio of steel yarn shall be less than 10 % | | |
| b | Diameter of wire rope: Decreased ratio in diameter shall be less than 7 % | | |
| c | Kink: Any kink shall not be allowed. | | |
| d | Deformation, rust and corrosion: There shall be no significant deformation, rust and corrosion. | | |
| e | Loosing of eye and joint: There shall be no loosing. | | |

Compressed clamp part

| | Inspection Point | Check | Remarks |
|---|--|-------|---------|
| a | Wear of alloy and damages: Thickness of alloy shall be more than tow-thirds that the original one and there shall be no significant damages. | | |
| b | Deformation of alloy: There shall be no significant deformation. | | |

Cargo hook

| | Inspection Point | Check | Remarks |
|---|---|-------|---------|
| a | Crack: There shall be no cracks. | | |
| b | Distortion: There shall be no distortion. | | |

Shackle

| | Inspection Point | Check | Remarks |
|---|--|-------|---------|
| a | Distortion and wear of shackle:: There shall be no distortion and no significant wear. | | |
| b | Crack: There shall be no cracks. | | |
| c | Turning part: There shall be normal turning. | | |
| d | Eye-bolt and pin: There shall be no vent, no crack and no wear. | | |

5. Check List for the Efficiency of Cargo Handling

(1) In the stage of “Before arrival of the port”

(fleet name: _____ No. of the barge: _____)

| | Confirmation Items | check | Remark |
|---|--|-------|--------|
| a | Arrival date and time , stay period | | |
| b | Kind and Quantity of main cargo | | |
| c | Arrangement of workers | | |
| d | Arrangement of truck and crane | | |
| e | schedule of delivery and import of the cargo | | |

*To complete necessary arrangement before a vessel arrives at the port

*To consider the completion period of cargo loading/unloading during a vessel’s stay and to secure berth allocation

(2) During vessel stay at the port

(fleet name: _____ No. of the barge: _____)

| | Confirmation Items | Check | Remarks |
|---|--|-------|---------|
| a | Start of cargo handling | | |
| b | Arranging situation of worker, crane, etc | | |
| c | Import and delivery situation of the cargo | | |
| d | Observance instruction of the stay period | | |
| 3 | Confirmation item of the safety measures | | |
| a | Mooring rope condition and state of the ship | | |
| b | Fire prevention and oil leakage measures | | |
| c | Setting of the safety working area | | |
| d | Monitor situation and give instructions to improve unsafe behavior/actions | | |

(3) Confirmation items of the safety measures

(fleet name: _____ No. of the barge: _____)

| | Confirmation Items | Check | Remarks |
|---|--|-------|---------|
| 3 | Confirmation item of the safety measures | | |
| a | Mooring rope condition and state of the ship | | |

The Project for Enhancement of Operation and Management Capacity of Inland Waterway in South Sudan

| | | | |
|---|--|--|--|
| b | Fire prevention and oil leakage measures | | |
| c | Setting of the safety working area | | |
| d | Monitor situation and give instructions to improve unsafe behavior/actions | | |

6. Key Points of Safe Docking

All barges and vessels must keep the side alongside the jetty.

Basic issues for safe docking are as follows:

- to make sure good wire ropes are being used to properly joint pusher and barge (side joint).
- to bring the barge in front of the jetty and to stop the barge at the position of 10m apart from and in parallel with the jetty.
- to slowly move the barge sideling and bring it alongside the jetty.
- to occasionally check the mooring ropes after docking the barge.

Recommendable mooring ropes are as follows:

- to take the breast line (Don't make it tight).
- to take the spring line from fore to aft.
- the mooring line must not be taken from a handrail or other structure other than the mooring bit.

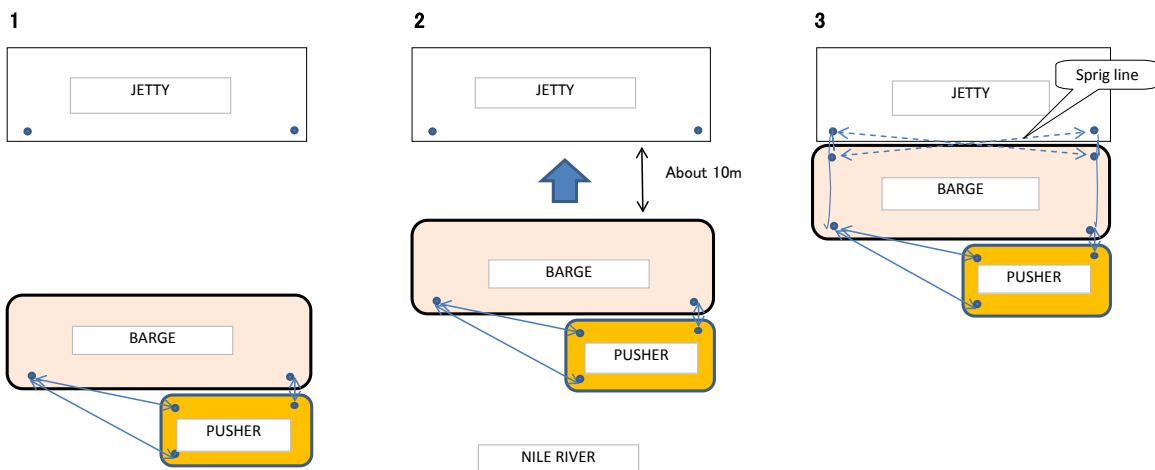

All barge and vessel must keep the side alongside the jetty.

1. Make sure to joint pusher and barge with a good wire rope (side joint).
2. Bring the barge in front of the jetty and stop the barge at the position of 10m apart from and in parallel with the jetty.
3. Slowly move the barge sideling and bring it alongside the jetty.
4. Check the mooring ropes sometimes after docking the jetty.

Recommended mooring lines.

1. Take a breast line (Don't make it tight).
2. Take a spring line from fore and aft.
3. Don't take a mooring line from hand rail or other structure other than a mooring bit.

Safety Docking

For reference

Safety Notification During Docking

1. Do not hit the barge against the jetty.
2. Do not hit the container or other cargo against the jetty.
3. Do not unload over-weighted cargo forcibly such as a heavy container.
4. Do not use damaged/wear ropes for mooring.
5. Take the mooring rope from the barge bit to the bit of the jetty.
6. Do not tighten the mooring rope excessively.
7. Do not dick and/or undock the barge to the jetty without the supervision of staff of the port administration office.
8. Do not carry out loading/unloading works without the supervision of staff of the port administration office.
9. Do not set the outrigger of the mobile crane outside except for the authorized position marked on the jetty.
10. Wear safety gear such as a safety helmet, gloves, safety shoes and a safety vest.
11. Ensure that it is a no-smoking area (the jetty and backyard area)
12. Do not throw away pet bottles and dump them into a garbage container.

7. Basic Concept for Berth Allocation

After commencement of the construction works for an expansion project, area for mooring barges would be limited. Therefore, establishment of a berth allocation system will be very important during the construction works.

However, so far detailed schedules of the construction works have not been determined yet, so a basic image for berth allocation during the construction works of the expansion project is presented below.

① Present situation

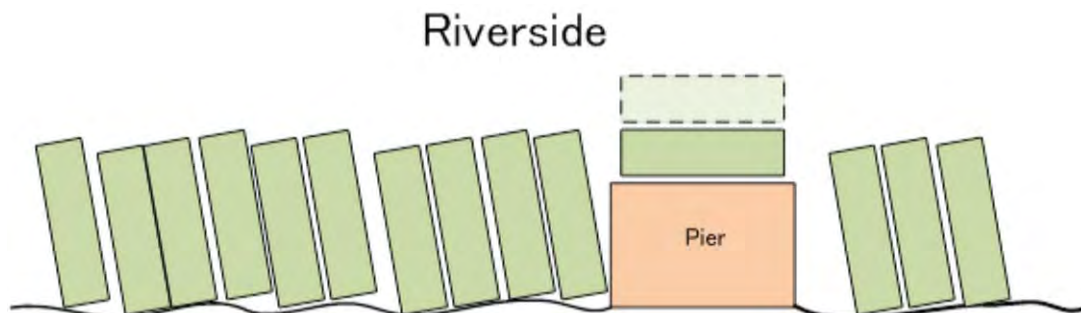

② First Stage of the construction Works

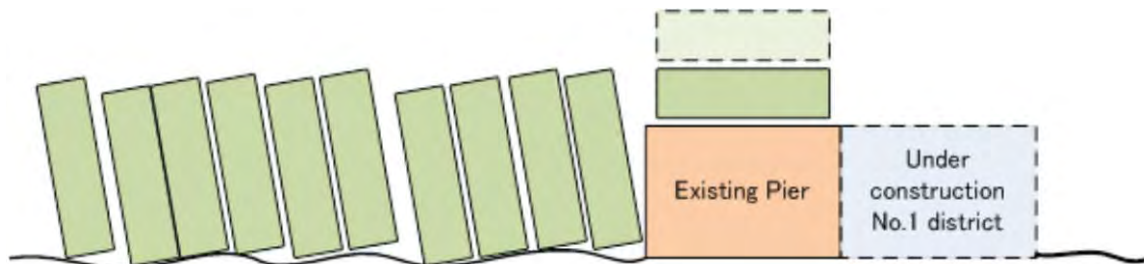

The pier next to the construction site might be affected by the construction works when a barge uses a pier but cannot use it fully.

Therefore, as for the construction works are going on next to the pier, the pier will not be able to be used for mooring.

③ After completion of the first stage of the construction works

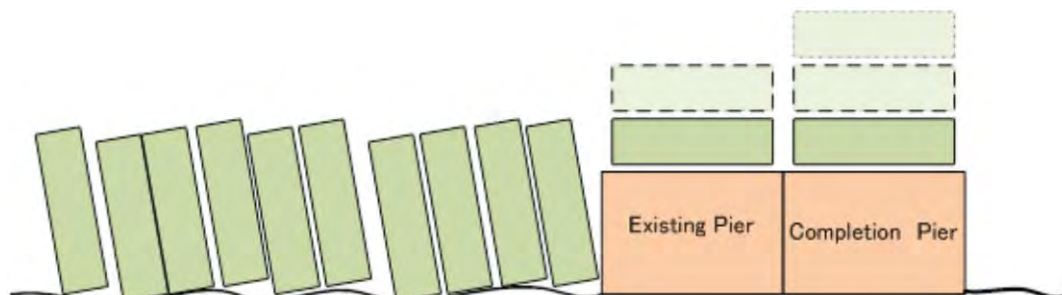

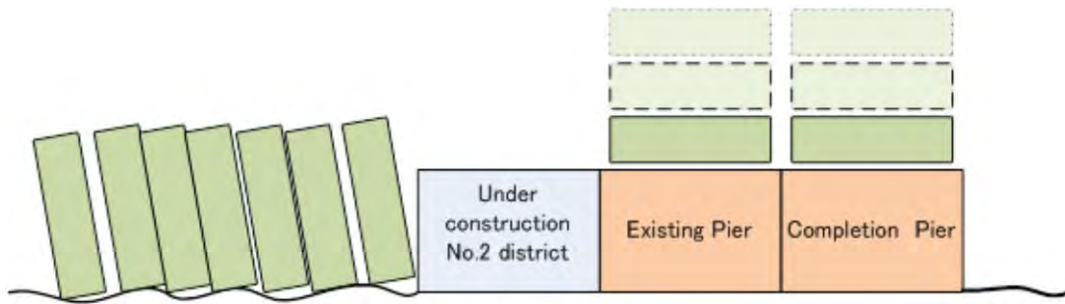

⑤ After completion of the construction works

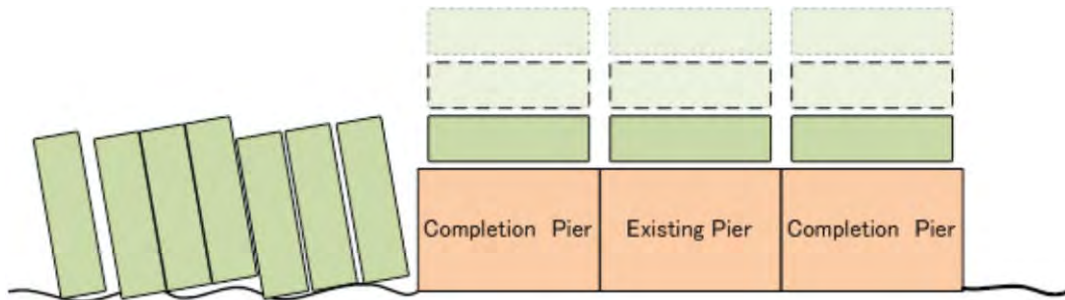

⑥ Third stage of the construction works

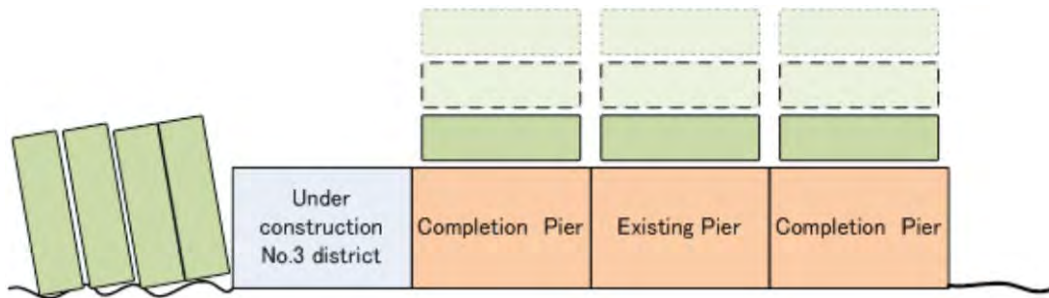

⑦ Fourth stage of the construction works

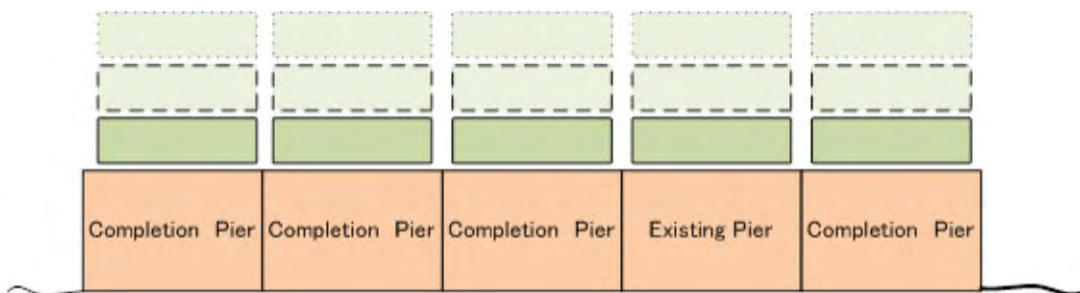

⑧ Final stage of the construction works



⑨ After completion of the construction works

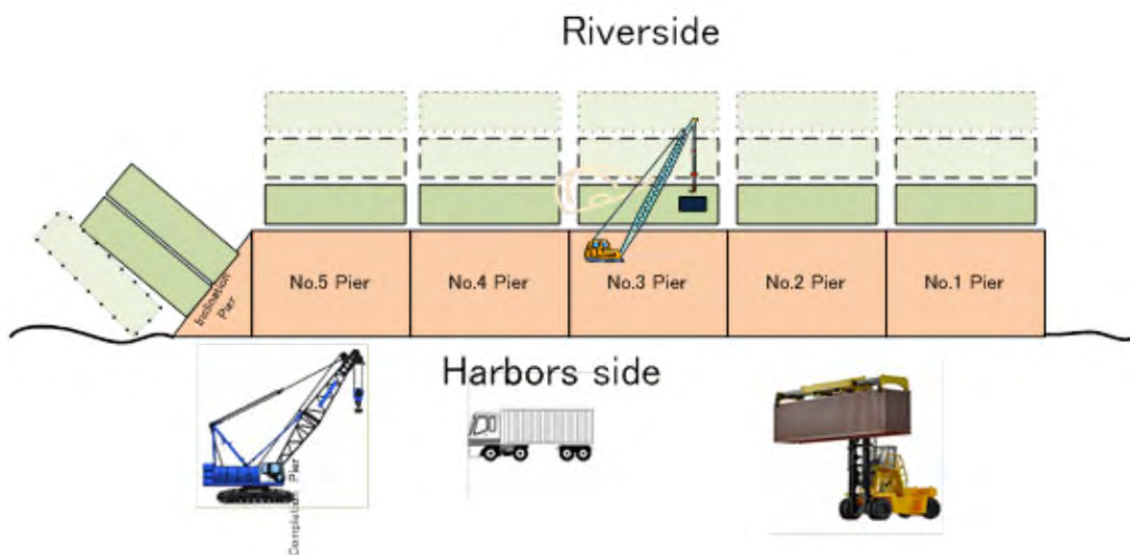

⑩ Docking method

It is better to use a tug boat to dock a barge to a pier.

When a barge maneuvers with a tug boat in front of a pier, it is effective to utilize the flow of the river as much as possible.

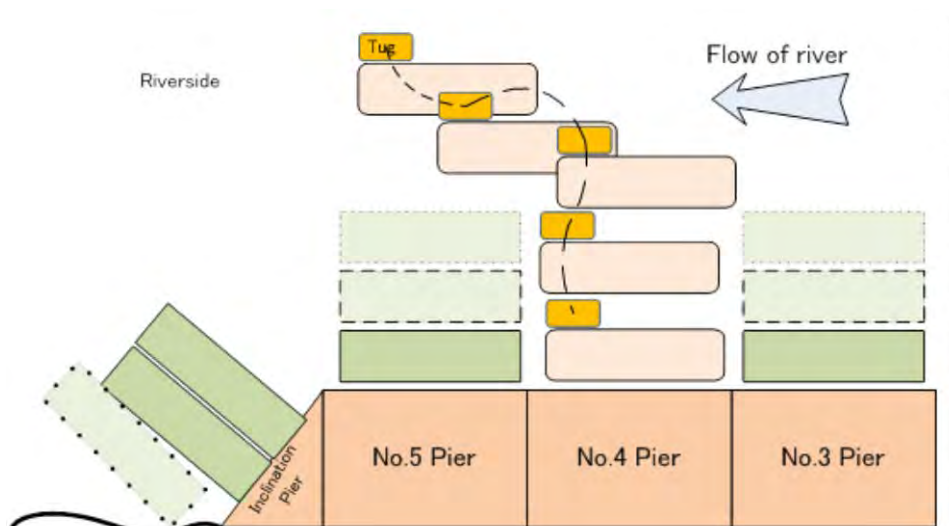

⑪ Safety docking

The direction of a barge has to always keep parallel to the pier.

Close communications among the captain of a pusher, tug boat and JRPA are required and safe method for docking a barge to a pier has to be adapted to prevent a barge from hitting the pier.

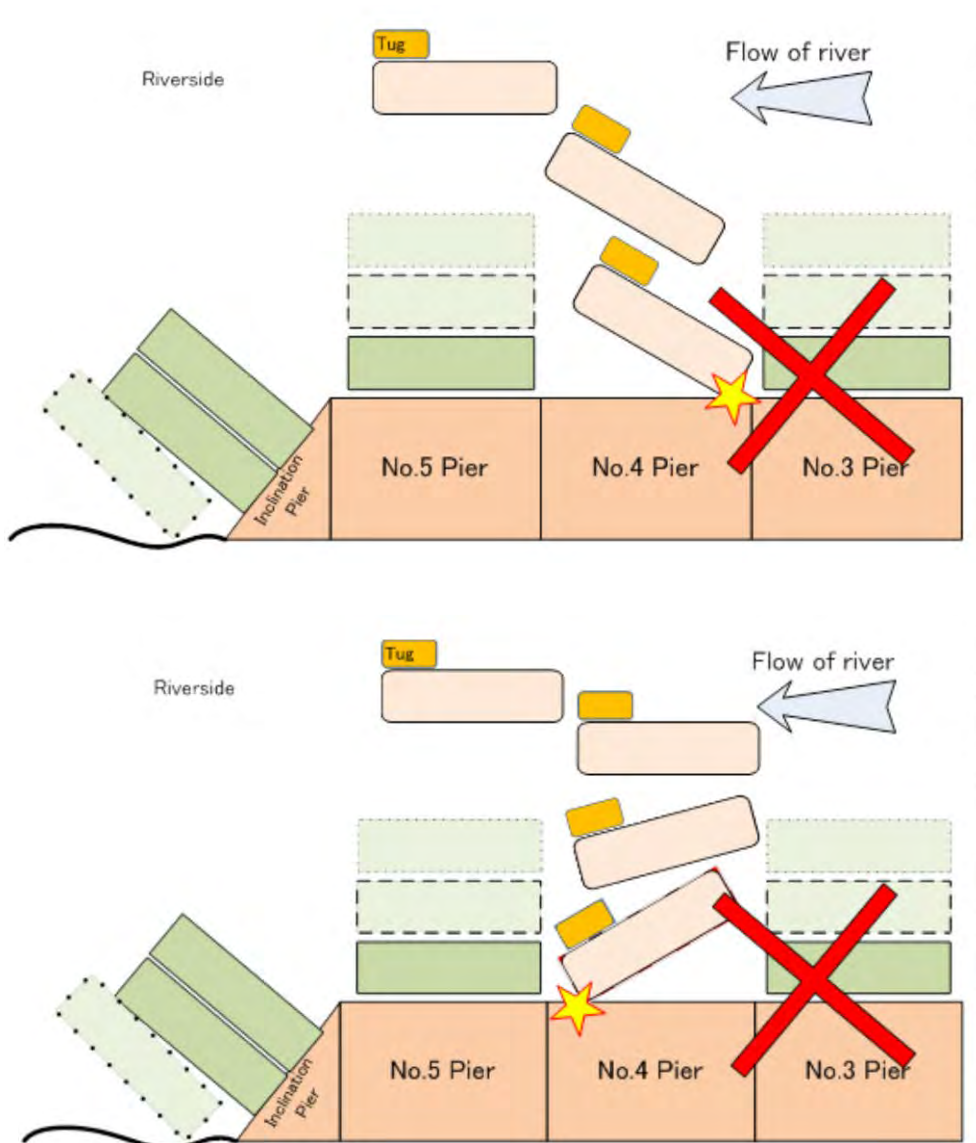

⑫ Recommended mooring lines

Recommended mooring lines are as follows.

- Take a breast line (do not make it tight)
- Take a spring line from fore to aft.
- Do not take a mooring line from handrail or other structure other than mooring bits.

All barges and vessels must keep the side alongside the jetty.

Followings are basic issues for safety docking:

- to make sure good wire ropes are used to properly joint pusher and barge (side joint).
- to bring the barge in front of the jetty and to stop the barge at the position of 10m apart from and in parallel with the jetty.
- to slowly move the barge sideling and bring it alongside the jetty.
- to occasionally check the mooring ropes after docking the barge.

8. Documentation for Port Entrance and Departure

This part is to explain the documentations to facilitate the operation works at the port.

Timing before the arrival of a ship to the port

A shipping company has to inform the following items to JRPA until one day before the arrival of a ship.

- a. ETA: Estimated time of arrival of a ship to Juba river port
- b. Pilot duties, including the necessity of the pilot
- c. Purpose of entering the port

JRPA (port administration office) has to arrange a berth for the ship and the pilot if necessary.

Port administration office has to make an arrangement of berthing schedule of each berth.

Timing after the arrival of a ship

A shipping company has to submit a “Notice of Ship Arrival to Juba Port” to the port administration office (attached a sample form OA-01).

A shipping company has to submit an “Application for the use of a jetty in Juba port” and/or “Application for the use of a jetty crane in Juba Port” to the port administration office if the jetty and/or the jetty crane would be used (attached a sample form OA-02 and OA-03).

A shipping company has to submit an “Application for the use of land” to the port administration office if the port premises would be used (attached a sample form OA-05).

The Port administration office has to confirm the following items based on the documents submitted by the shipping company.

- Confirmation of the ship’s name
- Confirmation of volume of cargo and kinds of cargo by loading/unloading
- Confirmation of dangerous cargo
- Confirmation of the number of passengers
- Confirmation of the use of jetty and a jetty crane
- confirmation of the necessity of a heavy duty machine such as a mobile crane
- Confirmation of the use of land for handling cargo
- Port charges and other dues

The port administration office has to grant permission as long as there is no special reason and/or problem.

The port administration has a power to collect port charge and other dues based on the approved regulations

and/or other authorized rules.

Timing after the departure of a ship

A shipping company has to inform ETD (estimated time of departure) to the port administration office.

The port administration office has to approve the application of departure as long as there is no specific reason and/or problem.

NOTICE OF SHIP ARRIVAL AND DEPARTURE IN JUBA PORT

Date of application: _____

Name of Applicant and contact: _____

1. Company Name : _____ Master's Name: _____

2. Ship's Name Pusher: _____

Barge1: _____ Barge2: _____

Barge3: _____ Barge4: _____

3. Time and Date of arrival: _____

4. Last port: _____ Next port: _____

5. Estimated time of departure: _____

6. Major unloaded cargo (Total unloading cargo quantity tons)

| Kind of cargo | Quantity |
|---|----------|
| | |
| | |
| | |
| | |
| Dangerous cargo list (Petroleum, Chemicals) | Quantity |
| | |
| | |
| Total Quantity of cargo | |

8. Actual Time and Date of departure. Inform to PA when you departure
: _____

9. Major loaded cargo

| Kind of cargo | Quantity |
|-------------------------|----------|
| | |
| | |
| Total Quantity of cargo | |

Received Signature of Port Administration

Arrival: _____ Departure: _____

Sample Form OA-02

APPLICATION FOR THE USE OF THE JETTY IN JUBA RIVER PORT

To: JUBA Port Manager

Date of application: _____

Name of applicant and contact: _____

I would like to apply for the use of the jetty. I will declare here to follow the safety notification when using the jetty and to compensate it when damaging the jetty or other facilities.

1. Company name: _____

2. Person in charge: _____

3. Pusher boat name: _____

4. Barge name/number: _____

5. Purpose of the use of the jetty: _____

6. Period of the use of the jetty:

From: _____ To: _____

Received Signature of Port Administration: _____

Sample Form OA-03

APPLICATION FOR THE USE OF THE JETTY CRANE IN JUBA RIVER PORT

To: JUBA Port Manager

Date of application: _____

Name of applicant and contact: _____

I would like to apply for the use of the jetty crane use. I will declare here to follow the safety notification when using the jetty and to compensate it when damaging the jetty or other facilities.

1. Company name: _____

2. Person in charge: _____

3. Period for the use of the jetty crane

From: _____ To: _____

4. Cargo

Type: _____ Volume _____

Type: _____ Volume _____

Type: _____ Volume _____

Received Signature of Port Administration: _____

Sample Form OA-05

APPLICATION FOR THE USE OF LAND FOR CARGO HANDLING AND/OR STORAGE

To: JUBA Port Manager

Date of application: _____

Name of Applicant and contact: _____

I would like to apply for the use of land.

1. Company name/individual: _____

2. Cargo name and quantity: _____

3. Place of use and area: _____

4. Period for the use of land From: _____ To: _____

5. Person in charge: _____

Received Signature of Port Administration: _____

3-3-1

Manual for Port Statistics

Contents

| | |
|--|--------|
| 1. Purpose of port statistics..... | 3-3-5 |
| 1-1. Using statistics to identify and solve problems | 3-3-5 |
| 2. Basic method of establishing port statistics | 3-3-6 |
| 3. Data items to be collected | 3-3-6 |
| 3-1. Ship Data..... | 3-3-6 |
| 3-2. Import Cargo Discharged, Export Cargo Loaded | 3-3-6 |
| 3-3. Import Container Discharged, Export Container Loaded | 3-3-7 |
| 3-4. Incoming Passenger, Outgoing Passenger | 3-3-7 |
| 3-5. Lorry Cargo | 3-3-7 |
| 4. Collection of data | 3-3-7 |
| 5. Compilation of data | 3-3-7 |
| 6. Management of data – Database | 3-3-9 |
| 6-1. “Port Statistics Survey by Vessel (One sheet per Ship)” | 3-3-9 |
| 6-1-1. Ship Data..... | 3-3-9 |
| 6-1-2. Import Cargo Discharged | 3-3-9 |
| 6-1-3. Export Cargo Loaded | 3-3-9 |
| 6-1-4. Import Container Discharged, | 3-3-10 |
| 6-1-5. Export Container Loaded | 3-3-10 |
| 6-1-6. Incoming Passenger | 3-3-10 |
| 6-1-7. Outgoing Passenger | 3-3-10 |
| 6-2. “Evaluation, Monitoring and Analysis [Ship and Cargo Information]” | 3-3-10 |
| 6-3. “Gate information” | 3-3-10 |
| 7. Analysis of data..... | 3-3-10 |
| 7-1. Basic concept | 3-3-10 |
| 7-2. Making of a statistical chart | 3-3-11 |
| 7-3. Calculation of statistics value..... | 3-3-13 |
| 8. Utilization..... | 3-3-13 |
| 9. Format | 3-3-14 |
| 9-1. Form-1 Port Statistics Survey by Vessel (One sheet per Ship) | 3-3-14 |
| 9-2. Form-2 Evaluation, Monitoring and Analysis [Ship and Cargo Information] | 3-3-15 |
| 9-3. Form-3 Gate information | 3-3-16 |
| 10. Annual report..... | 3-3-17 |
| 10-1. How to make the annual report..... | 3-3-17 |
| 10-2. Utilization of annual report | 3-3-33 |

1. Purpose of port statistics

Main purpose of port statistics is as follows.

- To clarify the actual situation.
- To grasp international and domestic economy trends.

Port statistics is very important and basic data for the establishment of national policy on ports. It also is a very important index when developing port facilities. In addition, port statistics are a good gauge of efficiency, safety, reliability for port users and can indicate whether or not service cost is satisfactory.

1-1. Using statistics to identify and solve problems

“The PPDAC cycle” is an effective framework for identifying and solving problems. This is the way of thinking “The PPDAC cycle” is divided into five stages; Problem, Plan, Data, Analysis and Conclusion.

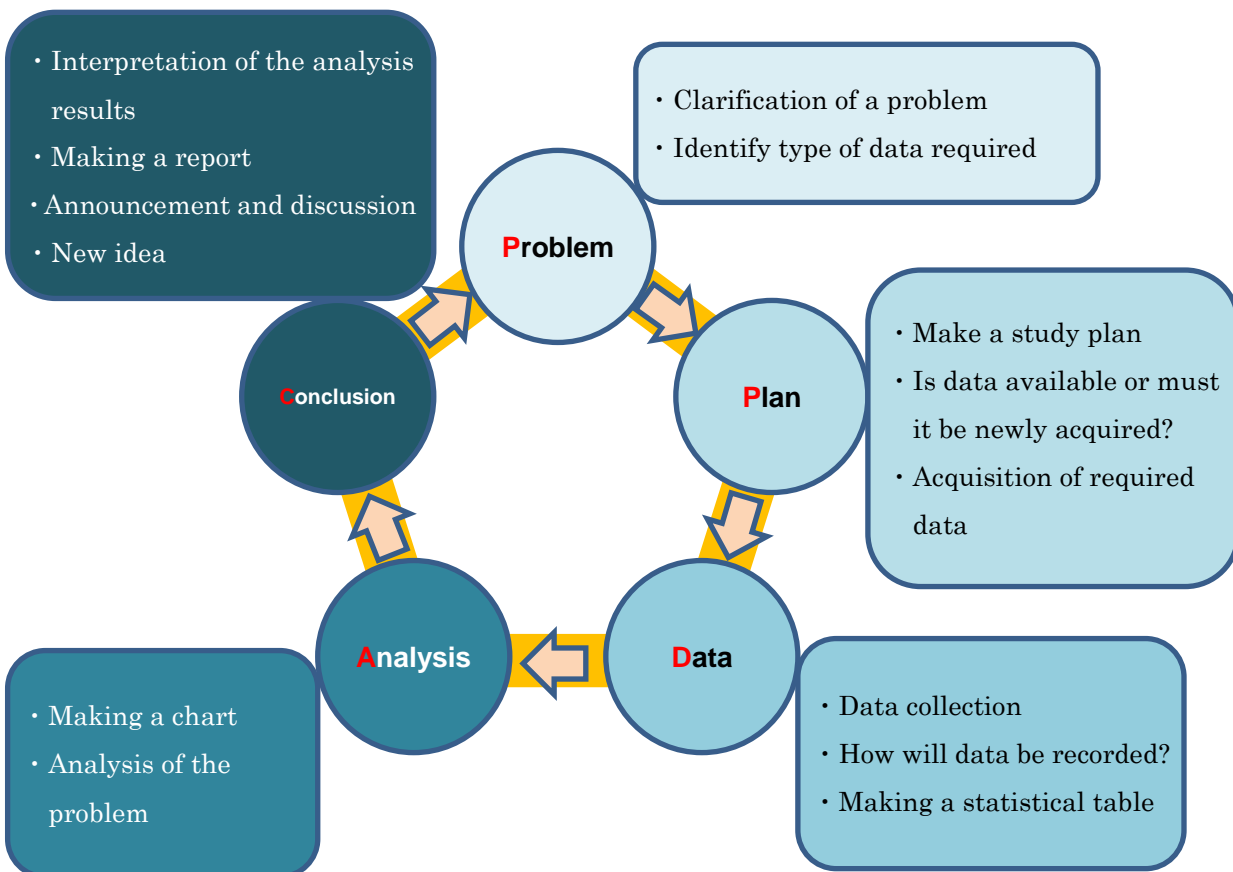

Using the statistics to solve problems and analyze objectively is very important for ensuring neutrality and fairness.

2. Basic method of establishing port statistics

Means to port statistics is as follows.

- Data items to be collected
- Collection of data
- Compilation of data
- Management of data — Database
- Analysis of data
- Utilization

Cooperation with the shipping company and other stakeholder is essential. Assignment of port staff to collect data is also essential.

3. Data items to be collected

JRPA staff has to collect the following data items.

3-1. Ship Data

- Name of Ship
- Barge No.
- International or Domestic
- Gross Tonnage
- Flag
- Ship Type
- Last Port Name
- Berthing Place
- Berthing Time
- Departure Time
- Berthing Hours
- Next Port Name
- Shipping Company
- Captain
- Engineer
- Chief of Barges
- Condition

3-2. Import Cargo Discharged, Export Cargo Loaded

- Cargo Name
- Cargo Type
- Weight of Cargo (kg)
- Name of First Loaded Port
- Name of Final Destination Port

3-3. Import Container Discharged, Export Container Loaded

- Number of Containers by Size
 - 20Feet Loaded, Empty
 - 40Feet Loaded, Empty
 - TEU Loaded, Empty

3-4. Incoming Passenger, Outgoing Passenger

- International or Domestic
- Number of Passengers
- Name of First Boarding Port
- Name of Last Destination Port

3-5. Lorry Cargo

- Cargo Name
- Quantity
- Weight(kg)
- Barge No.
- Lorry No.

4. Collection of data

JRPA staff already has collected some data. There is ship information and lorry cargo information. JRPA staff has been hearing and checking on ship and port gate. Collecting information lacks some cargo information. There are only discharged and loaded cargoes information of barges. It is important to compile port statistics data. Then it added a new format to collect some detail cargo information.

5. Compilation of data

JRPA staff can make a port statistics report on a monthly and annual basis using tables or graphs. For example, the report might include the following graphs.

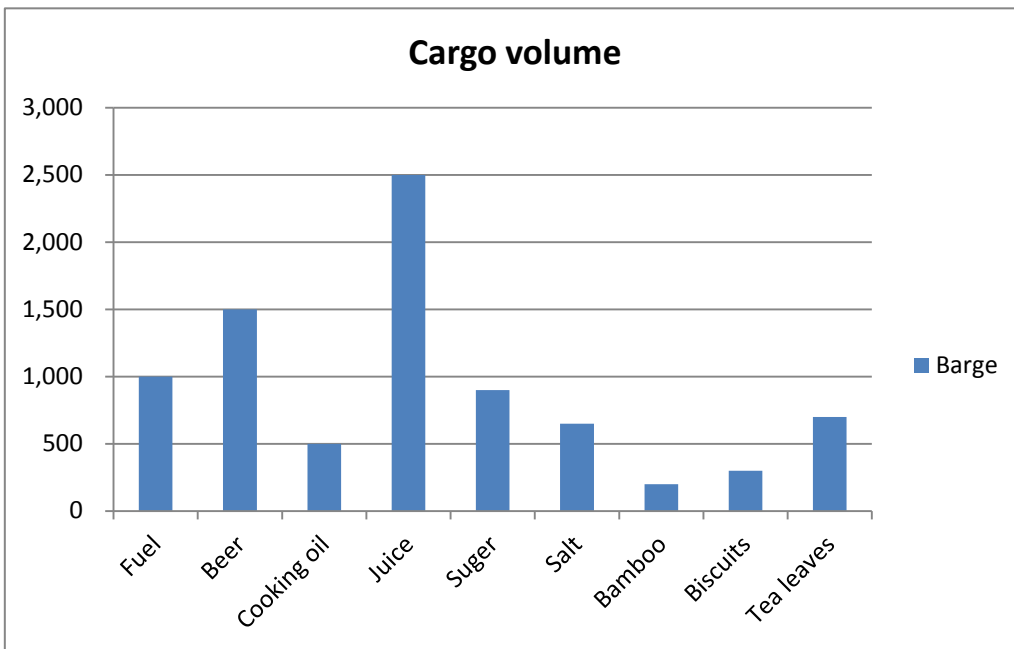
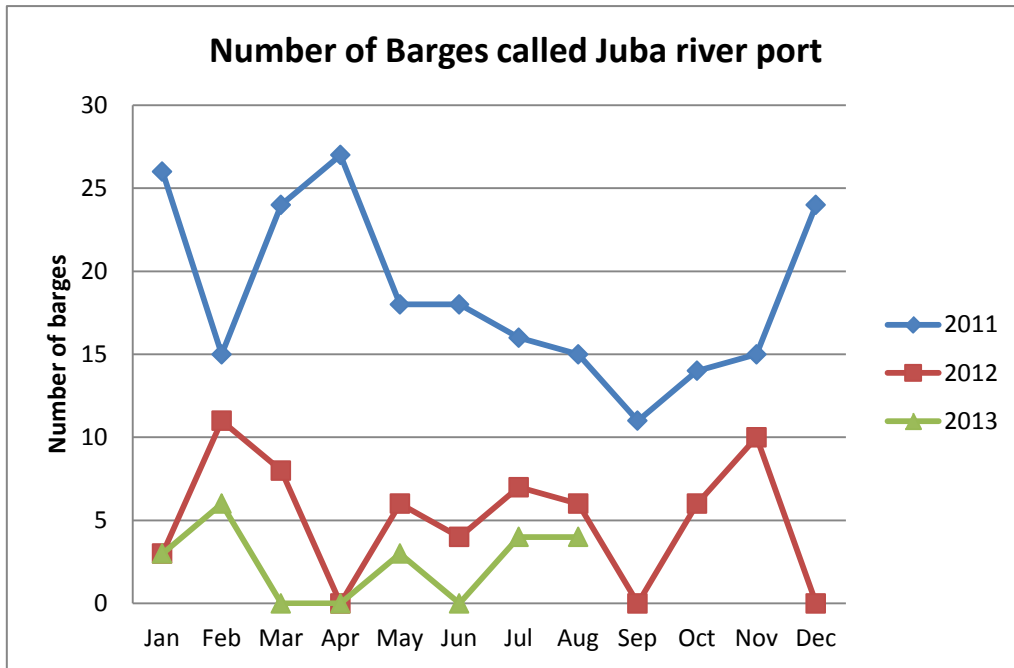

Follow figure shows the implementation method for making a report.

Implementation Structure

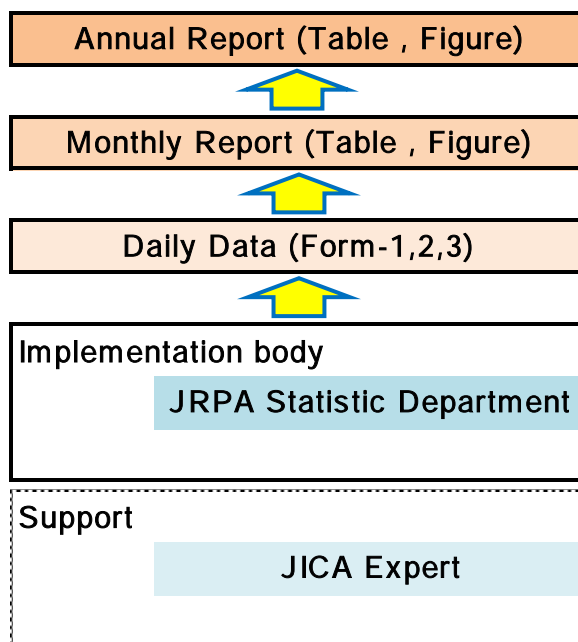

6. Management of data — Database

JRPA has three kinds of port statistics database formats, “Port Statistics Survey by Vessel (One sheet per Ship)”, “Evaluation, Monitoring and Analysis [Ship and Cargo Information]” and “Gate information”.

6-1. “Port Statistics Survey by Vessel (One sheet per Ship)”

“Port Statistics Survey by Vessel” includes has Ship Data, Import Cargo Discharged, Export Cargo Loaded, Import Container Discharged, Export Container Loaded, Incoming Passenger, and Outgoing Passenger. Contents of the information are as follows.

6-1-1. Ship Data

| | | |
|----------------|----------------|---------------------------|
| Name of Ship | Barge No. | International or Domestic |
| Gross Tonnage | Flag | Ship Type |
| Last Port Name | Berthing Place | Berthing Time |
| Departure Time | Berthing Hours | Next Port Name |

6-1-2. Import Cargo Discharged

| | |
|----------------------|---------------------------|
| Cargo name | Cargo Type |
| Weight of Cargo (kg) | Name of First Loaded Port |

6-1-3. Export Cargo Loaded

| | |
|----------------------|--------------------------------|
| Cargo name | Cargo Type |
| Weight of Cargo (kg) | Name of Final Destination Port |

6-1-4. Import Container Discharged,

- Number of Container by Size

| | |
|----------------|---------------|
| 20 Feet Loaded | 20 Feet Empty |
| 40 Feet Loaded | 40 Feet Empty |
| TEU Loaded | TEU Empty |

6-1-5. Export Container Loaded

- Number of Container by Size

| | |
|----------------|---------------|
| 20 Feet Loaded | 20 Feet Empty |
| 40 Feet Loaded | 40 Feet Empty |
| TEU Loaded | TEU Empty |

6-1-6. Incoming Passenger

| | | |
|---------------------------|----------------------|-----------------------------|
| International or Domestic | Number of Passengers | Name of First Boarding Port |
|---------------------------|----------------------|-----------------------------|

6-1-7. Outgoing Passenger

| | | |
|---------------------------|----------------------|-------------------------------|
| International or Domestic | Number of Passengers | Name of Last Destination Port |
|---------------------------|----------------------|-------------------------------|

6-2. "Evaluation, Monitoring and Analysis [Ship and Cargo Information]"

"Evaluation, Monitoring and Analysis" includes ship and cargo information. Contents of the information are as follows.

| | | | |
|-----------------|------------------|-----------------|----------------|
| Date | Shipping Company | Vessel | Captain |
| Engineer | Barge No. | Chief of Barges | Condition |
| Unload Quantity | Load Quantity | Arrival Date | Departure Date |

6-3. "Gate information"

"Gate information" has lorry cargo information. Contents of the information are as follows.

| | | |
|------------|-----------|------------|
| Cargo Name | Quantity | Weight(kg) |
| Barge No. | Lorry No. | |

7. Analysis of data

7-1. Basic concept

Statistics are easier to analyze if a statistical table is created. An analysis starts by making a chart based on the type of data calculating basic statistics.

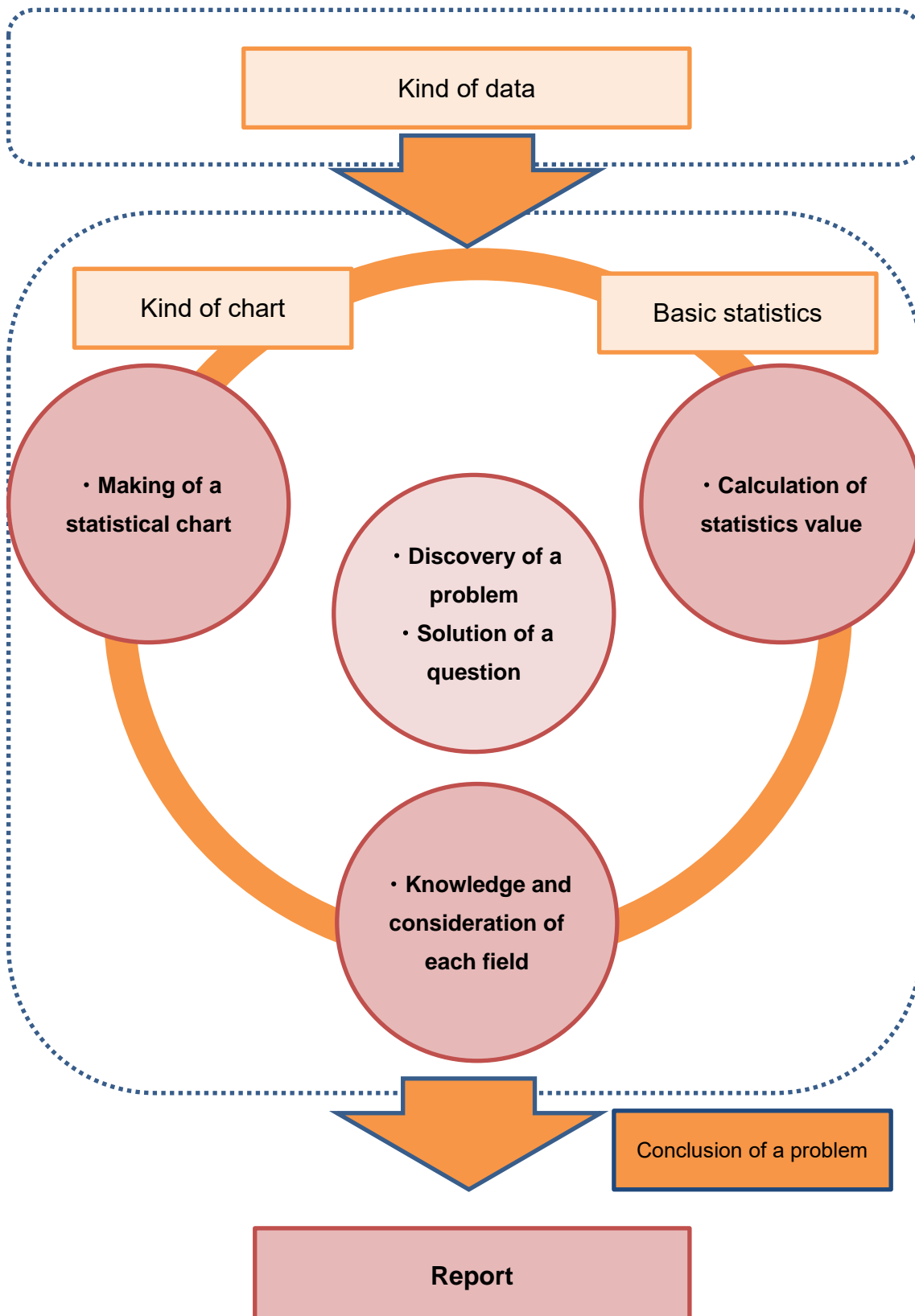

7-2. Making of a statistical chart

Comparison and distribution of statistical values can be displayed in a graph. Characteristic and trends can be easily grasped.

JRPA staff can extract necessary data from collected data and produce tables and graphs. Then JRPA can estimate the future cargo handling volume at Juba river port. For example, cargo handling trend could be presented as follows.

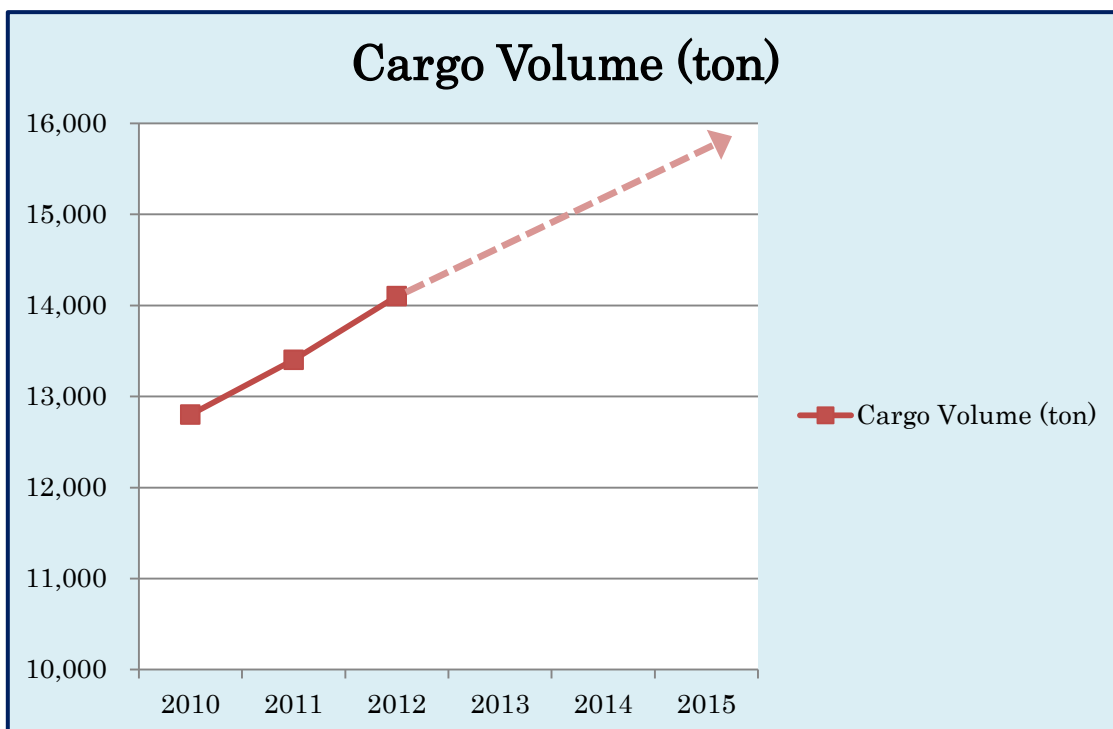

JRPA can grasp the number of barges at Juba river port each month. It can be used to examine which months the number of barges exceeded or fell below the average as shown in the following graph.

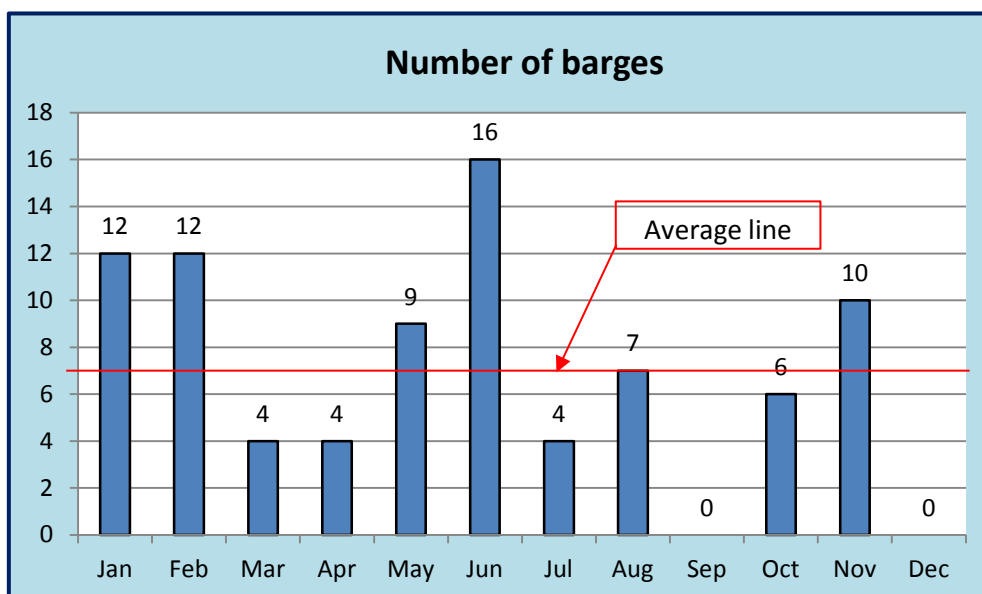

JRPA can also grasp what barges, which called Juba river port, were carrying. And the shares of each type of barge can be compared over periods of time. For example, the number can be compare in the following pie graphs.

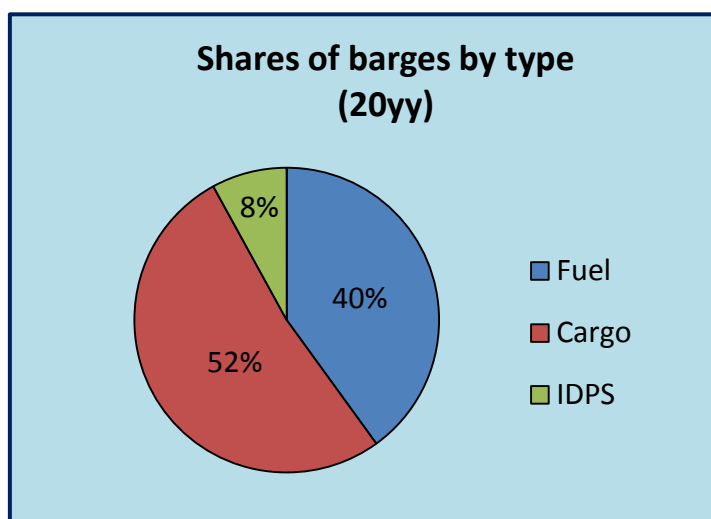
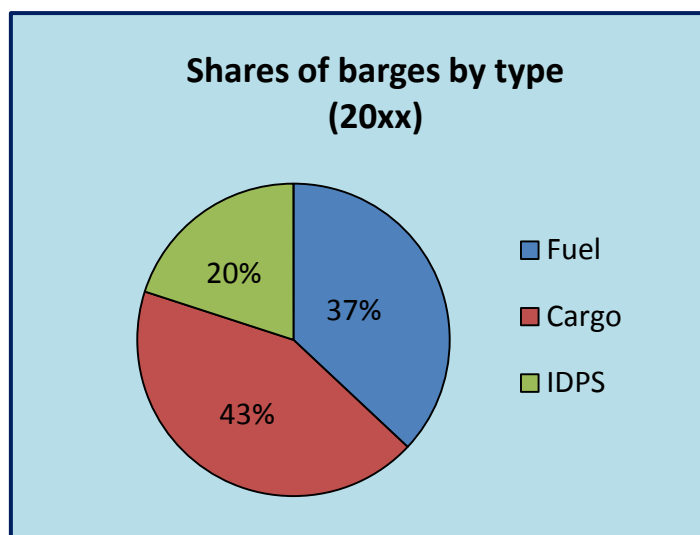

7-3. Calculation of statistics value

In making an analysis case, it is important to obtain concrete numerical value to grasp trends.

8. Utilization

JRPA shall announce the port statistics data to port users, consignees and consignors, all other relevant parties. This will contribute to attracting more port users. In addition, port statistics data will be used for the following purposes.

- To clarify the port actual situation.
- To grasp international and domestic economic trends.
- To use as basic data when drafting national policy on ports.
- To use as basic data when developing port facilities.
- To use as basic data for the improvement of port utilization.

9. Format

9-1. Form-1 Port Statistics Survey by Vessel (One sheet per Ship)

| Port Statistics Survey By Vessel (One sheet per Ship) | | | | | | | | | | | | | Form-1 |
|---|----------------------|-----------------------------|---------------------------|---------------------------|----------------------------|------------------------------|----------------|----------------------|--------------------------------|----------------|----------------|----------------|--------|
| Port Name | | | | | | | | | | | | | |
| Date of Port Call | | | | | | | | | | | | | |
| Reporter Dept./Section | | | | | | | | | | | | | |
| A. Ship Data | | | | | | | | | | | | | |
| Serial No. | Name of Ship | Barge No. | International or Domestic | GT | Flag | Ship Type | Last Port Name | Berthing Place | Berthing Time | Departure Time | Berthing Hours | Next Port Name | |
| | | | | ① | | | | | | | 0/000 | | |
| B-1. Import Cargo Discharged | | | | | B-2. Export Cargo Loaded | | | | | | | | |
| Cargo name | Code | Cargo Type | Weight of Cargo (kg) | Name of First Loaded Port | Cargo name | Code | Cargo Type | Weight of Cargo (kg) | Name of First Destination Port | | | | |
| | ② | | | | | ② | | | | | | | |
| Total | | | | 0 | Total | | | | 0 | | | | |
| C-1. Import Container Discharged | | | | | | C-2. Export Container Loaded | | | | | | | |
| Number of Containers by Size | | | | | | Number of Containers by Size | | | | | | | |
| 20Foot | | 40Foot | | TEU | | 20Foot | | 40Foot | | TEU | | | |
| Loaded | Empty | Loaded | Empty | Loaded | Empty | Loaded | Empty | Loaded | Empty | Loaded | Empty | | |
| | | | | | | | | | | | | | |
| Total | | | | | | Total | | | | | | | |
| D-1. Incoming Passenger | | | D-2. Outgoing Passenger | | | | | | | | | | |
| International or Domestic | Number of Passengers | Name of First Boarding Port | International or Domestic | Number of Passengers | Name of Last Boarding Port | | | | | | | | |
| | | | | | | | | | | | | | |
| Total | | | Total | | | | | | | | | | |
| Remarks, Notes and Comments (if any) | | | | | | | | | | | | | |
| | | | | | | | | | | | | | |
| | | | | | | | | | | | | | |
| | | | | | | | | | | | | | |

① : GT means total Gross Tonnage (e.g. Three 350ton/barge=1,050gross tonnage)

② : Cargo Name and Code is as follows. (Tentative)

| Cargo Name | Code | Cargo Name | Code |
|--------------------|------|----------------|------|
| Bamboo | 1 | Mattresses | 16 |
| Batteries | 2 | Milk | 17 |
| Beer | 3 | Motorcycles | 18 |
| Biscuits | 4 | Salt | 19 |
| Building materials | 5 | Shoes | 20 |
| Candles | 6 | Slippers | 21 |
| Cars | 7 | Soaps | 22 |
| Cigarettes | 8 | Sorghums | 23 |
| Cooking Oil | 9 | Spaghettis | 24 |
| Flour | 10 | Sugar | 25 |
| Fuel | 11 | Tea leaves | 26 |
| Garlic | 12 | UN vehicles | 27 |
| Iron Sheets | 13 | Washing Powder | 28 |
| Juice | 14 | Water | 29 |
| Maize Flour | 15 | | |

9-2. Form-2 Evaluation, Monitoring and Analysis [Ship and Cargo Information]

Form-2

Juba River Port Administration Department of Statistics
Evaluation, Monitoring and Analysis [Ship and Cargo Information]

Daily information data for September 2013

| No. | Date | Shipping Company | Vessel | Captain | Engineer | Barge No. | Chief of Barges | Condition | Unload Quantity | Load Quantity | Arrival Date | Departure Date |
|-------|------|------------------|--------|---------|----------|-----------|-----------------|-----------|-----------------|---------------|--------------|----------------|
| 1 | | | | | | | | | | | | |
| 2 | | | | | | | | | | | | |
| 3 | | | | | | | | | | | | |
| 4 | | | | | | | | | | | | |
| 5 | | | | | | | | | | | | |
| 6 | | | | | | | | | | | | |
| 7 | | | | | | | | | | | | |
| 8 | | | | | | | | | | | | |
| 9 | | | | | | | | | | | | |
| 10 | | | | | | | | | | | | |
| 11 | | | | | | | | | | | | |
| 12 | | | | | | | | | | | | |
| 13 | | | | | | | | | | | | |
| 14 | | | | | | | | | | | | |
| 15 | | | | | | | | | | | | |
| 16 | | | | | | | | | | | | |
| 17 | | | | | | | | | | | | |
| 18 | | | | | | | | | | | | |
| 19 | | | | | | | | | | | | |
| 20 | | | | | | | | | | | | |
| 21 | | | | | | | | | | | | |
| 22 | | | | | | | | | | | | |
| 23 | | | | | | | | | | | | |
| 24 | | | | | | | | | | | | |
| 25 | | | | | | | | | | | | |
| 26 | | | | | | | | | | | | |
| 27 | | | | | | | | | | | | |
| 28 | | | | | | | | | | | | |
| 29 | | | | | | | | | | | | |
| 30 | | | | | | | | | | | | |
| Total | | | | | | | | | 0 | 0 | | |

9-3. Form-3 Gate information

| Form-3 | | | | | | | |
|--|-------|----------|--------|-----------|---|-----------|---|
| Juba River Port Administration Department of Statistics Evaluation, Monitoring and Analysis | | | | | | | |
| Daily information data for September 2013 | | | | Date : | | | |
| | | | | Arrival | | Departure | |
| No. | Cargo | Quantity | Weight | Barge No. | | Lorry No. | |
| 1 | | | | | | | |
| 2 | | | | | | | |
| 3 | | | | | | | |
| 4 | | | | | | | |
| 5 | | | | | | | |
| 6 | | | | | | | |
| 7 | | | | | | | |
| 8 | | | | | | | |
| 9 | | | | | | | |
| 10 | | | | | | | |
| 11 | | | | | | | |
| 12 | | | | | | | |
| 13 | | | | | | | |
| 14 | | | | | | | |
| 15 | | | | | | | |
| 16 | | | | | | | |
| 17 | | | | | | | |
| 18 | | | | | | | |
| 19 | | | | | | | |
| 20 | | | | | | | |
| Total | | | 0 | Barge | 0 | Lorry | 0 |

10. Annual report

10-1. How to make the annual report

How to make an annual report on the “Number of Barges called Juba river port” annual report is shown as follows.

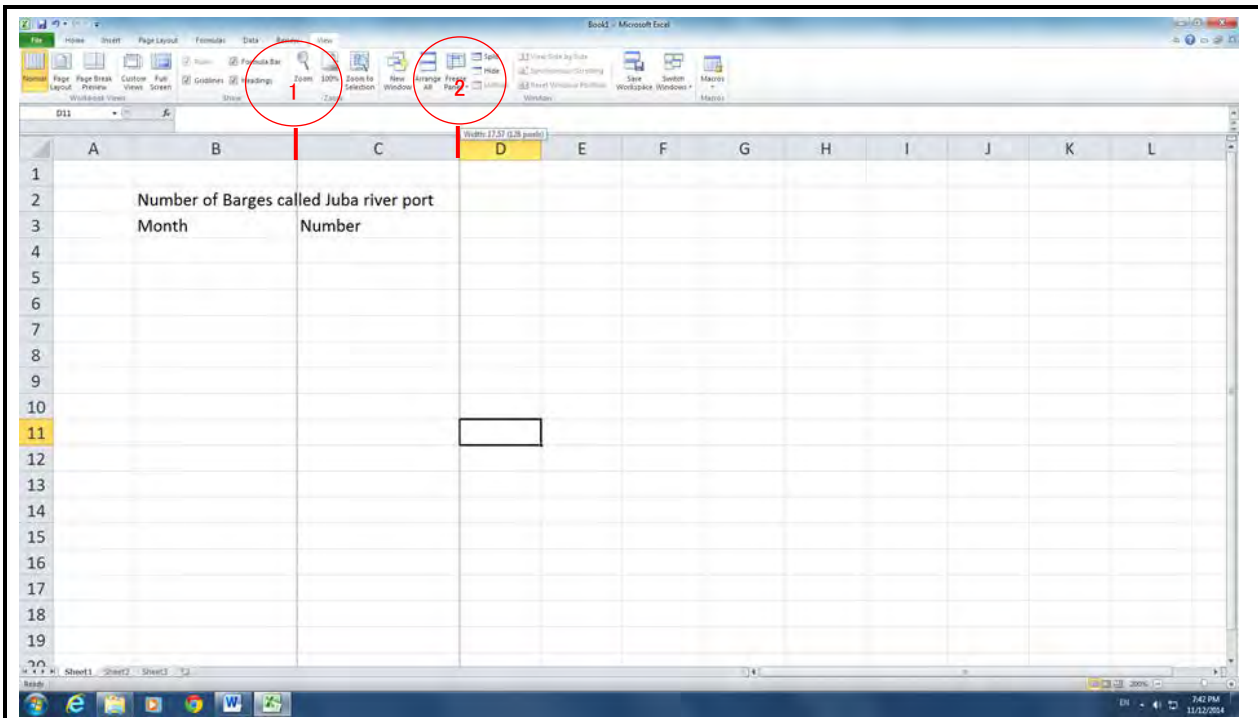

① Drag the mouse to increase B-row width

② Drag the mouse to increase C-row width

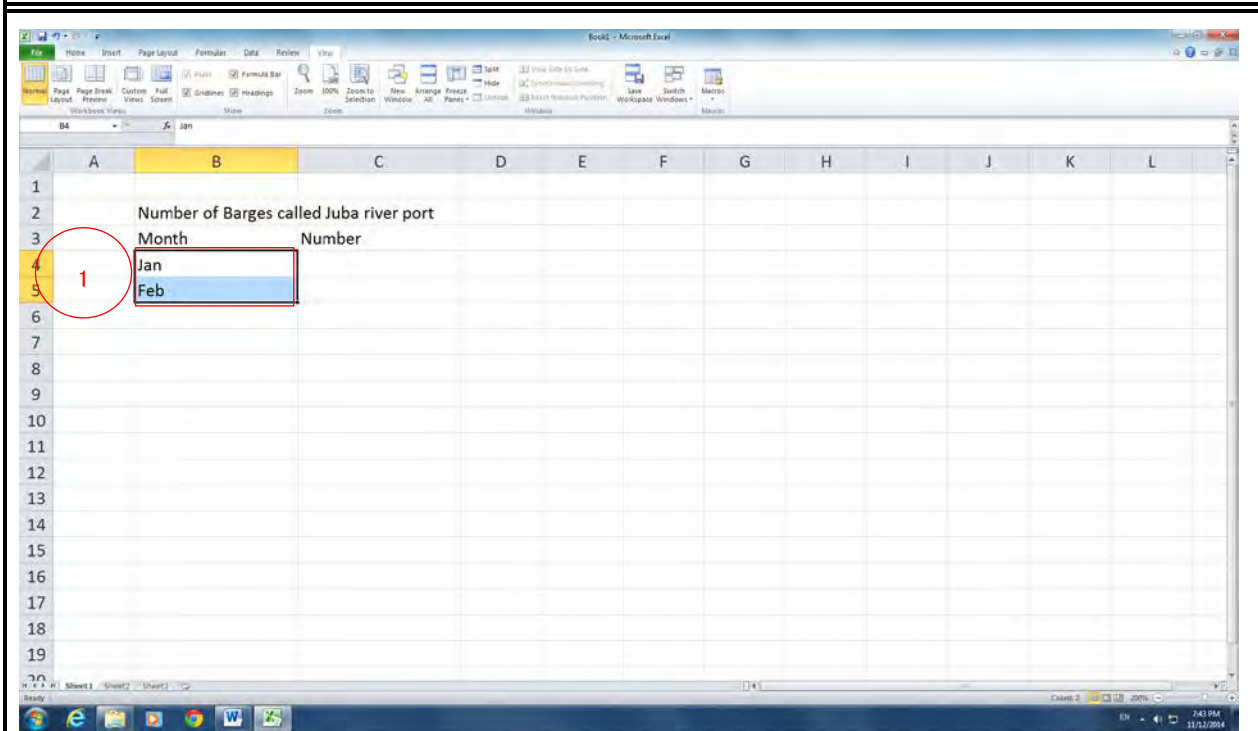

① Input “Jan” at cell B-4 and “Feb” at cell B-5.

The Project for Enhancement of Operation and Management Capacity of Inland Waterway in South Sudan

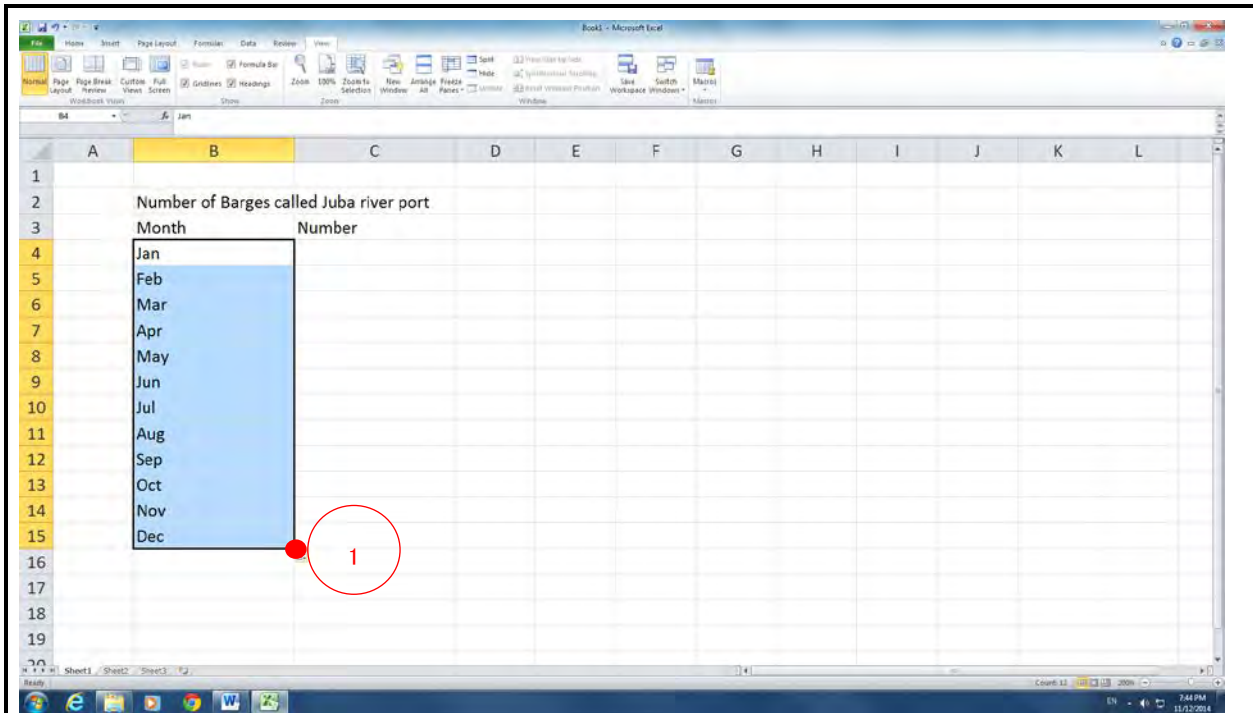

① Drag B-5cell to the bottom of right corner to B-15 cell and Excel will fill in the accompanying cells with the months of the gear.

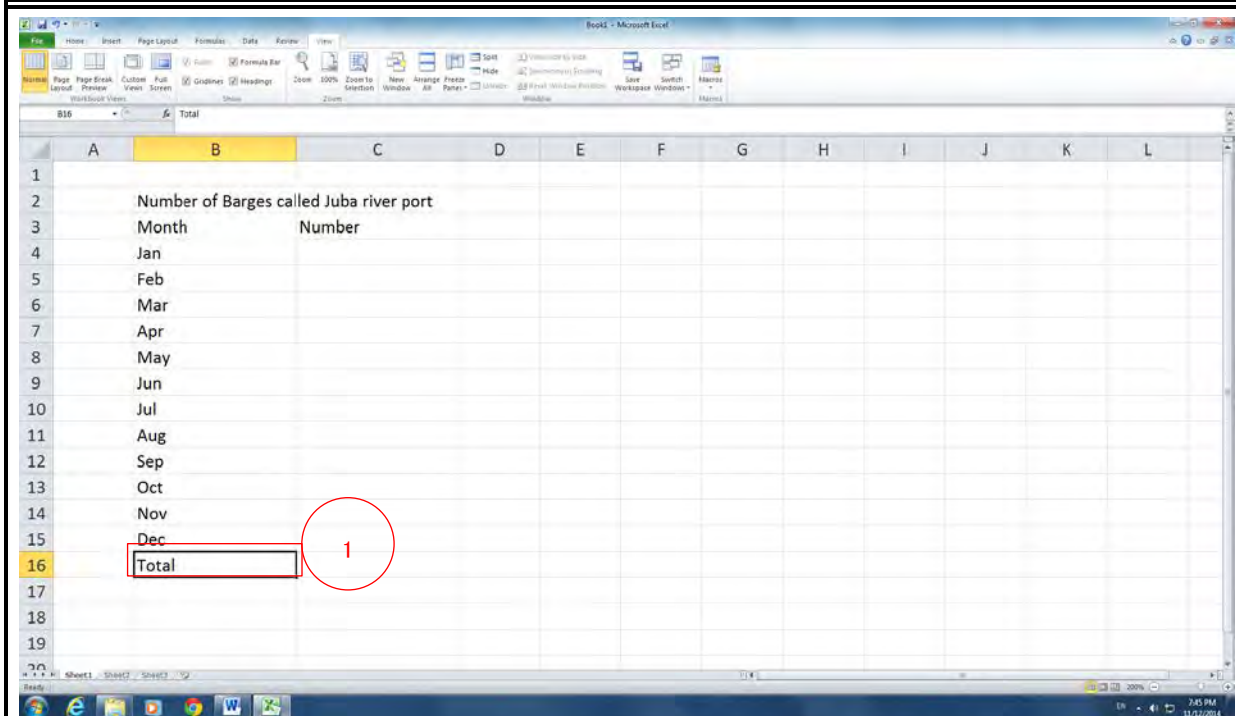

① Input "Total" at cell B-16.

The Project for Enhancement of Operation and Management Capacity of Inland Waterway in South Sudan

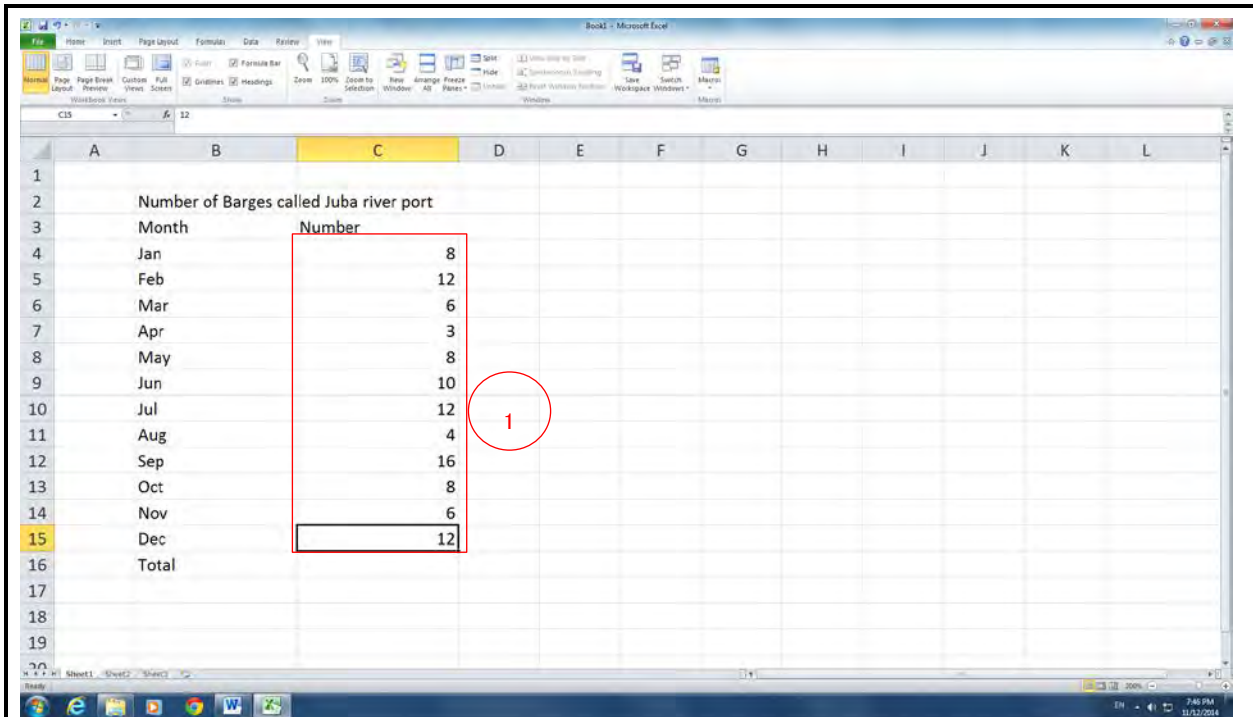

① Input “number of barges data” from cell C-4 to C-15.

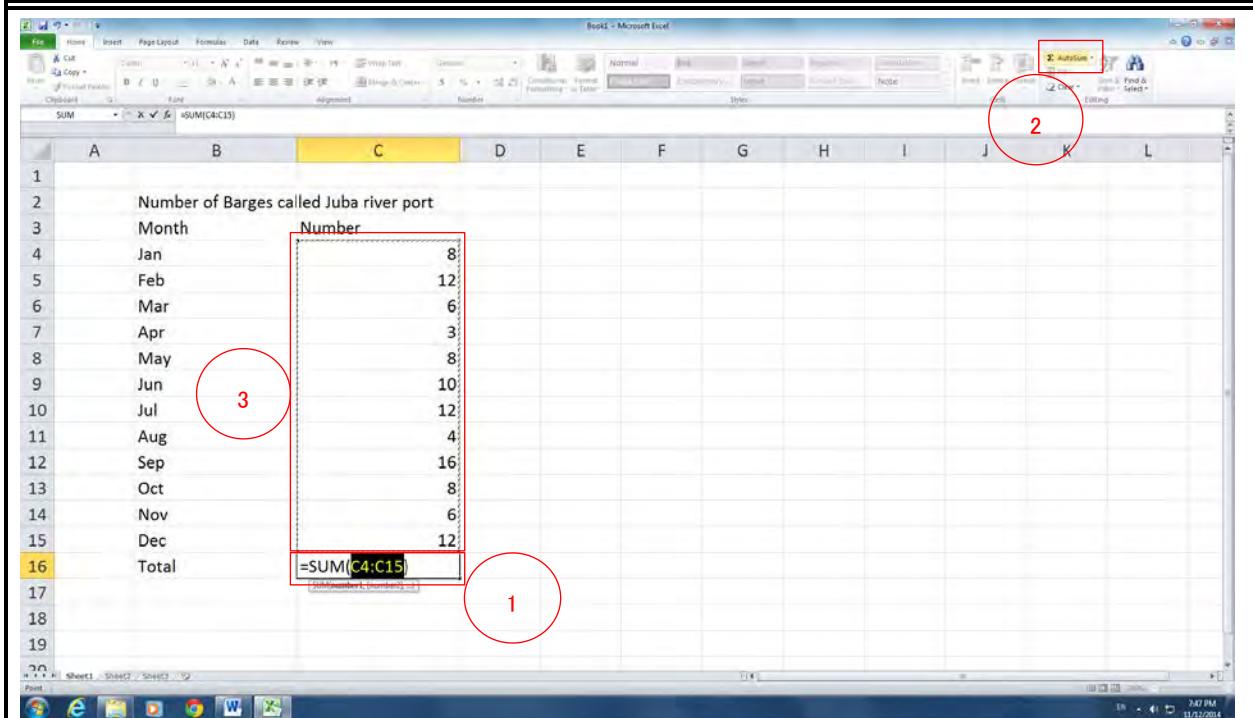

① Click cell C-16.

② Click “ Σ ” button.

③ Drag cell C-4 to the bottom right corner of cell C-15.

The Project for Enhancement of Operation and Management Capacity of Inland Waterway in South Sudan

| Month | Number |
|-------|--------|
| Jan | 8 |
| Feb | 12 |
| Mar | 6 |
| Apr | 3 |
| May | 8 |
| Jun | 10 |
| Jul | 12 |
| Aug | 4 |
| Sep | 16 |
| Oct | 8 |
| Nov | 6 |
| Dec | 12 |
| Total | 105 |

Total number of cell of calls is indicated in cell C-16.

| Month | Number |
|-------|--------|
| Jan | 8 |
| Feb | 12 |
| Mar | 6 |
| Apr | 3 |
| May | 8 |
| Jun | 10 |
| Jul | 12 |
| Aug | 4 |
| Sep | 16 |
| Oct | 8 |
| Nov | 6 |
| Dec | 12 |
| Total | 105 |

① Drag cell B-3 to cell C-16.

The Project for Enhancement of Operation and Management Capacity of Inland Waterway in South Sudan

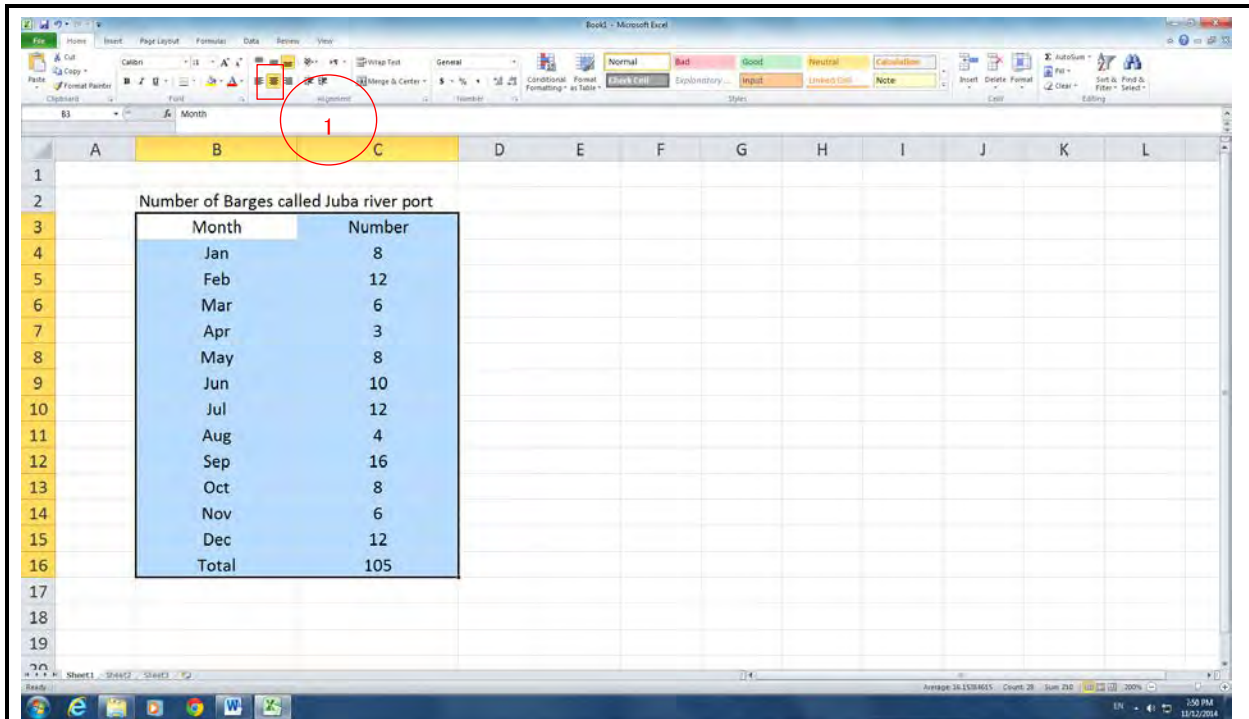

- 1 Click the “Centering” button.
Contents of each cell are centered.

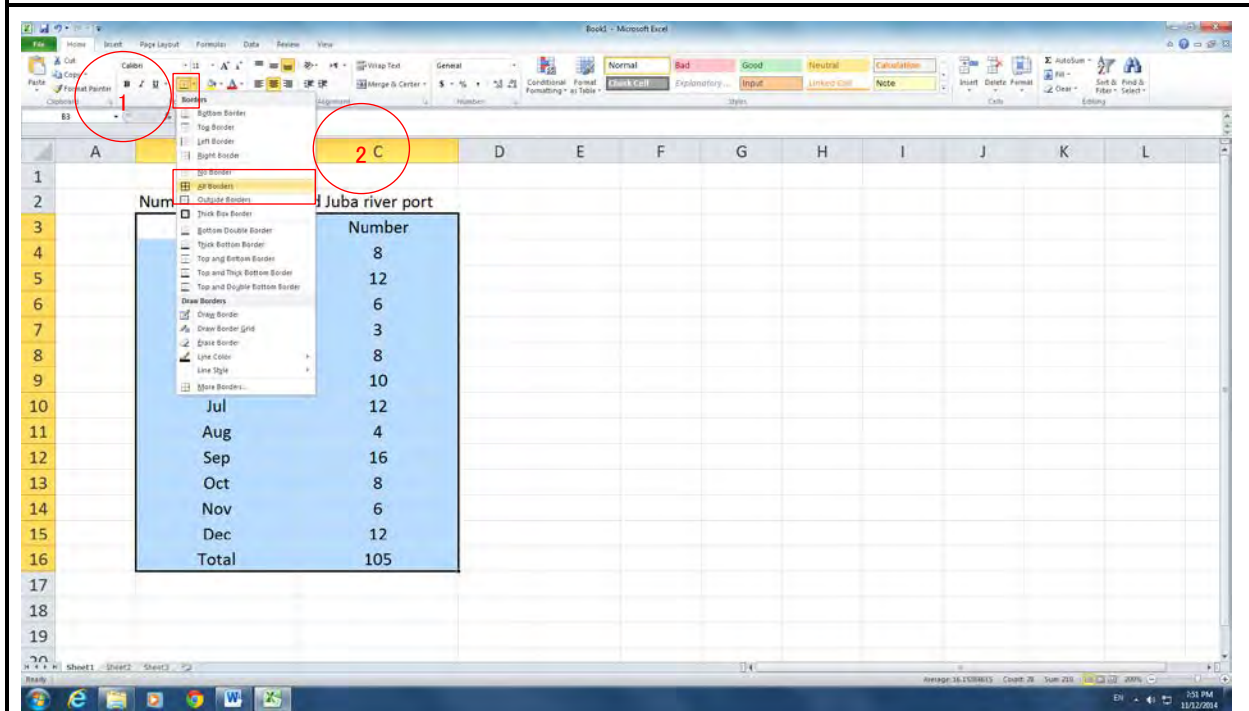

- 1 Click the “Underline” button.
- 2 Click the “Borders ” button.

The Project for Enhancement of Operation and Management Capacity of Inland Waterway in South Sudan

| Month | Number |
|-------|--------|
| Jan | 8 |
| Feb | 12 |
| Mar | 6 |
| Apr | 3 |
| May | 8 |
| Jun | 10 |
| Jul | 12 |
| Aug | 4 |
| Sep | 16 |
| Oct | 8 |
| Nov | 6 |
| Dec | 12 |
| Total | 105 |

A table showing the Number of Barges called Juba river port has been created.

| Month | Number |
|-------|--------|
| Jan | 8 |
| Feb | 12 |
| Mar | 6 |
| Apr | 3 |
| May | 8 |
| Jun | 10 |
| Jul | 12 |
| Aug | 4 |
| Sep | 16 |
| Oct | 8 |
| Nov | 6 |
| Dec | 12 |
| Total | 105 |

① Drag cell B-2 to cell C-15.

The Project for Enhancement of Operation and Management Capacity of Inland Waterway in South Sudan

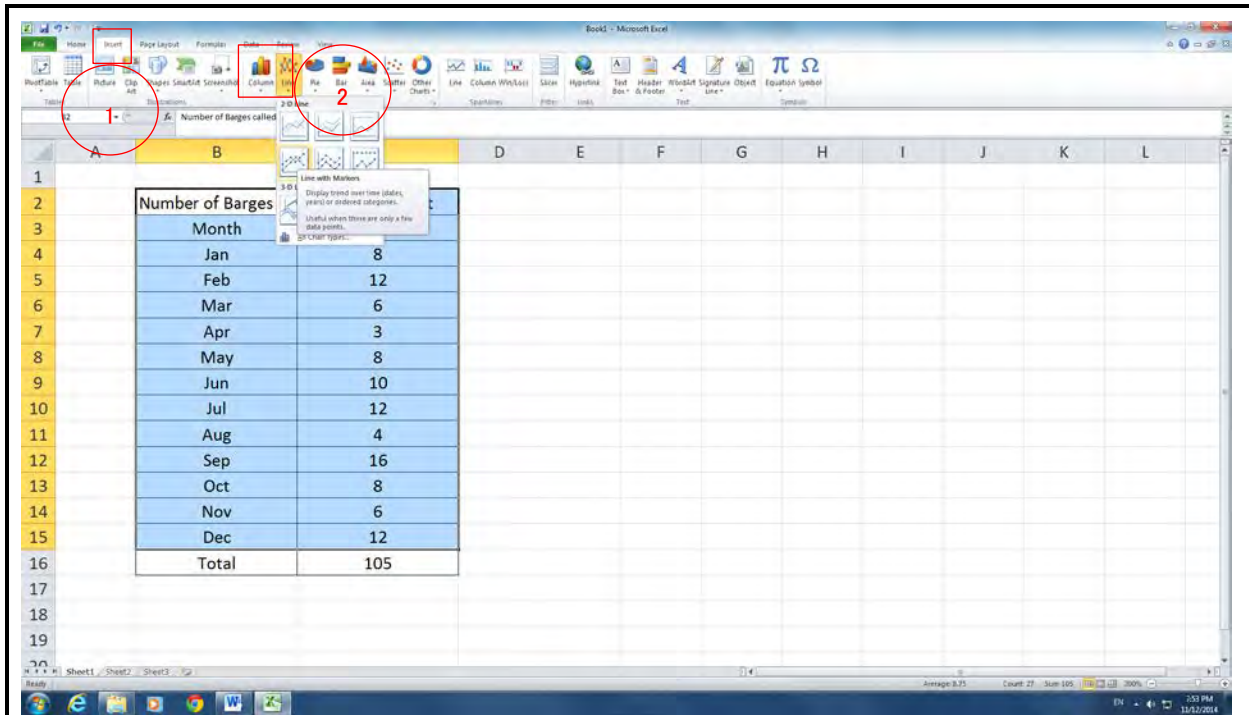

- 1 Click the "Insert" tag.
- 2 Click the "Column" button.

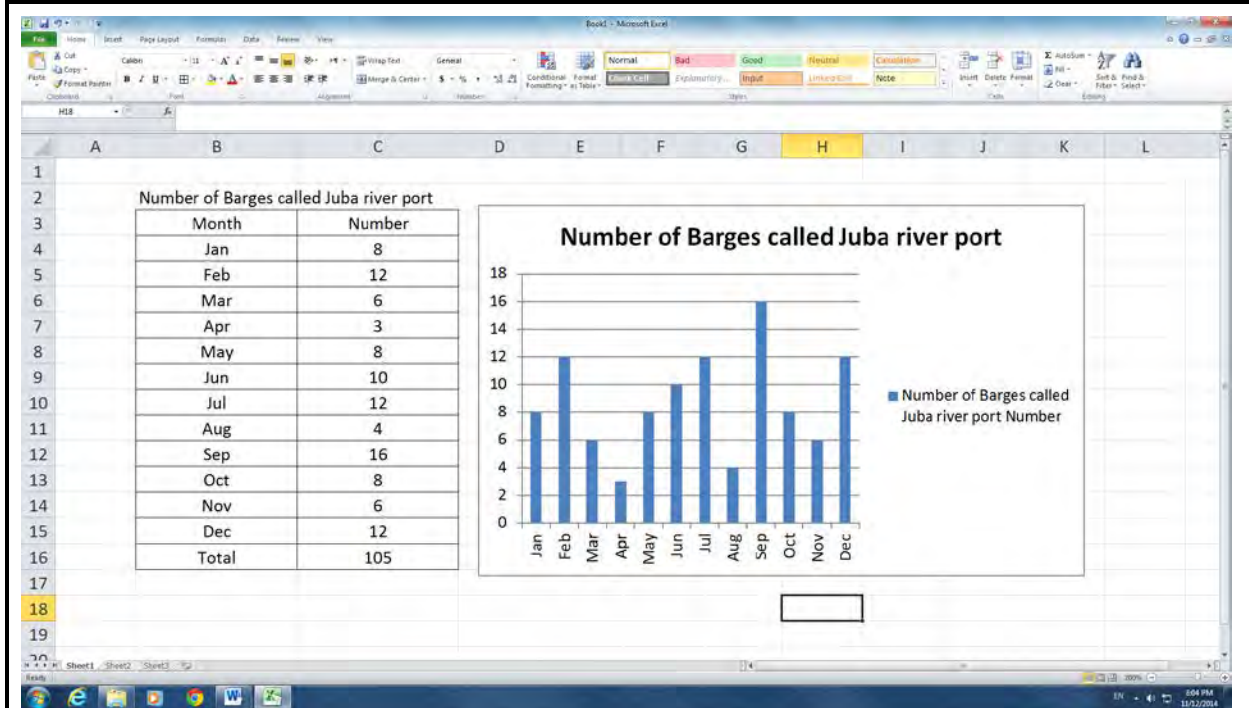

Data is displayed in a bar graph.

The Project for Enhancement of Operation and Management Capacity of Inland Waterway in South Sudan

How to make an annual report on the number of discharged import container is shown as follows.

| | 20ft | | 40ft | | TEU | |
|--------------|-----------|-----------|-----------|-----------|------------|------------|
| | Loaded | Empty | Loaded | Empty | Loaded | Empty |
| Jan | 10 | 2 | 0 | 0 | 20 | 4 |
| Feb | 5 | 5 | 1 | 0 | 11 | 10 |
| Mar | 6 | 6 | 0 | 2 | 12 | 14 |
| Apr | 10 | 8 | 0 | 3 | 20 | 19 |
| May | 8 | 1 | 2 | 0 | 18 | 2 |
| Jun | 4 | 3 | 1 | 5 | 9 | 11 |
| Jul | 6 | 4 | 0 | 2 | 12 | 10 |
| Aug | 3 | 5 | 3 | 1 | 9 | 11 |
| Sep | 2 | 1 | 2 | 0 | 6 | 2 |
| Oct | 2 | 3 | 4 | 3 | 8 | 9 |
| Nov | 2 | 2 | 6 | 2 | 10 | 6 |
| Dec | 6 | 4 | 5 | 1 | 17 | 9 |
| Total | 64 | 44 | 24 | 19 | 152 | 107 |

Create a table on the number of discharged import containers using the same described in the previous section.

| | 20ft | | 40ft | | TEU | |
|--------------|-----------|-----------|-----------|-----------|------------|------------|
| | Loaded | Empty | Loaded | Empty | Loaded | Empty |
| Jan | 10 | 2 | 0 | 0 | 20 | 4 |
| Feb | 5 | 5 | 1 | 0 | 11 | 10 |
| Mar | 6 | 6 | 0 | 2 | 12 | 14 |
| Apr | 10 | 8 | 0 | 3 | 20 | 19 |
| May | 8 | 1 | 2 | 0 | 18 | 2 |
| Jun | 4 | 3 | 1 | 5 | 19 | 11 |
| Jul | 6 | 4 | 0 | 2 | 12 | 10 |
| Aug | 3 | 5 | 3 | 1 | 9 | 11 |
| Sep | 2 | 1 | 2 | 0 | 6 | 2 |
| Oct | 2 | 3 | 4 | 3 | 8 | 9 |
| Nov | 2 | 2 | 6 | 2 | 10 | 6 |
| Dec | 6 | 4 | 5 | 1 | 17 | 9 |
| Total | 64 | 44 | 24 | 19 | 152 | 107 |

- ① Drag cell B-3 to cell E-16.
- ② Click the “Insert” tag.
- ③ Click the “Column” button.

The Project for Enhancement of Operation and Management Capacity of Inland Waterway in South Sudan

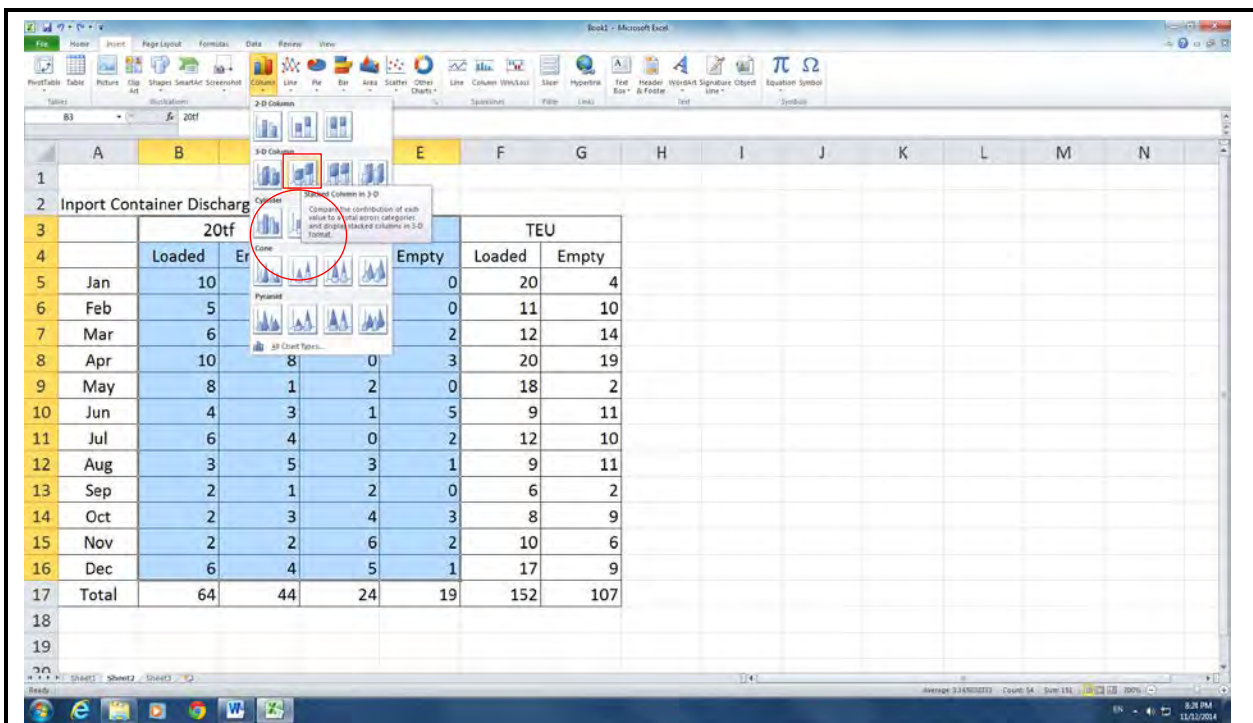

① Choose the type of graph.

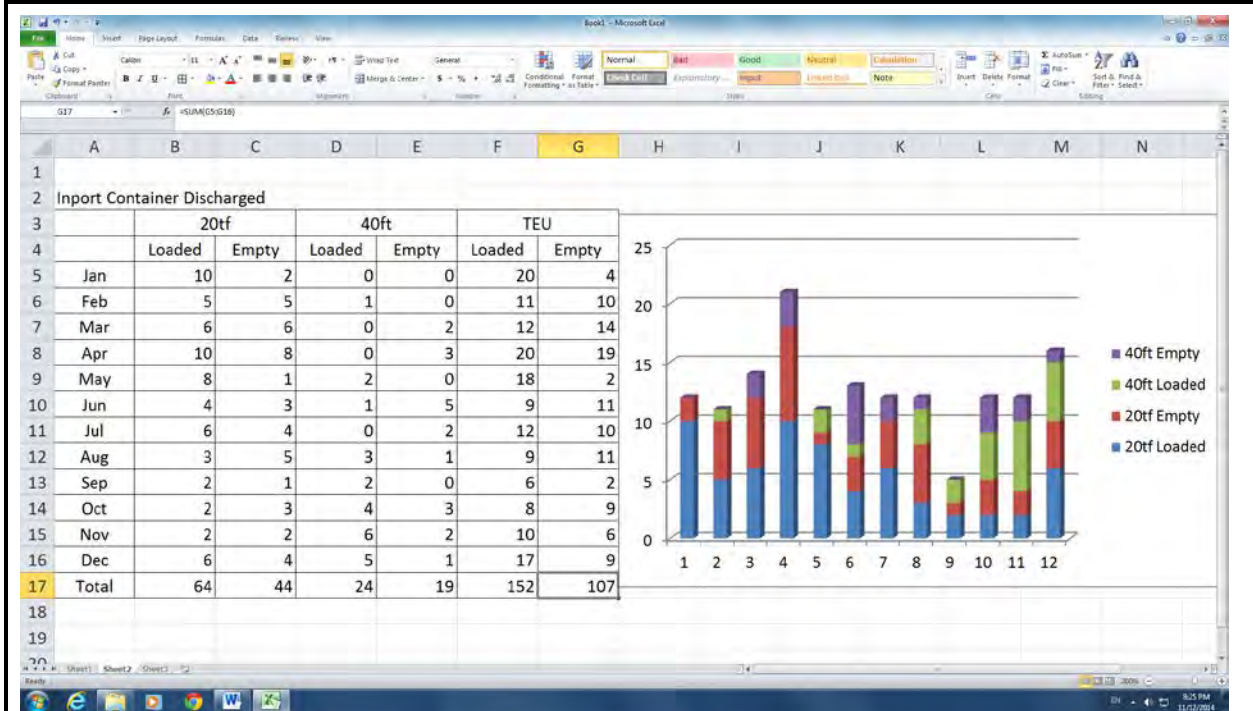

Club graph is indicating next table.

The Project for Enhancement of Operation and Management Capacity of Inland Waterway in South Sudan

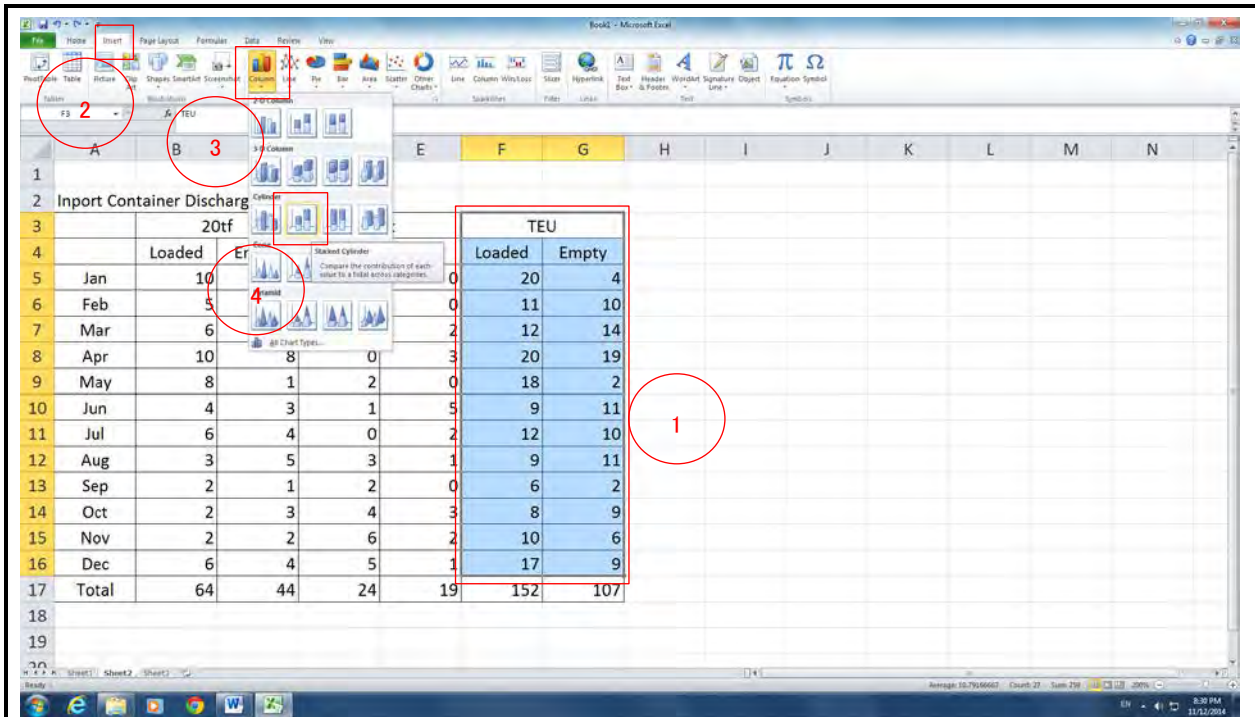

- ① Drag cell F-3 to cell G-16.
- ② Click the “Insert” tag.
- ③ Click the “Column” button.
- ④ Choose the type of graph.

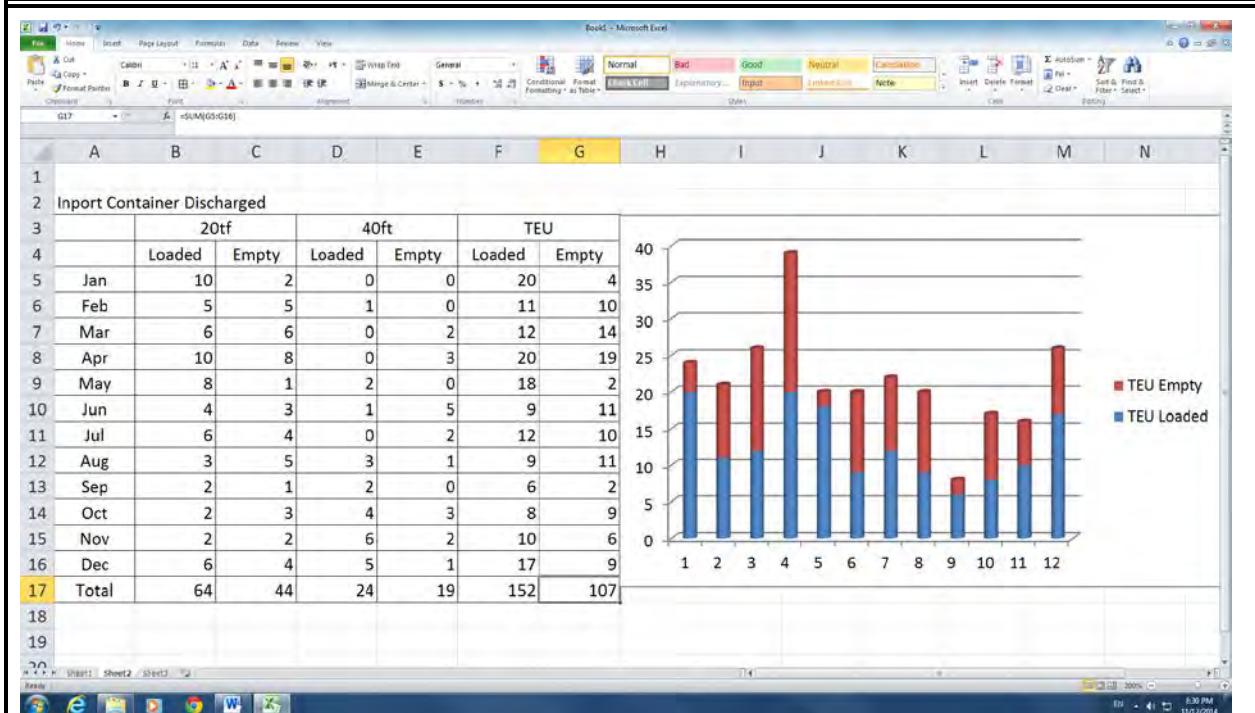

A bar graph will appear next to the table.

The Project for Enhancement of Operation and Management Capacity of Inland Waterway in South Sudan

How to copy the annual report sheet is shown as follows.

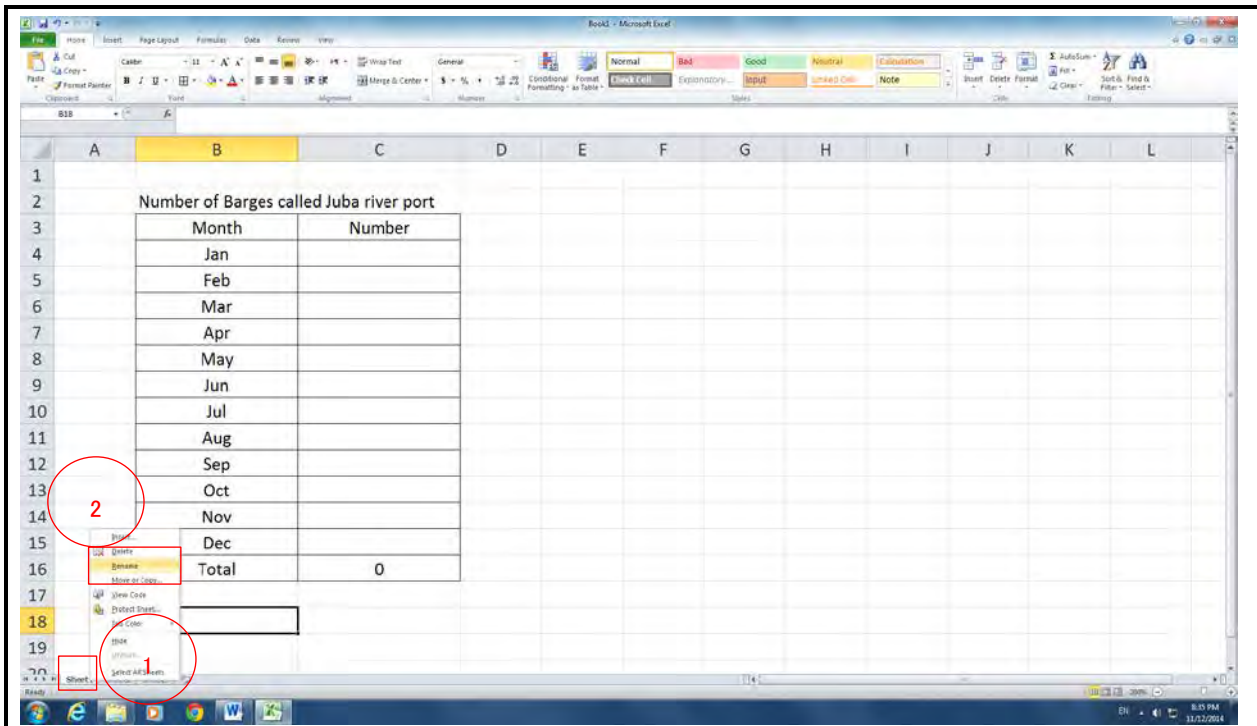

- ① Right click the “Sheet” tag.
- ② Click the “Rename” button.

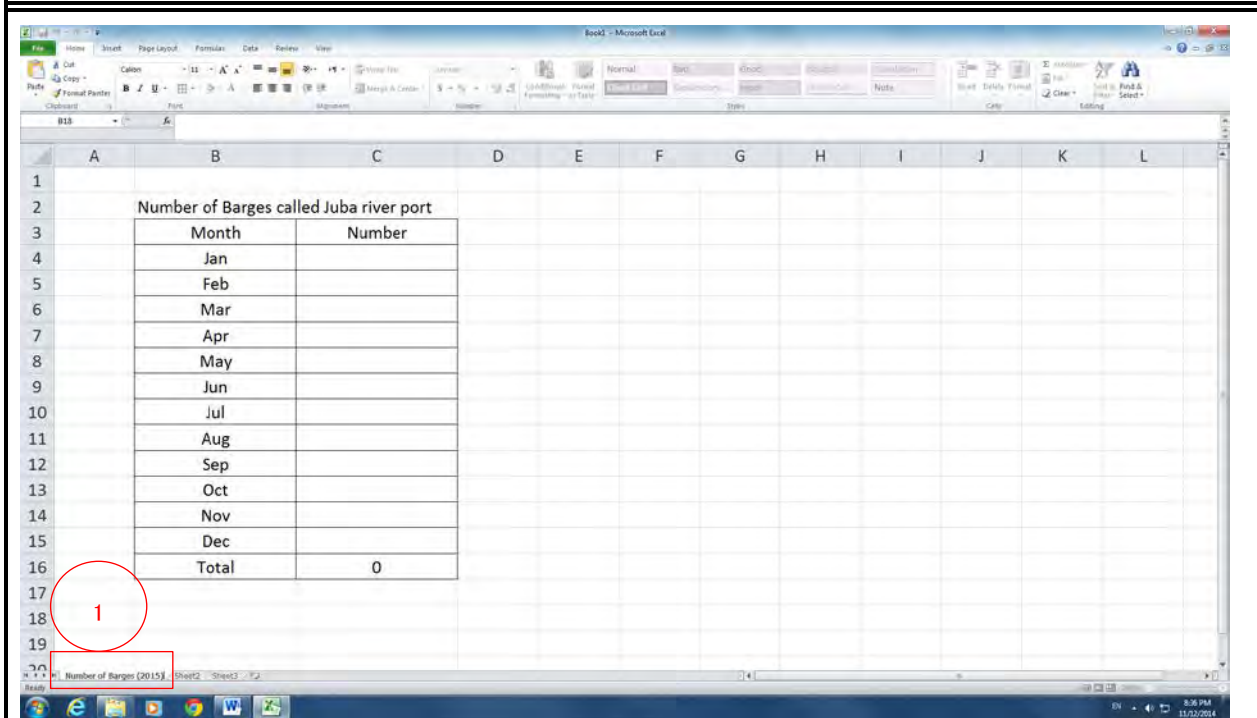

- ① Delete “Sheet 1” and type “Number of Barges (2015)”

The Project for Enhancement of Operation and Management Capacity of Inland Waterway in South Sudan

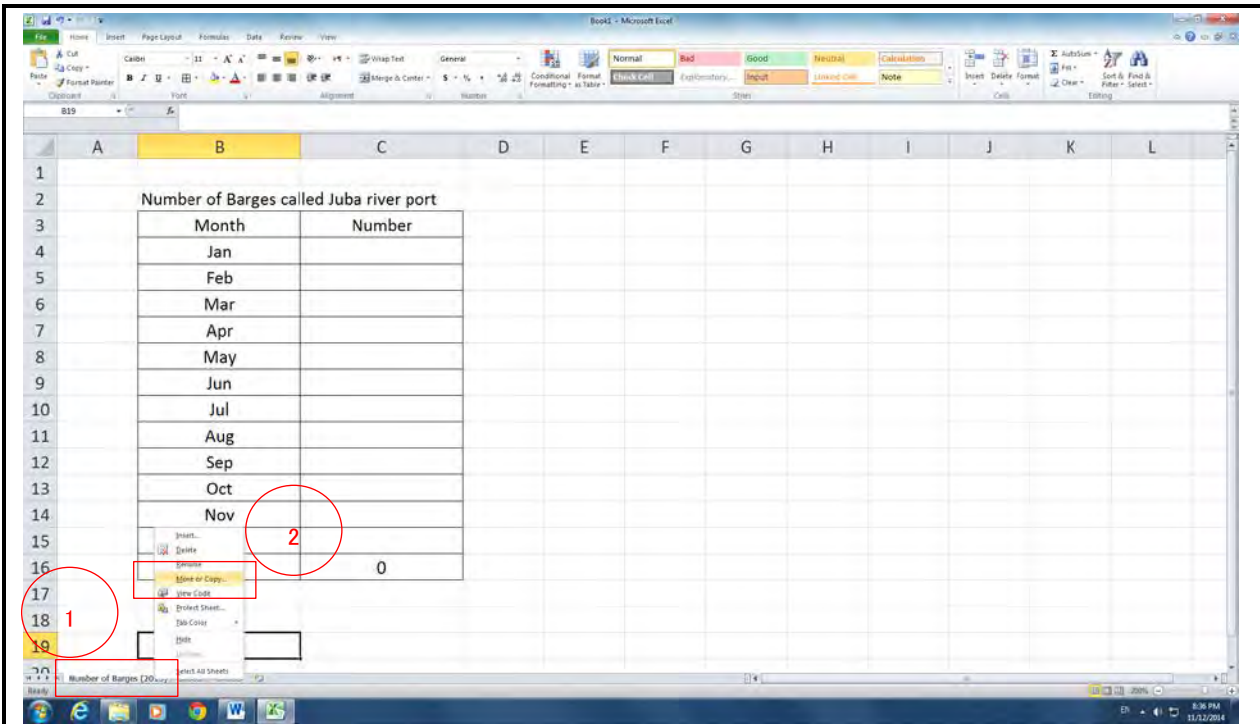

- ① Right click the “Number of Barges (2015)” tag.
- ② Click the “Move or Copy” button.

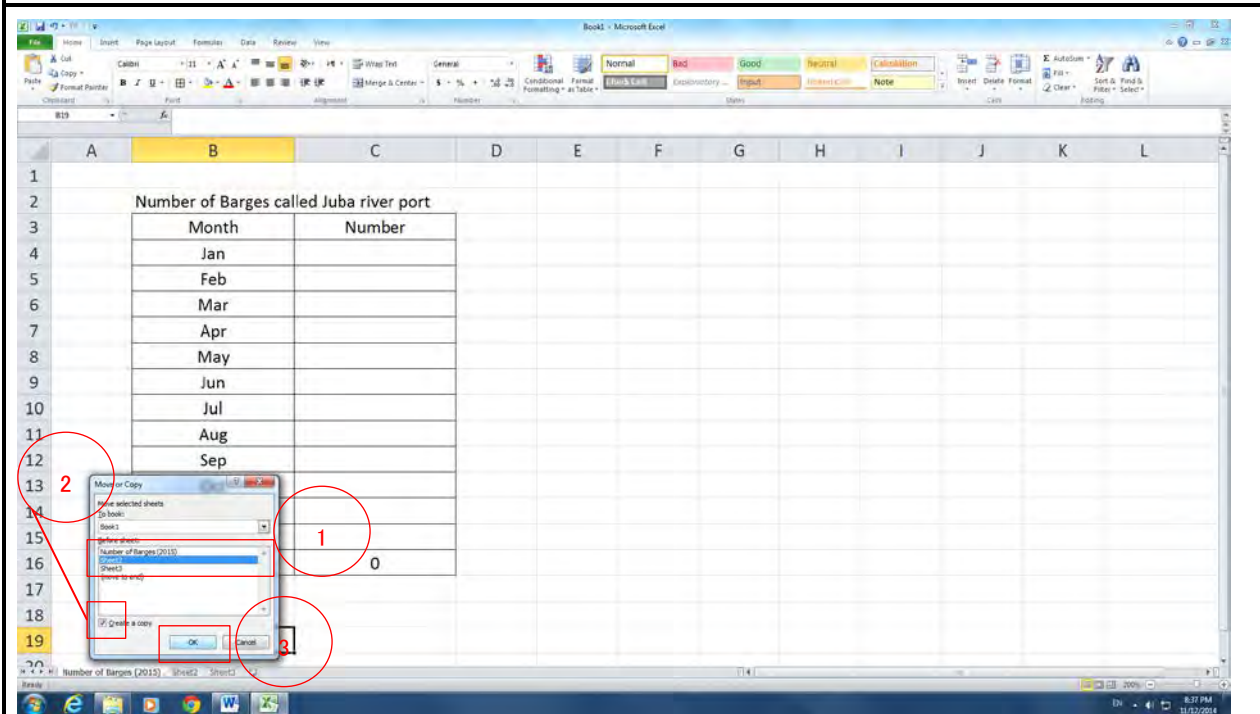

- ① Click “Sheet 2” where is the copy destination.
- ② Check the “Create a copy” button.
- ③ Click “OK” button.

The Project for Enhancement of Operation and Management Capacity of Inland Waterway in South Sudan

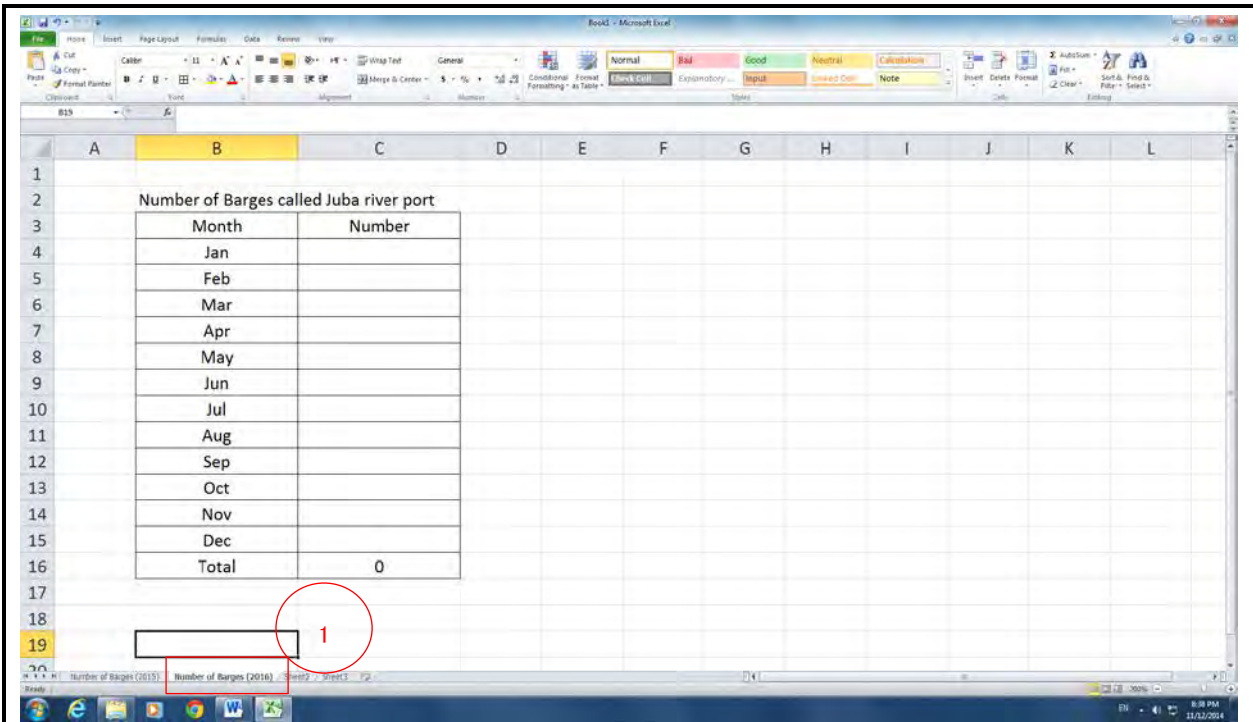

① Delete “Number of Barges (2015)” and type “Number of Barges (2016)”

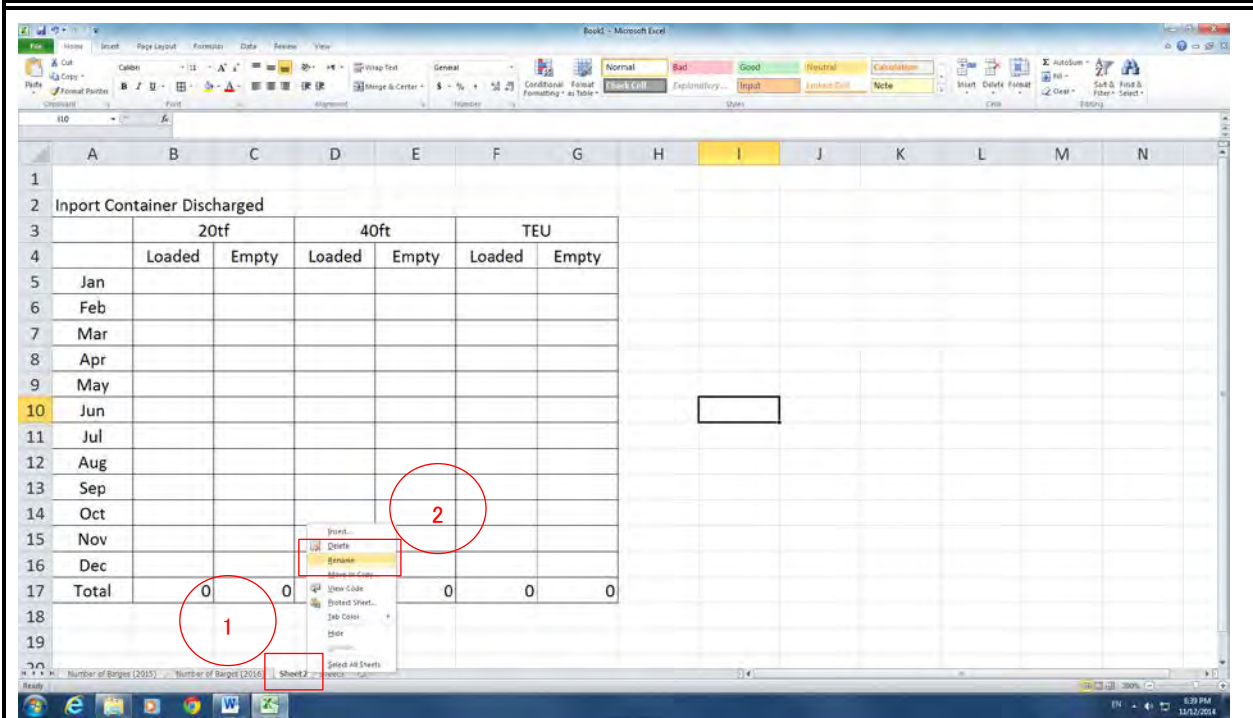

① Right click the “Sheet 2” tag.

② Click the “Rename” button.

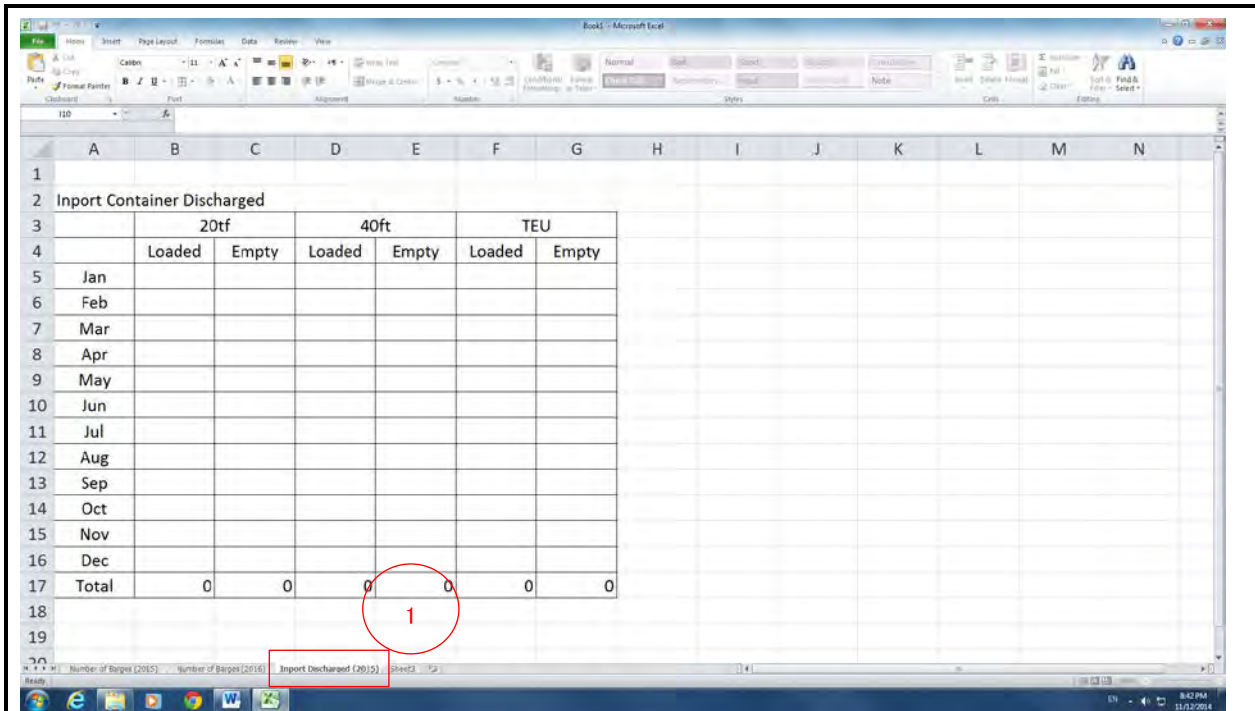

① Delete “Sheet 2” and type “Import Discharged (2015)”

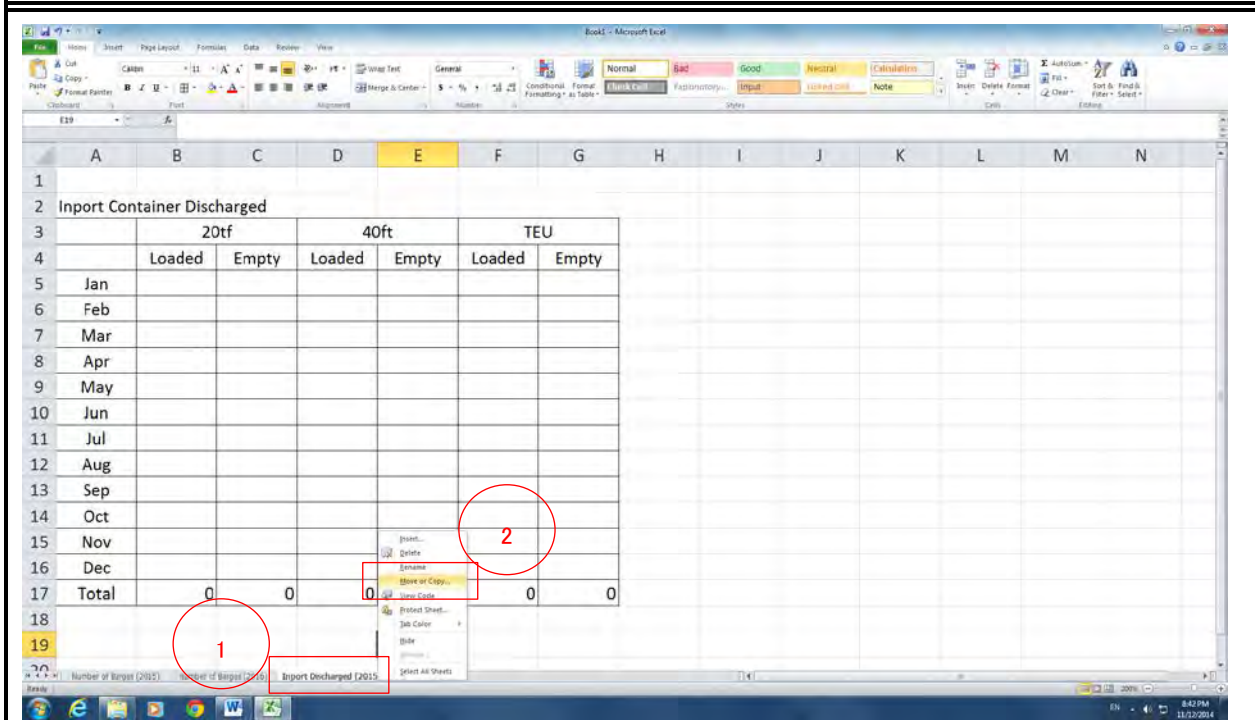

① Right click the “Import Discharged (2015)”.

② Check the “Create a copy” button.

The Project for Enhancement of Operation and Management Capacity of Inland Waterway in South Sudan

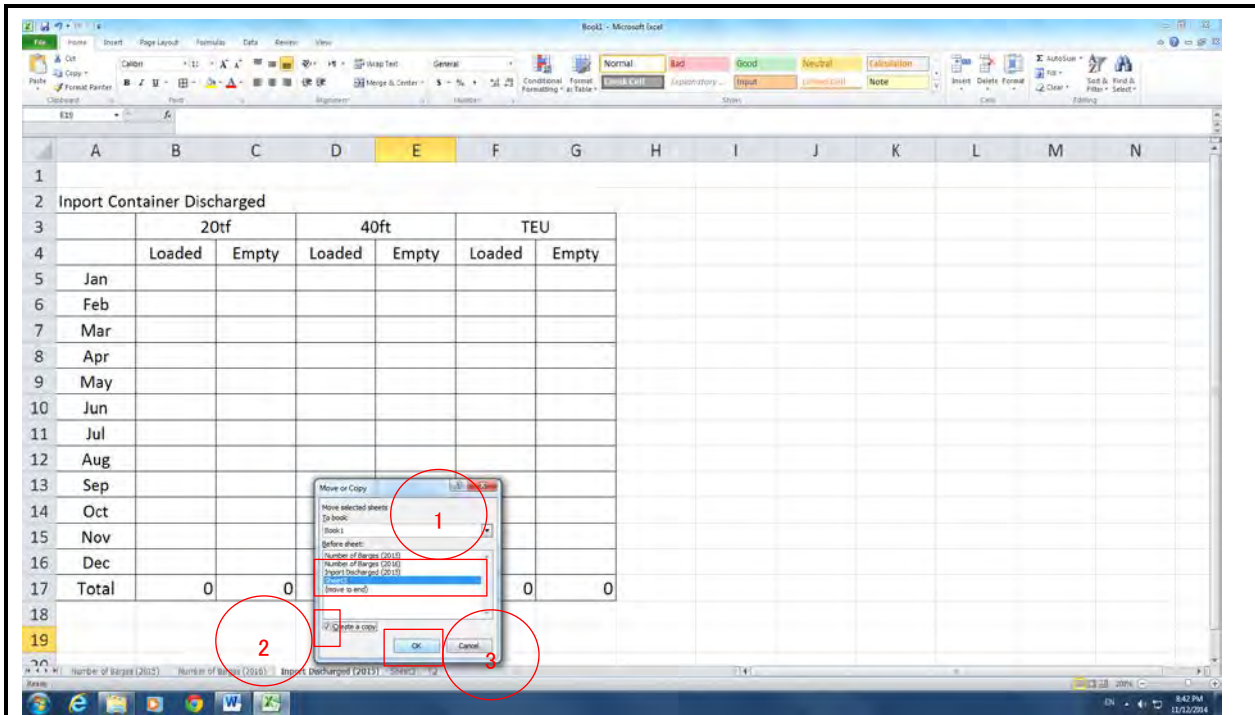

- ① Click “Sheet 3” which is the copy destination.
- ② Check the “Create a copy” button.
- ③ Click “OK” button.

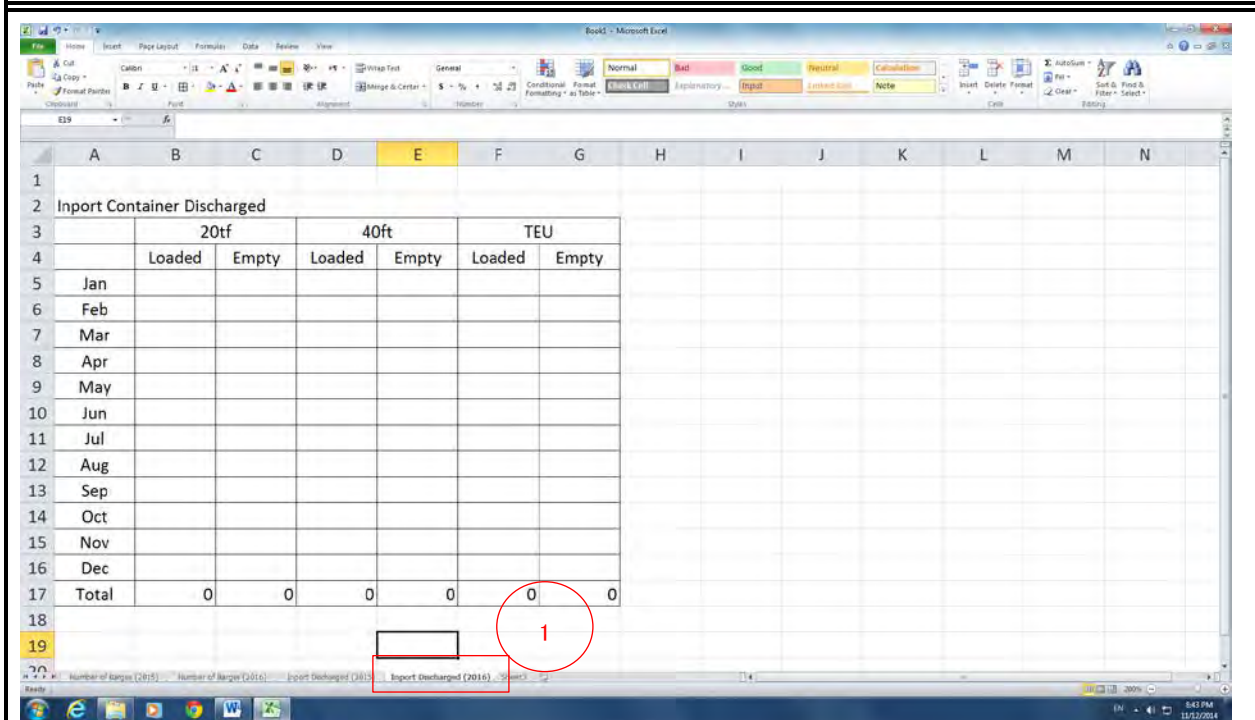

- ① Delete “Import Discharged (2015)” and type “Import Discharged (2016)”

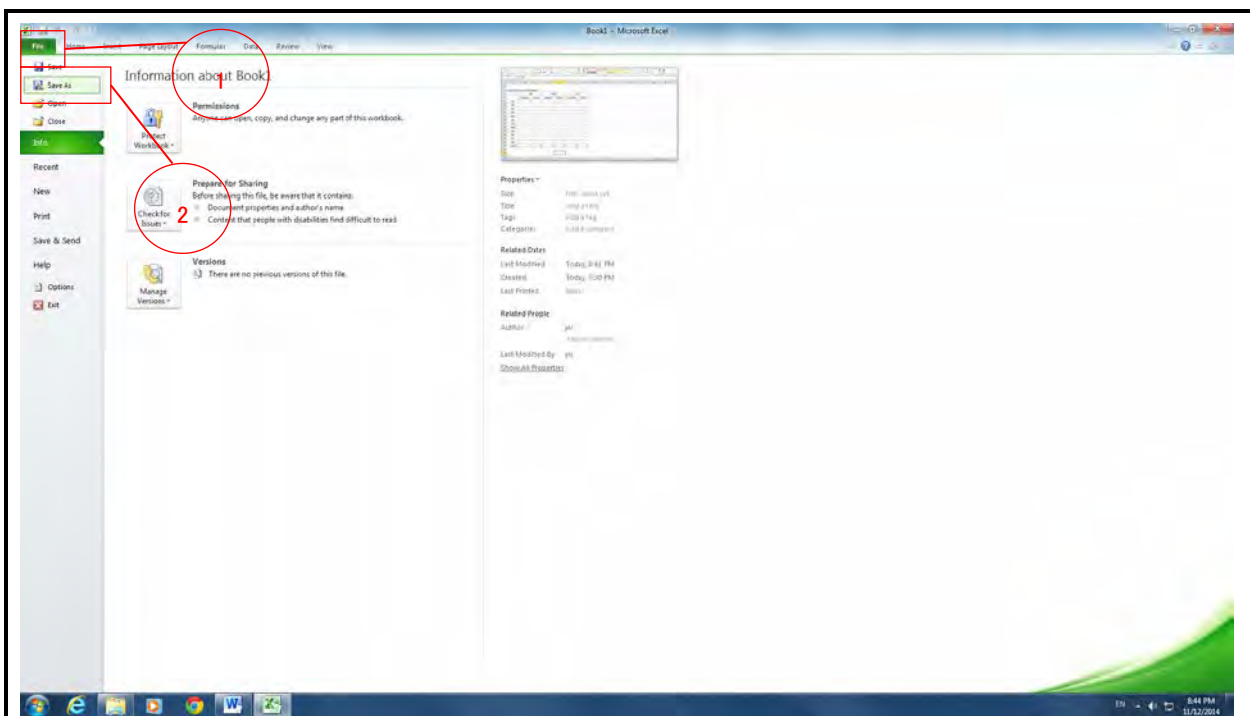

- ① Click the “File” tag.
- ② Click the “Save as” button.

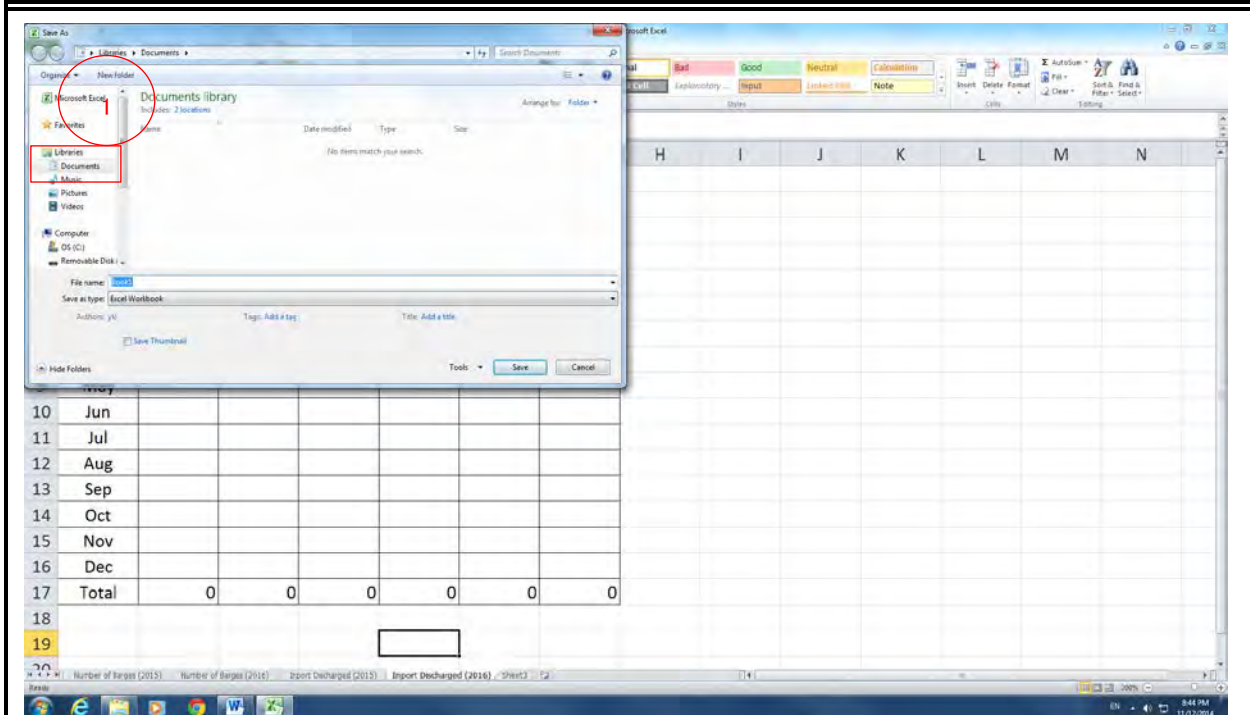

- ① Click the save button.

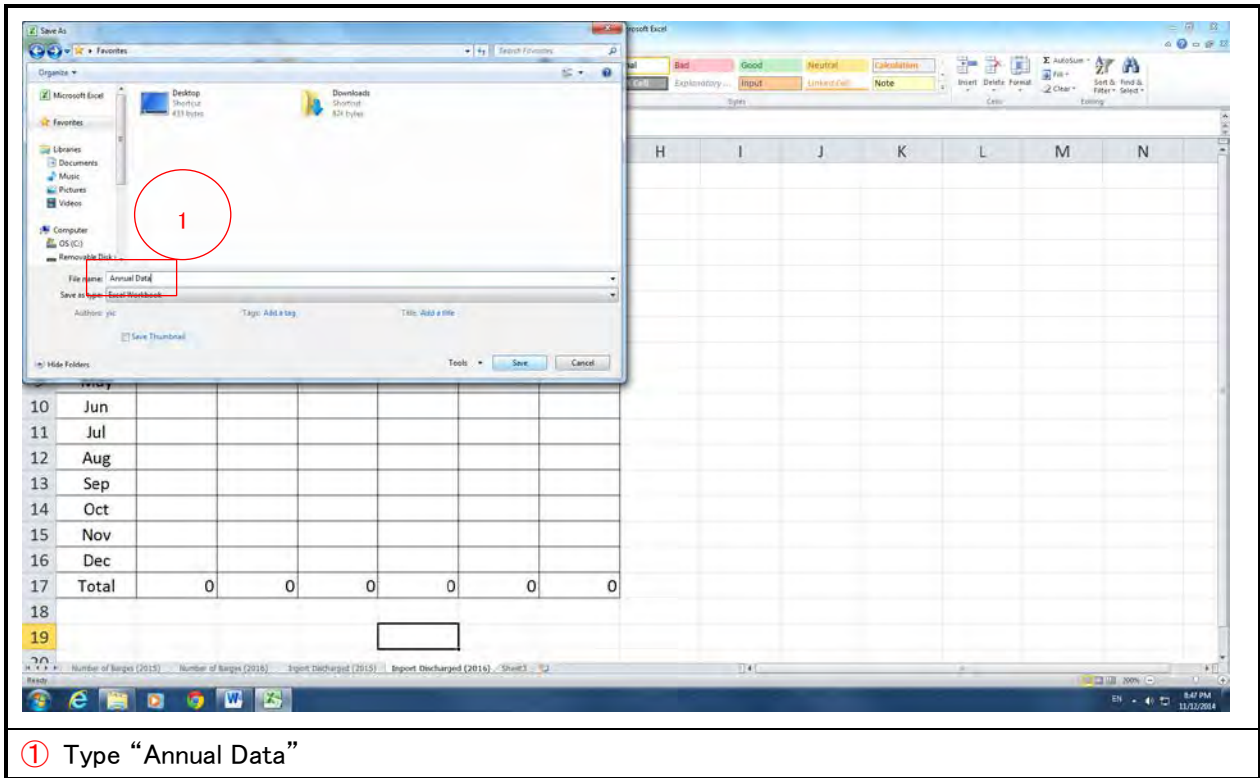

10-2. Utilization of annual report

Annual report on port statistics is a very effective tool as it can be used to grasp the situation of the port. Port Authority can use it to explain port conditions to various port related parties. It is also useful when submitting requests for budgets to the central government. Port Authority also can plan port facilities using the annual report.

Therefore, collecting data and compiling it into monthly and annual reports is essential.

**Training Course for
JRPA Staff
at Bandari College
(May 2017)**

Port Facility Maintenance

**Project on Monitoring Support
and Improvement of Operation
and Management of Juba River
Port in the Republic of South
Sudan**



HASEBE (OCDI)

Contents

1. General

2. Classification of Diagnosis

3. Check Points for Daily Checkup

4. Classification of Degradation Level

5. Necessity of Proper Maintenance of Port Facilities

6. Maintenance Method

7. Inspection Tests

8. Monitoring

9. Future Maintenance Plan

Additional Information (A1 – A3)

1. General

Port and harbor facilities, if properly maintained, can remain in service for a long period of time.

The facilities should be maintained systematically and appropriately so as to continuously satisfy the performance requirements over the service period.

Port and harbor facilities should be appropriately maintained taking the following factors into consideration:

- **Natural Conditions,**
- **Facility Use Plan,**
- **Importance and Substitutability,**
- **Designed Service Period,**
- **Structure Type, and**
- **Countermeasures.**

2. Classification of Diagnosis

Maintenance Start

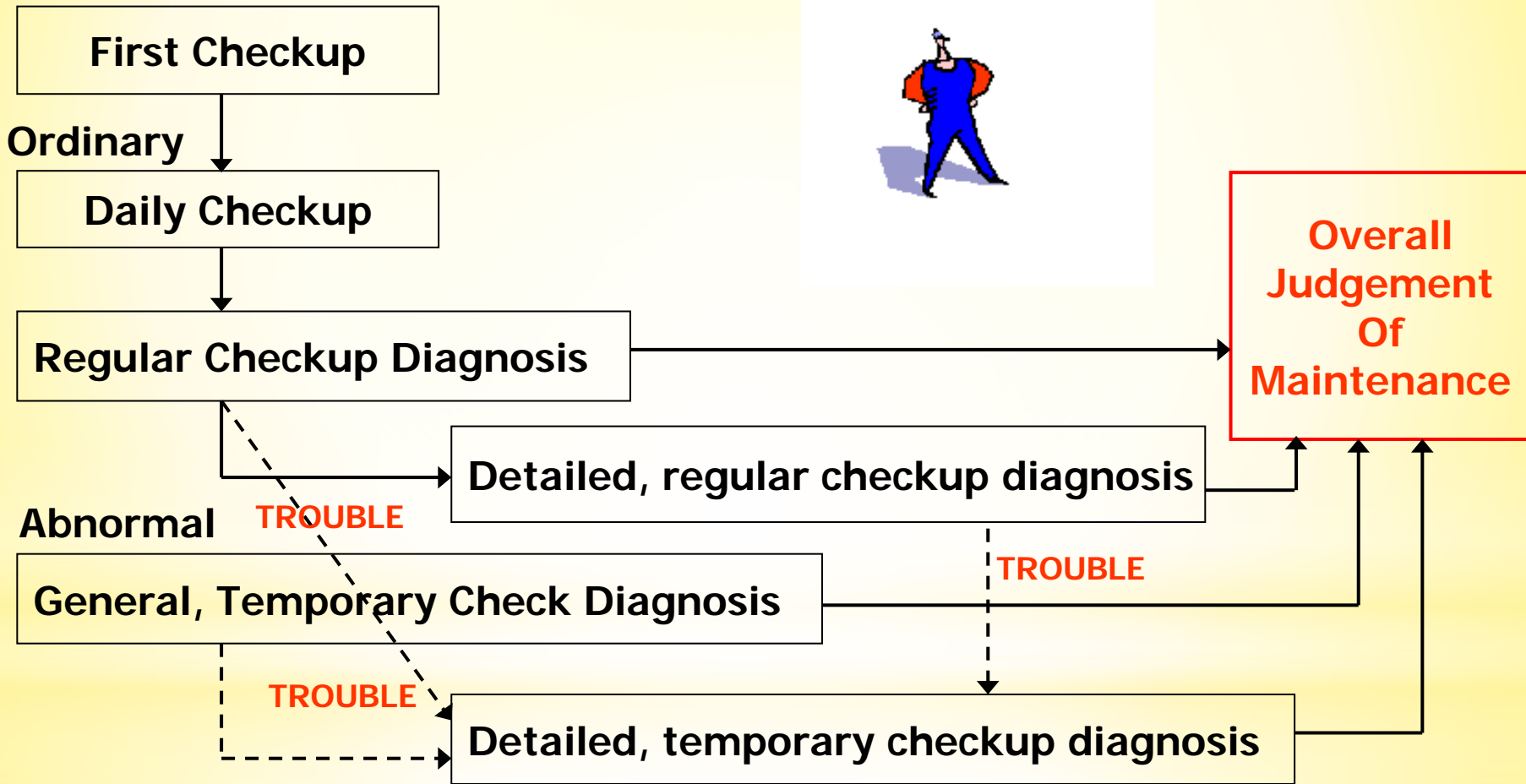

Visual and Simple Observation

Skilled Observation and Checkup

3. Check Points for Daily Visual Checkup

The purpose of daily check is to discover what will hinder the use of facilities such as cargo handling and it is to remove.

- Is the use assumed situation (in cargo handling work)?**
- Especially, does not the vehicle where weight is large progress?**
- Isn't there signs or report that receives an excessive impact such as ships?**
- Isn't there difference in a normal line and the joint?**
- Are there any abnormal sounds or vibrations?**
- Is not abnormality found in the incidental equipment?**

4. Classification of Degradation Level

| Classification of degradation level | Situation of part and materials |
|---|---|
|  a | The performance of the material has decreased remarkably. |
| b | The performance of the material has decreased. |
| c | A changed state has been observed though the performance of the material has not decreased. |
| d | A changed state has not been observed. |

4.1 Measurement Unit for Checkup (example)

| Facilities name | Checkup Diagnosis (a, b, c, d) |
|-----------------|--------------------------------|
| Jetty | 1 span each |

4.2 Regular Checkup (Facility)

(Facilities)

Format for regular checkup diagnosis(Plan 1)

Port name:

Area No.:

| Facilities | Checkup Items | Checkup Methods | Judging Standard | | |
|------------|------------------|--|--|--|---|
| Jetty | Mooring Post | Damage, Paint | Visual checkup • Damage, Change of shape • Situation of paint | a <input type="checkbox"/> It is not possible to use it due to damage. | |
| | | | | b - | |
| | | | | c <input type="checkbox"/> Paint has peeled off. | |
| | | | | d <input type="checkbox"/> No abnormalities. | |
| | Fender Beam | Damage, status of mounting hardware | Visual checkup • Damage of rubber part • Rust and damage of mounting | Visual checkup • Damage of rubber part • Rust and damage of mounting | a <input type="checkbox"/> There are a lack and a permanent transformation in the main body. <input type="checkbox"/> There are loosening of the mounting hardware, an omission, bending, and cutting. |
| | | | | | b - |
| | | | | | c <input type="checkbox"/> There are a loss, a crack, and a chipping. Rust has been generated in the mounting hardware. |
| | | | | | d <input type="checkbox"/> No abnormalities. |
| | Ladder | Damage, painting of main body, and corrosion | Visual checkup • Damage, Change of shape • Situation of paint • Corrosion | Visual checkup • Damage, Change of shape • Situation of paint • Corrosion | a <input type="checkbox"/> It misses. <input type="checkbox"/> It is dangerous in use remarkable damage and corrosion. |
| | | | | | b - |
| | | | | | c <input type="checkbox"/> Damage, the transformation, and the painting of the main body peel off and are corroded. Paint has peeled off and rusted. |
| | | | | | d <input type="checkbox"/> No abnormalities. |
| | Car stop | Damage, painting of main body, and corrosion | Visual checkup • Damage, Change of shape • Situation of paint • Corrosion | Visual checkup • Damage, Change of shape • Situation of paint • Corrosion | a <input type="checkbox"/> It misses. <input type="checkbox"/> Performance is located due to damage. |
| | | | | | b - |
| | | | | | c <input type="checkbox"/> Damage, the transformation, and the painting of the main body peel off and are corroded. |
| | | | | | d <input type="checkbox"/> No abnormalities. |
| | Jetty Nomal Line | Difference | Visual checkup • Difference / Settlement | Visual checkup • Difference / Settlement | a <input type="checkbox"/> There is a difference of 20cm or more between adjoining superstructure work. <input type="checkbox"/> Progress is transformed. |
| | | | | | b <input type="checkbox"/> There is a difference of about 10 to 20cm between adjoining superstructure work. |
| | | | | | c <input type="checkbox"/> There is a difference of less than 10cm between adjoining superstructure in a case other than the above. |
| | | | | | d <input type="checkbox"/> No abnormalities. |
| | Apron | Settlement/ caving Degradation/Damage of Concrete and Asphalts | Visual checkup | Visual checkup | a <input type="checkbox"/> There is an important obstacle in traffic and walking of the vehicle. |
| | | | | | b <input type="checkbox"/> There is a subsidence of 3cm or more (difference) in the apron. <input type="checkbox"/> There is a subsidence of 30cm or more (difference) between the apron and the hinterland. |
| | | | | | c <input type="checkbox"/> Subsidence of less than 3cm in the apron (difference). <input type="checkbox"/> Subsidence of less than 30cm between the apron and the hinterland (difference). |
| | | | | | d <input type="checkbox"/> No abnormalities. |

4.3 Regular Checkup Jetty Normal Line (example)

Check list for Existing Jetty

Date _____

Checker _____

| Top Elevation | | | | Normal Line | | | |
|---------------|------------------|-------------|------------|-------------|---------------|-------------|------------|
| Point No. | Design Elevation | Survey Data | Difference | Point No. | Design Length | Survey Data | Difference |
| ① | 453.700 | | | ⑦ | 17.000 | | |
| ② | 453.700 | | | ⑧ | 38.910 | | |
| ③ | 453.700 | | | ⑨ | 35.014 | | |
| ④ | 453.700 | | | | | | |
| ⑤ | 453.700 | | | | | | |
| ⑥ | 453.700 | | | | | | |
| Note | | | | | | | |



Checking Elevation

Back(Land Side)

Additional Normal Line

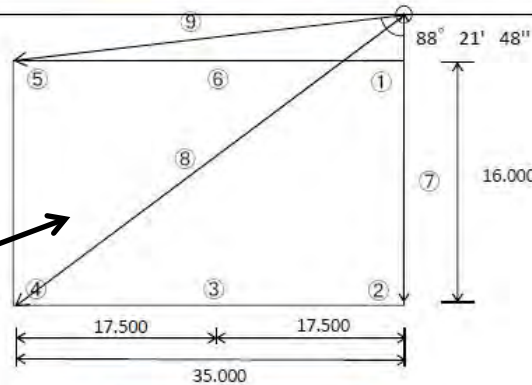

Existing Jetty
in Juba Port

FRONT(River Side)



4.4 Regular Checkup (Structure)

(Facilities)

Format for regular checkup diagnosis(Plan 2)

Port name:

Area No.:

| Structure | Checkup Items | | Checkup Methods | Judging Standard |
|--|--|---|--|---|
| Super structure | under surface | Deterioration / Damage of Concrete | Visual checkup • Crack occurrence direction • Crack number/length/width • Concrete Cover Hiatus condition • Rust occurrence • Re-bar Corrosion condition | Slub |
| | | | | <input type="checkbox"/> Network crack is more than 50% on the surface. |
| | | | | <input type="checkbox"/> There are concrete cover segregations. |
| | | | | <input type="checkbox"/> Rust occurs extensively. |
| | | | | Beam, Haunch |
| | | | | <input type="checkbox"/> There are cracks more than 3mm to axial re-bar. |
| | <input type="checkbox"/> There are concrete cover segregations.. | | | |
| | <input type="checkbox"/> Rust occurs extensively. | | | |
| | b | Slub | | |
| | | <input type="checkbox"/> Network crack is less than 50% on the surface. | | |
| | | <input type="checkbox"/> Rust occurs partially. | | |
| | Beam, Haunch | | | |
| <input type="checkbox"/> There are cracks less than 3mm to axial re-bar. | | | | |
| <input type="checkbox"/> Rust occurs partially. | | | | |
| c | Slub | | | |
| | <input type="checkbox"/> There are cracks or discharge gel . | | | |
| <input type="checkbox"/> Rust occurs as dots. | | | | |
| d | <input type="checkbox"/> No abnormalities. | | | |
| Sub structure | Jacket corrosion prevention | | Visual checkup • corrosion of steel, exposure • covering material damage • condition of protective shelf | a |
| | | | | <input type="checkbox"/> Steel is exposed and rust occurs extensively. |
| | | | | b |
| | | | | <input type="checkbox"/> There is damage until steel on covering material . |
| | <input type="checkbox"/> There is damage on protective shelf . | | | |
| | c | | | |
| | <input type="checkbox"/> There is damage on covering material . | | | |
| | <input type="checkbox"/> There is damage on protective shelf . | | | |
| d | <input type="checkbox"/> No abnormalities. | | | |
| Cathodic protection | | | Potential Measurement (electrode potentiometer) | a |
| | | | | <input type="checkbox"/> Protective potential is not maintained. |
| | | | | b |
| | | | | - |
| c | | | | |
| - | | | | |
| d | <input type="checkbox"/> Protective potential is maintained. | | | |

5. Necessity of Proper Maintenance of Port Facilities

【Buried channel by sediment flow】

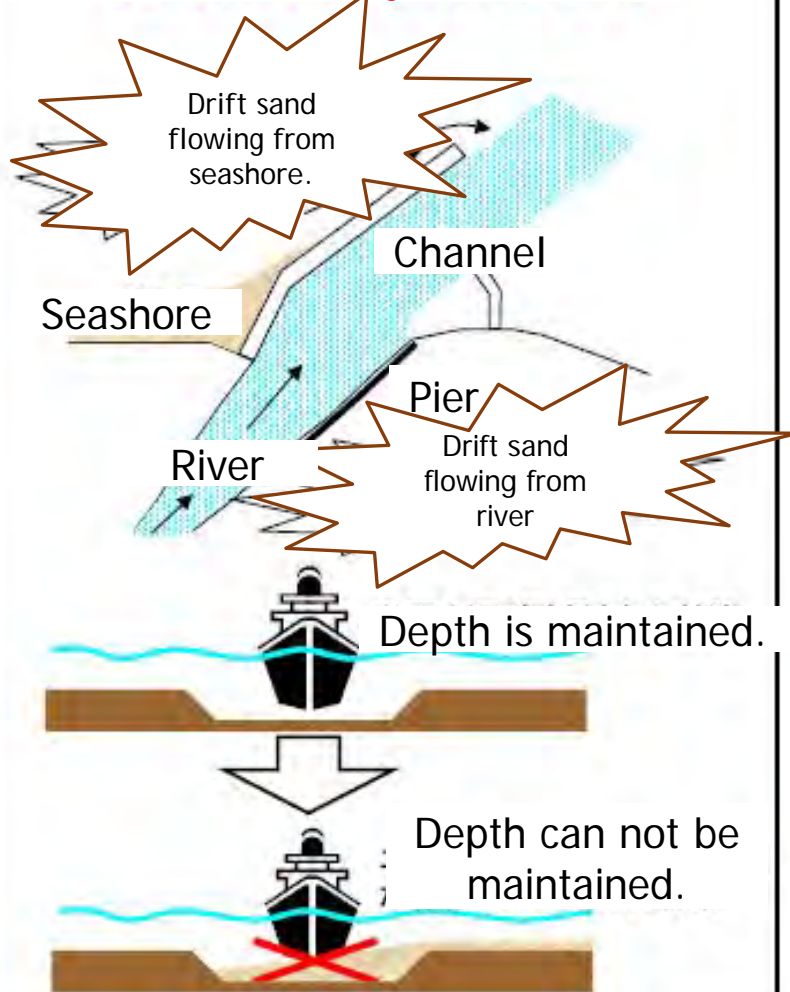

【Degradation of berthing facilities (Pier)】

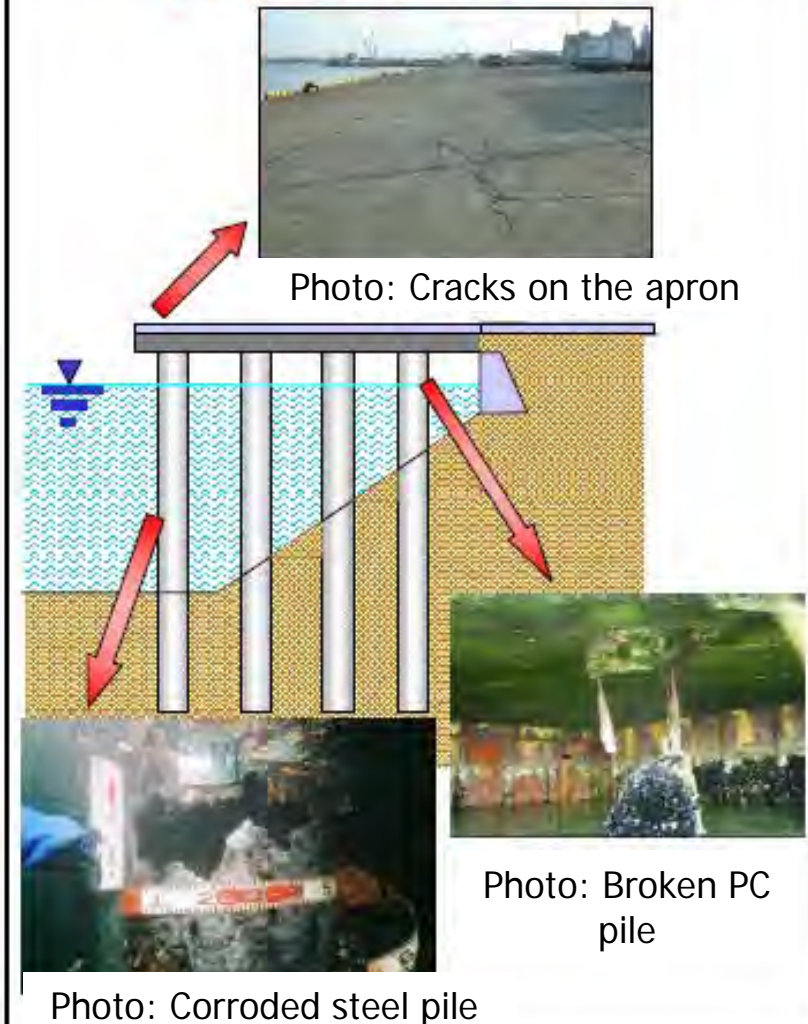

5.1 Necessity of Proper Maintenance of Port Facilities

Under deck view of portion of R.C. Pier

Concrete Pile



Bottom of Deck



Cross-sectional view of the facility

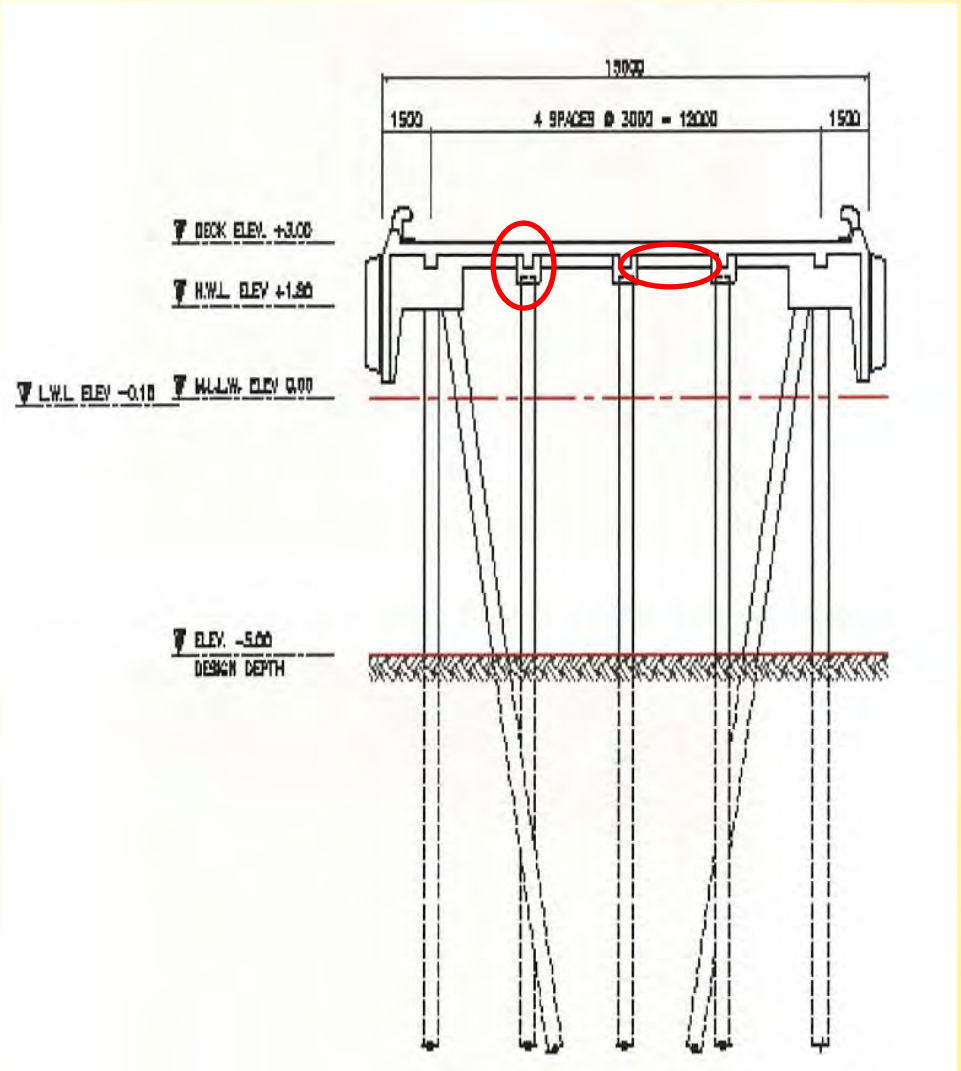

5.2 Corrosion of Steel Sheet Pile

Occurrence of Holes in
the Steel Sheet Pile

Damage to
Superstructure

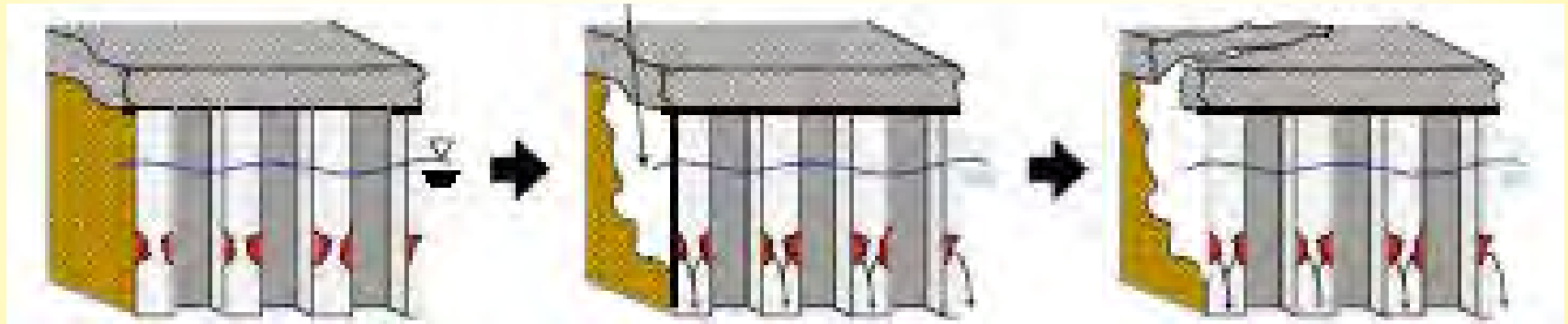

Outflow of Backfilling Sand



5.3 Corrosion of Steel Pipe Pile

Occurrence of holes in the steel pipe pile

Collapse of Structure

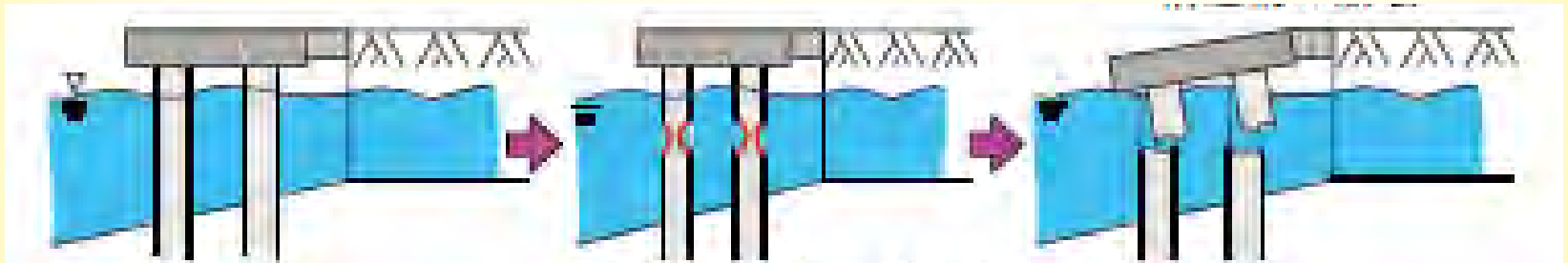

Corrosion of Steel Pipe Pile

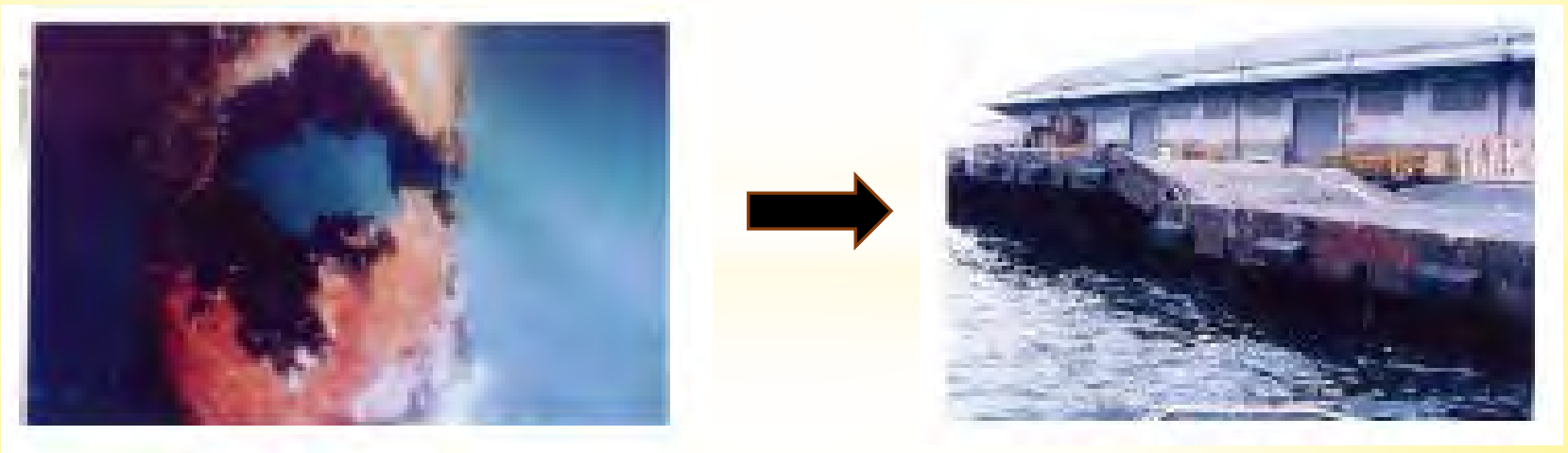

5.4 Sample of Sagging Accident by Damaged Port Facilities

【 Subsidence of Apron 】



**【 Falling Crane due to
Subsidence of Apron 】**



A crane engaged in cargo handling fell sideways due to subsidence of the apron.

6. Maintenance Method

6.1 Crack Repair Work (No.1)

Slab Beam (Minor Defect Area)

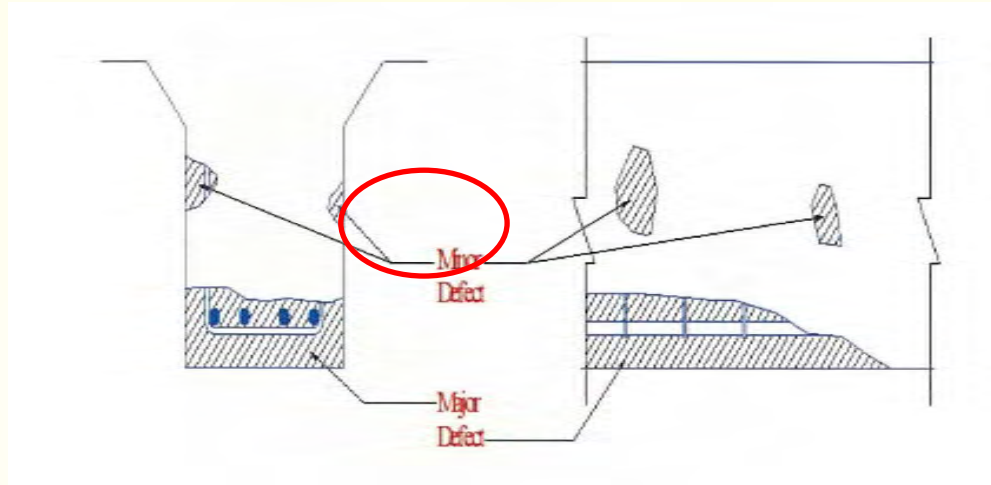

Crack Injection (Side of Beam)



Surface Coating (Side of Beam)



6.2 Crack Repair Work (No. 2)

Surface of Wharf Slab

Sealed Cracks after Injection with Epoxy Resin



6.3 Crack Repair Work (No.3)

Surface of Wharf Slab

Removal of Defective Concrete



After completion of Repair Works



6.4 Bollard Repair Work

Corrosion of Bolts, Nuts and Base-plates of Bollards



Application of Protective Coating



6.5 Structure Repair Work

Drainage Pipe



Revetment



7. Inspection Tests

Besides appraising the severity of the problem reported, the inspector must also carry out diagnosis to establish the source of the problem.

Chloride Test



Half Cell Potential Survey



7.1 Various Types of Inspection Tests

Sounding (Hammer) Test



**Schmidt Hammer Test
(Concrete Test Hammer)**



Cover-meter Test



Carbonation Test



8. Monitoring

Monitoring movements and monitoring crack width changes can be useful as a means of confirming any supposed cause besides checking if the damage is dormant or progressive.

Tell-Tale Crack Width Gauge



Card used to measure crack width

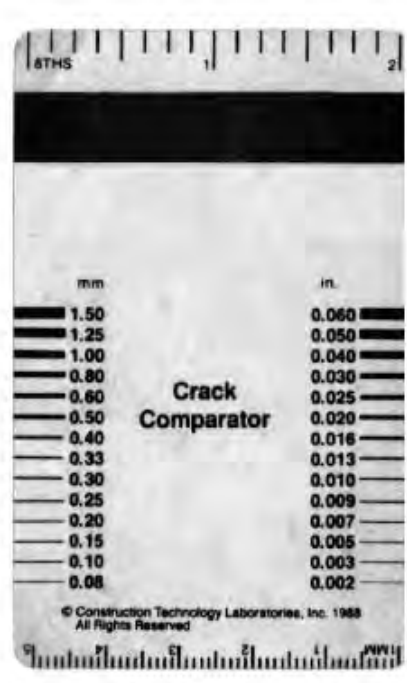

8.1 Monitoring Details

Limit of Crack Width in Need of Repair (Japan Concrete Institute)

| Classification | Other | Environment | Focus on Durability | | | Focus on Waterproof |
|---|--------|---------------|---------------------|---------------|----------------|---------------------|
| | | Factor | Severe | Medium | Gradual | |
| Crack Width in Need of Repair (mm) | Large | 0.4mm or more | 0.4mm or more | 0.6mm or more | 0.2mm or more | |
| | Medium | 0.4mm or more | 0.6mm or more | 0.8mm or more | 0.2mm or more | |
| | Small | 0.6mm or more | 0.8mm or more | 1.0mm or more | 0.2mm or more | |
| Crack Width in which Repair is Unnecessary (mm) | Large | 0.1mm or less | 0.2mm or less | 0.2mm or less | 0.05mm or less | |
| | Medium | 0.1mm or less | 0.2mm or less | 0.3mm or less | 0.05mm or less | |
| | Small | 0.2mm or less | 0.3mm or less | 0.3mm or less | 0.05mm or less | |

Factors (large, medium, small) show the degree of hazard on the durability and the waterproof state of concrete structures. (For example surface coat, depth of cracks, pattern of cracks, material, proportion, cover ,construction joint of concrete)

8.2 Monitoring (Visual Check Up)

Under Deck



1. Visual Survey

2. Photo (Beam or Slab)

3. Monitoring by Crack Width Gauge

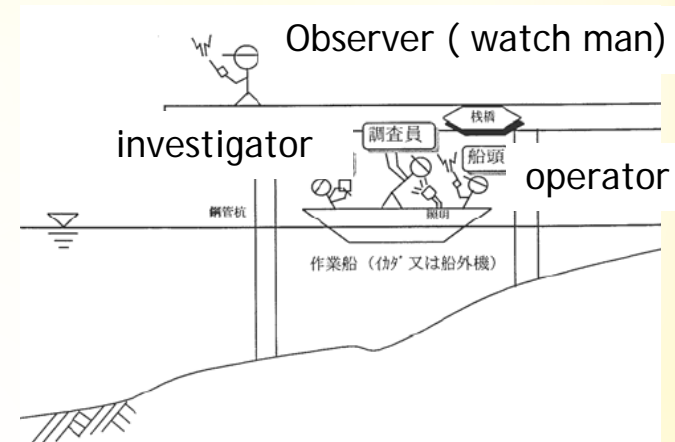

Under Bridge



9. Future Maintenance Plan

Conduct periodical checks for early detection of problems and to ensure safe operation.

Inspection Schedule

| Component | Routine inspection | Periodical visual inspection |
|----------------------|--------------------|------------------------------|
| RC deck | - | Every 5~10 years |
| Steel pipe pile | - | Every 5~10 years |
| Protective coating | - | Every 5~10 years |
| Cathodic protection | - | Every 5~10 years |
| Auxiliary equipments | Every 1 month | Every 1 year |
| Apron | Every 1 month | Every 1 year |
| Basins | Every 1 month | Every 1 year |

***END**

If we have time, move on to the next Additional Information.

Harmonized System

From Wikipedia, the free encyclopedia

The **Harmonized Commodity Description and Coding System**, also known as the **Harmonized System (HS)** of tariff nomenclature is an internationally standardized system of names and numbers to classify traded products. It came into effect in 1988 and has since been developed and maintained by the World Customs Organization (WCO) (formerly the Customs Co-operation Council), an independent intergovernmental organization based in Brussels, Belgium, with over 200 member countries.^[1]

Contents

- 1 Structure
- 2 Classification
- 3 Applications
- 4 Challenges in classification for companies
- 5 See also
- 6 References
- 7 External links
 - 7.1 Tariffs by region

Structure

Fundamentally, the HS is organized logically by economic activity or component material. For example, animals and animal products are found in one section of the HS, while machinery and mechanical appliances are found in another. The HS is organized into 21 sections, which are subdivided into 96 chapters. The 96 HS chapters are further subdivided into approximately 5,000 headings and subheadings.

Section and Chapter titles describe broad categories of goods, while headings and subheadings describe products in more detail. Generally, HS sections and chapters are arranged in order of a product's degree of manufacture or in terms of its technological complexity. Natural commodities, such as live animals and vegetables, for example, are described the early sections of the HS, whereas more evolved goods such as machinery and precision instruments are described in later sections. Chapters within the individual sections are also usually organized in order of complexity or degree of manufacture. For example, within Section X (*Pulp of wood or of other fibrous cellulosic material; Recovered (waste and scrap) paper or paperboard; Paper and paperboard and articles thereof*), Chapter 47 provides for *pulp of wood or of other fibrous cellulosic materials*, whereas Chapter 49 covers *printed books, newspapers, and other printed matter*. Finally, the headings within individual Chapters follow a similar order. For example, the first heading in Chapter 50 (*Silk*) provides for *silk worm cocoons* while articles made of silk are covered by the chapter's later headings.

The HS code consists of 6-digits. The first two digits designate the HS Chapter. The second two digits designate the HS heading. The third two digits designate the HS subheading. HS code 1006.30, for example indicates Chapter 10 (*Cereals*), Heading 06 (*Rice*), and Subheading 30 (*Semi-milled or wholly milled rice, whether or not polished or glazed*).

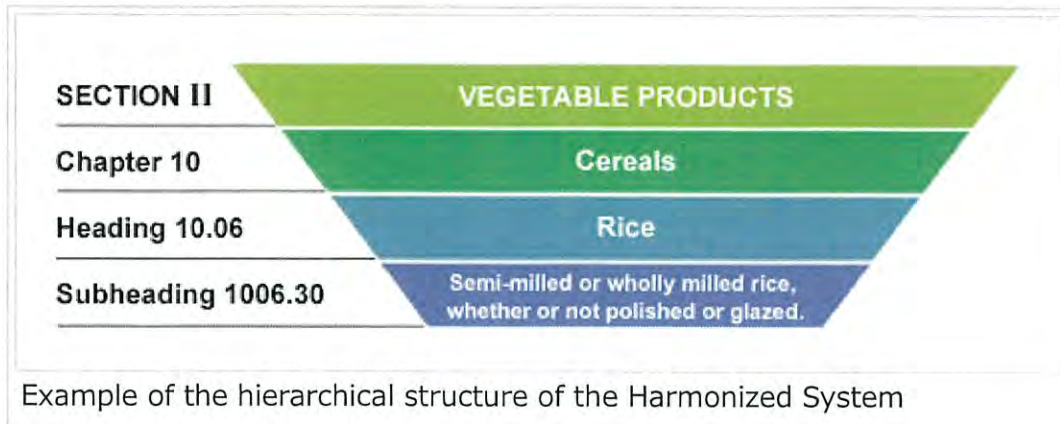

In addition to the HS codes and commodity descriptions, each Section and Chapter of the HS is prefaced by Legal Notes, which are designed to clarify the proper classification of goods.

To ensure harmonization, the contracting parties to the Convention on the Harmonized Commodity Description and Coding System, have agreed to base their national tariff schedules on the HS nomenclature and Legal Notes. Parties are permitted to subdivide the HS nomenclature beyond 6-digits and add their own Legal Notes according to their own tariff and statistical requirements. Parties often set their customs duties at the 8-digit "tariff code" level. Statistical suffixes are often added to the 8-digit tariff code for a total of 10 digits.

HS Chapter 77 is reserved for common use by the parties internationally. Chapters 98 and 99 are reserved for national use. Chapter 98 comprises special classification provisions, and chapter 99 contains temporary modifications pursuant to a parties' national directive or legislation.

Since its creation, the HS has undergone several revisions - ostensibly, to either eliminate headings and subheadings describing commodities that are no longer traded, or to create headings and subheadings that address technological advancements and environmental concerns. The next version of the HS will become effective on January 1, 2017.

Classification

The process of assigning HS codes is known as "HS Classification". All [[aluminum composite sheet]] can be classified in the HS by using the *General Rules for the Interpretation of the Harmonized System* ("GRI"). HS codes can be determined by a variety of factors including a product's composition, its form and its function. An example of a product classified according to its form would be whole potatoes. The classification will also change depending on whether the potatoes are fresh or frozen. Fresh potatoes are classified in position 0701.90, under the Header *Potatoes, fresh or chilled*, Sub header *Other*, while frozen potatoes are classified in position 0710.10 under the Header *Vegetables (uncooked or cooked by steaming or boiling in water), frozen*, Subheader *Potatoes*.

An example of a product classified according to its material composition is a picture frame. Picture frames made of wood are classified under subheading 4414.00, which provides for *Wooden frames for paintings, photographs, mirrors or similar objects*. Picture frames made of plastic are classified under subheading 3924.90, which provides for *Tableware, kitchenware, other household articles and hygienic or toilet articles, of plastics. Other*. Picture frames made of glass are classified under subheading 7020.00, which provides for *Other articles of glass*. And so on.

An example of a product classified according to its form is personal hygiene soap. When in the form of a bar, cake or moulded shape, such soap is classified under subheading 3401.11, which provides for *Soap and organic surface-active products and preparations, in the form of bars, cakes, moulded pieces or shapes, and paper, wadding, felt and nonwovens, impregnated, coated or covered with soap or detergent: For toilet use (including medicated products)*. Conversely, liquid personal hygiene soap is classified under either 3401.20, which provides for *Soap in other forms*, or 3401.30, which provides for *Organic surface-active products and preparations for washing the skin, in the form of liquid or cream and put up for retail sale, whether or not containing soap*.

An example of a product classified according to its function is a carbon monoxide (CO) detector. If the CO detector captures and displays gas measurements, then it is properly classified under subheading 9027.10, which provides for *Instruments and apparatus for physical or chemical analysis (for example, polarimeters, refractometers, spectrometers, gas or smoke analysis apparatus; instruments and apparatus for measuring or checking viscosity, porosity, expansion, surface tension or the like; instruments and apparatus for measuring or checking quantities of heat, sound or light (including exposure meters); microtomes. Gas or smoke analysis apparatus*. If the CO detector does not capture and display gas measurements, then it is properly classified under subheading 8531.10, which provides for *Electric sound or visual signaling apparatus (for example, bells, sirens, indicator panels, burglar or fire alarms), other than those of heading 85.12 or 85.30. Burglar or fire alarms and similar apparatus*.

Although every product and every part of every product is classifiable in the HS, very few are explicitly described in the HS nomenclature. Any product for which there is no explicit description can be classified under a "residual" or "basket" heading or subheading, which provide for *Other goods*. Residual codes normally occur last in numerical order under their related headings and subheadings.

An example of a product classified under a residual heading is a live dog, which must be classified under heading 01.06, which provides for *Other live animals* because dogs are not covered by headings 01.01 through 01.05, which explicitly provide for *live equine, live bovine, live swine, live sheep and goats, and live poultry*, respectively.

Applications

As of 2015, there were 180 countries or territories applying the Harmonized System worldwide,^[2]

HS code are used by Customs authorities, statistical agencies, and other government regulatory bodies, to monitor and control the import and export of commodities through:

- Customs tariffs
- Collection of international trade statistics
- Rules of origin

- Collection of internal taxes
- Trade negotiations (e.g., the World Trade Organization schedules of tariff concessions)
- Transport tariffs and statistics
- Monitoring of controlled goods (e.g., wastes, narcotics, chemical weapons, ozone layer depleting substances, endangered species)
- Areas of Customs controls and procedures, including risk assessment, information technology and compliance.

Companies use HS codes to calculate the total landed cost of imported products and parts, and to identify selling and sourcing opportunities abroad.

Challenges in classification for companies

HS classification is not always straightforward. Many automotive parts, for example, are not classified under heading 87.08, which provides for *Parts and accessories of the motor vehicles of headings 87.01 to 87.05*. Automotive seats are classified as articles of furniture under heading 94.01, which provides for *Seats (other than those of heading 94.02), whether or not convertible into beds, and parts thereof*, and more specifically under subheading 9401.20, which provides for *Seats of a kind used for motor vehicles*.

In many jurisdictions, traders alone bear the legal responsibility to accurately classify their goods. Depending on the severity of the infraction, incorrect classification can result in the imposition of non-compliance penalties, border delays or seizures, or denial of import privileges.

There are several resources available to traders to assist in properly classifying their goods including:

- The Official Explanatory Notes to the Harmonized System, published by the World Customs Organization
- The US Census "Classify your Commodity" engine:
<https://uscensus.prod.3ceonline.com/>
- Classify your Commodity video tutorial by US Census:
<http://www.census.gov/foreign-trade/data/video022.html>
- Explanatory notes to the Combined Nomenclature of the European Union by the European Commission (<http://eur-lex.europa.eu/legal-content/EN/TXT/PDF/?uri=OJ:C:2015:076:FULL&from=EN>)
- Customs Rulings Online Search System (CROSS), by U.S. Customs and Border Protection (<http://rulings.cbp.gov/>)
- Binding Tariff Information (BTI), by the European Commission (http://ec.europa.eu/taxation_customs/dds2/ehti/ehti_consultation.jsp?Lang=en)
- Informed compliance publications, by U.S. Customs and Border Protection (<http://www.cbp.gov/trade/rulings/informed-compliance-publications>)
- Classification Guides, by HM Revenue & Customs (<https://www.gov.uk/government/collections/classification-of-goods>)

See also

- Automated Export System
- Broad Economic Categories
- Combined Nomenclature
- Customs tariff
- Harmonized Tariff Schedule for the United States
- Standard International Trade Classification
- TARIC Coding System
- UNSPSC
- World Customs Organization

References

1. "What is the Harmonized System (HS)?" (<http://www.wcoomd.org/en/topics/nomenclature/overview/what-is-the-harmonized-system.aspx>). *World Customs Organization*.
2. "Membership" (<http://www.wcoomd.org/en/about-us/wco-members/membership.aspx>). *World Customs Organization*.

External links

- Why HS codes are important (<http://www.3ce.com/resources/faqs>)
- ITC's Product Conversion Table on Market Access Map (<http://www.macmap.org/SupportMaterials/ProductNomenclature/Conversions.aspx>), an online database of customs tariffs and market requirements. The table allows you to search for product codes by name and convert them into any HS revision.
- World Bank's list of HS Codes products (<http://wits.worldbank.org/data/public/HSProducts.xls>)
- World Bank, Concordances from HS to other nomenclatures (http://wits.worldbank.org/product_concordance.html)
- HS Code Search Database (<http://www.foreign-trade.com/reference/hscodet.htm>) by Foreign Trade Online
- EU Combined Nomenclature Search Engine (http://ec.europa.eu/eurostat/ramon/search/index.cfm?TargetUrl=SRH_LABEL) by European Commission - Eurostat

Tariffs by region

- Customs Tariff of Canada (Canada Border Services Agency) (<http://www.cbsa-asfc.gc.ca/trade-commerce/tariff-tarif/2016/menu-eng.html>)
- Integrated Tariff of the European Union - TARIC (http://ec.europa.eu/taxation_customs/dds2/taric/taric_consultation.jsp?Lang=en)
- German Electronic Customs Tariff EZT-online (http://www.zoll.de/b0_zoll_und_steuern/a0_zoelle/c0_zollanmeldung/d10_atlas/e1_ezt_online/index.html)
- Central Excise Tariff of India (<http://www.cbec.gov.in/htdocs-cbec/excise/cxt2015-16/cxt-1516-idx>) by Department of Customs, Ministry of Revenue,

- East Africa Community Common External Tariff (<http://tradehelpdesk.eachq.org/tf/html/index.htm>) by Customs and Trade, East Africa Community, Governments of Burundi, Rwanda, Kenya, Uganda and the United Republic of Tanzania
- Japan Tariff Association – webpage refers to Japan Harmonised System Code Search (<http://www.kanzei.or.jp/english/>)
- Mexico import-export codes (Harmonized Tariff Schedule) (<http://www.siicex-caaarem.org.mx>) by SIICEX and CAAAREM
- UK Tariff Codes Datasets (<http://data.gov.uk/dataset/uk-tariff-codes-2009-2010>) by Data.Gov.UK
- Official Tariff Book of South Africa (South African Revenue Service) (<http://www.sars.gov.za/Legal/Primary-Legislation/Pages/Schedules-to-the-Customs-and-Excise-Act.aspx>)
- United States of America
 - U.S. import codes (Harmonized Tariff Schedule) (<http://www.usitc.gov/tata/hts/index.htm>) by U.S. International Trade Commission
 - U.S. export codes (<http://www.census.gov/foreign-trade/schedules/b/>) by U.S. Census Bureau
- Australian Customs & Border Protection Service - Working tariff 2012 (<http://www.customs.gov.au/tariff/tariff2012.asp>)

Retrieved from "https://en.wikipedia.org/w/index.php?title=Harmonized_System&oldid=786432985"

Categories: [Standards](#) | [Product classifications](#) | [Chemical numbering schemes](#) | [International trade](#) | [World Customs Organization](#)

-
- This page was last edited on 19 June 2017, at 12:59.
 - Text is available under the Creative Commons Attribution-ShareAlike License; additional terms may apply. By using this site, you agree to the Terms of Use and Privacy Policy. Wikipedia® is a registered trademark of the Wikimedia Foundation, Inc., a non-profit organization.