

資料-7

水理計算書

## Hydraulic Calculation of Transmission Pipelines

RGC/Source Borehole	Water Demand		Operation Hours	Design Discharge			Actual Head					Head Loss											
	Water Demand (m3/day)	Allocated Demand (m3/day)		Discharge (m3/hr)	Discharge (m3/min)	Discharge (m3/sec)	Elevated Tank GL (m)	Elevated Tank HWL (m)	Borehole GL (m)	Borehole LWL (m)	Actual Head (1) (m)	Riser Pipe			Transmission Pipeline				Head Loss in Elevated Tank Yard (4) (m)	Total Head of Motor Pump (1)+(2) +(3)+(4) (m)			
												Velocity Coefficient	Pipe Diameter (mm)	Length* (m)	Head Loss (2) (m)	Velocity Coefficient	Pipe Diameter (m)	Length (m)			Head Loss (3)** (m)		
1. Nambale	50	50	6 Stand-by	8.40	0.140	0.0023	1,112.70	1,133.10	1,106.17	1,070.07	63.03	110	80	40.0	0.40	110	0.1446	1,276.70	0.37	1.00	64.80		
I-03-NBH-1				2.60	0.043	0.0007	1,112.70	1,133.10	1,108.10	1,082.12	50.98	110	80	30.0	0.04	110	0.1446	1,055.70	0.03	1.00	52.06		
2. Lambala	47	47	6	7.80	0.131	0.0022	1,085.40	1,109.00	1,175.50	1,045.38	63.62	110	80	35.0	0.32	110	0.0814	483	2.11	1.00	67.05		
I-06-NBH-1				3.53	0.059	0.0010	1,094.60	1,108.40	1,067.20	1,041.27	67.13	110	50	30.0	0.33	110	0.0536	1,035.00	8.04	1.00	76.50		
3. Naigobya	46	46	13	14.70	0.245	0.0041	1,122.90	1,141.50	1,082.50	1,043.62	97.88	110	80	45.0	1.30	110	0.1242	4,872.00	8.60	1.00	108.78		
JTB-06				17.00	0.283	0.0047	1,076.30	1,097.50	1,065.90	1,035.41	62.09	110	80	35.0	1.30	110	0.0936	1,265.00	11.40	1.00	75.79		
4. Kyamvuma	88	88	6	7.00	0.117	0.0020	1,117.10	1,135.90	1,099.30	1,062.18	73.72	110	50	45.0	1.77	110	0.0936	1,920.00	3.56	1.00	80.05		
I-06-NBH-2				10.16	0.170	0.0028	1,073.80	1,094.80	1,074.80	1,049.93	44.87	110	80	30.0	0.43	110	0.0814	862.00	5.88	1.00	52.18		
5. Kasassira	271	271	16	-	1,057.50	1,056.40	1,027.84	29.66	110	80	35.0	0.32	110	0.0536	81.70	2.73	-	-	-	32.71			
DWD55991				2.57	0.043	0.0008	-	1,057.70	1,056.70	1,031.81	25.89	110	80	35.0	0.05	110	0.0936	181.60	0.60	-	-	26.54	
6. Kameke	42	42	6	10.57	0.176	0.0030	1,070.10	1,088.60	-	1,057.00	31.60	-	-	-	110	0.0936	2,740.20	10.76	1.00	43.36			
JTB-11				10.16	0.170	0.0028	1,073.80	1,094.80	1,074.80	1,049.93	44.87	110	80	30.0	0.43	110	0.0814	862.00	5.88	1.00	52.18		
7. Kapala	74	56	7	-	1,066.86	1,055.50	1,027.70	39.16	110	50	35.0	1.02	110	0.0766	558.00	2.03	-	-	-	42.21			
P-04-NBH-1				12.00	0.200	0.0033	-	1,088.86	1,061.30	1,029.54	59.32	110	50	40.0	3.97	110	0.0936	799.00	3.74	-	-	67.03	
P-04-NBH-2				18.00	0.300	0.0050	1,090.60	1,111.80	-	1,088.86	22.94	-	-	-	-	110	0.136	1,445.20	2.37	1.00	26.31		
Junction Pipe	74	74	7	-	-	-	-	-	-	-	-	-	-	-	-	-	-	-	-	-			
8. Buseta	61	61	6	-	1,066.86	1,055.50	1,027.70	39.16	110	50	35.0	1.02	110	0.0766	558.00	2.03	-	-	-	42.21			
P^05-NBH-1				12.00	0.200	0.0033	-	1,088.86	1,061.30	1,029.54	59.32	110	50	40.0	3.97	110	0.0936	799.00	3.74	-	-	67.03	
9. Kidetok	108	36	6	18.00	0.300	0.0050	1,090.60	1,111.80	-	1,088.86	22.94	-	-	-	-	110	0.136	1,445.20	2.37	1.00	26.31		
JTB-17				72	6	12.00	0.200	0.0033	-	1,088.86	1,061.30	1,029.54	59.32	110	50	40.0	3.97	110	0.0936	799.00	3.74	-	67.03
JTB-18				108	6	18.00	0.300	0.0050	1,090.60	1,111.80	-	1,088.86	22.94	-	-	-	-	110	0.136	1,445.20	2.37	1.00	26.31
Junction Pipe	108	108	6	18.00	0.300	0.0050	1,090.60	1,111.80	-	1,088.86	22.94	-	-	-	110	0.136	1,445.20	2.37	1.00	26.31			

Note:

\*: The water source of which diameter is 5in shall have riser pipes of DN50mm, and the others DN80mm.

\*\* : The following Hazen-Williams Equation is applied for calculating head loss in pipelines.

$$H_p = 10.666 \cdot C^{-1.85} \cdot D^{-4.87} \cdot Q^{1.85} \cdot L$$

where;

C: Velocity Coefficient

D: Diameter of pipe (m)

Q: Discharge (m3/sec)

L: Length of pipeline (m)

H<sub>p</sub>: Head loss (m)

# Hydraulic Calculation of Distribution Pipelines

## 1. Nambale RGC

Nambale RGC: Pressure and Velocity (Pipe Number)

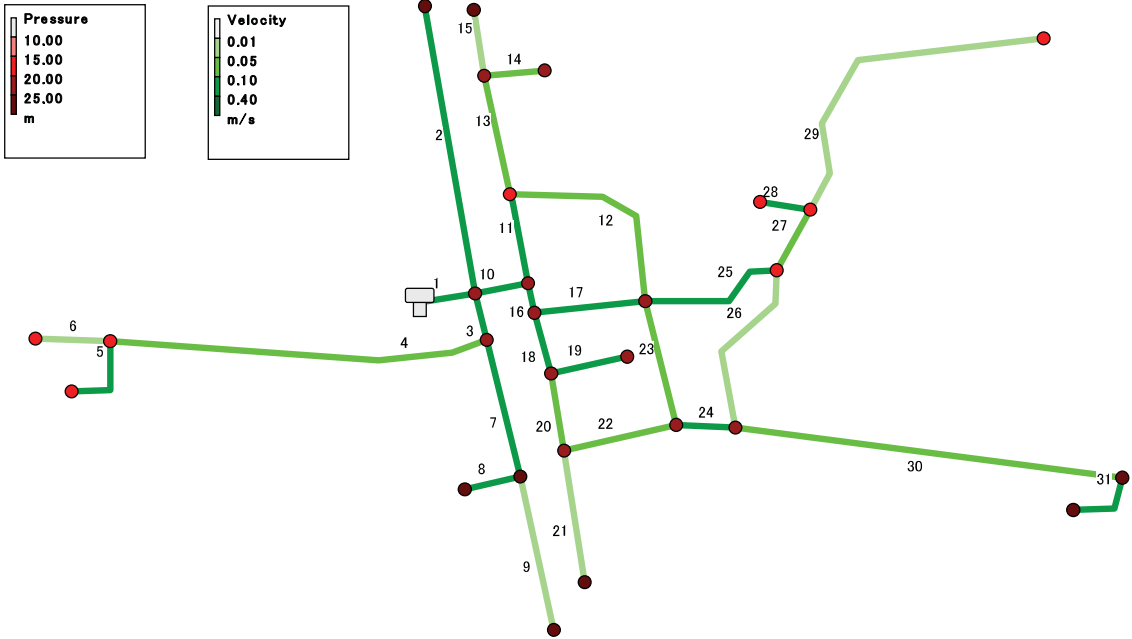

Nambale RGC (Node Number)

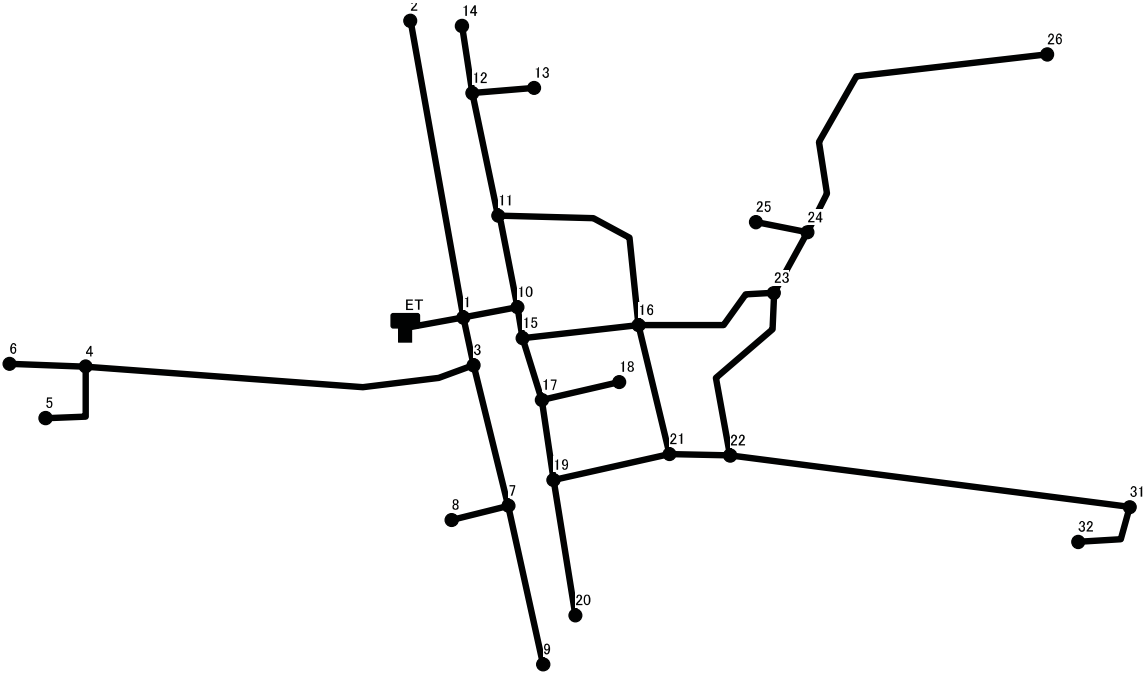

Nambale RGC : Network Table - Links

Link ID	Length(m)	Diameter(mm)	Roughness	Flow(CMD)	Velocity(m/s)	Unit Head loss(m/km)
Pipe1	12.70	99.40	110.00	200.12	0.30	1.78
Pipe2	567.40	57.00	110.00	27.28	0.12	0.67
Pipe3	69.00	81.40	110.00	58.88	0.13	0.49
Pipe4	601.50	81.40	110.00	32.28	0.07	0.16
Pipe5	6.10	28.40	110.00	8.88	0.16	2.48
Pipe6	13.80	57.00	110.00	5.88	0.03	0.04
Pipe7	173.10	57.00	110.00	22.60	0.10	0.47
Pipe8	13.70	28.40	110.00	9.40	0.17	2.76
Pipe9	223.20	57.00	110.00	4.68	0.02	0.03
Pipe10	30.10	81.40	110.00	109.96	0.24	1.56
Pipe11	76.70	57.00	110.00	32.71	0.15	0.93
Pipe12	187.80	57.00	110.00	11.71	0.05	0.14
Pipe13	249.90	57.00	110.00	17.00	0.08	0.28
Pipe14	1.70	28.40	110.00	5.40	0.10	0.96
Pipe15	235.70	57.00	110.00	5.36	0.02	0.03
Pipe16	20.30	81.40	110.00	73.25	0.16	0.73
Pipe17	102.10	57.00	110.00	30.34	0.14	0.81
Pipe18	53.80	57.00	110.00	38.91	0.18	1.29
Pipe19	11.20	28.40	110.00	14.76	0.27	6.37
Pipe20	84.00	57.00	110.00	20.15	0.09	0.38
Pipe21	300.40	57.00	110.00	4.68	0.02	0.03
Pipe22	100.80	57.00	110.00	11.47	0.05	0.13
Pipe23	135.10	57.00	110.00	-15.56	0.07	0.24
Pipe24	92.50	57.00	110.00	23.04	0.10	0.49
Pipe25	170.90	57.00	110.00	22.48	0.10	0.47
Pipe26	183.10	57.00	110.00	3.48	0.02	0.01
Pipe27	29.60	57.00	110.00	18.76	0.09	0.33
Pipe28	1.30	28.40	110.00	6.08	0.11	1.20
Pipe29	182.80	57.00	110.00	8.68	0.04	0.08
Pipe30	368.50	57.00	110.00	18.76	0.09	0.33
Pipe31	28.50	28.40	110.00	14.76	0.27	6.37

Nambale RGC : Network Table - Nodes

Node ID	Elevation(m)	Base Demand(CMD)	Demand(CMD)	Head(m)	Pressure(m)
Junc1	1112.72	1.00	4.00	1133.09	20.37
Junc2	1099.72	6.82	27.28	1132.71	32.99
Junc3	1112.56	1.00	4.00	1133.05	20.49
Junc4	1116.49	4.38	17.52	1132.96	16.47
Junc5	1116.76	2.22	8.88	1132.94	16.18
Junc6	1116.60	1.47	5.88	1132.96	16.36
Junc7	1106.69	2.13	8.52	1132.97	26.28
Junc8	1106.74	2.35	9.40	1132.93	26.19
Junc9	1096.77	1.17	4.68	1132.97	36.20
Junc10	1112.59	1.00	4.00	1133.04	20.45
Junc11	1113.06	1.00	4.00	1132.97	19.91
Junc12	1110.27	1.56	6.24	1132.90	22.63
Junc13	1109.86	1.35	5.40	1132.90	23.04
Junc14	1099.72	1.34	5.36	1132.89	33.17
Junc15	1112.41	1.00	4.00	1133.03	20.62
Junc16	1112.00	1.00	4.00	1132.94	20.94
Junc17	1111.88	1.00	4.00	1132.96	21.08
Junc18	1112.18	3.69	14.76	1132.89	20.70
Junc19	1110.47	1.00	4.00	1132.92	22.46
Junc20	1097.04	1.17	4.68	1132.92	35.88
Junc21	1111.11	1.00	4.00	1132.91	21.80
Junc22	1110.06	0.20	0.80	1132.87	22.81
Junc23	1113.82	1.80	7.20	1132.86	19.04
Junc24	1114.16	1.00	4.00	1132.85	18.69
Junc25	1114.16	1.52	6.08	1132.85	18.69
Junc26	1113.59	2.17	8.68	1132.84	19.25
Junc31	1106.66	1.00	4.00	1132.74	26.08
Junc32	1106.13	3.69	14.76	1132.56	26.43
Tank ET	1132.70	#N/A	-200.12	1133.11	0.41



## 2. Lambala RGC

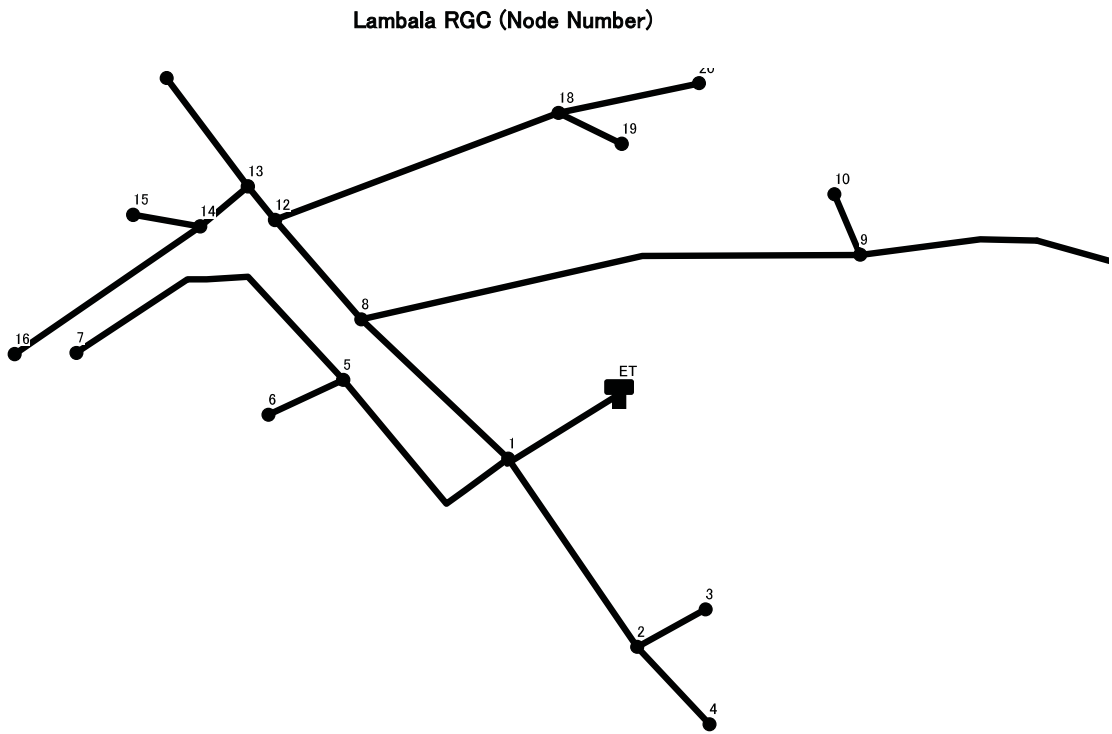
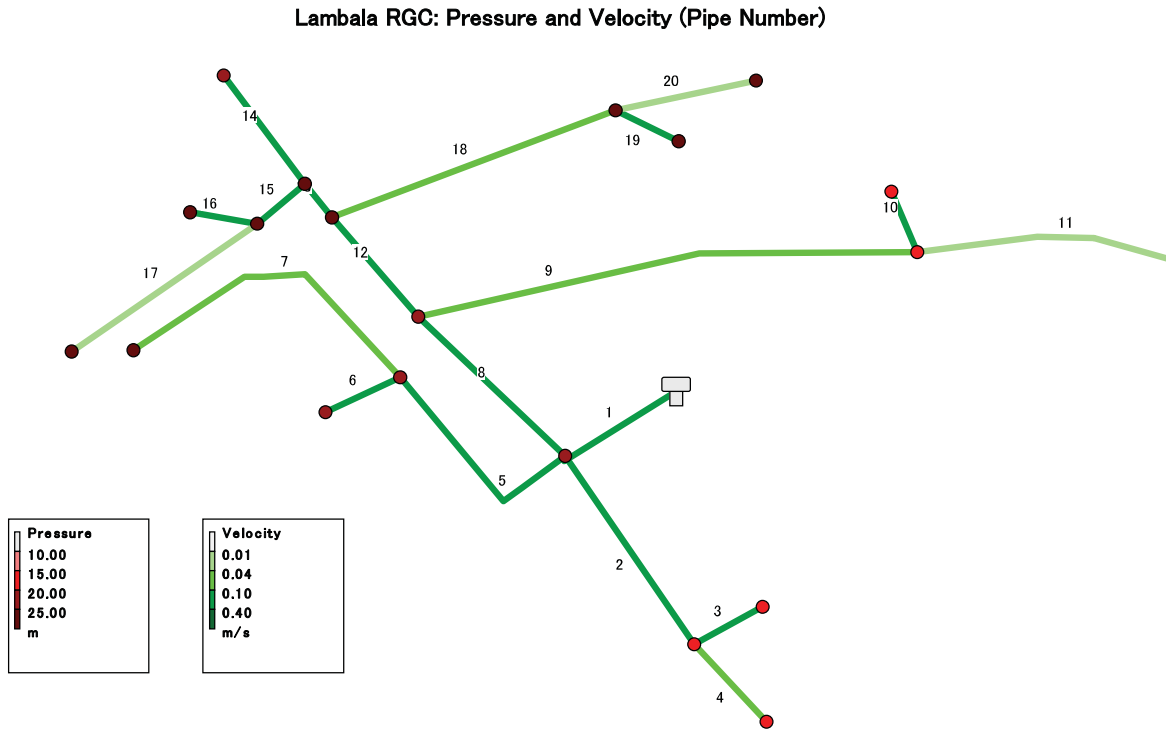

Lambala RGC : Network Table - Links

Link ID	Length(m)	Diameter(mm)	Roughness	Flow(CMD)	Velocity(m/s)	Unit Head loss(m/km)
Pipe1	87.70	99.40	110.00	188.12	0.28	1.59
Pipe2	394.30	57.00	110.00	24.16	0.11	0.53
Pipe3	2.90	28.40	110.00	10.08	0.18	3.16
Pipe4	0.40	57.00	110.00	10.08	0.05	0.19
Pipe5	108.90	57.00	110.00	29.60	0.13	0.78
Pipe6	2.40	28.40	110.00	8.08	0.15	2.08
Pipe7	255.40	57.00	110.00	17.52	0.08	0.29
Pipe8	106.00	99.40	110.00	127.64	0.19	0.77
Pipe9	345.60	81.40	110.00	26.88	0.06	0.11
Pipe10	19.50	28.40	110.00	10.08	0.18	3.14
Pipe11	169.40	81.40	110.00	10.08	0.02	0.02
Pipe12	137.50	81.40	110.00	96.76	0.22	1.23
Pipe13	30.00	81.40	110.00	69.88	0.16	0.67
Pipe14	206.90	57.00	110.00	41.72	0.19	1.47
Pipe15	16.70	57.00	110.00	24.16	0.11	0.53
Pipe16	210.20	28.40	110.00	12.08	0.22	4.39
Pipe17	132.40	57.00	110.00	8.08	0.04	0.07
Pipe18	241.10	57.00	110.00	20.16	0.09	0.38
Pipe19	4.00	28.40	110.00	9.12	0.17	2.60
Pipe20	79.20	57.00	110.00	7.04	0.03	0.05

Lambala RGC : Network Table - Nodes

Node ID	Elevation(m)	Base Demand(CMD)	Demand(CMD)	Head(m)	Pressure(m)
Junc1	1081.07	1.68	6.72	1105.67	24.60
Junc2	1086.84	1.00	4.00	1105.46	18.62
Junc3	1086.91	2.52	10.08	1105.45	18.54
Junc4	1086.84	2.52	10.08	1105.46	18.62
Junc5	1081.02	1.00	4.00	1105.59	24.57
Junc6	1081.02	2.02	8.08	1105.58	24.56
Junc7	1073.76	4.38	17.52	1105.51	31.75
Junc8	1081.28	1.00	4.00	1105.59	24.31
Junc9	1089.03	1.68	6.72	1105.55	16.52
Junc10	1088.56	2.52	10.08	1105.49	16.93
Junc11	1092.24	2.52	10.08	1105.55	13.31
Junc12	1076.21	1.68	6.72	1105.42	29.21
Junc13	1075.49	1.00	4.00	1105.40	29.91
Junc14	1075.06	1.00	4.00	1105.39	30.34
Junc15	1074.90	3.02	12.08	1104.47	29.57
Junc16	1073.84	2.02	8.08	1105.38	31.54
Junc17	1080.12	10.43	41.72	1105.10	24.98
Junc18	1076.95	1.00	4.00	1105.33	28.38
Junc19	1076.95	2.28	9.12	1105.32	28.37
Junc20	1077.54	1.76	7.04	1105.32	27.78
Tank ET	1105.40	#N/A	-188.12	1105.81	0.41

### 3. Naigobya RGC

Naigobya RGC: Pressure and Velocity ( Pipe Number )

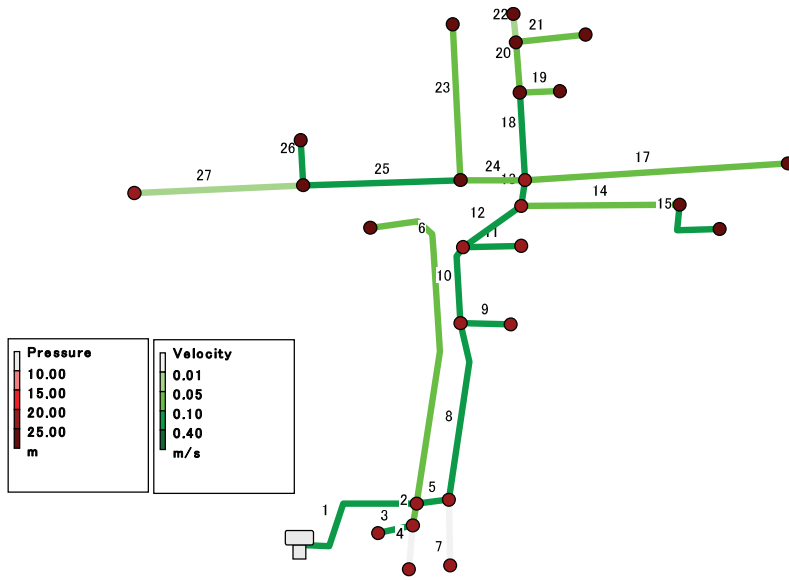

Naigobya RGC ( Node Number )

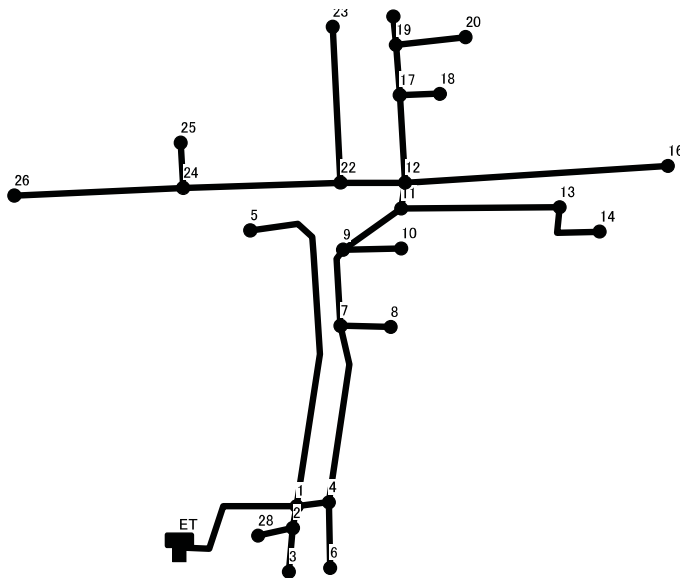

Naigobia RGC : Network Table - Links

Link ID	Length(m)	Diameter(mm)	Roughness	Flow(CMD)	Velocity(m/s)	Unit Head loss(m/km)
Pipe1	324.00	99.40	110.00	183.92	0.27	1.52
Pipe2	16.50	57.00	110.00	16.04	0.07	0.25
Pipe3	3.30	28.40	110.00	10.24	0.19	3.25
Pipe4	123.70	57.00	110.00	1.80	0.01	0.00
Pipe5	28.50	99.40	110.00	152.00	0.23	1.07
Pipe6	1061.70	57.00	110.00	11.88	0.05	0.14
Pipe7	126.60	57.00	110.00	1.76	0.01	0.00
Pipe8	419.80	81.40	110.00	146.24	0.33	2.64
Pipe9	1.50	28.40	110.00	13.80	0.25	5.61
Pipe10	293.20	81.40	110.00	128.44	0.29	2.07
Pipe11	8.70	28.40	110.00	13.80	0.25	5.62
Pipe12	63.80	81.40	110.00	110.64	0.25	1.57
Pipe13	28.50	81.40	110.00	83.04	0.18	0.92
Pipe14	179.20	57.00	110.00	21.68	0.10	0.44
Pipe15	2.00	28.40	110.00	13.80	0.25	5.62
Pipe17	317.70	57.00	110.00	13.80	0.06	0.19
Pipe18	372.00	57.00	110.00	23.76	0.11	0.52
Pipe19	3.30	28.40	110.00	4.92	0.09	0.83
Pipe20	344.40	57.00	110.00	12.92	0.06	0.17
Pipe21	4.10	28.40	110.00	5.36	0.10	0.96
Pipe22	191.90	57.00	110.00	3.56	0.02	0.02
Pipe23	865.70	57.00	110.00	13.76	0.06	0.19
Pipe24	42.00	81.40	110.00	-41.48	0.09	0.26
Pipe25	220.20	57.00	110.00	23.72	0.11	0.52
Pipe26	0.30	28.40	110.00	13.80	0.25	5.46
Pipe27	348.10	57.00	110.00	5.92	0.03	0.04

Naigobia RGC : Network Table - Nodes

Node ID	Elevation(m)	Base Demand(CMD)	Demand(CMD)	Head(m)	Pressure(m)
Junc1	1081.60	1.00	4.00	1104.42	22.82
Junc2	1082.51	1.00	4.00	1104.41	21.90
Junc3	1082.33	0.45	1.80	1104.41	22.08
Junc4	1081.60	1.00	4.00	1104.39	22.79
Junc5	1069.87	2.97	11.88	1104.26	34.39
Junc6	1082.51	0.44	1.76	1104.39	21.88
Junc7	1080.64	1.00	4.00	1103.28	22.64
Junc8	1080.64	3.45	13.80	1103.27	22.63
Junc9	1078.53	1.00	4.00	1102.67	24.14
Junc10	1078.53	3.45	13.80	1102.62	24.09
Junc11	1077.73	1.48	5.92	1102.57	24.84
Junc12	1077.59	1.00	4.00	1102.54	24.95
Junc13	1074.61	1.97	7.88	1102.49	27.88
Junc14	1074.61	3.45	13.80	1102.48	27.87
Junc16	1070.10	3.45	13.80	1102.48	32.38
Junc17	1075.40	1.48	5.92	1102.35	26.95
Junc18	1075.40	1.23	4.92	1102.35	26.95
Junc19	1075.89	1.00	4.00	1102.30	26.40
Junc20	1075.89	1.34	5.36	1102.29	26.40
Junc21	1074.99	0.89	3.56	1102.29	27.30
Junc22	1077.27	1.00	4.00	1102.53	25.26
Junc23	1075.52	3.44	13.76	1102.37	26.85
Junc24	1071.61	1.00	4.00	1102.42	30.81
Junc25	1071.61	3.45	13.80	1102.42	30.81
Junc26	1080.91	1.48	5.92	1102.41	21.50
Junc28	1082.51	2.56	10.24	1104.40	21.89
Tank ET	1104.60	#N/A	-183.92	1104.91	0.31

4. Kyanvuma RGC

Kyanvuma RGC : Pressure and Velocity ( Pipe Number )

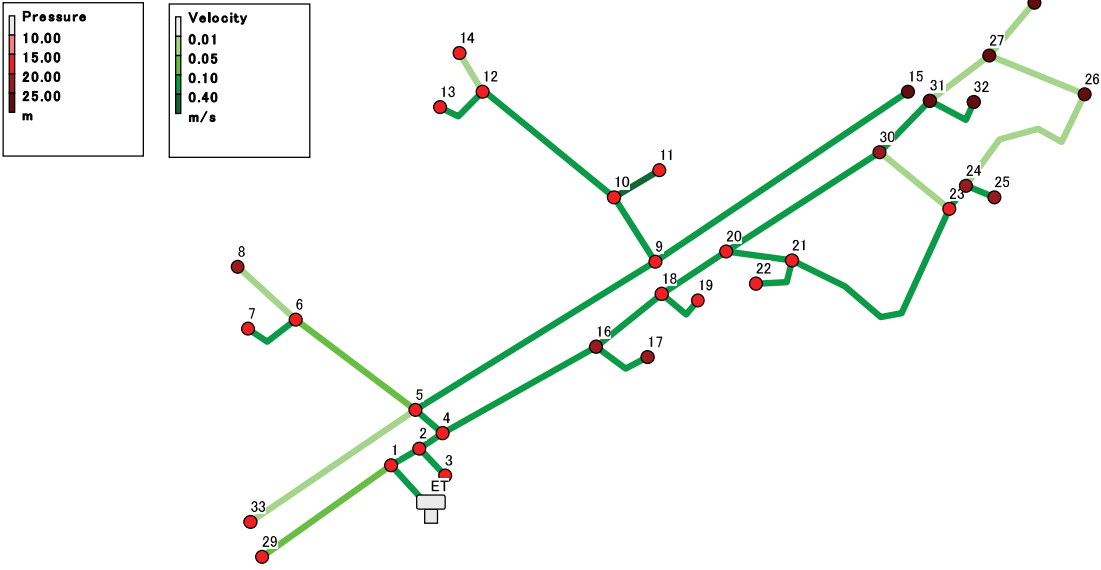

Kyanvuma RGC ( Node Number )

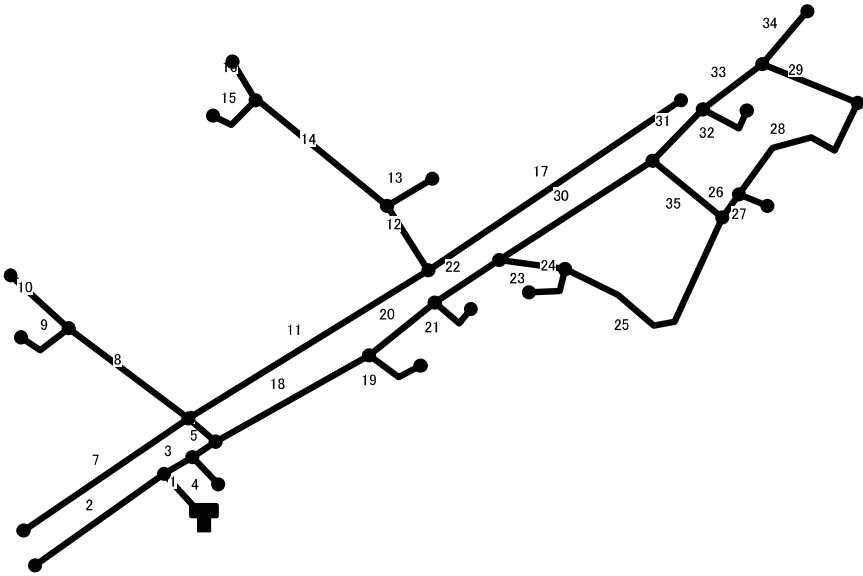

Kyanvuma RGC : Network Table - Links

Link ID	Length(m)	Diameter(mm)	Roughness	Flow(CMD)	Velocity(m/s)	Unit Head loss(m/km)
Pipe1	90.50	144.60	110.00	356.04	0.25	0.83
Pipe2	345.80	81.40	110.00	38.28	0.09	0.22
Pipe3	7.90	144.60	110.00	315.76	0.22	0.67
Pipe4	0.10	28.40	110.00	10.92	0.20	3.72
Pipe5	15.20	144.60	110.00	302.84	0.21	0.62
Pipe6	28.50	99.40	110.00	174.04	0.26	1.38
Pipe7	340.50	57.00	110.00	8.04	0.04	0.07
Pipe8	170.20	57.00	110.00	20.96	0.10	0.41
Pipe9	3.40	28.40	110.00	9.20	0.17	2.67
Pipe10	175.90	57.00	110.00	9.76	0.04	0.10
Pipe11	760.30	99.40	110.00	141.04	0.21	0.93
Pipe12	123.50	81.40	110.00	84.16	0.19	0.95
Pipe13	1.20	28.40	110.00	22.96	0.42	14.45
Pipe14	322.70	81.40	110.00	53.56	0.12	0.41
Pipe15	28.50	28.40	110.00	18.36	0.34	9.54
Pipe16	38.50	57.00	110.00	4.60	0.02	0.03
Pipe17	493.70	57.00	110.00	33.92	0.15	1.00
Pipe18	347.80	99.40	110.00	126.80	0.19	0.76
Pipe19	0.20	28.40	110.00	18.96	0.35	10.42
Pipe20	179.50	99.40	110.00	103.84	0.15	0.53
Pipe21	19.10	28.40	110.00	18.96	0.35	10.13
Pipe22	272.10	99.40	110.00	80.88	0.12	0.33
Pipe23	38.40	57.00	110.00	41.59	0.19	1.46
Pipe24	4.90	28.40	110.00	14.96	0.27	6.53
Pipe25	373.10	57.00	110.00	22.63	0.10	0.47
Pipe26	53.60	57.00	110.00	27.09	0.12	0.66
Pipe27	4.40	28.40	110.00	12.08	0.22	4.38
Pipe28	217.40	57.00	110.00	11.01	0.05	0.12
Pipe29	205.10	57.00	110.00	4.13	0.02	0.02
Pipe30	201.10	57.00	110.00	35.29	0.16	1.07
Pipe31	170.30	57.00	110.00	22.83	0.10	0.48
Pipe32	11.80	28.40	110.00	16.08	0.29	7.46
Pipe33	59.50	57.00	110.00	2.75	0.01	0.01
Pipe34	149.40	57.00	110.00	4.60	0.02	0.02
Pipe35	207.30	57.00	110.00	8.46	0.04	0.08

Kyanvuma RGC : Network Table - Nodes

Node ID	Elevation(m)	Base Demand(CMD)	Demand(CMD)	Head(m)	Pressure(m)
Junc1	1123.18	0.50	2.00	1138.23	15.05
Junc2	1123.14	0.50	2.00	1138.23	15.09
Junc3	1123.14	2.73	10.92	1138.23	15.09
Junc4	1122.84	0.50	2.00	1138.22	15.38
Junc5	1122.74	1.00	4.00	1138.18	15.44
Junc6	1120.60	0.50	2.00	1138.11	17.51
Junc7	1120.60	2.30	9.20	1138.10	17.50
Junc8	1117.41	2.44	9.76	1138.09	20.68
Junc9	1121.20	5.74	22.96	1137.47	16.27
Junc10	1121.13	1.91	7.64	1137.36	16.22
Junc11	1121.13	5.74	22.96	1137.34	16.20
Junc12	1119.93	7.65	30.60	1137.22	17.29
Junc13	1119.93	4.59	18.36	1136.95	17.02
Junc14	1119.77	1.15	4.60	1137.22	17.45
Junc15	1107.46	8.48	33.92	1136.98	29.52
Junc16	1116.74	1.00	4.00	1137.95	21.21
Junc17	1116.74	4.74	18.96	1137.95	21.21
Junc18	1118.83	1.00	4.00	1137.86	19.03
Junc19	1118.63	4.74	18.96	1137.67	19.04
Junc20	1121.08	1.00	4.00	1137.77	16.69
Junc21	1122.27	1.00	4.00	1137.71	15.45
Junc22	1121.32	3.74	14.96	1137.68	16.36
Junc23	1118.10	1.00	4.00	1137.54	19.44
Junc24	1117.42	1.00	4.00	1137.50	20.09
Junc25	1117.42	3.02	12.08	1137.48	20.07
Junc26	1112.12	1.72	6.88	1137.47	25.35
Junc27	1109.32	0.57	2.28	1137.47	28.15
Junc28	1102.80	1.15	4.60	1137.47	34.67
Junc29	1119.73	9.57	38.28	1138.16	18.43
Junc30	1116.96	1.00	4.00	1137.55	20.59
Junc31	1111.46	1.00	4.00	1137.47	26.01
Junc32	1111.46	4.02	16.08	1137.38	25.92
Junc33	1120.00	2.01	8.04	1138.16	18.16
Tank ET	1137.90	#N/A	-356.04	1138.31	0.41

5. Kasassira RGC

Kasassira RGC: Pressure and Velocity (Pipe Number)

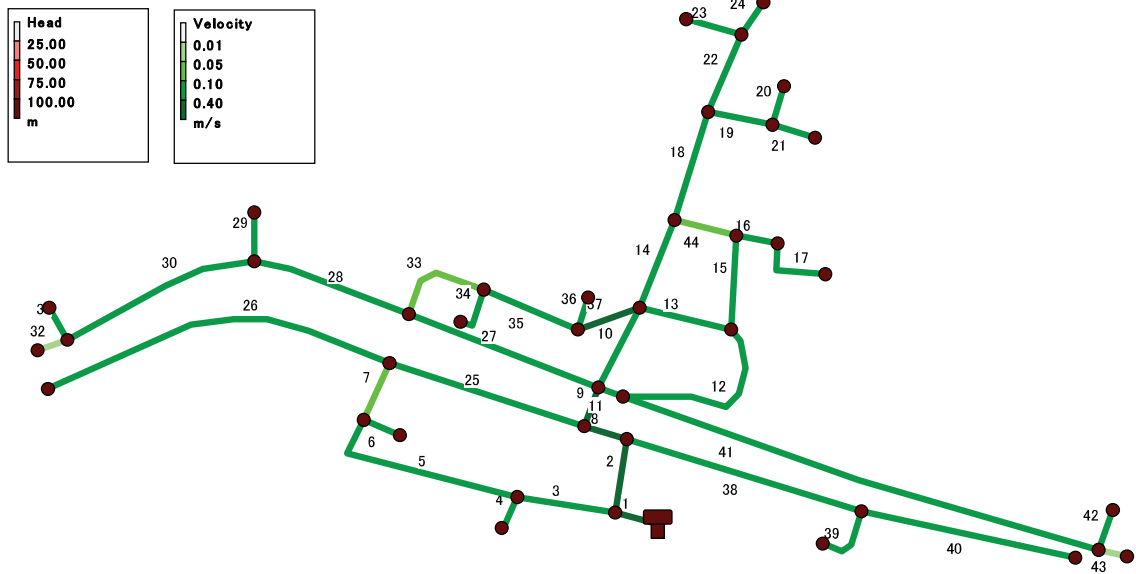

Kasassira RGC (Node Number)

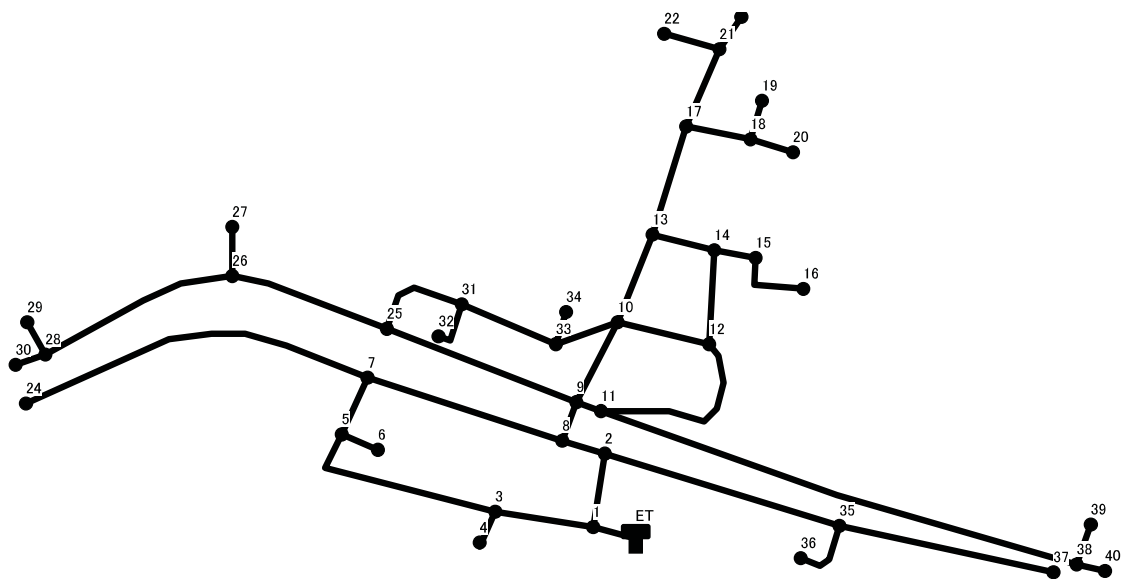



Kasassira RGC : Network Table - Links

Link ID	Length(m)	Diameter(mm)	Roughness	Flow(CMD)	Velocity(m/s)	Unit Head loss(m/km)
Pipe1	22.80	144.60	110.00	1086.20	0.77	6.58
Pipe2	87.20	144.60	110.00	905.90	0.64	4.70
Pipe3	131.20	81.40	110.00	178.30	0.40	3.81
Pipe4	5.10	57.00	110.00	51.76	0.23	2.19
Pipe5	275.20	81.40	110.00	118.54	0.26	1.79
Pipe6	4.10	57.00	110.00	51.76	0.23	2.18
Pipe7	72.20	81.40	110.00	44.18	0.10	0.29
Pipe8	61.80	144.60	110.00	743.26	0.52	3.26
Pipe9	28.50	144.60	110.00	635.92	0.45	2.44
Pipe10	71.50	144.60	110.00	383.93	0.27	0.96
Pipe11	31.60	99.40	110.00	119.47	0.18	0.69
Pipe12	180.20	57.00	110.00	25.67	0.12	0.60
Pipe13	130.40	57.00	110.00	-22.42	0.10	0.46
Pipe14	95.00	99.40	110.00	172.39	0.26	1.35
Pipe15	59.30	57.00	110.00	40.09	0.18	1.36
Pipe16	27.00	57.00	110.00	-43.76	0.20	1.60
Pipe17	2.40	57.00	110.00	-35.76	0.16	1.12
Pipe18	238.40	81.40	110.00	152.72	0.34	2.86
Pipe19	36.70	57.00	110.00	70.36	0.32	3.86
Pipe20	2.80	57.00	110.00	39.76	0.18	1.36
Pipe21	46.00	57.00	110.00	22.60	0.10	0.47
Pipe22	474.50	81.40	110.00	74.36	0.17	0.75
Pipe23	20.00	57.00	110.00	51.76	0.23	2.18
Pipe24	22.10	57.00	110.00	22.60	0.10	0.47
Pipe25	310.80	81.40	110.00	99.34	0.22	1.29
Pipe26	805.20	81.40	110.00	135.52	0.30	2.29
Pipe27	314.40	81.40	110.00	124.52	0.28	1.96
Pipe28	231.30	81.40	110.00	143.52	0.32	2.55
Pipe29	7.40	57.00	110.00	59.76	0.27	2.85
Pipe30	582.30	57.00	110.00	75.76	0.34	4.42
Pipe31	0.30	57.00	110.00	61.00	0.28	2.98
Pipe32	4.40	57.00	110.00	6.76	0.03	0.05
Pipe33	123.80	81.40	110.00	-27.00	0.06	0.12
Pipe34	1.70	57.00	110.00	55.76	0.25	2.50
Pipe35	212.80	81.40	110.00	-105.36	0.23	1.44
Pipe36	14.30	57.00	110.00	67.76	0.31	3.60
Pipe37	57.90	81.40	110.00	-181.12	0.40	3.92
Pipe38	446.80	81.40	110.00	154.64	0.34	2.92
Pipe39	3.10	57.00	110.00	40.64	0.18	1.39
Pipe40	392.70	57.00	110.00	54.24	0.25	2.38
Pipe41	825.00	99.40	110.00	85.80	0.13	0.37
Pipe42	0.10	57.00	110.00	33.88	0.15	0.74
Pipe43	36.20	57.00	110.00	6.76	0.03	0.05
Pipe44	93.10	57.00	110.00	11.67	0.05	0.14

Kasassira RGC : Network Table - Nodes

Node ID	Elevation(m)	Base Demand (CMD)	Demand(CMD)	Head(m)	Pressure(m)
Junc1	1076.40	0.50	2.00	1093.96	17.56
Junc2	1075.78	2.00	8.00	1093.55	17.77
Junc3	1075.36	2.00	8.00	1093.46	18.10
Junc4	1075.18	12.94	51.76	1093.45	18.27
Junc5	1071.97	5.65	22.60	1092.97	20.99
Junc6	1072.07	12.94	51.76	1092.96	20.89
Junc7	1070.90	2.00	8.00	1092.95	22.05
Junc8	1075.14	2.00	8.00	1093.35	18.21
Junc9	1075.08	2.00	8.00	1093.28	18.20
Junc10	1074.95	2.00	8.00	1093.21	18.26
Junc11	1075.36	2.00	8.00	1093.26	17.90
Junc12	1075.00	2.00	8.00	1093.15	18.15
Junc13	1074.52	2.00	8.00	1093.08	18.56
Junc14	1074.42	2.00	8.00	1093.07	18.65
Junc15	1074.62	2.00	8.00	1093.03	18.41
Junc16	1074.62	8.94	35.76	1093.02	18.41
Junc17	1070.82	2.00	8.00	1092.40	21.58
Junc18	1070.94	2.00	8.00	1092.26	21.32
Junc19	1070.89	9.94	39.76	1092.26	21.37
Junc20	1071.26	5.65	22.60	1092.24	20.98
Junc21	1065.22	0.00	0.00	1092.04	26.83
Junc22	1065.16	12.94	51.76	1092.00	26.84
Junc23	1064.99	5.65	22.60	1092.03	27.04
Junc24	1071.00	33.88	135.52	1091.10	20.10
Junc25	1070.62	2.00	8.00	1092.66	22.04
Junc26	1070.08	2.00	8.00	1092.07	21.99
Junc27	1069.92	14.94	59.76	1092.05	22.14
Junc28	1070.73	2.00	8.00	1089.50	18.77
Junc29	1070.73	15.25	61.00	1089.50	18.76
Junc30	1070.74	1.69	6.76	1089.50	18.76
Junc31	1069.90	5.65	22.60	1092.68	22.78
Junc32	1069.90	13.94	55.76	1092.67	22.78
Junc33	1074.01	2.00	8.00	1092.98	18.98
Junc34	1073.88	16.94	67.76	1092.93	19.06
Junc35	1076.50	14.94	59.76	1092.24	15.74
Junc36	1076.52	10.16	40.64	1092.24	15.72
Junc37	1077.13	13.56	54.24	1091.31	14.18
Junc38	1075.92	11.29	45.16	1092.95	17.03
Junc39	1075.92	8.47	33.88	1092.95	17.03
Junc40	1076.34	1.69	6.76	1092.95	16.61
Tank ET	1093.80	#N/A	-1086.20	1094.11	0.31

## 6. Kameke RGC

### Kamake RGC : Pressure and Velocity ( Pipe Number )

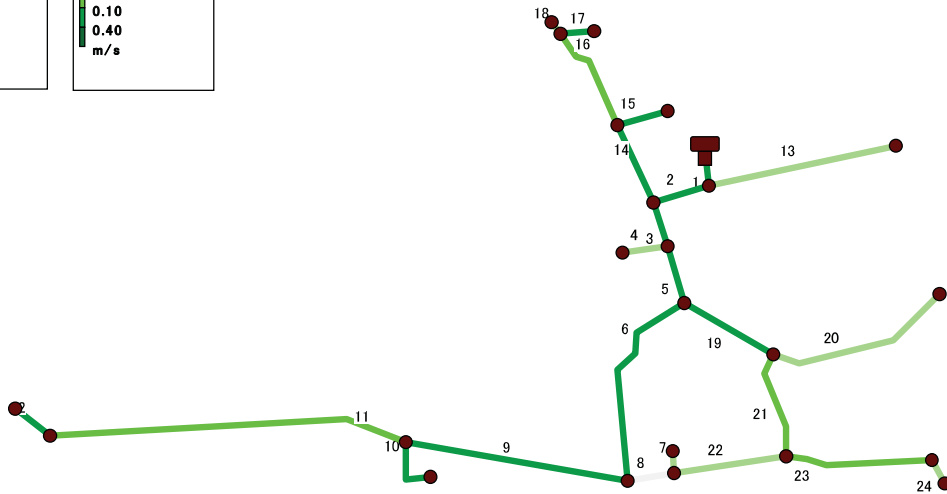
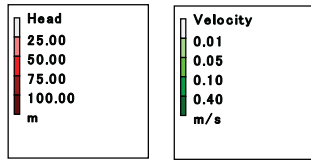

### Kamake RGC ( Node Number )

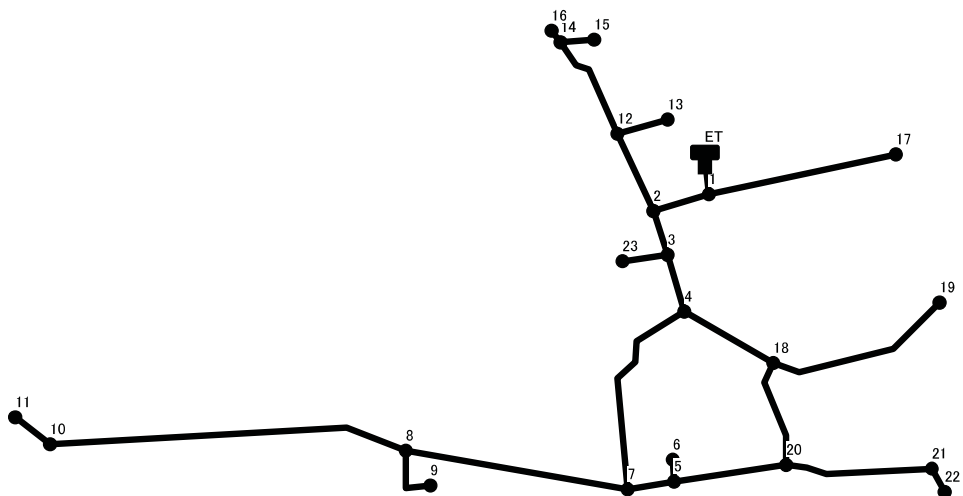

Kameke RGC: Network Table - Links

Link ID	Length(m)	Diameter(mm)	Roughness	Flow(CMD)	Velocity(m/s)	Unit Head loss(m/km)
Pipe1	25.10	99.40	110.00	168.00	0.25	1.29
Pipe2	81.20	99.40	110.00	157.40	0.23	1.14
Pipe3	45.30	99.40	110.00	122.00	0.18	0.71
Pipe4	17.60	57.00	110.00	10.60	0.05	0.11
Pipe5	54.20	99.40	110.00	107.40	0.16	0.56
Pipe6	257.20	81.40	110.00	50.39	0.11	0.37
Pipe7	7.90	57.00	110.00	8.60	0.04	0.08
Pipe8	31.40	81.40	110.00	-3.79	0.01	0.00
Pipe9	500.00	57.00	110.00	42.40	0.19	1.51
Pipe10	106.60	28.40	110.00	8.60	0.16	2.34
Pipe11	778.00	57.00	110.00	16.60	0.08	0.27
Pipe12	35.30	28.40	110.00	12.60	0.23	4.75
Pipe13	132.40	57.00	110.00	8.60	0.04	0.08
Pipe14	138.50	57.00	110.00	31.40	0.14	0.87
Pipe15	4.50	28.40	110.00	10.60	0.19	3.46
Pipe16	258.60	57.00	110.00	16.60	0.08	0.27
Pipe17	13.30	28.40	110.00	10.08	0.18	3.14
Pipe18	70.20	57.00	110.00	2.52	0.01	0.01
Pipe19	110.10	81.40	110.00	53.01	0.12	0.40
Pipe20	544.40	57.00	110.00	8.40	0.04	0.08
Pipe21	126.40	81.40	110.00	40.61	0.09	0.25
Pipe22	243.80	81.40	110.00	21.81	0.05	0.08
Pipe23	247.60	57.00	110.00	14.80	0.07	0.22
Pipe24	42.10	57.00	110.00	10.60	0.05	0.11

Kameke RGC : Network Table - Nodes

Node ID	Elevation(m)	Base Demand(CMD)	Demand (CMD)	Head(m)	Pressure(m)
Junc1	1116.93	0.50	2.00	1132.38	15.45
Junc2	1117.54	1.00	4.00	1132.28	14.74
Junc3	1117.51	1.00	4.00	1132.25	14.74
Junc4	1117.28	1.00	4.00	1132.22	14.94
Junc5	1116.95	4.25	17.00	1132.13	15.18
Junc6	1117.08	2.15	8.60	1132.13	15.05
Junc7	1116.53	1.05	4.20	1132.13	15.60
Junc8	1111.61	4.30	17.20	1131.37	19.77
Junc9	1110.87	2.15	8.60	1131.12	20.26
Junc10	1098.14	1.00	4.00	1131.17	33.03
Junc11	1099.28	3.15	12.60	1131.00	31.72
Junc12	1117.89	1.05	4.20	1132.17	14.28
Junc13	1117.99	2.65	10.60	1132.15	14.16
Junc14	1114.78	1.00	4.00	1132.10	17.32
Junc15	1114.99	2.52	10.08	1132.05	17.07
Junc16	1113.06	0.63	2.52	1132.10	19.04
Junc17	1115.44	2.15	8.60	1132.37	16.93
Junc18	1116.25	1.00	4.00	1132.18	15.92
Junc19	1111.12	2.10	8.40	1132.14	21.02
Junc20	1115.96	1.00	4.00	1132.15	16.18
Junc21	1111.88	1.05	4.20	1132.09	20.21
Junc22	1111.41	2.65	10.60	1132.09	20.68
Junc23	1117.79	2.65	10.60	1132.25	14.46
Tank ET	1132.10	#N/A	-168.00	1132.41	0.31

7. Kapala RGC

Kapala RGC : Pressure and Velocity ( Pipe Number )

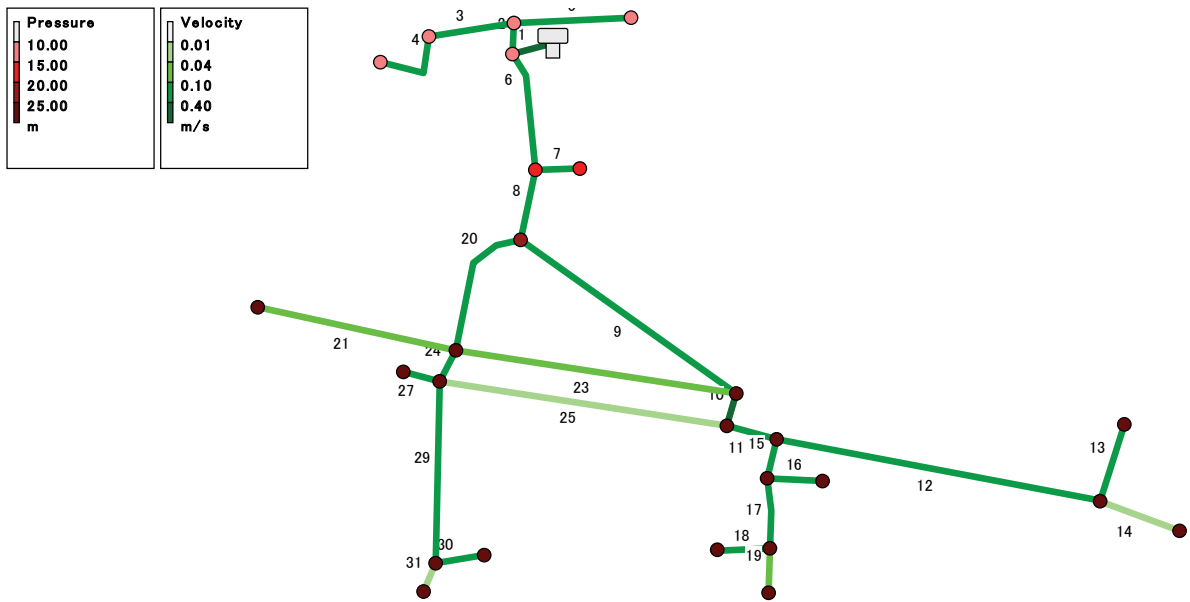

Kapala RGC ( Node Number )

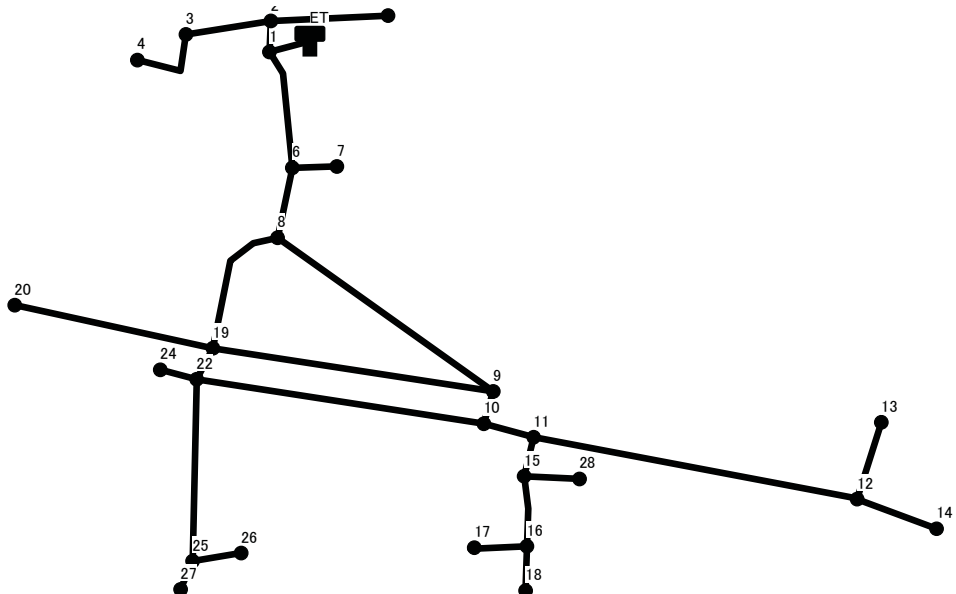

Kapala RGC : Network Table - Links

Link ID	Length(m)	Diameter(mm)	Roughness	Flow(CMD)	Velocity(m/s)	Unit Head loss(m/km)
Pipe1	4.60	99.40	110.00	295.96	0.44	3.67
Pipe2	10.70	81.40	110.00	75.48	0.17	0.78
Pipe3	101.50	57.00	110.00	45.12	0.20	1.69
Pipe4	8.30	28.40	110.00	18.76	0.34	9.92
Pipe5	84.20	57.00	110.00	26.36	0.12	0.63
Pipe6	499.50	99.40	110.00	216.48	0.32	2.06
Pipe7	3.80	28.40	110.00	18.76	0.34	9.93
Pipe8	171.00	99.40	110.00	178.96	0.27	1.45
Pipe9	509.40	81.40	110.00	114.46	0.25	1.67
Pipe10	32.40	57.00	110.00	89.28	0.40	5.99
Pipe11	45.20	57.00	110.00	87.44	0.40	5.77
Pipe12	300.40	57.00	110.00	26.76	0.12	0.64
Pipe13	23.50	28.40	110.00	18.20	0.33	9.39
Pipe14	34.20	57.00	110.00	4.56	0.02	0.02
Pipe15	31.40	57.00	110.00	56.68	0.26	2.59
Pipe16	9.10	28.40	110.00	14.76	0.27	6.36
Pipe17	162.90	57.00	110.00	37.92	0.17	1.23
Pipe18	4.20	28.40	110.00	16.48	0.30	7.81
Pipe19	99.20	57.00	110.00	17.44	0.08	0.29
Pipe20	372.90	57.00	110.00	56.90	0.26	2.60
Pipe21	9.20	57.00	110.00	-12.16	0.06	0.15
Pipe23	282.10	57.00	110.00	-21.18	0.10	0.42
Pipe24	27.80	57.00	110.00	58.32	0.26	2.72
Pipe25	18.20	57.00	110.00	5.76	0.03	0.04
Pipe27	5.70	28.40	110.00	-18.20	0.33	9.39
Pipe29	333.70	57.00	110.00	30.36	0.14	0.81
Pipe30	123.50	28.40	110.00	18.20	0.33	9.39
Pipe31	287.40	57.00	110.00	4.56	0.02	0.02

Kapala RGC : Network Table - Nodes

Node ID	Elevation(m)	Base Demand(CMD)	Demand(CMD)	Head(m)	Pressure(m)
Junc1	1072.77	1.00	4.00	1085.49	12.72
Junc2	1072.77	1.00	4.00	1085.48	12.71
Junc3	1072.95	6.59	26.36	1085.31	12.36
Junc4	1072.95	4.69	18.76	1085.23	12.28
Junc5	1073.00	6.59	26.36	1085.43	12.43
Junc6	1065.80	4.69	18.76	1084.46	18.66
Junc7	1065.80	4.69	18.76	1084.43	18.63
Junc8	1062.17	1.90	7.60	1084.22	22.05
Junc9	1058.02	1.00	4.00	1083.36	25.34
Junc10	1057.62	1.90	7.60	1083.17	25.55
Junc11	1057.21	1.00	4.00	1082.91	25.70
Junc12	1052.02	1.00	4.00	1082.71	30.70
Junc13	1052.19	4.55	18.20	1082.49	30.30
Junc14	1051.15	1.14	4.56	1082.71	31.56
Junc15	1057.07	1.00	4.00	1082.83	25.76
Junc16	1055.72	1.00	4.00	1082.63	26.91
Junc17	1055.72	4.12	16.48	1082.59	26.87
Junc18	1055.08	4.36	17.44	1082.60	27.52
Junc19	1054.87	1.90	7.60	1083.25	28.38
Junc20	1053.12	3.04	12.16	1083.24	30.12
Junc22	1055.02	1.00	4.00	1083.17	28.15
Junc24	1055.30	4.55	18.20	1083.12	27.82
Junc25	1054.74	1.90	7.60	1082.90	28.16
Junc26	1054.73	4.55	18.20	1081.74	27.01
Junc27	1054.74	1.14	4.56	1082.89	28.15
Junc28	1057.05	3.69	14.76	1082.77	25.72
Tank ET	1085.10	#N/A	-295.96	1085.51	0.41

# 8. Buseta RGC

## Buseta RGC: Pressure and Velocity (Pipe Number)

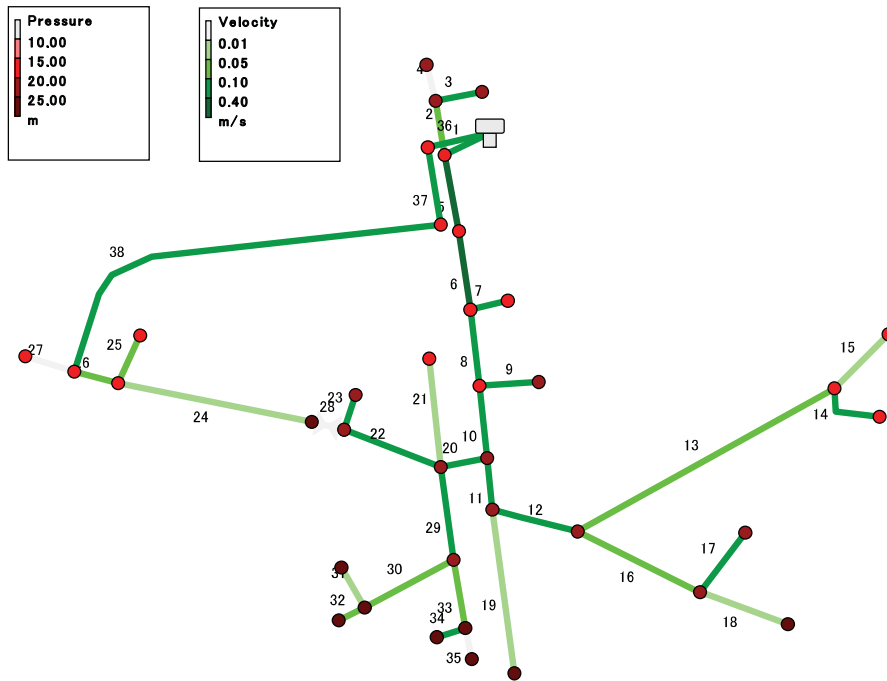

## Buseta RGC (Node Number)

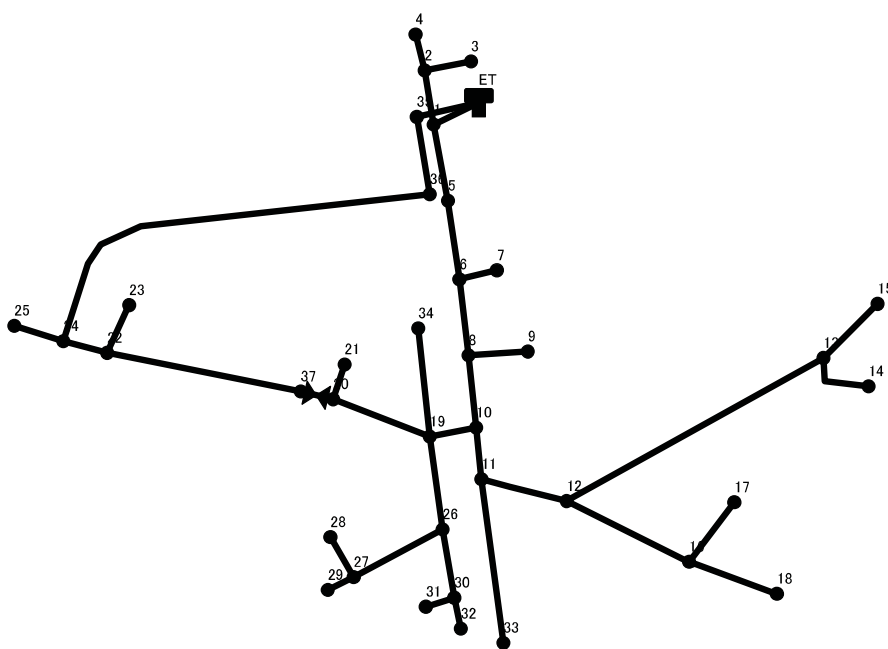

Buseta RGC : Network Table - Links

Link ID	Length(m)	Diameter(mm)	Roughness	Flow(CMD)	Velocity(m/S)	Unit Head loss(m/km)
Pipe1	19.70	99.40	110.00	213.52	0.32	2.01
Pipe2	227.20	57.00	110.00	17.04	0.08	0.28
Pipe3	10.30	28.40	110.00	11.32	0.21	3.89
Pipe4	100.80	57.00	110.00	1.72	0.01	0.00
Pipe5	160.30	81.40	110.00	192.48	0.43	4.38
Pipe6	241.30	81.40	110.00	181.12	0.40	3.92
Pipe7	8.50	28.40	110.00	13.04	0.24	5.07
Pipe8	276.70	81.40	110.00	162.40	0.36	3.20
Pipe9	79.90	28.40	110.00	10.24	0.19	3.24
Pipe10	232.20	81.40	110.00	148.16	0.33	2.70
Pipe11	66.00	57.00	110.00	55.64	0.25	2.50
Pipe12	94.50	57.00	110.00	-41.44	0.19	1.45
Pipe13	550.90	57.00	110.00	17.04	0.08	0.28
Pipe14	4.60	28.40	110.00	9.64	0.18	2.90
Pipe15	103.50	57.00	110.00	3.40	0.02	0.01
Pipe16	159.80	57.00	110.00	20.40	0.09	0.39
Pipe17	5.70	28.40	110.00	6.24	0.11	1.29
Pipe18	94.70	57.00	110.00	8.48	0.04	0.08
Pipe19	570.00	57.00	110.00	10.20	0.05	0.11
Pipe20	38.50	57.00	110.00	72.12	0.33	4.04
Pipe21	284.60	57.00	110.00	6.80	0.03	0.05
Pipe22	244.00	57.00	110.00	26.08	0.12	0.61
Pipe24	518.90	57.00	110.00	7.92	0.04	0.07
Pipe23	4.30	28.40	110.00	13.04	0.24	5.05
Pipe25	6.30	28.40	110.00	3.40	0.06	0.41
Pipe26	46.80	57.00	110.00	-15.32	0.07	0.23
Pipe27	33.50	57.00	110.00	1.72	0.01	0.00
Pipe29	149.50	57.00	110.00	35.24	0.16	1.07
Pipe30	209.90	57.00	110.00	18.72	0.08	0.33
Pipe31	10.80	57.00	110.00	9.64	0.04	0.10
Pipe32	4.40	28.40	110.00	3.40	0.06	0.41
Pipe33	264.30	57.00	110.00	12.52	0.06	0.16
Pipe34	3.90	28.40	110.00	6.80	0.12	1.51
Pipe35	19.80	57.00	110.00	1.72	0.01	0.00
Pipe36	19.70	57.00	110.00	30.72	0.14	0.83
Pipe37	160.30	57.00	110.00	26.72	0.12	0.64
Pipe38	656.00	57.00	110.00	22.72	0.10	0.48
Valve28	#N.iA	57.00	#N.iA	0.00	0.00	0.00



Buseta RGC : Network Table - Nodes

Node ID	Elevation(m)	Base Demand(CMD)	Demand	Head(m)	Pressure(m)
Junc1	1074.39	1.00	4.00	1091.67	17.28
Junc2	1070.14	1.00	4.00	1091.61	21.47
Junc3	1070.34	2.83	11.32	1091.57	21.23
Junc4	1067.45	0.43	1.72	1091.61	24.16
Junc5	1074.83	2.84	11.36	1090.97	16.14
Junc6	1073.50	1.42	5.68	1090.02	16.52
Junc7	1073.31	3.26	13.04	1089.98	16.67
Junc8	1069.53	1.00	4.00	1089.14	19.61
Junc9	1068.86	2.56	10.24	1088.88	20.02
Junc10	1065.79	5.10	20.40	1088.51	22.72
Junc11	1065.00	1.00	4.00	1088.34	23.34
Junc12	1065.30	1.00	4.00	1088.21	22.91
Junc13	1070.20	1.00	4.00	1088.05	17.85
Junc14	1069.92	2.41	9.64	1088.04	18.12
Junc15	1070.93	0.85	3.40	1088.05	17.12
Junc16	1063.59	1.42	5.68	1088.15	24.56
Junc17	1063.72	1.56	6.24	1088.14	24.42
Junc18	1062.82	2.12	8.48	1088.14	25.32
Junc19	1065.71	1.00	4.00	1088.35	22.64
Junc20	1064.68	3.26	13.04	1088.20	23.52
Junc21	1064.73	3.26	13.04	1088.18	23.45
Junc22	1074.42	1.00	4.00	1091.27	16.85
Junc23	1074.80	0.85	3.40	1091.27	16.47
Junc24	1074.93	1.42	5.68	1091.28	16.35
Junc25	1075.39	0.43	1.72	1091.28	15.89
Junc26	1063.94	1.00	4.00	1088.19	24.25
Junc27	1061.02	1.42	5.68	1088.12	27.11
Junc28	1060.67	2.41	9.64	1088.12	27.45
Junc29	1060.67	0.85	3.40	1088.12	27.45
Junc30	1060.34	1.00	4.00	1088.15	27.81
Junc31	1060.40	1.70	6.80	1088.15	27.75
Junc32	1060.24	0.43	1.72	1088.15	27.91
Junc33	1055.00	2.55	10.20	1088.28	33.28
Junc34	1069.00	1.70	6.80	1088.34	19.34
Junc35	1074.39	1.00	4.00	1091.69	17.30
Junc36	1074.83	1.00	4.00	1091.59	16.76
Junc37	1064.76	1.98	7.92	1091.23	26.47
Tank ET	1091.30	#N/A	-244.24	1091.71	0.41

9. Kidetok RGC

Kidetok RGC: Pressure and Velocity ( Pipe Number )

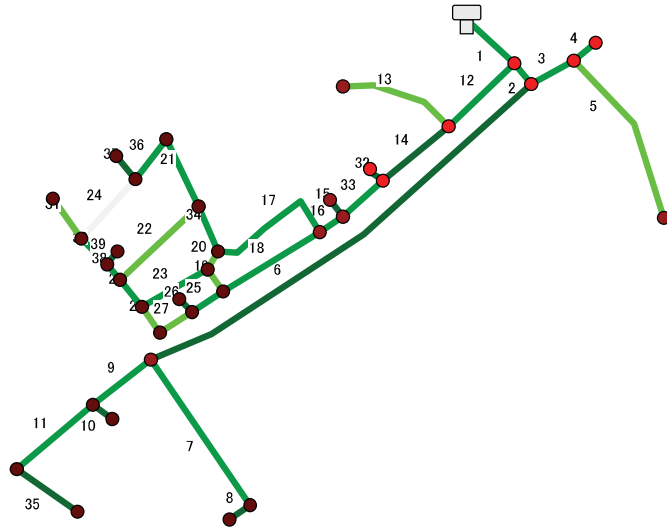
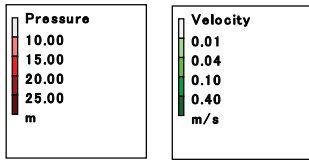

Kidetok RGC ( Node Number )

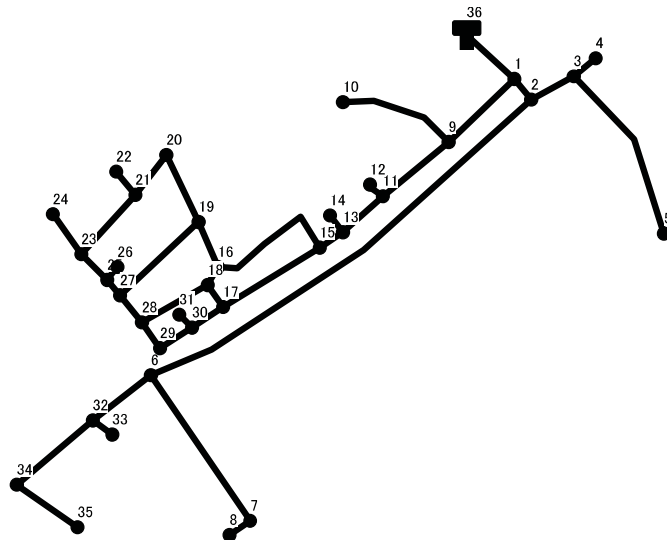

Kidetok RGC : Network Table - Links

Link ID	Length(m)	Diameter(mm)	Roughness	Flow(CMD)	Velocity(m/s)	Unit Head
Pipe1	140.40	144.60	110.00	432.00	0.30	1.19
Pipe2	31.70	81.40	110.00	174.08	0.39	3.64
Pipe3	69.20	57.00	110.00	29.92	0.14	0.79
Pipe4	4.40	28.40	110.00	15.56	0.28	7.02
Pipe5	346.00	57.00	110.00	10.36	0.05	0.11
Pipe6	1278.80	57.00	110.00	140.16	0.64	13.82
Pipe7	791.30	57.00	110.00	25.92	0.12	0.61
Pipe8	8.10	28.40	110.00	21.92	0.40	13.24
Pipe9	159.60	57.00	110.00	51.84	0.24	2.19
Pipe10	4.60	28.40	110.00	21.92	0.40	13.25
Pipe11	280.30	57.00	110.00	25.92	0.12	0.61
Pipe12	230.00	99.40	110.00	222.08	0.33	2.16
Pipe13	245.00	57.00	110.00	17.28	0.08	0.29
Pipe14	259.60	81.40	110.00	200.80	0.45	4.74
Pipe15	4.70	28.40	110.00	21.92	0.40	13.24
Pipe16	58.90	81.40	110.00	148.96	0.33	2.73
Pipe17	293.30	57.00	110.00	72.68	0.33	4.10
Pipe18	287.50	57.00	110.00	72.28	0.33	4.05
Pipe19	94.10	57.00	110.00	21.61	0.10	0.43
Pipe20	40.30	57.00	110.00	-10.80	0.05	0.12
Pipe21	160.50	57.00	110.00	34.41	0.16	1.03
Pipe22	293.00	57.00	110.00	19.47	0.09	0.36
Pipe23	242.40	57.00	110.00	28.41	0.13	0.72
Pipe24	240.20	57.00	110.00	-0.15	0.00	0.00
Pipe25	121.10	57.00	110.00	42.02	0.19	1.49
Pipe26	4.10	28.40	110.00	21.92	0.40	13.25
Pipe27	92.60	57.00	110.00	16.10	0.07	0.25
Pipe28	81.40	57.00	110.00	12.10	0.05	0.15
Pipe29	96.70	57.00	110.00	36.51	0.17	1.15
Pipe30	135.50	57.00	110.00	26.07	0.12	0.61
Pipe31	120.20	57.00	110.00	21.92	0.10	0.45
Pipe32	5.90	28.40	110.00	21.92	0.40	13.24
Pipe33	182.10	81.40	110.00	174.88	0.39	3.67
Pipe34	68.90	57.00	110.00	57.89	0.26	2.69
Pipe35	124.70	28.40	110.00	21.92	0.40	13.25
Pipe36	86.30	57.00	110.00	25.77	0.12	0.60
Pipe37	41.50	28.40	110.00	21.92	0.40	13.25
Pipe38	13.00	57.00	110.00	51.99	0.24	2.20
Pipe39	7.20	28.40	110.00	21.92	0.40	13.25

Kidetok RGC : Network Table - Nodes

Node ID	Elevation(m)	Base Demand(CMD)	Demand(CMD)	Head(m)	Pressure(m)
Junc1	1089.57	8.96	35.84	1108.34	18.77
Junc2	1091.24	1.00	4.00	1108.23	16.99
Junc3	1088.32	1.00	4.00	1108.17	19.85
Junc4	1088.32	3.89	15.56	1108.14	19.82
Junc5	1084.00	2.59	10.36	1108.13	24.13
Junc6	1066.85	15.60	62.40	1090.55	23.70
Junc7	1061.13	1.00	4.00	1090.07	28.94
Junc8	1061.35	5.48	21.92	1089.96	28.61
Junc9	1090.00	1.00	4.00	1107.85	17.85
Junc10	1087.00	4.32	17.28	1107.78	20.78
Junc11	1087.17	1.00	4.00	1106.61	19.45
Junc12	1087.28	5.48	21.92	1106.54	19.26
Junc13	1083.33	1.00	4.00	1105.95	22.61
Junc14	1083.37	5.48	21.92	1105.88	22.51
Junc15	1083.96	1.00	4.00	1105.79	21.82
Junc16	1074.00	1.00	4.00	1104.58	30.58
Junc17	1073.41	2.16	8.64	1104.62	31.21
Junc18	1071.00	1.00	4.00	1104.58	33.58
Junc19	1074.00	1.00	4.00	1104.40	30.40
Junc20	1075.00	2.16	8.64	1104.23	29.23
Junc21	1075.70	1.00	4.00	1104.18	28.48
Junc22	1075.60	5.48	21.92	1103.63	28.03
Junc23	1069.67	1.00	4.00	1104.18	34.51
Junc24	1070.40	5.48	21.92	1104.13	33.73
Junc25	1068.73	1.00	4.00	1104.27	35.53
Junc26	1068.99	5.48	21.92	1104.17	35.18
Junc27	1065.56	1.00	4.00	1104.29	38.74
Junc28	1068.00	1.00	4.00	1104.40	36.40
Junc29	1067.97	1.00	4.00	1104.42	36.45
Junc30	1070.35	1.00	4.00	1104.44	34.09
Junc31	1070.33	5.48	21.92	1104.39	34.06
Junc32	1063.26	1.00	4.00	1090.20	26.94
Junc33	1063.19	5.48	21.92	1090.14	26.95
Junc34	1055.05	1.00	4.00	1090.03	34.98
Junc35	1055.46	5.48	21.92	1088.38	32.92
Tank36	1108.10	#N/A	-432.00	1108.51	0.41

## 資料-8

商用電力引き込み工事費（概算）

Cost Estimate of Connection with Existing Power Line of UMEME  
to be Undertaken by MOWE

Based on the Minutes of Discussion made between the Preparatory Survey Team of JICA and MOWE on May 22, 2015, MOWE shall prepare the connections with the existing power line of UMEME for the construction of piped water supply facilities for Kidetok, Kapala, Kasassira, Naigobya and Kyamvuma RGCs.

This rough estimate is prepared to facilitate the above preparation by MOWE.

1. Scope of Preparation

The power lines shall be extended from the existing power line to the site of water source boreholes with down-transforming to 415V from 11,000V or 33,000V with 25kVA transformer (the minimum size of transformer of UMEME) as summarized below.

<Kidetok RGC>

- Extension of 11,000V power line to JTB-17 and JTB-18 with the distances of 540m and 867m, respectively.
- Installation of down transformers at each borehole site (25kVA) with distribution panels and meters.

<Kapala RGC>

- Extension of 11,000V line to P-04-NBH-1 with the distance of 732m.
- Installation of down transformer (25kVA) with distribution panel and meter at the borehole site.
- Further extension of 415V power line with 130m to the borehole site of P-04-NBH-2.

<Kasassira RGC>

- Extension of 11,000V power line to the borehole site of DWD55991 with the distance of 1,150m.
- Installation of down transformer (25kVA) with distribution panel and meter at the borehole site.

<Naigobya RGC>

- Extension of 11,000V of power line to the borehole site with the distance of 1,521m.
- Installation of down transformer (25kVA) with distribution panel and meter

<Kyamvuma RGC>

- Extension of 11,000V of power line to the borehole site with the distance of 45m.
- Installation of down transformer (25kVA) with distribution panel and meter.

The land for electric poles shall be arranged by the applicant according to UMEME.

## 2. Estimated Costs for Power Line Connections

The total amount of 16,500,000JPY is estimated as stated in the attached table.

**Total Connection Fee by UMEME**

(Unit:UGX)

No.	Items	Specification	Unit	Q'ty	Unit Price	Amount	Remark
1	Inspection Fee		L/S	1.0	-	531,000	
2	New Connection Fees (Non-Standard Connection)		L/S	1.0	-	1,000,000	
3	Connection Cost						
	Kidetok RGC		L/S	1.0	-	141,651,400	
	Kapala RGC		L/S	1.0	-	81,338,400	
	Kasassira RGC		L/S	1.0	-	97,350,000	
	Naigobya RGC		L/S	1.0	-	116,910,200	
	Kayanvuma RGC		L/S	1.0	-	36,317,000	
	Total 3					473,567,000	
4.	Total Cost for Connection					475,098,000	\$140,106
							¥16,490,523
	V.A.T. = 18%		%	0.18	-	85,517,640	
	Ground Total incl, VAT		L/S	1.0	-	560,615,640	\$165,326
							¥19,458,817

Rate: UGX/USD      3,390.98  
 JPY/USD      ¥117.70

Conditions;

1. Not include V.A.T.
2. Refer to General Conditions of Supply of UMEME and Electricity Regulatory Authority



(Unit:UGX)

No.	Items	Specification	Unit	Q'ty	Unit Price	Amount	Remark
<b>I.</b>	<b>Kidetok RGC</b>						(USD)
<b>1</b>	<b>Inspection Fee</b>						
1-1	Wayleave clearance, permission/consent) from affected land owners.		site	1.0	-	-	To be arranged by the applicant
1-2	Umeme Inspection Fee 2working dats per one site	3-Phase Time of use	site	1.0	88,500	88,500	
	Total 1					88,500	
<b>2</b>	<b>New Connection Fees (Non-Standard Connection)</b>						
<b>2-1</b>	Commercial- Three phase(Time of Use)	Scurity deposit	site	1.0	200,000	200,000	
	Total 2					200,000	
<b>3</b>	<b>Connection Cost</b>						
3-1	Survey Cost		L/S	1.0	-	1,500,000	
3-2	Woodn Pole, L=540m JTB-17	540m/100m=5nos	nos	5.0	860,000	4,300,000	
	Woodn Pole, L=867m JTB-18	867m/100m=8nos	nos	8.0	860,000	6,880,000	
3-3	Wireing 3 Phase 11kV line toJTB-17	L=540m	m	540.0	42,000	22,680,000	
	Wireing 3 Phase 11kV line toJTB-18	L=867m	m	867.0	42,000	36,414,000	
3-4	Installation Transformer and Accessories (11kV/415V) for JTB-17	Max. 25kVA	set	1.0	25,000,000	25,000,000	
	Installation Transformer and Accessories (11kV/415V) for JTB-18	Max. 25kVA	set	1.0	25,000,000	25,000,000	
3-5	Power distribution panel and electricity usage meter at JTB-17		set	1.0	3,500,000	3,500,000	
	Power distribution panel and electricity usage meter at JTB-18		set	1.0	3,500,000	3,500,000	
3-6	Others	10% of above Total Cost	L/S	1.0		12,877,400	
	Total 3					141,651,400	
	Total of Kidetok RGC					141,939,900	

(Unit:UGX)

No.	Items	Specification	Unit	Q'ty	Unit Price	Amount	Remark
II.	<b>Kapala RGC</b>						(USD)
1	Inspection Fee						
1-1	Wayleave clearance, permission/consent) from affected land owners.		site	1.0	-	-	To be arranged by the applicant
1-2	Umeme Inspection Fee 2working dats per one site	3-Phase Time of use	site	1.0	88,500	88,500	
	Total 1					88,500	
2	New Connection Fees (Non-Standerd Connection)						
2-1	Commercial- Three phase(Time of Use)	Scurity deposit	site	1.0	200,000	200,000	
	Total 2					200,000	
3.	Connection Cost						
3-1	Survey Cost		L/S	1.0	-	1,500,000	
3-2	Woodn Pole, L=732m NBH-1	732m/100m=7nos	nos	7.0	860,000	6,020,000	
	Woodn Pole, L=130m NBH-2	150m/100m=2nos	nos	2.0	860,000	1,720,000	
3-3	Wiring Cost, 3 Phase 11000Volt line to P-04-NBH-1		m	732.0	42,000	30,744,000	
	Wiring Cost, 3 Phase 415V line to P-04-NBH-2		m	130.0	42,000	5,460,000	
3-4	Installation Transformer and Accessories, 11kV/415V	Max. 25kVA	set	1.0	25,000,000	25,000,000	
3-5	Power distribution panel and electricity usage	with Arrester and Earthing	set	1.0	3,500,000	3,500,000	
3-6	Others	10% of above Total Cost	L/S	1.0		7,394,400	
	Total 3					81,338,400	
	Total of Kapala RGC					81,626,900	

No.	Items	Specification	Unit	Q'ty	Unit Price	Amount	Remark
III.	Kasassira RGC						
1	Inspection Fee						
1-1	Wayleave clearance, permission/consent) from affected land owners.		site	1.0	-	-	To be arranged by the applicant
1-2	Umeme Inspection Fee 2working dats per one site	3-Phase Time of use	site	1.0	88,500	88,500	
	Total 1					88,500	
2	New Connection Fees (Non-Standard Connection)						
2-1	Commercial- Three phase(Time of Use)	Security deposit	site	1.0	200,000	200,000	
	Total 2					200,000	
3.	Connection Cost						
3-1	Survey Cost		L/S	1.0	-	1,500,000	
3-2	Treated Wood Pole, L=1,150m	1,150m/100m=12nos	nos	12.0	850,000	10,200,000	
3-3	Wiring Cost, 3 Phase 11kV line to DWD55991		m	1,150.0	42,000	48,300,000	
3-4	Installation Transformer and Accessories, 11kV/415V	Max. 25kVA	set	1.0	25,000,000	25,000,000	
3-5	Power distribution panel and electricity usage	with Arrester and Earthing	set	1.0	3,500,000	3,500,000	
3-6	Others	10% of above Total Cost	L/S	1.0		8,850,000	
	Total 3					97,350,000	
	Total of Kasassira RGC					97,638,500	

(Unit:UGX)

No.	Items	Specification	Unit	Q'ty	Unit Price	Amount	Remark
<b>IV. Naigobya RGC</b>							(USD)
1	Inspection Fee						
1-1	Wayleave clearance, permission/consent) from affected land owners.		site	1.0	-	-	To be arranged by the applicant
1-2	Umeme Inspection Fee 2 working dats per one site		site	1.0	88,500	88,500	
	Total 1					88,500	
2	New Connection Fees (Non-Standerd Connection)						
2-1	Commercial- Three phase(Time of Use)	Scurity deposit	site	1.0	200,000	200,000	
	Total 2					200,000	
3.	Connection Cost						
3-1	Survey Cost		L/S	1.0	-	1,000,000	
3-2	Treated Wood Pole, L=1,521m	1,521m/100m=15nos	nos	15.0	860,000	12,900,000	
3-3	Wireing, 3 Phase 415Volt line to the source borehole		m	1,521.0	42,000	63,882,000	
3-4	Installation Transformer and Accessories (11kV/415V)	Max. 25kVA	set	1.0	25,000,000	25,000,000	
3-5	Power distribution panel and electricity usage	with Arrester and Earthing	set	1.0	3,500,000	3,500,000	
3-6	Others	10% of above Total Cost	L/S	1.0	-	10,628,200	
	Total 3					116,910,200	
	Total of Naigobya RGC					117,198,700	
<b>V. Kyamvuma RGC</b>							
1	Inspection Fee						
1-1	Wayleave clearance, permission/consent) from affected land owners.		site	1.0	-	-	To be arranged by the applicant
1-2	Umeme Inspection Fee 2 working dats per one site		site	1.0	88,500	88,500	
	Total 1					88,500	
2	New Connection Fees (Non-Standerd Connection)						
2-1	Commercial- Three phase(Time of Use)	Scurity deposit	site	1.0	200,000	200,000	
	Total 2					200,000	
3.	Connection Cost						
3-1	Survey Cost		L/S	1.0	-	500,000	
3-2	Woodn Pole, L=45m		nos	3.0	860,000	2,580,000	
3-3	Wireing, 3 Phase 11kV line to I-06-NBH-2		m	45.0	42,000	1,890,000	
3-4	Installation Transformer and Accessories (11kV/415V)	Max. 25kVA	set	1.0	25,000,000	25,000,000	
3-5	Power distribution panel and electricity usage	with Arrester and Earthing	set	1.0	3,500,000	3,500,000	
3-6	Others	10% of above Total Cost	L/S	1.0	-	3,347,000	
	Total 3					36,317,000	
	Total of Naigobya RGC					36,605,500	

# Naigobya and Kyanvuma

## Legend

● RGCS POINTS

## VOLTAGE

- 11
- 11,11
- 11,33
- 30
- 33
- 33,11
- 33,132
- 33,33

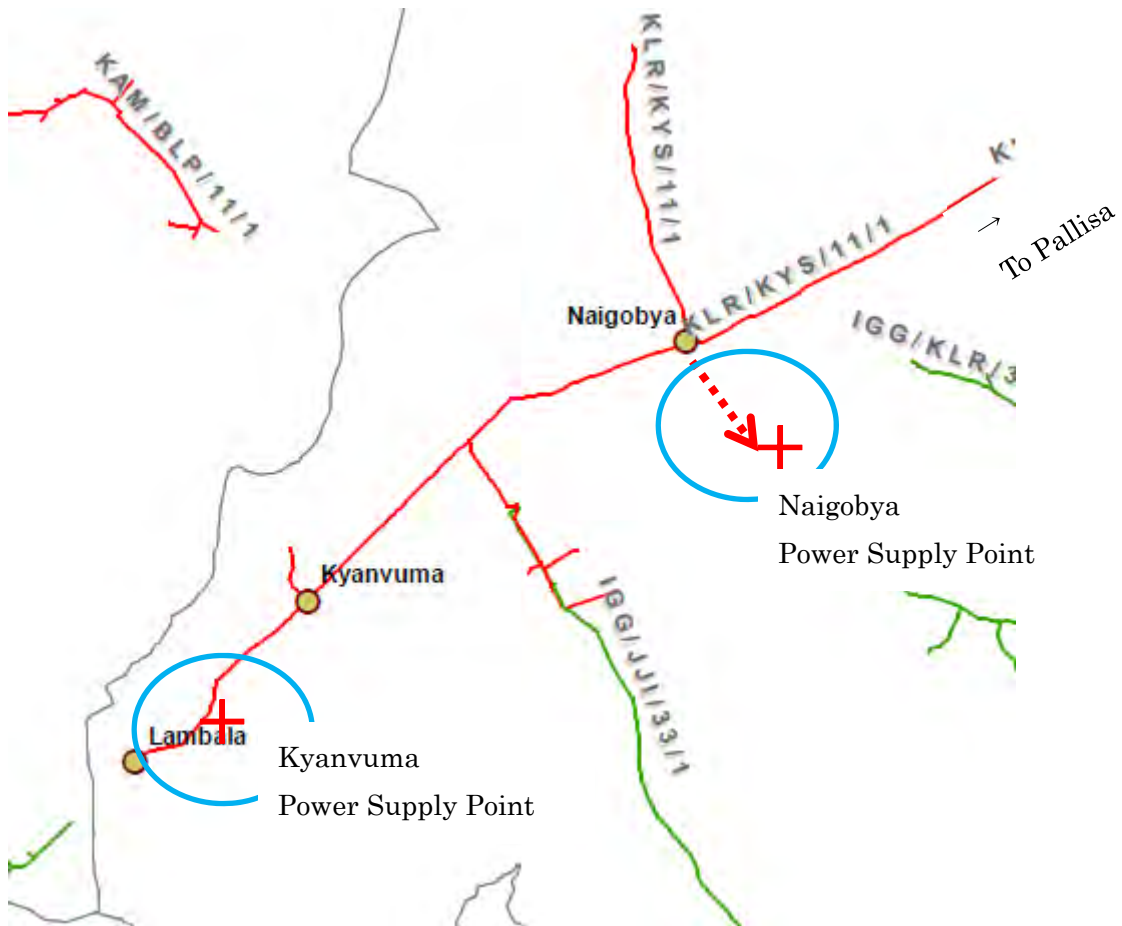

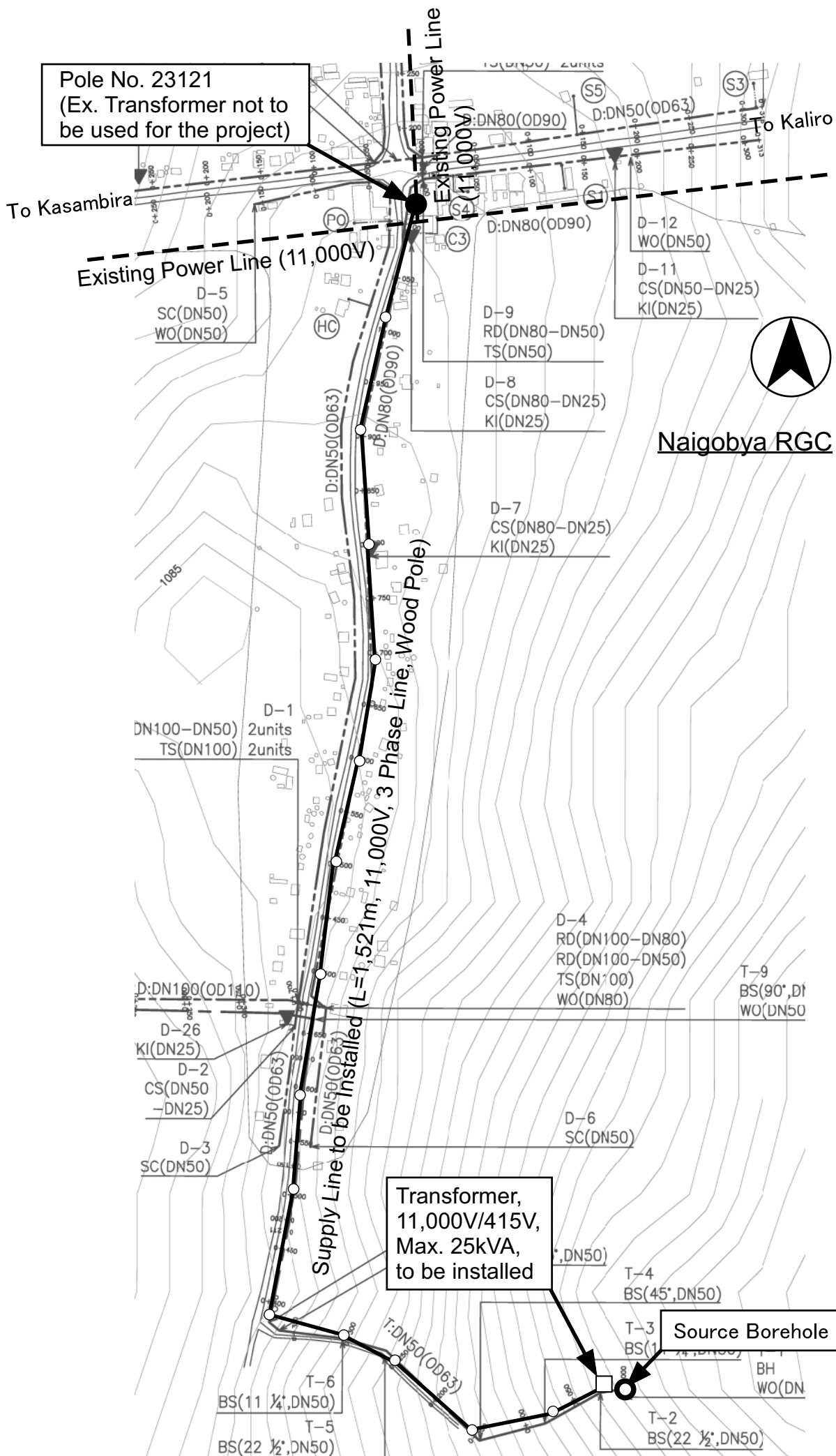

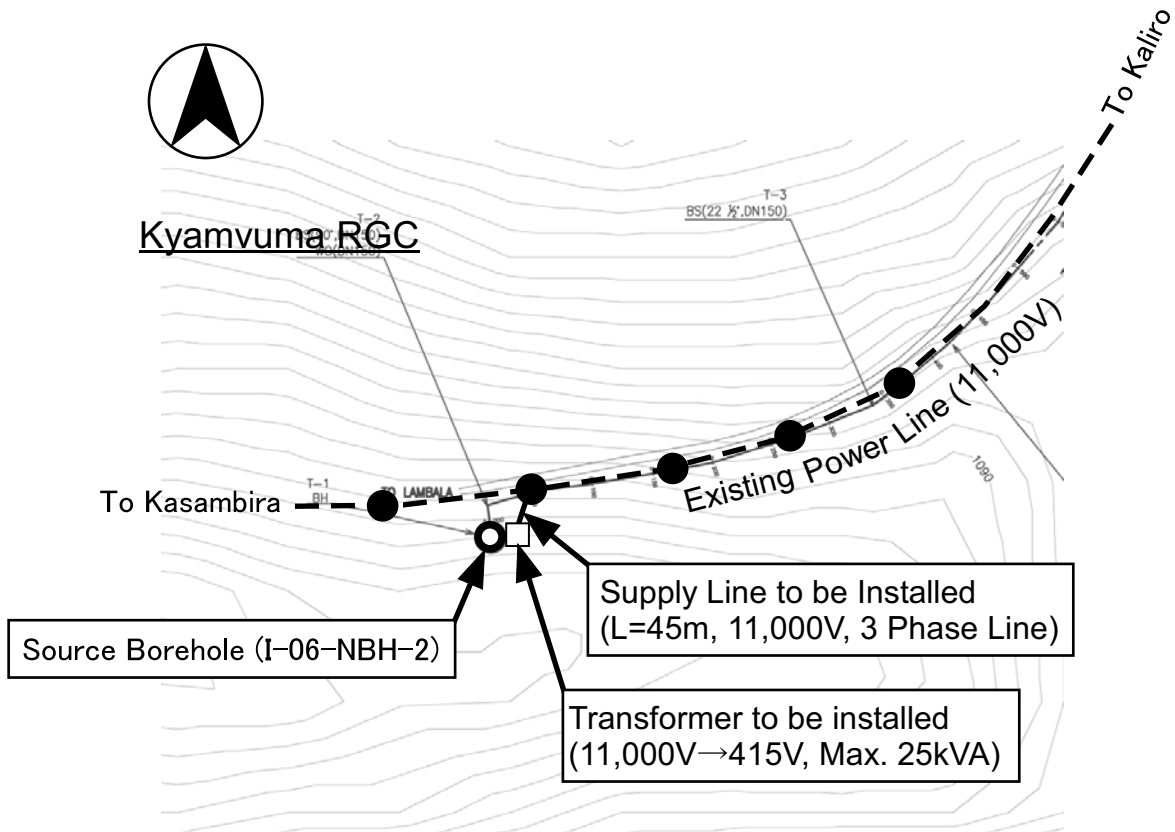

# Kidetok RGC

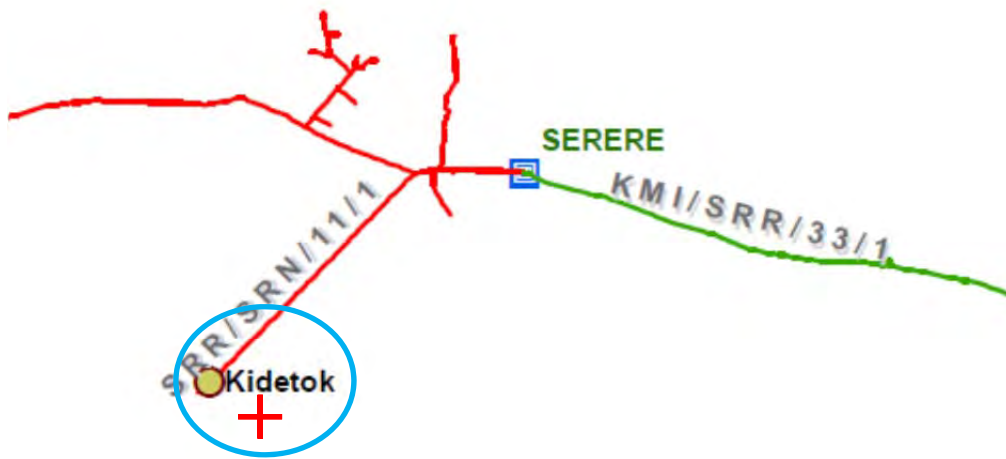

## Legend

● RGCS POINTS

## VOLTAGE

- 11
- 11,11
- 11,33
- 30
- 33
- 33,11
- 33,132
- 33,33





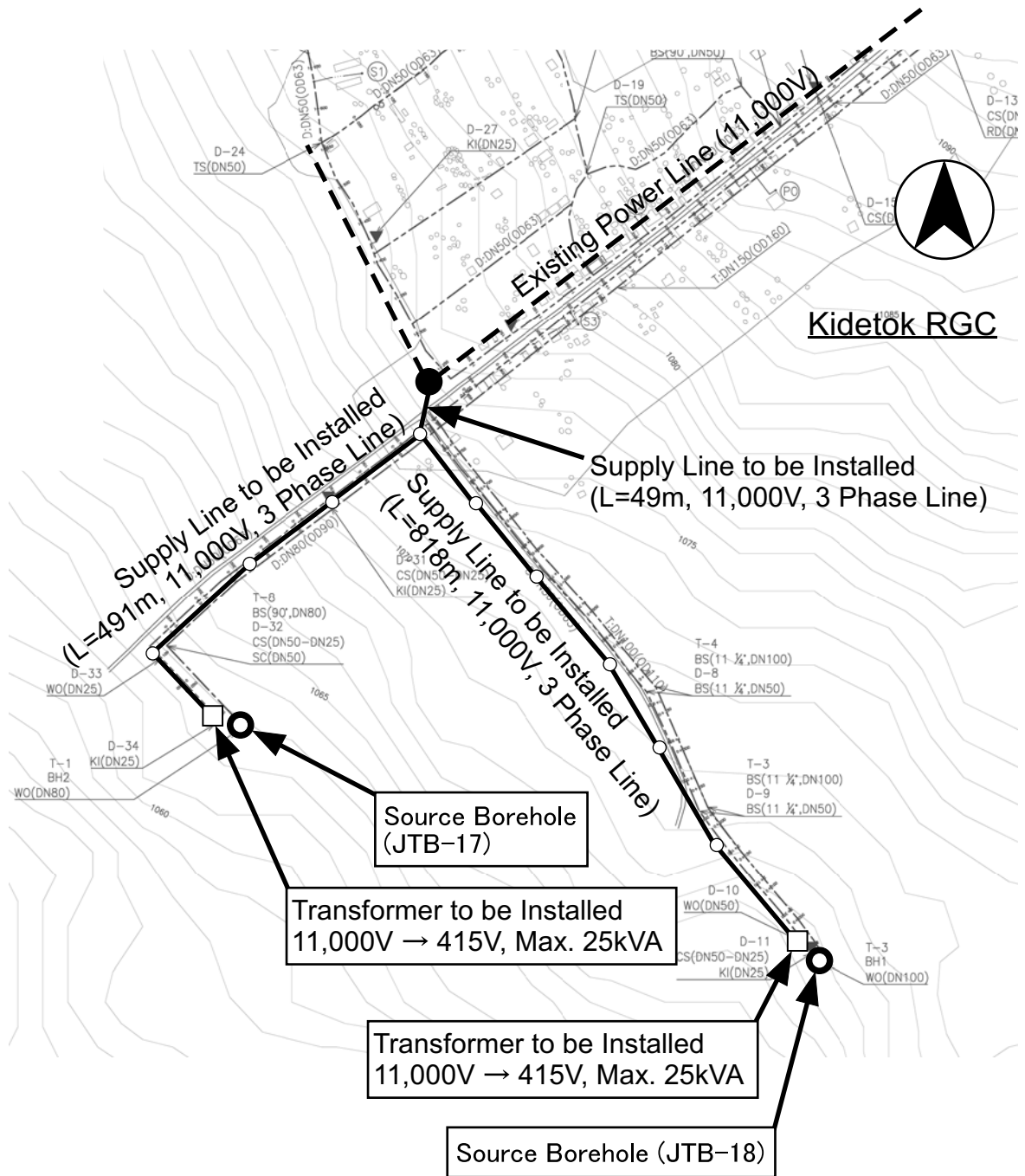

# Kapala and Kasassira RGC

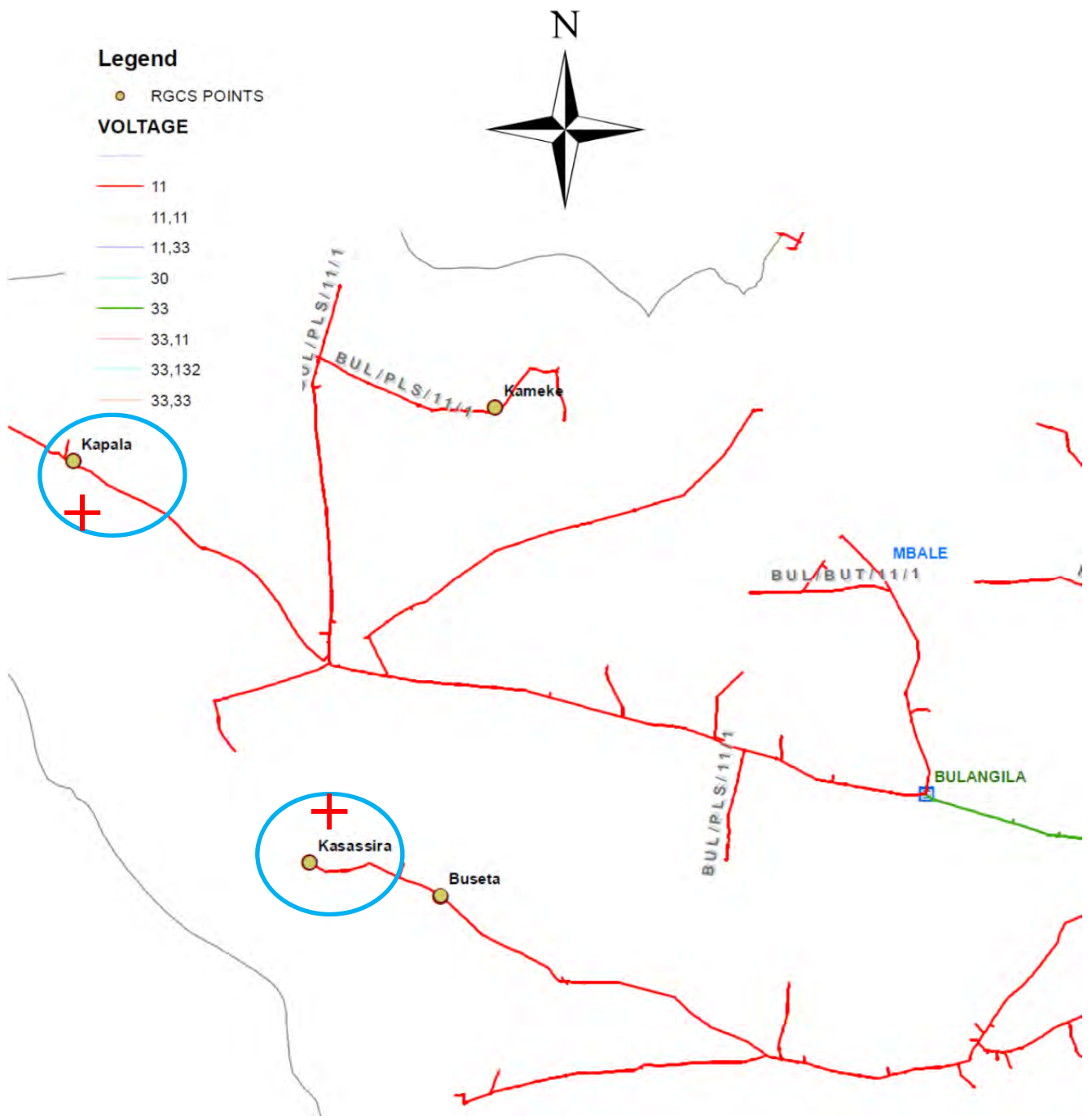

Supply Line to be Installed  
(L=732m, 11,000V,  
3 Phase Line, Wood Pole)

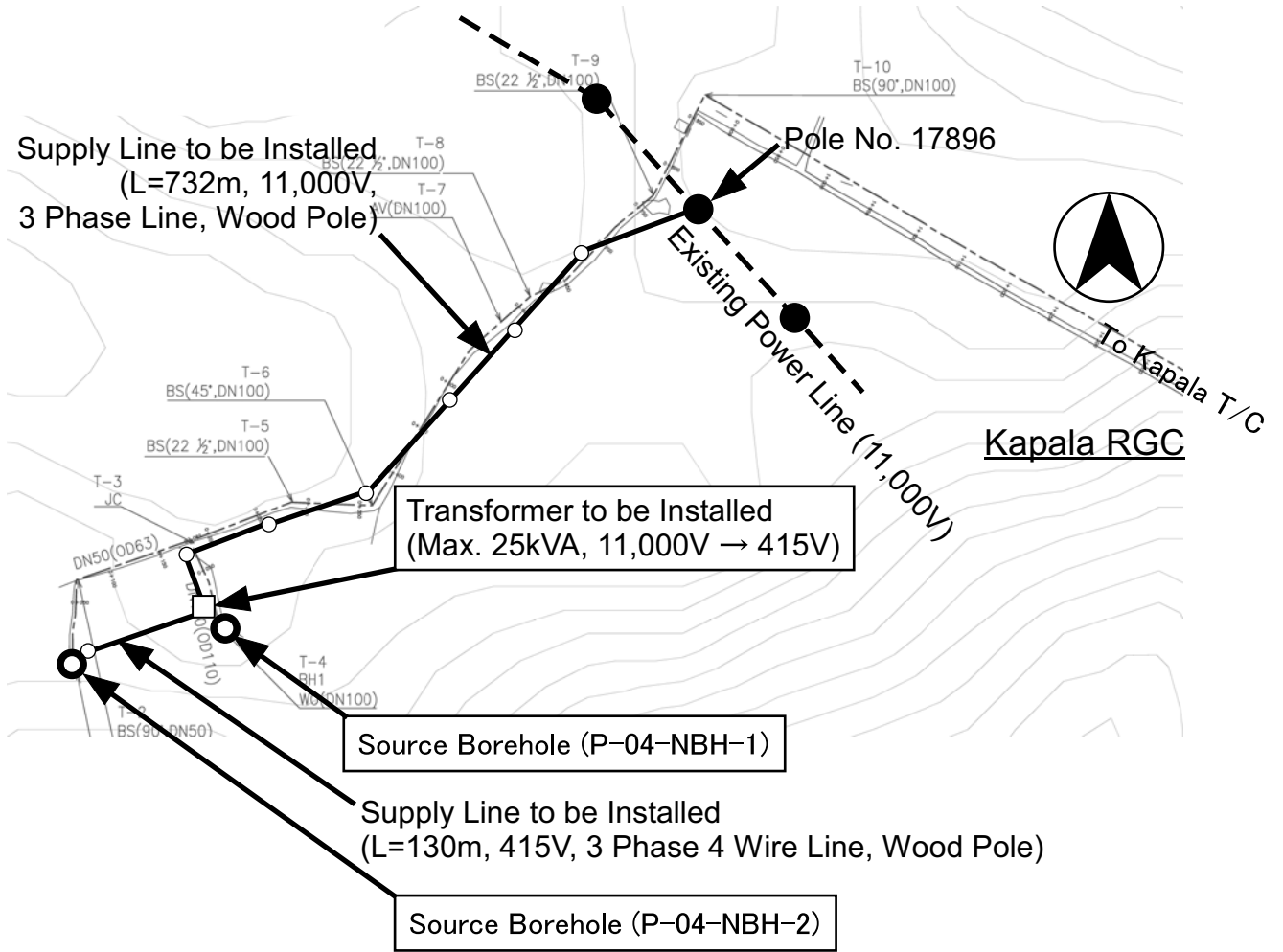

Transformer to be Installed  
(Max. 25kVA, 11,000V → 415V)

Source Borehole (P-04-NBH-1)

Supply Line to be Installed  
(L=130m, 415V, 3 Phase 4 Wire Line, Wood Pole)

Source Borehole (P-04-NBH-2)



# Kasassira RGC

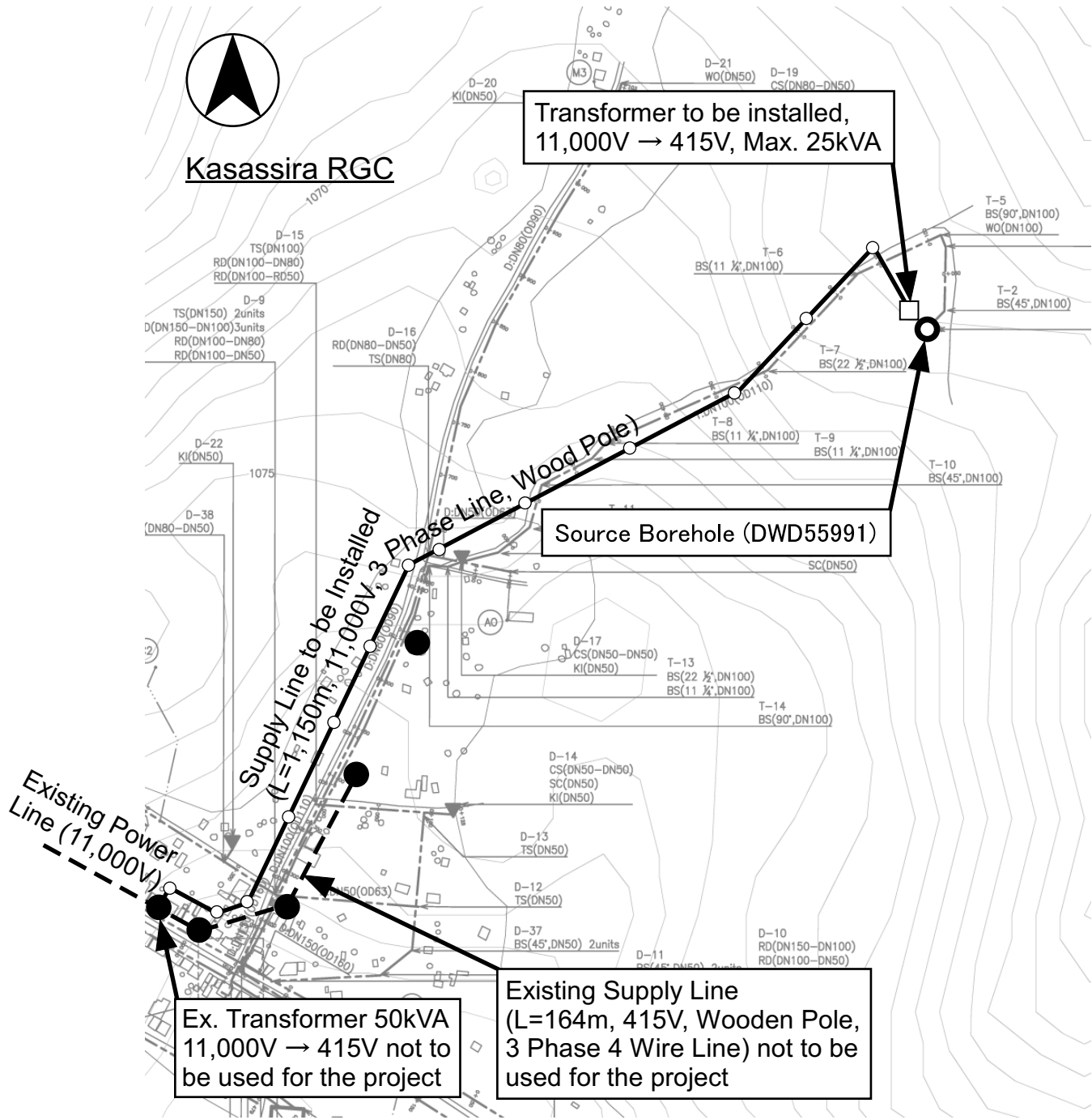

## 資料-9

### 管路給水施設維持管理費（概要）

Annual Operation and Maintenance Costs for  
Piped Water Supply Facilities

No	Item	Description	Unit	Rate	Nambale		Lambala		Naigobya	
					Quantities	Amount	Quantities	Amount	Quantities	Amount
				(UGX)		(UGX)		(UGX)		(UGX)
1.	Operation Costs									
a.	Scheme Operator		month	2,100,000	12.0	25,200,000	12.0	25,200,000	12.0	25,200,000
b.	Security Guards		month	500,000	12.0	6,000,000	12.0	6,000,000	-	-
c.	Kiosk Attendants	No. of Water Kiosks	Nos.	-	6.0	-	5.0	-	7.0	-
		Water Kiosk:	month	300,000	72.0	21,600,000	60.0	18,000,000	84.0	25,200,000
d.	Electricity									
	Normal Operation	Normal Operation days a week	days	-	Solar	-	Solar	-	7.0	-
		Operation Time (Off-peak)	Hrs./day	-	-	-	-	-	6.0	-
		Operation Time (Peak)	Hrs./day	-	-	-	-	-	1.0	-
		Operation Time (Shoulder)	Hrs./day	-	-	-	-	-	6.0	-
		Total Operation Time	Hrs./day	-	6.0	-	6.0	-	13.0	-
		Motor output	kW	-	10.40	-	7.20	-	1.50	-
		UMEME (Off-peak time)	kWh/day	313.4	-	-	-	-	9.0	2,821
		UMEME (Peak time)	kWh/day	695.7	-	-	-	-	1.5	1,044
		UMEME (Shoulder time)	kWh/day	533.5	-	-	-	-	9.0	4,802
		Electricity Consumption	kWh/day	-	-	-	-	-	-	8,667
		Electricity Consumption	Year	-	-	-	-	-	-	3,163,455
	Emergency Operation for Power Outage	Emergency Operation days a week	days	-	Solar	-	Solar	-	2.0	-
	Power outage of twice a week for 12 hours are considered.	Operation Time (Off-peak)	Hrs./day	-	-	-	-	-	0.0	-
		Operation Time (Peak)	Hrs./day	-	-	-	-	-	6.5	-
		Operation Time (Shoulder)	Hrs./day	-	-	-	-	-	0.0	-
		Total Operation Time	Hrs./day	-	-	-	-	-	6.5	-
		Motor output	kW	-	-	-	-	-	1.50	-
		UMEME (Off-peak time)	kWh/day	313.4	-	-	-	-	0.0	0
		UMEME (Peak time)	kWh/day	695.7	-	-	-	-	42.3	29,393
		UMEME (Shoulder time)	kWh/day	533.5	-	-	-	-	0.0	0
		Electricity Consumption	kWh/day	-	-	-	-	-	-	29,393
		Electricity Consumption	Year	-	-	-	-	-	-	3,056,872
e.	Fuel (Diesel)	Emergency Operation Time	Hrs.	-	-	-	-	-	-	-
	Generator (Diesel engine)	Unit Fuel Consumption	L/hr.	-	-	-	-	-	-	-
		Fuel (Diesel) Consumption	Year	2,690	-	-	-	-	-	-
f.	Chemicals	Volume of Elevated Tank	m3	-	64.0	-	64.0	-	80.0	-
	(Calcium Hypochlorite)	Chlorine Dosage	mg/l	-	0.2	-	0.2	-	0.2	-
		Amount of Chemicals Required	kg/day	-	0.021	-	0.021	-	0.027	-
		Chemicals Consumption	Year	22,381	7.8	174,273	7.8	174,273	9.7	217,842
	Sub-total					52,974,273		49,374,273		56,838,169
2.	Maintenance Costs									
a.	Mechanic & Electrician	8 days/Borehole per year	day	241,992	8.0	1,935,936	8.0	1,935,936	8.0	1,935,936
b.	Common Labors	50 days/Borehole per year	man/day	25,932	50.0	1,296,600	50.0	1,296,600	50.0	1,296,600
c.	Spare Parts	Submersible Motor Pump, etc.	L.S.		1.0	168,922,853	1.0	123,841,251	1.0	42,907,566
		Solar Modul, etc	sets	4,181,336	42	175,616,112	36	150,528,096		
		5% of procurement cost				17,226,948		13,718,467		2,145,378
	Sub-total					20,459,484		16,951,003		5,377,914
3.	Other Costs									
a.	Water Permit (up to 400m3)	DWRM	year	200,000	1.0	200,000	1.0	200,000	1.0	200,000
b.	Subscription Fee	Umbllerar East	year	100,000	1.0	100,000	1.0	100,000	1.0	100,000
c.	Allowance for Accountant		man-day	30,000	24.0	720,000	24.0	720,000	24.0	720,000
d.	Allowance for Members		man-day	20,000	48.0	960,000	48.0	960,000	48.0	960,000
	Sub-total					1,980,000		1,980,000		1,980,000
	Total					75,413,757		68,305,276		64,196,083
Served Population (2022)										
Daily Water Demand (m3/day)			m3/day	-	50	-	47	-	46	-
Annual Water Supply (m3/year)			m3/year	-	18,250	-	17,155	-	16,790	-
Annual Water Supply by Jerrycan (20L)			nos./year	-	-	-	-	-	-	-
Price for jerry can (Estimated price)			UGX/20L	-	-	82.6	-	79.6	-	76.5
Estimated by the results of socio-economic condition survey										
Willingness to Pay			UGX/20L	-	-	120.2	-	83.8	-	80.0
Payable Amount (4% of Annual Income)			UGX/20L	-	-	46.4	-	67.0	-	58.3

Annual Operation and Maintenance Costs for  
Piped Water Supply Facilities

No	Item	Description	Unit	Rate	Kyamvuma		Kasassira		Kameke	
					Quantitys	Amount	Quantitys	Amount	Quantitys	Amount
				(UGX)	(UGX)	(UGX)	(UGX)	(UGX)	(UGX)	
1.	Operation Costs									
a.	Scheme Operator		month	2,100,000	12.0	25,200,000	12.0	25,200,000	12.0	25,200,000
b.	Security Guards		month	500,000	-	-	-	-	12.0	6,000,000
c.	Kiosk Attendants	No. of Water Kiosks	Nos.	-	9.0	-	11.0	-	7.0	-
		Water Kiosk:	month	300,000	108.0	32,400,000	132.0	39,600,000	84.0	25,200,000
d.	Electricity									
	Normal Operation	Normal Operation days a week	days	-	7.0	-	5.0	-	Solar	-
		Operation Time (Off-peak)	Hrs./day	-	6.0	-	6.0	-	-	-
		Operation Time (Peak)	Hrs./day	-	0.0	-	6.0	-	-	-
		Operation Time (Shoulder)	Hrs./day	-	0.0	-	4.0	-	-	-
		Total Operation Time	Hrs./day	-	6.0	-	16.0	-	-	-
		Motor output	kW	-	7.50	-	5.50	-	7.20	-
		UMEME (Off-peak time)	kWh/day	313.4	45.00	14,103	33.0	10,342	-	-
		UMEME (Peak time)	kWh/day	695.7	0.00	0	33.0	22,958	-	-
		UMEME (Shoulder time)	kWh/day	533.5	0.00	0	22.0	11,737	-	-
		Electricity Consumption	kWh/day	-	-	14,103	-	45,037	-	-
		Electricity Consumption	Year	-	-	5,147,595	-	11,709,620	-	-
	Emergency Operation for Power Outage	Emergency Operation days a week	days	-	2.0	-	2.0	-	Solar	-
	Power outage of twice a week for 12 hours are considered.	Operation Time (Off-peak)	Hrs./day	-	0.0	-	4.0	-	-	-
		Operation Time (Peak)	Hrs./day	-	0.0	-	0.0	-	-	-
		Operation Time (Shoulder)	Hrs./day	-	3.0	-	0.0	-	-	-
		Total Operation Time	Hrs./day	-	3.0	-	4.0	-	-	-
		Motor output	kW	-	7.50	-	5.50	-	-	-
		UMEME (Off-peak time)	kWh/day	313.4	0.0	0	16.0	5,014	-	-
		UMEME (Peak time)	kWh/day	695.7	0.0	0	0.0	0	-	-
		UMEME (Shoulder time)	kWh/day	533.5	9.0	4,802	0.0	0	-	-
		Electricity Consumption	kWh/day	-	-	4,802	16.0	5,014	-	-
		Electricity Consumption	Year	-	-	499,408	-	521,456	-	-
e.	Fuel (Diesel)	Emergency Operation Time	Hrs.	-	-	-	24.0	-	-	-
	Generator (Diesel engine)	Unit Fuel Consumption	L/hr.	-	-	-	3.9	-	-	-
		Fuel (Diesel) Consumption	Year	2,690	-	-	93.6	13,092,768	-	-
f.	Chemicals	Volume of Elevated Tank	m3	-	168.0	-	324.0	-	48.0	-
	(Calcium Hypochlorite)	Chlorine Dosage	mg/l	-	0.2	-	0.2	-	0.2	-
		Amount of Chemicals Required	kg/day	-	0.056	-	0.108	-	0.016	-
		Chemicals Consumption	Year	22,381	20.4	457,468	39.4	882,259	5.8	130,705
		Sub-total				63,704,471		91,006,103		56,530,705
2.	Maintenance Costs									
a.	Mechanic & Electrician	8 days/Borehole per year	day	241,992	8.0	1,935,936	8.0	1,935,936	8.0	1,935,936
b.	Common Labors	50 days/Borehole per year	man/day	25,932	50.0	1,296,600	50.0	1,296,600	50.0	1,296,600
c.	Spare Parts	Submersible Motor Pump, etc.	L.S.		1.0	79,710,532	1.0	65,593,197	1.0	123,670,167
					SP14-27 (7.5kW)		SP14-23 (5.5kW)		Class SQF 2.5-2, 3 nos.	
		Solar Modul, etc	sets	4,181,336					36	150,528,096
		5% of procurement cost				3,985,527		3,279,660		13,709,913
		Sub-total				7,218,063		6,512,196		16,942,449
3.	Other Costs									
a.	Water Permit (up to 400m3)	DWRM	year	200,000	1.0	200,000	1.0	200,000	1.0	200,000
b.	Subscription Fee	Umbllerar East	year	100,000	1.0	100,000	1.0	100,000	1.0	100,000
c.	Allowance for Accountant		man-day	30,000	24.0	720,000	24.0	720,000	24.0	720,000
d.	Allowancese for Members		man-day	20,000	48.0	960,000	48.0	960,000	48.0	960,000
		Sub-total				1,980,000		1,980,000		1,980,000
		Total				72,902,534		99,498,299		75,453,154
Served Population (2022)										
	Daily Water Demand (m3/day)		m3/day	-	88	-	271	-	42	-
	Annual Water Supply (m3/year)		m3/year	-	32,120	-	98,915	-	15,330	-
	Annual Water Supply by Jerrycan (20L)		nos./year	-	-	-	-	-	-	-
	Price for jerry can (Estimated price)		UGX/20L	-	-	45.4	-	20.1	-	98.4
Estimated by the results of socio-economic condition survey										
	Willingness to Pay		UGX/20L	-	-	88.6	-	101.6	-	94.4
	Payable Amount (4% of Annual Income)		UGX/20L	-	-	69.7	-	59.0	-	79.9

Annual Operation and Maintenance Costs for  
Piped Water Supply Facilities

No	Item	Description	Unit	Rate	Kapala		Buseta		Kidetok	
					Quantitys	Amount	Quantitys	Amount	Quantitys	Amount
				(UGX)	(UGX)	(UGX)	(UGX)	(UGX)	(UGX)	
1.	Operation Costs									
a.	Scheme Operator		month	2,100,000	12.0	25,200,000	12.0	25,200,000	12.0	25,200,000
b.	Security Guards		month	500,000	-	-	12.0	6,000,000	-	-
c.	Kiosk Attendants	No. of Water Kiosks	Nos.	-	7.0	-	9.0	-	9.0	-
		Water Kiosk:	month	300,000	84.0	25,200,000	108.0	32,400,000	108.0	32,400,000
d.	Electricity									
	Normal Operation	Normal Operation days a week	days	-	7.0	-	Solar	-	7.0	-
		Operation Time (Off-peak)	Hrs./day	-	6.0	-	-	-	6.0	-
		Operation Time (Peak)	Hrs./day	-	0.0	-	-	-	0.0	-
		Operation Time (Shoulder)	Hrs./day	-	1.0	-	-	-	0.0	-
		Total Operation Time	Hrs./day	-	7.0	-	-	-	6.0	-
		Motor output	kW	-	4.10	-	7.20	-	8.50	-
		UMEME (Off-peak time)	kWh/day	313.4	24.6	7,710	-	-	51.0	15,983
		UMEME (Peak time)	kWh/day	695.7	0.0	0	-	-	0.0	0
		UMEME (Shoulder time)	kWh/day	533.5	4.1	2,187	-	-	0.0	0
		Electricity Consumption	kWh/day	-	-	9,897	-	-	-	15,983
		Electricity Consumption	Year	-	-	3,612,405	-	-	-	5,833,795
	Emergency Operation for Power Outage	Emergency Operation days a week	days	-	2.0	-	Solar	-	2.0	-
	Power outage of twice a week for 12 hours are considered.	Operation Time (Off-peak)	Hrs./day	-	0.0	-	-	-	0.0	-
		Operation Time (Peak)	Hrs./day	-	0.0	-	-	-	3.0	-
		Operation Time (Shoulder)	Hrs./day	-	3.5	-	-	-	0.0	-
		Total Operation Time	Hrs./day	-	3.5	-	-	-	3.0	-
		Motor output	kW	-	4.10	-	-	-	8.50	-
		UMEME (Off-peak time)	kWh/day	313.4	0.0	0	-	-	0.0	0
		UMEME (Peak time)	kWh/day	695.7	0.0	0	-	-	9.0	6,261
		UMEME (Shoulder time)	kWh/day	533.5	12.3	6,535	-	-	0.0	0
		Electricity Consumption	kWh/day	-	12.3	6,535	-	-	9.0	6,261
		Electricity Consumption	Year	-	-	679,640	-	-	-	651,144
e.	Fuel (Diesel)	Emergency Operation Time	Hrs.	-	-	-	-	-	-	-
	Generator (Diesel engine)	Unit Fuel Consumption	L/hr.	-	-	-	-	-	-	-
		Fuel (Diesel) Consumption	Year	2,690	-	-	-	-	-	-
f.	Chemicals	Volume of Elevated Tank	m3	-	144.0	-	80.0	-	196.0	-
	(Calcium Hypochlorite)	Chlorine Dosage	mg/l	-	0.2	-	0.2	-	0.2	-
		Amount of Chemicals Required	kg/day	-	0.048	-	0.027	-	0.065	-
		Chemicals Consumption	Year	22,381	17.5	392,115	9.7	217,842	23.8	533,712
		Sub-total				55,084,160		63,817,842		64,618,651
2.	Maintenance Costs									
a.	Mechanic & Electrician	8 days/Borehole per year	day	241,992	8.0	1,935,936	8.0	1,935,936	8.0	1,935,936
b.	Common Labors	50 days/Borehole per year	man/day	25,932	50.0	1,296,600	50.0	1,296,600	50.0	1,296,600
c.	Spare Parts	Submersible Motor Pump, etc.	L.S.		1.0	88,709,873	1.0	123,841,251	1.0	111,395,396
					SP7-23 (3.0kW)		Class SQF 3A-10, 3 nos.		SP7-23 (3.0kW)	
					SP3A-18 (1.1kW)				SP14-20 (5.5kW)	
		Solar Modul, etc	sets	4,181,336			36	150,528,096		
		5% of procurement cost				4,435,494		13,718,467		5,569,770
		Sub-total				7,668,030		16,951,003		8,802,306
3.	Other Costs									
a.	Water Permit (up to 400m3)	DWRM	year	200,000	1.0	200,000	1.0	200,000	1.0	200,000
b.	Subscription Fee	Umbllerar East	year	100,000	1.0	100,000	1.0	100,000	1.0	100,000
c.	Allowance for Accountant		man-day	30,000	24.0	720,000	24.0	720,000	24.0	720,000
d.	Allowances for Members		man-day	20,000	48.0	960,000	48.0	960,000	48.0	960,000
		Sub-total				1,980,000		1,980,000		1,980,000
		Total				64,732,190		82,748,845		75,400,957
Served Population (2022)										
	Daily Water Demand (m3/day)		m3/day	-	74	-	61	-	108	-
	Annual Water Supply (m3/year)		m3/year	-	27,010	-	22,265	-	39,420	-
	Annual Water Supply by Jerrycan (20L)		nos./year	-	-	-	-	-	-	-
	Price for jerry can (Estimated price)		UGX/20L	-	-	47.9	-	74.3	-	38.3
Estimated by the results of socio-economic condition survey										
	Willingness to Pay		UGX/20L	-	-	120.0	-	95.0	-	103.3
	Payable Amount (4% of Annual Income)		UGX/20L	-	-	72.6	-	132.0	-	78.0



## 資料-10

ソフトコンポーネント計画書

ウガンダ国  
チヨガ湖流域地方給水計画

ソフトコンポーネント計画書

2016年11月

○Ｙ○インターナショナル株式会社  
株式会社ＴＥＣインターナショナル

ウガンダ国 チョガ湖流域地方給水計画  
ソフトコンポーネント計画書

目 次

1. ソフトコンポーネントを計画する背景	1
1.1 対象プロジェクトの概要	1
1.2 ソフトコンポーネント計画の背景	1
1.3 ソフトコンポーネント導入の必要性(課題)	5
2. ソフトコンポーネントの目標	7
3. ソフトコンポーネントの成果	7
4. 成果達成度の確認方法	8
5. ソフトコンポーネントの活動(投入計画)	8
5.1 住民及び行政関係者の啓発・普及段階：ステージ1	9
(1) 活動内容	9
(2) 詳細投入計画(実施体制と投入計画)	10
5.2 給水衛生役員会の事前トレーニング段階（施設建設中）：ステージ2	12
(1) 活動内容	12
(2) 詳細投入計画(実施体制と投入計画)	15
5.3 給水衛生役員会が完成した施設の運営維持管理を通して実務を身に着ける段階 (施設建設後）：ステージ2	18
(1) 活動内容	18
(2) 詳細投入計画(実施体制と投入計画)	20
6. ソフトコンポーネントの実施リソースの調達方法	23
7. ソフトコンポーネントの実施工程	23
(1) 建設前啓発・普及活動の実施工程	23
(2) 建設中運営・維持管理トレーニング(WSSB 事前教育段階)の実施工程	24
(3) 建設後運営・維持管理トレーニング(WSSB による実管理開始後)の実施工程	24
8. ソフトコンポーネントの成果品	24
9. ソフトコンポーネントの概算事業費	25
10. 相手国実施機関の責務	25

## 【巻末資料】

巻末表 1 ソフトコンポーネントのPDM

巻末表 2 邦人コンサルタント（維持管理専門家）の作業内容（建設前啓発・普及）

巻末表 3 邦人コンサルタント（維持管理専門家）の作業内容（建設中運営維持管理トレーニング）

巻末表 4 邦人コンサルタント（維持管理専門家）の作業内容（建設後運営維持管理トレーニング）

ソフトコンポーネント活動工程表

---

### 本文中に登場する役員会及び委員会

- ・ Water supply and Sanitation Board (WSSB) : 給水衛生役員会  
管路給水施設の運営・維持管理を担う住民組織。
- ・ Water and Sanitation Committee (WSC) : 水管理委員会  
ハンドポンプ井戸などの点水源の運営・維持管理を担う住民組織。
- ・ Water and Sanitation Implementation Committee (WSIC) : 水衛生実行委員会  
事前センシタイゼーションの結果、各 RGC で本調査の支援のために結成された住民組織
- ・ Project Implementation Committee (PIC) : プロジェクト実行委員会  
MOU 署名の段階でプロジェクト実行をサポートするために形成された住民組織。

## 1. ソフトコンポーネントを計画する背景

### 1.1 対象プロジェクトの概要

「ウガンダ国チョガ流域地方給水計画」は、チョガ湖流域東部地域の給水率向上を目的として、無償資金協力で下記の事業を行うものである。

表1 対象プロジェクトの概要

項目	内容	概要
施設建設	管路給水施設の建設	9箇所（深井戸掘削、揚水施設、導水施設 高架水槽、公共水栓 (Kiosk) 及び Yard Tap (公共施設)、各水栓までの配管
ソフトコンポーネント	給水施設の維持管理能力向上	<ul style="list-style-type: none"> <li>給水衛生役員会(WSSB)の設立支援、WSSBメンバー、Scheme Operator (S/O)、Kiosk Attendant(K/A)の専任、教育及び訓練（管路給水施設の技術管理、水料金徴収と管理、管理報告書作成等、Kiosk・浸透枘の日常管理、水料金の徴収と管理等）</li> <li>住民の水と衛生に関する啓発</li> </ul>

主管官庁：水・環境省(MOWE)

実施機関：水開発総局(DWD)

### 1.2 ソフトコンポーネント計画の背景

#### 1) ウガンダ国における既存管路給水施設の運営・維持管理体制

既存管路給水施設調査結果より、実際にウガンダ国の地方部で行われている主な運営・維持管理方式について整理すると、次表のとおりである。

表2 ウガンダ国の地方部で行われている管路給水施設の運営・維持管理方式

維持管理体制	WSSB との関係	維持管理の責任	Operator の仕事	給水人口規模(目安)
① 国家上下水道公社 (NWSC)直営	なし	NWSC が全 O&M 業務を担う。		30,000 人以上
② 給水衛生役員会 (WSSB) + Private Operator (P/O)	業務委託契約 水料金収入の一定額あるいは一定率を WSSB に納める 委託先は会社組織	Operator メジャーリペアに関しては WSSB	ポンプの運転管理やその記録、水料金徴収、動力費の支払い、施設の点検、マイナーリペア	5,000 ~ 30,000 人
③ 給水衛生役員会 (WSSB) + Scheme Operator (S/O)	選任/雇用 (個人) 水料金収入の一部が Operator の給料として支払われる。	WSSB メジャーリペアに関しては WSSB	WSSB 役員との仕事分担に応じて色々なケースがある。ポンプの運転管理やその記録、水料金徴収、施設の点検、マイナーリペアまで行うことを MOWE は求めている。	5,000 人以下

これらの方式を本プロジェクトの対象 RGC に適用する場合の留意点について以下にまとめた。

- ・ NWSC 直営で運営・維持管理を実施するには施設規模が小さい。
  - ・ P/O による運営・維持管理方式は、P/O が会社組織のため諸経費が必要になる。規模の小さい管路給水システムでは、水料金収入に占める諸経費の割合が大きくなり、過去の事例からも財務面での維持管理を困難にする可能性が高い。
  - ・ MOWE に登録された契約可能な P/O は 17 社あるが、評判の良い P/O は非常に少ない。
  - ・ MOWE は本調査の開始時には、②WSSB+P/O 方式を推奨していたが、現在は本調査の対象となる給水規模の管路給水施設に対しては、③WSSB+S/O 方式を推奨している。
- 一方、対象 RGC の計画年次における給水計画人口は次表に示すとおりであり、Kasassira RGC 以外は 5,000 人以下である。

表 3 調査対象 RGC の人口

対象県	調査対象 RGC	人口(2022) (社会調査)
Iganga	Nambale	1,863
	Lambala	1,742
Luuka	Naiigobya	1,711
	Kyanvuma	3,228
Kibuku	Kasassira	5,676
	Buseta	2,276
Pallisa	Kameke	1,546
	Kapala	2,735
Serere	Kidetok	3,961

そのため、これまでに得られている知見及び人口規模からも「③WSSB+S/O」の方式が、本プロジェクトの対象 RGC には適していると考えられる。Kasassira については 5 千人規模を少々超えている。近隣の Buseta と合わせるとさらに 8 千人弱の人口規模になるため、両 RGC をひとつの P/O で管理し、スケールメリットを活かす案が考えられる。しかし、信頼できる P/O が少ないこと、MOWE も他ドナーも P/O 方式からの転換を図ろうとしていることから、やはり他の対象 RGC と同じ、「③WSSB+S/O」の方式が Kasassira にも適していると考えられる。

「WSSB+S/O」方式の具体的な運営維持管理体制としては、次の図に示すようなものが想定される。WSSB 役員と S/O の責任分担については、いくつかのパターンが考えられるが、それは個々の RGC での選択になる。



図1 本プロジェクトへの適用が想定される管路給水施設の運営維持管理体制

すなわち、サブ郡議会（LC3）より管路給水施設の運営・維持管理を任された WSSB（S/O、K/A 含む）が施設の運転・維持管理を行う。ただし、専門性を必要とする水中モーターポンプの点検については納入業者とのメンテナンス契約を結ぶ、大規模な修繕等については Umbrella Organization（以下、U/O）へ加盟しその支援を受ける、等の方法により対処する必要がある。

## 2) 本プロジェクトの実施主体であるウガンダ国政府の給水施設運営・維持管理支援体制

本プロジェクトで建設される給水施設の持続性を左右する運営・維持管理において中心的な役割を果すのは、施設の利用者である住民と彼らが組織する WSSB である。

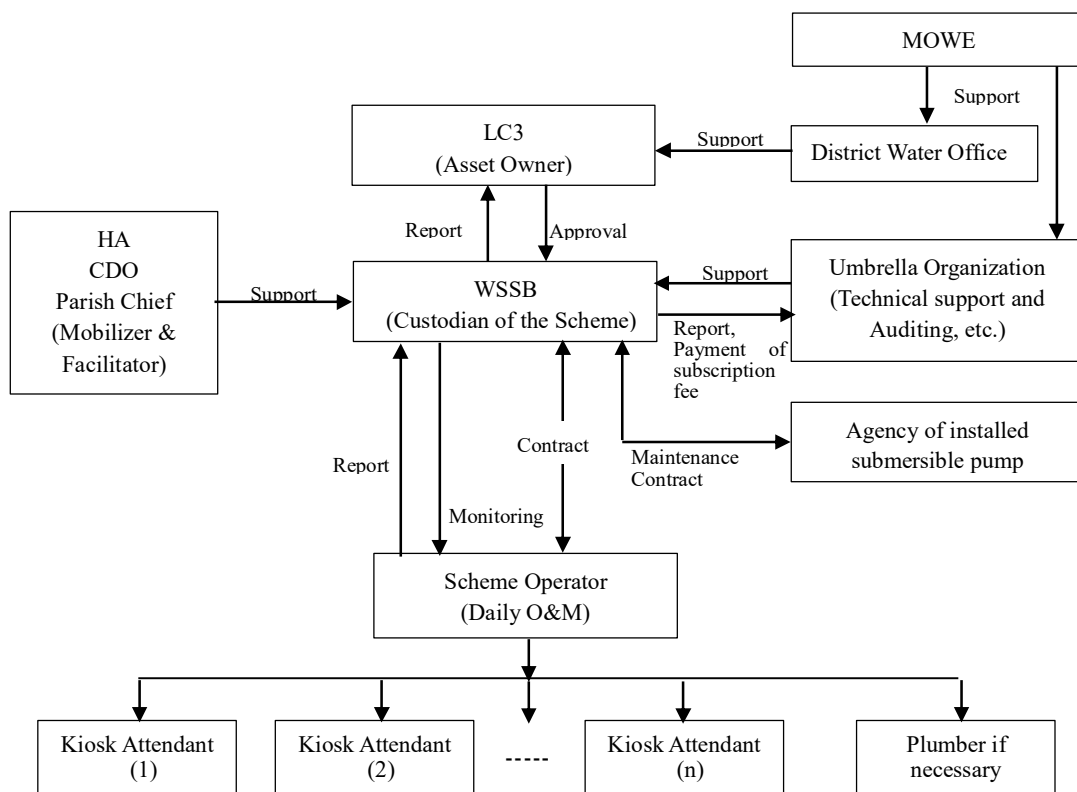
この運営・維持管理の実務を支援する政府組織としては、県水事務所(DWO)及び U/O がある。しかし、DWO は地方分権化の影響もあり、人力的にも非常に手薄であり、ハンドポンプ等の点水源なら未だしも、管路給水施設の運営・維持管理支援までは手が回らないのが実情である。一方、U/O は MOWE 傘下の管路給水施設の運営・維持管理支援に特化した会員制組織であり、維持管理に関するトレーニング、技術的助言、管理支援、予防的維持管理、料金徴収、施設の改築・拡張に関する計画等に関する支援、水質モニタリング等を行うことをそのミッションとしている。NWSC の管轄地域を除く全地域がその管轄範囲である。現在は、ウガンダ国内を6分割し、各地域に事務所を置いて管理している。調査対象

地域を管轄するのは Umbrella-East であり、Mbale に事務所がある。

以前は半官・半民組織であったが、2016 年になって完全な政府組織になった。ウガンダ政府はここに補助金を投入し、大規模な修理、施設の改築・拡張などが円滑に進むよう配慮している。したがって、本プロジェクトで建設される管路給水施設の持続性を担保する方策のひとつとして U/O に加盟し、その支援を受けることが必要である。

しかし、現状では U/O 自身はさほど大きな組織ではない。本プロジェクト地域を管轄する Umbrella East の場合、その人員構成は下記のとおりである。

表 4 Umbrella-East の人員構成

役 割	人員
所 長	1
業務調整/会計補助	1
電気/機械技術者	0
水質分析	1
コミュニティ動員	1
コミュニティ動員 (補)	1
技術補助員	1
秘 書	1
運転手	1
事務員	1

したがって、施設の日常の運営・維持管理は各 WSSB 役員と S/O が協働し責任をもって行える状態に仕上げる必要がある。あくまで U/O は支援組織である。

### 3) 他ドナーとの援助協調

管路給水施設の運営・維持管理体制については他ドナーもこれまで色々な試みを行ってきている。U/O、P/O (民間会社)、S/O (個人) 等はその試みの産物である。直近では、MOWE は小規模管路給水施設の運営・維持管理については、これまで推進してきた P/O による管理から諸経費のかからない S/O による管理に移行しようとしている。また、他ドナーもこの移行を支持している。そのため、他ドナーとの援助協調の観点からも、WSSB 役員と S/O の組合せによる管路給水施設の運営・維持管理を推進することが適当である。

### 4) 給水施設建設の前提要件

本プロジェクトで管路給水施設を建設するに当り、MOWE は対象サイトにおいてステークホルダー会議を開催し、対象県と覚書 (Memorandum of Understanding) を交わしている。その中で、「事業実施に際しては、コミュニティの衛生環境 (特にし尿処理) が 100% になることが保証されること」を義務としている (ただし、本プロジェクト実施の前提条件ではない)。そのため、啓発・普及活動を実施し、その具体的な改善計画を策定・推進することが必要である。



5) 啓発・普及活動及び運営・維持管理トレーニングに関するガイドライン類について  
ウガンダ国では、RGCにおける給水施設建設の際のコミュニティ動員、啓発・普及活動のステップを定めたガイドライン、“Steps in Carrying Out Mobilization Activities in Rural Growth Centres (September 2005)”があり、基本的にはここに定められた活動ステップを踏む必要がある。ただし、本計画では、ガイドラインに定められた活動のうち保健衛生に関するベースライン調査については、必要があれば先方政府によって実施、確認を行ってもらうこととする。

また、運営・維持管理に関するトレーニングに関しては、MOWE傘下のWater and Sanitation Development Facility (WSDF)がトレーニングマニュアルあるいはトレーナー用ガイドを整備している。

このような状況のため、ソフトコンポーネントの実施内容・投入の検討に当たっては、上述のガイドライン、マニュアル類を参照・遵守する必要がある。

#### 6) 技術協力プロジェクトとの連携について

現在、JICAは2015年9月より、MOWEに対し、技術協力プロジェクト「村落地方給水維持管理・衛生改善プロジェクト」(以下、「技協」と呼ぶ)を実施中である(協力期間:2015年9月~2019年9月)。そのために管路給水施設の専門家が派遣されており、今後、管路給水施設の運営・維持管理契約書雛形、月報フォーマットなどが作成される予定である。そのため、技協と連携してその成果を活用し、ソフトコンポーネント活動の効率化を図ることができる。

### 1.3 ソフトコンポーネント導入の理由／必要性

本プロジェクトにより地方部に建設される小規模管路給水施設の運営・維持管理の主体はWSSB、S/O及びK/Aである。彼らによる運営・維持管理の実施に当たっては、以下のような大きな課題がある。施設の継続的利用がなされるためには、これらの課題を事前に解決しておくことが重要であり、そのためにソフトコンポーネントを計画・実施する必要がある。

#### 課題① 住民が安全な水の重要性、安全な水と健康・保健・衛生との関係を理解していない。

管路給水施設の自律的な持続性確保のためには、安全な水の使用と衛生環境の創出・保全の重要性を住民が理解し、積極的に水料金を支払うことが必要である。その一方で、水料金設定に際しては、必要に応じて低所得者層に配慮することも必要である。これについては、ソフトコンポーネント活動の早い時期から啓発・普及活動を開始することが重要である。) )

しかし、社会調査結果によれば、乾季には1世帯平均8.9時間だった1日の水汲み労働時間が、雨期には2.4時間と激減している。これは雨期には、表流水や雨水を利用しているためと考えられる。

表 5 調査対象 RGC の水汲みの実態

対象県	コード	調査対象 RGC	水汲み所要時間 乾季(時間/日)	水汲み所要時間 雨季(時間/日)
Iganga	I-3	Nambale	11.9	2.1
Luuka	I-6	Lambala	4.0	1.9
	I-7	Naigobya	8.0	1.5
	I-9	Kyanvuma	8.8	3.1
Kibuku	P-2	Kasassira	10.5	2.9
	P-5	Buseta	7.8	1.4
Pallisa	P-3	Kameke	11.4	2.6
	P-4	Kapala	11.3	3.7
Serere	S-1	Kidetok	6.8	2.4
		平均	8.9	2.4

また、現地調査結果（既存井の水質試験）では、人口の多い Busesa、Kapala 等では複数の井戸から大腸菌が検出されており、MOWE が懸念しているように、人口が集中してきている RGC では水質の汚染が進行していると言える。

サブ郡毎にあるヘルスセンターで水因性疾患の患者数を調査したところ、次表に示すように罹患率が数%のところが多い。

表 6 水因性疾患の罹患率

県	サブ郡	対象 RGC	患者数 (年間)					サブ郡人口	罹患率 (%)
			下痢	寄生虫	腸内疾患	腸チフス	赤痢		
Iganga	Nambale	Nambale	648	2,088	0	18	N/A	47,115	5.8
	Makuutu	Nondwe	364	288	240	48	N/A	27,992	3.4
Luuka	Irongo	Lambala	239	433	N/A	6	N/A	28,691	2.4
		Kyanvuma							
		Naigobya	36	12	N/A	5	N/A	39,049	0.1
Kibuku	Kasassira	Kasassira	879	131	0	0		21,840	4.6
	Buseta	Buseta	1,392	756	0	0	89	16,709	13.4
Pallisa	Kameke	Kameke	250	180	0	0	N/A	17,273	2.5
	Gogonyo	Kapala	639	538	0	0	N/A	29,568	4.0
Serere	Pingire	Kidetok	121	1	N/A	N/A	N/A	34,581	0.4

一方、運営・維持管理の基本となる水料金の支払い・徴収に関してみると、ハンドポンプ施設利用の場合であるが、水料金を払わずに利用している人達が多い。コミュニティはそれを許容している。また、ハンドポンプ施設の修理等のための蓄えはなされておらず、その時々寄付金を集めている状態である。

課題② 行政及び住民が WSSB、S/O、K/A、U/O の目的・役割・重要性を理解していない。

対象 RGC には管路給水施設がないため、ほとんどの住民は適切且つ持続的な施設の運営・維持管理が行われるためには何が必要かを知らない。また、当然のことながら WSSB 役員、S/O、K/A、U/O の具体的な役割も知らない。一方、DWO は点水源の運営・維持管理については熟知していても、管路給水施設の運営・維持管理については詳しいとは言えない。そのため、WSSB、U/O の目的、役割、重要性を住民及び県行政関係者に周知する必要がある。

課題③ WSSB メンバーが役員会の目的、各々の役割の内容、及び組織運営方法を理解していない。

対象 RGC 及び対象 RGC のあるサブ郡には管路給水施設がないため、WSSB 構成員の中核メンバーとなるサブ郡議員もサブ郡チーフもその目的、役割及び組織運営方法を知らない。ましてや対象 RGC コミュニティから選ばれる他のメンバー（3名）も当然、何も知らないと言って良い。また、コミュニティの中にはハンドポンプの水管理委員会(WSC)でさえも機

能していない状況も見られる。

そのため、施設建設の過程で選出される WSSB 構成員に対しては、その目的、役割及び透明性確保を含めた具体的な組織運営方法を教育、トレーニングすることが必要である。

課題④ WSSB から選任される S/O は本プロジェクトで建設される管路給水施設の構造・点検・修理及び会計などの運営のための技術・知識を習得していない。

WSSB 役員が選任し日常の運営・維持管理を WSSB 役員とともに担う S/O は、具体的には、ハンドポンプメカニクスなどがその候補者になると想定されるが、当然、これらの人々に管路給水施設の維持管理の知識は期待できないのが現実の状況である。S/O は WSSB とともに主体的に日常の運営・維持管理を担うことが必要であり、これを実現するためには、彼らに基本知識を与えるワークショップを実施した上で、限られた工期の中ではあるが投入を多くし、出来る限りその運営・維持管理状況をモニタリングし必要な追加トレーニング内容を見極めつつ、OJT で繰り返しトレーニングを実施することが重要である。

課題⑤ K/A が Kiosk での水販売料金の徴収、流量計保全、Kiosk 及び浸透枘の清掃作業の重要性を理解していない。

K/A は管路給水施設の最先端で顧客である住民に安全な水の給水サービスを提供するとともに、施設の運営・維持管理の基となる水料金を集めるという重要な役割を担っている。そのため、その適切な実施には、Kiosk の保全、水料金徴収とその管理、流量計の管理と読み値記録等の知識が必要であるが、ハンドポンプの場合でも、枘が無い、浸透枘は目詰まりしている、壊れたら修理されず放置されている、というのが実態である。

課題②～課題⑤については、既往類似案件でも確認されている事項であり、給水栓の盗難、盗水に起因するバルブの破壊、マニュアル記載事項を遵守しないための故障等、施設の継続的利用を阻害する様々なことが起きている。そのため、本ソフトコンポーネントにおいては、施設の継続的利用等に係る事項の指導を繰り返し行い、関係者に周知・徹底することが必要である。

## 2. ソフトコンポーネントの目標

前述の「ソフトコンポーネント計画の背景」及び「ソフトコンポーネント導入の理由／必要性」を踏まえ、本プロジェクトで建設される管路給水施設が継続的に利用されることを目指して、本計画で実施するソフトコンポーネントの目標を以下のように設定する。

- 目標① 水料金徴収等の基本的な活動が円滑に実施され、財務的に安定して運営される。
- 目標② 建設された管路給水施設が適切な維持管理（点検と修理）の下で継続的に清潔に利用される。

## 3. ソフトコンポーネントの成果

ソフトコンポーネントプログラムの成果は次の通りである。

- 成果① 住民が安全な水の重要性、安全な水と健康・保健・衛生との関係を理解する。
- 成果② 行政及び住民が WSSB、S/O、K/A、U/O の目的・役割・重要性を理解する。
- 成果③ WSSB (S/O 及び K/A を含む) が役員会の目的、各々の役割の内容、及び組織運営方法を理解する。
- 成果④ WSSB (S/O を含む) が本プロジェクトで建設される管路給水施設の構造・点検・修理及び会計などの運営のための技術・知識を習得する。
- 成果⑤ WSSB (S/O 及び K/A を含む) が Kiosk での水販売料金の徴収、流量計保全、Kiosk 及び浸透枳の清掃作業の重要性を理解する。

#### 4. 成果達成度の確認方法

成果毎の達成度確認方法を以下に記す。

表 7 成果毎の達成度の確認方法

成果の内容	達成度の確認項目
① 住民が安全な水の重要性、安全な水と健康・保健・衛生との関係を理解する。	1. 水料金支払い意志の有る人が増えたか。
	2. 水料金支払い意志額は増えたか。
② 行政及び住民が WSSB、S/O、K/A、U/O の目的・役割・重要性を理解する。	1. WSSB の会議・住民集会在開催されているか。
	2. 住民集会参加者数は増えているか。
③ WSSB (S/O 及び K/A を含む) が役員会の目的、各々の役割の内容、及び組織運営方法を理解する。	1. S/O は雇用されたか。
	2. U/O に加盟したか。
	3. 水料金は設定されたか (低所得者層への配慮含む)。
	4. 銀行口座は開設されたか。
④ WSSB (S/O を含む) が本プロジェクトで建設される管路給水施設の構造・点検・修理及び会計などの運営のための技術・知識を習得する。	1. ポンプの運転は記録されているか。
	2. 水源井戸の生産量は記録されているか。
	3. Kiosk の流量は記録されているか。
	4. 定期的な点検はなされているか。
	5. マイナー修理はなされているか。
	6. 月報は作成されているか。
④ WSSB (S/O 及び K/A を含む) が Kiosk での水販売料金の徴収、流量計保全、Kiosk 及び浸透枳の清掃作業の重要性を理解する。	1. 流量計読み値は記録されているか。
	2. 流量計読み値に対応した水料金が回収されているか。
	3. Kiosk は清潔に保たれているか。
	4. 余剰水は浸透枳に浸透しているか。

#### 5. ソフトコンポーネントの活動 (投入)

上記の成果を導くために以下に述べる「住民及び行政関係者の啓発・普及活動」及び「給 WSSB (S/O、K/A 含む) のトレーニング」を実施する。

活動は、次の各ステージに分けて実施する。

ステージ 1 : 住民及び行政関係者の啓発・普及段階 (建設前)

(成果①、成果②に対する活動)

ステージ 2 : WSSB (S/O 及び K/A 含む) の事前教育段階 (建設中)

(成果③に対する活動)

ステージ 3 : WSSB (S/O 及び K/A 含む) が完成した施設の運営・維持管理を通して

実務を身に着ける段階（施設建設後）

ただし、施設完成がプロジェクト工期ギリギリになる RGC に対しては、既に完成した近隣の施設や建設中の施設を利用して、これを補う活動を行う

（成果④、成果⑤に対する活動。）

## 5.1. 住民及び行政関係者の啓発・普及段階（ステージ1）

### (1) 活動内容

啓発・普及活動は、次に示す通り、給水施設の建設前に実施する。

建設前： RGC 住民及びサブ郡行政担当者の意識向上と組織化を図るための、RGC 代表、プロジェクト実行委員会（Project Implementation Committee）、サブ郡担当者及び裨益住民を対象とするワークショップ

詳細設計開始とともに建設前啓発・普及活動を開始する。啓発・普及に係る具体的なソフトコンポーネント活動内容を以下に示す。

<ワークショップ>

表 8 建設前ワークショップ活動内容

ワークショップ	活動	対象	日数/RGC
第1回	<ul style="list-style-type: none"> <li>サブ郡・RGC リーダー・プロジェクト実行委員会への表敬・挨拶</li> <li>プロジェクトの紹介/説明、プロジェクトへの協力・援助の依頼</li> <li>リーダーによるトイレ建設の奨励</li> <li>対象 RGC 代表者及びプロジェクト実行委員会への説明</li> <li>給水施設建設前ワークショップの説明(目的・時期・回数)</li> <li>安全な水と健康についての説明</li> <li>給水施設の紹介(種類、機能、水の安全性、修理/点検等)</li> <li>運営維持管理方法の紹介・説明; 維持管理費(貢献金を含む)の説明</li> <li>貢献金内容 (U/O 加盟費、S/O 及び K/A 候補者への日当等)</li> <li>工事着手前に RGC 給水区域内のトイレ普及率 100% 目指した活動が定着していることが重要である旨の説明</li> <li>プロジェクトが RGC に望む事項の説明</li> </ul>	LC3 議員, サブ郡チーフ及び担当者, RGC 代表者(役員, 長老, 教師, 聖職者, 医療関係者等), LC1 長, プロジェクト実行委員会	1.0 日
第2回	<ul style="list-style-type: none"> <li>水衛生啓発・普及活動実行時のプロジェクト実行委員会の役割と義務の説明、及び実施の訓練</li> <li>水と保健衛生のプロモーション</li> <li>水料金設定の際の低所得者層への配慮の必要性</li> <li>バンドリズム対策（給水栓、バルブ等を含む給水サービス施設）について</li> <li>ジェンダー、エイズ、環境等の意識教育</li> <li>-男女の役割の違いや水に関する活動はほとんどすべて女性が担っていることの確認・意識化を行う。</li> <li>S/O 候補者に関する協議、募集広告の作成と募集開始。</li> </ul>	プロジェクト実行委員会メンバー, RGC 代表者(RGC 長, LC1 長, 長老, 教師, 聖職者, 医療関係者, 女性グループリーダー等)を含む住民	1.0 日
第3回	<ul style="list-style-type: none"> <li>受益世帯登録の説明と登録開始</li> <li>貢献金の徴収方法の決定と徴収開始</li> <li>水と保健衛生の説明</li> <li>ジェンダー、エイズ、環境等の意識教育</li> <li>-家庭の資産とジェンダーの関係の意識化（特に水に関する資産）</li> <li>トイレ普及率 100% 達成を目指す行動計画の作成と合意</li> </ul>	プロジェクト実行委員会メンバー, RGC 代表者(RGC 長, LC1 長, 長老, 教師, 聖職者, 医療関係者, 女	1.0 日

ワークショップ	活動	対象	日数/RGC
		性グループリーダー等を含む住民	
第4回	<ul style="list-style-type: none"> <li>・家庭訪問による安全な水の使用、健康衛生、コミュニティへの寄与の促進</li> <li>・登録受益世帯数の確認</li> <li>・水料金設定の際の低所得者層への配慮の必要性</li> <li>・バンドリズム対策（給水栓、バルブ等を含む給水サービス施設）について</li> <li>・ジェンダー、エイズ、環境等の意識教育 <ul style="list-style-type: none"> <li>-家庭の資産とジェンダーの関係の意識化（特に水に関係する資産）</li> </ul> </li> <li>・トイレ普及率 100% を目指す活動の進捗の確認</li> </ul>	プロジェクト実行委員会メンバー、RGC代表者(RGC長、LCI長、長老、教師、聖職者、医療関係者、女性グループリーダー等)を含む住民	1.0日
第5回	<ul style="list-style-type: none"> <li>・貢献金額の確認</li> <li>・登録受益世帯数の確認</li> <li>・トイレ普及率 100% 目指す活動の進捗の確認。</li> <li>・S/O トレーニング候補者（2～3名）の選定</li> </ul>	プロジェクト実行委員会メンバー、サブ郡	1.0日

## (2) 詳細投入計画（実施リソースと投入計画）

### 1) 活動対象サイト数

啓発・普及活動に必要な管路給水施設数（対象 RGC 数）は下記の通りである。

表 9 啓発・普及活動に必要な給水施設数

活動段階	施設数
	内訳
1. 建設前（詳細設計時）	管路給水施設（RGC 9 サイト）

### 2) 実施リソース

#### a. 実施リソースの種類と役割

啓発・普及活動は全体を通じて「邦人コンサルタント（維持管理）-コミュニティ開発専門家兼ファシリテーター(ローカル NGO/ローカルコンサルタント)-アシスタントファシリテーター各 1 名」の構成で実施する。

地方政府も含めた建設前普及活動に関する活動実施主体とその役割は、次の表にまとめた。

表 10 活動実施主体と役割

活動主体	役割
日本側	
1) 邦人コンサルタント（維持管理専門家）	<ul style="list-style-type: none"> <li>➢ ソフトコンポーネントプログラム全体の計画、実施管理、報告</li> <li>➢ ローカル NGO/ローカルコンサルタント指導</li> </ul>
2) コミュニティ開発専門家（ローカル NGO/コンサルタント）	<ul style="list-style-type: none"> <li>➢ ワークショップの教材・ハンドアウト及びプログラム運営に必要なフォームを作成</li> <li>➢ ワークショップ計画書、教材、報告書作成</li> <li>➢ 啓発・普及活動ワークショップのファシリテーション</li> <li>➢ 対象 RGC・サブ郡職員達との連絡・関係を保ち、サポート体制を強化</li> <li>➢ プロジェクトの進捗状況が住民に伝わるよう関係諸機関と調整</li> <li>➢ DWO、CDA、HA のサポート</li> <li>➢ 業務報告書の作成</li> </ul>
3) アシスタントファシリテーター	<ul style="list-style-type: none"> <li>➢ コミュニティ開発専門家が行うワークショップの補助。</li> </ul>

活動主体	役割
(ローカル NGO/コンサルタント)	
ウガンダ側	
1) DWD カウンターパート	<ul style="list-style-type: none"> <li>➢ 邦人コンサルタントと共にプログラムの全体計画管理</li> <li>➢ 邦人コンサルタントと共にローカル NGO/ローカルコンサルタントの指導</li> <li>➢ プログラム実施に伴う他省庁・県政府への協力要請</li> <li>➢ 邦人コンサルタント・ローカル NGO/ローカルコンサルタントと政府関係機関との関係調整</li> </ul>
2) DWO 職員	<ul style="list-style-type: none"> <li>➢ ワークショップ/トレーニングへの立会い</li> <li>➢ ローカル NGO・コンサルタントと RGC・サブ郡との関係調整</li> <li>➢ ローカル NGO/ローカルコンサルタントによる啓発・普及活動</li> <li>➢ プロジェクト実行委員会の指導、活動状況・対象 RGC の衛生状況の確認(モニタリング)</li> <li>➢ プロジェクト実行委員会のサポート</li> <li>➢ 必要に応じて RGC の保健衛生環境実態調査の実施。</li> </ul>
3) Capacity Development Officer (CDA)	<ul style="list-style-type: none"> <li>➢ ワークショップへの立会い</li> <li>➢ ローカル NGO/ローカルコンサルタントによる啓発・普及活動、進捗状況を確認</li> <li>➢ プロジェクト実行委員会の指導、活動状況・対象 RGC の衛生状況の確認(モニタリング)</li> <li>➢ 必要に応じて RGC の保健衛生環境実態調査の実施。</li> </ul>
4) Health Assistant (HA)	<ul style="list-style-type: none"> <li>➢ ローカル NGO/ローカルコンサルタントによる啓発・普及活動の内容や進捗状況の確認</li> <li>➢ 対象 RGC での保健・衛生状況の確認(モニタリング)</li> <li>➢ プロジェクト実行委員会のサポート</li> <li>➢ 必要に応じて RGC の保健衛生環境実態調査の実施。</li> </ul>

b. 投入の考え方及び投入人・月 (M/M)

実施リソースの種類別の投入の考え方、投入量は次表に示す通りである。

表 11 実施リソースの投入 (建設前啓発・普及活動)

実施リソース	投入の考え方	投入 M/M	渡航回数
①本邦コンサルタント			
維持管理専門家	啓発・普及活動開始前のローカルコンサルタント選抜と雇用契約及び教材作成や啓発・普及手法・工程の協議等に 1.5 ヶ月、また、活動完了後の活動成果と達成度の確認に 0.5 ヶ月、合計 2.0 ヶ月とする。(邦人コンサルタントの業務内容の詳細は巻末参照。)	2.0 M/M	2 回
小 計		2.0 M/M	2 回
②ローカル NGO/コンサルタント			
コミュニティ開発専門家	<ul style="list-style-type: none"> <li>➢ 業務実施の準備期間(使用するハンドアウトの準備、スケジュールの詳細、教材作成等)として 0.5M/M。</li> <li>➢ ワークショップ 1 回の開催に必要な日数を移動時間も含めてすべて 1.0 日とすると、RGC において開催するワークショップに必要な総暦日換算日数は 61 日(9 サイト×1.0 日×5 回)×1.35)、約 2.0M/M となる。</li> </ul> ワークショップ完了後の成果・達成度の確認・取りまとめ等に 0.5M/M。 総計：3.0M/M	3.0 M/M	
アシスタントファシリテーター	コミュニティ開発専門家が現地で実施するワークショップを補助する活動のため、同専門家のサイトでの活動と同じ 2.0M/M とする。	2.0 M/M	

注：暦日換算係数は 1.35 とする。

c. 移動手段

調査対象サイト周辺の道路は未舗装道路である点を考慮して、短期間で効率良く活動を実施するため4WD車での移動を前提とする。

3) 成果品の種類

本活動の成果品の種類は下記のとおりである。

表 12 啓発・普及活動の成果品

成果品	内 容
① 啓発・普及活動計画書	活動の内容・手順・手法など
② 啓発・普及活動教材	活動概要
	給水施設の紹介
	水と保健衛生（ハンドアウト含む）
	意識教育
③ Progress Report (1)/ 実施状況報告書(1)	給水施設の運営維持管理の概要（教材）
	会議・集会記録フォーム
	建設前啓発・普及活動終了時点 当初目標、投入・活動の履行状況、現時点の成果、

5.2. 給水衛生役員会の事前トレーニング段階（施設建設中）：ステージ2

(1) 活動内容

建設中:サイトの確認等建設に向けた準備、給水施設運営維持管理の知識の伝達、施設引渡し式等

RGC 毎に、施設が竣工した時点で、施設の仮引渡しを行う。仮引渡し後は、施設の供用が開始されるため、建設中にこの基本的過程を終えておくことが必要である。

これらの具体的な活動内容を以下に示す。

<ワークショップ>

WSSB（S/O 及び K/A 候補者含む）を対象に、運営・維持管理の基本事項に関する理解を得るまでの活動をワークショップ形式で実施する。

表 13 建設中に行うトレーニング（ワークショップ）

ワークショップ	主要項目と内容	対象者	日 数 /RGC
第1回	<ul style="list-style-type: none"> <li>施設建設サイトの確認 建設サイトの決定・承認は建設前に完了しているが、開始直前に最終確認し施設建設後に位置にかかる論争・思い違いなどを防ぐため、関係者の立会いのもとで施設建設サイトの確認を行う。また、関係者を連れて、すでに確保されているこれら水源井戸、送水管ライン、高架水槽建設予定地、配水管ライン、Kiosk 予定地を巡ることにより、施設の概要を理解してもらおうとともに、意識の高揚を図る。</li> <li>WSSB の設立とプロジェクト実行委員会の発展的解散</li> <li>公示前の活動で選定されている S/O トレーニング候補者（2~3名）のト</li> </ul>	プロジェクト実行委員会メンバー、住民、LC3 議員、RGC 代表、サブ郡職員	1.0 日



ワークショップ	主要項目と内容	対象者	日数 /RGC
	レーニングを受ける意志の確認		
第2回	<u>運営・維持管理 (O&amp;M) の概要説明</u> <ul style="list-style-type: none"> <li>・ O&amp;M の意味の理解、O&amp;M で発生する一般的な問題とその対策への理解、施設の持続のためには O&amp;M における費用回収と貯蓄の重要性への理解</li> <li>・ 低所得者層に配慮した水料金設定に関する予備検討</li> <li>・ 給水施設はすべて流量計で管理されることへの理解 (揚水施設、高架水槽、Kiosk、公共施設、各戸接続)</li> </ul>	WSSB (S/O 及び K/A 候補者含む)	1.0 日
第3回	<u>O&amp;M を担うサブ郡、WSSB、S/O、K/A、それぞれの義務の理解</u> <ul style="list-style-type: none"> <li>・ サブ郡議会、サブ郡事務所の義務の明確化</li> <li>・ WSSB の義務の明確化</li> <li>・ S/O の義務と業務内容の明確化</li> <li>・ K/A の義務の明確化</li> </ul>	WSSB (S/O 及び K/A 候補者含む)	1.0 日
第4回	<u>U/O の概要と加盟することの意義への理解</u> <ul style="list-style-type: none"> <li>・ U/O の目的、業務内容</li> <li>・ U/O の組織構造</li> <li>・ U/O の財源</li> <li>・ U/O により実施されるサービス・支援内容</li> <li>・ U/O に対する会員スキームの義務</li> <li>・ U/O 加盟方法及び傘下に入るために必要な費用</li> <li>・ 技術系の学習事項の復習</li> </ul>	WSSB (S/O 候補者含む)	1.0 日
第5回	<u>流量計の読みと記録</u> <ul style="list-style-type: none"> <li>・ 給水施設に使用される流量計の説明 (種類、設置個所)</li> <li>・ 流量計の読み方と適切な記録の仕方 <ul style="list-style-type: none"> <li>- WSSB が行う流量計の読みと記録について (月毎の総給水量チェック)</li> <li>- S/O が行う流量計の読みと記録について (ポンプ送水量、給水量 (高架水槽、Kiosk、公共施設の Yard Tap))</li> <li>- K/A が行う流量計の読みと記録について (毎日の給水開始前及び給水終了後)</li> </ul> </li> </ul>	WSSB (S/O 及び K/A 候補者含む)	1.0 日
第6回	<u>管路給水施設内容の理解</u> <ul style="list-style-type: none"> <li>・ 水源の構造とその維持管理</li> <li>・ 商用電源/ソーラーパネル/発電機の維持管理 (各 RGC で異なる) 商用電源の場合は、電気代の安価な時間帯に揚水する経済的な運転方法についても指導する。 ソーラーパネル電源の場合は、雨天時・曇天時には揚水量が減少するため、場合によっては節水対応が必要になる旨を説明。</li> <li>・ 導水管路の構造とその維持管理</li> <li>・ 高架水槽の構造とその維持管理 (塩素投入作業を含む)</li> <li>・ 配水管路網の構造とその維持管理</li> <li>・ 給水サービス施設の構造とその維持管理</li> <li>・ Kiosk の構造とその維持管理</li> <li>・ 警備小屋・フラッシュトイレの清掃</li> </ul>	WSSB (S/O 候補者含む)	1.0 日

ワークショップ プ	主要項目と内容	対象者	日数 /RGC
	<u>トラブル時のチェックポイントと対応</u> <ul style="list-style-type: none"> <li>・ 水源井戸から揚水されない。</li> <li>・ 高架水槽まで水が導水されない。</li> <li>・ Kiosk や Yard Tap に水が給水されない。</li> </ul> <u>給水施設（とくにソーラーシステム機材）の盗難防止</u>		
第7回	<u>財務管理（帳簿付け及び預金管理）</u> <ul style="list-style-type: none"> <li>・ 帳簿付けの定義と目的</li> <li>・ 帳簿付けの元となる用語・書類（領収書、請求書、出納簿等）の説明</li> <li>・ 各書類の様式と記載内容の説明</li> <li>・ 予算管理</li> <li>・ 運営維持管理の財務状態の計算</li> <li>・ 運営維持管理の財務状態の分析</li> </ul> <u>技術系の学習事項の復習</u>	WSSB（S/O 候補者含む）	1.0 日
第8回	<u>会計監査</u> <ul style="list-style-type: none"> <li>・ 帳簿における記載ミスの発見と修正</li> <li>・ 起こりやすいミスの説明</li> <li>・ チェックすべき記録の説明（領収書、銀行通帳、出納簿など）</li> <li>・ 監査報告書の作成と提出</li> <li>・ 監査結果の RGC コミュニティへの説明</li> <li>・ 銀行口座開設方法の説明（必要に応じて）</li> </ul> 注）会計監査は WSSB の中の議長・会計・秘書以外のメンバーが行うよう指導する。 <ul style="list-style-type: none"> <li>・ 技術系の学習事項の復習</li> </ul>	WSSB（S/O 候補者含む）	1.0 日
第9回	<u>WSSB の規定・定款の作成</u> <u>水料金との設定と予算作成</u> <ul style="list-style-type: none"> <li>・ 維持管理に必要な項目の特定と費用（支出）の推算</li> <li>・ 上記活動の優先度付け</li> <li>・ 収入項目の特定と期待される収入額</li> <li>・ 支出と収入のバランス評価</li> <li>・ 低所得者層に配慮した水料金設定</li> </ul> <u>銀行口座開設手続きの状況チェック</u>	WSSB（S/O 候補者含む）	1.0 日
第10回	<u>O&amp;M 計画作成</u> 管路給水施設建設を実際に体験し、建設前ワークショップのときは自分達の頭の中の知識としてしかなかった給水施設の運営・維持管理が、より身近で現実的な重みを増してくる。このように知識と現実のギャップが縮小した段階で、住民は維持管理の重要性を真に理解し始め、具体的な O&M 計画を作成することができる。維持管理活動は政府やプロジェクトから与えられた義務というのではなく、自分達で作成した計画の目標を達成するための手段であるということを理解したうえで、自発的に行なうことが給水施設の持続性にもつながる。 <u>銀行口座開設の確認</u> <u>S/O、K/A の選任</u>	WSSB（S/O 候補者含む）	1.0 日

ワークショップ	主要項目と内容	対象者	日数 /RGC
第 11 回	<ul style="list-style-type: none"> <li>サブ郡への施設引渡し</li> </ul> RGC による給水施設の使用開始時に、施設の完成とサブ郡への引渡しを地域住民が確認し、給水施設に対するオーナーシップを住民自らが確認することを目的として、地域住民を集めてセレモニーを各施設整備 RGC で開催する。 内容は、WSSB 役員やサブ郡担当者による挨拶と準備した引渡書を用いて仮引渡し式行い、住民のオーナーシップ促進を図る。	サブ郡担当者、WSSB、住民、RGC 代表、	1.0 日

< On the Job Training (OJT) >

表 14 建設中に行うトレーニング (OJT)

調査	主要項目と内容	対象者	日数 /RGC
複数回	各 RGC を巡回し、ワークショップを通じて得た知識をより具体化するために、On the Job Training を実施する。 運営面では、財務管理関係書類への理解、水料金の設定の考え方、水の販売の方法 (料金徴収方法)、帳簿の記載内容、WSSB の規約・約款の内容等について理解することを目指す。 技術的には、水中ポンプ敷設工事、送水管敷設工事、高架水槽建設工事サイトを活用して、自分たちが利用することになる施設の構造をサイトで具体的に理解することを目指す。 この活動は、施設完成までの期間のうちのワークショップを開催しない日を利用して行う。	WSSB (S/O 候補者、K/A 候補者含む)	工期内で繰り返し実施

(2) 詳細投入計画 (実施リソースと投入計画)

1) 活動対象サイト数

ワークショップ及び OJT の必要な管路給水施設数 (対象 RGC 数) は下記の通りである。

表 15 WSSB の建設中トレーニングが必要な給水施設数

活動段階	施設数	
	内	訳
1. 施設建設中	管路給水施設 (RGC 9 サイト)	

2) 実施リソース

a. 実施リソースの種類と役割

運営・維持管理の事前トレーニングは全体を通じて「邦人コンサルタント (運営・維持管理) - コミュニティ開発専門家 (ローカル NGO/コンサルタント) - 運営・維持管理専門家運営系、技術系各 1 名 (ローカル NGO/コンサルタント) の構成で実施する。運営系、技術系各 1 名を雇用するのは、両方の内容を一人で実施できる人材の確保が難しいためである。

施設建設中の運営・維持管理の事前トレーニングに関係する地方政府も含めた主な活動実施主体とその役割は、次の表にまとめた。

表 16 活動実施主体と役割（建設中）

活動主体	役割
日本側	
1) 邦人コンサルタント (維持管理専門家)	<ul style="list-style-type: none"> <li>➢ 運営・維持管理トレーニング全体の計画、実施管理、報告書作成</li> <li>➢ ローカル NGO/コンサルタント契約、指導</li> </ul>
2) コミュニティ開発専門家 (ローカル NGO/コンサルタント)	<ul style="list-style-type: none"> <li>➢ 邦人コンサルタントの下、運営維持管理専門家の監理・指導</li> <li>➢ トレーニング計画書、マニュアルの作成 必要に応じて、ステージ1啓発・普及活動結果のトレーニング計画・マニュアル作成への反映。</li> <li>➢ トレーニングの教材・ハンドアウト及びトレーニング運営に必要なフォームを作成</li> <li>➢ トレーニングのファシリテーションと実施</li> <li>➢ 対象 RGC での WSSB 活動の確認</li> <li>➢ RGC・サブ郡職員達との連絡・関係を保ち、サポート体制を強化</li> <li>➢ 管路給水施設建設の進捗状況の把握とトレーニング工程の調整</li> <li>➢ DWO、CDA、HA のサポート</li> <li>➢ 業務報告書の作成</li> </ul>
3) 運営維持管理専門家：運営系 (ローカル NGO/コンサルタント)	<ul style="list-style-type: none"> <li>➢ 施設の運営に係る財務管理、銀行口座開設、WSSB 約款作成等を担当する。</li> <li>➢ トレーニング計画書、マニュアルの作成</li> <li>➢ トレーニングの教材・ハンドアウト及びトレーニング運営に必要なフォームを作成</li> <li>➢ トレーニングのファシリテーションと実施。</li> </ul>
4) 運営維持管理専門家：技術系 (ローカル NGO/コンサルタント)	<ul style="list-style-type: none"> <li>➢ 施設の運転・維持管理に係る技術的な事項、WSSB 約款作成等を担当する。</li> <li>➢ トレーニング計画書、マニュアルの作成</li> <li>➢ トレーニングの教材・ハンドアウト及びトレーニング運営に必要なフォームを作成</li> <li>➢ トレーニングのファシリテーションと実施</li> </ul>
ウガンダ側	
1) DWD カウンターパート	<ul style="list-style-type: none"> <li>➢ 邦人コンサルタントと共にトレーニングプログラムの全体計画管理</li> <li>➢ 邦人コンサルタントと共にローカル NGO/ローカルコンサルタントの指導</li> <li>➢ トレーニング実施に伴う U/O、県政府等への協力要請</li> <li>➢ 邦人コンサルタント・ローカル NGO/ローカルコンサルタントと政府関係機関との関係調整</li> </ul>
2) U/O	<ul style="list-style-type: none"> <li>➢ トレーニングプログラムへのアドバイス</li> <li>➢ U/O の活動内容説明支援</li> <li>➢ WSSB の指導・管理、活動状況・維持管理費の積み立て状況・対象 RGC の衛生状況の確認(モニタリング)</li> <li>➢ WSSB のサポート</li> </ul>
3) DWO 職員	<ul style="list-style-type: none"> <li>➢ トレーニングへの立会い</li> <li>➢ ローカル NGO・コンサルタントと RGC・サブ郡との関係調整</li> <li>➢ ローカル NGO/ローカルコンサルタントによる運営・維持管理トレーニングの内容や進捗状況を確認</li> <li>➢ WSSB のサポート</li> </ul>
4) CDA	<ul style="list-style-type: none"> <li>➢ トレーニングへの立会い</li> <li>➢ ローカル NGO/ローカルコンサルタントによるトレーニング進捗状況の確認</li> <li>➢ WSSB のサポート</li> </ul>
5) HA	<ul style="list-style-type: none"> <li>➢ ローカル NGO/ローカルコンサルタントによるトレーニングの内容や進捗状況の確認</li> <li>➢ WSSB のサポート</li> </ul>

b. 投入の考え方及び投入人・月 (M/M)

- 実施リソースの種類別の投入の考え方、投入量は次表に示す通りである。

表 17 実施リソースの投入（建設中トレーニング活動）

実施リソース	投入の考え方	投入 M/M	渡航回数
①本邦コンサルタント			
維持管理専門家	<ul style="list-style-type: none"> <li>➢ 運営維持管理担当（運営系、技術計各1名）のローカル NGO/コンサルタント選抜と雇用契約及びトレーニングマニュアル作成やトレーニング内容・工程の協議等に 1.0M/M。</li> <li>➢ 活動教協の確認、活動上の問題点確認及びその対処、報告書作成に 1.0M/M。 (業務内容の詳細は巻末参照。)</li> </ul>	2.0 M/M	2 回
小 計		2.0 M/M	2 回
②ローカル NGO/コンサルタント			
コミュニティ開発専門家	<ul style="list-style-type: none"> <li>➢ 運営・維持管理トレーニングマニュアル作成やトレーニング手法、工程の協議等に 1.0 M/M。</li> <li>➢ 運営維持管理の基礎知識を WSSB に伝えるためのワークショップ実施を邦人コンサルタントに代わり管理するための活動に 1.0M/M。</li> <li>➢ 「最初の施設が完成した時点でのトレーニングの活動状況確認と問題点把握、その対処、報告書作成等を行うとともに、邦人コンサルタントの帰国後もソフトコンポーネント活動を管理するために 2.0 M/M。</li> </ul>	4.0 M/M	
運営維持管理専門家（運営系）	<ul style="list-style-type: none"> <li>➢ 運営・維持管理トレーニングマニュアル作成やトレーニング手法、工程の協議等に 1.0 M/M、</li> <li>➢ 運営・維持管理の基礎知識を WSSB に伝えるためのワークショップ実施。ワークショップ1回の開催に必要な日数を移動時間も含めてすべて1日とすると、全 RGC において開催するワークショップに必要な総暦日換算日数は 144 日（9 サイト x 1.0 日 x 11 回 x 1.35）、4.8M/M。</li> <li>➢ ワークショップの合間を縫って、各 RGC を巡回し、運営時に必要な水料金の設定、水の販売の方法（料金徴収方法）、帳簿の記載内容、WSSB の規約・約款の内容等について協議を重ね、OJT で啓発する活動に 2.7M/M。</li> <li>➢ 最初の施設が完成した時点でのトレーニングの問題点把握とその対処方策検討とまとめ等を行うために 0.5 M/M。</li> </ul>	9.0 M/M	
運営維持管理専門家（技術系）	<ul style="list-style-type: none"> <li>➢ 運営・維持管理トレーニングマニュアル作成やトレーニング手法、工程の協議等に 1.0 M/M、</li> <li>➢ 運営・維持管理の基礎知識を WSSB に伝えるためのワークショップ実施。ワークショップ1回の開催に必要な日数を移動時間も含めてすべて1日とすると、全 RGC において開催するワークショップに必要な総暦日換算日数は 144 日（9 サイト x 1.0 日 x 11 回 x 1.35）、4.8M/M。</li> <li>➢ ワークショップの合間を縫って、各 RGC を巡回し、工事サイト等で給水施設等の具体的な構成、構造等を OJT で教える活動に 2.7M/M</li> <li>➢ 最初の施設が完成した時点でのトレーニングの問題点把握とその対処方策検討とそのまとめ等を行うために 0.5 M/M。</li> </ul>	9.0 M/M	
小 計		18.0 M/M	

注：暦日換算係数は 1.35 とする。

c. 移動手段

調査対象サイト周辺の道路は未舗装道路である点を考慮して、短期間で効率良く活動を実施するため4WD車での移動を前提とする。

3) 成果品の種類

本活動の成果品の種類は下記のとおりである。

表 18 建設中トレーニングの成果品

成果品	内 容
① 運営維持管理トレーニング計画書	トレーニングの内容、手順・手法など
② 運営・維持管理マニュアル（初版）	管路給水施設概要図
	維持管理ハンドアウト(HO)/教材
	維持管理費徴収記録フォーム
	維持管理費出納記録フォーム
	給水施設稼働モニタリングフォーム
	WSSB 運営モニタリングフォーム
	S/O 教材
	K/A 教材
③ Progress Report (2)/ 実施状況報告書(2)	O&M 計画 HO/教材
	運営維持管理モニタリング HO/教材
	当初目標、投入・活動の履行状況、現時点の成果等。

5.3. 給水衛生役員会が完成した施設の運営・維持管理を通して実務を身に着ける段階  
(施設建設後)：ステージ3

(1) 活動内容

建設後：管路給水施設の建設が終了し仮引き渡しが行われ、WSSB (S/O、K/A) による運営・維持管理の実務が始まる。そのため、トレーニングの成果を生かし適切な運営・維持管理が行われるよう、フォローアップする活動を実施する。

施設建設後には、各 RGC を訪れ、施設の運営・維持管理状況、維持管理にかかわる WSSB (S/O、K/A 含む) 及び住民の活動状況についてモニタリングするとともに、能力不足事項の補完を目的とするワークショップを実施する。

しかし、現実には上記の机上で得た知識を基に実際の施設の運営維持管理を行うには困難とギャップを伴うことが予想される。そのため、このギャップを埋め、より短期間に円滑な施設の運営・維持管路ができるようになることを目指し、WSSB (S/O、K/A 含む) を主対象とする On the Job Training を実施する。

これらの活動を通じて、運営・維持管理活動の定着を図る。また、この定着度（成果達成度）を測るために、O&M 成果達成度確認調査及びその報告を行う。

それでも施設の運営や維持管理において課題が残ると判断される RGC については、その状況、問題の内容等につきとりまとめ、DWD、U/O、県行政に引継ぐ。

これらの具体的な活動内容を以下に示す。

<ワークショップ>

表 19 施設建設後に行うトレーニング（ワークショップ）

ワークショップ	主要項目と内容	対象者	日数/RGC
第1回	<p><u>施設の使用方法等の説明・確認（サブ郡へ施設引き渡し直後）</u>            給水施設の供用を開始するにあたり、施設の管理者である WSSB（S/O、K/A 含む）が行うべき事項を、実施設を用いて復習・確認する。            実施内容：            施設の取扱い方(水中ポンプのオン・オフ、ソーラーパネルの清掃、高架水槽の清掃、配水管バルブの開閉、配水量記録、送水管・配水管の漏水発見、公共水栓の流量記録、水栓周辺の清掃等の方法)の確認。            財務管理（帳簿付け、預金管理、現金管理等）の復習。            （施設の取扱いで技術的な事項については建設業者が実施し、ローカルコンサルタントはそれに立会うこととする。）</p>	WSSB（S/O、K/A 含む）	1.0 日
第2回	<p><u>WSSB 役員及び S/O による O&amp;M セルフモニタリング</u>            WSSB による運営維持管理が始まり、ある程度慣れてきた段階で実施する。            O&amp;M で特に重要な給水状況の把握、会計、監査に関するモニタリングフォームを活用したセルフモニタリングシステムについて説明・導入を図る。            セルフモニタリングシステムでは自らが定期的に活動の内容等について記録するため、フォームの内容及びその記録方法について説明・協議し、フォームを確定する。  <input type="checkbox"/> フォームの主な項目。            維持管理費の徴収状況、残高、会議での討議内容、運営上の問題等            給水施設について：水量、水質、水場の掃除、点検・修理状況等            住民の要望等</p>	WSSB（S/O、K/A 含む） サブ郡担当者	1.0 日
第3回	<p><u>O&amp;M セルフモニタリング実施状況の確認と改善</u>            （サブ郡担当者も参加）            WSSB によるセルフモニタリングの状況をサブ郡担当者、WSSB が協働でチェックする。            施設の利用状況、運営・維持管理活動の継続状況、活動の内容や問題点の有無等を確認し、活動の自立性や持続性確保の阻害となるような問題の存在が確認された場合、問題発生事情、問題の内容等について調査し、必要に応じて追加ワークショップの開催等についても検討する。</p>	WSSB（S/O、K/A 含む） サブ郡担当者、	1.0 日

<On the Job Training (OJT) >

表 20 施設建設後に行うトレーニング (OJT)

OJT	主要項目と内容	対象者	日数/RGC
複数回	<p><u>WSSB への OJT による指導</u>            各 RGC をできる限り頻繁に訪問し、現実の施設の運営・維持管理を実施して WSSB が直面している個々の課題をひとつひとつ指導・解決する活動を展開する。(この活動が施設完成後の運営維持管理を軌道に乗せるために重要な活動となる。)</p>	WSSB（S/O、K/A 含む）	工期内で繰り返し実施

<O&M 成果達成度確認調査及びその報告>

ワークショップ及び OJT による O&M トレーニング成果達成度を確認するために、次表に示す時期にコミュニティ開発専門家が該当 RGC を訪れ、WSSB がそれぞれの目標を達成で

きているか確認し、定型フォームによる報告を行う。

表 21 運営維持管理活動達成度調査と報告

調査	主要項目と内容	対象者	日数 /RGC
施設仮引渡し 約1ヶ月後	<u>達成が期待される目標</u> ・ S/O は雇用されたか。 ・ U/O に加盟したか。 ・ 水料金は設定されたか。 ・ 銀行口座は開設されたか。	WSSB (S/O、 K/A 含む)	1.0 日
施設仮引渡し 約2.5ヶ月後	<u>達成が期待される目標</u> ・ ポンプの運転は記録されているか。 ・ 水源井戸の生産量は記録されているか。 ・ Kiosk の流量は記録されているか (S/O)。 ・ Kiosk の流量計読み値は記録されているか (K/A) ・ 定期的な点検はなされているか。 ・ 月報は作成されているか。	WSSB (S/O、 K/A 含む)	1.0 日
施設仮引渡し 約4.0ヶ月後	<u>達成が期待される目標</u> ・ 流量計読み値に対応した水料金が回収されているか。 ・ Kiosk は清潔に保たれているか。 ・ 余剰水は浸透枳に浸透しているか。 ・ マイナー修理はなされているか (必要になった場合)。	WSSB (S/O、 K/A 含む)	1.0 日

注) 施設仮引渡しが工事工程上、工期間近かにならざるを得ず、上表中の調査実施時期を守れない RGC については、可能であれば適宜調整し、実施時期を早めて行うものとする。

## (2) 詳細投入計画 (実施リソースと投入計画)

### 1) 活動対象サイト数

啓発・普及活動の必要な管路給水施設数 (対象 RGC 数) は下記の通りである。

表 22 WSSB の事前教育が必要な給水施設数

活動段階	施設数
	内 訳
1. 施設建設後	管路給水施設 (RGC 9 サイト)

### 2) 実施リソース

#### a. 実施リソースの種類と役割

運営・維持管理の事前トレーニングは全体を通じて「邦人コンサルタント (運営・維持管理) - コミュニティ開発専門家 (ローカル NGO/コンサルタント) - 運営・維持管理専門家運営系、技術系各 1 名 (ローカル NGO/コンサルタント) の構成で実施する。運営系、技術系各 1 名を雇用するのは、両方の内容を一人で実施できる人材の確保が難しいと考えられるためである。

施設建設後の運営・維持管理の実務を通じたトレーニングに関係する地方政府も含めた主な活動実施主体とその役割は、次の表にまとめた。



表 23 活動実施主体と役割（建設後の活動）

活動主体	役割
日本側	
1) 邦人コンサルタント (維持管理専門家)	<ul style="list-style-type: none"> <li>➢ 運営・維持管理トレーニング課題の確認と対処方法検討</li> <li>➢ 活動結果とりまとめ、</li> <li>➢ 残された課題・問題 RGC の確認、「ウ」国側への引き継ぎ</li> <li>➢ 完了報告書の作成</li> </ul>
2) コミュニティ開発専門家（ローカル NGO/コンサルタント）	<ul style="list-style-type: none"> <li>➢ トレーニングの教材・ハンドアウトの見直し、改訂。</li> <li>➢ WSSB が行う O&amp;M セルフ・モニタリング・フォームの作成</li> <li>➢ 運営維持管理専門家が行うワークショップ、OJT の管理。</li> <li>➢ 対象 RGC での WSSB の運営・維持管理活動目標達成状況の確認と報告</li> <li>➢ RGC・サブ郡職員達との連絡・関係を保ち、サポート体制を強化</li> <li>➢ CDA、HA のサポート</li> <li>➢ ソフトコンポーネント活動結果のまとめ</li> </ul>
3) 運営維持管理専門家：運営系（ローカル NGO/コンサルタント）	<ul style="list-style-type: none"> <li>➢ WSSB が行う O&amp;M 活動のうち、財務管理等の運営に係る事項のモニタリング</li> <li>➢ 課題発見</li> <li>➢ OJT による課題への対応と改善のための指導</li> <li>➢ 活動結果と留意事項のまとめ</li> </ul>
4) 運営維持管理専門家：技術系（ローカル NGO/コンサルタント）	<ul style="list-style-type: none"> <li>➢ WSSB が行う O&amp;M 活動のうち、施設の運転等の技術的な事項のモニタリング</li> <li>➢ 課題発見</li> <li>➢ OJT による課題への対応と改善のための指導</li> <li>➢ 活動結果と留意事項のまとめ</li> </ul>
ウガンダ側	
1) DWD カウンターパート	<ul style="list-style-type: none"> <li>➢ 邦人コンサルタントと共にトレーニングプログラムの管理</li> <li>➢ 邦人コンサルタントと共にローカル NGO/ローカルコンサルタントの指導</li> <li>➢ トレーニング実施に伴う U/O、県政府等への協力要請</li> <li>➢ 邦人コンサルタント・ローカル NGO/ローカルコンサルタントと政府関係機関との関係調整</li> </ul>
2) U/O	<ul style="list-style-type: none"> <li>➢ トレーニングプログラムへのアドバイス</li> <li>➢ WSSB の指導・管理、活動状況、維持管理費の積み立て状況、対象 RGC の衛生状況の確認(モニタリング)</li> <li>➢ WSSB のサポート</li> </ul>
3) DWO 職員	<ul style="list-style-type: none"> <li>➢ トレーニングへの立会い</li> <li>➢ ローカル NGO・コンサルタントと RGC・サブ郡との関係調整</li> <li>➢ ローカル NGO/ローカルコンサルタントによる運営・維持管理トレーニングの内容や進捗状況を確認</li> <li>➢ WSSB のサポート</li> <li>➢ 必要に応じて RGC の保健衛生環境実態調査の実施</li> </ul>
4) CDA	<ul style="list-style-type: none"> <li>➢ トレーニングへの立会い</li> <li>➢ ローカル NGO/ローカルコンサルタントによるトレーニング進捗状況の確認</li> <li>➢ WSSB のサポート</li> <li>➢ 必要に応じて RGC の保健衛生環境実態調査の実施</li> </ul>
5) HA	<ul style="list-style-type: none"> <li>➢ ローカル NGO/ローカルコンサルタントによるトレーニングの内容や進捗状況の確認</li> <li>➢ WSSB のサポート</li> <li>➢ 必要に応じて RGC の保健衛生環境実態調査の実施</li> </ul>

b. 投入の考え方及び投入人・月（M/M）

実施リソースの種類別の投入の考え方、投入量は次表に示す通りである。

表 24 実施リソースの投入（建設後トレーニング活動）

実施リソース	投入の考え方	投入 M/M	渡航回数
①本邦コンサルタント			
維持管理専門家	<ul style="list-style-type: none"> <li>➢ 活動状況の確認、活動上の問題点確認及びその対処に 0.5M/M。</li> </ul>	1.5 M/M	2 回

実施リソース	投入の考え方	投入 M/M	渡航回数
	<ul style="list-style-type: none"> <li>➤ 残された課題の整理と「ウ」国側への引継ぎ、活動結果のまとめ、報告書作成に 1.0M/M。 (業務内容の詳細は巻末参照。)</li> </ul>		
小 計		1.5 M/M	2 回
②ローカル NGO/コンサルタント			
コミュニティ開発専門家	<ul style="list-style-type: none"> <li>➤ 邦人コンサルタントの帰国後も、運営維持管理専門家(ローカルコンサルタント)が行うワークショップ及び OJT 活動の工程管理、課題の把握と対応、境調査の管理などに 2.0M/M。</li> <li>➤ 対象 RGC での WSSB の運営・維持管理活動目標達成状況の確認と報告に 0.9 M/M (仮引渡し後活動期間の確保できる 6RGC について実施 (6RGC x 3 回 x 1 日 x 1.35 = 25 日 (0.9M/M))。)</li> <li>➤ 邦人コンサルタントとともに課題のまとめと報告書作成を行うために 1.0M/M。</li> </ul>	3.9 M/M	
運営維持管理専門家 (運営系)	<ul style="list-style-type: none"> <li>➤ 建設期間中のトレーニングで WSSB に伝えた O&amp;M の基礎知識の復習、WSSB のセルフモニタリングの説明、そのフォローアップのためのワークショップを開催する。ワークショップ 1 回の開催に必要な日数を移動時間も含めてすべて 1 日とすると、全 RGC において開催するワークショップに必要な総暦日換算日数は 37 日 (9 サイト x 1.0 日 x 3 回 x 1.35)、1.3M/M。</li> <li>➤ ワークショップの合間に各 RGC を巡回し、その O&amp;M 実施状況をモニターしつつ、課題発見、WSSB 活動の具体的指導を OJT で行う活動に 4.5M/M</li> <li>➤ 邦人コンサルタント及びコミュニティ開発専門家が行活動のとりまとめ作業の補助に 0.5 M/M。</li> </ul>	6.5 M/M	
運営維持管理専門家 (技術系)	同 上	6.5 M/M	
小 計		16.9 M/M	

注：暦日換算係数は 1.35 とする。

### c. 移動手段

調査対象サイト周辺の道路は未舗装道路である点を考慮して、短期間で効率良く活動を実施するため 4WD 車での移動を前提とする。

### 3) 成果品の種類

本活動の成果品の種類は下記のとおりである。

表 25 建設後トレーニングの成果品

成果品	内 容
① 運営・維持管理マニュアル (最終版)	管路給水施設概要図
	維持管理費徴収記録フォーム
	維持管理費出納記録フォーム
	給水施設稼動状況モニタリングフォーム
	給水施設点検フォーム
	WSSB 運営セルフモニタリングフォーム
② その他の重要な活動成果	会議集会記録フォーム
③ 運営・維持管理達成度確認報告	WSSB の運営規定・約款
④ Final Report	運営・維持管理の目標達成度確認結果報告
	活動計画と活動実績、計画した成果と成果の達成度、成果の達成度に影響を与えた要因、効果を持続・発展させるための今後の課題・

	提言、マニュアル等の成果物、
⑤ 完了報告書	活動実施状況確認資料、作成マニュアル類、実施機関職員・住民へのアンケート調査結果、Final Report を含む。

## 6. ソフトコンポーネントの実施リソースの調達方法

ウガンダ国ではこれまでも管路給水施設の建設が日本を初めとするドナーの援助で進められてきた。特に欧米のドナーは建設する施設の持続性を高めるため早くから住民の啓発のための活動をプロジェクト実施に取り入れてきた。RGC の管路給水施設の建設から運営・維持管理までを NGO に任せているドナーもある。また、ウガンダ国政府もプロジェクト実施の際の住民に対する啓発・普及活動はローカル NGO/ローカルコンサルタントの業務としてきており、管路給水施設の運営維持管理に関しては、P/O や S/O の使用など、色々な取り組みを行ってきている。

このため、ウガンダ国には本プロジェクトでソフトコンポーネント活動として計画されているような業務を実施できるローカル NGO/ローカルコンサルタントも多く存在し、経験豊かな専門家を有するコンサルタントも多い。また、運営・維持管理のトレーニングについては、ウガンダ政府に登録された P/O から構成される Association of Private Operators (APWO) に委託する方法も考えられる。

本プロジェクトでは、このような啓発・普及活動の経験を有するローカル NGO/ローカルコンサルタント/P/O 等の中からより経験豊かで本プロジェクトで提案されている啓発・普及業務、運営・維持管理トレーニング業務に精通したもの数社を DWD と協議の上指名し提案書を提出させ、最も実施能力が高く本プロジェクトのソフトコンポーネント活動実施に適するものを選抜し、サラリー等条件交渉の後、コンサルタントの一員あるいは契約コンサルタントとして業務を担当させる方針とする。

## 7. ソフトコンポーネントの実施工程

ソフトコンポーネント活動は詳細設計時（4 ヶ月）及び施設建設工事時（16 ヶ月）の期間に実施される。

### (1) 建設前啓発・普及活動の実施工程

給水施設建設前に実施する啓発・普及活動は詳細設計調査の期間中に実施する。コンサルタント契約後直ちにローカルコンサルタント要員の選抜を行い、選抜されたコミュニティ開発専門家（ファシリテーター兼務）とともに実施する啓発・普及活動の内容や工程について検討するとともに、使用するハンドアウト等を含むマニュアルを準備する。マニュアルに基づき現地での活動準備を行う。これらの準備作業に約 1.5 ヶ月を予定する。現地での啓発・普及活動の期間は 2.0 ヶ月とし、対象 9 RGC で必要なワークショップを開催する。その後、活動の成果確認ととりまとめに 0.5 ヶ月を予定し、各 RGC の達成度を確認する。これらの活動は一部オーバーラップさせるものとし、全体工程としては 4.0 ヶ月を予定する。これらの活動の内、特に重要な冒頭のワークショップおよび S/O トレーニング候補者の選定や貢献金の確認に関わるワークショップには実施機関から業務調整等のために派遣される政府職員も参加し、住民や関連機関にウガンダ国政府が実施するプロジェクトであることを示すと同時に重要事項の決定時に政府

職員が関与することにより、その後の運営維持管理の支援業務の促進を図る。建設前啓発・普及活動の成果と実施した活動の概要等を取りまとめたソフトコンポーネント実施状況報告書(1)を建設前啓発・普及活動の最終段階で提出する。

(2) 建設中運営・維持管理トレーニング(WSSB 事前教育段階)の実施工程

施設完成前に運営維持管理の基礎を WSSB が習得している必要があるため、建設中の運営・維持管理トレーニングは、工事の進捗に配慮して実施する。工事着工後約 1.0 ヶ月は準備工に費やされると想定し、邦人コンサルタント及びコミュニティ開発専門家は工事着工と同時に、ローカルコンサルタント（運営・維持管理専門家）選抜、マニュアル準備等を開始する。実際のトレーニングは雇用されたローカルコンサルタント（運営・維持管理専門家）により実施される。この活動に充てられる期間は施設完成までの期間であり、これを約 15 ヶ月の工事工程の間に実施する。この期間のワークショップでは S/O、K/A や会計担当者が実施する業務について実践的な訓練を実施するが、特に重要な水料金の設定や施設の引き渡しにかかるワークショップには政府職員も参加させる。最初の施設が完成した時点で、それまでの活動の概要等を取りまとめたソフトコンポーネント実施状況報告書(2)を提出する。

(3) 建設後運営・維持管理トレーニング（WSSB による実管理開始後）の実施工程

建設後運営・維持管理トレーニングは、完成した実施施設の WSSB による運営維持管理のモニタリングと OJT により実施される。そのため、最初の施設が完成した以降にこの活動を開始する。これを工事後半の約 9 ヶ月の間に実施する。また、この期間に、各 RGC の WSSB の運営・維持管理習得度を測るために、その達成度確認調査を行う。特にモニタリングは重要で、プロジェクト完了後に実施する支援の内容等に大きく影響するので、業務調整で現地に常駐する政府側関係者には必要に応じて適宜モニタリング活動にも参加させ、RGC 側の運営維持管理に関わる状況を体感させることが必須である。最終 1.0 ヶ月は、施設完成が工事工期間近くに迫った RGC を中心としてワークショップ及び OJT を集中的に行うとともに、それと並行して、これまでに実施した啓発・普及活動及びトレーニングの成果等の取りまとめ作業を行い、活動開始からの全ての活動の内容、工程、成果について取りまとめたソフトコンポーネント完了報告書を提出する。

8. ソフトコンポーネントの成果品

ソフトコンポーネントプログラムの各活動の成果品は次のとおりである。

表 26 ソフトコンポーネントの成果品

成果品	内 容
① 啓発・普及活動計画書	活動の内容・手順・手法など
② 建設前啓発・普及活動マニュアル	管路給水施設概要図
	維持管理費徴収記録フォーム
	維持管理費出納記録フォーム
	給水施設稼働状況モニタリングフォーム
	給水施設点検フォーム
	WSSB 運営セルフモニタリングフォーム

成果品	内 容
	会議・集会記録フォーム
③ Progress Report (1)/ 実施状況報告書(1)	建設前啓発・普及活動終了時点 当初目標、投入・活動の履行状況、現時点の成果、
④ 運営維持管理トレーニング計画書	トレーニングの内容、手順・手法など
⑤ Progress Report (2) 実施状況報告書(2)	施設建設中（最初の施設が完成する頃） 当初目標、投入・活動の履行状況、現時点の成果等。
⑥ 運営・維持管理マニュアル	管路給水施設概要図
	維持管理ハンドアウト(HO)/教材
	給水施設の紹介 HO/教材
	維持管理費徴収記録フォーム
	維持管理費出納記録フォーム
⑦ その他の重要な活動成果	給水施設稼動モニタリングフォーム
	WSSB 運営モニタリングフォーム
⑧ 運営・維持管理達成度確認報告	WSSB の運営規定・約款
⑨ Final Report	運営・維持管理の目標達成度確認結果報告
⑩ 完了報告書	活動計画と活動実績、計画した成果と成果の達成度、成果の達成度 に影響を与えた要因、効果を持続・発展させるための今後の課題・ 提言、マニュアル等の成果物、 活動実施状況確認資料、作成マニュアル類、実施機関職員・住民へ のアンケート調査結果、Final Report を含む。

## 9. ソフトコンポーネントの概略事業費

上記活動の実施に必要な概算事業費（暫定）は下表に示すとおりとなる。

表 27 ソフトコンポーネント費内訳（暫定）

項 目	日本円 (1,000 円)	現地貨 (1,000UGX)	円貨換算 (1,000 円)	合 計 (1,000 円)
1. 直接人件費	4,785	0	0	4,785
2. 直接経費	4,992	786,416	26,502	31,494
3. 間接費	6,125	0	0	6,125
総合計	15,902	786,416	26,502	42,404

(注) 1 USD=113.65 円、1 UGX=0.0337 円 (平成 28 年 2 月～平成 28 年 4 月の平均値)

## 10. 相手国の責務

ソフトコンポーネント活動による効果やその持続性を高めるため、また、活動を円滑に実施するためにウガンダ国側の負担で実施する事項は以下のとおりである。

- ・ DWD に配属されている啓発・普及要員(1名)の人件費と現場手当にかかる予算
- ・ 上記要員が使用する車輛と必要な燃料の供給にかかる予算
- ・ 協力対象 RGC に設立される WSSB の登録の際の DWD、DWO による補助・便宜
- ・ ソフトコンポーネント活動実施後の協力対象 RGC の施設運営及び維持管理にかかる持続性維持のためのモニタリング及びフォローアップ活動

なお、管路給水施設の運転について WSSB 及び S/O に対して行う技術指導は工事を受注する建設業者が工事の一環として必要な人材を派遣して実施することとする。

巻末表 1 ソフトコンポーネントの PDM

プロジェクト名： チョガ湖流域地方給水計画

期 間：

ターゲットグループ： 協力対象 RGC 住民、WSSB

Scheme Operator, Kiosk attendant

対象地域国： ウガンダ国

作成日：

2016 年 11 月

プログラムの要約	指 標	入手手段	外部条件
<p><b>プロジェクト目標（上位目標）</b></p> <ul style="list-style-type: none"> <li>当該 RGC における安全な水の給水量の増加を図り、当該 RGC における給水状況の改善を通じた生活環境の改善に寄与すること。</li> </ul>	<ul style="list-style-type: none"> <li>建設された管路給水施設による給水量</li> </ul>	<ul style="list-style-type: none"> <li>運営・維持管理月次報告書</li> </ul>	<p>ウガンダ国の水政策や国家開発政策に変更がない。</p>
<p><b>ソフトコンポーネントの目標</b></p> <ul style="list-style-type: none"> <li>水料金徴収等の基本的な活動が円滑に実施され、建設された給水施設が財務的に安定して運営される。</li> <li>建設された管路給水施設が適切な維持管理（点検と修理）の下で継続的に清潔に利用される。</li> </ul>	<ul style="list-style-type: none"> <li>水料金の徴収率(売上高)</li> <li>収入と支出のバランス</li> <li>管路給水施設の給水量</li> <li>Scheme Operator による修理点検回数・状況</li> </ul>	<ul style="list-style-type: none"> <li>水料金徴収記録・出納記録</li> <li>運営・維持管理月次報告書</li> <li>施設運転記録</li> <li>修理点検記録</li> </ul>	<p>住民や地方政府・DWD 担当者、Umbrella Organization が活動を継続する。</p>
<p><b>成 果</b></p> <ol style="list-style-type: none"> <li>住民が安全な水の重要性、安全な水と健康・保健・衛生との関係を理解する。</li> <li>行政及び住民が給水衛生役員会、Scheme Operator、Kiosk Attendant、Umbrella Orgzanization の目的・役割・重要性を理解する。</li> <li>給水衛生役員会（Scheme Operator 及び Kiosk Attendant を含む）が役員会の目的、各々の役割の内容、及び組織運営方法を理解する。</li> <li>給水衛生役員会（Scheme Operator を含む）が本プロジェクトで建設される管路給水施設の構造・点検・修理及び会計などの運営のための技術・知識を習得する</li> <li>給水衛生役員会（Scheme Operator 及び Kiosk Attendant を含む）が Kiosk での水販売料金の徴収、流量計保全、Kiosk 及び浸透樹の清掃作業の重要性を理解する。</li> </ol>	<ul style="list-style-type: none"> <li>水料金支払い意志の有無</li> <li>水料金支払い意志額</li> <li>給水衛生役員会の会議・住民集会開催頻度</li> <li>住民集会参加者数</li> <li>Scheme Operator の選任</li> <li>Umbrella Organization への加盟</li> <li>設定された水料金</li> <li>銀行口座の開設</li> <li>水中ポンプ運転記録、</li> <li>水源井戸の生産量</li> <li>Kiosk の流量</li> <li>定期点検頻度</li> <li>マイナー修理内容と数</li> <li>月報の有無</li> <li>Kiosk 流量計読み</li> <li>回収された水料金</li> <li>Kiosk 周辺の清掃状況</li> <li>浸透樹の清掃状況</li> </ul>	<ul style="list-style-type: none"> <li>「ウ」国側からの聴き取り調査</li> <li>実施状況報告書(1)</li> <li>Scheme Operator 選任記録/契約書</li> <li>Umbrella 登録証</li> <li>給水衛生役員会の運営規定・約款（水料金規定含む）</li> <li>銀行預金通帳</li> <li>運営・維持管理月次報告書</li> <li>運営・維持管理月次報告書</li> <li>現地視察</li> </ul>	<p>給水衛生役員会役員・地方政府関係者の入れ替えが頻繁にはおこなわれない。</p> <p>訓練された S/O が業務を継続する。</p> <p>住民がプロジェクトの活動に参加し続ける。</p> <p>住民の生活が天災などで大幅に変わらない。</p>
<p><b>活 動</b></p> <p><b>住民に対する啓発・普及活動</b></p> <p>①ステージ1 建設前: RGC 住民の意識向上と組織化を図るための、RGC 代表、プロジェクト実行委員会、サブ郡担当者及び裨益住民を対象とするワークショップを行う。</p> <p><b>給水衛生役員会（Scheme Operator、Kiosk Attendants 含む）のトレーニング</b></p> <p>②ステージ2 建設中: 運営・維持管理の基本事項に関するワークショップ及び OJT によるトレーニングを行う。</p> <p>③ステージ3 建設後: WSSB による運営・維持管理の実務を通してワークショップ及び OJT によるフォローアップを行う。</p>	<p style="text-align: center;"><b>投 入</b></p> <p style="text-align: center;">(日本側) (ウガンダ国側)</p> <ul style="list-style-type: none"> <li>雇用/業務委託団体(ローカル NGO/コンサルタント等)</li> <li>邦人コンサルタント派遣</li> <li>DWD で啓発・普及活動・保健衛生を担当する職員</li> <li>県水事務所で啓発・普及活動・保健衛生を担当する職員</li> <li>サブ郡に所属するコミュニティ開発アシスタント (CDA)、ヘルスアシスタント (HA)</li> <li>Umbrella East 職員</li> </ul>		<p><b>前提条件</b></p> <p>対象 RGC の住民が給水施設の建設に反対しない。</p>

巻末表 2 邦人コンサルタント（維持管理専門家）の作業内容（建設前啓発・普及）

作業内容	日数
<b>I. 第1回目(活動開始時): 作業準備、ローカルコンサルタント選定、活動資料等準備、ワークショップ模擬実施、活動状況確認(45日)</b>	
1. 移動(TYO⇒EBB)	2
2. DWD 協議・打合せ(全体スケジュール・活動内容確認、指名ローカルコンサルタント選定・ショートリスト)	1
3. ローカルコンサルタント業務概要書・TOR 準備、指名ローカルコンサルタント連絡、	3
4. DWD-DWO・サブ郡協議・打合せ(活動内容・スケジュール確認)、及び対象 RGC の状況確認	5
5. ローカルコンサルタント提案書受付・評価及び面接	2
6. ローカルコンサルタント契約のための協議・確認(TOR・スケジュール等)	1
8. ローカルコンサルタント(コミュニティ開発専門家)協議・打合せ(ワークショップ内容、活動教材準備、ワークショップ用ハンドアウト準備)	5
9. ワークショップ模擬実施、内容修正	2
10. 啓発・普及活動詳細実施スケジュール検討・設定	2
11. 啓発・普及活動実施状況確認(ローカルコンサルタントの活動状況を観察し、問題点について協議・改善策の指示)	4
12. DWD-DWO への報告・状況説明等	4
13. 移動(EBB⇒TYO)	3
合計	34 (34×1.35=46日) ↓ 45日
<b>II. 第2回目(活動完了時): 建設前活動結果確認、RGC 毎達成度確認、実施状況報告書準備(15日)</b>	
1. 移動(TYO⇒EBB)	2
2. DWD 打合せ(実施状況、問題点等)	1
3. RGC 毎啓発・普及活動達成度確認(問題 RGC の有無と対処方法検討)	2
4. RGC 毎活動とりまとめ	1
5. DWD-DWO 協議・打合せ(達成度報告、問題 RGC の対処)	2
6. DWD 協議・打合せ(活動結果・成果にかかる確認等)	1
7. 移動(EBB⇒TYO)	3
合計	12 (12×1.35=16日) ↓ 15日

巻末表3 邦人コンサルタント（維持管理専門家）の作業内容  
（建設中運営維持管理トレーニング）

作業内容	日数
<b>I. 第1回目(活動開始時): 作業準備、ローカルコンサルタント（運営維持管理）選定、活動資料等準備、トレーニング模擬実施、活動工程の調整（30日）</b>	
1. 移動(TYO⇒EBB)	2
2. DWD 協議・打合せ(全体スケジュール・活動内容確認)、指名ローカルコンサルタント連絡	1
3. ローカルコンサルタント業務概要書・TOR 準備、	2
4. DWD・DWO・サブ郡協議・打合せ(活動内容・スケジュール確認)、現地確認	4
5. ローカルコンサルタント（運営維持管理）提案書評価、面接	2
6. ローカルコンサルタント契約のための協議・確認(TOR・スケジュール等)	1
7. ローカルコンサルタント協議・打合せ(ワークショップ・トレーニング内容、ファシリテーター用活動マニュアル準備、ワークショップ用ハンドアウト準備)	4
8. ワークショップ・トレーニング模擬実施、内容修正	1
9. 建設業者打合せ(施工工程、施設取り扱い説明内容・ハンドアウト)	1
10. O&M トレーニング詳細スケジュール検討・設定(建設工程との調整)	1
11. DWD 報告・状況説明等	1
12. 移動(EBB⇒TYO)	3
合計	23 (23×1.35=31日) ↓ 30日
<b>II. 第2回目(活動途中): 活動状況確認、活動上の問題点確認と対処方法(30日)</b>	
1. 移動(TYO⇒EBB)	2
2. DWD 協議・打合せ(活動状況、スケジュール等)	1
3. コミュニティ開発専門家・運営維持管理専門家打合せ(活動状況と問題点)	1
4. 活動状況確認のための現地調査(活動成果確認、WSSB・S/O 候補者・住民意見聴取等)、RGC 踏査(特に課題のある RGC を重点的に調査)	4
5. 建設業者打合せ(建設時の住民・WSSB の対応及び問題点等)	2
6. コミュニティ開発専門家・維持管理専門家との打合せ(問題点と対処方法、活動方法見直し等)	2
7. 活動詳細スケジュール見直し・検討(建設工程との調整等)	2
8. DWD・DWO・サブ郡事務所協議(活動成果中間報告、問題点と対処、活動実施スケジュール等)	4
10. コミュニティ開発専門家・運営維持管理専門家打合せ (DWD・DWO・サブ郡事務所協議結果と対応)	1
11. DWD 報告・状況説明等	1
12. 移動(EBB⇒TYO)	3
合計	23 (23×1.35=31日) ↓ 30日



巻末表 4 邦人コンサルタント（維持管理専門家）の作業内容  
 （建設後運営維持管理トレーニング）

作業内容	日数
III. 第3回目(活動途中): 活動状況確認、活動上の問題点確認と対処方法(30日)	
1. 移動(TYO⇒EBB)	2
2. DWD 協議・打合せ(活動状況、スケジュール等)	1
3. コミュニティ開発専門家・運営維持管理専門家打合せ(活動状況と問題点)	0.5
4. 活動状況確認のための現地調査(活動成果確認、WSSB・S/O 候補者・住民意見聴取等)、RGC 踏査(特に課題のある RGC を重点的に調査)	2
5. 建設業者打合せ(建設時の住民・WSSB の対応及び問題点等)	0.5
6. コミュニティ開発専門家・維持管理専門家との打合せ(問題点と対処方法、活動方法見直し等)	2
7. DWD 報告・状況説明等	1
8. 移動(EBB⇒TYO)	3
合計	12 (12×1.35=16日) ↓ 15日
IV. 第4回目(活動完了時): 活動状況・活動成果確認、活動実態取りまとめ、問題 RGC の有無確認、ウガンダ国側への引継ぎ事項、報告書作成(30日)	
1. 移動(TYO⇒EBB)	2
2. DWD 協議・打合せ(スケジュール・活動内容)	1
3. DWDDWO 協議・打合せ(活動内容・スケジュール、活動効果測定方法等確認)	1
4. RGC 毎に運営維持管理状況確認(水料金徴収状況、運転記録、帳簿記録、給水サービス状況(流量計読み)、修理記録、問題 RGC の有無と対処方法)	7
5. RGC 毎に運営・維持管理状況取りまとめ	2
6. DWD・DWO・Umbrella 協議(維持管理状況報告、問題 RGC の対処、ウガンダ国側引継ぎ事項確認)	1
7. DWD 協議(活動結果・運営維持管理状況・ウガンダ国側引継ぎ事項確認等)	1
8. 建設中・後 O&M トレーニング活動実績、活動成果、問題点等とりまとめ、成果品確認	2
9. ソフトコンポーネント報告書作成(英語)	3
10. 移動(EBB⇒TYO)	3
合計	23 (23×1.35=31日) ↓ 30日

ソフトコンポーネント活動工程表

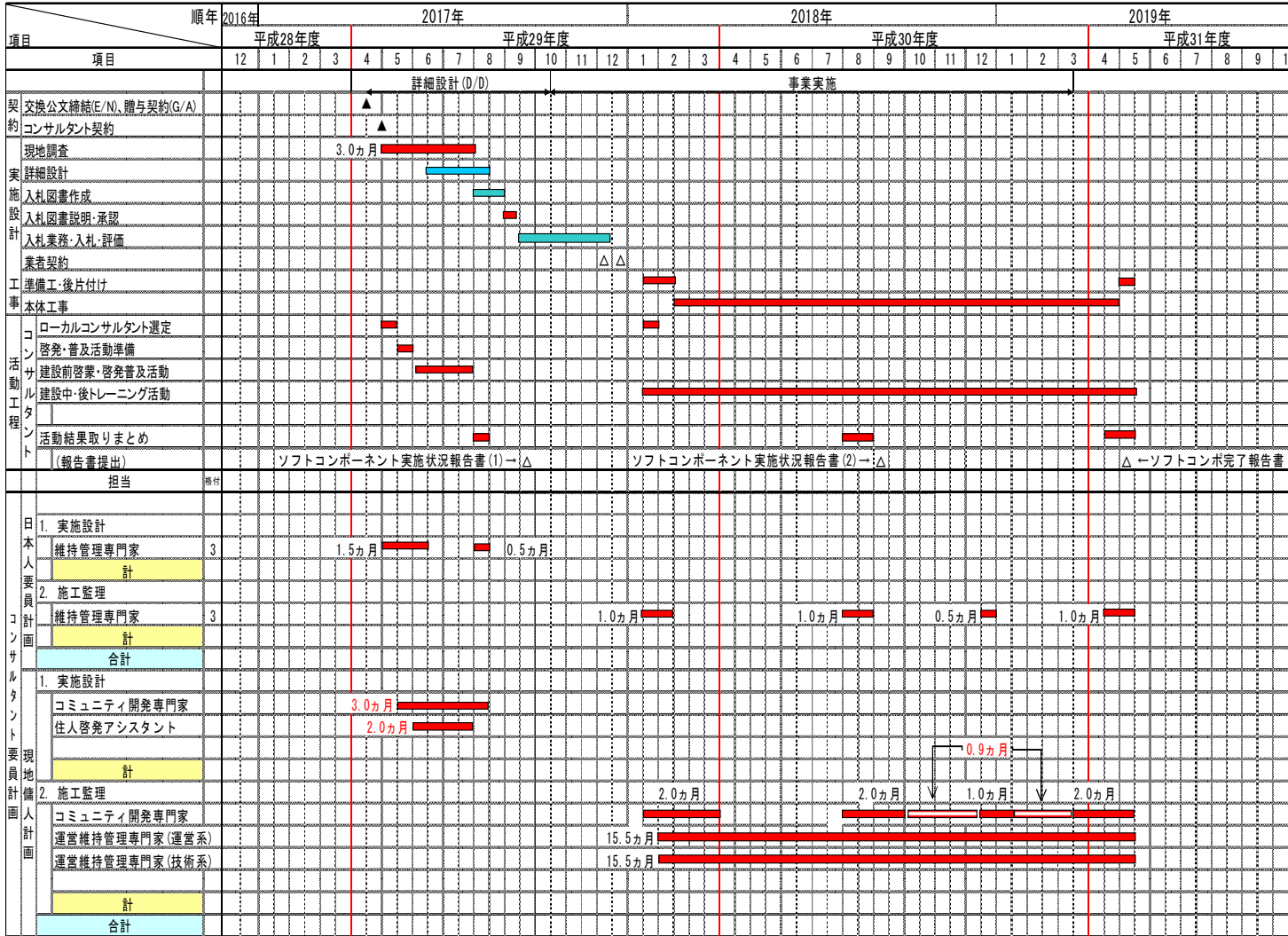

プロジェクトサイト: チョガ湖地域

国内業務 ■  
 現地業務 ■

合計

項目	報告書提出	ソフトコンポーネント実施状況報告書(1)-△			ソフトコンポーネント実施状況報告書(2)-△			△-ソフトコンボ完了報告書			合計		
		国内	現地	派遣	国内	現地	派遣	国内	現地	派遣	国内	現地	派遣
日本要員計画		M/M	M/M	回数	M/M	M/M	回数	M/M	M/M	回数	M/M	M/M	回数
1. 実施設計													
維持管理専門家	3	0.0	2.0	2.0									2.0
計		0.0	2.0	2.0									2.0
2. 施工監理													
維持管理専門家	3				0.0	3.5	4.0	3.5					
計					0.0	3.5	4.0	3.5					
合計		0.0	2.0	2.0	0.0	3.5	4.0	5.5					
1. 実施設計													
コミュニティ開発専門家		0.0	3.0	0.0									3.0
住人啓発アシスタント		0.0	2.0	0.0									2.0
計		0.0	5.0	0.0									5.0
2. 施工監理													
コミュニティ開発専門家									0.0	7.9	0.0	7.9	
運営維持管理専門家(運営系)					0.0	15.5	0.0	15.5					
運営維持管理専門家(技術系)					0.0	15.5	0.0	15.5					
計					0.0	38.9	0.0	38.9					
合計		0.0	5.0	0.0	0.0	38.9	0.0	43.9					

## 資料-11

### 参考資料

#### (1) 社会調査結果

Socio-economic Condition Survey for the Outline Design Survey for the Project for Rural Water Supply Phase III in Lake Kyoga Basin, Eastern Uganda

**Survey A: Simple Socio-economic Survey**

Date: \_\_\_\_\_ / \_\_\_\_\_ / 2015

RGC \_\_\_\_\_ RGC number \_\_\_\_\_ District \_\_\_\_\_ County \_\_\_\_\_  
 Sub county \_\_\_\_\_ Parish \_\_\_\_\_  
 Villages \_\_\_\_\_  
 Name of Enumerator \_\_\_\_\_ Respondent \_\_\_\_\_ Position \_\_\_\_\_  
 Phone Number \_\_\_\_\_  
 Location of the Centre (GPS Arc 1960) UTM-E (m) \_\_\_\_\_ UTM-N (m) \_\_\_\_\_ Altitude (m) \_\_\_\_\_

**A. Population and Households**

A1. Population of villages within the RGC by Interviewing

Name of Village	Population			No. of Households in RGC
	Total	Within RGC	Without RGC	
Total	-		-	

A2. Population of the Blocks in RGC by Counting

Block	Counted Households	per Households	Population
Block A			
Block B			
Block C			
Block D			
Block E			
Block F			
Block G			
Block H			
Total			

Compare
---------

A3. Population in RGC

Total:

**B. Public Institutions**

B1. Hospitals and Clinic

Name of Hospitals, Clinics, Health Centers etc.	No. Beds
1.	
2.	
3.	
4.	
5.	

B2. Educational Facilities

Name of Facility	No. of Students and/or Pupils	Public/Private	No. of Boarders in Dormitory
1.			
2.			
3.			
4.			
5.			
6.			
7.			
8.			

*Socio-economic Condition Survey for the Outline Design Survey for  
the Project for Rural Water Supply Phase III in Lake Kyoga Basin, Eastern Uganda*

B3. Public Offices

Name of Public Offices in RGC	Number
1. Sub-county Office	
2. Parish Office	
3. LC1 Office	
4. Police Office	
5.	
6.	
7.	
8.	
9.	
10.	

B4. Religious Facilities

No. of Churches: \_\_\_\_\_  
 No. of Mosques: \_\_\_\_\_  
 Others: \_\_\_\_\_

**C. Commercial and Industrial Facilities**

C1. Commercial Facilities

Name of Commercial Facilities	Number
Public Markets	
Shops, Stores and Restrants (total)	

Name of Hotels and Motels	No. of Beds for Guests
1.	
2.	
3.	

Name of Other Facilities	
1.	
2.	

C2. Industrial Facilities

Name of Industrial Facilities	Remarks
1.	
2.	
3.	
4.	
5.	

**D. Basic Infrastructures**

D1. Electric Power Supply

1. Existence of Electricity      a. None    b. Single Phases      c. Three Phases  
 2. When there is electric power service, how many hours (daily average) is there any electric power service?  
 (                      hr./day )

D2. Road Conditions

1. Vehicle Accessibility to the RGC in Dry Season      1. Good    2. No good    3. Impossible    4. Others ( \_\_\_\_\_ )  
 2. Vehicle Accessibility to the RGC in Rainy Season      1. Good    2. No good    3. Impossible    4. Others ( \_\_\_\_\_ )  
 3. Transportation      1. None    2. Daily bus    3. Weekly bus    4. Others ( \_\_\_\_\_ )  
 4. Daily Frequency of Bus (if daily bus is available)      1. Once a day    2. Twice a day    3. 3 times a day    4. Others ( \_\_\_\_\_ )

*Socio-economic Condition Survey for the Outline Design Survey for  
the Project for Rural Water Supply Phase III in Lake Kyoga Basin, Eastern Uganda*

**E. Hygiene and Sanitation**

E1. Coverage of Toilet in RGC: \_\_\_\_\_ %

E2. Types of household latrine in use

Type	% of all the existing households
Ordinary Pit Latrine	
Improved Pit Latrine	
Eco-sanitary Toilet	
Other (specify: _____)	

E3. What are the methods of latrine cleaning? Answer: \_\_\_\_\_

E4. \*What are some of the constraints to construction and use of latrine, if any? Answer: \_\_\_\_\_

E5. Water-Borne Diseases in RGCs

Disease	Prevalence			
	very common	common	rare	very rare
a. Malaria/fever				
b. Diarrhea				
c. Skin Disease				
d. Respiratory Disease				
e. Worms				
f. Eye Disease/Infection				
g. Typhoid and				
h. Other (Specify: _____)				

E6. Infant Mortality Rate (Year: \_\_\_\_\_) \_\_\_\_\_ /1000 Infant less than one year old

**F. Existing Water Source**

F1. Existing Water Supply

Water Source	Number	Main person to fetch water	Use of facility	Water Amount in Dry Season	Water Quality
		1. men 2. women 3. boys 4. girls	1. all season 2. dry season only 3. rainy season only	1. Good 2. o.k./ so-so 3. bad	1. Good 2. o.k./ so-so 3. bad
a. Borehole (functioning)		1, 2, 3, 4	1, 2, 3	1, 2, 3	1, 2, 3
b. Borehole (not functioning)					
c. Shallow Well		1, 2, 3, 4	1, 2, 3	1, 2, 3	1, 2, 3
d. Protected Spring		1, 2, 3, 4	1, 2, 3	1, 2, 3	1, 2, 3
e. Unprotected Spring		1, 2, 3, 4	1, 2, 3	1, 2, 3	1, 2, 3
f. Dam/Valley Tank		1, 2, 3, 4	1, 2, 3	1, 2, 3	1, 2, 3
g. River		1, 2, 3, 4	1, 2, 3	1, 2, 3	1, 2, 3
h. Other (Specify _____)		1, 2, 3, 4	1, 2, 3	1, 2, 3	1, 2, 3

F2. Are there any water purification facilities? 1. Yes 2. No

F3. If the answer of F2 is yes, what kind of water quality problems do you have? Answer: \_\_\_\_\_

F4. Do you have satisfaction with the existing water supply facilities? 1. Yes 2. No

F5. If the answer to F4 is No, what is the problem? Answer: \_\_\_\_\_

F6. What kind of activity did the villagers do for solving the problem? Answer: \_\_\_\_\_

*Socio-economic Condition Survey for the Outline Design Survey for  
the Project for Rural Water Supply Phase III in Lake Kyoga Basin, Eastern Uganda*

F7. Functioning Borehole

Functioning Boreholes (Location: area name)	UTM Coordinate (Northing)	UTM Coordinate (Easting)	DWD Number	Year Constructed	Well Depth (m)	Static Water Level (m)	Pumping Method 1. Engine 2. *Motor (Electric) 3. Wind mill 4. Handpump 5. Nothing	Constructed by 1. Government 2. UNICEF 3. Individual/ Private sector 4. Other donor 5. Don't know
Borehole 1							1, 2, 3, 4, 5	1, 2, 3, 4, 5
Borehole 2							1, 2, 3, 4, 5	1, 2, 3, 4, 5
Borehole 3							1, 2, 3, 4, 5	1, 2, 3, 4, 5
Borehole 4							1, 2, 3, 4, 5	1, 2, 3, 4, 5
Borehole 5							1, 2, 3, 4, 5	1, 2, 3, 4, 5
Borehole 6							1, 2, 3, 4, 5	1, 2, 3, 4, 5
Borehole 7							1, 2, 3, 4, 5	1, 2, 3, 4, 5
Borehole 8							1, 2, 3, 4, 5	1, 2, 3, 4, 5
Borehole 9							1, 2, 3, 4, 5	1, 2, 3, 4, 5

Functioning Borehole (continued)

Functioning Boreholes	Constructed by 1. Government 2. UNICEF 3. Individual/Private sector 4. Other (NGO) 5. Don't know	Water Fee if any (Ush. Per month)	Satisfaction 1. very satisfied 2. satisfied 3. o.k. 4. not satisfied 5. disgusted	Tank Volume (elevated tank) (m <sup>3</sup> )	Population Served	No. of Times Broken	Reason for Having been Broken	Spare Parts Changed
Borehole 1	1, 2, 3, 4, 5		1, 2, 3, 4, 5					
Borehole 2	1, 2, 3, 4, 5		1, 2, 3, 4, 5					
Borehole 3	1, 2, 3, 4, 5		1, 2, 3, 4, 5					
Borehole 4	1, 2, 3, 4, 5		1, 2, 3, 4, 5					
Borehole 5	1, 2, 3, 4, 5		1, 2, 3, 4, 5					
Borehole 6	1, 2, 3, 4, 5		1, 2, 3, 4, 5					
Borehole 7	1, 2, 3, 4, 5		1, 2, 3, 4, 5					
Borehole 8	1, 2, 3, 4, 5		1, 2, 3, 4, 5					
Borehole 9	1, 2, 3, 4, 5		1, 2, 3, 4, 5					

Functioning Borehole (continued)

Functioning Boreholes	Repair done by Whom	Cost of Repair (Ush.)	Method for Collection Money for Repair (who paid)
Borehole 1			
Borehole 2			
Borehole 3			
Borehole 4			
Borehole 5			
Borehole 6			
Borehole 7			
Borehole 8			
Borehole 9			

*Socio-economic Condition Survey for the Outline Design Survey for  
the Project for Rural Water Supply Phase III in Lake Kyoga Basin, Eastern Uganda*

F8. Non-Functioning Borehole

Non-Functioning Boreholes (Location: area name)	UTM Cordinate (Northing)	UTM Cordinate (Easting)	DWD Number	Year Constructed	Constructed by 1. Government 2. UNICEF 3. Individual/Private sector 4. Other donor 5. Don't know	Year Broken	Reason for being broken, if known
Borehole 1					1, 2, 3, 4, 5		
Borehole 2					1, 2, 3, 4, 5		
Borehole 3					1, 2, 3, 4, 5		
Borehole 4					1, 2, 3, 4, 5		
Borehole 5					1, 2, 3, 4, 5		

Non-Functioning Borehole (continued)

Non-Functioning Boreholes	Reason for no repair
Borehole 1	
Borehole 2	
Borehole 3	
Borehole 4	
Borehole 5	

F9. Functioning Shallow Well

Functioning Shallow Well (Location: area name)	UTM Cordinate (Northing)	UTM Cordinate (Easting)	DWD Number	Year Constructed	Well Depth (m)	Static Water Level (m)	Pumping Method 1. Engine 2. Motor 3. Wind mill 4. Handpump 5. Nothing	Constructed by 1. Government 2. UNICEF 3. Individual/Private sector 4. Other donor 5. Don't know
Well 1							1, 2, 3, 4, 5	1, 2, 3, 4, 5
Well 2							1, 2, 3, 4, 5	1, 2, 3, 4, 5
Well 3							1, 2, 3, 4, 5	1, 2, 3, 4, 5
Well 4							1, 2, 3, 4, 5	1, 2, 3, 4, 5
Well 5							1, 2, 3, 4, 5	1, 2, 3, 4, 5
Well 6							1, 2, 3, 4, 5	1, 2, 3, 4, 5
Well 7							1, 2, 3, 4, 5	1, 2, 3, 4, 5
Well 8							1, 2, 3, 4, 5	1, 2, 3, 4, 5
Well 9							1, 2, 3, 4, 5	1, 2, 3, 4, 5



*Socio-economic Condition Survey for the Outline Design Survey for  
the Project for Rural Water Supply Phase III in Lake Kyoga Basin, Eastern Uganda*

Functioning Shallow Well (continued)

Functioning Shallow well	O&M by 1. Government 2. UNICEF 3. Individual/Private sector 4. Other (NGO) 5. Don't know	Water Fee if any (Ush. Per month)	Satisfaction 1. very satisfied 2 satisfied 3. o.k. 4. not satisfied 5 disgusted	Tank Volume (elevated tank) (m <sup>3</sup> )	Population Served	No. of Times Broken	Reason for Having been Broken	Spare Parts Changed
Well 1	1, 2, 3, 4, 5		1, 2, 3, 4, 5					
Well 2	1, 2, 3, 4, 5		1, 2, 3, 4, 5					
Well 3	1, 2, 3, 4, 5		1, 2, 3, 4, 5					
Well 4	1, 2, 3, 4, 5		1, 2, 3, 4, 5					
Well 5	1, 2, 3, 4, 5		1, 2, 3, 4, 5					
Well 6	1, 2, 3, 4, 5		1, 2, 3, 4, 5					
Well 7	1, 2, 3, 4, 5		1, 2, 3, 4, 5					
Well 8	1, 2, 3, 4, 5		1, 2, 3, 4, 5					
Well 9	1, 2, 3, 4, 5		1, 2, 3, 4, 5					

Functioning Shallow Well (continued)

Functioning Shallow Well (continued)	Repair done by Whom	Cost of Repair (Ush.)	Method for Collection Money for Repair
Well 1			
Well 2			
Well 3			
Well 4			
Well 5			
Well 6			
Well 7			
Well 8			
Well 9			

F10. Non-Functioning Shallow Well

Non-Functioning Shallow Well (Location: area name)	UTM Cordinate (Northing)	UTM Cordinate (Easting)	DWD Number	Year Constructed	Constructed by 1. Government 2. UNICEF 3. Individual/Private sector 4. Other donor	Year Broken	Reason for being broken, if known
Well 1					1, 2, 3, 4, 5		
Well 2					1, 2, 3, 4, 5		
Well 3					1, 2, 3, 4, 5		
Well 4					1, 2, 3, 4, 5		
Well 5					1, 2, 3, 4, 5		

Non-Functioning Shallow Well (continued)

Non-Functioning Shallow Wells	Reason for no repair
Well 1	
Well 2	
Well 3	
Well 4	
Well 5	

*Socio-economic Condition Survey for the Outline Design Survey for  
the Project for Rural Water Supply Phase III in Lake Kyoga Basin, Eastern Uganda*

F11. Springs/Ponds/Rivers

	Type 1=Spring 2=Pond 3=River	UTM Cordinate (Northing)	UTM Cordinate (Easting)	Water amount 1= good, 2= so so, 3=no good	Water quality 1= good, 2= so so, 3=no good
Unprotected 1	1, 2, 3			1, 2, 3	1, 2, 3
Unprotected 2	1, 2, 3			1, 2, 3	1, 2, 3
Unprotected 3	1, 2, 3			1, 2, 3	1, 2, 3
Unprotected 4	1, 2, 3			1, 2, 3	1, 2, 3
Unprotected 5	1, 2, 3			1, 2, 3	1, 2, 3

6/14/2015

# THE SIMPLE SOCIO-ECONOMIC SURVEY OF 16 RGCs

The Simple Socio-Economic Condition Survey for the Preparatory Survey for the Project for Rural Water Supply Phase III in Lake Kyoga Basin, Eastern Uganda in the Republic of Uganda .

## Core Team Members

(I) STEVEN NKUMBI MUKIIBI Team Leader (+256-772433634)

(II) SAMUEL BUKENYA –Consultant (0701570558)

(III) JAMES KAWOOYA – Consultant (0772486024)

## CONTRACTOR

PERT Development Consult Ltd.

P.O. Box 5848 Kampala

Plot 7956 Mbogo Road, Kisugu Kampala

Tel- 0772433634

Contact Person – Steven Nkumbi Mukiibi

Email: [stevemuk1@gmail.com](mailto:stevemuk1@gmail.com)

## TABLE OF CONTENTS

Table of Figures .....	3
CHAPTER ONE: BACKGROUND AND PROJECT AREA DESCRIPTION .....	5
1.0 Introduction and Background to the Assignment .....	5
1.1 Justification for the study .....	5
1.2 The Objectives of the Assignment .....	5
1.3 Description of the Project Area .....	6
1.3.1 Location .....	6
1.3.2 Relief .....	8
1.3.3 Vegetation .....	8
1.3.4 Geology and soils .....	8
1.3.4 Climate .....	8
1.3.5 Water Resources .....	9
1.4 General Information and Location of RGCs .....	9
1.4.1 Soroti District .....	9
1.4.2 Serere District: .....	10
1.4.3 Pallisa District: .....	11
1.4.4 Kibuku District: .....	11
1.4.5 Iganga: .....	12
1.4.6 Luuka District .....	13
CHAPTER TWO: METHODOLOGY .....	14
2.0 Introduction .....	14
2.1 Activities .....	14
2.2 Enumerators .....	15
2.3 Key Informants .....	16
2.4 Methods, tools and reporting .....	16
CHAPTER THREE: PRESENTATION, OBSERVATION AND FINDINGS .....	18
3.0 Introduction .....	18
3.1 Population and Households .....	19
3.2 Health, Sanitation and Hygiene in the RGC .....	20

3.2.1 Health Facilities - Hospitals, Clinics, Dispensaries and Drug Shops.....	21
3.2.2 Latrine Coverage and Use.....	22
3.2.3 Latrine cleaning and Constraints against Latrine Construction. ....	26
3.2.4 Water Borne Diseases .....	27
3.2.5 Infant Mortality Rate .....	28
3.3 Schools and commercial facilities .....	30
3.3.1 Schools and Educational Institutions.....	30
3.3.1 Public Offices .....	31
3.3.2 Commercial Facilities.....	32
3.3.3 Religious Facilities.....	32
3.4 Basic infrastructure.....	34
3.4.1 Electricity Supply .....	34
3.4.2 Accessibility to the RGCs .....	35
3.5 Existing Water Sources .....	36
3.5.1 Quality of Water .....	36
3.5.2 Functionality of Water sources .....	37
3.5.3 Operation and Maintenance of Water Facilities .....	39
3.5.4 Use of facilities.....	39
3.5.5 Operation and Maintenance Fee.....	41
CHAPTER FOUR: ISSUES, CHALLENGES AND CONCLUSIONS .....	43
4.0 Issues and challenges.....	43
5.0 Conclusion .....	43

## TABLE OF FIGURES

Figure 1.1 Location of Kyoga Region.....	6
Figure 1.2 Detail of the Kyoga Region.....	7
Figure 1.3 RGCs surveyed .....	14
Figure 3.01: General Information and Location of RGCs .....	18
Figure 3.02: Population and Households.....	19
Figure 3.03: Population in the RGCs .....	20
Figure 3.04: Hospitals, Clinics, Dispensaries and Drug Shops.....	21
Figure 3.05: Types of Household Latrine in use.....	22
Figure 3.06 Ecosan Latrine Technology with photo of Ecosan toilet near Kameke RGC centre .....	23
Figure 3.07 Percentage of Ordinary pit latrines in each RGC .....	24
Figures 3.08 and 3.09 Percentage improved pit and ecosan toilets .....	24
Figure 3.10: Latrine Coverage, .....	25
Figure 3.11 Methods of Latrine Cleaning.....	26
Figure 3.12: Occurrence of Water Borne Diseases in the RGCs .....	27
Figure 3.13 RGCs reporting 'very common' for Malaria Typhoid and Diarrhoea.....	28
Figure 3.14 Reported Infant Mortality Rate in the RGCs.....	29
Figure 3.15: Educational Institutions in the RGCs .....	30
Figure 3.16: Public Offices .....	31
Figure 3.17: Commercial Facilities .....	32
Figure 3.18: Religious Facilities .....	33
Figure 3.19: Religious Facilities.....	33
Figure 3.20: Electricity Supply to the RGCs.....	34
Figure 3.21: Accessibility to the RGCs.....	35
Figure 3.22 Sources of Water in the RGCs .....	36
Figure 3.23 Sources of Water in the RGCs .....	37
Figure 3.24 Sources of Water in the RGCs .....	38
Figure 3.25 Main Person to Fetch Water.....	39
Figure 3.26 Method of Operation of Water Sources.....	40
Figure 3.27 Entity Responsible for Construction of the BH .....	40
Figure 3.28 Responsibility for Operation and Maintenance .....	41

## CHAPTER ONE: BACKGROUND AND PROJECT AREA

### DESCRIPTION

#### List of Acronyms

BH	Borehole
ECOSAN	Ecological Sanitation
HH	Household
HP	Hand Pump
JICA	Japan International Cooperation Agency
LPCPD	Litres Per Capita Per Day
MWE	Ministry of Water and Environment
O & M	Operation and Maintenance
PERT - DC	PERT Development Consult Ltd
RGCs	Rural Growth Centres
SACCO	Savings and Credit Cooperative Organisation
TECI	Tokyo Engineering Consultants International
UTM	Universal Transverse Mercator

#### List of Attachments

1. Questionnaire Social Economic Survey – the survey of 16 RGCs
2. Copy of the Technical Specifications/ Terms of reference
3. Photos from the RGCs
4. List of Water Sources in RGCs
5. List of Major Institutions in the RGCs

### 1.0 INTRODUCTION AND BACKGROUND TO THE ASSIGNMENT

In May 2015 JICA Study Team composed of OYO International Corporation and Tokyo Engineering Consultants Co., Ltd (“the Client”) commissioned - PERT Development Consult Ltd (PERT - DC) (“the Local Consultant”) to undertake the Simple Socio-economic Condition Survey for the Preparatory Survey for the Project for Rural Water Supply Phase III in Lake Kyoga Basin, Eastern Uganda in the Republic of Uganda. The survey covered 16 Rural Growth Centres (RGCs). This is a report of the observations and findings from the survey of 16 RGCs

### 1.1 JUSTIFICATION FOR THE STUDY

The Kyoga Basin area covered under this study is one of the areas where water coverage is still a problem. With a combined population of some 1,917,329 people, (2014 Census Results, www.citypopulation.de) the area is one of the major regions in the country. With a poor water coverage, the potential for water borne diseases and poor health in general increases, slowing the growth of the area. The region has also suffered some neglect due to the focus on the rehabilitation of the post conflict Northern Uganda. Yet the impact of the conflict was also felt in this region but due to the fact that it is not classified under the areas directly affected by the war, it has been by passed in terms of development activity.

This region is also one of the areas with a great potential for growth having good fertile soils and beautiful weather conditions that make for good agriculture. It is therefore important that conditions for growth especially in the RGCs which are quickly developing into towns are put in place. One of these is access to safe water.

In the last ten years, this region has also seen the break out of a number of mini epidemics of water borne diseases in particular typhoid, dysentery and other diarrhoeal diseases. This can be partly attributed to insufficient access to safe water and indeed the Government has responded with a number of measures including the introduction of chlorine dispenser to purify water at many of the water sources in the region. This underlines the need to understand the level of access to safe water as well as the hygiene and sanitation practices in area.

### 1.2 THE OBJECTIVES OF THE ASSIGNMENT

The objectives of the Village Survey of 16 RGCs were:

- To grasp actual condition of 16 RGCs,



### 1.3.2 RELIEF

Kyoga Basin lies at an altitude between 1,000m to 1800m ASL. The topography is hilly flat with wetlands and forested areas.

Lake Kyoga has undergone some changes in its old pattern. The older Kyoga was a larger lake than the present body of water. It is a shallow depression consisting of a number of arms, many of which are filled with swamp vegetation. The lake has a basin 7,500km<sup>2</sup> in area including 6,720 km<sup>2</sup> which form the areas occupied by the lake arms and enclosing high land up to an elevation of 1,030metres. The depth of the lake at its western end is from 3 to 5m, the maximum recorded depth is 7m.

The drainage basin of Lake Kyoga is characterised with a series of low hills and flat valleys with impeded drainage.

### 1.3.3 VEGETATION

The vegetation is typical savannah type mainly characterized by grass cover. Perennial trees normally shed their leaves during the dry season. Much of the natural vegetation has been felled down for economic activities including charcoal burning and farming.

### 1.3.4 GEOLOGY AND SOILS

The soil types vary from place to place but are generally well drained sandy loams and clay. Clay loams occupy areas along the rivers and streams. The soils are fertile, with potential for high productivity and especially suitable for agriculture. In some places the following soil exists: Foresails, Gleysols, Nitrosols, Reyasols and Cilhosols. The soils along major rivers in Kyoga Basin Region constitute mostly of Reyasols and Cilhosols which are poorly developed and prone to water logging.

The soil of a greater part of Kyoga Basin Region consists of ferruginous soil with a high percentage of sandy soils and therefore susceptible to erosion. Due to its sandy nature, the soil has low water retention capacity and high rate of water infiltration. The soils are usually deep with little differentiation into clearly defined zones and possess fine granular structure, others moulded into large, weak coherent clods that are very porous.

### 1.3.4 CLIMATE

In general, the Kyoga Basin Region gets average rainfall of between 1200 to 1450 mm a year. The monthly average rainfall varies between 14 mm in January and 230 mm in August. Temperature ranges from 15 to 39 degrees Centigrade. The climate is hot throughout the year with two marked rainy seasons from March to June and August to November.

It is hot, dry and windy from December to mid-March. The southern part is part of the lake Vitoria watershed and its climate is moderated by the lake. Both rainy and dry seasons are therefore less marked as there is some rain even in the dry season. The maximum temperature is about 31.8°C and the annual minimum temperature is about 17.3°C giving a mean annual temperature of 24.6°C.

### 1.3.5 WATER RESOURCES

The water resources of the area are heavily influenced by the rainfall pattern, topography and geological formation. The immediate response to rainfall is the runoff which finds its way to the streams and gradually into the groundwater system. The relatively dry and windy conditions mean that most of the rainfall is lost through evaporation.

Surface water is dominated by the marginally perennial rivers which essentially form the boundaries of districts, counties and sub-counties at times. Smaller streams can also be found within the vicinity of some RGCS. None of these streams are gauged and therefore there is no data on stream flows to inform planning.

These surface sources are used by the community for non-culinary purposes. The growing population, coupled with lack of enforcement of environment laws and regulations and a lack of alternative energy sources have had a serious impact on the quality of the water in the streams. The streams are heavily polluted.

Groundwater is the main source of drinking water although the geology of the area does not lend it to high expansive productive aquifers. Groundwater is found in valleys and in isolated pockets of the decomposed Precambrian rocks that form most of the geological stratum.

## 1.4 GENERAL INFORMATION AND LOCATION OF RGCS

The Preparatory Survey for the Project for Rural Water Supply Phase III in Lake Kyoga Basin in Uganda is proposed to cover the 6 selected districts namely: Soroti, Serere, Pallisa, Kibuku, Iganga and Luuka in Eastern Uganda. Below is a brief about each of the selected districts.

### 1.4.1 SOROTI DISTRICT

This is found in the Eastern region and it's named after its chief municipal, administrative and commercial headquarters, Soroti, where the district headquarters are located. Soroti District is bordered by Amuria District to the north, Katakwi District to the east, Ngora District to the south east, Serere District to the south, and Kaberemaido District to the west. The Soroti district headquarters is located approximately 116 kilometres (72 mi), by road, northwest of Mbale, the nearest large city.

**Population:**

As of now, the sub-region is home to an estimated 2.5 million people. The district has one of the highest levels of poverty in the country. In February 2009, it was estimated that 53% of the population in the district (an estimated 124,300 people), live on less than US\$1.00 per day. The two predominant ethnicities in the district are the Iteso, and the Kumam. The main languages spoken in the district are: (a) Ateso (b) Kumam and Swahili.

**Economic activity:**

Agriculture is the main economic activity in the district. Crops grown include: Millet, Cassava, Peas, Potatoes, Beans, Onions, Tomatoes, Cabbages, Simsim, Sunflower, Cotton, Sweet Potatoes. The produce is consumed locally and some is sold in the urban areas, particularly in Soroti Town.

**1.4.2 SERERE DISTRICT:**

Is a district also found in the Kyoga basin in Eastern Uganda It's named after its 'chief town Serere, where the district headquarters are located? Its weather is averagely 78°F (26°C), while the Wind is at 1 mph (2 km/h) and 63% humidity. Land coverage is at 1,965.4 km<sup>2</sup> (758.8 sq mi)

**Location**

Serere District is bordered by Soroti District to the north, Ngora District to the east, Pallisa District, and Kaliro District to the south. Kaberamaido lies to the west of Serere District. The district headquarters at Serere are located approximately 35 kilometers (22 mi), by road, south of Soroti, the largest town in the sub-region and approximately 205 kilometers (127 mi), by road, northeast of Kampala at: 01 30N, 33 33E.

Serere District was created by Act of Parliament and became functional effective 1 July 2010. Prior to that, it was part of Soroti District. Serere District is part of the Teso sub-region, home to an estimated 2.5 million people of Iteso and Kumam ethnicities.

The districts that constitute the sub-region are: 1. Amuria District 2. Bukedea District 3. Kaberamaido District 4. Katakwi District 5. Kumi District 6. Ngora District 7. Serere District and 8. Soroti District. The sub-region is home to an estimated 2.5 million people of Iteso and Kumam ethnicities.

**Population**

In 1991 the national population census estimated the district population at about 90,400. The national census in 2002 estimated the population at about 176,500 (51% women), with an overwhelmingly rural population (80%), and a very high proportion of children (56%, or 46.5% if you consider only under 5 year-old children). In 2012, the population of Serere District was estimated at about 294,100. The major ethnicities in the district are: Iteso, Kumam and Bakenye while the Density 149.6/km<sup>2</sup> (387/sq mi)

**1.4.3 PALLISA DISTRICT:**

This is also one of the districts also in the basin and in Eastern Uganda. Like most other Ugandan districts, it is named after its chief town, Pallisa, where the district headquarters are located.

**Location:**

Pallisa District is bordered to the north by (from west to east): Serere District, Ngora District, Kumi District, Bukedea District, Mbale District lies to the east while Budaka District to the southeast, Kibuku to the southwest and Kaliro District to the west. Pallisa the 'chief town' of the district, is located approximately 65 kilometers (40 mi), by road, west of Mbale the largest city in the sub-region.

**Population:**

In 2014, the population of Pallisa District was estimated at about 386, 074. The District covers an area of 1,487.7 km<sup>2</sup> (574.4 sq mi) of which 1,095.7 km<sup>2</sup> (423.1 sq mi) is land and 392 km<sup>2</sup> (151 sq mi) water with a population density of 330.9/km<sup>2</sup> (857/sq mi).

**Economic activities:**

Subsistence crop agriculture and animal husbandry are the two major economic activities in the district. To a lesser extent, fishing, fish farming and bee keeping are increasingly practiced in Pallisa District. The major crops include: Cassava, Millet, Sorghum, Maize, Ground nuts, Beans, Peas, Sweet Potatoes, Cotton, Sunflower, Soya beans, Banana, Matooke. Cattle, goats, sheep Poultry, and pigs are some of the animals raised in the district.

The district is further blessed with nine minor lakes that comprise part of the Lake Kyoga system. The following are the nine lakes: Lake Lemwa, Lake Kawi, Lake Nakwa, Lake Meito, Lake Geme, Lake Omunuo, Lake Nyanzala and Lake Nyaguo

There are nine stocked fish farms in the district. Fish farming offers a big potential to increase the supply of fish for the population and hence improve on the nutrition of the population.

**1.4.4 KIBUKU DISTRICT:**

Kibuku District was created by Act of the Uganda Parliament, on 1 July 2010. Prior to that the district was part of Pallisa District.

Kibuku District is bordered by Pallisa District to the north, Budaka District to the east, Butaleja District to the south, and Namutumba District to the west. The district headquarters at Kibuku, are located approximately 53 kilometers (33 mi), by road, west of Mbale, the largest city in the sub-region and on coordinates.



**Population:**

In the most recent census of 2014, the population of Kibuku District was estimated at approximately 202, 630.

**Economic activity:**

Agriculture (subsistence and commercial), is the mainstay of the district economy. crop agriculture involves the following crops: Matooke, Sweet bananas, Oranges, Pineapples, Maize, Sweet potatoes, Beans, Groundnuts, Cassava.

**1.4.5 IGANGA:**

This is a town in Eastern Uganda. It is the main municipal, administrative and commercial center of Iganga District and the district headquarters are located there. The district is named after the town Iganga.

**Location:**

Iganga is located in Uganda's Busoga sub-region. It lies approximately 45 kilometers (28 mi), by road, northeast of the city of Jinja, on the highway between Jinja and Tororo.

This location lies approximately 118 kilometers (73 mi), by road, southeast of Mbale, the largest city in Eastern Uganda and on coordinates:0°36'54.0"N, 33°29'06.0"E

The area cover by the district is 650.1 km<sup>2</sup> (251.0 sq mi)

**Population:**

In 2014, the national population census put Iganga's population at 506, 388 and hence a population density of 496.9/km<sup>2</sup> (1,039/sq mi)

**Overview.**

Iganga town has several Internet cafes, several guest houses, and a bustling market in the center of town beside the taxi park. Points of interest in the town include the Iganga Hospital, a 120-bed public hospital, administered by the Uganda Ministry of Health.

Iganga is served by a station on the Uganda Railways, the highway from the border with Kenya at Malaba, passes through Tororo and through Iganga, on the way to Jinja and on to Kampala, Uganda's capital and largest city.

**1.4.6 LUUKA DISTRICT****Location:**

Located at 1,200 m ASL (3,900 ft), Luuka District is bordered by Buyende District in the north, Kaliro District to the northeast, Iganga District to the southeast, Mayuge District to the south, Jinja District to the southwest and Kamuli District to the northwest.

Bulongo, where the district headquarters are located is approximately 33 kilometres (21 mi), by road, northwest of Iganga, the nearest large town. The coordinates of the district are: 00 42N, 33 18E.

**Overview:**

Luuka District was created by Act of Parliament and became functional on 1 July 2010. Prior to then, the district was *Luuka County* in Iganga District.

In Kisoga tradition, Luuka is one of the five traditional principalities of the Kingdom of Busoga. According to legend, Luuka was founded around 1737 A.D. and became a part of the British protectorate in Busoga in 1896 A.D. Its traditional ruler is known as the Tabingwa. The Luuka district is made up of 7 sub counties the following sub-counties namely: Bukanga, Bukooma, Bulongo, Ikumbya, Irongo, Nawampiti and Waibuga with 33 parishes and 17 villages.<sup>1</sup>

**Population.**

In 1991, the national population census estimated the district population at about 130,400. The national census in 2002 estimated the district population to be approximately 185,500. In 2012, the district population was estimated at about 260,900. The most recent census in 2014 put the population of Luuka at 241,453 with a density of 371.4.

## CHAPTER TWO: METHODOLOGY

### 2.0 INTRODUCTION

In reference to the bid document received by PERT - DC and the subsequent contract signed concerning the project for Preparatory Survey for the Project for Rural Water Supply Phase III in Lake Kyoga Basin, Eastern Uganda in the Republic of Uganda, PERT - DC was expected to complete the study; the Survey of sixteen (16) RGCs in 14 days. The surveys commenced on June 1st, 2015 and field data collection ended on 12<sup>th</sup> June however data processing, analysis and report preparation took a few more days than planned hence a short delay in the submission of the report.

### 2.1 ACTIVITIES

The exercise was conducted in the six (6) project districts namely, Serere, Soroti, Kibuku, Pallisa, Iganga and Luuka. Professional business visits were made to District Authorities, Sub-county Chiefs, Parish Chiefs, and Local Council Leadership. The focus of this report therefore is the Village Survey of the 16 RGCs. The list of the surveyed RGCs is presented in the table below.

FIGURE 1.3 RGCs SURVEYED

RGC	RGC No.	District	County	Sub-county
NABITENDE	I-1	IGANGA	KIGULU NORTH	NAMBALE
NAMUNGALWE	I-2	IGANGA	KIGULU	NAMUNGALWE
NAMBALE	I-3	IGANGA	KIGULU	NAMBALE
LAMBALA	I-6	LUUKA	LUUKA	IRONGO
NAIGOBYA	I-7	LUUKA	LUUKA	BUKOOMA
BUSESA	I-8	IGANGA	BUGWERI	IBULANKU
KYANVUMA	I-9	LUUKA	LUUKA	IRONGO
NAKIVUMBI	I-10	IGANGA	BUGWERI	IBULANKU
NONDWE	I-11	IGANGA	BUGWERI	MAKUUTU
KASASSIRA	P-2	KIBUKU	KIBUKU	KASASSIRA
KAMEKE	P-3	PALLISA	AGULE	KAMEKE
KAPALA	P-4	PALLISA	PALLISA	GOGONYO
BUSETA	P-5	KIBUKU	KIBUKU	BUSETA
KIDETOK	S-1	SERERE	KASILO	PINGILE
TUBUR	S-2	SOROTI	SOROTI	TUBUR
ACUNA	S-3	SOROTI	SOROTI	TUBUR

The activities that were carried out in the Village Survey of Sixteen (16) RGCs are highlighted below:

#### Preparatory work and Training of Enumerators

As part of the training, enumerators were guided in a review of the background of the project and the Terms of Reference for the survey. They were then taken through the questionnaire and the meaning of each question was explained. Practice on interviewing was done. Enumerators were then shown how to use the equipment including the counters, cameras and GPS.

#### Trial Survey

Field practice was also undertaken in Soroti to test the questionnaire as well as to have a feel of how to carry out the interview and the kind of responses and probes that have to be used to get the desired answers. The outcome was fed into the final questionnaire. The experience was used to refine the technique and strategy of the interviewers.

#### Interview Survey of Sixteen (16) RGCs

At each of the RGCs the local leaders namely the village (Local Council 1 Chairman) and where applicable the Parish (LC 2) and Sub-county (LC3) were interviewed. Opinion leaders consisting of business leaders, traditional and cultural leaders and influential faith based leaders were interviewed. In addition members of WSCs for water sources in the RGCs were also interviewed.

#### Photographic Documentation and GPS Coordinates

Water sources in the RGCs as well as the major institutions were photographed and their GPS locations as well as other details taken. The coordinates of the place considered as the centre of the RGC by the residents were also taken.

#### Reporting

The data thus gathered was edited and then processed. Some of it such as the photographs were coded and then organised and kept. The rest was entered into a computer data sheet which was subsequently used for analysis and production of this report.

### 2.2 ENUMERATORS

The Consultant – PERT - DC, deployed nine (9) enumerators for the Survey of the 16 RGCs who were directly accounting to the field supervisor. The field supervisor then reported to the team leader and lead consultant. Some of the enumerators are graduates from universities and other tertiary institutions with experience in research, supervision and monitoring. Team members were dispatched in three teams to each district and these were responsible for all the consultants' materials for data collection in addition to the supervisor who was in charge of quality assurance and overall supervision. All the enumerators were chosen on the basis

that they knew at least two of the languages in the study area and have also been in the area before and therefore know the geographical lay out of the same. These are people familiar with the area and could speak the local language.

The Consultant hired two (2) vehicles for the exercise. Motorcycles taxis were also hired on a day to day basis in line with the needs of the day.

### 2.3 KEY INFORMANTS

The key informants in the survey included; district officials, sub-county chiefs, sub-county chairmen, parish chiefs, local council leaders, WSC members and opinion leaders i.e. religious leaders, business leaders, the leaders of each RGC for the Village Survey of Sixteen (16) RGCs.

### 2.4 METHODS, TOOLS AND REPORTING

The main methods of data collection included; administration of Questionnaires, observations and discussions with Key informants. The contractor also collected data by use of Digital cameras and Geographical Positioning Systems (GPS).

Collected data was subjected to quality checks for consistency, validity and accuracy before entry. The data was entered in the database provided by the Client.

Before visiting each RGC a map of the RGC was reviewed with the team to become familiar with its boundaries and the features that mark this boundary on the ground. At the time of physical survey on the ground, members of the team checked for the boundary using the features marked on the map. The boundary was also explained to respondents at the time of collecting data so as to ensure that their responses particularly on population figures were consonant with the boundaries of the RGC.

Due to the fact that the RGC boundaries do not necessarily correspond with local administration boundaries on the ground, the team also counted households in each of the RGCs and used the most recent population figures for people per household in each of the RGCs. The population of each RGC was then derived by multiplying the counted households by the people per household according to the 2014 national population census results.

To effectively carry out the count of households, the RGC was divided into blocks based on the existing features such as roads or rivers. The enumerators then walked through each block, usually guided by a local person, while counting off the households using a counter. Two unique situations came to the attentions of the team.

A **household** usually consists of a number of persons who share a housing unit or part of a housing unit and share food and probably other essentials of living. Co-residence is a necessary condition though it is not sufficient. Individuals who share a housing unit but do

not share food and other essentials for living are not a household<sup>1</sup>. In this study we adopted this definition of a household. In the urbanizing parts of the RGCs however you find premises consisting of a business premise in front and a home at the back. Often these are on one long building with several of them in line. Each of these was counted as a household if we noted that a family lives in the back. Then there are homesteads which consist of several houses in one compound, here the criteria was based on the above definition. Where any of the houses or huts prepared meals alone, that was considered as a household.

Significant institutions in the RGCs were also documented with photographs as well as GPS coordinates. These included schools, churches and hotels. Shops and business premises were also investigated.

An intersection of several roads in an area of dense population in each RGC was treated as the center of the RGC and was documented with photographs and its coordinates also taken.

---

<sup>1</sup> Franz Willekens “Family and Household Demography” in Demography Vol II, UNESCO, EOLSS.

## CHAPTER THREE: PRESENTATION, OBSERVATION AND FINDINGS

### 3.0 INTRODUCTION

This section of the report has been broken down into the following themes:

- ♣ General Information and Location of the RGCS
- ♣ Population and Households
- ♣ Health, Sanitation and Hygiene in the RGC
- ♣ Schools and Commercial Facilities
- ♣ Basic Infrastructure
- ♣ Existing Water Sources

FIGURE 3.01: GENERAL INFORMATION AND LOCATION OF RGCS

No.	RGC	RGC No.	District	County	Sub-county	UTM - E	UTM - N	Altitude (m)
1	NABITENDE	I-1	IGANGA	KIGULU NORTH	NAMBALE	555650	93787	1090
2	NAMUNGALWE	I-2	IGANGA	KIGULU	NAMUNGALWE	554468	79607	1126
3	NAMBALE	I-3	IGANGA	KIGULU	NAMBALE	556076	86140	1109
4	LAMBALA	I-6	LUUKA	LUUKA	IRONGO	525712	79878	1077
5	NAIGOBYA	I-7	LUUKA	LUUKA	BUKOOMA	540456	91171	1073
6	BUSESA	I-8	IGANGA	BUGWERI	IBULANKU	566722	69529	1098
7	KYANVUMA	I-9	LUUKA	LUUKA	IRONGO	530321	84213	1129
8	NAKIVUMBI	I-10	IGANGA	BUGWERI	IBULANKU	567039	61252	1115
9	NONDWE	I-11	IGANGA	BUGWERI	MAKUUTU	566172	50708	1221
10	KASASSIRA	P-2	KIBUKU	KIBUKU	KASASSIRA	578281	121015	1080
11	KAMEKE	P-3	PALLISA	AGULE	KAMEKE	586003	139993	1123
12	KAPALA	P-4	PALLISA	PALLISA	GOGONYO	568421	137778	1067
13	BUSETA	P-5	KIBUKU	KIBUKU	BUSETA	583724	119623	1069
14	KIDETOK	S-1	SERERE	KASILO	PINGILE	546298	163480	1103
15	TUBUR	S-2	SOROTI	SOROTI	TUBUR	557636	216178	1091
16	ACUNA	S-3	SOROTI	SOROTI	TUBUR	552793	221674	1097

A general description of the districts in which the RGCs are located is provided in Section 1.4 of this report. In the table above, the precise location of each of the RGC in UTM Easting and Northing is stated. In addition the altitude of each of the RGCs is also indicated.

### 3.1 POPULATION AND HOUSEHOLDS

Households and families are basic units of analysis in demography. A household is composed of one or more people who occupy a housing unit (Jason & Lynne, 2001). In this study, information on Population and Households was collected. Figure 3.02 below presents a summary of the data on population and households in the different RGCs.

FIGURE 3.02: POPULATION AND HOUSEHOLDS

No.	RGC	RGC No.	District	Total No. of HHs Counted	Population Per HH*	Population of RGC
1	NABITENDE	I-1	IGANGA	2726	5	13,630
2	NAMUNGALWE	I-2	IGANGA	4058	4.9	19,884
3	NAMBALE	I-3	IGANGA	304	5	1,520
4	LAMBALA	I-6	LUUKA	277	5.4	1,496
5	NAIGOBYA	I-7	LUUKA	272	5.4	1,469
6	BUSESA	I-8	IGANGA	1227	5	6,135
7	KYANVUMA	I-9	LUUKA	508	5.4	2,772
8	NAKIVUMBI	I-10	IGANGA	570	5	2,850
9	NONDWE	I-11	IGANGA	859	5.4	4,369
10	KASASSIRA	P-2	KIBUKU	809	5.4	4,369
11	KAMEKE	P-3	PALLISA	197	6.2	1,221
12	KAPALA	P-4	PALLISA	360	6	2,160
13	BUSETA	P-5	KIBUKU	292	6	1,752
14	KIDETOK	S-1	SERERE	604	6.1	3,020
15	TUBUR	S-2	SOROTI	275	5.7	1,568
16	ACUNA	S-3	SOROTI	181	5.7	1,032

\*Sub-county 2014 Uganda census results

It is important to note at this juncture that an RGC is not a political or administrative entity and it can fall within two administrative and or political divisions. At the same time there will be smaller units or villages that are within this entity while at the same time there will also be villages that are associated with the RGC in terms of being close to or sharing resources and in some cases having part of their population living within the RGCs. This is the reason behind specifying villages within and villages associated with the specific RGCs.

Figure 3.03 below, is a graphic illustration of the population in the RGCs. Namungalwe in Iganga District is the most populated RGC with the Population of 19,884.

FIGURE 3.03: POPULATION IN THE RGCs

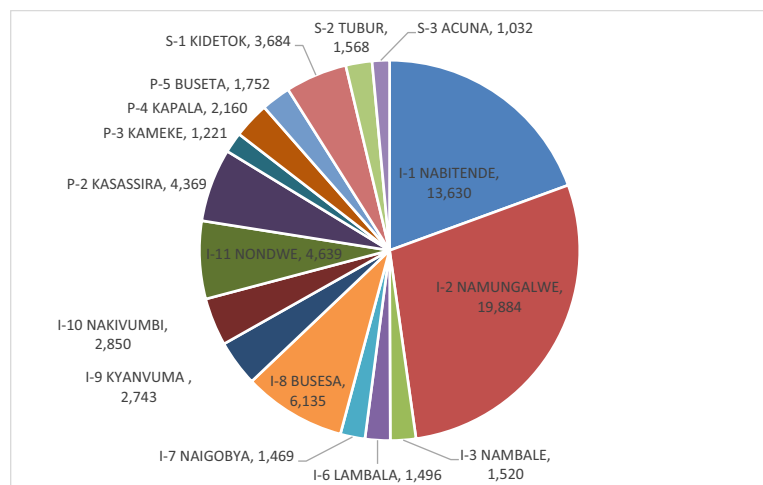

The second most populated RGC is Nabitende Banada followed by Busesa, Nondwe, Kasassira Kidetok, Nakivumbi, Kyanvuma, Kapala, Buseta, Tubur, Nambale, Lambala, Naigobya, Kameke and Acuna in that order. Acuna is the least populated with a population of 1,032 people.

### 3.2 HEALTH, SANITATION AND HYGIENE IN THE RGC

The maintenance and promotion of health is achieved through repertoire of attitudinal and behavioural patterns. Health care providers deliver systematic activities to prevent or cure health problems and promote good health in humans in communities. A health care provider is an individual or an institution that provides preventive, curative, promotional or

rehabilitative health care services in a systematic way to individuals, families or communities. In this study, institutions of note in the RGCs (also known as health facilities) included; hospitals, clinics, dispensaries and drug-shops.

#### 3.2.1 HEALTH FACILITIES - HOSPITALS, CLINICS, DISPENSARIES AND DRUG SHOPS

All the RGCs reported one or the other of the above facilities. The largest RGCs by population also have the largest number of hospitals and clinics. Uganda, hospitals and health facilities are arranged in order of size and facilities. At the lower level are the village Health Teams (VHT) being the smallest unit that assists the population with advisory/counselling services and having only to handle minor cases. At the second level are the Health Centre II facilities with a capacity of 5 -10 beds. Level III is at sub county level with 10-15 beds while level IV is at county level with up to 30 beds. Level V is at district level and beyond this are the referral hospitals at regional and national level being the largest among the systems of hospitals in Uganda.

Information on health facilities was obtained through interview augmented by observation by the survey team as they walked through the RGCs. In the interviews, the first 5 medical facilities mentioned by respondents unprompted were processed. Figure 3.04 below shows the results. There was one RGC with a level IV facility and that is Busesa.

FIGURE 3.04: HOSPITALS, CLINICS, DISPENSARIES AND DRUG SHOPS

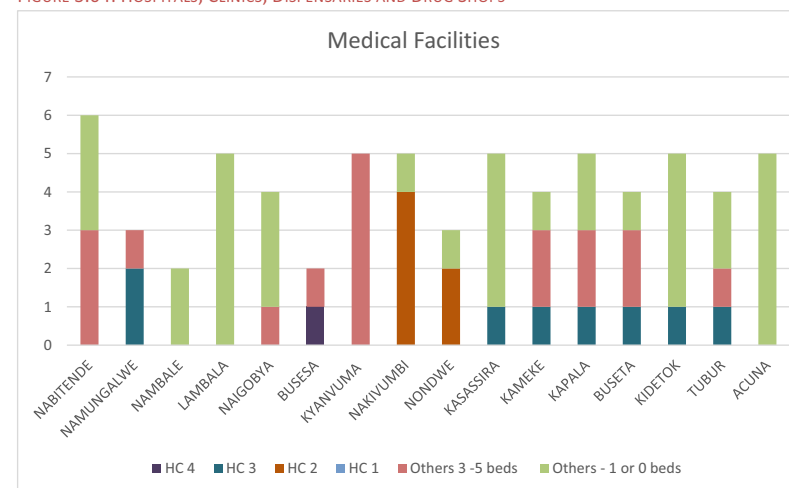

Seven RGCs namely Namungalwe, Kasassira, Kameke, Kapala, Buseta, Kidetok and Tubur have Health Centre 3 facilities. All the RGCs had one type of facility or other with all having at least one drug shop or clinic. A casual look will suggest that the RGC in the worst position in terms of health facilities is Nambale where all the health facilities are one bed or less.

### 3.2.2 LATRINE COVERAGE AND USE.

Information on types of household latrines in use was collected as illustrated in Figure 3.05 below. Latrine coverage ranged from 50% in Lambala to 90% in Nabitende and Namungalwe. The two with the highest percentage are also the largest RGCs of the lot and the most urbanised. It is plausible to conclude that the urban nature of the RGCs compels the residents to construct latrines without which, there is nowhere to defecate.

FIGURE 3.05: TYPES OF HOUSEHOLD LATRINE IN USE

ID.	RGC Name	District	Latrine Coverage rate in the RGC (%)	Ordinary Pit (%)	Improved Traditional P.T (%)	Eco San (%)	Others (Specify)
I-1	NABITENDE	IGANGA	90	70	18	2	0
I-2	NAMUNGALWE	IGANGA	90	70	18	2	0
I-3	NAMBALE	IGANGA	75	50	25	0	0
I-6	LAMBALA	LUUKA	50	40	10	0	0
I-7	NAIGOBYA	LUUKA	80	75	5	0	0
I-8	BUSESA	IGANGA	80	70	10	0	0
I-9	KYANVUMA	LUUKA	75	60	9	1	0
I-10	NAKIVUMBI	IGANGA	56	50	4	1	0
I-11	NONDWE	IGANGA	70	60	7.5	2.5	0
P-2	KASASSIRA	KIBUKU	80	70	10	0	0
P-3	KAMEKE	PALLISA	70	60	9	1	0
P-4	KAPALA	PALLISA	80	70	10	1	0
P-5	BUSETA	KIBUKU	70	52	18	1	0
S-1	KIDETOK	SERERE	60	50	9	1	0
S-2	TUBUR	SOROTI	65	60	4	1	0
S-3	ACUNA	SOROTI	60	45	13	2	0

It was observed that the main type of household latrine in use was the Ordinary Pit Latrine. The ordinary pit latrine is just a pit of from about 3 to 9 metres deep which is then covered with a cement slab and then a small house is built on top for privacy. The slab has a rectangular hole where one squats to defecate. Besides the pit which is similar with every pit latrine, the nature of the privacy shelter at the top also varies and in some extreme cases there is just a sisal mat hanging on some poles. Sometimes instead of a cement slab some poles are lined on the pit. The various materials have implications in terms of ease of cleaning as well as potential for transfer of diseases. The ordinary pit latrine is the easiest to construct and to maintain. Therefore it is not surprising that it is the most prevalent of the latrine types. Health workers recommend that pit latrines be covered at all times to prevent the free

movement of flies from there to people. This prevents even the little air circulation that would take place.

An improvement on the ordinary pit latrine is the ventilated improved pit latrine otherwise known as the VIP. This is similar to the ordinary pit latrine but has a pipe that comes from the pit and goes through the roof to allow gasses and fumes emanating from the decomposing waster to escape into the atmosphere. In the ordinary pit, these gases all rise through the same opening where one squats to take nature's call. This makes the ordinary pit smelly and often fly infested. The VIP overcomes this problem to some extent. However the VIP is more expensive to construct which is why it is less prevalent. Moreover some people do not see the need for the extra cost.

Ecological Sanitation or Ecosan toilets attempt to overcome the challenge of digging deep pits which can become a problem in marshy and rocky places. At the same time they attempt to promote recycling of waste. In Ecosan, urine and solid waste are separated (see illustration in figure 3.06 below). The urine is then directly applied to plants as fertiliser. The solid waste is treated with ash and later also used as fertiliser. In many places in Uganda Ecosan toilets have been constructed by NGOs and other institutions but most of them have been rejected. There are many reasons for this not least being that in all cultures in Uganda, human waste is repulsive. Additionally the culture of compost and manure does not exist in most places in Uganda due to the fertile soils that exist naturally in the whole country.

FIGURE 3.06 ECOSAN LATRINE TECHNOLOGY WITH PHOTO OF ECOSAN TOILET NEAR KAMEKE RGC CENTRE



Ecosan toilets are rare showing up at a mere 2.5% in Nondwe which reported the highest use of Ecosan toilets. In the various RGCs visited, the team observed that most of the Ecosan Toilets had been constructed by NGOs and local governments and they were at public

Percentage of Ecosan use per RGC			
ID.	RGC Name	District	Eco San (%)
I-11	NONDWE	IGANGA	2.5
I-1	NABITENDE	IGANGA	2
2-Jan	NAMUNGALWE	IGANGA	2
S-3	ACUNA	SOROTI	2
I-9	KYANVUMA	LUUKA	1
10-Jan	NAKIVUMBI	IGANGA	1
P-3	KAMEKE	PALLISA	1
P-4	KAPALA	PALLISA	1
P-5	BUSETA	KIBUKU	1
S-1	KIDETOK	SERERE	1
S-2	TUBUR	SOROTI	1
3-Jan	NAMBALE	IGANGA	0
6-Jan	LAMBALA	LUUKA	0
I-7	NAIGOBYA	LUUKA	0
I-8	BUSESA	IGANGA	0
P-2	KASASSIRA	KIBUKU	0

facilities see (picture above). It was also noted that a number of them are not in use as evidenced by the grass growing all around them. The rejection by the community may be due to lack of sensitisation or even the fact that they involve some work in terms of the treatment of the solid waste.

Figures 3.07, 3.08 and 3.09 below show the various variables of latrine coverage rate arranged from best to worst as well as percentage of Ordinary pit latrine use in each of the RGCs

FIGURE 3.07 PERCENTAGE OF ORDINARY PIT LATRINES IN EACH RGC

Percentage of Ordinary Pit Latrines per RGC			
ID.	RGC Name	District	Ordinary Pit (%)
I-7	NAIGOBYA	LUUKA	75
I-1	NABITENDE	IGANGA	70
1-2	NAMUNGALWE	IGANGA	70
I-8	BUSESA	IGANGA	70
P-2	KASASSIRA	KIBUKU	70
P-4	KAPALA	PALLISA	70
I-9	KYANVUMA	LUUKA	60
I-11	NONDWE	IGANGA	60
P-3	KAMEKE	PALLISA	60
S-2	TUBUR	SOROTI	60
P-5	BUSETA	KIBUKU	52
1-3	NAMBALE	IGANGA	50
1-10	NAKIVUMBI	IGANGA	50
S-1	KIDETOK	SERERE	50
S-3	ACUNA	SOROTI	45
1-6	LAMBALA	LUUKA	40

From the findings, Serere District had very low latrine coverage of (50%). Iganga district has indicated at least some advancement of using the Ecosan system as data from Nondwe, Nabitende and Namungalwe indicates.

FIGURE 3.10: LATRINE COVERAGE,

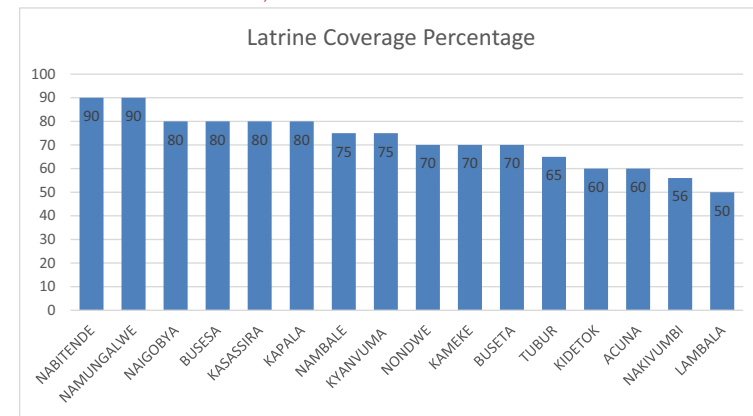

FIGURES 3.08 AND 3.09 PERCENTAGE IMPROVED PIT AND ECOSAN TOILETS

Percentage of Improved Ordinary Pit Latrines per RGC			
ID.	RGC Name	District	Improved Traditional P.T (%)
1-3	NAMBALE	IGANGA	25
I-1	NABITENDE	IGANGA	18
2-Jan	NAMUNGALWE	IGANGA	18
P-5	BUSETA	KIBUKU	18
S-3	ACUNA	SOROTI	13
6-Jan	LAMBALA	LUUKA	10
I-8	BUSESA	IGANGA	10
P-2	KASASSIRA	KIBUKU	10
P-4	KAPALA	PALLISA	10
I-9	KYANVUMA	LUUKA	9
P-3	KAMEKE	PALLISA	9
S-1	KIDETOK	SERERE	9
I-11	NONDWE	IGANGA	7.5
I-7	NAIGOBYA	LUUKA	5
10-Jan	NAKIVUMBI	IGANGA	4
S-2	TUBUR	SOROTI	4

The above findings generally indicate that most RGCs have an understanding on the importance of having latrines in place. However there is a lot of room for improvement. As the RGCs transit from rural to urban, there is going to be less space and bushed for those who do not have toilets. The likelihood is that there people will resort to the habit of defecating in plastic bags and throwing them anywhere as often happens in poorer parts of the main towns in Uganda.

There are places and culture in Uganda which are still opposed to the use of latrines with myths such as “going to a pit latrine will prevent you from giving birth and having children”

Effort of sensitisation on hygiene as well as the element of urbanisation like in Namungalwe and Nabitende Banada has made the percentage of latrine coverage to be high despite the increasing population in the mentioned areas. More effort is needed to make the percentage

of latrine coverage increase especially in the more rural RGCs like Kidetok in Serere District, Nakivumbi in Iganga district and Lambala in Luuka District

### 3.2.3 LATRINE CLEANING AND CONSTRAINTS AGAINST LATRINE CONSTRUCTION.

In all the RGCs, the method of choice in cleaning latrines is sweeping with a broom. Most people also reported washing with water. Other methods mentioned included smoking, spraying ash and smearing with cow dung. Figure 3.10 below illustrates the findings on latrine cleaning.

FIGURE 3.11 METHODS OF LATRINE CLEANING

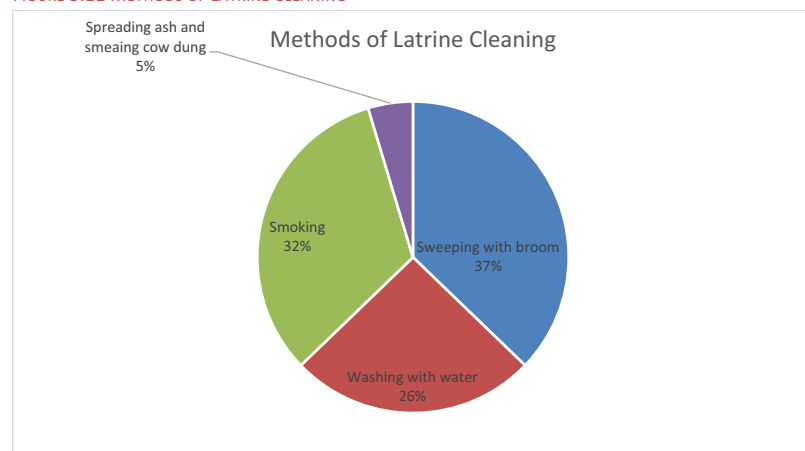

Latrine cleaning is an essential part of appropriate sanitation and hygiene in homes. Its need is made even more vital by the fact that most of the latrines, being detached some distance from the main house (to avoid the smell) are poorly lit especially in the evening, resulting into mistakes where solid waste and urine may be found on the surface of the latrine. Children who do not know how to properly use latrines also frequently soil the floors of latrines.

Sweeping with a broom is convenient and easy and this is probably the reason why it is the most prevalent method. The effectiveness of this method may depend on the surface of the floor of the latrine. Earth surfaces may not withstand continuous washing with water, in which case, sweeping may be the method of choice especially if the earth is smeared with cow dung. Moreover earth surfaces absorb moisture which quickly dries up waste reducing its potency

as a disease carrier. Smearing of the walls and in some cases floor with cow dung helps to block the holes where insects like cockroaches that feed on feces may hide or hibernate in the day waiting to migrate to homes in the night.

Washing with water is more appropriate for latrines that have a cement floor. In practice though, most people who use water in most cases don't use soap for proper cleaning of their hands and other parts of the body which actually accelerates the spread of the hygiene related problems.

The use of the smoking method has a long tradition in Uganda. The practice was the answer to the smell, fumes and flies emanating from the unventilated ordinary pit latrine. It is often combined with sweeping with a broom.

### 3.2.4 WATER BORNE DISEASES

Waterborne diseases are caused by pathogenic microorganisms which are directly transmitted when contaminated fresh water is consumed. The occurrence of waterborne disease in the RGCs is illustrated in Figure 3.12.

FIGURE 3.12: OCCURRENCE OF WATER BORNE DISEASES IN THE RGCs

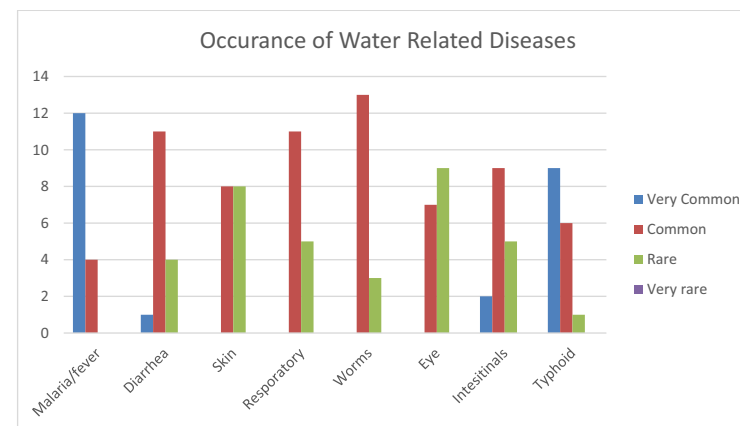

The data shows that Malaria and Typhoid are very common all the RGCs. Malaria is transmitted by mosquitoes that breed in stagnant water. Where there is a shortage of sources of water, people may resort to ponds and stagnant water pools for a source of water. These are a breeding ground for mosquitoes. The use of rain water tanks, especially in RGCs like Tubur may also promote the multiplication of mosquitoes and the transmission of Malaria.



The ingestion of infected human faeces is the main source typhoid infection. Human faeces are also the main source of diarrhoeal pathogens including dysentery, cholera and typhoid. Typhoid proliferates in conditions of poor hygiene either due to ignorance, say of the need to wash hand with soap after toilet or due to lack of facilities such as safe water. At a number of RGCS, chlorine dispensers were seen. These, it was reported, were put in place by government officials to treat water so as to reduce the transmission of typhoid.

Worm infestations are also reported as common though not very common. The transmission of worms is often facilitated by poor disposal of human waste as well as poor hygiene. The prevalence of all these water borne diseases in the RGCs points to a need for better sanitation facilities of which safe water is a major part. Sensitisation is also critical.

The RGCs where malaria and typhoid are reported to be very common were sorted and the results a presented in tables 3.13 below.

FIGURE 3.13 RGCs REPORTING 'VERY COMMON' FOR MALARIA TYPHOID AND DIARRHOEA

	Malaria	Typhoid	Diarrhoea
1	NABITENDE	ACUNA	LAMBALA
2	LAMBALA	TUBUR	
3	NAIGOBYA	NABITENDE	
4	NAKIVUMBI	LAMBALA	
5	NONDWE	KIDETOK	
6	KASASSIRA	KASASSIRA	
7	KAMEKE	KAPALA	
8	KAPALA	KAMEKE	
9	BUSETA	BUSETA	
10	KIDETOK		
11	TUBUR		
12	ACUNA		

Note that the order does not present intensity however what is noteworthy here is the fact that in these RGCs each of the diseases presented on the table was reported as being very common. These are therefore the most affected by these diseases namely Malaria and Typhoid. Note that while typhoid is reported to be very common in some 9 RGCs, Diarrhoea is reported to be very common in only one place and that is Lambala.

### 3.2.5 INFANT MORTALITY RATE

Infant mortality rate in the RGCs is illustrated in Figure 3.14 below. Infant mortality rate is the number of children dying under one year of age for every one thousand births. Most of the respondents were found to be ignorant about infant mortality and they tended to report

figures based on the experience of infant death in their environment. The figures while casual, nevertheless reflect the feeling of the respondents on the issue of infant mortality. Because respondents even in the same RGC gave widely varying figures, the most recurring figure (mode) in the data set was selected. In a few places where there was no figure repeated, the average was used.

FIGURE 3.14 REPORTED INFANT MORTALITY RATE IN THE RGCs

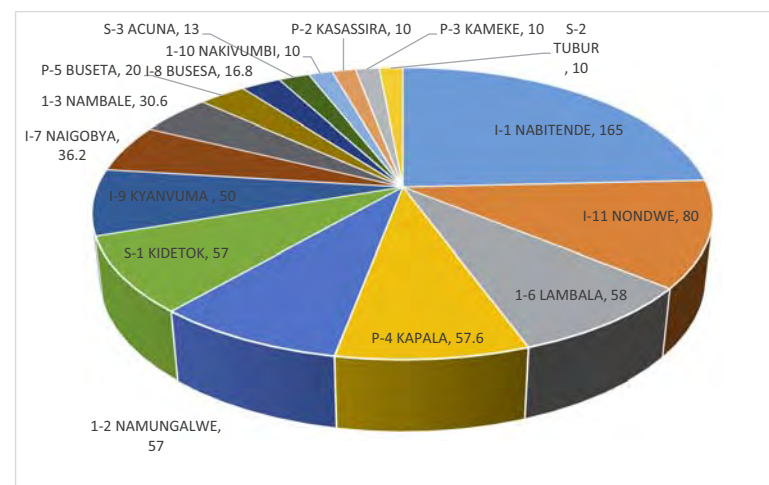

Based on the data reported, the highest figures of infant mortality was in Nabitende at 165 deaths per 1,000 births followed by Nondwe with Tubur, Kameke and Kasassira and Nakivumbi at the bottom with just 10 death per 1,000 births. Uganda has carried out extensive immunisation against the six killer diseases namely polio, whooping cough, tetanus, diphtheria. Most infant deaths are therefore now caused by other common problems and infections. In a 2007 demographic and health survey, the leading causes of death in children under-five years in Uganda were found to be malaria, perinatal and early neonatal conditions, meningitis, pneumonia, and HIV/AIDS. Sanitation and safe water is a factor in all these diseases.

### 3.3 SCHOOLS AND COMMERCIAL FACILITIES

#### 3.3.1 SCHOOLS AND EDUCATIONAL INSTITUTIONS

Schools and educational facilities are both a mechanism for improving enabling children in the area to access education but they are also a form of business which attracts resources and provides market for various products such as stationery and uniforms. Educational institutions therefore attract lots of other businesses to supply their needs and with them people who increase the population in the surroundings of schools. Schools and educational institutions also present significant concentrations of people during day and also during night for boarding institutions. These people need water and other sanitation facilities. The density of institutions as the numbers of pupils in the institutions therefore present and indicator of the need for safe water sources and sanitary facilities. In this study respondents were named the major institutions in their RGC. Figure 3.15 below summarises the findings on educational institutions.

FIGURE 3.15: EDUCATIONAL INSTITUTIONS IN THE RGCs

No.	RGC	Public School	Private School	Number of students/pupil	Number of Boarders
1	NABITENDE	3	5	7,000	530
2	NAMUNGALWE	3	5	5,950	462
3	NAMBALE	1	4	1,550	2
4	LAMBALA	1	3	2,270	-
5	NAIGOBYA	1	4	2,400	20
6	BUSESA	4	4	5,870	800
7	KYANVUMA	1	5	2,173	160
8	NAKIVUMBI	3	1	4,800	115
9	NONDWE	1	7	3,380	-
10	KASASSIRA	2	1	2,600	150
11	KAMEKE	0	4	3,620	450
12	KAPALA	3	4	3,030	44
13	BUSETA	0	5	2,270	80
14	KIDETOK	2	5	2,499	786
15	TUBUR	2	5	2,350	-
16	ACUNA	0	2	300	-
	TOTAL	27	64	52062	3599

The above table shows that all the RGCs have educational institution. Nabitende Namungalwe, Busesa, Nakivumbi, Kameke and Nondwe having the largest population in terms of the

numbers of pupils/students. The same RGCs have been found to have the largest number of institutions and probably have the biggest demand for institutional sanitation services.

#### 3.3.1 PUBLIC OFFICES

Public offices attract populations to locations due to the potential for business with them. Proximity to services is another reason why people locate near public offices. People who work with specific public offices will also in the long run locate close to those offices for convenience. Figure 3.16 below summarises the situation of public offices in the RGCs.

FIGURE 3.16: PUBLIC OFFICES

RGC	RGC No.	Sub-county office Number	Parish office Number	LC1 office Number	Police Station/post Number	Other 1 Number	Total
NABITENDE	I-1	0	1	2	1	0	4
NAMUNGALWE	I-2	1	1	3	1	0	6
NAMBALE	I-3	1	0	0	1	0	2
LAMBALA	I-6	0	0	1	0	0	1
NAIGOBYA	I-7	0	0	1	1	0	2
BUSESA	I-8	1	1	1	1	0	4
KYANVUMA	I-9	0	1	1	0	0	2
NAKIVUMBI	I-10	0	0	1	1	0	2
NONDWE	I-11	0	0	1	1	0	2
KASASSIRA	P-2	1	1	1	1	0	4
KAMEKE	P-3	1	0	0	1	0	2
KAPALA	P-4	1	1	1	1	0	4
BUSETA	P-5	0	1	1	0	0	2
KIDETOK	S-1	0	0	0	1	0	1
TUBUR	S-2	1	1	0	1	0	3
ACUNA	S-3	0	0	0	1	0	1

It can be seen that all RGCs have at least one public office; an LC office, a police post, a sub-county office or a parish office. Some of the RGCs have several offices of different types. The RGCs with highest number of offices are Namungalwe 6, Nabitende 4, Busesa 4, Kasassira 4 and Kapala 4. Those with 1 office only include Acuna, Kidetok and Lambala. Seven (7) RGCS namely Tubur, Kapala, Kameke, Kasassira, Busesa, Nambale and Namungalwe have Sub County offices.

### 3.3.2 COMMERCIAL FACILITIES

Figure 3.17 below summarises the data on commercial facilities, hotels, stores and restaurants.

FIGURE 3.17: COMMERCIAL FACILITIES

RGC	C1 Commercial Facilities		Hotels and Motels		Other Facilities			
	Public Markets	Shops, Store and Restaurants	No of Hotels	Total NO of Beds	Name	No	Name	No
NABITENDE	1	210	3	37	Mobile money	10	SACCOs	10
AMUNGALWE	2	274	3	60	Mobile money booths	10	SACCOS	12
NAMBALE	1	31	0	0	MOBILE MONEY POINTS	5	GRINDING MILL	1
LAMBALA	1	44	0	0	SACCO	3	0	0
NAIGOBYA	0	16	0	0	MOBILE MONEY BOOTHS	1	SACCOS	1
BUSESA	1	48	1	12	0	0	0	0
KYANVUMA	1	182	3	22	MAIZE MILLS	8	SACCOS	20
NAKIVUMBI	1	88	1	6	SALONS	12	BUTCHER	3
NONDWE	1	86	0	0	0	0	0	0
KASASSIRA	1	50	0	0	0	0	0	0
KAMEKE	1	36	0	0	Mobile money booths	2	SACCO	1
KAPALA	1	50	0	0	MOBILE MONEY	1	0	0
BUSETA	1	71	0	0	0	0	0	0
KIDETOK	1	50	0	0	ABATTOIR	1	MOBILE MONEY BOOTHS	3
TUBUR	1	61	0	0	SACCO	1	Mobile money business	1
ACUNA	1	19	1	0	0	0	0	0

Industrial facilities named included flour mills, rice hullers, abattoirs, metal workshops, timber mills and coffee processing factories. In one RGC a large cotton ginnery was seen.

### 3.3.3 RELIGIOUS FACILITIES

Places of worship are centres of communal action and are critical in the dissemination of health and hygiene messages. They are also critical agents for the mobilisation of resources for the establishment of communal facilities for water, sanitation and health. Figure 3.18 below summarises the data on religious facilities in the RGCs surveyed. The data is also

graphically illustrated in Figure 3.19 that follows. All the RGCs except Tubur reported at least one religious facility. In terms of total numbers, Namungalwe had the highest number of facilities (9) followed by Nabitende (8) and then interestingly, Acuna (6). It should be noted that recently the trend if for Christian worshipers gathering in regular building like schools and even recreational halls for prayer on Sunday. Thus besides the building that are clearly marked as churches, there are sometimes churches operating in regular buildings. Some shrines for the worship of traditional gods were also named in some RGCs.

Due to the culture of ablution on the part of the Islamic faith, most mosques also have a source of water in the form of a borehole or a shallow well and this was also witnessed in this survey. Most of these are set up privately by the mosque and usually they have no numbers.

FIGURE 3.18: RELIGIOUS FACILITIES

No.	RGC	No of Churches	No of Mosques	Total
1	NAMUNGALWE	6	3	9
2	NABITENDE	5	3	8
3	ACUNA	5	1	6
4	BUSESA	4	1	5
5	KYANVUMA	4	1	5
6	NAKIVUMBI	4	1	5
7	NONDWE	4	1	5
8	KIDETOK	2	0	5
9	NAMBALE	3	1	4
10	LAMBALA	3	1	4
11	NAIGOBYA	3	1	4
12	KASASSIRA	1	2	3
13	KAMEKE	3	0	3
14	KAPALA	2	0	2
15	BUSETA	3	2	2
16	TUBUR	0	0	0

FIGURE 3.19: RELIGIOUS FACILITIES

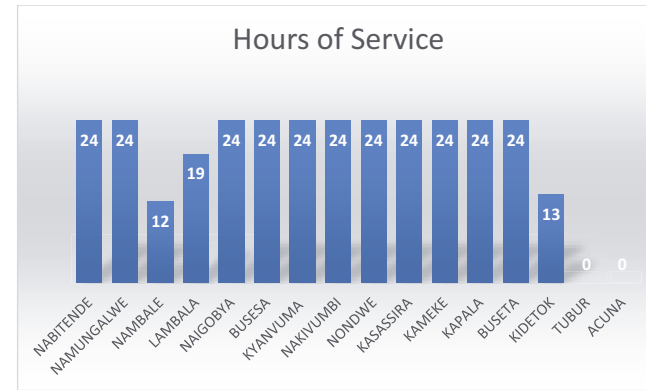
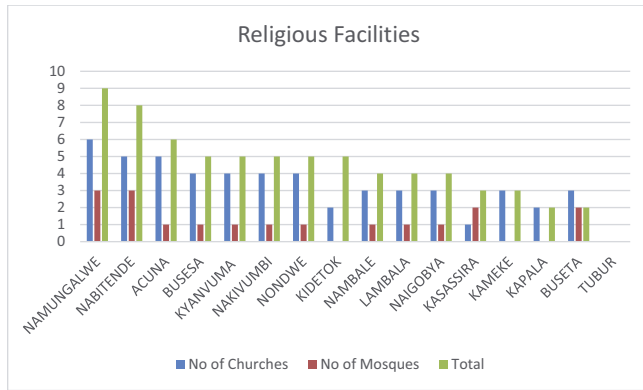

### 3.4 BASIC INFRASTRUCTURE

#### 3.4.1 ELECTRICITY SUPPLY

All except two RGCs have main power connection. The two places where no power was reported are Tubur and Acuna. Wherever single phase power was reported, there also three phase power was reported. The main difference therefore between the RGCs is the number of hours that power is estimated to be on. In Uganda, power interruptions and blackouts are the norm and people have learnt to ignore the power cuts. Therefore in many of the small towns and rural growth centres in the country, small industrial facilities such as grinding mills and grain hullers run mostly on diesel. Nevertheless access to power is one of the major predictors of growth as it enables access to information via TV and Radio, improves student performance as they are able to read even during the dark and makes possible business based on power. Figure 3.20 below shows the reported average number of hours that power is on in every 24 hours. At most of the RGCs the report is that power is on for 24 hours. However at Nambale and Kidetok it is on for 12 and 13 hours respectively.

FIGURE 3.20: ELECTRICITY SUPPLY TO THE RGCs

#### 3.4.2 ACCESSIBILITY TO THE RGCs

Figure 3.21 below shows the situation of access to the RGCs. Most of the RGCs are easily accessible by road during both the dry and the rainy seasons. The exception is Lambala RGC where most people feel that access is no good both during the dry and the wet season.

Not unexpectedly, access is more difficult during the wet season and during that season access is not so good for all except Nabitende, Naigobya, Busesa and Acuna. This therefore suggests that these are the RGCs with the best road access. There is at least a daily bus in 8 out of the 16 RGCs. (In Uganda a minibus is called a 'taxi'. For the purposes of this study, 'taxi' is treated as a bus. The government does not run any passenger transport service of any kind in the country)

Where there is no bus service, the most common mode of transportation is the motorcycle.

FIGURE 3.21: ACCESSIBILITY TO THE RGCs

RGC	Dry season access	Wet season access	Transportation		Frequency of Daily Bus	Name Others
			Bus	Other means		
NABITENDE	Good	Good	Daily	Motorcycles	Once	0
NAMUNGALWE	Good	No good	Daily	Motor bikes	Three times	0
NAMBALE	Good	No good	Daily	Motorcycle	Three times	All means of transport
LAMBALA	No good	No good	Daily	Taxis	Once	Bodaboda
NAIGOBYA	Good	Good	Motorcycle	0	None	Bodaboda
BUSESA	Good	Good	Daily	Motorcycles	None	0
KYANVUMA	Good	No good	Daily	Motorcycle, bicycles	Once	0
NAKIVUMBI	Good	No good	Motorcycle	Taxis and motorcycles	Once	0
NONDWE	Good	No good	Daily	0	Once	0
KASASSIRA	Good	No good	Motorcycle	Motorcycle -taxi	None	Trucks

KAMEKE	Good	No good	Motorcycle	Motorcycles	None	0
KAPALA	Good	No good	Motorcycle	Motorcycle	None	Boda-boda
BUSETA	Good	No good	Motorcycle	Motorcycles and cabs	None	0
KIDETOK	Good	Good	Daily	0	Once	0
TUBUR	Good	No good	Motorcycle	Pick up trucks	None	0
ACUNA	Good	Good	Motorcycle	Taxis - These are mini vans that serve as buses.	Once	0

### 3.5 EXISTING WATER SOURCES

The most prevalent water source in all the RGCs is the deep borehole. This is followed by the shallow well and the unprotected spring in that order. There was no river or valley tank reported in any of the RGCs. Most of the water sources are all season providing water both in the wet season and the dry season though the quantity and quality may vary depending on the season. In the dry season the amount of water in springs and shallow wells reduces. In Acuna the study team was shown a pond that is sometimes used as a source of water. In almost all the RGCs there were rain water harvest tanks both at institutions and in homes. Although rainwater tanks are not a permanent source of water, they relieve the pressure on existing sources especially during the rainy season.

Figure 3.22 below shows the prevalence of different sources of water in the RGCs at present.

FIGURE 3.22 SOURCES OF WATER IN THE RGCs

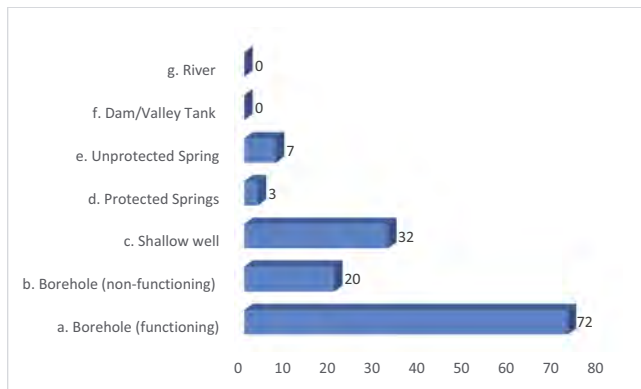

#### 3.5.1 QUALITY OF WATER

Most of the respondents felt that the quality of water from all the water sources was acceptable in general however quality was considered good with borehole water. Fewer people considered water from shallow wells to be good. Instead the number of people who felt that it is just fair was higher compared to the same category for borehole water. Protected and unprotected spring are clearly considered to have the worst water in terms of quality.

FIGURE 3.23 SOURCES OF WATER IN THE RGCs

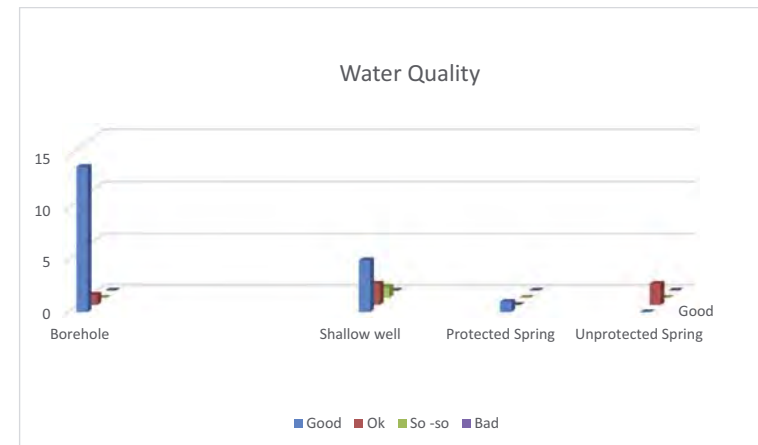

At Kameke, Kapala and Buseta, water purification facilities were reported and seen. There were water purification facilities in the name of chlorine dispensers at boreholes and shallow wells. Perhaps relatedly, at both Kameke and Kapala, there were also reports of a high frequency of typhoid and other water borne diseases. Chlorine dispensers placed at the point of water collection to treat water are a means of reducing biological contamination so as to prevent the transmission of diseases like typhoid.

Besides the threat of contamination other problems reported were water being dirty. The biggest problem however is that there are insufficient water sources in the first place. At all the RGCs the response to the question of satisfaction with the existing water, was almost universally in the negative. All the respondents are not satisfied with the water available. Both quality and quantity are short of the desires of the residents in the RGCs

#### 3.5.2 FUNCTIONALITY OF WATER SOURCES

A significant fact is that of all the existing boreholes, 21.3% were reported as non-functional. Non functionality is one of the major obstacles to access to safe water. Functionality is greatly improved if the community based mechanisms for operation and maintenance of water sources function well. A lot of these depend on the existence and effectiveness of the water and sanitation committees that are set up for each water source. However when people were asked what has been done in the face of non-functional sources, only a few reported taking action such as collecting money for repair. Many said that the community has appealed to the government for help. Some reported resorting to rain water and others to just trekking further away to get safe water.

FIGURE 3.24 SOURCES OF WATER IN THE RGCs

	RGC	a. Borehole (functioning)	b. Borehole (non-functioning)	c. Shallow well	d. Protected Springs	e. Unprotected Spring	f. Dam/Valley Tank	g. River	h. Other
I-1	NABITENDE	10	3	4	0		0	0	0
1-2	NAMUNGALWE	13	4	8	0	1	0	0	1
1-3	NAMBALE	2	0	0	0	1	0	0	0
1-6	LAMBALA	2	2	3	0	2	0	0	0
I-7	NAIGOBYA	3	0	2	0	0	0	0	0
I-8	BUSESA	7	0	5	0	0	0	0	WHT
I-9	KYANVUMA	3	1	3	0	0	0	0	WHT
1-10	NAKIVUMBI	5	0	2	3	0	0	0	0
I-11	NONDWE	2	2	1	0	2	0	0	0
P-2	KASASSIRA	4	0	0	0	0	0	0	0
P-3	KAMEKE	4	0	0	0	0	0	0	0
P-4	KAPALA	2	0	2	0	0	0	0	0
P-5	BUSETA	4	1	1	0	0	0	0	0
S-1	KIDETOK	10	5	1	0	0	0	0	0
S-2	TUBUR	0	1	0	0	0	0	0	WHT
S-3	ACUNA	1	1	0	0	1	0	0	0

NB: WHT = Water Harvest Tanks

The two biggest RGCs namely Nabitende and Namungalwe also have the highest number of boreholes at 10 and 13 respectively. They are closely followed by Kidetok and Busesa which have 10 and 7 respectively. Kidetok is somewhat a surprise as it is smaller than several others in terms of the population.

The list of all the water sources in the RGCs is presented as attachment 5 of this report

### 3.5.3 OPERATION AND MAINTENANCE OF WATER FACILITIES

The approach to Operation and Maintenance of water facilities is key to their functionality. Recognising this, the government of Uganda has adopted and disseminated and advocated an approach known as Community Based Management System where the communities within which the facilities are found are encouraged to form organisations to operate, manage and maintain the water facilities. A critical factor in this approach is the sense of ownership of the facility. In this study some aspects of O and M were investigated. These include the people who mostly fetch water from facilities, the individuals or groups that are responsible for their O and M and repair and maintenance issues.

### 3.5.4 USE OF FACILITIES.

Although all the people in household use water, the burden of ensuring enough water for homes falls unfairly on women and girls. Figure 3.25 below shows the people who mostly fetch water from the different types of water sources. As the table demonstrates, it is mostly the women and girls who fetch water. Girls and women are therefore the people that are inconvenienced most when water source break down. This is why it is important for women and girls to be involved in decision making in both the location of the water sources and in the management of the sources. Women also carry the biggest responsibility in home making child care and, in some communities, domestic income generation. The time spend in fetching water therefore impinges on how much time they can put in the other livelihood activities mentioned above and on the welfare of whole communities.

FIGURE 3.25 MAIN PERSON TO FETCH WATER

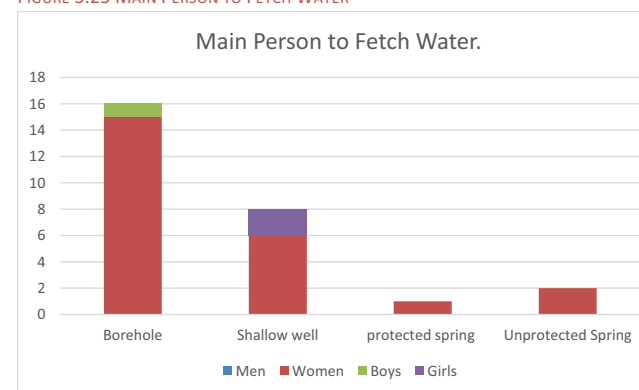
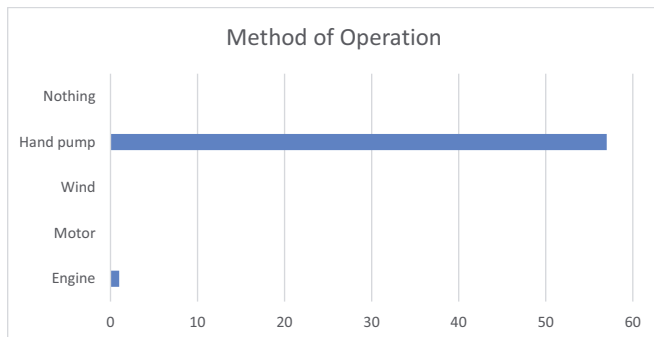

Figure 3.26 below shows the method of operation of deep boreholes the water sources (processed for the first seven sources of each type). The bulk of boreholes are operated with a hand pump. Only one of the facilities in the RGCs covered had a motor and that was in

Kidetok RGC. This technology is practical, cost effective and sustainable but it puts a strain on the people who fetch the water and also lengthens the time needed to collect water

FIGURE 3.26 METHOD OF OPERATION OF WATER SOURCES



Regarding the entity responsible for the construction of the borehole, most of the boreholes, it was reported, were constructed by government. There are various programmes under which government constructs boreholes from time to time. However some donor funded boreholes are also some times regarded as government constructed by the local communities. NGOs are the second largest group responsible for the construction of boreholes. NGOs also include faith based institutions like churches and mosques. A few individuals have also constructed boreholes.

FIGURE 3.27 ENTITY RESPONSIBLE FOR CONSTRUCTION OF THE BH

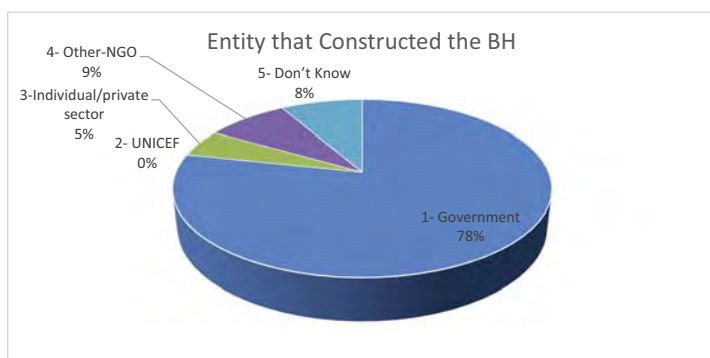

While construction is mostly attributed to government, operation is mostly attributed to individuals, the private sector and the community. There are still a few facilities where people reported that responsibility for O and M of a certain facility was with government. When people acknowledge responsibility for O and M there is a greater likelihood of sustainable management of facilities as they do not have to use them carelessly in the hope that someone will come from outside of the community to maintain their facility.

FIGURE 3.28 RESPONSIBILITY FOR OPERATION AND MAINTENANCE

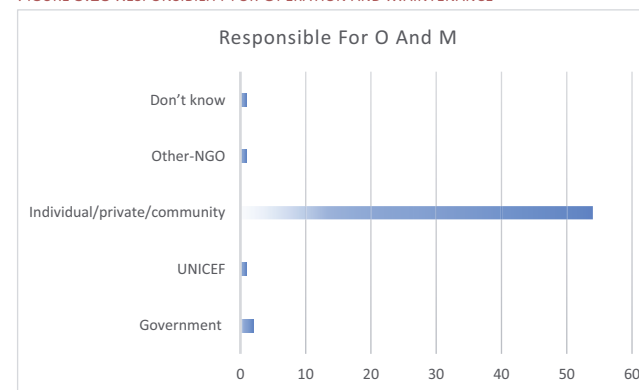

### 3.5.5 OPERATION AND MAINTENANCE FEE

One of the critical aspects of O and M for water facilities is the existence of a fund for maintenance and repair. This fund enables repairs to be effected rapidly so as to reduce down time. The collection approach and management of the fee is usually collectively decided by the community and this choice determines whether there will be funds for repair and maintenance when it is needed. 45% of the boreholes covered in this analysis reported that there was no clear fee for O and M. Most of those who reported a specific fee said that it is collected at household level and on a monthly basis. Understandably, this is more convenient than collecting at the water point which requires a person to be present all day and some hours of the night. This also implies that that person has to be paid. The average fee mentioned was 583 shillings while the mode was 1,000=. Most of the hand pumps were reported to have broken down at least twice and the main cause of break downs was “overuse” or “many users”. People felt that the great number of people using each facility led to more frequent break down. The most frequently mentioned parts replaced were pipes and rods while rubbers, cylinder, chain and pump head were also mentioned. The mean value for the cost of repair (among those who mention a value) was 99,000 while the mode was 150,000=.

None of the villages reported satisfaction with existing water facilities. The RGCs have different reasons for the dissatisfaction however these can be grouped into six categories. Clearly the largest problems have to do with insufficient facilities. However to be noted are the problems to do with operation and maintenance such as broken down facilities which form the second largest category.

When asked what they do to deal with these problems respondents reported that the action taken most frequently is to report to authorities and ask for help. The action taken the least times is the one of contributing money or mobilizing the village to deal with the problem and this pattern of behaviour is problematic and points to a dependency attitude which needs to be changed through some mobilization and sensitization so as to change attitudes.

## CHAPTER FOUR: ISSUES, CHALLENGES AND CONCLUSIONS

### 4.0 ISSUES AND CHALLENGES

One of the biggest challenges is the fact that the respondents did not have the concept of the boundaries of the RGCs in their minds. It was therefore very difficult for them to give precise information such as the population and even those who gave it quoted widely varying figures and they failed to agree with one another. This includes people that are in positions of responsibility such as LC chairmen and official of the sub counties.

There is also poor record keeping in the management of the water sources and there is minimal memory as individual with responsibility change from time to time and yet there are no written records. For this reason information on repair and maintenance is scanty. Therefore respondents struggled to give information on cost of repair and parts replaced. Perhaps this is aggravated by the fact the mechanics tend not to be transparent in their operations as a way of maintaining the advantage to charge for their services at will.

In the collection of data, the consultant's team took all necessary effort to ensure the collection of valid, consistent and coherent data. To this end, enumerators were trained to probe if data seemed to conflict or contradict at different points in the questionnaire and where necessary to check out the some of the information through observation. However, there are many challenges with data in this rural context where administrative arrangements for villages are still just being put in place in some cases. For that reason there are places where the consultant has had to check several times and with different people until a coherent picture of the situation of the RGC became clear. This was the situation particularly in the large RGCs including Namungalwe and Nabitende

The survey team faced a lot of logistical challenges in the execution of the assignment especially as the pace of the work was extremely high. However the study provided a vital learning experience from which all those that participated came away much more skilled and enlightened and for which the team is grateful to the client.

### 5.0 CONCLUSION

On a general note, the study team observed that access to water varies greatly from place RGC to RGC in the study area. There should be continuous investment in safe water sources by government and NGOs, however, government is constrained financially and many of the sources established are not well maintained and break down. RGCs are areas that are quickly changing from a rural lifestyle to an urban lifestyle and they tend to be characterised by a reduced sense of community spirit. This perhaps explains why many people confronted with failing facilities instead opt to turn to private rain water trapping as opposed to collecting



money to maintain communal facilities or even construct new ones. This suggests that there may be a need to transit gradually from a community based model of water provision to a commercial model where users have to pay per unit used.

The relationship between safe water, good health and improved household welfare has been demonstrated and articulated repeatedly by various authorities. This underlines the need for provision of safe water to the areas surveyed. Moreover some of the RGCs are urbanising fast and this poses a danger to the safety of ground water particularly from shallow wells which can be contaminated by faecal material seeping from latrines. Many of the current water sources will therefore probably be in safe in the next few years given the current rate of population growth and urbanisation in the larger RGCs.

While the most common means of disposing off human faecal matter is pit latrines, this form of waste management is not compatible with urbanisation which comes with storied buildings. Even without storied building, the increasing scarcity of space in all these RGCs means that pit latrines are going to be outmoded in favour of more space economic sanitation methods. In a very short time, the need for water in all these RGCs is likely to spike as people adopt flush toilets and other sanitation technologies that use more water, hence the need for investment in water especially in the larger and more populated RGCs.

From the data relating to the reasons for failure to repair broken HPs and other facilities, it is clear that there is a reluctance to pay for water and water service. This implies that there is a need for sensitisation of people in these RGCs to enable them embrace the reality that there is a cost associated with safe water and that government will not be able to sustain the provision of safe water for all at no cost. In any case, government already departed from the free water policy and now insists that communities must maintain their water sources. This kind message must be delivered effectively to all the residents of all the RGCs with every additional investment in water provision in the RGCs covered in this study and probably many others.

**Household Survey in Selected 12 RGCs**

Pre-requisite of respondent: Who has his/her family and live in the area within RGC

Date: \_\_\_\_\_ / \_\_\_\_\_ / 2016

Name of Enumerator \_\_\_\_\_

RGC \_\_\_\_\_ RGC No. \_\_\_\_\_ District \_\_\_\_\_ County \_\_\_\_\_  
 Sub county \_\_\_\_\_ Parish. \_\_\_\_\_ Village (LC1) \_\_\_\_\_  
 Name of Respondent \_\_\_\_\_ Age \_\_\_\_\_ Gender 1. Male 2. Female  
 Occupation \_\_\_\_\_ Religion \_\_\_\_\_ Tribe \_\_\_\_\_ Soc-class \_\_\_\_\_

**GENERAL**

- A. Household Composition Men and Women: adult (over 18 years old), Boys and Girls: under 17 years old  
 (Numbers) Men \_\_\_\_\_ Women \_\_\_\_\_ Boys \_\_\_\_\_ Girls \_\_\_\_\_  
 Total \_\_\_\_\_ persons
- B. Main role of each household members  
 B1 What is the main role of each person in the household?  
 Men \_\_\_\_\_ Women \_\_\_\_\_  
 Boys \_\_\_\_\_ Girls \_\_\_\_\_  
 B2 Do your female householded members work to get money or any products ? 1. Yes 2. No  
 B3 (If the answer of B2 is "Yes", ) What kind of works do they do? Specify \_\_\_\_\_
- C. Literacy of householded members  
 C1 How many householded members can read and write in Vernacular ? Male \_\_\_\_\_ Female \_\_\_\_\_  
 C2 How many householded members can read and write in English ? Male \_\_\_\_\_ Female \_\_\_\_\_

**WATER & HEALTH**

D. Current Condition of Water Source

D1. **Water in Dry Season**

D1-a Main sources(s) of water in **Dry Season**

	a. Borehole	b. Shallow well /Dug well	c. Protected spring	d. Unprotected spring	e. Rain harvest	f. Dam/ Valley tank	g. River/ Stream
Number of roundtrips per day							
Distance (m)							
Time for one roundtrip (min)							
Method of water transport H: hand B: bicycle V: vehicle C: cart							
Person to fetch water 1=most ~ 4=least	1	1	1	1	1	1	1
M: men W: women	2	2	2	2	2	2	2
B: boy G: girl	3	3	3	3	3	3	3
	4	4	4	4	4	4	4

D1-b Water Consumption in **Dry Season**

1. How many jerry cans of water do you fetch for your household? \_\_\_\_\_ jerry cans/day  
 2. Water consumption ( litres per capita per day ) \_\_\_\_\_ liter/capita/day  
 (To be calculated by the Enumerator)  $(No. of jerry cans \times 20 / No. of household members)$

D2. **Water in Rainy Season**

D2-a Main sources(s) of water in **Rainy Season**

	a. Borehole	b. Shallow well /Dug well	c. Protected spring	d. Unprotected spring	e. Rain harvest	f. Dam/ Valley tank	g. River/ Stream
Number of roundtrips per day							
Distance (m)							
Time for one roundtrip (min)							
Method of water transport H: hand B: bicycle V: vehicle C: cart							
Person to fetch water 1=most ~ 4=least	1	1	1	1	1	1	1
M: men W: women	2	2	2	2	2	2	2
B: boy G: girl	3	3	3	3	3	3	3
	4	4	4	4	4	4	4

D2-b Water Consumption in **Rainy Season**

1. How many jerry cans of water do you fetch for your household? \_\_\_\_\_ jerry cans  
 2. Water consumption ( litres per capita per day ) \_\_\_\_\_ liter/capita  
 (To be calculated by the Enumerator)  $(No. of jerry cans \times 20 / No. of household members)$

D3. Water Sellers

- D3-1 Have you bought water from water sellers? 1. Yes 2. No  
 a. (if Yes,) The in what situation did you have to buy this wat 1. Dry season 2. Specify \_\_\_\_\_

- b. (if Yes,) How many times did you buy water in the last year? \_\_\_\_\_ times
- c. (if Yes,) How many jerry cans did you buy at a time? \_\_\_\_\_ jerry cans
- d. (if Yes,) How much did you pay for one jerry can? \_\_\_\_\_ Ush/jerry can

D4. Water Source for Washing and Bathing

D4-1 What is your water source for Washing Clothes?

a. Borehole	b. Shallow well /Dug well	c. Protected spring	d. Unprotected spring	e. Rain harvest	f. Dam/ Valley tank	g. River/ Stream	h. Other ( )
-------------	---------------------------	---------------------	-----------------------	-----------------	---------------------	------------------	--------------

D4-2 What is your water source for bathing

a. Borehole	b. Shallow well /Dug well	c. Protected spring	d. Unprotected spring	e. Rain harvest	f. Dam/ Valley tank	g. River/ Stream	h. Other ( )
-------------	---------------------------	---------------------	-----------------------	-----------------	---------------------	------------------	--------------

D5. Water-Borne Disease in the Household.

Disease	Prevalence	Main Cause (Why did they get sick?)	Remedy/Coping Method (What do you do when you get sick?)
	1. very common 2. common 3. rare 4. very rare		
a. Fever			
b. Diarrhoea			
c. Skin Disease			
d. Respiratory Disease			
e. Worms			
f. Eye Disease/Infection			
g. Other (Specify: _____)			

E. Water and Health Problems of the household

E1 Circle (O) the ones that apply.

a. Water source is too far	
b. Little water at the source in dry season	
c. Little water at the source even in rainy season	
d. Water quality is bad; 1. smell, 2. color, 3. taste, 4. other:(specify _____)	
e. Too many people use the same water source	
f. Poor water drainage	
g. Broken / stolen handpump or water supply facilities	
h. Many children are sick; 1. fever, 2. diarrhoea, 3. skin disease, 4. respiratory disease, 5. worm, 6. eye infection, 7. other: (specify _____)	
i. Many adults are sick 1. fever, 2. diarrhoea, 3. skin disease, 4. respiratory disease, 5. worm, 6. eye infection, 7. other: (specify _____)	
j. No / too few latrines	
k. Clothes not clean	
l. Water containers not clean	
m. No drainage of domestic effluent	
n. No water for Hand washing	
p. Other; (specify _____)	

E2 Which one is the most severe problem for you among those in the list above? For the ranking, put an alphabet from "a" to "p" presented in the above table..

Rank (1=biggest problem)	1	2	3
--------------------------	---	---	---

E3 How many times did your household buy medicines last year ? \_\_\_\_\_ times

E4 How many times did your household receive medical treatment in last year ? \_\_\_\_\_ times

F. Effects of Water Fetching

F1 Are there any adverse effects of water fetching on job opportunity of women?

Yes (Specify) \_\_\_\_\_ No \_\_\_\_\_

F2 Are there any adverse effects of water fetching on school attendance of children?

Yes (Specify) \_\_\_\_\_ No \_\_\_\_\_

**INCOME AND EXPENDITURE**

**G. Household Income**

G1 What are the sources of your household's income

a. Salary by working for offices, factories, etc.

Householed member 1:	Monthly	_____	Ush	_____	months/year
	Weekly	_____	Ush	_____	weeks/year
	Daily	_____	Ush	_____	days/year
			Annual Total:	_____	Ush
Householed member 2:	Monthly	_____	Ush	_____	months/year
	Weekly	_____	Ush	_____	weeks/year
	Daily	_____	Ush	_____	days/year
			Annual Total:	_____	Ush
Householed member 3:	Monthly	_____	Ush	_____	months/year
	Weekly	_____	Ush	_____	weeks/year
	Daily	_____	Ush	_____	days/year
			Annual Total:	_____	Ush
			Grand Total:	_____	Ush

b Selling and production, etc.

Source of Income	householed Member in Charge	Monthly Income (Ush)	Yearly Income (Ush)
selling animals (specify: _____)			
selling agricultural crops (specify: _____)			
selling labour (specify: _____)			
commercial activity (specify: _____)			
other 1 (specify: _____)			
other 2 (specify: _____)			

G2 Are there any seasonal changes of the Household income? 1. Yes 2. No

G3 (If the answer of the G2 is "Yes",) How much change does happen usually? Difference

for corresponding month	Maximum _____ Ush in _____	Minimum _____ Ush in _____	
-------------------------	----------------------------	----------------------------	--

G4 How many livestock does the Household have?

No. of Cattle	_____	No. of Pigs	_____	No. of Goats	_____	Chicken/Ducks	_____
---------------	-------	-------------	-------	--------------	-------	---------------	-------

G5 Does the Household get Remittances from anyone in cities or abroad? 1. Yes 2. No.

G6 (If the answer of the G5 is "Yes",) How much remittances does your household get?  
 1. Monthly Remittances \_\_\_\_\_ Ush 2. Yearly Remittances \_\_\_\_\_ Ush

(If the answer of the G5 is "Yes",) Who remits the amount to your household?

1. One of the householed members 2. Relatives 3. Others

G7 Total Annual Income to be calculated by Enumerator \_\_\_\_\_ Ush

G8 Does the mother or the daughter have any role in increasing the income? 1. Yes 2. No.

(If the answer of the G8 is "Yes",) What is their role?

1. \_\_\_\_\_
2. \_\_\_\_\_
3. \_\_\_\_\_

**H Expenditure**

H1 How much does your Household spend for water? (O&M, water, jerrycan, etc.)

a Monthly contribution \_\_\_\_\_ Ush/month  
 b Water fee per jerry can \_\_\_\_\_ Ush/jerry can  
 Monthly ammount for water: \_\_\_\_\_ Ush/month

H2 Sanitation and hygiene-related issues/matters? (latrine expenses, soap, etc.) \_\_\_\_\_ Ush/month

H3 Health-related issues/matters? (medicine, hospital visit, etc.) \_\_\_\_\_ Ush/month (Check E3)

H4 Food \_\_\_\_\_ Ush/month

H5 Fuel for cooking \_\_\_\_\_ Ush/month

H6 Electricity (UMEME) \_\_\_\_\_ Ush/month

H7 Education \_\_\_\_\_ Ush/month

H8 Communication by mobile (Battery charge: \_\_\_\_\_ Ush and Airtime \_\_\_\_\_ Ush) \_\_\_\_\_ Ush/month

H9 Other main expenditure, if any ( Specify, \_\_\_\_\_ ) \_\_\_\_\_ Ush/month

( Specify, \_\_\_\_\_ ) \_\_\_\_\_ Ush/month

H10 Total Annual Expenditure: \_\_\_\_\_ Ush/year

**COOPERATIVE ORGANIZATION AND ACTIVITIES****I Water and Sanitation Committee (WSC) and Operation & Maintenance (O&M) Experience.**

- I1 Have you ever paid for water? 1. Yes 2. No
- I2 How much money **did** you pay as an initial contribution for water supply? a. \_\_\_\_\_ Ush. b. None c. don't know
- I3 How much money **did** you pay as water users' fee every month? a. \_\_\_\_\_ Ush. b. None c. don't know
- I4 The new piped water supply facility will make water fetching easier under the management of the Water Authority to be established under the Sub-county. What is the maximum amount you are willing to pay for water?  
a. \_\_\_\_\_ Ush/jerry can b. None c. don't know
- I5 How many women are in charge of any roles in your WSC?  
Circle (O) the ones that apply: 1 2 3 4 5
- I6 Women's opinions are taken well in any decision of WSC?  
Circle (O) the ones that apply: 1. Frequent 2. Sometimes 3. Ignored

**J Other Cooperative Organization**

- J1 Are you participating in any cooperative activities in the RGC including WSC? 1. Yes 2. No
- J2 If Yes; (Organization Name) \_\_\_\_\_ (Responsibility) \_\_\_\_\_
- J3 If No; (Reason of not participating) \_\_\_\_\_

**HYGIENE AND SANITATION**

(please ask to see the facilities and items so that you can confirm what the respondent says)

**K. Toilet**

- K1 Do you have a toilet in your house lot? 1. Yes 2. No  
(If yes) When was it installed? 1. \_\_\_\_\_ years ago 2. don't know  
(If no) Why does your house hold not have a toilet?  
1. No money 2. No space 3. Land is rocky 4. Swamp conditions  
5. Other \_\_\_\_\_
- K1-a (If answer of K1 is yes) Is your toilet easy to use? 1. Yes 2. No  
(If no) What is the problem in using your toilet?  
1. \_\_\_\_\_  
2. \_\_\_\_\_  
3. \_\_\_\_\_
- K1-b Type of Latrine/ toilet a) VIP b) Flush c) Ecosan d) Traditional Pit
- K1-c Sanitation Status of latrine/toilet a) Clean b) Dirty
- K1-d Availability of latrine/toilet cover/lid 1. Yes 2. No

**L. Kitchen**

- L1 Presence of Kitchen 1. Available 2. Not Available
- L2 Drying rack for dishes 1. Available 2. Not Available
- L3 Animal shelter 1. Available 2. Not Available
- L4 Fecal presence around compound 1. Yes 2. No
- L5 Compost pit availability 1. Yes 2. No
- L6 House hold drainage channel 1. Available 2. Not available

**M. Hand washing**

- M1 When do you wash your hands? 1. After toilet 2. Before meals 3. Others \_\_\_\_\_
- M2 Hand Washing Facility (HWF) availability 1. Yes 2. No  
(if yes)
- M2-a Type of hand wash facility. 1. Tippy tap 2. Faucet 3. Ordinary can 4. Other specify \_\_\_\_\_
- M2-b If yes, does it always have water? 1. Yes 2. No
- M2-c Does it have soap? 1. Yes 2. No
- M2-d Facility is used by 1. Everyone 2. Adults only 3. Children only
- M2-e Frequency of use of facility 1. Regularly 2. Periodically 3. Occasionally 4. Rarely
- M2-f If not used regularly, what is the problem 1. No water 2. No need 3. Other \_\_\_\_\_
- M2-g If the answer of M2 is No, reason \_\_\_\_\_

**N. Others**

- N1 Status of water collection containers 1. Clean 2. Dirty
- N2 Bath shelter 1. Available 2. Not available
- N3-a Covering of drinking water storage containers 1. Covered 2. Not covered
- N3-b Cleanliness of water storage containers 1. Clean 2. Not clean
- N3-c Drinking water storage treatment 1. Add chemice 2. Boiling 3. Prepacked 4. Filtering 5. No treatment
- N4 Cattles such as cows, goats, etc. can get their drinking water at the same water source for human beings? 1. Yes 2. No
- N4-a If "No", how do you water the cattle? 1. There is a cattle watering place that is separate from that of human beings  
2. Use bucket to convey water for animals away from that for human beings  
3. Others (Specify: \_\_\_\_\_)
- N5 If "Yes"., why don't you separate the watering of cattle from the source of water for human beings?  
Reason: \_\_\_\_\_

**Supplemental Data Collection (1) of Selected 12 RGCs**

Pre-requisite of respondent: Representatives of the RGC (LC1 Leaders in RGC)

Date: \_\_\_\_\_ / \_\_\_\_\_ / 2016

Name of Enumerator \_\_\_\_\_

RGC \_\_\_\_\_ RGC number \_\_\_\_\_ District \_\_\_\_\_ County \_\_\_\_\_

Sub county \_\_\_\_\_ Parish \_\_\_\_\_

Villages \_\_\_\_\_

Name of Respondent \_\_\_\_\_ Position \_\_\_\_\_ Phone Number \_\_\_\_\_

**GENERAL**

A. Unemployment rate (the number of people ages 15 and older who are actively looking for a job as a percentage of the labour force)

(Purpose: Gender issue) 1. Male \_\_\_\_\_ (%) 2. Female \_\_\_\_\_ (%)

B. Literacy (Purpose: Gender issue)

A1 Rate of people who can write and read in Vernacular in the RGC Male (%) \_\_\_\_\_ Female (%) \_\_\_\_\_

A2 Rate of people who can write and read in English in the RGC Male (%) \_\_\_\_\_ Female (%) \_\_\_\_\_

C. School enrollment ratio (Purpose: Gender issue)

C1	Kind of schools	School enrollment ratio		Holdover ratio		Graduation ratio	
		Male	Female	Male	Female	Male	Female
	Primary school						
	Secondary school ordinary level						
	Secondary school advanced level						

D. Commercial Electricity Supply (UMEME) (Purpose: Current situation of commercial Electricity Supply)

D1. Where the RGC has commercial electric power supply,

1. How many hours (daily average) is there any electricity supply? ( \_\_\_\_\_ hours/day)

2. How many days (weekly average) is there any electricity supply? ( \_\_\_\_\_ days/week )

**WATER**

E. Effects of Water Fetching (Purpose: Gender issue)

E1. Are there any adverse effects of water fetching on job opportunity of women?

Answer \_\_\_\_\_

E2. Are there any adverse effects of water fetching on school attendance of children?

Answer \_\_\_\_\_

F. Water Sellers (Purpose: to know the existence or non-existence of water sellers)

F1. Are there any Water Sellers in the RGC? 1. Yes 2.No \_\_\_\_\_

F1-a (if the answer of the F1 is "Yes",) How many water sellers are there ? \_\_\_\_\_ persons

F1-b (if the answer of the F1 is "Yes",) From where do they fetch water ? Water source \_\_\_\_\_

**INCOME AND EXPENDITURE**

(Purpose: to know average figure in the RGC, and check &amp; compare with HH survey results)

G. Income

G1. Sources of Income:

Sources of Income	Villagers Getting the Income			
	Many	Some	A few	None
1. Selling animals (specify: _____ )				
2. Selling agricultural crops (specify: _____ )				
3. Selling labor (specify: _____ )				
4. Forestry (specify: _____ )				
5. Other (specify: _____ )				
6. Other (specify: _____ )				

Circle (O) against the ones that apply in the above list

G2. Income per household (Average in the RGC)

1. Average monthly income per household \_\_\_\_\_ Ush

2. Average yearly income per household \_\_\_\_\_ Ush

3. Are there seasonal changes in income? Answer \_\_\_\_\_

4. Number of livestock per household No. of Cattle \_\_\_\_\_ No. of sheep \_\_\_\_\_ No. of goats \_\_\_\_\_

5. Remittances a. None b. Some c. Others (Specify: \_\_\_\_\_ )

## H. Expenditure

## H1. Health and Sanitation Expenditure (Average in the RGC)

1. Payment for water of a jerry can      a. \_\_\_\_\_ Ush      b. Nothing (Never pay)
2. Water consumption ( liters per capita per day )      1. less than 5    2. 6 ~ 10    3. 11 ~ 15    4. 16 ~ 20    5. 21 ~ 30  
6. 31 ~ 50    7. more than 50

## 3. Latrine cost including soap

Payment	Nothing	A little	in between a little and a lot	A lot
% of all the RGC household				

## 4. Payment for medicine and hospital

Payment	Nothing	A little	in between a little and a lot	A lot
% of all the RGC household				

**COOPERATIVE ORGANIZATIONS AND ACTIVITIES**I. Organization and Activities other than Water and Sanitation Committee *(Purpose: to know the experience of collective activities in the RGC)*

## I1. Organization and Activities

Organization / Group	Water-Related Activities	Other Activity	Comments (if any)
1. Women's Organization			
2. Youth Organization			
3. Other (Specify _____)			
4. Other (Specify _____)			

## I2. Water-Related Collective Activities (if any)

Water-Related Activity	Participants
1	
2	

## I3. Other Collective Activities (if any)

Activity	Participants
1	
2	

J. Contribution to the construction of a new piped water supply facility and O&M *(Purpose: Information for consideration of O&M of a new facility)*

## J1. What contribution can the RGC do for a new water facility construction?

- a. Collecting water fee      b. Operating the facility      c. Simple repairing of the facility  
d. Others (Specify: \_\_\_\_\_ )

J2-a Do you think villagers are willing to pay money regularly for O&M of the facility?      1. Yes      2. No      3. Don't know

J2-b Why do you think so?      Answer \_\_\_\_\_  
\_\_\_\_\_

**Supplemental Data Collection (3) of Selected 12 RGCs  
(Questionnaire to Water and Sanitation Committee (WSC))**

*Pre-requisite of respondent: Member of the water and sanitation committee*

Date: \_\_\_\_\_ / \_\_\_\_\_ / 2016

Name of Enumerator \_\_\_\_\_

RGC \_\_\_\_\_ RGC number \_\_\_\_\_ District \_\_\_\_\_ County \_\_\_\_\_  
 Sub county \_\_\_\_\_ Parishes \_\_\_\_\_ Village(LC1) \_\_\_\_\_

Name of Respondent \_\_\_\_\_ Position \_\_\_\_\_ Phone Number \_\_\_\_\_

**WATER SOURCE OF THE WATER AND SANITATION COMMITTEE (WSC)**

A. What is the water source

Water Source	1. Borehole	2. Shallow well	3. Dug well	4. Protected spring	5. Others

Circle (O) against the one that applies in the above list.

**ESTABLISHMENT OF THE WSC**

B. The WSC was 1. organized in \_\_\_\_\_ (year) , and is still existing  
 2. organized in \_\_\_\_\_ (year) , and lasted for \_\_\_\_\_ (year). It does not exist now.

C. Specify the number of committee members in the below table.

Role of committee member	Gender		Full term of the Role	Method of the selection of the members
	Male	Female		
a. Chair person				
b. Vice chair person				
c. Accountant/Treasurer				
d. Secretary				
e. Care taker				
f. Mobiliser				
g. Other (Specify: _____)				
h. Other (Specify: _____)				
i. Other (Specify: _____)				

**MANAGEMENT OF THE WSC**

D. Has the management of the WSC been going well? 1. Yes 2. No

D1. If the answer is "No", what is the problem?

- 1. No payment of water user fee
- 2. Insufficient activities of the WSC members
- 3. Insufficient enlightenment activities for users
- 4. Others (Specify: \_\_\_\_\_)

D1-a. (if the answer of D1 is "2",) What kind of activities of the WSC need for improvement?

Answer: \_\_\_\_\_

E. Did the WSC have any meetings in the past? 1. Yes 2. No

E1. (if "Yes",) How many times has the WSC had any meetings in the last year ? \_\_\_\_\_ times/year

E2. (if "Yes",) What was the purpose, agenda and frequency of the main meetings? And who could attend the meetings?

	Main Meeting 1	Main Meeting 2	Main Meeting 3	Main Meeting 4
Purpose				
Agenda				
Times/Year				
Participants	1. Committee member only 2. Male Union Members 3. Female Union Members 4. Special members only ( )	1. Committee member only 2. Male Union Members 3. Female Union Members 4. Special members only ( )	1. Committee member only 2. Male Union Members 3. Female Union Members 4. Special members only ( )	1. Committee member only 2. Male Union Members 3. Female Union Members 4. Special members only ( )

Participants: Circle (O) anyone that applies. If it is special members, specify.

E3. When female attendees participated, were there any opinions from them? 1. Yes 2. No

E3-a (if the answer to E3 is "Yes",) What kind of opinions did they have?.

Answer: \_\_\_\_\_

E3-b. (if the answer to E3 is "Yes",) Were the opinions of women treated the same way as those of men? 1. Yes 2. No

E4. Were there any motions/questions from the participants except the committee members? 1. Yes 2. No

E4-a (if the answer of E4 is "Yes",) what kind of motions/question came from the participants?

Answer: \_\_\_\_\_



E4-b (if the answer of E4 is "Yes",) Were there any improvements/changes of the activities of the WSC after the discussions?

1. Yes      2. No

E4-c (if the answer of E4-b is "Yes",) What kind of improvements/changes happened?

Answer: \_\_\_\_\_

E5. (if the answer of E is "No",) Why has the WSC not held meetings ?.

Reason: \_\_\_\_\_

F. Does/Did the WSC have records of incoming and 1. Yes      2. No

F1 (if "No",) Please specify the reason. Reason: \_\_\_\_\_

F2 (if "Yes",) Who was in charge of keeping such records?.

Choose from the committee member role, or Specify ( \_\_\_\_\_ )

F3 (if "Yes",) Does/Did the WSC have any check system?      1. Yes      2. No

F4 (If the answer of F3 is "Yes",) What kind of check system does/did the WSC have?

Answer \_\_\_\_\_

G. Did the WSC conduct any other activities in years past?      1. Yes      2. No

G1. (if "Yes",) Select the contents of the activities.

1. Repair of the facility      2. Some request to sub-county/DWO (Specify: \_\_\_\_\_ )  
3. Other (Specify \_\_\_\_\_ )

G2 Does the WSC have responsibilities to do the activities mentioned above?      1. Yes      2. No

H. How are decisions on important issues of the WSC are made.

1. Hold a meeting attended by all users      2. Hold a meeting attended by committee member and main users  
3. The committee has the power to decide.  
4. Other (Specify: \_\_\_\_\_ )

I Operation and Maintenance

I1 How much did a household pay as an initial contribution?      1. \_\_\_\_\_ Ush      2. None      3. don't know

I2-a How much does/did each household pay regularly for O&M?      1. \_\_\_\_\_ Ush/jerry can (20 liters

2. \_\_\_\_\_ Ush/month      3. None

4. Other (Specify \_\_\_\_\_ )

I2-b How often does/did each household pay the above amount?      1. monthly      2. weekly      3. Other (Specify \_\_\_\_\_ )

I2 -c What other method of payment for O and M has been used if any? \_\_\_\_\_

I3. (If money is collected regularly) How is it collected?

1. Collection at water source      2. Collection at each household  
3. Other (Specify \_\_\_\_\_ )

I4. (If money is collected regularly) Who collects the money for the WSC? Answer \_\_\_\_\_

I5. (If money is collected regularly) Where is the money kept?      1. Bank      2. Other (Specify \_\_\_\_\_ )

I6. What kind of repair did the WSC do on the water supply facilities? Answer \_\_\_\_\_

I7. Does the RGC have by-laws?      1. Yes      2. No

I8. (if the by-laws exist) Are they in operation?      1. Yes      2. No

I9. Does the WSC receive any service of O&M from the Government?      1. Yes      2. No

I9-a (If received) What service does the WSC receive?

Answer 1 (Hardware services): \_\_\_\_\_

Answer 2 (Softwater services): \_\_\_\_\_

I10. Do you think villagers will be willing to pay money or in-kind regularly for O&M?      1. Yes      2. No      3. Don't know

I11 Are there any members who do not pay water user fee?      1. Yes      2. No

I11-a (if the answer of I11 is "Yes",) Why they do not pay water user fee?. Reason: \_\_\_\_\_

I11-b (if the answer of I11 is "Yes",) What kind of efforts does the WSC take to collect the unpaid of water user fee?

1. Press the relevant members who do not pay the water user fee.  
2. Do not press the relevant members.  
3. Other (Specify: \_\_\_\_\_ )

I11-c (if the answer of the I11-b is "2",) Why doesn't the WSC press the relevant members?

Answer: \_\_\_\_\_

I11-d Did the WSC explain the reason why the payment of the water user fee is/was necessary to the users?      1. Yes      2. No

I12 If the WSC has not collected water user fee, specify the reason.

Answer: \_\_\_\_\_

I13. When the water supply facility breaks down and the WSC does not have enough savings, how is the facility repaired?

1. Temporary collection of necessary repair expense from users  
2. Request of necessary repair expense from local leaders  
3. Make a request for repair to the local government  
4. Other (Specify: \_\_\_\_\_ )

**INCOME AND EXPENDITURE OF THE WSC**

J. Income and expenditure of the WSC (Year: \_\_\_\_\_ )

Income \_\_\_\_\_ Ush      Expenditure \_\_\_\_\_ Ush

JK.. The breakdown

Income			Expenditure		
Water revenue		Ush	Manpower cost		Ush
		Ush	Fuel cost		Ush
		Ush	Maintenance		Ush
		Ush	Other cost		Ush

If the the WSC has other incomes, please specify in the above table.

**Supplemental Data Collection (2) of Selected 12 RGCs**  
**(Questionnaire to Health Center/Health Post/Sub-county)**

*Pre-requisite of respondent: Representatives of the Health Center/Health Post/Sub-county*

Date: / /

Name of Enumerator \_\_\_\_\_

RGC \_\_\_\_\_ RGC number \_\_\_\_\_ District \_\_\_\_\_ County \_\_\_\_\_  
 Sub county \_\_\_\_\_ Parishes \_\_\_\_\_ Village(LC1) \_\_\_\_\_

**Part 1: Pre-requisite of respondent: Representatives of the Health Center/Health Post/Sub-county**

Name of Respondent \_\_\_\_\_ Position \_\_\_\_\_ Phone Number \_\_\_\_\_

**HEALTH**

**A Health in the RGC**

**A1 Water-Borne Diseases in RGCs (Total)**

Disease	Prevalence	the Number of patients per year (year _____)				Notes
	1. common 2. Common 3. Rare 4. Very Rare	Total	Adults	Children	Infants	
a. Malaria/fever						
b. Diarrhea						
c. Skin Disease						
d. Respiratory Disease						
e. Worms						
f. Eye Disease/Infection						
g. Intestinal Infection						
h. Typhoid						
i. Other (Specify: _____)						

**A2 Difference of Prevalence between Rainy Season and Dry Season**

Disease	the Number of patients of Each Season		the Total number of patients per year
	Rainy Season	Dry Season	
a. Malaria/fever			
b. Diarrhea			
c. Skin Disease			
d. Respiratory Disease			
e. Worms			
f. Eye Disease/Infection			
g. Intestinal Infection			
h. Typhoid			
i. Other (Specify: _____)			

**WATER**

**B. Water consumption**

- B1 How much water does the Health Centre/Health Post use every day? Number of jerry cans \_\_\_\_\_  
 Litres per capita per day \_\_\_\_\_
- B2 Is the water supply enough for the Health Centre/Health Post ? 1. Yes 2. No \_\_\_\_\_
- B3 (if the answer of the B2 is "No", How much water does the Health Center/Post need every day?  
 Number of jerry can \_\_\_\_\_  
 Litres per capita per day \_\_\_\_\_

**Part 2: Pre-requisite of respondent: Sub county Chief/Health Assistant/Community Development Assistant**

Name of Respondent \_\_\_\_\_ Position \_\_\_\_\_ Phone Number \_\_\_\_\_

**Enlightenment Activities on Water, Sanitation and Hygiene**

**C. What kind of enlightenment activities you were able to do easily in the target F Circle (○) the one that apply.**

1. Promotion of Water, Sanitation and Hygiene development	2. Pre-planning of implementation of a project
3. Mobilization and training of communities	4. Standardization of systems and procedures
5. Effective operation and maintenance	6. Monitoring and adaptation to ensure sustainability
7. Establishment of an institutional framework and capacity building	8 Specify if any,

**D. D1. What kind of enlightenment activities you were **not** able to do easily in the target RGC? Circle (○) the one that apply.**

1, Promotion of Water, Sanitation and Hygiene development	2. Pre-planning of implementation of a project
3. Mobilization and training of communities	4. Standardization of systems and procedures
5. Effective operation and maintenance	6. Monitoring and adaptation to ensure sustainability
7. Establishment of an institutional framework and capacity building	8 Specify if any,

**D2. If there were some difficulties in the activities listed above, what were the reasons?**

Answer: \_\_\_\_\_

OYO INTERNATIONAL CORPORATION IN ASSOCIATION  
WITH TEC INTERNATIONAL CO., LTD.

THE SOCIO-ECONOMIC CONDITION SURVEY FOR THE PREPARATORY SURVEY FOR THE PROJECT FOR  
RURAL WATER SUPPLY PHASE III IN LAKE KYOGA BASIN, EASTERN UGANDA IN THE REPUBLIC OF  
UGANDA

---

FINAL REPORT FOR  
THE SOCIO ECONOMIC SURVEY IN THE 12  
SELECTED RGCS

---

MARCH 2016

Prepared By:

PERT DEVELOPMENT CONSULT LIMITED  
P.O. Box 5848 Kampala  
Plot 7956 Mbogo Road, Kisugu Kampala  
Tel- 0772433634  
Contact Person – Steven Nkumbi Mukiibi  
Email: [stevemuk1@gmail.com](mailto:stevemuk1@gmail.com)

### Acknowledgement

The execution of the various tasks and activities that have constituted this study culminating into this report have been the team effort of a number of people whose tolerance patience, endurance under pressure and commitment to delivering a worthy output is hereby acknowledged with great appreciation. Special acknowledgement to Project Director Steven Nkumbi Mukiibi and Assistant Director/team coordinator Peter Bagwana; statistical analysis and data management team consisting of Edson Byamukama, Polly Niwamanya and Christine Ayebazibwe, interviewers in no special order Ankunda Merab, Atim Marion, Cherere William, Mukyala Shamim, Wagosi Emmanuel, Yeku Mutengu and Peter Kitakule and office support and team administrator Janipher Nambozo. The guidance of project supervisors from companies OYO and TEC and their diligent and dedicated input in all stages of the survey were invaluable for the success of the survey. Great appreciation to all.

Steven Nkumbi Mukiibi - for the project team.

# The Socio-Economic Condition Survey for the Preparatory Survey for the Project for Rural Water Supply Phase III in Lake Kyoga Basin, Eastern Uganda in the Republic of Uganda.

## Contents

Acknowledgement .....	2
Table of Figures.....	9
List of Acronyms.....	12
List of attachments .....	12
Map of the study area.....	13
CHAPTER 1 - BACKGROUND AND PROJECT AREA DESCRIPTION .....	14
1.1 Introduction and Background to the Assignment.....	14
1.2 Justification for the study .....	14
1.3 The Objectives of the Assignment .....	14
1.4 Description of the Project Area.....	15
1.4.1 Location.....	15
1.4.2 Relief .....	16
1.4.3 Vegetation.....	16
1.4.4 Geology and soils .....	16
1.4.5 Climate .....	16
1.4.6 Water Resources.....	17
1.5 General Information and Location of RGCs .....	17
1.5.1 Soroti District .....	17
1.5.2 Serere District: .....	18
1.5.3 Pallisa District:.....	18
1.5.4 Kibuku District:.....	19
1.5.5 Iganga:.....	19
1.5.6 Luuka District .....	20
CHAPTER TWO - METHODOLOGY .....	20
2.1 The Household Survey .....	20
2.1.1 Sampling approach. ....	20
2.2 The Survey of LC 1 Village Leaders.....	22

2.3 The Survey of the Water and Sanitation Committees .....	23
2.4 The Survey of health centre 3 and 4 in the RGCs.....	24
2.5 Total Number of Respondents of Each Category in all the RGCs.....	25
2.6 Tasks and outputs of the Survey.....	26
2.7 Method for the execution of the assignment.....	26
2.7.1 Selection and Training of teams.....	26
2.7.2 Procedure for the collection of data .....	27
2.7.3 Deployment and action plan for the assignment .....	27
2.8 Personnel .....	27
2.9 Handling of data.....	27
2.9.1 Methods, tools and reporting.....	28
CHAPTER THREE - FINDINGS.....	28
3.1 THE HOUSEHOLD SURVEY.....	28
3.1.1 Introduction .....	28
3.1.1a Characteristics of the respondents .....	28
3.1.1b Household compositions .....	45
3.1.1c Main role of each HH member.....	48
3.1.1d Literacy of HH members .....	52
3.1.2 Water and Health.....	56
3.1.2 Current Condition of Water Sources.....	56
3.1.3 Water sources in rainy season .....	73
3.1.4 Water sellers .....	92
3.1.5 Water and Health.....	97
3.1.6 Effects of water fetching .....	106
3.1.7 Income and Expenditure of Households.....	109
3.1.8 Cooperative/communal Organisations and Activities .....	122
3.1.9 Hygiene and Sanitation. ....	128
3.2 THE CONDINTION OF VILLAGES .....	139
3.2.1 The Village Condition Survey - Introduction .....	139
3.2.2 Employment.....	139
3.2.3 Literacy.....	140
3.2.4 School enrolment – Primary School.....	142
3.2.5 Electricity supply .....	147

3.2.6 Water fetching .....	148
3.2.7 Water sellers .....	149
3.2.7 Income and expenditure .....	150
3.2.8 Cooperative (communal) activities and organisations .....	155
3.2.8e Willingness of villagers to pay O and M money regularly.....	156
3.3 ACTIVITIES OF THE WATER AND SANITATION COMMITTEES (WSCs).....	157
3.3.1 Characteristics of the respondents .....	157
3.3.2 Water sources .....	157
3.3.3 Establishment and existence of WSCs .....	158
3.3.4 Number of committee members in the WSC .....	158
3.3.5 Management of WSCs.....	160
Activities for improvement of management .....	161
Meetings of the WSC in the past. ....	161
Opinions from female participants.....	163
Decisions on important issues of the WSC .....	165
3.3.6 Operation and maintenance activities.....	165
3.3.7 Income and expenditure of WSCs.....	169
3.4 THE CONDITION OF HEALTH AND HEALTH SERVICES FOR THE RGCS .....	170
3.4.1 Introduction .....	170
3.4.2 Water borne diseases in the RGC .....	170
3.4.3 Differences in prevalence in dry and wet season. ....	171
3.4.4 Water supply and consumption for the health facilities. ....	172
3.4.5 Sensitisation/enlightenment activities on health and sanitation .....	173
CHAPTER FOUR - ISSUES CHALLENGES AND CONCLUSIONS.....	173
4.1 Challenges .....	173
4.2 Observations and Recommendations .....	175
4.3 Conclusion .....	181
List of Attachments .....	183
References .....	184

## List of Tables

Table 2.1-1 Households and sample size for each RGC.....	21
Table 2.2-2 Number of villages and projected number of village leader respondents .....	23
Table 2.2-3: RGCs and water sources.....	23
Table 2.2-4: Number of Health Centres in different RGCs.....	24
Table 2.2-5: Number of Health Centres covered in the study. ....	25
Table 2.2-6: Number of Respondents of each category in the survey. ....	25
Table 3.1-1. Age and sex characteristics of respondents .....	28
Table 3.1-2.Occupation of respondents .....	29
Table 3.1-3a Characteristics of respondents - Age .....	35
Table 3.1-4a.Religion of respondents – RGC Wide.....	40
Table 3.1-4b Series -Religion of respondents – RGC Wide .....	40
Table 3.1-5a.Tribe of Respondents – RGC Wide.....	44
Table 3.1-5b.Tribe of Respondents – RGC Wide .....	44
Table 3.1-6a.HH Composition – RGC Wide .....	46
Table 3.1-6b.HH Composition – RGC Wide .....	46
Table 3.1-7a Main role of each person in the HH .....	48
Table 3.1-7b Main role of each person in the HH - RGC Wide .....	49
Table 3.1-7b Main role of each person in the HH - RGC Wide .....	50
Table 3.1-7b Main role of each person in the HH - RGC Wide .....	50
Table 3.1-7b Main role of each person in the HH - RGC Wide .....	51
Table 3.1-8 a and b. Kind of work they do to get money. (n=263).....	52
Table 3.1-9a Literacy of HH members.....	53
Table 3.1-9b and c. Literacy of HH members .....	53
Table 3.1-9 b Literacy of HH members in English.....	54
Table 3.1-10a. A comparison of the Literacy (in English) of men and women in the different RGCs.....	54
Table 3.1-10b. A comparison of the Literacy (in vernacular) of men and women in the different RGCs...	55
Table 3.1-11a Main sources of water in the dry season - RGC Wide .....	56
Table 3.1-11b Main sources of water in the dry season - RGC Wide.....	57
Table 3.1-12 Comparison of number of round trips for different sources .....	62
Table 3.1-13a Time for round trip- minutes – dry season – RGC wide.....	63
Table 3.1-13b Time for round trip- minutes – dry season – RGC wise .....	63
Table 3.1-14 Time spent fetching water at the BH. ....	64
Table 3.1-15. Method of water transport- dry season.....	65
Table 3.1-16a. Person to fetch water in the dry season- RGC wide .....	67
Table 3.1-16b. Person to fetch water in the dry season- RGC wise .....	67
Table 3.1-16b. Person to fetch water in the dry season- RGC wise .....	67
Table 3.1-17a Person to fetch water by source – RGC wide .....	68
Table 3.1-17b Person to fetch water by source – RGC wise .....	68
Table 3.1-18a per-capita water consumption in the dry season .....	71
Table 3.1-18b series - Per capita water consumption in the Dry season RGC Wise.....	71
Table 3.1-19 HH using less than 20 litres per person per day in the RGCs. ....	73
Table 3.1-20a Main sources of water in the rainy season – RGC wide .....	73

Table 3.1-20b series - Main sources of water in the rainy season – RGC wise .....	74
Table 3.1-21a Number of round trips a day – rainy and dry seasons – RGC Wide .....	78
Table 3.1-21b Number of round trips a day – rainy season – RGC wise .....	79
Table 3.1-22a Method of water transport –rainy season RGC Wide .....	83
Table 3.1-22b Method of water transport –rainy season –RGC Wise .....	83
Table 3.1-23a Person to fetch water in the rainy season – RGC Wide.....	86
Table 3.1-23a Person to fetch water in the rainy season – RGC Wise .....	86
Table 3.1-24a Person to fetch water by source – rainy season RGC Wide.....	88
Table 3.1-24b series - Person to fetch water by source – rainy season - RGC Wise.....	88
Table 3.1-25a Per-capita water consumption in the rainy season –RGC wide .....	90
Table 3.1-25b series - Per-capita water consumption in the rainy season –RGC Wise .....	91
Table 3.1-26a Buying water from water sellers – RGC Wide .....	94
Table 3.1-26b series - Buying water from water sellers – RGC Wise .....	94
Table 3.1-27a Water sources for washing or bathing - RGC wide .....	95
Table 3.1-27b Water sources for washing or bathing - RGC wise.....	95
Table 3.1-28a Prevalence of water borne diseases – RGC Wide.....	97
Table 3.1-28b series - Prevalence of water borne diseases – RGC Wise .....	98
Table 3.1-29 Main cause of diseases .....	100
Table 3.1-30 Remedies to diseases. ....	101
Table 3.1-31a Purchase of medicine and receiving treatment in last year – RGC wide.....	105
Table 3.1-31b Purchase of medicine and receiving treatment in last year – RGC wise .....	105
Table 3.1-32a Adverse effects of water fetching on job opportunity of women (n=174) RGC Wide.....	106
Table 3.1-32b Adverse effects of water fetching on job opportunity of women - RGC Wise.....	106
Table 3.1-33a. Adverse Effect of water fetching on school attendance for children (n=195).....	108
Table 3.1-33b series - Adverse Effect of water fetching on school attendance for children – RGC wise ..	108
Table 3.1-34 HH members in salaried/wage employment .....	109
Table 3.1-35 Details on wage/salary employment HH .....	110
Table 3.1-36 contribution of wage income to HH income. ....	110
Table 3.1-37 Comparison of incomes of wage earners and those who produce and sell items .....	111
Table 3.1-38 Comparison of average income from sale of different items produced.....	112
Table 3.1-39 activities mentioned in “others” .....	112
Table 3.1-40 Household members in charge.....	113
Table 3.1-41 Livestock in the HHs .....	114
Table 3.1-42 Livestock in the different RGCs.....	115
Table 3.1-43 Comparison of the different sources of income .....	115
Table 3.1-44 Total annual income.....	116
Table 3.1-45a What mothers and daughters do to increase HH income – RGC wide.....	116
Table 3.1-45b What mothers and daughters do to increase HH income – RGC wise .....	116
Table 3.1-46a Expenditure on water – RGC wide.....	118
Table 3.1-46b Expenditure on water-RGC wise.....	118
Table 3.1-47a Items as a percentage of total annual expenditure – RGC Wide.....	119
Table 3.1-47b Items as a percentage of total annual expenditure – RGC Wise .....	119
Table 3.1-48 Comparing income and total annual expenditure. ....	120
Table 3.1-49 Classification of income based social classes in the RGCs (in 000 Shs) .....	121

Table 3.1-50 Average incomes by social class by RGC .....	121
Table 3.1-51a Payment – initial contribution, user fee and new facility .....	122
Table 3.1-51b Payment – initial contribution, user fee and new facility – RGC wise.....	123
Table 3.1-52a no of women with roles in the WSC – RGC wide .....	125
Table 3.1-52b no of women with roles in the WSC – RGC wise .....	125
Table 3.1-53a reasons for not having a toilet – RGC wide.....	129
Table 3.1-53b reasons for not having a toilet-RGC wise.....	129
Table 3.1-54a Condition of toilet/latrine – RGC wide .....	130
Table 3.1-54b Condition of toilet/latrine – RGC wise.....	130
Table 3.1-55 Condition of kitchen and home .....	133
Table 3.1-55 situations when respondents wash hands .....	134
Table 3.1-55 other situations named when respondents wash hands .....	134
Table 3.1-56 type of hand washing facility.....	134
Table 3.1-57a condition of hand washing facility .....	134
Table 3.1-57a condition of hand washing facility – RGC wise .....	135
Table 3.1-59 Condition of water storage containers – RGC wide .....	136
Table 3.1-59b Condition of water storage containers – RGC wise.....	136
Table 3.1-60a how to water cattle – RGC wide.....	137
Table 3.1-60b how to water cattle – RGC wise .....	137
Table 3.1-61a reasons for watering cattle from the same source as humans - RGC wide .....	138
Table 3.1-61b reasons for watering cattle from the same source as humans –RGC wise .....	138
Table 3.2-1 number of villages included in the survey .....	139
Table 3.2-2 proportion of men and women looking for jobs. ....	139
Table 3.2-3 School enrolment primary all RGCs.....	143
Table 3.2-4 electricity supply to the RGCS.....	147
Table 3.2-5 Adverse effect on job opportunity for women. ....	148
Table 3.2-6 Adverse effect on school attendance for children.....	149
Table 3.2-7 sources of income.....	150
Table 3.2-8 Seasonal changes in income .....	151
Table 3.2-9 Details on livestock in the RGCs. ....	151
Table 3.2-10 People receiving remittances .....	152
Table 3.2-11a Pay for water per jerry can .....	153
Table 3.2-11b Pay for water per jerry can .....	153
Table 3.2-12 water consumption – litres per capita per day. ....	153
Table 3.2-13a payment of toilet.....	154
Table 3.2-13b payment of toilet.....	154
Table 3.2-14a payment for medicine and hospital .....	155
Table 3.2-14b payment for medicine and hospital – RGC wise.....	155
Table 3.2-15 Women's organisation-Other activities .....	156
Table 3.2-16 YOUTH ORGANISATION-Other activities .....	156
Table 3.2-17 Contribution to the construction of new piped water facility .....	156
Table 3.3-1 Details on the respondents .....	157
Table 3.3-2 Water sources represented by the respondents .....	158
Table 3.3-3 Year of Establishment and age of WSC.....	158

Table 3.3-4 Details on WSC established between 2010 and 2015.....	158
Table 3.3-5 Years of existence of WSC.....	158
Table 3.3-6 Members on the WSC.....	159
Table 3.3-7 Full terms of the different positions on the WSC.....	159
Table 3.3-8a Method of selection.....	160
Table 3.3-8b Method of selection.....	160
Table 3.3-9 WSC meetings in the past.....	161
Table 3.3-10 Number of meeting in the past year.....	161
Table 3.3-11 a, Purpose of meeting of WSC.....	162
Table 3.3-11 b, Agenda of meeting.....	162
Table 3.3-12 Opinions submitted by women.....	163
Table 3.3-13 Type of motions submitted by the participants besides the WSC officials.....	163
Table 3.3-14 improvement in the activities of WSC.....	163
Table 3.3-15a existence of record of income and expense of WSC.....	164
Table 3.3-15b Reason for non-existence of records.....	164
Table 3.3-16 Person in charge of keeping records.....	164
Table 3.3-17 other activities carried out by the WSC in the last year.....	164
Table 3.3-18 How decisions on important issues of WSC are made.....	165
Table 3.3-19 amount paid by HH as initial.....	165
Table 3.3-20 Regular payment for O and M.....	165
Table 3.3-21 Amount each HH pays regularly for O and M per Month.....	165
Table 3.3-22 how often the amount is paid (12-b).....	166
Table 3.3-23 Where the money is kept.....	167
Table 3.3-24 Byelaws and O and M fees.....	168
Table 3.3-25 measures taken on those who do not pay.....	168
Table 3.3-26 Income and Expenditure of WSCs.....	169
Table 3.4-1. Health Centres Surveyed.....	170
Table 3.4-2a Prevalence of water borne diseases.....	170
Table 3.4-2b Prevalence in different age categories.....	171
Table 3.4-3. Difference in prevalence rainy and dry season.....	171
Table 3.4-4 Water consumption by the HCs.....	172
Table 3.4-5. Ease of carrying out sensitisation activities.....	173

### Table of Figures.

Figure 3.1-1 Location of Kyoga Region.....	15
Figure 3.1-2 Age and sex distribution of the respondents.....	29
Figure 3.1-3 Comparison of occupation across gender – RGC wide.....	35
Figure 3.1-4 Religious profile in the different RGCs.....	43
Figure 3.1-5. Tribe of respondents.....	44
Figure 3.1-6 Household composition.....	45
Figure 3.1-7 Household size.....	47
Figure 3.1-8. Composition of HHs.....	47
Figure 3.1-9a. Literacy in English across the RGCs.....	55

Figure 3.1-9b Literacy in vernacular across all the RGCs.....	56
Figure 3.1-10 Time for round trip RGC wise – dry season.....	64
Figure 3.1-11 Time spend fetching water at the BH – dry season.....	65
Figure 3.1-12. Method of water transport- dry season.....	66
Figure 3.1-13 Person to fetch water most – combined sources based on priority 1.....	68
Figure 3.1-14 Average per-capita water consumption – Dry Season RGC Wise.....	71
Figure 3.1-15 Main sources of water in the rainy season.....	74
Figure 3.1-16 average distance to source dry and rainy season.....	81
Figure 3.1-17 Time for round trip – rainy season and dry season.....	82
Figure 3.1-18 Person to fetch water most- rainy season – combined sources.....	86
Figure 3.1-19 comparison of per capita water consumption –dry season and rainy season.....	91
Figure 3.1-20 Water sellers in different RGCs.....	92
Figure 3.1-21 Reasons for buying water.....	93
Figure 3.1-22 problems with HH water supply.....	102
Figure 3.1-23 Problem with water quality.....	103

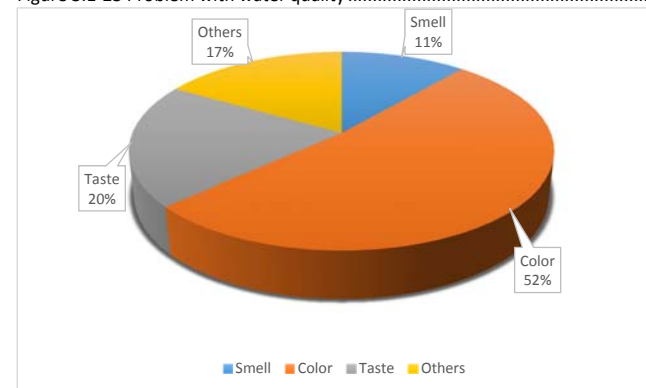

Figure 3.1-24 Sicknesses of children and adults.....	104
Figure 3.1- 25 Effects of water fetching.....	106
Figure 3.1- 26 HH involved in different activities for income generation.....	111
Figure 3.1- 27 Production and sale of items – contribution of different sources.....	112
Figure 3.1- 28 Seasonality of incomes.....	114
Figure 3.1- 29 Number of livestock in the different RGCs.....	115
Figure 3.1- 30 Expenditure on various HH items.....	117
Figure 3.1- 31 Average annual expenditure on water for the different RGCS.....	119
Figure 3.1- 32 Comparison of income and expenditure at HH level.....	120
Figure 3.1- 33 Average income for each social class for each RGC.....	122
Figure 3.1- 34 No of women with roles in the WSC.....	126
Figure 3.1- 35 Women’s opinions taken in WSC decisions.....	127
Figure 3.1- 36 Nature of cooperative organisations involved in.....	127
Figure 3.1- 37 Reasons for not participating in cooperative organisations.....	128



Figure 3.1- 38 Age or number of years since toilet was constructed .....	129
Figure 3.1- 39 Proportion of toilets assessed as clean in each RGC .....	133
Figure 3.2-1 Unemployment rates across the RGCs .....	140
Figure 3.2-2a Literacy in vernacular.....	140
Figure 3.2-2b Literacy in English. ....	141
Figure 3.2-2c Literacy in vernacular across the RGCs. ....	141
Figure 3.2-2d Literacy in English across the RGCs.....	142
Figure 3.2-3a Primary school enrolment across the RGCs.....	144
Figure 3.2-3b Primary school dropout rates across the RGCs .....	144
Figure 3.2-3c Drop out as a percentage of enrolment .....	145
Figure 3.2-4a Enrolment rates at S1 to S4 stage.....	145
Figure 3.2-4b Dropout rates S1 to S4 stage .....	146
Figure 3.2-5a Enrolment rates at S5 to S6 stage.....	146
Figure 3.2-5b Dropout rates at S5 to S6 stage .....	147
Figure 3.2-6 Electricity supply.....	148
Figure 3.2-7 Number of water sellers. ....	149
Figure 3.2-8 Comparison of HH income data.....	150
Figure 3.2-9 Comparison of HH income data.....	151
Figure 3.2-10 Details on livestock in the RGCs.....	152
Figure 3.2-11 Reasons why they would be willing to pay O and M fee regularly.....	157
Figure 3.3-1. Gender and the positions of the WSC .....	159
Figure 3.3-2. Reasons why management of WSC is not going well. ....	161
Figure 3.3-3 How money is collected (I3) .....	166
Figure 3.3-4 who collects the regular payment. ....	167
Figure 3.3-5 Actions taken to repair when there is no savings.....	169

## List of Acronyms

BH	Borehole
CDA	Community Development Assistant
CVs	Curriculum Vitae
DWO	District Water Officer
FB	Functioning Borehole
Gov't	Government
HA	Health Assistant
HCS	Health Centres
HH/HHS	Household/Households
HHQ	Household Questionnaire
JICA	Japan International Cooperation Agency
LC1	Local Council One (village council)
MDG	Millennium Development Goals
MoWE/MWE	Ministry Of Water and Environment
NFB	Non-Functioning Borehole
NGOs	Non-Government Organizations
NPHC	National Population and Housing Census
O and M	Operation and Maintenance
PERT DCC	PERT Development Consult Ltd
RGC No	Rural Growth Centre Number
RGCs	Rural Growth Centres
SACCOs	Savings and Credit Cooperative Organisations
TOR	Terms of Reference
UBOS	Uganda Bureau of Statistics
UNDP	United Nations Development Programme
UNICEF	United Nations Children Fund
UPE	Universal Primary Education
USD	United States Dollar
WB	World Bank
WHO	World Health Organisation
WSCs	Water and Sanitation Committees

## List of attachments

1. Questionnaire - HH survey
2. Questionnaire - Survey of village leaders
3. Questionnaire- Survey of WSC officials
4. Questionnaire – Survey of Health Centres in the RGCs
5. Detailed Field Deployment Plan
6. Directory of Gender Aspects in the Study

Map of the study area.

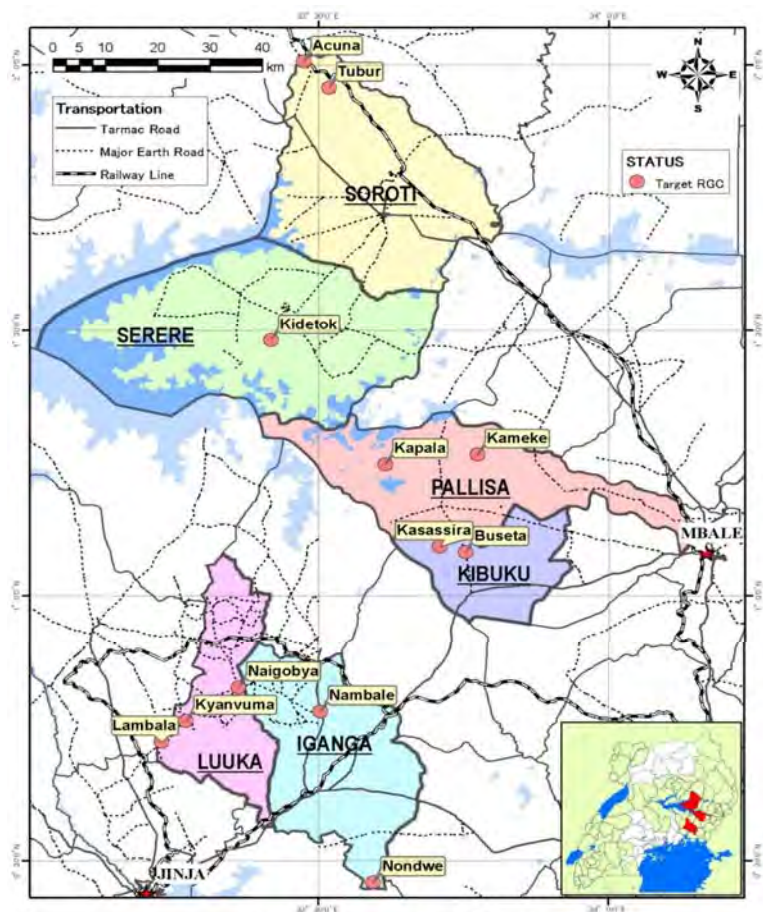

**Site Location Map**

NB. RGCs Kadama, Nakalama, Nakabugu, Nakivumbi, Busesa, Namungalwe, Nabitende Banada, and Mugarema were taken out of the scope of survey work.

## CHAPTER 1 - BACKGROUND AND PROJECT AREA DESCRIPTION

### 1.1 Introduction and Background to the Assignment

The Socio-Economic Condition Survey for the Preparatory Survey for the Project for Rural Water Supply Phase III in Lake Kyoga Basin, Eastern Uganda in the Republic of Uganda was commissioned by a consortium consisting of OYO INTERNATIONAL CORPORATION IN ASSOCIATION WITH TEC INTERNATIONAL CO., LTD (OYO-TECI) on behalf of the Japan International Cooperation Agency (JICA). The two companies were appointed by JICA as the consultants to carry out initial studies to guide the preparation and planning of the project.

The study code named **Survey B** is one of the two social studies, namely Survey A and Survey B. It is one of the initial studies to guide the preparation and planning of the project.

The OYO-TECI consortium contracted PERT Development Consult Ltd - (PERT DCC), a Ugandan Registered Development Consulting Firm to carry out the "The Socio-Economic Condition Survey for the Preparatory Survey for the Project for Rural Water Supply Phase III in Lake Kyoga Basin, Eastern Uganda in the Republic of Uganda (Survey B)".

Survey B consists of the household survey and the supplementary surveys for the representatives of RGCs including village (LC1) Leaders, WSCs and Health Centers. This report is the final report of Survey B that was carried out between 1<sup>st</sup> January 2016 and 15<sup>th</sup> March 2016. In this report, PERT DCC gives the background and objectives of the study, the methodology as well as the strategy and work plan for the execution of the assignment and the results and findings from the study.

### 1.2 Justification for the study

This study has collected data on a range of variables including household characteristics, water consumption and demand, health knowledge and practices and operation and maintenance culture and practices in the selected RGCs. A clear understanding of these variables is critical for the proper design of the water supply systems so as to ensure that they serve effectively for their design life time. Moreover it is important to understand the O and M behaviours of the recipient communities and the existence of systems and structures for effective operation and maintenance for the installed facilities. Where gaps in structures and systems exist, it is important to understand their nature so as to design intervention measures to eliminate them. To achieve all these aims, it was critical to carry out a socio-economic condition survey in the selected RGCs.

### 1.3 The Objectives of the Assignment

The objectives of the Socio-economic Condition Survey are:

- a. To grasp actual social and economic condition of the selected RGCs, and
- b. To obtain the basic data for designing water supply facilities and the formulation of efficient operation and maintenance plan for the Project.

## 1.4 Description of the Project Area

### 1.4.1 Location

As of December 2015, the proposed Kyoga Basin project area included the six districts of Iganga, Luuka, Palisa, Kibuku, Soroti and Serere. These districts lie on the eastern and southern parts of Lake Kyoga which is found in the centre of the Ugandan Territory. The lake is part of the river Nile which flows from Lake Victoria and on through West Nile to South Sudan and eventually to Egypt. Figure 1.3-1 below shows the location of the region in Uganda (coloured brown) and Figure 1.3-2 the detail of the region with the location of the RGCs that have been covered in the study.

Figure 3.1-1 Location of Kyoga Region.



### 1.4.2 Relief

Kyoga Basin lies at an altitude between 1,000m to 1800m ASL. The topography is hilly flat with wetlands and forested areas.

Lake Kyoga has undergone some changes in its old pattern. The older Kyoga was a larger lake than the present body of water. It is a shallow depression consisting of a number of arms, many of which are filled with swamp vegetation. The lake has a basin 7,500km<sup>2</sup> in area including 6,720 km<sup>2</sup> which form the areas occupied by the lake arms and enclosing high land up to an elevation of 1,030 metres. The depth of the lake at its western end is from 3 to 5m. The maximum recorded depth is 7m.

The drainage basin of Lake Kyoga is characterised with a series of low hills and flat valleys with impeded drainage.

### 1.4.3 Vegetation

The vegetation is typical savannah type mainly characterized by grass cover. Perennial trees normally shed their leaves during the dry season. Much of the natural vegetation has been felled down for economic activities including charcoal burning and farming.

### 1.4.4 Geology and soils

The soil types vary from place to place but are generally well drained sandy loams and clay. Clay loams occupy areas along the rivers and streams. The soils are fertile, with potential for high productivity and especially suitable for agriculture. In some places the following soil exists: Foresails, Gleysols, Nitrosols, Reyasols and Cilhosols. The soils along major rivers in Kyoga Basin Region constitute mostly of Reyasols and Cilhosols which are poorly developed and prone to water logging.

The soil of a greater part of Kyoga Basin Region consists of ferruginous soil with a high percentage of sandy soils and therefore susceptible to erosion. Due to its sandy nature, the soil has low water retention capacity and high rate of water infiltration. The soils are usually deep with little differentiation into clearly defined zones and possess fine granular structure, others moulded into large, weak coherent clods that are very porous.

### 1.4.5 Climate

In general, the Kyoga Basin Region gets average rainfall of between 1200 to 1450 mm a year. The monthly average rainfall varies between 14 mm in January and 230 mm in August. Temperature ranges from 15 to 39 degrees Centigrade. The climate is hot throughout the year with two marked rainy seasons from March to June and August to November.

It is hot, dry and windy from December to mid-March. The southern part is part of the lake Vitoria watershed and its climate is moderated by the lake. Both rainy and dry seasons are therefore less marked as there is some rain even in the dry season. The maximum temperature is about 31.8°C and the annual minimum temperature is about 17.3°C giving a mean annual temperature of 24.6°C.

#### 1.4.6 Water Resources

The water resources of the area are heavily influenced by the rainfall pattern, topography and geological formation. The immediate response to rainfall is the runoff which finds its way to the streams and gradually into the groundwater system. The relatively dry and windy conditions mean that most of the rainfall is lost through evaporation.

Surface water is dominated by the marginally perennial rivers which essentially form the boundaries of districts, counties and sub-counties at times. Smaller streams can also be found within the vicinity of some RGCs. None of these streams are gauged and therefore there is no data on stream flows to inform planning.

These surface sources are used by the community for non-culinary purposes. The growing population, coupled with lack of enforcement of environment laws and regulations and a lack of alternative energy sources have had a serious impact on the quality of the water in the streams. The streams are heavily polluted.

Groundwater is the main source of drinking water although the geology of the area does not lend it to high expansive productive aquifers. Groundwater is found in valleys and in isolated pockets of the decomposed Precambrian rocks that form most of the geological stratum.

#### 1.5 General Information and Location of RGCs

The Preparatory Survey for the Project for Rural Water Supply Phase III in Lake Kyoga Basin in Uganda covered the 6 selected districts namely: Soroti, Serere, Pallisa, Kibuku, Iganga and Luuka in Eastern Uganda. Below is a brief about each of the selected districts.

##### 1.5.1 Soroti District

This is found in the Eastern region and it's named after its chief municipal, administrative and commercial headquarters, Soroti, where the district headquarters are located. Soroti District is bordered by Amuria District to the north, Katakwi District to the east, Ngora District to the south east, Serere District to the south, and Kaberemaido District to the west. The Soroti district headquarters is located approximately 116 kilometres (72 mi), by road, northwest of Mbale, the nearest large city.

##### Population:

According to the 2014 population and housing census, Soroti District has some 297,154 people. The district has one of the highest levels of poverty in the country. In February 2009, it was estimated that 53% of the population in the district (an estimated 124,300 people), live on less than US\$1.00 per day. The two predominant ethnicities in the district are the Iteso, and the Kumam. The main languages spoken in the district are: (a) Ateso (b) Kumam and Swahili.

##### Economic activity:

Agriculture is the main economic activity in the district. Crops grown include: Millet, Cassava, Peas, Potatoes, Beans, Onions, Tomatoes, Cabbages, Simsim, Sunflower, Cotton and Sweet Potatoes. The produce is consumed locally and some is sold in the urban areas, particularly in Soroti Town.

##### 1.5.2 Serere District:

Is a district also found in the Kyoga basin in Eastern Uganda It's named after its 'chief town Serere, where the district headquarters are located? Temperature is on average 78°F (26°C), while the Wind is at 1 mph (2 km/h) and 63% humidity. Land coverage is at 1,965.4 km<sup>2</sup> (758.8 sq mi)

##### Location

Serere District is bordered by Soroti District to the north, Ngora District to the east, Pallisa District, and Kaliro District to the south. Kaberemaido lies to the west of Serere District. The district headquarters at Serere are located approximately 35 kilometers (22 mi), by road, south of Soroti, the largest town in the sub-region and approximately 205 kilometers (127 mi), by road, northeast of Kampala at:01 30N, 33 33E.

Serere District was created by Act of Parliament and became functional effective 1 July 2010. Prior to that, it was part of Soroti District. Serere District is part of the Teso sub-region, home to an estimated 2.5 million people of Iteso and Kumam ethnicities.

##### Population

According to the 2014 population census, Serere District has a population of 283,630 people, of who 137,657 are male and 145,973 female constituting 49 and 51 percent respectively. Population density is put at 149.6/km<sup>2</sup> (387/sq mi). The 2002 census reported an overwhelmingly rural population (80%), and a very high proportion of children (56%, or 46.5% if you consider only under 5 year-old children). The major ethnicities in the district are: Itesot, Kumam and Bakenye.

##### 1.5.3 Pallisa District:

This is also one of the districts in the Kyoga basin in Eastern Uganda. Like most other Uganda districts, it is named after its chief town, Pallisa, where the district headquarters are located.

##### Location:

Pallisa District is bordered to the north by (from west to east): Serere District, Ngora District, Kumi District and Bukedea District. Mbale District lies to the east while Budaka District to the southeast, Kibuku to the southwest and Kaliro District to the west. Pallisa the 'chief town' of the district, is located approximately 65 kilometers (40 mi), by road, west of Mbale the largest city in the sub-region.

##### Population:

In 2014, the population of Pallisa District was estimated at about 386, 074. The District covers an area of 1,487.7 km<sup>2</sup> (574.4 sq mi) of which 1,095.7 km<sup>2</sup> (423.1 sq mi) is land and 392 km<sup>2</sup> (151 sq mi) water with a population density of 330.9/km<sup>2</sup> (857/sq mi).

##### Economic activities:

Subsistence crop agriculture and animal husbandry are the two major economic activities in the district. To a lesser extent, fishing, fish farming and bee keeping are increasingly practiced in Pallisa District. The major crops include: Cassava, Millet, Sorghum, Maize, Ground nuts, Beans, Peas, Sweet Potatoes, Cotton, Sunflower, Soya beans, Banana, Matooke. Cattle, goats, sheep, Poultry, and pigs are some of the animals raised in the district.

The district is further blessed with nine minor lakes that comprise part of the Lake Kyoga system. The following are the nine lakes: Lake Lemwa, Lake Kawi, Lake Nakwa, Lake Meito, Lake Geme, Lake Omunuo, Lake Nyanzala and Lake Nyaguo. Due to the abundance of suitable conditions, fish farming is one of the

activities that is on the rise. Fish farming offers a big potential to increase the supply of fish for the population and hence improve on the nutrition of the population.

#### 1.5.4 Kibuku District:

Kibuku District was created by Act of the Uganda Parliament, on 1 July 2010. Prior to that the district was part of Pallisa District.

##### **Location**

Kibuku District is bordered by Pallisa District to the north, Budaka District to the east, Butaleja District to the south, and Namutumba District to the west. The district headquarters at Kibuku, are located approximately 53 kilometers (33 mi), by road, west of Mbale, the largest city in the sub-region.

##### **Population:**

In the most recent census of 2014, the population of Kibuku District was estimated at approximately 202,630 consisting of 97,008 women and 105,622 men.

##### **Economic activity:**

Agriculture (subsistence and commercial), is the mainstay of the district economy. Crop agriculture involves the following crops: Matooke, Sweet bananas, Oranges, Pineapples, Maize, Sweet potatoes, Beans, Groundnuts, Cassava.

#### 1.5.5 Iganga:

##### **Location:**

Iganga District is located in central-Eastern Uganda in Uganda's Busoga sub-region. It lies approximately 45 kilometers (28 mi), by road, northeast of the city of Jinja, on the highway between Jinja and Tororo. Iganga town is the main municipal, administrative and commercial center of Iganga District and the district headquarters are located there. The district is named after the town Iganga. The district covers an area of 650.1 km<sup>2</sup> (251.0 sq mi)

##### **Population:**

In 2014, the national population census put Iganga's population at 506,388 consisting of 242,023 men and 264,365 women and hence a population density of 496.9/km<sup>2</sup> (1,039/sq mi)

##### **Economic activities**

Like its neighbouring districts, the mainstay of Iganga district is agriculture with both food crops such as maize beans cassava and bananas and cash crops like coffee and sugarcane being grown.

Iganga town has several Internet cafes, several guest houses, and a bustling market in the center of town beside the taxi park. Points of interest in the town include the Iganga Hospital, a 120-bed public hospital, administered by the Uganda Ministry of Health.

Iganga is served by a station on the Uganda Railways, the highway from the border with Kenya at Malaba, passes through Tororo and through Iganga, on the way to Jinja and on to Kampala, Uganda's capital and largest city.

#### 1.5.6 Luuka District

##### **Location:**

Located at 1,200 m ASL (3,900 ft), Luuka District is bordered by Buyende District in the north, Kaliro District to the northeast, Iganga District to the southeast, Mayuge District to the south, Jinja District to the southwest and Kamuli District to the northwest.

Bulongo, where the district headquarters are located is approximately 33 kilometres (21 mi), by road, northwest of Iganga, the nearest large town. The coordinates of the district are: 00 42N, 33 18E.

##### **Population.**

In 1991, the national population census estimated the district population at about 130,400. The national census in 2002 estimated the district population to be approximately 185,500. In 2012, the district population was estimated at about 260,900. The most recent census in 2014 put the population of Luuka at 241,453 with a density of 371.4.

##### **Economic activities**

In Kisoga tradition, Luuka is one of the five traditional principalities of the Kingdom of Busoga. According to legend, Luuka was founded around 1737 A.D. and became a part of the British protectorate in Busoga in 1896 A.D. Its traditional ruler is known as the Tabingwa. Luuka district is made up of 7 sub counties the following sub-counties namely: Bukanga, Bukooma, Bulongo, Ikumbya, Irongo, Nawampiti and Waibuga with 33 parishes.

## CHAPTER TWO - METHODOLOGY

### 2.1 The Household Survey

The target respondents for the HH survey were the heads of the households in the selected RGCs. For the purpose of this study a household was defined as "one or more people living in the same dwelling, house or residence who also share at meals and may consist of a single family or some other grouping of people". A single dwelling was considered to contain multiple households if either meals or living space are not shared. Homesteads and Manyatas were considered as separate household if the different groupings inside do not share meals. The household survey was done using the Household Questionnaire which is attached to this report as **Attachment 1**.

#### 2.1.1 Sampling approach.

##### *Sample size*

The survey protocol specified a total number of 400 household surveyed in all the RGCs. This approximates to some 34 households per RGC. However, some RGCs have many more households than others. Therefore, to take the size of the RGC in account the number of households selected from each of the RGCs was based on the total number of households in the RGC. The formula used to arrive at the proportionate sample size in each household was; Number of HH in the RGC divided by the Total Number of HH in all the RGCs and multiplied by the total specified sample of 400 households. The results of the first survey i.e. Survey A indicated a total of 4,938 households in all the 12 RGCs that have been selected



for this survey. Based on this total number of households, a proportionate sample size was calculated for each of the RGCs as indicated in Table 2 below.

TABLE 2.1-1 HOUSEHOLDS AND SAMPLE SIZE FOR EACH RGC

No.	RGC	RGC No.	District	Total No. of HHs Counted	Sample Size
1	NAMBALE	I-3	IGANGA	304	25
2	LAMBALA	I-6	LUUKA	277	22
3	NAIGOBYA	I-7	LUUKA	272	22
4	KYANVUMA	I-9	LUUKA	508	41
5	NONDWE	I-11	IGANGA	859	70
6	KASASSIRA	P-2	KIBUKU	809	66
7	KAMEKE	P-3	PALLISA	197	16
8	KAPALA	P-4	PALLISA	360	29
9	BUSETA	P-5	KIBUKU	292	24
10	KIDETOK	S-1	SERERE	604	49
11	TUBUR	S-2	SOROTI	275	22
12	ACUNA	S-3	SOROTI	181	15
					401

#### Sample selection

The terms of the study specified that the sampling approach for household respondents should be scientific covering the whole spectrum of social classes so that at the point of analysis, it will be possible to cluster the respondents into three main social classes consisting of about 33% from the high social class, about 33% from the middle social class and about 33% from the low social class in the RGC. The sample of respondents should also meet another criteria namely that about 50% of the respondent should be women.

To achieve the gender criteria, interviewers were instructed to interview the female spouse in every second household selected.

To achieve the social class objective, a random sampling approach was adopted for this survey. In order to adopt random sampling approach with wider social class representation, the actual condition of the social class was confirmed by the LC1 Leader. According to the condition, the field coordinator then allocated the households with wider social class to interviewers.

The field coordinator explained the demarcations of the RGC as stipulated by the project to the village leader so that only the households in the RGC area were included in the sample. Where the RGC has more than one village, respondents were selected from each of the villages in proportion to the size of the village as represented in the RGC area.

Interviewers were then deployed to go to the selected households for interview with specific instructions to interview female or male adults. Female respondents were interviewed by female interviewers and

vice-versa. At the analysis stage, the criteria for each social class for each RGC was set and the different categories identified accordingly.

Interviewers were placed in teams of two people each as they were deployed so that there was mutual support. Interviewers in the same team moved in the same direction and monitored and supported one another.

Besides the HH respondents, other respondents such as Village leaders (LC1) and members of the Water and Sanitation Committees (WSCs) could be included in the relevant samples even if they were resident in areas outside of the demarcated RGC zone as long as their responsibilities as WSC or village leaders or health workers related to the demarcated area of the RGC.

#### Interview procedure

Once at the selected household, the interviewer was introduced by the village leader or his/he assistant. However in some cases where interviewers moved without the assistant, they introduced themselves. The interviewers then explained the purpose of the visit and the purpose of the survey. The interviewers also requested for the right respondent – female or male. Before beginning the interview, the interviewer assured the respondent of confidentiality and how the data collected is to be used. He/she informed the respondent that answers would be noted down on the questionnaire. The interviewer then proceeded to carry out the interview with the full consent of the respondent.

#### 2.2 The Survey of LC 1 Village Leaders.

The target respondent for this was one member of the village council executive for each village. This person could be any of the nine members of the village council but preferably the Chairperson, the Secretary and Treasurer or the Secretary for Women. The purpose of this survey was to collect views on the availability of water and the factors that affect this availability, operation and maintenance practices as well as sanitation and hygiene in the village. The role of leaders and other village actors in the promotion of sanitation and hygiene was also of interest in this survey. The questionnaire used in the survey of LC1 leader is included in this report as **Attachment 2**. Table 3 below shows the number of villages in each RGC as shown on the survey maps as well as the expected number of respondents planned for and those finally interviewed in each of the RGCs. All LC1 villages in each RGC were covered in the survey.

**TABLE 2.2-2 NUMBER OF VILLAGES AND PROJECTED NUMBER OF VILLAGE LEADER RESPONDENTS**

No.	District	Sub-county	Code	RGC	Number of Villages	Projected Number of Respondents	Number of respondents actually interviewed
1	Iganga	Nambale	I-3	Nambale	1	1	1
2	Luuka	Irongo	I-6	Lambala	2	2	2
3	Luuka	Bukooma	I-7	Naigobya	3	3	3
4	Luuka	Irongo	I-9	Kyanvuma	2	2	2
5	Iganga	Makuutu	I-11	Nondwe	2	2	2
6	Kibuku	Kasassira	P-2	Kasassira	4	4	6
7	Pallisa	Kameke	P-3	Kameke	2	2	2
8	Pallisa	Gogonyo	P-4	Kapala	3	3	3
9	Kibuku	Buseta	P-5	Buseta	2	2	3
10	Serere	Pingire	S-1	Kidetok	2	2	3
11	Soroti	Tubur	S-2	Tubur	2	2	1
12	Soroti	Tubur	S-3	Acuna	1	1	2
	TOTAL				26	26	30

### 2.3 The Survey of the Water and Sanitation Committees

The respondents in this survey were members of the water and sanitation committees of the main water sources in the RGC. The questionnaire used in the survey of WSCs is attached to this report as **Attachment 3**.

According to the results of survey A (the simple socio economic condition survey) carried out in May, there is a total of 69 different water sources consisting of 37 functioning boreholes, 13 non-functioning boreholes, 13 shallow wells, and 6 unprotected springs in the selected RGCs. Table 4 below shows the RGCs along with the water sources located in them. The last column on the right shows the actual number of WSCs that were included in this study in each of the RGCs.

**TABLE 2.2-3: RGCs AND WATER SOURCES.**

No		RGC	a. Borehole (functioning)	b. Borehole (non-functioning)	c. Shallow well	d. Protected Springs	e. Unprotected Spring	Total	No of WSCs covered
1	I-3	NAMBALE	2	0	0	0	1	3	3
2	I-6	LAMBALA	2	2	3	0	2	9	2
3	I-7	NAIGOBYA	3	0	2	0	0	5	7
4	I-9	KYANVUMA	3	1	3	0	0	7	4
5	I-11	NONDWE	2	2	1	0	2	7	5
6	P-2	KASASSIRA	4	0	0	0	0	4	6
7	P-3	KAMEKE	4	0	0	0	0	4	3
8	P-4	KAPALA	2	0	2	0	0	4	2
9	P-5	BUSETA	4	1	1	0	0	6	7
10	S-1	KIDETOK	10	5	1	0	0	16	6
11	S-2	TUBUR	0	1	0	0	0	1	2
12	S-3	ACUNA	1	1	0	0	1	3	2
			37	13	13	0	6	69	49

Some of the water sources, especially those that occur naturally as unprotected spring did not have any WSCs. The biggest contrast was at Kidetok where 16 water sources had been documented in survey A but

where only 6 of them were found to have a functioning WSC. In this survey, one member of each of the WSCs with a preference for the Chairperson, the Secretary or the Treasurer was interviewed. Where a woman was among these, she was chosen as the views and activities of women are considered important in the operation and maintenance of water sources. Where there was a new water source established since the survey in May 2015, the WSC associated with this water source was also covered in this survey.

### 2.4 The Survey of health centre 3 and 4 in the RGCs

At each RGC, the respondent in this was one leader or official in the health centre 3. In Uganda, Health Facilities are classified as Health centres 2 up to 4 with Health Centre 2 at Parish Level, Health Centre 3 at Sub-county Level, and Health Centre 4 at County level.

Since most of the RGCs are located near the sub-county headquarters, the most likely facilities to be located there are HC 3. Private/NGO institutions approximating to HC 2 and HC3 were also included in the survey but their characteristics were clearly indicated in the questionnaire responses. The leaders in the RGCs were approached to assist in the identification of the Health Centres where they are not obvious. Where there were no HCs within the RGC, the HC 3 where most residents in the RGC go for treatment (most probably the nearest to the RGC) was located for the interview. Where it happened that this HC3 was in another sub-county, clearance was sought from the client before an interview and data collection is carried out there.

According to the results of survey A carried out in May 2015, Health Centres are to be found in the various RGCs as in table 5 below. Table 2.2-5 shows the HCs that were covered in the survey.

**TABLE 2.2-4: NUMBER OF HEALTH CENTRES IN DIFFERENT RGCs.**

No.	RGC	RGC No.	District	HC4	HC3	HC2	Total
1	NAMBALE	I-3	IGANGA	0	0	0	0
2	LAMBALA	I-6	LUUKA	0	0	0	0
3	NAIGOBYA	I-7	LUUKA	0	0	1	0
4	KYANVUMA	I-9	LUUKA	0	0	0	0
5	NONDWE	I-11	IGANGA	0	0	2	2
6	KASASSIRA	P-2	KIBUKU	0	1	0	1
7	KAMEKE	P-3	PALLISA	0	1	0	1
8	KAPALA	P-4	PALLISA	0	1	0	1
9	BUSETA	P-5	KIBUKU	0	1	0	1
10	KIDETOK	S-1	SERERE	0	1	0	1
11	TUBUR	S-2	SOROTI	0	1	0	1
12	ACUNA	S-3	SOROTI	0	0	0	0

TABLE 2.2-5: NUMBER OF HEALTH CENTRES COVERED IN THE STUDY.

ID	RGC	HC
I-3	Nambale	1
I-6	Lambala	1
I-7	Naigobya	1
I-9	Kyanvuma	0
I-11	Nondwe	1
P-2	Kasassira	1
P-3	Kameke	1
P-4	Kapala	1
P-5	Buseta	1
S-1	Kidetok	1
S-2	Tubur	1
S-3	Acuna	0
<b>TOTAL</b>		<b>10</b>

The purpose of including the Health Centres was to assess their influence on the promotions of sanitation and hygiene in the RGCs and how they impact and are impacted by the available supply of safe water for household use. The questionnaire used for the HC survey is attached to this report as **Attachment 4**.

## 2.5 Total Number of Respondents of Each Category in all the RGCs

TABLE 2.2-6: NUMBER OF RESPONDENTS OF EACH CATEGORY IN THE SURVEY.

No.	RGC	RGC No.	District	Respondents HH Survey	Respondents Village leaders	Respondents WSCs	Respondents HCs (including HC3 at sub-county)	Total Projected No of Respondents
1	NAMBALE	I-3	IGANGA	30	1	3	1	35
2	LAMBALA	I-6	LUUKA	22	2	2	1	27
3	NAIGOBYA	I-7	LUUKA	22	3	7	1	33
4	KYANVUMA	I-9	LUUKA	44	2	4	0	50
5	NONDWE	I-11	IGANGA	70	2	5	1	78
6	KASASSIRA	P-2	KIBUKU	66	6	6	1	79
7	KAMEKE	P-3	PALLISA	16	2	3	1	22
8	KAPALA	P-4	PALLISA	29	3	2	1	35
9	BUSETA	P-5	KIBUKU	24	3	7	1	35
10	KIDETOK	S-1	SERERE	49	3	6	1	59
11	TUBUR	S-2	SOROTI	22	1	2	1	26
12	ACUNA	S-3	SOROTI	15	2	2	0	
<b>Total</b>				<b>409</b>	<b>30</b>	<b>49</b>	<b>10</b>	<b>479</b>

Where an RGC did not have a Health Centre, a respondent was selected from the HC3 in the same sub-county where the RGC is located.

## 2.6 Tasks and outputs of the Survey

From the above, the assignment therefore involved a series of tasks including

- Recruiting, training and equipping several teams of interviewers to carry out the survey as described above.
- Developing a deployment plan for the implementation of the field data collection.
- Making all necessary logistical arrangements for the mobility and maintenance of the interview team.
- Selecting household respondents in each of the RGCs for interviewing.
- Identifying the Villages in each of the RGCs and selecting a member from each of the village councils for inclusion in the survey as respondents.
- Identifying WSCs where they exist in the RGC and selecting an official from each of the WSC for interviewing as part of the survey.
- Identifying HC3s in the RGC or at the relevant RGC where the HC questionnaire was administered.
- Carrying out interviews with selected individuals as listed in 3 above.
- Processing, analysing and interpreting the results of the surveys to prepare a report of the survey.

The main output of this survey is this report with its observations, conclusions and recommendations.

## 2.7 Method for the execution of the assignment

### 2.7.1 Selection and Training of teams

The main qualifications for being selected on the team of interviewers were: past experience in similar assignment, integrity and a commendable work ethic and ability to speak one and preferably two of the languages in the region of the survey was another critical attribute. Nine (9) people were selected on the basis of this criteria and they were trained to ensure that they are able to carry out the tasks in the assignment with minimal errors. The team of interviewers was supported by two other people, one for administrative functions and the other for overall direction of the survey. In the final analysis, the team of personnel on this study consisted of 13 people whose brief profiles are also attached to this report as **Attachment 6**.

In terms of the training, the selected interviewers were taken through 2 days of training consisting of:

- Review of the details of the assignment and technical specifications to have a full understanding of the rationale and the demands of the assignment.
- A careful study of the questionnaire with role plays and rehearsals to make sure that it is clearly understood.
- Familiarization and practice with the materials and any equipment.
- A pre-test in the field to ensure that the interviewers are able to handle circumstances in the field.



### 2.7.2 Procedure for the collection of data

On arrival at each of the RGCs, the team reported to the leadership of the RGCs namely the sub-county and the LC1s to inform the leaders about the work being carried out. Contact was also made with the village leaders (LC1) who would help in the establishment and selection of household respondents and in guiding on the best walk routes. The survey team embarked on the work as planned for each RGC.

The RGCs were surveyed one by one according to the deployment plan attached to this report as Attachment 5. In each RGC teams were constituted according to the number of villages in the RGC. However in some of the RGCs all the interviewers worked as one team with a team leader allocating households, individuals and institutions for interviews. All the interviewers were trained to be able to carry out interviews with any of the four questionnaires being used in this study however in the final analysis some individuals became better at some of the questionnaires out of experience and these were asked to do those questionnaires again and again in different locations. The emphasis was on quality and tasks were evaluated on RGC to RGC basis and deployment of interviewers was varied from time to time.

### 2.7.3 Deployment and action plan for the assignment

The 12 RGCs surveyed are presented in the table 2.1-1 above. The detailed deployment for the assignment is outlined in attachment 5 of this report. At the planning stage, the basis of the deployment plan was the estimated time that it would take one interviewer to carry out one interview with the different types of questionnaires. The projected time for one interview originally put at 45 minutes included travel from one respondent to another as well as the time for identifying the respondent. The estimate of the number of days to be spent in each RGC was based on 36hrs of work a day turned in by 7 interviewers working 6 hours a day each. Though interviewers were working 8 hours a day, the rest of the time was reserved for editing and other data cleaning and processing work as quality was considered paramount in this study.

### 2.8 Personnel

Besides the interviewers, the team of personnel on this study included one data entry clerk, two data analysts and one sanitation specialist. All these came with the requisite competences and their profiles are attached to this report. The team was headed by two people with extensive experience in social research and social investigations.

### 2.9 Handling of data

The work load of the interviewers was planned to include editing of all questionnaires at the end of the day so as to be able to correct any mistakes while the memory of the interviewers was still fresh. A full time data entry clerk was recruited as part of the team and did the data entry as the questionnaires were delivered. Although it was planned that the data sheets would be submitted to the client RGC by RGC as soon as entry and cleaning was finished, it turned out to be extremely difficult to do this due to both logistical and planning reasons. The challenges associated with this development are outlined in a separate section in this report.

It was also planned that data would be analysed RGC by RGC and submitted as soon as analysis for an RGC is done. Analysis involved the production of frequencies, bivariate and multivariate tables. A full time data analyst was hired for this purpose. It was not possible to meet the planned schedule for the submission of analysis however eventually all analysed sheets were submitted.

### 2.9.1 Methods, tools and reporting

The following reports and records are to be submitted.

- 1) Preparation and Planning report
- 2) Draft Final Report
- 3) Final Report of the assignment (outline attached as attachment 6)

## CHAPTER THREE - FINDINGS

### 3.1 THE HOUSEHOLD SURVEY

#### 3.1.1 Introduction

A total of 409 HH were surveyed in the HH survey in this study. The purpose of the HH survey was to understand HH knowledge and practices on health, water and sanitation as well as to document other characteristics that have implications for water consumption and operation and maintenance of installed water facilities. The survey therefore investigated among others the sources of water used currently by the HHs, daily water consumption, water borne diseases and their prevalence, other health problems related to water, income and expenditure dynamics of HHs, collective community activities and hygiene and sanitation in homes. The number of respondents from each of the RGC has already been given in the preceding sections.

#### 3.1.1a Characteristics of the respondents

##### Gender

Of the total number of 409 respondents, 202 constituting 49.4% are male while 207 constituting 50.6% are female. The sample is therefore split almost 50% into male and female. This however is not necessarily representative of the reality in the population from which the sample was selected. It was the intention of this survey to have at least 50% of the respondents as female.

##### Age

Overall the greatest number of respondents were in the age range 21 to 40 years. This group constituted 59.2% of the total number of respondents. A comparison of the age distribution of the respondents is shown in table 3.1-1.

TABLE 3.1-1. AGE AND SEX CHARACTERISTICS OF RESPONDENTS

Age	Total		Male		Female	
	Number	%	Number	%	Number	%
15-20	12	2.9	2	1.0	10	4.8
21-30	121	29.6	43	21.3	78	37.7
31-40	121	29.6	59	29.2	62	30.0
41-50	80	19.6	45	22.3	35	16.9
51-60	47	11.5	33	16.3	14	6.8
60+	28	6.8	20	9.9	8	3.9
Total	409	100	202	100	207	100

It can be seen that the age distribution of both male and female respondents is similar with slight differences in the age bracket 21-30 where there are more women than men and 51-60 where there are slightly more men than women.

Figure 3.1-2 Age and sex distribution of the respondents

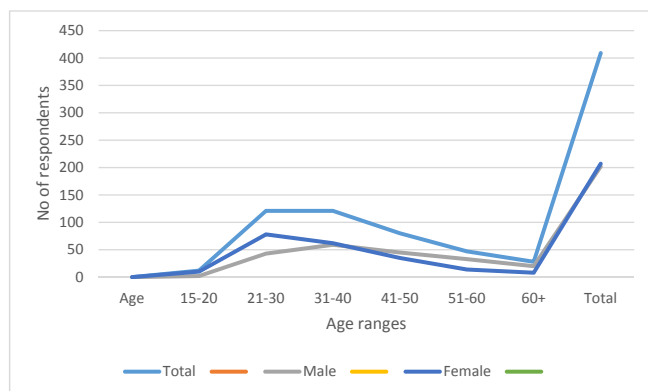

### Occupation

Regarding occupation, the data shows that the greatest number of respondents fall into two related categories namely farmer and peasant. Both the farmer and the peasant till the land or raise livestock using various methods and techniques as their primary occupation.

TABLE 3.1-2.OCCUPATION OF RESPONDENTS

Occupation	RGC wide					
	Total		Male		Female	
	Number	%	Number	%	Number	%
Peasant	115	28.1	66	32.7	49	23.7
Farmers	113	27.6	44	21.8	69	33.3
Trader	67	16.4	32	15.8	35	16.9
Housewife	29	7.1	1	0.5	28	13.5
Teacher	35	8.6	23	11.4	12	5.8
Health worker	19	4.6	9	4.5	10	4.8
Technician	6	1.5	6	3.0	0	0.0
Police Personnel	5	1.2	4	2.0	1	0.5
Student	2	0.5	1	0.5	1	0.5
Religious worker	2	0.5	2	1.0	0	0.0
Driver	3	0.7	3	1.5	0	0.0
Others	13	3.2	11	5.4	2	1.0
<b>Total</b>	<b>409</b>	<b>100</b>	<b>202</b>	<b>100</b>	<b>207</b>	<b>100.0</b>

A farmer was defined as one who produces primarily for sale, while a peasant is one who produces primarily for consumption. Traders also constituted a significant portion of the respondents at 16% while teachers were about half of traders at 8.6% of the respondents. Those whose primary engagement is taking care of home and family- "housewife"- constituted another significant proportion at 7.1%.

RGC wise, the leading categories of occupation remain similar namely Peasant, Farmer, Trader, and Housewife with minor alterations from RGC to RGC. Significant deviations from this pattern occur in Kidetok, Tubur, Kapala, Kameke, Kasasira, Naigobya and Lambala. In these RGCs, while Housewife is one of the major occupational categories, the occupational category Teacher surpasses it. In Buseta Health worker at 12.5% exceeds Trader - 8.3%, Housewife - 8.3% and Teacher - 4.2%! In Kapala, Technician constituting 6.9% of the respondents exceeds housewife at 3.4% while in Tubur Health Worker and Teacher, both at 9.1% exceed Housewife at 4.5%. The tables presenting the occupation profile of the respondents in each of the 12 RGCs are presented below.

Table 3.1-2b. Occupation of respondents in the different RGCs

Occupation	Kidetok					
	Total		Male		Female	
	Number	%	Number	%	Number	%
Peasant	10	20.4	7	30.4	3	11.5
Farmers	11	22.4	2	8.7	9	34.6
Trader	10	20.4	4	17.4	6	23.1
Housewife	3	6.1	0	0.0	3	11.5
Teacher	8	16.3	4	17.4	4	15.4
Health worker	3	6.1	2	8.7	1	3.8
Technician	1	2.0	1	4.3	0	0.0
Police Personnel	1	2.0	1	4.3	0	0.0
Student	0	0.0	0	0.0	0	0.0
Religious worker	0	0.0	0	0.0	0	0.0
Driver	1	2.0	1	4.3	0	0.0
Others	1	2.0	1	4.3	0	0.0
<b>Total</b>	<b>49</b>	<b>100</b>	<b>23</b>	<b>100</b>	<b>26</b>	<b>100</b>

Table 3.1-2c.

Occupation	Acuna					
	Total		Male		Female	
	Number	%	Number	%	Number	%
Peasant	7	46.7	5	71.4	2	25.0
Farmers	3	20.0	0	0.0	3	37.5
Trader	4	26.7	2	28.6	2	25.0
Housewife	0	0.0	0	0.0	0	0.0
Teacher	0	0.0	0	0.0	0	0.0
Health worker	1	6.7	0	0.0	1	12.5
Technician	0	0.0	0	0.0	0	0.0
Police Personnel	0	0.0	0	0.0	0	0.0
Student	0	0.0	0	0.0	0	0.0
Religious worker	0	0.0	0	0.0	0	0.0
Driver	0	0.0	0	0.0	0	0.0
Others	0	0.0	0	0.0	0	0.0
<b>Total</b>	<b>15</b>	<b>100</b>	<b>7</b>	<b>100</b>	<b>8</b>	<b>100</b>

Table 3.1-2d.

Occupation	Tubur					
	Total		Male		Female	
	Number	%	Number	%	Number	%
Peasant	6	27.3	5	45.5	1	9.1
Farmers	4	18.2	2	18.2	2	18.2
Trader	7	31.8	2	18.2	5	45.5
Housewife	1	4.5	0	0.0	1	9.1
Teacher	2	9.1	1	9.1	1	9.1
Health worker	2	9.1	1	9.1	1	9.1
Technician	0	0.0	0	0.0	0	0.0
Police Personnel	0	0.0	0	0.0	0	0.0
Student	0	0.0	0	0.0	0	0.0
Religious worker	0	0.0	0	0.0	0	0.0
Driver	0	0.0	0	0.0	0	0.0
Others	0	0.0	0	0.0	0	0.0
<b>Total</b>	<b>22</b>	<b>100</b>	<b>11</b>	<b>100</b>	<b>11</b>	<b>100</b>

Table 3.1-2e.

Occupation	Kapala					
	Total		Male		Female	
	Number	%	Number	%	Number	%
Peasant	7	24.1	4	26.7	3	21.4
Farmers	9	31.0	4	26.7	5	35.7
Trader	5	17.2	1	6.7	4	28.6
Housewife	1	3.4	0	0.0	1	7.1
Teacher	3	10.3	2	13.3	1	7.1
Health worker	1	3.4	1	6.7	0	0.0
Technician	2	6.9	2	13.3	0	0.0
Police Personnel	0	0.0	0	0.0	0	0.0
Student	0	0.0	0	0.0	0	0.0
Religious worker	0	0.0	0	0.0	0	0.0
Driver	0	0.0	0	0.0	0	0.0
Others	1	3.4	1	6.7	0	0.0
<b>Total</b>	<b>29</b>	<b>100</b>	<b>15</b>	<b>100</b>	<b>14</b>	<b>100</b>

Table 3.1-2f.

Occupation	Kameke					
	Total		Male		Female	
	Number	%	Number	%	Number	%
Peasant	5	31.3	4	50.0	1	12.5
Farmers	3	18.8	1	12.5	2	25.0
Trader	3	18.8	1	12.5	2	25.0
Housewife	1	6.3	0	0.0	1	12.5
Teacher	4	25.0	2	25.0	2	25.0
Health worker	0	0.0	0	0.0	0	0.0
Technician	0	0.0	0	0.0	0	0.0
Police Personnel	0	0.0	0	0.0	0	0.0
Student	0	0.0	0	0.0	0	0.0
Religious worker	0	0.0	0	0.0	0	0.0
Driver	0	0.0	0	0.0	0	0.0

Others	0	0.0	0	0.0	0	0.0
<b>Total</b>	<b>16</b>	<b>100</b>	<b>8</b>	<b>100</b>	<b>8</b>	<b>100</b>

Table 3.1-2g.

Occupation	Kasasira					
	Total		Male		Female	
	Number	%	Number	%	Number	%
Peasant	24	36.4	10	30.3	14	42.4
Farmers	21	31.8	12	36.4	9	27.3
Trader	4	6.1	0	0.0	4	12.1
Housewife	3	4.5	0	0.0	3	9.1
Teacher	4	6.1	3	9.1	1	3.0
Health worker	2	3.0	1	3.0	1	3.0
Technician	1	1.5	1	3.0	0	0.0
Police Personnel	3	4.5	2	6.1	1	3.0
Student	0	0.0	0	0.0	0	0.0
Religious worker	1	1.5	1	3.0	0	0.0
Driver	0	0.0	0	0.0	0	0.0
Others	3	4.5	3	9.1	0	0.0
<b>Total</b>	<b>66</b>	<b>100</b>	<b>33</b>	<b>100</b>	<b>33</b>	<b>100</b>

Table 3.1-2h.

Occupation	Buseta					
	Total		Male		Female	
	Number	%	Number	%	Number	%
Peasant	5	20.8	3	25.0	2	16.7
Farmers	9	37.5	3	25.0	6	50.0
Trader	2	8.3	2	16.7	0	0.0
Housewife	2	8.3	0	0.0	2	16.7
Teacher	1	4.2	1	8.3	0	0.0
Health worker	3	12.5	1	8.3	2	16.7
Technician	0	0.0	0	0.0	0	0.0
Police Personnel	0	0.0	0	0.0	0	0.0
Student	0	0.0	0	0.0	0	0.0
Religious worker	0	0.0	0	0.0	0	0.0
Driver	0	0.0	0	0.0	0	0.0
Others	2	8.3	2	16.7	0	0.0
<b>Total</b>	<b>24</b>	<b>100</b>	<b>12</b>	<b>100</b>	<b>12</b>	<b>100</b>

Table 3.1-2i.

Occupation	Naigobya					
	Total		Male		Female	
	Number	%	Number	%	Number	%
Peasant	7	31.8	4	40.0	3	25.0
Farmers	8	36.4	3	30.0	5	41.7
Trader	3	13.6	2	20.0	1	8.3
Housewife	1	4.5	0	0.0	1	8.3
Teacher	2	9.1	1	10.0	1	8.3
Health worker	1	4.5	0	0.0	1	8.3
Technician	0	0.0	0	0.0	0	0.0

Police Personnel	0	0.0	0	0.0	0	0.0
Student	0	0.0	0	0.0	0	0.0
Religious worker	0	0.0	0	0.0	0	0.0
Driver	0	0.0	0	0.0	0	0.0
Others	0	0.0	0	0.0	0	0.0
<b>Total</b>	<b>22</b>	<b>100</b>	<b>10</b>	<b>100</b>	<b>12</b>	<b>100</b>

Table 3.1-2j.

Occupation	Kyanvuma					
	Total		Male		Female	
	Number	%	Number	%	Number	%
Peasant	6	13.6	4	18.2	2	9.1
Farmers	13	29.5	3	13.6	10	45.5
Trader	7	15.9	4	18.2	3	13.6
Housewife	6	13.6	0	0.0	6	27.3
Teacher	5	11.4	5	22.7	0	0.0
Health worker	1	2.3	1	4.5	0	0.0
Technician	0	0.0	0	0.0	0	0.0
Police Personnel	0	0.0	0	0.0	0	0.0
Student	1	2.3	1	4.5	0	0.0
Religious worker	1	2.3	1	4.5	0	0.0
Driver	1	2.3	1	4.5	0	0.0
Others	3	6.8	2	9.1	1	4.5
<b>Total</b>	<b>44</b>	<b>100</b>	<b>22</b>	<b>100</b>	<b>22</b>	<b>100</b>

Table 3.1-2k.

Occupation	Lambala					
	Total		Male		Female	
	Number	%	Number	%	Number	%
Peasant	5	22.7	2	18.2	3	27.3
Farmers	6	27.3	2	18.2	4	36.4
Trader	5	22.7	5	45.5	0	0.0
Housewife	2	9.1	0	0.0	2	18.2
Teacher	3	13.6	2	18.2	1	9.1
Health worker	1	4.5	0	0.0	1	9.1
Technician	0	0.0	0	0.0	0	0.0
Police Personnel	0	0.0	0	0.0	0	0.0
Student	0	0.0	0	0.0	0	0.0
Religious worker	0	0.0	0	0.0	0	0.0
Driver	0	0.0	0	0.0	0	0.0
Others	0	0.0	0	0.0	0	0.0
<b>Total</b>	<b>22</b>	<b>100</b>	<b>11</b>	<b>100</b>	<b>11</b>	<b>100</b>

Table 3.1-2l.

Occupation	Nondwe					
	Total		Male		Female	
	Number	%	Number	%	Number	%
Peasant	22	31.4	13	37.1	9	25.7
Farmers	21	30.0	8	22.9	13	37.1
Trader	11	15.7	5	14.3	6	17.1

Housewife	5	7.1	1	2.9	4	11.4
Teacher	3	4.3	2	5.7	1	2.9
Health worker	2	2.9	2	5.7	0	0.0
Technician	2	2.9	2	5.7	0	0.0
Police Personnel	1	1.4	1	2.9	0	0.0
Student	1	1.4	0	0.0	1	2.9
Religious worker	0	0.0	0	0.0	0	0.0
Driver	0	0.0	0	0.0	0	0.0
Others	2	2.9	1	2.9	1	2.9
<b>Total</b>	<b>70</b>	<b>100</b>	<b>35</b>	<b>100</b>	<b>35</b>	<b>100</b>

Table 3.1-2m.

Occupation	Nambale					
	Total		Male		Female	
	Number	%	Number	%	Number	%
Peasant	5	16.7	4	26.7	1	6.7
Farmers	6	20.0	4	26.7	2	13.3
Trader	4	13.3	0	0.0	4	26.7
Housewife	11	36.7	5	33.3	6	40.0
Teacher	2	6.7	0	0.0	2	13.3
Health worker	0	0.0	0	0.0	0	0.0
Technician	0	0.0	0	0.0	0	0.0
Others	1	3.3	1	6.7	0	0.0
Police Personnel	0	0.0	0	0.0	0	0.0
Student	0	0.0	0	0.0	0	0.0
Religious worker	0	0.0	0	0.0	0	0.0
Driver	0	0.0	0	0.0	0	0.0
Tailor	1	3.3	1	6.7	0	0.0
<b>Total</b>	<b>30</b>	<b>100</b>	<b>15</b>	<b>100</b>	<b>15</b>	<b>100</b>

An examination of the gender break down of the different occupations shows that there are more females among the farmers and more male among the peasants. These are self-described titles and it may be that women see themselves more as producing for the market while many men in agriculture see themselves as producing for consumption in the home. As one would expect the occupation category housewife is dominated by women though there are some male home keepers as well. Drivers, Technicians and Religious workers are only male. These are occupations where women still have to make a break through. In the case of religious worker, this may be more difficult as many Holy Books strictly proscribe the role of women as religious leaders.

Figure 3.1-3 Comparison of occupation across gender – RGC wide

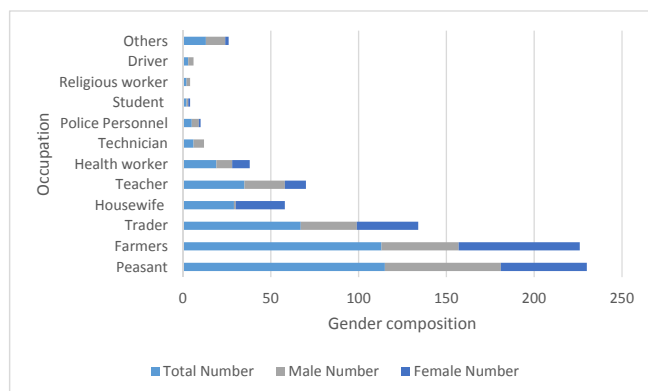

TABLE 3.1-3A CHARACTERISTICS OF RESPONDENTS - AGE

GENDER	TOTAL BY GENDER – RGC Wide				TOTAL COMBINED – RGC Wide	
	MALE		FEMALE		COUNT	%
AGE GROUP	COUNT	%	COUNT	%		
15-20	2	0.99	10	4.83	12	2.9
21-30	43	21.3	78	37.7	121	30
31-40	58	28.7	63	30.4	121	30
41-50	45	22.3	35	16.9	80	20
51-60	33	16.3	14	6.76	47	11
61+	21	10.4	7	3.38	28	6.8
<b>TOTAL</b>	<b>202</b>	<b>100</b>	<b>207</b>	<b>100</b>	<b>409</b>	<b>100</b>

When the respondents are put into age categories as above, the results show that the two age categories of 21-30 and 31-40 dominate the respondents with each of the two constituting 30% of the respondents. Together they add up to 60% of the respondents.

RGC wise, the pattern is similar except in Acuna where 41-50 amounting to 26.7% exceeds the group 21-30 and in Nambale where the group 41-50 at 43.3% is more than the combined categories of 21-30 and 31 to 40. It would appear that the age structure in both these RGCs has more middle aged people indicating that it is an ageing population in comparison to the rest of the RGCs. Aging populations tend to be in locations where birth rates are falling or where young people are emigrating. Emigration may itself be an indicator of hard living conditions including a difficult economic situation. The details of the age of respondents RGC wise are presented in table 3.1-3 b to m below.

Table 3.1-3b Kidetok

GENDER	TOTAL BY GENDER				TOTAL COMBINED	
	MALE		FEMALE		COUNT	%
AGE GROUP	COUNT	%	COUNT	%		
15-20	0	0.0	2	7.7	2	4.1
21-30	6	26.1	5	19.2	11	22.4
31-40	6	26.1	11	42.3	17	34.7
41-50	1	4.3	5	19.2	6	12.2
51-60	6	26.1	2	7.7	8	16.3
61+	4	17.4	1	3.8	5	10.2
<b>TOTAL</b>	<b>23</b>	<b>100</b>	<b>26</b>	<b>100</b>	<b>49</b>	<b>100</b>

Table 3.1-3c Tubur

GENDER	TOTAL BY GENDER				TOTAL COMBINED	
	MALE		FEMALE		COUNT	%
AGE GROUP	COUNT	%	COUNT	%		
15-20	0	0.0	0	0.0	0	0.0
21-30	4	36.4	4	36.4	8	36.4
31-40	5	45.5	3	27.3	8	36.4
41-50	1	9.1	4	36.4	5	22.7
51-60	0	0.0	0	0.0	0	0.0
61+	1	9.1	0	0.0	1	4.5
<b>TOTAL</b>	<b>11</b>	<b>100</b>	<b>11</b>	<b>100</b>	<b>22</b>	<b>100</b>

Table 3.1-3d Acuna

GENDER	TOTAL BY GENDER				TOTAL COMBINED	
	MALE		FEMALE		COUNT	%
AGE GROUP	COUNT	%	COUNT	%		
15-20	0	0.0	0	0.0	0	0.0
21-30	0	0.0	2	25.0	2	13.3
31-40	2	28.6	4	50.0	6	40.0
41-50	2	28.6	2	25.0	4	26.7
51-60	0	0.0	0	0.0	0	0.0
61+	3	42.9	0	0.0	3	20.0
<b>TOTAL</b>	<b>7</b>	<b>100</b>	<b>8</b>	<b>100</b>	<b>15</b>	<b>100</b>

Table 3.1-3e Kapala

GENDER	TOTAL BY GENDER				TOTAL COMBINED	
	MALE		FEMALE		COUNT	%
AGE GROUP	COUNT	%	COUNT	%		
15-20	0	0.0	2	14.3	2	6.9
21-30	3	20.0	4	28.6	7	24.1
31-40	3	20.0	6	42.9	9	31.0
41-50	5	33.3	2	14.3	7	24.1
51-60	2	13.3	0	0.0	2	6.9
61+	2	13.3	0	0.0	2	6.9
<b>TOTAL</b>	<b>15</b>	<b>100</b>	<b>14</b>	<b>100</b>	<b>29</b>	<b>100</b>

Table 3.1-3f Kameke

GENDER	TOTAL BY GENDER				TOTAL COMBINED	
	MALE		FEMALE		COUNT	%
AGE GROUP	COUNT	%	COUNT	%		
15-20	0	0.0	0	0.0	0	0.0
21-30	3	37.5	5	62.5	8	50.0
31-40	3	37.5	1	12.5	4	25.0
41-50	1	12.5	2	25.0	3	18.8
51-60	1	12.5	0	0.0	1	6.3
61+	0	0.0	0	0.0	0	0.0
<b>TOTAL</b>	<b>8</b>	<b>100</b>	<b>8</b>	<b>100</b>	<b>16</b>	<b>100</b>

Table 3.1-3g Kasasira

GENDER	TOTAL BY GENDER				TOTAL COMBINED	
	MALE		FEMALE		COUNT	%
AGE GROUP	COUNT	%	COUNT	%		
15-20	0	0.0	0	0.0	0	0.0
21-30	4	12.1	15	45.5	19	28.8
31-40	10	30.3	12	36.4	22	33.3
41-50	11	33.3	4	12.1	15	22.7
51-60	6	18.2	2	6.1	8	12.1
61+	2	6.1	0	0.0	2	3.0
<b>TOTAL</b>	<b>33</b>	<b>100</b>	<b>33</b>	<b>100</b>	<b>66</b>	<b>100</b>

Table 3.1-3h Buseta

GENDER	TOTAL BY GENDER		TOTAL COMBINED
	MALE	FEMALE	
15-20	0	0.0	0
21-30	6	27.3	15
31-40	7	31.8	14
41-50	1	4.5	2
51-60	1	4.5	3
61+	6	27.3	6
<b>TOTAL</b>	<b>22</b>	<b>100</b>	<b>44</b>

AGE GROUP	COUNT	%	COUNT	%	COUNT	%
15-20	0	0.0	1	8.3	1	4.2
21-30	2	16.7	5	41.7	7	29.2
31-40	6	50.0	3	25.0	9	37.5
41-50	0	0.0	0	0.0	0	0.0
51-60	4	33.3	2	16.7	6	25.0
61+	0	0.0	1	8.3	1	4.2
<b>TOTAL</b>	<b>12</b>	<b>100</b>	<b>12</b>	<b>100</b>	<b>24</b>	<b>100</b>

Table 3.1-3i Naigobya

GENDER	TOTAL BY GENDER				TOTAL COMBINED	
	MALE		FEMALE		COUNT	%
AGE GROUP	COUNT	%	COUNT	%		
15-20	0	0.0	0	0.0	0	0.0
21-30	2	20.0	5	41.7	7	31.8
31-40	3	30.0	3	25.0	6	27.3
41-50	2	20.0	3	25.0	5	22.7
51-60	2	20.0	1	8.3	3	13.6
61+	1	10.0	0	0.0	1	4.5
<b>TOTAL</b>	<b>10</b>	<b>100</b>	<b>12</b>	<b>100</b>	<b>22</b>	<b>100</b>

Table 3.1-3j Kyanvuma

GENDER	TOTAL BY GENDER				TOTAL COMBINED	
	MALE		FEMALE		COUNT	%
AGE GROUP	COUNT	%	COUNT	%		
15-20	1	4.5	3	13.6	4	9.1
21-30	6	27.3	9	40.9	15	34.1
31-40	7	31.8	7	31.8	14	31.8
41-50	1	4.5	1	4.5	2	4.5
51-60	1	4.5	2	9.1	3	6.8
61+	6	27.3	0	0.0	6	13.6
<b>TOTAL</b>	<b>22</b>	<b>100</b>	<b>22</b>	<b>100</b>	<b>44</b>	<b>100</b>

Table 3.1-3k Lambala

GENDER	TOTAL BY GENDER				TOTAL COMBINED	
	MALE		FEMALE		COUNT	%
AGE GROUP	COUNT	%	COUNT	%		
15-20	0	0.0	0	0.0	0	0.0

21-30	3	27.3	4	36.4	7	31.8
31-40	4	36.4	2	18.2	6	27.3
41-50	2	18.2	4	36.4	6	27.3
51-60	2	18.2	0	0.0	2	9.1
61+	0	0.0	1	9.1	1	4.5
<b>TOTAL</b>	<b>11</b>	<b>100</b>	<b>11</b>	<b>100</b>	<b>22</b>	<b>100</b>

Table 3.1-3l Nondwe

GENDER	TOTAL BY GENDER				TOTAL COMBINED	
	MALE		FEMALE		COUNT	%
AGE GROUP	COUNT	%	COUNT	%		
15-20	1	2.9	2	5.7	3	4.3
21-30	8	22.9	16	45.7	24	34.3
31-40	5	14.3	9	25.7	14	20.0
41-50	12	34.3	2	5.7	14	20.0
51-60	7	20.0	4	11.4	11	15.7
61+	2	5.7	2	5.7	4	5.7
<b>TOTAL</b>	<b>35</b>	<b>100</b>	<b>35</b>	<b>100</b>	<b>70</b>	<b>100</b>

Table 3.1-3m Nambale

GENDER	TOTAL BY GENDER				TOTAL COMBINED	
	MALE		FEMALE		COUNT	%
AGE GROUP	COUNT	%	COUNT	%		
15-20	0	0.0	0	0.0	0	0.0
21-30	2	13.3	4	26.7	6	20.0
31-40	4	26.7	2	13.3	6	20.0
41-50	7	46.7	6	40.0	13	43.3
51-60	2	13.3	1	6.7	3	10.0
61+	0	0.0	2	13.3	2	6.7
<b>TOTAL</b>	<b>15</b>	<b>100</b>	<b>15</b>	<b>100</b>	<b>30</b>	<b>100</b>

### Religion

Table 3.1-4a below shows the characteristics of the respondents in terms of their religion. Most people in semi urban settings feel a strong link to their religious faiths and many stay close to the dictates of their faiths in terms of behaviour and practices. For instance the Muslim faith recommends regular ablution during the day just before prayers done five times a day. Moslem homes therefore tend to have decent toilets and ablution facilities and many mosques also have boreholes for this purpose. The facilities at mosques tend to be used by all people.

Most of the respondents identified themselves as Christians, consisting of Protestant or Anglican at 33.3%, Catholic at 27.9% and Born Again or Pentecostal at 11%. Of these three, the biggest single category are the Anglicans or Protestants constituting 33.3 % of the total number of respondents. This was followed in size by Catholics at 27.9%. Born again Christians are generally people who became disillusioned with the complacency and permissiveness in the Anglican/protestant church and have increasingly identified themselves as born again indicating and reawakening of vibrancy and fidelity to biblical values and practices. Muslims constitute 25.9% of the respondents and this is not a small figure by any means.

Uganda is in most literature described as being 90% Christian. The 25.9% representing Muslims is therefore a significant finding and shows a growing presence of people of this faith in the sub region. The growth in the proportion of Muslims is most likely the result of natural growth rather than any significant population movements and it indicates a trend that could continue.

Both the Christian and Muslim god faiths have invested in water facilities to enhance their influence in the communities so as to get converts and also to improve the welfare of the communities. However unlike the Christian faith where issues of personal hygiene are generally not strictly prescribed, the Islamic faith prescribes a strict personal hygiene and ritualistic cleansing that makes water and personal hygiene essential to its practice. For that reason a water source is normally part of the infrastructure at a mosque and most of these are open to people of all faiths in the neighbourhood. These facilities are usually well maintained by the mosques providing a constant source of water. However they may not serve an effective demonstration effect for Community Based Operation and Maintenance since the cost of maintenance is usually met by the mosque. Nevertheless, sanitation and hygiene practices recommended by the Islamic faith are likely to keep growing and Operation and Maintenance plans need to take this into account.

TABLE 3.1-4A. RELIGION OF RESPONDENTS – RGC WIDE

Religion	Total		Male		Female	
	Number	%	Number	%	Number	%
Catholic	114	27.9	53	26.2	61	29.5
Protestant or Anglican	135	33.0	63	31.2	72	34.8
Moslem	106	25.9	54	26.7	52	25.1
Born again or Pentecostal	45	11.0	27	13.4	18	8.7
Others	9	2.2	5	2.5	4	1.9
<b>Total</b>	<b>409</b>	<b>100.0</b>	<b>202</b>	<b>100</b>	<b>207</b>	<b>100</b>

TABLE 3.1-4B SERIES -RELIGION OF RESPONDENTS – RGC WIDE

Table 3.1-4b Kidetok

Religion	Total		Male		Female	
	Number	%	Number	%	Number	%
Catholic	32	65.3	17	73.9	15	57.7
Protestant or Anglican	14	28.6	5	21.7	9	34.6
Moslem	0	0.0	0	0.0	0	0.0
Born again or Pentecostal	3	6.1	1	4.3	2	7.7
Others	0	0.0	0	0.0	0	0.0
<b>Total</b>	<b>49</b>	<b>100.0</b>	<b>23</b>	<b>100</b>	<b>26</b>	<b>100</b>

Table 3.1-4b Acuna

Religion	Total		Male		Female	
	Number	%	Number	%	Number	%
Catholic	6	40.0	3	42.9	3	37.5
Protestant or Anglican	4	26.7	0	0.0	4	50.0
Moslem	1	6.7	1	14.3	0	0.0
Born again or Pentecostal	4	26.7	3	42.9	1	12.5
Others	0	0.0	0	0.0	0	0.0
<b>Total</b>	<b>15</b>	<b>100.0</b>	<b>7</b>	<b>100</b>	<b>8</b>	<b>100</b>

Table 3.1-4b Tubur

Religion	Total		Male		Female	
	Number	%	Number	%	Number	%
Catholic	8	36.4	2	18.2	6	54.5
Protestant or Anglican	6	27.3	3	27.3	3	27.3
Moslem	0	0.0	0	0.0	0	0.0
Born again or Pentecostal	8	36.4	6	54.5	2	18.2
Others	0	0.0	0	0.0	0	0.0
<b>Total</b>	<b>22</b>	<b>100.0</b>	<b>11</b>	<b>100</b>	<b>11</b>	<b>100</b>

Table 3.1-4b Kapala

Religion	Total		Male		Female	
	Number	%	Number	%	Number	%
Catholic	10	34.5	4	26.7	6	42.9
Protestant or Anglican	18	62.1	10	66.7	8	57.1
Moslem	1	3.4	1	6.7	0	0.0
Born again or Pentecostal	0	0.0	0	0.0	0	0.0
Others	0	0.0	0	0.0	0	0.0
<b>Total</b>	<b>29</b>	<b>100.0</b>	<b>15</b>	<b>100</b>	<b>14</b>	<b>100</b>

Table 3.1-4b Kameke

Religion	Total		Male		Female	
	Number	%	Number	%	Number	%
Catholic	9	56.3	5	62.5	4	50.0
Protestant or Anglican	2	12.5	0	0.0	2	25.0
Moslem	0	0.0	0	0.0	0	0.0
Born again or Pentecostal	5	31.3	3	37.5	2	25.0
Others	0	0.0	0	0.0	0	0.0
<b>Total</b>	<b>16</b>	<b>100.0</b>	<b>8</b>	<b>100</b>	<b>8</b>	<b>100</b>

Table 3.1-4b Kasasira

Religion	Total		Male		Female	
	Number	%	Number	%	Number	%
Catholic	15	22.7	8	24.2	7	21.2
Protestant or Anglican	19	28.8	7	21.2	12	36.4
Moslem	20	30.3	10	30.3	10	30.3
Born again or Pentecostal	11	16.7	7	21.2	4	12.1
Others	1	1.5	1	3.0	0	0.0
<b>Total</b>	<b>66</b>	<b>100.0</b>	<b>33</b>	<b>100</b>	<b>33</b>	<b>100</b>

Table 3.1-4b Buseta

Religion	Total		Male		Female	
	Number	%	Number	%	Number	%
Catholic	9	37.5	4	33.3	5	41.7
Protestant or Anglican	4	16.7	2	16.7	2	16.7
Moslem	8	33.3	4	33.3	4	33.3
Born again or Pentecostal	3	12.5	2	16.7	1	8.3
Others	0	0.0	0	0.0	0	0.0
<b>Total</b>	<b>24</b>	<b>100.0</b>	<b>12</b>	<b>100</b>	<b>12</b>	<b>100</b>

Table 3.1-4b Naigobya

Religion	Total		Male		Female	
	Number	%	Number	%	Number	%
Catholic	6	27.3	0	0.0	6	50.0
Protestant or Anglican	8	36.4	6	60.0	2	16.7
Moslem	6	27.3	3	30.0	3	25.0
Born again or Pentecostal	1	4.5	0	0.0	1	8.3
Others	1	4.5	1	10.0	0	0.0
<b>Total</b>	<b>22</b>	<b>100.0</b>	<b>10</b>	<b>100</b>	<b>12</b>	<b>100</b>

Table 3.1-4b Kyanvuma

Religion	Total		Male		Female	
	Number	%	Number	%	Number	%
Catholic	10	22.7	6	27.3	4	18.2
Protestant or Anglican	14	31.8	10	45.5	4	18.2
Moslem	17	38.6	5	22.7	12	54.5
Born again or Pentecostal	3	6.8	1	4.5	2	9.1
Others	0	0.0	0	0.0	0	0.0
<b>Total</b>	<b>44</b>	<b>100.0</b>	<b>22</b>	<b>100</b>	<b>22</b>	<b>100</b>

Table 3.1-4b Lambala

Religion	Total		Male		Female	
	Number	%	Number	%	Number	%
Catholic	1	4.5	1	9.1	0	0.0
Protestant or Anglican	12	54.5	6	54.5	6	54.5
Moslem	5	22.7	2	18.2	3	27.3
Born again or Pentecostal	2	9.1	1	9.1	1	9.1
Others	2	9.1	1	9.1	1	9.1
<b>Total</b>	<b>22</b>	<b>100.0</b>	<b>11</b>	<b>100</b>	<b>11</b>	<b>100</b>

Table 3.1-4b Nondwe

Religion	Total		Male		Female	
	Number	%	Number	%	Number	%
Catholic	5	7.1	3	8.6	2	5.7
Protestant or Anglican	22	31.4	7	20.0	15	42.9
Moslem	36	51.4	21	60.0	15	42.9
Born again or Pentecostal	5	7.1	3	8.6	2	5.7
Others	2	2.9	1	2.9	1	2.9
<b>Total</b>	<b>70</b>	<b>100.0</b>	<b>35</b>	<b>100</b>	<b>35</b>	<b>100</b>

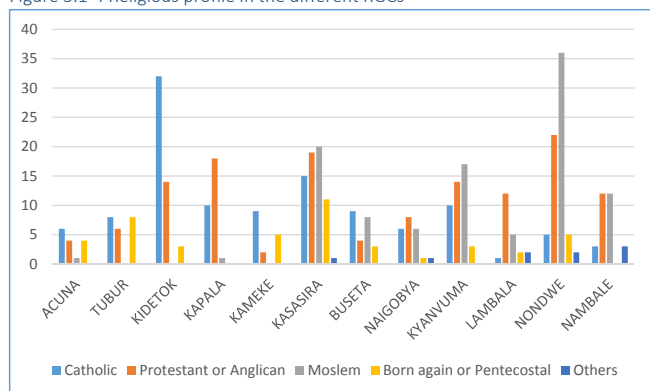

Table 3.1-4b Nambale

Religion	Total		Male		Female	
	Number	%	Number	%	Number	%
Catholic	3	10.0	0	0.0	3	20.0
Protestant or Anglican	12	40.0	7	46.7	5	33.3
Moslem	12	40.0	7	46.7	5	33.3
Born again or Pentecostal	0	0.0	0	0.0	0	0.0
Others	3	10.0	1	6.7	2	13.3
<b>Total</b>	<b>30</b>	<b>100.0</b>	<b>15</b>	<b>100</b>	<b>15</b>	<b>100</b>

Analysis of the religious distribution in the individual RGCs shows that people of the Moslem faith predominate in Nondwe, Kyanvuma and Kasasira while Catholics predominate in Kidetok, Tubur, Acuna, Kameke and Buseta. Protestant form the largest single religion in Kapala only.

Figure 3.1-4 Religious profile in the different RGCs



**Tribe**

Most of the respondents are Basoga (plural for Musoga) - 41.6% followed by Atesot (plural for Itesot) at 29.8%. These are followed by “Mugwere” and “Muganda” at 17.4% and 2.4% respectively. The proportion of Baganda (plural for Muganda) 2.4% though small, is significant due to the fact that this sub region has not traditionally been inhabited by Baganda. While urbanisation and education tend to mellow the influence of tribe in terms of sanitation and hygiene practices, some traditional practices die slowly and the tribal characteristics of the respondents are important for planning relating to the use of the new water facilities. Historically, Busoga and Buganda have not differed much in traditional practices in child rearing and sanitation and hygiene. However lately Busoga has been endemic with infestations such as jiggers that are associated with poor hygiene perhaps indicating a retardation in or a break down in the traditional sanitation and hygiene practices.

TABLE 3.1-5A. TRIBE OF RESPONDENTS – RGC WIDE

Tribe	Count	%
Musoga	170	41.6
Munyole	9	2.2
Japadola	3	0.7
Samiya	4	1.0
Mugwere	71	17.4
Itesot	122	29.8
Kumamu	4	1.0
Munyankole	8	2.0
Muganda	10	2.4
Others	8	2.0
<b>Total</b>	<b>409</b>	<b>100</b>

Figure 3.1-5. Tribe of respondents

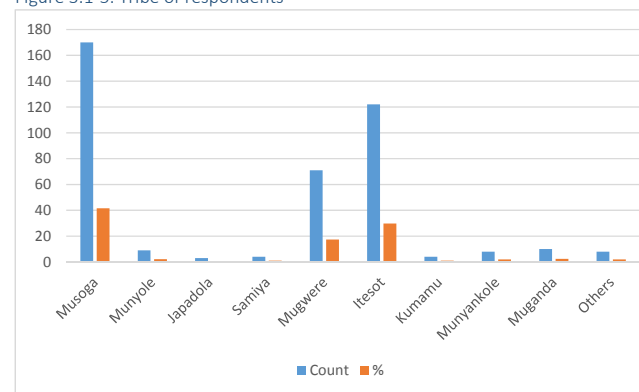

As would be expected, RGC wise, the proportions of the different tribes change according to the location with Atesot dominating in the RGCs in the Teso Region while Basoga dominate in the RGCs located in the Busoga Region. Kapala and Kameke in Palisa are also dominated by Ateso while Buseta and Kasasira in Kubuku are dominated by Bagwere (plural for Mugwere)

TABLE 3.1-5B. TRIBE OF RESPONDENTS – RGC WISE

Tribe	Kidetok		Acuna		Tubur		Kapala		Kameke		Kasasira	
	Count	%	Count	%	Count	%	count	%	count	%	count	%
Musoga	0	0.0	0	0.0	0	0.0	1	3.4	1	6.3	2	3.0
Munyole	0	0.0	0	0.0	0	0.0	0	0.0	0	0.0	1	1.5
Japadola	0	0.0	0	0.0	0	0.0	0	0.0	0	0.0	1	1.5
Samiya	0	0.0	0	0.0	0	0.0	0	0.0	0	0.0	0	0.0
Mugwere	0	0.0	0	0.0	0	0.0	1	3.4	1	6.3	52	78.8
Itesot	45	91.8	13	86.7	20	90.9	25	86.2	13	81.3	3	4.5
Kumamu	1	2.0	2	13.3	1	4.5	0	0.0	0	0.0	0	0.0
Munyankole	0	0.0	0	0.0	0	0.0	0	0.0	0	0.0	3	4.5
Muganda	1	2.0	0	0.0	1	4.5	0	0.0	1	6.3	2	3.0

Others	2	4.1	0	0.0	0	0.0	2	6.9	0	0.0	2	3.0
<b>Total</b>	<b>49</b>	<b>100</b>	<b>15</b>	<b>100</b>	<b>22</b>	<b>100</b>	<b>29</b>	<b>100</b>	<b>16</b>	<b>100</b>	<b>66</b>	<b>100</b>

Tribe	Buseta		Naigobya		Kyanvuma		Lambala		Nondwe		Nambale	
	Count	%	Count	%	Count	%	count	%	count	%	count	%
Musoga	0	0.0	21	95.5	40	90.9	20	90.9	58	82.9	27	90.0
Munyole	0	0.0	0	0.0	0	0.0	0	0.0	7	10.0	1	3.3
Japadola	0	0.0	0	0.0	0	0.0	0	0.0	2	2.9	0	0.0
Samiya	1	4.2	0	0.0	0	0.0	0	0.0	2	2.9	1	3.3
Mugwere	16	66.7	0	0.0	0	0.0	0	0.0	1	1.4	0	0.0
Itesot	2	8.3	0	0.0	1	2.3	0	0.0	0	0.0	0	0.0
Kumamu	0	0.0	0	0.0	0	0.0	0	0.0	0	0.0	0	0.0
Munyankole	3	12.5	0	0.0	0	0.0	1	4.5	0	0.0	1	3.3
Muganda	1	4.2	1	4.5	3	6.8	0	0.0	0	0.0	0	0.0
Others	1	4.2	0	0.0	0	0.0	1	4.5	0	0.0	0	0.0
<b>Total</b>	<b>24</b>	<b>100</b>	<b>22</b>	<b>100</b>	<b>44</b>	<b>100</b>	<b>22</b>	<b>100</b>	<b>70</b>	<b>100</b>	<b>30</b>	<b>100</b>

### 3.1.1b Household compositions

Figure 3.1-6 below shows the household composition in the survey area in terms of gender as well as age (adult or child). The figure shows that women (19%) are more than men (18%) and girls (32%) are more than boys (31%) in the households. These findings parallel those in the general population where the National Population and Housing Census (NPHC) of 2014 (Uganda Bureau of Statistics 2014) established a sex ratio of 94.5 males per 100 females. Put another way, for every 100 people in Uganda, 52.7 will be women.

Figure 3.1-6 Household composition

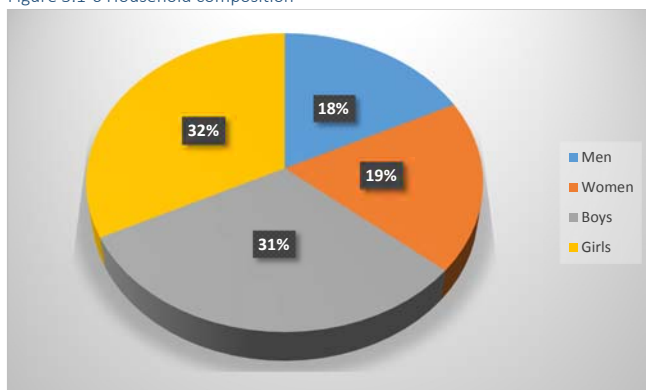

The data on HH compositions is presented in tables 3.1-6A and B. In general women exceed men in all the RGCs except Kasasira and Lambala. An examination of the proportion constituted by the combination of women and girls shows that again that combination exceeds that of men and boys in all the RGCs except

Tubur, Kapala, Kasasira, Kyanvuma and Lambala. This implies that in Tubur, Kapala and Kyanvuma, Girls significantly exceed boys. It is normal for women to be more than men in a home due to the fact that polygamy is legal and moderately practiced particularly in the rural and semirural areas. Islam allows each man to marry up to four wives if he has the resources to look after them well. However, the excess of women over men in specific RGCs does **not** appear to be related to the predominant religion. Islam is the predominant religion in Kasasira, Kyanvuma and Nondwe. In Kasasira, men actually exceed women in homes while in Kyanvuma and Nondwe, the proportions by which women exceed men are not that significantly different from the proportions by which women exceed men in the other RGCs where this is the case.

In general in Uganda, the unique situation is where men exceed women in a home. In many communities men are supposed to leave their parents homes and set up their own homes soon as they are adults – from 20 years onwards. On the other hand girls may not leave the home of their parents until they are married as it is traditionally frowned upon for a woman to set up home on her own without a husband. For that reason, it is normal for women to exceed men in homes but not the other way round. Not surprisingly there are just two RGCs - Kasasira and Lambala – where men exceed women. The reason for this is not clear yet.

TABLE 3.1-6A.HH COMPOSITION – RGC WISE

HH Member	Kidetok		Acuna		Tubur		Kapala		Kameke		Kasasira	
	Count	%	Count	%	Count	%	count	%	Count	%	count	%
Men	33	19.9	23	18.7	83	19.4	48	18.3	18	17.1	103	18.7
Women	35	21.1	23	18.7	85	19.9	51	19.5	18	17.1	90	16.3
Boys	44	26.5	34	27.6	133	31.1	93	35.5	27	25.7	181	32.8
Girls	54	32.5	43	35.0	126	29.5	70	26.7	42	40.0	177	32.1
<b>Total</b>	<b>166</b>	<b>100</b>	<b>123</b>	<b>100</b>	<b>427</b>	<b>100</b>	<b>262</b>	<b>100</b>	<b>105</b>	<b>100</b>	<b>551</b>	<b>100</b>

TABLE 3.1-6B.HH COMPOSITION – RGC WISE

HH Member	Buseta		Naigobya		Kyanvuma		Lambala		Nondwe		Nambale	
	Count	%	Count	%	Count	%	count	%	Count	%	count	%
Men	36	19.5	23	14.0	48	16.2	30	22.6	80	15.3	34	14.4
Women	40	21.6	33	20.1	54	18.2	27	20.3	86	16.4	47	19.9
Boys	50	27.0	50	30.5	105	35.5	45	33.8	168	32.1	67	28.4
Girls	59	31.9	58	35.4	89	30.1	31	23.3	190	36.3	88	37.3
<b>Total</b>	<b>185</b>	<b>100</b>	<b>164</b>	<b>100</b>	<b>296</b>	<b>100</b>	<b>133</b>	<b>100</b>	<b>524</b>	<b>100</b>	<b>236</b>	<b>100</b>

The HH size ranged from a minimum of 1 person to a maximum of 30 people. The average household size was 7.8 people and the most frequent family size was 6 people. Figure 3.1-7 below shows the distribution of the HH size among the HH in the survey. Most of the HH have between 3 and 10 members. There is only one HH which is larger than 21 and it has 30 members. In general, the larger the household, the greater the total amount of water that the HH uses though the increase in the total amount of water used will not be necessarily proportional to the increase in the number of members.

Figure 3.1-7 Household size

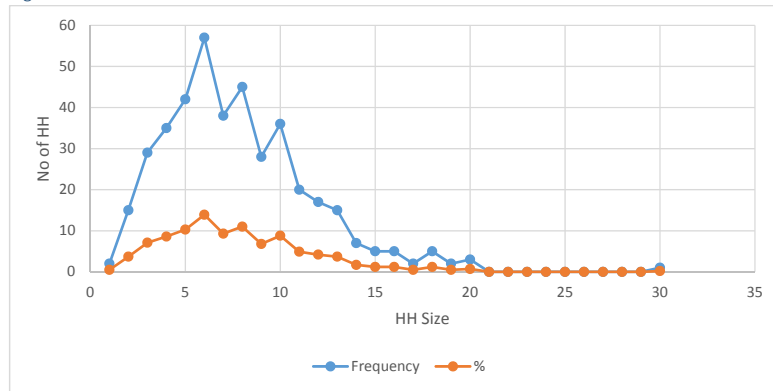

The number of men in each HH ranged from 0 for households without a man at all to 10 with the majority -71.6% of HHs having only one man. The average number of men in HH is 1.3 and the mode is 1 as well. On the side of women, the range is 0 to 7 with most HHs - 73.6% having only one woman. The average number of women in a HH is 1.4 and the mode is 1. For boys, the lowest is 0 while the highest is 18. The mean number of boys in a home is 2.4 while the mode is still 1. The lowest number of girls in a home is 0 while the largest is 6. The average is 2.5 and the mode is 2 girls. Figure 3.1-8 below is a graphic comparing the number of men, women, boys and girls in the HH is the survey area.

Figure 3.1-8. Composition of HHs

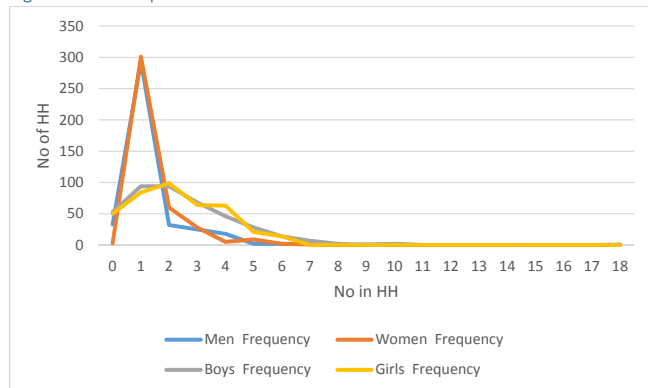

From the chart it appears that in general the number of men and women at the HH balances with neither of the gender greatly exceeding the other in number. In the same way the number of boys and girls is almost balanced. But most homes have more children and youth than the adults.

### 3.1.1c Main role of each HH member

Table 3.1-7a below summarises the main role of each HH members in the HH survey. For men the predominant role is “providing basic needs” 68.7% followed by the role of “Providing security for the family”. For women it is “cooking” 68% followed by “looking after children or babies” 13.0%. The main role of boys in the HH according to the findings is “fetching water” 36.4% followed by “looking after the livestock of the household” 17.8%. Boys also present significantly at 15.6% in the role of “cleaning home and compound”. The main role of girls in a HH according to the data is “fetching water” 34.2% followed by “Preparing of cooking food” 15.9%. All members in the HH have some responsibility for fetching water but the biggest responsibility based on the data falls on the boys followed by the girls then the women and lastly the men. But it is also important to mention that girls and women are charged with most of the domestic chores like washing clothes, cleaning utensils and cooking among others. To effect these roles, girls and women will require significant amounts of water and this turns them into main agents of water and sanitation. It is therefore important that boys and girls get to make an input in the planning for O and M of water facilities. Moreover sensitisation activities and software for O and M of water facilities must ensure the participation of boys and girls. One challenge is that these boys and girls also go to school and this makes it difficult for them to participate in software sensitisation activities that take place in the course of the week.

Owing to the fact that women are expected to be cooking and taking care of children, the expectation of wage employment is limited and even pursuits in that direction may be stifled. Moreover due to this role expectation, the aspirations of girls may be limited which also means that many girls may not even exert themselves to the maximum in school since they know that they are supposed to end up in the kitchen and looking after children. This critical roles in the home do not attract any financial pay and in fact most community members put 0 financial value on them. Women therefore cannot benefit financially from this labour and they are therefore not able to accumulate any financial capital or even to acquire property and other resources from the proceeds of their work. There are increasing calls for women’s domestic work to be recognised and financial value attached to it. This goal may be long coming in the semi-rural communities of Uganda but it is important to begin now to create awareness about the value of the work that women do at home in terms of cooking, looking after children and fetching water.

The significant role of boys and girls also amplifies the impact that the quality of water sources will have on school attendance, school performance and in some cases the potential for early pregnancies. Where boys and girls are very busy in school or are few, there are implications for sanitation and hygiene and diseases as well as for the sale of water.

TABLE 3.1-7A MAIN ROLE OF EACH PERSON IN THE HH

Roles	All RGCs			
	Men %	Women %	Boys %	Girls %
Cleaning home and compound	0.0	0.0	15.6	0.0
Digging, gardening, cultivation	0.0	0.0	1.2	0.0
Grazing animals	0.0	0.0	0.0	0.0
Home and compound cleaning	0.0	0.0	0.0	8.3
Looking after children or babies	0.0	13.0	0.0	1.7
Looking after the livestock of the household	1.5	0.0	17.8	0.0
Meeting the financial needs of the family	1.7	0.0	0.0	0.0
Physical care of family members and general household	7.8	6.6	0.0	0.0
Preparing food or cooking	0.0	68.0	0.0	15.9
Providing basic needs for the family	68.7	8.8	0.0	0.0

Roles	All RGCs			
	Men %	Women %	Boys %	Girls %
Providing leadership in the home	0.2	0.0	0.0	0.0
Providing security for the family	9.0	0.0	0.0	0.0
Collecting firewood	0.0	0.0	0.7	3.7
Fetching water	0.0	1.5	36.4	34.2
Washing clothes	0.0	1.2	0.7	3.2
Washing utensils	0.0	0.0	4.9	15.6
None	7.6	0.7	21.5	16.9
Others	3.4	0.2	1.0	0.5
<b>Total</b>	<b>100.0</b>	<b>100.0</b>	<b>100.0</b>	<b>100.0</b>

In line with the specifications of the study, the tables for the role of each HH member for each of the RGCs are also reproduced below. There is no significant difference the roles of the different members of the HH in the individual RGCs.

TABLE 3.1-7B MAIN ROLE OF EACH PERSON IN THE HH - RGC WISE

Roles	Kidetok				Acuna				Tubur			
	Men %	Women %	Boys %	Girls %	Men %	Women %	Boys %	Girls %	Men %	Women %	Boys %	Girls %
Cleaning home and compound	0.0	0.0	14.3	0.0	0.0	0.0	40.0	0.0	0.0	0.0	27.3	0.0
Digging, gardening, cultivation	0.0	0.0	0.0	0.0	0.0	0.0	6.7	0.0	0.0	0.0	0.0	0.0
Grazing animals	0.0	0.0	0.0	0.0	0.0	0.0	0.0	0.0	0.0	0.0	0.0	0.0
Home and compound cleaning	0.0	0.0	0.0	12.2	0.0	0.0	0.0	6.7	0.0	0.0	0.0	13.6
Looking after children or babies	0.0	14.3	0.0	0.0	0.0	20.0	0.0	0.0	0.0	22.7	0.0	0.0
Looking after the livestock of the household	2.0	0.0	26.5	0.0	0.0	0.0	20.0	0.0	0.0	0.0	9.1	0.0
Meeting the financial needs of the family	2.0	0.0	0.0	0.0	0.0	0.0	0.0	0.0	0.0	0.0	0.0	0.0
Physical care of family members and general household	8.2	4.1	0.0	0.0	0.0	0.0	0.0	0.0	0.0	0.0	0.0	0.0
Preparing food or cooking	0.0	67.3	0.0	12.2	0.0	60.0	0.0	13.3	0.0	72.7	0.0	9.1
Providing basic needs for the family	69.4	12.2	0.0	0.0	80.0	20.0	0.0	0.0	86.4	4.5	0.0	0.0
Providing leadership in the home	0.0	0.0	0.0	0.0	0.0	0.0	0.0	0.0	0.0	0.0	0.0	0.0
Providing security for the family	14.3	0.0	0.0	0.0	6.7	0.0	0.0	0.0	13.6	0.0	0.0	0.0
Collecting firewood	0.0	0.0	2.0	2.0	0.0	0.0	0.0	6.7	0.0	0.0	0.0	4.5
Fetching water	0.0	0.0	34.7	30.6	0.0	0.0	20.0	40.0	0.0	0.0	31.8	31.8
Washing clothes	0.0	0.0	0.0	6.1	0.0	0.0	0.0	0.0	0.0	0.0	0.0	0.0
Washing utensils	0.0	0.0	2.0	20.4	0.0	0.0	0.0	33.3	0.0	0.0	4.5	22.7
None	4.1	0.0	20.4	16.3	13.3	0.0	13.3	0.0	0.0	0.0	27.3	18.2
Others	0.0	2.0	0.0	0.0	0.0	0.0	0.0	0.0	0.0	0.0	0.0	0.0
<b>Total</b>	<b>100</b>	<b>100</b>	<b>100</b>	<b>100</b>	<b>100</b>	<b>100</b>	<b>100</b>	<b>100</b>	<b>100</b>	<b>100</b>	<b>100</b>	<b>100</b>

TABLE 3.1-7B MAIN ROLE OF EACH PERSON IN THE HH - RGC WISE

Roles	Kapala				Kameke				Kasasira			
	Men %	Women %	Boys %	Girls %	Men %	Women %	Boys %	Girls %	Men %	Women %	Boys %	Girls %
Cleaning home and compound	0.0	0.0	10.3	0.0	0.0	0.0	12.5	0.0	0.0	0.0	10.6	0.0
Digging, gardening, cultivation	0.0	0.0	0.0	0.0	0.0	0.0	6.3	0.0	0.0	0.0	1.5	0.0
Grazing animals	0.0	0.0	0.0	0.0	0.0	0.0	0.0	0.0	0.0	0.0	0.0	0.0
Home and compound cleaning	0.0	0.0	0.0	3.4	0.0	0.0	0.0	12.5	0.0	0.0	0.0	15.2
Looking after children or babies	0.0	27.6	0.0	0.0	0.0	31.3	0.0	6.3	0.0	9.1	0.0	4.5
Looking after the livestock of the household	3.4	0.0	37.9	0.0	6.3	0.0	6.3	0.0	0.0	0.0	22.7	0.0
Meeting the financial needs of the family	0.0	0.0	0.0	0.0	0.0	0.0	0.0	0.0	0.0	0.0	0.0	0.0
Physical care of family members and general household	10.3	13.8	0.0	0.0	6.3	12.5	0.0	0.0	12.1	7.6	0.0	0.0
Preparing food or cooking	0.0	55.2	0.0	10.3	0.0	50.0	0.0	18.8	0.0	66.7	0.0	22.7
Providing basic needs for the family	82.8	0.0	0.0	0.0	75.0	6.3	0.0	0.0	68.2	7.6	0.0	0.0
Providing leadership in the home	0.0	0.0	0.0	0.0	0.0	0.0	0.0	0.0	1.5	0.0	0.0	0.0
Providing security for the family	3.4	0.0	0.0	0.0	0.0	0.0	0.0	0.0	4.5	0.0	0.0	0.0
Collecting firewood	0.0	0.0	0.0	0.0	0.0	0.0	0.0	0.0	0.0	0.0	0.0	4.5
Fetching water	0.0	0.0	41.4	24.1	0.0	0.0	18.8	50.0	0.0	4.5	34.8	18.2
Washing clothes	0.0	0.0	0.0	13.8	0.0	0.0	6.3	0.0	0.0	4.5	1.5	3.0
Washing utensils	0.0	0.0	0.0	31.0	0.0	0.0	6.3	0.0	0.0	7.6	15.2	13.6
None	0.0	3.4	10.3	17.2	0.0	0.0	37.5	12.5	7.6	0.0	21.2	13.6
Others	0.0	0.0	0.0	0.0	12.5	0.0	6.3	0.0	6.1	0.0	0.0	3.0
<b>Total</b>	<b>100</b>	<b>100</b>	<b>100</b>	<b>100</b>	<b>100</b>	<b>100</b>	<b>100</b>	<b>100</b>	<b>100</b>	<b>100</b>	<b>100</b>	<b>100</b>

TABLE 3.1-7B MAIN ROLE OF EACH PERSON IN THE HH - RGC WISE

Roles	Buseta				Naigobya				Kyanvuma			
	Men %	Women %	Boys %	Girls %	Men %	Women %	Boys %	Girls %	Men %	Women %	Boys %	Girls %
Cleaning home and compound	0.0	0.0	0.0	0.0	0.0	0.0	4.5	0.0	0.0	0.0	15.9	0.0
Digging, gardening, cultivation	0.0	0.0	0.0	0.0	0.0	0.0	0.0	0.0	0.0	0.0	0.0	0.0
Grazing animals	0.0	0.0	0.0	0.0	0.0	0.0	0.0	0.0	0.0	0.0	0.0	0.0
Home and compound cleaning	0.0	0.0	0.0	0.0	0.0	0.0	0.0	13.6	0.0	0.0	0.0	2.3
Looking after children or babies	0.0	16.7	0.0	0.0	0.0	9.1	0.0	0.0	0.0	13.6	0.0	4.5
Looking after the livestock of the household	12.5	0.0	16.7	0.0	0.0	0.0	13.6	0.0	0.0	0.0	18.2	0.0

Meeting the financial needs of the family	8.3	0.0	0.0	0.0	0.0	0.0	0.0	0.0	0.0	2.3	0.0	0.0	0.0
Physical care of family members and general household	4.2	20.8	0.0	0.0	4.5	4.5	0.0	0.0	6.8	9.1	0.0	0.0	0.0
Preparing food or cooking	0.0	62.5	0.0	20.8	0.0	63.6	0.0	13.6	0.0	65.9	0.0	20.5	0.0
Providing basic needs for the family	70.8	0.0	0.0	0.0	63.6	18.2	0.0	0.0	61.4	9.1	0.0	0.0	0.0
Providing leadership in the home	0.0	0.0	0.0	0.0	0.0	0.0	0.0	0.0	0.0	0.0	0.0	0.0	0.0
Providing security for the family	0.0	0.0	0.0	0.0	9.1	0.0	0.0	0.0	15.9	0.0	0.0	0.0	0.0
Collecting firewood	0.0	0.0	0.0	0.0	0.0	0.0	0.0	9.1	0.0	0.0	0.0	0.0	0.0
Fetching water	0.0	0.0	33.3	45.8	0.0	4.5	40.9	31.8	0.0	0.0	38.6	34.1	0.0
Washing clothes	0.0	0.0	0.0	0.0	0.0	0.0	0.0	0.0	0.0	2.3	0.0	0.0	0.0
Washing utensils	0.0	0.0	4.2	16.7	0.0	0.0	13.6	13.6	0.0	0.0	6.8	9.1	0.0
None	4.2	0.0	41.7	16.7	13.6	0.0	27.3	18.2	6.8	0.0	20.5	29.5	0.0
Others	0.0	0.0	4.2	0.0	9.1	0.0	0.0	0.0	6.8	0.0	0.0	0.0	0.0
Total	100	100	100	100	100	100	100	100	100	100	100	100	100

TABLE 3.1-7B MAIN ROLE OF EACH PERSON IN THE HH - RGC WISE

Roles	Lambala				Nondwe				Nambale				
	Men %	Women %	Boys %	Girls %	Men %	Women %	Boys %	Girls %	Men %	Women %	Boys %	Girls %	
Cleaning home and compound	0.0	0.0	13.6	0.0	0.0	0.0	20.0	0.0	0.0	0.0	26.7	0.0	0.0
Digging, gardening, cultivation	0.0	0.0	0.0	0.0	0.0	0.0	1.4	0.0	0.0	0.0	3.3	0.0	0.0
Grazing animals	0.0	0.0	0.0	0.0	0.0	0.0	0.0	0.0	0.0	0.0	0.0	0.0	0.0
Home and compound cleaning	0.0	0.0	0.0	0.0	0.0	0.0	0.0	4.3	0.0	0.0	0.0	13.3	0.0
Looking after children or babies	0.0	9.1	0.0	4.5	0.0	7.1	0.0	0.0	0.0	0.0	0.0	0.0	0.0
Looking after the livestock of the household	0.0	0.0	13.6	0.0	0.0	0.0	8.6	0.0	0.0	0.0	0.0	0.0	0.0
Meeting the financial needs of the family	0.0	0.0	0.0	0.0	4.3	0.0	0.0	0.0	0.0	0.0	0.0	0.0	0.0
Physical care of family members and general household	18.2	9.1	0.0	0.0	7.1	2.9	0.0	0.0	0.0	0.0	0.0	0.0	0.0
Preparing food or cooking	0.0	63.6	0.0	13.6	0.0	80.0	0.0	17.1	0.0	80.0	0.0	6.7	0.0
Providing basic needs for the family	50.0	4.5	0.0	0.0	67.1	7.1	0.0	0.0	63.3	20.0	0.0	0.0	0.0
Providing leadership in the home	0.0	0.0	0.0	0.0	0.0	0.0	0.0	0.0	0.0	0.0	0.0	0.0	0.0
Providing security for the family	22.7	0.0	0.0	0.0	8.6	0.0	0.0	0.0	6.7	0.0	0.0	0.0	0.0
Collecting firewood	0.0	0.0	0.0	9.1	0.0	0.0	1.4	5.7	0.0	0.0	3.3	3.3	0.0
Fetching water	0.0	0.0	31.8	27.3	0.0	2.9	41.4	47.1	0.0	0.0	46.7	43.3	0.0
Washing clothes	0.0	4.5	0.0	0.0	0.0	0.0	1.4	4.3	0.0	0.0	0.0	3.3	0.0
Washing utensils	0.0	0.0	0.0	9.1	0.0	0.0	7.1	10.0	0.0	0.0	0.0	16.7	0.0
None	4.5	9.1	36.4	36.4	11.4	0.0	18.6	11.4	20.0	0.0	3.3	13.3	0.0
Others	4.5	0.0	4.5	0.0	1.4	0.0	0.0	0.0	3.3	0.0	3.3	0.0	0.0
Total	100	100	100	100	100	100	100	100	100	100	100	100	100

The study investigated whether female members of the HH also work to get money for the HH. Findings indicate that women in 64.3% of the HH do actually work to get money. Table 3.1-8A below, summarises the main kinds of work they do and the relative proportions of women engaged in those types of work. Because they are engaged in domestic chores as seen in 3.1.1c, there is only a minimum percentage of women (13.7) who work for wages or salaries. The situation is exacerbated by the low literacy levels of women compared to men as seen in 3.1.1d. The other types of work that are less frequently named are summarised in table 3.1-6B below. From this data, most of the female HH members that work do trading – 48.3% with farming a close second at 32.3%.

TABLE 3.1-8 A AND B. KIND OF WORK THEY DO TO GET MONEY. (N=263)

Kind of work they do	(%)
Business or trading	37.3
Farming - selling farm produce	44.9
Selling manual labour	2.7
Professional services - teacher etc	12.2
Skilled work - tailor, hair dressing, mechanic etc	3.0
Total	100

TABLE 3.1-8 B. FEMALE WORKING TO GET MONEY AND KIND OF WORK THEY DO TO GET MONEY.

	All RGCs (N=409)	Nambale (N=30)	Lambala (N=22)	Naigobya (N=22)	Kyanvuma (N=44)	Nondwe (N=70)	Kasassira (N=66)	Kameke (N=16)	Kapala (N=29)	Buseta (N=24)	Kidetok (N=49)	Tubur (N=22)	Acuna (N=15)
Female working to get money (%)	64.3	70.0	59.1	72.7	59.1	64.3	48.5	68.8	69.0	50.0	77.6	77.3	80.0
Business or trading	37.3	19.0	38.5	50.0	46.2	28.9	46.9	9.1	35.0	66.7	47.4	23.5	25.0
Farming - selling farm produce	44.9	61.9	38.5	43.8	34.6	48.9	34.4	63.6	55.0	25.0	36.8	41.2	75.0
Selling manual labour	2.7	0.0	7.7	0.0	7.7	4.4	0.0	9.1	0.0	0.0	0.0	5.9	0.0
Professional services - teacher etc	12.2	14.3	15.4	6.3	7.7	13.3	12.5	18.2	10.0	8.3	15.8	17.6	0.0
Skilled work - tailor, hair dressing, mechanic etc	3.0	4.8	0.0	0.0	3.8	4.4	6.3	0.0	0.0	0.0	0.0	11.8	0.0

### 3.1.1d Literacy of HH members

Table 3.1-9a below summarises the literacy of HH members. It shows that in vernacular, 45.2% of males are literate compared to 37.4% for women. The difference is significant and may be an indication of the fact that boys have better opportunities for school attendance compared to the girls. In English, the men still fare better with 45.8% of men literate in English compared to 38.6% of women. In general, both men and women are more literate in English than in vernacular. Perhaps this is due to the fact that written material in vernacular is less common compared to English. Many newspapers are now in English and so are information posters and information leaflets. In general, in Uganda, when budgets are limited, English

precedes in the production of brochures and leaflets. Most instructions on products such as soap and sanitary materials are also in English.

While the differences are still significant, there has been an improving trend with nationwide literacy rates for male and female 15 to 24 years rising from 80.3 and 69.4 respectively in 1997<sup>1</sup> to 89.6 and 85.5 respectively in 2015<sup>2</sup> according to the Uganda Bureau of Statistics. Literacy is key in employability as well as in providing opportunities for all types of income generating activities and being less literate limits the chances of women. Exposure through reading various types of materials enables the absorption and adoption of new practices in health, sanitation and hygiene and the fact that women are slightly less literate may undermine the welfare of households in that respect as women have a great impact on hygiene and sanitation practices in the HH. It also constrains their employment potential and relegates them to domestic chores. It's even worse for the girl child, as many of them end up being married off at an early age.

The literacy advantage that men have over women gives them an edge in employment and income generation. The literacy gap of the future can be closed with programmes which encourage parents to keep girls in school. But the literacy gap of today may be closed with programmes that target adults in adult literacy programmes. Either approach requires some amount of sensitisation to the communities concerned targeting particularly the men who need to let their wives and daughters to get into the literacy programmes.

TABLE 3.1-9A LITERACY OF HH MEMBERS

	All RGCs			
	Vernacular	%	English	%
<b>Male</b>	703	45.2	713	45.8
<b>Female</b>	604	37.4	627	38.76
<b>Total</b>	<b>1307</b>	<b>41.2</b>	<b>1337</b>	<b>42.2</b>

Tables 3.1-9b and c give details on literacy rates in each HH in vernacular - 13a) and English - 13b).

TABLE 3.1-9B AND C. LITERACY OF HH MEMBERS

**b) Literacy of HH members in vernacular**

Literacy Rate in each HH (Vernacular) (%)	Total	Male		Female	
		Count	%	Count	%
<b>Less than 10</b>	15.2	13	1.8	3	0.5
<b>Between 11 to 20</b>	11.2	40	5.7	17	2.8
<b>Between 21 to 30</b>	13.2	56	8.0	55	9.1
<b>Between 31 to 40</b>	16.9	102	14.5	93	15.4
<b>Between 41 to 50</b>	12.2	90	12.8	86	14.2
<b>Between 51 to 60</b>	7.6	84	11.9	85	14.0
<b>Between 61 to 70</b>	9.0	115	16.3	82	13.6
<b>Between 71 to 80</b>	5.9	73	10.4	60	9.9
<b>Between 81 to 90</b>	3.2	45	6.4	50	8.3

<sup>1</sup> Uganda national HH Survey 1997.

<sup>2</sup> Population census 2014

<b>Between 91 to 100</b>	5.6	86	12.2	70	11.6
<b>Total</b>	<b>100</b>	<b>704</b>	<b>100</b>	<b>605</b>	<b>100</b>

Data in 3.1-9a shows that in most households, between 21% and 50% of the members are literate in vernacular. The single category with the highest percentage of vernacular literate people is 31-40%. This pattern is equally representative of the situation of men and women in the HHs. In the same way, data in 3.1-7b shows that in most households, the highest proportion of members literate in English is between 11% and 50% with a low at 21 to 30%. The single category with the highest percentage of English literate people is 41% to 50%.

TABLE 3.1-9C LITERACY OF HH MEMBERS IN ENGLISH

Literacy Rate in each HH (English) (%)	Total	Male		Female	
		Count	%	Count	%
<b>Less than 10</b>	14.4	7	1.0	1	0.2
<b>Between 11 to 20</b>	15.2	50	7.0	29	4.6
<b>Between 21 to 30</b>	9.5	43	6.0	39	6.2
<b>Between 31 to 40</b>	15.2	99	13.9	83	13.2
<b>Between 41 to 50</b>	15.6	113	15.8	120	19.1
<b>Between 51 to 60</b>	6.4	66	9.3	70	11.2
<b>Between 61 to 70</b>	8.3	96	13.5	70	11.2
<b>Between 71 to 80</b>	5.1	76	10.7	70	11.2
<b>Between 81 to 90</b>	4.9	80	11.2	78	12.4
<b>Between 91 to 100</b>	5.4	83	11.6	67	10.7
<b>Total</b>	<b>100</b>	<b>713</b>	<b>100</b>	<b>627</b>	<b>100</b>

To compare the literacy rates in the different RGCs we worked out the average number of literate people per household by taking the total number of literate people in the RGC and dividing by the number of HHs in the RGC. The outcome is presented in 3.1-10a and b below. From the table, it is evident that when literacy in English is considered, Kidetok has the best average rate per HH followed by Kapala. The RGC that seems to be in the worst situation is Nondwe where the average English literacy per HH stands at 2.5 persons. In all but three RGCs the number of literate men in English exceeds that of women. The three RGCs that are the exception are Kapala, Buseta and Naigobya. In these three, the number of women who are literate in English exceeds that of men. The double comparison is further illustrated in the two subsequent charts.

TABLE 3.1-10A. A COMPARISON OF THE LITERACY (IN ENGLISH) OF MEN AND WOMEN IN THE DIFFERENT RGCs

RGC	ACQUA	TUBUR	KIDETOK	KAPALA	KAMERE	KASASIRA	BUSETA	NAIGOBYA	KYANVUNA	LAMBALA	NONDWE	NAMBALE	TOTAL
<b>MALE</b>	29	46	137	68	27	108	32	27	63	38	94	44	713
<b>FEMALE</b>	15	39	123	69	25	79	44	30	54	23	80	43	624
<b>TOTAL</b>	44	85	260	137	52	187	76	57	117	61	174	87	1,337
<b>NO OF HH</b>	15	22	49	29	16	66	24	22	44	22	70	30	409
<b>AVERAGE RATE PER HH</b>	2.9	3.9	5.3	4.7	3.3	2.8	3.2	2.6	2.7	2.8	2.5	2.9	

Figure 3.1-9a Literacy in English across the RGCs

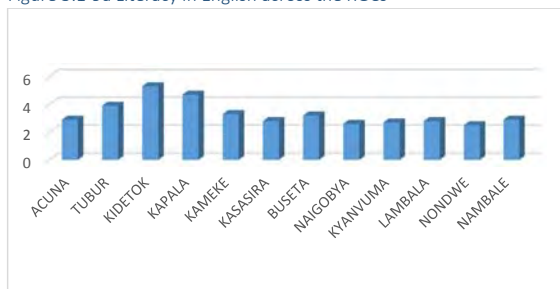
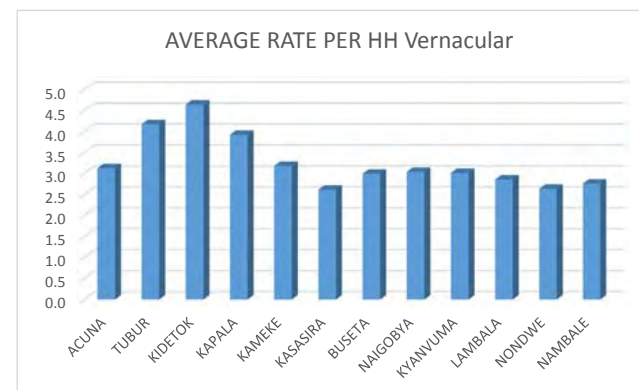

TABLE 3.1-10b. A COMPARISON OF THE LITERACY (IN VERNACULAR) OF MEN AND WOMEN IN THE DIFFERENT RGCs

RGC	ACUNA	TUBUR	KIDETOK	KAPALA	KAMEKE	KASASIRA	BUSETA	NAIGOBVA	KYANVUM A	LAMBALA	NONDWE	NAMBALE
MALE	27	48	121	63	28	98	30	34	71	37	105	42
FEMALE	20	44	107	51	23	75	42	33	62	26	80	41
TOTAL	47	92	228	114	51	173	72	67	133	63	185	83
NO OF HH	15	22	49	29	16	66	24	22	44	22	70	30
AVERAGE	3.1	4.2	4.7	3.9	3.2	2.6	3.0	3.0	3.0	2.9	2.6	2.8

Figure 3.1-9b Literacy in vernacular across all the RGCs

Data shows that when it comes to vernacular, literacy is highest in Kidetok, followed by Nondwe. Thus



Kidetok tops the literacy rates in both English and vernacular. However, while Nondwe is at the bottom when it comes to literacy in English, it is next to the best when it comes to vernacular. This strange turn of events for Nondwe is difficult to explain but could be the result of a high dropout rate at early primary since early primary has traditionally been taught in the local language and English is taken up from primary 2 onwards.

### 3.1.2 Water and Health

#### 3.1.2 Current Condition of Water Sources

##### 3.1.2a Water sources in dry season

Table 3.1-11a below summarises the main sources of water in the dry season and indicates that 92.9% of respondents indicated that their main source is borehole. This is followed by unprotected spring 13.4% and the shallow or dug well 11.0% and protected spring 10.8%. The sources least used are rain harvest and the dam and valley tank. As the rain water tanks and some of the shallow wells dry up in the dry season, the choice of water sources reduces leading people to resort to less safe sources such as unprotected spring and dug well. A lot of pressure will be exerted on these stable sources with the result that in the case of boreholes, chances of a break down are higher during this season.

TABLE 3.1-11A MAIN SOURCES OF WATER IN THE DRY SEASON - RGC WIDE

Yes	BH			Shallow well/Dug well			Protected Spring			Unprotected Spring		
%	92.91			11.00			11.00			13.45		
Yes	Min	Max	Average	Min	Max	Average	Min	Max	Average	Min	Max	Average
No of trips /day	1	24	4.78	1	18	5.16	1	15	3.76	1	12	3.73
Distance for round trip(m)	5	3,000	282.51	0	1,200	286.78	60	3,000	720.44	20	1,500	503.45
Time for round trip(min)	3	480	112.70	1	240	41.07	2	240	72.93	10	420	76.18

Yes %	Rain harvest			Dam/Valley tank			River/Stream		
	0.2			0.2			1.5		
Yes	Min	Max	Average	Min	Max	Average	Min	Max	Average
No of trips /day	0	0	0	1	1	1.00	1	20	7
Distance for round trip(m)	0	0	0	200	200	200	50	2,000	892
Time for round trip(min)	0	0	0	5	5	5.00	20	240	123

The tables for “Main source of water in the dry season” for each of the RGCs are also presented below. The pattern that emerges does not differ much from the RGC wide table above. The main source of water for all RGCs in the dry season is still the borehole though sources like protected spring have varying prominence in different RGCs in the dry season.

TABLE 3.1-11B MAIN SOURCES OF WATER IN THE DRY SEASON - RGC WISE

**Acuna**

Yes %	BH			Shallow well/Dug well			Protected Spring			Unprotected Spring		
	100.00			0.00			0.00			13.33		
Yes	Min	Max	Average	Min	Max	Average	Min	Max	Average	Min	Max	Average
No of trips /day	2	12	5.60	0	0	0	0	0	0	2	2	2.00
Distance for round trip(m)	60	400	179.33	0	0	0	0	0	0	300	1,000	650.00
Time for round trip(min)	10	130	78.00	0	0	0	0	0	0	30	120	75.00

Yes %	Rain harvest			Dam/Valley tank			River/Stream		
	0.00			0.00			0.00		
Yes	Min	Max	Average	Min	Max	Average	Min	Max	Average
No of trips /day	0	0	0	0	0	0	0	0	0
Distance for round trip(m)	0	0	0	0	0	0	0	0	0
Time for round trip(min)	0	0	0	0	0	0	0	0	0

**Tubur**

Yes %	BH			Shallow well/Dug well			Protected Spring			Unprotected Spring		
	100.00			0.00			0.00			4.55		
Yes	Min	Max	Average	Min	Max	Average	Min	Max	Average	Min	Max	Average
No of trips /day	1	10	4.77	0	0	0	0	0	0	3	3	3.00
Distance for round trip(m)	50	500	270.45	0	0	0	0	0	0	1,000	1,000	1000.00
Time for round trip(min)	30	300	110.45	0	0	0	0	0	0	180	180	180.00

Yes %	Rain harvest			Dam/Valley tank			River/Stream		
	0.00			0.00			0.00		
Yes	Min	Max	Average	Min	Max	Average	Min	Max	Average
No of trips /day	0	0	0	0	0	0	0	0	0
Distance for round trip(m)	0	0	0	0	0	0	0	0	0

Time for round trip(min)	0	0	0	0	0	0	0	0	0
--------------------------	---	---	---	---	---	---	---	---	---

**Kidetok**

Yes %	BH			Shallow well/Dug well			Protected Spring			Unprotected Spring		
	93.88			4.08			18.37			0.00		
Yes	Min	Max	Average	Min	Max	Average	Min	Max	Average	Min	Max	Average
No of trips /day	1	20	5.41	10	18	14.00	1	15	5.33	0	0	0
Distance for round trip(m)	50	1,000	264.13	100	100	100.00	400	3,000	1344.44	0	0	0
Time for round trip(min)	10	240	76.52	30	120	75.00	20	120	70.56	0	0	0

Yes %	Rain harvest			Dam/Valley tank			River/Stream		
	0.00			0.00			0.00		
Yes	Min	Max	Average	Min	Max	Average	Min	Max	Average
No of trips /day	0	0	0	0	0	0	0	0	0
Distance for round trip(m)	0	0	0	0	0	0	0	0	0
Time for round trip(min)	0	0	0	0	0	0	0	0	0

**Kapala**

Yes %	BH			Shallow well/Dug well			Protected Spring			Unprotected Spring		
	96.55			34.48			0.00			0.00		
Yes	Min	Max	Average	Min	Max	Average	Min	Max	Average	Min	Max	Average
No of trips /day	1	16	5.61	2	8	5.00	0	0	0	0	0	0
Distance for round trip(m)	20	500	292.50	5	700	149.50	0	0	0	0	0	0
Time for round trip(min)	15	300	120.89	2	60	28.70	0	0	0	0	0	0

Yes %	Rain harvest			Dam/Valley tank			River/Stream		
	0.00			0.00			0.00		
Yes	Min	Max	Average	Min	Max	Average	Min	Max	Average
No of trips /day	0	0	0	0	0	0	0	0	0
Distance for round trip(m)	0	0	0	0	0	0	0	0	0
Time for round trip(min)	0	0	0	0	0	0	0	0	0

**Kameke**

Yes %	BH			Shallow well/Dug well			Protected Spring			Unprotected Spring		
	100.00			0.00			6.25			6.25		
Yes	Min	Max	Average	Min	Max	Average	Min	Max	Average	Min	Max	Average
No of trips /day	1	12	4.25	0	0	0	8	8	8.00	1	1	1.00
Distance for round trip(m)	100	3,000	420.63	0	0	0	500	500	500.00	500	500	500.00



Time for round trip(min)	30	300	159.38	0	0	0	30	30	30.00	60	60	60.00
--------------------------	----	-----	--------	---	---	---	----	----	-------	----	----	-------

Yes %	Rain harvest			Dam/Valley tank			River/Stream		
	0.00			0.00			0.00		
Yes	Min	Max	Average	Min	Max	Average	Min	Max	Average
No of trips /day	0	0	0	0	0	0	0	0	0
Distance for round trip(m)	0	0	0	0	0	0	0	0	0
Time for round trip(min)	0	0	0	0	0	0	0	0	0

#### Kasasira

Yes	BH			Shallow well/Dug well			Protected Spring			Unprotected Spring		
%	100.00			12.12			0.00			22.73		
Yes	Min	Max	Average	Min	Max	Average	Min	Max	Average	Min	Max	Average
No of trips /day	1	12	4.44	2	6	4.00	0	0	0	1	6	3.20
Distance for round trip(m)	50	900	224.39	300	1,000	442.50	0	0	0	20	1,500	768.00
Time for round trip(min)	3	360	142.70	30	240	69.38	0	0	0	30	420	116.00

Yes %	Rain harvest			Dam/Valley tank			River/Stream		
	0.00			0.00			6.06		
Yes	Min	Max	Average	Min	Max	Average	Min	Max	Average
No of trips /day	0	0	0	0	0	0	1	20	9
Distance for round trip(m)	0	0	0	0	0	0	800	2,000	1,200
Time for round trip(min)	0	0	0	0	0	0	120	240	175

#### Buseta

Yes	BH			Shallow well/Dug well			Protected Spring			Unprotected Spring		
%	100.00			0.00			0.00			0.00		
Yes	Min	Max	Average	Min	Max	Average	Min	Max	Average	Min	Max	Average
No of trips /day	1	12	5.38	0	0	0	0	0	0	0	0	0
Distance for round trip(m)	50	600	204.17	0	0	0	0	0	0	0	0	0
Time for round trip(min)	5	360	86.46	0	0	0	0	0	0	0	0	0

Yes %	Rain harvest			Dam/Valley tank			River/Stream		
	0.00			0.00			0.00		
Yes	Min	Max	Average	Min	Max	Average	Min	Max	Average
No of trips /day	0	0	0	0	0	0	0	0	0
Distance for round trip(m)	0	0	0	0	0	0	0	0	0
Time for round trip(min)	0	0	0	0	0	0	0	0	0

#### Naigobya

Yes	BH			Shallow well/Dug well			Protected Spring			Unprotected Spring		
%	100.00			0.00			0.00			22.73		
Yes	Min	Max	Average	Min	Max	Average	Min	Max	Average	Min	Max	Average
No of trips /day	1	15	4.68	0	0	0	0	0	0	1	9	4.00
Distance for round trip(m)	5	700	321.14	0	0	0	0	0	0	100	800	400.00
Time for round trip(min)	30	300	101.59	0	0	0	0	0	0	15	120	49.00

Yes %	Rain harvest			Dam/Valley tank			River/Stream		
	0.00			0.00			4.55		
Yes	Min	Max	Average	Min	Max	Average	Min	Max	Average
No of trips /day	0	0	0	0	0	0	3	3	3
Distance for round trip(m)	0	0	0	0	0	0	500	500	500
Time for round trip(min)	0	0	0	0	0	0	20	20	20

#### Kyanvuma

Yes	BH			Shallow well/Dug well			Protected Spring			Unprotected Spring		
%	95.45			6.82			20.45			2.27		
Yes	Min	Max	Average	Min	Max	Average	Min	Max	Average	Min	Max	Average
No of trips /day	1	24	4.50	4	10	6.33	1	7	3.89	1	1	1.00
Distance for round trip(m)	10	800	174.05	100	500	266.67	200	1000	866.67	600	600	600.00
Time for round trip(min)	30	480	117.38	20	80	43.33	30	240	93.33	180	180	180.00

Yes %	Rain harvest			Dam/Valley tank			River/Stream		
	0.00			0.00			0.00		
Yes	Min	Max	Average	Min	Max	Average	Min	Max	Average
No of trips /day	0	0	0	0	0	0	0	0	0
Distance for round trip(m)	0	0	0	0	0	0	0	0	0
Time for round trip(min)	0	0	0	0	0	0	0	0	0

#### Lambala

Yes	BH			Shallow well/Dug well			Protected Spring			Unprotected Spring		
%	68.18			31.82			0.00			22.73		
Yes	Min	Max	Average	Min	Max	Average	Min	Max	Average	Min	Max	Average
No of trips /day	1	8	3.20	1	12	3.86	0	0	0	3	8	4.40
Distance for round trip(m)	100	3000	660.67	0	200	67.14	0	0	0	80	400	154.00
Time for round trip(min)	20	180	74.67	1	60	25.00	0	0	0	10	60	38.00

Yes %	Rain harvest			Dam/Valley tank			River/Stream		
	0.00			4.55			0.00		
Yes	Min	Max	Average	Min	Max	Average	Min	Max	Average
No of trips /day	0	0	0	1	1	1.00	0	0	0
Distance for round trip(m)	0	0	0	200	200	200.00	0	0	0
Time for round trip(min)	0	0	0	5	5	5.00	0	0	0

#### Nondwe

Yes %	BH			Shallow well/Dug well			Protected Spring			Unprotected Spring		
	80.00			21.43			17.14			34.29		
Yes	Min	Max	Average	Min	Max	Average	Min	Max	Average	Min	Max	Average
No of trips /day	1	15	3.54	2	10	5.07	1	8	3.25	1	12	4.25
Distance for round trip(m)	5	1500	358.70	100	1200	426.67	200	1000	508.33	100	1000	395.83
Time for round trip(min)	15	360	126.70	6	120	36.73	30	180	100.00	10	180	58.96

Yes %	Rain harvest			Dam/Valley tank			River/Stream		
	0.00			0.00			0.00		
Yes	Min	Max	Average	Min	Max	Average	Min	Max	Average
No of trips /day	0	0	0	0	0	0	0	0	0
Distance for round trip(m)	0	0	0	0	0	0	0	0	0
Time for round trip(min)	0	0	0	0	0	0	0	0	0

#### Nambale

Yes %	BH			Shallow well/Dug well			Protected Spring			Unprotected Spring		
	93.33			0			46.67			3.33		
Yes	Min	Max	Average	Min	Max	Average	Min	Max	Average	Min	Max	Average
No of trips /day	1	18	6.86	0	0	0	1	6	2.79	4	4	4
Distance for round trip(m)	10	1500	270.00	0	0	0	60	1000	422.86	500	500	500
Time for round trip(min)	3	240	103.54	0	0	0	2	120	41.21	30	30	30

Yes %	Rain harvest			Dam/Valley tank			River/Stream		
	0.00			0.00			3.333		
Yes	Min	Max	Average	Min	Max	Average	Min	Max	Average
No of trips /day	0	0	0	0	0	0	2	2	2
Distance for round trip(m)	0	0	0	0	0	0	50	50	50
Time for round trip(min)	0	0	0	0	0	0	20	20	20

#### 3.1.2b Number of trips a day – dry season

Round trips refer to a journey from home to water source and then back home. Table 3.1-12 below compares the roundtrips to the different water sources.

TABLE 3.1-12 COMPARISON OF NUMBER OF ROUND TRIPS FOR DIFFERENT SOURCES

	Min	Max	Average
Borehole	1	24	4.77
Shallow/dug well	2	18	5.18
Protected spring	1	15	3.82
Unprotected spring	1	12	3.73
Rain water harvest	0	0	0
Dam/valley tank	1	1	1
River/Stream	1	20	7

It is clear from the table that the source where the highest number of round trips was reported is the borehole. This is also the source which is used by the highest number of people 92.9%. Both the distance to and the number of round trips to borehole are therefore quite important in water access in any location in the region.

#### 3.1.2c Distance to source – dry season

The most important determinants of the round trips are the water demand in the household and the distance to the source. When average distance for a round trip is compared across the different water sources, it is clear that the longest average distance is with the river/stream which stands at 892 metres or nearly a km. Next is 720 to protected spring, then 503 to unprotected spring and then 282 for borehole. Springs occur naturally and no one determines that they will be located near the community. Moreover springs tend to occur near the bottom of valleys whereas traditionally people have preferred to live at the top of the hills due to the infestation of swamps in the low lands with mosquitoes. This may explain the longer average distance. On the other hand, BHs are normally located with population locations in mind and this may explain the shorter average distance. Average distance to rain water harvest is the smallest at 0 metres. This is not surprising as most of the rain water harvest tanks are located next to the main house in the compound and the rainwater is trapped from the roof of the house.

The UN Development Programme (UNDP)'s defines access as the proportion of the population using any of the following 'improved' water sources: piped water; public tap; borehole with a pump; protected well; springs; or rainwater. The World Bank specifies further that: in urban areas a safe water source should be located not more than 200 m away; in rural areas access implies that householders should not spend a disproportionate part of the day fetching water. The latter definition can be quite vague as it does not specify what constitutes a 'disproportionate part of the day' (Aiga. H, 2003).

In MWE documents, the terms access and coverage are often used interchangeably to refer to the percentage of people with access to an improved water source. The golden indicator for urban areas is **"% of people within 200m of an improved water source"** (MoWE, 2014). (RGCs are classified as urban areas) By these standards, access to safe water is still a challenge in all the RGCs in the area surveyed as most of the water sources are more than 200metres from the household.

#### Sphere standards – Key indicators for water access.

- Average water use for drinking, cooking and personal hygiene in any household is at least 15 litres per person per day (see guidance notes 1–7).
- The maximum distance from any household to the nearest water point is 500 metres
- Queuing time at a water source is no more than 30 minutes

### 3.1.2d Time for round trip

The time for a round trip ranges from a low of 1 minute at a shallow well to a high of 480 mins or 8 hours for a borehole

TABLE 3.1-13A TIME FOR ROUND TRIP- MINUTES – DRY SEASON – RGC WIDE

	Min	Max	Average
Borehole	3	480	112.70
Shallow/dug well	1	240	41.07
Protected spring	2	240	72.93
Unprotected spring	10	420	76.18
Rain harvest	0	0	0
Dam/Valley tank	5	5	5.00
River/stream	20	240	123

The average time for a round trip to the BH is the second highest at 112.7 minutes. This is approximately 2 hours. This is a long time to spend collecting one or two jerry cans of water if one is using hand. Such a person needing 6 jerry cans a day will use up 12 hours a day in collecting water and this leaves little room for other domestic chores and limits productivity and income generation.

On the ground, several factors inform the time for a round trip. These include the distance to the source, the number of people at the source (long line or short line) and the strategy that the family adopt to fetch water. In some HH, one person will carry about five jerry cans to the source and fill them over a period of fifteen minutes to several hours, then he/she will carry one home and come back for another and so on till all are finished. Another strategy is for one to go and line up for the water with say five jerry cans and then take one filled one home and call the rest of the family each to carry one home. Another strategy still is to take say five empty jerry cans to the source by hand or bicycle, place them in line (perhaps even before the borehole is opened) and then go and do other chores. When the person determines that the jerry cans have been filled, he/she will then go and fetch them one by one or even three at a time depending on whether he/she is using hand or bicycle.

Because of all these variables, the time for a round trip can vary greatly between one HH and another and some refinement has to be taken in account when calculating the total amount of time that people spend fetching water.

In table 3.1-13B below the time for a round trip in the dry season is compared in the different RGCs. The same data for the four main sources is illustrated in the chart below

TABLE 3.1-13B TIME FOR ROUND TRIP- MINUTES – DRY SEASON – RGC WISE

Average time for a round trip (Minutes) by RGC												
	Acuna	Tubur	Kidetok	Kapala	Kameke	Kasasira	Buseta	Naigobya	Kyanvuma	Lambala	Nondwe	Nambale
Borehole	78	110.45	76.52	120.89	159.38	142.7	86.46	101.59	117.38	74.67	126.7	103.54
Shallow/dug well	0	0	75	28.7	0	69.38	0	0	43.33	25	36.73	0
Protected spring	0	0	70.56	0	30	0	0	0	93.33	0	100	41.21
Unprotected spring	75	180	0	0	60	116	0	49	180	38	58.96	30
Rain harvest	0	0	0	0	0	0	0	0	0	0	0	0
Dam/Valley tank	0	0	0	0	0	0	0	0	0	5	0	0
River/stream	0	0	0	0	0	175	0	20	0	0	0	20

Figure 3.1-10 Time for round trip RGC wise – dry season

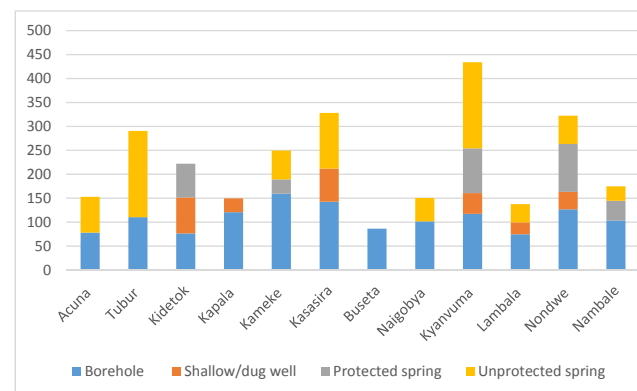

It becomes clear from the chart that the time for a round trip for Borehole is highest in Kameke and then Kasasira and it is lowest in Lambala and Kidetok. Some water sources are not represented in some RGCs. For instance in Buseta they only use Borehole. The higher the time for a round trip, the greater the need for alternative sources of water.

### 3.1.2e Time spent fetching water

TABLE 3.1-14 TIME SPENT FETCHING WATER AT THE BH.

	Time by Hand	Time by Bicycle
Min	0.0	0.1
Max	75.0	60.0
Mean	9.2	10.1
Mode	4.0	4.0

In table 3.1-14 to the left, time spent in fetching water at the borehole is calculated for people who use hand as a method and those who use bicycle. It can be seen that the average time is about the same at about 10 hours but the maximum time is higher for those using hand possibly because of the method. That a HH can spend 75 hours a day fetching water is not realistic and in this case. For those using hand, it was due to the strategy discussed above where they take several jerry cans to the source and leave them there for a number of hours and then they go back and collect them after some chores or even after returning from the garden. As can be seen from the same table the most frequently occurring figure in the time spent a day for those using hand is 4 hours and it is the same for those who use bicycle. Since bicycle tends to be faster than hand in transferring from one place to another, the fact that average time by hand and by bicycle are the same means that the largest contributor to the time spent fetching water is not the transit from home to source and back but what happens at the BH such as time of lining up and time of filling the jerry can. In general many projects make effort to locate boreholes near population centres and in good walking distance. However, this may come with crowding so that those who use bicycle may then go to more distant sources that are less crowded but by so doing they may spend more time in transit even if they spend less at the source itself.

Figure 3.1-11 Time spend fetching water at the BH – dry season

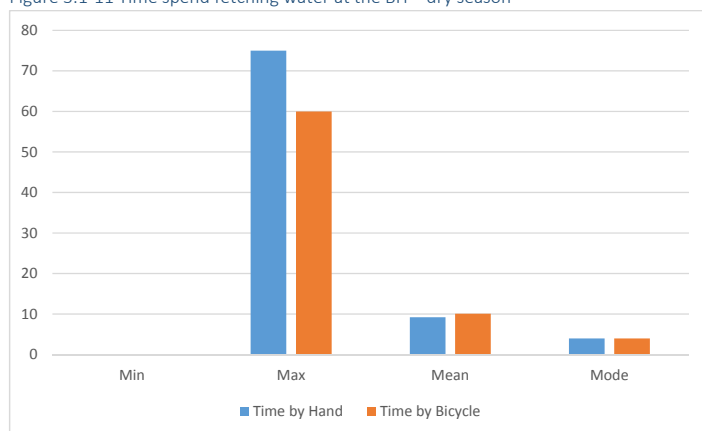

### 3.1.2f Method of water transport in dry season

The preferred method of water transport is clearly hand as 218 or 57.5% of all people fetching from borehole reported that they use hand while 42.2% reported that they use bicycle. Only one or 0.3% reported the use of a cart. No HH reported the use of a vehicle. The same preference for hand is seen with respect to “Shallow well” and “unprotected spring”. However, those who report fetching from protected spring showed a greater reliance on bicycle. The information on the method of carrying water is summarised in table 3.1-15 and figure 3.1-12. In Figure 3.1-12 the percentage of all users who use a specific method (last column to the right on table below) is calculated and is the basis for the chart.

For the most part this reliance on hand is explained by the lack of a bicycle to use to fetch water. However, the terrain and bad roads factor in. In many homes, it is the children who fetch the water and parents may also be reluctant to send their girls and boys with a bicycle to fetch water because of the risks involved to the safety of the child and the bicycle. The size of almost all the bicycles in the survey area is large – suited for adults.

TABLE 3.1-15. METHOD OF WATER TRANSPORT- DRY SEASON

Method	BH	Shallow well/Dug well	Protected spring	Unprotected spring	Rain harvest	Dam/ Valley tank	River/ stream	Total (most used)	%
Hand	218	39	17	31	0	1	3	309	58.3
Bicycle	160	4	28	24	0	0	3	219	41.3
Vehicle	0	0	0	0	0	0	0	0	0.0
Cart	1	1	0	0	0	0	0	2	0.4

Figure 3.1-12. Method of water transport- dry season

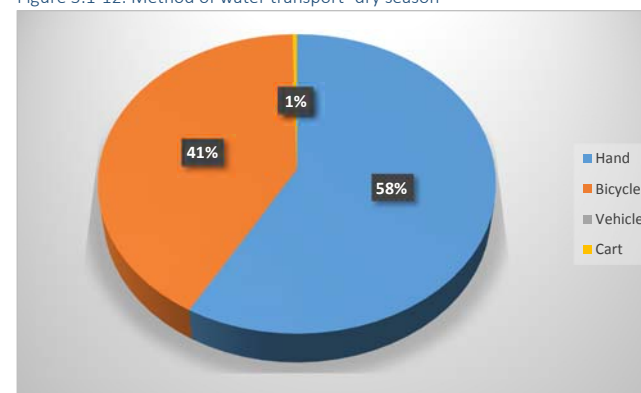

### 3.1.2g Person to fetch water in the dry season

When respondents were asked to rank the person to fetch water in the dry season, the ranking was as in table 3.1-16a below. Clearly the woman takes the first place followed by the girls, the boy and the man in that order. It appears therefore that the responsibility for water provision in the home is mostly on the female gender in the home. Indeed fetching water is one of the main roles listed against the woman, boys and girls. But boys also play a significant role. This pattern of responsibilities seems to be deeply ingrained in the culture and practices in all homes. When it comes to children, fetching water is one of the ways of training children to be hard working. However, children also like as it often gives them the opportunity to meet friends and play as they walk to and from the water source.

It should be noted that there are also risks associated with the children fetching water. Most important of these is teenage pregnancy especially where there are long lines at the source which provide opportunities for boys to entice girls into sexual activity. Secondly with children manning the operation of boreholes, operation and maintenance is more difficult as they have little care about proper operation and maintenance of the facility for long term sustainability. This means that programmes for sensitisation on O and M should also involve children.

Water fetching has far reaching impacts particularly on the female gender. It is already demonstrated that the females fetch water more often than their male counterparts. In the event, a lot of productive time is lost and this limits production and income generation on the part of females. It is demonstrated later on this study that the reliance on the woman for fetching water has impact on her other responsibilities and roles. Women reported arriving late to for work, losing customers and business as well as suffering poor health due to the duty of fetching water. Respondents also reported that fetching water has an impact on the education of boys and girls and is associated with poor performance due to reporting later for school, missing some lessons, having little time for home work, untidiness, fatigue leading to poor concentration in class and in some cases even sickness due to the work load.

The person who plays the least role in the fetching of water is the man. Probably this is due to the fact that the man is supposed to focus on income generation for the meeting of the basic needs of the home.

Because women and girls are the main persons to fetch water, it is important that they are involved in the O and M plans for all water facilities and that their voices and decisions on such issues get heard. The situation of each of the RGCs is shown in tables 3.1-16B and the data from the different RGCs is consistent in confirming the man as the one that is least likely to be fetching water. Out of the 12 RGCs, six (Kameke, Kasasira, Buseta, Kyanvuma, Lambala, Nondwe) put the Woman as first in fetching water and this is followed by the boy (Kidetok, Kapala, Naigobya) and girl (Tubur, Acuna, Nambale) each being named as the person to fetch water most frequently in three RGCs.

TABLE 3.1-16A. PERSON TO FETCH WATER IN THE DRY SEASON- RGC WISE

Person to fetch water (1=Most, 4= Least)	1	2	3	4
Man	34	55	122	241
Woman	192	142	157	24
Boy	133	146	124	43
Girl	173	175	76	34

TABLE 3.1-16B. PERSON TO FETCH WATER IN THE DRY SEASON- RGC WISE

Person to fetch water (1=Most, 4= Least)	Acuna				Tubur				Kidetok				Kapala				Kameke				Kasasira			
	1	2	3	4	1	2	3	4	1	2	3	4	1	2	3	4	1	2	3	4	1	2	3	4
Man	0	1	4	9	1	1	11	10	5	3	13	35	2	3	8	24	0	4	5	7	4	12	25	42
Woman	6	3	8	1	6	5	8	4	12	12	27	5	10	18	9	0	10	7	1	0	45	18	25	5
Boy	4	6	4	1	7	7	3	1	23	14	9	4	14	5	13	4	0	3	5	2	11	42	21	14
Girl	7	7	1	1	9	10	0	2	17	28	4	0	12	12	5	4	8	4	5	0	33	20	20	8

TABLE 3.1-16B. PERSON TO FETCH WATER IN THE DRY SEASON- RGC WISE

Person to fetch water (1=Most, 4= Least)	Buseta				Naigobya				Kyanvuma				Lambala				Nondwe				Nambale			
	1	2	3	4	1	2	3	4	1	2	3	4	1	2	3	4	1	2	3	4	1	2	3	4
Man	2	6	5	8	3	1	5	14	6	3	14	23	5	3	10	7	4	16	12	40	2	2	10	22
Woman	10	8	6	1	8	9	10	0	17	17	17	3	12	7	3	1	49	26	23	2	7	12	20	2
Boy	4	4	6	5	10	8	3	1	16	21	8	3	5	6	6	0	22	20	35	4	17	10	11	4
Girl	8	6	7	2	7	9	7	1	16	11	10	4	6	8	2	1	32	41	15	7	18	19	0	4

Figure 3.1-13 Person to fetch water most – combined sources based on priority 1

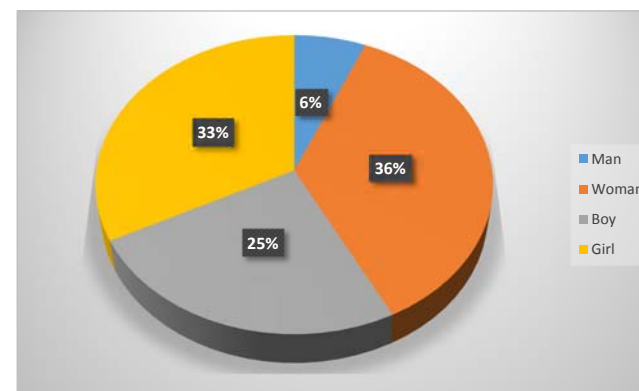

3.1.2h Person to fetch water by source –dry season

In table 3.1-17a and b below we have juxtaposed the people reported as priority number one in fetching water with respect to the different water sources. It can be seen that for the three sources, borehole, shallow/dug well and unprotected spring, the burden is mostly on the woman followed by the girl, then the boys and finally man. For protected spring, this pattern changes a little with boy being the priority followed by girl and then woman and man. In all cases, the burden falls least on man while in only one case does it fall mostly on the boy. Generally therefore the burden in on the woman and girl.

TABLE 3.1-17A PERSON TO FETCH WATER BY SOURCE – RGC WISE

Person to fetch water most to least	Borehole	Shallow/Dug well	Protected Spring	Unprotected Spring	Rain Harvest	Dam/Valley Tank	River/Stream
Man	27	1	3	1	0	1	1
Woman	136	25	6	23	0	0	2
Boy	91	9	21	11	0	0	1
Girl	126	10	15	20	0	0	2

TABLE 3.1-17B PERSON TO FETCH WATER BY SOURCE – RGC WISE

Person to fetch water most to least	Borehole	Shallow/Dug well	Protected Spring	Unprotected Spring	Rain Harvest	Dam/Valley Tank	River/Stream
Man	0	0	0	0	0	0	0
Woman	5	0	0	1	0	0	0

<b>Boy</b>	4	0	0	0	0	0	0
<b>Girl</b>	6	0	0	1	0	0	0

#### Tubur

Person to fetch water most to least	Borehole	Shallow/Dug well	Protected Spring	Unprotected Spring	Rain Harvest	Dam/Valley Tank	River/Stream
<b>Man</b>	1	0	0	0	0	0	0
<b>Woman</b>	6	0	0	0	0	0	0
<b>Boy</b>	7	0	0	0	0	0	0
<b>Girl</b>	8	0	0	1	0	0	0

#### Kidetok

Person to fetch water most to least	Borehole	Shallow/Dug well	Protected Spring	Unprotected Spring	Rain Harvest	Dam/Valley Tank	River/Stream
<b>Man</b>	4	0	1	0	0	0	0
<b>Woman</b>	11	0	1	0	0	0	0
<b>Boy</b>	16	1	6	0	0	0	0
<b>Girl</b>	15	1	1	0	0	0	0

#### Kapala

Person to fetch water most to least	Borehole	Shallow/Dug well	Protected Spring	Unprotected Spring	Rain Harvest	Dam/Valley Tank	River/Stream
<b>Man</b>	2	0	0	0	0	0	0
<b>Woman</b>	7	3	0	0	0	0	0
<b>Boy</b>	11	3	0	0	0	0	0
<b>Girl</b>	8	4	0	0	0	0	0

#### Kameke

Person to fetch water most to least	Borehole	Shallow/Dug well	Protected Spring	Unprotected Spring	Rain Harvest	Dam/Valley Tank	River/Stream
<b>Man</b>	0	0	0	0	0	0	0
<b>Woman</b>	9	0	0	1	0	0	0
<b>Boy</b>	0	0	0	0	0	0	0
<b>Girl</b>	7	0	1	0	0	0	0

#### Kasasira

Person to fetch water most to least	Borehole	Shallow/Dug well	Protected Spring	Unprotected Spring	Rain Harvest	Dam/Valley Tank	River/Stream
<b>Man</b>	3	0	0	0	0	0	1
<b>Woman</b>	33	5	0	6	0	0	1
<b>Boy</b>	6	1	0	4	0	0	0
<b>Girl</b>	24	2	0	5	0	0	2

#### Buseta

Person to fetch water most to least	Borehole	Shallow/Dug well	Protected Spring	Unprotected Spring	Rain Harvest	Dam/Valley Tank	River/Stream
<b>Man</b>	2	0	0	0	0	0	0
<b>Woman</b>	10	0	0	0	0	0	0
<b>Boy</b>	4	0	0	0	0	0	0
<b>Girl</b>	8	0	0	0	0	0	0

#### Naigobya

Person to fetch water most to least	Borehole	Shallow/Dug well	Protected Spring	Unprotected Spring	Rain Harvest	Dam/Valley Tank	River/Stream
<b>Man</b>	2	0	0	1	0	0	0
<b>Woman</b>	6	0	0	1	0	0	0
<b>Boy</b>	9	0	0	1	0	0	0
<b>Girl</b>	5	0	0	2	0	0	0

#### Kyanvuma

Person to fetch water most to least	Borehole	Shallow/Dug well	Protected Spring	Unprotected Spring	Rain Harvest	Dam/Valley Tank	River/Stream
<b>Man</b>	5	0	1	0	0	0	0
<b>Woman</b>	16	1	0	0	0	0	0
<b>Boy</b>	8	2	5	1	0	0	0
<b>Girl</b>	13	0	3	0	0	0	0

#### Lambala

Person to fetch water most to least	Borehole	Shallow/Dug well	Protected Spring	Unprotected Spring	Rain Harvest	Dam/Valley Tank	River/Stream
<b>Man</b>	3	1	0	0	0	1	0
<b>Woman</b>	5	3	0	4	0	0	0
<b>Boy</b>	3	2	0	0	0	0	0
<b>Girl</b>	4	1	0	1	0	0	0

#### Nondwe

Person to fetch water most to least	Borehole	Shallow/Dug well	Protected Spring	Unprotected Spring	Rain Harvest	Dam/Valley Tank	River/Stream
<b>Man</b>	4	0	0	0	0	0	0
<b>Woman</b>	24	13	2	10	0	0	0
<b>Boy</b>	12	0	5	5	0	0	0
<b>Girl</b>	16	2	5	9	0	0	0

## Nambale

Person to fetch water most to least	Borehole	Shallow/Dug well	Protected Spring	Unprotected Spring	Rain Harvest	Dam/Valley Tank	River/Stream
Man	1	0	1	0	0	0	0
Woman	4	0	3	0	0	0	0
Boy	11	0	5	0	0	0	1
Girl	12	0	5	1	0	0	0

### 3.1.2i Water consumption in the dry season.

TABLE 3.1-18A PER-CAPITA WATER CONSUMPTION IN THE DRY SEASON

	Min	Max	Mean	Mode
Jerry cans/ per day	1	30	7.23	4
litres/cap/day	5	80	20.27	20

Water consumption in the dry season ranged from 20 litres HH per day to 600 litres per HH per day. Per-capita water consumption ranged from 5 litres to 80 litres. The highest average per-capita water consumption was in Nambale RGC at 80 litres, while the smallest was in Kasasira RGC with 5 Litres. Data on per capita water consumption in the different RGCs is presented below.

Figure 3.1-14 Average per-capita water consumption – Dry Season RGC Wise

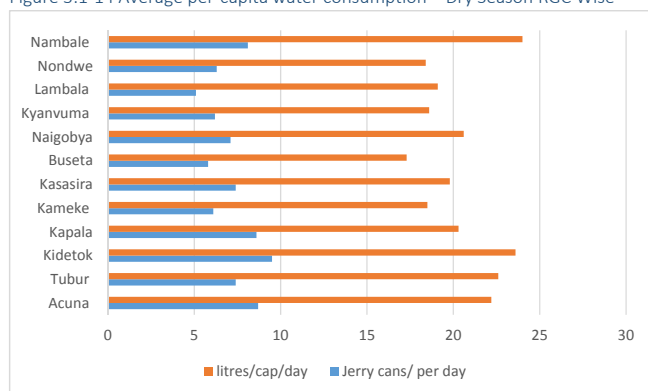

TABLE 3.1-18B SERIES - PER CAPITA WATER CONSUMPTION IN THE DRY SEASON RGC WISE

b) Acuna	Min	Max	Mean	Mode
Jerry cans/ per day	3	20	8.7	4
litres/cap/day	8	40	22.2	20.0

b) Tubur	Min	Max	Mean	Mode
Jerry cans/ per day	4	12	7.4	5
litres/cap/day	10	40	22.6	40.0

b) Kidetok	Min	Max	Mean	Mode
Jerry cans/ per day	2	24	9.5	10
litres/cap/day	7.5	66.6	23.6	30.0

b) Kapala	Min	Max	Mean	Mode
Jerry cans/ per day	2	16	8.6	15
litres/cap/day	6.7	50	20.3	20.0

b) Kameke	Min	Max	Mean	Mode
Jerry cans/ per day	3	13	6.1	5
litres/cap/day	8	34.2	18.5	20.0

b) Kasasira	Min	Max	Mean	Mode
Jerry cans/ per day	1	20	7.4	4
litres/cap/day	5	60	19.8	20.0

b) Buseta	Min	Max	Mean	Mode
Jerry cans/ per day	2	12	5.8	8
litres/cap/day	6.3	33.3	17.3	20.0

b) Naigobya	Min	Max	Mean	Mode
Jerry cans/ per day	3	15	7.1	3
litres/cap/day	10	50	20.6	20.0

b) Kyanvuma	Min	Max	Mean	Mode
Jerry cans/ per day	2	30	6.2	10
litres/cap/day	10	50	18.6	20.0

b) Lambala	Min	Max	Mean	Mode
Jerry cans/ per day	2	15	5.1	4
litres/cap/day	6.7	40	19.1	26.7

b) Nondwe	Min	Max	Mean	Mode
Jerry cans/ per day	2	20	6.3	4
litres/cap/day	5	40	18.4	20.0

b) Nambale	Min	Max	Mean	Mode
Jerry cans/ per day	4	20	8.1	6
litres/cap/day	8.3	80	24.0	33.3

### Per capita water consumption and international water access standards.

The World Health Organisation (WHO) and UNICEF provide the UN system's monitoring of progress on MDG target 10. They define safe drinking water and basic sanitation as follows:

- *Drinking water* is water used for domestic purposes, drinking, cooking and personal hygiene;
- Access to drinking water means that the source is less than 1 kilometer away from its place of use and that it is possible to reliably obtain at least 20 litres per member of a household per day;
- Safe drinking water is water with microbial, chemical and physical characteristics that meet WHO guidelines or national standards on drinking water quality;
- Access to safe drinking water is the proportion of people using improved drinking water sources: household connection; public standpipe; borehole; protected dug well; protected spring; rainwater.

*Basic sanitation* is the lowest-cost technology ensuring hygienic excreta and sullage disposal and a clean and healthful living environment both at home and in the neighborhood of users. Access to basic sanitation includes safety and privacy in the use of these services. Coverage is the proportion of people using improved sanitation facilities: public sewer connection; septic system connection; pour-flush latrine; simple pit latrine; ventilated improved pit latrine.

It is not confirmed in this study that the people consuming less than 20 litres per person per day are doing it due to access problems. However it is clear that many households as still falling below the recommended per-capita water access and this underlines the need for improving water supply in the selected areas. Data indicates that some 205 HH use less than 20 litres per capita per day in dry season and 152 HH use less than 20 litres per capita per day in rainy season. We isolated the number of HH that fall below the 20 litres per person per day indicator in the survey area and the data is presented in table 3.1-18 below.

TABLE 3.1-19 HH USING LESS THAN 20 LITRES PER PARSON PER DAY IN THE RGCS.

RGCS	ACUNA	TUBUR	KIDETOK	KAPALA	KAMEKE	KASASIRA	BUSETA	A KVANNUM	NAIGOBVA	LAMBALA	NONDWE	NAMBALE	TOTAL
HH Living on less than 20ltrs per capita per day	5	11	17	12	7	31	16	26	10	10	37	12	194
No of HH in RGC	15	22	49	29	16	66	24	44	22	22	70	30	409
% Living on less than 20ltrs per capita per day	33.3	50.0	34.7	41.4	43.8	47.0	66.7	59.1	45.5	45.5	52.9	40.0	47.4

The data shows that a total of 47.4% of the HH in the survey area are living on less than 20litres per capita per day with Buseta having the greatest proportion of these while Acuna has the least.

### 3.1.3 Water sources in rainy season

#### 3.3.3a Main water sources in the rainy season

Table 3.1-20a and b below summarises the main sources of water in the rainy season and indicates that 86.6% of all respondents indicated that their main source is borehole. This is followed by rain harvest at 74.8% and the shallow or dug well 6.8% and protected spring 5.1%. The sources least used in the rainy season are the Dam/valley tank and the river/stream, both of which score only 0.2% (only one person reported using them in the rainy season) This may be due to the high turbidity in those sources during the rainy season as runoff carries soil along with it. During the rainy season therefore the prominence of rain harvest as a source of water rises and many people resort to this convenient source dropping other sources such as shallow/dug well that took priority 2 in the dry season. While pressure on these sources reduces during this season, it does not necessarily mean that they will be better maintained. Negligence may set in for some and some may become overgrown with grass. That means that O and M activities need to be emphasised equally in dry and wet seasons.

TABLE 3.1-20a MAIN SOURCES OF WATER IN THE RAINY SEASON – RGC WIDE

#### D2. Main sources of water in the rainy season

Yes %	BH			Shallow/dug well			Protected spring			Un-protected Spring		
	Min	Max	Average	Min	Max	Average	Min	Max	Average	Min	Max	Average
Yes	86.6			6.8			4.4			5.1		
No of trips /day	1	20	3.55	1	18	5.29	1	15	3.06	1	8	2.86
Distance for round trip(m)	5	3000	278	0	1200	267	100	2000	683	0	800	367
Time for round trip(min)	1	240	48.4	0	120	27.9	2	150	48.2	3	300	64.4

Yes %	Rain harvest			Dam/Valley			River/Steam		
	Min	Max	Average	Min	Max	Average	Min	Max	Average
Yes	74.8			0.2			0.2		
No of trips /day	1	20	4.86	2	2	2	2	2	2
Distance for round trip(m)	0	300	4.7	200	200	200	50	50	50
Time for round trip(min)	0	40	2.2	5	5	5	20	20	20

Figure 3.1-15 Main sources of water in the rainy season.

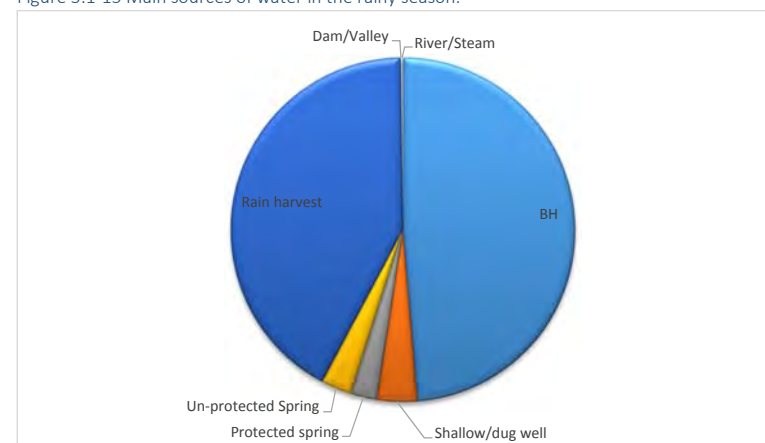

TABLE 3.1-20b SERIES - MAIN SOURCES OF WATER IN THE RAINY SEASON – RGC WISE

#### Acuna

Yes %	BH			Shallow/dug well			Protected spring			Un-protected Spring		
	Min	Max	Average	Min	Max	Average	Min	Max	Average	Min	Max	Average
Yes	100.00			0.00			0.00			0.00		
No of trips /day	1	10	4.5	0	0	0	0	0	0	0	0	0
Distance for round trip(m)	60	400	172.7	0	0	0	0	0	0	0	0	0
Time for round trip(min)	10	60	30.7	0	0	0	0	0	0	0	0	0

Yes %	Rain harvest			Dam/Valley			River/Steam		
	Min	Max	Average	Min	Max	Average	Min	Max	Average
Yes	53.33			0.00			0.00		
No of trips /day	2	14	5.38	0	0	0	0	0	0
Distance for round trip(m)	0	10	1.25	0	0	0	0	0	0
Time for round trip(min)	0	10	3.00	0	0	0	0	0	0

#### Tubur

Yes %	BH			Shallow/dug well			Protected spring			Un-protected Spring		
	Min	Max	Average	Min	Max	Average	Min	Max	Average	Min	Max	Average
Yes	95.45			0.00			0.00			0.00		
No of trips /day	1	12	3.9	0	0	0	0	0	0	0	0	0
Distance for round trip(m)	60	500	260.0	0	0	0	0	0	0	0	0	0
Time for round trip(min)	20	120	50.2	0	0	0	0	0	0	0	0	0



Yes %	Rain harvest			Dam/Valley			River/Steam		
	63.64			0.00			0.00		
Yes	Min	Max	Average	Min	Max	Average	Min	Max	Average
No of trips /day	2	8	3.64	0	0	0	0	0	0
Distance for round trip(m)	0	100	8.86	0	0	0	0	0	0
Time for round trip(min)	0	30	3.86	0	0	0	0	0	0

#### Kidetok

Yes %	BH			Shallow/dug well			Protected spring			Un-protected Spring		
	79.59			4.08			14.29			0.00		
Yes	Min	Max	Average	Min	Max	Average	Min	Max	Average	Min	Max	Average
No of trips /day	1	20	4.6	11	18	14.5	1	15	3.6	0	0	0
Distance for round trip(m)	50	1,000	271.5	100	100	100.0	300	2,000	1128.6	0	0	0
Time for round trip(min)	10	120	31.1	30	30	30.0	5	60	45.7	0	0	0

Yes %	Rain harvest			Dam/Valley			River/Steam		
	69.39								
Yes	Min	Max	Average	Min	Max	Average	Min	Max	Average
No of trips /day	1	20	6.91	0	0	0	0	0	0
Distance for round trip(m)	0	50	3.44	0	0	0	0	0	0
Time for round trip(min)	0	10	1.79	0	0	0	0	0	0

#### Kapala

Yes %	BH			Shallow/dug well			Protected spring			Un-protected Spring		
	96.55			13.79			0.00			0.00		
Yes	Min	Max	Average	Min	Max	Average	Min	Max	Average	Min	Max	Average
No of trips /day	1	8	3.6	2	12	7.0	0	0	0	0	0	0
Distance for round trip(m)	20	500	282.9	0	10	3.8	0	0	0	0	0	0
Time for round trip(min)	10	240	52.9	0	5	3.0	0	0	0	0	0	0

Yes %	Rain harvest			Dam/Valley			River/Steam		
	65.52			0.00			0.00		
Yes	Min	Max	Average	Min	Max	Average	Min	Max	Average
No of trips /day	1	10	4.63	0	0	0	0	0	0
Distance for round trip(m)	0	300	17.37	0	0	0	0	0	0
Time for round trip(min)	0	10	3.21	0	0	0	0	0	0

#### Kameke

Yes %	BH			Shallow/dug well			Protected spring			Un-protected Spring		
	93.75			6.25			0.00			6.25		
Yes	Min	Max	Average	Min	Max	Average	Min	Max	Average	Min	Max	Average
No of trips /day	1	12	4.1	6	6	6.0	0	0	0	2	2	2.0

Distance for round trip(m)	100	2,000	368.7	80	80	80.0	0	0	0	500	500	500.0
	Time for round trip(min)	20	120	43.3	30	30	30.0	0	0	0	60	60

Yes %	Rain harvest			Dam/Valley			River/Steam		
	62.50			0.00			0.00		
Yes	Min	Max	Average	Min	Max	Average	Min	Max	Average
No of trips /day	1	11	4.20	0	0	0	0	0	0
Distance for round trip(m)	0	100	11.80	0	0	0	0	0	0
Time for round trip(min)	0	40	4.80	0	0	0	0	0	0

#### Kasasira

Yes %	BH			Shallow/dug well			Protected spring			Un-protected Spring		
	89.39			7.58			0.00			4.55		
Yes	Min	Max	Average	Min	Max	Average	Min	Max	Average	Min	Max	Average
No of trips /day	1	10	3.8	2	4	3.4	0	0	0	2	4	3.3
Distance for round trip(m)	50	900	234.9	300	1,000	488.0	0	0	0	10	800	436.7
Time for round trip(min)	3	150	52.0	30	30	30.0	0	0	0	3	60	24.3

Yes %	Rain harvest			Dam/Valley			River/Steam		
	72.73			0.00			0.00		
Yes	Min	Max	Average	Min	Max	Average	Min	Max	Average
No of trips /day	1	15	4.88	0	0	0	0	0	0
Distance for round trip(m)	0	10	1.35	0	0	0	0	0	0
Time for round trip(min)	0	10	1.42	0	0	0	0	0	0

#### Buseta

Yes %	BH			Shallow/dug well			Protected spring			Un-protected Spring		
	100.00			0.00			0.00			4.17		
Yes	Min	Max	Average	Min	Max	Average	Min	Max	Average	Min	Max	Average
No of trips /day	1	9	3.2	0	0	0	0	0	0	2	2	2.0
Distance for round trip(m)	50	600	204.2	0	0	0	0	0	0	0	0	0.0
Time for round trip(min)	3	60	26.2	0	0	0	0	0	0	5	5	5.0

Yes %	Rain harvest			Dam/Valley			River/Steam		
	62.50			0.00			0.00		
Yes	Min	Max	Average	Min	Max	Average	Min	Max	Average
No of trips /day	2	8	4.33	0	0	0	0	0	0
Distance for round trip(m)	0	10	1.73	0	0	0	0	0	0
Time for round trip(min)	0	3	0.73	0	0	0	0	0	0

#### Naigobya

Yes %	BH			Shallow/dug well			Protected spring			Un-protected Spring		
	100.00			0.00			0.00			0.00		

Yes %	Min	Max	Average	Min	Max	Average	Min	Max	Average	Min	Max	Average
No of trips /day	1	6	2.5	0	0	0	0	0	0	0	0	0
Distance for round trip(m)	5	700	316.6	0	0	0	0	0	0	0	0	0
Time for round trip(min)	5	60	37.5	0	0	0	0	0	0	0	0	0

Yes %	Rain harvest			Dam/Valley			River/Steam		
	95.45			0			0.00		
Yes	Min	Max	Average	Min	Max	Average	Min	Max	Average
No of trips /day	1	14	5.38	0	0	0	0	0	0
Distance for round trip(m)	0	20	2.38	0	0	0	0	0	0
Time for round trip(min)	0	5	1.48	0	0	0	0	0	0

#### Kyanvuma

Yes %	BH			Shallow/dug well			Protected spring			Un-protected Spring		
	81.82			4.55			0.00			0.00		
Yes	Min	Max	Average	Min	Max	Average	Min	Max	Average	Min	Max	Average
No of trips /day	1	12	3.3	5	8	6.5	0	0	0	0	0	0
Distance for round trip(m)	10	800	172.5	200	500	350.0	0	0	0	0	0	0
Time for round trip(min)	6	240	57.3	20	60	40.0	0	0	0	0	0	0

Yes %	Rain harvest			Dam/Valley			River/Steam		
	90.91			0			0.00		
Yes	Min	Max	Average	Min	Max	Average	Min	Max	Average
No of trips /day	1	15	4.08	0	0	0	0	0	0
Distance for round trip(m)	0	20	2.75	0	0	0	0	0	0
Time for round trip(min)	0	10	2.20	0	0	0	0	0	0

#### Lambala

Yes %	BH			Shallow/dug well			Protected spring			Un-protected Spring		
	63.64			27.27			0.00			9.09		
Yes	Min	Max	Average	Min	Max	Average	Min	Max	Average	Min	Max	Average
No of trips /day	1	4	1.9	1	12	4.0	0	0	0	2	3	2.5
Distance for round trip(m)	100	3000	615.0	0	500	170.0	0	0	0	90	100	95.0
Time for round trip(min)	10	240	58.9	1	60	24.2	0	0	0	20	50	35.0

Yes %	Rain harvest			Dam/Valley			River/Steam		
	77.27			4.55			0.00		
Yes	Min	Max	Average	Min	Max	Average	Min	Max	Average
No of trips /day	2	7	4.24	2	2	2.00	0	0	0
Distance for round trip(m)	0	10	2.35	200	200	200.00	0	0	0
Time for round trip(min)	0	5	2.24	5	5	5.00	0	0	0

#### Nondwe

Yes %	BH	Shallow/dug well	Protected spring	Un-protected Spring
-------	----	------------------	------------------	---------------------

Yes %	77.14			10.00			10.00			20.00		
Yes	Min	Max	Average	Min	Max	Average	Min	Max	Average	Min	Max	Average
No of trips /day	1	15	3.2	1	7	3.4	1	4	2.3	1	8	2.9
Distance for round trip(m)	5	1500	343.9	200	1200	415.7	300	600	428.6	100	800	407.1
Time for round trip(min)	10	180	68.1	10	120	42.9	10	150	65.7	10	300	81.8

Yes %	Rain harvest			Dam/Valley			River/Steam		
	87.14			0			0.00		
Yes	Min	Max	Average	Min	Max	Average	Min	Max	Average
No of trips /day	2	10	4.34	0	0	0	0	0	0
Distance for round trip(m)	0	200	6.39	0	0	0	0	0	0
Time for round trip(min)	0	30	2.49	0	0	0	0	0	0

#### Nambale

Yes %	BH			Shallow/dug well			Protected spring			Un-protected Spring		
	90.00			3.33			13.33			0.00		
Yes	Min	Max	Average	Min	Max	Average	Min	Max	Average	Min	Max	Average
No of trips /day	1	12	4.1	7	7	7	2	5	3.5	0	0	0
Distance for round trip(m)	10	1500	268.9	100	100	100	100	500	350	0	0	0
Time for round trip(min)	1	120	46.8	4	4	4	2	40	21.75	0	0	0

Yes %	Rain harvest			Dam/Valley			River/Steam		
	63.33			0.0			3.33		
Yes	Min	Max	Average	Min	Max	Average	Min	Max	Average
No of trips /day	2	14	6.05	0	0	0	2	2	2
Distance for round trip(m)	0	15	2.35	0	0	0	50	50	50
Time for round trip(min)	0	5	1.47	0	0	0	20	20	20

#### 3.1.3b Number of trips a day – rainy season

Table 3.1-21a below compares the roundtrips to the different water sources. The data shows that in the rainy season, the highest number of round trips is to the borehole and rain harvest. In comparison to the dry season, the prominence of the shallow/dug is supplanted by rain harvest. Understandably, during the rainy season it is possible to trap rain water and many people do it. In the rainy season the average number of round trips to the borehole fall from 4.77 to 3.55 while those to water harvest rise from 1 to 4.86. Average number of trips to river/stream also fall significantly from 7 to 2. The changes in the other sources of water are relatively small.

TABLE 3.1-21A NUMBER OF ROUND TRIPS A DAY – RAINY AND DRY SEASONS – RGC WIDE

	Min Dry	Min Rainy	Max Dry	Max Rainy	Average Dry	Average Rainy
Borehole	1	1	24	20	4.77	3.55
Shallow/dug well	2	1	18	18	5.18	5.29
Protected spring	1	1	15	15	3.82	3.06
Unprotected spring	1	1	12	8	3.73	2.86
Rain water harvest	1	1	1	20	1	4.86

Dam/valley tank	1	2	1	2	1	2
River/stream	1	2	20	2	7	2

For the purpose of comparison the figures for the dry season are also reproduced in these tables. To guide the reader, the average figures for the rainy season are shaded. Round trips give an idea of the amount of water needed but by themselves are not sufficient to tell the exertion and resources committed to obtaining the water needed for HH use. The full story is given by the number of round trips and the time per round trip as well as the distance to the source.

TABLE 3.1-21B NUMBER OF ROUND TRIPS A DAY – RAINY SEASON – RGC WISE

Acuna	Min Dry	Min Rainy	Max Dry	Max Rainy	Average Dry	Average Rainy
Borehole	2	1	12	10	5.6	4.5
Shallow/dug well	0	0	0	0	0	0
Protected spring	0	0	0	0	0	0
Unprotected spring	2	0	2	0	2	0
Rain water harvest	0	2	0	14	0	5.38
Dam/valley tank	0	0	0	0	0	0
River/stream	0	0	0	0	0	0

Tubur	Min Dry	Min Rainy	Max Dry	Max Rainy	Average Dry	Average Rainy
Borehole	1	1	10	12	4.77	3.9
Shallow/dug well	0	0	0	0	0	0
Protected spring	0	0	0	0	0	0
Unprotected spring	3	0	3	0	3	0
Rain water harvest	0	2	0	8	0	3.64
Dam/valley tank	0	0	0	0	0	0
River/stream	0	0	0	0	0	0

Kidetok	Min Dry	Min Rainy	Max Dry	Max Rainy	Average Dry	Average Rainy
Borehole	1	1	20	20	5.41	4.6
Shallow/dug well	10	11	18	18	14	14.5
Protected spring	1	1	15	15	5.33	3.6
Unprotected spring	0	0	0	0	0	0
Rain water harvest	0	1	0	20	0	6.91
Dam/valley tank	0	0	0	0	0	0
River/stream	0	0	0	0	0	0

Kapala	Min Dry	Min Rainy	Max Dry	Max Rainy	Average Dry	Average Rainy
Borehole	1	1	16	12	5.61	4.2
Shallow/dug well	2	2	8	12	5	7
Protected spring	0	0	0	0	0	0
Unprotected spring	0	0	0	0	0	0
Rain water harvest	0	1	0	10	0	4.63
Dam/valley tank	0	0	0	0	0	0
River/stream	0	0	0	0	0	0

Kameke	Min Dry	Min Rainy	Max Dry	Max Rainy	Average Dry	Average Rainy
Borehole	1	1	12	8	4.25	3.6
Shallow/dug well	0	6	0	6	0	6
Protected spring	8	0	8	0	8	0

Unprotected spring	1	2	1	2	1	2
Rain water harvest	0	1	0	11	0	4.2
Dam/valley tank	0	0	0	0	0	0
River/stream	0	0	0	0	0	0

Kasasira	Min Dry	Min Rainy	Max Dry	Max Rainy	Average Dry	Average Rainy
Borehole	1	1	12	10	4.44	3.8
Shallow/dug well	2	2	6	4	4	3.4
Protected spring	0	0	0	0	0	0
Unprotected spring	1	2	6	4	3.2	3.3
Rain water harvest	0	1	0	15	0	4.88
Dam/valley tank	0	0	0	0	0	0
River/stream	1	0	20	0	9	0

Buseta	Min Dry	Min Rainy	Max Dry	Max Rainy	Average Dry	Average Rainy
Borehole	1	1	12	9	5.38	3.2
Shallow/dug well	0	0	0	0	0	0
Protected spring	0	0	0	0	0	0
Unprotected spring	0	2	0	2	0	2
Rain water harvest	0	2	0	8	0	4.33
Dam/valley tank	0	0	0	0	0	0
River/stream	0	0	0	0	0	0

Naigobya	Min Dry	Min Rainy	Max Dry	Max Rainy	Average Dry	Average Rainy
Borehole	1	1	15	6	4.68	2.5
Shallow/dug well	0	0	0	0	0	0
Protected spring	0	0	0	0	0	0
Unprotected spring	1	0	9	0	4	0
Rain water harvest	0	1	0	14	0	5.38
Dam/valley tank	0	0	0	0	0	0
River/stream	3	0	3	0	3	0

Kyanvuma	Min Dry	Min Rainy	Max Dry	Max Rainy	Average Dry	Average Rainy
Borehole	1	1	24	12	4.5	3.3
Shallow/dug well	4	5	10	8	6.33	6.5
Protected spring	1	0	7	0	3.89	0
Unprotected spring	1	0	1	0	1	0
Rain water harvest	0	1	0	15	0	4.08
Dam/valley tank	0	0	0	0	0	0
River/stream	0	0	0	0	0	0

Lambala	Min Dry	Min Rainy	Max Dry	Max Rainy	Average Dry	Average Rainy
Borehole	1	1	8	4	3.2	1.9
Shallow/dug well	1	1	12	12	3.86	4
Protected spring	0	0	0	0	0	0
Unprotected spring	3	2	8	3	4.4	2.5
Rain water harvest	0	2	0	7	0	4.24
Dam/valley tank	1	2	1	2	1	2
River/stream	0	0	0	0	0	0

Nondwe	Min Dry	Min Rainy	Max Dry	Max Rainy	Average Dry	Average Rainy
Borehole	1	1	15	15	3.54	3.2

Shallow/dug well	2	1	10	7	5.07	3.4
Protected spring	1	1	8	4	3.25	2.3
Unprotected spring	1	1	12	8	4.25	2.9
Rain water harvest	0	2	0	10	0	4.34
Dam/valley tank	0	0	0	0	0	0
River/stream	0	0	0	0	0	0

Nambale	Min Dry	Min Rainy	Max Dry	Max Rainy	Average Dry	Average Rainy
Borehole	1	1	18	12	6.86	4.1
Shallow/dug well	0	7	0	7	0	7
Protected spring	1	2	6	5	2.79	3.5
Unprotected spring	4	0	4	0	4	0
Rain water harvest	0	2	0	14	0	6.05
Dam/valley tank	0	0	0	0	0	0
River/stream	0	2	0	2	0	2

### 3.1.3c Distance to source – rainy season

Data shows that during the rainy season, the longest average distance is with the protected spring which stands at 683metres. A comparison of the distance to the source in the dry and rainy season is done in figure 3.1-16 below. For borehole, the distance falls lightly indicating that HHs may have better access to boreholes that are near them as the population at the boreholes decreases. The same appeared to be the case for Shallow/dug well as well as for protected spring the same which is understandable. The most significant change is the distance to the river/stream which falls drastically. This may be due to the fact that streams spring up everywhere in the rainy season. There is also significant change from 493 to 365 metres for the unprotected spring. This may also point to the fact that more springs become available in the rainy season.

Figure 3.1-16 average distance to source dry and rainy season.

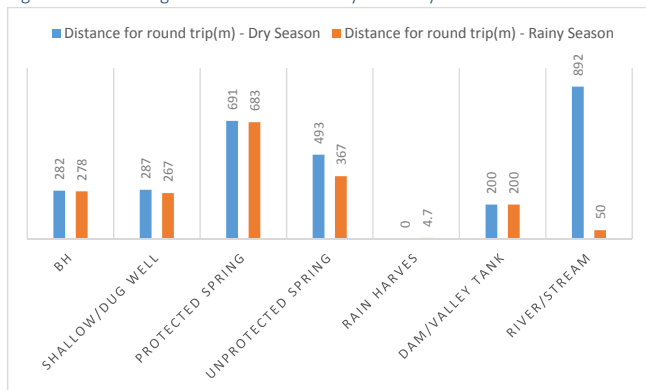

Some springs dry up during the dry season and they spring back forth during the rainy season becoming available for people to use.

### 3.1.3d Time for round trip – rainy season

The average time for a round trip in the rainy season ranges from a minimum of 0 minutes at the shallow/dug well and rain harvest, to a high of 300 minutes for unprotected spring. The average ranges from a low of 2 minutes for the rain harvest to a high of 64 minutes for unprotected spring. In general time for a roundtrip falls all around but the most significant fall is with rive/stream where it falls by some 103. 3 minutes or about 1hour and 43 minutes. At rain harvest the time also falls by some 57 minutes, while at the borehole, the time falls by some 65 minutes or about an hour.

The fall in time for a round trip can be attributed to the reduced numbers of people at the sources as people have more sources including rain harvest and some springs that have come to life in the rainy season. When the numbers are low at the sources it takes a shorter time to fetch a jerry can of water as there is no line. Additionally the flow from many sources such as springs improves. Moreover people can resort to sources that are closer to home as the crowding at the sources reduces.

This reduction in time for a round trip is significant especially as the borehole is named as the main source of water for the majority of the respondents. The time saved from the responsibility fetching water in the rainy season can be diverted to other chores and for groups like women and children, it can result into better health, more income and better school performance. New and stable water sources will effectively contribute to the reduction of this time leading to gains in the areas named.

Figure 3.1-17 Time for round trip – rainy season and dry season

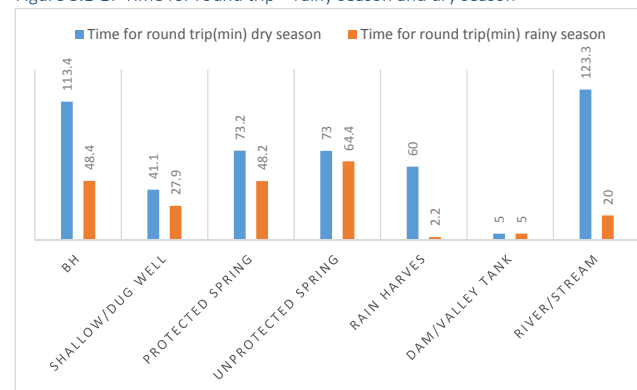

### 3.1.3e Access to safe water in the rainy season

As noted in section 3.1.4d above, access dynamics include the distance to source and queuing time. Both dynamics change in the rainy season and this impacts access significantly. However, since access is not the result of new safe sources, the improvement in access to safe water is debatable.

### 3.1.3f Method of water transport in the rainy season

The preferred method of fetching water in the rainy season still remains “hand”. 207 or 59% of all people fetching from borehole reported that they use hand while 41% reported that they use bicycle. Only one

person reported the use of a cart. No one reported the use of a vehicle. The same preference for hand is seen with respect to “Shallow well” and “unprotected spring” as well as rain harvest where it is nearly the only method.

The information on the method of carrying water is summarised in table 3.1-22a below. The factors determining the preference for these methods are likely the same as those mentioned in section 3.1.4d above namely, the lack of a bicycle to use to fetch water as well as the terrain which is amplified by the muddy conditions in the rainy season.

The situation in the respective RGCs does not change very much as seen in table 3.1-22b series below.

TABLE 3.1-22A METHOD OF WATER TRANSPORT –RAINY SEASON RGC WIDE

Method	BH	Shallow well/Dug well	Protected spring	Unprotected spring	Rain harvest	Dam/Valley tank	River/stream	Total (most used)
Hand	207	26	11	15	304	1	1	565
Bicycle	145	2	7	5	1	0	0	160
Vehicle	0	0	0	0	0	0	0	0
Cart	1	0	0	0	0	0	0	1

TABLE 3.1-22B METHOD OF WATER TRANSPORT –RAINY SEASON –RGC WISE

Acuna

Method	BH	Shallow well/Dug well	Protected spring	Unprotected spring	Rain harvest	Dam/Valley tank	River/stream	Total (most used)
Hand	8	0	0	0	8	0	0	16
Bicycle	7	0	0	0	0	0	0	7
Vehicle	0	0	0	0	0	0	0	0
Cart	0	0	0	0	0	0	0	0

Tubur

Method	BH	Shallow well/Dug well	Protected spring	Unprotected spring	Rain harvest	Dam/Valley tank	River/stream	Total (most used)
Hand	6	0	0	0	14	0	0	20
Bicycle	15	0	0	0	0	0	0	15
Vehicle	0	0	0	0	0	0	0	0
Cart	0	0	0	0	0	0	0	0

Kidetok

Method	BH	Shallow well/Dug well	Protected spring	Unprotected spring	Rain harvest	Dam/Valley tank	River/stream	Total (most used)
Hand	19	2	2	0	34	0	0	57
Bicycle	20	0	5	0	0	0	0	25
Vehicle	0	0	0	0	0	0	0	0
Cart	0	0	0	0	0	0	0	0

Kapala

Method	BH	Shallow well/Dug well	Protected spring	Unprotected spring	Rain harvest	Dam/Valley tank	River/stream	Total (most used)
Hand	12	4	0	0	19	0	0	35
Bicycle	15	0	0	0	0	0	0	15
Vehicle	0	0	0	0	0	0	0	0
Cart	1	0	0	0	0	0	0	1

Kameke

Method	BH	Shallow well/Dug well	Protected spring	Unprotected spring	Rain harvest	Dam/Valley tank	River/stream	Total (most used)
Hand	8	1	0	0	10	0	0	19
Bicycle	7	0	0	1	0	0	0	8
Vehicle	0	0	0	0	0	0	0	0
Cart	0	0	0	0	0	0	0	0

Kasasira

Method	BH	Shallow well/Dug well	Protected spring	Unprotected spring	Rain harvest	Dam/Valley tank	River/stream	Total (most used)
Hand	39	4	0	3	48	0	0	94
Bicycle	20	1	0	0	0	0	0	21
Vehicle	0	0	0	0	0	0	0	0
Cart	0	0	0	0	0	0	0	0

Buseta

Method	BH	Shallow well/Dug well	Protected spring	Unprotected spring	Rain harvest	Dam/Valley tank	River/stream	Total (most used)
Hand	16	0	0	1	15	0	0	32
Bicycle	8	0	0	0	0	0	0	8
Vehicle	0	0	0	0	0	0	0	0
Cart	0	0	0	0	0	0	0	0

Naigobya

Method	BH	Shallow well/Dug well	Protected spring	Unprotected spring	Rain harvest	Dam/Valley tank	River/stream	Total (most used)
Hand	13	0	0	0	21	0	0	34
Bicycle	9	0	0	0	0	0	0	9
Vehicle	0	0	0	0	0	0	0	0
Cart	0	0	0	0	0	0	0	0

Kyanvuma

Method	BH	Shallow well/Dug well	Protected spring	Unprotected spring	Rain harvest	Dam/Valley tank	River/stream	Total (most used)
Hand	12	4	0	0	19	0	0	35
Bicycle	15	0	0	0	0	0	0	15
Vehicle	0	0	0	0	0	0	0	0
Cart	1	0	0	0	0	0	0	1

Hand	21	2	0	0	40	0	0	63
Bicycle	15	0	0	0	0	0	0	15
Vehicle	0	0	0	0	0	0	0	0
Cart	0	0	0	0	0	0	0	0

#### Lambala

Method	BH	Shallow well/Dug well	Protected spring	Unprotected spring	Rain harvest	Dam/Valley tank	River/stream	Total (most used)
Hand	7	6	0	2	17	1	0	33
Bicycle	7	0	0	0	0	0	0	7
Vehicle	0	0	0	0	0	0	0	0
Cart	0	0	0	0	0	0	0	0

#### Nondwe

Method	BH	Shallow well/Dug well	Protected spring	Unprotected spring	Rain harvest	Dam/Valley tank	River/stream	Total (most used)
Hand	38	6	6	9	60	0	0	119
Bicycle	15	1	1	4	1	0	0	22
Vehicle	0	0	0	0	0	0	0	0
Cart	0	0	0	0	0	0	0	0

#### Nambale - Method of water transport

Method	BH	Shallow well/Dug well	Protected spring	Unprotected spring	Rain harvest	Dam/Valley tank	River/stream	Total (most used)
Hand	20	1	3	0	18	0	1	43
Bicycle	7	0	1	0	0	0	0	8
Vehicle	0	0	0	0	0	0	0	0
Cart	0	0	0	0	0	0	0	0

#### 3.1.3g Person to fetch water in the rainy season

The ranking of the person to fetch water in the rainy season does not differ much from the ranking in the dry season. The woman still takes the first place followed by the girls, the boy and the man in that order. Weather does not therefore appear to have any impact on who fetches water in the household. The graphic below shows the number of times that each person was ranked first.

Figure 3.1-18 Person to fetch water most- rainy season – combined sources

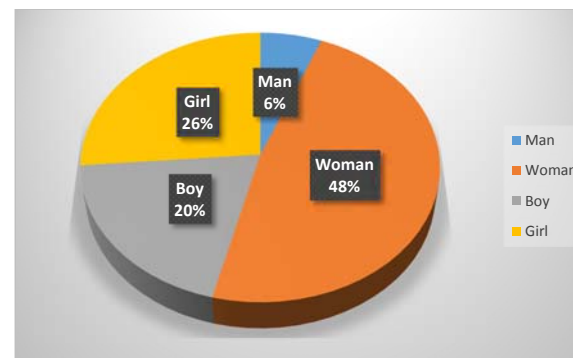

Just like in the dry season, the person who plays the least role in the fetching of water in the rainy season is the man. Tables 3.1-23A and B series present the data on the person to fetch water in the rainy season.

TABLE 3.1-23A PERSON TO FETCH WATER IN THE RAINY SEASON – RGC WIDE

Person to fetch water (1=Most, 4=Least)	1	2	3	4
Man	44	81	140	313
Woman	349	164	158	30
Boy	142	172	219	55
Girl	192	274	109	40

TABLE 3.1-23B PERSON TO FETCH WATER IN THE RAINY SEASON – RGC WISE

Person to fetch water (1=Most, 4=Least)	1	2	3	4
Man	0	1	3	17
Woman	10	2	10	1
Boy	7	6	7	1
Girl	6	14	3	0

#### Tubur

Person to fetch water (1=Most, 4=Least)	1	2	3	4
Man	3	1	14	17
Woman	13	6	10	5
Boy	11	7	9	3
Girl	8	21	1	3

#### Kidetok

Person to fetch water (1=Most, 4=Least)	1	2	3	4
Man	6	6	20	46
Woman	31	15	26	10
Boy	24	17	24	7

Girl	21	44	7	0
------	----	----	---	---

#### Kapala

Person to fetch water (1=Most, 4=Least)	1	2	3	4
Man	3	5	12	28
Woman	21	21	9	0
Boy	13	10	18	9
Girl	14	15	9	7

#### Kameke

Person to fetch water (1=Most, 4=Least)	1	2	3	4
Man	1	5	7	12
Woman	17	10	0	0
Boy	0	2	11	2
Girl	9	10	7	0

#### Kasaira

Person to fetch water (1=Most, 4=Least)	1	2	3	4
Man	5	19	24	41
Woman	70	16	22	6
Boy	11	40	37	15
Girl	29	33	22	12

#### Buseta

Person to fetch water (1=Most, 4=Least)	1	2	3	4
Man	4	6	7	13
Woman	16	14	5	1
Boy	5	6	10	4
Girl	14	9	9	2

#### Naigobya

Person to fetch water (1=Most, 4=Least)	1	2	3	4
Man	20	13	9	0
Woman	11	12	6	2
Boy	9	13	11	1
Girl	20	13	9	0

#### Kyanvuma

Person to fetch water (1=Most, 4=Least)	1	2	3	4
Man	6	8	17	24
Woman	45	16	13	2
Boy	11	24	20	7
Girl	16	26	15	4

#### Lambala

Person to fetch water (1=Most, 4=Least)	1	2	3	4
Man	3	8	12	11
Woman	20	7	7	1

Boy	9	11	8	1
Girl	8	9	4	2

#### Nondwe

Person to fetch water (1=Most, 4=Least)	1	2	3	4
Man	9	20	6	55
Woman	73	29	26	3
Boy	23	26	48	3
Girl	37	58	21	5

#### Nambale – person to fetch water rainy season

Person to fetch water (1=Most, 4=Least)	1	2	3	4
Man	1	2	7	30
Woman	13	15	21	1
Boy	17	11	21	1
Girl	21	22	0	4

#### 3.1.3h Person to fetch water by source –rainy season

In table 3.1-24a and b below we have juxtaposed the people reported as priority number one in fetching water with respect to the different water sources in the rainy season. It can be seen that for the four sources, borehole, shallow/dug well, unprotected spring and rain harvest, the burden is mostly on the woman. The burden then falls next on the girl with respect to Borehole, Shallow/dug well and Rain Harvest and these are the main sources in the rainy season. As in the dry season, the burden therefore falls mostly on the woman followed by the girl then the boy and lastly the man.

TABLE 3.1-24A PERSON TO FETCH WATER BY SOURCE – RAINY SEASON RGC WIDE.

Person to fetch water most to least	Borehole	Shallow/Dug well	Protected Spring	Unprotected Spring	Rain Harvest	Dam/Valley Tank	River/Stream
Man	29	0	2	0	12	1	0
Woman	120	14	4	12	198	0	0
Boy	94	6	8	5	30	0	1
Girl	110	8	4	4	65	0	0

TABLE 3.1-24B SERIES - PERSON TO FETCH WATER BY SOURCE – RAINY SEASON - RGC WISE.

#### Acuna

Person to fetch water most to least	Borehole	Shallow/Dug well	Protected Spring	Unprotected Spring	Rain Harvest	Dam/Valley Tank	River/Stream
Man	0	0	0	0	0	0	0
Woman	5	0	0	0	5	0	0
Boy	5	0	0	0	2	0	0
Girl	5	0	0	0	1	0	0

**Tubur**

Person to fetch water most to least	Borehole	Shallow/Dug well	Protected Spring	Unprotected Spring	Rain Harvest	Dam/Valley Tank	River/Stream
Man	1	0	0	0	2	0	0
Woman	4	0	0	0	9	0	0
Boy	9	0	0	0	2	0	0
Girl	7	0	0	0	1	0	0

**Kidetok**

Person to fetch water most to least	Borehole	Shallow/Dug well	Protected Spring	Unprotected Spring	Rain Harvest	Dam/Valley Tank	River/Stream
Man	4	0	1	0	1	0	0
Woman	10	0	1	0	20	0	0
Boy	14	0	4	0	6	0	0
Girl	11	2	1	0	7	0	0

**Kapala**

Person to fetch water most to least	Borehole	Shallow/Dug well	Protected Spring	Unprotected Spring	Rain Harvest	Dam/Valley Tank	River/Stream
Man	2	0	0	0	1	0	0
Woman	7	2	0	0	12	0	0
Boy	11	1	0	0	1	0	0
Girl	8	1	0	0	5	0	0

**Kameke**

Person to fetch water most to least	Borehole	Shallow/Dug well	Protected Spring	Unprotected Spring	Rain Harvest	Dam/Valley Tank	River/Stream
Man	0	0	0	0	1	0	0
Woman	10	0	0	1	6	0	0
Boy	0	0	0	0	0	0	0
Girl	5	1	0	0	3	0	0

**Kasasira**

Person to fetch water most to least	Borehole	Shallow/Dug well	Protected Spring	Unprotected Spring	Rain Harvest	Dam/Valley Tank	River/Stream
Man	3	0	0	0	2	0	0
Woman	28	4	0	2	36	0	0
Boy	8	0	0	0	3	0	0
Girl	20	1	0	1	7	0	0

**Buseta**

Person to fetch water most to least	Borehole	Shallow/Dug well	Protected Spring	Unprotected Spring	Rain Harvest	Dam/Valley Tank	River/Stream
Man	3	0	0	0	1	0	0
Woman	7	0	0	1	8	0	0

Boy	4	0	0	0	1	0	0
Girl	9	0	0	0	5	0	0

**Naigobya**

Person to fetch water most to least	Borehole	Shallow/Dug well	Protected Spring	Unprotected Spring	Rain Harvest	Dam/Valley Tank	River/Stream
Man	2	0	0	0	1	0	0
Woman	8	0	0	0	12	0	0
Boy	8	0	0	0	3	0	0
Girl	4	0	0	0	5	0	0

**Kyanvuma**

Person to fetch water most to least	Borehole	Shallow/Dug well	Protected Spring	Unprotected Spring	Rain Harvest	Dam/Valley Tank	River/Stream
Man	5	0	0	0	1	0	0
Woman	15	0	0	0	30	0	0
Boy	5	2	0	0	4	0	0
Girl	11	0	0	0	5	0	0

**Lambala**

Person to fetch water most to least	Borehole	Shallow/Dug well	Protected Spring	Unprotected Spring	Rain Harvest	Dam/Valley Tank	River/Stream
Man	2	0	0	0	0	1	0
Woman	4	2	0	2	12	0	0
Boy	3	3	0	0	3	0	0
Girl	5	1	0	0	2	0	0

**Nondwe**

Person to fetch water most to least	Borehole	Shallow/Dug well	Protected Spring	Unprotected Spring	Rain Harvest	Dam/Valley Tank	River/Stream
Man	6	0	1	0	2	0	0
Woman	18	6	1	6	42	0	0
Boy	13	0	3	5	2	0	0
Girl	16	1	2	3	15	0	0

**Nambale - person to fetch water by source - rainy season**

Person to fetch water most to least	Borehole	Shallow/Dug well	Protected Spring	Unprotected Spring	Rain Harvest	Dam/Valley Tank	River/Stream
Man	1	0	0	0	0	0	0
Woman	4	0	2	0	7	0	0
Boy	12	0	1	0	3	0	1
Girl	10	1	1	0	9	0	0

**3.1.3i Water consumption in the rainy season.****TABLE 3.1-25A PER-CAPITA WATER CONSUMPTION IN THE RAINY SEASON –RGC WIDE**

	Min	Max	Mean	Mode
--	-----	-----	------	------



Jerry cans/ per day	2	27	8.1	10
litres/cap/day	5.7	80	23.3	20

Water consumption in the rainy season ranged from 40 litres per HH per day to 540 litres per HH per day. Per-capita water consumption ranged from 5.7 litres to 80 litres.

When water consumption in the rainy season is compared to that in the dry season, the rates do not differ very much. Below is a graphic comparison of water consumption in the dry season compared to the wet season.

Figure 3.1-19 comparison of per capita water consumption –dry season and rainy season.

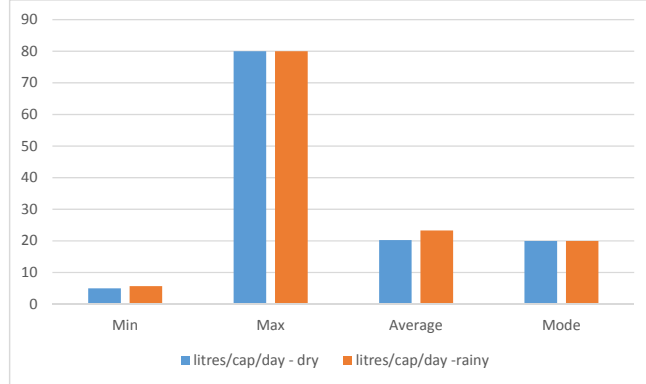

It can be seen that average per-capita water consumption in the rainy season is slightly higher than in the dry season but the difference is really quite small. Moreover most people report the same amount of per-capita water consumption in both the dry and in the rainy season i.e. 20 litres per day. Therefore it can be concluded that water consumption does not change much between the dry season and the rainy season.

TABLE 3.1-25B SERIES - PER-CAPITA WATER CONSUMPTION IN THE RAINY SEASON –RGC WISE

	Acuna				Tubur				Kidetok			
	Min	Max	Mean	Mode	Min	Max	Mean	Mode	Min	Max	Mean	Mode
Jerry cans/ per day	3	18	8.67	10	2	12	8.14	8	2	24	10.59	10
litres/cap/day	10	40	21.97	20	10	50	24.78	40	9	73.3	27.57	20

	Kapala				Kameke				Kasasira			
	Min	Max	Mean	Mode	Min	Max	Mean	Mode	Min	Max	Mean	Mode
Jerry cans/ per day	2	20	9.14	10	3	15	6.94	7	2	18	7.98	6
litres/cap/day	6.7	50	21.54	20	13	35	21.76	20	6.7	48	21.42	30

	Buseta				Naigobya				Kyanvuma			
	Min	Max	Mean	Mode	Min	Max	Mean	Mode	Min	Max	Mean	Mode
Jerry cans/ per day	2	11	6.46	9	2	18	8.18	5	2	27	7.00	4
litres/cap/day	5.7	44	19.95	15	6.7	60	23.37	20	6.7	56	21.64	20

	Lambala	Nondwe	Nambale

	Min	Max	Mean	Mode	Min	Max	Mean	Mode	Min	Max	Mean	Mode
Jerry cans/ per day	2	15	6.18	7	3	22	7.71	7	4	16	8.53	8
litres/cap/day	6.7	60	23.32	20	9.2	60	23.80	20	10	80	25.88	16

### 3.1.3j Conclusion on water sources and water consumption

It is clear from the data above that the main source of water, both in the rainy season and the dry season is the borehole. In the dry season the second most important water source is the unprotected spring. In the rainy season, the second most important source changes to rain harvest.

The 'preferred' method of water transport both in the dry season and in the rainy season is by far 'hand' followed by bicycle.

The person to fetch water is in both the dry and rainy season reported to be the woman followed by the girl and the boy with the man coming last.

Water consumption differs very little in the dry and the rainy season with average consumption in the rainy season exceeding consumption in the dry season by only about 2.8 litres per person per day. The most frequently named per capita consumption is 20 litres per day and this remains the same in the dry and the rainy seasons.

### 3.1.4 Water sellers

#### 3.1.4a Existence and use of water sellers.

Water sellers are an important part of the water supply arrangement in all urban areas. In most cases they run their businesses using bicycles or hand carts which they use to deliver water to various homes where they are paid by the jerry can. When asked whether they had bought water from water sellers, 52.3% of the respondents said that they had done so while 47.7% said that they had not done so. When analysed by RGC it was noted that people who have bought from water sellers (as a proportion of the sample) are more heavily present in Kidetok, Nondwe and Acuna RGCs and absent or minimally present in Buseta and Kasasira RGCs. This is demonstrated in table figure 3.1-20 below.

Figure 3.1-20 Water sellers in different RGCs

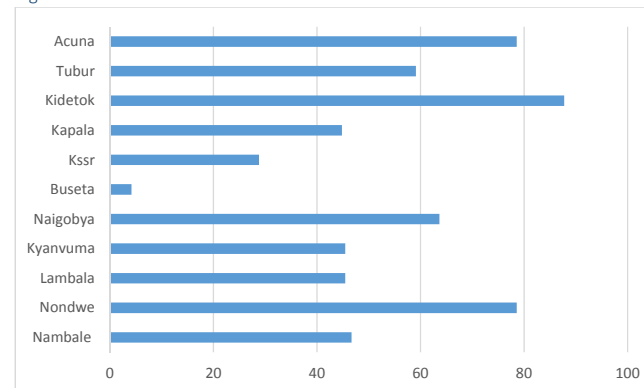

The reasons for buying water from water sellers were also investigated. The reasons given by respondents are summarised in figure 3.1-21 below.

Figure 3.1-21 Reasons for buying water

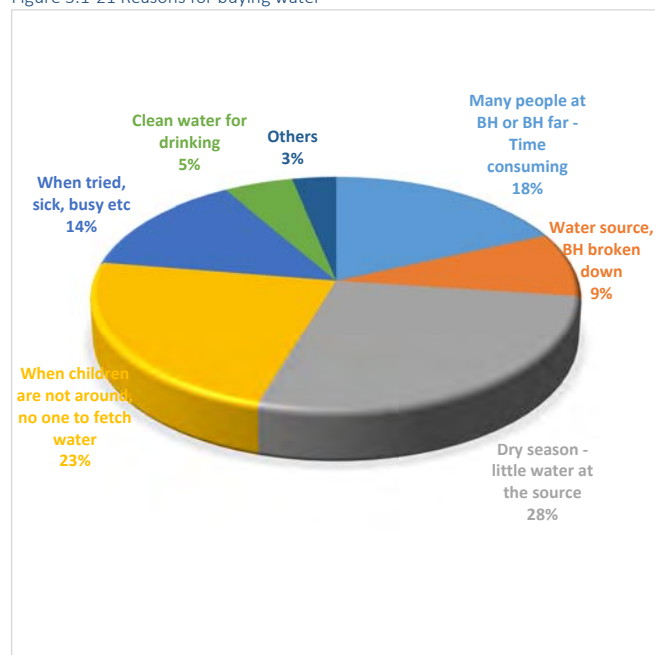

The main reasons given for buying water were “Dry Season” 28%, Children away” 23% and “Many people at the borehole” 18% .

While the reasons above are valid, water stressed locations tend to have more water sellers than those where access to water is easier. However the presence of water sellers may also point to relative affluence of the community with more affluent communities able to afford the services of water sellers while poorer communities

will be less able to afford the services of water sellers.

### 3.1.4b Frequency of buying water in the last year?

For those who reported buying water, the average number of times they bought water in the last year was 77.5. This comes to about 6 or 7 time a month. Some people reported to have bought water some 500 times in the previous year this translated to between 1 and 2 jerry cans a day. The person who reported buying the least amount of water is in Kameke RGC while the one who reported the most jerry cans is in Naigobya RGC

The number of jerry cans bought at a single time ranged from 1 to 12. While the price per jerry can ranged from Shs 30 to Shs 500 with an average of Shs 263. Again here, the lowest reported was in Nondwe RGC while the highest was in Acuna RGC.

TABLE 3.1-26A BUYING WATER FROM WATER SELLERS – RGC WIDE

	Min	Max	Mean	Mode
Times bought water	0	500	77.5	20
No of jerry cans	0	12	3.5	2
Pay per jerry can	30	500	263.0	200

While water sellers thrive in water scarce areas, it is not likely that the construction of the new water facilities will eliminate the business opportunities of water seller. First, the proposed water supply systems will not use house

connections. Therefore people will still need to get the water from the various points to the houses. Secondly the population and business operations in the RGCs are likely to grow and so is the population and this will create additional demand for the services of the water sellers. The RGC wise data on water sellers is presented in table 3.1-26b series below.

TABLE 3.1-26B SERIES - BUYING WATER FROM WATER SELLERS – RGC WISE

	Acuna				Tubur				Kidetok			
	Min	Max	Mean	Mode	Min	Max	Mean	Mode	Min	Max	Mean	Mode
Times bought water	20	120	55.0	-	5	300	75.5	50	2	360	65.7	20
No of jerry cans	2	4	3.3	4	2	12	4.8	5	1	12	4.2	4
Pay per jerry can	100	500	266.7	-	300	500	389.2	400	200	500	358.1	400

	Kapala				Kameke				Kasasira			
	Min	Max	Mean	Mode	Min	Max	Mean	Mode	Min	Max	Mean	Mode
Times bought water	3	240	40.2	20	1	300	58.6	60	2	360	58.1	6
No of jerry cans	3	6	4.1	4	2	5	3.3	3	2	6	3.1	2
Pay per jerry can	100	400	215.4	200	200	400	244.4	200	100	300	205.3	200

	Buseta				Naigobya				Kyanvuma			
	Min	Max	Mean	Mode	Min	Max	Mean	Mode	Min	Max	Mean	Mode
Times bought water	270	270	270.0	-	10	500	122.8	10	5	360	89.2	60
No of jerry cans	3	3	3.0	-	1	10	3.6	3	1	10	3.6	4
Pay per jerry can	200	200	200.0	-	200	300	221.4	200	200	400	220.0	200

	Lambala				Nondwe				Nambale			
	Min	Max	Mean	Mode	Min	Max	Mean	Mode	Min	Max	Mean	Mode
Times bought water	40	120	79.7	90	3	365	100.5	144	0	60	25.9	10
No of jerry cans	1	10	2.8	2	1	8	2.6	2	0	12	4.1	3
Pay per jerry can	100	500	280.0	300	30	500	227.8	200	200	300	221.4	200

### 3.1.4c Conclusion on water sellers

The buying of water is common enough in the survey area with 52.3% reporting that they have bought water from water sellers. The average number of jerry cans bought at one time is 3.5 while the average

price per jerry can is Shs 263. The practice of buying water is more prevalent in Kidetok (87.8%) followed by Nondwe (78.6%) RGCs and least prevalent in Buseta where (4.2%) RGC. Where the practice is more prevalent, it may be due to a greater water scarcity or perhaps relative affluence and where the practice is minimal it may be that there is good access to safe water or it may be that the people are relative less affluent or perhaps a measure of both. It is not likely that the establishment of the new water facilities will eliminate the business of water sellers. In fact it might promote it as they will have more reliable sources for safe water.

*Water sources for washing and bathing.*

**TABLE 3.1-27A WATER SOURCES FOR WASHING OR BATHING - RGC WIDE**

	BH %	Shallow Water %	Protected spring %	Unprotected spring %	Rain harvest %	Dam/valley tank %	River/Stream %	Other %
Washing	79.2	13.4	9.3	12.5	44.0	0.5	1.5	0.0
Bathing	81.2	11.7	8.6	11.0	45.5	0.7	1.5	0.0

The sources of water for washing and bathing are summarised in the table above. The data for the respective RGCs is also presented in tables 3.1-27b series below. The source named by most respondents for washing is borehole at 79.2% followed by rain harvest at 44%. Both Shallow well and unprotected spring also feature well at 13.4% and 12.5% respectively. Note that in this question, people could give multiple answers thus all the people can report borehole leading to 100% score while at the same time they also use other sources leading to those sources also having a score.

The same pattern is observed with water for bathing with the percentages in the table above.

The least used sources for both bathing and washing are the “river/stream” and the “Dam/valley tank”. These are relatively unsafe water sources and are last resort sources in case one cannot get water from the more safe sources.

Bathing and washing are considered less risky to the user if unsafe water is used. However both uses are sensitive to turbidity and colour which may be the reason people still opt for the safe and clean BH water. The use of the new water source for both these functions will therefore depend on convenience and price. If the price of the new water sources is comparable to that at the BH then people will resort to the new sources for washing and bathing. Should the price be higher and locations more inconvenient, the likelihood is that people will continue with their current sources of water for bathing and washing.

**TABLE 3.1-27B WATER SOURCES FOR WASHING OR BATHING - RGC WISE**

**Acuna**

	BH %	Shallow Water %	Protected spring %	Unprotected spring %	Rain harvest %	Dam/valley tank %	River/Stream %	Other %
Washing	100.00	0.00	0.00	20.00	13.33	0.00	0.00	0.00
Bathing	100.00	0.00	0.00	13.33	20.00	0.00	0.00	0.00

**Tubur**

	BH %	Shallow Water %	Protected spring %	Unprotected spring %	Rain harvest %	Dam/valley tank %	River/Stream %	Other %
Washing	93.18	6.82	20.45	0.00	61.36	0.00	0.00	0.00
Bathing	90.91	6.82	18.18	0.00	63.64	0.00	0.00	0.00

Washing	100.00	0.00	0.00	4.55	45.45	0.00	0.00	0.00
Bathing	100.00	0.00	0.00	4.55	45.45	0.00	0.00	0.00

**Kidetok**

	BH %	Shallow Water %	Protected spring %	Unprotected spring %	Rain harvest %	Dam/valley tank %	River/Stream %	Other %
Washing	93.88	4.08	10.20	0.00	40.82	0.00	0.00	0.00
Bathing	93.88	4.08	12.24	0.00	40.82	0.00	0.00	0.00

**Kapala**

	BH %	Shallow Water %	Protected spring %	Unprotected spring %	Rain harvest %	Dam/valley tank %	River/Stream %	Other %
Washing	82.76	37.93	3.45	0.00	34.48	0.00	0.00	0.00
Bathing	89.66	31.03	3.45	0.00	37.93	0.00	0.00	0.00

**Kameke**

	BH %	Shallow Water %	Protected spring %	Unprotected spring %	Rain harvest %	Dam/valley tank %	River/Stream %	Other %
Washing	100.00	6.25	6.25	6.25	43.75	0.00	0.00	0.00
Bathing	100.00	6.25	6.25	6.25	43.75	0.00	0.00	0.00

**Kasasira**

	BH %	Shallow Water %	Protected spring %	Unprotected spring %	Rain harvest %	Dam/valley tank %	River/Stream %	Other %
Washing	75.76	12.12	0.00	21.21	39.39	0.00	7.58	0.00
Bathing	80.30	10.61	0.00	18.18	39.39	0.00	7.58	0.00

**Buseta**

	BH %	Shallow Water %	Protected spring %	Unprotected spring %	Rain harvest %	Dam/valley tank %	River/Stream %	Other %
Washing	87.50	4.17	4.17	0.00	41.67	0.00	0.00	0.00
Bathing	95.83	0.00	0.00	0.00	54.17	0.00	0.00	0.00

**Naigobya**

	BH %	Shallow Water %	Protected spring %	Unprotected spring %	Rain harvest %	Dam/valley tank %	River/Stream %	Other %
Washing	95.45	0.00	0.00	22.73	68.18	0.00	4.55	0.00
Bathing	95.45	0.00	0.00	18.18	59.09	4.55	4.55	0.00

**Kyanvuma**

	BH %	Shallow Water %	Protected spring %	Unprotected spring %	Rain harvest %	Dam/valley tank %	River/Stream %	Other %
Washing	93.18	6.82	20.45	0.00	61.36	0.00	0.00	0.00
Bathing	90.91	6.82	18.18	0.00	63.64	0.00	0.00	0.00

### Lambala

	BH %	Shallow Water %	Protected spring %	Unprotected spring %	Rain harvest %	Dam/valley tank %	River/Stream %	Other %
Washing	50.00	54.55	0.00	4.55	54.55	4.55	0.00	0.00
Bathing	50.00	50.00	0.00	4.55	54.55	4.55	0.00	0.00

### Nondwe

	BH %	Shallow Water %	Protected spring %	Unprotected spring %	Rain harvest %	Dam/valley tank %	River/Stream %	Other %
Washing	47.14	21.43	15.71	35.71	48.57	0.00	0.00	0.00
Bathing	48.57	20.00	17.14	32.86	51.43	0.00	0.00	0.00

### Nambale

	BH %	Shallow Water %	Protected spring %	Unprotected spring %	Rain harvest %	Dam/valley tank %	River/Stream %	Other %
Washing	80.00	6.67	33.33	3.33	23.33	3.33	0.00	0.00
Bathing	83.33	3.33	23.33	3.33	23.33	3.33	0.00	0.00

## 3.1.5 Water and Health

### 3.1.5a Water Borne Diseases in the Household

#### Prevalence of water borne diseases.

Table 3.1-28a below summarises the information on the prevalence of water borne diseases while tables 3.1-26b series present the data from the respective RGCs. Data shows that the disease mentioned as 'very common' most times is fever 61.4% and this is followed by "others" at 33.3% and then "diarrhoea" at 7.3%. Fever is a common symptom for many diseases, however it is most commonly associated with malaria.

Among the diseases named as 'common' are Diarrhoea" 39.9%, "Fever" 28.4% and "Respiratory disease" 26.7%.

TABLE 3.1-28A PREVALENCE OF WATER BORNE DISEASES – RGC WIDE

Diseases	Very common %	Common %	Rare %	Very rare %
Fever	61.4	28.4	7.8	2.4
Diarrhoea	7.3	39.9	31.1	21.8
Skin Disease	0.7	16.7	27.7	54.9
Respiratory disease	2.2	26.7	20.8	50.4
Worms	3.7	31.1	25.2	40.1
Eye disease/infection	1.0	10.5	17.6	70.8
Others	33.3	38.7	22.7	5.3

Among the least common, the highest percentage is scored by respiratory diseases and eye diseases. While fever may be a general symptom for many diseases including malaria, diarrhoea is closely related to unsafe water. The fact that these diseases are pointed out as common means that there are frequent

opportunities for transmission of these diseases via contaminated water and it is important that people get access to safe water.

It can therefore be concluded that improving access to safe water will reduce the incidence of these diseases and their debilitating effects and enhance families' livelihoods and incomes.

TABLE 3.1-28B SERIES - PREVALENCE OF WATER BORNE DISEASES – RGC WISE

### Tubur

Diseases	Very common %	Common %	Rare %	Very rare %
Fever	59.1	40.9	0.0	0.0
Diarrhoea	9.1	36.4	36.4	18.2
Skin Disease	0.0	9.1	27.3	63.6
Respiratory disease	0.0	27.3	31.8	40.9
Worms	9.1	40.9	22.7	27.3
Eye disease/infection	4.5	0.0	18.2	77.3
Others	33.3	0.0	33.3	33.3

### Kidetok

Diseases	Very common %	Common %	Rare %	Very rare %
Fever	57.1	32.7	10.2	0.0
Diarrhoea	10.2	44.9	28.6	16.3
Skin Disease	0.0	10.2	24.5	65.3
Respiratory disease	2.0	32.7	22.4	42.9
Worms	2.0	34.7	30.6	32.7
Eye disease/infection	0.0	6.1	14.3	79.6
Others	35.7	57.1	0.0	7.1

### Kapala

Diseases	Very common %	Common %	Rare %	Very rare %
Fever	65.5	34.5	0.0	0.0
Diarrhoea	3.4	44.8	34.5	17.2
Skin Disease	3.4	17.2	20.7	58.6
Respiratory disease	3.4	27.6	17.2	51.7
Worms	0.0	34.5	20.7	44.8
Eye disease/infection	0.0	6.9	17.2	75.9
Others	44.4	44.4	0.0	11.1

### Kameke

Diseases	Very common %	Common %	Rare %	Very rare %
Fever	62.5	12.5	25.0	0.0
Diarrhoea	6.3	37.5	18.8	37.5
Skin Disease	0.0	31.3	25.0	43.8
Respiratory disease	0.0	25.0	12.5	62.5
Worms	0.0	31.3	25.0	43.8
Eye disease/infection	0.0	6.3	18.8	75.0
Others	20.0	0.0	80.0	0.0

### Kasasira

Diseases	Very common %	Common %	Rare %	Very rare %
Fever	62.1	31.8	6.1	0.0
Diarrhoea	4.5	45.5	36.4	13.6
Skin Disease	1.5	24.2	25.8	48.5

Respiratory disease	4.5	43.9	9.1	42.4
Worms	3.0	25.8	27.3	43.9
Eye disease/infection	0.0	21.2	7.6	71.2
Others	50.0	35.7	14.3	0.0

#### Buseta

Diseases	Very common %	Common %	Rare %	Very rare %
Fever	66.7	20.8	12.5	0.0
Diarrhoea	8.3	29.2	41.7	20.8
Skin Disease	0.0	4.2	25.0	70.8
Respiratory disease	0.0	12.5	16.7	70.8
Worms	0.0	33.3	29.2	37.5
Eye disease/infection	0.0	0.0	29.2	70.8
Others	40.0	20.0	40.0	0.0

#### Naigobya

Diseases	Very common %	Common %	Rare %	Very rare %
Fever	63.6	27.3	9.1	0.0
Diarrhoea	9.1	31.8	27.3	31.8
Skin Disease	0.0	18.2	22.7	54.5
Respiratory disease	0.0	13.6	22.7	63.6
Worms	9.1	18.2	18.2	54.5
Eye disease/infection	0.0	9.1	27.3	63.6
Others	0.0	66.7	0.0	33.3

#### Kyanvuma

Diseases	Very common %	Common %	Rare %	Very rare %
Fever	63.6	22.7	4.5	9.1
Diarrhoea	0.0	38.6	29.5	31.8
Skin Disease	2.3	6.8	18.2	72.7
Respiratory disease	0.0	20.5	25.0	54.5
Worms	4.5	25.0	18.2	52.3
Eye disease/infection	0.0	11.4	6.8	81.8
Others	14.3	42.9	28.6	14.3

#### Lambala

Diseases	Very common %	Common %	Rare %	Very rare %
Fever	54.5	31.8	4.5	9.1
Diarrhoea	9.1	31.8	22.7	36.4
Skin Disease	0.0	4.5	36.4	59.1
Respiratory disease	0.0	36.4	22.7	40.9
Worms	0.0	27.3	18.2	54.5
Eye disease/infection	0.0	9.1	13.6	77.3
Others	66.7	0.0	33.3	0.0

#### Nondwe

Diseases	Very common %	Common %	Rare %	Very rare %
Fever	67.1	18.6	8.6	5.7
Diarrhoea	8.6	42.9	28.6	20.0
Skin Disease	0.0	17.1	34.3	48.6
Respiratory disease	1.4	20.0	28.6	50.0
Worms	4.3	35.7	25.7	34.3
Eye disease/infection	1.4	10.0	27.1	60.0

Others	0.0	50.0	50.0	0.0
--------	-----	------	------	-----

#### Nambale – prevalence of water borne diseases

Diseases	Very common %	Common %	Rare %	Very rare %
Fever	50.0	36.7	13.3	0.0
Diarrhoea	10.0	26.7	43.3	20.0
Skin Disease	0.0	36.7	26.7	36.7
Respiratory disease	3.3	10.0	23.3	63.3
Worms	3.3	30.0	33.3	33.3
Eye disease/infection	3.3	20.0	23.3	53.3
Others	0.0	50.0	50.0	0.0

#### Main cause of diseases.

Unsafe water was most highly associated with Diarrhoea. This association is accurate scientifically and shows a high level of awareness of the relationship between the diseases and unsafe water. Fever was also highly associated with mosquitoes and this correlation is accurate as well.

TABLE 3.1-29 MAIN CAUSE OF DISEASES

Disease	Cause 1	Frequency	Cause 2	Frequency	Cause 3	Frequency
Fever	Mosquitoes or Mosquito bites	335	Dirty or unsafe water	33	Others	7
Diarrhea	Unsafe, dirty, bad water	176	Dirty environment, Poor sanitation at home	47	Contaminated, dirty food	89
Skin Disease	Contact with infected person or Sharing clothes	39	Unsafe or Contaminated water	97	Work done e.g. Rice growing, grazing etc.	6
Respiratory diseases	Contaminated water and food	30	Malaria	39	Smoking (cigarettes)	7
Worms	Using dirty, Contaminated or Unsafe water	123	Eating contaminated food, fruits	67	Poor personal hygiene and sanitation	30
Eye disease/infection	Smoke, dust, contaminated air	186	Using dirty or contaminated water	22	Flies	4

While these figures may not give an indication of the absolute levels of accurate information in the communities, they give an indication that people are in general aware about the relationship between unsafe water and unhygienic practices with sickness and are likely therefore to appreciate and value safe water. Moreover with this level of awareness, the introduction of safe water will lead to improvements in health and hygiene.

But there were some strange associations as well. For instance the people associated respiratory diseases with malaria

#### Remedies for diseases

Table 3.1-30 below shows the most frequently named remedies in connection with the water borne diseases in the survey area.

When the remedies to the various diseases are examined, it is clear that the first line remedy for almost all diseases is to seek medication from a health facility. However coming a close second for most diseases

is the preventive measures which include the use of mosquito nets for malaria, and safe water and good hygiene practices. This level of awareness of the fact that use of safe water and hygienic practices will reduce the incidence of diseases means that improving access to safe water will quickly lead to benefits in health and welfare. Moreover it also means that with a premium on safe water, there will be motivation for effective O and M including the regular payment of user fees.

TABLE 3.1-30 REMEDIES TO DISEASES.

Disease	Remedy 1	Frequency	Remedy 2	Frequency	Remedy 3	Frequency
Fever	Go to hospital or buy medicine	192	Sleep under mosquito net	181	Clear compound of grass or Stagnant water	14
Diarrhea	Go to hospital or health centre	71	Buy or take medicine	99	Use safe or treated water	99
Skin Disease	Go to hospital or Clinic	85	Buy medicine or smear with Creams	58	Improve personal and general hygiene	114
Respiratory diseases	Go to hospital or Health centre	120	Buy or use medicine	67	Use safe, clean, treated water	29
Worms	Go to health centre, Hospital or Clinic	42	Buy medicine and Deworm	79	Avoid contaminated, uncooked, raw foods or fruits	187
Eye disease/infection	Go to health centre, clinic or hospital	75	Buy, use medicine or eye drops	64	Wash face and eyes regularly with soap	111

### 3.1.5b Water and Health Problems in the HH

This study sought to establish the most felt water and health problem in the HHs. Overall the problem that most people gave the highest priority is “too many people at the same water source”. The problem that was named most frequently in the second priority is “water source is too far”. The pattern of ranking was generally similar in almost all the RGCs.

The graph below shows the ranking of the frequency with which specific problems were named at the different priorities in the study area. It can be seen that the problem “Water source is too far” also has a high number of mentions in priority 2.

Figure 3.1-22 problems with HH water supply

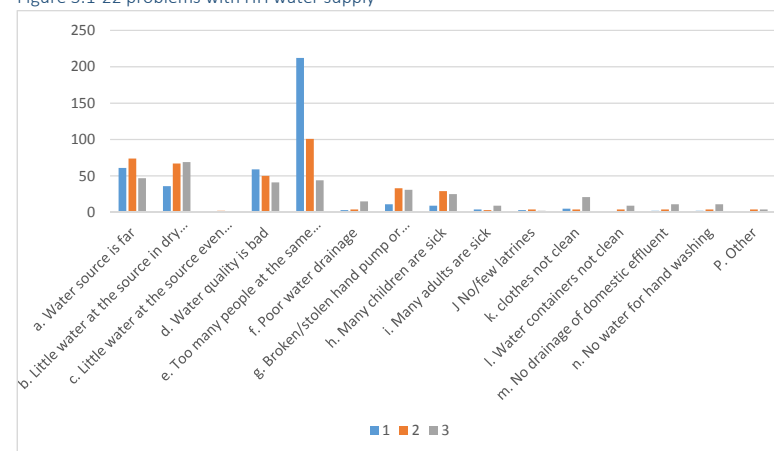

Where the respondents indicated that the water quality is bad, the study sought to understand what they meant by bad. Figure 3.1-23 below shows the relative priority of each of the water problems based on the number of people who mentioned it.

Figure 3.1-23 Problem with water quality

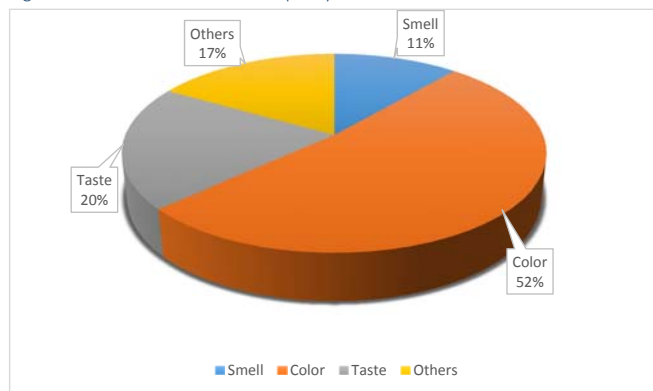

“Colour” was named at the top problem. This was followed by “taste 20% and then “others”-17% Smell was mentioned the fewest times at 11%. (Smell is usually associated with brackish water. Members of the study team examined one such a borehole in Lambala RGC and noted that although the water had been proved fit for human consumption, its smell and taste were really bad. Sparkling particles in water are usually associated with silica which should not be a problem except in cases where the development of the borehole was faulty or where there has been a caving in.) Among the other problems mentioned are visible living organisms and algae as well as the fact that the water is hard – does not foam easily.

3.1.5c Details on sickness of children and adults

Where the problem of “Children are sick” was named, the study sought to find out the maladies that the respondent were talking about. Figure 3.1-24 below show the sicknesses that were named and their priority based on the number of times that they were named.

Figure 3.1-24 Sicknesses of children and adults.

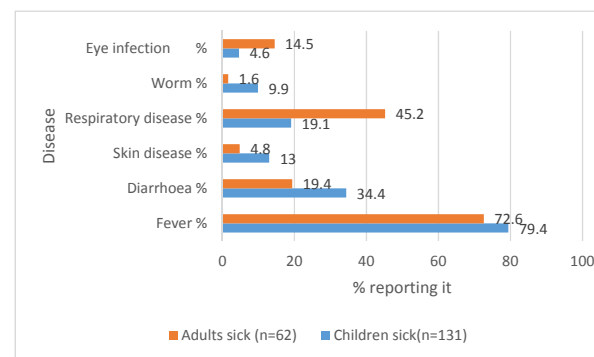

It can be seen from the graph that with respect to children, fever is the most pressing sickness followed by skin diseases. As noted before, while fever is a symptom for many different diseases, in Uganda it is mostly associated with Malaria. Both malaria and skin diseases are linked to water although the more direct link to dirty water is with skin disease.

Unlike with children where diarrhoea then features as the second most significant sickness, the second most significant disease for adults is respiratory disease. Eye infections and respiratory diseases are prominent among adults while fever, diarrhoea, skin diseases and worms are more prominent among children. Diarrhoea and worms are frequent in conditions of unsafe water combined with ignorance, paving the way for transmission. This may explain why they are more prevalent among children who are more ignorant about their transmission than adults.

3.1.5d Purchase of medicine and receiving treatment

Responses in this study indicated that the main reaction to all sicknesses is going to hospital or taking medicine. While this trend is positive, the guidelines from the ministry of health may differ from disease to disease. For fever, self-medication with recommended malaria drugs is recommended especially where hospitals are far. For diarrhoea, self-medication is recommended as a first aid but treatment should be at a hospital or a medical facility. Thus for some ailments, self-medication may not be a recommended practice.

Respondents reported that they bought medicine an average of 44 times in the last year. This comes to between three times to four times a month. Respondents also reported that they received medical treatment an average of 10.6 times. This is about once a month. Both indicate a fairly high level of frequency of ailments. Although such ailments may be small, given that the most frequently named diseases are fever and diarrhoea/respiratory infections, it appears that a lot of time may be lost in debilitation and health seeking for the residents.

TABLE 3.1-31A PURCHASE OF MEDICINE AND RECEIVING TREATMENT IN LAST YEAR – RGC WIDE

	Min	Max	Mean	mode
Times bought medicine	0	720	44.4	20
Times received treatment	0	14	10.6	10

TABLE 3.1-31B PURCHASE OF MEDICINE AND RECEIVING TREATMENT IN LAST YEAR – RGC WIDE

	Acuna				Tubur				Kidetok			
	Min	Max	Mean	mode	Min	Max	Mean	mode	Min	Max	Mean	mode
Times bought medicine	10	120	36.60	30	5	120	34.36	15	0	84	28.67	20
Times received treatment	2	18	6.60	3	0	28	10.09	10	0	72	9.98	5

	Kapala				Kameke				Kasasira			
	Min	Max	Mean	mode	Min	Max	Mean	mode	Min	Max	Mean	mode
Times bought medicine	0	99	36.28	20	3	100	26.38	30	0	720	56.45	10
Times received treatment	1	70	12.14	3	0	25	8.44	10	0	144	8.55	0

	Buseta				Naigobya				Kyanvuma			
	Min	Max	Mean	mode	Min	Max	Mean	mode	Min	Max	Mean	mode
Times bought medicine	3	120	27.83	10	2	192	43.36	20	1	360	68.73	20
Times received treatment	0	48	9.50	3	0	20	4.77	0	0	96	10.25	4

	Lambala				Nondwe				Nambale			
	Min	Max	Mean	mode	Min	Max	Mean	mode	Min	Max	Mean	mode
Times bought medicine	6	100	37.29	20	3	300	57.28	20	0	90	27.67	20
Times received treatment	0	90	13.09	10	0	90	13.06	3	0	60	15.63	10

### 3.1.5e Conclusion on water and health problems of the household.

The biggest water problem for households is “too many people use the same source” This speaks to the congestion at the water sources in particular the boreholes which are the source used by most of the respondents. “Water source is too far” and “water quality is bad” also featured fairly prominently.

With regard to quality mentioned above, the biggest problem is colour, while the least is smell.

The most prevalent sickness among adults and children is fever, but the second most prominent for adults is respiratory infections while for children it is diarrhoea.

In reaction to sickness, respondents reported that they bought medicine about 3 times a month and they received treatment about once a month in the previous year. This is a high frequency and may be associated with limited safe water supplies. This frequency of sickness will potentially affect production, productivity, income generation and livelihood.

### 3.1.6 Effects of water fetching

Figure 3.1-25 below compares the people who agree that water fetching has an impact on women and children and those who do not.

Figure 3.1- 25 Effects of water fetching.

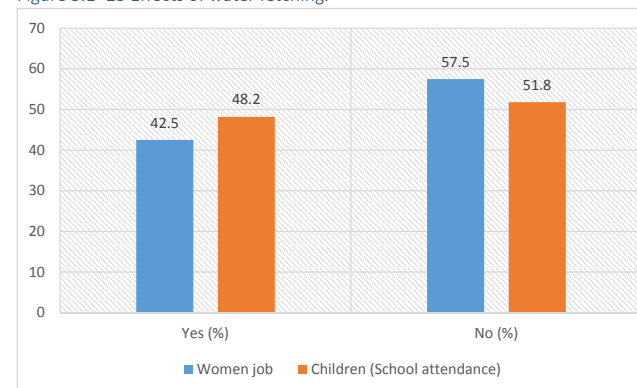

The 42.5% feel that water fetching has adverse effects on job opportunities for women while 48.2% feel that it has adverse effects on school attendance for children. Though slightly less than a half of the respondents, the proportion which agrees is significant and shows that taken together as a region,

the impact could be big in terms of both household welfare and school performance for children. Table 3.1-32a below shows the adverse effects as presented by the respondents.

A range of impacts on children’s school attendance were mentioned. Most of the people felt that water fetching leads children to get to school late thus losing valuable time. For women, the same effect of getting late to work was named most frequently. Other impacts named in relation to women included limited time for the work at home. The impact, both for women and children are shown in the tables 3.1-32a and 3.1-32b below. Most of these effects stem from the fact the women and girls, followed by boys fetch water most and spend considerable amount of time doing the same.

### Effects on job opportunity for women

TABLE 3.1-32A ADVERSE EFFECTS OF WATER FETCHING ON JOB OPPORTUNITY OF WOMEN (N=174) RGC WIDE

Item (effect)	Frequency	Percentage
Reporting late for work, opening business late	43	25.0
Loss of customer or business while fetching water	45	26.2
Other work suffers due to time spent collecting water	12	7.0
Carrying water affects a woman's health	8	4.7
Takes time for other domestic work	64	37.2
<b>Total</b>	<b>172</b>	<b>100</b>

TABLE 3.1-32B ADVERSE EFFECTS OF WATER FETCHING ON JOB OPPORTUNITY OF WOMEN - RGC WIDE

Item (effect)	Acuna		Tubur	
	Frequency	Percentage	Frequency	Percentage
Reporting late for work, opening business late	0	0.0	3	30.0
Loss of customer or business while fetching water	2	28.6	6	60.0
Other work suffers due to time spent collecting water	0	0.0	0	0.0



Carrying water affects a woman's health	0	0.0	1	10.0
Takes time for other domestic work	5	71.4	0	0.0
<b>Total</b>	<b>7</b>	<b>100</b>	<b>10</b>	<b>100</b>

Item (effect)	Kidetok		Kapala	
	Frequency	Percentage	Frequency	Percentage
Reporting late for work, opening business late	10	34.5	6	42.9
Loss of customer or business while fetching water	11	37.9	3	21.4
Other work suffers due to time spent collecting water	2	6.9	0	0.0
Carrying water affects a woman's health	1	3.4	0	0.0
Takes time for other domestic work	5	17.2	5	35.7
<b>Total</b>	<b>29</b>	<b>100</b>	<b>14</b>	<b>100</b>

Item (effect)	Kameke		Kasasira	
	Frequency	Percentage	Frequency	Percentage
Reporting late for work, opening business late	4	40.0	8	26.7
Loss of customer or business while fetching water	1	10.0	8	26.7
Other work suffers due to time spent collecting water	0	0.0	3	10.0
Carrying water affects a woman's health	1	10.0	3	10.0
Takes time for other domestic work	4	40.0	8	26.7
<b>Total</b>	<b>10</b>	<b>100</b>	<b>30</b>	<b>100</b>

Item (effect)	Buseta		Naigobya	
	Frequency	Percentage	Frequency	Percentage
Reporting late for work, opening business late	1	14.3	1	20.0
Loss of customer or business while fetching water	1	14.3	3	60.0
Other work suffers due to time spent collecting water	0	0.0	1	20.0
Carrying water affects a woman's health	0	0.0	0	0.0
Takes time for other domestic work	5	71.4	0	0.0
<b>Total</b>	<b>7</b>	<b>100</b>	<b>5</b>	<b>100</b>

Item (effect)	Kyanvuma		Lambala	
	Frequency	Percentage	Frequency	Percentage
Reporting late for work, opening business late	4	28.6	1	25.0
Loss of customer or business while fetching water	4	28.6	0	0.0
Other work suffers due to time spent collecting water	2	14.3	0	0.0
Carrying water affects a woman's health	0	0.0	0	0.0
Takes time for other domestic work	4	28.6	3	75.0
<b>Total</b>	<b>14</b>	<b>100</b>	<b>4</b>	<b>100</b>

Water fetching on job opportunity of women	Nondwe		Nambale	
	Frequency	Percentage	Frequency	Percentage
Reporting late for work, opening business late	1	3.8	4	30.8
Loss of customer or business while fetching water	3	11.5	0	0.0
Other work suffers due to time spent collecting water	2	7.7	2	15.4
Carrying water affects a woman's health	1	3.8	1	7.7
Takes time for other domestic work	19	73.1	6	46.2
<b>Total</b>	<b>26</b>	<b>100</b>	<b>13</b>	<b>100</b>

#### Effects on school attendance for children

Besides the main responses included in the table below for children, parents also mentioned that children often have to walk to school in dirty uniforms due to the fact that they get wet and muddy when they go to fetch water in the morning.

TABLE 3.1-33A. ADVERSE EFFECT OF WATER FETCHING ON SCHOOL ATTENDANCE FOR CHILDREN (N=195)

Item (effect)	Frequency	Percentage
Reach school late or miss some lessons	165	84.6
Poor attendance, can't focus due to fatigue	11	5.6
They get seduced at water source resulting into early pregnancy	4	2.1
Poor performance in class due to poor attendance	15	7.7
<b>Total</b>	<b>195</b>	<b>100</b>

This attracts ridicule on them. Children fail to do their homework due to delaying at the water source and sometimes sheer fatigue after carrying jerry cans of water. Cases were mentioned where children were noted to deliberately delay at school so as to avoid the work of fetching water. Cases of poor health associated with carrying heavy jerry cans of water were also mentioned. Clearly the impact of fetching water on women and school going children is significant and the new water facilities have the potential to reduce these impacts and to improve the welfare of women and children in the target area.

TABLE 3.1-33B SERIES - ADVERSE EFFECT OF WATER FETCHING ON SCHOOL ATTENDANCE FOR CHILDREN – RGC WISE.

Item (effect)	Acuna		Tubur	
	Frequency	Percentage	Frequency	Percentage
Reach school late or miss some lessons	8	100.0	13	81.3
Poor attendance, can't focus due to fatigue	0	0.0	1	6.3
They get seduced at water source resulting into early pregnancy	0	0.0	0	0.0
Poor performance in class due to poor attendance	0	0.0	2	12.5
<b>Total</b>	<b>8</b>	<b>100</b>	<b>16</b>	<b>100</b>

Item (effect)	Kidetok		Kapala	
	Frequency	Percentage	Frequency	Percentage
Reach school late or miss some lessons	23	85.2	16	100.0
Poor attendance, can't focus due to fatigue	2	7.4	0	0.0
They get seduced at water source resulting into early pregnancy	0	0.0	0	0.0
Poor performance in class due to poor attendance	2	7.4	0	0.0
<b>Total</b>	<b>27</b>	<b>100</b>	<b>16</b>	<b>100</b>

Item (effect)	Kameke		Kasasira	
	Frequency	Percentage	Frequency	Percentage
Reach school late or miss some lessons	8	88.9	33	94.3
Poor attendance, can't focus due to fatigue	1	11.1	1	2.9
They get seduced at water source resulting into early pregnancy	0	0.0	0	0.0
Poor performance in class due to poor attendance	0	0.0	1	2.9
<b>Total</b>	<b>9</b>	<b>100</b>	<b>35</b>	<b>100</b>

Item (effect)	Buseta		Naigobya	
	Frequency	Percentage	Frequency	Percentage
Reach school late or miss some lessons	7	70.0	4	50.0
Poor attendance, can't focus due to fatigue	0	0.0	1	12.5
They get seduced at water source resulting into early pregnancy	0	0.0	2	25.0
Poor performance in class due to poor attendance	3	30.0	1	12.5
<b>Total</b>	<b>10</b>	<b>100</b>	<b>8</b>	<b>100</b>

Item (effect)	Kyanvuma		Lambala	
	Frequency	Percentage	Frequency	Percentage
Reach school late or miss some lessons	15	93.8	6	85.7
Poor attendance, can't focus due to fatigue	0	0.0	0	0.0
They get seduced at water source resulting into early pregnancy	0	0.0	0	0.0
Poor performance in class due to poor attendance	1	6.3	1	14.3
<b>Total</b>	<b>16</b>	<b>100</b>	<b>7</b>	<b>100</b>

Adverse Effect of water fetching on school attendance for children	Nondwe		Nambale	
	Frequency	Percentage	Frequency	Percentage
Reach school late or miss some lessons	15	62.5	17	89.5
Poor attendance, can't focus due to fatigue	5	20.8	0	0.0
They get seduced at water source resulting into early pregnancy	0	0.0	2	10.5
Poor performance in class due to poor attendance	4	16.7	0	0.0
<b>Total</b>	<b>24</b>	<b>100</b>	<b>19</b>	<b>100</b>

### 3.1.7 Income and Expenditure of Households

#### 3.1.7a Formal Employment Income

This study also sought to establish the level of formal employment among the different members of the households, both men and women in the RGCs. Overall the responses show that more men report formal employment than women. In most of the wage employment the reason for the predominance of men are both domestic and work place based. At home men prefer that their spouses stay at home to look after the home and the children and even take care of the garden, animals and children – what one could call the home economy. This study has already revealed that female household members are charged with domestic chores and just a handful of them (13.7%) work for wages or salaries. Besides, the low literacy rate of women also negates their quest for formal employment compared to men. It is not surprising therefore that outside the domestic chores, many women are engaged in farming. At work, men tend to be more reliable due to the fact that they have no child bearing duties. Moreover being the head of the family, the man can report on time and even leave after time if work demands since he does not have to answer to anyone about this. Table 3.1-34 below shows the HH members that are in formal employment.

TABLE 3.1-34 HH MEMBERS IN SALARIED/WAGE EMPLOYMENT

Salary/wage earner	Times mentioned	Yearly wage		
		Min	Max	Average n=116
Father	90	360,000	22,840,000	5,098,066
Mother	43			
Daughter	8			
Son	6			

The majority of HH members in salaried employment are men. In fact the number of men—including the sons nearly doubles that of women. It is now widely believed that women's income has a greater

effect on HH welfare per unit for income than men (Jane Hopkins 1994). However it is encouraging to note that the number of daughters exceeds that of sons which may point to a trend where more women will be in salaried employment in the next ten years.

A small proportion of these, i.e. 15.6 % of all the women that report formal employment are named as daughters. This is understandable since the norm is that by the time girls start formal employment, they are also ready to set up homes of their own.

The incomes from this employment varied from a minimum of Shs 360,000 per year to a maximum of Shs 22,840,000 per year.

TABLE 3.1-35 DETAILS ON WAGE/SALARY EMPLOYMENT HH

No of salaried members	Count	% of all HH	Total income	Average income per HH
0	285	71.6	-	-
1	87	21.3	350,808,600	4,032,283
2	28	6.6	31,800,000	1,177,778
3	2	0.5	31,800,000	15,900,000

A total of 116 HH or 28.6% reported having one or more members in wage employment. Table 3.1-35 shows some details on HH which reported someone in wage employment. From the table it can be seen that the majority of HH in the sample have no one in wage employment. It can also be seen that the total wage income increases with the number of people in wage employment with the average for HH with a single employed member being Shs 4,032,283 while the average for HH with three employed members is Shs 15,900,000.

#### 3.1.7b Contribution of wage income to total HH income

When the proportion that wage income contributes to HH income is analysed, the results show that where household have both wage and non-wage income, wage income tends to contribute a higher proportion to the HH income. This is illustrated in the table below

TABLE 3.1-36 CONTRIBUTION OF WAGE INCOME TO HH INCOME.

	Wage income	Non-wage income	Total income from salary and sale of items
Min	360,000	20,000	-
Maximum	22,840,000	24,000,000	24,000,000
Average	5,098,066	2,960,621	4,232,798
Mode	4,800,000	1,800,000	1,200,000

All homes that reported wage and salary income also reported earning income from the production and sale of items. However the majority of HH earn their income entirely from the production and sale of items.

Analysis was undertaken to establish if women headed HHs fare worse in terms of income in comparison with HH with both man and woman. The analysis shows that the average income of female headed HH is 2,616,364 which is slightly over half of the average income of the typical HH with both man and woman. By implication, the welfare of residents of female headed HHs is likely to be at a lower level than that in HH that have both spouses.

### 3.1.7c Production and selling of items

#### Significance of different sources

Analysis of the different sources of income indicates that most people reported the selling of agricultural crops as a source of income. This was followed by the “selling of animals” which was mentioned as many times as “commercial activity”. The source mentioned least was selling of labour.

When the production and selling of different items is examined by gender, data shows that the income of women is much less than that of men when it comes to the sale of animals and agricultural crops by almost 50%. However the average income of women from the sale of labour is higher than that of men by about 200% with the average income for women being 1,644,100 while that of men from the same source is at 561,100. Average income from commercial activity is nearly the same for both men and women.

Figure 3.1- 26 HH involved in different activities for income generation

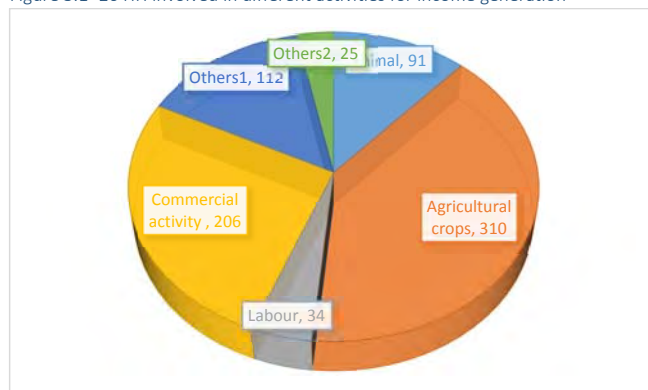

The average income of HH members from production and selling of items was US\$ 2,960,698 = (excluding those who did not report any income from this source at all). A comparison of the average income from the production and sale of items with income from wage employment shows that wage employment has a higher average annual income Shs 5,054,492 =, than production and sale of items. However only 117 respondents out of the 409 reported any income from wage employment.

TABLE 3.1-37 COMPARISON OF INCOMES OF WAGE EARNERS AND THOSE WHO PRODUCE AND SELL ITEMS

	Wage	Produce sales
Min	360,000	20,000
Max	22,840,000	24,000,000
Average	5,098,066	2,960,698
	n-116	n-385

Thus while more people are earning from production and sale of items, the average income of people involved in wage employment is higher by about Shs 2,093,794 or 70.7 % of the average income of those who report sale of produce.

TABLE 3.1-38 COMPARISON OF AVERAGE INCOME FROM SALE OF DIFFERENT ITEMS PRODUCED.

Income from other activities	Annual selling and production income		
	Min	Max	Mean
Animal	40,000	12,000,000	204,128
Agricultural crops	16,000	24,000,000	900,525
Labour	45,000	14,400,000	70,922
Commercial activity	25,000	18,000,000	1,058,306
Other 1	20,000	14,400,000	426,836
Other 2	84,000	21,600,000	127,643

The items that appears to be bringing in the highest income is “commercial activity” which is mostly trading and conducting businesses of different kinds. Commercial activity had the advantage of not being subject to conditions such as the weather and the cycles of dry and wet season.

These are a major cause of fluctuation of incomes with harvest season being a time of selling and getting income and planting seasons being one of financial scarcity since there is nothing to sell to get money. The contribution of the different items is shown graphically in figure 3.1-27 below.

Figure 3.1- 27 Production and sale of items – contribution of different sources

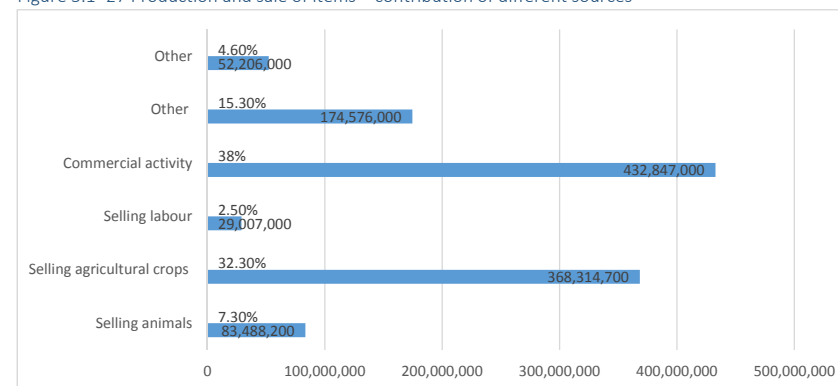

One of the categories under production and sale of items is “others”. The main items mentioned in this category are listed in table 3.1-38 below.

TABLE 3.1-39 ACTIVITIES MENTIONED IN “OTHERS”

Others 1	Frequency	Others 2	Frequency
Technical or Mechanical work	16	Fishing	1
Renting or Real Estate	18	Pension earner	1
Professional services	11	Renting	5
Others	5	Stone quarrying	1

The item mentioned most frequently is renting or real estate followed by mechanical worker.

### Household member in charge

Examination of the HH member in charge shows that for most of the activity, it is the father/husband or man that is in charge. The mother comes second in all the activities except "other". Just like in wage income therefore, most of the income from the production and sale of items is generated by the man. One of the reasons for this is that in all the communities surveyed, the man is often the one who controls the land and therefore has a say on what is produced and how it is sold. However, it should also be noted that there is a division of roles in homes which lays the responsibility of providing for the family squarely on the man and this may provide an impetus for the man to manage most of the cultivation and production with the other members of the family technically "providing labour".

When the gap between the man and the woman is examined. It can be seen that it is smallest with commercial activities. This may point to the greater skill and prowess of women in business or it may be that this is the area where women have more freedom to control resources and earnings. Many women run small businesses near home from where they earn income to supplement that which comes from the sale of agricultural produce. But this cannot be discussed in isolation of the fact that women are supposed to accomplish most of the household chores including taking care of the young ones. Therefore by running small businesses near their homes, they are able to attend to all their domestic roles and also bring home extra income.

TABLE 3.1-40 HOUSEHOLD MEMBERS IN CHARGE

	Father %	Mother %	Son %	Daughter %	Father and mother %
Animals	73.6	17.6	0.0	0.0	8.8
Agricultural production	55.3	27.5	0.0	0.3	16.8
Labour	60.6	24.2	3.0	0.0	12.1
Commercial activity	52.9	39.3	0.5	1.9	4.4
Other 1	52.3	38.7	1.8	0.9	5.4
Other 2	40.0	48.0	4.0	0.0	4.0

### 3.1.7d Seasonality of incomes

Respondents were asked if there was a seasonality to incomes i.e. a time of low income and a time of high income in the course of the year. 75% indicated that there is a time of low income and a time of high income. An analysis of the low income times and high time seasons shows that the month that is reported by the majority as a high income month is December while the one reported most as a low income month January.

Figure 3.1- 28 Seasonality of incomes

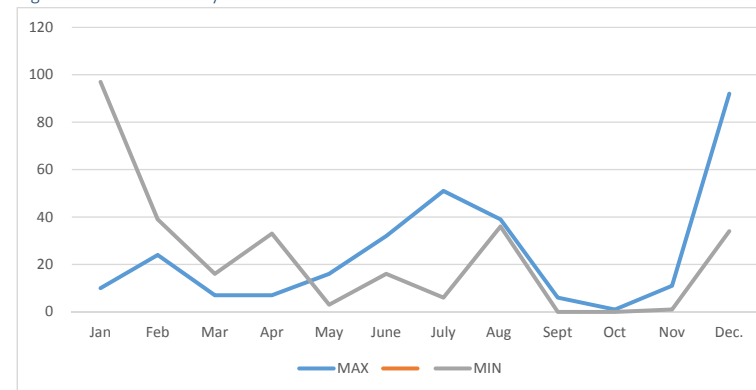

July is also reported as high income month by a significant number of people while August is also reported by a significant number of people as a low income month. It is significant that the low income months are juxtaposed with the high income months though given the nature of agricultural crop sales, it may not be surprising. Once the crop for the season is sold, the next month may be completely without income. These are dictated by the rain cycle. Not surprisingly these periods coincide with the periods of high income and low income respectively.

### 3.1.7e Livestock in the HHs

An examination of the data on livestock shows that most HHs do not have pigs. On average, each HH has one cow and one goat and 6 fowl including chicken and ducks. This is not surprising as pigs are highly sensitive in communities where there are people of the Muslims faith – and the religious profile of the survey area as seen in section 3.1.1a shows that Muslims constitute a significant proportion of the population especially in Iganga district. Cows are also labour intensive if they have to be kept in confined spaces (zero grazing) as those available in a typical home in any of the RGCs. The most convenient to keep are the chicken and duck and the data shows that on average each HH has some 6 of them.

TABLE 3.1-41 LIVESTOCK IN THE HHs

Livestock	Total	Min	Max	Mean
Cattle	392	0	30	1
Pigs	108	0	20	0.3
Goats	486	0	12	1
chicken	2,405	0	200	5.94

However, while fowl may be a source of income, most times, in setting such as those in the RGCs, they are kept for eating and not for sale. People who keep chicken and duck (fowl) for sale usually have 30 or more fowl. Table 3.1-42 and figure 3.1-29 below compare the livestock in the different RGCs and it can be seen from the table that when it comes to cows, Kasasira has the highest while Lambala has the fewest. Pigs are not existent in Nondwe and Lambala and Kidetok has the highest number of pigs. Kasasira also has the highest number of goats while Lambala has the fewest. In terms of total number of livestock, Kasasira has the highest number while Acuna and Lambala have the fewest.

TABLE 3.1-42 LIVESTOCK IN THE DIFFERENT RGCs

RGC	NAMBA LE	NOND WE	LAMBA LA	KYANVU MA	NAIGOB YA	KASASI RA	BUSET A	KAME KE	KAPAL A	KIDET OK	TUBU R	ACUN A
Cattle	22	15	12	17	40	83	39	19	29	75	24	17
Pigs	2	0	0	28	11	5	4	8	11	30	3	6
Goats	37	48	12	34	22	88	30	26	60	74	39	16
chicken	235	236	53	260	92	460	313	56	210	418	58	14

Figure 3.1- 29 Number of livestock in the different RGCs

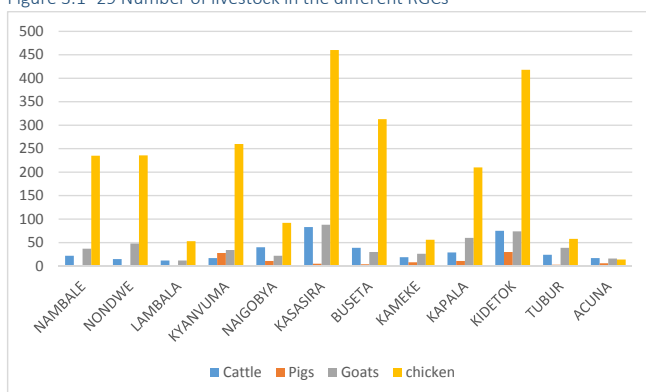

### 3.1.3f Remittances to the HHs

Remittances to HH can be a major source of income for some homes. Remittances can be from relatives living in the city or those working in developed economies in Europe or America, who send back money periodically to take care of their relatives. Out of the 409 respondents, only 93 or 23.5% report receiving any remittances. The amount ranged from Shs 20,000 per year to Shs 11,400,000/= per year on the high side. Compared to the other sources of income namely wage income and sale of produce, remittances constitute a smaller proportion of the income of the HH in the survey area. Nevertheless they are not an insignificant source. The comparison of the proportions that each of the sources roughly contributes to HH is given in table 3.1-43 below.

TABLE 3.1-43 COMPARISON OF THE DIFFERENT SOURCES OF INCOME

	Wage	Produce sales	Remittances (annual)
Min	360,000	-	20,000
Max	22,840,000	24,000,000	11,400,000
Average	5,098,066	2,968,409	735,988
	n-115	n-384	n-96

### 3.1.7g Total annual incomes of HHs

The total annual incomes of HH ranges from a minimum of Shs 100,000 (USD 29.8) to a maximum of Shs 30,000,000/= (USD 8,955). The average total income for all respondents stands at US\$ 4,448,072. (USD 1,327.7) This comes to USD 3.6 a day for a household. Note that the average HH size is 8 people in this study.

TABLE 3.1-44 TOTAL ANNUAL INCOME

Min	Max	Mean	Mode
100,000	30,000,000	4,448,072	1,800,000

According to the World Bank anyone living on less than USD1.90 a day is living in poverty. This threshold converts to a total annual income of Ushs 2,323,225 per person. Data shows that 184 HH or 44.9% receive less income than this threshold. Given an average of 8 people per household, a typical household would need USD 5,548 or Shs 18,585,800 annually just to meet the threshold above. Only 8 HH are earning enough to meet this criteria in the study area meaning that technically some 401HH or 92% are living in abject poverty.

Of course these hard statistics have to be interpreted with context in mind. Many people in semi urban setting live semi subsistence lives and money assumes a less significant role in their lives. Nevertheless with these levels of poverty the cost associated with accessing safe water needs to be kept as low as possible.

### 3.1.7h Role of mother or daughter in increasing income

The task of increasing household income is not exclusively tied on the shoulders of male members of the households alone. Directly or indirectly, women have contributed to the stability or increment in the incomes of many households. In this survey, 80.4% of the respondents pointed out that the mother and the daughter play part in increasing the income of the HH. What the mothers and daughters do to increase the HH income is summarised in table 3.1-44a below. The data relating to the respective RGCs is in table 3.1-45B series.

TABLE 3.1-45A WHAT MOTHERS AND DAUGHTERS DO TO INCREASE HH INCOME – RGC WIDE

(If mother or daughter has role in increasing income) the role	
Role	%
Farming and selling agricultural products or livestock	48.63
Earns salary in wage employment	8.51
Runs a personal business to earn money	41.64
Selling manual labour	0.61
Does domestic duties to allow man to focus on his paid work	0.91

TABLE 3.1-45B WHAT MOTHERS AND DAUGHTERS DO TO INCREASE HH INCOME – RGC WISE

(If mother or daughter has role in increasing income) the role	Acuna	Tubur	Kidetok	Kapala
Role	%	%	%	%
Farming and selling agricultural products or livestock	61.54	50.00	40.00	50.00
Earns salary in wage employment	0.00	15.00	13.33	7.69
Runs a personal business to earn money	38.46	35.00	46.67	42.31
Selling manual labour	0.00	0.00	0.00	0.00
Does domestic duties to allow man to focus on his paid work	0.00	0.00	0.00	0.00

(If mother or daughter has role in increasing income) the role	Kameke	Kasasira	Buseta	Naigobya
Role	%	%	%	%
Farming and selling agricultural products or livestock	73.33	50.00	57.89	50.00
Earns salary in wage employment	6.67	10.87	5.26	5.56
Runs a personal business to earn money	20.00	34.78	36.84	44.44
Selling manual labour	0.00	4.35	0.00	0.00
Does domestic duties to allow man to focus on his paid work	0.00	0.00	0.00	0.00

(If mother or daughter has role in increasing income) the role	Kyanvuma	Lambala	Nondwe	Nambale
Role	%	%	%	%
Farming and selling agricultural products or livestock	28.13	50.00	48.21	54.17
Earns salary in wage employment	6.25	6.25	3.57	16.67
Runs a personal business to earn money	59.38	43.75	46.43	29.17
Selling manual labour	0.00	0.00	0.00	0.00
Does domestic duties to allow man to focus on his paid work	6.25	0.00	1.79	

### 3.1.7i Expenditure of Households

#### Expenditure on various household needs

In figure 3.1-30 below, monthly and annual expenditure on various household needs is presented. From the graph it is evident that the highest expenditure item is education followed by food. The least expenditure is on charging the phone battery as well as on electricity. Water is one of the items where expenditure is quite small, in fact smaller than air time for the phone. However, it is notable that expenditure on sanitation is a little higher than that of water.

Figure 3.1- 30 Expenditure on various HH items

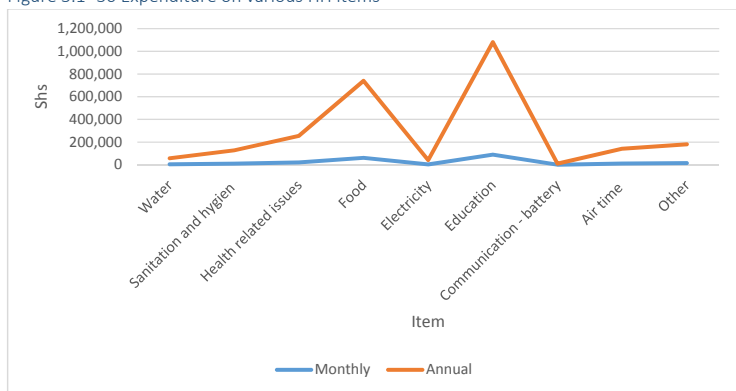

TABLE 3.1-46A EXPENDITURE ON WATER – RGC WIDE

	Monthly expenditure	Annual expenditure
Min	0	0
Max	120,000	1,440,000
Mean	4,793	57,512

Water is one of the basic items in life and it is essential for life. However as noted above the expenditure on water in the population surveyed is quite small. When compared to total annual expenditure, total expenditure

on water amounts to just 2.1% of total annual expenditure. Data on expenditure for the individual RGCs is shown in table 3.1-46B series.

TABLE 3.1-46B EXPENDITURE ON WATER-RGC WISE

	Acuna		Tubur		Kidetok	
	Monthly expenditure	Annual expenditure	Monthly expenditure	Annual expenditure	Monthly expenditure	Annual expenditure
Min	0	0	0	0	0	0
Max	10,000	120,000	52,000	624,000	52,000	624,000
Mean	1,850	22,200	8,635	103,618	8,896	106,751

	Kapala		Kameke		Kasasira	
	Monthly expenditure	Annual expenditure	Monthly expenditure	Annual expenditure	Monthly expenditure	Annual expenditure
Min	0	0	0	0	0	0
Max	20,500	246,000	25,500	306,000	25,000	300,000
Mean	2,097	25,166	4,478	53,738	2,019	23,861

	Buseta		Naigobya		Kyanvuma	
	Monthly expenditure	Annual expenditure	Monthly expenditure	Annual expenditure	Monthly expenditure	Annual expenditure
Min	0	0	0	0	0	0
Max	14,500	174,000	45,000	540,000	52,000	624,000
Mean	1,833	22,000	7,542	90,500	5,177	62,127

	Lambala		Nondwe		Nambale	
	Monthly expenditure	Annual expenditure	Monthly expenditure	Annual expenditure	Monthly expenditure	Annual expenditure
Min	0	0	0	0	0	0
Max	120,000	1,440,000	24,208	290,496	9,500	114,000
Mean	8,389	100,664	4,931	59,176	2,464	29,564

To compare the expenditure on water in the different RGCs, the average annual expenditure is graphed in figure 3.1-31 below. From the graph it is evident that average annual expenditure on water is highest in the RGCs of Kidetok, Tubur, Lambala and Naigobya and lowest in Buseta and Acuna. Expenditure on water may indicate a situation of scarcity of water sources, a greater commercialisation of the supply of water or a greater affluence on the part of some RGCs, Whatever the case, the people that are already spending significantly on water are likely to be more receptive to the concept of paying for water than those that are spending nearly nothing.

Figure 3.1- 31 Average annual expenditure on water for the different RGCS

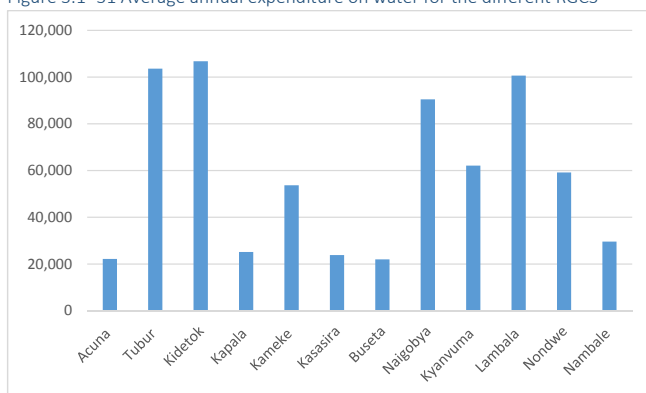

The proportion of expenditure taken by other items is shown in table 3.1-47a below. The subsequent tables i.e 3.1-47b show the situation in the individual RGCs. It is evident from the table that food tend to take a lion’s share of the expenditure in most of the RGCs and this is followed by education. Health is roughly in the third place.

TABLE 3.1-47A ITEMS AS A PERCENTAGE OF TOTAL ANNUAL EXPENDITURE – RGC WIDE

Water	Sanitation	Health	Food	Fuel	Electricity	Education	Battery	Airtime	Total communication
2.1	4.5	9.1	26.6	4.9	1.5	38.2	0.4	5.1	5.7

TABLE 3.1-47b ITEMS AS A PERCENTAGE OF TOTAL ANNUAL EXPENDITURE – RGC WISE

	Water	Sanitation	Health	Food	Fuel	Electricity	Education	Battery	Airtime	Total communication
Acuna	0.9	5.1	12.0	42.9	3.6	0.0	30.5	0.5	2.5	2.9
Tubur	3.1	3.8	7.6	41.5	7.0	0.0	22.8	0.3	5.8	6.0
Kidetok	1.2	3.7	4.3	29.7	4.3	1.4	46.0	0.2	3.6	3.8
Kapala	0.6	3.6	8.2	18.7	2.2	0.3	58.6	0.3	5.0	5.4
Kameke	2.1	3.3	7.9	32.3	3.8	3.5	26.0	0.4	5.7	0.4
Kasasira	0.9	3.8	9.3	27.4	3.5	0.8	34.1	0.4	3.8	4.1
Buseta	0.7	7.4	7.9	29.7	4.1	4.7	37.0	0.3	5.8	6.1
Naigobya	3.6	4.5	10.8	12.2	6.2	2.9	44.8	0.4	6.9	7.3
Kyanvuma	2.6	6.2	9.6	29.7	6.2	1.8	31.2	0.3	6.6	6.9
Lambala	5.4	6.0	12.1	29.7	3.2	4.5	23.0	0.9	5.9	6.8
Nondwe	3.0	5.5	16.2	20.3	8.3	0.4	33.2	0.6	6.9	7.5
Nambale	1.6	6.1	7.9	13.2	7.7	2.1	41.4	0.8	2.1	2.9

Most of the expenditure on water goes to paying a monthly fee for operation and maintenance. For those households that buy water, some of the money goes to paying for the water in jerry cans. The average monthly fee spent on the monthly O and m fee is Shs 1,268. That spent on buying water is Shs 138 while the combined total of both comes to Shs 4,911=(USD 1.5). There are indicators that for many HH, it is possible to increase the fee they spend on water if the people in charge of collecting it do their job effectively and consistently.

The total monthly expenditure ranged from a minimum of Shs 4,750 to a maximum of Shs 2,496,600. Average monthly expenditure stood at Shs 233,636. Total annual expenditure ranged from Shs 57,000 to a maximum of Shs 29,959,200= with average annual expenditure at Shs 2,803,635.

These figures were compared to the same figures for income and the output is presented in table 3.1-48 below.

TABLE 3.1-48 COMPARING INCOME AND TOTAL ANNUAL EXPENDITURE.

	Annual Income	Annual expenditure
Min	100,000	57,000
Max	30,000,000	29,959,200
Mean	4,448,072	2,803,635

Total annual income exceeds total annual expenditure in all respects. This means that on average, individuals are able to make a small saving. In reality however there were many people that were living beyond their means and some admitted to borrowing money or physical items regularly. Analysis of the individual incomes and expenditures showed that 19% of the respondents reported a deficit 0.2 (one person) reported a balance while the rest 81% reported a surplus.

Figure 3.1- 32 Comparison of income and expenditure at HH level

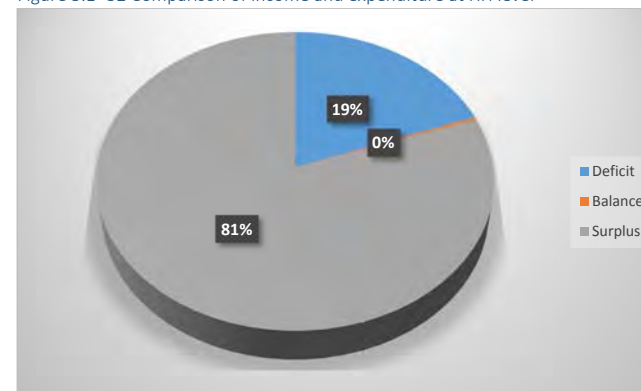

3.1.7j Income levels and social class

At the design stage, a decision was made to include as wide a spectrum of income levels as possible. Eventually the sample would be representative of the income levels in the communities in the survey area. Based on the data on income, the survey sample has been divided into three groups to reflect the three income levels namely low income, middle income and high income. Note that these classification are

specific to the survey area and have no applicability outside of the survey area. Moreover due to the different income levels in the different RGCs, even the income ranges for the different classes differ from one RGC to another.

In table 3.1-49 below, the thresholds for each income based social class in each of the RGCs is presented. In the subsequent table 3.1-50 an average is calculated for each of the social classes in each of the RGCs. This average is illustrated in figure 3.1- 33. The high income group’s average is highest in Buseta and lowest in Lambala and the data shows that there is significant disparity between the high classes in the different RGCs so that the average for the high class in Lambala is Shs 6million while the average for the high class in Buseta is Shs 16 million. The situation is however a little different with the middle and low class where the disparities in the averages of each social class is not so great.

TABLE 3.1-49 CLASSIFICATION OF INCOME BASED SOCIAL CLASSES IN THE RGCs (IN 000 SHs)

Class	RGC											
	Nambale	Nondwe	Lambala	Kyanvuma	Nalgobya	Buseta	Kasasira	Kameke	Kapala	Kidetok	Tubur	Acuna
Low	180 - 795	140 - 1,320	520 - 1,336	610 - 1,920	340 - 1,510	600 - 1,665	100 - 1,220	600 - 1,455	480 - 2,750	216 - 2,440	1,300 - 2,460	200 - 1,200
Mid dle	840 - 3,800	1,360 - 3,000	1,480 - 3,816	1,998 - 3,840	1,620 - 3,500	1,680 - 6,792	1,260 - 4,080	1,540 - 5,880	2,860 - 4,800	2,520 - 7,560	3,000 - 7,000	1,800 - 4,600
Hig h	5,040 - 12,500	3,120 - 15,540	4,800 - 8,160	4,200 - 17,480	3,840 - 20,880	7,999 - 24,700	4,700 - 21,600	6,750 - 11,570	7,920 - 22,840	7,800 - 30,000	7,900 - 16,392	4,980 - 7,230

TABLE 3.1-50 AVERAGE INCOMES BY SOCIAL CLASS BY RGC

Class	Average incomes per social class per RGC											
	Nambale	Nondwe	Lambala	Kyanvuma	Nalgobya	Buseta	Kasasira	Kameke	Kapala	Kidetok	Tubur	Acuna
Low	491,500	815,043	932,286	1,212,500	1,032,143	1,141,875	655,382	1,057,000	1,476,350	1,301,625	1,957,143	716,000
Mid dle	1,907,636	2,135,775	2,341,950	2,882,320	2,278,000	3,492,125	2,430,909	3,833,800	3,710,000	4,957,059	4,992,500	3,438,000
High	8,402,222	6,324,809	6,118,571	8,258,077	8,128,571	16,159,900	8,723,727	8,994,800	12,308,222	13,794,038	10,717,429	6,278,000

Figure 3.1- 33 Average income for each social class for each RGC

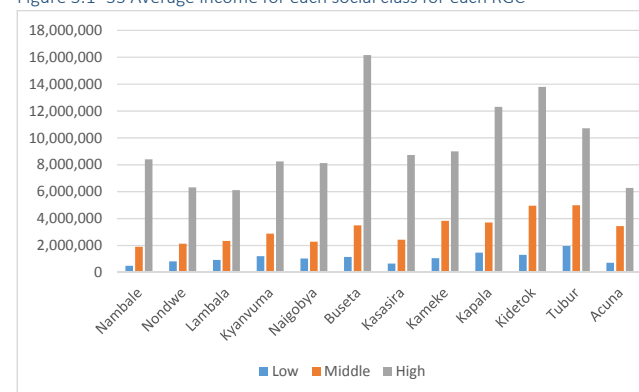

Data also shows that there is a great disparity in incomes within each RGC especially between middle and high class with extremes evident in Buseta, Nambale, Kasasira, Kapala and Kidetok.

### 3.1.8 Cooperative/municipal Organisations and Activities

#### 3.1.8a Payment for water

Some 90.2% of the respondents indicated that they had ever paid for water. The amount paid as **initial contribution** ranged from Shs 500 to a maximum of Shs 40,000-. The average amount was Shs 2,356 and the figure most frequently quoted is Shs 2,000.

When it comes to **water user fee**, the number of people who reported paying is much less-only 85 people or 20.7%. They were paying an average of Shs 944 per month. This pattern is not surprising; people tend to be eager to pay initial contribution as they are eager to get the water facility constructed. However, once the facility is constructed, they tend to relax and not pay the user fee regularly as they know that the facility is already there and no one is going to take it away. This data is summarised in table 3.1-50a and b below. The late series of tables present the situation in the individual RGCs.

TABLE 3.1-51A PAYMENT – INITIAL CONTRIBUTION, USER FEE AND NEW FACILITY

	Initial Contribution	User Fee	New Facility
Min	500	167	10
Max	40,000	5,000	300
Mean	2,356	944	87
Mode	2,000	2,000	100



TABLE 3.1-51b PAYMENT – INITIAL CONTRIBUTION, USER FEE AND NEW FACILITY – RGC WISE

Acuna	Initial Contribution	User Fee	New Facility
Min	1,000	1000	20
Max	2,000	2000	100
Mean	733	1033	58
Mode	1,000	1000	50

Tubur	Initial Contribution	User Fee	New Facility
Min	1,000	1,000	10
Max	5,000	5,000	300
Mean	1,455	1,818	105
Mode	2,000	2,000	100

Kidetok	Initial Contribution	User Fee	New Facility
Min	1,000	1,000	10
Max	10,000	5,000	200
Mean	1,571	1,633	101
Mode	2,000	2,000	100

Kapala	Initial Contribution	User Fee	New Facility
Min	500	500	20
Max	2,000	2,000	200
Mean	569	334	106
Mode	1,000	1,000	100

Kameke	Initial Contribution	User Fee	New Facility
Min	2,000	167	10
Max	7,000	3,000	200
Mean	2,125	1,385	94
Mode	2,000	2,000	100

Kasasira	Initial Contribution	User Fee	New Facility
Min	500	200	20
Max	30,000	5,000	200
Mean	2,727	491	34
Mode	2,000	2,000	100

Buseta	Initial Contribution	User Fee	New Facility
Min	500	1,000	15
Max	10,000	3,000	200
Mean	1,771	667	83
Mode	1,000	1,000	100

Naigobya	Initial Contribution	User Fee	New Facility
Min	1,000	500	20
Max	40,000	2,000	200

Mean	5,682	386	69
Mode	5,000	2,000	100

Kyanvuma	Initial Contribution	User Fee	New Facility
Min	500	500	30
Max	6,000	5,000	200
Mean	2,034	659	75
Mode	3,000	1,000	100

Lambala	Initial Contribution	User Fee	New Facility
Min	2,000	500	25
Max	10,000	3,000	200
Mean	2,568	516	76
Mode	2,000	2,000	50

Nondwe	Initial Contribution	User Fee	New Facility
Min	1,000	500	10
Max	20,000	5,000	200
Mean	2,686	1,150	74
Mode	1,000	1,000	100

Nambale	Initial Contribution	User Fee	New Facility
Min	1,000	500	35
Max	35,000	5,000	300
Mean	3,717	1,365	96
Mode	5,000	2,000	100

When respondents were asked how much money they are willing to pay for a jerry can of water from the proposed new water facility, the number who respondent in the affirmative was 364 or 89% of the respondents. The amount those who are willing to pay mentioned ranged from Shs 10 to Shs 300 with a mean of Shs 97. In general, the fee that they are willing to pay, at 97 is lower than what they are already paying at an average of Shs 263 per jerry can as seen in section 3.1.5 of this report. The fact that they are willing to pay less than they are already paying may show a feeling that they feel that they are already paying too much. Alternatively, once people perceive that there is a donor involved in a proposed project, they tend to understate what they are willing to pay in order to let the donor take the heaviest burden since they are convinced that donors have the money. This may underline the need for sensitisation prior to the project to cement the need for people to recognise that even though the project is donor supported, they have a central role to play in its establishment and maintenance.

Due to the central role of women in water fetching and provision in the home as noted in this study, women and children have to be involved in the O and M of water facilities and their opinions need to be

heard. When asked how many women are in charge of any roles in the WSC, the answers given by respondents are summarised in the table and graph below.

TABLE 3.1-52A NO OF WOMEN WITH ROLES IN THE WSC – RGC WIDE

No of women	Count	% of respondents
1	50	18.6
2	113	42.0
3	69	25.7
4	27	10.0
5	10	3.7
<b>Total</b>	<b>269</b>	<b>100.0</b>

Most of the respondents who acknowledge that there are women on the WSC 42% mentioned 2 women. The next most frequent figure is 3 women, then 1 woman. A WSC usually has 5 people and under the guidelines of the ministry, women should constitute a half of all the members. However in many cases this is ignored not only by the men but also by the women who often shun the roles in what they feel are male

dominated communities

TABLE 3.1-52B NO OF WOMEN WITH ROLES IN THE WSC – RGC WISE

Acuna			Tubur			Kidetok		
No of women	Count	% of respondents	No of women	Count	% of respondents	No of women	Count	% of respondents
1	0	0.0	1	0	0.0	1	7	16.7
2	2	50.0	2	10	62.5	2	14	33.3
3	1	25.0	3	5	31.3	3	12	28.6
4	0	0.0	4	1	6.3	4	8	19.0
5	1	25.0	5	0	0.0	5	1	2.4
<b>Total</b>	<b>4</b>	<b>100</b>	<b>Total</b>	<b>16</b>	<b>100</b>	<b>Total</b>	<b>42</b>	<b>100</b>

Kapala			Kameke			Kasasira		
No of women	Count	% of respondents	No of women	Count	% of respondents	No of women	Count	% of respondents
1	7	41.2	1	2	16.7	1	8	15.4
2	7	41.2	2	2	16.7	2	22	42.3
3	3	17.6	3	4	33.3	3	18	34.6
4	0	0.0	4	3	25.0	4	3	5.8
5	0	0.0	5	1	8.3	5	1	1.9
<b>Total</b>	<b>17</b>	<b>100</b>	<b>Total</b>	<b>12</b>	<b>100</b>	<b>Total</b>	<b>52</b>	<b>100</b>

Buseta			Naigobya			Kyanvuma		
No of women	Count	% of respondents	No of women	Count	% of respondents	No of women	Count	% of respondents
1	3	23.1	1	4	28.6	1	13	41.9
2	5	38.5	2	8	57.1	2	13	41.9
3	3	23.1	3	1	7.1	3	3	9.7
4	0	0.0	4	1	7.1	4	0	0.0
5	2	15.4	5	0	0.0	5	2	6.5

<b>Total</b>	13	100	<b>Total</b>	14	100	<b>Total</b>	31	100
--------------	----	-----	--------------	----	-----	--------------	----	-----

Lambala			Nondwe			Nambale		
No of women	Count	% of respondents	No of women	Count	% of respondents	No of women	Count	% of respondents
1	1	6.3	1	3	11.1	1	2	8.0
2	7	43.8	2	14	51.9	2	9	36.0
3	6	37.5	3	8	29.6	3	5	20.0
4	1	6.3	4	2	7.4	4	8	32.0
5	1	6.3	5	0	0.0	5	1	4.0
<b>Total</b>	<b>16</b>	<b>100</b>	<b>Total</b>	<b>27</b>	<b>100</b>	<b>Total</b>	<b>25</b>	<b>100</b>

Figure 3.1- 34 No of women with roles in the WSC

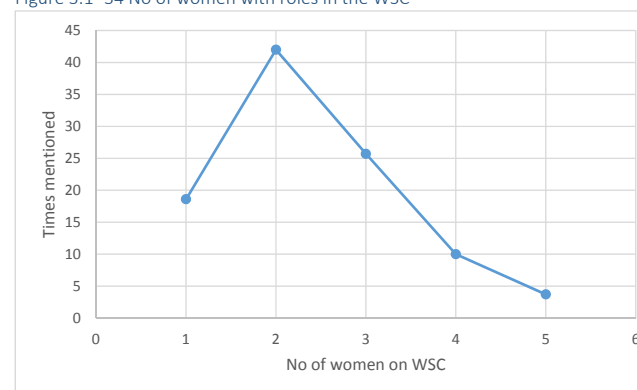

When asked if women's opinions are taken well in WSC decisions, 32.2% of the respondents said that they do not know or that they are not sure. However the rest i.e. 67.7% gave various opinions as shown in the chart below. Those who felt that women's opinions are ignored are in the minority and this is a good indicator of the trend of taking seriously the participation and the opinions of women. However the proportion of those who say that women's opinions are taken well frequently and those who say that they are sometimes not taken well are almost equal and this means that there is room for improvement with the right sensitisation as well as exposure.

Figure 3.1- 35 Women's opinions taken in WSC decisions.

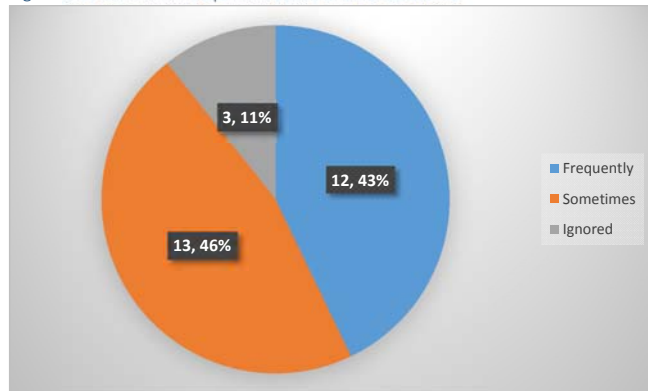

#### Other cooperative organisations

When asked whether they were involved in any cooperative organisation, 60.4% of the respondents said yes while 39.6% said no. Clearly many more people are involved in cooperative organisations than those who are not and it appears that the spirit of cooperation and joint activities is alive and well. This augers well for collective water facility O and M activities.

Those involved in cooperative activities named the organisations that they are involved in. When analysed, these fell into the following categories. Most of the people are involved in some form of development organisations including savings and credit (SACCOS) or those set up by NGOs. Burial and social support groups are also significant. These pool resources to come to the aid of those that have experienced a death in the family. They operate like insurance companies on a community level. All these cooperative organisations form a good basis for the exposure of the community to community and cooperative activities that can enhance the work of the WSCs.

Figure 3.1- 36 Nature of cooperative organisations involved in.

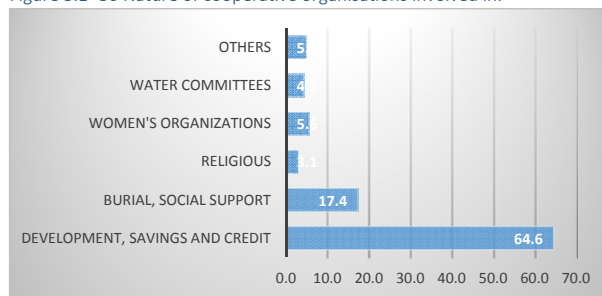

Reason was sought from those who said that they are not involved in cooperative activities for their lack of participation. The reasons given are as in the chart below.

The three main reasons for not participating in cooperative activities are being busy, having no money to pay for membership or to make the necessary contributions and mistrust of the leadership and management of the organisations.

Figure 3.1- 37 Reasons for not participating in cooperative organisations

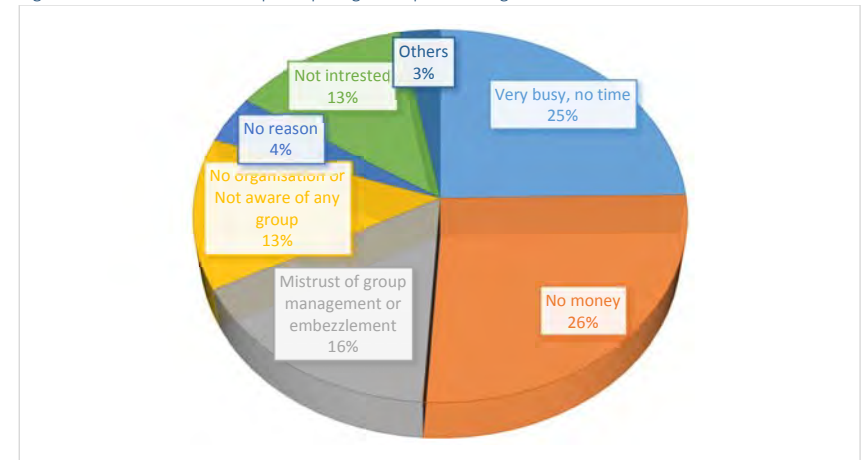

These become critical issues in any interventions to promote WSC activities and need to be taken into account in the software activities of the project. Indeed there are repeated concerns about embezzlement and poor management of finances and this discourages not only participation but regular contributions to O and M.

### 3.1.9 Hygiene and Sanitation.

#### 3.1.9a Introduction

Water is a critical element in improving health and welfare in household. But for this to happen HH must adopt appropriate hygiene and sanitation practices. The hygiene and sanitation practices of the HH in the survey area were also investigated. Interviewer asked questions on various hygiene and sanitation practices and also inspected homes according to set guidelines to confirm presence and quality of specific installations.

#### 3.1.9b Toilet and other infrastructure for household cleanliness

94.1% of the respondents had toilets of varying types in their house lot, 5.87 did not have any toilet. While some 52 or 13.6% did not know when these toilets were built, those who knew said that they ranged from 1 to 25 years ago. This data is summarised in figure 3.1-38 below.

Figure 3.1- 38 Age or number of years since toilet was constructed.

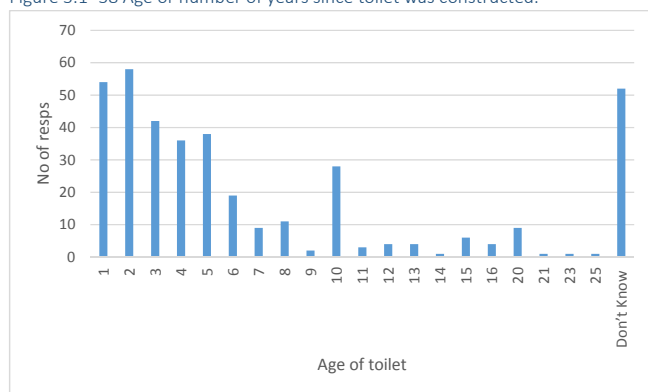

For the minority who did not have a toilet, the reasons given are summarised in the table below.

TABLE 3.1-53A REASONS FOR NOT HAVING A TOILET – RGC WIDE

Count	Reason
8	No money
4	No space
2	Land is rocky
0	Swamp conditions
9	other

But having a toilet and using it are two different things. Some toilets exist only in name and are so old and risky that people prefer to go in the bush. Asked if the toilets are easy to use, 81% of those with toilets said yes while some 18.8% admitted that they are not easy to use. Asked why they are not easy to use, respondents gave a range of answers including “too short”, “has no door”, “almost collapsing”, “has no wall”, “has no roof”, “floor/slab is cracked”, “too many

people using the toilet so that it is very dirty”, and that “it has no shelter”

The predominant reasons given in the different RGCs for not having a toilet are shown in table 3.1-53B below. The reasons vary somewhat from RGC to RGC. In Kidetok and Kasasira, the problem is not having the money to construct a toilet. In Kameke, Nondwe and Tubur, it is “other” reasons.

TABLE 3.1-53B REASONS FOR NOT HAVING A TOILET-RGC WISE

Reason	Acuna	Tubur	Kidetok	Kapala	Kameke	Kasasira
No money	0	0	3	0	0	4
No space	0	0	1	0	2	1
Land is rocky	1	1	0	0	0	0
Swamp conditions	0	0	0	0	0	0
other	0	2	1	0	2	1

Reason	Buseta	Naigobya	Kyanvuma	Lambala	Nondwe	Nambale
No money	0	1	0	0	0	0
No space	0	0	0	0	0	0

Land is rocky	0	0	0	0	0	0
Swamp conditions	0	0	0	0	0	0
other	0	0	0	0	3	0

On the type of latrine, the data is summarised in the table below.

TABLE 3.1-54A CONDITION OF TOILET/LATRINE – RGC WIDE

Type	Count	%	Sanitary condition	%	Cover available	%		
VIP	85	22.1	Clean	309	80.3	Available	78	20.3
Flash	1	0.3	Dirty	76	19.7	Not available	307	79.7
Eco-san	0	0.0						
Traditional pit	299	77.7						
<b>Total</b>	<b>385</b>	<b>100.0</b>		<b>385</b>	<b>100.0</b>		<b>385</b>	<b>100.0</b>

The predominant type of latrine is the traditional pit latrine. On the sanitary state of the toilet, 80.3% of the existing toilets were clean while 19.7% were dirty. On the availability of a cover most of the toilets 79.7% did not have a cover. Covering toilets is one of the ways of preventing flies from bringing contamination from the toilet to the HH and this practice needs to be promoted in the communities. The respective data from the different RGCs is presented in table 3.1-54B below.

TABLE 3.1-54B CONDITION OF TOILET/LATRINE – RGC WISE

#### Acuna

Type	Count	%	Sanitary condition	%	Cover available	%		
VIP	1	7.1	Clean	11	78.6	Available	0	0
Flash	0	0.0	Dirty	3	21.4	Not available	14	100.0
Eco-san	0	0.0						
Traditional pit	13	92.9						
<b>Total</b>	<b>14</b>	<b>100</b>		<b>14</b>	<b>100.0</b>		<b>14</b>	<b>100.0</b>

#### Tubur

Type	Count	%	Sanitary condition	%	Cover available	%		
VIP	3	15.8	Clean	12	63.2	Available	2	10.5
Flash	1	5.3	Dirty	7	36.8	Not available	17	89.5
Eco-san	0	0.0						
Traditional pit	15	78.9						
<b>Total</b>	<b>19</b>	<b>100.0</b>		<b>19</b>	<b>100.0</b>		<b>19</b>	<b>100.0</b>

**Kidetok**

Type	Count	%	Sanitary condition	%	Cover available	%		
VIP	18	40.9	Clean	41	93.2	Available	11	25.0
Flash	0	0.0	Dirty	3	6.8	Not available	33	75.0
Eco-san	0	0.0						
Traditional pit	26	59.1						
<b>Total</b>	<b>44</b>	<b>100.0</b>		<b>44</b>	<b>100.0</b>		<b>44</b>	<b>100.0</b>

**Kapala**

Type	Count	%	Sanitary condition	%	Cover available	%		
VIP	6	20.7	Clean	22	75.9	Available	5	17.2
Flash	0	0.0	Dirty	7	24.1	Not available	24	82.8
Eco-san	0	0.0						
Traditional pit	23	79.3						
<b>Total</b>	<b>29</b>	<b>100.0</b>		<b>29</b>	<b>100.0</b>		<b>29</b>	<b>100.0</b>

**Kameke**

Type	Count	%	Sanitary condition	%	Cover available	%		
VIP	0	0.0	Clean	11	91.7	Available	2	16.7
Flash	0	0.0	Dirty	1	8.3	Not available	10	83.3
Eco-san	0	0.0						
Traditional pit	12	100.0						
<b>Total</b>	<b>12</b>	<b>100.0</b>		<b>12</b>	<b>100.0</b>		<b>12</b>	<b>100.0</b>

**Kasasira**

Type	Count	%	Sanitary condition	%	Cover available	%		
VIP	8	13.3	Clean	42	70	Available	13	21.7
Flash	0	0.0	Dirty	18	30	Not available	47	78.3
Eco-san	0	0.0						
Traditional pit	52	86.7						
<b>Total</b>	<b>60</b>	<b>100.0</b>		<b>60</b>	<b>100.0</b>		<b>60</b>	<b>100.0</b>

**Buseta**

Type	Count	%	Sanitary condition	%	Cover available	%		
VIP	3	12.5	Clean	19	79.2	Available	3	12.5
Flash	0	0.0	Dirty	5	20.8	Not available	21	87.5
Eco-san	0	0.0						
Traditional pit	21	87.5						
<b>Total</b>	<b>24</b>	<b>100.0</b>		<b>24</b>	<b>100.0</b>		<b>24</b>	<b>100.0</b>

**Naigobya**

Type	Count	%	Sanitary condition	%	Cover available	%		
VIP	12	57.1	Clean	16	76.2	Available	4	19.0
Flash	0	0.0	Dirty	5	23.8	Not available	17	81.0
Eco-san	0	0.0						

Traditional pit	9	42.9						
<b>Total</b>	<b>21</b>	<b>100.0</b>		<b>21</b>	<b>100.0</b>		<b>21</b>	<b>100.0</b>

**Kyanvuma**

Type	Count	%	Sanitary condition	%	Cover available	%		
VIP	11	25.6	Clean	36	83.7	Available	6	14.0
Flash	0	0.0	Dirty	7	16.3	Not available	37	86.0
Eco-san	0	0.0						
Traditional pit	32	74.4						
<b>Total</b>	<b>43</b>	<b>100.0</b>		<b>43</b>	<b>100.0</b>		<b>43</b>	<b>100.0</b>

**Lambala**

Type	Count	%	Sanitary condition	%	Cover available	%		
VIP	3	13.6	Clean	16	72.7	Available	4	18.2
Flash	0	0.0	Dirty	6	27.3	Not available	18	81.8
Eco-san	0	0.0						
Traditional pit	19	86.4						
<b>Total</b>	<b>22</b>	<b>100.0</b>		<b>22</b>	<b>100.0</b>		<b>22</b>	<b>100.0</b>

**Nondwe**

Type	Count	%	Sanitary condition	%	Cover available	%		
VIP	15	22.4	Clean	56	83.6	Available	19	28.4
Flash	0	0.0	Dirty	11	16.4	Not available	48	71.6
Eco-san	0	0.0						
Traditional pit	52	77.6						
<b>Total</b>	<b>67</b>	<b>100.0</b>		<b>67</b>	<b>100.0</b>		<b>67</b>	<b>100.0</b>

**Nambale – Condition of toilet**

Type	Count	%	Sanitary condition	%	Cover available	%		
VIP	5	16.7	Clean	27	90.0	Available	9	30.0
Flash	0	0.0	Dirty	3	30.0	Not available	21	70.0
Eco-san	0	0.0						
Traditional pit	25	83.0						
<b>Total</b>	<b>30</b>	<b>100.0</b>		<b>30</b>	<b>100.0</b>		<b>30</b>	<b>100.0</b>

For illustration, the proportion of toilets that are reported as clean in each of the RGCs is isolated and presented in the graphic below. In general the state of toilets in terms of cleanliness is good in all the RGCs as only one RGC namely Tubur is below 60%. Kidetok, Kameke and Nambale have the best ratings.

Figure 3.1- 39 Proportion of toilets assessed as clean in each RGC.

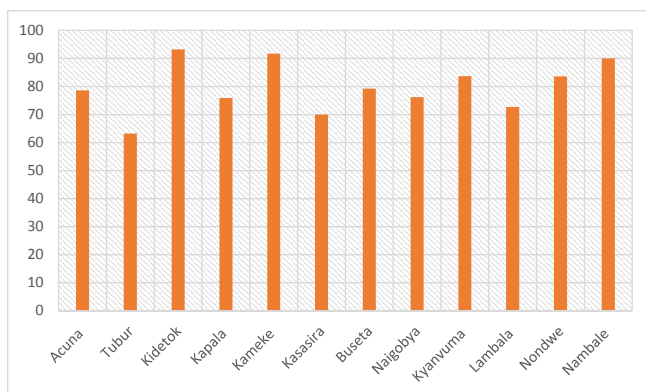

### 3.1.9c Condition of the Kitchen

The details of the condition of the kitchen and home are summarised in the table below.

TABLE 3.1-55 CONDITION OF KITCHEN AND HOME

	Presence of Kitchen	%	Availability of drying rack	%	Presence of animal shelter	%	Fecal Presence around the compound	%	Availability of compost pit	%	Availability of HH drainage channel	%
Yes	301	73.6	181	44.3	86	21.0	85	20.8	155	37.9	97	23.8
No	108	26.4	228	55.7	323	79.0	323	79.2	254	62.1	310	76.2
	409		409		409		408		409		407	

It can be seen from the data that the majority of HH – 73.6 have kitchens however only 44.3% have drying racks. Some 79.0% do not have an animal shelter and therefore there is a risk that animals will share the same house as the people, if there are animals. In 20.8% of the homes, faecal materials could be observed around the home and in 23.8% of the homes, there was no drainage channels (though it is possible that they are not needed in some of these homes. These data indicate that there is a lot of room for the improvement of sanitation and hygiene and some of these aspects need to be included in the software programme of the project. At the same time it has to be understood that the impact of the new water project will be tampered by these characteristics on the ground.

### 3.1.9d Hand Washing

Most of the respondents reported that they wash hands after toilet and before meals.

TABLE 3.1-56A SITUATIONS WHEN RESPONDENTS WASH HANDS

When do you wash hands	After toilet %	Before meals %	Others
	87.5	92.0	54.5

Other conditions under which they wash hands are summarised in the table below. These answers are not mutually exclusive. 32.8% reported that they wash hands after an activity that makes their hands dirty and this includes when they have been to the garden or perhaps if their work makes their hands dirty. This kind of washing hand is compelled more by the visible dirt than by the consciousness of potential infection and may not be a good indicator of awareness of hygiene and sanitation. 13.9% also wash hands after eating. Again this is more about visible dirt and smell.

TABLE 3.1-56B OTHER SITUATIONS NAMED WHEN RESPONDENTS WASH HANDS

Others	Frequency	%
After eating	57	13.9
After any activity that makes hands dirty	134	32.7
Before any activity that requires clean hands	15	3.7
Before prayers	7	1.7
Morning after waking up	7	1.7
Anytime	3	0.7

The frequency with which people wash hand may also be influenced by the presence of a hand washing facility. Among the respondents, some 77.5% had a hand washing facility. The nature of the hand washing facility is summarised in table below.

TABLE 3.1-57 TYPE OF HAND WASHING FACILITY

Tippy tap %	Faucet %	Ordinary can %	Others (Jerry cans) %
2.19	0.31	61.88	35.63

In addition to availability and nature it is important that a facility has water and soap. Sanitation experts have confirmed that soap must be used for hand washing to be effective in properly and hygienically cleaning hands. In table 3.1-58a below, other related aspect of the hand washing facility were also investigated. It is encouraging to note that 97.8% reported that the facility is used regularly. Also the 65.8% where soap was available is a positive sign. Nevertheless there is room for improvement in ensuring the presence of a hand washing facility which has water and soap as well as in the regularity of washing hands. Moreover people need to understand that beyond having hands that look clean, it is important to wash hand to ensure that they are free of dangerous organisms that can transmit disease and for this hands must be washed with soap.

TABLE 3.1-58A CONDITION OF HAND WASHING FACILITY

Condition of hand washing facility	Yes %	No %
M2-b. Facility has water	76.1	23.9
M2-c. Facility has soap	65.8	34.2

<b>M2-d. Facility used by everyone</b>	86.5	13.5
<b>Facility used by adult only</b>	13.5	86.5
<b>Facility used by children only</b>	0.0	100.0
<b>Facility used regularly</b>	97.8	2.2

TABLE 3.1-58B CONDITION OF HAND WASHING FACILITY – RGC WISE

	Acuna		Tubur		Kidetok	
	Yes %	No %	Yes %	No %	Yes %	No %
<b>Condition of hand washing facility</b>						
<b>M2-b. Facility has water</b>	66.7	33.3	80.0	20.0	84.4	15.6
<b>M2-c. Facility has soap</b>	55.6	44.4	53.3	46.7	81.8	18.2
<b>M2-d. Facility used by everyone</b>	100.0	0.0	86.7	13.3	90.9	9.1
<b>Facility used by adult only</b>	0.0	100.0	13.3	86.7	9.1	90.9
<b>Facility used by children only</b>	0.0	100.0	0.0	100.0	0.0	100.0
<b>Facility used regularly</b>	100.0	0.0	100.0	0.0	100.0	0.0

	Kapala		Kameke		Kasasira	
	Yes %	No %	Yes %	No %	Yes %	No %
<b>Condition of hand washing facility</b>						
<b>M2-b. Facility has water</b>	65.0	35.0	62.5	37.5	68.4	31.6
<b>M2-c. Facility has soap</b>	80.0	20.0	62.5	37.5	61.4	38.6
<b>M2-d. Facility used by everyone</b>	90.0	10.0	100.0	0.0	73.7	26.3
<b>Facility used by adult only</b>	10.0	90.0	0.0	100.0	26.3	73.7
<b>Facility used by children only</b>	0.0	100.0	0.0	100.0	0.0	100.0
<b>Facility used regularly</b>	100.0	0.0	100.0	0.0	100.0	0.0

	Buseta		Naigobya		Kyanvuma	
	Yes %	No %	Yes %	No %	Yes %	No %
<b>Condition of hand washing facility</b>						
<b>M2-b. Facility has water</b>	60.0	40.0	78.9	21.1	84.2	15.8
<b>M2-c. Facility has soap</b>	65.0	35.0	68.4	31.6	60.5	39.5
<b>M2-d. Facility used by everyone</b>	85.0	15.0	84.2	15.8	84.2	15.8
<b>Facility used by adult only</b>	15.0	85.0	15.8	84.2	15.8	84.2
<b>Facility used by children only</b>	0.0	100.0	0.0	100.0	0.0	100.0
<b>Facility used regularly</b>	95.0	5.0	89.5	10.5	100.0	0.0

	Lambala		Nondwe		Nambale	
	Yes %	No %	Yes %	No %	Yes %	No %
<b>Condition of hand washing facility</b>						
<b>M2-b. Facility has water</b>	93.3	6.7	73.2	26.8	89.7	10.3
<b>M2-c. Facility has soap</b>	73.3	26.7	62.5	37.5	65.5	34.5
<b>M2-d. Facility used by everyone</b>	80.0	20.0	91.1	8.9	96.6	3.4
<b>Facility used by adult only</b>	20.0	80.0	8.9	91.1	3.4	96.6
<b>Facility used by children only</b>	0.0	100.0	0.0	100.0	0.0	100.0
<b>Facility used regularly</b>	100.0	0.0	94.6	5.4	96.6	3.4

One of the critical factors in the safe water chain are the storage containers for the water. These too need to be clean. Table 3.1-59 summarises the condition of the water storage containers in the HHs surveyed. Conditions of water collection/storage containers. In general the rating for all the HH surveyed on these conditions was good with all of them scoring over 78%.

TABLE 3.1-59A CONDITION OF WATER STORAGE CONTAINERS – RGC WIDE

N1 to N3-b. Conditions of water collection/storage containers		
	Yes %	No %
<b>Water collection containers clean</b>	78.97	21.03
<b>Bath shelter available</b>	87.29	12.71
<b>Drinking water containers covered</b>	95.11	4.89
<b>Storage containers clean</b>	86.80	13.20

In water stressed situations, humans and livestock may be forced to share sources of water. The findings from this study show that there are still a few places (4.2% of respondents) where humans and animals get water from the same source. In other places, measures have been taken to separate animals from people using the techniques in table 3.1-60 below.

TABLE 3.1-59B CONDITION OF WATER STORAGE CONTAINERS – RGC WISE

N1 to N3-b. Conditions of water collection/storage containers	Acuna		Tubur		Kidetok	
	Yes %	No %	Yes %	No %	Yes %	No %
<b>Water collection containers clean</b>	73.33	26.67	86.36	13.64	81.63	18.37
<b>Bath shelter available</b>	80.00	20.00	81.82	18.18	93.88	6.12
<b>Drinking water containers covered</b>	93.33	6.67	95.45	4.55	97.96	2.04
<b>Storage containers clean</b>	93.33	6.67	86.36	13.64	85.71	14.29

N1 to N3-b. Conditions of water collection/storage containers	Kapala		Kameke		Kasasira	
	Yes %	No %	Yes %	No %	Yes %	No %
<b>Water collection containers clean</b>	68.97	31.03	87.50	12.50	80.30	19.70
<b>Bath shelter available</b>	82.76	17.24	93.75	6.25	92.42	7.58
<b>Drinking water containers covered</b>	96.55	3.45	93.75	6.25	100.00	0.00
<b>Storage containers clean</b>	93.10	6.90	75.00	25.00	80.30	19.70

N1 to N3-b. Conditions of water collection/storage containers	Buseta		Naigobya		Kyanvuma	
	Yes %	No %	Yes %	No %	Yes %	No %
<b>Water collection containers clean</b>	70.83	29.17	68.18	31.82	77.27	22.73
<b>Bath shelter available</b>	91.67	8.33	100.00	0.00	86.36	13.64
<b>Drinking water containers covered</b>	83.33	16.67	86.36	13.64	97.73	2.27
<b>Storage containers clean</b>	70.83	29.17	86.36	13.64	88.64	11.36

N1 to N3-b. Conditions of water collection/storage containers	Lambala		Nondwe		Nambale	
	Yes %	No %	Yes %	No %	Yes %	No %
Water collection containers clean	77.27	22.73	78.57	21.43	93.33	6.67
Bath shelter available	90.91	9.09	78.57	21.43	80.00	20.00
Drinking water containers covered	100.00	0.00	92.86	7.14	93.33	6.67
Storage containers clean	95.45	4.55	92.86	7.14	90.00	10.00

#### How to water cattle

Livestock is part of the people in some of the RGCs especially in Soroti and Serere Districts. Water is critical for the wellbeing of livestock and where sources are scarce animals and people are forced to share a source. Such sharing if not done in a proper way can lead to the transmission of diseases from animals to people and vice-versa. But of course the concern is more with the people. There are however ways in which such sharing of resources can be done safely. Respondents were asked how they water their cattle especially where they have to share a source. The responses RGC wide and RGC wise are summarised in tables 3.1-60A and 3.1-60B respectively. The most common method named is the use of a bucket to carry water from the source to some distance away where the cattle are watered. An average of 28.4 across all the RGCs indicated that they have a separate watering place.

TABLE 3.1-60A HOW TO WATER CATTLE – RGC WIDE

How to water cattle	%
There is a separate watering place	28.4
Use bucket to convey water for animals from that of human beings	58.9
Others	6.6

TABLE 3.1-60B HOW TO WATER CATTLE – RGC WISE

	Acuna	Tubur	Kidetok	Kapala	Kameke	Kasasira
How to water cattle	%	%	%	%	%	%
There is a separate watering place	26.7	13.6	24.5	20.7	18.8	42.4
Use bucket to convey water for animals from that of human beings	66.7	81.8	67.3	75.9	75.0	53.0
Others	13.3	0.0	0.0	0.0	6.3	3.0

	Buseta	Naigobya	Kyanvuma	Lambala	Nondwe	Nambale
How to water cattle	%	%	%	%	%	%
There is a separate watering place	50.0	31.8	29.5	31.8	31.4	%
Use bucket to convey water for animals from that of human beings	45.8	59.1	63.6	54.5	50.0	20.0
Others	12.5	9.1	9.1	13.6	12.9	80.0

In locations where cattle still access water together with the people, the reasons given for this condition are given in table 3.1-61 below. The reason presented by most people is weak management of the water source. The second most important reason is that there is no other water source or it is very far. Improving access to water will therefore help to reduce the risk posed when livestock is watered at the same sources as human beings.

TABLE 3.1-61A REASONS FOR WATERING CATTLE FROM THE SAME SOURCE AS HUMANS - RGC WIDE

Why the water source is not separated	%
No management of the water source	52.9
Only option, not in control	17.6
Water for animals very far	17.6
Don't know	11.8

TABLE 3.1-61B REASONS FOR WATERING CATTLE FROM THE SAME SOURCE AS HUMANS –RGC WISE

	Acuna	Tubur	Kidetok	Kapala	Kameke	Kasasira
Why the water source is not separated	%	%	%	%	%	%
No management of the water source	0.0	100	0.0	0	0	100
Only option, not in control	0.0	0	0.0	50	0	0
Water for animals very far	0.0	0	33.3	50	0	0
Don't know	0.0	0	66.7	0	0	0

	Buseta	Naigobya	Kyanvuma	Lambala	Nondwe	Nambale
Why the water source is not separated	%	%	%	%	%	%
No management of the water source	0	0	100	100	60	0
Only option, not in control	0	100	0	0	20	0
Water for animals very far	0	0	0	0	20	0
Don't know	0	0	0	0	0	0



## 3.2 THE CONDINTION OF VILLAGES.

### 3.2.1 The Village Condition Survey - Introduction

The survey of village leaders sought to obtain information on the situation of the communities in the RGCs with respect to a range of variables. The information was obtained from the village leaders or LC1 chairmen. Some of the RGCs have one LC1 village while some have two and more. The number of LC1 zones in each of the RGCs is summarised in table 3.2-1 below. It should be noted that the perimeter of the RGC as specified in this project do not necessarily tally with the jurisdictional areas of the LC1s, however LC1 chairmen were briefed about the perimeter of the RGC demarcations but most of the time they were not able to isolate the information pertaining to the included area only. For that reason data refers to the mentioned villages in the RGCs.

TABLE 3.2-1 NUMBER OF VILLAGES INCLUDED IN THE SURVEY

RGC	No of Villages
Acuna	2
Buseta	3
Kameke	2
Kapala	3
Kasasira	6
Kidetok	3
Kyanvuma	2
Lambala	2
Naigobya	3
Nambale	1
Nondwe	2
Tubur	1
<b>Total</b>	<b>30</b>

### 3.2.2 Employment

Village leaders were asked the number of women and men that are actively looking for jobs to be stated as a percentage of the labour force in their villages. The responses they gave are summarised in table 3.2-2 below. Their report show that for men on average 81.2% are actively looking for work while for women the equivalent statistic is 99% Given that in the general population the number of women is slightly higher than that of men, this means that there are more women looking for jobs than men. As mentioned in the HH section of this report, there are push and pull factors that determine the employability of women especially in the context of the survey area. Most of these act to reduce the chances of the employment of women.

TABLE 3.2-2 PROPORTION OF MEN AND WOMEN LOOKING FOR JOBS.

	Men	Women
<b>Min</b>	50	60
<b>Max</b>	95	99
<b>Average</b>	81.2	92.4
<b>Mode</b>	80	95

In Figure 3.2-1 below the rates of unemployment in the different RGCs are compared. Clearly according to the village leaders, the rates of unemployment in the RGCs are very high hovering in the 80s and 90s with female worse than male in all the RGCs. Buseta, Kyanvuma and Nondwe all tie in the worst situation with 96% of females being out of job while the situation of men is worst in Nambale where 90% of them are out of job according to the village leaders.

Figure 3.2-1 Unemployment rates across the RGCs

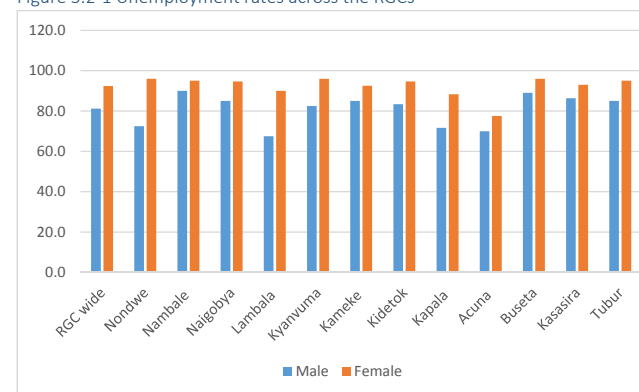

### 3.2.3 Literacy

Village leaders were also asked to indicate how many men and women are literate in vernacular and in English in their communities. Their answers are summarised in the chart below.

Figure 3.2-2a Literacy in vernacular.

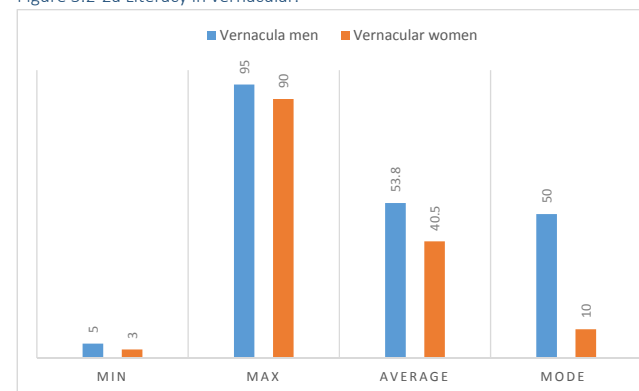

It can be seen from the table that a greater proportion of men are literate in vernacular. On average 53.8% of men are literate in vernacular while 40.5% of women are literate in vernacular

Figure 3.2-2b Literacy in English.

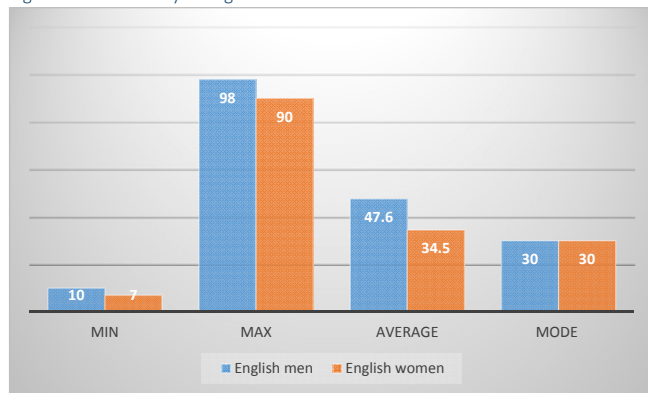

Again as in vernacular, greater proportions of men are literate in English as compared to women. These findings are consistent with those noted in the household survey and may point to the imbalance in school attendance for boys and girls. It should be noted that this would reflect the imbalance of some ten or so years ago and that the situation may have changed somewhat since then with more girls attending school now due to UPE.

A comparison of literacy across the RGCs is shown in figures 3.2-2c and 3.2-2d. According to the village leaders's assessment of their residents, the situation is worst in Nondwe, Knavuma and Kasasira while the best literacy rates in vernacular are in Tubur and Kameke. When it comes to English, the situation is worst in Nondwe and Nambale while it appears to be best in Acuna, Tubur and Kameke. Tubur and Kameke coincide at the top both in English and Vernacular indicating good levels of balanced education in these two villages.

Figure 3.2-2c Literacy in vernacular across the RGCs.

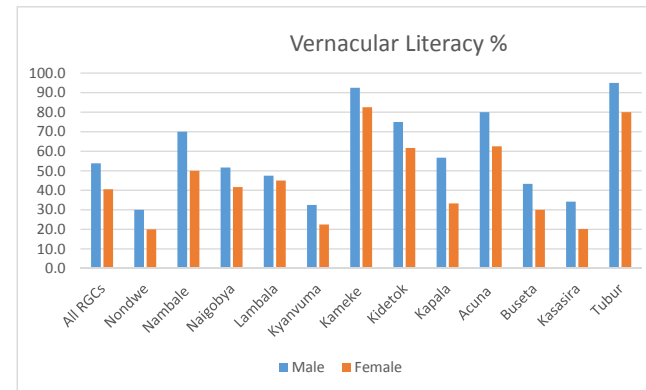
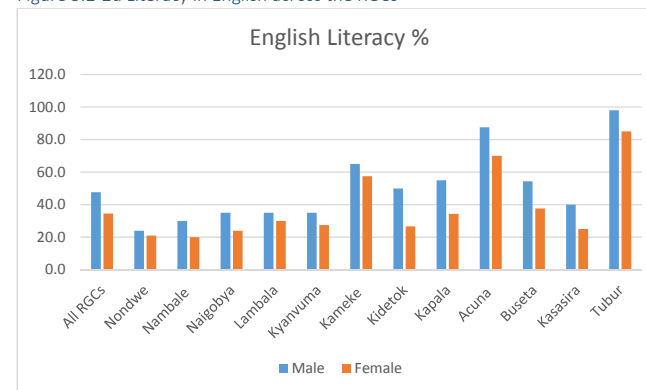

Figure 3.2-2d Literacy in English across the RGCs



### 3.2.4 School enrolment – Primary School

UNICEF defines **Net primary school enrolment ratio** as- The number of children enrolled in primary school who belong to the age group that officially corresponds to primary schooling, divided by the total population of the same age group. Table 3.2-3 shows the primary school enrolment data as provided by village leaders and in a few cases officials at the sub-county. Figure 3.2-3 compares the primary school enrolment rates in the different RGCs.

The illustration shows that total enrolment in primary school in terms of numbers is highest in Lambala and Kidetok RGCs while it is lowest in Kyanvuma and Acuna. Kidetok has a number of primary schools right in the RGC. Lambala also has two of them, however while the presence of primary schools may help, it may not be the complete explanation of the higher enrolment rates as Kyanvuma, Nondwe and other

RGCs also have schools right inside the RGCs. Schools attract pupils from long distances if they are good and poor schools will be skipped by pupils to go to those that are further off. The schools in Kidetok are of very high standards basing on the buildings, the teachers that we interacted with and the reputation at the national level. This may explain the enrolment rates. The same may be the case with those in Lambala.

When enrolment examined on the basis of gender, it is clear that females exceed male in enrolment in seven out of the 12 RGCs. The seven include Kapala, Kameke, Buseta, Kasasira, Naigobya, Lambala and Nambale. In the remaining 5 RGCs males exceed females in enrolment. The fact that there are more girls enrolled in primary schools in the majority of RGCs is positive pointer for those RGCs and predicts better literacy rates for girls and perhaps better employment for girls from those RGCs.

TABLE 3.2-3 SCHOOL ENROLMENT PRIMARY ALL RGCs

RGC	School enrolment rate			Graduation rate			Drop-out rate		
	Male	Female	Total Enrolment	Male	Female	Total Graduation	Male	Female	Total Drop out
Nambale	100	130	230	73	77	150	27	53	80
Nondwe	205	165	370	90	115	205	115	50	165
Lambala	261	365	626	191	123	314	70	242	312
Naigobya	260	325	585	182	208	390	78	117	195
Kyanvuma	49	36	85	45	35	80	4	1	5
Kasasira	90	125	215	35	28	63	55	97	152
Buseta	180	300	480	20	100	120	160	200	360
Kameke	90	110	200	37	60	97	53	50	103
Kapala	212	250	462	93	135	228	119	215	334
Kidetok	380	220	600	250	110	360	130	110	240
Acuna	53	54	107	0	0	0	0	0	0
Tubur	71	72	143	67	64	131	4	8	12
Average	162.6	179.3		90.3	87.9		67.9	95.3	

Figure 3.2-3a Primary school enrolment across the RGCs

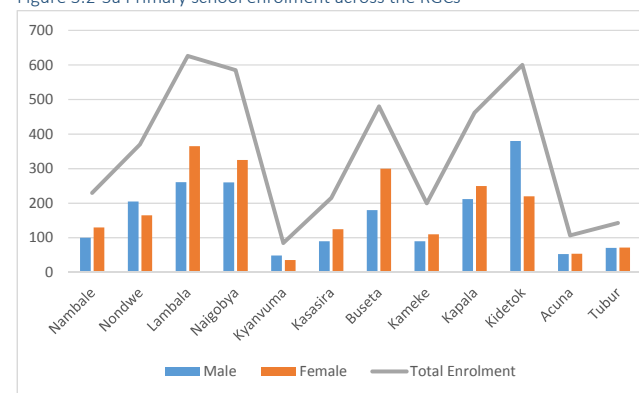
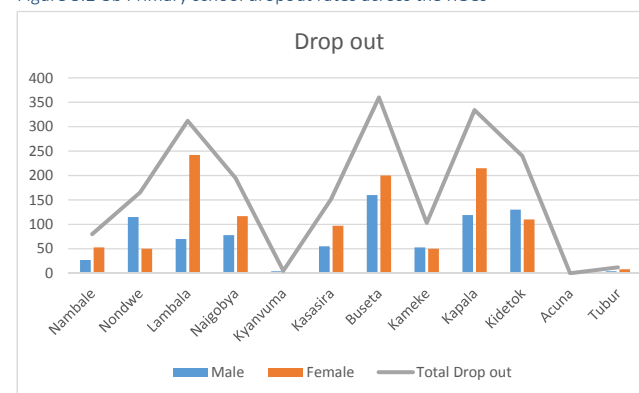

Figure 3.2-3b Primary school dropout rates across the RGCs



Dropout rates are highest in Buseta followed by Kapala and Lambala and they are lowest in Acuna and Kyanvuma. When dropout is expressed as a percentage of enrolment, the outcome is presented in figure 3.2-3c below. The highest percentage drop out rates are reported in Buseta, Kapala and Kasasira. In these

RGCs according to the data, more than a half of all the children who enrol in primary 1 drop out of school before they complete P7. While this dropout rate is to be interpreted carefully as it include those children who just change school, it points to a serious problem in those communities. In eastern Uganda in general, there have been increasing cases of children dropping out of school due to the increasing practice of growing rice as a cash crop. Children are compelled to stay at home to chase birds away from the rice crop. Rice is a major crop in Kapala though perhaps it is not as big in Buseta and Kasasira. The fact that

Kasasira and Buseta are in the same district and are close to one another may be significant. The problem of primary school dropout in these two RGCs needs to be explored.

Figure 3.2-3c Drop out as a percentage of enrolment

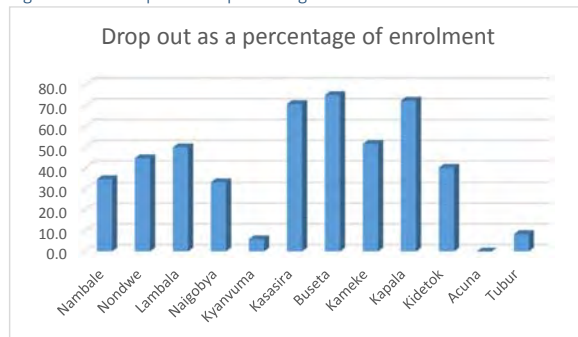

Enrolment rates for boys and girls at senior (S1 to S4) level are also explored in the figure 3.2-4a below. Total enrolment is highest at Kyanvuma followed by Lambala and Kameke. What is more, at all those RGCs, the number of girls enrolled is greater than that of boys. Enrolment rates at this stage are lowest at Nambale, Kasasira, Buseta, Kidetok and Acuna. For Kasasira and Buseta, a pattern seems to be emerging where children drop out at some stage in primary and they never get back to school at all. Again the fact that these are in the same district and are close to one another should not be ignored.

Figure 3.2-4a Enrolment rates at S1 to S4 stage

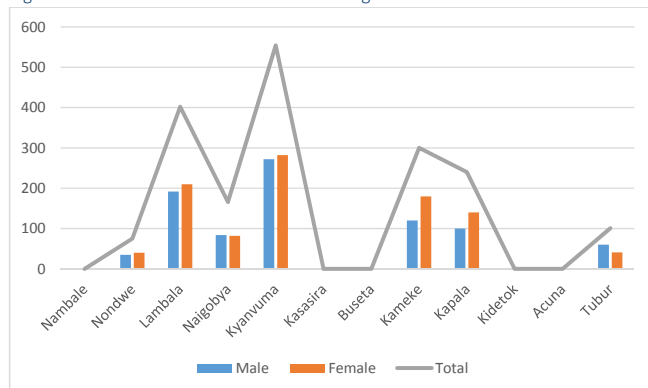
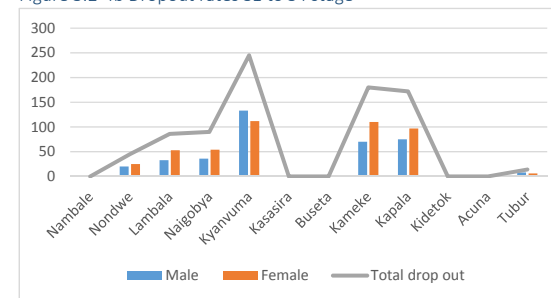

Figure 3.2-4b Dropout rates S1 to S4 stage



Dropout rates at this level are highest in Kyanvuma and Kameke and Kapala. They are lowest at Kasasira, Buseta, Nambale, Kidetok and Acuna. The case of Buseta and Kasasira is not necessarily good as the level of enrolment at this level is also low. The pattern that emerges from the two graphs is that where enrolment is low, drop out is also low. The exception is Lambala

where enrolment is high and drop out is relatively low putting Lambala in a good position in terms of retention of students at senior school level.

At S5 to S6 level, the data on enrolment shows that there are only two RGCs that report any enrolment and those are Nondwe and Naigobya. At Nondwe, the number of girls exceeds that of boys while at Naigobya it is the opposite.

Figure 3.2-5a Enrolment rates at S5 to S6 stage.

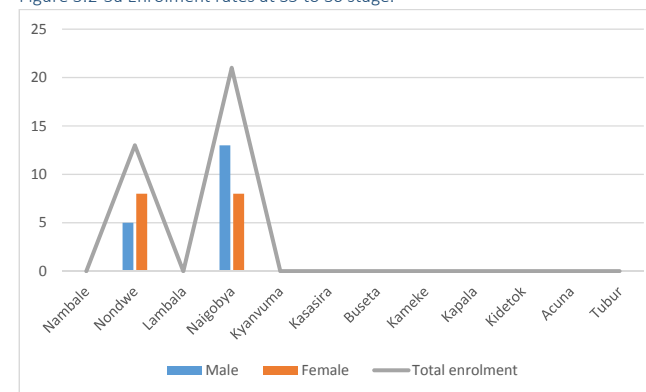

A graph of the dropout rates at the S5 to S6 level shows that in Nondwe, all the girls that enrol at this stage drop out before they complete while 40% of the boys do not complete the stage as well. In Naigobya, about 24% of the girls don't make it to the end of the stage while 4% of the boys also do not make it. In both RGCs the proportion of girls dropping out is higher than that of the boys. At this stage, the possible reasons for this are early marriages and teenage pregnancy. Long times spent at the water sources have been repeatedly blamed for teenage pregnancies. However there is not enough data to explain this observation in this study and the issue begs further investigation.

Figure 3.2-5b Dropout rates at S5 to S6 stage.

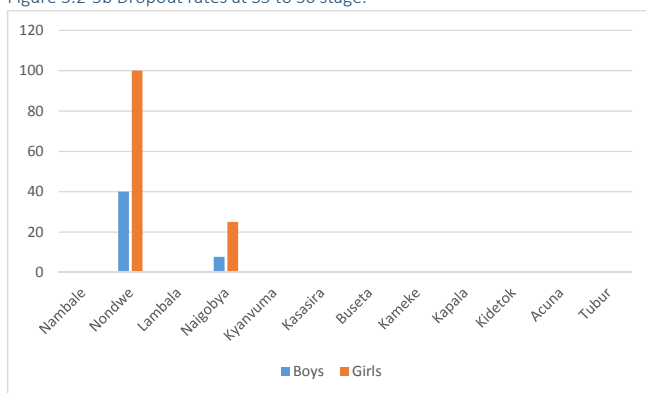

### 3.2.5 Electricity supply

TABLE 3.2-4 ELECTRICITY SUPPLY TO THE RGCs

	Hours a day	Days a week
Acuna	0.0	0.0
Buseta	2.7	1.3
Kameke	9.0	5.0
Kapala	16.7	4.7
Kasasira	4.8	2.5
Kidetok	13.3	5.0
Kyanvuma	12.0	5.0
Lambala	12.0	3.5
Naigobya	7.0	2.0
Nambale	18.0	5.0
Nondwe	12.0	3.5
Tubur	0.0	0.0
Min	0	0
Max	24	7
Average	8.5	3.1
Mode	0	0

Data on electricity supply to the RGCs is presented in table 3.2-4 to the left. Note that the figures are average figures based on the reports of one or more LC1 in an RGC. In some RGCs there are zones with power and zones without any power while in some RGCs, all zones have power but some have more frequent power cuts than others.

The data shows that Acuna and Tubur have no power at all. Others have power for differing numbers of hours a day and differing numbers of days a week. Kapala and Nambale are the RGCs with the most reliable power supply enjoying over 16 hours of power every day for at least 4 days a week. Kameke, Kidetok, Kyanvuma, Lambala and Nondwe also have fairly reliable power supply with at least 12 hours of power supply for at least 3.5 days a week.

Figure 3.2-6 Electricity supply.

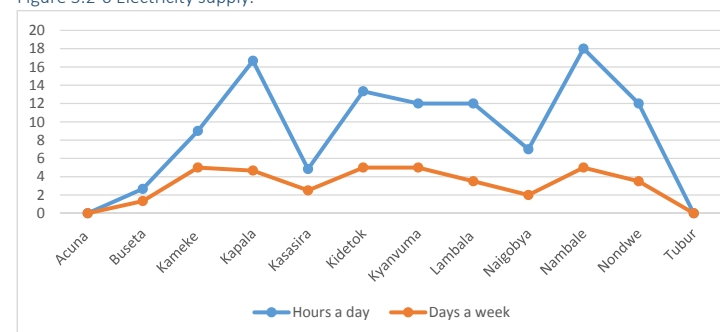

Steady power supply is very important for fostering investment in small enterprises as electricity is, in general, the least cost way of running machinery like flour mills and equipment like refrigerators. Reliable power supply helps industrialists to set up companies that create employment which the RGCs need desperately. Reliable power supply is now also believed to improve performance of children in school due to the convenience of doing their homework.

### 3.2.6 Water fetching

#### 3.2.6a Impact on job opportunity for women.

TABLE 3.2-5 ADVERSE EFFECT ON JOB OPPORTUNITY FOR WOMEN.

Adverse effect	Count	%
Reporting late for work, opening business late	11	36.7
Loss of customer or business while fetching water	1	3.3
Carrying water affects a human health	3	10.0
Takes time for other activities	13	43.3
There is no effect	2	6.7
Total	30	100

One of the major impacts of water fetching on job opportunities for women is that it takes time for other activities. This was mentioned by 43% of the respondents. The time spent fetching water is significant and

women are the HH members that have the greatest responsibility for fetching water. While they are fetching water their other engagements such as child care, cooking, and gardening suffer. Another significant impact is that those women who are already in employment are forced to report late for work. This undermines their ratings at work as well as their chances of promotion, at times their pay and sometimes it can even lead to losing their jobs.

#### 3.2.6b Adverse effect on school attendance for children

The effects named in connection with children are outlined in table below. The main one is that they reach school late or they miss lessons. In rural and semi-rural setting, one of the first chores for children is to go to the well or water source and collect the water for the day. For that purpose they have to wake up sometimes as early as 5.00 am. But even then, owing to the distance and the queue at the source, they are only able to return home just a few minutes before school time. By the time they jog to school, it will be past the acceptable time and they will get punished for being late and get into the class late having

missed some lessons. Moreover, sometimes out of lack of alternatives or due to the need to minimise time wastage, children often go to the water source in their school uniforms which also get wet and muddy making their school ordeal worse.

TABLE 3.2-6 ADVERSE EFFECT ON SCHOOL ATTENDANCE FOR CHILDREN

Adverse effect	Count	%
Reach school late or miss some lessons	16	53.3
Poor attendance, can't focus due to fatigue	8	26.7
They get seduced at water source resulting into early pregnancy	3	10.0
Poor performance in class due to poor attendance	2	6.7
There is no effect	1	3.3
<b>Total</b>	<b>30</b>	<b>100</b>

Late arrival at school leading to missing some lessons as well as poor attendance due to fatigue all lead to poor performance. Since girls carry a greater responsibility for fetching than boys, the impacts of water fetching are likely to affect girls more than boys, perpetuating the imbalance that already exists in literacy and employment.

### 3.2.7 Water sellers

#### 3.2.7a Existence of water sellers

On existence of water sellers, 53.3% of the village leaders reported that there are water sellers in their villages and 46.7% said that they do not have water sellers. The average number of sellers reported for all the villages is 6.25. The RGCs that report water sellers are seen in figure 3.2-7 below. The number of water sellers in those RGCs are also indicated.

Figure 3.2-7 Number of water sellers.

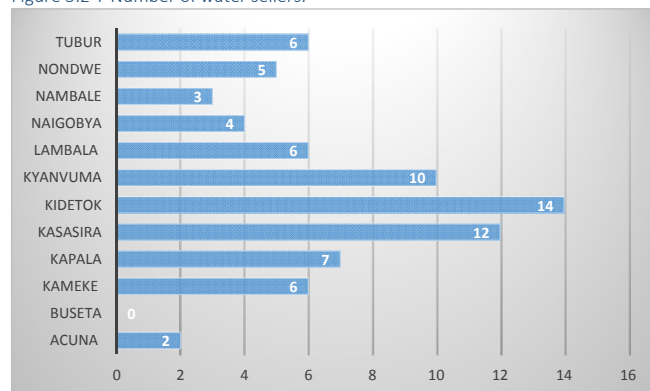

Kidetok RGC has the highest number of water sellers at 14 while Buseta has none. Data was also sought on where the water sellers fetch water. The main source of water for the water sellers was named as the borehole.

### 3.2.7 Income and expenditure

#### 3.2.7a Sources of income

Table 3.2-7 below shows the sources of income for the residents in the villages. Based on the data, the main source of income is the sale of agricultural produce. Selling labour comes second.

TABLE 3.2-7 SOURCES OF INCOME

Source of income	Villagers getting the income (count)			
	Many	Some	A few	None
Selling animals	1	4	17	8
Agricultural crops	29	1	0	0
Selling labour	9	9	10	2
Forestry	0	2	11	17
Others1 (business)	2	5	14	9
Others2 (business)	2	1	7	20

The observation on the sale of agricultural produce tallies with the household data where a lot of people reported the sale of agricultural produce as a source of income. Forestry ranked least as a source of income with most respondents indicating that none of the residents got their income from there.

#### 3.2.7b Income per HH

According to the village leaders, the average HH monthly income is around Shs 26,467- while the average annual income is around Shs 318,433. These data differ greatly from the self-reported data of respondents in the HH data. The HH data puts the monthly and annual incomes significantly higher. The difference is most likely due to the poor information that village leaders have on income of HH in their jurisdictional areas. Income is a highly private matter in most communities in Uganda. In particular HHs tend to greatly underestimate their incomes when interacting with LC1 leaders due to the fact that local government leaders have traditionally been associated with taxation. Village leaders may however also underestimate the incomes of members of the community if they believe that this will persuade project and services to be sent to the community. These two factors may have been at play in the reporting of the LC 1s.

Figure 3.2-8 Comparison of HH income data.

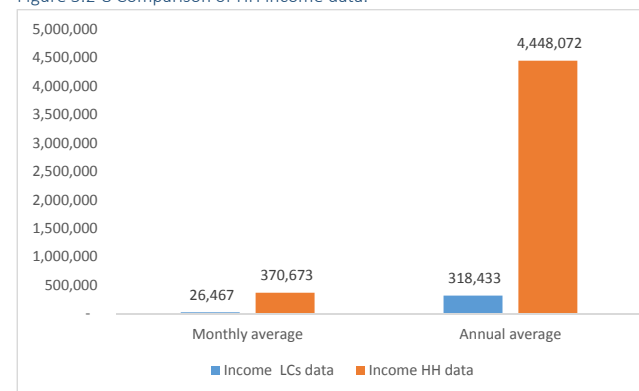

### 3.2.7c Seasonal Changes in income

Responses on seasonal changes in income are summarised in table 3.2-8 below. A major observation is that there is low income during the dry season. The dry season is associated with low agricultural production and low sales of agricultural produce. Harvest season is associated with high income due to the sale of agricultural produce and planting season is associated with low income due to the fact that there will not be any produce to sale. The fluctuation in incomes associated with the sale of agricultural produce reveals that storage and preservation of produce is a challenge and so is processing to longer lasting forms. Improvement in post-harvest handling, storage and processing can help to create a more stable flow of income to HHs in the survey area.

TABLE 3.2-8 SEASONAL CHANGES IN INCOME

Seasonal changes	Count	%
Income is constant	2	6.7
Low income during the dry season	12	40.0
High income during harvest/low income during planting season	8	26.7
Price fluctuation of agricultural products	1	3.3
Adverse conditions like pests, flooding, prolonged drought	7	23.3
<b>Total</b>	<b>30</b>	<b>100</b>

### 3.2.7d Number of livestock in the HH

Village leaders were also asked about the number of livestock in HH in their areas. According to the leaders, on average each HH has 1 cow, 1.8 goats and 0.3 sheep. By implication, many HH do not have any sheep while many HHs have more than 1 goat. The average number of livestock per village is 62.3 animals. The average per RGC has also been calculated and is shown in table 3.2-9 below.

Figure 3.2-9 Comparison of HH income data.

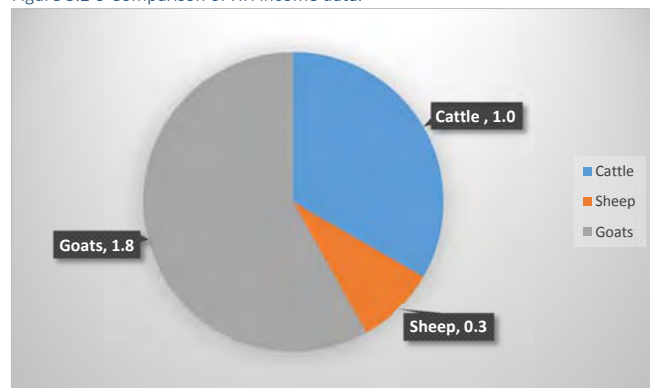
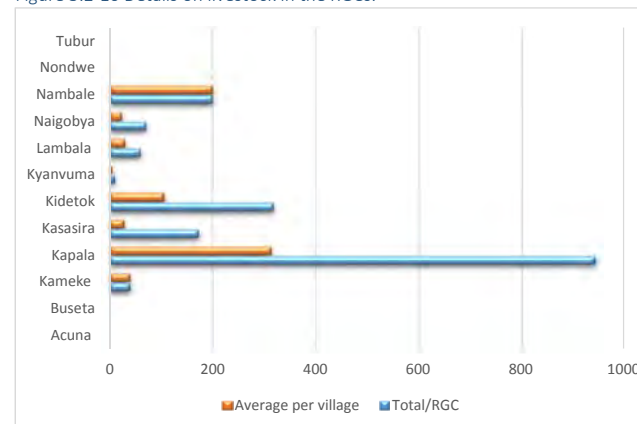

TABLE 3.2-9 DETAILS ON LIVESTOCK IN THE RGCs.

Cattle	Sheep	Goats	Total/RG C	No of villages	Average per village	Average for all Villages
Acuna	0	0	0	2	0	
Buseta	0	0	0	3	0	
Kameke	0	40	0	1	40	
Kapala	160	212	570	3	314	
Kasasira	64	24	85	6	28.8	
Kidetok	70	168	80	3	106	
Kyanvuma	0	10	0	2	5	
Lambala	10	0	50	2	30	
Naigobya	65	6	0	3	23.7	
Nambale	200	0	0	1	200	
Nondwe	0	0	0	2	0	
Tubur	0	0	0	1	0	
	569	460	785		747.5	62.29167

Figure 3.2-10 illustrates the figures for total per RGC and average per village. Kapala has the highest total and the highest average per village. Kidetok has a relatively high total for the RGC but the average per village is lower as there are 3 villages. Nambale has a good number of animals and the average is also the same since it has only one village.

Figure 3.2-10 Details on livestock in the RGCs.



### 3.2.7e Remittances

When data on remittances was analysed it showed that 33% of the people receive no remittances while 66.7% receive some remittances.

TABLE 3.2-10 PEOPLE RECEIVING REMITTANCES

Remittances	Count	%
-------------	-------	---

None	10	33.3
Some	20	66.7
Others	0	0

It would appear therefore that remittances contribute to the income of the majority of the residents in the villages where the survey took place.

### 3.2.7f Payment for water per jerry can

Fourteen (14) out of the 30 respondents or 46.7% indicated that they do not pay for water per jerry can.

TABLE 3.2-11A PAY FOR WATER PER JERRY CAN

	Uganda Shs
Minimum	50
Maximum	300
Average	200
Mode	300

The rest 16 or 53.3% indicated that they pay. The average pay per jerry can is Shs 200 though the leaders reported payment ranging from Shs 50 to Shs 300. Both Shs 200 and Shs 300 are mentioned the same number of times, indicating that these are the most common prices for one jerry can of water. This information is also illustrated in table 3.2-11b below.

TABLE 3.2-11B PAY FOR WATER PER JERRY CAN

Payment Per jerry can (Ugx)	Count
50	2
100	2
200	5
300	5
Nothing	16

### 3.2.7g Water consumption

Table 3.2-12 below presents the data on water consumption. The table shows that most people consume between 11 and 30 litres of water per person per day. However, as can be seen, most respondents reported a figure between 11 and 15 litres per person per day.

TABLE 3.2-12 WATER CONSUMPTION – LITRES PER CAPITA PER DAY.

Consumption - litres per capita per day	Count	%
Less than 5	0	0.0
6 to 10	5	16.7
11 to 15	10	33.3
16 to 20	7	23.3
21 to 30	6	20.0
31 to 50	2	6.7
More than 50	0	0.0

### 3.2.7g Latrine cost including soap

In most of the RGCs, there is no payment for toilet. However, most of these RGCs also do not have any public toilets. A public toilet was seen in Kameke however it appeared to be locked most of the time. Most people therefore use their personal toilets and when they are not at home they use institutional toilets

such as schools and government offices like the parish sub-county offices. In those RGCs where public toilets are to be found they are likely to be out of use due to lack of water or sheer misuse.

The lack of public toilets, free or paid for, is a major problem for sanitation and hygiene in the RGCs. Without convenient public toilets, people resort to urinating everywhere and finding the nearest bush or garden if they get a bout of diarrhoea. One of the major challenges with public toilets is water both for flushing and for washing hands. Improving access to safe water will help in facilitating the availability of public toilets in the RGCs.

Table 3.2-13a shows that most in most of the RGCs, going to the toilet costs nothing. Table 3.2-13B shows the situation in the respective RGCs. The culture of paying for toilets in the RGCs is absent except may be in Lambala where all people pay at least a little. The situation is however reversed for Tubur where it is indicated that most people pay a lot. It is not clear why this is the case in Tubur. However, this situation is also not helpful as people will still resort to unhygienic options either because they cannot pay or just to avoid the high cost of latrine. (note that the averages of table 3.2-13b will not equal the figures in table 3.2-13a as some of the figure in the later RGC wise table are themselves averages.)

TABLE 3.2-13A PAYMENT OF TOILET

Latrine cost including soap				
Payment	Nothing	A little	In between a little and much	A lot
Percentage (%)	80.83	8.80	3.33	7.03

TABLE 3.2-13B PAYMENT OF TOILET

RGC	Payment (%)			
	Nothing	A little	In between a little and a lot	A lot
Nambale	100	0	0	0
Nondwe	100	0	0	0
Lambala	0	92.5	5	2.5
Naigobya	100	0	0	0
Kyanvuma	100	0	0	0
Kasasira	100	0	0	0
Buseta	100	0	0	0
Kameke	52.5	2.5	10	35
Kapala	55.00	11.67	10.00	23.33
Kidetok	100	0	0	0
Acuna	75	12	10	3
Tubur	5	15	20	60

### 3.2.7h Payment for medicine and hospital

In the case of payment for medicine and hospital, the higher percentages in all the RGCs were reported to be paying a lot. The average of the percentage of the people who are paying a lot in all the RGCs is 55.1 and most of the RGCs are above this except for Naigobya and Tubur. The assessment of whether one is paying a lot or a little can be subjective but at least it tells us that the people in these locations feel that



they are paying a lot. When people feel that they are paying a lot, they may hesitate to seek medical attention due to concern over the expense and this could make the spread of infections worse.

TABLE 3.2-14A PAYMENT FOR MEDICINE AND HOSPITAL

Payment for medicine and hospital				
Payment	Nothing	A little	In between a little and much	A lot
Percentage (%)	8.50	19.00	35.00	37.50

TABLE 3.2-14B PAYMENT FOR MEDICINE AND HOSPITAL – RGC WISE

RGC	Payment (%)			
	Nothing	A little	In between a little and a lot	A lot
Nambale	10	20	20	50
Nondwe	0	0	10	90
Lambala	0.5	0.5	1	97.5
Naigobya	3	12.7	53.3	31
Kyanvuma	7.5	12.5	20	60
Kasasira	8.5	5.7	22.5	63.3
Buseta	30	8.3	11.7	50
Kameke	8.5	19	35	37.5
Kapala	5.7	14.3	26.7	53.3
Kidetok	15.0	10.0	21.7	53.3
Acuna	1.5	8.5	20	70
Tubur	10	15	70	5

### 3.2.8 Cooperative (communal) activities and organisations

#### 3.2.8a Organisation and activities

According to the O and M guidelines from the Government of Uganda, rural water sources are supposed to be maintained through the community bases operation and maintenance system. This system is based on the cooperative activities of all the water users who must regularly contribute some fee so that when the water facility breaks down, there is money for its repair. Where people have experience with cooperative and communal activities including the raising of funds and working on projects as a community, the establishment of O and M systems for water sources is likely to be easier. Previous experiences will be brought to bear on the new situation and this will ease the challenges associated with setting up the systems for the operation and maintenance of the new systems.

#### 3.2.8b Women's water related and other collective activities

Only one out of the 30 respondents reported any women's organisation for water related activities. Twenty nine (29) or 97% reported that there were no women's organisations for water in their villages. This is perhaps attributable to ministry guidelines that mandates the existence of WSCs for all water facilities. Besides, most of the organisations attract a monetary value and majority of the women would not find it satisfying to engage or start up water related organisations whose monetary returns may not easily be measure at face value. However women's organisations were reported for a series of other activities as outlined in table 3.2-15 below. The most frequently named activity is savings and credit –

what is commonly called SACCO in Uganda, where women pool money through saving and then lend it out to individual members for business. Other types of organisations named include those for farming and mobilisation and sensitisation for health.

TABLE 3.2-15 WOMEN'S ORGANISATION-OTHER ACTIVITIES

Women's organisation-Other activities	
Activity	Count
Savings and credit activity	18
Farming	4
Mobilisation and sensitisation on health	2
None	6
Total	30

#### 3.2.8c Youth water related and other collective activities

TABLE 3.2-16 YOUTH ORGANISATION-OTHER ACTIVITIES

Youth organisations-Other activities activity	
Activity	Count
Welding	1
Making bricks	4
Farming-Agric and livestock	5
Savings and credit	5
None	15
Total	30

Youth had no organisation involved in water related activities but when it came to other activities, there were quite a number as listed in table 3.2-16 with several naming savings and credit as well as farming with agriculture and livestock. Both "Farming and Agriculture" as well as "Saving and Credit" featured significantly in this list.

#### 3.2.8d Contribution to the construction of new piped water facility

Asked about the possible contribution of the RGC to the new piped water facility, more people communicated willingness to contribute with the highest score going to "collecting water fee" as well as "simple repair of the facility"

TABLE 3.2-17 CONTRIBUTION TO THE CONSTRUCTION OF NEW PIPED WATER FACILITY

Contribution	Yes	No
Collecting water fee	20	10
Operating the facility	15	15
Simple repair of the facility	19	11
Others	16	14

Other contributions were led by contributing land, providing labour and mobilisation of community members in that order.

#### 3.2.8e Willingness of villagers to pay O and M money regularly

Twenty nine out of thirty leaders reported that village residents are willing to pay for O and M regularly. The other person said that he did not know whether they are willing or not. The questionnaire also probed those who felt that people are willing to pay regularly for O and M the reason why they felt this is the case. The answers are presented in figure 3.2-11. The main reason is that the community needs water badly. However, the leaders also said that the residents are already paying for O and M and therefore they are familiar with the concept and action.

Figure 3.2-11 Reasons why they would be willing to pay O and M fee regularly.

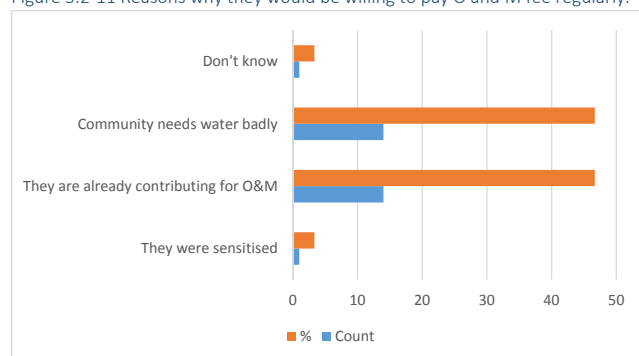

### 3.3 ACTIVITIES OF THE WATER AND SANITATION COMMITTEES (WSCs)

#### 3.3.1 Characteristics of the respondents

The activities of the water and sanitation committees were also investigated in this study. A questionnaire to collect information on the activities of the WSCs was designed and administered to members of the WSCs. A total of 49 respondents were interviewed with this questionnaire. The respondents held different responsibilities with their WSCs as outlined in table 3.3-1 below.

TABLE 3.3-1 DETAILS ON THE RESPONDENTS

Position of the respondent	Count
Chairperson	22
Vice chairperson	3
Secretary	4
Treasurer	2
Member	0
Caretaker	15
Mobiliser	2
Other	1

#### 3.3.2 Water sources

For each of the respondents, information on the water source that he/she is responsible for was collected. Most of the respondents were members of the WSC of boreholes. This is not surprising as most of the other sources such as protected spring and unprotected spring normally have weak or non-existent WSCs. This is because they do not need a lot of maintenance which involves cost and therefore there is little need to collect O and M fees regularly. It is also pertinent to note that in vernacular, both a deep borehole and a shallow well with a hand pump have the same name.

TABLE 3.3-2 WATER SOURCES REPRESENTED BY THE RESPONDENTS

Water Source	1. Borehole	2. Shallow well	3. Dug well	4. Protected spring	5. Unprotected Spring
Number	47	2	0	0	0

#### 3.3.3 Establishment and existence of WSCs

TABLE 3.3-3 YEAR OF ESTABLISHMENT AND AGE OF WSC

Year of construction	Number
1990-1995	2
1996 - 2000	4
2001 - 2005	1
2006 - 2009	5
2010 - 2015	34
2016 on	1

The year of establishment ranged from 1993 for the oldest WSC having lasted 23 years to one that was established just this year 2016. Most of the WSCs were established between 2010 and 2015. To give details these have been isolated and are presented in table 3.3-4 below.

TABLE 3.3-4 DETAILS ON WSC ESTABLISHED BETWEEN 2010 AND 2015

Year of establishment	No of WSCs	Age
2010	1	6
2011	3	5
2012	8	4
2013	5	3
2014	8	2
2015	9	1

The minimum number of years of existence was 0 as some of the WSCs had not seen their first birthday. The highest was 23 years while the mean was 5.3 years. The most frequently occurring single value was 1 and that means that a good number of WSCs were set up in 2015. The number of these as seen from the table above is actually 9.

TABLE 3.3-5 YEARS OF EXISTENCE OF WSC

	Year in existence
Min	0
Max	23
Average	5.3
Mode	1

All the respondents interviewed were members of existing WSCs which is the reason they were able to participate in the study. All the WSCs they represented are still existing and none has been disbanded.

#### 3.3.4 Number of committee members in the WSC

The data on the membership of the WSCs that were represented in this study is presented in table 3.3-6 below and is presented graphically in figure 3.3-1 below. From the graph it is easy to tell that men exceed women in all positions except that of treasurer. The reason for this is that women are generally believed to be more honest with money than men and most times they are voted into the position of treasurer to boost confidence in the WSC's management of finances. It is also possible that these committees are formed without proper sensitisation and guidance on how they should be structured, hence the male dominance in most of the key areas. Yet it's already been established in this survey that women are the ones that have the greatest responsibility for fetching the water needs of the home and should therefore be at the forefront of water and sanitation related activities.

TABLE 3.3-6 MEMBERS ON THE WSC

Number of members	Chairperson	Vice chair person	Treasurer	Secretary	Care taker	Mobiliser	Advisor	other1	Other 2	Other 3
Females	2	20	29	8	13	6	1	4	4	4
Males	47	23	19	38	32	31	11	5	4	0

Figure 3.3-1. Gender and the positions of the WSC

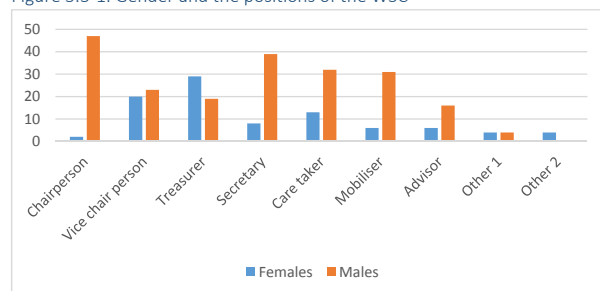

Regarding the full term of the different positions on the WSC, there is no standard across the region. Each WSC operates according to its byelaws. Due to the fact that positions on the WSC are volunteer positions – not paid and good committed

people are difficult to find, many WSCs find it convenient to leave committed officials for as long as they are willing to serve. In table 3.3-7 below, the responses to the question of the full term are analysed. It can be seen that different WSCs have different terms. At the same time there were a number of WSCs that clearly stated that they do not have limits on terms and that the longevity of the official in the position depends on his/ her performance. It can be seen however that the average is around 3.5 years.

TABLE 3.3-7 FULL TERMS OF THE DIFFERENT POSITIONS ON THE WSC

Role		C/person	Vice C/person	Treasurer	Secretary	Care taker/Mobiliser	Advisor	Other 1	Other 2	Other 3
Full term of the role	Min	1	1	1	1	1	1	1	2	2
	Max	15	15	15	15	15	15	15	5	2
	Average	3.5	3.6	3.6	3.6	3.6	3.5	3.6	3.2	2
	Mode	3	3	3	3	3	3	2	2	2

### Method of selection

Tables 3.3-8a and b below summarise the method of selection. Because each of the WSCs represented in this study has its way of selecting its leaders, it is not possible to just associate one method with a position. However it is clear from the data that most of the positions are filled by election by the water users. This approach is also recommended by the Ministry of Water as it enhances participation and ownership of the decisions that the leaders make.

TABLE 3.3-8a METHOD OF SELECTION

Method of selection	Count	%
Elected by water users	44	89.8
Took over due to poor management	1	2.0
Appointed by WSC official	1	2.0
Appointed by donor/sponsor/owner	3	6.1
Total	49	100.0

TABLE 3.3-8b METHOD OF SELECTION

	C/person	Vice C/person	Treasurer	Secretary	Care taker	Mobiliser	Advisor	Other 1	Other 2
Election by water users	46	38	45	44	43	36	21	8	4
Appointed by WSC officials	0	1	0	0	0	0	0	0	0
Appointed by donor/sponsor/owner of BH	2	3	2	1	1	1	1	0	0
Took over due to poor management	1	1	1	2	1	0	0	0	0

There are however some unique approaches to the selection of leaders mentioned and they include appointment by the donor or owner for facilities set up by missions or at the mosques. One unique approach that was mentioned is the taking over of management after mismanagement by the previous officials of the WSC. This is not a recommended method by the ministry.

### 3.3.5 Management of WSCs

When WSC officials were asked whether the management of their WSC is going well, 85.7% reported that it was going well while 14.3 percent reported that it was not going well.

When probed for the reasons for the management not going well the main answers were as presented in chart 3.3-2 below.

Figure 3.3-2. Reasons why management of WSC is not going well.

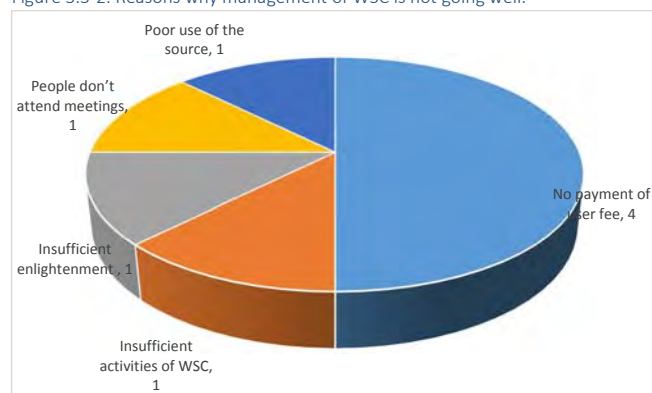

#### Activities for improvement of management

Two measures are suggested for the improvement of management by those who said that management was not going well and these are “saving water user fee collection from members for repair” and “common understanding between WSC and water users” (quoted verbatim) The first refers to collecting user fee regularly and accumulating it so that when there is a break down, funds for repair are easily available. The second refers to the promotion of harmony between the WSC and the water users and may be based on misunderstanding that exist in the area of the person that gave it. By implication, these practices are not well grounded in the WSCs where it was reported that management is not going well. This points to the need to have regular support to the WSCs from the officials in the local government as a way of enhancing O and M and the sustainability of handpumps.

#### Meetings of the WSC in the past.

On meetings in the foregone period, 98% of the respondents reported that their WSC had held meetings in the past. Only one reported that there had been no meetings in the past.

TABLE 3.3-9 WSC MEETINGS IN THE PAST.

WSC meeting in the past	Count	%
Yes	48	98.0
No	1	2.0

The number of meetings ranged from 0 to 8 meetings in the past year with an average of 2.6 meetings. With 8 meetings, the WSC is meeting almost once a month and this is quite a high frequency of meetings. Note that some of the people who reported that their WSC had had meetings in the past did not report a meeting in the past year perhaps indicating that it is more than a year since the last formal meeting of the WSC. Such a low frequency of meeting could be a sign of problems for the WSC.

TABLE 3.3-10 NUMBER OF MEETING IN THE PAST YEAR

E1-Number of meeting in the past year	
Minimum	0
Maximum	8

Average	2.6
---------	-----

The details of the meetings are given in the subsequent tables.

TABLE 3.3-11 A, PURPOSE OF MEETING OF WSC

Purpose	Meeting1 Count	meeting2 Count	meeting3 count	meeting4 Count
Election of WSC members	5	0	1	0
Ways of collecting user fees	5	8	2	2
Maintenance of the facility	21	11	2	2
Mobilisation and sensitisation on sanitation and hygiene	7	5	3	0
Source repair	5	1	4	0
Protection/fencing of the water source	1	0	2	1
Issues concerning new water project	0	2	0	0
Report on the condition of BH	0	0	0	2
Others	1	1	2	0

All together the most frequent purpose for meetings is “Maintenance of the facility”. Discussing “Ways of collecting user fees” is also a major reason for meetings as well as mobilisation and sensitisation on sanitation.

TABLE 3.3-11 B, AGENDA OF MEETING

Agenda	Meeting1 Count	Meeting2 Count	Meeting3 Count	Meeting 4 Count
Collection of user fee	14	13	1	2
Repair of the source	17	6	7	1
Maintenance-O&M	4	1	0	0
Election of leaders	4	0	1	0
Improving cleanliness, sanitation and hygiene	2	5	1	1
Water source management issues	2	0	2	0
Protection of the borehole	2	1	1	1
Hosting water providers	0	1	0	0
Establish number of water users	0	0	2	0
Report on the condition of BH	0	0	0	1

The data also shows that the predominant agenda item in all the meetings is “Collection of the user fee” and “Repair of the source”. Most of the WSC met once a year and the participants were dominated by the users both male and female.

### Opinions from female participants

Responses show that 93.8% observed that women submitted opinions in the meetings. In the same way, 97.8% of the respondents observed that when women submitted opinions, those opinions were treated the same way as those of men. Regarding questions from participants apart from the committee members, all respondents reported that such questions were there.

The type of opinions that they submitted are summarised in the table below and the type of motions that participants submitted are summarised in the subsequent table.

TABLE 3.3-12 OPINIONS SUBMITTED BY WOMEN

Opinion	Count	%
Ways of improving sanitation and hygiene	8	17.4
Improving collection, recording and management of user fees	11	23.9
Orderly use of the Borehole	10	21.7
Mobilising resources to get another borehole	3	6.5
To protect and secure the water source	4	8.7
Ensuring that facility is maintained and repaired	8	17.4
Improving the management of the facility	2	4.3
Total	46	100

The majority of the opinions were concerning improving collection, recording and management of user fees. The second most important category of opinions was concerning

orderly use of the borehole. The prominence of the issue of user fees is expected since this is the most vital and yet most troublesome issue in the management of water sources. The prominence of the issue of orderly use of the facility points to another important issue. Orderly use impacts the longevity of the facility as well as the sanitation and hygiene at the facility.

On the motions, data as seen in the table below, shows that the most frequent motions was on improving the management of the water source. The elements of this motion are similar to the contents of the opinions on orderly use of the borehole. There were also a significant number of motions on the treatment of water to make it safer. Some of the motions in this category had to do with the use of chlorine dispensed at the borehole while others were raising the issue of either coloured water or water with an undesirable taste and how to treat such water to make it more usable.

TABLE 3.3-13 TYPE OF MOTIONS SUBMITTED BY THE PARTICIPANTS BESIDES THE WSC OFFICIALS

Motions/questions	Count	%
Discussion on getting a new borehole	2	5
Improving maintenance and repair	3	7.5
Improving water source management	8	20
Protecting and fencing the source	2	5
Treating water to improve its safety	5	12.5
WSC to account for user fees collected	20	50

TABLE 3.3-14 IMPROVEMENT IN THE ACTIVITIES OF WSC

Improvement/changes	Count	%
Yes	32	80.0
No	8	20.0
Total	40	100

Regarding improvement in the activities of the WSC after the motions of the female participants, 61% of the respondent felt that indeed there were improvements in the activities and management of the WSC after the discussion.

Respondents specified six types of improvement as a consequence of the motions and decisions initiated by the female participants. The main ones of these improvement were that "accountability was provided to the users". Nineteen respondents or 59.4% mentioned this one. This one regards the management and use of the O and M fee regularly collected. The other improvement noted by seven or 21.9% of the respondents was that the rules for the proper use of the facility were enforced.

TABLE 3.3-15A EXISTENCE OF RECORD OF INCOME AND EXPENSE OF WSC

F- Does WSC have record of income and expenses	Count	%
Yes	44	89.8
No	5	10.2

On the existence of records of incoming and outgoing money, 89.8% of the respondents said that such records exist. This means that most of the WSCs were

doing well in terms of the documentation of financial transactions of the WSC. Where such records did not exist, the reasons given were as summarised in table 3.3-15b below. The passing on of the responsible official is a significant issue. The passing on or emigration of a WSC official has frequently proved a problem for many WSCs as organising for the replacement is often not done.

TABLE 3.3-15B REASON FOR NON-EXISTENCE OF RECORDS

Reasons for having no records	Count
Secretary died and has not been replaced	2
No money is collected	1
WSC has never resolved to keep records	1
Private borehole, no need of records	1

These records were for the most part in the hands of the secretary as seen from the table below.

TABLE 3.3-16 PERSON IN CHARGE OF KEEPING RECORDS

Person in charge of keeping records	Count	%
Chairperson	10	22.7
Secretary	28	63.6
Treasurer	3	6.8
Caretaker	2	4.5
School bursar	1	2.3

This is surprising since the person that should be in charge of collecting and spending finances is the treasurer. However, it may be that with many WSCs, the secretary is the person to do most of the day to day activities while the treasurer is left to manage the account and receive and organise for the keeping of the finances.

The number of WSCs with a check system was nearly equal with 56.5% saying that they have a system and 43.5% saying that they do not have one. This check system in the majority of cases involves the WSC sitting in a meeting and cross checking all the records one by one.

TABLE 3.3-17 OTHER ACTIVITIES CARRIED OUT BY THE WSC IN THE LAST YEAR

Activity	Count
Repair of facility	41
Request to sub-county /DWO	3
Improve sanitation and hygiene for the borehole	8
Raising funds for maintenance and repair	3
Fencing around the borehole	5

Besides the meetings and the activities mentioned above, 98% of the respondents said that the WSC carried out other activities in the last year. The kind of activities carried out are outlined in table 3.3-17 on the left. The leading activity was repair of the

facility named by 41 respondents. But there were also activities for the improvement of sanitation and hygiene for the borehole.

Respondents (98%) also admitted that the WSC has the mandate to carry out the activities named above.

#### Decisions on important issues of the WSC

TABLE 3.3-18 HOW DECISIONS ON IMPORTANT ISSUES OF WSC ARE MADE

How decisions on important issues of WSC are made	Count	%
Hold all water users meeting	34	66.7
Hold meeting of committee members and main users	9	17.6
Committee has power to decide	7	13.7
School administration	1	2.0

When respondents were asked how decisions on important matters are made, the responses they gave are listed in table 3.3-18. In 34 out of the 49 cases (or 69%), they hold a water users meeting and the motion is tabled and a decision made.

### 3.3.6 Operation and maintenance activities

#### 3.3.6a Payment of initial contribution.

Respondents reported different amounts paid as initial contribution. This information is summarised in table 3.3-19 below. 18.8% reported that initial contribution is not paid or that they do not know about it.

TABLE 3.3-19 AMOUNT PAID BY HH AS INITIAL.

Amount paid for initial contribution	Count	%
None	9	18.4
Don't know	3	6.1
2000 and below	18	36.7
2001-5000	15	30.6
Above 5000	4	8.2

The rest stated that it is paid and amounts varied from less than Shs 2,000 to Shs 10,000. People are often willing to give significant amounts of money for initial contribution so as to enable the community to get a facility.

Once a facility is constructed, it must be maintained. To this end it is recommended that users contribute money regularly to meet all the costs associated with maintenance and repair.

TABLE 3.3-20 REGULAR PAYMENT FOR O AND M

Regular payment for O&M	Count	%
Per jerry can	2	4.1
Per month	18	36.7
None	25	51.0
Whenever it breaks	4	8.2

Regarding regular payment, respondents reported that the favoured method of payment is payment per month. Payment per jerry can of water was reported by only two out of the 49 respondents with amounts ranging from Shs 100 to Shs 1,000 per jerry can.

The majority of water users pay a monthly fee ranging from Shs 100 to Shs 3,000 per month, with most reporting between 1,000 and 2,000= (3.3-20 below)

TABLE 3.3-21 AMOUNT EACH HH PAYS REGULARLY FOR O AND M PER MONTH

Amount per month	count
200	2
500	3
1000	6
2000	5

3000 2

TABLE 3.3-22 HOW OFTEN THE AMOUNT IS PAID (12-B)

How often HH pays the fee	Count	%
Monthly	16	35.6
Weekly	0	0.0
Other -When facility breaks down	23	51.1
Other yearly	6	13.3

When asked how often the amount is paid, the responses were concentrated mostly around "when facility breaks down" (51.1%), implying that the WSC makes an emergency meeting and takes up a collection for repair when the facility breaks down.

The second biggest proportion of responses 35.6% went to "monthly" reiterating the established practice of paying every month.

However, there are also other methods of payment. The most common of these is more of an excuse not to pay than a method. This method is making contribution whenever the HP breaks down and needs repair. The contribution can however come from a donor or the owner of the facility in case it was set up by a school or a religious organisation.

Where money for O and M was reported to be collected regularly, the method of collection was reported to be mostly collection at the water source followed by collection at the household. There were also instances where it was levied on the school fees of children and this is more practical if the water source is at the school and was constructed by the school.

Figure 3.3-3 How money is collected (13)

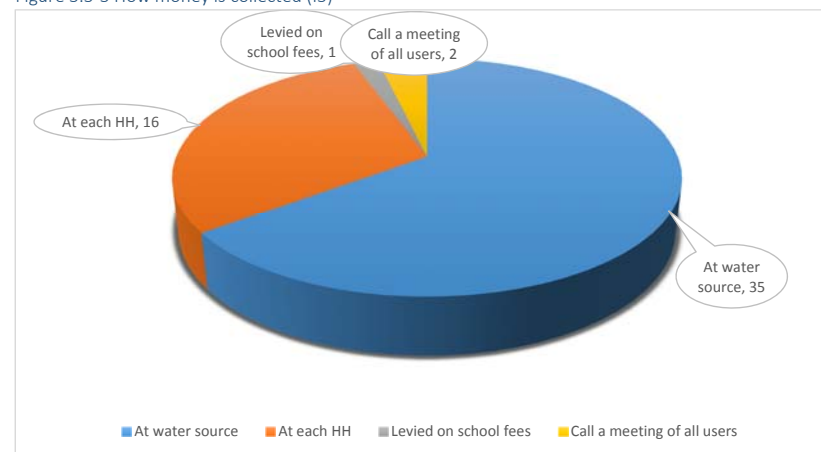

Where money is collected regularly, it was reported that it is collected mostly by the caretaker, followed by the chairperson and then the treasurer. The caretaker is very important in regular collection of O and

M money especially if it is collected at the source since it is the caretaker that has the responsibility of daily care of the source.

Figure 3.3-4 who collects the regular payment.

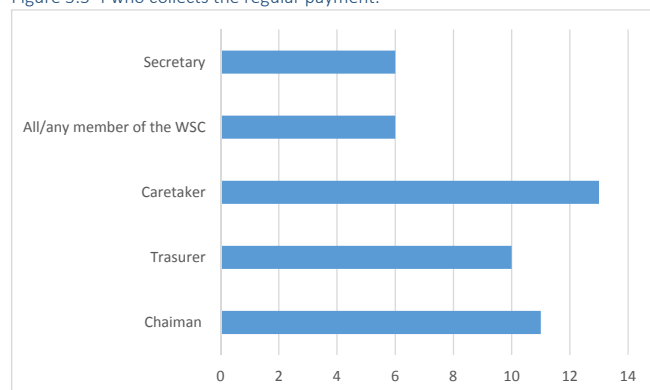

Money collected regularly poses a challenge of safe keeping. With easy availability of cash the chances of misappropriation and theft increase. When asked where the money is kept, village leaders gave the answers summarised in table 3.3-23 below.

TABLE 3.3-23 WHERE THE MONEY IS KEPT.

Where the money is kept	Frequency	%
Treasurer	34	69.4
Chairperson	2	4.1
Savings group/Bank	1	2.0
Used there and then	6	12.2
Secretary	1	2.0
Other, N/A	5	10.2

For the most part, the money is kept with the treasurer. Respondents also indicated that for some facilities the money is used immediately it is collected. However this is a method that may not be appropriate for regular collection of money. It is more suitable to situations where money is collected when there is a break down. The fact that only one leader indicated that the money is kept with a savings group is also

significant. The guideline for most of the facilities is that the money should be kept with microfinance institutions or banks. In practice however, this seems to be uncommon and indeed there are many challenges to its achievement including literacy and distances to bank branches.

Regarding the kinds of repairs done on the facility by the WSC, village leaders reported the replacement of different parts of a borehole including pipes, cylinder, chain, bearings, seals, rings and handles.

On the existence of byelaws, all village leaders reported that they exist. As to whether they are in operation, only 4.1% reported that they are not in operation. The rest – 95.9% said that they are in operation. Responses - 93.8% also indicated that the RGC's do not receive any O and M services from the government. Where it was reported that services were received, the service named was the repair of boreholes by the replacement of different parts. There were no software services reported.

95.9% of the village leaders also felt that village residents are willing to pay more regularly for O and M. Even so, 36.7% of the leaders reported that there are users who do not pay their water user fee. As to why they do not pay their user fees, the most common answer was that 'they do not have money' or 'they are poor'. All these data are summarised in table 3.3-24 below.

TABLE 3.3-24 BYELAWS AND O AND M FEES

Questions 17, 18, 19, 110, 111	Yes	%	No	%
Existence of bylaws	49	100.0	0	0.0
Are the bylaws in operation	47	95.9	2	4.1
WSC receives service of O and M from Govt.	3	6.1	46	93.9
Opinion on willingness to pay for O and M	47	95.9	1	2.0
Any members who do not pay water user fee	31	63.3	18	36.7

But when people default on their O and M payments is there any action taken to compel them to pay up? To this question the WSCs gave the answers in the table below. On the one hand there is pressure exerted on them to pay but this is only in the case of 15 of the 49 WSCs. One of the measures taken is to stop them from collecting water and this may also involve the confiscation of their jerry cans. This was reported by 65.3% of the respondents. However in some villages, the WSC leaders choose to be patient and instead sensitise and persuade the defaulters. There are also situations where they are just left to go on as usual, fetching water like the rest but not paying.

TABLE 3.3-25 MEASURES TAKEN ON THOSE WHO DO NOT PAY.

I11-b Effort to collect	Yes
Press relevant members	15
Do not press relevant members	2
Stop them from fetching water	18
Educate persuade mobilize	7
Leave them/ do nothing	7

NB. Answers not mutually exclusive. Percentage will not total to 100.

All except one of the respondents in this study indicated that the WSCs had explained the reason for payment of the water user fee.

When the facility breaks down and there is no money in the WSC purse to repair it, a number of options were given by the village leaders. These are outlined in the chart below.



Figure 3.3-5 Actions taken to repair when there is no savings

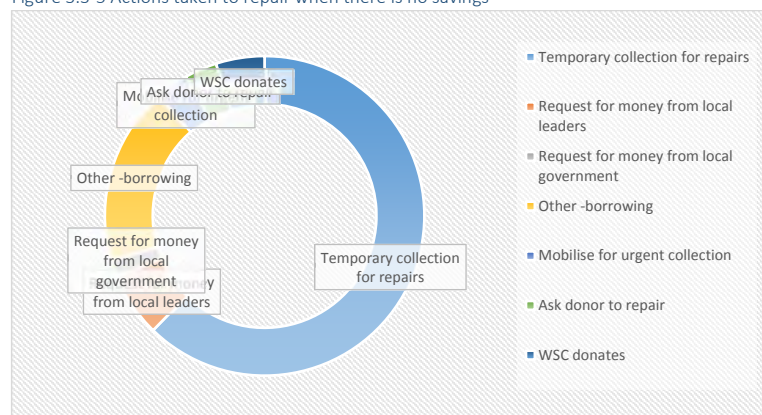

### 3.3.7 Income and expenditure of WSCs

TABLE 3.3-26 INCOME AND EXPENDITURE OF WSCs

	Income and Expenditure	
	Income	Expenditure
Min	0	0
Max	1,100,000	1,100,000
Average	204,824	195,559

WSCs gave some figure on income and expenditure of WSCs in their jurisdictional areas. These have been analysed and they are presented in table 3.3-26 to the left. Minimum annual income stood at Shs 0 while the maximum stood as Shs 1,100,000 and the average stood at 204,824. This average comes to around Shs 17,000 or USD

5.2 per month.

## 3.4 THE CONDITION OF HEALTH AND HEALTH SERVICES FOR THE RGCS

### 3.4.1 Introduction

The survey on the condition and health services in the RGCs targeted the health centre III in the RGCs and where the RGC did not have a centre located in it, the nearest HC III preferably in the same sub-county.

The purpose of including the Health Centres was to assess their influence on the promotions of sanitation and hygiene in the RGCs and how they impact and are impacted by the available supply of safe water. The questionnaire used for the HC survey is attached to this report as **Attachment 4**.

#### 3.4.1a Health centres surveyed

Ten HCs were covered in the survey. These are presented in table 3.4-1 below. At each of the health centres, the most senior officer present was interviewed. In the table, the positions of the respondent at each health centres is also presented.

TABLE 3.4-1. HEALTH CENTRES SURVEYED

District	Sub county	Name of Health Centre	Private/Government	Villages/location	Enumerator	Respondent/representative	Position of Respondent
KIBUKU	BUSETA	BUSETA HC3	GOVERNMENT	BUSETA C	EMMANUEL	OKOLERE	INCHARGE
PALLISA	KAMEKE	KAMEKE HC3	GOVERNMENT	KOMOLO B	CHERERE	ORINGA JUDE	HEALTH OFFICER
PALLISA	GOGONYO	GOGONYO HC3	GOVERNMENT	OUKOT	CHERERE	AMUGE JENNIFER	ENROLLED NURSE
KIBUKU	KASASIRA	KASASIRA HC3	GOVERNMENT	KASASIRA TOWNSHIP	CHERERE	NAMAJA RUTH	HEALTH OFFICER
SERERE	PINGIRE	KIDETOK MISSION HC3	PRIVATE	AGONYO 1	CHERERE	SISTER MARCELLINA	H/C IN CHARGE
LUUKA	IRONGO	IRONGO HC3	GOVERNMENT	LAMBALA	CHERERE	MUNOGI JENNIFER	RECORDS OFFICER
LUUKA	BUKOMA	NAIGOBYA NGO HC3	PRIVATE	NAIGOBYA TOWNSHIP	CHERERE	MUWERWA RITAH	RAB TECHNICIAN
IGANGA	NAMBALE	NAMBALE HC3	GOVERNMENT	NAMBALE	EMMANUEL	ACHENG MARTHA	ENROLLED NURSE
IGANGA	MAKUTU	KASOZI HC2	GOVERNMENT	NONDWE	CHERERE	ASUMAN MULINDA	ASSISTANT HEALTH OFFICER
SOROTI	TUBUR	TUBUR HC3	GOVERNMENT	TUBUR CENTRAL	EMMANUEL	IJONGAT HARRIET	NURSING OFFICER

### 3.4.2 Water borne diseases in the RGC

#### 3.4.2a Prevalence of water borne diseases

TABLE 3.4-2A PREVALENCE OF WATER BORNE DISEASES.

Disease	Prevalence			
	Very common	Common	Rare	Very rare
Malaria fever	10	0	0	0
Diarrhoea	3	6	1	0
Skin disease	0	8	2	0
Respiratory diseases	4	2	2	2
Worms	0	7	0	3
Eye disease/infection	0	7	1	2
Intestinal infection	0	1	0	9
Typhoid	0	1	1	8
Dysentery	0	2	0	8

When all the data from the 10 HCs is combined, the most prevalent disease is malaria/fever. Malaria/fever was ranked as very common by the majority of the respondent. This was followed by respiratory diseases which 4 people ranked as very common and diarrhoea which 3 people ranked as very common.



The ranking for very rare put the highest score at intestinal infections, followed by typhoid implying that from the health centre view, these are the least prevalent diseases when all the RGCs are taken together.

TABLE 3.4-2b PREVALENCE IN DIFFERENT AGE CATEGORIES

Disease	Age group	No. of patients	(%)
Malaria fever	Adults	32,895	67.02
	Children	252	0.51
	Infants	15,936	32.47
Diarrhea	Adults	2,349	48.85
	Children	29	0.60
	Infants	2,431	50.55
Skin Disease	Adults	1,852	56.84
	Children	29	0.89
	Infants	1,377	42.27
Respiratory diseases	Adults	13,130	63.38
	Children	7	0.03
	Infants	7,578	36.58
Worms	Adults	3,810	80.87
	Children	22	0.47
	Infants	879	18.66
Eye diseases	Adults	1,105	64.77
	Children	0	0.00
	Infants	601	35.23
Intestinal infection	Adults	475	74.92
	Children	18	2.84
	Infants	141	22.24
Typhoid	Adults	30	81.08
	Children	4	10.81
	Infants	3	8.11
Dysentery	Adults	75	65.79
	Children	0	0.00
	Infants	39	34.21

Data on prevalence in the different age groups is presented in table 3.4-2b. The data shows that for prevalence is higher among adults as compared to children and infants for all diseases except diarrhoea. This is not so surprising as awareness and care in the management of food and water is important for the prevention of diarrhoea. Infants tend to be less careful regarding what they eat out of ignorance hence the higher prevalence of diarrhoea among them (At the time of the study, it was found that most of the HCs are using a new system for the classification of patients. This system make a difference between adults and infants only. Anyone below the age of 5 is an infant while anyone above that age is an adult. However, there was one HC in Makuutu Nondwe, where the old system was being used. The old system has a category for children between the ages of 5 to 12 years.)

### 3.4.3 Differences in prevalence in dry and wet season.

TABLE 3.4-3. DIFFERENCE IN PREVALENCE RAINY AND DRY SEASON.

Disease	Number of patients per season			
	Rainy season	Dry season	Difference	% difference
Malaria fever	27,040	22,043	4,997	22.7
Diarrhoea	3,100	1,709	1,391	81.4
Skin disease	2,179	1,099	1,080	98.3
Respiratory diseases	3,175	7,759	-4,584	-59.1
Worms	3,073	1,638	1,435	87.6
Eye disease/infection	967	739	228	30.9
Intestinal infection	258	376	-118	-31.4
Typhoid	22	15	7	46.7
Dysentery	91	23	68	295.7

Data shows that in general the prevalence of diseases reduces in the dry season. Prevalence of all diseases except respiratory diseases and intestinal infections is lower in the dry season as compared to the wet season.

A possible reason for this is the ease with which water borne diseases can be transmitted in the wet season as compared to the dry season. Wet conditions normally favour the survival of microorganisms which makes them available in various ecologies to be transferred from one person to another. In addition, rains creates run off which carries improperly disposed human waste, spreading it so that more people especially in the low lying areas come in contact with it. In the

high density areas, people with poor toilet facilities sometimes dispose waste into the storm water so as to allow the storm water to carry the waste away. Poor drainage ensures that the storm water and its infectious load is available for a long time to facilitate transmission of infections. The infected people eventually end up in the HCs for treatment.

The most significant difference between the dry and the rainy seasons relates to skin diseases, worms and diarrhoea with 98.3%, 87.6% and 81.4% increase in the rainy season respectively.

There are some diseases however whose prevalence increases in the dry season and these are respiratory diseases and intestinal infections. The increase in respiratory diseases in the dry season is consistent with the reports of the responses in the HH survey where most people attribute it to dust and smoke, both of which are plentiful in the dry season. One of the sources of smoke in the dry season are the bush fires in the areas surrounding the RGCs while dust is a usual menace of the dry season as most surfaces are not paved.

The cause for the increase in intestinal infections in the dry season is more surprising but it may be associated with other seasonal development. In seasonal calendars, times of high intestinal infections have been associate with the mango ripening season due to the increase in flies associated with rotting fruit. The end of year dry season also tallies somewhat with the mango season and there may be a link between these two.

### 3.4.4 Water supply and consumption for the health facilities.

Water is a critical input in any health facility as it is a key ingredient in any cleaning activity. Table 3.4-4 below shows the average water consumption in the health centres surveyed. The average number of jerry cans required for a health centre is 39.3 and the average per-capita daily water consumption is 17 litres. These data reveal a dire situation for the health centres. At 17 litres per capita per day, the health centres is barely meeting Sphere the standards for a domestic setting leave alone a medical facility. Yet 39.3 jerry cans per day is a huge amount of water to fetch by hand or even bicycle.

TABLE 3.4-4 WATER CONSUMPTION BY THE HCS

	Water Consumption	Water needed	Deficit	Deficit as % of current consumption
No of jerry cans	39.3	74.4	35.1	89.3
Litres/capita per day	17	25.7	8.7	51.2

All of the HCs reported that on the basis of their current demand, none of them is getting enough water. In table 3.4-4, the deficit is indicated both in terms of litres per capita per day and in terms of jerry cans. A percentage deficit is also calculated and the data shows that on average, the HCs are only getting 10.7% of their water needs in jerry cans or 48.8% when it is measured in litres per capita per day.

### 3.4.5 Sensitisation/enlightenment activities on health and sanitation

#### 3.4.5a Characteristics of respondents

At the relevant sub-counties where HCs are located, officials were interviewed about sensitisation activities on hygiene and sanitation. The official interviewed included 3 Health Assistants – (HA), 3 Sub-county Chiefs, 3 parish Chiefs and 1 community Development Assistant (CDA)

#### 3.4.5b Kind of sensitisation activities combined

TABLE 3.4-5. EASE OF CARRYING OUT SENSITISATION ACTIVITIES.

Each sub-county has its own challenges, opportunities and resources and these are reflected in the ease with which they are able to carry out sensitisation on different aspects of sanitation and hygiene.

Activity	Circumstances of executing the activity	
	Ease	Difficulty
Promotion of water, sanitation and hygiene	5	5
Pre-planning of implementation of a project	10	0
Mobilization and training	7	4
Standardization of systems and procedure	3	6
Effective Operation and maintenance	5	4
Monitoring and adaptation	4	6
Establishment of an institutional framework	5	6
Specify if any	1	4

Data from the study shows that the easiest of the activities based on the number of nominations is “pre planning of implementation of a project”. The second easiest based on the

number of nominations is mobilisation and training. The one which scored the least in ease is standardisation of systems and procedure. Pre planning of implementation of projects usually comes with lots of eagerness from the community as there is high expectations from the project. Where there is nothing in particular that is being anticipated, community members are less eager to participate in sensitisation activities. Thus it may be wise that whenever there is a pre-planning of projects, a whole lot of sensitisation is also covered along with the main thrust of the project.

On the enlightenment or sensitisation activities that the local governments were not able to do with ease, the one scoring the highest is standardisation of systems and procedure. This was followed by monitoring and adaptation.

## CHAPTER FOUR - ISSUES CHALLENGES AND CONCLUSIONS

### 4.1 Challenges

The execution of this study encountered a number of challenges. These are briefly outlined below

#### 4.1.1 Logistical issues.

Among the logistical challenges were the issues related to the movement of the teams, the language challenges and the several public holidays.

In spite of detailed planning, there are many challenges that cannot be foreseen in an exercise like this. It was planned that the survey team would move together. This has many advantages, not least being the ease with which information can be shared. Every day there is some new lesson that comes from the experience in the field that day and it is important for all the team members to get that lesson so that the following day they do not have a similar challenge without a solution. However this comes with some challenges especially in an exercise like this where there were many sites in a wide area. There was a time

when the survey team had to be split into smaller teams to save time. However it was found that this was one of the issues that we discussed in one team were not covered in another hence a repetition of mistakes.

The region covered in this study is a multi-lingual area. Although many people understand English and Luganda, there are areas where these languages will not be understood. From the onset therefore one of the criteria for the recruitment of interviewers was the ability to speak one of the languages in the area of the survey. Yet there had to be a good mix of the languages. Even then it was difficult to find one person who could speak all the languages in the area. The pressure to have people conversant in the languages meant that there was pressure to overlook certain other qualifications such as past experience in interviewing of this nature. To reduce the impact of this, the survey management undertook rigorous training of the interviewers before embarking on data collection.

The concept of a RGC is real on paper but it is not a clearly demarcated entity on the ground. For that reason there are villages within the RGC which lie partly in the RGC and partly out of the RGC. At the time of data collection, it was difficult for the village leaders to isolate the details pertinent to the area within the RGC and those pertinent to the area outside of the RGC. Village leaders accumulate information on the village as a whole not on small part of each village. Therefore some of them ended up giving the general picture of the villages including the area beyond the RGC.

The survey was carried out in a period of political campaigns. This came with its own challenges. At times like this people are elated and often they expect that all activities going on in the community might have to do with some politicking. There are expectations associated with this and the survey team spent significant time explaining this away before they could embark on effective interviewing.

It was planned that data entry would be done as it is collected and to this effect two people were hired for data management. However their work is mostly computer based but in the conditions of the field there were many instances where they just could not do anything due to power cuts thus losing valuable time.

#### 4.1.2 Availability of valid data

In undertaking any survey, one proceeds under the premise that the respondent will have the required data and that he/she will be willing to divulge it correctly. However this was not always the case in this survey.

In the semi urban conditions of the RGCs surveyed, people in general have a poor record of statistics of everyday life. If you have to pay a monthly bill for water, you will have some idea of what it is expected to be. If you just pay on a daily basis as need arises, it may be more difficult to put a figure to it. Thus on situations like “no of jerry cans of water bought in the last year” people would struggle to put accurate figure mostly because they could not remember.

Information given by respondents is also sometimes coloured by their expectations. For instance, a village leader might underestimate the income of his subjects if he expects that this will persuade a donor to grant a project. Individuals might also underestimate their incomes if they think the information will somehow be used for taxation. Others might overestimate it if only to impress. With prior knowledge on these challenges, the survey team was intensively trained. Even then much time was spent on harmonising figures especially of aspects of income and expenditure with some respondents becoming unresponsive

when pressed about conflicts and inconsistencies in the data they were giving. At times these inconsistencies were discovered after the interview and interviewers had to go back or had to call or had to figure the reality out on the basis of the rest of the information in the questionnaire. These kinds of activities took a significant amount of unanticipated time.

Due to their positions in the local government and in the various institutions in the communities, community and local government leaders are supposed to have certain information. However it was found that this is not the case mainly because the system of data accumulation and data management at the local government level is in a sorry state. For instance information on school enrolment was expected from the village leaders but it was soon noticed that they did not have it as it was required.

Finally there are cultural issues relating to data and information. For a semi-rural person in Uganda, there is little difference between 3 Km and 4. But for an engineer from Japan 3 Km is quite different from 3Km and 10 metres. This level of accuracy had to be brought to bear on the interview situation sometimes causing irritation to the respondent. Perhaps he answers in one question that the borehole is 100 metres away from home and then in the other he says it is about 200metres. In reality he is saying it is not too far but it could be any number of metres. This respondent would be confronted with the contradiction but in reality he/she would be telling the truth in their context and frame of reference. It is also important to note that some of these measures are not familiar to some of the people in the semi-rural conditions of the RGCs who do not often reckon time or distances in these precise terms.

## 4.2 Observations and Recommendations

### 4.2.1 Introduction.

The objectives of the Socio-economic Condition Survey were: a) To grasp actual condition of RGCs, and b) To obtain the basic data for designing water supply facilities and the formulation of efficient operation and maintenance plan for the Project. The survey utilised three sources of information including HH respondents, the village leaders and Water and Sanitation Committee members to examine knowledge, behaviour patterns and practices relating to water including operation and maintenance of water facilities in the communities. The observation and recommendations arising from the survey are made in line with these major themes of the survey.

### 4.2.2 Household characteristics.

The typical household in the survey area has 7 people consisting of 1 man, 1 woman, 2 boys and 3 girls thus there will be three male members and four female members. Within the HH, the man is the leader and his main role is "providing basic needs". This means that he has to do any sort of work to earn the money to meet the basic needs of the family including food, clothing, housing and school fees for the children. Besides this he has to provide protection for the family. The main role of the wife is to prepare food and to take care of the children. The main role of the boy is to fetch water and to clean the compound while the main role of the girls is to fetch water and wash clothes. Chances are approximately 2.4:1 the HH will be Christian. While it is the role of the man to provide, in 64% of the homes, the woman will also be working to get money and she will most likely be involved in trading or some sort of farming. The man is more likely to be literate in both English and vernacular than the woman.

Because of this pattern of allocation of roles, the woman and the girl will most likely be found fetching water than the boy, and the man will rarely be found fetching water. This reality is important in planning both the hardware and software of the proposed facilities. Because women and girls are more likely to be fetching water, the physical arrangement and design of the facilities should be convenient for these people. Many women have no one to leave their babies with at home when they go to fetch water therefore they go with the babies. It would be a great relief if they had a place to sit and either breast feed or just rest as the queue for water moves on. Perhaps even space for the older kids to play so that as they fetch water they do not have to be concerned that the children will be endangered. Women need to be involved in all software activities and to be encouraged to participate in decision making in relation to O and M of all water facilities. Boys and girls need to be allowed to make an input in the planning for and O and M of water facilities. Moreover sensitisation activities and software for O and M of water facilities must ensure the participation of boys and girls. One challenge is that these boys and girls also go to school and this makes it difficult for them to participate in software sensitisation activities that take place in the course of the week.

### 4.2.3 Main source of water.

It is clear from the survey that the main source of water, both in the rainy season and the dry season is the borehole. In the dry season the second most important water source is the unprotected spring. In the rainy season, the second most important source changes to rain harvest. The preference for the BH is probably associated with several factors namely a) location in proximity to centres of population, b) the perception that it is a source of safe water, c) reliability - the fact that deep boreholes have a steady flow of water in both the dry and the rainy season and d) the relative affordability of water from boreholes. These conditions must be borne in mind as new facilities are put in place. All of these factors are within the control of the planners of the new facilities. The borehole is therefore a good benchmark for all these parameters in relation to the new facilities. But convenience may be the reason behind the choice of the unprotected spring in the dry season in preference to the protected spring. This should also inform planning.

The pressure on boreholes and other sources is relieved in the rainy season by rain harvest and it is clear from the survey that it forms a viable alternative especially as the region has two seasons of rainfall each lasting no less than three months thus ensuring water security for 6 months a year if well harnessed. There are two practical implications of this: the first is that investment in rain harvest could have good yield in water security and cost benefit studies need to be carried out to compare with the other alternatives water sources. The other is that while the relief on some sources in the rainy season makes fetching from these sources convenient, it may lead to negligence and partial abandonment and break down. This implies that the rainy season should not be a period of rest for those involved in the O and M of water facilities and O and M activities are as important in the rainy season as in the dry season.

### 4.2.4 Water consumption

Water consumption differs very little in the dry and the rainy season with average consumption in the rainy season exceeding consumption in the dry season by only about 2.8 litres per person per day. The most frequently named per capita consumption is 20 litres per day and the average per capita water consumption is 21.8 litres. The international standard for per-capita water consumption is a minimum of 20 litres. Besides litres per capita, there are also international standards for distance to source, queuing time, time for round trip and labour. All these things considered, there is a side gap between need and

availability in the survey area. This gap will expand with population growth hence the need to have some excess capacity in the proposed facilities.

#### *4.2.5 Paying for water and O and M*

There is a contradiction in the practice of paying for water and O and M. On the one hand people report that they are already buying water and paying for O and M and indeed most say that they are willing to pay a monthly fee for O and M. On the other hand WSCs report resistance to paying the regular O and M fee and when asked the amount that they are willing to pay for a jerry can of water people always state a figure below what they are already paying.

The source of the problem is likely to be the perception that water service provision is the responsibility of government and people should only pay in the face of government failure. There is therefore a huge need for proper information and sensitisation on the population to own the responsibility for water provision. Sensitisation should also aim to enable people to recognise that even though the project is donor supported, they have a central role to play in its establishment and maintenance. Unfortunately, such sensitisation is often undone by unscrupulous leaders who promise free water when they cannot deliver it. This underlines the need for this theme to be included in all software activities of the project.

#### *4.2.6 Water borne diseases*

Among the least common, the highest percentage is scored by respiratory diseases and eye diseases. While fever may be a general symptom for many diseases including malaria, diarrhoea is closely related to unsafe water. The fact that these diseases are pointed out as common means that there are frequent opportunities for transmission of these diseases via contaminated water and it is important that people get access to safe water.

It can therefore be concluded that improving access to safe water will reduce the incidence of these diseases and their debilitating effects and enhance families' livelihoods and incomes. An intervening factor in this respect is the level of awareness of the link between unsafe water and disease transmission. Therefore these have the potential for the greatest reduction in water borne diseases with the introduction of more safe water sources.

When the remedies to the various diseases are examined, it is clear that the first line remedy for almost all diseases is to seek medication from a health facility. However coming a close second for most diseases is the preventive measures which include the use of safe water and good hygiene practices. This level of awareness of the fact that use of safe water and hygienic practices will reduce the incidence of diseases means that improving access to safe water will quickly lead to benefits in health and welfare. Moreover it also means that with a premium on safe water, there will be motivation for effective O and M including the regular payment of user fees.

#### *4.2.7 Water and health problems*

The biggest water problem for households is "too many people use the same source" This speaks to the congestion at the water sources in particular the boreholes which are the source used by most of the respondents. "Water source is too far" and "water quality is bad" featured in second and third position respectively. With regard to quality mentioned above, the biggest problem is colour, while the least is smell.

#### *4.2.8 Effects of water fetching on women's work and children's school*

In the household survey, the people who agreed that water fetching has adverse effect on women's job opportunities and on children's school attendance were 42.5% and 48.2% respectively. This proportion is less than a half of the respondents but it is nevertheless significant. In the survey of village leaders, only 6.6% felt that there is no adverse effect on job opportunities for women and 3% felt that there were no adverse effects on school attendance for children. Overall therefore the message from the surveys is that there is an impact on both and that the impact is significant. Information from both types of respondents shows that the impact arises from the time spent in the activity of fetching water as well as the effort itself. It is clear that reducing the distance to the source, the queuing time will help to alleviate this problem for both women and children. The new water facilities will achieve both of these and will therefore reduce the adverse effects. Further reduction can be achieved by encouraging the man to take up some of the responsibilities of this duty in the software arrangements for the project. However, this has to be done with care so as not to cause a backlash against women and girls since this is a deeply ingrained cultural role allocation.

#### *4.2.9 Income and expenditure*

There are more men in paid employment than women by a ratio of 1.8:1. The average annual HH income from wage employment is US\$ 5,098,066 or USD 1,522 (n=116) while the average income from the production and sale of items is US\$ 2,960,621 or USD 883.7. This implies that HHs with both wage income and income from the production and sale of items have generally higher incomes than families with income from the production and sale of items only. The average annual income of HH in the RGCs all sources considered is US\$ 4,232,798 or USD 1,264. This comes to USD 3 per household per day or about USD 0.5 per person per day given an average of 7 people per HH. This income is way below the international standard of absolute poverty which stands at USD 1.9 per person per day. Therefore, the case for programmes of social support in the region is quite strong.

With such income levels the big question is whether the population then is able to contribute the O and M fees to sustain the established facilities. The answer will depend on the amount needed for the O and M of the facilities to be established. The HH shows that the average expenditure on water at present is US\$ 4,789. Results of the WSC study show that there is potential to increase this outlay on water if there is better mobilisation of the water users and if the management of the WSCs is improved to reduce the stigma of embezzlement that is now associated with WSC financial management affairs.

The key action from these observations is that WSCs have to understand the critical value of transparency when it comes to the financial management of WSC finances. This truth must be made part of the software sensitisation for this project. In addition, HHs need to understand the monetary cost associated with the adverse effects of water fetching on job opportunities for women and school attendance for children. Then they will be motivated to make regular contribution to the O and M fund for the new facilities.

Cycles of income may make it difficult to meet regular financial obligations for O and M especially during the times of low income. It was noted in the study that there is low income during the dry season. The dry season is associated with low agricultural production and low sales of agricultural produce. Harvest season is associated with high income due to the sale of agricultural produce and planting season is associated with low income due to the fact that there will not be any produce to sale. The fluctuation in incomes associated with the sale of agricultural produce reveals that storage and preservation of produce is a challenge and so is processing to longer lasting forms. Improvement of post-harvest handling, storage and

processing can help to create a more stable flow of income to HHs in the survey area. While this is out of the scope of this project, it can be a point of interaction with other programmes that are focused on income generation and agricultural output marketing. However, perhaps it is possible to work within these cycles if people in charge of O and M plan to make collection of dues during the times of high income.

The expenditure of HH is heavily skewed in favour of food and education with education being the single expenditure items with the highest outlay. This is an interesting observation given that there has been a programme for “Universal Primary Education” (UPE) for over 10 years now. This observation may come as a negative commentary on that programme but the expenditure shows that HH put a high premium on the education of children and this is a positive trend for incomes, literacy and health in the HH in the area in the future. The emphasis on education should be supported in the software activities of this project.

#### *4.2.10 Cooperative organisations and community activities.*

The observation from this study is that most of the people in the survey area are already familiar with cooperative or community activities especially in connection with water. Of all the HH respondents, 90.2% reported that they have paid initial contribution for water before. (Though only 20.7% are paying regular water user fees). Moreover women are participating in these communal activities with 65.8% of the respondents reporting that there is one or more women on the WSC in their area with. Additionally the majority of people who admit knowing what goes on in the WSC reported that women’s opinions are not ignored. Some 60.4% of respondents also reported that they are involved in other cooperative organisations of different categories with most of these being involved in savings and credit cooperatives SACCOS and other organisations focused on development and income generation. Other significant proportions (17.4%) reported that they are involved in social support groups such as those which save money regularly to support a member in times of loss of a family member or a relative.

These findings suggest that the environment for community activities in the operation and maintenance of the new facilities is good and mechanisms should be put in place to create the groups that will be responsible for O and M of the facilities. With fewer people reporting regular payment for O and M than those reporting initial contribution, it is important to address the issues that mitigate against the regular payments meaning including the weaknesses of the WSCs, the fluctuations in income and the negative reputation of WSC on financial management. These should all be taken care of in the software activities of the project.

#### *4.2.11 Sanitation and hygiene*

The sanitation situation in the survey area is well above average with 94.5% of respondents having toilets, 73.6% having kitchens and 77.5% having a hand washing facility and 79.2% having not faecal presence in the home. But there are issues to work on as well. These include ensuring that toilets have toilet covers, the construction of animal shelters, and construction or arrangement of compost pits in homes. People also need to understand that hand washing should be a regular activity and not just before meals or after an activity that makes hand dirty, as it the case right now. These aspects should be emphasised in the software activities of the project but this does not mean that others like the 100% toilet coverage and cleanliness of toilets should not be mentioned.

#### *4.2.12 The employment situation in the villages*

The survey of village leaders shows that there is a high level of unemployment in the RGCs with a greater proportion of women – 99% looking for employment than that of men - 81.2%. These are extremely high levels of unemployment and they mean that there is a lot of disguised unemployment as it is not apparent

form appearances that there are so many people that are actively looking for jobs. In the HH survey most people describe themselves as farmers and it may be that farming is some form of escape from unemployment where if someone has something else to do, he/she will quickly abandon farming and get into that employment. However, as noted in the report these figure need to be interpreted with care as there is no formal registration for unemployment and neither are there organised statistics on employment in the villages. In water projects in Northern Uganda, one of the consistent request of the communities was to employ the local youths in the construction of the water facilities. This action while not verbalised in this survey might be one way to reduce unemployment during the time of the construction of the facilities and it should be borne in mind at the planning stage of the project.

#### *4.2.13 Activities of the Water and Sanitation Committees (WSCs)*

Besides boreholes and shallow wells there are no other types of water sources with WSCs. The reason for this is most likely that boreholes as a rule and most shallow wells, have hand pumps of different types without which it is impossible or very difficult to access the water at the source. This means that if there is a mechanical breakdown at the facility the community must organise for repair which makes the WSC necessary. Sources like the protected spring and the unprotected spring cannot break down in the technical sense of the word. Therefore a WSC is not essential. The proposed facilities have the same potential to break down as boreholes and they will need some form of organisation to manage the operation and maintenance of the facilities and outlets.

On the existing WSCs, most of the members are men and indeed most of the senior positions are occupied by men. Out of the 49 WSCs referred to in the study of WSCs 47 were chaired by men. The proportion of women increases with the lesser positions but in all cases the number of men in any specific position exceeded that of women except in the position of treasurer where there were more women than men. The choice of women in this position is a vote of confidence in them as they are seen as more honest and trustworthy to handle the finances of the people than the men. In the same vein the selection of women in all the other senior positions should be encouraged.

The members of the WSC are almost in all cases elected by the water users which is a very good practice. However, once they are elected, there is no limit to how long they can serve in a position and most of the respondents reported that it is a matter of ability and performance. This reference to ability and performance in the face of a lack of a strict performance criteria and a repeated failure by most WSCs to collect O and M fees belies a reluctance of member of the community to serve on these committees on the one hand and a reluctance of those in the positions of responsibility to relinquish responsibility. For effective management, it is important that there are periodic evens for the selection of new leaders or the renewal of terms of service. This will enhance the accountability of the leaders to the water users and even integrity in the handling of the affairs of the WSC.

One of the critical roles of the WSC is the collection of the water user fee for O and M. The reports from the study show that where it is collected, the collection is done mostly by the caretaker followed by the chairman and the treasurer. However regular collection is a major problem in all WSCs. This has compelled many WSCs to adopt the approach of calling a meeting and making an emergency collection whenever the facility breaks down. This approach has almost become the standard modus operandi in all the WSCs. While this approach may eventually work, it lengthens the down time of facilities and exacerbates all the costs associated with fetching water such as distance to source queuing time and even health effects. Therefore in the setup of O and M activities and organisations for the new facilities the regular collection

of O and M fees needs to be emphasised and the community needs to agree on action to be taken on defaulters including a criteria for accepting people to use the facility for free on account of their old age, disability and poor income status.

#### 4.2.14 Health centres (HCs)

The case load of HCs in the RGCs is dominated by a few diseases. The main ones among these are Malaria fever, Respiratory infections, and diarrhoea and worm infestations. Malaria exceeds all the rest by far. The intensity of these diseases increases in the rainy season and decreases in the dry season except in the case of respiratory infections which intensify in the dry season and ebb in the wet season. The causes associated with these diseases as given by the respondents give a hint as to why this is the case. Malaria is associated with mosquitoes and stagnant water hence its intensity in the rainy season. The mechanism of transmission of the other 3 namely contaminated water becomes abundantly available in the wet season.

In connection with various infections, HH members reported going to hospital as the main resort when they get sick. This behaviour is appropriate but it also ensures that the hospitals are heavily loaded during the wet season and even the dry season. But HCs have a serious deficit of safe water which can even undermine their efforts to treat this heavy case load. On average HC have a water deficit of 89.3% measured against current supply in jerry cans or 51.2% measured against current supply in litres per capita per day. This shortage is critical and demands urgent attention. Where possible, HCs should be linked to the new water supply facilities with an outlet right at the HC.

HCs reported engaging in a variety of sensitisation or enlightenment activities. In their assessment, the easier activity is preplanning of the implementation of a project while the most difficult is standardisation of systems and procedure.

### 4.3 Conclusion

This study set out to achieve two main objective namely:

- a. To grasp actual social and economic condition of the selected RGCs, and
- b. To obtain the basic data for designing water supply facilities and the formulation of efficient operation and maintenance plan for the Project.

To achieve these objectives, the survey collected data from various sources including members of households in the 12 RGCs, the village leaders in the 12 RGCs, officials of the WSCs in the 12 RGCs and Health Centres within and in the proximity of the 12RGCs. The study used four different instrument namely the HH questionnaire, the questionnaire for the WSCs, the questionnaire for the Village leaders and an instrument for collecting data on HCs. Besides these, interviewers and assistants used observation and informal interaction with residents and individuals in the RGC to obtain data on various other related factors such as the seasons for the agricultural cycle and aspects of sanitation and hygiene in the RGCs.

As with any social study, there were many developments in the field that could not have been predicted and the team did the best to manage these and still obtain the required data. At the end of the field data collections exercise the team had the required data and this has been analysed and observations have been outlined in the preceding pages of this report.

The report outlines findings relating to the key social economic conditions of the 12 RGCs including the characteristics of household, sources and access to water, sources and levels of income as well as

expenditure patterns. The report has also documented details on community cooperative activities including activities for the operation and maintenance of water sources, health issues including disease incidence and seasonality, hygiene and sanitation situation in homes and communities as a whole, school enrolment for boys and girls as well as literacy in households. Also documented in the report is the situation of Health Centres in terms of water supply and use as well as the case load and common diseases treated.

Needless to say, water is one of the most important resources in the lives of the people in the area and it is still in short supply with many homes living on less water than that which is recommended according to international standards. Besides access to sufficient volumes of safe water, it is clear that there are significant strides that have to be made in all the RGCs in the areas of health, education and sanitation and hygiene even to maintain the current inadequate situation in the face of a growing population. Given the current situation, it is clear that improving access to safe water will have immense benefits in terms of reduction of water borne diseases, reduction of time and resources wasted in the process of fetching water, enhancing the status and welfare of women and girls who are the HH members with the responsibility for water fetching and improving incomes of HH through better employment for women. The potential for women to engage in income generating activities to enhance the welfare of home will also improve as they will have more time to be effective in those engagements. In the same way, improving access to safe water supply is likely to enhance literacy rates for women and to improve school attendance and performance for both boys and girls and even to reduce teenage pregnancy rates.

With the data from this study, the engineers and planners of the proposed water facilities can be able to design systems that will supply safe water in quantities and in access points in locations where it may be used effectively for the maximum benefit of the community.



#### List of Attachments

1. The HH questionnaire
2. The Village Leaders Questionnaire
3. The Questionnaire – Survey of WSC Officials
4. Questionnaire – Survey of Health Centres
5. Detailed Field Deployment Plan
6. Directory on Gender Aspects in the Study

#### References

- Aiga. H, Umenai. T. "Standardisation of the Definition of Access to Safe Water." *The Lancet No 9375, 2156*, 2003: 361.
- Jane Hopkins, Carol Levin and Lawrence Haddad. "Women's Income and Household Expenditure Patterns: Gender or Flow? Evidence from Niger." *American Journal of Agricultural Economics No 76*, 1994: 1219-1225.
- MoWE. *Water and Environment Sector Performance Report 2014*. Kampala : Government of Uganda, 2014.
- Uganda Bureau of Statistics. *NATIONAL POPULATION AND HOUSING CENSUS 2014*. Census Report, Kampala : Government of Uganda, 2014.

## 資料-11

### 参考資料

#### (2) 既存井の揚水試験結果



The project for Rural water supply Phase III in Kyoga Basin, Eastern Uganda			
OBSERVATION RECORD BY BOREHOLE CAMERA			
Items	Description of observation in the BH	Casing schedule	
Executed Date:	16-Jul-15		5
Borehole No.:	I-01-EX01		
Village:	Nabitende		
Working Time:	1hr	SWL = 9.8m	
Depth of HP:		→ PLAIN CASING	
Casing Depth:	38.9M		15
Casing Size :	6"		20
Casing material:	Metallic		
Static Water Table:	9.8M		
Screen Depth:	30.2m-25.2m, 28.5m-31m, 33.8m-36.8m		25
Sedimentation:			
Safe yield		→ SCREENS	30
Dynamic drawdown at safe yield			35
Top of casing Pipes (m)		→ SCREENS	40
			45
		→ OPEN HOLE UP TO 48.3M	45
			50
			55
			60
			65
			70
			75
			80
			85
			90
			95
			100
			105
			110
			115
			120

I-01-EX01(Nabitende Banada)

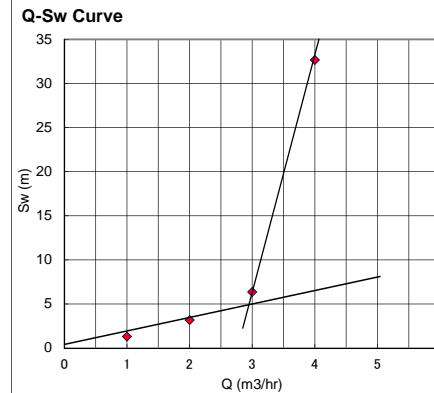
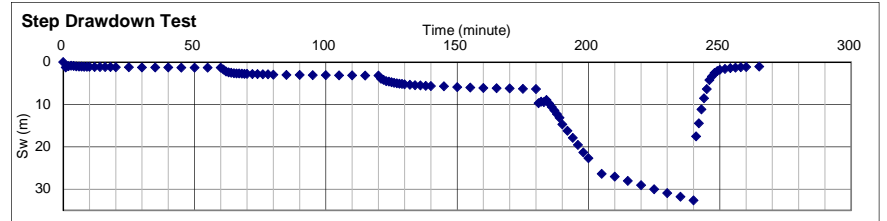

Q(m <sup>3</sup> /h)	Sw(m)
1.0	1.33
2.0	3.19
3.0	6.38
4.0	32.67

Critical Yield	2.9
Safe Yield	2.32

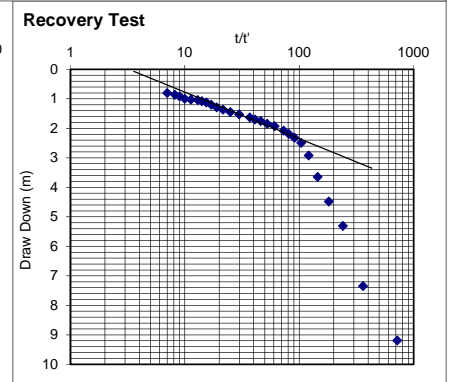
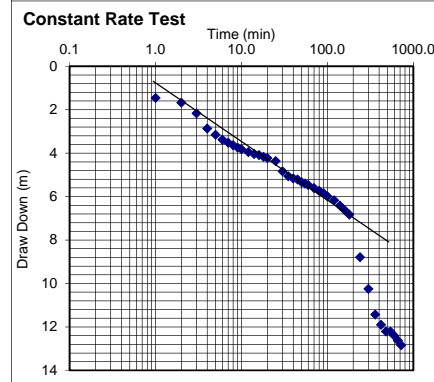
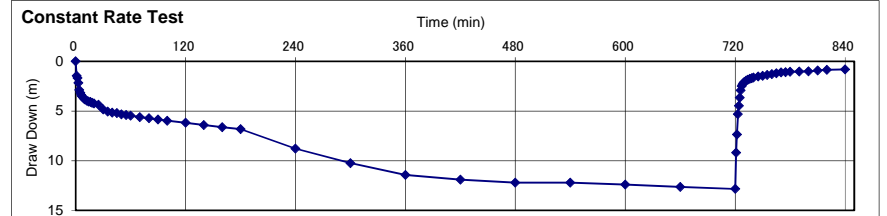

The project for Rural water supply Phase III in Kyoga Basin, Eastern Uganda

OBSERVATION RECORD BY BOREHOLE CAMERA

Items	Description of observation in the BH	Casing schedule
Executed Date:	3-Jul-15	5
Borehole No.:	I-01-EX02	
Village	NABITENDE	
Working Time:	1hr	
Depth of HP	SWL =10.2m	PLAIN CASING
Casing Depth:	45.3M	15
Casing Size :	5"	20
Casing material	UPVC	
Static Water Table:	10.2M	25
Screen Depth:	36.3M -44.3M	30
Sedimentation:		
Safe yield		
Dynamic drawdown at safe yield		
Top of casing Pipes (m)		35
		40
		45
		50
		55
		60
		65
		70
		75
		80
		85
		90
		95
		100
		105
		110
		115
		120

I-01-EX02(Nabitende Banada)

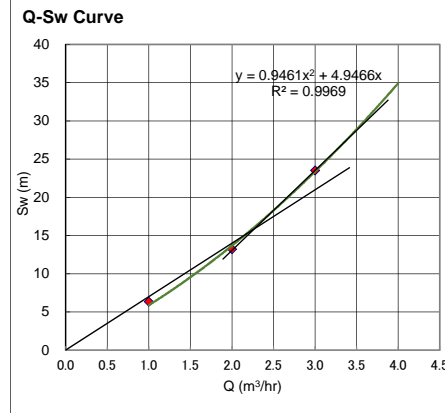
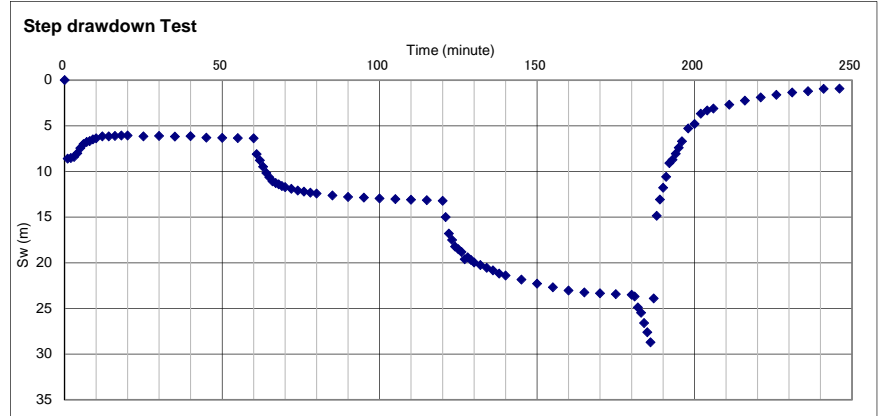

Q-Sw Curve	
Q(m <sup>3</sup> /h)	Sw(m)
1.0	6.36
2.0	13.21
3.0	23.51

Critical Yield	2.4
Safe Yield	1.9

The project for Rural water supply Phase III in Kyoga Basin, Eastern Uganda

OBSERVATION RECORD BY BOREHOLE CAMERA

Items	Description of observation in the BH	Casing schedule
Executed Date:	8-Jul-15	5
Borehole No.:	I-01-EX04	
Village	NABITENDE	
Working Time:	1hr 20 minutes	10
Depth of HP	SWL =6.9m	PLAIN CASING
Casing Depth:	35M	15
Casing Size :	5"	20
Casing material	UPVC	
Static Water Table:	6.8M	25
Screen Depth:	26.5M -32.2M	
Sedimentation:		30
Safe yield		SCREENS
Dynamic drawdown at safe yield		35
Top of casing Pipes (m)		40
		OPEN HOLE UPTO 47.5M
		45
		50
		55
		60
		65
		70
		75
		80
		85
		90
		95
		100
		105
		110
		115
		120

I-01-EX04(Nabitende Banada)

Step Drawdown Test

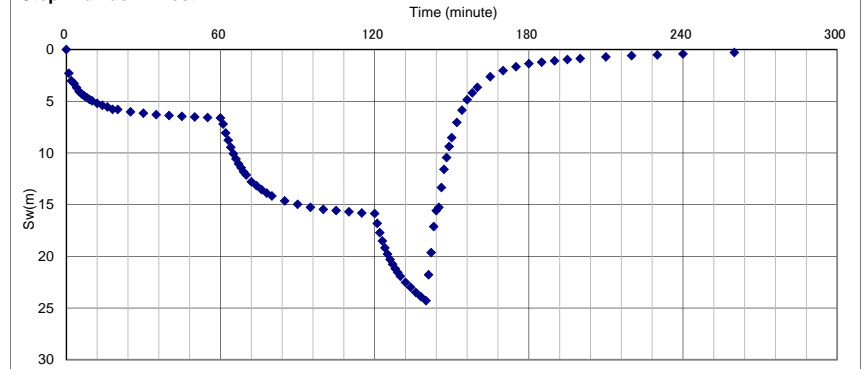

Q-Sw Curve

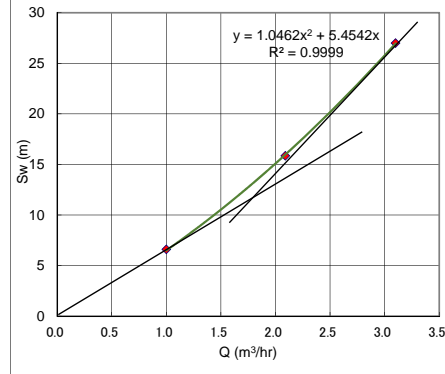

Q-Sw Curve

Q(m <sup>3</sup> /h)	Sw(m)
1.00	6.61
2.09	15.86
3	27

Critical Yield	1.8
Safe Yield	1.44

The project for Rural water supply Phase III in Kyoga Basin, Eastern Uganda

OBSERVATION RECORD BY BOREHOLE CAMERA

Items	Description of observation in the BH	Casing schedule
Executed Date:	1-Jul-15	5
Borehole No.:	I-01-EX06	
Village	Nabitende	
Working Time:	1hr 20 minutes	10
Depth of HP		
Casing Depth:	49M	15
Casing Size :	6"	20
Casing material	Metalic	
Static Water Table:	8.8M	25
Screen Depth:	N/A	
Sedimentation:		30
Safe yield		
Dynamic drawdown at safe yield		35
Top of casing Pipes (m)		40
		45
		50
		55
		60
		65
		70
		75
		80
		85
		90
		95
		100
		105
		110
		115
		120



I-01-EX06(Nabitende Banada)

Step Drawdown Test

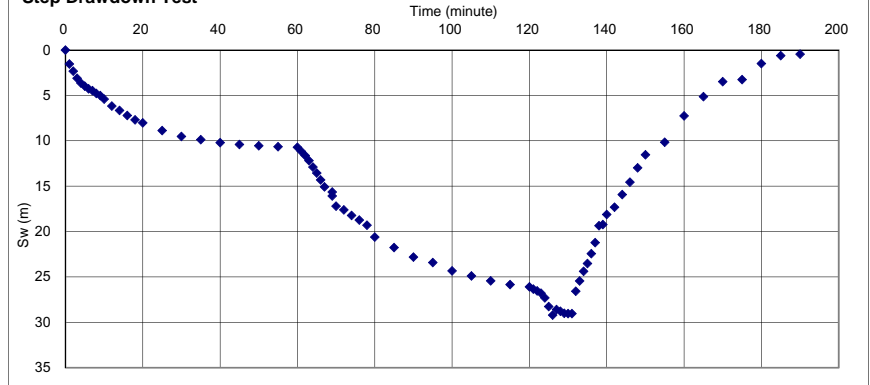

Q-Sw Curve

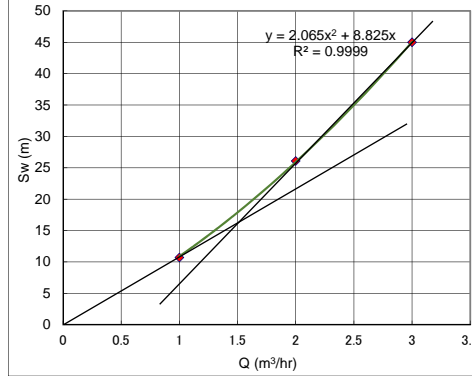

Q-Sw Curve

Q(m <sup>3</sup> /h)	Sw(m)
1.0	10.71
2.0	26.09

Critical Yield	1.4
Safe Yield	1.12

The project for Rural water supply Phase III in Kyoga Basin, Eastern Uganda

OBSERVATION RECORD BY BOREHOLE CAMERA

Items	Description of observation in the BH	Casing schedule
Executed Date:	8-Jul-15	5
Borehole No.:	I-01-EX09	
Village	Nabitende	
Working Time:	1hr	
Depth of HP	SWL =10.8m	PLAIN CASING
Casing Depth:	30.5M	15
Casing Size :	5"	20
Casing material	UPVC	
Static Water Table:	10.8M	25
Screen Depth:	26.1M-28.8M	
Sedimentation:		
Safe yield		SCREENS
Dynamic drawdown at safe yield		35
Top of casing Pipes (m)		40
		45
		50
		55
		OPEN HOLE UPTO 58M
		60
		65
		70
		75
		80
		85
		90
		95
		100
		105
		110
		115
		120

I-01-EX09(Nabitende Banada)

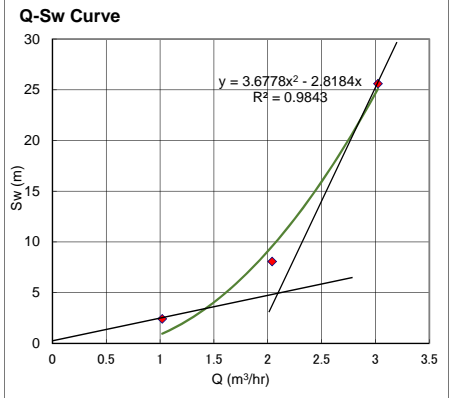
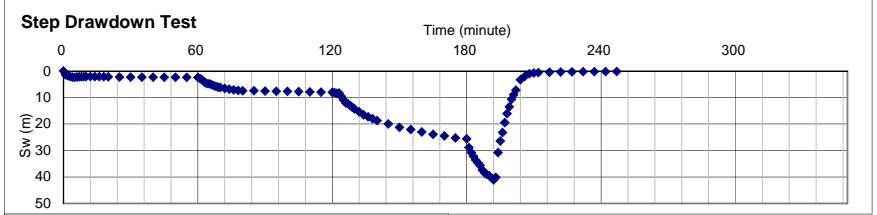

Q(m <sup>3</sup> /h)	sw(m)
1.02	2.41
2.04	8.07
3.023	25.6
4.08	41.12

Critical Yield	2.1
Safe Yield	1.68

A11-2-5



The project for Rural water supply Phase III in Kyoga Basin, Eastern Uganda			
OBSERVATION RECORD BY BOREHOLE CAMERA			
Items	Description of observation in the BH		Casing schedule
Executed Date:	23-Jul-15		5
Borehole No.:	I-02-EX04		10
Village	NAMUNGALWE		15
Working Time:	1hr		20
Depth of HP	30.0M		25
Casing Depth:	APROXIMATELY 30.0M		30
Casing Size :	5"		35
Casing material	UPVC		40
Static Water Table:	11.3M		45
Screen Depth:	25.0 - 30.0		50
Sedimentation:			55
Safe yield			60
Dynamic drawdown at safe yield			65
Top of casing Pipes (m)			70
			75
		80	
		85	
		90	
		95	
		100	
		105	
		110	
		115	
		120	

I-02-EX04(Namungalwe)

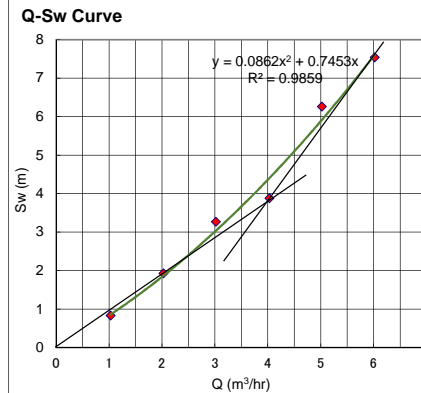
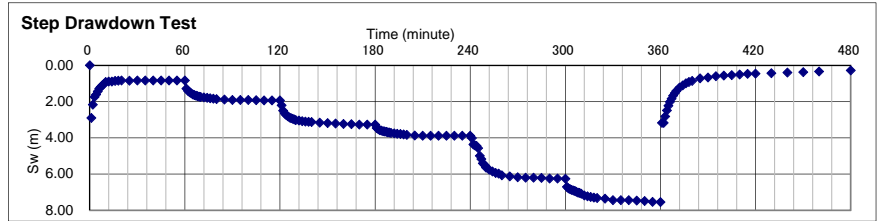

Q(m <sup>3</sup> /h)	Sw(m)
1.03	0.83
2.0	1.93
3.0	3.27
4.0	3.88
5.0	6.26
6.02	7.54

Critical Yield	4.0
Safe Yield	3.2

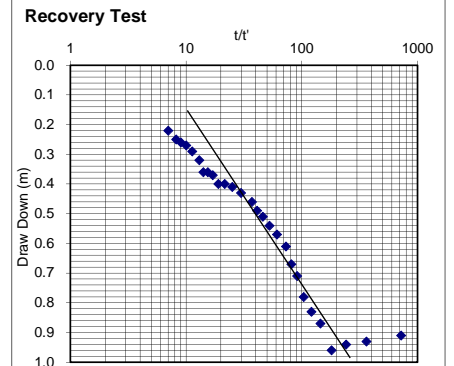
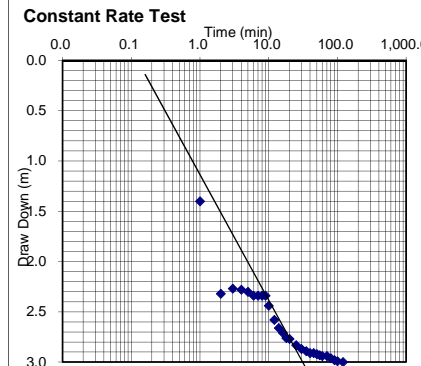
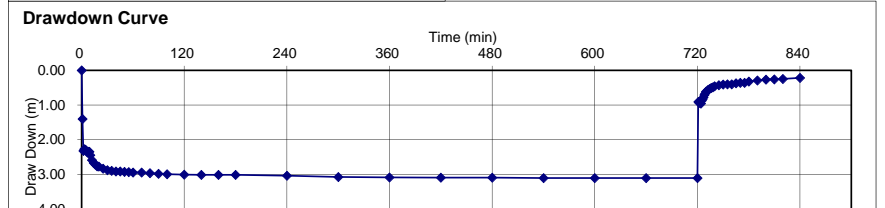

The project for Rural water supply Phase III in Kyoga Basin, Eastern Uganda

OBSERVATION RECORD BY BOREHOLE CAMERA

Items	Description of observation in the BH	Casing schedule
Executed Date:	23-Jul-15	5
Borehole No.:	I-02-EX05B	
Village	NAMUNGALWE	
Working Time:	1hr	10
Depth of HP:	SWL = 11.3m	
Casing Depth:	APROXIMATELY 40.5M	15
Casing Size :	5"	20
Casing material	STEEL	25
Static Water Table:	11.3M	30
Screen Depth:	-	35
Sedimentation:		40
Safe yield		45
Dynamic drawdown at safe yield		50
Top of casing Pipes (m)		55
		60
		65
		70
		75
		80
		85
		90
		95
		100
		105
		110
		115
		120



I-02-EX05B(Namungalwe)

Step Drawdown Test

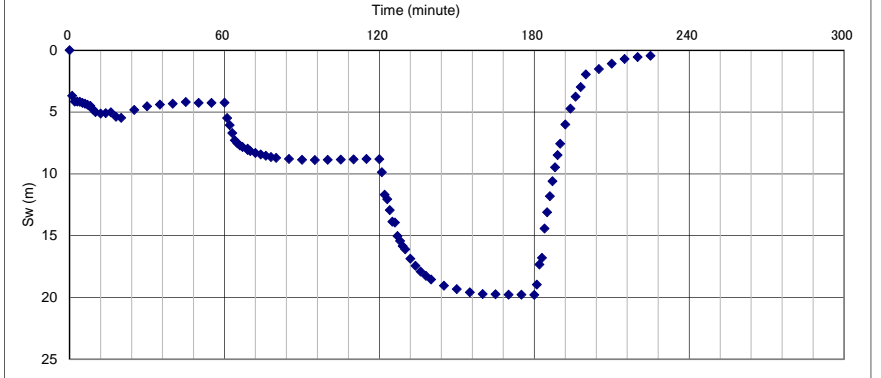

Q-Sw Curve

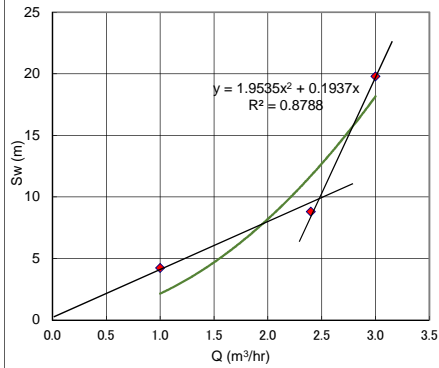

Q-Sw Curve

Q(m <sup>3</sup> /h)	Sw(m)
1.0	4.24
2.4	8.81
3.0	19.79

Critical Yield	2.5
Safe Yield	2



The project for Rural water supply Phase III in Kyoga Basin, Eastern Uganda

OBSERVATION RECORD BY BOREHOLE CAMERA

Items	Description of observation in the BH	Casing schedule
Executed Date:	4-Jul-15	5
Borehole No.:	I-03-EX02	
Village	NAMBALE	10
Working Time:	1hr 10 minutes	SWL = 9.7m → PLAIN CASING
Depth of HP		15
Casing Depth:	46.4M	20
Casing Size :	5"	25
Casing material	UPVC	30
Static Water Table:	9.7M	35
Screen Depth:	Visual obstruction due to turbidity	40
Sedimentation:		45
Safe yield		50
Dynamic drawdown at safe yie		55
Top of casing Pipes (m)		60
		65
		70
		75
		80
		85
		90
		95
		100
		105
		110
		115
		120

A11-2-9

I-03-EX02(Nambale)

Step Drawdown Test

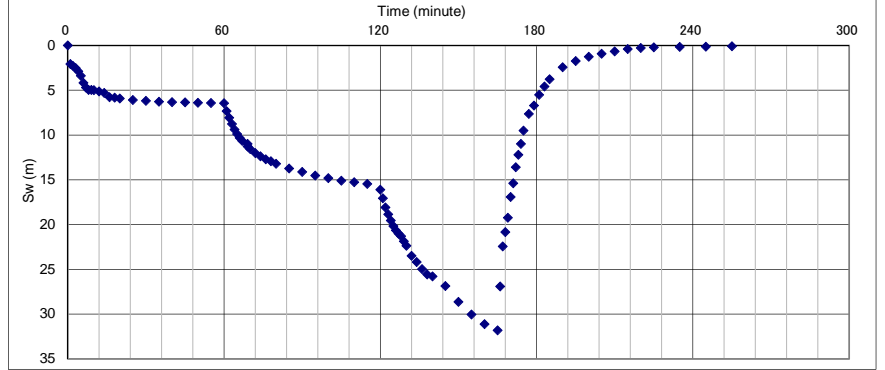

Q-Sw Curve

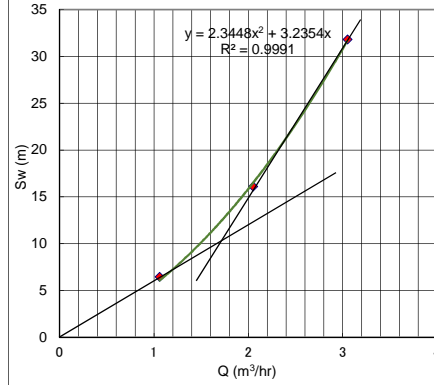

Q-Sw Curve

Q(m <sup>3</sup> /h)	Sw(m)
1.06	6.44
2.05	16.1
3.05	31.81

Critical Yield	1.7
Safe Yield	1.36

The project for Rural water supply Phase III in Kyoga Basin, Eastern Uganda

OBSERVATION RECORD BY BOREHOLE CAMERA

Items	Description of observation in the BH	Casing schedule
Executed Date:	1-Jul-15	5
Borehole No.:	I-06-EX02	
Village	Lambala	
Working Time:	1hr 20 minutes	10
Depth of HP	SWL =10.6m	PLAIN CASING
Casing Depth:	30.2M	15
Casing Size :	5"	20
Casing material	UPVC	25
Static Water Table:	6M	SCREENS
Screen Depth:	23M -26M	30
Sedimentation:		
Safe yield		
Dynamic drawdown at safe yield		35
Top of casing Pipes (m)		OPEN HOLE UPTO 44.7M
		40
		45
		50
		55
		60
		65
		70
		75
		80
		85
		90
		95
		100
		105
		110
		115
		120



I-06-EX02(Lambala)

Step Drawdown Test

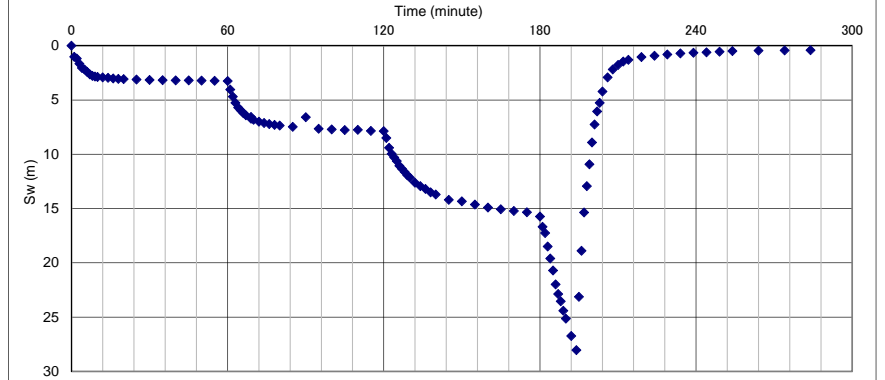

Q-Sw Curve

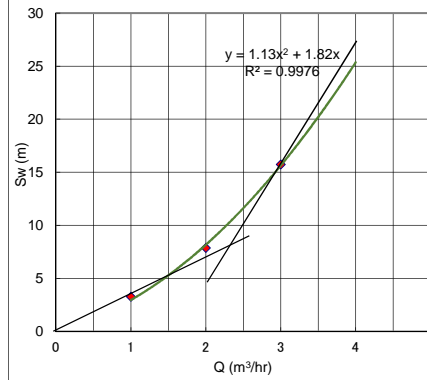

Q-Sw Curve

Q(m <sup>3</sup> /h)	Sw(m)
1.0	3.25
2.0	7.86
3.0	15.73

Critical Yield	2.4
Safe Yield	1.92

A11-2-10

The project for Rural water supply Phase III in Kyoga Basin, Eastern Uganda

OBSERVATION RECORD BY BOREHOLE CAMERA

Items	Description of observation in the BH	Casing schedule
Executed Date:	29-Jun-15	5
Borehole No.:	I-06-EX04	
Village	Lambala	10
Working Time:	1hr 30 minutes	15
Depth of HP	SWL =5.5m	20
Casing Depth:	39.6M	25
Casing Size :	5"	30
Casing material	UPVC	35
Static Water Table:	5.5M	40
Screen Depth:	33.7m-36.7m	45
Sedimentation:		50
Safe yield		55
Dynamic drawdown at safe yield		60
Top of casing Pipes (m)		65
		70
		75
		80
		85
		90
		95
		100
		105
		110
		115
		120

I-06-EX04(Lambala)

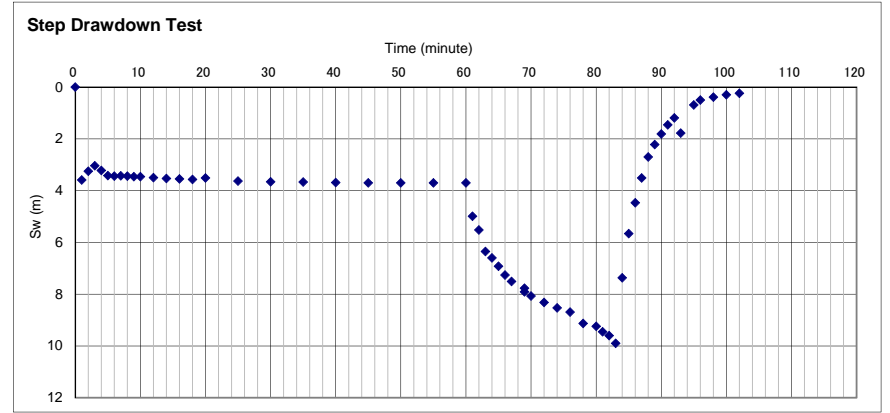

The project for Rural water supply Phase III in Kyoga Basin, Eastern Uganda

OBSERVATION RECORD BY BOREHOLE CAMERA

Items	Description of observation in the BH	Casing schedule
Executed Date:	25-Jun-15	5
Borehole No.:	I-07-EX02	
Village	NAIGOBYA	
Working Time:	1hr 10 minutes	10
Depth of HP	SWL =9.2m	PLAIN CASING
Casing Depth:	29.6M	15
Casing Size :	5"	20
Casing material	UPVC	
Static Water Table:	9.2M	25
Screen Depth:	Visual obstruction due to turbidity	
Sedimentation:		30
Safe yield		35
Dynamic drawdown at safe yield		40
Top of casing Pipes (m)		45
		50
		55
		60
		65
		70
		75
		80
		85
		90
		95
		100
		105
		110
		115
		120



I-07-EX02(Naigobya)

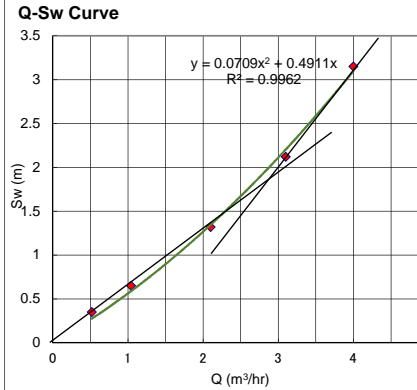
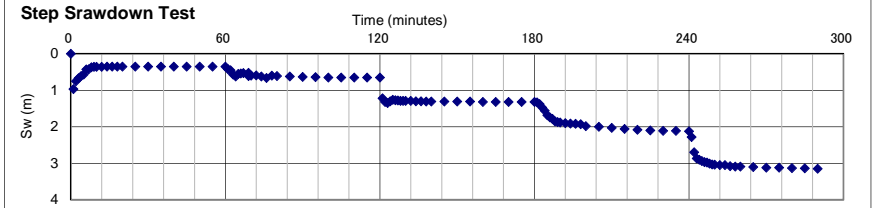

Q(m³/h)	sw(m)
0.52	0.35
1.0	0.65
2.1	1.32
3.1	2.12
4	3.15

Critical Yield	2.8
Safe Yield	2.2

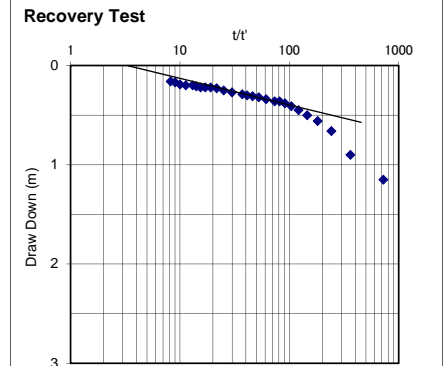
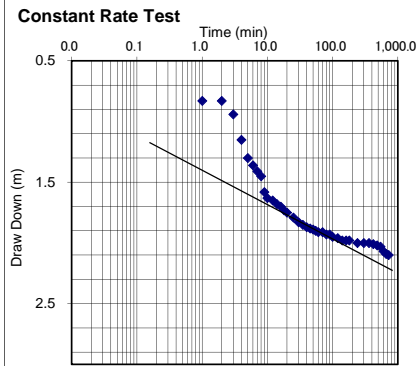
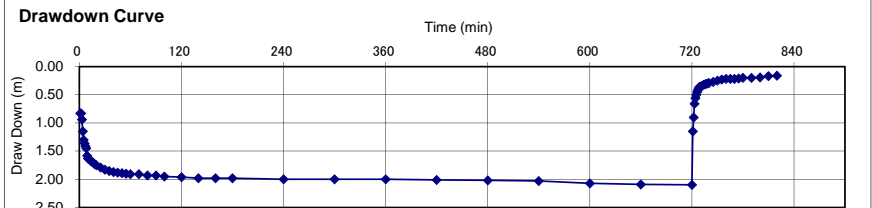

The project for Rural water supply Phase III in Kyoga Basin, Eastern Uganda

OBSERVATION RECORD BY BOREHOLE CAMERA

Items	Description of observation in the BH	Casing schedule
Executed Date:	25-Jun-15	5
Borehole No.:	I-07-EX04	
Village	NAIGOBYA	
Working Time:	1hr	10
Depth of HP	SWL =9.6m	PLAIN CASING
Casing Depth:	27.3M	15
Casing Size :	5"	20
Casing material	UPVC	
Static Water Table:	9.6M	25
Screen Depth:	-	
Sedimentation:		30
Safe yield		35
Dynamic drawdown at safe yield		
Top of casing Pipes (m)		40
		OPEN HOLE UPTO 35.6M
		45
		50
		55
		60
		65
		70
		75
		80
		85
		90
		95
		100
		105
		110
		115
		120

I-07-EX04(Naigobya)

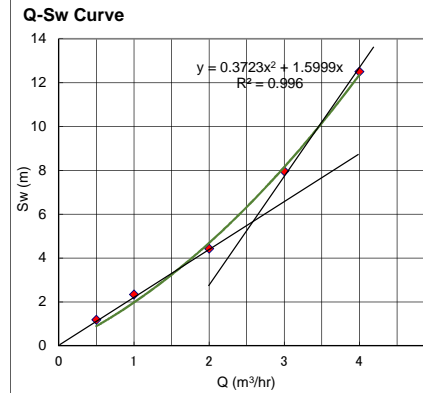
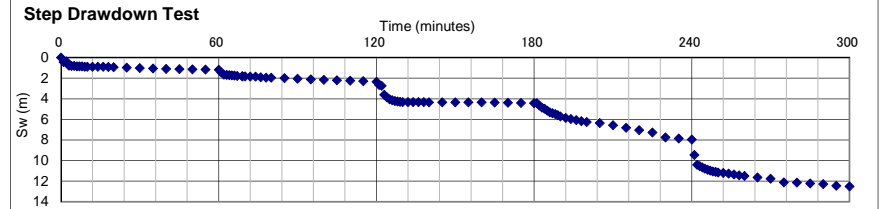

Q(m <sup>3</sup> /h)	sw(m)
0.5	1.18
1.0	2.34
2.0	4.43
3.0	7.96
4	12.5

Critical Yield	2.5
Safe Yield	2.0

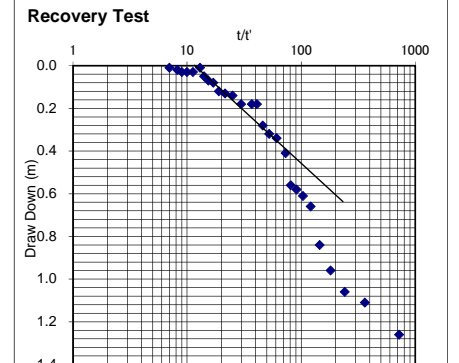
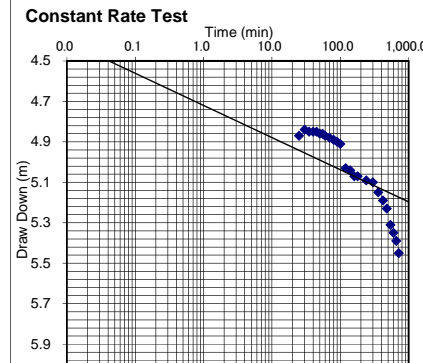
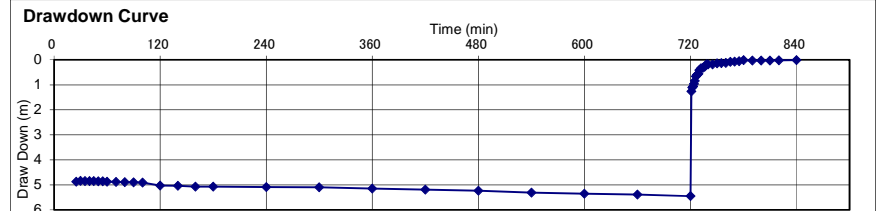

The project for Rural water supply Phase III in Kyoga Basin, Eastern Uganda

OBSERVATION RECORD BY BOREHOLE CAMERA

Items	Description of observation in the BH	Casing schedule
Executed Date:	10-Jul-15	5
Borehole No.:	I-08-EX01	
Village	Buses	SWL =6.7m
Working Time:	1hr 30 minutes	PLAIN METALLIC CASING UP TO 32.7m
Depth of HP		10
Casing Depth:	32.7M	15
Casing Size :	6"	20
Casing material	Metalic	
Static Water Table:	6.7M	PLAIN CASING UP TO 41m
Screen Depth:	N/A	25
Sedimentation:		
Safe yield		Collapsed pipes at 28.9m-32.7m
Dynamic drawdown at safe yield		30
Top of casing Pipes (m)		35
		40
		45
		50
		55
		60
		65
		70
		75
		80
		85
		90
		95
		100
		105
		110
		115
		120

A11-2-14

I-08-EX01(Busesa)

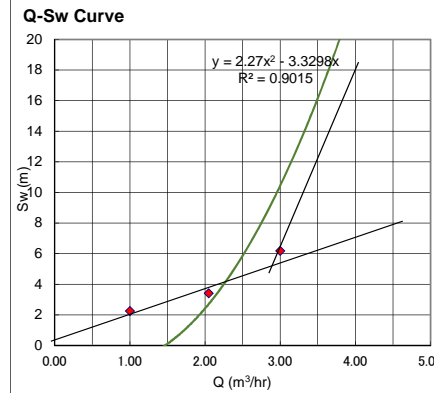
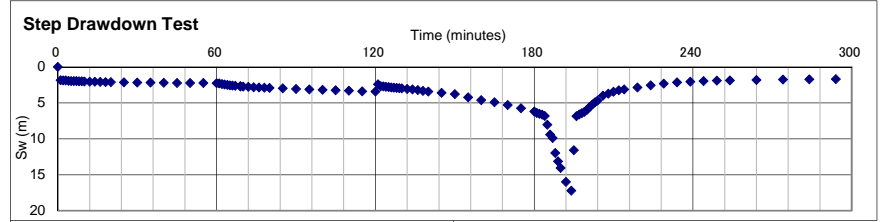

Q(m <sup>3</sup> /h)	sw(m)
1	2.25
2.1	3.42
3.0	6.19
4.0	

  

Critical Yield	2.9
Safe Yield	2.3

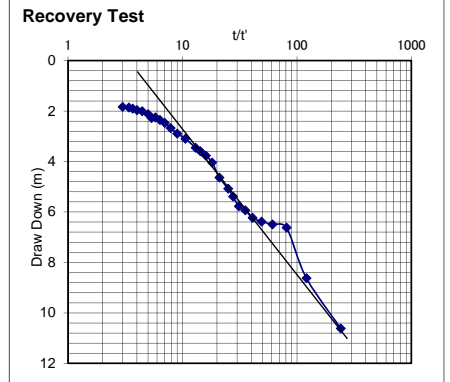
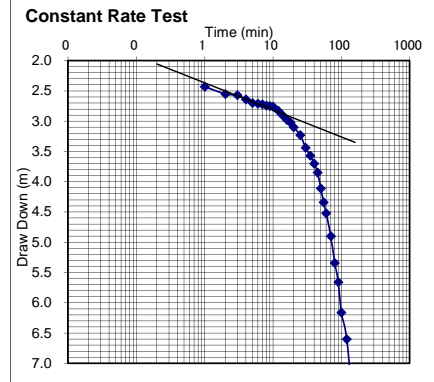
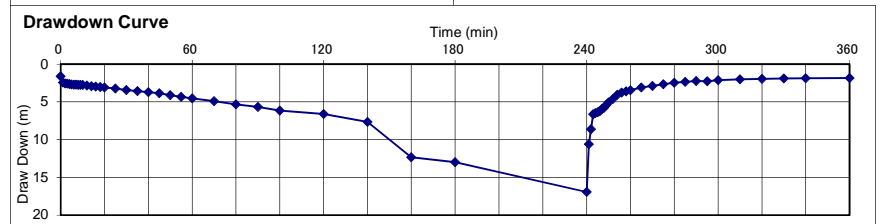

The project for Rural water supply Phase III in Kyoga Basin, Eastern Uganda			
OBSERVATION RECORD BY BOREHOLE CAMERA			
Items	Description of observation in the BH	Casing schedule	
Executed Date:	6-Jul-15		5
Borehole No.:	I-08-EX02		10
Village	Busesa		15
Working Time:	1hr 20 minutes		20
Depth of HP			25
Casing Depth:	21.6M		30
Casing Size :	5"		35
Casing material	UPVC		40
Static Water Table:	11.1M		45
Screen Depth:	16.2M -19M		50
Sedimentation:		55	
Safe yield		60	
Dynamic drawdown at safe yield		65	
Top of casing Pipes (m)		70	
		75	
		80	
		85	
		90	
		95	
		100	
		105	
		110	
		115	
		120	

I-08-EX02(Busesa)

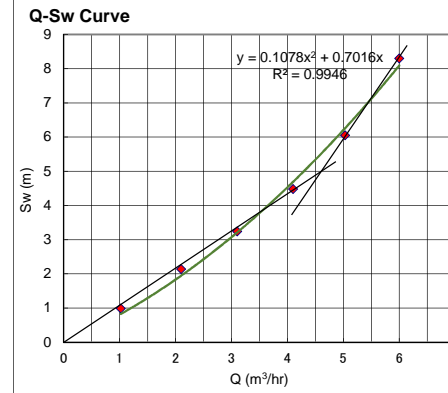
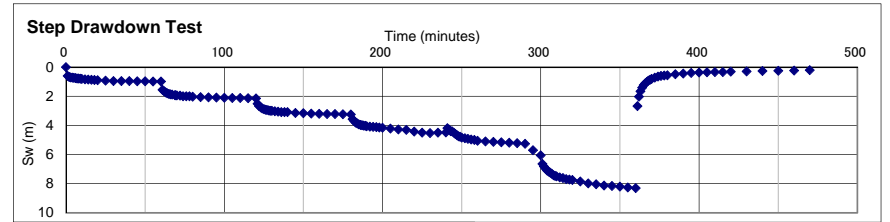

Q (m³/h)	Sw (m)
1.02	0.99
2.1	2.14
3.1	3.24
4.1	4.48
5.03	6.05
6	8.3

Critical Yield	4.6
Safe Yield	3.7

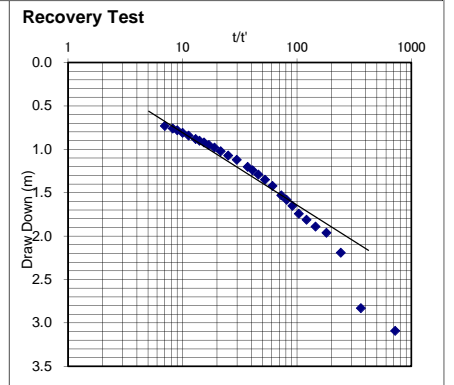
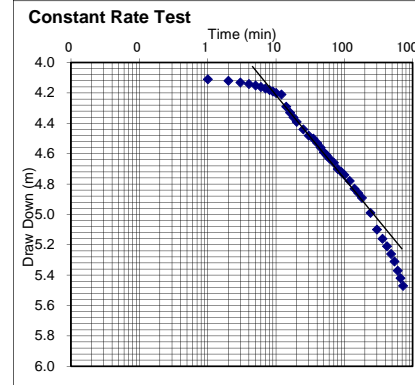
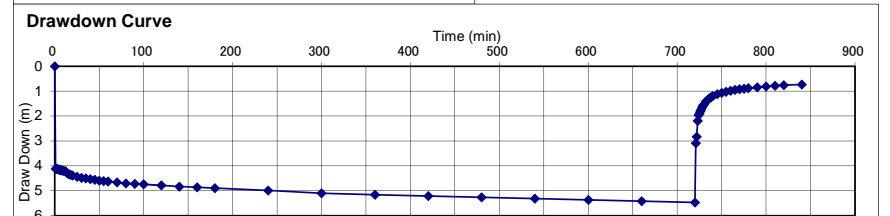

The project for Rural water supply Phase III in Kyoga Basin, Eastern Uganda

OBSERVATION RECORD BY BOREHOLE CAMERA

Items	Description of observation in the BH	Casing schedule
Executed Date:	10-Jul-15	
Borehole No.:	I-08-EX03	
Village	Busesa	
Working Time:	1hr 31 minutes	
Depth of HP	SWL =12.1m	PLAIN CASING
Casing Depth:	16.3M	
Casing Size :	5"	
Casing material	UPVC	
Static Water Table:	12.1M	
Screen Depth:	NOT VISIBLE	
Sedimentation:		
Safe yield		
Dynamic drawdown at safe yield		
Top of casing Pipes (m)		OPEN HOLE UPTO 66.2M
		40
		45
		50
		55
		60
		65
		70
		75
		80
		85
		90
		95
		100
		105
		110
		115
		120

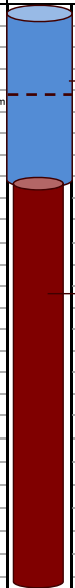

I-08-EX03(Busesa)

Step Drawdown Test

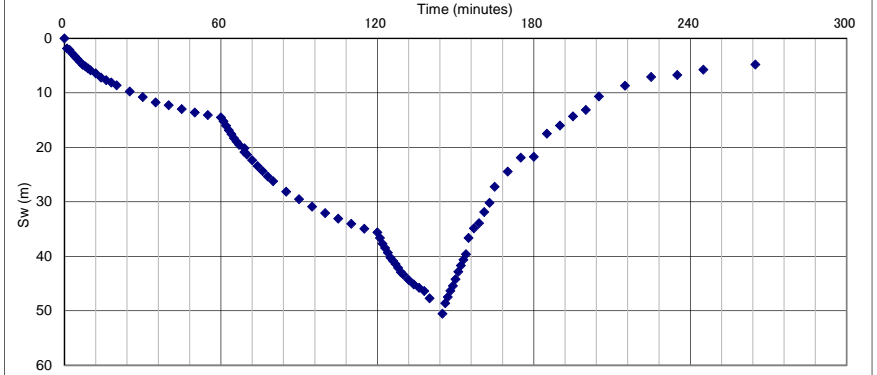

Q-Sw Curve

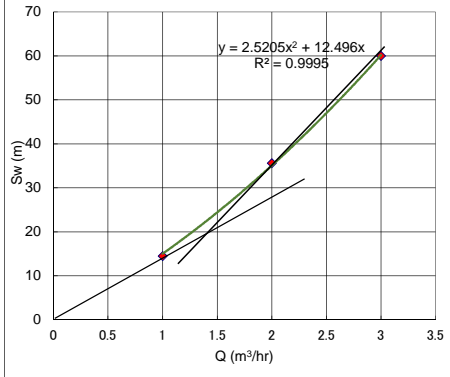

Q-Sw Curve

Q(m <sup>3</sup> /h)	Sw(m)
1.0	14.5
2.0	35.59
3.0	60

Critical Yield	1.4
Safe Yield	1.12



The project for Rural water supply Phase III in Kyoga Basin, Eastern Uganda

OBSERVATION RECORD BY BOREHOLE CAMERA

Items	Description of observation in the BH	Casing schedule
Executed Date:	9-Jul-15	5
Borehole No.:	I-08-EX05	
Village	Busesa	
Working Time:	1hr 20 minutes	
Depth of HP	SWL =6.9m	
Casing Depth:	28.6M	10
Casing Size :	5"	15
Casing material	UPVC	20
Static Water Table:	6.9M	
Screen Depth:	20.4M -25.9M	25
Sedimentation:		30
Safe yield		35
Dynamic drawdown at sa		
Top of casing Pipes (m)		35
		40
		45
		50
		55
		60
		65
		70
		75
		80
		85
		90
		95
		100
		105
		110
		115
		120

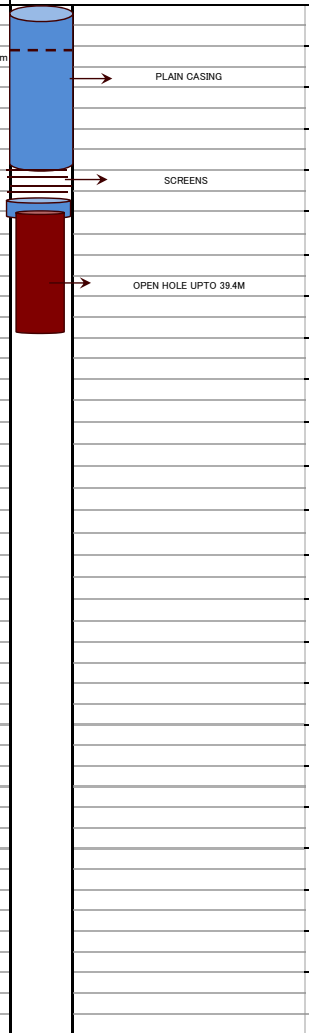

I-08-EX05(Busesa)

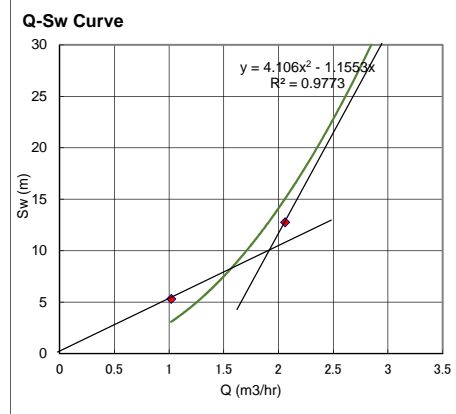
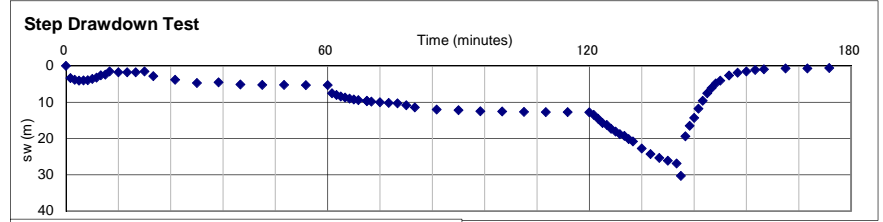

Q(m <sup>3</sup> /h)	Sw(m)
1.02	5.32
2.1	12.76

Critical Yield	1.8
Safe Yield	1.4

The project for Rural water supply Phase III in Kyoga Basin, Eastern Uganda

OBSERVATION RECORD BY BOREHOLE CAMERA

Items	Description of observation in the BH	Casing schedule
Executed Date:	10-Jul-15	5
Borehole No.:	I-08-EX06	
Village	Busesa	
Working Time:	1hr 10 minutes	10
Depth of HP	SWL =11.1m	15
Casing Depth:	23.0M	20
Casing Size :	5"	25
Casing material	UPVC	30
Static Water Table:	11.1M	35
Screen Depth:	20.4M -25.9M	40
Sedimentation:		45
Safe yield		50
Dynamic drawdown at safe yield		55
Top of casing Pipes (m)		60
		65
		70
		75
		80
		85
		90
		95
		100
		105
		110
		115
		120

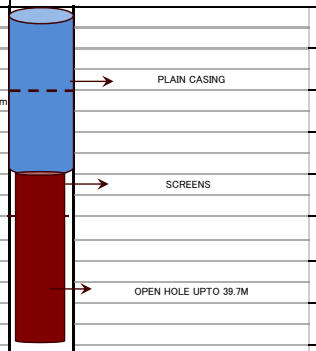

I-08-EX06(Busesa)

Step Drawdown Test

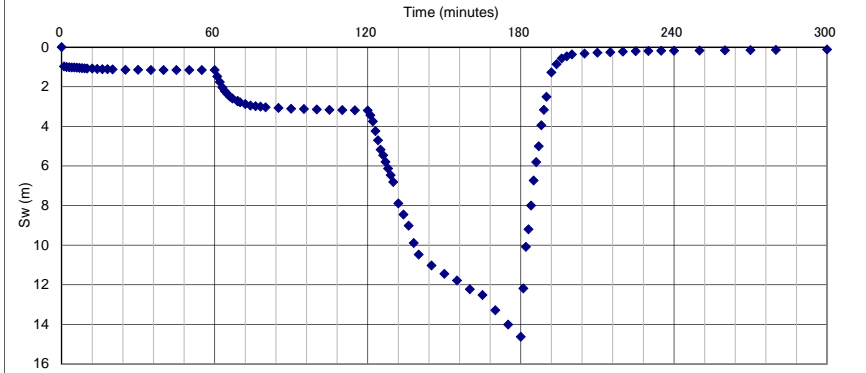

Q-Sw Curve

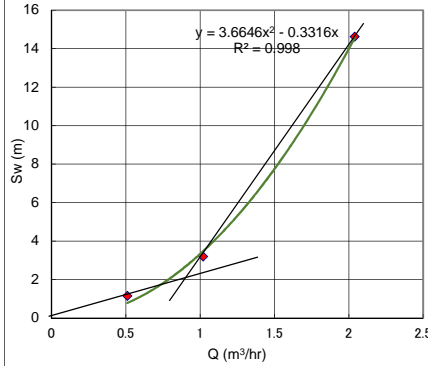

Q-Sw Curve

Q(m <sup>3</sup> /h)	Sw(m)
0.5	1.15
1.0	3.2
2.04	14.62

Critical Yield	0.9
Safe Yield	0.72

The project for Rural water supply Phase III in Kyoga Basin, Eastern Uganda

OBSERVATION RECORD BY BOREHOLE CAMERA

Items	Description of observation in the BH	Casing schedule
Executed Date:	26-Jun-15	5
Borehole No.:	I-09-EX04	
Village	Kyamvuma	
Working Time:	1hr 20 minutes	
Depth of HP	SWL = 10.3m	PLAIN CASING
Casing Depth:	31.2M	10
Casing Size :	5"	15
Casing material	UPVC	20
Static Water Table:	10.3M	25
Screen Depth:	24.6m-30.6m	SCREENS
Sedimentation:		30
Safe yield		35
Dynamic drawdown at safe yield		40
Top of casing Pipes (m)		45
		50
		55
		60
		65
		70
		75
		80
		85
		90
		95
		100
		105
		110
		115
		120

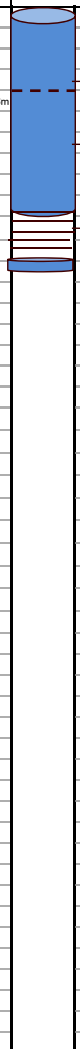

I-09-EX04(Kyamvuma)

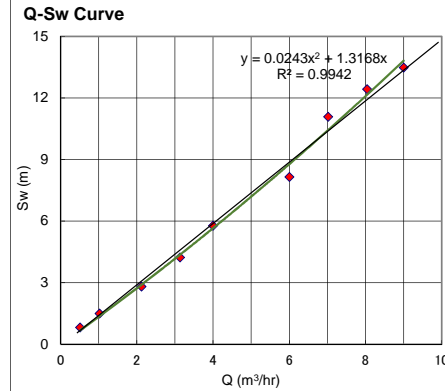
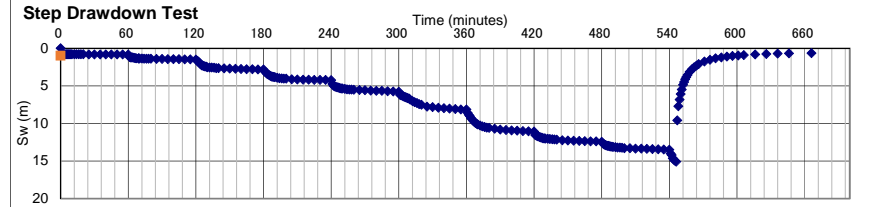

### Q-Sw Curve

Q(m³/h)	Sw(m)
0.51	0.82
1.0	1.49
2.1	2.81
3.1	4.23
4	5.77
6	8.15
7.02	11.08
8.04	12.43
9	13.48
10.02	15.1

6min.

Critical Yield	9
Safe Yield	7.2

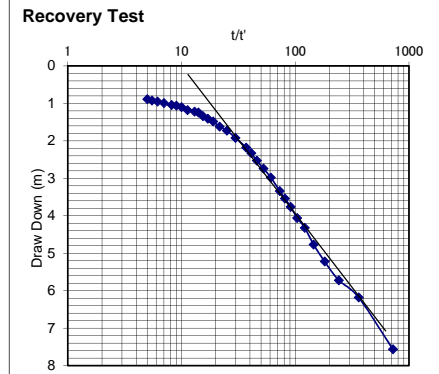
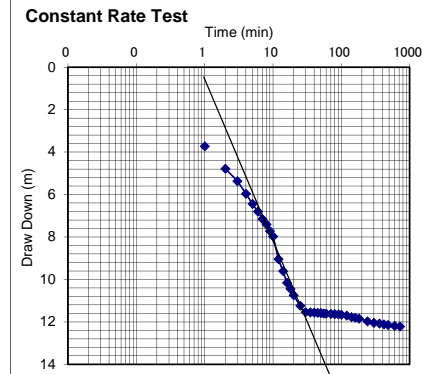
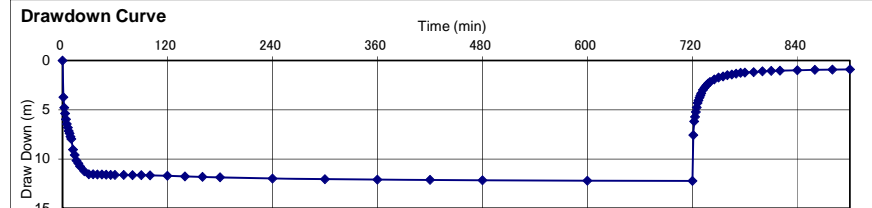

The project for Rural water supply Phase III in Kyoga Basin, Eastern Uganda

OBSERVATION RECORD BY BOREHOLE CAMERA

Items	Description of observation in the BH	Casing schedule
Executed Date:	26-Jun-15	5
Borehole No.:	I-09-EX06	10
Village	KASASIRA	15
Working Time:	1hr	20
Depth of HP	SWL = 10.6m	25
Casing Depth:	42.2M	30
Casing Size :	5"	35
Casing material	UPVC	40
Static Water Table:	10.6M	45
Screen Depth:	34M -39M	50
Sedimentation:		55
Safe yield		60
Dynamic drawdown at safe yield		65
Top of casing Pipes (m)		70
		75
		80
		85
		90
		95
		100
		105
		110
		115
		120

I-09-EX06(Kyamvuma)

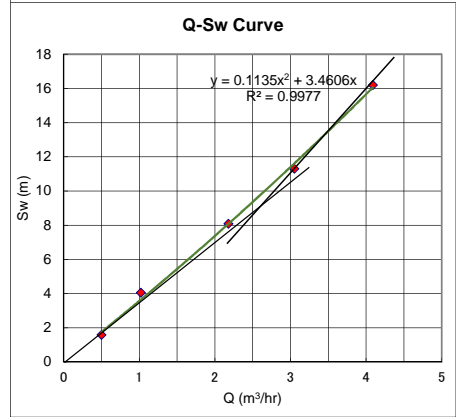
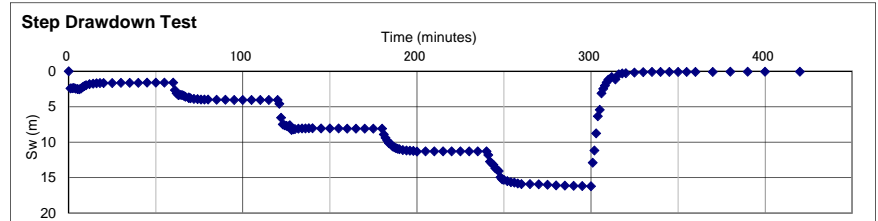

The project for Rural water supply Phase III in Kyoga Basin, Eastern Uganda

OBSERVATION RECORD BY BOREHOLE CAMERA

Items	Description of observation in the BH	Casing schedule
Executed Date:	11-Jul-15	
Borehole No.:	I-10-EX03	
Village	Nakivumbi	SWL = 5.5m
Working Time:	1hr 10 minutes	
Depth of HP		5
Casing Depth:	21.6M	10
Casing Size :	5"	15
Casing material	UPVC	20
Static Water Table:	5.5M	25
Screen Depth:	16.5m-21.5m	30
Sedimentation:		35
Safe yield		40
Dynamic drawdown at safe yield		45
Top of casing Pipes (m)		50
		55
		60
		65
		70
		75
		80
		85
		90
		95
		100
		105
		110
		115
		120

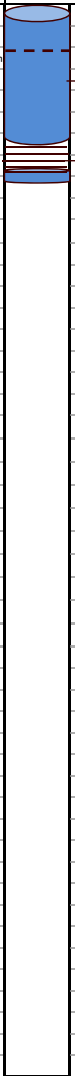

I-10-EX03(Nakivumbi)

Step Drawdown Test

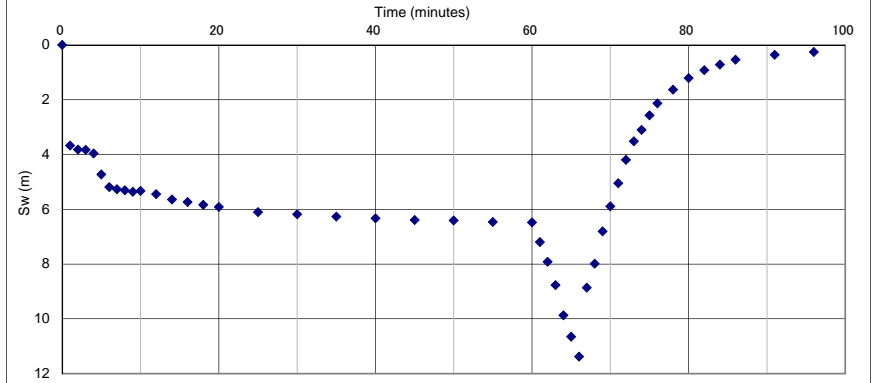

Q-Sw Curve

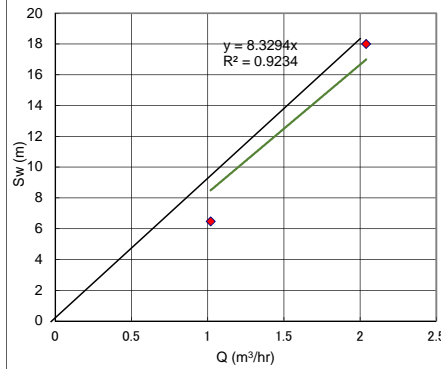

Q-Sw Curve

Q(m <sup>3</sup> /h)	Sw(m)
1.0	6.48

Critical Yield	
Safe Yield	

The project for Rural water supply Phase III in Kyoga Basin, Eastern Uganda

OBSERVATION RECORD BY BOREHOLE CAMERA

Items	Description of observation in the BH	Casing schedule
Executed Date:	23-Jun-15	5
Borehole No.:	I-11-EX01	
Village	NONDWE	
Working Time:	1hr 10 minutes	PLAIN CASING
Depth of HP		10
Casing Depth:	30.2M	15
Casing Size :	5"	20
Casing material	UPVC	
Static Water Table:	15.4M	25
Screen Depth:	ISUAL OBSTRUCTION IMPEEDEMEN	
Sedimentation:		30
Safe yield		35
Dynamic drawdown at safe yield		40
Top of casing Pipes (m)		45
		50
		55
		60
		65
		70
		75
		80
		85
		90
		95
		100
		105
		110
		115
		120

I-11-EX01(Nondwe)

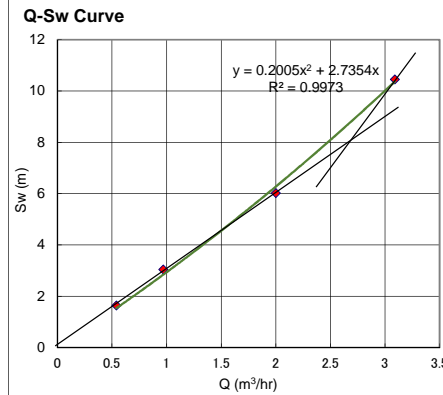
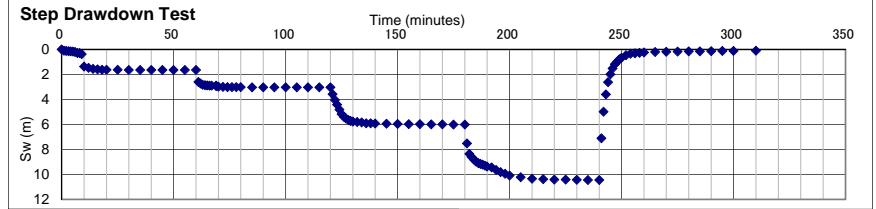

Q-Sw Curve	
Q(m <sup>3</sup> /h)	Sw(m)
0.54	1.64
1.0	3.04
2.0	6.02
3.1	10.45

Critical Yield	2.7
Safe Yield	2.1

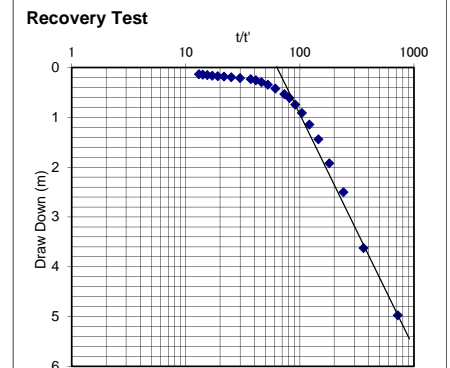
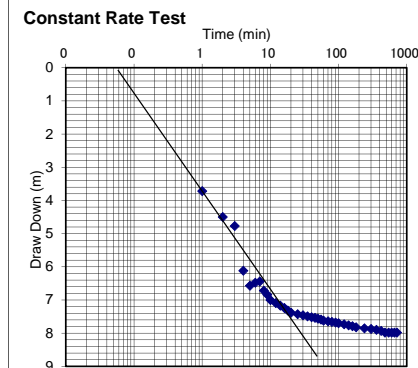
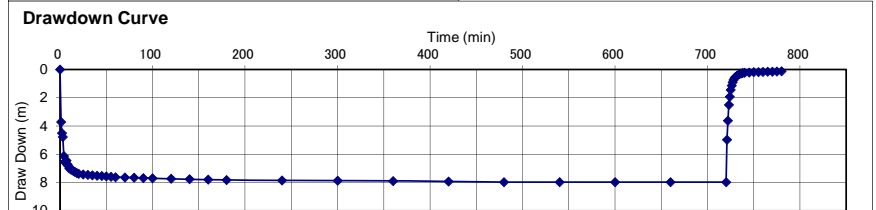

The project for Rural water supply Phase III in Kyoga Basin, Eastern Uganda

OBSERVATION RECORD BY BOREHOLE CAMERA

Items	Description of observation in the BH	Casing schedule
Executed Date:	23-Jun-15	5
Borehole No.:	I-11-EX03	
Village	Nondwe	10
Working Time:	1hr	→ STEEL CASING
Depth of HP	SWL =12.6m	15
Casing Depth:	OVER 27.6M BUT OBSTRUCTED	20
Casing Size :	6"	25
Casing material	STEEL	30
Static Water Table:	12.6M	35
Screen Depth:	-	40
Sedimentation:		45
Safe yield		50
Dynamic drawdown at safe yield		55
Top of casing Pipes (m)		60
		65
		70
		75
		80
		85
		90
		95
		100
		105
		110
		115
		120

I-11-EX03(Nondwe)

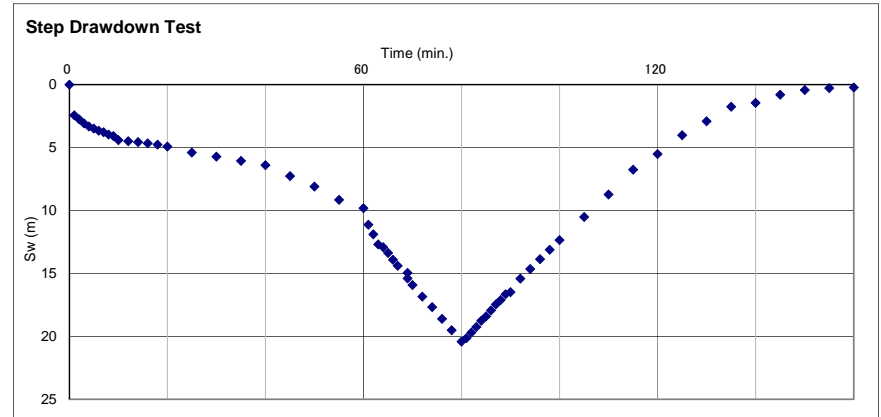

Q-Sw Curve

Q(m <sup>3</sup> /h)	Sw(m)
0.5	9.81

Critical Yield	
Safe Yield	

The project for Rural water supply Phase III in Kyoga Basin, Eastern Uganda

OBSERVATION RECORD BY BOREHOLE CAMERA

Items	Description of observation in the BH	Casing schedule
Executed Date:	13-Jul-15	5
Borehole No.:	P-25-EX03	
Village	Kasasira	10
Working Time:	1hr 20 minutes	PLAIN CASINGS
Depth of HP	SWL =8.1m	15
Casing Depth:	44.4M	20
Casing Size :	5"	25
Casing material	UPVC	30
Static Water Table:	8.1M	35
Screen Depth:	38m- 44m	40
Sedimentation:		45
Safe yield		50
Dynamic drawdown at safe yield		55
Top of casing Pipes (m)		60
		65
		70
		75
		80
		85
		90
		95
		100
		105
		110
		115
		120

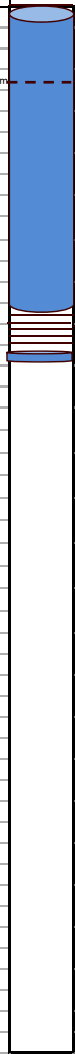

P-02-EX03(Kasassira)

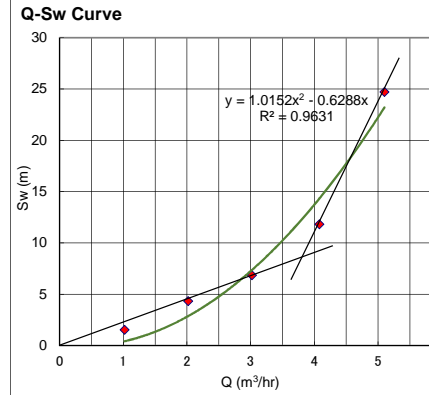
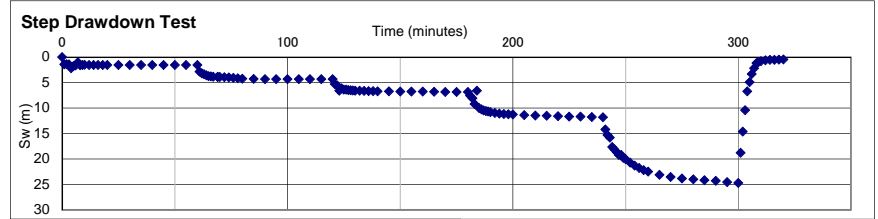

Q(m³/h)	Sw(m)
1.02	1.53
2.02	4.33
3.02	6.85
4.08	11.81
5.1	24.72

Critical Yield	3.8
Safe Yield	3.04

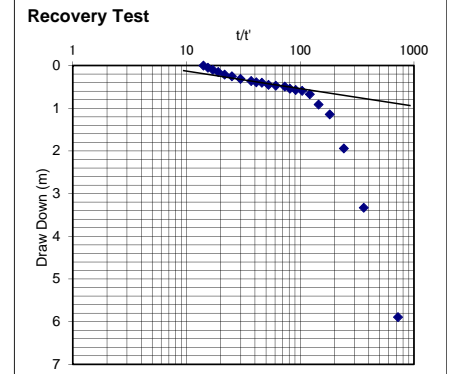
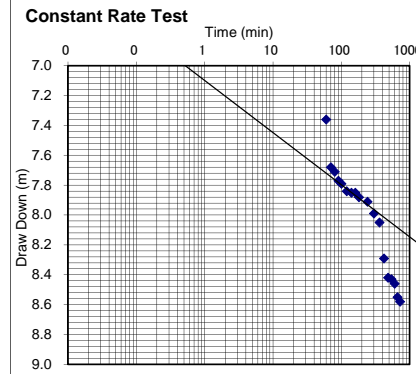
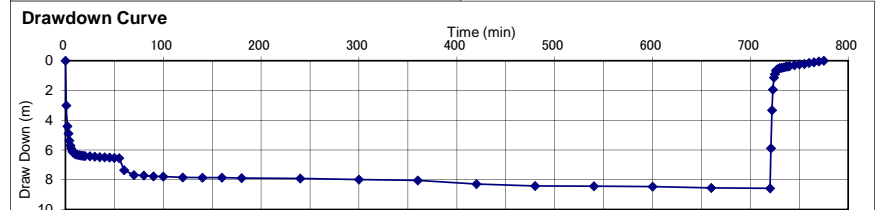



The project for Rural water supply Phase III in Kyoga Basin, Eastern Uganda

OBSERVATION RECORD BY BOREHOLE CAMERA

Items	Description of observation in the BH	Casing schedule
Executed Date:	7/114/2015	5
Borehole No.:	P-02-EX04	
Village	Kasasira	
Working Time:	1hr 30 minutes	10
Depth of HP	SWL =7.5m	PLAIN CASINGS
Casing Depth:	24.5M	15
Casing Size :	5"	20
Casing material	UPVC	
Static Water Table:	7.5M	25
Screen Depth:		30
Sedimentation:		
Safe yield		
Dynamic drawdown at safe yield		35
Top of casing Pipes (m)		OPEN HOLE UPTO 67.9M
		40
		45
		50
		55
		60
		65
		70
		75
		80
		85
		90
		95
		100
		105
		110
		115
		120

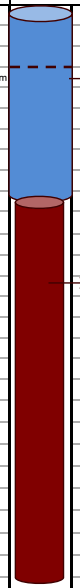

P-02-EX04(Kasasira)

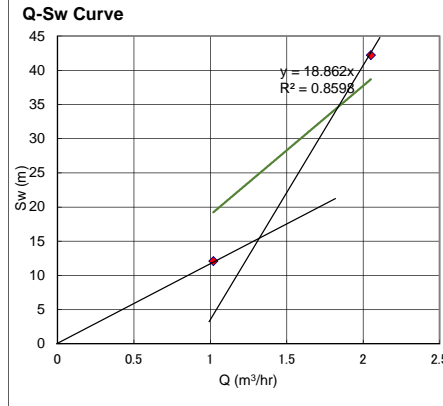
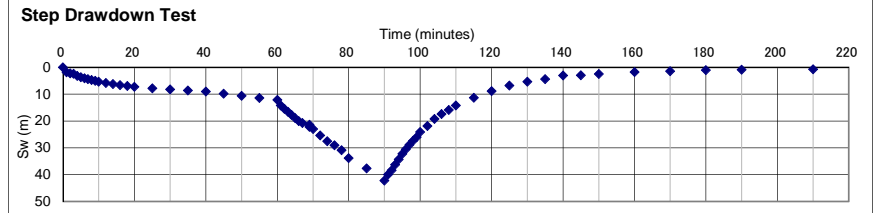

Q-Sw Curve	
Q(m <sup>3</sup> /h)	Sw(m)
1.02	12.1
2.05	42.22

Critical Yield	1.3
Safe Yield	1.04



The project for Rural water supply Phase III in Kyoga Basin, Eastern Uganda

OBSERVATION RECORD BY BOREHOLE CAMERA

Items	Description of observation in the BH	Casing schedule
Executed Date:	15-Jul-15	5
Borehole No.:	P-02-EX06	
Village	Kasasira	
Working Time:	1hr 30 minutes	
Depth of HP	SWL = 7.2m	10
Casing Depth:		15
Casing Size :		20
Casing material	UPVC	
Static Water Table:	7.2M	25
Screen Depth:	25.8M -28.7M, 37.5M- 40.4M	
Sedimentation:		30
Safe yield		35
Dynamic drawdown at safe yield		40
Top of casing Pipes (m)		45
		50
		55
		60
		65
		70
		75
		80
		85
		90
		95
		100
		105
		110
		115
		120

P-02-EX06(Kasasira)

Step Drawdown Test

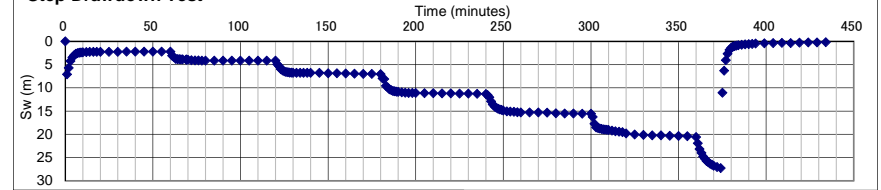

Q-Sw Curve

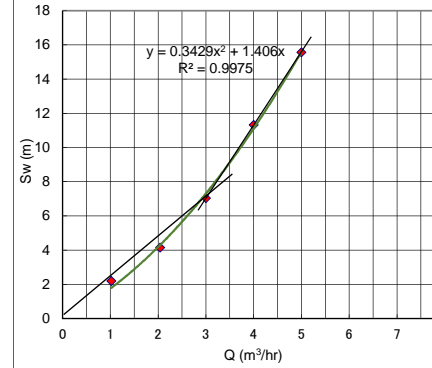

Q-Sw Curve

Q(m³/h)	Sw(m)
1.02	2.19
2.04	4.15
3.00	7.04
4.00	11.32
5.00	15.57
6.00	20.56
7.10	27.24

Critical Yield	3.2
Safe Yield	2.6

Drawdown Curve

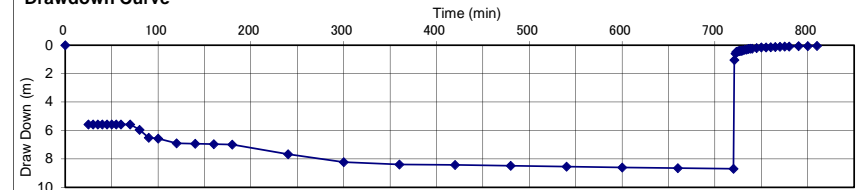

Constant Rate Test

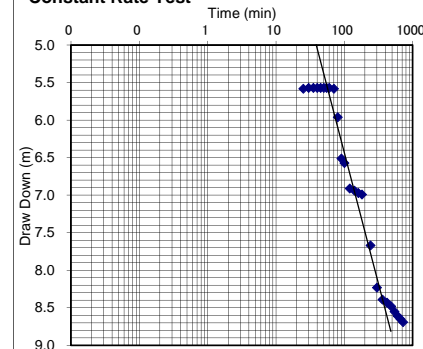

Recovery Test

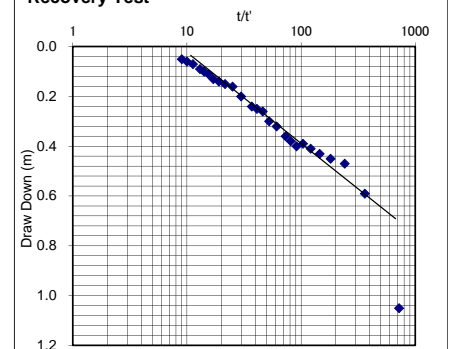

The project for Rural water supply Phase III in Kyoga Basin, Eastern Uganda			
OBSERVATION RECORD BY BOREHOLE CAMERA			
Items	Description of observation in the BH		Casing schedule
Executed Date:	19-Jul-15		5
Borehole No.:	P-04-EX01		10
Village	Kapala		15
Working Time:	1hr 20 minutes		20
Depth of HP			25
Casing Depth:	25.5M		30
Casing Size :	5"		35
Casing material	UPVC		40
Static Water Table:	5.9M		45
Screen Depth:	20.1m-22.9m		50
Screen Depth:	20.1m-22.9m	55	
Sedimentation:		60	
Safe yield		65	
Dynamic drawdown at safe yield		70	
Top of casing Pipes (m)		75	
		80	
		85	
		90	
		95	
		100	
		105	
		110	
		115	
		120	

P-04-EX01(Kapala)

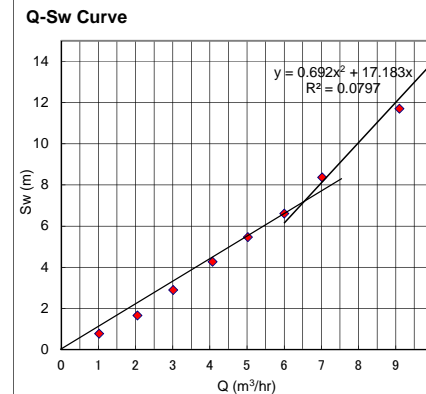
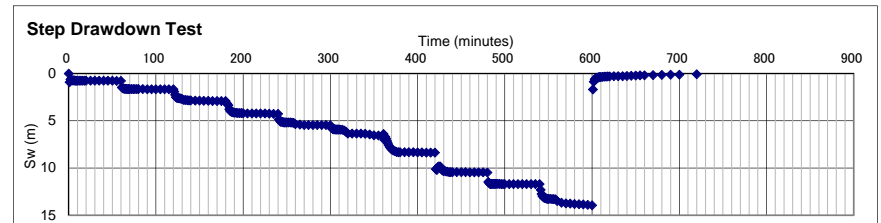

Q-Sw Curve	
Q(m <sup>3</sup> /h)	Sw(m)
1.02	0.77
2.05	1.66
3.01	2.9
4.07	4.27
5.02	5.46
6	6.61
7.02	8.37
8	10.48
9.1	11.7
10	13.93

Critical Yield	6.5
Safe Yield	5.2

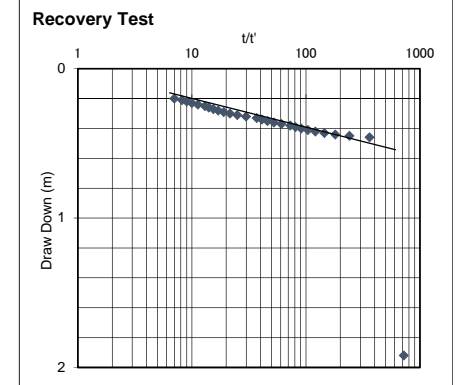
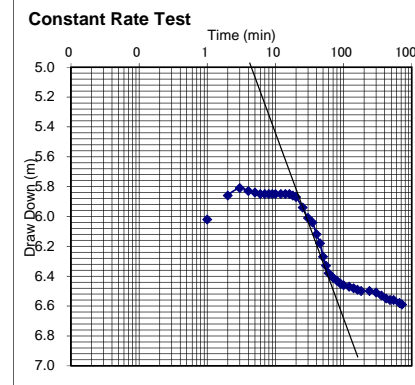
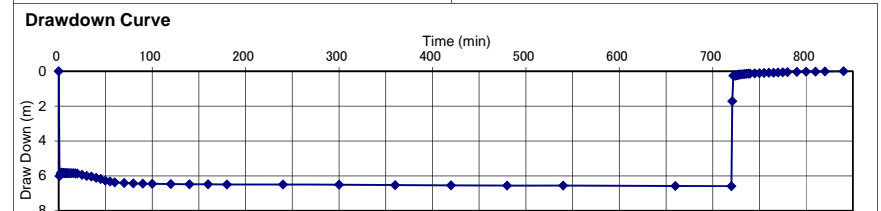

The project for Rural water supply Phase III in Kyoga Basin, Eastern Uganda

OBSERVATION RECORD BY BOREHOLE CAMERA

Items	Description of observation in the BH	Casing schedule
Executed Date:	19-Jul-15	
Borehole No.:	P-04-EX03	SWL =4.6m
Village	Kapala	
Working Time:	1hr 20 minutes	
Depth of HP		10
Casing Depth:	31.5M	15
Casing Size :	5"	20
Casing material	UPVC	
Static Water Table:	4.6M	25
Screen Depth:	27M -30M	
Sedimentation:		30
Safe yield		35
Dynamic drawdown at safe yield		40
Top of casing Pipes (m)		45
		50
		55
		60
		65
		70
		75
		80
		85
		90
		95
		100
		105
		110
		115
		120

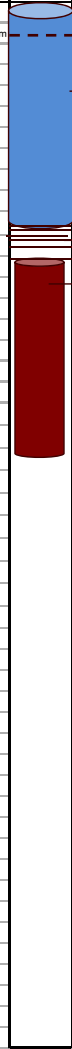

P-04-EX03(Kapala)

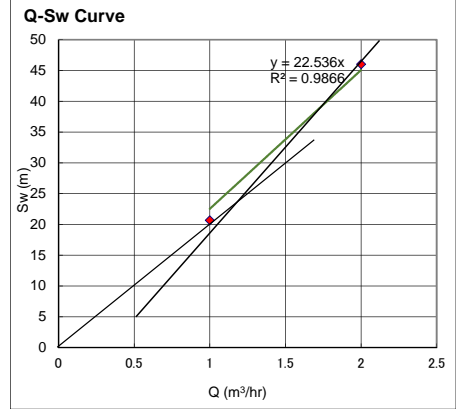
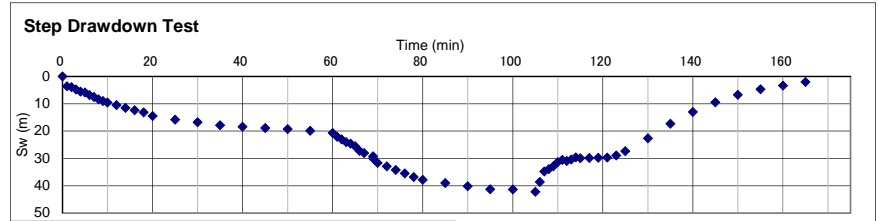

Q-Sw Curve	
Q(m <sup>3</sup> /h)	Sw(m)
1.02	20.68
2.04	46

Critical Yield	1.2
Safe Yield	0.96

The project for Rural water supply Phase III in Kyoga Basin, Eastern Uganda		
OBSERVATION RECORD BY BOREHOLE CAMERA		
Items	Description of observation in the BH	Casing schedule
Executed Date:	19-Jul-15	
Borehole No.:	P-04-EX05	5
Village:	Kapala	
Working Time:	1hr 30 minutes	10
Depth of HP	SWL =9.5m	PLAIN CASING
Casing Depth:	26.3M	15
Casing Size :	5"	20
Casing material	UPVC	SCREENS
Static Water Table:	9.5M	25
Screen Depth:	18.5M - 26.3M	30
Sedimentation:		35
Safe yield		40
Dynamic drawdown at safe yield		45
Top of casing Pipes (m)		50
		55
		60
		65
		70
		75
		80
		85
		90
		95
		100
		105
		110
		115
		120

P-04-EX05(Kapala)

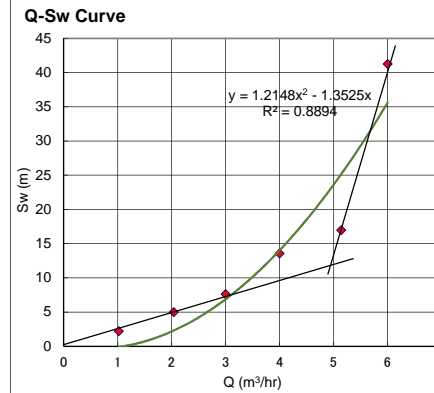
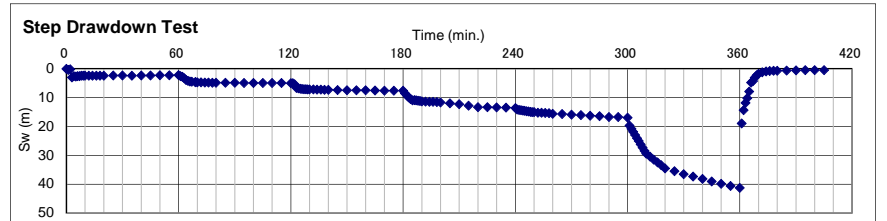

Q(m <sup>3</sup> /h)	Sw(m)
1.02	2.19
2.04	4.97
3	7.6
4	13.57
5.14	16.96
6	41.27

Critical Yield	4.9
Safe Yield	3.9

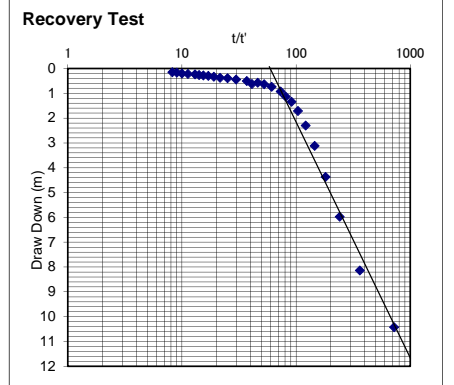
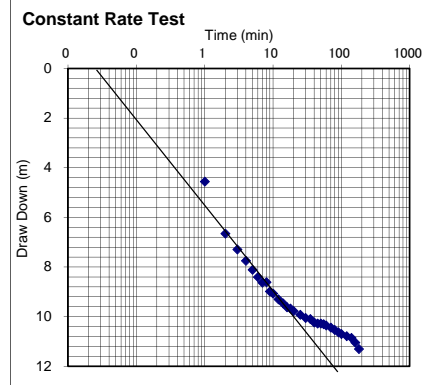
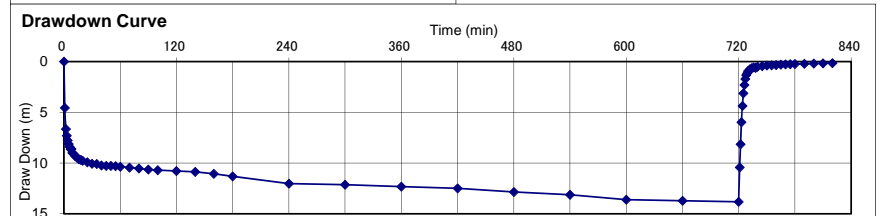

The project for Rural water supply Phase III in Kyoga Basin, Eastern Uganda

OBSERVATION RECORD BY BOREHOLE CAMERA

Items	Description of observation in the BH	Casing schedule
Executed Date:	17-Jul-15	5
Borehole No.:	P-05-EX02	
Village	Buseta	
Working Time:	1hr 10 minutes	10
Depth of HP	SWL =6.2m	PLAIN CASING
Casing Depth:	23.5M	15
Casing Size :	5"	20
Casing material	UPVC	
Static Water Table:	6.2M	25
Screen Depth:		30
Sedimentation:		35
Safe yield		40
Dynamic drawdown at safe yield		45
Top of casing Pipes (m)		OPEN HOLE UPTO 39.7M
		40
		45
		50
		55
		60
		65
		70
		75
		80
		85
		90
		95
		100
		105
		110
		115
		120

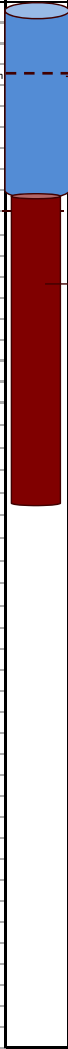

P-05-EX02(Buseta)

Step Drawdown Test

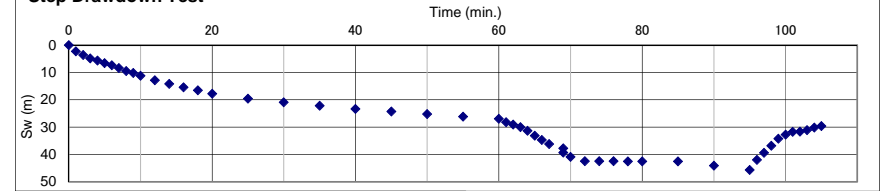

Q-Sw Curve

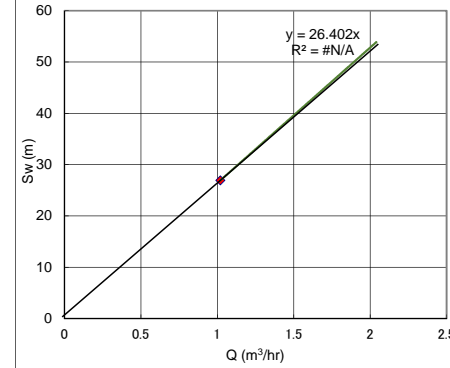

Q-Sw Curve	
Q(m <sup>3</sup> /h)	Sw(m)
1.02	26.93

Critical Yield	
Safe Yield	

The project for Rural water supply Phase III in Kyoga Basin, Eastern Uganda

OBSERVATION RECORD BY BOREHOLE CAMERA

Items	Description of observation in the BH	Casing schedule
Executed Date:	18-Jul-15	5
Borehole No.:	P-05-EX03	5
Village	Buseta	10
Working Time:	1hr 30 minutes	10
Depth of HP		15
Casing Depth:	41.5M	20
Casing Size :	5"	20
Casing material	UPVC	20
Static Water Table:	3.9M	25
Screen Depth:	31.4m-34.4m, 37.1m-40.1m	30
Sedimentation:		30
Safe yield		35
Dynamic drawdown at safe yield		35
Top of casing Pipes (m)		35
		40
		45
		50
		55
		60
		65
		70
		75
		80
		85
		90
		95
		100
		105
		110
		115
		120

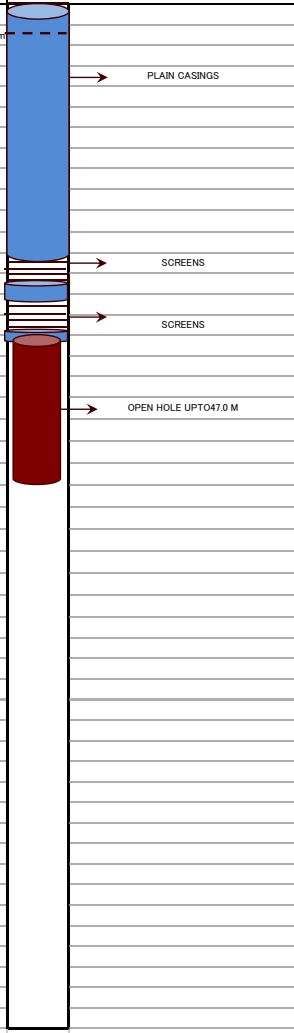

P-05-EX03(Buseta)

Step Drawdown Test

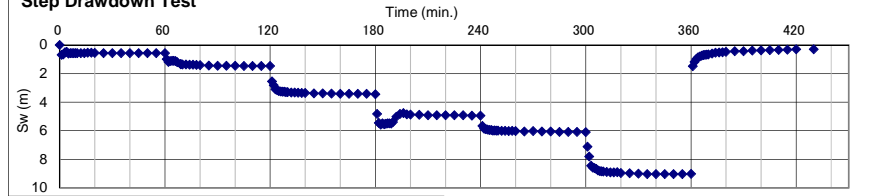

Q-Sw Curve

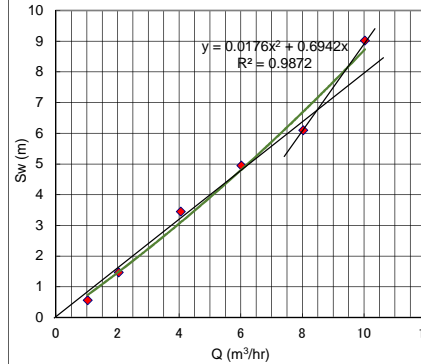

Q-Sw Curve

Q(m <sup>3</sup> /h)	Sw(m)
1.03	0.56
2.04	1.47
4.05	3.45
6.02	4.95
8.03	6.10
10.03	9.02

Critical Yield	8.5
Safe Yield	6.8

Drawdown Curve

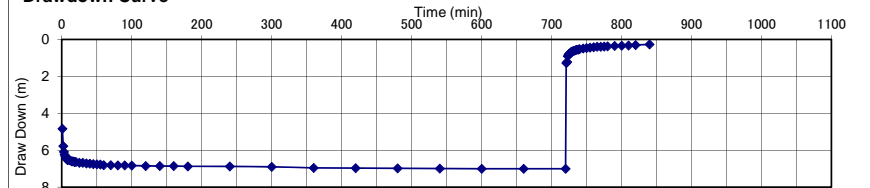

Constant Rate Test

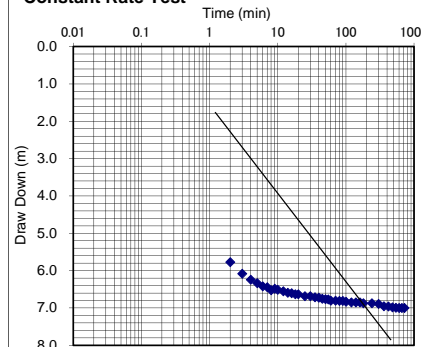

Recovery Test

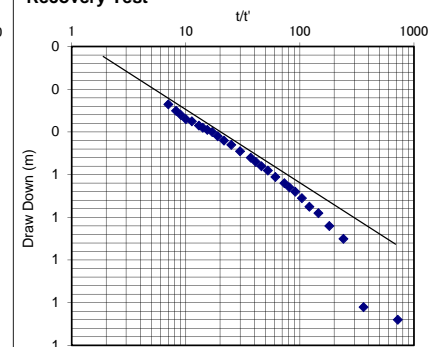



The project for Rural water supply Phase III in Kyoga Basin, Eastern Uganda

OBSERVATION RECORD BY BOREHOLE CAMERA

Items	Description of observation in the BH	Casing schedule
Executed Date:	18-Jul-15	5
Borehole No.:	P-05-EX05	10
Village:	Buseta	15
Working Time:	1hr 20 minutes	20
Depth of HP		25
Casing Depth:	9.9M	30
Casing Size :	5"	35
Casing material	UPVC	40
Static Water Table:	11.1M	45
Screen Depth:	16.2M -19M	50
Sedimentation:		55
Safe yield		60
Dynamic drawdown at safe yield		65
Top of casing Pipes (m)		70
		75
		80
		85
		90
		95
		100
		105
		110
		115
		120

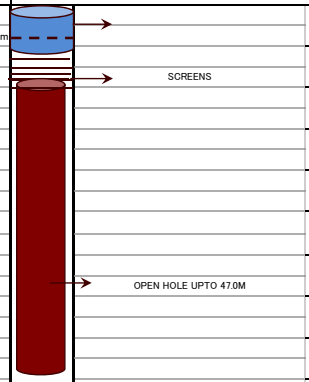

P-05-EX05(Buseta)

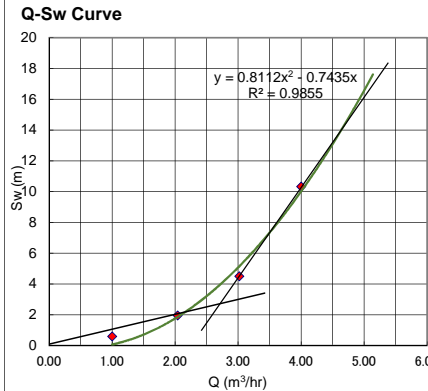
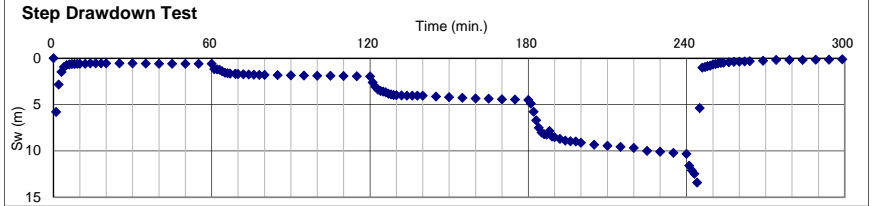

Q-Sw Curve	
Q(m³/h)	Sw(m)
1	0.59
2.04	1.95
3.02	4.50
4	10.32

Critical Yield	2.7
Safe Yield	2.2

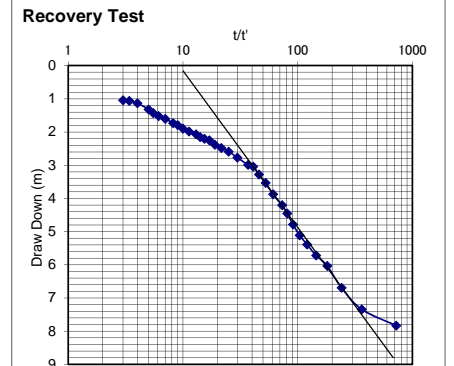
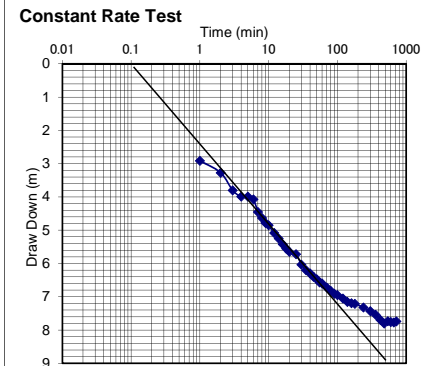
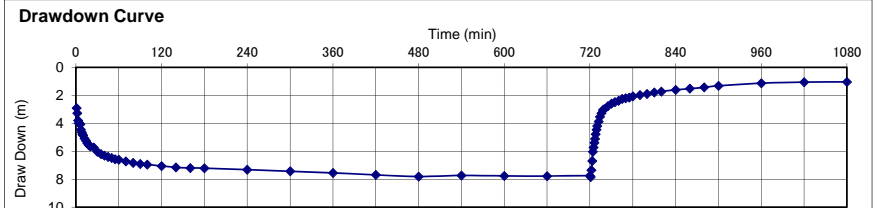

The project for Rural water supply Phase III in Kyoga Basin, Eastern Uganda

OBSERVATION RECORD BY BOREHOLE CAMERA

Items	Description of observation in the BH	Casing schedule
Executed Date:	14-Jul-15	5
Borehole No.:	P-05,EX06	
Village	Buseta	
Working Time:	1hr 20 minutes	
Depth of HP	SWL =10.0m	PLAIN CASING
Casing Depth:	Not identified due to visual obstruction	15
Casing Size :	5"	20
Casing material	UPVC	
Static Water Table:	10.0M	SCREENS
Screen Depth:	19.7M - 22.4, 25.4M - 8.4M	25
Sedimentation:		30
Safe yield		35
Dynamic drawdown at safe yield		40
Top of casing Pipes (m)		45
		50
		55
		60
		65
		70
		75
		80
		85
		90
		95
		100
		105
		110
		115
		120

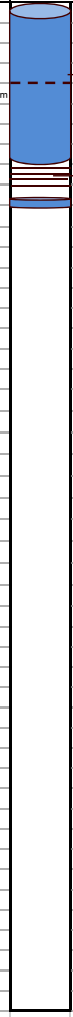

P-05-EX06(Buseta)

Step Drawdown Test

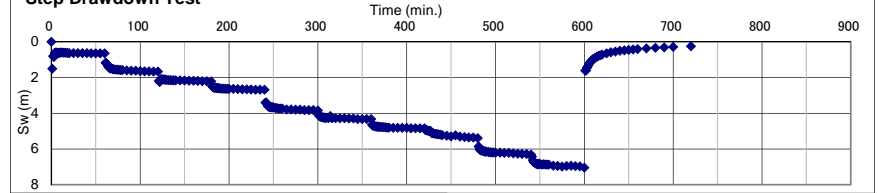

Q-Sw Curve

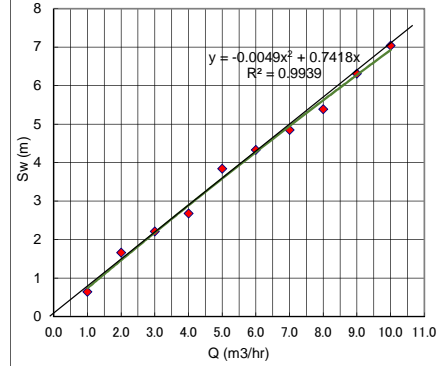

Q-Sw Curve

Q(m <sup>3</sup> /h)	Sw(m)
1	0.64
2	1.66
3	2.21
4	2.68
5	3.84
6	4.33
7	4.85
8	5.39
9	6.31
10	7.04

Critical Yield	10.0
Safe Yield	8.0

Drawdown Curve

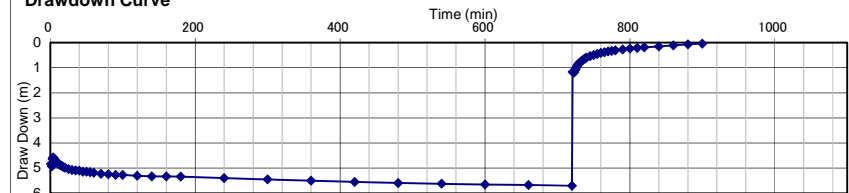

Constant Rate Test

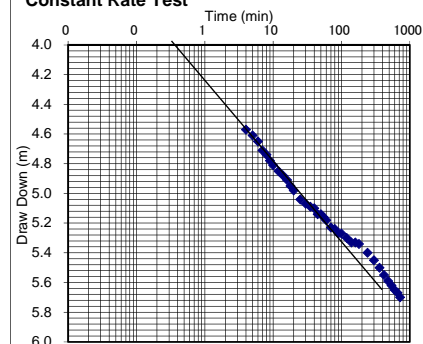

Recovery Test

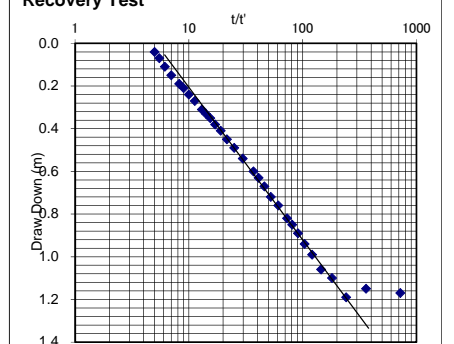

The project for Rural water supply Phase III in Kyoga Basin, Eastern Uganda

OBSERVATION RECORD BY BOREHOLE CAMERA

Items	Description of observation in the BH	Casing schedule
Executed Date:	16-Jul-15	5
Borehole No.:	P-05-EX07	
Village	Buseta	10
Working Time:	1hr 20 minutes	15
Depth of HP		20
Casing Depth:	32.4M	25
Casing Size :	5"	30
Casing material	UPVC	35
Static Water Table:	5.8M	40
Screen Depth:	25.5M -28.3M, 30.7M- 32.4M	45
Sedimentation:		50
Safe yield		55
Dynamic drawdown at safe yield		60
Top of casing Pipes (m)		65
		70
		75
		80
		85
		90
		95
		100
		105
		110
		115
		120

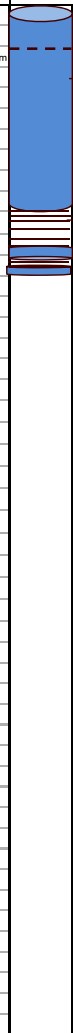

P-05-EX07(Buseta)

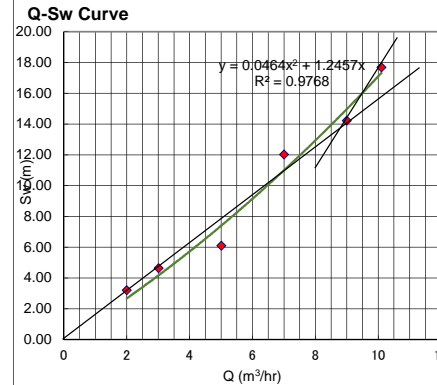
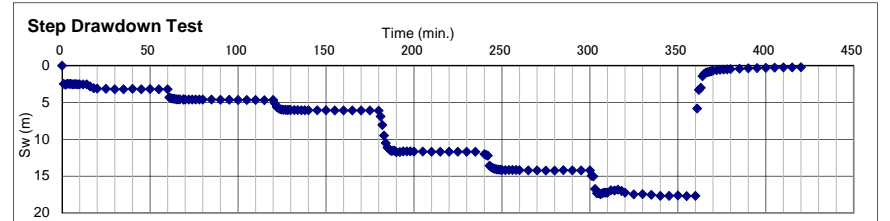

Q(m <sup>3</sup> /h)	Sw(m)
2	3.20
3.01	4.64
5.01	6.10
7	12.02
9	14.22
10.1	17.68

Critical Yield	9.0
Safe Yield	7.2

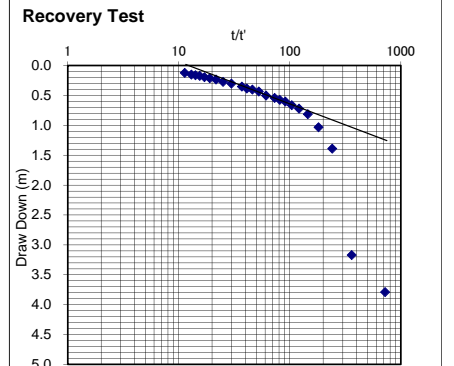
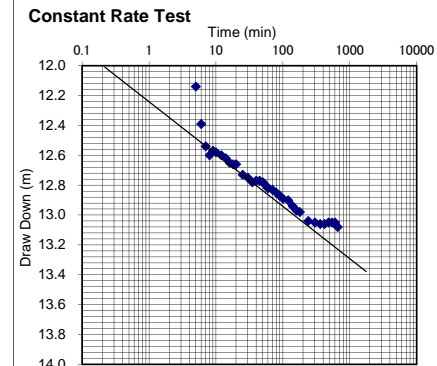
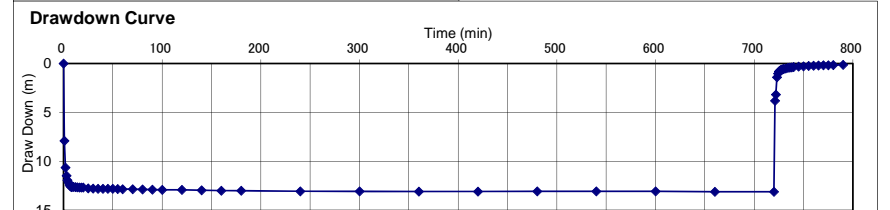

The project for Rural water supply Phase III in Kyoga Basin, Eastern Uganda

OBSERVATION RECORD BY BOREHOLE CAMERA

Items	Description of observation in the BH	Casing schedule
Executed Date:	21-Jul-15	5
Borehole No.:	S-02-EX02 SWL =4.2m	
Village	Tubur	10
Working Time:	1hr10 minutes	15
Depth of HP		20
Casing Depth:	19-Jan-00	25
Casing Size :	5"	30
Casing material	UPVC	35
Static Water Table:	4.2M	40
Screen Depth:	17m-20m	45
Sedimentation:		50
Safe yield		55
Dynamic drawdown at safe yield		60
Top of casing Pipes (m)		65
		70
		75
		80
		85
		90
		95
		100
		105
		110
		115
		120

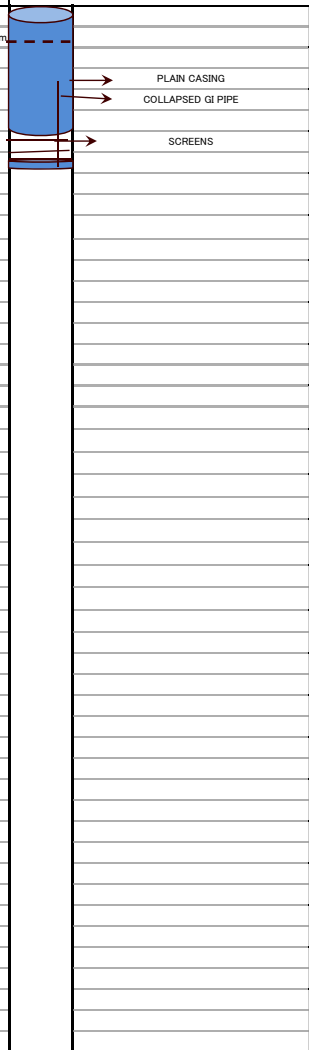

S-02-EX02(Tubur)

Step Drawdown Test

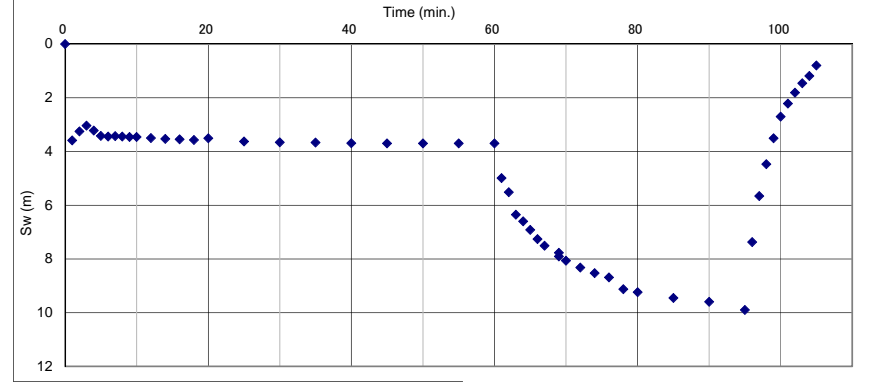

Q-Sw Curve

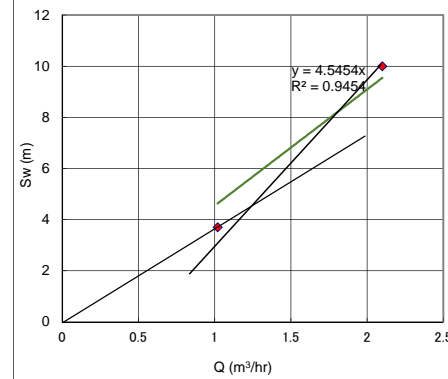

Q-Sw Curve

Q(m <sup>3</sup> /h)	Sw(m)
1.0	3.7

Critical Yield	
Safe Yield	

Result of Pumping Test and Water Quality Analysis

RGC Name	Existing BH No.	Hostility (Yes: ×, No: ○)	Availability of Pumping Test	Reason of Abort of Pumping Test	Borehole Camera			Step Drawdown Test		Continuous Test			Recovery Test	Water Quality at Field					Colour	Turbidity	TDS	TSS	Hardness	Magnesium	Chloride	Fluoride	Total Iron	Sulphate	Nitrate	Nitrite	Ammonia	Manganese	Arsenic	Sodium	Potassium	
					Depth (m)	Casing Bottom (m)	SWL (m)	Critical Yield (m <sup>3</sup> /hr)	Safe Yield (m <sup>3</sup> /hr)	Discharge Rate (m <sup>3</sup> /hr)	Transmissivity (m <sup>2</sup> /hr)	Storage Co-efficient		Transmissivity (m <sup>2</sup> /hr)	Temperature (oC)	pH	EC (mS/cm)	TDS (mg/L)																		Coliform (No./100 mL)
Nabitende Banada	I-01-EX01	×	○		48.3	38.8	9.8	2.9	2.3	2.5	0.23	0.24	0.29	24.7	6.25	338	250	1	0	0.2	163	0	120	12	12	0.16	0.003	5	0.02	0	0	0	<0.001	10.3	0.9	
	I-01-EX02	×	○		48.0		10.10	2.4	1.9	-	-	-	-	25.1	6.37	593	310	1	2	0.5	300	0	130	14.4	13.5	0.21	0.004	7	0.03	0	0.004	0	<0.001	13.5	2.3	
	I-01-EX03	○		Small Dia.						-	-	-	-																							
	I-01-EX04	×	○		47.5	35.0	6.33	<2.0	<2.0	-	-	-	-	25.6	6.06	360	180	7	7	0.9	185	0	130	14.4	15.5	0.22	0.009	6	0.02	0	0.005	0	<0.001	10.5	1.8	
	I-01-EX05	×		Rust						-	-	-	-																							
	I-01-EX06	×	○		49.0	38.8	8.70	<2.0	<2.0	-	-	-	-	26.5	6.03	514	260	0	4	0.7	170	0	130	14.4	11.7	0.23	0.006	5	0.03	0	0.001	0	<0.001	11.3	1.7	
	I-01-EX07	×		Hostility						-	-	-	-																							
	I-01-EX09	×	○					2.1	1.7	-	-	-	-	25.8	6.07	252	130	0	44	8.5	143	6	80	7.2	8.4	0.14	0.032	4	0.04	0.002	0.023	0.001	<0.001	10.3	1.2	
	I-01-EX10	-		Shallow well						-	-	-	-																							
	I-02-EX01	-		Too Old						-	-	-	-																							
Namungalwe	I-02-EX02	△	○		53.9	27.5	7.6	2.0	1.6	-	-	-	-	26.2	6.75	386	200	0	16	1.9	200	2	130	14.4	16	0.21	0.022	6	0.03	0	0.007	0.001	<0.001	7.4	1	
	I-02-EX03	-		Too Old						-	-	-	-																							
	I-02-EX04	△	○		30.0	-	11.3	4.0	3.2	3.4	0.57	8.49	1.09	25.9	6.2	199	100	0	8	0.9	115	0	85	7.2	7.5	0.12	0.014	4	0.02	0	0.001	0	<0.001	6.2	0.9	
	I-02-EX05A	○		Small Dia.						-	-	-	-																							
	I-02-EX05B	×	○		40.2	33.4	11.1	2.5	2.0	-	-	-	-	25.9	6.1	190	200	0	7	0.9	115	0	75	7.2	7.4	0.12	0.011	3	0.02	0	0.06	0	<0.001	5.2	0.5	
	I-02-EX06	-		Too Old						-	-	-	-																							
Nambale	I-03-EX01	○	○		25.6	-	8.80	<2.0	<2.0	-	-	-	-	26.0	5.86	231	120	0	4	0.7	134	0	75	8.4	6.2	0.13	0.009	4	0.01	0	0.001	0	<0.001	9.5	0.9	
	I-03-EX02	×	○		50.0			2.1	1.7	-	-	-	-	26.4	5.74	237	120	0	14	1.6	130	1	70	7.2	5	0.12	0.018	4	0.02	0	0.006	0.001	<0.001	11.5	1.7	
Lambala	I-06-EX02	×	○		45.0	30.2	5.60	2.0	1.6	-	-	-	-	25.5	6.00	360	180	0	2	0.5	204	0	140	14.4	17	0.23	0.006	5	0.02	0	0.001	0	<0.001	9.7	1.2	
	I-06-EX03	-		Shallow Well						-	-	-	-																							
	I-06-EX04	×	○		49.3	39.5	5.50	<2.0	<2.0	-	-	-	-	26.5	5.98	310	110	0	3	0.7	170	0	140	12	16.5	0.21	0.005	5	0.03	0	0.004	0	<0.001	10.3	1.2	
I-06-EX05	-		Shallow Well						-	-	-	-																								
Naigobya	I-07-EX02	×	○		30.5		9.30	2.8	2.2	2.5	1.69	0.006	1.83	27.7	5.87	490	230	0	0	0.3	120	0	70	7.2	6.9	0.13	0.004	2	0.02	0	0.005	0	<0.001	10.3	1.2	
	I-07-EX04	×	○		62.7	35.6	9.70	2.5	2.0	2.0	2.15	0.4	0.76	26.9	6.02	360	180	0	0	0.2	178	0	144	15.4	15	0.16	0.003	6	0.02	0	0.001	0	0	9.8	1.4	
Busesa	I-08-EX01	○	○		32.7	21.0	6.70	2.9	2.3	2.5	0.91	0.68	0.08	26.2	5.83	248	160	>50	13	1.6	155	1	120	9.6	8.4	0.12	0.018	4	0.02	0	0.003	0.001	<0.001	5.4	0.6	
	I-08-EX02	○	○		42.8	21.6	11.10	4.6	3.7	3.8	1.24	6.52	0.87	26.4	5.71	184	120	0	7	0.9	103	0	50	4.8	2.5	0.06	0.008	1	0.01	0	0.003	0	<0.001	9.4	1.1	
	I-08-EX03	○	○		66.1		12.78	<2.0	<2.0	-	-	-	-	25.5	6.00	395	210	0	0	0.3	200	0	156	14.4	15.2	0.18	0.004	7	0.03	0	0	0	<0.001	8.1	1.2	
	I-08-EX05	○	○		39.4		7.50	<2.0	<2.0	-	-	-	-	26.6	6.01	314	160	0	16	2	177	1	130	12	12.8	0.15	0.019	5	0.03	0	0.09	0.001	<0.001	13	1.9	
	I-08-EX06	○	○		39.6		11.98	<2.0	<2.0	-	-	-	-	26.2	6.08	247	130	>50	9	1.2	135	0	85	8.4	13.5	0.16	0.012	4	0.03	0	0.008	0.001	<0.001	9.2	1.6	
Kyanvuma	I-09-EX04	×	○		31.2		10.30	9.0	7.2	7.5	0.2	0.61	0.2	26.0	5.52	240	120	0	8	0.9	135	0	80	7.2	5.6	0.12	0.009	4	0.02	0	0.001	0	<0.001	8.8	0.9	
	I-09-EX05	×		Small Dia.						-	-	-	-																							
	I-09-EX06	×	○		63.7	42.2	10.60	2.6	2.1	-	-	-	-	23.9	5.95	379	-	0	0	0.3	200	0	140	14.4	13.9	0.17	0.004	5	0.03	0	0.003	0	<0.001	12.4	1.9	
Nakivumbi	I-10-EX01	×		Hostility						-	-	-	-																							
	I-10-EX02	×		Hostility						-	-	-	-																							
	I-10-EX03	×	○				15.40	<2.0	<2.0	-	-	-	-	27.6	6.01	397	200	0	7	0.9	190	0	144	12	15.2	0.16	0.01	6	0.02	0	0.002	0.001	<0.001	8.4	0.9	
Nondwe	I-11-EX01	○	○		32.2		16.28	2.7	2.2	2.2	0.18	0.05	0.23	29.4	-	-	-	2	0	0.2	66	0	30	2.4	0.5	0	0.003	0	0	0	0.002	0	<0.001	7.3	0.8	
	I-11-EX03	○	○		39.1		13.39	<2.0	<2.0	-	-	-	-	24.6	5.37	158	160	0	8	0.9	100	0	45	6	1.2	0.07	0.008	1	0	0	0.04	0.001	<0.001	9.5	1	
Kasassira	P-02-EX03	○	○		44.4		8.1	3.8	3.04	3	1.22	2.29	1.37	28.8	5.89	400	200	0	8	1	216	0	160	14.4	16.5	0.17	0.011	6	0.02	0	0	0.002	<0.001	9.4	1.1	
	P-02-EX04	○	○		67.9	24.5	7.6	<2.0	<2.0	-	-	-	-	28.7	6.11	760	380	0	19	3.2	375	2	240	24	19.4	0.27	0.044	10	0.04	0.002	0.003	0.001	<0.001	12.4	1.9	
	P-02-EX05	○	○		49.3		6.0	2.1	1.68	-	-	-	-	29.6	6.57	1,470	730	0	10	1.3	435	0	280	28.8	31.2	0.3	0.022	18	0.03	0.002	0.005	0.001	<0.001	13.9	2.2	
	P-02-EX06	○	○		42.0	42	7.2	3.2	2.56	3.1	0.17	25.03	1.53	29.5	6.37	1,460	730	0	3	0.7	800	0	388	36	49.5	0.39	0.008	78	0.03	0	0.001	0	<0.001	22.5	4.3	
Kapala	P-04-EX01	○	○		38.2	25.5	5.9	6.5	5.2	5.7	0.9																									

## 資料-11

### 參考資料

#### (3) 既存管路給水施設調査結果

## 既存管路給水施設調査結果(1)

項目	内容	
管路系給水施設名	Bugiri Urban Water Supply System	
位置/行政区	N0°34'10.10" E33°44'50.96" 1,124m(Branch Office)/ Bugiri District, Bugiri Town Council	
維持管理主体 情報提供者	National Water & Sewerage Cooperation (NWSC) Bugiri Branch P.O.Box 94, Iganga/0800100977  Mr.Tumwesigye Godfrey /NWSC Bugiri Maneger/ 0772536770 Mr.Ochieng Benard/ NWSC Pump Attendant/ 0751117385 Mr.Atoo Jimmy/ Plant Attendant/0779373150	
給水施設等情報	水源	地下水/3基の深井戸/Ndifakuliya 地区(15m <sup>3</sup> /hr)、Kirongo 地区 (17m <sup>3</sup> /hr)、Bugodandala 地区 (17m <sup>3</sup> /hr、現在揚水中断) / 全て 2001 年に掘削/ ケーシング設置区間が表層区間に限定され深部は裸孔/ シルトによる濁度が恒常的に観察/ 乾季には水位降下が見られる。
	高架水槽	2基: コンクリート製地上型水槽(低標高 Musongo 地区、V=150m <sup>3</sup> 、増圧ポンプ2基併設 9.5m <sup>3</sup> /hr) 及びコンクリート製高架水槽(高標高 Kapyanga 地区 V=100m <sup>3</sup> )、両サイトとも塩素注入機は故障、貯水槽水位ゲージは故障し、一部漏水痕跡が認められる。
	給水受益人口	約 31,000 人
	導水管長	計 6,196m
	送水管長	計 32.8km
	コネクション数	約 900ヶ所(内 約 300ヶ所は未稼働、Kiosk/Public Taps:21カ所、他は Domestic, Institutional, Commercial Connections)
	水料金 (m <sup>3</sup> 当たり)	Kiosk:1,377UGX、Domestic:2,236UGX、Commercial:2,752UGX、Institution:3,376UGX、Kioskでは 100UGX/20ℓで販売されている。 Care Taker は2週間に一度 NWSC 職員が読み取る水道メーター表示数値からマージン分を差し引いた金額を NWSC 口座に振り込み、その他利用者は NWSC より月一度配布される請求書を基に同上口座振り込みあるいは事務所にて支払うことになっている。
	運用状況	稼働水源井戸は現在2井、商用電力で稼働、不安定な給電状況のためスタンドバイ発電機が併設されている。水源井戸ごとに導水する水槽が異なり、水槽ごとにサービス区域が区分されている。簡易水質検査結果では問題点は確認できなかったが、シルトにより白濁色を帯びた水道水である。
	➤ NWSC による給水施設の運用、維持管理が実施されている。小規模な修理は本事務所に対応できるが、規模が大ききものは NWSC 本部に対応する。	

運営/財務状況	<ul style="list-style-type: none"> <li>➢ 2015年1月に Kagulu Engineering Services Ltd. (PO) より、給水施設の運営・維持管理を引き継いでいる。</li> <li>➢ Branch Office の人員：10名</li> <li>➢ 財務情報の提供は拒まれたが、口頭情報では PO 時代の放漫な水道経営が徐々に改善しつつあるとのことである。</li> </ul>
維持管理状況	<ul style="list-style-type: none"> <li>➢ PO 時代の施設維持管理状況は改善しつつある（生産井の再稼働など）。</li> <li>➢ 維持管理担当者は以前の PO 職員がそのまま継続勤務しているため、施設現況、背景、関連情報に明るい利点を指摘した。</li> <li>➢ NWSC に移管後、部分的に資機材の更新が実施されているが、経年劣化した施設躯体や主要資機材の修理、更新は引き続き実施する必要がある。</li> </ul>
課題点	<ul style="list-style-type: none"> <li>➢ PO 管理時代から抱えていた課題が多く解決されないまま残っている。</li> <li>➢ 非稼働の水源があることより利用可能水量は限定的で、井戸構造に致命的な課題があるためシルト混じりの水道水が給水されている。</li> <li>➢ 接続ポイントの3割強が未稼働なのは、水料金未払いの他施設の劣化や維持管理に課題がある可能性も考えられる。</li> <li>➢ 水質浄化機材が長年稼働していず、塩素注入すら実施されていない。</li> <li>➢ 給水施設の施工品質に問題が多く、新規建設や施設の更新以外抜本的な改善は期待できない。</li> <li>➢ 給水資機材仕様に課題があり、過剰な電力消費や燃料の消費を強いられている。</li> <li>➢ 本システムは中国の援助で、地元業者を使わず独自で施工したものである。大半の資機材は中国製で、故障時に純正部品の更新は不可能である。深井戸、貯水槽等目視できる施設だけでも施工品質に課題が確認できるがリハビリされないまま継続利用されているため、一部の施設は運転効率の悪い運用が散見される。</li> <li>➢ 不安定な給電状況が恒常的に見られ、揚水や給配水機材の故障や劣化が進行している。</li> </ul>
教訓	<ul style="list-style-type: none"> <li>➢ 本システムは PO から NWSC に移管されて1年未満であるが、NWSC は未稼働水源の再生等により正常な水道経営の健全化に努力している。ウガンダでは NWSC による給水施設の運営が管路給水施設の継続性のひとつの答えになる可能性が高い。</li> <li>➢ PO 時代には井戸当たりの揚水可能量が今以上に限定的であった。また、財務資料が整理されていず収支に不透明な操作すら見られたという。NWSC に移管後、労働条件が見直された結果、職員の待遇改善が進み職員の労働意欲が向上している。財務の透明性の確保が重要である。</li> </ul>

既存管路給水施設調査結果（2）

項目	内容
管路系給水施設名	Buwuni Town Water Supply & Sanitation System
位置/行政区	N0 °31'43.27" E33°51'49.85" 1,093m ( Community Center)/Bugiri District、Bulesa Sub-County



維持管理主体 情報提供者	National Water & Sewerage Cooperation (NWSC) 、 Buwuni Branch 2015年11月中に給水部門が Town Water Board (WSSB) から NWSC に完全に移管する予定。給水施設移管後も衛生部門は WSSB が運営する。  Mr. Ojambo Wilber /Buwuni Town Water Services Board Chairman/ 0772539046, 0705929363	
給水施設等情報	水源	地下水 /1 基の深井戸 (DWD44115)/ Buyenbe 地区 (14m <sup>3</sup> /hr)/ 井戸深度:134m、安全揚水量 14m <sup>3</sup> /hr/水源サイト (595964,057737 1,106m) には新設の発電機/ポンプ室、深井戸、エコサントイレ、警備員控え室が建設されている。現在は商用電力に未接続で、現在は発電機で揚水している。
	貯水槽	1 基 (コミュニティ西方の丘斜面上に立地) /パネル製地上型水槽 (V=176m <sup>3</sup> ) /片麻岩基盤を切土/塩素注入室併設/施設建設は終了しているが、アクセス道路、配線工事、一部機材の設置は近日中に終了とのことである。9 時間揚水量で貯水槽が満水になる。
	給水受益人口	10,000 人以上を想定
	導水管長	情報得られず。
	送水管長	情報得られず。
	コネクション数	137 ヶ所 (内数は公共水栓 4 カ所で建設済み、なお、水道メーターは NWSC が設置、ヤードタップ (Domestic Connection) 133 ヶ所はすでに水道メーターが設置され給水事業が試験的に開始されている。 公共水栓はコミュニティ中心部に設置され、1 基当たり 4 蛇口付 (両サイドに 2 蛇口)、水道メーターは NWSC が設置する予定。
	水料金 (m <sup>3</sup> 当たり)	2,500UGX、一律価格
	公共トイレ	WSSB が運営する計画、コミュニティ広場に面した一角に新規建設済、雨水貯留装置を併設し処理水に利用、男女別、4 トイレ (座便器 1、かがみ便器 3)、1 シャワールーム、使用料金：200UGX/回
運用状況	現在はすべての施設が最終仕上げ段階にあり、Domestic Connection のみ試験運用されている。11 月中にすべての施設工事が終了、その後 NWSC が本格的に給水施設の運営・維持管理に携わることになっている。	
運営/財務状況	<ul style="list-style-type: none"> <li>➤ 本給水システムは EU、ドイツ復興金融公庫(KfW)、オーストリア開発公社 (Austrian Development Cooperation : ADC) の支援 (バスケットファンド) で建設された。</li> <li>➤ WSSB は 5 名のスタッフからなり、今後、給水分野は NWSC を支援し衛生分野では主体的に公共サービスの運営を担うことになっている。</li> <li>➤ すでに稼働している Domestic Connection は NWSC が代理に水道代金</li> </ul>	

	を徴集した。利用者の支払い意識は高く徴収率はほぼ 100%となっている。
維持管理状況	➤ 給水施設の維持管理に当たっては、地域住民のオーナーシップの熟成が重要な項目であるが、本システムでは住民に対するセンシタイゼーションを念入りに実施しているとの情報を得た。
課題点	➤ 深井戸、浅井戸、表流水、湧水等の既存水源からパイプ給水施設への移行を推進するため住民に対してセンシタイゼーションが必要。

既存管路給水施設調査結果（3）

項目	内容	
管路系給水施設名	Kaliro Urban Water Supply System	
位置/行政区	557749E 098608N, 1057m (High Potential BH Site)/Kaliro District, Kaliro Town Council	
維持管理主体 情報提供者	National Water & Sewerage Cooperation (NWSC), Kaliro Branch  Mr. Bwana Karls Alex/ NWSC Assistant Manager/ 075115649 Mr. Grisi George Culbert /NWSC Office Attendant/ 0757115642	
給水施設等情報	水源	地下水/Town より東方向に分布する深井戸 2 基/Buyunga 地区(12m <sup>3</sup> /hr)、Buwalugyo 地区 (35m <sup>3</sup> /hr、45m 深度) / スタンドバイ発電機が併設。 前者の生産井は良好な施工で現在は揚水量が需要量を大きく上回るため、1 日 6 時間だけ揚水している。後者の生産井は本年 (2015 年) 掘削。1 エーカーの敷地内に生産井、ポンプハウス、エコサントイレ、警備員室が整備された取水施設である。 高ポテンシャル生産井の商用電気代金は月 2.5~2.6 百万 UGX に達する。
	高架水槽	NWSC 事務所に隣接した 2 基 (2000 年及び 2015 年に建設された高架水槽が並列) / パネル製高架水槽 (それぞれ V=100m <sup>3</sup> 、古い水槽が H=17.5m で新しい水槽が H=20m)。 水槽毎にサービス地区が分離され、水槽間にバイパスの設置はない。 2000 年に建設された貯水槽には漏水が確認される。
	給水受益人口	約 40,000 人
	導水管長	計 2.5km
	送水管長	情報なし。
	コネクション数	Taps: 445 カ所(内訳不明)、 現在急速に増加傾向にある。
	水料金 (m <sup>3</sup> 当たり)	Domestic 2,365UGX、Institutional 2,752UGX、Commercial (Hotel, Bar, Restaurant, etc.) 3,376UGX (含 VAT 及び Service Fee)
		2 井の稼働水源井は商用電力の不安定な給電のためスタンドバイ発電機がそれぞれに併設、生産水量は潤沢で 7,650m <sup>3</sup> /月、販売水量は 6,400m <sup>3</sup> /月、水源井戸ごと

	運用状況	に導水する貯水槽が異なり、貯水槽ごとにサービス区域が分けられている。末端の Tap ごとに Care Taker が配置されていて、200UGX/200で販売している。Commercial Tap 当たり月間販売水量は 10m3 程度との情報を得た。夜間にはバルブ、水道メーターを金属 Box で被覆施錠し盗水防止対策を講じている。
運営/財務状況	<ul style="list-style-type: none"> <li>➤ NWSC は 2014 年に Mutaka Technical Services Ltd. (PO) から給水施設の運営・維持管理を引き継ぎ、現在はスタッフ 6 名で業務を運営している。</li> <li>➤ 潤沢な地下水源を背景に、「ウ」国政府は給水ネットワークの拡大計画を温めていて、迅速な計画実施を望んでいる。具体的には約 5km 南に隣接する Nabitende Banada (一次調査対象 RGC) にパイプ給水システムを伸延する給水計画及び約 6km 離れた Kasokwe 地区に貯水槽を建設し、周辺村落への給水計画も検討している。さらに、12 基の Water Kiosk を建設する計画もある。</li> <li>➤ 財務収支の改善は著しく、月別水料金収入は 14~15 百万 UGX との情報を得た。</li> </ul>	
維持管理状況	<ul style="list-style-type: none"> <li>➤ 前 PO 時代に実施されていた運営・維持管理業務は全般的に効率が悪く、生産水量は現在の 1/3 以下 (2,000m3/月以下) で、生産井 (Buyunga 地区井戸) の揚水量は 8m3/hr のみで発電機も設置されていなかった。また、維持管理の不備から機材故障が頻発し、最大 2 か月にわたって断水が生じたこともあった。水料金の未払いや不適切な会計処理が原因で PO 職員の給与が 4-5 か月未払いのこともあり職員の勤務モチベーションの低下が著しかった。そのような運営実態と比較すると、移管後は給水サービスの品質が向上し NWSC は利用者から高い評価を受けている。</li> <li>➤ 維持管理担当者は元 PO 職員で NWSC に継続して雇用されているが、現場事情に明るくモーターバイクでサイト間を移動し迅速かつ適切な対応をとることが可能になったとの報告を受けた。</li> </ul>	
課題点	<ul style="list-style-type: none"> <li>➤ 電力供給状況は恒常的に不安定で、電圧の変動が顕著である。</li> <li>➤ 新旧貯水槽間にバイパスの設置がないため、1 槽が故障するとそのサービス地区に給水できない。</li> <li>➤ 古い受水槽には顕著な漏水がみられる (近日 NWSC HQ 派遣の修理グループが修理予定)。</li> <li>➤ 給水施設運用記録、技術情報や財務収支等事業運営に係る記録は給水ビジネスを改善し発展するために不可欠で、これらの現行化、整備体制を確立する必要がある。</li> </ul>	
参考事項	<ul style="list-style-type: none"> <li>➤ PO から NWSC に移行後、給水事業が拡大し維持管理面での向上も見られる。</li> <li>➤ PO は公共サービスとの認識が相対的に希薄で、営利目的が優先する傾向があった。</li> <li>➤ Kaliro は近年人口増加が著しく、各種接続の新規設置申請も増加している。地下水源は潤沢にあるものの揚水機材の故障が頻発し、良質の給水サービスを提供できないケースも考えられ、将来的には近隣に多く分布する湿地の表流水の利用も代替水源としたい意向をもっている。</li> </ul>	

既存管路給水施設調査結果（４）

項 目	内 容	
管路給水施設	Kamuli Water Supply System	
行政区	Kamuli District , Kamuli Town Council	
事業体/情報提供者	National Water & Sewerage Corporation (NWSC)  Mr. Walakira Stephen/Area manager Mr. Kasajja John/ Accountant/ 0752-919227 Mr. Mwenda Alex/ Technical Supervisor/ 0782-612527, 0704-209779	
施設の概要	水源	地下水と表流水 3基の深井戸より揚水： Southern 地区：No.1: 37m 深 (7 m <sup>3</sup> /hr)、No.2: 37m 深 (5 m <sup>3</sup> /hr)、Bugailb 地区：No.3: 27m 深 (6 m <sup>3</sup> /hr)、維持管理状況は良～普通程度 人工貯水ダム (1952年に小河川の河床を10m余り掘削したもの)より取水、V=約 20,000m <sup>3</sup> 、ポンプ取水量 3m <sup>3</sup> /hr
	高架水槽容量	Tirinyi 貯水槽 180 m <sup>3</sup> 、コンクリート製 Kibuku 貯水槽 120 m <sup>3</sup> 、鋼製パネル製
	現給水人口	人口約 10,000 人、給水原単位 約 80ℓ/capita/day
	コネクション数	全体で 1,680 カ所、Public Tap (1 蛇口と水道メーター) は 6ヶ所、Kiosk が 2ヶ所、いずれの施設にも Tap Operator が常駐し取水時に水料金を受領する。その他の接続 (Domestic, Commercial, Institutional Taps) は請求書額に基づいて銀行振替で支払われる。
	水料金 (m <sup>3</sup> 当たり) *1Unit=1,000ℓ	料金体系： <ul style="list-style-type: none"> <li>• Commercial : 3,084UGX</li> <li>• Institutional : 2,900UGX</li> <li>• Domestic : 2,234UGX</li> <li>• Kiosk : 1,280UGX (34UGX/20ℓ)</li> </ul> NWSC が運営している都市の水道料金は全国的に統一価格を適用している。市場では管理組合が Commercial 料金で支払っていて、Tap Operator は同組合が雇用している。住宅地では近隣の商店に Domestic 料金で水料金を支払えば、その都度止水装置が外されて給水可能となる。
	運転状況	給水施設は Local Government 予算で 1962 年に建設されている。 24 時間稼働。需要水量に比べ給水量が少ないため、高架タンクが午前中で空になり午後に断水することがある。貯水池からの取水量はポンプのコストパフォーマンスが悪いため 3m <sup>3</sup> /hr と限定的である。全体の給水量は 17~18m <sup>3</sup> /hr 程度である。
	<ul style="list-style-type: none"> <li>➤ NWSC は「ウ」国政府の公益事業体で、中～大規模の都市の給水施設の運営・維持管理を全国的に拡大しつつある。</li> <li>➤ 当 NWSC は 2015 年 6 月 1 日に Kagulu Multiple Services Ltd. (PO) か</li> </ul>	

<p>運営/財務状況</p>	<p>ら、給水事業を引き継いでから年月が経っていないため、PO の負の遺産を背負っている。</p> <ul style="list-style-type: none"> <li>➤ 事務所 Staff: 17 名、Supporting Staff (Temporary): 6 名</li> <li>➤ システムの営業収支</li> </ul> <p>2014 年年収入は 80,000,000UGX が予想されていたが、実際の徴収額は 35,000,000UGX に留まっている。本年の営業収支は赤字で、その他都市での黒字分で補っている。</p> <ul style="list-style-type: none"> <li>➤ PO 運営時に見られた運営上の問題点としては、以下の点が確認された。 <ul style="list-style-type: none"> <li>● 月毎の水道データが未整備</li> <li>● 営業収支（含電気代）が不透明</li> <li>● 水道利用者リストが Up-date されていない。</li> </ul> </li> </ul>
<p>維持管理の状況</p>	<ul style="list-style-type: none"> <li>➤ 現在は事業体移管後であらゆる面で運営・維持管理面の正常化には時間がかかっているが、NWSC は現場事情に通じた元 PO 職員も雇用し業務の正常化を急いでいる。</li> <li>➤ 給水施設の老朽化と維持管理の課題から無収水率は高い。</li> </ul>
<p>課題点</p>	<ul style="list-style-type: none"> <li>➤ パイプ給水開始年が 1962 年で多くの資機材、特に管材の劣化が進行していて早急な更新が必要である。</li> <li>➤ 配管敷設実態が正確に把握されていず、給水ネットワークは 100%確認されていない。</li> <li>➤ 給配水パイプ口径が小さく、約 70%の給水地点で水圧が弱く末端まで配水できず供給水量が不足である。</li> <li>➤ 道路工事により配管が損傷を受ける。</li> <li>➤ 表流水取水ポンプ能力が限定的である。</li> <li>➤ 浄水場は旧式で簡易的システムのため、水量、水質面で課題が残る。</li> <li>➤ 管材敷設には用地問題が潜在している。</li> <li>➤ 不法な盗水が横行するため、警察と連携行動をとるなどしてコミュニティ全体で給水施設の保全を促すことが重要である。そのためのセンシタイゼーションの実施や料金のかからない電話通報システム等が勧められている。</li> <li>➤ 市街より 5 kmほど離れた Butendem 村に Kiosk があり、2010 年に大統領名で竣工した給水施設である。コミュニティ (LC1) との協定では、従量制で水料金を請求することになっていて、コミュニティが Operator のマージンを上乗せして住民から水料金を徴収することになっていた。しかし、住民は、水は無料などと考え、水料金を払わなかったため、建設後 5 か月程度しか稼働しなかった。</li> </ul>
<p>教 訓</p>	<ul style="list-style-type: none"> <li>➤ NWSC の経営戦略は 2015 年の新 Managing Director 着任以降変更になり、2016 年までに国内の中～大規模都市の給水施設の運営・維持管理は NWSC が主体的に担っていくことになった。</li> <li>➤ 施設規模によっては、PO が運営・維持管理を担うことが技術、財務・経済、人的資源から困難な例も見られる。</li> <li>➤ 元 PO 職員によると、当時の PO 事業体の財務状況は不安定で給与の未払いが頻繁に生じたとのことである。</li> <li>➤ 給水施設の更新が水道料金の高騰に直結すると多くの住民が考えている。</li> <li>➤ PO には給水施設の更新、改善、拡張まで実施する技術スキルはなかったものと考えられる。</li> <li>➤ Kamuli 市内にはハンドポンプ付の深井戸が点在していて、現在でも並行して利用されている。</li> </ul>

既存管路給水施設調査結果（５）

項目	内容	
管路系給水施設名	Busembatia Water Supply System	
位置/行政区	569106E 086327N 1125m (Office)/ Iganga District、 Busembatia Sub-county	
維持管理主体 情報提供者	Trandit Ltd. (Private Water Operator ; PO)  Mr. Hamington Rutaro/ Manager/ 0776604662 Mr. Mataba Fatihi /Area Assistant Manager/ 0751022346	
給水施設等情報	水源	地下水/深井戸 3 基(Majengo 村 (DW13051)、Kakogi 村 (2011 年さく井、井戸深度 100m) の 2 井は稼働、他の 1 井(D13053)は 2 年前より揚水中断/ 総揚水量:20m3/hr (Majengo 村 6m3/hr、Kakogi 村 14m3/hr、休止井戸は 8m3/hr)/ 年間を通じてほぼ一定量の揚水可能/ 給水量 3,750m3/月/消費電力 2,900kwh/月、スタンドバイ発電機 (Kipor 製) は Kakogi 井戸のみに設置
	高架水槽	Mbale-Iganga 道路沿いに 2 基並設/おのおの貯水量 120m3/ 受水槽及びバルブ、送水管より顕著な漏水/塩素注入装置は故障
	給水受益人口	約 31,000 人
	ネットワーク 延長距離	約 24km (主要幹線)
	コネクション 数	Yard Taps:742 (内、470 基が稼働中、含 5Public Taps)、 Institutional & Commercial コネクションはない。
	水料金 (m <sup>3</sup> 当 たり)	2,500UGX、一律料金 水道代は受益者が直接 Office にて支払うシステムをとっている。 Public Taps には Care Taker が常駐し、100UGX/20lで販売しマージンは約 4%である。
	運用状況	Trandit Ltd. が給水施設の運営・維持管理を Sub-county、 WSB より請け負って実施している。 給水施設の老朽化が進行し、特に管材の劣化等により無収水率が高い (29%)。稼働中断井戸や 4 割弱の Taps が利用できない状況から施設運用率は低い。
運営/財務状況	<ul style="list-style-type: none"> <li>➢ 総給水量 3,750m3/月、総販売水量 2,652m3/月で、損失水量が多い。</li> <li>➢ PO Staffs : 6 名(Manager, Assistant Manager, Pump Attendant, 2 Plumbers, Secretary)</li> <li>➢ 本年 9 月の財務収支によると収入は 5.35 百万 UGX、支出は約 4.93 百万 UGX (内 33%が運転費、32%が電気代金、22%が人件費等) でわずかに黒字経営となっている。</li> <li>➢ 水道代徴収率は 97.2%と記録されている。</li> </ul>	
維持管理状況	<ul style="list-style-type: none"> <li>➢ 給水施設の維持管理は全般的に普通～不良で、PO 職員が恒常的に施設の稼働状況をチェックして、問題があれば迅速な対応をとるシステムが構築されていない。このため、人為的要因と思われる施設の劣化・ダメージや盗水が散見される。</li> </ul>	

課題点	<ul style="list-style-type: none"> <li>➤ PO は給水事業の運営実態を十分把握してはず契約業務内容を全うしていないことが協議・現地説明から確認できた。</li> <li>➤ 一見水料金の徴収率は高いが、約 1/3 の受益者は支払い遅延の常習者である。</li> <li>➤ ネットワーク拡張計画はあるが、予算確保が困難なため頓挫している。</li> <li>➤ 電気代金未納のため2年前から揚水を中断している生産井は人為的損傷を受け荒れ放題で放置されている。</li> <li>➤ PO はマイナーな施設修理も含めて対応できていない。車輛やバイクも所有せず迅速な運営・維持管理の実施は難しい。</li> <li>➤ 稼働していない深井戸数値も統計内にカウントして水増し報告する等の作為的な報告書には誠実な運営を実施している。</li> <li>➤ 未稼働井戸は電気代金の滞納が 4 百万 UGX 以上あり、Umeme は変圧器を撤去し給電を中断している。</li> </ul>
-----	--

既存管路給水施設調査結果（6）

項目	内容	
管路系給水施設名	Busia Water Supply System	
位置/行政区	620728E051665N 1,210m (Busia Branch Office & Town-council)/ Busia District、 Busia Town Council	
維持管理主体 情報提供者	Jowa Engineering Services Ltd. (JES ; PO), Busia Branch  Ms. Malowine Harriel/ Manager/ 0782485206 Mr. Ojambo Fred Mutere / Technical Officer/ 0774986991 Mr. Bkiire Hatbert/ Plant Attendant (IOWA Engineering Co.)/ 0779958679	
給水施設等情報	水源	地下水/ 深井戸7基/ Busia 市街地の東西地区に集中分布 /1.Solo 地区(8m3/hr)、2.Kisenji B 地区 (8m3/hr)、3.Madibir 地区 (8m3/hr)、4.Mawero 地区 (12m3/hr)、5.Mawero B 地区 (14m3/hr)、6.Buchicha 地区 (8m3/hr)、7.Solo C 地区(14-17m3/hr) いずれもスタンドバイ発電機の設置なし/現在、No.6 井ポンプは故障中/Town 西方に 3 井 (System A) /東方に 4 井(System B) が分布する。
	高架水槽	水源位置により System A 水槽(V=250m3) と System B 水槽(V=300m3)の2基、パネル水槽で架台は頑強な構造。市街地内の System B はフェンスなく基部に掘立小屋が林立している。両貯水槽には滴下する程度の漏水がみられる。
	給水受益人口	約 60,000 人程度
	導水管長	計 9.3km
	送水管長	計 30.4km
	コネクション数	全体で 1,934 ケ所 (内 1,150 ケ所給水可能)、内数は Domestic Taps: 1,756 ケ所、Commercial & Institutional Taps: 135 ケ所、Public Taps: 43 ケ所

	水料金 (m <sup>3</sup> 当たり)	2,119UGX(含 VAT 及び Service Fee)、一律料金
	運用状況	<p>現在稼働中の 6 水源井は商用電力だけで運用されている。</p> <p>System A の増圧ポンプ槽へは 3 井から集水され、Grundfos 製縦軸ポンプ、30m<sup>3</sup>/hr 能力、水頭圧 59Hm (2 基が交互運転) で高架水槽に導水される。System B の増圧ポンプ槽にも 3 井 (元は 4 井) から集水され、同じ仕様の縦軸ポンプで高架水槽に導水されている。</p> <p>末端の Kiosk ごとに Care Taker が配置されていて、50UGX/20l で販売している。1Tap 当たり一日に 7m<sup>3</sup> 程度の販売水量との情報を得た。なお、Unit 当たりのマージンは 600UGX である。Domestic Taps 及び Commercial &amp; Institutional Taps では職員の検針メーターを基に送付される請求書に基づいてカスタマーが事務所で支払う。</p>
運営/財務状況	<ul style="list-style-type: none"> <li>➤ JES は Busia 市給水施設の運営・維持管理を 2006 年 10 月からすでに 9 年間実施している。なお、Kumi District の Kumi、Bukedea 等の中規模都市でも同様管理業務を請け負っている。</li> <li>➤ JES/PO は Town Council と業務契約を交わし、通常 1 契約期間は 3 年であるが、JES/PO はパフォーマンスを評価され、継続して契約を得ている。</li> <li>➤ 昨年度の概略収入額は 50 百万 UGX/月、支出額 (エネルギー費、人件費等) は 30 百万 UGX/月が記録されている。</li> <li>➤ 水料金収入額の 5% が Water Board、19% が機材更新等のための積立、残り 76% が運営費 + 収益として JES/PO に行き渡る。ビジネスとしてはそれなりの利益が期待できているとの発言があった。</li> <li>➤ 水道メーター供与は国の補助金を受けて Umbrella East が仲介している。</li> <li>➤ Busia の人口増加と都市化に対応するため、給水ネットワークの拡張計画がある。</li> <li>➤ 水料金徴収率は 96~98% で、消費者の支払い意識は高い。なお、この数値は良質の水道サービスの提供が徴収率の向上につながっているものと考えられる。</li> </ul>	
維持管理状況	<ul style="list-style-type: none"> <li>➤ 水道施設のマイナー修理は JES/PO が実施するが、メジャー修理は Municipal Council と協議・調整したうえで対応を決めることになっている。</li> <li>➤ 社会インフラの重要度が住民に十分浸透していないため、給水施設に損傷が加えられている。</li> <li>➤ 給水施設の施工品質が相対的に普通~やや悪いものが多いが、JES/PO は維持管理に下請け人材も配置して財政的に可能な範囲できめ細かなケアを施している。</li> <li>➤ JES/PO は「ウ」国東部では給水施設の運営・維持管理に実績のある会社で、Manager は今後の市場開拓に意欲的である。</li> </ul>	
課題点	<ul style="list-style-type: none"> <li>➤ 市内には現在でも数多く住民が浅井戸から生活用水を得ており、安全な給水認識が未だ浸透していない。また、一部の住民には水料金の支払い責任が浸透していない。</li> <li>➤ 高架水槽からの漏水は早急に対応する必要がある。</li> <li>➤ 稀に起こる停電に備えスタンドバイ用発電機が生産井に設置されていない。</li> <li>➤ 乾期には水位低下が進み、計画揚水量を確保できない水源井もある。</li> </ul>	



	<p>➤ 不法な盗水行為が横行し、高い無収入率が算出される。</p>
教訓	<p>➤ 昨今は NWSC が県都等の大都市で水道サービスを PO より移管され運営しているが、Busia のように PO が長期間にわたって運営・維持管理に携わっているのは、地元根ざした給水ノウハウの蓄積とサービス品質が一要因と考えられる。</p>

既存管路給水施設調査結果 (7)

項目	内容	
管路系給水施設名	Kasambira Water Supply Scheme	
位置/行政区	517146E 086969N 1059m(生産井地点)/ Kamuli District	
維持管理主体 情報提供者	<p>Basic Ltd. (Private Water Operator; PO)</p> <p>Mr. Kiyuwa Micheal Jackson / Chairman of Water Supply and Sewerage Board/ 0782847479</p> <p>Mr. Asilimale Sosani / PO Assistant Manager /0776444479</p> <p>Mr. Kalogo Emmanuel/ PO Plumber/ 0775512618</p>	
給水施設等情報	水源	地下水/1 基の深井戸/ コミュニティ北方の低平地に位置/井戸深度約 60m/ 単位揚水量 15m <sup>3</sup> /hr/ スタンドバイ発電機設置/ 計器、バルブ等正常に稼働/ 揚水量は年間を通じてほぼ一定
	高架水槽	1 基/コミュニティ東方の高位地区に位置/ プレススチール製高架水槽 (V=90m <sup>3</sup> ) / 貯水槽や架台にサビが目立ち脆弱化/3 年前より漏水顕著/ 目視で約 2m <sup>3</sup> /hr は漏水して、基部に水溜まりが現出し基礎土質の地耐力さえ懸念/ 漏水により給水可能水量が減少し、高位地区への給水不可能/ 早急な対策が不可欠。 給水計画では 6 時間揚水で貯水槽を満水できているが、現在は 2 時間余計に揚水する必要がある。なお、水位指示器は作動していない。
	給水受益人口	コミュニティ人口約 50,000 人の内約 25,000 人が給水人口、給水スキームにアクセスできない住民はハンドポンプ付深井戸あるいは湿地の表流水を生活用水に利用しているため、衛生上の問題が恒常的に見られる。
	コネクション数	全体で 541ヶ所 (内稼働分 481カ所)/ Kiosk 9ヶ所/ 給水ネットワーク拡張を検討しているが、高架水槽の漏水がネックとなっている。
	水料金 (m <sup>3</sup> 当たり)	1,750UGX、一律価格、住民の水道代金支払い意識は高い。Kiosk では 100UGX/20ℓで Tap Operator が現金販売。なお、Operator の受領するマージンは 5%である。
	運用状況	PO は Water Supply Board (WSB)の契約監視の基、給水施設の運営・維持管理を請け負っている。ポテンシャルのある生産井で現在 8 時間/日揚水している。しかし、貯水槽より漏水するため無収入が極端に高い。現在給水受益地区はコミュニティの中心地区に

		限定され、リモート地区への給水はできない。なお、コミュニティ全体の日消費水量は 50m <sup>3</sup> 程度と算定されている。
運営/財務状況	<ul style="list-style-type: none"> <li>➤ 水道代徴収後月末に銀行に一時預金され、その内の 85%を PO に運営・維持管理費用として支払っている。</li> <li>➤ PO 職員は財務収支に関してほとんど知見を持ち合わせていない。</li> <li>➤ WSB は水道事業は持続的なサービス提供が重要と認識している一方、運営方法によっては十分な利益も期待できると認識している。</li> </ul>	
維持管理状況	<ul style="list-style-type: none"> <li>➤ PO 職員に給水技能に長けた人材はみられず、マイナーな修理以上の業務は期待されていないが、維持管理状況は普通程度である。貯水槽に見られるようなメジャーな故障については DWO に対応を申請している。</li> </ul>	
課題点	<ul style="list-style-type: none"> <li>➤ 高架水槽の容量が少ない上、漏水量が多く高位地区への送水が難しいため無収水量が大きい。</li> <li>➤ 管口径が小さく水圧が弱いこともありネットワークの拡大にネックとなっている。</li> </ul>	

既存管路給水施設調査結果（8）

項目	内容	
管路系給水施設名	Masafu Water Supply Scheme	
位置/行政区	614997E 045627N 1,219m (Masafu Water Supply Office)/Busia District, Masafu Sub- County	
維持管理主体 情報提供者	Kagulu Multiple Service (Private Water Contractor in Tororo)  Ms. Lhepkowi Viola / Commercial Manager/ 0773086842 Mr. Wejuri Rajabu /Pump Attendant/ 0787774067 Mr. Nliobi Ibrahim/ Plumber/0783299414	
給水施設等情報	水源	<p>地下水/2 基の深井戸/Dutoote 地区(DWD17068、8m<sup>3</sup>/hr、45m 深度)、Mirra 地区 (DWD16395、3m<sup>3</sup>/hr、37m 深度)、いずれも元はハンドポンプで取水していた生産性の高い井戸を 2010~2012 年に水中ポンプ取水に転用したものである。いずれの井戸にもスタンドバイ発電機を併設している。</p> <p>Dutoote 地区ポンプハウスは事務所より南南東方向約 1.5km の圃場内に位置し、整理整頓、維持管理が行き届き、管理人は近隣に居する地元住民が担当し施設に課題は認められない。</p> <p>Mirra 地区ポンプハウスは事務所より北北東方向約 500m に位置し、維持管理はなされているが、コントロールパネルの故障修理を要請中で現在は稼働していない。単位揚水量が相対的に少なく管口径は細い。いずれのポンプハウス内のバルブ、メーター類も問題なく稼働している。</p> <p>年間静水位変動はほとんど感知されていず、ほぼ一定である。</p> <p>Masafu では商用電力給電状況は良好で、近年は安定した電力を享受できる。</p>

	高架水槽	コミュニティ西方向の小学校に隣接したサイト (614656E、045814N、1,280m) に設置された 1 基 (V=187m <sup>3</sup> 、H=18m)、漏水なく施設維持管理状況良好、浄水プラントは設置されていないが、水質に係る問題を関係機関から指摘されたことはないとのことである。
	給水受益人口	約 25,00 人 (概略数値)
	導水管長	Dutoote 地区 (1,500m) Mirra 地区 (800m) 計 2,300m
	送水管長	7,400m
	コネクション数	255 ヶ所 (内 210 ヶ所稼働)、内訳は Kiosk (Public Taps) 5 ヶ所 (故障 1 ヶ所)、Commercial & Institutional 11 ヶ所、Domestic Connection 195 ヶ所
	水料金 (m <sup>3</sup> 当たり)	2,714UGX、一律価格、大半の利用者は事務所或いは取水地点で職員に支払う。水料金徴収率は約 90%と算定されている。
	運用状況	現在、Dutoote 地区の深井戸よりのみ取水、Mirra 地区の深井戸は 2ヶ月前より電気系統の故障のため揚水を中断している。3日に2回揚水し貯水すれば、日消費水量 94m <sup>3</sup> を賄うことができる。高架水槽から、各コネクションに重力送水されている。Domestic/Commercial/Institutional Connection は各戸に 1 水栓+水道メーターが屋外に設置されていて、月 1 回職員が検針に訪れ、後日請求書に従ってユーザーが事務所で支払う。Kiosk (サービス時間 6:00~18:00) では 100UGX/200で Care Taker から現金払いで給水を受ける。水道メーターとバルブが併設されサービス時間外は金属製箱で被せ施錠されている。
運営/財務状況		<ul style="list-style-type: none"> <li>➤ 本 PO は本給水施設建設時に建設費の 10%を資本参加していて、2009 年に Water Board から給水施設の運営・維持管理を引き継いだ。</li> <li>➤ PO は修理ツールや機材を保有していて、水道メーターなどの政府補助金を受けられる機材は Umbrella East を通じて受け取っている。</li> <li>➤ 大まかな月毎の水料金収入は 4 百万 UGX、電気代や人件費等の運用費は 3 百万 UGX とある。会社は Water Board との契約に則り、水料金収入の 95%を一旦受領し (残り 5%分は Water Board に配分)、必要経費を支払った残金が収益となる。ビジネスとしては悪くはないとの印象をもっている。</li> <li>➤ Sub-county/Water Board が給水事業を管理、監査し、PO は月、四半期ごとに業務報告書を上記機関及び DWO、Umbrella East に提出している。</li> <li>➤ 今日までカスタマーから運営・会計処理に関してクレームを受けたことはないとのことである。</li> <li>➤ 現在のところ給水ネットワークの拡張計画は検討されていない。</li> </ul>
維持管理状況		<ul style="list-style-type: none"> <li>➤ 事務所職員は 4 名 (Commercial Manager, Operational Manager, Plumber, Askari)</li> <li>➤ 給水施設を視察すると、各施設の維持管理が行き届いている。施設の Care Taker はその隣接家屋に居住していて、施設の保全に問題はない。</li> </ul>

課題点	<ul style="list-style-type: none"> <li>➤ 未だに給水は無償との認識を持つ住民に対して、徹底的なセンシタイゼーションが必要である。</li> </ul>
教訓	<ul style="list-style-type: none"> <li>➤ 給水施設の施工品質が良好なこと、ポテンシャルの高い水源井がある等の理由で連続的に良質の給水サービスが提供できている。このことがカスタマーから高い評価を得、惹いては高い水料金徴収率から円滑な施設運営が担保され、安定した給水事業が推進されているものと考えられる。</li> <li>➤ 地元に根付いた PO が運営維持管理を担当しており、Sub-county とは 3 年毎の契約更新はあるが、そのパフォーマンスを高く評価され契約延長が続いている。</li> </ul>

既存管路給水施設調査結果（9）

項目	内容	
管路系給水施設名	Ngora Water Supply Scheme	
位置/行政区	588439E 162964N 1,164m (Treatment Plant)/ Ngora District、Ngora Town Council	
維持管理主体 情報提供者	Sankawa Engineering Ltd. (Private Water Operator ; PO)  Mr. Ekiwapit Cervos/ Foreman/ 077493776 Mr. Aporu Alfred / Operation Assistant/ 0775871843	
給水施設等情報	水源	表流水/Ngora 浄水場より西方約 15km 地点に位置する Agu 川より取水/ 取水量は 28m <sup>3</sup> /hr
	浄水場及び水槽	浄水場及び地上型水槽は Ngora コミュニティ東方約 3km に位置するモナドノック（粗粒花崗岩）高位部に位置する。給水 Scheme は 1959 年に英国の援助で建設され、浄水場は原水流入口より Aeration, Sedimentation, Filtration（緩速砂濾過）の施設が標高差を利用して配置されている。塩素注入装置を経て地上型コンクリート製 350m <sup>3</sup> 容量の貯水槽に重力で送られる。
	給水受益人口	約 30,000 人。 浄水場から周辺のコミュニティに送水されている。特に浄水場近隣には多くの学校、病院、行政機関が集中的に分布するため消費水量は多い。
	総管延長距離	不明。増圧ポンプは設置されていず重力式送配水システムを適用している。
	コネクション数	不明、Ngora コミュニティには Public Taps が 4 基設置されている（1 基は破損）。
	水料金（m <sup>3</sup> 当たり）	4,835UGX の用途区分のない一律価格、共同水栓では 100UGX/20l（VAT 及び Service Fee 込）、利用者の水料金支払い状況は良好で、徴収率は高い。Public Taps ごとに Care Taker が配置されていて、水料金を支払った後に給水を受けることができる。なお、Care Taker のマージンは 4UGX/20l と決められている。その

		<p>他は水道メーター表示による請求書を基に銀行あるいは事務所にて支払うことになっている。住民の水道代金支払い意識は高いとのことである。</p>
	運用状況	<p>年間を通じて河川原水の取水が可能である。ただし、取水ポンプの運用時間は給電状況により変動する。浄水施設には凝集槽はないが、原水の濁度は通常低いとのことである。</p> <p>地理的優位性からすべてのサービス地区に重力給水が可能である。</p> <p>Ngora コミュニティ内の Public Taps では 5,000UGX/unit あるいは 100UGX/20ℓ で販売されている。</p>
運営/財務状況		<ul style="list-style-type: none"> <li>➤ PO が給水事業の運営を Municipal Town Council/ Water Authorities と契約を締結し給水施設の運営・維持管理を実施している。PO は Soroti に事務所を構え、週 2 回担当者が施設運用チェック、故障個所の修理、水料金収支のチェック等を実施するため出張業務を行っている。日常の施設運用は現地雇用の人材を充てている。</li> <li>➤ Town Council は水料金収入額の 83% を PO に支払う契約になっている。PO は受領金から電気代金を含む運営・維持管理費を支払った残額を利潤として計上される。</li> <li>➤ 2015 年 10 月の水料金収入額は 12 百万 UGX であった。</li> </ul>
維持管理状況		<ul style="list-style-type: none"> <li>➤ 日常的な維持管理は PO が雇用している人材が、主に浄水場の管理や薬品補充等に当たっていて、日々の維持管理記録が整備されている。</li> </ul>
課題		<ul style="list-style-type: none"> <li>➤ 浄水・貯水施設が古く、多くのパーツや躯体に劣化が見られる。送配水管の劣化も進行していて無収水率は高いものと考えられる。施設の改善、更新に必要な経費は多額につき、Town Council 単独では対応できない。</li> <li>➤ Ngora の人口増、都市化が進むにもかかわらず、給水ネットワークの拡張や接続の増加はみられない。このため、多くのコミュニティでは未だ浅井戸、ハンドポンプ付深井戸あるいは保護されていない湧泉より取水し生活用水に利用している。</li> <li>➤ 管口径が小さく水圧が低いため、ネットワーク末端まで給水できない時間帯がある。</li> <li>➤ 給電状況が不安定でしばしば停電するが、規模の大きな貯水槽のため、一定時間の給水は担保される。</li> </ul>
教訓		<ul style="list-style-type: none"> <li>➤ 給水施設は古く旧式でも、PO に技術知見、経験があり、財務面でも透明性の高い運営を行えば、十分に機能する。</li> </ul>

既存管路給水施設調査結果 (10)

項目	内容
管路系給水施設名	Serere Piped Water Scheme
位置/行政区	N11°31'10.20" E33°27'33.47" 1,125m (Office)/ Serere District, Serere Town Council
維持管理主体 情報提供者	Bisca Ltd. (Private Water Operator ; PO)  Mr. Isabirye Godfrey/ Serere Urban Water Office/ 0757254537

給水施設等情報	水源	地下水/Serere 北西方約 5km 地点/深井戸 1 基/ 井戸深度 80m/ 単位揚水量 10m <sup>3</sup> /hr/ 日揚水時間 8 時間/年間を通じてほぼ一定の揚水量が得られる 2011 年にポテンシャルの高いハンドポンプ付深井戸を生産井に転用しパイプ給水系の水源に仕上げている。なお、転用時に揚水管を GI 管より PVC 管に更新している。給電状況が不安定なことからモーターに負荷がかかり故障原因となることから無停電装置が近年設置された。
	高架水槽	Serere 北方の丘陵頂に設置された横円筒型コンクリート台座高架水槽 (ウガンダ製) /貯水容量 70m <sup>3</sup> /側面の穿孔から漏水/配水管口径 5" の HPDE 管/バルクメータ正常稼働/水位計故障
	給水受益人口	不明 (PO は把握していない)
	ネットワーク延長距離	不明 (PO は把握していない)
	コネクション数	総接続数 192 ヶ所 (内稼働中 162 カ所) /Domestic Taps 25 ヶ所、Yard Taps 139 ヶ所、Commercial Taps 28 ヶ所/Kiosk での給水はない。
	水料金 (m <sup>3</sup> 当たり)	2,500UGX、一律価格、Yard Tap は数戸に 1 基設置されていて、水料金は Tap 掛かりの戸単位で責任をもって支払われている。なお、水道メーター以降の資機材及び施工費用は消費者負担となっている。
	運用状況	Bisca Ltd. が Town Council と 3 年契約で給水事業の運営・維持管理を請け負っている。給水施設が地理的に広がりをもつことから、配管距離は長いが給水量は限定的である。現場業務は前 PO (Jowa Engineering Services Ltd.) の元職員が継続して担当している。 10 月の生産水量 2,660m <sup>3</sup> 、給水量 1,924m <sup>3</sup> 、販売水量 1,554m <sup>3</sup> で、多い漏水量と高い無収水率が想定される。
運営/財務状況	<ul style="list-style-type: none"> <li>➢ PO の人員は 4 名 (Manager, Assistant Manager, Pump Attendant, Plumber) からなる。</li> <li>➢ 水道代は顧客が直接 Office に支払いに出向くシステムをとっている。</li> <li>➢ PO によると給電状況次第で、利益率が大きく変化する。</li> <li>➢ 現場レベルでは PO の財務資料は入手できなかった。</li> </ul>	
維持管理状況	<ul style="list-style-type: none"> <li>➢ 給水施設が点在することから、きめ細かな維持管理が実施されていない。</li> <li>➢ 元 PO 職員が継続して現場での維持管理に携わっている。このため施設特性は周知しているが、維持管理レベルアップにつながっていない。</li> <li>➢ 施設の維持管理業務の記録が、ほとんど整理されていない。</li> </ul>	
	<ul style="list-style-type: none"> <li>➢ 停電が頻発し給電状況が不安定である。</li> <li>➢ 管材品質に課題がある HDPE 管設置区間が多く、縦割れが頻発し漏水が頻発することから漸次 PVC 管に更新している。</li> </ul>	

課題点	<ul style="list-style-type: none"> <li>➤ 管径が小さいため水圧が低く配水範囲が限定的である。</li> <li>➤ 給水ネットワークは規模が小さく、給水サービスは Town Council 中心部に限定されている。</li> <li>➤ 給水施設の維持管理は全般的に不良～普通で、PO の職員が日常的に施設の稼働状況をチェックして、故障・課題があれば迅速に対応するシステムが構築されていない。</li> <li>➤ 給水施設が点在するにもかかわらず、PO に施設点検用の交通手段がないため、きめ細かな維持管理が実施できていない。</li> <li>➤ PO がマイナーな施設修理に対応することになっているが、実際は十分に対応されていない。また、メジャーな修理は Town Council に報告した上で適切な対応を提言することになっているが、この点での働きかけも鈍い。</li> </ul>
教訓	<ul style="list-style-type: none"> <li>➤ この PO は営業実績の向上には熱心であるが、契約業務の誠実な実施には課題がある。良質な PO 選びがポイントである。</li> </ul>

既存管路給水施設調査結果 (11)

項目	内容	
管路系給水施設名	Blumba Water Supply Project	
位置/行政区	550406E 111043N1062m (Town Board Office)/Kaliro District	
維持管理主体 情報提供者	Blumba Water Services Board (WSB)  Mr. Klaako Festo / Plumber / 0751160202	
給水施設等情報	水源	地下水/深井戸1基/ Town Board Office 近くの圃場内に位置/揚水可能量 10m <sup>3</sup> /hr/ 揚水可能量の年間変動はない。ポンプハウス内施設は水圧計、バルクメータ、コントロールパネル等基本的機材すら設置されていないため正確な給水データーが記録できない。商用電気からの引き込み線工事は粗雑で漏電の危険性も指摘できる。スタンドバイ発電機の設置はない。
	高架水槽	1基/コミュニティ中心部に位置/横円筒形プレススチール高架水槽 (V=60m <sup>3</sup> ) / 水位指示計は故障/ 漏水はない。
	給水受益人口	1,000人以上 (接続数以外の数値は把握されていない)。
	導水管長	約 1km
	送水管長	計 300m
	コネクション数	Domestic Connections (Yard Taps) 33カ所及び Public Taps 2カ所の計 35ヶ所 (内水道代未払いで接続中断数 4ヶ所) なお、Commercial、institutional Connections はない。
	水料金 (m <sup>3</sup> 当たり)	2,200UGX の一律料金、裨益者は水道メーター表示に沿った請求金額を WSB 事務所で現金で支払う。

	運用状況	本給水プロジェクトは6年前に始まった。ほぼ2日に一度15時間揚水し貯水槽を満たし、重力配水している。送水管径が小さく水圧が低く、現施設仕様ではネットワークの拡張は不可能である。
運営/財務状況		<ul style="list-style-type: none"> <li>➤ Blumba Town Board Office 内の WSB が給水施設の運営・維持管理を担っている。</li> <li>➤ 施設の老朽化、資機材の故障が見られ早急な改修や更新が必要であるが、Town Board Office には予算手当できる余力がなく、外部支援に頼らざるを得ない。</li> <li>➤ WSB Staffs は8名(Chairman, Plumber, Treasure, Secretary, 4 Supporting Staffs)からなる。</li> <li>➤ 平均月粗収入は300,000UGX 程度である。</li> <li>➤ 月間概略運営経費：電気代金 100,000UGX、交通費 10,000UGX、配管工給与 50,000UGX、維持管理費 70,000、複写費 10,000 で、Umbrella の登録費用、職員給与等も入れるとほとんど積立できない。</li> </ul>
維持管理状況		<ul style="list-style-type: none"> <li>➤ 運営、維持管理のモニタリング、監査、管理は Town Board Office が担っている。</li> <li>➤ 給水施設の維持管理状況は不良と判断される。</li> <li>➤ WSB には給水技術に長けた職員は在籍していず、メジャーな修理は Umbrella East や DWO に頼らざるを得ない。</li> </ul>
課題点		<ul style="list-style-type: none"> <li>➤ 不安定な給電状況が日常的に見られるが、スタンドバイ発電機は設置されていない。</li> <li>➤ ポンプ揚水能力が低い上、管径が小さく適正な水圧が得られない。</li> <li>➤ 塩分濃度が高いと利用者からクレームが出ている。(今回、調査団員が現地で計測した EC 値は 1,040m s/cm で、やや高い程度と判断された)。</li> <li>➤ 小規模のパイプ給水システムで運営、維持管理状況が総じて低調で、収支バランスに剰剰金が計上できないため、給水施設に課題があっても改修、更新できない。</li> <li>➤ WSB 職員は給水技術の知見に乏しいため改修の対応がとれず日々の施設運用に追われている。</li> </ul>
教訓		<ul style="list-style-type: none"> <li>➤ コミュニティ規模が小さく目立った産業も育成されていない村落におけるパイプ給水施設の運営維持管理には工夫を要する。</li> </ul>

既存管路給水施設調査結果 (12)

項目	内容	
管路系給水施設名	Kisozi Piped Water Supply Scheme	
位置/行政区	5009227E 081884N1097m (Water Services Board Office)/Kamuli District, Buzaaya County, Kisozi Sub County	
維持管理主体 情報提供者	Kisozi Water Supply and Sewerage Board (WSSB) P.O.Box 881 Kamuli  Mr. Kitimbo Samuel/ Chair-person/0752936969 Mr. Wanbuzi Joseph/ Plumber / 0758576377/ 0774698676	
	水源	地下水/1基の深井戸(DWD21568)/揚水可能量11m3/hr/ Grundfos 製ポンプ深度113.5m/計器、バルブ等は稼働し



給水施設等情報		ているが、維持管理状況不良/ スタンドバイ発電機未設置/ 塩素注入器機は8か月前より稼働せず/ 不安定な給電状況が揚水機に負荷をかけている。
	高架水槽	1基/ コミュニティ東方丘陵斜面上に位置/ 横円筒形プレススチール高架水槽 (V=80m <sup>3</sup> ) / 漏水なし/ 水位指示計は故障。
	給水受益人口	約2,500人 (学校6校や公共施設での消費水量が多い)
	導水管長	約2.2km (HDPE管 OD110mm PN16)
	送水管長	計10,540m
	コネクション数	Domestic Connections (Yard Taps) 67カ所 (内3カ所は非稼働)、 Institutional Connection 6カ所及びPublic Taps 2カ所、 Public Tap 当たり約30家族が給水利用 Domestic Connection には Tap 毎に所有者がいて、他隣人に販売するケースもある。
	水料金 (m <sup>3</sup> 当たり)	3,000UGX、水料金は水道メーターに基づく従量制で算定され Tap 所有者は事務所で直接水道代を支払う。徴収率は総じて高い。Public Tap ごとに Care Taker がいて給水時に現金を受領し、1週間の売り上げ額から約17%のマージンを差し引いた残りを事務所に支払う。
	運用状況	給電事情や高い電気代金のため2日に1度6時間揚水し貯水槽を満たしている。給水人口が少なく給水原単位も15ℓ/人/日程度のため、給水量に過不足は見られない。
運営/財務状況	<ul style="list-style-type: none"> <li>➢ 運営、維持管理は WSSB が担っている。</li> <li>➢ Sub-county は WSSB を事業管理、監査、資金管理の役割がある。</li> <li>➢ WSSB Staffs は3名 (Chairman, Plumber, Secretary) からなる。</li> <li>➢ 月毎の水料金収入額、利益率は低く、資機材更新費や故障部品の修理費を捻出できない。</li> <li>➢ 給水率の改善を目的に給水ネットワークの拡大計画 (案) をまとめ投資会社に打診したことがあった。新規深井戸建設やネットワーク拡大を軸とした計画で、2025年を計画年として約6,300人に対して日需要量を200m<sup>3</sup>/日を24時間給水するものとしている。しかし、その後のアクションが確認されていないことから、どの会社からも賛同がなかったものと思われる。</li> </ul>	
維持管理状況	<ul style="list-style-type: none"> <li>➢ 給水施設の日常的な維持管理は実施されていない。</li> <li>➢ 施設の技術的ケア及び運営・営業まで Plumber 一人で対応していて、なんとか施設運用だけはできている程度。</li> <li>➢ 規模の大きな修理や更新は WSSB - Sub-county レベルでは技術的、財務的に対応不可能である。</li> <li>➢ Umbrella East からの技術支援は期待されていない。</li> </ul>	
課題点	<ul style="list-style-type: none"> <li>➢ 給水事業の利益率は低く、積立金が少ないため資機材更新や修理費を捻出できない。</li> <li>➢ 不安定な給電状況及び高額な電気代金がネックとなっている。</li> <li>➢ スタンドバイ発電機が併設されていない。</li> <li>➢ 給水の実務は Plumber 一人に任されていて、施設の維持管理、メー</li> </ul>	

	ターチェック、請求手続き、集金業務等をもれなくこなすのは困難である。
--	------------------------------------

既存管路給水施設調査結果 (13)

項目	内容	
管路系給水施設名	Nankoma Water Supply Scheme	
位置/行政区	N0°26'57.88" E33°40'46.43" 1,200m (Community Center)/ Bugiri District	
維持管理主体 情報提供者	Nankoma Water Supply Services Board (WSB)  Mr. Ngia Abedi / Chairman of Water Board/ 0774481895 Mr. Bukonekeisa / LC1 Chairman /0777268938	
給水施設等情報	水源	地下水/1基の深井戸/ Itakaibolu 地区; コミュニティ西方の谷状地/井戸深度 52m/日揚水可能量 60m <sup>3</sup> /ポンプ深度 41m/揚水管 63-PN16 HDPE/ Grundfos 製ポンプ SP8A-37N 2013年12月より水中モーターが故障し、今日まで修理されないまま放置されているため本 scheme は稼働していない。 ポンプハウス内には 2 基の故障水中モーター及びポンプが放置され、発電機も設置されたままである。屋外にある孔口は簡易な蓋で覆われているが、揚水管は除去されている。なお、揚水可能量は変動することなく、以前と同様の揚水量が得られるとの口頭情報を得た(この根拠は不明)。
	高架水槽	1 基 (コミュニティ内の高標高地点) /横円筒形プラスチック高架水槽 (V=60m <sup>3</sup> ) /水位指示計は故障/ 漏水はない。 フェンスが設置されて家畜用草地になっている。
	給水受益人口	約 10,000 人、現在はコミュニティ内のハンドポンプ付深井戸あるいは近隣の湿地の河川水から生活用水を得ている。パイプ給水施設稼働時とくらべ、取水に費やす時間が掛かり衛生上の問題や利用水量の減少等の問題が見られるとの口頭情報を得た。
	導水管長	約 2km
	送水管長	計 300m
	コネクション数	給水施設の稼働時には、Public Taps が 8 カ所 (稼働数 5 カ所)、Yard Taps が 102 カ所に設置されていた。前者には Care Taker がいて現金支払いを受けて給水していた。サービス時間帯は 8:00~17:00 で、なお、夜間には盗水防止のため施錠していた。
	水料金 (m <sup>3</sup> 当り)	3,000UGX/m <sup>3</sup> 。発電機なので割高になっている。公共水栓での水料金は 75~80UGX/20L jerry can (やや不明瞭な答え)。 稼働時には水料金の支払い状況はおおむね問題はなかった。

	運用状況	Scheme が運用を中断するまでの約 5 年間 WSSB が運営・維持管理を実施していた。水源井戸では 2 日に一度 8 時間揚水で 60m <sup>3</sup> を揚水し、高架水槽を満水していた。給電状況が悪く、スタンドバイ発電機を使用して給電することが多かった。ポンプ性能と発電量のバランスに問題があり、不安定な電圧変動からモーターに過剰な負荷が掛かりダメージを受けたとの報告を受けた。一度は Umbrella East の支援も受けてローンを組みモーターを更新したが、同様な故障が再度生じた。WSB 及び Sub County にはハード面の技能人材が在籍していないばかりか、修理費や更新費を捻出する予算手当も不可能であった。現在、DWO や Umbrella East に支援を要請するも、未だ返答は得られていない (Umbrella East に確認したところ会費が納入されていない状態とのこと)。
運営/財務状況	運営、維持管理は WSB/Sub County が担っていた。	<p>WSB メンバーは 4 名(Chairman, Secretary, Operator, Health Assistant)から構成され、現在も解散せず組織は残っているが、活動は中断したままである。</p> <p>コネクションが少なすぎるため、PO とは契約していない。</p> <p>水料金は徴収率が高く、銀行に年間百万 UGX 程度の積立もあった。なお、水料金徴収は Sub-county 内の Town Agent が実施していて、月当たりの水料金収入は 50 万 UGX 程度あったとの情報を得た。</p> <p>口頭情報によると監査を含む会計業務一般に問題があり、Sub County による不透明な資金流用 (他分野への転用) があったとのことである。そのため給水施設の修理や更新のための予算が消失し、国や県の支援を仰がなくてはならない状況である。</p> <p>運転が出来ていた時期は下記のような方式で運営していた。</p> <ul style="list-style-type: none"> <li>・運転は、高架水槽の水位が下がったら満杯にするようにしている。</li> <li>・Chairman と Members がポンプのスイッチのオン・オフをする。</li> <li>・週に 1 回の割合で、オイル注し等の維持管理をしている。</li> <li>・Plumber はいない。必要になったら Bugiri から呼ぶ。NWSC と相談する。</li> <li>・集金は Sub County の Town Agent が集める。WSSB のメンバーではない。Allowance は支払っていない。メーター読み。</li> <li>・集金されたお金は平日なら、銀行に預ける。</li> <li>・収入：順調にシステムが稼働していたときで 500,000 UGX/月程度。</li> <li>・集金したお金は発電機の燃料とサービスに使う。</li> <li>・燃料：1 jerry can (20 L)/day (3,000UGX/L 程度)。</li> <li>・サービス：オイルフィルター、ディーゼルフィルターへの油注し。この部分は機械工を雇用している。週 1 回 (40,000UGX/day)。</li> <li>・公共水栓には Tap Attendant がいて料金をその場で徴収する。サービスタイムは AM 8:00 – PM 5:00。その他の時間はタップに施錠する。</li> </ul>
維持管理状況	➤	WSB には給水技術のスキルをもつ職員は皆無で、モーターの異変を事前に感知できず、問題を抱えたまま施設稼働していたことで“傷口”がさらに拡大した可能性がある。
課題点	➤	<p>Sub County は本 Scheme の責任機関であるが、資金管理がずさんで Scheme が中断した際に修理・更新に必要な予算手当ができなかった。</p> <p>WSB はポンプさえ交換できれば改めて Scheme の再稼働が可能と認識しているが、3 年間の給水中断期間に施設の自然劣化も進行して再稼働は容易ではない。</p>

	<ul style="list-style-type: none"> <li>➤ パイプ給水 Scheme が稼働しなくなると、住民はハンドポンプ付深井戸や近隣の表流水から生活用水を得ざるを得ない。</li> <li>➤ この Scheme の給水規模では、PO に運営・維持管理を委託することは財務的に困難と判断され WSSB 独自で運営することになったとのことであるが、それにより発生する問題点への対策がなんら取られていない。</li> </ul>
教訓	<ul style="list-style-type: none"> <li>➤ Sub County が水料金積立金を何ら関係ない部門に流用するという杜撰な経理が行われたとのことで、透明性の高い経理システムが必要である。</li> <li>➤ 電力の不安定な供給や資機材（仕様）選定等の施設設計にも揚水機の故障原因が求められ、設計段階からの注意が必要である。</li> </ul>

既存管路給水施設調査結果（14）

項目	内容	
管路系給水施設名	Namwendwa Piped Water Scheme	
位置/行政区	529660E 101833N 1133m (Office)/ Kamuli District	
維持管理主体 情報提供者	Namwendwa Piped Water Supply Board (WSB)  Mr. Barchibinga Charles/ Chairman/ 0777674454 Mr. Namanda James / Plumber/ 0784748830 / 0756215470 Mr. Mukungu Simon / Plumber/ 0750842461	
給水施設等情報	水源	地下水/深井戸（DWD23049）1基/コミュニティ周辺の住宅地区に位置/2006年10月に建設/揚水可能量 194m <sup>3</sup> /日 スタンドバイ発電機が併設されていず、商用電力の中断が頻発し、揚水できずポンプに過剰な負荷を及ぼす。年間にわたって揚水可能量に大きな変動は見られないが、給電状況によって 45~110m <sup>3</sup> /日と大きく変化する。ポンプハウス内の計器やバルブ類、電気系統機器は問題なく稼働している。
	高架水槽	横円筒型プレスチール貯水槽/コミュニティ内スラム地区に位置/ 貯水可能量 60m <sup>3</sup> / H=12m/ 10~12 時間の揚水で貯水槽が満水となるが、給水可能時間は 8 時間/水槽端より顕著な漏水/ 貯水槽底部、架台の酸化進行/ 3 ヶ月に 1 回は洗浄実施（口頭情報）
	給水受益人口	約 10,000 人
	総管延長距離	約 11km
	コネクション数	Total Taps: 385 カ所(含 6Kiosk+4Public Standard Taps +375Domestic Connections)、その内 119 ヶ所で揚水されず、稼働率は 68.5%に留まる。多くは水料金未払いのために使用停止を受けたものである。すべての Taps には水道メーターが併設されている。
	水料金（m <sup>3</sup> 当たり）	Public、Domestic Taps では 1,800UGX、Kiosk では 1,300UGX(含 VAT 及び Service Fee) となっている。

	運用状況	稼働水源井戸は商用電力で運用、商用電力の不安定な給電が恒常的に生起する。9月の月間生産水量：1,736m <sup>3</sup> 、給水量：1,722m <sup>3</sup> 、販売水量：1,704m <sup>3</sup> で良好な実績が記録されている。 Public Standard Tap ごとに Care Taker が配置されていて、200UGX/20ℓで販売している。
運営/財務状況		<ul style="list-style-type: none"> <li>➤ WSB の職員数：6 名 (Chairman, Treasurer, 3Plumber, Secretary )、Chairman には健全な公共サービスを担っている自負が感じられた。</li> <li>➤ 四半期に一度 DWO Kamuli, Umbrella East, Water Board Member, Internal Auditor に業務報告書を提出し、業務実績を共有している。この記録が将来のネットワーク拡大に当たって重要な基礎資料になるとの認識ももっている。</li> <li>➤ 2015 年 9 月分報告書によると同月の請求書発行額は 3,310 千 UGX で収入額は 3,200 千 UGX となって、約 97%が納入されている。これは職員が一丸となって集金活動を推進した賜物である。しかし、月によっては収支が赤字となり、給与支払いの遅れが生じることもある。</li> <li>➤ Umbrella East を通じて政府補助金により水道メーターの供与を受けている。</li> <li>➤ 末端給水施設 (水道メーター以後) の資機材は受益者が負担し、WSB が設置することになっている。</li> </ul>
維持管理状況		<ul style="list-style-type: none"> <li>➤ ポンプ担当者は生産井の運用経歴を詳細に記録している。</li> <li>➤ 高架水槽はスラム街に位置し、フェンス周辺にゴミ山が積み上げられるなど衛生環境の課題があり、施設の維持管理には職員だけでなくコミュニティ住民の理解と協力が不可欠である。</li> </ul>
課題		<ul style="list-style-type: none"> <li>➤ 導水管口径が小さく水圧が低いため、乾季にはネットワーク末端まで送水できない場合もある。</li> <li>➤ 電力供給状況は不安定で電圧の変動も顕著なため、信頼に足るエネルギーとは考えられない。このため、スタンドバイ発電機の設置が不可欠である。</li> <li>➤ 高架水槽に顕著な漏水がみられ、漏水口が拡大する前に修理する必要がある。</li> </ul>
教訓		<ul style="list-style-type: none"> <li>➤ WSB が主体的に運営・維持管理を担っているコミュニティであり、Chairman が積極的に事業運営を主導し、基本的なデータの蓄積に基づいた給水事業の質的改善とネットワークの拡張を計画している。指導者層の人材確保も大切。</li> </ul>

既存管路給水施設調査結果 (15)

項目	内容	
管路給水施設	Busalamu Water Supply System	
行政区	Luuka District	
維持管理主体/情報提供者	Water Mission (NGO), Iganga  Mr. Bazila Emmanuel/Project Operator/ 0785493829 Mr. Ibrahim Casada/Tap Operator/0785493829	
	水源	地下水/深井戸 1 基 (DWD48644、2014 年 7 月にさく井) / コミュニティ西方の緩勾配の谷に位置/揚水可能量 5 m <sup>3</sup> /hr/ソーラーシステム+直流ポンプ?により揚水/地表部のコ

給水施設等の概要		ンクリートボックス内に深井戸、コントロールパネル設置/良好な施工品質で安全性高い。
	高架水槽	コミュニティ中央部に位置/容量 10 m <sup>3</sup> の黒色円柱硬質プラスチック貯水槽/H=8m 架台
	給水人口	>3,000 人、給水人口は概数。
	コネクション数	Public Taps が 7 ヶ所、Kiosks が 4 ヶ所
	水料金(m <sup>3</sup> 当り)	100UGX/20ℓ、一律価格、サービスタイムは 6:00~18:00、Tap Operator が現金販売するシステムをとっている。
	運用状況	2014 年に施工されたシステムで、1 年 2 ヶ月前より運用されている。 1 日の消費水量は平均 7m <sup>3</sup> /day、現在 (11 月時点) は 4~5 m <sup>3</sup> /day で、2 日に一度貯水槽に充填している。 給水施設は午前 6 時から午後 6 時までの 12 時間運用、それ以外の時間帯は Kiosk が閉鎖され Public Taps は施錠される。
運営/財務状況	<ul style="list-style-type: none"> <li>➢ Water Mission の職員 3 名が給水施設の運営・維持管理業務に当たっている。</li> <li>➢ 戸当たりの日消費水量は 4~6x20ℓ/HH/day、1 戸当たり 8 人程度で構成のため、給水原単位は 12-15ℓ/capita/day と算定</li> <li>➢ いずれの給水箇所でも Tap Operator がいて、取水時に水料金を徴収している。Operator の給料は歩合制で、20m<sup>3</sup> 販売で 20,000UGX のマージンが得られる。</li> <li>➢ Public Taps には Chairman、Secretary、Accountant 等 7 名からなる Tap Water Committee が組織化されていて、業務には給水施設の維持管理の他に住民啓蒙活動も含まれる。</li> <li>➢ 1 ヶ月で 1 百万 UGX 以上の収入があり、Jinja の Agent Manager に月末に送金している。これらはプロジェクトの運営費等に充てられている。</li> </ul>	
維持管理の状況	<ul style="list-style-type: none"> <li>➢ ソーラーシステムは維持管理が基本的に不要</li> <li>➢ コミュニティ中央部に塩素注入室 (1 日に 4 タブレットを投入) が設置され、屋上に 5 枚のモジュール (盗難防止のため) が設置されている。</li> </ul>	
課題点	<ul style="list-style-type: none"> <li>➢ モジュール数が少なく十分な発電量が得られないことから、揚水量が限定的との報告を受けた。</li> <li>➢ Tap Operator が納入された水料金を持ち逃げしたことがある。</li> </ul>	
教訓	<ul style="list-style-type: none"> <li>➢ コミュニティ住民に対する事前センシタイゼーションが浸透しており、水料金支払いは問題なく履行されている。</li> <li>➢ 水料金は利用時に現金払いされるため、確実な料金収入が行われている。</li> </ul>	

既存管路給水施設調査結果 (16)

項目	内容
管路給水施設	Tiryini & Kibuku Water Supply System

県	Kibuku	
施設の概要	水源	井戸 2ヶ所 : 14 m <sup>3</sup> /hr、6 m <sup>3</sup> /hr
	高架水槽容量	Tirinyi Reservoir 150 m <sup>3</sup> Kibuku Reservoir 100 m <sup>3</sup>
	計画給水人口	Tirinyi : 人口 10,000 人、20L/Capita Kibuku : 人口 9,000 人、20L/Capita
	コネクション数	現在 483 コネクション。Public Tap は全体で 4ヶ所のみ (100 UGX/jerry can)
	運転状況	2012 年建設。稼働中 週 2 回揚水。需要がその程度。1 日 12 時間半運転。 週 3~4 回停電する。ジェネレーターはあるが、機械的な問題で動いていない。その管理も PO の仕事。無収水量は 20% 以下。
運営方式	WSSB と PO との契約方式 Private Operator の人員構成 (Mutaka Technical Services Ltd: Jinja にある。運営しているのは、この管路給水システムのみ。) Manager 1、Plimber 2、Pump attendant 1、 Assistant Pump Attendant 1、Accountant 1	
維持管理の状況	<ul style="list-style-type: none"> <li>➤ Private Connection Fee ; 59,000 UGX。使用料 2,950 UGX/m<sup>3</sup>。この接続料金には、配水管から 50m 以内 (流量計まで) のサービス管の設置と給水栓の設置が含まれる。流量計までが国の財産。給水栓は個人の財産。</li> <li>➤ 流量計、Private Tap は皆個人の敷地内にある。これは Vandalism により流量計を壊されるのを防ぐのが目的。</li> <li>➤ システムの会計 年間収入 : 24,000,000 UGX 年間支出 : 21,000,000 UGX 支出の内訳 : Private Operator 85 % Water Service Board 5 % Further Investment 10 %</li> <li>➤ Private Operator への支出には、下記のコストも含まれる。 DWRM Grandwater extraction fee 200,000 UGX/年 Umbrella 年会費 400,000 UGX/年 Umeme 電力使用量 8,000,000 UGX/年程度) PO の人件費 9,000,000 UGX/年程度</li> <li>➤ 集めたお金は電力やマイナーな修理に充てられ、残らない。Connection を拡張するお金がない。</li> <li>➤ Town Council はまず Umeme に支払うよう、PO を指導する。</li> </ul>	
教訓	<ul style="list-style-type: none"> <li>➤ このシステムは運営がうまく行っているケース。秘訣は、WSSB と PO の信頼関係。WSSB が PO の行うシステム管理にやたらと干渉しないこと。PO が運営資金不足にあるときは、WSSB が一時的に援助すること。</li> </ul>	

既存管路給水施設調査結果 (17)

項目	内容	
管路給水施設	Pallisa Town Water Supply System	
県	Pallisa	
施設の概要	水源	チョガ湖
	高架水槽容量	高架水槽 (160m <sup>3</sup> 、110m <sup>3</sup> )

		水務所にある高架水槽は標高が低く、圧力が末端管路に届かず、水供給できない地域がある。
	コネクション数	280
	運転状況	High Lift Pump が壊れており休止中。 電力供給：Stand by Generator はあるが、容量 (21kV) が小さすぎてシステムを運転するには足りない。納入業者は Sumadhra。40Kv の Generator が必要である。
運営方式	Pallisa WSSB と PO との契約方式、その後 WSSB 直営	
維持管理の状況	<ul style="list-style-type: none"> <li>➤ 水料金は、2,360 UGX/m<sup>3</sup> (=50 UGX/jerry can)。</li> <li>➤ PO が雇用するのは Plumber 等であり、Engineer は雇わない。彼らは、利益優先である。技術力はない。大きな故障には対応できない。電話をしても来ない。MOWE にはその旨報告しているが、反応はよくない。</li> <li>➤ PO はスタッフのサラリーさえ払わない。Umeme への電気代も払わない。</li> <li>➤ PO との契約は3年ごと。 <ul style="list-style-type: none"> <li>①Bison (3年契約)</li> <li>②George &amp; company (3年契約)</li> <li>③Trandit (3年契約)</li> <li>④WSSB 直営で O&amp;M を始めた。 水中ポンプが壊れ 2 年間の間、給水は行われていなかった。その後、MOWE が代替の水中ポンプを供与してくれた。Pump house の Transmission 用の Pump が壊れた。原因はオーバーユース。13 年間使った。その他の原因としては、電力の変動。原水 (湖水) による堆砂が挙げられる。交換したいが予算がない。</li> </ul> </li> <li>➤ 塩素投入装置も短期間で壊れた。</li> <li>➤ 雨期は処理水が黄色になるので、その時期は家庭用水にしか使えない。</li> <li>➤ 沈殿でサクシオンポンプの Intake が埋まってしまう。</li> <li>➤ 濁りはフィルターサンドで処理するが、Back Wash ではなく表面に溜まったものを掻き取る方式。そのため、フィルターサンドも一緒に掻き取ってしまい無くなってしまう。</li> <li>➤ 料金はメーターによる従量制。 日常修理は PO の責任だが、ポンプのようなものは MOWE と Umbrella に依頼する。Application が必要で、現在、その準備中である。</li> </ul>	
教訓	<ul style="list-style-type: none"> <li>➤ 料金支払いにはセンシタイゼーションが必要である。</li> <li>➤ ユーザーはトイレや水撒きに高価な水を使うが、料金は支払わない。</li> </ul>	

既存管路給水施設調査結果 (18)

項目	内容	
管路給水施設	Budaka Piped Water Supply System	
県	Budaka	
施設の概要	水源	2井戸
	高架水槽容量	50m <sup>3</sup>
	コネクション数	246
	運転状況	2000年~2001年にシステムを建設し、10年以上運転した。2014年に水中モーターポンプが故障し



		た。その後、約1年半、システムは稼働していない。
運営方式	WSSB と PO の契約方式	
維持管理の状況	<ul style="list-style-type: none"> <li>➤ PO は4社と契約してきた。このうち、Reform Uganda および Trandit Company が自社利益優先で良くなかった。</li> <li>➤ 新しい PO (Power Tech Service (U) Ltd.) と昨年契約したが、キックオフはできていない。理由は、水中モーターポンプの購入に 44,000,000UGX 必要なこと。電力使用量の未払い分が未だ 10,000,000 UGX 残っていること。</li> <li>➤ コミュニティによるバンダリズムがある。具体的には、メーターの破壊。不法接続。</li> </ul>	
教 訓	<ul style="list-style-type: none"> <li>➤ +現場で実務を行うオペレーターに Pumping System に関するスキルがない。</li> <li>➤ PO が先に自分たちのコストをとってしまい、維持管理にお金を回さない。</li> <li>➤ 上記のような話がある一方で、Budaka TC の管路給水システムが現在、給水不能の状態に陥っているのは、WSSB が PO の運営管理に干渉しすぎたためとの話もある (Mutaka Technical Services Ltd( PO)の話)。</li> </ul>	

Umbrella East での確認結果 (所長 : Mr. Martine Wamalma)

項 目	内 容												
管路給水システムのハンドオーバー手続き	+Performance Contract を MOWE と WSSB が結ぶ。 +Management Contract を WSSB と PO が結ぶ。 +Asset Register (Compiled Document as built drawing) Contractor が Water Authority に Asset Register を提出。 + O&M Manual												
Umbrella の加盟費用および年会費	* Admission Fee (入会金) : 500,000 UGX * Subscription Fee(年会費): Connection 数による。 <table style="margin-left: 40px; border-collapse: collapse;"> <tr> <td style="padding-right: 20px;">Connection</td> <td style="padding-right: 20px;">1 ~ 50</td> <td>100,000 UGS</td> </tr> <tr> <td></td> <td>50 ~ 150</td> <td>150,000 UGS</td> </tr> <tr> <td></td> <td>150 ~ 300</td> <td>300,000 UGS</td> </tr> <tr> <td></td> <td>300 ~</td> <td>350,000 UGS</td> </tr> </table>	Connection	1 ~ 50	100,000 UGS		50 ~ 150	150,000 UGS		150 ~ 300	300,000 UGS		300 ~	350,000 UGS
Connection	1 ~ 50	100,000 UGS											
	50 ~ 150	150,000 UGS											
	150 ~ 300	300,000 UGS											
	300 ~	350,000 UGS											
会員へのサービス	会員から集めた加盟費用および年会費を Rolling Fund としてサービスを提供している。最初に Seed Fund が MOWE から与えられた。 例えば、揚水ポンプを新たに購入するために Revolving Fund を使う場合、会員は次の額を 12 か月~36 ヶ月で支払う。 $8,000,000 \text{ UGS} \times (1 + \text{利子 } 2\% \sim 5\%)$ 。 この借金と返済のサイクルが次々と回転(revolving)して、成り立つのが Rolling Fund (Revolving Found)である。 しかし、実際には、揚水ポンプが壊れた場合には WSSB では返済ができない。そのため、実態としては、MOWE からの補助金が入るので、それを揚水ポンプの供与に充てている。												
維持管理の状況	<ul style="list-style-type: none"> <li>✧ PO を使ったスキームの6割が失敗している。</li> <li>✧ 失敗例の主要原因は電力料金の不払いである。</li> <li>✧ Private Operator (PO) が Water Supply and Sanitation Board (WSSB) よりも技術的に優位にたつので、WSSB が PO をコントロールできない。そのため、Umbrella が WSSB をサポートするようにしている。</li> <li>✧ PO の問題としては、書類上は人材が整っているように見えるが、実際には整っていないことが多い。収入があっても、スタッフ</li> </ul>												

	<p>の訓練やスキームの O&amp;M に使われず、スタッフのサラリーに消えてしまう。企業だから自社の収益を上げようとする。</p> <p>✧ メーターが壊れたら、取り替えるのは Water Authority(WA)の義務だが、予算がないので実際には MOWE の予算で購入して Umbrella が WA に渡す。Private Connection でも水料金を払っていけば同じ扱いをする。</p>
その他	<p>いくつかのスキームでは、O&amp;M に失敗した後、NWSC にスキームをハンドオーバーした例がある。</p>
教訓	<p>* Association of Private Water Operator (APWO) という組織がある。GIZ が支援している。Umbrella とは無関係。</p> <p>* 管理給水スキームの規模にもよるが、一人の Scheme Operator で 2~3 のスキームを管理するのが良いと考えている。近い RGC 同志を 1 つのクラスターにして一人の PO で O&amp;M を行う。これを District 毎に作る。</p>