

資料-5

テクニカルノート(T/N)

- (1) テクニカルノート (2015年7月28日署名)
- (2) テクニカルノート (2015年10月27日署名)
- (3) テクニカルノート (2015年12月11日署名)
- (4) テクニカルノート (2016年5月24日署名)
- (5) テクニカルノート (2016年7月22日署名)
- (6) テクニカルノート (2016年9月9日署名)

TECHNICAL NOTES
ON
THE FIRST FIELD SURVEY OF THE PREPARATORY SURVEY
ON
THE PROJECT FOR RURAL WATER SUPPLY PHASE III
IN
LAKE KYOGA BASIN, EASTERN UGANDA,
IN
THE REPUBLIC OF UGANDA

Based on the Minutes of Discussions (hereinafter referred to as "M/D") on the Preparatory Survey on the Project for Rural Water Supply Phase III in Lake Kyoga Basin, Eastern Uganda, in the Republic of Uganda (hereinafter referred to as "the Project") signed on May 22, 2015 between the Preparatory Survey Team (hereinafter referred to as "the Team") of Japan International Cooperation Agency (hereinafter referred to as "JICA") and Ministry of Water and Environment (hereinafter referred to as "MOWE"), of the Government of the Republic of Uganda, the consultant members of the Team (hereinafter referred to as "OYO-TECI") had a series of discussions and conducted field surveys from May 18 to July 28, 2015.

As a result of the discussions and the surveys, both sides confirmed the technical conditions described as per Attachment.

Kampala, July 28, 2015

Ichiro TANAKA
Chief Consultant,
JICA Preparatory Survey Team for
the Project for Rural Water Supply
Phase III in Lake Kyoga Basin,
Eastern Uganda, in the Republic of
Uganda

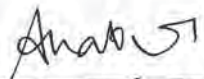
Eng. Aaron M. Kabirizi
Director,
Directorate of Water Development,
Ministry of Water and Environment,
Government of the Republic of
Uganda

ATTACHMENT

Both parties agreed upon and confirmed the following items.

1. Target RGCs for the Field Survey

Prior to commencing the field survey, it was confirmed that the following RGCs are to be excluded from the target RGCs.

- Kadama RGC: The NWSC (National Water and Sewerage Corporation) is implementing "Water Management Development Program (WMDP)" with the support of World Bank. The project includes construction of piped water systems at the townships and RGCs located along the national road between Mbale and Tyrini. Kadama is one of the targets of this project. They are preparing the tender documents for the construction of project facilities according to the person in charge of this project in the Head Office of NWSC.
- Nakalama RGC: The NWSC has the extension plan of their piped water system from Iganga to Nakalama. They have already procured a half of the necessary transmission pipes, and are going to procure the rest of transmission pipes. The construction of transmission pipelines is commenced on July, and is planned to be completed by December 2015 according to the Area Manager of NWSC Iganga Area Office, and District Water Officer of Iganga.
- Mugarema RGC: Mugarema already has a piped water supply system. This system was constructed by the Ministry of Agriculture, Animal Industry and Fisheries (MAAIF) for improving the livelihoods of the fish dependent communities under the assistance by Icelandic International Development Agency (ICEIDA).
- Nakabugu RGC: In the Luuka town, a piped water system is under construction. This system covers the Nakabugu RGC, and construction of the transmission pipeline has been commenced in the Nakabugu RGC. This construction is planned to be completed on September 2016 according to the District Water Officer of the Luuka district.

As a result of the above exclusion of four (4) RGCs, the total number of RGCs to be surveyed in the field survey becomes 16 from the requested 20.

2. Field Survey

Prior to the commencement of the socio-economic survey and the aquifer tests, OYO-TECI visited each target RGC, and confirmed the boundaries of RGCs with the local leaders on the maps as presented in Appendix-2. The field surveys were conducted based on the confirmed boundary lines indicated on the maps.

(1) Aquifer Tests Conducted

The aquifer tests were planned to be conducted in the field survey for 44 boreholes in order to grasp the ground water potential in the target RGCs. The tests were carried out in 37 boreholes in all, however the test was not conducted in some RGCs because the users of the respective boreholes were not convinced in agreeing to accept the tests in writing in time though various efforts were extended by the district water offices as well as MOWE. Consequently, the aquifer tests were not conducted in the following RGCs,

- Acuna RGC of the Soroti district (2 sites)
- Nakivumbi RGC of the Iganga district (2 sites out of 3 sites)
- Nabitende Banada RGC of the Iganga district (1 site out of 6 sites)

(2) Socio-economic Survey

The socio-economic survey was carried out in the 16 target RGCs to obtain the basic data for preparing the prioritization list of the RGCs for the project implementation and for designing water supply facilities and the formation of efficient operation and maintenance plan for the Project. Some outputs of the survey relating to the prioritization are presented in Table 1 together with the interim results of the aquifer tests.

3. Utilization of NWSC Water

It is considered possible to use the treated water of NWSC for the following RGCs. The use of NWSC water will be considered when the groundwater potential is judged to be poor and short comparing the water demand estimated for these RGCs.

- Acuna and Tubur RGCs in the Soroti district: Transmission from the trunk main to the Kaberamaido township under the NWSC Soroti area office
- Busesa RGC in the Iganga district: Extension of the trunk main from the Nakalama RGC under the NWSC Iganga area office
- Namungalwe RGC in the Iganga district: Transmission from the trunk main to the Namungalwe RGC under the NWSC Iganga area office

(1) Acuna and Tubur RGCs

In the previous development study, the use of NWSC water is proposed for the Acuna and Tubur RGCs. The proposed plan is to transmit the water to the RGCs from the existing elevated tank in the health center of the Tiriri village. The distance of the pipelines from the bifurcation point located at about 3.9km from Tiriri, to the Acuna and the Tubur RGCs are measured to be 6.0km and 5.9km, respectively. The ground elevations at Acuna and Tubur are measured to be 1,122m and 1,094m, respectively, which are considered higher than 1,062m at the elevated tank. To convey the water from the elevated tank in Tiriri Village to Acuna and Tubur will require the use of booster pump.

The water for Tiriri is conveyed from the NWSC's trunk main to Kaberamaido branching out at Katine (about 6.5km south from Tiriri) by the HDPE pipe (2in dia.). The pressure was measured at the branching point, and found to vary around 100m during the night time from 18:30 to 9:00 when the water flow is considered less and the pressure rather higher. The ground elevation at Katine branch is measured to be 1,040m, and the total distance from Katine to Acuna and Tubur is calculated to be over 16km. Taking into account that the pressure during the day time is depressed due to water flow in the trunk main to Kaberamaido. To convey water to Acuna and Tubur will require boosting.

(2) Busesa RGC

As mentioned in Item 1 of this attachment, NWSC Iganga area office intends to expand its service area to Nakalama, and its construction is about to be commenced. This expansion of service area is implemented based on "Design Report: Idudi Town Water Supply System (June 2014)" prepared by MOWE. According to this report, 1,070m³/day of water demand is estimated for Nakalama, Butende, Busesa and Idudi based on the 2018 population, and it is necessary to expand the conveyance capacity from Jinja to Iganga to fulfill the demand after 2018. Out of the total demand of 1,070m³/day presented in the said report, 241m³/day is allocated for Busesa. This demand of 2018 is considered reasonable comparing with the demand of 263m³/day estimated for 2022 based on the population worked out from the results of the socio-economic survey carried out in this field survey.

The distance from Nakalama to Busesa is measured to be 11.6km, and booster pump system may be necessary to push up the water to the elevated tank for the service area according to the report. More detailed investigations will be required in order to determine the best water source for the RGC. The result of the step drawdown test carried out in the aquifer tests of this field survey does not suggest good potential of groundwater. To fulfill the above demand of 263m³/day, about 15m³/hr of borehole yield is required to be explored considering the operation hour of 18hr.

(3) Namungalwe RGC

The MOWE further plans to expand its service area to the Namungalwe RGC towards the north. According to the Final Feasibility Study Report - Namungalwe RGC (June 2015), the capacity of transmission main from Jinja to Iganga is 4,992m³/day. The total volume supplied to Iganga and Mayuge was 2,132m³/day for May 2015, and it implies the capacity of the transmission main is 42.7% utilized. The demand of Namungalwe (547m³/day) estimated for 2019 represents 10.9% of the transmission main capacity. Consequently, the report concluded that it is possible to convey the volume of Namungalwe demand by the existing transmission main.

On the other hand, the Design Report for Idudi and other towns presented in the above Item (2) expresses the necessity of the augmentation of the existing transmission main to meet with the demand after 2018.

4. Evaluation for Prioritization

(1) Coverage of Safe Water

The target coverage of rural water supply is set at 79% in the National Development Plan (2015/16 - 2020/21) (NDP), and some RGCs may exceed it as a result of the socio-economic

condition survey carried in the field survey. The MOWE requests to include those RGCs in the prioritization though their coverage exceed the target values of NDP, because the government is promoting the piped water supply facilities for RGCs in the rural areas in accordance with "Long-term Strategy for Investment Planning, Implementation and Operation & Maintenance of Water Supply and Sanitation in Rural Growth Centers (May 2005)". According to this strategy, since growing urbanization in RGC areas causes the contamination of the protected point sources, the needs of piped water supply systems are increasing. The improved access to safe water by the piped water supply system mitigates the loads of water fetching of women. OYO-TECI agreed to bring the requested issue for the further discussion in Japan.

(2) Commercial Electricity Supply

According to the results of field survey, it was found that the commercial electricity supply facilities are provided, or being installed and completed by the end of 2015 in all the target RGCs. The completion of such installation was confirmed with UMEME also. Therefore, it is not necessary to consider the availability of such commercial supply in the prioritization.

(3) RGCs for which Aquifer Tests were not Conducted

In connection with Item 2 of this Attachment, OYO-TECI will convey this issue of opposing the aquifer tests to Japan for further discussions on the adequateness of considering the fact as one of the factors in prioritization and selection of RGCs, taking into account the difficulties expected in the implementation of the Project as well as in the 2nd field survey.

5. Mobilization of RGCs

(1) Stakeholder Meeting

The stakeholder meetings will be held in each selected RGCs during the 2nd field survey under the responsibility of MOWE, and the specific names and titles of decision-makers and local stakeholders will be identified in the initial stage of the 2nd field survey in order to facilitate the field survey.

(2) Necessity of Mobilization and Sensitization during the Preparatory Survey

The layout plans of the project facilities need to be accepted by the users including the land use by the project facilities such as pipelines, elevated tanks, water kiosks, etc. To facilitate the acceptance of land owners and stakeholders for the land to be occupied by the project facilities, it is necessary to commence the activities for mobilization and sensitization of villagers in the stage of preparatory survey. However, the period is considered quite limited though the numbers of the selected RGC may be over ten. Therefore, the MOWE requests to assign some local social specialists also under the Team's control to assist the staff of the district water offices. OYO-TECI will convey this request to Japan for the further discussion with JICA.

6. Use of Boreholes Drilled by JICA

There are the following boreholes in the areas of target RGCs which were drilled in the course of the field survey of the Development Study on Water Resources Development and Management for Lake Kyoga Basin and being used by the neighboring villagers as point water sources.

- Naigobiya RGC (Luuka district): JTB-6 (3.65m³/hr)
- Lambala RGC (Luuka district): JTB-8 (1.2m³/hr)
- Kameke RGC (Pallisa district): JTB-11 (7.2m³/hr), JTB-12 (1.8m³/hr)
- Kidetok RGC (Serere district): JTB-17 (7.2m³/hr), JTB-18 (13.2m³/hr), JTB-19 (1.8m³/hr)

These boreholes are considered as the important water sources for the respective target RGCs, and planned to be used as one of the water sources for the target RGCs. The MOWE promised to secure the use of the above boreholes as the water sources of the Project in case the respective RGCs are selected for the implementation.

7. Water Quality Standard to be Applied

According to Water Supply Design Manual (2nd Edition), the water quality standards shall conform to the Uganda Standard (US201: 2008) of the Uganda National Bureau of Standards (UNBS). Since the said standard was revised as US EAS 12 dated October 15, 2014, this revised standard will be applied for the Project.

8. Requested Equipment

The MOWE submitted the updated list of the equipment requested to be procured under the Project as per Appendix-1 attached hereto. OYO-TECI will bring it to Japan for the further study on the procurement component.

Appendix-1: List of Requested Equipment Submitted by MOWE

Appendix-2: Plan of Target RGCs Indicating Boundaries Agreed with Local Administrations

Table 1 Interim Results of Field Survey

No.	Code	Name	District	Population (2015)	Pop. Growth Rate (%)	Population (2022)	Functioning Boreholes	Shallow Wells	Protected Springs	Public School	Private School	Admin Facilities	Business Facilities	JICA Boreholes No. (Safe Yield m ³ /h)	Step Drawdown Tests No. (Safe Yield m ³ /h)
1	I-1	Nabliende B.	Iganga	13,630	2.95	16,706	10	4	0	3	5	4	210	2 (0)	5 (2.4, <2...)
2	I-2	Nanungalwe	Iganga	19,884	2.95	24,372	13	8	0	3	5	6	274		3 (2.5, <2...)
3	I-3	Nambale	Iganga	1,520	2.95	1,863	2	0	0	1	4	2	31		2 (<2...)
4	I-6	Lambala	Luuka	1,496	2.20	1,742	2	3	0	1	3	1	44	2 (1.2, 0.3)	2 (<2...)
5	I-7	Naigobya	Luuka	1,469	2.20	1,711	3	2	0	1	4	2	16	2 (3.7, 0)	2 (2.2, 2.2)
6	I-8	Bussesa	Iganga	6,135	2.95	7,520	7	5	0	4	4	4	48		5 (3.7, 2.3, <2...)
7	I-9	Kyanvuma	Luuka	2,772	2.20	3,228	3	3	0	1	5	2	182		2 (7.5, <2)
8	I-10	Nakivumbi	Iganga	2,850	2.95	3,493	5	2	3	3	1	2	88		1 (<2)
9	I-11	Nondwe	Iganga	4,369	2.95	5,355	2	1	0	1	7	2	86		2 (2.1, <2)
10	P-2	Kasassira	Kibuku	4,369	3.81	5,676	4	0	0	2	1	4	50		4 (3.0, 2.6, <2...)
11	P-3	Kameke	Pallisa	1,221	3.43	1,546	4	0	0	0	4	2	36	2 (7.2, 1.8)	-
12	P-4	Kapala	Pallisa	2,160	3.43	2,735	2	2	0	3	4	4	50		3 (5.2, 3.4, <2)
13	P-5	Buseta	Kibuku	1,752	3.81	2,276	4	1	0	0	5	2	71		5 (8.0, 8.0, 7.0, 2.8, <2)
14	S-1	Kideok	Serere	3,020	3.95	3,961	10	1	0	2	5	1	50	3 (13.2, 7.2, 1.8)	-
15	S-2	Tubur	Soroti	1,568	3.58	2,006	0	0	0	2	5	3	61		1 (<2)
16	S-3	Acuna	Soroti	1,032	3.58	1,320	1	0	0	0	2	1	19	1 (0.3)	0 (...)

Notes: The values and figures on the above table are tentative worked out based on the interim results of the field survey, and may be changed and modified in the final results.

APPENDIX-1

List of Requested Equipment Submitted by MOWE

AM

NUMBER OF REQUESTED EQUIPMENT

S/No.	Equipment	District/Ministry						
		Soroti	Serere	Pallisa	Kibuku	Iganga	Luuka	Rural water supply and Sanitation Department
1	4X4 Wagons							2
2	4X4 Double Cabin Pickups		1	1				1
3	Mobile Water Quality Kits	1	1	1	1	1	1	1
4	GPS Receivers	1	1	1	1	1	1	1
5	Computers and Accessories	1	1	1	1	1	1	1
6	Office furniture	1	1	1	1	1	1	1

DETAILS OF REQUESTED EQUIPMENT

S/No.	Equipment	Delivery site	Ownership	Purpose	Specification
1	4X4 Wagons	Ministry of Water and Environment, Kampala	Ministry of Water and Environment, Kampala (Principal Engineer and Senior Sociologist)	To be used by the project coordinator and the in charge of mobilization (station wagon required as they always move out with a team of project implementation team that calls for siting space)	<p>Year of manufacture: Above 2015</p> <p>Mechanical Specifications: 3.0 litre 4 cylinder in-line Turbo Diesel engine with intercooler, 16 valve Double Overhead Cam (DOHC) with Common Rail direct injection system. Max power of 127kW @ 3400rpm. Max torque of 410Nm @ 1600 - 2800rpm. Diesel fuel economy (L/100km) and CO2 emissions (g/km) - Combined ADR 81/02. Driveline - Fulltime 4WD with high-low ratio, 5-speed Electronically Controlled Automatic Transmission (ECT) with Artificial Intelligence (AI)</p> <p>Brakes and Suspension: Brakes - power assisted ventilated front and rear disc brakes Anti-lock Braking System (ABS) with Electronic Brake-force Distribution (EBD), Brake Assist (BA), Vehicle Stability Control (VSC), Active Traction Control (A-TRC), Hill-start Assist Control (HAC), Downhill Assist Control (DAC) and Trailer Sway Control (TSC). Front suspension fully independent double wishbone with coil springs and stabilizer bar; rear suspension 4 link rigid axle with lateral control rod, coil springs and stabilizer bar. Kinetic Dynamic Suspension System (KDSS)</p> <p>Exterior features: 7.5J x 18" Alloy wheels with 265/60R18 steel belted radial ply tyres, full size spare tyre stored under floor.</p>

S/No.	Equipment	Delivery site	Ownership	Purpose	Specification
					<p>Headlights - High Intensity Discharge (HID) lights with LED low beam with pop-up headlight cleaners, LED Daytime Running Lights (DRL) and fog lights in lower bumper. Body coloured front bumper and exterior door handles, front grille with chrome accents. Body coloured electric retractable heated exterior rear view mirrors with side indicators. Acoustic windscreen and front side glass green tinted with UV reduction, rear side and rear dark grey privacy glass. Roof Rails - Black painted. Side steps. Windscreen wipers - Variable intermittent and mist functions</p> <p>Interior Features and Convenience: Front seats with driver's 8-way and passenger 4-way power adjustment, drivers power lumbar function; driver and passenger seat heaters. 2nd row seats 60/40 split fold, slide, recline and walk-in functions; 3rd row 50/50 split fold, manual fold down. Variable Flow Control (VFC) road speed sensitive power-assisted rack and pinion steering. Minimum turning circle 11.6m with 3 turns lock to lock. 4-spoke leather covered steering wheel with audio, Multi-information Display, Bluetooth and wide view monitor controls. Triple zone climate control air conditioning with separate driver, front passenger and 2nd row seat controls and clean air filter. Meters - Two ring style with speedometer, tachometer, fuel gauge and LCD Multi-Information Display (MID). 4.2" TFT Multi-Information Display (MID) with outside temperature, cruising range, multiple fuel consumption readings, ave speed and elapsed run time. Cruise control. Overhead console with sunglass holder and conversation mirror. Interior rear view mirror with day/night anti-glare function. Door pockets with bottle holders, seatback pockets, cup holders, glove box, front storage tray. Luggage area with removable tonneau cover. Side opening lift-up rear door with separately opening glass hatch</p> <p>Audio: Display audio with AM/FM radio and single disc in-dash MP3 CD player, Bluetooth phone and audio player connectivity with 9 speakers</p> <p>Safety and Security: Airbag system - Driver and passenger front (dual stage for driver), driver's knee, front seat side, front/2nd/3rd row curtain shield airbags. Engine immobilizer and alarm system. Front seat belts: 2x3-point, ELR front seat belts with pre-tensioners and force limiters. Height adjustable seat belt anchors. Rear seat belts: 2x3-point ALR/ELR with height adjustable seat belt anchors and 1x3 point ELR 2nd row and 2x3 point ELR 3rd row seat belts.</p>

1.3

S/No.	Equipment	Delivery site	Ownership	Purpose	Specification
2	4X4 Double Cabin Pickups	Ministry of Water and Environment, Kampala	Ministry of Water and Environment, Kampala (Senior Engineer/senior hydrogeologist, District Water Officers)	To be used by the project supervisor from the Ministry and the Districts. (Double cabin required to carry along the field equipment)	<p>Smart key system with front door and luggage door touch sensors Reversing camera (display in audio) with guide lines moving, with a wide view front and side monitor. Fire extinguisher of Compact 1.0kg dry powder extinguisher, with mounting bracket. Refillable and meets AS/NZS 1841.5 standards. First Aid Kit with Personal first aid kit for first response and minor injuries</p> <p>Dimensions: Overall length - 4760mm / width-1885mm / height-1890mm / wheelbase- 2790mm. Gross vehicle weight -2990kg. Kerb weight - 2315Kg Minimum- 2365 Kg Maximum. Towing capacity kg - (750 un-braked / 2500 braked). Luggage capacity - litres (2nd & 3rd seats up / 3rd row down / 2nd & 3rd row down / 2nd & 3rd row down to roof) -104 / 553 / 974 / 1833. Satellite Navigation package - includes AVN JBL 14 speaker audio system, AM/FM Diversity, SUNA Traffic and DAB antenna</p> <p>Year of manufacture: Above 2015</p> <p>Type: Right Hand Drive 4wheel drive(part time) Double cabin pick up, Laminated wind screen, 4 Doors, 5 seater including driver (Front Separate seats), all seats fitted with seat belts, front and rear head rests, Length (5330 mm), Width (1855 mm), Over height (1834 mm) Wheelbase (3085mm).</p> <p>ENGINE Type: Variable Nozzle Turbo charger diesel engine with intercooler and high altitude compensator, EGR, Start- Stop system, Roller Rocker Arm with valve lash adjuster, 4 Cylinders, 2800cc, 177PS, 420Nm, 1400-2600rpm. Water cooled heavy duty tropicalized radiator</p> <p>FUEL SYSTEM: Diesel, GD, Fuel Injection System, Tank Capacity: At least 80 Litres</p> <p>TRANSMISSION: Manual Floor Shift; 6 Speed Manual Transmission and One reverse gear with low gear 4x4 Transfer case. Part time 4 WD with floor mounted shift selector and Automatic front free wheel hubs Rear axle fitted with slip differential or differential lock. Steering. Power Steering, Leather Wrapped wheel Tyres Minimum size: R17 Ply Rating: Tubeless, Sport rims. One spare tyre complete with rim</p> <p>SUSPENSION: Heavy Duty Suspension- Dynamic control suitable for Uganda. Front: Heavy Duty double wishbone or coil spring with telescope shock absorbers. Rear: Heavy duty leaf springs or heavy duty coil springs with stabilizer bar and telescopic shock absorbers</p> <p>Brakes: Front; Ventilated Discs, Rear; Ventilated Discs/ drums, EBD</p>

1.4

S/No.	Equipment	Delivery site	Ownership	Purpose	Specification
3	Mobile Water Quality Kits	Ministry of Water and Environment, Kampala	Ministry of Water and Environment, Kampala (District water officers/system operators)	To be used by the project implementation team for monitoring of the water quality.	<p>system, ABS Braking system.</p> <p>Accessories: Transfer Case protector, Air Conditioner. Dual ventilation options (Hot and Cold). Air cleaner/ cyclone type, Power steering, Power Windows, Power Mirrors, Radio/ CD Player MP-3, 4 speakers, Tilt steering provision, 3rd Rear brake light, Fog lights, Sun visor(2 Nos), Side impact beam, Front & Rear mud guards, Heater & Cooling Boots ventilator, Driving Mirror, Side Mirrors (2 Nos), Spare Wheel, Modern tool kit& Jack.</p> <p>Safety and Security: Power locking system, Traction control, Hill assisted control, trailer sway control, Air bag (7 No.s), Key less entry, Vehicle Immobilizer, Fire extinguisher of Compact 1.0kg dry powder extinguisher, with mounting bracket. Refillable and meets AS/NZS 1841.5 standards, Reversing camera (display in audio) with guide lines moving, with a wide view front and side monitor, First Aid Kit with Personal first aid kit for first response and minor injuries, Car Tracking System.</p> <p>Extras: Bull Bar, Roll Bar, Cabin Tray</p> <p>Manuals: Operators manual- 1No.(Translated to English)</p> <p>Analyses for many physical (temperature, color, smell, taste and turbidity) , chemical (minerals, metals and chemicals) and microbiological (bacteria, viruses, protozoa, and worms) contaminants can be carried out in the field or in a temporary laboratory using specifically designed products that are portable and relatively easy to use. Portable water quality test kits should have the following characteristics: easy to use with simple instructions, small and easy to transport, no restrictions on air transport, fast results, limited requirement for distilled or deionized water, dilution not necessary, does not require calibration, robust (limited effects from UV light, shock, humidity or temperature), can test several parameters, easy to repair or replace, limited consumables or consumables are easy to obtain.</p>
4	GPS Receivers	Ministry of Water and Environment, Kampala	Ministry of Water and Environment,	To be used by the supervising team both at the	<p>GPS DESCRIPTION/ SPECIFICATIONS</p> <p>Card reader: Micro-SD</p> <p>Preloaded Maps: Full maps of the Uganda installed</p>

1-5

S/No.	Equipment	Delivery site	Ownership	Purpose	Specification
			Kampala	Ministry and District for reporting and data update.	Interface: USB Antenna: Built-in Light sensor: Yes Rechargeable battery: Yes (± 4 h) Assisted Satellite Navigation: Yes Display Type: TFT - Color - Yes Display Illumination: Yes Connector Type: USB Battery Type: Lithium ion Battery Run Time: Min 6hour(s) Included Accessories: Car power adapter, USB cable, Suction cup mount
5	Computers and Accessories	Ministry of Water and Environment, Kampala	Ministry of Water and Environment, Kampala (principal Engineer, Senior Engineer, hydrogeologist and District water officers)	To be used by the project implementation team to document project activities.	Laptop DESCRIPTION/SPECIFICATIONS Processor: 3rd Generation Intel Core i7-3520M Processor(2.90GHz 1600MHz 4MB) Software: Windows 8 64-bit Microsoft Office 2013 Video card: Intel HD Graphics 4000 Memory: 8.0GB PC3-12800 DDR3 SDRAM 1600 MHz Chipset: Mobile Intel® HM67 Express Chipset Hard disk drive: 1TB Solid State Drive (SSD) or 1TB SATA Audio: Integrated Sound Card line in, line out, microphone ports, Internal speakers Connectivity: Gigabit Ethernet, Blue tooth, Intel 802.11bg Wireless Ports: AC Adapter, Network connector (RJ45),USB 3.0 (2),USB 2.0 (1),USB 2.0/eSATA combo (1),Microphone jack, Headphone/speaker out,8-in-1 card reader,34 mm Express Card,15-pin VGA video connector, HDMI connector, Full size, spill-resistant keyboard with numeric keypad, mandatory backlit keyboard with numeric keypad, Standard Gesture Multi-Touchpad Keyboard: Full Size Pointing Device: Industry Standard Multi-touch 2 button touchpad Display: (12-14)" HD Glare with integrated camera 1600x900 Mouse: OEM mouse (from the same manufacturer) Battery: 6 Cell Lithium-Ion Warranty: Two Year warranty; One Year on Battery Carry Case: OEM Executive Carry Case (from the same manufacturer) Form Factor: Netbook Camera: Integrated HD 720p Camera

1-5

1-5

1-6

S/No.	Equipment	Delivery site	Ownership	Purpose	Specification
					Machine Type: Desktop (DT) Processor: Intel Core i5Processor 3M cache 2.40 GHz Software: Microsoft Windows 8 - X64, Microsoft Office 2013 Professional Monitor: 21" TFT Screen Chipset: Intel Q45 Chipset Memory: 8GB PC-8500 (1066MHz) DDR3 Storage: 1TB Solid State Drive (SSD) or 2TB SATA Optical drive: DVD+/-RW Drive, Dual Layer DVD Rewriter. Audio: Integrated Sound Card line in, line out, microphone ports, Internal speakers. Connectivity: Gigabit Ethernet, Blue tooth Graphics: Intel GMA 4500. Keyboard/Mouse: USB Full-size Keyboard with Fingerprint feature. Security: TPM 1.2 Chip Ports: 6 USB 2.0 ports, Integrated slot-in DVD reader/writer,7in1 card reader (MS, MSPro, SD, SDHC, SDXC, MMC, MMC Plus),Headphone,Mic,HDMI,1 serial,RJ45,Audio in/out Wireless Connectivity: 802.11 b/g/n Wi-Fi Power: 280W Active PFC Keyboard: Full Size Warranty: Two Years warranty UPS DESCRIPTION/SPECIFICATIONS Output: Output Power Capacity; 1980 Watts / 2200 VA, Max Configurable Power; 1980 Watts / 2200 VA, Nominal Output Voltage; 120V, Efficiency at Full Load; 95%, Output Frequency (sync to mains); 47 - 63 Hz for 50 Hz nominal, Waveform Type; Sinewave, Output Connections; (8) outlets (Battery Backup). Input: Nominal Input Voltage; 120V, Input Frequency; 50/60 Hz +/- 3 Hz (auto sensing), Input Connections; UK/English, Cord Length; 6 feet (1.83 meters), Input voltage range for main operations; 82 - 144V, Input voltage adjustable range for main operations; 75 -154V, Size; 8.0 x 28.0 x 15.0 - 15 x 35 x 20 cm. Batteries & Runtime: Battery Type; Maintenance-free sealed Lead-Acid battery with suspended electrolyte : leak proof, Typical recharge time; 24 hour(s). Communications & Management: Audible Alarm; No alarm, Control panel; LED Status display with On Line : On Battery, Warranty; Full Two Year Warranty.

1-6

1-6

8-7

1-7

S/No.	Equipment	Delivery site	Ownership	Purpose	Specification
					<p>Printer DESCRIPTION/SPECIFICATIONS Print speed, black (best quality mode): Up to 35 ppm First page out time: Less than 7 seconds Processor speed: 500 MHz Recommended monthly volume: maximum; 150,000 pages A4 Print quality / technology: Print technology; Laser, Print Resolution, black; 1200 x 1200 dpi. Paper handling / media: Paper trays, std; 2, Input capacity: 250 sheets, Output capacity: 150sheets face down, Duplex printing; Automatic, Media types; Paper (plain, letterhead, pre-punched, preprinted, recycled). Memory / print languages: Memory: 128MB, Memory Max: 1GB, Print languages: PCL 6, 5e, PDF and PostScript 3, Typefaces: 80. Connectivity: Connectivity/interfaces: USB 2.0, 1 Gigabit Ethernet, Macintosh compatible: Yes, Print drivers: PCL 6, PCL 5e, PDF and PostScript 3. Power: Power Consumption: AC 220-240v 50/60Hz, Items in the box: Printer, power cord, printer software, documentation, black cartridge Dimensions / weight / warranty: Warranty: Two-year warranty</p> <p>SCANNER DESCRIPTION/ SPECIFICATIONS Scan type: Flatbed, ADF Scan technology: Charge Coupled Device (CCD), Light source (scanning): Cold Cathode Fluorescent Lamp (CCFL), Scan resolution: optical: Up to 600 dpi, hardware: Up to 600 x 600 dpi, Output resolution dpi settings: 75, 100, 150, 200, 240, 300, 400, 500, 600, Bit depth/Grayscale levels: 48-bit internal/24-bit external/256 grayscale levels, Color scanning: Yes, Duplex ADF scanning: Yes, Standard connectivity: 1 USB (2.0/3.0), Digital sending standard features: Scan to folder, scan to email, scan to copy, scan to application, Multi-feed detection: Yes, Duty cycle (daily): Up to 5000 pages per day, Media types: Paper (plain, inkjet, photo), envelopes, cards (index, greeting), Scan file formats: PDF (formatted Text and Graphics, normal with images, searchable image over text, MRC, PDF/A), TIFF (single page, multi-page, compressed), JPG, BMP, PNG, DOC, RTE, TXT, WPD, XLS, HTM, OPF, UNICODE, XML, XPS, Scan speed ADF: Up to 50 ppm/100 ipm (letter, color, black and white, grayscale, 200 dpi), up to 40 ppm/80 ipm (black and white, grayscale, 300 dpi), up to 40 ppm/66 ipm (color, 300 dpi),</p>

8-7

8-8

S/No.	Equipment	Delivery site	Ownership	Purpose	Specification
6	Office furniture	Ministry of Water and Environment, Kampala	Ministry of Water and Environment, Kampala (RGC operators)	To be used by the Ministry and district implementation team to carry out day to day project activities.	<p>Scan size (ADF): Minimum: 2.75 x 5.8 in (70 x 148 mm), Maximum: 11.7 x 34 in (300 x 864 mm), Paper sizes supported (ADF): Letter, legal, executive, A3, A4, A5, A6, US check, long paper up to 864 mm (34 in), Automatic document feeder capacity: 200 sheets, Compatible operating systems: Microsoft, Linux, and Mac OS.</p> <p>Office Chairs, office desks, filing cabinets, office shelves, meeting tables and arm chairs.</p>

APPENDIX-2

Plan of Target RGCs Indicating Boundaries Agreed with Local Administrations

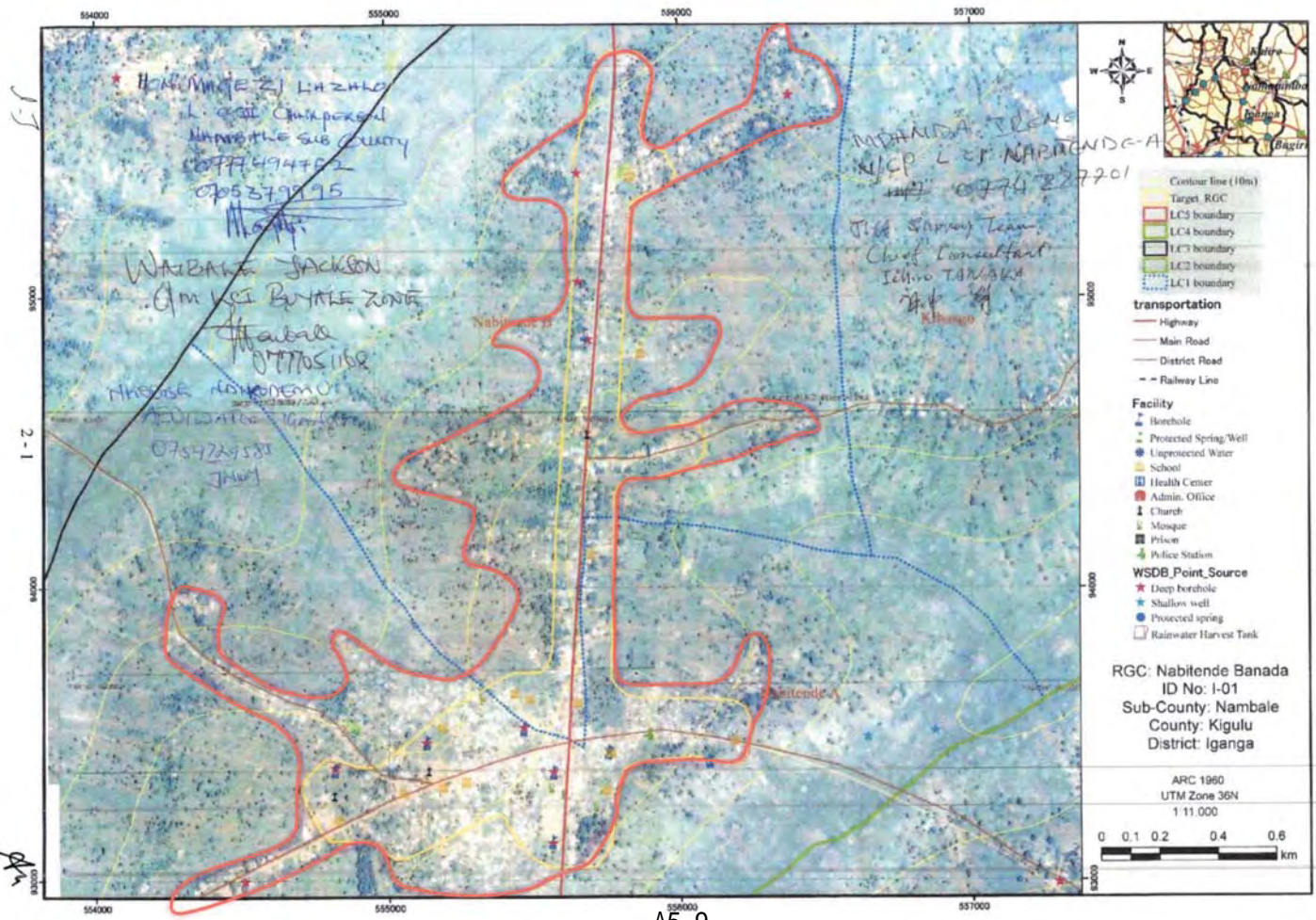

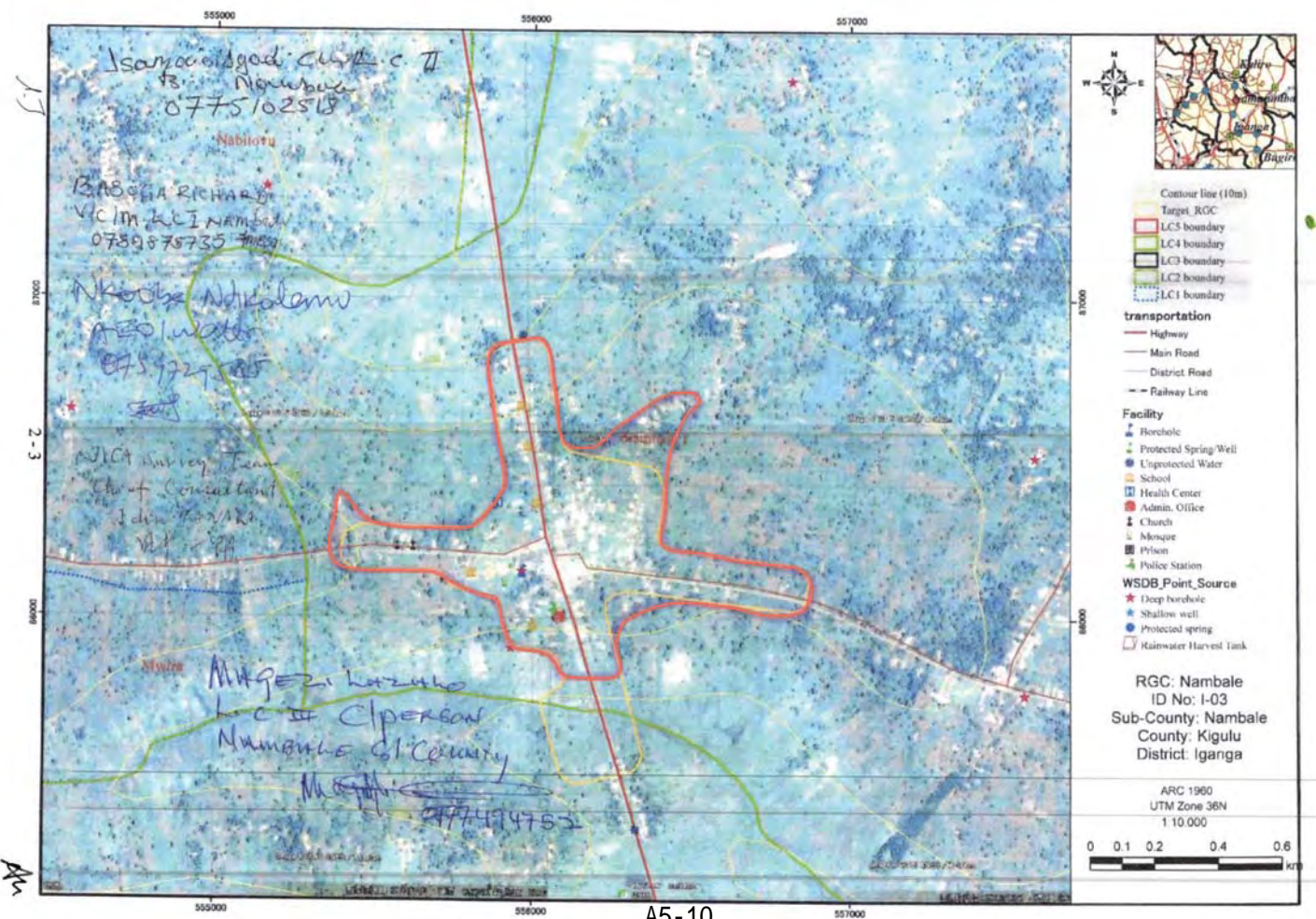
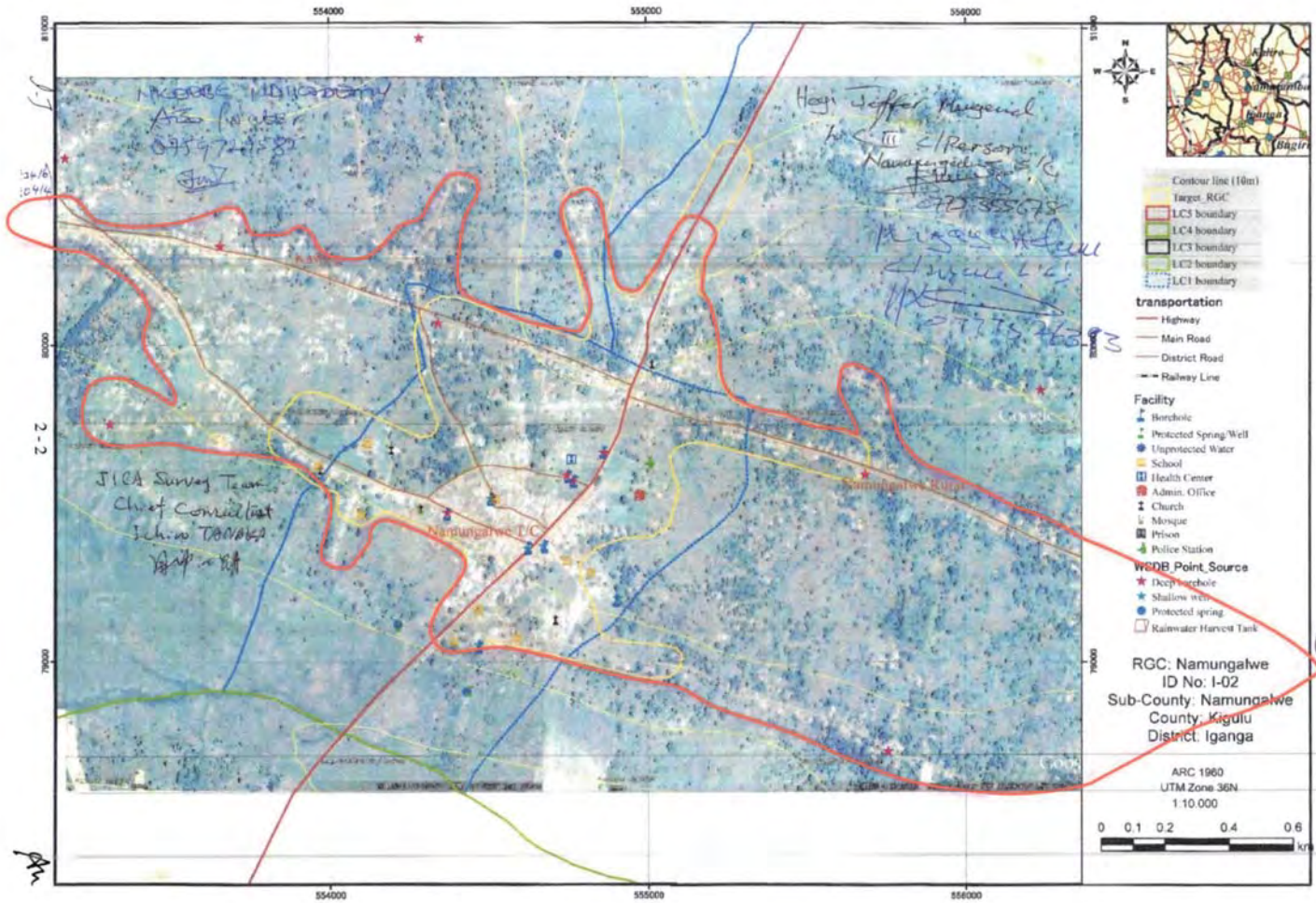

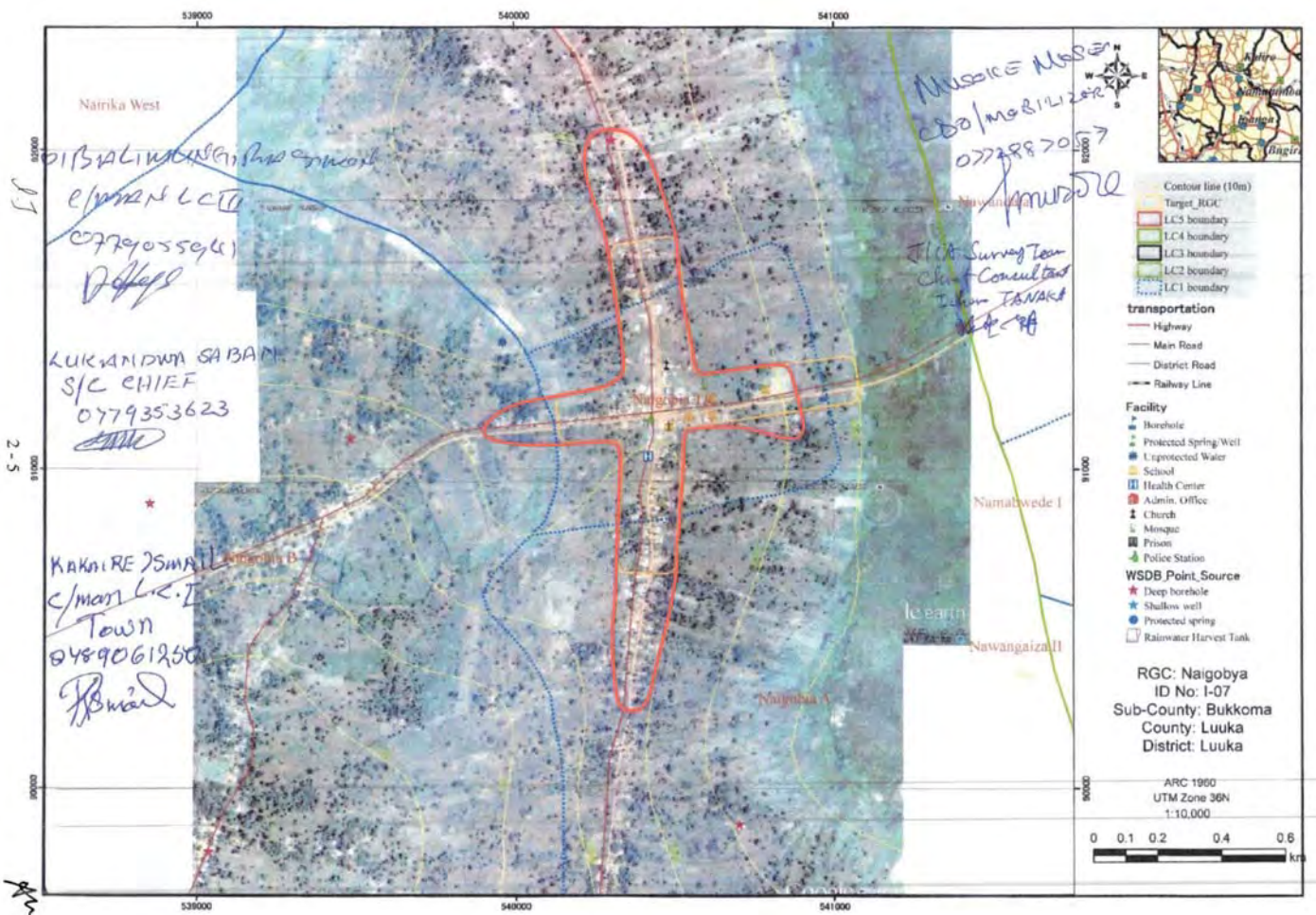
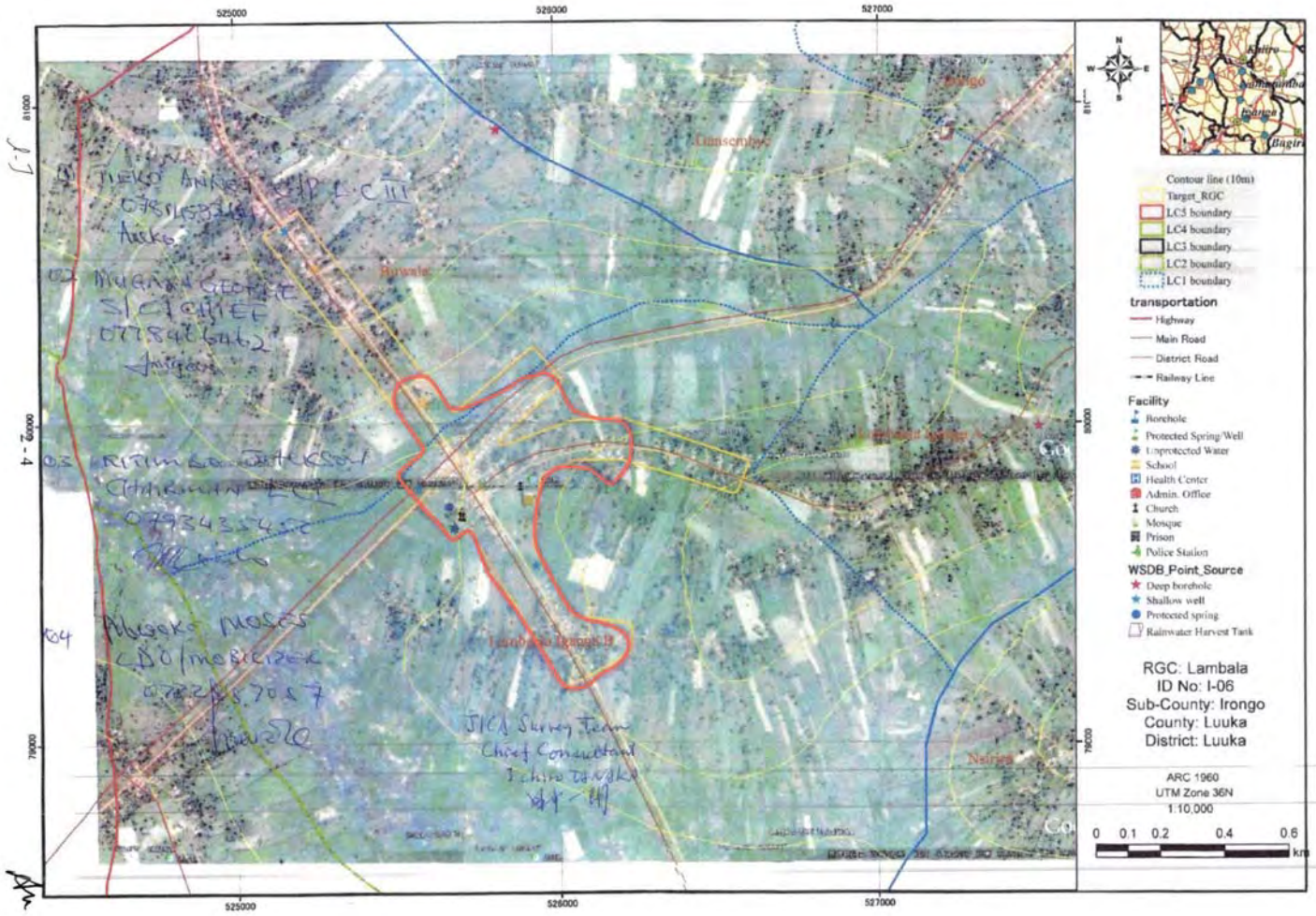

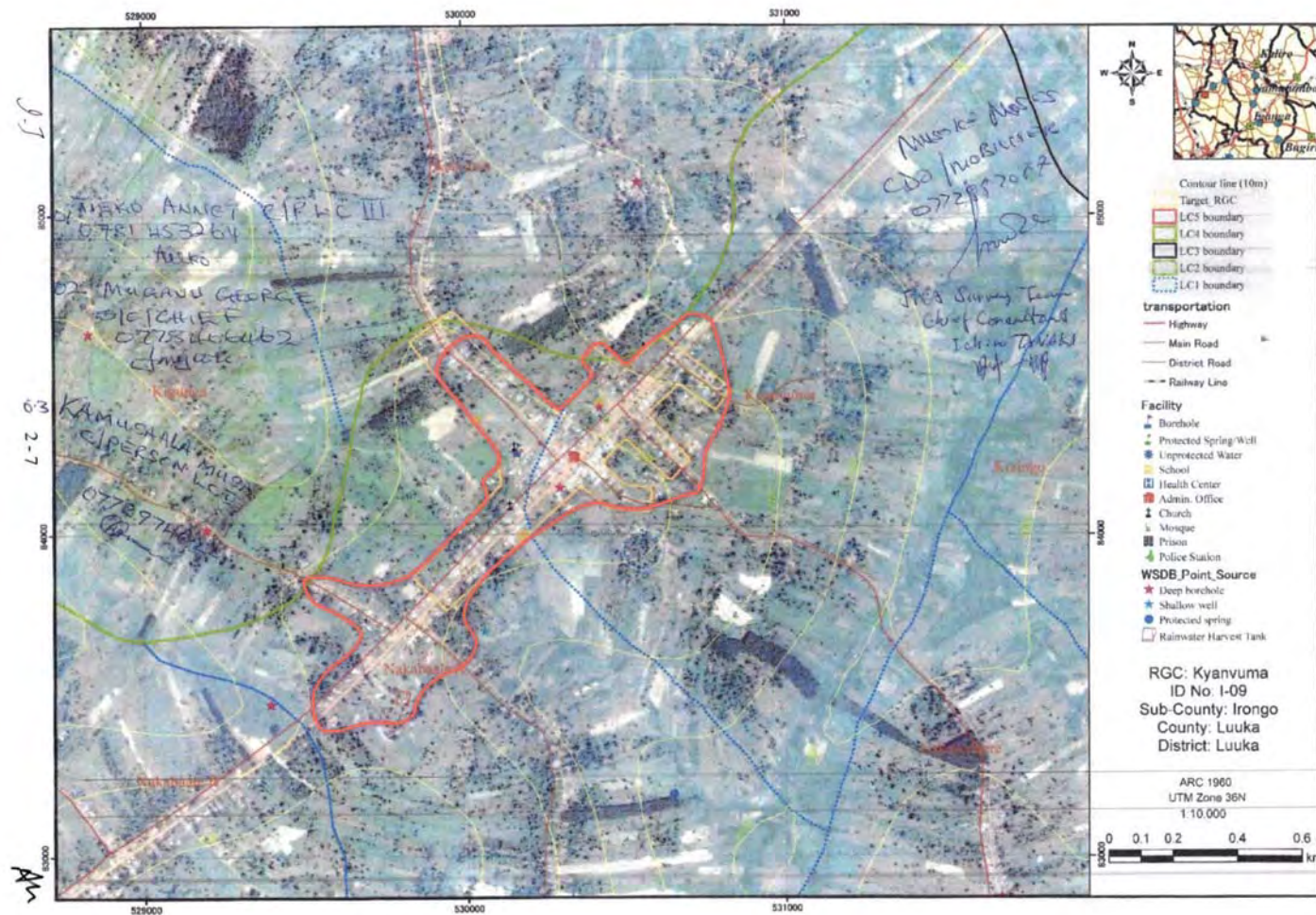
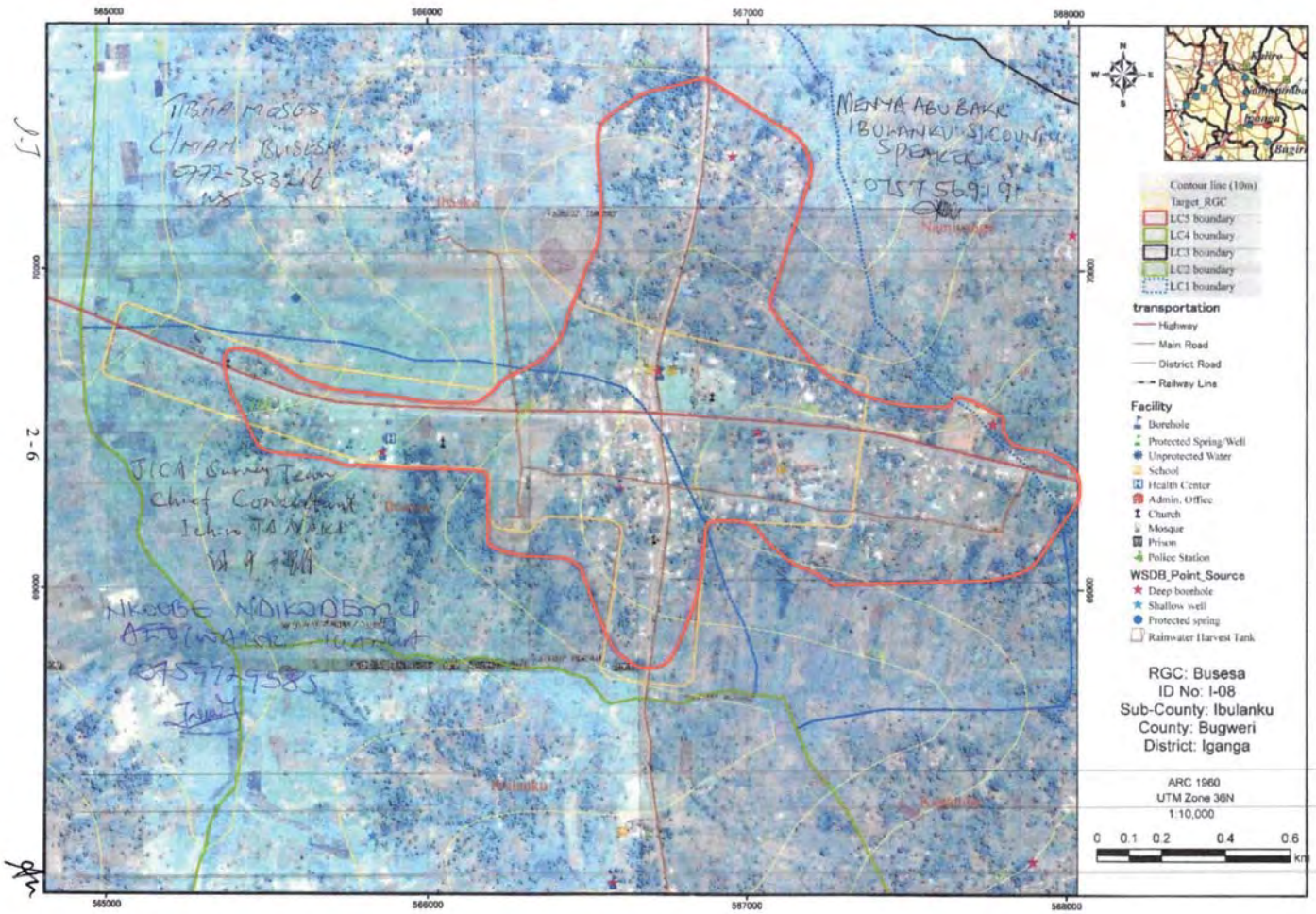

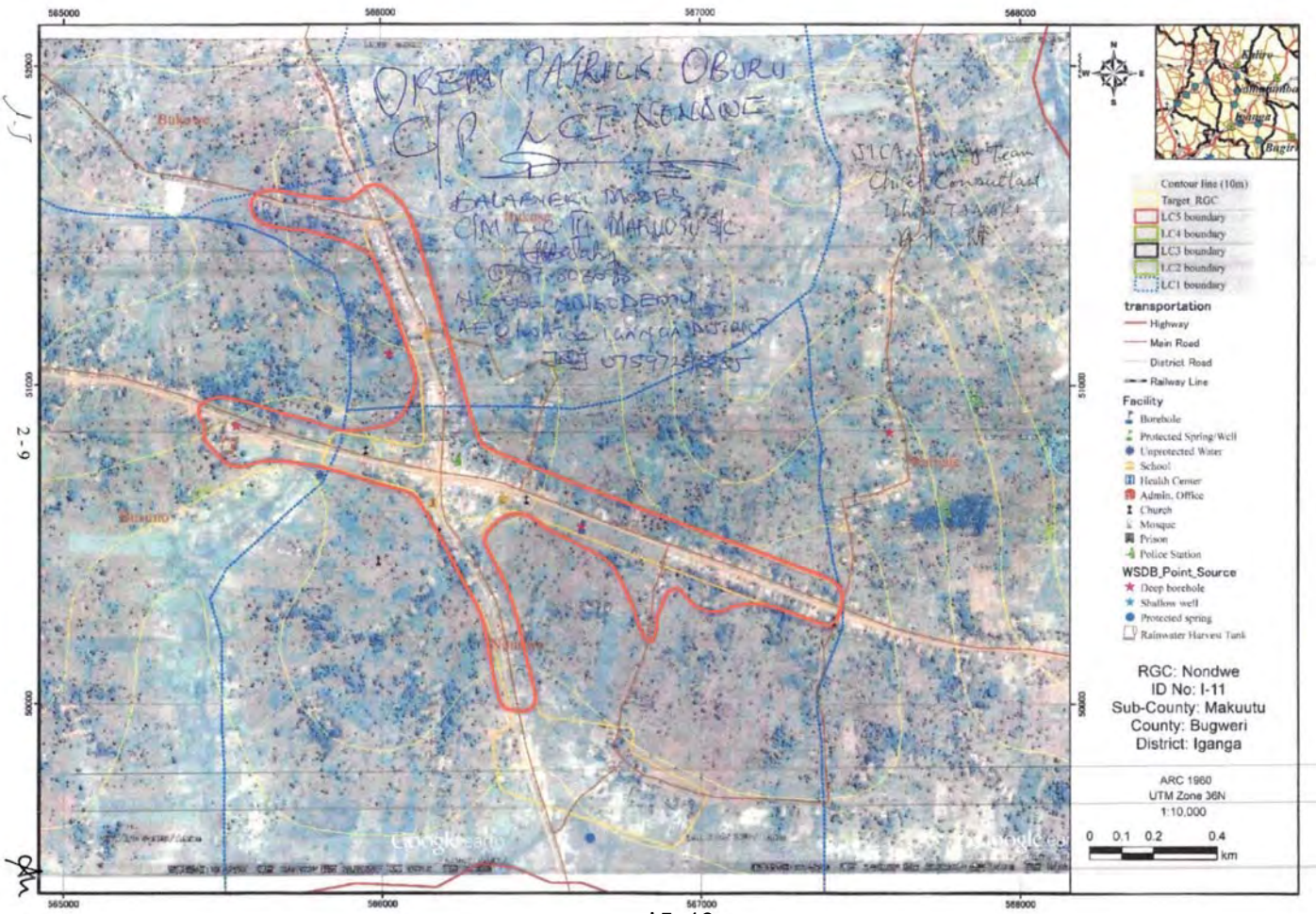
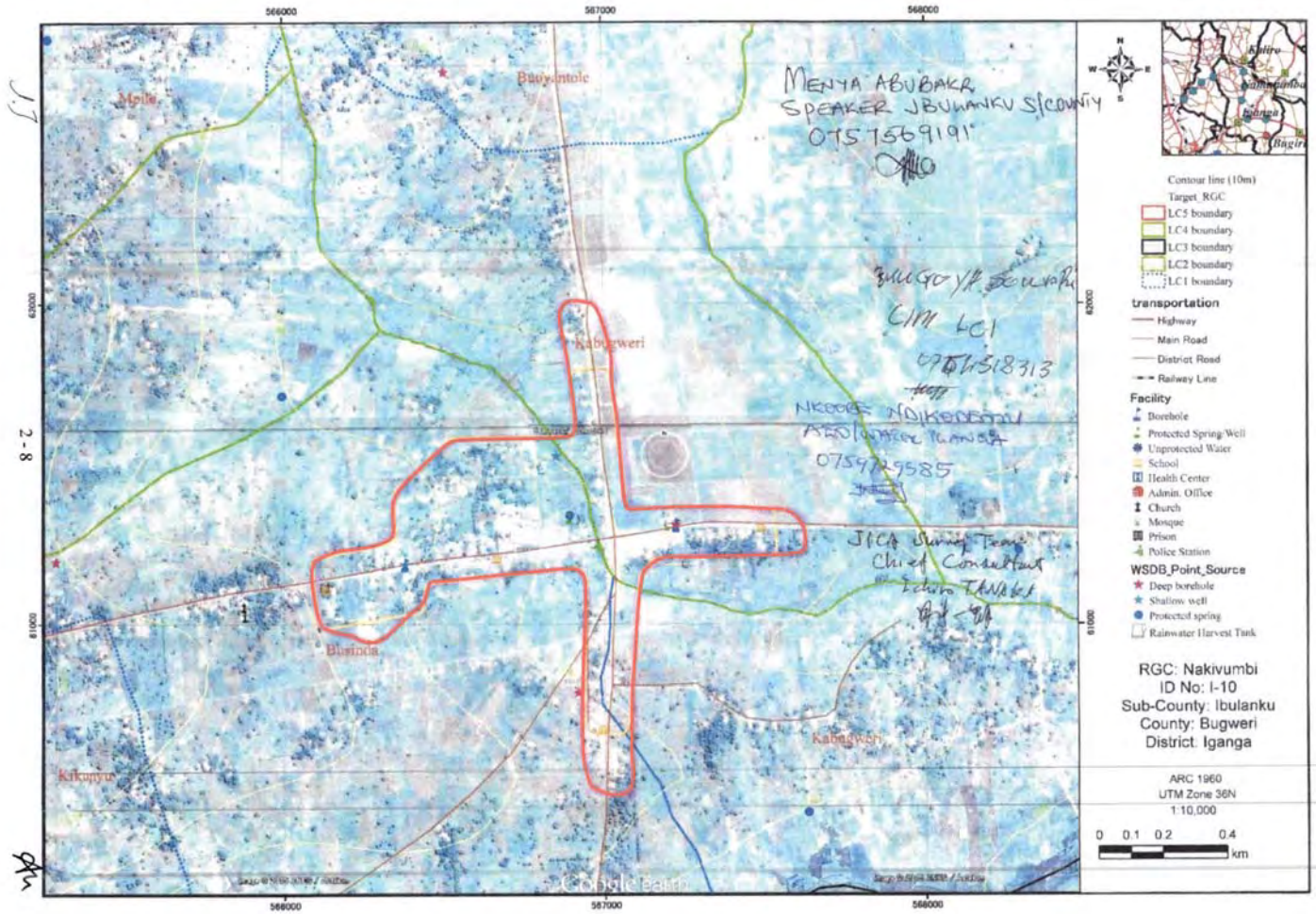

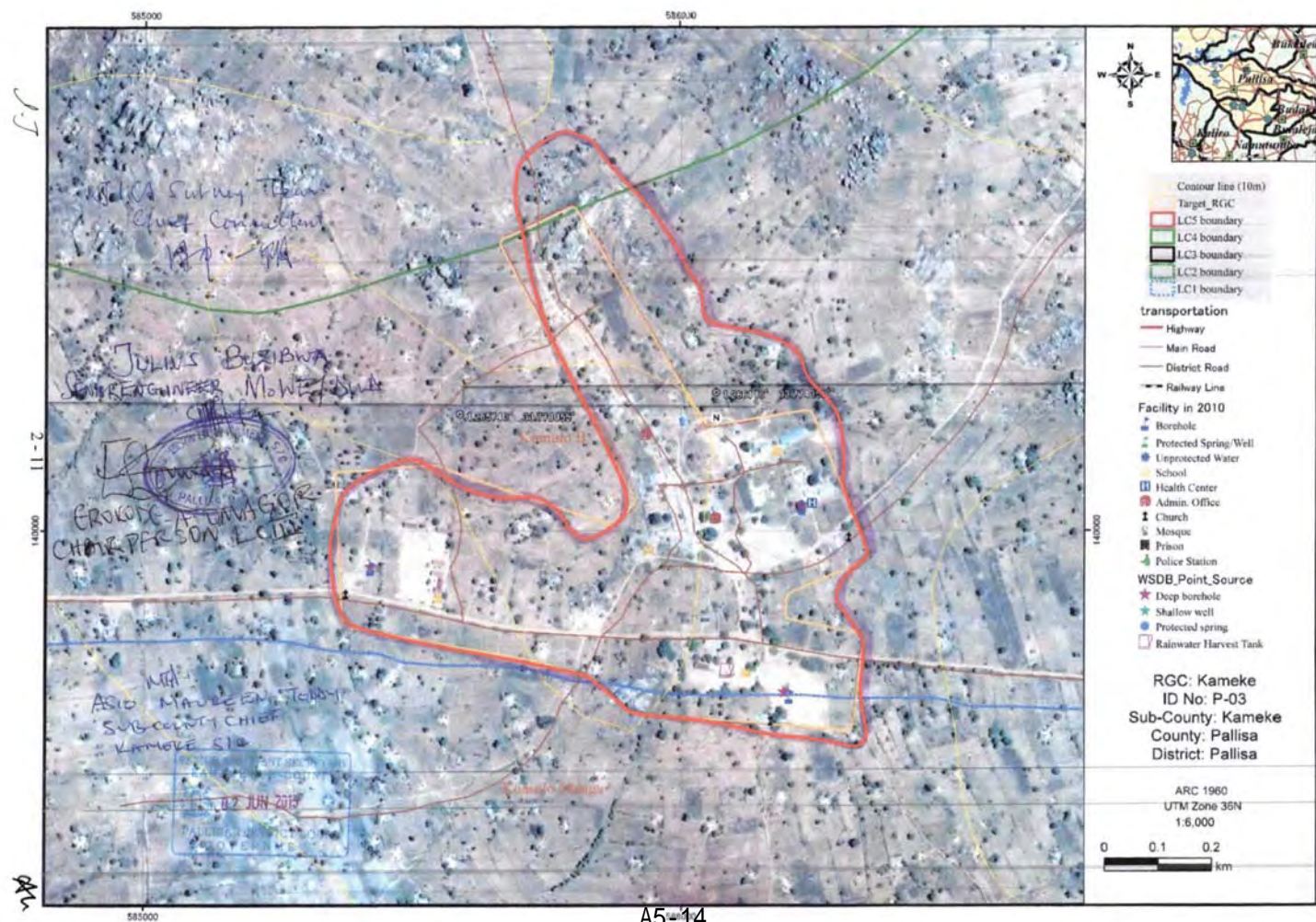
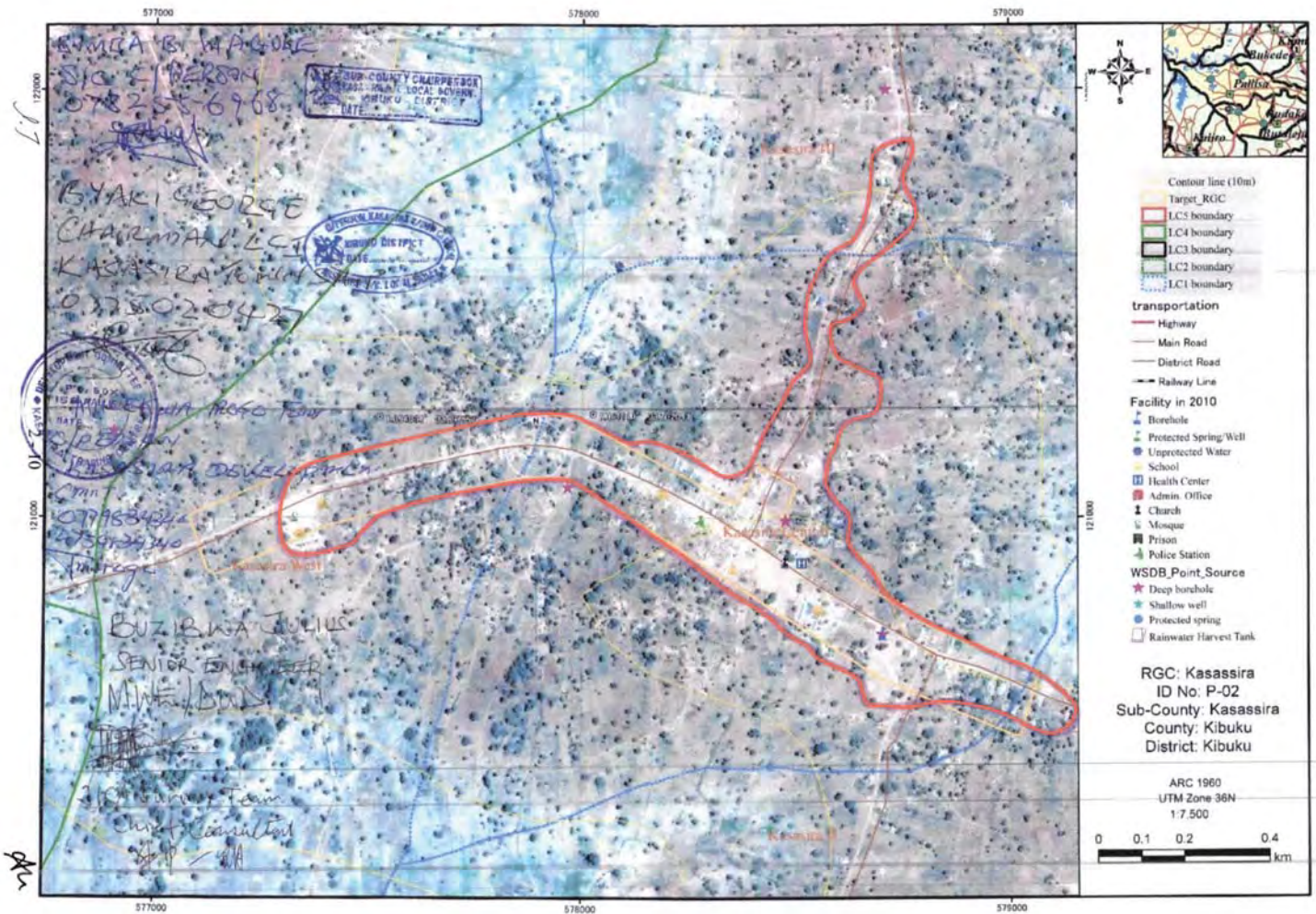

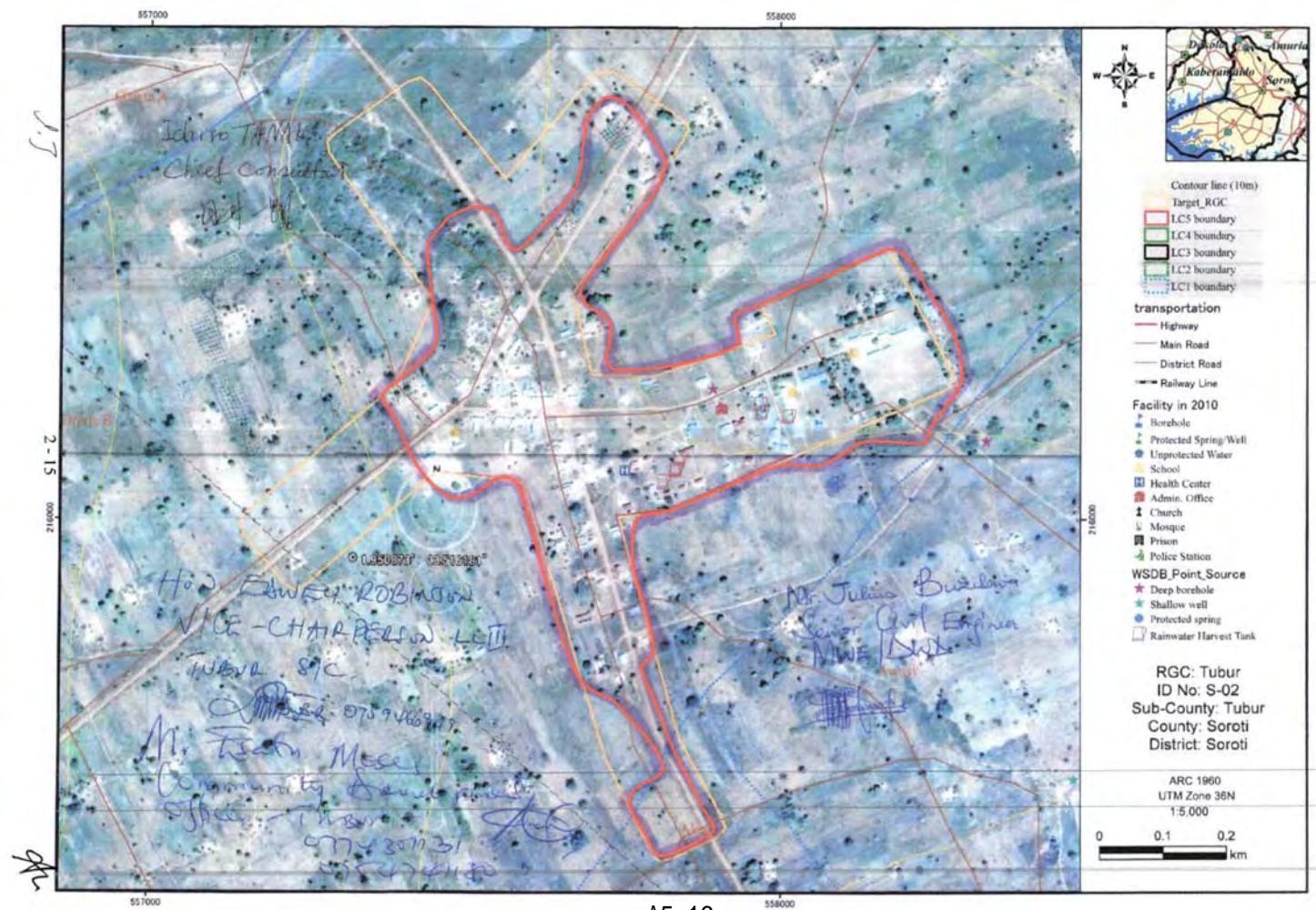
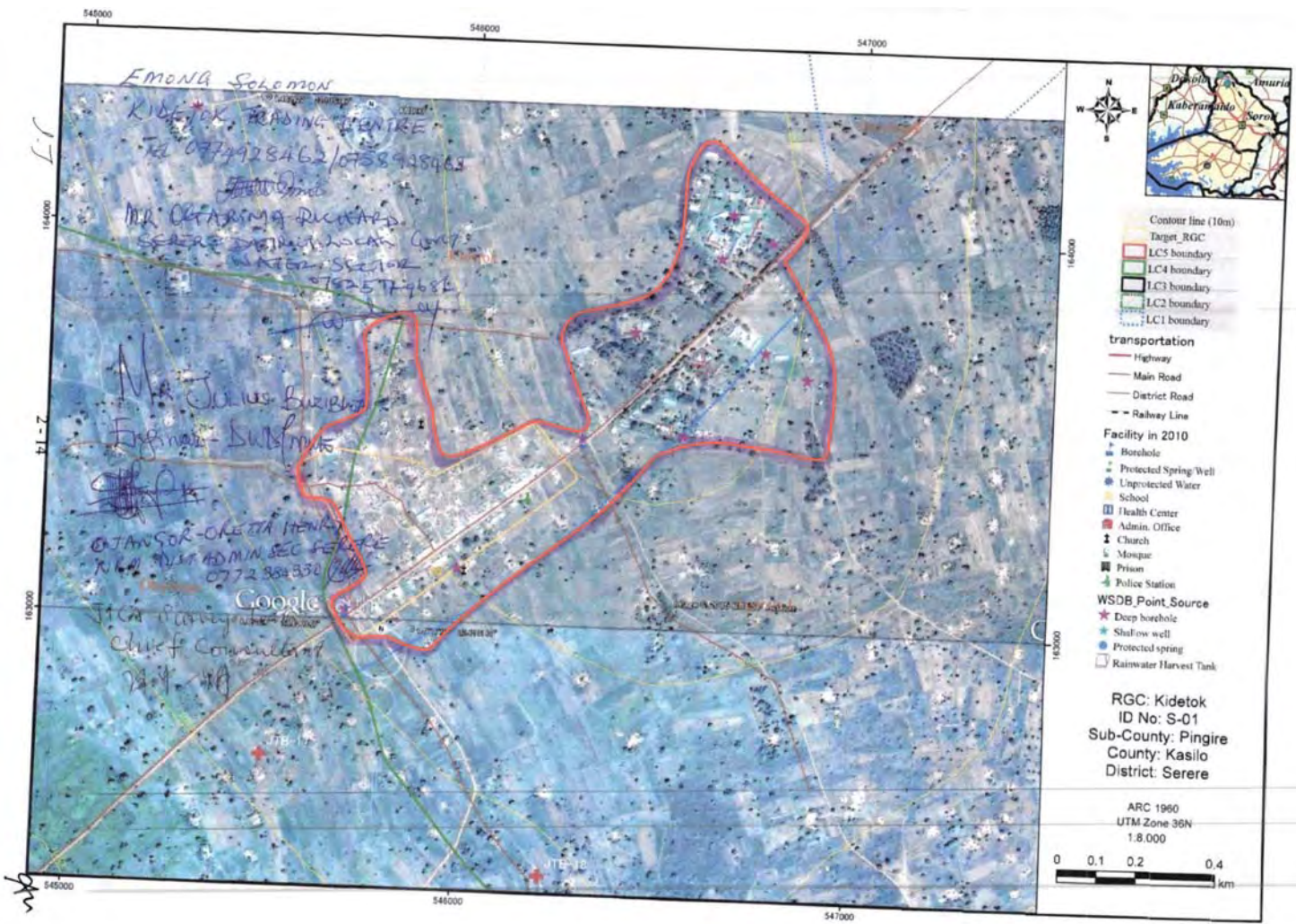

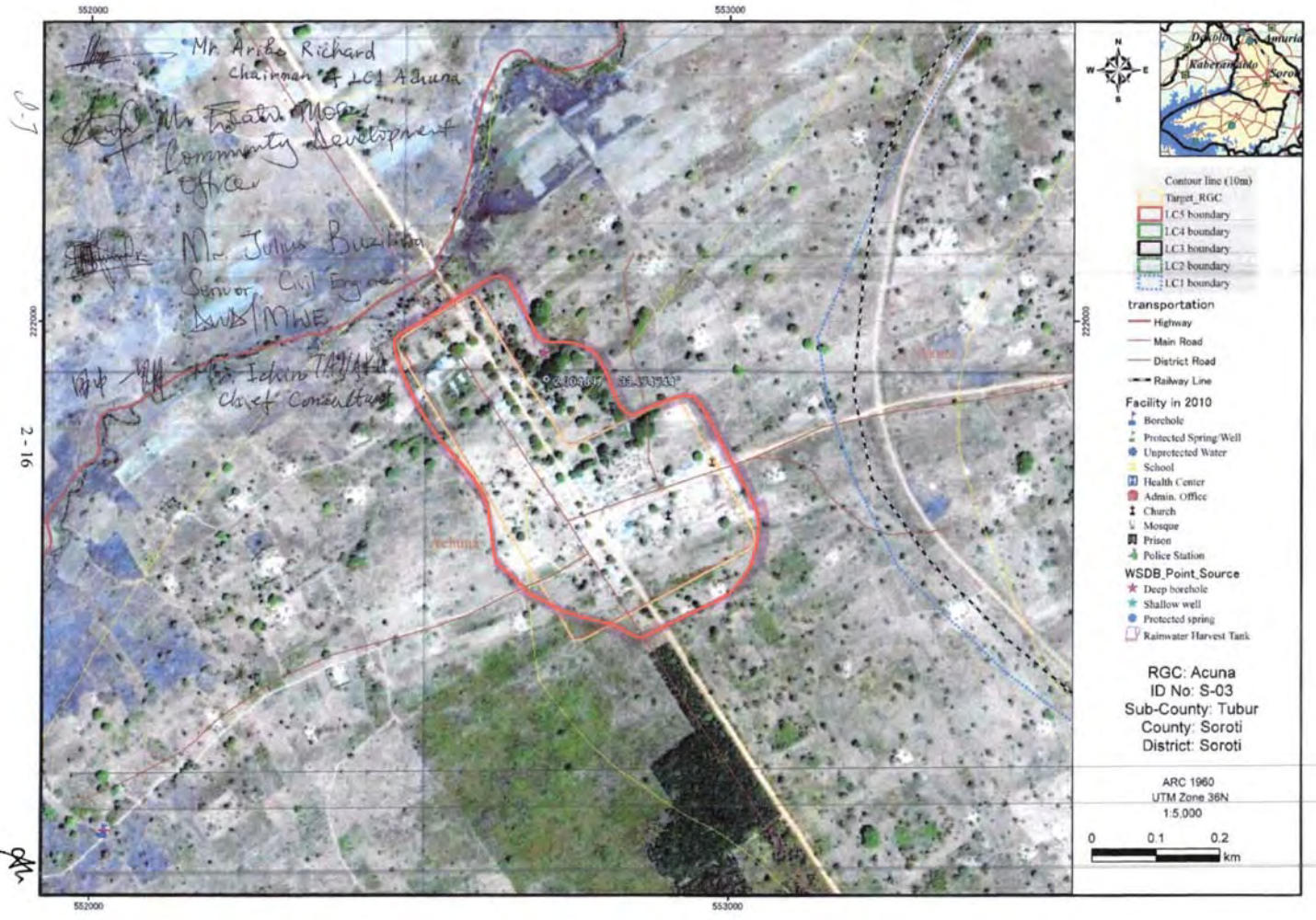

TECHNICAL NOTES (No.2)
ON
THE SECOND FIELD SURVEY OF THE PREPARATORY SURVEY
ON
THE PROJECT FOR RURAL WATER SUPPLY PHASE III
IN
LAKE KYOGA BASIN, EASTERN UGANDA,
IN
THE REPUBLIC OF UGANDA

Based on the Minutes of Discussions (hereinafter referred to as "M/D") on the Preparatory Survey on the Project for Rural Water Supply Phase III in Lake Kyoga Basin, Eastern Uganda, in the Republic of Uganda (hereinafter referred to as "the Project") signed on October 14, 2015 between the Preparatory Survey Team (hereinafter referred to as "the Team") of Japan International Cooperation Agency (hereinafter referred to as "JICA") and Ministry of Water and Environment (hereinafter referred to as "MOWE"), of the Government of the Republic of Uganda, the consultant members of the Team (hereinafter referred to as "OYO-TECI") had a series of discussions on the process of pre-sensitization activities, etc. from October 15, 2015 to date.

As a result of the discussions and the surveys, both sides confirmed the technical conditions described as per Attachment.

Kampala, October 27, 2015

for 伊藤 伸一
Ichiro TANAKA
Chief Consultant,
JICA Preparatory Survey Team for
the Project for Rural Water Supply
Phase III in Lake Kyoga Basin,
Eastern Uganda, in the Republic of
Uganda

Ahabisi
Eng. Aaron M. Kabirizi
Director,
Directorate of Water Development,
Ministry of Water and Environment,
Government of the Republic of
Uganda

ATTACHMENT

Both parties agreed upon and confirmed the following items.

1. Pre-sensitization Activities for Selected RGCs

Pre-sensitization activities will be conducted as agreed in the M/D signed on October 14, 2015 for the selected 12 RGCs as listed below.

Table 1 Selected RGCs

No.	RGC	Code	District	County	Sub-county	UTM-E	UTM-N	Altitude (m)
1	Nambale	I-3	Iganga	Kigulu	Nambale	556076	86140	1109
2	Lambala	I-6	Luuka	Luuka	Irongo	525712	79878	1077
3	Naigobya	I-7	Luuka	Luuka	Bakooma	540456	91171	1073
4	Kyanvuma	I-9	Luuka	Luuka	Irongo	530321	84213	1129
5	Nondwe	I-11	Iganga	Bugweri	Makuutu	566172	50708	1221
6	Kasassira	P-2	Kibuku	Kibuku	Kasassira	578281	121015	1080
7	Kameke	P-3	Pallisa	Agule	Kameke	586003	139993	1123
8	Kapala	P-4	Pallisa	Agule	Gogonyo	568421	137778	1067
9	Buseta	P-5	Kibuku	Kibuku	Buseta	583724	119623	1069
10	Kridetok	S-1	Serere	Kasilo	Pingire	546298	163480	1103
11	Tubur	S-2	Soroti	Soroti	Tubur	557636	216178	1091
12	Acama	S-3	Soroti	Soroti	Tubur	552793	221674	1097

Prior to the commencement of the pre-sensitization activities, a series of discussions have been made between OYO-TECI and MOWE, and as a result of such discussions the Planning and Preparation Report for Pre-sensitization Activities for the Selected RGCs were prepared as per Appendix-1 of this Attachment. It is confirmed that the pre-sensitization activities would be conducted with the process and way of decision making as presented in this report with the primary responsibility of MOWE for the negotiation with stakeholders.

2. Required Resources for Pre-sensitization Activities

In order to facilitate the pre-sensitization activities one (1) local social specialist was hired by OYO-TECI including his transportation as agreed in the M/D signed on October 14, 2015, and the allowances for two (2) staff of MOWE will be provided by OYO-TECI.

In addition to the above in-put of resources, the local resources as presented in the table 2 are considered to be required for smooth implementation of the pre-sensitization process. According to this table, the required local resources are calculated to be 76m-d/RGC for explaining and organizing the consensus of the RGC community, reaching 912m-d for whole of the selected 12 RGCs.

Table 2 Resources Required for Pre-sensitization Activities per RGC

Resources covered by JICA	
Pre-Sensitization activities from the end of October to the middle of December	Consultant : One (1) Ugandan, One (1) Japanese
	Allowance for MOWE Representative : 80man-day (40 days x 2 persons)
	Transportation for MOWE Representative by the vehicle of the Team Stationery and photocopy of materials and handouts
Other Resources required	
Activities 1, 2 and 6	Not considered
Activity 3	DWO : 1 person
	CDO/HA : 1 person

	Transportation (by the vehicle of the Team)
	LC III Chairman : 1 person
	Sub-County Chief (allowance and mobilization expenses) : 1 person
	LC I Chairman : 3 persons
	WSC Members : 6 persons
	Refreshments : 16 persons
Consultative Meeting (allowance, transport and mobilization expenses)	RGC Representatives : 6 persons Supporters (DWO, CDO/HA, LC III Chairman, Sub-County Chief, etc.) : 6 persons
Activity 4	Same as Activity 3
Consultative Meeting (2)	Same as First Consultative Meeting
Activity 4 (2)	Same as Activity 3
Activity 5	Same as Activity 3

添付割愛

Activity No.	1	2	3	CM	4	CM (2)	4 (2)	5	6	Total	Unit
Stakeholders	-	-	1	-	1	-	1	1	-	4	Man-day
DWO	-	-	1	-	1	-	1	1	-	4	Man-day
CDO/HA	-	-	1	-	1	-	1	1	-	4	Man-day
LCIII Chairman	-	-	1	-	1	-	1	1	-	4	Man-day
Sub County	-	-	1	-	1	-	1	1	-	4	Man-day
LCI Chairman	-	-	3	-	3	-	3	3	-	12	Man-day
WSUC	-	-	6	-	6	-	6	6	-	24	Man-day
RGC Representatives	-	-	-	6	-	6	-	-	-	12	Man-day
Supporters	-	-	-	6	-	6	-	-	-	12	Man-day

76 man-day per IRGC

Note: CM: Consultative Meeting

It was agreed that the facilitation for the other resources required in the above Table 2 will be covered by MOWE considering the responsibility of this pre-sensitization.

Appendix-1: Planning and Preparation Report for Pre-sensitization Activities for the Selected RGCs, October 2015

TECHNICAL NOTES (No.3)
ON
THE SECOND FIELD SURVEY OF THE PREPARATORY SURVEY
ON
THE PROJECT FOR RURAL WATER SUPPLY PHASE III
IN
LAKE KYOGA BASIN, EASTERN UGANDA,
IN
THE REPUBLIC OF UGANDA

Based on the Minutes of Discussions (hereinafter referred to as “M/D”) on the Preparatory Survey on the Project for Rural Water Supply Phase III in Lake Kyoga Basin, Eastern Uganda, in the Republic of Uganda (hereinafter referred to as “the Project”) signed on October 14, 2015 between the Preparatory Survey Team (hereinafter referred to as “the Team”) of Japan International Cooperation Agency (hereinafter referred to as “JICA”) and Ministry of Water and Environment (hereinafter referred to as “MOWE”), of the Government of the Republic of Uganda, the consultant members of the Team (hereinafter referred to as “OYO-TECI”) had a series of discussions on the process of pre-sensitization activities, etc. from October 15, 2015, and Technical Notes (No.2) on the Second Field Survey of the Preparatory Survey on the Project for Rural Water Supply Phase III in Lake Kyoga Basin, Eastern Uganda, in the Republic of Uganda (hereinafter referred to as “T/N No.2”) was concluded on October 27, 2015.

MOWE and OYO-TECI conducted the pre-sensitization activities based on the T/N No.2, and both sides confirmed on the results of these activities as described in the Attachment.

Kampala, December 11, 2015

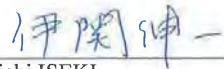

Shinichi ISEKI
Deputy Chief Consultant,
JICA Preparatory Survey Team for
the Project for Rural Water Supply
Phase III in Lake Kyoga Basin,
Eastern Uganda, in the Republic of
Uganda

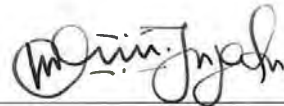

Eng. Joseph Oriono Eyatu
Commissioner
Rural Water Supply and Sanitation
Department
Directorate of Water Development,
Ministry of Water and Environment,
Government of the Republic of
Uganda

ATTACHMENT

Both parties agreed upon and confirmed the following items.

1. Completion of Pre-sensitization Activities for Selected RGCs

All the activities for the pre-sensitization of the selected 12 RGCs were conducted in accordance with the manners and procedures agreed in the T/N No.2 concluded on October 27, 2015, and completed on November 25, 2015 successfully as shown in the attached “Report on Pre-sensitization of the Selected 12 RGCs”.

2. Consensus on Acceptance of Surveys and Investigations for the Project

As a result of the pre-sensitization activities, the consensus of the communities of all the selected 12 RGCs were obtained for accepting the surveys and investigations required for the Project planning, and the Form of Acceptance was concluded and signed among the representatives of RGCs and the officials of the respective district and sub-county local governments.

Status of Acceptance in Selected 12 RGCs

No.	RGC	Code	District	County	Sub-county	Form of Acceptance
1	Nambale	I-3	Iganga	Kizulu	Nambale	Concluded
2	Lambala	J-6	Luuka	Luuka	Irongo	Concluded
3	Naigobya	I-7	Luuka	Luuka	Bukooma	Concluded
4	Kyanvuma	I-9	Luuka	Luuka	Irongo	Concluded
5	Nondwe	I-11	Iganga	Bugweri	Makuutu	Concluded
6	Kasassira	P-2	Kibuku	Kibuku	Kasassira	Concluded
7	Kameke	P-3	Pallisa	Agule	Kameke	Concluded
8	Kapala	P-4	Pallisa	Agule	Gogonyo	Concluded
9	Buseta	P-5	Kibuku	Kibuku	Buseta	Concluded
10	Kidetok	S-1	Serere	Kasilo	Pingire	Concluded
11	Tubur	S-2	Soroti	Soroti	Tubur	Concluded
12	Acuna	S-3	Soroti	Soroti	Tubur	Concluded

Appendix: Report on Pre-sensitization of the Selected 12 RGCs, December 2015





添付割愛

TECHNICAL NOTES (No.4)
ON
THE SECOND FIELD SURVEY OF THE PREPARATORY SURVEY
ON
THE PROJECT FOR RURAL WATER SUPPLY PHASE III
IN
LAKE KYOGA BASIN, EASTERN UGANDA,
IN
THE REPUBLIC OF UGANDA

Based on the Minutes of Discussions (hereinafter referred to as "M/D") on the Preparatory Survey on the Project for Rural Water Supply Phase III in Lake Kyoga Basin, Eastern Uganda, in the Republic of Uganda (hereinafter referred to as "the Project") signed on October 14, 2015 between the Preparatory Survey Team (hereinafter referred to as "the Team") of Japan International Cooperation Agency (hereinafter referred to as "JICA") and Ministry of Water and Environment (hereinafter referred to as "MOWE"), of the Government of the Republic of Uganda, the consultant members of the Team (hereinafter referred to as "OYO-TECI") had a series of discussions on the process of pre-sensitization activities, etc. from October 15, 2015, and Technical Notes (No.2) and (No.3) on the Second Field Survey of the Preparatory Survey on the Project for Rural Water Supply Phase III in Lake Kyoga Basin, Eastern Uganda, in the Republic of Uganda (hereinafter referred to as "T/N No.2") were concluded on October 27, 2015 and on December 11, 2015 respectively.

MOWE and OYO-TECI has conducted the field activities based on these M/D, T/N (No.2) and T/N (No.3), and both sides confirmed on the results of these activities as described in the Attachment.

Kampala, May 24, 2016

Ichiro TANAKA
Chief Consultant,
JICA Preparatory Survey Team for
the Project for Rural Water Supply
Phase III in Lake Kyoga Basin,
Eastern Uganda, in the Republic of
Uganda

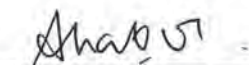
Eng. Aaron M. Kabirizi
Director,
Directorate of Water Development,
Ministry of Water and Environment,
Government of the Republic of
Uganda

1. Water Source

1.1. The result of test borehole drilling

Total of 20 test boreholes were drilled in and around the target 7 RGCs. According to the Minutes of Meeting signed on 14th October 2015, in 7 RGCs 2 test boreholes were drilled in each RGC at first. Then after the drilling result of the 14 numbers boreholes and discussing between MOWE and the Team, remaining 6 boreholes to be drilled were allocated 3 numbers each to Nondwe RGC and Kasassira RGC. The field work was done from 12th January to 24th April 2016. The result is shown in the following table.

Table 1 The Result of the Drilled Test Boreholes

Code	RGC	District	ID	DWD No.	UTM-E (m)	UTM-N (m)	Elevation (m)	Drilling Depth (m)	Static Water Level (m)	Safe Yield (m ³ /hr)
I-03	Nambale	Jganga	NBH-1	53149	557077	85941	1107	80.23	12.17	15.0
		Jganga	NBH-2	53150	556878	86027	1105	70.85	10.00	2.6
I-06	Lambala	Luuka	NBH-1	53198	525640	80002	1074	66.29	-1.30	28.0
		Luuka	NBH-2	53199	526675	80288	1084	66.01	-1.82	40.0
I-09	Kyanvuma	Luuka	NBH-1	53176	530037	84475	1123	73.42	9.45	2.0
		Luuka	NBH-2	53162	530220	84292	1119	74.75	10.50	0.5
I-11	Nondwe	Mayuge	NBH-1	53167	568597	50179	1185	102.52	2.20	3.1
		Jganga	NBH-2	53215	567999	52794	1157	61.40	6.40	1.0
		Mayuge	NBH-3	53213	568631	50187	1178	65.78	5.75	3.0
		Mayuge	NBH-4	53212	568579	50211	1176	83.30	1.90	9.0
		Jganga	NBH-5	53214	566769	51702	1185	65.16	14.02	0.52
P-02	Kasassira	Kibuku	NBH-1	53164	579005	120630	1077	109.78	6.00	0.8
		Kibuku	NBH-2	53165	578426	120888	1079	102.74	8.60	2.6
		Kibuku	NBH-3	53211	577717	121540	1068	61.37	6.00	0.5
		Kibuku	NBH-4	53200	579052	121584	1061	87.47	9.45	2.1
		Kibuku	NBH-5	53169	579028	121487	1065	83.22	10.30	2.0
P-04	Kapala	Pallisa	NBH-1	53148	566839	137935	1056	79.93	7.05	8.0
		Pallisa	NBH-2	53166	566703	137901	1052	79.27	6.85	2.6
P-05	Buseta	Kibuku	NBH-1	53168	582972	120041	1076	70.81	11.20	22.7
		Kibuku	NBH-2	53216	582892	119923	1077	91.91	Dry borehole	

1.2. Handover of the test boreholes

OYO-TECI handed over the boreholes to MOWE. OYO-TECI proposed the usage of the boreholes, and MOWE agreed to it. After handover these boreholes, MOWE has responsibility to preserve these boreholes till handover to a contractor of the Project.

Table 2 Proposed Usage of the Drilled Test Boreholes

Code	RGC	DWD No.	Safe Yield (m ³ /hr)	Usage
I-03	Nambale	53149	15.0	Water Source for the Project
		53150	2.6	Water Source for the Project

Table 2 Proposed Usage of the Drilled Test Boreholes

Code	RGC	DWD No.	Safe Yield (m ³ /hr)	Usage
I-06	Lambala	53198	28.0	Water Source for the Project
		53199	40.0	Water Source for the Project send to Kyanvuma
I-09	Kyanvuma	53176	2.0	Handpump Well.
		53162	0.5	Monitoring Well
I-11	Nondwe	53167	3.1	Handpump Well
		53215	1.0	Handpump Well.
		53213	3.0	Water Source for the Project
		53212	9.0	Water Source for the Project
		53214	0.52	Handpump Well.
P-02	Kasassira	53164	0.8	Handpump Well.
		53165	2.6	Water Source for the Project
		53211	0.5	Monitoring Well
		53200	2.1	Monitoring Well
P-04	Kapala	53169	2.0	Handpump Well.
		53148	8.0	Water Source for the Project
P-05	Buseta	53166	2.6	Water Source for the Project
		53168	22.7	Water Source for the Project
		53216	Dry borehole	Monitoring Well

1.3. Use of the test drilled borehole in Lambala RGC for Kyanvuma RGC

Since the water yields of boreholes which were drilled in the Kyanvuma RGC were not sufficient for the water supply system, OYO-TECI recommended to use the borehole which was drilled at Lambala-2 and the yield is quite enough. MOWE agreed to use the Lambala-2 borehole to send the water to Kyanvuma RGC, the distance is 4.9 km from Lambala.

1.4. Use of the existing borehole in Naghonga Village for Kasassira RGC

Since the total yield of boreholes which were drilled in the Kasassira RGC was not sufficient for the water supply system, OYO-TECI recommended to use the existing borehole which is in the Naghonga village where neighbor village of Kasassira RGC. MOWE successfully negotiated to the community in Naghonga village to use the existing borehole for the water supply system. OYO-TECI will renovate the borehole to meet the structure of the borehole to JICA specification in the Detail Design stage.

1.5. Treatment of group well in Nondwe RGC

As for the usage of both boreholes I-11-NBH-3 and I-11-NBH-4, MOWE will ensure the utilization of them for water source of the Project with the written confirmation from Directorate of Water Resource Management (DWRM). The result will be shared to Japanese side.

To determine the scale of the water facility, MOWE will implement exploration of extra

borehole close to the service area by the expenses of MOWE, and will inform the result of pumping test to Japanese side by the end of June. If the capacity of extra borehole exceeds 2.5m³/hr, OYO-TECI will identify the borehole as applicable one to the water source of the Project.

In case total capacity of boreholes doesn't reach to the capacity of 15.1m³/hr, OYO-TECI will design the facility within the total capacity of applicable boreholes..

1.6. Use of NWSC water for Acuna and Tubur RGCs

Since the Acuna and the Tubur RGCs are located in the low groundwater potential area, the water of NWSC was proposed to be used for the water supply of these two (2) RGCs branching off from the trunk main to Kaberamaido in the former JICA development study. In this preparatory survey, the aquifer test of the existing boreholes in this area was conducted, and as a result, it is judged difficult to explore the ground water resources in this area. Therefore, it is confirmed that the water for these two (2) RGCs are conveyed from the said trunk main.

As shown in the figure, the transmission pipeline for the Acuna and the Tubur RGCs is branched out from the trunk main at Katine located about 19km northwest of Soroti. The booster pump station is planned to be provided in the yard of the health center in Tiriri located about 7.1km north of Katine to increase the water pressure of the transmission pipeline. The pipeline is branched into two (2) transmission pipelines to the Acuna and the Tubur RGCs at Corner Kilak located about 4.0km north of Tiriri. The pipelines extend to the elevated tanks of the Acuna and the Tubur RGCs towards north and east for about 8.4km and 6.4km, respectively.

The trunk main of NWSC to Kaberamaido has the transmission capacity of 390m³/day to supply the water to the Kaberamaido town and small trading centers on the way. The present flow of the trunk main is not on the full stage of the original plan varying from 130 to 170m³/day according to the Soroti Area Office of NWSC, but the record of reading flow meter on the Kaberamaido trunk main indicates the average flow of about 300m³/day. The balance of 90m³/day is available and same as the demand of the Acuna and the Tubur RGCs.

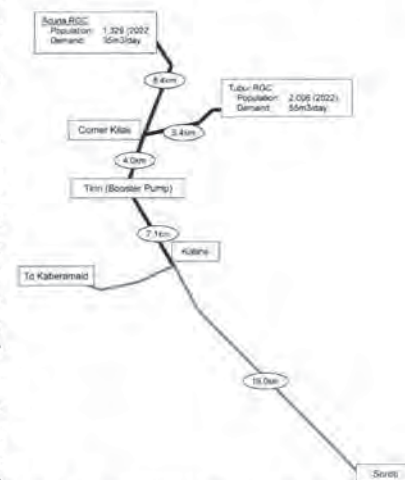

Fig. 1 Transmission Pipelines for Acuna and Tubur RGCs

On the other hand, two (2) boreholes

were successfully drilled in Kaberamaido; confirmed yields are 25m³/hr and 15m³/hr. Considering the operation hour of 12hr/day, it is expected to supply 480m³/day to the population of Kaberamaido. When the construction of connection works to the water distribution networks of the town is completed, the main source of the water supply will be switched to these new boreholes and the water volume estimated at about 180m³/day being conveyed from Soroti at present will not be used for Kaberamaido except for urgent cases. Therefore, the sum of 270m³/day (90m³/day + 180m³/day) will be available for the supply to the Tubur and the Acuna RGCs. The selection of the contractor for this work is about to be completed, and the construction will be commenced in July 2016 completing by the end of December 2016.

MOWE assured the authorization of an agreement of NWSG on water allocation of 90m³/day from the trunk main to Kaberamaido for the Acuna and the Tubur RGCs. The letter of NWSG to MOWE is attached hereto.

The two RGCs of Tubur and Acuna shall on completion be handed over to NWSG for operation and maintenance. MOWE shall make the necessary formalities for such handover before the completion of the construction in order for the smooth commencement of the operation of water supply facilities for these two (2) RGCs.

2. Piped Water Supply System

2.1. Planning conditions and water demand

The population, the water demand and the available water for planning the project facilities shall be as tabulated below.

Table 3 Population, Water Demand and Available Water of Each RGC

No.	Code	Name	District	Pop. (2022)	Average Day Demand (m ³ /day)	Max. Day Demand (x1.3) (m ³ /day)	Loss (UFW, +5%)	Available Water (m ³ /hr)	Remarks
1	I-3	Nambale	Iganga	1,863	37	48	50	11.6	BHs under Project
2	I-6	Lambala	Luuka	1,742	35	45	47	28.0	BH under Project
3	I-7	Naigobya	Luuka	1,711	34	44	46	3.7	BH drilled by JICA Dev. Study
4	I-9	Kyanvuma	Luuka	3,228	65	84	88	40.0	BH under Project
5	I-11	Nondwe	Iganga	5,686	199	259	272	TBD	Refer to section 1.5
6	P-2	Kasassira	Kibuku	5,676	199	258	271	17.5	Existing BH
7	P-3	Kameke	Pallisa	1,546	31	40	42	7.2	BHs drilled by JICA Dev. Study
8	P-4	Kapala	Pallisa	2,735	55	71	74	10.7	BHs under Project
9	P-5	Buseta	Kibuku	2,276	46	59	61	22.7	BH under Project
10	S-1	Kidetok	Sererere	3,961	79	103	108	20.4	BHs drilled by JICA Dev. Study
11	S-2	Tubur	Soroti	2,006	40	52	55	90m ³ /day	NWSG Trunk Main to Kaberamaido
12	S-3	Acuna	Soroti	1,320	26	34	35		

Note Target Year: 2022 as agreed in the Minutes of Discussion dated May 22, 2015
 Consumption per capita: RGC Population less than 5,000 20 L/day/capita
 5,000-20,000 35 L/day/capita
 more than 20,000 50 L/day/capita
 Peak Day Factor: 1.3 (Water Supply Design Manual 2nd Edition, MOWE)
 Un-accounted for Water (UFW): 5%

The further studies and analyses shall be carried out for the above-listed 12 RGCs by

OYO-TECI in Japan.

2.2. Piped water supply system (Typical piped water supply system)

The water supply systems to be provided under the Project shall consist of the facilities shown in the following illustration.

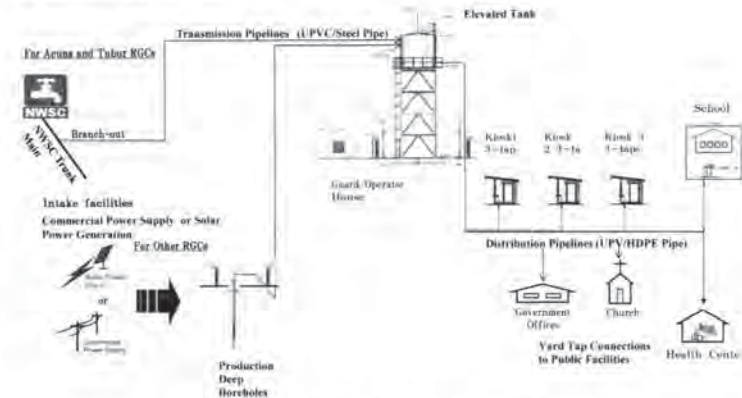

Fig. 2 Typical Piped Water Supply Facility

2.3. Possible power source of submersible pump for each target RGC under the condition of given borehole yields

Power source of the submersible motor pump shall be either solar power generation or commercial electricity supply depending on the confirmed borehole yields, the lifting heads from borehole sites to elevated tank, and required discharges of transmission pipelines to elevated tank. The first priority shall be put on the submersible DC motor pump powered by solar power generation, and if this system is considered difficult in view of the above conditions, the submersible AC motor pump powered by the commercial electricity supply shall be applied.

The following table shows the power sources selected by the above considerations.

Table 4 Power Sources to be Applied for Submersible Pumps in Each RGC

No.	Code	Name of RGC	Borehole Code	Safe Yield (m ³ /hr)	Water Demand (m ³ /day)	Minimum Discharge Required (m ³ /hr)		Required Lifting Head (m)	Type of Motor for Submersible Pump	Type of Power Supply
						Solar Power Generation (6hr Op.)	Commercial P. Supply (18hr Op.)			
1	I-03	Nambale	J-03-NBH-1	9.0	50	8.4	2.8	69	DC	Solar Gen.
			J-03-NBH-2*	2.6				63		
2	I-06	Lambala	I-06-NBH-1	28.0	47	7.8	2.6	62	DC	Solar Gen.
3	I-07	Naigobya	JTB-6***	3.7	46	7.8	2.6	78	AC	Com. Sup.

No.	Code	Name of RGC	Borehole Code	Safe Yield (m ³ /hr)	Water Demand (m ³ /day)	Minimum Discharge Required (m ³ /hr)		Required Lifting Head (m)	Type of Motor for Submersible Pump	Type of Power Supply
						Solar Power Generation (6hr Ope.)	Commercial P Supply (18hr Ope.)			
4	I-09	Kyanvuma	I-06-NBH-2	40.0	88	14.7	4.9	97	AC	Com. Sup.
			I-11-NBH-3	3.0				96	AC	
5	I-11	Nondwe	I-11-NBH-4	9.0	272	45.3	15.1	129	AC	Com. Sup.
			TBD	-				-	-	
6	P-02	Kasassira	DWD55991**	17.5	271	45.3	15.1	67	AC	Com. Sup.
7	P-03	Kameke	JTB-11***	7.2	42	6.9	2.3	80	DC	Solar Gen.
8	P-04	Kapala	P-04-NBH-1	8.0	74	12.3	4.1	74	AC	Com. Sup.
			P-04-NBH-2	2.7				64	AC	
9	P-05	Buseta	P-05-NBH-1	22.7	61	10.5	3.5	51	DC	Solar Gen.
10	S-01	Kidetok	JTB-17***	7.2	108	18.0	6.0	83	AC	Com. Sup.
			JTB-18***	13.2				81	AC	
11	S-02	Tubur	NWSC	-	55	9.0		88		
12	S-03	Acuma	NWSC	-	35	6.0		(Booster)	AC	Com. Sup.

Note: * The borehole of I-03-NBH-2 is used as Stand-by of the borehole of I-03-NBH-1.
 ** The existing borehole of DWD55991 is used for the water source after renovation to increase the casing diameter from 5in. to 6in.
 *** The casing diameter of the boreholes of JTB-6, 11, 17 and 18 are 5in, while those of the other boreholes are 6in.

In the Kyanvuma and the Kidetok RGCs, AC motor pumps are adopted though solar powered DC motor pumps should be applied in view of the available water; safe yields of the Kyanvuma and the Kidetok RGCs estimated at 40m³/hr and 20.4m³/hr are considered much enough to fulfill the demands of solar powered operation of 14.7m³/hr and 18.0m³/hr, respectively. However, the lifting heads required for conveying from the borehole sites to the elevated tank are estimated over 80m in both RGCs, and there is no DC motor pump to match to these lifting heads considering the casing diameters installed in the source boreholes. Therefore, AC motor pumps shall be adopted for the intake pump of these two (2) RGCs. The power source shall be the commercial supply of the national electricity grids considering the vulnerability and short durability of inverter system required for solar power generation.

Provision of standby generator for the commercial electricity supply shall be determined considering total cost of the project, reliability of commercial electricity supply and putting priority on maintaining the number of RGCs to be implemented.

Pump capacity shall be determined by considering safe yield of the boreholes and low off peak electricity tariff.

2.4. Connecting electricity lines to the borehole construction sites from nearby existing grid by MOWE

As agreed in the Minutes of Discussion concluded on May 22, 2015, the Ugandan side shall provide the required electricity connection from the available existing power lines to the borehole site for enabling the operation of intake motor pump under his responsibility. The Ugandan side agreed that the water supply systems of the following RGCs shall require such connections, and the Ugandan side shall provide the necessary extensions ready to use before the commencement of the construction works.

Table 6 Boreholes Requiring Electricity Connection

No.	Code	Name of RGC	Borehole Code	Distance of Extension (m)	Tentative Pump Capacity (kVA)
1	I-07	Naigobya	JTB-6	1,445	2
2	I-09	Kyanvuma	I-06-NBH-2	45	10
			I-11-NBH-3	86	14
			I-11-NBH-4	-	-
			TBD	-	-
4	P-02	Kasassira	DWD55991	945	7
5	P-04	Kapala	P-04-NBH-1	732	6
			P-04-NBH-2	-	-
6	S-01	Kidetok	JTB-17	673	4
			JTB-18	818	7
7	S-02	Tubur	Booster Pump to be provided in the yard of the Tiriri Health Center	25	4
8	S-03	Acuma			

2.5. Materials of transmission and distribution pipes

The transmission pipelines, the distribution pipelines and the service pipes shall tentatively be of the following materials.

- Transmission pipelines: uPVC and HDPE pipes for varied parts and steel pipes for swamp and river crossing parts
- Distribution pipelines: uPVC or HDPE pipes
- Service Pipe: uPVC and GI pipes

2.6. Kiosks and yard taps

The water kiosks for the population in the RGC and the yard tap connections for public facilities shall be provided under the Project. The locations of the water kiosks shall be determined considering the availability of land plots, distribution of RGC population and hauling distance of jerrycans. The yard tap connections shall be provided for the public facilities such as churches, mosques, schools, police posts, government offices, health centers etc. in the service area of RGC. No private connection shall be provided under the Project, which shall be provided by the Water Supply and Sanitation Board (WSSB) as required after the handover of the water supply facilities to Ugandan side.

2.7. Security measure for the piped water supply facilities

The security measure is one of the important considerations in planning the solar power generation system. The following measures shall be taken to prevent the system from thefts and damage by violation.

- Siting of solar power generation system: The solar power generation modules shall be installed in the secured yard in the rather

- Installation of generation modules: populated area where the villagers of RGC easily watch the situation of power generation modules. The generation modules shall be installed on the single support so high that it is difficult for the theft to climb up the height of modules.
- Security facilities: High steel-made security fences and security lights shall be provided.
- Security guards: WSSB shall be advised to hire security guards to watch to prevent the modules from damage by violation and thefts.

2.8. Office and Guard House

In order to facilitate the operation of the facilities, a house with an office space for operation and maintenance staff and a space for guard shall be provided. Such house shall be furnished with a toilet with flushing.

2.9. Draft layout plan of piped water supply system for each target RGC

The draft of the layout plan of the piped water supply facilities were prepared as presented in Annexes, and explained to the representatives of each RGC in the stakeholder meeting held in each RGC for their understandings as shown in the Minutes of Understandings (MOU).

3. Land for Facilities to be Provided under the Project

The water supply facilities shall be located considering the followings.

- Boreholes and pumping equipment: Boreholes are located usually in the private lands contributed by the respective land owner, and the Land Agreement was concluded for the use of the land for the boreholes and relating equipment before commencement of the drilling works.
- Pipelines: Pipelines shall be basically placed in the road reserves and the widths of road reserves were confirmed with the respective road authorities.
- Elevated tanks: Elevated tanks are located in the yards of private and lands of public facilities and the Land Agreement was concluded for the use of the land for elevated tanks.
- Water kiosks: Water kiosks are located in the yards of private

- Booster pump station: and land of public facilities and the Land Agreement was concluded for the use of the land for water kiosks. Booster pump station for the Acuna and the Tubur RGCs is located in the yard of the Tiriri Health Center, and the Land Agreement was concluded for the used of the land for the booster pump station.

The signed Land Agreement for the above water supply facilities are presented in Annexes.

4. Operation & Maintenance

The idea of method of operation and maintenance for piped water supply system other than Acuna and Tubur RGCs is as follows:

- Management structure

Management structure is shown in Fig. 3

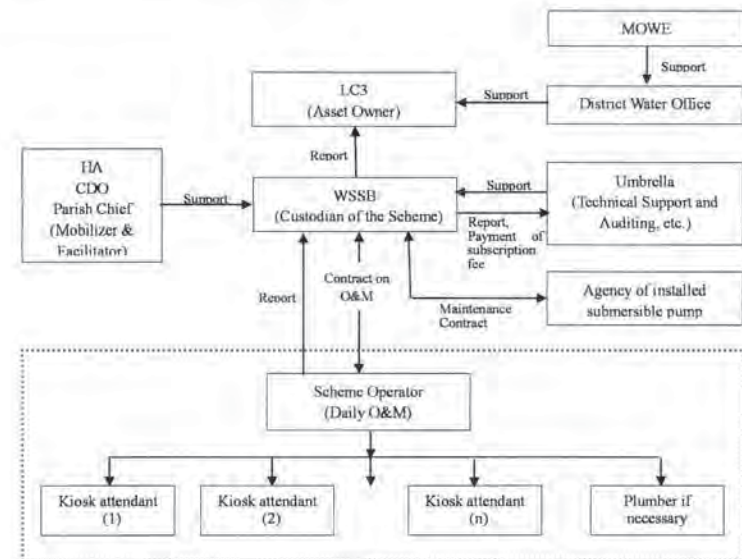

Fig. 3 Management Structure of Piped Water Supply System

LC3 Council becomes a Water Authority after gazette by MOWE and the owner of the scheme

Handwritten signature

Handwritten signature

Handwritten signature

Handwritten signature

asset. Water Supply & Sanitation Board (WSSB) is a body representing water users of the relevant community and to manage the scheme. The board member shall be selected from the relevant communities where the scheme constructed except secretary (Sub county chief). A scheme operator is an individual private person that is employed by the WSSB to run the scheme on their behalf on contract terms. Umbrella is a governmental organization which strongly supports the WSSB from various aspects.

- * Envisaged role of each organization/stuff

The roles of each operation and maintenance organization are summarized in the following table.

Table 7 Envisaged Roles of Main Organizations on Operation and Maintenance of the Scheme

Organization	Role of the Organization	Staffing
LC3	Owner of the relevant piped water supply scheme	Sub county council
Water Supply and Sanitation Board (WSSB) Composition 4 Community member shall be selected by election 1 Chairperson 1 from institutions, 1 from business 1 from community (no restriction) One of them at least shall be woman. Secretary (Sub county chief)	<ul style="list-style-type: none"> • Set up water tariff. • Formulation of by-laws • Having bank account for keeping collected money • Hold a meeting monthly • Approve on each private connection • Repair of the scheme (arrangement) • Submission of monthly report to LC3 	WSSB
Scheme Operator	<ul style="list-style-type: none"> • Daily maintenance of water source, transmission pipes, elevated tank, distribution pipes and each flowmeters. • Management of Kiosk attendants • Keeps daily records of water consumed from every Kiosk and yard tap • Collections of water user fee • Keep records of the cash realized from the scheme. • Minor repair of the scheme. • Prepare monthly technical and financial reports of the scheme to the WSSB. 	Treasurer
	<ul style="list-style-type: none"> • Collection of water user fee. • Record of the sold water user fee • Meter reading and recording the figure at Kiosk. • Submission of the records and collected water user fee to scheme operator. • Cleaning of Kiosk and soak pit 	Kiosk attendant (hired by Scheme Operator)
Umbrella	<ul style="list-style-type: none"> • Training of WSSB & Scheme Operator • Financial & technical audit • Assist WSSB to prepare various report • Water quality monitoring 	

- Collection of water user fees.

At least, monthly or bimonthly collection of water user fee is recommended ensure the

payment for UMEME, Umbrella and so on. The amount and method of water user fee collection should be determined by the WSSB, and stated in their by-laws.

- Technical Operation & Maintenance
Periodical check and maintenance of submersible pumps is a key issue for sustainability of the scheme. It is difficult to handle the issue for a scheme operator. Maintenance contract between the WSSB and an agency of the installed pump in Kampala may be one of the solutions. Becoming a member of Umbrella and receiving its support is a must requirement for the operation & maintenance of the scheme.

In case of the Acuna and the Tubur RGCs, operation and maintenance of the water supply facilities shall be implemented by NWSC.

5. Stakeholder Meetings

A series of stakeholder meetings was held in each RGC from April 22 to May 9, 2016 to explain the general features of the project facilities to be provided under the Project as well as to confirm the responsibilities of each stakeholder such as Ministry of Water and Environment (MOWE), District Local Administration, Sub-county Local Administration and RGC community. The Memorandum of Understandings was concluded and signed for each RGC as presented in Annexes.

6. Design Review by MOWE

The design review by MOWE shall be conducted as agreed by M/D dated 14th October, 2015 based on the request from MOWE. To facilitate the implementation of outline design in time, MOWE and OYO-TECI agreed to complete the design review within one week, which are held from the middle of September. To do that, OYO-TECI will send the design documents, consisting of draft design drawings and hydraulic calculation to MOWE before the commencement of the discussion as much as possible.

7. Taking Special Project ID for the Project (Smooth implementation of the Project)

MOWE promised to complete the procedure to obtain the specific Project ID for the Project from the Ministry of Finance, Planning and Economic Development in Uganda by the time of December 2016. MOWE requested to OYO-TECI to inform the rough project cost by December 2016 for the purpose. MOWE ensured enough budgets for covering applicable Ugandan tax imposed to the Japanese nationals working for the Project based on the estimated amount of the project cost including budget for the fiscal year 2016/2017.

8. Social & Environmental Consideration

Project Brief for EIA application, which describes outline of piped water supply systems and social and environmental issues of the Project, has been prepared in cooperation with MOWE.

and OYO-TECI

Both side confirmed that EIA procedure for the Project proceed by DWD under the terms of M/D on the Second Field Survey which held on October 14th, 2015, at MOWE. MOWE promised that the actual EIA procedure will complete by the time of formal approval of the Project by the Japanese government. It means that the dead line will be before December 2016 after contracting with certified and registered environmental practitioner

ANNEXES
OF
TECHNICAL NOTES (No.4)
ON
THE SECOND FIELD SURVEY OF THE PREPARATORY SURVEY
ON
THE PROJECT FOR RURAL WATER SUPPLY PHASE III
IN
LAKE KYOGA BASIN, EASTERN UGANDA,
IN
THE REPUBLIC OF UGANDA

Annexes

- Annex-1: Agreement on the Use of the Existing Borehole in Kasassira
- Annex-2: Draft Layout Plan of Piped Water Supply System
- Annex-3: Signed Land Agreement
- Annex-4: MoU & Minutes of Stakeholder Meeting of each Target RGC
- Annex-5: Agreement between MOWE and NWSC for Water Supply to the Acuna and the Tubur RGCs

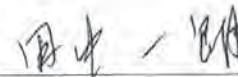

Ichiro TANAKA
Chief Consultant,
JICA Preparatory Survey Team for
the Project for Rural Water Supply
Phase III in Lake Kyoga Basin,
Eastern Uganda, in the Republic of
Uganda

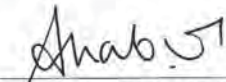

Eng. Aaron M. Kabirizi
Director,
Directorate of Water Development,
Ministry of Water and Environment,
Government of the Republic of
Uganda

添付割愛

TECHNICAL NOTES (No.5)
ON
THE SECOND FIELD SURVEY OF THE PREPARATORY SURVEY
ON
THE PROJECT FOR RURAL WATER SUPPLY PHASE III
IN
LAKE KYOGA BASIN, EASTERN UGANDA,
IN
THE REPUBLIC OF UGANDA

Attachment

Based on the Minutes of Discussions (hereinafter referred to as “M/D”) on the Preparatory Survey on the Project for Rural Water Supply Phase III in Lake Kyoga Basin, Eastern Uganda, in the Republic of Uganda (hereinafter referred to as “the Project”) signed on October 14, 2015 between the Preparatory Survey Team (hereinafter referred to as “the Team”) of Japan International Cooperation Agency (hereinafter referred to as “JICA”) and Ministry of Water and Environment (hereinafter referred to as “MOWE”), of the Government of the Republic of Uganda, the consultant members of the Team (hereinafter referred to as “OYO-TECI”) had a series of discussions on the process of pre-sensitization activities, etc. from October 15, 2015, and Technical Notes (No.2) and (No.3) on the Second Field Survey of the Preparatory Survey on the Project for Rural Water Supply Phase III in Lake Kyoga Basin, Eastern Uganda, in the Republic of Uganda (hereinafter referred to as “T/N No.2”) were concluded on October 27, 2015 and on December 11, 2015 respectively. MOWE and OYO-TECI has further conducted the field activities based on these M/D, T/N (No.2) and T/N (No.3), and the T/N (No.4) for the results of these activities was concluded on May 24, 2016.

OYO-TECI has conducted the study and analysis to prepare the outline design, and found the necessity to discuss on the scope of the project. Both sides reached the agreement through the discussions as described in the Attachment.

Kampala, July 22, 2016



Ichiro TANAKA
Chief Consultant,
JICA Preparatory Survey Team for
the Project for Rural Water Supply
Phase III in Lake Kyoga Basin,
Eastern Uganda, in the Republic of
Uganda

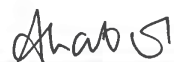

Eng. Aaron M. Kabirizi
Director,
Directorate of Water Development,
Ministry of Water and Environment,
Government of the Republic of
Uganda

1. Reduction of the Project Scope

The following Options were proposed by OYO-TECI to reduce the project cost.

Option 1: To exclude spans of distribution pipes extending over the last Kiosks and Yard Taps for public facilities, and running only for future private connections in each RGC.

Option 2: To exclude yard taps constructions for public facilities.

Option 3: To exclude Office buildings with toilets in each RGC

Option 4: Regarding the power source of submersible pump, the planned solar power generation system is changes to the commercial supply as initially requested

Both sides agreed that Option 3 is accepted because these office buildings are not considered indispensable in the grant aid project. The other options are not taken up because of the following reasons.

a. Exclusion of a part of the distribution pipelines and public tap connections to the public facilities from the project component (Options 1 and 2):

- As a policy of MOWE, the distribution networks shall be extended such that all the customers in the service area are able to apply for house connections at any time, and yard tap connections to the public facilities are also necessary in the same aspect.
- Further construction of additional distribution pipelines by MOWE is difficult since the priority of the RGCs for which the piped water supply system is once provided will become rather low.

b. Alteration of power source from solar power generation to commercial power supply (Option 4):

- The water supply systems powered by solar generation is being promoted under the policy of Rural Water Supply and Sanitation Department (RWSSD), and the tariff of the national grid rises year by year resulting in the difficulties in payment by the respective water board.
- The solar power generation is considered friendly to the environment in the policy of MOWE.

2. Selection of RGCs for Implementation

Both sides agreed that the following RGCs are excluded from those for project implementation in order to select the most appropriate RGCs to be implemented under the Japanese Grant Aid because of the following reasons.

- Acuna and Tubur RGCs:

The initial investment cost per capita of these RGCs is quite high comparing with the other RGCs, and the tariff rates provided by NWSC responsible for operation and maintenance of the water supply facilities will be so high that the population of such RGCs may not be able to pay. MOWE will provide a suitable alternative water source to the two RGCs.



- Nondwe RGC

The water sources planned at present are considered vulnerable since the available safe yields of such source boreholes are utilized at maximum operation level of 18-hours operation a day. It is considered difficult to expand its service area in future when the population thereof will grow. In addition, the initial investment cost of this RGC is very high.

According to the agreement above mentioned, the target RGCs of the Project are following 9 RGCs; Busetta, Kameke, Kapala, Kasassira, Kidetok, Kyanvuma, Naigobya, Nambale and Lambala.

3. Amount of V.A.T.

Both sides agreed that MOWE shall be informed of the estimated amount of V.A.T. to be paid by MOWE as a response to the request of MOWE, when the draft final report of the outline design is submitted at the end of November 2016.

4. Notice to RGCs

Both sides agreed that three (3) RGCs excluded from the project component; Acuna, Tubur, and Nondwe RGCs, shall be informed of the decision of exclusion in the earliest timing. MOWE requested OYO-TECI to accompany with MOWE for the consultative meeting for explanation. The representatives of the respective RGCs and the officials of the related local administrations shall be invited to such consultative meetings on the exclusion of RGCs. The necessary measures to ensure the security at the meeting shall be taken by MOWE.

AS - 31



TECHNICAL NOTES (No.6)
ON
THE SECOND FIELD SURVEY OF THE PREPARATORY SURVEY
ON
THE PROJECT FOR RURAL WATER SUPPLY PHASE IIIIN
LAKE KYOGA BASIN, EASTERN UGANDA,
IN
THE REPUBLIC OF UGANDA

Attachment

Based on the Minutes of Discussions (hereinafter referred to as "M/D") on the Preparatory Survey on the Project for Rural Water Supply Phase III in Lake Kyoga Basin, Eastern Uganda, in the Republic of Uganda (hereinafter referred to as "the Project") signed on October 14, 2015 between the Preparatory Survey Team (hereinafter referred to as "the Team") of Japan International Cooperation Agency (hereinafter referred to as "JICA") and Ministry of Water and Environment (hereinafter referred to as "MOWE"), of the Government of the Republic of Uganda, the consultant members of the Team (hereinafter referred to as "OYO-TECI") had a series of discussions and activities for field survey, etc. from October 15, 2015, and Technical Notes (No.2), (No.3), (No.4) and (No.5) on the Second Field Survey were concluded on October 27, 2015, on December 11, 2015, on May 24, 2016 and July 22, 2016, respectively.

The Design Review by MOWE conducted as agreed by M/D dated 14th October, 2015 and Technical Note (No.4) dated 24th May, 2015. OYO-TECI has been dispatched for the presentation and discussions on the draft of the outline design. Consequently, both sides reached the agreement as described in the Attachment.

Kampala, September 9, 2016



Ichiro TANAKA
Chief Consultant,
JICA Preparatory Survey Team for
the Project for Rural Water Supply
Phase III in Lake Kyoga Basin,
Eastern Uganda, in the Republic of
Uganda

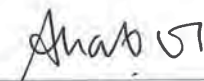

Eng. Aaron M. Kabirizi
Director,
Directorate of Water Development,
Ministry of Water and Environment,
Government of the Republic of
Uganda

1. Result of Design Review

Both sides agreed that the draft design presented by OYO-TECI was generally accepted by MOWE after the discussions on the said draft. The key issues shown in Appendix 1 were discussed in the Design Review.

2. Seismic Design

Both sides agreed that the elevated tanks shall be designed so as to fulfill the requirements of seismic resistant design of Japan because the elevated tanks are considered as basic facilities in the water supply system.

In accordance with the Guidelines for Seismic Resistant Method of Construction of Water Supply Facilities of Japan (1997) which is applied in the water supply projects in Japan, the elevated tanks are classified in Rank A of which facilities shall be indispensable and essential in the water supply system, and the facilities classified in Rank A shall get no damage from and be resistant to the earthquake of Level 1 (L1) probability supposed to take place one (1) or two (2) times during their service period considering rare occurrence in Uganda

The loads to be applied for the above L1 earthquake shall be calculated by the seismic coefficient method, and the section sizes of materials shall be determined by the allowable stress method.

The design horizontal seismic coefficient shall be set as stated below.

$$K_{H1} = C_z \cdot K_{h01}$$

$$= 1.0 \times 0.20$$

$$= 0.20$$

Where; K_{H1} : Design Horizontal Seismic Coefficient of L1 earthquake

C_z : Correction Factor of 1.0 for L1 earthquake

K_{h01} : Standard Horizontal Seismic Coefficient working on the gravity center of the facility ($K_{h01}=0.2$)

3. Notice on exclusion of the 3 RGCs (Acuna, Tubur, Nondwe) from the Project

MOWE agreed that they shall officially notify the relevant stakeholders on the exclusion of 3 RGCs (Acuna, Tubur, Nondwe) from the Project.

4. Coverage of toilet considered in the conditions of implementation of the Project

Both sides agreed that the achievement of coverage of toilet to 100% shall not be considered as the condition of implementation of the Project, since only the preparation of action plan for the promotion of toilet construction and the agreement of the said plan by the RGC population are included in the Project scope.

5. Social & Environmental Consideration

Both side confirmed that EIA procedure for the Project to be preceded by MOWE under





the terms of M/D signed on October 14th, 2015 shall be completed by the end of November 2016. OYO-TECI requested MOWE to apply JICA's EIA guidelines in their procedure, and MOWE agreed to this request.

6. Project ID for the Project

MOWE promised to complete the procedure to obtain the Project ID for the Project from the Ministry of Finance, Planning and Economic Development by the end of December 2016. MOWE requested to OYO-TECI to present in writing the project cost including the amount of VAT by December 2016 for this purpose. OYO-TECI promised to convey this request to JICA Headquarters in Japan.

MOWE promised to ensure enough budgets for covering applicable Ugandan tax imposed to the Japanese nationals working for the Project based on the estimated amount of the project cost including budget for the fiscal year 2016/2017.

7. Protection of drilled test boreholes

MOWE promised that they shall take protection measures of the drilled test boreholes by the end of September 2016.

8. Undertaking of Ugandan Side

In addition to the items agreed in M/D dated May 22, 2015, both sides agreed to provide the followings under the responsibility of Ugandan side.

- Temporary access roads and yards for the construction works.
- Water to be used for pressure tests and disinfection of the facilities.

Appendix 1: Key issues discussed in the Design Review

Key issue 1: Target Year of the Project

MOWE insisted that the project period has to be in line with the MOWE's design manual. OYO-TECI explained that the project period shall be a few years only in the grant project of Japan, because the grant project is basically provided as a urgent measurement, and that the target year of 2022 was agreed in the first M/D. MOWE agreed this explanation.

Key issue 2: Hydraulic Calculation of the Near Future Water Use

MOWE requested OYO-TECI to proceed with the hydraulic calculation so as to distribute the water even to edges of the pipelines after the water kiosks, because the present calculation is made on condition that the water is distributed to the population of RGC by water kiosks and service pipes connected to public facilities. OYO-TECI accepted this request and promised to submit the results of calculation based on the revised conditions when the mission for draft outline design is dispatched.

Key issue 3: Converters for Solar Power System

MOWE explained that they are promoting the use of AC motor pumps for the solar powered system in Uganda. OYO-TECI explained that AC motor pumps are not applied for the solar power systems of Japanese grant projects because of low reliability of the DC/AC inverters. MOWE inquired if the AC/DC converters are installed as a package of the solar system. OYO-TECI promised to consult with JICA on this issue in Japan.

Key issue 4: Power Loss by Long Transmission in Solar Power Generation

MOWE inquired that in case that the distance between solar power generation station and water source borehole is long, power loss may become large. OYO-TECI explained that such power loss was already considered in the design of electricity facilities, and MOWE agreed this explanation. Further, OYO-TECI explained that security lamps, security fences and guard houses will be provided at the solar power generation sites.

Key issue 5: High Project Costs

MOWE insisted that the project implementation costs are so high that they are not able to explain to the public. OYO-TECI explained that in the grant project of Japan only Japanese contractors are entitled to offer the project implementation to ensure the qualities of the works as same as in Japan. Therefore, the cost estimate is also conducted based on the Japanese standard.

Key issue 6: Procurement of Vehicle

MOWE inquired about the reason why the procurement of the requested vehicles is excluded from the project scope. OYO-TECI explained that in principle the procurement of vehicles is not included in the scope in the grant project. MOWE understood the explanations.

Appendix 2

Attendants List for
Design Review for the Project for Rural Water Supply Phase III in Lake Kyoga
Basin, Eastern Uganda, in the Republic of Uganda

Date & Time: 2016/9/6 10:00 - 14:00

Venue: Old Board Room in DWD

	Name	Position/Title
1	Christpher Tumusiime	Assistant Commissioner
2	Ahmed Sentumbwe	Assistant Commissioner
3	Mutiibwa Robert	Principal Water Officer
4	James Sseguya	Principal Engineer
5	Olmeny Lamu	Principal Engineer
6	Ian Arebahona	Principal Engineer
7	David Kabugo	Senior Engineer
8	Kaguhangire Steven	Engineer
9	Muzanira Augustus	Engineer
10	Carolyn Kasisira	Engineer
11	Ssennyunja Adam	Social Scientist
12	Sabila Eva	Social Scientist
13	Mugeiga Kato	Social Scientist
14	Cate Namyalo	Environmental Health Officer
15	Baliyana Damali	Communication Officer
16	Sakamoto Daisuke	JICA Expert
17	Tanaka Ichiro	Chief Consultant
18	Yumoto Soichiro	Water Supply Facility Design
19	Iseki Shinichi	Hydrogeologist

Key issue 7: Provision of disinfection facilities

MOWE explained that the provision of disinfection facilities are required for piped water supply system to secure the quality of distributed water, and inquired if such facilities are provided under the project. OYO-TECI promised to convey the request to JICA in Japan.

BT

BT

BT

BT

資料-6

概略設計図面集

概略設計図面リスト

番号	図面タイトル
1.	Location Map
2.	Nambale RGC, General Layout
3.	Lambala RGC, General Layout
4.	Naigobya RGC, General Layout
5.	Kyamvuma RGC, General Layout (1/4)
6.	Kyamvuma RGC, General Layout (2/4)
7.	Kyamvuma RGC, General Layout (3/4)
8.	Kyamvuma RGC, General Layout (4/4)
9.	Kasassira RGC, General Layout
10.	Kameke RGC, General Layout (1/2)
11.	Kameke RGC, General Layout (2/2)
12.	Kapala RGC, General Layout (1/2)
13.	Kapala RGC, General Layout (2/2)
14.	Buseta RGC, General Layout
15.	Kidetok RGC, General Layout (1/2)
16.	Kidetok RGC, General Layout (2/2)
17.	Typical Trench Excavation and Pipe Installation
18.	Typical Concrete Thrust Block
19.	Typical Air Valve Chamber
20.	Valve Chamber for Borehole Water Transmission Pipes DN100 (OD110) and DN50 (OD63) uPVC
21.	Typical Valve Chamber for Distribution Pipe DN50 (OD63) uPVC
22.	Typical Borehole and Intake Facilities
23.	Nambale RGC, Plan of Elevated Tank and Solar Power Generation Array
24.	Nambale and Lambala RGCs, Elevated Tank
25.	Lambala RGC, Plan of Elevated Tank and Solar Power Generation Array
26.	Naigobya RGC, Plan of Elevated Tank
27.	Kyamvuma RGC, Plan of Elevated Tank
28.	Kasassira RGC, Plan of Elevated Tank
29.	Kasassira RGC, Elevated Tank
30.	Kameke RGC, Plan of Elevated Tank and Solar Generation Array
31.	Kapala RGC, Plan of Elevated Tank
32.	Buseta RGC, Plan of Elevated Tank and Solar Power Generation Array
33.	Kidetok RGC, Plan of Elevated Tank
34.	Typical Fence and Gate
35.	Water Kiosk House
36.	Guard House
37.	Kasassira RGC, Generator House
38.	Nambale, Lambala, Kameke and Buseta RGCs, Solar Cell Panel Stand

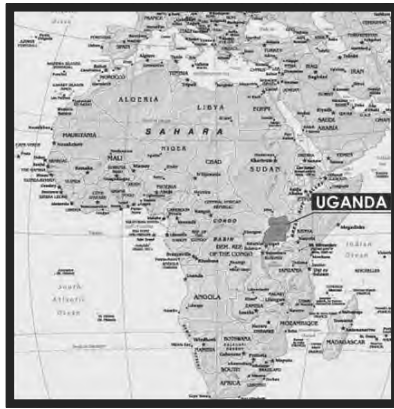

AFRICAN CONTINENT

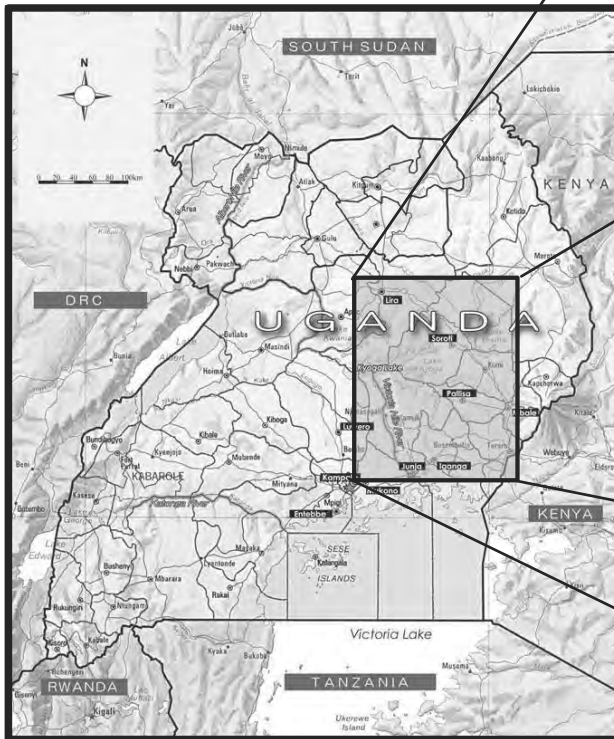

UGANDA

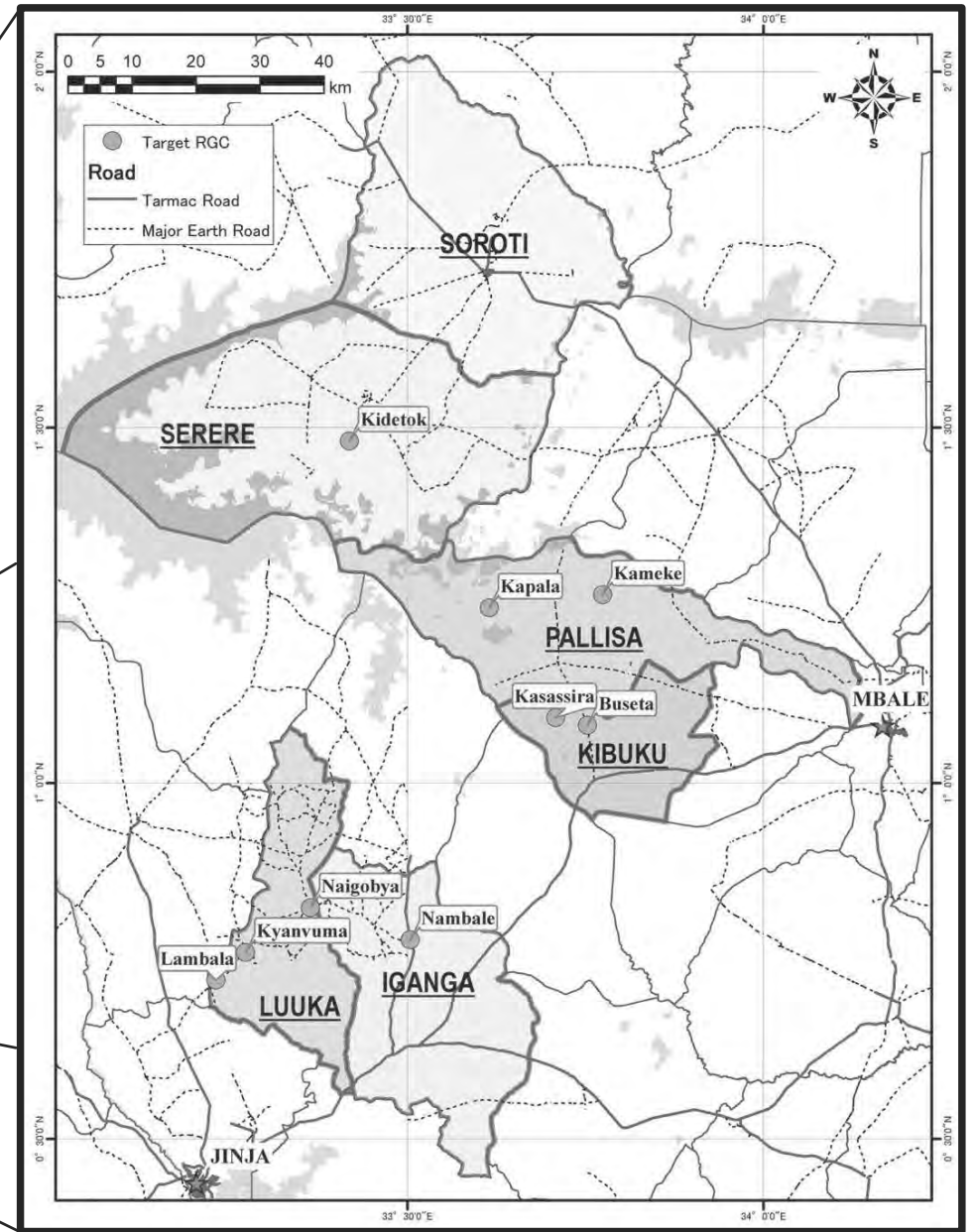

TARGET RGCs

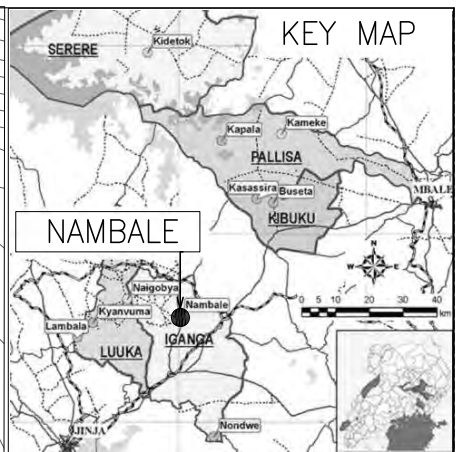
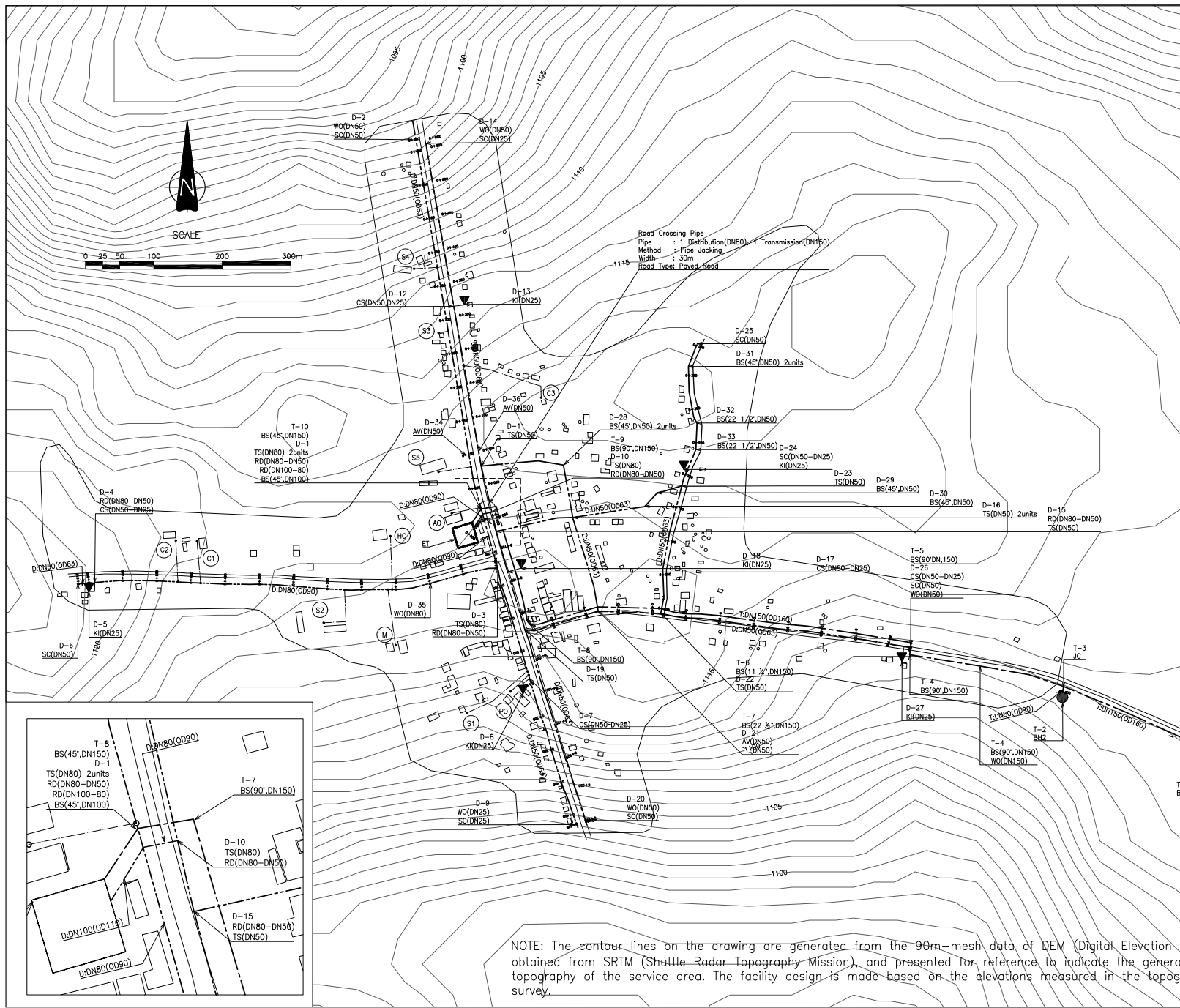

SUMMARY OF QUANTITIES

DESCRIPTION[UNIT]	FIGURES
TARGET POPULATION 2022	1863
TRANSMISSION PIPELINE[m]	1286
DISTRIBUTION PIPELINE[m]	4265
WATER SOURCE BOREHOLE[unit]	2
JUNCTION[unit]	1
WATER KIOSK[unit]	6
YARD TAP[unit]	12
ELEVATED TANK[unit]	1
AIR VALVE[unit]	3
WASHOUT[unit]	7

LEGEND

SYMBOL	DESCRIPTION
---	TRANSMISSION PIPE
----	DISTRIBUTION PIPE
----	WATER SUPPLY PIPE
T:D(N)(OD)	NOMINAL & OUTSIDE DIAMETER OF TRANSMISSION PIPE
D:D(N)(OD)	NOMINAL & OUTSIDE DIAMETER OF DISTRIBUTION PIPE
ET	ELEVATED TANK
BH	BOREHOLE
▲	PIPE JACKING
●	WATER KIOSK
T-NO.	FACILITIES & MATERIALS ON TRANSMISSION PIPE
D-NO.	FACILITIES & MATERIALS ON DISTRIBUTION PIPE
(DN)	NOMINAL DIAMETER
JC	JUNCTION
AV	AIR VALVE
WO	WASHOUT
RD	REDUCER(BIGGER - SMALLER)
TS	T-SHAPE SOCKET
CS	CLAMP SADDLE(DISTRIBUTION PIPE - WATER SUPPLY PIPE)
SC	STOP COCK
BS	BEND SOCKET(ANGLE, DN)

PUBLIC FACILITIES OF YARD TAP

CODE	NAME OF INSTITUTION
S1	LIGHT STAR SDA NUR & P/S
S2	NAMBALE P/S
S3	NAMBALE ADVENTISTS P/S
S4	NAMBALE MOSLEM
S5	ST. PAUL P/S
HC	NAMBALE HEALTHY CENTRE III
AO	ADMINISTRATION OFFICE
PO	POLICE OFFICE / POST
C1	NAMBALE C.O.U.
C2	NAMBALE SEVENTH DAY ADVENTIST CHURCH
C3	BORN AGAIN CHURCH
M	NAMBALE MOSQUE

NOTE: The contour lines on the drawing are generated from the 90m-mesh data of DEM (Digital Elevation Model) obtained from SRTM (Shuttle Radar Topography Mission), and presented for reference to indicate the general topography of the service area. The facility design is made based on the elevations measured in the topographic survey.



THE PREPARATORY SURVEY ON THE PROJECT FOR RURAL WATER SUPPLY PHASE III IN LAKE KYOGA BASIN, EASTERN UGANDA, IN THE REPUBLIC OF UGANDA
 MINISTRY OF WATER AND ENVIRONMENT,
 GOVERNMENT OF THE REPUBLIC OF UGANDA



OYO INTERNATIONAL CORPORATION
 TOKYO JAPAN
 TEC INTERNATIONAL CO., LTD.
 TOKYO JAPAN
 TITLE : I-03 NAMBALE RGC GENERAL LAYOUT

SCALE :
 DRAWING NO. :
 APPROVED BY :
 PREPARED BY :
 DATE : NOVEMBER 2016

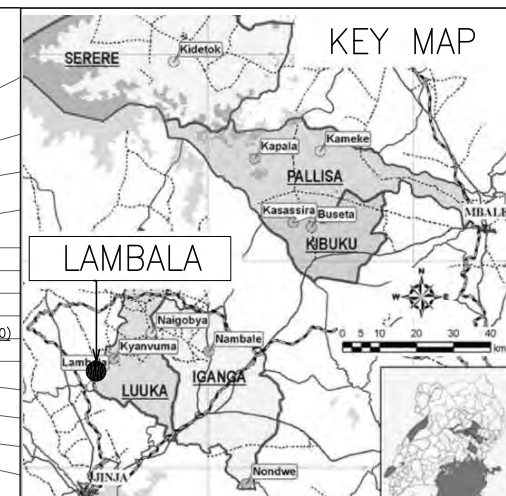
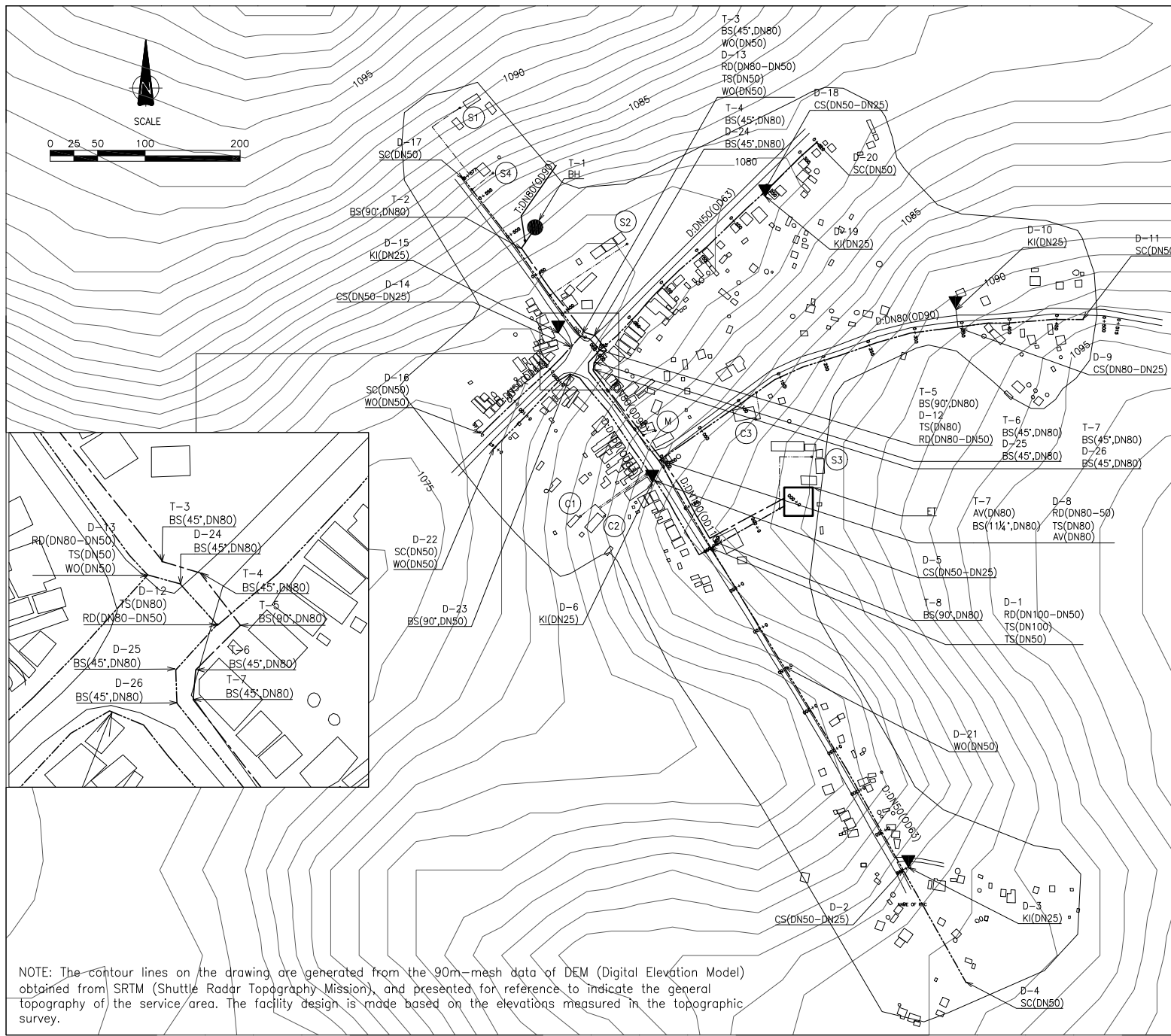

SUMMARY OF QUANTITIES		
DESCRIPTION[UNIT]	FIGURES	
TARGET POPULATION 2022	1742	
TRANSMISSION PIPELINE [m]	483	
DISTRIBUTION PIPELINE [m]	2338	
WATER SOURCE BOREHOLE [unit]	1	
JUNCTION [unit]	0	
WATER KIOSK [unit]	5	
YARD TAP [unit]	8	
ELEVATED TANK [unit]	1	
AIR VALVE [unit]	2	
WASHOUT [unit]	5	

LEGEND	
SYMBOL	DESCRIPTION
---	TRANSMISSION PIPE
----	DISTRIBUTION PIPE
----	WATER SUPPLY PIPE
T:DN(OD)	NOMINAL & OUTSIDE DIAMETER OF TRANSMISSION PIPE
D:DN(OD)	NOMINAL & OUTSIDE DIAMETER OF DISTRIBUTION PIPE
[Square]	BUILDING
[Elevated Tank]	ELEVATED TANK
[Borehole]	BOREHOLE
[Pipe Jacking]	PIPE JACKING
[Water Kiosk]	WATER KIOSK
T-NO.	FACILITIES & MATERIALS ON TRANSMISSION PIPE
D-NO.	FACILITIES & MATERIALS ON DISTRIBUTION PIPE
(DN)	NOMINAL DIAMETER
JC	JUNCTION
AV	AIR VALVE
WO	WASHOUT
RD	REDUCER(BIGGER - SMALLER)
TS	T-SHAPE SOCKET
CS	CLAMP SADDLE(DISTRIBUTION PIPE - WATER SUPPLY PIPE)
SC	
BS	

PUBLIC FACILITIES OF YARD TAP	
CODE	NAME OF INSTITUTION
S1	HILL VIEW NUR. P/S
S2	GONZA SSS
S3	LAMBALA P/S C.O.U.
S4	SCHOOL
C1	UNIVERSAL APOSTLES CHURCH
C2	PENTECOSTAL HOLINESS
C3	LAMBALA PROTESTANT CHURCH
M	LAMBALA MOSQUE

NOTE: The contour lines on the drawing are generated from the 90m-mesh data of DEM (Digital Elevation Model) obtained from SRTM (Shuttle Radar Topography Mission), and presented for reference to indicate the general topography of the service area. The facility design is made based on the elevations measured in the topographic survey.

NOTE: The contour lines on the drawing are generated from the 90m-mesh data of DEM (Digital Elevation Model) obtained from SRTM (Shuttle Radar Topography Mission), and presented for reference to indicate the general topography of the service area. The facility design is made based on the elevations measured in the topographic survey.

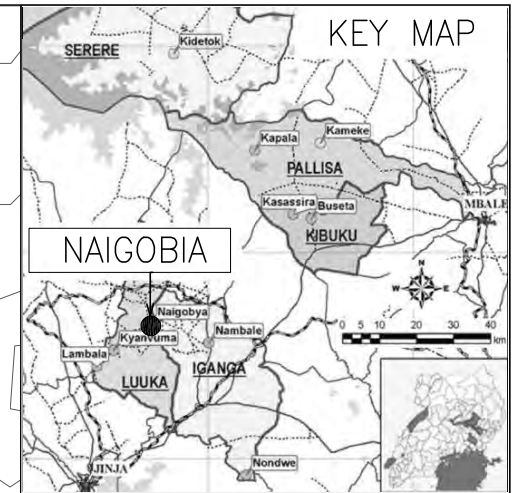
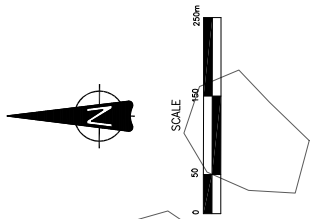

SUMMARY OF QUANTITIES		
DESCRIPTION[UNIT]	FIGURES	
TARGET POPULATION 2022	1711	
TRANSMISSION PIPELINE[m]	1035	
DISTRIBUTION PIPELINE[m]	5367	
WATER SOURCE BOREHOLE[unit]	1	
JUNCTION[unit]	0	
WATER KIOSK[unit]	7	
YARD TAP[unit]	9	
ELEVATED TANK[unit]	1	
AIR VALVE[unit]	1	
WASHOUT[unit]	9	

LEGEND	
SYMBOL	DESCRIPTION
---	TRANSMISSION PIPE
- - - -	DISTRIBUTION PIPE
---	WATER SUPPLY PIPE
---	NOMINAL & OUTSIDE DIAMETER OF TRANSMISSION PIPE
D:DN(OD)	NOMINAL & OUTSIDE DIAMETER OF DISTRIBUTION PIPE
□	BUILDING
ET	ELEVATED TANK
BH	BOREHOLE
JK	PIPE JACKING
JK	WATER KIOSK
T-NO.	FACILITIES & MATERIALS ON TRANSMISSION PIPE
D-NO.	FACILITIES & MATERIALS ON DISTRIBUTION PIPE
(DN)	NOMINAL DIAMETER
JC	JUNCTION
AV	AIR VALVE
WO	WASHOUT
RD	REDUCER(BIGGER - SMALLER)
TS	T-SHAPE SOCKET
CL	CLAMP SADDLE(DISTRIBUTION PIPE - WATER SUPPLY PIPE)
SC	STOP COCK
BS	BEND SOCKET(ANGLE, DN)
PUBLIC FACILITIES OF YARD TAP	
CODE	NAME OF INSTITUTION
S1	NANGOBYA COMMUNITY P/S
S2	NAIGOBYA TECHNICAL SCHOOL
S3	NANGOBYA LIGHT FUTURE P/S
S4	NANGOBYA ISLAMIC P/S
S5	ST. PAUL P/S
HC	NANGOBYA NGO HEALTH CENTRE III
PO	NANGOBYA POLICE POST
C1	NANGOBYA HOLY DELIVERANCE CHURCH
C2	SEVENTH DAY ADVENTISTS CHURCH
C3	CHURCH

A6-5

JAPAN INTERNATIONAL COOPERATION AGENCY (JICA)	THE PREPARATORY SURVEY ON THE PROJECT FOR RURAL WATER SUPPLY PHASE III IN LAKE KYOGA BASIN, EASTERN UGANDA, IN THE REPUBLIC OF UGANDA	OYO INTERNATIONAL CORPORATION TOKYO JAPAN	TITLE :	I-07 NAIGOBYA GENERAL LAYOUT	SCALE :	APPROVED BY :
	MINISTRY OF WATER AND ENVIRONMENT, GOVERNMENT OF THE REPUBLIC OF UGANDA		TEC INTERNATIONAL CO., LTD. TOKYO JAPAN		DRAWING NO. :	PREPARED BY :

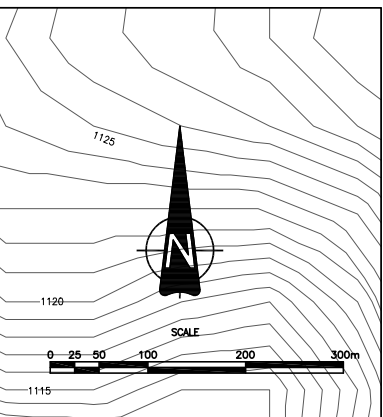
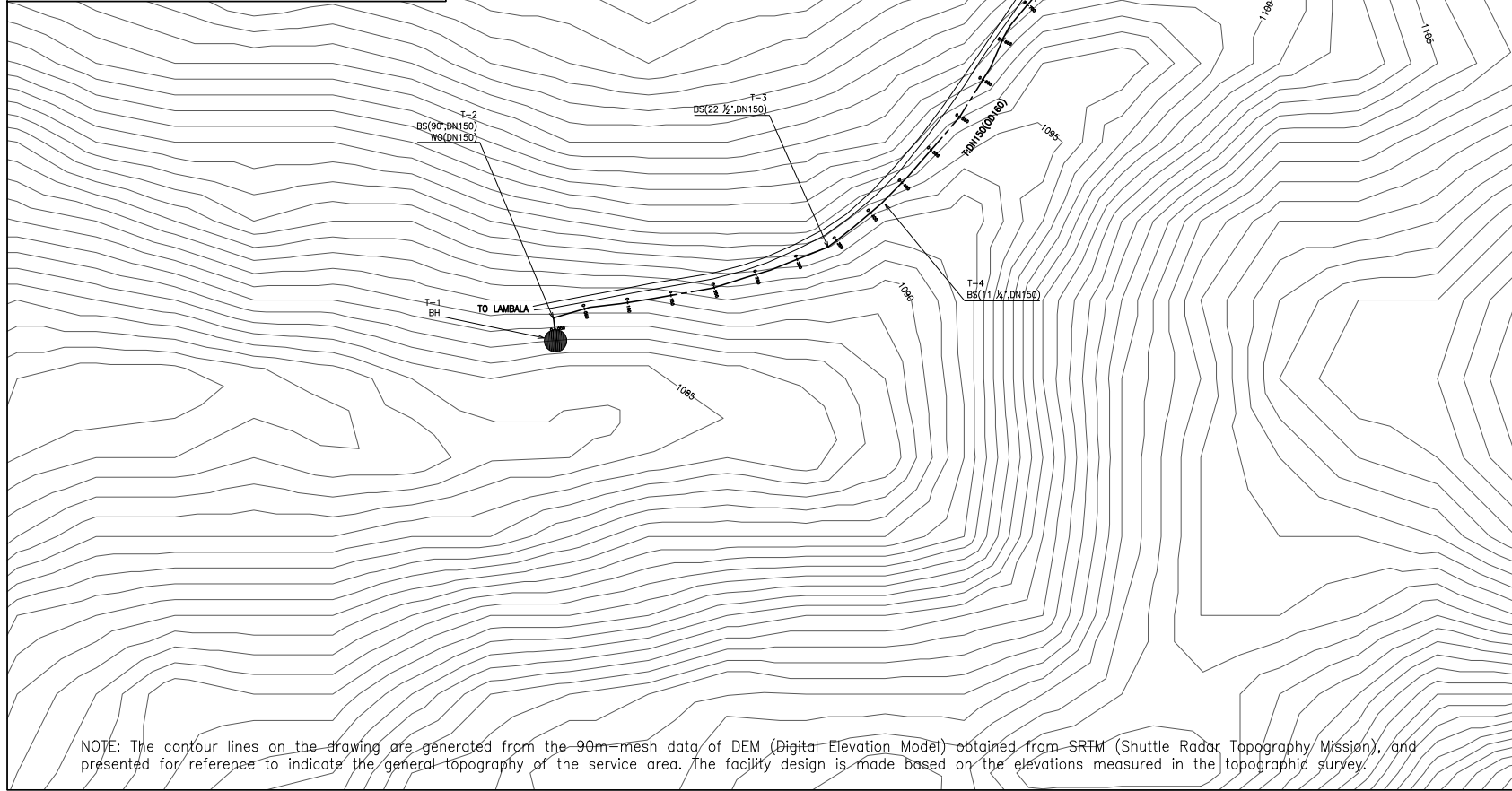
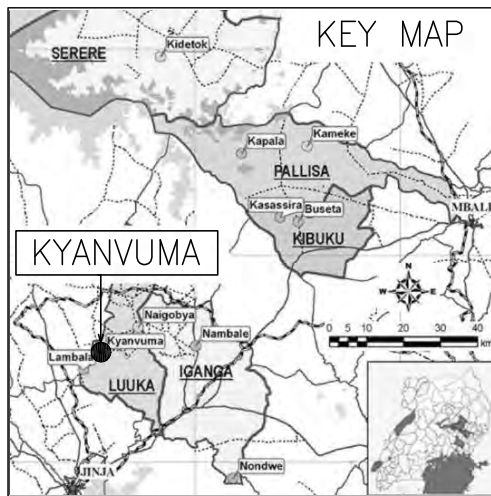

SUMMARY OF QUANTITIES	
DESCRIPTION[UNIT]	FIGURES
TARGET POPULATION 2022	3228
TRANSMISSION PIPELINE[m]	4872
DISTRIBUTION PIPELINE[m]	5388
WATER SOURCE BOREHOLE[unit]	1
JUNCTION[unit]	0
WATER KIOSK[unit]	9
YARD TAP[unit]	12
ELEVATED TANK[unit]	1
AIR VALVE[unit]	4
WASHOUT[unit]	10

LEGEND	
SYMBOL	DESCRIPTION
---	TRANSMISSION PIPE
----	DISTRIBUTION PIPE
----	WATER SUPPLY PIPE
T:DN(OD)	NOMINAL & OUTSIDE DIAMETER OF TRANSMISSION PIPE
D:DN(OD)	NOMINAL & OUTSIDE DIAMETER OF DISTRIBUTION PIPE
[]	BUILDING
[]	ELEVATED TANK
[]	BOREHOLE
[]	PIPE JACKING
[]	WATER KIOSK
T-NO.	FACILITIES & MATERIALS ON TRANSMISSION PIPE
D-NO.	FACILITIES & MATERIALS ON DISTRIBUTION PIPE
(DN)	NOMINAL DIAMETER
JC	JUNCTION
AV	AIR VALVE
WO	WASHOUT
RD	REDUCER(BIGGER - SMALLER)
TS	T-SHAPE SOCKET
CS	CLAMP SADDLE(DISTRIBUTION PIPE - WATER SUPPLY PIPE)
SC	STOP COCK
BS	BEND SOCKET(ANGLE, DN)
PUBLIC FACILITIES OF YARD TAP	
CODE	NAME OF INSTITUTION
S1	MODERN TIMES P/S
S2	A& B P/S
S3	NHIDAAYA ISLAMIC P/S
S4	KYANVUMA P/S
S5	KYANVUMA PARENTS P/S
S6	NAKABAAL P/S
S7	NAKABAAL S/S
C1	OPEN BIBLE CHURCH
C2	NAKABAAL CHURCH OF UGANDA
C3	CATHOLIC CHURCH
C4	CHURCH
M	MOSQUE

NOTE: The contour lines on the drawing are generated from the 90m-mesh data of DEM (Digital Elevation Model) obtained from SRTM (Shuttle Radar Topography Mission), and presented for reference to indicate the general topography of the service area. The facility design is made based on the elevations measured in the topographic survey.

<p>JAPAN INTERNATIONAL COOPERATION AGENCY (JICA)</p>	<p>THE PREPARATORY SURVEY ON THE PROJECT FOR RURAL WATER SUPPLY PHASE III IN LAKE KYOGA BASIN, EASTERN UGANDA, IN THE REPUBLIC OF UGANDA</p>	<p>OYO INTERNATIONAL CORPORATION TOKYO JAPAN</p>	<p>TITLE :</p> <p>1-09 KYANVUMA RGC GENERAL LAYOUT(1/4)</p>	<p>SCALE :</p>	<p>APPROVED BY :</p>
	<p>MINISTRY OF WATER AND ENVIRONMENT, GOVERNMENT OF THE REPUBLIC OF UGANDA</p>				

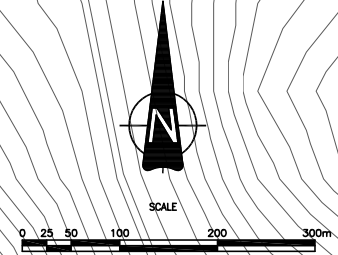
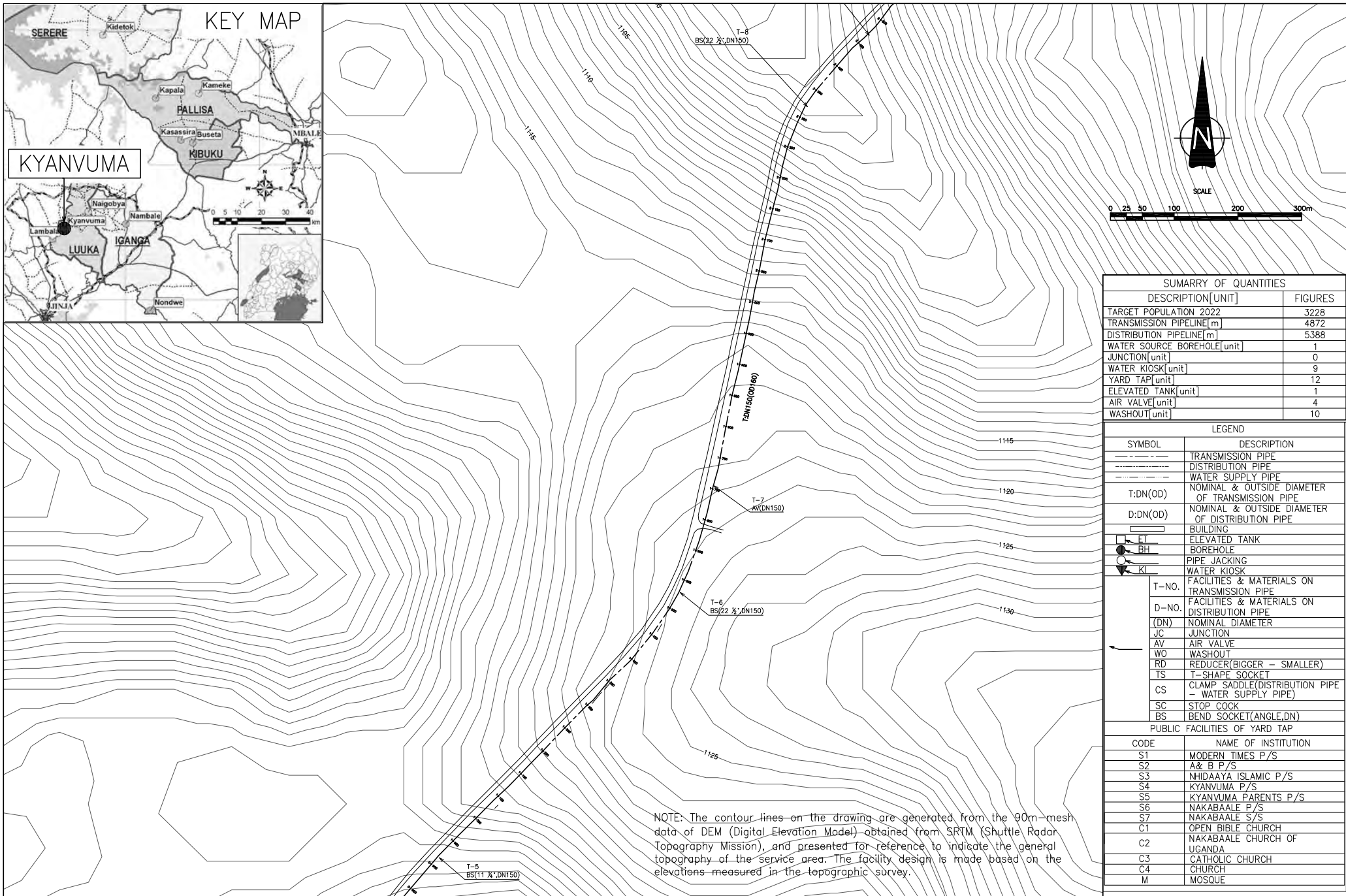
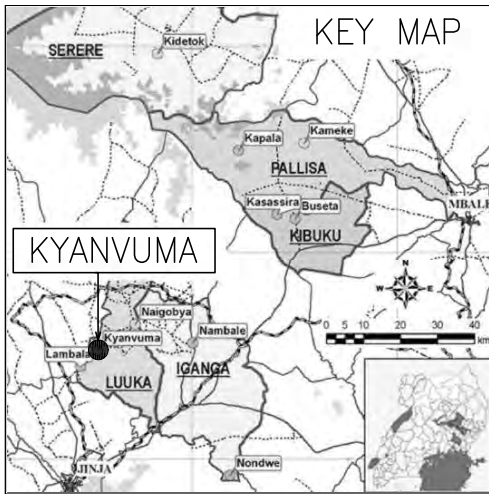

SUMMARY OF QUANTITIES	
DESCRIPTION[UNIT]	FIGURES
TARGET POPULATION 2022	3228
TRANSMISSION PIPELINE[m]	4872
DISTRIBUTION PIPELINE[m]	5388
WATER SOURCE BOREHOLE[unit]	1
JUNCTION[unit]	0
WATER KIOSK[unit]	9
YARD TAP[unit]	12
ELEVATED TANK[unit]	1
AIR VALVE[unit]	4
WASHOUT[unit]	10

LEGEND	
SYMBOL	DESCRIPTION
---	TRANSMISSION PIPE
----	DISTRIBUTION PIPE
-----	WATER SUPPLY PIPE
T:DN(OD)	NOMINAL & OUTSIDE DIAMETER OF TRANSMISSION PIPE
D:DN(OD)	NOMINAL & OUTSIDE DIAMETER OF DISTRIBUTION PIPE
[Rectangle]	BUILDING
[Circle]	ELEVATED TANK
[Circle with dot]	BOREHOLE
[Circle with cross]	PIPE JACKING
[Circle with triangle]	WATER KIOSK
T-NO.	FACILITIES & MATERIALS ON TRANSMISSION PIPE
D-NO.	FACILITIES & MATERIALS ON DISTRIBUTION PIPE
(DN)	NOMINAL DIAMETER
JC	JUNCTION
AV	AIR VALVE
WO	WASHOUT
RD	REDUCER(BIGGER - SMALLER)
TS	T-SHAPE SOCKET
CS	CLAMP SADDLE(DISTRIBUTION PIPE - WATER SUPPLY PIPE)
SC	STOP COCK
BS	BEND SOCKET(ANGLE, DN)
PUBLIC FACILITIES OF YARD TAP	
CODE	NAME OF INSTITUTION
S1	MODERN TIMES P/S
S2	A & B P/S
S3	NHIDAYA ISLAMIC P/S
S4	KYANVUMA P/S
S5	KYANVUMA PARENTS P/S
S6	NAKABAALE P/S
S7	NAKABAALE S/S
C1	OPEN BIBLE CHURCH
C2	NAKABAALE CHURCH OF UGANDA
C3	CATHOLIC CHURCH
C4	CHURCH
M	MOSQUE

NOTE: The contour lines on the drawing are generated from the 90m-mesh data of DEM (Digital Elevation Model) obtained from SRTM (Shuttle Radar Topography Mission), and presented for reference to indicate the general topography of the service area. The facility design is made based on the elevations measured in the topographic survey.

<p>JAPAN INTERNATIONAL COOPERATION AGENCY (JICA)</p>	<p>THE PREPARATORY SURVEY ON THE PROJECT FOR RURAL WATER SUPPLY PHASE III IN LAKE KYOGA BASIN, EASTERN UGANDA, IN THE REPUBLIC OF UGANDA</p>	<p>OYO INTERNATIONAL CORPORATION TOKYO JAPAN</p>	<p>TITLE :</p> <p>1-09 KYANVUMA RGC GENERAL LAYOUT(2/4)</p>	<p>SCALE :</p>	<p>APPROVED BY :</p>
	<p>MINISTRY OF WATER AND ENVIRONMENT, GOVERNMENT OF THE REPUBLIC OF UGANDA</p>				

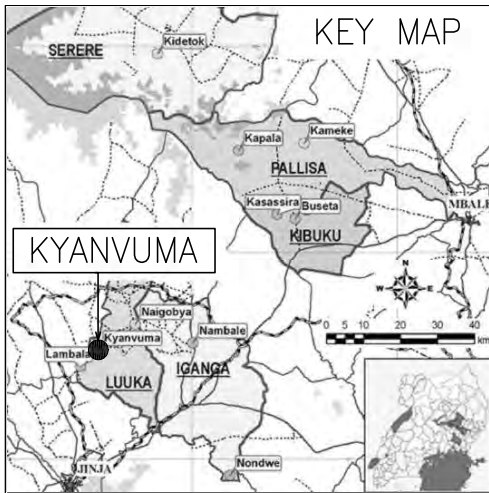

NOTE: The contour lines on the drawing are generated from the 90m-mesh data of DEM (Digital Elevation Model) obtained from SRTM (Shuttle Radar Topography Mission), and presented for reference to indicate the general topography of the service area. The facility design is made based on the elevations measured in the topographic survey.

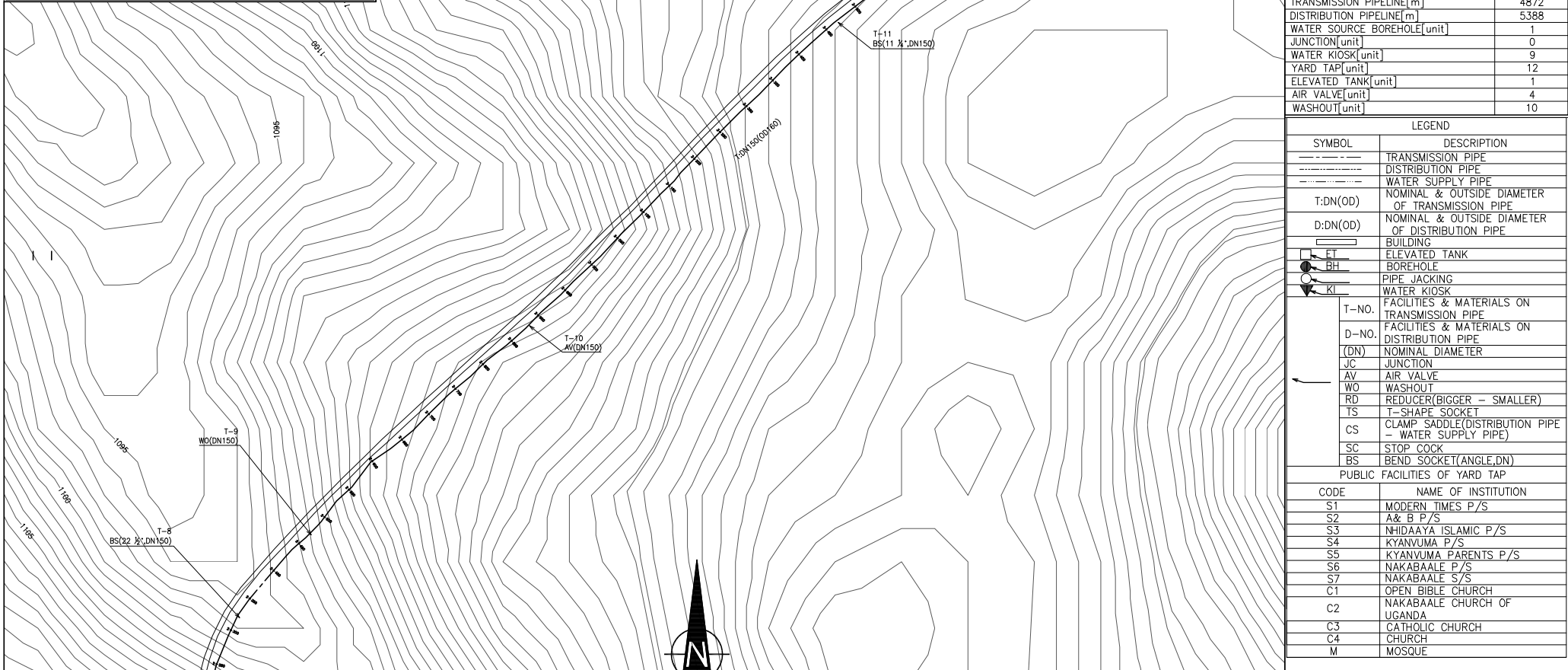

SUMMARY OF QUANTITIES	
DESCRIPTION[UNIT]	FIGURES
TARGET POPULATION 2022	3228
TRANSMISSION PIPELINE[m]	4872
DISTRIBUTION PIPELINE[m]	5388
WATER SOURCE BOREHOLE[unit]	1
JUNCTION[unit]	0
WATER KIOSK[unit]	9
YARD TAP[unit]	12
ELEVATED TANK[unit]	1
AIR VALVE[unit]	4
WASHOUT[unit]	10

LEGEND	
SYMBOL	DESCRIPTION
---	TRANSMISSION PIPE
----	DISTRIBUTION PIPE
----	WATER SUPPLY PIPE
T:DN(OD)	NOMINAL & OUTSIDE DIAMETER OF TRANSMISSION PIPE
D:DN(OD)	NOMINAL & OUTSIDE DIAMETER OF DISTRIBUTION PIPE
[Building symbol]	BUILDING
[Tank symbol]	ELEVATED TANK
[Borehole symbol]	BOREHOLE
[Pipe jacking symbol]	PIPE JACKING
[Kiosk symbol]	WATER KIOSK
T-NO.	FACILITIES & MATERIALS ON TRANSMISSION PIPE
D-NO.	FACILITIES & MATERIALS ON DISTRIBUTION PIPE
(DN)	NOMINAL DIAMETER
JC	JUNCTION
AV	AIR VALVE
WO	WASHOUT
RD	REDUCER(BIGGER - SMALLER)
TS	T-SHAPE SOCKET
CS	CLAMP SADDLE(DISTRIBUTION PIPE - WATER SUPPLY PIPE)
SC	STOP COCK
BS	BEND SOCKET(ANGLE, DN)
PUBLIC FACILITIES OF YARD TAP	
CODE	NAME OF INSTITUTION
S1	MODERN TIMES P/S
S2	A & B P/S
S3	NHIDAYA ISLAMIC P/S
S4	KYANVUMA P/S
S5	KYANVUMA PARENTS P/S
S6	NAKABAAL P/S
S7	NAKABAAL S/S
C1	OPEN BIBLE CHURCH
C2	NAKABAAL CHURCH OF UGANDA
C3	CATHOLIC CHURCH
C4	CHURCH
M	MOSQUE

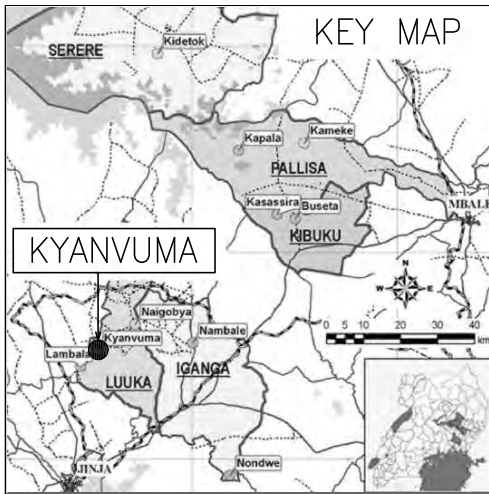

NOTE: The contour lines on the drawing are generated from the 90m-mesh data of DEM (Digital Elevation Model) obtained from SRTM (Shuttle Radar Topography Mission), and presented for reference to indicate the general topography of the service area. The facility design is made based on the elevations measured in the topographic survey.

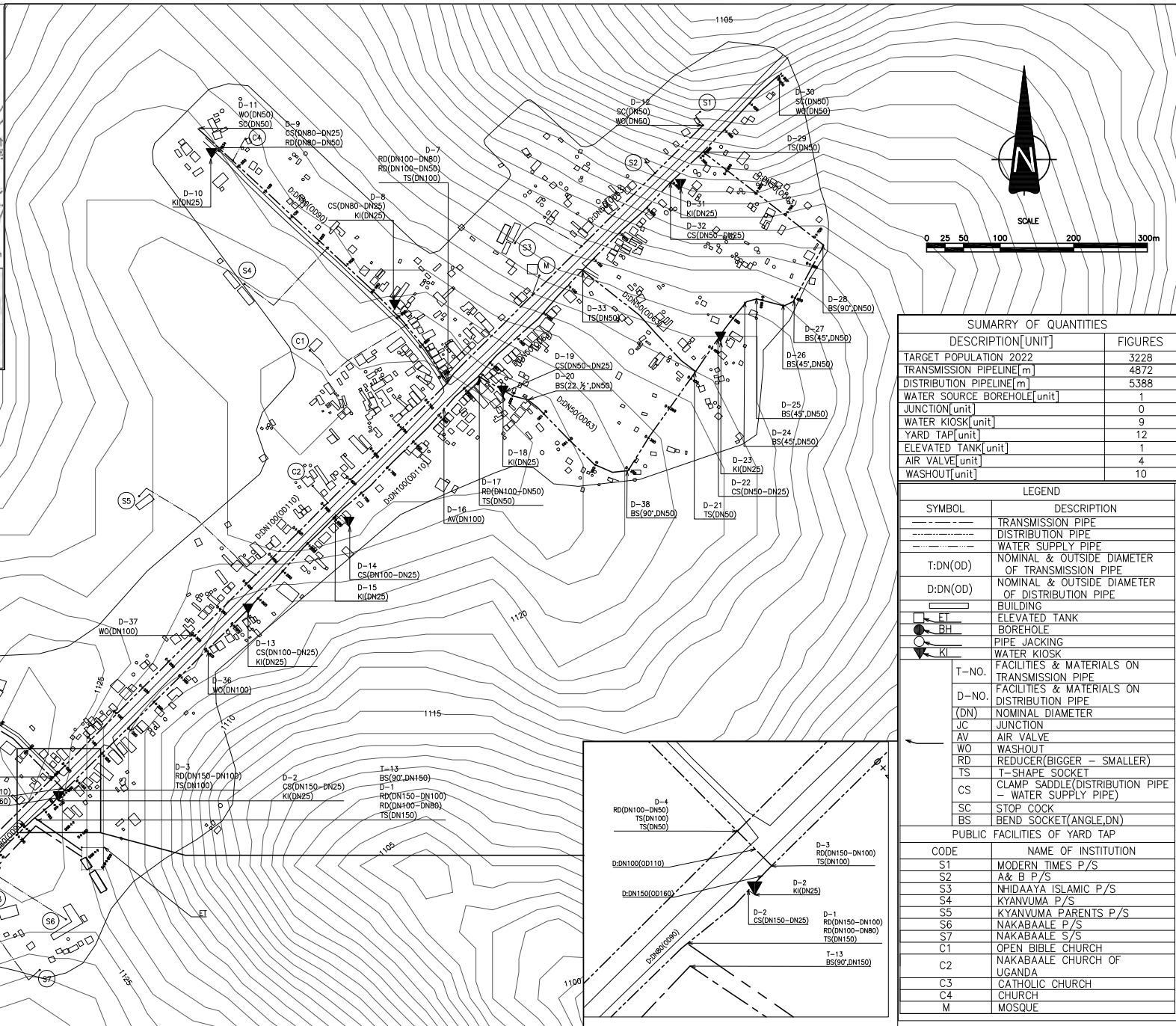

SUMMARY OF QUANTITIES	
DESCRIPTION[UNIT]	FIGURES
TARGET POPULATION 2022	3228
TRANSMISSION PIPELINE[m]	4872
DISTRIBUTION PIPELINE[m]	5388
WATER SOURCE BOREHOLE[unit]	1
JUNCTION[unit]	0
WATER KIOSK[unit]	9
YARD TAP[unit]	12
ELEVATED TANK[unit]	1
AIR VALVE[unit]	4
WASHOUT[unit]	10

LEGEND	
SYMBOL	DESCRIPTION
---	TRANSMISSION PIPE
- - - -	DISTRIBUTION PIPE
---	WATER SUPPLY PIPE
T:DN(OD)	NOMINAL & OUTSIDE DIAMETER OF TRANSMISSION PIPE
D:DN(OD)	NOMINAL & OUTSIDE DIAMETER OF DISTRIBUTION PIPE
[Building symbol]	BUILDING
[Tank symbol]	ELEVATED TANK
[Borehole symbol]	BOREHOLE
[Jacking symbol]	PIPE JACKING
[Kiosk symbol]	WATER KIOSK
T-NO.	FACILITIES & MATERIALS ON TRANSMISSION PIPE
D-NO.	FACILITIES & MATERIALS ON DISTRIBUTION PIPE
(DN)	NOMINAL DIAMETER
JC	JUNCTION
AV	AIR VALVE
WO	WASHOUT
RD	REDUCER(BIGGER - SMALLER)
TS	T-SHAPE SOCKET
CS	CLAMP- SADDLE(DISTRIBUTION PIPE - WATER SUPPLY PIPE)
SC	STOP COCK
BS	BEND SOCKET(ANGLE, DN)

PUBLIC FACILITIES OF YARD TAP	
CODE	NAME OF INSTITUTION
S1	MODERN TIMES P/S
S2	A& B P/S
S3	NHIDAYA ISLAMIC P/S
S4	KYANVUMA P/S
S5	KYANVUMA PARENTS P/S
S6	NAKABAALE P/S
S7	NAKABAALE S/S
C1	OPEN BIBLE CHURCH
C2	NAKABAALE CHURCH OF UGANDA
C3	CATHOLIC CHURCH
C4	CHURCH
M	MOSQUE

AG-9

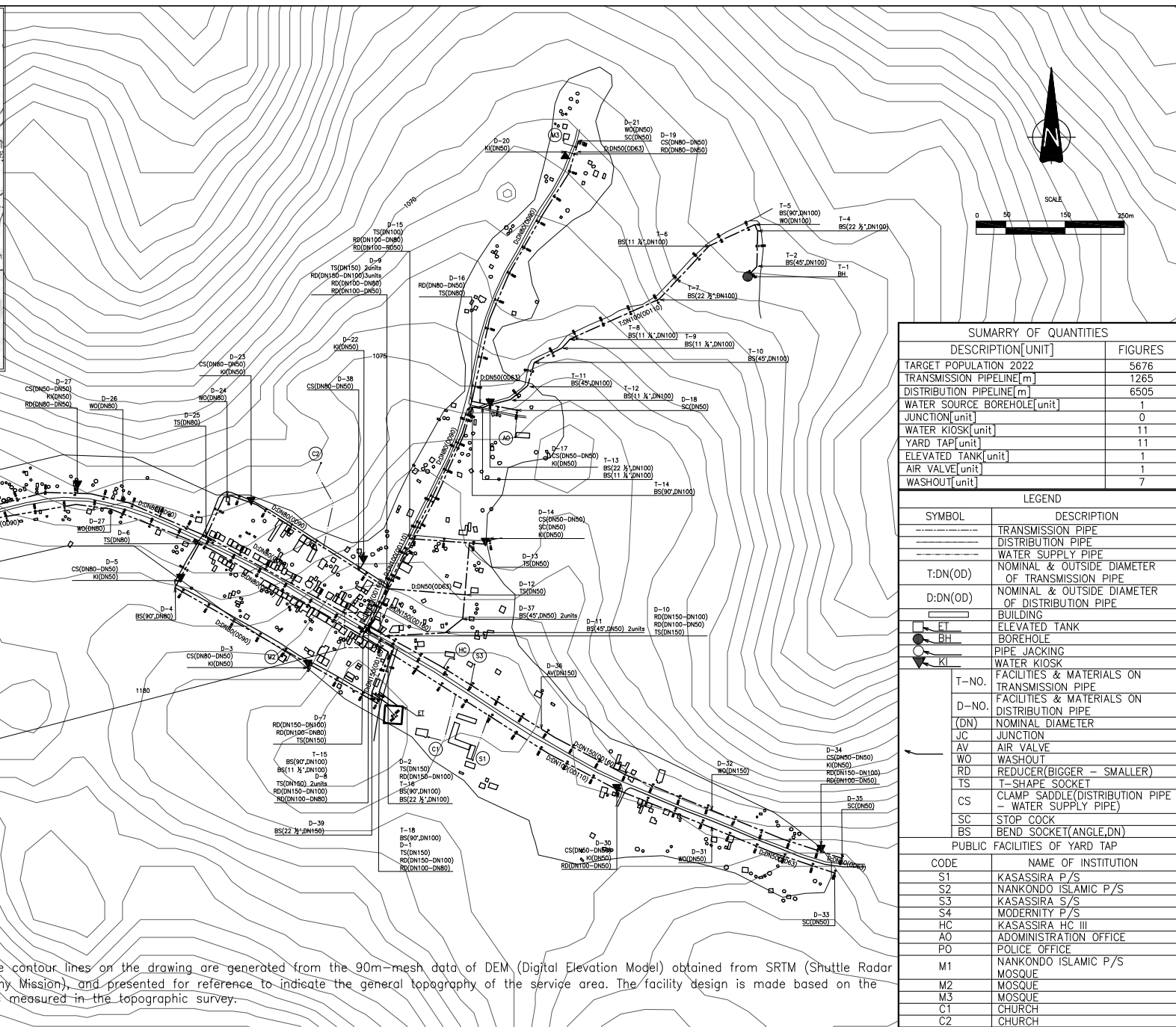

SUMMARY OF QUANTITIES		
DESCRIPTION[UNIT]	FIGURES	
TARGET POPULATION 2022	5676	
TRANSMISSION PIPELINE[m]	1265	
DISTRIBUTION PIPELINE[m]	6505	
WATER SOURCE BOREHOLE[unit]	1	
JUNCTION[unit]	0	
WATER KIOSK[unit]	11	
YARD TAP[unit]	11	
ELEVATED TANK[unit]	1	
AIR VALVE[unit]	1	
WASHOUT[unit]	7	

LEGEND	
SYMBOL	DESCRIPTION
—	TRANSMISSION PIPE
- - -	DISTRIBUTION PIPE
—	WATER SUPPLY PIPE
T:DN(OD)	NOMINAL & OUTSIDE DIAMETER OF TRANSMISSION PIPE
D:DN(OD)	NOMINAL & OUTSIDE DIAMETER OF DISTRIBUTION PIPE
[Building symbol]	BUILDING
[Elevated tank symbol]	ELEVATED TANK
[Borehole symbol]	BOREHOLE
[Pipe jacking symbol]	PIPE JACKING
[Water kiosk symbol]	WATER KIOSK

PUBLIC FACILITIES OF YARD TAP	
CODE	NAME OF INSTITUTION
S1	KASASSIRA P/S
S2	NANKONDO ISLAMIC P/S
S3	KASASSIRA S/S
S4	MODERNITY P/S
HC	KASASSIRA HC III
AO	ADMINISTRATION OFFICE
PO	POLICE OFFICE
M1	NANKONDO ISLAMIC P/S
M2	MOSQUE
M3	MOSQUE
C1	CHURCH
C2	CHURCH

NOTE: The contour lines on the drawing are generated from the 90m-mesh data of DEM (Digital Elevation Model) obtained from SRTM (Shuttle Radar Topography Mission), and presented for reference to indicate the general topography of the service area. The facility design is made based on the elevations measured in the topographic survey.

AG-10

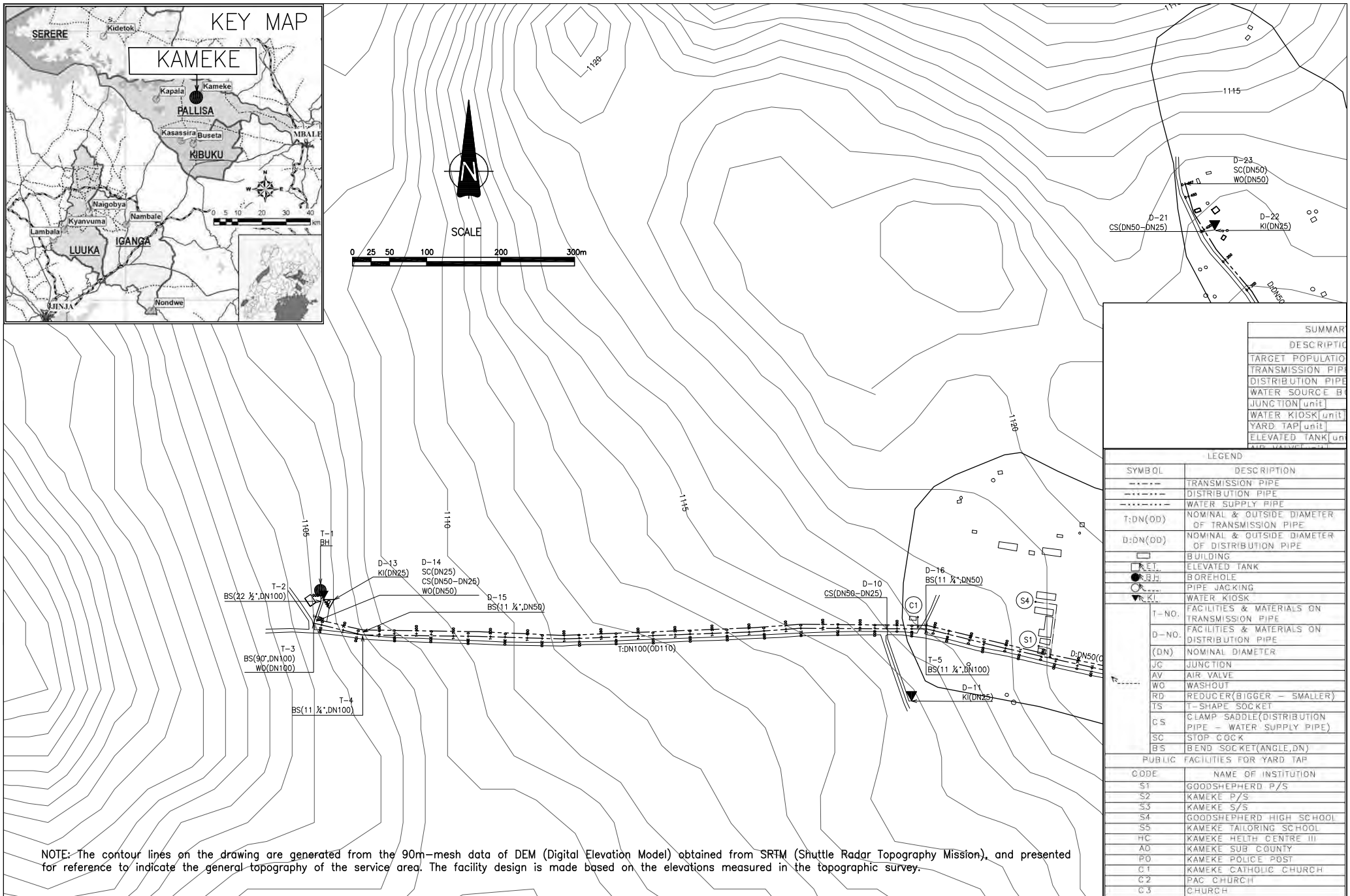
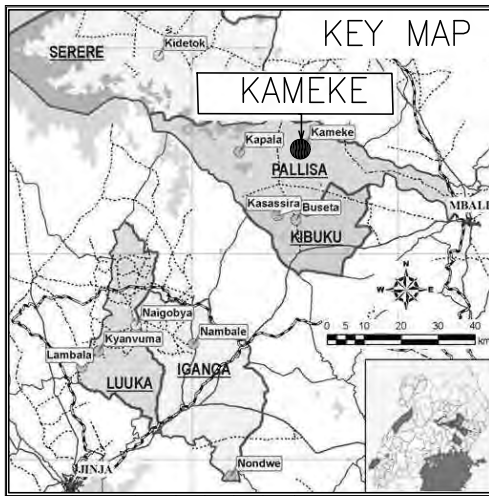

NOTE: The contour lines on the drawing are generated from the 90m-mesh data of DEM (Digital Elevation Model) obtained from SRTM (Shuttle Radar Topography Mission), and presented for reference to indicate the general topography of the service area. The facility design is made based on the elevations measured in the topographic survey.

SUMMARY	
DESCRIPTION	
TARGET POPULATION	
TRANSMISSION PIPE	
DISTRIBUTION PIPE	
WATER SOURCE	
JUNCTION[unit]	
WATER KIOSK[unit]	
YARD TAP[unit]	
ELEVATED TANK[unit]	
PIPE JACKING	

LEGEND	
SYMBOL	DESCRIPTION
---	TRANSMISSION PIPE
----	DISTRIBUTION PIPE
-----	WATER SUPPLY PIPE
T:DN(OD)	NOMINAL & OUTSIDE DIAMETER OF TRANSMISSION PIPE
D:DN(OD)	NOMINAL & OUTSIDE DIAMETER OF DISTRIBUTION PIPE
[Building symbol]	BUILDING
[Elevated tank symbol]	ELEVATED TANK
[Borehole symbol]	BOREHOLE
[Pipe jacking symbol]	PIPE JACKING
[Water kiosk symbol]	WATER KIOSK
T-NO.	FACILITIES & MATERIALS ON TRANSMISSION PIPE
D-NO.	FACILITIES & MATERIALS ON DISTRIBUTION PIPE
(DN)	NOMINAL DIAMETER
JG	JUNCTION
AV	AIR VALVE
WO	WASHOUT
RD	REDUCER(BIGGER - SMALLER)
TS	T-SHAPE SOCKET
CS	CLAMP SADDLE(DISTRIBUTION PIPE - WATER SUPPLY PIPE)
SC	STOP COCK
BS	BEND SOCKET(ANGLE, DN)
PUBLIC FACILITIES FOR YARD TAP	
CODE	NAME OF INSTITUTION
S1	GOODSHEPHERD P/S
S2	KAMEKE P/S
S3	KAMEKE S/S
S4	GOODSHEPHERD HIGH SCHOOL
S5	KAMEKE TAILORING SCHOOL
HC	KAMEKE HEALTH CENTRE III
A0	KAMEKE SUB COUNTY
P0	KAMEKE POLICE POST
C1	KAMEKE CATHOLIC CHURCH
C2	PAC CHURCH
C3	CHURCH

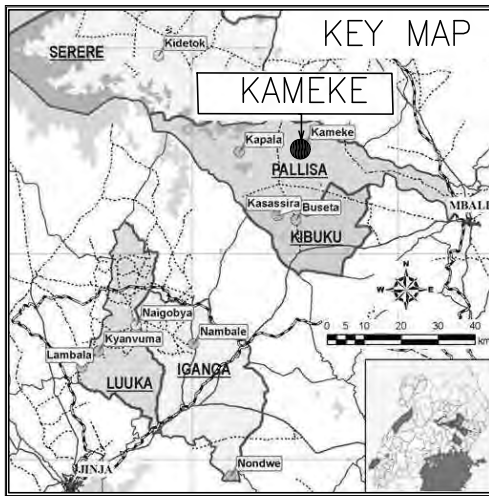

AG-12

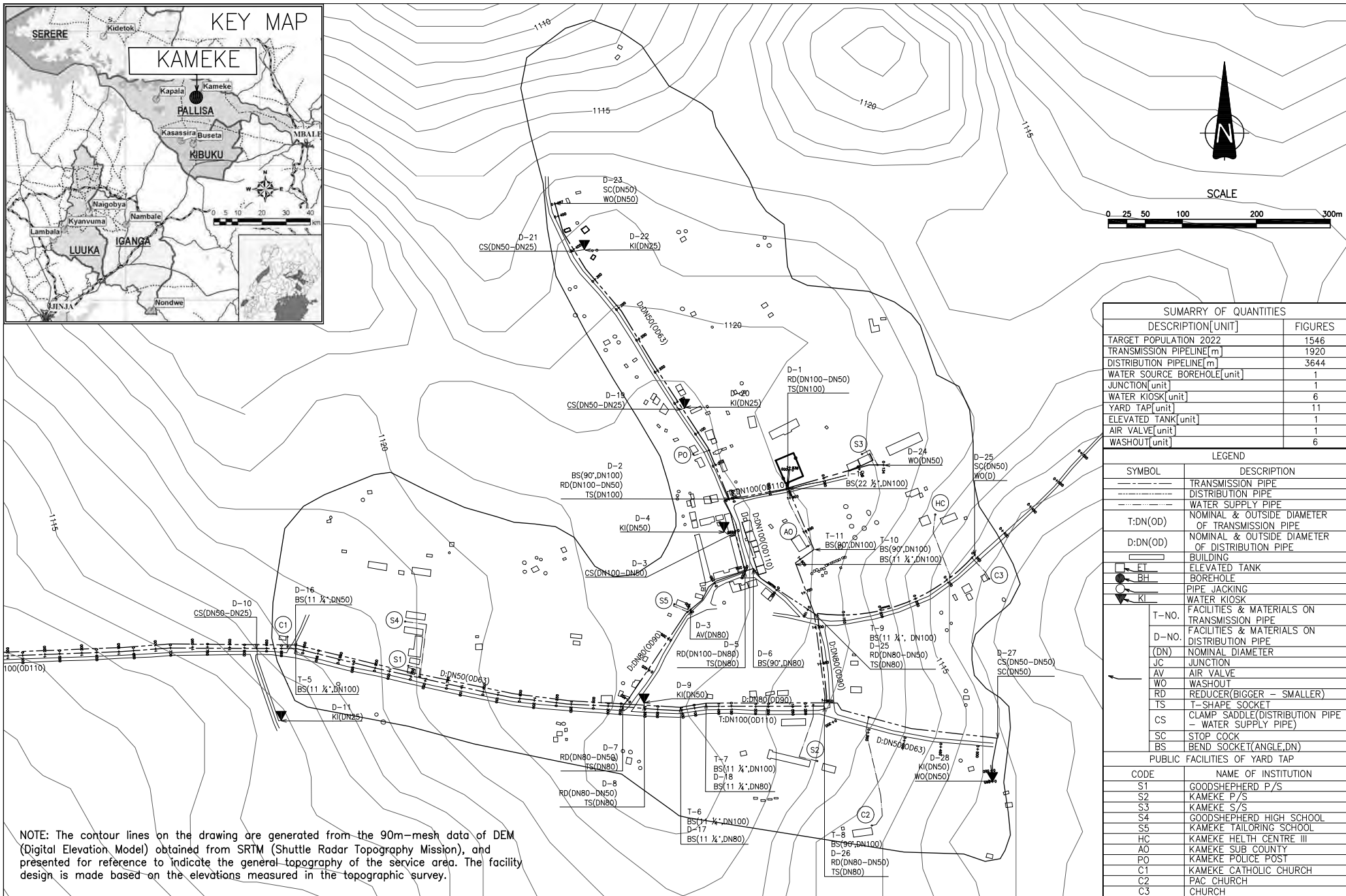

SUMMARY OF QUANTITIES	
DESCRIPTION[UNIT]	FIGURES
TARGET POPULATION 2022	1546
TRANSMISSION PIPELINE[m]	1920
DISTRIBUTION PIPELINE[m]	3644
WATER SOURCE BOREHOLE[unit]	1
JUNCTION[unit]	1
WATER KIOSK[unit]	6
YARD TAP[unit]	11
ELEVATED TANK[unit]	1
AIR VALVE[unit]	1
WASHOUT[unit]	6

LEGEND	
SYMBOL	DESCRIPTION
---	TRANSMISSION PIPE
- - - -	DISTRIBUTION PIPE
---	WATER SUPPLY PIPE
T:DN(OD)	NOMINAL & OUTSIDE DIAMETER OF TRANSMISSION PIPE
D:DN(OD)	NOMINAL & OUTSIDE DIAMETER OF DISTRIBUTION PIPE
[Building symbol]	BUILDING
[Elevated tank symbol]	ELEVATED TANK
[Borehole symbol]	BOREHOLE
[Pipe jacking symbol]	PIPE JACKING
[Water kiosk symbol]	WATER KIOSK
T-NO.	FACILITIES & MATERIALS ON TRANSMISSION PIPE
D-NO.	FACILITIES & MATERIALS ON DISTRIBUTION PIPE
(DN)	NOMINAL DIAMETER
JC	JUNCTION
AV	AIR VALVE
WO	WASHOUT
RD	REDUCER(BIGGER - SMALLER)
T-	SHAPE SOCKET
TS	SADDLE(DISTRIBUTION PIPE - WATER SUPPLY PIPE)
CS	CLAMP
SC	STOP COCK
BS	BEND SOCKET(ANGLE, DN)

PUBLIC FACILITIES OF YARD TAP	
CODE	NAME OF INSTITUTION
S1	GOODSHEPHERD P/S
S2	KAMEKE P/S
S3	KAMEKE S/S
S4	GOODSHEPHERD HIGH SCHOOL
S5	KAMEKE TAILORING SCHOOL
HC	KAMEKE HELTH CENTRE III
AO	KAMEKE SUB COUNTY
PO	KAMEKE POLICE POST
C1	KAMEKE CATHOLIC CHURCH
C2	FAC CHURCH
C3	CHURCH

NOTE: The contour lines on the drawing are generated from the 90m-mesh data of DEM (Digital Elevation Model) obtained from SRTM (Shuttle Radar Topography Mission), and presented for reference to indicate the general topography of the service area. The facility design is made based on the elevations measured in the topographic survey.

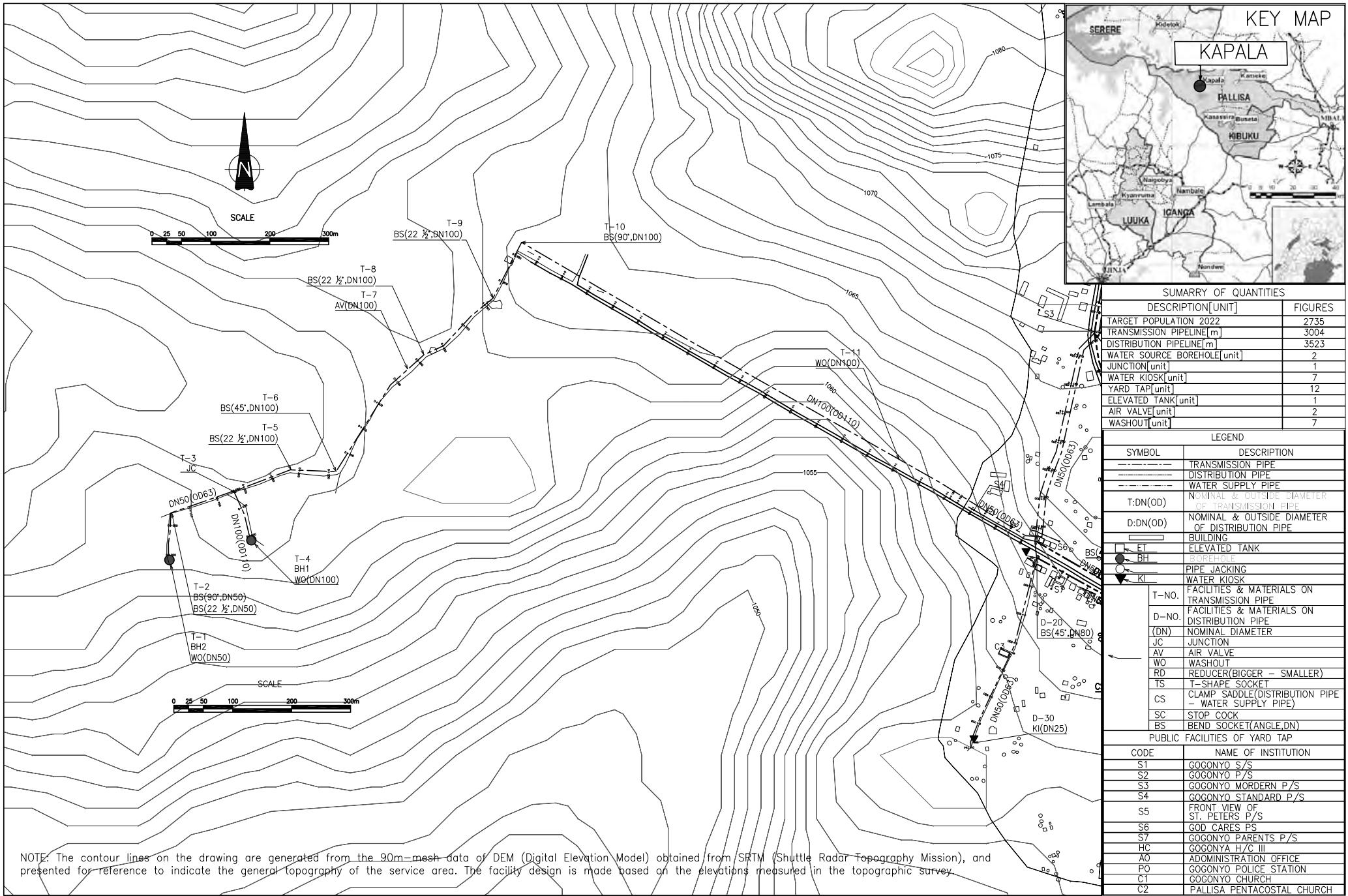

NOTE: The contour lines on the drawing are generated from the 90m-mesh data of DEM (Digital Elevation Model) obtained from SRTM (Shuttle Radar Topography Mission), and presented for reference to indicate the general topography of the service area. The facility design is made based on the elevations measured in the topographic survey.

SUMMARY OF QUANTITIES	
DESCRIPTION[UNIT]	FIGURES
TARGET POPULATION 2022	2735
TRANSMISSION PIPELINE[m]	3004
DISTRIBUTION PIPELINE[m]	3523
WATER SOURCE BOREHOLE[unit]	2
JUNCTION[unit]	1
WATER KIOSK[unit]	7
YARD TAP[unit]	12
ELEVATED TANK[unit]	1
AIR VALVE[unit]	2
WASHOUT[unit]	7

LEGEND	
SYMBOL	DESCRIPTION
—	TRANSMISSION PIPE
- - -	DISTRIBUTION PIPE
—	WATER SUPPLY PIPE
T:DN(OD)	NOMINAL & OUTSIDE DIAMETER OF TRANSMISSION PIPE
D:DN(OD)	NOMINAL & OUTSIDE DIAMETER OF DISTRIBUTION PIPE
[Building symbol]	BUILDING
[ET symbol]	ELEVATED TANK
[BH symbol]	BOREHOLE
[KIOSK symbol]	WATER KIOSK
[T-NO. symbol]	FACILITIES & MATERIALS ON TRANSMISSION PIPE
[D-NO. symbol]	FACILITIES & MATERIALS ON DISTRIBUTION PIPE
(DN)	NOMINAL DIAMETER
JC	JUNCTION
AV	AIR VALVE
RD	REDUCER(BIGGER - SMALLER)
TS	T-SHAPE SOCKET
CS	CLAMP SADDLE(DISTRIBUTION PIPE - WATER SUPPLY PIPE)
SC	STOP COCK
BS	BEND SOCKET(ANGLE, DN)

PUBLIC FACILITIES OF YARD TAP	
CODE	NAME OF INSTITUTION
S1	COGONYO S/S
S2	COGONYO P/S
S3	COGONYO MORDERN P/S
S4	COGONYO STANDARD P/S
S5	FRONT VIEW OF ST. PETERS P/S
S6	COD CARES PS
S7	COGONYO PARENTS P/S
HC	COGONYA H/C III
A0	ADMINISTRATION OFFICE
P0	COGONYO POLICE STATION
C1	COGONYO CHURCH
C2	PALLISA PENTACOSTAL CHURCH

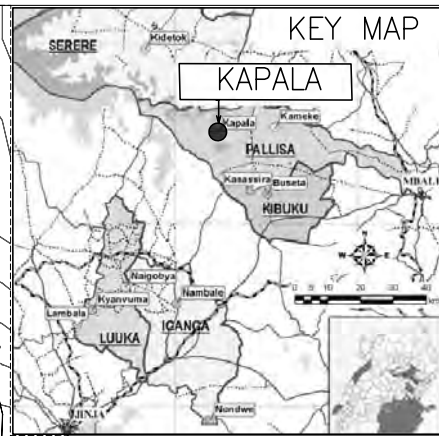
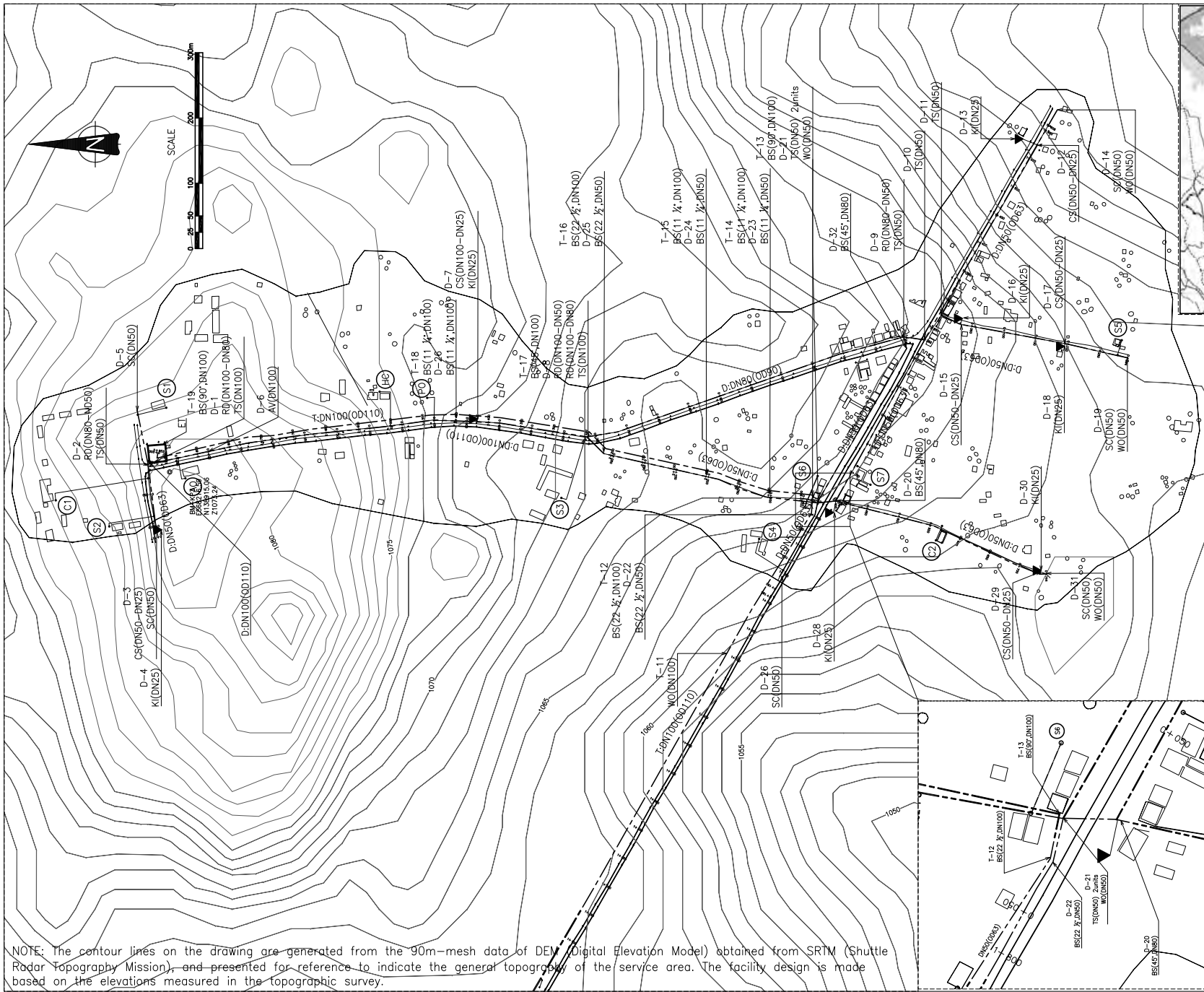

SUMMARY OF QUANTITIES

DESCRIPTION[UNIT]	FIGURES
TARGET POPULATION 2022	2735
TRANSMISSION PIPELINE[m]	3004
DISTRIBUTION PIPELINE[m]	3523
WATER SOURCE BOREHOLE[unit]	2
JUNCTION[unit]	1
WATER KIOSK[unit]	7
YARD TAP[unit]	12
ELEVATED TANK[unit]	1
AIR VALVE[unit]	2
WASHOUT[unit]	7

LEGEND

SYMBOL	DESCRIPTION
---	TRANSMISSION PIPE
---	DISTRIBUTION PIPE
---	WATER SUPPLY PIPE
T:DN(OD)	NOMINAL & OUTSIDE DIAMETER OF TRANSMISSION PIPE
D:DN(OD)	NOMINAL & OUTSIDE DIAMETER OF DISTRIBUTION PIPE
[Building]	BUILDING
[Tank]	ELEVATED TANK
[Arrow]	PIPE JACKING
[Circle]	WATER KIOSK
[Triangle]	WATER KIOSK
T-NO.	FACILITIES & MATERIALS ON TRANSMISSION PIPE
D-NO.	FACILITIES & MATERIALS ON DISTRIBUTION PIPE
(DN)	NOMINAL DIAMETER
JC	JUNCTION
AV	AIR VALVE
WO	WASHOUT
RD	REDUCER(BIGGER - SMALLER)
TS	T-SHAPE SOCKET
CS	CLAMP SADDLE(DISTRIBUTION PIPE - WATER SUPPLY PIPE)
SC	STOP COCK
BS	BEND SOCKET(ANGLE, DN)

PUBLIC FACILITIES OF YARD TAP

CODE	NAME OF INSTITUTION
S1	GOGONYO S/S
S2	GOGONYO P/S
S3	GOGONYO MODERN P/S
S4	GOGONYO STANDARD P/S
S5	FRONT VIEW OF ST. PETERS P/S
S6	GOD CARES PS
S7	GOGONYO PARENTS P/S
HC	GOGONYA H/C III
AO	ADMINISTRATION OFFICE
PO	GOGONYO POLICE STATION
C1	GOGONYO CHURCH
C2	PALLISA PENTACOSTAL CHURCH

NOTE: The contour lines on the drawing are generated from the 90m-mesh data of DEM (Digital Elevation Model) obtained from SRTM (Shuttle Radar Topography Mission), and presented for reference to indicate the general topography of the service area. The facility design is made based on the elevations measured in the topographic survey.

JAPAN INTERNATIONAL COOPERATION AGENCY (JICA)	THE PREPARATORY SURVEY ON THE PROJECT FOR RURAL WATER SUPPLY PHASE III IN LAKE KYOGA BASIN, EASTERN UGANDA, IN THE REPUBLIC OF UGANDA	OYO INTERNATIONAL CORPORATION TOKYO JAPAN TEC INTERNATIONAL CO., LTD. TOKYO JAPAN	TITLE :	P-04 KAPALA RGC GENERAL LAYOUT(2/2)	SCALE :	APPROVED BY :
	MINISTRY OF WATER AND ENVIRONMENT, GOVERNMENT OF THE REPUBLIC OF UGANDA		DRAWING NO. :	PREPARED BY :	DATE : NOVEMBER 2016	

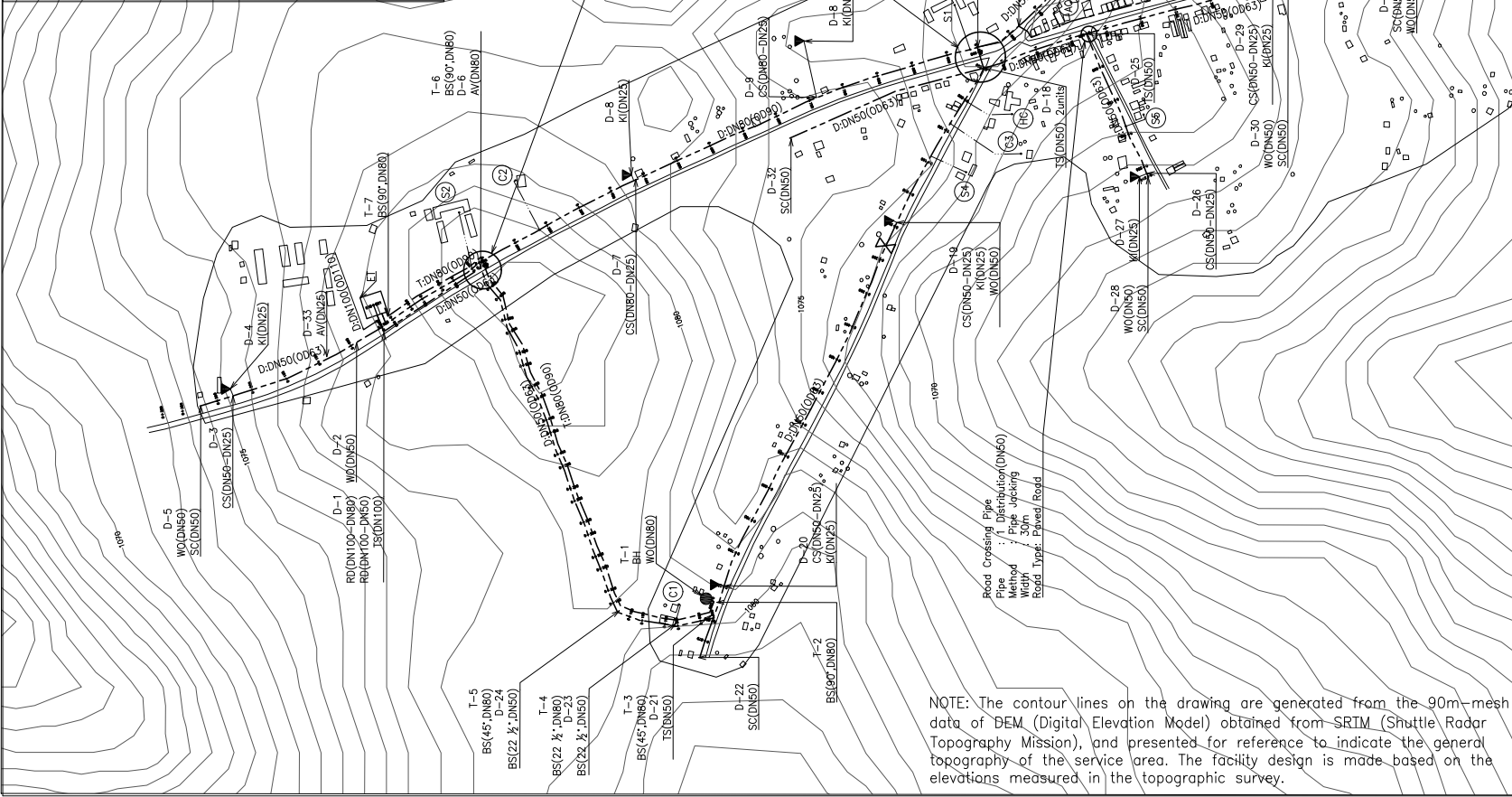
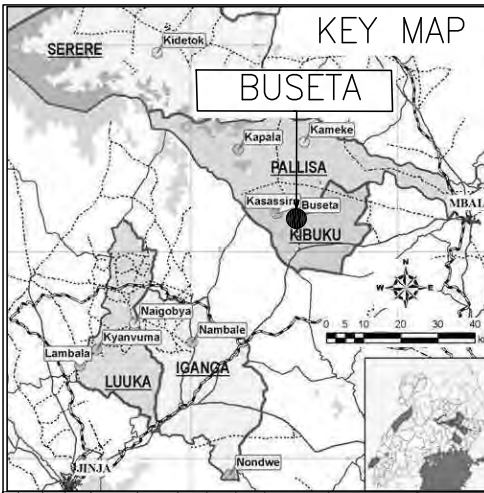

SUMMARY OF QUANTITIES		
DESCRIPTION[UNIT]	FIGURES	
TARGET POPULATION 2022	2276	
TRANSMISSION PIPELINE[m]	862	
DISTRIBUTION PIPELINE[m]	5583	
WATER SOURCE BOREHOLE[unit]	1	
JUNCTION[unit]	0	
WATER KIOSK[unit]	9	
YARD TAP[unit]	11	
ELEVATED TANK[unit]	1	
AIR VALVE[unit]	2	
WASHOUT[unit]	8	

LEGEND	
SYMBOL	DESCRIPTION
---	TRANSMISSION PIPE
----	DISTRIBUTION PIPE
----	WATER SUPPLY PIPE
T:DN(OD)	NOMINAL & OUTSIDE DIAMETER OF TRANSMISSION PIPE
D:DN(OD)	NOMINAL & OUTSIDE DIAMETER OF DISTRIBUTION PIPE
[Building symbol]	BUILDING
[Valve symbol]	VALVE
[Elevated tank symbol]	ELEVATED TANK
[Borehole symbol]	BOREHOLE
[Pipe jacking symbol]	PIPE JACKING
[Water kiosk symbol]	WATER KIOSK
T-NO.	FACILITIES & MATERIALS ON TRANSMISSION PIPE
D-NO.	FACILITIES & MATERIALS ON DISTRIBUTION PIPE
(DN)	NOMINAL DIAMETER
JC	JUNCTION
AV	AIR VALVE
WO	WASHOUT
RD	REDUCER(BIGGER - SMALLER)
TS	T-SHAPE SOCKET
CS	CLAMP SADDLE(DISTRIBUTION PIPE WATER SUPPLY PIPE)
SC	STOP COCK
BS	BEND SOCKET(ANGLE, DN)
PUBLIC FACILITIES OF YARD TAP	
CODE	NAME OF INSTITUTION
S1	MIDIR P/S
S2	JOY PARENTS P/S
S3	ST. JUDE SCHOOL
S4	BUSETA ISLAMIC SCHOOL
S5	NOOR ISLAMIC P/S
S6	SCHOOL
HC	BUSETA H/C III
C1	CHURCH
C2	CHURCH
C3	BAPTIST CHURCH
AO	ADMINISTRATION OFFICE

NOTE: The contour lines on the drawing are generated from the 90m-mesh data of DEM (Digital Elevation Model) obtained from SRTM (Shuttle Radar Topography Mission), and presented for reference to indicate the general topography of the service area. The facility design is made based on the elevations measured in the topographic survey.

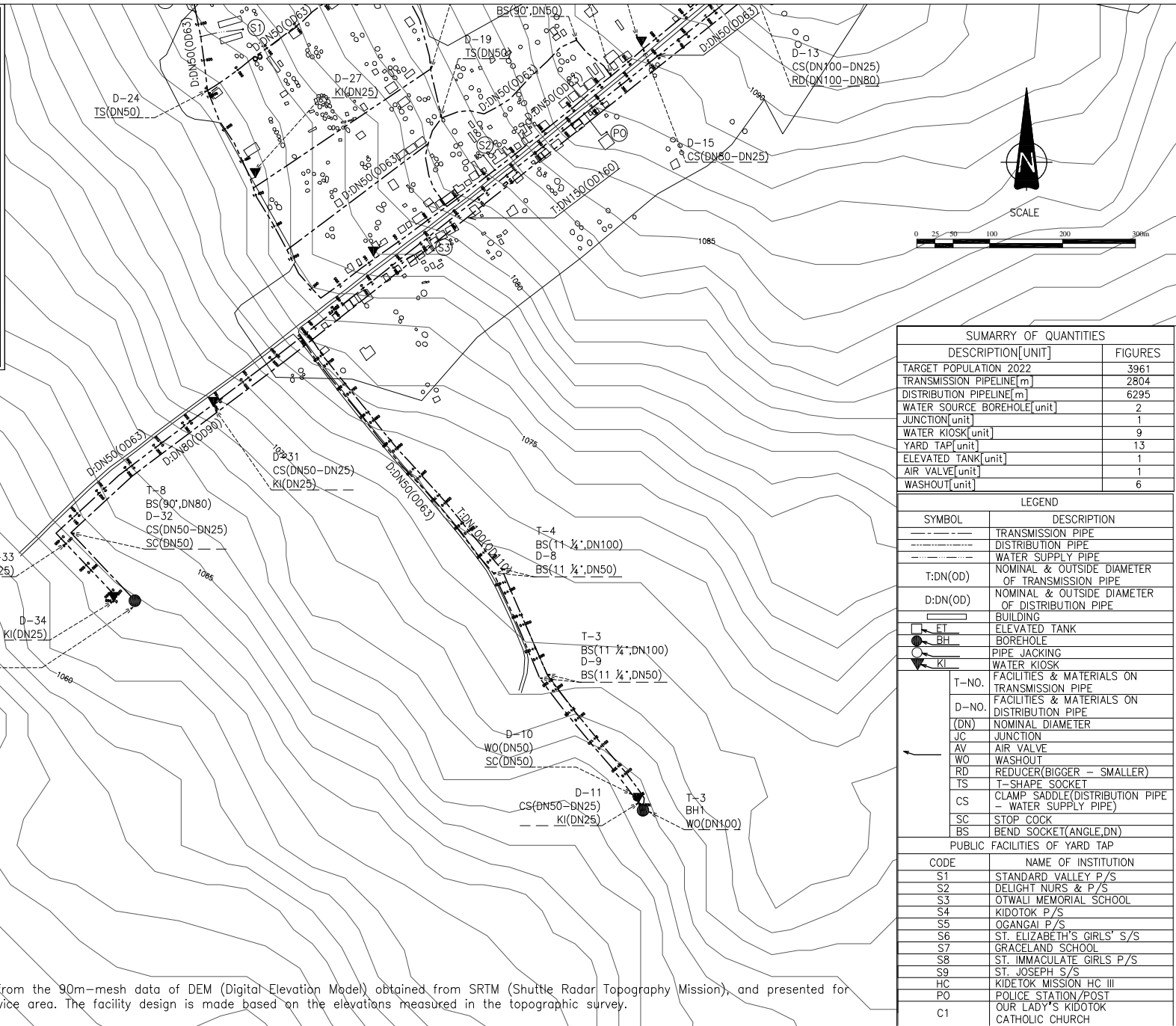
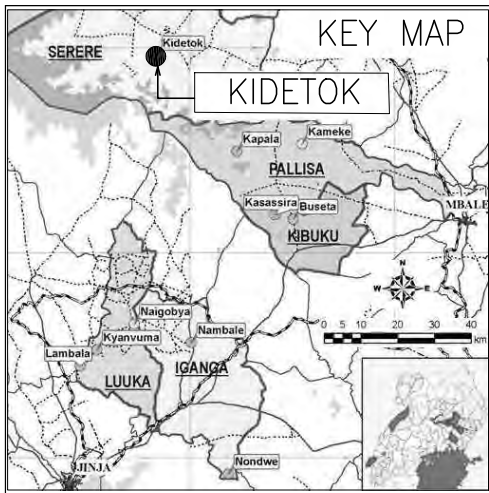

SUMMARY OF QUANTITIES	
DESCRIPTION[UNIT]	FIGURES
TARGET POPULATION 2022	3961
TRANSMISSION PIPELINE[m]	2804
DISTRIBUTION PIPELINE[m]	6295
WATER SOURCE BOREHOLE[unit]	2
JUNCTION[unit]	1
WATER KIOSK[unit]	9
YARD TAP[unit]	13
ELEVATED TANK[unit]	1
AIR VALVE[unit]	1
WASHOUT[unit]	6

LEGEND	
SYMBOL	DESCRIPTION
	TRANSMISSION PIPE
	DISTRIBUTION PIPE
	WATER SUPPLY PIPE
$T:DN(OD)$	NOMINAL & OUTSIDE DIAMETER OF TRANSMISSION PIPE
$D:DN(OD)$	NOMINAL & OUTSIDE DIAMETER OF DISTRIBUTION PIPE
	BUILDING
	ELEVATED TANK
	BOREHOLE
	PIPE JACKING
	WATER KIOSK
T-NO.	FACILITIES & MATERIALS ON TRANSMISSION PIPE
D-NO.	FACILITIES & MATERIALS ON DISTRIBUTION PIPE
(DN)	NOMINAL DIAMETER
JC	JUNCTION
AV	AIR VALVE
WO	WASHOUT
RD	REDUCER(BIGGER - SMALLER)
TS	T-SHAPE SOCKET
CS	CLAMP - SADDLE(DISTRIBUTION PIPE - WATER SUPPLY PIPE)
SC	STOP COCK
BS	BEND SOCKET(ANGLE, DN)
PUBLIC FACILITIES OF YARD TAP	
CODE	NAME OF INSTITUTION
S1	STANDARD VALLEY P/S
S2	DELIGHT NURS & P/S
S3	OTWALI MEMORIAL SCHOOL
S4	KIDOTOK P/S
S5	OGANGAL P/S
S6	ST. ELIZABETH'S GIRLS' S/S
S7	GRACELAND SCHOOL
S8	ST. IMMACULATE GIRLS P/S
S9	ST. JOSEPH S/S
HC	KIDETOK MISSION HC III
P0	POLICE STATION/POST
C1	OUR LADY'S KIDOTOK CATHOLIC CHURCH

NOTE: The contour lines on the drawing are generated from the 90m-mesh data of DEM (Digital Elevation Model) obtained from SRTM (Shuttle Radar Topography Mission), and presented for reference to indicate the general topography of the service area. The facility design is made based on the elevations measured in the topographic survey.

JAPAN INTERNATIONAL COOPERATION AGENCY (JICA)	THE PREPARATORY SURVEY ON THE PROJECT FOR RURAL WATER SUPPLY PHASE III IN LAKE KYOGA BASIN, EASTERN UGANDA, IN THE REPUBLIC OF UGANDA	OYO INTERNATIONAL CORPORATION TOKYO JAPAN	TITLE : S-01 KIDETOK RGC GENERAL LAYOUT(1/2)	SCALE :	APPROVED BY :
	MINISTRY OF WATER AND ENVIRONMENT, GOVERNMENT OF THE REPUBLIC OF UGANDA				
					DATE : NOVEMBER 2016

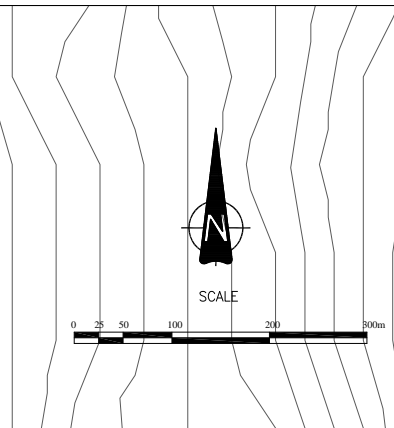
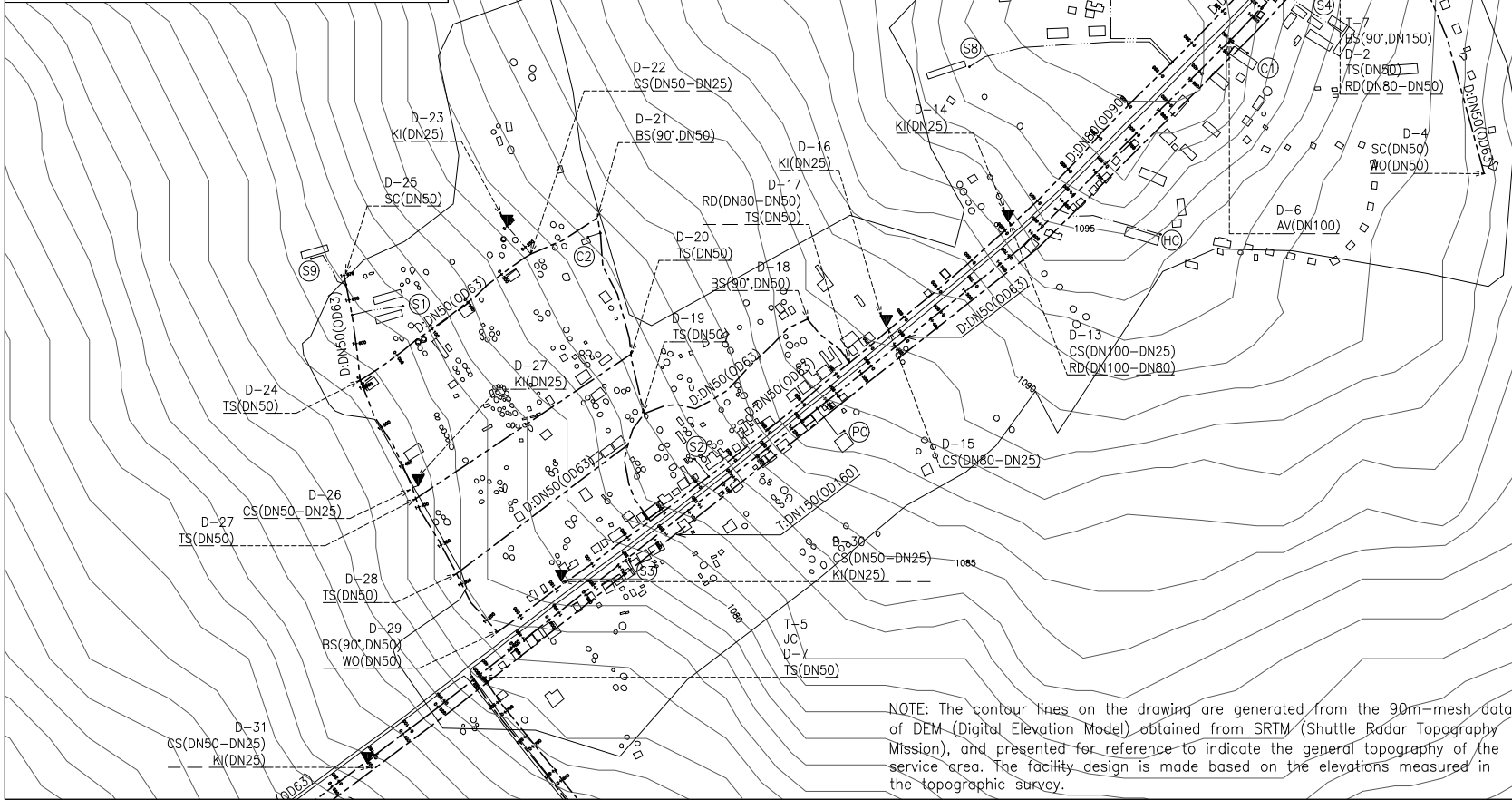
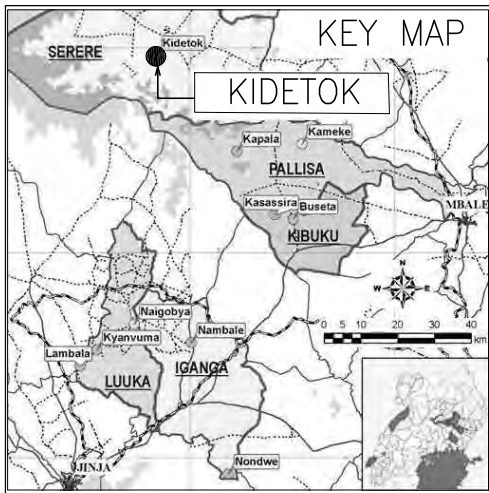

SUMMARY OF QUANTITIES	
DESCRIPTION[UNIT]	FIGURES
TARGET POPULATION 2022	3961
TRANSMISSION PIPELINE[m]	2804
DISTRIBUTION PIPELINE[m]	6295
WATER SOURCE BOREHOLE[unit]	2
JUNCTION[unit]	1
WATER KIOSK[unit]	9
YARD TAP[unit]	13
ELEVATED TANK[unit]	1
AIR VALVE[unit]	1
WASHOUT[unit]	6

LEGEND	
SYMBOL	DESCRIPTION
---	TRANSMISSION PIPE
---	DISTRIBUTION PIPE
---	WATER SUPPLY PIPE
T:DN(OD)	NOMINAL & OUTSIDE DIAMETER OF TRANSMISSION PIPE
D:DN(OD)	NOMINAL & OUTSIDE DIAMETER OF DISTRIBUTION PIPE
[Building symbol]	BUILDING
[Tank symbol]	ELEVATED TANK
[Borehole symbol]	BOREHOLE
[Kiosk symbol]	WATER KIOSK
[Pipe symbol]	PIPE JACKING
[Valve symbol]	AIR VALVE
[Washout symbol]	WASHOUT
[Reducer symbol]	REDUCER(BIGGER - SMALLER)
[Socket symbol]	T-SHAPE SOCKET
[Clamp symbol]	CLAMP SADDLE(DISTRIBUTION PIPE - WATER SUPPLY PIPE)
[Cock symbol]	STOP COCK
[Socket symbol]	BEND SOCKET(ANGLE, DN)
PUBLIC FACILITIES OF YARD TAP	
CODE	NAME OF INSTITUTION
S1	STANDARD VALLEY P/S
S2	DELIGHT NURS & P/S
S3	OTWALI MEMORIAL SCHOOL
S4	KIDOTOK P/S
S5	OGANGA P/S
S6	ST. ELIZABETH'S GIRLS' S/S
S7	GRACELAND SCHOOL
S8	ST. IMMACULATE GIRLS P/S
S9	ST. JOSEPH S/S
HC	KIDOTOK MISSION HC III
PO	POLICE STATION/POST
C1	OUR LADY'S KIDOTOK CATHOLIC CHURCH

NOTE: The contour lines on the drawing are generated from the 90m-mesh data of DEM (Digital Elevation Model) obtained from SRTM (Shuttle Radar Topography Mission), and presented for reference to indicate the general topography of the service area. The facility design is made based on the elevations measured in the topographic survey.

AG-17

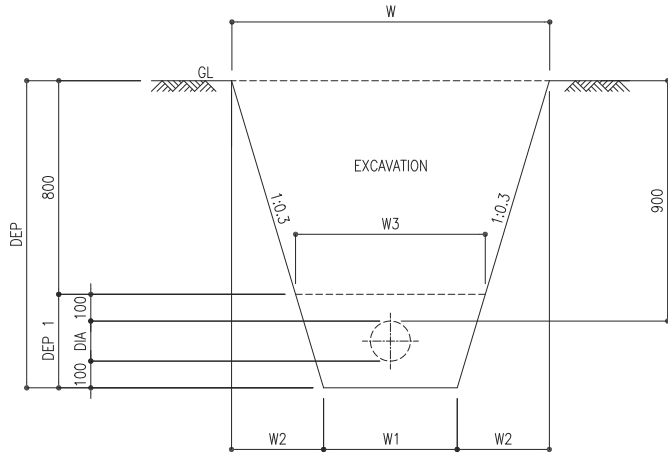

TRENCH EXCAVATION

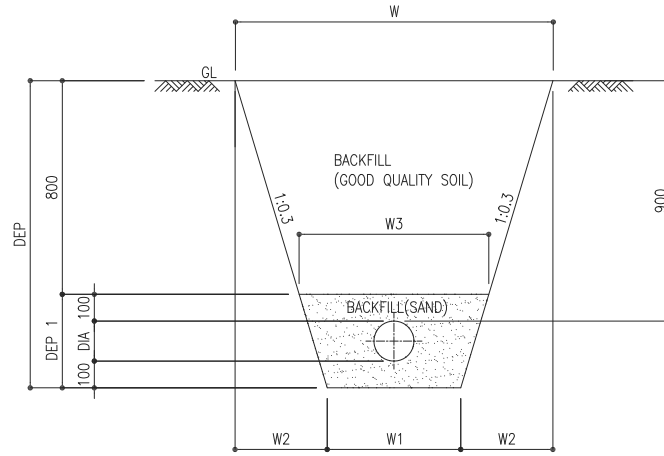

PIPE INSTALLATION

DIMENSION						
DIA	DEP	DEP1	W	W1	W2	W3
DN50(OD63)	1,050	250	1,130	500	315	650
DN80(OD90)	1,080	280	1,148	500	324	668
DN100(OD110)	1,100	300	1,160	500	330	680
DN150(OD160)	1,150	350	1,190	500	345	710

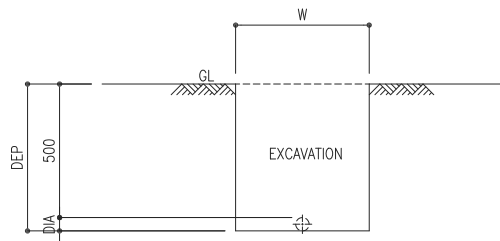

TRENCH EXCAVATION

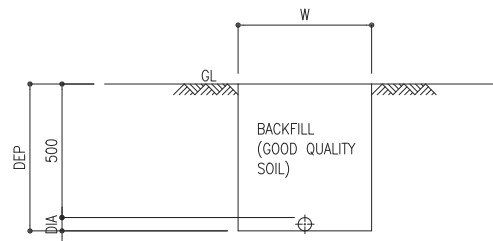

SERVICE PIPE INSTALLATION

DIMENSION		
DIA	DEP	W
DN25(OD32)	525	500
DN50(OD63)	550	500

1. HORIZONTAL BEND

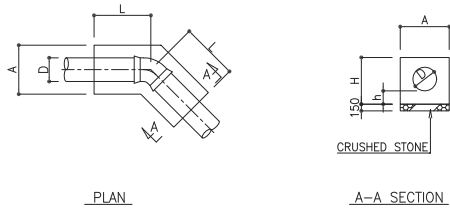

PLAN

A-A SECTION

UNIT:mm

D	·	DIMENSION			
		A	H	L	h
50	90	330	320	670	150
80		330	320	670	150
100		350	340	960	150
150		400	380	1540	150
50	45	330	320	420	150
80		330	320	420	150
100		350	340	580	150
150		400	380	920	150
50	22.5	330	320	210	150
80		330	320	210	150
100		350	340	300	150
150		400	380	470	150
50	11.25	330	320	110	150
80		330	320	110	150
100		350	340	150	150
150		400	380	240	150

2. TEE

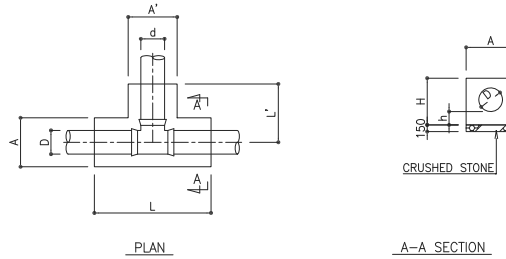

PLAN

A-A SECTION

UNIT:mm

D	d	DIMENSION						
		A	H	L	L'	A'	h	
50	50	330	320	810	420	330	150	
80	50	330	320	810	420	330	150	
80	80	330	320	810	420	330	150	
100	80	350	340	810	460	330	150	
100	100	350	340	1020	460	350	150	
150	80	400	380	910	430	330	150	
150	100	400	380	1200	440	350	150	
150	150	400	380	1670	480	400	150	

3. TAPER

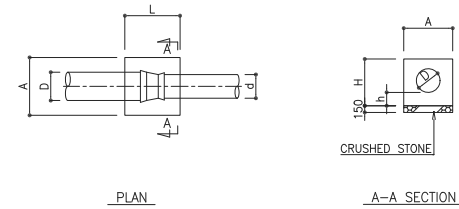

PLAN

A-A SECTION

UNIT:mm

D	d	DIMENSION			
		A	H	L	h
80	50	350	340	810	150
100	80	350	340	810	150
150	100	400	380	1140	150

4. CAP AND PLUG

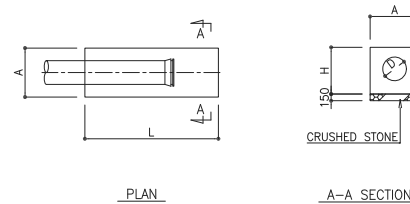

PLAN

A-A SECTION

UNIT:mm

D	DIMENSION		
	A	H	L
50	370	350	600
80	370	350	600
100	430	400	600
150	480	450	600

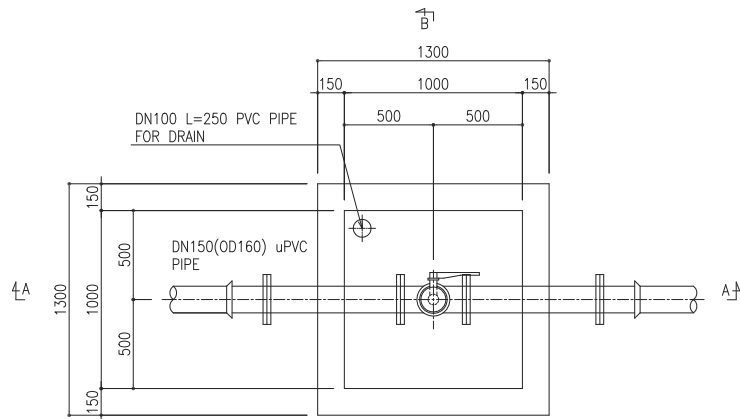

BOTTOM PLAN

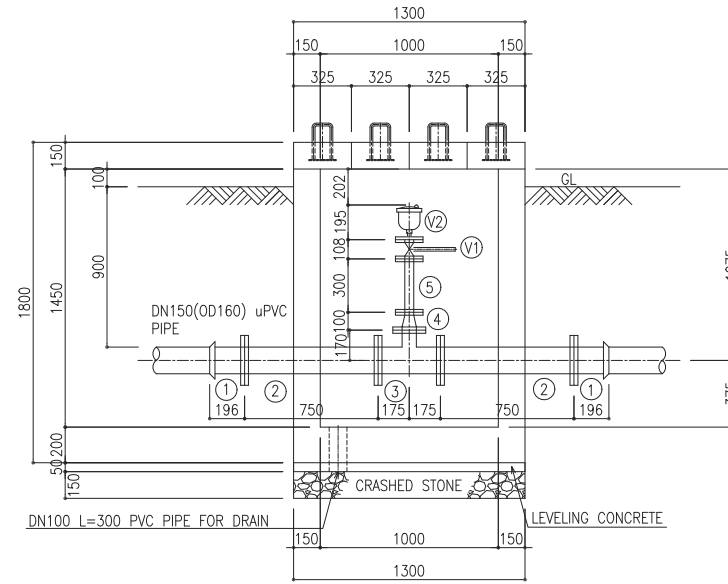

SECTION A - A

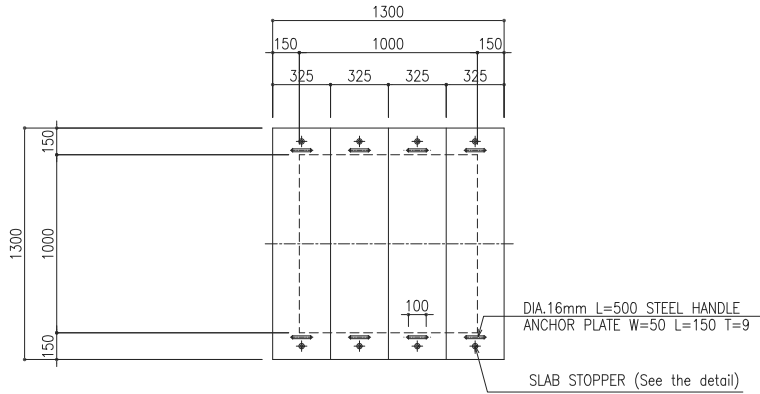

TOP PLAN

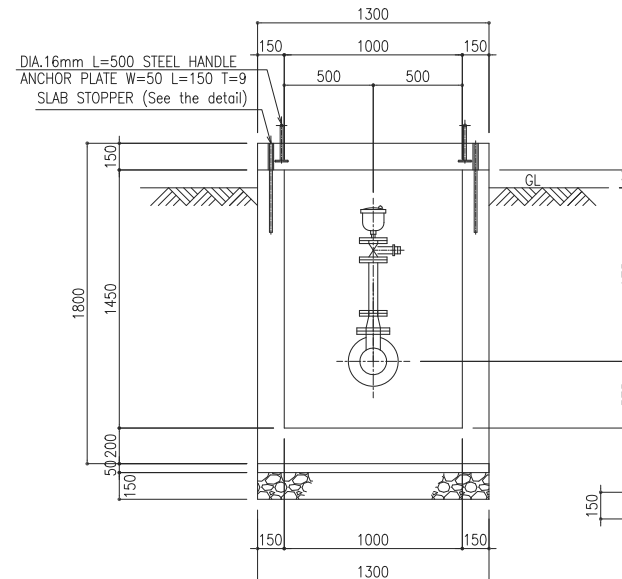

SECTION B - B

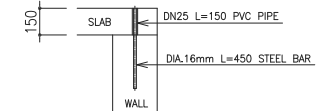

DETAIL OF SLAB STOPPER NONE SCALE

PIPING LIST				
No.	DN50(OD63)	DN80(OD90)	DN100(OD110)	DN150(OD160)
1	DN50(OD63) FLANGED SPIGOT (uPVC)	DN80(OD90) FLANGED SPIGOT (uPVC)	DN100(OD110) FLANGED SPIGOT (uPVC)	DN150(OD160) FLANGED SPIGOT (uPVC)
2	DN50X800 DOUBLE FLANGED PIPE (GSP)	DN80X800 DOUBLE FLANGED PIPE (GSP)	DN100X750 DOUBLE FLANGED PIPE (GSP)	DN150X750 DOUBLE FLANGED PIPE (GSP)
3	DN50XDN50 ALL FLANGED TEE (GSP)	DN80XDN50 ALL FLANGED TEE (GSP)	DN100XDN50 ALL FLANGED TEE (GSP)	DN150XDN80 ALL FLANGED TEE (GSP)
4	NONE	NONE	NONE	DN80X50 DOUBLE FLANGED TAPER (GSP)
5	DN50X400 DOUBLE FLANGED PIPE (GSP)	DN50X400 DOUBLE FLANGED PIPE (GSP)	DN50X400 DOUBLE FLANGED PIPE (GSP)	DN50X300 DOUBLE FLANGED PIPE (GSP)
V1	DN50 DOUBLE FLANGED BUTTERFLY VALVE, LEVER OPERATION TYPE (FCD)	SAME AS ON THE LEFT	SAME AS ON THE LEFT	SAME AS ON THE LEFT
V2	DN50 AIR VALVE WITH FLANGE (FCD)	SAME AS ON THE LEFT	SAME AS ON THE LEFT	SAME AS ON THE LEFT

NOTE :
 uPVC : Un-plasticized Poly Vinyl Pipe
 GSP : Galvanized Steel Pipe
 FCD : Ferrum Casting Ductile

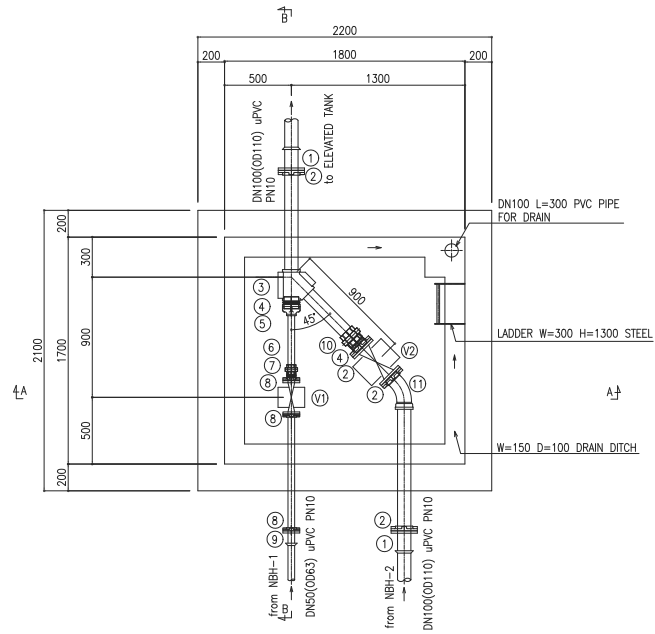

BOTTOM PLAN

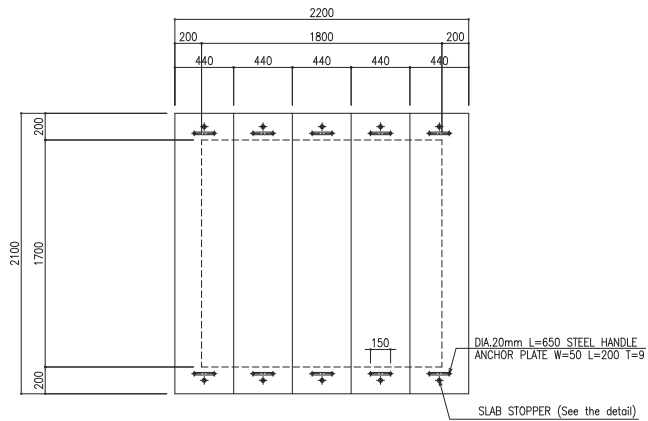

TOP PLAN

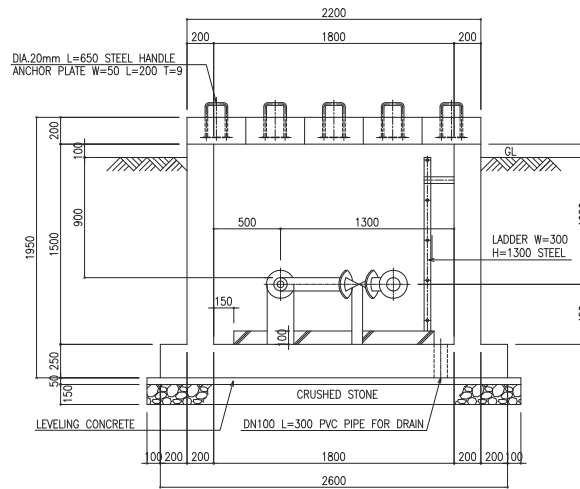

SECTION A - A

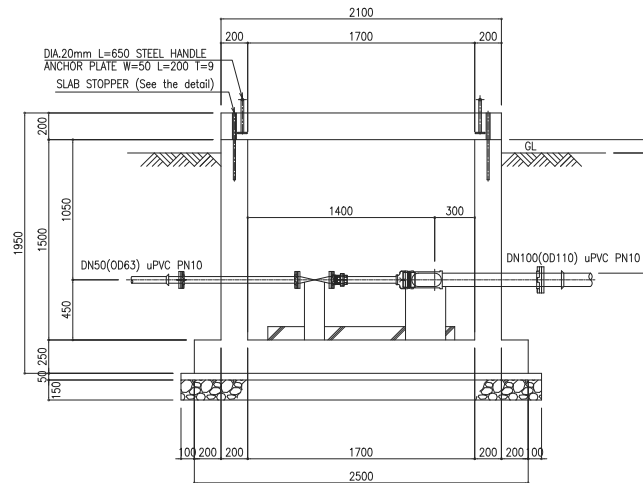

SECTION B - B

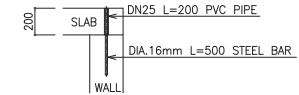

DETAIL OF SLAB STOPPER NONE SCALE

PIPING LIST		
NO.	DESCRIPTION	MATERIAL
1	DN100(OD110) FLANGED SPIGOT	uPVC
2	DN100(4") FLANGE	MCIP
3	DN100(4")XDN100(4") 45 DEGREES ANGLE BRANCH	MCIP
4	DN100(4") NIPPLE	MCIP
5	DN100(4")XDN50(2") REDUCING SOCKET	MCIP
6	DN50(2") UNION	MCIP
7	DN50(2") NIPPLE	MCIP
8	DN50(2") FLANGE	MCIP
9	DN50(OD63) FLANGED SPIGOT	uPVC
10	DN100(4") UNION	MCIP
11	DN100(4")X45 DEGREES BEND (FEMALE AND MALE)	MCIP
V1	DN50 SLUICE VALVE	FCD
V2	DN100 SLUICE VALVE	FCD

NOTE :
 uPVC : Un-plasticized Poly Vinyl Chloride Pipe
 GSP : Galvanized Steel Pipe
 MCIP : Malleable Cast Iron Pipe (Screwed Type)
 FCD : Ferrum Casting Ductile

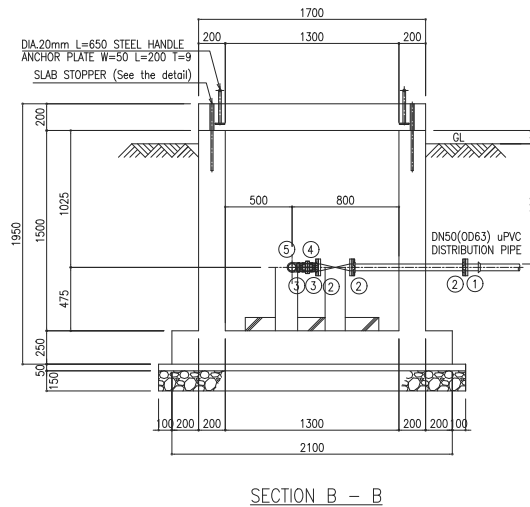
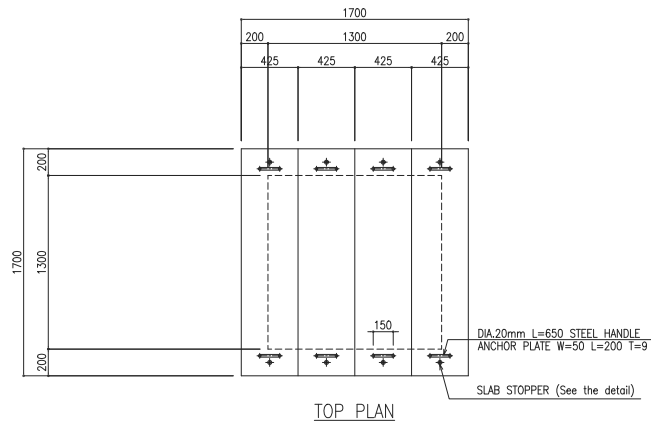
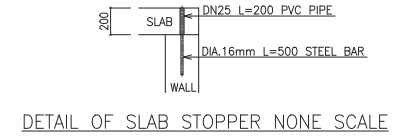
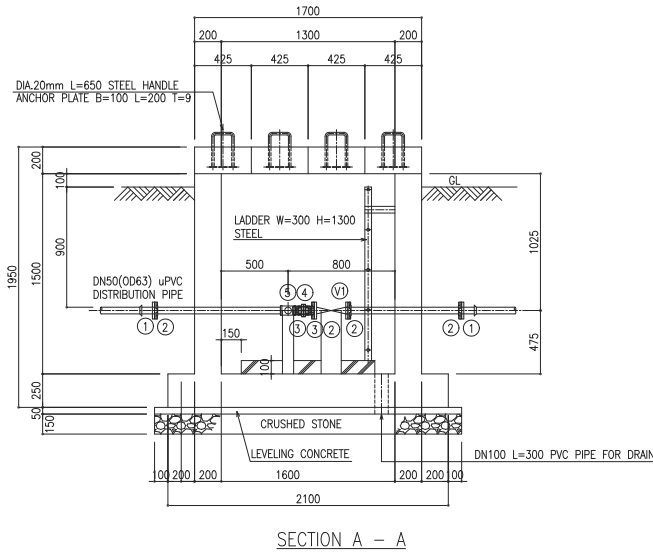
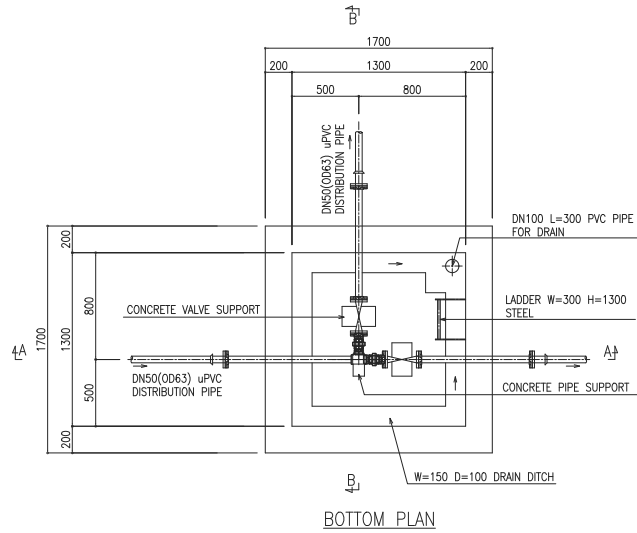

PIPING LIST		
NO.	DESCRIPTION	MATERIAL
1	DN50(OD63) FLANGED SPIGOT	uPVC
2	DN50(2") FLANGE	MCIP
3	DN50(2") NIPPLE	MCIP
4	DN50(2") UNION	MCIP
5	DN50(2")XDN50(2") TEES	MCIP
V1	DN50 SLUICE VALVE	FCD

NOTE :
 uPVC : Un-plasticized Poly Vinyl Chloride Pipe
 GSP : Galvanized Steel Pipe
 MCIP : Malleable Cast Iron Pipe (Screwed Type)
 FCD : Ferrum Casting Ductile

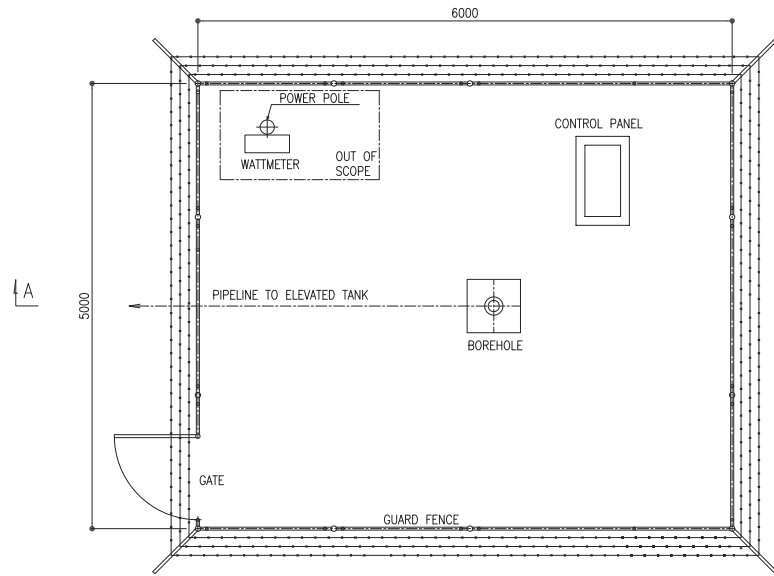

PLAN OF BOREHOLE

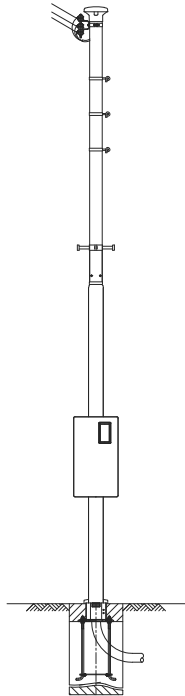

POWER POLE

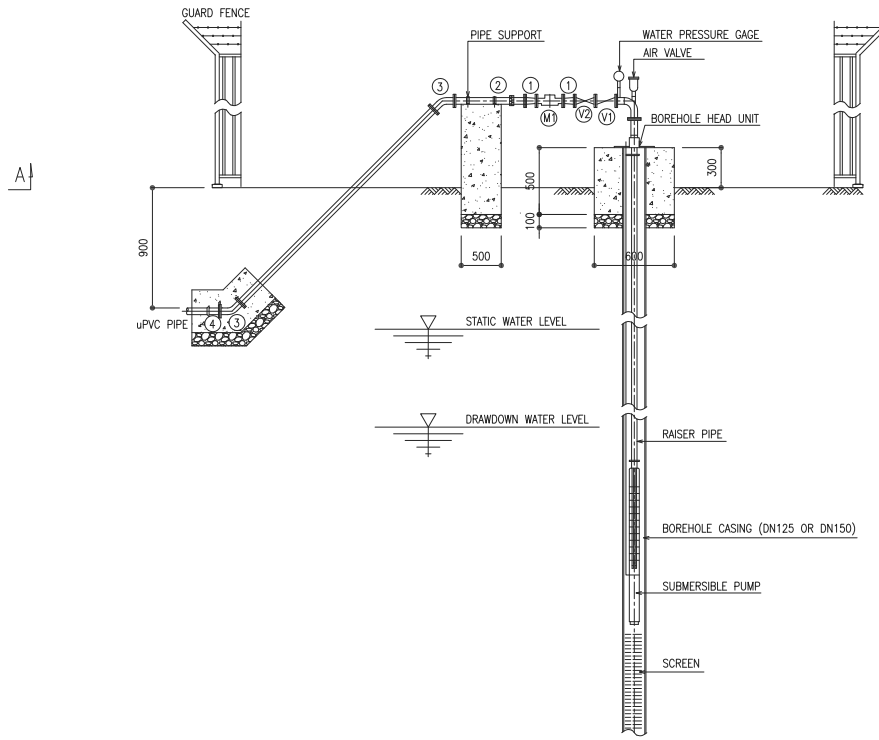

SECTION A - A

No.	PIPING LIST			
	DN50(2")	DN80(3")	DN100(4")	DN150(6")
1	DN50(2")xDN40(1.5") DOUBLE FLANGED TAPER (GSP)	DN80(3")xDN50(2") DOUBLE FLANGED TAPER (GSP)	DN100(4")xDN80(3") DOUBLE FLANGED TAPER (GSP)	DN150(6")xDN100(4") DOUBLE FLANGED TAPER (GSP)
2	DN50(2") SLEEVE JOINT (SP)	DN80(3") SLEEVE JOINT (SP)	DN100(4") SLEEVE JOINT (SP)	DN150(6") SLEEVE JOINT (SP)
3	DN80(3")x45° BEND (GSP)	DN80(3")x45° BEND (GSP)	DN100(4")x45° BEND (GSP)	DN150(6")x45° BEND (GSP)
4	DN50(200S) FLANGED SOCKET (uPVC)	DN80(200S) FLANGED SOCKET (uPVC)	DN100(200S) FLANGED SOCKET (uPVC)	DN150(200S) FLANGED SOCKET (uPVC)
5	DN50x400 DOUBLE FLANGED PIPE (GSP)	DN80x400 DOUBLE FLANGED PIPE (GSP)	DN100x400 DOUBLE FLANGED PIPE (GSP)	DN150x300 DOUBLE FLANGED PIPE (GSP)
M1	DN40 WATER FLOW METER	DN50 WATER FLOW METER	DN80 WATER FLOW METER	DN100 WATER FLOW METER
V1	DN50 CHECK VALVE (FCD)	DN80 CHECK VALVE (FCD)	DN100 CHECK VALVE (FCD)	DN150 CHECK VALVE (FCD)
V2	DN50 SLUICE VALVE WITH WHEEL HANDLE (FCD)	DN80 SLUICE VALVE WITH WHEEL HANDLE (FCD)	DN100 SLUICE VALVE WITH WHEEL HANDLE (FCD)	DN150 SLUICE VALVE WITH WHEEL HANDLE (FCD)

NOTE :
 uPVC : Un-plasticized Poly Vinyl Pipe
 GSP : Galvanized Steel Pipe
 SP : Steel Pipe
 FCD : Ferrum Casting Ductile

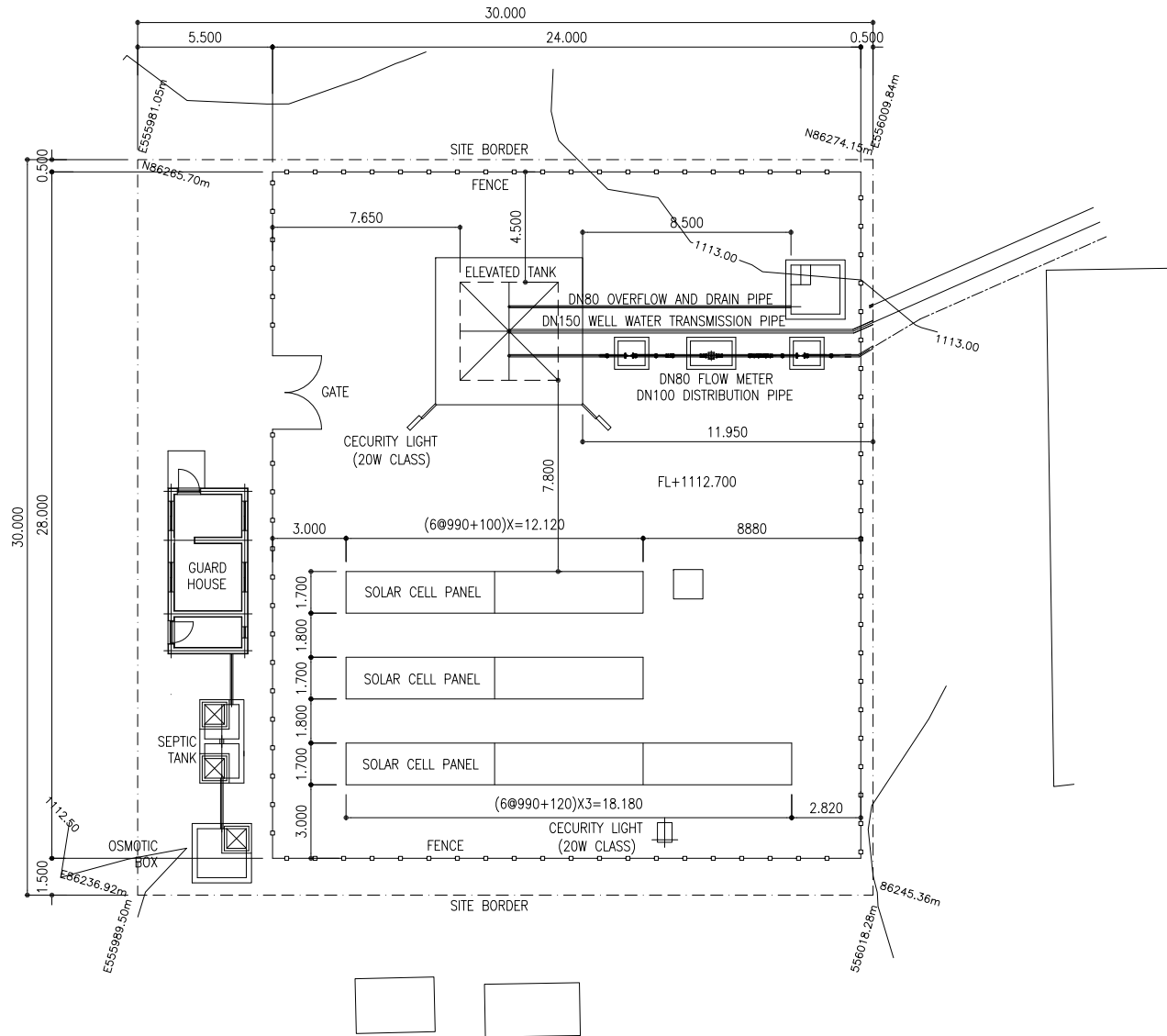

 JAPAN INTERNATIONAL COOPERATION AGENCY (JICA)	THE PREPARATORY SURVEY ON THE PROJECT FOR RURAL WATER SUPPLY PHASE III IN LAKE KYOGA BASIN, EASTERN UGANDA, IN THE REPUBLIC OF UGANDA	 OYO INTERNATIONAL CORPORATION TOKYO JAPAN  TEC INTERNATIONAL CO., LTD. TOKYO JAPAN	TITLE : NAMBALE RGC	SCALE : S=1:200	APPROVED BY :
	 MINISTRY OF WATER AND ENVIRONMENT, GOVERNMENT OF THE REPUBLIC OF UGANDA		PLAN OF ELEVATED TANK AND SOLAR POWER GENERATION ARRAY	DRAWING NO. :	PREPARED BY :

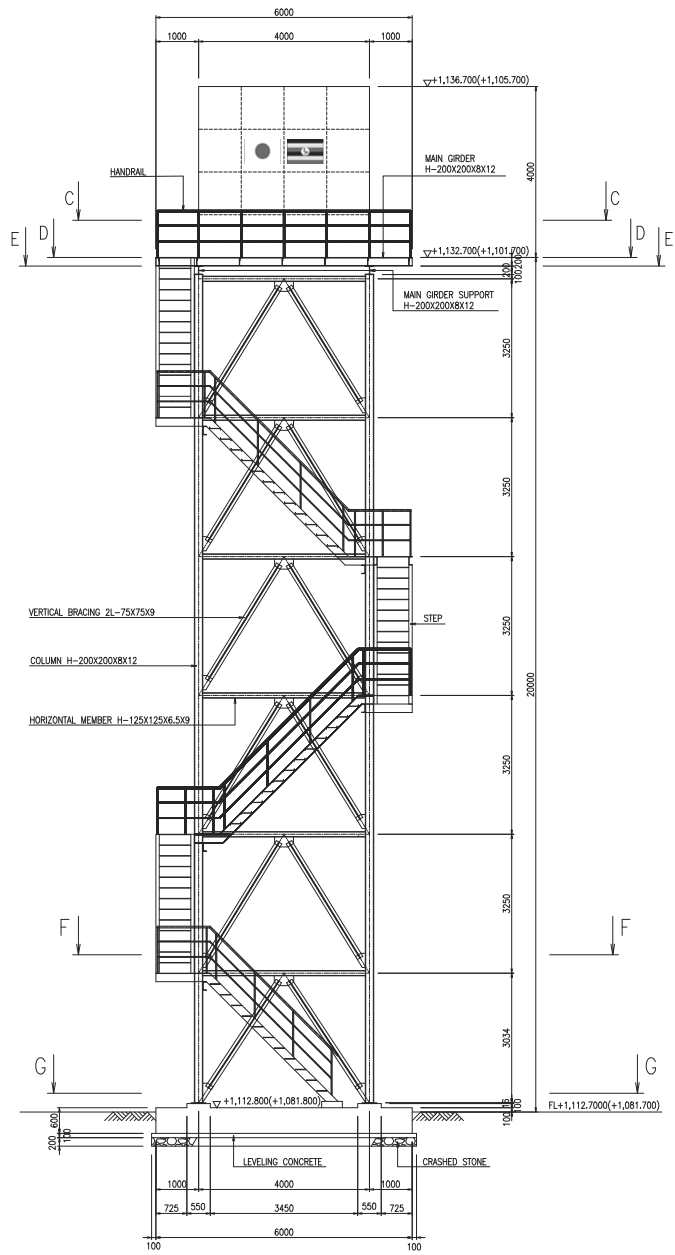

SECTION A-A

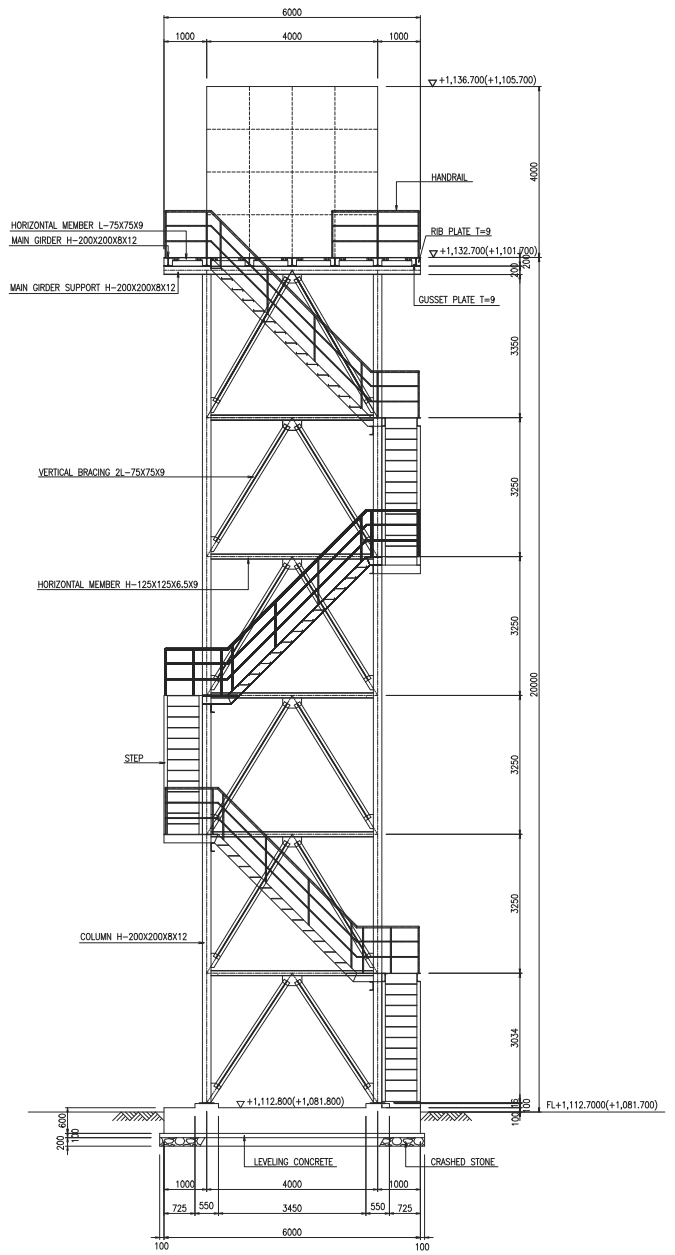

SECTION B-B

NOTE:
Formation level of Lamba is +1,081.700.

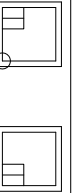
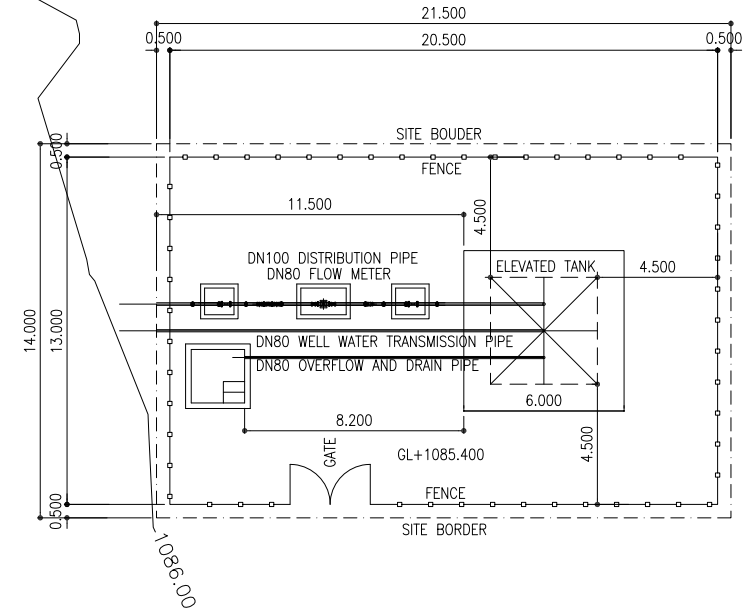
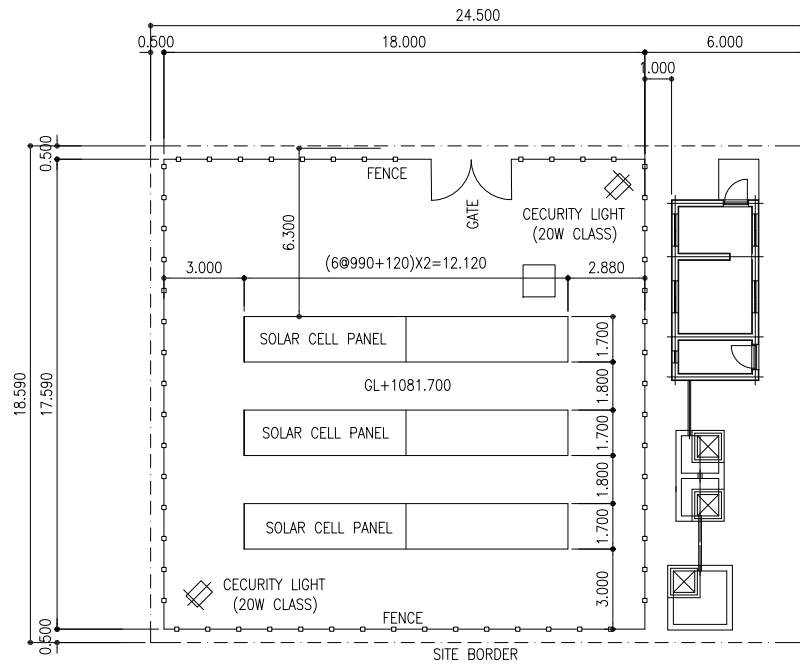

JAPAN INTERNATIONAL COOPERATION AGENCY (JICA)

THE PREPARATORY SURVEY ON THE PROJECT FOR RURAL WATER SUPPLY PHASE III IN LAKE KYOGA BASIN, EASTERN UGANDA, IN THE REPUBLIC OF UGANDA



MINISTRY OF WATER AND ENVIRONMENT, GOVERNMENT OF THE REPUBLIC OF UGANDA



OYO INTERNATIONAL CORPORATION TOKYO JAPAN



TEC INTERNATIONAL CO., LTD. TOKYO JAPAN

TITLE : LAMBALA RGC

PLAN OF ELEVATED TANK AND SOLAR POWER GENERATION ARRAY

SCALE :

S=1:200

DRAWING NO. :

APPROVED BY :

PREPARED BY :

DATE :

NOVEMBER 2016

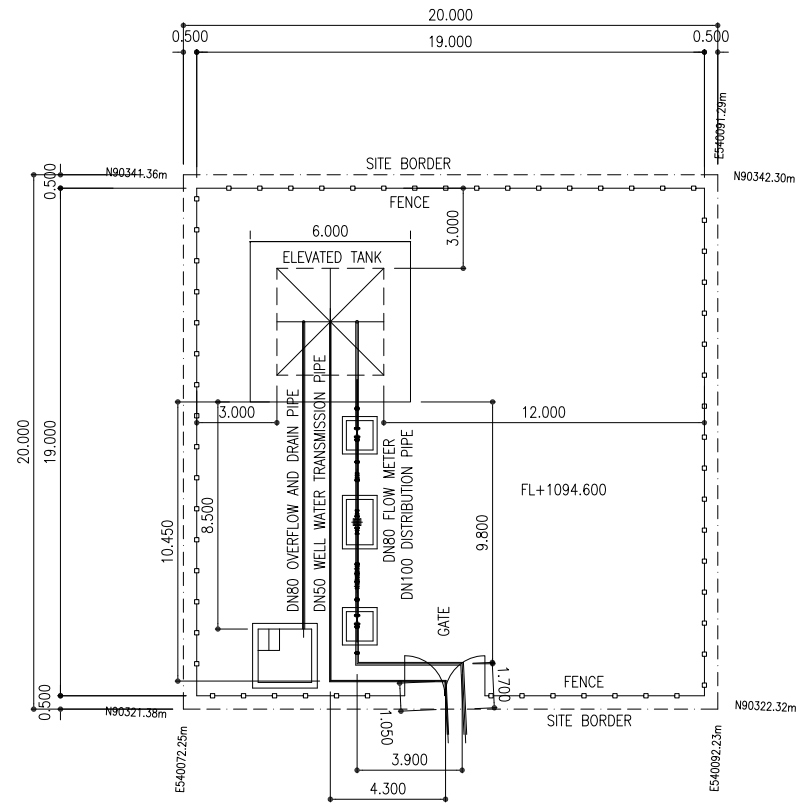

3 NAIGOBYA



JAPAN INTERNATIONAL COOPERATION AGENCY (JICA)

THE PREPARATORY SURVEY ON THE PROJECT FOR RURAL WATER SUPPLY PHASE III IN LAKE KYOGA BASIN, EASTERN UGANDA, IN THE REPUBLIC OF UGANDA



MINISTRY OF WATER AND ENVIRONMENT, GOVERNMENT OF THE REPUBLIC OF UGANDA



OYO INTERNATIONAL CORPORATION TOKYO JAPAN



TEC INTERNATIONAL CO., LTD. TOKYO JAPAN

TITLE : 3 NAIGOBYA RCC

PLAN OF ELEVATED TANK

SCALE : S=1:200

DRAWING NO. :

APPROVED BY :
PREPARED BY :
DATE : NOVEMBER 2016

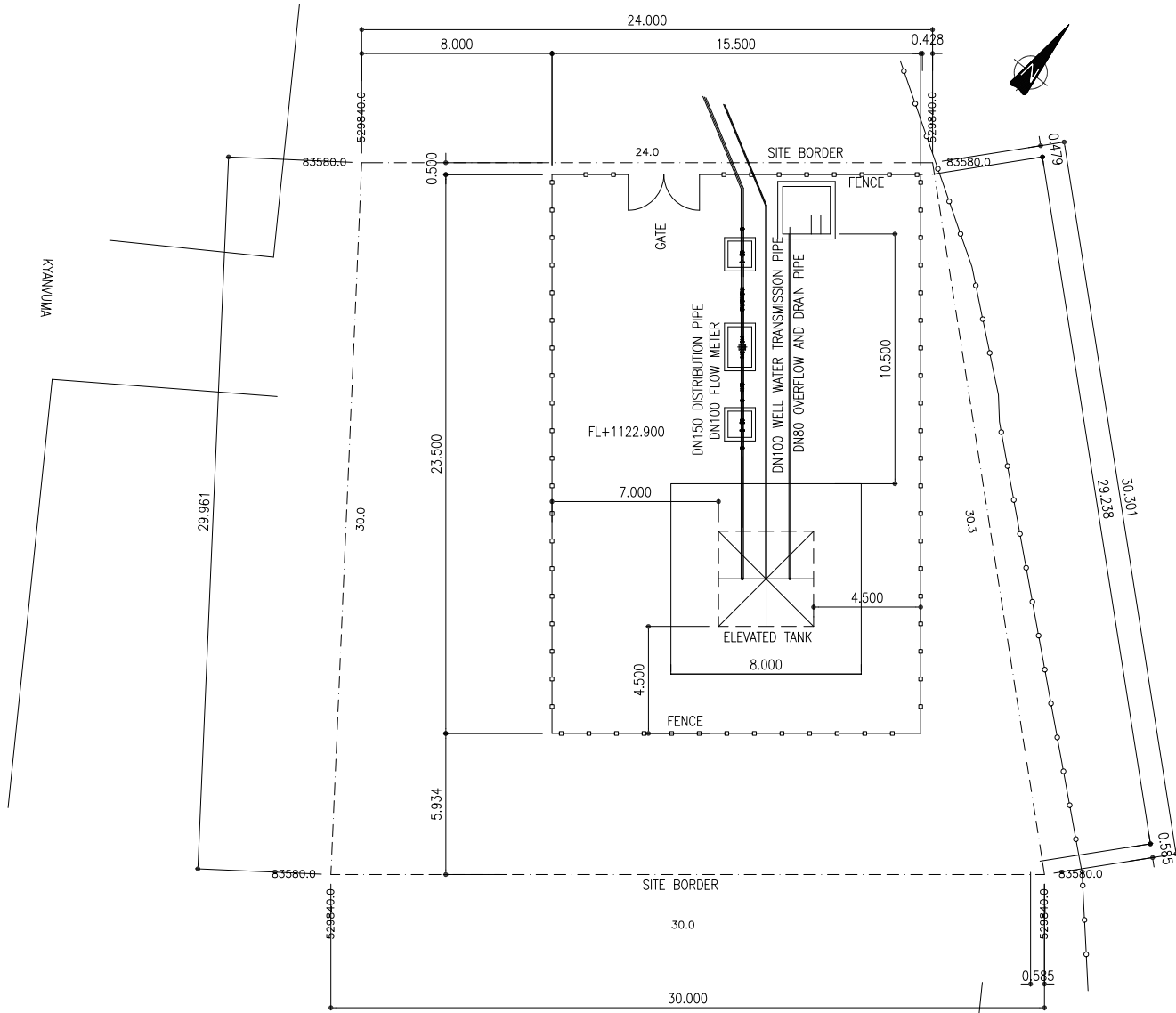

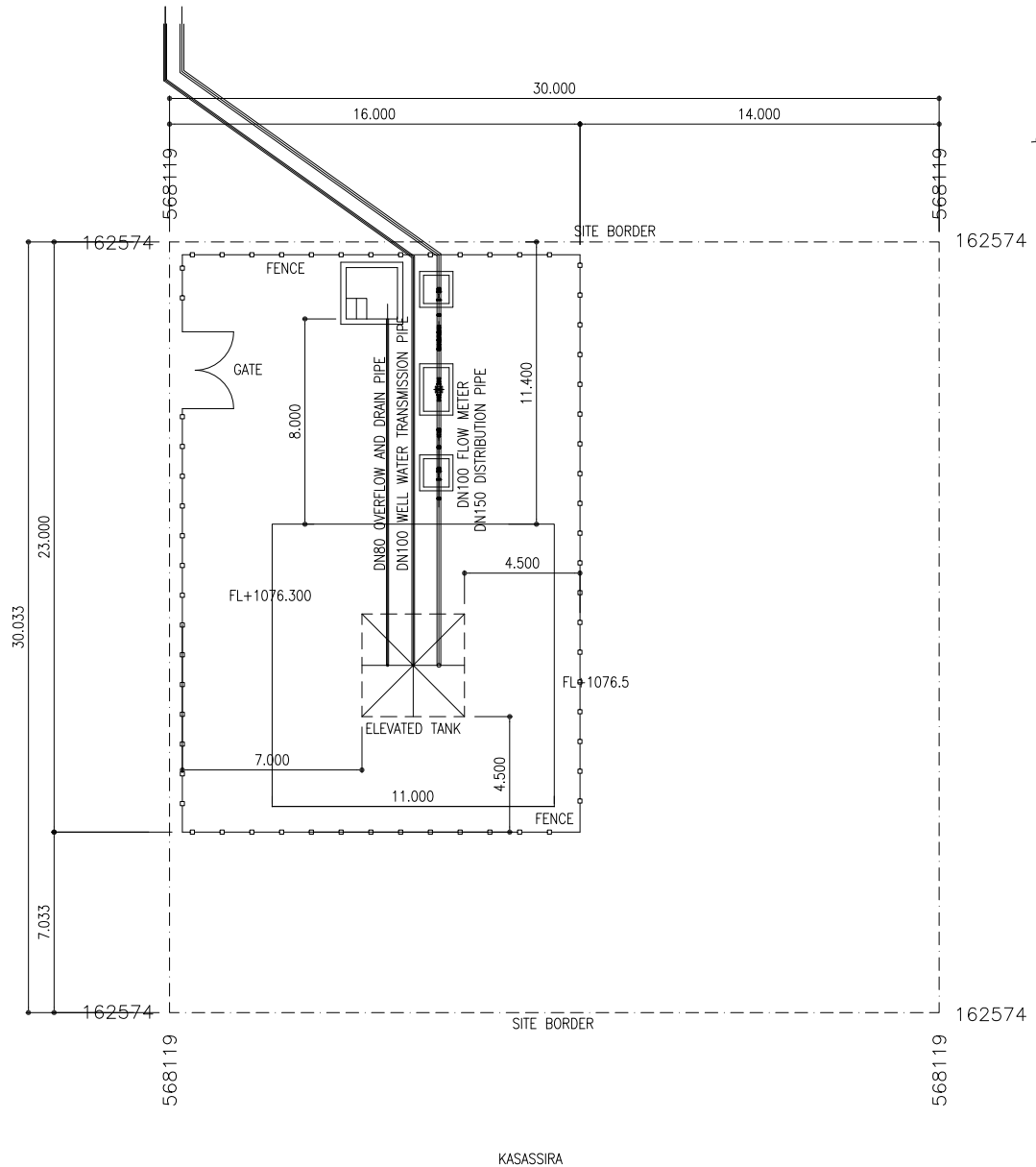

KASASSIRA

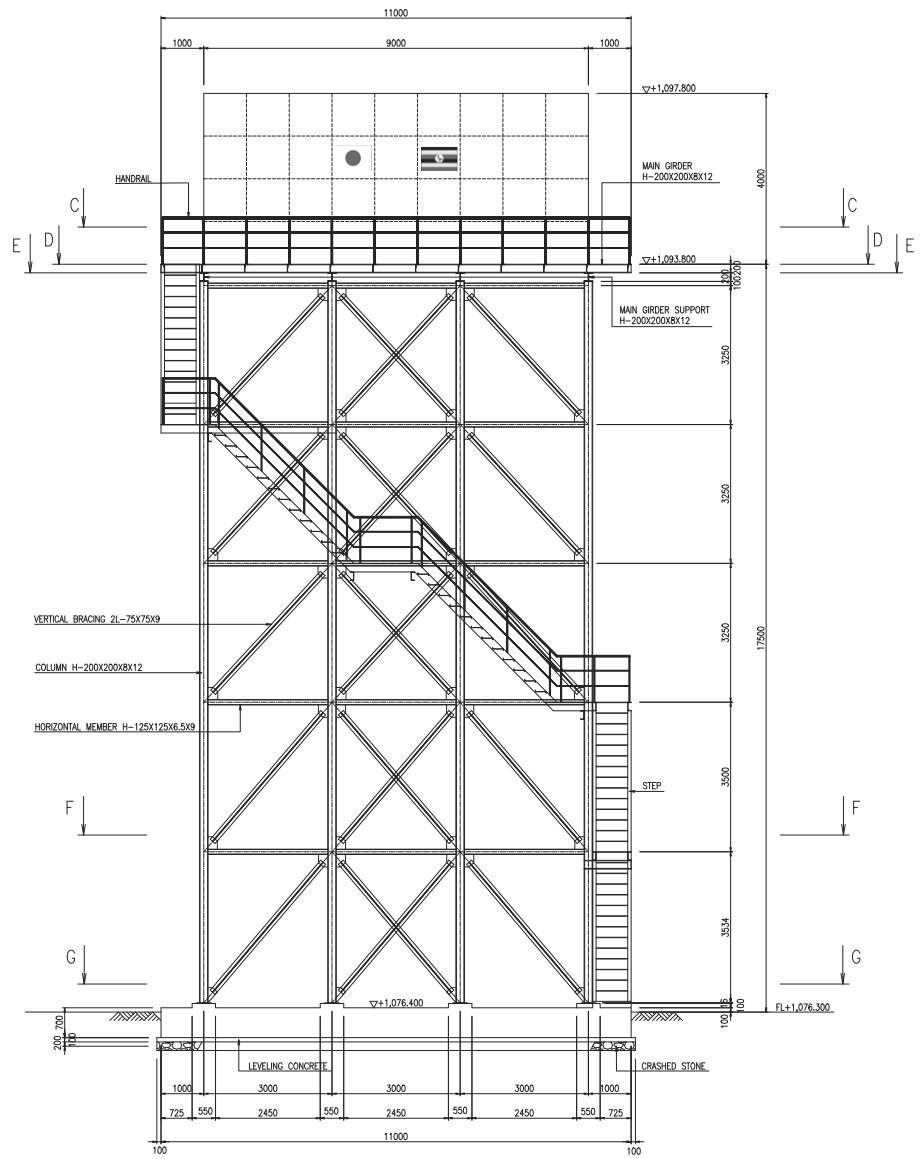

SECTION A-A

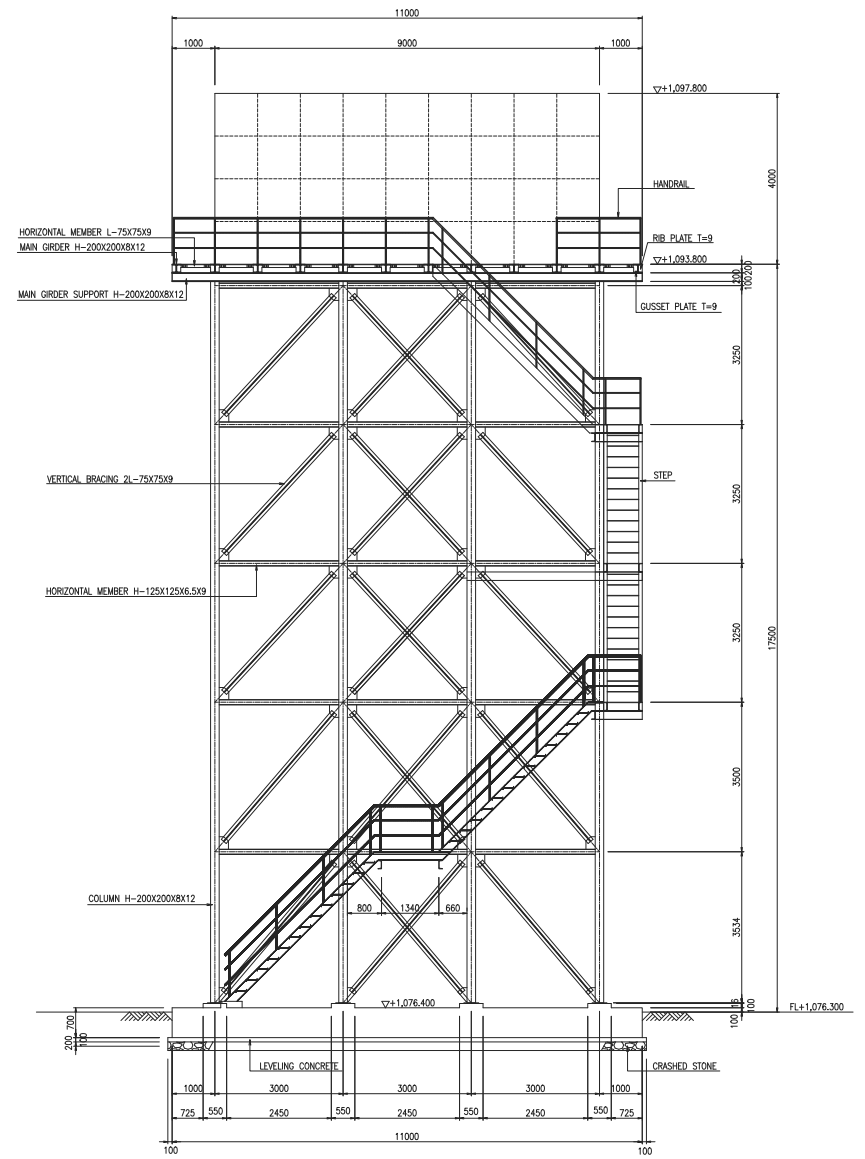

SECTION B-B

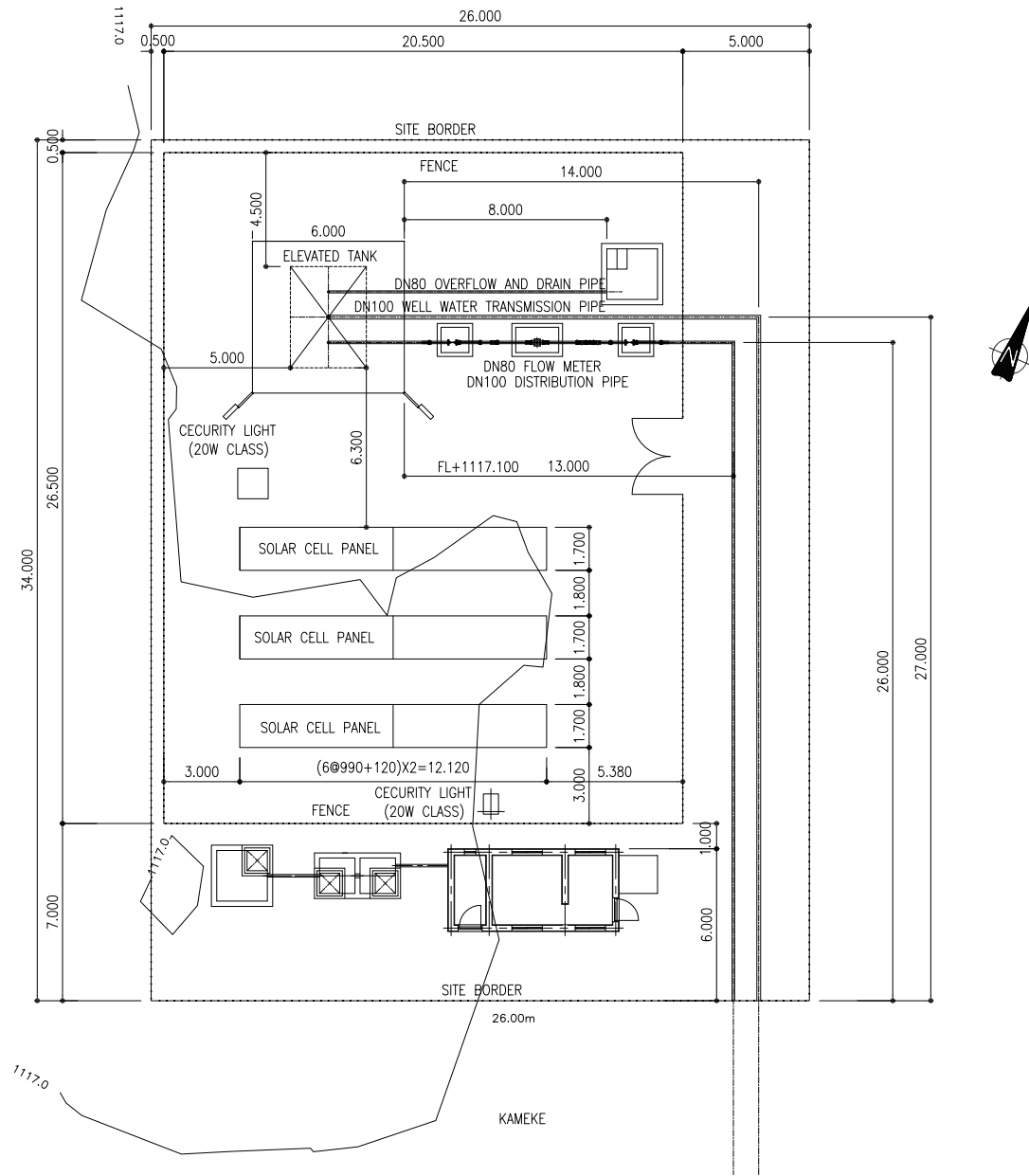

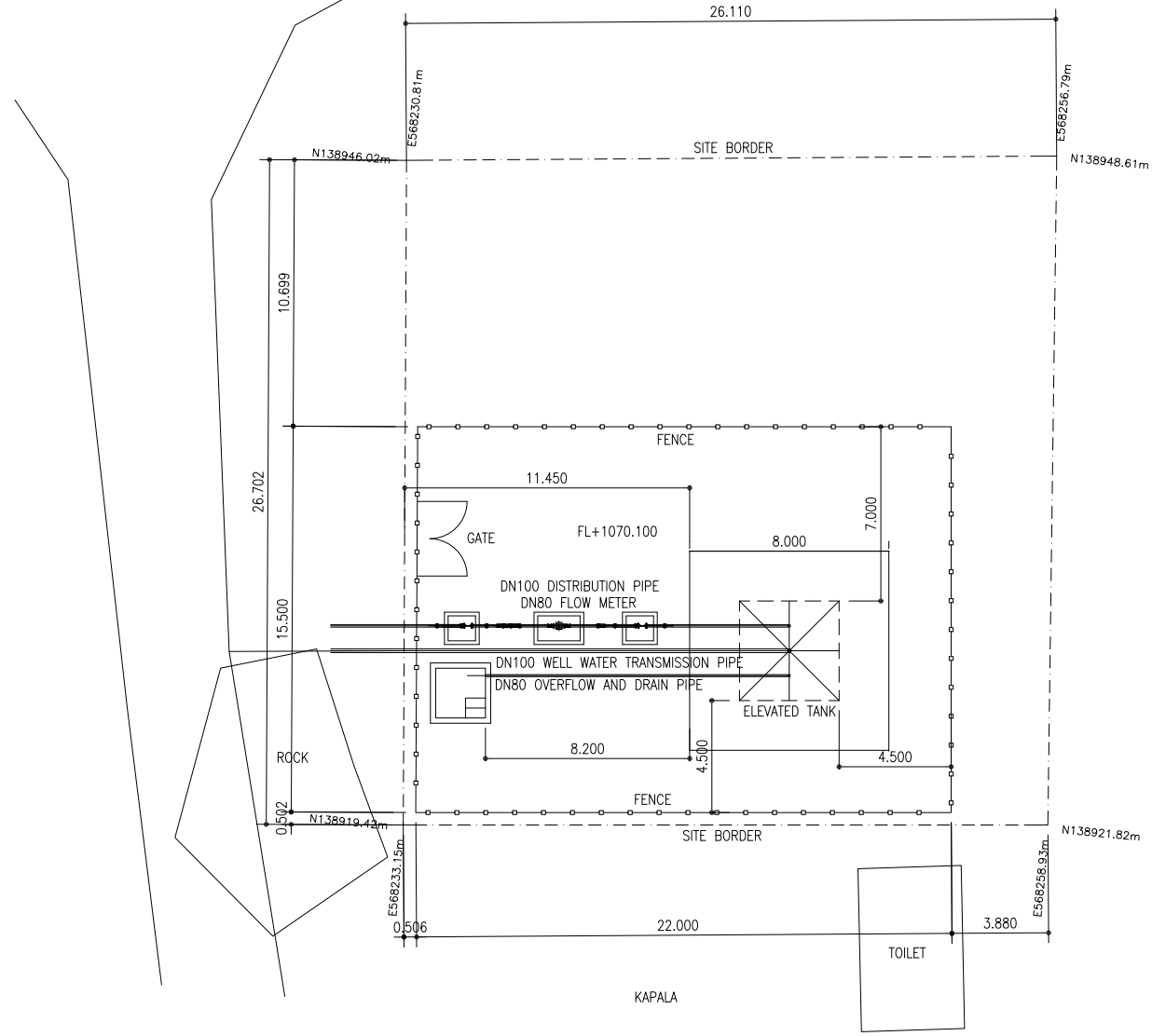

<p>JAPAN INTERNATIONAL COOPERATION AGENCY (JICA)</p>	<p>THE PREPARATORY SURVEY ON THE PROJECT FOR RURAL WATER SUPPLY PHASE III IN LAKE KYOGA BASIN, EASTERN UGANDA, IN THE REPUBLIC OF UGANDA</p>	<p>OYO INTERNATIONAL CORPORATION TOKYO JAPAN</p>	<p>TITLE : 8 KAPALA RCC</p>	<p>SCALE : S=1:200</p>	<p>APPROVED BY :</p>
	<p>MINISTRY OF WATER AND ENVIRONMENT, GOVERNMENT OF THE REPUBLIC OF UGANDA</p>		<p>TEC INTERNATIONAL CO., LTD. TOKYO JAPAN</p>	<p>GENERAL PLAN OF ELEVATED TANK</p>	<p>DRAWING NO. :</p>
					<p>DATE : NOVEMBER 2016</p>

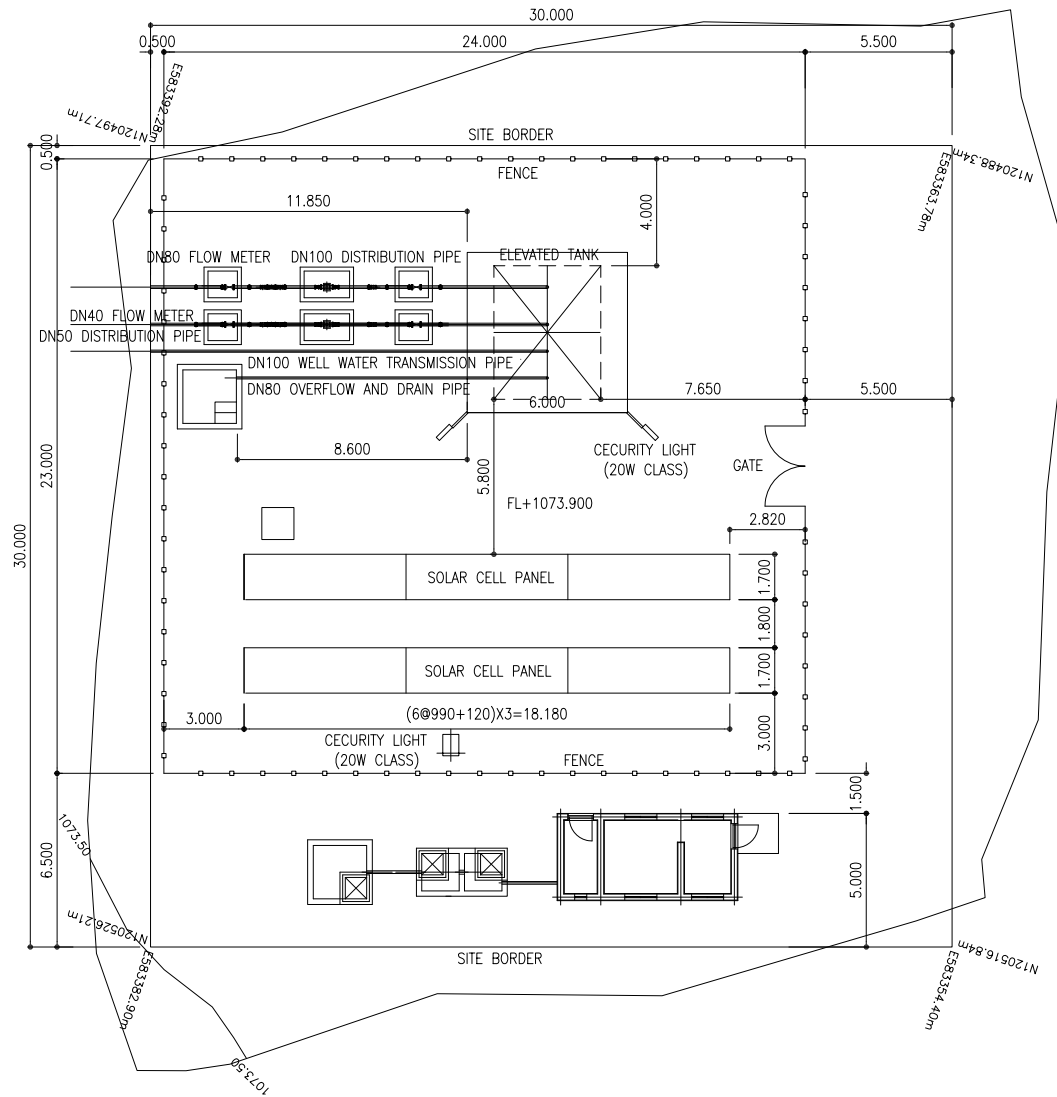

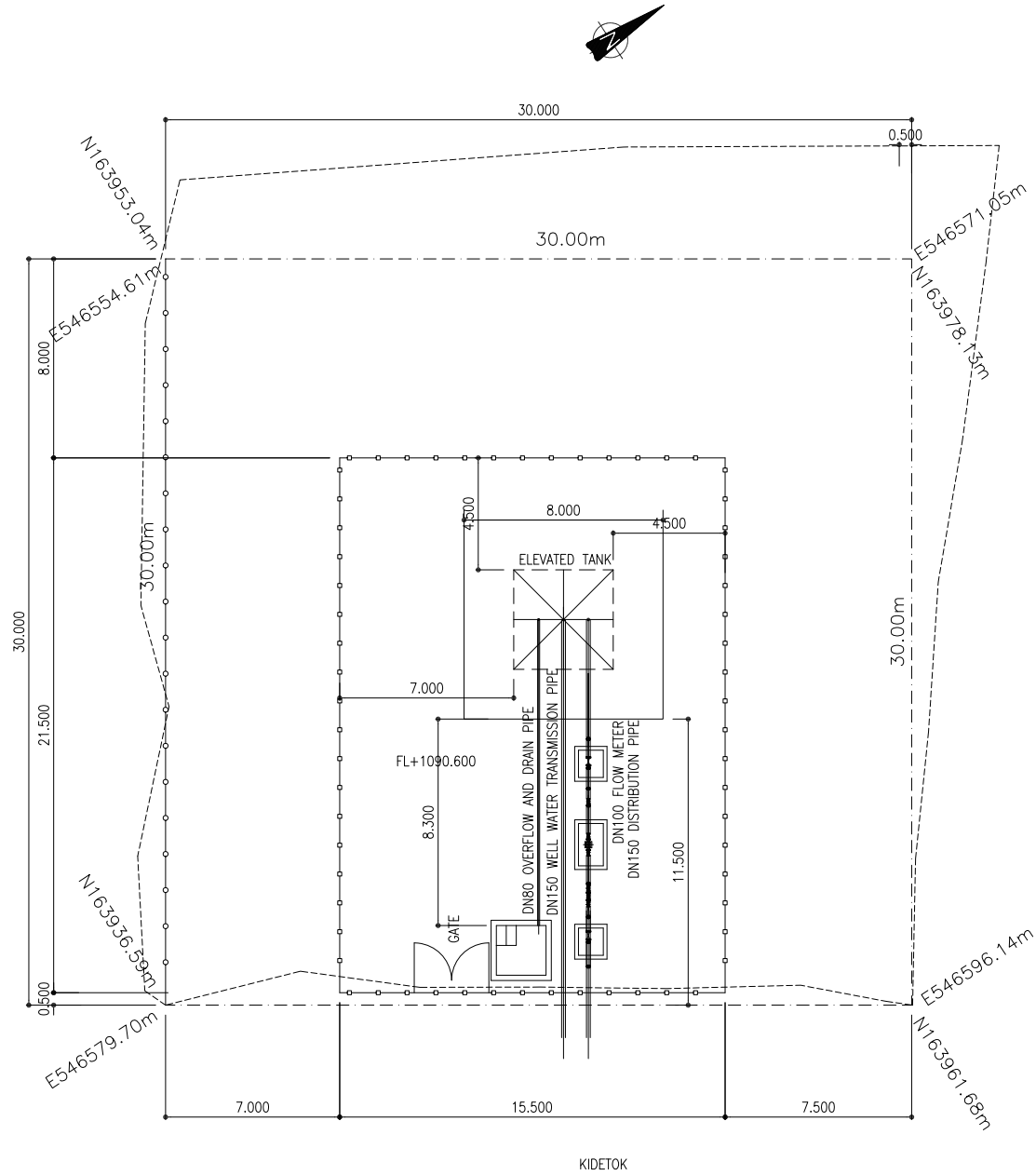

KIDETOK



JAPAN INTERNATIONAL COOPERATION AGENCY (JICA)



THE PREPARATORY SURVEY ON THE PROJECT FOR RURAL WATER SUPPLY PHASE III IN LAKE KYOGA BASIN, EASTERN UGANDA, IN THE REPUBLIC OF UGANDA

MINISTRY OF WATER AND ENVIRONMENT, GOVERNMENT OF THE REPUBLIC OF UGANDA



OYO INTERNATIONAL CORPORATION TOKYO JAPAN



TEC INTERNATIONAL CO., LTD. TOKYO JAPAN

TITLE : 10 KIDETOK RGC

GENERAL PLAN OF ELEVATED TANK

SCALE : S=1:200

DRAWING NO. :

APPROVED BY :

PREPARED BY :

DATE : NOVEMBER 2016

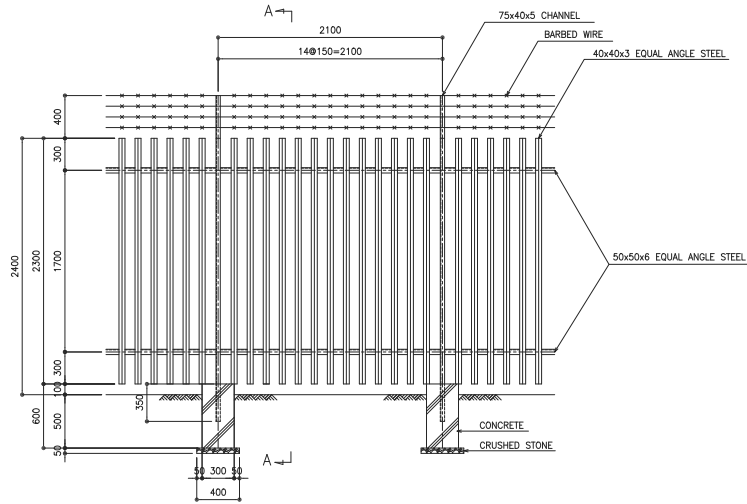

VIEW OF FENCE (EXTERNAL SIDE)

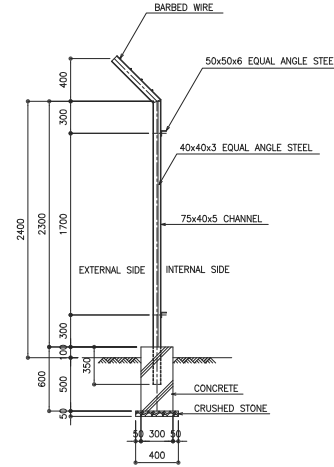

SECTION A-A

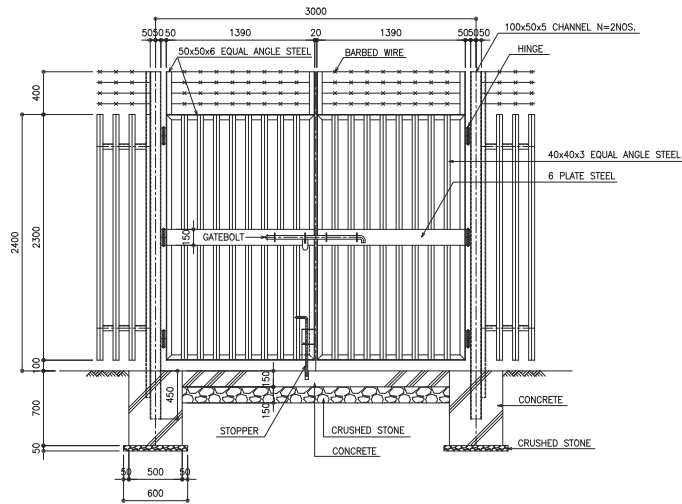
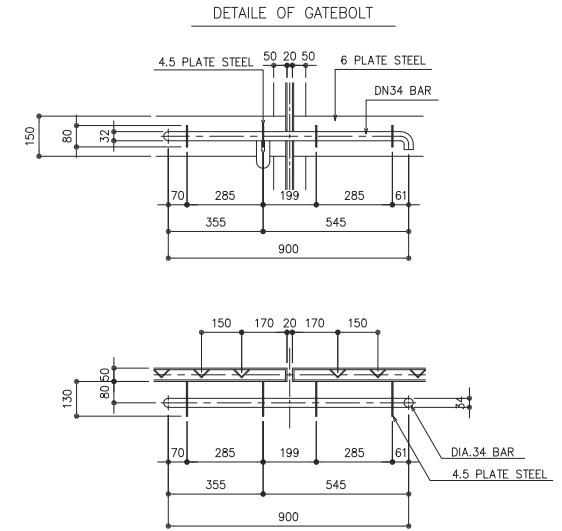

VIEW OF GATE (EXTERNAL SIDE)

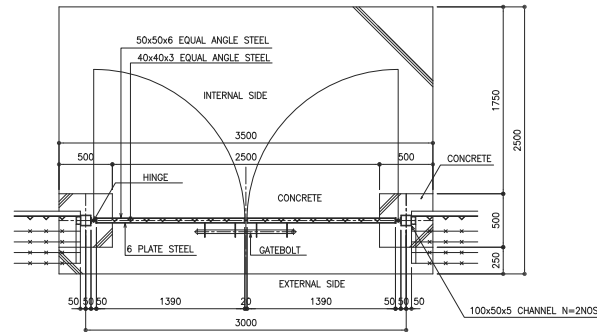

PLAN OF GATE

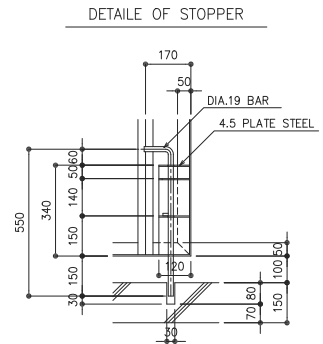

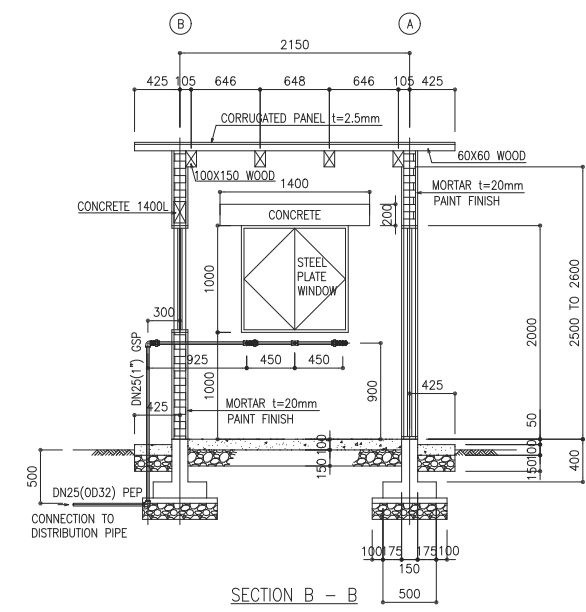
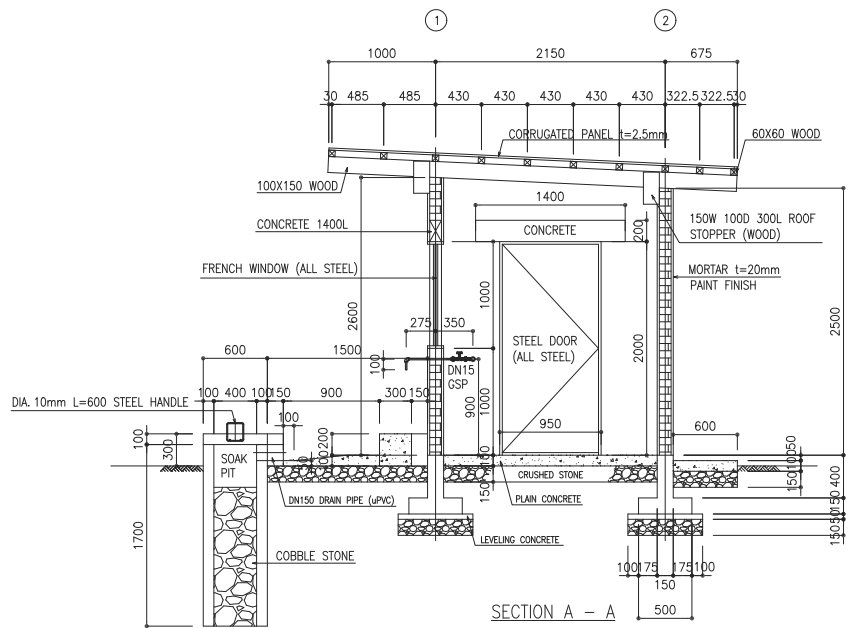
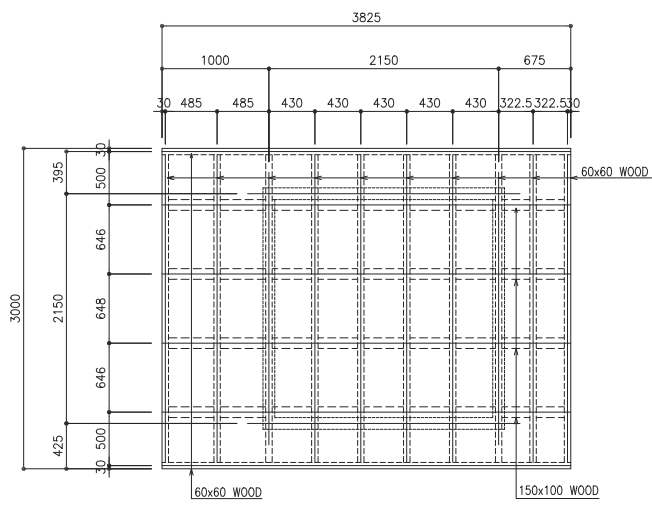
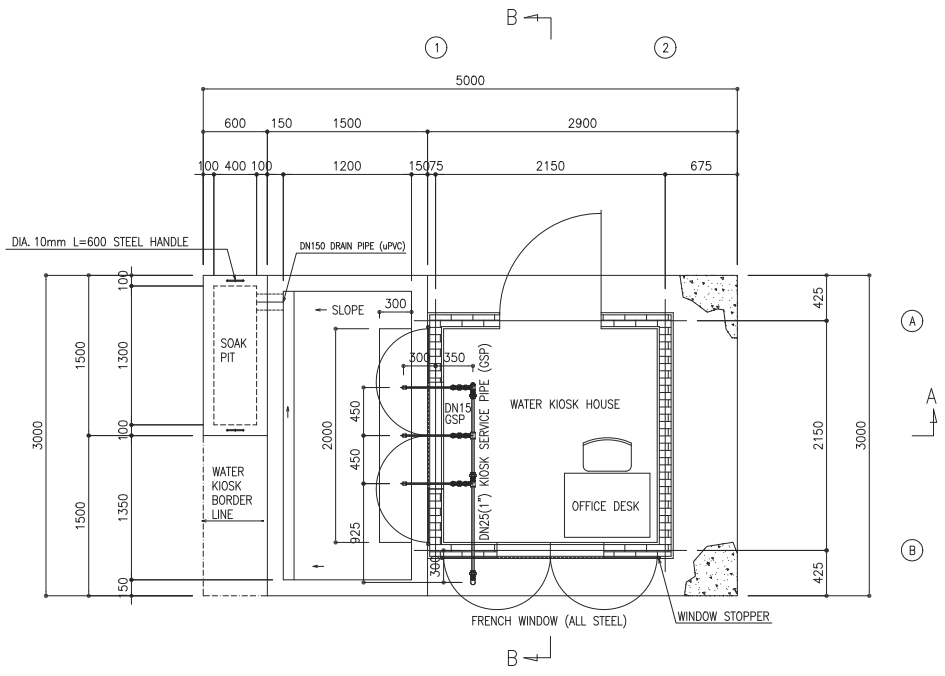

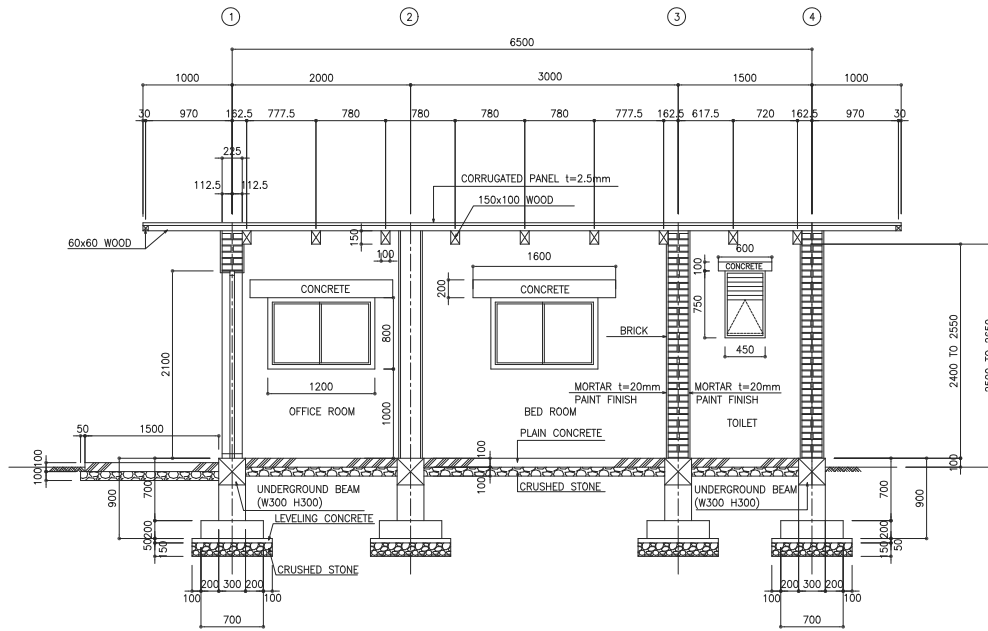

SECTION A - A

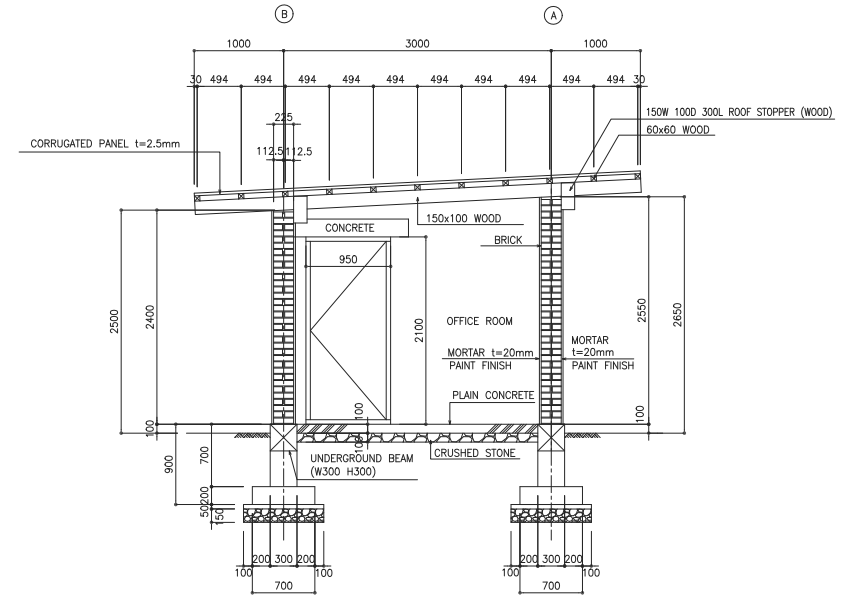

SECTION B - B

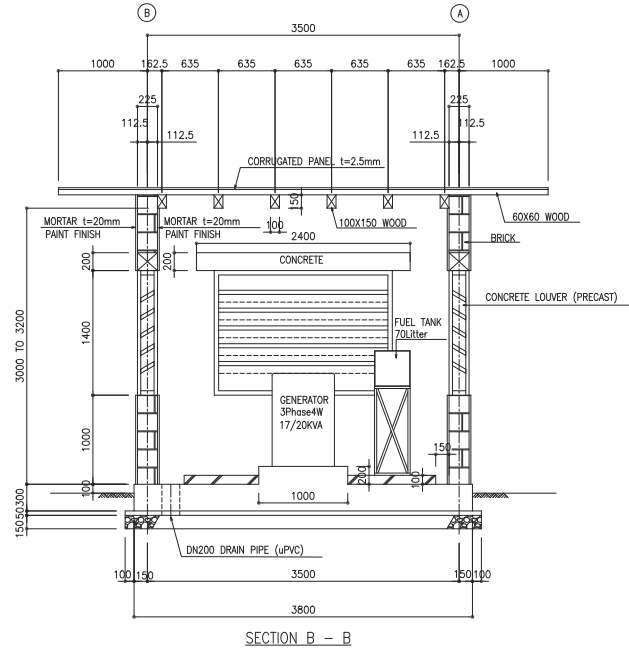
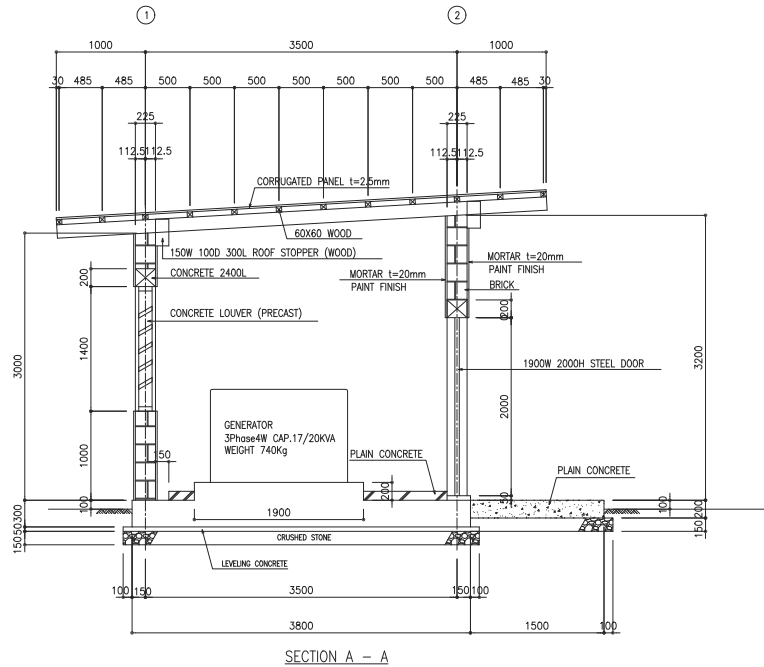
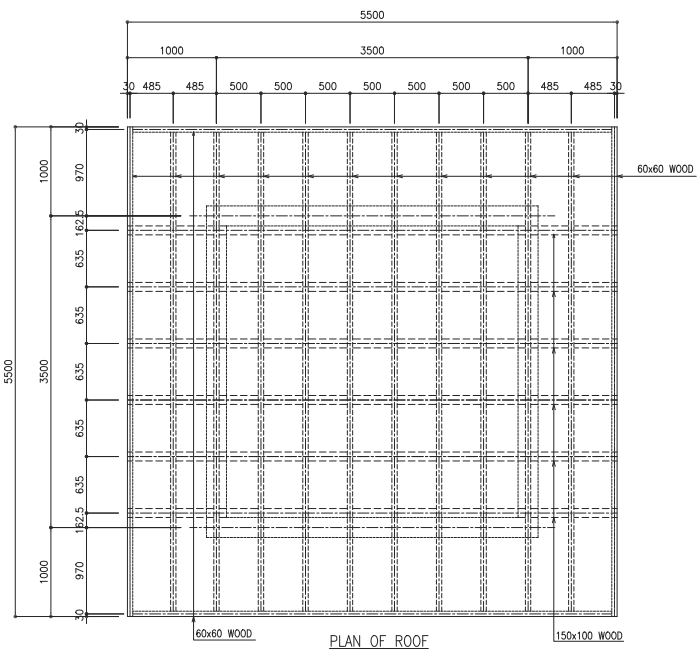
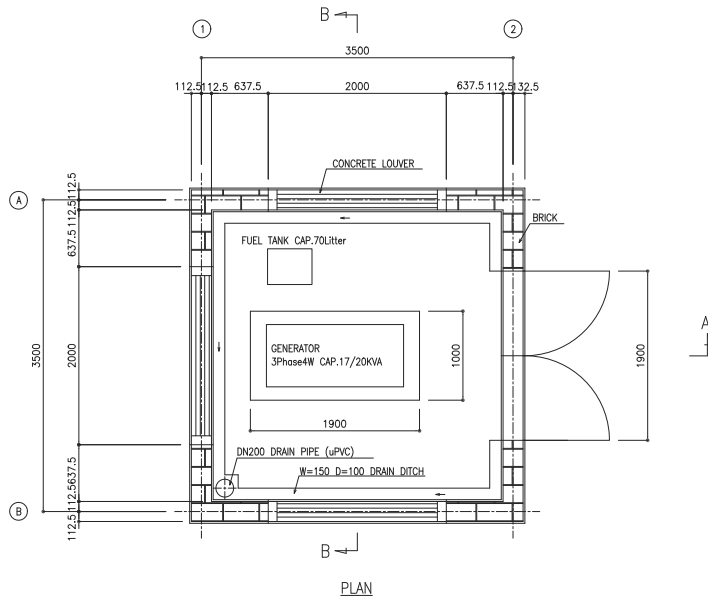

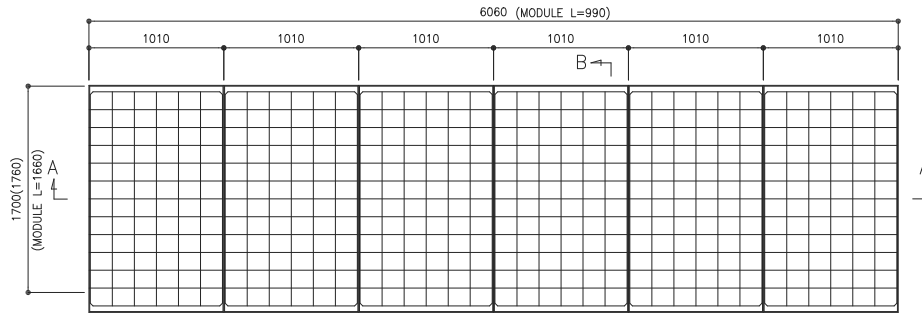

PLAN OF CELL

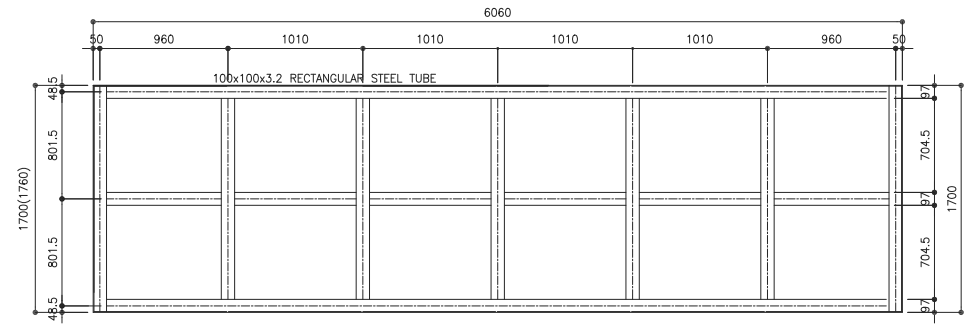

PLAN OF EQUAL ANGLE STEEL

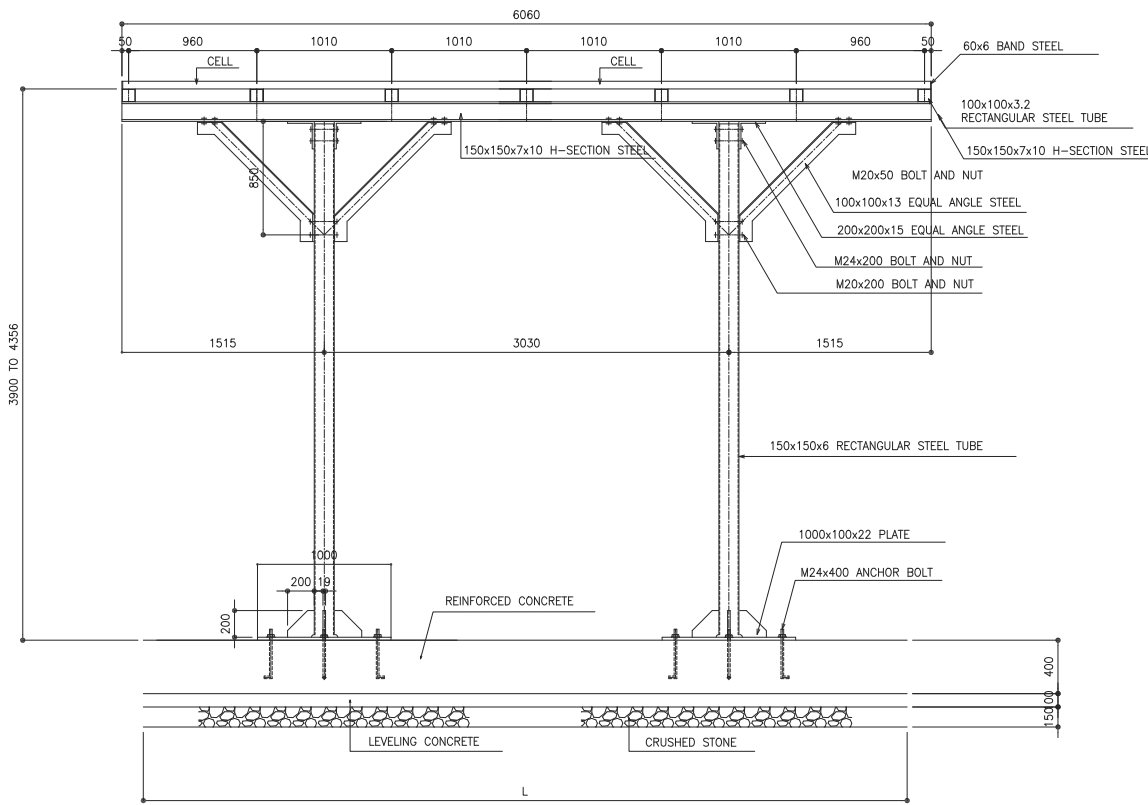

SECTION A-A

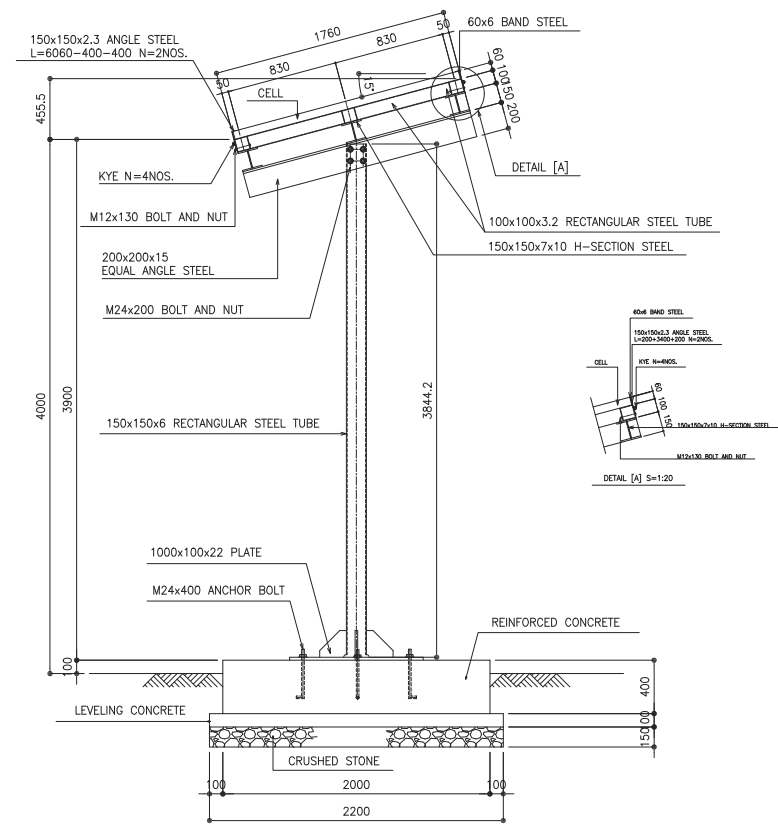

SECTION B-B