

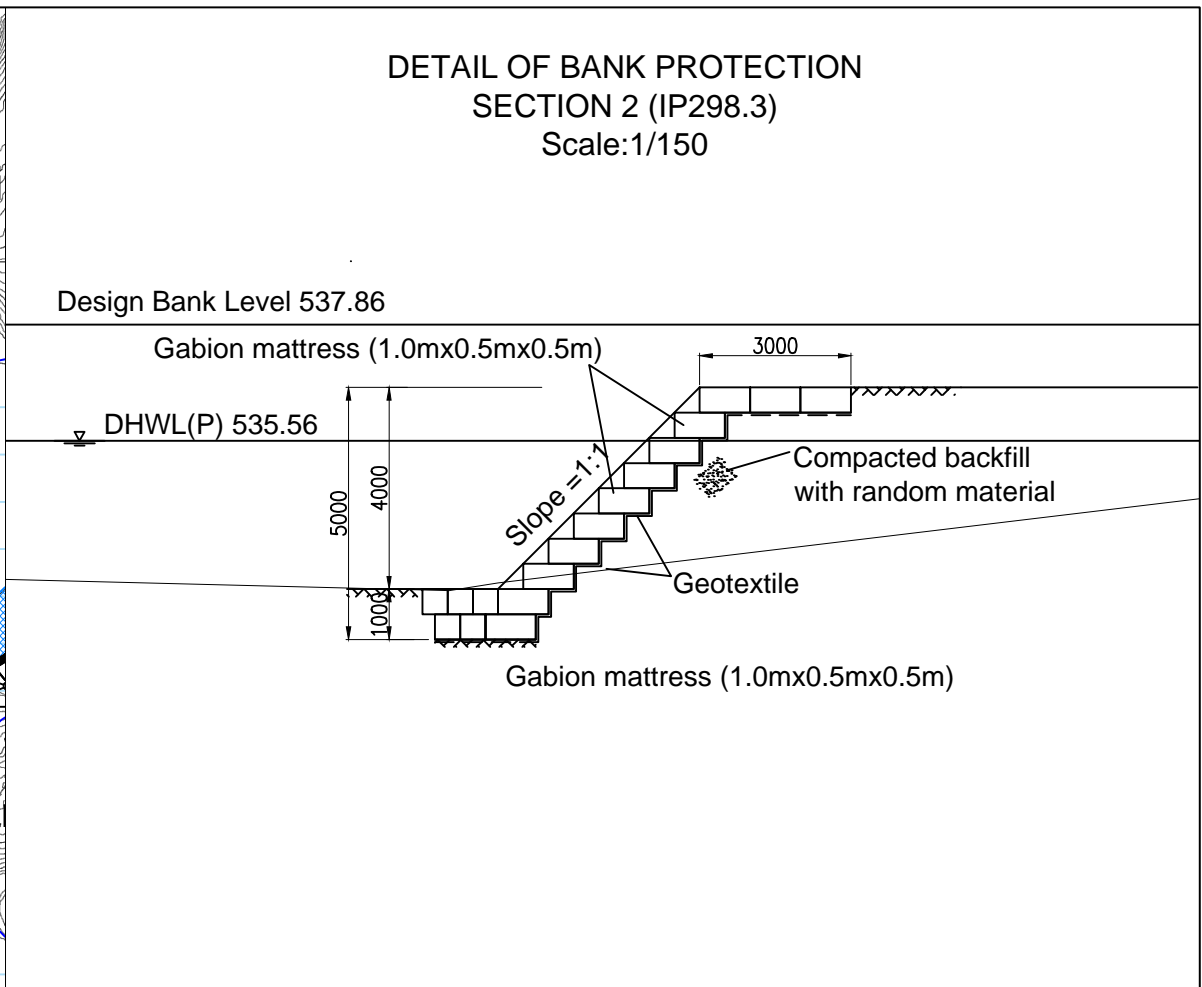

GOVERNMENT AGENCIES:		JICA STUDY TEAM:	PROJECT & LOCATION:	SHEET CONTENTS:	DWG NUM
JAPAN International Cooperation Agency	Reli Assets Holding Company (RAHCO), Tanzania	PADECO Co., Ltd., Nippon Koei Co., Ltd., Japan International Consultants for Transportation Co., Ltd., and Fukken Engineering Co., Ltd.	Preparatory Survey on Flood Protection Measures for Central Railway Line in the United Republic of Tanzania	PLAN, CROSS SECTION AND DETAIL OF BANK PROTECTION SECTION 1-2 (IP297)	

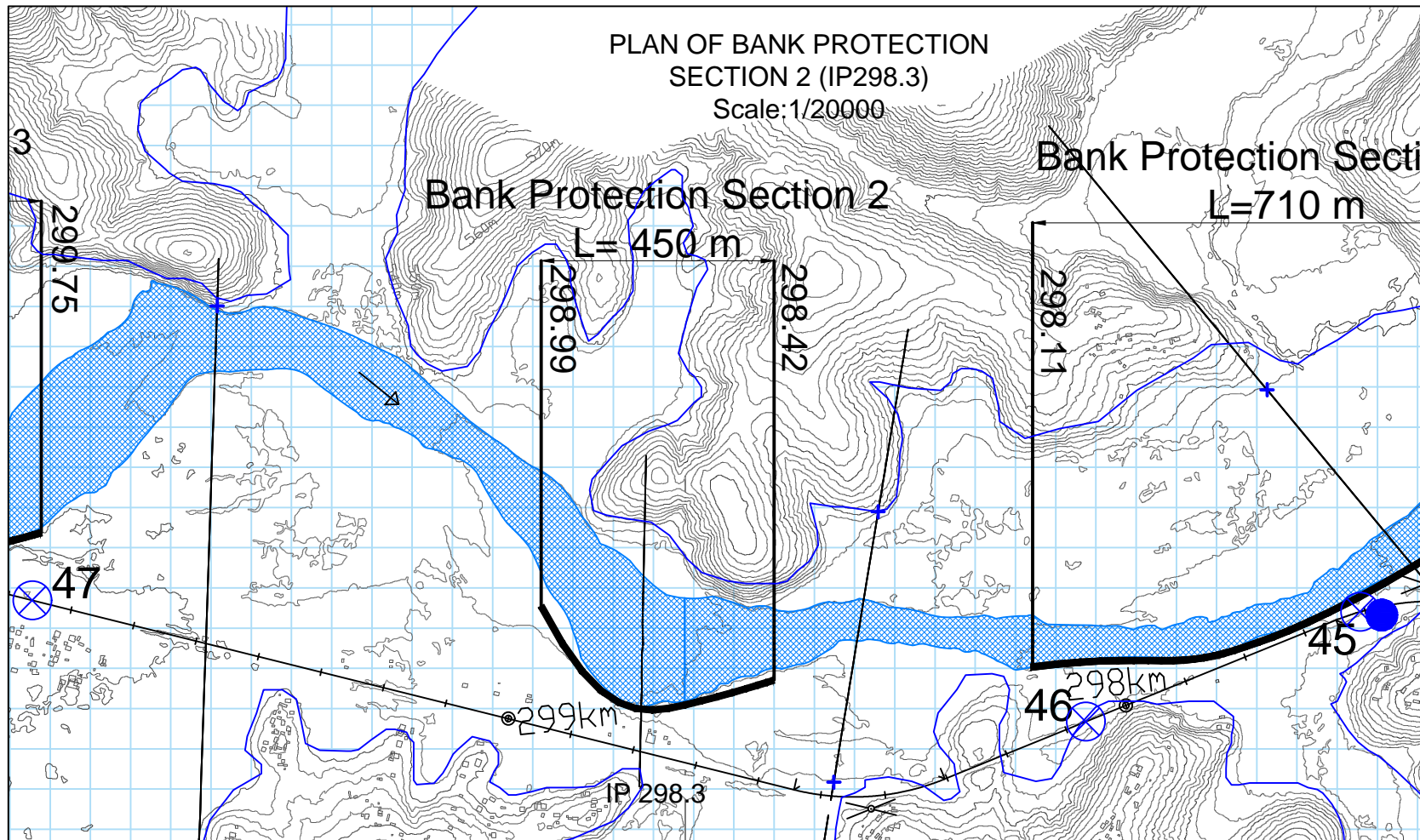

CROSS SECTION OF BANK PROTECTION SECTION 2 (IP298.3)
Scale: H:1/3000, V:1/600

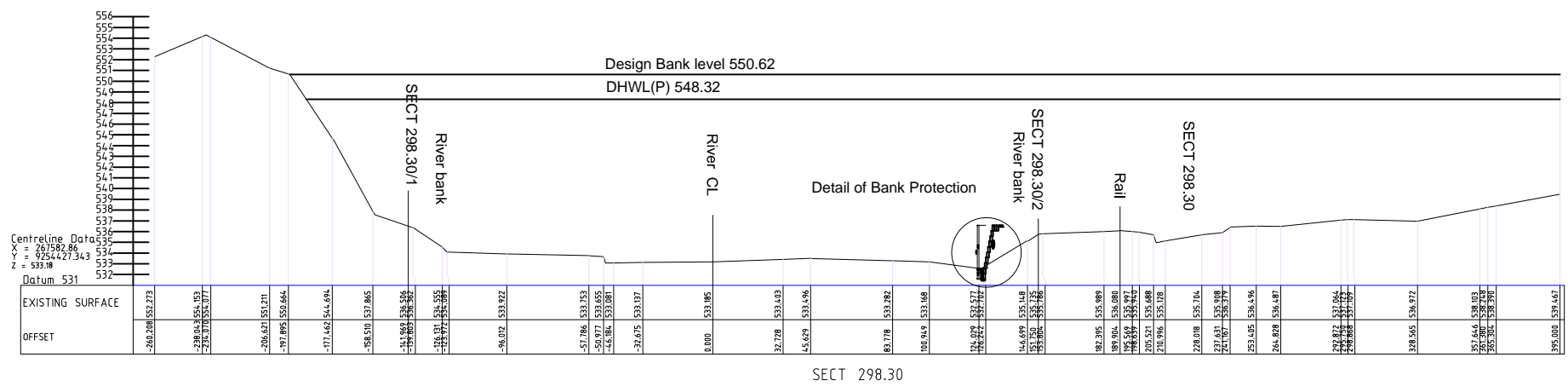

DHWL(P): Design High Water Level for Present Riverbed Level

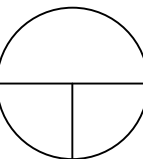
GOVERNMENT AGENCIES:  JAPAN International Cooperation Agency  Reli Assets Holding Company (RAHCO), Tanzania		JICA STUDY TEAM: PADECO Co., Ltd., Nippon Koei Co., Ltd., Japan International Consultants for Transportation Co., Ltd., and Fukken Engineering Co., Ltd.	PROJECT & LOCATION: Preparatory Survey on Flood Protection Measures for Central Railway Line in the United Republic of Tanzania	SHEET CONTENTS: PLAN, CROSS SECTION AND DETAIL OF BANK PROTECTION SECTION 2 (IP298.3)	DWG NUM 
--	--	---	---	---	---

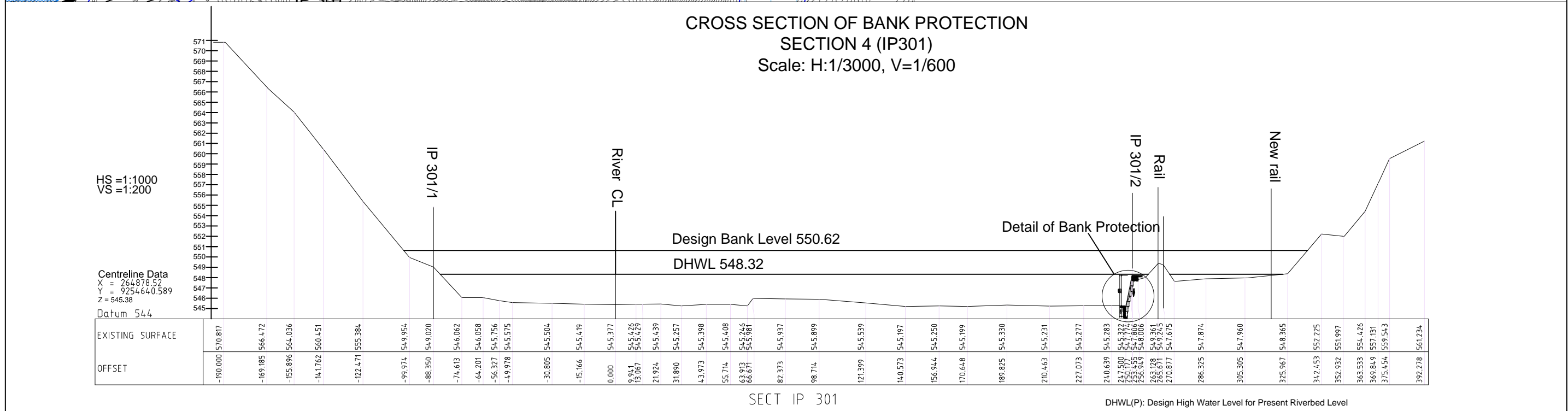
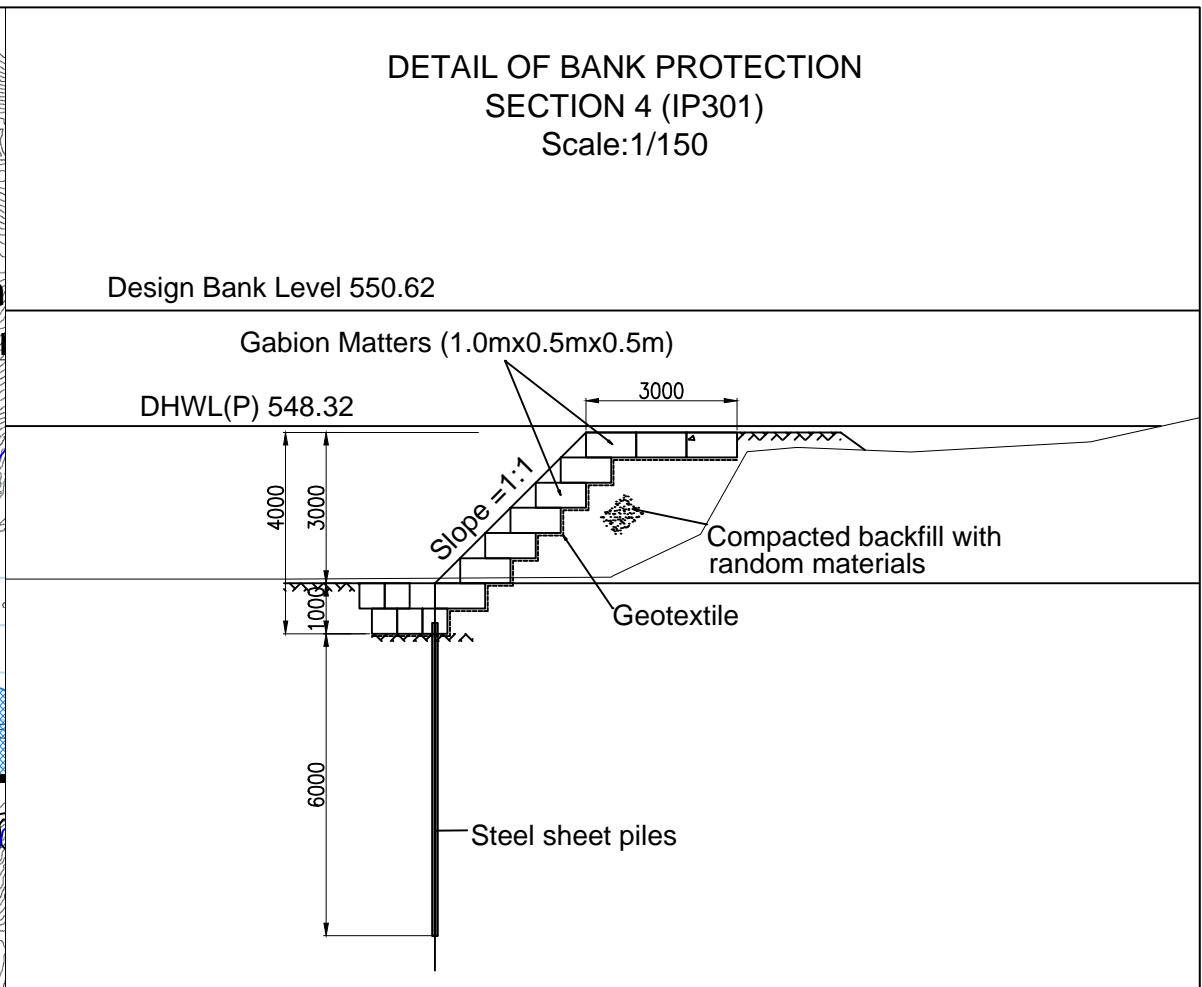
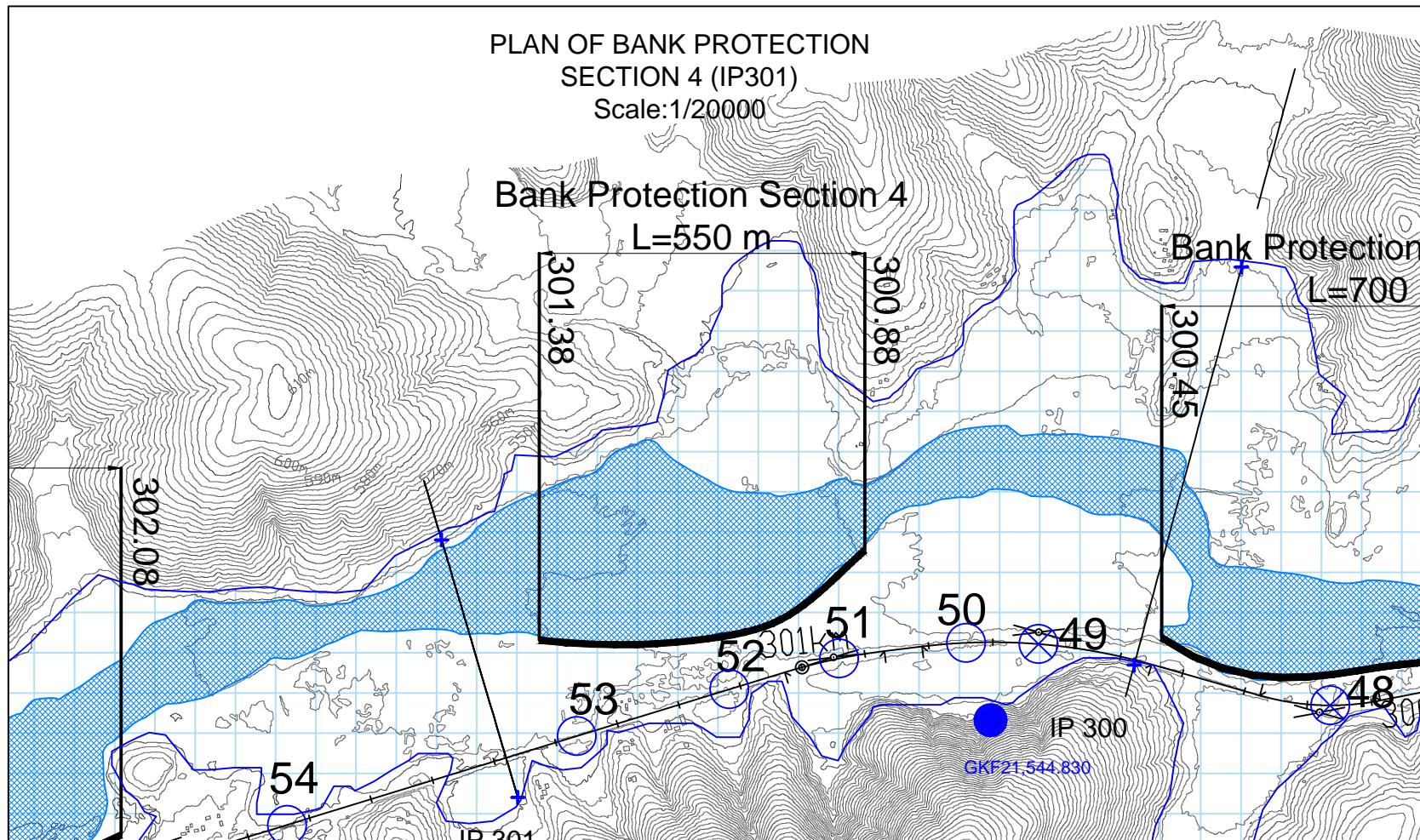

GOVERNMENT AGENCIES: JAPAN International Cooperation Agency		JICA STUDY TEAM: PADECO Co., Ltd., Nippon Koei Co., Ltd., Japan International Consultants for Transportation Co., Ltd., and Fukken Engineering Co., Ltd.		PROJECT & LOCATION: Preparatory Survey on Flood Protection Measures for Central Railway Line in the United Republic of Tanzania		SHEET CONTENTS: PLAN, CROSS SECTION AND DETAIL OF BANK PROTECTION SECTION 4 (IP301)		DWG NUM
---	--	---	--	---	--	---	--	--------------------

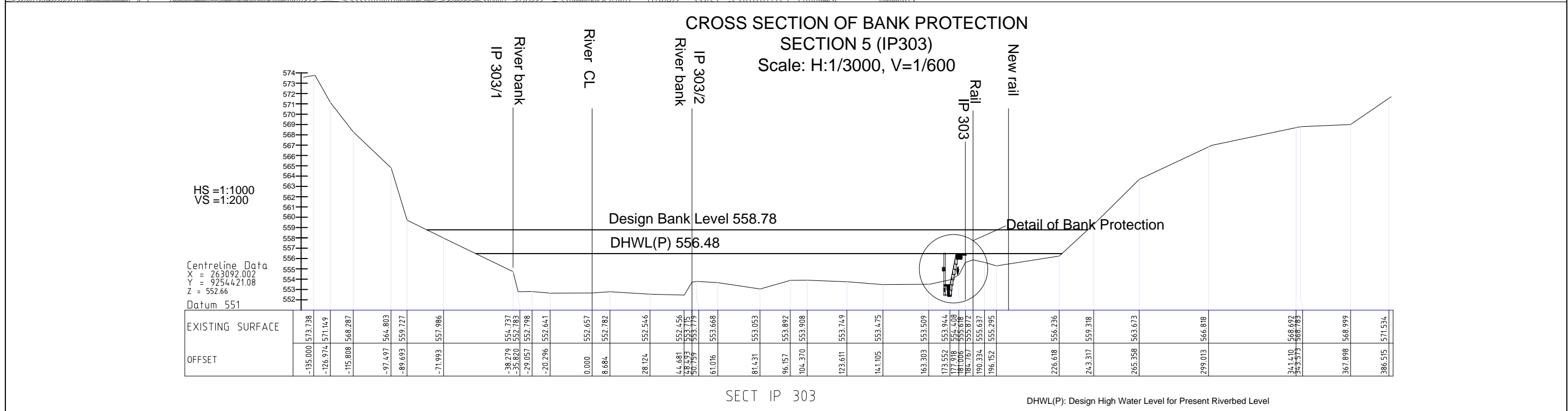
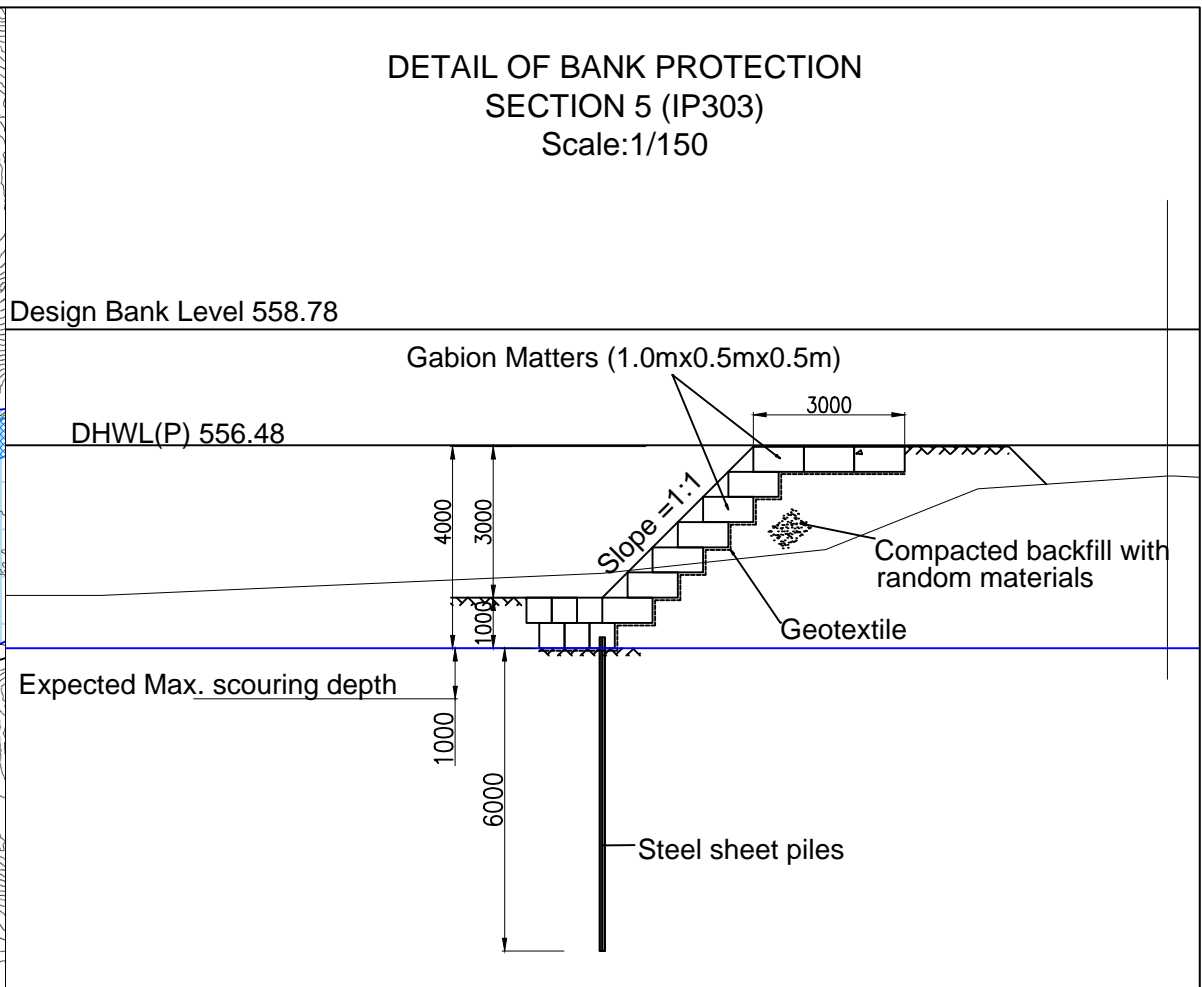
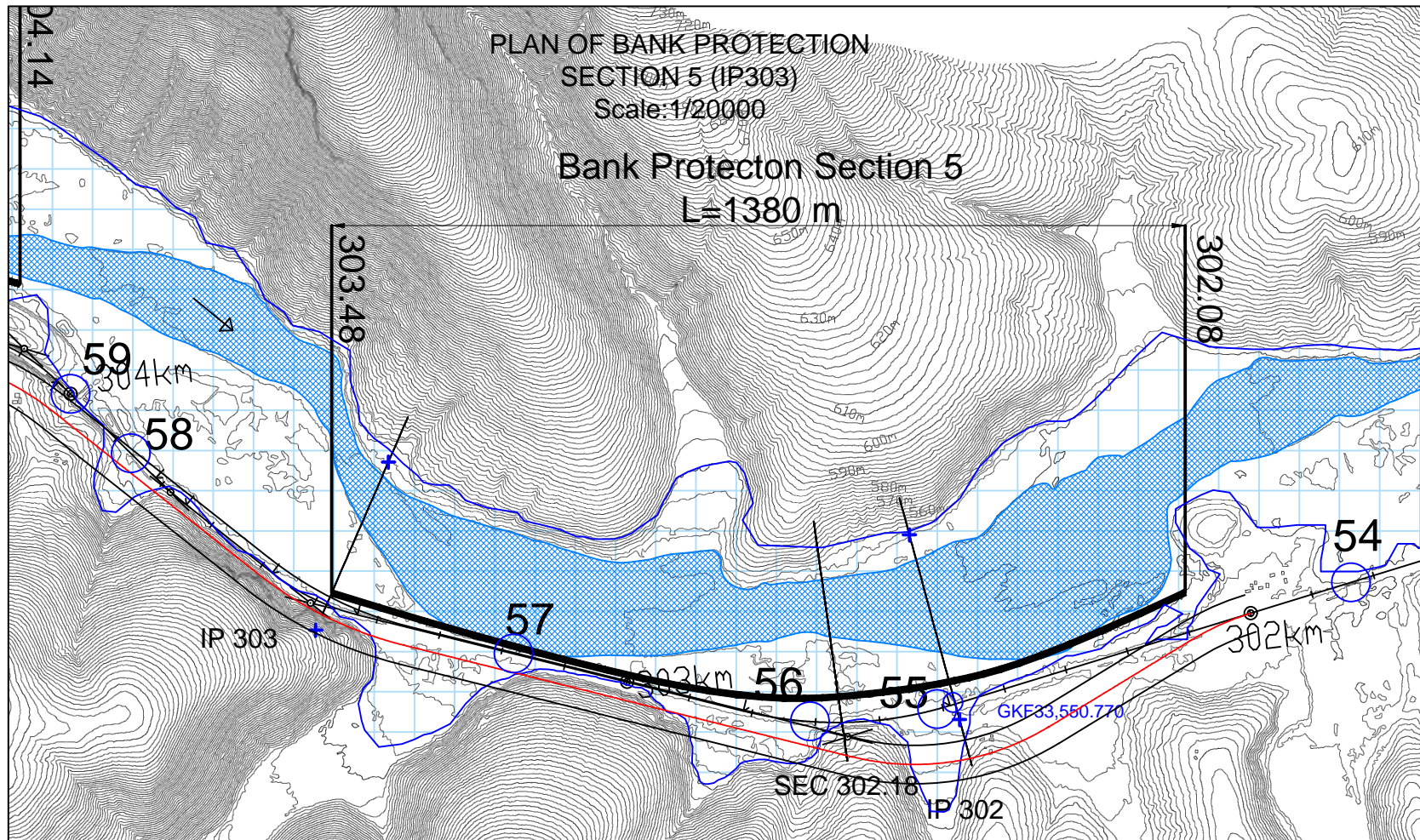

GOVERNMENT AGENCIES:		JICA STUDY TEAM:	PROJECT & LOCATION:	SHEET CONTENTS:	DWG NUM
	JAPAN International Cooperation Agency	Reli Assets Holding Company (RAHCO), Tanzania	PADECO Co., Ltd., Nippon Koei Co., Ltd., Japan International Consultants for Transportation Co., Ltd., and Fukken Engineering Co., Ltd.	Preparatory Survey on Flood Protection Measures for Central Railway Line in the United Republic of Tanzania	PLAN, CROSS SECTION AND DETAIL OF BANK PROTECTION SECTION 5 (IP303)

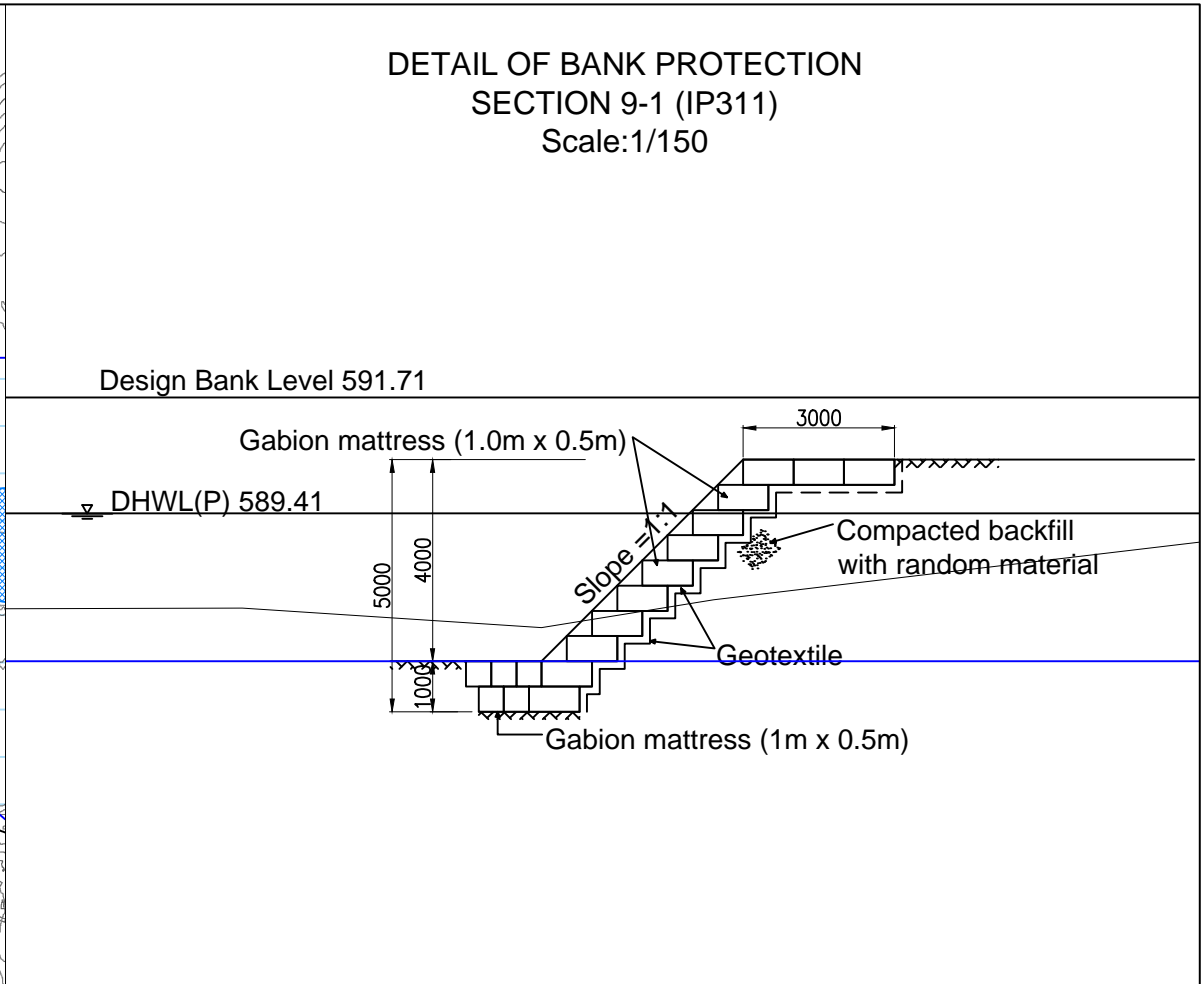
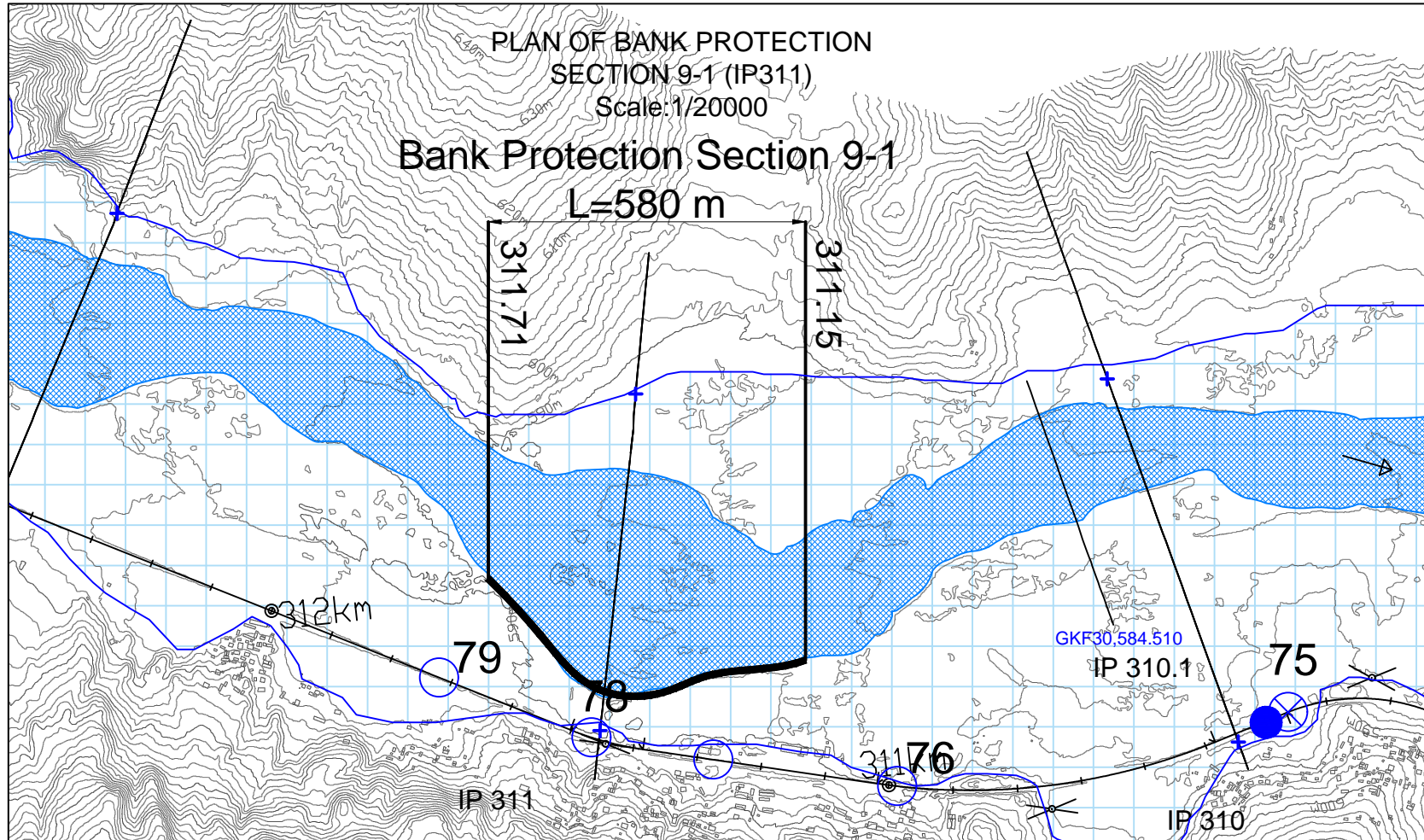

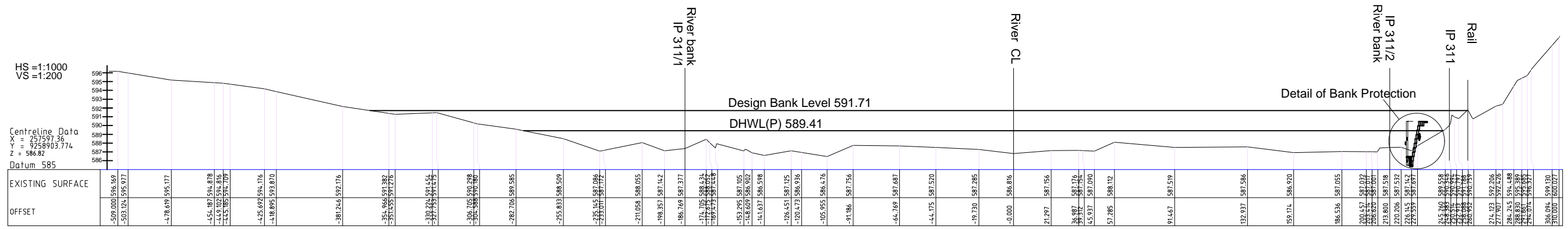

CROSS SECTION OF BANK PROTECTION SECTION 9-1 (IP311) Scale: H:1/3000, V=1/600



SECT IP 311

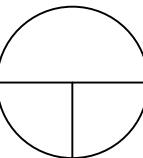

DHWL(P): Design High Water Level for Present Riverbed Level

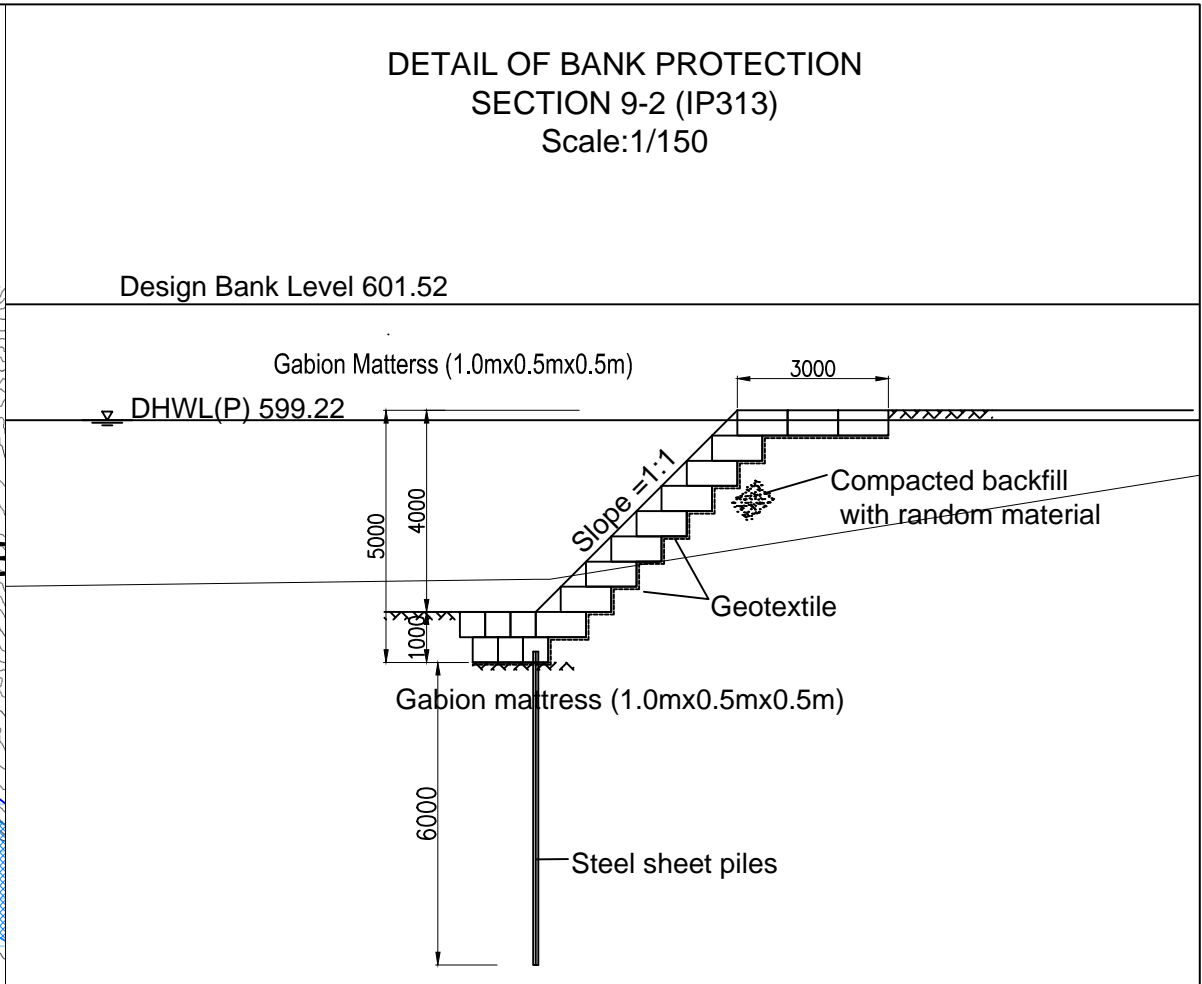
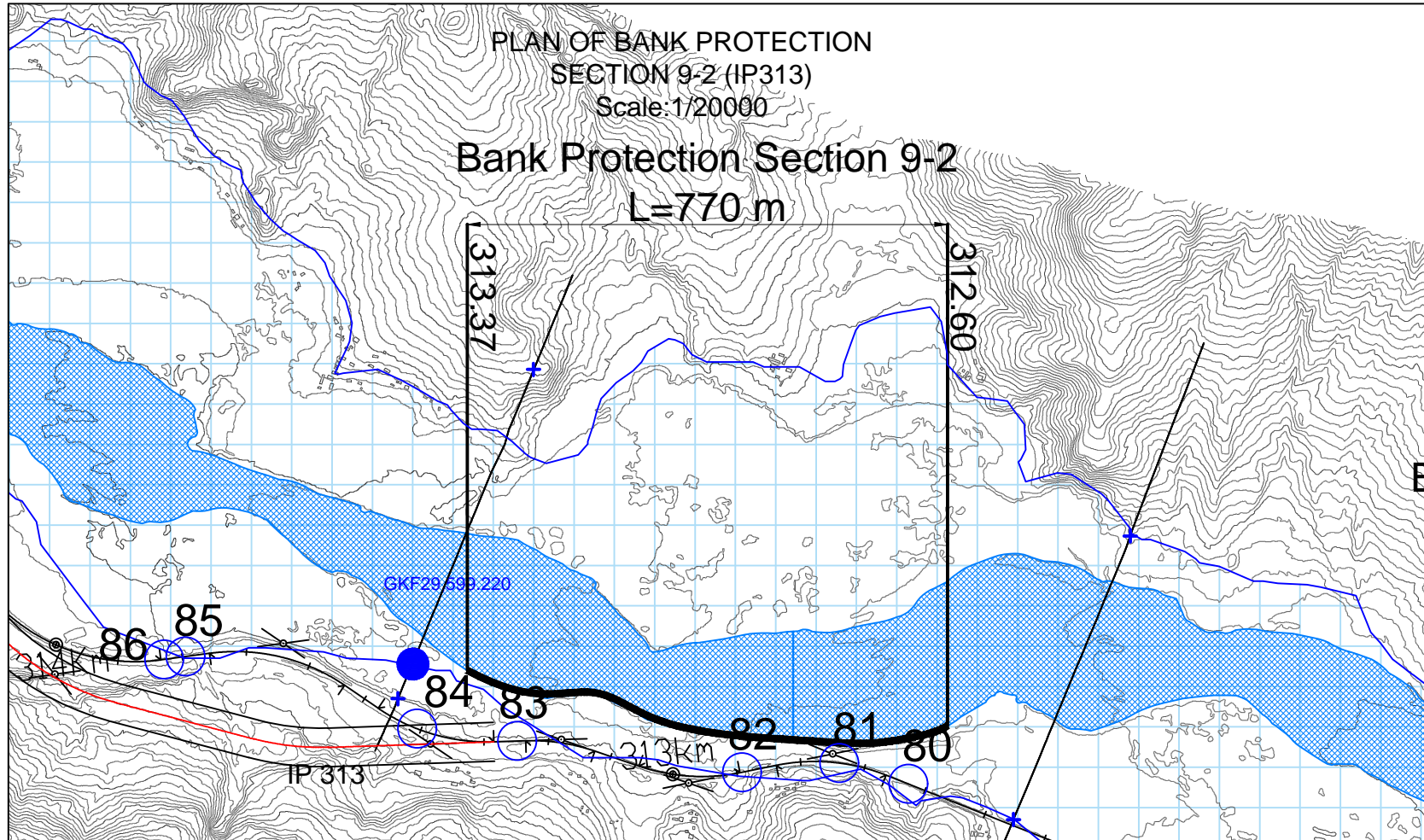
GOVERNMENT AGENCIES:		JICA STUDY TEAM:	PROJECT & LOCATION:	SHEET CONTENTS:	DWG NUM
 JAPAN International Cooperation Agency	 Reli Assets Holding Company (RAHCO), Tanzania	PADECO Co., Ltd., Nippon Koei Co., Ltd., Japan International Consultants for Transportation Co., Ltd., and Fukken Engineering Co., Ltd.	Preparatory Survey on Flood Protection Measures for Central Railway Line in the United Republic of Tanzania	PLAN, CROSS SECTION AND DETAIL OF BANK PROTECTION SECTION 9-1 (IP311)	

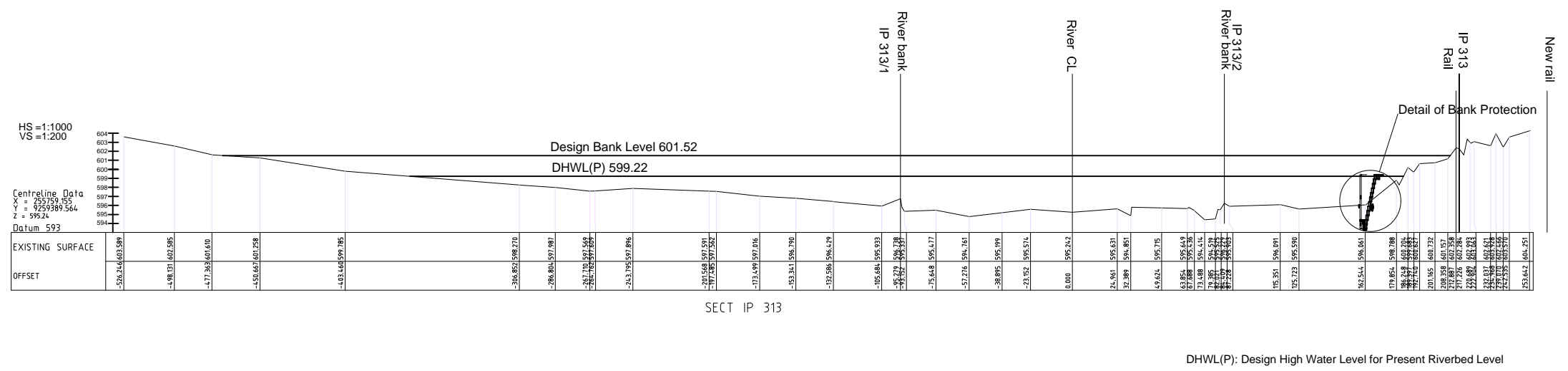

CROSS SECTION OF BANK PROTECTION
SECTION 9-2 (IP313)
Scale: H:1/3000, V=1/600

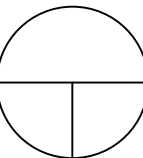

GOVERNMENT AGENCIES:		JICA STUDY TEAM:	PROJECT & LOCATION:	SHEET CONTENTS:	DWG NUM
 JAPAN International Cooperation Agency	 Reli Assets Holding Company (RAHCO), Tanzania	PADECO Co., Ltd., Nippon Koei Co., Ltd., Japan International Consultants for Transportation Co., Ltd., and Fukken Engineering Co., Ltd.	Preparatory Survey on Flood Protection Measures for Central Railway Line in the United Republic of Tanzania	PLAN, CROSS SECTION AND DETAIL OF BANK PROTECTION SECTION 9-2 (IP313)	

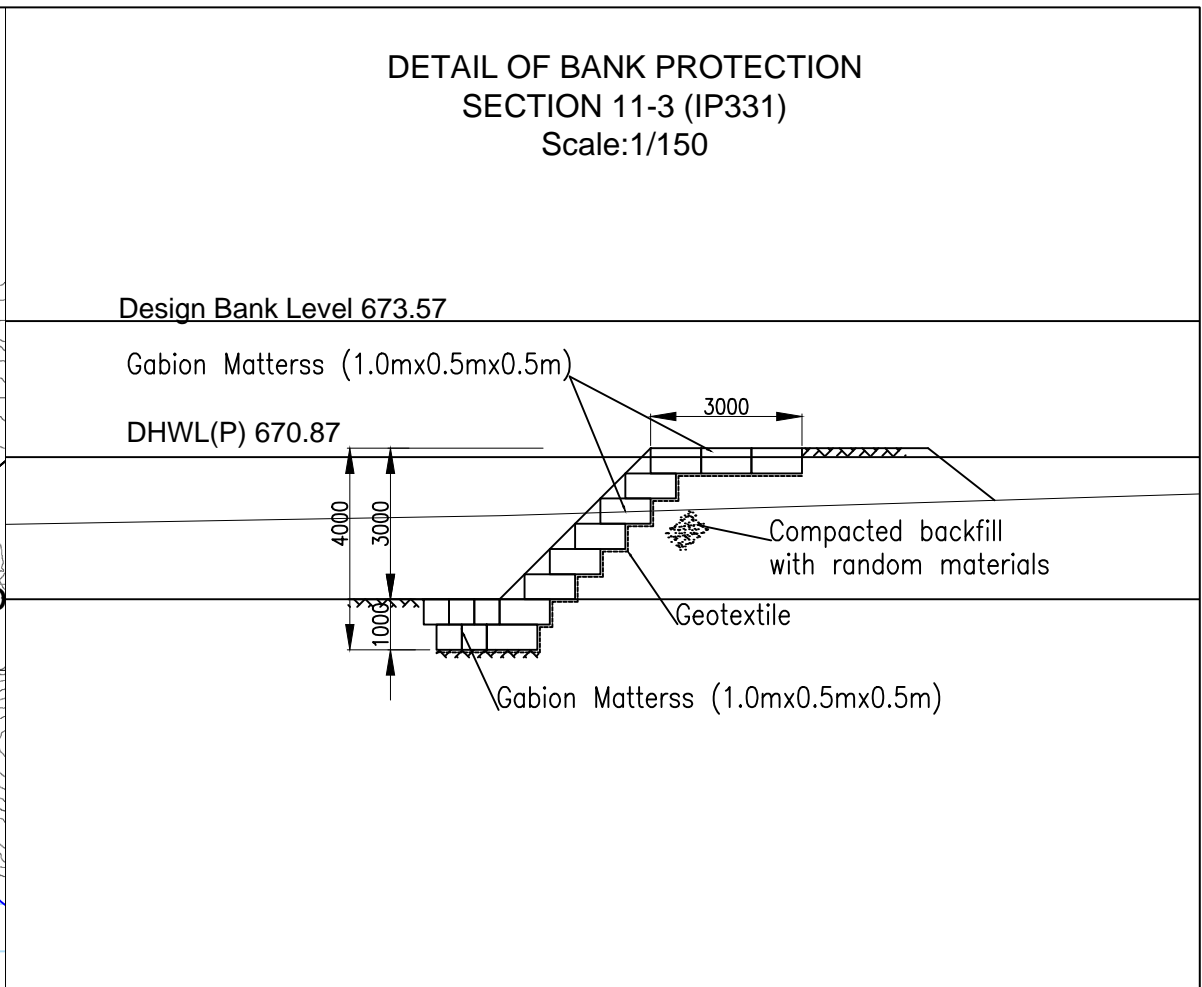
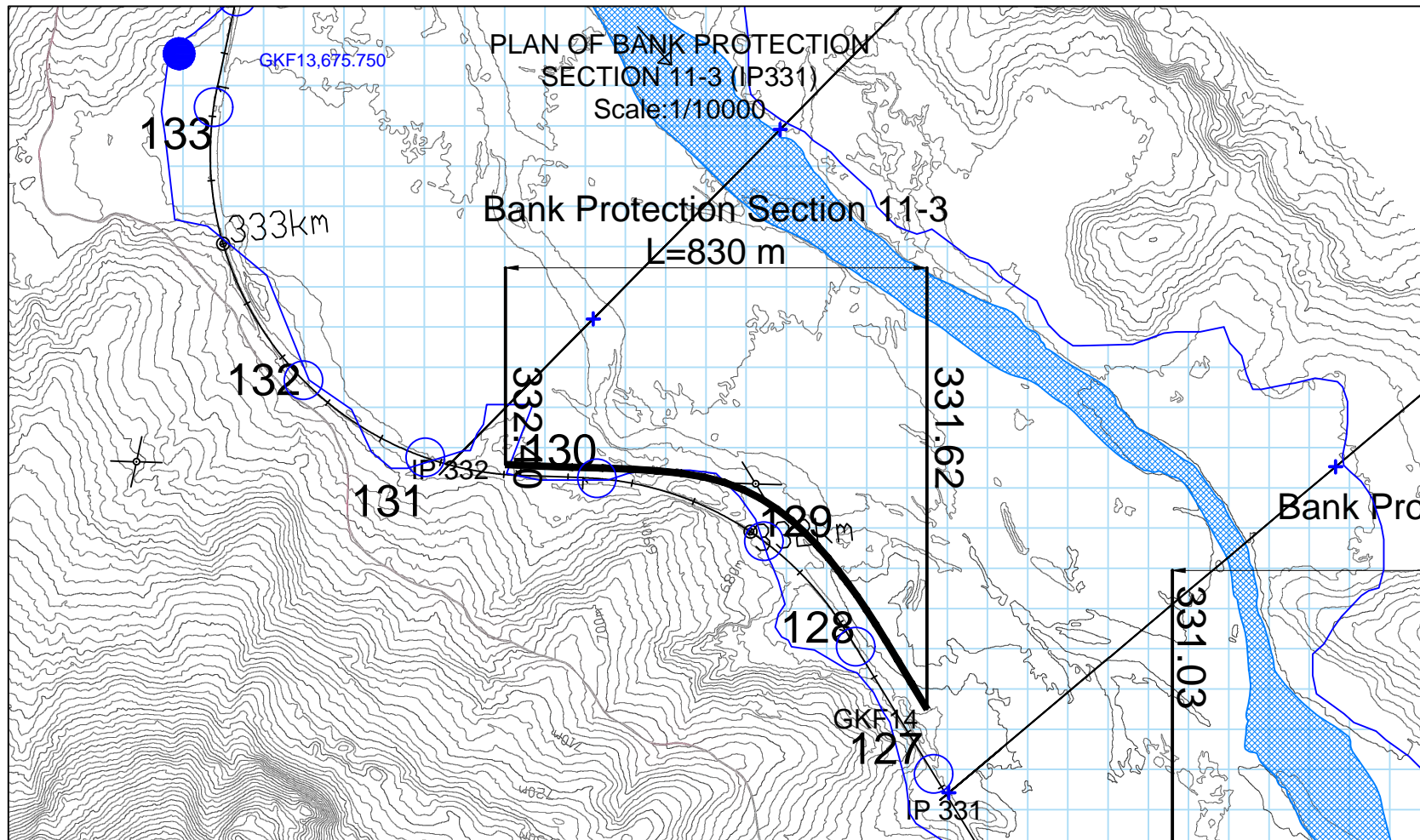

CROSS SECTION OF BANK PROTECTION SECTION 11-3 (IP331) Scale: H:1/3000, V:1/600

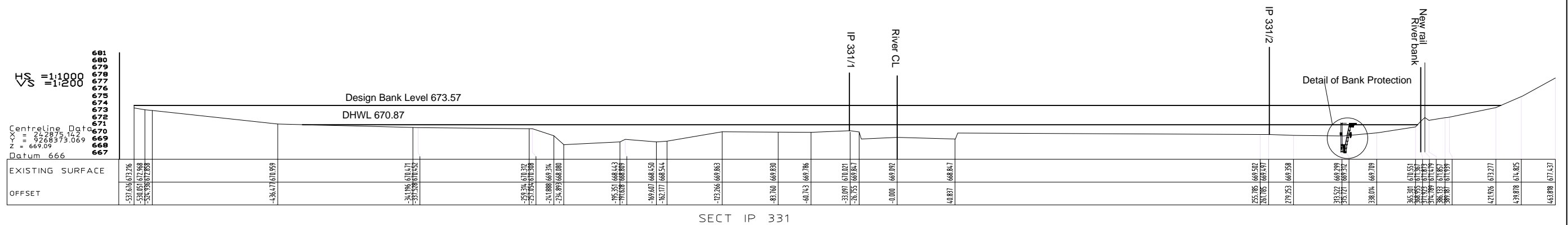

GOVERNMENT AGENCIES:



JICA STUDY TEAM:

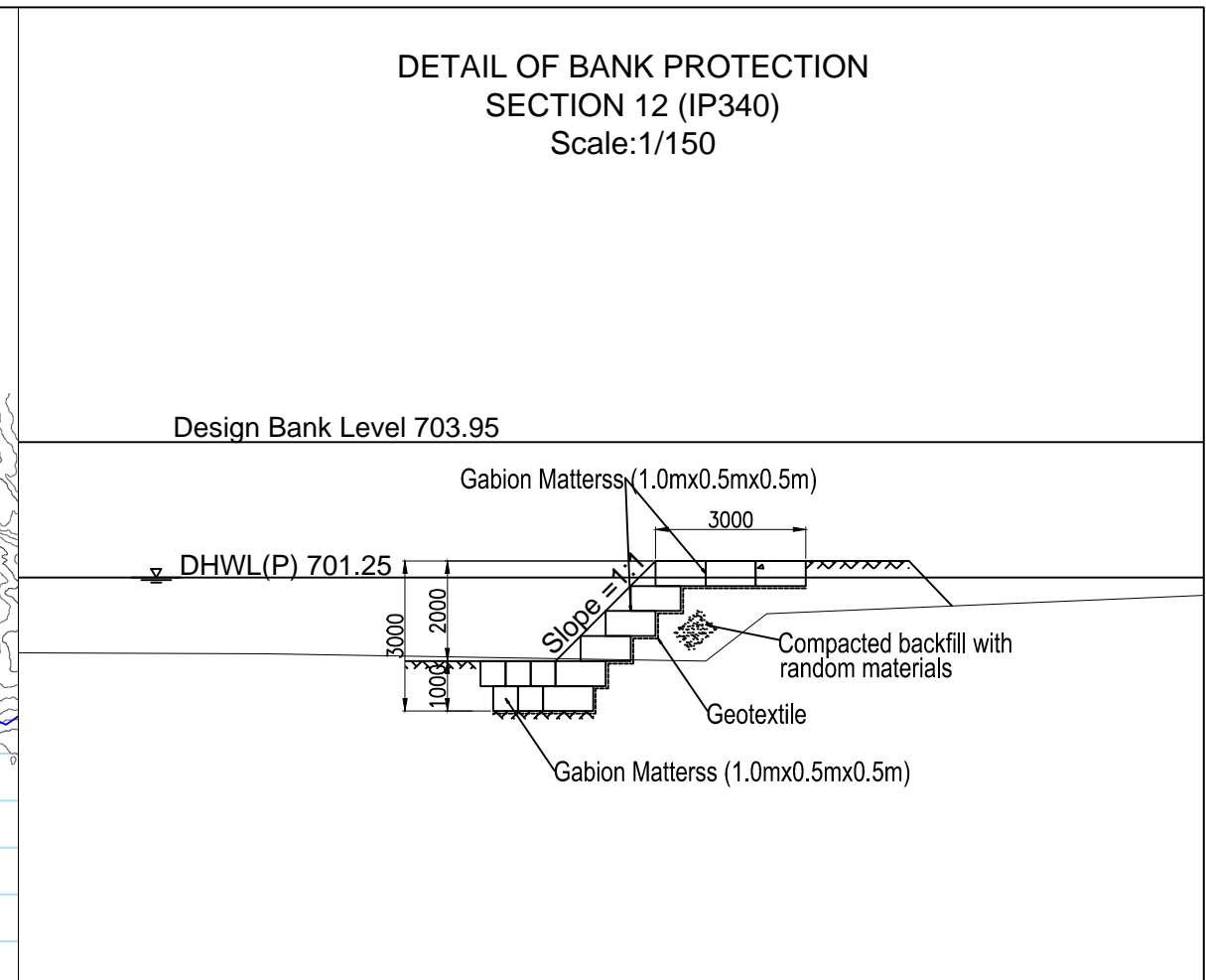
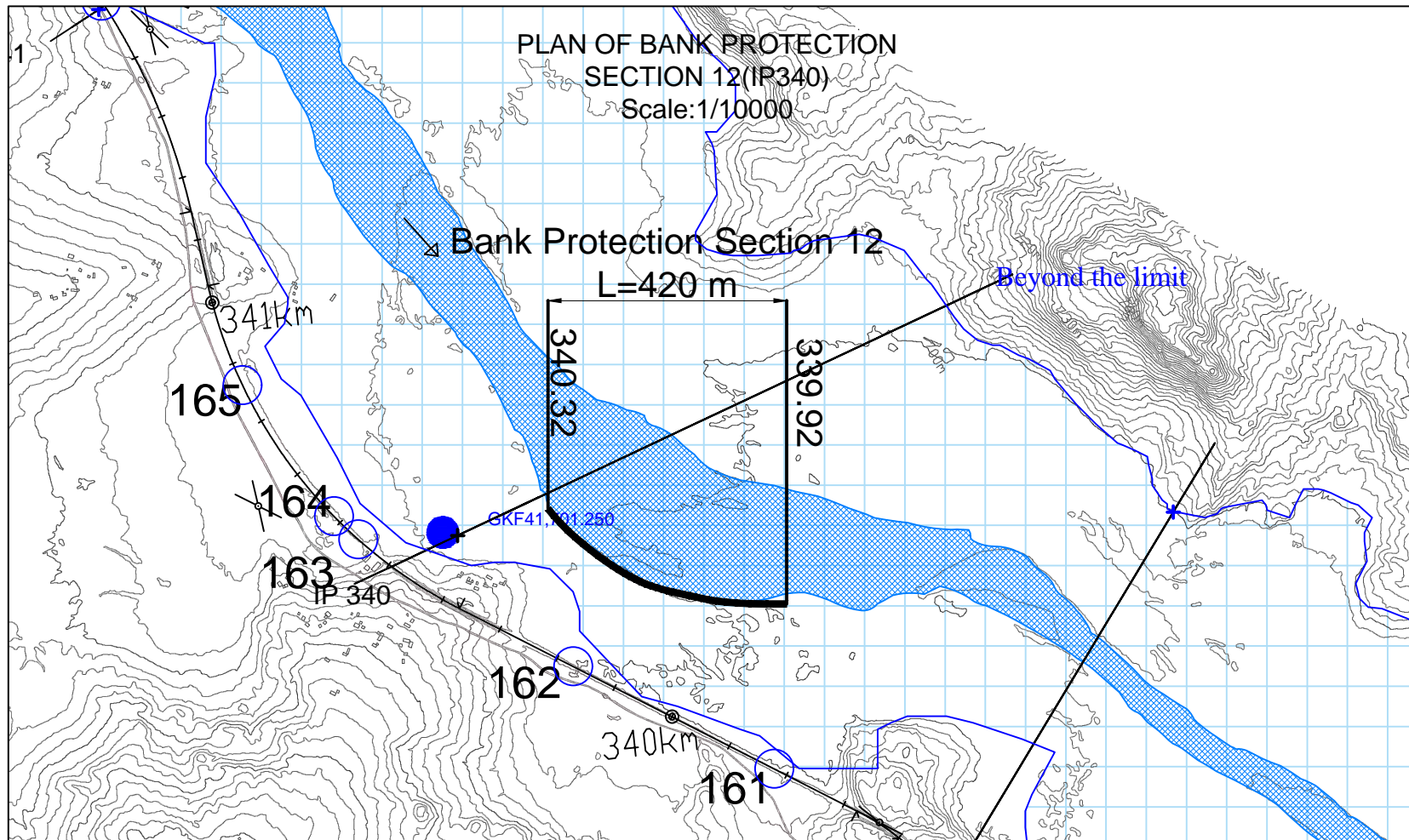

PADECO Co., Ltd.,
Nippon Koei Co., Ltd.,
Japan International Consultants
for Transportation Co., Ltd., and
Fukken Engineering Co., Ltd.

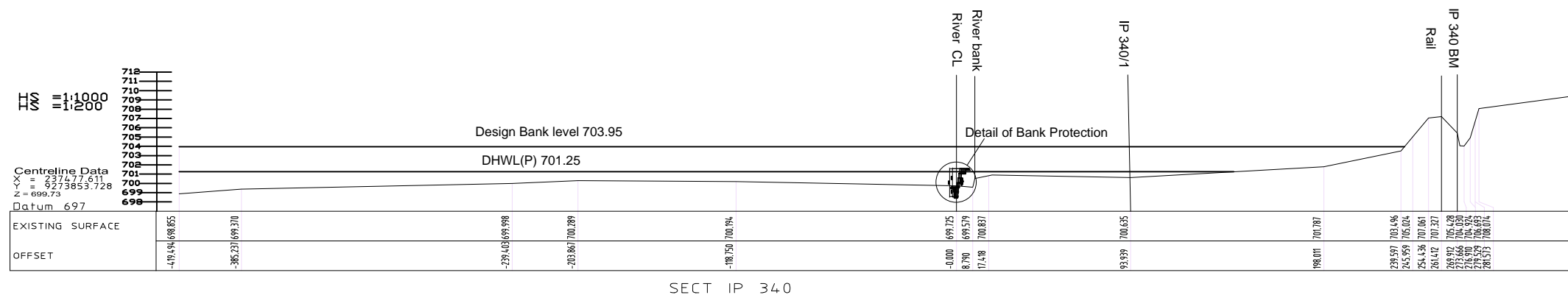

CROSS SECTION OF BANK PROTECTION SECTION 12 (IP340) Scale: H:1/3000, V:1/600



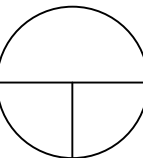

DHWL(P): Design High Water Level for Present Riverbed Level

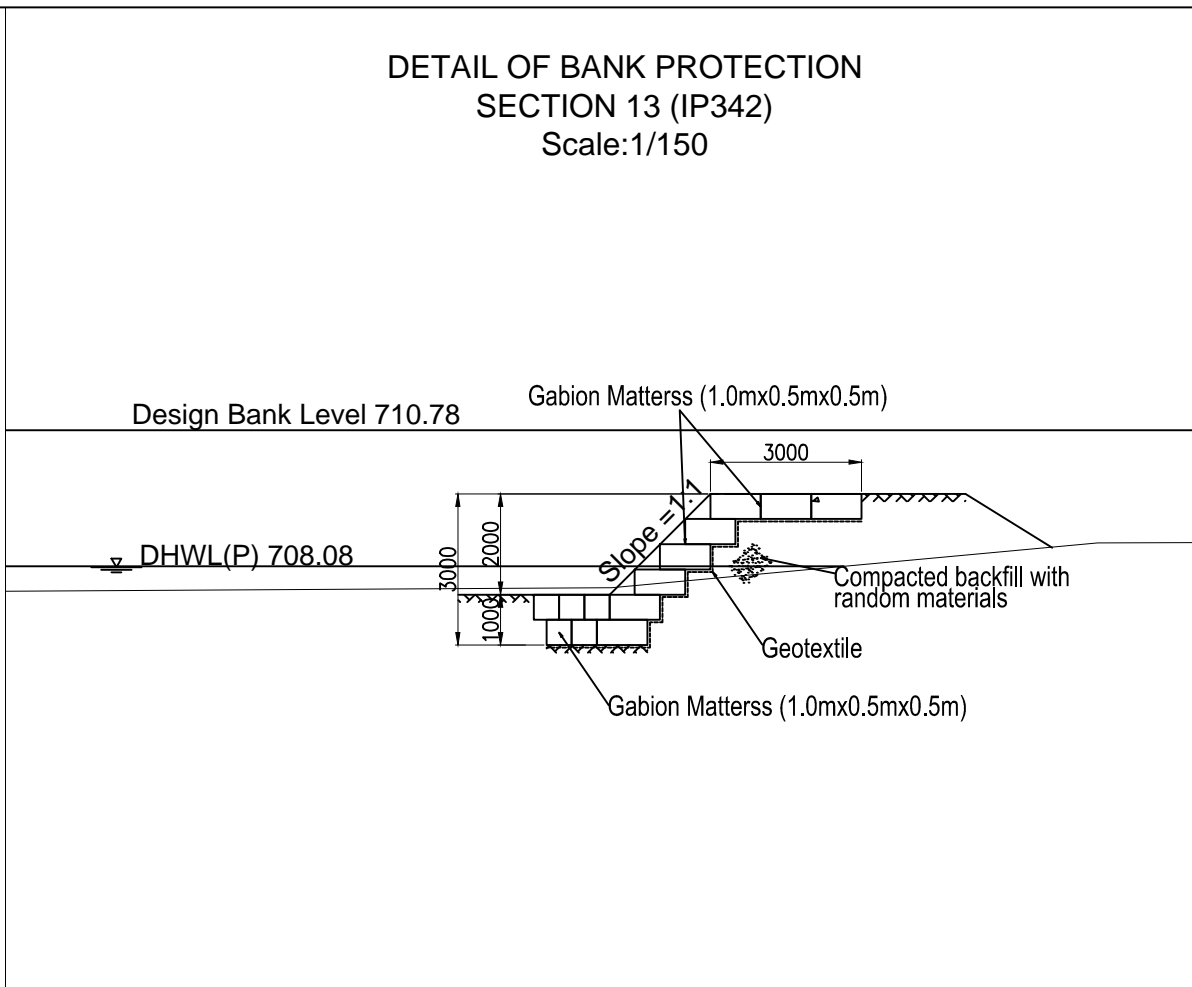
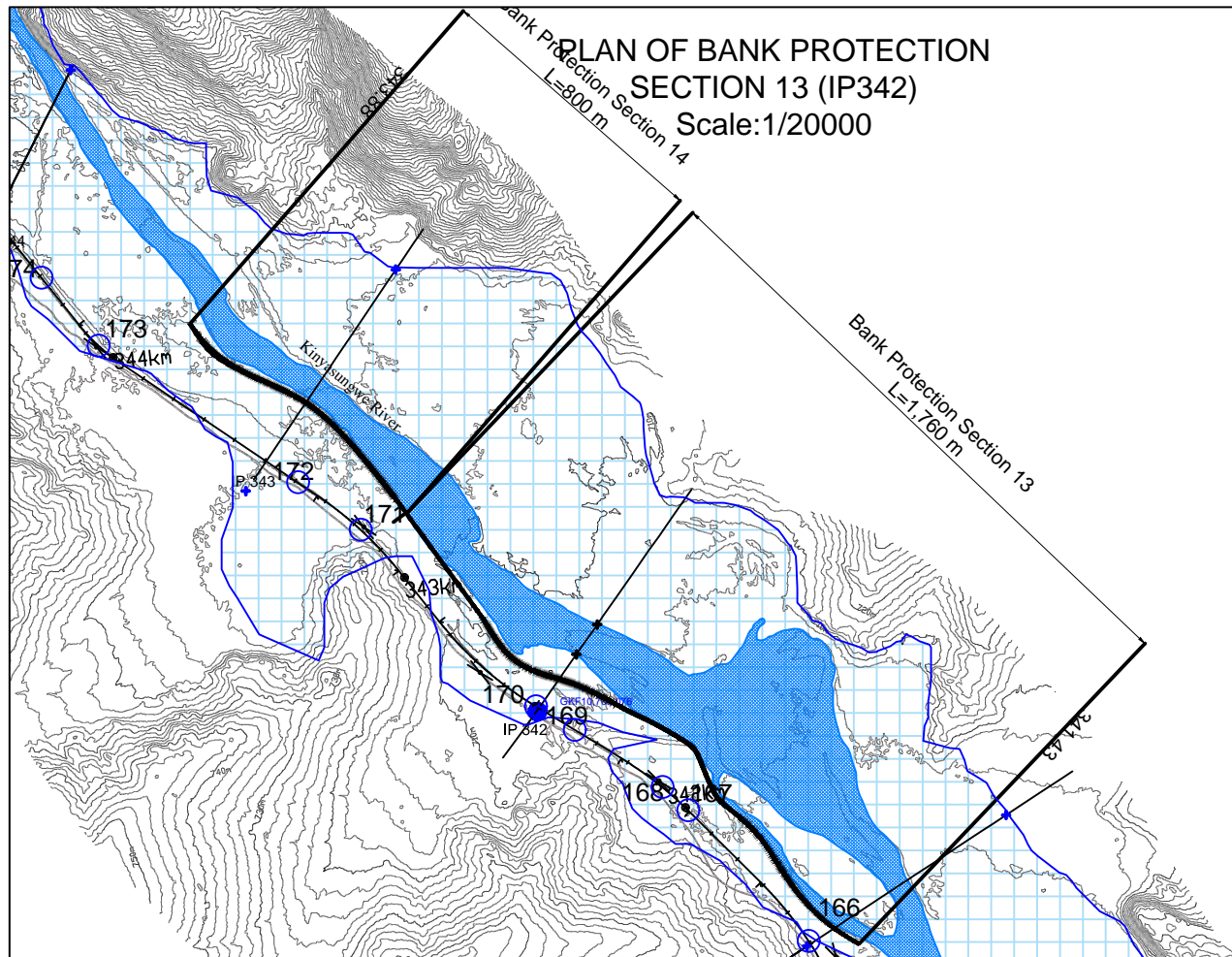
GOVERNMENT AGENCIES:		JICA STUDY TEAM:	PROJECT & LOCATION:	SHEET CONTENTS:	DWG NUM
 JAPAN International Cooperation Agency	 Reli Assets Holding Company (RAHCO), Tanzania	PADECO Co., Ltd., Nippon Koei Co., Ltd., Japan International Consultants for Transportation Co., Ltd., and Fukken Engineering Co., Ltd.	Preparatory Survey on Flood Protection Measures for Central Railway Line in the United Republic of Tanzania	PLAN, CROSS SECTION AND DETAIL OF BANK PROTECTION SECTION 12 (IP340)	

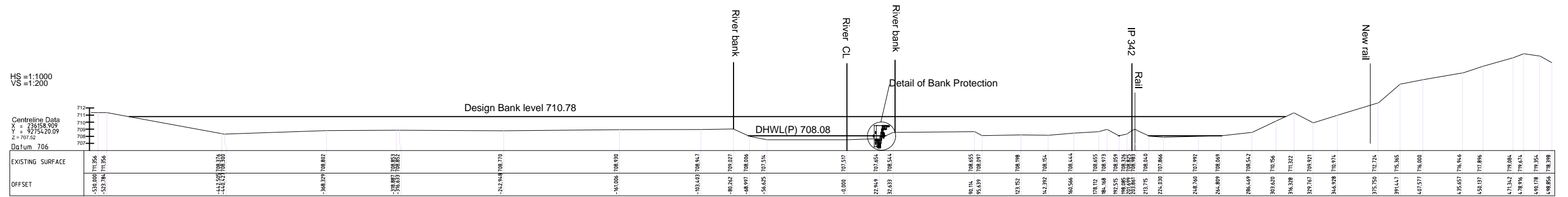

CROSS SECTION OF BANK PROTECTION SECTION 13 (IP342) Scale: H:1/3000, V:1/600

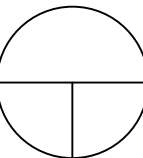

GOVERNMENT AGENCIES:		JICA STUDY TEAM:	PROJECT & LOCATION:	SHEET CONTENTS:	DWG NUM
 JAPAN International Cooperation Agency	 Reli Assets Holding Company (RAHCO), Tanzania	PADECO Co., Ltd., Nippon Koei Co., Ltd., Japan International Consultants for Transportation Co., Ltd., and Fukken Engineering Co., Ltd.	Preparatory Survey on Flood Protection Measures for Central Railway Line in the United Republic of Tanzania	PLAN, CROSS SECTION AND DETAIL OF BANK PROTECTION SECTION 13 (IP342)	

PLAN OF BANK PROTECTION
SECTION 14 (IP343)
Scale:1/20000

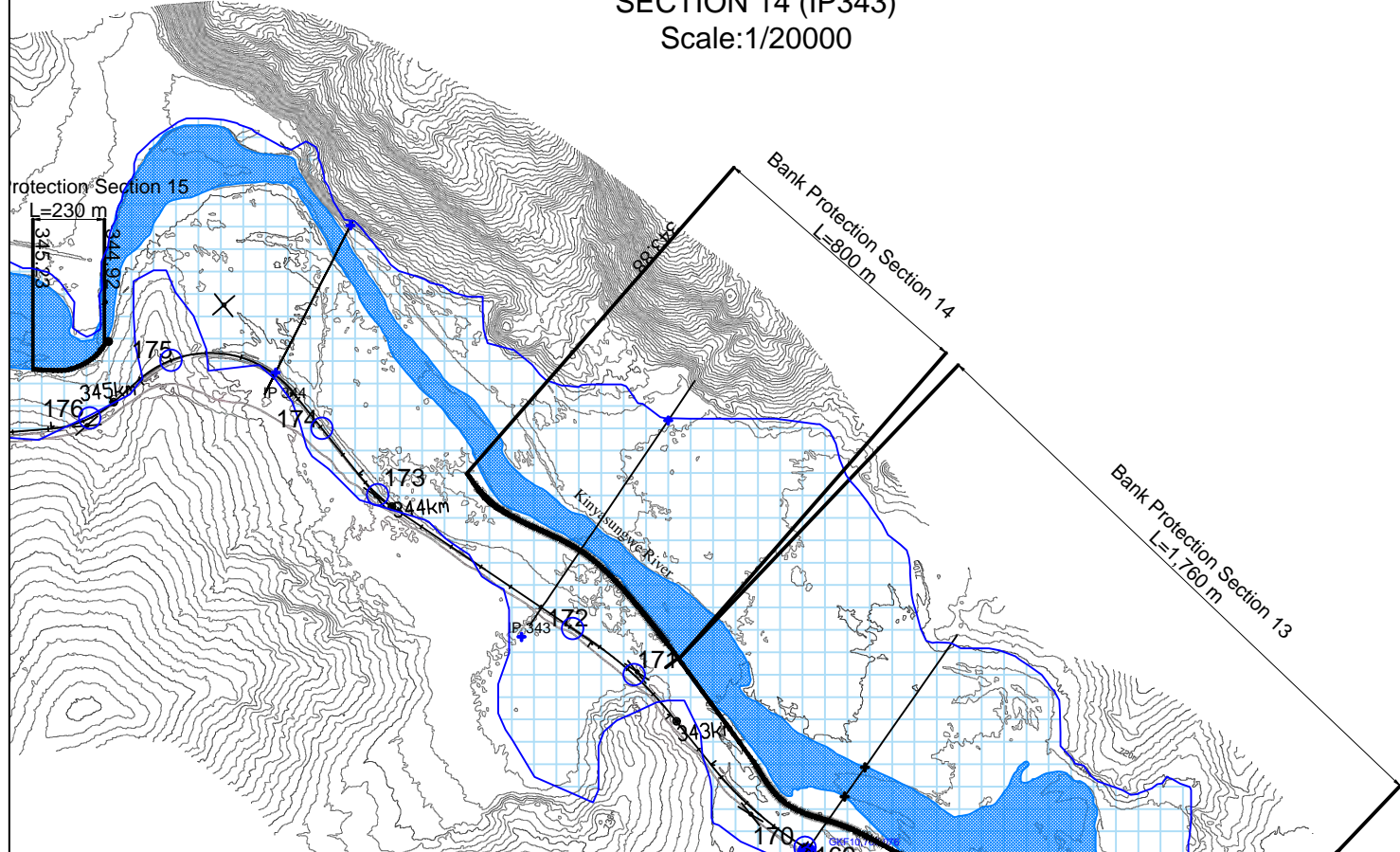

DETAIL OF BANK PROTECTION
SECTION 14 (IP343)
Scale:1/150

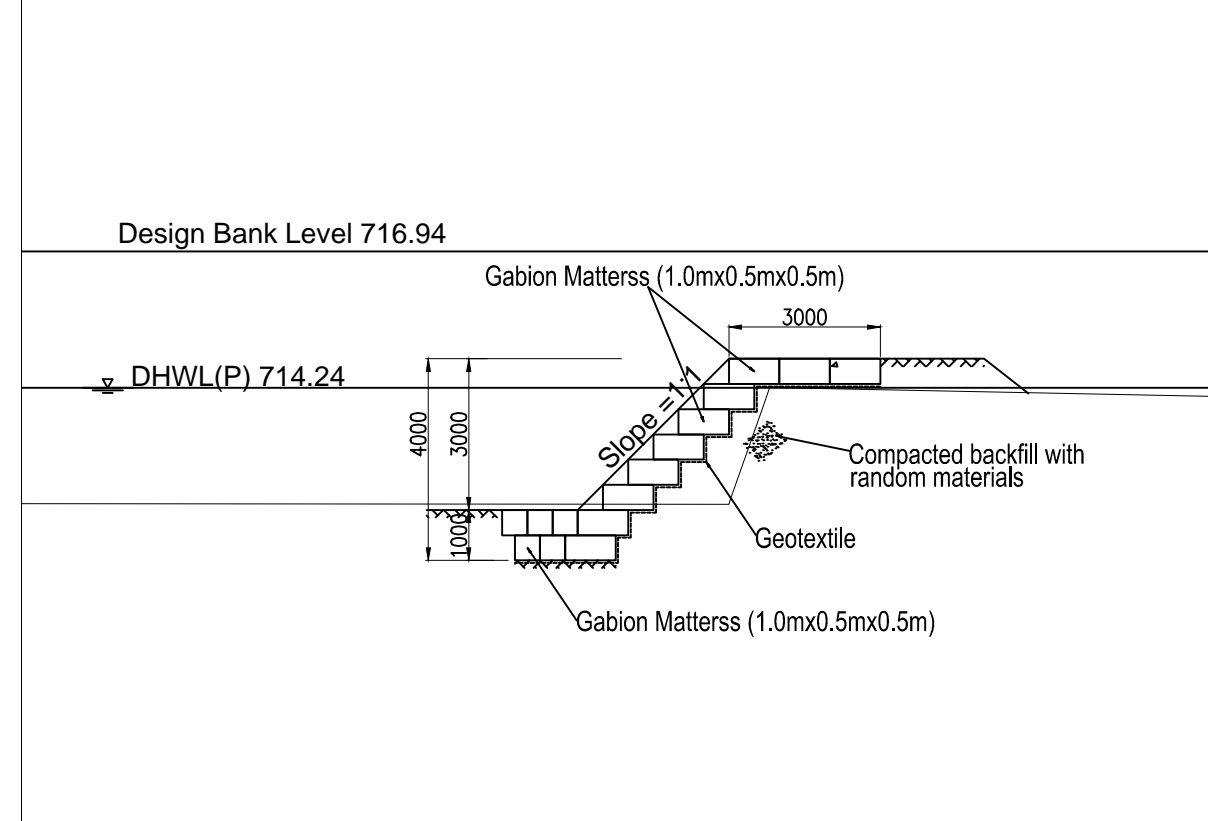

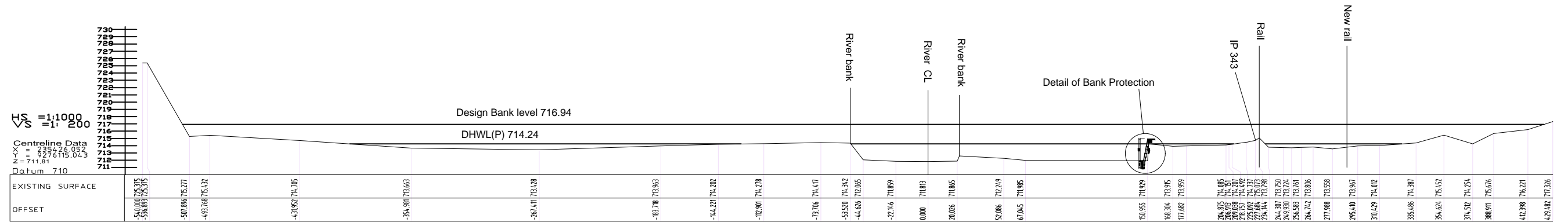

CROSS SECTION OF BANK PROTECTION
SECTION 14 (IP343)
Scale: H:1/3000, V=1/600



SECT IP 343

DHWL(P): Design High Water Level for Present Riverbed Level

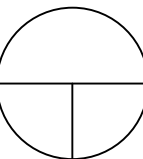
GOVERNMENT AGENCIES:		JICA STUDY TEAM:	PROJECT & LOCATION:	SHEET CONTENTS:	DWG NUM
 JAPAN International Cooperation Agency	 Reli Assets Holding Company (RAHCO), Tanzania	PADECO Co., Ltd., Nippon Koei Co., Ltd., Japan International Consultants for Transportation Co., Ltd., and Fukken Engineering Co., Ltd.	Preparatory Survey on Flood Protection Measures for Central Railway Line in the United Republic of Tanzania	PLAN, CROSS SECTION AND DETAIL OF BANK PROTECTION SECTION 14 (IP343)	

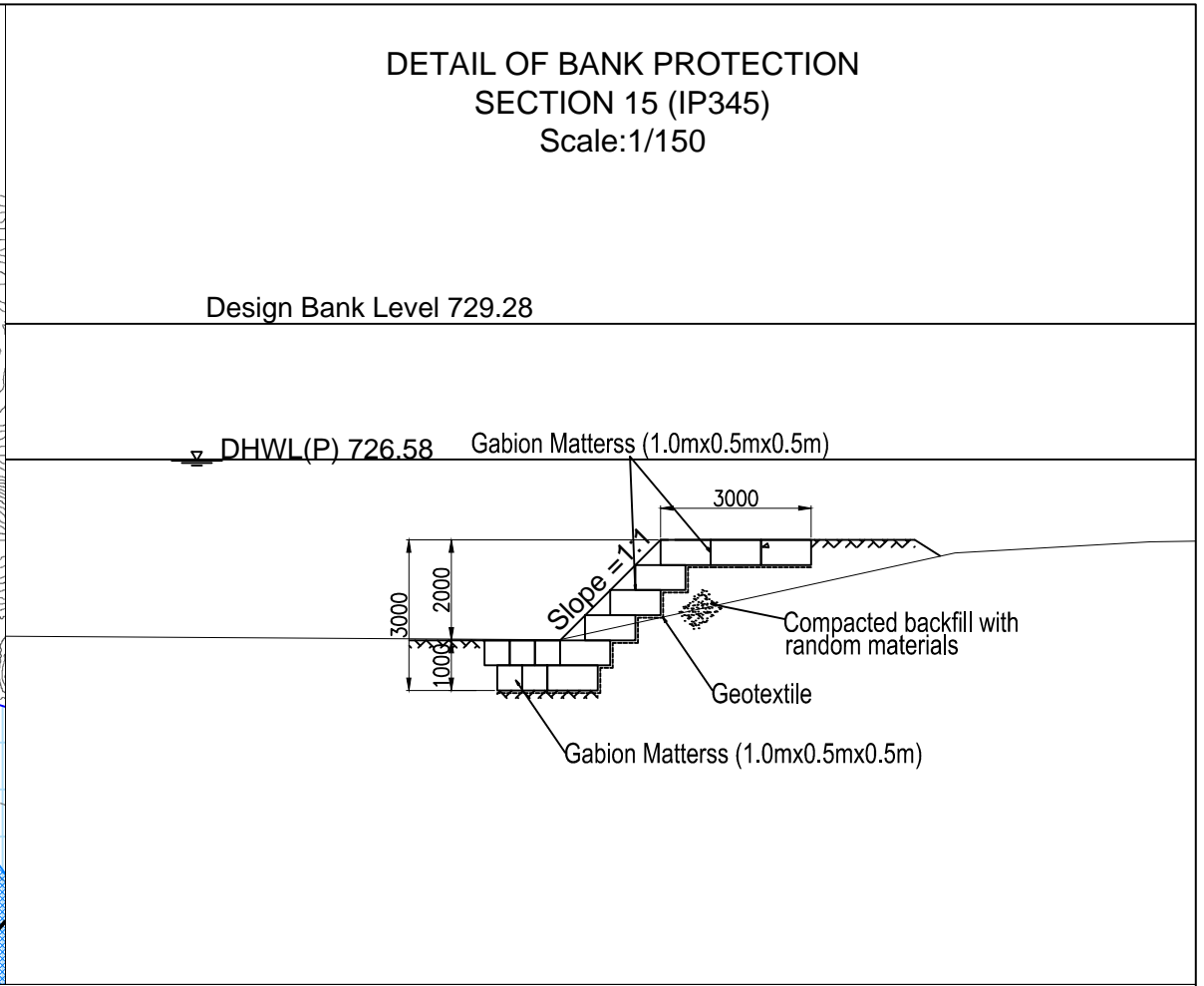
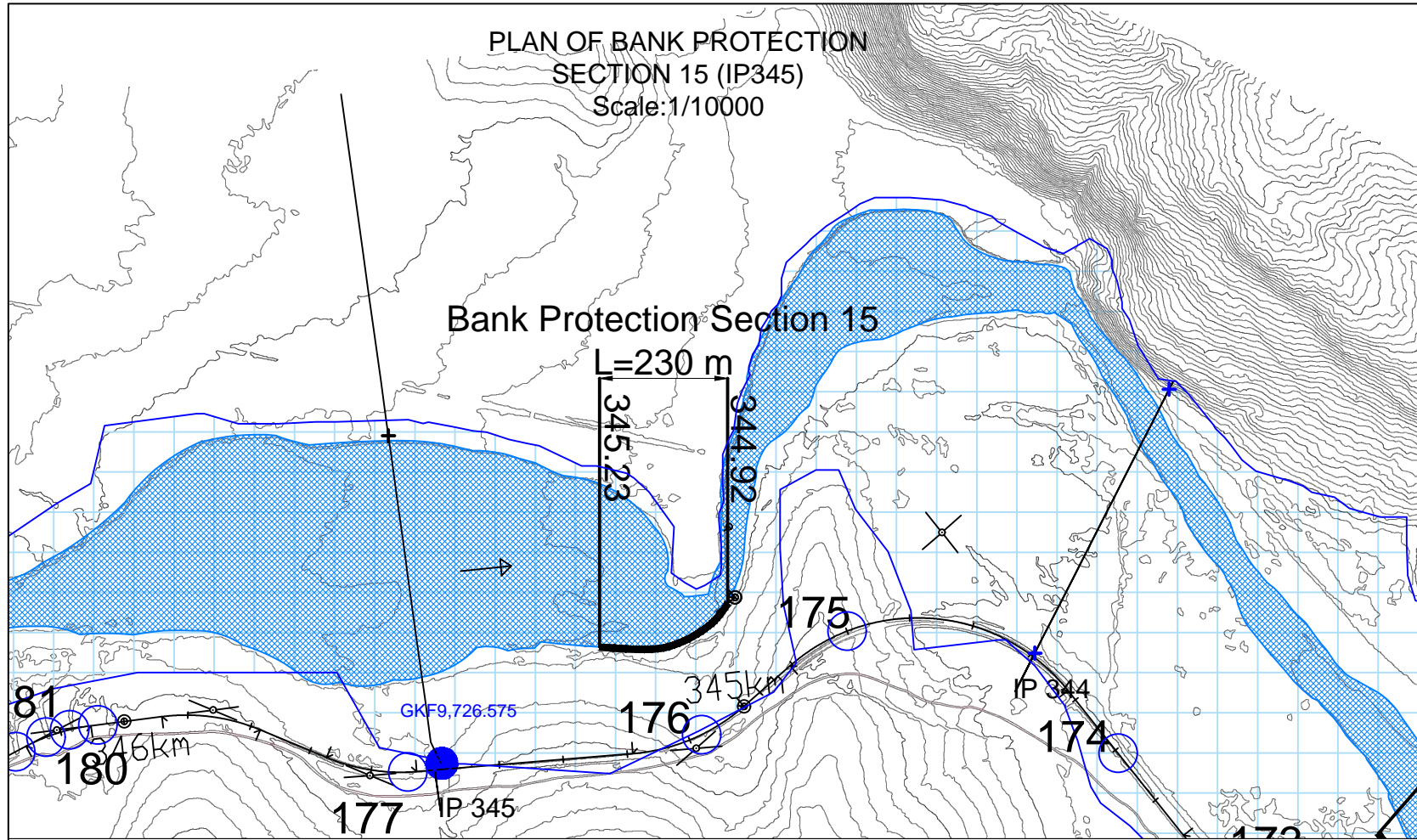

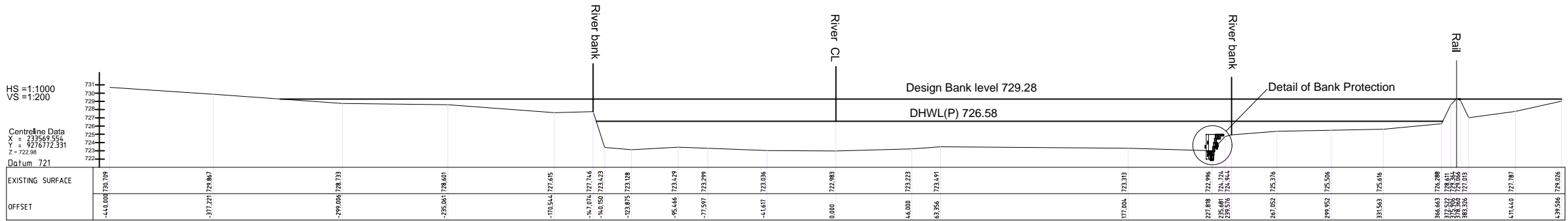

CROSS SECTION OF BANK PROTECTION SECTION 15 (IP345) Scale: H:1/3000, V=1/600



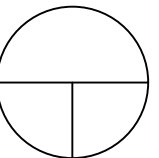

SECT IP 345

DHWL(P): Design High Water Level for Present Riverbed Level

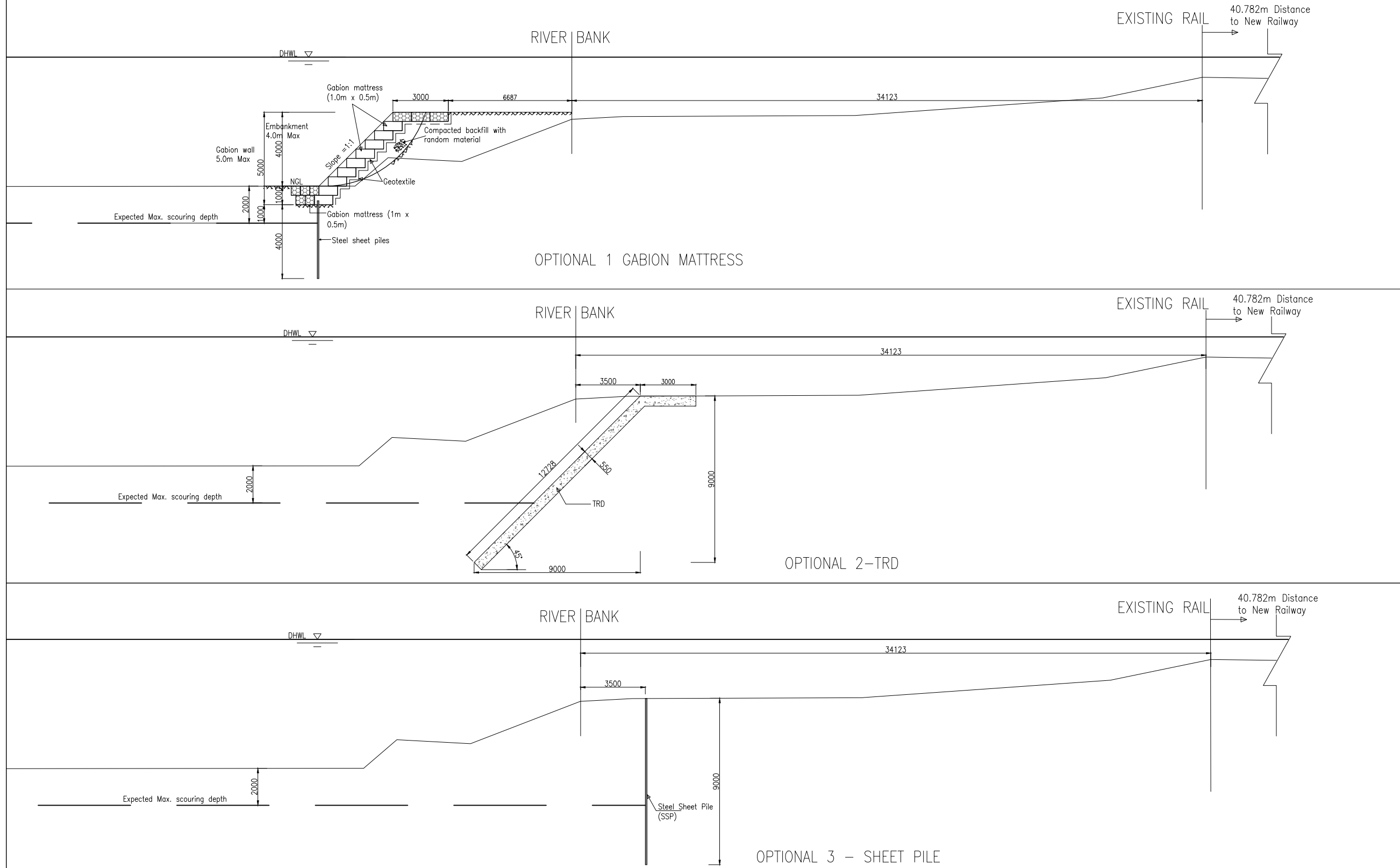

GOVERNMENT AGENCIES:		JICA STUDY TEAM:	PROJECT & LOCATION:	SHEET CONTENTS:	DWG NUM
 JAPAN International Cooperation Agency	 Reli Assets Holding Company (RAHCO), Tanzania	PADECO Co., Ltd., Nippon Koei Co., Ltd., Japan International Consultants for Transportation Co., Ltd., and Fukken Engineering Co., Ltd.	Preparatory Survey on Flood Protection Measures for Central Railway Line in the United Republic of Tanzania	PLAN, CROSS SECTION AND DETAIL OF BANK PROTECTION SECTION 15 (IP345)	

COMPARISON OF BANK PROTECTION WORKS IN SITE 315

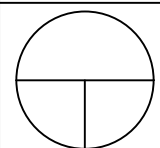

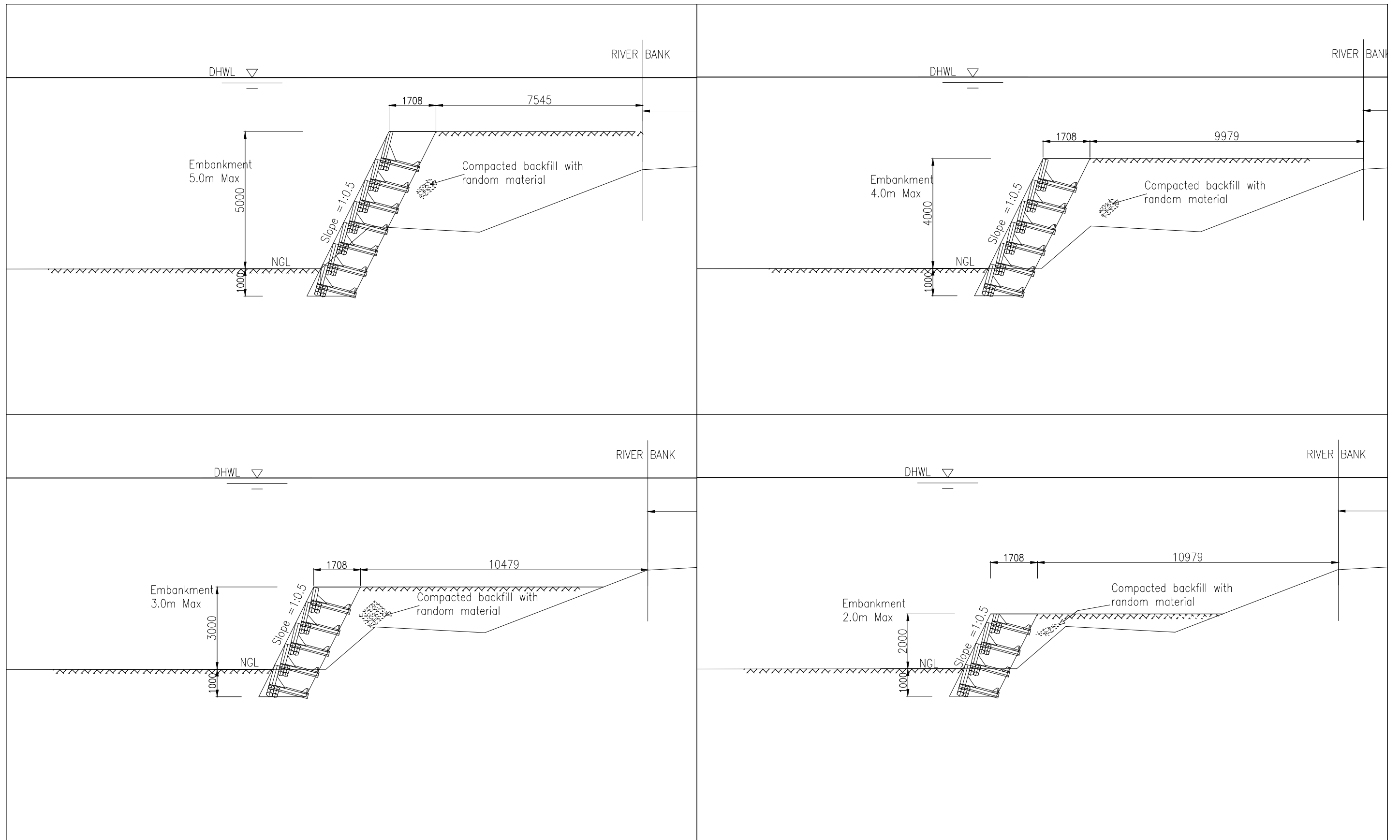
GOVERNMENT AGENCIES:		JICA STUDY TEAM:	PROJECT & LOCATION:	SHEET CONTENTS:	DWG NUM
 JAPAN International Cooperation Agency	 Reli Assets Holding Company (RAHCO), Tanzania	PADECO Co., Ltd., Nippon Koei Co., Ltd., Japan International Consultants for Transportation Co., Ltd., and Fukken Engineering Co., Ltd.	Preparatory Survey on Flood Protection Measures for Central Railway Line in the United Republic of Tanzania	Comparison of River Bank Protection Works for TRD (Trench Cutting Re-mixing Deep Wall) Method and Sheet Piling	

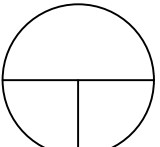

GOVERNMENT AGENCIES:		JICA STUDY TEAM:	PROJECT & LOCATION:	SHEET CONTENTS:	DWG NUM
 JAPAN International Cooperation Agency	 Reli Assets Holding Company (RAHCO), Tanzania	PADECO Co., Ltd., Nippon Koei Co., Ltd., Japan International Consultants for Transportation Co., Ltd., and Fukken Engineering Co., Ltd.	Preparatory Survey on Flood Protection Measures for Central Railway Line in the United Republic of Tanzania	Typical Section of River Bank Protection Works Branch Block (H=2m, 3m, 4m, 5m)	

COMPARISON OF TYPE OF SLOPE PROTECTION WORKS IN MASWALA RIVER

CONVENTIONAL METHOD (GABION MATTRESS)

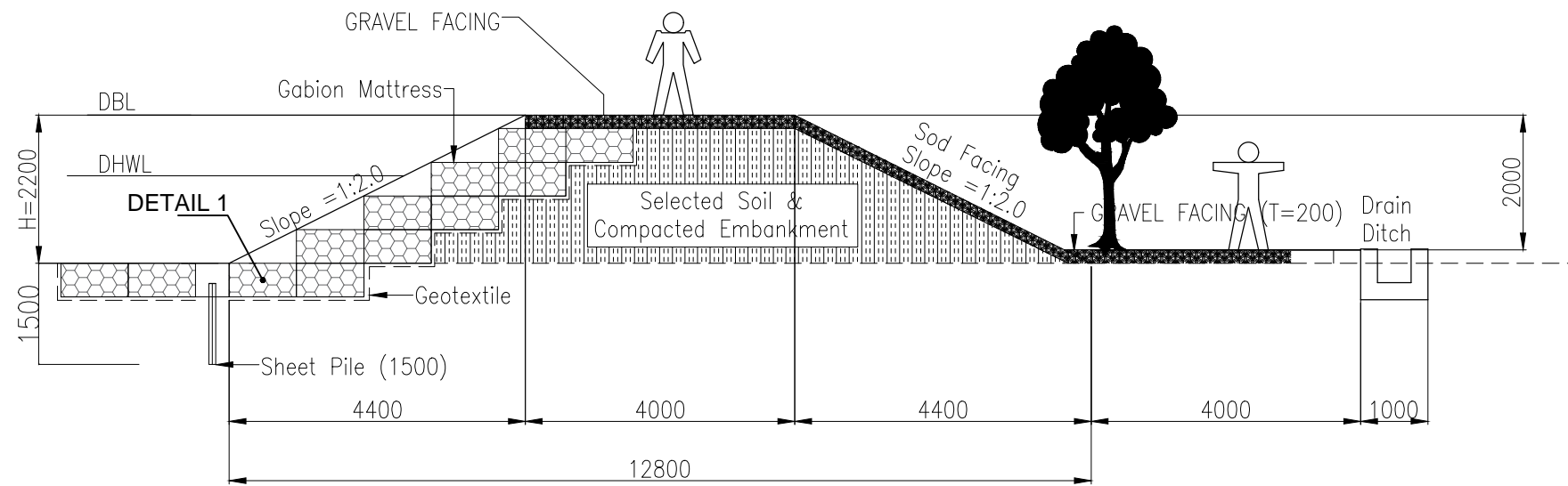

DETAIL 1: GABION

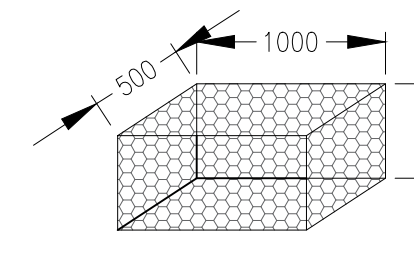

DETAIL 2: FILTER UNIT

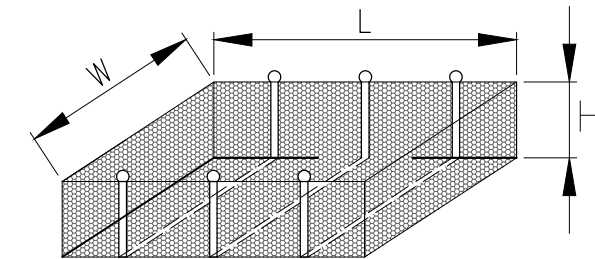

OPTION (BRANCH BLOCK AND FILTER UNIT)

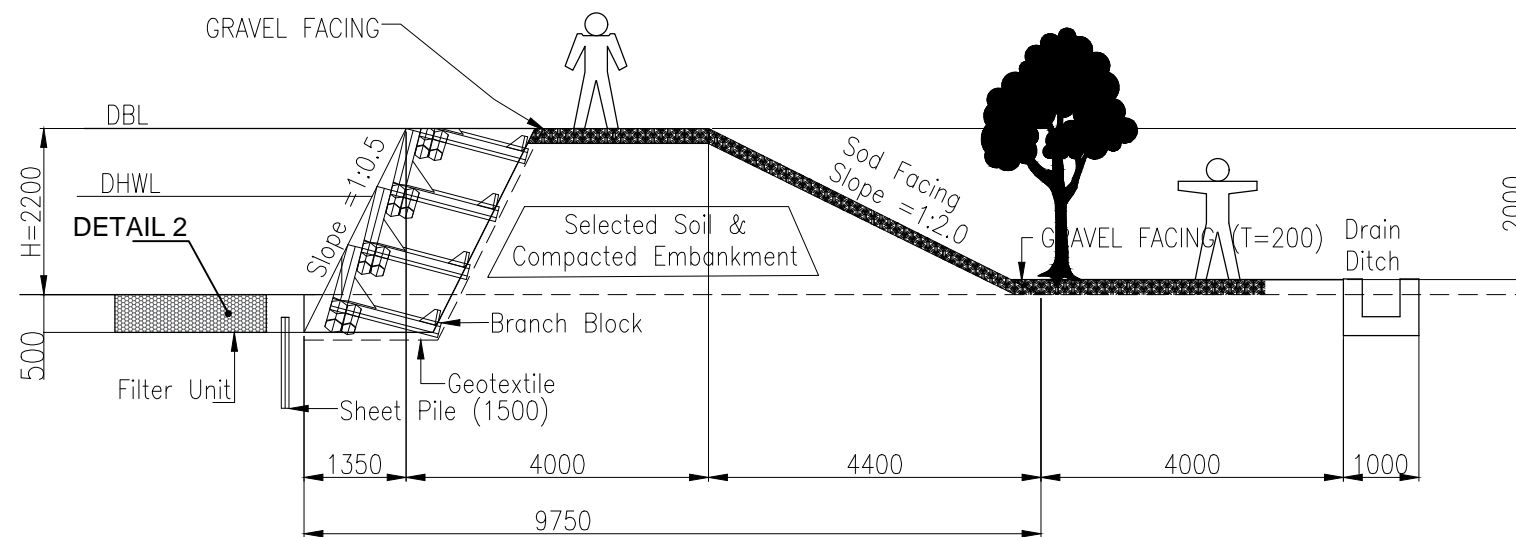

FILTER UNIT DESCRIPTION TABLE

0.6m ³ Filter Unit	1m ³ Filter Unit	1.2m ³ Filter Unit
1m(W) x 2m(L) x 0.3m(H)	1m(W) x 2m(L) x 0.5m(H)	1.2m(W) x 2m(L) x 0.5m(H)

GOVERNMENT AGENCIES:



JAPAN International Cooperation Agency



Reli Assets Holding Company (RAHCO), Tanzania

JICA STUDY TEAM:

PADECO Co., Ltd.,
Nippon Koei Co., Ltd.,
Japan International Consultants for Transportation Co., Ltd., and
Fukken Engineering Co., Ltd.

PROJECT & LOCATION:

Preparatory Survey on Flood Protection Measures for Central Railway Line in the United Republic of Tanzania

SHEET CONTENTS:

COMPARISON OF BANK PROTECTION WORKS FOR RIVER TRAINING WORKS IN MASWALA RIVER

DWG NUM

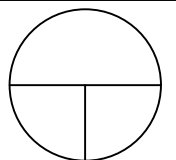

COMPARISON OF BANK PROTECTION FOR RIVER TRAINING WORKS IN TRIBUTARIES – MZASE RIVER

CONVENTIONAL METHOD (GABION MATTRESS)

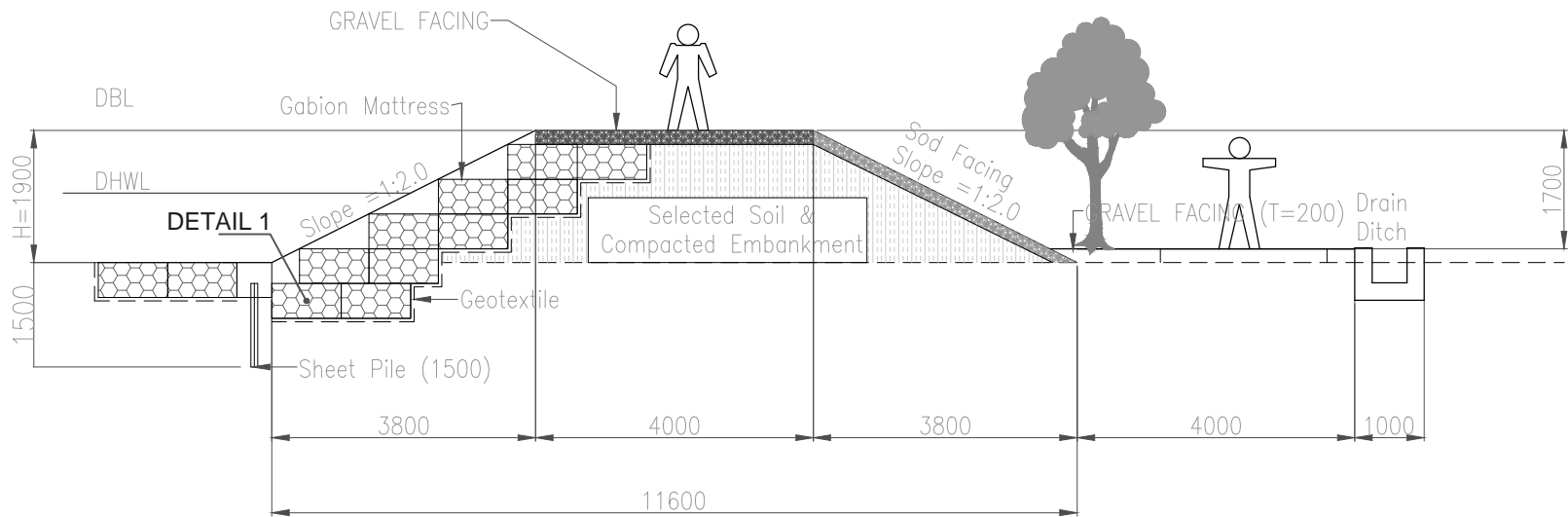

DETAIL 1: GABION

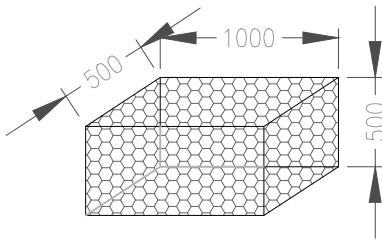

DETAIL 2: FILTER UNIT

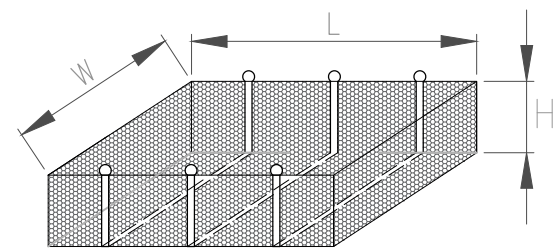

OPTION (BRANCH BLOCK AND FILTER UNIT)

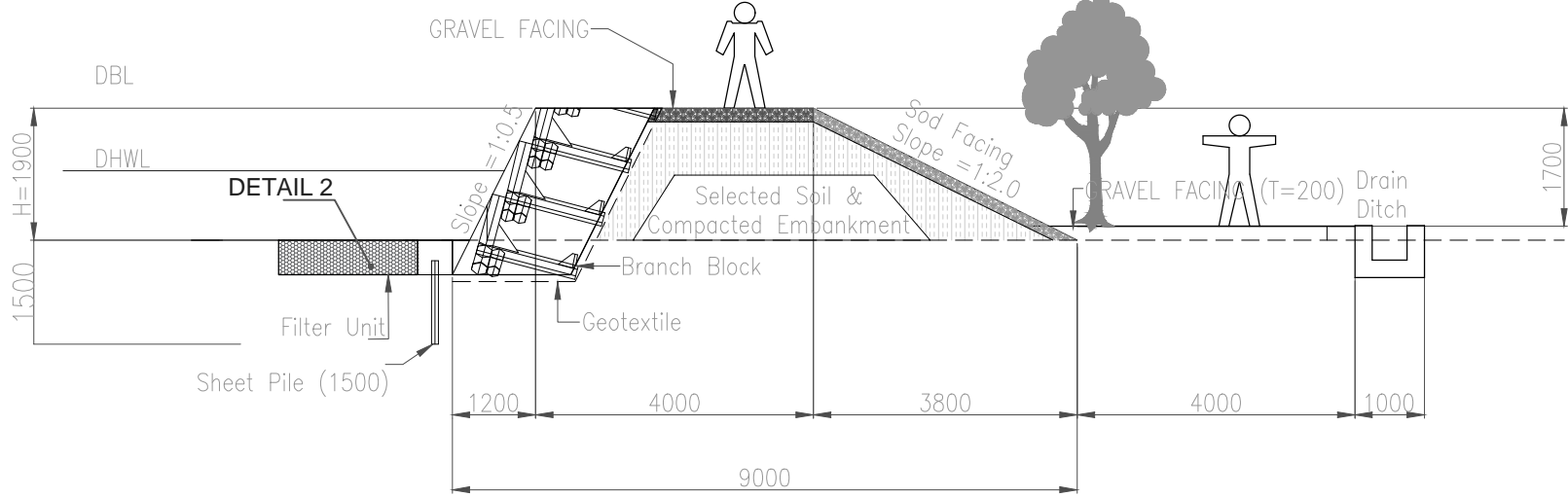

FILTER UNIT DESCRIPTION TABLE

0.6m ³ Filter Unit	1m ³ Filter Unit	1.2m ³ Filter Unit
1m(W) x 2m(L) x 0.3m(H)	1m(W) x 2m(L) x 0.5m(H)	1.2m(W) x 2m(L) x 0.5m(H)

GOVERNMENT AGENCIES:



Reli Assets Holding Company (RAHCO), Tanzania

JICA STUDY TEAM:

PADECO Co., Ltd., Nippon Koei Co., Ltd., Japan International Consultants for Transportation Co., Ltd., and Fukken Engineering Co., Ltd.

PROJECT & LOCATION:

Preparatory Survey on Flood Protection Measures for Central Railway Line in the United Republic of Tanzania

SHEET CONTENTS:

COMPARISON OF BANK PROTECTION FOR RIVER TRAINING WORKS IN TRIBUTARIES - MZASE RIVER

DWG NUM

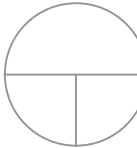

MAIN DAM PROTECTION DETAILS
SCALE; 1:1

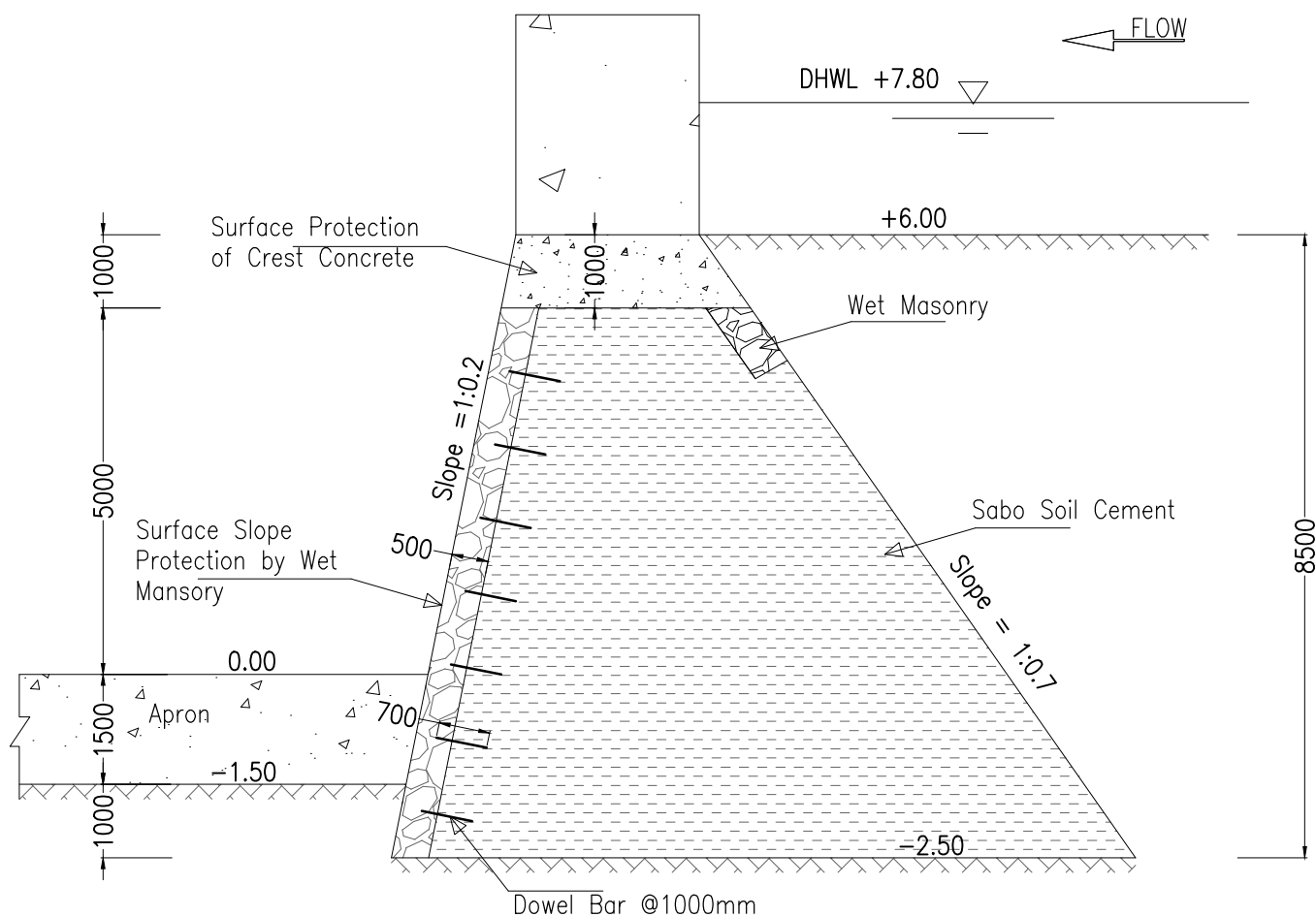

RETAINING WALL

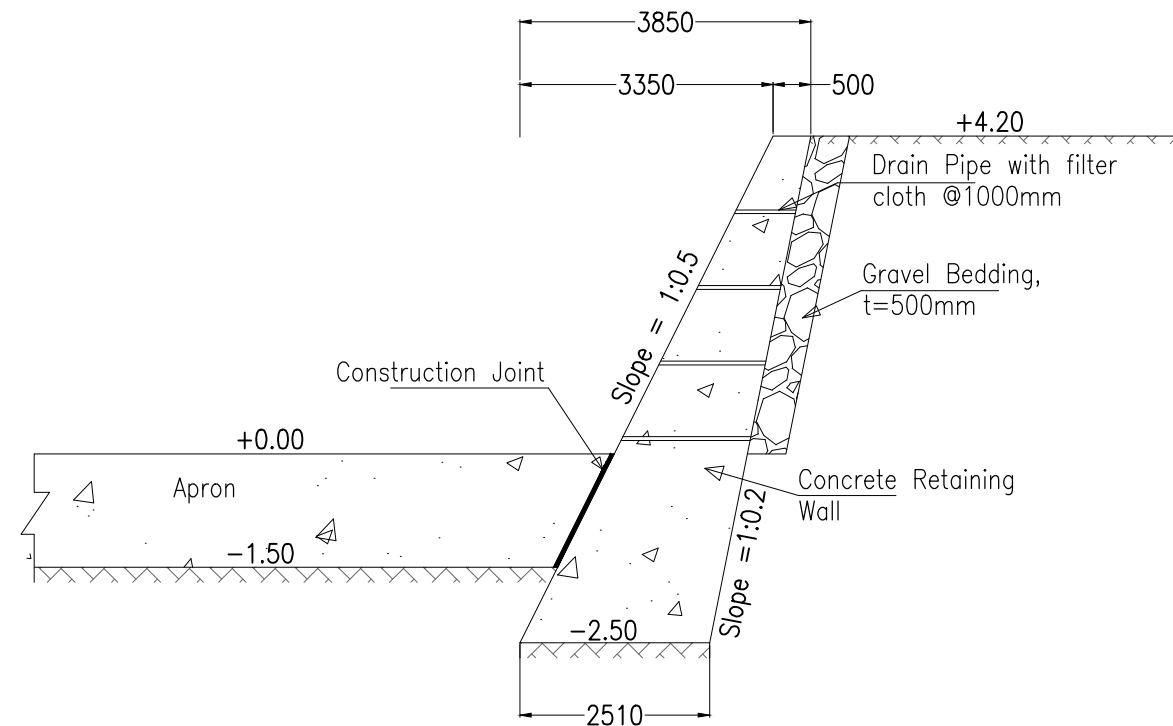

SUB DAM PROTECTION DETAILS
SCALE; 1:1

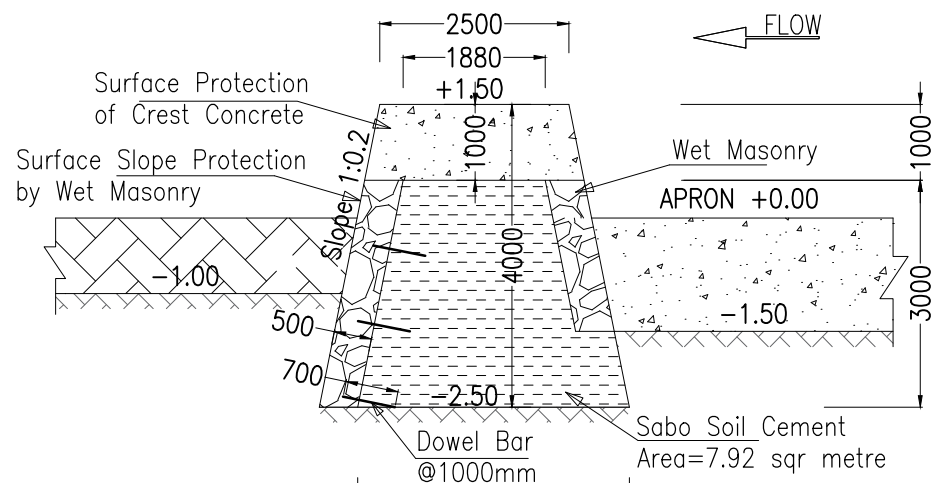

GROUNDSILL PROTECTION DETAILS
SCALE; 1:1

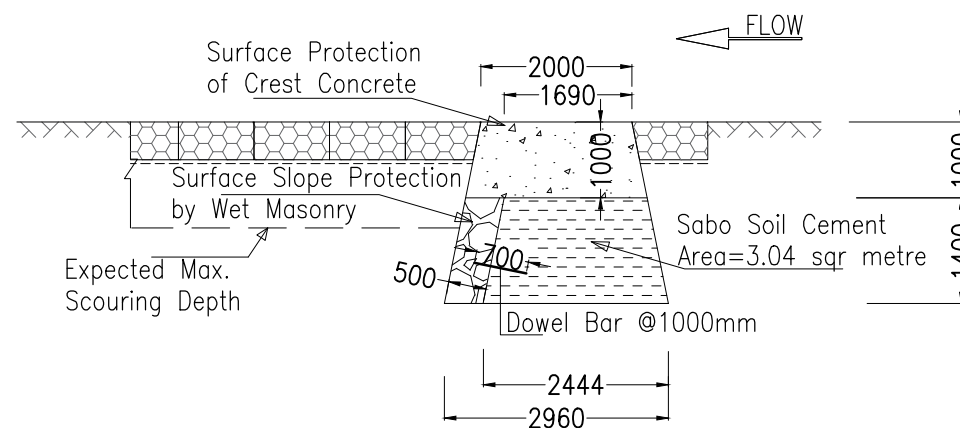

GOVERNMENT AGENCIES:



JAPAN International Cooperation Agency



Reli Assets Holding Company (RAHCO), Tanzania

JICA STUDY TEAM:

PADECO Co., Ltd.,
Nippon Koei Co., Ltd.,
Japan International Consultants for Transportation Co., Ltd., and
Fukken Engineering Co., Ltd.

PROJECT & LOCATION:

Preparatory Survey on Flood Protection Measures for Central Railway Line in the United Republic of Tanzania

SHEET CONTENTS:

DWG NUM

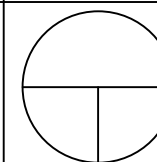

DETAIL OF GOUNDSILL IN MZASE RIVER

Scale 1/400

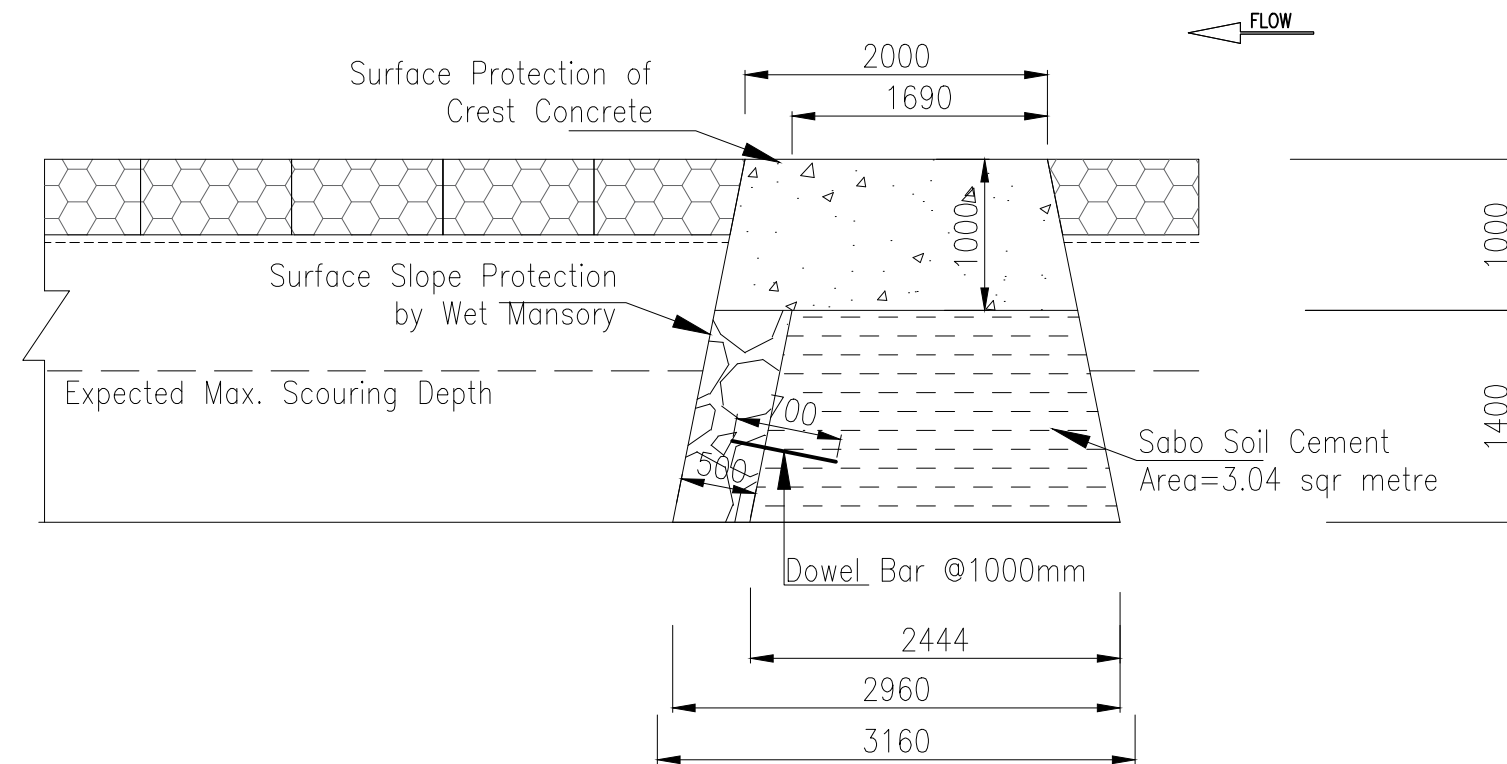

GOVERNMENT AGENCIES:		JICA STUDY TEAM:	PROJECT & LOCATION:	SHEET CONTENTS:	DWG NUM
 JAPAN International Cooperation Agency	 Reli Assets Holding Company (RAHCO), Tanzania	PADECO Co., Ltd., Nippon Koei Co., Ltd., Japan International Consultants for Transportation Co., Ltd., and Fukken Engineering Co., Ltd.	Preparatory Survey on Flood Protection Measures for Central Railway Line in the United Republic of Tanzania		