





| | | | | | | | | | |
|---|--|---|---|--|--|---|--|---|--|
| GOVERNMENT AGENCIES: | | JICA STUDY TEAM: | | PROJECT & LOCATION: | | SHEET CONTENTS: | | DWG NUM | |
|  | JAPAN International Cooperation Agency |  | Reli Assets Holding Company (RAHCO), Tanzania | PADECO Co., Ltd., Nippon Koei Co., Ltd., Japan International Consultants for Transportation Co., Ltd., and Fukken Engineering Co., Ltd. | | Preparatory Survey on Flood Protection Measures for Central Railway Line in the United Republic of Tanzania | | PLAN, CROSS SECTION AND DETAIL OF BANK PROTECTION SECTION 1-2 (IP297) | |
| | | | | | | | |  | |



**CROSS SECTION OF BANK PROTECTION
SECTION 2 (IP298.3)
Scale: H: 1/3000, V: 1/600**

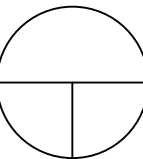
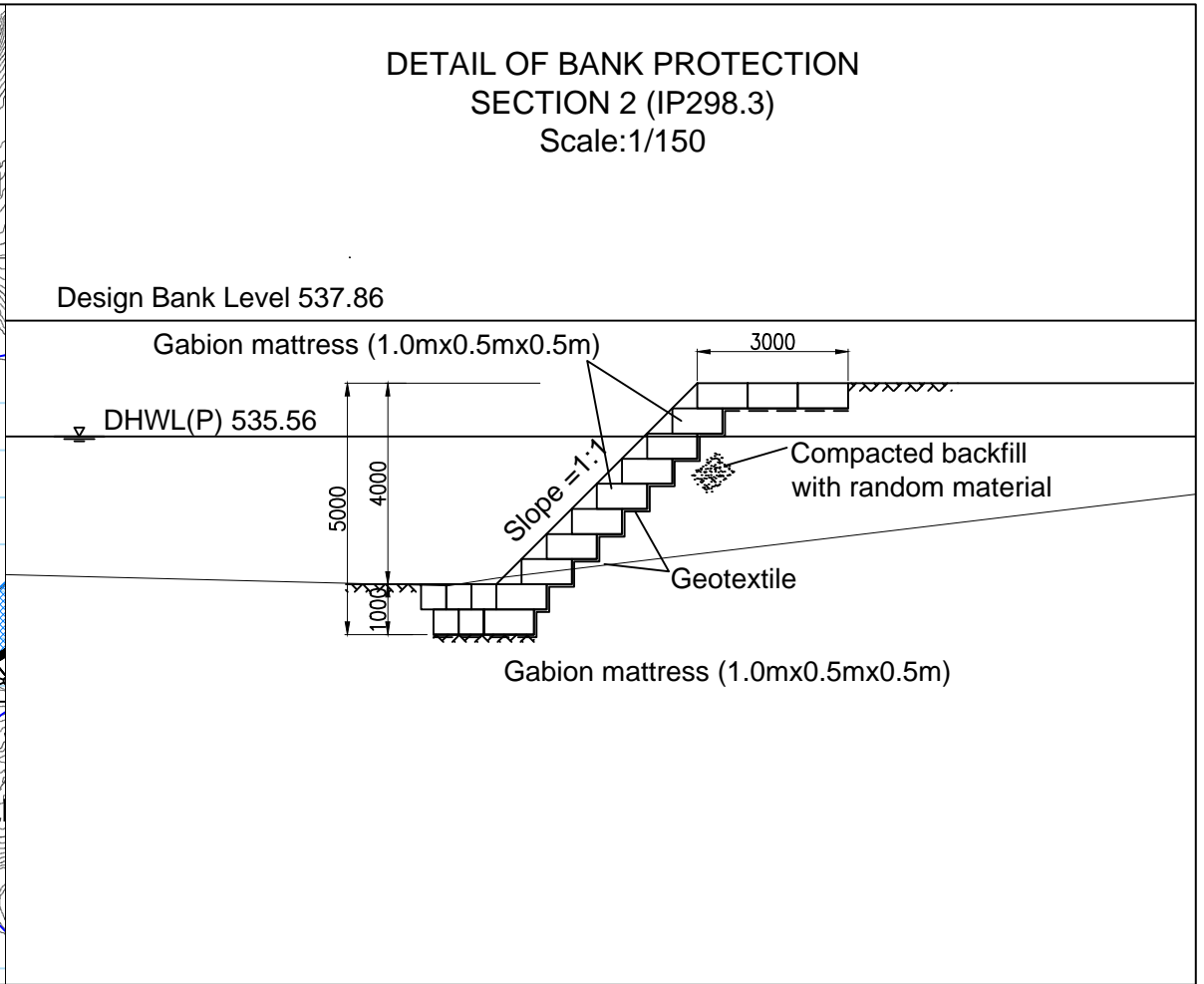
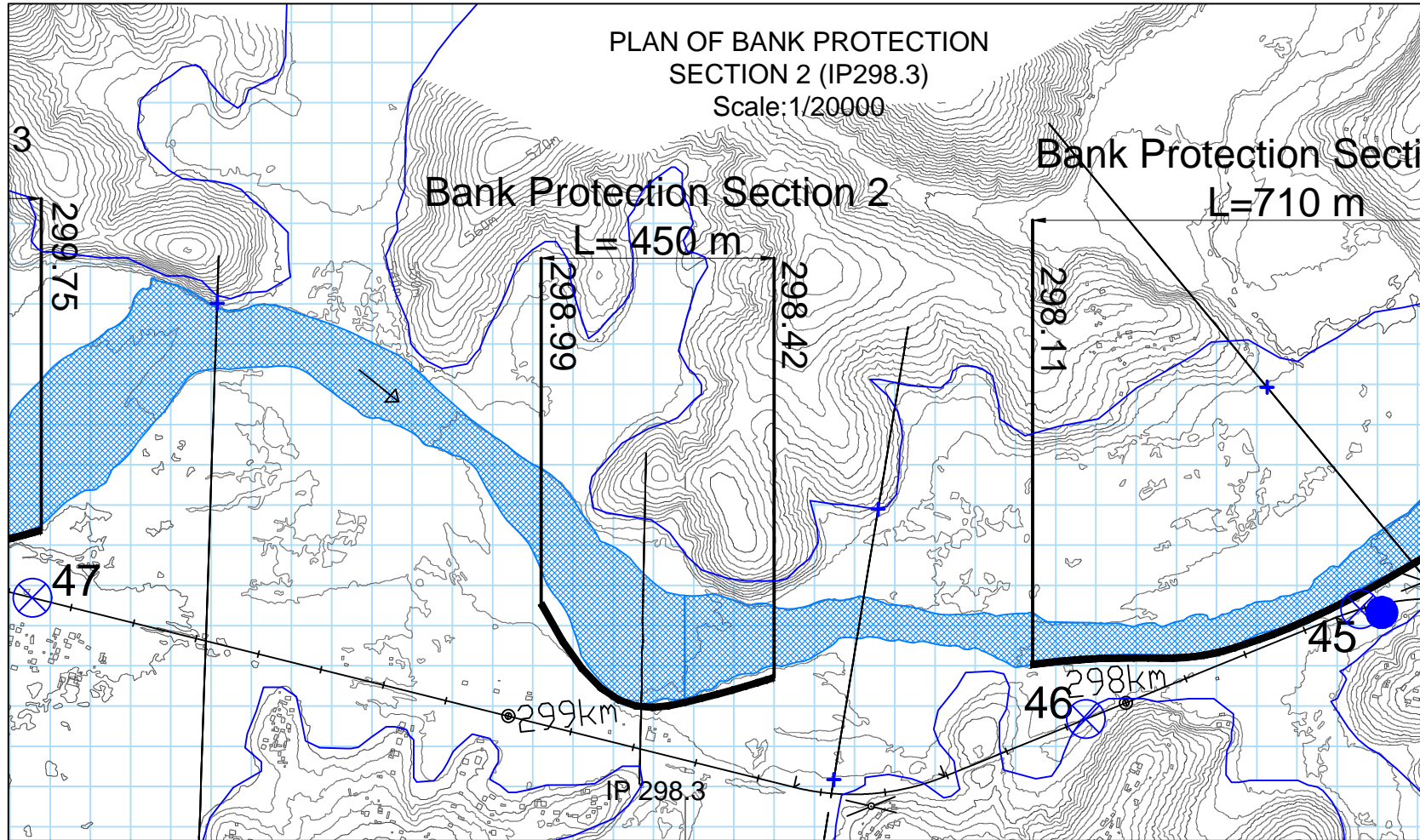
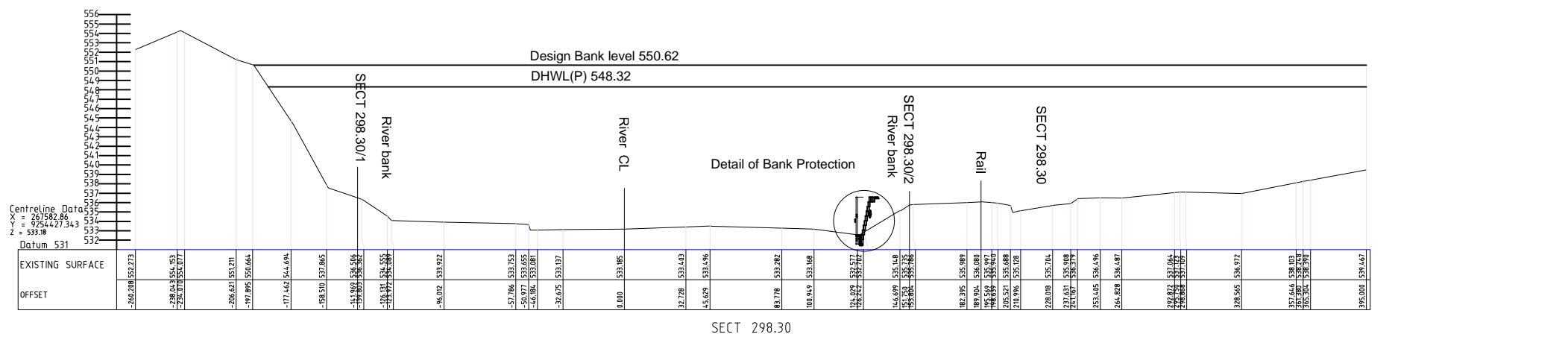

DHWL(P): Design High Water Level for Present Riverbed Level

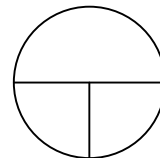
| | | | | | | | | | |
|---|--|---|---|--|--|---|--|---|--|
| GOVERNMENT AGENCIES: | | JICA STUDY TEAM: | | PROJECT & LOCATION: | | SHEET CONTENTS: | | DWG NUM | |
|  | JAPAN International Cooperation Agency |  | Reli Assets Holding Company (RAHCO), Tanzania | PADECO Co., Ltd., Nippon Koei Co., Ltd., Japan International Consultants for Transportation Co., Ltd., and Fukken Engineering Co., Ltd. | | Preparatory Survey on Flood Protection Measures for Central Railway Line in the United Republic of Tanzania | | PLAN, CROSS SECTION AND DETAIL OF BANK PROTECTION SECTION 2 (IP298.3) | |
| | | | | | | | |  | |

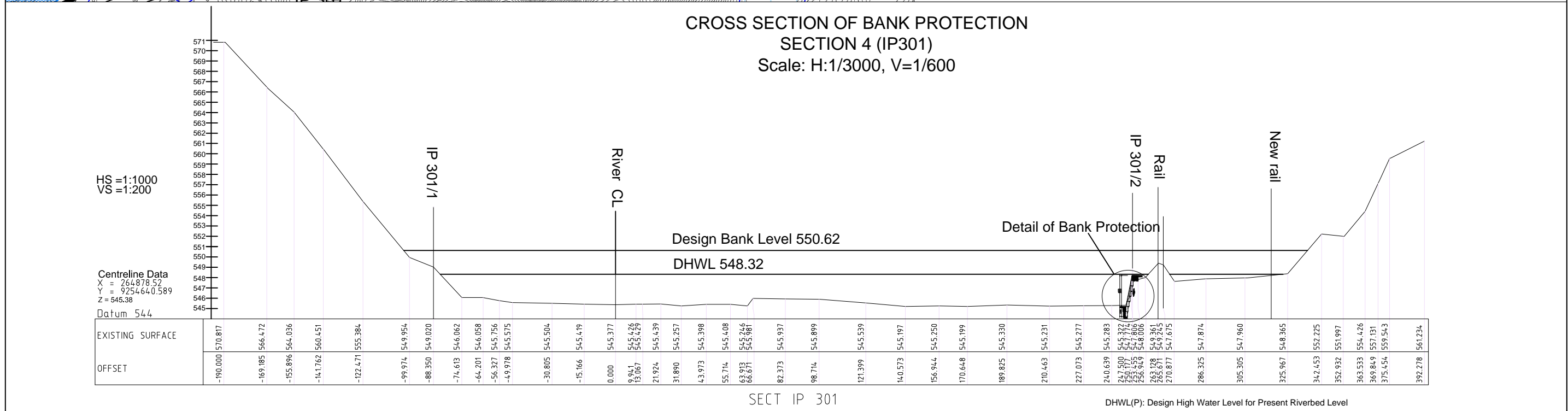
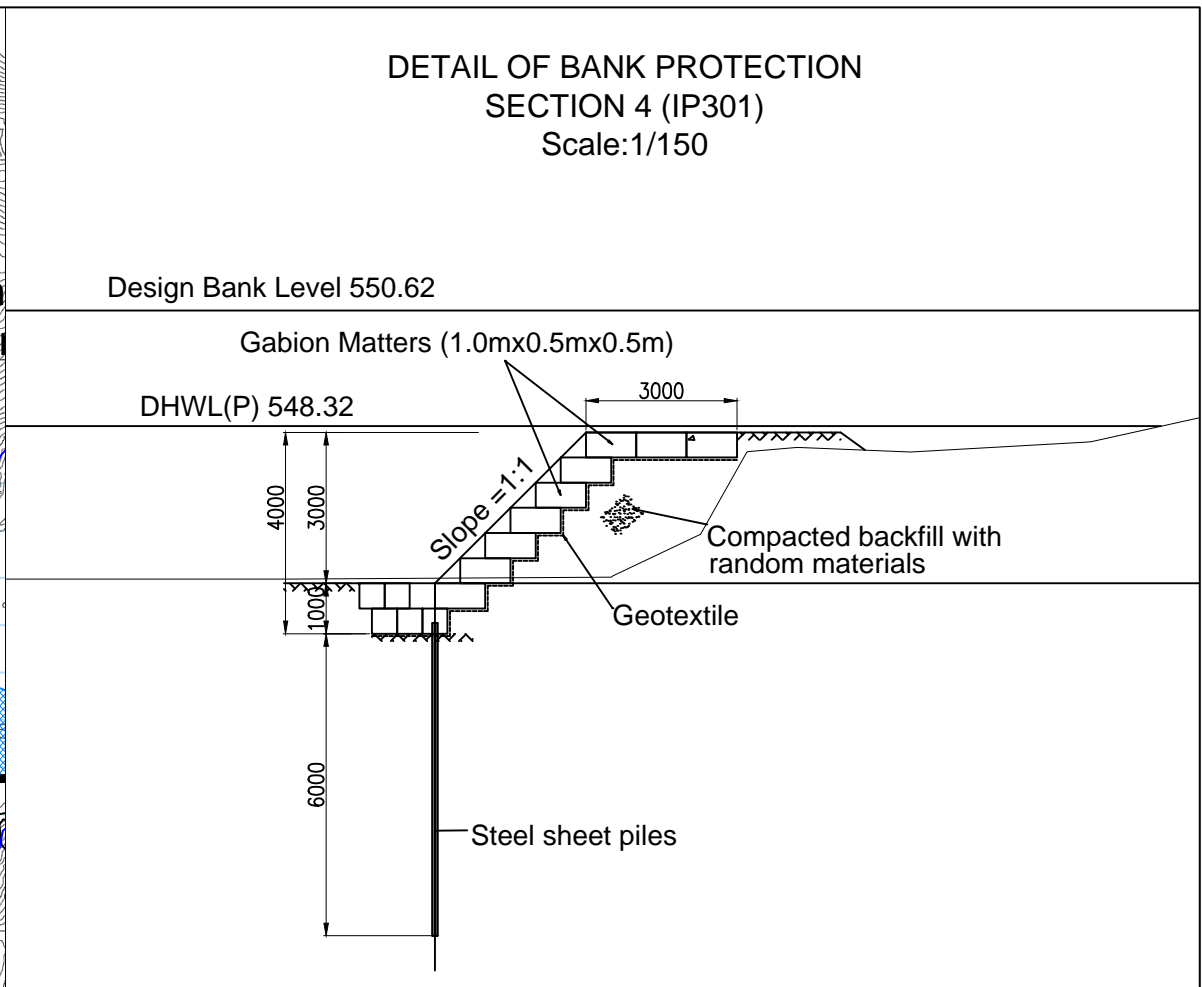
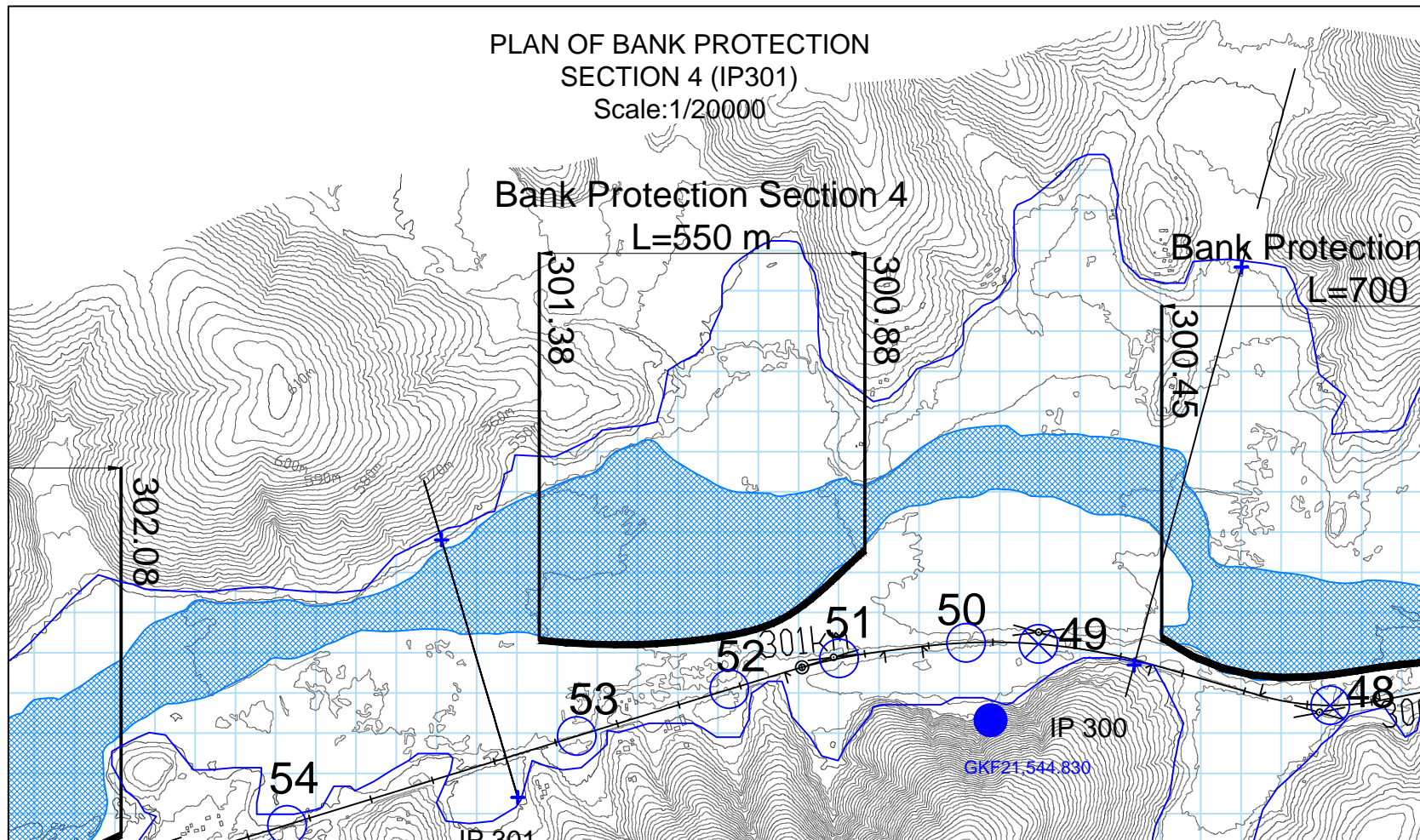

| GOVERNMENT AGENCIES: | | JICA STUDY TEAM: | PROJECT & LOCATION: | SHEET CONTENTS: | DWG NUM |
|----------------------|--|---|--|---|---|
| | JAPAN International Cooperation Agency | Reli Assets Holding Company (RAHCO), Tanzania | PADECO Co., Ltd., Nippon Koei Co., Ltd., Japan International Consultants for Transportation Co., Ltd., and Fukken Engineering Co., Ltd. | Preparatory Survey on Flood Protection Measures for Central Railway Line in the United Republic of Tanzania | PLAN, CROSS SECTION AND DETAIL OF BANK PROTECTION SECTION 4 (IP301) |
| | | | | | |

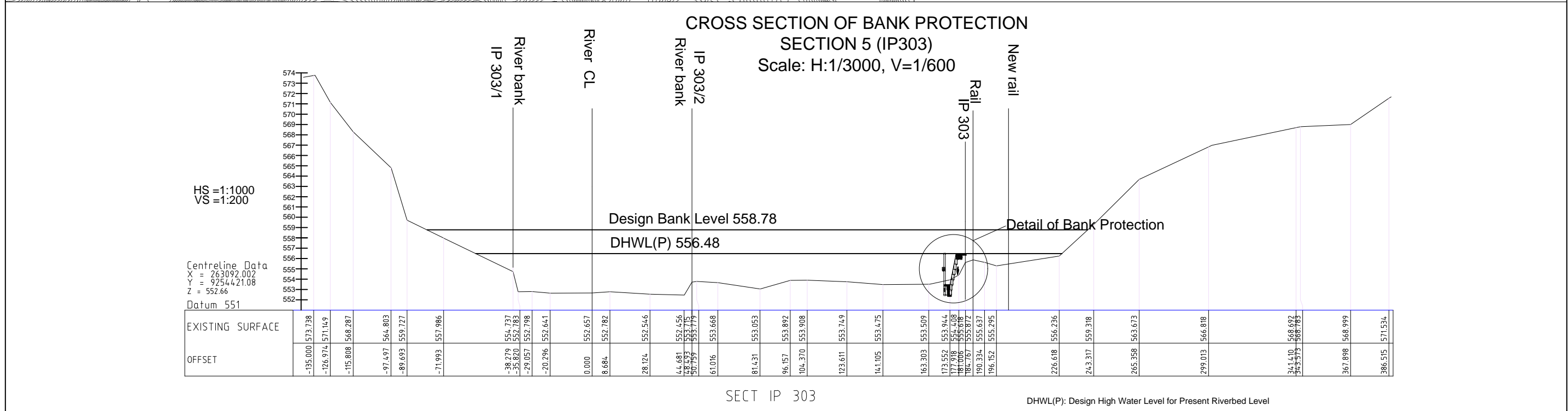
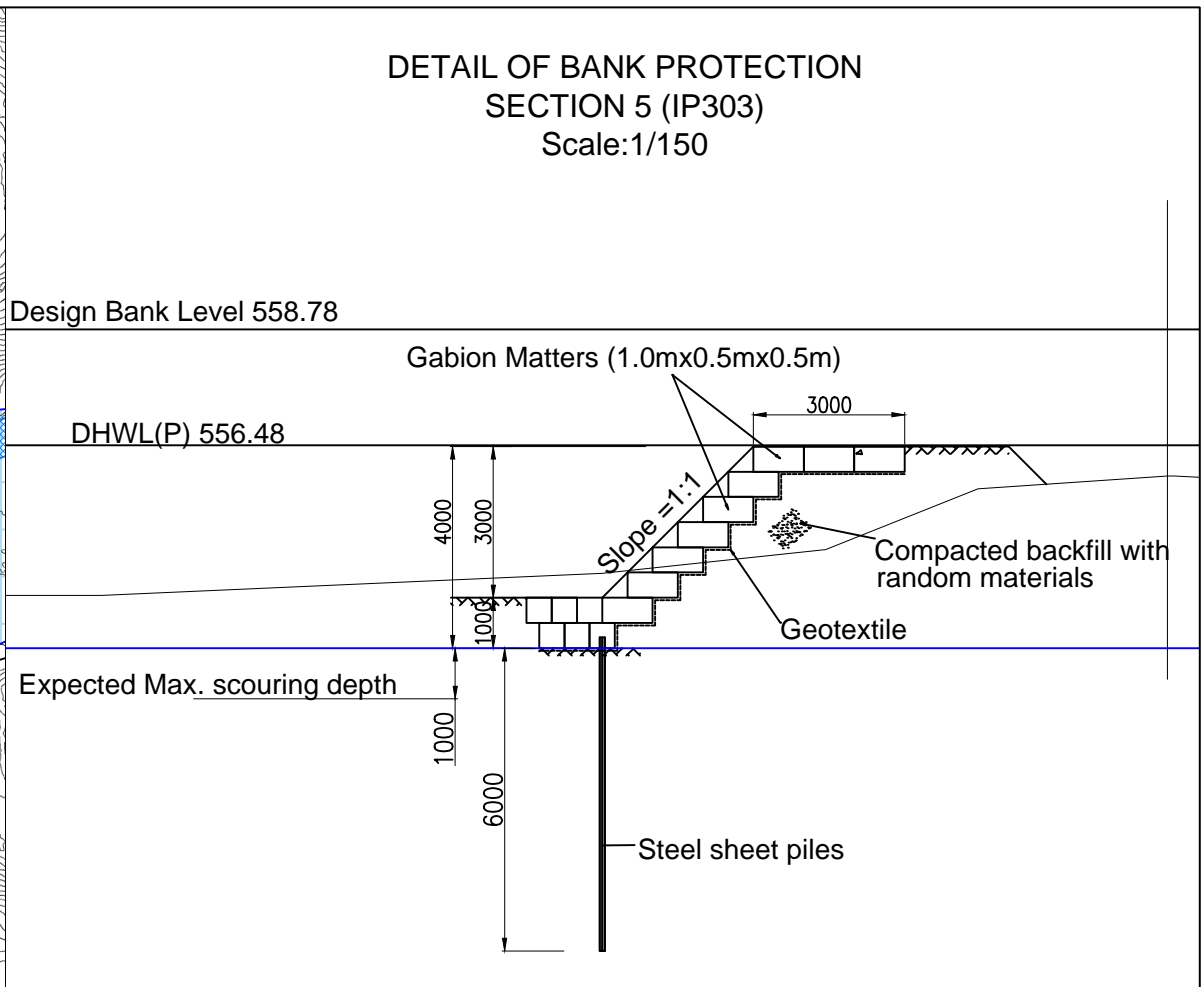
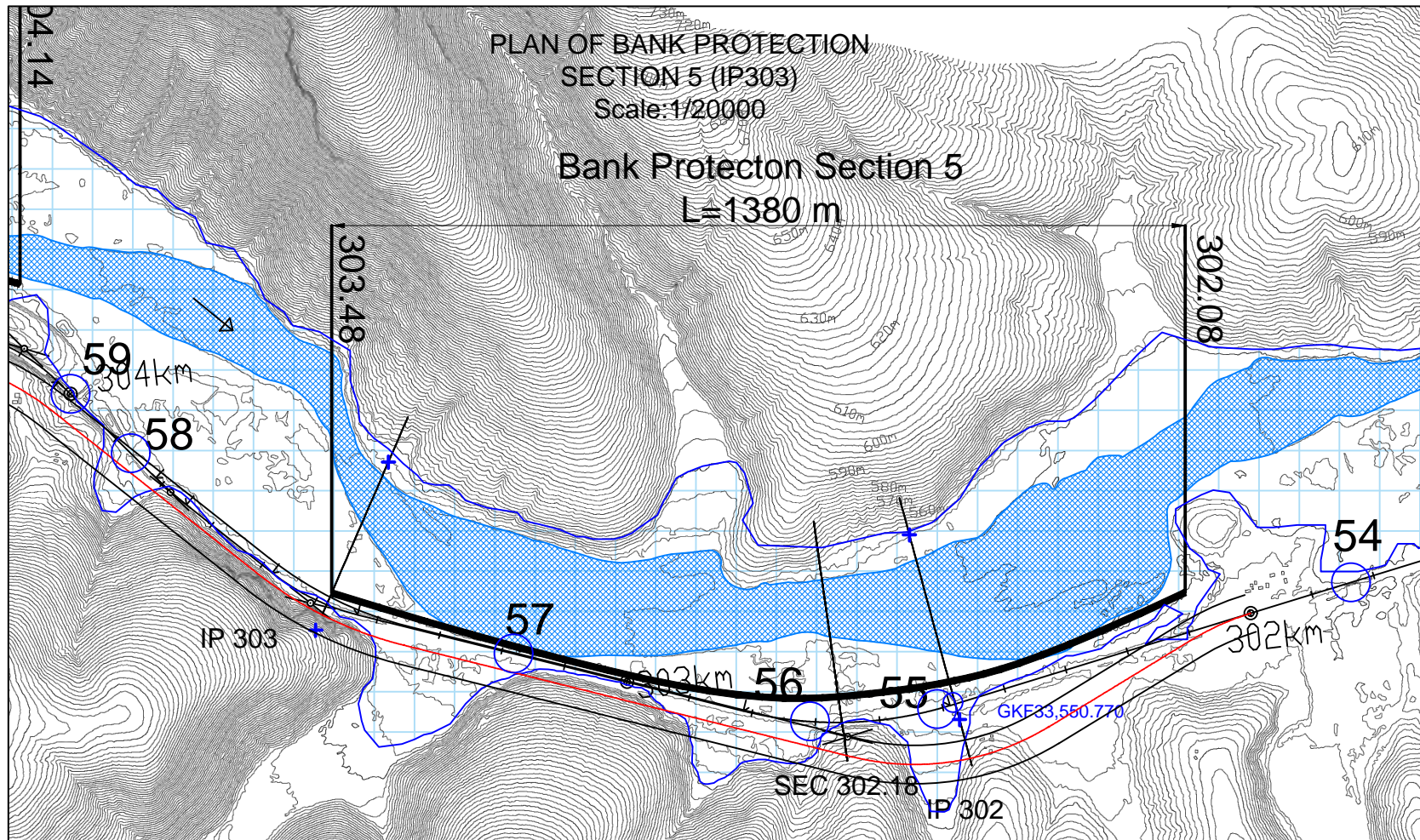

| | | | | | | | | |
|---|--|---|--|---|--|---|--|--------------------|
| GOVERNMENT AGENCIES: JAPAN International Cooperation Agency | | JICA STUDY TEAM: PADECO Co., Ltd., Nippon Koei Co., Ltd., Japan International Consultants for Transportation Co., Ltd., and Fukken Engineering Co., Ltd. | | PROJECT & LOCATION: Preparatory Survey on Flood Protection Measures for Central Railway Line in the United Republic of Tanzania | | SHEET CONTENTS: PLAN, CROSS SECTION AND DETAIL OF BANK PROTECTION SECTION 5 (IP303) | | DWG NUM |
|---|--|---|--|---|--|---|--|--------------------|

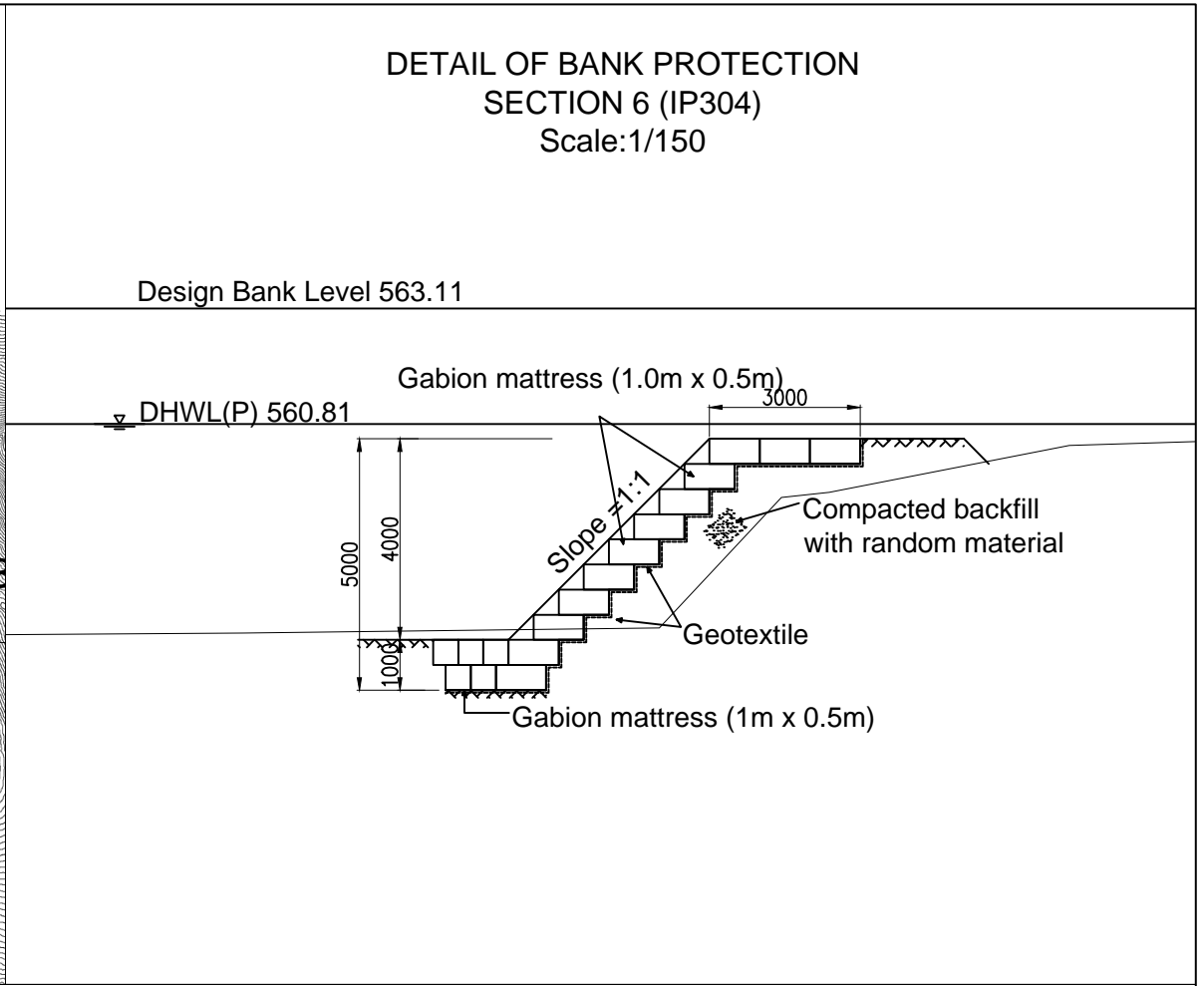
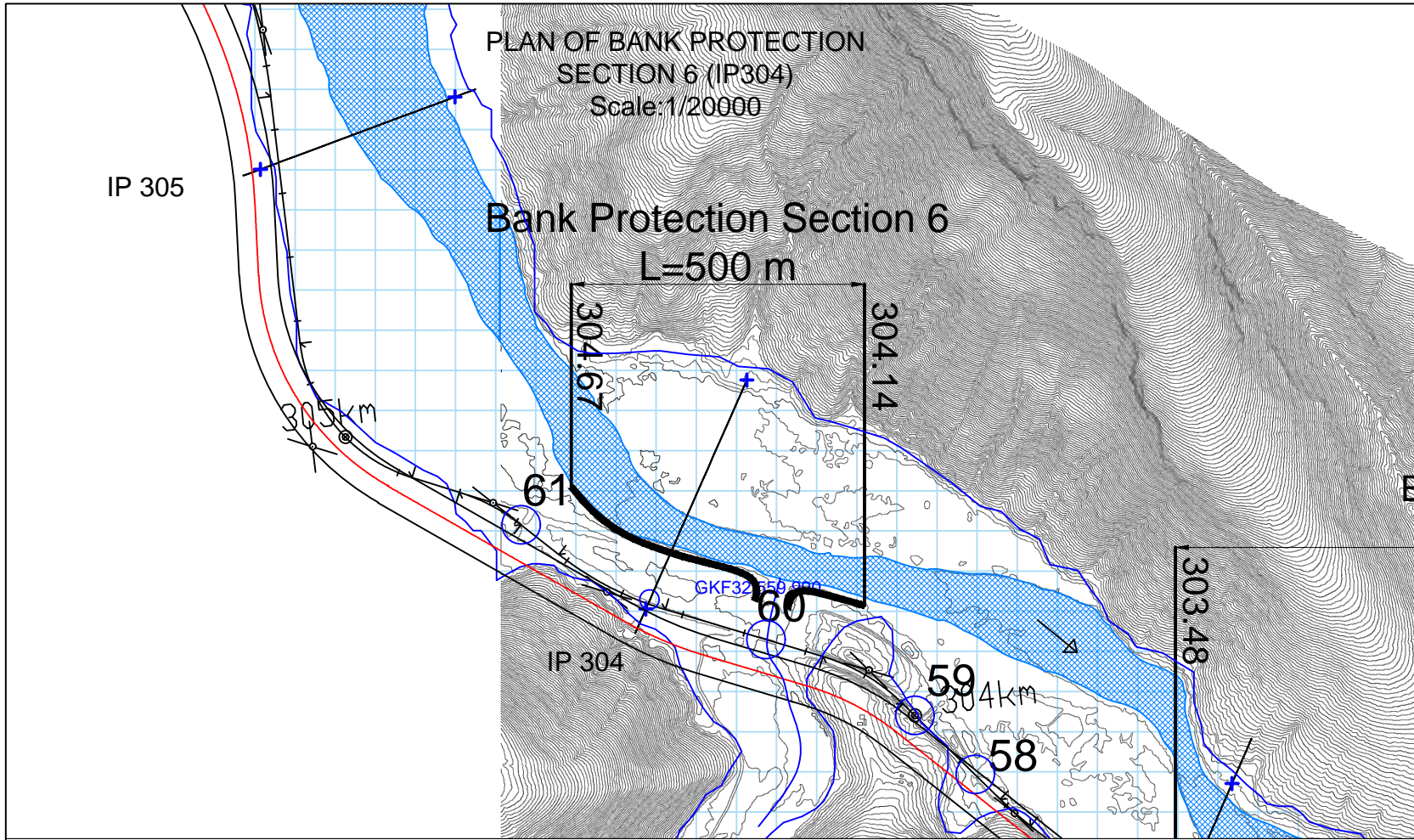

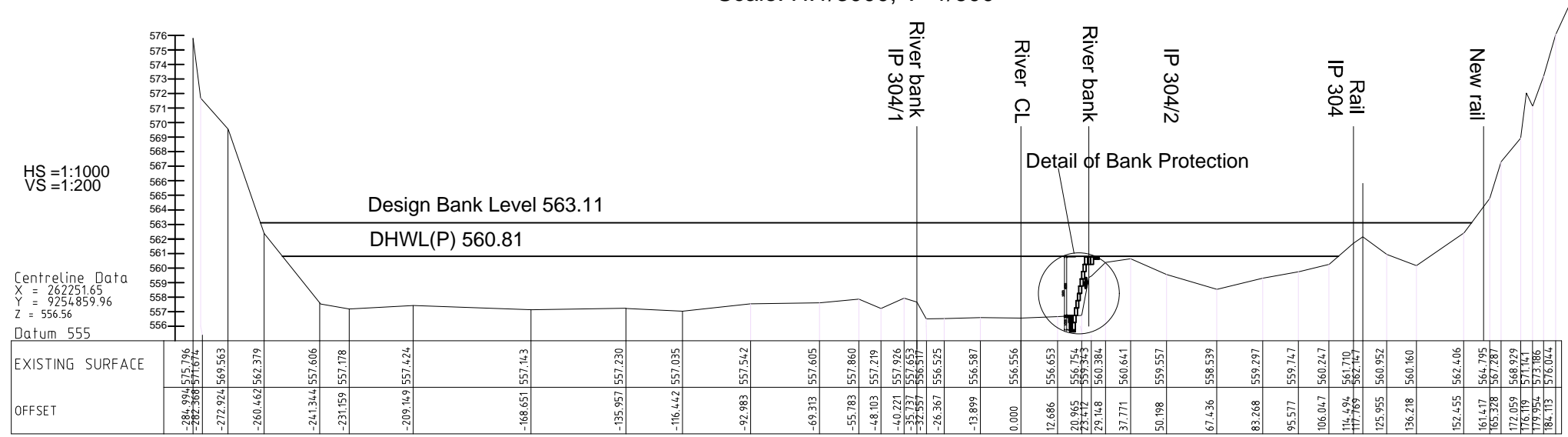

CROSS SECTION OF BANK PROTECTION SECTION 6 (IP304) Scale: H:1/3000, V:1/600



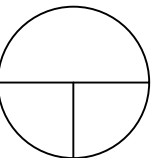

SECT IP 304

DHWL(P): Design High Water Level for Present Riverbed Level

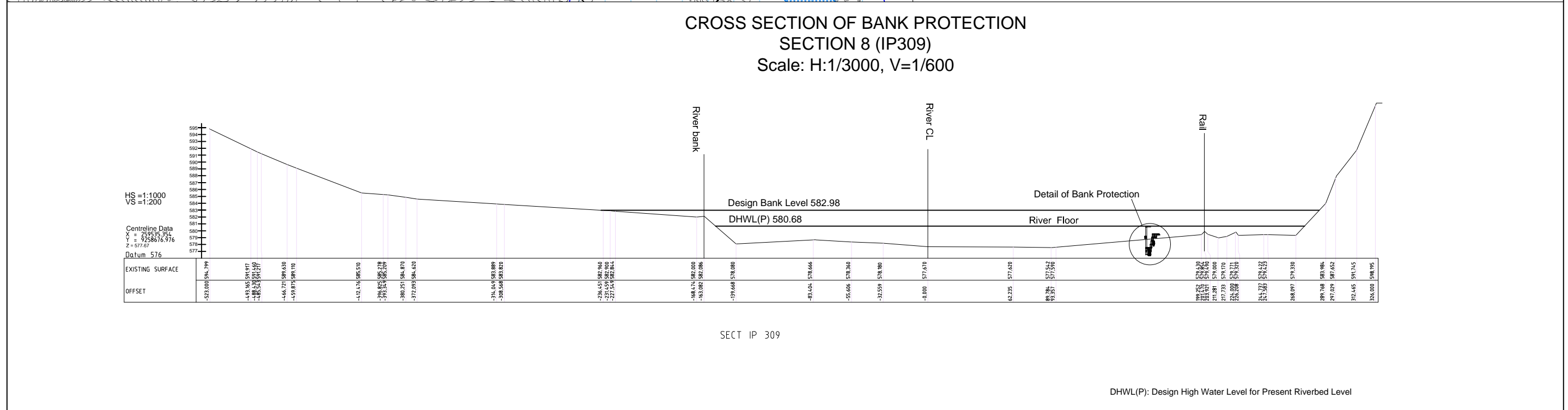
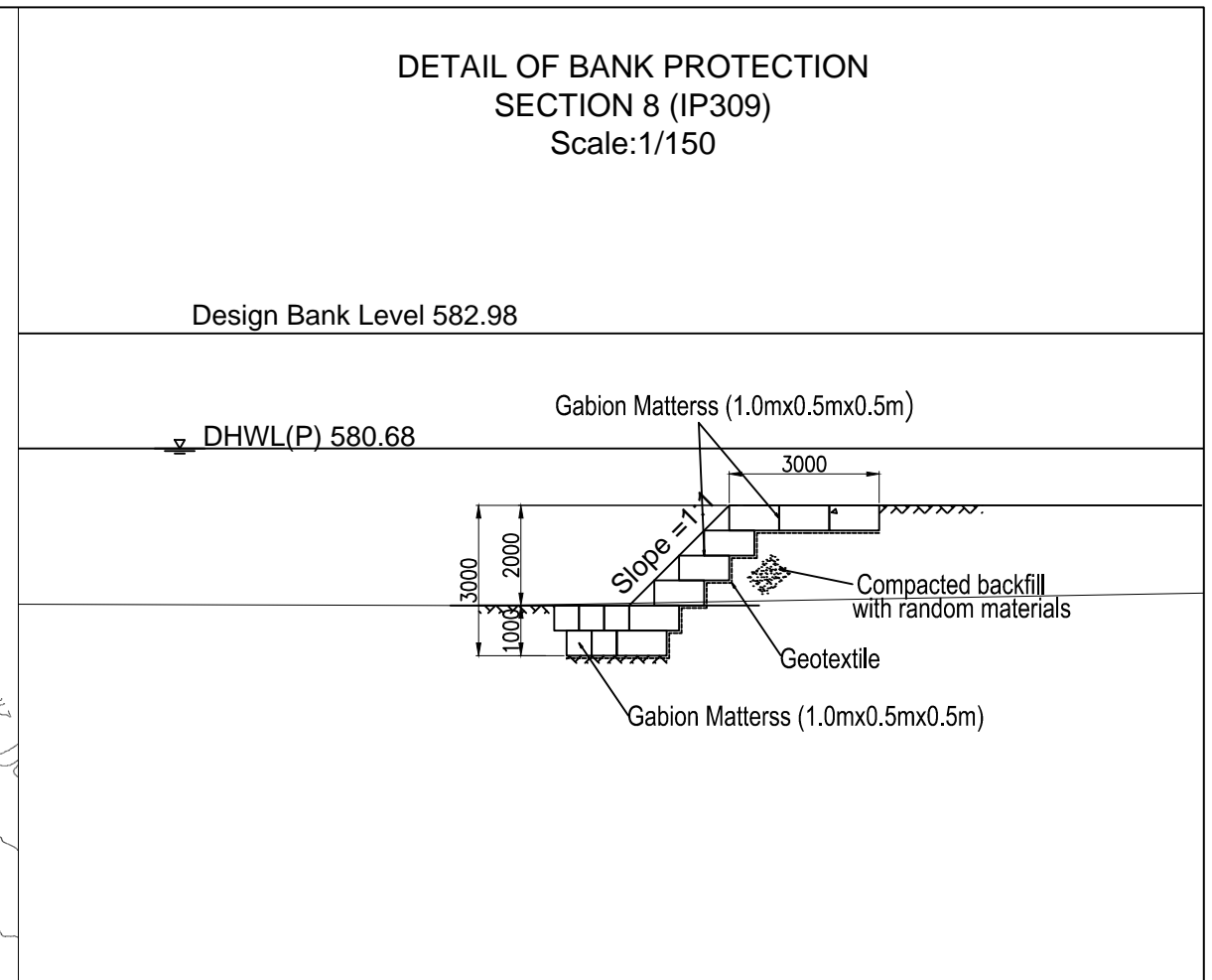
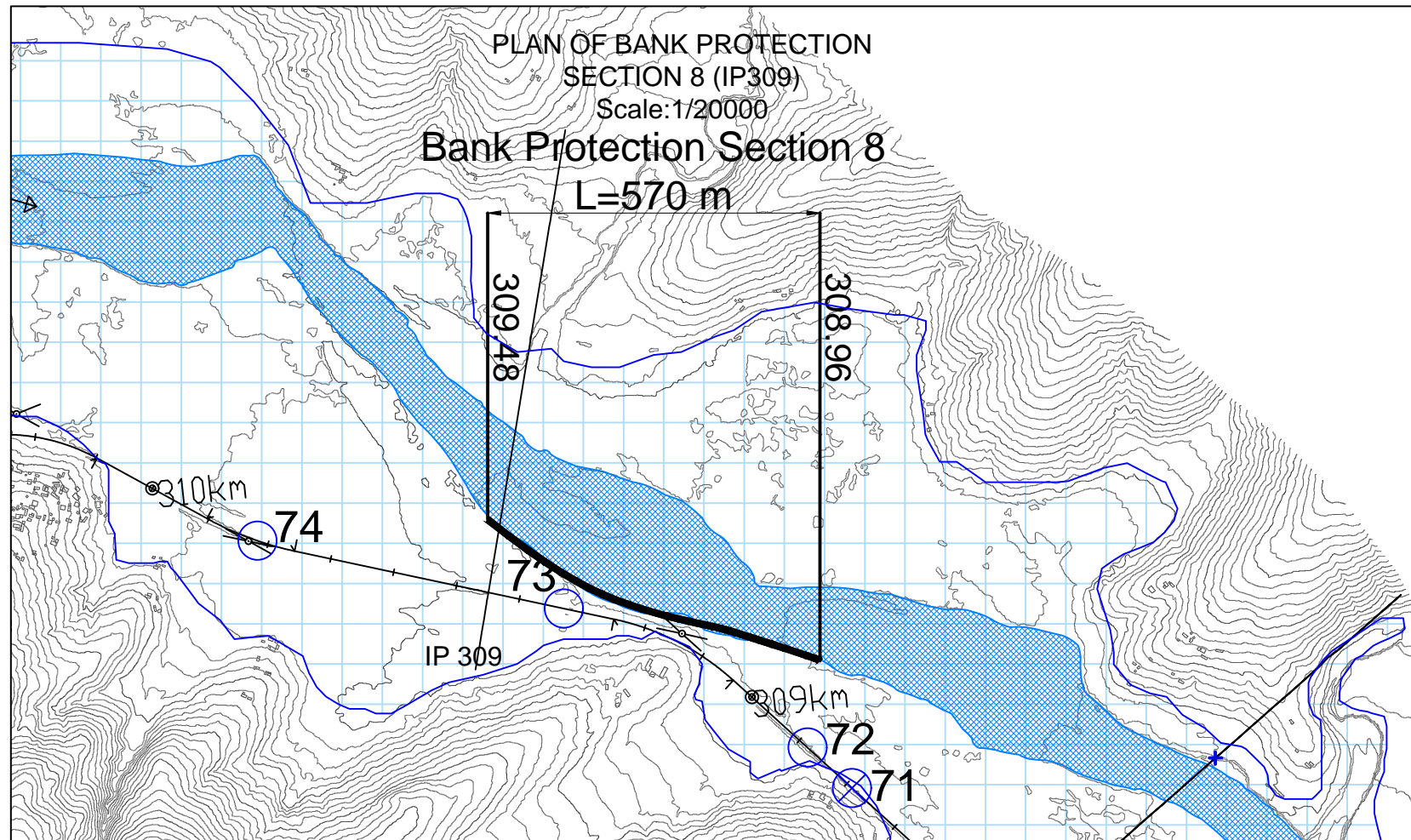
| | | | | | | | | |
|---|--|---|---|--|---|---|--|---|
| GOVERNMENT AGENCIES: | | JICA STUDY TEAM: | | PROJECT & LOCATION: | | SHEET CONTENTS: | | DWG NUM |
|  | JAPAN International Cooperation Agency |  | Reli Assets Holding Company (RAHCO), Tanzania | PADECO Co., Ltd., Nippon Koei Co., Ltd., Japan International Consultants for Transportation Co., Ltd., and Fukken Engineering Co., Ltd. | Preparatory Survey on Flood Protection Measures for Central Railway Line in the United Republic of Tanzania | PLAN, CROSS SECTION AND DETAIL OF BANK PROTECTION SECTION 6 (IP304) | |  |

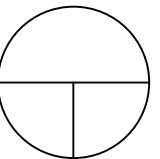

| | | | | | | | | | |
|---|--|---|---|--|--|---|--|---|--|
| GOVERNMENT AGENCIES: | | JICA STUDY TEAM: | | PROJECT & LOCATION: | | SHEET CONTENTS: | | DWG NUM | |
|  | JAPAN International Cooperation Agency |  | Reli Assets Holding Company (RAHCO), Tanzania | PADECO Co., Ltd., Nippon Koei Co., Ltd., Japan International Consultants for Transportation Co., Ltd., and Fukken Engineering Co., Ltd. | | Preparatory Survey on Flood Protection Measures for Central Railway Line in the United Republic of Tanzania | | PLAN, CROSS SECTION AND DETAIL OF BANK PROTECTION SECTION 8 (IP309) | |
| | | | | | | | |  | |

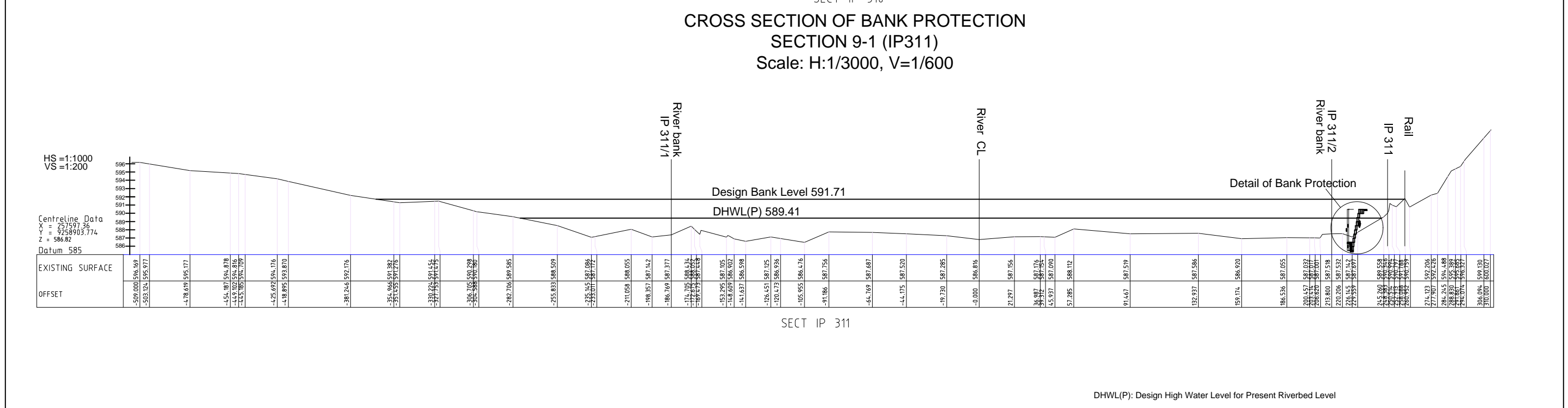
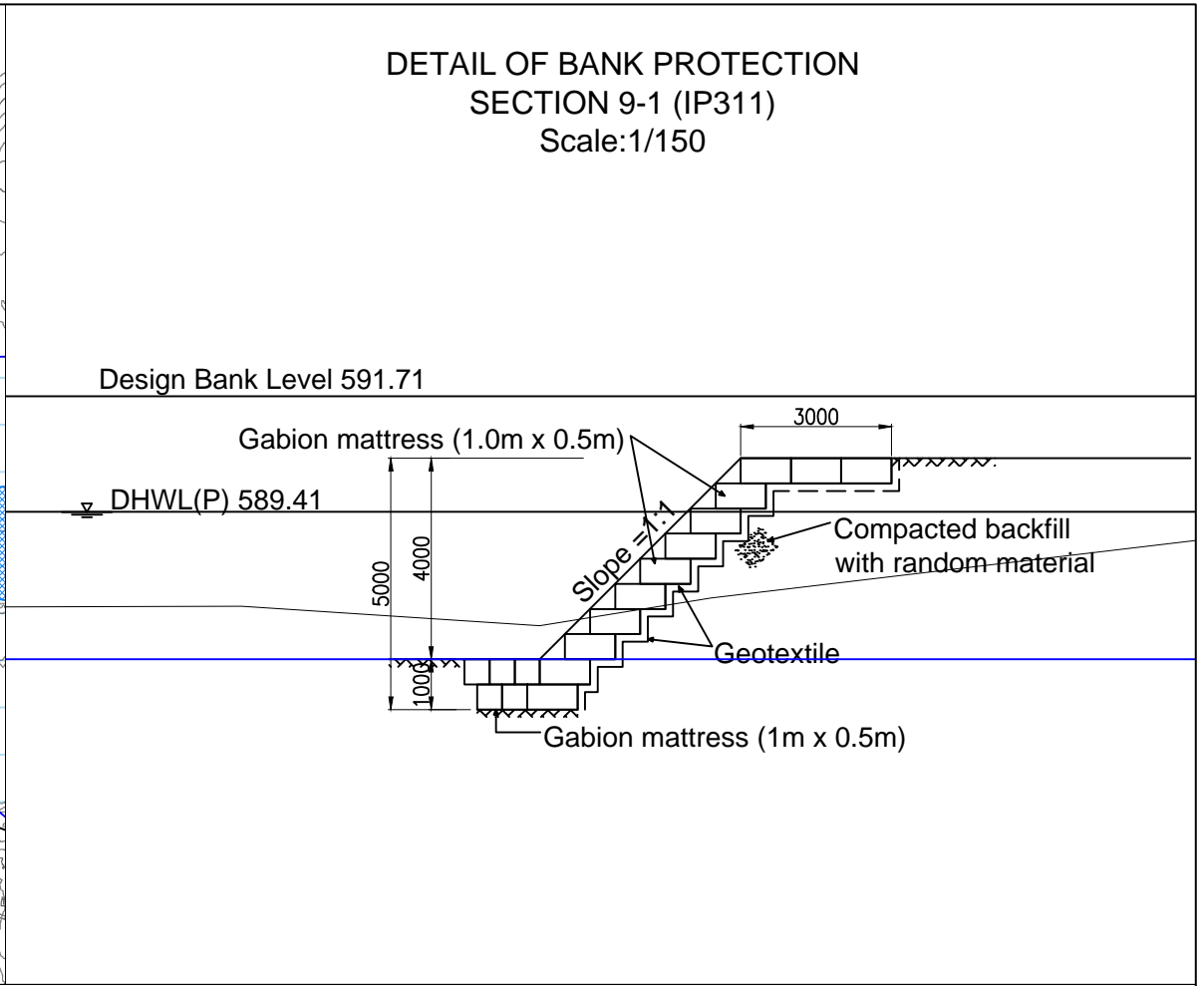
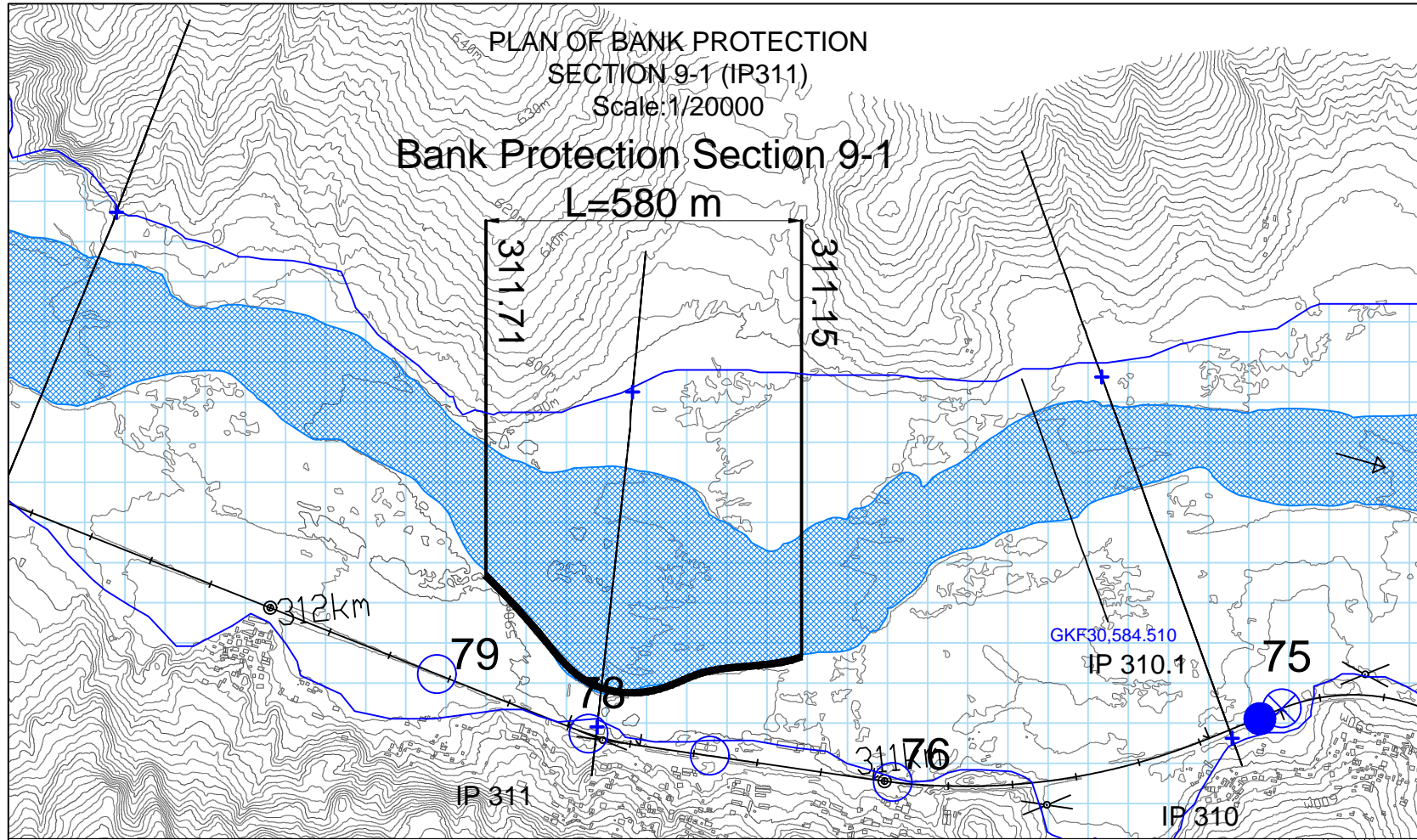

| GOVERNMENT AGENCIES: | JICA STUDY TEAM: | PROJECT & LOCATION: | SHEET CONTENTS: | DWG NUM |
|--|---|--|---|---|
| JAPAN International Cooperation Agency | Reli Assets Holding Company (RAHCO), Tanzania | PADECO Co., Ltd., Nippon Koei Co., Ltd., Japan International Consultants for Transportation Co., Ltd., and Fukken Engineering Co., Ltd. | Preparatory Survey on Flood Protection Measures for Central Railway Line in the United Republic of Tanzania | PLAN, CROSS SECTION AND DETAIL OF BANK PROTECTION SECTION 9-1 (IP311) |
| | | | | |

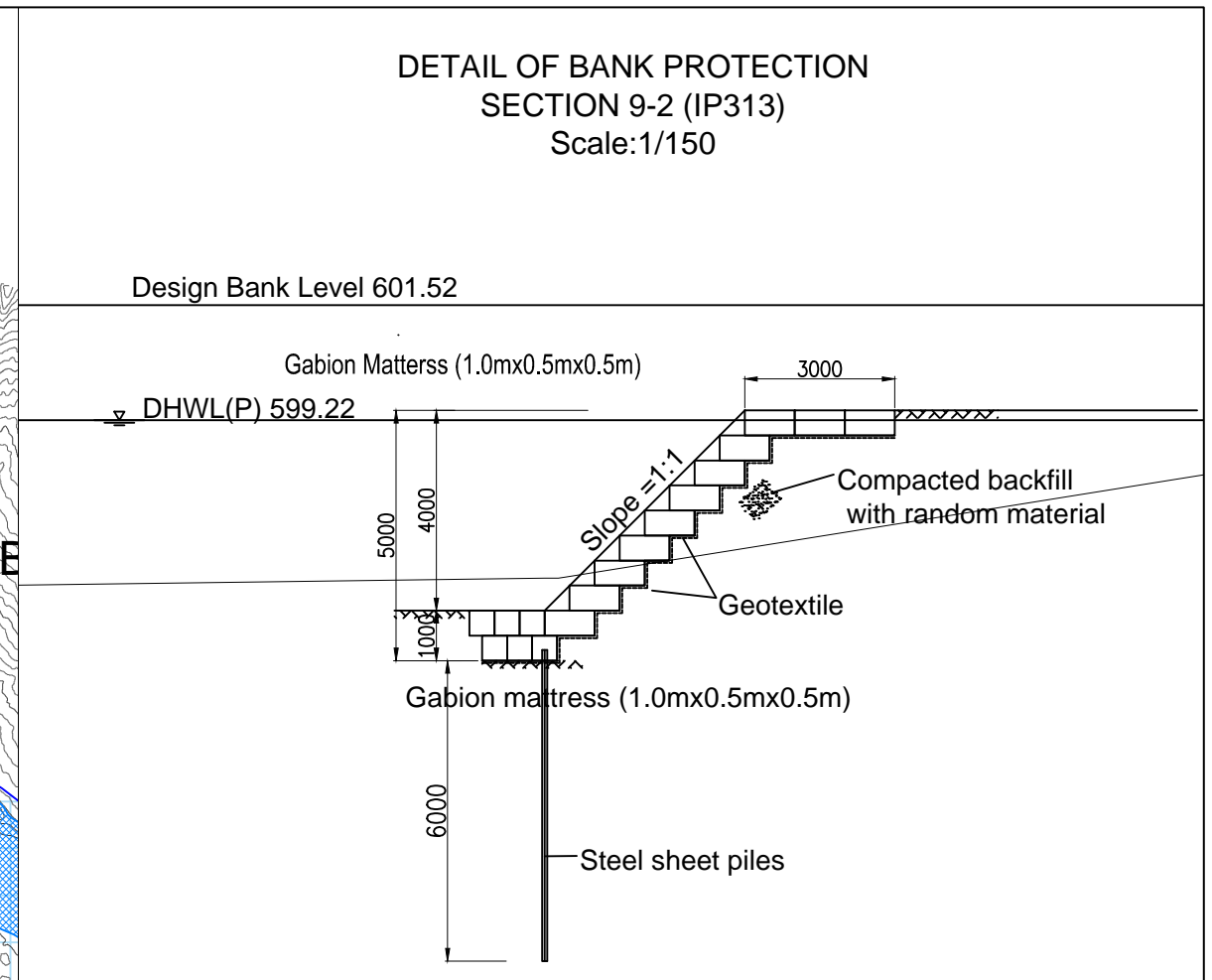
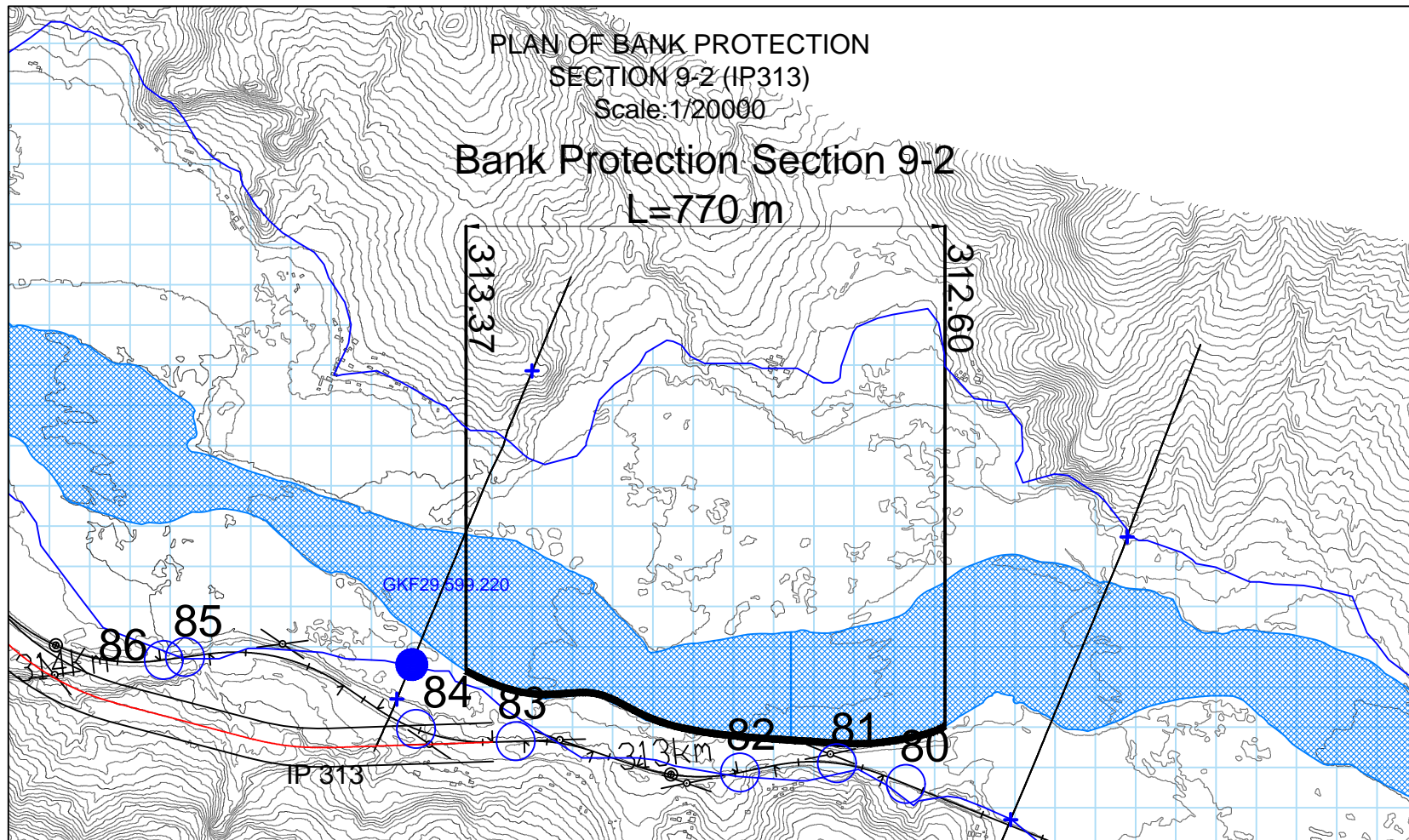

CROSS SECTION OF BANK PROTECTION
SECTION 9-2 (IP313)
Scale: H:1/3000, V=1/600

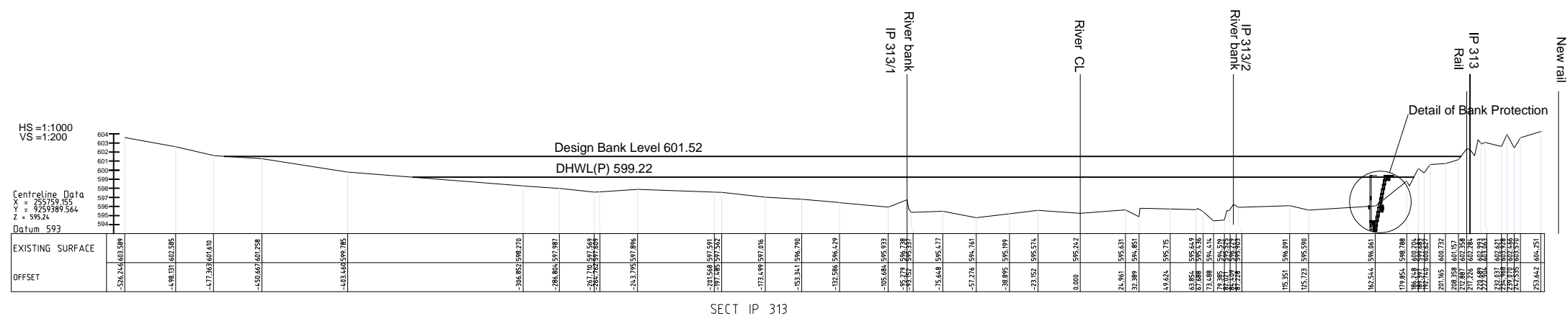

DHWL(P): Design High Water Level for Present Riverbed Level

| GOVERNMENT AGENCIES: | | JICA STUDY TEAM: | PROJECT & LOCATION: | SHEET CONTENTS: | DWG NUM |
|----------------------|---|------------------|--|---|---|
| | JAPAN International Cooperation Agency | | PADECO Co., Ltd., Nippon Koei Co., Ltd., Japan International Consultants for Transportation Co., Ltd., and Fukken Engineering Co., Ltd. | Preparatory Survey on Flood Protection Measures for Central Railway Line in the United Republic of Tanzania | PLAN, CROSS SECTION AND DETAIL OF BANK PROTECTION SECTION 9-2 (IP313) |
| | Reli Assets Holding Company (RAHCO), Tanzania | | | | |

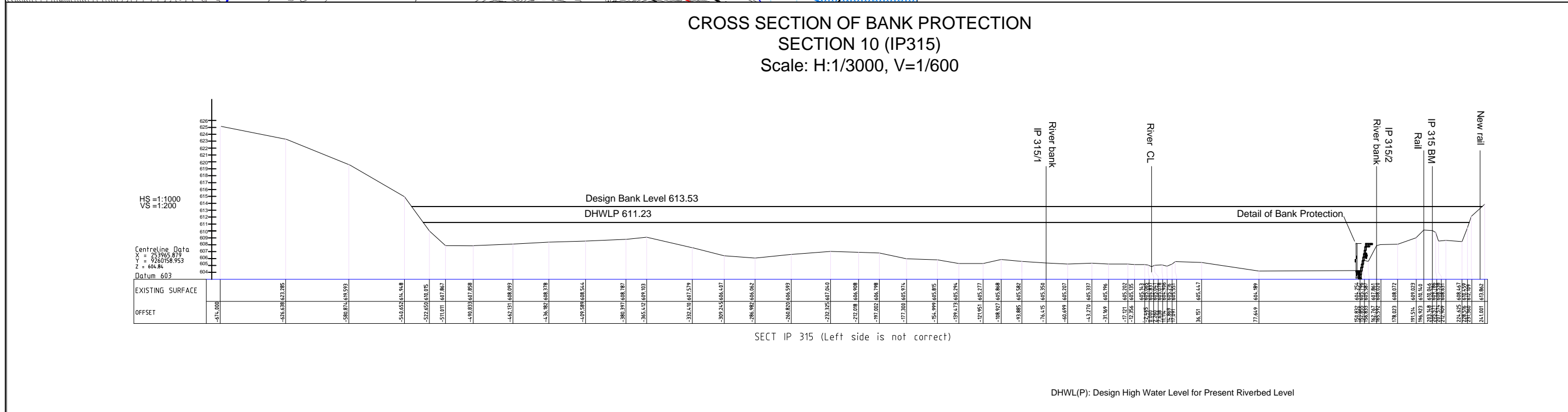
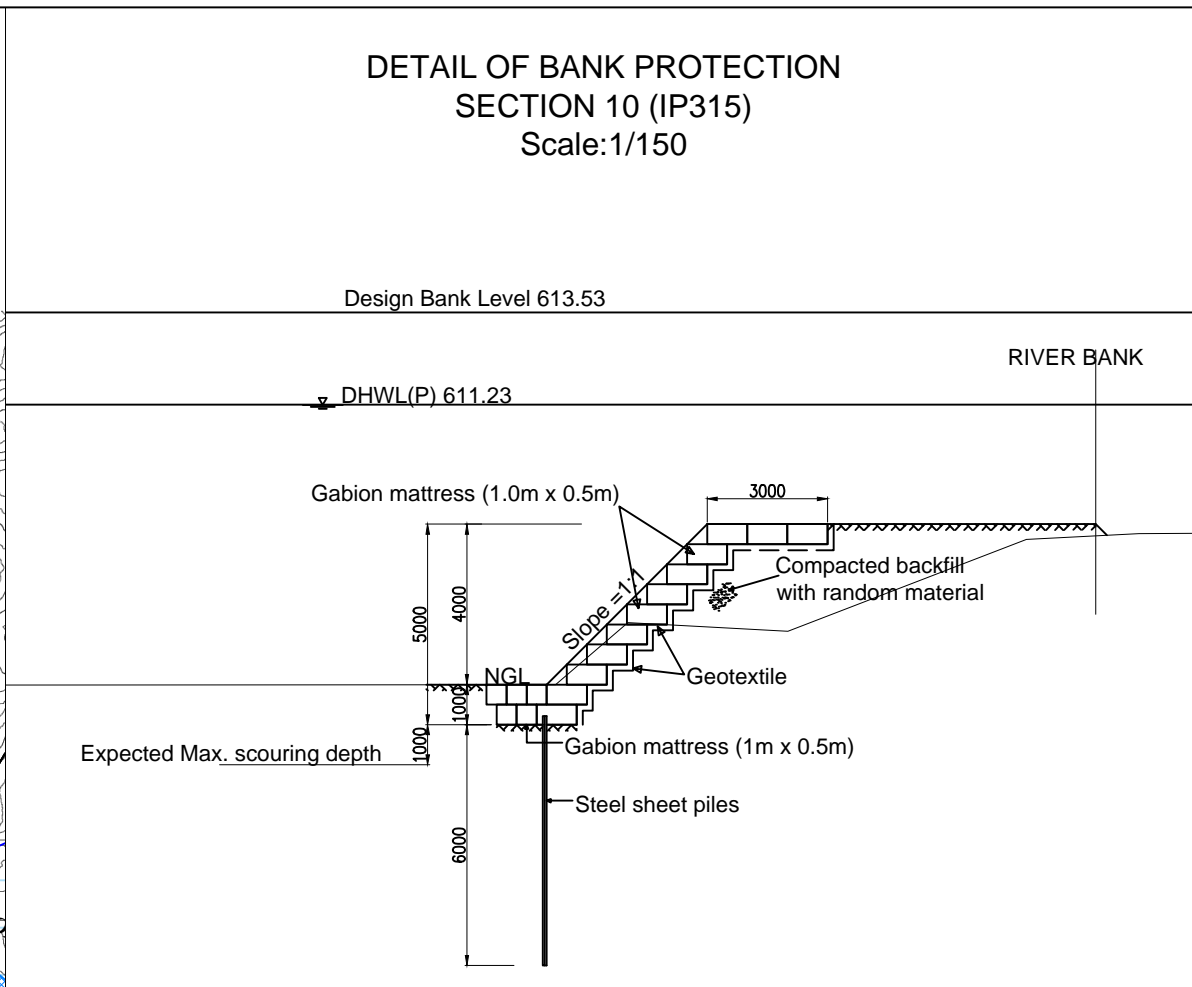
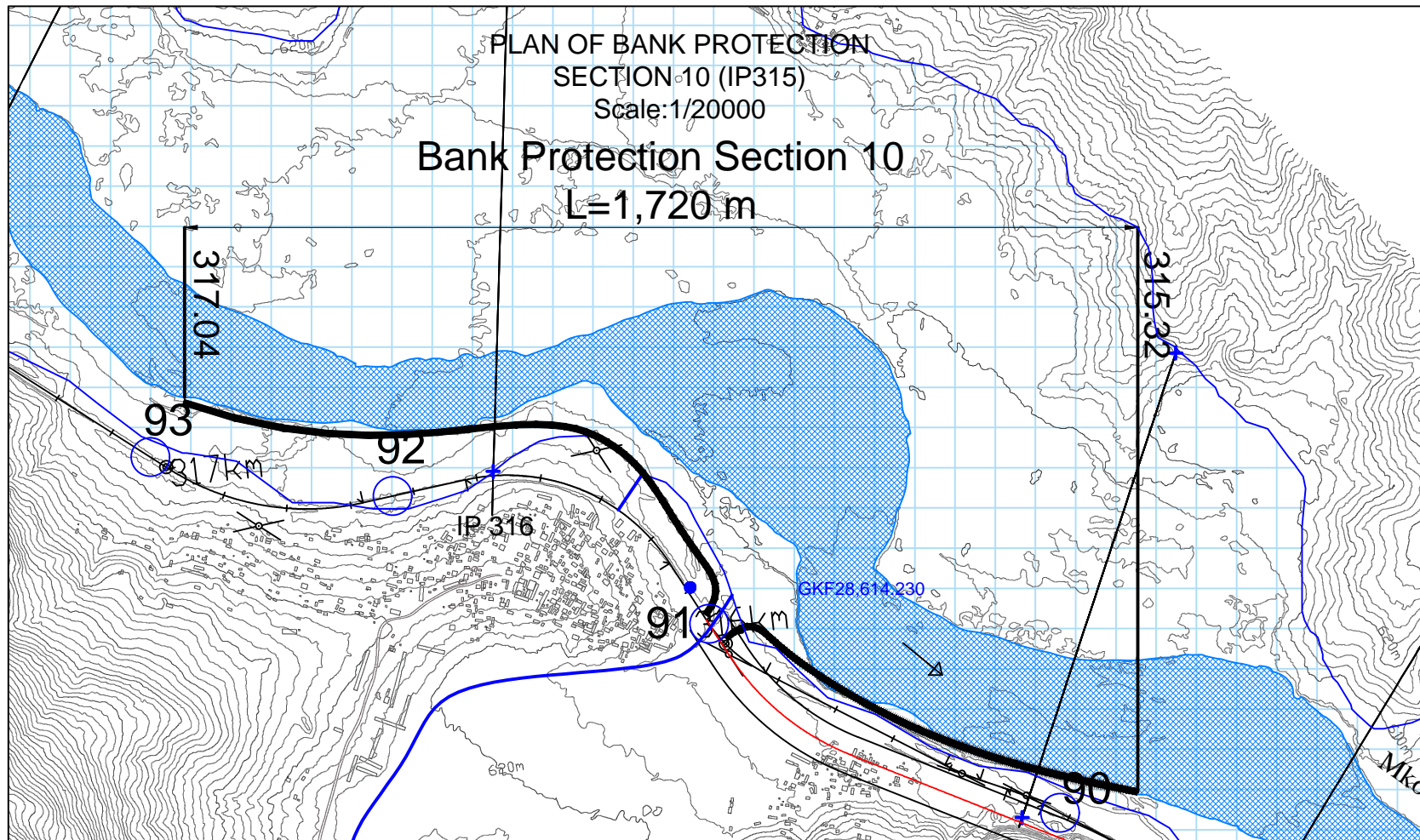

| GOVERNMENT AGENCIES: | | JICA STUDY TEAM: | PROJECT & LOCATION: | SHEET CONTENTS: | DWG NUM |
|----------------------|--|------------------|--|---|--|
| | JAPAN International Cooperation Agency | | PADECO Co., Ltd., Nippon Koei Co., Ltd., Japan International Consultants for Transportation Co., Ltd., and Fukken Engineering Co., Ltd. | Preparatory Survey on Flood Protection Measures for Central Railway Line in the United Republic of Tanzania | PLAN, CROSS SECTION AND DETAIL OF BANK PROTECTION SECTION 10 (IP315) |
| | | | | | |

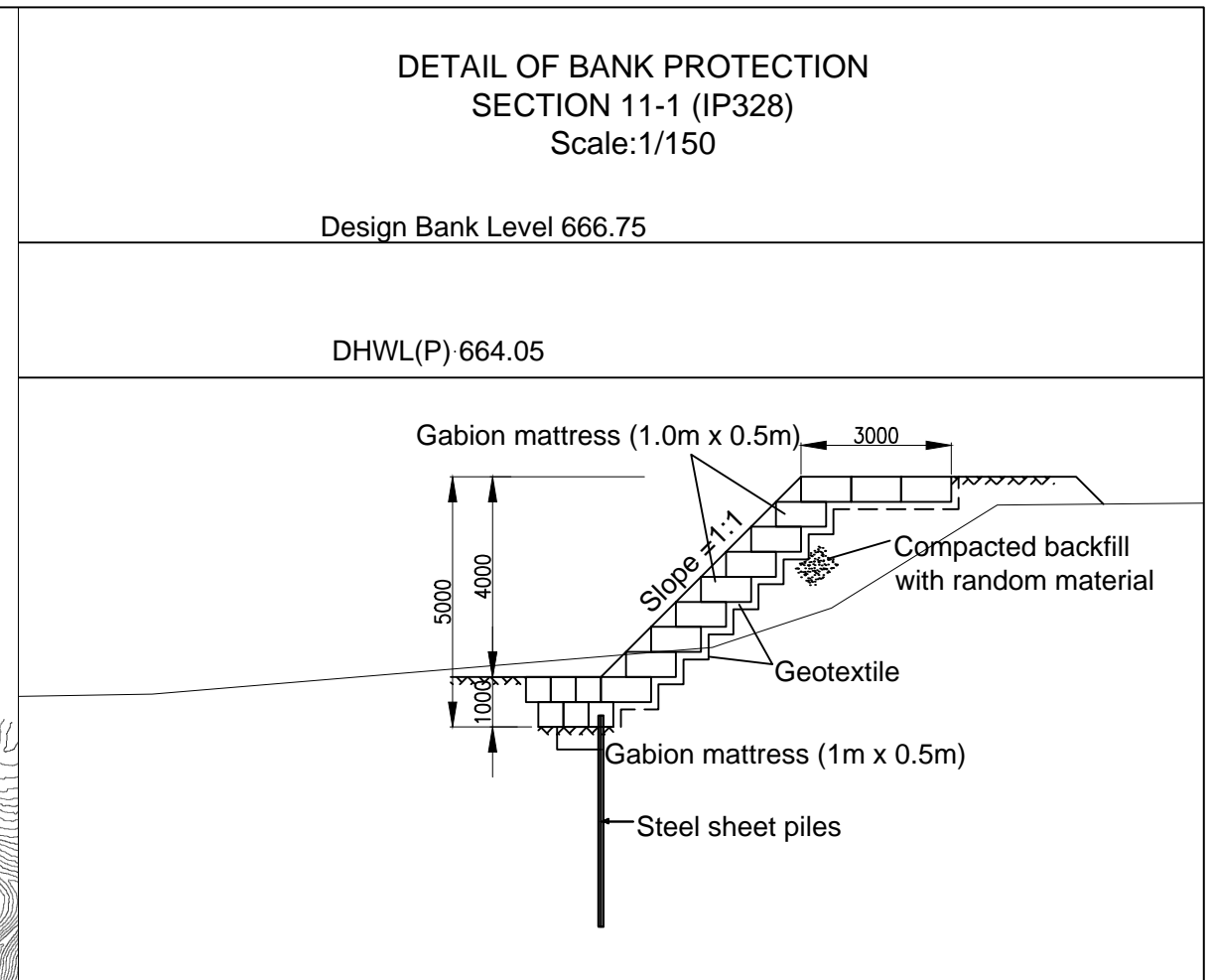
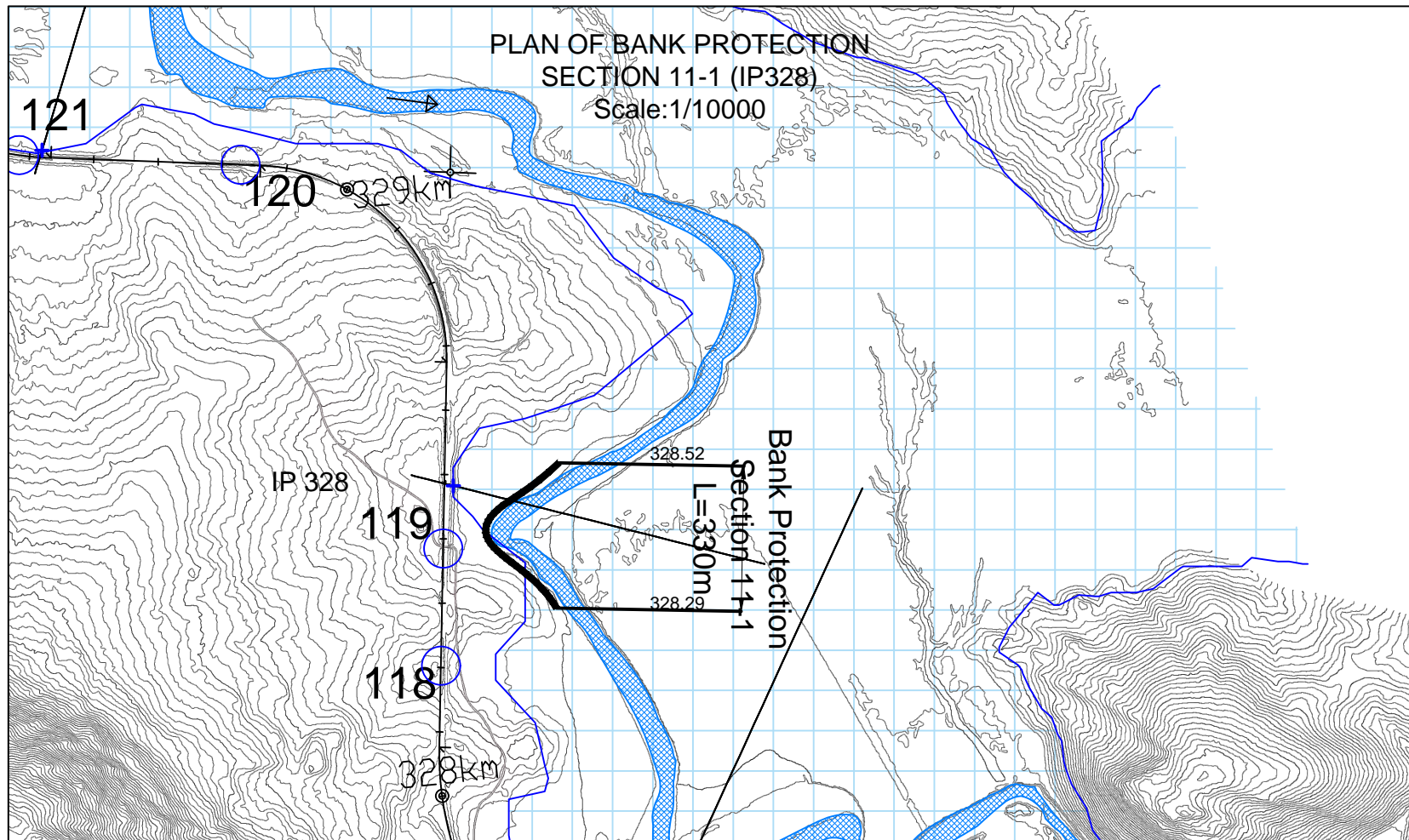

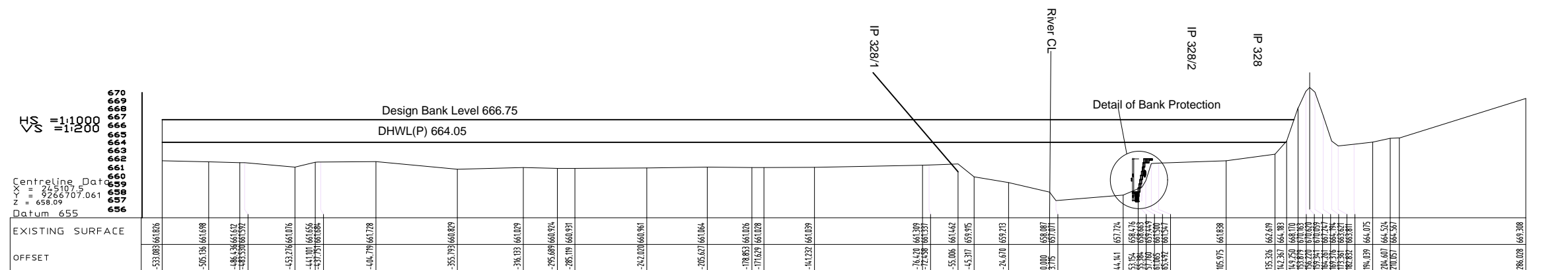

SECT IP 327
CROSS SECTION OF BANK PROTECTION SECTION 11-1 (IP328)
 Scale: H:1/3000, V:1/600



SECT IP 328

DHWL(P): Design High Water Level for Present Riverbed Level

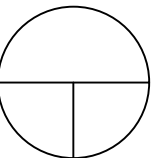

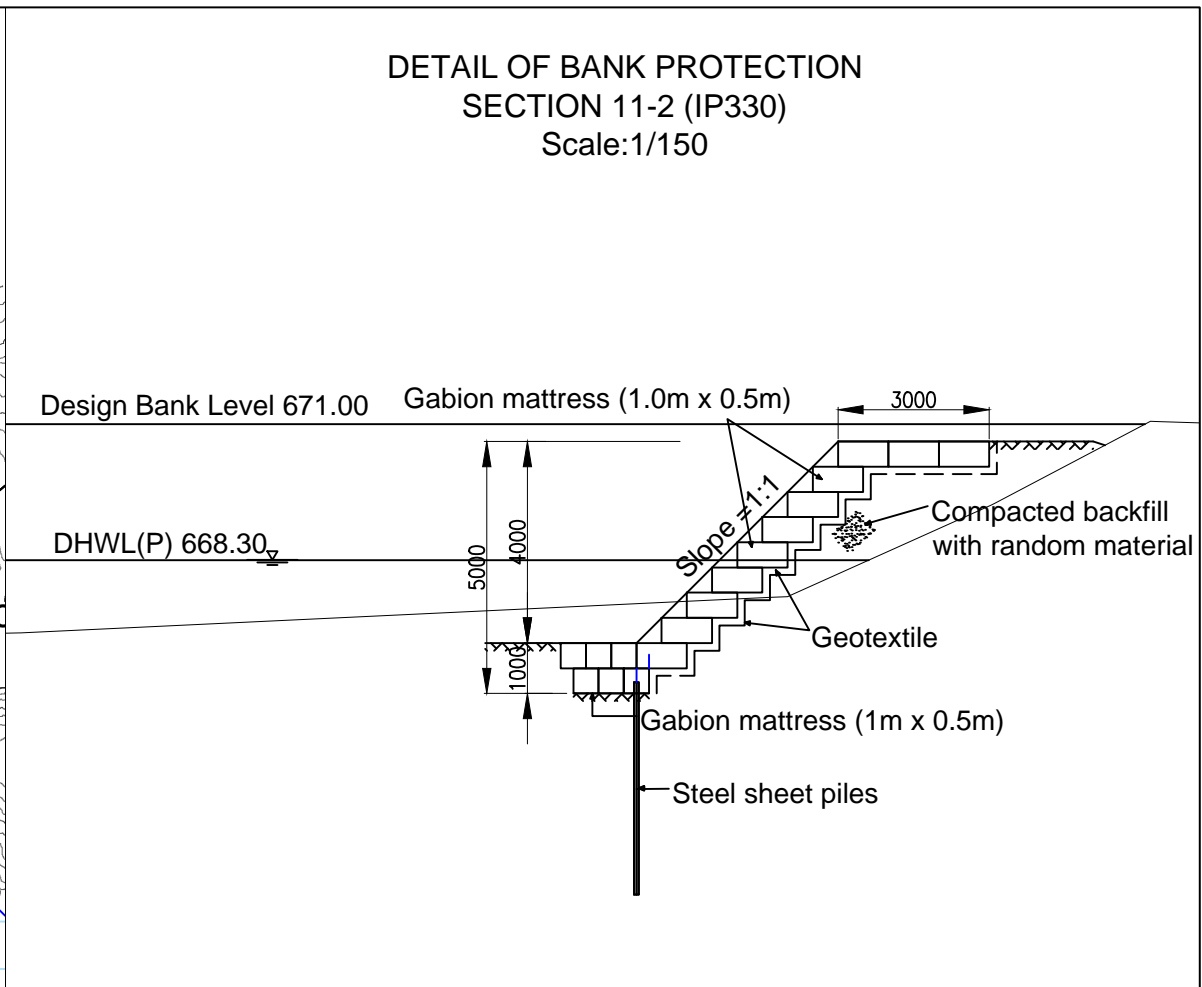
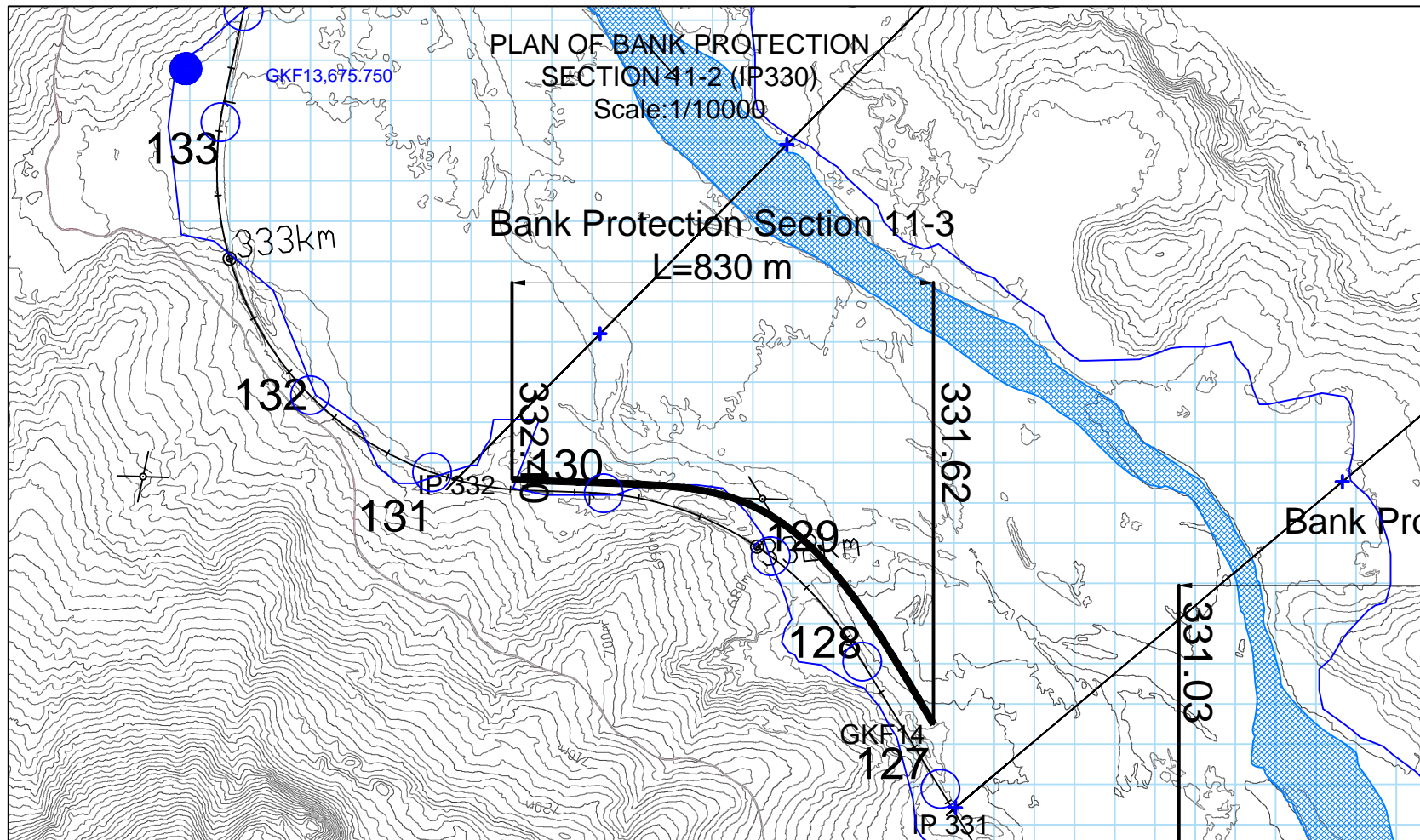
| GOVERNMENT AGENCIES: | | JICA STUDY TEAM: | PROJECT & LOCATION: | SHEET CONTENTS: | DWG NUM |
|--|---|--|---|--|---|
|  JAPAN International Cooperation Agency |  Reli Assets Holding Company (RAHCO), Tanzania | PADECO Co., Ltd., Nippon Koei Co., Ltd., Japan International Consultants for Transportation Co., Ltd., and Fukken Engineering Co., Ltd. | Preparatory Survey on Flood Protection Measures for Central Railway Line in the United Republic of Tanzania | PLAN, CROSS SECTION AND DETAIL OF BANK PROTECTION SECTION 11-1 (IP328) |  |

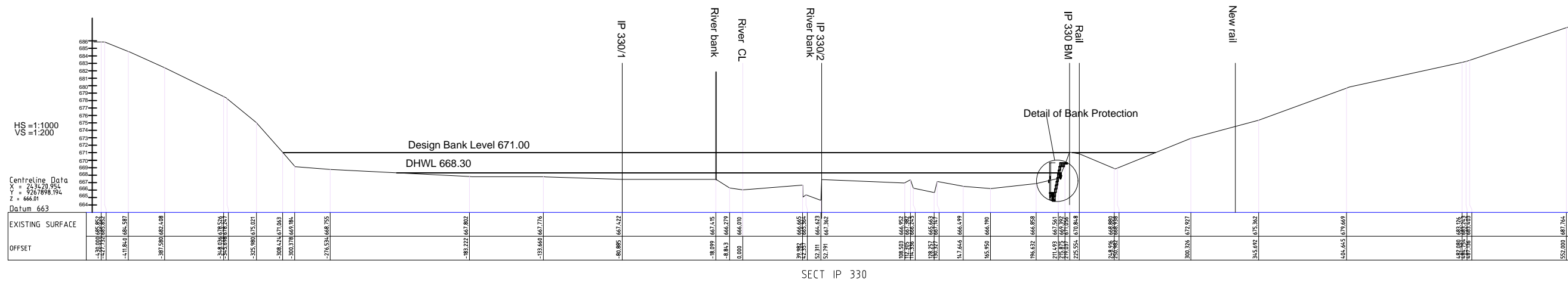

CROSS SECTION OF BANK PROTECTION SECTION 11-2 (IP330) Scale: H:1/3000, V=1/600

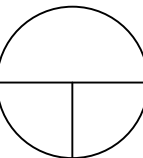

DHWL(P): Design High Water Level for Present Riverbed Level

| GOVERNMENT AGENCIES: | | JICA STUDY TEAM: | PROJECT & LOCATION: | SHEET CONTENTS: | DWG NUM |
|--|---|--|---|--|---|
|  JAPAN International Cooperation Agency |  Reli Assets Holding Company (RAHCO), Tanzania | PADECO Co., Ltd., Nippon Koei Co., Ltd., Japan International Consultants for Transportation Co., Ltd., and Fukken Engineering Co., Ltd. | Preparatory Survey on Flood Protection Measures for Central Railway Line in the United Republic of Tanzania | PLAN, CROSS SECTION AND DETAIL OF BANK PROTECTION SECTION 11-2 (IP330) |  |

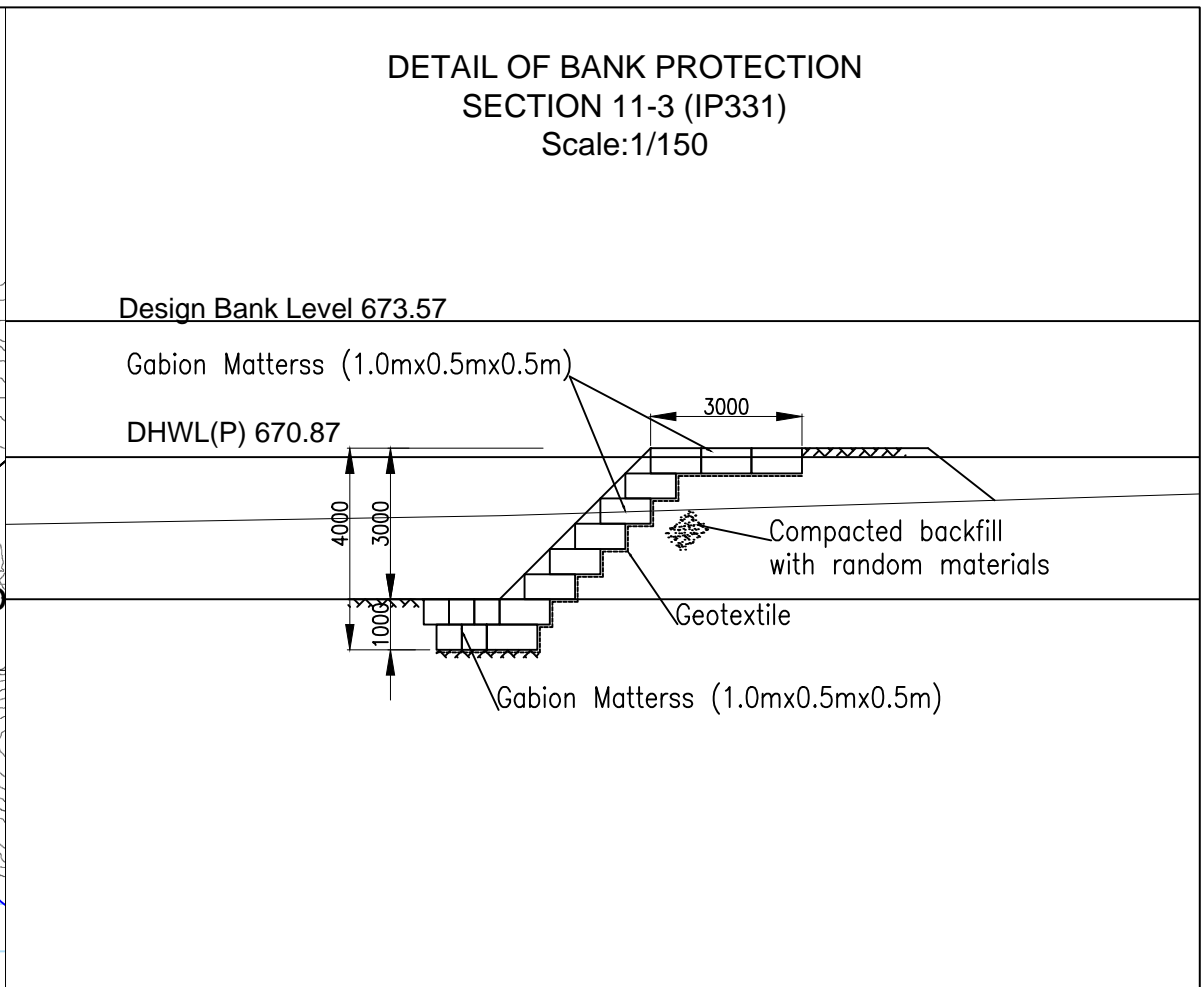
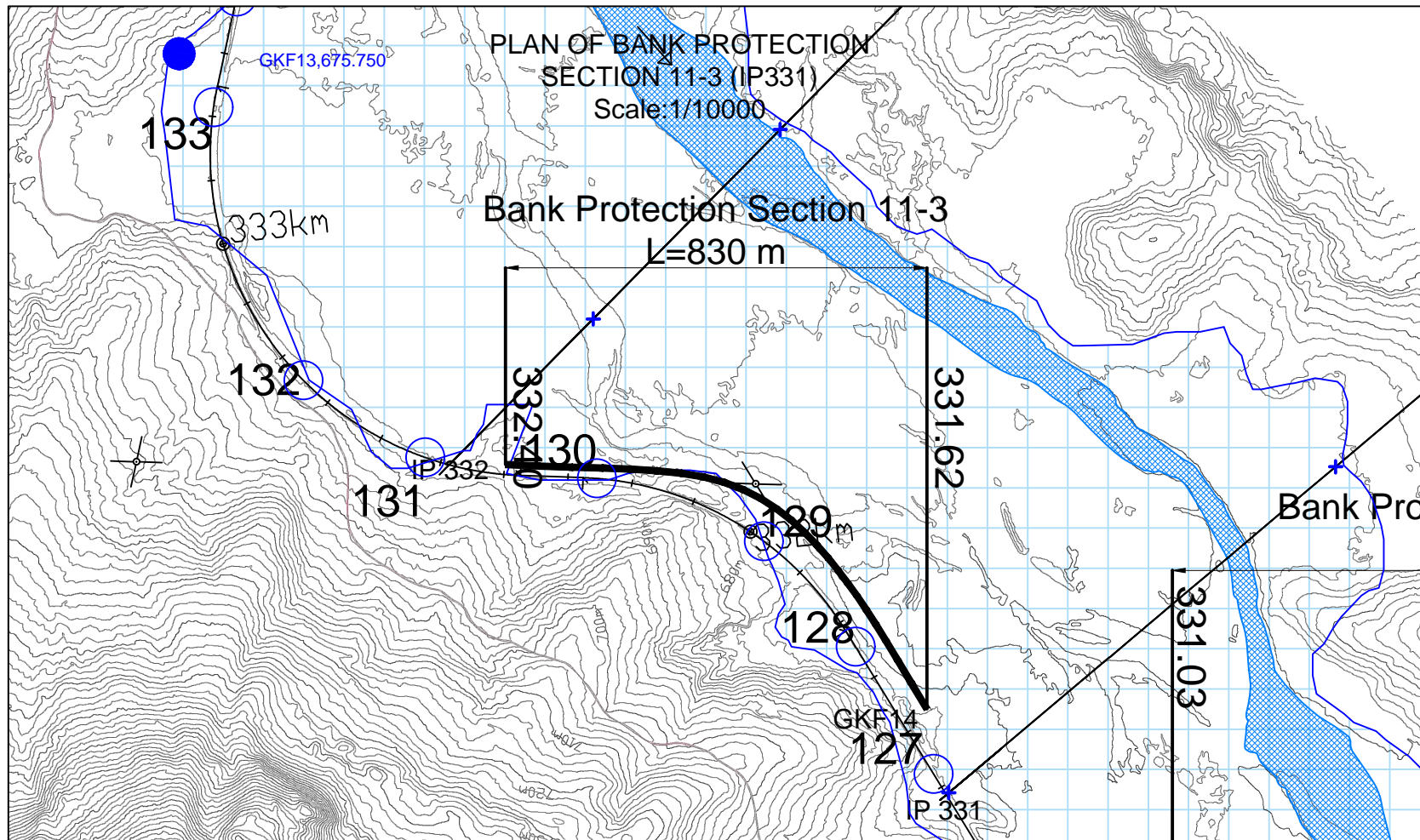

CROSS SECTION OF BANK PROTECTION SECTION 11-3 (IP331) Scale: H:1/3000, V:1/600

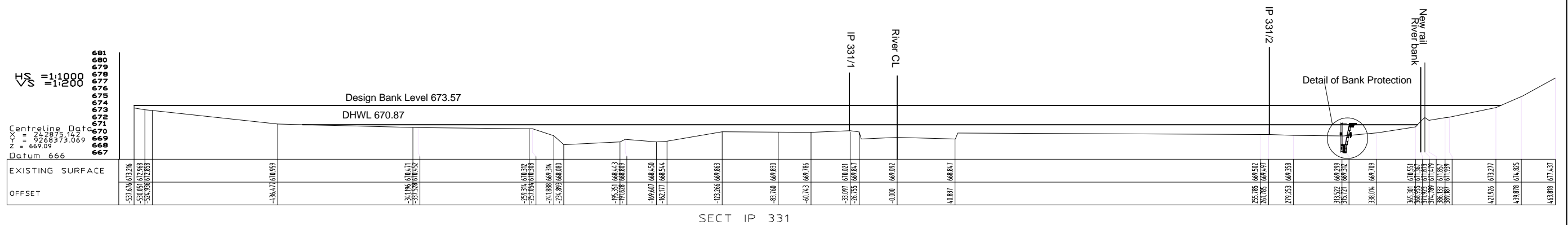

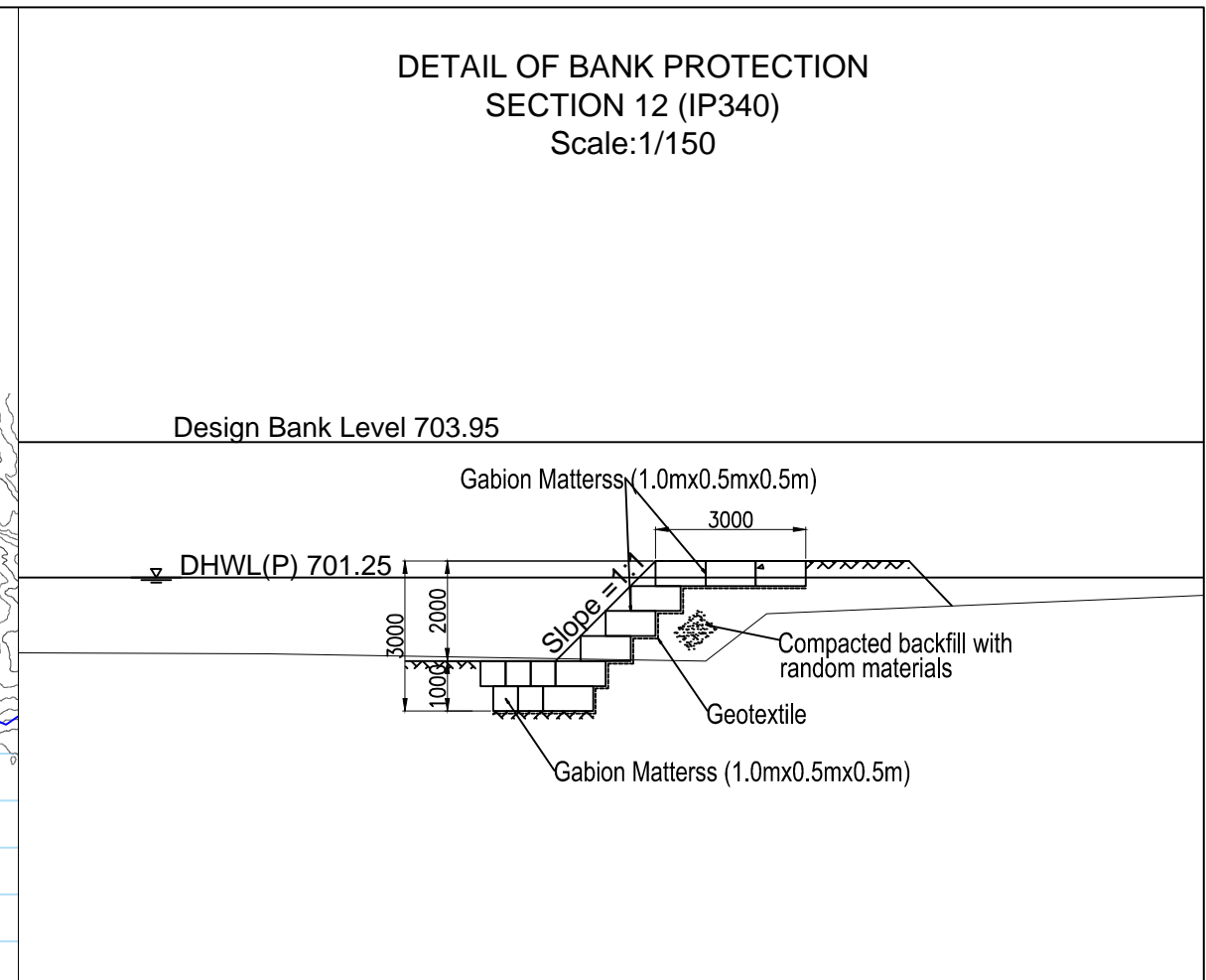
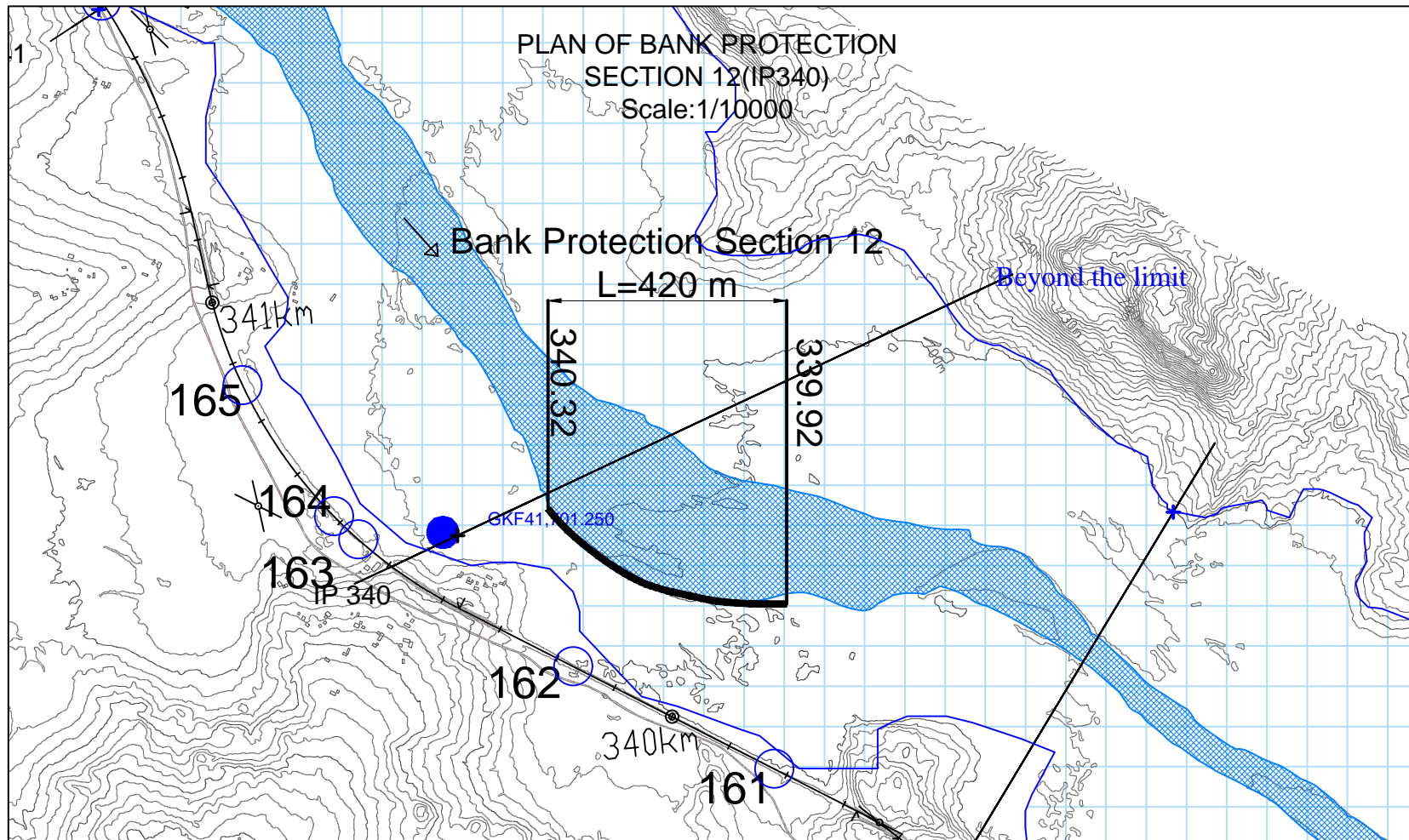

| GOVERNMENT AGENCIES: | | JICA STUDY TEAM: | PROJECT & LOCATION: | SHEET CONTENTS: | DWG NUM |
|--|---|--|---|--|---------|
| JAPAN International Cooperation Agency | Reli Assets Holding Company (RAHCO), Tanzania | PADECO Co., Ltd., Nippon Koei Co., Ltd., Japan International Consultants for Transportation Co., Ltd., and Fukken Engineering Co., Ltd. | Preparatory Survey on Flood Protection Measures for Central Railway Line in the United Republic of Tanzania | PLAN, CROSS SECTION AND DETAIL OF BANK PROTECTION SECTION 11-3 (IP331) | |

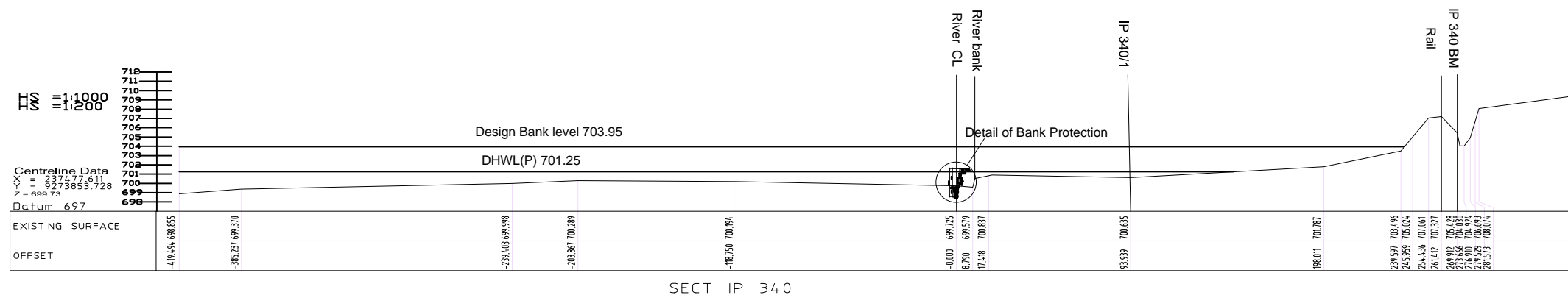

CROSS SECTION OF BANK PROTECTION SECTION 12 (IP340) Scale: H:1/3000, V:1/600

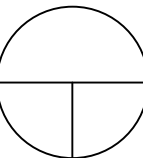

DHWL(P): Design High Water Level for Present Riverbed Level

| GOVERNMENT AGENCIES: | | JICA STUDY TEAM: | PROJECT & LOCATION: | SHEET CONTENTS: | DWG NUM |
|--|---|--|---|--|---|
|  JAPAN International Cooperation Agency |  Reli Assets Holding Company (RAHCO), Tanzania | PADECO Co., Ltd., Nippon Koei Co., Ltd., Japan International Consultants for Transportation Co., Ltd., and Fukken Engineering Co., Ltd. | Preparatory Survey on Flood Protection Measures for Central Railway Line in the United Republic of Tanzania | PLAN, CROSS SECTION AND DETAIL OF BANK PROTECTION SECTION 12 (IP340) |  |

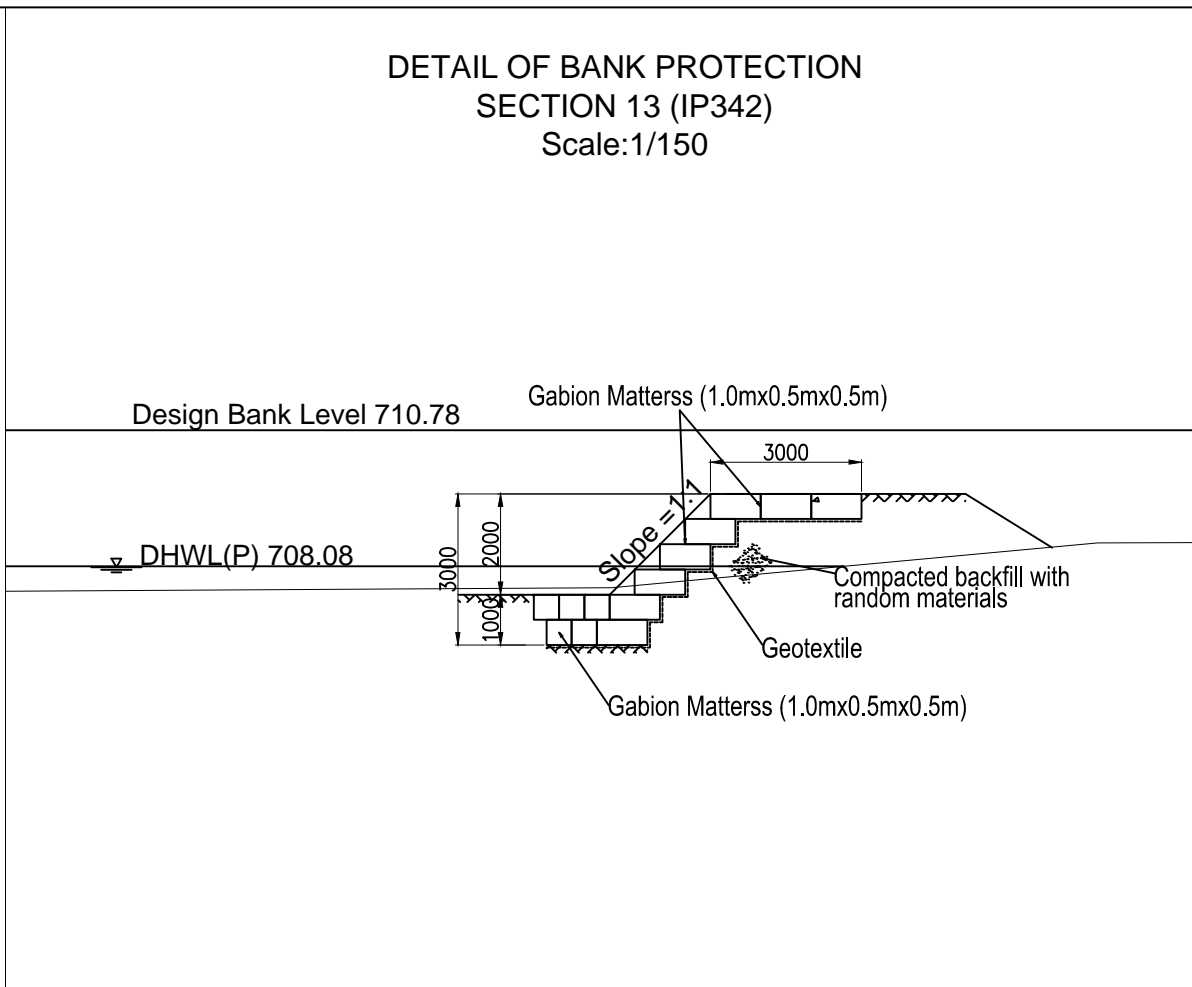
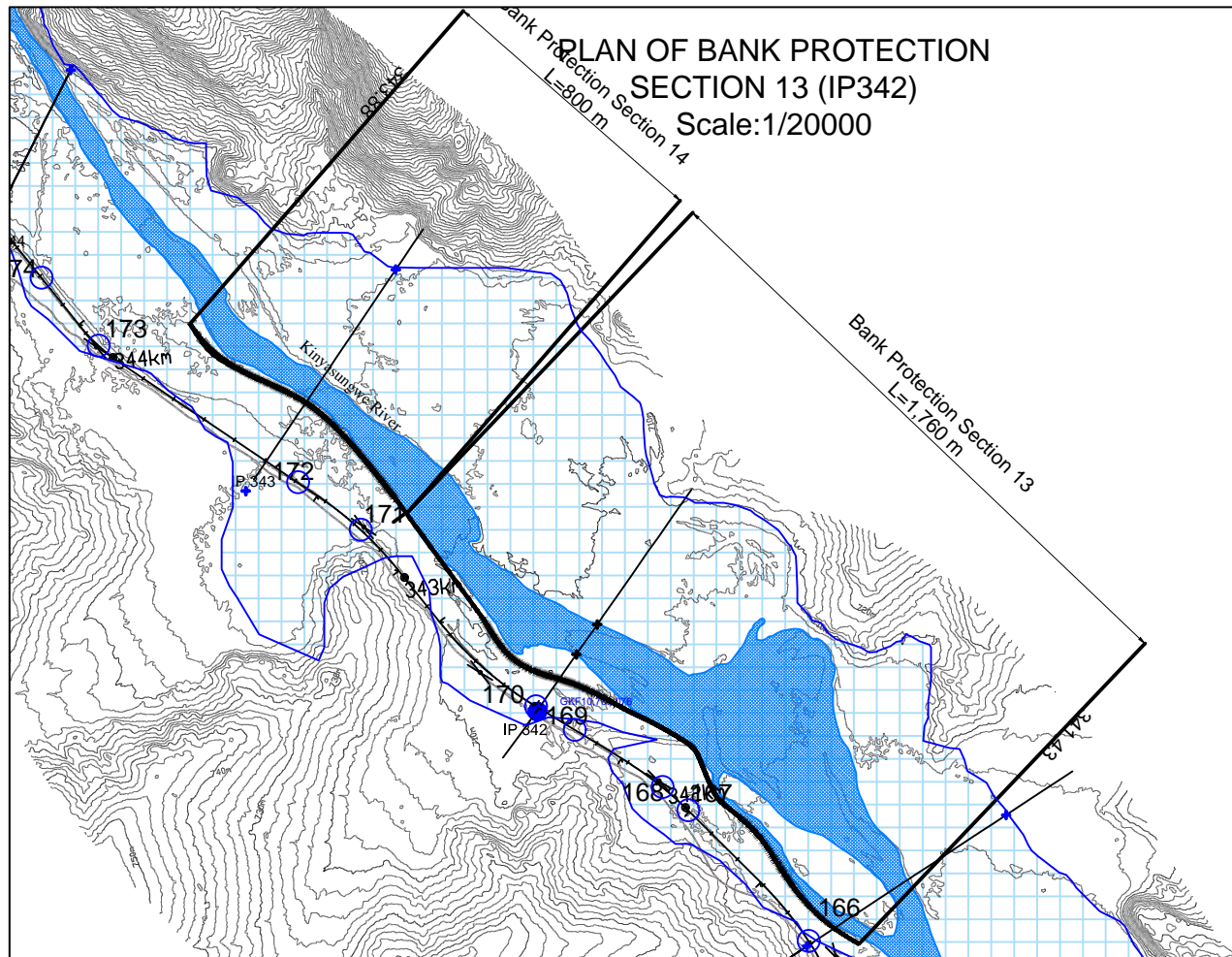

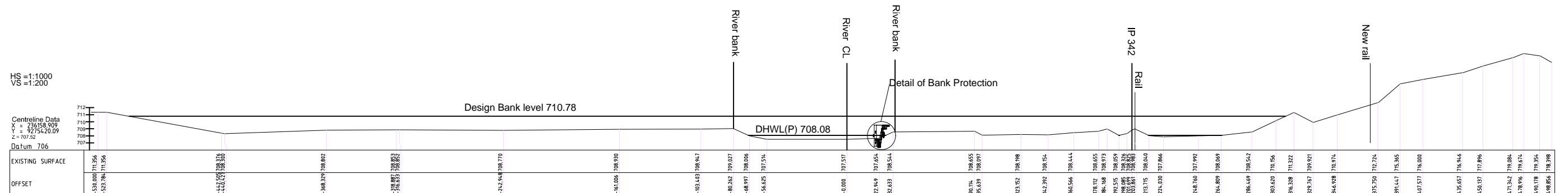

CROSS SECTION OF BANK PROTECTION SECTION 13 (IP342) Scale: H:1/3000, V:1/600



SECT IP 342

DHWL(P): Design High Water Level for Present Riverbed Level

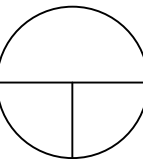
| GOVERNMENT AGENCIES: | | JICA STUDY TEAM: | PROJECT & LOCATION: | SHEET CONTENTS: | DWG NUM |
|--|---|--|---|--|---|
|  JAPAN International Cooperation Agency |  Reli Assets Holding Company (RAHCO), Tanzania | PADECO Co., Ltd., Nippon Koei Co., Ltd., Japan International Consultants for Transportation Co., Ltd., and Fukken Engineering Co., Ltd. | Preparatory Survey on Flood Protection Measures for Central Railway Line in the United Republic of Tanzania | PLAN, CROSS SECTION AND DETAIL OF BANK PROTECTION SECTION 13 (IP342) |  |

PLAN OF BANK PROTECTION
SECTION 14 (IP343)
Scale:1/20000

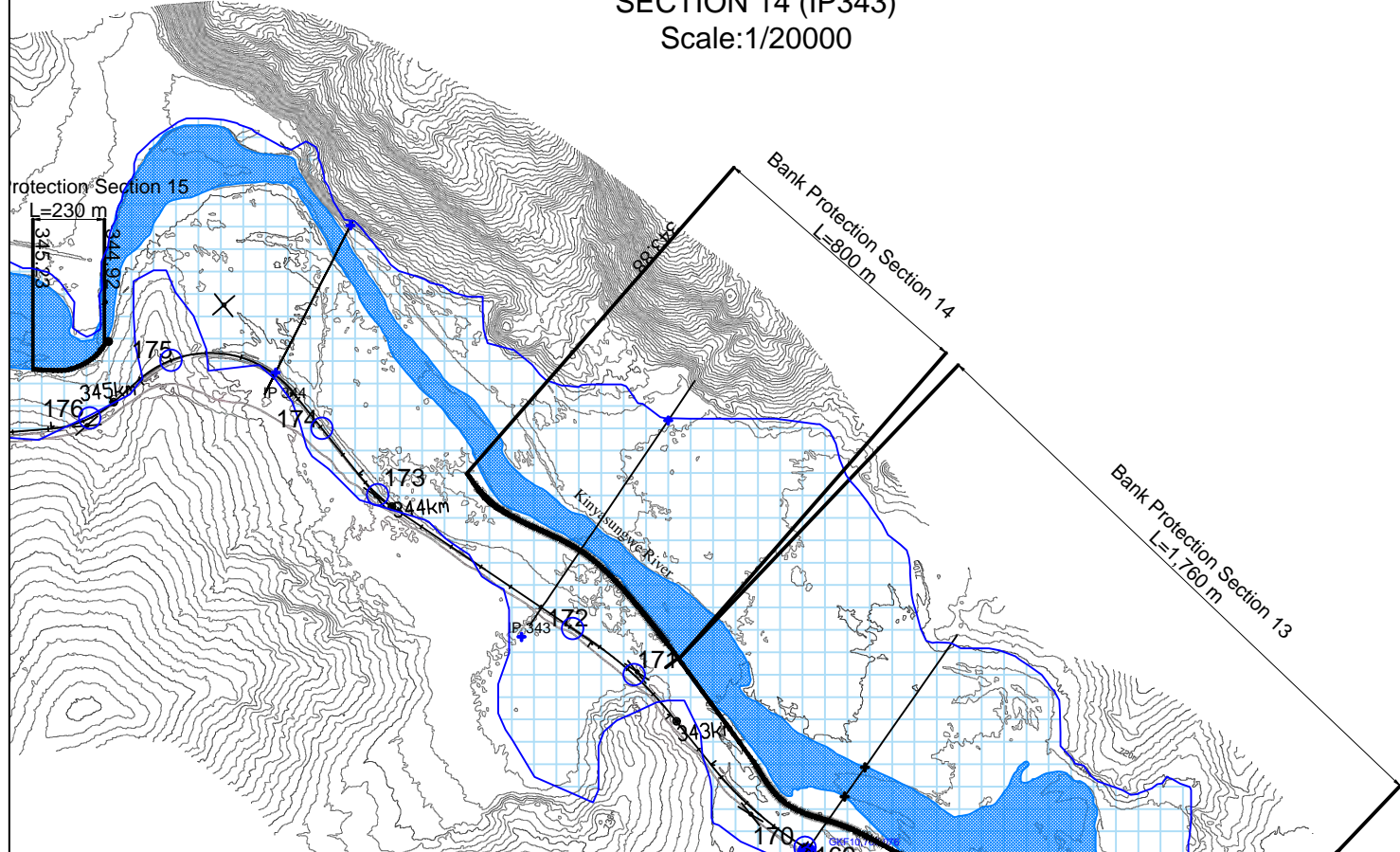

DETAIL OF BANK PROTECTION
SECTION 14 (IP343)
Scale:1/150

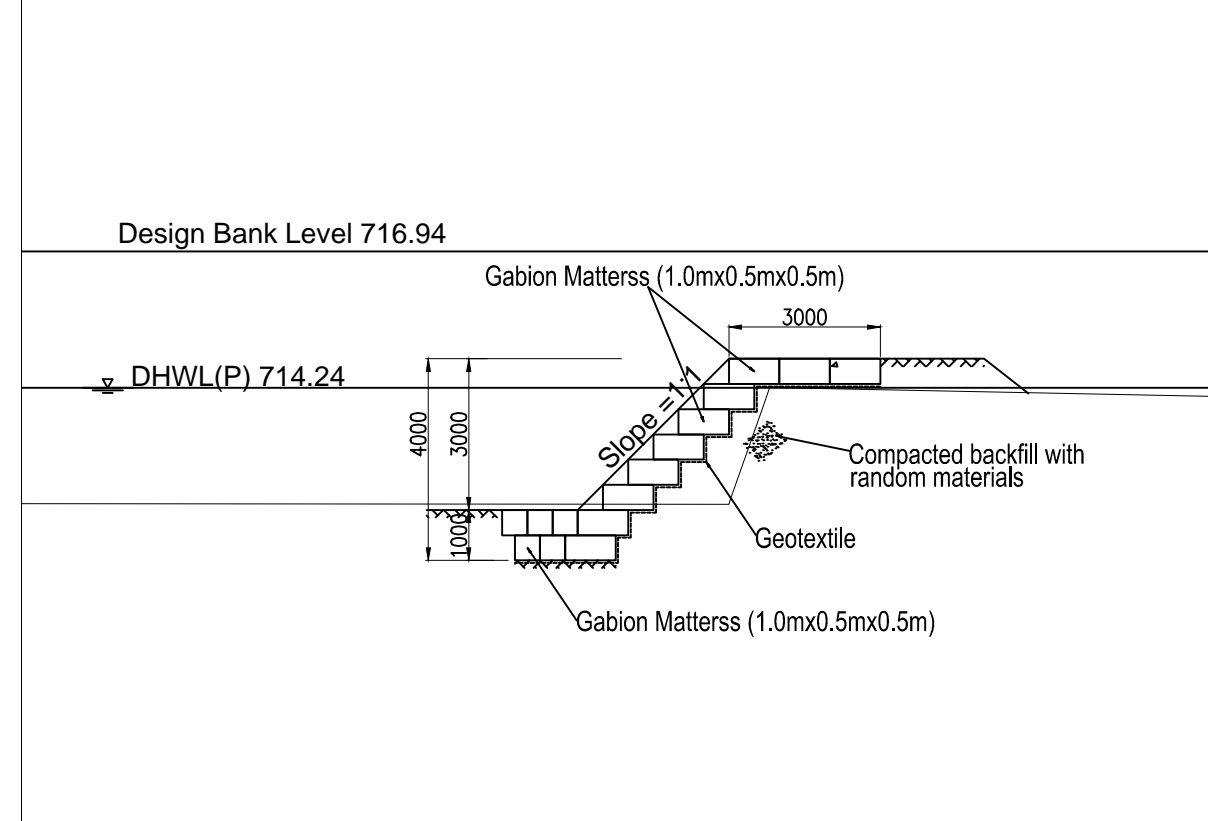

CROSS SECTION OF BANK PROTECTION
SECTION 14 (IP343)
Scale: H:1/3000, V=1/600

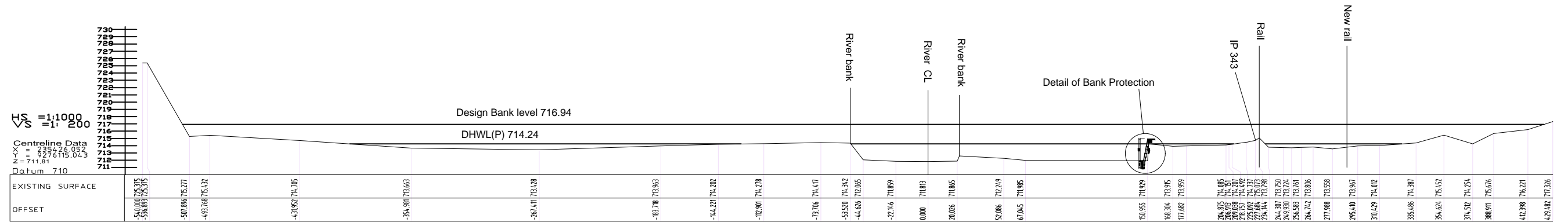

SECT IP 343

DHWL(P): Design High Water Level for Present Riverbed Level

| | | | | | |
|--|--|---|---|--|--------------------|
| GOVERNMENT AGENCIES: JAPAN International Cooperation Agency Reli Assets Holding Company (RAHCO), Tanzania | | JICA STUDY TEAM: PADECO Co., Ltd., Nippon Koei Co., Ltd., Japan International Consultants for Transportation Co., Ltd., and Fukken Engineering Co., Ltd. | PROJECT & LOCATION: Preparatory Survey on Flood Protection Measures for Central Railway Line in the United Republic of Tanzania | SHEET CONTENTS: PLAN, CROSS SECTION AND DETAIL OF BANK PROTECTION SECTION 14 (IP343) | DWG NUM |
|--|--|---|---|--|--------------------|

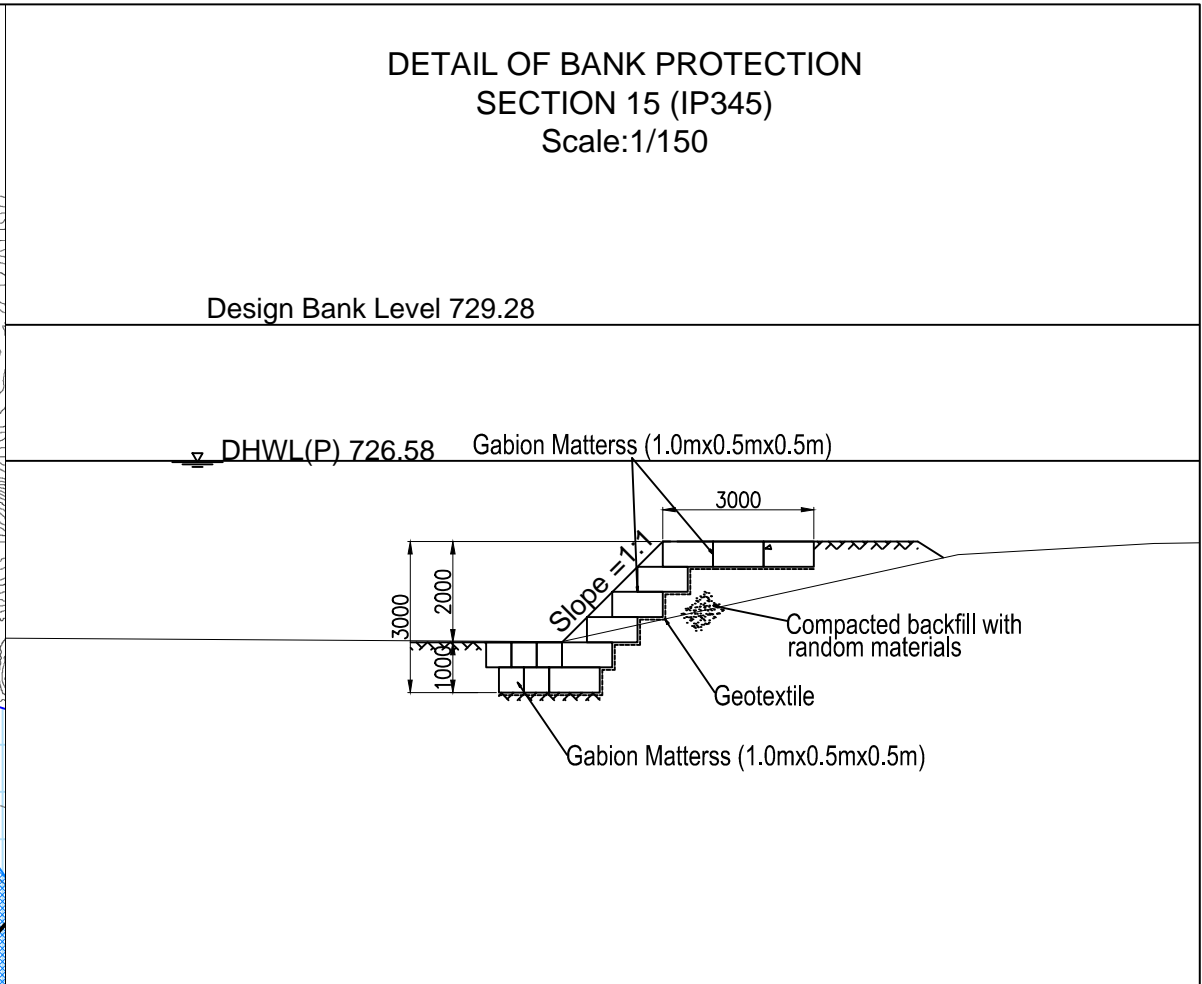
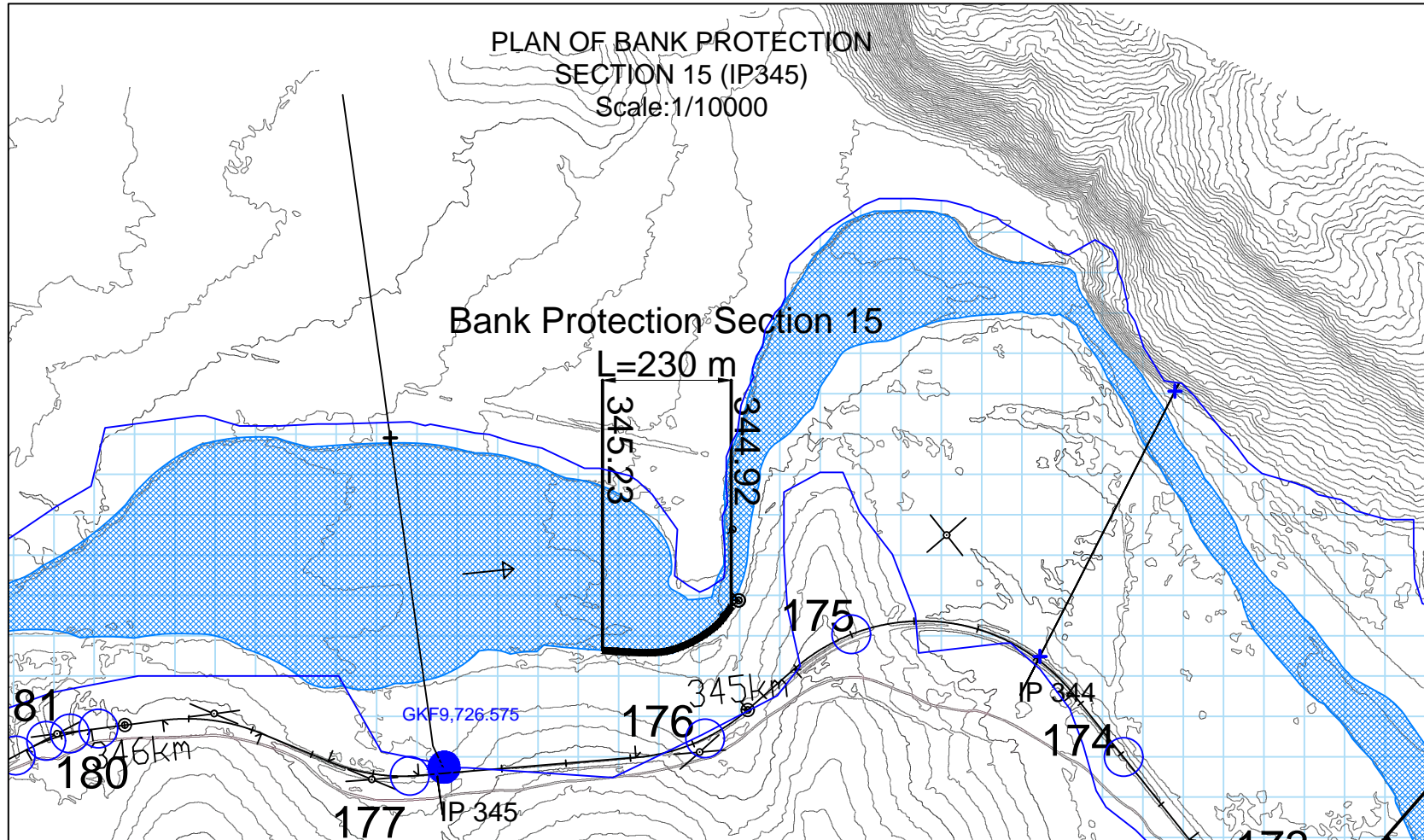

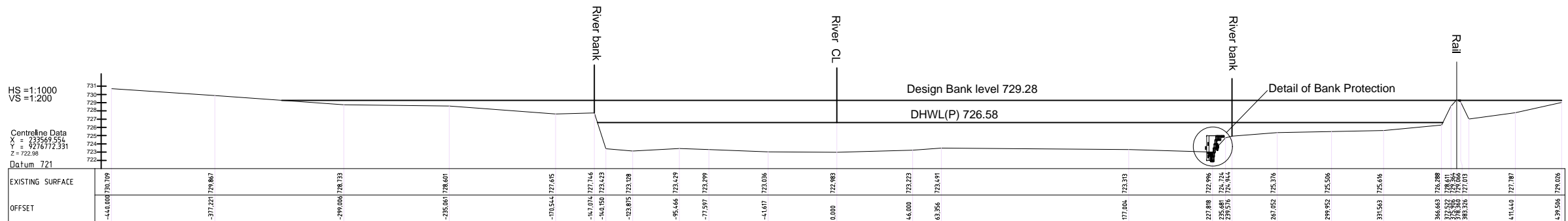

CROSS SECTION OF BANK PROTECTION SECTION 15 (IP345) Scale: H:1/3000, V=1/600



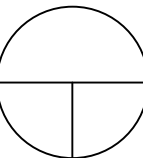

SECT IP 345

DHWL(P): Design High Water Level for Present Riverbed Level

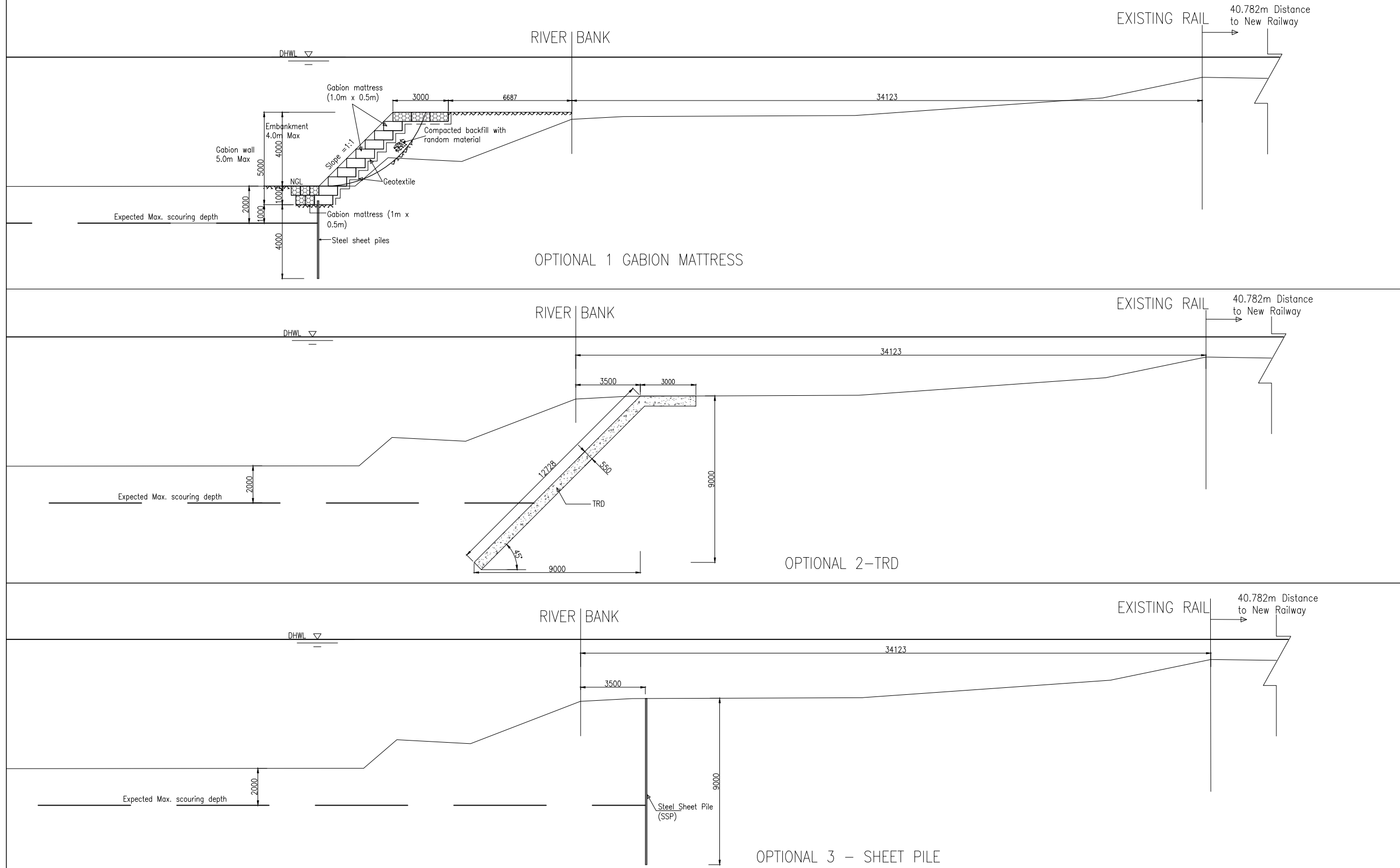

| GOVERNMENT AGENCIES: | | JICA STUDY TEAM: | PROJECT & LOCATION: | SHEET CONTENTS: | DWG NUM |
|--|---|--|---|--|---|
|  JAPAN International Cooperation Agency |  Reli Assets Holding Company (RAHCO), Tanzania | PADECO Co., Ltd., Nippon Koei Co., Ltd., Japan International Consultants for Transportation Co., Ltd., and Fukken Engineering Co., Ltd. | Preparatory Survey on Flood Protection Measures for Central Railway Line in the United Republic of Tanzania | PLAN, CROSS SECTION AND DETAIL OF BANK PROTECTION SECTION 15 (IP345) |  |

COMPARISON OF BANK PROTECTION WORKS IN SITE 315

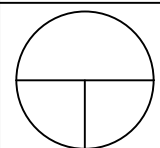

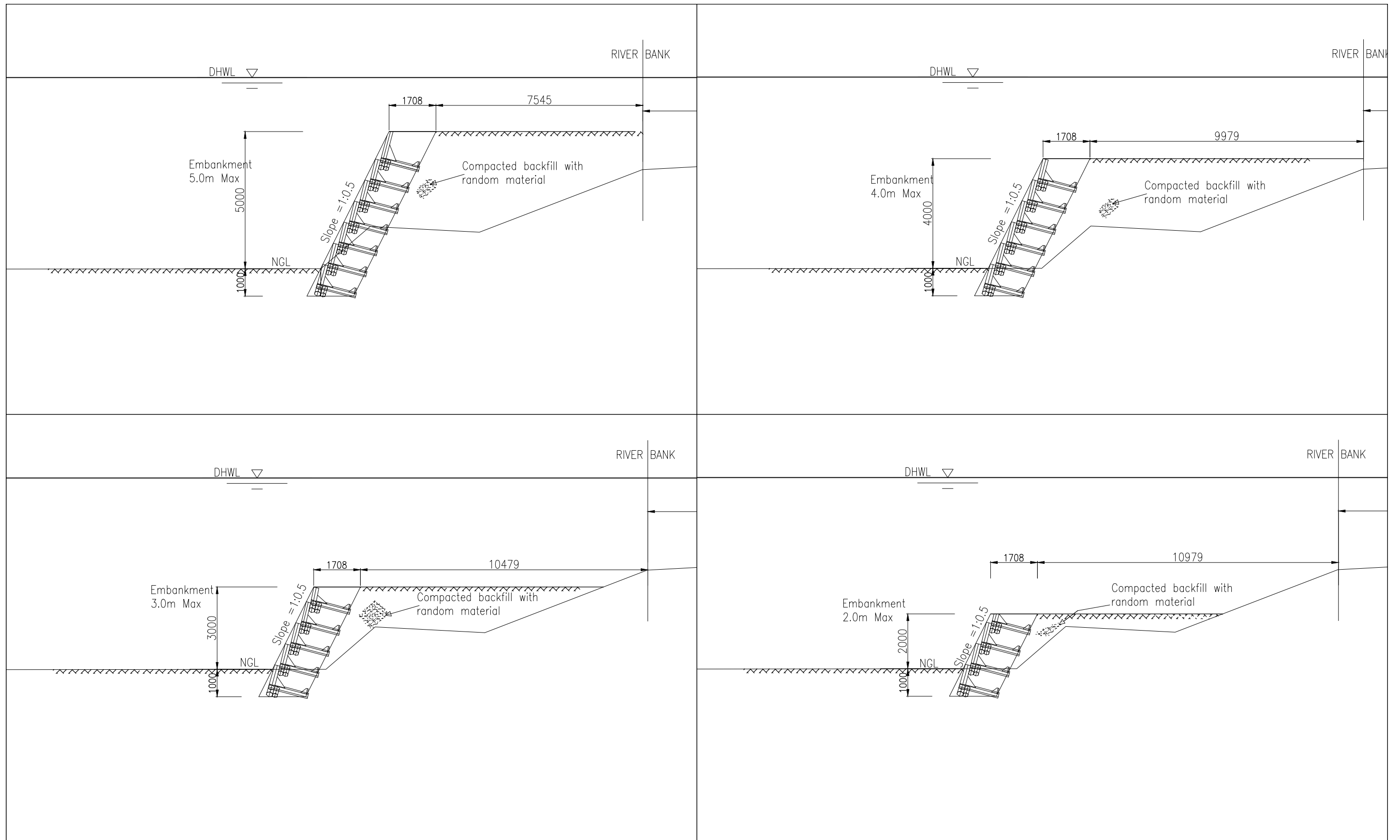
| GOVERNMENT AGENCIES: | | JICA STUDY TEAM: | PROJECT & LOCATION: | SHEET CONTENTS: | DWG NUM |
|--|---|--|---|--|---|
|  JAPAN International Cooperation Agency |  Reli Assets Holding Company (RAHCO), Tanzania | PADECO Co., Ltd., Nippon Koei Co., Ltd., Japan International Consultants for Transportation Co., Ltd., and Fukken Engineering Co., Ltd. | Preparatory Survey on Flood Protection Measures for Central Railway Line in the United Republic of Tanzania | Comparison of River Bank Protection Works for TRD (Trench Cutting Re-mixing Deep Wall) Method and Sheet Piling |  |

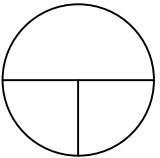

| GOVERNMENT AGENCIES: | | JICA STUDY TEAM: | PROJECT & LOCATION: | SHEET CONTENTS: | DWG NUM |
|--|---|--|---|--|---|
|  JAPAN International Cooperation Agency |  Reli Assets Holding Company (RAHCO), Tanzania | PADECO Co., Ltd., Nippon Koei Co., Ltd., Japan International Consultants for Transportation Co., Ltd., and Fukken Engineering Co., Ltd. | Preparatory Survey on Flood Protection Measures for Central Railway Line in the United Republic of Tanzania | Typical Section of River Bank Protection Works Branch Block (H=2m, 3m, 4m, 5m) |  |

COMPARISON OF TYPE OF SLOPE PROTECTION WORKS IN MASWALA RIVER

CONVENTIONAL METHOD (GABION MATTRESS)

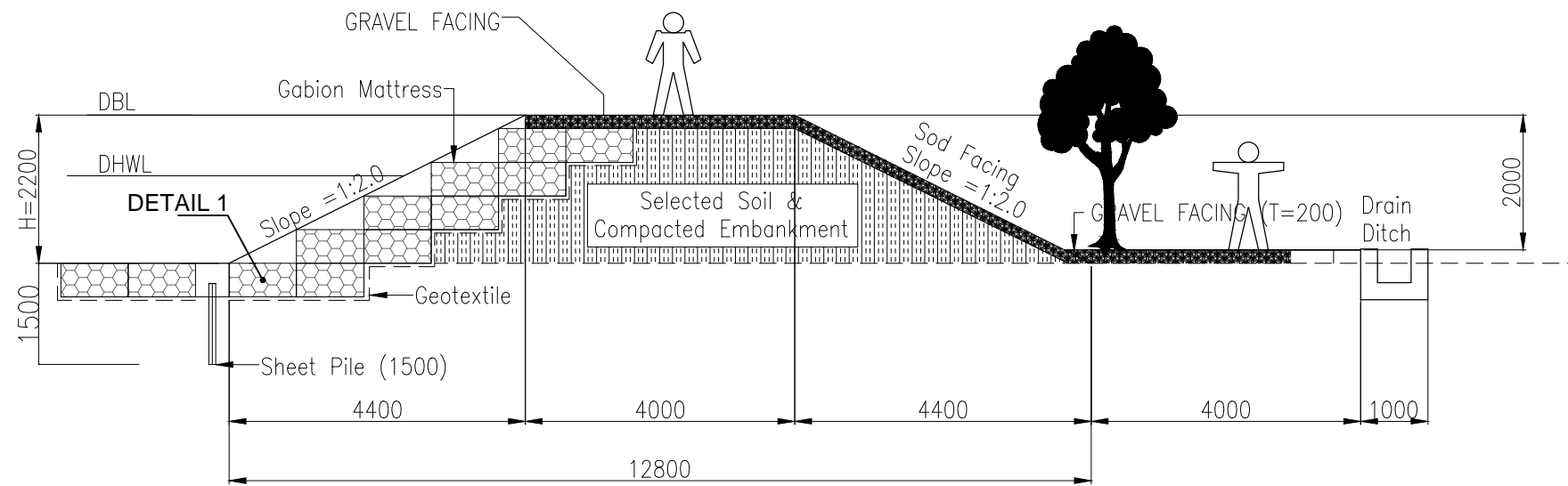

DETAIL 1: GABION

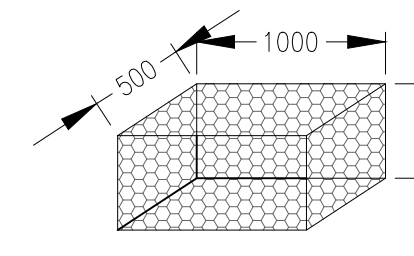

DETAIL 2: FILTER UNIT

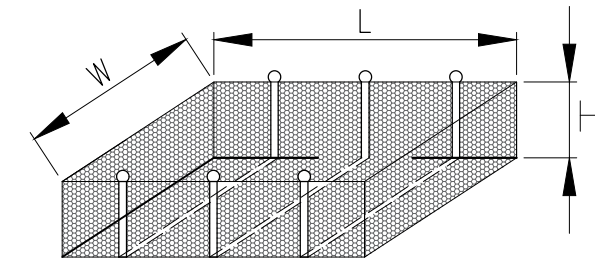

OPTION (BRANCH BLOCK AND FILTER UNIT)

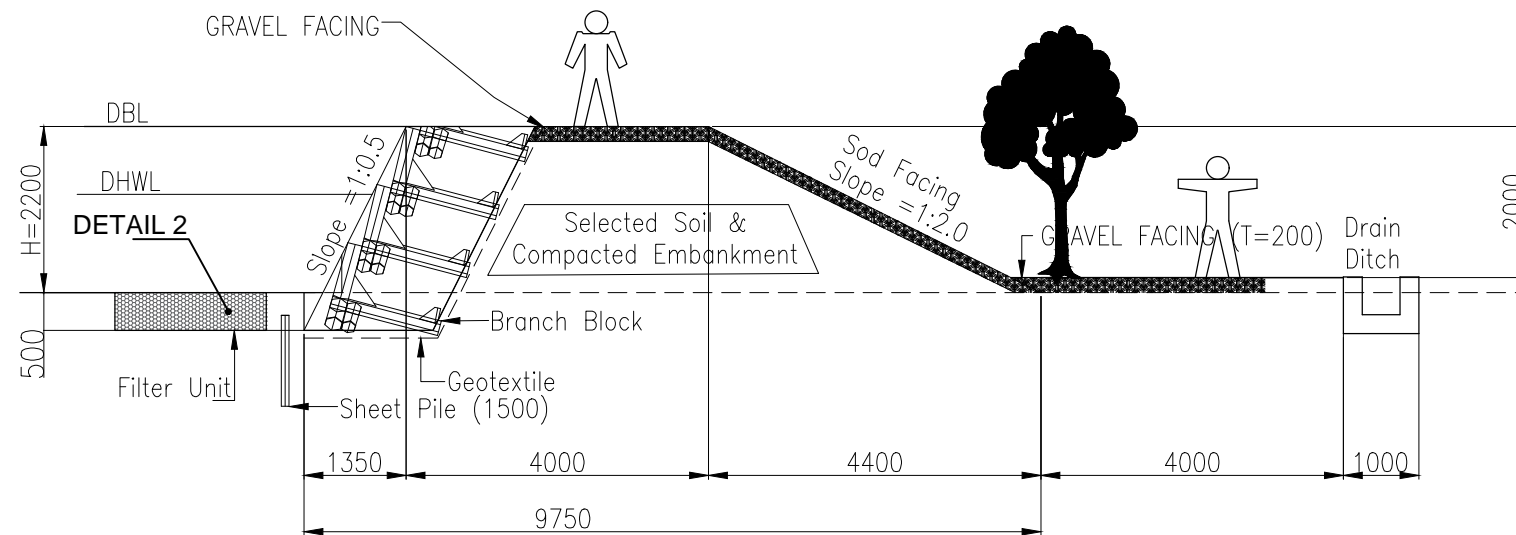

FILTER UNIT DESCRIPTION TABLE

| 0.6m ³ Filter Unit | 1m ³ Filter Unit | 1.2m ³ Filter Unit |
|-------------------------------|-----------------------------|-------------------------------|
| 1m(W) x 2m(L) x 0.3m(H) | 1m(W) x 2m(L) x 0.5m(H) | 1.2m(W) x 2m(L) x 0.5m(H) |

GOVERNMENT AGENCIES:



JAPAN International Cooperation Agency



Reli Assets Holding Company (RAHCO), Tanzania

JICA STUDY TEAM:

PADECO Co., Ltd.,
Nippon Koei Co., Ltd.,
Japan International Consultants for Transportation Co., Ltd., and
Fukken Engineering Co., Ltd.

PROJECT & LOCATION:

Preparatory Survey on Flood Protection Measures for Central Railway Line in the United Republic of Tanzania

SHEET CONTENTS:

COMPARISON OF BANK PROTECTION WORKS FOR RIVER TRAINING WORKS IN MASWALA RIVER

DWG NUM

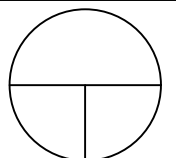

COMPARISON OF BANK PROTECTION FOR RIVER TRAINING WORKS IN TRIBUTARIES – MZASE RIVER

CONVENTIONAL METHOD (GABION MATTRESS)

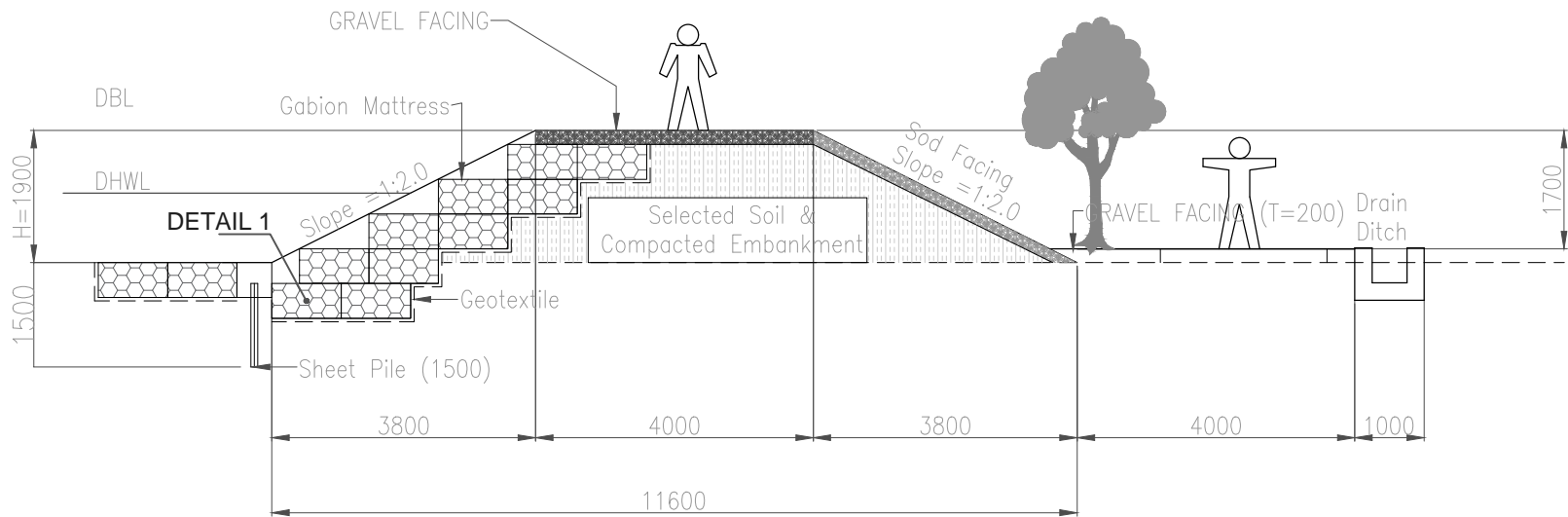

DETAIL 1: GABION

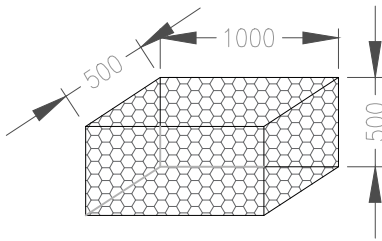

DETAIL 2: FILTER UNIT

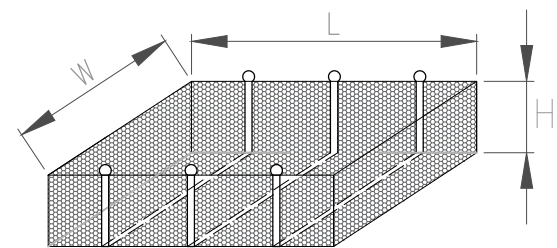

OPTION (BRANCH BLOCK AND FILTER UNIT)

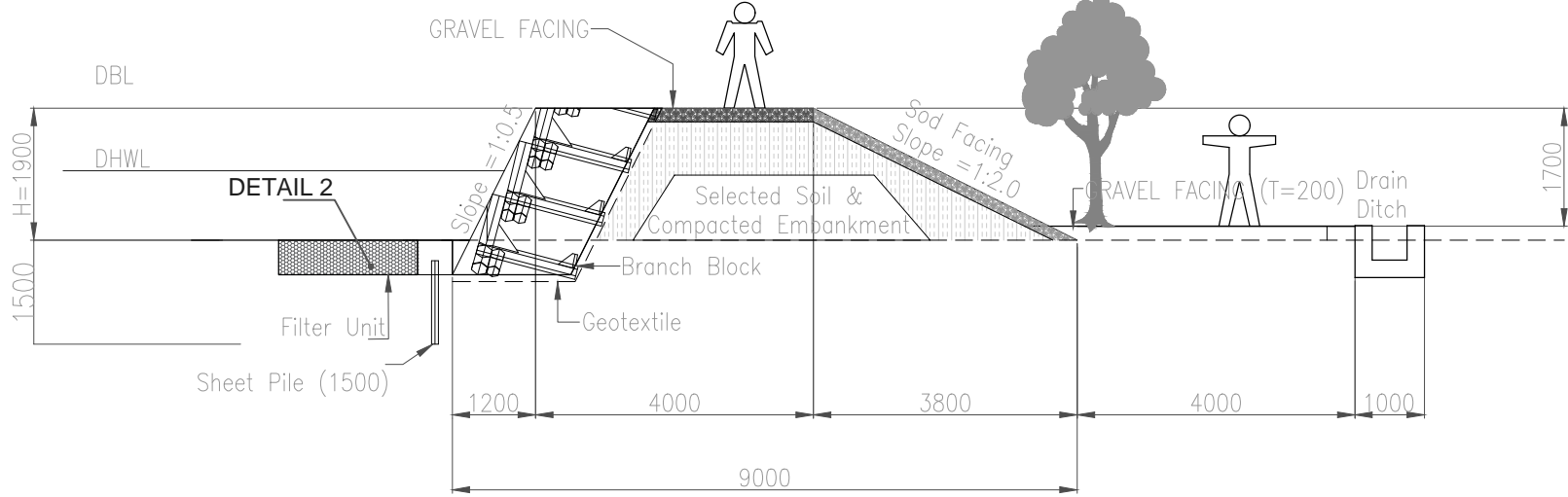

FILTER UNIT DESCRIPTION TABLE

| 0.6m ³ Filter Unit | 1m ³ Filter Unit | 1.2m ³ Filter Unit |
|-------------------------------|-----------------------------|-------------------------------|
| 1m(W) x 2m(L) x 0.3m(H) | 1m(W) x 2m(L) x 0.5m(H) | 1.2m(W) x 2m(L) x 0.5m(H) |

GOVERNMENT AGENCIES:



Reli Assets Holding Company (RAHCO), Tanzania

JICA STUDY TEAM:

PADECO Co., Ltd., Nippon Koei Co., Ltd., Japan International Consultants for Transportation Co., Ltd., and Fukken Engineering Co., Ltd.

PROJECT & LOCATION:

Preparatory Survey on Flood Protection Measures for Central Railway Line in the United Republic of Tanzania

SHEET CONTENTS:

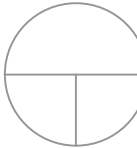

COMPARISON OF BANK PROTECTION FOR RIVER TRAINING WORKS IN TRIBUTARIES - MZASE RIVER

DWG NUM

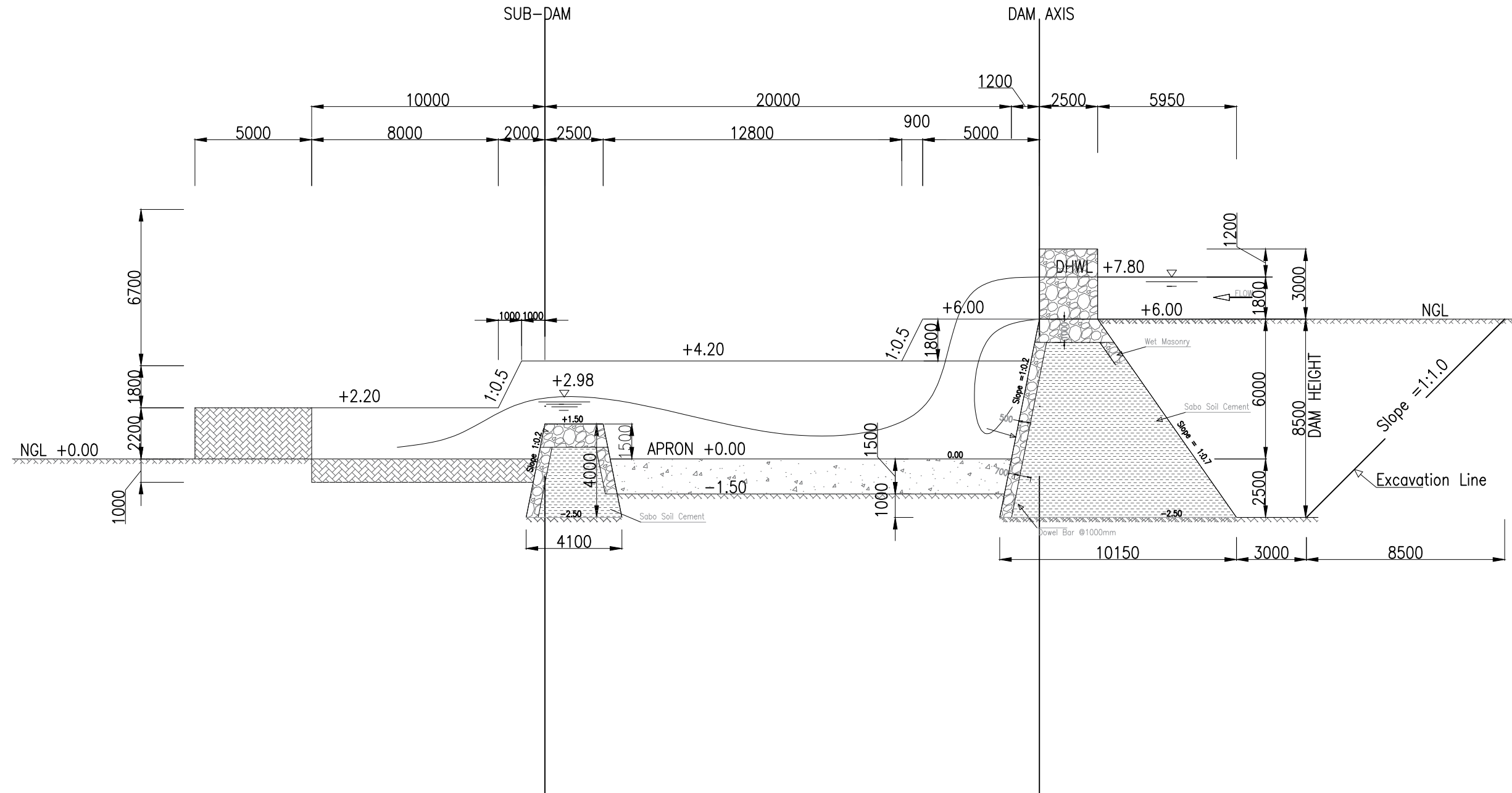

LONGITUDINAL SECTION OF CHECK DAM IN MASWALA RIVER
 (Option: Sabo Soil Cement)
 Scale 1/200

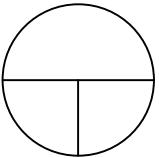

| GOVERNMENT AGENCIES: | | JICA STUDY TEAM: | PROJECT & LOCATION: | SHEET CONTENTS: | DWG NUM |
|---|--|---|--|---|---|
|  | JAPAN International Cooperation Agency |  Reli Assets Holding Company (RAHCO), Tanzania | PADECO Co., Ltd., Nippon Koei Co., Ltd., Japan International Consultants for Transportation Co., Ltd., and Fukken Engineering Co., Ltd. | Preparatory Survey on Flood Protection Measures for Central Railway Line in the United Republic of Tanzania |  |

MAIN DAM PROTECTION DETAILS
SCALE; 1:1

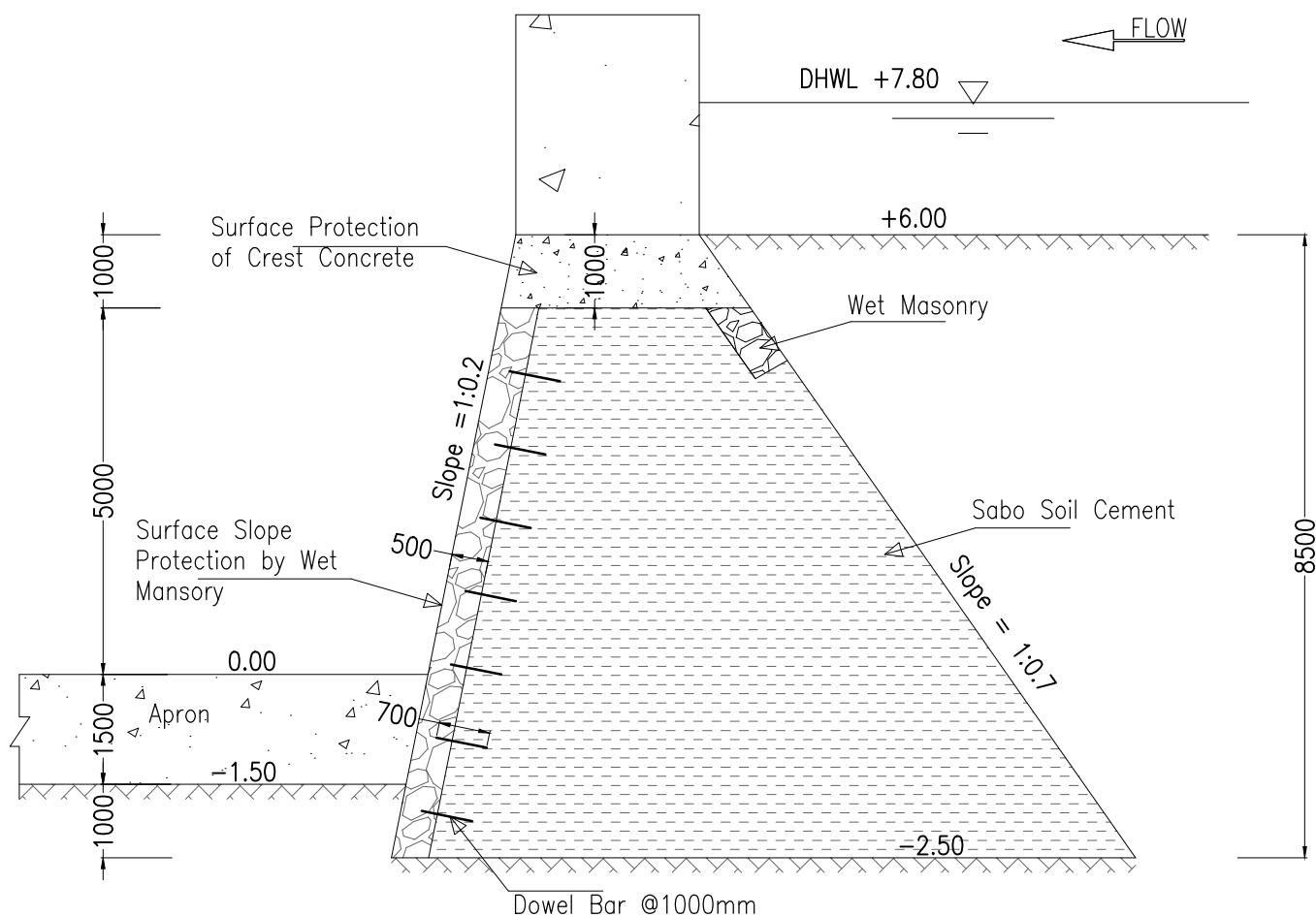

RETAINING WALL

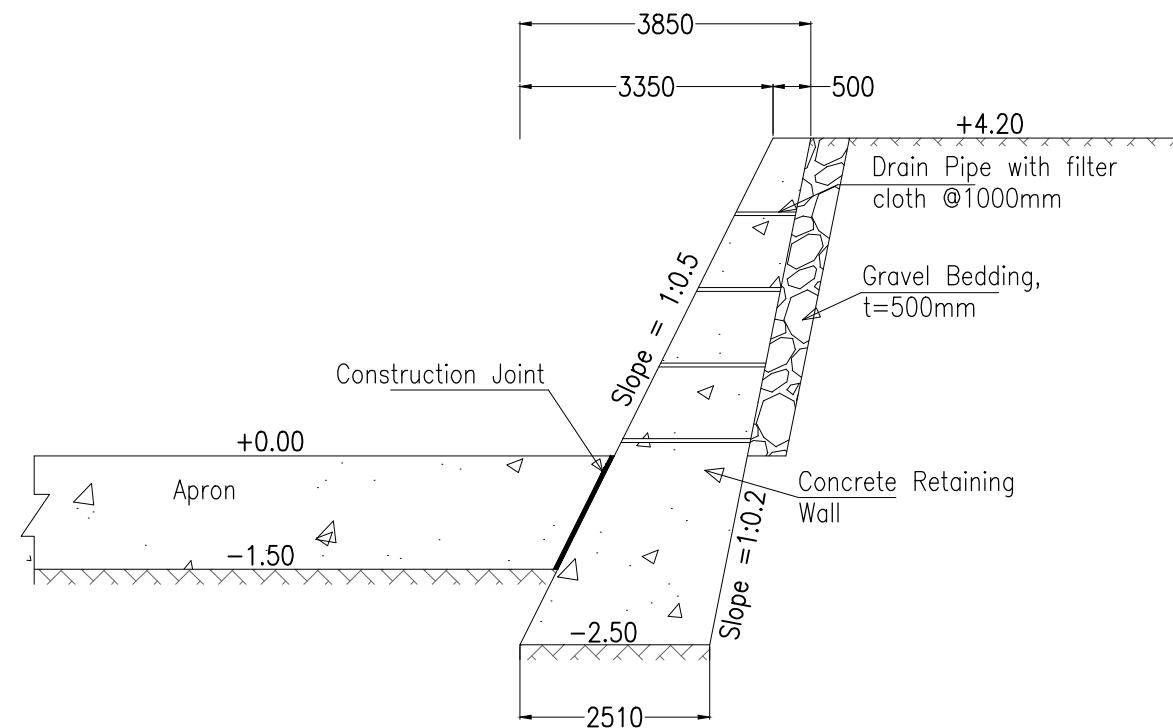

SUB DAM PROTECTION DETAILS
SCALE; 1:1

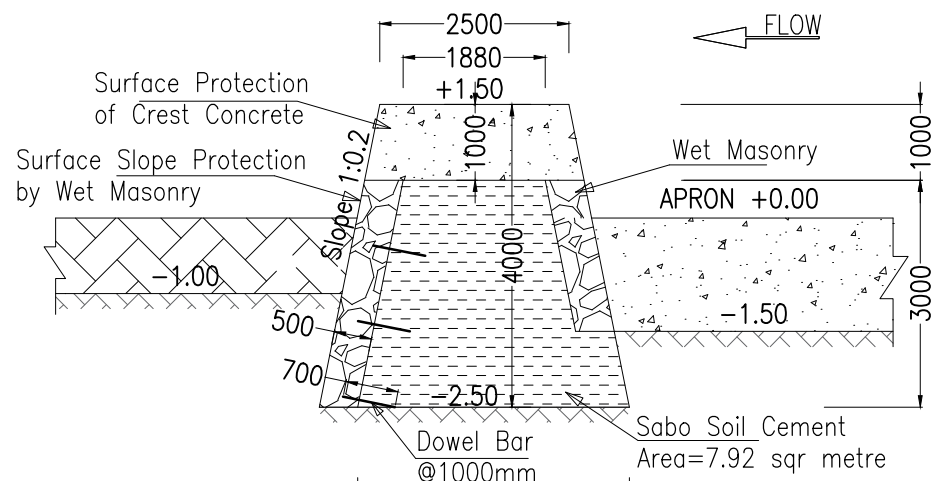

GROUNDSILL PROTECTION DETAILS
SCALE; 1:1

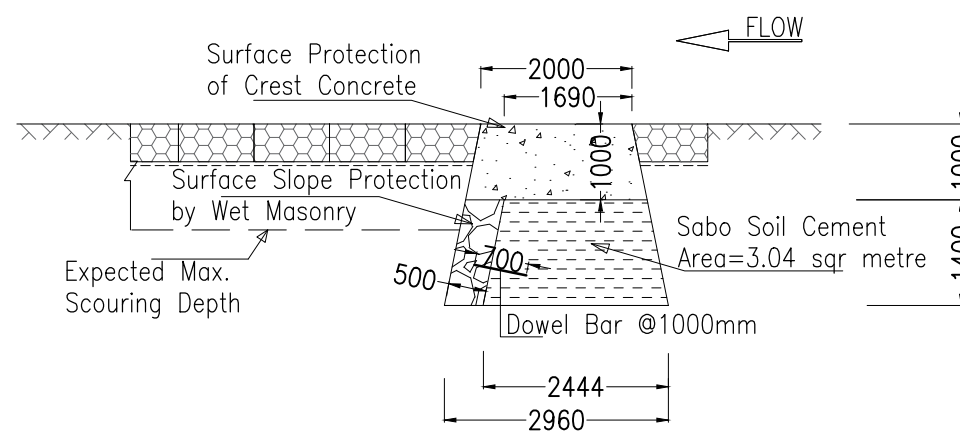

GOVERNMENT AGENCIES:



JAPAN International Cooperation Agency



Reli Assets Holding Company (RAHCO), Tanzania

JICA STUDY TEAM:

PADECO Co., Ltd.,
Nippon Koei Co., Ltd.,
Japan International Consultants for Transportation Co., Ltd., and
Fukken Engineering Co., Ltd.

PROJECT & LOCATION:

Preparatory Survey on Flood Protection Measures for Central Railway Line in the United Republic of Tanzania

SHEET CONTENTS:

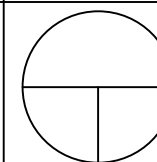

DWG NUM

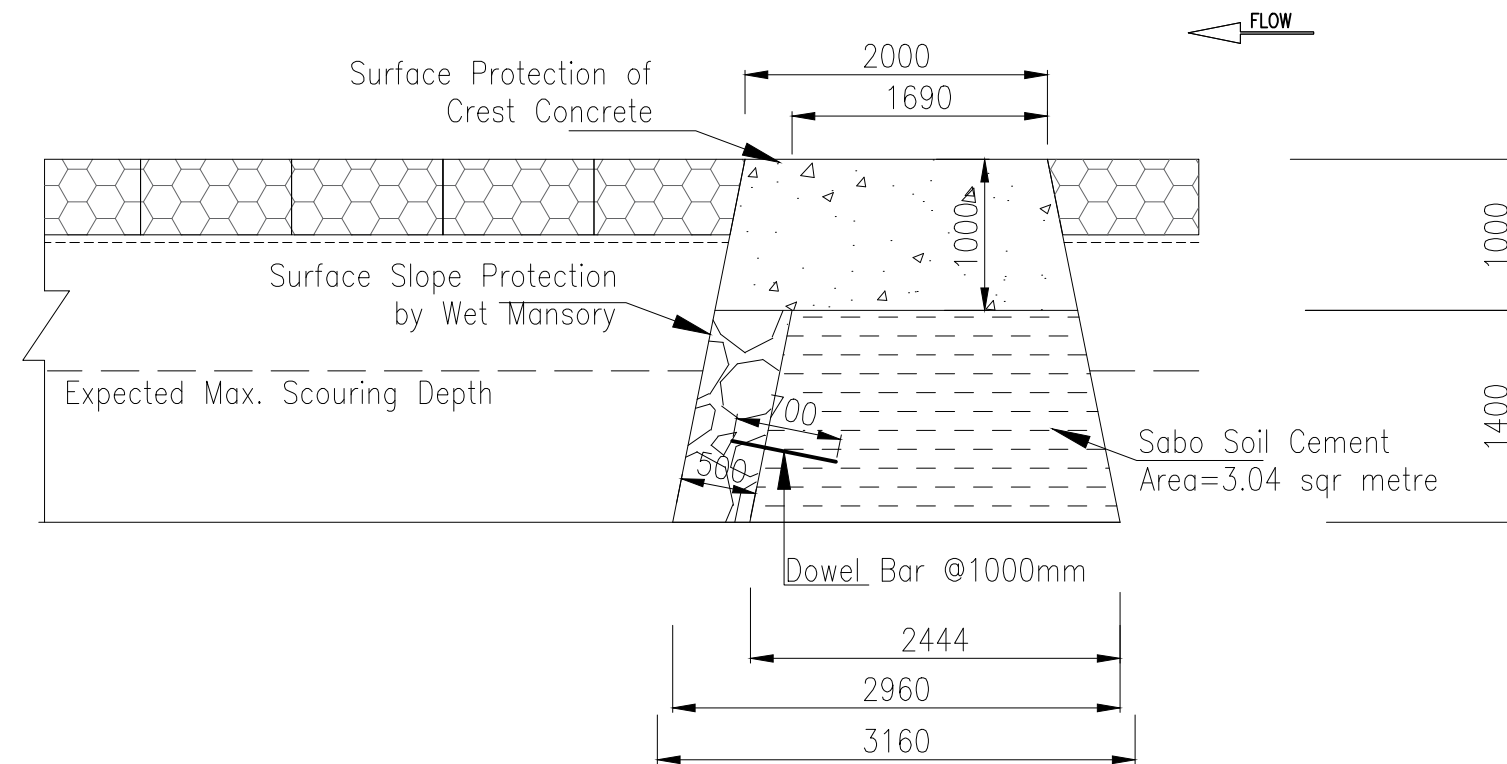

DETAIL OF GOUNDSILL IN MZASE RIVER

Scale 1/400

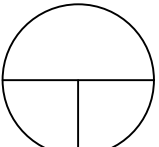

| GOVERNMENT AGENCIES: | | JICA STUDY TEAM: | PROJECT & LOCATION: | SHEET CONTENTS: | DWG NUM |
|---|--|---|--|---|---|
|  | JAPAN International Cooperation Agency |  Reli Assets Holding Company (RAHCO), Tanzania | PADECO Co., Ltd., Nippon Koei Co., Ltd., Japan International Consultants for Transportation Co., Ltd., and Fukken Engineering Co., Ltd. | Preparatory Survey on Flood Protection Measures for Central Railway Line in the United Republic of Tanzania |  |