

6. 対象校敷地測量図

A-6-1

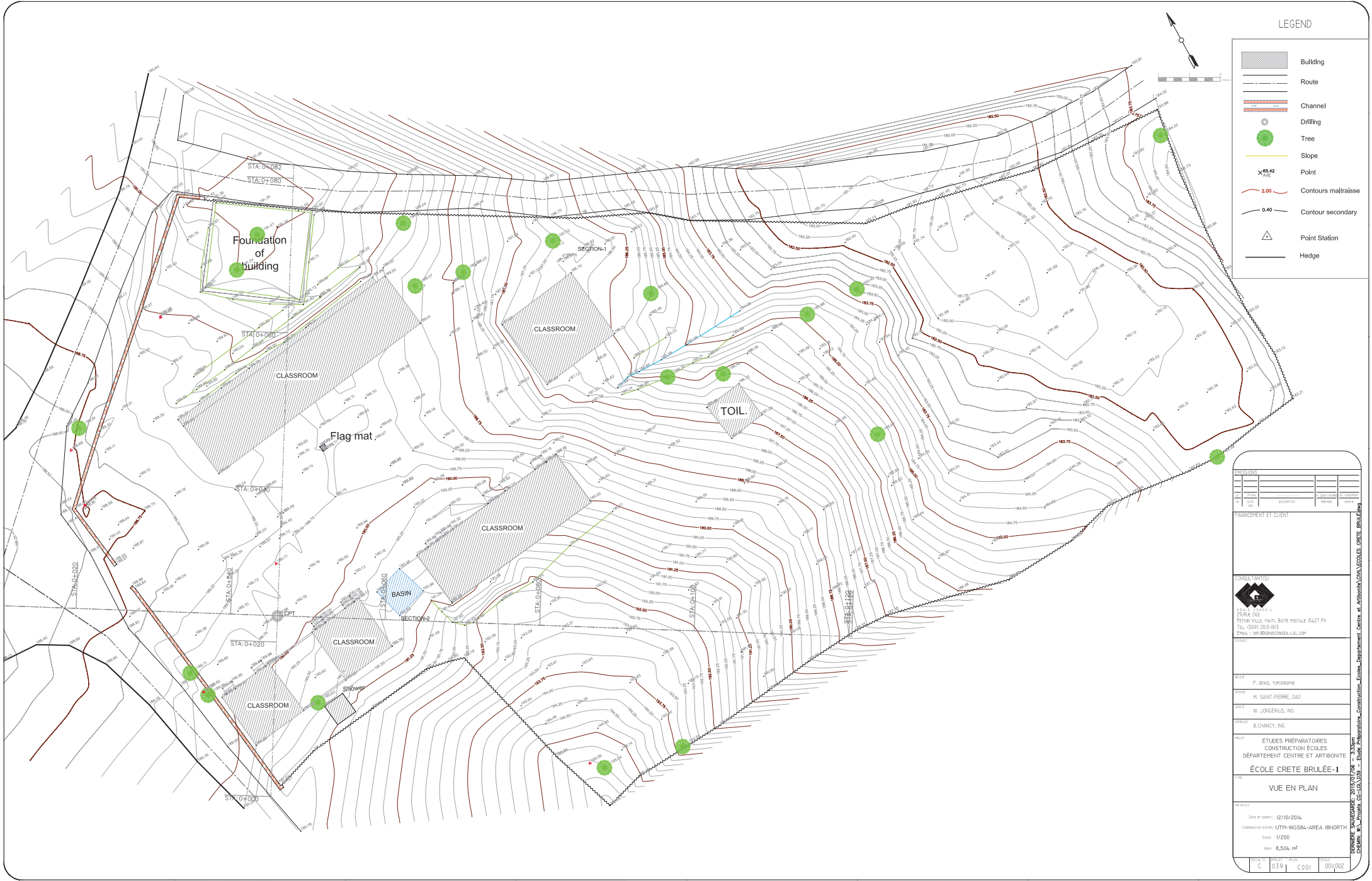

LEGEND

- Building
- Route
- Channel
- Drilling
- Slope
- Point
- 2.00 Contours maitrise
- 0.40 Contour secondary
- Point Station
- Hedge

PROJETS	
FINANCIER ET CLIENT	
CONSULTANTS	
1150 AVENUE 114 25 AVENUE ODE FORTIN VILLE, HATIL, SAINTE-ROSE (SAZ) PV TEL: (509) 2813-813 EMAIL: INFO@ETUDESCONSTRUCTIONECOLESCRETEBRULEE.COM	
PROJET	
PROJET	P. DENIS, TOROULAPPE
DESIGN	M. SAINT-PIERRE, DAO
PROJET	W. JOUGERIS, ING
PROJET	B. CHANDY, ING
PROJET	ÉTUDES PRÉPARATOIRES CONSTRUCTION ÉCOLES DÉPARTEMENT CENTRE ET ARTIBONITE
PROJET	ÉCOLE CRETE BRULÉE-1
PROJET	VUE EN PLAN
DATE OF SURVEY: 12/10/2014	
COORDINATION SYSTEM: UTM-WGS84-AREA 18NORT	
SCALE: 1/200	
AREA: 8,504 m²	
REV.	DATE
C	03/11/2014

PROJET: 2014/07/08 - ÉTUDES PRÉPARATOIRES CONSTRUCTION ÉCOLES DÉPARTEMENT CENTRE ET ARTIBONITE
 CHEMIN: 114, Projets - C-143, 039 - Étude Préparatoire Construction Écoles - Département Centre et Artibonite, Crête Brulée

A-6-2



LEGEND

	Building
	Route
	Channel
	Drilling
	Tree
	Slope
	Point
	Contours maltrésée
	Contour secondary
	Point Station
	Hedge

PROJECTIONS:

UTM	WGS84	Zone 18N	Projection	UTM	Zone
ETRS	89	Zone 18N	Projection	ETRS	Zone

FINANCIER ET CLIENT

CONSULTANTS

1150 RUE DE LA
 25 AV. OLE
 PENTON VILLE, MATH, SAINTE ROSALE 15A27 PV
 TEL: 257-1746, 257-8310, Fax 256-0759
 EMAIL: INFO@PRECONCELE.COM

PROJET:

CLIENT:

PROJET:

ÉTUDES PRÉPARATOIRE CONSTRUCTION
 ÉCOLES DÉPARTEMENT CENTRE ET
 ARTIBONITE

PROJET:

ÉCOLE TRIANON-3

VUE EN PLAN

DATE DE SUPPLÉMENT:

DATE OF SUPPLY: 12/04/2014

COORDINATION SYSTEM: UTM-WGS84-AREA 18NORT

SCALE: 1/200

AREA: 5,342 m²

REV.	PROJ.	DATE	FILE
C	039	C001	001/002

PROJET: 2014/07/08 - 13/12/14
 CHEMIN: \\s:\Projet\CG-163\039 - Ecole Préparatoire Construction - Ecoles - Département Centre et Artibonite\CG-163\039 - ÉCOLE TRIANON-3.dwg

A-6-3

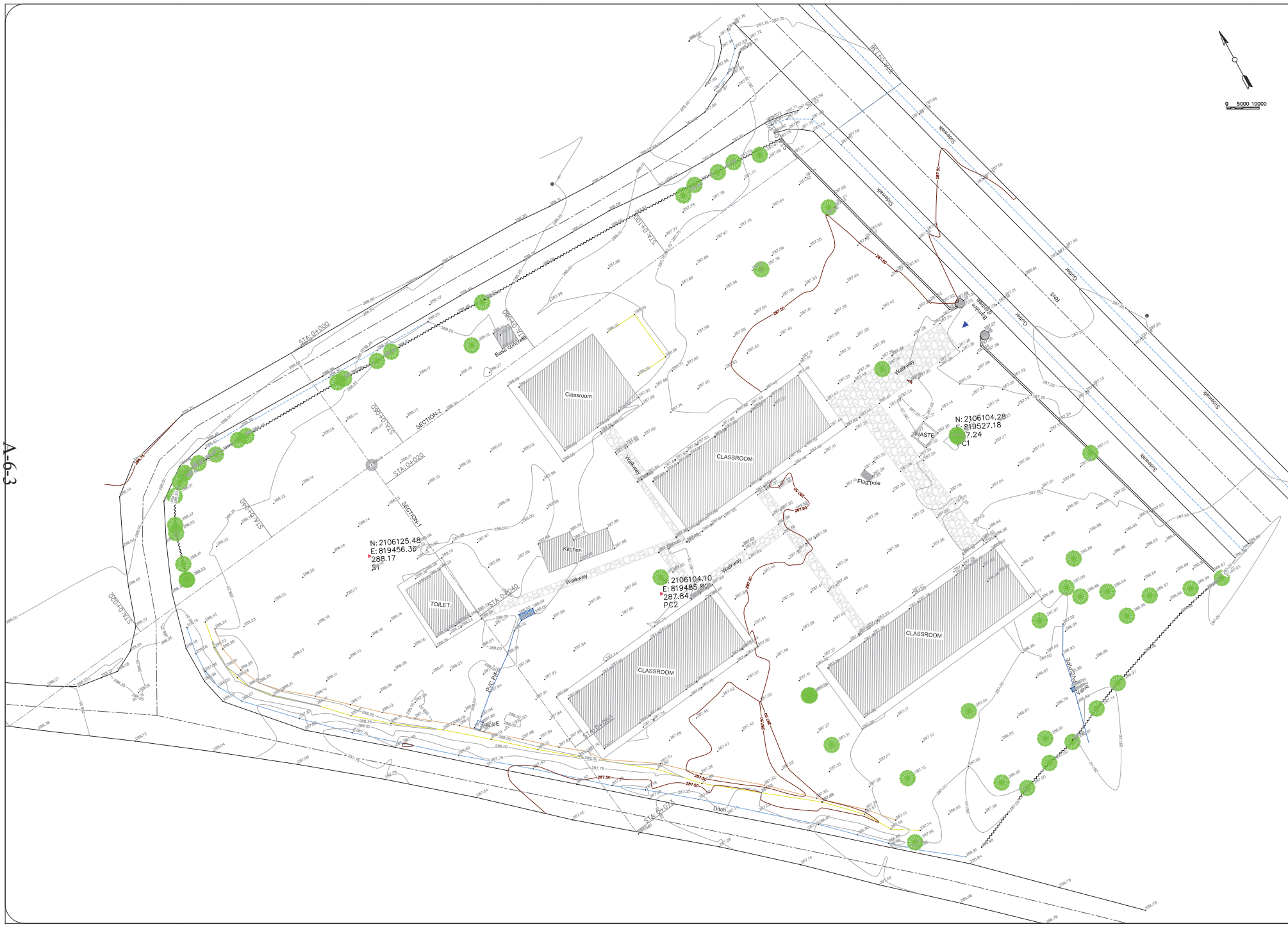

LEGEND

- Building
- Route
- Channel
- Drilling point
- Tree
- Slope
- Point elevation
- Contour major
- Contour secondary
- Bench Mark
- Hedge

PROJECTIONS

PROJET	DESCRIPTION	PROJET	VERIFICATION

FRANCAISE ET CLIENT

CONSULTANT(S)

ÉTUDES PRÉPARATOIRES
CONSTRUCTION ÉCOLES
DÉPARTEMENT CENTRE ET ARTIBONITE

ÉCOLE NLE
HENRY CHRISTOPHE-6

VUE EN PLAN

DATE	P. DENIS, TOPOGRAPHE
DESIGNÉ	M. SAINT-PIERRE, DAO
PROJETÉ	W. JONGÉRIUS, ING
APPROUVÉ	B. CHANZY, ING
PROJETÉ	ÉTUDES PRÉPARATOIRES CONSTRUCTION ÉCOLES DÉPARTEMENT CENTRE ET ARTIBONITE
PROJETÉ	ÉCOLE NLE HENRY CHRISTOPHE-6
PROJETÉ	VUE EN PLAN
DATE DE SURVEY	12/15/2014
COORDINATION SYSTEM	UTM-WGS84-AREA 18NORTH
SCALE	1/200
AREA	6,924 M ²
DATE	05/11/2015
DESIGNÉ	C 05/11/2015
PROJETÉ	C 001
APPROUVÉ	001/002

CONSULTANT(S) : B. CHANZY, ING. 20 RUE CALE, PITON VILLE, HAÏTI, BOITE POSTALE 15427 PV, TEL. (509) 2815-815, EMAIL : INFO@BCHANZY.COM, WWW.BCHANZY.COM
 PROJETÉ : ÉTUDES PRÉPARATOIRES, CONSTRUCTION ÉCOLES, DÉPARTEMENT CENTRE ET ARTIBONITE, ÉCOLE NLE HENRY CHRISTOPHE-6
 DATE DE SURVEY : 12/15/2014, COORDINATION SYSTEM : UTM-WGS84-AREA 18NORTH, SCALE : 1/200, AREA : 6,924 M², DATE : 05/11/2015, DESIGNED : C 05/11/2015, PROJECTED : C 001, APPROVED : 001/002

A-6-4

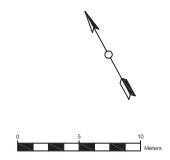
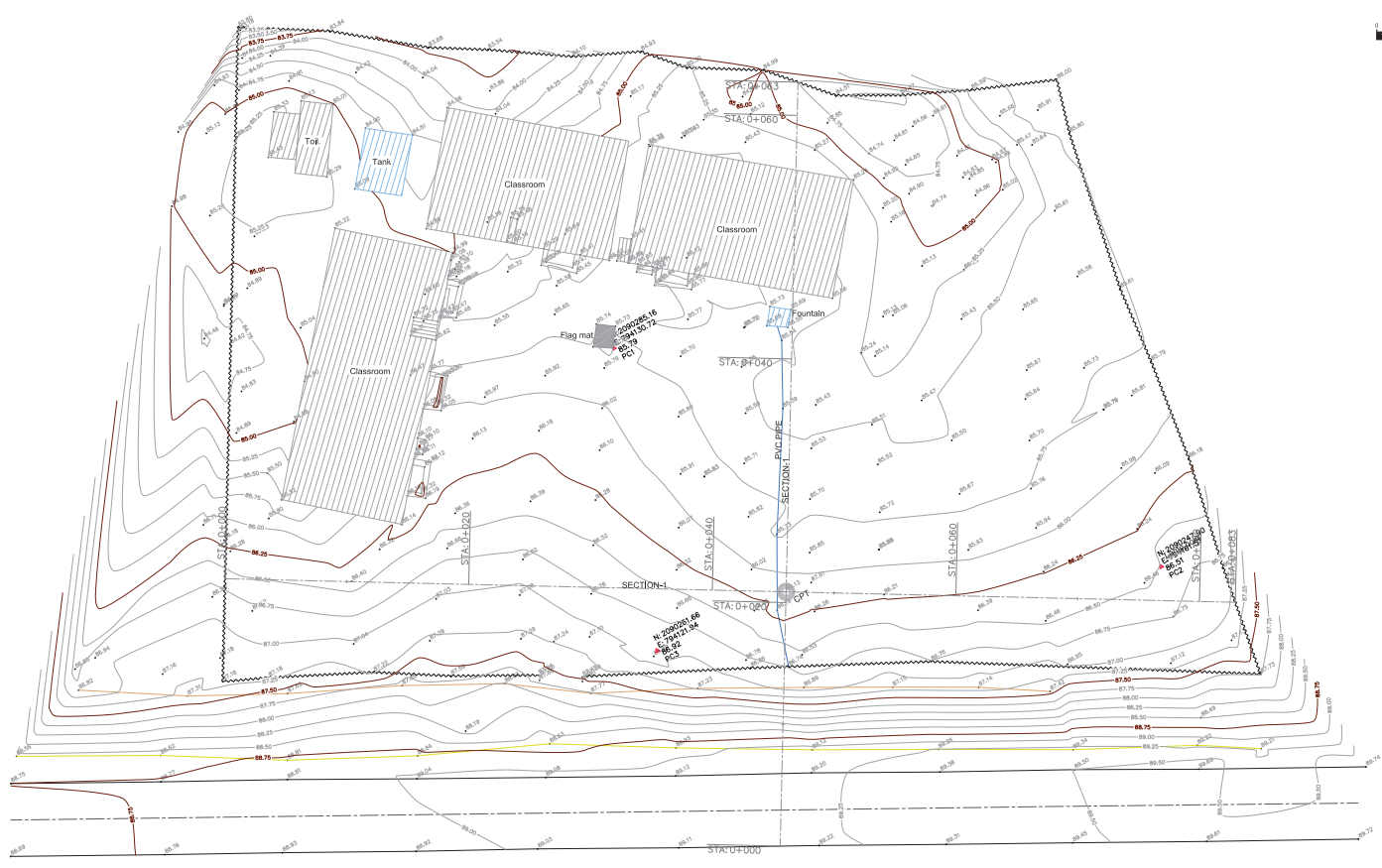

LEGEND

- Building
- Route
- Channel
- Drilling
- Tree
- Slope
- Point
- Contours maltrasse
- Contour secondary
- Point Station
- Hedge
- Valve
- PVC PIPE

PROJECTIONS	
FINANCEMENT ET CLIENT	
CONSULTANTS	
11, RUE DE LA ENRUE OUE PERONVILLE, HAUTS SAINTES-PROVINCIALES (S27) PV TEL: (506) 283-8813 EMAIL: INFO@INTECHCONSULTING.COM	
PROJET	
DESIGNER	P. DENIS, TOPOGRAPHE
DRAWN	M. SAINT-PIERRE, DAO
CHECKED	W. JOUGERIS, ING
APPROVED	B. CHANDY, ING
CLIENT	ÉTUDES PRÉPARATOIRES CONSTRUCTION ÉCOLES DÉPARTEMENT CENTRE ET ARTIBONITE ÉCOLE NLE DESTAINGVILLE-0
VUE EN PLAN	
DATE OF SURVEY: 12/04/2014	
COORDINATION SYSTEM: UTM-WGS84-AREA 18NORT	
SCALE: 1/200	
AREA: 3,782 M ²	

Dessiné par: 2014/07/20 14:30
 Projet: CC-14-039 - Ecole Préparatoire Construction Écoles - Département Centre et Artibonite

A-6-5

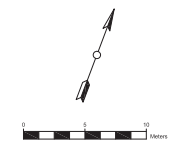
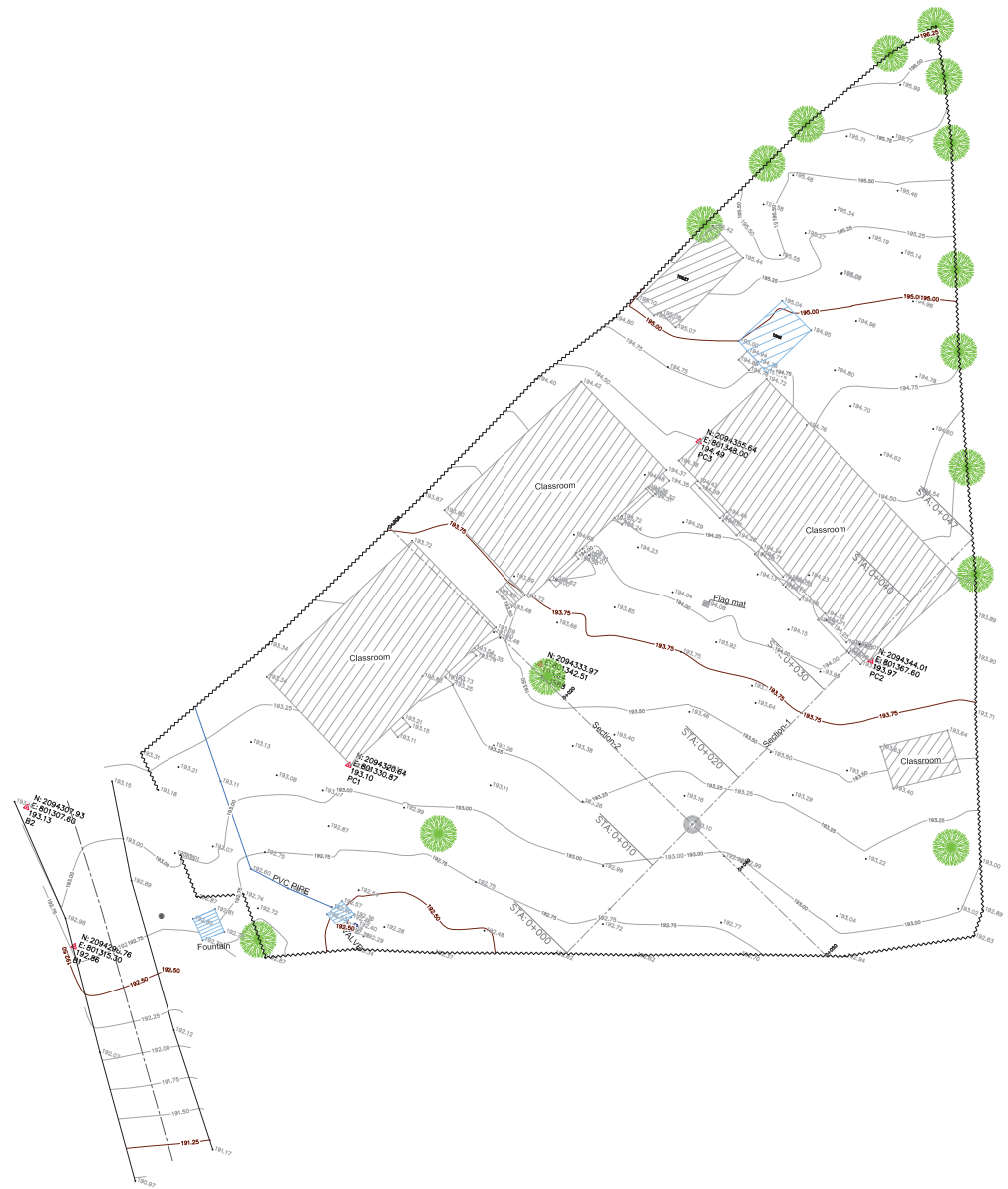

LEGEND

- Building
- Route
- Channel
- Drilling
- Tree
- Slope
- Point
- Contours matrisale
- Contour secondary
- Point Station
- Hedge
- Valve
- Conduite

PROJECTIONS

PROJ.	PROJ.	PROJ.	PROJ.	PROJ.	PROJ.

FINANCIER ET CLIENT

CONSULTANTS

1145
25 AV. OLE
PENTON VILLE, HATIL, SAINTE-ROSE (SA27 PV)
TEL. (509) 2813-813
EMAIL : INFO@INGENIERIE-LL.COM

PROJET

PROJÉTÉ P. DENIS, TOPOGRAPHE

DESIGNÉ M. SAINT-PIERRE, DAO

PROJÉTÉ W. JOYNERIS, ING

PROJÉTÉ B. CHANDY, ING

ÉTUDES PRÉPARATOIRES
CONSTRUCTION ÉCOLES
DÉPARTEMENT CENTRE ET ARTIBONITE
ÉCOLE NLE BOUCAN CARRÉ-10

VUE EN PLAN

DATE OF SUPPLY: 12/04/2014
COORDINATION SYSTEM: UTM-WGS84-AREA 18NORT
SCALE: 1/200
AREA: 3,457 M²

REV.	PROJ.	PROJ.	PROJ.
C	0.59	C.001	001/002

L'ÉCOLE NLE BOUCAN CARRÉ-10
 PROJETÉ PAR: P. DENIS, TOPOGRAPHE
 CHEMIN: "A", Projets, CC-103, 0399 - Étude Préliminaire, Construction, Écoles, Département, Centre et Artibonite, Boucan Carré-10

A-6-6

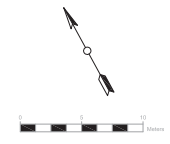
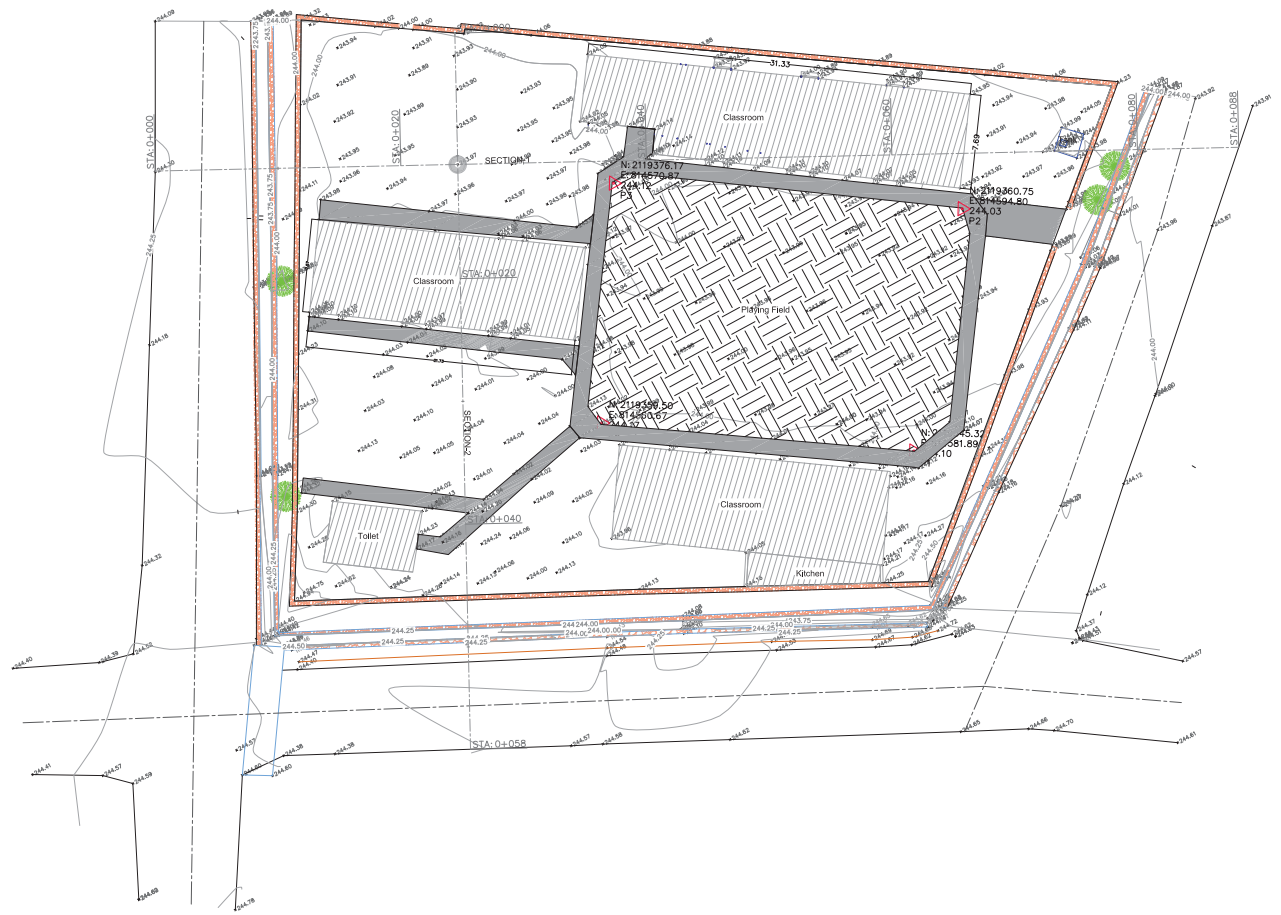

LEGEND

- Building
- Route
- Channel
- Drilling point
- Tree
- Point elevation
- Contours mayor
- Contour secondary
- Bench Mark
- Hedge
- Fence bloks
- Strip Concrete

PROJECTIONS

PROJ.	PROJ. N.	PROJ. E.	PROJ. S.	PROJ. O.

FINANCIER ET CLIENT

CONSULTANTS

B. CHANCY, INC.
 25 AV. ODE
 PENTON VILLE, HATIL, SAINTE-ROSE, HAÏTI
 TEL: (509) 283-8813
 EMAIL: INFO@BCHANCY.COM

PROJETS

PROJ. P: DENIS, TOROULAPHE
 PROJ. M: SAINT-PIERRE, DAO
 PROJ. W: JOUGERIS, INC
 PROJ. B: CHANCY, INC

PROJETS
 ÉTUDES PRÉPARATOIRES
 CONSTRUCTION ÉCOLES
 DÉPARTEMENT CENTRE ET ARTIBONITE
**ÉCOLE NLE IMMACULÉE
 CONCEPTION-11**

VUE EN PLAN

DATE OF SUPPLY: 12/15/2014
 COORDINATION SYSTEM: UTM-WGS84-AREA 18NORT
 SCALE: 1/200
 AREA: 2,595,207 m²

REV.	PROJ.	DATE	SCALE
C	0.39	C 001	001/002

PROJET: École Préparatoire - Construction - Écoles - Département Centre et Artibonite - Centre St. Armand - 01/17 - ÉCOLES IMMACULÉE - CONCEPTION-11
 PROJET: École Préparatoire - Construction - Écoles - Département Centre et Artibonite - Centre St. Armand - 01/17 - ÉCOLES IMMACULÉE - CONCEPTION-11
 PROJET: École Préparatoire - Construction - Écoles - Département Centre et Artibonite - Centre St. Armand - 01/17 - ÉCOLES IMMACULÉE - CONCEPTION-11

A-6-7



LEGEND

- Building
- Route
- Channel
- Drilling point
- Tree
- Slope
- Point elevation
- Contours mayor
- Contour secondary
- Point Station
- Hedge
- Fence blocs
- Strip Concrete

PROJETS

NO	DATE	DESCRIPTION	PROJETANT	APPRUE	DATE

FINANCIER ET CLIENT

CONSULTANTS

1150 RUE DE LA
 25 AV. ODE
 PENTON VILLE, HATIL, SAINTE-ROSE (SAZ72 PV)
 TEL. (509) 283-8813
 EMAIL: INFO@INTECONEX-LL.COM

PROJET: ÉTUDES PRÉPARATOIRES
 CONSTRUCTION ÉCOLES
 DÉPARTEMENT CENTRE ET ARTIBONITE
 ÉCOLE NLE
 TOUSSAINT LOUVERTURE-12
 VUE EN PLAN

DATE OF SUPPLY: 12/15/2014
 COORDINATION SYSTEM: UTM-WGS84-AREA 18NORT
 SCALE: 1/200
 AREA: 2,595,207 m²

REV.	PROJ.	PLAN.	DATE
C	039	C001	001/002

PROJETANT: TOUSSAINT LOUVERTURE INC. - 25 AV. ODE - PENTONVILLE, HATIL, SAINTE-ROSE (SAZ72 PV) - TEL. (509) 283-8813 - EMAIL: INFO@INTECONEX-LL.COM
 PROJETANT: TOUSSAINT LOUVERTURE INC. - 25 AV. ODE - PENTONVILLE, HATIL, SAINTE-ROSE (SAZ72 PV) - TEL. (509) 283-8813 - EMAIL: INFO@INTECONEX-LL.COM
 PROJETANT: TOUSSAINT LOUVERTURE INC. - 25 AV. ODE - PENTONVILLE, HATIL, SAINTE-ROSE (SAZ72 PV) - TEL. (509) 283-8813 - EMAIL: INFO@INTECONEX-LL.COM

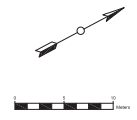
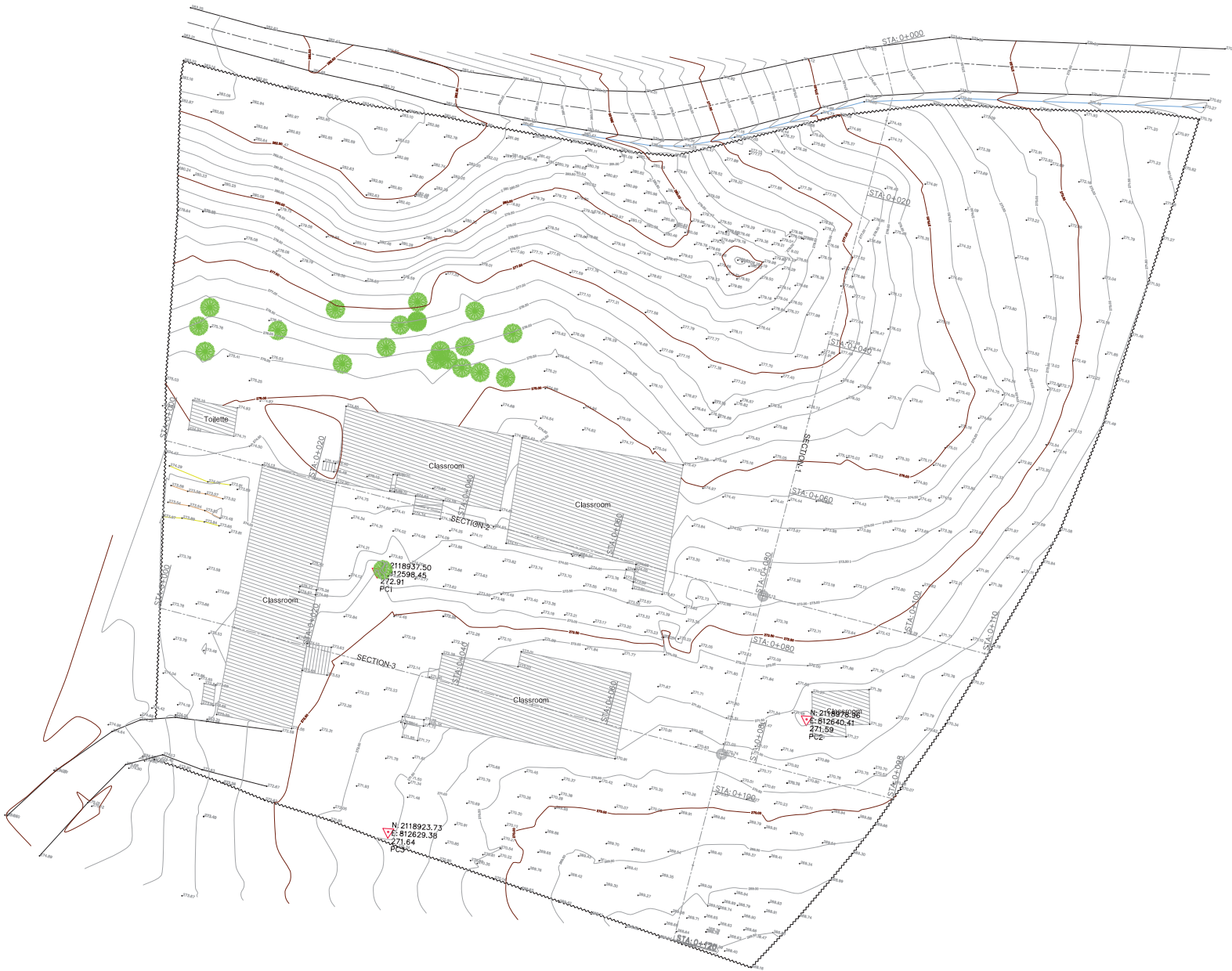

LEGEND	
	Building
	Route
	Channel
	Drilling point
	Tree
	Slope
	Point elevation
	Contours mayor
	Contour secondary
	Bench Mark
	Hedge

PROJECTIONS	
FINANCEMENT ET CLIENT	
CONSULTANTS	
 <p>ÉTUDES PRÉPARATOIRES CONSTRUCTION ÉCOLES DÉPARTEMENT CENTRE ET ARTIBONITE ÉCOLE NLE GUY MALARY-13</p>	
<p>13, RUE ODE PÉTON VILLE, HAÏTI, SAÏTE POSTALE 0427 PV TEL. (509) 2813-813 EMAIL : INFO@CONCELECOLE.COM</p>	
PROJÉ	
DESIN	P. DENIS, TOPOGRAPHE
DESIN	M. SAINT-PIERRE, DAO
DESIN	W. JOYNERUS, ING
DESIN	B. CHANCY, ING
PROJÉ	ÉTUDES PRÉPARATOIRES CONSTRUCTION ÉCOLES DÉPARTEMENT CENTRE ET ARTIBONITE ÉCOLE NLE GUY MALARY-13
VUE EN PLAN	
DATE OF SURVEY: 12/15/2014	
COORDINATION SYSTEM: UTM-WGS84-AREA 18NORT	
SCALE: 1/250	
AREA: 11,347 M ²	
REVISION	
C	039 C001 001/002

PROJET: École Préparatoire Construction Écoles - Département Centre et Artibonite - École NLE GUY MALARY-13
 CLIENT: M. A. Projets - CC-143-039 - École Préparatoire Construction Écoles - Département Centre et Artibonite - École NLE GUY MALARY-13

A-6-9



LEGEND

- Building
- Route
- Channel
- Drilling point
- Tree
- Slope
- Point elevation
- Contours mayor
- Contour secondary
- Bench Mark
- Hedge

PHYSICIENS			
NOM	PRENOM	DESIGNATION	N. PROFESSIONNEL

FINANCIER ET CLIENT

CONSULTANT(S)

ÉTUDES PRÉPARATOIRES
CONSTRUCTION ÉCOLES
DÉPARTEMENT CENTRE ET ARTIBONITE

ÉCOLE NLE MARMONT-14

VUE EN PLAN







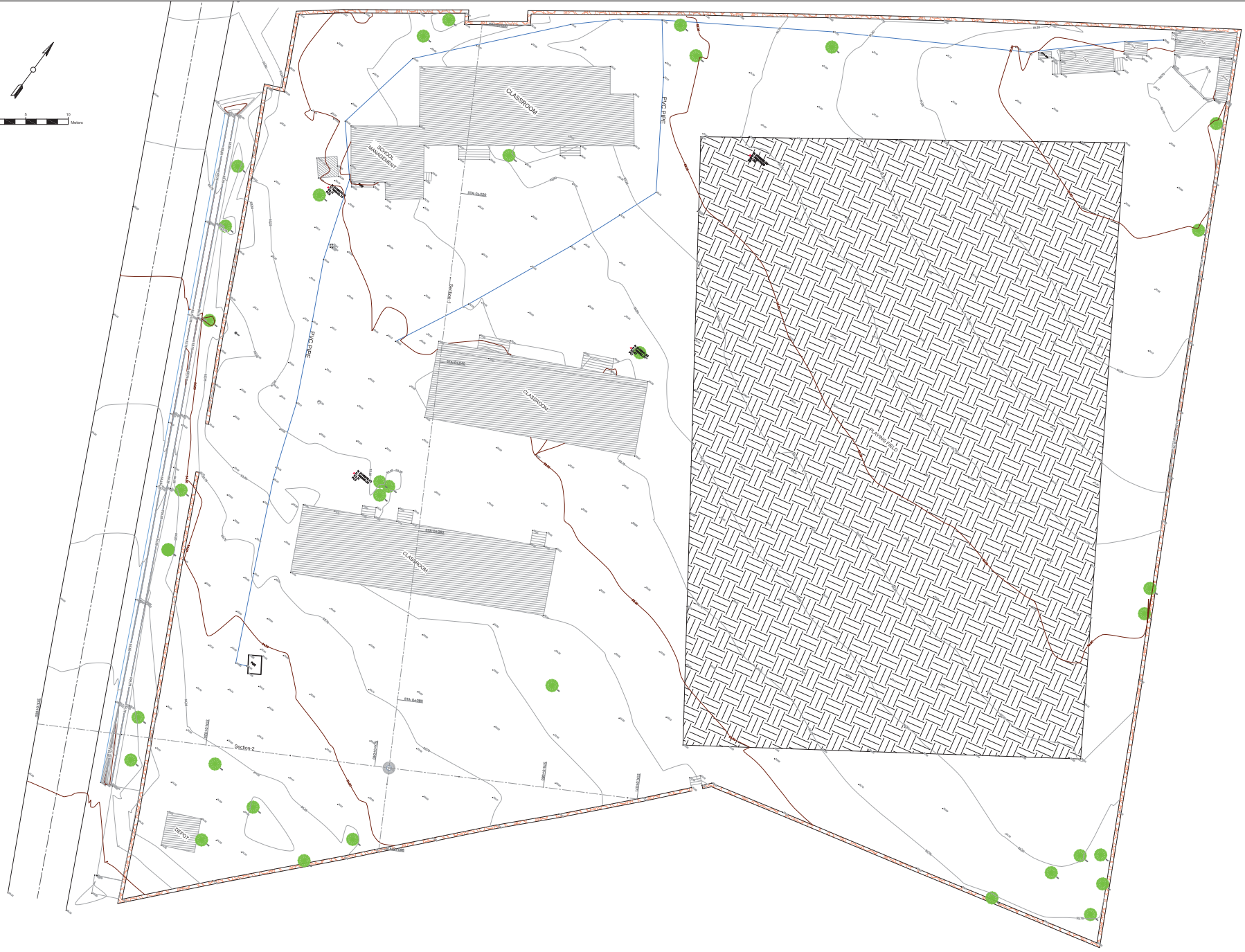
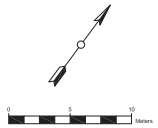





DATE DE SURVEY: 12/15/2014
COORDINATION SYSTEM: UTM-WGS84-AREA 18NOR
SCALE: 1/200
DESIGN: 4,145 HP

REVISED	DATE	BY	REASON
C	05/1	C001	001/002

GENÈVE: 2014/07/13
 CLIENT: "Projet CC-UC-039 - École Préparatoire Construction École Département Centre et Artibonite"



LEGEND

-  Building
-  Route
-  Channel
-  Drilling
-  Tree
-  Slope
-  Point
-  Contours maîtrise
-  Contour secondary
-  Point Station
-  Hedge
-  PVC PIPE

PROPOSÉ

NO	DESCRIPTION	DATE	STATUT

FINANCIER ET CLIENT

CONSULTANTS



11, rue de la
29 rue de
Rivonville, HÔTEL BOITE POSTALE 15427 PV
TEL: 257-1746, 257-8310, FAX 254-0739
EMAIL: INFO@ENCONSEIL.COM

DESIGN	F. DENIS, TOPOGRAPHE
DESSIN	M. SAINT-PIERRE, DAO
CHÉF	M. JONGERUS, ING
PROJETÉ	B. CHANCY, ING
PROJETÉ	ÉTUDES PRÉPARATOIRE CONSTRUCTION ÉCOLES DÉPARTEMENT CENTRE ET ARTIBONTE
PROJETÉ	ÉCOLE CHARLES BELAIR-18
VUE EN PLAN	

DATE OF DRAWING: 12/04/2016
COORDINATION SYSTEM: UTM-WGS84-AREA 18NORT
SCALE: 1/200
AREA: 11,300 M²

PROJETÉ	PROJETÉ	PROJETÉ	PROJETÉ
C	039	C001	001/002

A-6-11

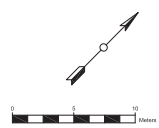

LEGEND

- Building
- Route
- Channel
- Drilling
- Tree
- Slope
- Point
- Contours maîtrise
- Contour secondary
- Point Station
- Hedge

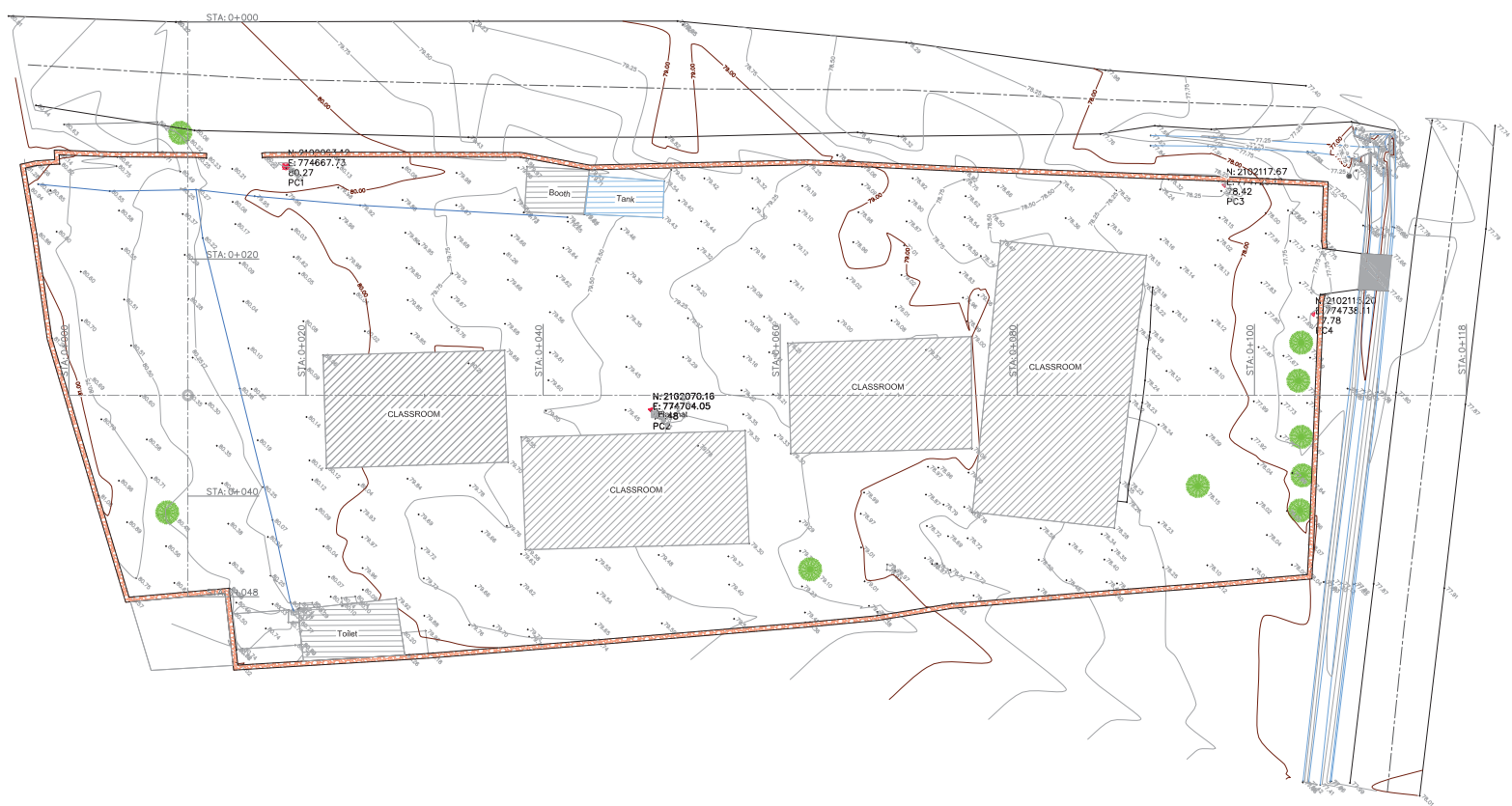

PROJECTIONS

PROJ.	PROJ. N.	PROJ. E.	PROJ. UTM	PROJ. LOCAL

FINANCIER ET CLIENT

CONSULTANTS

1150 RUE DE LA
2^E AV. OUE
PENTON VILLE, HATFIELD, QUÉBEC H2T 2P7
TEL. (514) 283-8813
EMAIL: INFO@INGENIEUR-LECLERCQ.COM

PROJ. :
 P. DENIS, TOPOGRAPHE
 DESSEIN :
 M. SAINT-PIERRE, DAO
 DÉSIGNÉ :
 W. JOUSSELYN, ING
 B. CHANDY, ING
 PROJET :
 ÉTUDES PRÉPARATOIRES
 CONSTRUCTION ÉCOLES
 DÉPARTEMENT CENTRE ET ARTIBONITE
 ÉCOLE NLE DESARMES-19

VUE EN PLAN

DATE DE SUPPLÉMENT : 12/04/2014
 COORDONNÉES SYSTEME : UTM-WGS84-AREA 18NORT
 ÉCHELLE : 1/200
 SURFACE : 4,122 M²

REV.	PROJ.	DATE	PROJ.
C	0.39	C.001	001/002

PROJET : ÉTUDES PRÉPARATOIRES CONSTRUCTION ÉCOLES DÉPARTEMENT CENTRE ET ARTIBONITE ÉCOLE NLE DESARMES-19
 CHEMIN : 1150 RUE DE LA 2^E AV. OUE PENTON VILLE, HATFIELD, QUÉBEC H2T 2P7
 TEL. : (514) 283-8813 EMAIL : INFO@INGENIEUR-LECLERCQ.COM

A-6-12

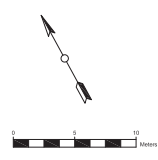

LEGEND

- Building
- Route
- Channel
- Drilling point
- Tree
- Skipe
- Point elevation
- Contours mayor
- Contour secondary
- Bench Mark
- Hedge

PROCESUS			
DATE	DESCRIPTION	PROJET	STATUT

FINANCEMENT ET CLIENT

CONSULTANT(S)

 3,13 RUE DE L'ÉLIE
 20 RUE LOUE
 PETIT VILLAGE, HAÏTI, BOITE POSTALE 15427 PV
 TEL. (509) 2813-813
 EMAIL: INFO@RENCONSEL.COM

RELEVÉ: P. DENIS, TOPOGRAPHE
 COORDONATEUR: M. SAINT-PIERRE, DAD
 DÉSIGNÉ: M. JONGERIS, ING
 APPROUVÉ: S. CHANCY, ING

PROJET: ÉTUDES PRÉPARATOIRES
 CONSTRUCTION ÉCOLES
 DÉPARTEMENT CENTRE ET ARTIBONITE
 ÉCOLE NLE COLLADERE-24

TITRE: VUE EN PLAN
 DATE DE SAISON: 12/04/2014
 COORDONATEUR SYSTEME: UTM-WGS84-AREA 18NORTH
 ÉCHELLE: 1/200
 SURFACE: 2,024 M²

DIRECTION GÉNÉRALE DES ÉTUDES ET DES PROJETS - ÉTUDES PRÉPARATOIRES - CONSTRUCTION ÉCOLES - DÉPARTEMENT CENTRE ET ARTIBONITE - HAÏTI
 CHIMIN, M. V. Projet: CE-15-039 - ÉTUDES PRÉPARATOIRES - CONSTRUCTION ÉCOLES - DÉPARTEMENT CENTRE ET ARTIBONITE - HAÏTI

A-6-13

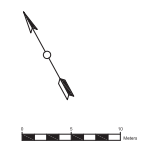
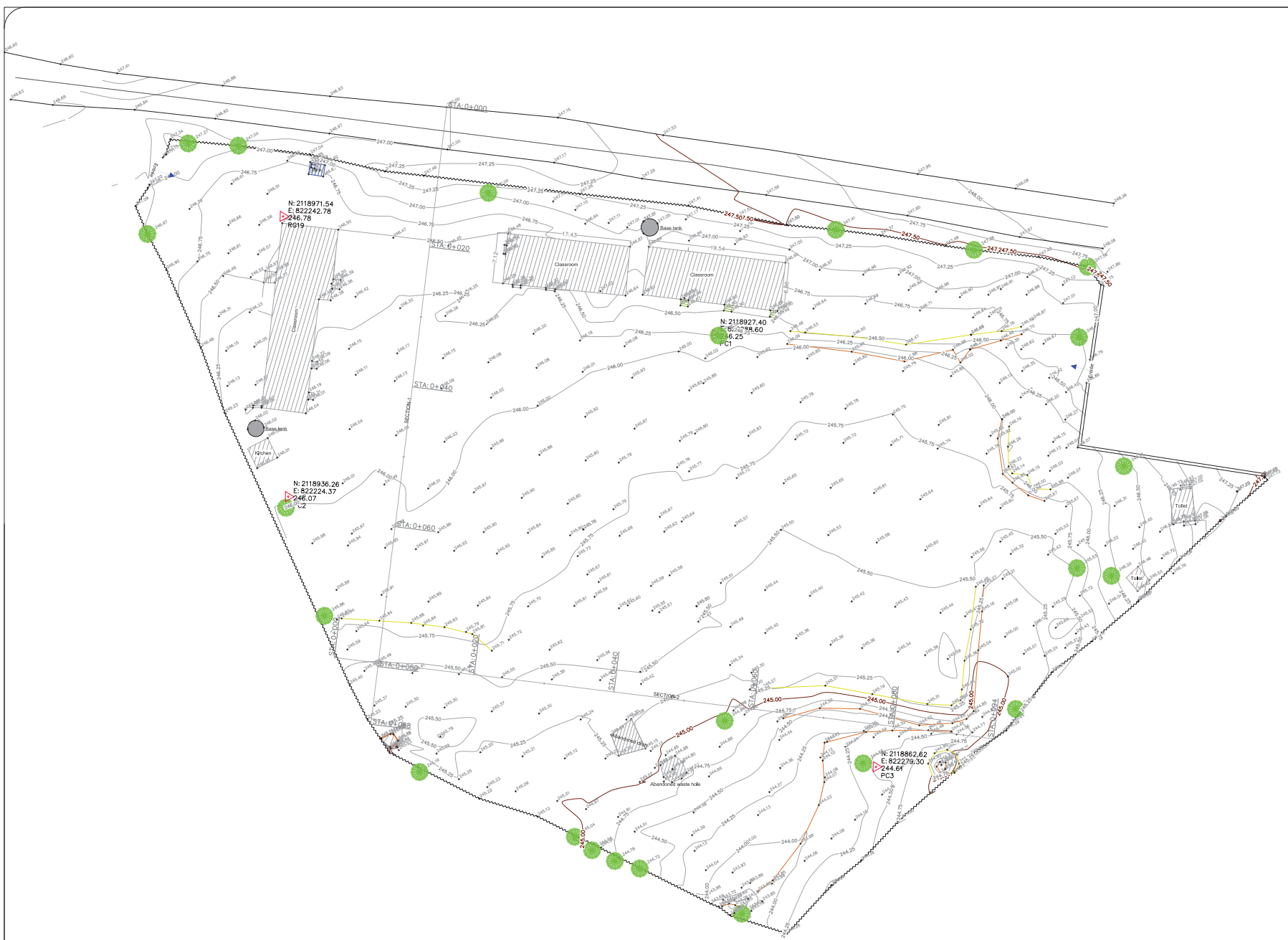

LEGEND

- Building
- Route
- Channel
- Drilling
- Tree
- Slope
- Point
- Contours maitrisse
- Contour secondary
- Point Station
- Hedge
- Fence bloks
- Strip Concrete

PRODIGES	
N°	DATE

FINANCEMENT ET CLIENT

CONSULTANTS

 15, rue de la République
 29 Rue Dige
 REGION MAIRIE HALTE, BOITE POSTALE 15427 PV
 TEL: (591) 2815-813
 EMAIL: INFO@DMCQUEBEC.COM

PROJ1: ETUDES PREPARATOIRES
 CONSTRUCTION ÉCOLES
 DÉPARTEMENT CENTRE ET ARTIBONITE
 ÉCOLE LOS PALIS-25

VUE EN PLAN

DATE DE SUPPL: 12/04/2016
 COORDINATION SYSTEM: UTM-WGS84-AREA 18NORTH
 SCALE: 1/200
 AREA: 10,588 H²

PROJET	PROJET	PROJET	PROJET
C	039	C001	001/002

RÉVISIONS: 01/12/2016 13 - 01/12/2016
 CHANGEMENTS: 01/12/2016 13 - 01/12/2016
 CHANGEMENTS: 01/12/2016 13 - 01/12/2016
 CHANGEMENTS: 01/12/2016 13 - 01/12/2016

7. 対象校地盤・地質調査結果



**Complementary report thirteen Schools in *Centre* and *Artibonite*
Departments
20150323-KHV**

March 23, 2015

NOTATIONS AND SYMBOLS

Unless otherwise indicated, the following terminology and symbols and their definitions, shall be used throughout this report.

- B : width (m or in);
- D : depth (m or ft.);
- FS : Safety factor
- g : acceleration due to gravity (m/s^2);
- L : length (m or in);
- N : standard penetration test blowcount (N-value) from the field (blows/0.3 m);
- N_{60} : N-value normalized to 60% energy efficiency (blows/0.3 m);
- $(N_1)_{60}$: N-value normalized to 60% energy and 100 kPa effective vertical stress (blows/0.3 m);
- PI : penetration index (in mm/blow);
- q_{adm} : allowable bearing pressure on foundations (kPa or bar);
- q_{ser} : applied service bearing pressure on the soil (kPa or bar);

INTRODUCTION

As part of the construction of thirteen (13) schools in *Centre* and *Artibonite* departments, the Geosciences Research Unit (URGéo) of the Faculty of Sciences (FDS) was assigned by SGC SA, represented by Mr. Bernard Chancy, to complete the geotechnical report (reference 2014-1103) submitted by the firm IMSRN within the framework of the construction of the above-mentioned schools.

Purpose and scope of this report

This report aims to provide the admissible stress at different levels below the foundation and had no claim to cancel the previous report. The attention of the client is drawn on the fact that all the assumptions stated in the previous report, including geotechnical recommendations and conditions of validity of the results remain unchanged.

Basic study data and assumptions

For this study, our main reference is the geotechnical report for the 13 schools submitted to our Unit. Beside the number of levels and the approximate area, no information on the projected building was available at the time of preparation of this report. However, it is our understanding that they will be built in reinforced concrete.

The following table summarizes the type of test made on each site and the depth of investigation reached by the test.

SITE N°	DESIGNATION	NO OF STORY	TYPE OF TEST	DEPTH OF INVESTIGATION
1	École nationale de Crête-Brûlée, Mirebelais	1	DCP	3.0 m
3	École nationale de Trianon, Mirebelais	1	DCP	3.0 m
6	École nationale d'Henry Christophe, Thomonde	3	DCP	3.0 m
9	École nationale de Destaingville, Saut d'Eau	1	DCP	3.0 m
10	école nationale de boucan carre, boucan carre	3	SPT	10.7 m
11	École nationale d'Immaculée Conception, Hinche	3	SPT	7.5 m
12	École nationale de Toussaint Louverture, Hinche	2	SPT	5.3 m
13	École nationale de Guy Malary, Hinche	3	SPT	10.7 m
14	École nationale de Marmont, Hinche	1	DCP	3.0 m
18	École nationale de Charles Belair, Verrettes	3	SPT	2.1 m

SITE N°	DESIGNATION	NO OF STORY	TYPE OF TEST	DEPTH OF INVESTIGATION
19	École nationale de Desarmes, Verrettes	3	SPT	10.7 m
24	École nationale de Colladere, Hinche	1	DCP	3.0 m
25	École nationale de Los Palis, Hinche	1	DCP	3.0 m

Table 1. Summary of the tests undertake on each site

The results of the Dynamic Cone Penetrometer Trest (DCPT) rise some questions. The first one concern the N values. We assume that the N given is the number of blows requires to draw the string of rods to a certain level. Based on that assumption, we wondering if some coefficients were applied to the N value of DPT. Indeed, where whole number is expected for N, value with decimal number were given. In the following, the N value will be round to the nearest integer. In addition (we come to our second concern), the depth of each tests is relatively straightforward (1.0, 2.0 and 3.0 m) which let presume (this information was not specified in the report) that the DCPT was made in the bottom of a previously made borehole. Thus, the test cannot be taken as continuous nor the N value as cumulative.

In the other hand, according to Salgado and Yoon (2003)¹, the penetration index PI is equal to the ratio of penetration depth to the blow counts corresponding to this penetration. Therefore, if N is the blow counts, by its very own definition, the corresponding plastic set is equal the penetration index times N. However, the assumption of N being the blow counts of the DCPT test leads to resistances, evaluate using the dynamic driving formula, that are completely unrealistic. At the end, **it seems reasonable to think that those “N value” are in fact equivalent N SPT, deduced from a correlation** that was unfortunately not given.

BEARING CAPACITY BASED ON SPT

The evaluation of the admissible stress based on the results of standard penetration test (SPT) will be made by using the empirical formula suggested by MEYERHOF (1969). This formula, based on the assumption of a uniform settlement less than 25 mm, used the depth of embedment of the footing:

$$q_a = \begin{cases} 12N_{60}k_d & \text{for } B \leq 1.2 \text{ m} \\ 8N_{60} \left[\frac{B + 0.305}{B} \right]^2 k_d & \text{for } B > 1.2 \text{ m} \end{cases}$$

¹ Salgado, R. & Yoon, S. 2003. Dynamic cone penetration test (DCPT) for subgrade assessment. Report No. FHWA/IN/JTRP-2002/30.

Where:

q_{adm} is the admissible stress express in kN/m^2 ;

k_d a coefficient defined by $k_d = 1 + 0.33 \times \frac{D}{B} \leq 1.33$, with a limited value of 1.33;

and N the normalized SPT value, average of the SPT value around the depth of embedment of the foundation.

Thus, considering the Meyerhof formula, the variation of the admissible stress with the width of the footing B and for different depth of embedment are reported in the figure #1 to #6 (Appendix B).

BEARING CAPACITY BASED ON DCP TEST

The allowable stress is derived from the dynamic driving resistance q_d , calculated using the Dutch formula. The latter is based on energy balance between the kinetic energy of the ram at impact and the plastic deformation energy of the soil around the pile. Let M denote the mass of the striking hammer, P the total passive mass, v the speed of the mass at impact, A cone tip area and e the plastic set. The Dutch formula give the dynamic resistance writing as follow:

$$q_d = \frac{1}{A} \frac{\frac{1}{2} M v^2}{e} \frac{M}{M + P} \quad (1.1)$$

In the case of shallow foundation embedded in sand or clay, the allowable stress is obtained by applying to the dynamic driving resistance a safety factor (SF) of 20.

The following table resume the characteristic of the dynamic penetrometer as given in the manual submitted:

FREE FALL	VELOCITY AT IMPACT	CONE TIP DIAMETER	CONE TIP AREA	DROP WEIGHT
508 mm (20 po)	3.16 m/s	38.1 mm (1½ po)	1140 mm ²	6.81 kg (15 lbs)

Table 2. Characteristics of the dynamic cone penetrometer

However, the mass of each rod (used in the calculation of the passive mass) was not given in the manual. They were estimated by supposing the rods are made of steel and have a diameter of 1-3/8".

SITE NO	POINT NO	DEPTH (M)	N VALUE ROUNDED (-)	PI (MM/BLOW)	q _d (MPa)	q _a (MPa)
1	1	1.0	10	0.21	51.4	2.57
	2	2.0	6	0.30	27.7	1.39
	3	3.0	13	0.17	39.8	1.99
3	3A-1	1.0	5	0.45	24.0	1.20
	3A-2	2.0	7	0.38	21.9	1.09
	3A-3	3.0	10	0.16	42.3	2.11
	3B-1	1.0	3	0.64	16.9	0.84
	3B-2	2.0	5	0.43	19.3	0.97
	3B-3	3.0	10	0.34	19.9	0.99
6	1	1.0	11	0.20	54.0	2.70
	2	2.0	8	0.25	33.3	1.66
	3	3.0	6	0.32	21.1	1.06
9	1	1.0	6	0.64	16.9	0.84
	2	2.0	21	0.14	59.4	2.97
14	1	1.0	12	0.16	67.4	3.37
	2	2.0	4	0.54	15.4	0.77
24	1	1.0	1	1.85	5.8	0.29
	2	2.0	4	1.04	8.0	0.40
	3	3.0	4	0.87	7.8	0.39
25	1	1.0	5	0.39	27.7	1.38
	2	2.0	10	0.23	36.2	1.81
	3	3.0	8	0.24	28.2	1.41

Table 3. Admissible stress in DCP tests at the different penetration levels

As show in Table 3, the assumption of N being the number of blows in the DCP test leads to resistances that are completely unrealistic. It seems reasonable to think that those “N value” are in fact equivalent N SPT, deduced from a correlation. Taking into account this hypothesis, the Meyerhof (1960) formula could also be used, just as before, to evaluate the allowable stress at different level from the DCP test. The figures #7 to #14 (Appendix C) resume the calculation

undertake.

At the request of the client, for each site, a distribution of the allowable bearing capacity was given up to 5.0 m depth, with a regular increment of 0.5 m. See Appendix A. Noted that the bearing capacity, estimating using the Meyerhof (1969) formula, takes into account the dimensions of the footing. Therefore, a rough estimation of the footing's width is needed in order to fill the submitted table. For this purpose, the width of the footing is estimating as follows: assuming an uniform service load of 10.0 kN/m² distributed over an area of 50 m² (corresponding to an average column spacing around 7 m), the total load by column and by floor worth 500 kN. For two (2) and three (3) stories buildings, one can found a load of 1000 kN and 1500 kN respectively. However, if the actual load reporting to the footings is very different from the estimation, the calculation should be retaken accordingly. In addition, the reader should also bear in mind that the very large width observe in some case simply means that a different solution of foundation (e.g. raft foundation, substitution of the weak soil, etc.) should be considered.

VALIDITY OF RESULTS

Stratigraphic variations on the site, both horizontal and vertical, may exist. Therefore, any extrapolation of data to the entire site involves certain risks. The results set out in this report should not be generalized without further study.

Prepared by



Karl Henry VICTOR, Ing.
khvictor9@gmail.com

Approved by



Dominique BOISSON, Dr.-Ing.
dmboisson@yahoo.com

APPENDIX A – TABLE FOR ALLOWABLE BEARING CAPACITY

Table for Allowable Bearing Capacity (kN/m²)

School No.	1	3		6	9	10	11	12	13		14	18	19	24	25
Test	CPT	CPT1	CPT2	CPT	CPT	SPT	SPT	SPT	SPT1	SPT2	CPT	SPT	SPT	CPT	CPT
Foundation Structure	Isolated	Isolated		Isolated	Isolated	Isolated	Isolated	Isolated	Isolated		Isolated	Isolated	Isolated	Isolated	Isolated
Wall	Reinforced Concrete														
Building Area(m ²)	Concrete Block														
Total Area(m ²)	250	250		290	250	290	180	640	620		250	290	180	250	250
Story	1	1		3	1	3	3	2	3		1	3	3	1	1
Depth(m)	Allowable Bearing Capacity (kN/m ²)														
-															
0.50	-														
1.00	119.3	57.8	32.7	106.4	91.7	57.5	76.4	59.5	112.7	56.2	126.2	100.0	70.1	10.1	63.2
1.50	101.7	73.6	45.8	84.9	300.0	56.3	64.9	56.1	174.6	158.3	87.8	311.3	102.9	27.5	101.9
2.00	80.9	90.7	60.0	82.4	340.6	54.9	52.4	52.1	244.6	267.2	45.8	553.6	137.6	45.8	143.3
2.50	131.1	114.9	94.1	74.2	[-]	47.9	63.0	74.7	279.8	178.8	[-]	[-]	103.2	47.7	129.0
3.00	179.3	135.2	130.0	65.5		40.0	68.4	98.9	307.1	92.5			60.4	49.7	114.6
3.50	[-]	[-]	[-]	[-]		41.2	70.5	210.6	298.9	74.0			68.5	[-]	[-]
4.00						53.6	72.5	306.4	292.1	62.9			54.4		
4.50						62.5	208.9	477.4	319.4	78.9			55.8		
5.00						63.9	350.0	638.3	348.1	94.3			53.9		

B=2.2 m B=2.9 m B=2.9 m B=4.8 m B=1.3 m B=6.1 m B=4.7 m B=3.2 m B=2.3 m B=4.0 m B=3.3 m B=2.2 m B=5.0 m B=3.3 m B=1.9 m

[-] depth of investigation reach

NOTES. Noted that the bearing capacity, estimating using the Meyerhof (1969) formula, takes into account the dimensions of the footing. Therefore, a rough estimation of the footing's width is needed in order to fill the submitted table. For this purpose, the width of the footing is estimating as follows: assuming an uniform service load of 10.0 kN/sq. m distributed over an area of 50 sq. m (corresponding to an average column spacing around 7 m), the total load by column and by floor worth 500 kN. For two (2) and three (3) stories buildings, one can found a load of 1000 kN and 1500 kN respectively. However, if the actual load reporting to the footings is very different from the estimation, the calculation should be retaken accordingly. In addition, the reader should also bear in mind that the very large width observe in some case simply means that a different solution of foundation (e.g. raft foundation, substitution of the weak soil, etc.) should be considered.

Appendix B – Tables for allowable bearing capacity Meyerhoff 01-06

VARIATION OF THE ADMISSIBLE STRESS WITH THE WIDTH OF THE FOOTING B AND FOR DIFFERENT DEPTH OF EMBEDMENT

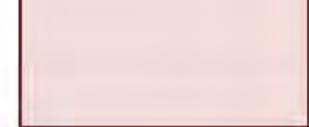
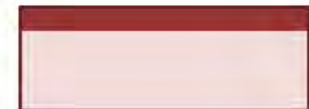
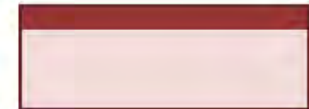
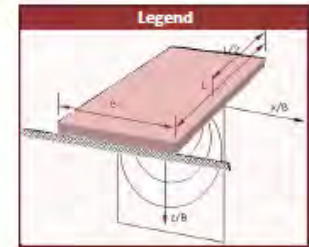
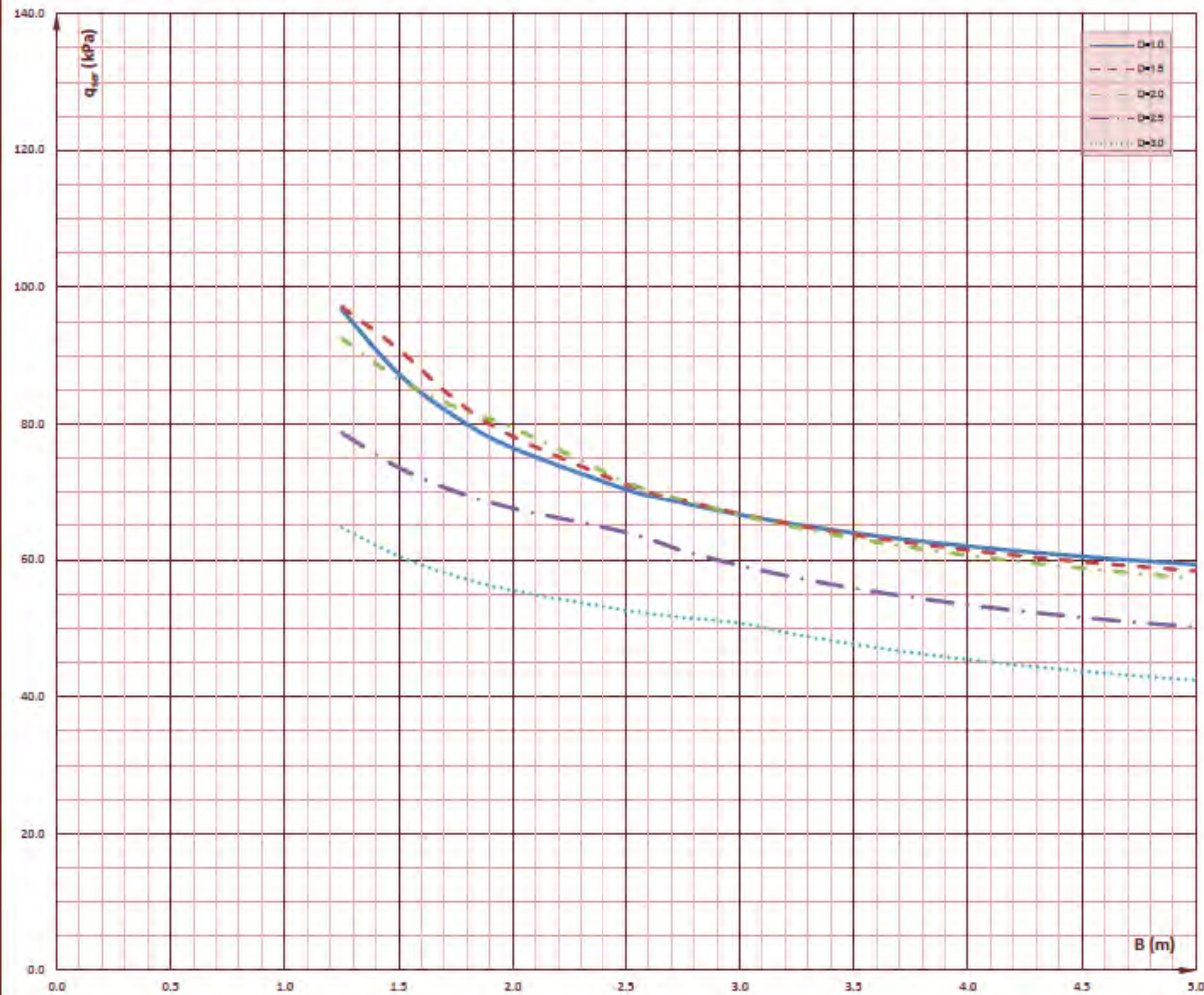

VARIATION OF THE ADMISSIBLE STRESS WITH THE WIDTH OF THE FOOTING B AND FOR DIFFERENT DEPTH OF EMBEDMENT

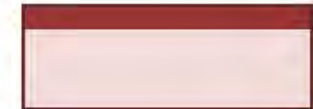
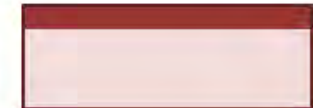
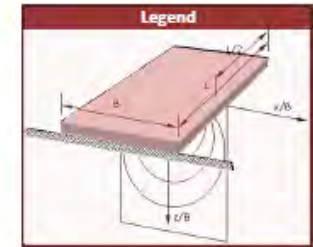
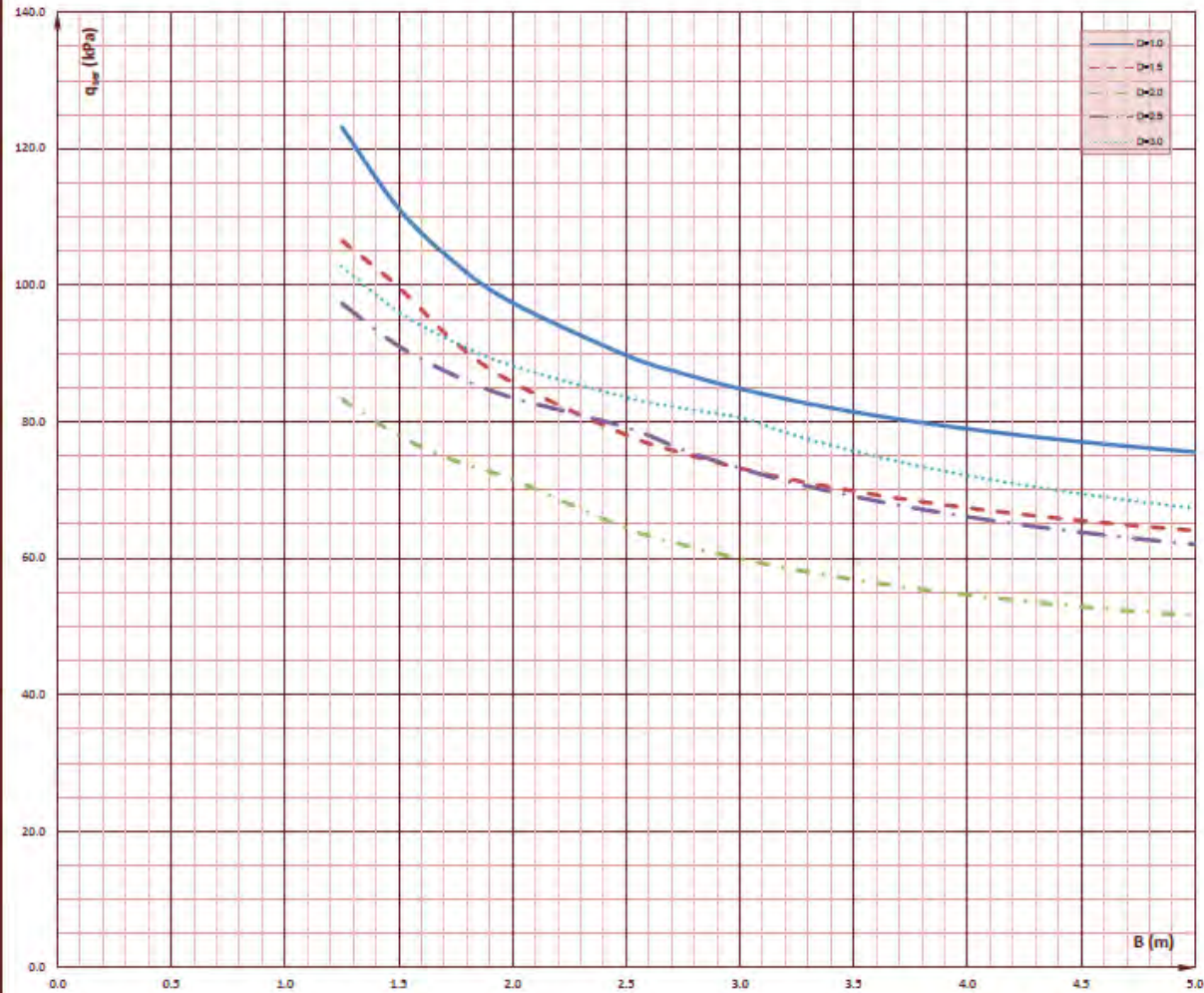

VARIATION OF THE ADMISSIBLE STRESS WITH THE WIDTH OF THE FOOTING B AND FOR DIFFERENT DEPTH OF EMBEDMENT

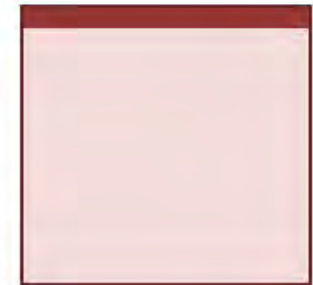
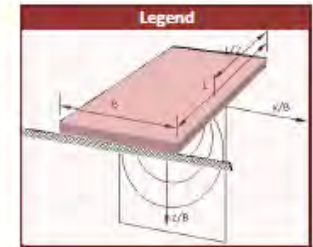
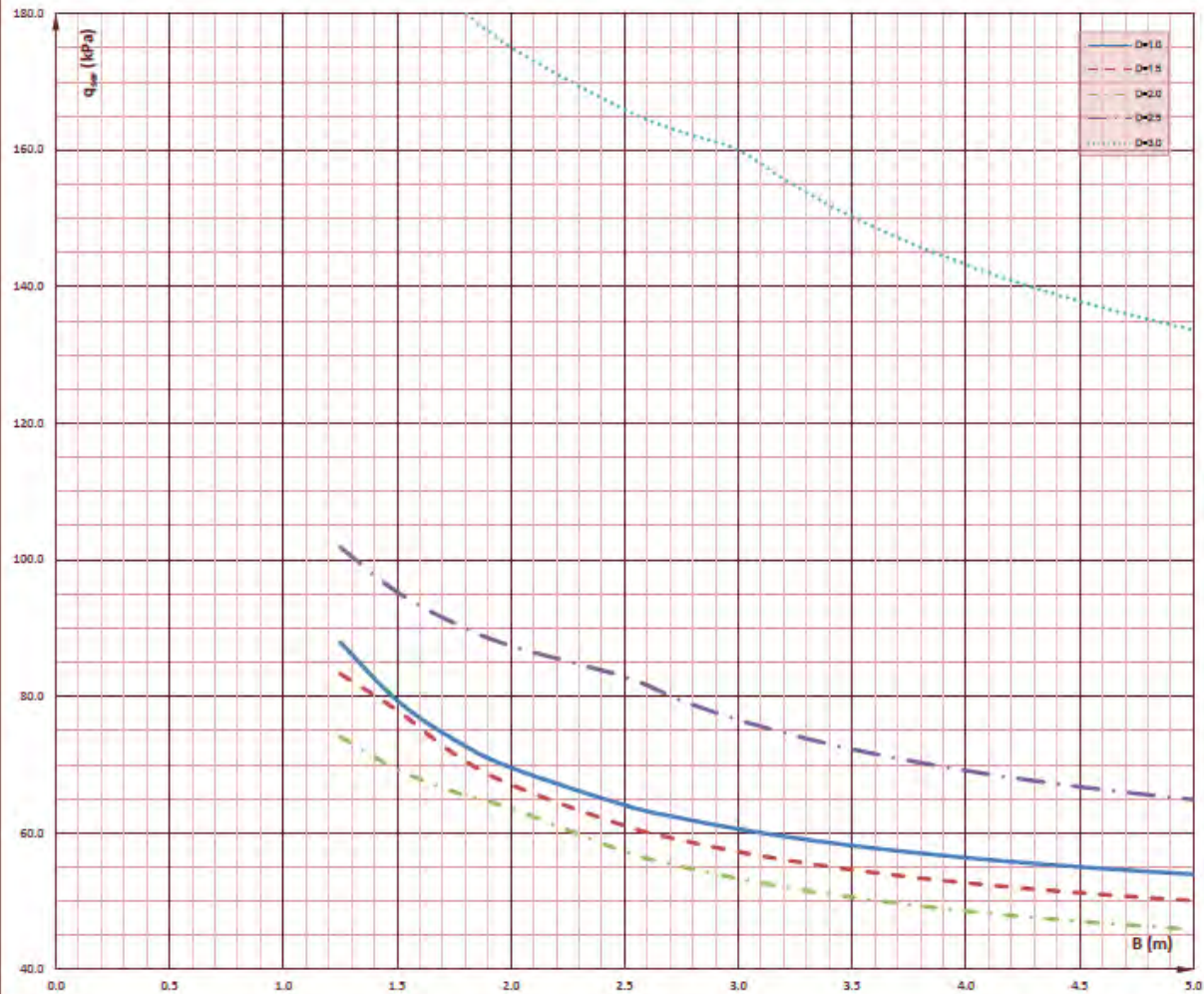

VARIATION OF THE ADMISSIBLE STRESS WITH THE WIDTH OF THE FOOTING B AND FOR DIFFERENT DEPTH OF EMBEDMENT

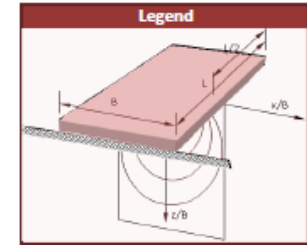
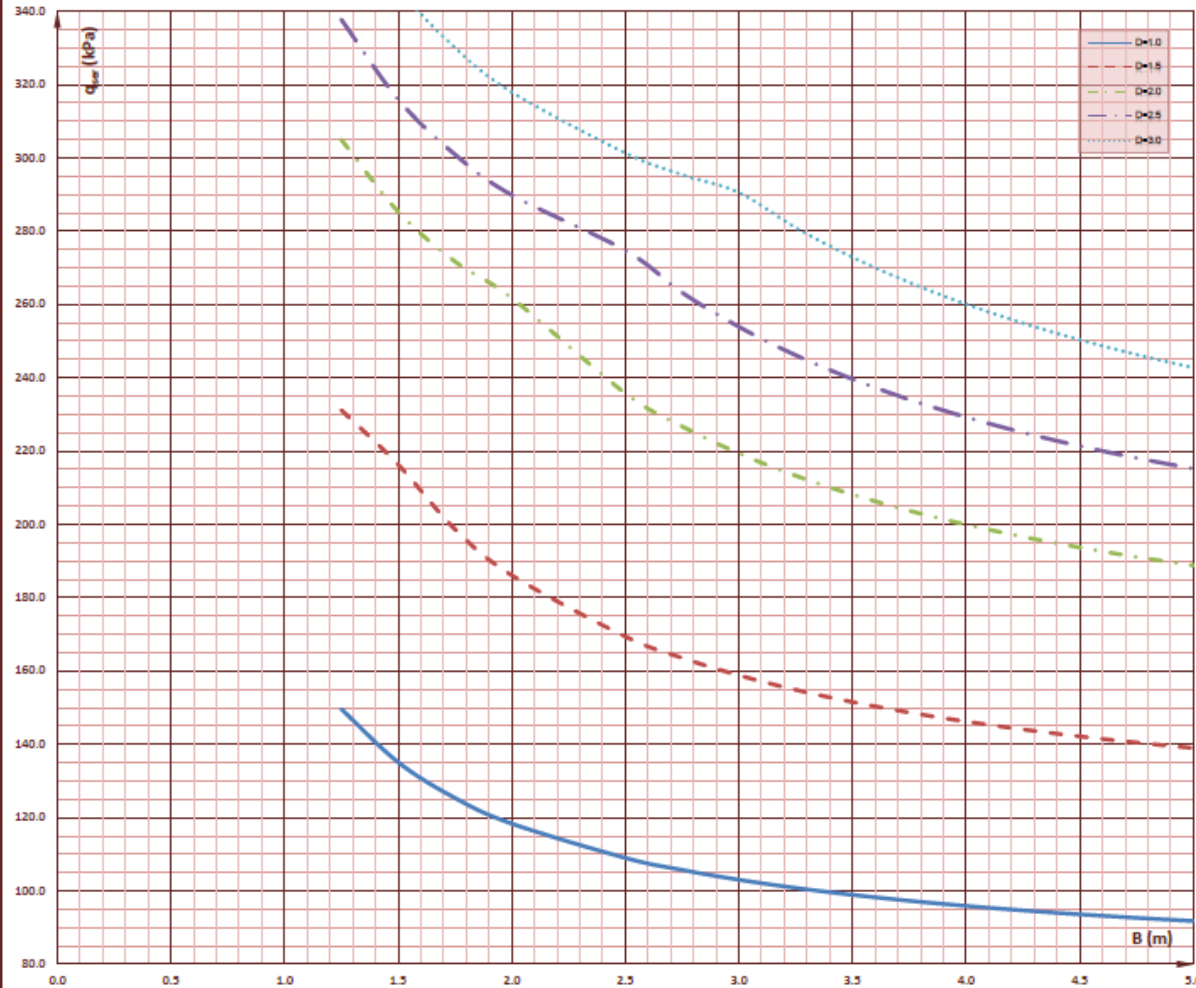

A-7-14

VARIATION OF THE ADMISSIBLE STRESS WITH THE WIDTH OF THE FOOTING B AND FOR DIFFERENT DEPTH OF EMBEDMENT

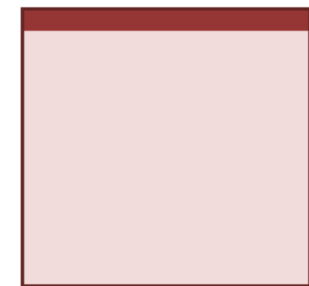
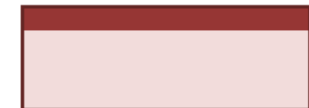
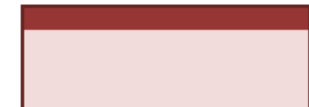
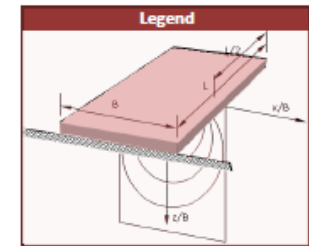
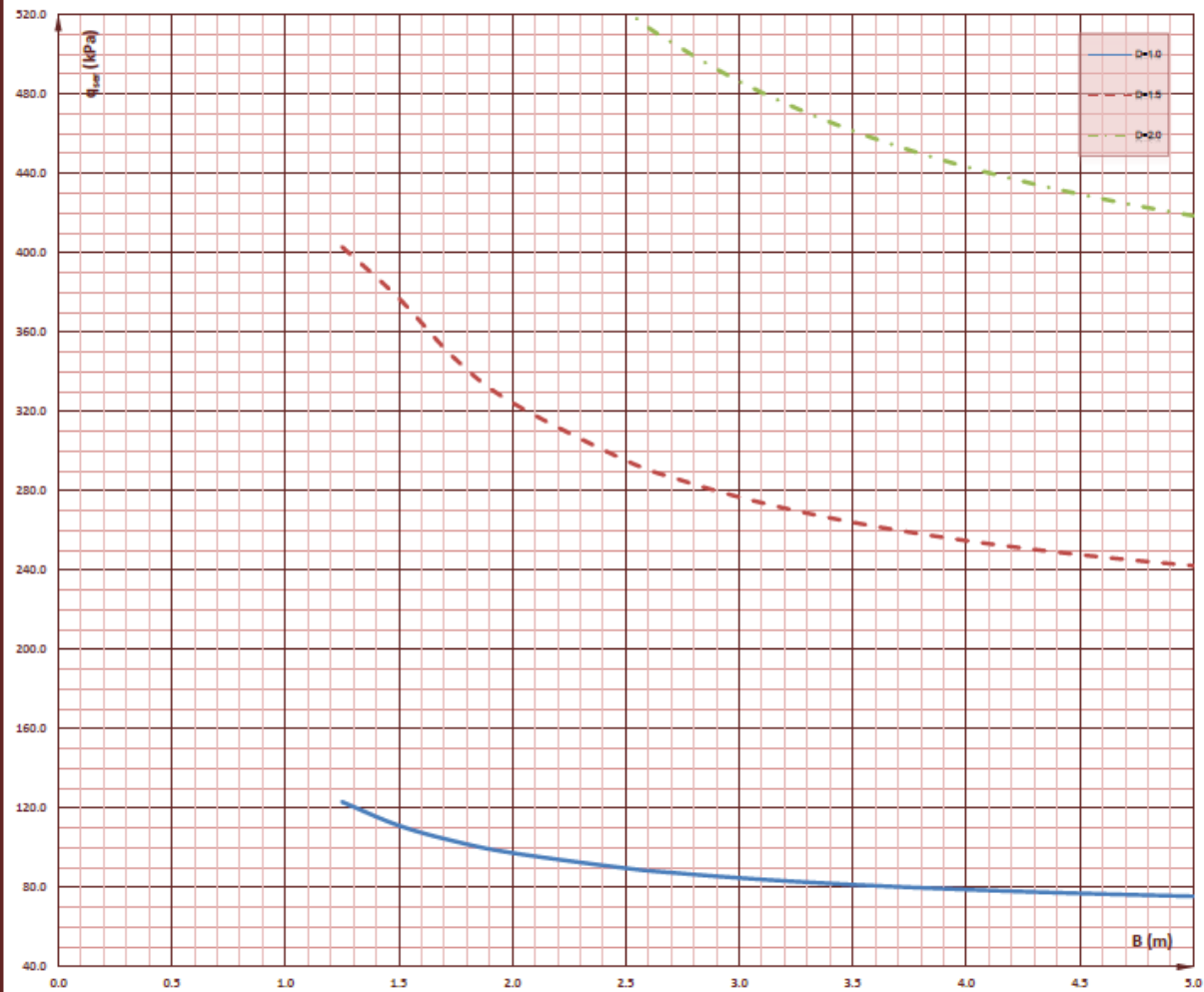

VARIATION OF THE ADMISSIBLE STRESS WITH THE WIDTH OF THE FOOTING B AND FOR DIFFERENT DEPTH OF EMBEDMENT

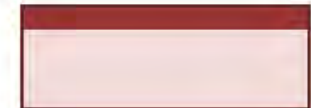
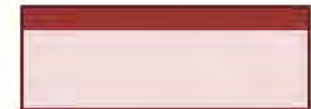
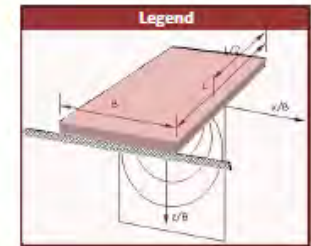
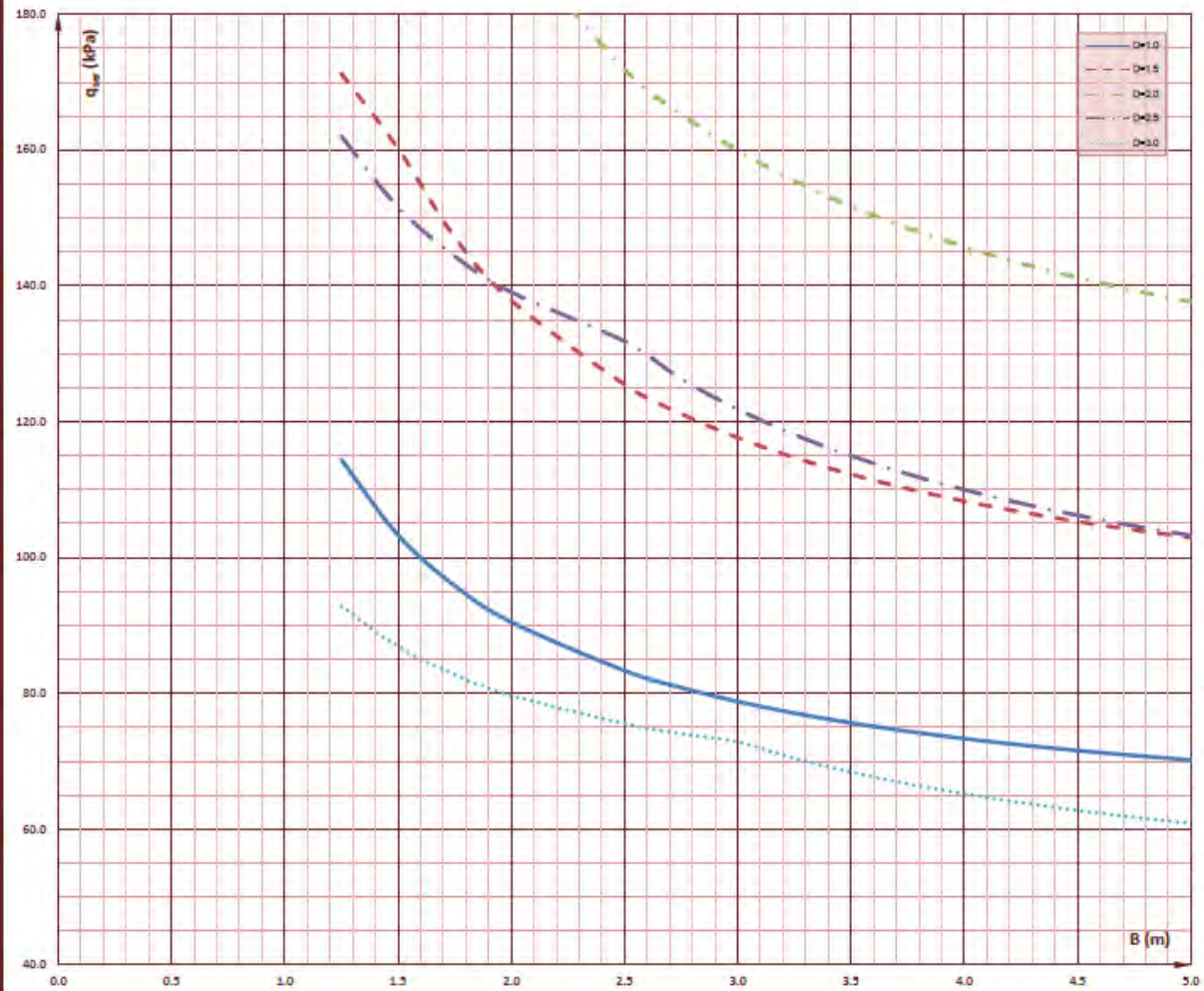

Appendix C – Tables for allowable bearing capacity Meyerhoff 07-14

VARIATION OF THE ADMISSIBLE STRESS WITH THE WIDTH OF THE FOOTING B AND FOR DIFFERENT DEPTH OF EMBEDMENT

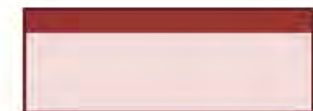
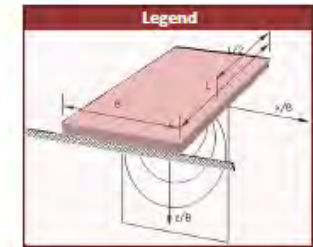
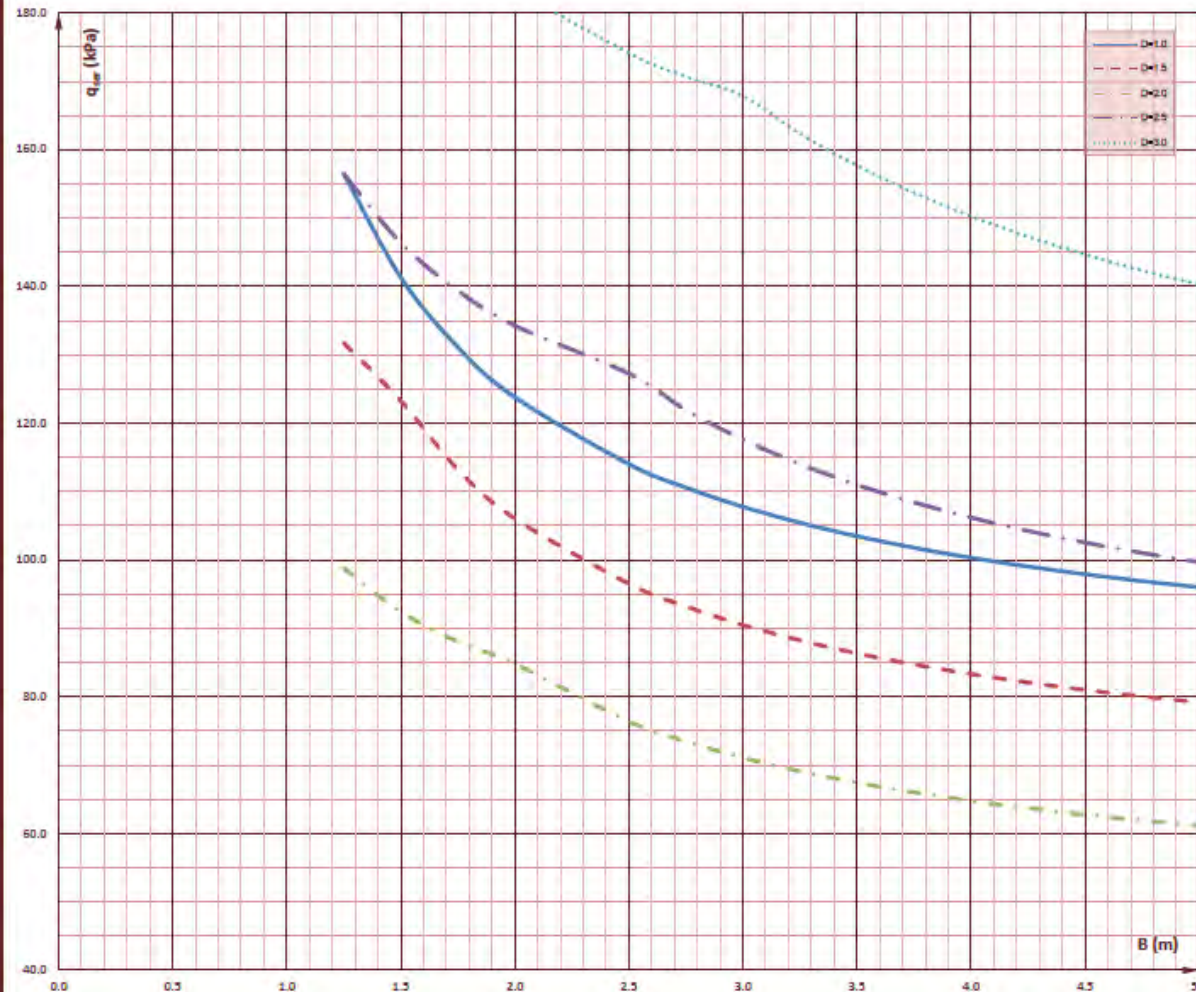

VARIATION OF THE ADMISSIBLE STRESS WITH THE WIDTH OF THE FOOTING B AND FOR DIFFERENT DEPTH OF EMBEDMENT

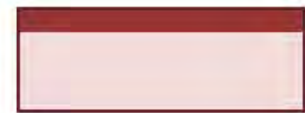
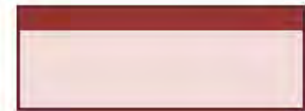
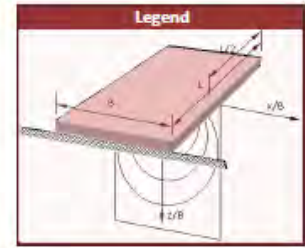
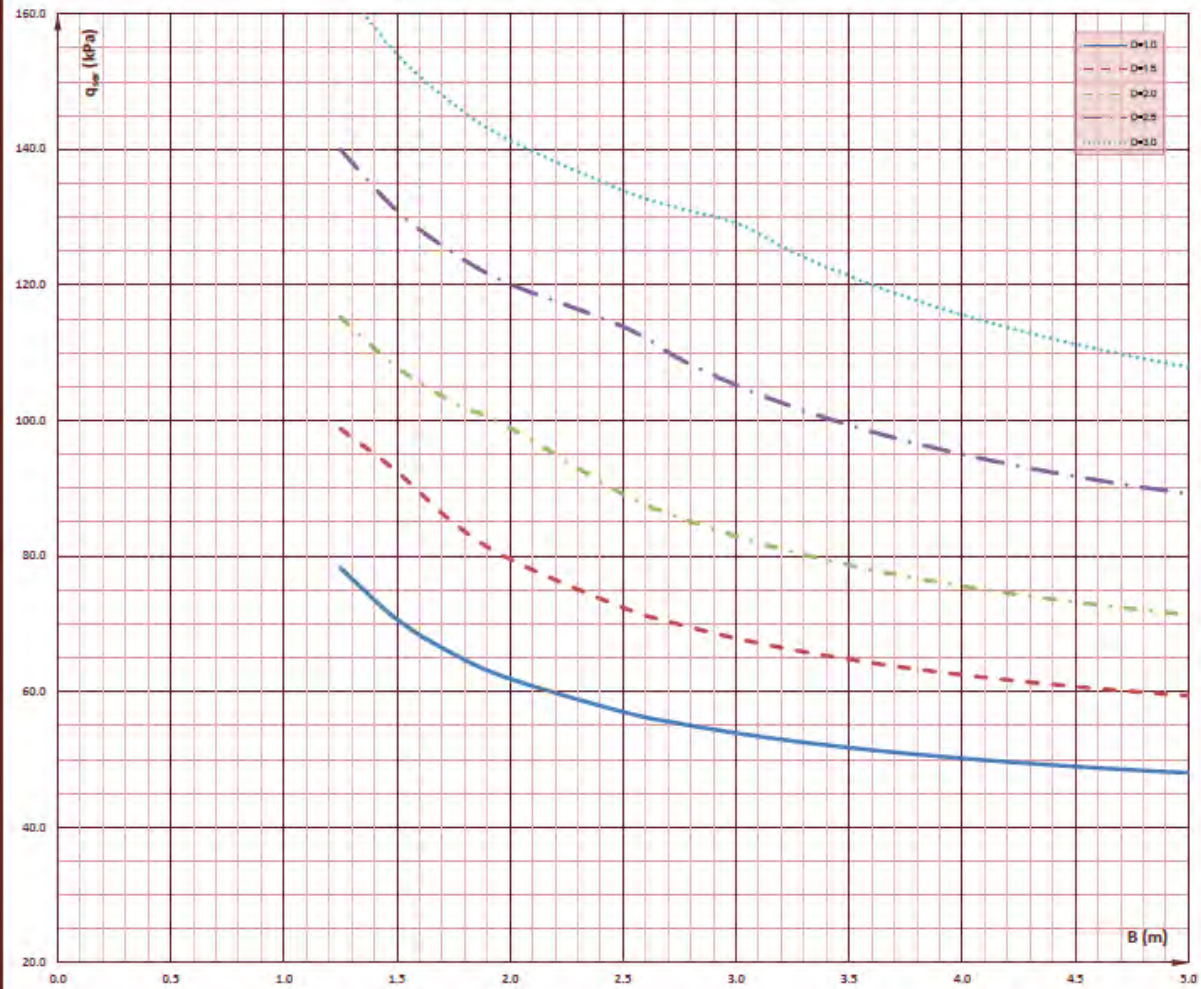

VARIATION OF THE ADMISSIBLE STRESS WITH THE WIDTH OF THE FOOTING B AND FOR DIFFERENT DEPTH OF EMBEDMENT

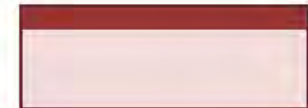
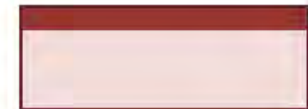
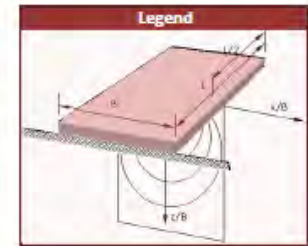
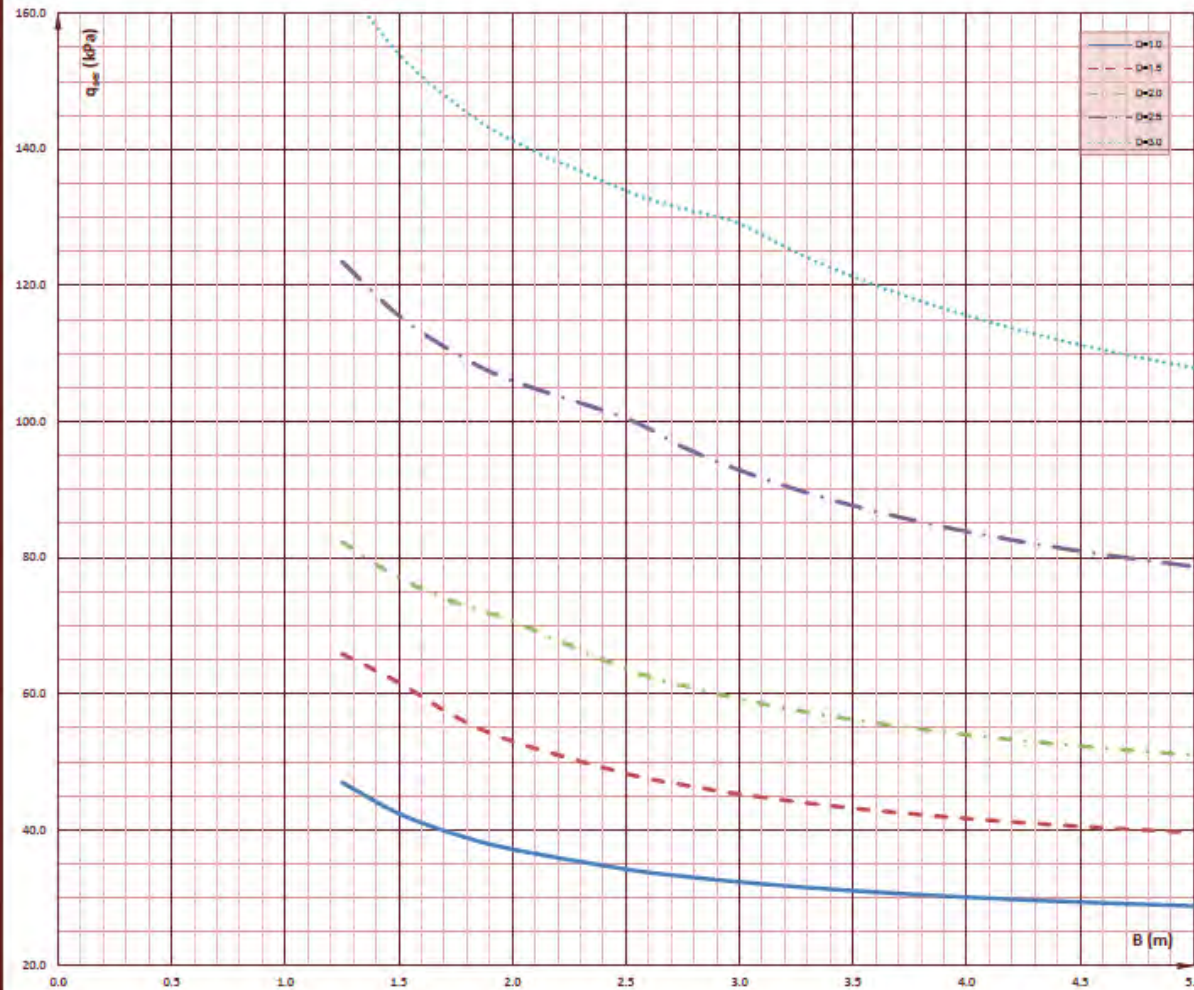

VARIATION OF THE ADMISSIBLE STRESS WITH THE WIDTH OF THE FOOTING B AND FOR DIFFERENT DEPTH OF EMBEDMENT

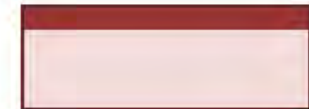
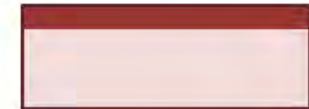
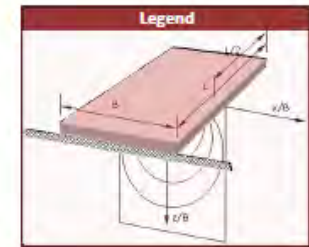
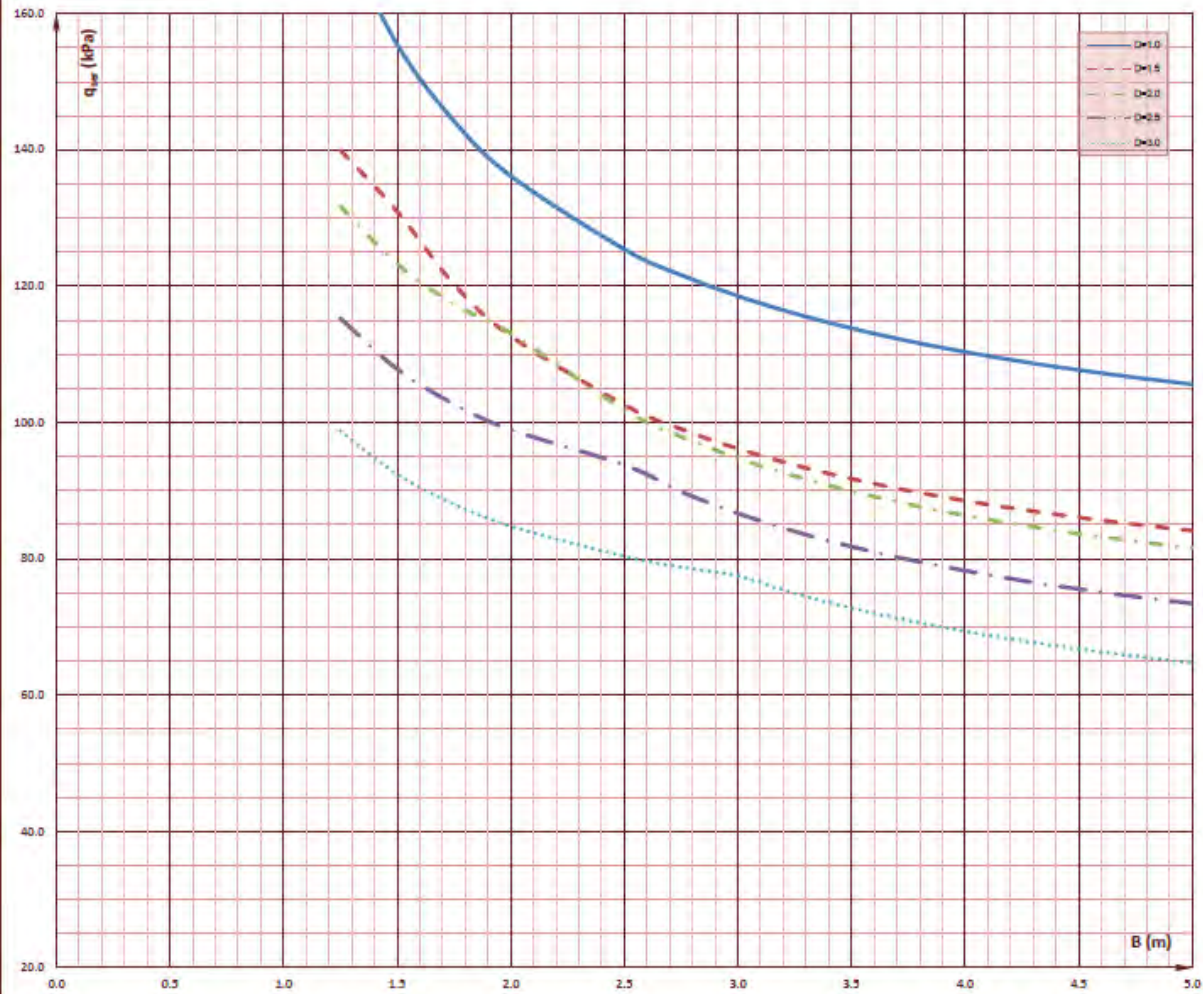

VARIATION OF THE ADMISSIBLE STRESS WITH THE WIDTH OF THE FOOTING B AND FOR DIFFERENT DEPTH OF EMBEDMENT

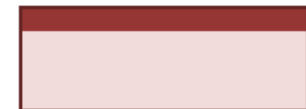
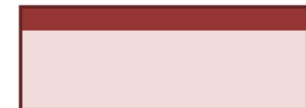
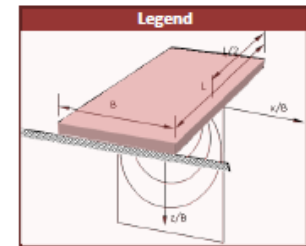
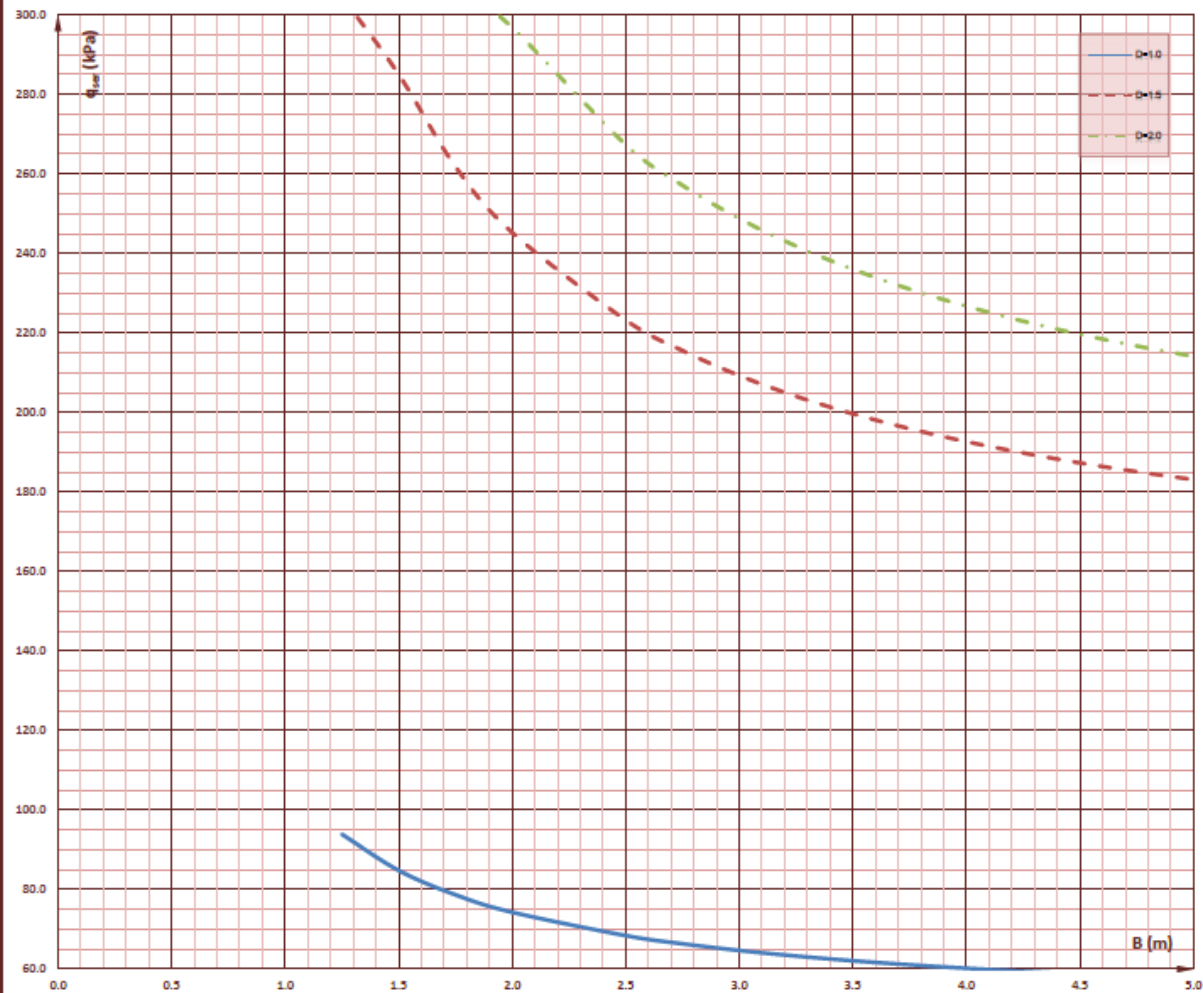

VARIATION OF THE ADMISSIBLE STRESS WITH THE WIDTH OF THE FOOTING B AND FOR DIFFERENT DEPTH OF EMBEDMENT

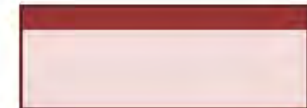
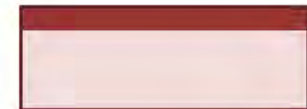
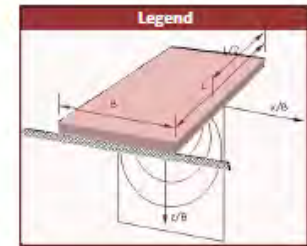
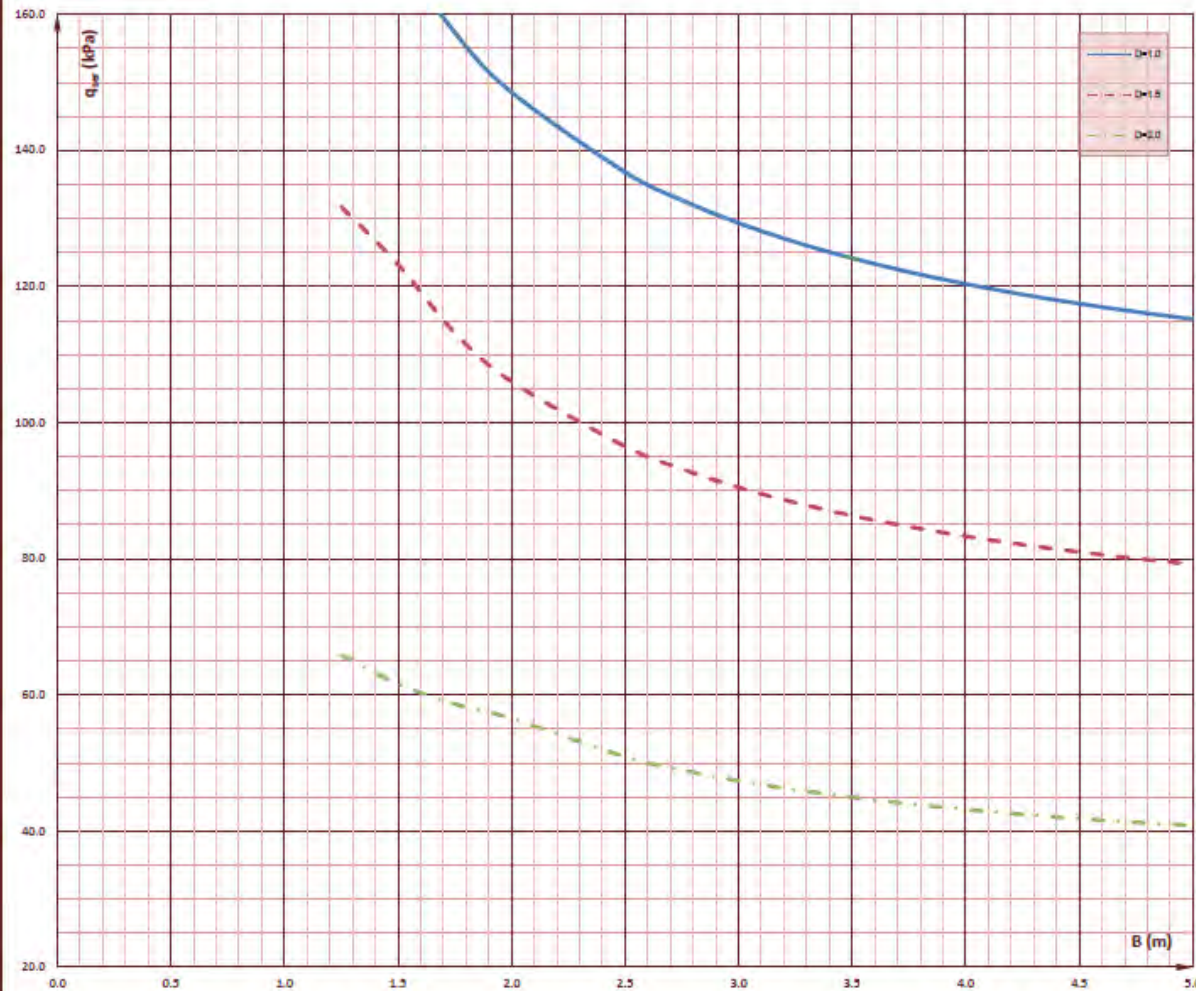

VARIATION OF THE ADMISSIBLE STRESS WITH THE WIDTH OF THE FOOTING B AND FOR DIFFERENT DEPTH OF EMBEDMENT

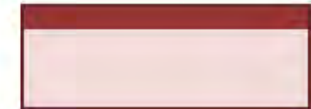
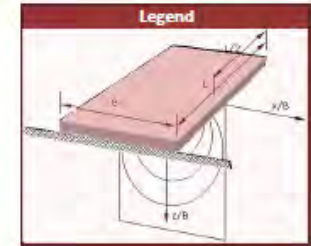
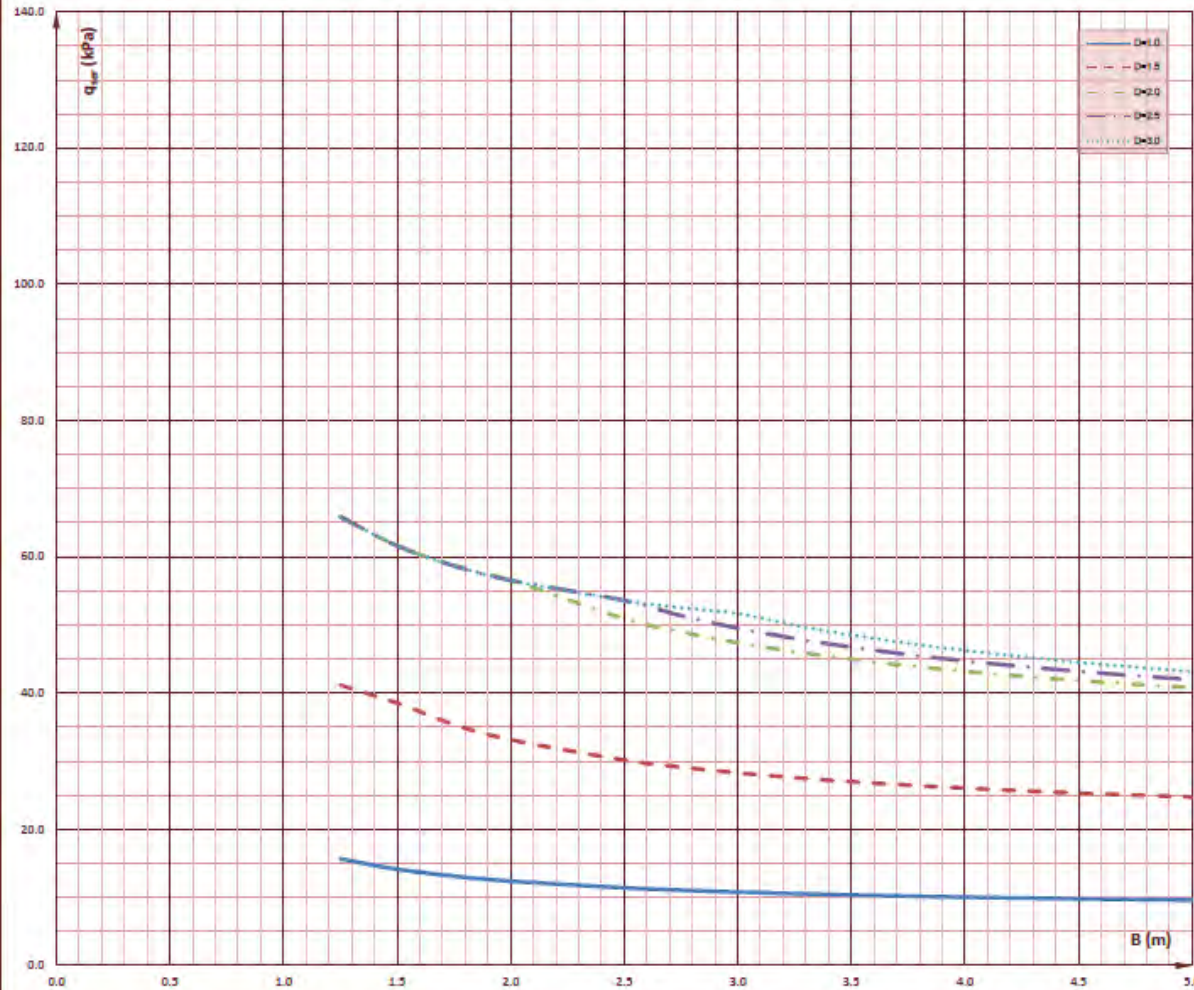

A-7-24

VARIATION OF THE ADMISSIBLE STRESS WITH THE WIDTH OF THE FOOTING B AND FOR DIFFERENT DEPTH OF EMBEDMENT

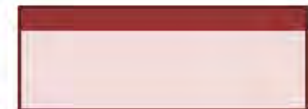
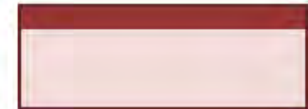
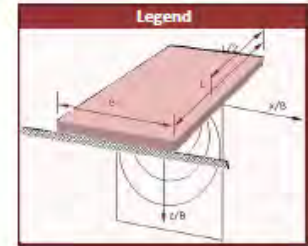
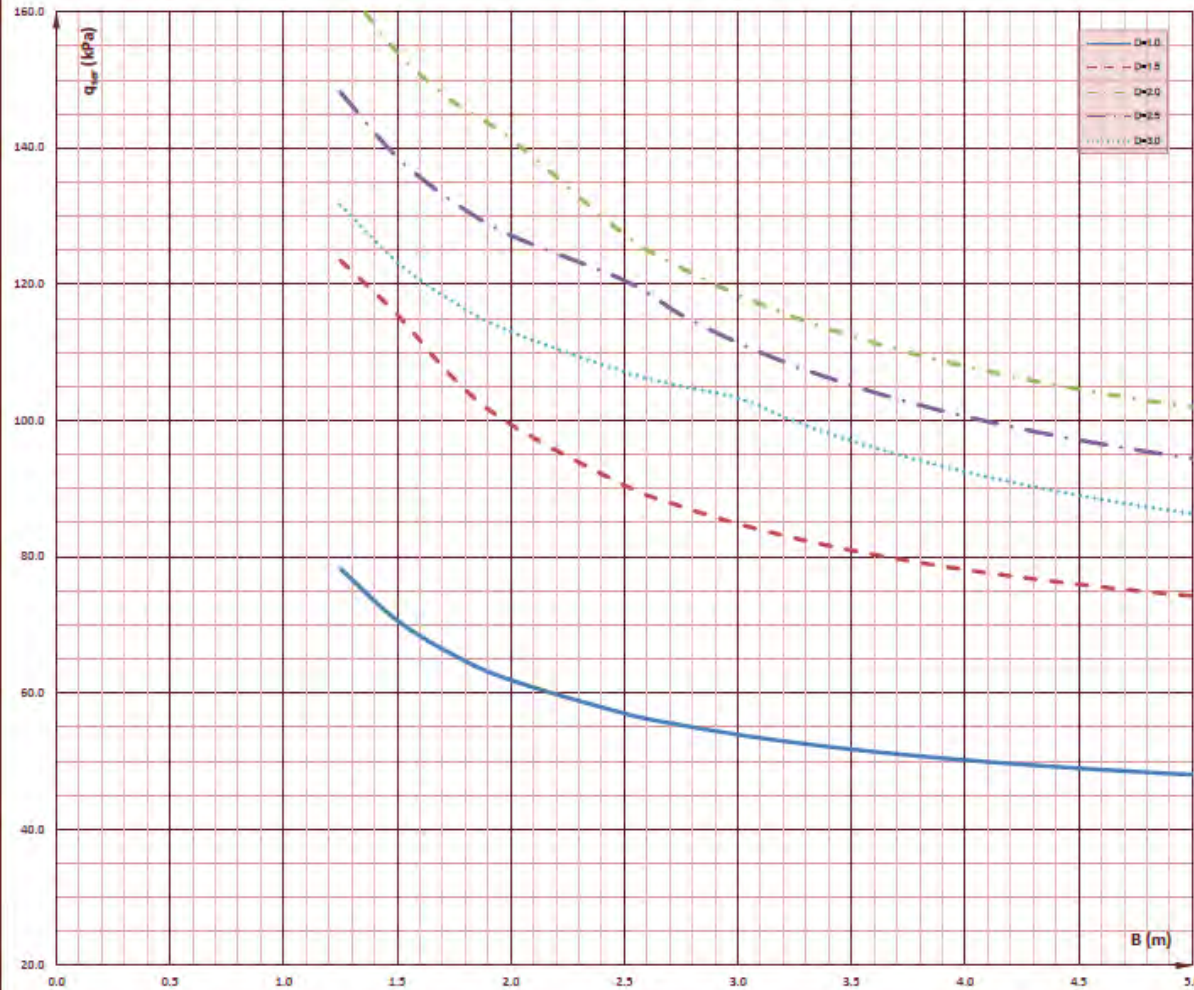

At the request of **M. Bernard CHANCY** and on behalf of **S.G.C. SA society**

Construction project of the building of 13 schools at 2 or 3 levels. Centre and Artibonite prefecture



- Geotechnical study -

File # 2014-1103

indice	date	établi par	vérifié par
0	02/2015	Modvenn SILI et Ch. CAUQUOT	Florence THAURONT

Succursale d'Haïti IMSRN Haïti - #3 Rue Sunshine, Vivy Mitchell – Port au Prince
Tél : (+509)2949-6308 / (+509)3460-6308 / (+509)3453-3818 – email : haiti@imsrn.com – www.imsrn.com

Siège social : IMSRN - Parc Pré Millet - 680, r. Aristide Bergès - 38330 MONTBONNOT
tél : (+33)4 76 52 41 20 - fax : (+33)4 76 52 49 09 - email : ims@imsrn.com - www.imsrn.com

SAS capital 400 000 € - Registre du Commerce de Grenoble B 392 133 633

SUMMARY

This page is a summary of the reports, it is not exhaustive

The study corresponds to a geotechnical study. It is carried out at the request of M **Bernard CHANCY** and on behalf of **SGC SA society**. This study is located in the Centre and Artibonite departments. The project consists on the buildings of 13 schools at 2 or 3 levels.

Here is a summary of the laboratory, soil's nature, soil's sismic class, N values and bearing capacity about all sites in Centre and Artibonite Departments:

	SITE 1	SITE 3a- 3b	SITE 6	SITE 9	SITE 10	SITE 11	SITE 12
Nat. water content.	11.1 %	18.2	11.5 %	12.7 %	35 %	10.5 %	10.7 %
Soils	sand	Sand	Sand	Sand	Sand & gravel	Sand	Sand (with clay)
Sismic cl.	/	/	/	/	D	D	D
Min-max N value	5.6-12.9	3.4-9.6	5.6-10.7	5.6-20.8	3.9-26.2	5.1-50	4.5-50
Bearing cap. (bars)	1.28	1.04	1.60	1.36	0.96	1.12	0.88

	SITE 13a-13b	SITE 14	SITE 24	SITE 25		SITE 18	SITE 19
Nat. water content.	16 %	7.1 %	12.8 %	6.0 %		13.3 %	20.2 %
Soils	Sand (with clay)	Sand	Sand	sand		Sand	Sand
Sismic cl.	D	/	/	/		C	D
Min-max N value	5->50	3.9-11.8	1.1-3.9	5.1-9.6		7.9-41.1	4.5-42.8
Bearing cap. (bars)	1.44	1.60	0.60	1.20		1.28	1.17

Sites studied with CPT
(Cone Penetration Test)

Sites studied with SPT
(Standard Penetration Test)

This graph shows N values for all sites with CPT :

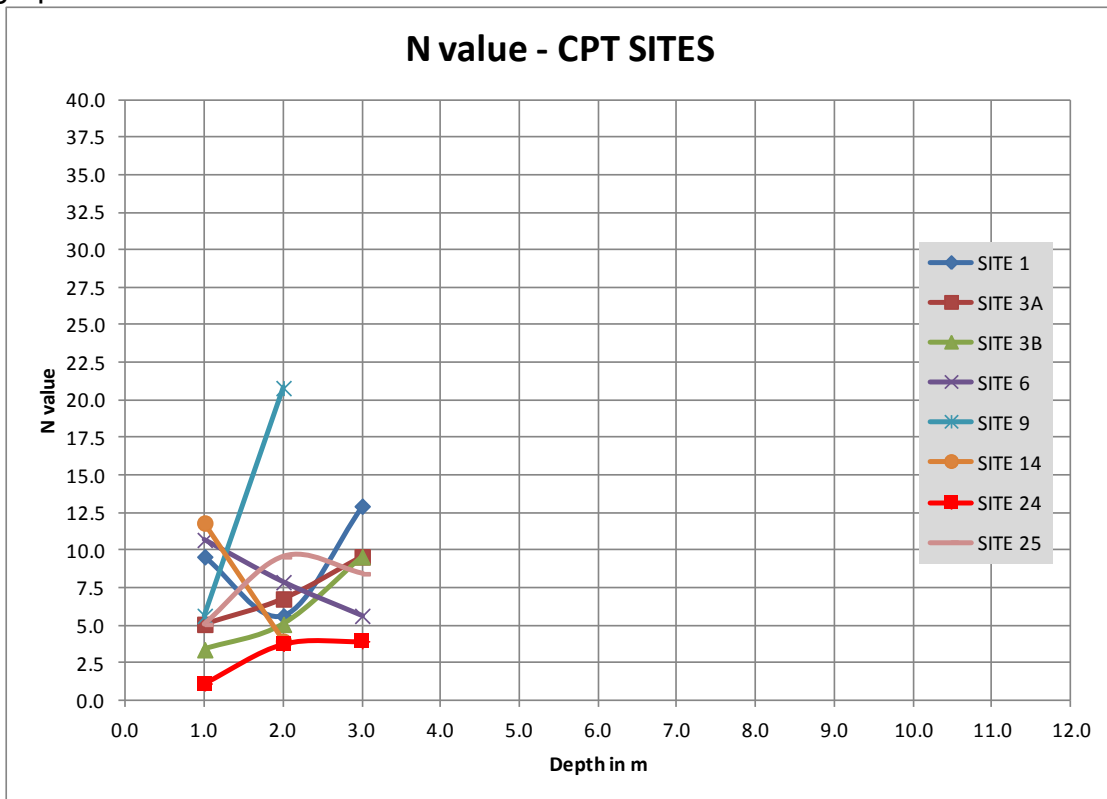

This graph shows N values for all sites with SPT :

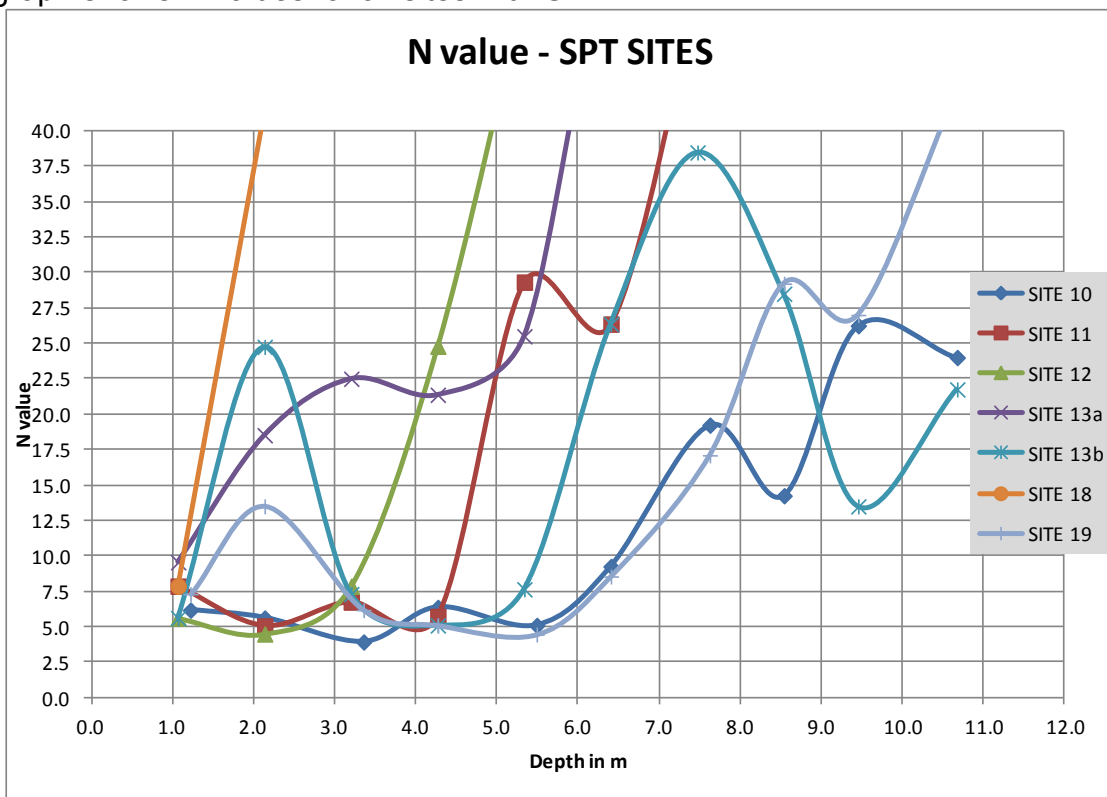

Essays made on sites and in the laboratory :

SITE N°	Place	Essay	DEPTH (in m)	SPT made	Lab essaies asked	Lab essaies made			
						SA	AL	W%	SG
1	crete-b	CPT	3.0	X	3	3	sand	3	3
3A	trianon	CPT	3.0		3	3	sand	3	3
3B	trianon	CPT	3.0		3	3	sand	3	3
6	henry ch	CPT	3.0		3	3	sand	3	3
9	destaingv	CPT	2.0		3	2	sand	2	2
10	boucan	SPT	10.7	10	5	5	1	5	5
11	immacul	SPT	7.5	7	5	5	sand	5	5
12	toussaint	SPT	5.3	5	5	5	sand	5	5
13A	guy mal	SPT	10.7	10	5	5	1	5	5
13B	guy mal	SPT	10.7	10	5	5	2	5	5
14	marmont	CPT	2.0	X	3	2	sand	2	2
24	colladère	CPT	3.0		3	3	sand	3	3
25	los palis	CPT	3.0		3	3	sand	3	3
18	charles b	SPT	2.1	2	5	2	sand	2	2
19	desarmes	SPT	10.7	10	5	5	1	5	5
TOTAL		8 CPT and 7 SPT			59	54	5	54	54

SOMMAIRE

INTRODUCTION	9
SITE #1 – ECOLE NATIONALE DE CRETE-BRULEE, MIREBELAIS	11
1. LOCALIZATION	11
2. GEOLOGY.....	12
3. GEOTECHNICAL STUDIES	12
3.1. MECHANICAL BORING TEST – CPT	12
3.2. LABORATORY TESTS	13
4. GEOTECHNICAL RECOMMENDATIONS	14
4.1. BUILDING LOCATION.....	14
4.2. EXCAVATIONS	14
4.3. PROJECT ENVIRONNEMENT	15
4.4. FOUNDATIONS.....	15
5. SEISMIC PARAMETERS.....	15
5.1. BUILDING CODE	15
5.2. SITE SEISMICITY	16
SITE #3 – ECOLE NATIONALE DE TRIANON, MIREBELAIS	17
1. LOCALISATION	17
2. GEOLOGY.....	18
3. GEOTECHNICAL STUDIES	18
3.1. MECHANICAL BORING TEST – CPT1	19
3.2. MECHANICAL BORING TEST – CPT2	20
3.3. LABORATORY TESTS	20
4. GEOTECHNICAL RECOMMENDATIONS	21
4.1. BUILDING LOCATION.....	21
4.2. EXCAVATIONS	21
4.3. PROJECT ENVIRONNEMENT	22
4.4. FOUNDATIONS.....	22
5. SEISMIC PARAMETERS.....	22
5.1. BUILDING CODE	22
5.2. SITE SEISMICITY	23
SITE #6 – ECOLE NATIONALE D’HENRY CHRISTOPHE, THOMONDE.....	25
1. LOCALISATION	25
2. GEOLOGY.....	26
3. GEOTECHNICAL STUDIES	26
3.1. MECHANICAL BORING TEST – CPT	26
3.2. LABORATORY TESTS	27
4. GEOTECHNICAL RECOMMENDATIONS	28
4.1. BUILDING LOCATION.....	28
4.2. EXCAVATIONS	28

4.3. PROJECT ENVIRONNEMENT	28
4.4. FOUNDATIONS.....	29
5. SEISMIC PARAMETERS.....	29
5.1. BUILDING CODE	29
5.2. SITE SEISMICITY	29
SITE #9 – ECOLE NATIONALE DE DESTAINGVILLE, SAUT D’EAU.....	31
1. LOCALIZATION	31
2. GEOLOGY.....	32
3. GEOTECHNICAL STUDIES	32
3.1. MECHANICAL BORING TEST – CPT	32
3.2. LABORATORY TESTS	33
4. GEOTECHNICAL RECOMMENDATIONS	34
4.1. BUILDING LOCATION.....	34
4.2. EXCAVATIONS	34
4.3. PROJECT ENVIRONNEMENT	34
4.4. FOUNDATIONS.....	34
5. SEISMIC PARAMETERS.....	35
5.1. BUILDING CODE	35
5.2. SITE SEISMICITY	35
SITE #10 – ECOLE NATIONALE DE BOUCAN CARRE, BOUCAN CARRE.....	37
1. LOCALIZATION	37
2. GEOLOGY.....	38
3. GEOTECHNICAL STUDIES	38
3.1. MECHANICAL BORING TEST – SPT.....	38
3.2. LABORATORY TESTS	40
4. GEOTECHNICAL RECOMMENDATIONS	40
4.1. BUILDING LOCATION.....	41
4.2. EXCAVATIONS	41
4.3. PROJECT ENVIRONNEMENT	41
4.4. FOUNDATIONS.....	41
5. SEISMIC PARAMETERS.....	42
5.1. BUILDING CODE	42
5.2. SITE SEISMICITY	42
SITE #11 – ECOLE NATIONALE D’IMMACULEE CONCEPTION, HINCHE.....	43
1. LOCALIZATION	43
2. GEOLOGY, MORPHOLOGY, HYDROGEOLOGY	44
2.2. MORPHOLOGY AND SURFACE GEOLOGICAL OBSERVATIONS	44
2.3. HYDROGEOLOGY	45
3. GEOTECHNICAL STUDIES	45
3.1. MECHANICAL BORING TEST – SPT.....	45
3.2. LABORATORY TESTS	46

4. GEOTECHNICAL RECOMMENDATIONS	47
4.1. BUILDING LOCATION	47
4.2. EXCAVATIONS	47
4.3. PROJECT ENVIRONNEMENT	47
4.4. FOUNDATIONS	47
5. SEISMIC PARAMETERS	48
5.1. BUILDING CODE	48
5.2. SITE SEISMICITY	48
SITE #12 – ECOLE NATIONALE DE TOUSSAINT LOUVERTURE, HINCHE	49
1. LOCALIZATION	49
2. GEOLOGY, MORPHOLOGY, HYDROGEOLOGY	50
2.1. GEOLOGY	50
2.2. MORPHOLOGY AND SURFACE GEOLOGICAL OBSERVATIONS	50
2.3. HYDROGEOLOGY	51
3. GEOTECHNICAL STUDIES	51
3.1. MECHANICAL BORING TEST – SPT	51
3.2. LABORATORY TESTS	52
4. GEOTECHNICAL RECOMMENDATIONS	53
4.1. BUILDING LOCATION	53
4.2. EXCAVATIONS	53
4.3. PROJECT ENVIRONNEMENT	53
4.4. FOUNDATIONS	53
5. SEISMIC PARAMETERS	54
5.1. BUILDING CODE	54
5.2. SITE SEISMICITY	54
SITE #13 – ECOLE NATIONALE DE GUY MALARY, HINCHE	55
1. LOCALIZATION	55
2. GEOLOGY	56
3. GEOTECHNICAL STUDIES – HOLE 1 AND HOLE 2	56
3.1. MECHANICAL BORING TESTS – SPT	56
3.2. LABORATORY TESTS	58
4. GEOTECHNICAL RECOMMENDATIONS	60
4.1. BUILDING LOCATION	60
4.2. EXCAVATIONS	60
4.3. PROJECT ENVIRONNEMENT	60
4.4. FOUNDATIONS	61
5. SEISMIC PARAMETERS	61
5.1. BUILDING CODE	61
5.2. SITE SEISMICITY	61
SITE #14 – ECOLE NATIONALE DE MARMONT, HINCHE	63
1. LOCALIZATION	63
2. GEOLOGY	64

3. GEOTECHNICAL STUDIES	64
3.1. MECHANICAL BORING TEST – CPT	64
3.2. LABORATORY TESTS	65
4. GEOTECHNICAL RECOMMENDATIONS	66
4.1. BUILDING LOCATION.....	66
4.2. EXCAVATIONS	66
4.3. PROJECT ENVIRONNEMENT.....	66
4.4. FOUNDATIONS.....	67
5. SEISMIC PARAMETERS.....	67
5.1. BUILDING CODE	67
5.2. SITE SEISMICITY	67
SITE #24 – ECOLE NATIONALE DE COLLADERE, HINCHE.....	69
1. LOCALIZATION	69
2. GEOLOGY.....	70
3. GEOTECHNICAL STUDIES	70
3.1. MECHANICAL BORING TEST – CPT	70
3.2. LABORATORY TESTS	71
4. GEOTECHNICAL RECOMMENDATIONS	72
4.1. BUILDING LOCATION.....	72
4.2. FOUNDATIONS.....	72
5. SEISMIC PARAMETERS.....	73
5.1. BUILDING CODE	73
5.2. SITE SEISMICITY	73
SITE #25 – ECOLE NATIONALE DE LOS PALIS, HINCHE.....	75
1. LOCALIZATION	75
2. GEOLOGY, MORPHOLOGY, HYDROGEOLOGY	76
2.1. GEOLOGY.....	76
3. GEOTECHNICAL STUDIES	76
3.1. MECHANICAL BORING TEST – CPT	76
3.2. LABORATORY TESTS	77
4. GEOTECHNICAL RECOMMENDATIONS	78
4.1. BUILDING LOCATION.....	78
4.2. EXCAVATIONS	78
4.3. PROJECT ENVIRONNEMENT.....	78
4.4. FOUNDATIONS.....	79
5. SEISMIC PARAMETERS.....	79
5.1. BUILDING CODE	79
5.2. SITE SEISMICITY	79
SITE #18 – ECOLE NATIONALE DE CHARLES BELAIR, VERRETTES.....	81
1. LOCALIZATION	81
2. GEOLOGY, MORPHOLOGY, HYDROGEOLOGY	82

2.2. MORPHOLOGY, SURFACE GEOLOGICAL OBSERVATIONS AND HYDROGEOLOGY	82
3. GEOTECHNICAL STUDIES	83
3.1. MECHANICAL BORING TEST – SPT	83
3.2. LABORATORY TESTS	84
4. GEOTECHNICAL RECOMMENDATIONS	84
4.1. BUILDING LOCATION	84
4.2. EXCAVATIONS	84
4.3. PROJECT ENVIRONNEMENT	85
4.4. FOUNDATIONS	85
5. SEISMIC PARAMETERS.....	85
5.1. BUILDING CODE	85
5.2. SITE SEISMICITY	86
SITE #19 – ECOLE NATIONALE DE DESARMES, VERRETTES	87
1. LOCALIZATION	87
2. GEOLOGY, MORPHOLOGY, HYDROGEOLOGY	88
2.1. GEOLOGY	88
2.2. MORPHOLOGY, SURFACE GEOLOGICAL OBSERVATIONS AND HYDROGEOLOGY	88
3. GEOTECHNICAL STUDIES	89
3.1. MECHANICAL BORING TEST – SPT	89
3.2. LABORATORY TESTS	90
4. GEOTECHNICAL RECOMMENDATIONS	91
4.1. BUILDING LOCATION	91
4.2. EXCAVATIONS	91
4.3. PROJECT ENVIRONNEMENT	91
4.4. FOUNDATIONS	92
5. SEISMIC PARAMETERS.....	92
5.1. BUILDING CODE	92
5.2. SITE SEISMICITY	93
GEOTECHNICAL UNCERTAINTIES AND CONTRACTUAL CONDITIONS	95
APPENDIX	97
APPENDIX 1 : SITES LOCATION	98
APPENDIX 2 : BORING LOGS	101
APPENDIX 3 : LABORATORY TEST RESULTS	117
APPENDIX 4 : SEISMICITY	181

INTRODUCTION

This study is carried out at the request of M. **Bernard CHANCY** and on behalf of **LGL society**.

The different schools are located in 6 different township:

- Mirebelais,
- Thomonde,
- Saut d'Eau,
- Boucan Carre,
- Hinche and
- Verrettes.

It corresponds to geotechnical study and its objectives are:

- to specify the local geotechnical context,
- to determine the project ground-related characteristics (excavations, foundations, drainage, seismic parameters...),

Tests carried out for the study (see test locations map, Appendix 1):

- geological, hydrogeological and morphological observations,
- 7 drillings with SPT (N-value) @ 1 m,
- 8 drillings with CPT (N-value) @ 1 m,
- 59 laboratory tests.

Documents used:

- Geological map of Haïti – 1/250 000 – BME
- Règles de Calcul Intérimaires pour les Bâtiments en Haïti – MTPTC – February 15th 2011

N.B: This study only aims at determining the building construction parameters. In particular, it will not concern rainwater or wastewater disposal, access road realization, or possible flood hazard.

In the following, « /NS » means « depth from the natural surface », at the day of the field tests.

SITE #1 – ECOLE NATIONALE DE CRETE-BRULEE, MIREBELAIS

1. LOCALIZATION

The study plot is located in Mirebalais, 4^{ème} section Crête-Brulée at the following coordinates: **N18°46'28.20" / W072°05'53.01"**



Location

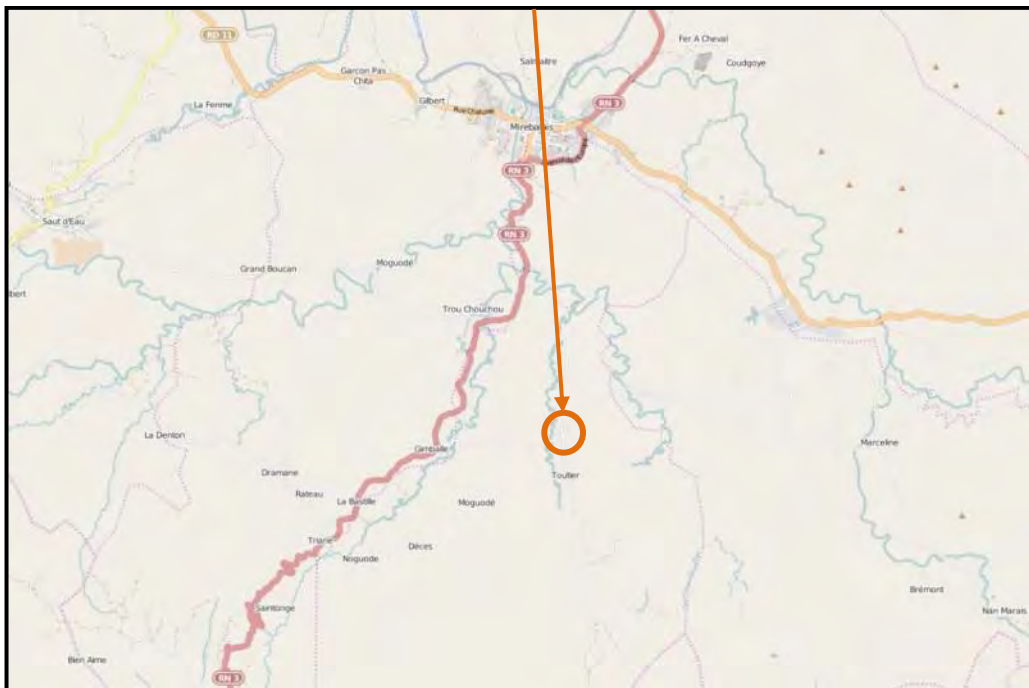

Location of the studied plot (orthophoto GeoEye from January 2010 and Open Street Map)

2. GEOLOGY

Based on the geological map of Haïti (South-East, 1/250000), the studied site is located on formations belonging to the upper Miocene. Those formations are composed of sandstone or conglomerates, overcome by silts more or less thin (ms on the map).

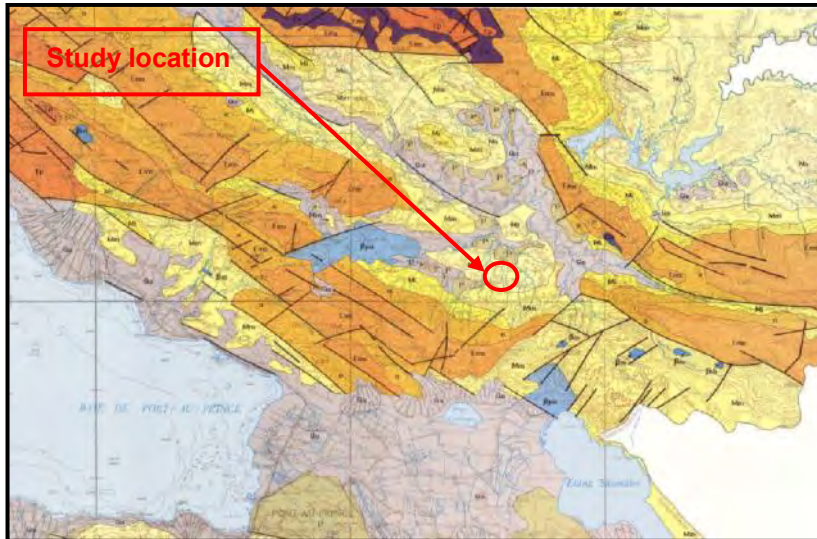

Sample of the geological map of Haïti (South-East, 1/250000)

No water neither spring nor stagnant water area was observed on the studied plot at the time of the visit.

And no water was found during the CPT Test.

In order to the plot geometry, infiltrations phenomenon seem preponderant than runoff water.

They are strongly possible during a raining period.

3. GEOTECHNICAL STUDIES

3.1. Mechanical boring test – CPT

Here are the N values and the penetration index :

SITE 1

Point	Depth in m	N value
1	1.0	9.56
2	2.0	5.62
3	3.0	12.93

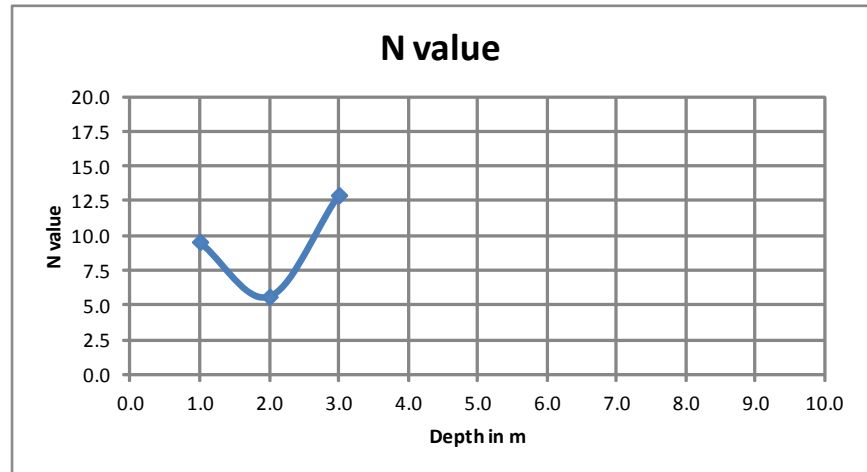

Point	Depth in m	Penetration Index
1	1.0	0.21
2	2.0	0.30
3	3.0	0.17

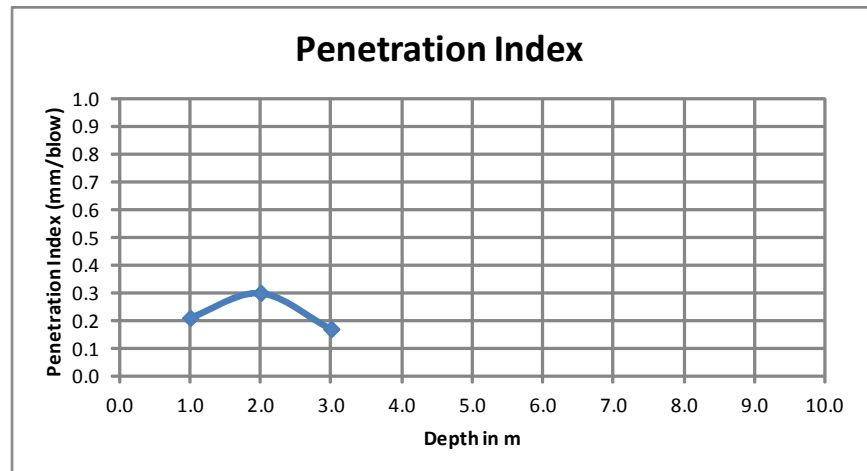

Pen. Ind., PI = $\Delta D_p / \Delta BC$

3.2. Laboratory tests

We took 3 samples in the drilling, then we made:

- a water natural content,
- a sieve analysis,
- a specific gravity.

These are the results (see in appendix 2, board and curve):

ID	Soil's nature	W%	% to 50% (in mm)	Atterberg limits	Specific gravity
Hole 1 @1m	Sand	10.3	1.3	/	2.64
Hole 1 @2m	Sand	10.1	1.3	/	2.61
Hole 1 @3m	Sand	13.0	1.5	/	2.69

This ground is constituted thus by sands ; the water natural content is on average 11.1 %
These sands are little compact before 2.6 m and averagely compact from 2.6 m.

4. GEOTECHNICAL RECOMMENDATIONS

The recommendations of this report do not take into account any possible future constructions not stated in the introduction, which can modify the stability context of the area (Backfill, excavation...).

These recommendations are only to be applied for the project presented in the introduction and cannot be used for another one, even located on the same plot.

4.1. Building location

The locations of the future buildings within the plot are not restricted from a geotechnical point of view.

4.2. Excavations

From what is known at the time of the study, the excavation works will concern:

- The ground excavation for the construction basis,
- The foundations excavation.

The excavations will begin by the cleaning of the covert ground (layer above the sands). Residual roots must be purged and evacuated outside of the influence of the project. During the construction phase, the platform will have a slope of about 2% to promote the flow of water.

The excavations will be preferentially realized in dry season.

4.3. Project environnement

According to the plot area topography and slope, infiltration phenomenon seems preponderant than runoff water (sands).

During the excavation phase:

- A fill slope protection against raining water must be established.

On the final phase:

- **An outlying drainage of the buried parts of the building must be constructed.**

The collected waters (outlying drainage, roof, access roads...) have to be evacuated, when possible, to a wastewater collection system.

4.4. Foundations

No information about vertical loads on building foundations were given by the client. However, the project concerns a structure considered as “light” (1 or 2 levels).

According to the soil’s nature, the CPT and the ground water level encountered on the plot study area and to avoid differential settlement under the constructions, which could lead to their ruin, it is recommended to plan:

Footings resting or isolated massifs anchored in 1.2 m ; the anchoring will be 0.3 m minimum in sands ; the foundation’s width, B will be less than 1.22 m.

The following bearing capacity values were calculated from the geotechnical test results, and with the Meyerhof’s formula, allowing considering the settlements as negligible at a long-term period:

$q_{adm} = 1.28 \text{ bars} = 0,13 \text{ MPa}$ (Service Limit State)

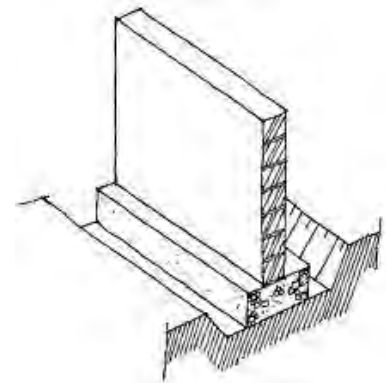

5. SEISMIC PARAMETERS

5.1. Building code

According to MTPTC recommendations given in “Règles de calcul intérimaires pour les bâtiments en Haïti », the parasismic building code authorized in Haïti, in wait of a

specific haïtian code, are CNBC, ACI-318, International Building Code, EuroCode 8 and CUBiC.

5.2. Site seismicity

The plot is located in a **highly seismic area**.

Directs effects

Direct effects are soil vibrations and major geological accidents.

- Topographic amplification: seismic wave amplification can be modified by the site topography and by the ground geodynamic characteristics. The study plot is quite horizontal, there are no slopes nearby, so **the amplification coefficient ST is 1,0**.
- Geological accident: this area of Mirebalais contains few faults.

Induced effects

Induced effects are ground movements, tsunami and soil liquefaction.

- Ground movements: at the location of the land plot, no major sign of instability was spotted. Based on the site topography, the risk of landslide or rock fall can be excluded.
- Tsunami : no risk here.
- Liquefaction: the geotechnical tests carried out on the land plot show that there is no risk of liquefaction for the first meters of the ground (sands).

SITE #3 – ECOLE NATIONALE DE TRIANON, MIREBELAIS

1. LOCALISATION

The study plot is located in Mirebelais, 3^{ème} section Grand Boucan at the following coordinates: **N18°46'01.82" / W072°08'02.70"**

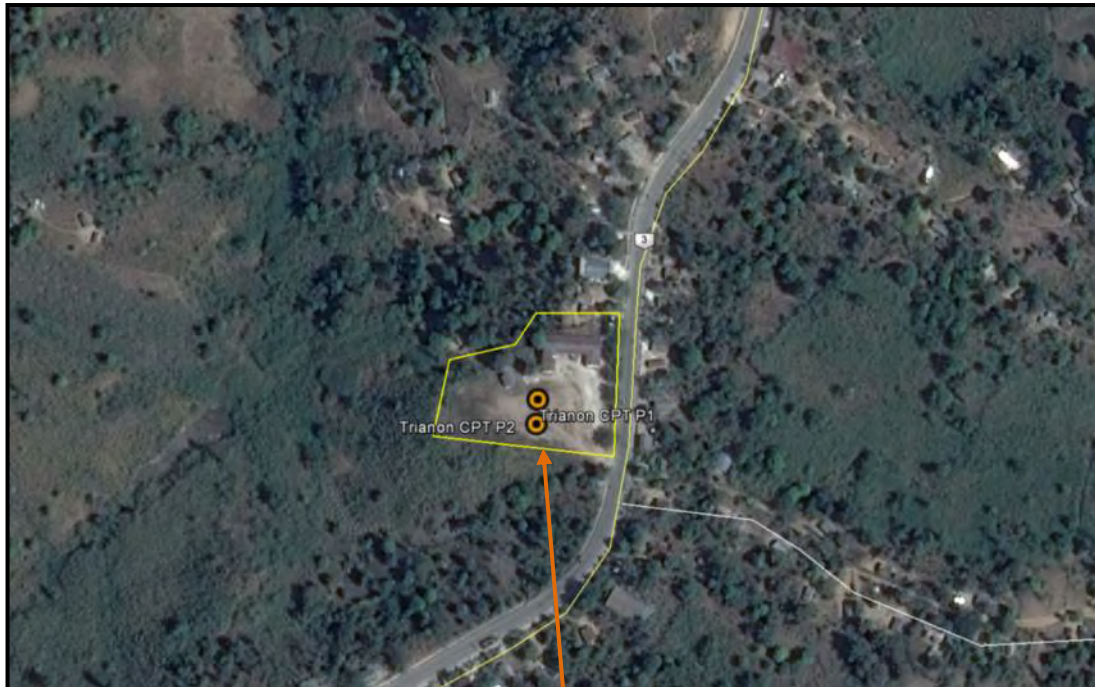

Location

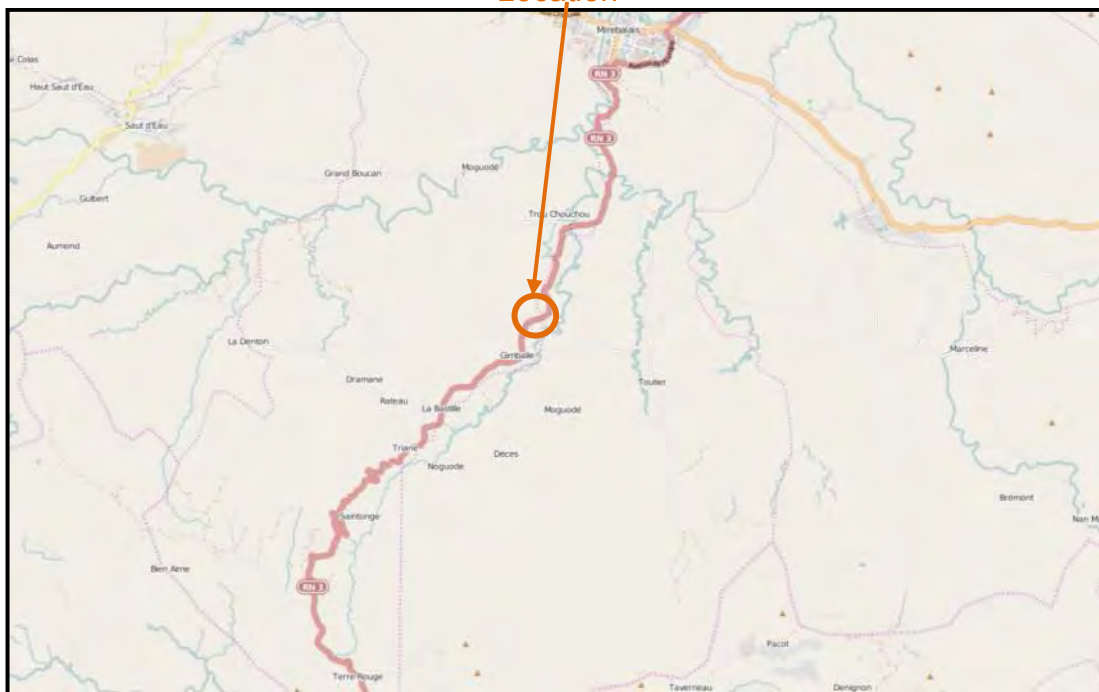

Location of the studied plot (orthophoto GeoEye from January 2010 and Open Street Map)

2. GEOLOGY

Based on the geological map of Haïti (South-East, 1/250000), the studied site is located on formations belonging to the upper Miocene. Those formations are composed of sandstone or conglomerates, overcome by silts more or less thin (ms on the map).

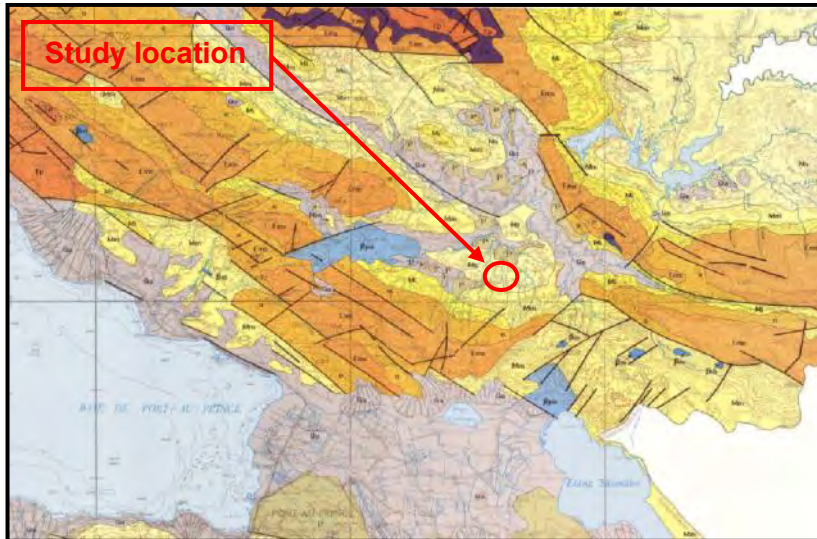

Sample of the geological map of Haïti (South-East, 1/250000)

No water neither spring nor stagnant water area was observed on the studied plot at the time of the visit.

And no water was found during the CPT Test.

In order to the plot geometry, infiltrations phenomenon seem preponderant than runoff water.

They are strongly possible during a raining period.

3. GEOTECHNICAL STUDIES

For this site, we have made 2 CPT.

3.1. Mechanical boring test – CPT1

Here are the N values and the penetration index :

SITE 3A

Point	Depth in m	N value
1	1.0	5.06
2	2.0	6.75
3	3.0	9.56

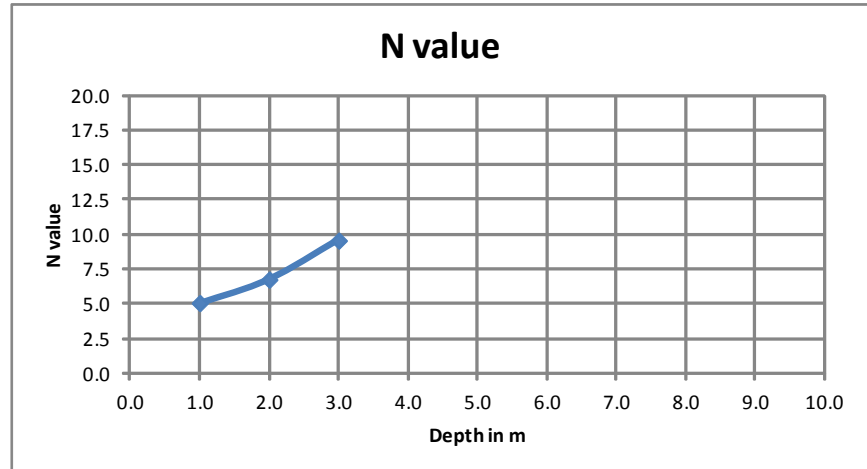

Point	Depth in m	Penetration Index
1	1.0	0.45
2	2.0	0.38
3	3.0	0.16

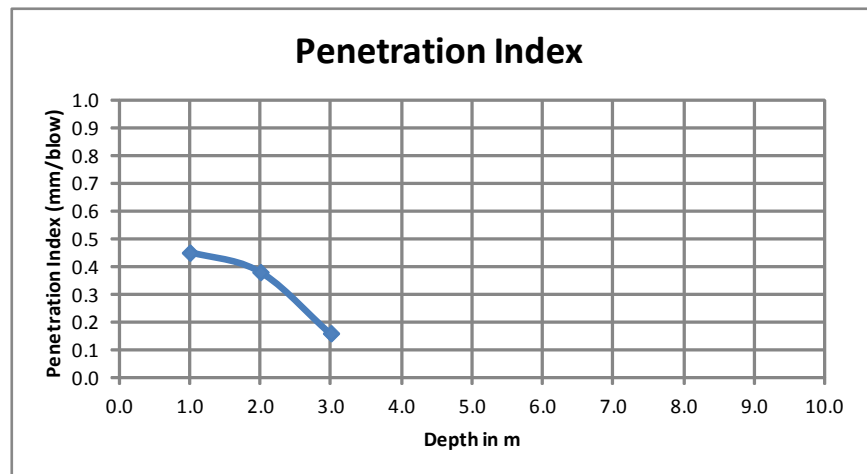

Pen. Ind., PI = $\Delta D_p / \Delta BC$

We have good values (N >5) from 1.0 m.

3.2. Mechanical boring test – CPT2

Here are the N values and the penetration index :

SITE 3B

Point	Depth in m	N value
1	1.0	3.37
2	2.0	5.06
3	3.0	9.56

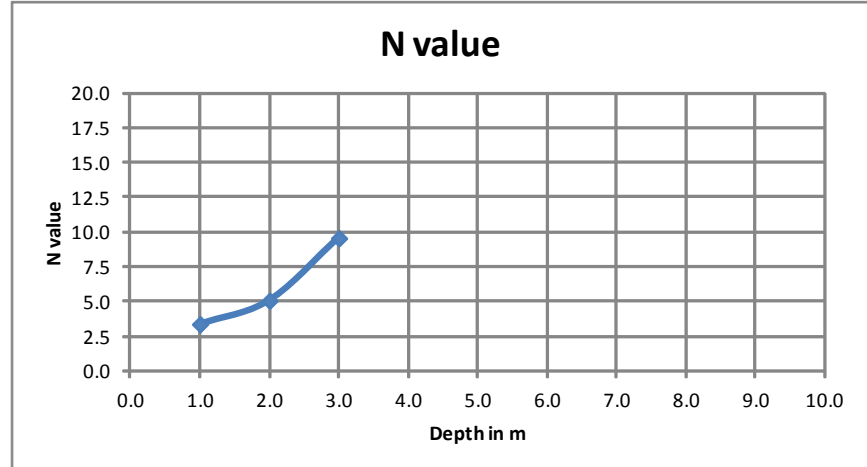

Point	Depth in m	Penetration Index
1	1.0	0.64
2	2.0	0.43
3	3.0	0.34

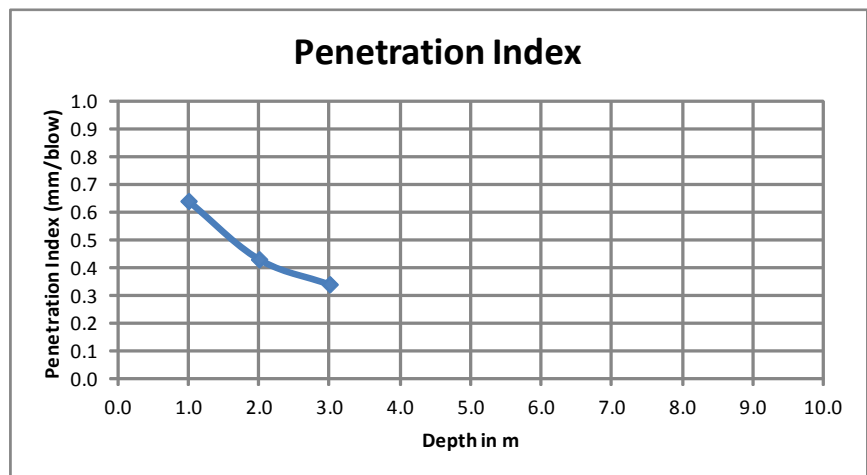

Pen. Ind., PI = $\Delta D_p / \Delta BC$

Here, we have good values from 2.0 m.

3.3. Laboratory tests

We took 6 samples in the drilling, then we made:

- a water natural content,
- a sieve analysis
- a specific gravity

These are the results (see in appendix 2, board and curve):

ID	Soils's nature	W%	% to 50% (in mm)	Atterberg limits	Specific gravity
Hole 1 @1m	Sand	24.0	2.0	/	2.70
Hole 1 @2m	Sand	12.5	1.8	/	2.74
Hole 1 @3m	Sand	14.4	1.6	/	2.70
Hole 2 @1m	Sand	19.8	2.4	/	2.69
Hole 2 @2m	Sand	10.6	2.2	/	2.73
Hole 2 @3m	Sand	27.7	1.5	/	2.75

This ground is constituted by sands;
The water natural content is on average 18.2 %.
These sands are little compact (N value : 4-10)

4. GEOTECHNICAL RECOMMENDATIONS

The recommendations of this report do not take into account any possible future constructions not stated in the introduction, which can modify the stability context of the area (Backfill, excavation...).

These recommendations are only to be applied for the project presented in the introduction and cannot be used for another one, even located on the same plot.

4.1. Building location

The locations of the future buildings within the plot are not restricted from a geotechnical point of view.

4.2. Excavations

From what is known at the time of the study, the excavation works will concern:

- The ground excavation for the construction basis,
- The foundations excavation.

The excavations will begin by the cleaning of the covert ground (layer above the sands). Residual roots must be purged and evacuated outside of the influence of the project. During the construction phase, the platform will have a slope of about 2% to promote the flow of water.

The excavations will be preferentially realized in dry season.

4.3. Project environnement

According to the plot area topography and slope, infiltration phenomenon seems preponderant than runoff water.

During the excavation phase:

- A fill slope protection against raining water must be established.

On the final phase:

- **An outlying drainage of the buried parts of the building** must be constructed.

The collected waters (outlying drainage, roof, access roads...) have to be evacuated, when possible, to a wastewater collection system.

4.4. Foundations

No information about vertical loads on building foundations were given by the client. However, the project concerns a structure considered as “light” (1 or 2 levels).

According to the soil's nature, the CPT and the ground water level encountered on the plot study area and to avoid differential settlement under the constructions, which could lead to their ruin, it is recommended to plan:

Footings resting anchored in 1.8 m; the anchoring will be 0.5 m minimum in sands ; the foundation's width, B will be less than 1.22 m.

The following bearing capacity values were calculated from the geotechnical test results, and with the Meyerhof's formula, allowing considering the settlements as negligible at a long-term period:

$q_{adm} = 1.04 \text{ bars} = 0,10 \text{ MPa}$ (Service Limit State)

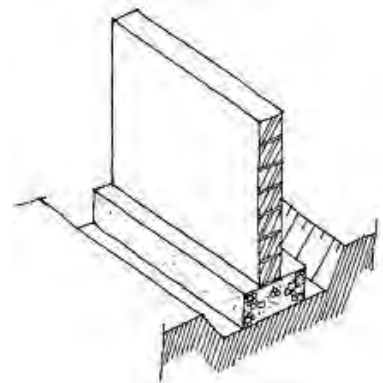

5. SEISMIC PARAMETERS

5.1. Building code

According to MTPTC recommendations given in “Règles de calcul intérimaires pour les bâtiments en Haïti », the paraseismic building code authorized in Haïti, in wait of a specific haïtian code, are CNBC, ACI-318, International Building Code, EuroCode 8 and CUBiC.

5.2. Site seismicity

The plot is located in a **highly seismic area**.

Directs effects

Direct effects are soil vibrations and major geological accidents.

- Topographic amplification: seismic wave amplification can be modified by the site topography and by the ground geodynamic characteristics. The study plot is quite horizontal, there are no slopes nearby, so **the amplification coefficient ST is 1,0**.
- Geological accident: this area doesn't contain important faults.

Induced effects

Induced effects are ground movements, tsunami and soil liquefaction.

- Ground movements: at the location of the land plot, no major sign of instability was spotted. Based on the site topography, the risk of landslide or rock fall can be excluded.
- Tsunami : no risk here.

Liquefaction: the geotechnical tests carried out on the land plot show that there is no risk of liquefaction for the first meters of the ground (sands).

SITE #6 – ECOLE NATIONALE D'HENRY CHRISTOPHE, THOMONDE

1. LOCALISATION

The study plot is located in Thomonde, 1^{ère} Cabral at the following coordinates:
N19°01'21.82" / W071°57'53.76"



Location

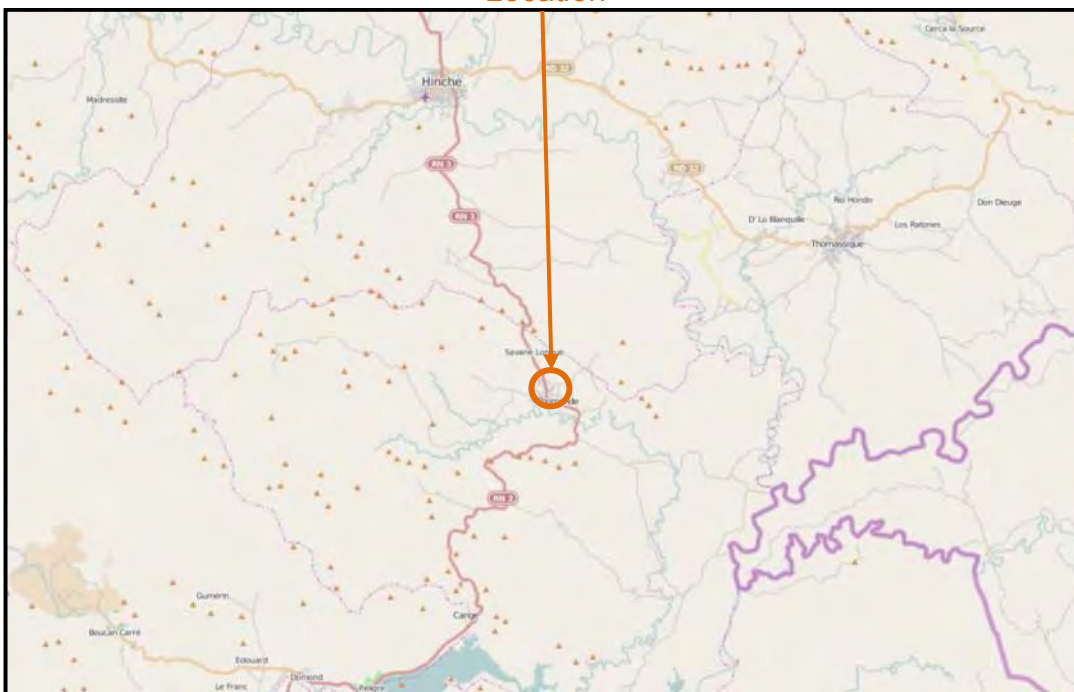

Location of the studied plot (orthophoto GeoEye from January 2010 and Open Street Map)

2. GEOLOGY

Based on the geological map of Haïti (North-East 1/250000), the studied site is situated on formations belonging to the middle Miocene. Those formations are composed by 3 different facies: blue/grey marl, fine sandstone or detrital series with discontinuous limestone series (Mm on the map).

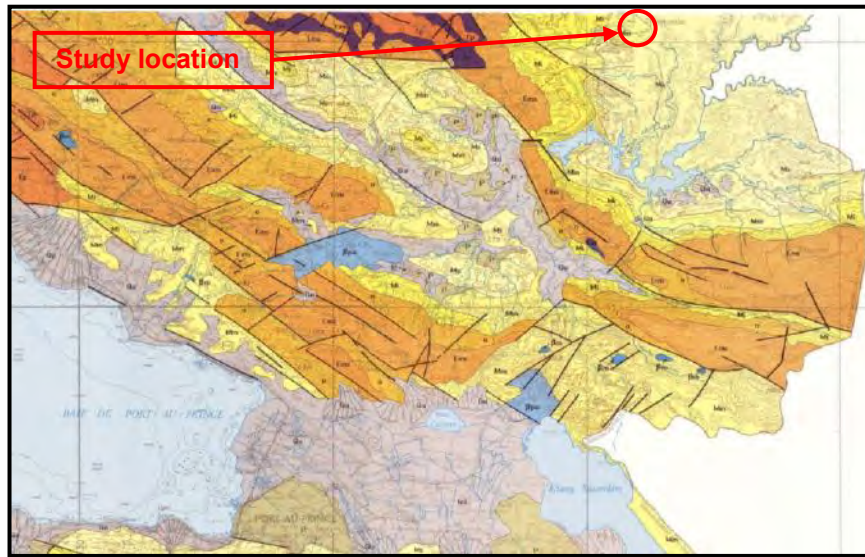

Sample of the geological map of Haïti, (North-East 1/250000)

No water neither spring nor stagnant water area was observed on the studied plot at the time of the visit.

And no water was found during the CPT Test.

In order to the plot geometry, infiltrations phenomenon seem preponderant than runoff water.

They are strongly possible during a raining period.

3. GEOTECHNICAL STUDIES

3.1. Mechanical boring test – CPT

Here are the N values and the penetration index :

SITE 6

Point	Depth in m	N value
1	1.0	10.68
2	2.0	7.87
3	3.0	5.62

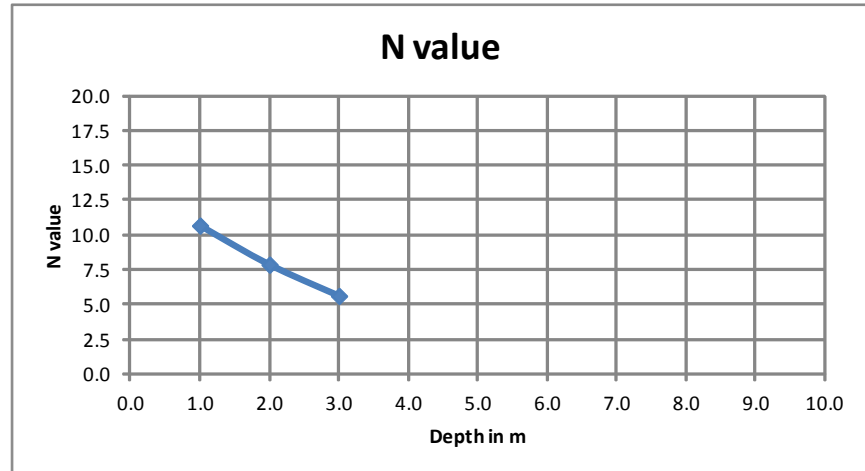

Point	Depth in m	Penetration Index
1	1.0	0.20
2	2.0	0.25
3	3.0	0.32

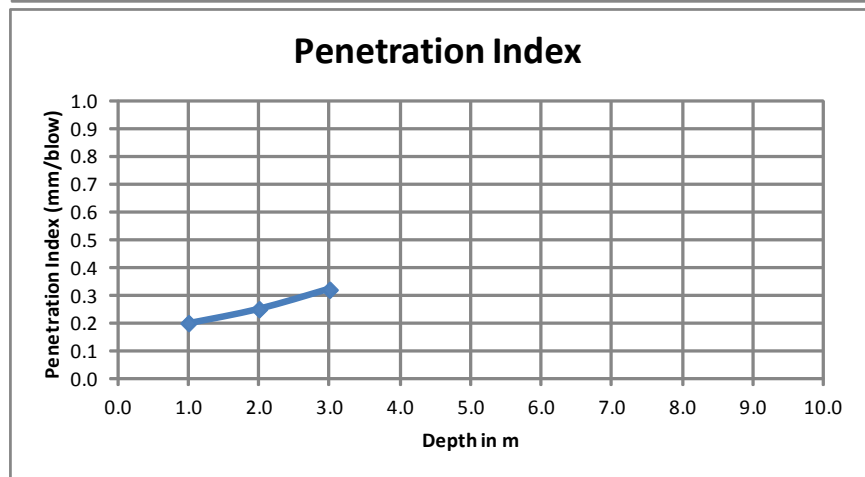

Pen. Ind., PI = $\Delta D_p / \Delta BC$

We have very good N values between 1m and 2 m (10 to 8), then they decrease ; the PI has good values : 0.2-0.3 mm/blow.

3.2. Laboratory tests

We took 3 samples in the drilling, then we made:

- a water natural content,
- a sieve analysis
- a specific gravity

These are the results (see in appendix 2, board and curve):

ID	Soils's nature	W%	% to 50% (in mm)	Atterberg limits	Specific gravity
Hole 1 @1m	Sand	11.7	1.0	/	2.63
Hole 1 @2m	Sand	11.7	0.9	/	2.63
Hole 1 @3m	Sand	11.0	0.9	/	2.69

This ground is constituted by sands;
The water natural content is on average 11.5 %.
These sands are little compact, depending of the N values.

4. GEOTECHNICAL RECOMMENDATIONS

The recommendations of this report do not take into account any possible future constructions not stated in the introduction, which can modify the stability context of the area (Backfill, excavation...).

These recommendations are only to be applied for the project presented in the introduction and cannot be used for another one, even located on the same plot.

4.1. Building location

The locations of the future buildings within the plot are not restricted from a geotechnical point of view.

4.2. Excavations

From what is known at the time of the study, the excavation works will concern:

- The ground excavation for the construction basis,
- The foundations excavation.

The excavations will begin by the cleaning of the covert ground (layer above the sands). Residual roots must be purged and evacuated outside of the influence of the project. During the construction phase, the platform will have a slope of about 2% to promote the flow of water.

The excavations will be preferentially realized in dry season.

4.3. Project environnement

According to the plot area topography and slope, infiltration phenomenon seems preponderant than runoff water.

During the excavation phase:

- A fill slope protection against raining water must be established.

On the final phase:

- **An outlying drainage of the buried parts of the building** must be constructed.

The collected waters (outlying drainage, roof, access roads...) have to be evacuated, when possible, to a wastewater collection system.

4.4. Foundations

No information about vertical loads on building foundations were given by the client. However, the project concerns a structure considered as “light” (1 or 2 levels).

According to the soil's nature, the SPT and the ground water level encountered on the plot study area and to avoid differential settlement under the constructions, which could lead to their ruin, it is recommended to plan:

Footings resting on isolated massifs anchored in 1.1 m; the anchoring will be 0.3 m minimum in sands ; the foundation's width, B will be less than 1.22 m.

The following bearing capacity values were calculated from the geotechnical test results, and with the Meyerhof's formula, allowing considering the settlements as negligible at a long-term period:

$q_{adm} = 1.60 \text{ bars} = 0,16 \text{ MPa}$ (Service Limit State)

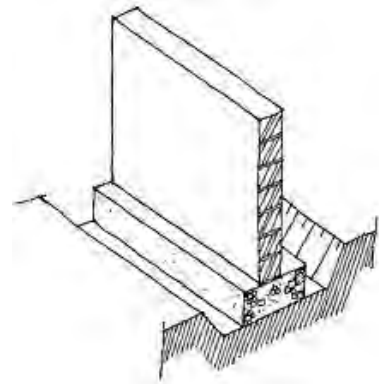

5. SEISMIC PARAMETERS

5.1. Building code

According to MTPTC recommendations given in “Règles de calcul intérimaires pour les bâtiments en Haïti », the parasismic building code authorized in Haïti, in wait of a specific haïtian code, are CNBC, ACI-318, International Building Code, EuroCode 8 and CUBiC.

5.2. Site seismicity

The plot is located in a **highly seismic area**.

Directs effects

Direct effects are soil vibrations and major geological accidents.

- Topographic amplification: seismic wave amplification can be modified by the site topography and by the ground geodynamic characteristics. The study plot is quite horizontal, there are no slopes nearby, so **the amplification coefficient ST is 1,0**.
- Geological accident: there isn't any visible fault in this area.

Induced effects

Induced effects are ground movements, tsunami and soil liquefaction.

- Ground movements: at the location of the land plot, no major sign of instability was spotted. Based on the site topography, the risk of landslide or rock fall can be excluded.
- Tsunami : no risk here.
- Liquefaction: the geotechnical tests carried out on the land plot show that there is no risk of liquefaction for the first meters of the ground (sands).

SITE #9 – ECOLE NATIONALE DE DESTAINVILLE, SAUT D'EAU

1. LOCALIZATION

The study plot is located in Saut d'Eau, La Selle at the following coordinates:
N18°53'01.34" / W072°12'29.61"

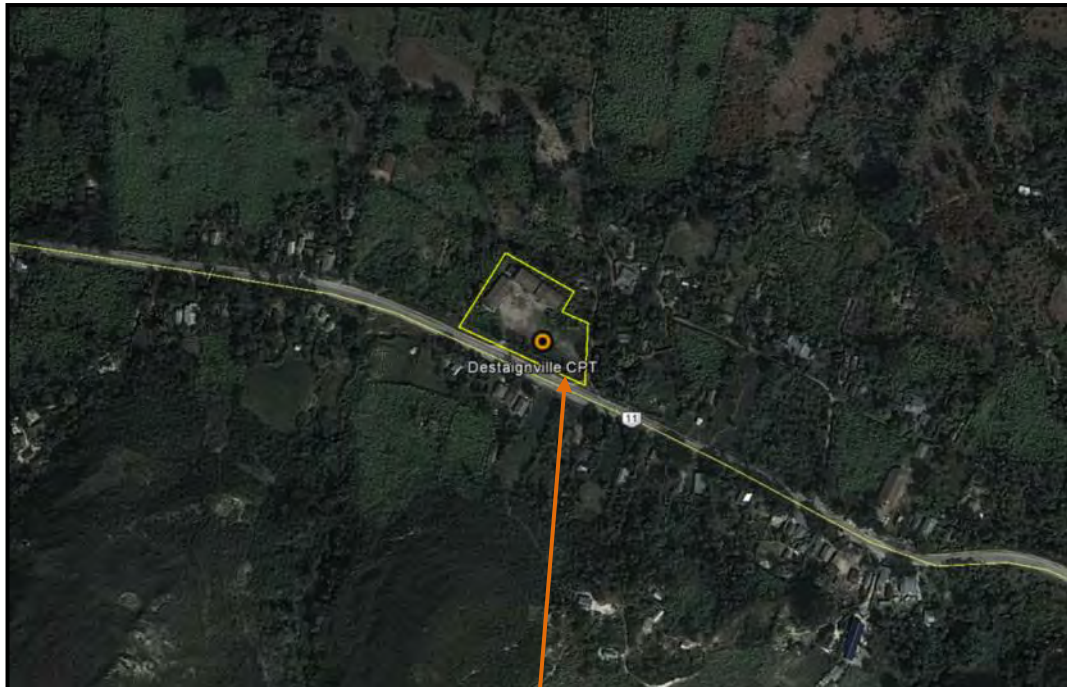

Location

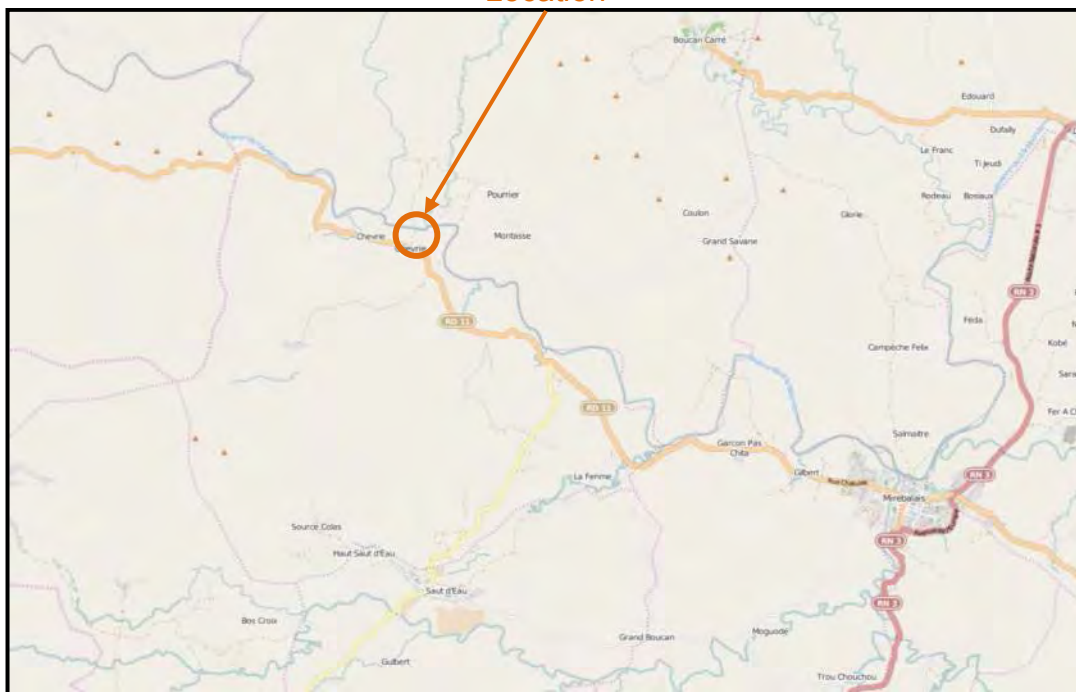

Location of the studied plot (orthophoto GeoEye from January 2010 and Open Street Map)

2. GEOLOGY

Based on the geological map of Haïti (North-East 1/250000), the studied site is situated on formations belonging to the middle Miocene. Those formations are composed by 3 different facies: blue/grey marl, fine sandstone or detrital series with discontinuous limestone series (Mm on the map).

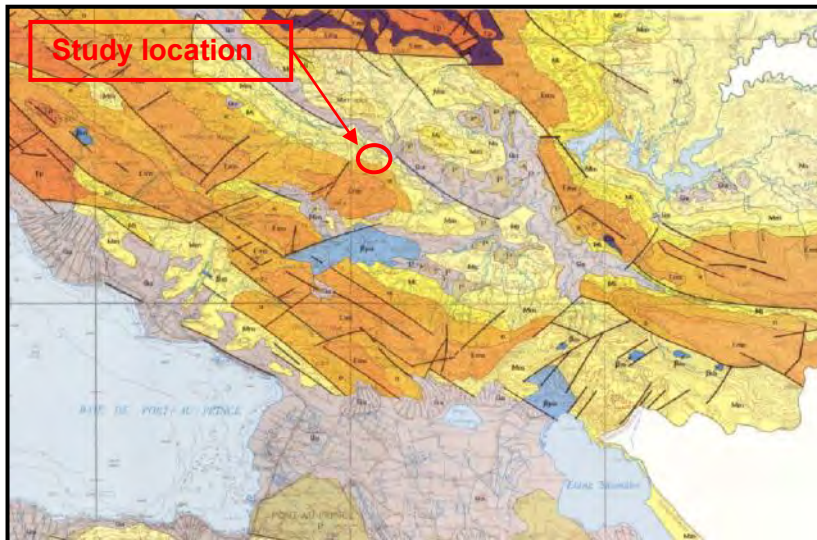

Sample of the geological map of Haïti (South-East, 1/250000)

No water neither spring nor stagnant water area was observed on the studied plot at the time of the visit.

And no water was found during the CPT Test.

In order to the plot geometry, infiltrations phenomenon seem preponderant than runoff water.

They are strongly possible during a raining period.

3. GEOTECHNICAL STUDIES

3.1. Mechanical boring test – CPT

Here are the N values and the penetration index :

SITE 9

Point	Depth in m	N value
1	1.0	5.62
2	2.0	20.80
3	3.0	

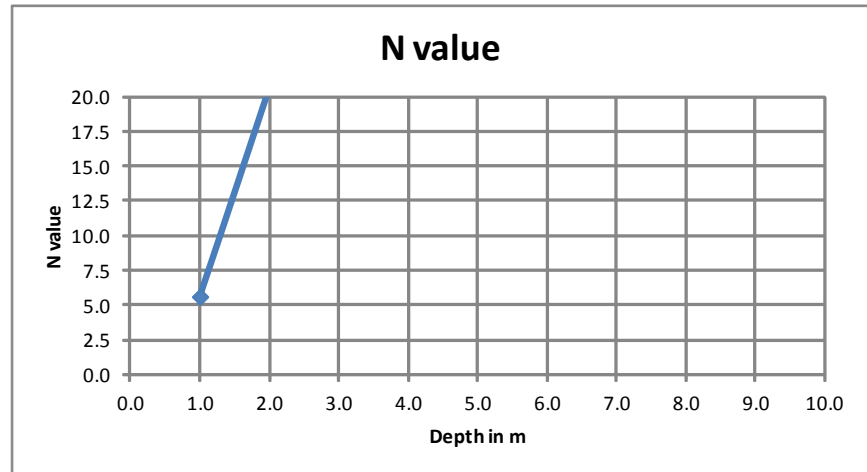

Point	Depth in m	Penetration Index
1	1.0	0.64
2	2.0	0.14
3	3.0	

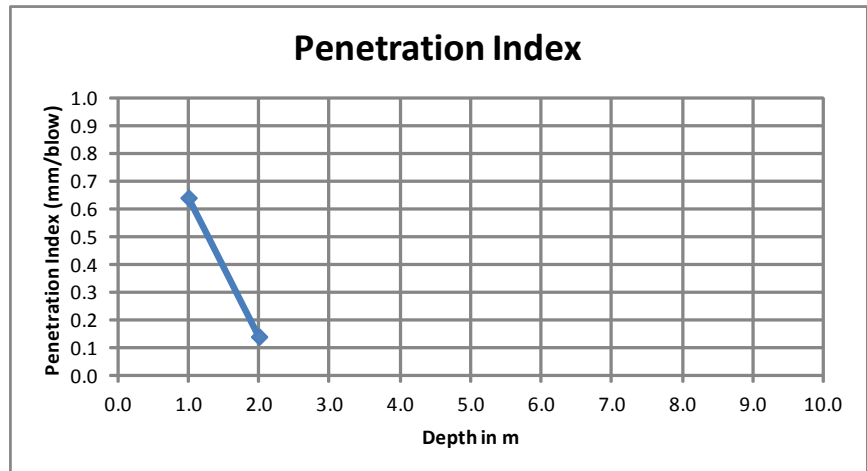

Pen. Ind., PI = $\Delta D_p / \Delta BC$

We have very good N values from 1 m (5 to 20).

3.2. Laboratory tests

We took 2 samples in the drilling, then we made:

- a water natural content,
- a sieve analysis.
- a specific gravity

These are the results (see in appendix 2, board and curve):

ID	Soil's nature	W%	% to 50% (in mm)	Atterberg limits	Specific gravity
Hole 1 @1m	Sand	10.5	1.3	/	2.67
Hole 1 @2m	Sand	14.8	1.2	/	2.63

This ground is constituted thus by sands ; the water natural content is on average 12.7 %. These sands are little compact until 1.2 m and averagely compact after 1.2 m.

4. GEOTECHNICAL RECOMMENDATIONS

The recommendations of this report do not take into account any possible future constructions not stated in the introduction, which can modify the stability context of the area (Backfill, excavation...).

These recommendations are only to be applied for the project presented in the introduction and cannot be used for another one, even located on the same plot.

4.1. Building location

The locations of the future buildings within the plot are not restricted from a geotechnical point of view.

4.2. Excavations

From what is known at the time of the study, the excavation works will concern:

- The ground excavation for the construction basis,
- The foundations excavation.

The excavations will begin by the cleaning of the covert ground (layer above the sands). Residual roots must be purged and evacuated outside of the influence of the project. During the construction phase, the platform will have a slope of about 2% to promote the flow of water.

The excavations will be preferentially realized in dry season.

4.3. Project environnement

According to the plot area topography and slope, infiltration phenomenon seems preponderant than runoff water.

During the excavation phase:

- A fill slope protection against raining water must be established.

On the final phase:

- **An outlying drainage of the buried parts of the building** must be constructed.

The collected waters (outlying drainage, roof, access roads...) have to be evacuated, when possible, to a wastewater collection system.

4.4. Foundations

No information about vertical loads on building foundations were given by the client. However, the project concerns a structure considered as "light" (1 or 2 levels).

According to the soil's nature, the CPT and the ground water level encountered on the plot study area and to avoid differential settlement under the constructions, which could lead to their ruin, it is recommended to plan:

Footings resting or isolated massifs anchored in 1.2 m; the anchoring will be 0.3 m minimum in sands ; the foundation's width, B will be less than 1.22 m.

The following bearing capacity values were calculated from the geotechnical test results, and with the Meyerhof's formula, allowing considering the settlements as negligible at a long-term period:

$q_{adm} = 1.36 \text{ bars} = 0,14 \text{ MPa}$ (Service Limit State)

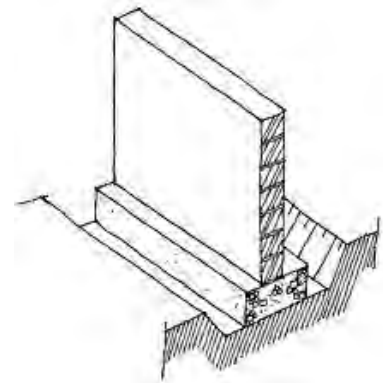

5. SEISMIC PARAMETERS

5.1. Building code

According to MTPTC recommendations given in “Règles de calcul intérimaires pour les bâtiments en Haïti », the paraseismic building code authorized in Haïti, in wait of a specific haïtian code, are CNBC, ACI-318, International Building Code, EuroCode 8 and CUBiC.

5.2. Site seismicity

The plot is located in a **highly seismic area**.

Directs effects

Direct effects are soil vibrations and major geological accidents.

- Topographic amplification: seismic wave amplification can be modified by the site topography and by the ground geodynamic characteristics. The study plot is quite horizontal, there are no slopes nearby, so **the amplification coefficient ST is 1,0**.

- Geological accident: At some kilometers of this site, this area of Saut d'eau contains 2 faults : NW-SE and SW-NE.

Induced effects

Induced effects are ground movements, tsunami and soil liquefaction.

- Ground movements: at the location of the land plot, no major sign of instability was spotted. Based on the site topography, the risk of landslide or rock fall can be excluded.
- Tsunami : no risk here.
- Liquefaction: the geotechnical tests carried out on the land plot show that there is no risk of liquefaction for the first meters of the ground (sands).

SITE #10 – ECOLE NATIONALE DE BOUCAN CARRE, BOUCAN CARRE

1. LOCALIZATION

The study plot is located in Boucan Carré, at the following coordinates: **N18°55'08.69"** / **W072°08'21.83"**

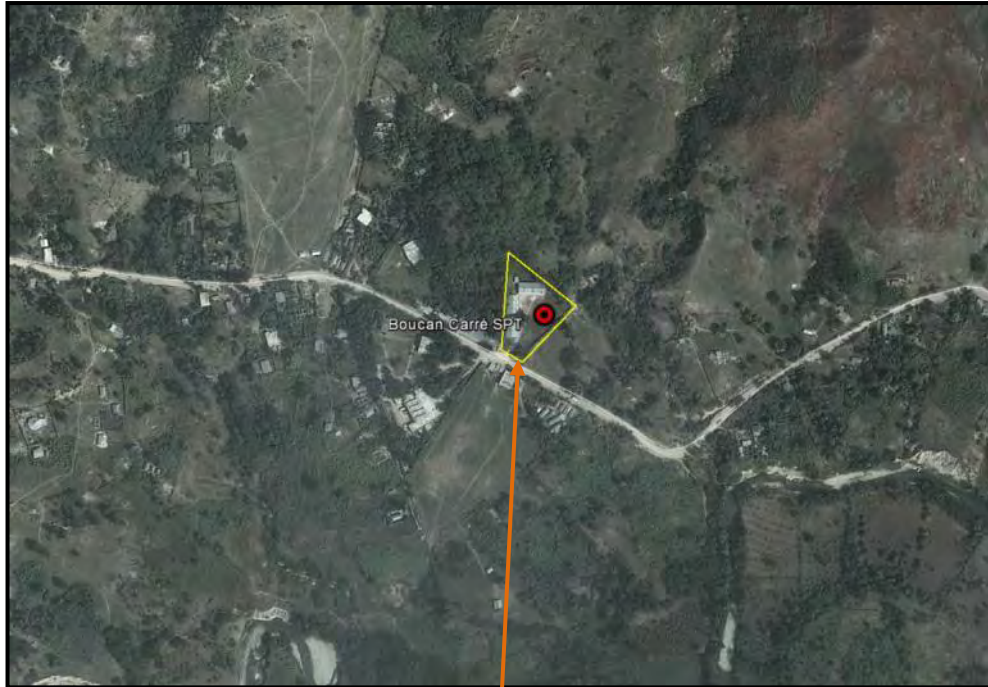

Location

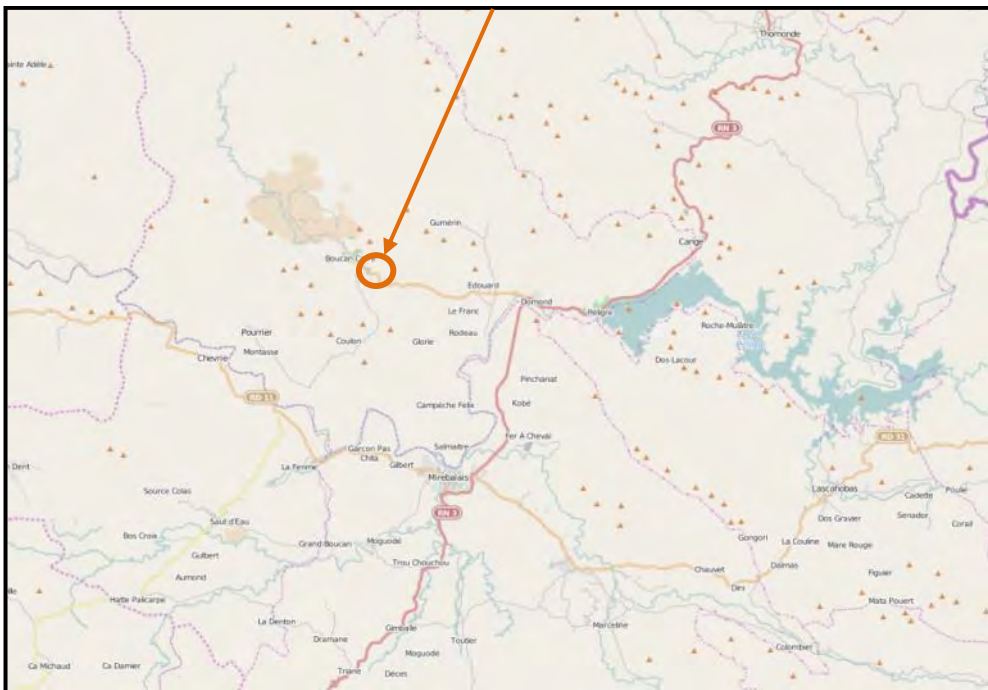

Location of the studied plot (orthophoto GeoEye from January 2010 and Open Street Map)

2. GEOLOGY

Based on the geological map of Haïti (South-East, 1/250000), the studied site is located on formations belonging to the upper Miocene. Those formations are composed of sandstone or conglomerates, overcome by silts more or less thin (ms on the map).

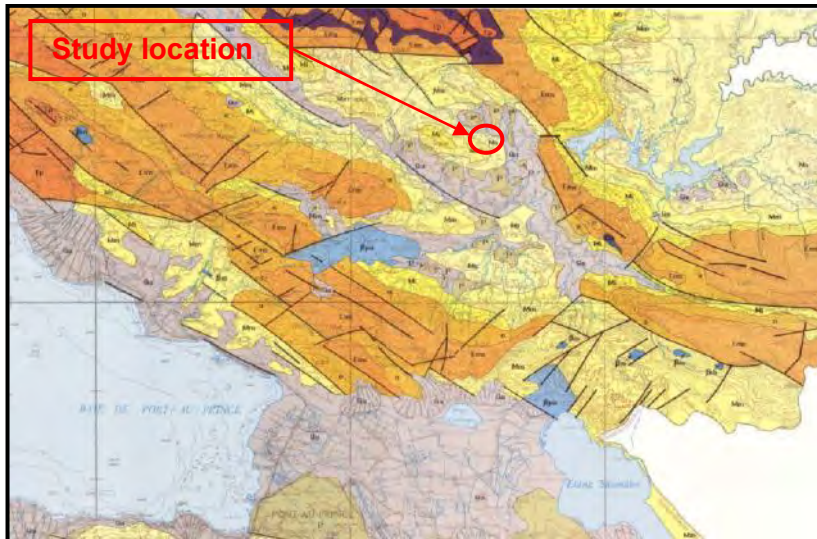

Sample of the geological map of Haïti (South-East, 1/250000)

No water neither spring nor stagnant water area was observed on the studied plot at the time of the visit.

And no water was found during the SPT Test. However, the water natural content of the samples is very high. That means may be we have a level of water near the surface (groundwater).

In order to the plot geometry, infiltrations phenomenon seem preponderant than runoff water.

They are strongly possible during a raining period.

3. GEOTECHNICAL STUDIES

3.1. Mechanical boring test – SPT

In every drilling, we realized the measure of the resistance of the soil with a penetrometer according to the depth (SPT) and according to the standard ASTM D1586 (see in appendix 1, the boring log). The results of the essays are given in the following board:

Location	N (15cm)	N (30cm)	N (45cm)	% recouvre
Forage 1				
4ft	3	5	6	88.88
7ft	3	4	6	77.7
11ft	3	3	4	105.5
14ft	3	4	6	94.44
18ft	4	4	4	94
21ft	4	4	9	105.55
25ft	7	11	16	133
28ft	5	7	13	150
31ft	7	15	20	150
35ft	6	12	20	150

Correction pour les conditions de terrain :

$$N_{60} = N \eta_H \eta_B \eta_S \eta_R / 60 \quad \text{Lorsque,}$$

η_H = efficacité de marteau (%) = 45 pour US Donut sur la corde et la poulie

η_B = correction pour diamètre de trou = 1.0 (4.7 pouce restriction)

η_S = correction pour l'échantillonneur = 1.0 pour standard sampler

η_R = correction pour la longueur de tige = 0.75 (0–3,6m) / 0.85 (3,6 – 6m) / 0.95 (6 – 9,1m)

Here are the values N and the corresponding curve:

Point	Depth in m	N value
1	1.2	6.18
2	2.1	5.62
3	3.4	3.93
4	4.3	6.37
5	5.5	5.10
6	6.4	9.26
7	7.6	19.23
8	8.5	14.25
9	9.5	26.25
10	10.7	24.00

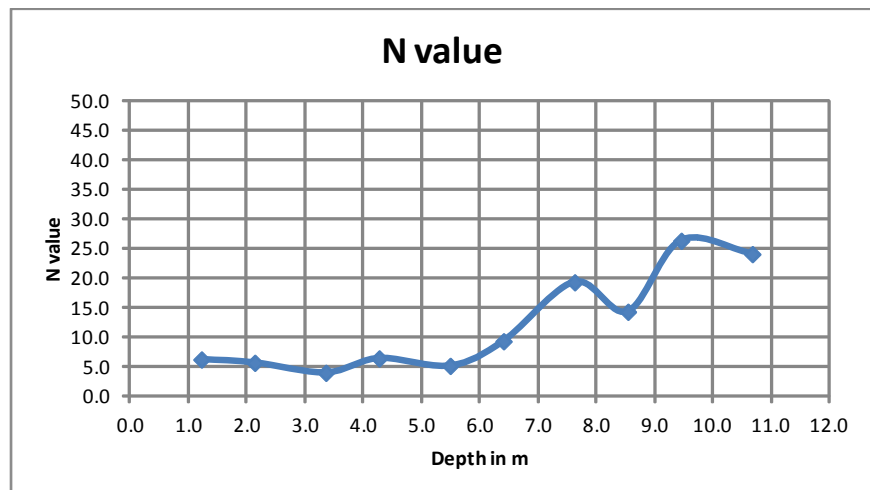

The seismic class of this site is : D

3.2. Laboratory tests

We took 10 samples in the drilling, then we made:

- A water natural content,
- A sieve analysis.

These are the results (see in appendix 2, board and curve):

ID	Soil's nature	W%	% to 50% (in mm)	Atterberg limits	Specific gravity
Hole 1 @1.2m	Gravel	28.2 %	> 5 mm	/	2.65
Hole 1 @2.1m	Big sand	36.6	3.5 mm	/	
Hole 1 @3.4m	Big sand	36.9	2.7 mm	/	
Hole 1 @4.3m	Sand with silt	33.7	1.0 mm	/	2.63
Hole 1 @5.5m	Sand with silt	33.6	2.0 mm	LL=48.6 ; PI=9.8	
Hole 1 @6.4m	Gravel	31.5	> 5 mm	/	2.65
Hole 1 @7.6m	Gravel	33.9	5.0 mm	/	
Hole 1 @8.5m	Gravel	41.8	> 5 mm	/	2.67
Hole 1 @9.5m	Gravel	35.5	5.0 mm	/	
Hole 1 @10.7m	Big sand	38.8	3.5 mm	/	2.65

This ground is constituted thus especially by gravels and by sand; it has between 4.3 m and 5.5 m a layer of sand containing silts-clay, with a PI= 9.8 (few clayey) ; depending of the grain size distributions, the samples contain very few clay or silt . The water natural content is on average 35.1 %

Depending of the N values, this ground is little compact until 6.4 m and averagely compact from 6.4 m.

4. GEOTECHNICAL RECOMMENDATIONS

The recommendations of this report do not take into account any possible future constructions not stated in the introduction, which can modify the stability context of the area (Backfill, excavation...).

These recommendations are only to be applied for the project presented in the introduction and cannot be used for another one, even located on the same plot.

4.1. Building location

The locations of the future buildings within the plot are not restricted from a geotechnical point of view.

4.2. Excavations

From what is known at the time of the study, the excavation works will concern:

- The ground excavation for the construction basis,
- The foundations excavation.

The excavations will begin by the cleaning of the covert ground (layer above the gravels). Residual roots must be purged and evacuated outside of the influence of the project. During the construction phase, the platform will have a slope of about 2% to promote the flow of water.

The excavations will be preferentially realized in dry season.

4.3. Project environnement

According to the plot area topography and slope, infiltration phenomenon seems preponderant than runoff water.

During the excavation phase:

- A fill slope protection against raining water must be established.

On the final phase:

- **An outlying drainage of the buried parts of the building** must be constructed.

The collected waters (outlying drainage, roof, access roads...) have to be evacuated, when possible, to a wastewater collection system.

4.4. Foundations

No information about vertical loads on building foundations were given by the client. However, the project concerns a structure considered as "light" (1 or 2 levels).

According to the soil's nature, the SPT and the ground water level encountered on the plot study area and to avoid differential settlement under the constructions, which could lead to their ruin, it is recommended to plan:

Footings resting or isolated massifs anchored in 1.2 m; the anchoring will be 0.5 m minimum in gravels ; the foundation's width, B will be less than 1.22 m.

The following bearing capacity values were calculated from the geotechnical test results, and with the Meyerhof's formula, allowing considering the settlements as negligible at a long-term period:

$$q_{adm} = 0,96 \text{ bars} = 0,10 \text{ MPa (Service Limit State)}$$

5. SEISMIC PARAMETERS

5.1. Building code

According to MTPTC recommendations given in “Règles de calcul intérimaires pour les bâtiments en Haïti », the paraseismic building code authorized in Haïti, in wait of a specific haïtian code, are CNBC, ACI-318, International Building Code, EuroCode 8 and CUBiC.

5.2. Site seismicity

The plot is located in a **highly seismic area**.

Directs effects

Direct effects are soil vibrations and major geological accidents.

- Topographic amplification: seismic wave amplification can be modified by the site topography and by the ground geodynamic characteristics. The study plot is quite horizontal, there are no slopes nearby, so **the amplification coefficient ST is 1,0**.
- Soil classification: according to the SPT test realized on the study plot, the site is located on soils belonging **to the soil class NEHRP D**. The soil pick ground acceleration map (PGA), established by USGS, indicates a **PGA of around 0,60 g** ($g = 9,81 \text{ m/s}^2$) for the area of Boucan Carre.

Induced effects

Induced effects are ground movements, tsunami and soil liquefaction.

- Ground movements: at the location of the land plot, no major sign of instability was spotted. Based on the site topography, the risk of landslide or rock fall can be excluded.
- Tsunami : no risk here.
- Liquefaction: the geotechnical tests carried out on the land plot show that there is no risk of liquefaction for the first meters of the ground.

SITE #11 – ECOLE NATIONALE D'IMMACULEE CONCEPTION, HINCHE

1. LOCALIZATION

The study plot is located in Hinche, at the following coordinates:
N19°08'35.84" / W072°00'34.72"

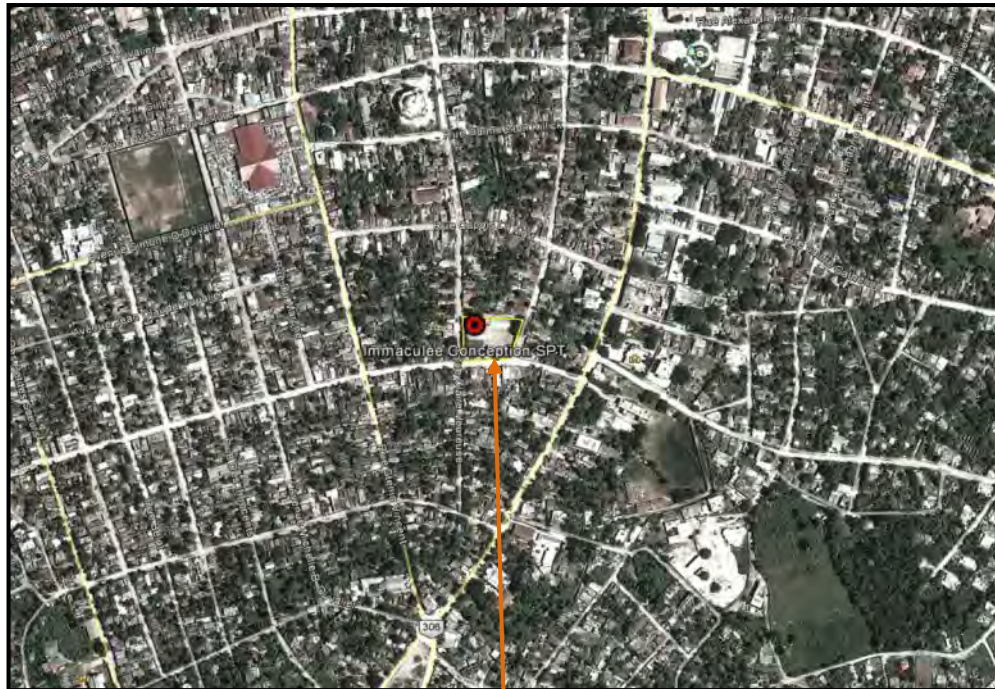

Location

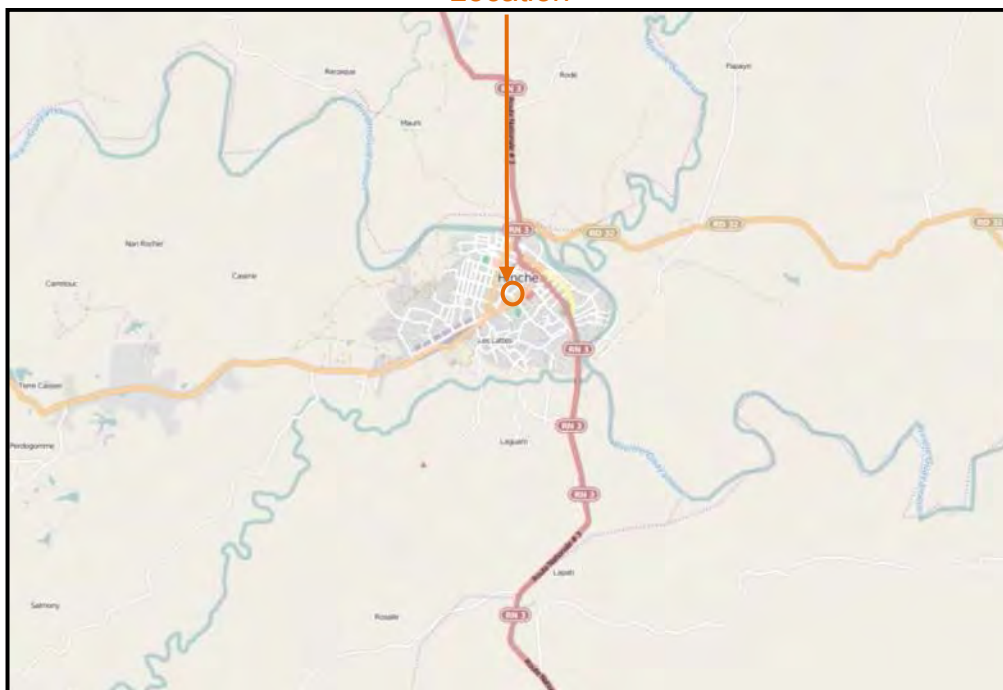

Location of the studied plot (orthophoto GeoEye from January 2010 and Open Street Map)

2. GEOLOGY, MORPHOLOGY, HYDROGEOLOGY

Based on the geological map of Haïti (1/250000), the studied site is located between recent deposits like alluvium (Qa on the map) and sandstone or conglomerates, overcome by silts more or less thin (ms on the map).

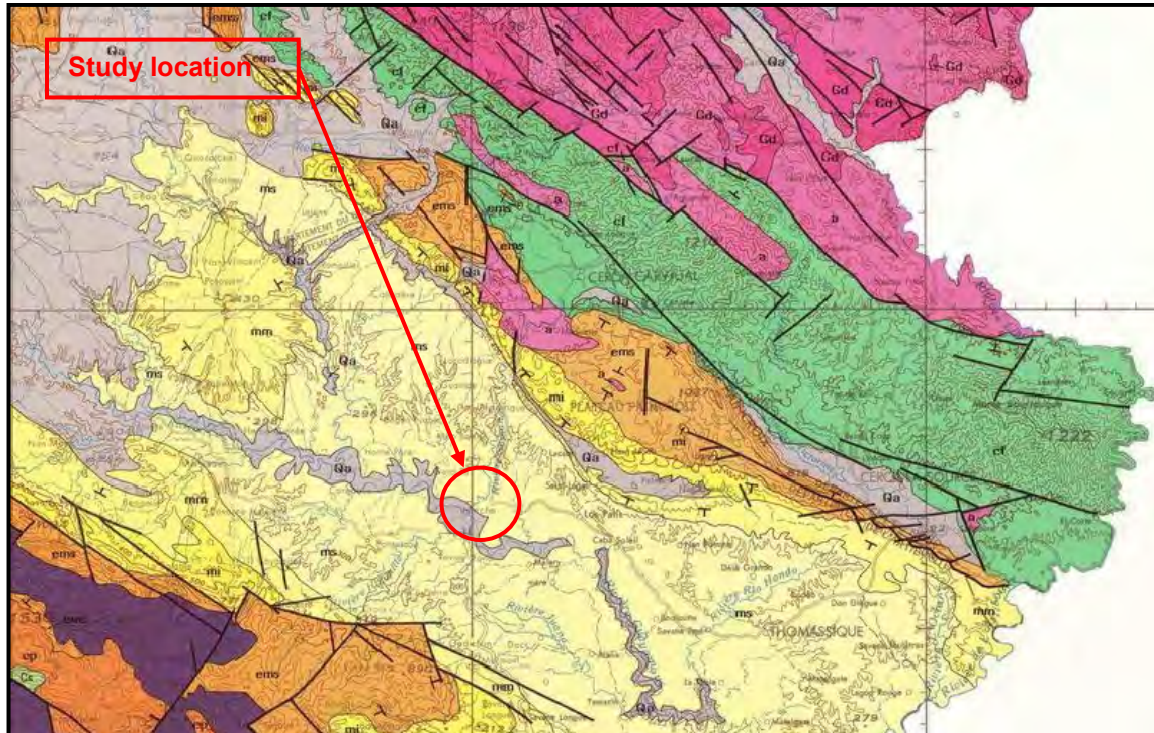

Sample of the geological map of Haïti (Nord-East, 1/250000)

2.2. Morphology and surface geological observations

The study land plot is occupied by 3 schools buildings at 1 level (pictures a, b and c). It is quite horizontal (pictures a, band c). The ground is covered by rocky and sandy materials (pictures a, b and c).



Picture a



Picture b



Picture c

2.3. Hydrogeology

No water neither spring nor stagnant water area was observed on the studied plot at the time of the visit.

And no water was found during the SPT Test.

In order to the plot geometry, infiltrations phenomenon seem preponderant than runoff water.

They are strongly possible during a raining period.

3. GEOTECHNICAL STUDIES

3.1. Mechanical boring test – SPT

In every drilling, we realized the measure of the resistance of the soil with a penetrometer according to the depth (SPT) and according to the standard ASTM D1586 (see in appendix 1, the boring log). The results of the essays are given in the following board:

Location	N 5.90''	N 11.81''	N 17.71''	% recouvre
Forage 1				
3,5ft	4	6	8	15''
10.5ft	3	4	5	15''
21ft	3	3	6	16''
28ft	26	22	15	17''
35ft	45	50	-	17''

Correction pour les conditions de terrain :

$N_{60} = N \eta_H \eta_B \eta_S \eta_R / 60$ Lorsque,

η_H = efficacité de marteau (%) = 45 pour US Donut sur la corde et la poulie

η_B = correction pour diamètre de trou = 1.0 (4.7 pouce restriction)

η_S = correction pour l'échantillonneur = 1.0 pour standard sampler

η_R = correction pour la longueur de tige = 0.75 (0–11,80ft)/ 0.85 (11,8 – 19,6ft)/ 0.95 (19,6 – 29,8ft)

Here are the values N and the corresponding curve:

Point	Depth in m	N value
1	1.1	7.87
2	2.1	5.06
3	3.2	6.75
4	4.3	5.73
5	5.3	29.32
6	6.4	26.36
7	7.5	50.00
8	8.5	
9	9.5	
10	10.7	

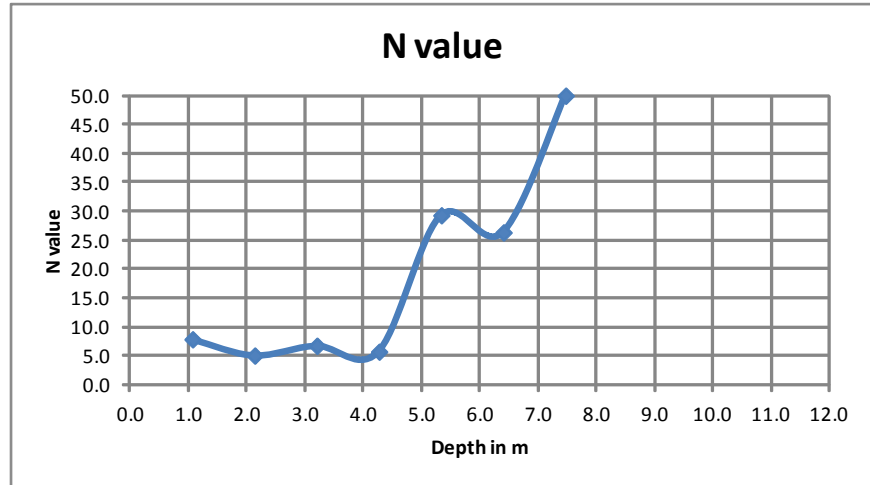

The sismic class of this site is : D

3.2. Laboratory tests

We took 5 samples in the drilling, then we made:

- A water natural content,
- A sieve analysis.

These are the results (see in appendix 2, board and curve):

ID	Soils's nature	W%	% to 50% (in mm)	Atterberg limits	Specific gravity
Hole 1 @1.2m	Sand	12.0	0.7 mm	/	2.64
Hole 1 @2.1m	Sand	18.0	0.7 mm	/	2.65
Hole 1 @4.3m	Sand	13.2	0.5 mm	/	2.67
Hole 1 @6.4m	Sand	6.0	2.0 mm	/	2.65
Hole 1 @7.6m	Sand	3.4	2.0 mm	/	2.63

This ground is constituted thus by sands. The water natural content is on average 10.5 %. Depending of the N values, this ground is little compact until 4.6 m and averagely compact after this value.

4. GEOTECHNICAL RECOMMENDATIONS

The recommendations of this report do not take into account any possible future constructions not stated in the introduction, which can modify the stability context of the area (Backfill, excavation...).

These recommendations are only to be applied for the project presented in the introduction and cannot be used for another one, even located on the same plot.

4.1. Building location

The locations of the future buildings within the plot are not restricted from a geotechnical point of view.

4.2. Excavations

From what is known at the time of the study, the excavation works will concern:

- The ground excavation for the construction basis,
- The foundations excavation.

The excavations will begin by the cleaning of the covert ground (layer above the sands). Residual roots must be purged and evacuated outside of the influence of the project.

During the construction phase, the platform will have a slope of about 2% to promote the flow of water.

The excavations will be preferentially realized in dry season.

4.3. Project environnement

According to the plot area topography and slope, infiltration phenomenon seems preponderant than runoff water.

During the excavation phase:

- A fill slope protection against raining water must be established.

On the final phase:

- **An outlying drainage of the buried parts of the building** must be constructed.

The collected waters (outlying drainage, roof, access roads...) have to be evacuated, when possible, to a wastewater collection system.

4.4. Foundations

No information about vertical loads on building foundations were given by the client. However, the project concerns a structure considered as "light" (1 or 2 levels).

According to the soil's nature, the SPT and the ground water level encountered on the plot study area and to avoid differential settlement under the constructions, which could lead to their ruin, it is recommended to plan:

Footings resting or isolated massifs anchored in 1.2 m; the anchoring will be 0.3 m minimum in sands ; the foundation's width, B will be less than 1.22 m.

The following bearing capacity values were calculated from the geotechnical test results, and with the Meyerhof's formula, allowing considering the settlements as negligible at a long-term period:

$q_{adm} = 1.12 \text{ bars} = 0,11 \text{ MPa}$ (Service Limit State)

5. SEISMIC PARAMETERS

5.1. Building code

According to MTPTC recommendations given in "Règles de calcul intérimaires pour les bâtiments en Haïti », the parasismic building code authorized in Haïti, in wait of a specific haïtian code, are CNBC, ACI-318, International Building Code, EuroCode 8 and CUBiC.

5.2. Site seismicity

The plot is located in a **highly seismic area**.

Directs effects

Direct effects are soil vibrations and major geological accidents.

- Topographic amplification: seismic wave amplification can be modified by the site topography and by the ground geodynamic characteristics. The study plot is quite horizontal, there are no slopes nearby, so **the amplification coefficient ST is 1,0**.
- Soil classification: according to the SPT test realized on the study plot, the site is located on soils belonging **to the soil class NEHRP D**. The soil pick ground acceleration map (PGA), established by USGS, indicates a **PGA of around 0,35 g** ($g = 9,81 \text{ m/s}^2$) for the area of Hinche.

Induced effects

Induced effects are ground movements, tsunami and soil liquefaction.

- Ground movements: at the location of the land plot, no major sign of instability was spotted. Based on the site topography, the risk of landslide or rock fall can be excluded.
- Tsunami : no risk here.
- Liquefaction: the geotechnical tests carried out on the land plot show that there is no risk of liquefaction for the first meters of the ground.

SITE #12 – ECOLE NATIONALE DE TOUSSAINT LOUVERTURE, HINCHE

1. LOCALIZATION

The study plot is located in Hinche, at the following coordinates:
N19°08'29.86" / W072°00'15.49"

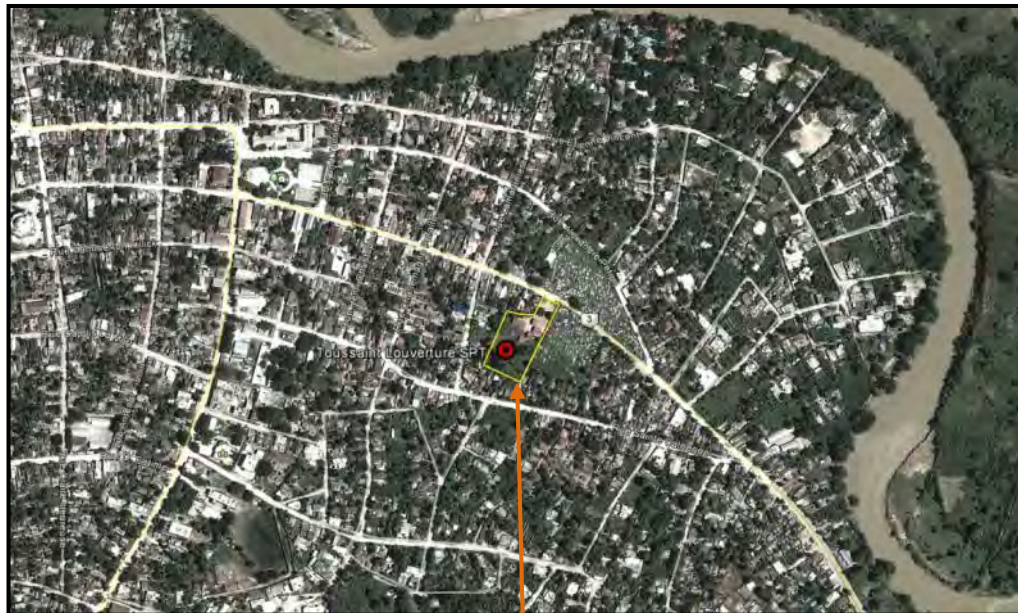

Location

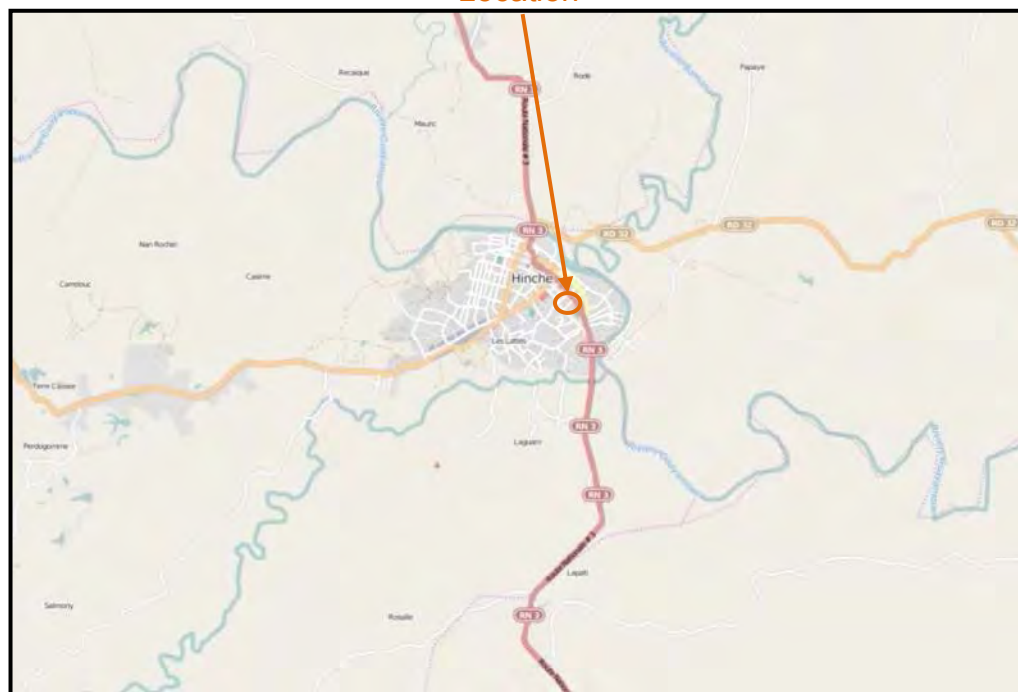

Location of the studied plot (orthophoto GeoEye from January 2010 and Open Street Map)

2. GEOLOGY, MORPHOLOGY, HYDROGEOLOGY

2.1. Geology

Based on the geological map of Haïti (1/250000), the studied site is located between recent deposits like alluvium (Qa on the map) and sandstone or conglomerates, overcome by silts more or less thin (ms on the map).

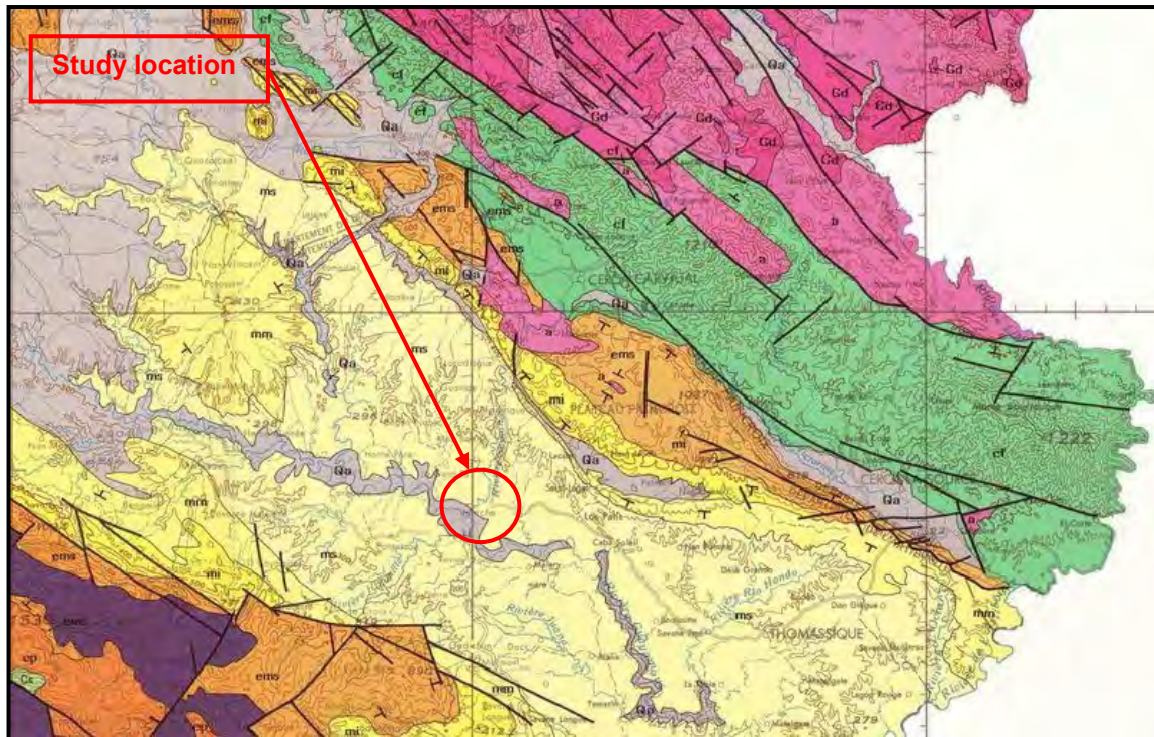

Sample of the geological map of Haïti (North-East, 1/250000)

2.2. Morphology and surface geological observations

The study land plot is occupied by few schools buildings at 1 level (pictures a and b). It is quite horizontal (pictures a, b and c). The ground is covered by short grass (pictures a, b and c). There are also some few trees (pictures b and c).



Picture a



Picture b



Picture c

2.3. Hydrogeology

No water neither spring nor stagnant water area was observed on the studied plot at the time of the visit.

And no water was found during the SPT Test.

In order to the plot geometry, infiltrations phenomenon seem preponderant than runoff water.

They are strongly possible during a raining period.

3. GEOTECHNICAL STUDIES

3.1. Mechanical boring test – SPT

In every drilling, we realized the measure of the resistance of the soil with a penetrometer according to the depth (SPT) and according to the standard ASTM D1586 (see in appendix 1, the boring log). The results of the essays are given in the following board:

Location	N	N	N	% recouvre
	5.90''	11.81''	17.71''	
Forage 1				
3,5ft	4	4	6	16''
7ft	5	4	4	16''
10.5ft	6	6	8	15''
14ft	3	35	-	17''
17.5ft	49	50	-	16''

Correction pour les conditions de terrain :

$N_{60} = N \eta_H \eta_B \eta_S \eta_R / 60$ Lorsque,

η_H = efficacité de marteau (%) = 45 pour US Donut sur la corde et la poulie

η_B = correction pour diamètre de trou = 1.0 (4.7 pouce restriction)

η_S = correction pour l'échantillonneur = 1.0 pour standard sampler

η_R = correction pour la longueur de tige = 0.75 (0–11,80ft)/ 0.85 (11,8 – 19,6ft)/ 0.95 (19,6 – 29,8ft)

Here are the values N and the corresponding curve:

Point	Depth in m	N value
1	1.1	5.62
2	2.1	4.50
3	3.2	7.87
4	4.3	24.80
5	5.3	50.00
6	6.4	
7	7.5	
8	8.5	
9	9.5	
10	10.7	

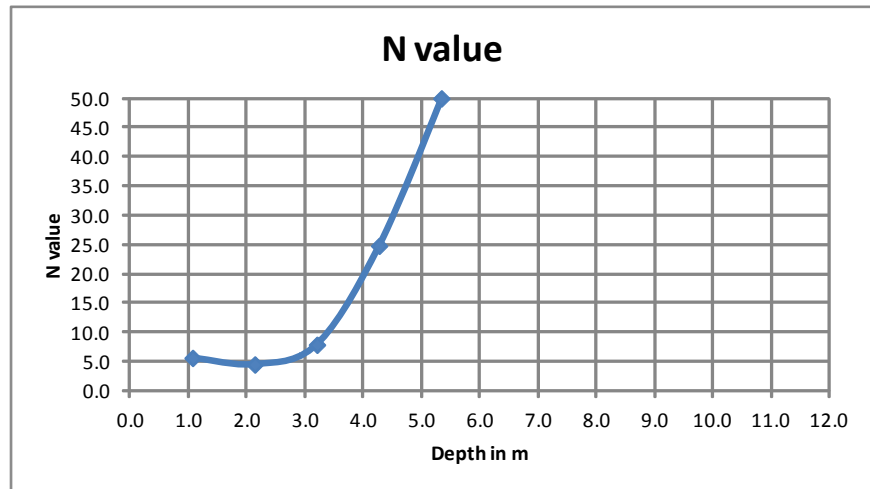

The sismic class of this site is : D

3.2. Laboratory tests

We took 5 samples in the drilling, then we made:

- A water natural content,
- A sieve analysis.

These are the results (see in appendix 2, board and curve):

ID	Soils's nature	W%	% to 50% (in mm)	Atterberg limits	Specific gravity
Hole 1 @1.2m	Sand with clay	14.2	1.0 mm	/	2.64
Hole 1 @2.1m	sand	6.7	0.4 mm	/	2.63
Hole 1 @3.4m	sand	6.8	2.2 mm	/	2.65
Hole 1 @4.3m	Sand with clay	14.5	0.35 mm	/	2.67
Hole 1 @5.5m	Sand with clay	11.2	1.0 mm	/	2.65

This ground is constituted thus especially by sands with few silt or clay.

The water natural content is on average 10.7 %.

Depending of the N values, this ground is little compact until 3.4 m and averagely compact from 3.4 m.

4. GEOTECHNICAL RECOMMENDATIONS

The recommendations of this report do not take into account any possible future constructions not stated in the introduction, which can modify the stability context of the area (Backfill, excavation...).

These recommendations are only to be applied for the project presented in the introduction and cannot be used for another one, even located on the same plot.

4.1. Building location

The locations of the future buildings within the plot are not restricted from a geotechnical point of view.

4.2. Excavations

From what is known at the time of the study, the excavation works will concern:

- The ground excavation for the construction basis,
- The foundations excavation.

The excavations will begin by the cleaning of the covert ground (layer above the sand with clay). Residual roots must be purged and evacuated outside of the influence of the project.

During the construction phase, the platform will have a slope of about 2% to promote the flow of water.

The excavations will be preferentially realized in dry season.

4.3. Project environnement

According to the plot area topography and slope, infiltration phenomenon seems preponderant than runoff water.

During the excavation phase:

- A fill slope protection against raining water must be established.

On the final phase:

- **An outlying drainage of the buried parts of the building** must be constructed.

The collected waters (outlying drainage, roof, access roads...) have to be evacuated, when possible, to a wastewater collection system.

4.4. Foundations

No information about vertical loads on building foundations were given by the client. However, the project concerns a structure considered as "light" (1 – 2 levels).

According to the soil's nature, the SPT and the ground water level encountered on the plot study area and to avoid differential settlement under the constructions, which could lead to their ruin, it is recommended to plan:

Wide foundation ($B > 1.22$ m) or mattress foundation anchored in 1.2 m; the anchoring will be 0.5 m minimum in sands.

The following bearing capacity values were calculated from the geotechnical test results, and with the Meyerhof's formula, allowing considering the settlements as negligible at a long-term period:

$q_{adm} = 0.88$ bars = 0.09 MPa (Service Limit State)

5. SEISMIC PARAMETERS

5.1. Building code

According to MTPTC recommendations given in "Règles de calcul intérimaires pour les bâtiments en Haïti », the paraseismic building code authorized in Haïti, in wait of a specific haïtian code, are CNBC, ACI-318, International Building Code, EuroCode 8 and CUBiC.

5.2. Site seismicity

The plot is located in a **highly seismic area**.

Directs effects

Direct effects are soil vibrations and major geological accidents.

- Topographic amplification: seismic wave amplification can be modified by the site topography and by the ground geodynamic characteristics. The study plot is quite horizontal, there are no slopes nearby, so **the amplification coefficient ST is 1,0**.
- Soil classification: according to the SPT test realized on the study plot, the site is located on soils belonging **to the soil class NEHRP D**. The soil pick ground acceleration map (PGA), established by USGS, indicates a **PGA of around 0,35 g** ($g = 9,81$ m/s²) for the area of Hinche.

Induced effects

Induced effects are ground movements, tsunami and soil liquefaction.

- Ground movements: at the location of the land plot, no major sign of instability was spotted. Based on the site topography, the risk of landslide or rock fall can be excluded.
- Tsunami : no risk here.
- Liquefaction: the geotechnical tests carried out on the land plot show that there is no risk of liquefaction for the first meters of the ground.

SITE #13 – ECOLE NATIONALE DE GUY MALARY, HINCHE

1. LOCALIZATION

The study plot is located in Hinche, at the following coordinates:
N19°08'22.32" / W072°01'42.19"

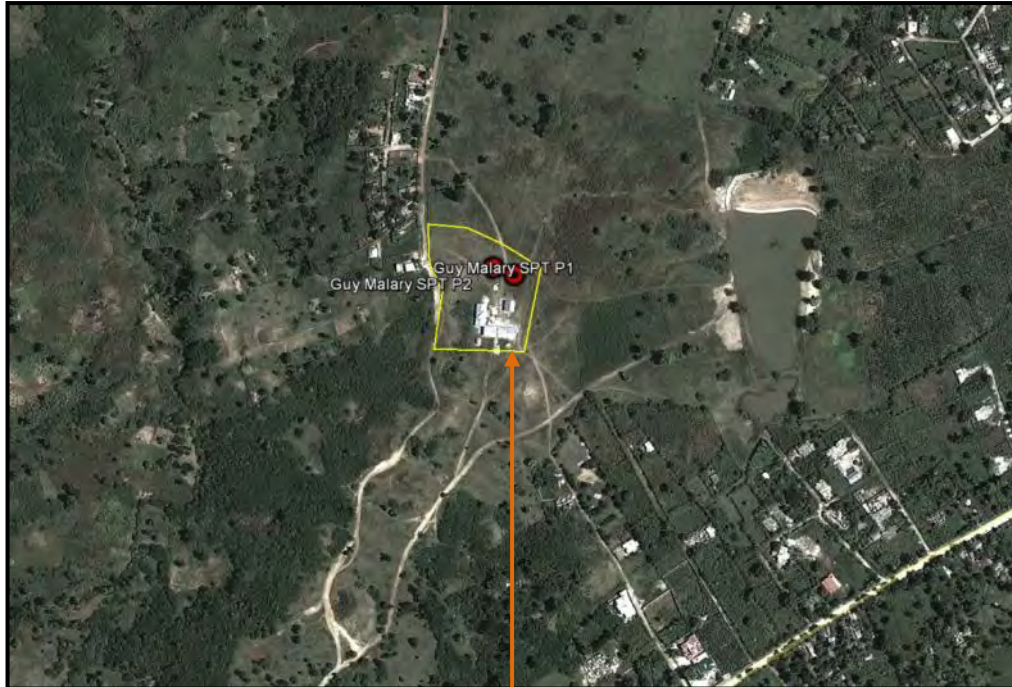

Location

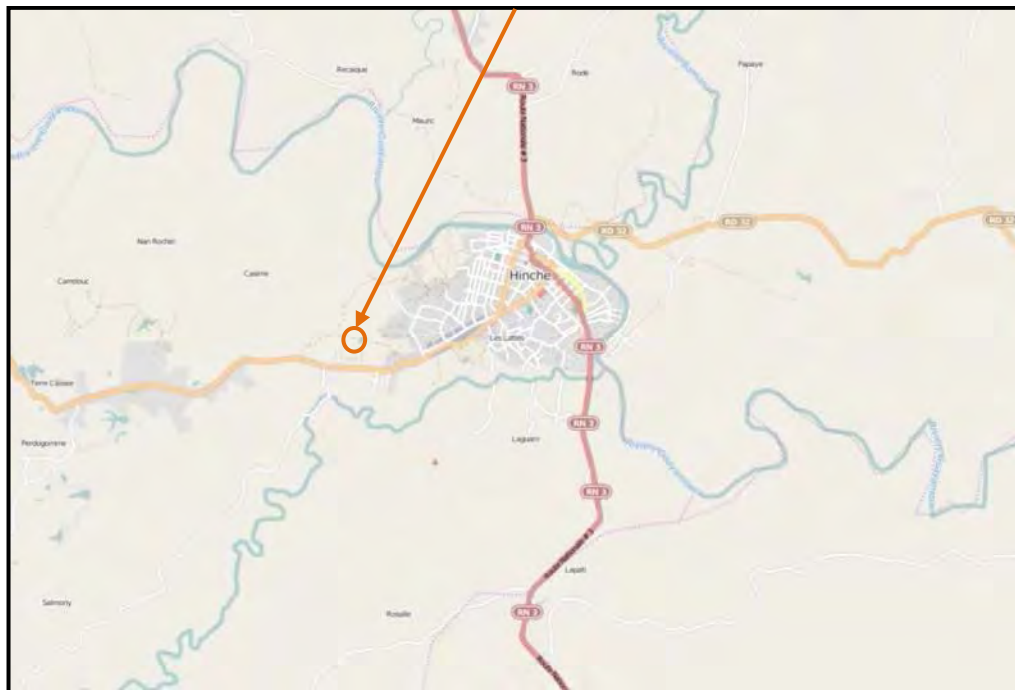

Location of the studied plot (orthophoto GeoEye from January 2010 and Open Street Map)

2. GEOLOGY

Based on the geological map of Haïti (1/250000), the studied site is located between recent deposits like alluvium (Qa on the map) and sandstone or conglomerates, overcome by silts more or less thin (ms on the map).

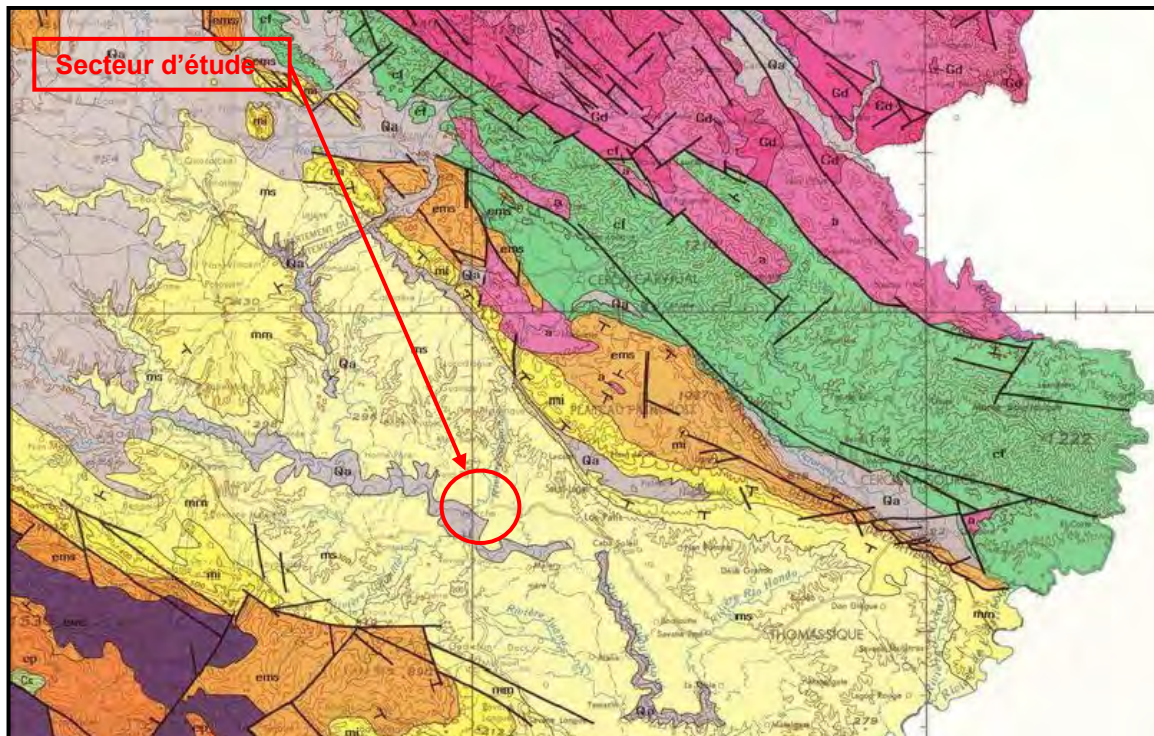

Sample of the geological map of Haïti (North-East, 1/250000)

No water neither spring nor stagnant water area was observed on the studied plot at the time of the visit.

And no water was found during the two SPT Tests.

In order to the plot geometry, infiltrations phenomenon seem preponderant than runoff water.

They are strongly possible during a raining period.

3. GEOTECHNICAL STUDIES – HOLE 1 AND HOLE 2

3.1. Mechanical boring tests – SPT

In every drilling, we realized the measure of the resistance of the soil with a penetrometer according to the depth (SPT) and according to the standard ASTM D1586 (see in appendix 1, the boring log). The results of the essays are given in the following board:

Location	N 5.90''	N 11.81''	N 17.71''	% recouvre
Forage 1				
3,5ft	4	7	10	10''
10.5ft	7	15	25	18''
21ft	15	30	43	18''
28ft	14	22	40	20''
35ft	12	26	43	22''

Location	N 5.90''	N 11.81''	N 17.71''	% recouvre
Forage 1				
3,5ft	4	5	5	17''
10.5ft	6	6	7	18''
21ft	8	16	21	14''
28ft	10	18	22	15''
35ft	12	14	15	4''

Correction pour les conditions de terrain :

$$N_{60} = N \eta_H \eta_B \eta_S \eta_R / 60 \quad \text{Lorsque,}$$

η_H = efficacité de marteau (%) = 45 pour US Donut sur la corde et la poulie

η_B = correction pour diamètre de trou = 1.0 (4.7 pouce restriction)

η_S = correction pour l'échantillonneur = 1.0 pour standard sampler

η_R = correction pour la longueur de tige = 0.75 (0–11,80ft)/ 0.85 (11,8 – 19,6ft)/ 0.95 (19,6 – 29,8ft)

Here are the values N and the corresponding curve (hole 1 and hole 2):

Point	Depth in m	N value
1	1.1	9.56
2	2.1	18.52
3	3.2	22.50
4	4.3	21.37
5	5.3	25.50
6	6.4	52.01
7	7.5	46.31
8	8.5	44.17
9	9.5	45.75
10	10.7	51.75

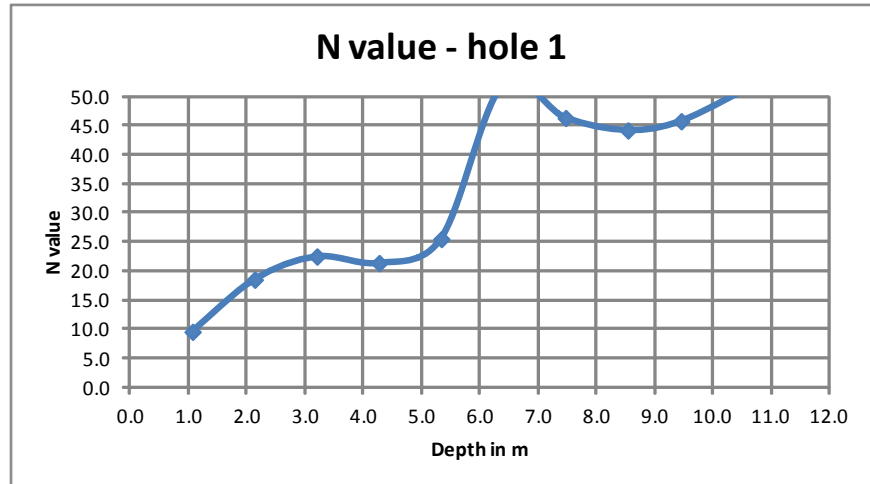

Point	Depth in m	N value
1	1.1	5.62
2	2.1	24.75
3	3.2	7.31
4	4.3	5.10
5	5.3	7.65
6	6.4	26.36
7	7.5	38.47
8	8.5	28.50
9	9.5	13.50
10	10.7	21.75

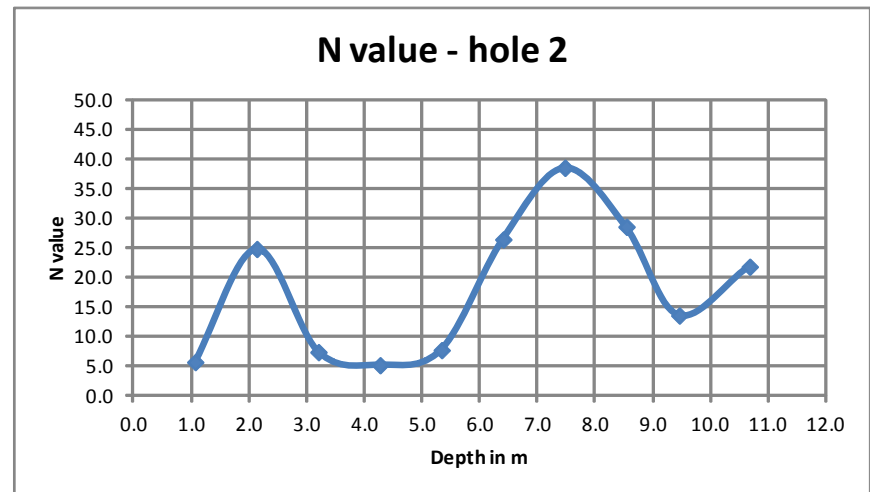

The hole 1 gives very good values N (>10) from 1 m ; the hole 2 gives too good values, between 1.1 m and 2.1 m, (5 to 25).

The sismic class of this site is : D

3.2. Laboratory tests

We took 10 samples in the drilling, then we made:

- A water natural content,
- A sieve analysis.

These are the results for the hole 1 and hole 2 (see in appendix 2, board and curve):

ID hole 1	Soil's nature	W%	% to 50% (in mm)	Atterberg limits	Specific gravity
Hole 1 @1.2m	sand	14.3 %	0.8 mm	/	2.63
Hole 1 @3.4m	Sand with clay	15.6	1.3 mm	LL=52.7 ; PI=27.7	2.65
Hole 1 @6.4m	sand	21.3	2.0 mm	/	2.67
Hole 1 @8.5m	sand	28.5	1.5 mm	/	2.65
Hole 1 @10.7m	sand	26.8	1.2 mm	/	2.64

This ground is constituted thus especially by sands; it has between 1.1 m and 6.4 m a layer of sand with clay : the PI is 27.7 ; this sample is a clayey sand.

ID hole 2	Soil's nature	W%	% to 50% (in mm)	Atterberg limits	Specific gravity
Hole 2 @1.2m	Clayey fine sand	9.8 %	0.55 mm	LL=29.5 ; PI=8.1	2.62
Hole 2 @3.4m	Fine sand	7.2	0.45 mm	/	2.64
Hole 2 @6.4m	sand	18.6	1.1 mm	/	2.65
Hole 2 @8.5m	Clayey fine sand	20.2	0.6 mm	LL=33.3 ; PI=13.3	2.62
Hole 2 @10.7m	Sand with clay	24.0	3.5 mm	/	2.64

This ground is constituted thus especially by clayey sand; it has between 3.5 ' and 28 ' a layer of sand. However, the grain size distributions show that all those samples are sands or fine sands with clay (some percents) ; the PI = 8.1 and 13.3 give a sample few clayey. The water natural content is on average 16%.

Depending of the N values, this ground is averagely compact, except for the hole 2 which is little compact at 3.5' and between 10' and 19'.

4. GEOTECHNICAL RECOMMENDATIONS

The recommendations of this report do not take into account any possible future constructions not stated in the introduction, which can modify the stability context of the area (Backfill, excavation...).

These recommendations are only to be applied for the project presented in the introduction and cannot be used for another one, even located on the same plot.

4.1. Building location

The locations of the future buildings within the plot are not restricted from a geotechnical point of view.

4.2. Excavations

From what is known at the time of the study, the excavation works will concern:

- The ground excavation for the construction basis,
- The foundations excavation.

The excavations will begin by the cleaning of the covert ground (layer above the sands slightly clayey). Residual roots must be purged and evacuated outside of the influence of the project.

During the construction phase, the platform will have a slope of about 2% to promote the flow of water.

The excavations will be preferentially realized in dry season.

4.3. Project environnement

According to the plot area topography and slope, infiltration phenomenon seems preponderant than runoff water.

During the excavation phase:

- A fill slope protection against raining water must be established.

On the final phase:

- **An outlying drainage of the buried parts of the building** must be constructed.

The collected waters (outlying drainage, roof, access roads...) have to be evacuated, when possible, to a wastewater collection system.

4.4. Foundations

No information about vertical loads on building foundations were given by the client. However, the project concerns a structure considered as “light” (1 or 2 levels).

According to the soil’s nature, the SPT and the ground water level encountered on the plot study area and to avoid differential settlement under the constructions, which could lead to their ruin, it is recommended to plan:

Footings resting or isolated massifs anchored in 1.2 m; the anchoring will be 0.3 m minimum in sands slightly clayey ; the foundation’s width, B will be less than 1.22 m.

The following bearing capacity values were calculated from the geotechnical test results, and with the Meyerhof’s formula, allowing considering the settlements as negligible at a long-term period:

$q_{adm} = 1.44 \text{ bars} = 0,14 \text{ MPa}$ (Service Limit State)

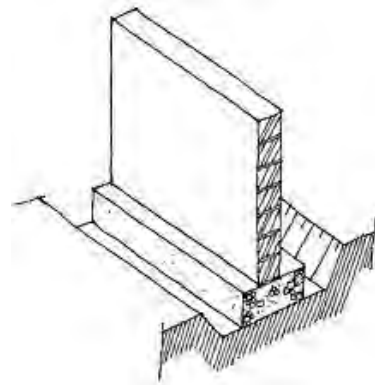

5. SEISMIC PARAMETERS

5.1. Building code

According to MTPTC recommendations given in “Règles de calcul intérimaires pour les bâtiments en Haïti », the paraseismic building code authorized in Haïti, in wait of a specific haïtian code, are CNBC, ACI-318, International Building Code, EuroCode 8 and CUBiC.

5.2. Site seismicity

The plot is located in a **highly seismic area**.

Directs effects

Direct effects are soil vibrations and major geological accidents.

- Topographic amplification: seismic wave amplification can be modified by the site topography and by the ground geodynamic characteristics. The study plot is quite horizontal, there are no slopes nearby, so **the amplification coefficient ST is 1,0**.
- Soil classification: according to the SPT test realized on the study plot, the site is located on soils belonging **to the soil class NEHRP D**. The soil pick ground acceleration map (PGA), established by USGS, indicates a **PGA of around 0,35 g** ($g = 9,81 \text{ m/s}^2$) for the area of Hinche.

Induced effects

Induced effects are ground movements, tsunami and soil liquefaction.

- Ground movements: at the location of the land plot, no major sign of instability was spotted. Based on the site topography, the risk of landslide or rock fall can be excluded.
- Tsunami : no risk here.
- Liquefaction: the geotechnical tests carried out on the land plot show that there is no risk of liquefaction for the first meters of the ground.

SITE #14 – ECOLE NATIONALE DE MARMONT, HINCHE

1. LOCALIZATION

The study plot is located in Hinche, Marmont at the following coordinates:
N19°03'50.83" / W071°59'09.68"

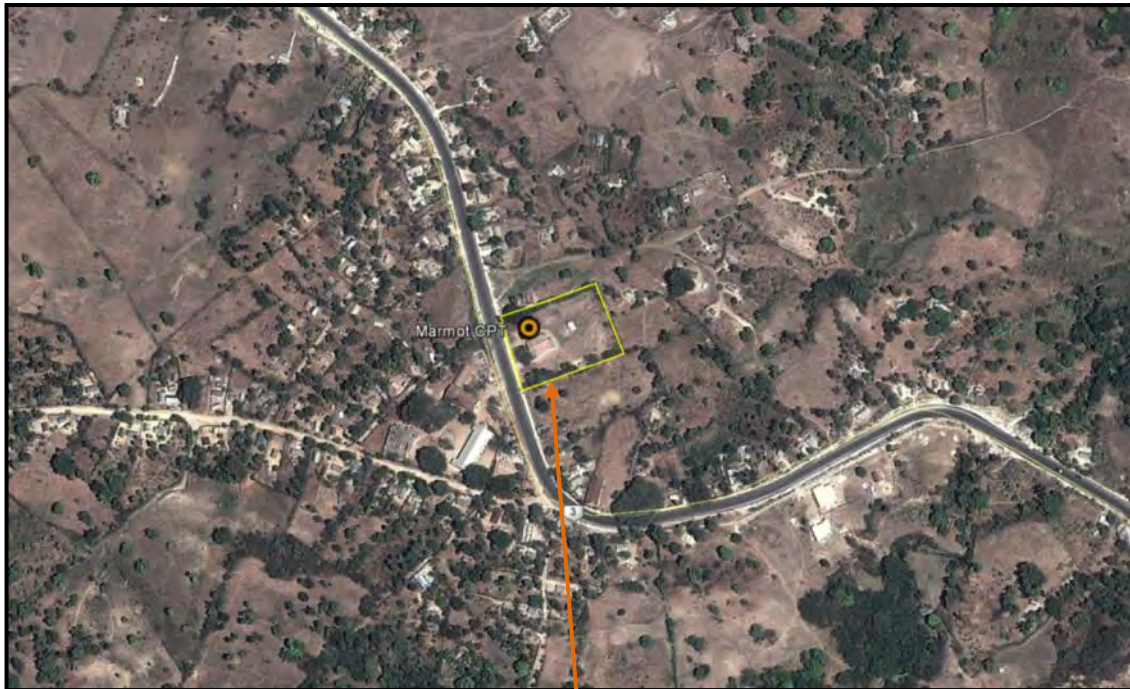

Location

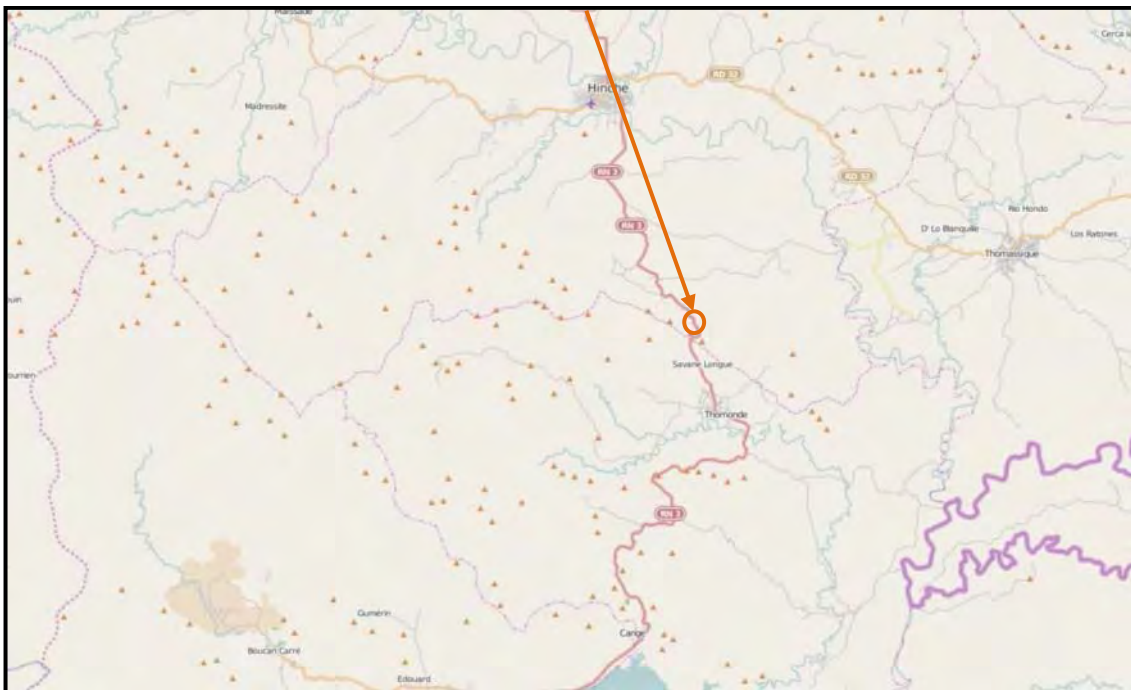

Location of the studied plot (orthophoto GeoEye from January 2010 and Open Street Map)

2. GEOLOGY

Based on the geological map of Haïti (North-East, 1/250000), the studied site is located on formations belonging to the upper Miocene. Those formations are composed of sandstone or conglomerates, overcome by silts more or less thin (ms on the map).

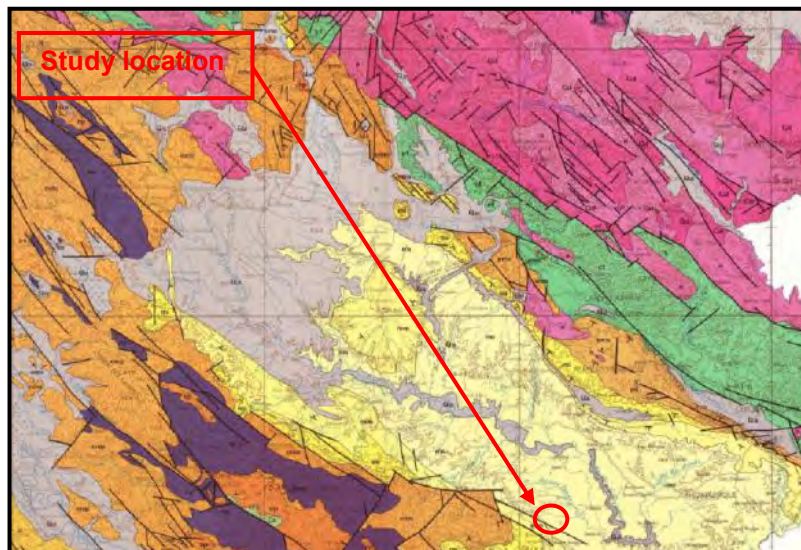

Sample of the geological map of Haïti (North-East, 1/250000)

No water neither spring nor stagnant water area was observed on the studied plot at the time of the visit.

And no water was found during the CPT Test.

In order to the plot geometry, infiltrations phenomenon seem preponderant than runoff water.

They are strongly possible during a raining period.

3. GEOTECHNICAL STUDIES

3.1. Mechanical boring test – CPT

Here are the N values and the penetration index :

SITE 14

Point	Depth in m	N value
1	1.0	11.81
2	2.0	3.93
3	3.0	

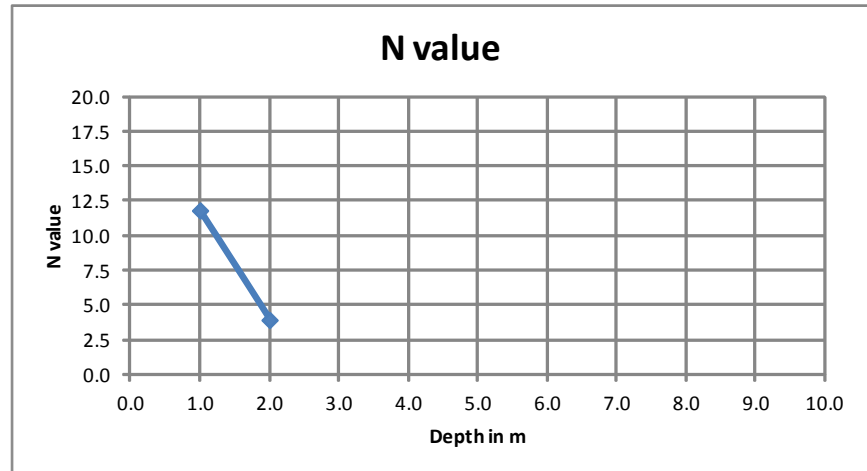

Point	Depth in m	Penetration Index
1	1.0	0.16
2	2.0	0.54
3	3.0	

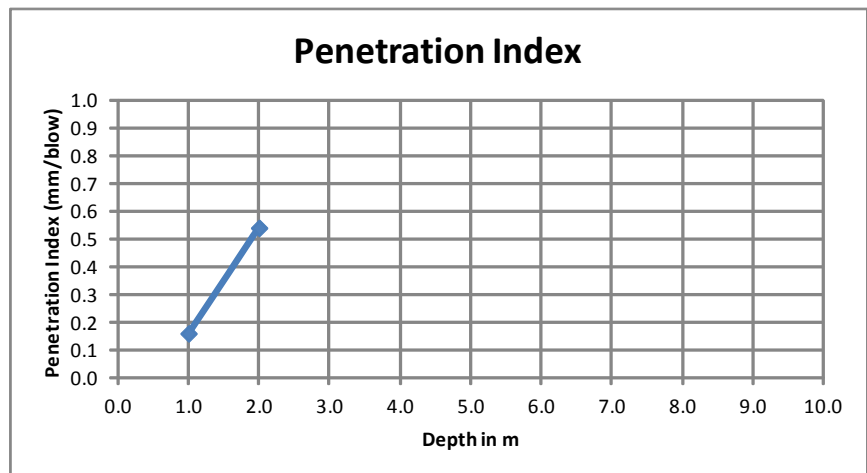

Pen. Ind., PI = $\Delta D_p / \Delta BC$

3.2. Laboratory tests

We took 2 samples in the drilling, then we made:

- a water natural content,
- a sieve analysis
- a specific gravity

These are the results (see in appendix 2, board and curve):

ID	Soils's nature	W%	% to 50% (in mm)	Atterberg limits	Specific gravity
Hole 1 @1m	Sand	4.9	2.3	/	2.71
Hole 1 @2m	sand	9.3	1.2	/	2.65

This ground is constituted thus by sand; the water natural content is on average 7.1 %
These sands are little compact (N values between 4 and 10)

4. GEOTECHNICAL RECOMMENDATIONS

The recommendations of this report do not take into account any possible future constructions not stated in the introduction, which can modify the stability context of the area (Backfill, excavation...).

These recommendations are only to be applied for the project presented in the introduction and cannot be used for another one, even located on the same plot.

4.1. Building location

The locations of the future buildings within the plot are not restricted from a geotechnical point of view.

4.2. Excavations

From what is known at the time of the study, the excavation works will concern:

- The ground excavation for the construction basis,
- The foundations excavation.

The excavations will begin by the cleaning of the covert ground (layer above the sands). Residual roots must be purged and evacuated outside of the influence of the project. During the construction phase, the platform will have a slope of about 2% to promote the flow of water.

The excavations will be preferentially realized in dry season.

4.3. Project environnement

According to the plot area topography and slope, infiltration phenomenon seems preponderant than runoff water.

During the excavation phase:

- A fill slope protection against raining water must be established.

On the final phase:

- **An outlying drainage of the buried parts of the building** must be constructed.

The collected waters (outlying drainage, roof, access roads...) have to be evacuated, when possible, to a wastewater collection system.

4.4. Foundations

No information about vertical loads on building foundations were given by the client. However, the project concerns a structure considered as “light” (1 or 2 levels).

According to the soil’s nature, the CPT and the ground water level encountered on the plot study area and to avoid differential settlement under the constructions, which could lead to their ruin, it is recommended to plan:

Footings resting or isolated massifs anchored in 0.9 m; the anchoring will be 0.3 m minimum in sands ; the foundation’s width, B will be less than 1.22 m.

The following bearing capacity values were calculated from the geotechnical test results, and with the Meyerhof's formula, allowing considering the settlements as negligible at a long-term period:

$q_{adm} = 1.60 \text{ bars} = 0,16 \text{ MPa}$ (Service Limit State)

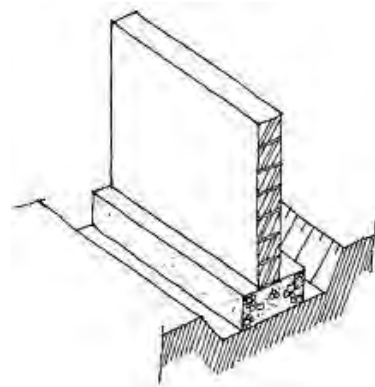

5. SEISMIC PARAMETERS

5.1. Building code

According to MTPTC recommendations given in “Règles de calcul intérimaires pour les bâtiments en Haïti », the paraseismic building code authorized in Haïti, in wait of a specific haïtian code, are CNBC, ACI-318, International Building Code, EuroCode 8 and CUBiC.

5.2. Site seismicity

The plot is located in a **highly seismic area**.

Directs effects

Direct effects are soil vibrations and major geological accidents.

- Topographic amplification: seismic wave amplification can be modified by the site topography and by the ground geodynamic characteristics. The study plot is quite horizontal, there are no slopes nearby, so **the amplification coefficient ST is 1,0**.
- Geological accident: this site is near a known fault.

Induced effects

Induced effects are ground movements, tsunami and soil liquefaction.

- Ground movements: at the location of the land plot, no major sign of instability was spotted. Based on the site topography, the risk of landslide or rock fall can be excluded.
- Tsunami : no risk here.
- Liquefaction: the geotechnical tests carried out on the land plot show that there is no risk of liquefaction for the first meters of the ground (sands).

SITE #24 – ECOLE NATIONALE DE COLLADERE, HINCHE

1. LOCALIZATION

The study plot is located in Hinche, 4^{ème} Aguahedionde at the following coordinates: **N19°15'19.14" / W072°01'42.05"**

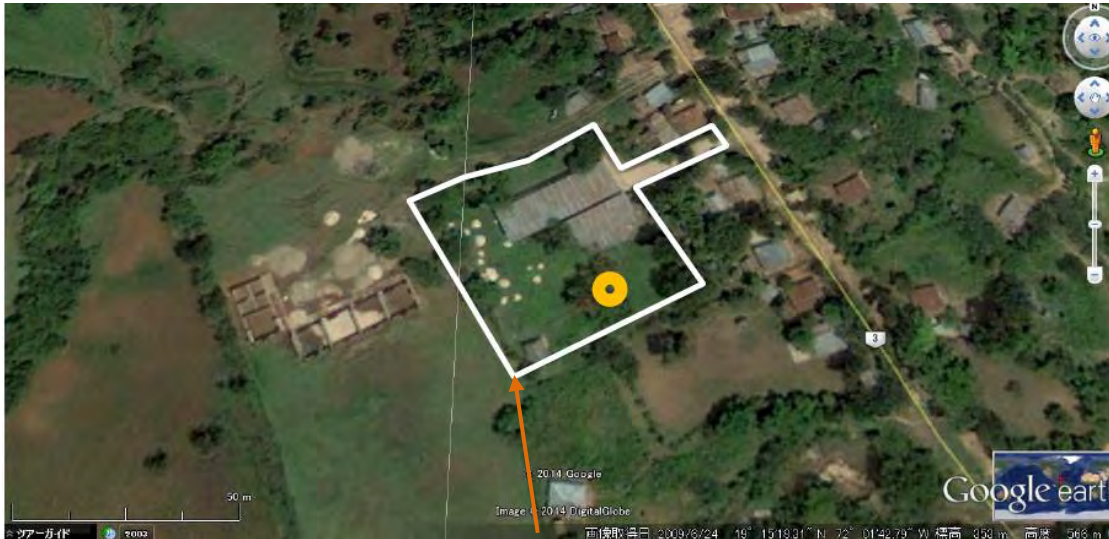

Location

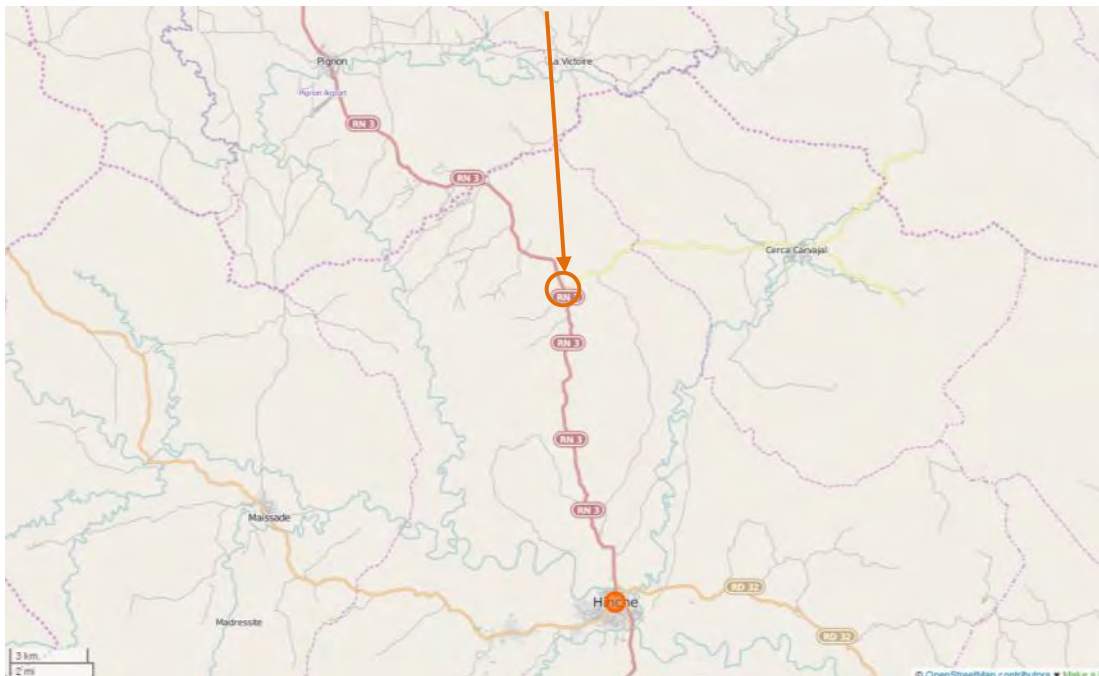

Location of the studied plot (orthophoto GeoEye from January 2010 and Open Street Map)

2. GEOLOGY

Based on the geological map of Haïti (North-East, 1/250000), the studied site is located on formations belonging to the upper Miocene (ms on the map). Those formations are composed of sandstone or conglomerates, overcome by silts more or less thin.

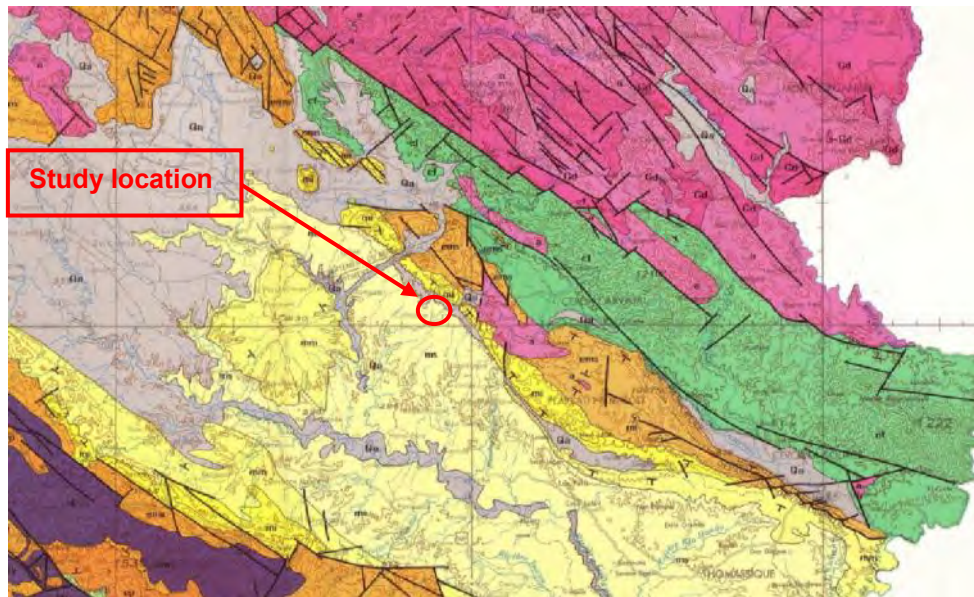

Sample of the geological map (north east) of Haiti, 1/250000

No water neither spring nor stagnant water area was observed on the studied plot at the time of the visit.

And no water was found during the CPT Test.

In order to the plot geometry, infiltrations phenomenon seem preponderant than runoff water.

They are strongly possible during a raining period.

3. GEOTECHNICAL STUDIES

3.1. Mechanical boring test – CPT

Here are the N values and the penetration index :

SITE 24

Point	Depth in m	N value
1	1.0	1.12
2	2.0	3.75
3	3.0	3.93

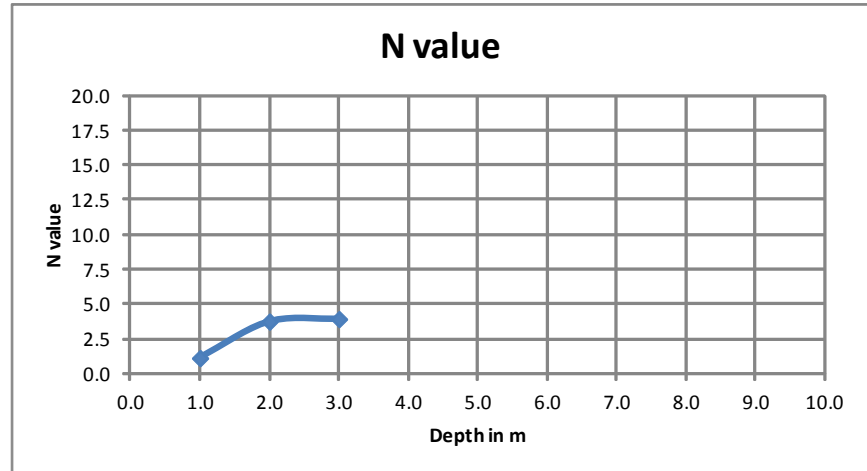

Point	Depth in m	Penetration Index
1	1.0	1.85
2	2.0	1.04
3	3.0	0.87

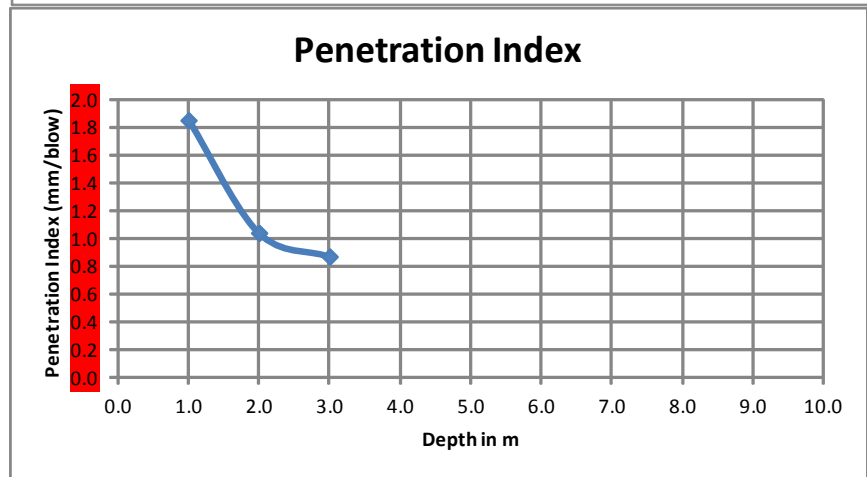

Pen. Ind., PI = $\Delta D_p / \Delta BC$

The N values of this site **are very low** (small). A follow-up study will be necessary.

3.2. Laboratory tests

We took 3 samples in the drilling, then we made:

- a water natural content,
- a sieve analysis
- a specific gravity

These are the results (see in appendix 2, board and curve):

ID	Soils's nature	W%	% to 50% (in mm)	Atterberg limits	Specific gravity
Hole 1 @1m	Sand	9.1	1.5	/	2.76
Hole 1 @2m	Sand	21.0	0.6	/	2.72
Hole 1 @3m	Sand	8.4	1.5	/	2.71

This ground is constituted thus by sands;
The water natural content is on average 12.8 %.
Depending of the N values, these sands are **very little compact**.

4. GEOTECHNICAL RECOMMENDATIONS

The recommendations of this report do not take into account any possible future constructions not stated in the introduction, which can modify the stability context of the area (Backfill, excavation...).

These recommendations are only to be applied for the project presented in the introduction and cannot be used for another one, even located on the same plot.

4.1. Building location

The locations of the future buildings within the plot are not restricted from a geotechnical point of view.

4.2. Foundations

No information about vertical loads on building foundations were given by the client. However, the project concerns a structure considered as “light” (1 -2 levels).

We did not meet good expanding grounds for this site.
A complementary geotechnical study turns out consequently essential.

A solution would be to compact these sands; it will be necessary to verify then the good compactness of these sands and to calculate a new bearing capacity to know if they can accept this building.

Another solution would be to remove these sands on a depth of at least 5', then to realize the compaction of an elevation.

Other solution: to realize a mattress foundation, but we do not know the depth of the good ground.

The following bearing capacity values were calculated from the geotechnical test results, and with the Meyerhof's formula, allowing considering the settlements as negligible at a long-term period:

$q_{adm} = 0.60 \text{ bars} = 0,06 \text{ MPa}$ (Service Limit State)

This value is insufficient to built any building.

5. SEISMIC PARAMETERS

5.1. Building code

According to MTPTC recommendations given in “Règles de calcul intérimaires pour les bâtiments en Haïti », the paraseismic building code authorized in Haïti, in wait of a specific haïtian code, are CNBC, ACI-318, International Building Code, EuroCode 8 and CUBiC.

5.2. Site seismicity

The plot is located in a **highly seismic area**.

Directs effects

Direct effects are soil vibrations and major geological accidents.

- Topographic amplification: seismic wave amplification can be modified by the site topography and by the ground geodynamic characteristics. The study plot is quite horizontal, there are no slopes nearby, so **the amplification coefficient ST is 1,0**.
- Geological accident: this area of Hinche doesn't contain fault.

Induced effects

Induced effects are ground movements, tsunami and soil liquefaction.

- Ground movements: at the location of the land plot, no major sign of instability was spotted. Based on the site topography, the risk of landslide or rock fall can be excluded.
- Tsunami : no risk here.
- Liquefaction: an additional geotechnical test would be necessary to show if there is risk of liquefaction.

SITE #25 – ECOLE NATIONALE DE LOS PALIS, HINCHE

1. LOCALIZATION

The study plot is located in Hinche, Aguahedionde at the following coordinates:
N19°08'18.49" / W071°56'12.99"

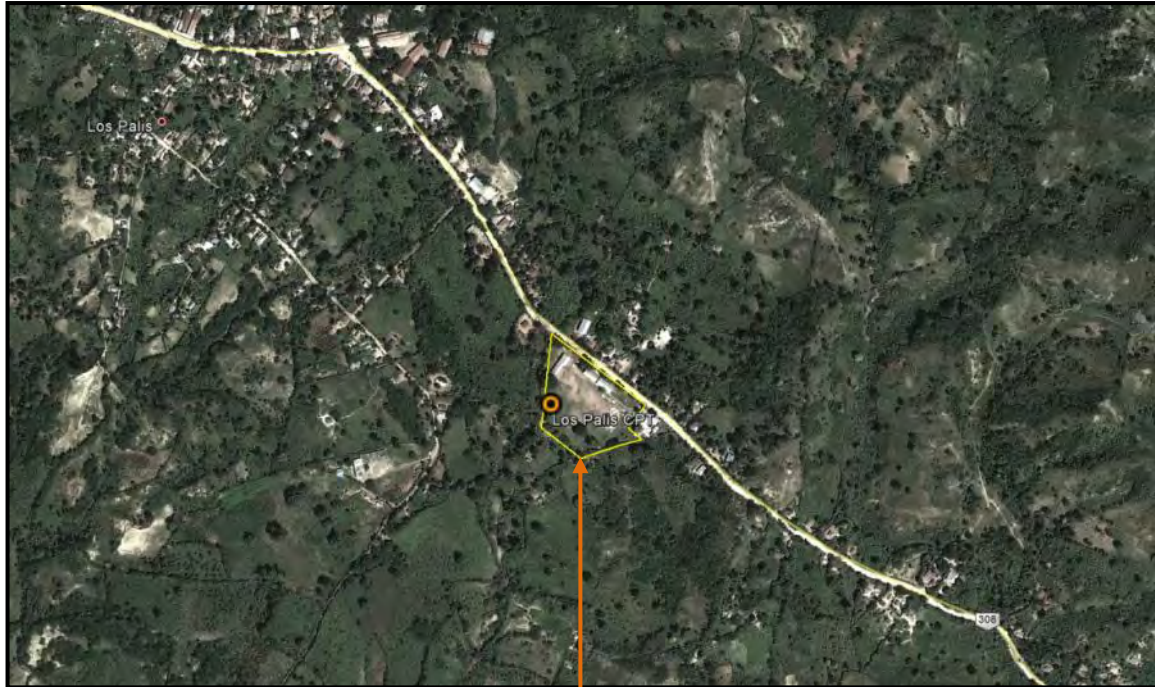

Location

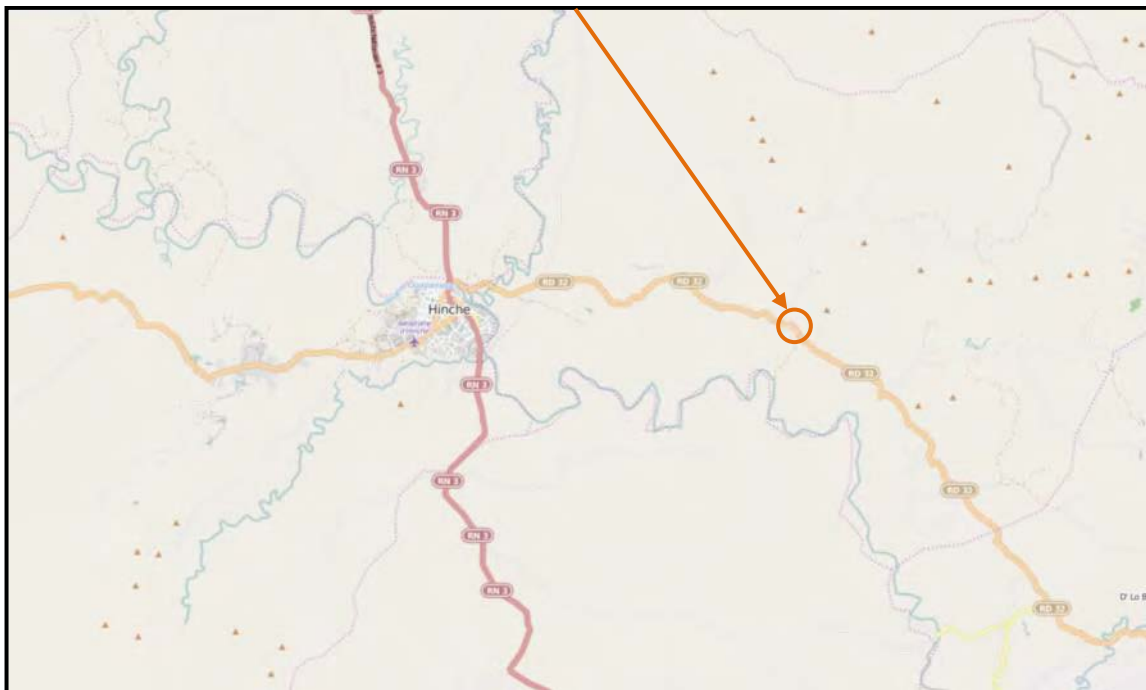

Location of the studied plot (orthophoto GeoEye from January 2010 and Open Street Map)

2. GEOLOGY, MORPHOLOGY, HYDROGEOLOGY

2.1. Geology

Based on the geological map of Haïti (North-East, 1/250000), the studied site is located on formations belonging to the upper Miocene. Those formations are composed of sandstone or conglomerates, overcome by silts more or less thin (ms on the map).

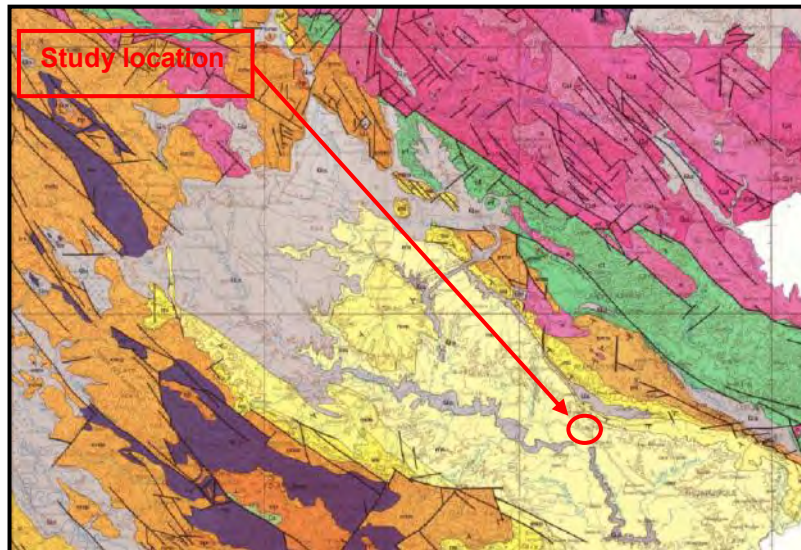

Sample of the geological map of Haïti (North-East, 1/250000)

No water neither spring nor stagnant water area was observed on the studied plot at the time of the visit.

And no water was found during the CPT Test.

In order to the plot geometry, infiltrations phenomenon seem preponderant than runoff water.

They are strongly possible during a raining period.

3. GEOTECHNICAL STUDIES

3.1. Mechanical boring test – CPT

Here are the N values and the penetration index :

SITE 25

Point	Depth in m	N value
1	1.0	5.06
2	2.0	9.56
3	3.0	8.43

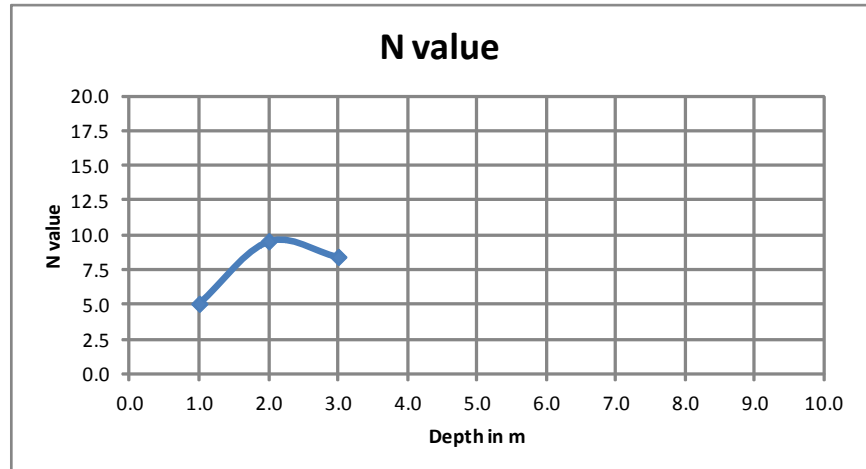

Point	Depth in m	Penetration Index
1	1.0	0.39
2	2.0	0.23
3	3.0	0.24

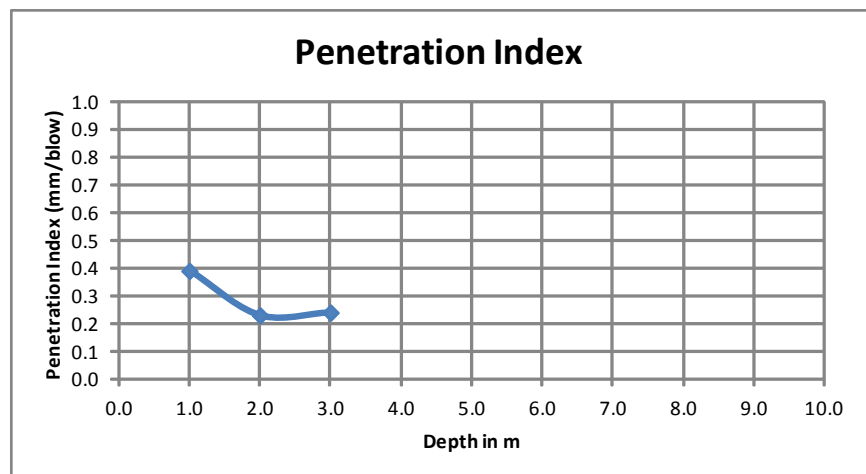

Pen. Ind., PI = $\Delta D_p / \Delta BC$

3.2. Laboratory tests

We took 3 samples in the drilling, then we made:

- a water natural content,
- a sieve analysis
- a specific gravity

These are the results (see in appendix 2, board and curve):

ID	Soils's nature	W%	% to 50% (in mm)	Atterberg limits	Specific gravity
Hole 1 @1m	Sand	3.6	1.5	/	2.7
Hole 1 @2m	Sand with silt	7.2	1.0	/	2.7
Hole 1 @3m	Sand	7.2	1.6	/	2.7

This ground is constituted thus especially by sands; it has between 1 m and 2 m a layer of sand containing silts. The water natural content is on average 6.0 %. These sands are little compact (N values between 5 and 10).

4. GEOTECHNICAL RECOMMENDATIONS

The recommendations of this report do not take into account any possible future constructions not stated in the introduction, which can modify the stability context of the area (Backfill, excavation...).

These recommendations are only to be applied for the project presented in the introduction and cannot be used for another one, even located on the same plot.

4.1. Building location

The locations of the future buildings within the plot are not restricted from a geotechnical point of view.

4.2. Excavations

From what is known at the time of the study, the excavation works will concern:

- The ground excavation for the construction basis,
- The foundations excavation.

The excavations will begin by the cleaning of the covert ground (layer above the sands). Residual roots must be purged and evacuated outside of the influence of the project. During the construction phase, the platform will have a slope of about 2% to promote the flow of water.

The excavations will be preferentially realized in dry season.

4.3. Project environnement

According to the plot area topography and slope, infiltration phenomenon seems preponderant than runoff water.

During the excavation phase:

- A fill slope protection against raining water must be established.

On the final phase:

- **An outlying drainage of the buried parts of the building** must be constructed.

The collected waters (outlying drainage, roof, access roads...) have to be evacuated, when possible, to a wastewater collection system.

4.4. Foundations

No information about vertical loads on building foundations were given by the client. However, the project concerns a structure considered as “light” (1 or 2 levels). According to the soil’s nature, the CPT and the ground water level encountered on the plot study area and to avoid differential settlement under the constructions, which could lead to their ruin, it is recommended to plan:

Footings resting or isolated massifs anchored in 1.5 m; the anchoring will be 0.3 m minimum in sands ; the foundation’s width, B will be less than 1.22 m.

The following bearing capacity values were calculated from the geotechnical test results, and with the Meyerhof’s formula, allowing considering the settlements as negligible at a long-term period:

$q_{adm} = 1.20 \text{ bars} = 0,12 \text{ MPa}$ (Service Limit State)

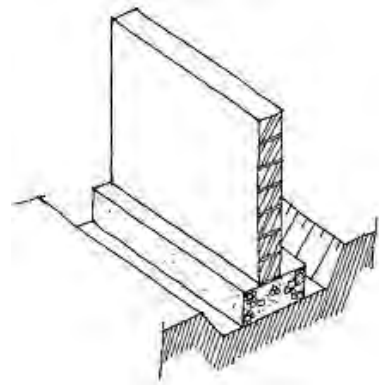

5. SEISMIC PARAMETERS

5.1. Building code

According to MTPTC recommendations given in “Règles de calcul intérimaires pour les bâtiments en Haïti », the paraseismic building code authorized in Haïti, in wait of a specific haïtian code, are CNBC, ACI-318, International Building Code, EuroCode 8 and CUBiC.

5.2. Site seismicity

The plot is located in a **highly seismic area**.

Directs effects

Direct effects are soil vibrations and major geological accidents.

- Topographic amplification: seismic wave amplification can be modified by the site topography and by the ground geodynamic characteristics. The study plot is quite horizontal, there are no slopes nearby, so **the amplification coefficient ST is 1,0**.
- Geological accident: this area near Thomassique doesn't contain fault.

Induced effects

Induced effects are ground movements, tsunami and soil liquefaction.

- Ground movements: at the location of the land plot, no major sign of instability was spotted. Based on the site topography, the risk of landslide or rock fall can be excluded.
- Tsunami : no risk here.
- Liquefaction: the geotechnical tests carried out on the land plot show that there is no risk of liquefaction for the first meters of the ground (sands).

SITE #18 – ECOLE NATIONALE DE CHARLES BELAIR, VERRETTES

1. LOCALIZATION

The study plot is located in Verrettes, at the following coordinates:
N19°03'17.41" / W072°27'58.32"

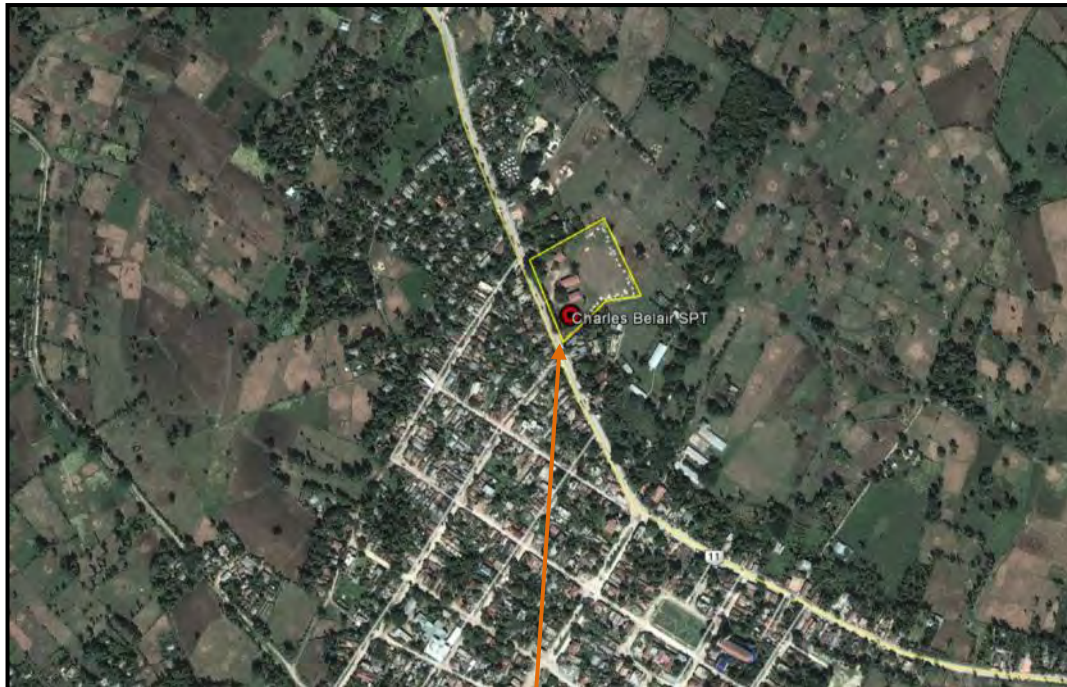

Location

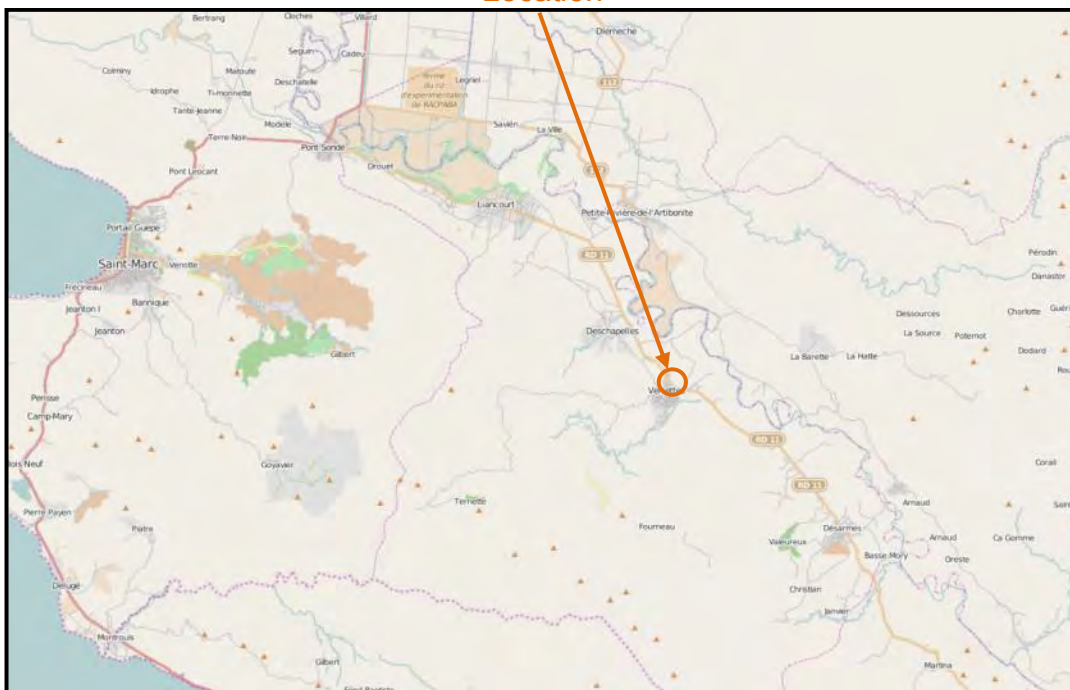

Location of the studied plot (orthophoto GeoEye from January 2010 and Open Street Map)

2. GEOLOGY, MORPHOLOGY, HYDROGEOLOGY

Based on the geological map of Haïti (North-East 1/250000), the studied site is situated on recent deposits like alluvium (Qa on the map).

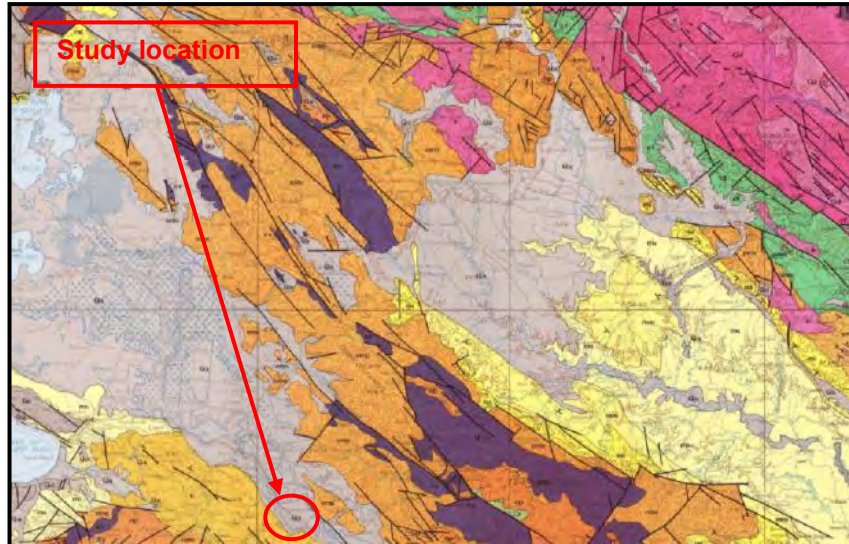

Sample of the geological map of Haïti, (North-East 1/250000)

2.2. Morphology, surface geological observations and hHydrogeology

The study land plot is occupied by 3 schools buildings at 1 level (pictures a, b and c). It surface is quite horizontal (pictures a, b and c). The ground is covered by short grass (picture c). There are also some few trees (pictures a and b).



Picture a



Picture b



Picture c

No water neither spring nor stagnant water area was observed on the studied plot at the time of the visit.

And no water was found during the SPT Test.

In order to the plot geometry, infiltrations phenomenon seem preponderant than runoff water.

3. GEOTECHNICAL STUDIES

3.1. Mechanical boring test – SPT

In every drilling, we realized the measure of the resistance of the soil with a penetrometer according to the depth (SPT) and according to the standard ASTM D1586 (see in appendix 1, the boring log). The results of the essays are given in the following board:

Location	N (15cm)	N (30cm)	N (45cm)	% recouvre
Forage 1				
4ft	4	6	8	105.55
7ft	20	40	33	105.55

Correction pour les conditions de terrain :

$$N_{60} = N \eta_H \eta_B \eta_S \eta_R / 60 \quad \text{Lorsque,}$$

η_H = efficacité de marteau (%) = 45 pour US Donut sur la corde et la poulie

η_B = correction pour diamètre de trou = 1.0 (4.7 pouce restriction)

η_S = correction pour l'échantillonneur = 1.0 pour standard sampler

η_R = correction pour la longueur de tige = 0.75 (0–3,6m)/ 0.85 (3,6 – 6m)/ 0.95 (6 – 9,1m)

Here are the values N and the corresponding curve:

Point	Depth in m	N value
1	1.1	7.87
2	2.1	41.06

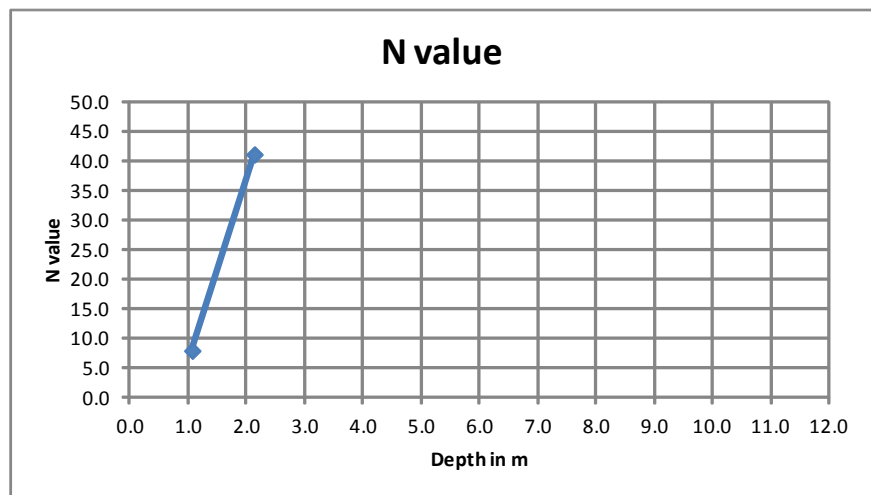

The sismic class of this site is : C

3.2. Laboratory tests

We took 2 samples in the drilling, and then we made:

- A water natural content,
- A sieve analysis.

These are the results (see in appendix 2, board and curve):

ID	Soils's nature	W%	% to 50% (in mm)	Atterberg limits	Specific gravity
Hole 1 @1.2m	Sand	16.3	2.6 mm	/	2.67
Hole 1 @2.1m	Sand	10.2	1.5 mm	/	2.67

This ground is constituted thus by sand ; the water natural content is on average 13.3 %.

Depending of the N values (>10), these sands are averagely compact and well compact.

4. GEOTECHNICAL RECOMMENDATIONS

The recommendations of this report do not take into account any possible future constructions not stated in the introduction, which can modify the stability context of the area (Backfill, excavation...).

These recommendations are only to be applied for the project presented in the introduction and cannot be used for another one, even located on the same plot.

4.1. Building location

The locations of the future buildings within the plot are not restricted from a geotechnical point of view.

4.2. Excavations

From what is known at the time of the study, the excavation works will concern:

- The ground excavation for the construction basis,
- The foundations excavation.

The excavations will begin by the cleaning of the covert ground (layer above the sands). Residual roots must be purged and evacuated outside of the influence of the project.

During the construction phase, the platform will have a slope of about 2% to promote the flow of water.

The excavations will be preferentially realized in dry season.

4.3. Project environnement

According to the plot area topography and slope, infiltration phenomenon seems preponderant than runoff water.

During the excavation phase:

- A fill slope protection against raining water must be established.

On the final phase:

- **An outlying drainage of the buried parts of the building must be constructed.**

The collected waters (outlying drainage, roof, access roads...) have to be evacuated, when possible, to a wastewater collection system.

4.4. Foundations

No information about vertical loads on building foundations were given by the client. However, the project concerns a structure considered as “light” (1 or 2 levels).

According to the soil's nature, the SPT and the ground water level encountered on the plot study area and to avoid differential settlement under the constructions, which could lead to their ruin, it is recommended to plan:

Footings resting or isolated massifs anchored in 1.1 m; the anchoring will be 0.3 m minimum in sands ; the foundation's width, B will be less than 1.22 m.

The following bearing capacity values were calculated from the geotechnical test results, and with the Meyerhof's formula, allowing considering the settlements as negligible at a long-term period:

$q_{adm} = 1.28 \text{ bars} = 0,13 \text{ MPa}$ (Service Limit State)

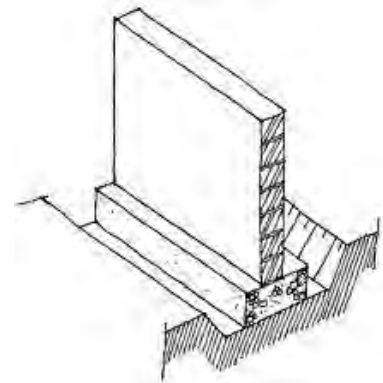

5. SEISMIC PARAMETERS

5.1. Building code

According to MTPTC recommendations given in “Règles de calcul intérimaires pour les bâtiments en Haïti », the paraseismic building code authorized in Haïti, in wait of a

specific haïtian code, are CNBC, ACI-318, International Building Code, EuroCode 8 and CUBiC.

5.2. Site seismicity

The plot is located in a **highly seismic area**.

Directs effects

Direct effects are soil vibrations and major geological accidents.

- Topographic amplification: seismic wave amplification can be modified by the site topography and by the ground geodynamic characteristics. The study plot is quite horizontal, there are no slopes nearby, so **the amplification coefficient ST is 1,0**.
- Soil classification: according to the SPT test realized on the study plot, the site is located on soils belonging **to the soil class NEHRP C**. The soil pick ground acceleration map (PGA), established by USGS, indicates a **PGA of around 0,65 g** ($g = 9,81 \text{ m/s}^2$) for the area of Verrettes.

Induced effects

Induced effects are ground movements, tsunami and soil liquefaction.

- Ground movements: at the location of the land plot, no major sign of instability was spotted. Based on the site topography, the risk of landslide or rock fall can be excluded.
- Tsunami : no risk here.
- Liquefaction: the geotechnical tests carried out on the land plot show that there is no risk of liquefaction for the first meters of the ground.

SITE #19 – ECOLE NATIONALE DE DESARMES, VERRETTES

1. LOCALIZATION

The study plot is located in Verrettes, at the following coordinates:
N18°59'35.41" / W072°23'25.96"

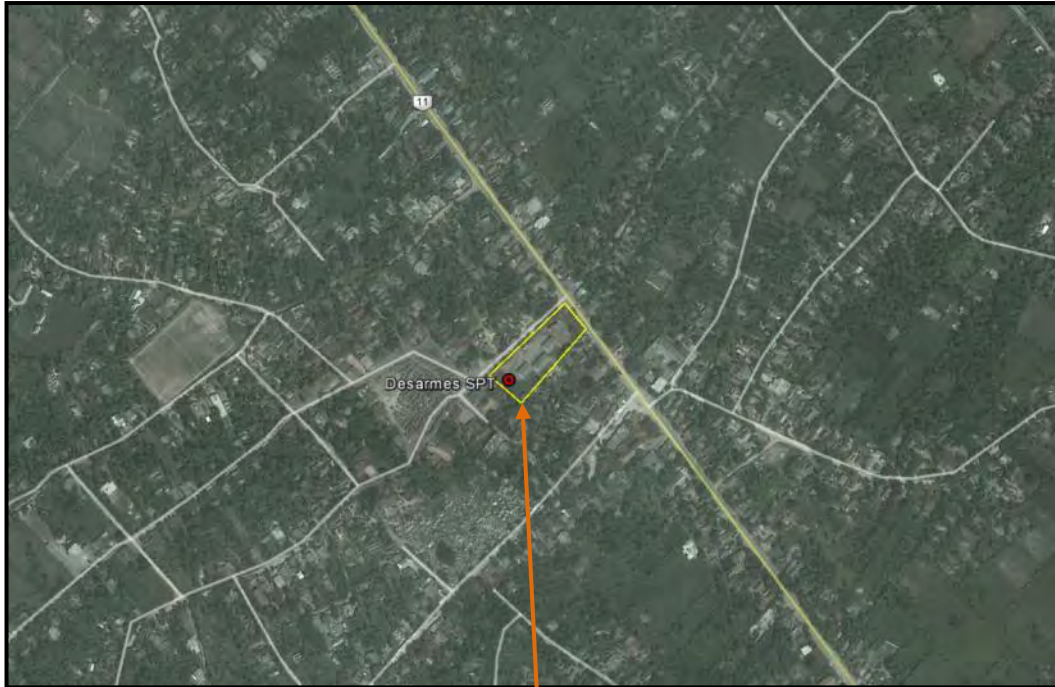

Location

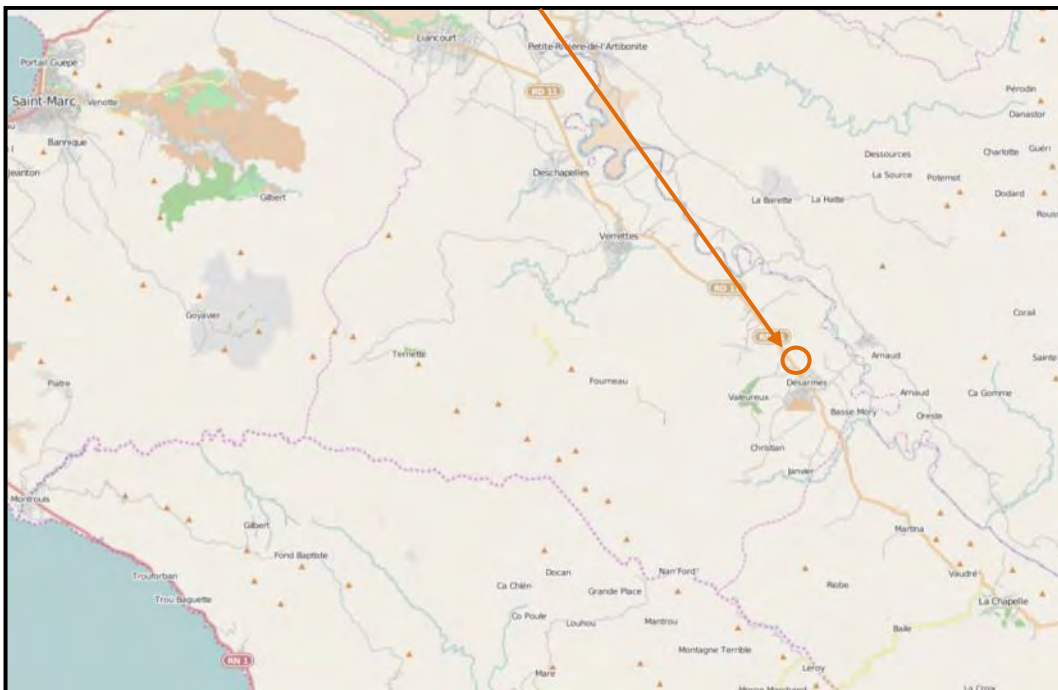

Location of the studied plot (orthophoto GeoEye from January 2010 and Open Street Map)

2. GEOLOGY, MORPHOLOGY, HYDROGEOLOGY

2.1. Geology

Based on the geological map of Haïti (South-East 1/250000), the studied site is situated on formations belonging to the middle Miocene. Those formations are composed by 3 different facies: blue/grey marl, fine sandstone or detrital series with discontinuous limestone series (Mm on the map).

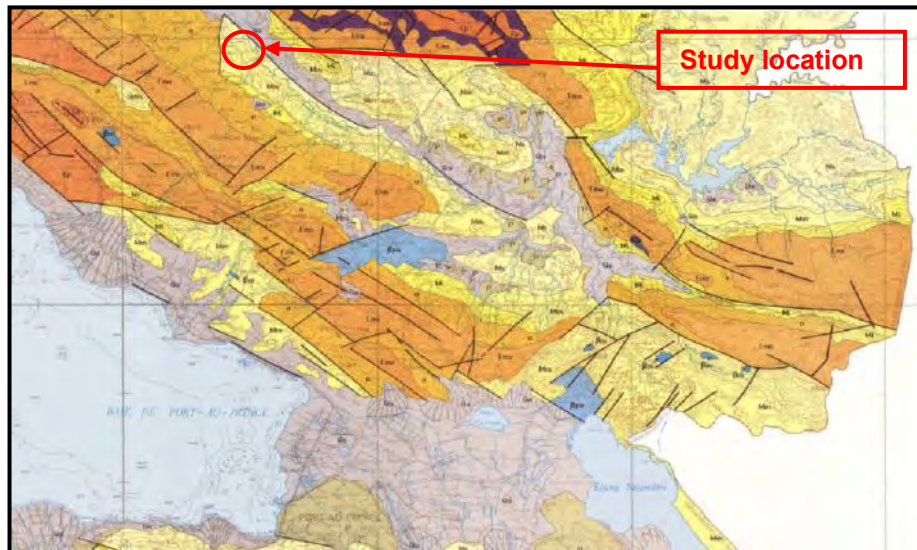

Sample of the geological map of Haïti, (South-East 1/250000)

2.2. Morphology, surface geological observations and hydrogeology

The study land plot is occupied by 3 schools buildings at 1 level (picture a). It has a very slight slope to the north (pictures a and b). The ground is covered by short grass (pictures a and b) and some few corn and banana plantation on the South part (picture c).



Picture a



Picture b



Picture c

No water neither spring nor stagnant water area was observed on the studied plot at the time of the visit.

And no water was found during the SPT Test.

3. GEOTECHNICAL STUDIES

3.1. Mechanical boring test – SPT

In every drilling, we realized the measure of the resistance of the soil with a penetrometer according to the depth (SPT) and according to the standard ASTM D1586 (see in appendix 1, the boring log). The results of the essays are given in the following board:

Here are the values N and the corresponding curve:

Location	N (15cm)	N (30cm)	N (45cm)	% recouvre
Forage 1				
4ft	4	6	7	122,22
7ft	3	6	18	116.66
11ft	13	8	3	27.77
14ft	8	4	4	127,77
18ft	2	3	4	105.55
21ft	2	4	6	138.88
25ft	6	10	14	111.11
28ft	10	16	25	83.33
32ft	10	16	20	27.77
35ft	25	21	36	

Correction pour les conditions de terrain :

$N_{60} = N \eta_H \eta_B \eta_S \eta_R / 60$ Lorsque,

η_H = efficacité de marteau (%) = 45 pour US Donut sur la corde et la poulie

η_B = correction pour diamètre de trou = 1.0 (4.7 pouce restriction)

η_S = correction pour l'échantillonneur = 1.0 pour standard sampler

η_R = correction pour la longueur de tige = 0.75 (0–3,6m)/ 0.85 (3,6 – 6m)/ 0.95 (6 – 9,1m)

Here are the values N and the corresponding curve:

Point	Depth in m	N value
1	1.2	7.31
2	2.1	13.50
3	3.4	6.18
4	4.3	5.10
5	5.5	4.46
6	6.4	8.55
7	7.6	17.10
8	8.5	29.21
9	9.5	27.00
10	10.7	42.75

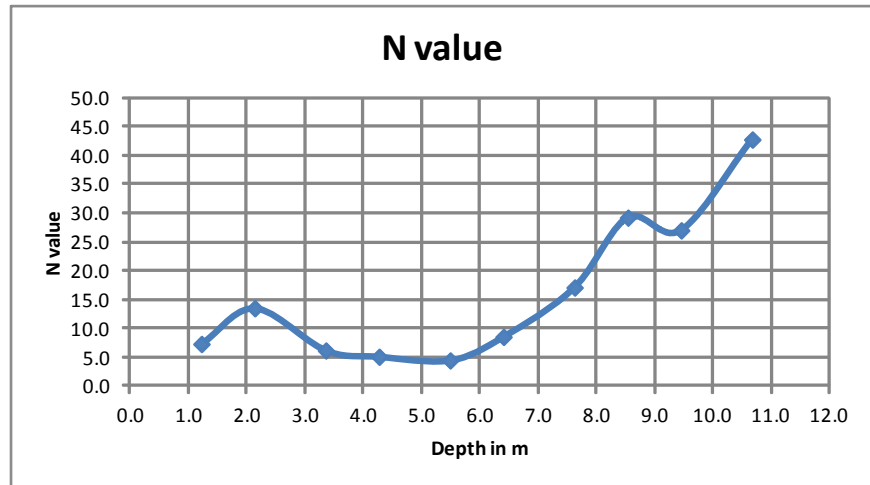

The seismic class of this site is : D

3.2. Laboratory tests

We took 10 samples in the drilling, then we made:

- A water natural content,
- A sieve analysis.

These are the results (see in appendix 2, board and curve):

ID (in m)	Soil's nature	W %	% to 50% (in mm)	Atterberg limits	Specific gravity
Hole 1@1.2	Sand with clay	14.3	2.5 mm	/	2.69
Hole 1 @2.1	Sand with clay	16.0	2.0 mm	LL=27.1 ; PI=14.0	
Hole 1 @3.4	Gravel	7.6	> 5 mm	/	2.62
Hole 1 @4.3	Sand	28.1	?? mm	/	
Hole 1 @5.5	Sand	22.9	1.7 mm	/	2.67
Hole 1 @6.4	Sand	25.6	2.3 mm	/	
Hole 1 @7.6	Sand	21.2	2.6 mm	/	
Hole 1 @8.5	Big sand	19.4	3.3 mm	/	2.65
Hole 1 @9.5	Sand	27.6	2.6 mm	/	
Hole1@10.7	Big sand	19.6	3.0 mm	/	2.63

This ground is constituted thus by sands and sands with clay at the beginning of the drilling, till a depth of 2.1 m ; the PI=14.0 means a sample with few clay. All the grain size distributions show sand with few clay. The water natural content is on average 20.2 %.

Depending of the N values, this ground is little compact until 6.7 m and averagely compact from 6.7 m and at the depth of 2.1 m.

4. GEOTECHNICAL RECOMMENDATIONS

The recommendations of this report do not take into account any possible future constructions not stated in the introduction, which can modify the stability context of the area (Backfill, excavation...).

These recommendations are only to be applied for the project presented in the introduction and cannot be used for another one, even located on the same plot.

4.1. Building location

The locations of the future buildings within the plot are not restricted from a geotechnical point of view.

4.2. Excavations

From what is known at the time of the study, the excavation works will concern:

- The ground excavation for the construction basis,
- The foundations excavation.

The excavations will begin by the cleaning of the covert ground (layer above the sands few clayey). Residual roots must be purged and evacuated outside of the influence of the project.

During the construction phase, the platform will have a slope of about 2% to promote the flow of water.

The excavations will be preferentially realized in dry season.

4.3. Project environnement

According to the plot area topography and slope, infiltration phenomenon seems preponderant than runoff water.

During the excavation phase:

- A fill slope protection against raining water must be established.

On the final phase:

- **An outlying drainage of the buried parts of the building** must be constructed.

The collected waters (outlying drainage, roof, access roads...) have to be evacuated, when possible, to a wastewater collection system.

4.4. Foundations

No information about vertical loads on building foundations were given by the client. However, the project concerns a structure considered as “light” (1 or 2 levels).

According to the soil’s nature, the SPT and the ground water level encountered on the plot study area and to avoid differential settlement under the constructions, which could lead to their ruin, it is recommended to plan:

Footings resting or isolated massifs anchored in 1.1 m; the anchoring will be 0.4 m minimum in little clayey sands ; the foundation’s width, B will be less than 1.22 m.

The following bearing capacity values were calculated from the geotechnical test results, and with the Meyerhof’s formula, allowing considering the settlements as negligible at a long-term period:

$q_{adm} = 1.17 \text{ bars} = 0,12 \text{ MPa}$ (Service Limit State)

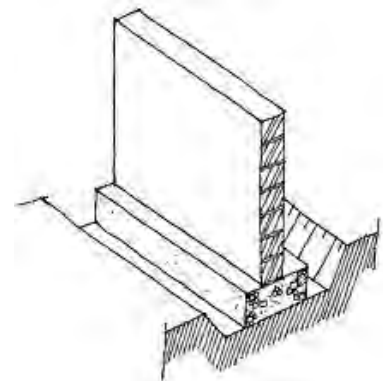

5. SEISMIC PARAMETERS

5.1. Building code

According to MTPTC recommendations given in “Règles de calcul intérimaires pour les bâtiments en Haïti », the paraseismic building code authorized in Haïti, in wait of a specific haïtian code, are CNBC, ACI-318, International Building Code, EuroCode 8 and CUBiC.

5.2. Site seismicity

The plot is located in a **highly seismic area**.

Directs effets

Direct effects are soil vibrations and major geological accidents.

- Topographic amplification: seismic wave amplification can be modified by the site topography and by the ground geodynamic characteristics. The study plot is quite horizontal, there are no slopes nearby, so **the amplification coefficient ST is 1,0**.
- Soil classification: according to the SPT test realized on the study plot, the site is located on soils belonging **to the soil class NEHRP D**. The soil pick ground acceleration map (PGA), established by USGS, indicates a **PGA of around 0,65 g** ($g = 9,81 \text{ m/s}^2$) for the area of Verrettes.

Induced effects

Induced effects are ground movements, tsunami and soil liquefaction.

- Ground movements: at the location of the land plot, no major sign of instability was spotted. Based on the site topography, the risk of landslide or rock fall can be excluded.
- Tsunami : no risk here.
- Liquefaction: the geotechnical tests carried out on the land plot show that there is no risk of liquefaction for the first meters of the ground.

GEOTECHNICAL UNCERTAINTIES AND CONTRACTUAL CONDITIONS

1- Soil investigations are carried out thanks to profiles and punctual tests, the results are not strictly extrapolables to the whole site. There are still some uncertainties (like local heterogeneities, interface variations) that could cause changes in the conception or the execution of the project. This cannot be chargeable to the geotechnical company.

2- These reports and its appendix are a whole that cannot be dissociated. The wrong use that can be made from a partial communication or reproduction of this report cannot commit **IMS_{RN}**.

3- Modifications in the location, design or size of the buildings, as well as the hypothesis used, in particular in the “Introduction” part of this report, can lead to changes in the recommendations. A new study must be carried out by **IMS_{RN}** in order to adapt its conclusions or validate the new project.

4- Any new elements discovered during the works on the construction site and that had not been detected during the geotechnical study (such as cavities, local heterogeneities, water...) can cancel some recommendations given in this report.

8. 収集資料リスト

収集資料リスト

番号	名 称	形態：図書・ビデオ・地図・写真等	オリジナルコピー	発 行 機 関	発行年
1	6e ANNEE CURRICULUM DE L'ECOLE FONDAMENTALE 6学年の教育カリキュラム	資料	オリジナル	Ministère de l'Education Nationale et de la Formation Professionnelle 教育・職業訓練省	1989
2	Programme Accélééré 速成プログラム	資料	オリジナル	Ministère de l'Education Nationale et de la Formation Professionnelle 教育・職業訓練省	2011
3	ANNUAIRE STATISTIQUE DES ÉCOLE FONDAMENTALES (1er ET 2er CYCLES) D'HAITI ハイチ国における学校教育に係る年間統計（第1-第2サイクル）	資料	オリジナル	Ministère de l'Education Nationale et de la Formation Professionnelle 教育・職業訓練省	2010
4	ANNUAIRE STATISTIQUE DES ÉCOLE FONDAMENTALES (3er CYCLES) D'HAITI ハイチ国における学校教育に係る年間統計（第3サイクル）	資料	オリジナル	Ministère de l'Education Nationale et de la Formation Professionnelle 教育・職業訓練省	2010
5	ANNUAIRE STATISTIQUE DE L'ENSEIGNEMENT FONDAMENTAL POUR L'ANNÉE 2013-2014 ハイチ国における学校教育に係る年間統計	資料	データ (PDF)	Ministère de l'Education Nationale et de la Formation Professionnelle 教育・職業訓練省	2014
6	DOCUMENTS ANNEXES AU BUDGET EXERCICE 2014-2015 2014-2015年度の年間予算資料	資料	オリジナル	Ministère de l'Education Nationale et de la Formation Professionnelle 教育・職業訓練省	2014
7	Plan Opérationnel 2010-2015 ハイチ共和国教育システムの再構築に向けた実施計画 2010-2015年	資料	データ (PDF)	Ministère de l'Education Nationale et de la Formation Professionnelle 教育・職業訓練省	2012
8	Enquête Mortalité, Morbidité et Utilisation des Services-V / 2012 疾病・死因・保健サービス利用に関する調査	資料	データ (PDF)	Ministère de la Santé Publique et de la Population 保健・人口省	2012
9	Normes de Construction des Bâtiments Scolaires / Juin 2013 学校建設基準	資料	データ (PDF)	Ministère de l'Education Nationale et de la Formation Professionnelle 教育・職業訓練省	2013

番号	名 称	形態：図書・ ビデオ・地 図・写真等	オリジナル コピー	発 行 機 関	発行年
10	Code National du Bâtiment d'Haïti ハイチ国家建築基準	資料	データ (PDF)	Ministère des Travaux Publics, Transports et Communications 公共事業・運輸・通信省	2012