

Report of

Structural Experiments on 2012 and 2013 by CNCRP

March 2014

Revised in June 2015

CNCRP (PWD and JICA)

Contents

Part 1

Summary of Structural Experiment 2013

Part 2

Experiment of year 2013

1. General
2. Testing plan
3. Load-deflection curve
4. Material test
5. Consideration

Part 3

Experiment of year 2012

1. General
2. Testing plan
3. Load-deflection curve
4. Material test
5. Consideration

.

Part 1 Summary of Structural Experiment, 2013

Structural experiment was conducted in 2012 and 2013 by CNCRP. Following is the summary of year 2013.

1) Frame model

Existing mid-rise RC frame, a scaled 1 span 1 story frame model has been selected for the structural experiment.

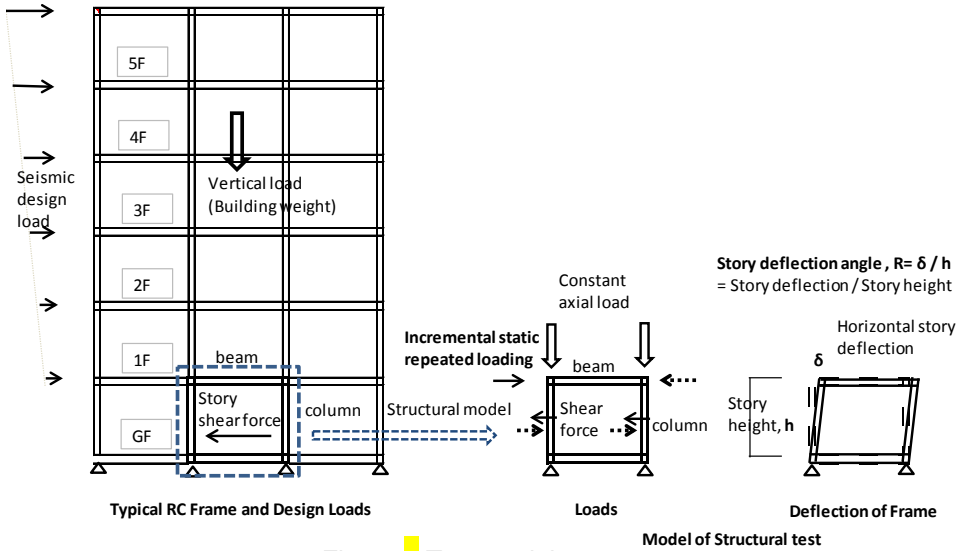

Figure 1 Test model

2) Testing apparatus

Load-meter and dial gauge relation has been controlled at the lab. Load-cell and displacement Transducer has been recorded by data-logger.

Constant vertical load (N=16 tonf) and repeated static incremental horizontal loading were provided.

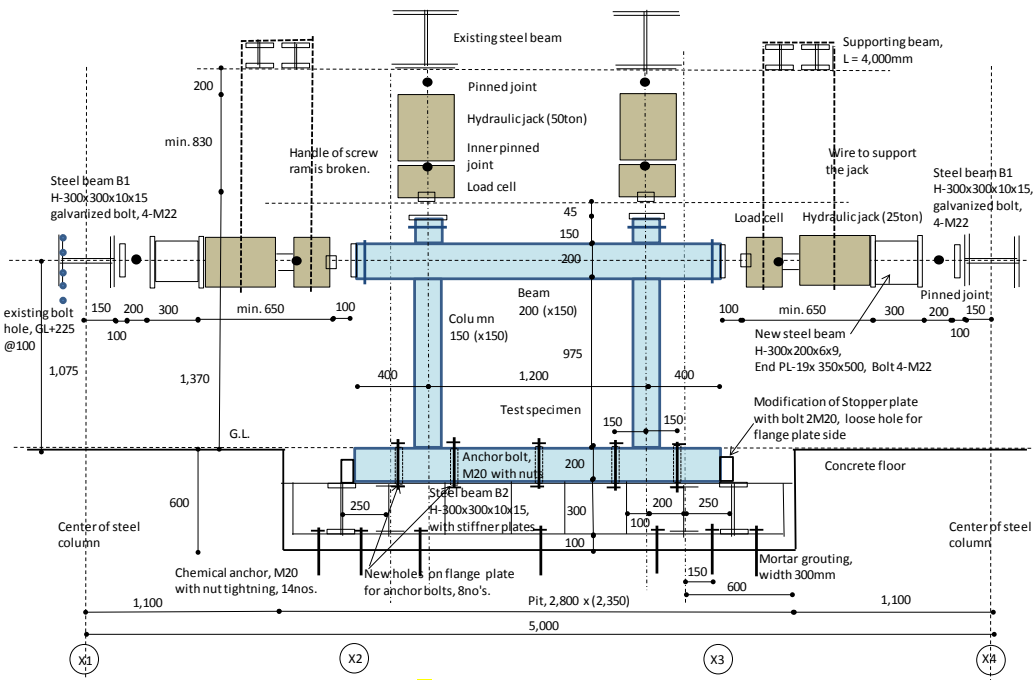

Figure 2 Testing Apparatus, unit (mm)

3) **Specimen**, total 6 specimens including 2 specimens for retrofit were tested in 2013.

Specimen No.1 is a standard specimen of a typical frame. Column size is 150mmx150mm. Beam size is 150mmx200mm. Specimen No.2 is expressing end frame that anchor of beam main re-bar to column is 180 degree hook. Specimen No.3 has brick standing wall with thickness 65mm, and the height is 3/4 of clear height. Glass window is installed at the opening. Specimen No.4 has brick wall without no opening. Specimen No.5 is a retrofitted specimen by RC wall. Specimen No.6 is a retrofitted specimen by steel framed brace. Because of the capacity limitation of the horizontal hydraulic jacks, relatively low strength retrofit was planned.

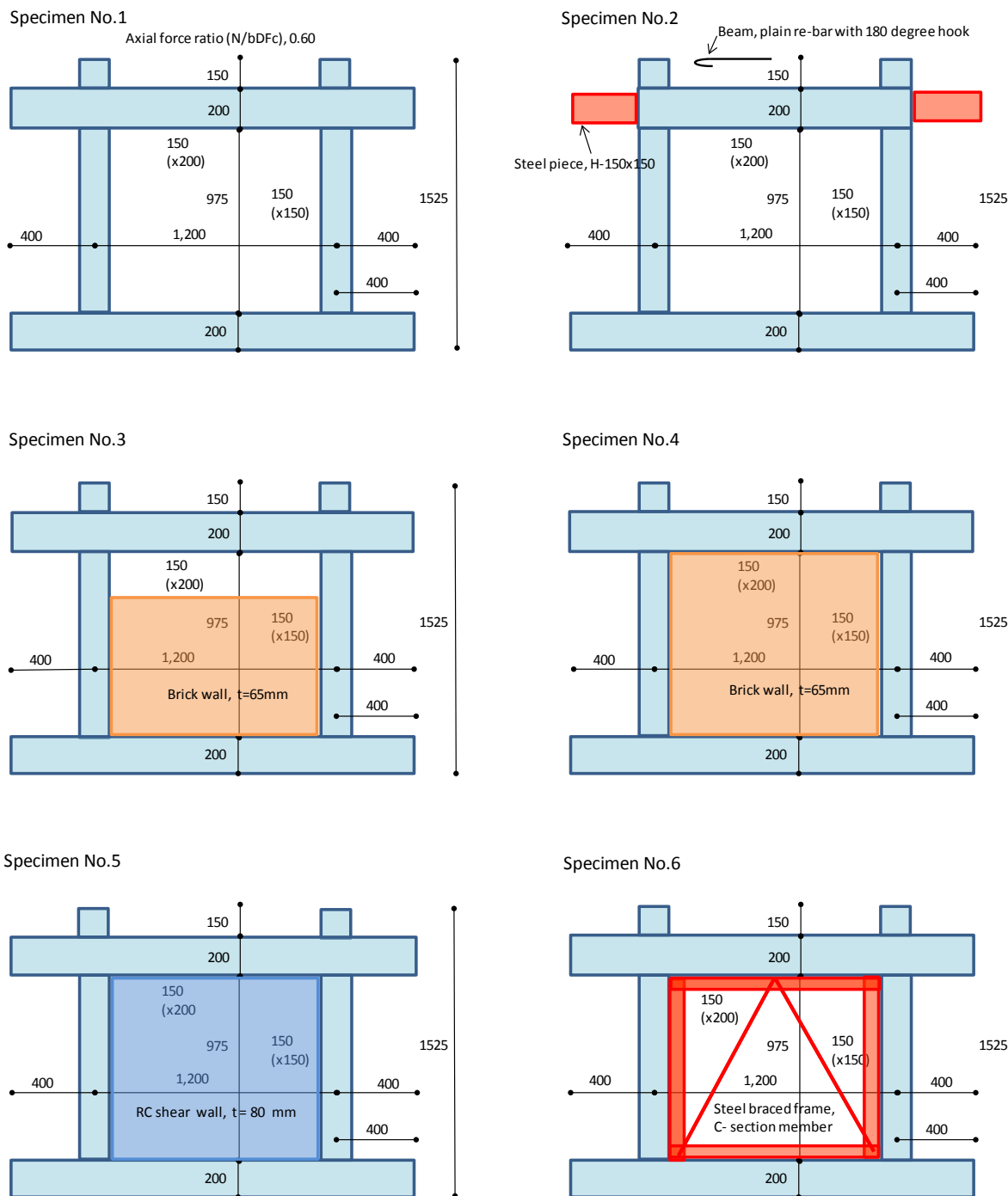

Figure 3 Test Specimen

Low strength concrete of 10.8N/mm² was casted. High axial force ratio ($N/b \cdot D \cdot F_c = 0.68$) was realized. Poor shear reinforcement was supposed. Joint of plain bars is lap joint. Column tie was changed to @195 instead of @150, due to the use of re-bar $\phi 7.45\text{mm}$, from No.1 to No.6. Detail of specimen No.1 is shown below.

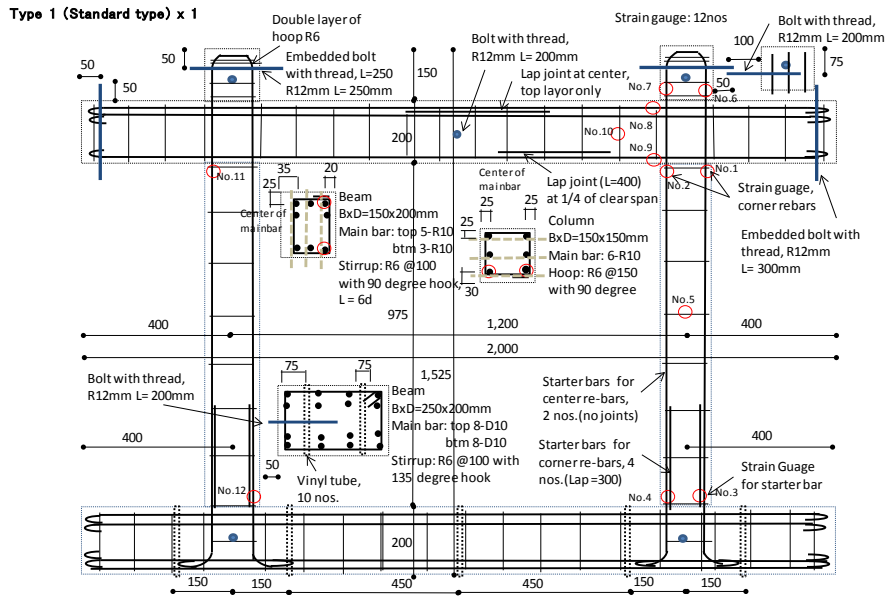
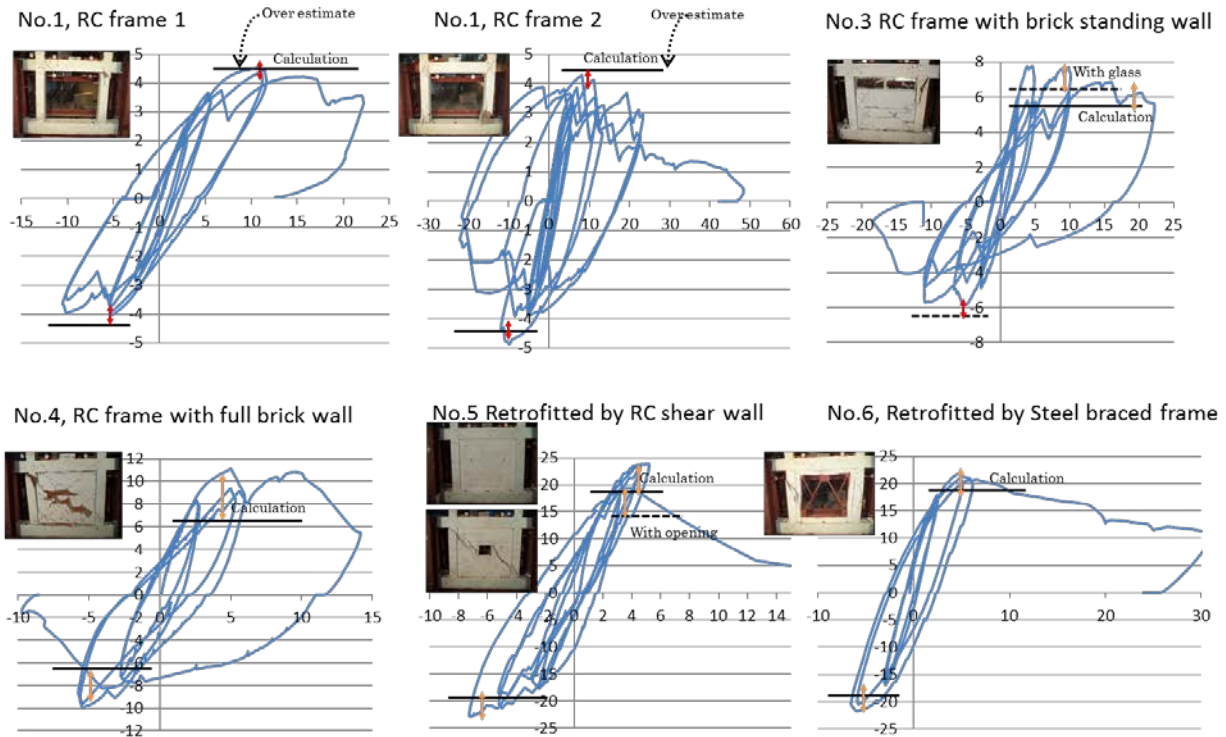

Figure 4 Test Specimen No.1

4) Horizontal load and deflection curve (Unit: tonnage and mm)



Retrofit design calculation for No.5 and No.6

Figure 5 Horizontal load and deflection curve

Outline (displacement shown is the reading value of the dial gauge at upper side of beam)

Specimen No. 1:

R<1/100 ($\delta < 11.75\text{m}$), max. load was positive 4.5ton and negative 4.0ton. Flexural cracks occurred at top and bottom of columns. Vertical cracks also occurred at bottom of columns. Diagonal crack occurred at the top of column. Diagonal crack at left column occurred at R < 1/200 ($\delta < 5.88\text{mm}$).

R<1/50 ($\delta < 23.5\text{mm}$), shear failure at the top of right column occurred at positive 3.5 at (25.7mm), and the vertical load dropped.

Specimen No. 2:

R<1/100 ($\delta < 11.75\text{m}$), max. load was observed positive 3.9ton and negative 5.0ton. Diagonal crack extended at both side of beam column panel zone, and strength dropped from 3.5 ton (at 7.8mm) to 3.0 ton (12.4mm). Flexural cracks occurred at bottom of columns.

R<1/50 ($\delta < 23.5\text{mm}$), Diagonal crack extended at both panel zone. Cover concrete at bottom of column (especially rear side) was detached.

R<1/25 ($\delta < 47.0\text{mm}$), Bottom of column was failed. Cracks of panel zone were extended. Vertical load was reduced at (30mm).

Specimen No. 3:

R<1/200 ($\delta < 5.88\text{mm}$), max. load was positive 7.7ton and negative was 6.0 ton. Cracks extended for columns and brick walls.

R<1/100 ($\delta < 11.75\text{m}$), Diagonal and vertical crack extended on right column. Many flexural cracks at left column observed.

R<1/50 ($\delta < 23.5\text{mm}$), Positive load 7.0ton and dropped to 5.8 ton due to the Glass broken. Shear failure of right column occurred at (- 17.1mm) of negative loading, and vertical load was also dropped.

Specimen No. 4:

R<1/200 ($\delta < 5.88\text{mm}$), max. load at positive was 11.0ton, and negative was 10.0 ton. Diagonal crack occurred at top of left column. Cracks extended on brick wall.

R<1/100 ($\delta < 11.75\text{mm}$), Shear failure occurred at left column at (10mm) of positive loading. Big diagonal crack extended on brick wall and bottom of right column. At negative loading, horizontal stiffness decreased and could not support the vertical load.

Specimen No. 5:

R<1/200 ($\delta < 5.88\text{mm}$), max. load was positive 23.3ton(limit of jack, at 4.3mm) and negative was 21.2ton. Horizontal crack observed at left column, diagonal crack developed at wall. Small square hole was provided on the wall at the lab. to reduce the strength, and loaded again. Shear failure occurred at positive loading 19.6 ton at 5.0mm. Axial load started the drop at around 8mm.

Specimen No. 6:

R<1/200 ($\delta < 5.88\text{mm}$), max. load was positive 22.0ton at (5.2mm), and negative load was 22.0ton at (6.2mm). New diagonal crack occurred at middle of left column at 3rd positive cycle. Slight Buckling of out of plain direction of left bracing was observed.

R < 1/100 ($\delta < 11.75\text{mm}$), Shear failure occurred at left column at positive 20 ton at (9.0mm).

Buckling of left vertical steel frame was observed. Yield of left side brace and out of plain direction buckling at right side steel bracing was observed. Horizontal crack beneath the beam at grout mortar was observed. Vertical load drop started at 20.9mm.

5) Evaluation of Horizontal Strength

Horizontal strength of each specimen was calculated as follows. Calculated value is shown as horizontal line on Figure 5.

Calculated strength of **specimen No.1** as flexural failure was slightly over estimated, possible reason will be the use of plain bar and lap joint of main bar. Calculated strength of **specimen No.2** was also slightly over estimated. It was supposed some drop of strength due to the anchor of beam re-bar, but there was no clear reduction of the strength in this specimen. **Specimen No.3** was evaluated as flexural failure column and shear failure column. Contribution of the strength of window with frame was not negligible, which was estimated as 1.2 ton. **Specimen No.4** was estimated as shear failure column at both side, and excessive strength was the contribution of brick wall. **Specimen No.5** is the shear failure column at both side and shear failure RC wall. Strength evaluation without opening and with opening seems reasonable. Strength evaluation of **Specimen No.6** is the summation of shear failure strength of both column and strength of brace (yield strength of tension side and buckling strength of compression side). Strength evaluation seems reasonable.

Column

Flexural strength is calculated by Eq. A1.1-1 of the J. Standard, Shear strength of column is calculated by Eq. A1.1-1 of the J. Standard. Estimated collapse mechanism of the frame is shown in Figure 6.

Shear wall for retrofit

Shear strength of concrete panel plus column shear strength, shear strength of post-installed anchor and grout mortar are calculated.

Steel framed brace for retrofit

Steel brace of tension and compression (buckling strength) plus column shear strength, shear strength of stud/ post-installed anchor and grout mortar are calculated.

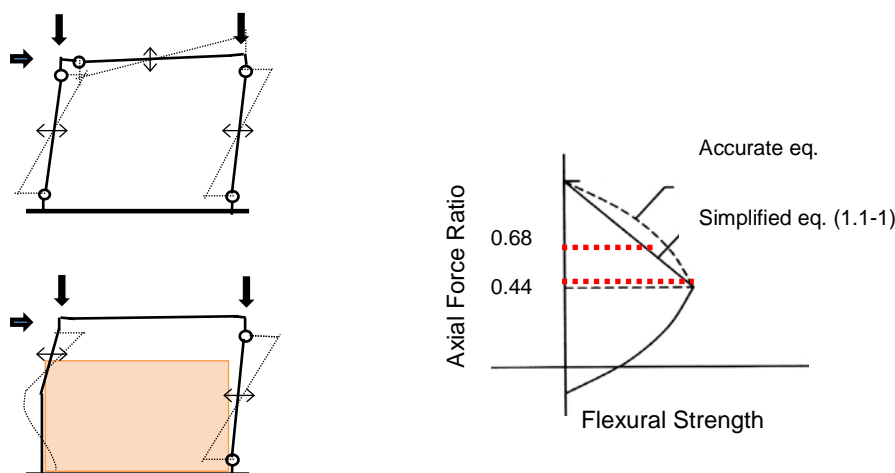

Figure 6 Estimated collapse mechanism of frame and M-N interaction curve

6) Simplified Monotonic Horizontal Load- Deflection Curve

Following simplified monotonic loading-deflection curve is estimated based on the result of cyclic loading and incorporating the engineering judgment.

Axial force ratio: Specimen No.1 ~ No.4, $N / (b \cdot D \cdot F_c) = 0.68$ ($F_c = 10.6 \text{ N/mm}^2$, $N = 163 \text{ kN}$)

Specimen 2012-No.4, 5, $N / (b \cdot D \cdot F_c) = 0.44$ ($F_c = 16.5 \text{ N/mm}^2$, $N = 163 \text{ kN}$)

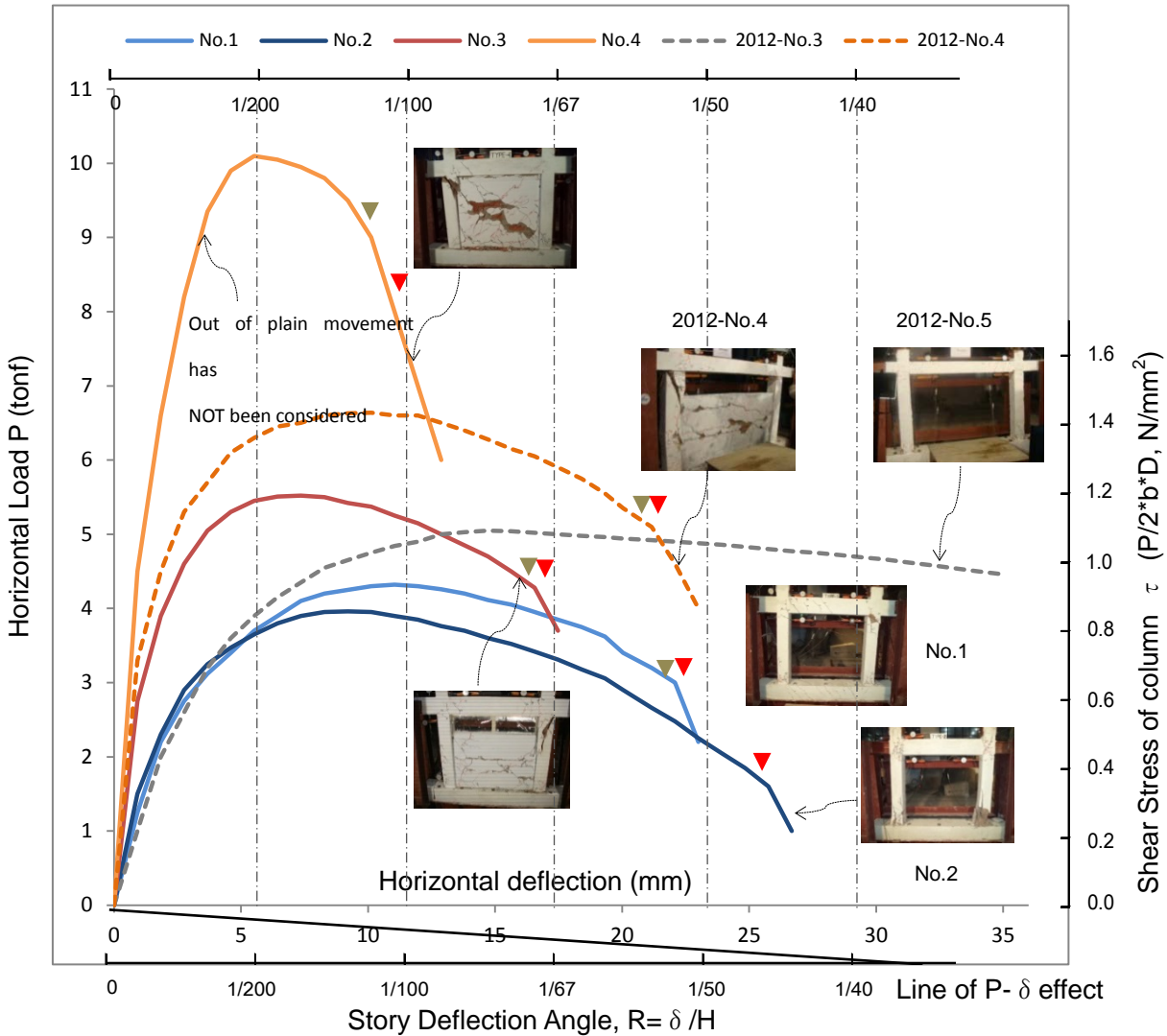

Note: Marking: ▼ denotes a point of “Drop in vertical strength”.

▼ denotes a point of “Shear failure” by the visual observation.

R: Story deflection angle = Horizontal deflection (mm)/ Story height (1,175mm)

b*D: Width and depth of column (mm* mm)

Fc: Concrete strength (N/mm^2)

1tonf = 2, 205lbf=9.8kN, 1Mpa= 1N/mm2, 1N/mm2 = 145 psi

Figure 7 Simplified Monotonic Load- Deflection Curve (1/2)

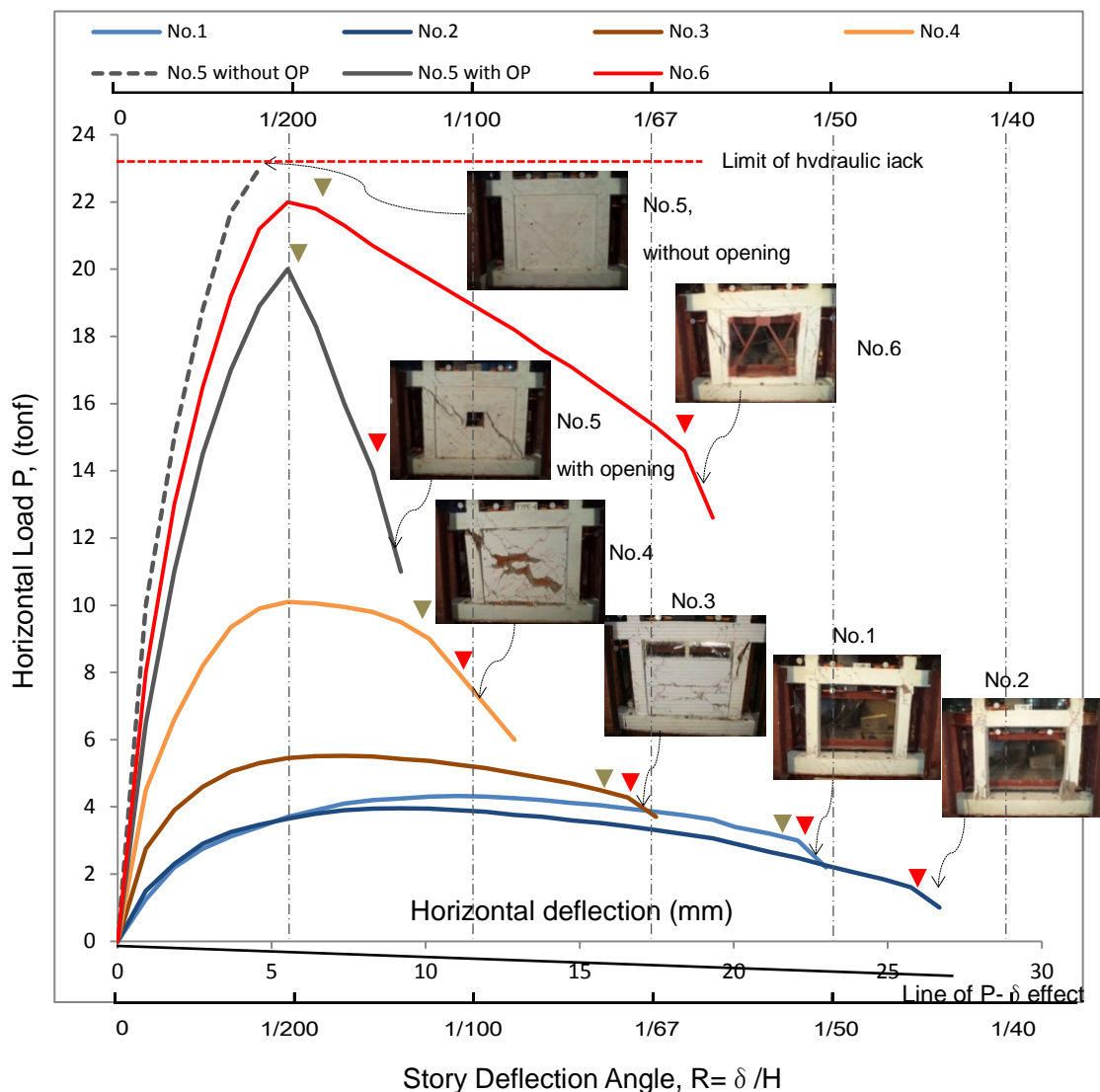

Note: Marking: ▼ denotes a point of “Drop in vertical strength”.

▽ denotes a point of “Shear failure” by the visual observation.

R: Story deflection angle = Horizontal deflection (mm)/ Story height (1,175mm)

b*D: width and depth of column (mm* mm)

Fc: Concrete strength (N/mm²)

Axial force ratio: Specimen No.1 ~ No.6, N/ (b*D*Fc) = 0.68 (Fc=10.6N/mm², N=163kN)

Retrofit: Specimen No.5, Fc of wall =10.7N/mm²

Figure 7 Simplified Monotonic Load- Deflection Curve (2/2)

7) Summary

Basic experiment for the seismic evaluation and retrofit design of existing RC buildings in Dhaka was done. Summary is as follows.

(1) Specimen and loading:

1. RC frame of plain bar and low strength concrete ($f_c=10.6\text{N/mm}^2$) with/without brick-wall.
2. High axial force ratio ($N/b*D*f_c$) of column 0.68.
3. Repeated horizontal load is provided until the point of drop in vertical load (= drop of floor).

(2) Results:

1. Horizontal load- story deflection angle relation was shown.
2. High axial force ratio causes low ductility of frame in addition to strength reduction.
3. Shear failure of column causes the drop in vertical strength.
4. Brick-wall affects the behavior of frame, with respect to stiffness, strength and ductility.

(3) Retrofit:

1. RC shear wall and steel braced frame is effective to increase shear strength of frames, but reduce the deformability, if no column jacketing, in case of vulnerable column.

(4) Strength evaluation:

1. Flexural and shear strength of column, shear strength of RC wall and strength of steel brace including connection for retrofit were evaluated and compared with test results.
2. Flexural strength by the calculation will be reduced in case of low strength concrete.

(5) The Issue to be investigated further :

1. Strength of beam column connection, evaluation of poor quality control at sites.
Quantitative evaluation of 90 degree hook of column tie, use of plain main bar and lap joint.
2. Ductility evaluation of above item 1.

(6) Limitation of the Tests

Material (Def. of low strength concrete, less than 13.5 N/mm^2)

1. Concrete; low strength concrete, 10.6 N/mm^2 at 8 weeks. For information, 16.5N/mm^2 in 2012.

	Yield stress	Original requirement	2012
2. Plain Re-bar ϕ 10mm	$\sigma_y = 350\text{N/mm}^2$		327 N/mm^2
3. Plain Re-bar ϕ 7.4mm	$\sigma_y = 353\text{N/mm}^2$	ϕ 6mm	(560 N/mm^2)
4. Deformed re-bar D10mm	$\sigma_y = 274\text{N/mm}^2$		387 N/mm^2
5. Steel angle plate 4.2mm	$\sigma_y = 363\text{ N/mm}^2$	3.0mm, $\sigma_y = 250\text{N/mm}^2$	

Interval of shear reinforcement (column tie) and detail of steel bracing were modified accordingly.

Loading

1. Inclination of foundation beam under the specimen; Slight inclination of foundation steel beam was observed in plane and out of plane direction, and filler plates were provided where a gap exists under the specimen.
2. Limitation of horizontal hydraulic jacks; capacity was 23 ton (230kN) only.

Part 2 Experiment of year 2013

2.1 General

Testing plan, load-deflection curve, material test, and strength evaluation are introduced at here.

2.2 Testing plan

Revised: Specimen No.2, numbering of strain gauges, bridge box, strain gauge bonding (8/28)

Numbering of DT/DG, name of specimen, appendix: fabrication of specimen (10/24)

1) Purpose

2nd structural experiment is conducted to supplement the 1st test of existing building and to evaluate the effect of retrofitting.

2) Outline

1. Reinforced concrete frame with 1 story, 1span will be selected for the experiment.
2. Mid-rise buildings constructed around 25 years ago, and 1/3 scale frame and 1/2 scale of member.

3) Test Specimen

Total 6 set of RC frames are planned.

Column size; 150mmx150mm、 beam size; 150mm x 200mm (previous size was 150mmx150mm)

Capping portion of column will be reinforced or concrete casting will be properly done to ensure the loading of axial force.

1. Axial force ratio 0.6, common to each specimen, to show strength decrease after the peak of load-deflection curve. (previous one was 0.43).
2. Anchoring of beam main bar, anchoring of beam main bar with hook to column and slippage.
3. Brick wall type 1, brick standing wall with 65mm, height 3/4 of cleat height, possibility of shear failure of column in case of not strong beam.
4. Brick wall type 2, brick wall without opening, thickness 65mm, increase of stiffness and strength, used for the evaluation of soft story.
5. Retrofit by RC shear wall, strength increase.
6. Retrofit by steel braced frame, strength increase.

4) Material

Concrete: Trial mix of 3 types will be conducted to get low strength concrete of 11~12N/mm² at 8 weeks (original design strength is 14N/mm²). Water cement ratio including moisture volume of aggregates will be controlled. (Concrete strength of 2012 was 16.5N/mm², and low strength concrete was not achieved). Mix design will be decided after the result of 3 types of trial mix.

Concrete work: Concreting shall be casted in one day for total 6 specimens, to reduce the deviation of concrete strength. Formwork shall be prepared for 6 sets. Curing of concrete will be 8 weeks before loading.

Re-bar: Material procurement shall be done soon after the selection of the contractor. Re-bar test shall be done

Structural Experiment by CNCRP

soon for plain bar 10mm, 6mm and deformed bar 10mm.

Re-bar material and steel plate shall be provided to JET for the test in Japan.

Steel: Tensile test shall be done for the piece of structural steel for retrofitting. Test piece shall be provided to JET for the test in Japan.

Bond test: simple test of bond strength for lap joint of re-bar and re-bar anchor with hook.

5) Model (typical)

1. Column, size: 150mmx150mm, Main bars: 6-φ10mm (round bar),
Shear reinforcement: φ6mm @150 with 90 degree hook
2. Beam, size: 150mmx 200mm
Main bars: top 5-φ10mm top and 5-φ10mm bottom
Shear reinforcement: φ6mm @100 with 90 degree hook
3. Beam column connection; no hoop
4. Brick wall, 250x125x75mm, thickness 60mm with height of 750mm
250x60x75mm, thickness 60mm with full

6) Frame sizes, Height; 1.525m, Span; 1.2m (Span length was reduced from 1.6m to 1.2m considering the capacity of horizontal jack, 25 ton, against retrofitted specimen of No.5 and No.6.)

7) Strain gauge on re-bar

To cooperate the work for putting strain gauge on re-bar of specimen by students of BUET.

8) Displacement transducer (DT), Dial gauge (DG)

A piece of glass will be put on a specimen where DT and DG are provided.

9) Setting of a specimen

Alignment of vertical jack and specimen will be measured properly.

Note: Axial force ratio is $N/bDFc$.

	Axial force ratio	Beam main bar anchor	Brick wall	Retrofit	Name
No.1	0.6	nil	Nil	Nil	Frame06ST andard
No.2	0.6	To panel zone	Nil	Nil	Frame06AN chor
No.3	0.6	Nil	With opening	Nil	Frame06B rick 1
No.4	0.6	Nil	No opening	Nil	Frame06B rick 2
No.5	0.6	Nil	Nil	Shear wall	Frame06S hear W all
No.6	0.6	Nil	Nil	Steel braced frame	Frame06S teel B racedframe

10) Specimen

Total 6 specimens

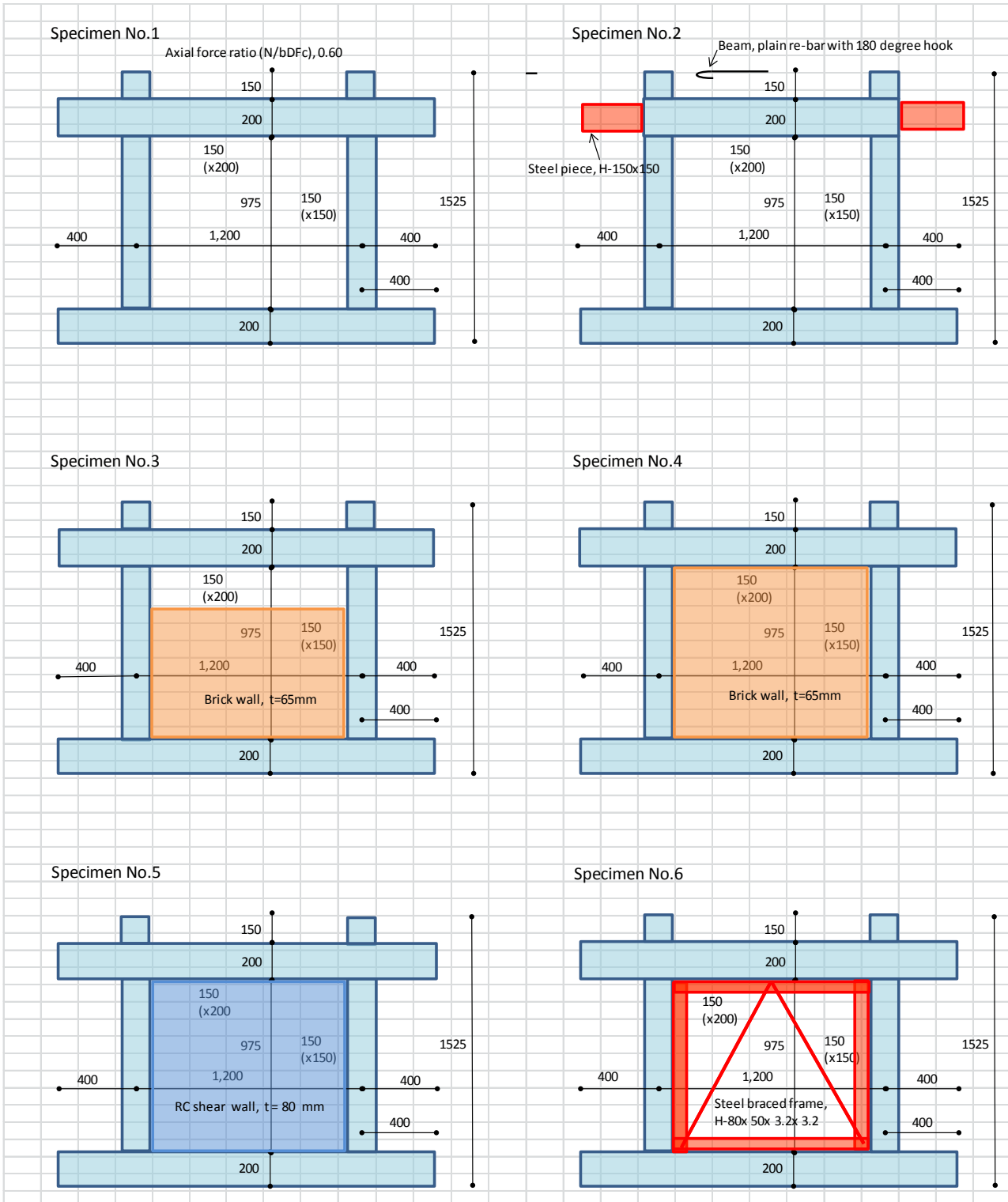

11) Plan of loading

Existing reaction frame with hydraulic jack and load cell will be used.

Horizontal load; 250kN capacity, stroke 100mm, Vertical load; 500kN capacity, stroke 100mm

Additional 2 nos. of steel members for horizontal loading will be provided for the reaction frame.

12) Loading program (draft)

Repeated static incremental horizontal load is provided.

1/400 of story height 1,175mm, 2.94mm, 2 cycles (step will be controlled by load)

1/200 5.88mm, 2 cycles

1/100 11.75mm, 2 cycles

1/50 23.5mm, 2 cycles (step will be controlled by displacement)

1/25 47.0mm, 2 cycles

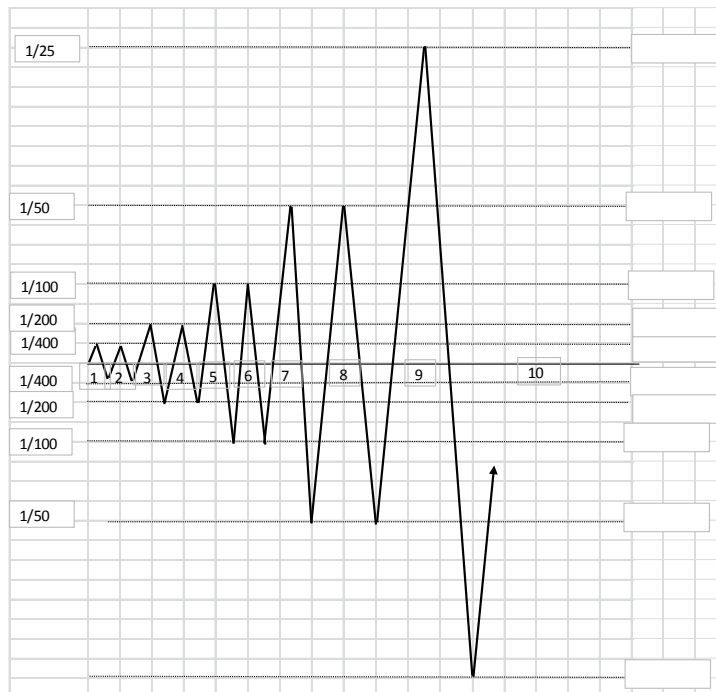

13) Place of the Experiment

Testing laboratory of Department of Civil Engineering, BUET

14) Measurement of strain of re-bar

Strain gauges are bonded to re-bars. The 3-wire system of No. 2 bridge box is adopted to minimize the impact of temperature change.

Bridge Box

●ひずみゲージブリッジの組み方例

No.	呼称	具体例	回路	出力	備考	ブリッジボックス DB-120A,350A
1	1アクティブゲージ法 2線式 ゲージ枚数 1枚			$e_o = \frac{E}{4} K_s \cdot \epsilon$ K_s : ゲージ率 ϵ : ひずみ E : ブリッジ電圧 e_o : 出力電圧 R_g : ゲージ抵抗 R : 固定抵抗	周囲温度変化の少ない場合 に適す 温度補償なし 出力:1倍	
2	1アクティブゲージ法 3線式 ゲージ枚数 1枚			$e_o = \frac{E}{4} K_s \cdot \epsilon$	温度補償なし リード線の 温度影響消去 出力:1倍	

Kyowa Electrical Instruments Co., Ltd. Japan

Data of strain gauges for re-bars

Data of strain gauge

Data of strain gauges provided on re-bars are transferred to the data-logger (Dewetron) through a bridge box. Strain (mm/mm) is calculated by following equation which converts the measured voltage by data-logger (Dewetron) through bridge box to strain.

Strain ϵ is expressed by,

$$\epsilon = 4 / (E \times K_s) \times e_o \text{ (output voltage)}$$

K_s (Gauge factor) = 2.08 (information by the maker of strain gauge, to be confirmed)

E (Bridge voltage) = 2.5V (2.5V will be selected as excitation by Dewetron, typical value is 2V in case of a Japanese data-logger)

$$\epsilon = 4 / (2.5 \times 2.08) \times e_o \text{ (output voltage)}$$

$$= 0.7692 \times e_o \text{ (output voltage)}$$

$$\epsilon = (0.7692 / 1000) \times e_o \text{ (output voltage in mV/V)}$$

Data logger, DEWE-2600 series (BUET)

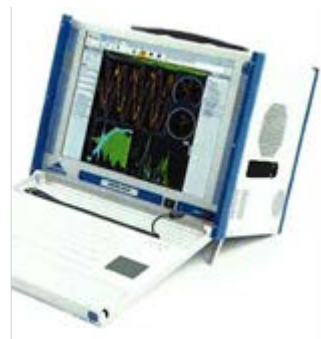

Note: $10,000 \mu (10^{-6}) = 10^{-2} = 1\%$

Refer to Appendix for temperature compensation gauge.

Attachment: The Drawings

1) Testing Apparatus (unit: mm)

1-1) General

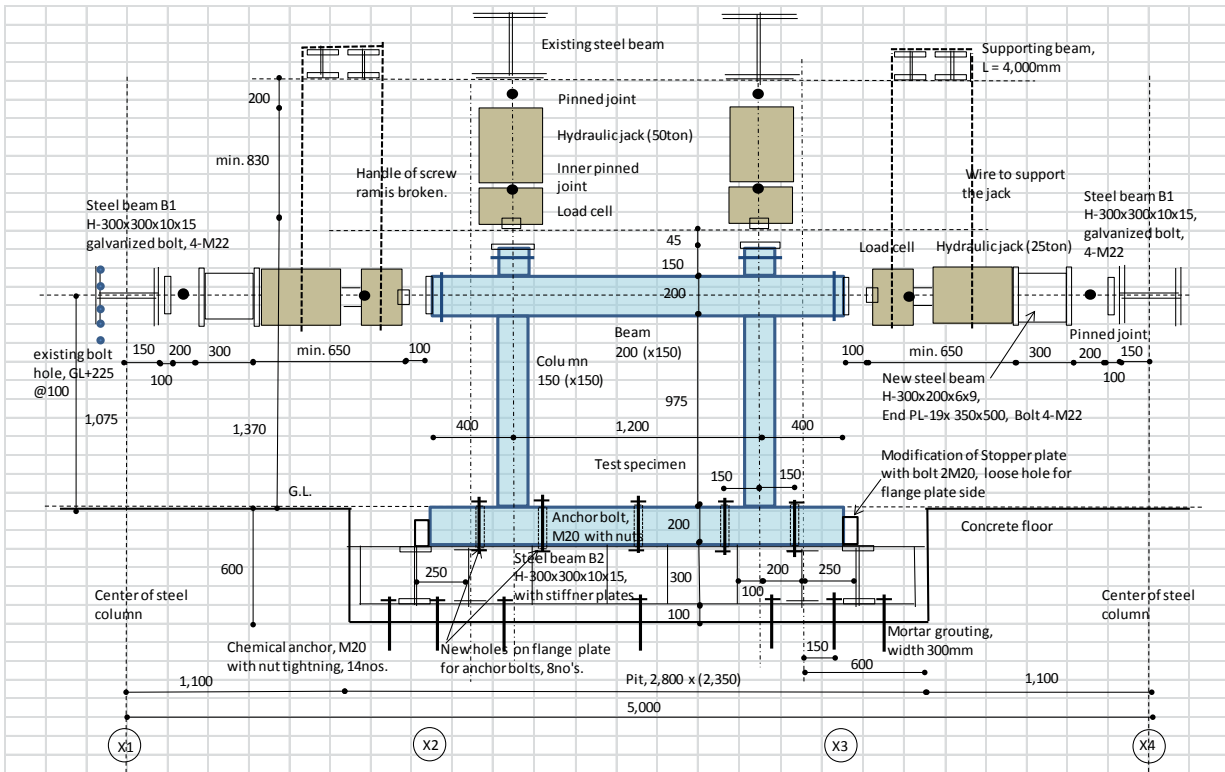

1-2) Measurement (Numbering based on the view from the front side)

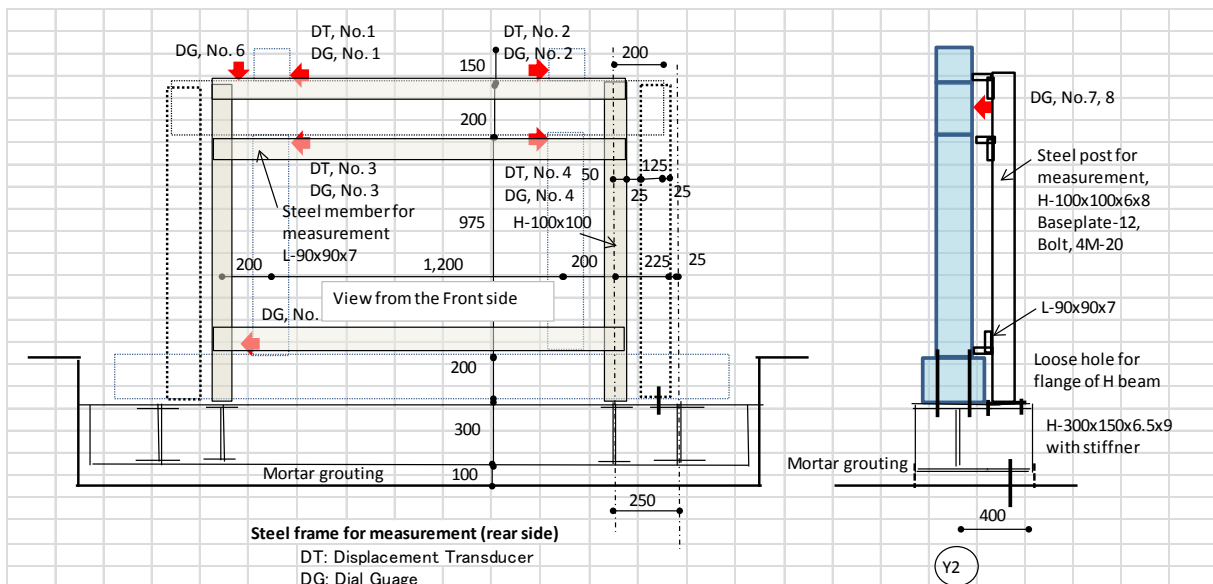

3) Structural steel (following 4 drawings, unit; mm)

2013.6.15
1/4

• Steel member for Test Specimen No. 2

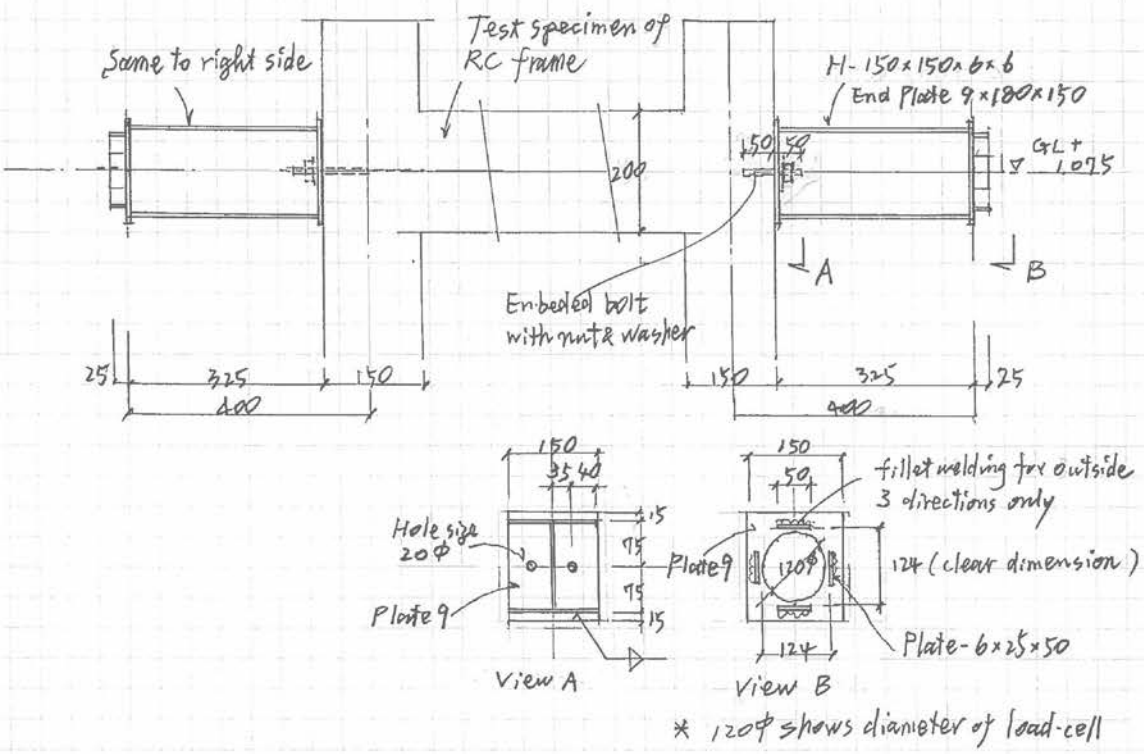

• New capping for RC beam with depth 200mm x 2 pieces

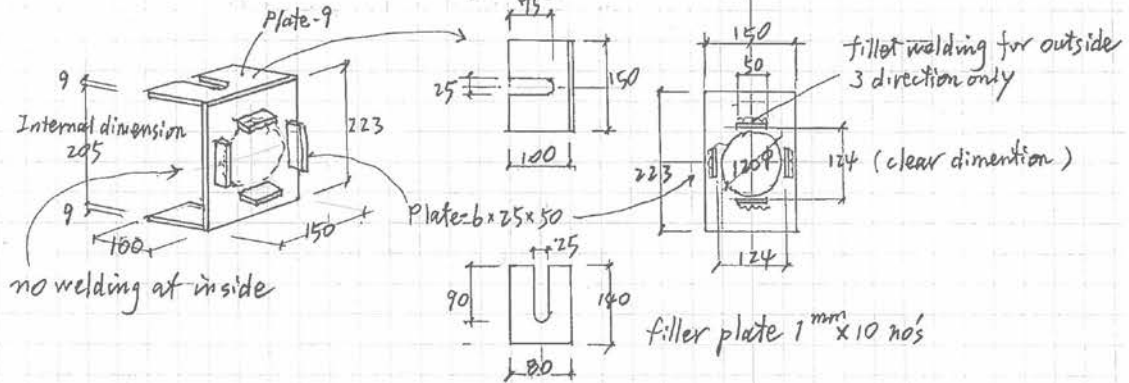

• Modification of existing capping for column x 2 pieces

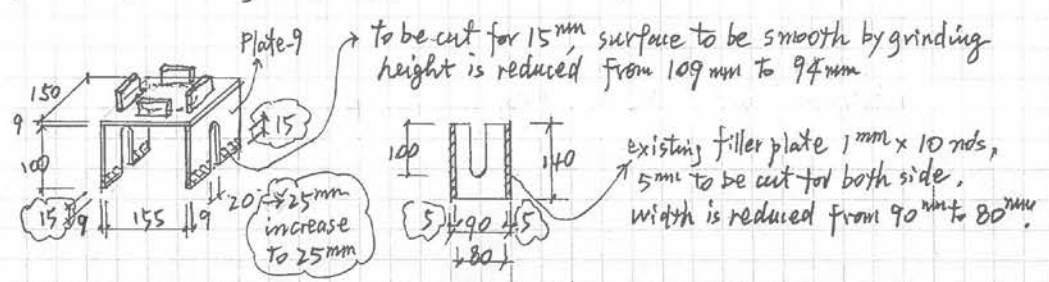

Note: Submit shop drawings for the Approval of the Engineer

2013.6.15
2/4

• Steel beam for horizontal loading x 2 pieces

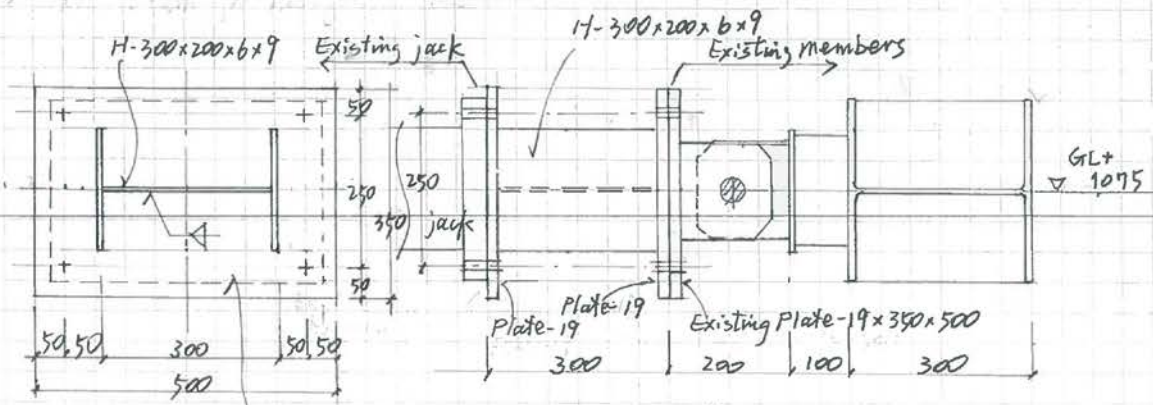

End Plate-19x350x500 at both side

Bolt size is same to existing bolt for fixing baseplate of hydraulic jack.

2013.07.15
JET.

Modification of Steel beam for new holes of anchor bolts

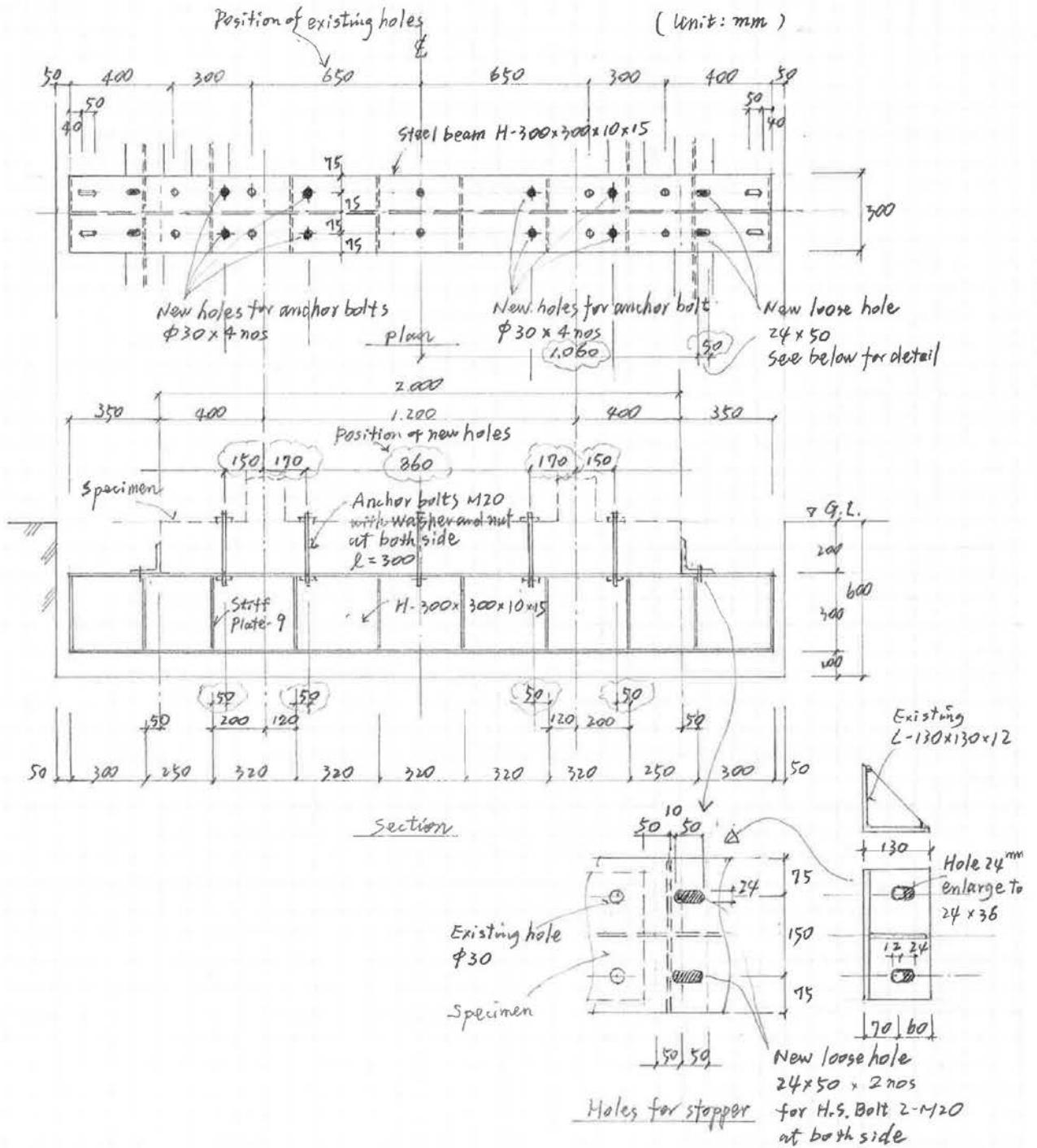

• Detail of Steel Braced Frame

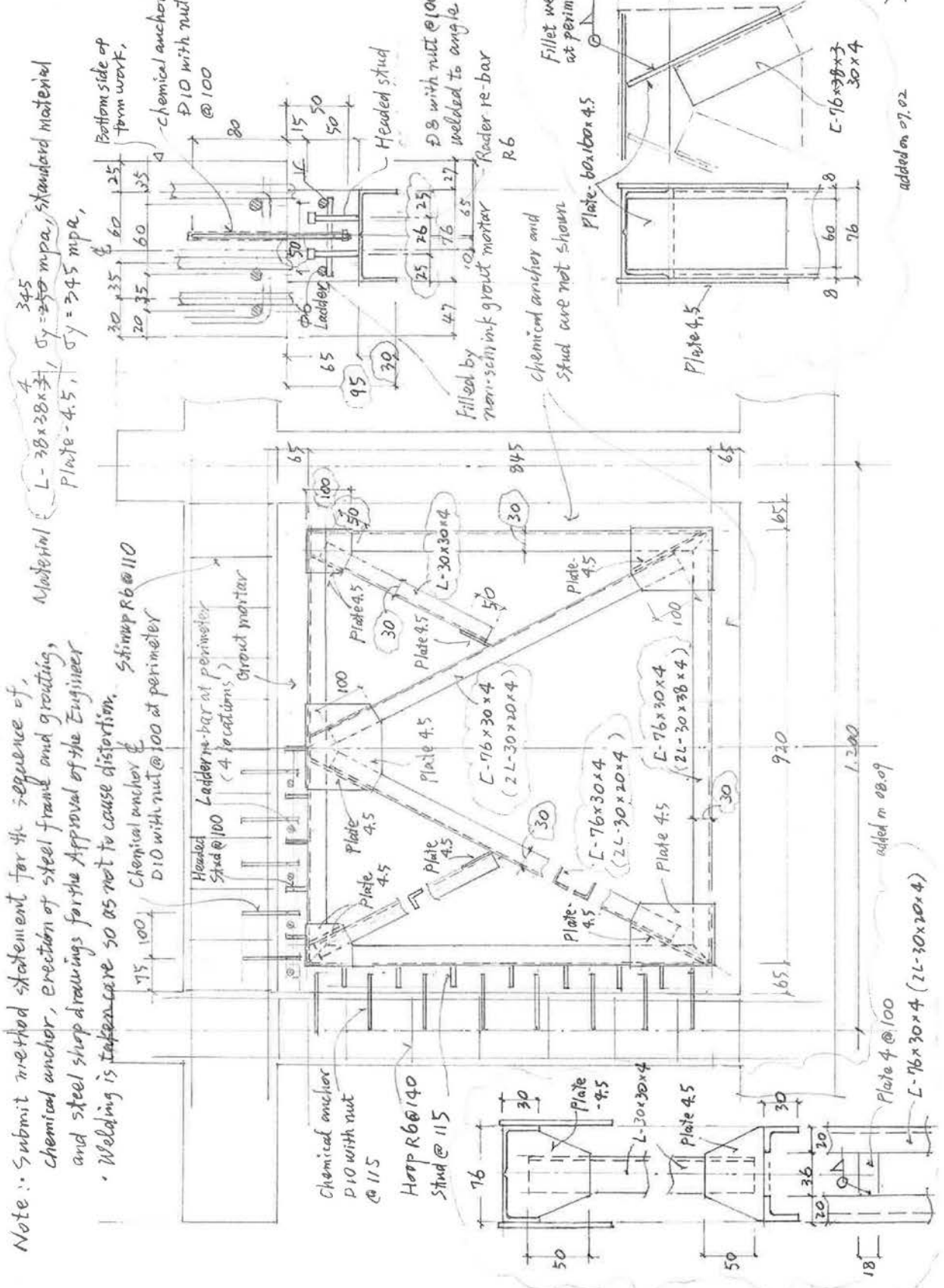

Note: Submit method statement for the sequence of, chemical anchor, erection of steel frame and grouting, and steel shop drawings for the Approval of the Engineer. Welding is taken care so as not to cause distortion.

Material: L-38x38x4, Plate-4.5, Sy=250 mpa, Sx=345 mpa, Sx=345 mpa.

2013.07.02
08.15
08.09
4/4

added on 08.09

added on 07.02

4) Supplemental drawing

07.02
2013.06.29
revised 07.15

Structural Test - Supplement

B.Q. Item B-7 Tensile Test of Re-bar for Concrete Bond Stress.

a) 3 pieces for bond stress, concrete size $75^{mm} \times 75^{mm} \times$ length (shown below)

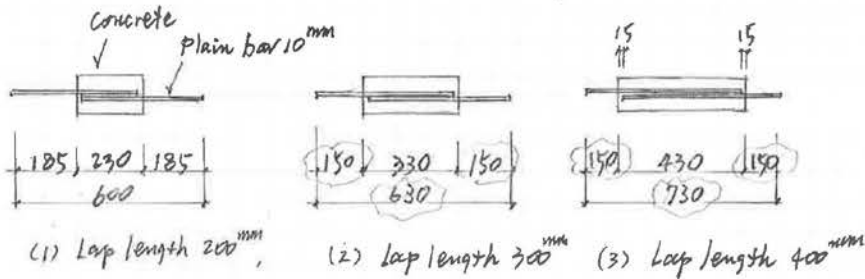

b) 3 pieces with hook, concrete size $75^{mm} \times 75^{mm} \times$ length (shown below)

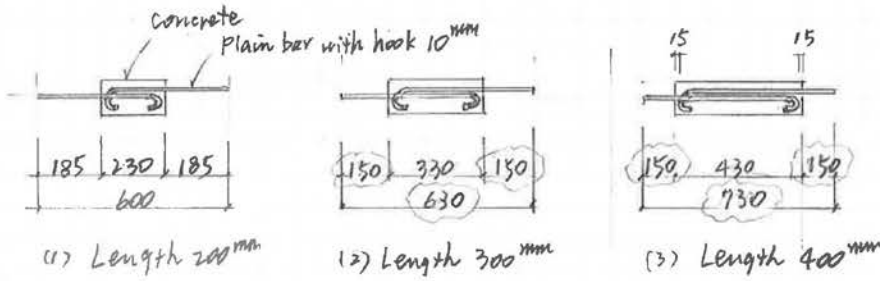

Note: Detail might be changed subject to the discussion with the lab. of BUET.

B.Q. Item B-8 Plain Concrete Block with size of $600^{mm} \times 600^{mm} \times 150^{mm}$ (height)

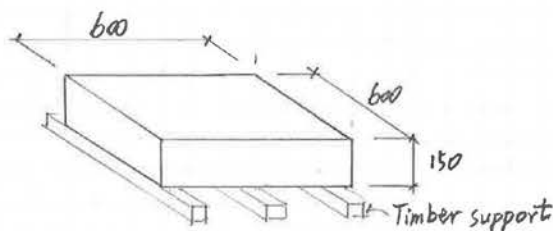

Including, 1) transportation to inside of lab. of BUET for core drilling.

2) supporting work for core drilling by PWD engineers ($\phi 100 \times 3, \phi 50 \times 3$)

3) demolishing after coredrilling

Note: Concrete shall be cast on the same day of structural test specimen.

Attachment 3: Scope of Services

2013/07/14

		PWD, JET	BUET	DUET
1	Detail plan of experiment, design of additional steel members, and specimens	<input type="radio"/>	Review and confirmation	Review and confirmation
2	Fabrication of steel member	<input type="radio"/> (sub contractor)		
3	Trial mix of concrete	<input type="radio"/> (sub contractor)		
4	Tensile test of re-bar and steel plate, including stress strain curve	<input type="radio"/> (coordination)	<input type="radio"/> (application from sub contractor)	
5	Bond test of re-bar	<input type="radio"/> (coordination)	<input type="radio"/> (application from sub contractor)	
6	Adjustment of data-logger	<input type="radio"/> (coordination)	<input type="radio"/> (exercise by re-bar tensile test)	
7	Pasting strain gauge on re-bar and steel braced frame	<input type="radio"/> (Supply of strain gauges)	<input type="radio"/> (Paste work of strain gauge)	
8	Formwork, re-bar, concreting, curing of specimen,	<input type="radio"/> (sub contractor)		
9	Calibration of load cell		<input type="radio"/>	
10	Installation of additional steel members and adjustment of reaction frame	<input type="radio"/> (sub contractor)	<input type="radio"/> (coordination, if required)	
11	Installation and dismantle of test specimen	<input type="radio"/> (sub contractor)		
12	Cable connection and setting DG and DT	<input type="radio"/> (coordination, providing DT and DG)	<input type="radio"/> (main)	<input type="radio"/> (support)
13	Loading and measurement	<input type="radio"/> (coordination and provide labors)	<input type="radio"/> (main)	<input type="radio"/> (support)
14	Preparation of load deflection curve by load-cell and DT, and load-meter and DG	<input type="radio"/> (coordination)	<input type="radio"/> (main)Note 2	<input type="radio"/> (support)
15	Photos of specimen	<input type="radio"/> (coordination)	<input type="radio"/> (sub)	<input type="radio"/> (main)
16	Compilation of report	<input type="radio"/> (main)	<input type="radio"/> (support)	<input type="radio"/> (support)

Note: 1) DT means Displacement Transducer, and DG means Dial Gauge.

2) Load deflection curve of each specimen will be prepared on the next of the experiment.

Attachment 4: Time Schedule

Preliminary test schedule		2013/8/13														
No.	Activity	2013										2014				
		Apr.	May	Jun.	Jul.	Aug.	Sept.	Oct.	Nov.	Dec.	Jan.	Feb.				
1	Plan of experiment, design & specification of additional steel members and specimen															
2	Document for subcontract															
3	Quotation & subcontract															
4	Trial mix of concrete															
5	Re-bar tensile test															
6	Exercise of data-logger for strain gauge of re-bar test															
7	Steel shop drawing															
8	Fabrication of steel members															
9	Test of bond and anchor of re-bar															
10	Preparation of site space with roof for specimen															
11	Formwork, re-bar with strain gauge and concreting of 7 test specimen															
12	Concreting for core sampling															
13	Brick work for specimen															
14	Retorfit work of specimen by steel bracing and RC shear wall															
14	Adjustment of steel members at the site															
16	Adjustment of data-logger and load cell															
17	Loading and measurement for 6 specimen															
18	Report of test result															
19	Review and comment															
20	Final report															

Note:

Structural Experiment by CNCRP

Appendix 1: Photos (3 sheets),
1st Experiment (2012)



Reaction frame (Painting and lighting)



Specimen



Control panel



Vertical and horizontal hydraulic jack

Pinned connection
Built-in pinned connection



Data-ligger (BUET)

Bridge box for strain gauge

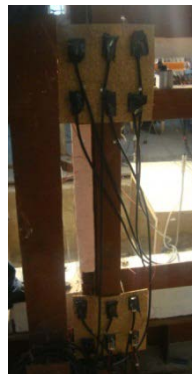

Displacement transducer and dial gauge



Detail of load cell and specimen



Transportation of specimen by 2 ton capacity lift



Structural Experiment by CNCRP

Laboratory of Civil Engineering Department, BUET

Existing Column



Width 300mm, depth 400mm, position of bolt hole 30mm from the edge, hole diameter 22mm to 24mm, hole vertical interval 100mm. Bolt hole, ground floor plus 225 @100 up to 1,725.

Flange thickness 20mm, hole size, approx. 22 to 24mm

Vertical jacks



Baseplate of the jack, approx. 300mm x 450mm x 55mm (thickness), interval of bolt holes, approx. 250mm and 400mm, bolt size approx.22mm

Horizontal jack

Edge of the Load cell

Fabrication of the test specimen of 2st experiment (2013)



Assembly of re-bar

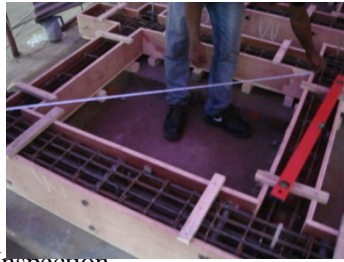

Inspection



Re-bar arrangement

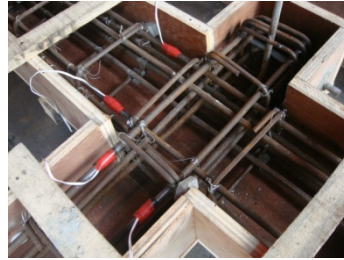

Bonding of strain gauge and water proofing coating

Concreting



Weight meter



Cement, brick chip and cement



Fresh concrete



Slump test



Concreting and surrface finishing



Plain concrete for core sampling



Specimen for bond test



Appendix 2

1. Explanation of Front side and Rear side of a Specimen

The front side of standing position of a specimen for loading is the bottom side of lying position for concreting.

Concreting with lying position

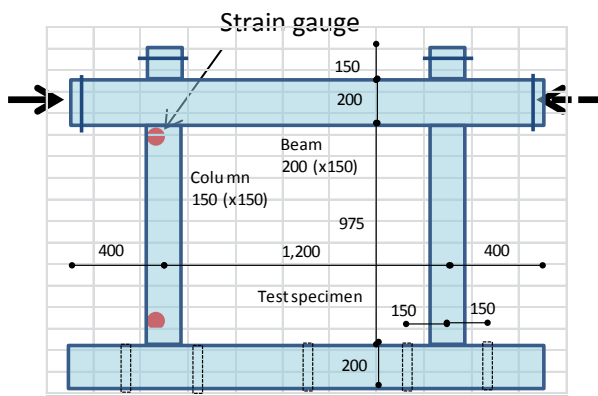
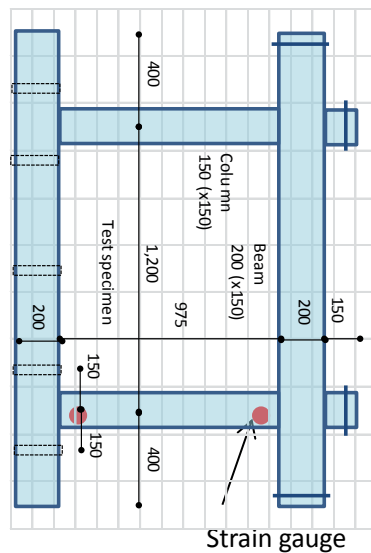

Front side of Standing Position for loading

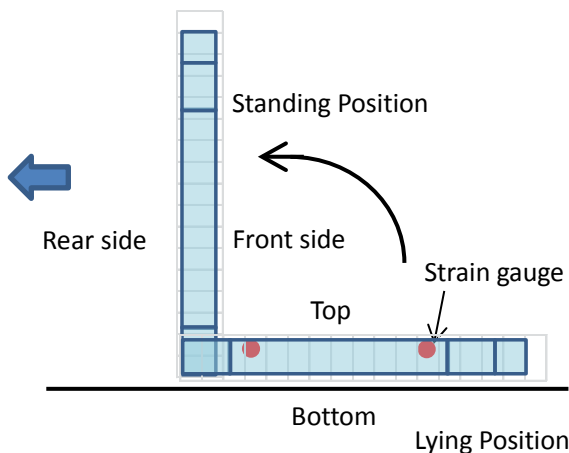

2. Bonding Strain Gauges

Bonding strain gauge and water protection coating are shown below.



Refer to “Strain gauge bonding procedure” of the Kyowa’s brochure, for the procedure (1) to (8).

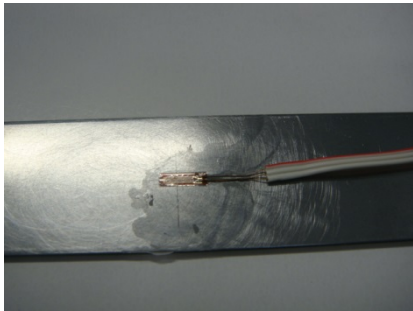

8. Bonding strain gauge with polyethylene sheet by thumb for 60 seconds

9. Remove excessive adhesive by sandpaper if any, and putting VM tape without air.



10. Putting AK-22 clay under the lead-wire

11. Putting AK-22 clay for overall

12. Provide vinyl tape to protect AK-22 and strain gauge during concreting.



Strain Gage Bonding Procedure

The strain-gage bonding method differs depending on the type of the strain gage, the applied adhesive and operating environment. Here, for the purpose of strain measurement at normal temperatures in a room, we show how to bond a typical leadwire-equipped KFG gage to a mild steel specimen using CC-33A quick-curing cyanoacrylate adhesive.

(1) Select strain gage

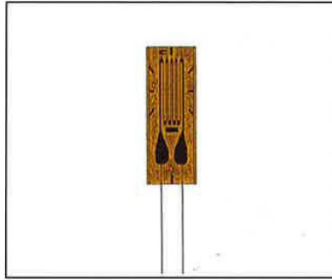

Select the strain gage model and gage length which meet the requirements of the measuring object and purpose. For the linear expansion coefficient of the gage applicable to the measuring object, refer to page 13. Select the most suitable one from the 11 choices.

(5) Apply adhesive.

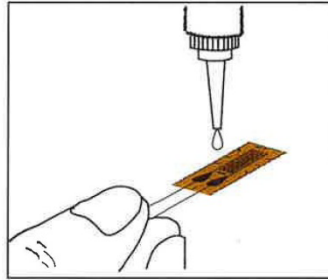

Ascertain the back and front of the strain gage. Apply a drop of CC-33A adhesive to the back of the strain gage. Do not spread the adhesive. If spreading occurs, curing is adversely accelerated, thereby lowering the adhesive strength.

(2) Remove dust and paint.

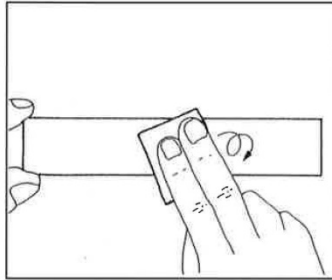

Using a sand cloth (#200 to 300), polish the strain-gage bonding site over a wider area than the strain-gage size. Wipe off paint, rust and plating, if any, with a grinder or sand blast before polishing.

(6) Bond strain gage to measuring site.

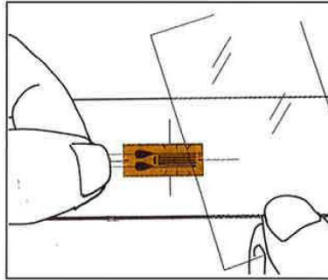

After applying a drop of the adhesive, put the strain gage on the measuring site while lining up the center marks with the marking-off lines.

(3) Decide bonding position.

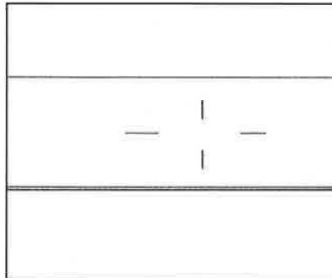

Using a #2 pencil or a marking-off pin, mark the measuring site in the strain direction. When using a marking-off pin, take care not to deeply scratch the strain-gage bonding surface.

(7) Press strain gage.

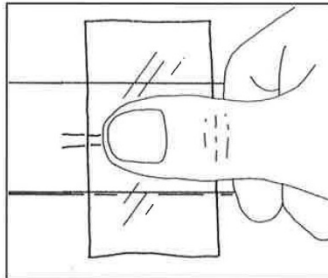

Cover the strain gage with the accessory polyethylene sheet and press it over the sheet with a thumb. Quickly perform steps (5) to (7) as a series of actions. Once the strain gage is placed on the bonding site, do not lift it to adjust the position. The adhesive strength will be extremely lowered.

(4) Remove grease from bonding surface and clean.

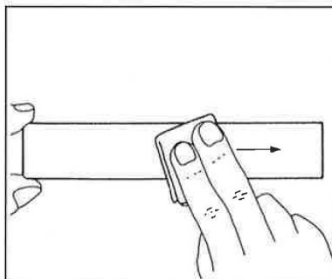

Using an industrial tissue paper (SILBON paper) dipped in acetone, clean the strain-gage bonding site. Strongly wipe the surface in a single direction to collect dust and then remove by wiping in the same direction. Reciprocal wiping causes dust to move back and forth and does not ensure cleaning.

(8) Complete bonding work.

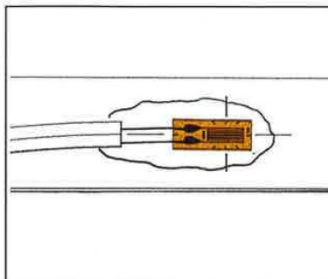

After pressing the strain gage with a thumb for one minute or so, remove the polyethylene sheet and make sure the strain gage is securely bonded. The above steps complete the bonding work. However, good measurement results are available after 60 minutes of complete curing of the adhesive.

Leadwire Temperature Compensation

The use of the self-temperature-compensation gage (SELCOM gage) eliminates the thermal effect from the gage output. But leadwires between the gage and the strain-gage bridge are also affected by ambient temperature. This problem too should be solved.

With the 1-gage 2-wire system shown in Fig. 16, the resistance of each leadwire is inserted in series to the gage, and thus leadwires do not generate any thermal problem if they are short. But if they are long, leadwires adversely affect measurement. The copper used for leadwires has a temperature coefficient of resistance of $3.93 \times 10^{-3}/^{\circ}\text{C}$. For example, if leadwires 0.3mm^2 and $0.062 \Omega/\text{m}$ each are laid to 10 m length (reciprocating distance: 20 m), a temperature increase by 1°C produces an output of 20×10^{-6} strain when referred to a strain quantity.

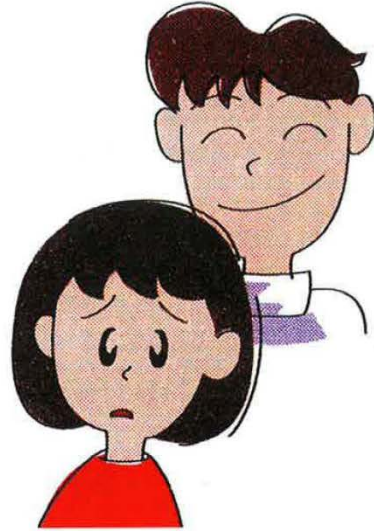
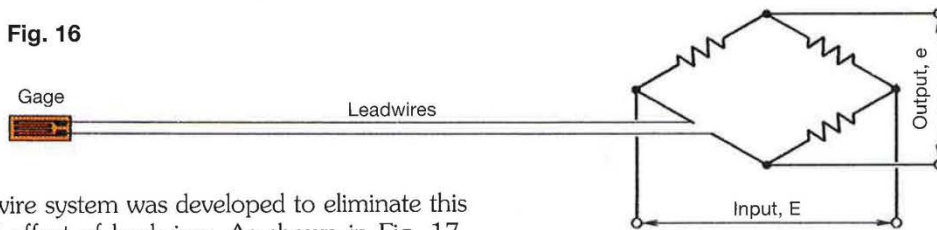
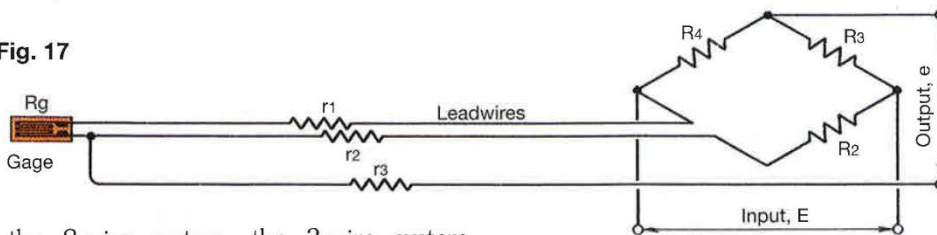

Fig. 16



The 3-wire system was developed to eliminate this thermal effect of leadwires. As shown in Fig. 17, the 3-wire system has two leadwires connected to one of the gage leads and one leadwire connected to the other.

Fig. 17



Unlike the 2-wire system, the 3-wire system distributes the leadwire resistance to the gage side of the bridge and to the adjacent side. In Fig. 17, the leadwire resistance r_1 enters in series to R_g and the leadwire resistance r_2 enters in series to R_2 . That is, the leadwire resistance is distributed to adjacent sides of the bridge. The leadwire resistance r_3 is connected to the outside (output side) of the bridge, and thus it produces virtually no effect on measurement.

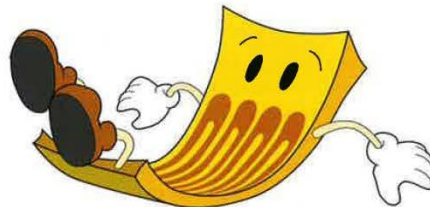

2.3 Load-deflection curve

Loading date of each specimen and incidents occurred are shown as follows;

No.	Date	Remarks (observation during the loading)
3	28 October 2013	Broken of screw stroke of right hydraulic jack was observed. Strain gauge no.5, 7 and 12 were not working. DT/DG of right lower position dropped after 2 nd cycle.
4	3 November	Strain gauge no.10 and 12 were not working.
1	5, 6 November	Strain gauge no.12 was not working. Dial gauge at right lower position was not working well.
2	9 November	Filler plates were inserted at the boundary of RC beam and steel foundation beam. Strain gauge no.10 and 12 were not working. After the cycle 6, upper reaction steel beam moved horizontally and was corrected.
5	12, 16 November	Filler plates were inserted at the boundary of RC beam and steel foundation beam to fill the gap. Loading suspended because hydraulic jack capacity 23ton, and wall with size of 200mmx250mm was provided at wall on 13 November. Loading was continued on 16 November.
6	18 November	Strain gauge No.1 and no.2 are missing. No.12 is not working. After the 3 rd cycle, left lower DT/DT has some error due to a needle on a crack of concrete surface.

Note: 1. "Hartal (political demonstration)" was executed during the period of load-measurement period,

- 1) 27 October ~ 29 October (60hours)
 - 2) 4 November ~ 6 November (60 hours)
 - 3) 10 November ~ 13 November (72 hours)
2. BUET admission test related, 31 October ~ 2 November

General



Reaction frame



Hydraulic jack and load cell



Steel foundation beam and measurement frame



Filler plate for reaction beam



Setting of Displacement transducer and Dial gauge



Data logger and connecting cables

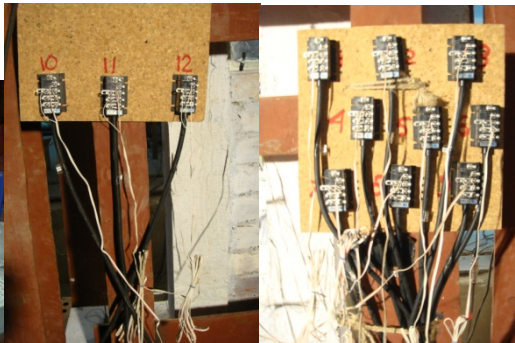

bridge box for strain gauge

Structural Experiment by CNCRP

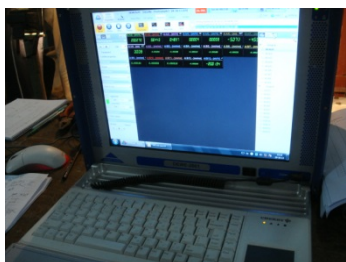

Setting of Displacement Transducer and Dial Gauge

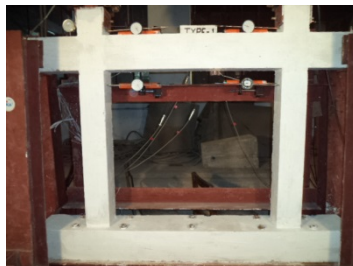

Setting initial value for data logger



Filler plate at bottom of beam



loading



Damage of column top (No.3) was minor after the test.



DT at side of bottom beam for No.5



Result of specimen No.1

R=0 (R; story deflection angle = story deflection/ story height)

(Providing axial force)

Axial force of 16 ton which is axial force (N/bdFc) ratio 68% was imposed.

When axial force was imposed with step of 4, 8, and 12ton, diagonal crack occurred at left side of top and bottom beam, then load was increased to 14 and 16 ton. Possible reason of crack is that there is a gap between bottom beam and foundation steel beam with 1~2mm. Because vertical deflection of left side of upper beam showed 3.6mm by DG, which is very big, when vertical load was imposed.

R<1/400 ($\delta < 2.94\text{mm}$), 1st and 2nd Cycle,

Initial stiffness was 1.25t/mm (= 1ton/0.8mm).

Max. load: positive 1st, 2.3ton. 2nd, 2.6ton, negative 1st, 2.7 ton, 2nd 3.0ton

No crack was observed on columns.

Diagonal cracks occurred on top and bottom of beam.

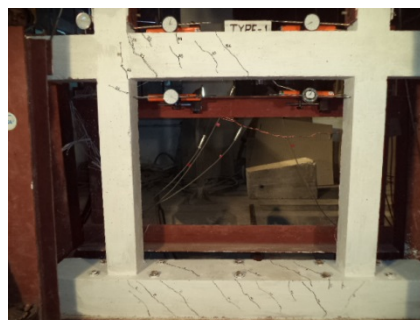

R<1/200 ($\delta < 5.88\text{mm}$), 3rd and 4th cycle,

Max. load: positive 3rd, 3.7ton. 4th, 3.6ton, negative 3rd, 4.0ton, 4th 3.7ton

Diagonal crack was observed on top of left column.

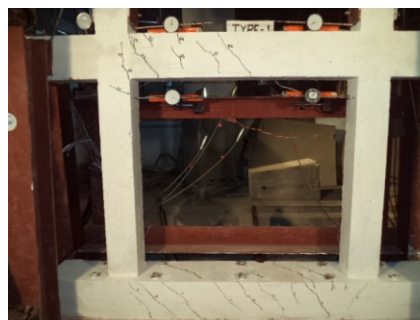

R<1/100 ($\delta < 11.75\text{mm}$), 5th and 6th cycle

Max. load: positive 5th, 4.5ton. 6th, 4.3 ton, negative 5th, 4.0ton, 6th 3.5 ton

Flexural cracks occurred at top and bottom of columns.

Vertical cracks also occurred at bottom of columns.

Diagonal crack occurred at top of right column.



R<1/50 ($\delta < 23.5\text{mm}$), 7th cycle

Max. load: 7th positive, 4.2ton to 3.5ton.

7th positive, 3.5 ton at 23.5mm, shear failure at the top of right column occurred. Horizontal load reduced from 3.5 ton to 2.0 ton at 25.7mm, and 1.7 ton at 26.0mm. Vertical



Structural Experiment by CNCRP

load reduced from 16 ton to 3 ton only. The column cannot support vertical load at $R=1/50$. The load was released.



Load-deflection curve, No.1

1. DT (average of four) and Load cell

Diagonal crack occurred

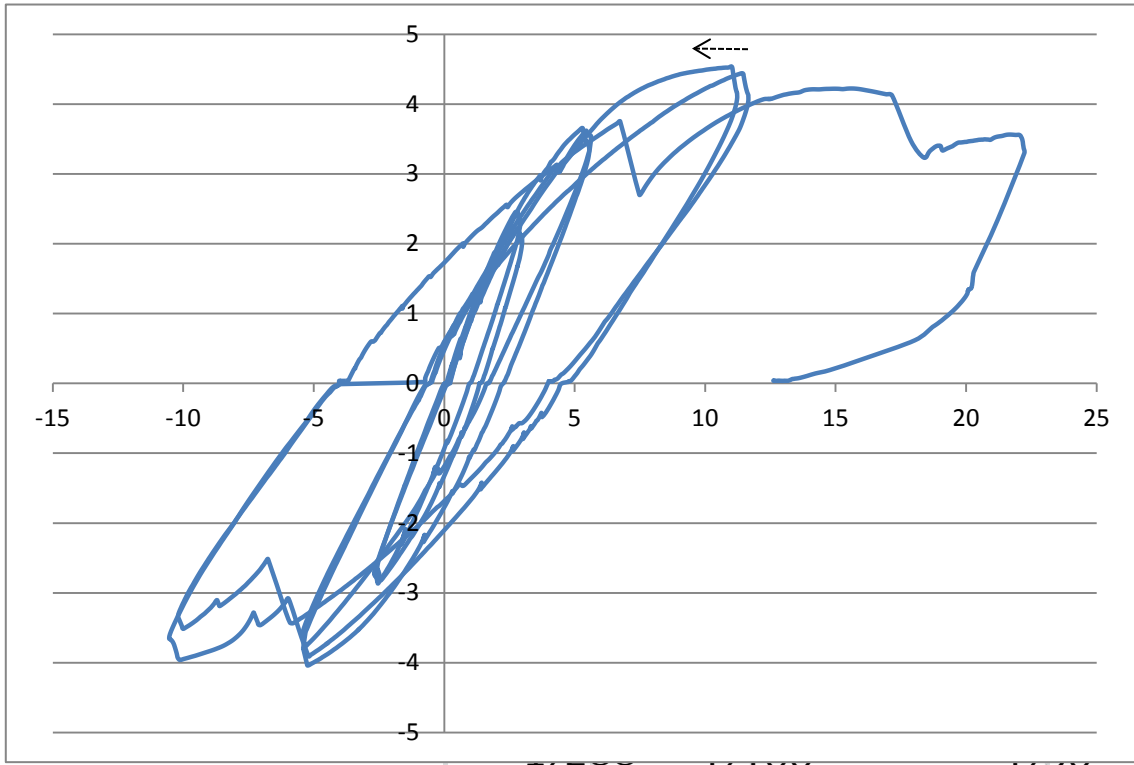

2. Dial Gauge (Left top D.G.) and load meter

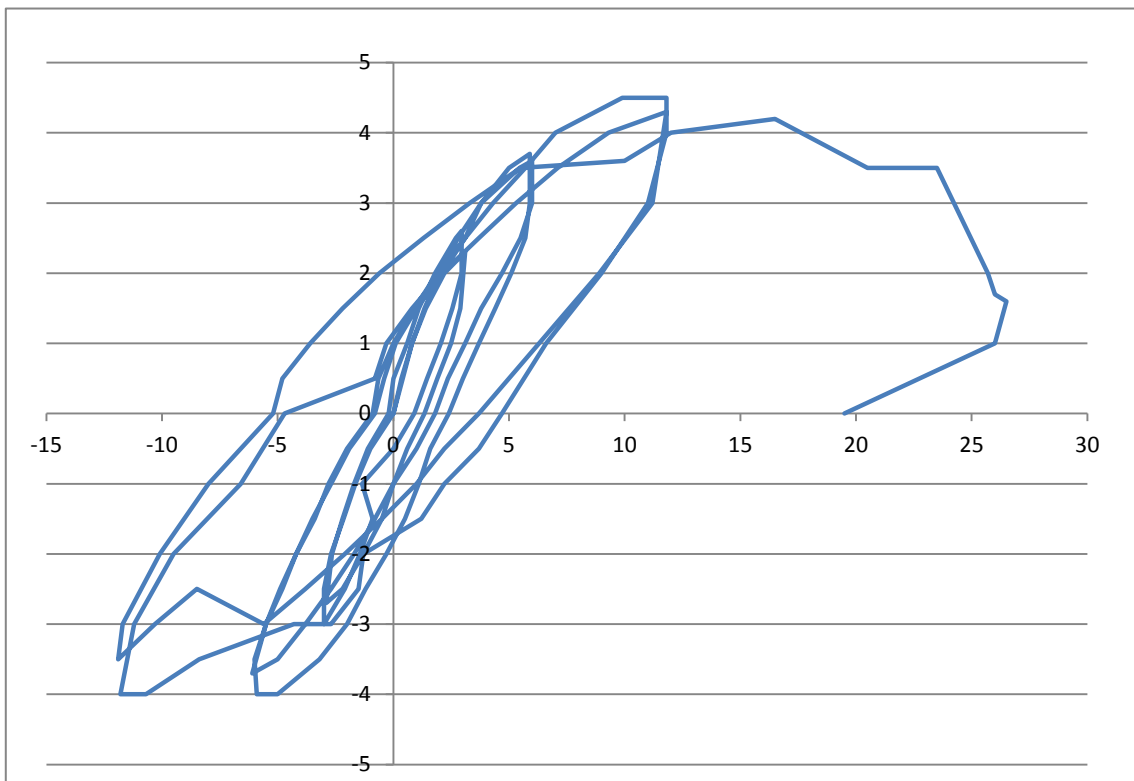

Result of specimen No.2 2013/11/09 (Sat.)

Axial load, 16 ton.



(left) Filler plate of 1mm thickness was inserted between RC beam and steel foundation. A inclination was observed on top of steel foundation beam. (right) Reaction beam was slide at 6th cycle. Rectification was done, and vertical load and horizontal load was provided again.

Behavior;

Axial load, with step of 4, 8, 12, 16 ton was provided. Out of plain movement of columns was observed.

R<1/400 ($\delta < 2.94\text{mm}$), 1st and 2nd Cycle,
 Initial stiffness was 1.85t/mm (= 1ton/0.55m).
 Max. load: positive 1st, 2.0 ton. 2nd, 2.5ton, negative 1st, 3.0 ton, 2nd 3.0ton
 Slip with 1.2mm was caused at 2.0 ton, 1st cycle positive loading.
 Crack was observed at front side of bottom of left column.



R<1/200 ($\delta < 5.88\text{mm}$), 3rd and 4th cycle,
 Max. load: positive 3rd, 3.3ton. 4th, 3.2ton, negative 3rd, 4.0ton, 4th 3.8ton
 No clear change was observed.



R<1/100 ($\delta < 11.75\text{m}$), 5th and 6th cycle
 Max. load: positive 5th, 3.9ton. 6th, 3.5 ton, negative 5st, 5.0ton, 6th 4.0 ton
 Vertical crack extended at both panel zone, and strength dropped from 3.5 ton (7.8mm) to 3.0 ton (12.4mm).



Structural Experiment by CNCRP

Flexural cracks occurred at bottom of columns.

R<1/50 ($\delta < 23.5\text{mm}$), 7th and 8th cycle

Max. load: positive 7th, 4.0ton. 8th, 3.5 ton, negative 7th, 3.7 ton, 8th 3.0 ton

Vertical and diagonal crack extended at both panel zone.
Cover concrete at bottom of column (especially rear side) was detached.



R<1/25 ($\delta < 47.0\text{mm}$), 9th cycle

Max.load; positive 3.5 ton (at -6.5mm), was reduced to 3.0ton (at +10mm), to 1.7 ton (at 20.1mm).

Vertical load was reduced from 16 to 8 ton at 30mm, and dropped to 4 ton further at 35mm. Bottom of column was failed.

Cracks of panel zone were extended.



Structural Experiment by CNCRP



No.2 Load-deflection curve

1. DT (average of four) and Load cell

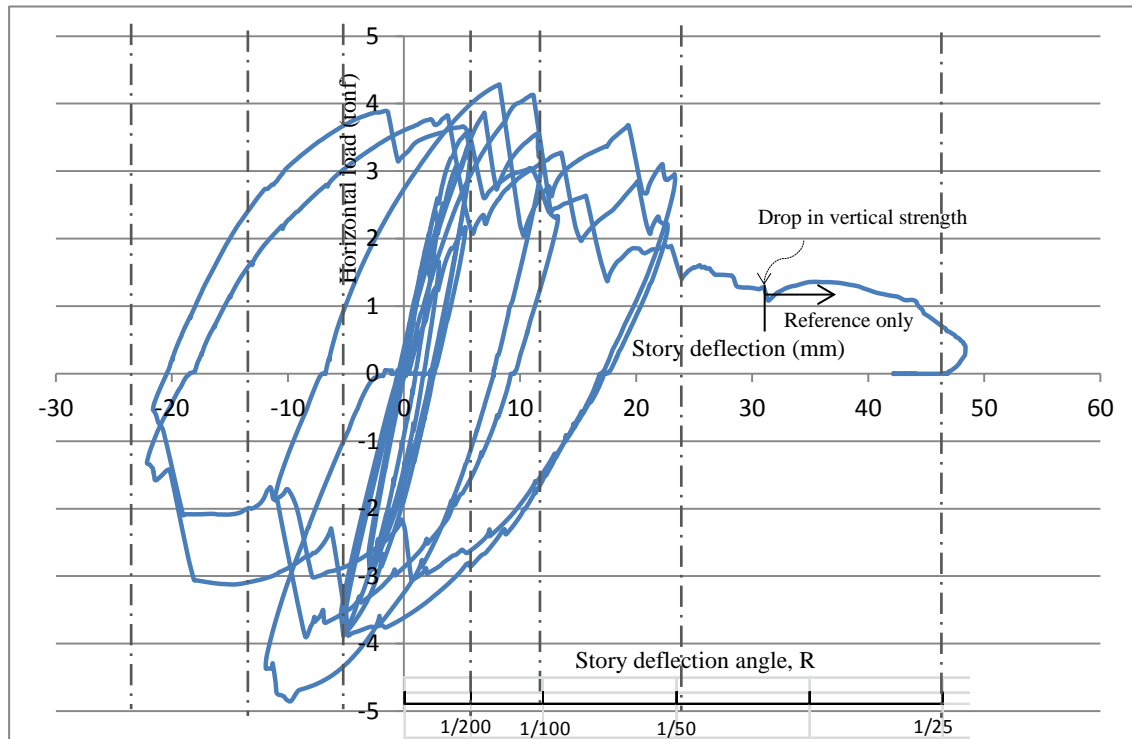

2. Dial Gauge (Left top D.G.) and load meter

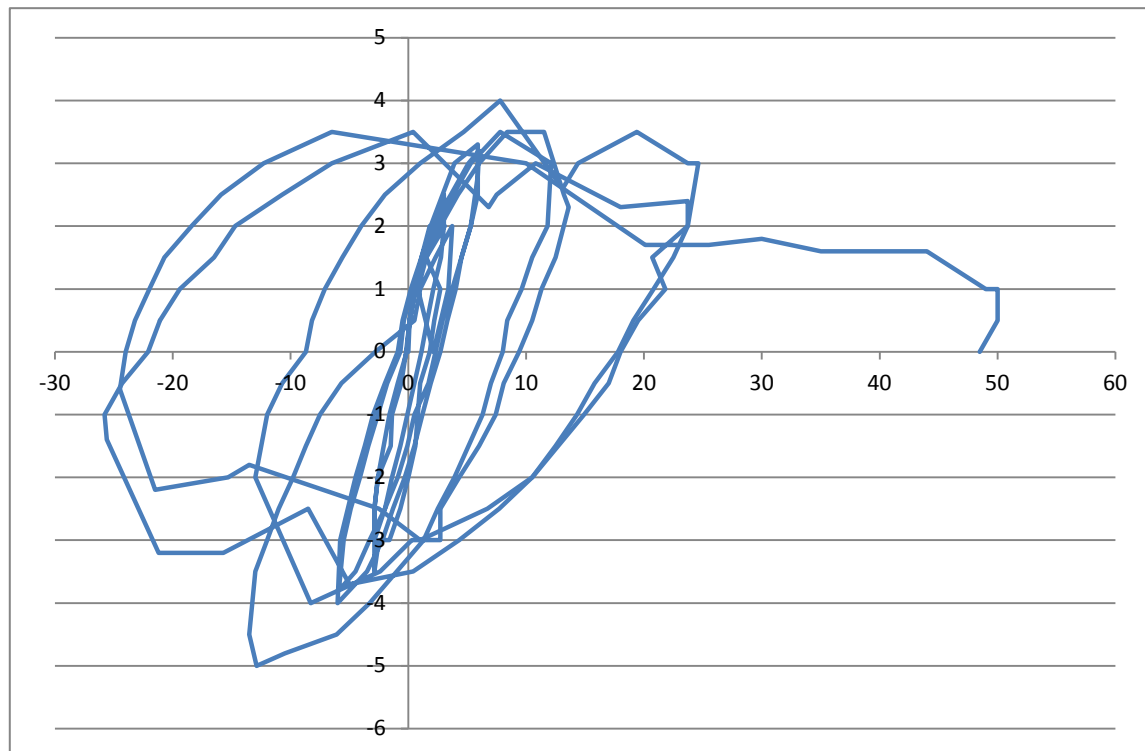

Specimen, No.3

Date: 2013/10/28

Brick wall with thickness 60mm and with opening (with a window)

Observed collapse mode: shear failure of right side column.



R=0 (R; story deflection angle = story deflection/ story height)

(Providing axial force)

Axial force of 16 ton which is axial force (N/bdFc) ratio 60% was imposed.

When axial force was imposed with step of 4, 8, 12 and 16 ton, vertical crack occurred between left column and brick wall, and 1.65mm vertical displacement of column observed, while no clear cracks were observed at right column. Vertical deflection 1.65mm, which is 0.169% of column length, was observed.

R<1/400 ($\delta < 2.94\text{mm}$), 1st and 2nd Cycle,

Initial stiffness was 6.67t/mm (= 1ton/0.15mm).

Max. load: positive 1st, 6.2ton. 2nd, 5.7ton, negative 1st, 4.7 ton, 2nd 4.3ton

Flexural crack occurred at bottom of left and right column.

Cracks occurred for brick wall.



R<1/200 ($\delta < 5.88\text{mm}$), 3rd and 4th cycle,

Max. load: positive 3st, 7.7ton. 4th, 5.7ton, negative 3rd, 6.0 ton, 4th 4.5ton

Cracks extended for columns and brick walls

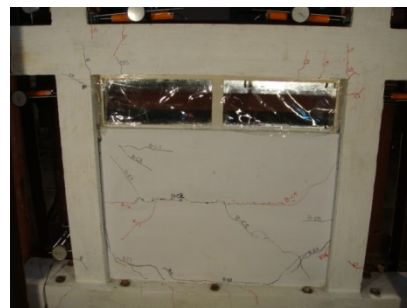

Structural Experiment by CNCRP

R<1/100 ($\delta < 11.75\text{mm}$), 5th and 6th cycle

Max. load: positive 5th, 7.6ton. 6th, 6.1ton, negative 5st, 5.6 ton, 6th 4.7ton

Diagonal and vertical crack extended on right column, crack occurred at 5th cycle.

Many flexural cracks occurred at left column.



R<1/50 ($\delta < 23.5\text{mm}$), 7th cycle

Max. load: 7th positive, 7.0ton and dropped to 5.8 ton at R=1/50. Glass was broken. 7th negative, 8 ton and shear failure of right column occurred at 8.7mm, dropped to 2.7 ton at 17.1mm, and load was released.

Glass was broken with the decrease of strength of 1.2ton.

Shear failure of right column occurred at negative loading.

Right column couldn't support vertical load and vertical load was released.

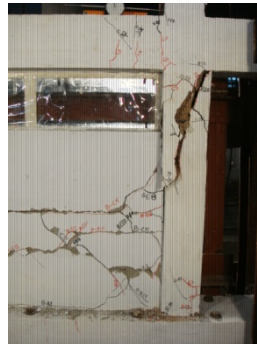

Shear failure of right column



Out of plane movement of brick wall

No.3 Load-deflection curve

1. Displacement transducer (average of four DT) -Load cell

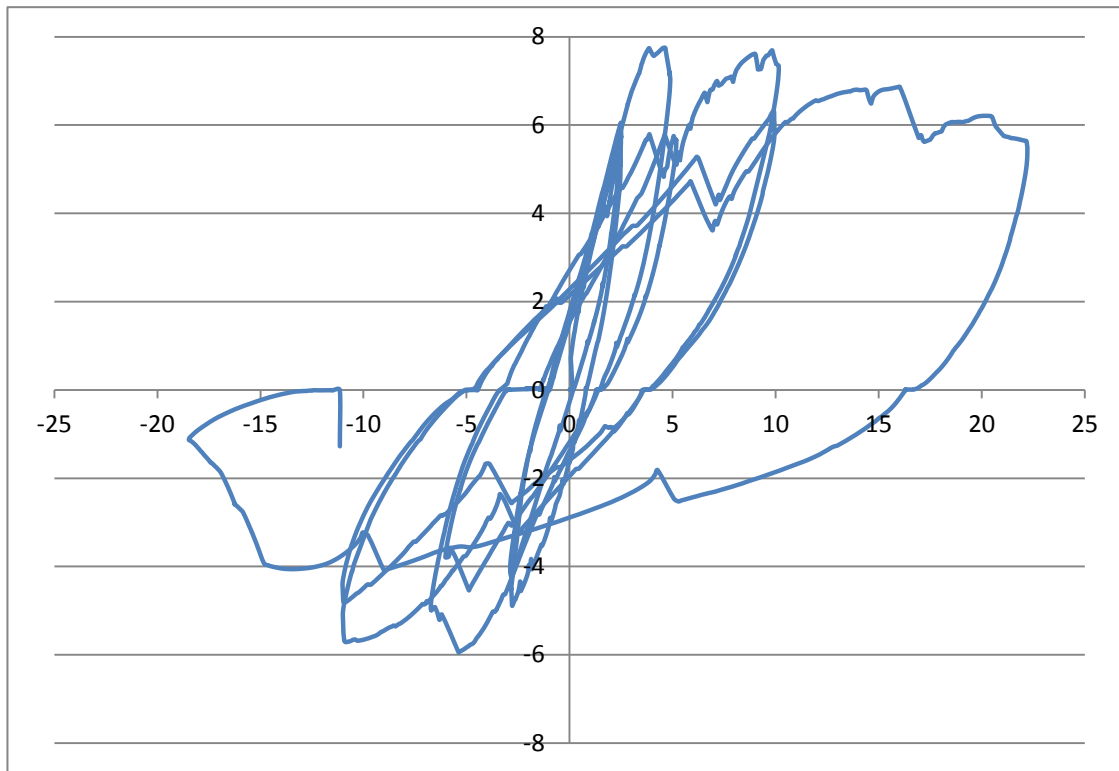

2. Dial Gauge (left upper)-- Load meter of Jack

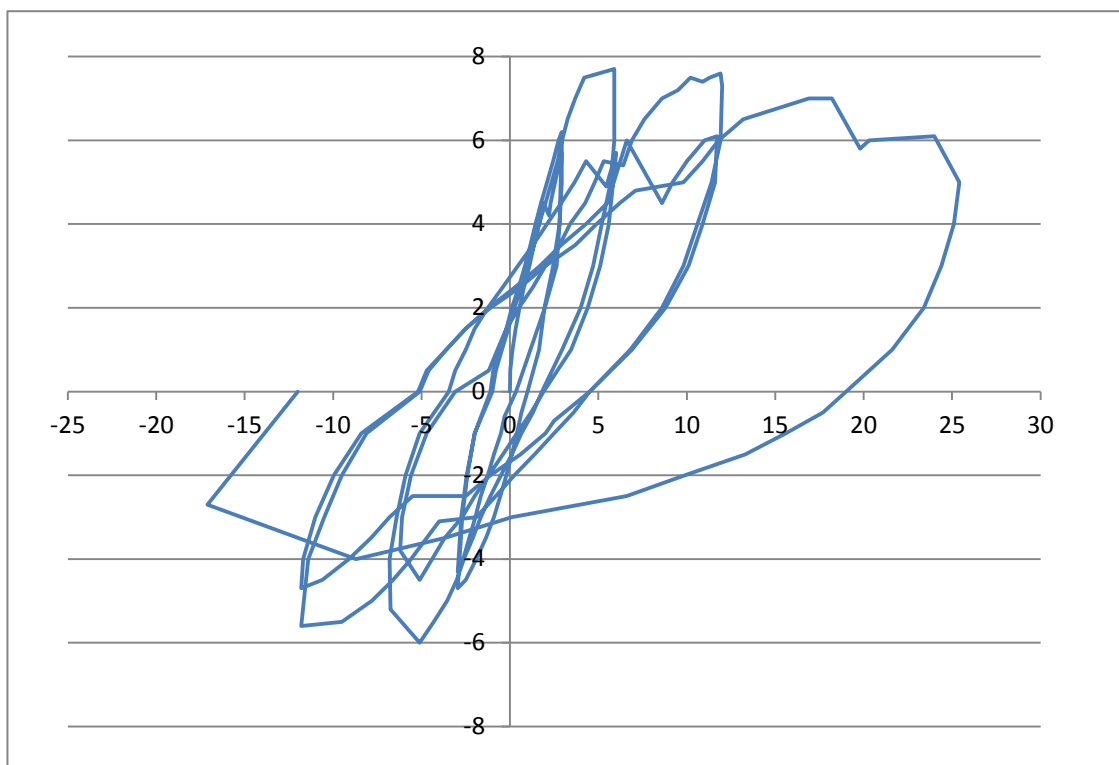

Specimen No.4 (brick wall with full-height of thickness 60mm, equivalent to actual size of 125mm, axial force ratio of column 0.68), loading on 3 November 2013.



R=0 (story deflection angle = story deflection/ story height), 0th cycle, vertical loading 16 ton, vertical deflection was 1.10mm, which is 0.0936% of storey height 1,175mm.

Vertical hair crack occurred at the boundary of left column and brick wall.

Note: According to the tensile test of re-bar 10mm, yield strain is 0.161% (=yield stress/young's modulus=350N/mm²/2.17x10⁵N/mm²).

R = $\delta / h < 1/400$, 1st and 2nd cycle, $\delta < 2.94$ mm

Initial stiffness ; 2.0ton/0.3mm=6.67 ton/mm

Max. load: positive 1st, 8.2ton. 2nd, 8.5ton, negative 1st, 7.5 ton, 2nd 7.25ton

Diagonal crack occurred at upper beam.

Diagonal crack and horizontal cracks occurred at top and bottom of brick wall.

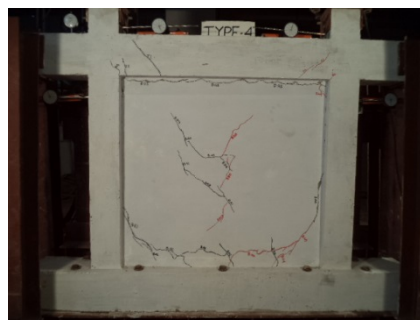

R<1/200 ($\delta < 5.88$ mm), 3rd and 4th cycle,

Max. load: positive 3rd, 11.0ton. 4th, 9.5ton, negative 3rd, 10.0 ton, 4th 9.75ton

Diagonal crack occurred at top of left column at 3rd cycle.

Cracks extended on brick wall.



R<1/100 ($\delta < 11.75$ mm), 5th cycle,

Shear failure occurred at left column at R=1/118 (10mm/1175mm) of positive loading.

Horizontal load dropped suddenly from 10ton at R=1/118 to 6.5 ton at R=79 (14.8mm/1175mm), however maintained the vertical load.



Structural Experiment by CNCRP

Big diagonal crack extended on brick wall.

At negative loading, horizontal stiffness decreased from the point of -7.5ton/1.2mm and maximum load was -8 ton at -2.7mm/1175, and could not support vertical load. Vertical load dropped from -16 ton to -8 ton from the point of - 7.0ton/-7.5mm to 1.5ton/-12.5mm.



Shear failure of right column (front and rear side)



Shear failure of left column

Brick wall (front and rear side)

Load-deflection curve, No.4

1. Displacement transducer (average of four DT) -Load cell

Diagonal crack developed

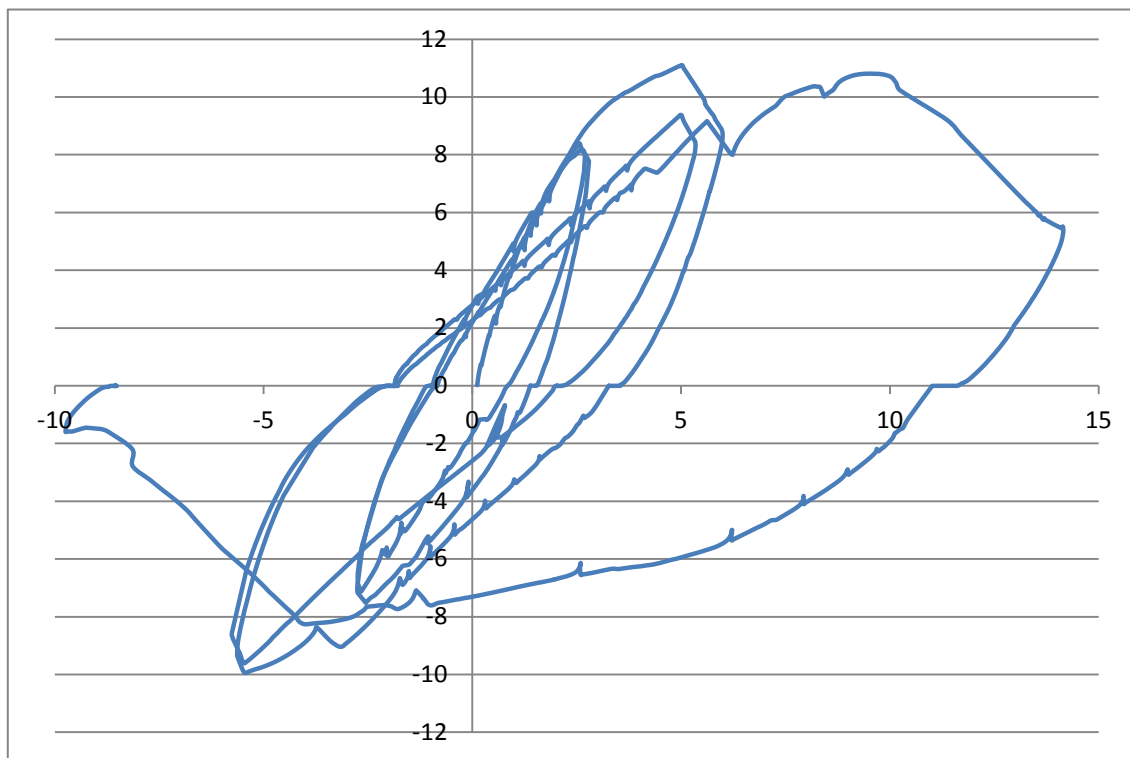

2. Load meter of Jack-Dial Gauge (left upper)

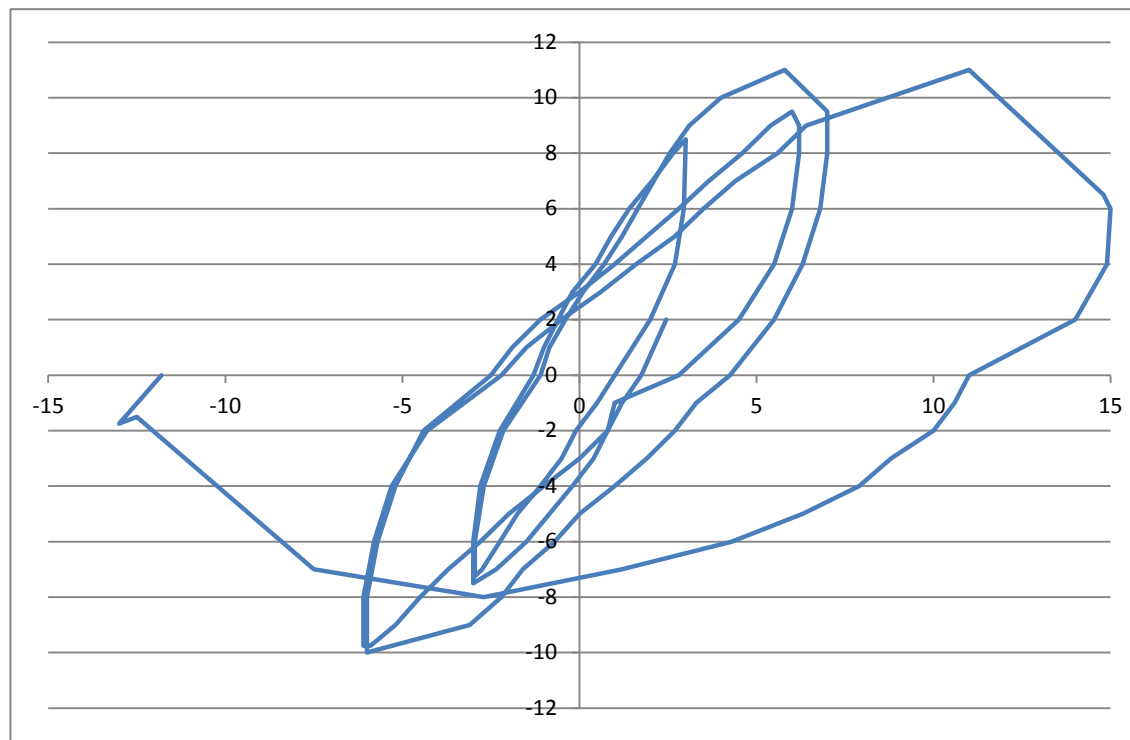

1/25

Specimen No.5 2013/11/12 suspended and wall opening on 13

Specimen retrofitted by RC wall.

Concrete strength is 1552 psi at 28 days (10.9N/mm²).

Design concrete strength for retrofit wall was 16[^]18N/mm².

There is the limitation of capacity 25 ton (practically 23ton) for horizontal hydraulic jack.

Strength of the specimen was higher than the capacity. After the 5th cycle, loading was suspended, and providing small rectangular opening (200mm x 250mm) on the wall to reduce strength approximately 20%, then re-loading was started.

Slippage at the boundary of RC bottom beam and steel foundation beam with approximately 0.5~0.8mm for positive and negative loading, and the result was adjusted by DT located at the bottom of column.

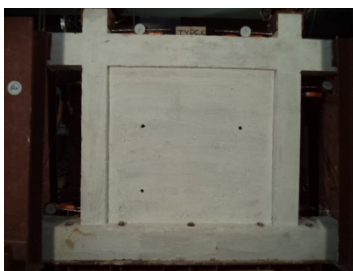

Behavior

R=0 (story deflection angle = story deflection/ story height), 0th cycle, vertical loading 16 ton, vertical deflection was 1.10mm, which is 0.0936% of storey height 1,175mm.

Out of plain movement (torsion) occurred, more than +10mm at right side and -8mm for left side.

R = $\delta / h < 1/400$, 1st and 2nd cycle, $\delta < 2.94$ mm

Initial stiffness ; 2.0ton/0.08mm=25.0ton/mm,
4ton/0.2mm=20ton/mm.

Max. load: positive 1st, 18.5ton. 2nd, 20.6ton, negative 1st, 17.5ton, 2nd 17.8ton

Diagonal crack occurred at top of left column, and diagonal crack also occurred at RC wall at positive and negative loading of 1st cycle.

Horizontal crack (tension crack??) observed at middle of left column at positive loading.

Horizontal crack (tension crack??) observed at middle of right column at negative loading.

Horizontal crack occurred at bottom of right column and right side wall.

No cracks were observed at the boundary between bottom of upper beam and top of wall.

R = $\delta / h < 1/200$, 3rd and 4th cycle, $\delta < 5.88$ mm

Max. load: positive 3rd, 23.3ton(limit of jack, at 4.3mm). 2nd, 23.3ton (limit of jack at 4.5mm),

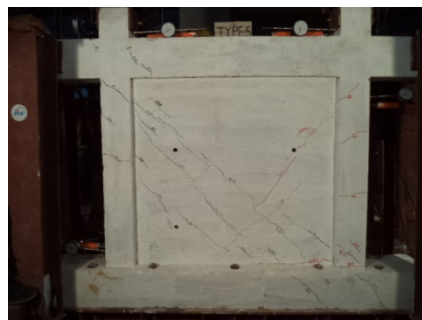

Structural Experiment by CNCRP

negative 1st, 21.2ton, 2nd 19.5ton
 Horizontal crack (tension crack??) observed at left column, diagonal crack developed at wall.
 No cracks were observed at the boundary between bottom of upper beam and top of wall.

$R = \delta / h < 1/100$, 5rd and 6th cycle, $\delta < 11.75\text{mm}$
5th cycle; positive 23.3ton (jack limitation) at 5.0mm, negative 23.0ton (jack limitation) at 8.5mm. 12 November 2013.

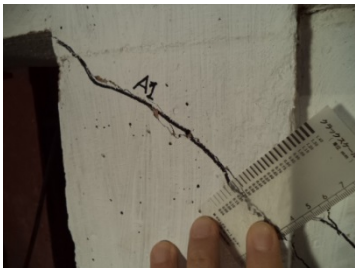

Diagonal crack width of left column is 0.3mm, right column is 0.1mm shear crack of column

Wall opening (200mm x 250mm) was provided on 13 November 2013,

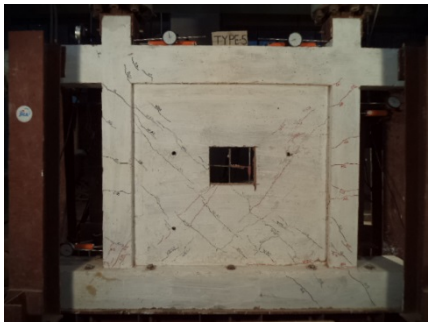

DG for checking of slide at base of specimen

6th cycle, positive loading, shear failure occurred 19.6 ton at 5.0mm, horizontal load reduced from 19.6 ton to 4.5ton at 22.5mm. Axial load dropped from 16ton to 8.5 ton for both columns. Tried to increase axial load to 12 ton, but reduced to 7ton (left column) and



Structural Experiment by CNCRP

11 ton (right column). Horizontal load reduced to 0.5 ton at 38.5mm.

Decline of vertical strength occurred from 16ton at 7.75mm to 13.8 ton (left column), and 14.3ton (right column) at 10.9mm

Shear failure at deflection 22.5mm

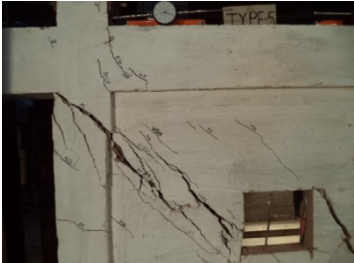

Failure n at deflectio 38.5mm



Rear side

No.5 Load- deflection,

1. Average DT and load cell, Jack capacity +/-23ton. After the providing wall opening, loading started and deflection of DG was adjusted.

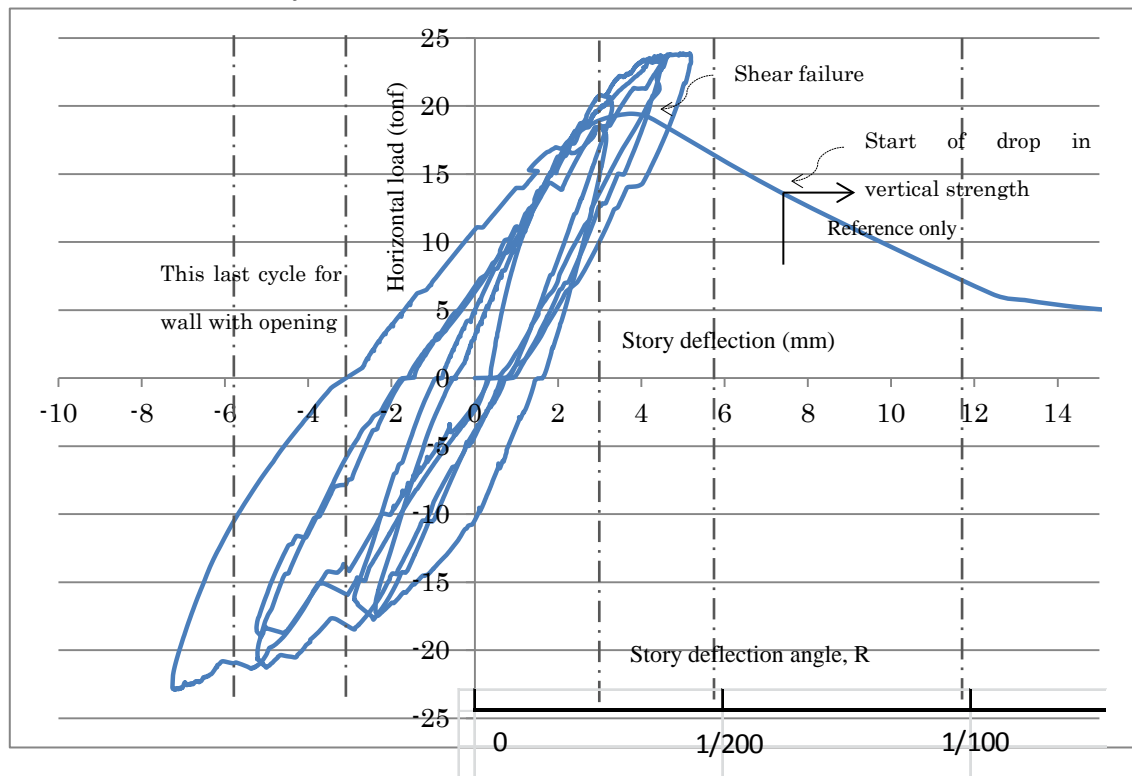

2. Upper DG and Load meter

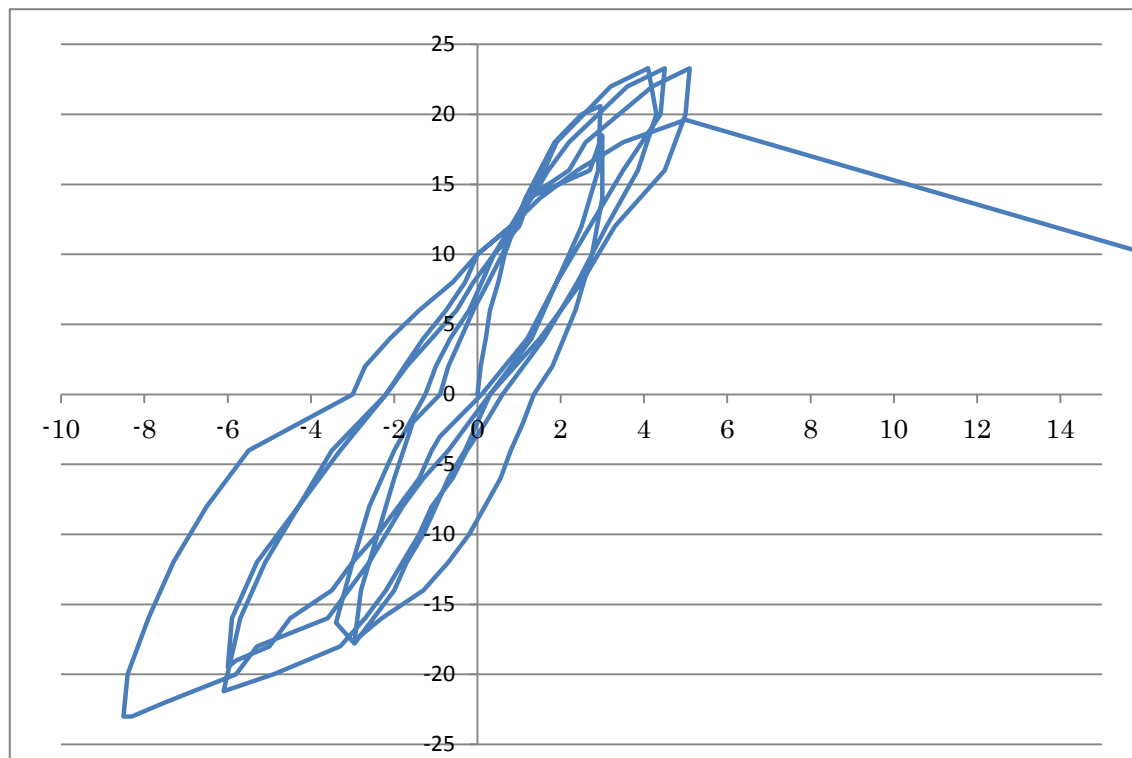

Specimen No.6 (Retrofitting by Steel Braced Frame)



Behavior

R=0 (story deflection angle = story deflection/ story height), 0th cycle, vertical loading 16 ton, vertical deflection was 1.31mm.

Out of plain movement (torsion) occurred, more than +2.3mm (rear side) at right side and +2mm (rear side) at left side.

Note: According to the tensile test of re-bar 10mm, yield strain is 0.161% (=yield stress/young's modulus=350N/mm²/2.17x10⁵N/mm²).

R = $\delta / h < 1/400$, 1st and 2nd cycle, $\delta < 2.94$ mm

Initial stiffness ; 2.0ton/0.1mm=20.0ton/mm,

4ton/0.25mm=16ton/mm.

Max. load: positive 1st, 15.7ton at 2.95mm. 2nd, 18.0ton at 3.0mm, negative 1st, 17.ton at 2.9mm, 2nd 16.6ton at 3.1mm.

During the 1st positive loading from 14.0 ton to 15.7ton, diagonal crack occurred at top and middle of left column. Diagonal crack occurred at beam.

Diagonal crack occurred at the top of right column during 1st negative loading.

Cracks occurred at grout mortar of vertical portion.

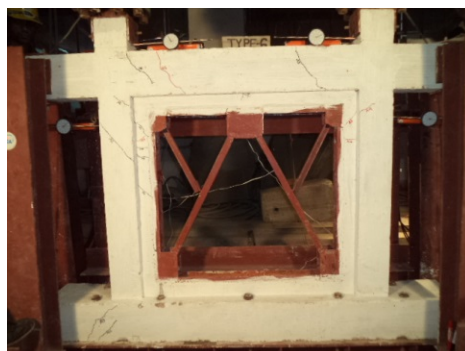

Structural Experiment by CNCRP

R (story deflection angle = story deflection/ story height) = $\delta / h < 1/200$, $\delta \leq 5.88\text{mm}$, 3rd and 4th cycle,

Max. load: positive 3rd, 22.0ton at 5.2mm reduced to 20.8ton at 7.3mm. 2nd, 20.0ton at 5.1mm and increased to 6.1mm. 3.0mm, negative 3rd, 22.0ton at 6.2mm, 4th 20.5mmton at 6.0mm.

New diagonal crack occurred at middle of left column at 3rd positive cycle.

After the 3rd cycle, left lower DT/DT has some error due to a needle on a crack.

Slight Buckling of out of plain direction of left bracing was observed at 4th cycle of negative loading.

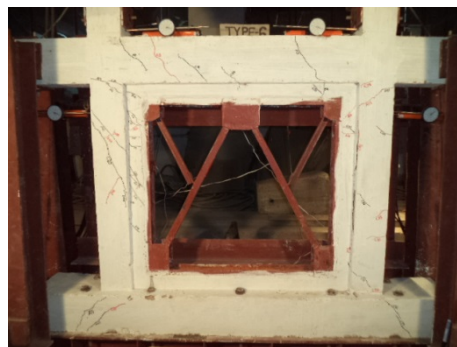

$R < 1/100$ ($\delta < 11.75\text{mm}$), 5th cycle, positive 20 ton at 9.0mm reduced to 14 ton at 20.9mm.

Shear failure occurred at left column that developed diagonal crack observed at 3rd cycle, and penetrated grout mortar portion.

Failure with diagonal and vertical crack occurred at left column.

Axial load of 16 ton was maintained, and reduced to 14 ton for left column and right column maintained 16ton. Buckling of left frame observed, which acted as a column.

Horizontal strength of 12ton was observed at 26mm, and vertical load dropped to 10to for left column.

Out of plain direction buckling was observed at right steel bracing.

Observed slippage at the base was 0.15mm after the 5th cycle, which will be negligible.

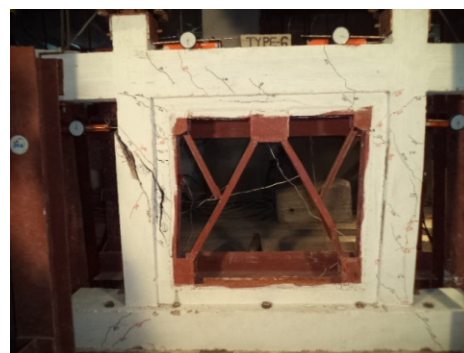

Failure at deflection 20.9mm

Structural Experiment by CNCRP

After the loading, at 26mm



Structural Experiment by CNCRP

Load- deflection, No.6

Load cell and DT

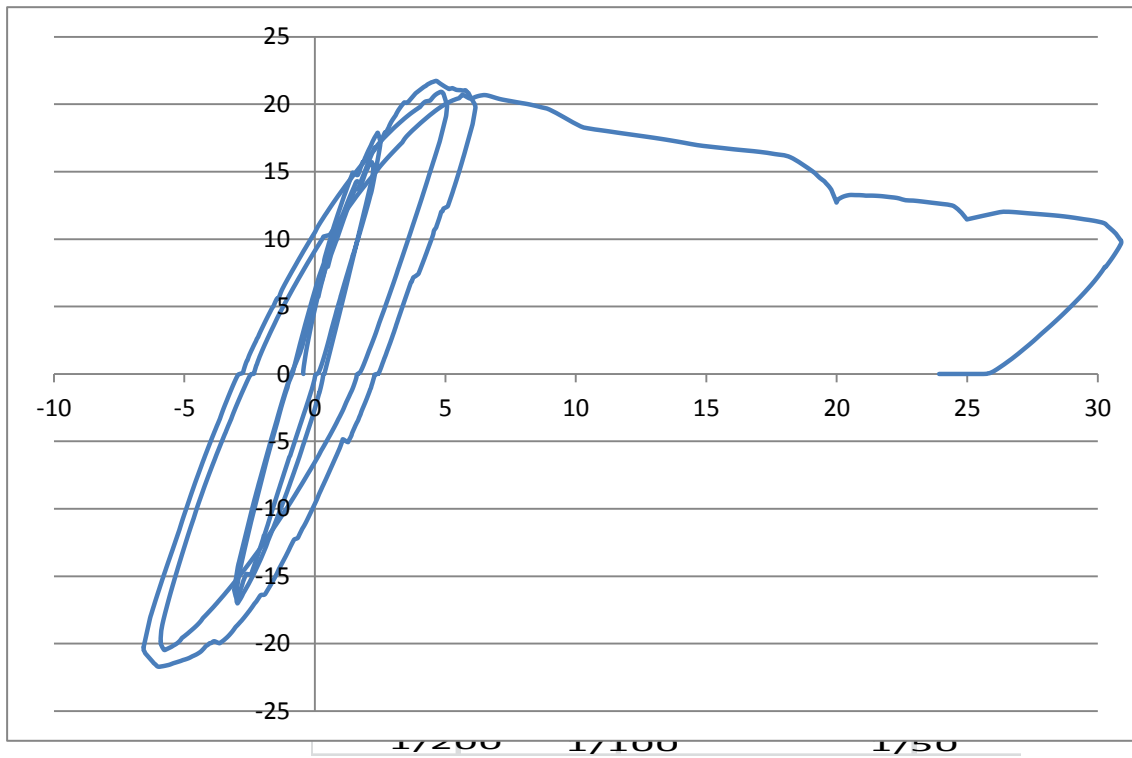

2. Upper DG and Load meter

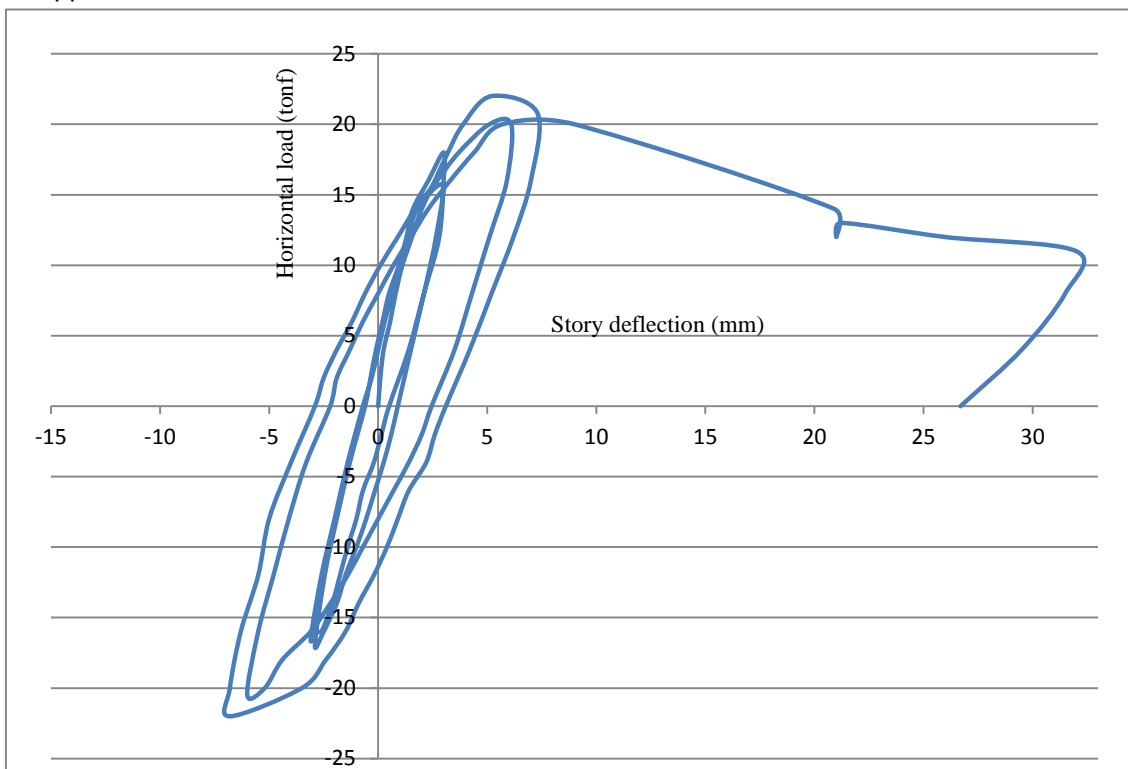

2.4. Material test

1) Concrete Strength

Result of concrete strength for the specimen (UAP). Concrete of 6 specimens was casted on 6 September 2013. Concreting of 3 cylinders for 6 weeks was casted on 30 October.

Table 1.1 (Unit: N/mm²)

	1 week (13/Sep)	4 weeks (4/Oct)	8 weeks (30/Oct)	8 weeks (1/Nov)
No.1	6.3	11.8	10.3	11.5
No.2	6.1	11.5	10.4	9.7
No.3	7	9.2	12.1	9.7
Average	6.5	10.8	10.6	

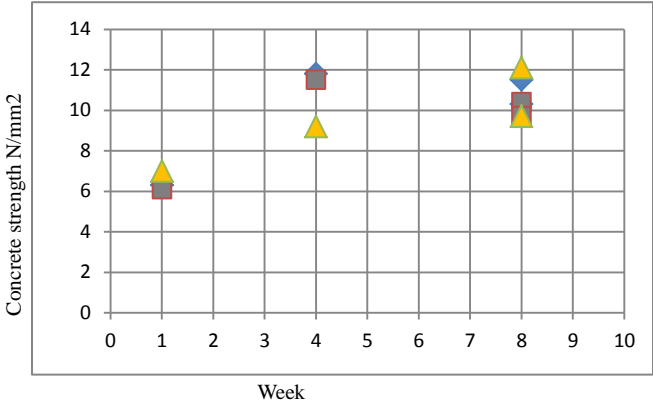

2) Trial Mix

Trial mix was done for 3 different type of mix using brick chips on 10 July 2013, and mix no. 8 was adopted for the low strength concrete (not more than 13.5N/mm2).

Table-2 Design Mix (by Prof. Tarek, UAP)

Mix No.	Maximum Aggregate Size (mm)	W/C	Sand to aggregate absolute volume ratio	Cement Content (kg/m3)	Water Content (kg/m3)	Fine Aggregate Content (kg/m3)	Coarse Aggregate Content (kg/m3)	Volumetric Ratio*
3	10	0.65	0.44	230	149.5	865	898	1:3.5:4.2
7	10	0.80	0.44	230	184.0	826	857	1:3.4:4.0
8	10	0.90	0.44	230	207.0	800	830	1:3.3:3.9

Table-3 Strength result of trial mix

Mix. no	W/C ratio (%)	Slump (cm)	8 days, on 18 July	Ave. N/mm2 (Ave. psi)	29days, on 8 Aug.	Ave. N/mm2 (Ave. psi)
3	65	0	6.3	6.5 (941) a lot of voids on the surface of concrete were observed caused by poor compaction	8.1	9.2 (1,339)
			6.9		9.6	
			6.3		10.0	
7	80	7	7.1	7.2 (1,051)	8.4	9.1 (1,326)
			7.3		9.8	
			7.4		9.3	
8	90	15	5.8	6.4 (926)	8.9	8.7 (1,268)
			7.0		9.8	
			6.3		7.6	

Note: Sand and brick chips with wet condition at surface were used for the trial mix.



Mix No.3

Mix No.7

Mix No.8

Photo-1 Measurement of Slump value

Strength of non-shrink grout mortar

Mortar was grouted for frame specimen No.5 and No.6 on 8 October and tested on 14 November 2013.

Table

	Height (mm)	Diameter (mm)	Crushed load (kN)	Crushed strength (kN/mm ²)	Average (kN/mm ²)
1	200	103.7	344.	40.7	39.6
2	200	102.3	316	38.4	
3	--	--	--	--	

Note: Stone chip was used.



Concrete strength for shear wall

Concrete wall was casted for frame specimen No.5 on September 7 and tested on 7 October 2013.

Table

	Height (mm)	Diameter (mm)	Crushed load (kN)	Crushed strength (kN/mm ²)	Average (kN/mm ²)
1	200	103.5	101.	12.0	10.7
2	200	99.1	82.	10.6	
3	200	104.2	82.	9.6	

Note: Stone chip was used. 31 days.

Mortar strength test for brick wall

Brick wall work was done on 6 October for frame specimen No.3 and No.4, and strength test of mortar was done on 4 November 2013

Table

	Cube size (mm)	Crushing Load(kN)	Strength(N/mm ²)	Average (N/mm ²)
1	52.5	12.7	4.6	Ave. 4.5
2	51.8	11.5	4.3	
3	52.4	12.7	4.6	

Note: brick chip was used.

Structural Experiment by CNCRP



Photo Fabrication of Specimen No.5 and No.6

3) Reinforcing bar**(1) Summary of re-bar and steel plate material test**

Re-bar tests of Bangladesh made used for the structural test are summarized as follows.

Re-bars(Unit: N/mm²)、Specified yield stress of re-bar: 275Mpa (275N/mm²),

Specified yield stress of steel plate: 275Mpa (275N/mm²),

Case 1(BUET), yield stress (N/mm²) only shown, there are 5 universal machines at the lab of BUET.

Bar	No.	Section area (mm ²)(diameter)	Yield stress (N/mm ²)	Tensile stress (N/mm ²)	Elongation %	Yong's modulus X 10 ⁵ N/mm ²
Plain bar 10mm	1	76.97 (9.9)	325	455	28.	2.04 x10 ⁵
	2	76.97 (9.9)	325	460	26.	2.00 x10 ⁵
	3	74.97 (9.9)	310	450	29.	2.02x10 ⁵
	Ave.	76.97.	320	455	28.	2.02 x10 ⁵
Plain bar 6mm	1	42.99 (7.4)	314	418	27.	1.96 x10 ⁵
	2	41.85 (7.3)	334	430	27.	1.97 x10 ⁵
	3	42.99 (7.4)	314	418	25.	1.99x10 ⁵
	Ave.	42.60.	353	422	26	1.97 x10 ⁵
Deformed bar 10mm	1	79.0	270	420	24	1.82 x10 ⁵
	2	79.0	260	420	28	1.82x10 ⁵
	3	79.0	245	420	28	1.82x10 ⁵
	Ave.	79.0 (nominal)	258	420	26	1.82x10 ⁵
Steel plate	1	88=4.12x21.4	330	510	19	1.85 x10 ⁵
	2	94=4.30x21.9	400	510	18	1.85 x10 ⁵
	3	90=4.12x21.8	330	510	18	1.91x10 ⁵
	Ave.	90.7	353	510	18	1.87 x10 ⁵

Case 2 (Building Material Testing Center, Urawa Japan), 31 July 2013 浦和建材センター

Bar	No.	Section area (mm ²)(diameter)	Yield stress (N/mm ²)	Tensile stress (N/mm ²)	Elongation %	Yong's modulus X 10 ⁵ N/mm ²
Plain bar 10mm	1	76.77 ()	346	471	32.	--
	2	76.41 ()	345	477	34.	--
	3	74.72 ()	358	493	34.	2.17x10 ⁵
	Ave.	75.97.	350	456	33	--
Plain bar 6mm	1	39.97 ()	387	473	N.A.	--
	2	44.73 ()	332	428	33	--
	3	46.20 ()	340	437	N.A.	2.15x10 ⁵
	Ave.	43.63.	353	456	33	--
Deformed	1	79.0	276	425	38	--

Structural Experiment by CNCRP

bar 10mm	2	79.0	277	425	35	--
	3	79.0	269	419	35	1.99×10^5
	Ave.	79.0 (nominal)	274	423	36	--
Steel plate	1	105.3	346	537	30	
	2	108.2	375	542	30	
	3	102.3	368	549	29	2.09×10^5
	Ave.	315.8	363	443	30	

Note

1) Steel plate is fabricated from angle member as type 5 of JIS, which is 25mm width.

Stress-strain curve, Urawa building material lab. in Japan

φ10mm

D10mm



図-1 応力-ひずみ曲線 (丸鋼φ10mm)



図-3 応力-ひずみ曲線 (異形棒鋼D10)

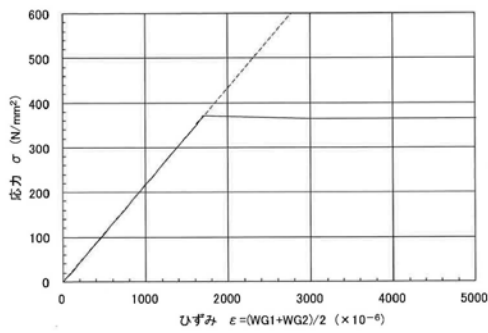

図-2 応力-ひずみ曲線 (丸鋼φ6mm)

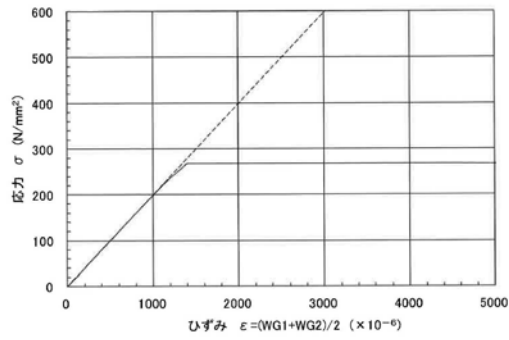

図-4 応力-ひずみ曲線 (鋼板 t=4mm)

4) Comparison of strength between cylinder test and concrete core sampling test (reference only)

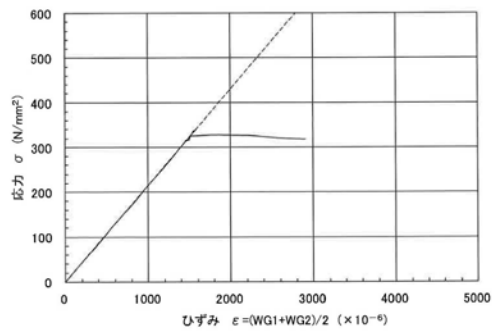
Diameter; 50mm

	Height (mm)	Diameter (mm)	Crushed load (kN)	Crushed strength (kN/mm ²)	L/D	Correction factor	Corrected strength (kN/mm ²)	Average (kN/mm ²)
1	96.8	49.5	18.1	9.4	2.0	1.0	9.4	9.0
2	101.2	49.4	17.1	8.9	2.0	1.0	8.9	
3	101.0	49.6	16.8	8.7	2.0	1.0	8.7	

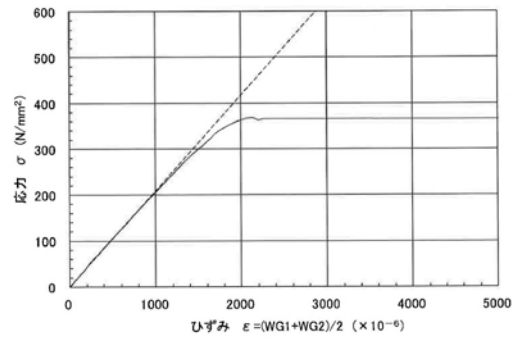
Diameter; 100mm

	Height (mm)	Diameter (mm)	Crushed load (kN)	Crushed strength (kN/mm ²)	L/D	Correction factor	Corrected strength (kN/mm ²)	Average (kN/mm ²)
1	150.4	99.3	63.7	8.2	1.5	0.96	7.9	9.0
2	151.8	99.3	88.0	11.3	1.5	0.96	10.9	
3	150.0	99.2	66.7	8.6	1.5	0.96	8.3	

Note: Result of concrete cylinder test was 10.6N/mm² at 4 weeks. Strength of core was 15% lower than cylinder strength. (9.0/10.6 = 0.849).



2.5. Consideration

1) Evaluation of horizontal strength of frame

Comparison of experimental result and analysis (unit; ton)

Observed maximum load for positive and negative loading are compared with the calculated strength as shown below (value of load meter is shown).

Specimen no. (date)	Experimental load, Qe (ton)			Analytical strength at collapse mechanism, Qa (ton)			
	Positive loading	Negative loading	Average	Calculated strength, Qa	Qe(posi.) /Qa	Qe(nega.) /Qa	Note
1 (Nov/5,6)	4.5	4.0	4.25	4.4	1.02	0.91	Typical frame
2 (Nov/9)	4.0	5.0	4.50	4.4	0.91	1.14	End frame
3 (Oct/28)	7.7	6.0	6.85	3.1+ 2.2=5.6 Shear + flex.	1.38	1.07	Frame with brick standing wall
4 (Nov/3)	11.0	10.0	10.5	Shear of brick wall, $10.5-3.1 \times 2 = 4.3$ Shear stress, $4300/6 \times 105 = 6.8 \text{ kg/cm}^2$			Frame with full brick wall
5 (Nov/12,16)	23.0 Limit of jack	23.0 Limit of jack	--	3.1(shear) \times 2+12.0(RC panel)=18.2, Qe/Qa=23/18.2=1.26 (Punching shear of column, 4.9).			Retrofitted by RC shear wall
5 (Nov/16)	19.6	--		Opening 20cm \times 25cm, reduction 0.19, Shear strength, $18.2 \times 0.81 = 14.7$ Qe/Qa=19.6/14.7= 1.33			Retrofitted by RC shear wall with opening
6 (Nov/18)	22.0	22.0	22.0	3.1(shear) \times 2+12.5 (steel brace)=18.7 Qe/Qa=22/18.7=1.18 (punching shear of column, 4.9)			Retrofitted by steel braced frame

Concrete, supposed $F_c = 12 \text{ N/mm}^2 \sim 10 \text{ N/mm}^2$ (average concrete strength at 8 week is 10.6 N/mm^2)

Shear force by flexural strength of a column (Eq. A1,1-1)

$$Q = 11.0 \sim 10.5 \times 10^3 \text{ kN} \cdot \text{mm} / h (975 \text{ mm}) = 22.6 \sim 21.6 \text{ kN}$$

Shear strength of a column (Eq. A1-1.2)

$$Q_{u1} = 32.1 \sim 30.8 \text{ kN}$$

In case coefficient 0.068 (mean value) is applied instead of 0.053,

$$Q_{u2} = 34.5 \sim 33.0 \text{ kN}$$

In case reduction factor for low strength concrete ($\sigma_b < 13.5$), Yamamoto's equation, is applied.

$$k_r = 0.056 \cdot \sigma_b + 0.244 = 0.056 \cdot 10.4 + 0.244 = 0.826$$

$$Q_{u3} = 26.5 \sim 25.5 \text{ kN}$$

Punching shear, $Q_p = 48.9 \text{ kN}$

Shear strength of RC wall panel, $wQ_{su} = 120 \text{ kN}$

Shear of steel brace, $Q = (123.3(C) + 140(T)) \cos 61.7^\circ = 124.8 \text{ kN}$

Mortar strength of brick wall, $f_c = 4.5 \text{ N/mm}^2$

Basic Information

Axial strength of column

Re-bar: 6-10mm diameter, $A=6 \times 76.9\text{mm}^2=462\text{mm}^2$, $\sigma_y=320\text{N/mm}^2$

$$A \cdot \sigma_y = 147.8\text{kN}$$

Concrete: $F_c 10.6\text{N/mm}^2$ (low strength concrete, average of 8 weeks)

$$b \cdot D \cdot F_c = 150\text{mm} \cdot 150\text{mm} \cdot 10.6\text{N/mm}^2 = 238.5\text{kN}$$

Total $A \cdot \sigma_y + b \cdot D \cdot F_c = 147.8\text{kN} + 238.5\text{kN} = 386.3\text{kN}$

Axial force: $N = 1600\text{kg}$ (163.3kN)

Axial force ratio: $N / (b \cdot D \cdot F_c) = 163.3/238.5 = 0.68$

In case design concrete strength: $N / (b \cdot D \cdot F_c) = 163.3 \cdot 10^3 / (150 \cdot 150 \cdot 14.0) = 0.52$

Axial force ratio against strength:

$$N / (A \cdot \sigma_y + b \cdot D \cdot F_c) = 163.3 / (147.8 + 238.5) = 0.42$$

Axial force ratio against strength (using design concrete strength):

$$N / (A \cdot \sigma_y + b \cdot D \cdot F_c) = 163.3 / (147.8 + 315.0) = 0.35$$

Specimen 2012-No.5: Concrete strength, 16.5N/mm^2

Axial force ratio; $N / (b \cdot D \cdot F_c) = 163.3/371.3 = 0.44$

Axial force and Flexural moment Relation (N- M Interaction Curve)

Stress (Strain) of Re-bar

Plain bar 10mm, $E = 2.17 \times 10^5\text{N/mm}^2$, $\sigma_y = 350\text{N/mm}^2$, $\epsilon_y = 0.00161$ (0.161%)

By URAWA building material testing center, Japan

Material (Urawa building material center)

Plain bar $\phi 10$, $\sigma_y = 350\text{N/mm}^2$

$$\phi 6, \sigma_y = 353\text{N/mm}^2$$

Deformed bar D10, $\sigma_y = 274\text{N/mm}^2$

Steel plate, $t=4\text{mm}$, $\sigma_y = 363\text{N/mm}^2$

Concrete, supposed $F_c = 12\text{N/mm}^2 \sim 10\text{N/mm}^2$ (8 week concrete strength is 10.6N/mm^2)

Cement mortar of brick wall, $f_c =$

Column

Main bar 6- $\phi 10$ $P_t = 76.0 \times 3 / 150 \cdot 123 = 0.0122$

Hoop 6 @150 $P_w = 43.6 \cdot 2 / 150 \cdot 150 = 0.00388$ (Actual size is $\phi 7.45$ @195, $P_w = 0.00298$)

Flexural strength of column

Structural Experiment by CNCRP

$N > 0.4bDFc$ (Eq. A1,1-1, and coefficient 0.7 is used instead of 0.8, because of small dimension)

$$\begin{aligned} \mu &= \{0.7 \cdot A_t \cdot \sigma_y \cdot D + 0.12 \cdot b \cdot D^2 \cdot F_c\} (N_{\max} - N) / (N_{\max} - 0.4 \cdot b \cdot D \cdot F_c) \\ &= 11.0 \sim 10.5 \cdot 10^3 \text{ kN} \cdot \text{mm} \end{aligned}$$

Flexural strength of beam

(Upper tension) $\mu = 18.6 \cdot 10^3 \text{ kN} \cdot \text{mm}$

(Lower tension) $\mu = 11.2 \cdot 10^3 \text{ kN} \cdot \text{mm}$

Shear force by flexural strength of a column (Eq. A1,1-1)

$$Q = 11.0 \sim 10.5 \cdot 10^3 \text{ kN} \cdot \text{mm} / h (975 \text{ mm}) = \mathbf{22.6 \sim 21.6 \text{ kN}}$$

Shear strength of column (Eq. A1-1.2)

$$Q_{u1} = \mathbf{32.1 \sim 30.8 \text{ kN}}$$

In case coefficient 0.068 (mean value) is applied instead of 0.053,

$$Q_{u2} = \mathbf{34.5 \sim 33.0 \text{ kN}}$$

In case reduction factor for low strength concrete ($\sigma_b < 13.5$), Yamamoto's equation, is applied.

$$k_r = 0.056 \cdot \sigma_b + 0.244 = 0.056 \cdot 10.4 + 0.244 = 0.826$$

$$Q_{u3} = \mathbf{26.5 \sim 25.5 \text{ kN}}$$

Shear wall

Shear strength of infilled RC panel plus shear strength of column was evaluated.

Steel braced frame

Steel brace

2L-30*30*4.2 ($A=386 \text{ mm}^2$, $\sigma_y=363 \text{ N/mm}^2$), since designed 2L-38:38*3.0 (603.2 mm^2 , $\sigma_y=250 \text{ N/mm}^2$) was not available.

$i_y=0.908 \text{ cm}^2$ (i_y of L-30*30*3 is used)

λ (slenderness ratio) $= 1100/2 \cdot 9.08 = 60.6 > 60$, effective $\lambda = 700/2 \cdot 9.08 = 38.5$

$f_c = 191 \cdot 1.5 / 363 / 325 = 320 \text{ kg/mm}^2$

Com. C $= 320 \cdot 386 \text{ mm}^2 = 123.2 \text{ kN}$

Ten. T $= 363 (\sigma_y) \cdot 386 \text{ mm}^2 = 140.1 \text{ kN}$

Brace Q $= (C+T) \cos 61.7^\circ = 124.8 \text{ kN}$

Punching shear of a column $Q_p = 48.9 \text{ kN}$ ($F_c = 10 \text{ N/mm}^2$)

Shear strength of a column $Q_s = 33.0 \text{ kN}$ (Hoop @ 195, $P_w = 0.00298$)

Total $Q_1 = 48.9 + 33.0 + 124.8 = 206.7 \text{ kN}$

$$Q_2 = 33.0 \cdot 2 + 124.8 = 190.8 \text{ kN}$$

Post installed anchor, embed length $8 \cdot d_a$, D10*8=80+10=90mm (length of hole)

Shear strength

$Q_{a1}(\text{steel}) = 0.7 \cdot \sigma_y \cdot a = 0.7 \cdot 235 \cdot 1.1 \cdot 78.5 = 14.2 \text{ kN}$

$Q_{a2}(\text{pressure}) = 0.4 \sqrt{E_c \cdot \sigma_b} \cdot s \cdot A_e = 0.4 \sqrt{(1.7 \cdot 10^4 \cdot 10)} \cdot 78.5 = 12.9 \text{ kN} < 14.2$,

Structural Experiment by CNCRP

@100 = 129kN

Shear strength of stud (ϕ 8mm headed stud)

$$Q_{ud} = 0.64 \cdot \sigma_{\max} \cdot A_s = 0.64 \cdot 400 \cdot 1.1 \cdot 50 = 14.1 \text{ kN}, \text{ @100 double, } 28.2 \text{ kN} > 129 \text{ kN}$$

Mortar strength of brick mortar

4.5N/mm²

Appendix

In the following formula, $0.7 \cdot a_t \cdot \sigma_y \cdot D$ was used instead of $0.8 \cdot a_t \cdot \sigma_y \cdot D$, considering the small size of the specimen.

For $N_{max} \geq N > 0.4b \cdot D \cdot F_c$

$$M_u = \left\{ 0.8a_t \cdot \sigma_y \cdot D + 0.12b \cdot D^2 \cdot F_c \right\} \cdot \left(\frac{N_{max} - N}{N_{max} - 0.4b \cdot D \cdot F_c} \right)$$

For $0.4b \cdot D \cdot F_c \geq N > 0$

$$M_u = 0.8a_t \cdot \sigma_y \cdot D + 0.5N \cdot D \cdot \left(1 - \frac{N}{b \cdot D \cdot F_c} \right) \quad (\text{N} \cdot \text{mm})$$

For $0 > N \geq N_{min}$

$$M_u = 0.8a_t \cdot \sigma_y \cdot D + 0.4N \cdot D$$

(A1.1-1)

where:

N_{max} = Axial compressive strength = $b \cdot D \cdot F_c + a_g \cdot \sigma_y$ (N).

N_{min} = Axial tensile strength = $-a_g \cdot \sigma_y$ (N).

N = Axial force (N).

a_t = Total cross sectional area of tensile reinforcing bars (mm^2).

a_g = Total cross sectional area of reinforcing bars (mm^2).

b = Column width (mm).

D = Column depth (mm).

σ_y = Yield strength of reinforcing bars (N/mm^2).

F_c = Compressive strength of concrete (N/mm^2).

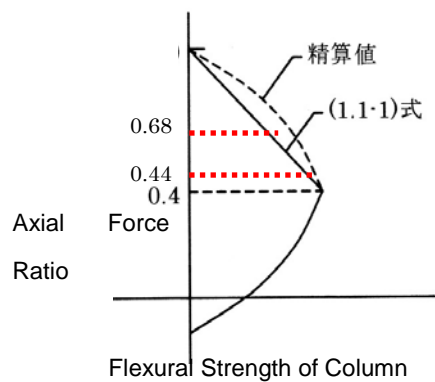

Shear strength of column (ref.1)

$$Q_{su} = \left\{ \frac{0.053 p_t^{0.23} (18 + F_c)}{M/(Q \cdot d) + 0.12} + 0.85 \sqrt{p_w \cdot s \sigma_{wy}} + 0.1 \sigma_0 \right\} \cdot b \cdot j \quad (N) \quad (A1.1-2)$$

where:

- p_t = Tensile reinforcement ratio (%).
- p_w = Shear reinforcement ratio, $p_w = 0.012$ for $p_w \geq 0.012$.
- $s \sigma_{wy}$ = Yield strength of shear reinforcing bars (N/mm^2).
- σ_0 = Axial stress in column (N/mm^2).
- d = Effective depth of column. $D-50mm$ may be applied.
- $\frac{M}{Q}$ = Shear span length. Default value is $\frac{h_0}{2}$.
- h_0 = Clear height of the column.
- j = Distance between centroids of tension and compression forces, default value is $0.8D$.

(b) If the value of $M/(Q \cdot d)$ is less than unity or greater than 3, the value of $M/(Q \cdot d)$ shall be unity or 3 respectively in using Eq. (A1.1-2). And if the value of σ_0 is greater than $8N/mm^2$, the value of σ_0 shall be $8N/mm^2$ in using Eq. (A1.1-2).

Proposed **reduction factor** of shear strength for low strength concrete.

This was not used for the strength evaluation.

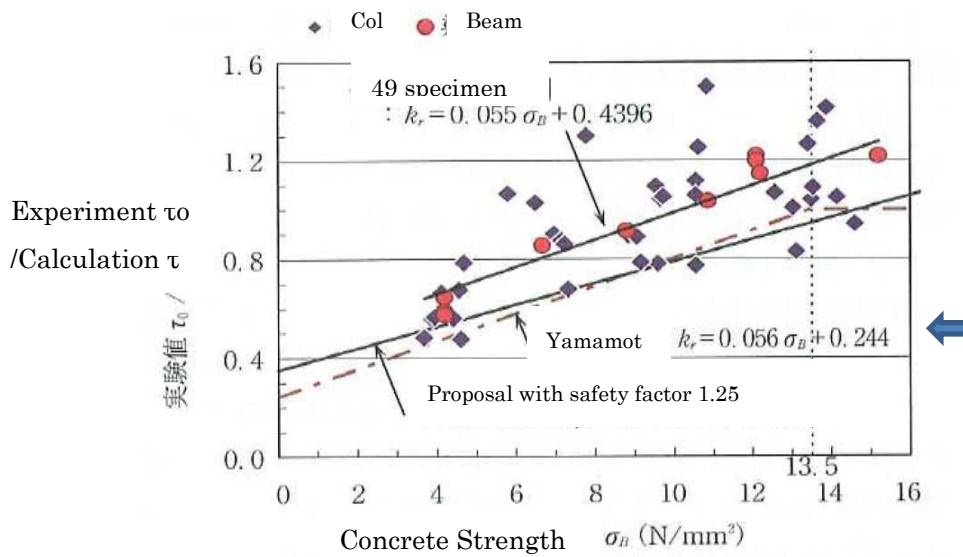

Japan Concrete Institute, "Low strength Concrete",
 Minami, Concrete Journal, vol. 48, No.7, Jul. 2010

Part 3. Experiment 2012

3.1 General

1) Purpose

Main purposes of the test re shown below.

1. To see the strength and directly the behavior of RC frame till the collapse stage.
2. To disseminate the experiment to other engineers and concerned organization.
3. To get useful data/information related to strength and ductility necessary to evaluate existing RC frame buildings in Bangladesh, and related to issues those may not covered by the Japanese code.

Test results are not necessarily successful, and reasons are shown.

3.2 Testing Plan

Proposed Plan for Structural Experiment is shown below.

1) Outline

1. Reinforced concrete frame with 1 story, 1span will be selected for the experiment.
2. Mid-rise buildings constructed around 30 years ago, and 1/3 scale will be selected.

2) Parameters to be considered

1. Axial force ratio of column ($N/BDF_c = 0.25, 0.50$), to be decoded by actual data
2. Column collapse and beam (or joint) collapse
3. Brick-wall (thickness and height)
4. Lap joint (without hook and no lap joint for main bars)
6. Type of main-bar (plain bar and deformed bar to compare with the bond)

3) Material

Concrete: F_c 14N/mm² (design mix, and max.) with brick chips, will be decided by the result of trial mix with a few types (strength of 7 days, 28 days, 42 days, 56 days).

Main Re-bar and shear reinforcement: yield stress: 275N/mm²

4) Model (typical)

1. Column, size: 150mmx150mm
 Main bars: 6- ϕ 10mm (round bar)
 Shear reinforcement: ϕ 6mm @ 150 with 90 degree hook
2. Beam, size: 150mmx 150cm
 Main bars: top 4- ϕ 10mm top and 2- ϕ 10mm bottom
 Shear reinforcement: ϕ 6mm @ 100 with 90 degree hook
3. Beam column connection; no hoop
4. Brick wall, 250x125x75mm, thickness 125mm with height of 500mm
 250x60x75mm, thickness 60mm with height of 750mm

5) Frame sizes, Height; 1.15m, Span; 1.6m

6) Number of Specimen

Total 7 specimens.

No.	1	2	3	4	5	6	7
Beam	Strong type	Strong type	Strong type	Strong type	Standard type	Standard type,	Standard type,
Main bar	Deformed	Deformed	Deformed	Deformed	Plain	Plain	Deformed

10) Schedule

		2012										2013		
		April	May	June	July	August	September	October	November	December	January	February	March	
1	Detail plan of experiment, design & specification of additional steel members and specimen		■	■										
2	Document for subcontract			■										
3	Quotation & subcontract				■									
4	Survey of existing steel reaction frame				■									
5	Steel shop drawing					■								
6	Fabrication of steel frame						■							
7	Trial mix of concrete & strength test, re-bar test				■	■								
8	Formwork, re-bar with strain gauge, concreting, curing of test specimen,						■	■	■					
9	Soil removal at pit and steel beam at pit with grouting work							■						
10	Installation of additional steel members and adjustment of reaction frame								■					
11	calibration of load cell				■									
12	Adjustment of datalogger and load cell				■									
13	Installation of 1st specimen and assembly of loading & measurement equipment									■				
14	First Test (1 specimen)										■			
15	Test (6 specimen)										■	■		
16	Report											■		

Note:

- 1) Trial mix of concrete to be done as soon as possible (7 days, 28days, 42days, 56 days).
- 2) Calibration of load-cell and connection test for data-logger will be done at an early stage.
- 3) Duration of test is supposed as 2 days for setting and preparation and 2 days for measurement.
Total 4 working days for a specimen.
- 4) Pinned joints (total 4 sets) are requested to fabricate as a part structural steel for loading.
- 5) Roller for horizontal guide (total 4 sets) will be purchased in Japan.

11) Results

a) Experiment

Load-deflection curve will be provided through the test.

Initial horizontal stiffness, horizontal strength and ductility will be measured.

Structural Test by CNCRP

Failure mode will be observed.

Influence of parameters, such as axial force ratio, beam column joint, brick wall will be reviewed.

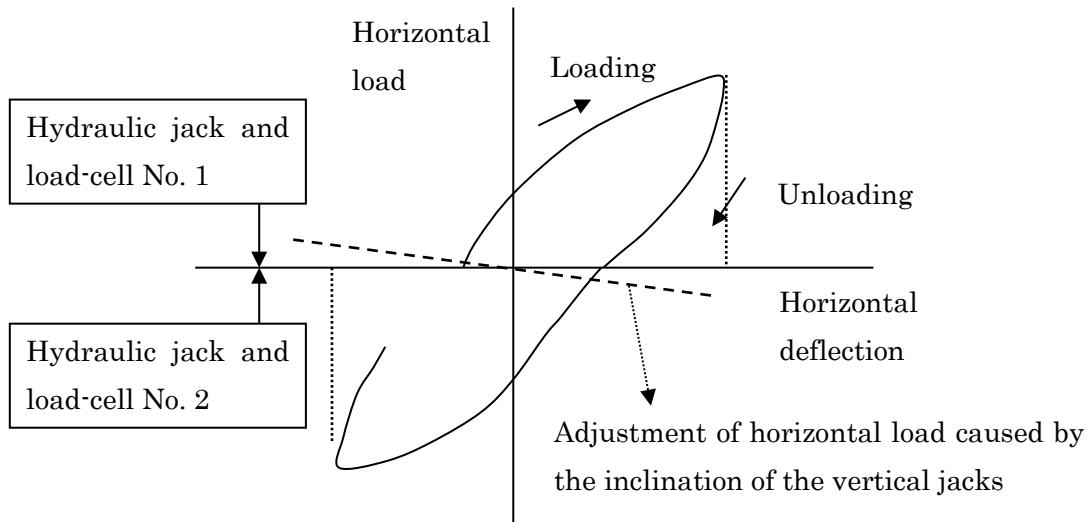

Hydraulic jack and load-cell is released when other jack and load-cell is working.

b) Analysis

Analysis for load-deflection will be done by standard method, and will be compared with the experimental results.

Stiffness, crack stress, column flexural strength and shear strength will be estimated.

Beam-column strength will be estimated.

12) Proposed Scope of Work

		PWD, JET	BUET
1	Detail plan of experiment, design & specification	<input type="radio"/>	Review and confirmation of detail plan
2	Document for subcontract	<input type="radio"/>	
3	Subcontract	<input type="radio"/>	
4	Survey of existing reaction frame	<input type="radio"/> (sub contractor)	<input type="radio"/> (coordination)
5	Steel shop drawing	<input type="radio"/> (sub contractor)	
6	Fabrication of steel frame	<input type="radio"/> (sub contractor)	
6	Trial mix of concrete & strength test, re-bar test (note 1)	<input type="radio"/> (sub contractor), advise on mix design by UAP	
7	Formwork, re-bar, concreting, curing of specimen,	<input type="radio"/> (sub contractor, supply of strain gauge)	<input type="radio"/> (installation of strain gauge)
8	Removal of soil at pit and installation of steel beam	<input type="radio"/> (sub contractor)	<input type="radio"/> (coordination)
9	Installation of additional steel members and adjustment of reaction frame, and new painting	<input type="radio"/> (sub contractor)	<input type="radio"/> (coordination)
10	Calibration of load cell (4 nos.)		<input type="radio"/>
11	Adjustment of data-logger (20 channels) and load cell		<input type="radio"/>
12	Laptop computer with software		<input type="radio"/>
13	Installation of test specimen and removal, and steel frame for guide and measurement	<input type="radio"/> (provide labors), Provide 2 nos of roller for guide.	<input type="radio"/> (advice)
14	Installation of measurement equipment, such as DT, DG	<input type="radio"/> (provide 100mm DTx4 with cables, 100mm DGx4, bridgebox x12with cables for strain gauge)	<input type="radio"/> (50mm DTx4, 50mm DGx4, 25mmDGx2, magnetx10)
15	Loading and measurement (total 7 specimen)	<input type="radio"/> (provide labors)	<input type="radio"/> including crack observation and photos, records
16	Report	<input type="radio"/> (Load-deflection curve by analysis, stiffness and strength by analysis)	<input type="radio"/> (Load-deflection curve by test, summary, failure mode and influence of axial force, brick wall, lap joint, plain bar)

Note: 1) DT: Displacement transducer, DG: Dial gauge.

Laboratory of Civil Engineering Department, BUET

Structural Test by CNCRP



Reaction frame



Hydraulic jack and load cell (1)



Hydraulic jack and load cell (2)



Control panel



Lift (2ton capacity)



Space for fabrication of specimen

Structural Test by CNCRP



13) Structural Experiment

Plan of Testing Apparatus (unit: mm)

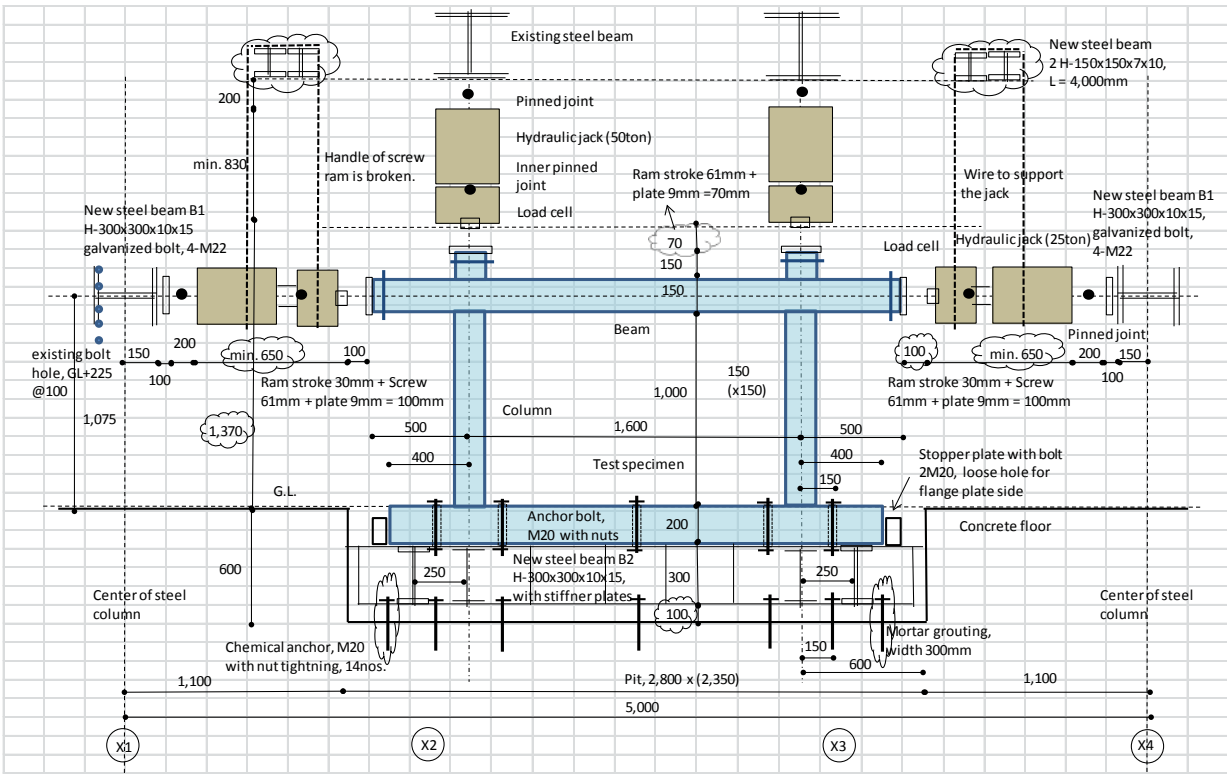

Posts for guide

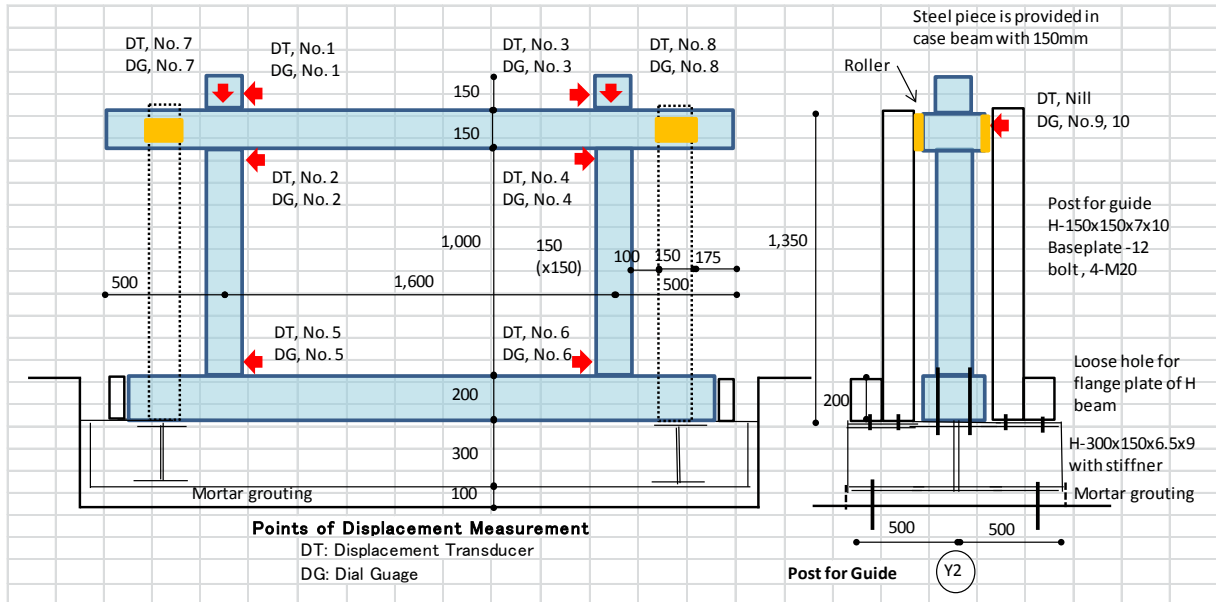

Note: Roller was not used because of the material availability.

Measurement

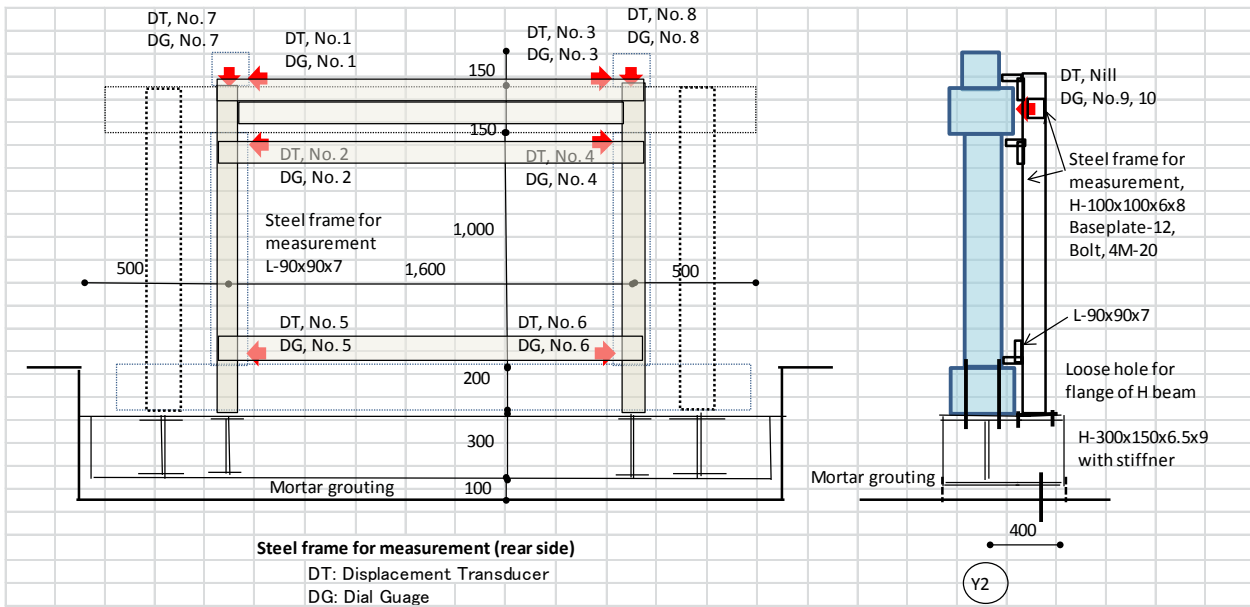

Steel frame for measurement is provided.

Displacement transducer; stroke of 100mm will be used for No.1 through no.4

Dial gauge; stroke of 100mm will be used for No.1 through no.4

14) Plan of Specimen

Type 1 (Strong beam and plain bar with lap joint without hook) x 2

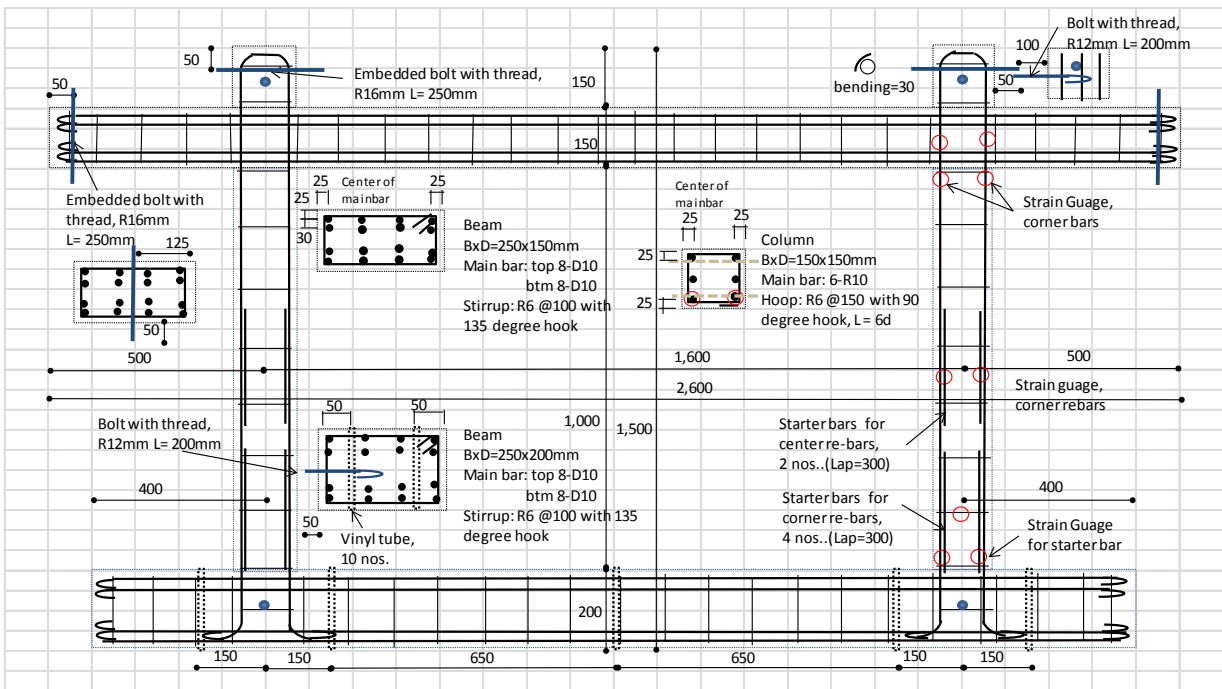

Type 1a & 1b (Strong beam, plain bar and brick wall) x 1 each (total 2)

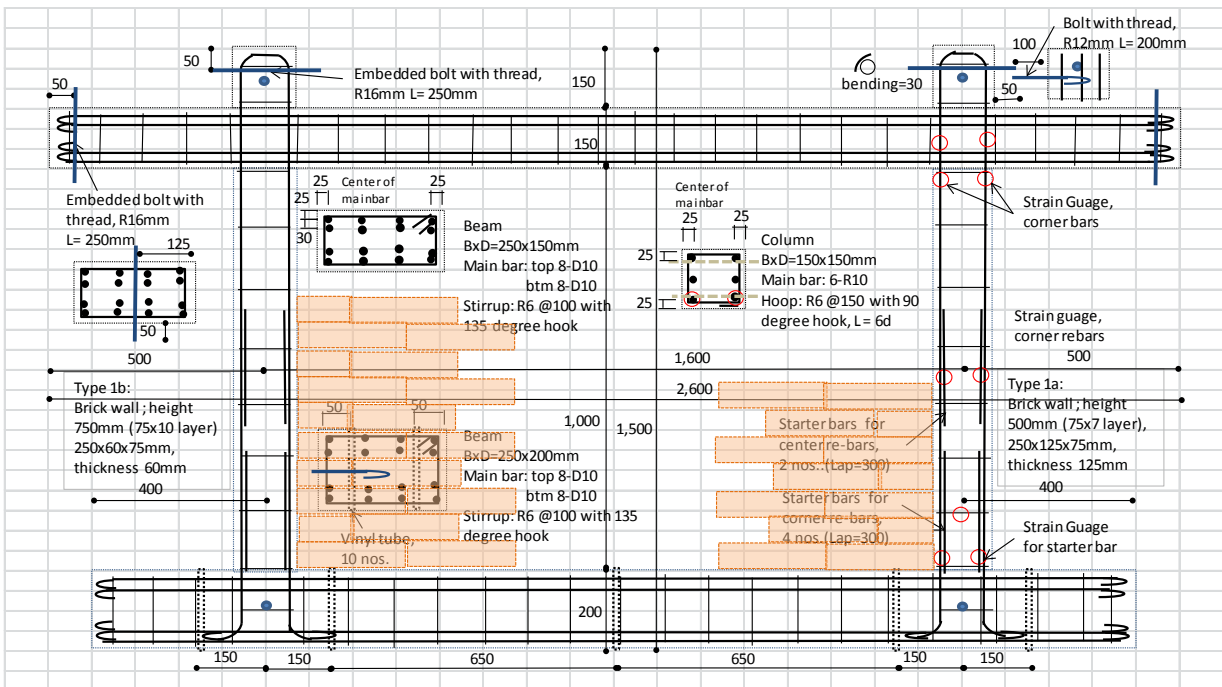

Structural Test by CNCRP

Type 2 (Standard beam and plain bar without lap joint) x 1

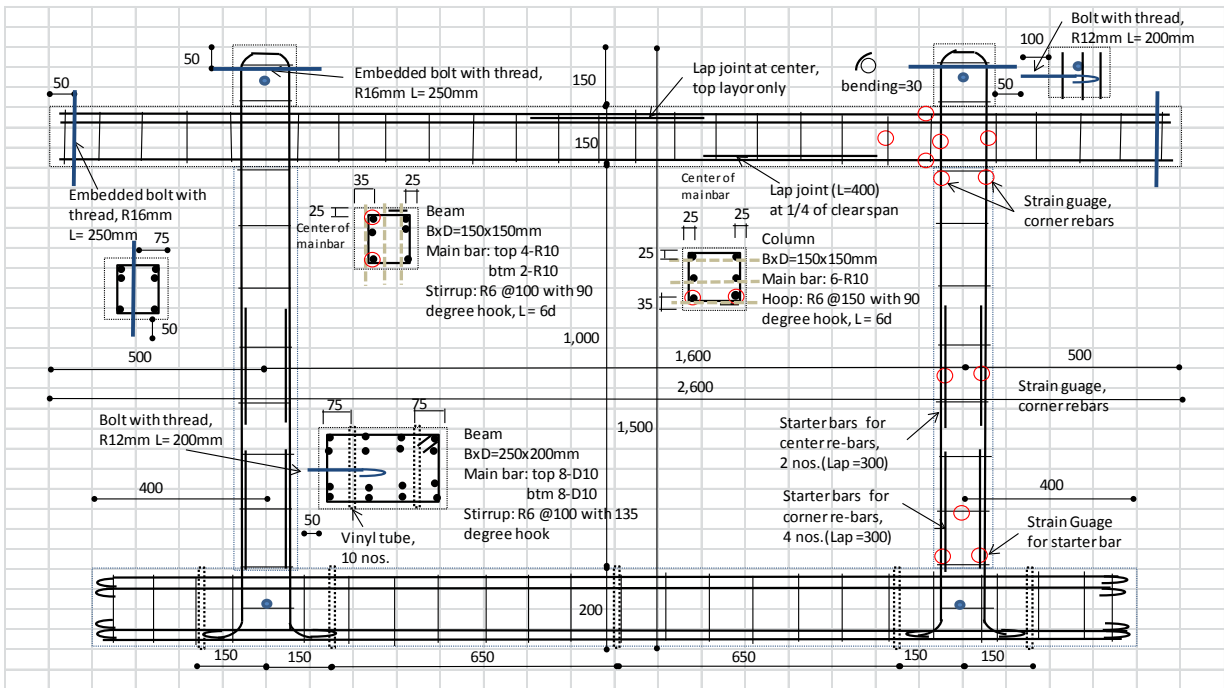

Type 2a (Standard beam and plain bar without lap joint) x 1

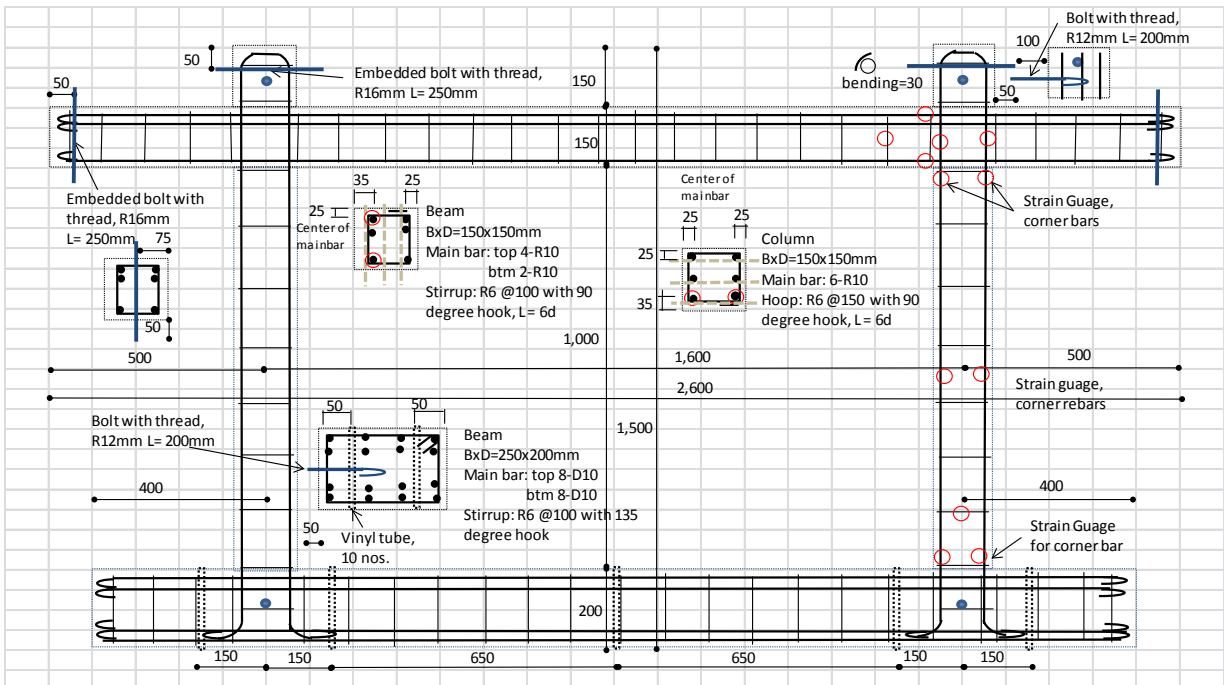

Structural Test by CNCRP

Type 2b (Standard beam & deformed bar with lap joint) x 1

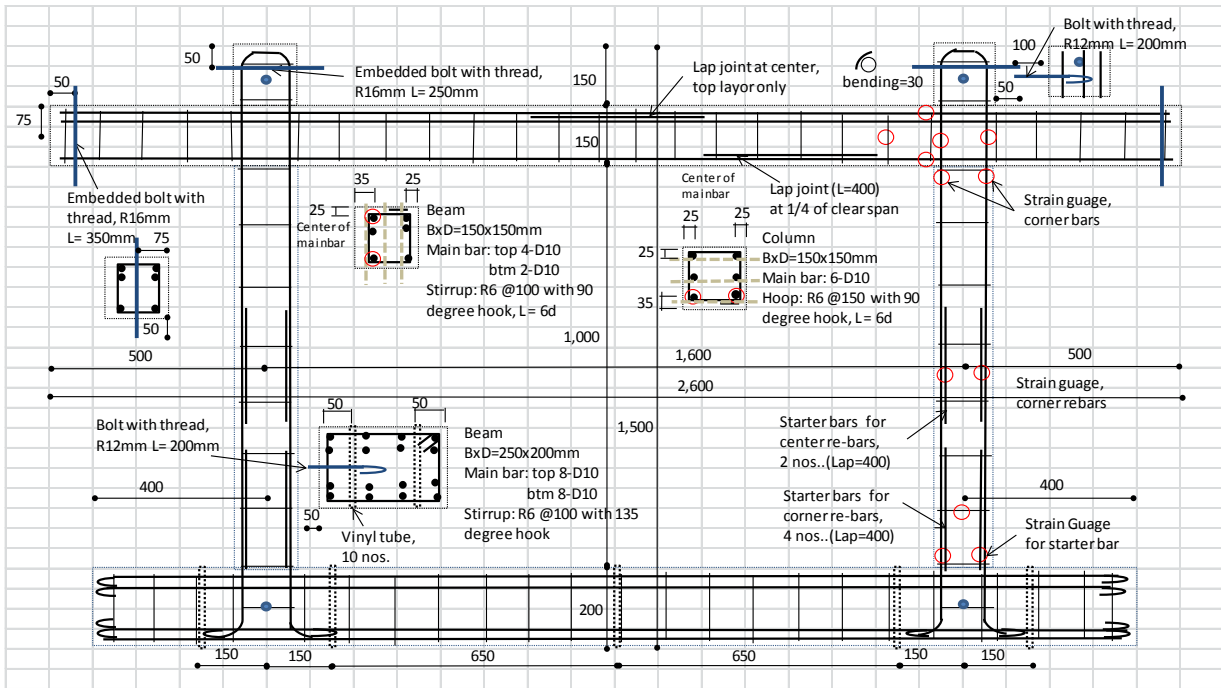

3.3 Load-deflection curve

Loading date of each specimen is shown as follows;

Specimen No.	Date	Remarks (observation during the loading)
1	5, 6 November 2012	Dial gauge (right upper for loading control) didn't work smoothly, within the range of 1mm.
2	10, 11, 12 November	Dial gauge (right upper for loading control) didn't work smoothly, within the range of 1mm.
6	14, 15 November	Embedded bolts hit measurement frame up to 4 th cycle.
7	24 November	
5	18, 19, 29 November	
3	27, 28 November	
4	5 December	

Load-deflection curves by

- ① Displacement Transducer (DT) and load-cell, and
- ② Dial Gauge (DG) and load-cell are shown for each specimen.

and

- ③ Hand written load-deflection curve is shown form next pages.

This hand written curve was prepared by the analogue load-meter of hydraulic jack and a dial gauge of upper right position during the loading. Specimen of No.1 of hand written is not accurate and is reference only.

As shown it is necessary to modify the data of DT (Data-logger) such as,

Points of missing data were connected by straight line intentionally. **Possible reason of missing data is that cables were not connected to data-logger properly.**

No.1, data of DT is not continuous.

No.2, data of R=1/100 and 1/50 are missing.

Average of DT of left up and left down is shown. Other two DT are not working properly and are excluded.

No.5, data of DT is not continuous.

No.6, average of DT maybe not proper, since the vertical axis is not the center of curves.

Following story deflection angle R is numerical value of Dial gauge of right upper portion, divided by story height 1,150mm.

Result of specimen No.1

(Strong beam type, plain bar without lap joint for column, axial force ratio 0.215)

Axial force; 8ton(16.5Mpa concrete)

Behavior is similar to that of no.2. Out of plane behavior was observed at the bottom of columns.

Unstable behavior that cannot control deflection was observed at the second loading cycle of R<1/50.

Following load-deflection curve is rough and is reference only.

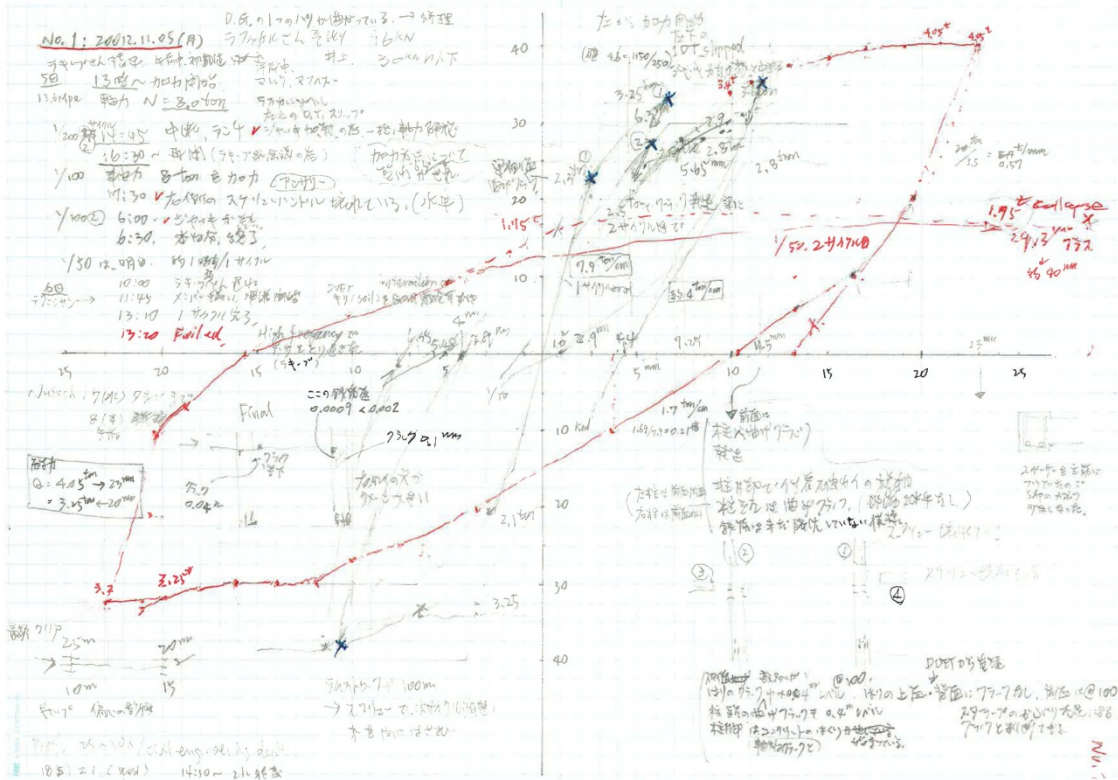

No.1 DT, average of top 2 DT(column C and D, not C and E?) (left top and left down?)

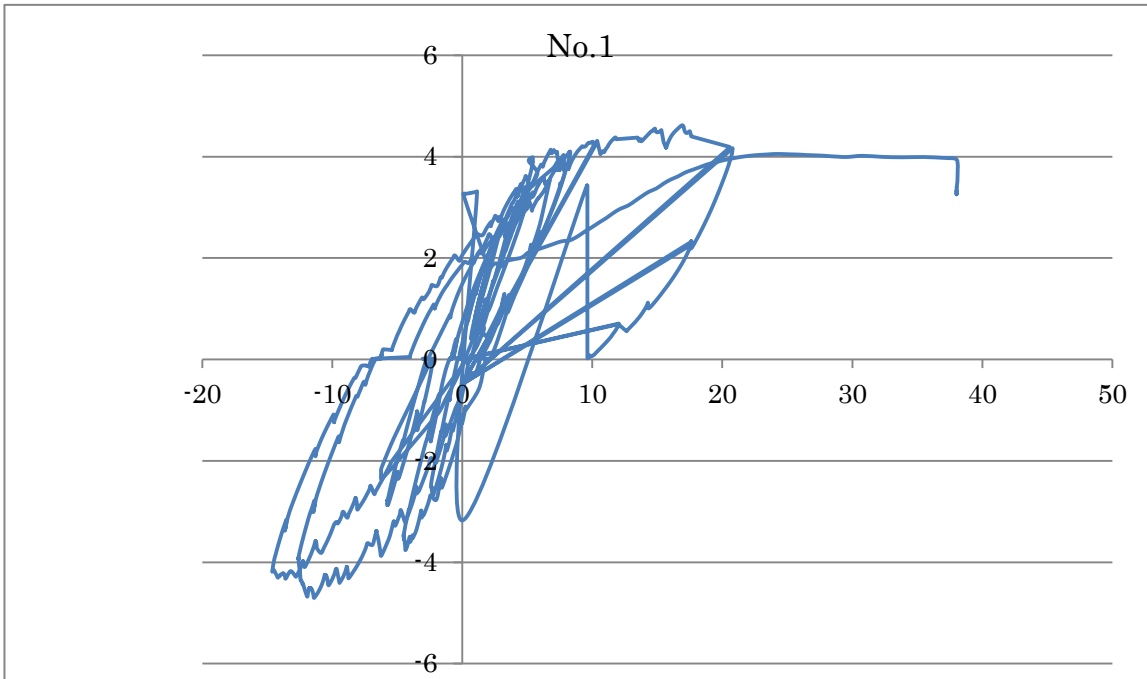

No.1 Dial Gauge (Right top D.G.)

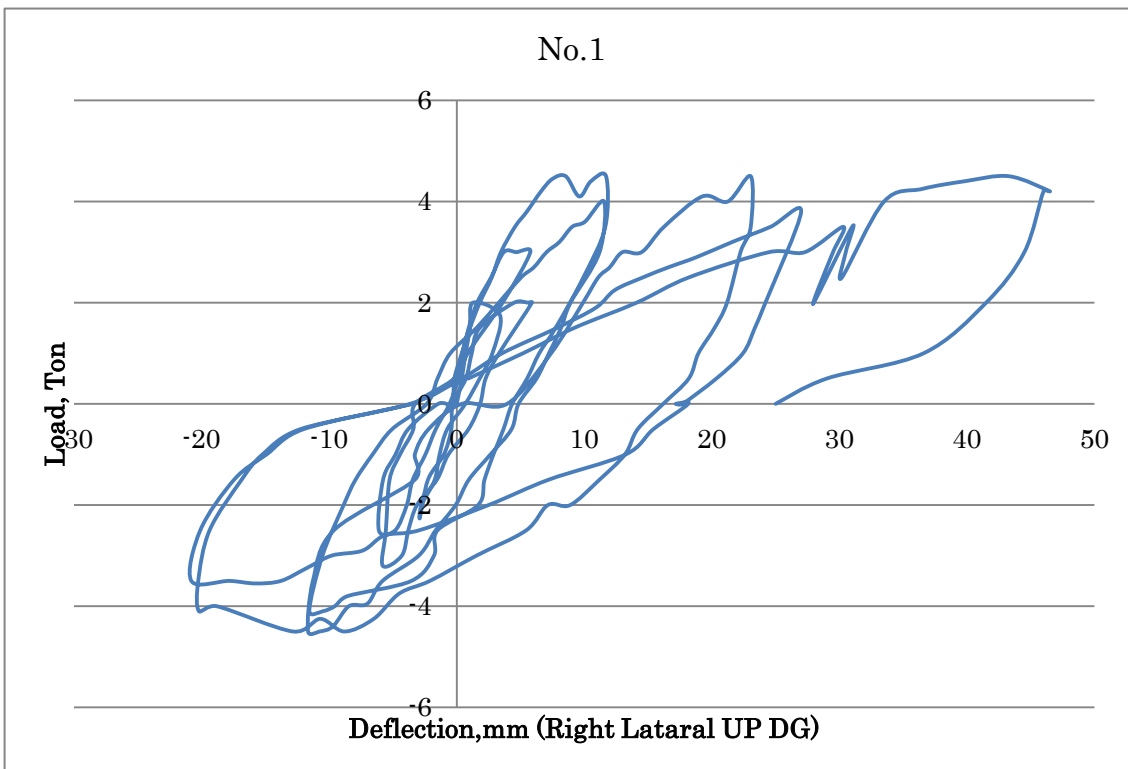

Result of specimen No.2

(Strong beam type, plain bar without lap joint for column, axial force ratio 0.32)

1/4 of capping concrete of top of left column was damaged by introducing axial force with 18 ton only, and then the axial force was reduced to 12 ton.

Behavior;

$R(\text{story deflection angle}) = \delta / h < 1/200, 3^{\text{rd}}$ cycle

Vertical cracks were observed at side of beam (this was caused by the shortage of concrete cover of stirrups), vertical and horizontal cracks were observed at the bottom of right column.

R < 1/100 (11.5mm), 5th cycle

Flexural and shear cracks were observed on upper beam, vertical and horizontal cracks were observed at the bottom of columns, shear crack on top of column.

R < 1/50 (23.0mm), 6th cycle

Compressive failure of covering concrete of top of column, split and detachment of concrete (by bond stress) at the bottom of column were observed.

Enlargement of crack at top of column and flexural cracks on beam, and compressive failure of covering concrete at the bottom of columns were observed.

R < 1/25 (46mm), 7th cycle

Detachment of covering concrete at the top of column, and split of concrete at the bottom of column were enlarged.

Enlargement of flexural cracks on top of column, and compressive failure of covering concrete were observed.

R < 1/50, top and bottom of column



R<1/25, top and bottom of column



Collapse of column top caused by axial force was observed (after the test). Possible reason is that concrete was weak with honeycomb. This limited the size of vertical loading.

Load- deflection curve, specimen no.2

DG of right upper position was not work smoothly, this was found at later stage of the experiment.

(a)

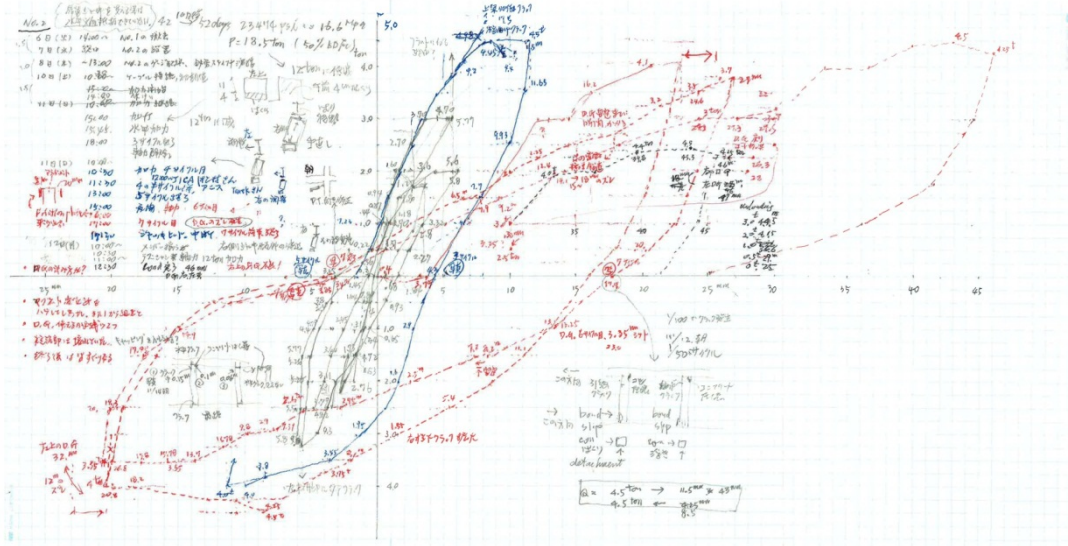

No.2,

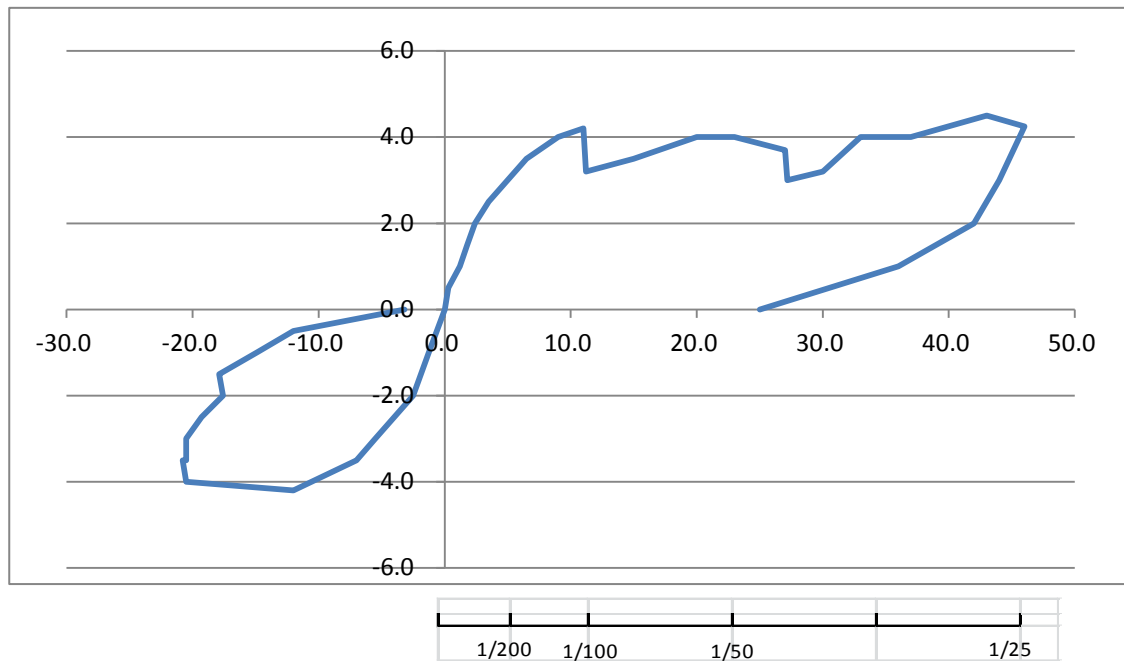

No.2 の加力制御に使った右上 D.G.はスムーズに動いてなかったのが実験中に確認された。非対称となっているが、鉛直荷重の加力が偏心していた可能性がある。

No.2

Deflection; Average of DT of left up and left down is shown. DT of right down was not working, max. more than 100mm), right up also not stable (not working at the beginning).

Data of loading cycle R=1/100 (11.5mm), R=1/50 (23mm) are missing.

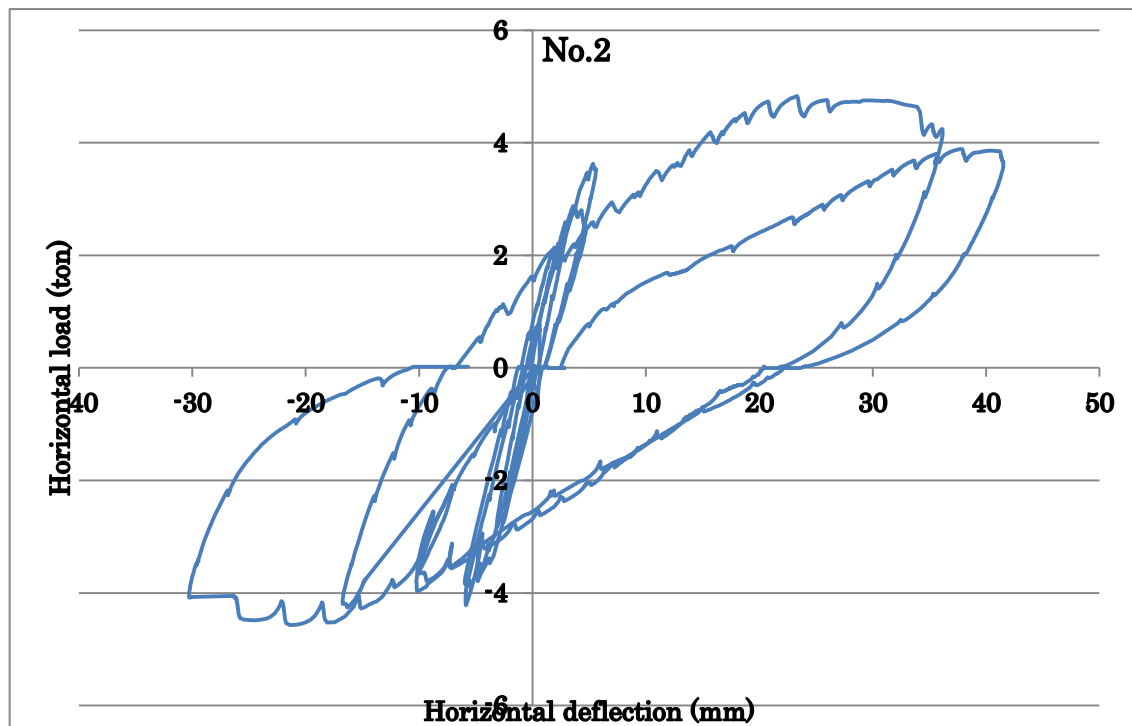

No.2, Dial Gauge, Left top DG (recorded left upper DG is used)

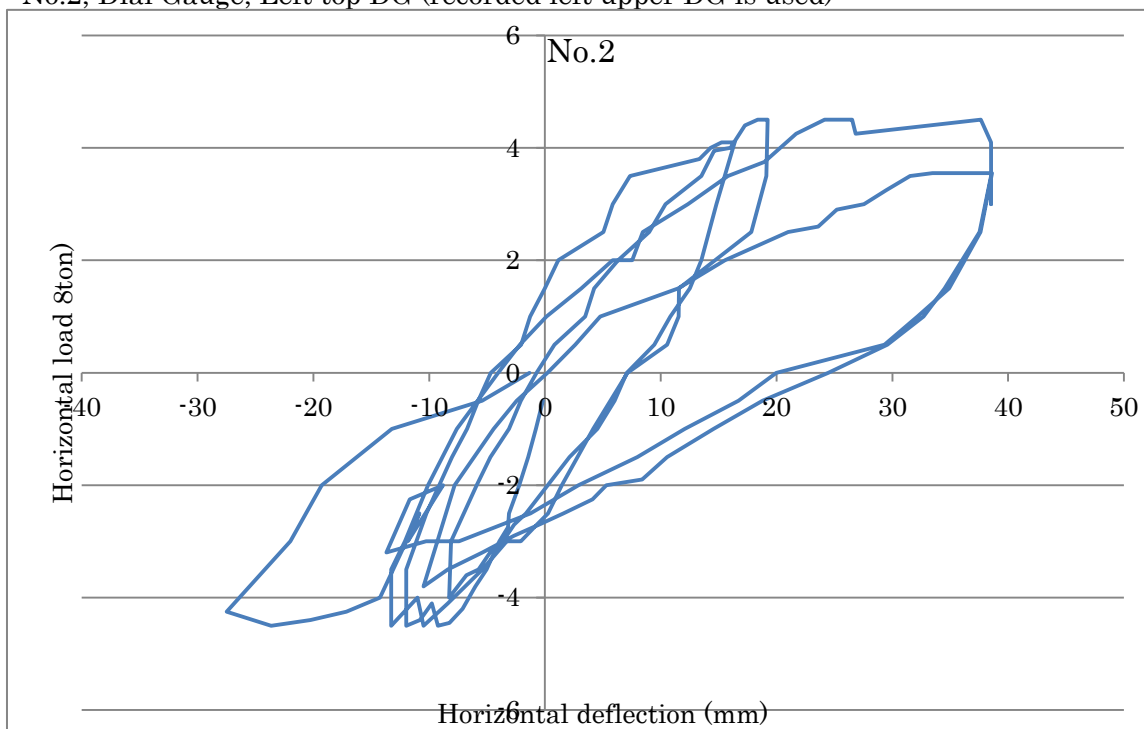

No.2 の DT は、左上と右上の平均を表示している。右上は不安定（開始時点で動いていなかった）、右下も 100mm を超えた数値が出ており適切に動いていなかった。

R=1/100、R=1/50 の DT のデータが欠如している。

Specimen, No.3

(strong beam, lap joint of plain bar without hook for column, axial force ratio 0.43, with brick wall), loading on 2012/11/27~28

Height of brick standing wall is half of clear height of column (beam to beam) and thickness is 115mm.

Maximum strength; positive direction $Q=7.25\text{ton}$ ($\delta =10.8\text{mm}$)

Negative direction $Q=6.8\text{ton}$ ($\delta =11.58\text{mm}$), average is 7.03ton.

Shear failure occurred at left side column (loading was provided from left to right first). Shear (diagonal) cracks were observed at right column but no serious damage was observed, when left column failed.



Behavior of left column is shown below:

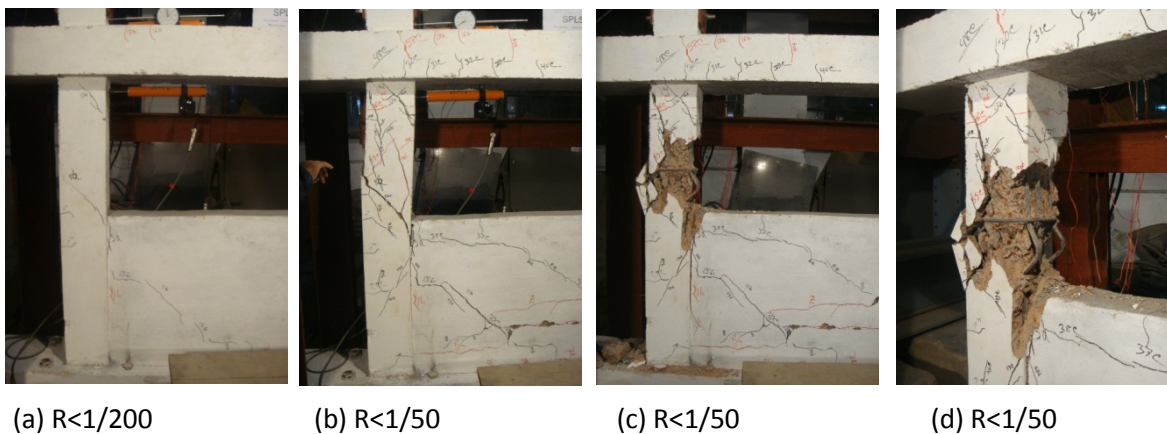

Figure 2.3.2. Behavior of left column

(R; story deflection angle = story deflection/ story height)

R<1/400 ($\delta < 2.88\text{mm}$), 1st cycle, crack on finishing mortar observed. Max. load is 4.9 ton in positive loading.

R<1/200 ($\delta < 5.75\text{mm}$), 2nd cycle, two shear cracks were observed on left column. Max. positive load is 6.5 ton. Refer to above figure (a).

R<1/100 ($\delta < 11.5\text{mm}$), 3rd cycle, max. load is 7.25ton for positive loading and 6.8 ton for negative loading.

R<1/50 (23.5mm), 5th cycle, max. load is 6.7 ton for positive loading and 5.7 ton for negative loading.

R<1/50 (23.5mm), 6th cycle, shear failure of column occurred at 2nd positive cycle, at 4.7 ton /16.2mm, and the load of 4.7 ton reduced to 3.5 ton/ 22.5mm after shear failure. Refer to above figure (b).

R<1/50 (23.5mm), 6th cycle, detachment of covering concrete at 2nd negative cycle, buckling of main re-bar occurred at $\delta =1.7\text{mm}$ / 2.0 ton of negative loading, vertical load carrying capacity reduced, and vertical load was released to zero. Refer to above figure (c) and (d).

Structural Test by CNCRP



Buckling of main re-bar

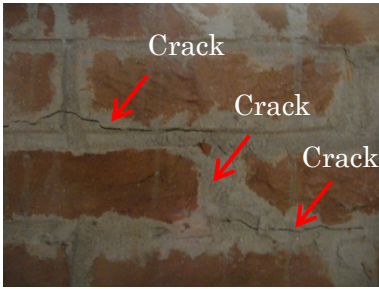

Cracks of joint mortar of brick standing wall (rear side)



No. 3, load- deflection curve (reading value of hydraulic jacks and a dial gauge)

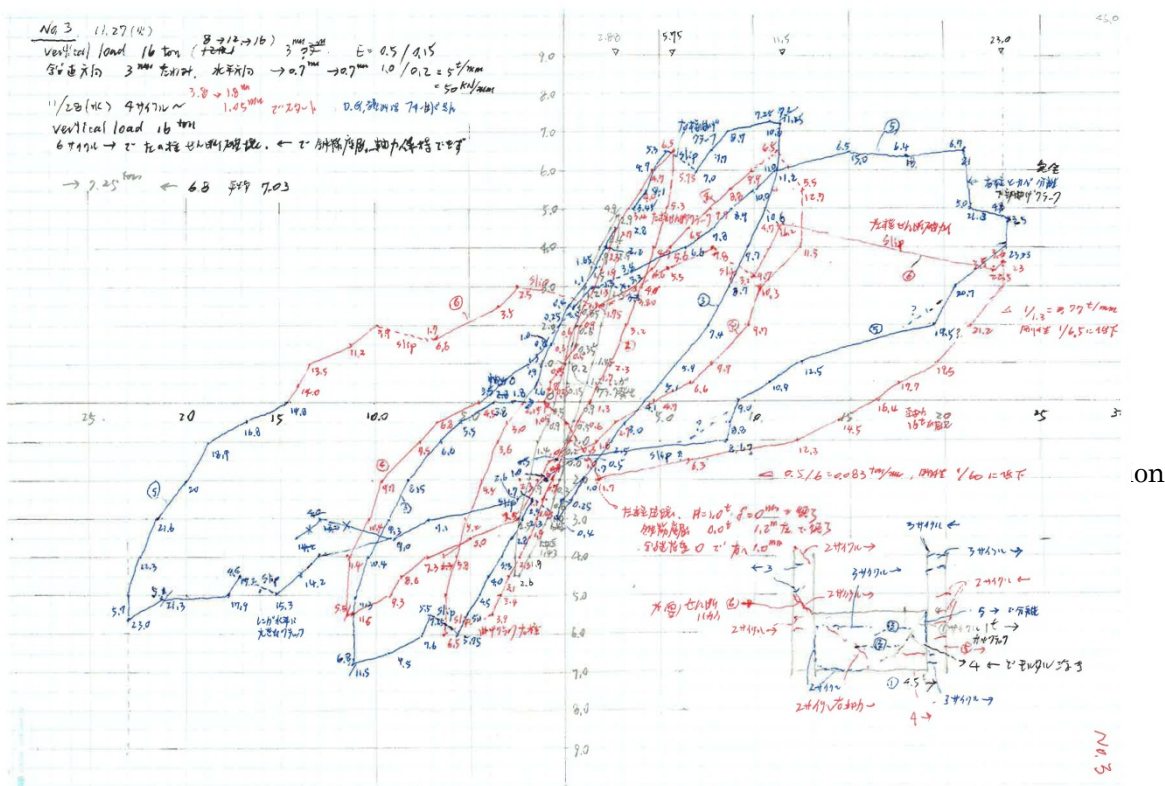

No.3, Simplified load-deflection curve covering peak values (vertical axis; ton, horizontal axis; mm)

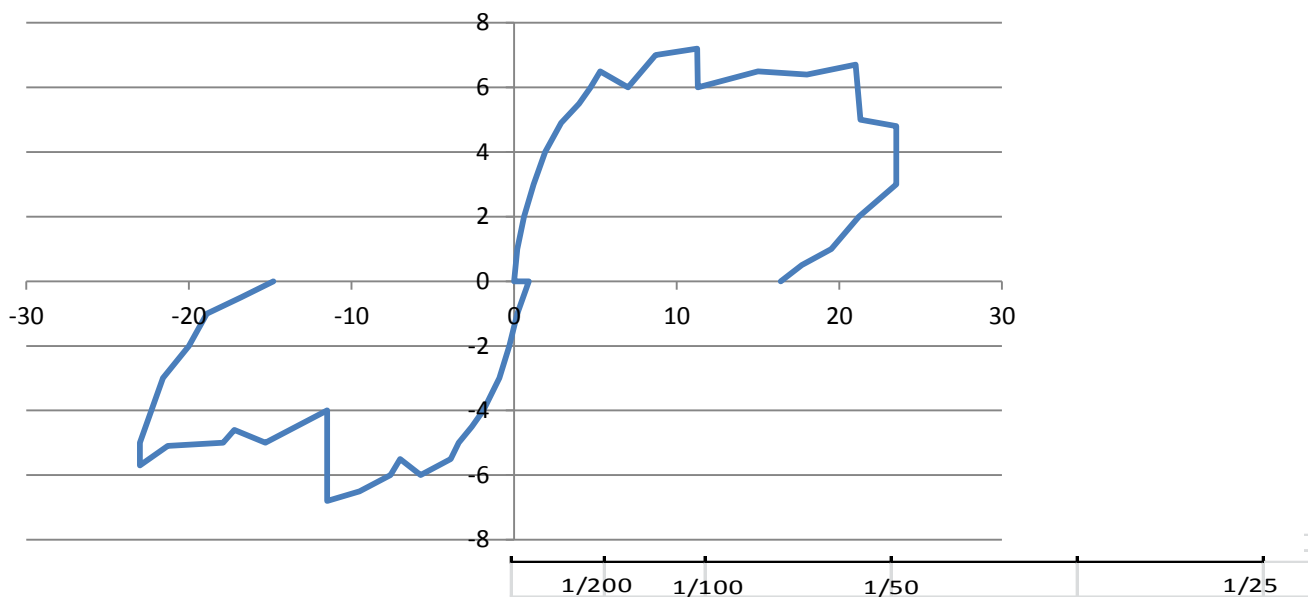

Structural Test by CNCRP

No.3

Deflection; average of 4 DT

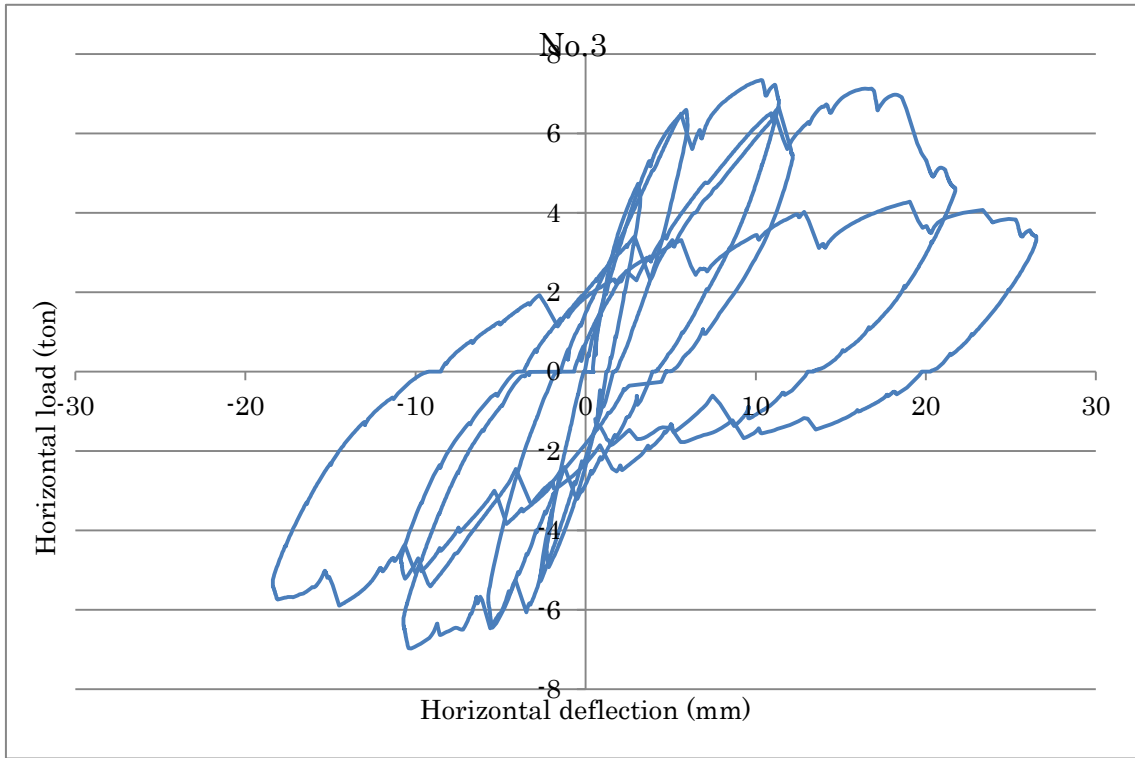

No.3 Dial Gauge, right top DG

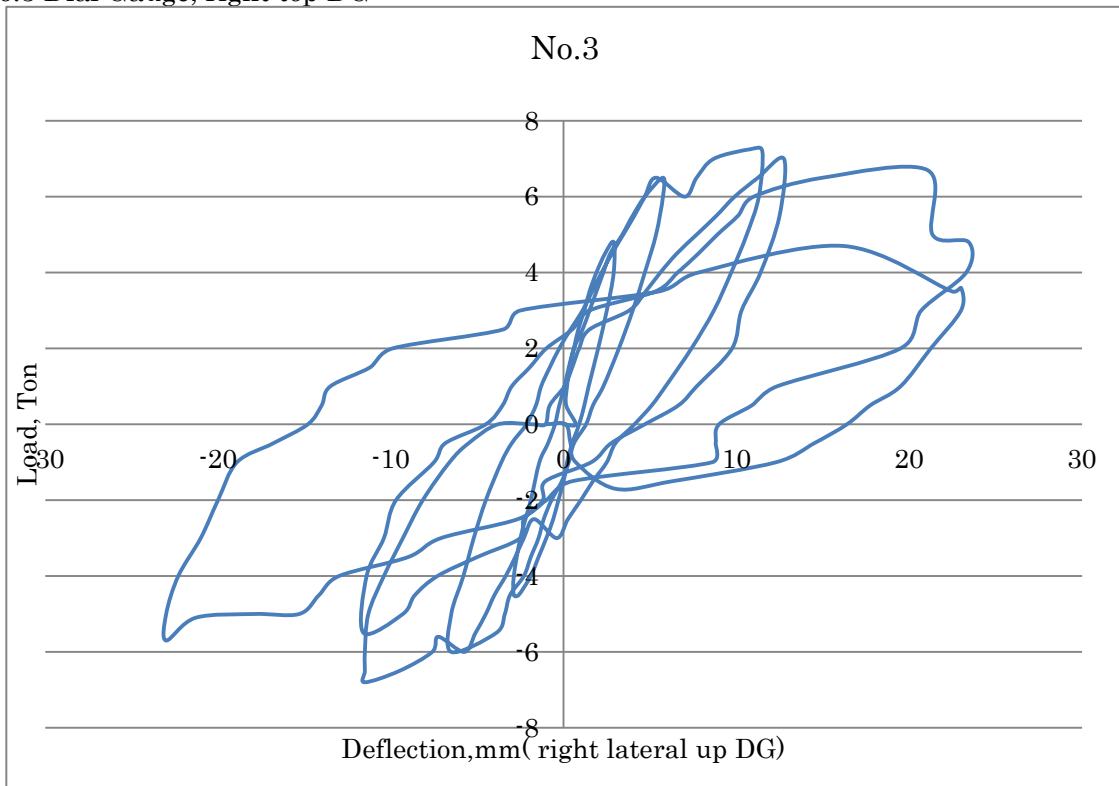

Specimen No.4 (Strong beam, plain main bar with lap joint, brick wall with thickness equivalent to single layer, axial force ratio of column 0.43), loading on 5 December 2012.

Height of brick standing wall is 3/4 of clear height (top of beam to beam dimension), 760mm. thickness of wall is 60mm including mortar, and 50~55mm excluding finishing mortar, which is 0.4 times column width.

Initial stiffness ; 1.0ton/0.2mm=5 .0 ton/mm

R (story deflection angle = story deflection/ story height)= $\delta / h < 1/400$, 1st cycle, $\delta < 2.88\text{mm}$

Two diagonal cracks (shear cracks) were observed on top of left column at 1st positive loading. Cracks on standing wall observed.



R<1/200 ($\delta < 5.75\text{mm}$), 2nd cycle,

Detachment of finishing mortar on brick standing wall started.



R<1/100 ($\delta < 11.5\text{mm}$), 3rd, 4th cycle,

Vertical crack occurred at lower part of left column at positive loading. Diagonal cracks (shear cracks) were observed on top of right column at positive and negative loading. Flexural cracks at the bottom of right column.



Structural Test by CNCRP

R<1/50 ($\delta < 23\text{mm}$), 5th cycle.

Compressive failure of covering concrete at external side of left column started. Enlargement of vertical crack on left column was observed at negative loading.

R<1/50 ($\delta < 23\text{mm}$), 6th cycle.

Shear failure of left column occurred during positive loading at deflection angle 1/100, with loading of 4 ton. Brick standing wall was almost collapsed with upward movement at the center.



R<1/25 ($\delta < 46\text{mm}$), 7th cycle,

Vertical load carrying capacity of left column reduced from 16ton to 8 ton at horizontal deflection of 30mm and horizontal load 3.5 ton. Vertical load was release ton zero at 35mm/ 2.0ton. Shear cracks were observed for right column but no shear failure was observed.



Upper of left column



lower of left column

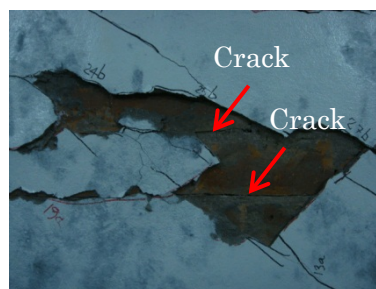

Horizontal crack of mortar joints

Structural Test by CNCRP



No. 4, load- deflection curve (reading value of hydraulic jacks and dial gauge)

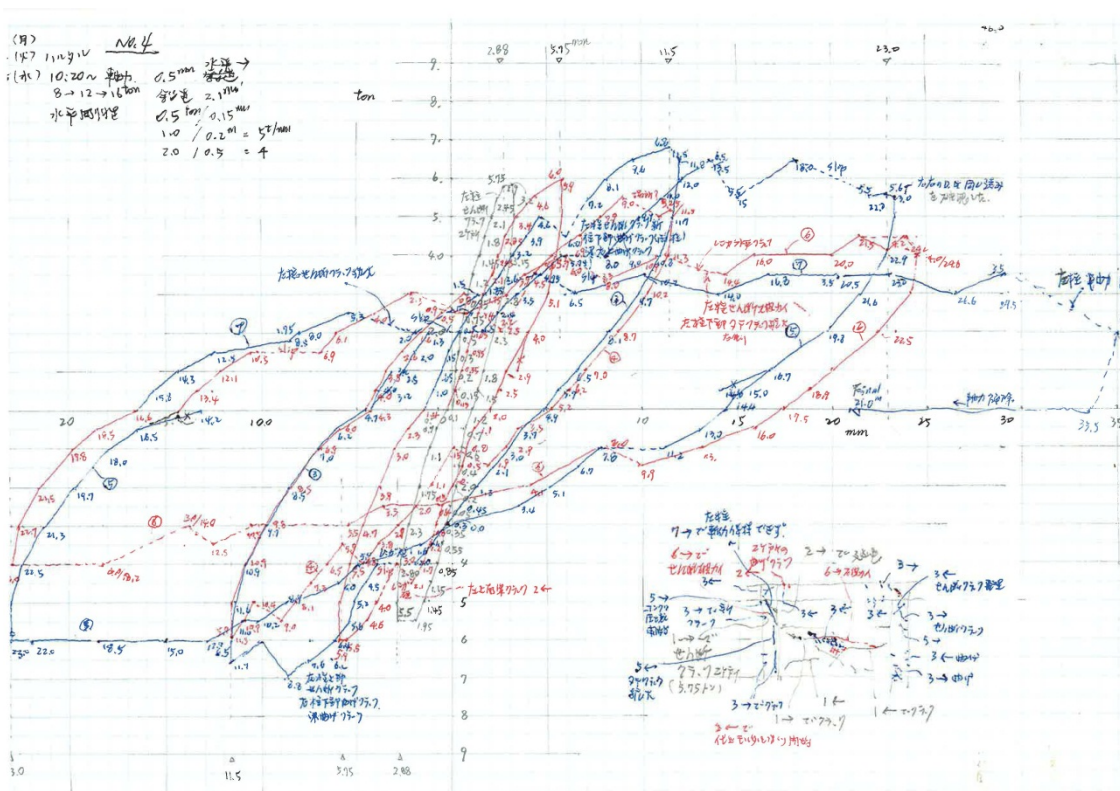

No.4, simplified load-deflection curve covering peak values (vertical load, ton, horizontal axis, mm)

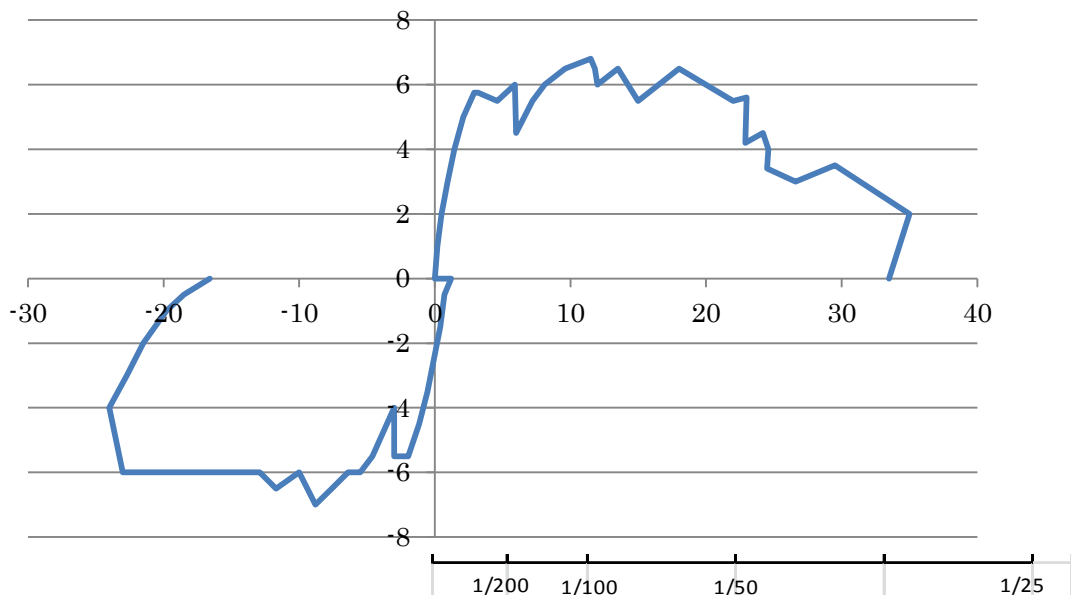

Structural Test by CNCRP

No.4

Deflection; average of 4 no's DT

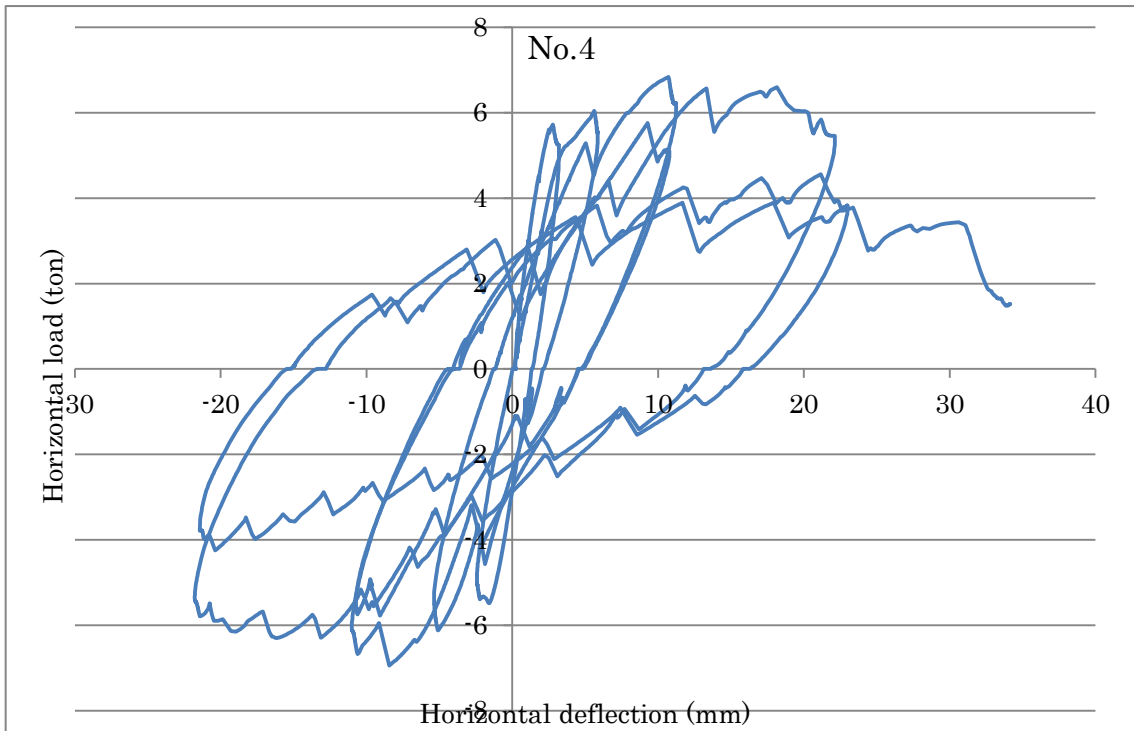

Dial gauge, right top DG

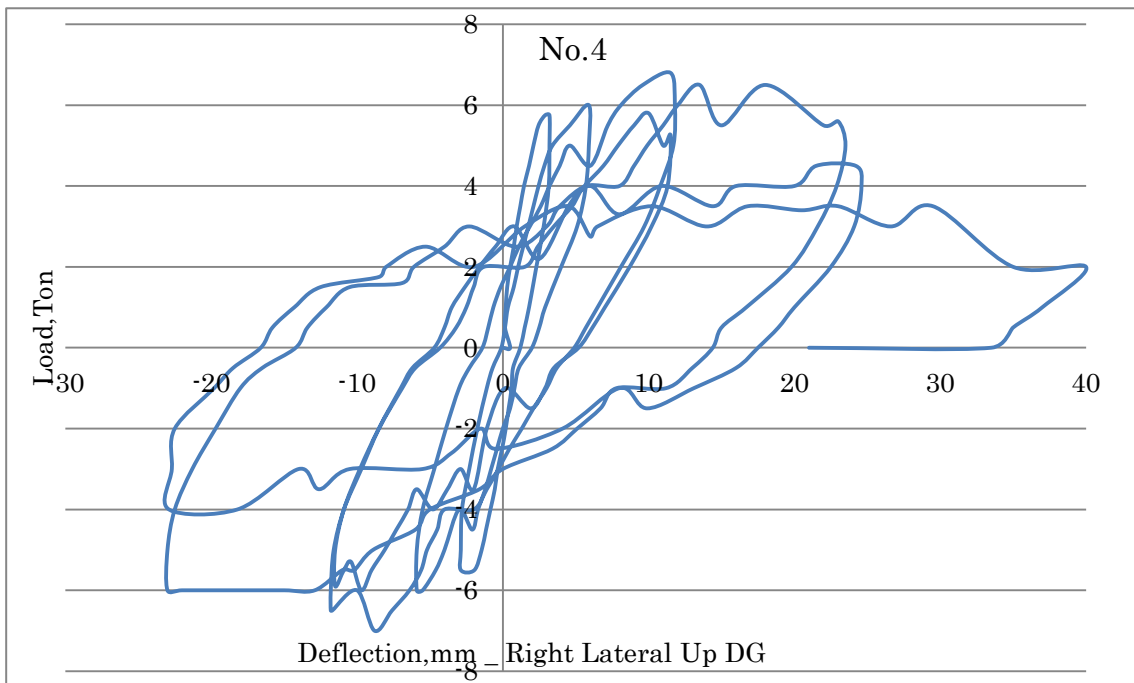

Specimen No.5

(standard beam, plain main bar with lap joint, axial force ratio 0.43)

It is supposed that concrete strength of specimen no. 5 was high. If the concrete strength is $F_c=18.3\text{Mpa}$, then axial force ratio (N/bdF_c) is 0.389. This will help to increase the ductility related to the axial force ratio in spite of original plan of the experiment.

Behavior

R (story deflection angle = story deflection/ story height)= $\delta / h < 1/200$, $\delta < 5.75\text{mm}$, 2nd cycle, Flexural cracks on beam, shear crack on the left side of beam, bottom of left column observed.

$R < 1/100$ ($\delta < 11.5\text{mm}$), 4th cycle

Increase of flexural cracks on beam, shear crack on the left side of beam, bottom of left column observed. Vertical crack at the bottom of column, diagonal crack of left panel area (beam column joint), diagonal crack at the bottom of column were observed.

$R < 1/50$ ($\delta < 23.0\text{mm}$), 6th cycle

Diagonal crack at the top of column, diagonal crack at the top of column and panel area, flexural crack at the top of right column, diagonal crack at the bottom of column were observed. Failure of covering concrete at the bottom of column started.

$R < 1/25$ ($\delta < 46\text{mm}$), 7th cycle

Detachment of covering concrete at the bottom of column, extension of split (vertical) crack at the bottom of column, compressive failure of covering concrete, enlargement of flexural crack and shear crack at the top of column, extension of flexural crack on beam were observed.

Figures are shown below.

$R < 1/25$

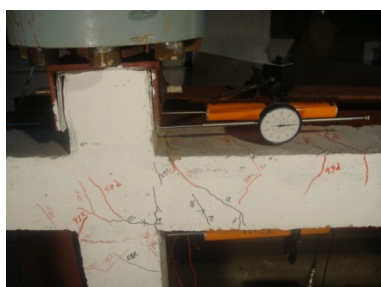



Specimen No.5, Concrete cracks and failure of covering concrete



Cracks above beam, crack width on left side is big, but right side is small.

Crack beneath beam, left side is 0.15mm, and right side is small.

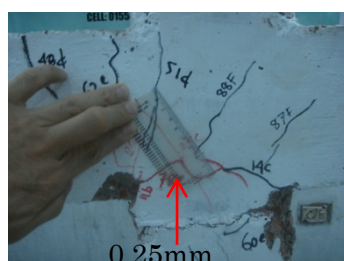
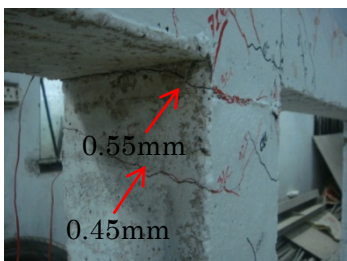

Left column, cracks on upper part Right column, cracks on upper part and panel area, 0.25mm

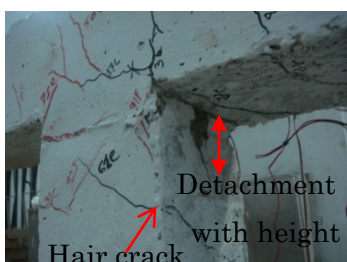

Left column, compressive failure at the top Right column, detachment and compressive failure

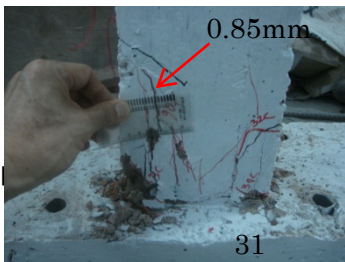
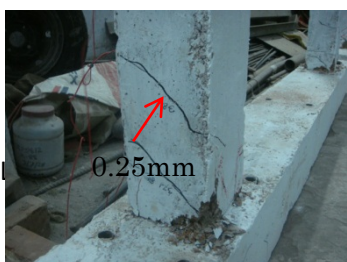

Structural Test by CNCRP

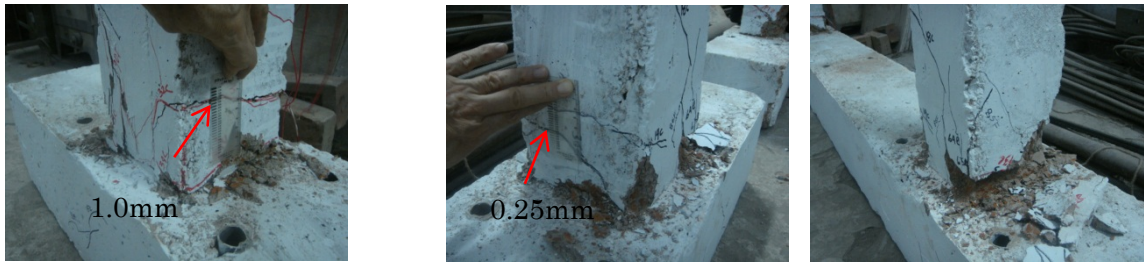

Left column, flexural crack 1.0mm Right column, flexural crack 0.25mm and compressive failure

No. 5, load- deflection curve (reading value of hydraulic jacks and dial gauge)

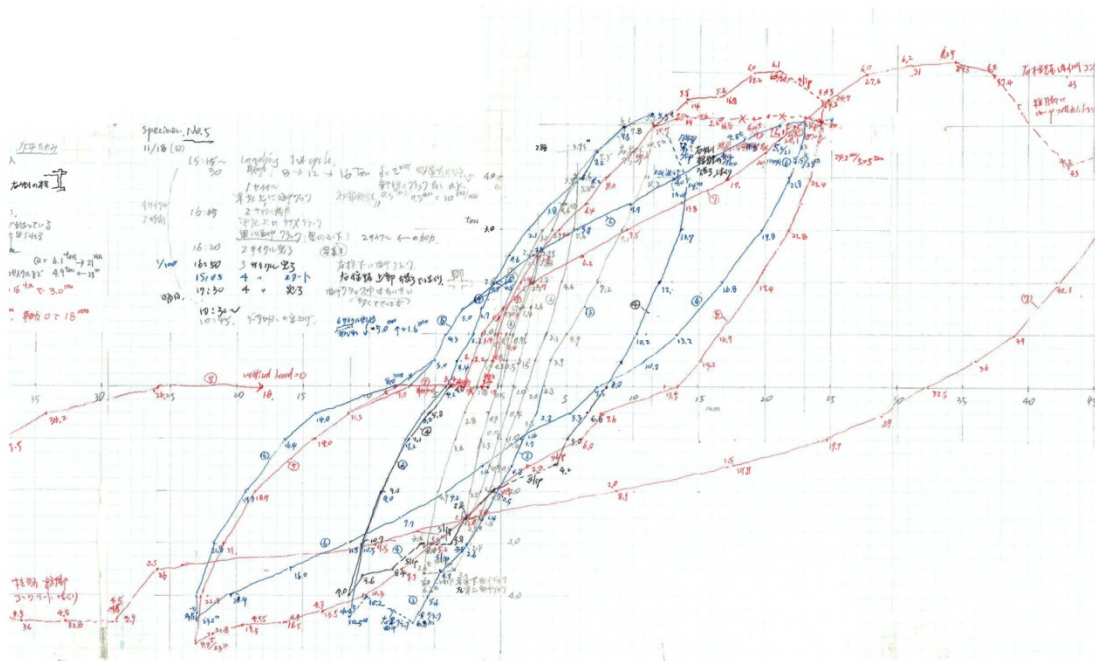

1

No.5, Simplified load-deflection curve covering peak values (vertical load; ton, horizontal axis; mm)

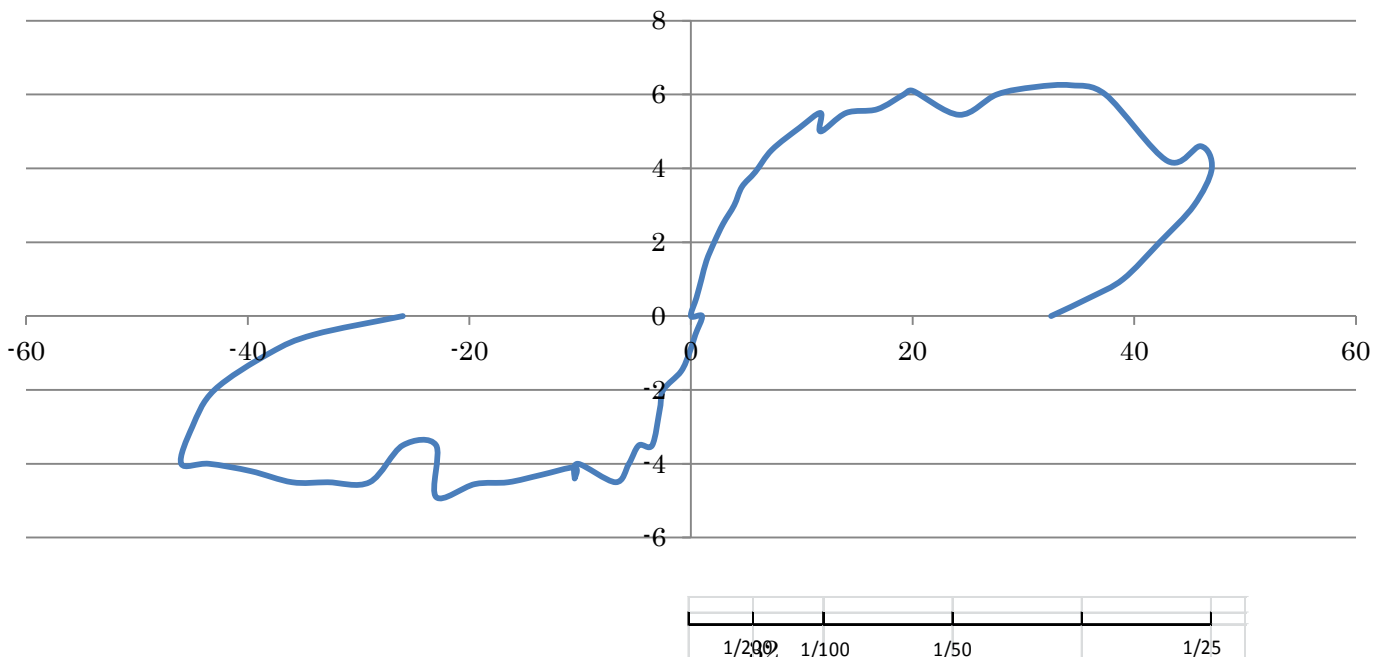

Structural Test by CNCRP

No.5 Average of top 2 DT, gap of data at raw 12,094, data till 13,281 are used?

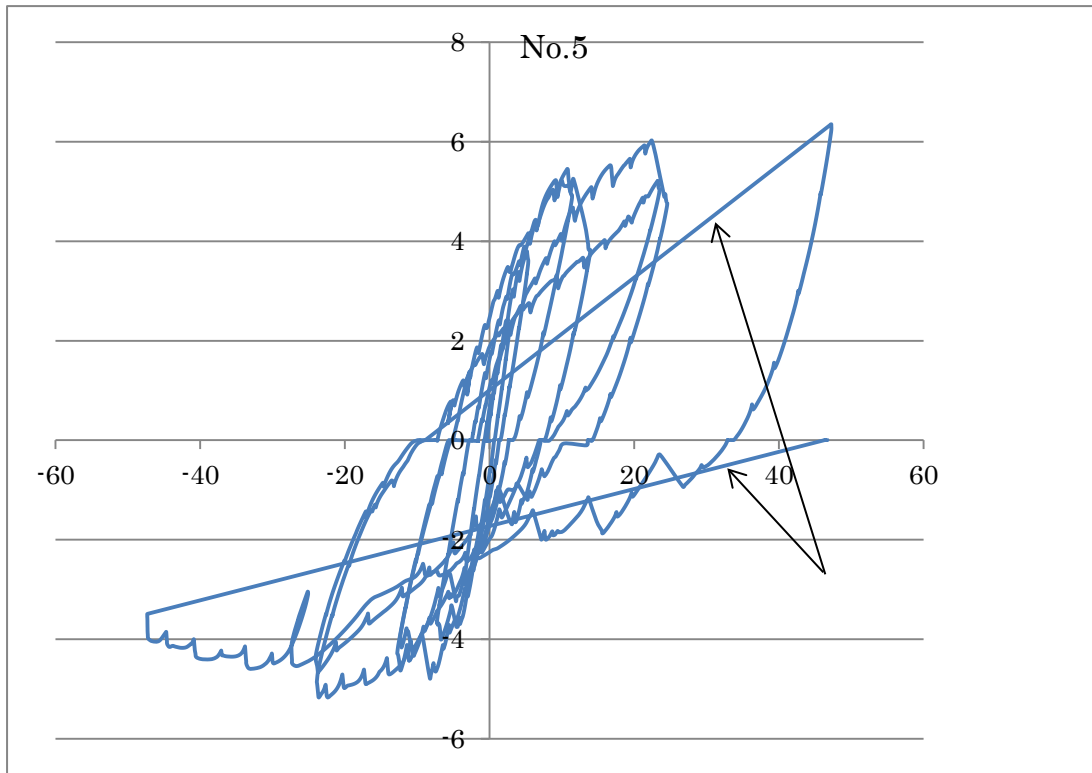

No.5, Dial gauge (right up DG) -hydraulic jack

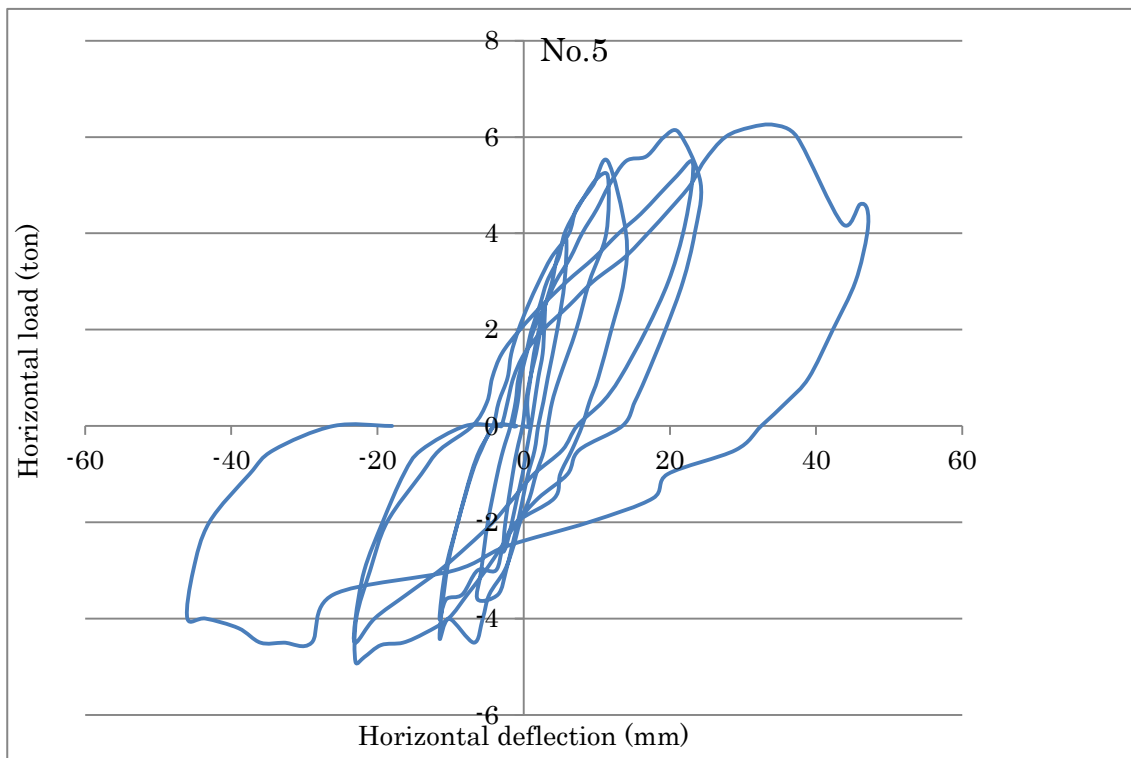

Specimen No.6 (Standard beam, plain main-bar without lap joint, axial force ratio 0.43)

Behavior

R (story deflection angle = story deflection/ story height)= $\delta / h < 1/200$, $\delta < 5.75\text{mm}$, 2nd cycle,
 Flexural cracks on side of beam, (main reason will be shortage of concrete cover of stirrups).

R < 1/100 ($\delta < 11.5\text{mm}$), 4th cycle

Flexural cracks and shear crack on beam, vertical crack at the bottom of column observed.

R < 1/50 ($\delta < 23.0\text{mm}$), 6th cycle

Compressive failure of covering concrete at the top of column started, enlargement of flexural crack on top of concrete and beam, compressive failure at the bottom of left column and right column.

R < 1/25 ($\delta < 46\text{mm}$), 7th cycle

Detachment of covering concrete at top of column, enlargement of split crack at the bottom of column, enlargement of flexural crack at the top of column, compressive failure of covering concrete at the top of column.

After R=1/100, 4th cycle and

R=1/50, 6th cycle, bottom of left column



After R=1/25, 7th cycle

shear crack, width 1.2mm



Detachment of covering concrete

Compressive failure of covering concrete



Bottom of left column (force toward out of plane?)

bottom of right column

No. 6, load- deflection curve (reading value of hydraulic jacks and dial gauge)

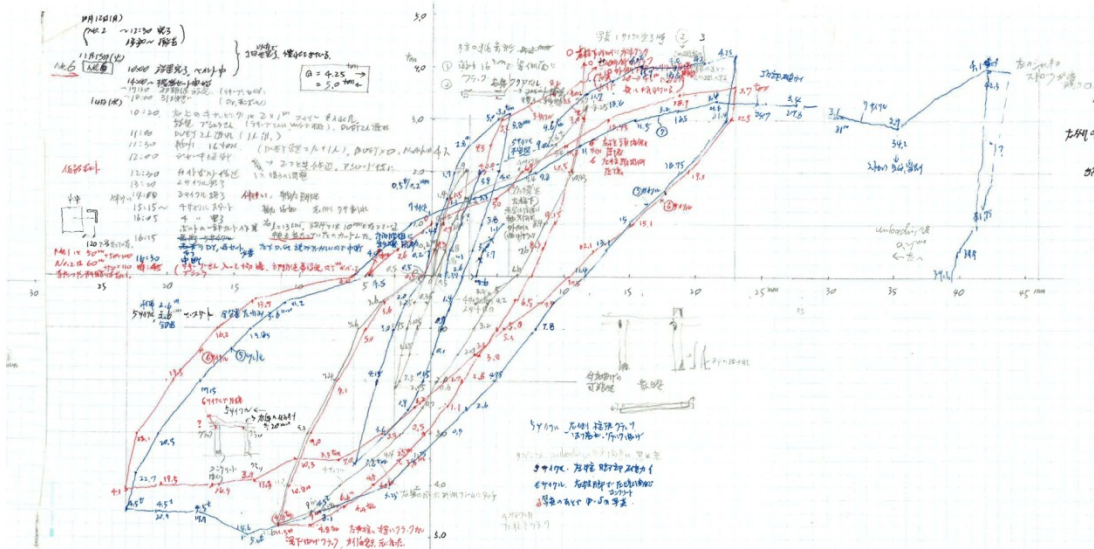

No.6

n)

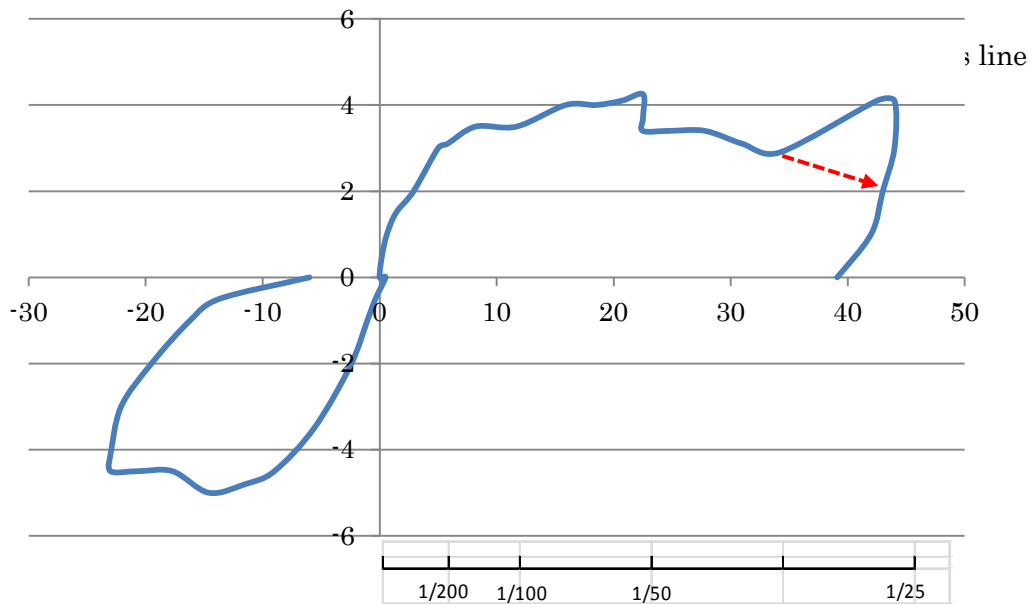

Structural Test by CNCRP

No.6 は、仮設の埋め込みボルトの長さが長く、計測フレームに4サイクルまで接触していた。ボルトをカットした際に計測フレームに振動が生じ、DT、DG の位置がずれ再セットした。

No.6 Average of top 4 DT, center line (vertical axis) moved to left side.

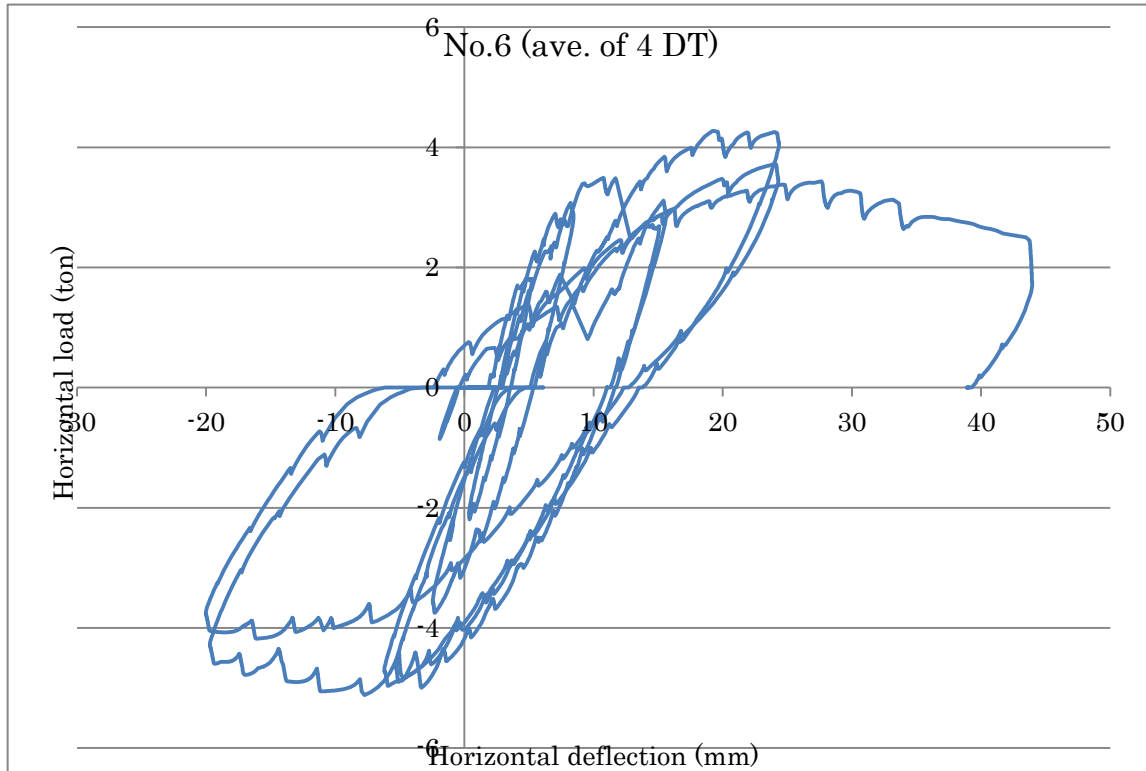

No.6, Dial Gauge (Right up DG)

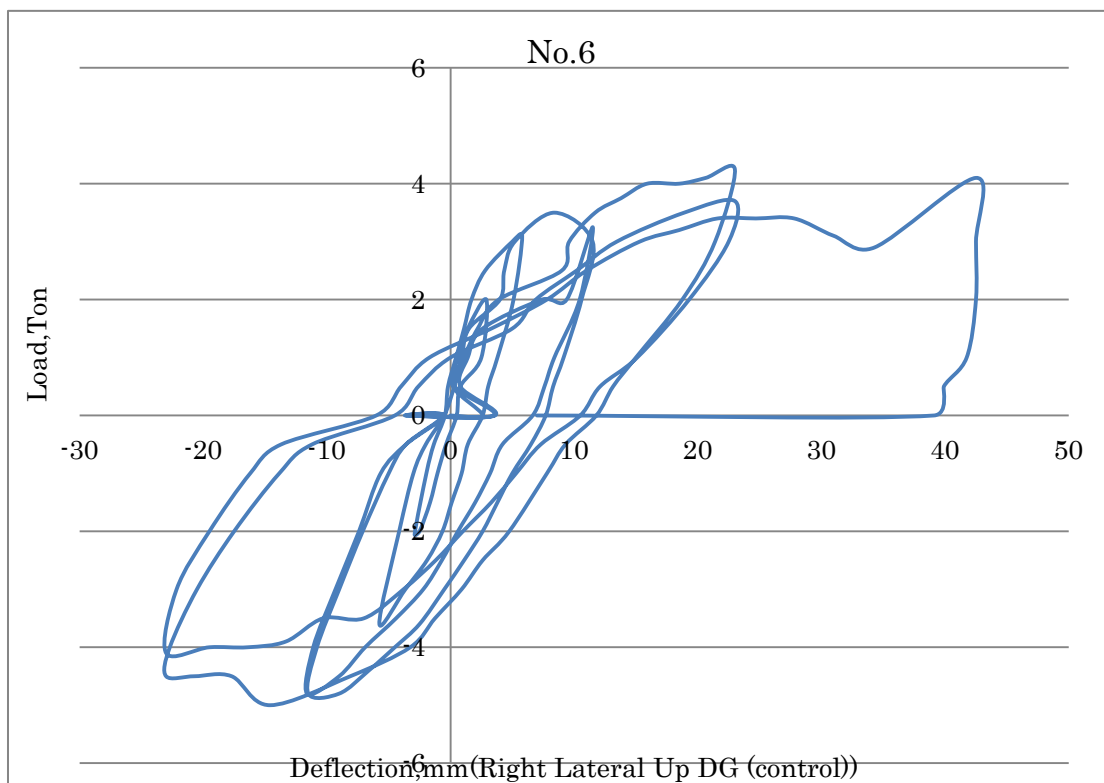

Structural Test by CNCRP

Specimen No.7 (Standard beam, deformed main bar with lap joints, axial force ratio 0.43)

Initial stiffness

$$0.5\text{ton}/0.4\text{mm}=1.25\text{ton}/\text{mm}=12.5\text{kN}/\text{mm}$$

Maximum strength Positive Q=5.0 ton

Negative Q=5.25 ton

Behavior

$$R \text{ (story deflection angle)} = \delta / h < 1/200$$

Cracks on side of beam (main reason will be no concrete cover for stirrups)

$$R < 1/100, (11.5\text{mm})$$

Flexural cracks on beam.

$$R < 1/50, (23.0\text{mm})$$

Flexural cracks on top and bottom of columns, compressive failure for covering concrete at column.

$$R < 1/25, (46\text{mm})$$

Detachment of concrete at bottom of column, enlargement of concrete split at the bottom of column, enlargement of flexural cracks at top of column, compressive failure of covering concrete at the bottom of column.

Movement towards out of plane was 10~15mm.

Specimen after the R<1/25 (46mm), detachment of covering concrete at the bottom of column, split failure at the column.

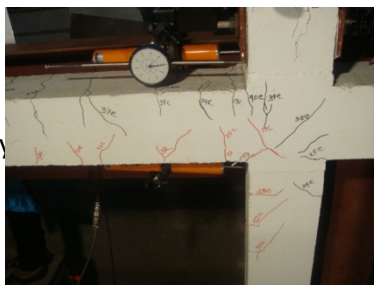
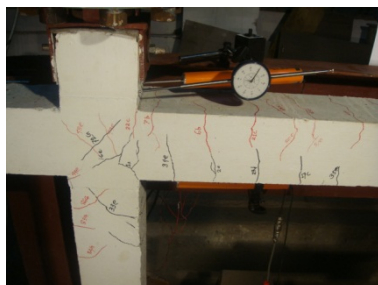

Crack at side of wall caused by

Flexural crack on beam, shear crack at panel area



Compressive failure of covering concrete



Compressive failure of covering concrete and split (vertical crack) failure

No. 7, load- deflection curve (reading value of hydraulic jacks and dial gauge)

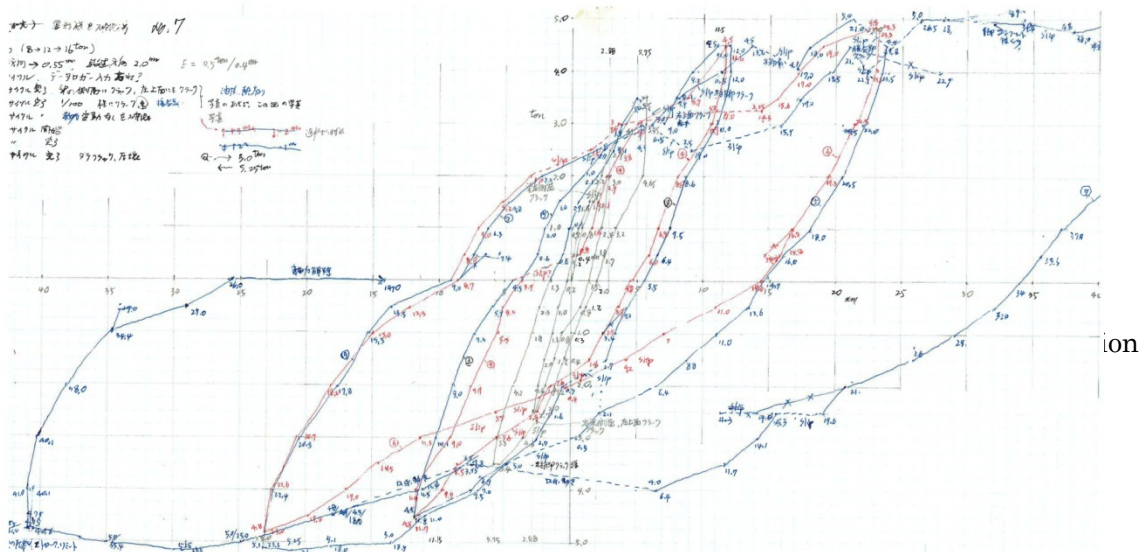

No.7, Simplified Load-deflection curve covering peak values (vertical load; ton, horizontal axis; mm)

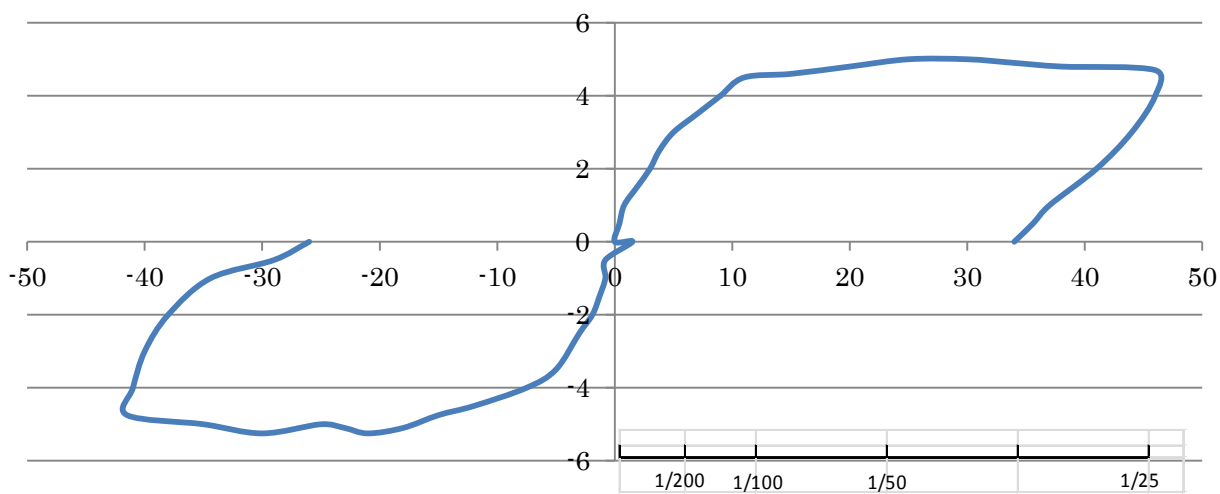

Structural Test by CNCRP

No.7, Average of top 2 DT

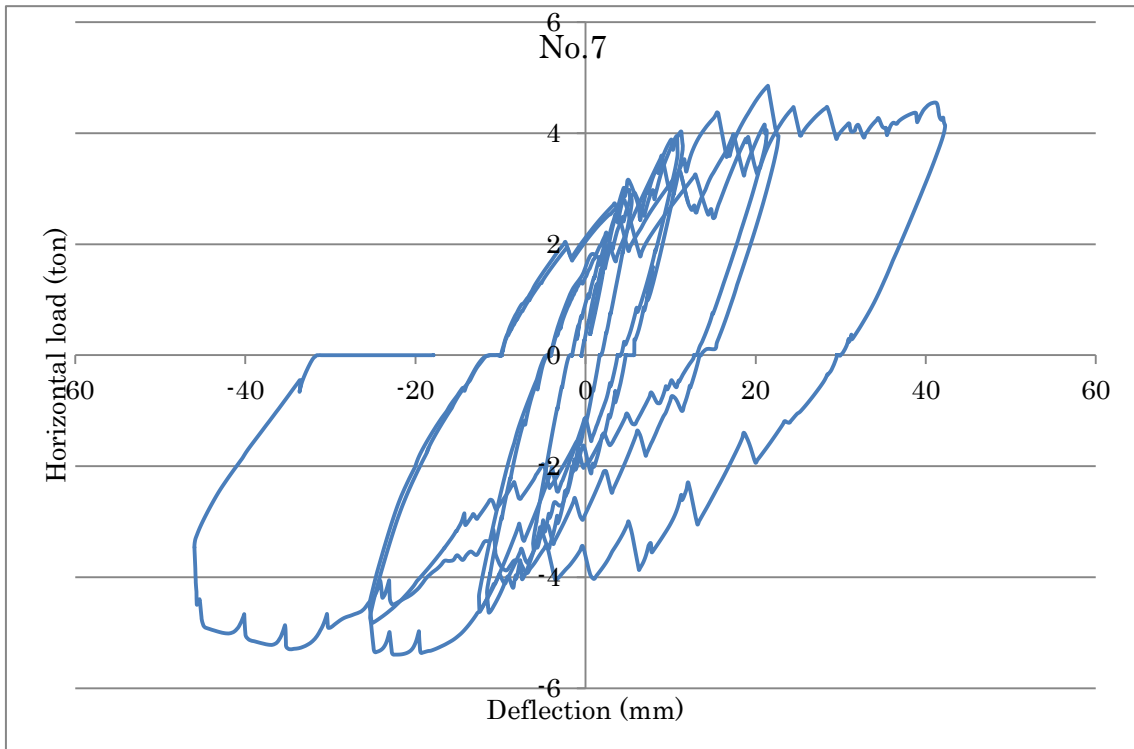

No.7, Dial Gauge, right up DG

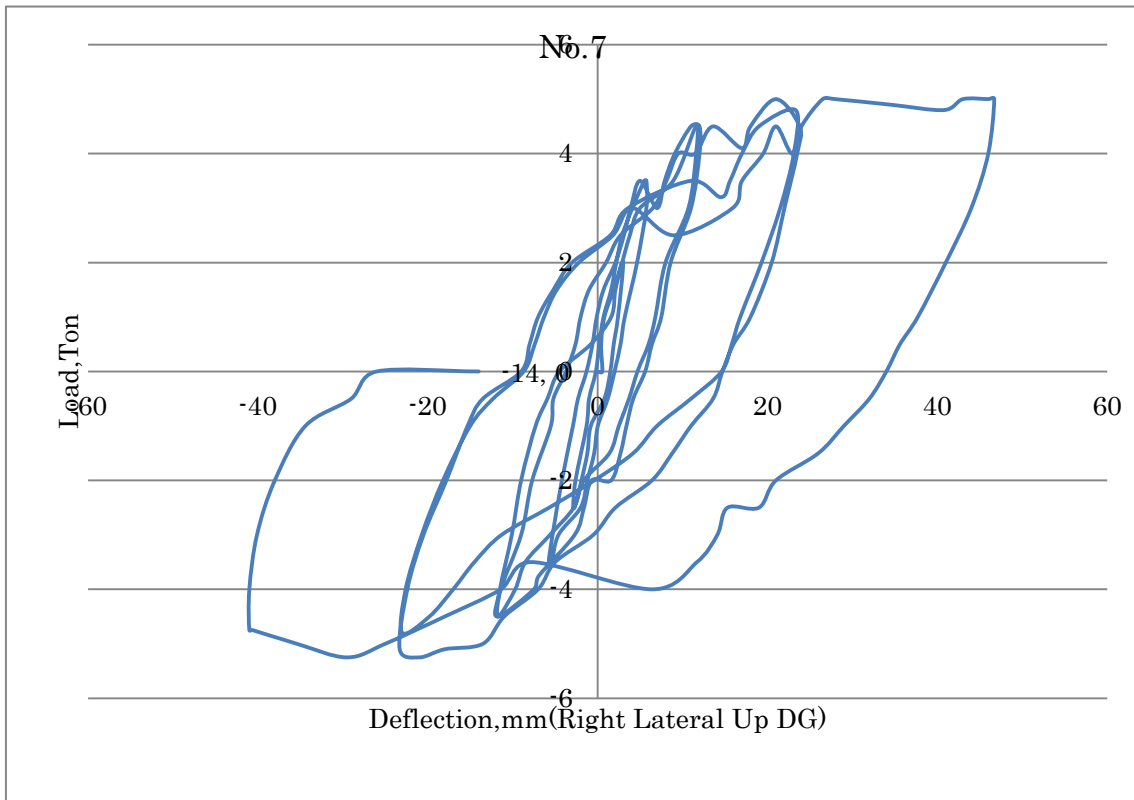

3.4 Material Test

1) Concrete; Specified concrete strength: 12Mpa (12N/mm2)

Design mix

Following trial mix was proposed for 28-day compressive strength of concrete from 1500 psi (10.3N/mm2) to 2000 psi (13.8N/mm2). 1psi = 0.06895n/mm2

Mix No.	Maximum Aggregate Size (mm)	W/C	Sand to aggregate absolute volume ratio	Cement Content (kg/m ³)	Water Content (kg/m ³)	Fine Aggregate Content (kg/m ³)	Coarse Aggregate Content (kg/m ³)	Volumetric Ratio*
1	10	0.65	0.44	260	169	831	814	1:3:3.3
2	10	0.70	0.44	260	182	816	800	1:2.9:3.3
3	10	0.75	0.44	260	195	802	785	1:2.9:3.3

Slump = 100 mm to 175 mm, * Amount of water is to be varied as per specified W/C.

Stress strain relation of 3 types by UAP is shown below.

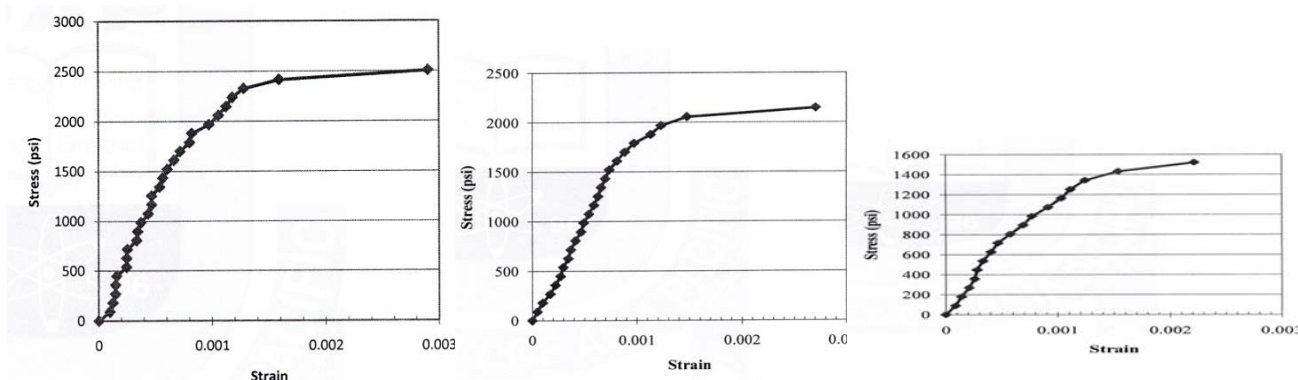

Mix No. 3 was selected to get concrete strength 11~12Mpa.

But actual concrete strength of specimens was 15Mpa for 28 days and 16.5Mpa for 56 days. Main cause of the increase of concrete strength is considered as out of control of water contents of fine aggregate and course aggregate.

Results of concrete strength test

Concrete (Unit: N/mm2) average of three molds

No. of Specimen	Casted date	7days	28days	42days	56days
1, 2	14-Sep	12.0	13.6	**	16.6
5, 6	19-Sep	9.2	**	15.3	16.5
3, 4& 7	25-Sep	9.1	16.5	**	16.1

Schmitt hammer test, result by the formula of Architectural Institute of Japan

Average of 20~40 x 5 times measurements were done at the lower beam, unit; Mpa (N/mm²)

	No.1	No.2	No.3	No.4	No.5	No.6	No.7
Strength	14.9	16.4	16.0	(20.3)	18.3	16.9	16.5

Concrete strength of no.5 is higher than the average and strength of no.1 is lower than the average. Strength of no.4 is measures with the condition of fixing with foundation beam with bolts. No. 3 is measured with horizontal position of the specimen. Others were measures from the side for the lower beam with standing position of specimens.

Cement mortar strength test

Mortar strength for brick standing wall

30Mpa (30days, cylinder equivalent)

5707, 5351, 5024Mpa (Cube) is converted to cylinder, and average is 4,370Mpa (30Mpa, 307kg/cm²)

2) Reinforcing bar

2013/03/04, revised on 03/11

1) Summary of re-bar test in Japan using Bangladesh made re-bar

Re-bar tests of Bangladesh made used for the structural test are summarized as follows.

Re-bars(Unit: N/mm²)、 Specified yield stress of re-bar: 275Mpa (275N/mm²)

Case 1(BUET), yield stress (N/mm²) only shown, there are 5 universal machines at the lab.

	Plain bar 10mm	Plain bar 6mm	Deformed bar 10mm
1	445	490	400
2	480	475	390
3	470	940	390
Average	465 N/mm ²	635 (482 ave. of 1,2)	396 N/mm ²

Note; Ave. Young's modulus was 2.0x10⁵Mpa.

Case 2 (UAP), yield stress (N/mm²) only shown,

	Plain bar 10mm	Plain bar 6mm	Deformed bar 10mm
1	544	297	284
2	284	303	284
3	393	303	284
Average	407 N/mm ²	301 N/mm ²	284 N/mm ²

Note; Yong's modulus test was not done.

Case 3 (Building Material Testing Center, Urawa Japan), 27 February 2013

Bar	No.	Section area (mm ²)(diameter)	Yield stress (N/mm ²)	Tensile stress (N/mm ²)	Elongation %	Yong's modulus X 10 ⁵ N/mm ²
Plain bar 10mm	1	82.0 (10.22)	316	464	26	--
	2	81.2 (10.17)	320	464	33	--

Structural Test by CNCRP

	3	82.2 (10.23)	346	478	30	2.02x10 ⁵
	Ave.	81.8	327	469	29	--
Plain bar 6mm	1	36.1 (6.78)	Not clear	449	24	--
	2	35.5 (6.72)	Not clear	438	18	--
	3	41.4 (7.26)	561	632	--	1.95x10 ⁵
	Ave.	37.7	----	506	(21)	--
Deformed bar 10mm	1	79.0	(391)	569	--	--
	2	79.0	(392)	526	24	--
	3	79.0	379 (0.2%)	542	21	1.89x10 ⁵
	Ave.	79.0 (nominal)	(387)	546	(22)	--

Note;

- 1) Young's modulus was measured by providing strain gauge for No. 3 of each type.
- 2) Plain bar 6mm, clear yield stress of No.1 and No.2 of plain bar 6mm was not observed. Yield stress of No.3 was bigger than tensile stress of No.1 and no.2, and material grade seems different from that of No.1 and No. 2. It is supposed that yield stress will be 0.65 times 444 (ave. tensile stress of No.1 and No.2) is 289 N/mm²
- 3) Deformed bar 10mm; Lot of No. 1 and No.2, No.3 might be different, because shape of rib is different.
- 4) Deformed bar 10mm; Clear yield stress was not observed and stress of 0.2% strain was used for No.3. Yield stress of No.1 and No.2 are also shown with parenthesis as reference information.
- 5) Elongation is shown, but the specimen that the fracture occurred at outside of the measurement points is not shown.

Stress-strain curve, Urawa building material lab. in Japan



図-1 応力-ひずみ曲線 (φ6mm)



図-3 応力-ひずみ曲線 (D10)

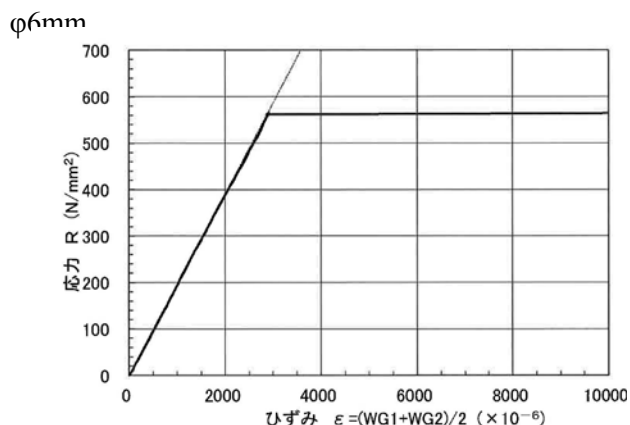

2) Re-bar tensile test in Japan and Bangladesh for Japanese made re-bar 2013/05/15

1: Building material testing center, Urawa branch, Japan 浦和建材試験所

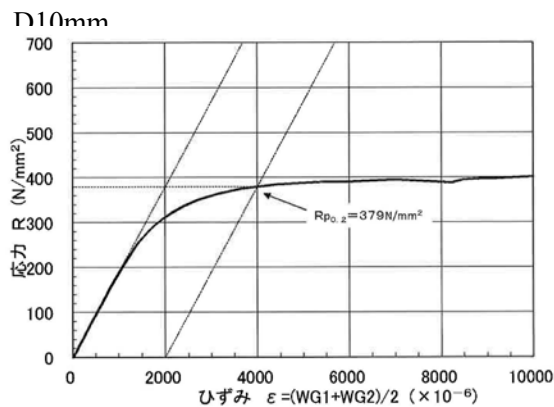
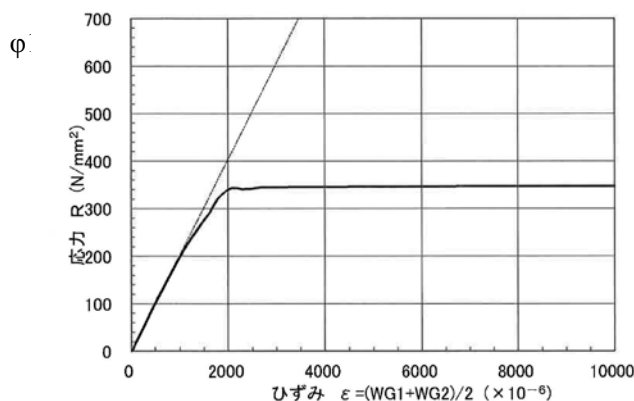
Date: 18 January 2013

Contents:

Re-bar: SD295A, diameter 10mm, nominal area A= 71.33mm², weight w=0.560kg/m

Modulus of elasticity was measured through provided strain gauges.

Result:

	Yong's modulus (N/mm ²)	Yield load (kN)	Yield stress (N/mm ²)	Tensile load (kN)	Tensile stress (N/mm ²)	Elongation (%)
No. 1	----	27.6	387	36.4	510	29
No. 2	----	26.8	376	36.2	508	29
No. 3	1.94 x 10 ⁵	26.7	374	36.4	510	27
Average	----(100%)	27.0(100%)	379	36.3(100%)	509	28(100%)

- 1) 1,000kN capacity automatic universal testing machine (Maekawa manufacturing). Maintenance of a machine is done annually by the maker. 1st class level is maintained.
- 2) Data-logger is used for elastic modulus to get data from strain gauges on re-bar.
- 3) Elongation is measured by a Nogisu.

Stress-strain curve is as follow;



図-1 応力-ひずみ曲線

2.BUET, Date; 24 Jan 2013. It is noted that there are 5 universal machines at the lab.

	Yong's modulus (N/mm ²)	Yield load (kN)	Yield stress (N/mm ²)	Ultimate load (kN)	Ultimate stress (N/mm ²)	Elongation (%)
No. 1	1.98 x 10 ⁵	26.0	330	36.0	450	32
No. 2	1.98 x 10 ⁵	26.7	340	36.0	450	34
No. 3	2.02 x 10 ⁵	26.3	335	35.0	450	32
Average	1.99 x 10 ⁵ (103%)	26.3(97%)	335	35.7(98%)	450	33(118%)

Actual diameter, 9.35mm is shown. Strain is measured based on 200mm gauge length.

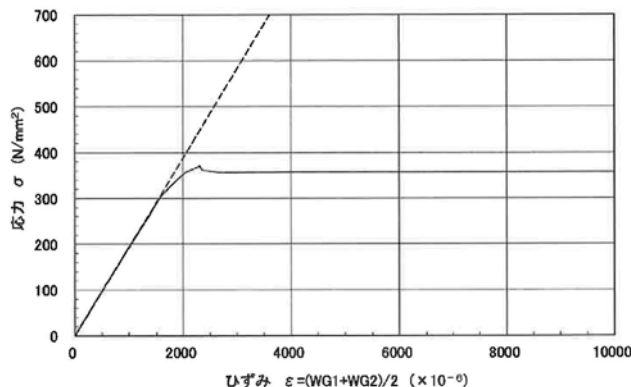
Structural Test by CNCRP

Unit weight; 0.539kg/m (96% of the measurement in Japan)

Section area; 78.9mm² (No.1), 78.5mm² (No.2), 78.5mm² (No.3), are calculated from yield load and yield stress. Nominal area of 79mm² is shown in the test report. 71.33m² is the nominal area of SD295A.

Load is compared with others, and not stress, since used section area was different.

Stress-strain curve by BUET is shown;

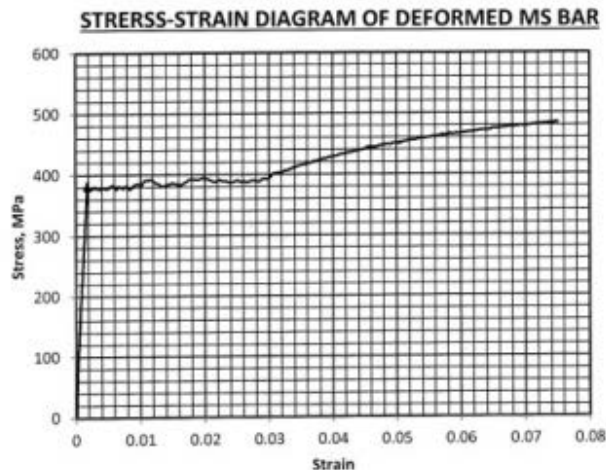

3. UAP, Date; 30 Jan 2013

	Yong's modulus (N/mm ²)	Yield load (kN)	Yield stress (N/mm ²)	Ultimate load (kN)	Ultimate stress (N/mm ²)	Elongation (%)
No. 1	--	19	271	33	462	25
No. 2	--	19	271	31	434	24
No. 3	--	23	325	34	475	24
Average	---	20(75%)	289	33(90%)	457	24(86%)

Measured actual diameter 9.50mm is shown.

Stress-strain test was not executed, because equipment is under repair.

4. HBRI (Housing and Building Research Institute), Date; 18 April 2013. Stress is compared.

	Yong's modulus (N/mm ²)	Yield load (kN)	Yield stress (N/mm ²)	Ultimate load (kN)	Ultimate stress (N/mm ²)	Elongation (%)
No. 1	--	28.9	368.	37.8	482	21.9
No. 2	--	29.4	374	38.1	485	22.5
No. 3	--	27.9	355	38.0	484	19.5
Average	---	28.7(106%)	365	38.0(105%)	483	21.3(76%)

Stress was converted to load using section area of 78.5mm² (10mmRB) shown in the test report. A=71.3mm² (D10) .

3.5 Consideration

1) Evaluation of maximum strength

(1) Comparison of experimental result and analysis (unit; ton)

Observed maximum load for positive and negative loading are compared with the calculated strength as shown.

Specimen no. (date)	Experimental load, Qe (ton)			Analytical strength at collapse mechanism, Qa (ton)			
	Positive loading	Negative loading	Average	Calculated strength, Qa	Qe(posi.) /Qa	Qe(nega.) /Qa	Note
1 (11/5,6)	4.62	4.70	4.66	5.22 (5.16)	0.89 (0.89)	0.91 (0.91)	Strong beam (in case Fc14.9)
2 (11/10,11,12)	4.83	4.57	4.70	5.77	0.84	0.79	Strong beam
3 (11/27,28)	7.34	6.97	7.16	3.42(shear) +2.93=6.35	1.15	1.09	Strong beam with brick wall
4 (12/4)	6.84	6.94	6.89	(6.35)	(1.08)	(1.09)	Supposed same to No.3
5 (11/18,19,20)	6.35	5.17	5.76	4.42 (4.63)	1.44 (1.37)	1.17 (1.12)	Standard beam (in case Fc18.5)
6 (11/14,15)	4.28	5.12	4.70	4.42	0.97	1.16	Standard beam
7 (11/24)	4.75	5.32	5.04	4.98	0.95	1.07	Deformed bar

Conditions of strength calculation:

- Strength at collapse mechanism is calculated using concrete strength of 16.5Mpa, and re-bar yield stress of, 327N/mm² for plain bar 10mm,
289 N/mm² for plain bar 6mm, and
387 N/mm² for deformed bar 10mm
- Provided axial load is 8 ton for No.1, 12 ton for No.2, and 16 ton for No. 3 to No. 7
- Column collapse mechanism is supposed for columns of No.1 and No.2, which is strong beam type.
- Column collapse mechanism is supposed for No.3 and No.4. Clear span of left column is supposed as 500mm and right column is 1,000mm. Shear strength is 3.42ton/column for left column of No. 3 is smaller than shear force at flexural strength 4.40 ton in case clear span length is 500mm. 3.42 (left column) plus 2.93 (right column) is 6.35 ton.
- Column collapse at the bottom and beam collapse at the top of frame is supposed for specimen No. 5, No.6 and no.7.

(2) Supposed collapse mechanism and strength

Supposed collapse mechanism, member and frame strength (Qa) of each specimen are shown below.

Structural Test by CNCRP

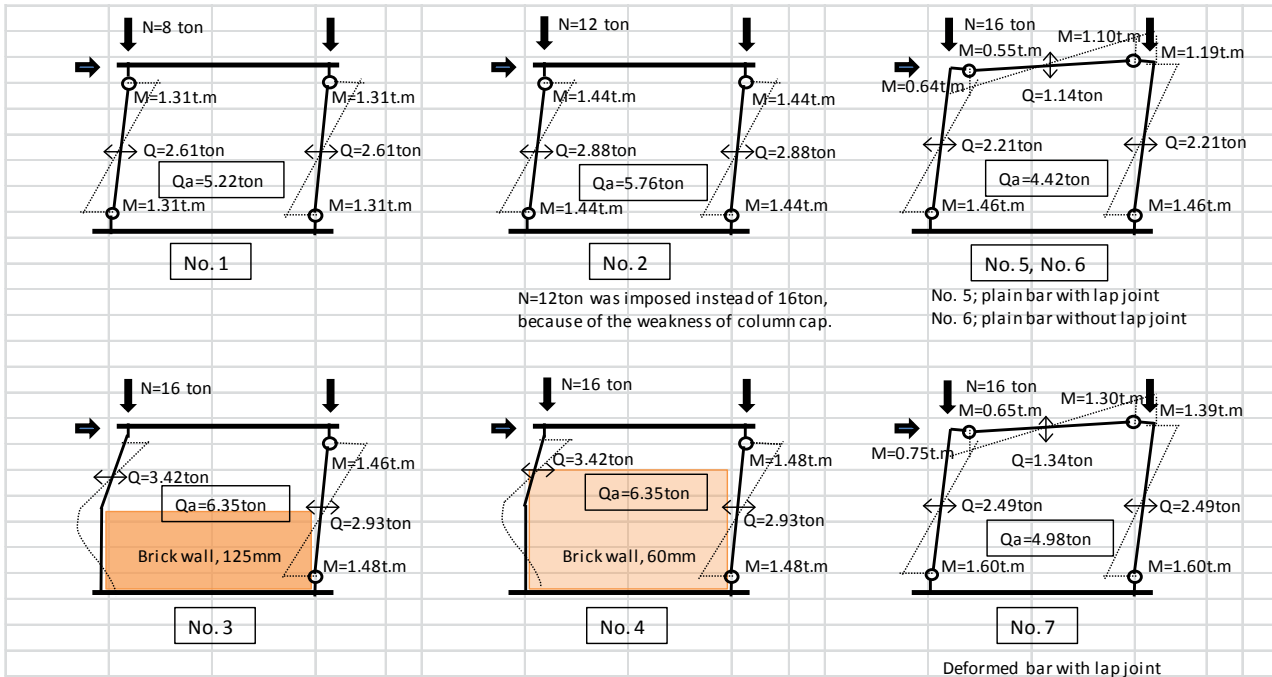

Note; 1ton=9.80kN, 1m=39.4in=3.28ft

Calculated strength is compared with experimental result.

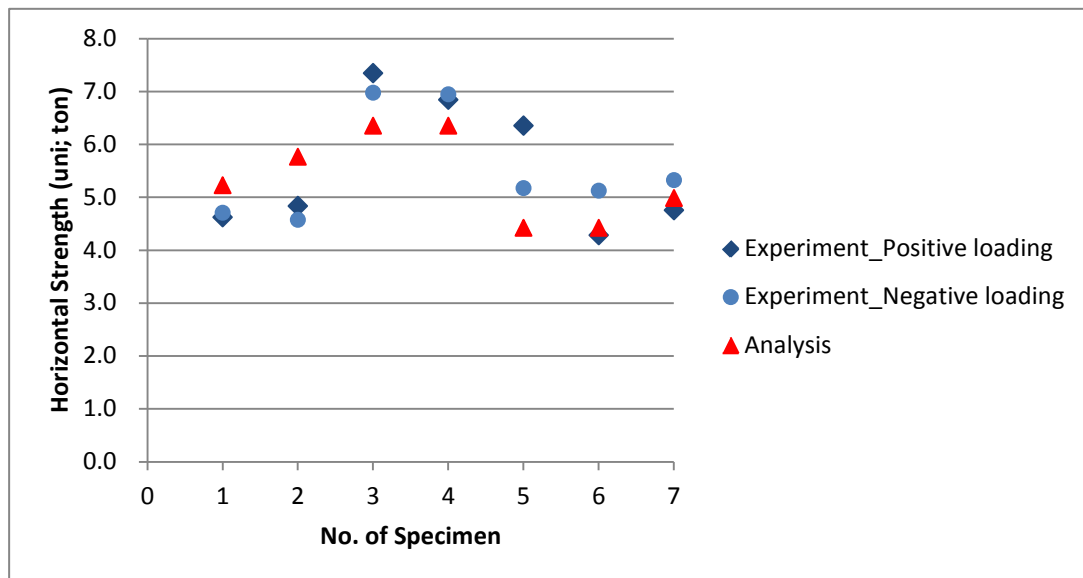

Supposed simplified monotonic load-deflection curve for specimen No.2, No.3 and No.4

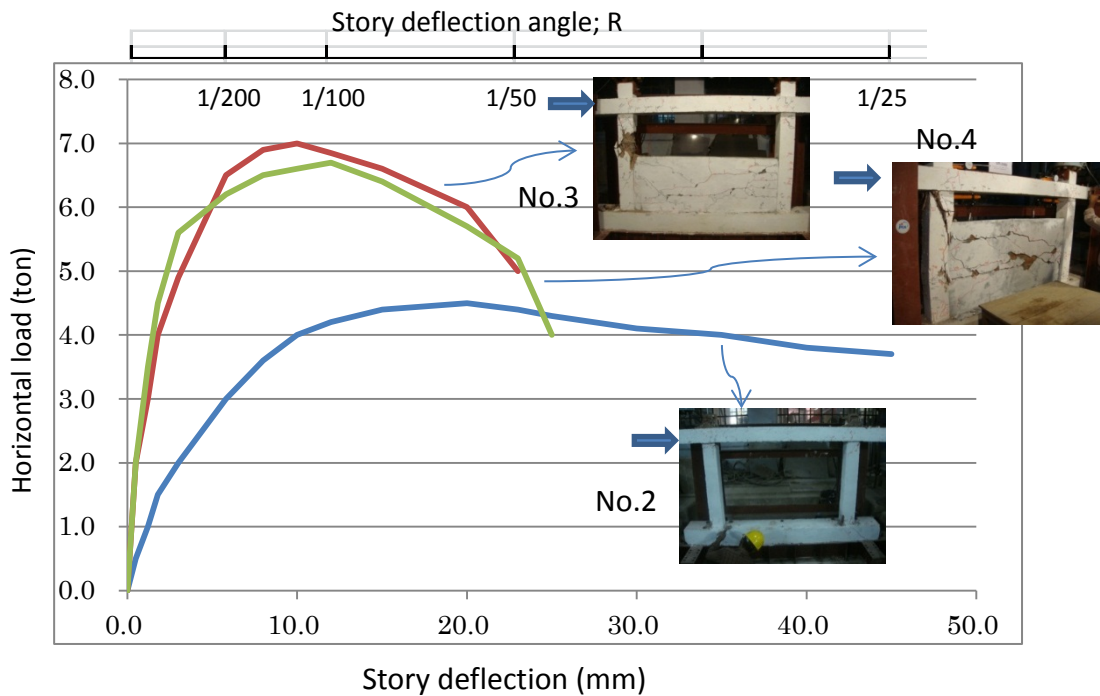

Appendix

Flexural strength (ref.1)

In the following formula, $0.7 \cdot a_t \cdot \sigma_y \cdot D$ was used instead of $0.8 \cdot a_t \cdot \sigma_y \cdot D$, considering the small size of the specimen.

For $N_{max} \geq N > 0.4b \cdot D \cdot F_c$

$$M_u = \left\{ 0.8a_t \cdot \sigma_y \cdot D + 0.12b \cdot D^2 \cdot F_c \right\} \cdot \left(\frac{N_{max} - N}{N_{max} - 0.4b \cdot D \cdot F_c} \right)$$

For $0.4b \cdot D \cdot F_c \geq N > 0$

$$M_u = 0.8a_t \cdot \sigma_y \cdot D + 0.5N \cdot D \cdot \left(1 - \frac{N}{b \cdot D \cdot F_c} \right) \quad (\text{N} \cdot \text{mm})$$

For $0 > N \geq N_{min}$

$$M_u = 0.8a_t \cdot \sigma_y \cdot D + 0.4N \cdot D \quad (\text{A1.1-1})$$

where:

N_{max} = Axial compressive strength = $b \cdot D \cdot F_c + a_g \cdot \sigma_y$ (N).

N_{min} = Axial tensile strength = $-a_g \cdot \sigma_y$ (N).

N = Axial force (N).

a_t = Total cross sectional area of tensile reinforcing bars (mm^2).

a_g = Total cross sectional area of reinforcing bars (mm^2).

b = Column width (mm).

D = Column depth (mm).

σ_y = Yield strength of reinforcing bars (N/mm^2).

F_c = Compressive strength of concrete (N/mm^2).

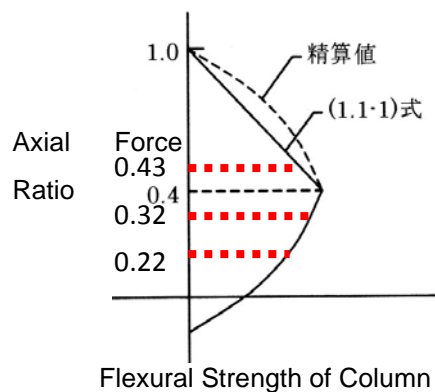

Shear strength of column (ref.1)

$$Q_{su} = \left\{ \frac{0.053 p_t^{0.23} (18 + F_c)}{M/(Q \cdot d) + 0.12} + 0.85 \sqrt{p_w \cdot s \cdot \sigma_{wy}} + 0.1 \sigma_0 \right\} \cdot b \cdot j \quad (\text{N}) \quad (\text{A1.1-2})$$

where:

- p_t = Tensile reinforcement ratio (%).
- p_w = Shear reinforcement ratio, $p_w = 0.012$ for $p_w \geq 0.012$.
- $s \cdot \sigma_{wy}$ = Yield strength of shear reinforcing bars (N/mm^2).
- σ_0 = Axial stress in column (N/mm^2).
- d = Effective depth of column. $D-50\text{mm}$ may be applied.
- $\frac{M}{Q}$ = Shear span length. Default value is $\frac{h_0}{2}$.
- h_0 = Clear height of the column.
- j = Distance between centroids of tension and compression forces, default value is $0.8D$.

(b) If the value of $M/(Q \cdot d)$ is less than unity or greater than 3, the value of $M/(Q \cdot d)$ shall be unity or 3 respectively in using Eq. (A1.1-2). And if the value of σ_0 is greater than $8\text{N}/\text{mm}^2$, the value of σ_0 shall be $8\text{N}/\text{mm}^2$ in using Eq. (A1.1-2).