

DEPARTMENT OF TRANSPORTATION AND COMMUNICATIONS (DOTC)
REPUBLIC OF THE PHILIPPINES

**THE SUPPLEMENTARY SURVEY
ON
NORTH SOUTH COMMUTER RAIL PROJECT
(PHASE II-A)
IN
THE REPUBLIC OF THE PHILIPPINES

FINAL REPORT**

NOVEMBER 2015

JAPAN INTERNATIONAL COOPERATION AGENCY

ORIENTAL CONSULTANTS GLOBAL CO., LTD.

ALMEC CORPORATION

KATAHIRA & ENGINEERS INTERNATIONAL

TOSTEMS, INC.

1 R
CR(3)
15-045

**DEPARTMENT OF TRANSPORTATION AND COMMUNICATIONS (DOTC)
REPUBLIC OF THE PHILIPPINES**

**THE SUPPLEMENTARY SURVEY
ON
NORTH SOUTH COMMUTER RAIL PROJECT
(PHASE II-A)
IN
THE REPUBLIC OF THE PHILIPPINES**

FINAL REPORT

NOVEMBER 2015

JAPAN INTERNATIONAL COOPERATION AGENCY

ORIENTAL CONSULTANTS GLOBAL CO., LTD.

ALMEC CORPORATION

KATAHIRA & ENGINEERS INTERNATIONAL

TOSTEMS, INC.

Exchange Rate (June 2015)

1 Philippine Pesos (PhP) = Japanese Yen (JpY) 2.72

1 US dollar (US\$) = JpY 120.7

1 US\$ = PhP 44.4

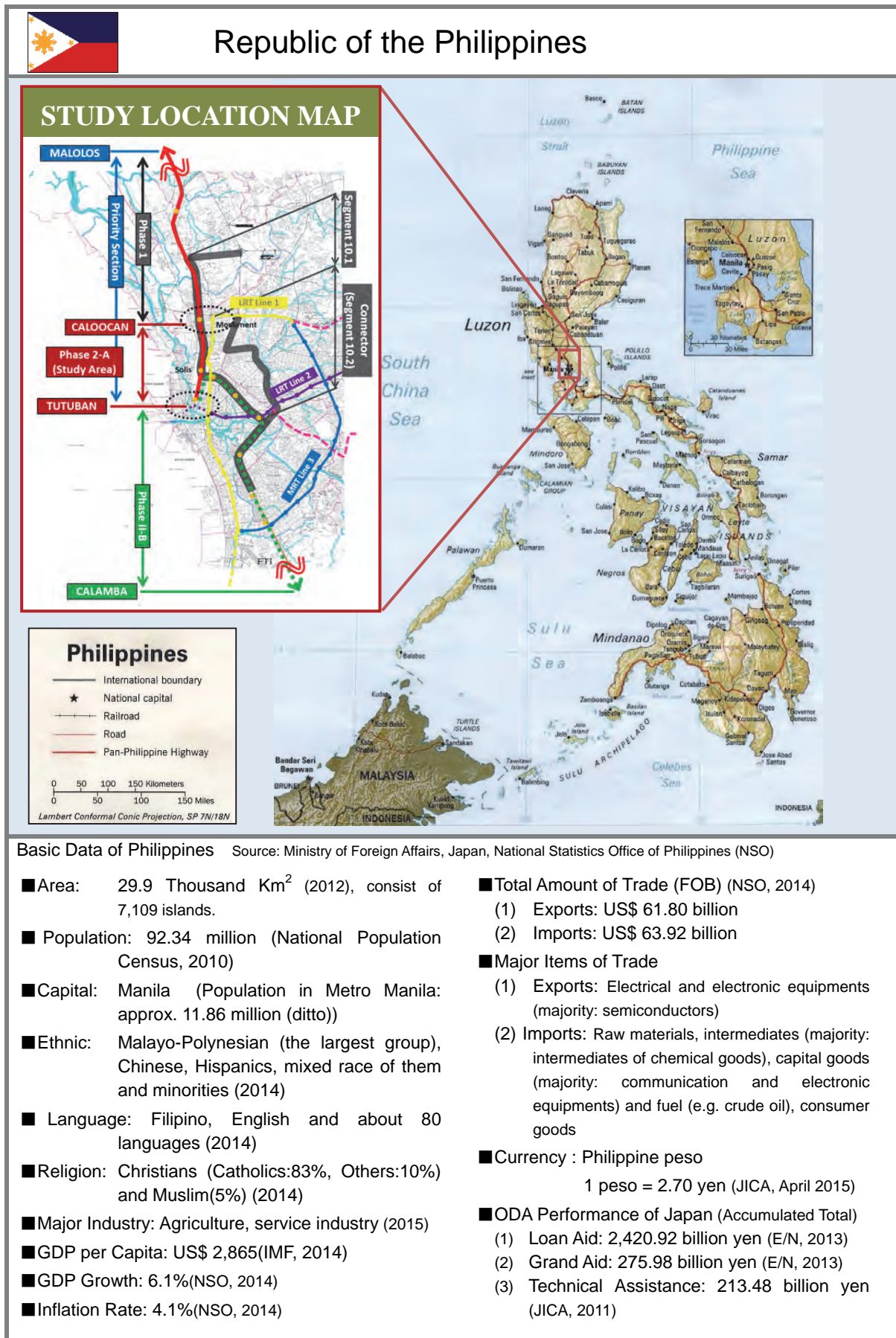

THE SUPPLEMENTARY SURVEY
ON
NORTH SOUTH COMMUTER RAIL PROJECT (PHASE II-A)
IN THE REPUBLIC OF THE PHILIPPINES
FINAL REPORT
TABLE OF CONTENTS

LOCATION MAP
ABBREVIATION LIST

Page

CHAPTER 1 INTRODUCTION

1.1	Background of the Study	1-1
1.2	Objectives of the Study	1-1
1.3	Study Area	1-1
1.4	Items to be Studied	1-3

CHAPTER 2 NECESSITY AND BACKGROUND OF THE PROJECT

2.1	Situation and Issues in GCR Transportation Sector.....	2-1
2.1.1	Transport Infrastructure	2-1
2.1.2	Philippines National Railways (PNR).....	2-2
2.1.3	Urban Mass Transit Lines.....	2-4
2.2	Reconfirmation of Latest Plans and Policies in the Transportation Sector	2-6
2.2.1	Summary of the Recent Development Plans in Metro Manila.....	2-6
2.2.2	Transportation Plans and Projects	2-10
2.3	Confirmation of Project Necessity	2-23
2.3.1	Necessity of Integration with Region Development Strategy.....	2-23
2.3.2	Necessity of Solving Traffic Problem.....	2-24
2.3.3	Necessity to Increase Competitive in Global Market	2-25

CHAPTER 3 ROUTE PLAN

3.1	Review of Route Plan and Travel Demand Forecast.....	3-1
3.1.1	Methodology.....	3-1
3.1.2	Traffic Survey	3-3
3.1.3	Population Forecast.....	3-6
3.1.4	Demand Forecast.....	3-7
3.1.5	Highlights of Results	3-19
3.2	Comparative Analysis of Alternatives	3-20
3.2.1	Without Project Option (Zero Option).....	3-20
3.2.2	Route Alternative Options	3-20
3.2.3	Depot Alternative Options	3-23
3.2.4	Structure Alternative Options	3-24

CHAPTER 4 PROPOSAL OF PROJECT FRAMEWORK

4.1	Route Plan	4-1
4.1.1	Overview	4-1
4.1.2	Alignment Plan	4-2
4.1.3	Location of Station	4-3
4.1.4	Route Plan	4-4
4.2	Rolling Stock Plan	4-11
4.2.1	Introduction	4-11
4.2.2	Prerequisite for Rolling Stock Plan	4-11
4.2.3	Review of Existing Rolling Stock in Manila	4-11
4.2.4	Requirement for Rolling Stock	4-12
4.2.5	Passenger Capacity and Train Formation	4-13
4.2.6	Body Materials	4-16
4.2.7	Acceleration Performance	4-17
4.2.8	Main Specifications	4-17
4.2.9	Maintenance	4-20
4.2.10	Superiority of Japanese Rolling Stock Technology for Commuter Train	4-21
4.3	Operation Plan	4-22
4.3.1	Basic Concepts of Operation Plan	4-22
4.3.2	Operating Route	4-22
4.3.3	Passenger Demand	4-23
4.3.4	Capacity of Rolling Stock	4-23
4.3.5	Operation Headway	4-23
4.3.6	Travel Time	4-24
4.3.7	Required Number of Trains	4-24
4.3.8	Rolling Stock Procurement Plan	4-25
4.4	Civil Facilities Plan	4-26
4.4.1	Alternative Structure Types	4-26
4.4.2	Proposed Structure Plan	4-34
4.4.3	Recommendation of the Construction Package	4-42
4.4.4	Inspection Policy	4-52
4.4.5	Universal Design and Gender Considerations for Station Facility	4-54
4.5	Depot and Workshop Plan	4-56
4.5.1	Inspection and Maintenance System	4-56
4.5.2	Preconditions	4-56
4.5.3	Necessary Number of Tracks	4-58
4.5.4	Necessary Facilities	4-59
4.5.5	Draft Layout Plan	4-64
4.6	Electrification System Plan	4-66
4.6.1	General	4-66
4.6.2	DC Feeding System	4-66
4.6.3	Traction Power Substations	4-67
4.6.4	Overhead Contact System (OCS)	4-69
4.6.5	Distribution System for Station Facilities	4-70
4.6.6	Stray Current	4-70
4.7	Signal and Telecommunication System Plan	4-72
4.7.1	Signal Equipment Servicing Plan	4-72
4.7.2	Communication Equipment Plan	4-82
4.8	TOD and Transportation Junction Plan	4-86
4.8.1	Importance of TOD at Tutuban Station	4-86
4.8.2	Desirable Layout of NSCR at Tutuban Station Area	4-86
4.8.3	Access Route and Station Layout Planning	4-89

CHAPTER 5 PROJECT IMPLEMENTATION PLAN

5.1	Examination of Preliminary Construction Plan	5-1
5.1.1	Temporary Works	5-1
5.1.2	Viaduct	5-2
5.1.3	Elevated Stations	5-6
5.1.4	Embankment	5-7
5.1.5	Depot	5-8
5.2	Traffic Management and Safety Planning During the Construction Period	5-9
5.3	Procurement Plan	5-10
5.3.1	Civil	5-10
5.3.2	Rolling Stock	5-11
5.3.3	Electrical and Mechanical Systems	5-11
5.4	Study on Applicability of STEP	5-13
5.5	Project Implementation Schedule	5-18
5.6	Examination of Consulting Services, TOR and Manning Schedule	5-20
5.6.1	Objectives of Consulting Services	5-20
5.6.2	TOR	5-20
5.6.3	Manning Schedule	5-21
5.7	Cost Estimation	5-29
5.7.1	Cost Breakdown	5-29
5.7.2	Foreign/ Local Procurement Rate for Breakdown Cost Items	5-33
5.7.3	Preconditions for Project Cost Estimation	5-35
5.7.4	Overall Project Cost	5-35
5.7.5	O&M Cost for NSCR	5-37

CHAPTER 6 REVIEW OF PROJECT IMPLEMENTATION STRUCTURE

6.1	Review of Existing Related Agencies and Organizations	6-1
6.1.1	Department of Transportation and Communications (DOTC)	6-1
6.1.2	Bases Conversion Development Authority (BCDA)	6-6
6.1.3	North Luzon Railway Corporation (NLRC)	6-10
6.1.4	Philippines National Railway (PNR)	6-13
6.1.5	Light Rail Transit Authority (LRTA)	6-19
6.2	Proposal for Implementation Plan (long term)	6-22
6.2.1	Organizational Structure	6-22
6.2.2	Scope of Work	6-27
6.2.3	Organization Structure and Staffing of LRC	6-27
6.2.4	Possibilities of Technical Assistance for Project Implementation and O&M Bodies	6-29
6.3	Proposed Implementation Plan for NSCR (short term)	6-31
6.3.1	Proposed Operation & Maintenance Scheme	6-31
6.3.2	Scope of Work	6-32
6.3.3	Organization Structure	6-34
6.3.4	Staffing of Operator and Maintenance Contractor	6-39
6.4	The Prospect for a Public-Private Partnership (PPP) Scheme	6-40

CHAPTER 7 ENVIRONMENTAL AND SOCIAL CONSIDERATIONS

7.1	Environmental Impact Assessment Report	7-1
7.1.1	Project Outline	7-1
7.1.2	Project Alternatives	7-2
7.1.3	Environmental and Social Conditions	7-3
7.1.4	Legal and Institutional Frameworks and Procedures on Environmental and Social Consideration in Philippines	7-60

7.1.5	Scoping	7-66
7.1.6	Prediction and Assessment of Noise and Vibration	7-70
7.1.7	Impact Assessment	7-80
7.1.8	Environmental Management Plan	7-88
7.1.9	Environmental Monitoring Plan	7-99
7.1.10	Estimated Cost of Environmental Management Plan and Environmental Monitoring Plan	7-104
7.1.11	Stakeholder Consultations	7-106
7.2	RAP	7-121
7.2.1	Potential Impacts by the Project	7-121
7.2.2	Objectives of the Rap	7-124
7.2.3	Results of Socio Economic Survey	7-125
7.2.4	Legal Framework	7-132
7.2.5	Project Resettlement Policy	7-136
7.2.6	Measures of Compensation and Assistance	7-142
7.2.7	Relocation Site	7-149
7.2.8	Grievance Redress Mechanism	7-155
7.2.9	Institutional Mechanism for the Implementation of Rap	7-158
7.2.10	Implementation Schedule	7-162
7.2.11	Cost and Budget	7-165
7.2.12	Monitoring and Evaluation	7-166
7.2.13	Stakeholders Consultation	7-168
7.3	Due Diligence Report on the Northrail Resettlement Program	7-168
7.3.1	Background	7-168
7.3.2	Objectives and Methodology of Due Diligence Study	7-168
7.3.3	Summaries of the Displacements under the Northrail Project	7-169
7.3.4	Findings from the Resettlement Programs of the Northrail Project	7-169
7.3.5	Living Standards of the Relocated ISFs	7-171
7.3.6	Points Which Need to be Taken into Consideration	7-171
7.3.7	Framework for Additional Assurances	7-171
7.4	Consultation with DOTC Regarding EIA, Draft RAP and Draft DDR	7-172
7.4.1	EPRMP	7-172
7.4.2	Draft RAP	7-172
7.4.3	Draft DDR	7-172

CHAPTER 8 ASSESSMENT OF CLIMATE CHANGE MITIGATION POTENTIAL

8.1	Emission Reduction of GHG from Vehicles	8-1
8.2	Loss of Carbon Stock by Land Conversion	8-3
8.3	Estimation of Reduction Effect for Climate Change	8-4

CHAPTER 9 PROJECT EVALUATION

9.1	Project Performance Indicators	9-1
9.2	Review of Qualitative Effects	9-3
9.2.1	Review of Qualitative Effects	9-3
9.2.2	Improvement of local traffic circulation	9-3
9.3	Economic Evaluation	9-7
9.3.1	Methodology	9-7
9.3.2	Economic Cost of the Project	9-7
9.3.3	Economic Benefits	9-7
9.3.4	Results of Economic Evaluation	9-9

9.4	Financial Viability	9-11
9.4.1	Methodology.....	9-11
9.4.2	Project Costs.....	9-11
9.4.3	Project Revenues.....	9-12
9.4.4	Results of Financial Evaluation.....	9-12
9.5	Case Analysis.....	9-15
9.6	Necessity of the Project.....	9-21

CHAPTER 10 KEY CONSIDERATIONS ON PROJECT IMPLEMENTATION

10.1	Agreement with Philippine Government	10-1
10.1.1	Usage of PNR's ROW for NSCR.....	10-1
10.1.2	Segment 10(from Samson Road, Caloocan City to Governor Pascual Avenue, Malabon City)	10-1
10.1.3	Project Implementation Structure.....	10-1
10.1.4	Operation and Maintenance Structure.....	10-1
10.2	South line of North-South Railway Project	10-2
10.3	Key Factor for Early Project Commitment.....	10-2
10.4	Human Resource and Capacity Building	10-3

APPENDICES

APPENDIX A: NSCR Alignment (Plan and Profile)

APPENDIX B: Design Guideline for the North South Commuter Railway (NSCR) Tutuban Station

LIST OF FIGURES

	Page
Figure 1.3.1	Project Location Map..... 1-2
Figure 2.1.1	Operational and Planned Railway lines in GCR Area 2-1
Figure 2.1.2	PNR Network in Luzon 2-3
Figure 2.1.3	PNR Annual Passenger Traffic, 2001-2014 2-3
Figure 2.1.4	PNR Average Daily Passenger by Station in 2014 2-4
Figure 2.1.5	Ridership of LRT Lines 1, 2 and MRT 3..... 2-5
Figure 2.2.1	Metro Clark Area..... 2-7
Figure 2.2.2	Spatial Strategy of Central Luzon 2-7
Figure 2.2.3	CALABARZON Quadrant and Cluster Spatial Framework 2-9
Figure 2.2.4	Railway and Highway Network Proposed in the Roadmap Study 2-11
Figure 2.2.5	Daang-Hari SLEX Project 2-12
Figure 2.2.6	NLEX-SLEX Connector Project..... 2-13
Figure 2.2.7	NAIA Expressway Project..... 2-14
Figure 2.2.8	C-6 &Laguna Lakeshore Expressway Dike 2-15
Figure 2.2.9	C-6 Expressway North and South Sections with Global City Link 2-15
Figure 2.2.10	C5 FTI Skyway Connector 2-16
Figure 2.2.11	R-7 Expressway 2-16
Figure 2.2.12	Cavite Extension of LRT Line 1 2-17
Figure 2.2.13	LRT Line 1 North Extension Project 2-18
Figure 2.2.14	Prototype LRV for MRT3..... 2-19
Figure 2.2.15	MRT 7 Route 2-20
Figure 2.2.16	Mass Transit System Loop Route..... 2-20
Figure 2.2.17	Mega Manila Subway Route 2-21
Figure 2.2.18	Location of ITS Terminals..... 2-22
Figure 2.3.1	Regional Development Strategy along North- South Corridor 2-23
Figure 2.3.2	Regional Development Potential along North- South Transportation Corridor 2-24
Figure 2.3.3	Volume- Capacity Ratio in 2030 in Metro Manila 2-25
Figure 2.3.4	Estimated Travel Time from Manila after “Dream Plan”..... 2-26
Figure 3.1.1	NSCR Study Travel Demand Model, and Outline..... 3-2
Figure 3.1.2	Population Forecast Metro Manila, 2012, 2020 and 2040..... 3-6
Figure 3.1.3	Daily Passenger Volumes by Station, 2020..... 3-8
Figure 3.1.4	AM Peak Hour Passenger Volumes by Station, 2020, Southbound 3-9
Figure 3.1.5	AM Peak Hour Passenger Volumes by Station, 2020, North Bound..... 3-9
Figure 3.1.6	Daily Passenger Volumes by Station, 2025..... 3-10
Figure 3.1.7	AM Peak Hour Passenger Volumes by Station, 2025, Southbound 3-12
Figure 3.1.8	AM Peak Hour Passenger Volumes by Station, 2025, Northbound 3-12
Figure 3.1.9	Daily Passenger Volumes by Station, 2030..... 3-13
Figure 3.1.10	AM Peak Hour Passenger Volumes by Station, 2030, Southbound 3-15
Figure 3.1.11	AM Peak Hour Passenger Volumes by Station, 2030, North Bound..... 3-15
Figure 3.1.12	Daily Passenger Volumes by Station, 2040..... 3-16
Figure 3.1.13	AM Peak Hour Passenger Volumes by Station, 2040, Southbound 3-18
Figure 3.1.14	AM Peak Hour Passenger Volumes by Station, 2040, Northbound 3-18
Figure 3.2.1	Route of Alternative Options 3-21
Figure 3.2.2	Relationship between NSCR and Highway in terms of the Use of PNR ROW 3-21
Figure 4.1.1	Rolling Stock Gauge and Structure Gauges 4-2
Figure 4.1.2	Site Conditions between Malolos and Calocan..... 4-6
Figure 4.1.3	Route Plan between Solis and Tutuban 4-8

Figure 4.1.4	Site Conditions between Caloocan and Solis	4-9
Figure 4.1.5	Site Conditions between Solis and Tutuban	4-10
Figure 4.2.1	An Example of Universal Design for Car Design	4-13
Figure 4.2.2	Cross Section of Rolling Stock.....	4-13
Figure 4.2.3	A Typical Layout of Commuter Train Cars.....	4-14
Figure 4.2.4	A Typical Formation of 8-car Commuter Train-set.....	4-16
Figure 4.2.5	Acceleration Performance	4-17
Figure 4.3.1	Track Layout of the Route	4-22
Figure 4.4.1	RC Slab Type	4-27
Figure 4.4.2	Reinforced Concrete Beams type Section	4-27
Figure 4.4.3	Composite Steel H-beams type Section.....	4-27
Figure 4.4.4	PC-Beam-Type Section	4-28
Figure 4.4.5	PC Box Type Section	4-28
Figure 4.4.6	AASHOT specified Prestressed Concrete Bulb T-Girder	4-28
Figure 4.4.7	AASHTO Type Launching Girder.....	4-29
Figure 4.4.8	Segmental Type PC-Box Launching Girder.....	4-29
Figure 4.4.9	Example of Construction Method for Girder Erection.....	4-29
Figure 4.4.10	PC Continuous Beam Type.....	4-31
Figure 4.4.11	Truss Type.....	4-31
Figure 4.4.12	Long Span Bridge Delhi Metro Phase2, India	4-31
Figure 4.4.13	Steel Truss Type Girder	4-32
Figure 4.4.14	Photo of Steel Truss Type Girder	4-32
Figure 4.4.15	Rigid Frame Type for Station	4-33
Figure 4.4.16	Typical Plan of Station Facilities	4-33
Figure 4.4.17	Typical Cross Section of Viaduct	4-35
Figure 4.4.18	Example of Existing Northrail Structures	4-35
Figure 4.4.19	Long Span Bridges Overpassing Existing Structure	4-36
Figure 4.4.20	Cross Section of Structure under Segment 10.1	4-36
Figure 4.4.21	Typical Cross Section of Stations.....	4-37
Figure 4.4.22	Cross Section of Caloocan Station.....	4-38
Figure 4.4.23	GRS Retaining Wall	4-39
Figure 4.4.24	Typical Cross Section of Conventional L-shaped Retaining Wall and GRS.....	4-39
Figure 4.4.25	Structure Plan (JICA New Option Plan)	4-41
Figure 4.4.26	Construction Package for Civil Works	4-42
Figure 4.4.27	Road Accessibility during Construction	4-45
Figure 4.4.28	Tullahan River.....	4-52
Figure 4.4.29	Example of Universal Design applied to Station Facilities	4-55
Figure 4.5.1	Inspection and Maintenance Program.....	4-56
Figure 4.5.2	Temporary Bogie.....	4-61
Figure 4.5.3	Bogie Changing Machine.....	4-62
Figure 4.5.4	Wheel Load Measuring System.....	4-62
Figure 4.5.5	Axle Ultrasonic Flaw Detector.....	4-63
Figure 4.5.6	Wheel Re-profiling Machine	4-63
Figure 4.5.7	Shunting Car	4-64
Figure 4.5.8	Draft Layout Plan of Depot and Workshop.....	4-65
Figure 4.5.9	Location for Depot and Workshop in Valenzuela.....	4-65
Figure 4.6.1	Overall View of the Power Supply System.....	4-67
Figure 4.7.1	Illustration of a Train Protection in a Moving Block System	4-73
Figure 4.7.2	Illustration of the Differences in the Equipment Used in Track Circuit Train Detection Systems and in Radio-operated Train Detection Systems.....	4-80
Figure 4.7.3	Illustration of the Basic Equipment Configuration of the CBTC System	4-81
Figure 4.7.4	Illustration of a Rail Transit System Configuration that Uses Optical Transmission Lines	4-83

Figure 4.7.5	Illustration of Operations of a Digital Train Radio System	4-84
Figure 4.7.6	Illustration of a Rail System Network Using an Optical-fiber Transmission Lines...	4-85
Figure 4.8.1	Concept of TOD.....	4-86
Figure 4.8.2	TOD for Tutuban Station Area	4-87
Figure 4.8.3	Typical Section of Dagupan Street Widening with NSCR	4-88
Figure 4.8.4	Access and Transfer Routes of Alternative 1	4-90
Figure 4.8.5	Access and Transfer Routes of Alternative 2-1	4-91
Figure 4.8.6	Access and Transfer Routes of Alternative 2-2	4-92
Figure 4.8.7	Image of Alternative 1.....	4-93
Figure 5.1.1	Necessary ROW for Elevated Structures	5-1
Figure 5.1.2	Pier Column Construction – LRT Line 2	5-3
Figure 5.1.3	PC Box Girder Erection (Truss Type Erection Gantry) – LRT Line 2.....	5-5
Figure 5.1.4	Typical Erection Gantry (Steel Box Girder Type).....	5-5
Figure 5.1.5	Girder Erection by Single Truck Mounted Crane – LRT Line 1 NEP	5-6
Figure 5.1.6	Example of Fixed Supporting Method	5-6
Figure 5.1.7	Station Construction – LRT Line 1 NEP.....	5-7
Figure 5.1.8	Construction Method of GRS Retaining Wall.....	5-8
Figure 5.5.1	Project Implementation Schedule.....	5-19
Figure 5.7.1	NSCR Alignment (Elevated and Embankment Section).....	5-31
Figure 6.1.1	Organizational Structure of DOTC	6-5
Figure 6.1.2	BCDA Organization Chart.....	6-8
Figure 6.1.3	BCDA Corporate and Ownership Structure Chart.....	6-8
Figure 6.1.4	NLRC Organization Structure Chart	6-12
Figure 6.1.5	Organization Chart of PNR.....	6-14
Figure 6.1.6	Rolling Stock and Existing Facility of PNR.....	6-17
Figure 6.1.7	Organizational Structure of LRTA.....	6-20
Figure 6.2.1	Proposed Organizational Chart for PRA	6-23
Figure 6.2.2	Concept of a New Hierarchy for Railways in the Philippines	6-24
Figure 6.2.3	Organizational Structure of PMO.....	6-25
Figure 6.3.1	Functional Organization Structure for O&M Scheme	6-31
Figure 6.3.2	Organization Chart of Operator	6-35
Figure 6.3.3	Organization Chart of Maintenance Contractor.....	6-35
Figure 6.4.1	Contractual Variations of a PPP.....	6-41
Figure 6.4.2	The Different PPP Modalities and Corresponding Risk Allocations.....	6-41
Figure 7.1.1	Location Map of Malolos to Tutuban NSCR Project	7-1
Figure 7.1.2	Malolos City Land Use Map Showing NSCR Alignment	7-8
Figure 7.1.3	Land Use Map of Municipality of Guiguinto Showing NSCR Alignment.....	7-9
Figure 7.1.4	Municipality of Balagtas Land Use Map Showing NSCR Alignment.....	7-10
Figure 7.1.5	Bocaue City Land Use Map Showing NSCR Alignment.....	7-11
Figure 7.1.6	Municipality of Marilao Land Use Plan Showing NSCR Alignment.....	7-12
Figure 7.1.7	Meycauayan City Land Use Plan Showing NSCR Alignment.....	7-13
Figure 7.1.8	Valenzuela City Land Use Map Showing NSCR Alignment.....	7-14
Figure 7.1.9	City of Malabon Land Use Map Showing NSCR Alignment.....	7-14
Figure 7.1.10	City of Caloocan Land Use Map Showing NSCR Alignment	7-15
Figure 7.1.11	City of Manila Land Use Map Showing NSCR Alignment	7-16
Figure 7.1.12	Stratigraphic Column for Central Luzon Basin	7-19
Figure 7.1.13	Geomorphologic Map of Metro Manila.....	7-21
Figure 7.1.14	Topographic Map of Western and Central Metro Manila.....	7-22
Figure 7.1.15	Stratigraphic Column for Southern Sierra Madre	7-23
Figure 7.1.16	Geologic Map of Western Section of Metro Manila	7-24

Figure 7.1.17	Earthquake-Triggered Landslide Susceptibility Map Based on Critical Acceleration Values and Earthquake Intensities	7-25
Figure 7.1.18	Liquefaction Susceptibility Map	7-26
Figure 7.1.19	Preliminary Liquefaction Hazard Map of Metro Manila	7-27
Figure 7.1.20	Distribution of Active Faults and Trenches in Northern, Central and Southern Portion of Luzon Island	7-28
Figure 7.1.21	Risk to Earthquakes Map	7-29
Figure 7.1.22	Preliminary Ground Shaking Hazard Map of Metro Manila	7-30
Figure 7.1.23	Preliminary Tsunami Hazard Map of Metro Manila	7-31
Figure 7.1.24	Sites for Flora and Fauna Survey	7-32
Figure 7.1.25	Valenzuela Area Showing Locations of Pterocarpus Indicus Willd or Narra	7-34
Figure 7.1.26	Pampanga River Basin Map	7-39
Figure 7.1.27	Pasig-Laguna de Bay Basin Map	7-40
Figure 7.1.28	Preliminary Flooding Hazard Map of Metro Manila	7-42
Figure 7.1.29	Flood Hazard Map of the Project Area	7-43
Figure 7.1.30	Coronas Classification of Climate in the Philippines	7-44
Figure 7.1.31	Number of Extreme Typhoons with Maximum Sustained Winds of above 150 kph in the PAR	7-45
Figure 7.1.32	Trends in the Extreme Rainfall Intensity of the Philippines	7-46
Figure 7.1.33	Maps Showing the Projected Rainfall Change (increase/decrease) in % in 2020 and 2050 in the Philippines.	7-47
Figure 7.1.34	Current and Projected Extreme Rainfall in the Philippines in 2020 and 2050 under Midrange Scenario	7-48
Figure 7.1.35	Sites for Ambient Air Quality, Noise and Vibration Level Measurement	7-51
Figure 7.1.36	Site of (River) Water Sampling Stations	7-53
Figure 7.1.37	Satellite Photo of old Meycauayan Dumpsite	7-55
Figure 7.1.38	Flow Chart of EIA Process in the Philippines	7-61
Figure 7.1.39	Arrangement of Sound Source, Sound Receiving Point and Explanation of Path Difference	7-73
Figure 7.2.1	Additional Railway ROW Requirement	7-121
Figure 7.2.2	Area to be Affected by the NSCR Project	7-123
Figure 7.2.3	Additional Railway ROW Requirement	7-124
Figure 7.2.4	Location Map of Candidate Relocation Sites	7-151
Figure 7.2.5	Grievance Redress Mechanism Procedure	7-157
Figure 7.2.6	RAP Implementation Structure	7-159
Figure 7.2.7	Structure of PMO, RIMT and Internal Monitoring Agent	7-159
Figure 7.2.8	Organizational Chart of LIAC	7-161
Figure 9.2.1	Survey Locations	9-4
Figure 9.3.1	Cash Flow of the Economic Costs and Benefits	9-10
Figure 9.4.1	Cash Flow of Financial Cost and Revenue	9-14
Figure 9.5.1	Cash Flow of the Economic Costs and Benefits (test case)	9-18
Figure 9.5.2	Cash Flow of Financial Cost and Revenue (test case)	9-20

LIST OF TABLES

	Page
Table 1.4.1	Items to be Studied 1-3
Table 2.2.1	CALABARZON Centers, Corridors and Wedges, per Province 2-8
Table 3.1.1	Railway and Road Projects 3-1
Table 3.1.2	Summary of Traffic Count Results 3-3
Table 3.1.3	Outline of Bus Passenger Interview Survey 3-4
Table 3.1.4	Summary of Traffic Count Data 3-5
Table 3.1.5	Summary of Vehicle Occupancy Count Result 3-5
Table 3.1.6	Train Fare 3-7
Table 3.1.7	Passenger Demand for NSCR 3-7
Table 3.1.8	Estimated PPHPD for NSCR 3-7
Table 3.1.9	Daily Passenger Volumes, 2020 3-8
Table 3.1.10	Daily Passenger Volumes, 2025 3-11
Table 3.1.11	Daily Passenger Volumes, 2030 3-14
Table 3.1.12	Daily Passenger Volumes, 2040 3-17
Table 3.1.13	Network Performance Indicators, GCR 3-19
Table 3.2.1	Comparison of Route Alternative Options 3-22
Table 3.2.2	Comparison of Alternative Options for Depot Sites 3-23
Table 3.2.3	Comparison of Railway Structure Type 3-25
Table 4.1.1	Design Condition for the Alignment of NSCR 4-1
Table 4.1.2	Chainage and Distance between Stations 4-3
Table 4.1.3	Comparison of the Route Using “Side by Side” Method 4-7
Table 4.2.1	Review of Existing Rolling Stock in Manila 4-12
Table 4.2.2	Requirements for Rolling Stock 4-12
Table 4.2.3	Congestion Rate in Japan 4-15
Table 4.2.4	Standard Passenger Capacity 4-15
Table 4.2.5	Passenger Capacity for 3 Different Train Formations 4-15
Table 4.2.6	Comparison of Body Materials 4-16
Table 4.2.7	Main Recommended Specifications of Rolling Stock 4-18
Table 4.2.8	Typical Maintenance System in Japan 4-20
Table 4.3.1	PPHPD 4-23
Table 4.3.2	Capacity of Rolling Stock 4-23
Table 4.3.3	Capacity of Train 4-23
Table 4.3.4	Capacity of Train 4-23
Table 4.3.5	Capacity of Train 4-24
Table 4.3.6	Regular Running Time 4-24
Table 4.3.7	Round Trip Time 4-24
Table 4.3.8	Required Number of Trains 4-24
Table 4.3.9	Rolling Stock Procurement Plan 4-25
Table 4.4.1	Characteristics of Each Structure Type 4-26
Table 4.4.2	Basic Comparison table between PC-T Beam and Box Girder 4-30
Table 4.4.3	Comparison of Embankment Types 4-34
Table 4.4.4	Construction Package for Civil Works (Mainline) 4-42
Table 4.4.5	Existing Access Road 4-44
Table 4.4.6	Judgment of Structure State and Standard Soundness 4-53
Table 4.5.1	Number of Train Sets and Cars of NSCR 4-57
Table 4.5.2	Maintenance Period 4-57
Table 4.5.3	Cleaning Period 4-58
Table 4.5.4	Necessary Hours for Inspection, Maintenance and Cleaning Works 4-58

Table 4.5.5	Necessary Number of Tracks for Depot and Workshop	4-58
Table 4.5.6	Main Facility Equipment List	4-59
Table 4.6.1	Major Assumptions for Estimation of Power Consumption	4-68
Table 4.6.2	Estimated Power Demand and Transformer Capacity	4-68
Table 4.6.3	Permissible Lowest and Highest, and Nominal Voltage in IEC	4-68
Table 4.6.4	Estimated Maximum Power per Hour for One Substation and Rated Capacity of a Transformer for Traction Power	4-69
Table 4.6.5	Outlines of Overhead Contact Systems	4-70
Table 4.7.1	Comparison of Features of the Different Signaling Systems	4-72
Table 4.7.2	Present Manila Metropolitan Railway Signal Equipment Outline	4-75
Table 4.7.3	Technical Parameters of Signaling System	4-76
Table 4.7.4	Plans of Train Protection Systems of NSCR	4-76
Table 4.7.5	Plan-A of Train Protection Systems of NSCR	4-77
Table 4.7.6	Plan-B of Train Protection Systems of NSCR	4-78
Table 4.7.7	Plan-C of Train Protection Systems of NSCR	4-79
Table 4.7.8	Comparison of Each Plan	4-81
Table 4.8.1	Alternative Station Structure	4-89
Table 4.8.2	Summary of Pros and Cons	4-94
Table 5.1.1	Example of Duration for 1 Pile Construction – LRT Line 2	5-2
Table 5.1.2	Example of Duration for 1 Span Erection – LRT Line 2	5-4
Table 5.2.1	List of Agencies Relevant to Traffic/Safety Management during Construction	5-9
Table 5.3.1	Main Materials and Equipment	5-10
Table 5.3.2	Main Temporary Equipment	5-11
Table 5.3.3	Procurement Plan for Materials and Equipment - E&M System	5-12
Table 5.4.1	STEP Potential Items	5-13
Table 5.5.1	Project Package	5-18
Table 5.6.1	Staffing Requirements	5-21
Table 5.7.1	Viaduct and Bridge: Length by Type	5-30
Table 5.7.2	Layout of Station Building	5-32
Table 5.7.3	Station Facilities	5-33
Table 5.7.4	Foreign/ Local Procurement Rate	5-34
Table 5.7.5	Project Cost	5-36
Table 5.7.6	O&M Cost	5-37
Table 6.1.1	BCDA Staffing	6-9
Table 6.1.2	PNR Staffing	6-15
Table 6.1.3	PNR Financial Highlights	6-18
Table 6.1.4	LRTA Staffing	6-21
Table 6.2.1	LRC Tasks and Duties	6-27
Table 6.3.1	Tasks & Duties Matrix for Maintenance	6-33
Table 6.3.2	LRC Staffing	6-39
Table 6.4.1	Advantages and Disadvantages of PPP	6-40
Table 7.1.1	ECC for Northrail Project and NSCR Project	7-2
Table 7.1.2	Table of Population (2010)	7-3
Table 7.1.3	List of Industrial Sites in Bulacan	7-4
Table 7.1.4	List of Industry Sectors in Bulacan	7-4
Table 7.1.5	Environmentally Critical Areas in Cities and Municipalities Covered by NSCR	7-18
Table 7.1.6	Stratigraphy of Central Luzon Basin - East	7-20
Table 7.1.7	List of Threatened Species under DAO 2007-1 and IUCN 2007	7-33
Table 7.1.8	National List of Threatened Fauna In and Around Bulacan Region	7-34
Table 7.1.9	List of Fauna Encountered during the Site Survey	7-35

Table 7.1.10	List of Bird Species Encountered in Valenzuela and Guiguinto	7-36
Table 7.1.11	Residency and Conservation Status of Bird Species Encountered in the Caloocan to Tutuban Segment	7-38
Table 7.1.12	List of Tropical Cyclone with Maximum Sustained Wind of Above 150 kph in the Philippines Area of Responsibility	7-44
Table 7.1.13	List of Extreme Rainfall Events that Cause Severe Flooding	7-46
Table 7.1.14	Seasonal Rainfall Change (in %) in 2020 and 2050 under Medium-Range Emission Scenario in Provinces in Region 4-A	7-48
Table 7.1.15	Prevalent Wind Direction Recorded from PAGASA Weather Stations	7-49
Table 7.1.16	Speed and Direction During Air Quality Sampling (September 24-26, 2013)	7-49
Table 7.1.17	Observed Ambient Air Concentrations	7-52
Table 7.1.18	Summary of Test Results for Surface Water Samples	7-54
Table 7.1.19	Summary of Heavy Metals Analysis for Soil Sample in the Former Meycauayan Dumpsite (mg/kg dry matter)	7-56
Table 7.1.20	Observed 24 hour Noise Levels (dB)	7-58
Table 7.1.21	Observed Vibration Level at Recorded Peak Acceleration	7-59
Table 7.1.22	Important Laws and Manuals of PEISS	7-60
Table 7.1.23	Summary of Environmentally Critical Projects (ECPs)	7-61
Table 7.1.24	Summary of Environmentally Critical Areas (ECAs)	7-62
Table 7.1.25	Summary of Project Groups, EIA Report Types, Decision Documents, Deciding Authorities and Processing Duration	7-63
Table 7.1.26	Philippines' Environmental Laws, Regulations and Environmental Quality Standards	7-65
Table 7.1.27	Scoping for NSCR Project	7-66
Table 7.1.28	Weighted Power Level of Construction Type	7-70
Table 7.1.29	Results of Prediction of Construction Noise	7-71
Table 7.1.30	Total Number of Operated Trains (one-way)	7-74
Table 7.1.31	Prediction of Noise Level during Train Operation from 2020 to 2040 (Without noise barrier)	7-75
Table 7.1.32	Prediction of Noise Level during Train Operation from 2020 to 2040 (With noise barrier)	7-76
Table 7.1.33	Noise Sensitive Receptors	7-77
Table 7.1.34	Vibration Level of Construction Machinery and Damping Ratio	7-78
Table 7.1.35	Results of Prediction of Construction Vibration	7-78
Table 7.1.36	Prediction Model of Vibration Levels	7-79
Table 7.1.37	Estimated Vibration Level VL (dB)	7-80
Table 7.1.38	Impact Assessment Based on the Survey	7-81
Table 7.1.39	Environmental Management Plan	7-89
Table 7.1.40	Environmental Monitoring Plan (EMoP) for the North South Commuter Rail Project	7-100
Table 7.1.41	Estimated Cost of EMP and EMoP	7-104
Table 7.1.42	Schedule of the Stakeholders Consultations Conducted along the Alignment from Malolos to Caloocan	7-107
Table 7.1.43	Schedule of the IEC Activities and Stakeholders Consultations Conducted along the Alignment from Caloocan to Tutuban	7-108
Table 7.1.44	Summary of Main Opinions and Concerns during the Stakeholder Consultation Meeting for EIA	7-109
Table 7.1.45	Summary of Main Opinions and Concerns during the Stakeholder Consultation Meeting for RAP Survey Results	7-111
Table 7.1.46	Summary of Main Opinions and Concerns during the Stakeholder Consultation Meeting for EIA and RAP Survey Results	7-112
Table 7.1.47	Summary of Main Opinions and Concerns during the Stakeholder Consultation Meeting for Draft RAP Compensation Policy	7-112

Table 7.1.48	Summary of Main Opinions and Concerns during the Stakeholder Consultation Meeting for Draft RAP (Relocation Sites).....	7-114
Table 7.1.49	Summary of Main Opinions and Concerns during the IEC Meetings	7-116
Table 7.1.50	Summary of Main Opinions and Concerns during the EIA and RAP Scoping Meeting.....	7-117
Table 7.1.51	Summary of Main Opinions and Concerns during the Stakeholder Consultation Meeting for EIA and RAP Results.....	7-119
Table 7.1.52	Focus Group Discussion	7-119
Table 7.1.53	Summary of FGD for Vulnerable Groups	7-120
Table 7.1.54	Assessment on How NSCR will Affect Vulnerable Groups.....	7-120
Table 7.2.1	Necessity of Land Acquisition at 10 Stations	7-122
Table 7.2.2	Affected Cities and Municipalities and Corresponding Barangays by NSCR Project	7-125
Table 7.2.3	Number of PAFs.....	7-126
Table 7.2.4	Legal PAFs by LGUs	7-127
Table 7.2.5	ISFs by LGUs	7-128
Table 7.2.6	Affected Lands: Area (m2)	7-128
Table 7.2.7	Affected Structures	7-128
Table 7.2.8	Affected Improvements	7-129
Table 7.2.9	Affected Trees	7-129
Table 7.2.10	Relevant Laws on Land Acquisition and Involuntary Resettlement in the Philippines	7-133
Table 7.2.11	Comparison between JICA Guideline and Legal Framework in the Philippines on Involuntary Resettlement.....	7-133
Table 7.2.12	Cut-off Date of Eligibility	7-138
Table 7.2.13	Categories of Business Activity	7-141
Table 7.2.14	Draft Entitlement Matrix.....	7-143
Table 7.2.15	Tentative Candidate Relocation Sites	7-150
Table 7.2.16	Public Transportation Available in the Resettlement Sites	7-152
Table 7.2.17	Public Facilities such as Schools and Health Centers for the Resettlement Sites	7-153
Table 7.2.18	Organizational Coordination	7-158
Table 7.2.19	RAP Implementation Schedule (Tentative).....	7-163
Table 7.2.20	Estimated RAP Implementation Cost	7-165
Table 7.2.21	RAP Monitoring Schedule.....	7-168
Table 7.3.1	Summary of the Two Displacements under the Northrail Project.....	7-169
Table 7.3.2	Mapping of the Aspects used for the Analysis	7-169
Table 7.3.3	Additional Assurances to PAPs Provided by NSCR Project (Draft).....	7-172
Table 8.1.1	Reference Vehicle CO2 Emission Factor.....	8-2
Table 8.1.2	Emission Reduction of GHG	8-2
Table 9.1.1	Operation and Impact Indicators.....	9-2
Table 9.1.2	Estimated Impact of Project on Network Improvement	9-2
Table 9.2.1	Morning Peak Traffic Volume in 2020 (Congested Road Only)	9-3
Table 9.2.2	Improvement Effect (10% reduction in traffic volume and 10% increase in road capacity).....	9-5
Table 9.2.3	Improvement Effect (20% reduction in traffic volume and 20% increase in road capacity).....	9-5
Table 9.3.1	Estimated Economic Cost of the Project.....	9-7
Table 9.3.2	Unit VOC in the Philippines, 2014	9-8
Table 9.3.3	Present and Future Time Value of Passengers.....	9-8
Table 9.3.4	Summary of Economic Benefits for Benchmark Years	9-8
Table 9.3.5	Evaluation of Economic Costs and Benefits	9-9

Table 9.3.6	Results of Economic Valuation.....	9-10
Table 9.3.7	Sensitivity Analysis of Economic Evaluation.....	9-10
Table 9.4.1	Estimated Project Cost	9-11
Table 9.4.2	O&M Cost (repeated)	9-12
Table 9.4.3	Revenue Projections for Benchmark Years.....	9-12
Table 9.4.4	Evaluation of Financial Costs and Revenues.....	9-13
Table 9.4.5	Results of Financial Valuation.....	9-14
Table 9.4.6	Sensitivity Analysis of Financial Evaluation.....	9-14
Table 9.5.1	Number of Daily Boarding Passenger and PPHPD (test case)	9-15
Table 9.5.2	Operation and Impact Indicators (test case).....	9-15
Table 9.5.3	Estimated Impact of Project on Network Improvement (test case)	9-16
Table 9.5.4	Summary of Economic Benefits for Benchmark Years (test case)	9-16
Table 9.5.5	Evaluation of Economic Costs and Benefits (test case)	9-17
Table 9.5.6	Results of Economic Valuation (test case).....	9-18
Table 9.5.7	Sensitivity Analysis of Economic Evaluation (test case).....	9-18
Table 9.5.8	Revenue Projections for Benchmark Years (test case).....	9-18
Table 9.5.9	Evaluation of Financial Costs and Revenues (test case).....	9-19
Table 9.5.10	Results of Financial Valuation (test case).....	9-20
Table 9.5.11	Sensitivity Analysis of Financial Evaluation (test case).....	9-20

ABBREVIATION LIST

Term	English
ADB	Asian Development Bank
AER	Airport Express Railway
AFC System	Automatic Fare Collection System
ATC	Automatic Train Control
ATO	Automatic Train Operation
ATP	Automatic Train Protection
ATS	Automatic Train Stop
BCDA	Bases Conversion and Development Authority
BRT	Bus Rapid Transit
CBD	Central Business District
CBTC	Communication Based Train Control
CBR	Cost Benefit Ratio
CCTV	Closed Circuit Television
CIA	Clark International Airport
CTC	Centralized Traffic Control
DDR	Due Diligence Report
DENR	Department of Environment and Natural Resources
DOF	Department of Finance
DOTC	Department of Transportation and Communications
DPWH	Department of Public Works and Highways
E&M	Electrical and Mechanical
ECC	Environmental Compliance Certificate
EIA	Environmental Impact Assessment
EIRR	Economic Internal Rate of Return
EPRMP	Environmental Performance Report and Management Plan
FIRR	Financial Internal Rate of Return
F/S	Feasibility Study
FTI	Food Terminal Incorporated
GAA	General Appropriations Act
GCR	Greater Capital Region
GDP	Gross Domestic Product
GOV	Government of Philippines
GRDP	Gross Regional Domestic Product
IEE	Initial Environmental Examination
ISFs	Informal Settler Families
JBIC	Japan Bank For International Cooperation
JCC	Joint Coordinating Committee
JICA	Japan International Cooperation Agency
JPY	Japanese Yen
JV	Joint Venture
LCX	Leaky Coaxial cable
LED	Light Emitting Diode
LIAC	Local Inter-Agency Committees

Term	English
LGUs	Local Government Units
LRC	Luzon Railway Corporation
LRT	Light Rail Transit
MERALCO	The Manila Electric Company
METI	Ministry of Economy, Trade and Industry
MM	Metro Manila
MMDA	Metropolitan Manila Development Authority
MMTC	Metro Manila Transit Cooperation
MNTC	Manila North Tollways Corporation
MRT	Metro Rail Transit
MRTC	Metro Rail Transit Corporation Limited
NAIA	Ninoy Aquino International Airport
NCR	National Capital Region
NEDA	National Economic Development Authority
NHA	National Housing Authority
NLEX	North Luzon Expressway
NLRC	North Luzon Railways Corporation
NPV	Net Present Value
NSCR	North South Commuter Railway
NSPR	North South Philippines Railway
NSRP	North South Railway Project
O&M	Operation & Maintenance
OCC	Operation Control Center
OCS	Overhead Catenary System
OD	Origin-Destination
ODA	Official Development Assistance
OEM	Original Equipment Manufacturer
PABX	Private Automatic Branch eXchange
PAFs	Project Affected Families
PAPs	Project Affected People
PC	Prestressed Concrete
PCG	Philippine Coast Guard
PEISS	Philippines Environmental Impact Statement System
PhP, PHP	Philippine Pesos
PMO	Project Management Office
PNR	Philippine National Railways
PPHPD	Passenger Per Hour Per Direction
PPP	Public Private Partnership
PRA	Philippines Railway Authority
PSD	Platform Screen Door
PUJ	Public Utility Jeepney
RAP	Resettlement Action Plan
RIMT	RAP Implementing and Management Team
ROW	Right-of-Way
RTU	Remote Terminal Unit

Term	English
SCADA	Supervisory Control And Data Acquisition
SEA	Strategic Environmental Assessment
SLEX	South Luzon Expressway
SWR	Shadow Wage Rate
TMV	Ticket Vending Machine
TOD	Transit Oriented Development
TTC	Travel Time Cost
TWG	Technical Working Group
ULC	Universal LRT Corporation
UPS	Uninterruptible Power-supply System
VAT	Value Added Tax
VGf	Viability Gap Fund
VOC	Vehicle Operation Costs
VOT	Value of Time
VVVF	Variable Voltage Variable Frequency
WB	World Bank

CHAPTER 1

INTRODUCTION

CHAPTER 1 INTRODUCTION

1.1 Background of the Study

A commuter railway service to connect Metro Manila with its adjacent northern and southern suburban areas is deemed as one important mass transit backbone for the metropolis as well as for the growth corridor of the Greater Capital Region (GCR), which comprises of Region III, Metro Manila and Region IV-A. This is the focus of many mass transit studies of the Department of Transportation and Communications (DOTC) and the commuter rail service from Malolos to Calamba, in particular, is highlighted as one of the priority projects for the region. The significance of the project is likewise reflected in the recent National Economic Development Authority (NEDA) study on the Roadmap for Transport Infrastructure Development of Metro Manila and Its Surrounding Areas (Region III and Region IV-A).

A feasibility study on Commuter Railway for Malolos to Caloocan was a Japan International Cooperation Agency (JICA)-funded initiative of DOTC to escalate project preparedness for a likely implementation within the short term period (i.e., 2014 - 2016). It took off from the previous pre-feasibility study for the Airport Express Rail (AER) Study, which was geared to develop a railway strategy for connecting Clark International Airport (CIA) to the National Capital Region (NCR) or Metro Manila.

This study aims to conduct supplementary surveys on Caloocan and Tutuban section of North South Commuter Railway (NSCR), which was out of scope in the recent concluded feasibility study, to evaluate the necessity and feasibility of an urban rail transit system for Malolos to Tutuban section, a section with one of the highest priorities as per DOTC, and to prepare necessary material for project appraisal.

1.2 Objectives of the Study

This study aims to conduct supplementary surveys on the Caloocan and Tutuban section, a part of the priority section from Malolos to Tutuban of NSCR, to develop a preliminary design and project cost estimation. The purpose of these supplementary surveys is to advance the realization of the project through the evaluation of necessity and propriety of the priority project between Malolos and Tutuban section in consideration for consistency and adequacy of whole railway system.

In addition, examination on i) Inter-modal enhancement with transit oriented development and examination of the universal design facility plan at junction stations, ii) Estimation of potential greenhouse gas reduction will be carried out.

1.3 Study Area

As shown in the Project Location Map shown below, the section of this study extends approximately 5.6 km from Caloocan to Tutuban within the NSCR (Malolos- Tutuban).

The result of the feasibility study on Malolos- Caloocan section shall be reviewed from the viewpoint of consistency and adequacy of whole railway system between Malolos and Tutuban. In addition, supplemental survey and examination shall be conducted on Malolos- Caloocan section, if any additional information or data required for appraisal of Yen Loan.

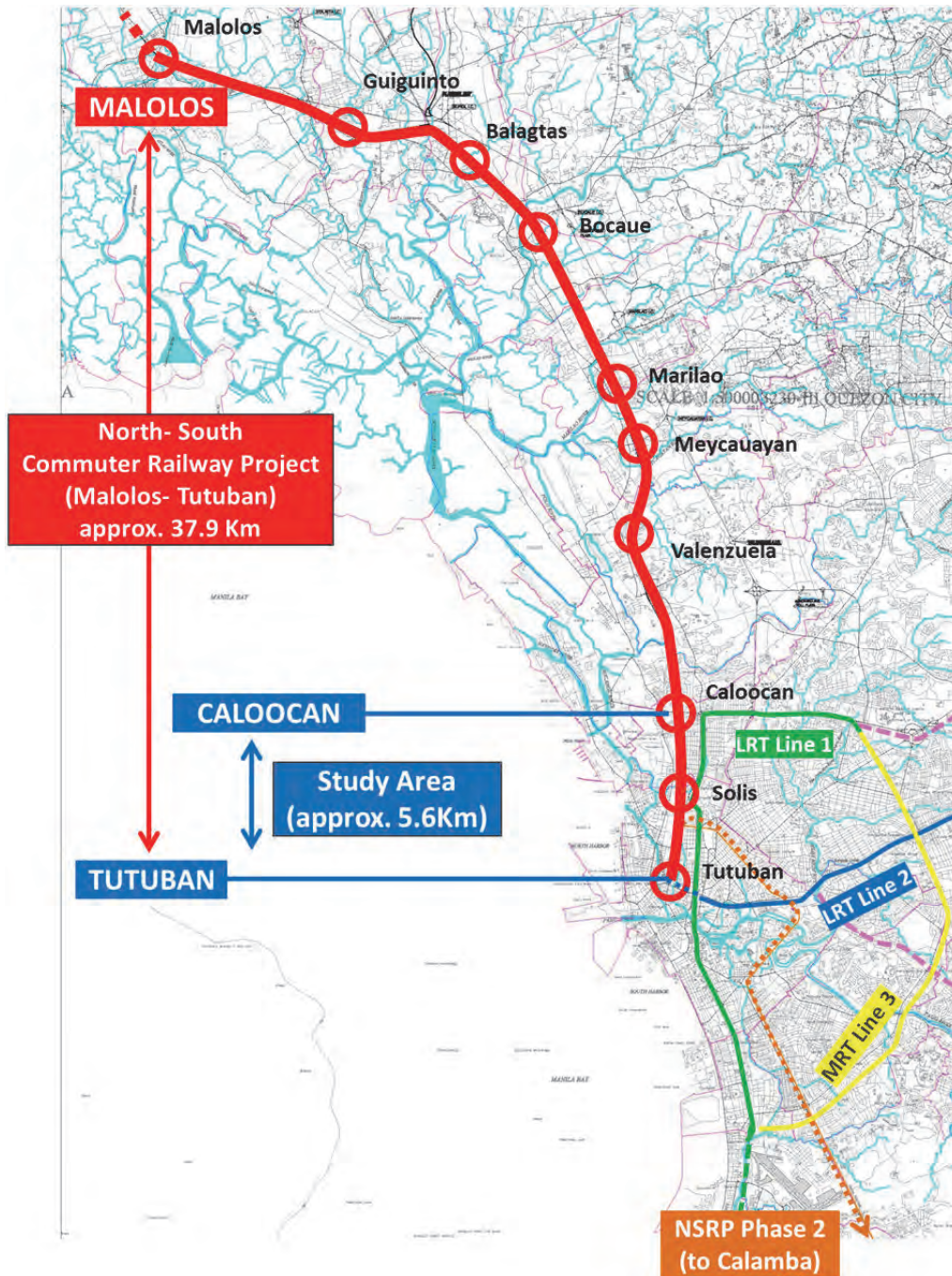

Source: JICA Study Team

Figure 1.3.1 Project Location Map

1.4 Items to be Studied

Items which will be studied are shown in Table 1.4.1.

Table 1.4.1 Items to be Studied

Scope	Methodology
1) Confirmation of Necessity and Background of Project	<ul style="list-style-type: none"> • Review of the result of F/S on Malolos- Caloocan section • Review and updating the socio- economic indices and the current situations of public transportation systems in Metro Manila • Current status of the relevant plans and projects in the urban development/ urban transportation sector • Current status of the study and latest project implementation schedule of the west extension of LRT Line-2 • Current status of the improvement of existing PNR by PPP center • Progress and latest plans of NLEX- SLEX Connector Road projects • Other donors' assistance status in the railway sector
2) Review of Existing Route Plan	<ul style="list-style-type: none"> • Review and check of the route plan in Pre-F/S and F/S • Update of demand forecasting in consideration with latest plans of relevant projects such as LRT Line-2, etc. • Set of the evaluation criterion for route planning, finalization of the route plan
3) Proposal of Project Framework	<ul style="list-style-type: none"> • Implementation of additional field survey and necessary studies for route plan and station location, train operation, service facility etc. • Conducting the following studies and establish a project framework: i) Route, ii) Specification of rolling stock design, iii) Operation plan, iv) Civil and facility, v) Depot and workshop, vi) Electrical and mechanical facility and equipment, vii) Signal and telecommunication, viii) Junction plan
4) Project Implementation Planning	<ul style="list-style-type: none"> • Setting of consultant services for the project, TOR and manning schedule • Study on traffic management/ safety plan during construction • Establishment of a project implementation plan including procurement plan for material and equipment, implementation schedule, project cost estimation as ODA loan projects • Examination on project cost saving
5) Review of Project Implementation Structure	<ul style="list-style-type: none"> • Review of finance, budget structure and technical level, operation and maintenance system of the implementation/ operation agencies • Review of technical assistance plan to implementation/ operation agencies • Discussion with relevant authorities such as DOTC, North Luzon Railway Corporation (NLRC), Department of Budget and Management (DBM) etc. regarding establishment of implementation/ O&M bodies • Applicability of PPP scheme • Applicability of STEP
6) Consideration of Environmental and Social Impacts	<ul style="list-style-type: none"> • Conducting necessary field survey regarding EIA, land acquisition and resettlement • Preparation of draft EIA, draft RAP, draft DDR and draft CAP
7) Estimation of Climatic Mitigation	<ul style="list-style-type: none"> • Identification and collection of data for calculation, estimation of potential GHGs reduction
8) Project Evaluation	<ul style="list-style-type: none"> • Calculation of indices for operation effectiveness, review of qualitative benefit • Calculation of EIRR and FIRR

Scope	Methodology
9) Recommendation on Project Implementation	<ul style="list-style-type: none">• Recommendation on project implementation plan, structure of implementation agency, conditions of contract, technical standards, construction schedule etc.• Establishment of a strategy on railway operation, business management and maintenance
10) Preparation of Video for Introduction of the Project	<ul style="list-style-type: none">• Preparation of video for Introduction of the Project

Source: JICA Study Team

CHAPTER 2

*NECESSITY AND BACKGROUND
OF THE PROJECT*

CHAPTER 2 NECESSITY AND BACKGROUND OF THE PROJECT

2.1 Situation and Issues in GCR Transportation Sector

2.1.1 Transport Infrastructure

The current rail network in Greater Capital Region (GCR) consists of the Philippines National Railway (PNR) Lines and urban mass transit lines within Metro Manila. The operational lines and future planned/proposed lines shown in Figure 2.1.1 are as follows.

- PNR Commuter service between Metro Manila and Alabang; and PNR long distance services in Luzon Island;
- LRT Line 1, a north-south line from Roosevelt (Quezon City) to Baclaran (Pasay City);
- LRT Line 2 an east-west line from Santolan (Pasig City) to Recto in Manila City, and
- MRT 3 a semi-circle north-south line from North Avenue in Quezon City to EDSA station in Pasay City.

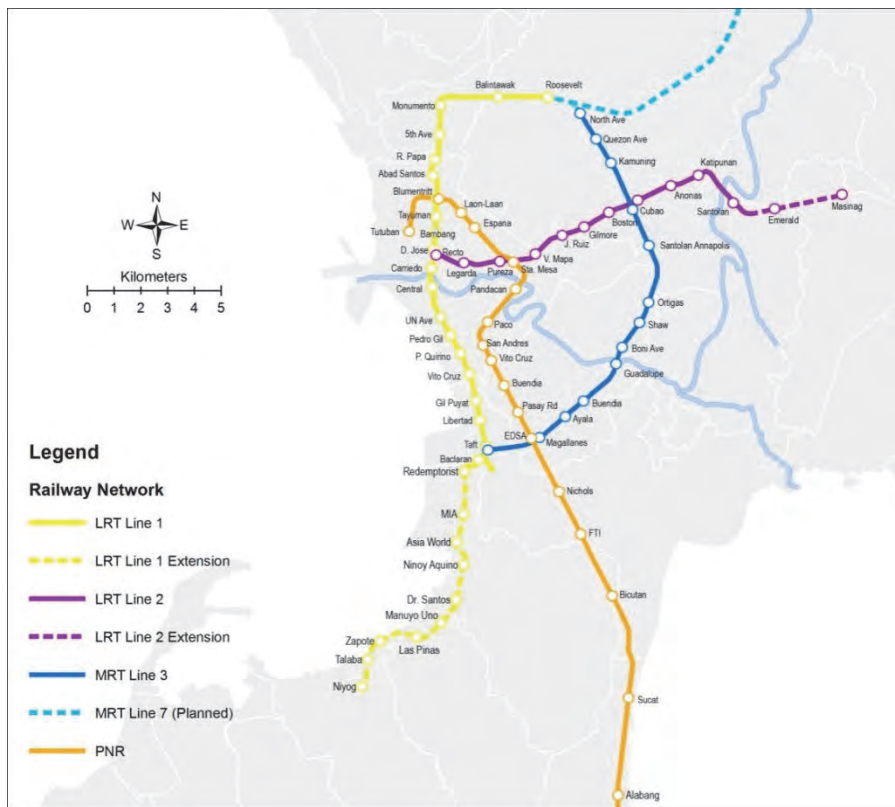

Source: LRTA Website & Updated by JICA Study Team

Figure 2.1.1 Operational and Planned Railway lines in GCR Area

2.1.2 Philippines National Railways (PNR)

1) Background

PNR was created in 20 June 1964 by virtue of Republic Act No. 4156, in order to provide a nationwide railway transportation system. The PNR is an attached agency under DOTC.

PNR used to operate over 797 km (495 miles) of route from La Union down to Bicol. However, continued neglect and damage from natural calamities in past decades reduced PNR's efficiency and railroad coverage. Persistent problems with informal settlers in the 1990s contributed further to PNR's decline¹.

2) Overall Network and Operations

The PNR in the Luzon region mainly consists of a north-south line operating out of Metro Manila main railway station in Tutuban. Based on data culled from the Philippine Statistical Yearbook, both patronage and level of service have deteriorated during the 2001-2008 period. Services to the north out of Metro Manila have been suspended since commencement of the North Railway Project², while the long distance services to the south of Metro Manila to the Bicol region were suspended after a strong typhoon devastated the area in September 2006. The Bicol service is currently under rehabilitation in preparation for the resumption of the Bicol Express run to Naga City in Camarines Sur province and eventually to the southern terminal in Legazpi City in Albay province³. Since 2006, the only remaining ongoing service is the Metro Manila and Alabang section.

The PNR network in the south of Luzon Island is shown in Figure 2.1.2. It is mostly single track, except the section between Tutuban and Alabang, from Metro Manila to Bicol / Mayon with a total length 415 km. When still in operation, the PNR run 3-trains a week to Bicol and three trains back to Metro Manila. In addition, the PNR also run limited commuter services in Bicol area with patronage less than 2,000 passengers per day. As per PNR's time-table the trip from Metro Manila to Bicol should take about 13 hours only, but it is common knowledge that more often it takes as long as 20 to 24 hours. This is mostly due to very poor track condition, numerous at-grade level crossings, and old rolling stock. Therefore, for obvious reasons, the patronage has been very low on the long haul section. This service was run for socially oriented purposes at a very low fare rather than to provide efficient rail travel between Metro Manila and Bicol region.

The PNR network in the Greater Capital Region, which extends from Tutuban to Alabang, consists of a narrow gauge double track (except Sucat to Alabang section) over a length of about 28 km. PNR's service level over the last decade paints a bleak picture as evidenced by the precipitous drop in ridership. However, the trend of patronage has been vastly improved since 2009 by introduction of new, mostly refurbished, rolling stock for services between Metro Manila and Alabang and some limited service to Biñan, and beyond to the Bicol region.

¹ PNR website (www.pnr.gov.ph)

² The Philippine government suspended the Northrail contract as it contained provisions perceived to be disadvantageous to the country.

³ PNR website (www.pnr.gov.ph)



Source: PNR / Study Team

Figure 2.1.2 PNR Network in Luzon

3) Patronage

PNR operates this section from 5:00 a.m. to 7 p.m. daily, with 30-minute service during the a.m. and p.m. peak periods (06:00 a.m. to 11:00 a.m. and 3:00 p.m. to 7:00 p.m.) from Monday through Saturday and hourly service during the inter-peak times and on Sundays.

Figure below shows the annual passenger traffic on the PNR network for Metro Manila to Alabang. This data shows that since 2001 PNR has been losing ridership from 5 million passengers per annum and finally hit rock bottom in 2008 with just over 1.1 million passengers. However, with the acquisition of new rolling stock in mid-2009, the decline in ridership was reversed. Over the next two years, ridership has increased sharply to reach some 25 million passengers by 2014.

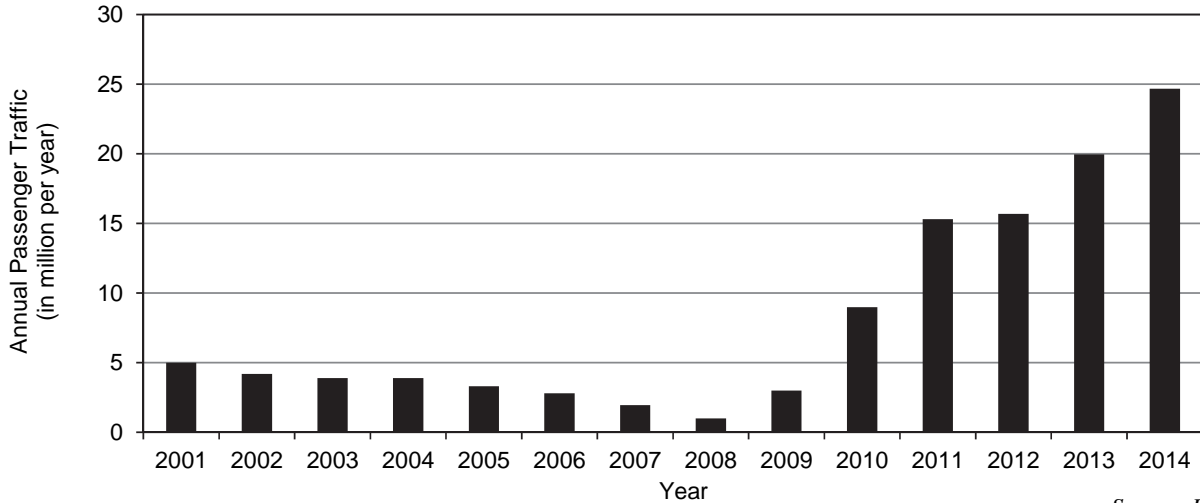

Source: PNR

Figure 2.1.3 PNR Annual Passenger Traffic, 2001-2014

The average daily ridership by station for the Metro Manila to Alabang section is shown in Figure below. Passenger from Alabang station is much more than the other stations. The sum of daily ridership for this section reaches about 70,000 passengers and means the importance of the Alabang to Tutuban section as a north-south corridor and possibility of demand growth in the future.

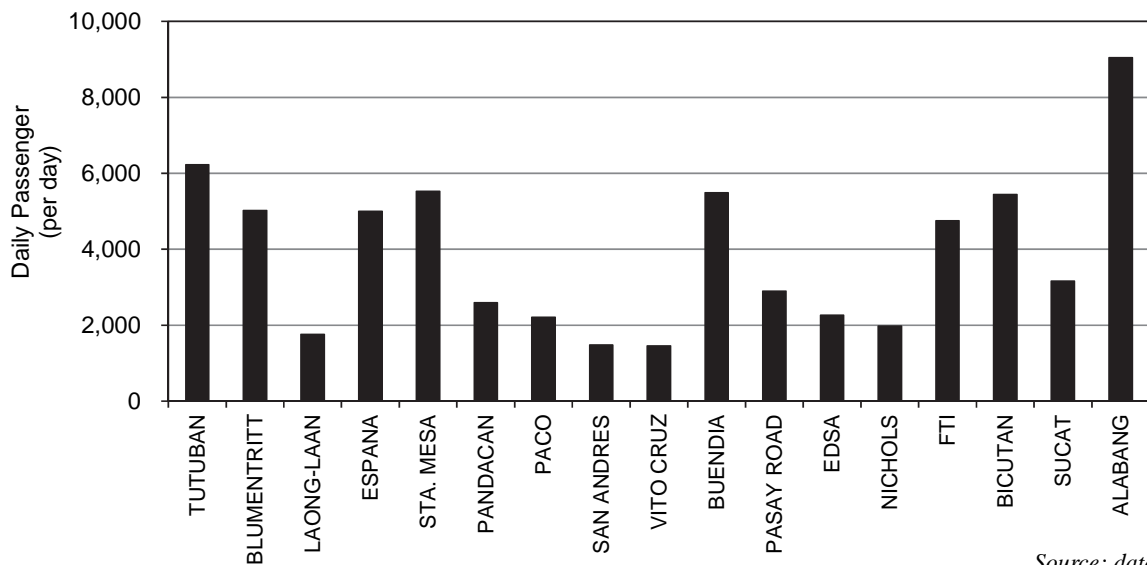

Source: data.go.ph

Figure 2.1.4 PNR Average Daily Passenger by Station in 2014

2.1.3 Urban Mass Transit Lines

1) Metro Manila LRT Line 1

Metro Manila’s first elevated Light Rail Transit started with a 14- km long line from Baclaran in the south to Monumento in the north. It had 18 stations along some of the busiest roads, Rizal Avenue and Taft Avenue opened for revenue service in December 1984. In 1985, the 1st full year of operation, the patronage of Line 1 was 69.7 million passengers. The growth in demand was steady and it reached 127.8m by 1990, and increased to a peak of 145.8 million passengers by 1994 (an average growth rate of about 8.5% p.a. from 1985 to 1994). Then the ridership started to decline due to poor maintenance and other technical reasons. The decline in patronage continued until 2004 (further exacerbated by the 20% increase in LRT fares in December 2003) and it was 96.8 million Pax in 2004, almost 40% less than it was a decade before that.

However, the declining patronage trend was reversed in 2005. In 2011, patronage of 156.9 million passengers was recorded on Line 1 after an eastward extension from Monumento of 5.7 km with two new stations (Balintawak & Roosevelt) opened in 2010. This gives an annual average growth rate for the decade: 2001 to 2011 of 3.62% per annum.

Annual patronage of Line 1 since opening is shown in Figure below. It can be seen that the drop in patronage from 145 million annual passengers to around 100~110 million annually throughout the 1st half of the last decade was mostly related to the available capacity of the rolling stock. With the provision of the additional rolling stock, growth in population and the economy, and ever increasing road congestion, Line 1 was able get its patronage back to the peak of over 160 million passengers per annum in 2012.

2) Metro Manila LRT Line 2

Metro Manila’s latest elevated Light Rail Transit Line 2 12.6km long with 11 stations runs from Recto in Manila City to Santolan (Pasig City) in the east along the busy east-west radial Marcos Highway, Aurora Blvd. Magsaysay Av. and CM Recto Av. The line opened for revenue service in April 2003. In 2004, the 1st full year of operation, the patronage on Line 2 was 20.6 million passengers. The growth in demand was instantaneous and the ridership more than doubled by 2005 to 41.9 million passengers, and increased

by another 40% by 2008 to reach 58.9 million passengers. After that the demand growth rate steadied and an average growth of about 3% from 2008 to 2011 has been recorded. By the end of 2014 the annual patronage had reached nearly 72.8 million passengers.

Line 2 annual patronage since opening is illustrated in Figure below. It can be seen that since 2008 the growth had steadied. The peak demand is met by operation of 4-car trains at 5 minute headways, at a comfortable load factor of about 60~70% under 1,000 passengers per train which has a crush capacity of 1,600 passengers per train. In the evening peak the load factor is even lower than the morning peak, providing a more comfortable ride.

3) Metro Manila MRT 3

Metro Manila’s Mass Rail Transit MRT 3, is 16.9 km long with 13 stations from EDSA (Pasay City) in the south to North Avenue (Quezon City) in the north-east. The alignment is mostly elevated along the busiest circumferential road (C-4) of Metro Manila, with the exception of a small section in Makati City where it is underground. It partially opened to service in late 1999, and the full line opened for revenue service in July 2000. In 2001, the 1st full year of operation, the patronage on the line was 90.2 million passengers, more than double from the passengers carried in 2000, and constantly increased until its peak year of 2013.

However, four accidents occurred since 2012, after the maintenance service by Sumitomo- Mitsui expired, including train collision with a parked train at MRT depot, passenger injury by abrupt stop, car fire caused by a short circuit and most recently a derail and injuring at least 36 people in August 2014. In addition, broken rail failures increase from 4 in 2011 to 22 in 2014. It causes decreasing MRT services such as slower operation speed, longer waiting time etc.

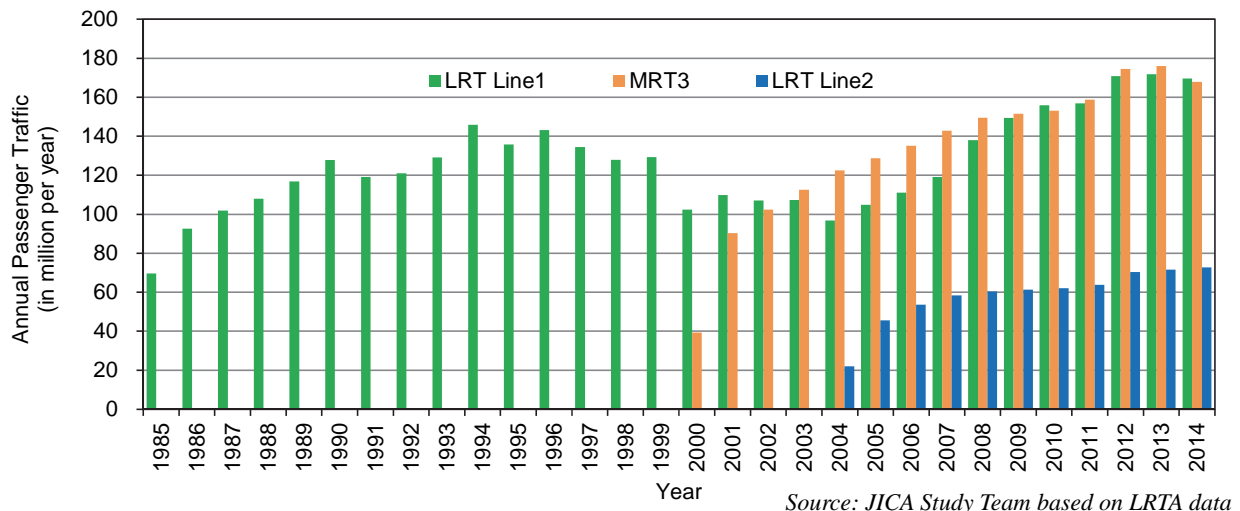

Figure 2.1.5 Ridership of LRT Lines 1, 2 and MRT 3

2.2 Reconfirmation of Latest Plans and Policies in the Transportation Sector

2.2.1 Summary of the Recent Development Plans in Metro Manila

A several programs and action plans have been proceeded by the national government, such as the construction of NLEX and SLEX, the development of the Bataan and Cavite Export Processing Zones together with the provision of fiscal and non-fiscal incentives to investors in these areas, the construction of the Batangas Seaport, and more recently the development of the Southern Tagalog Arterial Road (STAR), and the Subic and Clark special economic zones.

Despite these policies, projects and package of incentives, Metro Manila continues to attract migrants and investors. However, because of cheaper land and services outside Metro Manila, the different urban centers in Central Luzon and CALABARZON have grown. Statistics show that after Metro Manila, these two regions have attracted the most number of new investments, including foreign direct investments, than other regions in the country.

1) The Philippine Development Plan 2011–2016

The Philippine Development Plan (PDP) 2011-2016 cites that the country needs to develop suitable locations to ensure that business process outsourcing (BPO) investments and expansions can be accommodated, and that physical and Information technology (IT) infrastructures are key solutions to address the growth of the industry. In 2009, the government and the private sector collaborated on a project dubbed as the “Next Wave Cities” wherein focus is directed on locations with high growth potential in the BPO services. Among the 10 cities identified, six are in CALABARZON (Sta. Rosa in Laguna, Metro Cavite (Bacoor, Dasmarias, Imus), Lipa and Batangas City in Batangas, and Malolos, Bulacan in Central Luzon. In 2010, five other cities were added as BPO potential destinations. One of them is Metro Subic in Central Luzon.

The PDP also prescribes strengthening the country’s international logistics and supply chain activities, and specifically cites the existing ports in Batangas and Subic not only to decongest Metro Manila but also to open opportunities to worldwide shipping in the new areas. Also cited is the strengthening of the integrated air and sea connectivity of Clark-Subic to enhance the profile of this growth center among foreign and local investors. (Philippine Development Plan 2011-2016).

2) Development of the Subic-Clark-Manila- Batangas (SCMB) Corridor

Prior to the current PDP, the Medium Term Philippine Development Plan (MTPDP) 2004-2010 already recognized the need for a transport logistics system that will decongest Metro Manila by ensuring efficient linkages between its business centers and nearby provinces. In 2007, the Subic-Clark-Manila-Batangas (SCMB) Corridor, which connects the three regions accounting for two-thirds of the country’s GDP, was envisioned as a major transshipment and logistics hub in the Asian region. The SCMB Corridor handles more than 80 percent of the volume of the national cargo throughput, but its potential is constrained by inefficient logistics operations and infrastructure support.

According to the MTPDP, this has primarily resulted in high transport costs of goods and services that have made the corridor less competitive. To address this, the MTPDP prescribed a seamless multimodal logistics system along the SCMB Corridor to support intra-regional trade and investment, an increase in the level of services of an integrated transport system, and an efficient flow of commodities, supplies and inputs to tourism areas and various economic and industrial zones. (Medium Term Philippine Development Plan 2004-2010)

The current PDP’s strategic plan and focus with respect to the transport sector specifically highlights the need to develop an integrated multimodal logistics and transport system. It states: “The SCMB Corridor and other strategic logistics corridors must be developed to become a seamless intermodal logistics corridor.... The extension of the SCMB logistics corridor farther to the north and to the south will also be

pursued. To support this, the viability of establishing an efficient long-distance, high-speed mass rail transit system, integrated with the mass transit commuter rail system in Metro Manila, shall be explored. The feasibility of freight-rail services for all strategic logistics corridors will also be considered.”

3) Central Luzon Physical Framework and Development Agenda

Central Luzon Regional Development Plan 2011–2016 stated the vision of the region for 2025, “Central Luzon: A Sustainable and Caring Global Gateway through Public-Private-Partnership and Growth for All.” This plan further strengthens the policies of the PDP, with particular focus on Central Luzon. The plan’s objectives include: (a) Increased level of services of strategic roads and north-south linkages; (b) Integrated land, air and sea transport modes; and (c) Development of Clark-Subic as a regional tourism hub. The plan capitalizes on its strength as a major logistics hub, its being a major agricultural and food production area of the country, as well as its strong tourism potentials. The development issues in the region are identified as inclusive growth, insufficient transportation for economic development, lack of housing, disaster risk management, etc.

In physical development terms, the plan continues to adopt the “Enhanced ‘W’ Growth Corridor” spatial strategy (see Figure 2.2.2) with the Clark International Airport and its adjoining cities of Angeles and Mabalacat in the center. Each corridor has a different development strategy: tourism development for the blue corridor in the west; industrial development for the orange corridor in the center; agricultural development of high value crops and agro-forestry for the dark green corridor; and tourism and agricultural development for the east-west light green corridor. “Sustainable land use activities” is suggested as one of five goals.

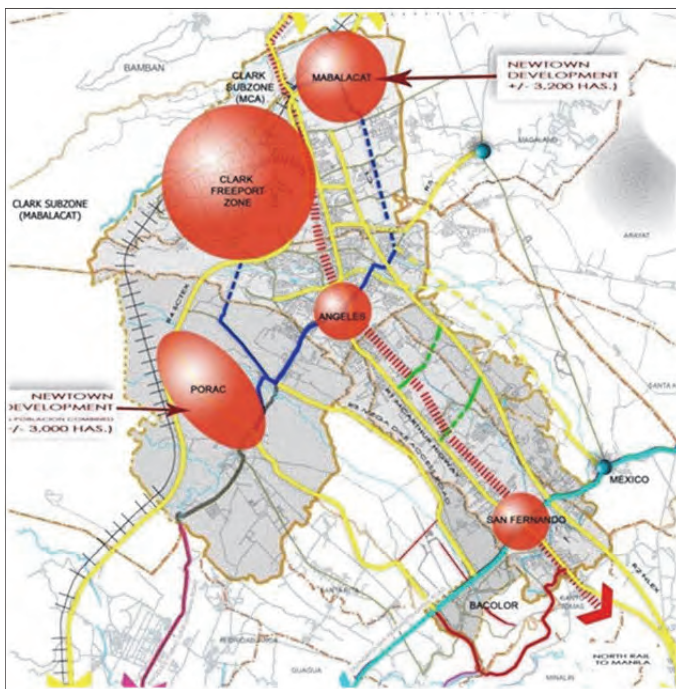

Source: Central Luzon Regional Development Plan 2011 - 2016

Figure 2.2.1 Metro Clark Area

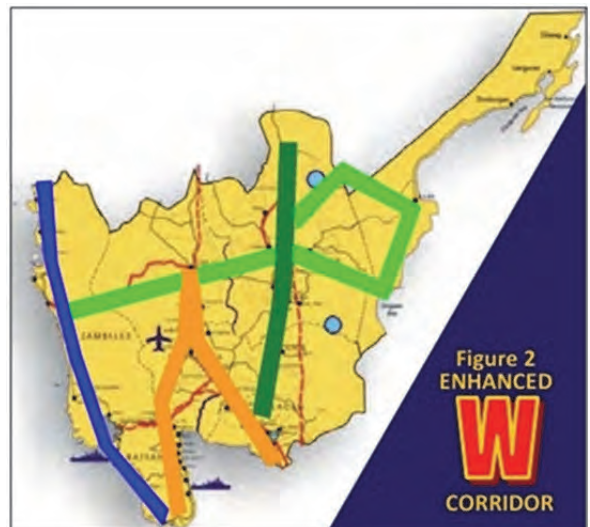

Source: Central Luzon in Regional Development Plan 2011-2016

Figure 2.2.2 Spatial Strategy of Central Luzon

4) CALABARZON Regional Development Plan 2011-2016

The plan acknowledges the need to focus developmental support to the province of Quezon because it lags behind the other provinces of the region according to the Human Development Index. It also recognizes the dominant influence of the private sector in defining housing and real estate development in the region, noting that master-planned tend to locate along major roads. The region (particularly in Rizal, Laguna and Cavite) has traditionally been one of the favorite location of government-developed resettlement sites for informal settlers, and has recently accommodated more such communities. The plan espouses the rehabilitation of the PNR and further development of the Batangas Port as high priority. It envisions the region as a major alternative residential and commercial node to Metro Manila.

However, the plan cites a number of challenges, such as: 1) Inadequate transport infrastructure; 2) Unbalanced distribution of settlements; 3) Limits to the use of land and other natural resources; 4) Disaster risk reduction and climate change adaptation concerns; and 5) Inadequate public service. In physical development terms, the plan has adopted the “Cluster/Center Corridor Wedge” spatial strategy which aims to direct and stimulate development and growth west to east, as well as strengthen the north-south corridor. This strategy specifically cites that “Proposed land uses and urban developments will be grouped in clusters, each borne from the predominant conditions, existing strengths, and potential opportunities of each area. Examples of land uses in the west include beach and mountain tourism, waterfront mixed uses, agropolis or highly-specialized agricultural and urban development in Batangas, agro-industrial uses, metropolitan and commercial urban development in Batangas City.” (CALABARZON Regional Development Plan 2011-2016).

Table 2.2.1 CALABARZON Centers, Corridors and Wedges, per Province

Province	Centers	Corridors	Wedges
Rizal	Antipolo City	Rodriguez, San Mateo, Cainta, Taytay, Angono	Other Municipalities
Laguna	Calamba City	San Pedro, Binan, Sta. Rosa City, Cabuyao, Los Banos, Bay, Sta. Cruz, San Pablo	Other Municipalities
Cavite	Dasmaringas City	Bacoor, Imus, Kawit, GMA, Carmona, Noveleta, Cavite City, Tagaytay, Silang, Rosario, Gen. Trias, Tanza, Trece Martirez City	Other Municipalities
Batangas	Batangas City	San Jose, Bauan, Lipa City, Sto. Tomas, Malvar, Tanauan City	-
Quezon	Lucena City	Tiaong, Candelaria, Sariaya, Tayabas, Pagbilao	Other Municipalities

Source: CALABARZON Regional Development Plan 2011-2016.

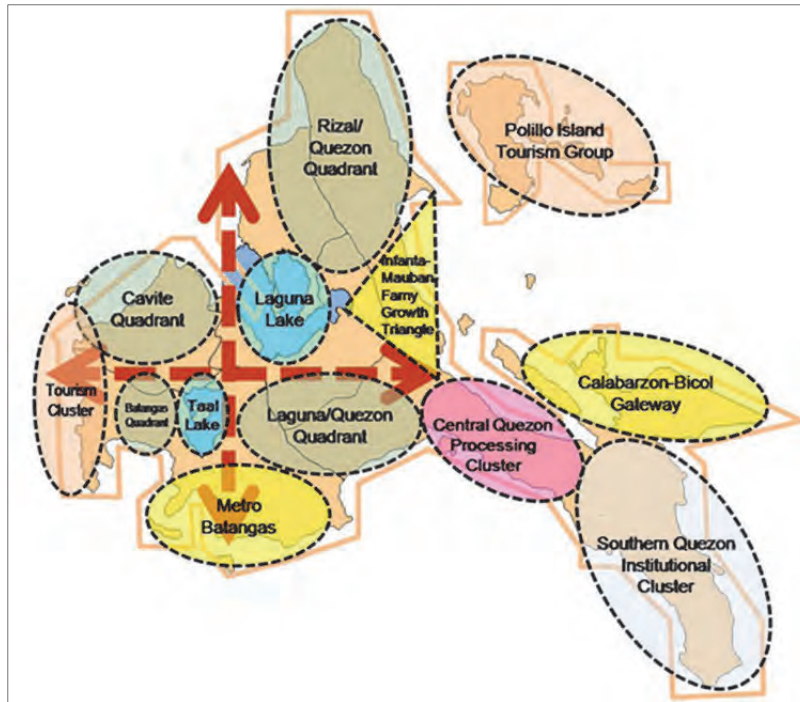

Source: CALABARZON Regional Development Plan (RDP) 2011-2016.

Figure 2.2.3 CALABARZON Quadrant and Cluster Spatial Framework

The strategy seeks compact urban development through cluster development and land use control to prevent sprawl, particularly the spillover from Metro Manila, and to protect agricultural and forest areas. Mixed-use and multi-use communities are encouraged as an appropriate urban development model for walkable community development, traffic reduction, reduction of pollution, efficient land use, and profitable development. Green wedges for agri-tourism, agriculture, forest and leisure areas are proposed as buffer zones and growth boundaries between urbanized areas. The coastal areas in the region will be developed according to the characteristics of each area, i.e., the vicinities of Laguna De Bay for waterfront development, housing, commercial, tourism, and other urban development, and the Taal Lake areas for eco-tourism and recreational purpose.

The need for land use management is pointed out for balanced spatial development and economic development. The plan suggests 10 principles for livable towns and cities and physical development design guidelines as spatial development strategies. Green policies for development, so-called “8Gs of Development,” are emphasized for environmental protection, balanced and high-quality life, and sustainability.

Millennium Development Goals plan for provision of safe housing unit for 80% of the population. CALABARZON is often selected for relocation sites for informal settlers in Metro Manila. The plan also indicates needs for cooperation among sending and receiving LGUs and the central government agencies, because accepting the relocations increases the burden on the receiving LGUs, such as providing public services.

5) Metro Manila Greenprint 2030 Print

The Metropolitan Manila Development Authority (MMDA) has embarked on creating a green development plan for the metropolis to replace the outdated National Capital Region (NCR) Development Plan. Strong stake holders participation is a requisite of the plan and, thus, the process entails the active participation of the private sector, academe and the civil society in general. The MMDA has plotted several goals to be set out in the plan, as follows:

-
- (i) Urban environment that is more conducive for investors, entrepreneurs, and innovators as well as creative minds that will enhance our competitive vis-à-vis other cities in Asia;
 - (ii) Improved coordination among key players, especially the 17 local government units of the NCR;
 - (iii) Provide a spatial framework to guide the future urban form of the metropolis as well consider the spatial framework of neighboring areas in the CALABARZON and Central Luzon regions; and
 - (iv) Provide primary infrastructure, green systems and the clustering of economic activities to improve livability.

2.2.2 Transportation Plans and Projects

To alleviate the ever growing demand for transportation infrastructure, several transportation projects within the GCR have been identified for implementation. These projects have been centered primarily on Metro Manila in view of the need to address the need for better transportation infrastructure and services that have reached critical proportions.

1) Roadmap for Transport Infrastructure Development

The background of recent economic growth, since the increasing of foreign direct investments in recent years, NEDA requested to the Government of Japan to carry out the study on Roadmap Study for Transport Infrastructure Development for Metro Manila and Its Surrounding Areas (Region III and Region IV-A) (Roadmap Study) in order to achieve the drastic development of transportation infrastructure in Metro Manila to solve a bottleneck for further economic growth of Philippines.

Objectives of this study is to establish a long term plan to be consistent with various transportation development plans and to formulate the “Transportation Infrastructure Roadmap” for sustainable development of Metro Manila and Region III and IV-A, surrounding areas of Metro Manila.

Outputs of this study are as follows.

- To establish the “Dream Plan”, showing policy for the adequate transportation network development towards 2030
- To formulate the “Roadmap for Transport Infrastructure Development” towards 2016 and 2020
- To designate priority projects

Transportation network named “Dream Plan” which aims to achieve “5 NOs” in 2030, consists of multiple projects to justify traffic management including about 300 km of railway, about 500 km of highway, rationalization of public transport etc.

- No traffic congestion
- No households living in high hazard risk areas
- No barrier for seamless mobility
- No excessive transport cost burden for low-income groups
- No air pollution

In the plan it is proposed the establishment of the North-South economic growth corridor of Metro Manila to promote an integrated urban development. The North-South backbone corridor which is consisting of the traffic network of railway and highway as an axis, to connect adjacent Region III, and Region IV-A of Metro Manila.

NSCR formulate a part of the North- South trunk corridor in the GCR and to contribute to strengthening the connectivity between Metro Manila and adjoining municipalities in Region III and IV-A, and to promote adequate urban development to formulate new urban centers along the corridor to meet large demand of resettlement.

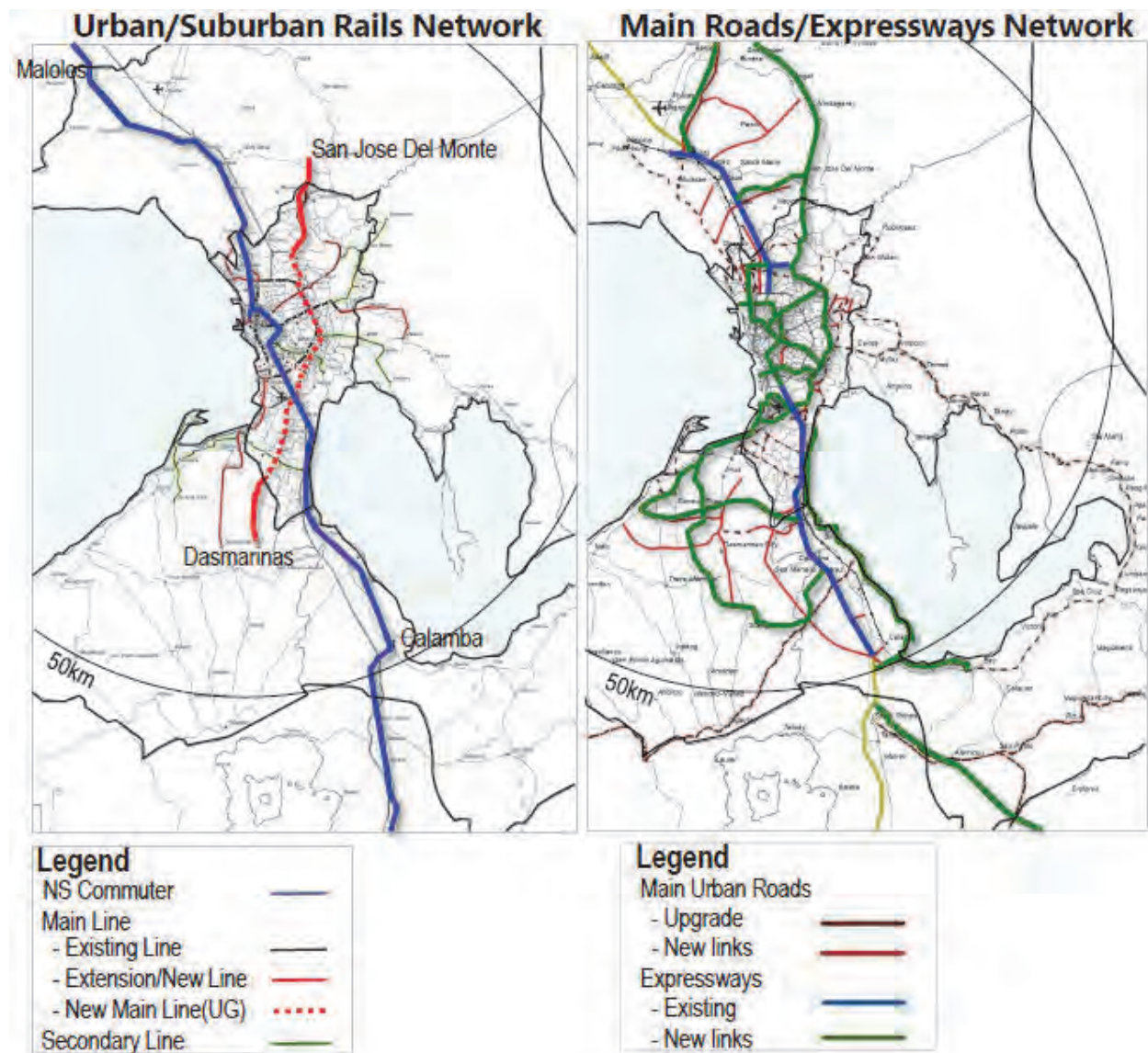

Source: Roadmap Study for Transport Infrastructure Development for Metro Manila and Its Surrounding Areas (Region III and Region IV-A)

Figure 2.2.4 Railway and Highway Network Proposed in the Roadmap Study

2) Urban Highways/Expressways

The major road projects that will either link Metro Manila with nearby provinces or provide additional road capacity within the Metropolis are currently being planned by the DPWH in the form of expressways. These projects are envisioned to be implemented via Public -Private Partnership (PPP) mode.

a) Daang Hari - SLEX Link Project

For this Project the Concession Agreement has already been signed between DPWH and Ayala Corporation on 03 April 2012. It involves construction of 4 km 4-lane toll road that will connect Bacoor

Cavite to the South Luzon Expressway with a cost of about PhP. 1.96 Billion. Target date of completion is March 2015.

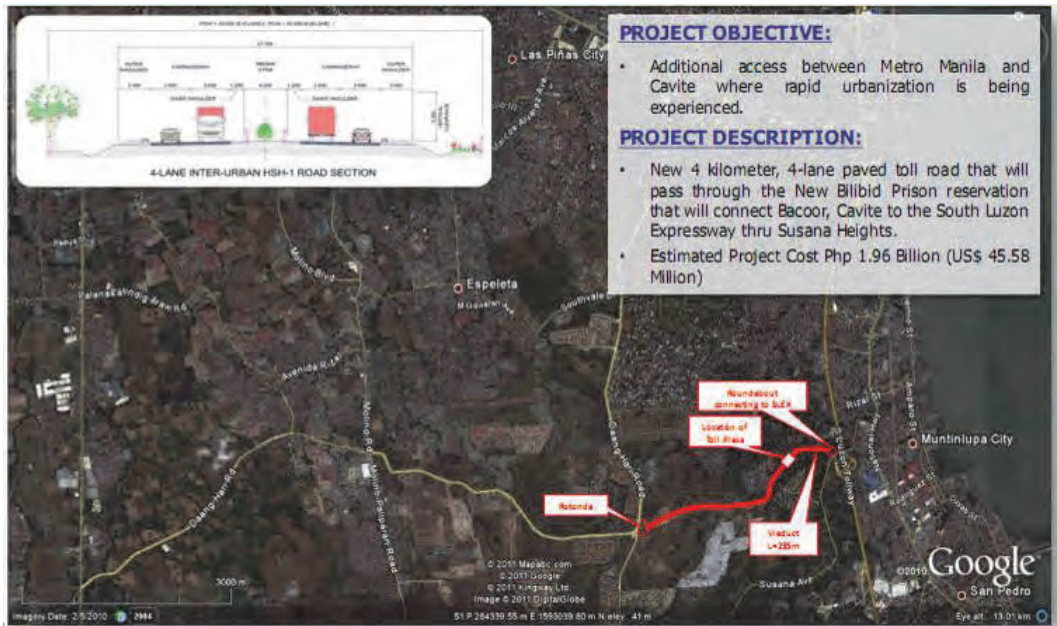

Source: DPWH

Figure 2.2.5 Daang-Hari SLEX Project

b) NLEX-SLEX Connector Road Project

This Project, or called Segment 10.2, will be integrated to Segment 10.1, a 5.65 km road that starts where Segment 9 ends on MacArthur Highway and stretches all the way to C3 Road and aims to completely connect the North Luzon Expressway to the South Luzon Expressway as to provide access to the Manila Ports and Decongest Metro Manila thoroughfares. It has a Project cost of about PhP. 25.56 Billion and has a total length of 13.5 km. It shall be composed of a 4 lane elevated expressway passing through Metro Manila and utilizing the Philippine National Railways' Right of Way.

A Memorandum of Agreement (MOA) between DPWH, DOTC and PNR is yet to be executed on the sharing of PNR Right-of-Way (ROW). The NLEX-SLEX Connector Road will be at the second level side by side with NSCR and the NSRP South Line of the DOTC.

This project was recently returned to its original scheme of an unsolicited proposal from the recent scheme of JV. Manila North Tollways Corporation (MNTC) first submitted an unsolicited proposal in 2010 for the connector road, and on Jan. 21 2014, signed a joint venture agreement with state-run Philippine National Construction Corporation (PNCC) -- the holder of the NLEX franchise -- to build that road together. But seven months later, on July 7, the Department of Justice (DoJ) issued an opinion on the joint venture proposal, saying that the NEDA Board approval of the agreement between MNTC and PNCC is "without factual basis or justification.". The DoJ opinion also stated that the DPWH, under Section 3 of the Build-Operate-Transfer Law, could proceed with the consideration of the unsolicited proposal. NEDA Board re-approve under unsolicited proposal subject to a Swiss Challenge in February 2015.

However, the NEDA-ICC deferred its approval on July 20, 2015 due to a defect in the application to the NEDA Board. Swiss challenge process is expected to take at least three months and would not likely be completed within the year.

According to the expected schedule as of August 2015, signing of contract and issuance of notice to proceed will be in March 2016, commencement of the work will be in September 2016, completion of the work will be in September 2021.

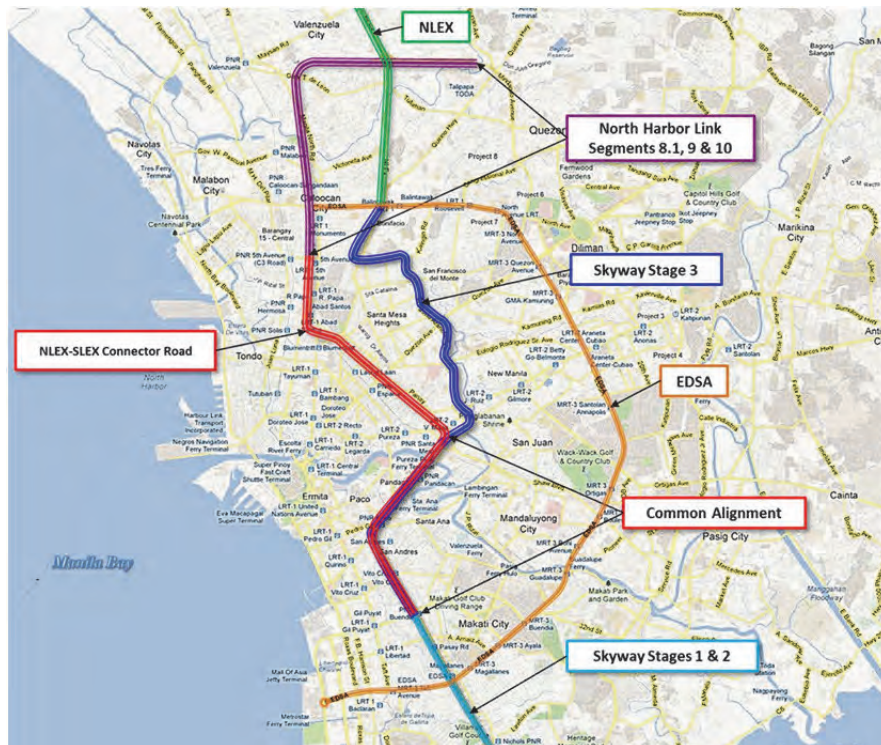

Figure 2.2.6 NLEX-SLEX Connector Project

Source: DPWH

c) NAIA Expressway Project

The Project aims to provide improved access to the Ninoy Aquino International Airport and PAGCOR Entertainment City, to connect to the Skyway network of NCR, and to decongest at-grade roads. It will be a 4-lane elevated road, 7.15 Km from Sales Street to Macapagal Boulevard in PAGCOR City with a total project cost of PhP15.86 Billion. It has been approved by the National Economic and Development Authority (NEDA) Board in May 2012 and successfully bided in May 2013. It is currently under construction by a San Miguel Corporation subsidiary. Revised target date of completion is October 2015 for Phase II-A, April 2016 for Phase II-B.



Source: DPWH

Figure 2.2.7 NAIA Expressway Project

d) Laguna Lakeshore Expressway Dike (LLED)

The project involves the construction of 43.6 km 4-lane road dike from Taguig to Calamba Laguna passing along the coastal area of Laguna de bay. It is envisioned to decongest the main roads of Muntinlupa while serving as a flood control measure. This project is currently in the procurement stage and the target date of start construction is September 2015.

e) C-6 Expressway North and South Sections (Global City Link)

This expressway which will be the outermost circumferential road of NCR as planned in the UTSMMA will serve as alternate route for the C-5.

The North Section shall be built by the MRT 7 Consortium as part of the Mass Rail Transit Line 7 Project with cost of about PhP. 7.85 Billion and length of 16.5 km with 4 lanes. It will start from the North Luzon Expressway entry at Marilao/Bocaue Bulacan and will terminate at San Jose Del Monte. Status of the MRT 7 Project is discussed in the succeeding Sections of this Report.

The South Section will then start at San Jose Del Monte Bulacan and shall pass through Rodriguez, San Mateo, Antipolo, and Taytay in the Province of Rizal and from there shall connect with the Skyway in Bicutan, Taguig. It will have 59 km including a Global City Link of 3 km. It will be at grade with some elevated sections in Taguig with 4 to 6 lanes and cost is about PHP 44.59 Billion. The Project is ongoing and the target data of completion is by 2016.



Source: DPWH

Figure 2.2.8 C-6 & Laguna Lakeshore Expressway Dike



Source: DPWH

Figure 2.2.9 C-6 Expressway North and South Sections with Global City Link

f) C-5 FTI Skyway Connector

This project will provide access to the FTI from C5 and Skyway. It has an estimated project cost of PhP 5.64 billion with 2 to 4 lanes and length of 6.8 km including ramps. The Feasibility Study has been completed in 2006 and the detailed design is currently being reviewed by the Bureau of Design of DPWH..

g) R-7 Expressway

The Project will be constructed over one of the major and congested roads in Metro Manila, which are the Don Mariano Marcos Avenue and Quezon Avenue. It will be a partially elevated and partially underground expressway with transition at grade sections having 4 lanes and length of about 16.1 km. It is aimed at providing a high speed road connection between Manila and Quezon City. Project Cost is estimated at PhP 23.98 Billion. Start of the Business Case Study is targeted to be by August 2012. The Business Case Study is currently ongoing.



Source: DPWH

Figure 2.2.10 C5 FTI Skyway Connector



Source: DPWH

Figure 2.2.11 R-7 Expressway

3) Railway Project

a) NSRP South Line

The North South Railway Project (NSRP) South Line is a part of the GOP's efforts to promote inclusive growth. The Project aims to revive and improve the existing railway to provide enhanced passenger transport services to currently underserved areas in southern Luzon and encourage more productive activities. The implementation agencies of the NSRP South Line are DOTC and PNR under its PPP program.

The Project will entail the construction, financing, operations, and maintenance of three segments of rail connecting Manila to the provinces of southern Luzon.

- Commuter Line from Manila to Calamba City in Laguna (56km);
- Long-Haul Line from Manila to Legazpi City in the Bicol Region (478 km main line);
- Long-Haul Line Expansion consisting of (a) an extension from Legazpi City to Matnog in Sorsogon (117km) (the "Long Haul Line Extension") and (b) a branch line from Calamba to Batangas City (58km) (the "Long Haul Line Branch")

b) Northrail

The Northrail project is originally envisioned to provide additional transport capacity along Metro Manila to Central Luzon and Northern Luzon. The overall scope of the scope of the Northrail project is about 470 km in total for the main line and some 110 km for the branch line. The project is divided into four phases.; Phase I, the rail line between Caloocan City in Metro Manila and the Clark Freeport Zone in Panpanga; Phase II, construction of branch line to the Subic Economic Freeport Zone; Phase III, extension from Caloocan to the Bonifacio Global City and the Ninoy Aquino International Airport (NAIA); and Phase IV, Extension from Pampanga to San Fernando, La Union. Phase I of the project is

divided into two sections, Section I involves the rehabilitation/upgrade/ construction of the Caloocan to Malolos section; Section II extends from Malolos to the Clark Special Economic Zone.

The Northrail project Phase I is planned along the PNR right-of-way. The project also includes upgrading of the existing single track to elevated dual-track system, and the conversion of the rail gauge from narrow to standard gauge.

The Project is funded through a loan secured from the Export-Import Bank China.

An EPC Contract Agreement between NLRC and the Contractor China National Machinery and Equipment Group (CNMEG, which recently changed its acronym to Sinomach) was signed December 2003 with a total cost amounting to US\$ 421,050,000.00 wherein NLRC has the obligation to provide ROW with a free of squatters and of any obstacles to construction.

NLRC issued a Notice to Proceed to CNMEG on 19 February 2007, with an effective date of 26 February 2007.

In February 2012, the Supreme Court disagreed with CNMEC and stated that the contract between Northrail and CNMEC is not an executive agreement and thus, could be subject of annulment proceedings. The Supreme Court then remanded the case to the trial court for further proceedings. In October 2012 the Supreme Court eventually ruled that the project was contrary to law as it did not undergo proper bidding process.

c) Extension of LRT Line 1 to the South & North

The Line 1 south extension project, as known as the Cavite Extension, would extend the line by 11.7km from Baclaran Terminal to Niyog Station at Bacoor in Cavite Province. The extension line consists of approximately 10.5 km of elevated section and 1.2 km of at-grade section with eight new stations with a provision for two additional stations in future. Construction period is expected from July 2014 until December 2018.

Concession Agreement has been already signed with Light Rail Manila Consortium (LRMC), notice to proceed for ODA Consultant (CMX) was issued in January 2015, and the bidding for the Independent Consultant is on-going.

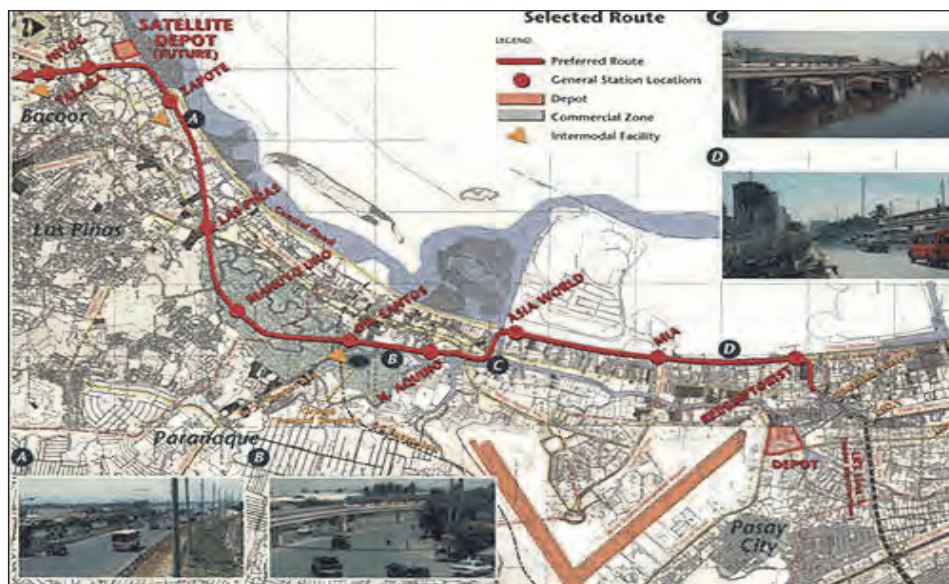

Source: DOTC

Figure 2.2.12 Cavite Extension of LRT Line 1

The Line 1 extension to the north-east to connect with MRT 3 provides direct transfer of passengers between MRT 3 and Line 1. It involves the construction of a 5.5 km double track elevated line from

Monumento Station of Line 1 to North Avenue Station of MRT 3. Balintawak and Roosevelt Stations are now open for commercial operations.

The last phase of this project is to build a Common Station that will connect the Line 1 and MRT 3, and in the future with MRT 7 as well. The construction of this station has been suspended by a Supreme Court Temporary Restriction Order (TRO) due to commercial disputes between a major retail shopping mall conglomerate and the DOTC/LRTA over the location of the said station.



Source: DOTC

Figure 2.2.13 LRT Line 1 North Extension Project

d) Extension of LRT Line 2 to the East & West

The Line 2 East Extension was identified in the Metro Manila Urban Transport Integration Study (MMUTIS) as one of the priority components of the long term master plan for transport development. The project involves the construction of 4.2 km eastern extension from its current terminus and depot at Santolan in Pasig City to Masinag Junction in Antipolo, Rizal with additional two passenger stations of Emerald and Masinag Station.

The work of Package 1 for construction of viaduct was commenced in June 2015, procurement of package 2 for design and build of stations is currently ongoing. Preparation of performance specifications and bidding documents for the E&M works under ODA loan has been commenced by CMX consortium. Expected completion period of the work is January 2016 for civil works and June 2016 for E&M works.

The Line 2 West Extension project involves the construction of approximately 3 km of westward extension of LRT Line 2 from current western terminus of Recto Avenue Station up to Pier 4 at the port area, with new transfer station of Tutuban to NSCR Tutuban Station and development of station plaza by DOTC. The project was approved by NEDA-ICC in May 2014, award of bid for detailed engineering design (DED) and construction supervision consultant is scheduled on November 13, 2015, issuing the notice to proceed will be December 2015. Bid for contractor will be opened in April 2016, commencement of the work will be in September 2016.

e) MRT 3 Capacity Expansion

The design peak capacity of 23,600 passengers per hour per direction (PPHPD) of MRT3 has already been achieved and surpassed on many occasions. The project aims to improve the passenger-carrying capacity to 32,160 PPHPD corresponding to the projected increase of 36% of the passenger demand. The

project involves the expansion of current fleet of 73 new Light Rail Vehicles (LRV) by MRTC and current three car trains with three minute headway configuration is to be improved to achieve four car trains with two minute headway configuration.

DOTC will start a rail replacement work with the delivery of approximately 7.3km of brand new rails. Meanwhile six new maintenance projects awarded to various contractors include (1) maintenance of rolling stocks, depot equipment, and signaling; (2) maintenance of rail tracks and permanent ways; (3) maintenance of buildings and facilities; (4) maintenance of power supply and overhead catenary systems; (5) upgrade and maintenance of communications systems; and (6) maintenance of ticketing systems. In addition, brand-new 48 LRVs product by China-based Dalian Locomotive will be introduced. Prototype is arrived on schedule for mid- August 2015, dynamic testing will be started in November, and monthly deliveries will begin in January 2016.



Source: DOTC press release, September 9, 2015

Figure 2.2.14 Prototype LRV for MRT3

f) LRT Line 4 and 6⁴

NEDA approved two PPP projects, implementation of LRT Line 4 and LRT Line 6 on September 4, 2015.

PhP 42.89 billion (USD 914 million) of LRT Line 4 project is a proposed 11.3 km railway from SM City in Taytay, Rizal to the intersection of Ortigas Avenue and EDSA in Ortigas. The proposed ROW alignment is along Taytay Diversion Road and Ortigas Avenue with six stations, namely: (i) EDSA (transfer station with the MRT) (ii) Meralco Avenue, (iii) Pasig, (iv) Bonifacio Avenue, (v) L Wood Road, and (vi) SM Taytay.

LRT Line 4 aims to provide improved local transportation solutions and a better link to Metro Manila for the large and growing population in and around Taytay region.

PhP 65.09 billion (USD 1,446 million) of LRT Line 6 Project is a proposed 19 Km railway from the terminus of the LRT 1 Cavite extension of Niyog, Bacoor to Dasmariñas City. The proposed ROW alignment is along the Aguinaldo Highway with 7 stations, namely: (i) Niyog, (ii) Tirona, (iii) Imus, (iv) Daang Hari; (v) Salitran, (vi) Congressional Avenue, and (vii) Governor's Drive.

LRT Line 6 aims to improve passenger mobility and reduce the road traffic volume in Cavite area by providing a higher capacity mass transit system. It also aims to spur economic development along the extension corridor.

g) Implementation of the MRT 7

The MRT 7 involves construction of 22.8km of dual tracks rail system to serve the expected 2 million commuters in the northern parts of Quezon and Caloocan cities. It will connect North Avenue at the corner of EDSA in Quezon City, passing through Commonwealth Avenue, Regalado Avenue and Quirino Highway up to the proposed intermodal transportation terminal in San Jose del Monte City in Bulacan. The project was approved by NEDA in November 2012 which included 14 stations, traction power substations with third rail system and signal facilities.

⁴ "LRT Line 4, Line 6 set for roll-out" PPP Center, September 7, 2015

Approximately \$10 billion project was awarded to the Marubeni- D.M. Consunji Inc. Consortium in May 2012. However, announced in November last year San Miguel would bid out again the construction contract because of the need to update the project’s cost, with prices of construction materials changing substantially since 2012. ULC received the performance undertaking for the MRT7 project from the government in October 2014. San Miguel, through unit San Miguel Holdings Corp., is a part owner of Universal LRT Corp., the proponent of MRT7 project, is targeted to begin the project by middle of 2016.



Source: DOTC

Figure 2.2.15 MRT 7 Route

h) Mass Transit System Loop

Mass Transit System Loop, Manila's first subway, has been approved by the NEDA-ICC in January 2015. The project involves approximately 20 km of railway system with 16 km of elevated and 4 km of underground section with 11 stations, and will run from Bonifacio Global City (BGC), Makati CBD, Mall of Asia in Pasay City. Project cost is estimated approximately 370 billion pesos and expected to be the current biggest PPP project in Philippines.

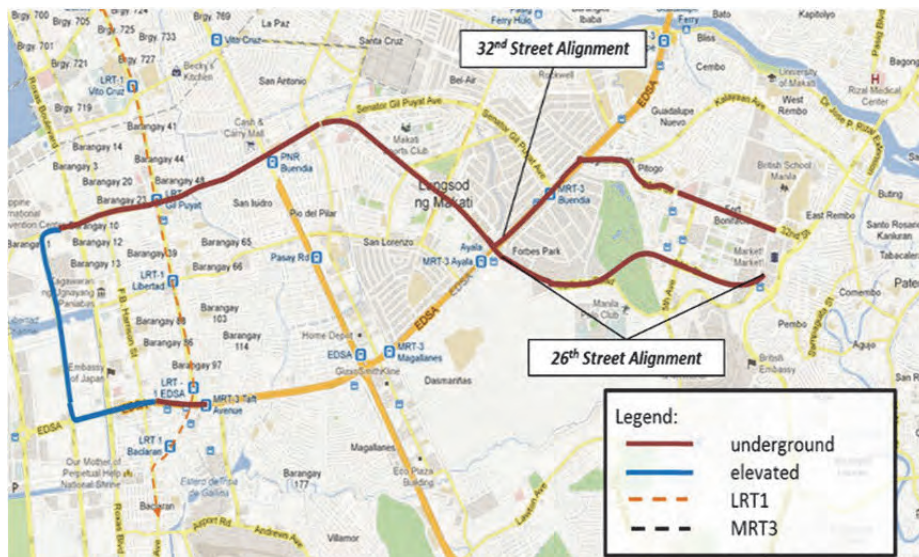

Source: PPP Center

Figure 2.2.16 Mass Transit System Loop Route

i) Mega Manila Subway Project

The Mega Manila subway project, designated to as one of the north- south economic growth corridor in the “Roadmap for Transport Infrastructure Development”, will runs from the northern start of San Jose del Monte to the south end of Dasmariñas, pass along EDSA. The information collection survey has been conducted by JICA and completed in October 2015.



Source: Roadmap Study for Transport Infrastructure Development for Metro Manila and Its Surrounding Areas (Region III and Region IV-A)

Figure 2.2.17 Mega Manila Subway Route

4) Integrated Transport System

The Integrated Transport System (ITS) aims to maximize road usage by reducing vehicle volume and improving traffic flow along Metro Manila’s major thoroughfares, particularly EDSA. This is envisioned to be realized by eliminating provincial bus traffic within Metro Manila and providing intermodal terminals outside of the congested corridors.

The project involves the establishment of three mass transportation intermodal terminals at the suburbs of Metro Manila; the ITS North terminal planned in the north of EDSA is to serve passengers to/from northern Luzon region, ITS South terminal is to serve passengers to/from Laguna and Batangas region, ITS Southwest terminal is to serve to/from Cavite region.

Ayala Land Inc. has bagged the right to build and operate 35year concession agreement for the 4 billion pesos, 5.57 hectare of ITS South terminal with DOTC in August 2015. MWM Terminals, the consortium of Megawide Corp. and WM Property Management Inc., awarded construction of the P3.2-billion ITS Southwest terminal in January 2015 and targeted to complete by June 2017. DOTC is now finalizing a deal to build the ITS North terminal at the Veterans Memorial Hospital in Quezon City.



Source: JICA Study Team based on the DOTC Map

Figure 2.2.18 Location of ITS Terminals

2.3 Confirmation of Project Necessity

2.3.1 Necessity of Integration with Region Development Strategy

Above problems in Metro Manila are difficult to be solved within Metro Manila, development of Region III and Region IV-A is an effective ways to maximize positive impacts of Metro Manila and contribute to mitigate Metro Manila’s problems.

Due to development of traffic backbone in Metro Manila integrated with regional development clusters, it is necessary to develop north-south transport backbones formulated of expressway and suburban rail network to meet necessity of resettlement of informal settlers from high hazard risk areas, and to formulate affordable housing plan in new urban areas with good accessibility and living environment in Bulacan, Cavite and Laguna areas.

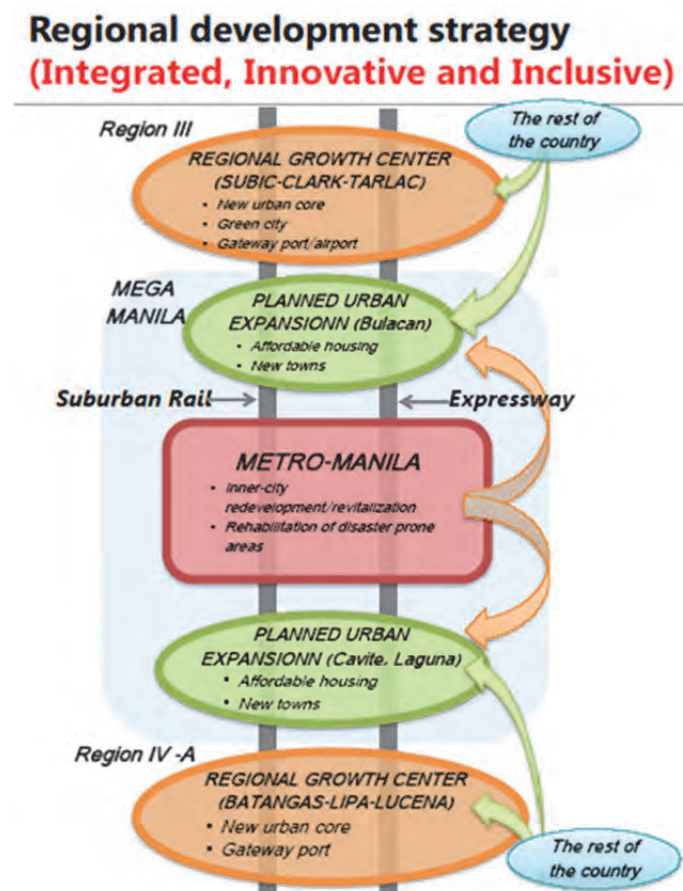

Source: Roadmap Study for Transport Infrastructure Development for Metro Manila and Its Surrounding Areas (Region III and Region IV-A)

Figure 2.3.1 Regional Development Strategy along North- South Corridor

It is also necessary to be integrated with retrofit, regenerate and new plans of urban transportation development in port areas, new NAIA (international airport), water front and others within Metro Manila area to meet requirement of strengthening of economic competitive.

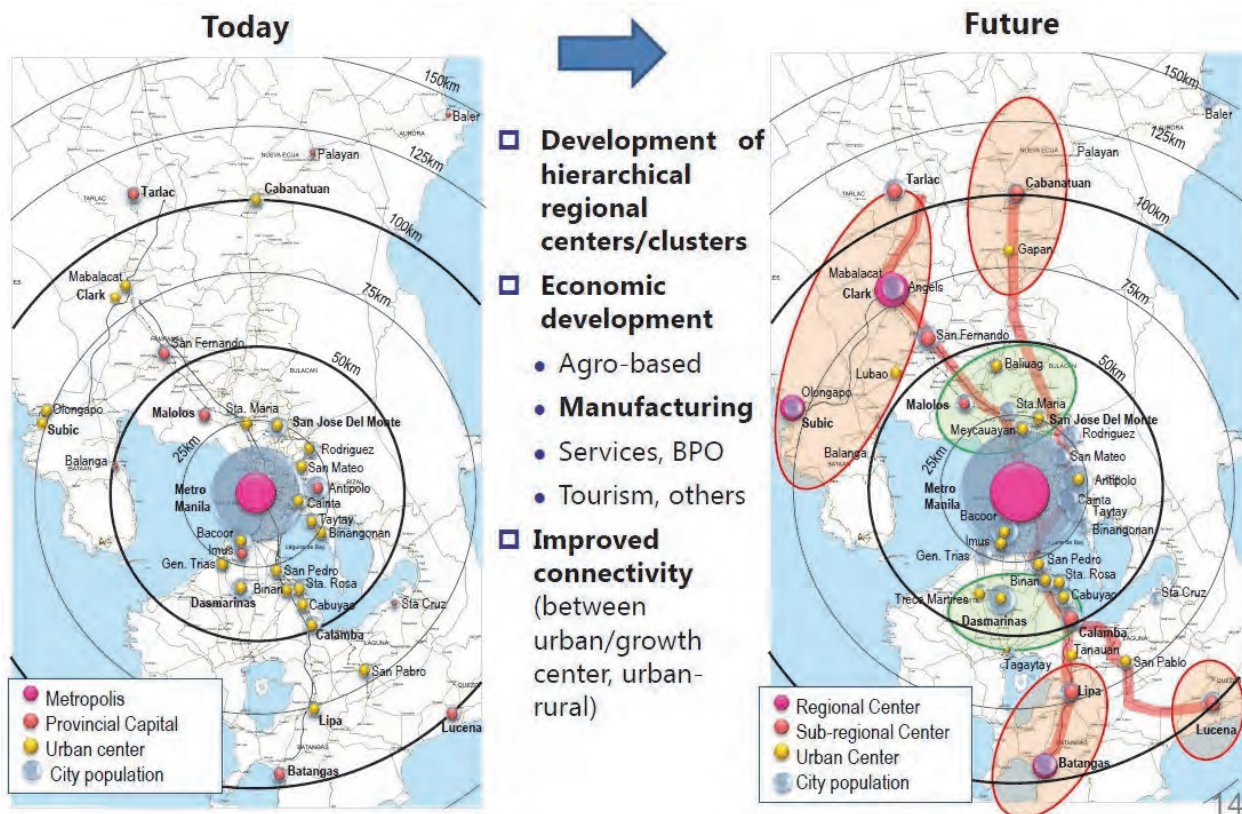

Source: Roadmap Study for Transport Infrastructure Development for Metro Manila and Its Surrounding Areas (Region III and Region IV-A)

Figure 2.3.2 Regional Development Potential along North- South Transportation Corridor

2.3.2 Necessity of Solving Traffic Problem

Population growth and urbanization have led to traffic congestion in Metro Manila. In addition, expansion in car ownership and decline in car occupancy also resulted in increased car traffic, while reducing public transport use at certain level since 1996. As a result, the traffic volume almost reached the capacity of the current road network and travel speed declined significantly, specifically on major arterial roads, such as EDSA. In spite of declined public transport use, road based public transport services, including buses, jeepney, and Asian utility vehicles (AUVs), are still dominant on road. These public transport performance and congestion of roads result in a vicious cycle. For example, frequent stops of buses or jeepney aggravate traffic congestion, while traffic congestion lowers travel speed of public transport.

The impact of the current traffic congestion in Metro Manila cannot be neglected. According to DOTC, the traffic congestion caused economic loss of Php137.7 billion in 2012. This would cover lost opportunities of business, inefficiency in economy, pollution, waste of energy and resources, impact on health, decline of quality of life, increased risk of accidents, etc. It was estimated that the economic losses originated from traffic congestion in the last decade are indeed four times larger than investments needed for the public transport projects in Metro Manila. As discussed, motor vehicles are the main polluter of air as well as and the emitter of GHG.

Traffic congestion in Metro Manila needs integrated approach based on urban mass transit, since improvement of road network alone cannot solve the issue. In particular, for the urban poor, a lack of transport choices significantly restricts their mobility and then reduces a job opportunity, because of high transport cost. Without any intervention, the traffic congestion problem is anticipated to exacerbate so that its cost would be more than doubled by 2030.

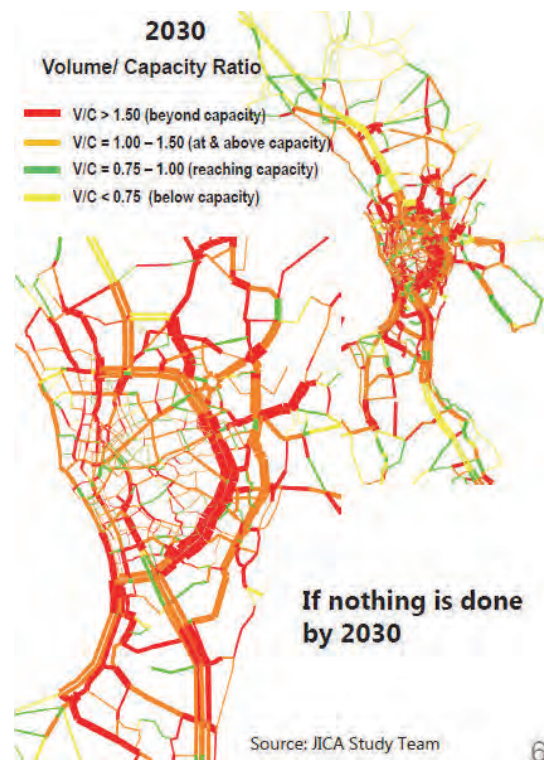

Source: Roadmap Study for Transport Infrastructure Development for Metro Manila and Its Surrounding Areas (Region III and Region IV-A)

Figure 2.3.3 Volume- Capacity Ratio in 2030 in Metro Manila

2.3.3 Necessity to Increase Competitive in Global Market

Due to progress of economic development of hierarchical regional centers and clusters to meet with growth of agro-based industry, manufacturing, services and business process outsourcing services, tourism and others, it is necessary to promote north-south urban growth, to improve mobility and accessibility along EDSA and other roads, and to create new urban land development opportunities.

Integrated urban mass transit will contribute to regional mobility and accessibility to city center and key traffic hub and to strengthening connectivity of Metro Manila, Region III and Region IV-A, and to global market, and connectivity through transport development and industry location strategies with integrated urban mass transportation system consisting of railway and highway.

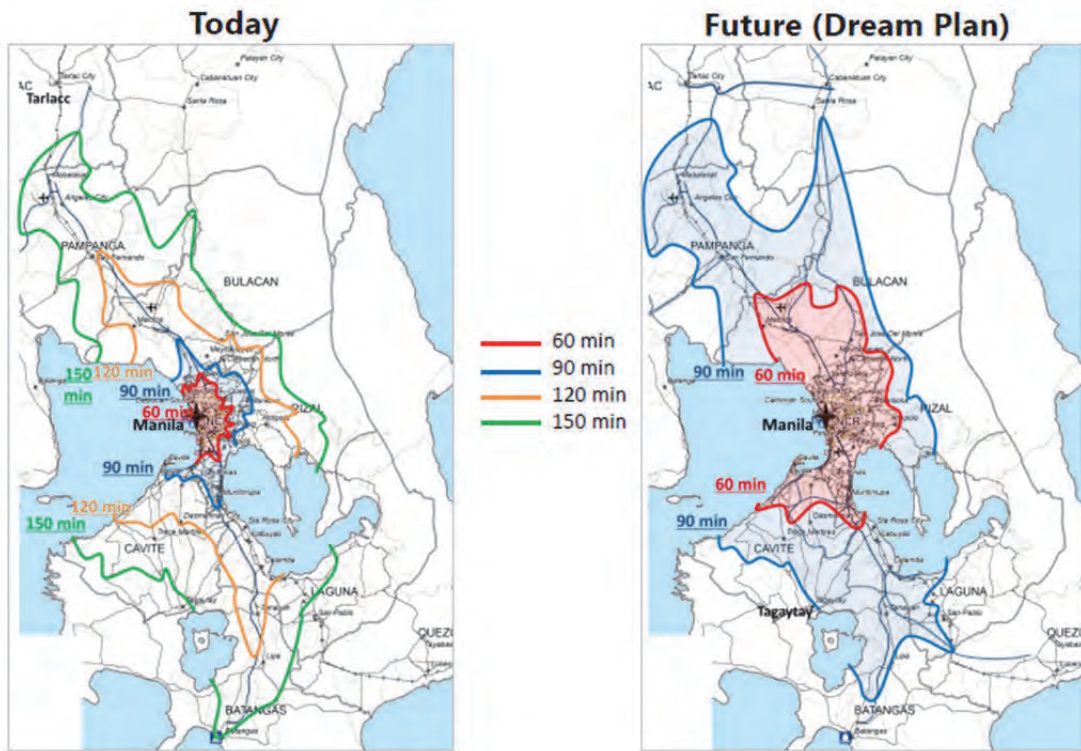

Source: JICA

Figure 2.3.4 Estimated Travel Time from Manila after “Dream Plan”

CHAPTER 3

ROUTE PLAN

CHAPTER 3 ROUTE PLAN

3.1 Review of Route Plan and Travel Demand Forecast

3.1.1 Methodology

Travel demand model was developed to forecast patronage with key features and main components. State-of-the-art ‘CUBE’ transport planning software was used for traffic modeling tasks. The key steps involved in the development, validation and use of the traffic model are summarized below (see Figure 3.1.1):

- (i) Convert MMUTIS and HSH study area O/D trip matrices to the project traffic model zone system.
- (ii) Create O/D trip matrices for base year 2012 taking off from the HSH 2009 database
- (iii) Combine 2012 MMUTIS and HSH O/D trip matrices by selecting the whole of MMUTIS area trips for the Mega Manila area, and HSH O/D trips for the remainder of the GCR regions.
- (iv) Develop the study area highway and railway network from HSH study and update where necessary.
- (v) Validate the 2012 O/D trip matrices by assigning to the 2012 network and comparing the assigned traffic volume against available secondary data from previous studies and the results of the traffic and passenger surveys undertaken for the Study.
- (vi) Prepare future year O/D trip tables for forecast years 2020, 2025, 2030 and 2040 and assign these to the corresponding networks that have been updated to include the new highway and rail networks. These would comprise the "without project" scenario. The future year network model considered the following railway lines and Roads.

Table 3.1.1 Railway and Road Projects

Year	Rail Project	Section
2020	Line 7	Trinoma - San jose del Monte
	LRT1 Extension	Baclaran–Niog– Das Marinas
	LRT2 East Extension	Santolan -Masinag
	MTSL	BGC - Makati
2025	LRT2 West Extension	Recto-Tutuban
2035	Mega Manila Subway	San Jose Del Monte-Dasmarinas
Year	Road Project	
2020	Segment 9 & 10	
	NLEX-SLEX Connector Road	
	Skyway Stage 3	
	NAIA Expressway	
	Laguna Lake Shore Expressway Dike	
	Calamba - Las Binas	
	CALA expressway	
	Plaridel Bypass Road	

Source: JICA Study Team

The model was then run for the same forecast years but with the project rail links incorporated in the networks for the "with project" scenario. The model results on passenger boarding and alighting and peak line demand served as inputs for the calculation of system requirements. On the other hand, the difference between the Daily and Peak Hour network performances of "With" and "Without" the project scenarios in terms of resulting vehicle-kilometers, vehicle-hours, and passenger-hours were used in the analysis of Project economic benefits and fare box revenue streams.

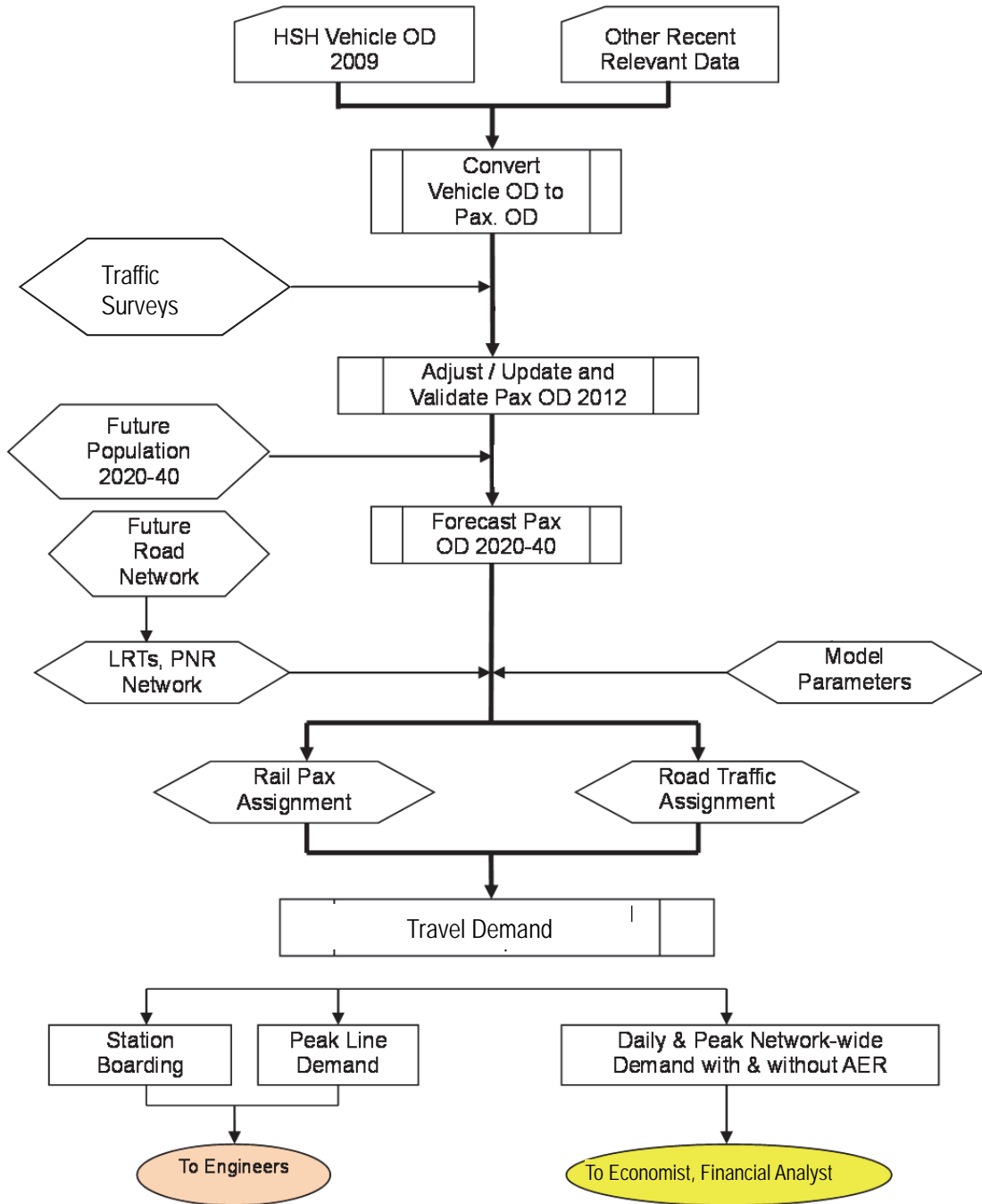

Source: JICA Study Team

Figure 3.1.1 NSCR Study Travel Demand Model, and Outline

3.1.2 Traffic Survey

3.1.2.1 General

The study examined various data sources for the development of the travel demand forecast model including: “The Master Plan on High Standard Highway Network Development in the Republic of the Philippines” and the on-going MUCEP study as well as other previous studies that have been conducted in the corridor. While various traffic data were already available several information gaps were still noted. Thus in order to augment, update and improve the database, some traffic and travel demand surveys were conducted by previous survey.

3.1.2.2 Traffic Survey on NLEX and MacArthur Highway

Traffic count survey on NLEX and MacArthur Highway was conducted by previous study as follows;

- (i) Description of Survey: Manual classified counts were made to determine the traffic volume by hourly interval, by vehicle type, and direction of travel. The survey duration was 18 or 24 hours; and,
- (ii) Summary of Survey Results: Traffic count results by site and direction are summarized in Table 3.1.2.

Table 3.1.2 Summary of Traffic Count Results

Road Name	Station Name	Entrance /Exit	SB (Entrance*)	NB (Exit*)	Total
MacArthur Highway	Bgy. Wakas Bocaue, Bulacan	-	5,972	6,228	12,200
NLEX	Balintawak Toll	-	33,142	37,336	70,478
	Mindanao Ave. Toll	Entrance	12,044	12,320	24,364
	Valenzuela IC	Entrance	9,238	3,551	12,789
		Exit	3,894	5,804	9,698
		Total	13,132	9,335	22,467
	Meycauayan IC	Entrance	7,866	6,097	13,963
		Exit	888	2,507	3,395
		Total	8,754	8,604	17,358
	Marilao IC	Entrance	4,437	1,200	5,637
		Exit	1,231	4,538	5,769
		Total	5,667	5,738	11,405
	Bocaue IC	Entrance	4,528	2,993	7,521
		Exit	2,900	4,106	7,006
		Total	7,428	7,099	14,527
	Tabang Toll*	Entrance	8,050	7,640	15,690
	Balagtas Toll*	Entrance	4,681	4,939	9,620
	Sta. Rita IC	Entrance	1,948	1,032	2,980
		Exit	1,593	1,788	3,381
		Total	3,541	2,820	6,361
	Pulilan IC	Entrance	1,788	2,163	3,951
Exit		2,100	1,775	3,875	
Total		3,888	3,938	7,826	

Source: Supplemental Traffic Survey conducted by JICA Study Team

3.1.2.3 Bus Passenger Surveys

The bus passenger surveys were conducted to gather information on travel characteristics of passengers to and from Bulacan. The surveys also provided information on bus occupancy counts. Data from various sources were utilized for areas south of Laguna.

- (i) Description of Surveys: This survey was conducted to determine the passenger travel characteristics (trip origin and destination, trip purpose, home address of interviewee, and total fare paid from origin to destination) and the bus information (number of passengers and seating capacity, and route origin and destination). Two types of interviews were conducted, one for public mode passengers and the other was for public mode drivers on the 29th and 30th of October and the 3rd of November 2012.
- (ii) Summary of Survey Results: The number of buses surveyed and the number of passengers interviewed are shown in Table 3.1.3. These data were used to update the OD matrix.

Table 3.1.3 Outline of Bus Passenger Interview Survey

Origin			Destination	No. of Buses Surveyed	No. of Passengers Interviewed
Region	Province	City/Municipality			
3	Bulacan	Marilao	Muntinlupa City	1	10
3	Bulacan	Bulacan	Quezon City	2	20
3	Bulacan	Bulacan	Manila City	6	62
3	Bulacan	Balagtas	Manila City	7	70
3	Bulacan	Malolos	Quezon City	3	30
3	Bulacan	Hagonoy	Pasay City	7	70
3	Bulacan	Hagonoy	Quezon City	3	46
3	Bulacan	Calumpit	Caloocan City	2	20
3	Bulacan	Pulilan	Quezon City	4	40
3	Bulacan	Plaridel	Quezon City	4	40
3	Bulacan	Santa Maria	Quezon City	3	28
3	Bulacan	San Jose del Monte	Manila City (Sta. Cruz)	3	40
3	Bulacan	Baliwag	Pasay City	2	20
3	Bulacan	Baliwag	Quezon City	9	96
3	Bulacan	Baliwag	Caloocan City	4	40
3	Bulacan	Angat	Manila City	8	80
3	Bulacan	San Miguel	Manila City	4	40
3	Bulacan	San Miguel	Caloocan City	4	40
3	Bulacan	San Rafael	Caloocan City	4	40
TOTAL				80	832

Source: Supplemental Survey conducted by JICA Study Team

3.1.2.4 Traffic Surveys at SLEX and Skyway Corridor

Traffic count and occupancy surveys were conducted at SLEX and Skyway corridors as follows;

- (i) Description of Surveys: The traffic count and occupancy surveys were conducted in the south of FTI/NAIA areas focusing on the SLEX/ Skyway Corridor. The surveys conducted are:
 - Manual Classified Vehicle Counts on Skyway, SLEX and Service Roads; and
 - Vehicle Occupancy Counts at selected survey points of (1) above in the inbound (towards Metro Manila) direction only.

The surveys were conducted for a period of 18 hours from 05:00 to 23:00 on Tuesday, 23 April 2013 and Thursday, 25 April 2013. Traffic volumes were counted in both northbound and southbound directions. The vehicle occupancy survey was conducted for a period of 12 hours from 06:00 to 18:00 hours on the same day with the traffic count.

- (ii) **Summary of Survey Results:** A summary of the traffic count data from the manual classified counts are shown in Table 3.1.4 below while the summary of the vehicle occupancy counts are given in Table 3.1.5.

Table 3.1.4 Summary of Traffic Count Data

Station Code	Station Name	Duration	Northbound (On-Ramp)	Southbound (Off-Ramp)	Total
Sta. A-1	SLEX (North of C-5 Access Ramp)	24-Hrs	28,873	32,815	61,688
Sta. A-2	East Service Road (Screenline)	24-Hrs	25,573	16,573	42,268
Sta. A-3	West Service Road (Screenline)	24-Hrs	15,937	12,160	28,097
Sta. B-1	SLEX	18-Hrs	36,740	44,614	81,354
Sta. B-2	East Service Road	18-Hrs	4,989	3,966	8,955
Sta. B-3	West Service Road	18-Hrs	7,153	9,368	16,521
Sta. C-1	SLEX	24-Hrs	58,692	55,738	114,430
Sta. D-1	Sales Road	18-Hrs	22,774	25,564	48,338
Sta. S-1	Skyway - Arnaiz (Entry/Exit Ramps)	18-Hrs	-10,727	-10,361	21,088
Sta. S-2	Skyway -Sales Road (Entry/Exit Ramps)	18-Hrs	-15,340	-15,293	30,633
Sta. S-3	Skyway - North of C-5 (Screenline)	24-Hrs	24,487	23,491	47,978
Sta. S-4	Skyway - Bicutan Entry/Exit Ramps	18-Hrs	-4,323	-5,683	10,008
Sta. S-5	Skyway - Sucat Entry/Exit Ramps	18-Hrs	-5,140	-3,872	9,012
Sta. S-6	Skyway - Hillsborough Entry/Exit Ramps	18-Hrs	-9,887	-8,046	17,933
Sta. S-7	Skyway Alabang Entry/Exit Ramps	18-Hrs	-5,364	-4,993	10,337

Source: Supplemental Survey conducted by JICA Study Team

Table 3.1.5 Summary of Vehicle Occupancy Count Result

Station Code	Station Name	Direction	Private Cars	Private/ Public Vans (seats 8 to 19)	Jeepneys (Seats 20+)	All Buses
Sta. A-1	SLEX (North of C-5 Access Ramp)	Northbound	1.8	2.4	22.2	45.0
Sta. A-2	East Service Road (Screenline)	Northbound	1.8	2.7	16.4	30.9
Sta. A-3	West Service Road (Screenline)	Northbound	1.6	1.9	17.2	2.0
Sta. B-1	SLEX	Northbound	1.7	5.5	17.0	44.5
Sta. B-2	East Service Road	Northbound	1.8	2.4	8.1	0.0
Sta. B-3	West Service Road	Northbound	1.5	2.7	10.9	1.7
Sta. D-1	Sales Road	Eastbound	1.7	2.6	6.2	31.2
Sta. S-1	Skyway Arnaiz Entry/Exit Ramps	On-Ramp	1.6	2.5	0.0	10.0
Sta. S-2	Skyway Sales Road Entry/Exit Ramps	On-Ramp	2.0	2.6	1.0	24.9
Sta. S-4	Skyway Bicutan Entry/Exit Ramps	On-Ramp	1.4	14.5	24.1	11.7
Sta. S-5	Skyway Sucat Entry/Exit Ramps	On-Ramp	1.9	10.9	21.0	0.0
Sta. S-6	Skyway Hillsborough Entry/Exit Ramps	On-Ramp	1.4	2.8	22.6	51.3
Sta. S-7	Skyway Alabang Entry/Exit Ramps	On-Ramp	1.5	4.1	10.0	8.0

Source: Supplemental Survey conducted by JICA Study Team

3.1.3 Population Forecast

One of the key inputs to the demand forecast model is the future population. Population forecasts were estimated for this project using analysis of historical trends at varying levels:

- 11 cities/aggregation of cities of Metro Manila
- Provincial level for Pampanga, Bulacan, Cavite, Laguna & Rizal
- Regional level for Regions III & IV-A and
- National level

Current and future populations are shown in Figure 3.1.2 for Metro Manila (NCR). While the Philippine's population growth rate is expected to decline from 1.2% - 1.5% from 2020 to 2040, the study area growth rate would be above this range. In Metro Manila, population growth rates of the area east of Metro Manila, City of Manila, Caloocan City, and Pasay City are lower than on the west side of Metro Manila.

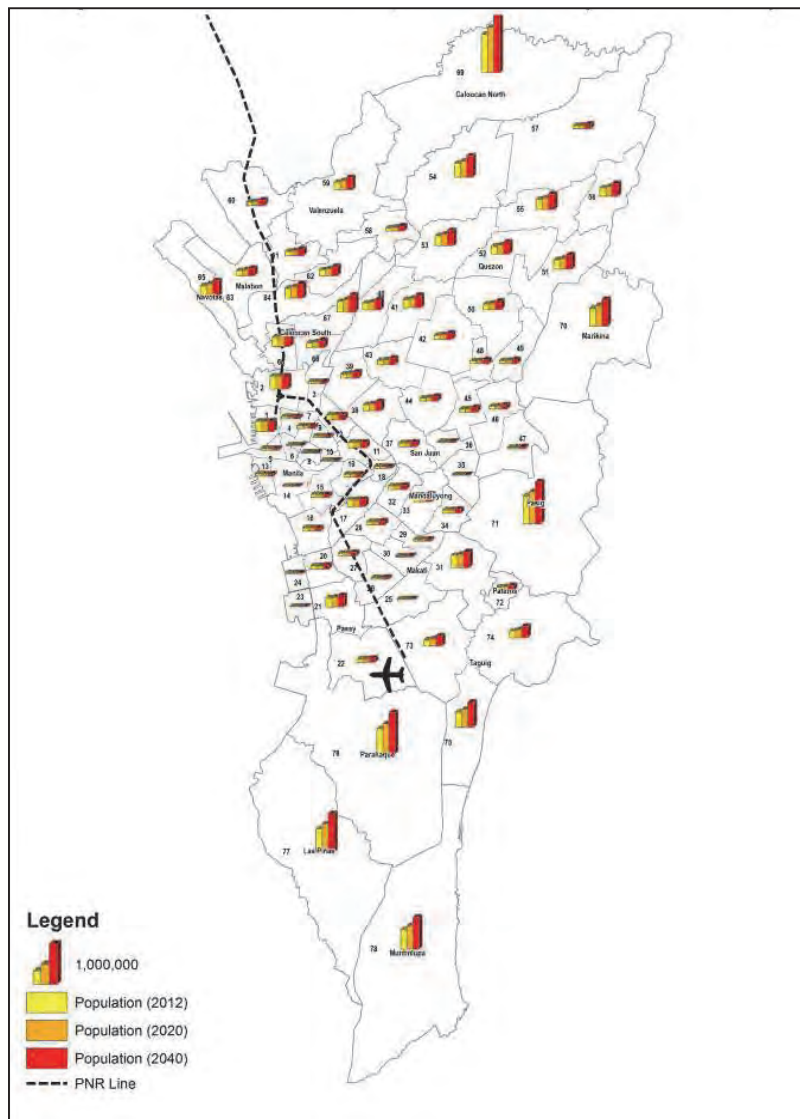

Source: JICA Study Team

Figure 3.1.2 Population Forecast Metro Manila, 2012, 2020 and 2040

3.1.4 Demand Forecast

3.1.4.1 Fare Setting

The tested train fare for demand forecast is same as the fare which was proposed by AER pre-FS project. It was increased based on GRDP growth rate in study area. The tested fare level is higher than one of existing LRT or MRT. However it is same level with the long trip bus.

Table 3.1.6 Train Fare

2020	2025	2030	2040
30+2.2/km PhP	38+2.8/km PhP	48+3.6/km PhP	64.8+4.9/km PhP

Source: JICA Study Team

3.1.4.2 Passenger Ridership Summary

The ridership is estimated for 2020, 2025, 2030 and 2040 as shown in the following tables.

Table 3.1.7 Passenger Demand for NSCR

Section	No. of Passenger/day (000)				AGR (%/year)		
	2020	2025	2030	2040	2020 - 25	2025 - 30	2030 - 40
Malolos–Calamba	-	953	1,385	1,596	-	7.8	1.4
Malolos– FTI	-	692	1,019	1,097	-	8.0	0.7
Malolos–Tutuban	407	430	574	630	1.1	5.9	0.9

Source: JICA Study Team

Table 3.1.8 Estimated PPHPD for NSCR

Section	PPHPD (passenger/hour/direction) ¹⁾				AGR (%/year)		
	2020	2025	2030	2040	2020 - 25	2025 - 30	2030 - 40
Malolos– Solis	13,210 (Solis- Caloocan)	18,290 (Caloocan- Solis)	20,680 (Malabon- Caloocan)	18,930 (Malabon- Caloocan)	6.7	2.5	-0.9
Solis – FTI	-	16,500 (Buendia- Paco)	20,380 (Vito Cruz- Paco)	19,990 (Paco-Vito Cruz)	-	4.3	-0.2
FTI –Calamba	-	13,650 (Bictan- FTI)	16,720 (FTI- Bictan)	16,760 (FTI- Bicutan)	-	4.1	0.0
Solis - Tutuban	11,440 (Tutuban- Solis)	9,700 (Tutuban- Solis)	10,910 (Tutuban- Solis)	11,190 (Tutuban- Solis)	-3.2	2.4	0.3

Source: JICA Study Team

1) peak hour rate is assumed to be 10% of the largest daily traffics volume.

3.1.4.3 Station Passenger Volumes

1) Forecast year 2020

For this year, there are 10 stations and the average trip length of passengers is 9.5 km. Forecast includes volumes of passengers boarding and alighting per station and corresponding line loads for year 2020 (see Figure 3.1.3 and Table 3.1.9).

- The station with the highest number of 2-way passengers per day is Tutuban with roughly 114,000 passengers boarding and 113,000 passengers alighting. Following is Caloocan with 72,000 passengers boarding and 71,000 passengers alighting.

- The highest daily line load for the southbound direction occurs at Caloocan Station with 131,200 passengers, followed by Solis and Valenzuela with 112,900 and 112,200 passengers respectively. For the northbound direction, Solis has the highest volume with 132,100 passengers followed by Tutuban with 114,400 passengers and Caloocan with 114,000 passengers.

It will be noted that for the Peak hour, the station with highest boarding volume for one direction would also register the highest alighting volume for the other direction. For the southbound direction, the highest figure for boarding is registered at Valenzuela station with 5,510 passengers followed by Caloocan with 4,500 passengers while for alighting it is at Tutuban with 11,290 passengers and at Solis with 4,200 passengers. Conversely, the highest boarding volume for northbound is at Tutuban with 11,440 passengers and Solis with 3,980 while highest alighting volume is at Valenzuela with 5,290 passengers and at Caloocan with 4,530 passengers. The highest line load for the southbound direction is at Caloocan with 13,120 passengers and Solis with 11,290. For the northbound it is at Solis with 13,210 passengers and Tutuban with 11,440.

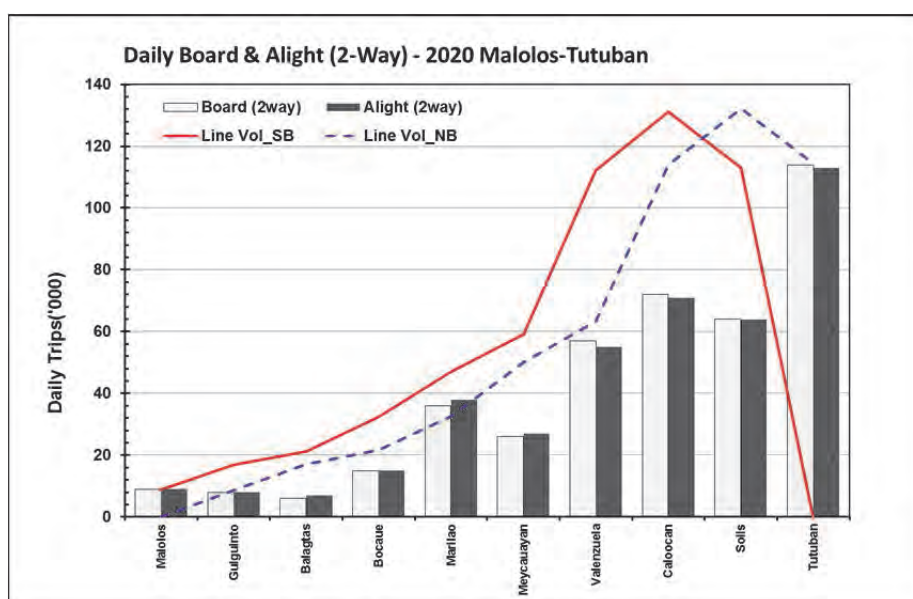

Source: JICA Study Team

Figure 3.1.3 Daily Passenger Volumes by Station, 2020

Table 3.1.9 Daily Passenger Volumes, 2020

No.	Station	South Bound			North Bound			Distance (km)
		Board	Alight	Line Vol.	Board	Alight	Line Vol.	
1	Malolos	8,800	-	8,800	-	8,600	-	6.2
2	Guiguinto	8,100	-	16,900	-	8,400	8,600	4.6
3	Balagtas	5,400	1,000	21,300	1,000	5,600	17,000	4.0
4	Bocaue	13,000	1,900	32,400	1,800	12,800	21,600	5.4
5	Marilao	25,000	10,500	46,900	10,500	27,900	32,600	1.9
6	Meycauayan	19,200	6,900	59,200	7,000	20,200	50,000	3.6
7	Valenzuela	55,100	2,100	112,200	2,100	52,900	63,200	5.7
8	Caloocan	45,000	26,000	131,200	27,200	45,300	114,000	3.6
9	Solis	23,700	42,000	112,900	39,800	22,100	132,100	2.0
10	Tutuban	-	112,900	-	114,400	-	114,400	-
Total (Max)		203,300	203,100	131,200	203,800	203,800	132,100	6.2

Source: JICA Study Team

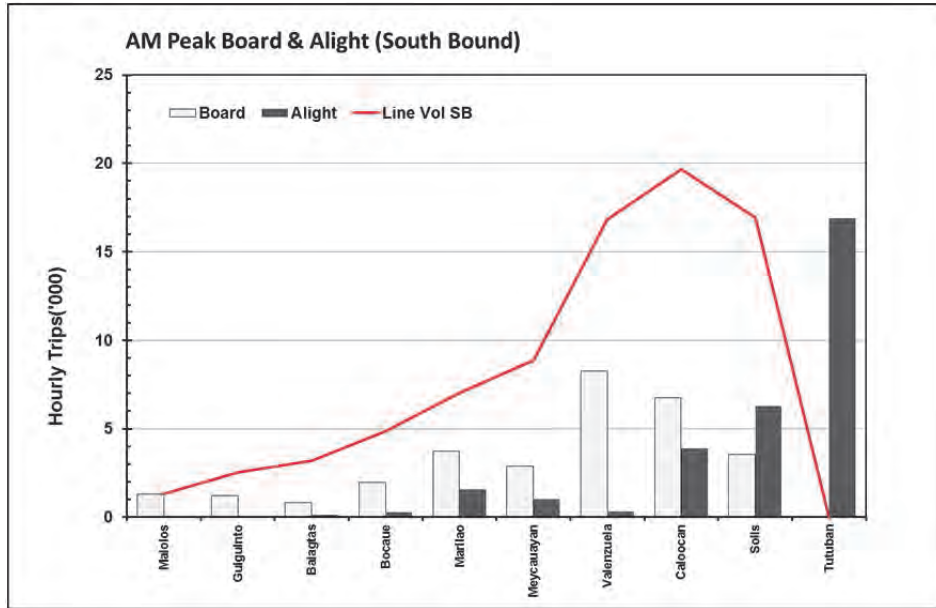

Source: JICA Study Team

Figure 3.1.4 AM Peak Hour Passenger Volumes by Station, 2020, Southbound

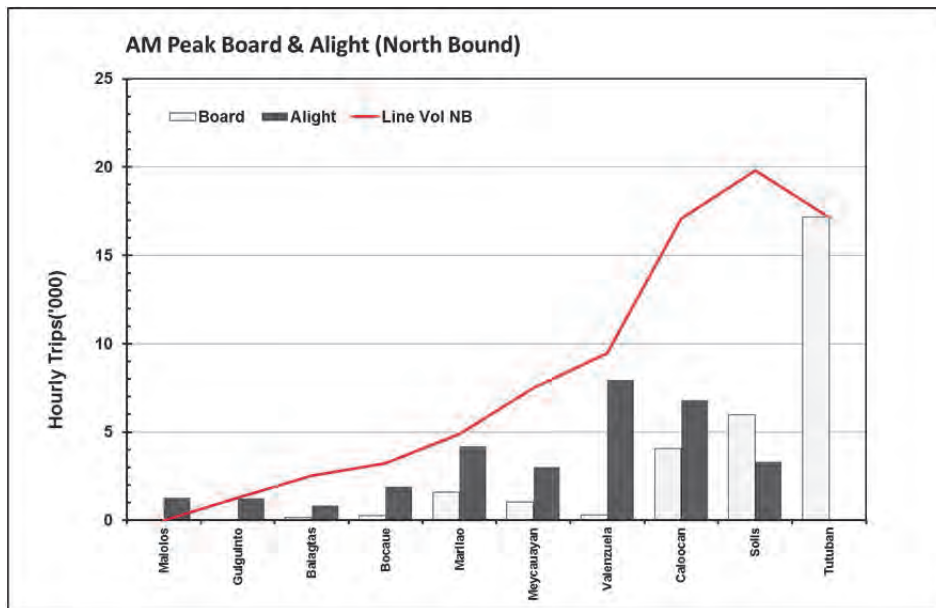

Source: JICA Study Team

Figure 3.1.5 AM Peak Hour Passenger Volumes by Station, 2020, North Bound

2) Forecast year 2025

For 2025 NSCR will connect Malolos to Calamba with 34 stations. The daily passengers by station are shown in Figure 3.1.6 and Table 3.1.10. Figure 3.1.7 and Figure 3.1.8 provides those for the Peak hour.

Tutuban has the highest number of 2-way passengers boarding and alighting per day with 97,000 passengers boarding and 94,200 passengers alighting. Caloocan follows with 88,800 passengers boarding and 88,700 passengers alighting.

The highest line load for the southbound direction occurs at Caloocan with 182,900 passengers, followed by Paco with 164,100. The highest line load for the northbound direction occurs at Solis with 182,800 passengers.

For the Peak hour southbound direction, the highest figure for boarding is occurred at Caloocan station with 6,500 passengers followed by Valenzuela with 5,600 passengers. The highest number of alighting passengers in southbound is occurred at Tutuban with 9,420 passengers followed by EDSA with 4,430 passengers. The highest boarding volume for northbound is Tutuban with 9,700 passengers and EDSA with 4,410. For alighting volumes the highest is at Caloocan with 6,540 passengers followed closely by Valenzuela with 5,760 passengers. The highest line load southbound is at Caloocan with 18,290. For northbound it is at Solis with 18,280 passengers.

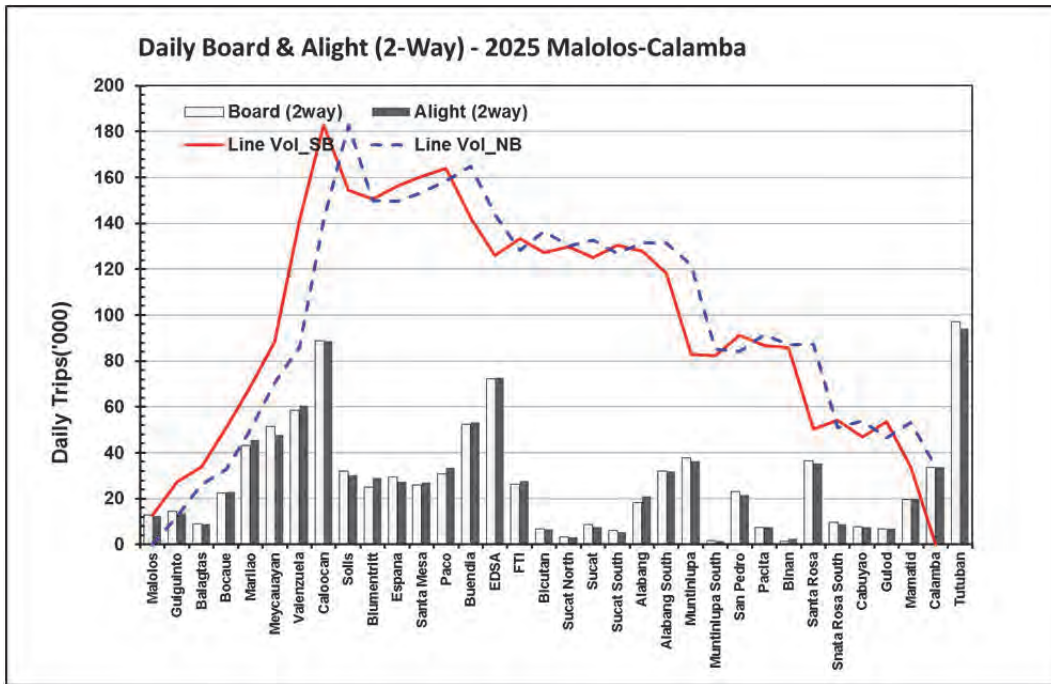

Source: JICA Study Team

Figure 3.1.6 Daily Passenger Volumes by Station, 2025

Table 3.1.10 Daily Passenger Volumes, 2025

No.	Station	South Bound			North Bound			Distance (km)
		Board	Alight	Line Vol.	Board	Alight	Line Vol.	
1	Malolos	12,800	-	12,800	-	12,400	-	6.2
2	Guiguinto	14,500	-	27,300	-	13,800	12,400	4.6
3	Balagtas	7,700	1,100	33,900	1,200	7,800	26,200	4.0
4	Bocause	19,700	2,700	50,900	2,800	20,100	32,800	5.4
5	Marilao	30,700	12,600	69,000	12,600	33,000	50,100	1.9
6	Meycauayan	34,800	15,600	88,200	16,600	32,300	70,500	3.6
7	Valenzuela	56,000	3,000	141,200	2,600	57,600	86,200	5.7
8	Caloocan	65,000	23,300	182,900	23,800	65,400	141,200	3.6
9	Solis	31,700	200	94,200 ^{*1}	200	30,100	182,800	2.0 ^{*1}
				154,300 ^{*2}				1.3 ^{*2}
10	Tutuban	-	94,200	-	97,000	-	97,000	-
11	Blumentritt	11,200	15,100	150,400	13,900	13,800	149,800	1.9
12	Espana	16,300	10,400	156,300	13,200	17,000	149,700	1.4
13	Santa Mesa	15,700	11,700	160,300	10,300	15,200	153,500	3.5
14	Paco	17,600	13,800	164,100	13,000	19,600	158,400	2.9
15	Buendia	15,900	37,600	142,400	36,600	15,500	165,000	1.9
16	EDSA	28,000	44,300	126,100	44,100	28,300	143,900	4.5
17	FTI	17,200	10,000	133,300	9,200	17,600	128,100	2.2
18	Bicutan	200	6,400	127,100	6,500	200	136,500	2.0
19	Sucat North	2,900	300	129,700	400	2,800	130,200	2.0
20	Sucat	1,200	5,800	125,100	7,400	1,700	132,600	1.8
21	Sucat South	5,800	400	130,500	300	4,900	126,900	1.6
22	Alabang	7,400	10,100	127,800	11,000	10,900	131,500	2.2
23	Alabang South	11,400	20,800	118,400	20,600	11,000	131,400	1.0
24	Muntinlupa	500	35,900	83,000	37,100	300	121,800	1.5
25	Muntinlupa South	500	1,200	82,300	1,200	400	85,000	1.0
26	San Pedro	15,300	6,500	91,100	7,900	15,100	84,200	1.7
27	Pacita	1,700	6,000	86,800	5,800	1,500	91,400	2.7
28	Binan	800	1,700	85,900	500	900	87,100	4.1
29	Santa Rosa	-	35,400	50,500	36,600	-	87,500	1.5
30	Santa Rosa South	6,200	2,600	54,100	3,500	6,400	50,900	3.3
31	Cabuyao	200	7,500	46,800	7,600	200	53,800	2.8
32	Gulod	6,800	100	53,500	100	6,900	46,400	2.8
33	Mamatid	-	19,800	33,700	19,600	-	53,200	3.3
34	Calamba	-	33,700	-	33,600	-	33,600	-
Total (Max)		455,700	489,800	182,900	496,800	462,800	182,800	4.0

Source: JICA Study Team

*1: Solis-Tutubn, *2: Solis-Bulumentrit

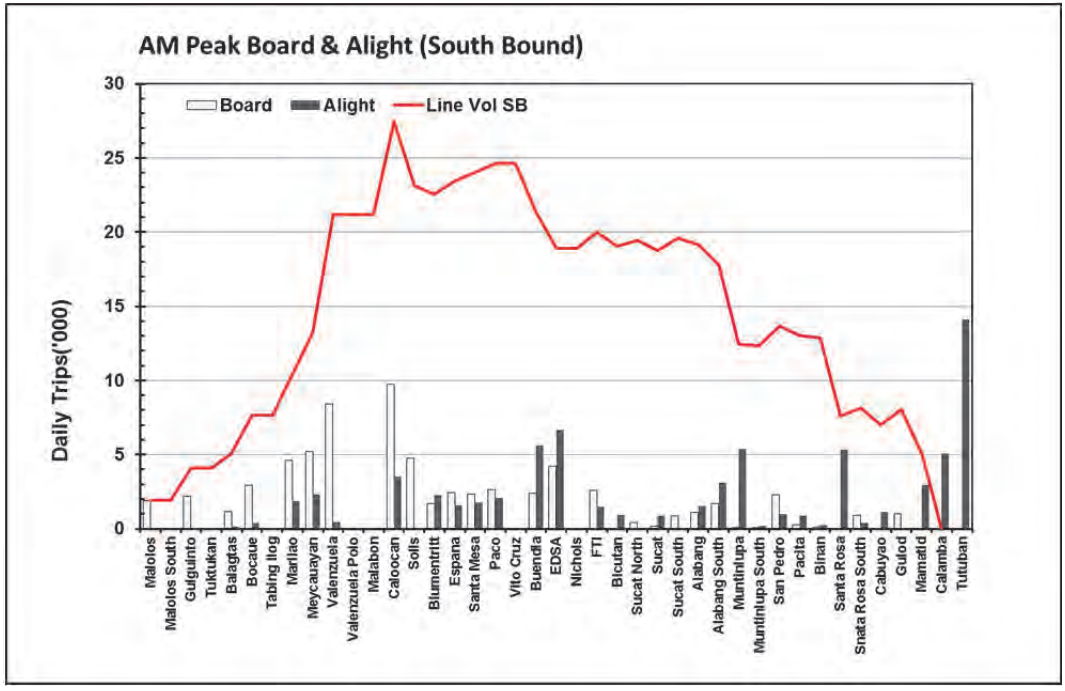

Source: JICA Study Team

Figure 3.1.7 AM Peak Hour Passenger Volumes by Station, 2025, Southbound

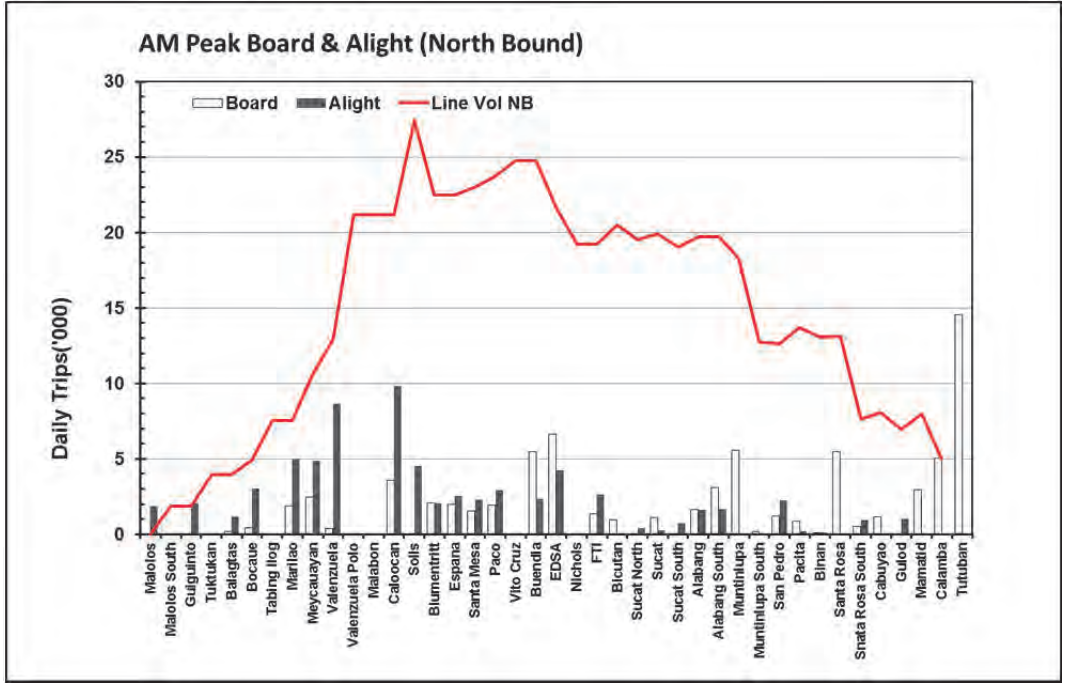

Source: JICA Study Team

Figure 3.1.8 AM Peak Hour Passenger Volumes by Station, 2025, Northbound

3) Forecast year 2030

For 2030 the number of stations was increased to 41 and the resulting average trip length is 15.2 kilometers. The forecast volumes of passengers boarding and alighting per station and corresponding line loads is presented in Figure 3.1.9 for the daily ridership and in Figure 3.1.10 and Figure 3.1.11 for the Peak hour. The daily passenger volume is indicated in Table 3.1.11.

It is observed that passenger volumes at the stations were dispersed with the opening of more intermediate stations, marking reduced figures at most stations. EDSA now has the highest number of 2-way passengers boarding and alighting per day with 114,400 passengers boarding and 113,800 passengers alighting. Tutuban follows with 109,100 passengers boarding and 108,800 passengers alighting.

The highest line load for the southbound direction shifted to Malabon with 206,800 passengers. Caloocan with 206,300 passengers lead in the northbound direction.

For the Peak hour southbound direction, the highest figure for boarding is registered at EDSA station with 6,240 passengers while for alighting it is at Tutuban with 10,880 passengers. The highest boarding volume for northbound is Tutuban with 10,910 passengers. However for alighting volumes the highest is at EDSA with 6,270 passengers. The highest line load southbound is at Malabon with 20,680passengers. For northbound it is at Caloocan with 20,630 passengers.

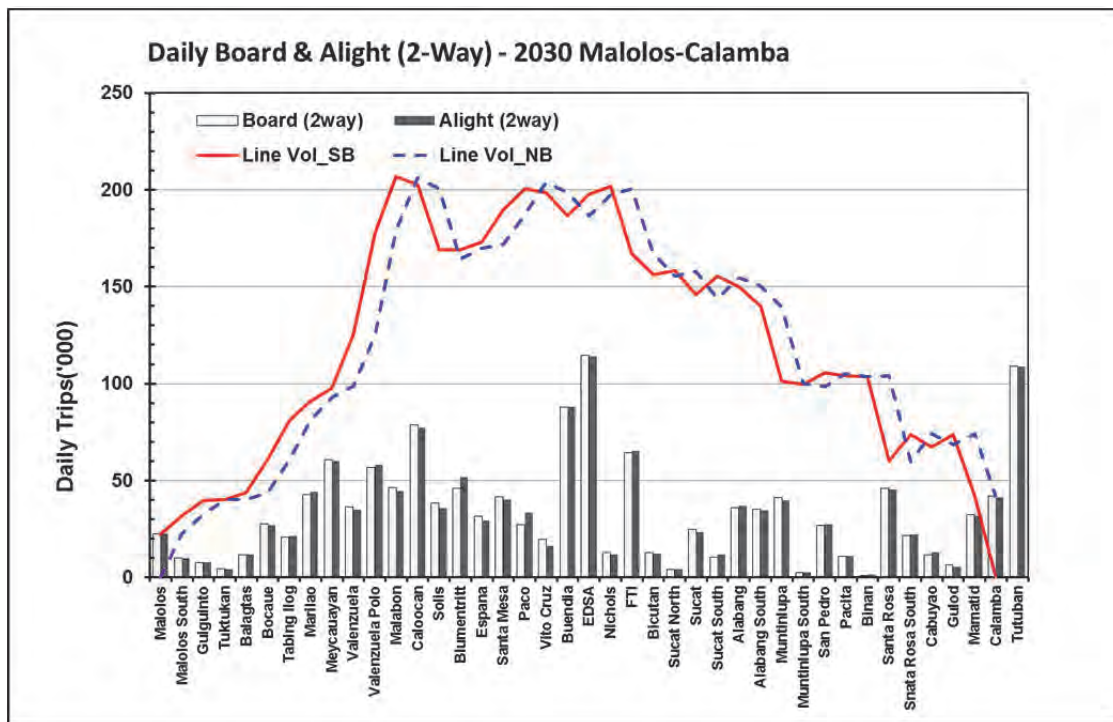

Source: JICA Study Team

Figure 3.1.9 Daily Passenger Volumes by Station, 2030

Table 3.1.11 Daily Passenger Volumes, 2030

No.	Station	South Bound			North Bound			Distance (km)
		Board	Alight	Line Vol.	Board	Alight	Line Vol.	
1	Malolos	22,300	-	22,300	-	22,600	-	3.5
2	Malolos South	10,100	-	32,400	-	9,900	22,600	2.8
3	Guiguinto	7,600	-	40,000	-	7,700	32,500	2.3
4	Tuktukan	2,400	2,000	40,400	2,300	2,500	40,200	2.3
5	Balagtas	7,600	4,300	43,700	4,200	7,600	40,400	4.0
6	Bocause	22,200	5,000	60,900	5,400	22,200	43,800	2.7
7	Tabingllog	20,300	500	80,700	500	20,800	60,600	2.7
8	Marilao	26,400	16,100	91,000	16,200	28,100	80,900	1.9
9	Meycauayan	33,600	27,000	97,600	27,100	33,000	92,800	3.6
10	Valenzuela	32,100	4,200	125,500	4,200	30,800	98,700	1.8
11	Valenzuela Polo	54,600	2,100	178,000	2,200	56,100	125,300	2.8
12	Malabon	37,100	8,300	206,800	9,100	36,200	179,200	1.2
13	Caloocan	36,800	41,100	202,500	42,000	36,200	206,300	3.6
14	Solis	38,200	300	108,800 ^{*1}	200	35,600	200,500	2.0 ^{*1}
				171,700 ^{*2}				1.3 ^{*2}
15	Tutuban	-	108,800	-	109,100	-	109,100	-
16	Blumentritt	22,500	22,700	168,900	23,400	28,900	164,300	1.9
17	Espana	17,100	12,800	173,200	14,500	16,500	169,800	1.4
18	Santa Mesa	29,200	12,500	189,900	12,300	27,700	171,800	3.5
19	Paco	20,000	9,400	200,500	7,300	23,900	187,200	1.6
20	Vito Cruz	7,800	9,800	198,500	11,900	6,500	203,800	1.3
21	Buendia	37,700	49,800	186,400	50,200	38,400	198,400	1.9
22	EDSA	62,400	51,100	197,700	52,000	62,700	186,600	2.3
23	Nichols	7,900	3,700	201,900	4,800	8,100	197,300	2.2
24	FTI	15,800	50,500	167,200	48,400	14,900	200,600	2.2
25	Bicutan	500	11,600	156,100	12,400	600	167,100	2.0
26	Sucat North	3,300	1,000	158,400	900	3,400	155,300	2.0
27	Sucat	5,300	17,800	145,900	19,600	5,700	157,800	1.8
28	Sucat South	10,000	500	155,400	300	11,200	143,900	1.6
29	Alabang	16,200	21,900	149,700	19,800	15,200	154,800	2.2
30	Alabang South	12,400	22,300	139,800	22,800	12,300	150,200	1.0
31	Muntinlupa	800	39,200	101,400	40,300	600	139,700	1.5
32	Muntinlupa South	700	2,300	99,800	2,000	500	100,000	1.0
33	San Pedro	16,600	10,700	105,700	10,100	16,800	98,500	1.7
34	Pacita	4,600	6,400	103,900	6,300	4,700	105,200	2.7
35	Binan	700	800	103,800	300	900	103,600	4.1
36	Santa Rosa	700	44,500	60,000	45,300	700	104,200	1.5
37	Santa Rosa South	17,900	4,100	73,800	3,700	18,200	59,600	3.3
38	Cabuyao	2,500	9,100	67,200	9,300	3,900	74,100	2.8
39	Gulod	6,500	100	73,600	100	5,500	68,700	2.8
40	Mamatid	-	31,900	41,700	32,300	-	74,100	3.3
41	Calamba	-	41,700	-	41,800	-	41,800	-
Total (Max)		670,400	707,400	206,800	714,600	677,100	206,300	4.0

Source: JICA Study Team

*1: Solis-Tutubn, *2: Solis-Bulumentrit

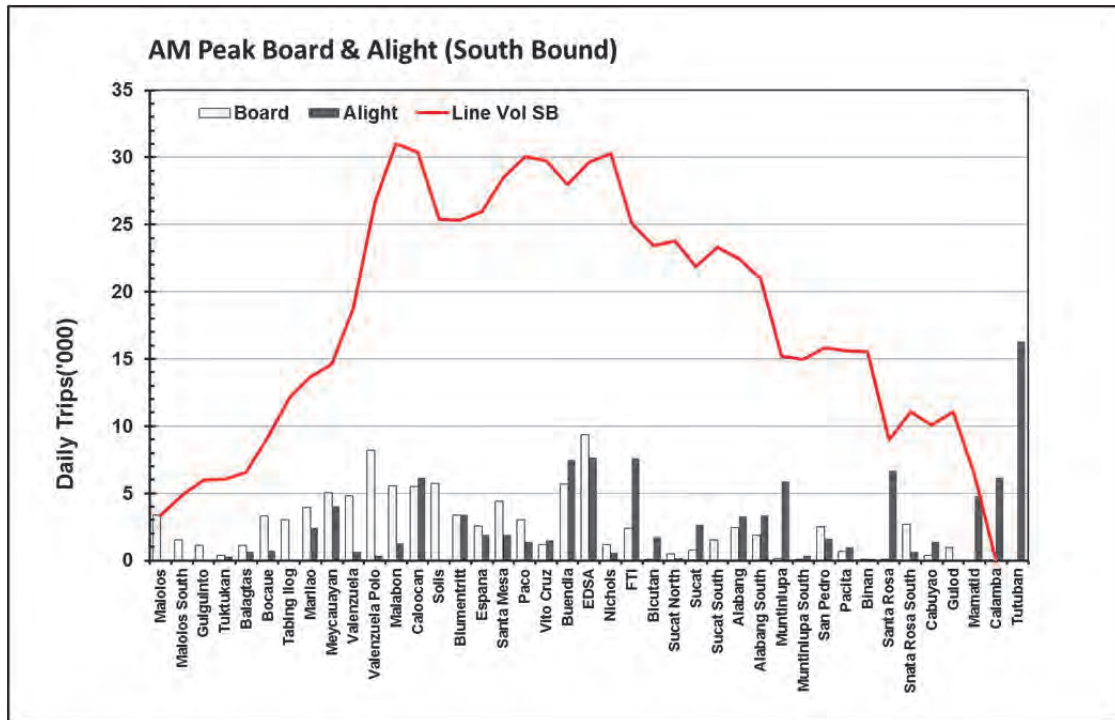

Source: JICA Study Team

Figure 3.1.10 AM Peak Hour Passenger Volumes by Station, 2030, Southbound

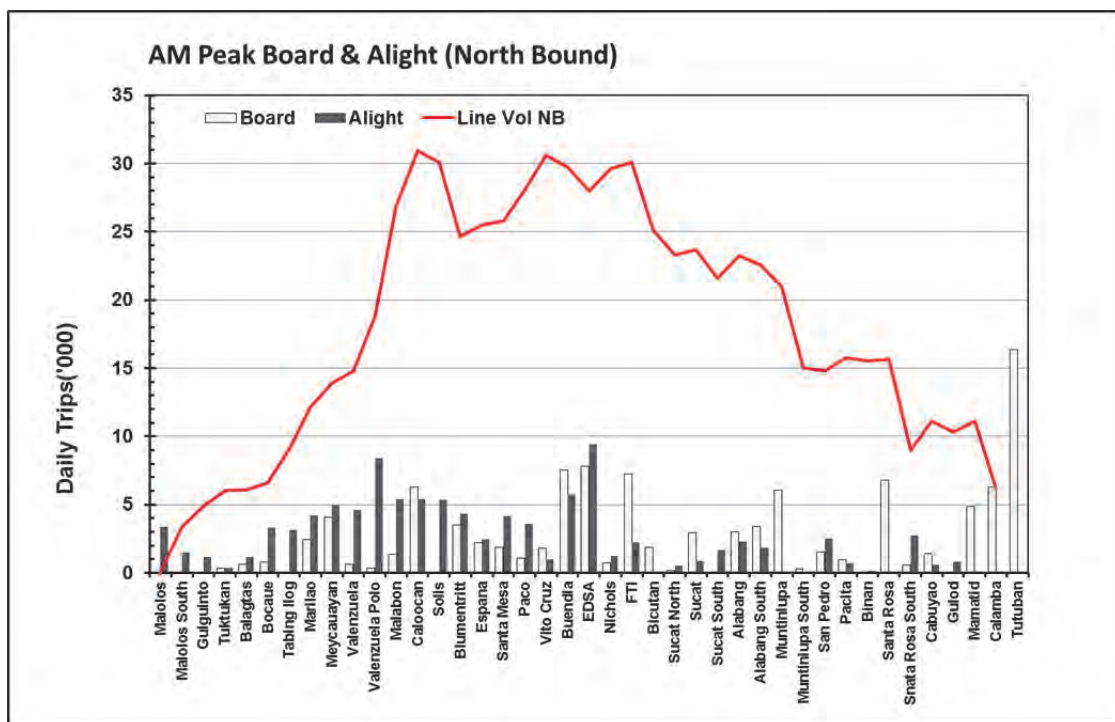

Source: JICA Study Team

Figure 3.1.11 AM Peak Hour Passenger Volumes by Station, 2030, North Bound

4) Forecast year 2040

The number of stations for his forecast year is still at 41. The average trip length was 15.1 kilometers.

Figure 3.1.12 and Table 3.1.12 shows the forecast daily volumes of passengers boarding and alighting per station and corresponding line loads. Figure 3.1.13 and Figure 3.1.14 provides those for the Peak hour.

The highest daily 2-way boarding and alighting station is Tutuban with 111,900 passengers and 111,800 passengers. Far second is EDSA at 95,500 passengers for boarding and 95,900 passengers for alighting.

The highest daily line loading for the southbound would now occur at the Paco with 199,000 passengers followed by Nichols with 197,900 passengers. For the northbound Vito Cruz beats the rest with 197,600 passengers followed by FTI with 195,700 passengers.

The most important station for the Peak hour boarding southbound direction is Polo, Valenzuela with 5,710 passengers. Highest alighting for this direction is at Tutuban with 11,180 passengers. The highest boarding volume for northbound is also at Tutuban with 11,190 passengers. The highest alighting for this direction is at Polo, Valenzuela with 5,400 passengers. The highest line load for the southbound direction occurs at Paco with 19,990 passengers. For the northbound direction it is at Vito Cruz with 19,760 passengers.

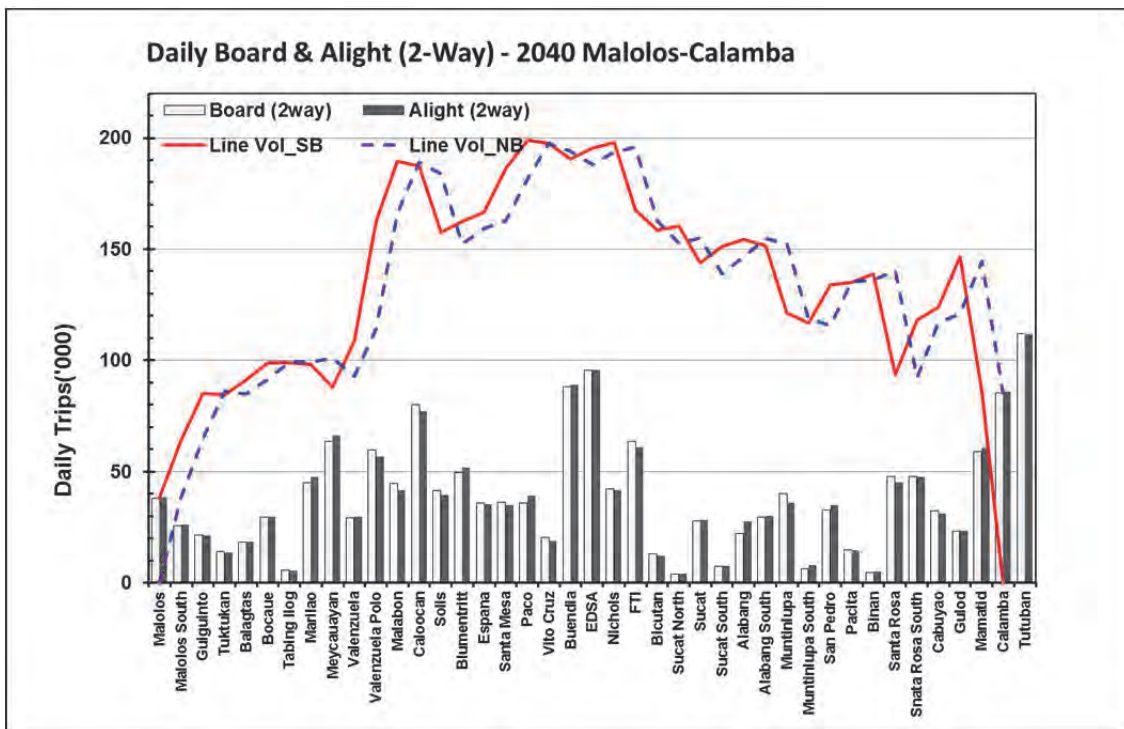

Source: JICA Study Team

Figure 3.1.12 Daily Passenger Volumes by Station, 2040

Table 3.1.12 Daily Passenger Volumes, 2040

No.	Station	South Bound			North Bound			Distance (km)
		Board	Alight	Line Vol.	Board	Alight	Line Vol.	
1	Malolos	38,100	-	38,100	-	38,400	-	3.5
2	Malolos South	25,800	-	63,900	-	26,400	38,400	2.8
3	Guiguinto	21,400	-	85,300	-	21,500	64,800	2.3
4	Tuktukan	6,500	7,200	84,600	7,700	6,300	86,300	2.3
5	Balagtas	12,300	5,800	91,100	6,100	12,600	84,900	4.0
6	Bocause	18,800	10,900	99,000	10,800	18,800	91,400	2.7
7	TabingIlog	2,600	2,800	98,800	3,200	2,900	99,400	2.7
8	Marilao	22,400	22,900	98,300	22,700	24,700	99,100	1.9
9	Meycauayan	26,200	36,500	88,000	37,600	29,600	101,100	3.6
10	Valenzuela	24,800	4,200	108,600	4,300	25,700	93,100	1.8
11	Valenzuela Polo	57,100	2,900	162,800	2,700	54,000	114,500	2.8
12	Malabon	35,000	8,500	189,300	9,700	33,100	165,800	1.2
13	Caloocan	40,200	42,100	187,400	40,100	34,900	189,200	3.6
14	Solis	41,100	400	111,800*1	500	39,200	184,000	2.0*1
				157,700*2				1.3*2
15	Tutuban	-	111,800	-	111,900	-	111,900	-
16	Blumentritt	27,000	22,400	162,300	500	39,200	184,000	1.9
17	Espana	19,800	15,600	166,500	22,600	29,600	152,200	1.4
18	Santa Mesa	27,100	7,400	186,200	16,000	19,700	159,200	3.5
19	Paco	24,900	12,100	199,000	9,000	27,800	162,900	1.6
20	Vito Cruz	8,700	10,300	197,400	11,100	27,000	181,700	1.3
21	Buendia	40,900	47,900	190,400	11,900	8,500	197,600	1.9
22	EDSA	52,800	47,700	195,500	47,200	41,100	194,200	2.3
23	Nichols	21,300	18,900	197,900	42,700	48,200	188,100	2.2
24	FTI	16,800	47,100	167,600	20,800	22,900	193,600	2.2
25	Bicutan	1,600	10,700	158,500	46,800	13,900	195,700	2.0
26	Sucat North	3,100	1,200	160,400	11,500	1,400	162,800	2.0
27	Sucat	5,800	22,400	143,800	700	3,100	152,700	1.8
28	Sucat South	7,400	-	151,200	22,100	5,800	155,100	1.6
29	Alabang	14,600	11,500	154,300	-	7,700	138,800	2.2
30	Alabng South	13,700	16,400	151,600	7,700	16,000	146,500	1.0
31	Muntinlupa	3,300	33,400	121,500	15,800	13,600	154,800	1.5
32	Muntinlupa South	1,700	6,400	116,800	36,700	2,800	152,600	1.0
33	San Pedro	26,400	9,300	133,900	4,700	1,700	118,700	1.7
34	Pacita	8,000	7,000	134,900	6,300	25,900	115,700	2.7
35	Binan	4,800	900	138,800	6,800	7,500	135,300	4.1
36	Santa Rosa	-	45,300	93,500	-	4,200	136,000	1.5
37	Santa Rosa South	36,300	11,500	118,300	47,900	-	140,200	3.3
38	Cabuyao	19,000	13,600	123,700	11,700	36,200	92,300	2.8
39	Gulod	23,000	100	146,600	13,500	17,700	116,800	2.8
40	Mamatid	-	60,700	85,900	100	23,500	121,000	3.3
41	Calamba	-	85,900	-	59,100	-	144,400	-
Total (Max)		780,300	821,600	199,000	815,300	774,000	197,600	4.0

Source: JICA Study Team

*1: Solis-Tutubn, *2: Solis-Bulumentrit

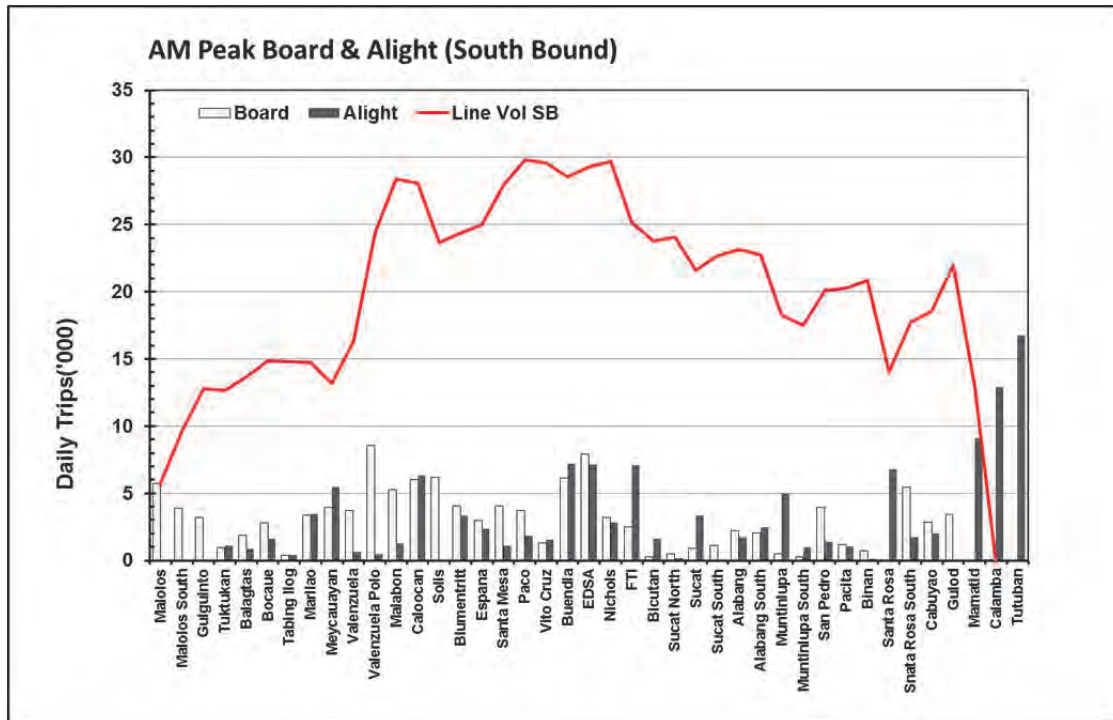

Source: JICA Study Team

Figure 3.1.13 AM Peak Hour Passenger Volumes by Station, 2040, Southbound

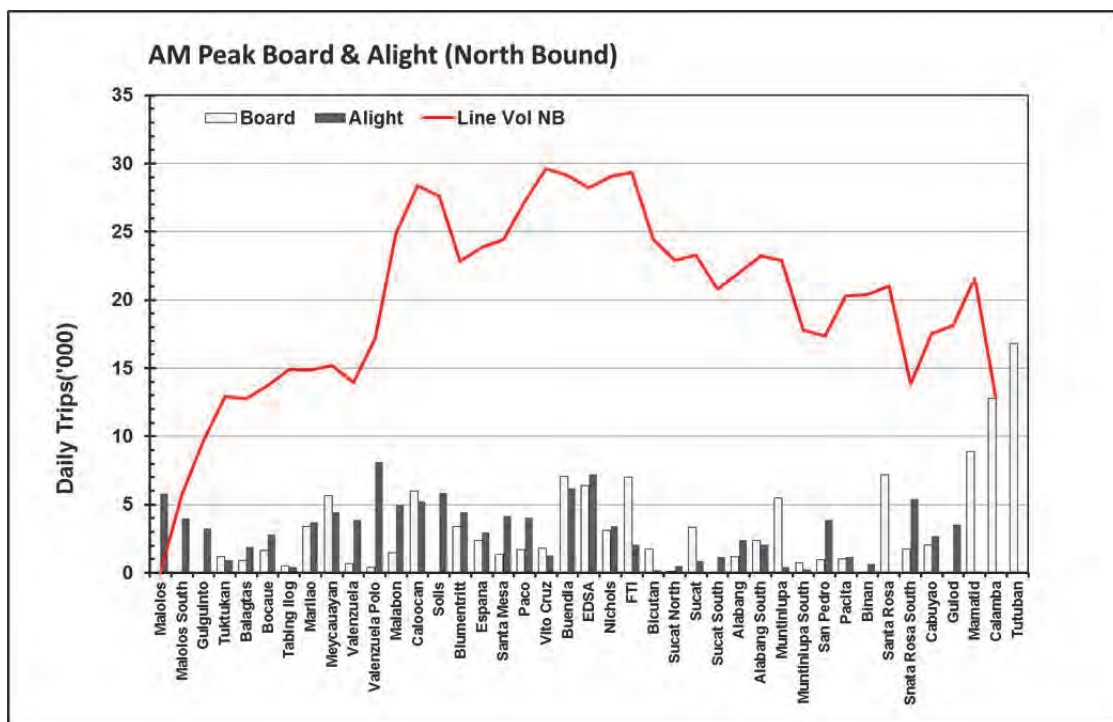

Source: JICA Study Team

Figure 3.1.14 AM Peak Hour Passenger Volumes by Station, 2040, Northbound

3.1.4.4 Network Performance Indicators

The resulting network performance indicators for the cases "without project" and "with project" throughout the forecast years 2020, 2025, 2030 and 2040 are given in Table 3.1.13.

The decongesting effect of the project can be discerned by comparing the results for the "without project" case and for "with project" case. There is a consistent reduction in average volume capacity ratios and in the percentage of road links with less than 10 kph and 20 kph operating speeds.

While it is expected that the indicators for public transport such as passenger-kilometers, passenger-hours, passenger car unit-kilometers and passenger car unit-hours would substantially improve with the operation of the line, it is noteworthy that significant improvement on the said indicators are also observed for private cars.

Table 3.1.13 Network Performance Indicators, GCR

Indicators		2020			2025			2030			2040			
		Road		Rail	Road		Rail	Road		Rail	Road		Rail	
		Car	Public		Car	Public		Car	Public		Car	Public		
Without	V/C Ratio	0.45		-	0.50		-	0.57		-	0.67		-	
	% of Sections	< 10 kph		-	25.8		-	28.5		-	32.2		-	
		< 20 kph		38.5		-	40.5		-	43.0		-	47.5	
	Demand	No. of Rail Boarding (million pax)	-		4.7	-		4.9	-		5.9	-		8.4
		Person kms ('000)	89,622	197,377	40,507	98,360	223,176	42,113	110,522	248,770	46,362	131,546	285,219	63,001
		Person hrs ('000)	6,391	10,778	1,234	7,319	12,489	1,289	8,624	15,045	1,393	11,127	18,717	1,753
		pcu kms ('000)	74,477	18,112	-	82,465	20,403	-	93,095	22,657	-	112,081	25,902	-
pcu hrs ('000)		5,014	1,070	-	5,759	1,230	-	6,820	1,467	-	8,951	1,800	-	
With	V/C Ratio	0.45		-	0.50		-	0.56		-	0.67		-	
	% of Sections	< 10 kph		-	24.9		-	27.7		-	30.9		-	
		< 20 kph		38.2		-	40.1		-	42.5		-	47.1	
	Demand	No. of Rail Boarding (million pax)	-		5.0	-		5.3	-		6.4	-		9.0
		Person kms ('000)	88,920	194,678	44,318	97,098	219,310	48,283	109,227	243,994	53,154	129,646	280,076	70,730
		Person hrs ('000)	6,295	10,426	1,304	7,131	11,945	1,411	8,386	14,297	1,520	10,771	17,834	1,895
		pcu kms ('000)	74,064	17,762	0	81,720	19,906	0	92,320	21,988	0	110,972	25,232	0
pcu hrs ('000)		4,940	1,028	0	5,624	1,167	0	6,650	1,377	0	8,695	1,703	0	
Difference	% of Sections	< 10 kph		-	-0.9		-	-0.8		-	-1.3		-	
		< 20 kph		-0.4		-	-0.5		-	-0.4		-	-0.4	
	Demand	No. of Rail Boarding (million pax)	-		0.4	-		0.4	-		0.5	-		0.6
		Person kms ('000)	-702	-2,699	3,811	-1,262	-3,866	6,170	-1,295	-4,777	6,792	-1,901	-5,143	7,729
		Person hrs ('000)	-96	-352	70	-188	-544	122	-238	-747	127	-356	-882	141
		pcu kms ('000)	-412	-350	-	-746	-498	-	-776	-669	-	-1,109	-670	-
		pcu hrs ('000)	-74	-42	-	-135	-63	-	-171	-90	-	-256	-96	-

Source: JICA Study Team

3.1.5 Highlights of Results

The results of the model runs imply substantial passenger ridership for the proposed line. For year 2020 the most important stations in terms of daily passengers are within the NCR. The highest line loads would occur in the vicinity of Caloocan and Solis. For the AM Peak the busiest stations are Valenzuela and Tutuban.

By 2025 the 2-way daily highest boarding and alighting would be occurred at Tutuban followed by Caloocan. The high line load will occur at Caloocan for southbound and Solis for northbound.

By 2030 it is observed that passenger volumes at the stations would be dispersed with the opening of more intermediate stations in the line, leading to less passengers at some stations. While EDSA would have the highest number of 2-way passengers per day, it would be followed by Tutuban. The other more important stations would include FTI and Buendia.

By 2040 the highest boarding and alighting would be occurred at Tutuban. High line load will occur at Paco. The highest AM peak hourly line loading for the southbound would now occur at Paco. Vito Cruz will have the highest line load for the northbound direction.

From the resulting performance indicators, it is concluded that the project will provide considerable decongestion effect on the overall GCR transport network throughout the forecast years, causing reduction in passenger and vehicle travel times and travel distances not only for the road-based public transport mode but also for the private car transport mode.

3.2 Comparative Analysis of Alternatives

3.2.1 Without Project Option (Zero Option)

A mass transit service to connect Metro Manila to its adjacent areas has not been provided and therefore it becomes a bottleneck in the sound development of Metro Manila with its adjacent northern and southern suburban areas. The PNR diesel commuter has been operated to Calamba City, Laguna, southern suburban areas of Metro Manila, but only a few train services are currently provided. On the other hand, there are no train services to the northern suburban areas of Metro Manila. In particular, from northern Metro Manila to Malolos City, Bulacan, since the residential area has been expanded without any public mass transit services, development of mass transit service in these regions has been recognized as a pressing issue.

Therefore, if the NSCR project, the mass transit system to connect Metro Manila to its adjacent northern suburban areas, will not be implemented, the sustainable development of the commerce and industry of these regions will be hindered. Furthermore, the surrounding environment might be further degraded due to the traffic congestion and air pollution. Thus, the without the project case was not selected.

3.2.2 Route Alternative Options

The alternative options for the railway ROW from Malolos, northern Metro Manila, to Tutuban, the city center of Metro Manila are considered first to minimize land acquisition and involuntary resettlement. The ROW options are selected to use the railway ROW, road ROW and public land as much as possible. The following alternative options are compared and their routes are shown in Figure 3.2.1.

3.2.2.1 Option 1: Use of Railway ROW of PNR and Northrail

There is a railway ROW developed by the Northrail Project Phase 1 Section 1 from Malolos to Caloocan. The most of the ROW remains unused. In addition, there is the existing PNR ROW from Caloocan to Tutuban. Some sections are still used by the PNR operation. The NSCR project can use the PNR ROW so as not to prevent its continuous operation. Thus Option 1 is the alternative to use the existing railway ROW.

However, in part of the section between Caloocan to Tutuban, NSCR will run parallel to the highway planned by the Department of Public Works and Highways (DPWH). Therefore necessary adjustments for both projects have been discussed in the Philippine government. Although the alignment of NSCR is considered to use preferentially the existing PNR ROW in Option 1 (refer to Case 2 in Figure 3.2.2), it may run off the existing PNR ROW (refer to Case 1 in Figure 3.2.2). In this case, additional land acquisition and involuntary resettlement may occur. In Table 3.2.1, the worst case, i.e., the largest impact case will be used for comparison of alternative options.

3.2.2.2 Option 2: Use of Road ROW of NLEX and Quezon Avenue

The North Luzon Expressway (NLEX) is an 8-lane limited-access toll expressway that connects northern Metro Manila to Pampanga Province of the Central Luzon region. The expressway has a length of 82.6 kilometers. From Malolos to Guiguinto, the proposed route uses the ROW of Northrail as same as Option 1. From Guiguinto to the NLEX Guiguinto exit, it goes through the local road to connect the NLEX. Then it runs through the inside of NLEX up to the northern Metro Manila exit. After the NLEX exit, it uses the ROW of Quezon Avenue, which is a radial road from the city center to Quezon Memorial Circle. Option 2 pass through CBD of Quezon city and connect with MRT Line 3 at North Avenue Station and Quezon Avenue Station.

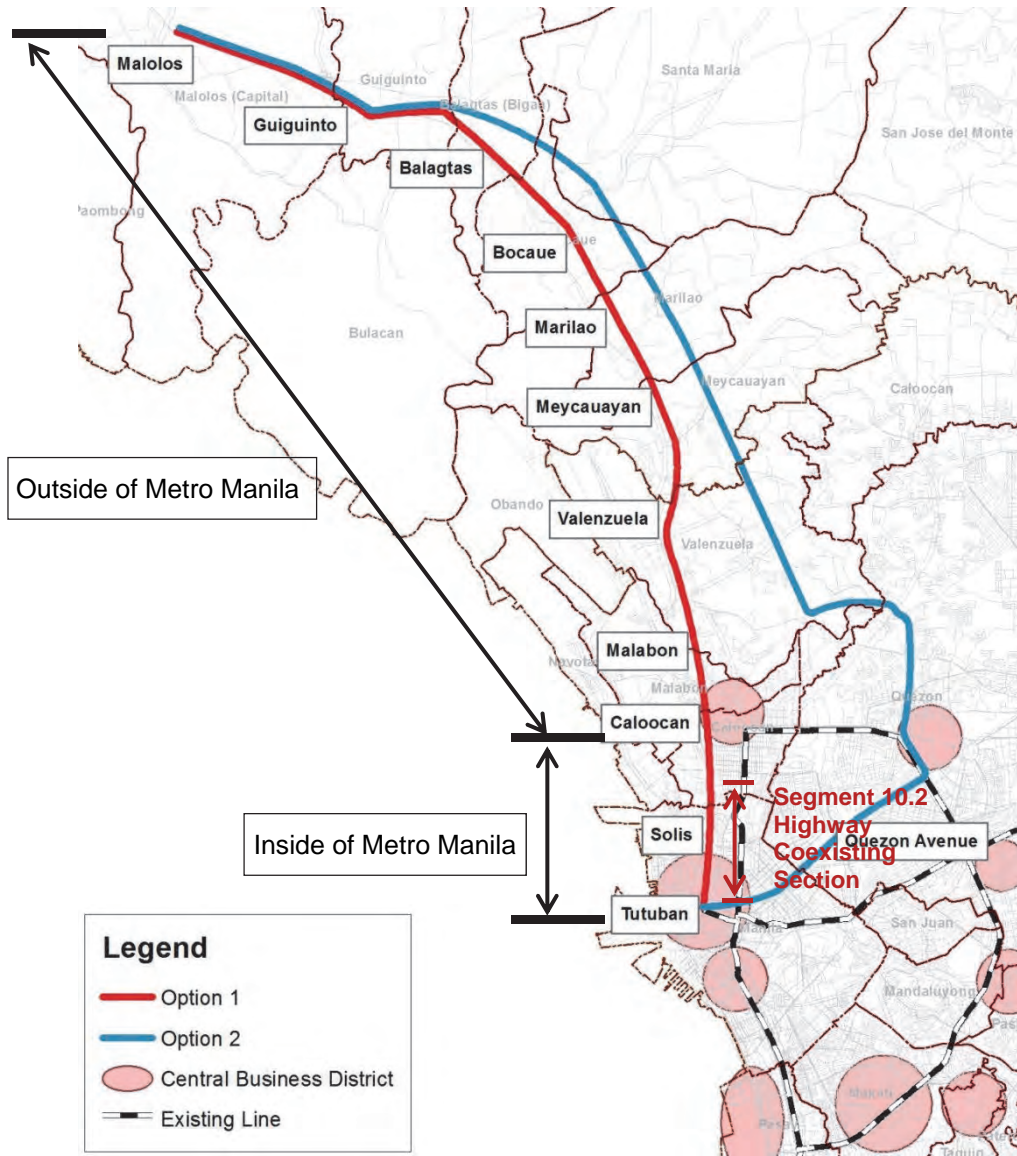

Source: JICA Study Team

Figure 3.2.1 Route of Alternative Options

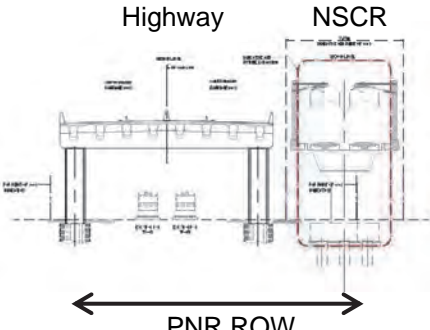
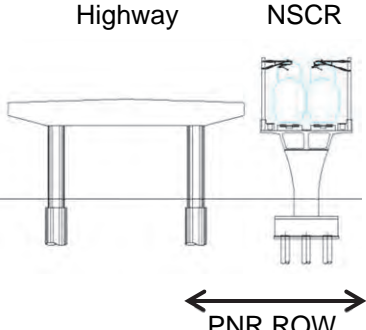
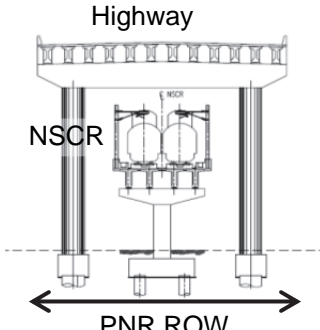
 <p>Highway NSCR</p> <p>PNR ROW</p>	 <p>Highway NSCR</p> <p>PNR ROW</p>	 <p>Highway NSCR</p> <p>PNR ROW</p>
<p>Case 1: NSCR runs off the existing PNR ROW (NSCR share the existing PNR ROW with the highway side by side.)</p>	<p>Case 2: NSCR preferentially uses the existing PNR ROW</p>	<p>Case 3: Both NSCR and the highway use the existing PNR ROW</p>

Source: JICA Study Team

Figure 3.2.2 Relationship between NSCR and Highway in terms of the Use of PNR ROW

3.2.2.3 Result of Comparison of Alternative Options

The result of comparison of 2 alternative options is shown in Table below. In the social environment, the estimated total number of affected households to be resettled is about 1,300 for Option 1 and about 2,100 for Option 2. Therefore the affected households of Option 1 are fewer than that of Option 2. In the natural environment, because the route of Option 2 passes through the swamps, land alteration and access during the floods are the concerned impacts. Both options require the abatement measures for noise and vibration, especially for residential areas. Considering these impacts on natural and social environment, Option 1 which uses the railway ROW of PNR and Northrail is selected for the NSCR route.

Regarding the part of section between Caloocan to Tutuban where NSCR and the highway share the existing PNR ROW, based on the meeting result of the Secretaries of DOTC and DPWH, the necessary adjustments on the policy that NSCR preferentially uses the existing PNR ROW have been carried out in the Philippine government. A further coordination with the highway project will be made to minimize the involuntary resettlement.

Table 3.2.1 Comparison of Route Alternative Options

Items \ Alternatives	Option 1 Use of Railway ROW of PNR and Northrail	Option 2 Use of Road ROW of NLEX and Quezon Ave
Social Environment		
Involuntary Resettlement	<ul style="list-style-type: none"> Malolos - Caloocan: Resettlement due to additional land acquisition for ROW and stations and depot will be needed. The estimate of affected households will be about 300. Caloocan –Tutuban: In the section of side by side with the highway, if the NSCR alignment will run off the existing PNR ROW, resettlement due to additional land will be unavoidable. About 1,000 households need to be resettled. <p>If NSCR will be able to use the existing PNR ROW, the estimate of affected households will be less than 200.</p>	<ul style="list-style-type: none"> No involuntary resettlement in the NLEX ROW is expected. Resettlement due to additional land acquisition to connect from Guiguinto to NLEX will be needed. The estimate of affected households will be about 100. Resettlement due to additional land acquisition from NLEX interchange to Mindanao Avenue and Quezon Avenue will be needed. The estimate of affected households will be about 2,000.
Total number of households to be resettled	About 1,300 households	About 2,100 households
Historical/cultural heritage	<ul style="list-style-type: none"> The old PNR stations are recognized as historical heritage sites and are considered for preservation. 	<ul style="list-style-type: none"> There is no historical/cultural heritage along the route.
Natural Environment		
Protected Area	<ul style="list-style-type: none"> There is no protected area in the vicinity of the project area. 	<ul style="list-style-type: none"> There is Quezon Memorial National Park. The distance between the park and the proposed route is about 500 m.
Land alteration	<ul style="list-style-type: none"> There exist some access roads to the construction sites, therefore, the area of land alteration may not be foreseen. 	<ul style="list-style-type: none"> Temporary land alteration in swamp area will likely occur due to the installation of access roads to the construction sites.
Risk of flooding	<ul style="list-style-type: none"> The route will go through the flood prone areas in Bulacan, but will not directly pass through the swamps, that are used to be flood path and long flood duration. 	<ul style="list-style-type: none"> The access to the railway will become difficult during the storm because the route passes through the swamps.
Pollution		
Noise and vibration	<ul style="list-style-type: none"> Noise and vibration will cause a nuisance along the route, especially for residential areas. 	<ul style="list-style-type: none"> Noise and vibration will cause a nuisance along the route, especially for residential areas.
Water quality	<ul style="list-style-type: none"> Since the route will not pass though the swamps, turbid water will not directly deteriorate water quality of the swamps. 	<ul style="list-style-type: none"> Water quality of swamps will be likely to be deteriorated by suspended solids discharged from construction sites.

Source: JICA Study Team

3.2.3 Depot Alternative Options

3.2.3.1 Depot Alternative Options

Two candidate sites for the depot were compared. The required area of the depot is about 14 hectares.

Option 1: Valenzuela

The Northrail has leased 13.822 hectares of the property of National Food Authority (NFA) to be used as exclusively for the Depot.

Option 2: Marilao

The candidate site is agricultural land located at the border of Marilao and Bocaue.

3.2.3.2 Result of Comparison of Alternative Options

The result of comparison of 2 alternative options is shown in Table below. If DOTC will be able to continue to lease the site in Valenzuela from NFA, acquisition of the land will not be needed. On the other hand, the candidate site in Marilao is agricultural land and there are many informal settler families (ISFs). Resettlement of affected families and loss of livelihood of agricultural workers are unavoidable. Therefore, the Option 1, Valenzuela was selected for the depot site.

Table 3.2.2 Comparison of Alternative Options for Depot Sites

Items \ Alternatives	Option 1 Valenzuela	Option 2 Marilao
Social Environment		
Land use	• Unused land including small wet land	• Agricultural land (palay)
Land Acquisition	• The site can be leased from NFA.	• Land Acquisition is required.
Involuntary resettlement	• About 20 ISFs need to be relocated.	• About 100 ISFs need to be relocated.
Natural Environment		
Protected Area	• There is no protected area in the vicinity of the project area.	• There is no protected area in the vicinity of the project area.
Land alteration	• Loss of about 2 ha wet land	• Loss of about 13ha agricultural land
Pollution		
Noise and vibration	• Noise and vibration will cause a nuisance for residential areas.	• Noise and vibration will not cause a nuisance because there are few houses.
Water quality	• Since there is no creek in the proposed site, the risk of deterioration of water quality will not be foreseen.	• Water quality of a small creek will be likely to be deteriorated by suspended solids discharged from construction sites.

Source: JICA Study Team

3.2.4 Structure Alternative Options

3.2.4.1 Structure Alternative Options

The following three structure types were compared:

Option 1: At grade structure type including embankment

Option 2: Elevated structure type (viaduct)

Option 3: Underground structure type

The type of railway structure is mainly determined based on development conditions of the adjacent area along the NSCR. Also it will consider the following: (i) construction cost, (ii) construction period, (iii) advantages to NSCR users, (iv) social and environmental impacts, (v) risk of flood, and (vi) from the point of view of operation and maintenance. In particular, risk of flood must be considered for selection of structure type because people in the vicinity of the NSCR project are worried about frequent flooding.

3.2.4.2 Result of Comparison of Alternative Options

Comparisons of the advantages and disadvantages of three structure types, embankment, viaduct and underground were discussed in Table below.

At-grade structure (embankment) is the lowest construction cost and applicable to the section where the risk of flood is low and there are few level crossings. On the other hand, the elevated structure (viaduct) is recommended for the section where the railway goes through flood-prone areas or there are the intersections with the main road. Although the underground structure type may have the smallest impacts on natural and social environment, the construction cost is the highest. There are no obstacles to be avoided since the NSCR alignment will use the existing PNR ROW, therefore the underground structure will not be adopted for all sections.

1) Malolos to Meycauayan

The elevated structure will be selected for the section where the alignment goes through the build-up areas and crosses the main roads. The embankment structure will be used for the section where there are no crossings of the main roads. However, the elevated structure will be selected for the section where the alignment goes through the flood-prone areas in this section.

2) Meycauayan to Tutuban

The alignment will not pass through the flood-prone areas in this section. However, the elevated structure will be selected for the section where the alignment goes through the build-up areas and crosses many main roads.

Table 3.2.3 Comparison of Railway Structure Type

Item	Option 1 At-grade Structure (Embankment)	Option 2 Elevated Structure (Viaduct)	Option 3 Underground Structure (Shield Tunnel)
Construction Cost	lowest cost	Low cost compared to underground structures	Very high cost
Width of ROW	In case where high embankment are necessary, additional ROW is needed.	Land acquisition is necessary for entrance and exit of the stations	Land acquisition is necessary for entrance and exit of stations and ventilation shafts.
Construction Period	Short in comparison to viaducts except in the case of ground improvement	Short in comparison with underground structure	Long construction period is required
Measures for Flooding	Embankment acts as a dam, therefore it is necessary to construct additional drainage to minimize flooding	No specific countermeasures are required	Drainage systems such as emergency pump systems must be provided. Floodgate will be required.
Operation /Maintenance	Easy due to availability of access	Easy because of ease of access	Difficult, maintenance cost is high because the systems are underground systems. Periodical inspections must be carried out especially for underground leakage of water which causes electrolytic corrosion.
Disaster Prevention	Comparatively safe. Easier to take countermeasure compared to an underground structure.	Comparatively safe. Easier to take countermeasure compared to underground structures.	Fire in a tunnel can cause big disaster.
Ground Subsidence	In case where soft soil is encountered, there is possibility that ground subsidence can occur.	Ground Subsidence will not occur.	There is a possibility of ground Subsidence during construction of TBM.
Earthquake	Embankment must be designed considering earthquake loads.	Structure must be designed considering earthquake load	An underground structure is not susceptible to earthquake. However underground structures must be designed considering earthquake load
Land Acquisition and involuntary resettlement	Additional land acquisition is necessary for the narrow ROW section and cause involuntary resettlement.	Additional land acquisition is necessary for the narrow ROW section and cause involuntary resettlement.	Land acquisition is less required and can be minimized.
Noise (Inside Train)	Little noise	Little noise	Much noise
Noise (Outside Train)	Noise will occur along the railway but installation noise barrier can mitigate noise.	Noise will occur along the railway but installation noise barrier can mitigate noise.	No noise pollution along the railway.
View from the Window	Good	Good	Uncomfortable
Landscape	Shape of structures shall be designed considering landscape.	Shape of structures shall be designed considering landscape.	No influence
Safety	Level crossing is needed and traffic accidents and congestion are expected.	No level crossing	No level crossing
Overall evaluation	O: Lowest construction cost: X: Increase risk of flooding X: Level crossings The lowest cost. Recommend for not flood-prone area and not crossing the main roads	X: Construction cost is higher than that of embankment O: Low risk of flooding O: No level crossing Recommend for flood-prone area and many crossings of the main roads	X: Highest construction cost O: Low risk of flooding, but needs drainage systems O: No level crossing Not recommended since there are no obstacles since the NSCR alignment will use the existing PNR ROW. Moreover highest cost.

Source: JICA Study Team

CHAPTER 4

PROPOSAL OF PROJECT FRAMEWORK

CHAPTER 4 PROPOSAL OF PROJECT FRAMEWORK

4.1 Route Plan

4.1.1 Overview

NSCR was envisioned at the beginning of the Pre-Feasibility Study of 2012 as a commuter line that will eventually link Clark to NAIA with the intention of combining an Airport Rail Express Service with the Commuter Service within the same infrastructure. Later, changes were made regarding the alignment based on study findings, coordination with relevant agencies, and deliberations and decisions within DOTC. Alignment changes such as Clark to FTI in Manila, then shortening the north terminal to Malolos and extending the service to the south (i.e., Calamba), and dropping the Airport Rail Express Service were considered. Since middle 2012, the feasibility study and the supplementary survey have been carried out where the horizontal and vertical alignments have been investigated, together with other parameters such as a demand, environmental and social impacts, E&M system, and operation plan, among others. The main design conditions for the alignment are mentioned in Table 4.1.1.

Among the conclusions from the mentioned studies is the decision to follow the PNR's ROW as the basic horizontal alignment for the entire length of system. However, as the selected alignment is also shared with three different highway projects by DPWH, the vertical and horizontal alignments between the Caloocan – FTI Section have been challenging due to its huge cost and severe environmental/social implications for all projects involved. Despite this, a final agreement has been reached and the main features of the NSCR alignment are described in this section.

Table 4.1.1 Design Condition for the Alignment of NSCR

Items		Description
Horizontal Curve Radius	For Main Line	More than 300m
	For Station	More than 400m
	For Turnout	More than 160m (for main line), More than 100m (for depot)
Transition Curve Length		Maximum out of L_1, L_2, L_3 $L_1=800C$ $L_2=7.5CV$ $L_3=6.75C_sV$
Length between Transition Curves		More than 20m
Maximum Gradient	For Main Line	25/1,000 (standard), 35/1,000 (absolute maximum)
	For Depot	Level (0), 5/1,000 (absolute maximum)
	For Stabling Yard	Level (0)
Vertical Curve		Vertical curve is required for more than 10/1,000 of gradient change Radius 3,000m (4,000m where curve radius is less than 800m)
Width of Formation		More than 2.75m
Distance between Track Centers		More than 4.0m (Main Line), More than 4.0m (Station), More than 4.0m (Stabling Yard)
Width of Structure Gauge		3.8m
Station Platform		Platform Length 180m
		Platform Width 8m (standard)

Source: JICA Study Team

Proposed rolling stock gauge and structure gauge are shown in the figure below.

ROLLING STOCK GAUGE

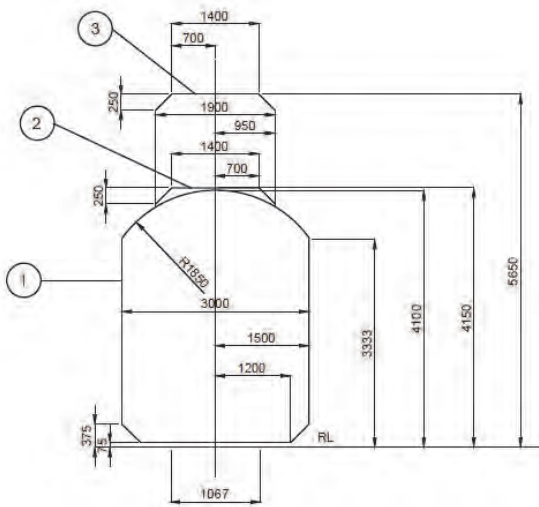

- 1. Basic gauge.
- 2. Gauge for equipment on roof in the case of folding pantograph.
- 3. Gauge for equipment on roof in the case of unfolding pantograph.

STRUCTURE GAUGE

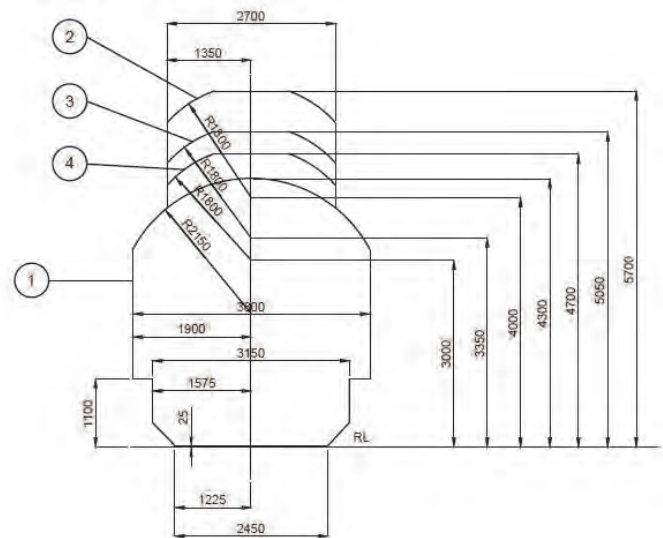

- 1. Basic gauge.
- 2. Gauge for track on which train runs receiving supply of direct current.
- 3. Gauge for tunnel, bridge and overpass along track on which trains runs receiving supply of direct current.
- 4. Gauge for the tunnel section in the case of using rigid overhead wire or safe supporting system.

Source: JICA Study Team

Figure 4.1.1 Rolling Stock Gauge and Structure Gauges

4.1.2 Alignment Plan

1) Horizontal Alignment

The horizontal alignment of the section between Malolos and Caloocan is set based on the alignment of Northrail Project.

The Northrail Project was planned by NLRC. This section length of the North Rail Project was a 32.12 km, double track railway line running in a North-South direction within the existing PNR's ROW. It could have started from Caloocan City, Metro Manila up to Malolos, in the Province of Bulacan and included six stations (Caloocan, Valenzuela, Marilao, Bocaue, Guiguinto, and Malolos) and one Depot in Valenzuela. 19 Diesel Multiple Units (DMU) would have carried passengers at a maximum speed of 120km/h.

A large scale of land acquisition is expected to improve sharp curve to increase running speed, the radius of sharp curve shall be maintained as existing.

2) Vertical Alignment

In principle the elevation of vertical alignment for the ordinary section of the NSCR shall keep more than 9.08 m in height above ground to keep the height of structure gauge for road as shown below.

Height of Track	: 0.70 m
Height of Girder	: 2.00 m
Height of Girder Support	: 1.00 m
Height of Structure Gauge for Road	: 4.88 m
Overlay of Road	: 0.50 m
Total	: 9.08 m

The elevation of rail level at two-storied station shall be 9.20 m in height above ground as shown below.

Height of Track	: 0.70 m
Height of Slab	: 0.50 m
Height of Beam	: 1.00 m
Height of Clearance for Concourse	: 6.00 m
Height of Floor	: 1.00 m
Total	: 9.20 m

The profile outline figure of the NSCR is shown in Appendix A.

4.1.3 Location of Station

Station locations are selected as shown in Table below based on the following respects.

- Transportation node
- Residential area, commercial area and industrial area
- Station interval considering railway station sphere
- Former PNR station location, Northrail project station location and existing PNR station location

Table 4.1.2 Chainage and Distance between Stations

Station	Chainage (Station Center)	Distance between Stations (Km)	Note
Tutuban	15+777	-	
Solis	18+433	2.66	
Caloocan	21+221	2.79	
(Malabon)	-	-	Open in future
(Valenzuela Polo)	-	-	Open in future
Valenzuela	27+297	6.08	
Meycauyan	30+888	3.59	
Marilao	32+797	1.91	
(Tabinglong)	-	-	Open in future
Bocause	38+187	5.39	
Balagtas	42+142	3.96	
(Tuktukan)	-	-	Open in future
Guiguinto	46+797	4.66	
(Malolos South)	-	-	Open in future
Malolos	53+037	6.24	

Source: JICA Study Team

4.1.4 Route Plan

1) Section between Malolos and Caloocan

The horizontal and vertical alignments are planned according to the project section described before, and those alignment features are determined based on the topographic and socio-environmental limitations in the region, and on the characteristics of train operation. The type of structure that is recommended for the different sections of the alignment, whether elevated, at-grade, or underground, was based on a selection criteria that prioritizes safety and cost efficiency.

The most part of NSCR alignment is basically planned on the existing PNR ROW, however, there is a section where the entire or a part of structure may be located outside the PNR ROW due to conflict with the future structure of Segment 10.1 of NLEX-SLEX Connector Road implemented by DPWH. The land acquisition and social impacts have been considered in this study and are described in Chapter 7 “Environmental Impact Assessment”.

Typical site conditions are shown in the photographs below.

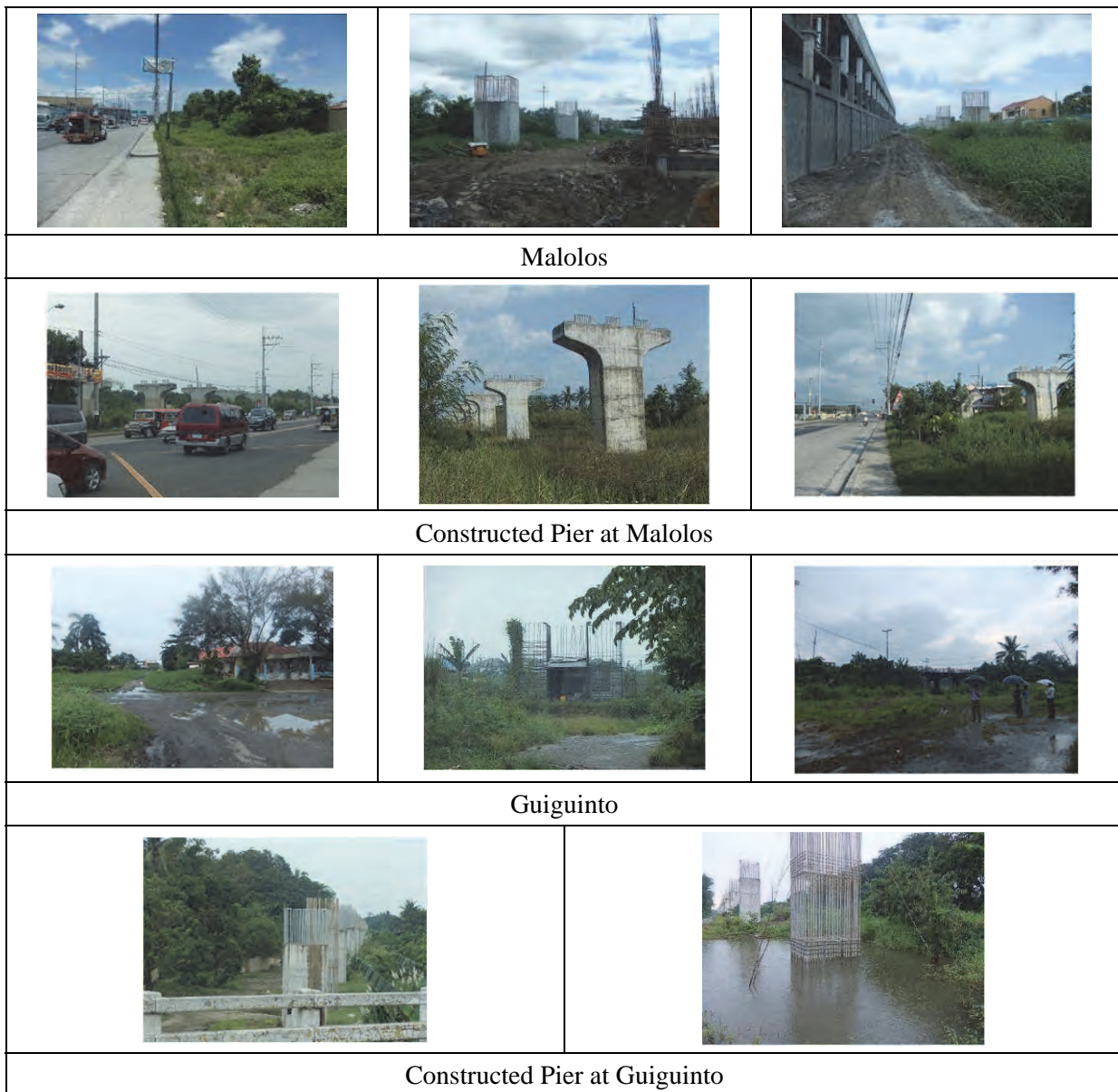

		
Meycauayan River		
		
Meycauayan		
		
Bocau		
		
Near Bocau River		
		
Marilao		
		
Marilao River		



Source: JICA Study Team

Figure 4.1.2 Site Conditions between Malolos and Caloocan

2) Section between Caloocan and Solis

In the preceding study for the railway section between Clark and Manila, the horizontal alignment of this section was prepared based on the horizontal alignment which used the PNR's selected land by the highway.

As for the utilization method of ROW in Segment 10.1, DPWH and DOTC had discussions during the preceding study period, and decided to adopt the "Top and bottom" method till Samson Road and "Side by Side" method from the south of Samson Road to C3 Road (end of Segment 10.1).

The utilization method of ROW in Segment 10.2 is now under review and two points being considered is that it is preferred that the commuter line will use the PNR land and that the structure plan will be conducted in such a way that will not interfere with the structure of commuter line.

The following three cases are set and examined in the route plan aiming to minimize the number of houses requiring resettlement.

The estimation for the number of houses which will need to be relocated has been conducted for the elevated construction section only in the direction of Tutuban. The junction construction section of NSRP will be constructed by GOP in the future.

The plane views in the following page show the horizontal alignment of NSCR with the widened ROW by facilities, and required resettlement (in color) owing to the construction of NSCR. Detailed alignment of Segment 10.2 has not been determined, basically it will be located on the Eastside of NSCR.

Table 4.1.3 Comparison of the Route Using “Side by Side” Method

Item	Case 1	Case 2	Case 3
Proposed by	DPWH	Study team	Study team
Land of NR/PNR	Preferentially using by the highway.	Sharing by highway and NSCR.	Preferentially using by the NSCR.
Route alignment of NSCR	At the general section, 15m width land adjacent to highway will be secured.	At the general section, land of NR/PNR will be use preferentially. At the switch section, land of NR/PNR will be shared by highway and NSCR.	Minimizing the resettlement at the elevated construction section only in the direction of Tutuban.
Estimated number of resettlement (number of households)	Approx. 1,000	Approx. 500	Approx. 200 Approx. 50 or less (in case of elevated construction section only in the direction of Tutuban)
Track formation at junction section	Double track (to Tutuban direction), Double track (NSRP)	Double track (to Tutuban direction), Double track (NSRP)	Double track (to Tutuban direction), Top and bottom two tracks (NSRP)
Solis station			Moving approx. 460m to Caloocan side (more than Case1 and 2)

*Source: JICA Study Team
 Remarks) Plane view of NSRP junction section and Solis station ^{*1}*

As the result of comparative examination, the required number of resettlement owing to the construction of NSCR are estimated at approximately 1,000 households in Case 1, approximately 500 households in Case 2 and approximately 200 households in Case 3. Case 3 shows significant minimization of resettlement. In addition, in case that the connection of NSRP is postponed/ delayed, which means the case in which the construction section is only for the Tutuban direction, the required number of resettled households is estimated at approximately 50 or less.

Consequently, it is basically agreed with DPWH that the Case 3 is the most recommendable option, further study in cooperation with DPWH regarding the detailed structure layout will be required.

Case 1 (DPWH Original Plan)

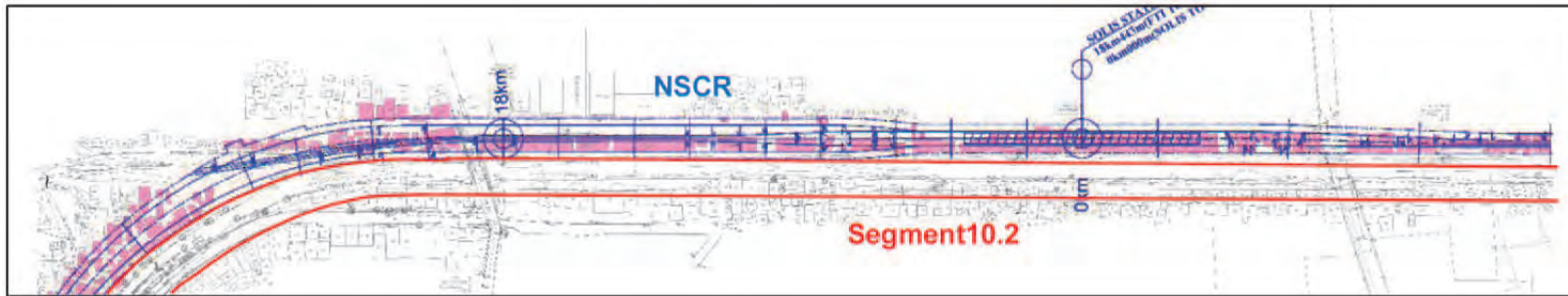

Case 2 (JICA Option Plan)

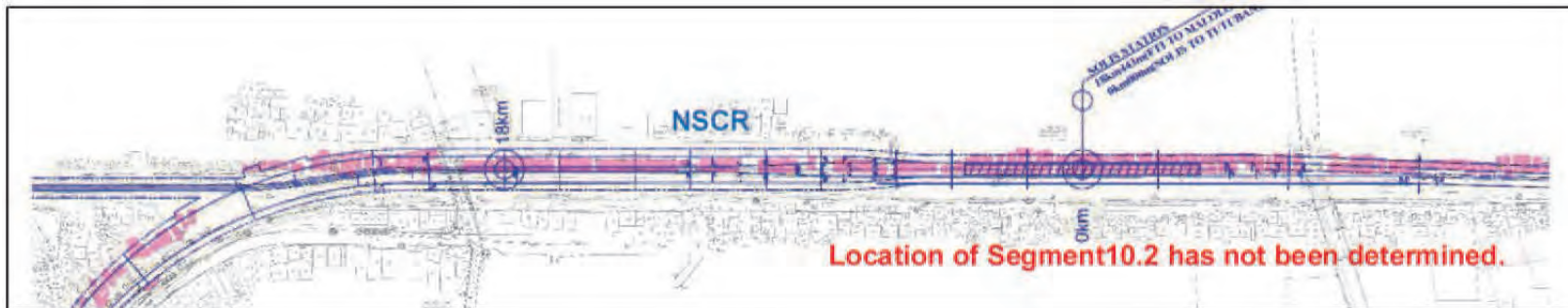

Case 3 (JICA New Option Plan)

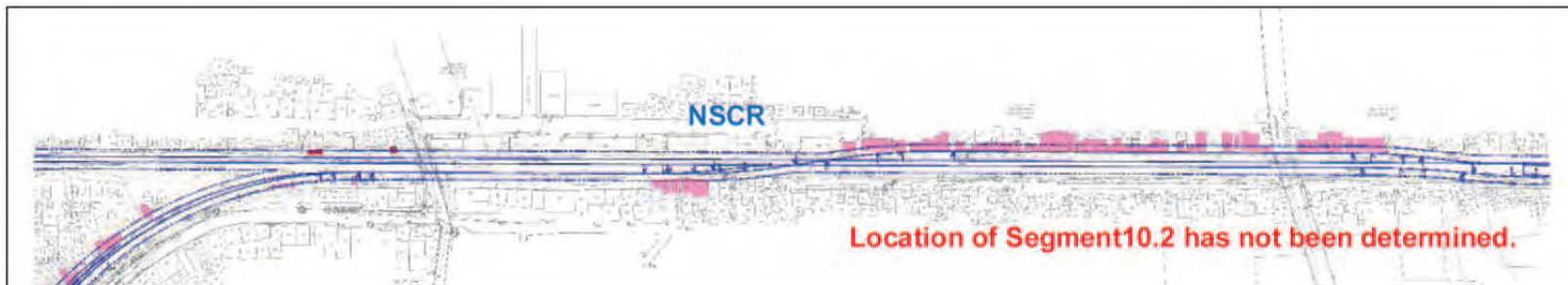

Source: JICA Study Team

Figure 4.1.3 Route Plan between Solis and Tutuban

Typical site conditions are shown in the photographs below.

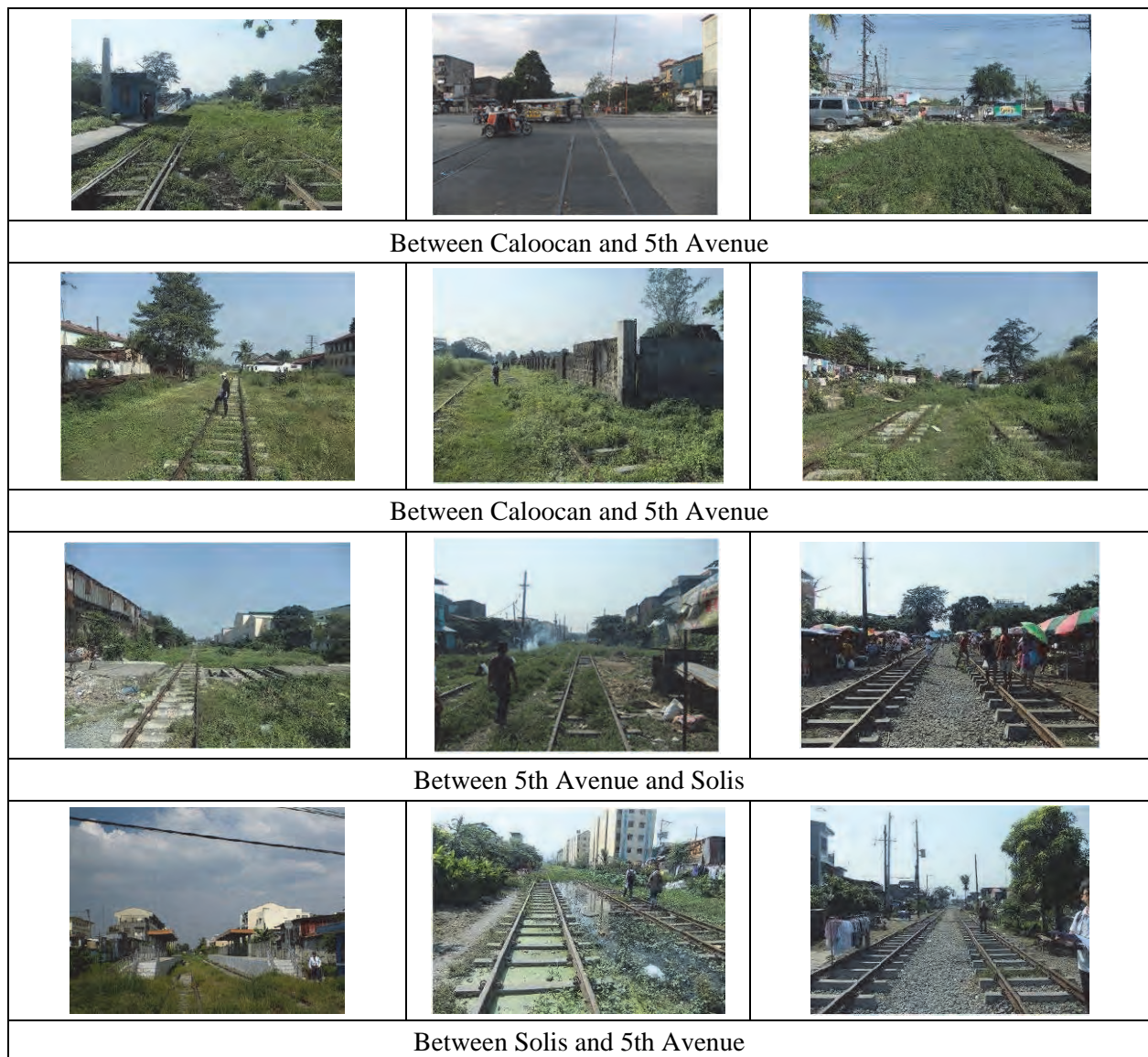

Source: JICA Study Team

Figure 4.1.4 Site Conditions between Caloocan and Solis

3) Section between Solis and Tutuban

Alignment of the section between Solis and Tutuban is planned upto Recto Avenue along Dagupan Street. Western extension section of LRT Line 2 will be located on the Recto Avenue and connected with Line 2 Tutuban Station and NSCR new Tutuban Station. Terminal station of NSRP supposed to be located in Tutuban.

Detailed plans of alignment between Solis and Tutuban, and development of traffic terminal are described in Section 4.8 “TOD and Transportation Junction Plan”.

Typical site conditions are shown in the photographs below.

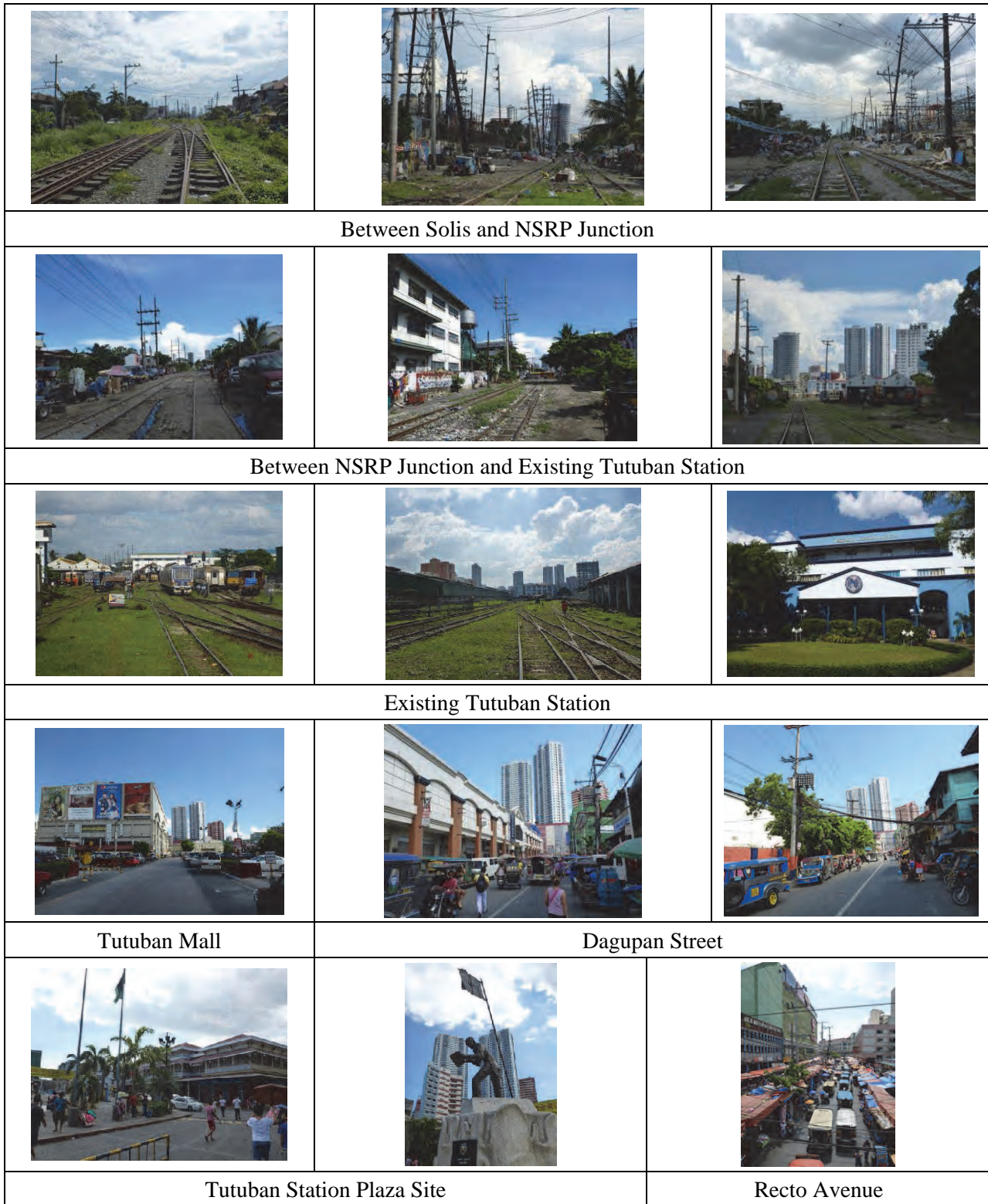

Source: JICA Study Team

Figure 4.1.5 Site Conditions between Solis and Tutuban

4.2 Rolling Stock Plan

4.2.1 Introduction

An electrified railway is an integrated system composed of sub-systems—such as rolling stock, power supply system, and signaling—that interact with and affect each other, so it is necessary to consider overall optimization, not simply partial optimization of the individual sub-systems.

The main features which should be decided for a rolling stock plan are maximum speed, gauge, passenger capacity, train formation, body size and materials. There are many factors which should be considered to formulate rolling stock features and specifications. Some of the more important items are:

- Characteristics of the railway line
 - Role of the line: commuter/ intercity
 - Passenger demand volume
 - Alignment of route: minimum curve radius/ maximum gradient
- Sub-systems related
 - Track gauge
 - Construction gauge
 - Power supply system: AC/DC, voltage level, OHC/ third rail
 - Signaling & communication systems
- Standards & regulations

4.2.2 Prerequisite for Rolling Stock Plan

The rolling stock plan should be corresponding to the technical characteristics of NSCR. According to such characteristics, the following feature is important preconditions for the rolling stock plan.

- Adoption of EMU system
- Track gauge : Narrow gauge, 1,067 mm
- Power supply : DC1,500V
- Rolling stock gauge
 - Width 3,000 mm
 - Height 4,100 mm or less
- Passenger capacity: 2,238 (pax./train)
- Maximum operation Speed
 - Suburban zone : 120 km/h
 - Commuter zone : 80 km/h

4.2.3 Review of Existing Rolling Stock in Manila

There are four railway lines in Manila, PNR, LRT-1, LRT-2 and MRT-3. The features of each line are reviewed in Table 4.2.1 to consider whether the system might be adopted in this project.

PNR is an old railway system with track gauge of 1,067 mm. It is not electrified and DMU and train with locomotive and passenger cars are operated. The systems are not well maintained especially tracks.

LRT-1 and MRT-3 are based on a so-called light rail transit (LRT) system. Therefore, the passenger capacity is insufficient to accommodate the large volumes of passengers necessary for this project.

Although the name is LRT, the LRT-2 line is a mass transit system based on heavy rail. The passenger capacity is possibly adequate for this project, but the body width of the rolling stock is too wide for the gauge of this project.

From the review two points should be noted: the car body material has shifted from steel to stainless steel, and the motor system is tending to shift from DC systems to AC systems.

Table 4.2.1 Review of Existing Rolling Stock in Manila

Railway Line	Review
LRT-1	<ul style="list-style-type: none"> • LRT system, Small passenger capacity, Articulated formation, DC 750V supplied from Overhead Contact System. • Track gauge : 1,435 mm • 2nd and 3rd generation vehicle has applied stainless steel body, and VVVF inverter system with AC motors instead of steel body, while chopper control system with DC motors is applied for 1st generation.
LRT-2	<ul style="list-style-type: none"> • Mass transit EMU, Large passenger capacity, heavy weight, all motor cars formation • Track gauge : 1,435 mm • Body size is 3,200 mm(width) × 23,300 mm (length) × 4,100 mm (height) • DC 1500V supplied from Overhead Contact System • Stainless steel bodies, VVVF inverter system with AC motors
MRT-3	<ul style="list-style-type: none"> • LRT system, Small passenger capacity, Articulated formation, • DC 750V supplied from Overhead Contact System • Track gauge : 1,435 mm • Heavy weight steel body, Chopper control with IGBT & DC motors
PNR	<ul style="list-style-type: none"> • Not electrified system, track gauge : 1,067 mm • Stainless body DMU with air conditioning system • Old type locomotive and second handed passenger car converted from EMU

4.2.4 Requirement for Rolling Stock

A commuter train should provide convenient and inexpensive mass transport to passengers. Requirements for each type of rolling stock are given in Table below.

Lead car is used as the exclusive for female, senior and disable person for LRTs and MRT in Manila. It is considerable to introduce such exclusive car as a gender and disable considerations. In the detailed design, universal design shall be utilized for a facility design such as wheel chair user, visually handicapped persons etc.

Table 4.2.2 Requirements for Rolling Stock

Feature	Requirement
Concept	Convenient to mass passengers
Running performance	Adequate speed & high acceleration ratio
Passenger capacity	High capacity with high ratio of standing space
Doorways	Arrangement: 3–5 doorways on each side of cars Type: double sliding door, 1300mm width or wider
Seats	Longitudinal seat alongside windows
Air conditioning	High capacity to cope with high volume of passengers
Special Facilities	Exclusive car for female, senior and disable person Wheel chair space with fastener, gap- reduced entrance Braille for car number, door number etc.

Source: JICA Study Team

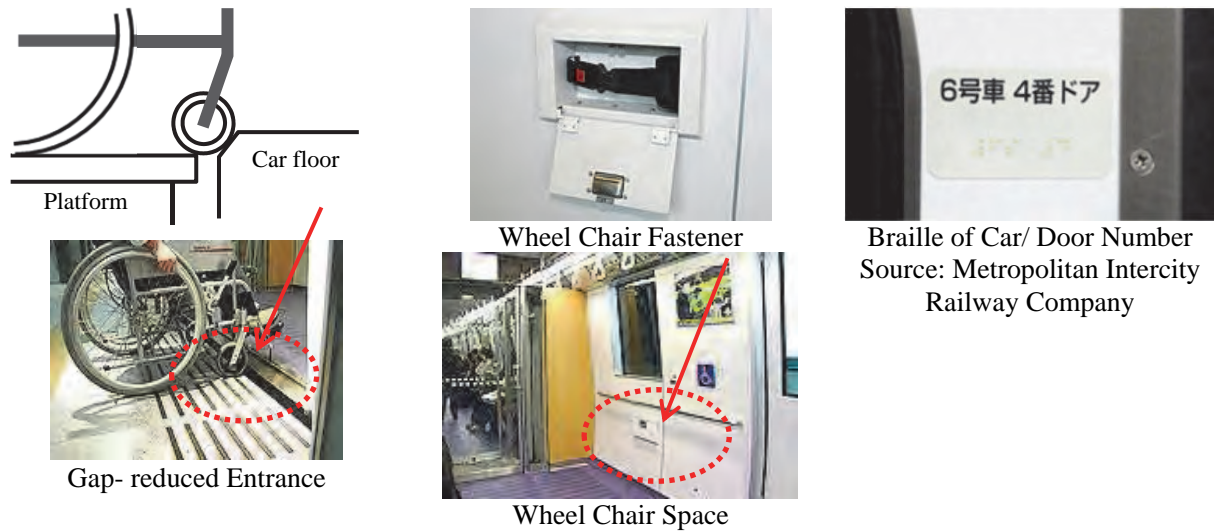

Source: JICA Study Team

Figure 4.2.1 An Example of Universal Design for Car Design

4.2.5 Passenger Capacity and Train Formation

1) Floor Layout

Car Body Size

- Body Width : 2,950 mm
(Cross section is shown in the Figure)
- Lead car length 19,710 mm
(Distance between couplers' surface 20,000 mm),
- Driver's cab length 1970 mm
Intermediate car length :19,500 mm
(Distance between couplers' surface 20,000 mm)
- Doors : 4 doors on each side of a car
1300 mm width x 1850 mm height

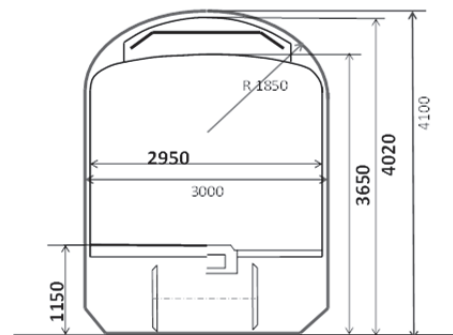

Source: JICA Study Team

Figure 4.2.2 Cross Section of Rolling Stock

From the view point of barrier-free, wheelchair space should be provided. Lavatories should be provided in case running time is over about 2 hours and headway is over 30 minutes. When lavatories are installed on trains, equipment for sanitary disposal is needed at the depot or workshop, and the operation plan for drainage should be considered. In this project, section is from Malolos to Tutuban and it is appropriate that lavatories are not placed because the running time will be under one hour and trains will be relatively frequent.

Floor layout is shown in Figure 4.2.3.

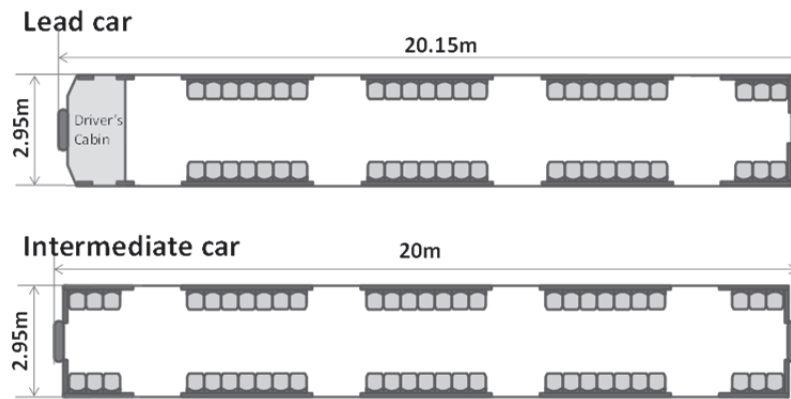

Source: JICA Study Team

Figure 4.2.3 A Typical Layout of Commuter Train Cars

2) Standard Passenger Capacity

Concerning the calculation of passenger capacity, it is important to determine the standing passenger capacity of cars to be set as standard. The standard passenger capacity varies widely. Generally, standing capacities are measured as passengers per square meter. These range from $4/m^2$, considered tolerable in the US and Western Europe, to $8/m^2$ in Asian cities.

Many railway engineering projects express rolling stock loading requirement as follows.

- AW0, empty weight
- AW1, with weight seated passenger load
- AW2, weight with average peak-hour passenger load
- AW3, crush loaded weight





* AW: Added Weight

Some variations include that AW2 is set as a weight with average passenger load, AW2 and AW3 is raised up to AW3 and AW4 respectively.

Peak-hour passengers are usually based on 4 passengers/ m^2 of floor space in North America, 4-5 passengers/ m^2 in Europe and 5-6 passengers/ m^2 in Asia, after discounting space used for cabs and sitting passengers. Crush loads are 6, 6-7, and 8 passengers/ m^2 respectively.

In the Japanese method, the standard passenger capacity of a car is defined as the total number of seats plus the standing capacity. The standing capacity is calculated from the quotient of effective floor space (m^2) divided by 0.3 square meters. This means that one standing person occupies 0.3 square meters, which is equivalent to 3.3 passengers/ m^2 . Based on this standard passenger capacity, the grades of congestion rate are shown in the table below. In this table, the AW factor is designated as the standing capacity (passengers/ m^2). In Japan a congestion rate of 150%, which is equal to 6 passengers/ m^2 , is expected to be the peak-hour congestion rate in the future.

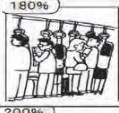
Table 4.2.3 Congestion Rate in Japan

Congestion rate in Japan (%)	Image	Corresponding AW (pax./m ²)
100%		AW: 3.3
113%	Standard	AW:4
150%		AW:6
170%	Maximum	AW:7
180%		AW:7.5
200%		AW:9

Source: MLIT arranged by JICA Study Team

Considering all the above, the standard passenger capacity in the project should be 4 passengers/m² and the peak-hour capacity should be 7 passengers/m².

3) Passenger capacity and Train Formation

Depending on the standard passenger capacity defined above, the capacity from the total of number of seats and with the standing capacity as 4 passengers/m², and under the assumptions of vehicle structure below, the passenger capacities of the lead car and intermediate cars is calculated respectively.

Table 4.2.4 shows the car capacities of lead car and intermediate car based on 4 pax/m² and 7 pax/m².

Table 4.2.4 Standard Passenger Capacity

Type	Seats	Standing		Total	
		4 pax/m ²	7pax/m ²	4pax/m ²	7pax/m ²
Lead car	48	123	216	171	264
Intermediate car	54	132	231	186	285

Source: JICA Study Team

For assuming train formation and frequency passenger capacity of peak hour that is 7 pax/m² is considered. Table 4.2.5 indicates passenger capacity of one train set in different train formation.

Table 4.2.5 Passenger Capacity for 3 Different Train Formations

Train Formation	Passenger Capacity		
	Seats	Standing	Total
6 cars	312	1356	1668
8 cars	420	1818	2238
10 cars	528	2280	2808

Source: JICA Study Team

Although the exact passenger capacity will change according to the floor layout after locating such items as lavatories or wheel chair spaces, 8-car formation will be selected based on the operation plan.

Figure 4.2.4 shows a typical formation of 8-car commuter train-set.

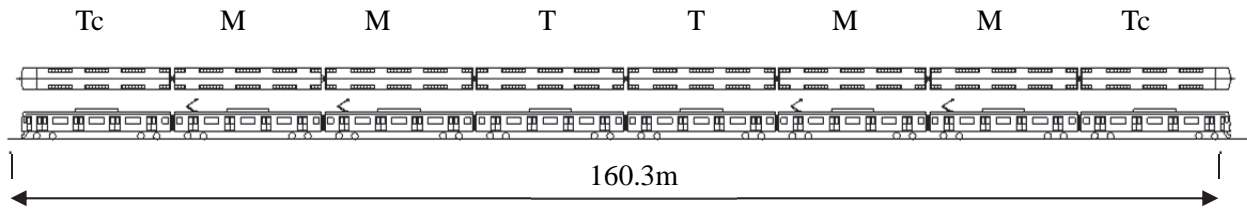

Source: JICA Study Team

Figure 4.2.4 A Typical Formation of 8-car Commuter Train-set

4.2.6 Body Materials

The materials that are generally used for rolling stock are steel, stainless steel or aluminum alloy. Table 4.2.6 shows a comparison of the main characteristics of these three body materials.

Table 4.2.6 Comparison of Body Materials

Materials	Steel	Stainless Steel	Aluminum Alloy
Density (g/cm ³)	around 8	around 8	around 3
Tractive strength	High	High	Low
Surface hardness	Low	High	Low
Welding technology	Easy	Difficult	Most difficult
Reparability in case of accident	Easy	Difficult	Almost irreparable
Corrosion resistance	Low	High	High
Painting	Needed	Not needed	Not needed
Manufacturing complex design	Possible	Impossible, use FRP [†] if necessary	Possible
Cost	Low	Expensive	Most expensive

[†] Fiber reinforced plastic

Source: JICA Study Team

As its name indicates, stainless steel does not corrode. Stainless steel cars do not need to be designed with extra initial strength to allow for the decline in strength due to corrosion and need not to be painted either. Therefore the weight of a car made of stainless is much lighter than that of steel body. In addition, Japanese manufactures particularly excel in light weight technology. Further, the surface of a stainless steel body is harder, which contributes to damage resistance, and does not need painting, which reduces the need for maintenance. A disadvantage of stainless steel is the difficulty in manufacturing complex designs. If such a complex design is necessary, fiber reinforced plastics (FRP) should be used with.

Although aluminum alloy is lighter than stainless steel, the surface is soft and easily damaged. Moreover, the welding technology of aluminum alloy is the most difficult of these three materials. The body material should be selected considering these advantages and disadvantages including cost.

The most recent practice is that most of the body materials used for commuter trains are stainless or aluminum alloy. In Japan, most commuter trains are made of stainless steel, whereas aluminum alloy is mainly used for subways, in which the distance between stations is very short at about 1 km, meaning that the trains need lighter weight for higher acceleration. In this project the distance between stations is considerably longer, meaning that minimizing weight is less of a priority.

Considering the possibility of damage by vandalism or accidents by operation of an at-grade railway line with level crossings, stainless steel is recommended for this project.

4.2.7 Acceleration Performance

In this project, train operation speed is planned to be 80 km/h in urban zones and 120 km/h in suburban zones. In order to confirm that a train can accelerate up to the maximum operation speed, a rough calculation of the acceleration curve was performed. The calculation assumptions are as follows and the results are shown in Figure 4.2.5. The assumptions are:

- Train formation: 8 cars, composed of 4 motor cars and 4 trailer cars
- Train weight : Standing passenger capacity : 4 pax./m² , 337 ton/train
- Acceleration rate at starting: 3.3 km/h/s
- Traction motor 120 kw, 16 units

According to this calculation, a commuter train can accelerate up to 80 km/h in 450 m and to 120 km/h in 2500 m to reach the maximum speed of 120km/h distance between stations must be more than 3500m including brake distance. Average distance of stations is about 4km therefore planned maximum speed can be achieved in this project.

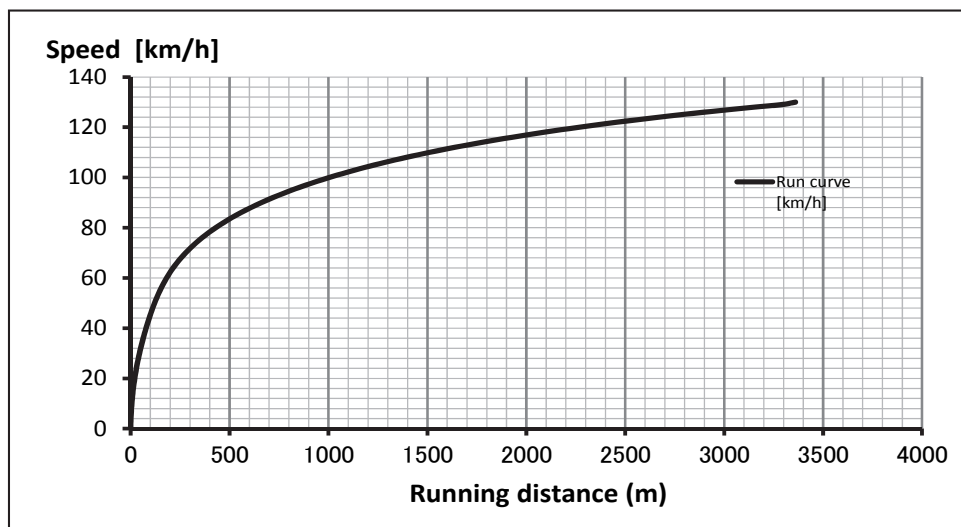

Source: JICA Study Team

Figure 4.2.5 Acceleration Performance

4.2.8 Main Specifications

Based on the main characteristics described above, including passenger capacity, train formation, body materials and acceleration performance, one example of the main specifications recommended for this project is shown in Table 4.2.7. Some major items are explained in the following sections.

Table 4.2.7 Main Recommended Specifications of Rolling Stock

Item		Specification
Train composition Tc: Trailer car with driver's cab M: Motor car T: Trailer car		EMU System 8-car: 4M4T (Tc+M+M+T+T+M+M+Tc)
Major dimensions	Lead car length	20,150 mm
	Intermediate car length	20,000 mm
	Body width	2,950 mm
Passenger capacity per train	Seat	8-car: 420
	Standard: 4 pax/m ²	8-car: 1,458
	Maximum: 7 pax/m ²	8-car: 2,238
Weight per train (Tare)		8-car: 254t
Body materials		Light weight stainless steel
Saloon design	Doorways	4 doorways each side of a car
	Door type	Double sliding doors, 1,300 mm width
	Seat type	Longitudinal seats
Maximum operation speed		120 km/h
Traffic performance	Acceleration	3.3 km/h/s at start
	Deceleration (Service/Emergency)	Service: 4.2 km/h/s Emergency: 4.7 km/h/s
Propulsion system	Power collector	<ul style="list-style-type: none"> • DC 1,500 V • Single-arm pantograph • 1 unit per M car
	Control system	<ul style="list-style-type: none"> • VVVF inverter with IGBT elements • 1 set per M car
	Traction motor	<ul style="list-style-type: none"> • 3-phased induction motors • 120 kW × 4 units per M car
Brake system		All electric command electro-pneumatic brakes with regenerative braking
Bogies		Bolster-less type
Air conditioning equipment		Roof top type
Auxiliary power supply equipment		SIV: 3-phase inverter with IGBT element
Passenger information system		<ul style="list-style-type: none"> • Public address system via loudspeakers • Visual information system via LCD screens

Source: JICA Study Team

1) Bogie

There are two bogie types used recently in heavy rail systems. The first type has a bolster, the center beam that supports the body weight and can rotate around the center pin of the bogie frame. It enables the bogie to rotate with the rotation of the bolster around the center pin. The other type does not have a bolster and is referred to as the bolsterless type.

A bolsterless bogie supports the body weight with the air suspension directly mounted on the bogie frame and this enables the body to rotate by the twist of air suspension. The bolsterless type is a simple structure, light and low maintenance. Therefore it is proposed if the minimum curve radius can be kept more than 200m.

2) Traction System

The traction system is composed of power collectors, power control systems and traction motors. Technology of the traction system is ever-improving. The system which is most suited among state of the art technologies should be adopted.

- Power collector

DC 1500V Overhead Catenary System is selected for the power supply system, thus a power collector would be a single-arm pantograph and they should be mounted on the roofs of each unit.

- Power control system.

Nowadays VVVF-(PWM) inverter system employing IGBT elements is the main form of power control system. This type should be adopted. One inverter, which controls four traction motors, is mounted on each motor car, ensuring redundancy of operation.

In the case of using an AC 25kV feeding system, additional equipment to transform electricity from AC to DC and corresponds to high voltage, such as transformer, AC-DC converter, VCB and so on, are necessary, resulting in higher cost for rolling stock.

*VVVF: Variable Voltage Variable Frequency

*PWM: Pulse Width Modulation

*IGBT : Insulated Gate Bipolar Transistor

*VCB : Vacuum Circuit Breaker

- Traction motor

Induction motors are predominant for the traction motor of rolling stock. They are lighter, stronger, more efficient and require less maintenance than direct current motors because they have no commutator. Induction motors should be adopted and especially an enclosed type is preferable because sweeping in the motor is unnecessary.

3) Braking System

The braking system should be an electric command electro-pneumatic braking system. The propulsion equipment provides regenerative braking and a pneumatic friction brake system adds brake power to the regenerative brake when high deceleration is required or at final stopping. Furthermore a pneumatic brake provides fail-safe emergency braking. It performs electro-pneumatic calculations to ensure air supplement controls for the trailers and increases efficiency of the regenerative braking system.

4) Air-conditioning System

Air conditioning is one of the most important facilities for achieving passenger comfort. It consists of 4 functions, cooling, heating, drying and ventilation. The climate around Manila is hot and humid meaning that the cooling and drying functions are especially important and heating is most likely unnecessary. The capacities are determined through calculations based on climatic conditions and passenger capacity so as to provide comfortable conditions such as not over 28 °C and less than 60% relative humidity. In the case of a commuter type, they will need to be mounted on roofs because the capacity is much larger than those of an express type due to its larger passenger capacity.

Temperature and humidity sensors are placed on each vehicle to facilitate optimum control over the atmospheric conditions. The control system operates automatically in accordance with the conditions detected from the sensors. The air-condition mode can be selected from a monitor screen of Train Information and Management System installed in drivers cab, and the target temperature can be set as desired by the crew.

5) Passenger Information Systems

The passenger information systems consist of:

- Public Address system, providing audible information via mounted loudspeakers.
- Visual information from LCD screens located in the passenger saloon, thus permitting a view for all passengers.

The Public Address system includes a digital voice announcement to provide automatic transmission of information such as the name of the next station.

The LCD screens display general information and/or advertisement to passengers.

4.2.9 Maintenance

The rolling stocks to be used in this project will be of modern technology. However the reliability, availability and durability of the new rolling stock will depend not only on its original capability but also on maintenance. The maintenance system is usually presented by the rolling stock supplier because it is in tight connection with its design policy.

Basically Planned Preventive Maintenance is applied to rolling stock maintenance because an accident of rolling stock might cause fatalities, and even a trivial failure would affect widespread damage to traffic. Maintenance system and period are modified according to the progress of technology. A Typical Planned Preventive Maintenance system in Japan is shown as an example in the following table.

Table 4.2.8 Typical Maintenance System in Japan

Type	Periodicity	Duration	Contents of Work	Site
Daily Inspection	Every 2-6 days	1 hour	<ul style="list-style-type: none">• External visual examination• Visual examination and functional verification of roof-mounted electrical equipment, brakes, doors and driving controls• Oil & Grease	Depot
Functional Maintenance	Every 90 days or 300,000 km	1 day	<ul style="list-style-type: none">• Inspection of pantographs, traction circuit, driving unit, brakes and doors• Inspection of body condition• Inspection of function and insulation of electrical components• Ultrasonic axel inspection• Lathing wheel profile as required	Depot
Major equipment maintenance	Every 4 years or 600,000 km	10 days	<ul style="list-style-type: none">• Removal, disassembly and detailed inspection of traction motors, power transmission units, driving units and braking unit• Bogie replacement	Workshop
General Inspection	Every 8 years or 1,200,000 km	2 weeks	<ul style="list-style-type: none">• Removal, disassembly and detailed inspection of traction motors, power transmission units, driving units and braking units• Replacement of certain major components, depending on condition• Bogie replacement• Interior passenger accommodation overhaul• Car body repair and re-painting as required	Workshop

Source: JICA Study Team

4.2.10 Superiority of Japanese Rolling Stock Technology for Commuter Train

1) General

In Japan, the EMU system is used not only in commuter transport but also in high speed rail. Japan has one of the largest volumes of commuter train transportation in the world. EMUs for commuter train are capable of transporting passengers punctually and reliably at adequate speed, playing a key role as the transportation system in and around metropolitan cities. Its technologies are continually being improved and developed to enhance passenger riding comfort, be more efficient, reliable and environmentally friendly.

With so much experience in the manufacturing of rolling stock for commuter trains, Japan has led other countries in introducing optimum rolling stock. The chief characteristics of these technologies are light-weight car structure, highly efficient propulsion system, and an easily maintained structure.

2) Light-weight Technology

The weight of rolling stock directly affects the operational energy consumption and thus operation cost. Furthermore, light weight rolling stock confers an advantage to the construction of more compact infrastructure because the light weight reduces the required load resistance of the infrastructure, resulting in lower construction cost.

Japanese rolling stock manufacturers along with railway operating companies have been pursuing light weight technology and have achieved excellence in this field. Especially, light weight stainless structures have been achieved that are as light as rail cars with aluminum alloy bodies. In Japan, stainless steel has been used for most of commuter rolling stocks recently.

3) Efficient Propulsion System

Induction motors and VVVF with IGBT system has become the most popular propulsion system for rolling stock in recent years. It is energy efficient and requires less maintenance. However, technology in this field is constantly advancing towards more efficient systems.

The permanent magnet synchronous motor (PMSM) is the one of the latest technologies. A PMSM has permanent magnets in its rotor, and makes the most use of the magnetic energy. So the efficiency of MPSM is even higher than that of an induction motor. This contributes to lower energy consumption. Since a PMSM generates less heat, a full hermetically enclosed structure is possible which contributes to maintenance reduction. Some manufactures in Japan are currently developing a VVVF-inverter with silicon carbide (SiC) module, which is more efficient than a conventional IGBT inverter. The most-suited system could be selected among a variety of systems, considering cost performance.

4) Easy-maintenance Structure

Frequent maintenance is one of the most important factors to determine the reliability of rolling stock. On the other hand, reducing maintenance work can lower operation cost, so if it can be achieved without lowering safety or reliability, it is highly desirable. The structure of bolsterless bogies is very simple and reduces the number of wearing parts. Light stainless steel bodies, bolsterless bogies, induction motors and the VVVF system have reduced maintenance work dramatically.

Furthermore, automatic inspection functions of a train information management system and self-diagnosis functions for major equipment save maintenance work. Rolling stock manufactured with Japanese technology satisfies both high reliability and easy-maintenance.

4.3 Operation Plan

4.3.1 Basic Concepts of Operation Plan

The following basic concepts of the Operations Plan for the proposed commuter service are geared towards achieving a more attractive, comfortable and cost-efficient commuter railway:

- Selection of the optimum frequency of train service to meet sectional capacity requirements;
- Initial train configuration plan of 8 cars/train;
- Provision of train service for 18 hours a day (0600H to 2400H).

In order to optimize this railway system capacity, the train configuration and/or service intervals are adjusted according to the traffic demand forecasts. The system capacity design is based primarily on the maximum loaded section of the line. This system capacity can be increased either by increasing the number of cars per train and/or reducing the headway. The train service will commence service at 0600H and will end each day at 2400H. This can also be extended if the traffic demand warrants it.

4.3.2 Operating Route

Operating route is from Malolos to Tububan running distance is about 37.2km. Initially 10 stations will be constructed and from the year 2030 five more stations will be open.

Following figure shows track layout of the route. Dark gray boxes indicate the stations which will open from initial stage. Light gray boxes indicate the stations to be open in the future.

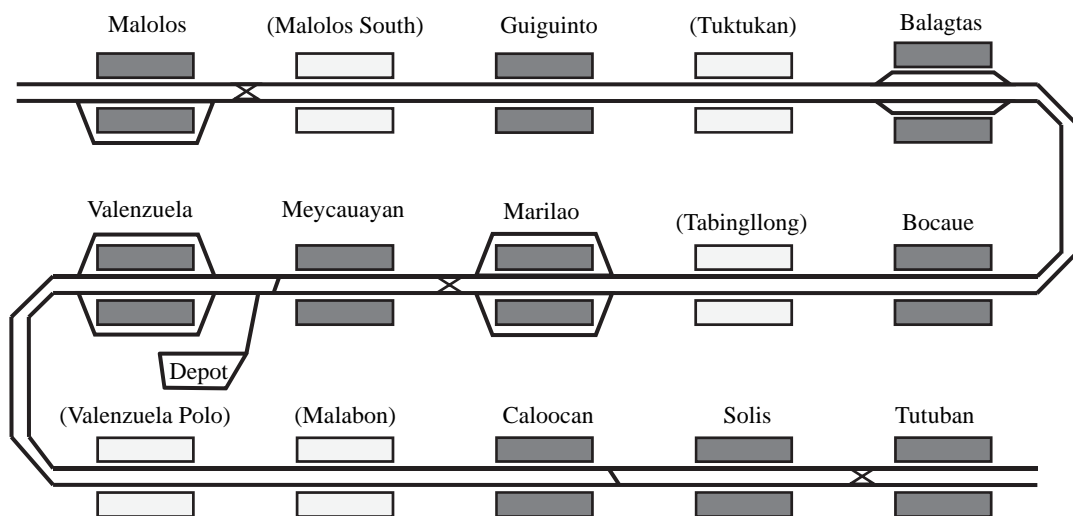

Source: JICA Study Team

Figure 4.3.1 Track Layout of the Route

4.3.3 Passenger Demand

PPHPD (Passenger Per Hour Per Direction) is applied for assuming the number of train to operate in peak hour and it is the base of number of train to be provided. Based on the demand forecast PPHPD of each milestone year is as follows.

Table 4.3.1 PPHPD

	2020	2025	2030	2040
PPHPD	13,210	18,290	20,680	19,990

Source: JICA Study Team

4.3.4 Capacity of Rolling Stock

Rolling stock is commuter type rolling stock with 4 bi-parting sliding doors at one side of each car with longitudinal seat. Maximum speed is 120km/h and maximum acceleration at starting is 3.3km/h/s. Train consists of lead car and intermediate car. 7 pax/m² of standing passengers is considered for estimating capacity of rolling stock for peak hour. Capacity of each car type and 8-car consist is indicated in Table below.

Table 4.3.2 Capacity of Rolling Stock

	Seated	Standing	Total
Lead car	48	216	264
Intermediate car	54	231	285

Source: JICA Study Team

The capacity of the 8-car train configuration is 2,238 passengers as shown Table below.

Table 4.3.3 Capacity of Train

	Number of cars		Train capacity
	Lead car	Intermediate car	
8 car	2	6	2,238

Source: JICA Study Team

The system capacity per hour per direction for 8-car train configurations for different headways is shown in Table below.

Table 4.3.4 Capacity of Train

Headway (min)	8	6	5	4
8 car consist	16,785	22,380	26,856	33,570

Source: JICA Study Team

4.3.5 Operation Headway

Based on the rail ridership demand forecast and system capacity, operational headway and train composition during peak-period for each phase is estimated as below. At the initial phase, train operation will start at 6-minute headways with 8-car train. In the year 2025, train composition and frequency will remain the same as initial phase.

Table 4.3.5 Capacity of Train

	2020	2025	2030	2040
Traffic demand (PPHPD)	13,210	18,290	20,680	19,990
Train consist	8	8	8	8
Headway	6	6	6	6
System capacity	22,380	22,380	22,380	22,380
Load factor	59.0%	81.7%	92.4%	89.3%

Source: JICA Study Team

4.3.6 Travel Time

Train travel time is calculated through a computer assisted simulation. Regular running time is defined based on calculated time adding recovery time and it is applied for a train schedule. In the initial year there are 10 stations however from the year 2030 five more stations will be opened. Therefore traveling time becomes longer after the year 2030. Regular running times on the operations plan for each phase with their corresponding scheduled speed is given in the table below.

Table 4.3.6 Regular Running Time

Year	Section	Number of stations	Travel time	Scheduled speed
2020~	Malolos – Tutuban	10	35 min 35 sec	61.7 km/h
2030~	Malolos – Tutuban	15	43 min 0 sec	52.3 km/h

Source: JICA Study Team

Assuming that minimum turn back time at terminal is 6 minutes, roundtrip time for each phase is indicated below.

Table 4.3.7 Round Trip Time

Phase	Section	Roundtrip time
2020~	Malolos – Tutuban	83 min 10 sec
2030~	Malolos – Tutuban	98 min 0 sec

Source: JICA Study Team

4.3.7 Required Number of Trains

The required numbers of trains are calculated using the round trip time and headway for peak period. Likewise, the number of reserved trains is also estimated. In total for the service from Malolos to Tutuban, 11 train sets with 2 reserved trains are required at initial year, it is increased to 14 train sets with 3 reserved trains in the year 2025. 17 train sets with 3 reserved trains are required after the year 2030 when number of station is increased.

Table 4.3.8 Required Number of Trains

	2020	2025	2030	2040
Trains in operation	11	14	17	17
Reserved trains	2	3	3	3
Required number of trains	13	17	20	20
Train consist	8 car	8 car	8 car	8 car

Source: JICA Study Team

4.3.8 Rolling Stock Procurement Plan

Based on the train operation plan described above, rolling stock procurement plan is indicated in Table 4.3.9. In the initial stage 13 train sets shall be procured. The procurement of the initial rolling stock should commence a few years before the scheduled opening operation year of 2020. Assuming that increase of ridership is linear, additional 4 train sets are procured in the year 2023. In the year 2030 additional 3 train sets are required as number of stations is increased. Number of rolling stock to procure is indicated in Table 4.3.9.

Table 4.3.9 Rolling Stock Procurement Plan

	2020	2023	2030
Train consist	8 car	8 car	8 car
Number of trains	13	17	20
Number of rolling stock	104	136	160
Rolling stock to procure	104	34	24

Source: JICA Study Team

4.4 Civil Facilities Plan

4.4.1 Alternative Structure Types



4.4.1.1 General

Generally, elevated railway structure is classified into the following two structure types, viaduct/ bridge and embankment.

Type of railway structure is mainly determined based on development conditions of the adjacent area along the NSCR. Also it will consider the following: (i) construction cost, (ii) construction period, (iii) advantages to NSCR users, (iv) social and environmental impacts, (v) flooding, (vi) and from the point of view of operation and maintenance. Especially flooding problems must be considered for selection of structure type because people in the vicinity of the NSCR project are worried about flooding that regularly occurs.

Comparisons of the advantages and disadvantages of each type of structures are summarized as shown below.

Table 4.4.1 Characteristics of Each Structure Type

Item	Viaduct/ Bridge	Embankment
Examples of Structures		
Construction Cost	• Low cost compared to underground structures. (approx. JPY 1.9 billion/km for typical type of civil structure type only).	• Very low cost compared to an elevated structure (Approx. JPY 0.8 billion/ km of embankment with soil improvement)
R.O.W	Land acquisition is necessary for entrance and exit of the stations.	In case where high embankment are necessary, additional ROW is needed.
Construction Period	Short in comparison with underground structure.	Short in comparison to viaducts except in the case of ground improvement.
Countermeasure for Flooding	No specific countermeasures are required	Embankment acts as a dam, therefore it is necessary to construct additional drainage to minimize flooding.
Operation /Maintenance	Easy because of ease of access.	Easy due to availability of access.
Noise (Inside Train)	Little noise	Little noise
Noise (Outside Train)	Noise will occur along the railway but installation noise barrier can mitigate noise.	Noise will occur along the railway but installation noise barrier can mitigate noise.
Disaster Prevention	Comparatively safe. Easier to take countermeasure compared to underground structures.	Comparatively safe. Easier to take countermeasure compared to an underground structure.
Ground Settlement	Ground settlement will not occur.	In case where soft soil is encountered, there is possibility that ground settlement can occur.
Earthquake	Structure must be designed considering earthquake load	Embankment must be designed considering earthquake loads.
View from the Window	Good	Good
Scenery	Shape of structures shall be designed considering scenery.	Shape of structure shall be designed considering the scenery.
Recommendation	○ Basically Recommended	Recommended under specific conditions

Source: JICA Study Team

4.4.1.2 Alternative Structure Types

The followings are description of the civil structure types. The selection of the types of civil structure shall be made in consideration with the following factors:

- Cost performance and environmental conditions;
- NSCR alignment area which is prone to flooding;
- Prevention worsening of flooding due to construction of embankment.
- The recently constructed structures by NORTH RAIL PROJECT at Igolot, Bocaue, Santol, and Guiguinto rivers should be avoided for selection of civil structure, i.e. piers, abutments, etc.

1) Viaduct

Elevated structures such as bridges with piers that have a span length of less than ten meters ($L < 10\text{m}$) will be recommended with a reinforced concrete slab type (Simple beam) see Figure 4.4.1.

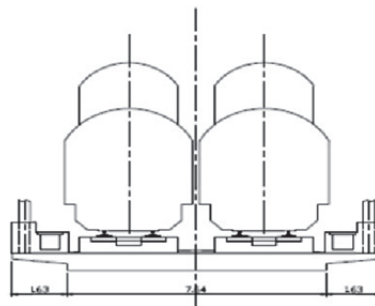

Source: JICA Study Team

Figure 4.4.1 RC Slab Type

Elevated structures such as bridges with piers that have a span length between ten and twenty meters, ($10\text{m} < L < 20\text{m}$) will be recommended with reinforced concrete beams and composite steel H-beams type (Simple beam see Figure 4.4.2 and Figure 4.4.3.

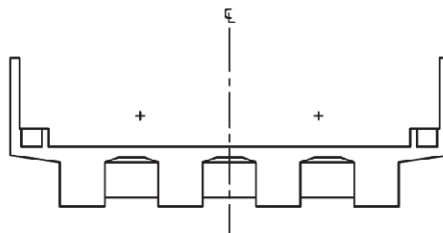

Source: JICA Study Team

Figure 4.4.2 Reinforced Concrete Beams type Section

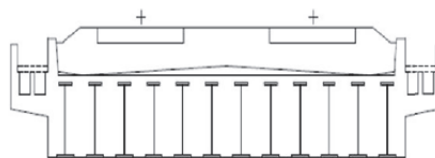

Source: JICA Study Team

Figure 4.4.3 Composite Steel H-beams type Section

Elevated structures such as bridges with piers that have a span length of more than 20 meters but is less than 50 meters ($20\text{m} < L < 50\text{m}$) will be recommended from pre-stressed concrete beams (PC Beam-type/ PC Box type) a simple-beam type. (Figure 4.4.4, Figure 4.4.5).

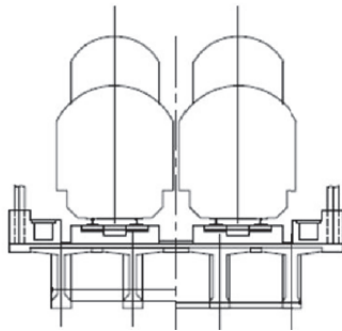

Figure 4.4.4 PC-Beam-Type Section

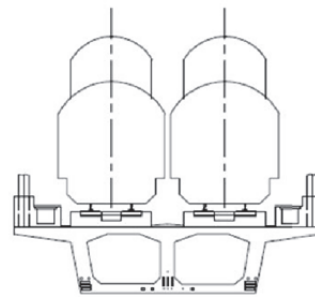
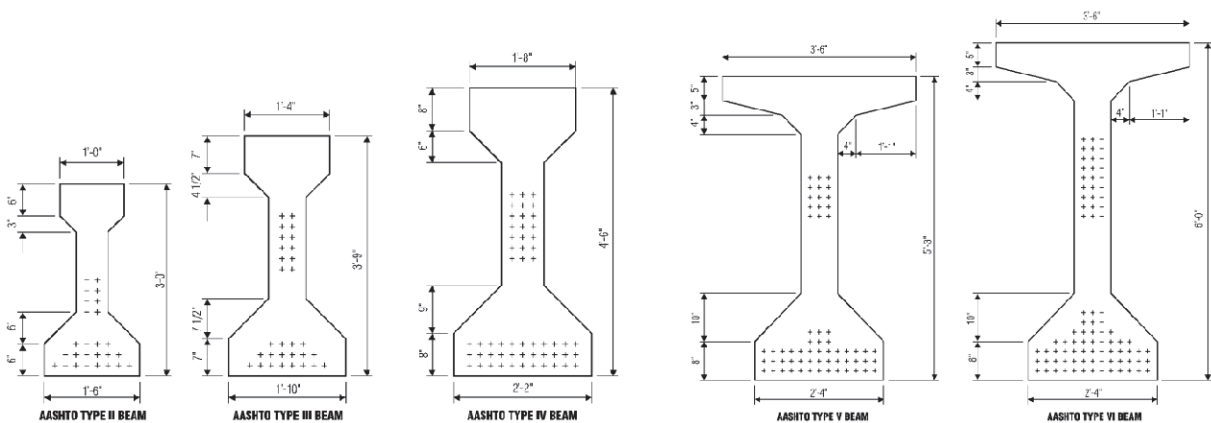

Figure 4.4.5 PC Box Type Section

Source: JICA Study Team

An AASHTO girder in the Philippines generally has an I-type cross-section. This girder type is widely available and is produced locally. Girder fabrication can be done both by cast-in-place and pre-cast methods of construction. AASHTO type sections used for highway structures are typically available in Type-I to Type VI with spans ranging from 18 to 48 meters (Figure 4.4.6), each type of girder geometry has its own particular advantage and the goal is to economize the section whenever possible without compromising structural integrity.



Source: Standard Plans for Highway Bridges, vol. I, Concrete Superstructures, FHWA

Figure 4.4.6 AASHTO specified Prestressed Concrete Bulb T-Girder

In order to establish the form of construction of the guideway using AASHTO girders, consideration needs to be given to the following aspects in the design stage: (i) typical section and alignment; (ii) span composition; (iii) structure types; (iv) span to depth ratios; (v) major site constraints. AASHTO type girders are generally limited to straight spans or with spans of big radius of curvature.

For guideway structures utilizing AASHTO type girders, deck joints should be designed considering longitudinal and transverse movements as well as rotation caused by thermal expansion and contraction as well as from various loading conditions. One of the erection methods of AASHTO beam is shown in below figure.

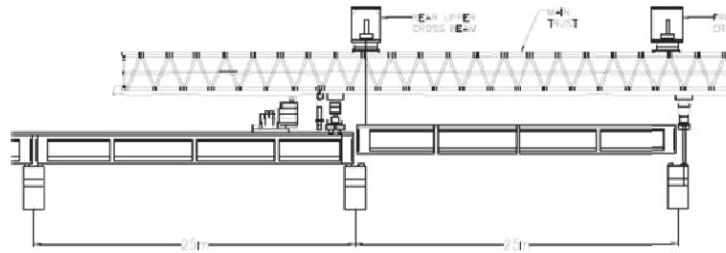

Source: JICA Study Team

Figure 4.4.7 AASHTO Type Launching Girder

Pre-cast segmental construction typically makes use of box girder sections with a closed trapezoidal shape. The box girder provides substantial torsional stiffness making the section effective in resisting large torsion loads from train derailment and other lateral forces, and is suitable for use in short-radius curves. The trapezoidal shape optimizes the section in allowing a reduced width bottom flange. Segmental construction allows the use of smaller segments for transportation and handling, and reduces the required size and cost of temporary erection gantries. Segmental construction may be used where the construction schedule or access to the site delivery of segmental units. One of the erection methods of PC box girder is shown in below figure.

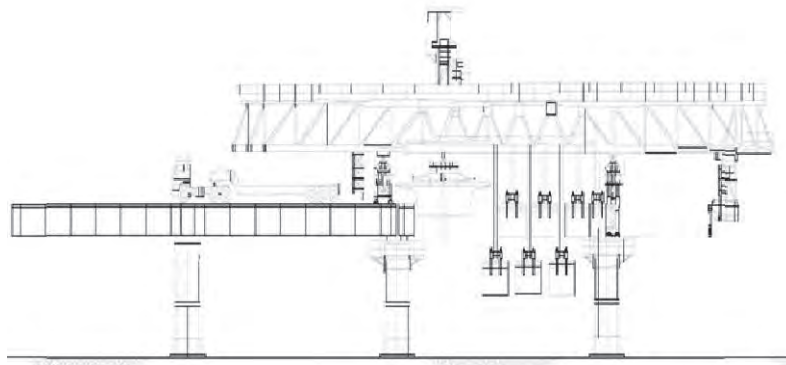

Source: JICA Study Team

Figure 4.4.8 Segmental Type PC-Box Launching Girder



Source: JICA Study Team

Figure 4.4.9 Example of Construction Method for Girder Erection

Refer to Table below for a basic comparative study of the two forms of PC type for guideway construction. The viaduct girders feature simply supported bearings.

Table 4.4.2 Basic Comparison table between PC-T Beam and Box Girder

Guideway type	Type 1A-PC T Beam	Type 1B-PC Box Girder
Construction cost	Less than Type 1B	
Constructability	Girders cast in advance in casting yard. Pre-stressing done in casting yard. Easy to construct span by span with conventional crane. Deck slab and transverse beams require in-situ concrete construction. Launching girder erection method can be used in the case of difficulty area by crane erection.	Segments cast in advance in casting yard. Pre-stressing done in situ. Erection gantry required to support segments. Easy to construct span by span if spans simply supported. Minimal in-situ concrete construction. Segments joined with epoxy.
Construction Time	Girders are fully pre-stressed prior to erection but then require some in-situ concreting work.	Minimal in-situ concreting work is required minimal but match casting and stressing operations are required on sit
Difference in construction time is not a major factor.		
Structure aspect	Not torsionally stiff. Not suitable for highly curved alignments. Requires transverse beam to distribute loads transversely. Decks are simply supported. Requires bearings at each girder end.	Substantial torsional stiffness. Suitable for short radius alignments. Does not require diaphragms to distribute loads transversely. Requires reduced number of bearings than Type 1A.
Maintenance	Type 1A requires a larger number of bearings than Type 1B and therefore Type 1A has more maintenance.	
Maintenance aspects are similar concrete construction offers minimal maintenance obligations.		
Remark	Recommendable for straight alignment.	Recommendable for highly curved alignments.

Source: JICA Study Team

2) Long Span Bridge

Elevated structures such as bridges with piers that have a span length of more than 50 meters but less than 100 meters ($50m < L < 100m$) will be recommended from pre-stressed concrete continuous beam type (Figure 4.4.10) applicable in the vicinity of towns and steel truss type (Figure 4.4.11) applicable for all river crossing.

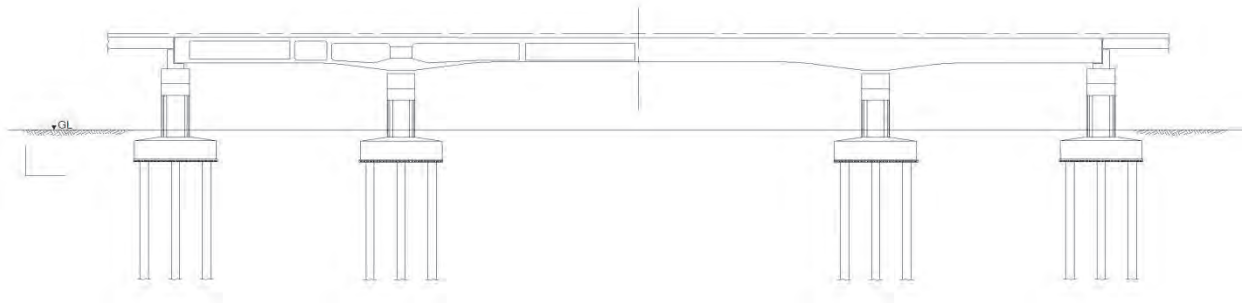

Figure 4.4.10 PC Continuous Beam Type

Source: JICA Study Team

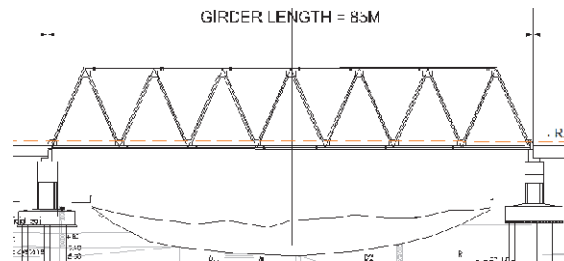

Figure 4.4.11 Truss Type

Source: JICA Study Team

(a) Long Span at Road Intersections using Continuous Type (Type 2)

Continuous pre-stress girders, cast monolithically, offer the advantages of having improved durability, seismic performance and allows for longer span. In a designed continuous girder bridge, the depth of the sections along its length normally varies from a minimum at the center to maximum at the supports, giving it an architectural advantage over simply-supported type girder bridges. The continuous type of girder requires fewer expansion joints which reduces maintenance cost. However, Continuous type girders require more formwork, falsework, and labour during the construction stage.



Figure 4.4.12 Long Span Bridge Delhi Metro Phase2, India

Source: JICA Study Team

(b) Special Span at a River using Truss Type Girder (Type 3)

Truss type bridge structures utilize a network of members arranged in triangular configuration. This type of bridge distributes the forces on structural members in either tension or compression. This type bridge configuration can cover span greater than 50 meters; the structure's configuration is simple and the design mainly depends on its function. Normally, truss-types are used for river crossings where the supporting columns are placed only at the side of the river banks making for a longer span requirement. For guideway structures designed for a truss type shown in Figure 4.4.13 and Figure 4.4.14.

Since truss type bridges are made of steel materials, regular maintenance is required to check the components, connections, and protective coatings to ensure longer serviceability. But if steel materials are made of weather resistant material, maintenance time will be reduced.

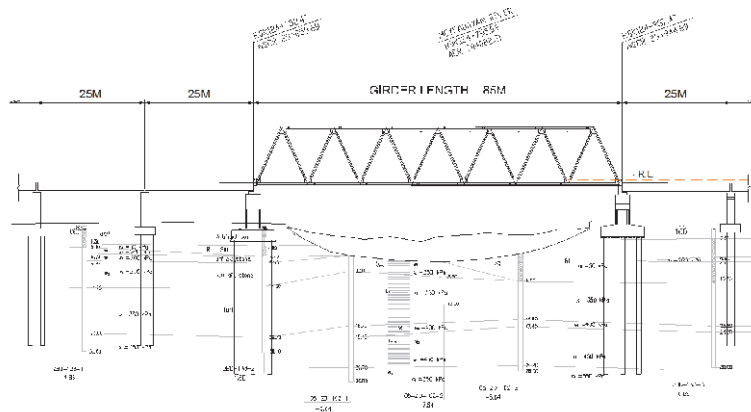

Source: JICA Study Team

Figure 4.4.13 Steel Truss Type Girder



Source: <http://en.structurae.de/structures/stype/>

Figure 4.4.14 Photo of Steel Truss Type Girder

3) Elevated Station

Elevated structure such as station will be recommended from rigid frame structure.

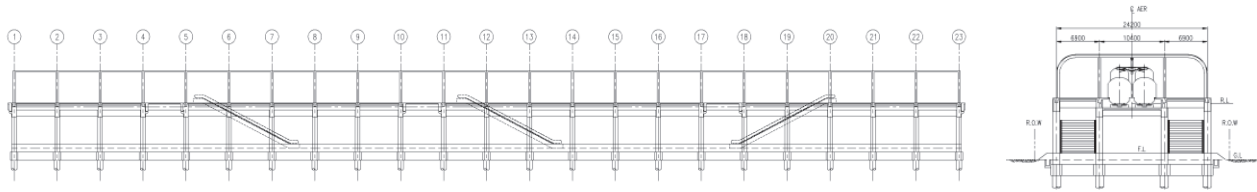

Source: JICA Study Team

Figure 4.4.15 Rigid Frame Type for Station

Typical plan drawing of station facilities is shown in Figure 4.4.16.

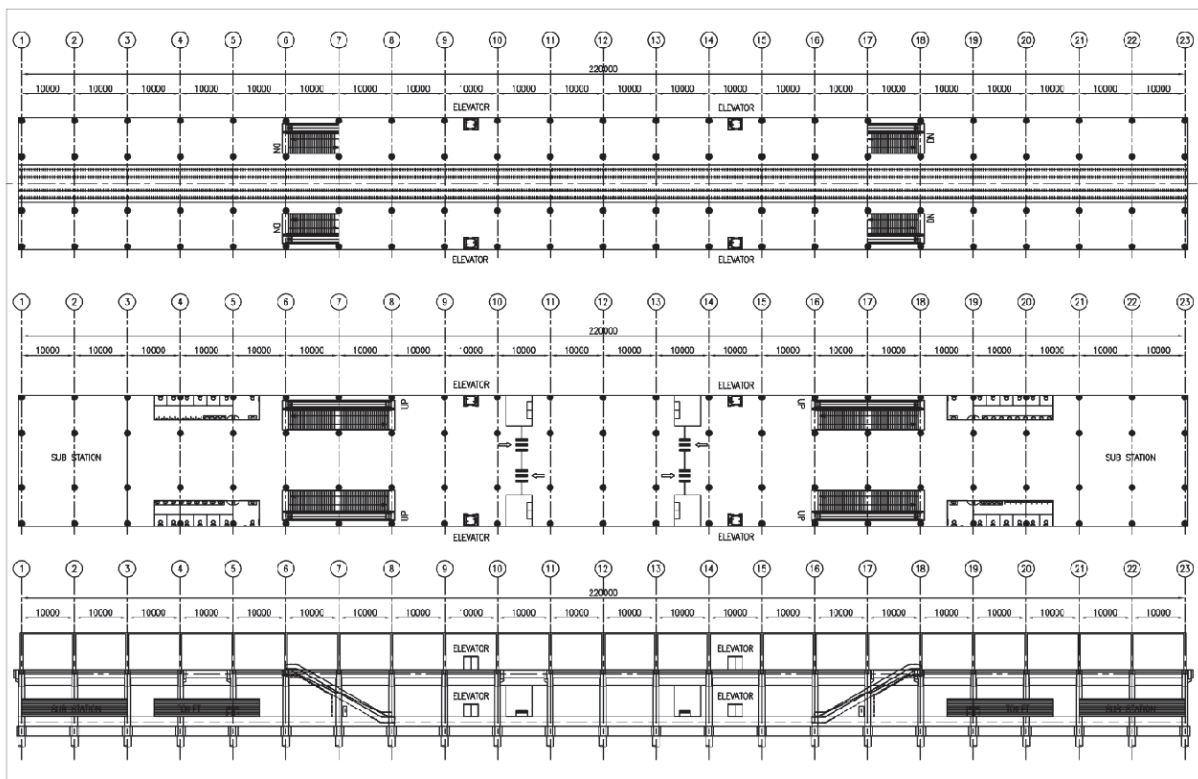



Source: JICA Study Team

Figure 4.4.16 Typical Plan of Station Facilities

4) Embankment

Candidate types of embankment structure are; (i) Normal Embankment (ii) Retaining Walls; and (iii) Reinforced Retaining Wall types.

Table 4.4.3 Comparison of Embankment Types

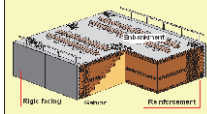
Type of Embankment	Normal embankment	Retaining wall	Reinforced Retaining Wall
			
Face Form	Slope 1:1.5~2.0	Nearly Perpendicular	Nearly Perpendicular
Face Material	Sodding /Flame block	Reinforced Concrete	Reinforced Concrete
Required ROW		Less	Less
Accessibility to the Track	Necessity installation of fence	Difficult	Difficult
Seismic Resistance	Weak	Strong	Strong
Slope Stability against Rainfall	Weak	Stable	Stable
Soil condition	Soil stability has to be kept. If soil condition of sliding is under safety factor of soil stability, soil improvement method is adopted. If consolidation settlement by embankment load and train load will be occurred, a pre-loading method and/or soil improvement method is adopted.		

Source: JICA Study Team

4.4.2 Proposed Structure Plan

4.4.2.1 Section between Malolos and Caloocan

The first section of the NSCR Project would feature a mixture of different structures, elevated, embankment, and long span bridges. This is based on the analysis of the topographic and socio-environmental limitations in the area as well as priority consideration given to safety and cost efficiency.

1) Viaduct

As a result, close to 20% of mainline structure of the entire section is recommended to be an embankment with double retaining wall. The rest of the alignment is on an elevated viaduct, 79% of mainline structure of the entire section on PC girders viaducts. The rest corresponds to special bridge structures and viaducts. The existence of several control points along the route led to this high percentage of structure to be elevated. There are four types of control points that should be cleared, to wit:

- (i) **Cross roads:** To avoid level crossing at road the vertical alignment (rail level) was set to allow enough vertical clearance over the roads. In case of roads with a width of 20m and over, PC simple girder or PC box girder is adopted. In case of roads with a width of under 20m, girder viaduct of RC simple girder or H-shaped steel composite girder structure is adopted. A typical cross section of a PC simple girder viaduct is shown in Figure 4.4.17.
- (ii) **Existing structures:** The structures which were constructed during the Northrail Project should not be reused or demolished, unless allowed by DOTC. Vertical alignment is planned passing above those existing structures by a long span truss type steel bridge. Five subject areas include Gov. Pascual Avenue, Bocaue River, Santol River, Guiguinto River and Malolos.

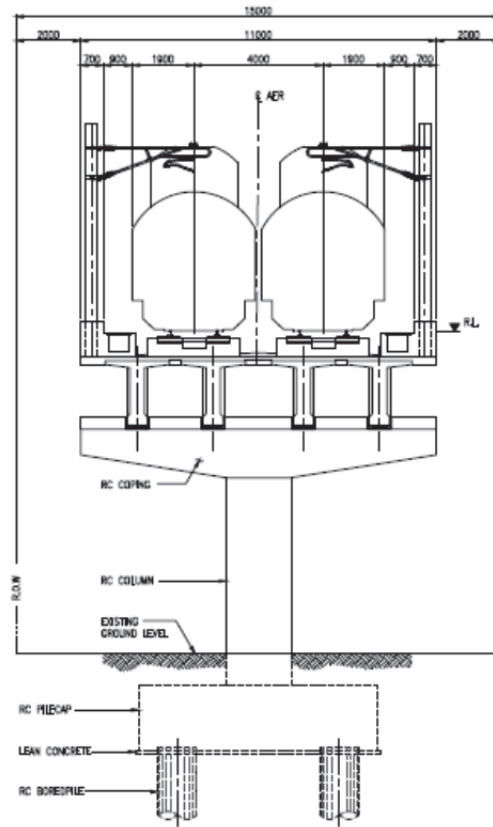

Source: JICA Study Team

Figure 4.4.17 Typical Cross Section of Viaduct



Source: JICA Study Team

Figure 4.4.18 Example of Existing Northrail Structures

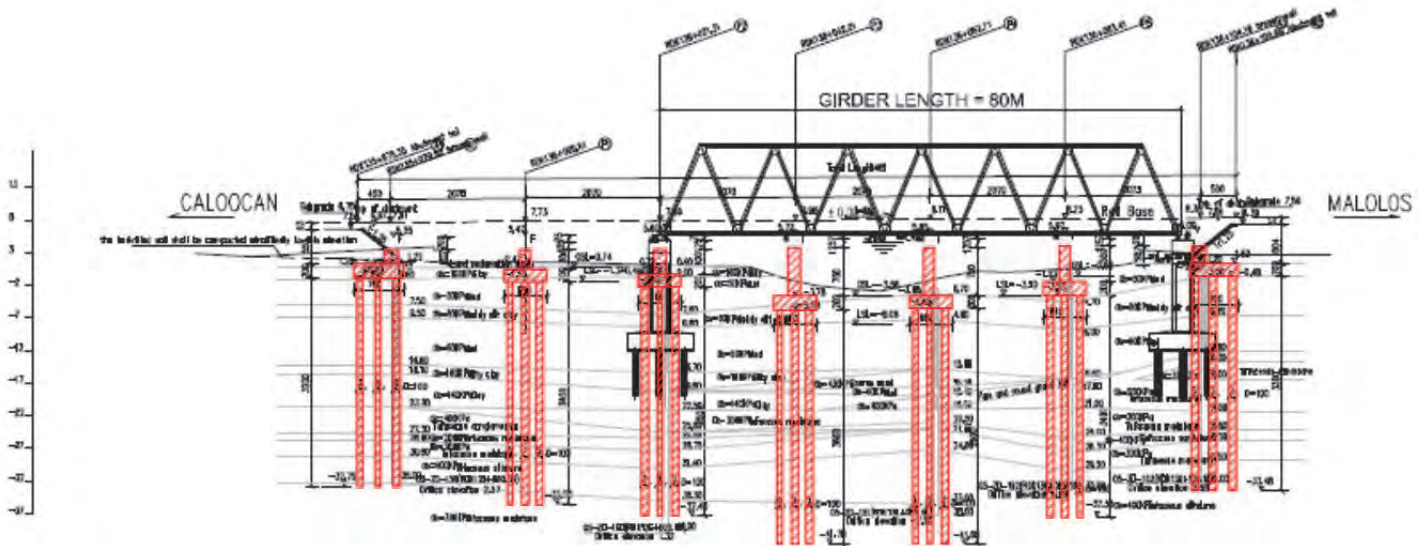

Source: JICA Study Team

Figure 4.4.19 Long Span Bridges Overpassing Existing Structure

- (iii) **River:** At the cross river section, rail level is set considering the estimated 100 year high-water level of the river.
- (iv) **Segment 10.1:** The alignment of NSCR will share the exiting PNR ROW with the DPWH's Segment 10.1 from Valenzuela area to Caloocan and C-3 Avenue. In this case, the highway would be at a third level and the NSCR would continue at the normal second level. The effect on ROW along this section is considerably inferior than for section for Segment 10.2, as explained in the following pages. Figure 4.4.20 shows the typical viaduct structures along the area shared with Segment 10.1.

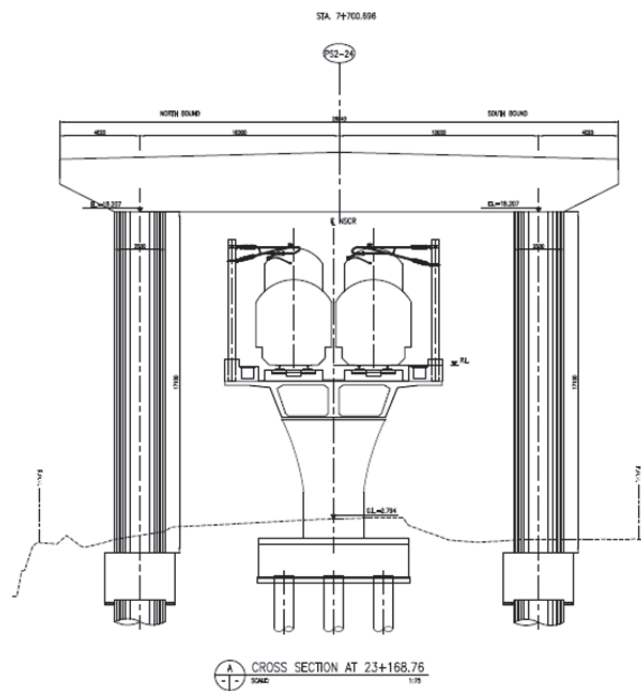

Source: JICA Study Team

Figure 4.4.20 Cross Section of Structure under Segment 10.1

2) Stations

The standard station design consists of a two-story building with the concourse on ground floor, the platform on second floor, and with side platforms. However, three stations would have additional 2 tracks for possible express service in the future. The stations with rail level on the second floor are at Malolos, Balagtas, Bocaue, Meycauayan, Valenzuela, and Caloocan. Typical cross section of this type of stations is shown in Figure 4.4.21.

The stations at Marilao and Guiguinto are three-story buildings with the concourse on the second floor and platform on third floor since these are located on roads.

Figure 4.4.22 shows cross section of Caloocan station.

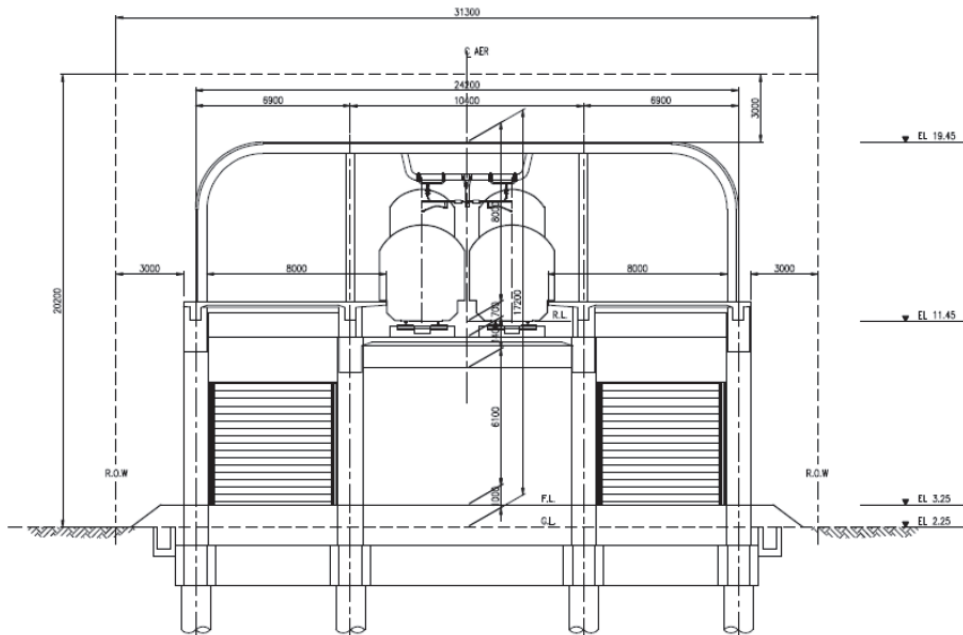
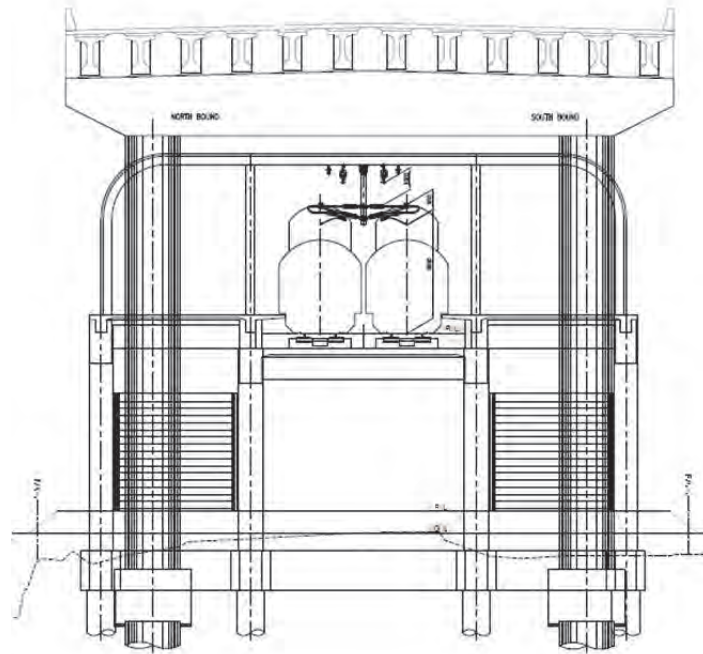

Figure 4.4.21 Typical Cross Section of Stations

Source: JICA Study Team



Source: JICA Study Team

Figure 4.4.22 Cross Section of Caloocan Station

3) Embankment

To reduce the construction cost, the planned vertical height is set as low as possible in some sections and the type of structure is decided to be embankments in those sections. The minimum height of the embankment is set 5m because it is possible that the height of flooding is over 2m according to the result of flood damage simulation along the route. The construction of transversal drainage and pedestrian roads with a minimum of 3m high can be used as a mitigation measure against flooding, and an additional 2 meters is necessary on top of those drainage/roads box culverts.

A variety of geosynthetic reinforced soil (GRS) retaining wall for railways including high-speed railway are introduced in Japan. RRR (Reinforced-soil Railroad structures with Rigid facing) -B type established in 1991 is widely applied and performed well durability in case of major earthquakes including Great Hanshin- Awaji Earthquake in 1995 and Great East Japan Earthquake in 2011.

GRS retaining wall is composed from three elements, soil, reinforcing geogrid and facing structure. The characteristics of GRS retaining wall are high stability and durability for heavy rainfall and earthquake, high cost efficiency in construction and maintenance. Maximum height applied to Hokkaido Shinkansen reaches 11 meters, furthermore it is adopted in the highly densely inhabited, busy traffic section of Yamanote Line in Tokyo.

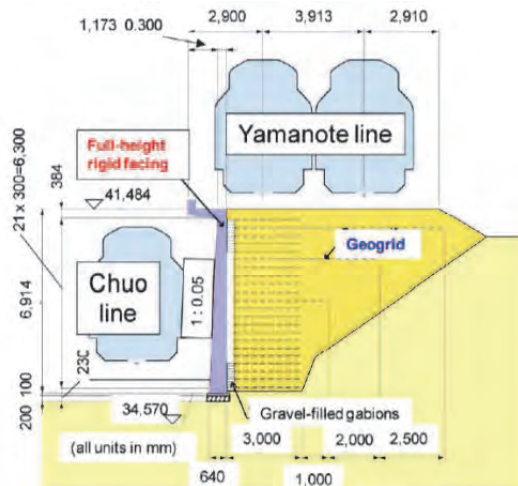

Source: Tokyo University of Science

Figure 4.4.23 GRS Retaining Wall

GRS method is also cost-less structure. The following figure shows the GRS retaining wall comparing to the conventional L-shaped retaining wall. Even the ground conditions requires pile foundation as shown figure below, GRS retaining wall method can be constructed without using foundation piles.

Conventional L-shaped Retaining Wall

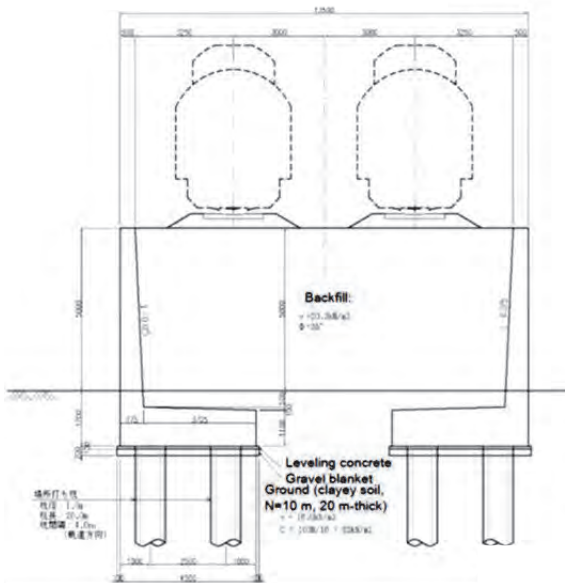

GRS Retaining Wall

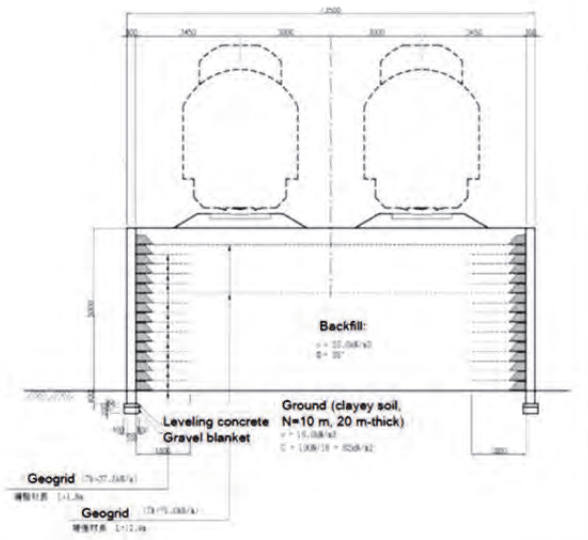

Source: Tokyo University of Science

Figure 4.4.24 Typical Cross Section of Conventional L-shaped Retaining Wall and GRS

4.4.2.2 Section between Caloocan and Solis

1) General Section in Main Line

The structure type of the main line between Caloocan and Tutuban is all elevated. Basically, the substructure of the general section of the main line is planned as a single pier and pile foundation, and the superstructure is PC simple girder.

Alignment along the section from Caloocan to Tutuban will follow the same principle as section from Malolos to Caloocan, but the main restriction is that the existing PNR ROW will have to be shared on the same level with Segment 10.2. Hence, acquisition of additional land is unavoidable. The horizontal alignment of NSCR would run west alongside Segment 10.2 (south portion) from C-3 up to Santa Mesa. Detailed alignment of Segment 10.2 is currently under examination by DPWH.

At Solis station, the NSCR will branch off on two different directions: towards Tutuban and towards FTI, which would become the main line in the future.

2) Section between Solis Station and NSRP Junction

Figure below shows the plane views of Solis station and NSRP junction section, and the general cross section of each structure type.

As the train operations of the Tutuban Route between Malolos and Tutuban and of the Calamba Route between Malolos and Calamba cross in some points in this section, the route alignment becomes complex and the structure types are different.

The route alignment of the Tutuban Route, for both lines of the Malolos and Tutuban directions, is planned at the same track elevation, keeping the same distance between the tracks (excluding the station section) and running side by side. On the other hand, the route alignment of the Calamba Route becomes rather complex, and changes from a double side by side track to a single track with a top and bottom, and then back to a double side by side track.

The Northbound track of the Calamba Route runs over the elevated structure of the LRT Line 1, then descends the R=300m curve section steeply, running through a lower track of a single track section with a top and bottom, and connects to the Northbound track of the Tutuban Route. The Southbound track of the Calamba Route branches off from the main line towards the Tutuban Station after departing Solis station, rising steeply, crossing over the main line towards Tutuban Station via an overpass, going through onto the upper track of a single track section with top and bottom, rising up the R=300m curve section and forming the double side by side track with the track towards Malolos.

Owing to this complicated alignment, in addition to the said single pier for double track, the substructure of the junction section of NSRP is basically planned as a two layered portal rigid-frame pier for a single track section with a top and bottom, a two layered portal rigid-frame pier for the overpass section towards Tutuban Station with a double track, a single pier for the single track section, and twin piers for the triple track section. The superstructure is planned as a two box PC double girder for the double track section, a single box PC girder for the single track section and a PC- I shaped girder for the triple track section.

4.4.2.3 Section between Solis and Tutuban

Civil facility plan between Solis and Tutuban is described in Section 4.8 "TOD and Transportation Junction Plan". Terminal station of NSRP supposed to be located in Tutuban.

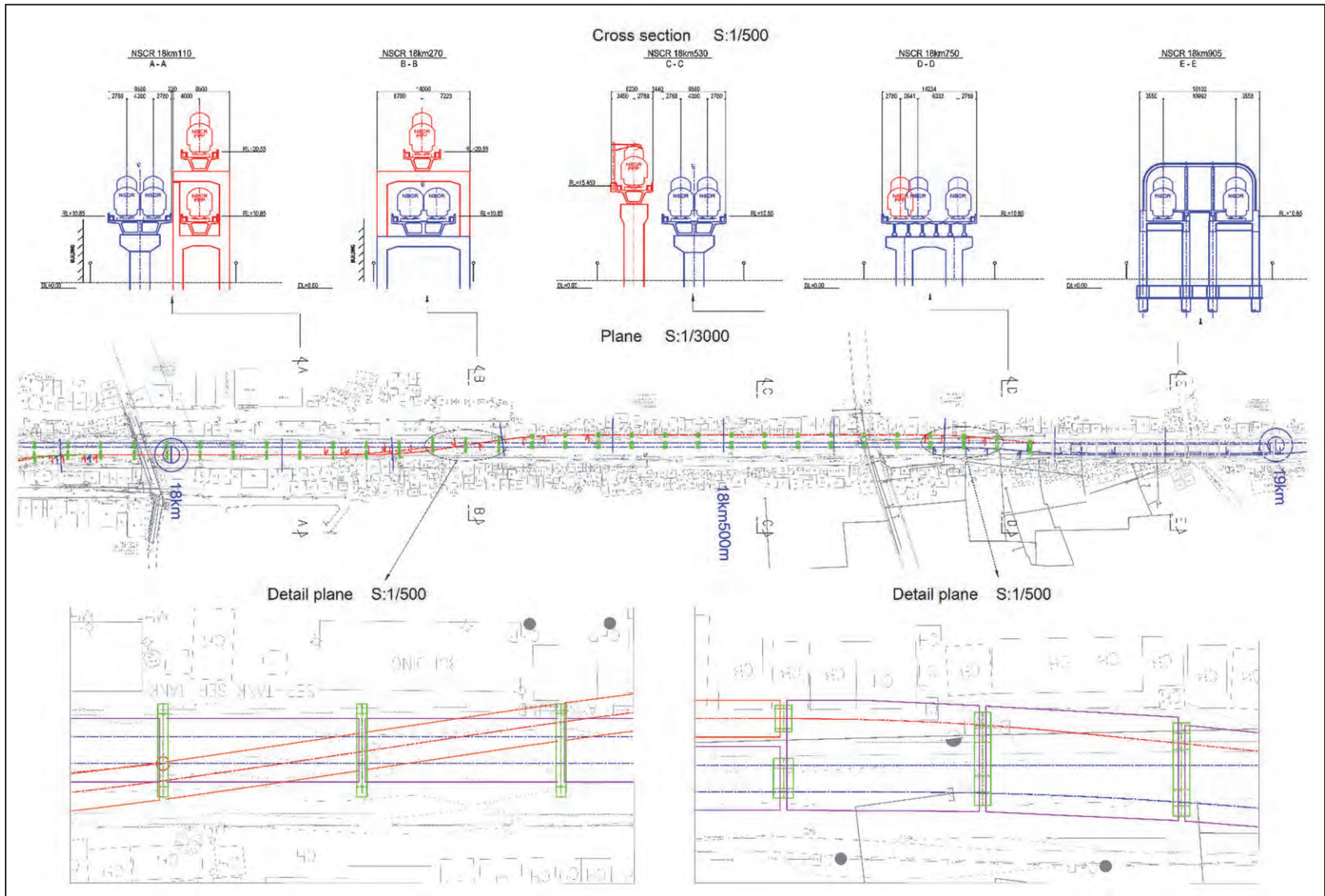

Source: JICA Study Team

Figure 4.4.25 Structure Plan (JICA New Option Plan)

4.4.3 Recommendation of the Construction Package

4.4.3.1 Construction Package

The JST recommends the following construction packages for civil works which were taken into consideration acceptable access routes for construction.

Table 4.4.4 Construction Package for Civil Works (Mainline)

	Chainage	Section	Station	Length
CW1	15+687- 21+131	Tutuban- Caloocan	1. Tutuban 2. Solis	5.4 km
CW2	21+131- 26+470	Caloocan- Valenzuela	3. Caloocan	5.3 km
CW3	26+470- 32+597	Valenzuela- Marilao	4. Valenzuela 5. Meycauayan	6.1 km
CW4	32+597- 36+320	Marilao- Bocaue	6. Marilao	3.7 km
CW5	36+320- 42+542	Bocaue- Balagtas	7. Bocaue 8. Balagtas	6.2 km
CW6	42+542- 47+880	Balagtas- Guiguinto	9. Guiguinto	5.3 km
CW7	47+880- 53+608	Guiguinto- Malolos	10. Malolos	5.7 km

Source: JICA Study Team

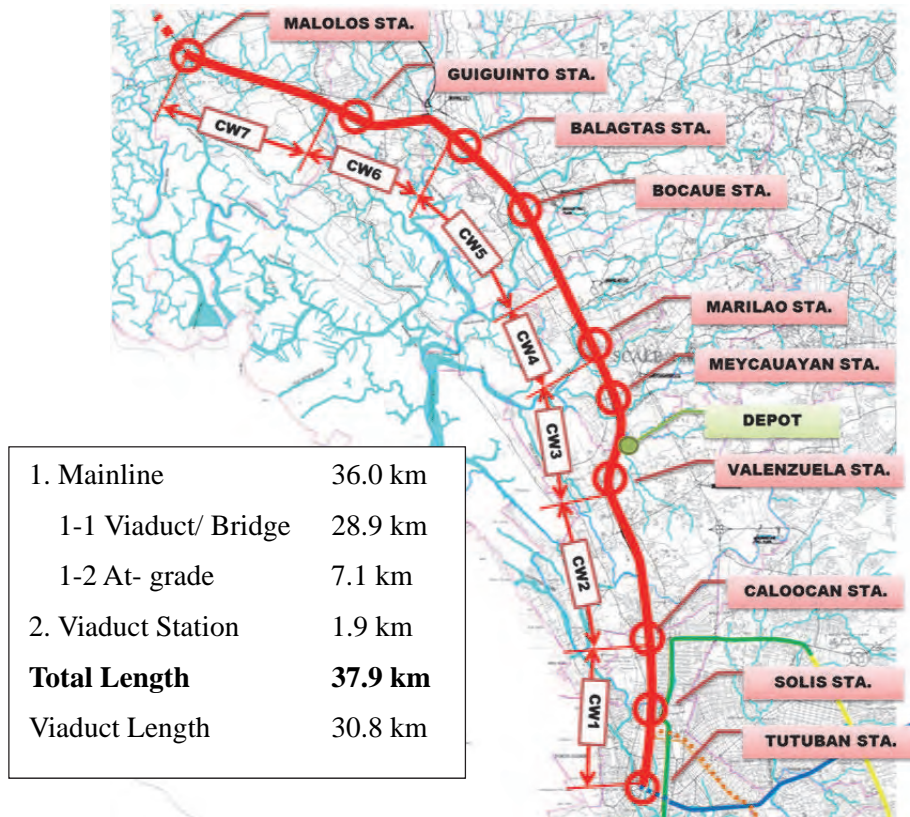

Source: JICA Study Team

Figure 4.4.26 Construction Package for Civil Works

4.4.3.2 Accessibility to the Site

There are numerous bridges and viaducts along the Caloocan to Malolos alignment proposed under the NSCR project, and access conditions for each bridge and viaduct site needs to be carefully considered. Based on the various types of equipment and materials necessary for transport and construction, such as erection gantries, heavy equipment and building materials, access to project sites, both by land and river, are discussed in this section.

1) Site Access by Roadway

The viaduct of guideway, stations are all accessible by land with the McArthur Highway providing a convenient link from Valenzuela to the Malolos area for the transport of materials and equipment. However, access to the subdivision areas is sometimes limited because the difficulty in negotiating narrow streets; therefore only short- to average-lengths transport vehicles will be appropriate for use.

Existing roads for each package are shown in figure below.

Table 4.4.5 Existing Access Road

Civil Package	Kiropost	Access Road Name	Width of Road(m)
CW1/ CW2	21 km 437 m 18	Samson Road	12
	22 km 880 m 59	Gov. Pascual Ave.	12
	24 km 204 m 53	San Francisco	6
	25 km 492 m 90	McArthur Highway	15
	25 km 821 m 72	Road to San Isidro Labrador	8
	26 km 1 m 70	San Miguel, Road to Balubaran	8
	26 km 157 m 62	Roadway to Buenaventura	6
	26 km 335 m 72	Encarnacion	6
	26 km 468 m 12	Roadway to FDC Factory	8
	26 km 606 m 22	A.Marcelino St.	6
26 km 837 m 52	Sumilang St., Roadway to S. Bernardo	8	
CW3	27 km 116 m 2	C. Santiago	8
	27 km 426 m 2	T. Santiago	6
	28 km 353 m 63	Road to NFA Training Center	10
	28 km 633 m 0	Bancal St.	6
	29 km 243 m 4	Tugatog Road	8
	30 km 393 m 49	Maligaya St., Road to Bulak	10
	30 km 622 m 11	Malhacan Road	8
	31 km 392 m 89	L. Sullera St.	8
	31 km 562 m 41	Roadway to Floro Subd.	6
	32 km 33 m 93	Rosas St., Roadway to EJUST College	8
32 km 122 m 80	Roadway to Medallion Homes	10	
CW4	32 km 433 m 84	Camia St., Roadway to St. Martin Subd.	10
	32 km 462 m 42	Roadway to SM Marilao	12
	32 km 533 m 7	SM Road	12
	32 km 660 m 10	SM Road	12
	32 km 759 m 86	Road to SM Marilao	12
	32 km 923 m 89	Lias St.	10
	33 km 338 m 73	Saog St.	6
	33 km 634 m 89	M. Villarica Road	8
34 km 363 m 0	Roadway to Meralco Housing	6	
36 km 312 m 69	Libis St., Roadway to Bundukan	6	
CW5	37 km 574 m 89	Roadway to Igulot	6
	38 km 333 m 90	Gov. Fortunato Halli Ave.	8
	38 km 547 m 31	Roadway to Ayukit Subd.	8
	39 km 239 m 19	Nicolas St., Taal-Bocause Road	8
	39 km 624 m 59	Taal-Makam Road	8
	41 km 327 m 92	Atienza St., Roadway to Longos St.	4
42 km 348 m 45	Kaissahan St., Radway to Brgy. Burof	6	
CW6	44 km 675 m 37	C. Joaquin St.	10
	44 km 882 m 39	Krus St., Roadway to Brgy. Tabe	10
	45 km 451 m 8	Catindig St., Roadway to Brgy. Malis	8
	45 km 782 m 89	Roadway to Brgy. Ilang-ilang	10
	46 km 369 m 29	Access Road to Masagana	6
	47 km 56 m 2	Saint Francis St.	8
47 km 308 m 96	McArthur Highway (Maharlika Road, Tabang Guiguinto)	12	
CW7	48 km 58 m 7	Access Road to Bulacan industrial City	20
	48 km 456 m 22	Access Road to Tan Chiong Co.	6
	48 km 879 m 40	Access Road to Sun King Electronic co. & Meralco Tabang Sub-Station	4
	49 km 144 m 68	Roadway to Brgy. San Pablo	8
	49 km 416 m 63	Lucero St.	16
	50 km 310 m 10	Roadway to Marcelo del Pilar High School	16
	50 km 575 m 19	Access Road to Brgy. Isabel	16
	51 km 634 m 43	Access Road to Malolos Sport Center	6
	51 km 702 m 63	Access Road to Valcres Homes	4
	51 km 797 m 61	Access Road Malolos Resort Club Royale	6
	51 km 873 m 60	Road to Brgy. Mabolo, Fausta Subd.	10
	52 km 675 m 15	Paseo del Congreso St.	18
53 km 303 m 49	(Catmon Road) Blas Ople diversion Road	12	

Source: JICA Study Team

<p>CW1/ CW2</p>		<p>Caloocan Station 21km Access road: Samson road</p>
<p>CW2</p>		<p>Malabon to Valenzuela Station 24km+204m Access road: San Francisco road</p>
<p>CW 2</p>		
<p>CW 2</p>		<p>Malabon to Valenzuela Station 22km+880m Access road: Gov. Pascual</p>

Source: JICA Study Team

Figure 4.4.27 Road Accessibility during Construction

<p>CW 3</p>		<p>Valenzuela to Meycauayan Station 27km+900m</p>
<p>CW 3</p>		<p>Valenzuela to Meycauayan Station 29km+243m Access road: Tugatog road</p>
<p>CW 3</p>		<p>Valenzuela to Meycauayan Station 30km+622m Access road: Malhacan road</p>
<p>CW 3</p>		<p>Valenzuela to Meycauayan Station 30km+393m Access road: Maligaya street road to Bulak</p>

Source: JICA Study Team

Figure 4.4.27 Road Accessibility during Construction (2)

<p>CW2/ CW 3</p>		<p>Valenzuela South station to Valenzuela Station 27km+7m Package boundary C1/C2</p>
<p>CW 3</p>		<p>Valenzuela to Meycauayan Station 29km Access road: Tugatog road</p>
<p>CW3/ CW4</p>		<p>Meycauayan Station to Marilao Station 32km+250m Package boundary C2/C3</p>
<p>CW4</p>		<p>Marilao Station to Tabing Ilog Station 33km Access road: M. Villarica road</p>

Source: JICA Study Team

Figure 4.4.27 Road Accessibility during Construction (3)

CW 4		<p>Marilao to Tabing Ilog Station 33km+634m Access road: M Villarica road</p>
CW 4		<p>Marilao to Tabing Ilog Station 33km+634m Access road: M Villarica road</p>
CW 4/ CW5		<p>Bocaue to Balagtas Station 36km+320m Package boundary C3/C4 Access road: Libis St. roadway to Bundukan</p>
CW 5		<p>Bocaue Station to Balagtas Station 38km+333m Access road: Gov. Fortunato Halili Avenue</p>

Source: JICA Study Team

Figure 4.4.27 Road Accessibility during Construction (4)

<p>CW 5</p>		<p>Bocaue to Balagtas Station 39km+239m Access road: Nicolas St. Taal-Bocaue road</p>
<p>CW 5</p>		<p>Bocaue to Balagtas Station 39km+239m Access road: Nicolas St. Taal-Bocaue road</p>
<p>CW 5</p>		<p>Balagtas to Guiguinto Station 42km+348m Access road: Kaisahan st. roadway to barangay BuroI</p>
<p>CW5/ CW6</p>		<p>Balagtas to Guiguinto Station 42km+348m Package boundary C4/C5 Access road: Kaisahan st. roadway to barangay BuroI</p>





Source: JICA Study Team

Figure 4.4.27 Road Accessibility during Construction (5)

<p>CW 6</p>		<p>Balagtas to Guiguinto Station 44km Access road: C. Joaquin street</p>
<p>CW 6</p>		<p>Balagtas to Guiguinto Station 45km+451m Access road: Catindig street roadway to barangay Malis</p>
<p>CW6</p>		<p>Guiguinto Station to San Pablo Station 47km+340m Package boundary C5/C6 Access road: Access road to Tan Chiong Co.</p>
<p>CW6</p>		<p>Tuktukan Station to Guiguinto Station 45km+782m Access road: Roadway to barangay Ilang-Ilang</p>

Source: JICA Study Team

Figure 4.4.27 Road Accessibility during Construction (6)

<p>CW6/ CW7</p>		<p>Guiguinto Station to Malolos Station 47km+340m Package boundary C5/C6 Access road: Access road to Tan Chiong Co. C_{sm} =Depot</p>
<p>CW7</p>		<p>Guiguinto Station to Malolos Station 48km+058m Access road: Access road to Bulacan Industrial City</p>
<p>CW7</p>		<p>Malolos station 53km Access road: Catmon road.</p>
<p>CW7</p>		<p>Guiguinto Station to Malolos Station 52km+675m Access road: Paseo del Congreso street 1.2AS</p>

Source: JICA Study Team

Figure 4.4.27 Road Accessibility during Construction (7)

2) Site Access by River

The Tullahan River, approximately 15 kilometres long, flows to the north of Manila from Navotas through Malabon into Valenzuela area. It has been a major water transportation means in the past. The Tullahan River is considered as an alternative access transportation route for materials and equipment to the construction sites. However, transporting equipment by barge using this route will be difficult because of some narrow passages under the existing road bridge and choke points along the river, and therefore route survey is necessary.



Source: JICA Study Team

Figure 4.4.28 Tullahan River

4.4.4 Inspection Policy

Due to various natural disaster risks are expected such as flood, earthquake and so on where the NSCR alignment located. It is considerable to introduce Japan's standard for inspection to NSCR structure.

Japan's standard designates the structural performance index with judging of its soundness. It is prescribed that the soundness is judged with appropriate categories based on the results of determined deterioration causes and prediction of deterioration.

Table below shows structural conditions for each soundness ranks. This table shows that prescriptions are established, in principle, in consideration of the characteristics of each structure.

Judgment of soundness in general inspections and extraordinary inspections is generally categorized into ranks A, B, C, and S based on survey results. However, when a state thought to cause a hazard in normal train operation is found, the rank is judged as AA, and measures such as stopping trains shall be taken. The rank is also judged to be AA when exfoliation of concrete fragments threatens public safety, and countermeasures such as immediately knocking down loose concrete fragments, and prohibiting entry underneath viaducts must be devised in this instance.

As for individual inspections, if the state of the structure is judged as rank A in the general inspection and/or extraordinary inspection, identification of the causes of deterioration and prediction of deterioration are conducted. Judgment of soundness is also furtherer sub-categorized into A1 and A2.

Table 4.4.6 Judgment of Structure State and Standard Soundness

Soundness	Structure State
A	State that threatens operational safety, safety of passengers, public safety, guarantee of regular train operation, or deterioration that might cause this state
	AA Deterioration that threatens operational safety, safety of passengers, public safety, or the guarantee of regular train operation, and which require emergency countermeasures
	A1 Progressive deterioration that causes the performance of structures to drop, or heavy rain, floods, or earthquakes that might impair the performance of structures
	A2 Deterioration that might cause a future performance drop of structures
B	Deterioration that might result in a future soundness rank of A
C	Slight deterioration
S	Sound

Note: Soundness ranks A1 and A2, and soundness B, C and S may be categorized by individual railway operators in consideration of the actual inspection circumstances.

Source: RTRI

The categories of inspection for structures are as follows.

1) Initial Inspection

Initial inspection covers new structures and reconstructed/replaces structures, and is performed for the purpose of ascertaining the initial state of the structure. Initial inspection should also be performed as necessary when large-scale repair/strengthening has been made.

2) General Inspections

The maintenance standard categorizes general inspection into two categories, regular general inspection and special general inspection.

Regular general inspection is performed mainly to detect deterioration to the structures. Special general inspection is performed mainly to improve accuracy in judging soundness.

3) Individual Inspection

Individual inspection is performed for the purpose of judging soundness with high accuracy in structures where deterioration has occurred or might occur.

Individual inspection is performed on deterioration judged as soundness A in general inspection and extraordinary inspection to reliably ascertain the state of that deterioration and to perform higher accuracy judgment of soundness. Even when attempting to extend the inspection interval by special general inspection through survey, methods for determining the causes of deterioration and predicting deterioration shall conform to the provisions of individual inspection. When the life cycle cost is taken into consideration, even for structures with integrity of B to S, the concept of preventive maintenance is also sometimes important and countermeasures should be taken for predicted deterioration. Even for such purposes, judgment of soundness and selection of countermeasures should be conducted in compliance with the provisions of individual inspections.

4) Extraordinary Inspection

When deterioration has occurred in a structure, track, or overhead catenaries due to earthquakes, heavy rain or automobile collisions, restriction of service (e.g. suspension or slowing down of train operation)

are generally placed in accordance with the operation control manual stipulated by the railway operator. The following prescribes inspection, judgment criteria, and countermeasures to be performed to judge whether or not the restriction of service (suspension or slowing down) should be continued before performing individual inspection.

Inspections for structures that are performed non-periodically include roundup or blanked inspections performed when an earthquake or other disaster has occurred, and when deterioration has been discovered on similar structures, and inspection of locations where a public disaster is feared due to concrete exfoliation. These inspections also are included and handled within the scope of extraordinary inspections.

The standard prescribes countermeasure methods, timing, type, monitoring methods, repairs/strengthening, restriction of service of structures, reconstruction/replacement, and handling after countermeasures. Countermeasures will be performed based on the soundness judgment category, such as: a) monitoring, b) repair/strengthening, c) restriction of service, and d) reconstruction/replacement.

One or a combination of these is selected. Of course, in selecting the countermeasure, the soundness, importance, constructability, economy, and other factors of the structure are taken into consideration.

4.4.5 Universal Design and Gender Considerations for Station Facility

In consideration with increasing the usability for all passengers from the following viewpoints, barrier-free, universal design and gender consideration facility shall be introduced in the station facilities design.

1) Easiness to Access

- Installation of escalator and elevator between concourse and platform level.
- Slope passage for wheelchair
- Wide type ticket gate

2) Easiness to Understand

- Braille block on the floor
- Braille for ticketing machine, signboard, handrail etc.
- Visibility consideration for signage system (e.g., layout, position etc.)

3) Easiness to Use, Gender Considerations

- Adoption of doubled handrail for stairway and slope
- Introduction of male- female separated lavatory, multipurpose lavatory
- Exclusive platform area for female



Wide Type Ticket Gate



See-through Type Elevator



Slope with doubled handrail



Braille Block

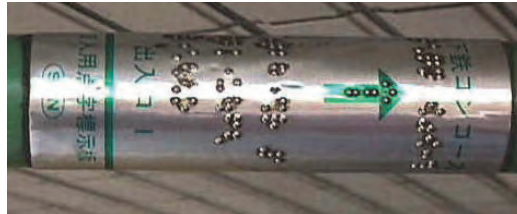

Braille Signage on Handrail



Multipurpose Lavatory

Source: JICA Study Team

Figure 4.4.29 Example of Universal Design applied to Station Facilities

4.5 Depot and Workshop Plan

4.5.1 Inspection and Maintenance System

1) Inspection and Maintenance Policy

Essential in achieving efficiency, safety, and reliability in commuter trains operation is the formulation of an inspection and maintenance system. Another important factor is the design of the facility and the scale of the depot and workshop that is available for utilization during periods of congested commuter train operations.

Key factors for inspection and maintenance are as follows.

- Based on the Japanese standard practice on preventive maintenance
- Efficient maintenance facilities
- Safe and reliable mechanization

2) Inspection and Maintenance Program

The schedule and duration of inspection and maintenance is determined based on the Japanese preventive maintenance practices/standard. The program for inspection and maintenance works are as shown below.

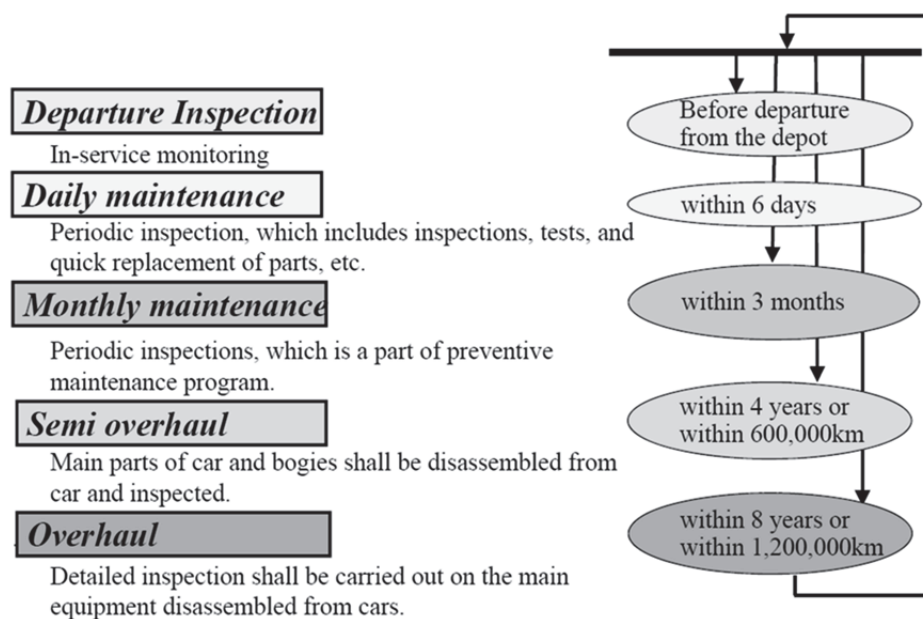

Source: JICA Study Team

Figure 4.5.1 Inspection and Maintenance Program

4.5.2 Preconditions

1) Basic Feature

The design of the depot and workshop should take into account requirements for rolling stock maintenance under future train operations plan. On the other hand, the plan should be utilized not only to minimize cost and streamline organizational structures but also for the introduction of modern maintenance facilities.

Therefore, it is recommended that the locations of depot and workshop are in the same area.

2) Number of Train Sets and Cars

The design capacity of the depot is for year 2030 when the number of train sets increase due to opening of five more stations. Capacity of stabling track shall have some allowance for the trains of south section from Solis to be stabled or for future extension to north. The number of train sets and cars of commuter trains for the line from Malolos to Tutuban are indicated below.

Table 4.5.1 Number of Train Sets and Cars of NSCR

Year	No. of Trains	No. of Rolling Stock	Car number per Train Set
2020	13	104	8 cars/train
2023	17	136	8 cars/train
2030	20	160	8 cars/train

Source: JICA Study Team

3) Period for Maintenance and Cleaning

The following Table 4.5.2 shows the maintenance periods. The maintenance periods for the new trains is based on the Japanese maintenance period, based on past experience, lessons-learnt and achievements.

Table 4.5.2 Maintenance Period

Type		Period	Maintenance Content
Departure Inspection		Before departure	Check in-service monitoring, visual check of major parts of cars.
Light Maintenance	Daily Inspection	Every 6 days	Check status of bogies, wheels, pantograph, doors and other items while cars are connected. Replace consumables for brakes, pantographs and other items.
	Monthly Inspection	Every 3 months	Confirm the status of cars and their functions while cars are connected. Replace consumables, measure voltage of auxiliary circuits, control circuit and other circuits, inspect functioning of main circuit, etc.
Heavy Maintenance	Semi overhaul	Every 4 years or 600,000 km	Remove bogies, wheels, wheel axles, brakes, main motors and other major parts, perform detailed inspection and replace parts
	Overhaul	Every 8 years or 1,200,000 km	Disassemble almost all parts, perform detailed inspection of devices. Paint car body.
Other Maintenance	Unscheduled Repair	Whenever necessary	Replace broken-down parts. (bogies, pantograph, air conditioner, etc.).
	Renewal	Whenever necessary	Renewal of car body and major parts
	Wheel re-profiling	Whenever necessary	Use wheel profiler to correct wheel shape and maintain ride comfort level.

Source: JICA Study Team

The following Table 4.5.3 shows the cleaning period. The cleaning period for new trains shall be based on the Japanese cleaning period and the current practices in the Philippines.

Table 4.5.3 Cleaning Period

Type		Period	Cleaning Content
Cleaning	Turn back cleaning	Every turn back and Every entering depot	Easily picked up trash.
	Daily cleaning	Every 3 days	Interior cleaning (wipe the floor, window glass, etc.). Exterior washing (front and rear).
	Monthly cleaning	Every month	Interior cleaning (wipe and wax the floor, window glass, wall panel, hand-rail, passenger seat, etc.) Exterior washing (all car body and window glass).
	Automatic train washing	Every 3 days	Washing of car side body.

Source: JICA Study Team

4) Necessary Hours for Inspection, Maintenance and Cleaning Works

Necessary hours for inspection, maintenance and cleaning based on typical Japanese maintenance program are shown below.

Table 4.5.4 Necessary Hours for Inspection, Maintenance and Cleaning Works

Category	Necessary Hours or Days
Daily maintenance	2 hours
Monthly maintenance	1 day
Semi-overhaul	15 days
Overhaul	20 days
Wheel re-profiling	2 days
Daily cleaning	2 hours
Monthly cleaning	1 day

Source: JICA Study Team

4.5.3 Necessary Number of Tracks

Necessary number of tracks for depot and workshop in 2020 and 2025 are calculated from the number of cars and necessary hours for works.

Table 4.5.5 Necessary Number of Tracks for Depot and Workshop

Item	Number/Capacity		Remarks
	2020	2030	
Inspection track for daily and monthly inspection	2 trains	2 trains	
Inspection track after overhaul and semi overhaul	1 train	1 train	(workshop)
Track for occasional repair	1 train	1 train	(workshop)
Assembling and disassembling track	1 train	1train	(workshop)
Stabling track	17	20	
Washing track	1	1	Rolling stock washing plant
Washing track	2	2	Manual washing
Wheel re-profiling track	1	1	

Source: JICA Study Team

4.5.4 Necessary Facilities

1) Necessary Facilities

An example of facilities provided in the workshop is as follows. In the workshop, parts, spare parts, instruments, repair tools and tools that can be shared should be integrated and used. With regards to parts that are mishandled, these parts should be strictly managed. The assembled train sets shall undergo voltage resistance and performance tests on the inspection track outside the workshop, and then undergo running tests on the test track.

- Assembling shop
- Traction motor shop
- Mechanical parts shop
- Electronic parts shop
- Car body shop
- Warehouse
- Bogie shop
- Air conditioning shop
- Electrical parts shop
- Pneumatic parts shop
- Steel work shop

2) Machinery, Tools and Equipment

The following Table 4.5.6 is a list of examples of main items of machinery, tools and equipment to be installed in the Main Work Shop in the Depot/Workshop. It will be required to be determined more precisely in the next survey.

Table 4.5.6 Main Facility Equipment List

Machine No.	Machinery	Quantity
1	Wheel load measuring equipment	1
2	Overhead travelling crane	10
3	Bogie turntable	4
4	Mobile car-body jack set	1
5	Under-floor equipment lifter (mobile)	1
6	Battery-driven temporary bogie	10
7	Wheel set turntable	8
8	Bogie disassembly/assembly lifter	5
9	Bogie washing booth	1
10	Bogie painting/drying booth, painting machine	1
11	Magnetic particle inspection equipment (portable)	1
12	Hydraulic press	1
13	Magnetic particle inspection equipment	1
14	Axle bearing pulling/fitting press	2
15	Wheel-set washing machine	1
16	Axle grinding machine	1
17	Magnetic flaw detector	1
18	Axle ultrasonic flaw detector	1
19	Oil flushing equipment	1
20	Axle lathe	1
21	Wheel fitting press	1
22	Wheel boring machine	1
23	Insulation resistance tester(incl. HIPOT)	1
24	Jib crane 1t	1

Machine No.	Machinery	Quantity
25	Induction heater for motor bearing	1
26	Induction heater for flexible coupling	1
27	Grease supply equipment	1
28	Pure water equipment	1
29	A/C Filter washing machine	1
30	Axial fan washing equipment	1
31	Motor filter washing equipment	1
32	Pantograph testing equipment	1
33	Bogie replacing equipment	1
34	Wheel re-profiling machine	1
35	Shunting car	1
36	Automatic train washing machine	1
37	Shunting locomotive	1
38	2t Forklift truck	1
39	1t Forklift truck	2
40	2t Battery car	1
41	1t Battery car	2
42	Vehicle	1
43	Vehicle (5T)	1
44	Air compressor	5
45	Air reservoir	2
46	Measuring instruments, Gauges	1
47	General tools	1
48	Rescue device	2
49	Waste water treatment system	1
50	Water supply system	1
51	Fuel supply system	1
52	Compressor tester	1
53	Air Conditioner tester	1
54	Coupler tester	1
55	Brake control unit tester	1
56	Pressure detection unit tester	1
57	Tachometer generator tester	1
58	Electrical coupler tester	1
59	Jumper wire tester	1
60	SIV tester	1
61	Heavy Current Generator	1
62	ATO/ATC tester	1
63	Brake tester	1
64	CI tester	1
65	VVVF tester	1
66	Radio tester	1
67	Monitor tester	1
68	TIS tester	1

Source: JICA Study Team

3) Examples of Maintenance Facilities

In the following chapter, some examples of principal machinery to be installed in the Depot/Workshop are discussed and shown which are technically recommended for maintenance of modern rolling stock.

a) Temporary Bogie

The temporary bogies have functions of moving and lifting a car-body with batteries. This facility is used for moving and lifting a car-body during the semi-overhaul and the overhaul after the bogie is disassembled from a car. In this design, it has been suggested that a set of mobile jacks will be installed at the entrance in the building, because the set is used for disassembling a bogie from a car and attaching a temporary bogie to the car. This method to combine a set of mobile jacks with a temporary bogie is of lower cost than a massive jack-up system which can move the whole body of a train set up and down. Also, a temporary bogie will be essential in the future when an express train-car, which needs the painting, is introduced and moved to the painting shop.



Source: JICA Study Team

Figure 4.5.2 Temporary Bogie

b) Bogie Changing Machine

“Drop-Pit type” is the bogie changing device which is used for changing large equipment under the floor, a wheel-set, and a bogie, in either condition each train being coupled or uncoupled. A train moves on the device by itself or by being shunted with a shunting-car during bogie changing. After a train has stopped at a designated position, the body is supported by car-body supporting device. Then the removed bogie is dropped into the pit under the floor with a lifter traverser. When changing devices under the floor, these devices are dropped down without using a car-body supporting device. A lifter traverser transports a bogie to the next rail in the pit under the floor. After that, it lifts the bogie and releases it on the rail. Installation of spare equipment will be done in a reverse process. This facility enables the train operations to secure high efficiency and high stability.

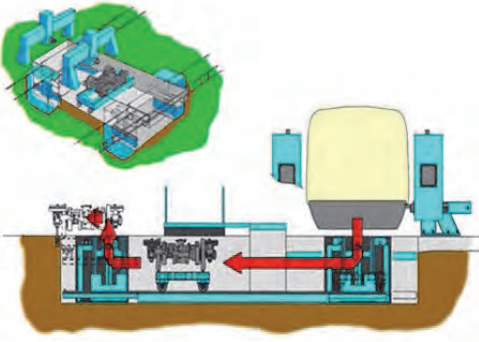

Source: JICA Study Team

Figure 4.5.3 Bogie Changing Machine

c) Wheel Load Measuring System

The wheel load measuring system can weigh each wheel of a car at the same time. This process is carried out to confirm whether each wheel load and wheel load balance is within the limit designated in the rolling stock maintenance manual. Therefore, this system will be essential to sustain a car with high reliability and security.



Source: JICA Study Team

Figure 4.5.4 Wheel Load Measuring System

d) Axle ultrasonic Flaw Detector

An axle ultrasonic flaw detector is used for detecting a material defect on the surface of a wheel axle using the ultrasonic technology. This detector will be installed in the Wheel & Axle Replacement Shop. An axle in fixed position is measured on its surface. A series of processes from positioning to measuring to releasing the axle is carried out automatically. The measurement results are displayed on the computer screen, enabling the operator to check the outcomes of the tests. The detector can inform the operator of abnormalities by an alarm and a flashing light in case of detecting a flaw higher than the pre-set depth or any other flaw. This facility will also raise reliability and safety of the rolling stock.



Source: JICA Study Team

Figure 4.5.5 Axle Ultrasonic Flaw Detector

e) Wheel Re-profiling Machine

The wheel re-profiling machine, a type of under-floor wheel lathe, can machine a wheel axle's tread, flange, front- and back faces, and axle-mounted brake discs precisely. This machine has the following functions.

- Re-profiling wheels on bogies without removing them from a train;
- Re-profiling wheels on bogies removed from a train;
- Re-profiling wheels on each wheel-set removed from bogies.

Additionally, this machine can re-profile two wheels or two disk brakes simultaneously. A train runs over the machine with being combined. All machining processes are performed automatically by the CNC system. The machine has also the functions of controlling the process, managing and recording the measuring data, managing the wheel-set data, etc. It will be installed at the dedicated pit in the wheel re-profiling shop. It will be also be essential for sustaining high reliability and safety of the rolling stock.



Source: JICA Study Team

Figure 4.5.6 Wheel Re-profiling Machine

f) Shunting Car

The shunting car is a small powered car called a shunter which is used for shunting a train set in the wheel re-profiling shop. Examples of the specifications are indicated as follows.

- Type : Hi-rail type, cab box, windshield and wiper(s), both rail and road drive;
- Operation : Manual and/or remote radio operation;
- Speed : Creep speed (0 – 1 km/h), Max speed single car 5Km (at horizontal level);
- Couplers : Tight-lock coupler and bar-coupler to fit into rolling stock;
- Brake : Normal brake and parking brake for both of rail and road drive.



Source: JICA Study Team

Figure 4.5.7 Shunting Car

4.5.5 Draft Layout Plan

1) Draft Layout Plan

The required area for depot and workshop is approximately 14 - 15 hectares including following buildings and facilities (see Figure 4.5.8).

- (i) Main work shop
- (ii) Stabling yard for approximately 20 train-sets
- (iii) Operations control center
- (iv) Substation
- (v) Automatic train washing machine, etc.

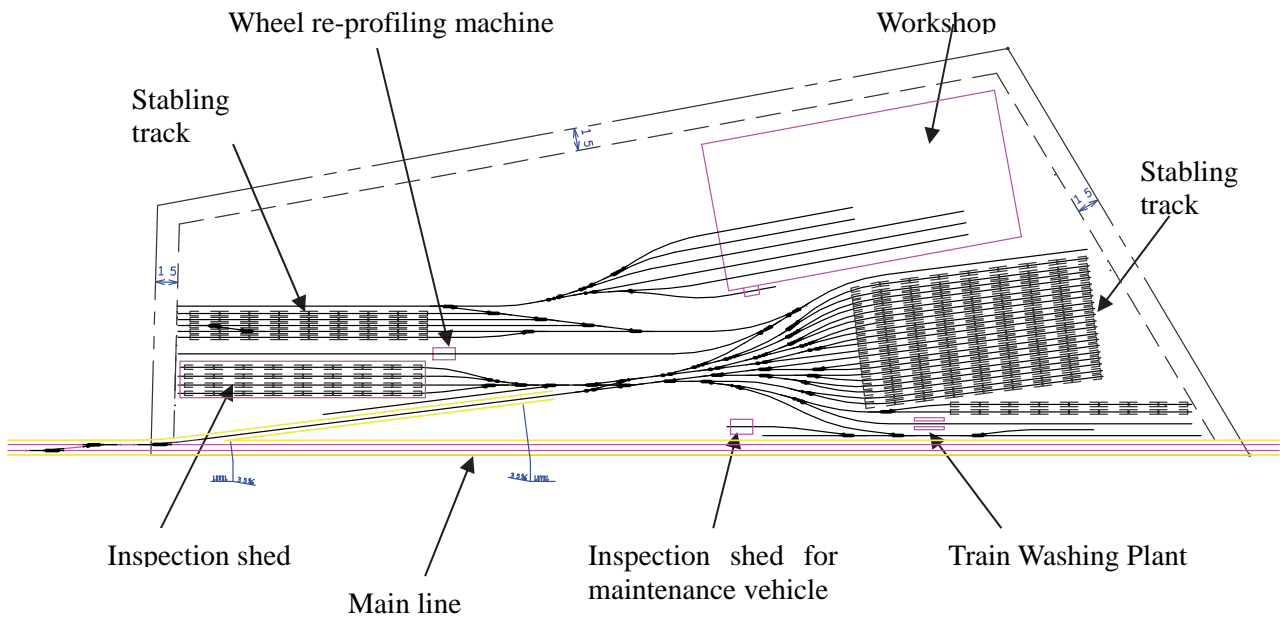

Source: JICA Study Team

Figure 4.5.8 Draft Layout Plan of Depot and Workshop

2) Location for Depot and Workshop

The planned location for the depot and workshop is at Valenzuela for the initial phase. The proposed location for these facilities is shown in the Figure below. The available area for the depot is 14.1 hectares.



Source: JICA Study Team

Figure 4.5.9 Location for Depot and Workshop in Valenzuela

4.6 Electrification System Plan

4.6.1 General

The design of the power supply system for NSCR aims to harmonize the following conflicting criteria at a high quality level.

- High safety and reliability applying proven technologies
- Cost reduction through optimizing the entire railway system
- Environmentally friendly and an energy saving system by introducing state-of-the-art technologies
- Less construction cost

From an electrical point of view, an electrical railway system consists of three main components: rolling stock, fixed equipment (traction power substations and overhead contact system or OCS) and the high voltage national grid feeding into the railway. Therefore, the main electrical interfaces are at the pantograph and at grid connections. The key technical parameters have to be consistent at these two interfaces.

Rolling stock characteristics and traffic patterns will determine the power demand of the OCS of the railway line. Rolling stock provide motive power and could generate reactive power and harmonics (power fluctuations and abnormalities that create harmonics which can severely distort the power supply and cause problems for others connected to the same source) which will be taken into account in the fixed equipment.

The OCS contact system is designed to supply the rolling stock with a voltage range which complies with the performance of the rolling stocks.

The national grid will supply the necessary traction power demand and will have to supply the reactive power for the OCS and locomotives depending of their driving systems. Harmonic currents will be injected into the OCS and into the national grid via the traction transformers.

The key parameters on grid connection interface to supply energy are as follows.

- Capacity of high voltage grid and power demand (total of active and reactive power demand)
- Harmonic currents generated by the rolling stock

4.6.2 DC Feeding System

DC feeding system is proposed for NSCR because rolling stock for DC cheaper than AC and less clearance is required between overhead contact system and other structures.

Two DC feeding systems are considered for NSCR. One is a DC 1.5kV feeding system, and the other is a DC 750V feeding system. The DC 1.5kV feeding system is suitable for a DC 750V when the system's voltage drop is larger and the gap between substations is narrower than the DC 1.5kV feeding system. Therefore a DC 1.5kV feeding system is suitable from the perspective of a more cost effective solution.

An overall view of the power supply systems are as shown in figures below.

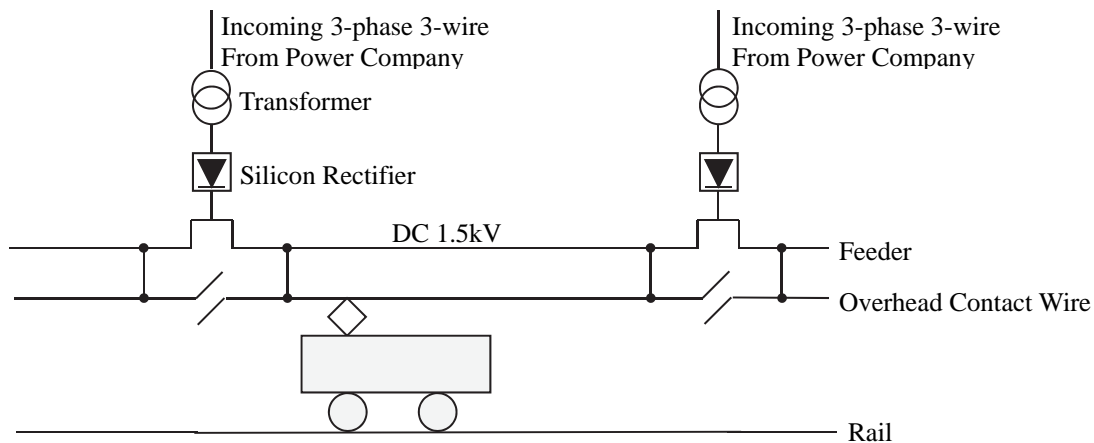

Source: JICA Study Team

Figure 4.6.1 Overall View of the Power Supply System

4.6.3 Traction Power Substations

1) Number and Incoming Voltage of Substations

Generally the rectifier substations in a typical Japanese urban metro line directly receive the power from the grid at multiple substations at 66 kV or 22 kV of incoming voltage, and the substations in a typical Japanese High Speed Railway directly receive the power from the grid at multiple substations at 220 kV or 114 kV of incoming voltage.

However, voltage of receiving power for substations of existing lines in the urban railway in Metro Manila is 34.5 kV.

2) Design Criteria

The criteria for substation design, i.e., deciding on the intervals between substations and the capacity of rectifiers, are as follows.

- When one substation is down, neighboring substation are able to compensate.
- In compliance with the IEC standards, the voltage of the contact line should not be out of permissive range.
- The distance between substations should as long as possible while meeting the above-mentioned requirements in order to reduce the number of substations while reducing construction cost.

The locations of Substations have to meet the following conditions.

- Accessible from the road
- Easy land acquisition
- The area of around 400 square meter is necessary for a DC substation
- Grid connection from a power company is available

3) Capacity of Substation

The capacity of a substation is estimated as the sum of the total power consumption, including traction power and the power for station facilities. This is based on the assumptions of minimum head way, number of cars and passenger density during operation periods, as shown in Table 4.6.1.

Table 4.6.1 Major Assumptions for Estimation of Power Consumption

Year	2020-2024	After 2025
Minimum Headway	6	6
No. of cars	6	8

Source: JICA Study Team

The power demand has been estimated based on the estimate of traction power. The estimate includes 120% of a reserve factor for the substation transformers. The distribution power was estimated in proportion to the number of stations. The results of the estimates are summarized in Table 4.6.2.

Table 4.6.2 Estimated Power Demand and Transformer Capacity

Year	2020-2022	2023-2029	After 2030
Traction [MVA]	14	18	25
Station Facilities [MVA]	4.5	4.5	6.5

Source: JICA Study Team

4) The Average Distance between Substations

The larger the distance between substations, the less number of substations are required to be constructed. This contributes to the cost reduction of construction of substations and for easy operations and maintenance (O&M).

A major factor determining the distance between the substations is the voltage drop in the contact line under operational train service conditions. The voltage drop in the contact line is proportional to the distance from the substations; and a higher traction voltage has a larger reserve of permissive minimum voltage.

Table 4.6.3 Permissive Lowest and Highest, and Nominal Voltage in IEC

Electrification System	Lowest Permissive Voltage	Nominal Voltage	Highest Permissive Voltage
DC 1.5kV	1,000V	1,500V	1,800V

Source: IEC 60850 Ed.2

The average distance of substations based on Japanese railway systems is approximately 10km for DC 1.5kV feeding systems.

5) Calculation of Voltage Drop

The maximum interval distance between the substations was determined by calculating the contact line voltage to meet above-mentioned criteria. The most severe case is selected from train schedule for the calculation of voltage drops.

The details of the calculations and the assumptions, such current flow, are described as follows.

Although the permissive lowest voltage of the contact line is DC 1,000V as per the design criteria, the calculation of the voltage drop is made to secure more than DC 1,100V for the contact line to have a margin.

The results of the calculation are that the voltage of the contact line will not lower the permissive lowest voltage (DC 1,000V), even in case that one of the substations is down.

6) Location of DC 1.5kV Substation

As a result of the calculation of the voltage drop in the contact line, the average interval distance between the substations must be shorter than 9.5 km in an urban area; and must be shorter than 13.4 km in a suburban area. The location of a substation is also affected by the design of the station structure, and the interval distance according to the conditions of a station.

Table 4.6.4 shows the estimated maximum power per hour for one substation when a DC1, 500V system will be adopted. The table shows the required power for one substation under normal operational conditions.

Table 4.6.4 Estimated Maximum Power per Hour for One Substation and Rated Capacity of a Transformer for Traction Power

Item	2020-2024	After 2025
Normal operation	6 MVA	11 MVA

Source: JICA Study Team

4.6.4 Overhead Contact System (OCS)

Overhead Contact Systems (OCS) are widely used in railways all over the world. The type of OCS should be considered so that the selected contact line is suitable for entire line.

The OCS is applied for LRT and MRT. The overhead contact systems have a long technical history of many years and it is known for high performance under high speed operation.

Three types of overhead contact system are considered for NSCR. Main features of three kinds of overhead contact system are described in Table 4.6.5.

In conventional OCS feeder wire is installed separately and messenger wire and contact wire are installed.

A feeder messenger system has a wire that functions both as a messenger and a feeder. The system enables a cost reduction and O&M. It also has a simple appearance which is preferable from the aesthetic point of view. The type is recommended for the DC feeding system.

A simple catenary is the most basic structure for an overhead catenary. This also has a cost advantage, and should be installed at the workshop/depot tracks. But high speed operation could not be adopted.

A twin simple catenary is the most complex structure of overhead catenaries. This has a cost disadvantage, and the system is not suitable for NSCR. The construction and maintenance costs are higher than the other systems because of its complexity.

A compound catenary is simpler than the twin system. The catenary should be installed at the main line, and high speed operation can be adopted.

Therefore, the compound catenary is proposed to be installed at the main line, and the simple catenary at the workshop/depot.

Table 4.6.5 Outlines of Overhead Contact Systems

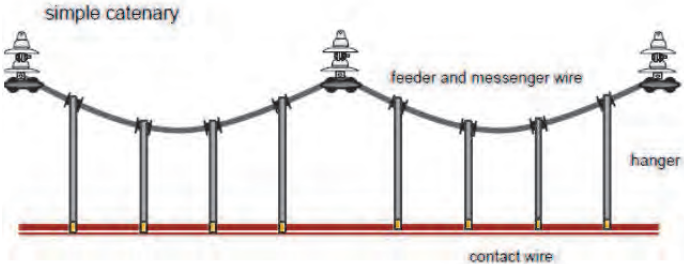
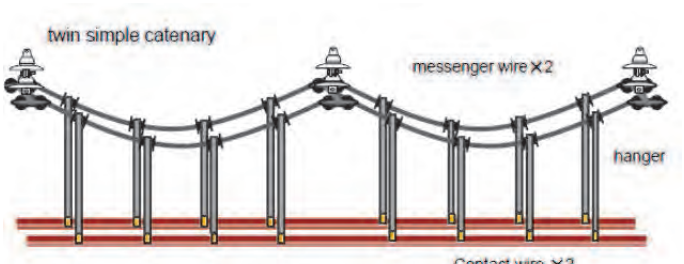
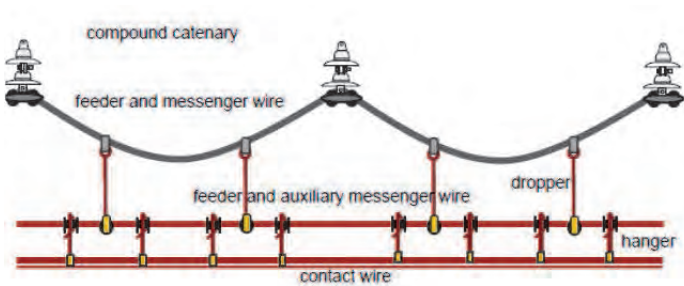
Type	Feature	Application
 <p>simple catenary</p> <p>feeder and messenger wire</p> <p>hanger</p> <p>contact wire</p>	<p>Messenger wire has a function of feeder wire. This system does not require additional feeder wire.</p> <p>For medium speed. (Under 100km/h)</p>	<p>Workshop /Depot</p>
 <p>twin simple catenary</p> <p>messenger wire X2</p> <p>hanger</p> <p>Contact wire X2</p>	<p>This system requires additional feeder wire. It is complex structure, and the maintenance costs are higher than the others systems.</p> <p>For high speed. (Under 160km/h)</p>	<p>Main line</p>
 <p>compound catenary</p> <p>feeder and messenger wire</p> <p>feeder and auxiliary messenger wire</p> <p>dropper</p> <p>hanger</p> <p>contact wire</p>	<p>Messenger wire and auxiliary wire have a functional feeder wire. This system does not require additional wires.</p> <p>For high speed. (Under 160km/h)</p>	

Source: JICA Study Team

4.6.5 Distribution System for Station Facilities

Low voltage, AC 220V for a single phase and AC 380V for three phase, power supply for all station electrical facilities will be fed from a substation similar to the existing lines.

A traction power substation will supply power to the substation and the rolling stock.

A transformer for the substations changes high voltage to low voltage.

Two distribution systems are considered for NSCR. One is a loop system, and the other is a parallel system. It would be better to adopt the loop system, because the loop system has a lower cost than a parallel system; and the loop system is generally used in the Philippines. If more reliability will be required than the existing lines, the parallel system should be considered for NSCR. One line would be for signal equipment and the other line would be for station facilities.

It should be carefully studied which of the systems should be adopted after the start of detail design.

4.6.6 Stray Current

Stray current is a leakage current from the rails to ground. A stray current that flows into the ground instead of the rails, may cause electrolytic corrosion of underground metal tubes buried in the vicinity of the rails. In addition, a rail current tends to flow from the main line toward the workshop/depot, where the

combined electrical resistance of the rails is lower than the mainline since many rails lie in parallel. This could lead to an electrocution hazard to workers on the tracks for inspection and repair.

1) Electrolytic Corrosion Caused by Stray Current

Electrolytic corrosion is a kind of galvanic corrosion by an electrochemical process in which one metal corrodes when in electrical contact with a different type of metal with both metals immersed in an electrolyte.

As shown Figure 4.6.2, electrolytic corrosion is generally caused by the metal tube near a substation where return current flows into it. Stray currents tend to flow toward the rails in the workshop/depot from the main line, for the parallel connection of congested rails in the workshop/depot makes a lower combined ground resistance. Consequently, corrosion problems tend to happen especially in the workshop/depot.

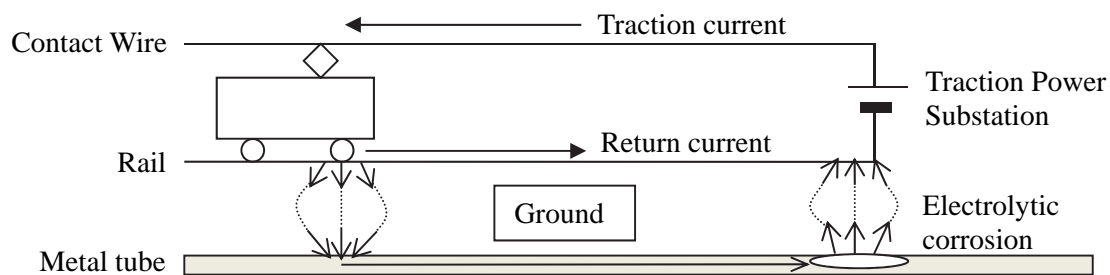

Source: JICA Study Team

Figure 4.6.2 Electrolytic Corrosion Caused by Return Current

2) Mitigation Measures against Influence of Stray Current

Reduction of stray current is the most basic mitigation measure to prevent electrolytic corrosion. It becomes possible by decreasing the traction current, return conductor resistance and leakage time.

- Traction current: average traction current will be decreased by the installation of a regenerating system.
- Return conductor resistance: installation of thicker and longer rails and appropriate maintenance of rail bonds will decrease the return conductor.
- Leakage time: it is difficult to decrease the leakage time from rails in the main line because of the constraints of operation schedules. It is possible, however, to decrease the leakage time in a workshop/depot installing automatic return current switchgear that allowing a one-way flow of return current at an appropriate point. It insulates both contact line and rails by opening an isolator when there is no rolling stock at the workshop/depot.

4.7 Signal and Telecommunication System Plan

4.7.1 Signal Equipment Servicing Plan

Signal equipment controls the operation of trains in a rail system. There are two types of such equipment: (i) the wayside signal type and (ii) the cab signal type. In recent years, accompanying high speed processing of information, made possible by the widely use of electronic devices and the progress in telecommunications technology, the introduction of automatic train control devices based on the cab signals in trains has become the mainstream. In the case of urban railways, which use electric multiple units (EMU) that are particularly suitable for controlling train speeds, there are significant advantages to introducing the cab signal system that includes an automatic train control device such as a speed control appropriate for vehicle performance and reduction of space between trains.

The following questions have to be considered before a cab signal-type automatic train device can be adopted:

- Is there sufficient demand and vehicle density to warrant the provision of a cab-type signal equipment?
- Will there be any outstanding security issues regarding the confirmation of safety, using the existing signal indication system?
- Are all the trains in service equipped with speed control devices?
- Is environment of the facilities such that it is capable of transmitting on-board signal and control information?
- Are all or most of the trains in service capable of being operated under a cab signal system?

In the present plan, it is hoped that a train protection system based on a cabin signal system that employs automatic train control will be considered, because: 1) to ensure the safety of high speed train operations; 2) to carry out high density operations during commuter transport from day one of service; 3) to provide all new signal devices; and 4) to lay the route in such a way that it will not be shared by other sections of the route. Adopting the cabin signal system will reduce reliance on wayside signals. Also, adopting a system that detects and controls train movements by radio, recently developed and put into use, will largely further reduce reliance on wayside signals. As for block signal systems, given the expected increase in transport capacity in the future, it is recommended that a moving block system be adopted because it can easily accommodate shortening of the intervals between trains as well as take advantage of, among other benefits, the low cost of introducing, maintaining and improving such a system.

The differences between the cab signal- and the wayside signal systems and the number of signals actually installed are shown in the table below.

Table 4.7.1 Comparison of Features of the Different Signaling Systems

Selected item on Train Operation	Cab Signaling System	Wayside Signaling System
Signal indication system	Indication in Inside of rolling stock	Installation of wayside signal
Block system	Moving block	Fixed block
Speed check	Continuous control	Intermittent control
Automatic Train Operation (ATO)	Possible under particular conditions	Impossible
Installation environment	Installed mainly on newly constructed tracks	Adapted under any circumstances due to lengthy track record
Adaptability to trains whose speed is different	Adapted in case of some systems	
Adaptability to crossings	Adapted in case of some systems	
Adaptability to operation in different section of track	Need to install particular equipment to all rolling stocks	Adapted despite change of rolling stocks

Source: JICA Study Team

However, the following questions should be considered as prerequisites for designing signaling equipment for the present plan:

- Q1) Will it be possible, in the future, to develop both a limited express access line to the airport as well as a commuter transport line that stops at each station and runs at a different speed than the airport access line?
- Q2) Will it be possible to operate a line that connects to existing lines of the Philippine National Railways (PNR)?
- Q3) Is there a possibility that level crossings will be installed along the route?

For each of these questions, it will be necessary to consider adopting an automatic train control device controlled by radio. The difference in speed between the airport access line and the commuter line will appear in the difference in their braking distances. This will cause a difference in the block interval with the train ahead. Thus it will be necessary to consider a block distance appropriate for high-speed trains that will require a longer braking distance if a wayside fixed block system is used, thus increasing the number and complexity of equipment and devices that will have to be installed. If the automatic control device is controlled by radio, it will be possible to set the block distance on board a train by a moving block. In this regard, a moving block system has an advantage, but there have been only a few cases where it has been adopted, and there have been hardly any cases where it has been adopted for sections where trains run at different speeds. However, the facilities themselves will be able to deal with any problem that may arise by increasing the type of trains. Thus this should not become a serious problem.

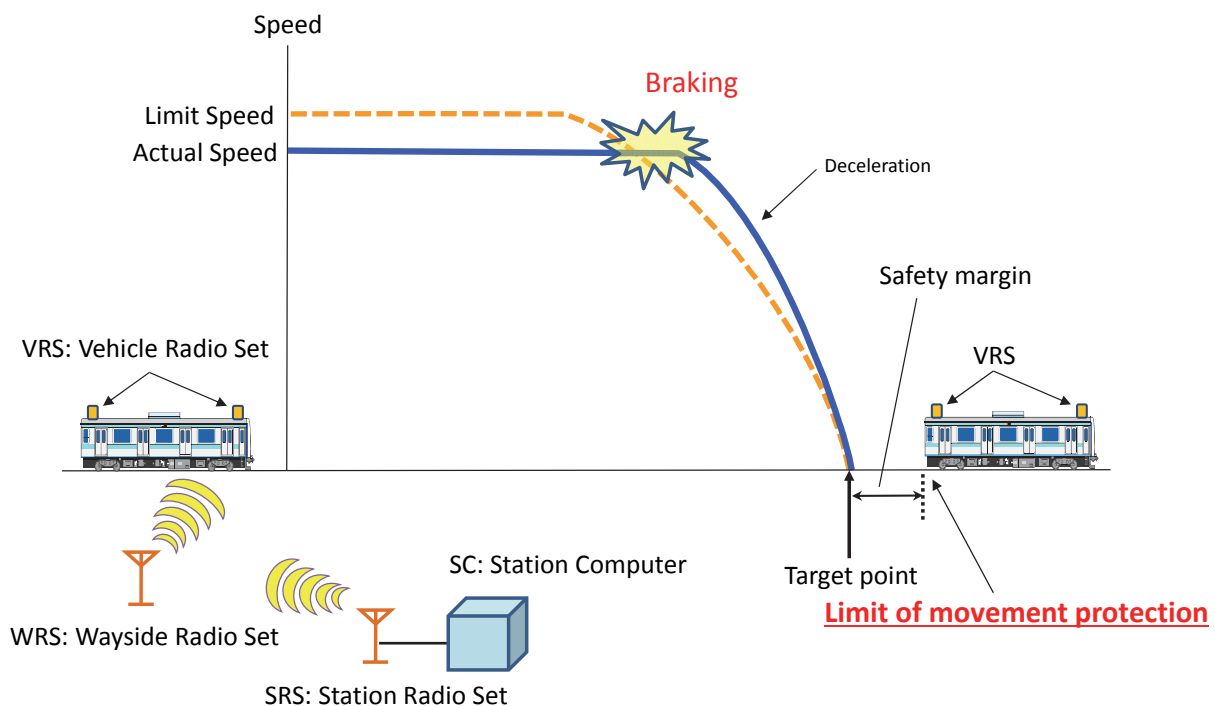

Figure 4.7.1 Illustration of a Train Protection in a Moving Block System

With regard to Q2) and Q3), this project (NSCR) is a plan based on independent operations. However, since the southern half of the route is planned at the same site as the existing routes of the PNR; letting PNR share the same tracks with the proposed lines is often discussed. If the same tracks are to be shared, the trains operated by the PNR will have to be able to accommodate a cab-signal system. If the same tracks are shared by trains operated by the PNR or trains that are not equipped with speed control devices

or are unable to receive information sent by cab signals, NSCR's approach to signal systems will need to be thoroughly reviewed. In that case, it will be necessary to consider adopting a wayside signal system so that trains operated by the PNR will be able to share the same tracks with the proposed lines so that safely and securely are fully observed. Also, in cases where train speeds cannot be controlled automatically, it will be necessary to consider installing an auto train stop system (ATS) exclusively for preventing runaway trains.

Moreover, in cases where the PNR shares the same tracks with the proposed lines or the PNR lines are reused or extended so that they will be able to share the same tracks with the proposed lines, it will be necessary to consider installation of level crossings. The PNR has installed only a limited number of radio operated automatic train control devices, so it has hardly any experience operating routes with level crossings.

Installation of a signal system will have to be considered for cases where NSCR trains and vehicles are operated in routes that have level crossings.

Nonetheless, a signal system will be an important element to enabling PNR to share the same tracks with the proposed lines. The entire signal system will be radically changed depending on the conditions of the vehicles and the route that will be shared. In this connection, a thorough study of the conditions for installing a signal system will be indispensable.

In considering the present plan for providing a railway signal system in the Philippines, a study was conducted covering a wide range of topics including unified regulations for installing signals, and laws and regulations governing devices for securing the safety of train operations. The study found that there are no laws or regulations specifically governing such devices. Therefore, there are no significant limitations on the introduction of signal systems. In fact, the Philippines Government has requested that reliable signal systems with proven track record of operations in Japan and other countries be introduced to the Philippines.

PNR already operates an urban railway system in the Manila Metropolitan Area. The present plan has not received any request for the direct sharing of tracks. However, to ascertain the performance of Metro Manila Urban Rail (MMUR), the way the system is operated, or its operations under the Philippine's unique weather conditions. A study was conducted to observe the signal systems installed in three urban railway systems in the Philippines during which personnel associated with its operation were interviewed. The study findings are summarized in the table below.

Table 4.7.2 Present Manila Metropolitan Railway Signal Equipment Outline

Item	LRT Line-1	LRT Line-2	MRT Line-3
Block system	Automatic block system (Fixed block system)	Automatic block system (Fixed block system)	Automatic block system (Fixed block system)
Signal indication system	Wayside signal (ATP Panel don't indicate signal) On train ahead : red signal No train ahead : green signal	Cab signal The signal shows the speed that should run.	Wayside signal (ATP Panel don't indicate signal) On train ahead : red signal No train ahead : green signal
Train detection system	Axle counter	Track circuit	Track circuit
ATP system	Communication with balise and on-board antenna Driver's panel shows speed, and shows braking distance	Communication with ATP's balise and on-board antenna	Communication with balise and on-board antenna Driver's panel shows speed, and shows braking distance
Train control system	Train control by driver	ATO system Communication with ATO's balise and on-board antenna	Train control by driver
Train speed up	Manual by driver	ATO on-board control system (When ATO breaks down, Manual by driver with has checked by ATP Vehicle logic unit)	Manual by driver
Train speed down	Manual by driver with has supervised by ATP on-board unit	ATO on-board control system (When ATO breaks down, Manual by driver with has checked by ATP Vehicle logic unit)	Manual by driver with has supervised by ATP Vehicle logic unit
OCC signal control system	Programmed route control with interlocking	Programmed route control with interlocking Information of PRC is conveyed by ATO.	Programmed route control with interlocking

Source: JICA Study Team

From the above discussion it is revealed that, (i) the various routes in the Philippines differ widely depending on the way each route was introduced; (ii) the scale of the route introduced; (iii) and the systems that were introduced. LRT-1 Line and MRT-3 Line adopted the same signal system. However, if the differences of specifications of signal transmission system between the two lines will not be solved, the two lines will not be able to share the same tracks unless steps are taken to remove or unify these differences. Unless signal systems that are compatible with both lines are mounted on trains operating on these two lines, it will not be possible for the two lines to share each other's tracks. One reason for this is that when the Metro Manila Urban Rail was introduced, including LRT-2, no rules or regulations were laid down containing detailed specifications based on the assumptions that the three urban railway lines, including LRT-2, would share the same tracks.

On all three lines, train movements are controlled under a centralized traffic control system, which controls traffic together with train position management by coordinating signal indication and train protection functions. For this reason, while signal indications on both the LRT-1- and the MRT-3 lines are

in the process of being simplified to transmit signals only for proceeding and stopping, train speeds are being controlled by coordinating them with the position of the train in front.

Most of the signal equipment used by PNR is foreign made. As far as the equipment used in PNR's signal systems is concerned, the situation is the same as in Japan; that is to say, the signal equipment is stored in air-conditioned signal houses. In the future, when signal systems are introduced, they should be installed in properly air conditioned signal houses as they are today so that they will be able to withstand the hot weather in the Philippines.

The basic concept of the railway system that will be needed, considering the signal system to be adopted in the present plan, is set out in the table below.

Table 4.7.3 Technical Parameters of Signaling System

Item	Description
Railway division, Route length	Malolos to F.T.I (52 km)
Profile of railway line	Double track operation (The right side passing) No Level Crossing
Maximum Commercial Speed of Train	Airport Express (future) : 160 km/h Commuter : 120 km/h
Traction power	Overhead catenary system, 1,500V-DC
Rolling stock	EMU,
Method of operation	One-man operation
Regular running time	Commuter : Minimum 7 minutes Express : 20 -30 minutes
Platform screen door	No need at the initial stage
Signaling system	CBTC & ATO & ATP

Source: JICA Study Team

Three signal systems will be compared in terms of (i) the characteristics of the present plan; (ii) the conditions required for train operations; and (iii) the signal systems currently adopted by Metro Manila Urban Rail.

Table 4.7.4 Plans of Train Protection Systems of NSCR

Item	<Plan-A>	<Plan-B>	<Plan-C>
Signal indication system	Wayside signal	Cab signal	Cab signal
collision avoidance system of train	Automatic Train Protection system (ATP)	Automatic Train Control system (ATC)	Automatic Train Control system (ATC)
Transmission method of the train control information	Specified communication points	Continuously transmits by track circuit	Continuously transmits by radio communication
Block system	Fixed block system	Fixed block system	Moving block system
Method of train detection device	Track circuit or axle counter	Track circuit or axle counter	Radio communication

Source: JICA Study Team

The characteristics of each proposal are discussed below.

PLAN-A: Wayside Signal Equipment and Position Detection Train Control (Ground Coil) System

This is a system that has been used since the early days of railways. It involves operating trains according to information sent by signal equipment installed along railway tracks. In order to prevent train collisions, information from a ground coil, placed at positions based on signal aspects, is transmitted to trains. Automatic train protection (ATP) equipment is installed so that trains will be able to determine automatically how fast they are traveling using an axle speedometer; and, if the conditions deem dangerous, brakes will be automatically activated. While a large number of ATP equipment will be required on the ground, a much lesser number of equipment will be required on inside a train. Therefore, ATP is suitable for sections where various types of trains share the same tracks. The sets of equipment that will be required for blocking will increase when train density increases, by shortening the block sections.

Table 4.7.5 Plan-A of Train Protection Systems of NSCR

Systems	Plan-A
Signal indication system	Wayside signal
Collision avoidance system of trains	Automatic Train Protection system (ATP)
Transmission method of the train control information	Specified points communication
Block system	Fixed block system
Method of train detection device	Track circuit or axle counter

Source: JICA Study Team

- The Metro Manila Urban Rail has already adopted this signal system on its LRT-1 Line and MRT-3 Line; so introduction of this signal system should be relatively easy;
- Trains operating with the wayside signal system and position detection train control system have already been clocked at 160 km/h, so Plan-A will be able to meet future demand for high speed rail service;
- On-board train control devices are compact, so it will be possible to mount them on many types of trains;
- Since the wayside signal system is a position control system, it requires a relatively small number of wayside equipment. Work will be required to maintain that system;
- If the signal system is upgraded to meet future demand for more transport capacity, a large number of equipment will have to be upgraded. Thus the total cost will increase.

As described above, the wayside signal equipment and position detection train control (ground coil) system of Plan A has been introduced widely in both Japan and the Philippines; so the signal equipment that will be adopted in this plan will be capable of accommodating speeds of up to 160 km/h. However, since signal aspects and train control are basically different types of equipment, a large number of devices will be required. Given that the visibility of wayside signals will have to be considered, installation of these signals will require considerable assessment. In addition, if train density is to be further increased, nearly all of the equipment will have to be upgraded, so that the cost of upgrading the signal equipment on Metro Manila Urban Rail may actually increase as demand for rail service is expected to grow in the future. Given that the tracks on the new route will be shared by other sections, and that there are no constraints, it will be more expedient to introduce signal equipment that is state-of-the-art, tested, and flexible.

PLAN-B: On-Board Signal System and Track Circuit Superposition Control System (ATC)

Plan-B is a system that controls train speeds by using an automatic train control system (ATC) that continuously sends control information through an under-track circuit superposition system that functions as a cab signal system in place of a wayside signal system. In major cities in Japan, Plan-B system is widely employed on commuter lines and subways. Shinkansen trains are also operating using this system.

Table 4.7.6 Plan-B of Train Protection Systems of NSCR

Systems	Plan-B
Signal indication system	Cab signal
Collision avoidance system of trains	Automatic Train Control system (ATC)
Transmission method of the train control information	Continuously transmits by track circuit
Block system	Fixed block system
Method of train detection device	Track circuit or Axle counter

Source: JICA Study Team

- This is a system that resembles the signal system adopted by the LRT-2 Line of the Metro Manila Urban Rail. It therefore has an operational track record and it will be easy to further introduce;
- Plan-B system has been used in Japan's urban commuter lines and Shinkansen, so it has a track record of accommodating transport density and high speed transport;
- In terms of aspect transmission and train control, a cab signal system is more suitable for operating trains at 160 km/h than a wayside signal system;
- By continuously controlling train movements, it will be possible to operate trains at high density and high speeds;
- A cab signal system is suitable for operating ATC and ATO systems;
- A large quantity of wayside equipment, such as track circuit devices and transmitter-receivers, will have to be installed on rails to control train movements;
- With an on-board signal system, the wayside control devices are more expensive than with the wayside signal system. Likewise, more expensive wayside equipment will be required.

As discussed above, construction of the new lines proposed do not include sharing of tracks with other lines, a cab signal system is more suitable than a wayside signal system for the present plan, which requires trains to run at 160k/h. A smaller quantity of wayside equipment will be required with Plan-B than with Plan-A. Also, if an under-track circuit superposition system is installed, a much fewer position-detection coils will be required.

However, since track circuits are used to detect trains and ensure train interval blocking, a large number of track circuits will have to be installed, resulting in higher costs. Since a major equipment upgrade will be required for partition construction of track circuits, among other complications, it will be impossible to deal effectively with fluctuating demands. Moreover, with a track circuit superposition control system, it will be necessary to insulate the track from ground potential.

As a train control system, there is no problem with Plan-B. It meets all the route criteria stipulated in the present plan. Thus it is a system that will function satisfactorily as an ATC system. However, with Plan-B, the problems related to track circuits and those related to dividing railway lines into block sections have

to be considered. But with Plan-C, which is discussed below, there are devices that will solve the problems inherent in Plan B.

Plan-C: On-Board Signal System and Radio Operated Train Detection and Control System (CBTC)

Like Plan-B, Plan-C is a cab signal system, but one that employs communications based train control (CBTC). CBTC is a train detection and train control system that uses radio to i) reduce the additional quantity of equipment required; and ii) realize moving blocks as the main vehicle constituent.

Table 4.7.7 Plan-C of Train Protection Systems of NSCR

Systems	Plan-C
Signal indication system	Cab signal
Collision avoidance system of trains	Automatic Train Control system (ATC)
Transmission method of the train control information	Continuously transmits by radio communication
Block system	Moving block system
Method of train detection device	Radio communication

Source: JICA Study Team

- Plan-C is a cab signal system that involves transmitting and receiving train detection and control information by communicating via a radio antenna installed along the tracks;
- A cab signal system is suitable for operating ATC and ATO systems;
- With CBTC all data required for controlling train movements is done via radio antenna, so there is no need for any other equipment for train detection and train control. This reduces the quantity of equipment required;
- Since it is run by radio, CBTC is able to realize a moving block system of sending and receiving signals, thereby reducing train intervals to a minimum and implementing high density train operations;
- A fewer quantity of equipment will be required to introduce Plan-C on the newly constructed railway, and, as in the case of a track circuit, installation work will not have any indirect impact on the tracks;
- Since train detection by rail will not be necessary, a fewer quantity of equipment will need to be installed on the tracks and along the tracks, with a fewer areas requiring maintenance;
- Since Plan-C was introduced only in recent years, and it has been adopted in only a few instances. There have been only a few examples of its use in sections where trains run at different speeds or where there are crossings. But in theory such use of a control system is possible.

The most outstanding characteristic of Plan-C is that while under conventional cabin signal systems, the main component of train detection and train control is located on the wayside, it has been moved to the vehicle by the introduction of continuous communication by radio. As a result, without being restricted by wayside equipment, block- and train protection sections are now adopted on the basis of measuring accurate distance between trains. While high speed transport can be realized through maximum utilization of track capacity, because the train protection sections can be determined on the wayside based on train speeds, it is possible to accurately control the movements of trains by the speed of each train.

More importantly, because most of the train detection- and train control devices around the tracks will be redundant, there will be a reduction in the quantity of equipment around the tracks, which, in addition, are subject to more wear and tear than equipment in other parts of a railway system. This will in turn result in a significant reduction in the cost of maintenance. Appropriate steps have to be taken each time a rail is replaced or patched. Not only that, equipment failure and the concomitant need for repair will arise as a result of constant vibration and oscillation of the tracks. Since various kinds of equipment had to be installed around the tracks to deal with these issues, their unit costs were high. But the most outstanding characteristic of Plan-C is that it greatly lowers the running cost of signal equipment by significantly reducing the quantity of equipment. Of course, given the fact that with conventional signal systems, transfer cables and other types of equipment have to be installed in each facility, the quantity of equipment will be greatly reduced.

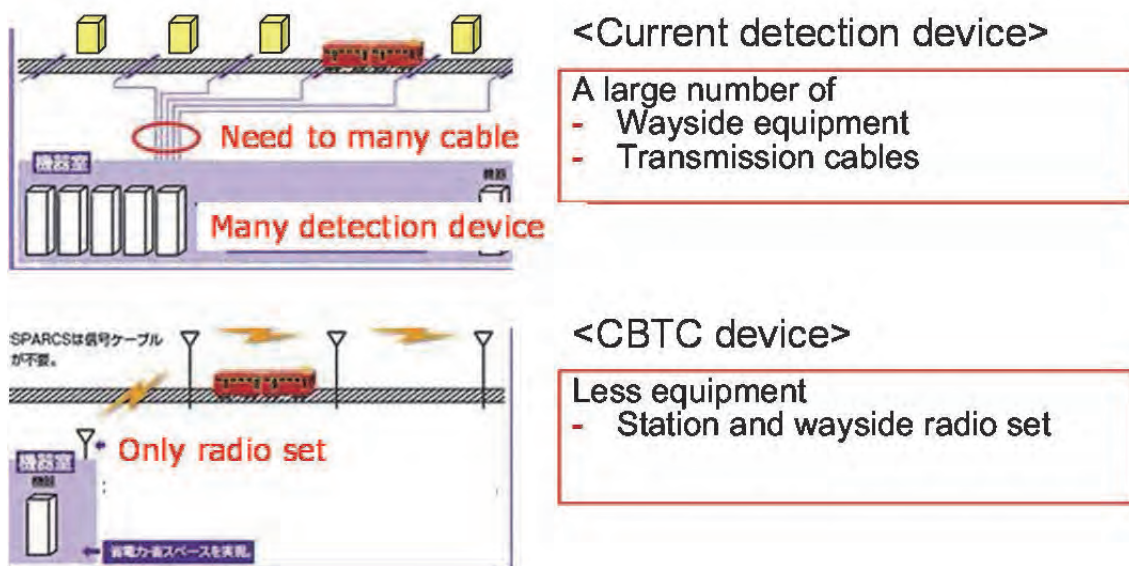

Source: JICA Study Team

Figure 4.7.2 Illustration of the Differences in the Equipment Used in Track Circuit Train Detection Systems and in Radio-operated Train Detection Systems

Moreover, the CBTC system developed in recent years is particularly suitable for urban railways where not only train detection and train control functions, but also wayside interlocking control and train operation control system, are unified. Although the various systems used in Plan-B and the Metro Manila Urban Rail comprise of an assembly of existing systems, the equipment composition of CBTC includes only essential pieces of equipment. In this respect, Plan-C also will have a cost advantage when it is introduced.

The three signal systems were compared after considering the above details. The results are summarized below.

Table 4.7.8 Comparison of Each Plan

Systems	Plan-A	Plan-B	Plan-C
Wayside equipment	Large quantity of equipment required	Large quantity of equipment required	Fewer equipment required
On-board protection equipment	Little or low cost	Standard	Standard
Efficiency of a Maintenance	Large quantity of equipment required	Large quantity of equipment required	Fewer equipment required
Increase in transport capacity in the future	Need rearrangement	Need rearrangement	No need for rearrangement
Total management cost	△:High	△:High	○:Low

Source: JICA Study Team

During the formulation of a policy for a signal system with the Philippines' parties, an agreement was reached to adopt CBTC equipped with ATO and backup ATP once it is confirmed that the total cost can be reduced.

Since a detailed system of railway lines, their track arrangements and similar issues have not yet been decided, it is still not possible to make concrete cost comparisons of the various systems. That said, it will still be necessary to examine and compare different systems with the CBTC as the basis of comparison.

<CBTC system>

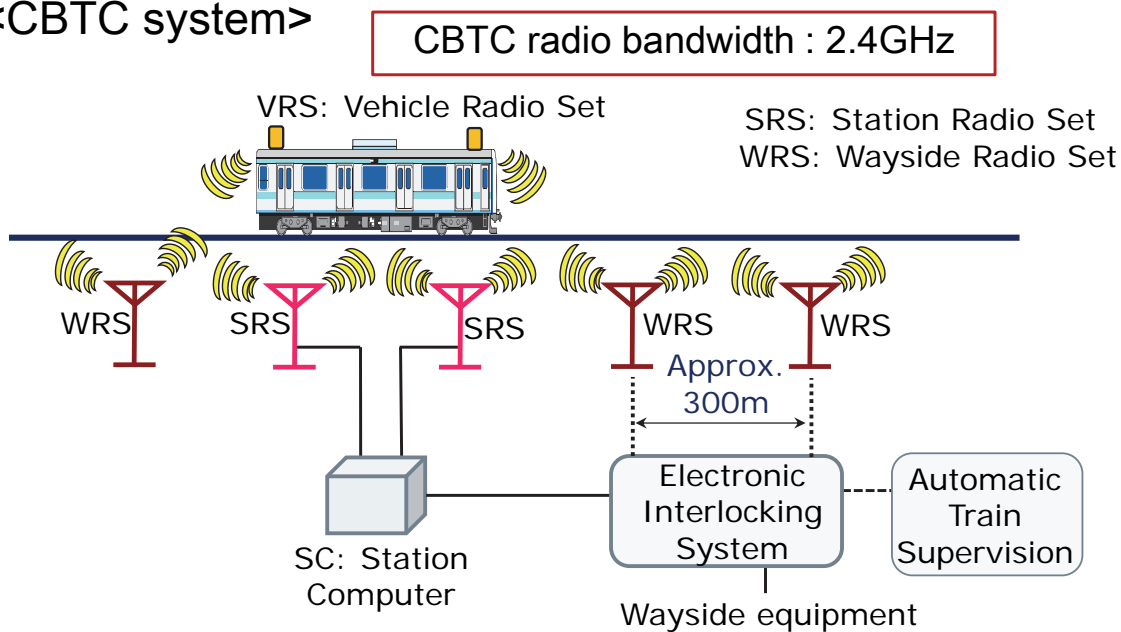

Source: JICA Study Team

Figure 4.7.3 Illustration of the Basic Equipment Configuration of the CBTC System

4.7.2 Communication Equipment Plan

The signal systems discussed above are extremely important and essential equipment for the operation of trains. In order to operate trains safely and accurately, signal equipment is absolutely critical. To be able to control traffic by controlling the signal equipment in a dedicated manner, it is important to have communication lines that will connect the various pieces of equipment that will be installed along the tracks and in train stations. Communication lines have to be configured so that required information will be sent and received quickly and accurately.

Thanks to recent developments in technology, optical-fiber cables for communication based on transmission of light have come to be used widely as communication lines replacing metal cables that use conventional conductive wires. Particularly, optical-fiber cables capable of sending and receiving large volumes of information at high speeds are indispensable for railways that require, as is the case with the present plan, communication of large volumes of information that link the beginning and end of a railway line; as well as information for signal equipment installed at each station and for train control, among others. Specifically, optical cables are required if an entire sections of a railway line is to be comprehensively controlled using CBTC and streamlined under a system that controls the entire railway line from a single control unit. Also, from the viewpoint of a signal system that controls movements of trains, it will be necessary to control an entire section of a railway line by installing optical-fiber cables evenly along the tracks.

Optical fiber-fiber cables are able to transmit much more information than metal cables. A wide range of information other than information from a signal system can be transmitted through optical-fiber transmission lines of a railway system; including information for train radio, traveler's guide, time tone, electricity management, telephone, ticket facility, images, and accident prevention. Optical-fiber fiber cables will cab be installed on both sides of the main line of a double system (up and down).

A multi-media transmission line employs gigabyte ether technology that effectively transmits image data that are much larger than voice data. Thus it will be used to transmit image data for monitoring the safety of platforms during rush hours and for prevention of overcrowding, accidents, crime etc. on platforms. Also, a transmission channel capable of sending and receiving necessary information instantaneously will be installed for a supervisory control and data acquisition (SCADA) system and an information service that provides users and transit agencies with train operation information.

However, signal systems for controlling train movements and optical transmission lines through which other types of information are communicated will be built separately. More importantly, since it is the function and purpose of railway communications to transmit information concerning train control and train operation control, lines used in signal systems (which are basically train security systems) have their own transmission channels. Thus they will not be interfere with other systems.

Also, railway operators can provide services in which they lend out optical-fiber lines channels to other companies for use unrelated to railway operations. Optical-fiber transmission lines secure large capacity in anticipation of increased future demand; but such a service allows companies to also make use of unused capacity of the lines (dark fiber). Optical-fiber transmission lines employed by signal systems make it possible to offer functions within a scope that will not interfere with train operation control.

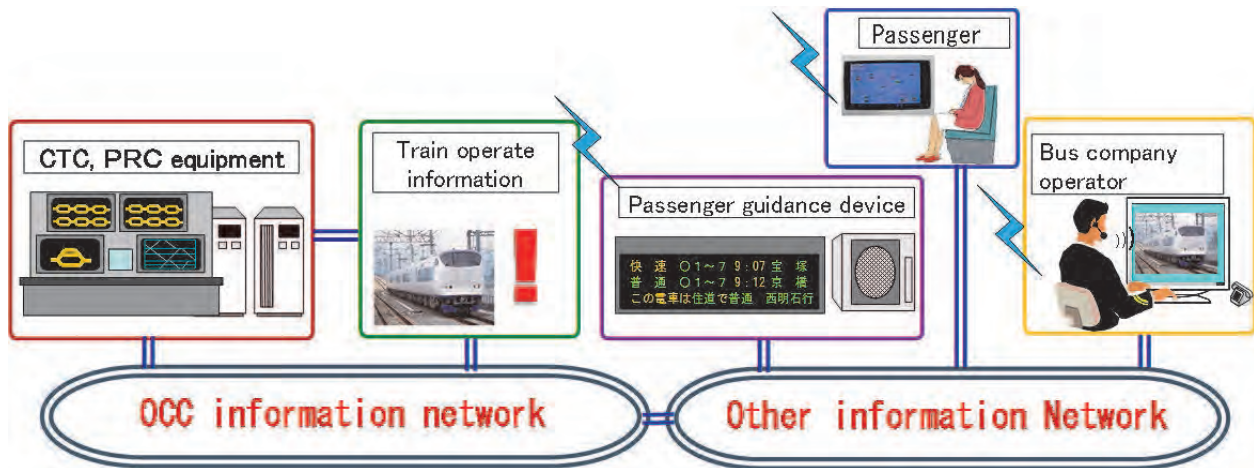

Source: JICA Study Team

Figure 4.7.4 Illustration of a Rail Transit System Configuration that Uses Optical Transmission Lines

Communication between a train crew and a train dispatcher is carried out via radio. Analog train radio involves voice transmission. However, with the introduction of digital train radio, it is possible to transmit various types of data over a single line. Thus existing railways are increasingly adopting digital radio to transmit various types of data. A modern digital train radio is capable of performing the following functions.

- | | |
|--------------------------|---|
| Call system | <ul style="list-style-type: none"> • Speedy confirmation of images displayed on a cab monitor (operation schedule changes, speed limits, etc.); • Call to designated train from a dispatcher (multiple lines); • Call to dispatcher from a train crew. |
| Emergency system | <ul style="list-style-type: none"> • Emergency train protection signal sent from a train with stop command sent to nearby trains; • Emergency interruption by a train crew of a dispatcher talking on the phone; • Notice to a train dispatcher from an emergency communicator installed on trains and platforms to stop power transmission. |
| Maintenance work system | <ul style="list-style-type: none"> • Call to various places along the tracks from maintenance crews via cell phone. |
| Data transmission system | <ul style="list-style-type: none"> • Provided to a conductor (condition of connection trains, delay time, etc.); • Display on LCD in a cabin (traffic information during accidents, delays, etc.); • Quick transmission to a car depots (information concerning breakdown of on-board equipment). |

The present plan will adopt a digital train radio system. The clear advantage of multi-functionality as need arises is not the only reason for this decision. The second reason is that, once production of analog radio equipment is discontinued, it will be difficult to maintain such equipment (spare parts will no longer be available).

<Train Radio System>

Train radio bandwidth : 400MHz ~ 900MHz

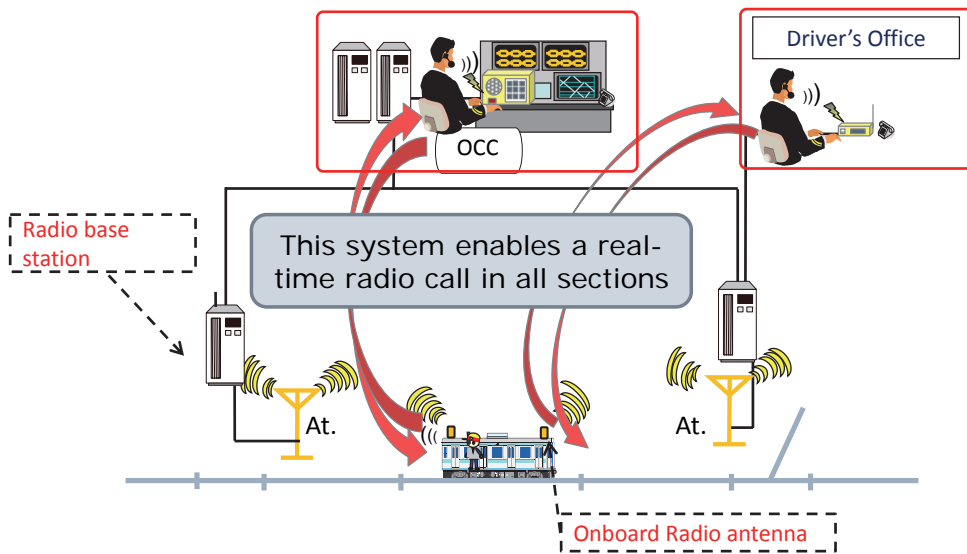

Source: JICA Study Team

Figure 4.7.5 Illustration of Operations of a Digital Train Radio System

Time displays in stations, OCC and depots as well as time delay control by AFC, SCADA, OCTV, etc. all require the sharing of accurate clock time. The new network clock will provide accurate reference time of all clocks, train controls, and for passenger information.

The passenger guidance device, that notifies passengers on a platform of approaching trains and traffic conditions, is another important piece of equipment. Since announcements that accurately convey the traffic conditions of trains are demanded, a passenger guidance device will be designed so that it will be able to obtain information concerning traffic conditions on a timely basis by linking it to a centralized traffic control system of OCC by which train operations are centrally controlled.

In order to carry out smooth operations of trains during rush hours, station attendants and OCC train dispatchers have to be able to see the actual conditions on platforms and concourses. Fixed- and remote controlled cameras will be used to check the security of train facilities. Fixed cameras will be placed in locations where it is difficult for a conductor to confirm the situation by sight; while a TV monitor will be installed where a conductor can confirm the safety of passengers getting on and off the train. Cameras will be placed at important locations such as OCCs, depots and substations to implement accident prevention monitoring and management.

CCTV technology has made remarkable advances, including multi-display screen images, display screen images switching, and image storage. Broadcast facilities that issue voice based caution and warnings from the OCC will be provided. Optical transmission lines will bring large capacity communication into action with the installation of these types of equipment.

Substations, train stations, and switching stations at depots will be unmanned. Remote supervisory control from the OCC will be carried out via remote terminals. A central monitoring system will be installed at the OCC so that if equipment malfunctions is detected at a substitution or a switching station and a protection sequence system will automatically be activated.

Moreover, the SCADA system that monitors the steady-state situation of electronic and electric devices such as signals and communication equipment, and switches systems will be introduced using the state-of-the-art equipment to providing suitable preventive maintenance. In this way, the incidence of railway system accidents will be reduced as much as possible, and a railway can be maintained as a

safe and secure means of transportation. Toward this end, a study will be conducted to determine the best way to obtain and make use of information concerning, among other things, engineering structures like rails and climate conditions along the tracks, and earthquake and other disaster protection, with a view to achieving a more stable train operation.

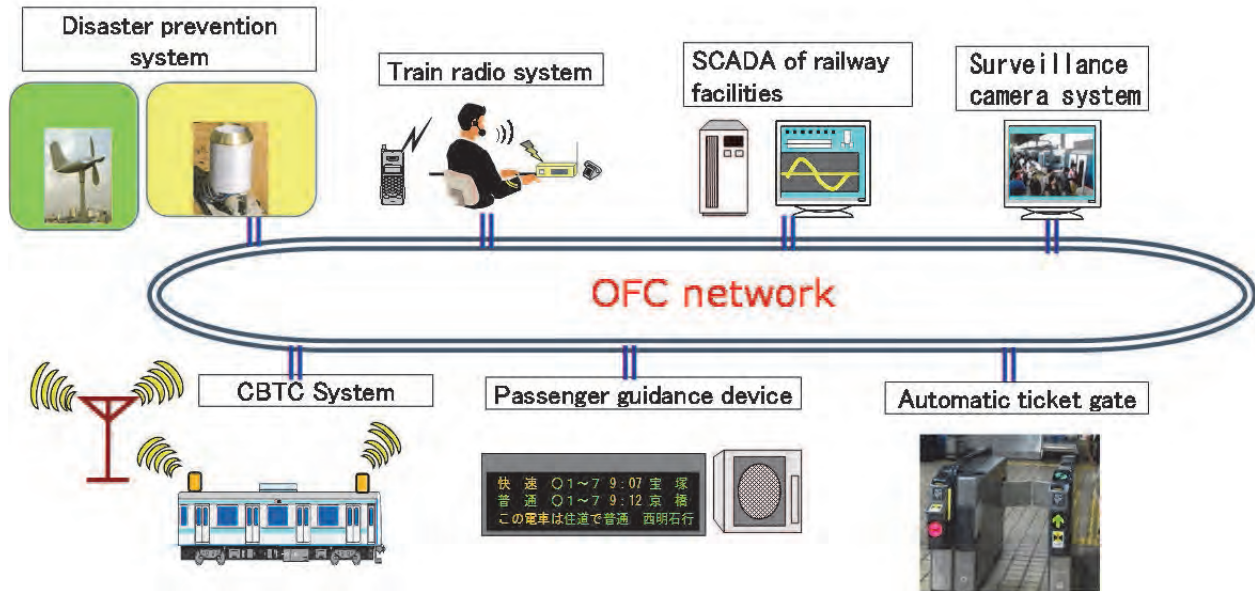

Source: JICA Study Team

Figure 4.7.6 Illustration of a Rail System Network Using an Optical-fiber Transmission Lines

4.8 TOD and Transportation Junction Plan

4.8.1 Importance of TOD at Tutuban Station

TOD (Transit Oriented Development) is primarily aiming for promotion of public transportation with the multiplier effects by the integration of transportation development and other types of development such as commercial, office, and residential development. Consequently, TOD stimulates the growth of the public transportation and contributes to the improvement of the local community in terms of social, economic and environmental aspects as shown in Figure 4.8.1. Since Tutuban station will become a major terminal station of NSCR and a transfer station to LRT-Line 2 due to the consolidated large property (approximately 20ha) in the historic center of Manila, TOD needs to be implemented in order to maximize the effects of NSCR project as well as to revitalize the city of Manila.

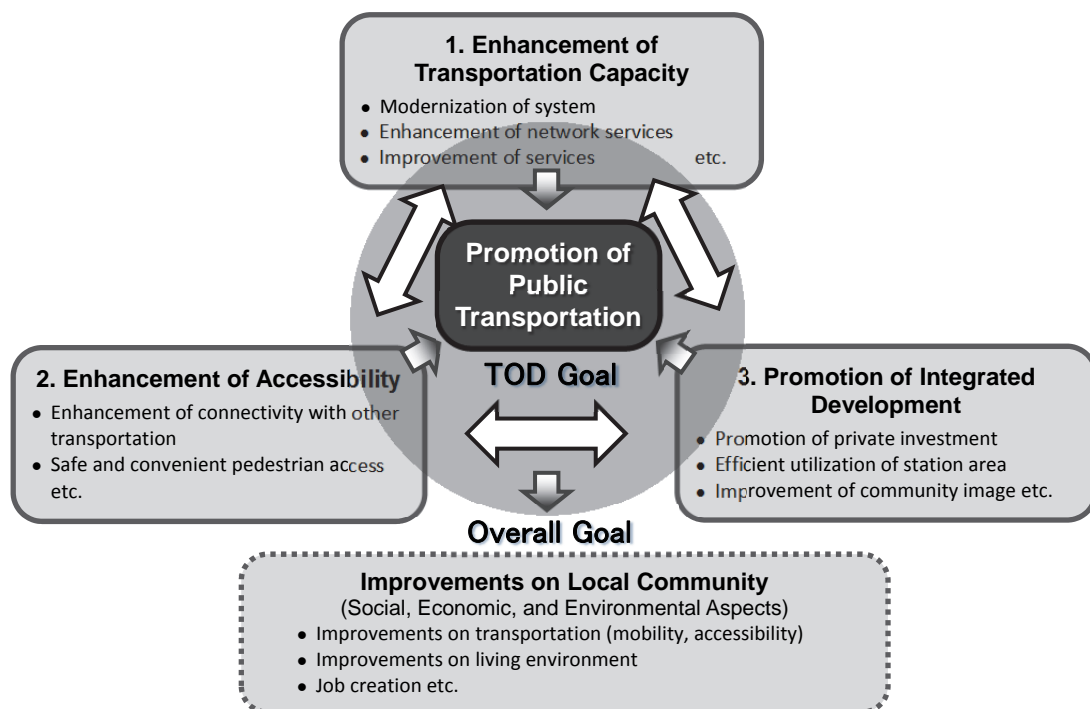

Source: JICA Study Team

Figure 4.8.1 Concept of TOD

4.8.2 Desirable Layout of NSCR at Tutuban Station Area

In order to implement TOD in the most effective manner in Tutuban station area, it is essential to take the followings into the consideration;

- Enhancement of accessibility of passengers of NSCR and LRT-Line 2 from/to the stations on foot and/or by vehicle, which also contributes to the improvement of local traffic circulation in the adjacent areas.
- Maximization of urban development opportunities in the prime area not only to promote new investments but also to benefit local stakeholders.

Based on such consideration, layout plan is prepared for Tutuban station area. The layout plan includes the key improvements as follows; (see Figure 4.8.2)

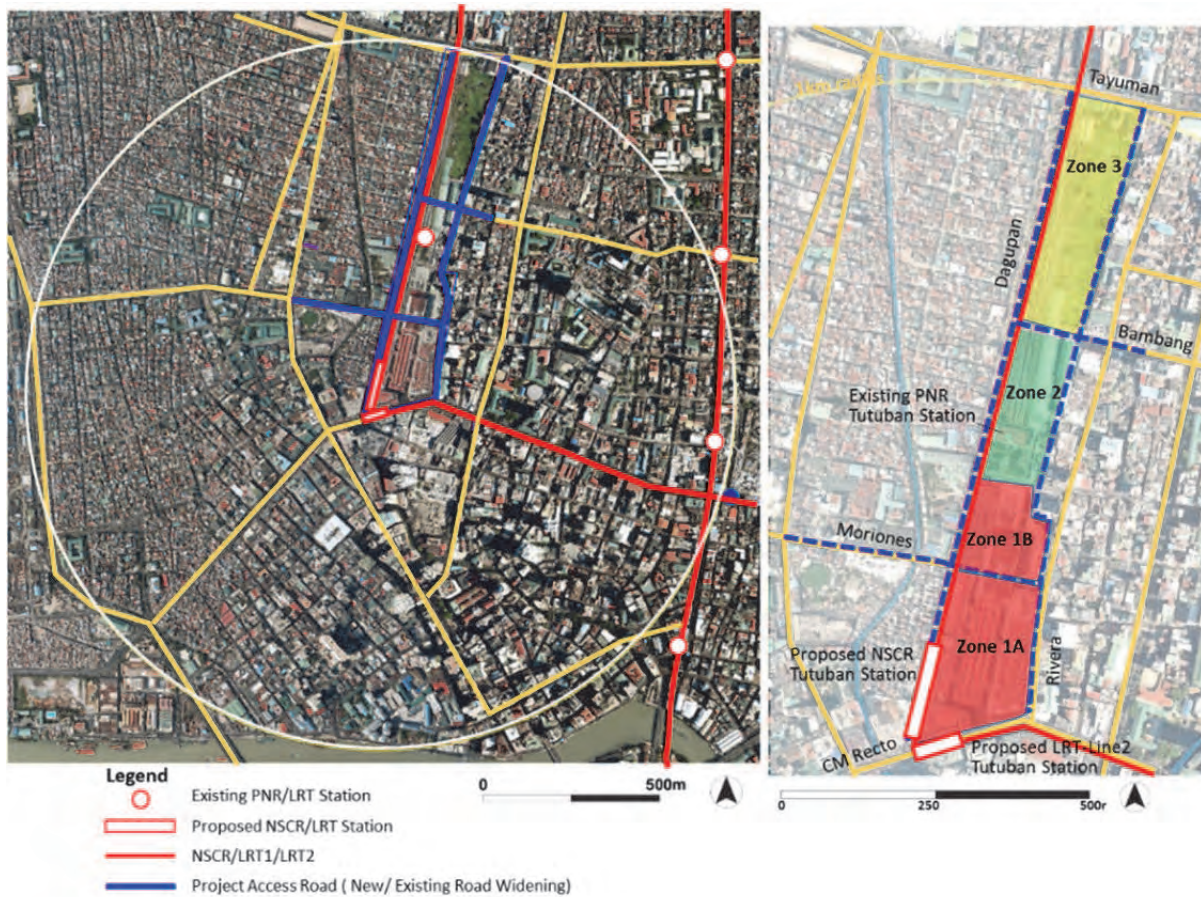

Source: JICA Study Team

Figure 4.8.2 TOD for Tutuban Station Area

(i) Location of NSCR alignment in accordance with widening of Dagupan street

Proposed location enables the maximum use of Tutuban station area by contributing the improvement of Dagupan street as well as road network in the area. Integrated development with Dagupan street widening and construction of NSCR viaduct can generate additional opportunities for commercial and public use of the space under the viaduct along the sidewalk of Dagupan street. This space has potential to accommodate the existing street vendors as well as new small scale investments. Implementation of Dagupan widening prior to the construction of NSCR enables to mitigate the negative traffic impact during the construction.

(ii) Improvement of other relevant roads

In addition to Dagupan street widening, improvements on the other relevant roads such as Moriones and Rivera street are proposed. Although they are designated as national roads, most of them do not comply with the requirements of national road standard (minimum width of 20m). Upgrading of these roads significantly improves the traffic situation in Tutuban station area and it also contributes to the promotion and the attraction of various high quality investments in the area.

(iii) Development of Tutuban station area

Currently following facilities are proposed in each zone shown in Figure 4.8.2.

- Zone 1: Upgraded multi-story commercial/business complex integrated with NSCR and Line 2 stations and multi-modal transportation facilities
- Zone 2: Symbolic public space with landmark facility and commercial/amusement complex surrounded by green/open space
- Zone 3: Mixed use multi-story residential/commercial/business facilities with intermodal transportation facilities

Section at the Viaduct

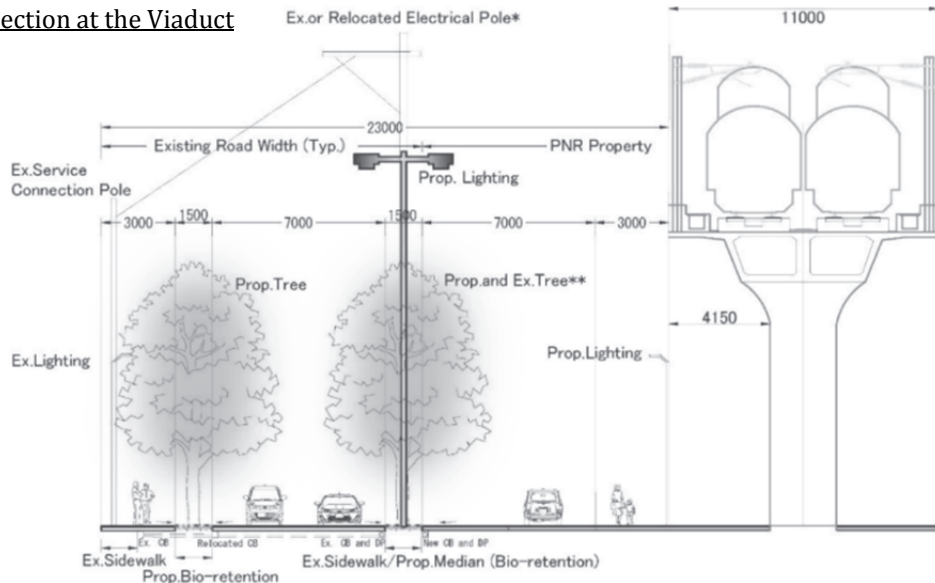

* Ex. Poles located in this section will be preserved. (Other poles will be relocated to this section)
 ** Ex. Trees located in this section will be preserved. (Other trees will be removed and replaced with new trees in this section)

Section at Tutuban Station

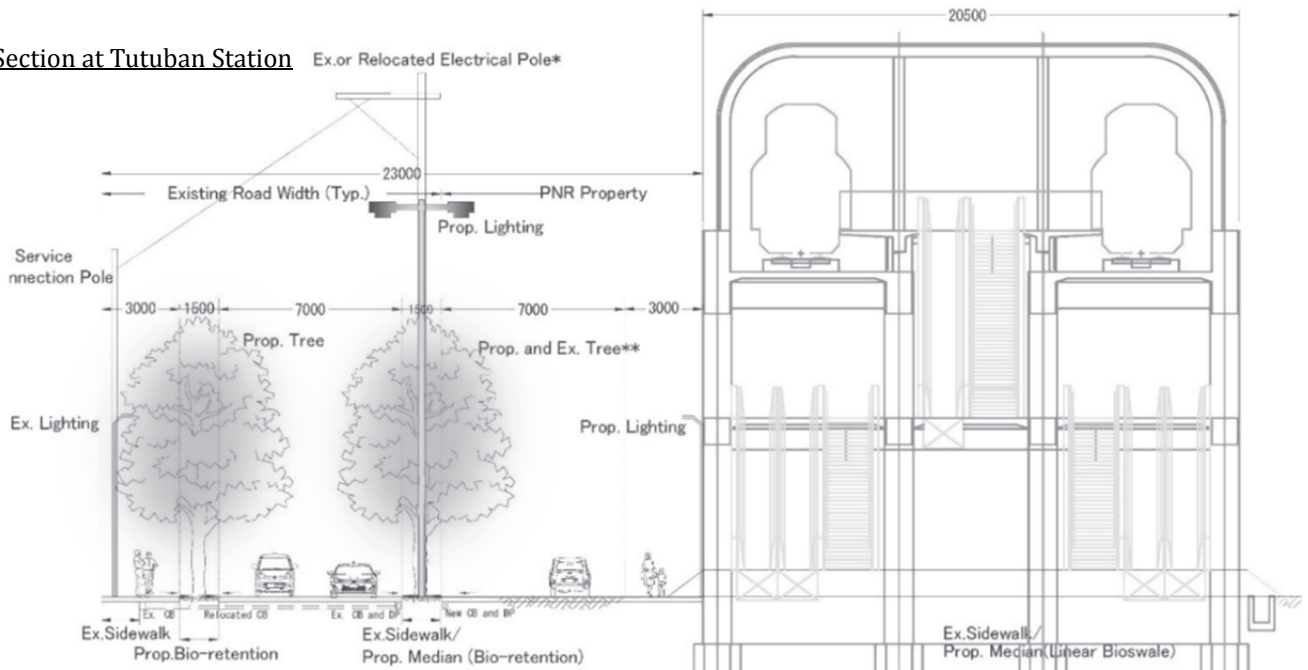

* Ex. Poles located in this section will be preserved.
 (Other poles will be relocated to this section)
 ** Ex. Trees located in this section will be preserved.
 (Other trees will be removed and replaced with new trees in this section)

Source: JICA Study Team

Figure 4.8.3 Typical Section of Dagupan Street Widening with NSCR

4.8.3 Access Route and Station Layout Planning

In order to implement a safe and convenient access including the transfer between NSCR and LRT-Line2 at Tutuban station, three alternatives are studied for NSCR Tutuban station as follows;

- (i) Alternative 1: 3-story structure with island platform type
- (ii) Alternative 2-1: 2-story structure with island platform type
- (iii) Alternative 2-2: 2-story structure with side platform type

Structure of the station affects the accessibility of NSCR and LRT-Line 2 passengers from/to the stations as well as integrated urban development including the use of the spaces in the station areas. The types of structure studied for NSCR Tutuban station are illustrated in Table 4.8.1.

Table 4.8.1 Alternative Station Structure

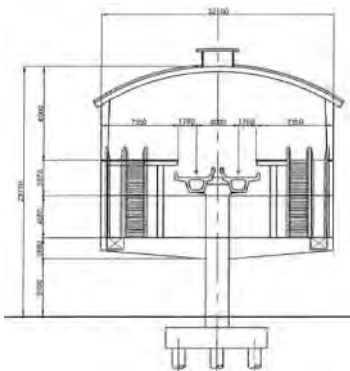
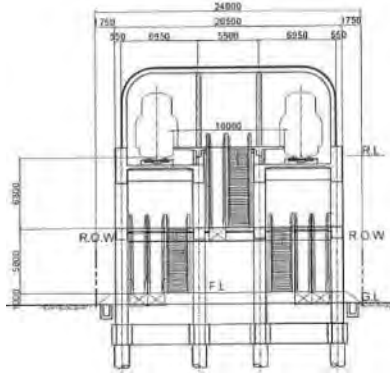
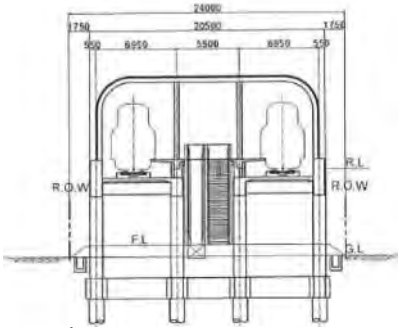
	Alternative 1	Alternative 2
LRT-Line2 Tutuban Station	 <p>Platform: 3rd Floor Concourse: 2nd Floor</p>	
NSCR Tutuban Station	 <p>Platform: 3rd Floor Concourse: 2nd Floor</p>	 <p>Platform: 2nd Floor Concourse: 1st /ground Floor</p>

Source: JICA Study Team

(1) Alternative 1: 3-story structure with island platform type

In this alternative, the concourse is located on the second floor similar to LRT-Line 2. As both stations are connected by the pedestrian deck on the second floor, passengers of both lines can easily find their direction to the ticket gate via the pedestrian deck. As needed, exclusive transfer route can be secured as shown in Figure 4.8.4.

The most significant advantage of this option is to accommodate commercial and public transportation facilities (approximately total of 4,500 square meters) on the ground floor of the station. Since the street

vendors to be affected due to the construction of LRT-Line 2 need permanent relocation site and majority of them are hoping to continue their business nearby CM Recto Ave.,¹utilization of the space under the viaduct for them is one of the most desirable option. Also, certain space under the viaduct needs to be secured to provide boarding/alighting area for the passengers of jeepneys in order to mitigate the current serious traffic congestion along CM Recto Ave. mainly caused by the jeepneys. By locating the concourse floor above the ground floor, such spaces can be secured and they also help to distinguish the routes for the passengers of the trains and the feeder transportation services such as jeepneys and taxis located on the ground floor.

The disadvantage of this alternative is the increase of the construction cost of NSCR station due to the addition of 3rd floor. Also, travel distance of transfer between NSCR and LRT-Line 2 will be slightly longer (approximately additional 50m on average) than Alternative 2 as the passengers have to come down to the concourse level on the 2nd floor and go up to the platform on the 3rd floor to change the train.

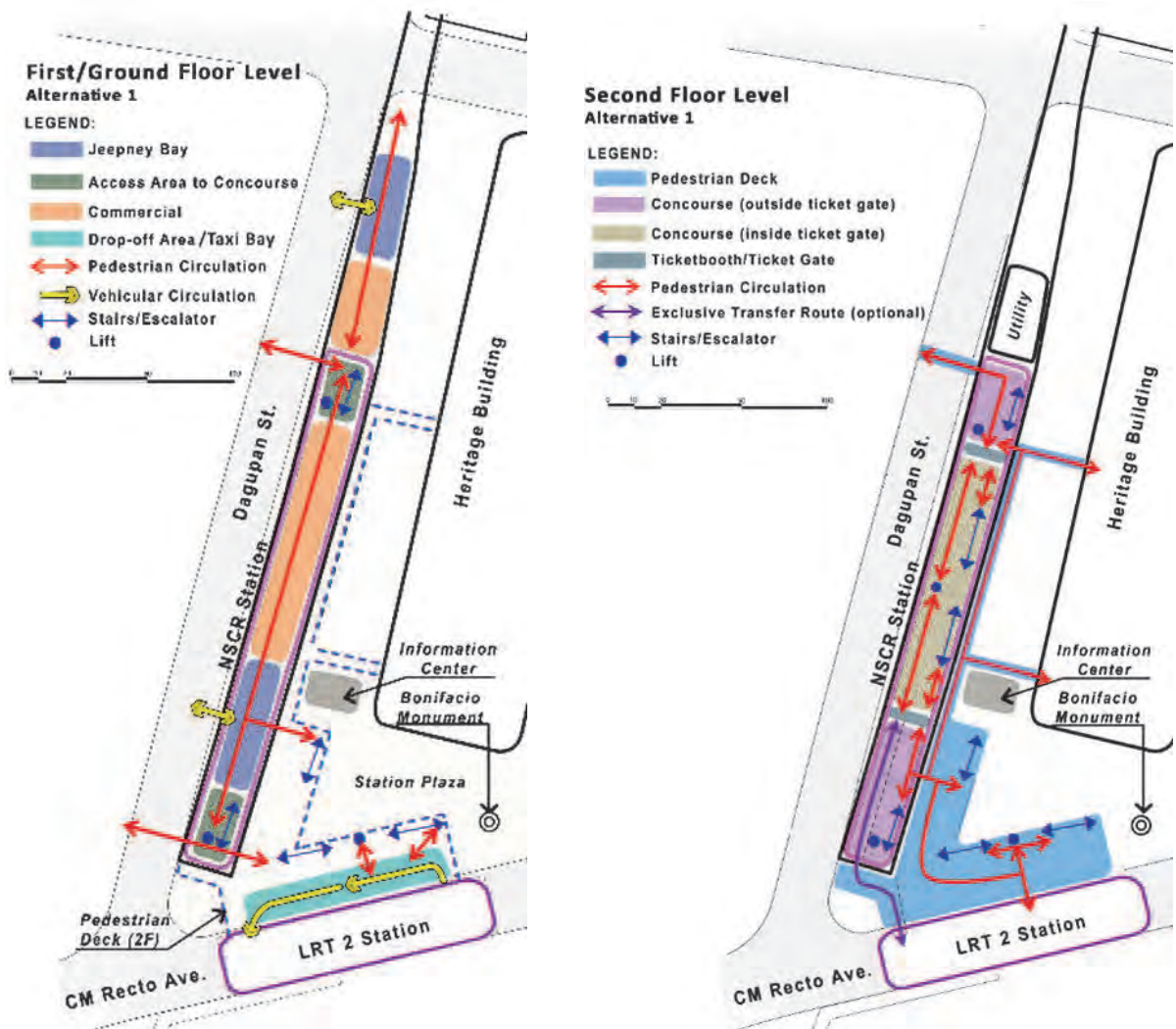

Source: JICA Study Team

Figure 4.8.4 Access and Transfer Routes of Alternative 1

¹ According to the survey conducted at Stakeholder Meeting held on November 27th, 2014

(2) Alternative 2-1: 2-story structure with island platform type

While NSCR Tutuban Station for alternative 1 has 3-story structure, this option has 2-story structure consisting of the first/ground floor for the concourse and second floor for the platform.

The most significant advantages of this option are the reduction of construction cost and travel distance of transfer comparing to Alternative 1.

Even though the length of transfer route from/to NSCR to/from LRT-Line 2 is shorter than Alternative 1, the shape of the platform (island type) prevents the direct access from the platform to the adjacent commercial facility via pedestrian deck. Therefore, other platform type (side platform type) was studied for Alternative 2 to explore the possibility to improve the access for the adjacent commercial facility.

The other major disadvantage of this option is the inability to utilize the space on the ground floor of the station for other purposes than railway station as shown in Figure 4.8.5. Since both passages of the trains and the feeder transportation services have to share the limited space on the ground floor, their access routes cannot be clearly distinguished comparing to the Alternative 1.

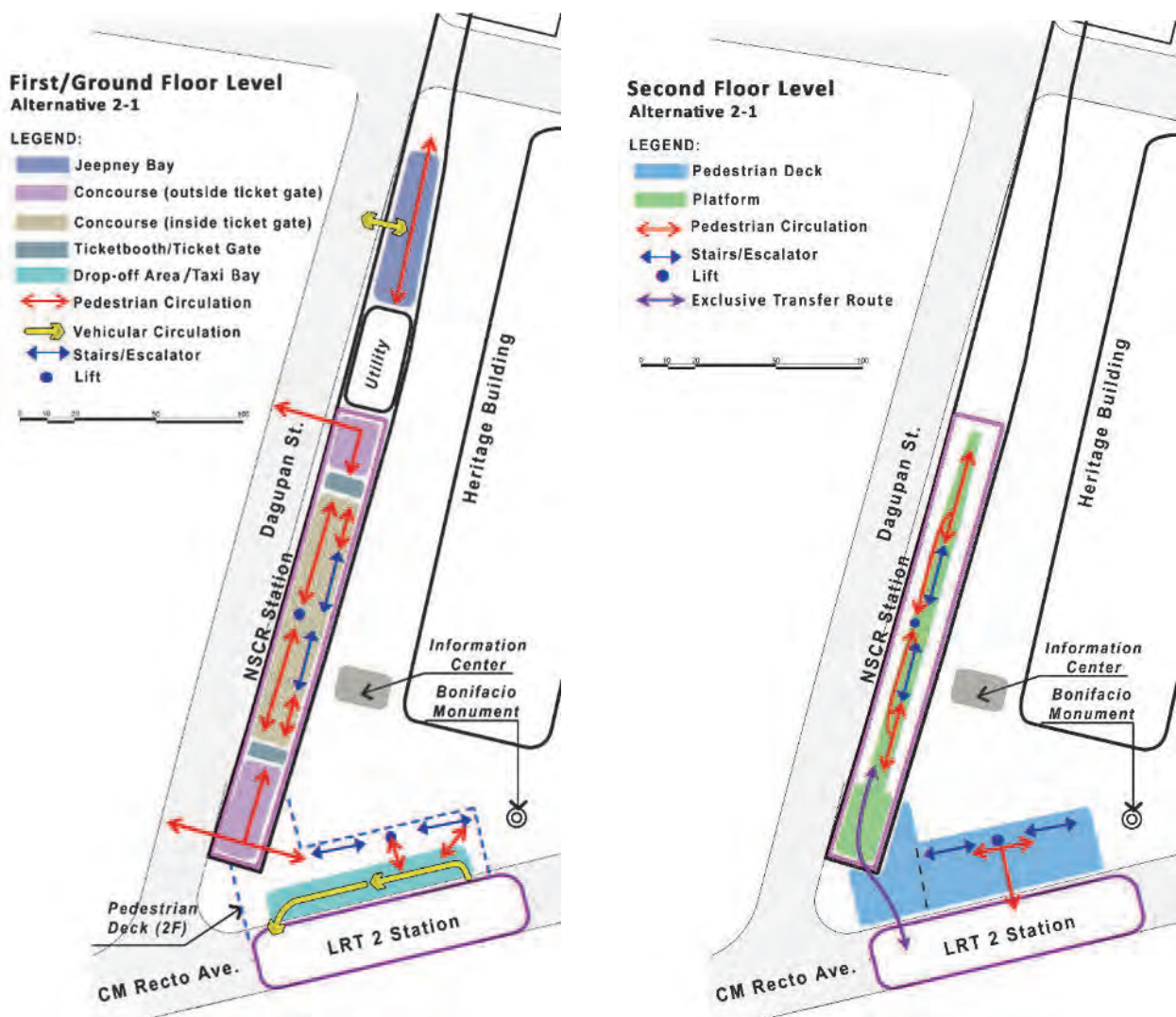

Source: JICA Study Team

Figure 4.8.5 Access and Transfer Routes of Alternative 2-1

(3) Alternative 2-2: 2-story structure with side platform type

This option has 2-story structure and major advantages similar to the Alternative 2-1. Due to the shape of the platform (side platform type), it can access to the adjacent commercial facility via pedestrian deck. However, the access is still limited (east side platform only) and without the ticket booth and gate on the pedestrian deck, the access will be limited as the exit from the platform to the pedestrian deck. Also, the difficulty to accommodate other function than train station on the ground floor is still the major issue.

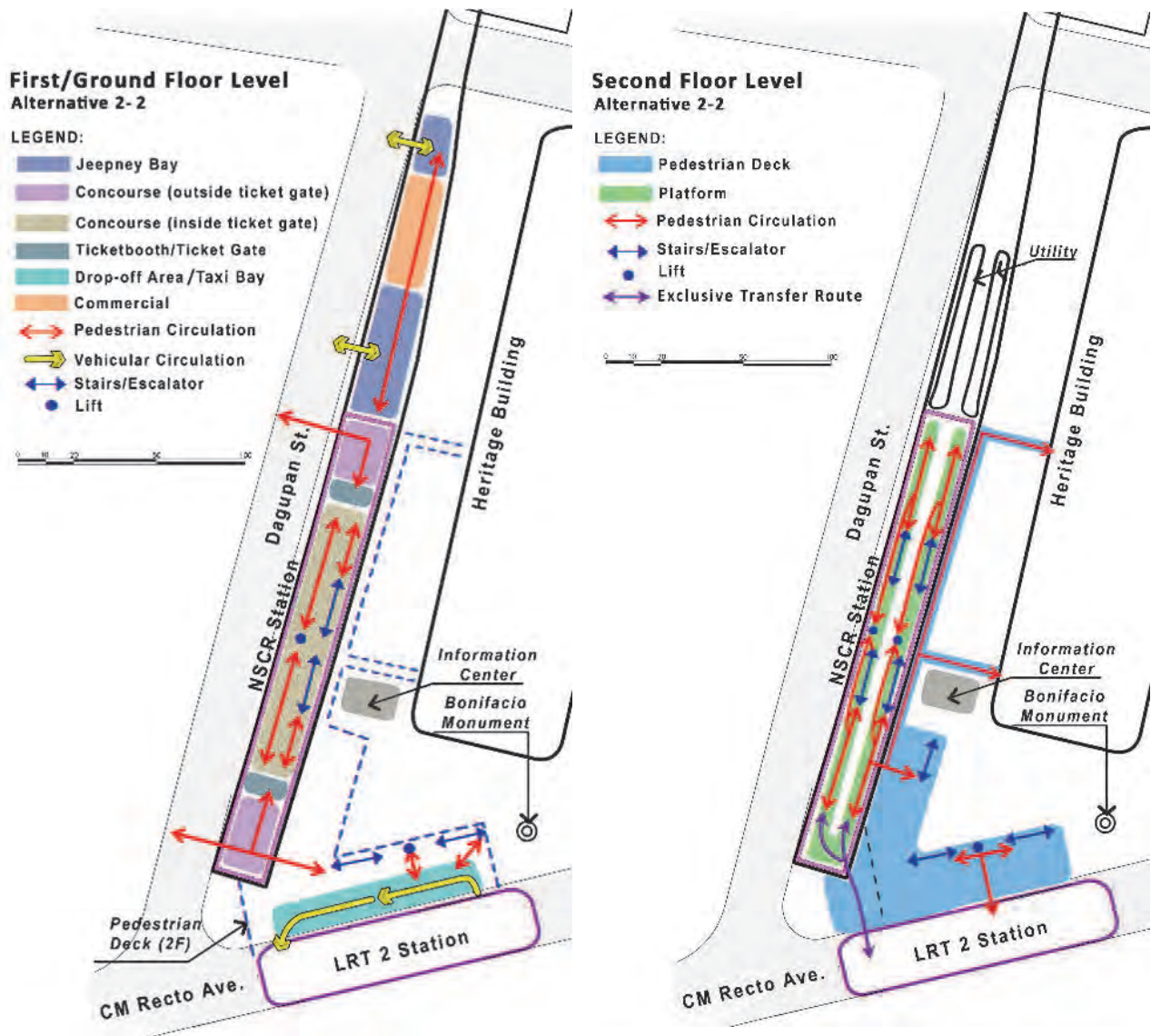

Source: JICA Study Team

Figure 4.8.6 Access and Transfer Routes of Alternative 2-2

Based on the study for all these alternatives, Alternative 1 is recommended as the preferred option for the following reasons.

- Utilization of the ground floor of the station as jeepney boarding/alighting and commercial area will contribute to mitigate the traffic congestion along CM Recto Ave. as well as to meet the demands of affected street vendors by the construction of LRT-Line 2 station.

- Convenient and safe access will be secured among stations of NSCR and LRT-2, adjacent commercial facility, and feeder transportation facilities.

Image of Alternative 1 is shown in Figure 4.8.7.



Source: JICA Study Team

Figure 4.8.7 Image of Alternative 1

(4) Summary and Preliminary Recommendation

Table 4.8.2 summarizes the advantages and disadvantages of alternatives of NSCR station structure. Even though Alternative 1 has advantages with significant potential to contribute to the success of NSCR through TOD, considerate planning needs to be prepared and implemented in order to fully take advantage of these benefits. For example, strategic business plan and coordination with prospective tenants need to be implemented prior to the construction of NSCR for the utilization of the spaces on the ground floor as the commercial facilities. As the street vendors to be affected by the construction of LRT-Line 2 are one of the most prospective tenants, coordination among relevant stakeholders needs to be implemented in a timely manner.

In terms of safe and convenient access, construction of the pedestrian deck needs to include certain consideration to maximize the opportunity for the access improvement. For example, pedestrian deck crossing Dagupan street should be constructed as it enhances the connectivity with the adjacent community on west side as well as to provide the direct access to the concourse as shown in Figure 4.8.4. Construction schedule also needs to be considered as the area of the pedestrian deck associated with LRT-Line 2 station will be constructed prior to the construction of NSCR according to the current plan. Elevation and area of the deck need to be carefully designed and constructed to avoid any physical gaps triggering safety risk between the pedestrian deck of LRT-Line 2 and NSCR.

Since design of the NSCR station will provide the significant impact on the station area, it needs to be elaborated in a careful manner by taking the historic significance of the area into consideration. Therefore, Design Guideline for the NSCR station which is consistent with the Design Guideline for the redevelopment of Tutuban PNR property is prepared as shown in Appendix 1.

Table 4.8.2 Summary of Pros and Cons

	Alternative 1 (Platform: 3rd floor, Concourse: 2nd floor)	Alternative 2 (Platform: 3rd floor, Concourse: 2nd floor)
Pros	<ul style="list-style-type: none"> • 1st/ground floor of NSCR station can be utilized for other public transportation and commercial facility. • Routes for the passengers of the trains and other public transportation are clearly distinguished. • Direct access between the ticket gate of NSCR and LRT-Line 2 is established via pedestrian deck. 	<ul style="list-style-type: none"> • Construction cost of NSCR will be lower than Alternative 1. • Transfer route is shorter than Alternative 1 (3F↔2F)
Cons	<ul style="list-style-type: none"> • Construction cost of NSCR will be higher than Alternative 1. • Transfer route is longer than Alternative 1 (3F→2F→3F) 	<ul style="list-style-type: none"> • Routes for the passengers of trains and other public transportation need to be coexisted on the 1st/ground floor of the station. • Utilization of 1st/ground floor of NSCR station is limited. • Access to the adjacent commercial facility via pedestrian deck is limited.

Source: JICA Study Team