

A11-4 下水処理場およびポンプ場の施設更新計画

JAPAN INTERNATIONAL COOPERATION AGENCY (JICA)

PARANA STATE SANITATION COMPANY (SANEPAR)

**PROJECT
FOR
IMPROVEMENT OF OPERATION AND MAINTENANCE
OF
WATER SUPPLY AND SEWERAGE SYSTEMS
IN
PARANA STATE**

RENOVATION PLAN OF SEWAGE TREATMENT PLANTS

September 2013

**JAPAN INTERNATIONAL COOPERATION AGENCY
(JICA)**

NIHON SUIDO CONSULTANTS Co., Ltd

1. Basic Survey

1.1 Current condition of sewerage system

According to the census by IBGE, the population of Curitiba in 2010 is 1,746,896. The increase rate of the population from 2000 to 2010 dropped to circa 10% while that until 2000 was high like more than 20%. According to SANEPAR, the water service rate has been 100% from 2004 and the sewer connection rate in Curitiba City and in Curitiba Metropolitan Area (CMA) is 92.8% and 71.6% (17 out of 25 cities) in 2011.

SANEPAR are providing the water work service for 28 cities and the sewerage works for 18 out of 28 cities in CMA, and the water and sewerage works for 5 out of 7 cities in the coastal area. (Fig. 1.1.1 and 1.1.2)

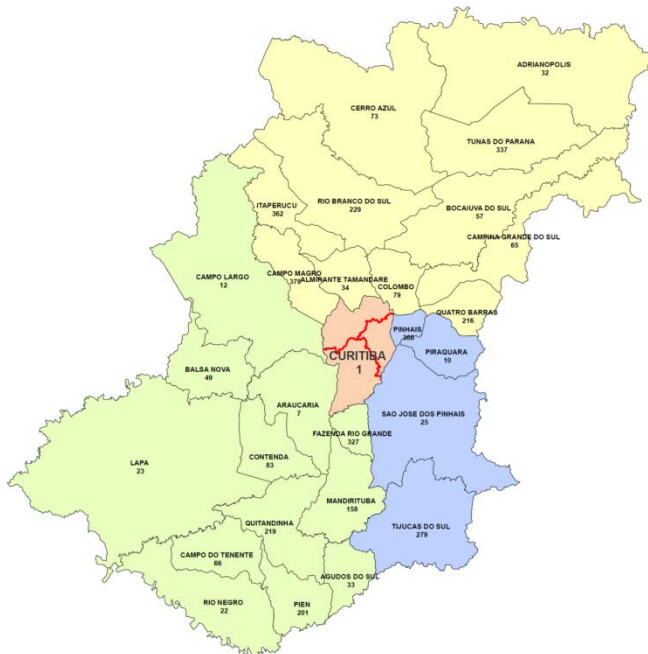

Fig. 1.1.1 Cities in CMA



Fig. 1.1.2 Cities in the coastal area
(Out of service of SANEPAR in Cities in white color)

Table 1.1.1 shows the water service condition in the target area of the project as of 2010 and Table 1.1.2 shows the sewerage service condition. The total volume of sewer collected was 299,059m³/day (290,293m³/day in CMA and 8,766m³/day in the coastal area) while the water produced was 694,889m³/day (664,644m³/day in CMA and 30,245m³/day in the coastal area). The sewer volume collected was only circa 42% of the water produced. And the total volume of sewer treated was 295,291m³/day (286,525m³/day in CMA and 8,766m³/day in the coastal

area) while the water consumption was 417,360m³/day (397,866m³/day in CMA and 19,494m³/day in the coastal area). In this comparison, the sewer volume treated is only circa 70% of the volume of the water consumption.

This means that the capacity of the sewer collection and treatment is insufficient.

Table 1.1.1 Water service condition as of 2010

Código do município	Município	UF	POPULAÇÃO ATENDIDA		QUANTIDADES DE LIGAÇÕES		VOLUMES DE ÁGUA		VOLUMES DE ÁGUA		
			População total	População urbana	Total (ativas + inativas)	Ativas Micro medidas	Tratado em ETA(s)	Tratada por simples desinfecção	Produzido	Consumido	Faturado
			AG001 - serviced population	serviced population in urban area	AG021 - total number of connection	effective number of connection	AG007 - water quantity produced	AG015 - water quantity disinfected	AG006 - produced quantity	AG010 - water consumption	AG011 - revenue earning water
			habitante	habitante	ligação	ligação	1.000 m ³ /ano	1.000 m ³ /ano	1.000 m ³ /ano	1.000 m ³ /ano	1.000 m ³ /ano
CMA			AG001	AG026	AG021	AG004	AG007	AG015	AG006	AG010	AG011
410020	Adrianópolis	PR	3,174	2,060	1,246	1,079	0,0	196,6	196,6	146,1	179,7
410030	Agudos do Sul	PR	4,253	2,822	1,565	1,405	0,0	196,9	196,9	152,9	210,3
410040	Almirante Tamandaré	PR	91,155	91,155	30,480	26,117	1,952,4	5,252,9	7,205,3	3,759,4	4,553,7
410180	Araucária	PR	111,544	110,205	33,310	31,545	9,992,3	66,7	10,059,1	6,000,1	6,871,5
410230	Balsa Nova	PR	10,865	6,870	3,678	3,441	261,3	255,7	517,0	430,0	557,8
410310	Bocaiúva do Sul	PR	6,847	5,128	2,260	2,109	0,0	420,7	420,7	269,5	333,3
410400	Campina Grande do Sul	PR	32,544	31,961	11,346	9,745	1,768,6	235,4	2,004,0	1,250,2	1,577,6
410420	Campo Largo	PR	95,803	94,171	30,792	28,850	3,319,3	2,773,6	6,092,9	4,017,1	4,941,9
410425	Campo Magro	PR	19,872	19,547	6,573	5,748	470,1	770,4	1,240,4	790,7	968,0
410520	Cerro Azul	PR	7,408	4,808	2,704	2,413	414,6	0,0	414,6	298,0	389,6
410580	Colombo	PR	200,342	200,342	62,758	56,482	12,393,8	5,551,4	17,945,2	8,317,5	10,070,7
410620	Contenda	PR	10,686	9,231	3,537	3,281	0,0	512,5	512,5	383,1	499,4
410690	Curitiba	PR	1,751,907	1,751,907	465,782	438,920	169,086,2	0,0	169,086,2	103,528,8	117,620,6
410765	Fazenda Rio Grande	PR	79,636	75,928	24,687	22,644	4,328,2	0,0	4,328,2	2,991,8	3,682,7
411125	Itaperuçu	PR	18,867	18,867	6,217	5,259	101,7	1,233,0	1,334,7	673,5	850,0
411320	Lapa	PR	29,783	27,222	10,491	9,475	494,9	1,082,5	1,577,4	1,145,0	1,485,9
411430	Mandirituba	PR	10,903	7,414	3,707	3,353	131,6	447,3	578,9	456,7	571,1
411910	Piên	PR	6,477	4,523	2,245	2,043	0,0	300,3	300,3	234,7	311,9
411915	Pinhais	PR	116,343	116,343	35,566	33,308	10,317,5	0,0	10,317,5	5,631,5	6,608,2
411950	Piraquara	PR	78,264	45,738	27,692	22,686	5,907,3	0,0	5,907,3	3,285,3	4,011,3
412080	Quatro Barras	PR	18,230	17,941	6,486	5,632	1,452,6	41,9	1,494,5	863,8	1,036,2
412120	Quitandinha	PR	5,648	4,887	1,979	1,848	0,0	319,0	319,0	217,1	287,6
412545	São José das Palmeiras	PR	2,786	2,411	909	898	0,0	178,4	178,4	119,2	148,2
412760	Tijucas do Sul	PR	6,654	2,285	2,550	2,279	96,6	270,9	367,5	259,1	352,5
CMA Total			2,719,991	2,653,766	778,560	720,560	222,489	20,106	242,595	145,221	168,120
(m³/day)							609,559	55,085	664,644	397,866	460,602
Coast											
410950	Guaraqueçaba	PR	2,497	2,497	949	831	155,5	0,0	155,5	96,7	130,1
410960	Guaratuba	PR	32,095	28,805	20,338	17,870	3,634,8	0,0	3,634,8	2,248,4	3,400,6
411570	Matinhos	PR	29,428	29,279	22,586	20,874	3,192,4	0,0	3,192,4	2,603,2	4,391,9
411620	Morretes	PR	11,379	7,178	4,189	3,661	809,2	0,0	809,2	489,1	614,3
411995	Pontal do Paraná	PR	20,920	20,743	21,381	20,234	3,247,5	0,0	3,247,5	1,677,9	3,286,4
Coast Total			96,319	88,502	69,443	63,470	11,039	0	11,039	7,115	11,823
(m³/day)							30,245	0	30,245	19,494	32,392
Total informações desagregadas			2,816,310	2,742,268	848,003	784,030	233,528	20,106	253,634	152,336	179,943
(m³/day)							639,804	55,085	694,889	417,360	492,994

(: 2010 SISTEMA NACIONAL DE INFORMAÇÕES SOBRE SANEAMENTO – SNIS)

Table 1.1.2 Sewerage service condition as of 2010

Código do município	Município	UF	POPULAÇÃO ATENDIDA		QUANTIDADES DE LIGAÇÕES		VOLUMES DE ESGOTO		
			População total	População urbana	Total (ativas + inativas)	Ativas	Coletado	Tratado	Faturado
			ES001 Population under sewer service	ES026 Population in urban area with sanitary sewage	ES009 Number of sewer connection	ES002 Active number of connection	ES005 Sewage quantity collected	ES006 Sewage quantity treated	ES007 Revenue earning sewage
			habitante	habitante	ligação	ligação	1.000 m³/ano	1.000 m³/ano	1.000 m³/ano
CMA			ES001	ES026	ES009	ES002	ES005	ES006	ES007
410020	Adrianópolis	PR							
410030	Agudos do Sul	PR							
410040	Almirante Tamandare	PR	12,263	12,263	3,884	3,657	537.6	537.6	645.4
410180	Araucária	PR	41,151	41,151	12,433	11,763	1,922.5	1,862.8	2,257.6
410230	Balsa Nova	PR	2,464	2,464	826	796	99.7	99.7	129.0
410310	Bocaiuva do Sul	PR	0	0	1	1	0.9	0.9	0.9
410400	Campina Grande do Sul	PR	25,447	25,447	8,160	7,564	876.1	876.1	1,157.4
410420	Campo Largo	PR	38,223	38,223	12,054	11,438	1,668.6	1,668.6	2,021.0
410425	Campo Magro	PR	4,464	4,464	1,360	1,267	173.2	173.2	214.5
410520	Cerro Azul	PR	170	170	57	53	6.1	6.1	8.3
410580	Colombo	PR	59,966	59,966	19,254	17,097	2,303.7	2,303.7	2,885.5
410620	Contenda	PR							
410690	Curitiba	PR	1,629,921	1,629,921	390,190	369,769	90,485.7	89,320.4	103,007.7
410765	Fazenda Rio Grande	PR	29,264	29,264	8,712	8,214	989.4	989.4	1,206.9
411125	Itaperucu	PR							
411320	Lapa	PR	21,401	21,401	7,325	6,804	812.1	810.7	1,045.1
411430	Mandirituba	PR	594	594	185	176	26.1	26.1	31.5
411910	Pien	PR							
411915	Pinhais	PR	75,226	75,226	22,057	20,798	3,283.1	3,140.8	3,891.1
411950	Piraquara	PR	52,910	45,738	16,786	15,335	2,279.3	2,272.5	2,858.2
412080	Quatro Barras	PR	10,941	10,941	3,715	3,363	493.0	493.0	602.0
412120	Quitandinha	PR							
412545	Sao Jose das Palmeiras	PR							
412760	Tijucas do Sul	PR							
CMA Total			2,004,405	1,997,233	506,999	478,095	105,957	104,581	121,962
(m3/day)							290,293	286,525	334,142
Coast									
410950	Guaraquecaba	PR	2,241	2,241	840	739	90.9	90.9	119.3
410960	Guaratuba	PR	32,095	28,805	8,922	8,453	1,222.7	1,222.7	1,870.2
411570	Matinhos	PR	29,428	29,279	7,451	7,103	1,236.7	1,236.7	2,115.5
411620	Morretes	PR	5,382	5,382	1,921	1,789	259.6	259.6	312.7
411995	Pontal do Parana	PR	16,805	16,805	4,650	4,582	389.7	389.7	818.0
Coast Total			85,951	82,512	23,784	22,666	3,200	3,200	5,236
(m3/day)							8,766	8,766	14,344
Total informacoes desagregadas			2,090,356	2,079,745	530,783	500,761	109,156	107,781	127,198
(m3/day)							299,059	295,291	348,487

(: 2010 SNIS)

1.2 Treatment capacity of sewage treatment plants

Fig. 1.2.1 shows the location of the target sewage treatment plants (STPs).

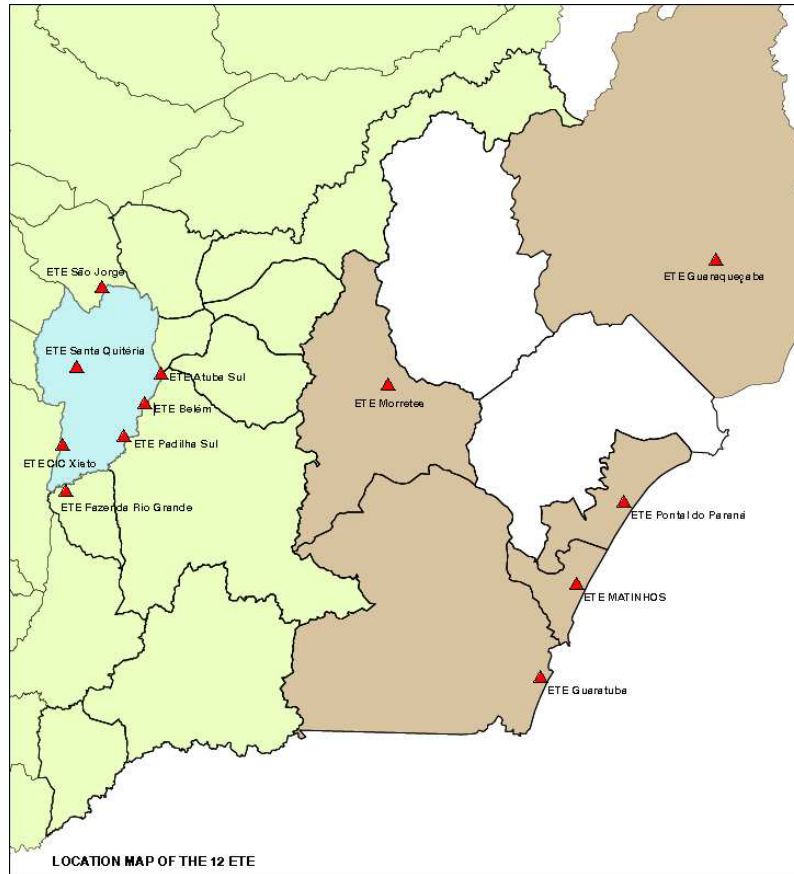

Fig. 1.2.1 Location of target STPs

Table 1.2.1 shows the outline of the target STPs in CMA and **Table 1.2.2** shows that in the coastal area.

Table 1.2.1 Outline of the target STPs in CMA

STP	①Sao Jorge		②Santa Quiteria		③CIC Xisto		④Atuba Sul		⑤Faz Rio Grande		⑥Padilha Sul		⑦Belem	
Site area (m2)	73,000		26,000		320,000		72,000		150,000		110,000		260,000	
Startup year	2003		UASB1998	DAF2010	2002		UASB1998	DAF2009	2007		2002		1974	
Design capacity(L/s)	140	(12,096m3/d)	770	(66,528m3/d)	1,270	(109,728m3/d)	2,180	(188,352m3/d)	280	(24,192m3/d)	525	(45,360m3/d)	2,440	(210,816m3/d)
Present capacity(L/s)	70	(6,048m3/d)	420	(36,288m3/d)	490	(42,336m3/d)	1,120	(96,768m3/d)	210	(18,144m3/d)	420	(36,288m3/d)	840	(72,576m3/d)
Lift pump	1	—	1	—	—	—	1	—	1	—	1	—	1	—
Grit chamber	1	—	1	—	—	—	1	—	1	—	1	—	1	—
UASB tank	1	2000m3/tank HRT 8.0hr	6	2000m3/tank HRT 8.0hr	7	2000m3/tank HRT 8.0hr	16	2000m3/tank HRT 8.0hr	3	2000m3/tank HRT 8.0hr	6	2000m3/tank HRT 8.0hr	—	—
OD	—	—	—	—	—	—	—	—	—	—	—	—	—	2
Settling tank	—	—	—	—	—	—	—	—	—	—	—	—	—	2 ø65m, surface loading 11m3/m2/d
Lagoon	—	—	—	—	1	164,620m3 HRT 3.9day	—	—	1	164,620m3 HRT 3.6day	2	164,620m3 HRT 4.1day	—	—
DAF	1	70L/S/tank	2	210L/S/tank	—	—	4	420L/S/tank	—	—	—	—	—	—
Contact aeration tank	—	—	—	—	—	—	—	—	—	—	—	—	—	—
Sludge thickener	—	—	1	—	1	—	1	—	1	—	1	—	1	—
Dehydrator	—	—	1	Centrifugal 4m3/hr	1	Centrifugal 4m3/hr	2	Belt press 8m3/hr Centrifugal m3/hr	1	Centrifugal 4m3/hr	1	Centrifugal 4m3/hr	3	Centrifugal
Sludge storage yard	—	—	1	4 beds	1	—	1	—	1	6 beds	1	8 beds	1	- beds
Drying bed	1	8 beds	—	—	—	—	—	—	—	—	—	—	—	—
Site for expansion	—	exist	—	exist	—	exist	—	expanding	—	UASB 1 tank	—	—	—	existing*3
Others	Plan for renovating to rapid settling + activated sludge process		—	—	—	—	—	—	Sufficient capacity		—	—	—	—

Table 1.2.2 Outline of the target STPs in the coastal area

STP	⑧Guaraquecaba		⑨Guaratuba		⑩Matinhos		⑪Morretes		⑫Pontal do parana	
Site area (m2)	12,000		200,000		94,500		24,000		93,550	
Startup year	2007		2004		2008		2007		2008	
Design capacity(L/s)		(0m3/d)	350	(30,240m3/d)	350	(30,240m3/d)		(0m3/d)	280	(24,192m3/d)
Present capacity(L/s)	35	(3,024m3/d)	210	(18,144m3/d)	210	(18,144m3/d)	35	(3,024m3/d)	140	(12,096m3/d)
Lift pump	—	—	—	—	—	—	—	—	—	—
Grit chamber	1	—	1	—	1	—	1	—	1	—
UASB tank	1	1000m3/tank HRT 9.3hr	3	2000m3/tank HRT 7.9hr	6	1000m3/tank HRT 7.9hr	1	1000m3/tank HRT 7.9hr	4	1000m3/tank HRT 7.9hr
OD		—	—	—	—	—	—	—	—	—
Settling tank	1	φ14m, 615m3 Surface loading	—	—	—	—	1	φ14m, 615m3 Surface loading 20m3/m2/d	—	—
Lagoon	—	—	1	164,620m3 HRT 3.7day	—	—	—	—	—	—
DAF	—	—	—	—	3	70L/S/tank	—	—	2	70L/S/tank
Contact aeration tank	1	30L/S/tank	—	—	—	—	1	35L/S/tank	—	—
Sludge thickener	—	—	—	—	1	—	1	—	1	—
Dehydrator	—	—	—	—	—	—	—	—	—	—
Sludge storage yard	—	—	—	—	—	—	—	—	—	—
Drying bed	1	2 beds	2	4 beds	3	6 beds	3	6 beds	4	8 beds
Site for expansion		no		UASB 2 tanks		UASB 4 tanks DAF 2 tanks		UASB 4 tanks settling tank 1 tank		UASB 4 tanks DAF 2 tanks
Others	Accept leachet from solid waste plant		no licence for agricultural use of sludge				Licence for agricultural use of sludge storage in STP		no licence for agricultural use of sludge	

2. Analysis of the current situation and issues of SRTs

2.1 Current situation and issues of treatment facilities

2.1.1 Elapsed years of treatment facilities

Fig. 2.1.1 and Fig. 2.1.2 shows the elapsed years of the treatment facilities of the target 12 STPs. 6 STPs i.e. Belem, Santa Quiteria, Atuba Sul, Sao Jorge, CIC Xisto and Padilha Sul STP already reached to the renovation period of mechanical and electrical equipment which is usually considered to be 15 years while the elapsed years of 5 STPs in the coastal area is less than 10 years.

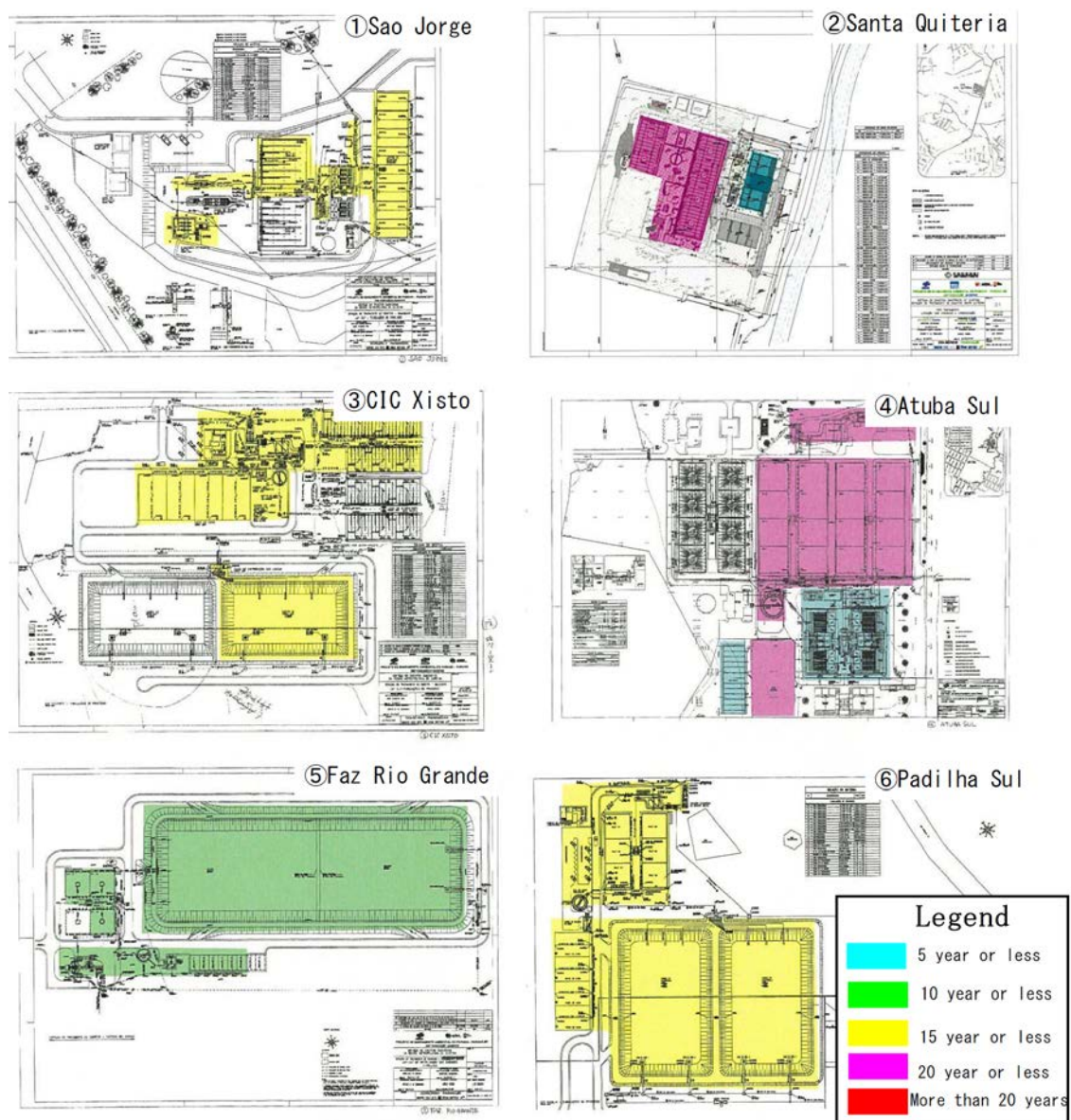

Fig.2.1.1 Outline of elapsed years of treatment facilities

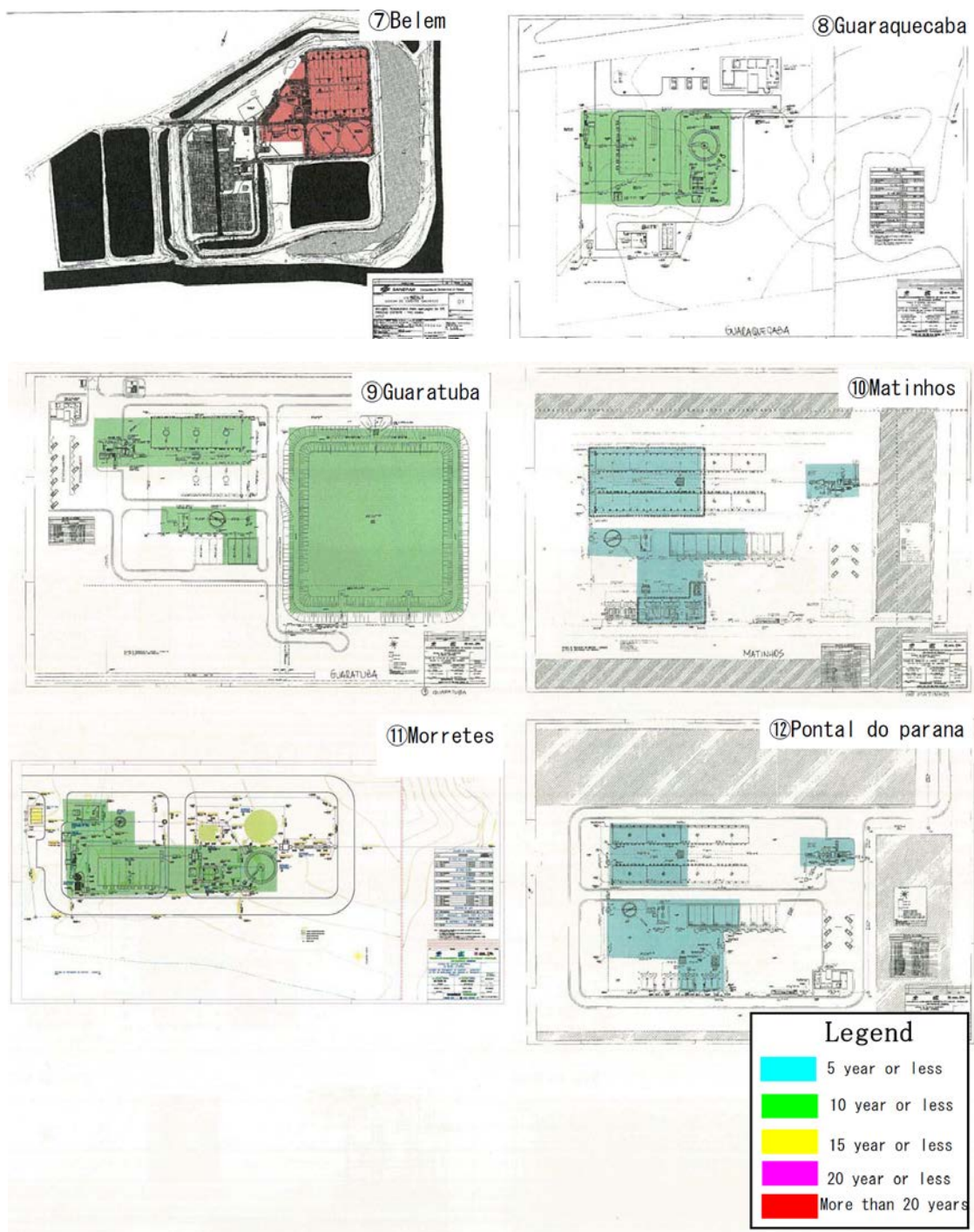

Fig. 2.1.2 Outline of elapsed years of treatment facilities

2.1.2 Water quality and effluent loading to discharging rivers

Table 2.1.1 shows the water quality, pollutant removal ratio and annual effluent pollutant loading by each treatment process. It is apparent in the table that the pollutant removal ratio in

Belem and Faz. Rio Grande STP where aerobic treatment process is adopted is high.

Fig. 2.1.1 indicates effluent quality and **Fig. 2.1.2** indicates annual effluent pollutant loading of each STP. Effluent quality in STPs in the coastal area is better than that in CMA due to low influent pollutant concentration. Effluent quality of STPs in CMA where anaerobic treatment process is adopted sometimes violates the effluent standards, i.e. BOD 50mg/L, COD 125mg/L and SS 50mg/L while that in Belem and Faz. Rio Grande treated by aerobic process is rather good. Especially, the annual effluent pollutant loading in Belem is remarkably low.

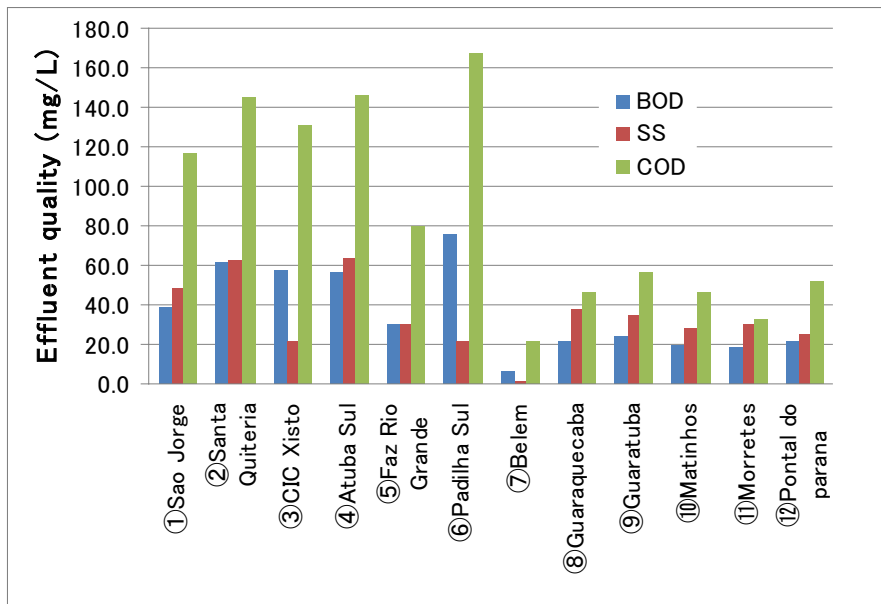

Fig. 2.1.1 Effluent quality in each STP

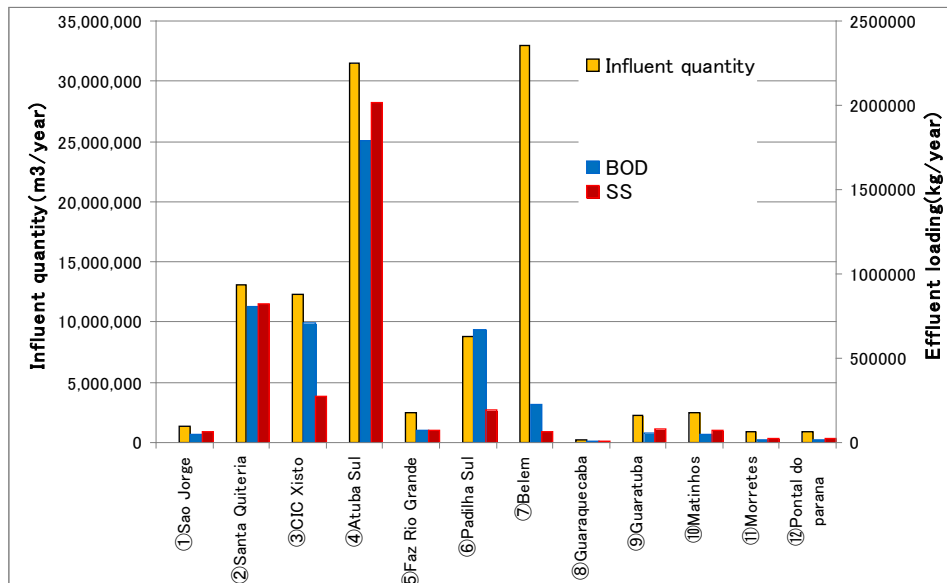

Fig. 2.1.2 Annual effluent pollutant loading

Table 2.1.1 Water quality, pollutant removal ratio and annual effluent pollutant loading

DAF with coagulant addition

STP	①Sao Jorge		②Santa Quitéria		④Atuba Sul		⑩Matinhos		⑫Pontal do parana		Treatment efficiency
Influent quantity (m3/year)	3,622m3/d	1,322,030m3/d	35,757m3/d	13,051,305m3/d	86,149m3/d	31,444,385m3/d	6,903m3/d	2,519,595m3/d	2,324m3/d	848,260m3/d	except coastal area
①Influent(mg/L)	Quality	Removal rate (%)	Quality	Removal rate (%)	Quality	Removal rate (%)	Quality	Removal rate (%)	Quality	Removal rate (%)	
	BOD	-	217.0	-	193.0	-	37.6	-	44.6	-	
	SS	-	147.0	-	136.0	-	63.4	-	61.6	-	
②UASB outlet(mg/L)	Quality	(①-②)/①	Quality	(①-②)/①	Quality	(①-②)/①	Quality	(①-②)/①	Quality	(①-②)/①	(①-②)/①
	BOD	54.3	77.0%	58.8	72.9%	76.8	60.2%	-	-	-	70.0%
	SS	78.0	60.4%	69.0	53.1%	87.5	35.7%	-	-	-	49.7%
③Effluent(mg/L)	Quality	(②-③)/②	Quality	(②-③)/②	Quality	(②-③)/②	Quality	(②-③)/②	Quality	(②-③)/②	(②-③)/②
	BOD	38.9	28.4%	61.5	4.6%	56.9	25.9%	19.8	-	22.1	16.6%
	SS	48.3	38.1%	63.0	8.7%	64.0	26.9%	28.1	-	25.5	24.5%
Total removal rate	Quality	(①-③)/①	Quality	(①-③)/①	Quality	(①-③)/①	Quality	(①-③)/①	Quality	(①-③)/①	(①-③)/①
	BOD	-	83.5%	-	71.7%	-	70.5%	-	47.3%	-	50.4%
	SS	-	75.5%	-	57.1%	-	52.9%	-	55.7%	-	58.6%
Annual effluent loading (kg)	Quality	Loading	Quality	Loading	Quality	Loading	Quality	Loading	Quality	Loading	
	BOD	38.9	51,426,967	61.5	802,655,258	56.9	1,789,185,507	19.8	49,887,981	22.1	18,746,546
	SS	48.3	63,854,049	63.0	822,232,215	64.0	2,012,440,640	28.1	70,800,620	25.5	21,630,630
COD	Quality	Loading	Quality	Loading	Quality	Loading	Quality	Loading	Quality	Loading	
	BOD	117.0	154,677,510	146.0	1,905,490,530	147.0	4,622,324,595	46.3	116,657,249	52.4	44,448,824
	SS	117.0	154,677,510	146.0	1,905,490,530	147.0	4,622,324,595	46.3	116,657,249	52.4	44,448,824

Lagoon

STP	③CIC Xisto(Anaerobic)		⑤Faz Rio Grande(Aerobic)		⑥Padiha Sul (Anaerobic)		⑨Guaratuba (Anaerobic)		Treatment efficiency
Influent quantity (m3/year)	33,851m3/d	12,355,615m3/d	6,808m3/d	2,484,920m3/d	24,071m3/d	8,785,915m3/d	6,065m3/d	2,213,725m3/d	
①Influent(mg/L)	Quality	Removal rate (%)	Quality	Removal rate (%)	Quality	Removal rate (%)	Quality	Removal rate (%)	
	BOD	249.0	-	402.0	-	349.0	-	71.6	-
	SS	176.0	-	363.0	-	200.0	-	113.0	-
②UASB outlet(mg/L)	Quality	(①-②)/①	Quality	(①-②)/①	Quality	(①-②)/①	Quality	(①-②)/①	(①-②)/①
	BOD	93.8	62.3%	74.8	81.4%	111.0	68.2%	100.0%	70.6%
	SS	125.0	29.0%	91.0	74.9%	82.0	59.0%	100.0%	54.3%
③Effluent(mg/L)	Quality	(②-③)/②	Quality	(②-③)/②	Quality	(②-③)/②	Quality	(②-③)/②	Only anaerobic
	BOD	57.7	38.5%	30.6	59.1%	75.9	31.6%	25.2	-
	SS	22.3	82.2%	30.6	66.4%	21.7	73.5%	35.3	-
Total removal rate	Quality	(①-③)/①	Quality	(①-③)/①	Quality	(①-③)/①	Quality	(①-③)/①	Only anaerobic
	BOD	-	76.8%	-	92.4%	-	78.3%	-	64.8%
	SS	-	87.3%	-	91.6%	-	89.2%	-	68.8%
Annual effluent loading (kg)	Quality	Loading	Quality	Loading	Quality	Loading	Quality	Loading	
	BOD	57.7	712,918,986	30.6	76,038,552	75.9	666,850,949	25.2	55,785,870
	SS	22.3	275,530,215	30.6	76,038,552	21.7	190,654,356	35.3	78,144,493
COD	Quality	Loading	Quality	Loading	Quality	Loading	Quality	Loading	
	BOD	131.0	1,618,585,565	79.6	197,799,632	168.0	1,476,033,720	57.2	126,625,070
	SS	131.0	1,618,585,565	79.6	197,799,632	168.0	1,476,033,720	57.2	126,625,070

Contact aeration + settling tank

STP	⑧Guaraquecaba		⑪Morretes		Treatment efficiency
Influent quantity (m3/year)	738m3/d	269,370m3/d	2,445m3/d	892,425m3/d	
①Influent(mg/L)	Quality	Removal rate (%)	Quality	Removal rate (%)	
	BOD	105.0	-	62.4	-
	SS	118.0	-	71.5	-
②UASB outlet(mg/L)	Quality	(①-②)/①	Quality	(①-②)/①	
	BOD	100.0%	-	-	-
	SS	100.0%	-	-	-
③Effluent(mg/L)	Quality	(②-③)/②	Quality	(②-③)/②	
	BOD	22.0	#DIV/0!	18.9	-
	SS	37.7	#DIV/0!	30.6	-
Total removal rate	Quality	(①-③)/①	Quality	(①-③)/①	(①-③)/①
	BOD	-	79.0%	-	69.7%
	SS	-	68.1%	-	57.2%
Annual effluent loading (kg)	Quality	Loading	Quality	Loading	
	BOD	22.0	5,926,140	18.9	16,866,833
	SS	37.7	10,155,249	30.6	27,308,205

(: Result of questioneir in SANEPAR)

2.1.3 Treatment costs

Table 2.1.4 shows the treatment costs of STPs in CMA in 2011. Fig. 2.1.3, Fig. 2.1.4 and Fig. 2.1.5 shows the comparison of the unit treatment costs in STPs in CMA, the breakdown of average treatment costs in STPs adopting anaerobic process and the breakdown of treatment costs in Belem STP respectively.

Table 2.1.4 Comparison of the unit treatment costs in STPs in CMA

COSTS (R\$)	①Sao Jorge		②Santa Quiteria		③CIC Xisto		④Atuba Sul		⑤Faz Rio Grande		⑥Padilha Sul		⑦Belem		Total		Anaerobic Ave.	
	Total	R\$/ m3	Total	R\$/ m3	Total	R\$/ m3	Total	R\$/ m3	Total	R\$/ m3	Total	R\$/ m3	Total	R\$/ m3	Total	R\$/ m3	Total	R\$/ m3
Person	238,181	0.18	550,041	0.04	926,733	0.08	1,189,018	0.04	139,753	0.06	659,098	0.07	1,236,220	0.04	4,939,045	0.05	3,563,072	0.05
Chemicals	136,807	0.10	1,235,025	0.10	1,295,463	0.11	1,860,480	0.06	17,370	0.01	785,523	0.09	986,289	0.03	6,316,956	0.06	5,313,297	0.08
Materials	0	0.00	32,963	0.00	154,158	0.01	200,127	0.01	227	0.00	67,501	0.01	154,647	0.01	609,624	0.01	454,750	0.01
Energy	49,678	0.04	308,020	0.02	294,122	0.02	385,340	0.01	185,380	0.08	215,927	0.02	3,531,365	0.11	4,969,832	0.05	1,253,087	0.02
Outsourcing Job	0	0.00	241,011	0.02	545,903	0.05	829,717	0.03	175,821	0.07	347,423	0.04	416,323	0.01	2,556,198	0.03	1,964,054	0.03
Taxes	0	0.00	4,828	0.00	17,632	0.00	13,282	0.00	0	0.00	14,860	0.00	11,587	0.00	62,189	0.00	50,602	0.00
Maintenance	63,061	0.05	321,135	0.03	327,215	0.03	739,517	0.02	47,049	0.02	212,635	0.02	1,141,102	0.04	2,851,713	0.03	1,663,562	0.03
Others	0	0.00	17,212	0.00	24,085	0.00	947	0.00	320	0.00	0	0.00	9,931	0.00	52,495	0.00	42,244	0.00
TOTAL (R\$)	487,728	0.37	2,710,235	0.21	3,585,311	0.30	5,218,428	0.17	565,920	0.23	2,302,966	0.25	7,487,464	0.24	22,358,052	0.23	14,304,668	0.22
Treated Volume (m3)	1,329,745		12,713,709		12,035,585		30,941,456		2,448,060		9,111,451		30,886,988		99,466,994		66,131,946	
R\$ / m3	0.37		0.21		0.30		0.17		0.23		0.25		0.24		0.225		0.216	

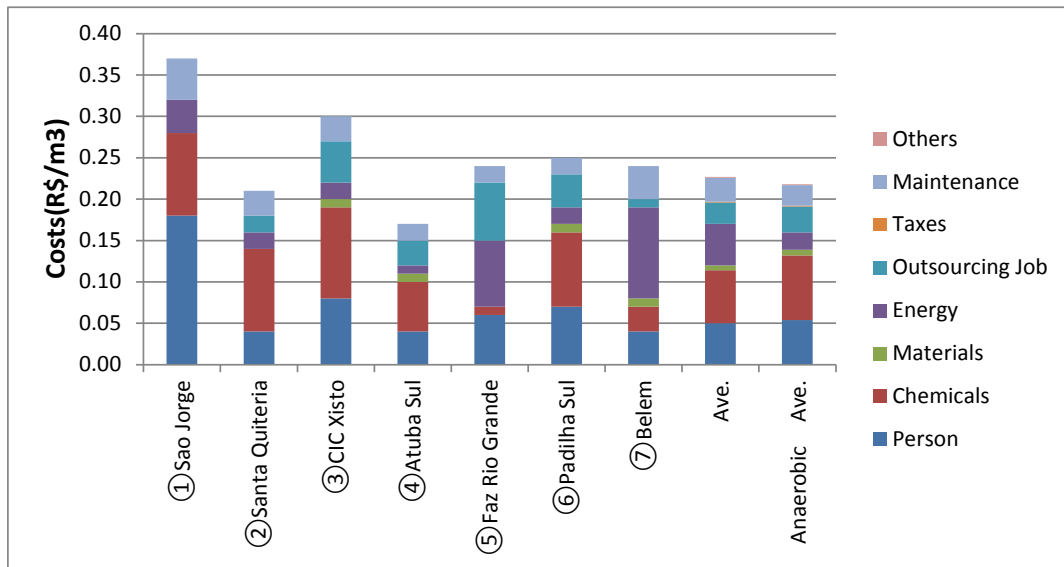

Fig. 2.1.3 Comparison of treatment costs

As shown in the table, average treatment cost is 0.225R\$/m³ which is equivalent to 10yen/m³ (43yen/R\$). In comparison with the treatment cost in Tokyo Metropolitan area in 2010, i.e. 58yen/m³, the cost in STPs in SANEPAR is not considered to be adequate.

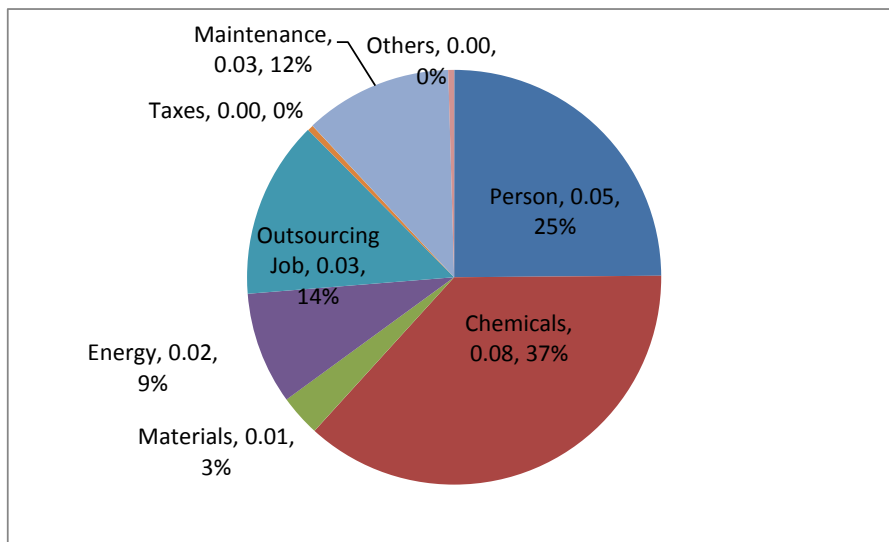

Fig. 2.1.5 Breakdown of average treatment cost in STPs adopting anaerobic process

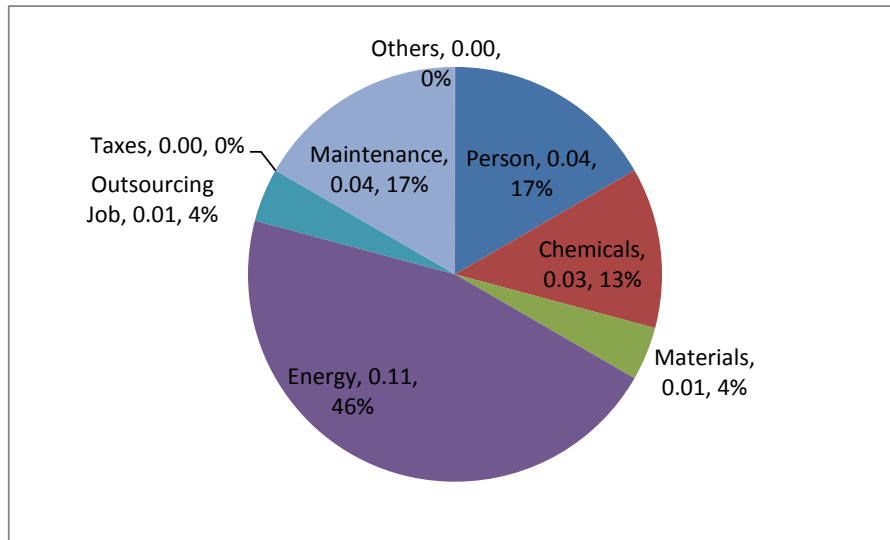

Fig. 2.1.6 Breakdown of treatment costs in Belem STP

As shown in the figures, the cost for chemicals is 37% and the outsourcing jog is 14% in STPs adopting anaerobic treatment while those in Belem STP are only 13% and 4% respectively. It means that adoption of energy saving facilities for Belem on the occasion of renovation of pump and aeration facility is desired.

2.1.4 Current condition and issues of treatment facilities

Table 2.1.5 summarizes the current condition and issues in the target STPs.

Table 2.1.5 Current condition and issues in target STPs

Facility	Current condition and issues	Relevant STPs	Measures
Lift pump	1. Maintenance is hard due to single pump pit.	1. Atuba Sul, Belem	1. Construction of more than 2 pump pits and installation of stand-by pumps, 2. Choice of pump proper for lifting quantity and height,
Screen, Grit removal	1. Maintenance is hard due to single screen and grit removal facility,	All STPs	1. Increase the facility 2. Review of the system on the occasion of renovation
OD tank	*High power consumption due to excessive agitation *DO control is hard.	Belem	Review of agitation and operation control system
UASB tank	1. Concrete corrosion at outflow channel and upper floor, 2. Scheduled withdrawal of sludge is hard. 3. Generation of scum, 4. Generation of H ₂ S,	All STPs adopting anaerobic treatment,	1. Implement anti-corrosion painting for each treatment line, 2. Control of sludge-liquid surface level and adjust sludge withdrawal quantity, 3. Improve scum removal work, 4. Consider biological deodorization etc.
DAF tank	*No tight floc is formed even by addition of coagulant. *No proper operation control is taken place.	*Sao Jorge, Santa Quiteria, Atuba Sul, Matinhos, Pontal do Parana	*Improvement of addition process of coagulant and DAF pump control, *Review of operation control system,
Contact aeration tank	*No treatment efficiency is found.	*Morretes, Guaraquecaba	Stop operation in consideration of treatment efficiency
Final settling tank	Necessity of sludge level control in the tank,	Belem, Morretes, Guaraquecaba	Adjust withdrawal and return sludge quantity,
Sludge thickener	*Excluded from treatment system in STPs in the coastal area, *Mechanical equipment is dismantled in STPs above,	Faz. Rio Grande, Matinhos, Morretes, Pontal do Parana,	*Establishment of treatment system including thickener into STPs where mechanical dehydrator is planned to be installed.
Mechanical dehydrator	*No stand-by dehydrator *Insufficient treatment capacity	Santa Quiteria, CIC Xist, Atuba Sul, Faz. Rio Grande, Padilha Sul, Belem	*Installation of dehydrator coped with the volume of sludge generated, *Installation of stand-by,
Lagoon	1. In the case of facultative pond, measures against odor is required. 2. Adequate removal rate of pollutant is obtained in aerobic tank. 3. Control of sludge accumulated is not implemented in all lagoon.	1. CIC Xist, Padilha Sul, Guaratuba, 2. Faz. Rio Grande, 3. All lagoon	1. Installation of aerators 2. Not required 3. Implementation of dredging of sludge
CIC Xist	*No as-built drawing *UASB tank is not level due to land subsidy.		Existing tanks are hardly reusable in the occasion of renovation.

2.2 Current condition and issues in rivers accepting effluent of STPs

The Federal Water Resources Agency (ANA) has water quality networks consisting of 17 federal units and the network in Parana state is managed by IAP.

The followings refer to the data collected in 2010 and result of investigation shown in “CONJUNTURA dos RECURSOS HIDRICOS no BRASIL/ INFORME 2012”.

2.2.1 Water quality index (IQA)

ANA has 2,259 monitoring points of water quality in 17 states out of 27, which are managed by each state and continue the monitoring by independent frequency and monitoring parameters. Recently, analysis of IQA was carried out based on the data in 2010 in 1,988 monitoring points.

Fig. 2.2.1 shows the result of the IQA.

The result shows that water pollution is obvious in the high population density area in large cities. The water quality in the main large cities like Sao Paulo, Belo Horizonte and Curitiba are labeled to be “inferior” which is considered to be caused by large amount of wastewater discharged.

The upper streams of the Iguacu which are reported to be “inferior” and “poor” in the IQA 2010 are as follows;;

Rio Iguacu, Rio Passauna, Rio Barigui, Rio Irai, Rio Padilha, Rio Palmital, Rio Agua Verde, Rio Belem, Rio Parolim, Rio Fany, Rio Ivo,

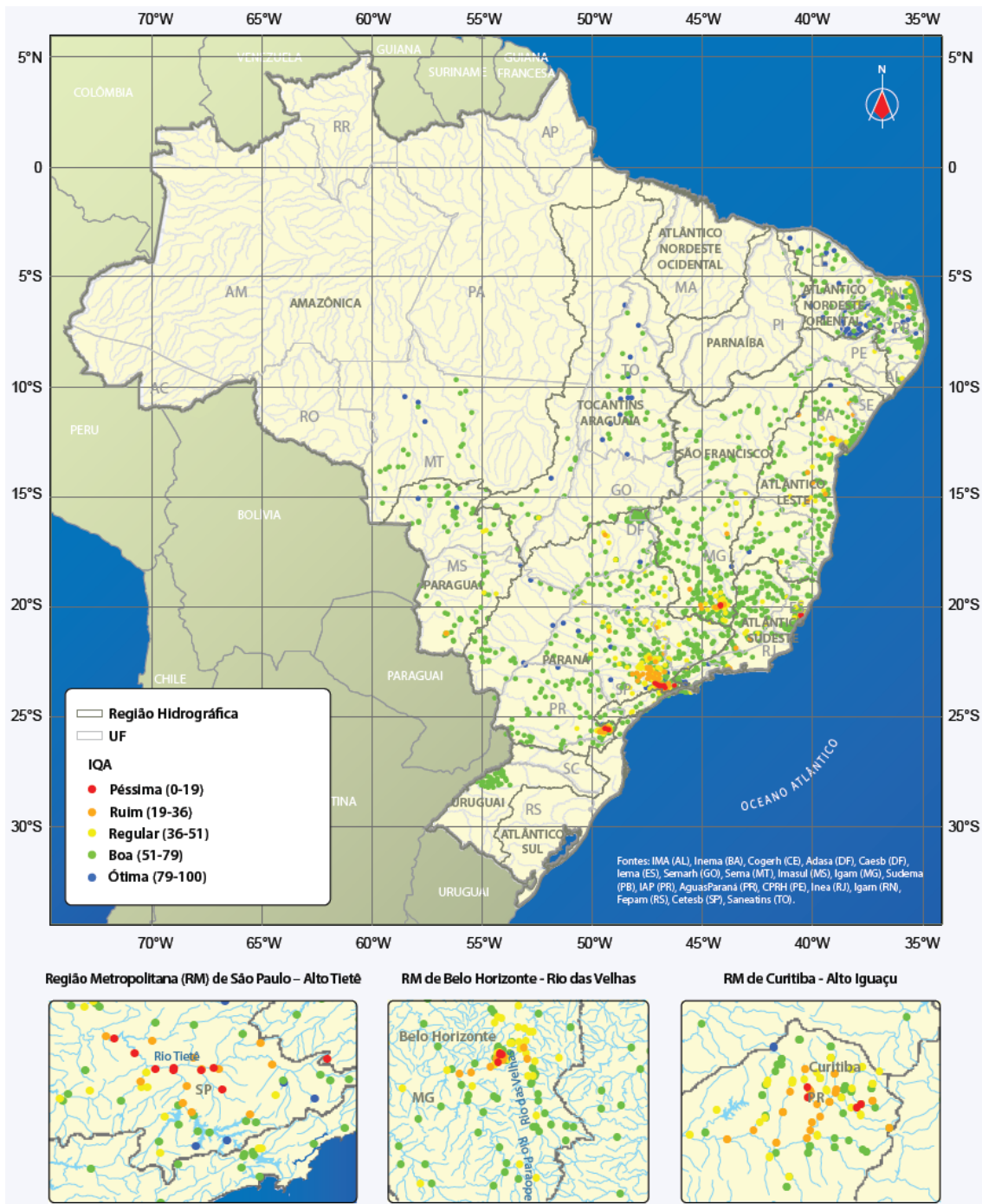

: <http://conjuntuna.ana.gov.br/>

Fig. 2.2.1 Result of IQA by 2010 data

2.2.2 Nutritional State Index (IET)

Eutrophication of river water also considered to damage the water quality by providing abnormal propagation of hydrophytes. It also provides threatening for water hygiene and may

cause odor and/or mortality of aquatic fauna.

Main accelerating factor of the eutrophication is considered to be the existence of excessive amount of nutrient like nitrogen and phosphorus. IET is for classification of water basin by nutrients degree and is calculated from total phosphorus concentration in rivers and reservoirs by using Lamparelli (2004) method which is the method to evaluate the nutritional state of rivers in Sao Paulo State by using total phosphorus concentration and chlorophyll. **Fig. 2.2.2** shows the result of IET.

Most of the river basins considered to be excessive pollutant loading are located in high population density cities like Sao Paulo, Rio de Janeiro and Curitiba. Domestic, industrial, mining and agricultural wastewater is considered to be main pollution source and the cut of pollutant loading discharged is a relevant issue in those areas.

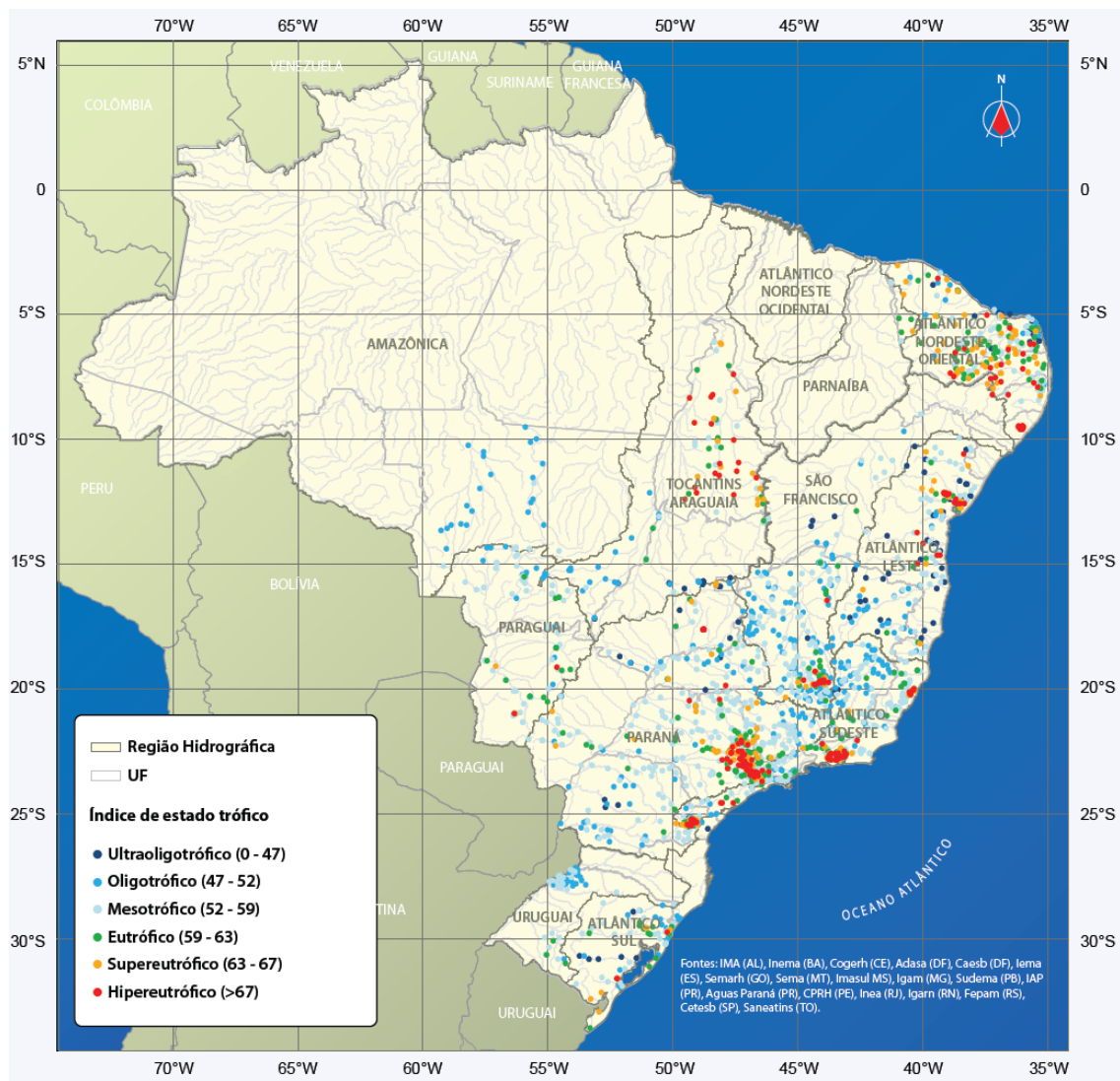

Fig. 2.2.2 Result of Nutritional State Index (IET)

3. Review of basic condition

3.1 Relevant legislative system

3.1.1 Environmental and effluent standard

Environmental standard in Brazil in respect of water quality is regulated in the CONAMA Act 20/86. The standard consists of 2 categories, one is that for living environment and the other is that for toxic substances. Standard for living environment in freshwater area is divided into 5 classes depending on the usage of water as shown in **Table 3.1.1**. The standard values of those 5 classes regarding living environment are as shown in **Table 3.1.2**.

Table 3.1.1 Classification enforced for public water bodies

Class		Distinction
Freshwater bodies	Superfine	no need of disinfection, drinking water and conservation of ecosystem by simple disinfection,
	1	drinking water by simple purification process, recreation (swimming, water-skiing, diving), conservation of aquatic habitats, irrigation for vegetables, fruits and crops, aquaculture of fish and water for livestock,
	2	drinking water by regular purification process, recreation (swimming, water-skiing, diving), conservation of aquatic habitats, irrigation for vegetables, fruits and crops, aquaculture of fish and water for livestock,
	3	drinking water by regular purification process, irrigation for trees, crops and stock-farm and water for livestock,
	4	navigation, conservation of scenery and usage regardless of water quality,

Table 3.1.2 Environmental standard values in public water bodies

Parameter	Standard value				
	Freshwater area				
	Superfine	1	2	3	4
Suspended solid (mg/L)	-	VA	VA	VA	VA
Oil (mg/L)	VA	VA	VA	VA	Oil film VA
Fecal coliform (MPN/100mL)		< 200	< 1,000	< 4,000	-
BOD (mg/L)	-	< 3.0	< 5.0	< 10.0	-
DO (mg/L)	-	> 6.0	> 5.0	> 4.0	> 2.0
pH (-)	-	6.0 ~ 9.0	6.0 ~ 9.0	6.0 ~ 9.0	6.0 ~ 9.0

VA: no visible or no detective

Oil film VA: no visible oil film

As shown in **Table 3.1.2**, no water quality standard for fecal coliform and BOD is regulated in freshwater Class 4 and it is entrusted to decision of each state.

Effluent standard is regulated as shown in **Table 3.1.3** and BOD standard for effluent of STP is set at 90mg/L.

Table 3.1.3 Effluent standard for sewage treatment system

Parameter	Federal	Parana state
	CONAMA Act 357/05 430/11	SEMA Act 021/09
pH (-)	5 ~9	-
Water Temperature (°C)	< 40	-
	Rise of temperature at mixing zone < 3	-
Sediment (mg/L)	< 1	-
Suspended solid (mg/L)	ND	-
Oil and grease (mg/L)	100	20 ^{*1} (50) ^{*2}
COD (mg/L)	-	225
BOD (mg/L)	120 (minimum removal rare 60%)	90

*1: mineral oil

*2: animal and vegetable oil

Standard		Effluent Standard					
		IAP			IPAGUAS		
		BOD	COD	SS	BOD	COD	SS
1	Atuba Sul	90	225	< 1	50	125	50
2	San Jorge	90	225	< 1	50	125	50
3	Santa Quiteria	90	225	< 1	50	125	50
4	CIC Xist	90	225	< 1	50	125	50
5	Faz. Rio Grande	90	225	< 1	90	125	90
6	Padilha Sul	90	225	< 1	50	125	50
7	Belem	90	225	< 1	50	125	50
8	Morretes	90	225	< 1	90	125	100
9	Guaraquecaba	90	225	< 1	50	125	50
10	Pontal do Parana	90	225	< 1	50	125	50
11	Matinhos	90	225	< 1	50	125	50
12	Guaratuba	90	225	< 1	50	125	50

(:mg/L)

3.1.2 Standard for agricultural application of sewage sludge

According to the standard for agricultural application of sewage sludge regulated in CONAMA Act 375/2006, Article 10 to 18, sewage sludge is categorized into 2 classes. Sludge categorized in A class is applicable for all crops except for those restricted in Article 12 and 15 in the Act. B class is applicable for coffee tree, forestry, plant for fiber and plant for oil processing by scattering for ditch and/or pit made by agricultural equipment, except for crops restricted in Article 15, XI Clause and Article 18.

Article 12 stipulates the restriction of sewage sludge for cultivation of crops edible part of which contact with soil like pasture, green vegetables, root vegetables and crops cultivated by irrigation. And Article 15 stipulates the inapplicable area and condition in detail.

Article 16 stipulates the procedures for use of sewage sludge and its derivative products. In brief, as described in Annex III of the Act, presentation of a plan of use of sludge for agriculture by specialist with sufficient technical knowledge is required. Annex VI of the Act regulates the necessity of instruction to the owner of farmland and user of land on the occasion of carrying out of sludge that the sludge control unit (UGL) has to inform the characteristics of sewage sludge and its derivatives, information in respect of the treatment process for reduction of pathogen and application of sludge in accordance with the application plan for agricultural use.

The tolerance level of pathogen in sludge is set for both types of sludge as shown in **Table 3.1.4** while no distinction between the types is set for inorganic substances contained in sludge and the tolerant values are set as shown in **Table 3.1.5**.

Table 3.1.4 Tolerant level of pathogen for use of sludge to agriculture

Type of sludge	Parameter	Tolerant conc.
A (Applicable for all crops except mentioned in provision 12 and 15 of CONAMA Act 375/2005)	Heat-resistant coliform bacteria	10 ³ MPN/g TS
	Parasite egg	0.25/g TS
	Existence of salmonellae per 10g of TS	None
	Bacteria	<0.25 PFU or FFU/g TS
B (Applicable for coffee tree, forestry, plant for fiber and plant for oil processing by scattering for ditch and/or pit made by agricultural equipment, except for crops restricted in Article 15, XI Clause and Article 18)	Heat-resistant coliform bacteria	10 ⁶ MPN/g TS
	Parasite egg	10/g TS

MPN: Most Provable Number,
 TS: Total solid conc.,
 PFU: Plaque Formation Unit
 FFU: Focus Formation Unit

Table 3.1.5 Tolerant level of inorganic substances for agricultural use

Inorganic substance	Tolerant level (mg/kg)
Arsenic	41
Barium	1,300
Cadmium	39
Lead	300
Copper	1,500
Chromium	1,000
Mercury	17
Molybdenum	50
Nickel	420
Selenium	100
Zinc	2,800

Classification of sludge for agricultural use is described in a provision of Annex of CONAMA (ANEXO 1) by sterilization process as shown below. The provision is set based on the environmental conservation law of the environmental ministry of UA (40 CEF Part 503-Appendix B).

➤ **Sludge sterilization process considered to be Class B;**

- a) Aerobic digestion; pile more than 40 days in 20°C or more than 60 days in 15°C,
- b) Sludge drying bed; Dry up more than 3 months in drying bed with sand or concrete floor,
- c) Anaerobic digestion; Store more than 15 days in 35~50°C or more than 60 days in 20°C
- d) Composting; Pile more than 4 hours at 55°C of peak temperature continuously and more than 5 days at 40°C of the minimum temperature.
- e) Stabilization with addition of lime; Keep more than 2 hours at pH higher than 12 after adding sufficient amount of lime.

➤ **Sludge sterilization process considered to be Class A;**

- a) Composting; Pile more than 3 days in 55°C under aeration or more than 15 days in 55°C with mechanical cutting at least 5 days.
- b) Thermal dry; Dry up to less than 10% of moisture content at higher than 80°C.
- c) Thermal dry; Dry up more than 30 minutes at 180°C.
- d) Aerobic digestion; Keep more than 10 days at 55~60°C.

Radiation exposure and pasteurization also is listed.

3.2 Design sewage flow

3.2.1 Design flow in the target STPs of the project

Design flow in the 12 target STPs is shown in **Table 3.2.1**. The design flow shown in

the Master-plan under preparation by SANEPAR is described for the 5 STPs in CMA and original design flow is described in the table for the other 7 target STPs.

Average daily sewage flow is used for the design of treatment facilities because it is used in the master-plan.

According to the master-plan, treatment capacity is insufficient in 4 STPs, i.e. Santa Quitéria, CIC Xist, Atuba Sul and Belem; especially in Belem STP, the capacity is only 37% of the average daily influent quantity in 2013.

Total of average daily sewage flow in CMA will rise 1.4 time from 447,400m³/d in 2013 to 613,800m³/d in 2043.

In some STPs in the coastal area, the treatment capacity is higher than the average daily flow while that the capacity is insufficient against the maximum daily flow.

Table 3.2.1 Design sewage flow in the target STPs of the project

		year								
		2013	2014	2018	2023	2028	2033	2038	2043	
①Sao Jorge	Qmax(m3/d)	0	0	0	0	0	0	0	0	
	Qave.(m3/d)	3,700	0	0	0	0	0	0	0	
	Existing capacity(m3/d)	6,100	6,100	6,100	6,100	6,100	6,100	6,100	6,100	
	Additional capability(m3/d)	0	0	0	0	0	0	0	0	
	Total capacity(m3/d)	6,100	6,100	6,100	6,100	6,100	6,100	6,100	12,100	
②Santa Quitéria	Qmax(m3/d)	74,500	75,900	79,200	81,900	84,400	87,500	90,400	93,300	
	Qave.(m3/d)	48,600	50,200	52,900	55,200	56,900	58,800	60,700	62,600	
	Existing capacity(m3/d)	36,300	36,300	48,400	66,600	66,600	66,600	66,600	66,600	
	Additional capability(m3/d)	0	12,100	18,200	0	0	0	0	0	
	Total capacity(m3/d)	36,300	48,400	66,600	66,600	66,600	66,600	66,600	66,600	
③CIC Xisto	Qmax(m3/d)	98,600	101,600	120,100	149,700	155,700	160,700	165,200	169,800	
	Qave.(m3/d)	61,400	63,100	72,800	87,000	92,900	99,400	103,900	108,400	
	Existing capacity(m3/d)	42,400	42,400	78,700	108,900	108,900	108,900	108,900	108,900	
	Additional capability(m3/d)	0	36,300	30,300	0	0	0	0	0	
	Total capacity(m3/d)	42,400	78,700	108,900	108,900	108,900	108,900	108,900	108,900	
④Atuba Sul	Qmax(m3/d)	224,900	226,000	256,100	261,100	266,200	276,400	280,700	285,000	
	Qave.(m3/d)	103,300	109,300	124,900	139,000	147,500	155,700	162,800	169,500	
	Existing capacity(m3/d)	96,800	96,800	145,200	145,200	145,200	169,400	169,400	169,400	
	Additional capability(m3/d)	0	48,400	0	0	24,200	0	0	0	
	Total capacity(m3/d)	96,800	145,200	145,200	145,200	169,400	169,400	169,400	169,400	
⑤Faz Rio Grande	Qmax(m3/d)	0	0	0	0	0	0	0	0	
	Qave.(m3/d)	6,900	0	0	0	0	0	0	0	
	Existing capacity(m3/d)	18,200	18,200	18,200	18,200	18,200	18,200	18,200	18,200	
	Additional capability(m3/d)	0	0	0	0	0	0	0	6,100	
	Total capacity(m3/d)	18,200	18,200	18,200	18,200	18,200	18,200	18,200	24,200	
⑥Padilha Sul	Qmax(m3/d)	44,000	46,100	51,800	55,000	59,600	62,400	65,400	68,300	
	Qave.(m3/d)	29,600	30,700	32,900	35,200	37,400	39,800	41,800	43,900	
	Existing capacity(m3/d)	36,300	36,300	36,300	36,300	36,300	45,400	45,400	45,400	
	Additional capability(m3/d)	0	0	0	0	9,100	0	0	0	
	Total capacity(m3/d)	36,300	36,300	36,300	36,300	45,400	45,400	45,400	45,400	
⑦Belem	Qmax(m3/d)	289,100	291,000	296,500	302,900	313,400	320,400	327,700	334,900	
	Qave.(m3/d)	193,900	195,400	204,200	209,600	214,400	219,300	224,300	229,400	
	Existing capacity(m3/d)	72,600	72,600	72,600	217,800	217,800	217,800	217,800	217,800	
	Additional capability(m3/d)	0	0	145,200	0	0	0	0	0	
	Total capacity(m3/d)	72,600	72,600	217,800	217,800	217,800	217,800	217,800	217,800	
CMA Total	Qmax(m3/d)	731,100	740,600	803,700	850,600	879,300	907,400	929,400	951,300	
	Qave.(m3/d)	447,400	448,700	487,700	526,000	549,100	573,000	593,500	613,800	
	Existing capacity(m3/d)	308,910	308,910	405,710	599,310	599,310	632,610	632,610	632,610	
	Additional capability(m3/d)	0	96,800	193,700	0	33,300	0	0	12,270	
	Total capacity(m3/d)	308,910	405,710	599,310	599,310	632,610	632,610	632,610	644,680	
⑧Guaraquecaba	Qmax(m3/d)	7,400	0	0	0	0	0	0	0	
	Qave.(m3/d)	800	0	0	0	0	0	0	0	
	Existing capacity(m3/d)	3,100	3,100	3,100	3,100	3,100	3,100	3,100	3,100	
	Additional capability(m3/d)	0	0	0	0	0	0	0	0	
	Total capacity(m3/d)	3,100	3,100	3,100	3,100	3,100	3,100	3,100	3,100	
⑨Guaratuba	Qmax(m3/d)	25,800	0	0	0	0	0	0	0	
	Qave.(m3/d)	6,100	0	0	0	0	0	0	0	
	Existing capacity(m3/d)	18,200	18,200	18,200	18,200	18,200	18,200	18,200	18,200	
	Additional capability(m3/d)	0	0	0	0	0	0	0	12,100	
	Total capacity(m3/d)	18,200	18,200	18,200	18,200	18,200	18,200	18,200	30,300	
⑩Matinhos	Qmax(m3/d)	17,200	0	0	0	0	0	0	0	
	Qave.(m3/d)	7,000	0	0	0	0	0	0	0	
	Existing capacity(m3/d)	18,200	18,200	18,200	18,200	18,200	18,200	18,200	18,200	
	Additional capability(m3/d)	0	0	0	0	0	0	0	12,100	
	Total capacity(m3/d)	18,200	18,200	18,200	18,200	18,200	18,200	18,200	30,300	
⑪Morretes	Qmax(m3/d)	0	0	0	0	0	0	0	0	
	Qave.(m3/d)	2,500	0	0	0	0	0	0	0	
	Existing capacity(m3/d)	3,100	3,100	3,100	3,100	3,100	3,100	3,100	3,100	
	Additional capability(m3/d)	0	0	0	0	0	0	0	0	
	Total capacity(m3/d)	3,100	3,100	3,100	3,100	3,100	3,100	3,100	3,100	
⑫Pontal do parana	Qmax(m3/d)	10,000	0	0	0	0	0	0	0	
	Qave.(m3/d)	2,400	0	0	0	0	0	0	0	
	Existing capacity(m3/d)	12,100	12,100	12,100	12,100	12,100	12,100	12,100	12,100	
	Additional capability(m3/d)	0	0	0	0	0	0	0	12,100	
	Total capacity(m3/d)	12,100	12,100	12,100	12,100	12,100	12,100	12,100	24,200	
Coastal Total	Qmax(m3/d)	60,400	0	0	0	0	0	0	0	
	Qave.(m3/d)	18,800	0	0	0	0	0	0	0	
	Existing capacity(m3/d)	54,700	54,700	54,700	54,700	54,700	54,700	54,700	54,700	
	Additional capability(m3/d)	0	0	0	0	0	0	0	36,300	
	Total capacity(m3/d)	54,700	54,700	54,700	54,700	54,700	54,700	54,700	91,000	
Total	Qmax(m3/d)	791,500	740,600	803,700	850,600	879,300	907,400	929,400	951,300	
	Qave.(m3/d)	466,200	448,700	487,700	526,000	549,100	573,000	593,500	613,800	
	Existing capacity(m3/d)	363,610	363,610	460,410	654,010	654,010	687,310	687,310	687,310	
	Additional capability(m3/d)	0	96,800	193,700	0	33,300	0	0	48,570	
	Total capacity(m3/d)	363,610	460,410	654,010	654,010	687,310	687,310	687,310	735,680	

※1 is STP out of the target of the master-plan. The values are based on questionnaire.

※2 Red letters shows the insufficiency against the average daily flow.

3.2.2 Design effluent loading

Fig. 3.2.1 shows the design sewage flow and effluent pollutant loading calculated by influent pollutant concentration and removal rate, which means that the present treatment process is supposed to be continuously used in the future. Table 3.2.2 shows the result of calculation.

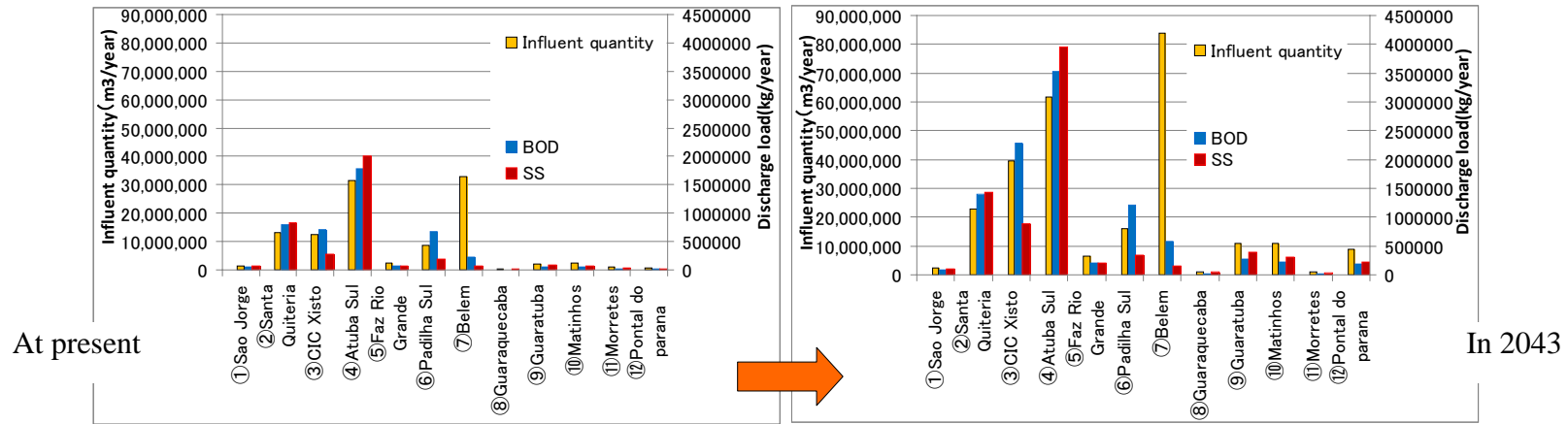

Fig.3.2.1 Design sewage flow and effluent pollutant loading in the case when the present treatment process is used in the future

Table 3.2.2 Effluent pollutant loading in 2043 when the present treatment process is continuously used in the future

STP	①Sao Jorge		②Santa Quitéria		③CIC Xisto		④Atuba Sul		⑤Faz Rio Grande		⑥Padilha Sul		⑦Belem		⑧Guaraquecaba		⑨Guaratuba		⑩Matinhos		⑪Morretes		⑫Pontal do parana					
	Flow rate (m³/year) in second column	quality	removal rate (%)	quality	removal rate (%)	quality	removal rate (%)	quality	removal rate (%)	quality	removal rate (%)	quality	removal rate (%)	quality	removal rate (%)	quality	removal rate (%)	quality	removal rate (%)	quality	removal rate (%)	quality	removal rate (%)	quality	removal rate (%)			
①Influent quality (mg/L)	BOD	256.0	-	217.0	-	249.0	-	193.0	-	402.0	-	349.0	-	238.0	-	105.0	-	71.6	-	62.4	-	37.6	-	44.6	-	61.6	-	
	SS	197.0	-	147.0	-	176.0	-	136.0	-	363.0	-	200.0	-	188.0	-	118.0	-	113.0	-	63.4	-	71.5	-	61.6	-	71.5	-	
	COD	424.0	-	366.0	-	474.0	-	377.0	-	563.0	-	591.0	-	429.0	-	182.0	-	134.0	-	56.6	-	106.0	-	75.1	-	106.0	-	
②UASB outlet (mg/L)	quality	(1)-(2)/(1)	quality	(1)-(2)/(1)	quality	(1)-(2)/(1)	quality	(1)-(2)/(1)	quality	(1)-(2)/(1)	quality	(1)-(2)/(1)	quality	(1)-(2)/(1)	quality	(1)-(2)/(1)	quality	(1)-(2)/(1)	quality	(1)-(2)/(1)	quality	(1)-(2)/(1)	quality	(1)-(2)/(1)	quality	(1)-(2)/(1)	quality	(1)-(2)/(1)
	BOD	54.3	77.0%	58.8	72.9%	93.8	62.3%	76.8	60.2%	74.8	81.4%	111.0	68.2%	-	-	100.0%	100.0%	-	-	100.0%	100.0%	100.0%	100.0%	100.0%	100.0%	100.0%	100.0%	100.0%
	SS	78.0	60.4%	69.0	53.1%	125.0	29.0%	87.5	35.7%	91.0	74.9%	82.0	59.0%	-	-	100.0%	100.0%	-	-	100.0%	100.0%	100.0%	100.0%	100.0%	100.0%	100.0%	100.0%	100.0%
③Effluent quality (mg/L)	COD	149.0	64.9%	166.0	54.6%	282.0	40.5%	184.0	51.2%	175.0	68.9%	261.0	55.8%	-	-	100.0%	100.0%	-	-	100.0%	100.0%	100.0%	100.0%	100.0%	100.0%	100.0%	100.0%	100.0%
	quality	(2)-(3)/(2)	quality	(2)-(3)/(2)	quality	(2)-(3)/(2)	quality	(2)-(3)/(2)	quality	(2)-(3)/(2)	quality	(2)-(3)/(2)	quality	(2)-(3)/(2)	quality	(2)-(3)/(2)	quality	(2)-(3)/(2)	quality	(2)-(3)/(2)	quality	(2)-(3)/(2)	quality	(2)-(3)/(2)	quality	(2)-(3)/(2)	quality	(2)-(3)/(2)
	BOD	28.9	28.4%	61.5	4.6%	57.7	38.5%	56.9	25.9%	30.6	59.1%	75.9	31.6%	6.9	-	22.0	-	25.2	-	19.8	-	18.9	-	22.1	-	22.1	-	
Total removal rate	SS	48.3	38.1%	63.0	8.7%	22.3	82.2%	64.0	26.9%	30.6	66.4%	21.7	73.5%	1.9	-	37.7	-	35.3	-	28.1	-	30.6	-	25.1	-	25.1	-	
	COD	117.0	21.5%	146.0	12.0%	131.0	53.5%	147.0	20.1%	79.6	54.5%	168.0	35.6%	21.8	-	46.6	-	57.2	-	46.3	-	33.8	-	52.4	-	52.4	-	
	quality	(1)-(3)/(1)	quality	(1)-(3)/(1)	quality	(1)-(3)/(1)	quality	(1)-(3)/(1)	quality	(1)-(3)/(1)	quality	(1)-(3)/(1)	quality	(1)-(3)/(1)	quality	(1)-(3)/(1)	quality	(1)-(3)/(1)	quality	(1)-(3)/(1)	quality	(1)-(3)/(1)	quality	(1)-(3)/(1)	quality	(1)-(3)/(1)	quality	(1)-(3)/(1)
Annual effluent loading (kg)	BOD	28.9	186,630	61.5	1,405,214	57.7	2,282,958	56.9	3,520,289	30.6	203,276	75.9	1,216,222	6.9	577,744	22.0	24,904	25.2	278,712	19.8	218,988	18.9	21,395	22.1	195,209	22.1	195,209	
	SS	48.3	107,664	63.0	1,439,487	22.3	882,322	64.0	3,959,552	30.6	203,276	21.7	347,121	1.9	159,089	37.7	42,676	35.3	390,418	28.1	310,786	30.6	34,639	25.1	225,242	25.1	225,242	
	COD	117.0	260,559	146.0	3,335,954	131.0	5,183,146	147.0	9,094,596	79.6	528,783	168.0	2,692,032	21.8	1,825,336	46.6	52,751	57.2	632,632	46.3	512,078	33.8	38,262	52.4	462,849	52.4	462,849	

As shown in the figure and table, the effluent pollutant loading in Santa Quiteria, CIC Xist, Atuba Sul increases remarkably due to increase of influent quantity and low removal rate of pollutant. In Belen STP, increase of the loading is not serious in spite of increase of influent quantity; it is because removal rate of pollutant is high.

3.2.3 Review of the treatment process

As shown in the estimation of design effluent loading, further increase of the loading from CMA into the Rio Iguacu is expected. Therefore, aerobic treatment process of which pollutant removal rate is high is recommended to adopt on the occasion of renovation of STPs.

3.3 Design factors

3.3.1 Design sewage flow

Table 3.3.1 shows the design sewage flow and influent quality and **Table 3.3.2** shows the pollutant removal rate by treatment process. The present values are used for both the quality and removal rate in the tables.

Table 3.3.1 Design flow rate and influent quality in 2034

		①Sao Jorge	②Santa Quiteria	③CIC Xisto	④Atuba Sul	⑤Faz Rio Grande	⑥Padilha Sul	⑦Belem
Ave.Inf.Quantity		6,100m ³ /d	62,600m ³ /d	108,400m ³ /d	169,500m ³ /d	18,200m ³ /d	43,900m ³ /d	229,400m ³ /d
Influent Water Quality (mg/L)	BOD	240	220	250	200	410	350	240
	SS	200	150	180	140	370	200	190
	COD	430	370	480	380	570	600	430

		⑧Guaraquecaba	⑨Guaratuba	⑩Matinhos	⑪Morretes	⑫Pontal do parana
Ave.Inf.Quantity		3,100m ³ /d	30,300m ³ /d	30,300m ³ /d	3,100m ³ /d	24,200m ³ /d
Influent Water Quality (mg/L)	BOD	110	80	40	70	50
	SS	120	120	70	80	70
	COD	190	140	60	110	80

Table 3.3.2 Pollutant removal rate by treatment process

	BOD	SS	COD
UASB	Inf.Water Quality×70%	Inf.Water Quality×50%	Inf.Water Quality×57%
DAF	UASB Out×17%	UASB Out×25%	UASB Out×18%
Lagoon(Aerobic)	UASB Out×73%	UASB Out×84%	UASB Out×67%
Lagoon(Anaerobic)	UASB Out×10%	UASB Out×64%	UASB Out×23%
OD	Inf.Water Quality×97%	Inf.Water Quality×99%	Inf.Water Quality×95%
UASB+Settling Tank	Inf.Water Quality×74%	Inf.Water Quality×63%	Inf.Water Quality×71%

: Actual data in STPs in SANEPAR

3.3.1.1 Aerobic treatment processes and design factors

Organic pollutants, i.e. BOD and COD are regarded as the target water quality in

consideration of effluent quality level required. Conventional activated sludge process is basically planned to adopt for sewage treatment in consideration of effective utilization of UASB tanks. Design factors of the treatment facilities are set as shown in **Table 3.3.3**.

Table 3.3.3 Design factors for conventional activated sludge process

Factor	Unit	Value in Design Manual	Values adopted
Surface loading in first settling tank	m ³ /m ² ·day	25~70 (separate sewer)	50
HRT in reaction tank	hour	6~8	6
Surface loading in second settling tank	m ³ /m ² ·day	20~30	20

The removal rate for each pollutant is set as shown in **Table 3.3.4**.

Table 3.3.4 Removal rate for each pollutant (conventional activated sludge process)

Process	BOD	SS	COD
Primary treatment	40	50	40
Secondary treatment	92.5	92.5	80
Total	95.5	96.3	88.0

(:%)

3.3.1.2 Evaluation of treatment capacity of existing treatment facilities

Table 3.3.5 shows the treatment capacity when the existing UASB tanks are converted to primary settling tank, reaction tank and secondary settling tank of conventional activated sludge (CAS) process.

Table 3.3.5 Treatment capacity in the case of conversion of UASB tanks to CAS

STP	Width (m)	Length (m)	Depth (m)	Water surface (m ²)	Volume (m ³)
Santa Quiteria	21.0	21.0	4.5	441	1,985
CIC Xist	20.0	20.0	4.6	400	1,840
Atuba Sul	21.0	21.0	4.5	441	1,985

(: per tank)

Table 3.3.6 shows the number of tank required in the case of conversion to CAS based on the tank volume indicated in **Table 3.3.5**. Number of tank for the conversion is insufficient in every STP as shown in the table. It means that shortage of site area is obvious for the conversion

of UASB tanks to CAS process.

Table 3.3.6 Number of tank required for the conversion to CAS

STP	Influent quantity (m ³ /day)	Primary settling tank	Reaction tank	Secondary settling tank	Insufficiency
Santa Quiteria	66,600	3	9	8	12
CIC Xist	108,900	5	15	14	21
Atuba Sul	169,400	8	21	19	24

3.3.1.3 Membrane biological reactor (MBR) process and its design factors

The MBR process is designed to be operated by constant flow rate; consequently equalization tank is commonly constructed. Even though because the operation of MBR against fluctuation of flow rate is its weak point, the CAS process will be used as far as site area permit and the combination use of CAS and MBR is proposed.

Fig. 3.3.1 shows the comparison of both treatment processes. Table 3.3.7 shows the design factors, Table 3.3.8 shows design influent and effluent quality and removal rate and Table 3.3.9 shows the number of tanks required in the combination use of both processes.

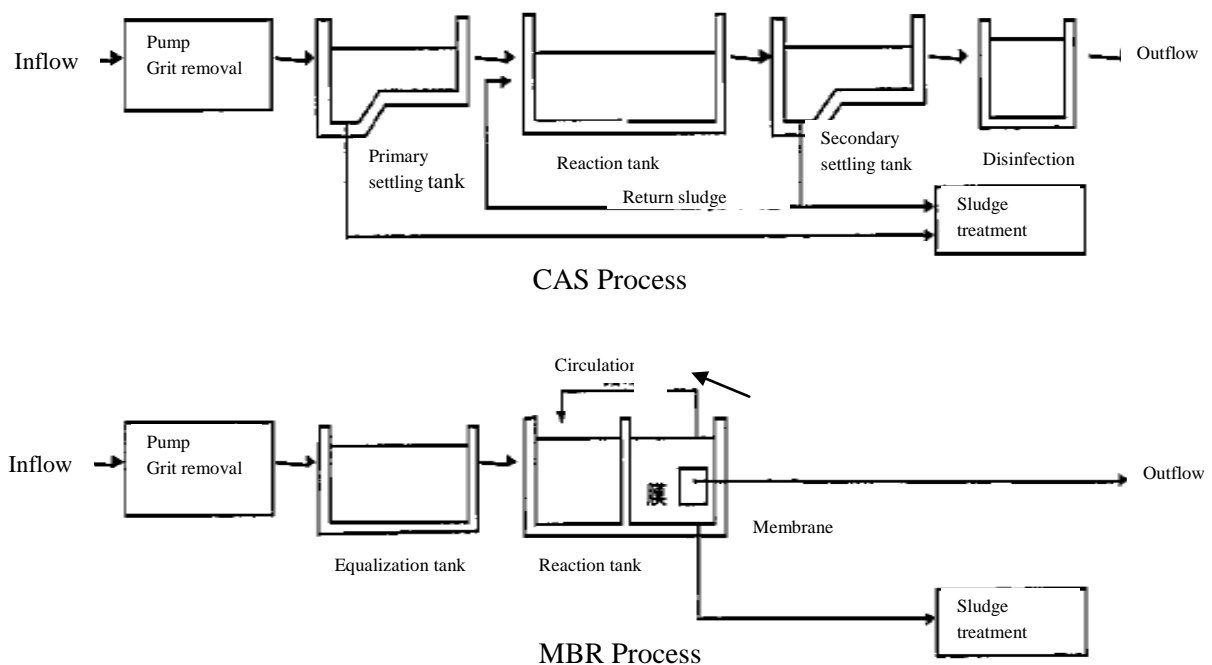

Fig.3.3.1 Comparison of CAS and MBR process

Table 3.3.7 Design factors

Parameter		Unit	Value in the Manual	Value adopted
HRT in reaction tank	Anaerobic tank	hours	3	3
	Aerobic tank		3	3

Table 3.3.8 Design influent and effluent quality and removal rate

	BOD	SS	Total nitrogen
Influent (mg/L)	200	200	35
Effluent (mg/L)	2.0	1.0	10
Removal rate (%)	99.0	99.5	71.4

* Influent and effluent quality and the removal rate is the standard value.

Table 3.3.9 Number of tanks required in the combination use of both processes

STP	Total capacity	Capacity in each process		Primary settling tank	Reaction tank	Secondary settling tank
		CAS	MBR			
Santa Quitéria	66,600	CAS	16,000	1	2	2
		MBR	50,600	-	5	-
CIC Xist	108,900	CAS	42,400	2	6	5
		MBR	66,500	-	9	-
Atuba Sul	169,400	CAS	32,000	2	4	4
		MBR	137,400	-	17	-

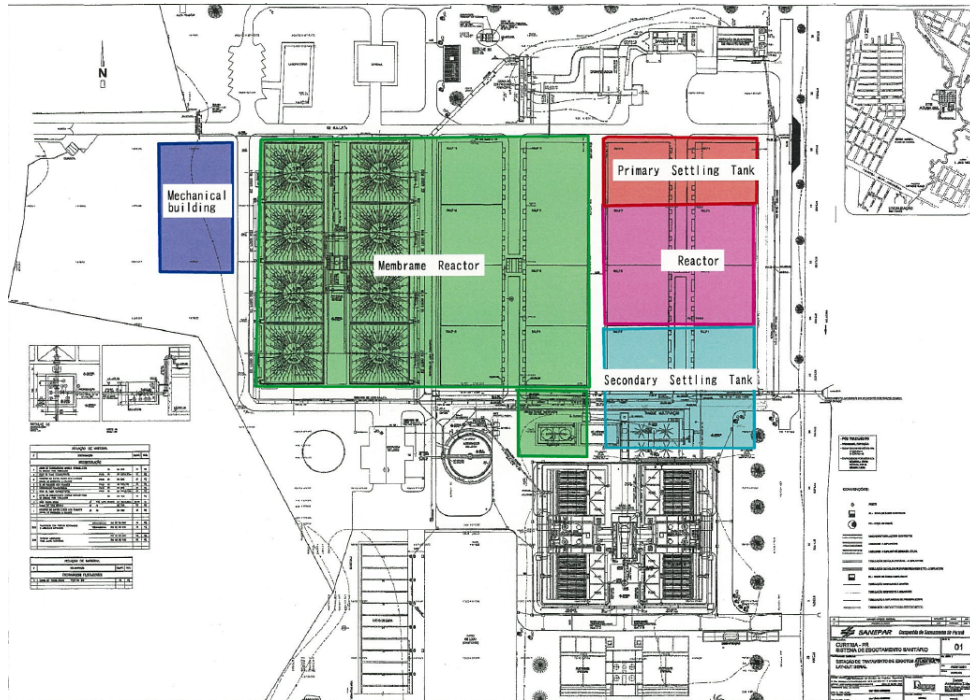

Fig. 3.3.4 Layout planning in Atuba Sul STP

3.3.2 Estimation of sludge volume generated

3.3.2.1 Estimation of sludge volume in present treatment process

(1) Estimation of waste sludge volume is based on removed SS volume and conversion of dissolved BOD to SS or autolysis is premised to be excluded.

Sludge volume from UASB (dry solid ton/day) =

$$\text{Design influent quantity} * \text{SS removal rate of SS in UASB} * 10^{-6}$$

Waste sludge volume (dry solid ton/day) =

$$\text{Design influent quantity} * \{ \text{design inflow SS Conc.} * (1 - \text{SS removal rate in UASB}) * \text{SS removal rate in FAD or Lagoon} \} * 10^{-6}$$

(2) Design influent SS concentration in each STP is as shown in **Table 3.3.1**. Treatment capacity of sludge treatment facilities is estimated based on the design influent quality with 20% of surplus by circulating water from sludge treatment process.

(3) SS removal rate in UASB is set at 50%, the actual average value.

(4) Other SS removal rate is as shown in **Table 3.3.2**.

(5) Concentration and recovery rate of every kinds of sludge is as shown in Table 3.3.10 below.

Table 3.3.10 Concentration and recovery rate of every kinds of sludge

Sludge	Value	Remark
Sludge generation rate by removed SS	75%	OD process
Thickened sludge concentration in UASB	5.5%	Based on actual average value in SANEPAR
Waste sludge concentration	5.5%	ditto
Water content of dehydrated sludge	77.1%	ditto

The result of estimation of sludge volume is shown in **Table 3.3.11**.

Table 3.3.11 Result of estimation of sludge volume

STP	①Sao Jorge	②Santa Quiteria	③CIC Xisto	④Atuba Sul	⑤Faz Rio Grande	⑥Padilha Sul	⑦Belem	⑧Guaraquecaba	⑨Guaratuba	⑩Matinhos	⑪Morretes
Sludge volume (m ³ /day)	3,622	35,757	33,851	86,149	6,808	24,071	90,236	738	6,065	6,903	2,445
②Design SS conc. (mg/l)	236	176	211	163	436	240	226	142	136	76	86
③SS removal rate in UASB (%)	60.4%	53.1%	29.0%	35.7%	74.9%	59.0%	0.0%	52.0%	52.0%	52.0%	52.0%
④Design effluent Ss conc. (mg/l)	48.3	63	22.3	64	30.6	21.7	1.9	37.7	35.3	28.1	30.6
⑤Thickened sludge conc. in UASB (%)	7.1%	4.4%	5.0%	5.8%	7.9%	6.1%	1.0%	6.0%	6.0%	6.0%	6.0%
⑥Waste sludge conc. (%)	7.1%	4.4%	5.0%	5.8%	0.8%	0.8%	2.7%	0.8%	0.8%	0.8%	0.8%
⑦Sludge volume in UASB = ①×②×③/106 (t-Ds/day)	0.5	3.3	2.1	5.0	2.2	3.4	0.0	0.1	0.4	0.3	0.1
⑧Wastesludge = ①× (②-④) /10 ⁶ -⑦ (t-Ds/day)	0.2	0.7	4.3	3.5	0.5	1.8	20.2	0.0	0.2	0.1	0.0
a Moisture content of dehydrated sludge	50.0%	81.1%	79.6%	80.0%	82.5%	74.9%	85.2%	75.0%	75.0%	75.0%	75.0%
⑨Dehydrated sludge = (⑦+⑧)/(100-a)×100 (m ³ /day)	1.4	21.4	31.3	42.6	15.8	20.9	136.6	0.3	2.4	1.3	0.5
⑩Primary sludge = ⑦/⑤ (m ³ -WB/day)	7	77	42	86	28	56	0	1	7	5	2
⑪Waste sludge = ⑧/⑥ (m ³ -WB/day)	2	16	86	61	67	231	749	3	23	7	3
⑫Sludge volume generated = ⑩+⑪ (m ³ -WB/day)	10	93	128	147	95	287	749	4	30	12	5
Average influent SS conc.	197	147	176	136	363	200	188	118	113	63	72
Scale factor regarding circulation water	1.2	1.2	1.2	1.2	1.2	1.2	1.2	1.2	1.2	1.2	1.2
Design sludge volume in a month (m3/M)	296	2,874	3,966	4,554	2,953	8,892	23,218	115	926	365	158
Design dehydrated sludge volume (m3/M)	42	663	971	1,322	489	649	4,236	10	76	41	17
Actual sludge volume (m3/M)	84	863	277	1,279	280	1,146	13,574				
Actual dehydrated sludge volume (m3/M)	61	207	42	416	47	317	2,912				

3.3.2.2 Estimation of sludge volume generated in aerobic treatment process

(1) Estimation of waste sludge volume is based on removed SS volume and conversion of dissolved BOD to SS or autolysis is premised to be excluded.

Sludge volume from UASB (dry solid ton/day) =

$$\text{Design influent quantity} * \text{SS removal rate of SS in UASB} * 10^{-6}$$

Waste sludge volume (dry solid ton/day) =

$$\text{Design influent quantity} * \{ \text{design inflow SS Conc.} * (1 - \text{SS removal rate in UASB}) * \text{SS removal rate in FAD or Lagoon} \} * 10^{-6}$$

(2) Design influent SS concentration in each STP is as shown in **Table 3.3.12**. Treatment capacity of sludge treatment facilities is estimated based on the design influent quality with 20% of surplus by circulating water from sludge treatment process.

(3) SS removal rate in primary settling tank is set at 50%.

(4) Overall SS removal rate in reaction tank and secondary settling tank is premised at 92.5% and that in MBR is at 99.5%.

(5) Concentration and generation rate of types of sludge is premised as shown in **Table 3.3.12**.

Table 3.3.12 Concentration and generation rate of types of sludge

Types of sludge	Value (%)	Process
Sludge generation rate by removed SS	100	CAS
Concentration of primary sludge	2.0	ditto
Concentration of waste sludge	0.8	ditto
Sludge generation rate by removed SS	64	MBR
Concentration of waste sludge	1.2	ditto
Moisture rate of dehydrated sludge	78	-

(6) In consideration of future centralization of sludge treatment, sludge generation rate important for deciding diameter of sludge pipe etc. is estimated based on the design influent SS concentration.

The result of estimation of types of sludge generation rate in aerobic treatment is shown in **Table 3.3.13**.

Table 3.3.13 Estimation of types of sludge generation rate in aerobic treatment

STP Sludge volume	②Santa Quiteria		③CIC Xisto		④Atuba Sul		Total
	CAS	MBR	CAS	MBR	CAS	MBR	
①Daily average flow rate (m ³ /day)	12,000	50,600	41,900	66,500	32,100	137,400	340,500
②Design SS conc. (mg/l)	180	180	220	220	170	170	
③SS removal rate in primary settling tank (%)	50.0%		50.0%		50.0%		
④secondary treatment	92.5%	99.5%	92.5%	99.5%	92.5%	99.5%	
⑤Overall removal rate 100-(100-③) ×(100-④)	96.3%	99.5%	96.3%	99.5%	96.3%	99.5%	
⑥Effluent SS conc. (mg/l)	7	1	9	2	7	1	
⑦Primary sludge conc. (%)	2.0%		2.0%		2.0%		
⑧Waste sludge conc. (%)	0.8%	1.2%	0.8%	1.2%	0.8%	1.2%	
⑨Sludge generation rate by removed sludge	100.0%	64.0%	100.0%	64.0%	100.0%	64.0%	
⑩Primary sludge volume ⑩ = ①×②×⑦/100×⑨ (t-Ds/day)	1.1	0.0	4.6	0.0	2.7	0.0	8
⑪Waste sludge volume ⑪=①× (②-⑥) /100×⑨-⑩ (t-Ds/day)	1.0	5.8	4.2	9.3	2.5	14.9	38
a Moisture content of dehydrated sludge	78.0%	78.0%	78.0%	78.0%	78.0%	78.0%	
⑫Dehydrated sludge volume ⑫=(⑩+⑪)/(100-a)×100 (m ³ /day)	9.4	26.3	40.2	42.2	23.8	67.6	209
⑬primary sludge volume ⑬ = ⑩ / ⑦ (m ³ -WB/day)	54.0		230.5		136.4		421
⑭Waste sludge volume ⑭ = ⑪ / ⑧ (m ³ -WB/day)	124.5	483.1	529.0	773.2	313.0	1,238.4	3,461
⑮Generated sludge volume ⑮ = ⑬ + ⑭ (m ³ -WB/day)	178.5	483.1	759.4	773.2	449.4	1,238.4	3,882
Average influent SS conc.	150	150	180	180	140	140	
Scale factor regarding circulation water	1.2	1.2	1.2	1.2	1.2	1.2	
Design sludge volume in a month (m ³ /M)	4,641	12,560	19,745	20,103	11,684	32,199	100,932
Design dehydrated sludge volume (m ³ /M)	245	685	1,045	1,097	618	1,756	5,446
Actual sludge volume (m ³ /M)	863		277		1,279		2,419
Actual dehydrated sludge volume (m ³ /M)	207		42		416		665

4. Renovation program of sewage treatment plants

4.1 Basic idea

4.1.1 Outlooks of renovation program

Based on the current situation and issues of STPs, the renovation program of STPs is set up as following ideas.

4.1.1.1 Idea in the first stage

- (1) Extension of facilities shall be preceded in Santa Quiteria, CIC Xist, Atuba Sul and Belem STP where treatment capacity will be insufficient based on the Master-plan. Existing plan for expansion of sludge treatment in STPs also be preceded.
- (2) Rehabilitation of mechanical and electrical equipment including installation of stand-by shall be implemented for screen, grit removal facility and sludge dehydrator etc. which is now under trouble.
- (3) Civil construction and/or expansion required for installation of stand-by machines also shall be implemented.
- (4) Installation of sludge pump in UASB tank and rehabilitation of sludge thickener and storage tank shall be carried out.
- (5) Anti-concrete corrosion works for outlet channel and upper floor of UASB tanks shall be implemented in turn in consideration of decline of treatment capacity during the works.
- (6) Aeration facility shall be installed in all lagoon and establish sludge dredging, storage and dehydration process.
- (7) Deodorization facility shall be installed in Padilha Sul STP where aerobic treatment process is not planned to be adopted and Atuba Sul STP where conversion construction to aerobic process is set behind the other STPs.
- (8) Effluent water quality standard shall be kept in all STP by systematization of sewage and sludge treatment process mentioned above.

4.1.1.2 Idea in the second stage

- (1) Effluent pollutant loading shall be reduced in CMA based on the current water quality in discharging rivers.
- (2) Reconstruction project with combination of CAS and MBR shall be commenced in Santa Quiteria, CIC Xist and Atuba Sul STP where effluent pollutant loading is exceedingly larger than other STPs.
- (3) Renovation project of facilities shall be carried out avoiding decline of existing treatment capacity as much as possible.

4.1.1.3 Idea in the third stage

- (1) Sludge volume in 2043 in CMA is estimated circa 450m³/day when anaerobic treatment is continuously used while that is estimated circa 550m³/day when aerobic treatment is adopted in 3 STPs.
- (2) Transfer of sludge in 2028 shall be considered in Belem and Atuba Sul STP where thermal drying of sludge is now under planning.
- (3) In order to cope with the transfer above, centralization treatment of sludge shall be considered. CIC Xist STP where the site area is the largest among STPs in CMA shall be proposed for the centralization site.
- (4) Centralization of sludge treatment shall be established by pumping thickened sludge from Santa Quiteria, Atuba Sul, Padilha Sul and Belem STP to the proposed site. 2 pipes shall be laid for transferring sludge and a pipe for returning filtrate also shall be prepared. Dehydrated sludge shall be transferred from the other STPs to the site.
- (5) Recycling water from sludge treatment process generated in the site shall be returned and treated in Santa Quiteria, Atuba Sul , Padilha Sul and Belem.
- (6) Sludge volume reduction by thickening, dehydration and incineration shall be implemented in the centralization site and incinerated ash shall basically be transferred to disposal site. As for beneficial use of sludge, raw material of cement and roadbed material (in the case of stoker furnace) shall be considered.
- (7) Dehydration of sludge generated in 4 STPs in the coastal area, i.e. Guaratuba, Matinhos, Morretes and Pontal do Parana can be managed by 4m³/hr of dehydration capacity; consequently mobile dehydration system shall be adopted into the 4 STPs.

4.2 Renovation Program in 12 STPs

Based on the condition above, renovation program on target 12 STPs is prepared as shown in **Table 4.2.1**.

Table 4.2.1 Renovation program on target 12 STPs

		year																																
		2013	2014	2015	2016	2017	2018	2019	2020	2021	2022	2023	2024	2025	2026	2027	2028	2029	2030	2031	2032	2033	2034	2035	2036	2037	2038	2039	2040	2041	2042	2043		
①Sao Jorge 2003	Qmax(m3/d)	0	0	0	0	0	0	0	0	0	0	0	0	0	0	0	0	0	0	0	0	0	0	0	0	0	0	0	0	0	0			
	Qave(m3/d)	3,700	0	0	0	0	0	0	0	0	0	0	0	0	0	0	0	0	0	0	0	0	0	0	0	0	0	0	0	0	0			
	Existing capacity(m3/d)	6,100	6,100	6,100	6,100	12,200	12,200	12,200	12,200	12,200	12,200	12,200	12,200	12,200	12,200	12,200	12,200	12,200	12,200	12,200	12,200	12,200	12,200	12,200	12,200	12,200	12,200	12,200	12,200	12,200	12,200			
	Additional capacity(m3/d)	0	0	0	6,100	0	0	0	0	0	0	0	0	0	0	0	0	0	0	0	0	0	0	0	0	0	0	0	0	0	0	0		
	Total capacity(m3/d)	6,100	6,100	6,100	12,200	12,200	12,200	12,200	12,200	12,200	12,200	12,200	12,200	12,200	12,200	12,200	12,200	12,200	12,200	12,200	12,200	12,200	12,200	12,200	12,200	12,200	12,200	12,200	12,200	12,200	12,200	12,200		
	Expansion	Screen (mechanical)				Second unit																												
		Grit chamber				Second unit																												
		UASB				6,100																												
		Floatation																																
		Sludge storage																																
	centrifugal dehydrator																																	
	Lift pump																																	
	Lift pump																																	
	Screen (mechanical)																																	
	Grit chamber																																	
	UASB Sludge removal pump																																	
	UASB anticorrosion of concrete																																	
	DAF control unit																																	
	Existing capacity(m3/d)	6,100	6,100	6,100	12,200	6,100	12,200	12,200	12,200	12,200	12,200	12,200	12,200	12,200	12,200	12,200	12,200	12,200	12,200	12,200	12,200	12,200	12,200	12,200	12,200	12,200	12,200	12,200	12,200	12,200	12,200	12,200		
	Qave(m3/d)	3,700	3,700	3,700	3,700	3,700	3,700	3,700	3,700	3,700	3,700	3,700	3,700	3,700	3,700	3,700	3,700	3,700	3,700	3,700	3,700	3,700	3,700	3,700	3,700	3,700	3,700	3,700	3,700	3,700	3,700			
	Sludge volume generated (m3-WB/d)	21	21	21	21	21	21	21	21	21	21	21	21	21	21	21	21	21	21	21	21	21	21	21	21	21	21	21	21	21	21			
	5.5%	5.22	5.22	5.22	5.22	5.22	5.22	5.22	5.22	5.22	5.22	5.22	5.22	5.22	5.22	5.22	5.22	5.22	5.22	5.22	5.22	5.22	5.22	5.22	5.22	5.22	5.22	5.22	5.22	5.22	5.22			
	4m3/h	0.4	0.4	0.4	0.4	0.4	0.4	0.4	0.4	0.4	0.4	0.4	0.4	0.4	0.4	0.4	0.4	0.4	0.4	0.4	0.4	0.4	0.4	0.4	0.4	0.4	0.4	0.4	0.4	0.4	0.4			
	Dehydrator number 7hrs in one day and 6days in a week																																	
	Qmax(m3/d)	74,500	75,900	76,725	77,550	78,375	79,200	79,740	80,280	80,820	81,360	81,900	82,440	82,980	83,400	83,900	84,400	85,020	85,640	86,260	86,880	87,500	88,080	88,660	89,240	89,820	90,400	90,980	91,560	92,140	92,720			
	Qave(m3/d)	48,600	50,200	50,875	51,550	52,225	52,900	53,360	53,820	54,280	54,740	55,200	55,540	55,880	56,220	56,560	56,900	57,280	57,660	58,040	58,420	58,800	59,180	59,560	59,940	60,320	60,700	61,080	61,460	61,840	62,220			
	Existing capacity(m3/d)	36,300	36,300	48,400	48,400	48,400	48,400	48,400	66,600	66,600	66,600	66,600	66,600	66,600	66,600	66,600	66,600	66,600	66,600	66,600	66,600	66,600	66,600	66,600	66,600	66,600	66,600	66,600	66,600	66,600	66,600			
	Additional capacity(m3/d)	0	12,100	0	0	0	18,200	0	0	0	0	0	0	0	0	0	0	0	0	0	0	0	0	0	0	0	0	0	0	0	0			
	Total capacity(m3/d)	36,300	48,400	48,400	48,400	48,400	66,600	66,600	66,600	66,600	66,600	66,600	66,600	66,600	66,600	66,600	66,600	66,600	66,600	66,600	66,600	66,600	66,600	66,600	66,600	66,600	66,600	66,600	66,600	66,600	66,600			
②Santa Quitéria 1998	Expansion	Screen (mechanical)				Second unit																												
		Grit chamber				Second unit																												
		UASB				12,100																												
		Floatation																																
		Sludge storage																																
		Lift pump																																
		Lift pump																																
		Screen (mechanical)																																
		Grit chamber																																
		UASB Sludge removal pump																																
	UASB anticorrosion of concrete																																	
	DAF control unit																																	
	Membrane Reactor								18,200	12,100	12,100																							
	Blower etc.																																	
	Primary Settling tank																																	
	Reactor																																	
	Final Settling tank																																	
	Sludge Transportation Pump																																	
	Sludge Transportation Pipe																																	
	Existing capacity(m3/d)	36,300	48,400	48,400	48,400	48,400	66,600	54,500	54,500	60,550	48,450	48,450	66,600	66,600	66,600	66,600	66,600	66,600	66,600	66,600	66,600	66,600	66,600	66,600	66,600	66,600	66,600	66,600	66,600	66,600	66,600			
	UASB(m3/d)	36,300	48,400	48,400	48,400	48,400	48,400	18,200	18,200	34,333	50,467	50,467	50,467	50,467	50,467	50,467	50,467	50,467	50,467	50,467	50,467	50,467	50,467	50,467	50,467	50,467	50,467	50,467	50,467	50,467	50,467			
	Membrane Reactor(m3/d)																																	
	Reactor(m3/d)																																	
	Sludge volume generated (m3-WB/d)	55	74	74	74	74	248	229	365	510	491	722	722	722	722	722	722	722	722	722	722	722	722	722	722	722	722	722	722	722	722			
③CIC Xisto 2002	Qmax(m3/d)	98,600	101,600	106,225	110,850	115,475	120,100	126,020	131,940	137,860	143,780	149,700	150,900	152,100	153,300	154,500	155,700	156,700	157,700	158,700	159,700	160,700	161,600	162,500	163,400	164,300	165,200	166,120	167,040	167,960	168,880	169,800		
	Qave(m3/d)	61,400	63,100	65,525	67,950	70,375	72,800	75,640	78,480	81,320	84,160	87,000	88,180	89,360	90,540	91,720	92,900	94,200	95,500	96,800	98,100	99,400	100,300	101,200	102,100	103,000	103,900	104,800	105,700	106,600	107,500	108,400		
	Existing capacity(m3/d)	42,400	42,400	78,700	78,700	78,700	78,700	78,700	109,000	109,000	109,000	109,000	109,000	109,000	109,000	109,000	109,000	109,000	109,000	109,000	109,000	109,000	109,000	109,000	109,000	109,000	109,000	109,000	109,000	109,000	109,000	109,000		
	Additional capacity(m3/d)	0	36,300	0	0	0	30,300	0	0	0	0	0																						

A11-5 再生水利用のための高度処理施設導入の実現可能性に係る調査結果

February, 2014

Results of Feasibility Study for Introducing Advanced Treatment to Use Reclaimed Water

JICA Expert Team

1. Background of Reclaimed Water Use

CURITIBA city, where average altitude ranges 900m, has been origins of major rivers. That is why the city has to obtain water resource from Assungui river which is approximately 100 km near the boundary of Parana state. The altitude difference ranges up to 500m. Water resource is lifted over those altitude difference and used for drinking water resource.

On the other hand, the southern part of the city near CIC Xisto STP, there is an industrial area related with oil industry. And needs for industrial water supply is high. SANEPAR already has industrial water supply service for this area. SANEPAR constructed Araucaria industrial water plant (300 liter per second, 25920 m³/day. 5.7 km from request site) that intake raw water from Iguace river and supply industrial water to the industrial area.

However, recently degree of water pollution has been prevailed in Iguace river. Many complaints come to the plant and some of the factories cancelled buying the existing industrial water and changed to use drinking water instead.

To those problems, SANEPAR has an idea to upgrade effluent water quality of CIC Xisto STP drastically and utilize its effluent as industrial water and would reduce water resource now used for industrial use and keep it for future population increase.

Based on those situations, this research has done a feasibility study to upgrade existing final effluent of CIC Xisto STP and supply it as industrial water to make clear what kind of problems are assumed as well as what consideration of solution strategy and expected expenses are to be made.

2. Content of project assumed by the feasibility study

(1) Content of project assumed

Reuse water produced by advanced treatment process of sewage treatment of CIC Xisto STP is to be supplied to nearby factory which locate 2.2 km apart from CIC Xisto STP

(2) Supposed scale of project

Scale of project is supposed 400 l/sec (34,560 cubic meter per day)

Dimension of treatment facilities of CIC Xisto is as follows. Noticeably CIC Xisto STP will actually become a specific industrial water plant that produce industrial water from sewage.

Existing treatment capacity : 490 l/sec (42,336 cubic meter per day)

Average treatment capacity : 440 l/sec (38,000 cubic meter per day)

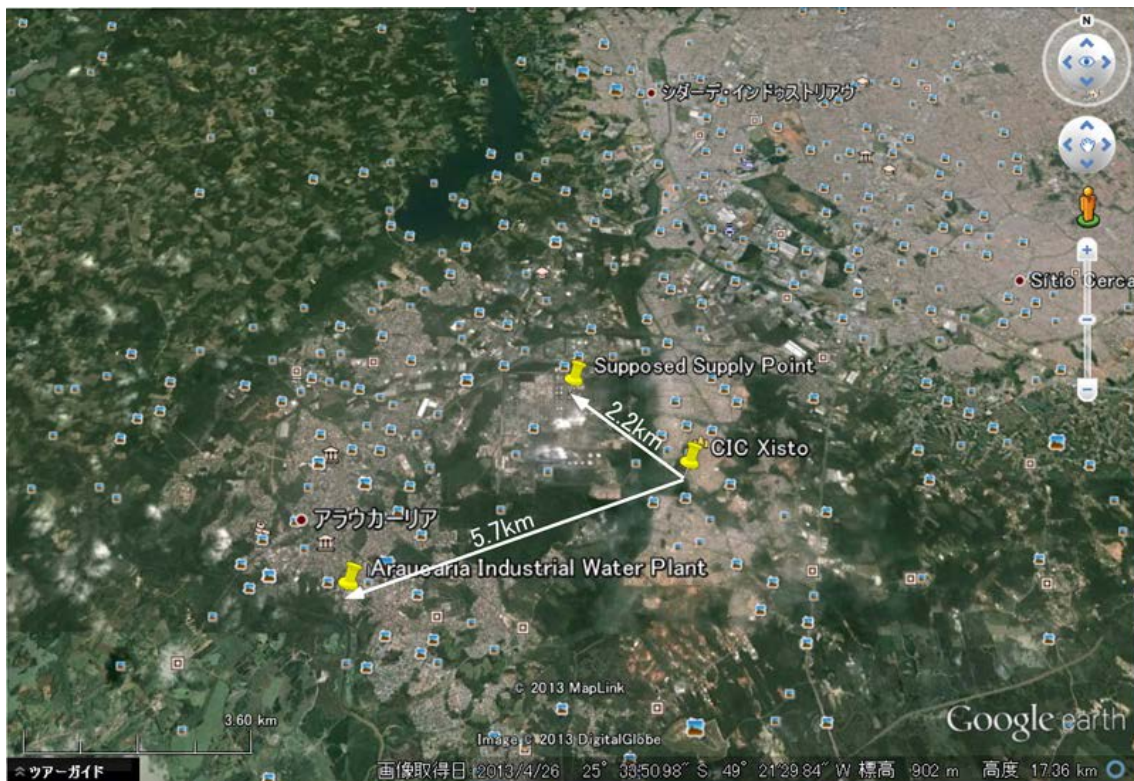

3. Contents of research work

(1) Required water quality for existing industrial water

Beginning of industrial water works in Japan was started as one of major countermeasures against land subsidence since pump up of ground water by industries caused land subsidence of surrounding area. Industrial water works has started from 1955's. Recently the number tends to decrease though, still 131 water works are still being operated in Japan ("Industrial water works handbook 1996", p.92)

Generally speaking, needs for quality of industrial water depends on the process used for. However, upgrading of water quality corresponds to increase of process cost. Normally, estimate has been made as an allowable limit as "Standard Water Quality for Industrial Water Supply" as listed in Table 1. ("Industrial Water Handbook 1996",

p280) Furthermore in Japan, those supplied industrial water in many cases will be treated further inside the factory to the necessary quality level corresponding to the process in which the water is used.

Table 1 Standard Water Quality for Industrial Water Supply in Japan

Component	Unit	Standard	Notes
Turbidity	Degree	20	
p H	-	6.5~8.0	
Alkalinity	mg/L	75	CaCO ₃
Total Hardness	mg/L	120	CaCO ₃
Total Solid	mg/L	250	
Chloride Ion	mg/L	80	
Fe	mg/L	0.3	
Mn	mg/L	0.2	

Recent water quality situations of Araucaria WTP are summarized in Table 2. Red characters indicate water quality problems now rising. The water quality values were the ones that obtained when visiting the WTP (June 10th, 2013). The view of JICA experts were listed on the comment column.

Table 2 Recent Water Quality Situations of Araucaria WTC

	Raw Water Maximum Limit	Supply Water Maximum Limit	Raw Water (Present)	Supply Water (Present)	Comment
Surface Active Agent (mg/l ABS)	0.2	0.2	0.64	0.37	Insufficient removal rate of existing water treatment process, in spite of high concentrations in raw water is evident for surface active agent.
Total Alkalinity (mg/l CaCO ₃)	80	50	40	27.33	
Free Carbonic Acid (mg/l CO ₂)	13	20			
Ca (mg/l Ca)	15	20			
CN (mg/l CN)	0.1	0.1			
Cl (mg/l Cl)	28	40	9.66	21.66	

Electric Conductivity ($\mu\text{S}/\text{cm}$)	200	400			On the plant survey, explanation was made as so many claims had come as to the saline content. However, electric conductivity has not been measured daily. Daily analysis should be established.
Color (μH)	65	10	351.75	8.25	At the time of visit, rise of color in raw water was remarkable. Existing process showed treatment capability which is able to treat barely under allowable limit.
Total Hardness (mg/CaCO_3)	70	100			
Phenol (mg/l)	0.1	0.1			
F ($\text{mg}/\text{l F}$)	0.1	0.1		0	
Mg (mg/l)	5	5			
TOC (mg/l)	6	3		0	
NO ₃ ($\text{mg}/\text{l NO}_3$)	1	1			
NO ₂ ($\text{mg}/\text{l NO}_2$)	1	0.2			
pH	6.2-8.2	6.2-8.2	7.05	6.84	
SS (mg/l)	50	2			
TS (mg/l)	270	192			
Soluble Matter (mg/l)	220	190			
SO ₄ (mg/l)	14	50	6	37	
Turbidity (NTU)	10	2	32.44	0.25	Increase in raw water is remarkably higher than previous. However, existing treatment process has been able to correspond and keep it under allowable limit.
BOD (mg/l)	9	3			
COD (mg/l)	26	8			
T-P ($\text{mg}/\text{l P}$)	0.8	0.1	0.69	0.05	
NH ₃ -N ($\text{mg}/\text{l N}$)	1	2			
T-N ($\text{mg}/\text{l N}$)	2	5			
Oil (mg/l)	10	3			
Al ($\text{mg}/\text{l Al}$)	0.2	0.1	0.07	0.02	
As ($\text{mg}/\text{l As}$)	0.1	0.1			
Ba ($\text{mg}/\text{l Ba}$)	0.2	0.1			
Cd ($\text{mg}/\text{l Cd}$)	0.1	0.1			
Pb ($\text{mg}/\text{l Pb}$)	0.1	0.1			

Cu (mg/l Cu)	0.1	0.05			
Cr (mg/l Cr)	0.1	0.1			
Total Fe (mg/l Fe)	0.1	0.1	2.34	0.1	Increase in raw water is remarkably higher than previous. However, existing treatment process has been able to correspond and keep it under allowable limit.
Mn (mg/l Mn)	0.1	0.1	0.19	0.01	Increase in raw water is remarkably higher than previous. However, existing treatment process has been able to correspond and keep it under allowable limit.
Hg (mg/l Hg)	0.1	0.1			
K (mg/l K)	6	6			
Ag (mg/l Ag)	0.1	0.1			
Se (mg/l Se)	0.1	0.1			
SiO ₂ (mg/l SiO ₂)	12	12			
Na (mg/l Na)	25	30			
Zn (mg/l Zn)	0.1	0.1			

"Raw Water Maximum Limit" is preset value for allowable set limit for raw water for Araucaria WTP, "Supply Water Maximum limit" is preset allowable limit for supply water from the WTP.

By comparing Table 1 of Japanese standard with Table 2 of supply water maximum limit of Araucaria, one can easily see that in all components standard of Araucaria has been set more strict than in Japan including "Turbidity", "Alkalinity", "Total Hardness", "Total Solid", "Chloride Ion", "Fe", "Mn" and et. al. One should know that needs for water quality for this area are extensively higher than those in Japan.

In addition, viewing requirements from users of industrial water to Araucaria WTP at present, foam build-up by "Surface Active Agent" and corrosion effect increase caused by "Electric Conductivity" and "Soluble Matter" is the major subject to be solved.

(2) Target water quality of water works under consideration

Based on the above results, target water quality of water works under consideration was set as in Table 3 to solve those existing problems. However, for T-N, higher value than the supply water limit of Araucaria was set to reflect reality..

Table 3 Target water quality

Component	Unit	Target	Basis of target setting
-----------	------	--------	-------------------------

		water quality	
Surface Active Agent	mg/L	0.2	Supply Water Maximum Limit of Araucaria
Turbidity	degree	2	Supply Water Maximum Limit of Araucaria
p H	-	6.2 - 8.2	Supply Water Maximum Limit of Araucaria
Alkalinity	mg/L	50	Supply Water Maximum Limit of Araucaria
Total Hardness	mg/L	100	Supply Water Maximum Limit of Araucaria
Total Solid	mg/L	192	Supply Water Maximum Limit of Araucaria
Suspended Solid	mg/L	2	Supply Water Maximum Limit of Araucaria
Soluble Matter	mg/L	190	Supply Water Maximum Limit of Araucaria
Electric Conductivity	uS/cm	200	Supply Water Maximum Limit of Araucaria
COD	mg/L	8	Supply Water Maximum Limit of Araucaria
BOD	mg/L	2	Tentative
T-N	mg/L	8	Tentative

(3) Consideration of advanced treatment process to up to reclaimed water supply

Before considering advanced treatment process for supposed water works, final effluent of CIC Xisto was taken for analysis on July 4th, 2013 to face the present situations. Table 4 shows the results.

Table 4 Final effluent quality of CIC Xisto STP

Component	Unit	Result of analysis
Turbidity	degree	59
p H	-	6.84

Alkalinity	mg/L	180
Total Hardness	mg/L	80
Total Solid	mg/L	295
Suspended Solid	mg/L	32
Soluble Matter	mg/L	263
Electric Conductivity	µS/cm	674
COD	mg/L	134

By comparing results of analysis of CIC Xisto effluent of Table 4 with "Raw Water Maximum Limit" of Table 2, effluent of CIC Xisto now indicates higher value than raw water of Araucaria by

- Turbidity 6 times,
- Alkalinity 2 times,
- Electric Conductivity 3 times,
- COD 5 times.

The results shows at least the final effluent of the STP ranges higher than existing river water quality by above four components. Especially saline concentration and organic matter represented by COD should be the major subject of water quality problems. This indicates that even when introducing reclaimed water treatment process to CIC Xisto STP, a similar type of treatment process, physical-chemical process would be poor in feasibility. than comparing to upgrade Araucaria WTP.

So only one possibility should be the one that introduces drastic advanced treatment process to CIC Xisto and upgrade its effluent extensively.

Following removal necessities in supposed advanced treatment in CIC Xisto STP are summarized in Table 5.

Table 5 Raw water and target reclaimed water quality and estimated removal rate of CIC Xisto

Component	Unit	Assumed Raw Water Quality 1)	Estimated Reclaimed Water Quality	Removal Rate
Surface active agent	mg/L		0.2	
Turbidity	degree		2	
p H	-	7.2	6.2 - 8.2	

Alkalinity	mg/L		50	
Total Hardness	mg/L		100	
Total Solid	mg/L		192	
Suspended Solid	mg/L	228	2	99.1
Soluble Matter	mg/L		190	
Electric Conductivity	μS/cm	674 ²⁾	200	70.3
COD	mg/L	633	8	98.7
BOD	mg/L	290	2	99.3
T-N	mg/L	51	8	84.3

1) Results of analysis on 2012/11/7

2) Supposed to be of the same value as analyzed for final effluent on 2013/7/4

From Table 5, advanced treatment process should have

"more than 99% of organic matter including surface active agent"

"more than 84% of removal rate for nitrogen"

"more than 70% of removal rate for total solid and electric conductivity".

(4) Selection of treatment process (Part 1)

As to the performance of advanced treatment processes, required treatment criteria are being provided under article 5-5 of enforcement ordinance of Sewage Law of Japan. In those criteria, ultimate quality level are being established as "less than or equal to 10 mg/L BOD", "less than or equal to 10 mg/L T-N", "less than or equal to 0.5 mg/L T-P" for capable treatment processes such as "Nitrified Liquor Recycled Membrane Bioreactor (Coagulant Dose)" and "Anaerobic Anoxic Oxidation Process (Organic and Coagulant Dose) with Rapid Filter".

"Membrane Bioreactor" has been recently focused and many technology development and technology evaluation has been done. By those results of long term proving operation, almost of the components except salinity has been reported as capable to meet the reclaimed water quality as listed above.

An example is listed in Table 6. The data is quoted from the following technology evaluation report by Japan Sewage Works Agency.

"Technology Evaluation Report of Membrane Bioreactor" Nov. 2003.

The data quoted from treatment performance of MBR has been of pilot plant testing from 1999 to 2001 by four companies with five testing plants that were located in

conventional activated sludge plant having 310,000 cubic meter per day capacity.

Specification of pilot plant as the experimental results shown in Table 6 are as follows.

HRT : 6 hrs

SRT : 20 days

ASRT : 11.4 days

MLSS at aerobic tank : 9200 mg/L

Nitrified liquor recycle ratio : 3

PAC dose rate : 0 (none)

Flux : 0.5 ~ 1.0 m/d

Type of membrane : flat sheet membrane

Flow sheet of pilot plant was shown in Fig. 1.

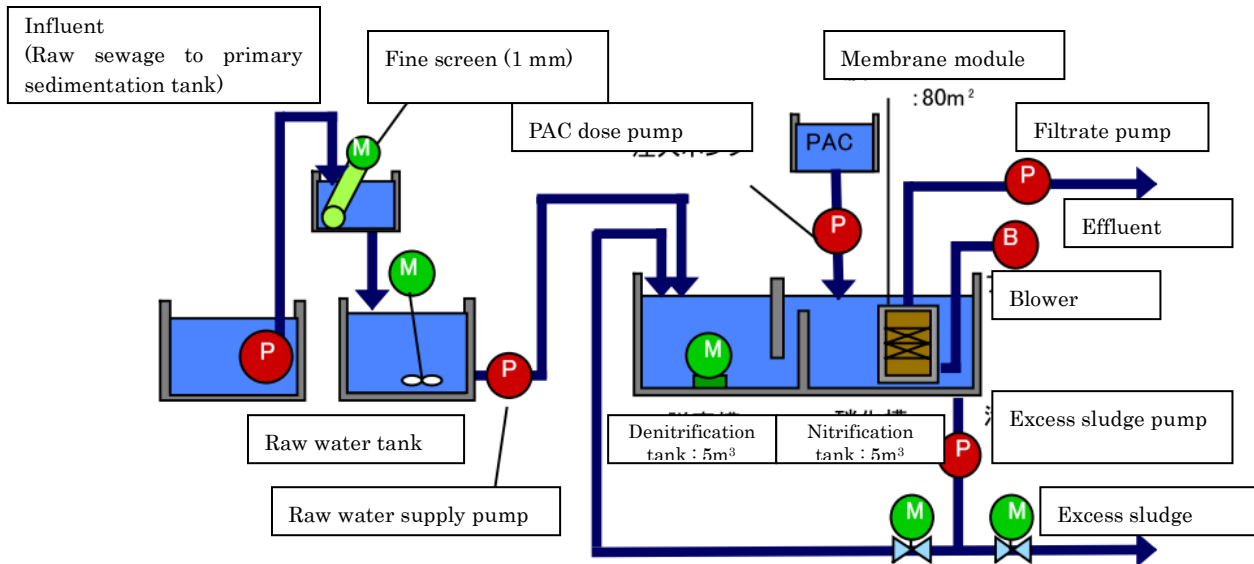

Fig. 1 Flow sheet of pilot plant membrane bioreactor as referred

Table 6. Examples of treatment performance by membrane bioreactors

Components	Unit	Influent water			Effluent water		
		Average	Range	Number of data	Average	Range	Number of data
pH	—	7.15	6.97~7.47	68	7.17	6.80~7.50	67
Alkalinity	mg/l	173	132~215	69	82	55~102	69
T-BOD	mg/l	191	92~497	67	1.0	0.5~2.3	63
s-BOD	mg/l	43.1	21.5~78.6	69	—	—	
T-COD	mg/l	111	52~313	68	7.8	6.2~10.0	67

s.COD	mg/l	31.5	19.1~43.7	71	—	—	
TOC	mg/l	111	40~337	69	6.0	4.1~8.1	70
s.TOC	mg/l	27.6	12.7~62.9	74	—	—	
SS	mg/l	222	65~867	66	<0.4	<0.4~0.7	71
T-N	mg/l	34.1	21.5~58.7	37	5.0	2.1~6.9	36
Kj-N	mg/l	34.0	20.8~58.6	37	1.0	0.6~1.8	39
NH ₄ -N	mg/l	20.1	12.2~26.9	40	0.3	0.1~0.9	39
Org-N	mg/l	14.2	3.1~35.8	36	0.7	0.0~1.0	37
NO ₂ -N	mg/l	0.0	0.0~0.5	41	0.1	0.0~0.2	39
NO ₃ -N	mg/l	0.1	0.0~0.6	41	4.0	1.2~5.8	38
T-P	mg/l	4.75	2.74~9.51	37	0.52	0.09~2.16	37
PO ₄ -P	mg/l	1.95	1.01~3.03	40	0.46	0.05~2.26	40
Coliform group	n/ml	3.6E+05	9.6E+04 ~ 7.3E+05	9	0.24	ND~11.00	69
SO ₄	mg/l	97	78~182	15	106	64~144	17
Cl	mg/l	83	69~114	16	86	61~123	17
Zn	mg/l	0.11	0.05~0.41	16	0.03	0.02~0.04	16
Total Fe	mg/l	0.78	0.44~1.50	16	0.06	0.04~0.10	17
Al	mg/l	2.48	0.78~11.63	17	0.03	0.02~0.06	17

By the above results, one can see "Membrane Bioreactor Process" can bring treatment performance for BOD removal 99.5%, COD 93%(note value of COD_{Mn}), SS approximately 100%, T-N 85%, T-P 89%.

By comparing those values with the target reclaimed water quality as listed in Table 5, membrane bioreactor process was estimated to have supposed removal rate as required. Only remaining subjects are removal of "electric conductivity" or "chloride ion". To solve that problem, "reverse osmosis membrane" will be regarded as a solution strategy.

Following is the research example of making reclaimed water by "Membrane Bioreactor + Reverse Osmosis Membrane".

(5) Selection of treatment process (Part 2)

The research work to make reclaimed water by directly desalting sewage in sewage treatment plant in Japan should be scarce in number. Valuable example should be the one that Water Reuse Promotion Center reported on 2011, the result of pilot plant

research by using "Membrane Bioreactor followed by Reverse Osmosis Membrane" to produce industrial water from sewage. The report should be instructive for this consideration and summarized as followings.

Summary of the referred report:

"Low power water resource recycle system feasibility study" (Study of reuse water production by combining low power membrane bioreactor) March 2012.

Scale of pilot plant

Reclaimed water production capacity : 50 m³/day is supplied by combining complex flow. (Reclaimed water from sewage amount to 35 to 40 m³/day from sewage while 10 to 15m³/day is produced from sea water)

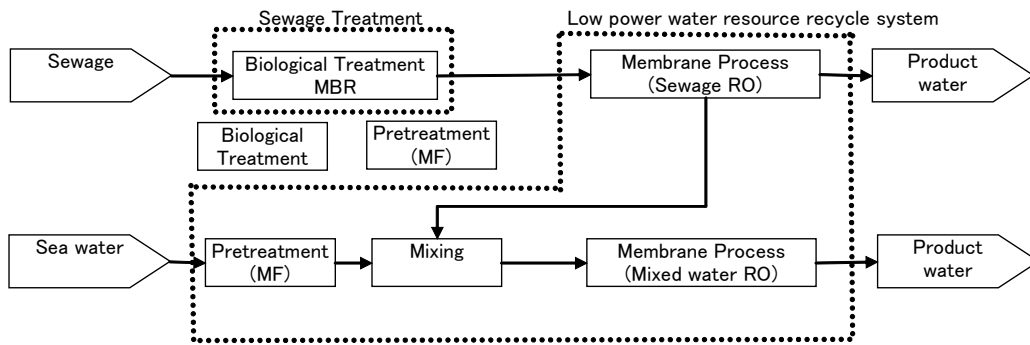

Fig. 2 Flow sheet of the feasibility study of Membrane Bioreactor + Reverse Osmosis Membrane



Fig. 3 Image of plant layout of Membrane Bioreactor + Reverse Osmosis Membrane

Table 7 Effluent water quality examples of Membrane Bioreactor + Reverse Osmosis Membrane

Component	Unit	Raw water	Treated Effluent			Reference ⁽¹⁾
		Average	Average	Minimum value	Maximum value	
Total Dissolved Solid (TDS)	mg/L	221	<11.3	<10	20	≤250
Turbidity	degree	_ (2)	_ (2)	_ (2)	_ (2)	≤20
Chloride Ion(C1 ⁻)	mg/L	67.9	<0.4	<0.1	1.4	≤80
Fe	mg/L	0.02	<0.01	<0.01	<0.01	≤0.3
Mn	mg/L	0.04	<0.01	<0.01	<0.01	≤0.2
Alkalinity	mgCaCO ₃ /L	27.6	3.56	3.0	4.8	≤75
Hardness	mgCaCO ₃ /L	61.1	<1.2	<1.2	<1.2	≤120

(1) Standard Water Quality for Industrial Water (Established in 1971)

(2) Turbidity became less than 1 degree because of permeate from RO membrane

From the above results, a possible treatment process that can change CIC Xisto STP into an industrial water supply plant should have compound treatment process of

"Membrane Bioreactor" with "Reverse Osmosis Membrane", that would attain treatment performance as listed in Table 8 and should be able to attain target reclaimed water quality.

Table 8 Expected reclaimed water quality by "Membrane Bioreactor + Reverse Osmosis Membrane"

Component	Unit	Assumed raw water	Target reclaimed water	Assumed reclaimed water
Surface active agent	mg/L		0.2	0 ³⁾
Turbidity	degree		2	0 ¹⁾
p H	-	7.2	6.2 - 8.2	6.4 ¹⁾
Alkalinity	mg/L		50	4 ¹⁾
Total hardness	mg/L		100	2 ¹⁾
Total solid	mg/L		192	10 ¹⁾
Suspended solid	mg/L	228	2	0 ¹⁾
Dissolved solid	mg/L		190	10 ¹⁾
Electric conductivity	uS/cm	674	200	2 ¹⁾
COD	mg/L	633	8	1 ³⁾
BOD	mg/L	290	2	0 ³⁾
T-N	mg/L	51	8	5 ²⁾

1) Referred from water quality estimation as written in the report original

2) Referred from example of analyzed results in Table 6

3) Tentative assumed value

(6) Results of selecting treatment process and facility volume

From the above results, "Nitrified liquor recycled nitrification-denitrification MBR process + RO membrane" should be selected as a treatment process.

However, to correspond to variations of inflow or amount of need for reclaimed water, "equalization tank", "MBR effluent reservoir" and "reclaimed water reservoir" should be constructed in the treatment facilities.

Following is a calculated results of major facility capacity for reclaimed water treatment plant of capacity 400 L/sec (34,560 m³/day)

1)"Raw water equalization tank"

Faculty: Stabilize treating amount for MBR process against variation of incoming sewage flow.

Capacity: 2880 m³ in total of two tanks (24m×12m×5mH×2tank)

Basis of setting: assumed 3 hours to retain tentatively

2) "Membrane Bioreactor Facility"

Faculty: Nitrified liquor recycled nitrification-denitrification MBR process which includes screen, nitrified liquor recycle pump and membrane modules.

Capacity: 8640m³ (12m×18m×5mH×8tanks)

Basis of setting: "HRT for MBR needs around 6 hours" as referred from "Report regarding to technology evaluation for MBR" (Japan Sewage Works Agency, 2003)

3) "MBR effluent reservoir"

Faculty: Stabilize flow variation for RO membrane separation facilities followed.

Capacity: 2880 m³ in total of two tanks (24m×12m×5mH×2tank)

Basis of setting: assumed 3 hours to retain tentatively

4) "RO membrane separation facility"

Faculty RO membrane separation facility including high pressure pump, chemical dosing facility to prevent fouling, safety filter, RO membrane modules.

Capacity: RO spiral element (φ201×1016) ×1200elements. One module stores 5 elements. Configuration of 5 elements×24modules×10units

Area taken up by RO membrane separation facilities:

17280m²(60m×30m×10units)

Basis of setting:

Number of RO spiral elements: Permeate flow is recommended as 30m³/day for each element by a membrane supplier, "NITTO DENKO ES20-D8

(φ201×1016) permeate flow 30m³/day"

(<http://www.nitto.co.jp/product/datasheet/membrane/005/>)

So required number of RO spiral elements is calculated as 34560m³/day÷30m³/day=1152elements => 1200elements.

Regarding to area taken up by RO membrane separation facilities : From the research report "Feasibility study of membrane separation technology to sewage treatment plant" (Japan Sewage Works Agency, 1995), 500m² was estimated for 1000m³/day capacity including chemical dosing equipments

and pumps and was used for the calculation. However, at a detailed design procedure, larger scaling should make more space intensive placement and can reduce space to large extent.

5) "Reclaimed water reservoir"

Faculty: Buffer reclaimed water shortage between difference of reclaimed water supply and its need variations.

Capacity: 2880 m³ in total of two tanks (24m×12m×5mH×2tank)

Basis of setting: assumed 3 hours to retain tentatively

(7) Result of facility layout consideration

Supposed facility layout is shown in Fig. 4.

Plan locates "Influent equalization tanks (two) " near the existing pumping well and utilize existing distribution tank for UASBs to supply sewage to "Membrane Bioreactors (8 tanks)" which are to be newly constructed.

In the other hand, effluent from MBR should be stored in "Effluent reservoir of MBR (2 tanks)" temporally and pumped up to "RO membrane separation facilities (10 units)". The permeate from RO membrane should be stored into "Reclaimed water reservoir (2 tanks)" and finally pumped down to users.

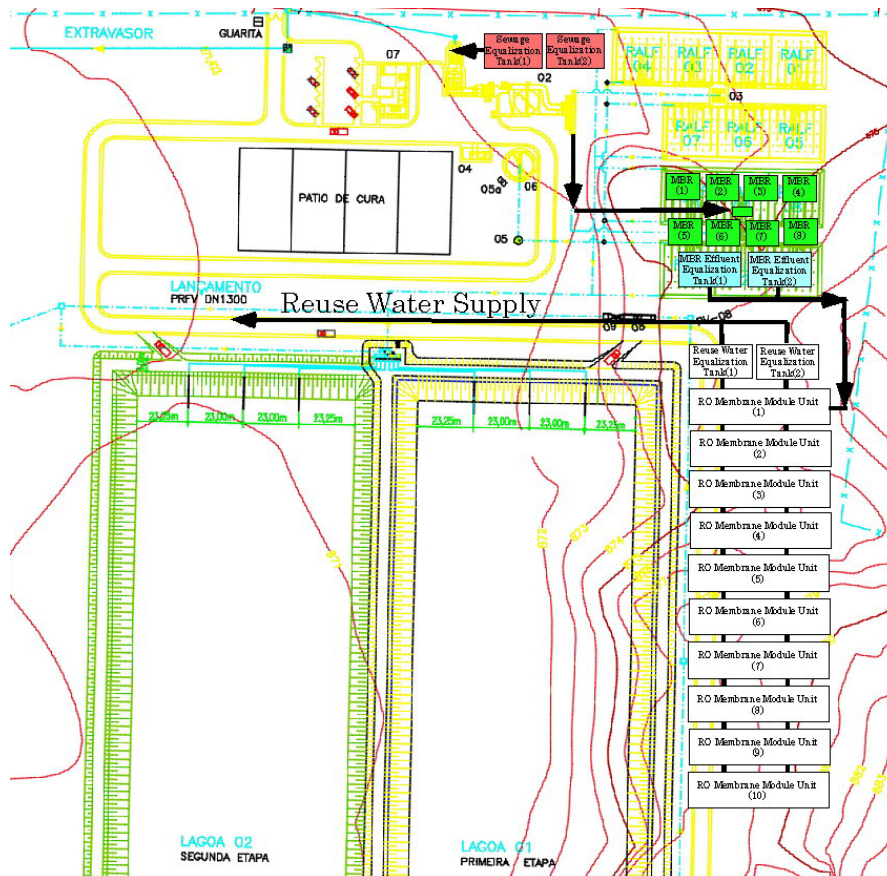

Fig. 4 Supposed facility layout

(8) Cost estimation to make reclaimed water

Estimation of construction cost and operation and maintenance cost was made by using cost estimation formulas in reports publicized in Japan.

1) Estimation of construction cost and operation and maintenance cost for Membrane Bioreactor

As for Membrane Bioreactor facilities, relation was presented in Fig. 5 between treatment capacity with construction cost as well as operation and maintenance cost in the report of "Report of technology evaluation of Membrane Bioreactor" (Japan Sewage Works Agency, 2003). For calculating operation and maintenance cost estimation under the level payment of yearly interest of 1.5%, redemption of 30 years were assumed.

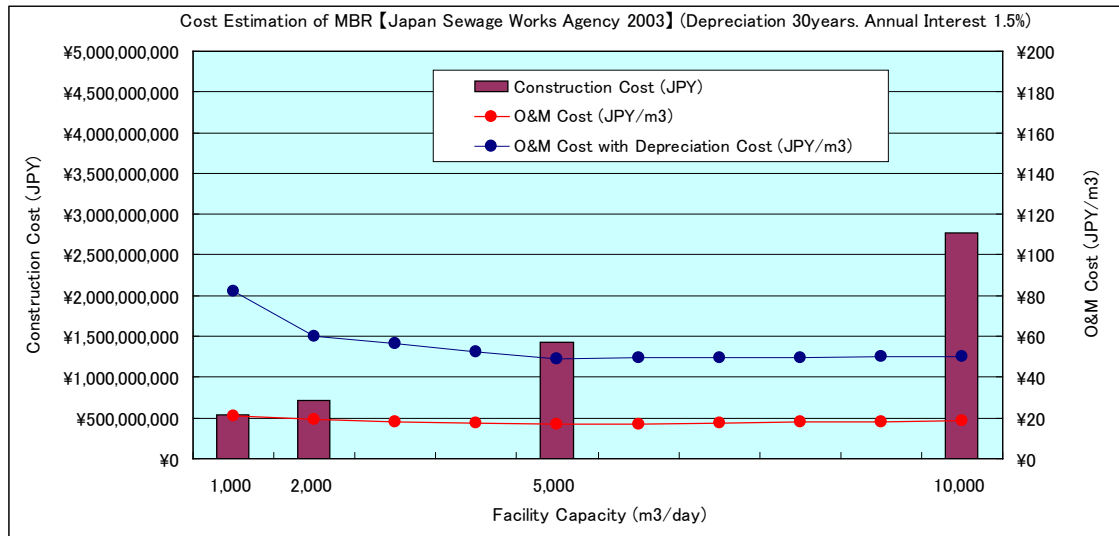

Fig. 5 Calculation example of estimating construction cost as well as that of operation and maintenance

From the above results, project expenses should be estimated as below.

Construction cost : JPY 9,580,000,000

Basis of calculation : (JPY2,772,000,000 for 10,000m³/day capacity) ×3.456

Operation and maintenance cost : JPY50.2 / m³

Basis of calculation : Same as those unit cost for 10,000 m³/day capacity

2) Estimation of construction cost and operation and maintenance cost for RO membrane separation facility

Although recently there has not been publicized report, attached material of "cost estimation formula examples" in "Guideline for introducing membrane separation to sewage works" (second version) March 2011 which should bring cost of RO membrane separation facilities alone. The difference between "coagulant addition + sand filtration + RO membrane separation" (Fig. 6) and "coagulant addition + sand filtration" (Fig. 7). should be the cost for "RO membrane separation" and was calculated to have the cost for "RO membrane filtration".

The cost for "RO membrane filtration" was shown in Fig. 8 and project expenses are assumed as below.

Construction cost : JPY4,580,000,000

Basis of calculation : (construction cost for 10,000 m³/day estimated
JPY1,326,380,000) ×3.456

Operation and maintenance cost : JPY52.4 / m³

Basis of calculation : unit cost for 10,000 m³/day capacity

Namely, cost for producing reclaimed water should be summing up of both "Membrane Bioreactor" and "RO membrane separation facilities" as described below.

Construction cost: JPY 14,160,000,000

Operation and maintenance cost: JPY 103/ m³

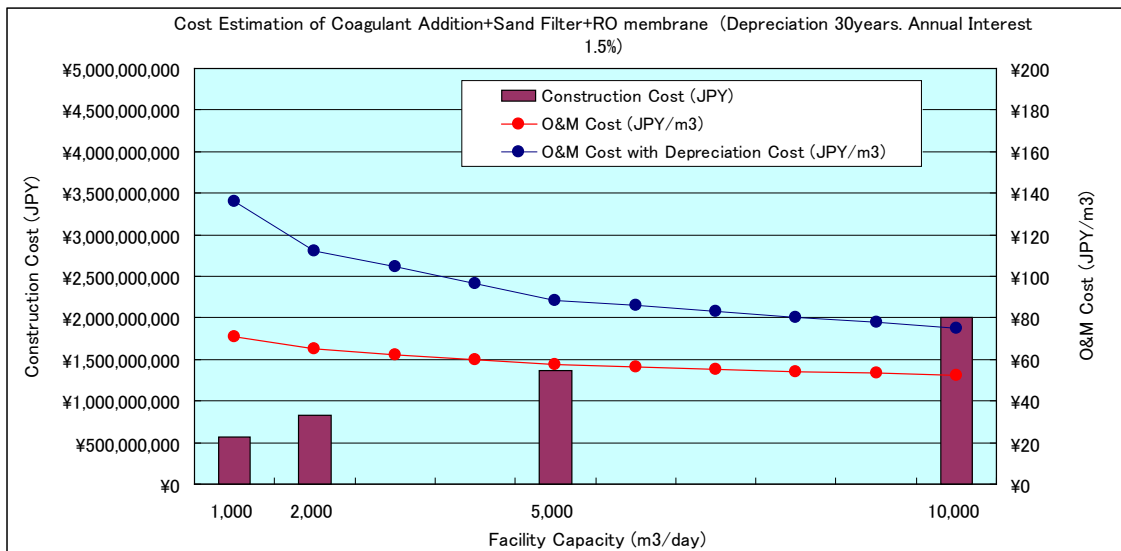

Fig. 6 Calculation example of construction cost and operation and maintenance cost for "Coagulant dose + Sand filtration+ RO membrane filtration process"

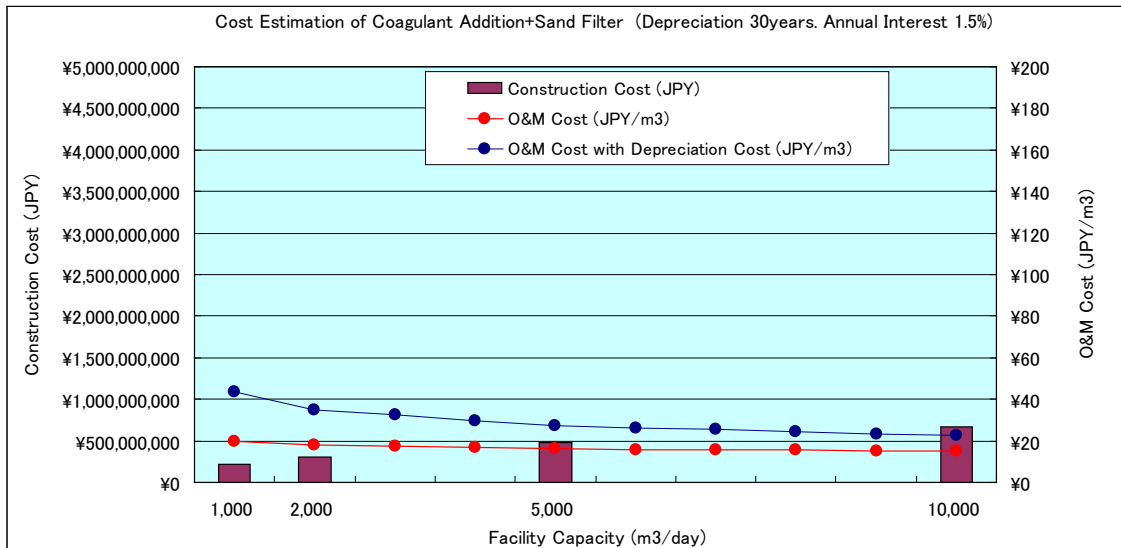

Fig. 7 Calculation example of construction cost and operation and maintenance cost for "Coagulant dose + Sand filtration"

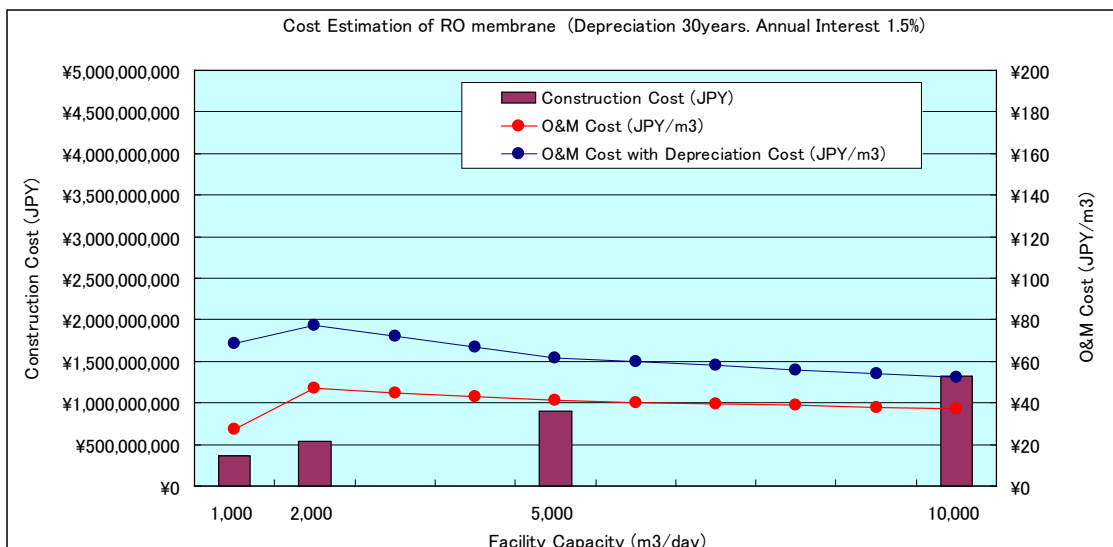

Fig. 8 Calculation example of construction cost and operation and maintenance cost for "RO membrane separation"

3) Cost estimation for equalization tanks etc.

Tank structure like those of "Raw water equalization tank", "Membrane Bioreactor", "Reclaimed water reservoir" was expected to be built by concrete structure and was estimated JPY50,000 in order to construct 1 m³.

"Raw water equalization tank": 2880m³ in total of two tanks.

(24m×12m×5mH×2tank)

Construction cost: JPY144,000,000 for both tanks

"Membrane Bioreactor effluent reservoir": 2880m³ in total of two tanks.

(24m×12m×5mH×2tank)

Construction cost: JPY144,000,000 for both tanks

"Reclaimed water reservoir": 2880m³ in total of two tanks.

(24m×12m×5mH×2tank)

Construction cost: JPY144,000,000 for both tanks

(9) Estimation of construction cost for laying out water pipe and its pumping equipment.

In addition, the project has to lay a new specific water pipe to the demand site which is 2.2 km away. Cost for the laying was estimated from cost estimation formula by "Guide line to estimate renewal water treatment works" (Ministry of Health, Labor and Welfare 2011)

1) Water supply equipment (As for water supply capacity, the project adopted 50,000 m³/day capacity to allow some margin.)

Construction cost : JPY768,000,000

2) Laying water supply pipe

Diameter is expected 800mm (the construction cost should be JPY624,000 per 1m), as water current was supposed to be 10 m/sec.

Construction cost: JPY624,000×2,200m=JPY1,373,000,000

3) Construction cost of water supply pipe and pumping equipments added together.

Total cost = JPY 2,140,000,000

(10) Estimation of total cost for the project

Above results were summarized in Table 9 along with Fig. 9.

The results show that in this case, construction cost would need JPY16,732,000,000 by referring cost estimation formula used in Japan, while unit price to produce 1m³ of reclaimed water should be JPY 111.2.

Cost breakdown shows that Membrane Bioreactor occupies 57%, RO Membrane Separation 27% and water pipe and pumping equipment needs 13%.

Table 9 Results of cost estimation for introducing advanced treatment facilities for reclaimed water use

	Construction Cost	Operation and Maintenance Cost	Note
Raw water equalization tank	JPY144,000,000	JPY 0.5 /m ^{3*})	*) Amount of depreciation
Membrane Bioreactor	JPY 9,580,000,000	JPY 50.2 /m ³	
Membrane Bioreactor effluent reservoir.	JPY144,000,000	JPY 0.5 /m ^{3*})	*) Amount of depreciation
RO Membrane Separation Facility	JPY 4,580,000,000	JPY 52.4 /m ³	
Reclaimed Water Reservoir	JPY144,000,000	JPY 0.5 /m ^{3*})	*) Amount of depreciation
Water Pipe and Pumping Equipment	JPY 2,140,000,000	JPY 7.1 /m ^{3*})	*) Amount of depreciation

Total	JPY16,732,000,000	JPY 111.2 /m ³	
-------	-------------------	---------------------------	--

*) As for "depreciation part", 30 years redemption with annual interest 1.5% was calculated and expressed as a unit price for 400 L per sec (34560m³/day) was calculated.

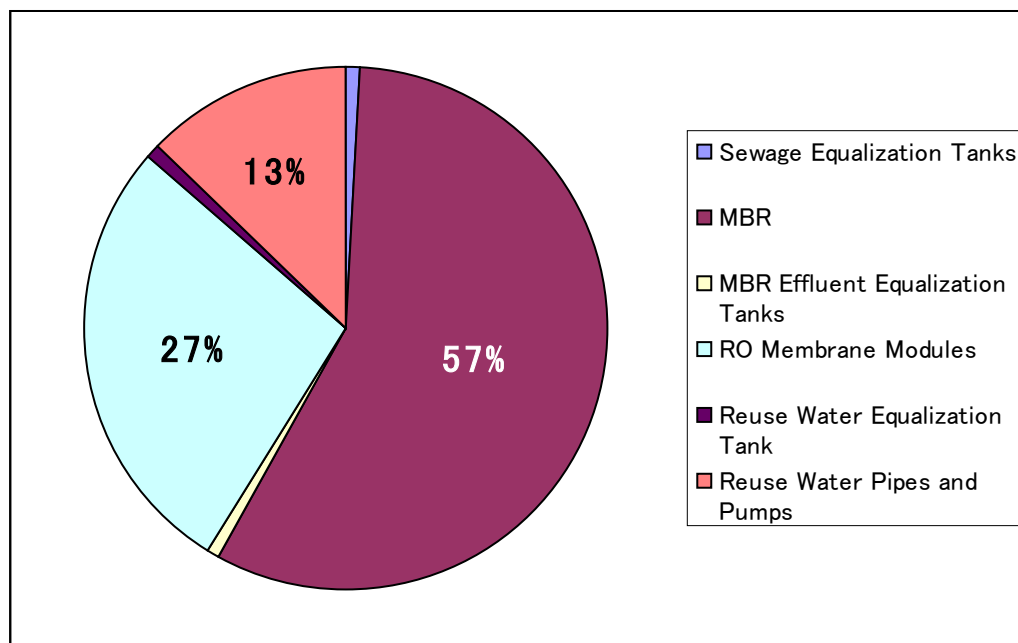

Fig. 9 Ratio of components occupying of the total construction work

4. Result of consideration toward feasibility

(1) Cost

The result of consideration calculated total project expenses JPY16,732,000,000 for total project expense along with reclaimed water production cost of JPY111 for 1 m³. However, the cost does not include man power or repair work cost.

On the other hand, existing unit charge for 1m³ industrial water has been set as R\$2.4, which is equivalent to JPY103 as 1R\$=42.95JPY assumed. In this example the unit cost for producing 1 m³ estimates JPY103 which should demand further to take into account the expenses of management and others, should require further cost increase. The industrialization of the project would require substantial charge rate increase as a result.

(2) Secure reliable plant makers

The project under consideration assumes application of state-of-the-art technology of both "Membrane Bioreactor" and "RO membrane separation". Careful research should be made if it is possible to secure good equipment in domestic market in Brazil. Investigation so far revealed that in São Paulo, similar process called "*The Aquapolo Ambiental water-reuse project*" (*) that has capacity of 1000L per second (86400m³ per

day) started operation recently. To consider feasibility of this project, careful research should be made as to what kind of products are used and what kind of problems they have.

(*) <http://www.chemicalprocessing.com/vendor-news/2013/aquapolo-water-reuse-project-wins-brazilian-sustainability-award/>)

(3) Operating system

CIC Xisto STP which has operational experiences of only UASB and lagoon has to obtain sufficient operation experiences of "Membrane Bioreactor" and "RO membrane separation" by pilot plant before starting operation of full scale facilities. To secure human resource is also necessary.

Furthermore, organization dealing with customers' claim or with urgent response to emergency should be built up as a "Water Treatment Plant" which requires a substantially different level than "Sewage Treatment Plant".

(4) Treatment of concentrated brine wastewater from RO membrane

One of the subjects which have likely overlooked is the treatment and disposal of brine wastewater from RO membrane. Though no detail consideration was made in this consideration, drain of "high concentration of salt" should be actually discharged as a effluent from CIC Xisto STP. Also sufficient research should be made as to whether the effluent can be conveyed to the lagoon or not.

(5) Conclusion

Through those considerations, this project has to face the conclusion that it has many difficult aspects of cost and others to attain practical implementation.

However, substantial needs to secure drinking water resource for CURITIBA are still remaining and it should be solved by other schemes.

To meet those needs, a supposition might be proposed as it proceeds to upgrade supply water quality of existing Araucaria WTP. Practically, an introduction of "RO membrane separation facility" which can reduce ABS and saline concentrations. Reported example also shows RO membrane can reduce ABS by 80%.

In this case as values listed in Table 9, the industrial water additional cost for introducing RO membrane separation for full capacity has been calculated as JPY52.4 for 1m³, JPY26.2 for half the capacity, that may be worth while to study its feasibility instead.

The End

A11-6 浄水場の運転維持管理マニュアル

Irai WTP Operation Manual

Manual 1

General Aspects

1. Intake.....	4
2. Coagulation	10
3. Flocculation	12
4. DAF System.....	13
5. Contact Chamber	14
6. Saturation / Floatation.....	15
7. Sludge Treatment System.....	16
8. Recirculation (of Filter Backwash Effluent).....	18
9. Clear Water Reservoir	20
10. Chemicals Dosing System	24
11. Utilities.....	26

Manual 2 Maintenance

1 Irai Intake	4
2 WTP.....	12
3. Compressors / Dryers/ Blowers	43
4. Agitators AND Mixers	55
5. Raw Water Screening System.....	68
6. Valves AND Sluice Gates	70
7. Preparation Of Chemicals	86
8. Preparation Of Sludge	87
9.1. Schwanke (Crane Hoist)	90

Manual 3

Operation

1 Intake.....	4
2 Coagulation	14
3 Flocculation	19
4. Floto-Filtration.....	23
5 Contact Chamber	30
6. Saturation.....	34
7 Sludge	43
8. Recirculation	48
9 Clear Water Reservoir	53
10 Application of Chemical Products.....	57

**Manual 4
Quality**

1. Analytic Control Plan for WTPs of Integrated Supply System in Curitiba – SAIC/USPD.....	3
2. Cleanliness and Conservation of the Laboratory.....	4
3. Sample Collection and Care to be taken	5
4. Analyses for Guidance	6
5. Alkalinity Analysis;.....	7
6. pH Analysis.....	8
7. Turbidity Analysis;	9
8. Organoleptic Analyses	10
9. Color Analysis	11
10. Odor and Taste Analysis.....	12
11. Fluorine Analysis.....	13

12. Phosphate Analysis.	14
13. Metal Analysis.....	15
14. Aluminum Analysis:.....	16
15. Metal Analysis.....	17
16. Manganese Analysis:.....	18
17. Chlorine Analysis	19
18. Toxin Analysis	20
19. Care for Coliform Analyses.....	21
20. Determination of Temperature:	22
21. Chlorine Analysis	23
22. Iron Analysis.	24

Irai WTP Operation Manual

General Aspects

Manual elaborated to provide basic knowledge about Irai Water Treatment Plant

TABLE OF CONTENTS

1. Intake.....	4
2. Coagulation	10
3. Flocculation	12
4. DAF System.....	13
5. Contact Chamber	14
6. Saturation / Floatation	15
7. Sludge Treatment System	16
8. Recirculation (of Filter Backwash Effluent).....	18
9. Clear Water Reservoir	20
10. Chemicals Dosing System	24
11. Utilities.....	26

1. INTAKE

PIRAQUARA DAM I

Located in the municipality of Piraquara, 25Km from the city of Curitiba, it was built between the years 1978 and 1979.

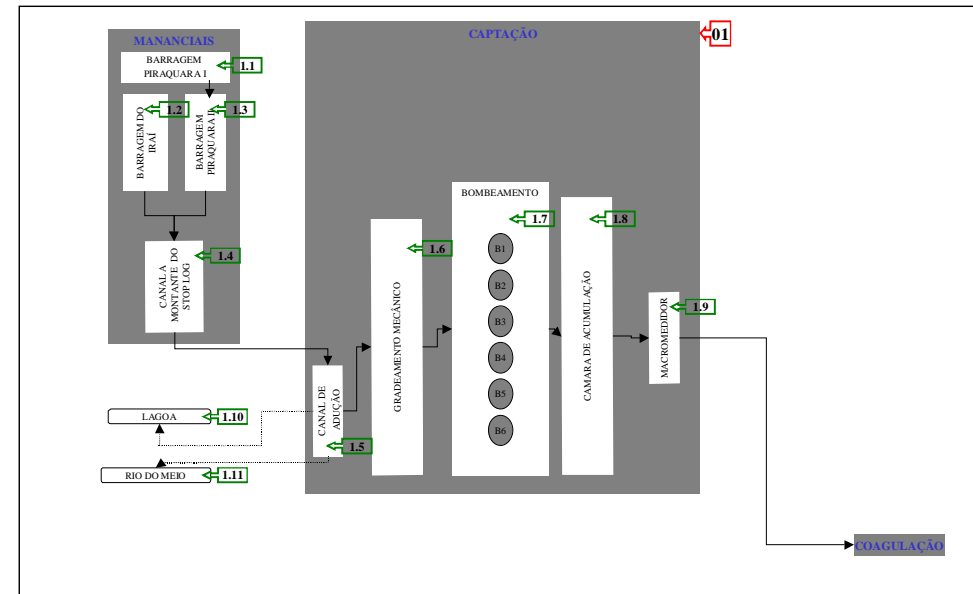

The purpose of its construction is to provide water to the city of Curitiba. It comprises a compacted earth dam, a bypass gallery, and a ski jumping type spillway.

Main characteristics:

Dammed river	Caguava River
Location	Municipality of Piraquara
Designer	IPT – Milder Kaiser S.A
Construction Company	C.R. Almeida S.A
Period of Construction	1978 – 1979
Type of Dam	Earth

Length of the crest	280m
Width of the crest	10m
Maximum height of the crest over the foundation	30m
Volume of the Reservoir	25x106 m3
Area of the Reservoir	2.9 km2
Type of Spillway	Ski Jumping
Overflowing elevation	907.2m

Instrumentation:

- The following measurement instruments were installed:
- Pneumatic Piezometers (PP) = 18
- Casagrande Piezometers (PG) = 25
- Electric Piezometers (PE) = 2
- Water level meters (MA) = 11
- Inclinometers (SI) = 3
- Magnetic pressure meters (RP) = 4
- Superficial pressure measurers (RS) = 15
- Landmarks (RN) = 6
- Discharge meters = 3

IRAÍ DAM

Iraí Dam is located in the municipalities of Piraquara and Pinhais, 19km from the city of Curitiba. It was built in the period between June 1997 and October 1999, and its first overflow occurred in February 2001. Today, it is fully operational.

The purpose of its construction is to contribute to the water supply system of the Metropolitan Region of Curitiba, and supplementary with the function of protecting against the floods of the downstream areas.

The work comprises a compacted earth dam and a single reinforced concrete structure, which concentrates the bypass gallery, water intake tower, and tulip type spillway.

Main characteristics:

Dammed river	Iraí River
Location	Municipalities of Pinhais and Piraquara
Designer	COBA
Construction Company	Andrade Gutierrez and CESB Consortium
Period of Construction	1997 to 1999
Type of Dam	Earth
Length of the crest	1220m
Width of the crest	7.0m
Maximum height of the crest over the foundation	19m
Volume of the Reservoir	58hm ³
Area of the Reservoir	14.6 km ²
Type of Spillway	Tulip
Height of the Tulip well	13.00m
Overflowing height	888 m
Volume of the massif	750,000m ³

Hydro-meteorological data:

Water basin area	113km ²
Maximum recorded discharge	7.19m ³ /s
Minimum recorded discharge	0.19m ³ /s
Regularized discharge LRA (Long Run Average)	1.52m ³ /s
Design flood discharge (10,000 years)	1520m ³ /s
Bypass flood discharge (25 years)	50 m ³ /s
EMP Discharge	3640m ³ /s

Instrumentation:

The following measurement instruments were installed:

- Hydraulic Piezometer (PG) = 46
- Pneumatic Piezometers (PP) = 20
- Pressure meter (PR) = 12
- Superficial Landmark (MS) = 37
- Discharge meter (MV) = 2

PIRAQUARA DAM II

Located in the municipality of Piraquara, 25 from the city of Curitiba, it was built between the years 2003 and 2008.

The purpose of its construction is to provide water to the city of Curitiba.

It comprises a compacted earth dam, a bypass gallery, and a free sill tulip type spillway.

Main characteristics:

Dammed river	Piraquara River
Location	Municipality of Piraquara
Designer	Paranasan Consortium
Construction Company	Contrutora Itaú Ltda
Period of Construction	2003 – 2008
Type of Dam	Earth
Length of the crest	670m
Width of the crest	7m
Maximum height of the crest over the foundation	17m
Maximum height of the dam over the ground	13m
Volume of the massif	465,960m ³
Regularized discharge	1.76m ³ /s
Volume of the Reservoir	20x10 ⁶ m ³
Area of the Reservoir	5.2 km ²
Type of Spillway	Free tulip type
Overflowing height	907.2m

Instrumentation:

The following measurement instruments were installed:

- Open tube piezometers = 13
- Magnetic piezometers = 11
- Discharge meters = 3
- Superficial displacement landmarks = 11

Channel upstream the stop log

Bypass channel that splits in the Spillway Channel or Clean Water Channel and the Iraí River Channel, which supplies the Iraí Intake.

The Clean Water Channel supplies water to the Iguaçú WTP, which also receive inputs from Itaqui and Pequeno Rivers. The Iraí River Channel supplies Iraí WTP.

Pressurized channel

Intended to intake, built in trapezoidal shape, 120 m long and 7.50 m wide at the bottom, by 17.30 m of upper width, lined on the sides and on the bed with Reno mattress type gabions, thickness = 0.23 m.

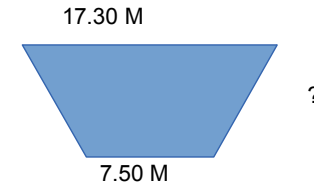

Level Dam

Built upstream the pressurized channel protection works. Its main function is to regularize the level of water inflowing into the pressurized channel.

Pumping

The raw water pressurization is performed by 05 (five) submersible motor pump sets, with the following characteristics:

BRAND	FLYGT
MODEL	CP 3531- DU 765
Q	750 l/s
Hm	13.3 mca
Power	190 hp

The channel of access to the well where the motor pump sets to pressurize the raw water are installed is comprised of a manual grating system, followed by another mechanized one and sluices, as follows:

Manual grating: 03 (three) units, for grating and removing debris from the Iraí River raw water.

Mechanized grating: 03 (three) units, for grating and removing debris from the Iraí River raw water. The actuation is done by an electric engine.

Sluices: 01 (one) 800mm x 800mm sluices, and 06 (six) 1280mm x 2300mm sluices, all manually actuated, through the suspension pedestal and steering wheel.

For the maintenance of the Raw Water Pumping Station pumps, a load movement system is installed, comprised of electric hoist and trolley, with hoisting height = 9.00 m, and nominal capacity of 8,000 kg.

Raw water pressurization

The raw water is pressurized through the DN 1500 steel pipeline, totalizing 114.20 of extension, from the raw water pressurization to the WTP distribution box.

Comments:

2. COAGULATION

After catchment, water is **pressurized to the pumping station** and conveyed

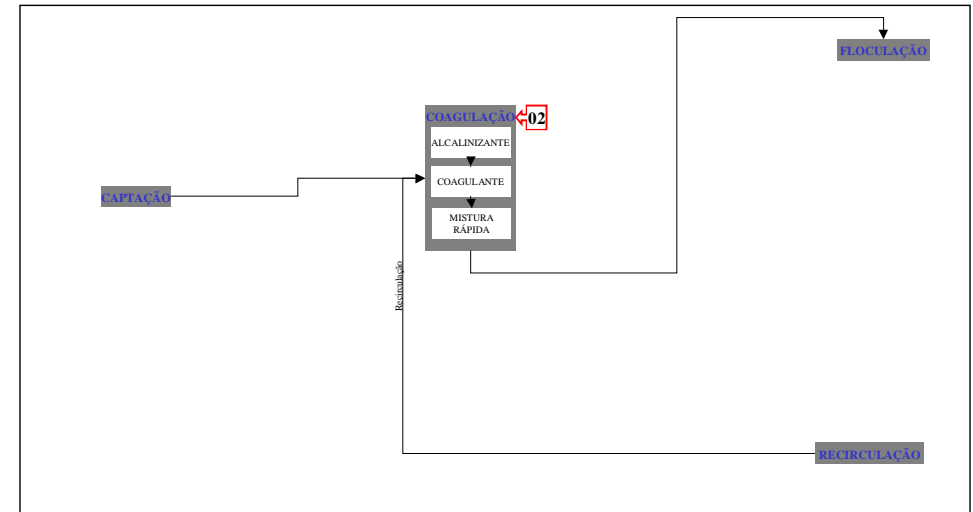

by **gravity through** a pressurized pipeline **to** the center of the treatment plant, where there is a quick mixture chamber. This chamber **is comprised of** an agitator and 4 outlets to the **flocculators**, **which take the flocculated water** to the 4 treatment modules.

Before the coagulation process, there is a recirculation water inlet point, coming from the washing water of the 4 modules filters.

Comments:

3. FLOCCULATION

Flocculation is the process of agglutinating the flocs, after coagulation.

There are 3 flocculators in each treatment module at the Irai WTP, with 3

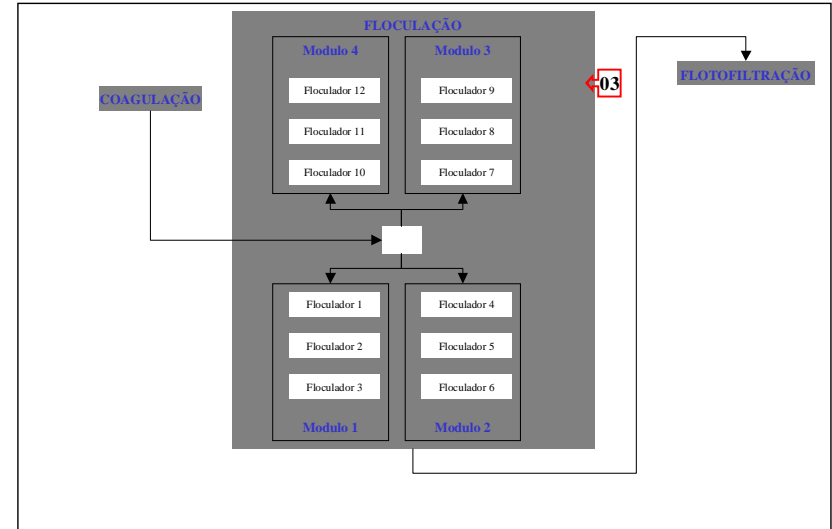

motorized agitators in each flocculator.

In this process, a flocculation ancillary can be dosed (Polymer).

Comments:

4. DAF SYSTEM

Diagram for DAF system is as follows.

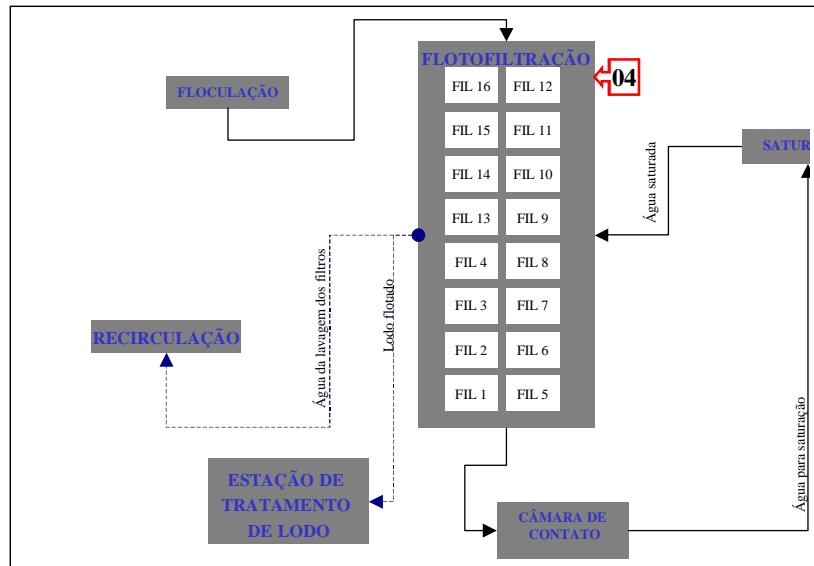

5. CONTACT CHAMBER

Person responsible for the information:

6. SATURATION / FLOATATION

Person responsible for the information:

Basically, saturation consists of dissolving air into the water. In the plant, there are two tanks per module, to which water is taken pressurized after filtration, either by a submersible pump or by an external pump, via carbon steel or stainless steel pipeline, respectively. Remark: Except for module 4 which pipelines are always of stainless steel.

When compressed air is injected in those tanks that are under pressure (around 47mca), it is dissolved in the water. The interaction between air and water is increased through the filling in the tanks formed by Raschig rings. In Iraí WTP, these are simply sections of 3/4" PP pipes. This water saturated with air is then conveyed to the floto-filters. Each floto-filter has 8 submersed pipes in which the uniform distribution of saturated water takes place in holes with 2.5 mm diameter. In such holes, there is the formation of micro-bubbles, due to the pressure difference (Δp) between the pressure in the tanks and the pressure in the floto-filters (in practical terms, the atmospheric pressure). In turn, the micro-bubbles in contact with flakes drag them to the surface forming a layer of floated sludge. Periodically, the holes are clogged and need to be cleared (in the supervisory, there is an alert when the discharge of saturated water per filter is **less than 10 L/s**).

The automation of the saturation process in the tanks does not work properly, and the operation ends up occurring in the **local manual mode**. Remark: air control valve, air flow meters, water level sensors do not work. The outlet pipelines from the saturation tanks to the filters are made of PPP, and frequently break up, requiring repair maintenance with hot welding.

In Iraí WPT, the process is of dissolved air flotation with filtration (DAFF), and with pressurized post-filtration water recirculation. I.e., the filtration occurs in the same tank of the flotation, and part of the filtered water (in the design is 8%, currently) is recirculated to the saturation tanks.

7. SLUDGE TREATMENT SYSTEM

Sludge dewatering

This unit receives the floated sludge from the sludge tanks, for dewatering.

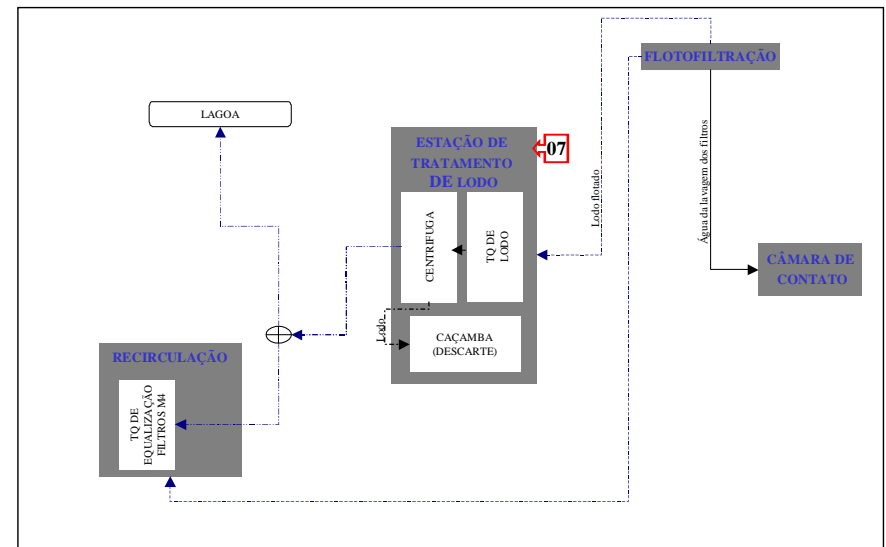

This building also shelters 02 (two) tanks for the polyphosphate solution, which descriptions are detailed as follows in the systems of chemicals dosing and application.

Equipment used for dewatering the floated sludge: 02 (two) centrifuged decanters.

01 (one) dispenser and dissolver of polymers, to ensure the continuous flow of constant density material.

Comments:

Hm	57.0 mca
Power	800 hp

9.3.2 Piraquara Pressurization

This is performed through 03 (three) vertical shaft motor-pump sets, with the following characteristics:

BRAND	KSB
MODEL	RDL V 150 500 A
Q	360 m ³ /h
Hm	125 mca
Power	350 hp

9.4. PROCESS SUPPLEMENTATION

The Iraí Treated Water Pumping Station is also comprised by the following processes:

9.4.1 PRIMER SYSTEM

This system is comprised of 02 (two) water ring vacuum pumps with 3,000 l/s discharge and 10 hp, and 01 (one) vacuum lung tank with 1,000 m of useful height and 400 mm Ø.

9.4.2 COMPRESSED AIR SYSTEM

This system operates pneumatic valves. It is comprised of 02 (two) screw type Ingersoll-Rand compressors, 01 (one) air drier, in addition to valves, filters, pipelines, and fittings.

9.4.3 HYDRAULIC TRANSIENTS PROTECTION SYSTEM

This system is comprised of 03 (three) hydro-pneumatic reservoirs RHO's, for the Tarumã, Jacob Macanhan, and Piraquara pressurization systems, respectively. For the RHO-03 of the Tarumã pressurization system, the existing one will be used, currently at the existent Raw Water Pumping Station.

9.4.4 LOAD MOVING SYSTEM

This system is comprised of 01 (one) electric hoist and overhead bridge crane with 6.50 m hoisting height, and nominal capacity for 10,000 kg.

9.5. IRAÍ/JACOB MACANHAN/TARUMÃ TREATED WATER PRESSURIZATION SYSTEM

8,455.00 m of pipes of the following types and diameters were installed:

FD JE DN 800 pipe	3,725.00 m
FD JE DN 1000 pipe	2,870.00 m
DN 1000 welded steel pipe	1,860.00 m

9.6. JACOB MACANHAN RESERVATION CENTER

9.6.1 JACOB MACANHAN TREATED WATER PUMPING STATION

9.6.1.1 Jacob Macanhan High Zone Pressurization

This is performed through 03 (three) vertical shaft motor-pump sets, with the following characteristics:

BRAND	KSB
MODEL	RDL V 200 400 A
Q	477.0 m ³ /h
Hm	30.0 mca
Power	75 hp

9.6.1.2 High Neighborhood Pressurization

This is performed through 03 (three) vertical shaft motor-pump sets, with the following characteristics:

BRAND	KSB
MODEL	RDL V 300 400 A
Q	850.0 m ³ /h
Hm	33.0 mca
Power	150 hp

9.7. PROCESS SUPPLEMENTATION

The Jacob Macanhan Treated Water Pumping Station is also comprised by the following processes:

9.7.1 COMPRESSED AIR SYSTEM

This system operates pneumatic valves. It is comprised of 02 (two) lung type Ingersoll-Rand compressors, 01 (one) air drier, in addition to valves, filters, pipelines, and fittings.

9.7.2 LOAD MOVING SYSTEM

This system is comprised of 01 (one) electric hoist with 6.5 m hoisting height, and nominal capacity for 2,000 kg.

9.8. SUPPORTED RESERVOIR OF 10,000 m³

Cylindrical reservoir, built in steel, with reservation capacity of 10,000 m³.

9.9. TARUMÃ RESERVATION CENTER

The existing Pumping Station for Cajuru was expanded. Another 04 (four) vertical shaft motor-pump sets were purchased and installed, with the following characteristics:

BRAND	KSB
MODEL	RDL V 300 340 A
Q	1,415.0 m ³ /h
Hm	43.0 mca
Power	300 hp

Comments:

10. CHEMICALS DOSING SYSTEM

Alkalinizing

The plant was designed to use bagged hydrated lime.

In the beginning of the operation, because of lack of operation staff and deficient automation system functioning, it was necessary to change the alkalinizing agent to sodium hydroxide.

Currently, a suspension of calcium hydroxide is used, and the reasons for using such product are that there are no ergonomic risks, preparation problems, it has a great quality, and does not cause clogging.

Flocculation ancillary

Initially, the Cationic Polymer had and still has the purpose of removing/restraining algae coming from the Dams supplying raw water to Iraí WTP. However, its utilization as flocculation ancillary also proved to be effective.

Coagulant

The plant was designed to use ferric chloride.

Since this product has a very limited range of activity, other products were tested, such as:

Aluminum Poly Chloride (Poly Aluminum Chloride – more correct denomination)

Aluminum sulfate, currently used.

Disinfectant

The plant was designed to use the chlorine dioxide system for disinfection.

Since the dosing of chlorine dioxide could cause problems of removing the iron and manganese encrusted in old pipelines, as well as did not leave easily identifiable wastes, the use of chlorine gas was decided.

Initially, an emergence chlorine dosing system was installed, comprised of two batteries with 900 kg cylinders.

Currently, the plant has a chlorine house, with two batteries of 7 900 kg cylinders each.



Iraí WTP Operation Manual

Maintenance

Manual elaborate to help operating the Iraí Water Treatment Plant

TABLE OF CONTENTS.

1 IRAI INTAKE	4
2 WTP.....	12
3. COMPRESSORS / DRIERS/ BLOWERS	43
4. AGITATORS AND MIXERS	55
5. RAW WATER GRATING SYSTEM.....	68
6. VALVES AND SLUICES.....	70
7. PREPARATION OF CHEMICALS	86
8. PREPARATION OF THE SLUDGE	87
9.1. SCHWANKE (CRANE HOIST).....	90

1 IRAI INTAKE

1) PUMPS

Raw water pressurization pumps



Register information

Site:	catchment
Qty:	5 motor-pumps
Brand:	flygt
Model:	cp 3531/765
Discharge:	2700m ³ /h = 750 L/s
Man. height:	13.3mca
Power:	172 hp
Voltage:	440v
Current:	252a
Rotation:	705rpm

Localizer SMI: pq.d3.bm

Position	Pump tag	Motor tag	Series no.	Start
01	pump-017	motr-064	s 008 1013	soft start
02	pump-018	motr-065	s 008 1085	inverter
03	pump-019	motr-066	s 008 1014	soft start
04	pump-020	motr-067	s 008 1015	inverter
05	pump-021	motr-068	s 008 1086	soft start

Lubrication data

Motor-pump set:

Works with oil bath

Recommended oil whiterex 309 – mobil

Required qty. 5 liters

Oil change Each 8,000 hours

Bearings:

Work with grease

Recommended grease unirex n3 – esso

Grease again at each disassembling

Summary lubrication table

components	lubricant	Qty.	frequency
Motor-pump	whiterex 309 – mobil	5 liters	8,000 h
Bearings	unirex n3 - esso	2 liters	-

Accessories and spare parts

item	code	Qty.	denomination
01		1.0 part	impeller
02		1.0 part	Upper seal
03		1.0 part	Lower seal
04		1.0 part	Bearing
05		2.0 parts	Bearing
06		1.0 part	Bearing
07		1.0 part	O rings kit
08		1.0 part	O rings kit

09	10.0 m	Voltage cable
10	10.0 m	Command electric cable
11	2.0 parts	Sealing bushing
12	6.0 parts	Sealing bushing

Periodical maintenance

Due to the type of installation of motor-pump sets, which are always submersed, the items to observe during inspection are as follows:

Weekly:

Check in the command panel whether the pumps are working within the nominal current (for a frequency of 60Hz, the current should be approximately 252A);

Check in the installation site, through the pressurization pipeline, the existence of abnormal noise or vibration in the pumps;

Check through the raw water discharge meter the nominal of each pump, and whether this corresponds to the number of pumps on (1 pump = 900L/s).

Monthly:

Clean the electric panels;

Check the electric contacts temperature through the radiometer;

Check the general state of power and command cables, and the tightening;

Check the existence of leaks in the pressurized pipeline flanges;

Biannually

-Change of pumps oil;

-Verification of the rotor oil;

Annually:

Remove the motor-pumps from the channel for a general verification;

Remove a sample of the lubricant oil to check contamination with water;

Check clearances in the pedestal and guide tubes;

Check the conditions of electric cables, mainly in the inlet of pumps;

2 - RAW WATER CHANNELS DRAINAGE



Register information

Site: catchment
 Qty: 1 motor-pump
 Brand: flygt
 Model: cs 3127 mt
 Discharge: 108m³/h = 30 L/s
 Man. Height: 10 mca
 Power: 10 hp
 Voltage: 440v
 Current: 26A
 Rotation: 1725rpm

Localizer smi: pq.d3.bm

Position	Pump tag	Motor tag	Series no.	Start
01	pump-000	motr-000	s 007 0257	direct

Lubrication data

Motor-pump set:

Works with oil bath

- Recommended oil whiterex 309 – mobil
- Required qty. 2.0 liters
- Oil change Each 12 months

Bearings:

Work with grease

- Recommended grease unirex – esso
- Required qty. 0.03 Kg
- frequency Only in cases of reassembling

Summary lubrication table

components	lubricant	Qty.	frequency
Motor-pump	whiterex 309 – mobil	2 liters	2,000 h
Bearings	unirex - esso	0.03 Kg	4,000 h

Accessories and spare parts

item	code	Qty.	denomination
01		1.0 part	impeller
02		1.0 part	Upper seal
03		1.0 part	Lower seal
04		1.0 part	Bearing
05		2.0 parts	Bearing
06		1.0 part	Bearing
07		1.0 part	O rings kit
08		1.0 part	O rings kit
09		10.0 m	Voltage cable
10		10.0 m	Command electric cable
11		2.0 parts	Sealing bushing
12		6.0 parts	Sealing bushing

Periodical maintenance

Monthly:

- Put the pump inside one of the suction channels, and turn in on for ten minutes;
- Observe the water flow coming out from the hose;

- Check the existence of abnormal noise;
- Check the conditions of the electrical cable and fittings;
- Remove the water, clean and check the conditions of the pump painting;

Annually:

- Remove a sample of the lubricant oil to check its state; change if necessary;
- Paint the whole pump;

3. VALVES AND SLUICE GATES

Barbará valves

1 drainage chamber of raw water accumulation

1 slide valve manually actuated through the maneuver shaft

- Type: Slide valve
- Brand: barbará
- Gauge: DN 250
- Material: Ductile iron
- Pressure: pn 10
- Fittings: flanges

2 connections of the raw water channel with the bottom lake

slide valve manually actuated through the maneuver shaft

- Type: Slide valve
- Brand: barbará
- Gauge: DN 250
- Material: Ductile iron
- Pressure: pn 10
- Fittings: flanges

Fontaine sluices

Dam at the access channel inlet

1 squared sluice manually actuated through a handle

- Type: squared
- Brand: fontaine
- Dimensions: 1000 x 1000 mm
- Model: 204-1016x1016-b-cw
- Material: stainless steel

Catchment - raw water channel drainage

-Rectangular sluice manually actuated through a handle

- Type: squared
- Brand: fontaine

- Dimensions: 800 x 800 mm
- Model: 204-812x812-b-cw
- Material: stainless steel

Ouro fino sluices

Catchment - raw water suction channels inlet

6 rectangular sluices manually actuated through a steering wheel

- Type: rectangular
- Brand: ouro fino
- Dimensions: 1280 x 2400 mm
- Model: 204-1016x1016-b-cw
- Material: stainless steel

Position	tag
01	fbv-170
02	fbv-171
03	fbv-172
04	fbv-173
05	fbv-174
06	fbv-176

2 WTP

RECIRCULATION OF FILTERS WASHING WATER



Register information

Qty: 5 motor-pumps

Pump data

Brand: netzsch
 Type: nemo
 Model: nm 090 sy 01 lo 4b
 Discharge: 60 (30 to 90)m³/h = 16.6 (8.3 to 25.0) L/s
 Pressure: 1.5kgf/cm² = 15 mca
 Absorb. Power: 15 hp
 Rotation: 180 (90 to 280) rpm

Engine data

Brand: weg
 Carcass: 160 l
 Power: 20 hp
 Voltage: 440 v
 Current: 28.4 A
 Frequency: 60 Hz(three phase)

Rotation: 1165 rpm
 Protection: ip 55 (completely closed with fan)
 f. of power: 0.78
 Insulation: f

Transmission

Motor Pulley: Ø100 mm
 Moved Pulley: Ø550 mm
 Belts: 8 x (3 v 850 x 2160)

flanges

Standard: ansi b 16,1
 Pressure: 125 lbs
 Material: Cast iron
 Dimensions: suction pressurization
 di 6" 6"
 df 241.3 241.3
 de 285.0 285.0
 holes 8xØ22.2 8xØ22.2

Safety and relief valve

Diameter: DN 100
 Pressure: 0 – 6 bar

Position	Pump tag	Motor tag	Series no.	Start
Mod. 01	pump-004	motr-015	b 34510	inverter
Mod. 02	pump-007	motr-030	b 34508	inverter
Mod. 03	pump-014	motr-061	b 34507	inverter
Mod. 04	pump-011	motr-046	b 34509	inverter
reserve	pump-000	motr-000	b 34511	

Lubrication data

Motor-pump set: Works with oil bath

- Recommended oil shell omala 460
 - Required qty. 215 cm³
 - Oil change at each disassembling

Bearings: Work with grease

- Recommended grease shell alvania g3
 - Required qty. 0.070 Kg
 - frequency Grease again at each disassembling

Summary lubrication table

components	lubricant	Qty.	frequency
Motor-pump	shell omala 460	215 cm³	-
Bearings	shell alvania g3	0.07 Kg	-

Accessories and spare parts

item	code	Qty.	denomination
01	3005	1.0 part	stator
02	8015	1.0 part	O ring
03	1998	1.0 part	Coupling axle
04	5075	2.0 parts	pin
05	8235	2.0 parts	Sm sealing
06	8060	4.0 parts	O ring
07	8065	1.0 parts	O ring
08	5065	2.0 parts	Safety ring
09	5110	1.0 m	Fixation rings
10	5115	1.0 m	Safety bushing
11	1999	1.0 part	rotor
12	5425	2.0 parts	Retainer

Periodical maintenance

guidance

- a) Pump should be cleaned or washed regularly, because the transported liquid form crusts (sediments);
- b) If this is necessary, open the pump and turn off the engine disconnecting it to prevent accidental start (remove the fuse);
- c) The frequency of cleanings should be defined by the user; the time interval depends on the fluid and on the service system. For this case, the monthly cleaning of the pump is recommended.
- d) The pump can be cleaned as follows:
 - Through the cleaning orifices in the pump body;
 - Manually, previously disassembling the pump;
 - Automatically (cip cleaning) in case of the pump having a special body, with intakes for washing liquid.

Frequency of interventions

Weekly:

- Check whether the pump is working within the nominal current (60Hz=5.25A)
- Check the pump discharge with the discharge meter (4 to 8m³/h=1.11 to 2.22L/s)
- When the pump is functioning, check for noise or vibration.

Monthly:

- Stop the pump for some minutes and check the tensioning of belts. Observe the pump start; if the belts are not sufficiently tensioned, they will slip on the pulleys accelerating their wear and tear. In order to adjust belts, rotate the screw at the engine base in the way to make it rise. Thus, belts will become more tensioned.
- Check for excessive leak through gaskets (50 to 200 drops/min.). If there are excessive leaks, tighten the packing glands with the hand until reducing dripping;
- Clean according to instructions.

Annually:

- Check the general conditions of gaskets. If necessary, replace them. Check the netsch's services manual
- Remove the protection and check the conditions of belts; replace them if necessary;
- Perform the general cleaning of the command panel (remove dust carefully using a soft and dry paintbrush);

Lubrication:

- Bearings of the actuation shaft are lubricated during assemblage, and do not require subsequent lubrication. If, for any reasons, the pillow block is disassembled, clean the bearings and apply new lubricant, according to the guidance of the netsch's services manual;
- Likewise, whenever worn out parts are replaced or the pump is opened for any other reasons, lubricate the pin type articulations, according to the guidance of the services manual, item 7 – maintenance.

Lubricants recommended:

- Bearings = shell alvania g3 grease;
- Joints or articulation coupling = shell omala 460 oil

A. Relief valves (4.0)

Such valves are part of the motor-pump sets, and have the function of relieving the pump pressure if there is any obstruction in the pressurized pipeline, without harming the pipeline and the pump itself. It is recommended to remove the valve and verify the internal pressure regulation spring annually, as well as cleaning and lubricating, according to the guidance in the manual. After reinstallation, turn on the pump and test the relief valve, quickly closing and opening the blockage valve existing in the pressurized pipeline, in order to hear the sound of water passing through the recirculation pipe, just above the pump.

B. blockage valves manually actuated by a handle (8.0)

Monthly:

- Move the valve to prevent jamming;

-Check if there is a clearance in the lever fit with the actuation shaft.
Tighten if necessary.

Annually:

-Remove the valve and check its conditions; clean and lubricate the shaft.

C. Retention valves (4.0)

Monthly:

-Observe the functioning when turning the pump off;

Annually:

-Remove the valve and check the flap state; clean and lubricate the flap axle

Position of nemo type pumps, per module

Module	pressurization	Pump tag	Motor tag	Series
1	water	pump-004	motr-015	b 34510
	sludge	pump-003	motr-012	b 34506
2	water	pump-007	motr-030	b 34508
	sludge	pump-006	motr-029	b 34502
3	water	pump-014	motr-061	b 34507
	sludge	pump-013	motr-058	b 34503
4	water	pump-011	motr-046	b 34509
	sludge	pump-010	motr-043	b 34505

Bomax

DISCHARGE OF CHEMICALS



Register information

Qty: 4 motor-pumps

a) Pump data

Brand: bomax
 Model: maxbloc 421/3
 Discharge:
 Man. Height:
 Material: polypropilene
 Sealing: smh
 Ø rotor: 120 mm
 Power: 5.0 hp
 Rotation: 3485 rpm

b) Pump data

Brand: weg
 Carcass: 100 l
 Voltage: 220/380/440 v
 Current: 13.1/7.58/6.55 a
 Frequency: 60
 f.s.: 1.15

cos φ: 0.89
 Yield: 84.5%
 Front bearing: 6206 zz
 Back bearing: 6205 zz
 Lubricant: Lithium-based grease

Position	Pump tag	Motor tag	Series no.
sulfate	pump-072	motr-072	03 maint 2
fluorine	pump-075	motr-075	03 maint 2
Chlorine ac.	pump-	motr-	03 maint 2
chlorite	pump-	motr-	03 maint 2

Lubrication data

For the discharge motor-pumps

Bearings: Work with grease

- Recommended grease: Lithium-based grease
- Required qty.: 0.200 Kg
- Frequency (grease again at each): 500 hours

Summary lubrication table

components	lubricant	Qty.	frequency
Motor Pump (bearings)	Lithium-based grease Lithium-based grease	- 0.200kg	- 500 h

Accessories and spare parts

item	code	Qty.	denomination
01		1.0 part	rotor
02		2.0 parts	Bearings
03		1.0 part	Mechanical sealing

Periodical maintenance

guidance

For being a pump to pressurize chemicals it is recommendable to take the following care, which regard more operation than maintenance, in order to extend the useful life, and to prevent undesired halts:

1. Do not turn on the pump without the product to pressurize (dry), because it can jam inside and no longer work;
2. Clean it with clean water after finishing to discharge the product;
3. Keep the equipment clean and it will be always ready to work; as well as the hoses used to discharge the chemicals should be cleaned and orderly site in an easy access site.

Frequency of interventions

Monthly:

Check whether the pump is working within the nominal current (13.1
When the pump is functioning, check for abnormal noise or vibration;
Observe whether the electric engine is not overheating.

Annually:

Check for leaks and the mechanical seal conditions; replace if necessary;
Check the conditions of the engine electrical cables isolation since the
motor-pumps are installed outdoors;

Check bomax's services manual to see more details about the annual verifications.

prominent

DOSING OF COAGULANT (SULFATE)



Register information

Qty: 2 dosing motor-pumps
 Brand: prominent
 Model: sigma
 Type: s3 cah 070 410 pvt 0120 aa op ooc
 Voltage: 200-240 v
 Power: 0.50 kw
 Dosing capacity: 500l/h (132.1 gph)
 Protection: ip 55
 Frequency: 50 Hz
 Current: 3.7 a
 Pressure: 7 bar

Position	Pump tag	Motor tag	Series no.
01	fcz-001	motr-073	2001 069 789
02	fcz-002	motr-074	2001 069

Lubrication data

For dosing pumps

a) Motor-pump sets: Works with oil bath
 Recommended oil:

Required qty.:

Frequency (grease again at each):

b) bearings: Work with grease

Recommended grease:

Required qty.:

Frequency (grease again at each):

Summary lubrication table

components	lubricant	Qty.	frequency
Motor-pump		2 liters	2 2000 h
Bearings		2 liters	4000 h

Accessories and spare parts

item code Qty. denomination

POLYMER DOSING



Register information

Qty: 2 dosing pumps
 Brand: prominent
 Model: sigma
 Type: s3 cah 040 830 pct 0120 aa op ooc
 Voltage: 200-240 v
 Power: 0.50 kw
 Dosing capacity: 500l/h (132.1 gph)
 Protection: ip 55
 Frequency: 50 Hz
 Current: 3.7 a
 Pressure: 7 bar

Position	Pump tag	Motor tag	Series no.
01	fcz-001	motr-073	2001 069 789
02	fcz-002	motr-074	2001 069

Lubrication data

For dosing pumps

a) Motor-pump set: Works with oil bath
 Recommended oil:
 Required qty.: liters

frequency (grease again at each hours):
 b) bearings: Work with grease
 Recommended grease:
 Required qty.:
 frequency (grease again at each hours):

Lubrication summary table

components	Lubricant	Qty.	frequency
Motor-pump		2 liters 2	2000 h
Bearings		2 liters	4000 h

Accessories and spare parts

item code Qty. denomination

POLYPHOSPHATE DOSING



Register data

Qty.: 4 dosing pumps
 Brand: prominent
 Model: sigma
 Type: s3 cah 120 145 pvt 0120 aa op ooc
 Voltage: 200-240 v
 Power: 0.50 kw
 Dosing capacity: 160l/h (42.3 gph)
 Protection: ip 55
 Frequency: 50/60 Hz
 Current: 3.7 a
 Pressure: 10 bar

position	Pump tag	Motor tag	Series no.
01	fcz-029	motr-124	2001 069 781
02	fcz-028	motr-123	2001 069 782
03	fcz-027	motr-122	2001 069 783
04	fcz-026	motr-121	2001 069 779

Lubrication data

For dosing pumps

a) Motor-pump set: Works with oil bath

Recommended oil:

Required qty.: liters

frequency (grease again at each hours):

b) bearings: Work with grease

Recommended grease:

Required qty.:

frequency (grease again at each hours):

Lubrication summary table

components	Lubricant	Qty.	frequency
Motor-pump		2 liters	2000 h
Bearings		2 2 liters	4000 h

Accessories and spare parts

item code Qty. denomination

1.5. ksb

1.5.1. process water pressurization

1.5.2. water sample collection system

1.5.3. irai-macanhann treated water pressurization

1.5.4. irai-piraquara treated water pressurization

1.5.5. macanhann-bairro alto treated water pressurization

1.5.6. macanhan-zona alta treated water pressurization

1.5.7. tarumã-cajurú treated water pressurization

PROCESS WATER PRESSURIZATION (DRAGGING)



Register data

Qty.: 2 Motor-pump sets

a) pump

Brand: ksb
Model: meganorm 50-160
Discharge: 6.48 m³/h = 1.8 L/s
Man. Height: 40 mca
Power: 15 hp
Rotation: 3500 rpm

b) pump

Brand: weg
Model: 132 h 0701
Voltage: 440 v
Current: 13.5 a
Power: 15 hp
Rotation: 3500 rpm
Power f.: 0.8

position	Pump tag	Motor tag	Series no.	start
01	fcz-031	motr-125	op 335410	inverter
02	fcz-032	motr-126	op 335411	inverter

Lubrication data

a) Motor-pump set: Works with oil bath

- Recommended oil: marbrax tr-68
- Required qty.: 0.5 liters
- frequency: at each 8000 hours (annually)

b) gaskets: Replace when they are excessively leaking

Lubrication summary table

components	Lubricant	Qty.	frequency
Motor-pump	marbeax tr-68	0.5 l	8000 h

Accessories and spare parts

item	code	Qty.	denomination
01	210	1,0	axle
02	230	1,0	rotor
03	321	1,0	Bearings (pair)
04	421	2,0	Retainer (pair)
05	461	4,0	Gasket (5 rings)
06	502.1	2,0	Wearing ring (body)
07	503.1	2,0	Wearing ring (rotor)
08	524	1,0	Axle protecting sleeve
09	-	4,0	Set of gaskets

Periodical maintenance

Weekly:

- Check for the existence of noise or vibration;
- Check overheating of pillow blocks;
- Check for gasket dripping; regulate if necessary;
- Check nominal current (13.5 a);

Check the pressurization pressure (40mca), for a pump in operation;

Monthly:

Clean the pump and the electric panel.

Check conditions of electrical cables and the fittings of the engine connections box;

Check the pump oil level; supplement if necessary.

Annually:

Check the general conditions of the gasket; replace if necessary;

Change oil according to the lubrication guidance.

WATER SAMPLE COLLECTION SYSTEM



Collection of coagulated water

Register data

Qty.: 1 motor-pump set
Brand: ksb
Model: hydrobloc c-500
Discharge: 10 – 80 l/min (0.16 – 1.33 L/s)
Man. Height: 22 – 14 mca
Power: 0.37 kw = 0.5 hp
Voltage: 220 v
Rotation: 3450 rpm
Frequency: 60 Hz
Current: 3.2 a
Protection: ip 44

position	Pump tag	Motor tag	Series no.
01	fcz-034	motr-	0401

Periodical maintenance

These are small pumps installed in strategic sites, however distant from each other in order to collect water samples and convey them by pressure to the laboratory. This pump disposition somehow makes inspection difficult. Therefore, we recommend to check:

Weekly:

Water discharge in the laboratory taps in order to know whether there was any change; if yes, check in the pumps sites whether the blockage valves are totally opened;

Monthly:

Clean and lubricate

Check for abnormal noise and excessive leak through the gasket;

Annually:

General verification of motor-pump sets; replace gaskets and bearings

COLLECTION OF FILTERED WATER

Register data

Qty.: 2 motor-pump sets
 Brand: ksb
 Model: hydrobloc c-500
 Discharge: 10 – 80 l/min (0.16 – 1.33 L/s)
 Man. height: 22 – 14 mca
 Power: 0.37 kw = 0.5 hp
 Voltage: 220 v
 Rotation: 3450 rpm
 Frequency: 60 Hz
 Current: 3.2 a
 Protection: ip 44

position	Pump tag	Motor tag	Series no.
Modules 01/02	pump-	motr-	0401
Modules 03/04	pump-	motr-	0401

Periodical maintenance

These are small pumps installed in strategic sites, however distant from each other in order to collect water samples and convey them by pressure to

the laboratory. This pump disposition somehow makes inspection difficult.

Therefore, we recommend to check:

Weekly:

Water discharge in the laboratory taps in order to know whether there was any change; if yes, check in the pumps sites whether the blockage valves are totally opened;

Monthly:

Clean and lubricate

Check for abnormal noise and excessive leak through the gasket;

Annually:

General verification of motor-pump sets; replace gaskets and bearings

COLLECTION OF FILTERS WASHING WATER

Register data

Qty.: 4 motor-pump sets
 Brand: ksb
 Model: hydrobloc c-500
 Discharge: 10 – 80 l/min (0.66 – 1.33 L/s)
 Man. Height: 22 – 14 mca
 Power: 0.37 kw = 0.5 hp
 Voltage: 220 v
 Rotation: 3450 rpm
 Frequency: 60 Hz
 Current: 3.2 a
 Protection: ip 44

position	Pump tag	Motor tag	Series no.
Mod. 01	pump-	motr-	0401
Mod. 02	pump-	motr-	0401
Mod. 03	pump-	motr-	0401
Mod. 04	pump-	motr-	0401

Periodical maintenance

These are small pumps installed in strategic sites, however distant from each other in order to collect water samples and convey them by pressure to the laboratory. This pump disposition somehow makes inspection difficult. Therefore, we recommend to check:

Weekly:

Water discharge in the laboratory taps in order to know whether there was any change; if yes, check in the pumps sites whether the blockage valves are totally opened;

Monthly:

Clean and lubricate

Check for abnormal noise and excessive leak through the gasket;

Annually:

General verification of motor-pump sets; replace gaskets and bearings

COLLECTION OF TREATED WATER

Register data

Qty.: 4 motor-pump sets
Brand: ksb
Model: drainer d-500
Discharge: 20 – 140 l/min (0.33 – 2.33 L/s)
Man. Height: 8,0 – 2.0 mca
Power: 0.37 kw = 0.5 hp
Voltage: 220 v
Rotation: 3450 rpm
Frequency: 60 Hz
Current: 2.2 a
Protection: ip 44

position	Pump tag	Motor tag	Series no.
Mod. 01	pump-035	motr-	0701

Mod. 02	pump-036	motr-	0701
Mod. 03	pump-039	motr-	0701(1276)
Mod. 04	pump-040	motr-	0701

Periodical maintenance

These are small pumps installed in strategic sites, however distant from each other in order to collect water samples and convey them by pressure to the laboratory. This pump disposition somehow makes inspection difficult. Therefore, we recommend to check:

Weekly:

Water discharge in the laboratory taps in order to know whether there was any change; if yes, check in the pumps sites whether the blockage valves are totally opened;

Monthly:

Clean and lubricate

Check for abnormal noise and excessive leak through the gasket;

Annually:

General verification of motor-pump sets; replace gaskets and bearings

IRAÍ-MACANHANN TREATED WATER PRESSURIZATION



Register data

Qty.: 5 motor-pumps
 Brand: ksb
 Model: rdlv 500-790 f
 Discharge: 2700 m³/h = 750 L/s
 Man. height: 57 mca
 Power: 800 hp
 Voltage: 6600 v
 Current: 63 a
 Rotation: 880 rpm

position	Pump tag	Motor tag	Series no.	start
01	pump-044	motr-140	op 667258	soft start
02	pump-045	motr-141	op 667256	soft start
03	pump-046	motr-142	op 667254	soft start
04	pump-047	motr-143	op 667255	soft start

05	pump-048	motr-144	op 667257	soft start
----	----------	----------	-----------	------------

Lubrication data

- a) **gevisa electric engine:** Works with oil bath
- Recommended oil:
 Upper pillow block: marbrax tr-68 lubrax
 Lower pillow block: marbrax tr-32 lubrax
 - Required qty.: Upper pillow block: 54.0 liters
 Lower pillow block: 5.5 liters
 - Oil change Each 8000 hours
- b) **ksb pump:** Works with grease
- Recommended grease: Lithium-based
 - Required qty.: 0.5 Kg
 - frequency (grease again at each 8000 hours):

Lubrication summary table

components	Lubricant	Qty.	frequency
Gevisa engine (ms)	marbrax tr-68 lubrax	54.0 l	8000 h
	marbrax tr-32 lubrax	5.5 l	8000 h
Gevisa engine (mi)	Lithium-based grease	0.5 Kg	8000 h
Ksb pump			

Accessories and spare parts

item	code	Qty.	denomination
01	321	1,0	esf-a 6324 / c3 radial bearing

Periodical maintenance

Weekly:

- Check for the existence of noise or vibration;
- Check overheating of pillow blocks;
- Check for gasket dripping; regulate if necessary;
- Check nominal current (63 a);
- Check the pressurization pressure (57 mca) and discharge (750 to 900 L/s), for a pump in operation;

- Check temperature of the electrical engine pillow blocks (varies between 50 and 80°C)

Monthly:

- With the equipment off, check the oil level of the electric engine; it should be indicating half the display, both in the upper pillow block and the lower pillow block; supplement if necessary;
- Check the need of lubricating the intermediary pillow block of the pump, verifying the hour counter, the amount of hours each set has operated;
- Check the electric contacts temperature through the radiometer;
- Check conditions of electrical cables and the fittings of the engine connections box;
- Clean the pump and the electric panel.

Annually:

- Check the general conditions of the gasket; replace if necessary;
- Replace the electric engine oil; check the ksb's services manual;
- Open the lid of the intermediary pillow block in order to remove the excess grease and clean; check the ksb's services manual.
- With the equipment off, tighten again all the fittings of the connection box and of the bus bars in the electrical panels.

1.5.4. IRAÍ-PIRAQUARA TREATED WATER PRESSURIZATION



Register data

Qty.: 3 motor-pumps
 Brand: ksb
 Model: rdlv 150-500 a
 Discharge: 360 m³/h = 100 L/s
 Man. Height: 125 mca
 Power: 350 hp
 Voltage: 440 v
 Rotation: 1750 rpm
 Current: 395 a

position	Pump tag	Motor tag	Series no.	start
01	pump-050	motr-146	op 667261	soft start
02	pump-051	motr-147	op 667260	soft start
03	pump-052	motr-148	op 667259	soft start

Lubrication data

a) bearings: Work with grease

- Recommended grease Lithium-based
- Required qty. 0.3 Kg
- frequency Grease again at each 8000 hours or 1 year

Lubrication summary table

components	Lubricant	Qty.	frequency
Bearings	Lithium-based grease	0.3 Kg	8000 h

Accessories and spare parts

item	code	Qty.	denomination
01	234	1,0	rotor
02	502	4,0	Carcass wearing ring
03	503	4,0	Rotor wearing ring
04	-	1,0	Axle with feather key and nut
05	321	1,0	Antifriction pillow blocks
06	524.1	2,0	Axle protecting sleeve
07	524.2	2,0	Axle protecting sleeve
08	545	1,0	pillow block bushing
09	457	1,0	packing gland ring
10	466	16,0	Packing ring
11	-	6,0	Set of gaskets

Periodical maintenance

Weekly:

- Check for the existence of noise or vibration;
- Check overheating of pillow blocks;
- Check for gasket dripping; regulate if necessary;
- Check nominal current (395 a);
- Check the pressurization pressure (125 mca) and discharge (100 L/s), for a pump in operation;
- Check temperature of the electrical engine pillow blocks (varies between 50 and 80°C)

Monthly:

- Check the need of lubricating the intermediary pillow block of the pump, verifying the hour counter, the amount of hours each set has operated;
- Check the electric contacts temperature through the radiometer;

-Check conditions of electrical cables and the fittings of the engine connections box;

-Clean the pump and the electric panel.

Annually:

-Check the general conditions of the gasket; replace if necessary;

-Open the lid of the intermediary pillow block in order to remove the excess grease and clean; check the ksb's services manual.

-With the equipment off, tighten again all the fittings of the connection box and of the bus bars in the electrical panels.

Motor-pumps nash – 1.6

3. COMPRESSORS / DRYERS / BLOWERS

ingersoll rand
hbr
roboschi
ingersoll rand-2.1 compressors

INSTRUMENTATION AIR COMPRESSORS

site: Treated water pumping station



Register data

Qty.: 2.0 sets with reservoir
Brand: ingersoll
Type: Piston
Model: b2 475n 7-5
Displac.: m³/min
Pressure: bar
Power: 5.5 hp
Voltage: 440 v

POSITION	PUMP TAG	MOTOR TAG	SERIES
01	cpmr-009	motr-	120b 020081
02	cpmr-010	motr-	120b 020084

Lubrication data

- a) compressor: Works with oil bath
Recommended oil t30 selected ingersoll
Required qty. 2.50 liters
Oil change 1000 hours or 6 months
- b) electric engine: Works with grease (2 pillow blocks)
Recommended grease: multifak ep2 – nlg 2 texaco
Required qty. . 0.05 Kg
frequency 2000 hours or 12 months

Lubrication summary table

components	Lubricant	Required qty.	frequency
compressor	t30 selected ingersoll	2.50 liters	1000 h
Electric engine	multifak ep2 – 2 texaco	0.05 Kg	2000 h

Periodical maintenance

Daily:

- Drain the water condensed in the tank;
- Check for the existence of abnormal noise or vibration.

Weekly:

- Inspect the lubricant oil level.

Monthly:

- Inspect / clean the air filter;
- Check if there is contamination of the lubricant oil. Change if necessary;
- Clean outside the heat exchanger;

- Check the functioning of the low oil level switch;
- Operate relief valves manually;
- Clean the refrigeration wings of the cylinders;
- Check for tension in the belts;
- Clean outside the ventilation system;
- Check all the screws. Tighten again if necessary;
- Check for the existence of air leaks in the equipment and in the

lines.

Bi-annual (1000 hours);

- Change the lubricant oil.

Annually (2000 hours):

- Inspect and lubricate the engine bearings (2);
- Lubricate the O ring with lubricant for 200°f;
- Inspect and clean the compressor valves. Replace if necessary.

site: Rho of the pressurized pipeline for Piraquara



Register data

QTY.: 1.0 SET WITH RESERVOIR

Brand: ingersoll
 Type: Piston
 Model: h2 340 d2
 Displac.: m³/mim
 Pressure: bar

Power: 2.0 hp

Voltage: 440 v

POSITION	PUMP TAG	MOTOR TAG	SERIES
01	cpmr-011	motr-	30t 956941

Lubrication data

a) compressor: Works with oil bath

Recommended oil: t30 selected ingersoll

Required qty. 2.50 liters

Oil change At each 1000 hours or 6 months

b) Electric engine: Works with grease

Recommended grease: multifak ep2 – nlgi 2 texaco

Required qty.: 0.05 Kg

Frequency: 2000 hours or 12 months

Lubrication summary table

components	Lubricant	Required qty.	frequency
compressor	t30 selected ingersoll	2.50 liters	1000 h
Electric engine	multifak ep2 texaco	0.05 Kg	2000 h

Periodical maintenance

Daily:

- Drain the water condensed in the tank;
- Check for the existence of abnormal noise or vibration.

Weekly:

- Inspect the lubricant oil level.

Monthly:

- Inspect / clean the air filter;
- Check if there is contamination of the lubricant oil. Change if necessary;
- Clean outside the heat exchanger;

- Check the functioning of the low oil level switch;
- Operate relief valves manually;
- Clean the refrigeration wings of the cylinders;
- Check for tension in the belts;
- Clean outside the ventilation system;
- Check all the screws. Tighten again if necessary;
- Check for the existence of air leaks in the equipment and in the

lines.

Bi-annual (1000 hours);

- Change the lubricant oil.

Annually (2000 hours):

- Inspect and lubricate the engine bearings (2);
- Lubricate the O ring with lubricant for 200°f;
- Inspect and clean the compressor valves. Replace if necessary.

RHO'S OF IRAÍ – MACANHANN / TARUMÃ PRESSURIZED PIPELINES



Register data

QTY.: 2.0 SETS WITH RESERVOIR
 Brand: ingersoll
 Type: Piston

Model: b2 340 e15
 Displac.: m³/mim
 Pressure: bar
 Power: 3.7 hp
 Voltage: 440 v

POSITION	PUMP TAG	MOTOR TAG	SERIES
01	cpmr-012	motr-	031b 010197
02	cpmr-013	motr-	031b 010199

Lubrication data

a) compressor: Works with oil bath

Recommended oil: t30 selected ingersoll

Required qty. 2.50 liters

Oil change 1000 hours or 6 months

b) Electric engine: Works with grease (2 pillow blocks)

Recommended grease: multifak ep2 – nlgi 2 texaco

Required qty.: 0.05 Kg

Frequency: 2000 hours or 12 months

Lubrication summary table

components	Lubricant	Required qty.	frequency
compressor	t30 selected ingersoll	2.50 liters	1000 h
Electric engine	multifak ep2 texaco	0.05 Kg	2000 h

Periodical maintenance

Daily:

- Drain the water condensed in the tank;
- Check for the existence of abnormal noise or vibration.

Weekly:

- Inspect the lubricant oil level.

Monthly:

- Inspect / clean the air filter;
- Check if there is contamination of the lubricant oil. Change if necessary;
- Clean outside the heat exchanger;
- Check the functioning of the low oil level switch;
- Operate relief valves manually;
- Clean the refrigeration wings of the cylinders;
- Check for tension in the belts;
- Clean outside the ventilation system;
- Check all the screws. Tighten again if necessary;
- Check for the existence of air leaks in the equipment and in the lines.

Bi-annua (1000 hours):

- Change the lubricant oil.

Annually (2000 hours):

- Inspect and lubricate the engine bearings (2);
- Lubricate the O ring with lubricant for 200°F;
- Inspect and clean the compressor valves. Replace if necessary.

SATURATION AIR COMPRESSORS

Treatment modules



Register data

QTY.:	2.0 sets with separated lung
Brand:	ingersoll
Type:	Rotative
Model:	ss-xf25
Displac.:	2.90 m ³ /mim
Pressure:	7.00 bar
Power:	30 hp
Voltage:	440 v

POSITION	PUMP TAG	MOTOR TAG	SERIES
01	cpmr-003	motr-	jx 320 3u 0123
02	cpmr-004	motr-019	jx 320 4u 0123

Lubrication data

compressor

-Recommended oil: ultra coolant

-Required qty. 12 liters

-Change period: At each 8000 hours or 2 months

-Oil filter: 1st change after 150 hours; the others after 2000

hours

Remark

- in filter changes up to 8000 hours, only supplements the oil level.

b) electric engine:

-Recommended grease móbil shc 220

-Required qty. 0.230 Kg

-frequency Grease again at each 2000 hours or 9 months

Lubrication summary table

components	Lubricant	Required qty.	frequency
compressor	ultra coolant	12 liters	8000 h
Electric	móbil shc 220	0.230 Kg	2000 h

engine

Periodical maintenance:

REPLACE THE GUIDANCE BELOW, SINCE THE FOLLOWING ARE FOR PISTON COMPRESSORS: SEE INGERSOLL RAND MANUAL FOR SS-XF25 COMPRESSORS

Daily:

- Drain the water condensed in the tank;
- Check for the existence of abnormal noise or vibration.

Weekly:

- Inspect the lubricant oil level.

Monthly:

- Inspect / clean the air filter;
- Check if there is contamination of the lubricant oil. Change if

necessary;

- Clean outside the heat exchanger;
- Check the functioning of the low oil level switch;
- Operate relief valves manually;
- Clean the refrigeration wings of the cylinders;
- Check for tension in the belts;
- Clean outside the ventilation system;
- Check all the screws. Tighten again if necessary;
- Check for the existence of air leaks in the equipment and in the

lines.

Bi-annual (1000 hours):

- Change the lubricant oil.

Annually (2000 hours):

- Inspect and lubricate the engine bearings (2);
- Lubricate the O ring with lubricant for 200°f;
- Inspect and clean the compressor valves. Replace if necessary.

HBR -2.2 AIR DRIERS

By the instrumentation air compressors of treatment modules



Register data

QTY.:	1.0 unit
Brand:	hbr
Model:	hbr-060
Series:	11406/01
Discharge:	101 m³/h
Pressure:	12.3 bar
Compressor:	embraco ffi-12-hbx
Refrig. type:	r-134 a
Coalescent elem.:	0060/m20
Voltage:	220/1/60 v

Lubrication data

See Hbr services manual

Periodical maintenance

See Hbr services manual

By the instrumentation air compressors of the Iraí-Macanhann treated water pumping station

Register data

QTY.:	1.0 unit
BRAND	hbr
Model:	hbr-040
Series:	11049/01

Discharge: 68 m³/h
 Pressure: 12.3 bar
 Compressor: embraco ffi8,5-hbx
 Refrig. type: r-134^a
 Coalescent elem.: ef-0060 / m20
 Voltage: 220/ 1 / 60 v

Lubrication data

See Hbr services manual

Periodical maintenance

- See Hbr services manual

ROBUSCHI – 2.3 AIR BLOWERS

Air blowers for washing the filters



site: Treatment modules

Register data

QTY.: 4.0 sets
 Brand: robuschi
 Type: roots
 Model: rb-lp 101 / u
 Displac.: 62 m³/mim
 Pressure: 4.00 bar
 Power: 75 hp
 Voltage: 440 v

POSITION	PUMP TAG	MOTOR TAG	SERIES
01	cpmr-001	motr-	unit/00-10652
02	cpmr-002	motr-	unit/00-09729
03	cpmr-005	motr-	unit/00-10650
04	cpmr-006	motr-	unit/00-07752

Lubrication data

a) compressor: Works with oil bath

Recommended oil

Required qty. liters

Oil change At each hours

b) electric engine: Works with grease

Recommended grease:

Required qty. kg

frequency grease again at each hours

Lubrication summary table

components	Lubricant	Required qty.	frequency
compressor		liters	h
Electric engine		kg	h

Spare parts

- See Robuschi services manual

Periodical maintenance

- See Robuschi services manual

4. AGITATORS AND MIXERS

3.1. flygt

3.2. ecosan

3.3. sanidro/nord

FLYGT MIXERS

Filters washing water reservoir



Register data

QTY.: 8 units
 Brand: flygt
 Type: mixer
 Model: 4640
 Power: 5.0 hp
 Voltage: 440 v
 Current: 6.7 a
 Rotation: 885 rpm

POSITION	PUMP TAG	MOTOR TAG	SERIES NO.	START
Mod. 1	mix-001	motr-013	410 0060 146	inverter
Mod. 1	mix-002	motr-014	410 0060 141	inverter
Mod. 2	mix-003	motr-031	410 0060 143	inverter

Mod. 2	mix-004	motr-032	410 0060 144	inverter
Mod. 3	mix-005	motr-044	410 0060 142	inverter
Mod. 3	mix-006	motr-045	410 0060 139	inverter
Mod. 4	mix-007	motr-059	410 0060 140	inverter
Mod. 4	mix-008	motr-060	410 0060 145	inverter

Lubrication data

For the Flygt mixers

a) reduction box: Works with oil bath

-Recommended grease:

-Required qty. liters

-Oil change at each hours

b) electric engine pillow blocks work with grease

-Recommended grease

-Required qty. kg

-frequency Grease again at each hours

Summary lubrication table

Components	Lubricant	Qty.	frequency
reduction box		liters	h
Electric engine		liters	h

Accessories and spare parts

item code Qty. denomination

Periodical maintenance

Of submersible mixers

Weekly:

- Check in the command panel if the mixers are working within the nominal current (60 Hz =6,7 a);
- Check in the installation site for the existence of abnormal noise or vibration, observing through the mixers supports;

Monthly:

- Clean the electrical panels;
- Check the temperature of electric contacts through the radiometer;

- Check the general state of power and command cables; tighten them again if necessary

Annually:

- Remove the mixers from the reservoir for general verification;
- Take a sample of lubricant oil to check contamination with water
- Replace the lubricant oil if necessary;
- Check for clearances in the pedestal and guide pipes;
- Check the conditions of electrical cables, especially in the mixers inlet fittings;

SLAKED LIME PREPARATION TANK



Register data

Qty. : 2 units
 Brand: flygt
 Type: mixer
 Model: 4440
 Power: 3.0 hp
 Voltage: 380 v
 Current: 4.9 a
 Rotation: 1690 rpm

POSITION	PUMP TAG	ENGINE TAG	SERIES NO.	START
Tank 1	mix-009	motr-093	010 0060 009	inverter
Tank 2	mix-011	motr-095	010 0060 008	inverter

Lubrication data

For the Flygt mixers

a) reduction box: Works with oil bath

- Recommended oil
- Required qty. liters
- Oil change at each hours

b) electric engine pillow boxes: work with grease

- Recommended grease
- Required qty. kg
- frequency Grease again at each hours

Summary lubrication table

Components	Lubricant	Qty.	frequency
reduction box		liters	h
Electric engine		liters	h

Accessories and spare parts

item code Qty. denomination

Periodical maintenance

Of submersible mixers

Weekly:

- Check in the command panel if the mixers are working within the nominal current (60 Hz =6,7 a);
- Check in the installation site for the existence of abnormal noise or vibration, observing through the mixers supports;

POLYPHOSPHATE MIXERS



Register data

Qty.: 2 units
 Brand: ecosan
 Type: Radial flow
 Model:
 vmin.:
 vmax.:
 Power:
 Voltage: 440 v
 Rotation:
 Rel. transm.: i =

POSITION	PUMP TAG	ENGINE TAG	SERIES NO.	START
01	agit-020	motr-		
02	agit-021	motr-		

Lubrication data

a) reduction box: Works with oil bath

Recommended oil

Required qty. liters

Oil change at each hours

b) electric engine pillow blocks work with grease

Recommended grease

Required qty. kg

Oil change Grease again at each hours

Summary lubrication table

Components	Lubricant	Qty.	frequency
reduction box		liters	h
Electric engine		liters	h

Accessories and spare parts

item code Qty. denomination

Periodical maintenance

Weekly:

- Check for the existence of abnormal noise or vibration;
- check for overheating of the engine and/or reducer.

Monthly

- Check the oil level of the reducer;
- Lubricate the pillow blocks of the engine;
- Check the conditions of the frequency inverter;

Annually:

- Change the reducer oil (see the manual)
- Check the axle coupling and the conditions of propellers

sanidro / nord

- Check the axle coupling and the conditions of propellers

5. RAW WATER SCREENING SYSTEM

5.1. sanidro/nord

MECHANICAL SCREENS FOR RAW WATER CATCHMENT



Register data

Qty.: 3 units
Brand: sanidro / nord
Model: sew
reduction: 1:294.26
Power: 0.5 hp
Rotation: 1720 rpm (engine)
Voltage: 220/380 v
Current: 2.07/1.20 a

POSITION	Grate tag	ENGINE TAG	SERIES	START
01	grdm-001	motr-	2000 1219 1006-1	inverter
02	grdm-002	motr-	2000 1219 1006-1	inverter
03	grdm-003	motr-	2000 1219 1006-1	inverter

Lubrication data

a) reduction box: Works with oil bath

CMC valves

WTP

Inlet of treatment modules 01, 02, 03, 04



4 valves with pneumatic actuator

a) valve

- Type: Butterfly
- Brand: cmc
- Gauge: DN 1200
- Material: Ductile iron
- Pressure: pn 10
- Fittings: flanges

b) actuator

- Type: Pneumatic cylinder
- Brand: keystone
- Model: alga 3c-385
- Air pressure: 76 psi

Module	SERIES	tag
01	00 1602 603 001	fbv-001
02	00 1602 603 003	fbv-002
03	00 1602 603 004	fbv-003
04	00 1602 603 002	fbv-004

Outlet of filtered water

- 16 valves with pneumatic actuator

a) valve

- Type: Butterfly
- Brand: cmc
- Gauge: DN 450
- Material: Ductile iron
- Pressure: pn 10
- Fittings: wafer

b) actuator

- Type: Pneumatic cylinder
- Brand: keystone
- Model: f79u 091
- Air pressure: 120 psi
- Fittings: ¼" npt

Outlet of filtered water

- 16 valves with pneumatic actuator

a) valve

- Type: Butterfly
- Brand: cmc
- Gauge: DN 600
- Material: Ductile iron
- Pressure: pn 10
- Fittings: wafer

b) actuator

- Type: Pneumatic cylinder
- Brand: keystone
- Model: f79u 091
- Air pressure: 120 psi
- Fittings: ¼" npt

- outlet of filters washing water

- 16 valves with pneumatic actuator

a) valve

- Type: Butterfly
- Brand: cmc
- Gauge: DN 600
- Material: Ductile iron
- Pressure: pn 10
- Fittings: **wafer**

b) actuator

- Type: Pneumatic cylinder
- Brand: keystone
- Model: f79u 091
- Air pressure: 120 psi
- Fittings: ¼" npt

Drainage of filters water

16 valves with pneumatic actuator

a) valve

- Type: Butterfly
- Brand: cmc
- Gauge: DN 300
- Material: Ductile iron
- Pressure: pn 10
- Fittings: **wafer**

b) actuator

- Type: Pneumatic cylinder
- Brand: keystone
- Model: f79u br 024
- Air pressure: 120 psi
- Fittings: ¼" npt

inlet of filters washing air (blower)

16 valves with pneumatic actuator

a) valve

- Type: Butterfly
- Brand: cmc

- Gauge: DN 250
- Material: Ductile iron
- Pressure: pn 10
- Fittings: **wafer**

b) actuator

- Type: Pneumatic cylinder
- Brand: keystone
- Model: f79u 036
- Air pressure: 120 psi
- Fittings: ¼" npt

Drainage of the well of the filters washing water pump

2 valves with pneumatic actuator

a) valve

- Type: Butterfly
- Brand: cmc
- Gauge: DN 300
- Material: Ductile iron
- Pressure: pn 10
- Fittings: **wafer**

b) actuator

- Type: Pneumatic cylinder
- Brand: keystone
- Model: f79u br 024
- Air pressure: 120 psi
- Fittings: ¼" npt

iraí – macanhann/tarumã treated water pumping station

6 butterfly valves with manual actuation through the reducer and steering wheel

- | | | | |
|-------------|--------------|----------|---------|
| - Type: | Butterfly | POSITION | tag |
| - Brand: | cmc | 01 | fbv 348 |
| - Gauge: | DN 800 | 02 | fbv 349 |
| - Material: | Ductile iron | 03 | fbv 350 |

- Pressure: pn 10 04 fbv 351
- Fittings: flanges 05 fbv 352
- 06 fbv 353

5 quick closure retention valves

- Type: clasar POSITION tag
- Brand: alstom 01 042
- Gauge: DN 700 02 043
- Material: Ductile iron 03 044
- Pressure: pn 10 04 045
- Fittings: flanges 05 046

5 butterfly valves with pneumatic actuation

a) valve

- Type: Butterfly POSITION tag
- Brand: cmc 01 fbv 354
- Gauge: DN 700 02 fbv 355
- Material: Ductile iron 03 fbv 356
- Pressure: pn 10 04 fbv 357
- Fittings: flanges 05 fbv 358

b) actuator

- | | | |
|---------------------------|----------|-----------------|
| Type: Pneumatic cylinder | POSITION | SERIES |
| Brand: keystone | 01 | 00 1602 602 004 |
| Model: alga 1.5c-280 | 02 | 00 1602 602 006 |
| Max. air pressure: 75 psi | 03 | 00 1602 602 005 |
| 04 | | 00 1602 602 003 |
| 05 | | 00 1602 602 001 |

iraí – piraquara treated water pumping station

4 butterfly valves with manual actuation through the reducer and steering wheel

- Type: Butterfly POSITION tag
- Brand: cmc 01 fbv 360
- Gauge: DN 400 02 fbv 361
- Material: Ductile iron 03 fbv 362

- Pressure: pn 10 04 fbv 363

- Fittings: flanges

3 retention valves

- Type: clasar POSITION tag
- Brand: alstom 01 048
- Gauge: DN 300 02 049
- Material: Ductile iron 03 050
- Pressure: pn 16
- Fittings: flanges

3 butterfly valves with pneumatic actuation

a) valve

- Type: Butterfly POSITION tag
- Brand: cmc 01 fbv 364
- Gauge: DN 300 02 fbv 365
- Material: Ductile iron 03 fbv 366
- Pressure: pn 16
- Fittings: flanges

b) actuator

- Type: Pneumatic cylinder
- Brand: keystone
- Model: f79u 091
- Max. air pressure: 120 psi
- Air fitting: ¼" npt

iraí – Vila Amélia treated water pumping station

3 butterfly valves with manual actuation through the reducer and steering wheel

- Type: Butterfly POSITION tag
- Brand: cmc 01 fbv 368
- Gauge: DN 400 02 fbv 369
- Material: Ductile iron 03 fbv 370
- Pressure: pn 10
- Fittings: flanges

Outlet runlet -

DN 1000 pressurized pipeline (irai – macanhann/tarumã)

- 1 butterfly valve with manual actuation through the reducer and steering wheel

- Type: Butterfly
- Brand: cmc
- Gauge: DN 900
- Material: Ductile iron
- Pressure: pn 10
- Fittings: flanges

DN 900 pressurized pipeline (irai –tarumã)

- 1 butterfly valve with manual actuation through the reducer and steering wheel

- Type: Butterfly
- Brand: cmc
- Gauge: DN 800
- Material: Ductile iron
- Pressure: pn 10
- Fittings: flanges

– dn 400 water main (irai –piraquara)

- 1 butterfly valve with manual actuation through the reducer and steering wheel

- Type: Butterfly
- Brand: cmc
- Gauge: DN 400
- Material: Ductile iron
- Pressure: pn 16
- Fittings: flanges

dn 400 water main (irai – vila amelia)

- 1 butterfly valve with manual actuation through the reducer and steering wheel

- Type: Butterfly
- Brand: cmc
- Gauge: DN 300
- Material: Ductile iron
- Pressure: pn 10
- Fittings: flanges

Hydro-pneumatic reservoir (rho) -

Dn 1000 water main

a) rho inlet

- 1 butterfly valve with manual actuation through the reducer and steering wheel

- Type: Butterfly
- Brand: cmc
- Gauge: DN 700
- Material: Ductile iron
- Pressure: pn 10
- Fittings: flanges
- Tag: fbv 375

b) rho inlet

- 1 butterfly valve with manual actuation through the steering wheel

- Type: Slide valve
- Brand: fal
- Gauge: DN 100
- Material: Ductile iron
- Pressure: pn 16
- Fittings: flanges

Dn 900 water main

a) rho inlet

- 1 butterfly valve with manual actuation through the reducer and steering wheel

- Type: Butterfly
- Brand: cmc

- Gauge: dn 700
- material: Ductile iron
- Pressure: pn 10
- Fittings: flanges
- Tag: fbv 376

b) rho inlet

- **1 butterfly valve with manual actuation through the reducer and steering wheel**

- Type: Slide valve
- Brand: fal
- Gauge: dn 100
- material: Ductile iron
- Pressure: pn 16
- Fittings: flanges

Dn 400 water main

a) rho inlet

- **1 butterfly valve with manual actuation through the reducer and steering wheel**

- Type: Butterfly
- Brand: cmc
- Gauge: dn 250
- material: Ductile iron
- Pressure: pn 10
- Fittings: flanges
- Tag: fbv 374

b) rho inlet

- **1 butterfly valve with manual actuation through the reducer and steering wheel**

- Type: Slide valve
- Brand: fal
- Gauge: dn 100
- material: Ductile iron

- Pressure: pn 16
- Fittings: flanges

Fontaine sluices

Catchment -

Dam of the access channel inlet

- **1 squared sluice with manual actuation through a handle**

- Type: Squared
- Brand: fontaine
- Dimensions: 1000 x 1000 mm
- Model: 204-1016x1016-b-cw
- material: stainless steel
- Tag:

raw water channel drainage

- **1 rectangular sluice with manual actuation through a handle**

- Type: Squared
- Brand: fontaine
- Dimensions: 800 x 800 mm
- Model: 204-821x812-b-cw
- material: stainless steel

Treated water reservoir (8000 m³)

Chambers inlet

- **4 squared sluices with manual actuation through a handle**

- Type: Squared
- Brand: fontaine
- Dimensions: 1500 x 1500 mm
- Model: 204-1524x1524-b-cw
- material: stainless steel

Pumps suction inlet

- **2 squared sluices with manual actuation through a handle**

- Type: Squared

- Brand: fontaine
- Dimensions: 1500 x 1500 mm
- Model: 204-1524x1524-b-cw
- material: stainless steel

ouro fino sluices

Catchment –

Inlet of raw water suction channels

6 rectangular sluices with manual actuation through a steering wheel

- Type: rectangular
- Brand: ouro fino
- Dimensions: 1280 x 2400 mm
- Useful height: 1200 mm
- material: fiberglass

position	Tag
01	fbv-170
02	fbv-171
03	fbv-172
04	fbv-173
05	fbv-174
06	fbv-176

WTA -

Inlet of flocculated water into the filters

16 rectangular sluices with pneumatic actuator

a) sluice

- Type: rectangular
- Brand: ouro fino
- Dimensions: 1100 x 1900 mm
- material: fiberglass

b) sluice

- Type: Double action pneumatic cylinder

- Brand: festo
- Model: dnc 125 500 ppva r3
- Max. air pressure: 10 bar

Periodical maintenance

Of valves and sluices
Sluice with manual actuation of the regularization dam

Monthly

- Check the state of the fuse and guides;
- Check for leaks;
- Check the actuations;
- Lubricate if necessary.

Sluice with manual actuation of the intake channel

Monthly

- Check the state of the fuse and guides;
- Check for leaks;
- Check the actuations;
- Lubricate if necessary.

Sluices with manual actuation of the suction channels

Monthly

- Check the state of the fuse and guides;
- Check for leaks;
- Check the actuations;
- Lubricate if necessary.

Drain valve for the accumulation chamber

Monthly

- Check the state of the actuation shaft and of the steering wheel;
- Check for the watertightness;
- Lubricate if necessary.

Inlet valves of coagulated water (4.0)

Weekly:

- Check for the existence of air leaks in the pneumatic actuation system;

- Check for watertightness after closing the valve.
- Lubricate if necessary.

Monthly

- Clean and lubricate the west-lock valves.

Annually

- Check the extreme cleanliness conditions; paint if necessary;
- Check the conditions of compressed air hoses; replace if necessary.

Filters (16 units)

Sluices with pneumatic actuation of the filters inlet (16.0)

Weekly:

- Check for the existence of air leaks in the pneumatic actuation system;
- Check for watertightness after closing the sluices.

Monthly

- Clean and lubricate the west-lock valves.

Annually

- Check the extreme cleanliness conditions; paint if necessary;
- Check the conditions of compressed air hoses; replace if necessary.

Valves with pneumatic actuation of the filtered water outlet (16.0)

Weekly:

- Check for the existence of air leaks in the pneumatic actuation system;
- Check for watertightness after closing the sluices.

Monthly

- Clean and lubricate the west-lock valves.

Annually

- Check the conditions of compressed air hoses; replace if necessary.

Valves with pneumatic actuation of the washing water outlet (16.0)

Weekly:

- Check for the existence of air leaks in the pneumatic actuation system;

- Check for the watertightness after closing each valve, observing whether water continuous to come out through the respective washing water outlet channels.

Monthly

- Clean and lubricate the west-lock valves.

Annually

- Check the extreme cleanliness conditions; paint if necessary;
- Check the conditions of compressed air hoses; replace if necessary.

Valves with pneumatic actuation of the bottom discharge (16.0)

Weekly:

- Check for the existence of air leaks in the pneumatic actuation system;
- Check for the watertightness after closing each valve, observing whether water continuous to come out through the respective washing water outlet channels.

Monthly

- Clean and lubricate the west-lock valves.

Annually

- Check the extreme cleanliness conditions; paint if necessary;
- Check the conditions of compressed air hoses; replace if necessary.

Valves with pneumatic actuation of the filters inlet (16.0)

Weekly:

- Check for the existence of air leaks in the pneumatic actuation system;
- Check for the watertightness after closing each valve, observing whether water continuous to come out through the respective washing water outlet channels.

Monthly

- Clean and lubricate the west-lock valves.

Annually

- Check the conditions of compressed air hoses; replace if necessary.
- Check the extreme cleanliness conditions; paint if necessary;



7. PREPARATION OF CHEMICALS

prominent

8. PREPARATION OF SLUDGE

pieralisi

Sludge centrifuges

Technical features

General data

Site:	Sludge preparation
Qty.:	2 centrifuges
Brand:	pieralisi
Model:	fp 600 2rs m
Manufacture year:	2000
Min. discharge:	7.5m ³ /h
Max. discharge:	15 m ³ /h
Pressure:	0.5 bar
Max. density:	1.4 kg/dm ³

b) Drum

Shape:	Sludge preparation
No. of cylindrical sectors:	3
Internal diameter:	353 mm
Useful length:	1145 mm
slenderness ratio:	4.32
Normal rotation:	3500 rpm
Maximum rotation:	4000 rpm
Max. central acceleration:	3200(xg)

c) Coupling

Normal differential:	15 rpm
Maximum differential:	25 rpm

d) Main engine

Power:	15 kw
No. of poles:	2
Voltage:	220 v

Frequency: 60 Hz

Start: direct

e) Scraper engine

Power: 0.25 kw

Voltage: 440 v

Frequency: 60 Hz

Start: direct

f) reducer

Site: Sludge preparation

Type: Hepicycloidal

position	Tag	Manufacturing no.
01	rsep-001	mo 6436
02	rsep-002	mo 6437

Lubrication

a) scraper reducer: Does not require lubrication, long life grease provided

b) hepicycloidal reducer: Works with oil bath

-Recommended oil: móbil shc 629

-Required qty.: 2 liters, approx.

-Oil change : At each 2000 hours

c) Hydrodynamic coupling: Works in the presence of oil

-Recommended oil: esso atf dextron ii (sae 10 w)

-Required qty.: 2 liters, approx.

-Oil change : At each 4.000 hours

d) drum pillow blocks and pulley: Work with grease

-Recommended grease: kluber isoflex nbu 15

-Required qty.: 0.4 kg, approx..

-Grease again: At each 250 hours

e) scraper bearing: Work with grease

-Recommended grease: kluber tribostar 2 ep

-Required qty.: 1 kg, approx..

-Grease again: At each 24 hours

Summary lubrication table

Components	Lubricant	Qty.	Frequency
hepicycloidal reducer	mobil shc 629	2 liters	2000 h
Hydrodynamic coupling	esso atf dextron ii (10 w) oil	2 liters	4000 h
Bearing pillow blocks	kluber isoflex nbu 15 grease	0.4 kg	250 h
scraper bearing	kluber tribostar 2 ep grease	1.0 kg	24 h

Accessories and spare parts

ref.	code	Qty.	denomination
1	601000	1	Toolbox
2	660126	10	Safety pin
3	216730815	1	360 h100 belt
4	216730835	1	420 h100 belt
5	214180136	3	spa 1632 belt
6	217200072	2	62-75 clamp
7	217200058	6	44-58 clamp
8	217200030	2	21-30 clamp
9	316131002	1	Oil for reducer (1kg)
10	316130001	1	Oil for coupling (1kg)
11	009305135	1	Grease (0.4 kg)
12	316300016	1	Grease for scraper

9.1. SCHWANKE (CRANE HOIST)

- 9.1.1. Single-girder overhead bridge cranes and electric hoists
 - 9.1.1.1. Single-girder overhead bridge cranes and electric hoists
 - 9.1.1.1.1. Raw water pumping station
 - 1 single-girder overhead bridge crane with electrical hoist
 - 9.1.1.1.2. Drainage of raw water channels
 - 1 single-girder overhead bridge crane with manual hoist
 - 9.1.1.1.3. Pressurization of filters washing water
 - 2 single-girder overhead bridge cranes with electrical hoist
 - 9.1.1.1.4. Saturation water pressurization
 - 4 single-girder overhead bridge cranes with electrical hoist
 - 9.1.1.1.5. Deep water drainage
 - 1 single-girder overhead bridge crane with manual hoist
 - 9.1.1.1.6. 8000 reservoir drainage
 - 1 portico with manual hoist
 - 9.1.1.1.7. Mechanics workshop
 - 1 single-girder overhead bridge crane with electrical hoist
 - 9.1.1.1.8. Treated water pumping station
 - 1 single-girder overhead bridge crane with electrical hoist
 - 9.1.1.1.9. Macanhann reservoir
 - 1 single-girder overhead bridge crane with electrical hoist

Periodical maintenance

For single-girder overhead bridge cranes with electrical hoist

Monthly:

- Check the functioning of the hoist, moving it in all directions;
- Observe the sensitiveness of the control buttons as for the existence of bad contact;
- Remove one of the pumps and check the ascending and descending speeds, as well as the lateral displacements;
- Check if the buttons panel is placed in a place protected from the weather.

Periodical maintenance

For manual hoists with chains



Monthly:

- Check the actuation conditions;
- Lubricate the chains of manual hoists.

Annually:

- Remove the hoist, clean, paint, and lubricate

Iraí WTA Operation Manual

Operation

Manual elaborated to support the operation of Iraí Water Treatment Plant

TABLE OF CONTENTS.

1 INTAKE	4
2 COAGULATION	14
3 FLOCCULATION	19
4. FLOTO-FILTRATION	23
5 CONTACT CHAMBER	30
6. SATURATION	34
7 SLUDGE	43
8. RECIRCULATION	48
9 RESERVATION	53
10 APPLICATION OF CHEMICAL PRODUCTS	57

1 INTAKE

PERSON RESPONSIBLE FOR THE INFORMATION:

Osny Machado

CATCHMENT BLOCK DIAGRAM

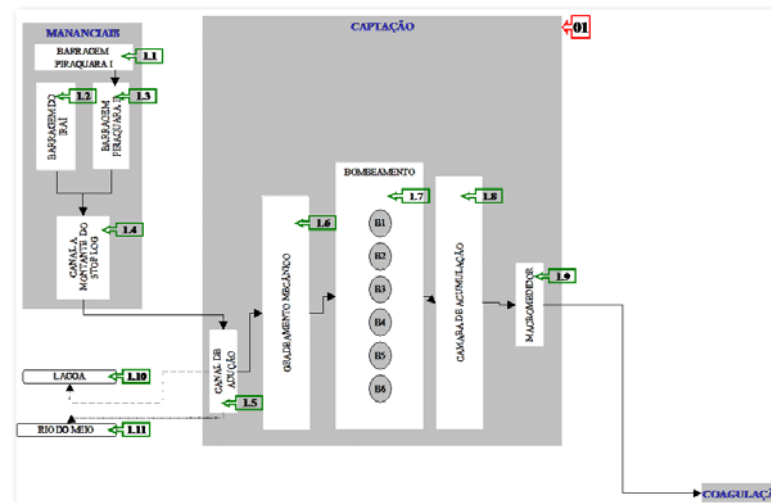

CATCHMENT SPECIFICATION;

The raw water used at Iraí WTP comes from superficial springs, dams and river of the region, which comprise the three open reservoirs.

The water intake is controlled through the operation of the DAMS SLUICES SYSTEM (PF/NEG/0166), which allows using the water of the three dams simultaneously or not. This control prevents wasting reserved water.

Water coming from the dams is conveyed to the WTPs through the clean water channel or spillway channel. Near the "STOP LOG", the clean water channel has a bypass, splitting into spillway channel or clean water channel, and Iraí River channel or intake channel, which supplies IRAÍ WTP catchment, and the clean water channel supplies IGUAÇU WTP.

In this part of the process, no control is performed in regard to the raw water quality, however the IT/OPE/1784 (IRAI WTP operation), in item 5, describes the emergency procedure, such as pollution, contamination, etc.

Irai WTP catchment is comprised of an intake channel, grating to retain vegetation, and 5 (five) motor-pump sets and an equalization tank.

The Maximum Discharge of the WTP with 5 (five) pumps on would be approximately 4,200L/s, but due to its construction the maximum discharge of the operation is approximately (4 pumps) 3,300 L/s in normal conditions (spring quality).

The pumps no.01, no. 03, and no. 05 do not have frequency inverter system, i.e. the water intake volume is constant, between 850L/s and 900L/s. On the other hand, pumps no.02 and no.04 have a frequency inverter that allows the operator to increase or reduce the pump discharge, and thus to vary the intake water volume, varying between 450L/s and 900L/s.

Therefore, it is possible to adjust the inlet intake with the volume necessary to meet the required demand.

DOCUMENTS:

IT/OPE/1784 – IRAÍ WTP OPERATION

PF/NEG/0166 – STANDARD OF OPERATION OF PASSAÚNA, IRAÍ, PIRAQUARA I AND II DAMS SLUICES.

IT/AMB/0028 – EMERGENCY PLAN FOR ENVIRONMENTAL ACCIDENTS AND EMERGENCIES IN SPRINGS.

OPERATED EQUIPMENT:

Level Sensors

Ph Sensor

Turbidity Analyzer

Conductivity Analyzer

Sluices

Grating

Electromechanical fork/rake (vegetation removal)

Manual fork/rake (vegetation removal)

Vegetation Containment Barrier

Pumps (five in total, two through frequency inverter)

Equalization Tank

Pre-Alkalinization Pipeline Valves

EQUIPMENT VERIFICATION

Cleaning;

Sensors Functioning;

Spring Changes;

Pumps Operation;

Valves Functioning;

Sluices Functioning.

IMPORTANCE:

The correct Catchment functioning directly impacts water production with quality and quantity, aiming to supply water to the people, within the parameters defined by legislation (Ordinance 2914/11).

COMMENTS:

Some pieces of equipment are not working as they should, or are not used at all with value forced in the supervisory system (pH Sensors, conductivity, turbidity, mechanical forks).

The system should work in automatic mode, however due to the failure in equipment (PLCs, circuit breakers, etc.), system interlocking, Catchment is operating in manual mode via supervisory.

OPERATION PROCEDURE

When the WTP was built, the turning on/off process would originally be performed with a single “click” in the START button, in the initial supervisory screen.

TURNING ON AND OFF

IN AUTOMATIC MODE

Prepare the whole system in AUTOMATIC mode, the motor-pumps, chemicals dispensers, saturation system, and dragging water. Program the desired discharge in the set point, and select modules to be used.

Check the raw water levels in the channel, which should be above 1.70cm, this can be observed in the "OVERVIEW OF THE SUPERVISORY", in items "LT001" and "LT002".

Firstly, instrumentation and saturation compressors should be turned on, and then the dragging or process water:

Turning on the instrumentation compressors

These compressors (two) are installed in the back of the charcoal house.

They are only actuated in local mode.

When the turning on-off commands (green-red) are powered, they are visualized in the upper part of the device, in order to turn on just press the green button, or the red button to turn it off.

After being turned on, the system takes approximately five minutes to be in full load. It should be checked whether the working pressure is above 50mca, which can be verified in the screen "OVERVIEW OF THE SUPERVISORY" IN "PT036", if such value is not reached, wait for some more time, in not reaching the value, turn off the compressor and actuate the reserve compressor in the same site, using the same procedures, and request for maintenance in order to appraise the occurrence.

After reaching the pressure of 50mca, continue the procedure of turning

COMPRESSORES	
SATURAÇÃO	INSTRUMENT.
PT08 53,7 mca	PT36 51,9 mca
SECADOR DE AR 	

on the WTP.

Remark: Pay attention to the fact that the compressed air outlet valve located in the back of the compressor should be open.

Turning on the dragging water

The dragging or process water originates in the outlet pipeline for distribution, which feeds the high water reservoir, and through pressure the other sites where the dragging water is used. However, the dragging water pump should be turned on, and they are located underneath the staircase accessing modules 3 and 4 in the back of the WTP.

In order to actuate such pumps, click on the figure "DRAGGING WATER" in the general supervisory, and a sub-screen will appear showing the configuration of pumps, in the right side of the screen, click on the pump icon, and a new window will appear, in which it will be possible to actuate manually or automatically the dragging water pumps.

In the automatic mode, this will turn on when we start the WTP, and in the manual mode, we should select one of the modules and press the turn on button, enter the desired Hz, and check whether the pressure is above 50mca in the "PT037".

Turning on the Saturation compressor

The saturation compressor should be manually turned on, and is located near the raw water intake, between filters galleries.

In order to turn it on, the green button located in the front



compressor panel should be pushed, and to turn it off, push the red button in the same place.

After turning it on, check the working pressure, which should be above 50mca, and is observed in the "OVERVIEW OF THE SUPERVISORY" in the "PT008".

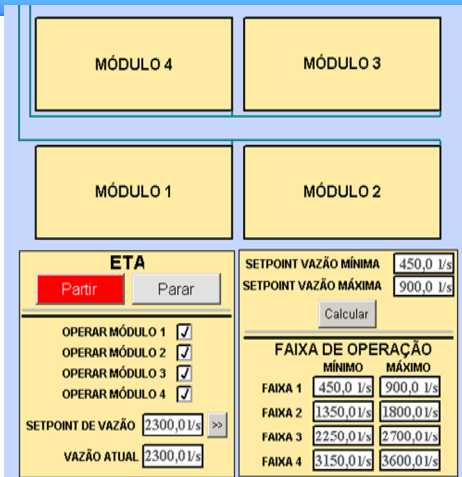

Habilite operation modules

In order to habilitate the modules, click on the window of the pumps intake channel, and a new window will appear where it will be possible to habilitate WTP modules, clicking on the place indicated of each module.

Once this is done, a forced (fictitious) discharge should be simulated in the system, in the same window, in order the other pieces of equipment are released to operate, which will be kept until the first motor-pump is turned on in catchment.

After this and upon confirming if the chemicals dosing is in the automatic mode, start the procedure to turn on the catchment pumps, as follows:

Click on the intake channel figure in the overview of the supervisory, where the configuration of the catchment pumps will appear, as the figure below.

Click on "FT001", and a new window will appear, where it will be possible

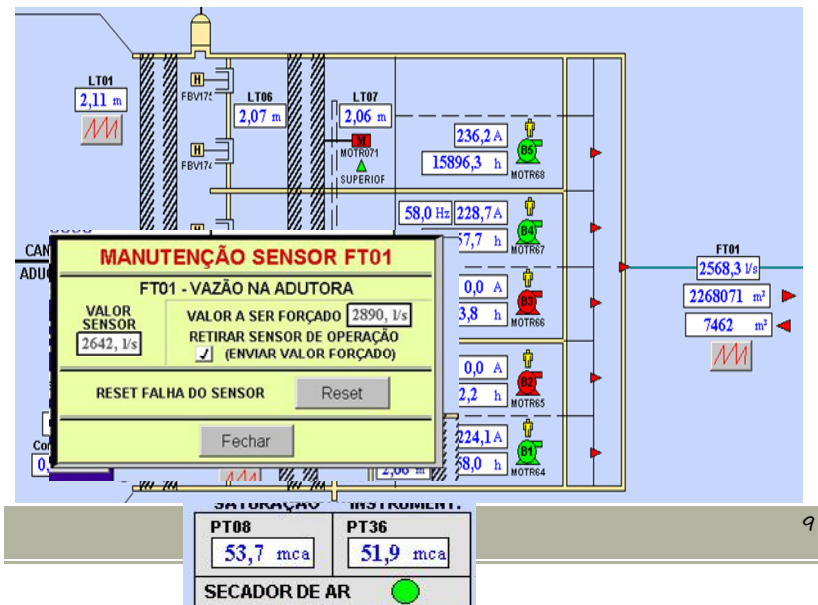

to enter the fictitious discharge, which shall be kept until the start of the first pump intake, i.e. after turning on the first pump, the forced discharge is removed, and the actual discharge prevails.

Then, click on "RAW WATER PUMPING STATION" located in the screen "OVERVIEW OF THE SUPERVISORY", where the window of modules will appear, in the upper part there is the command to "START or STOP THE WPT". Clicking on the START button, this will happen through pump no. 01, until reaching the maximum frequency or 60 Hz, passing to no. 02 until reaching the maximum capacity, or programmed discharge.

If the discharge exceeds this value, use pumps no. 02 or 04 to adjust to the desired volume.

If there is any system failure, such as lack of coagulant in the saturated water, and others, pumps turn off automatically.

In case of "DOUBLE INVERTER FAILURE, DOUBLE CURRENT FAILURE, OR START FAILURE", click on the RESET icon beside the failure. Wait for 5 minutes, and try to actuate it again as described above. If there is failure again, call maintenance and open a service order.

Register the request in the WTP occurrences book, and open a RO pursuant to IA/NEG/0004, and if necessary, open a RACP pursuant to IA/NEG/0006.

To turn off the catchment pump, click on the raw water pumping station, located in the overview screen, click on the respective pump icon, in the window click on the "MANUAL" button and then on "TURN OFF AND CLOSE".

Register the times when the motor-pumps were turned on or off at the IA/OPE/0318.

TURNING ON THE MANUAL MODE

Use the same procedure already mentioned in the previous item until the point of turning on the motor-pumps, which shall follow the procedures described as follows:

Prepare the system to MANUAL mode.

Commands turning on and off catchment pumps are located in the Supervisory, located in Iraí WTP control room, and in Substation No. 02, in front of the electrical command panels.

These commands should only be actuated when there is a failure of communication with the Supervisory in the operation room, and with the presence of the maintenance staff.

In order to actuate the **motor-pump no. 01** in the EEB – IRAÍ – B1 panel, the selecting switch “1” should be positioned to OPERATE, and the other switch “3” to LOCAL, and then the RED button, “4”, should be pushed.

In order to actuate the motor-pump no. 02, in EEB – IRAÍ – B2 panel, the selecting switch “1” should be positioned to OPERATE, and the other switch “3” to LOCAL, in addition to change to manual it also has the function of turning on the pump. In this motor-pump, it is possible to regulate rotation, which is done with selecting switch “4” (to the left, it is reduced, to the right, it is increased).

In order to actuate the **motor-pump no. 03** in the EEB – IRAÍ – B3 panel, the selecting switch “1” should be positioned to OPERATE, and the other switch “3” to LOCAL, and then the RED button, “4”, should be pushed.

In order to actuate the **motor-pump no. 04**, in EEB – IRAÍ – B4 panel, the selecting switch “1” should be positioned to OPERATE, and the other switch “3” to LOCAL, in addition to change to manual it also has the function of turning on the pump. In this motor-pump, it is possible to regulate rotation, which is done with selecting switch “4” (to the left, it is reduced, to the right, it is increased).

In order to actuate the **motor-pump no. 05** in the EEB – IRAÍ – B5 panel, the selecting switch “1” should be positioned to OPERATE, and the other switch “3” to LOCAL, and then the RED button, “4”, should be pushed.

To turn off the motor-pumps in manual mode, at Substation 02, position the selecting switch “1” to TURN OFF.

To return the motor-pumps to automatic mode, in the Substation 02, position the selecting switch “3” to REMOTE.

To turn off the catchment pump, click on the Raw Water Pumping Station, located in the OVERVIEW screen, click on the respective pump icon, in the window click on the “MANUAL” button and then on “TURN OFF AND CLOSE”.

Register the times when the motor-pumps were turned on or off at the IA/OPE/0318.

DURING THE OPERATION PROCESS

A - Daily activities.

Check the correct functioning of pumps, in regard to the discharge defined;

Check for failure in the equipment;

Monitor the Catchment level;

Monitor the raw water quality;

Check for possible alterations in the spring quality;

Register in the treatment bulletin (SCI) and in the BDT

Intake discharge

Number of pumps in use

Register the results of the physical-chemical analyses

IMPORTANT TOPICS AND WORK PROCEDURE.

Proper discharge – Production x Distribution

Monitoring of the Channel Level

Manual Cleaning of Grating, with the use of a fork/rake

2 – PROBLEM SOLVING.

Analyze the occurrence, and when necessary call the USEM

B – WEEKLY ACTIVITIES.

Clean the channel near the retention barrier/footbridge

Cleaning/removal of trash from the channel sides

IMPORTANT TOPICS AND WORK PROCEDURE.

Correct functioning of the system

Cleaning the site, appearance

Reducing risk of damages to the equipment

2 - PROBLEM SOLVING.

Analyze the occurrence, and when necessary call the USEM

MONTHLY ACTIVITIES.

Cleaning of the pumps channel

IMPORTANT TOPICS AND WORK PROCEDURE.

Unforeseen

PROBLEM SOLVING.

Analyze the occurrence, and when necessary call the USEM

ANNUAL ACTIVITIES.

Removal of vegetation from the sides of the conveyance channel

Drainage of the channel (siltation)

01 - IMPORTANT TOPICS AND WORK PROCEDURE.

Drainage of the channel (siltation)

02 - PROBLEM SOLVING.

Analyze the occurrence, and when necessary call the USEM

ACTIVITIES CHECKING WORKSHEET.

Daily Closure Bulletin, discharge control

Registration in the occurrences book, when there are problems, failures in the system

Daily Treatment Bulletin where discharge and volume, produced hourly, are registered

OPERATION DATA AND FEEDBACK.

EMERGENCY SITUATIONS.

In case of need, USEM (Alert Team), Manager (Technical-Chemical alert team), and Bodies concerned with the emergency situation should be called to.

2 COAGULATION

PERSON RESPONSIBLE FOR THE INFORMATION:

Roberto Carlos Tomaz

COAGULATION BLOCK DIAGRAM

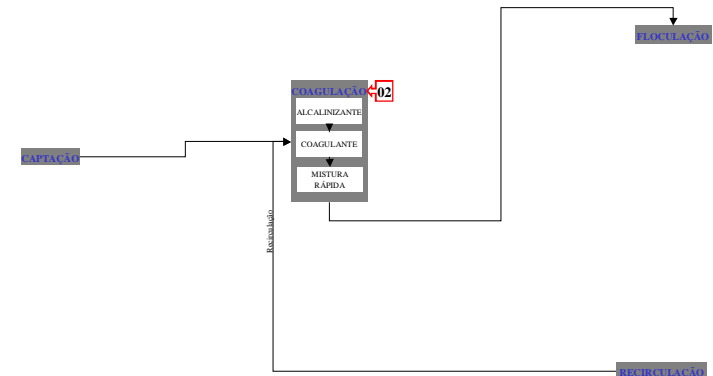

SPECIFICATION OF THE COAGULATION:

Coagulant dosing at IRAÍ WTP

WTP has four reservation tanks that are used both for dosing and for storing chemicals, and we are currently using the ferrous aluminum sulfate.

It is pumped to the raw water pipeline, through dosing pumps, and the system has two Dispensers, usually one in operation and the other in standby.

After catchment, water is conveyed through a pressurized until the center of the treatment plan, where there is a quick mixture chamber. This chamber

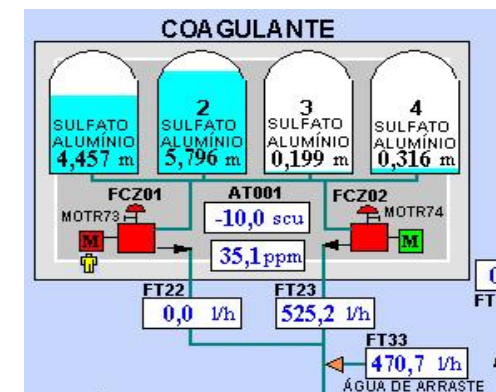

has one agitator and 4 outlets for the coagulated water, which takes it to the 4 treatment modules.

In this phase of the process, the cationic polymer is added to help flocculation.

Note: Before starting the operation, it should be checked whether the valves systems are correctly open, and whether those which should be closed are really closed.

In this phase of the process, the cationic polymer is added to help flocculation.

DOCUMENTS:

IT/OPE/1781 – Coagulant dosing in Iraí System

OPERATED EQUIPMENT:

Dosing motor-pumps of the prominent Model SIGMA

Pneumatic valves

Level sensors

Agitators

Equipment verification

Cleaning of pumps

Sensors functioning

Verification of the dosing diaphragm or membrane

IMPORTANCE:

If one of these topics does not work correctly, it will halt the production, and consequently there will be lack of water supply to the people.

Besides, resulting in losses to the Company.

COMMENTS:

Currently, the operational coagulant dosing system needs a preventive maintenance, and the renovation of pipelines and valves, more strongly, due to the time of operation. It is more than 11 years only with corrective maintenance.

In the supervisory, we have found several icons that no longer correspond to the reality found in the physical area of the WTP, due to the alterations performed, in addition to various commands that no longer respond

to the action to which they were created, hampering **the action of the operator**, who has to go to the site to check.

OPERATION PROCEDURE

TURNING ON

In order to put the system into operation, from the “OVERVIEW” screen in the supervisory, we should select the window COAGULANT, and then click on the dosing pump where it will be used, a new window will appear, where there are several possibilities of operation, and the most used is the ppm;

Clicking on the button MANUAL, we can operate the dispenser manually, i.e. all commands should be entered, such as dosing ppm, PID control, which should also be in the manual mode, etc.

If we click on the automatic button, this will operate automatically, and we should only inform the ppm of the operation.

The dosed coagulant is transported until the raw water main, with the help of the dragging water, in a rigid PVC pipeline.

If there is a failure in the operation, we can reset the operation, and restart.

TURNING OFF

For the system, we just have to enable the system washing, and click on the turn off button.

DURING THE OPERATION PROCESS

The functioning of the dosing pumps is verified

Dosing is checked

The hourly consumption is registered in the BDT

Dosing is adjusted when necessary.

DAILY ACTIVITIES.

Registration of the h/day consumption in the BDT

Evaluation of the flakes and filters behavior, and of the filters turbidity

Correct dosing when necessary

Verification of pumps functioning

IMPORTANT TOPICS AND WORK PROCEDURE.

Chemicals saving.

Good quality coagulation, and consequently a longer filtering line

Good quality filtered water

PROBLEM SOLVING.

This is performed with the USEM and Automation staff.

And with the knowledge and experience of Employees

WEEKLY ACTIVITIES:

Verification of the containment tank valves

IMPORTANT TOPICS

Already mentioned

PROBLEM SOLVING.

Already mentioned

MONTHLY ACTIVITIES.

Verification and entering the inventory in the WTP consumption worksheets

IMPORTANT TOPICS AND PROCEDURES

PROBLEM SOLVING.

Call USEM staff when it is a mechanical problem

Call the Automation staff when it is an Electronic problem

Call the Chemical Technician when it is a quality problem

ANNUAL ACTIVITIES

None

IMPORTANT TOPICS AND PROCEDURES

PROBLEM SOLVING

ACTIVITIES CHECKING WORKSHEET

None

OPERATION DATA AND FEEDBACK

Data are entered in the SCI and BDT, and Feedback is performed through the "OCCURRENCES BOOK" and when the shift is changed.

Via e-mail

EMERGENCY SITUATIONS

In emergency situations, the seriousness of the facts is appraised, and the applicable measures are adopted, such as halting the production system, calling the responsible people, or solving the problem.

3 FLOCCULATION

PERSON RESPONSIBLE FOR THE INFORMATION:

Ulisses Brasileiro Barcellos Nunes

FLOCCULATION BLOCK

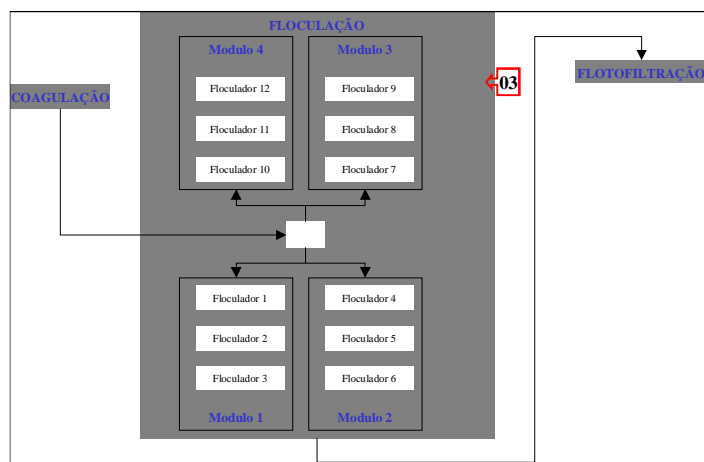

FLOCCULATION OPERATION SPECIFICATION

Flocculation is the process of flakes agglutination, after the coagulation, by adding the coagulant agent, and in the case if Irai WTP, the Liquid Aluminum Sulfate is used. After adding the coagulant, flakes start to form, which is directly related to the treatment, affecting the final quality of the water product.

The WTP has a central agitator to better mix the product, and if necessary, it is turned on. There are also 3 (three) chambers/flocculators per module, each of them with one agitator (that can be used depending on the need and on the size of flakes).

Each flocculator chamber has the purpose of reducing the speed of the filter inlet water, and in this path forming flakes of the necessary size for their better flotation.

Also about flocculation, WTP adopted the use of Cationic Polymer, before used to control algae (cyanobacteria) as a flocculation ancillary, with good results.

DOCUMENTS:

IT/OPE/1781-001 and IT/OPE/1784-01

OPERATED EQUIPMENT:

- Coagulant Dispensers
- Valves
- Agitators
- Cationic Polymer Preparer
- Flocculation Chambers
- Equipment verification
- Functioning of dispensers (coagulant and polymer)
- Functioning of agitators (in use)
- Leak in valves and pipelines

Importance:

The correct functioning of the system aims to produce a better quality water, because the ideal treatment conditions depend on the flocculation and saturation suite.

Comments:

OPERATION PROCEDURE

TURNING ON

With the system functioning, coagulant and polymer dispensers on, as well as the catchment pumps in operation, the flocculation process does not depend on intervention, since after pumping the raw water in the pumping station before receiving the coagulant, it starts the rest of the process by gravity, and the water way will pass through flocculators.

TURNING OFF

When stopping the necessary raw water pumping, the system will close the filters, thus stopping flocculation.

During the operation process.

Visually follow up the formation of flakes

Daily activities.

Important topics and work procedure.

Visual follow-up of the formation of flakes, to a better dosing of products, and final water quality.

PROBLEM SOLVING.

In case of system problems, USEM should be called, and a Service order (HSS) opened.

WEEKLY ACTIVITIES.

- Cleaning of flocculators

IMPORTANT TOPICS AND WORK PROCEDURE.

- Flocculators should be cleaned to prevent the formation of moss and dirty in their walls, improving the visual aspect, and also facilitating the observation of flakes.

PROBLEM SOLVING.

In case of system problems, USEM should be called, and a Service order (HSS) opened.

MONTHLY ACTIVITIES.

Important topics and work procedure.

Request to the USEM the maintenance of dispensers and the verification of the electrical part of command panels (circuit breakers and engines)

PROBLEM SOLVING.

In case of system problems, USEM should be called, and a Service order (HSS) opened.

ANNUAL ACTIVITIES.

Important topics and work procedure.

Nothing planned yet

PROBLEM SOLVING.

In case of system problems, USEM should be called, and a Service order (HSS) opened.

Activities checking worksheet.

None

Operation data and feedback.

EMERGENCY SITUATIONS.

- In case of need, USEM (Alert Team), Manager (Technical-Chemical alert team), and Bodies concerned with the emergency situation should be called to.

4. FLOTO-FILTRATION

PERSON RESPONSIBLE FOR THE INFORMATION:

Ivo Darolt

4 FLOTO-FILTRATION BLOCK DIAGRAM

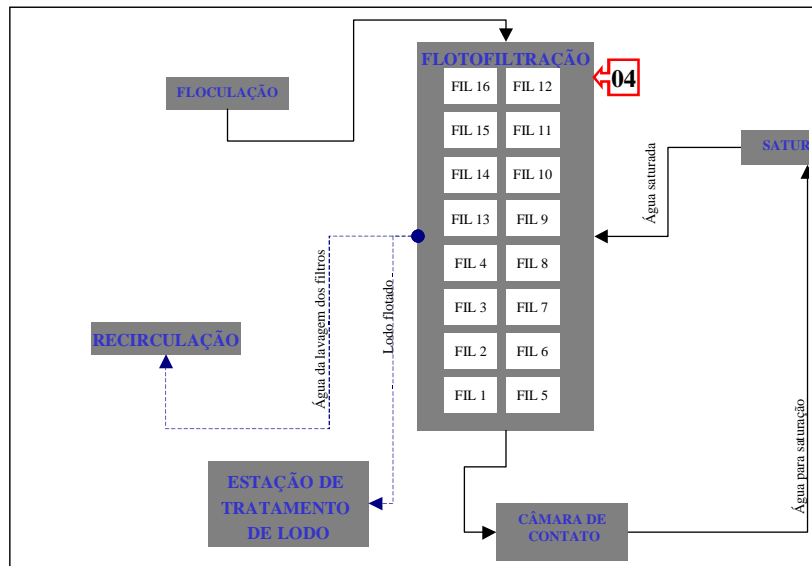

SPECIFICATION OF FLOTO-FILTRATION;

DOCUMENTS:

IT/OPE/1801 – FILTERS WASHING

IT/OPE/1806 – OPERATION OF THE SATURATION SYSTEM AT IRAÍ

WTP

OPERATED EQUIPMENT:

Saturation pumps Modules 01, 02, 03, and 04

Back washing pumps

Saturation compressors 01 and 02

Saturation tanks 01, 02, 03, 04, 05, 06, 07, and 08

Pressure control valves;

Discharge control valves;

Valves to control the saturated water discharge;

Level sensors

Blowers of air into the filters

Filters 01, 02, 03, 04, 05, 06, 07, 08, 09, 10, 11, 12, 13, 14, 15, and 16

EQUIPMENT VERIFICATION

Verification of the saturation pumps functioning;

Verification of saturation compressors functioning;

Verification of pressure control valves;

Verification of saturation discharge

Verification of the loss of load in filters.

IMPORTANCE:

Flakes formation – after adding the coagulant, flotation occurs, which is a process in which colloidal particles agglomerate. This happens due to two different actions: The first is the destabilizing where, by adding chemicals, superficial electrical forces are neutralized, and annul the repulsive forces (coagulation). In the second, there is an agglomeration of “discharged” colloids until the formation of flakes, which are dragged to the surface by a controlled mix of water and compressed air, (saturated water). This is called flocculation, however without breaking them. Comments:

Flotation is a mix of water and compressed air (saturated water) that promotes the separation of water colloidal particles, taking them to the surface, where a layer of such material will be formed, and will be scraped away.

In turn, filters are tanks filled with sustentation materials (pebbles, rough gravels, and fine gravels), and over this material, there is the filtering layer itself formed of anthracite coal and sand, through which water passes in a descending flow.

This process occurs “on” the filters, the already clarified water descends and transposes the filtering layer, becoming free from any particles that cause

turbidity, reaching the contact chamber where it goes through quality corrections in order to ensure its drinkability, then going to the reservoir.

After several hours of operation, filters lose their load, and need to be washed.

OPERATION PROCEDURE:

After passing through the agitation system, where the agitation speed is slowly reduced, with the aim of facilitating the agglomeration of impurities and increasing the contact time between flakes, these are distributed in 4 treatment modules, each one comprised of 3 flocculator chambers and 4 filters, totaling 12 flocculators and 16 filters.

Each module discharge is controlled through discharge control valves, located at the outlet of the raw water main, which are called "FBV001", for module no. 01, "FBV002" for module no. 02, "FBV003", for module no. 03, "FBV004" for module no. 04, in addition to regulating the amount of water entering in each module, these valves have the function of adjusting the modules discharge when filters are being washed, thus preventing overflow, and consequently loss.

Once this is done, water goes through the channels until the operating filters inlet, and at each filter inlet, there is an automatic valve (FBV) that regulates the flocculated water entrance in the diffuser, which is controlled by a level sensor (LCV).

This flocculated water joins the saturated water (air/water), coming from saturators, which is injected under pressure through the saturation pumps. When passing through the orifices in the pipelines located inside the filters, a little over the filtering layer, there is a sudden pressure variation, and consequently there is the release of micro air bubbles, which will join the flocculation flakes, forcing them to suspend and remain on the filters surface, creating a sludge layer, which is removed by a scraping system.

It is in this stage when the second phase of the process takes place, i.e., the removal of the raw water impurities.

Following, there is the filtration, which is done soon below the saturated water. Filtering layers are composed of layers of activated coal, sand, and

stones with several diameters, with the purpose of retaining smaller particles. This process is controlled through the filter outlet valve, and this also controls the filter level.

Being a continuous process, it forms a layer of impurities (sludge), on the surface of the filtering layer, hampering the passage of water through the filter, and the layers should be washed to improve the operation efficiency.

TURNING ON

This system is linked to the WTP functioning, when turning on one catchment pump, the saturation/flotation system and the filters are enabled to work.

-Saturation pumps are turned on with the minimum frequency (48Hz), and the air inlet is opened with a relatively high discharge; insofar the pressure increases, the pump speed is increased, and the air inlet is reduced until stabilizing level and pressure.

Meanwhile, filters start operation automatically, requiring the monitoring by the supervisory.

TURNING OFF

The halting procedure is triggered with the global halt of the WTP, or at any moment according to the need; the saturation pumps are turned off, and the compressed air inlet is closed; filters are automatically closed as soon as there is no more entering water, and the sensors detect the level below the functioning set-point.

DURING THE OPERATION PROCESS.

During the operation, the filters loss of load is verified, and should be washed when necessary, and the saturation discharge in each filter, unclogging them if the discharge is below 12L/s.

Adjustments are performed in the pump current and in the air quality in order to obtain an efficient saturation.

Daily activities.

Monitoring of the filters level.

Monitoring of filters chain

Determination of filters turbidity each two hours
Washing filters when necessary
Registration of turbidity obtained, and of the time and volume spent in washing
Monitoring of the system functioning in the supervisory.
Cleaning of discharge little channels of the sludge coming from the scrapers
Clearance of saturated water distribution pipelines.

IMPORTANT TOPICS AND WORK PROCEDURE.

This stage is important not only to remove the water turbidity, but also because the removal of pathogenic microorganisms starts there. Filtering is a sanitary barrier of the treatment, because proper water safety in regard to pathogens cannot be guaranteed if it does not pass through filters.

For a good saturation, the system pressure should be above 40mca.

With the occasional reduction of the saturation discharge, the pump discharge should also be reduced, to prevent overpressure and leaks in the pipelines; After clearing them, the pump discharge is again increased.

Filters are usually washed once a day, with extra washings in case of accentuated loss of load.

PROBLEMS SOLVING:

When it is a mechanical problem, a service order is opened to Usem (Electromechanical service unit).

When the problem regards automation, the service is requested to that Area.

When it is an operational problem, adjustments and corrections are performed in the system, if there is no result, the system Manager or the Chemical Technician in alert is warned.

WEEKLY ACTIVITIES.

None

IMPORTANT TOPICS AND WORK PROCEDURE.

Already mentioned

PROBLEM SOLVING.

Already mentioned

MONTHLY ACTIVITIES.

Closing the washing water consumption (system loss)

Closing the washing number and the filtering chain

Verification of the amount of turbidity out of the specification, and 75% of turbidity should be below 0.50 NTU.

IMPORTANT TOPICS AND WORK PROCEDURE.

The turbidity of the filtered water should be kept below 0.50 NTU, for at most 75% of determinations, in order to comply with the determination of the IT/OPE/1543, (PCA).

PROBLEMS SOLVING:

If turbidity is above specification, the origin of the cause should be checked. If this is an increase of raw water turbidity, the problem is solved by increasing the coagulant dosing, adjusting alkalinity with calcium hydroxide, reducing the discharge. If due to the filters, the filter with a high turbidity goes through a backwash.

ANNUAL ACTIVITIES:

There are no annual activities.

IMPORTANT TOPICS AND WORK PROCEDURE.

Already mentioned

PROBLEM SOLVING.

Already mentioned

ACTIVITIES CHECKING WORKSHEET.

There is no checking worksheet for this item

OPERATION DATA AND FEEDBACK

EMERGENCY SITUATIONS

The filter is halted, and the occurrence is verified. Fixing is requested, and then it starts operation again.

5 CONTACT CHAMBER

PERSON RESPONSIBLE FOR THE INFORMATION:

Claudio Carignano

CONTACT CHAMBER BLOCK DIAGRAM

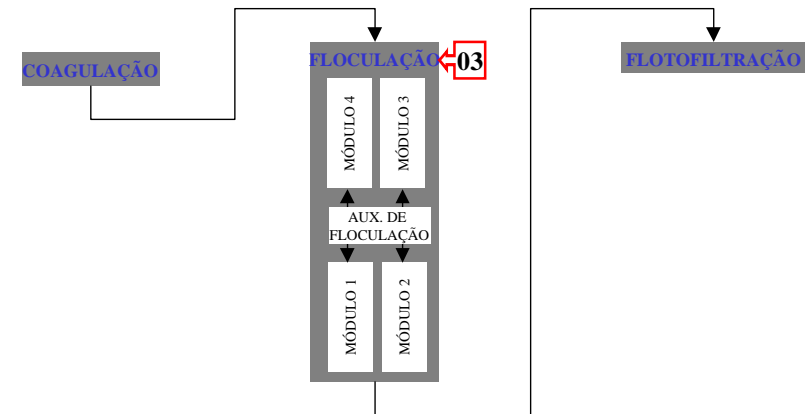

SPECIFICATION OF THE CONTACT CHAMBER OR CONTACT TANK:

After filtration, water flows to the contact tank (chamber), where the final stages of the treatment will take place.

Which are:

A) - Disinfection

Chemical product added: CHLORINE

After filtration, some microorganisms might still exist in the filtered water. In order to remove them, chlorine is added as a disinfectant.

Ordinance 2914/2011 defines that the sanitation company should deliver to the consumer treated water with the minimum contents of free residual chlorine of 0.6 mg/l.

B) – Fluoridation

Chemical product added – Fluosilicic Acid

The fluosilicic acid releases fluoride in the water, the ionic form of the chemical element fluorine, one of the elements responsible for the reduction of

dental caries in Brazil. The addition of fluorine to public supply waters in Brazil started in 1953, in Espírito Santo, in the city of Baixo Guandú, becoming Federal Law in 1974, and expanding for the whole country in the 1980s. In 2006, it already benefitted more than 100 million people.

Bacteria present in the dental plaque produce acids that remove minerals from the teeth (demineralization), making them vulnerable to caries. However, when we ingest fluorinated water since childhood, this fluoride starts to be part of the organism, and its concentration is increased in the blood and saliva, thus participating in the teeth minerals recomposition process (re mineralizing), making them resistant to caries.

In most of Brazil, the fluorine contents used in water is between 0.6 to 0.8 mg/l.

C) – pH neutralization or correction

Chemical product added – Calcium Hydroxide

Hydrated lime or calcium hydroxide is a chemical product used in the treatment of water to correct the pH (potential of Hydrogen). During treatment, water gets in contact with chemicals that grants acidity features to it, and this needs to be corrected.

pH is a scale that varies from “0 to 14”, where “7” is the neutral point indicating that the substance is not acidic nor alkaline.

Number above 7 indicate alkalinity, and those below 7, acidity.

The objective of adding Hydroxide in the water treatment is to stabilize the pH so that it becomes as near as possible of the indicator 7.

Ordinance 2.914/2011 recommends that the minimum pH for treated water should be 6, and the maximum 9.5.

D – Ortho-polyphosphate of Sodium

Chemical product added - ORTHOPOLYSPHOSPHATE OF SODIUM

Used as phosphatizing of metallic iron in metallic pipelines, as sequestrant and inhibitor of color and taste in piped water.

DOCUMENTS

Ordinance 2914/2011

IT/OPE/1784 – IRAÍ WTP Operation

IT/OPE/1770 – Replacement and Dosing of Chlorine Gas in Iraí System

IT/OPE/1797 – Dosing of Fluosilicic Acid in Iraí WTP

OPERATED EQUIPMENT:

Fluosilicic acid dispensers

Calcium hydroxide dispensers

Ortho-polyphosphate dispensers

Chlorinators of chlorine

Mechanical agitators

Tanks inlet and outlet valves

Dragging water pumps

EQUIPMENT VERIFICATION

They are verified by USEM when assistance is asked for malfunctioning

IMPORTANCE:

Contact chambers are responsible for homogenizing filtered water with the other above mentioned chemicals, in addition to equalizing the system.

COMMENTS:

In Iraí WTP, there are 4 contact chambers and one distribution reservoir, and the contact chambers are located in the lower part of the filters, being interconnected among themselves.

OPERATIONAL PROCEDURES:

There are no operational procedures in this stage of the process.

TURNING ON AND OFF:

There are no equipment in this stage, since it works in connection with catchment and distribution pumps.

Contact Chamber System

DURING THE OPERATION PROCESS:

In this stage, no control is performed, except in the supervisory.

Values such as pH; Fluorine, ClO₂ and Level control (LTs) appear in the supervisory, however the values are not correct because the system is deactivated.

DAILY ACTIVITIES:

Activities are performed in this stage.

PROBLEMS SOLVING

WEEKLY ACTIVITIES:

There are no activities to report

IMPORTANT TOPICS AND WORK PROCEDURE:

The most important thing is to prevent outflow. This is controlled in the distribution reservoir.

PROBLEMS SOLVING:

MONTHLY ACTIVITIES.

There are no monthly activities to report.

IMPORTANT TOPICS AND WORK PROCEDURE:

None

PROBLEMS SOLVING:

ANNUAL ACTIVITIES:

There are no monthly activities to report.

IMPORTANT TOPICS AND WORK PROCEDURE:

None

PROBLEMS SOLVING:

Activities checking worksheet:

There is no worksheet.

OPERATION DATA AND FEEDBACK.

EMERGENCY SITUATIONS

FOR THE WTP

6. SATURATION

PERSON RESPONSIBLE FOR THE INFORMATION:

Sergio Aparecido de Oliveira

Orlando Coutinho

SATURATION BLOCK DIAGRAM

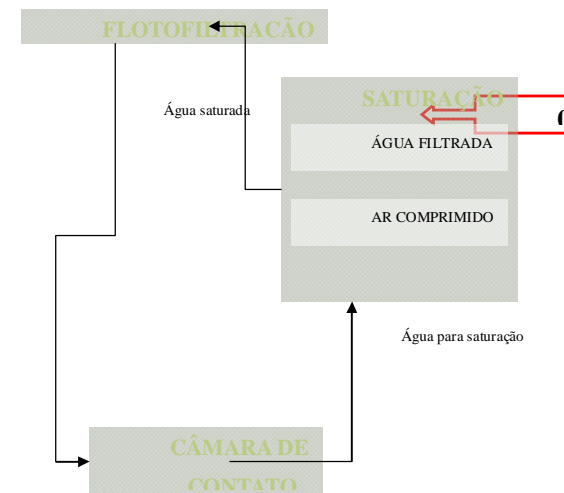

SPECIFICATION OF SATURATION:

The saturation system is composed of eight tanks, two per module, aiming at mixing the compressed air provided by compressors to the water pumped by the four pumps installed beside the modules. This mixture takes place inside the tanks, from where it is distributed through the pipeline, with several holes of more or less 3mm each, in the bottom, which take the saturated water to the filters where it is spread. Under this pipeline, there is a plastic tube cut in half, with the purpose of drive the saturated water jet, orienting the micro bubble to the surface. This takes place just above the filtering layer. This saturated water, when leaving the pipeline, goes through a violent pressure reduction, which causes the release of micro bubbles that were

aggregated to the compressed air, forming a white mist, thus allowing a highly efficient dirty removal.

This system was implemented due to the algae blooming at Iraí Dam, because it is a more efficient process to remove algae, attaining 99.9% of removal.

DOCUMENTS:

IT/OPE/1806

Operated equipment:

Saturation tanks

Pumps

Valves

Compressors

Manometers

Equipment Verification

Functioning of pumps

Functioning of compressors

Leaks in pipelines and valves

Water discharge in the filters

Pipeline clogging

Pressure control

IMPORTANCE:

The correct functioning of the system aims to better remove sludge in the process, and also to get better quality water after filtration. In case of leaks in the pipeline, call maintenance, and in case of clogging in the pipeline, arrange for its cleaning.

COMMENTS:

In case of polypropylene pipeline broken (Black Pipeline), the maintenance is carried out by an outsourced company that is called by USEM team.

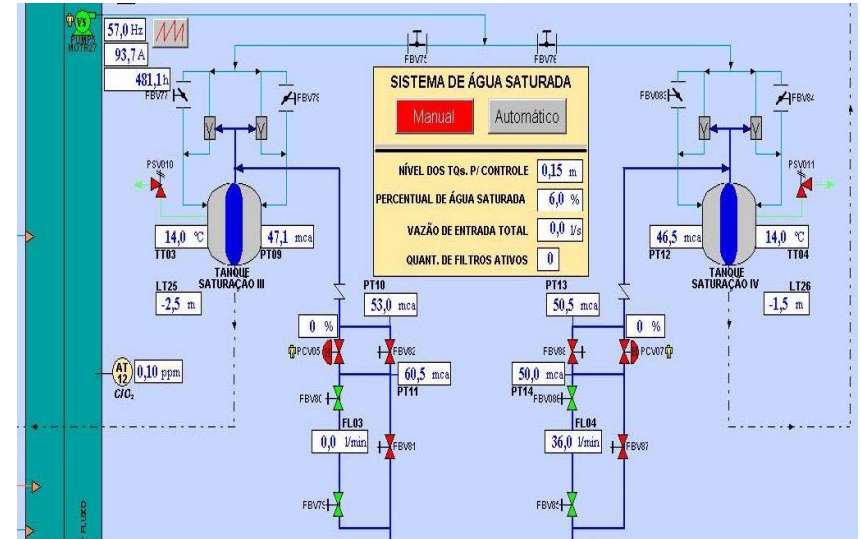

OPERATION PROCEDURE

SATURATORS CONFIGURATION

TURNING ON

To turn on the saturator, first the compressors should be turned on, and there are two compressors for saturation, and two for instrumentation, which are interconnected. However, for operation, only one compressor is used, which is located in the lower gallery, near the blowers, and the other is in the compressors room, located behind the charcoal house.

The gallery compressor is actuated by pushing the green button in compressor no. 01 and/or the purple button in compressor no. 02, which are located in the compressor panel itself.

The compressors located behind the charcoal house are also actuated in the compressor itself, by pushing the green button to turn it on, and the red button to turn it off.

When the compressor screen does not show the phrase "READY TO START", in the compressor no. 01, the "RELIEF VALVE" reset button should be pushed, and if the previous phrase is not shown, maintenance should be called

to check the problem, and just after the other compressors should be turned on, otherwise turn on the first as usual.

Check whether the outlet valves are open, where for compressor No. 01 it is the valve "FBV046", and for compressor No. 02, "FBV047".

The water used in the saturation system comes from the contact chambers, and is pumped through submersible pumps installed inside the contact chambers, which are nowadays considered as reserves, because four pumps were installed besides the contact chamber, which operates in the range between 45Hz (initial) and 60Hz (maximum). With a pressure of more or less 30 cm of pressure, and 40mca to 50mca in the tanks.



COMMAND PANEL OF THE SATURATED WATER PUMP

After turning on the air and the water in the system, the mix control is started, operating in the range between 45mca and 50mca, and being controlled in tank no. 01 by valve, "PCV001", in tank no. 02 by valve "PCV003", in tank no. 03 by valve "PCV005", in tank no. 04 by valve "PCV007, in tank no. 6 by valve "PCV011, in tank no. 7 by valve "PCV013, in tank no. 08 by valve

"PCV015, and these valves have the function of opening and closing the air inlet in the system.

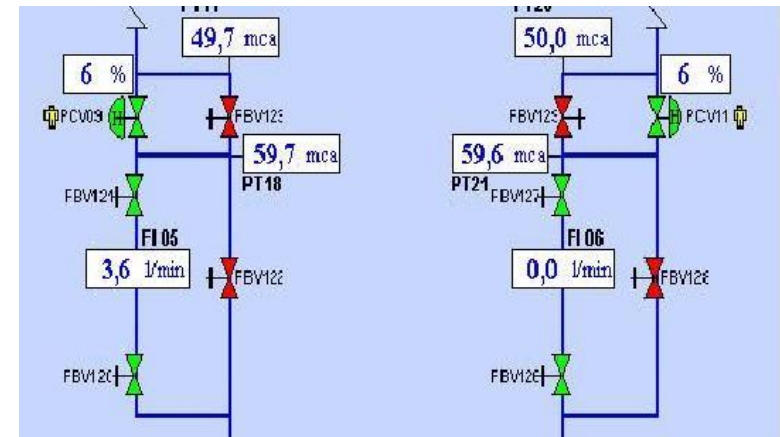

PARTIAL VIEW OF PCV VALVES – AIR COMMAND IN SATURATION

"PCV" VALVES COMMAND PANEL

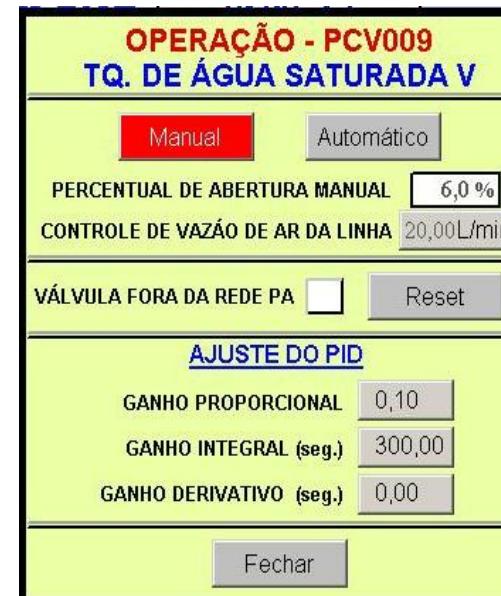

The air/water mix is conveyed to the filters by pressure, which is controlled by “FBV” valves in the filter inlet. Clicking on this valve icon, the following command window will appear:

“FCV” VALVES COMMAND PANEL

In such command panel, the valve opening percentage can be changed, and consequently to increase or reduce the saturated water volume in the filters, and such volume is shown by the “FT” discharge measurer.

However, it is possible to operate in automatic mode, through the control of the saturated water (FT) inlet discharge, i.e., if we enter in the supervisory in “FT” valve the desired volume of saturated water, this will try to keep the defined volume throughout the process.

In this same valve, there is the command to change the discharge alarms values, and to operate with force values, i.e., the operator programs a work value, and the system accepts such command, even if it is actually not correct. This is usually used in maintenance, or in the beginning of the process.

“FT” VALVE COMMAND

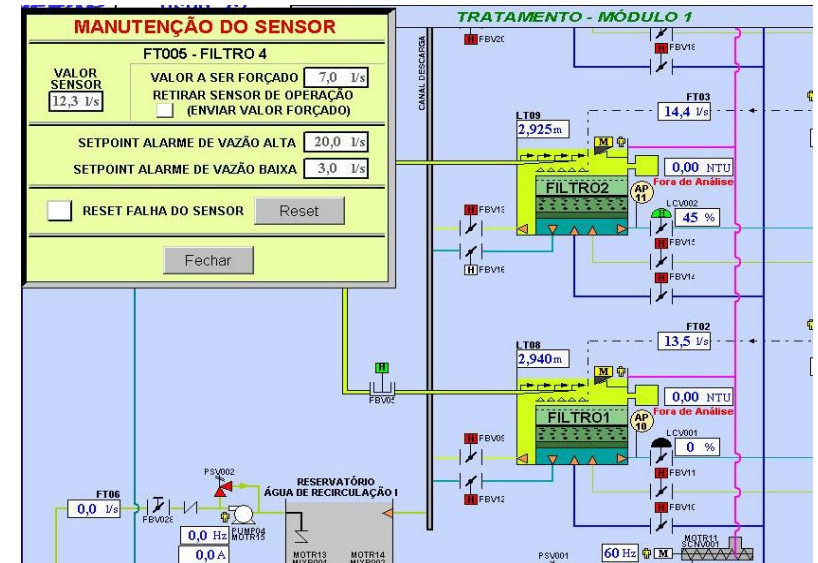

TURNING OFF

- Turn off the pumps
- Close the air inlets
- Close and/or open the valves, if necessary

DURING THE OPERATION PROCESS.

- Gauge the manometers
- Pressure in the tanks
- Inlet discharge in the tanks
- Saturated water discharge in the filters
- Leaks or clogging of the system

DAILY ACTIVITIES.

None

IMPORTANT TOPICS AND WORK PROCEDURE.

Keep a discharge between 12L/s and 20L/s in each filter.

Turbidity analyses are performed in the filtered water in order to evidence the effectiveness of the saturation system.

PROBLEM SOLVING.

In case of system problems, call USEM, when there are leaks in the steel or polypropylene (black pipe) pipelines. In case of clogging (discharge smaller than 12 L/s), the operational team cleans/clears the pipeline or the holes inside the filters, and such work is performed in a daily basis, and registered in the daily closing worksheet in field 8.1 (saturation clearance).

WEEKLY ACTIVITIES.

Clearance of pipeline inside the filters, cleaning of holes

IMPORTANT TOPICS AND WORK PROCEDURE.

Keep a discharge between 12L/s and 20 in each filter.

Chemicals saving.

Good quality coagulation, and consequently a longer filtering line

Good quality filtered water

PROBLEM SOLVING.

This is performed with the USEM and Automation staff.

And with the knowledge and experience of Employees

MONTHLY ACTIVITIES.

None

IMPORTANT TOPICS AND WORK PROCEDURE.

Already mentioned

PROBLEM SOLVING.

None

ANNUAL ACTIVITIES.

None

IMPORTANT TOPICS AND WORK PROCEDURE.

Already mentioned

PROBLEM SOLVING.

None

ACTIVITIES CHECKING WORKSHEET.

OPERATION DATA AND FEEDBACK.

- In case of failures or problems in the system, this is shown to the maintenance team that, after taking the measures necessary to solve the problem, teaches the operational team how to proceed to stabilize the system. The WTP manager or the technical team in alert is also called, in addition to communicating the CCO, in case of need to change the work discharge.

EMERGENCY SITUATIONS.

- In case of need, USEM (Alert Team), Manager (Technical-Chemical alert team), and Bodies concerned with the emergency situation should be called to.

7 SLUDGE

PERSON RESPONSIBLE FOR THE INFORMATION:

Ulisses

SLUDGE PLANT BLOCK DIAGRAM

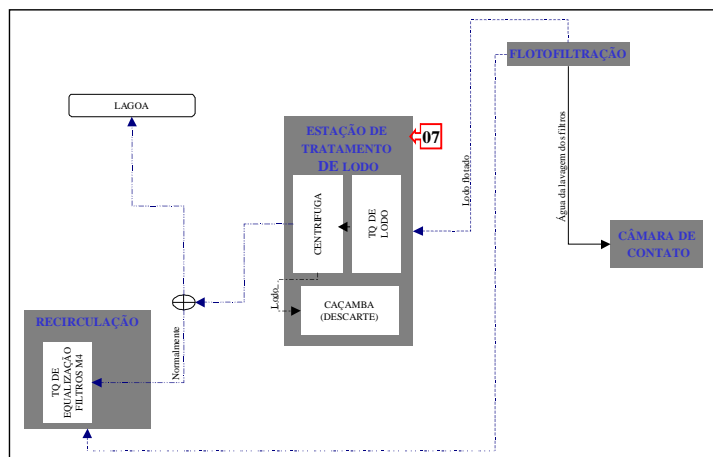

SPECIFICATION OF THE SLUDGE TREATMENT PLANT OPERATION

Irai WTP was designed to use the dissolved air flotation system, whereby the flakes formed after coagulation and flocculation tend to remain on the surface of photo-filters, creating a sludge layer that is continuously scraped, and such sludge is conveyed to the floated sludge tank where it is pumped up from sludge pumping stations to the centrifuge.

There are 16 (sixteen) filters, separated in 4 (four) treatment modules, each module having a Floated Sludge tank, with 200 m³ capacity each, and their respective Sludge Pumping Station, totalizing 4 (four) pumping stations.

DOCUMENTS:

IT/OPE/1784-001

OPERATED EQUIPMENT:

Floated Sludge Tanks

Agitators

Sludge Scrapers

Stop valves and valves

Circuit breakers

Sludge Elevation Pumps

Centrifuges

Anionic Polymer Dispensers

Anionic Polymer Preparer

Sludge Containers

Hoists

Dragging water of gutters

Equipment Verification

Functioning of dispensers

Functioning of Agitators in the sludge tanks

Functioning of Sludge Scrapers

Cleaning of Sludge gutters

Cleaning of Sludge Pumping Stations

Leaks in pipelines and valves

Functioning of Centrifuges

Verification of Trash Containers, tracks and hoists

Polymer preparer

IMPORTANCE:

The correct functioning of the Sludge system aims to protect the environment, because the generated waste (sludge) can be used for other purposes, not being disposed of in the environment.

COMMENTS:

Currently, the system cannot receive the whole sludge volume generated by the WTP, and the volumes need to be readjusted.

OPERATION PROCEDURE

TURNING ON

The system should work in the automatic mode, and when there is level in sludge tanks, the process does not require a lot of intervention from the operator.

When sludge scrapers are in operation, check whether there is level in the sludge tank

Check whether the polymer preparer is working, and whether the polymer tanks have the product

Check whether there is an empty container beneath the centrifuges

Enable the sludge elevating pumps in the pumping stations, setting them in the automatic mode or turning them on manually

From here on, it should be operated in the manual mode, through the supervisory, due problems in the system, already known

Open the anionic polymer valves

Open the Sludge Inlet valves,

Turn on centrifuges (two engines)

TURNING OFF

Close the Sludge Inlet and Anionic Polymer valves

Turn off the Sludge Elevation Pumps

Open the Cleaning Water valves, and keep the centrifuges on for 30 (thirty) minutes to wash the centrifuges and the lines

During the operation process.

Check the functioning of dispensers

Check the sludge produced (need to the increase/reduce polymer)

Handle the sludge containers

DAILY ACTIVITIES.

Cleaning the site, floor

Prepare the anionic polymer (fill the preparer reservoir)

Follow up the containers replacement (truck)

Washing of centrifuges

Lubrication of pillow blocks

IMPORTANT TOPICS AND WORK PROCEDURE.

Visual check of the sludge consistency

Removal of possible air pockets in the pumps (primers)

Visual check of centrifuges rotation

PROBLEM SOLVING.

In case of system problems, USEM should be called, and a Service order (HSS) opened.

WEEKLY ACTIVITIES.

- Cleaning of Sludge Pumping Stations

-Lubrication of pillow blocks and axles

IMPORTANT TOPICS AND WORK PROCEDURE.

Wash the sludge pumping stations with water.

Problem solving.

In case of system problems, USEM should be called, and a Service order (HSS) opened.

Monthly activities.

- There is no activity

IMPORTANT TOPICS AND WORK PROCEDURE.

Request to the USEM the maintenance of dispensers, elevating pumps and the verification of the electrical part of command panels (circuit breakers and engines)

PROBLEM SOLVING.

In case of system problems, USEM should be called, and a Service order (HSS) opened.

ANNUAL ACTIVITIES.

IMPORTANT TOPICS AND WORK PROCEDURE.

Nothing planned yet

Problem solving.

In case of system problems, USEM should be called, and a Service order (HSS) opened.

ACTIVITIES CHECKING WORKSHEET.

Daily Closing Bulletin, where the product inventory is controlled

Registration in the system alterations (problems) occurrence book

Daily Treatment Bulletin where the product consumption and dosing are registered every hour

OPERATION DATA AND FEEDBACK.

Data are entered in the reports and in the Occurrence book, via E-mail and shift change, in addition to dialogue between employees.

EMERGENCY SITUATIONS.

- In case of need, USEM (Alert Team), Manager (Technical-Chemical alert team), and Bodies concerned with the emergency situation should be called to.

8. RECIRCULATION

PERSON RESPONSIBLE FOR THE INFORMATION:

Claudio Carignano

RECIRCULATION BLOCK DIAGRAM

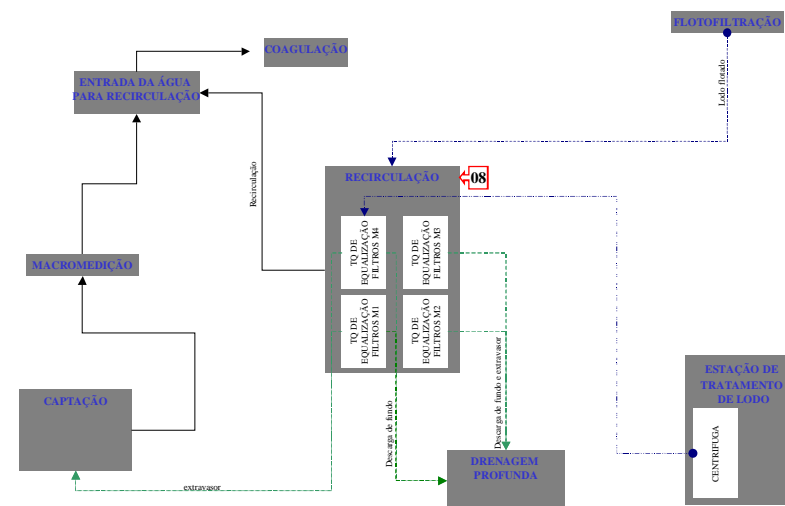

SPECIFICATION OF RECIRCULATION;

At IRAÍ WTP, the recirculation system is fed by backwash water of the filters and by the filters overflow.

These waters are stored in four tanks 400 m³ each, one for each module.

This tank has a level sensor that when reaching 3.00 m³ actuate the corresponding elevating Netzsch motor-pump, conveying it to the raw water inlet pipeline at the WTP, with discharge capacity between 60 and 90 m³/h.

They turn on when the level reaches 1.30 m³ in the recirculation tank.

DOCUMENTS:

No document was created about this subject

OPERATED EQUIPMENT:

Washing water elevating motor-pumps

Agitators in the sludge and recirculation tank
Valves and stop valves necessary in the process.

EQUIPMENT VERIFICATION

- Wash the motor-pumps regularly, internal part.
- Check the pump discharge by the discharge measurer
- Observe whether there is noise or vibration during the operation

IMPORTANCE:

The good functioning of the equipment results in less material to be discarded in the environment.

COMMENTS:

Currently, the system cannot receive the whole water volume to be recirculated by the WTP.

The exceeding amount has to be disposed of in the environment.

OPERATION PROCEDURE

TURNING ON

The washing water recuperation system of the filters can operate in automatic and in manual modes:

IN AUTOMATIC – We just have to set all the system in the automatic mode, which will start the recirculation when the level reaches 3.00m, and will turn off when the volume reaches 1.30m.

IN MANUAL VIA SUPERVISORY -

Click on the icon of the module to be operated, the filters window will be opened in the bottom of the screen, then we find the recirculation tank and the pump figure. When clicking on the pump icon, a new screen will appear with its command.

To change to manual, turn it on and adjusted the desired Hz, the ideal for the operation is 80Hz, and this is limited to the maximum of the pump.

Adjust the emptying time, which shall be near 100min.

Turn on the mixer by clicking on the engine figure, the command screen will appear, in which the command should be set in manual and turned on.

IN MANUAL VIA LOCAL -

Change all the recirculation system to manual in the supervisory.

In the recirculation pumps room, of each module, there is a command panel where it is possible to operate in local mode as follows:

Change "REC. ÁGUA RECIR" "LOCAL/REMOTO" buttons to localTurn on "REEC. ÁGUA RECIR" button.

In buttons "REC. ÁGUA RECIR." - "VELOC. LOCAL – DIM/AUM." – adjust the desired Hz.

Change "RMO VEDOR. DE LODO" – "LOCAL/REMOTO" buttons to Local.

In buttons "LIGAR O MOTOR" – "LIGAR A ROSCA" (Obs.: Today, there is no more threads, however the command should be pushed to block the system).

In buttons "REMOVEDOR DE LODO", "VELOC. LOCAL – DIM/AUM." adjust the desired Hz.

Change button "MIST. SUBMERSÍVEL", "LOCAL/REMOTO" to local.

In button "LIGA" – turn on mixer.

This serves for both mixers.

TURNING OFF

FOR THE AUTOMATIC:

Click on the icon of the lifting pump.

Change to manual, and click on the "DESLIGAR" button.

FOR MANUAL VIA SUPERVISORY:

Click on the icon of the lifting pump, and click on "DESLIGAR" button.

FOR MANUAL LOCAL:

In order to turn off this system, the reverse order should be done, i.e.:

Turn off the mixer, and change it to automatic.

Turn off the recirculation pump, and change it to automatic.

DURING THE OPERATION PROCESS.

Monitor the reservoir levels.

Monitor the beginning and the end of the operational functioning.

Observe natural water turbidity for possible alterations.

DAILY ACTIVITIES.

Register macro measurers "FT" in the recirculation worksheet.

Important topics and work procedure.

When observing that the outlet water of the raw water main is dirty, make the necessary adjustments.

Problem solving.

When problems occur, the intervention of USEM is requested.

When there is clogging, this is fixed by USPD staff.

WEEKLY ACTIVITIES.

There is no weekly activity.

IMPORTANT TOPICS AND WORK PROCEDURE.

PROBLEM SOLVING.

MONTHLY ACTIVITIES.

There is no monthly activity.

IMPORTANT TOPICS AND WORK PROCEDURE.

PROBLEM SOLVING.

ANNUAL ACTIVITIES.

There is no annual activity.

IMPORTANT TOPICS AND WORK PROCEDURE.

PROBLEM SOLVING.

OPERATION DATA AND FEEDBACK.

Data are entered in the report and in the Occurrences book, via E-mail and in the shift change, in addition to dialogue between employees.

EMERGENCY SITUATIONS.

- In case of need, USEM (Alert Team), Manager (Chemical Technician in alert), the Competent Bodies should be called to an emergency situation.

9 RESERVATION

RESERVATION BLOCK DIAGRAM

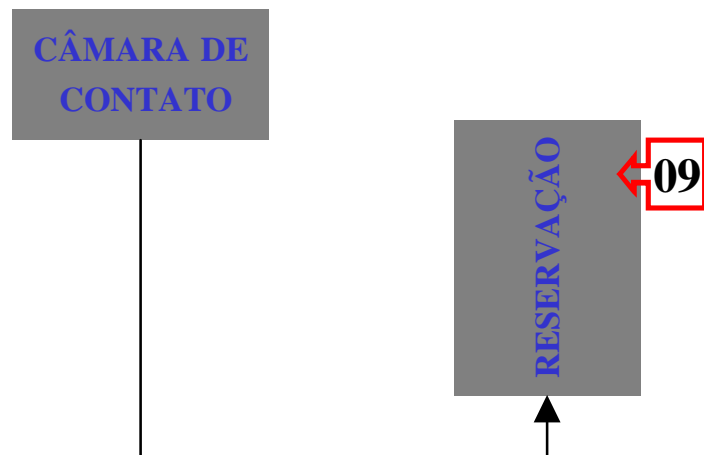

PERSONS RESPONSIBLE FOR THE INFORMATION:

Sergio Aparecido
Orlando Coutinho

SPECIFICATION OF THE RESERVATION:

CONTACT CHAMBER RESERVOIR

The reservation system is comprised of four contact chambers located beneath the filters, one for each module, aiming to mix the filtered water with the chemicals needed for the treatment, namely the alkalizing agent, fluosilicic acid, chlorine, and ortho-polyphosphate. Reserve saturation pumps are also located in such chambers, one for each module, and the filter washing pumps are located in the chambers of modules I to IV.

8,000-LITER SUPPORT RESERVOIR

These chambers discharge water in the reservoirs of each module. The capacity of each reservoir is 3,000m³, and they are connected to the external reservoir with 8,000m³ capacity through a pipeline.

This reservoir is built in reinforced concrete, and there is 1 submersible motor-pump set installed for cleaning and maintenance.

TREATED WATER PUMPING STATION - IRAÍ

IRAÍ WTP pumping station is comprised of 11 lifting pumps distributed as follows:

Five motor-pumps to lift water to the Tarumã and Jacob Macanham reservoirs.

Three lifting pumps for the Piraquara system.

And three lifting pumps for the Vila Amélia system.

They are commanded from the COC (Center of Operational Control)

DOCUMENTS:

There are no documents referring to the WTP reservation.

OPERATED EQUIPMENT:

Motor Pumps

Sluices

Macro measurers

Level sensor

VERIFICATION OF EQUIPMENT

Pumps functioning.

Sluices functioning.

IMPORTANCE:

The correct handling of reservoirs results in better conditions of the produced water, as well as keeping the work level for activities essential to the treatment (filters washing, saturation, and dosing of chemicals).

COMMENTS:

Sluices are located at the inlet of the external reservoir, and it is divided into three chambers where the communication is also done through sluices, which are closed when cleaning is necessary. The COC pumps suction well is located in the central chamber, and the lateral chambers receive the water coming from the WTP reservoir, which have inspection a manhole.

OPERATION PROCEDURE

TURNING ON

There is no equipment to be turned on in this process, because it is controlled from the COC, for the WTP operation, and there is only one reservation stage.

TURNING OFF

Idem to previous item.

DURING THE OPERATION PROCESS.

Keep the reservoir levels to meet the consumption demand.

DAILY ACTIVITIES.

Monitor the reservation levels first, to keep the demand of treated water, and secondly check whether there is the need to increase or reduce the production, orienting accordingly.

Monitor parameters determined in the PCA (IT.OPE.1543), and in the ordinance related to water, concerning the treated water inflowing to the reservoir.

IMPORTANT TOPICS AND WORK PROCEDURE.

Keep the reservoirs full.

PROBLEM SOLVING.

In case of problems with the reservoir level, either high or low, check with the COC for the need to increase or reduce the operation discharge.

Electrical or mechanical problems are the responsibility of USEM.

WEEKLY ACTIVITIES.

There is no record of weekly activity.

IMPORTANT TOPICS AND WORK PROCEDURE.

Inexistent.

PROBLEM SOLVING.

Already mentioned.

MONTHLY ACTIVITIES.

There is no record of monthly activity.

IMPORTANT TOPICS AND WORK PROCEDURE.

Already mentioned.

PROBLEM SOLVING.

Already mentioned.

ANNUAL ACTIVITIES.

Already mentioned.

IMPORTANT TOPICS AND WORK PROCEDURE.

PROBLEM SOLVING.

ACTIVITIES CHECKING WORKSHEET.

OPERATION DATA AND FEEDBACK.

- In case of energy outage or equipment failure making impossible to transmit data to the COC, or of very high or very low level, COC work team is contacted via phone 3330-7007. The chemical technical team in alert is communicated, and USEM alert team is also communicated when necessary.

EMERGENCY SITUATIONS.

In case of need, USEM (Alert Team), Manager (Chemical Technician in alert), the Competent Bodies should be called to an emergency situation.

10 APPLICATION OF CHEMICAL PRODUCTS OF

10.1 APPLICATION OF ALKALINIZING AGENT

PERSON RESPONSIBLE FOR THE INFORMATION:

Ivo Darolt

SPECIFICATION OF THE ALKALINIZING AGENT APPLICATION (CALCIUM HYDROXIDE);

DOCUMENTS:

IT/OPE/1803-001

OPERATED EQUIPMENT:

Lifting centrifuge pump (receiving the product)
Storage tanks (silos) 01 and 02 - 50m³ capacity, solution received at 20%
Lifting centrifuge pumps – 01 and 02 (transference to the preparation tank).

Agitators of silo tanks – 01 and 02

Application tanks 01 and 02 - 20m³ capacity, solution at 10%.

Agitators of application tanks - 01 and 02

Peristaltic pumps for application, modules 01, 02, 03, 04

Peristaltic pumps for application of alkalinizing agent at PRE 01 and 02

Reserve peristaltic pump (serves all modules)

Pneumatic valves with remote actuation

Manual valves with local operation

Command panel to select tanks

Level sensors

Macro measurers

Process water pump

VERIFICATION OF EQUIPMENT

Functioning failures of valves, pumps, and agitators.

Leaks in pipelines, and clogging.

Selection of tanks, and maneuvers of necessary valves.

IMPORTANCE:

Calcium hydroxide serves to correct the pH of the produced water, and is also occasionally added to the natural water to supply the alkalinity needed to the correct chemical reaction with the coagulant, helping coagulation.

Comments:

OPERATION PROCEDURE

TURNING ON

Check whether tanks and pumps are in automatic mode;

Check the availability of the solution in the tanks;

Modules where it will be applied are defined;

Corresponding dosing pumps are enabled;

One tank and one line are selected (there are two tanks and two lines available);

Turn on the dosing pumps needed to the process;

Adjust the desired PPM.

TURNING OFF

Operating pump(s) is disabled;

Lines are washed;

Dosing pumps are turned off.

Remark: The functioning of dosing pumps is connected to the modules, if a module is stopped, the corresponding pump will also be.

DURING THE OPERATION PROCESS.

The control of level is performed every hour in the solution tanks.

Cleaning is performed, and the line is alternated.

Dosing control is performed as needed, with analyses results.

DAILY ACTIVITIES.

Level control in the solution tank being used.

Registered in the BDT (Daily Treatment Bulletin).

Cleaning of the line and of the application pump.

Ph Control.

IMPORTANT TOPICS AND WORK PROCEDURE.

The system operates in automatic mode, including the recharging of tanks with the line washing, however it is recommendable to start it manually, and to monitor the operation until the end, leaving the command as stop in the end.

PROBLEM SOLVING.

Possible problems not fixed with the reset should be informed to the USEM.

WEEKLY ACTIVITIES.

Inexistent.

IMPORTANT TOPICS AND WORK PROCEDURE.

Clean the pumps and the site.

PROBLEM SOLVING.

In case of mechanical and electrical problems, the USEM staff should be called.

When there is a clogging problem, it should be solved by the operation staff.

MONTHLY ACTIVITIES.

Cleaning of the solution tank.

IMPORTANT TOPICS AND WORK PROCEDURE.

It is recommendable to totally empty each application tank on a monthly basis, cleaning it entirely.

PROBLEM SOLVING.

Already mentioned

ANNUAL ACTIVITIES.

Inexistent.

IMPORTANT TOPICS AND WORK PROCEDURE.

It is recommendable to totally empty each application tank on a monthly basis, cleaning it entirely.

PROBLEM SOLVING.

Already mentioned

ACTIVITIES CHECKING WORKSHEET.

OPERATION DATA AND FEEDBACK.

Every intervention in the equipment and in the tanks is previously scheduled, with communication to the persons responsible for the execution, and also to the technician responsible on that moment.

EMERGENCY SITUATIONS.

In case of need, USEM and/or the alert team should be called.

In case of operational emergency, call the Manager and/or the Chemical Technician in alert.

10.2 FLOCCULATION ANCILLARY (CATIONIC POLYMER)

PERSON RESPONSIBLE FOR THE INFORMATION:

Ulisses

SPECIFICATION OF THE FLOCCULATION ANCILLARY OPERATION (CATIONIC POLYMER);

Initially, the Cationic Polymer had and still has the purpose of removing/restraining algae coming from the Dams supplying raw water to Iraí WTP. However, its utilization as flocculation ancillary also proved to be effective.

DOCUMENTS:

IT/OPE/1796-001

OPERATED EQUIPMENT:

Product preparation tanks

Dispensers

Valves

Circuit breakers

Equipment verification

Functioning of dispensers

Functioning of Agitators in the preparation tanks

Leaks in pipelines and valves

IMPORTANCE:

The correct functioning of the system and an adjustment of the application dosing aim to better remove algae in the process, and also to improve the water clarification, resulting in a better quality water for the treatment.

Since this is a material that after wetted becomes slippery, accidents should be avoided in case of leaks.

COMMENTS:

Since this is a material that after wetted becomes slippery, accidents should be avoided in case of leaks.

OPERATION PROCEDURE:

TURNING ON

Check whether there is product in the dosing tank (black tank), near the dispensers;

Check whether the valves necessary for the system operation are duly opened or closed, as needed;

Open the Command Panel beside the dispensers, and press the green button of the circuit breakers of the dispenser to be turned on.

Adjust the application dosing.

TURNING OFF

Open the Command Panel, and press the red button of circuit breakers.

Close and/or open the valves, if necessary.

DURING THE OPERATION PROCESS.

Check the product dosing.

Control the applied PPM.

DAILY ACTIVITIES.

Register the consumption on an hourly basis in the BDT.

Read the ruler in the storage Tank.

Survey the inventory.

IMPORTANT TOPICS AND WORK PROCEDURE.

- Checking the product dosing in the 4 (four) modules, defining the dosing necessary for the correct functioning of the system and an effective application (in PPM), for the function to which the product is intended.

PROBLEM SOLVING.

In case of system problems, USEM should be called, and a Service order (HSS) opened.

WEEKLY ACTIVITIES.

- Cleaning of the dosing lines, performed by discharging the water in the pipelines, opening and closing the specific water valves.

IMPORTANT TOPICS AND WORK PROCEDURE.

Cleaning of dosing lines prevents their clogging, caused because of the product characteristics.

PROBLEM SOLVING.

In case of system problems, USEM should be called, and a Service order (HSS) opened.

MONTHLY ACTIVITIES.

Closing the inventory.

Registration in the BDT.

IMPORTANT TOPICS AND WORK PROCEDURE.

Request to the USEM the maintenance of dispensers and the verification of the electrical part of command panels (circuit breakers and engines)

PROBLEM SOLVING.

In case of system problems, USEM should be called, and a Service order (HSS) opened.

ANNUAL ACTIVITIES.

Inexistent.

IMPORTANT TOPICS AND WORK PROCEDURE.

Nothing planned yet

PROBLEM SOLVING.

In case of system problems, USEM should be called, and a Service order (HSS) opened.

ACTIVITIES CHECKING WORKSHEET.

Daily Closing Bulletin, where the product inventory is controlled

Registration of the product preparation, as well as alterations (problems) in the system, in the occurrence book.

Daily Treatment Bulletin where the product consumption and dosing are registered every hour

OPERATION DATA AND FEEDBACK.

Every intervention in the equipment and in the tanks is previously scheduled, with communication to the persons responsible for the execution, and also to the technician responsible on that moment.

EMERGENCY SITUATIONS.

- In case of need, USEM (Alert Team), Manager (Chemical Technician in alert), the Competent Bodies should be called to an emergency situation.

10.3 COAGULANT DOSING

PERSON RESPONSIBLE FOR THE INFORMATION:

Orlando Coutinho

SPECIFICATION OF THE COAGULATION DOSING;

The coagulant system is comprised of four tanks, with a storage capacity of 50m³ each, composed of two dosing pumps with 1,000 L/h of capacity each (FCZ 01 and FCZ 02), and a valve to control the coagulant dilution water inlet (FCV 021). Two dosing lines and two application points.

DOCUMENTS:

IT/OPE/1781-001

OPERATED EQUIPMENT:

Storage tanks

Dosing Pumps

Stop valves and Valves

Equipment verification

Pumps functioning.

Leaks in pipelines and valves

Pipeline clogging

Discharge control

IMPORTANCE:

. The correct functioning of the system implies in the correct dosing of the coagulant necessary to treat the raw water. This will result in a better quality water, and in a more efficient process.

In case of leaks in the pipeline, call maintenance, and in case of clogging in the pipeline, arrange for its cleaning.

COMMENTS:

Only one pump, one line, and one application point are used at the WTP inlet. In case of need to change the application point (optional at the catchment

staircase foot), the maneuver is performed by valves located in the application lines inside the concrete gutters.

In case of pipeline breaking, perform the maneuver changing the application point, and call USEM to check for the possibility of changing the pipeline, or of contracting out a company to do that.

OPERATION PROCEDURE

TURNING ON

Inform the system the concentration and density of the coagulant and the desired dosing in PPM, so that the pump can dose the amount needed according to the inlet discharge, in automatic mode. If dosing in the automatic mode is not possible, change the pump to manual mode, and inform the working frequency for the necessary dosing.

Procedures used to turn on the dosing pumps are described in the IT/OPE/1781, both in the automatic, as well as in the manual modes of the system.

TURNING OFF

Dosing pumps are turned off.

Close and/or open the valves, if necessary

Procedures used to turn on the dosing pumps are described in the IT/OPE/1781, both in the automatic, as well as in the manual modes of the system.

DURING THE OPERATION PROCESS.

Gauge the discharge measurers.

Control the tanks levels.

Discharge of the dilution water.

Coagulant discharge.

Leaks or clogging of the system

DAILY ACTIVITIES.

Control PPM expended

Enter data in the BDT

Perform the consumption and inventory closures

Control filtered and treated waters turbidity

Adjust dosing

Perform jar test

IMPORTANT TOPICS AND WORK PROCEDURE.

Keep the correct application of the coagulant.

Turbidity analyses are performed in the filtered water in order to evidence the effectiveness of the system.

Flocculation tests (jar-tests) are performed to find the best coagulant dosing.

PROBLEM SOLVING.

In case of problems in the system, USEM should be called. In case of leaks or breakage of the pipeline, and of clogging, the operational cleans/clear the pipeline.

WEEKLY ACTIVITIES.

Cleaning the dosing system.

IMPORTANT TOPICS AND WORK PROCEDURE.

Already mentioned.

Problem solving.

Already mentioned.

MONTHLY ACTIVITIES.

Already mentioned.

IMPORTANT TOPICS AND WORK PROCEDURE.

Already mentioned.

PROBLEM SOLVING.

Already mentioned.

ANNUAL ACTIVITIES.

Already mentioned.

IMPORTANT TOPICS AND WORK PROCEDURE.

Already mentioned.

PROBLEM SOLVING.

Already mentioned.

ACTIVITIES CHECKING WORKSHEET.

Daily Treatment Bulletin

Service order - USEM

Consumption control spreadsheets

OPERATION DATA AND FEEDBACK.

- In case of failures or problems in the system, this is shown to the maintenance team that, after taking the measures necessary to solve the problem, teaches the operational team how to proceed to stabilize the system. The WTP manager or the technical team in alert is also called, in addition to communicating the CCO, in case of need to change the work discharge.

EMERGENCY SITUATIONS.

- In case of need, USEM (Alert Team), Manager (Chemical Technician in alert), the Competent Bodies should be called to an emergency situation.

10.4 CHLORINE GAS DOSING

PERSON RESPONSIBLE FOR THE INFORMATION:

Fabio Wolanski de Lima

CHLORINE DOSING SPECIFICATION

55-400 series remote vacuum switching unit is designed to allow the autonomous automatic switching of the gas supply.

This remote assemblage unit provides vacuum manifold of several gas recipients to high capacity advances of up to 4000 ppb (1800 kg / day of chlorine, or its equivalent).

The unit is installed in a vacuum gas feeding line between separated benches of vacuum regulating valves and the gas control unit, a new or existing system of gas fed disinfection.

The remote switching unit was designed to control and show the vacuumed gas flow, from two separated benches of gas storage cylinders. It provides a way of initially isolating a cylinders bench, and then to provide a certain level of vacuum in the gas feeding line, opening this isolated bench to allow that cylinders feed gas.

The unit is designed to be installed with or in one gas feeding water, disinfection systems (dragging water).

At IRAÍ WTP, the chlorine gas dosing system is composed of 2 batteries of 7 cylinders with 900 kg each.

It has 5 gas dispensers, one for each module and one for reserve, which can be used in any of the modules or at the pre.

A chlorine gas washing system

A automatic battery change system.

DOCUMENTS:

IT/OPE/1770 - IA/OPE 0753 - IT/RHU/0084

OPERATION PROCEDURE

TURNING ON

Open the chlorine dragging water (DN 150). Check if the dragging water pump is on.

The description of the system, and the valve and stop valve which should be opened or closed, indicating the dosing direction, is found in IT/OPE/1770, and in the operational unit scheme in annex.

Open cylinders (which should be closed during stoppages).

Open the outlet of chlorine dispensers CL0 034, 35, 36, and 37;

Open chlorinators inlets, if they are closed.

Turn on chlorinators, check the dragging water pressure by following the table below:

Up to 40mca	2 chlorinators
Above 40mca	Turn on up to 4 dispensers

Reserve valves should be closed.

TURNING OFF

Close the cylinders being used, zero chlorinators, if this is a stoppage where the system will undergo intervention or if it is a long stoppage, wait until the complete emptying of the line, and close the dragging water. However, if this is a temporary stoppage, or if the system will not undergo intervention, close cylinders and chlorinators, and leave the dragging water opened.

If the stoppage is to change chlorinator or line, close the line with problem and its corresponding chlorinator. Wait for the emptying of gas, and close the dragging water. At the same moment, open the reserve chlorinator dragging water, and open and close valves according to the scheme below.

Further details of stop valves and valves that should be opened or closed when changing chlorinators of the dosing line, or even to change the battery, can be found in the IT/OPE/1770.

Remark: The valve of the dragging water is located in the outlet of the water main, after the distribution pumps house, and the reserve dragging water valve is located in module four, above the saturation water pump.

During the operation process.

If it is necessary to use the reserve system, use the maneuvers scheme in annex.

DAILY ACTIVITIES.

Gauging of applied PPM

Cleaning of the application system

Annotations of BDT consumption on an hourly basis

Entering the material used in the consumption spreadsheet

End of the day closing

Verification of leaks in the system

Check cylinders pressure

IMPORTANT TOPICS AND WORK PROCEDURE.

Adjust consumption (ppm)

Keep application within specification

Perform quantitative chemical analysis of the consumption

Register the product used on an hourly basis

At the end of the day, perform inventory control.

PROBLEM SOLVING.

Problems should be solved by USEM, when mechanical or related to automation, through a service request. If the problem is operational, it should be solved by the operation team.

WEEKLY ACTIVITIES.

Disconnect the empty battery

Connect the full battery

Check the physical state of flexible and Yokes

Monitor the level of the neutralization tank of the chlorine gas washer

Clean the emergency kit

Check the functioning of safety equipment, such as the chlorine contamination sensor, the breathable air system.

Take note of the checks in the spreadsheet.

IMPORTANT TOPICS AND WORK PROCEDURE.

Cleaning of chlorine emergency kits.

Check the pressure of breathable oxygen cylinders.

Cleaning and inspection of masks and of breathable air system.

Entering the daily consumption in the expenditures spreadsheet

PROBLEM SOLVING.

Procedure already mentioned.

MONTHLY ACTIVITIES.

Consumption report

Inventory scheduling and purchase request

Check of the chlorination system

CHECK OF THE EXHAUSTION SYSTEM

Important topics and work procedure.

Consumption report.

Inventory scheduling and purchase request.

Check of the chlorine gas washer system.

PROBLEM SOLVING.

Procedure already mentioned.

ANNUAL ACTIVITIES.

Maintenance of chlorinators, valve, serpentine

Changing of chlorine filters and pipelines

Changing of flexibles.

Maintenance of the hoist.

Building maintenance.

IMPORTANT TOPICS AND WORK PROCEDURE.

Maintenance of chlorinators, valve, serpentines

Changing of filters

Maintenance of the hoist.

Building maintenance.

PROBLEM SOLVING.

Procedure already mentioned.

Activities checking worksheet.

Chlorine emergency kits control worksheet

Oxygen tanks pressure control worksheet

Eyes washer functioning worksheet

BDT

Inventory control

Traceability of chlorine cylinders.

OPERATION DATA AND FEEDBACK.

In case of failures or problems in the system, this is shown to the maintenance or automation team that, after taking the measures necessary to solve the problem, teaches the operational team how to proceed to stabilize the system. The COC staff is also called, in case of need of changing the work volume.

EMERGENCY SITUATIONS.

Use the escape mask until connecting to the breathable air system.

Connect to the breathable air system.

Immediately close the chlorine cylinders valves.

Close the manifold valves.

With the help of ammonia vapor, which will produce a white vapor in the presence of chlorine, check if the leak was fixed.

If it is identified that the leak occurs in the valve, and such leak cannot be fixed by closing this valve, put the emergency kit, pursuant to IT/RHU/0084.

CHLORINE GAS WASHING SYSTEM:

The system is composed of a tank with caustic soda solution. When there is a chlorine leak, one of the chlorine detectors installed in the site, which has an electro-chemical sensor calibrated to automatically actuate the system, puts a soda circulation pump in operation, in a gas exhauster.

In case of chlorine gas leak, the waste generated by the gas washing system is sodium hypochlorite, which can be stored in drums, and used to clean glasses and glass recipients of the laboratory.

The chlorine gas washing system should be inspected at each 2 months, checking if the equipment is in perfect use conditions, also checking for the need of replacing or supplementing the solution in the tank, by measuring the pH, which shall be between 12 and 14, and the volume through a ruler, which shall be between 90 and 110 cm (centimeters).

If it is necessary to change this solution, for being saturated or for any other reason, and it should be disposed of in the sewage system, the solution should be corrected to pH 6 to 7.

These operations should be registered in the IA/OPE/0753.

10.5 FLUORIDIZING DOSING

PERSON RESPONSIBLE FOR THE INFORMATION:

Lunardon

FLUORIDIZING SPECIFICATION;

The process of applying fluosilicic acid has the aim of helping to prevent dental caries in the population.

At IRAÍ WTP, this procedure is directly done in the contact chamber, through two dosing pumps, which are connected to two storage tanks with 15 m³ capacity each. There are two with the same capacity, working as reserve silo.

The process is controlled based on IT/OPE/1543 parameters, i.e., by PCA and Ordinance 2914.

DOCUMENTS:

IT/OPE/1797 and IT/OPE/1543

OPERATED EQUIPMENT:

Storage tanks

Dosing Pumps

Stop valves and Valves

Equipment verification

Pumps functioning.

Leaks in pipelines and valves

Pipeline clogging

Discharge control

EQUIPMENT VERIFICATION

Watson Marlow Dosing Pumps – 520 BP Model – 0.1 to 220 rpm.

Cleaning at least once a day

IMPORTANCE:

Meet Governmental requirements and the PCA.

COMMENTS.

Only one pump, one line, and one application point are used in the contact chamber. In case of need to change the application point, the maneuver is performed by valves located in the application lines inside the concrete gutters.

In case of pipeline breaking, perform the maneuver changing the application point, and call USEM to check for the possibility of changing the pipeline, or of contracting out a company to do that.

OPERATION PROCEDURE

TURNING ON

The procedure to turn on the Fluorine dosing system is described in the IT/OPE/1797, in items 3.1 to 3.3, including the stop valves and valves that should be opened and closed in each operation.

TURNING OFF

The procedure to turn on the Fluorine dosing system is described in the IT/OPE/1797, in items 3.1 to 3.3, including the stop valves and valves that should be opened and closed in each operation.

DURING THE OPERATION PROCESS.

Control the volume applied

Control PPM

Register occurrences

DAILY ACTIVITIES.

To adjust the necessary PPM to meet the ordinance requirement

IMPORTANT TOPICS AND WORK PROCEDURE.

. The correct functioning of the system implies in the correct dosing of the coagulant necessary to treat the raw water. This will result in a better quality water, and in a more efficient process.

PROBLEM SOLVING.

In case of problems in the system, USEM should be called. In case of leaks or breakage of the pipeline, and of clogging, the operational cleans/clear the pipeline.

WEEKLY ACTIVITIES.

Inexistent.

IMPORTANT TOPICS AND WORK PROCEDURE.

Inexistent.

PROBLEM SOLVING.

Inexistent.

MONTHLY ACTIVITIES.

Inexistent.

IMPORTANT TOPICS AND WORK PROCEDURE.

Inexistent.

PROBLEM SOLVING.

Inexistent.

ANNUAL ACTIVITIES.

Inexistent.

IMPORTANT TOPICS AND WORK PROCEDURE.

Inexistent.

PROBLEM SOLVING.

Inexistent.

ACTIVITIES CHECKING WORKSHEET.

Daily Treatment Bulletin

Inventory Control Worksheet

OPERATION DATA AND FEEDBACK.

In case of failures or problems in the system, this is shown to the maintenance or automation team that, after taking the measures necessary to solve the problem, informs or guides the operational team how to proceed to stabilize the system. The COC staff is also called, in case of need of changing the work volume.

EMERGENCY SITUATIONS.

In case of need, USEM (alert team) should be called. The manager (Chemical Technical Alert) or the competent entities in case of emergency.

10.6 CHELATOR DOSING (ORTHO-POLYPHOSPHATE)

PERSON RESPONSIBLE FOR THE INFORMATION:

Claudio Carignano

CHELATOR DOSING SPECIFICATION

Most of water supply systems in Brazil have "red water" problems in the distribution network, as well as a high degree of encrusting in the pipelines, resulting in a high rate of complaints from customers in regard to the product quality.

Metals present in the fresh water, possibly and strongly complex with the humic compounds, are very soluble and difficult to remove through conventional treatment processes.

After filtration and application of Chlorine, they oxidize the organic matter releasing and oxidizing metals, mainly Iron and Manganese. These Metallic Hydroxides are insoluble in water, resulting in a light yellow, brick orange, reddish brown, black color, etc. Such reactions as function of the Carbon gas release can take up to 48 hours to be entirely processed, i.e., there are precipitation reactions similar to those occurring in the flocculation process. Such reactions will mainly occur in networks, where the water speed is low. After flocculation, there is the formation of an electrically positive colloid, which will aggregate in the pipeline wall, due to the electrically negative load the pipelines have due to grounding.

DOCUMENTS:

IT/OPE/1796

OPERATED EQUIPMENT:

2 product preparation tanks

Agitators of the preparation tanks

2 application lines

Dragging water

Valves

Circuit breakers

4 dosing pumps

Equipment Verification

Functioning of agitators in the preparation tanks

Quantity of product for application

Functioning of dispenser pumps

Leaks in pipelines and valves

Opening and closing of valves, as necessary

IMPORTANCE:

The correct functioning of the sodium ortho-polyphosphate preparation and application system ensures a proper dosing in ppm, to eliminate the reddish color in the distributed water, when necessary.

COMMENTS:

The applied quantity depends on the contents of iron and manganese that is needed to complex.

OPERATION PROCEDURE

TURNING ON

1 – in the supervisory

- a) an application line is enabled
- b) a prepared tank is opened
- c) one or more dosing pumps are turned on
- d) the desired ppm is entered

2 – in manual local:

Procedures a; b; c; d

TURNING OFF

Undo procedures a; b; c; d

During the operation process.

- a) operational chemical analysis
- b) dosing calibration

DAILY ACTIVITIES.

Gauging of applied PPM

Preparation of ortho-polyphosphate solutions

Cleaning of the application system

Annotations of BDT consumption on an hourly basis

Entering the material used in the consumption spreadsheet

End of the day closing

IMPORTANT TOPICS AND WORK PROCEDURE.

- a) keep application within specification
- b) Perform quantitative chemical analysis of the consumption
- c) Register the product used on an hourly basis
- d) At the end of the day, perform inventory control.

PROBLEM SOLVING.

Problems should be solved by USEM, when mechanical or related to automation, through a service request. If the problem is operational, it should be solved by the operation team.

WEEKLY ACTIVITIES.

Cleaning of the work place

Important topics and work procedure.

a) periodical cleaning of the preparation and application environment, because the product is slippery, and the lack of cleaning can make employees fall

PROBLEM SOLVING.

Keep the place clean and dry

Problem solving with the help of USEM

MONTHLY ACTIVITIES.

Closing of the consumption report

Request for material replacement

Material reception

IMPORTANT TOPICS AND WORK PROCEDURE.

Inexistent.

PROBLEM SOLVING.

Inexistent.

ANNUAL ACTIVITIES.

Inexistent.

IMPORTANT TOPICS AND WORK PROCEDURE.

- a) not foreseen
- b) not usual

PROBLEM SOLVING.

Inexistent.

ACTIVITIES CHECKING WORKSHEET.

- a) daily treatment bulletin (BDT), where product analyses and consumption are taken note of on an hourly basis.
- b) daily closing bulletin (BFD), where the inventory control is performed at the end of the day.
- c) occurrences book, where the product preparation and any system problem is registered.

OPERATION DATA AND FEEDBACK.

In case of failures or problems in the system, this is shown to the maintenance or automation team that, after taking the measures necessary to solve the problem, teaches the operational team how to proceed to stabilize the system. The COC staff is also called, in case of need of changing the work volume.

EMERGENCY SITUATIONS.

In case of need, USEM (alert team) should be called. The manager (Chemical Technical Alert) or the competent entities in case of emergency.

Iraí WTP Operation Manual

Quality

Manual elaborated to support the Laboratory of Iraí Water Treatment Plant

TABLE OF CONTENTS

1. Analytic Control Plan for WTPS of Integrated Supply System in Curitiba–SAIC/USPD	3
2. Cleanliness and Conservation of the Laboratory	4
3. Sample Collection and Care to be Taken.....	5
4. Analyses for Guidance.....	6
5. Alkalinity Analysis.....	7
6. pH Analysis	8
7. Turbidity Analysis	9
8. Organoleptic Analyses	10
9. Color Analysis.....	11
10. Odor and Taste Analysis.....	12
11. Fluorine Analysis	13
12. Phosphate Analysis	14
13. Metal Analysis.....	15
14. Aluminum Analysis.....	16
15. Iron Analysis	17
16. Manganese Analysis	18
17. Chlorine Analysis	19
18. Toxin Analysis.....	20
19. Care for Coliform Analyses.....	21
20. Determination of Temperature:	22
21. Chlorine Analysis	23
22. Iron Analysis	24

1. ANALYTIC CONTROL PLAN FOR WTPS OF INTEGRATED SUPPLY SYSTEM IN CURITIBA-SAIC/USPD

Documents:

IT/OPE/1543

Objective:

To define parameters and frequencies of the WTP analytical control, as well as the responsibilities for actions when parameters are out of standard.

Importance:

Comments:

2. CLEANLINESS AND CONSERVATION OF THE LABORATORY

Documents:

IT/LAB/0127

IT/LAB/0091

Importance:

- Used glassware should be washed always at the end of an analysis, thus preventing encrusting of dirty and spots, which affect the final result of the analysis, and can cause the involuntary noncompliance with important parameters, such as in fluorine analysis.
- Equipment should always be clean and closed, to prevent their light bulbs and receptors to become dirty, which can cause a wrong reading in the analysis.

Comments:

3. SAMPLE COLLECTION AND CARE TO BE TAKEN

Documents:

IT/LAB/0475

Importance:

It describes the sample collection procedures for the bacteriological, physical-chemical, hydrobiological, spectrophotometric, and chromatographic examination of water.

These collections are done for WTP analyses, as well as they are sent for analysis at SANEPAR central laboratory.

Comments:

4. ANALYSES FOR GUIDANCE

Analyses such as of alkalinity, pH, and turbidity that help in making decisions in performing the treatment at the plant.

5. ALKALINITY ANALYSIS

Total alkalinity is the measurement of carbonates, bicarbonates, and hydroxides existent in the water.

In order to determine the hydroxide alkalinity, phenolphthalein is used, and this is only determined with pH above 8.3.

In water treatment plants, a mixed indicator is used, determining the amount of carbonates and bicarbonates.

Documents:

IT/LAB/0015

Equipment:

Burette

Equipment verification

Inexistent.

Importance:

Used to determine the need of applying artificial alkalinizing agent to the water.

The need to use artificial alkalinizing agent can be determined through the stoichiometric proportion, when it is noticed that there is no sufficient alkalinity.

It can also be verified through the alkalinity consumption, through the analysis of the fresh water and filtered water, checking how much of alkalinity was consumed, and if this is in accordance with the stoichiometric proportion.

Comments:

6. PH ANALYSIS

pH is the measure of the ionic hydrogen potential existent in a solution.

Documents:

IT/LAB/0025

Equipment:

pH meter.

Equipment verification

Once per shift.

Importance:

Used to determine if the coagulant is being applied at the ideal pH, remembering that dosing with inappropriate pH can cause the solubilization of aluminum, and this can be transmitted to the network.

Comments:

7. TURBIDITY ANALYSIS

Used to determine the amount of material suspended in the water. It is a parameter very easy and quick to measure

Documents:

IT/LAB/0029

Equipment:

Turbidity meter

Equipment verification

Once per shift.

Importance:

Some types of fresh water easily changes, such as after the rain, and the characteristic of the water requires to change the dosing of chemical products.

In filtered water, it shows that there was a proper removal of colloidal particles and suspended materials.

For filtered water, the legal standard is turbidity below 0.5NTU in 95% of the filtration units, for the year of 2015.

The turbidity analysis of filtered water was included as obligatory in ordinance 2914/2011, to ensure a high removal of microorganisms, Cryptosporidium and Giardia among them.

Comments:

8. ORGANOLEPTIC ANALYSES

Organoleptic are the properties of bodies or substances that impress the senses, such as analysis of color, odor, and taste.

Importance:

As water is treated to be drinkable, the consumer requires that it is odorless, colorless, and insipid.

If this does not happen, customers will complain.

9. COLOR ANALYSIS

Documents:

IT/LAB/0024

Equipment:

Colorimetric disk.

Equipment verification

Inexistent.

Importance:

Comments:

10. ODOR AND TASTE ANALYSIS

Documents:

IT/LAB/0029

Equipment:

Equipment verification

Inexistent.

Importance:

Comments:

11. FLUORINE ANALYSIS

The use of fluorine in public supply water is to reduce, mainly in poorer regions, caries in the population.

Documents:

IT/LAB/0013

Equipment:

Fluorine meter or colorimeter or spectrophotometer.

Equipment verification

Inexistent.

Importance:

Dosing below the requirements in the legislation makes it innocuous for the people, which means that there is no benefit, therefore, in this case it is like if we were "throwing away the product", i.e., wasting money.

Dosing above the legislation requirement causes dental fluorosis.

Comments:

12. PHOSPHATE ANALYSIS

Phosphate (ortho-polyphosphate) is used in water to complex (chelate) iron, and thus reducing the color of the water.

Documents:

IT/OPE/0136

Equipment:

Colorimeter or spectrophotometer.

Equipment verification

Inexistent.

Importance:

Analysis is performed to check if the ortho-polyphosphate dosing is correct at the WTP.

There is not legal requirement as for the frequency of analyses, but it should preferably be done with a higher frequency in the beginning of the application, until stabilization, and can be reduced when stabilized.

Comments:

13. METAL ANALYSIS.

14. ALUMINUM ANALYSIS

Documents:

IT/LAB/0456

Equipment:

Colorimeter or spectrophotometer.

Equipment verification

Inexistent.

Importance:

Comments:

15. IRON ANALYSIS

Documents:

IT/LAB/0462

Equipment:

Colorimeter or spectrophotometer.

Equipment verification

Inexistent.

Importance:

See with Carlos Rattmann

Comments:

16. MANGANESE ANALYSIS

Documents:

IT/LAB/0464

Equipment:

Colorimeter or spectrophotometer.

Equipment verification

Inexistent.

Importance:

See with Carlos Rattmann

Comments:

17. CHLORINE ANALYSIS

Chlorine is used as disinfectant in water treatment, for killing most of the viruses, protozoans, and bacteria, and also for leaving a free residual in the water, what prevents the contamination in the supply network.

Documents:

IT/LAB/0019

Equipment:

Colorimeter or spectrophotometer.

Equipment verification

Inexistent.

Importance:

When dosed in an amount below the requirement, it can cause water contamination in the supply network.

When dosed above the required amount, there is waste of chlorine, thus increase of water production cost.

Comments:

18. TOXIN ANALYSIS

Microcystin Analysis.

Documents:

IT/LAB/1174

Equipment

ELISA

Equipment verification

Inexistent.

Importance:

Analysis performed for treatment plants using the water from dams, with problems with cyanobacteria.

Microcystin is a hepatotoxic toxin.

It is strictly controlled because in dialyses very small concentrations can cause death, as occurred in Caruaru.

In periods of high algae counting (microcysts), the analysis of the produced water is done more frequently, with the aim of ensuring that the water is within the legal parameters.

Microcystin analysis is performed at SANEPAR central laboratory, USAV.

Comments:

19. CARE FOR COLIFORM ANALYSES

20. DETERMINATION OF TEMPERATURE:

Documents:

IT/LAB/0021

Equipment:

Thermometer.

Equipment verification

Twice a day.

Importance:

See with Audrey or Bruna

Comments:

21. CHLORINE ANALYSIS

Related documents

666

Objective

To perform chlorine analysis

Importance:

For a correct disinfection

Comments.

22. IRON ANALYSIS

Related documents

777

Objective

To know the iron contents

Importance:

Iron makes water yellowish, and can stain clothes and dishes

Comments.