

Study for Safety Operation and Management of Railway in the Republic of Ghana



Technical Seminar; Rolling Stock, Wheel set

March 2014
JICA Study Team
Rolling Stock Expert : Mitsuyuki OSAWA
: Tadaaki TAKAO

Study for Operation and Management of Railway in the Republic of Ghana



Items



- **Basic Dimensions**
- **Diameter and Flange**
- **Risk of small diameter**
- **Major Dimensions**
- **Tread Profile**

- If $C > B \rightarrow$ Climbing on the rail
- If $D < B \rightarrow$ Derailment
- $C = A + 2b$ A : Back gauge, b : Flange thickness
C : Flange gauge, d: Tyre width
- $D = A + b + d$

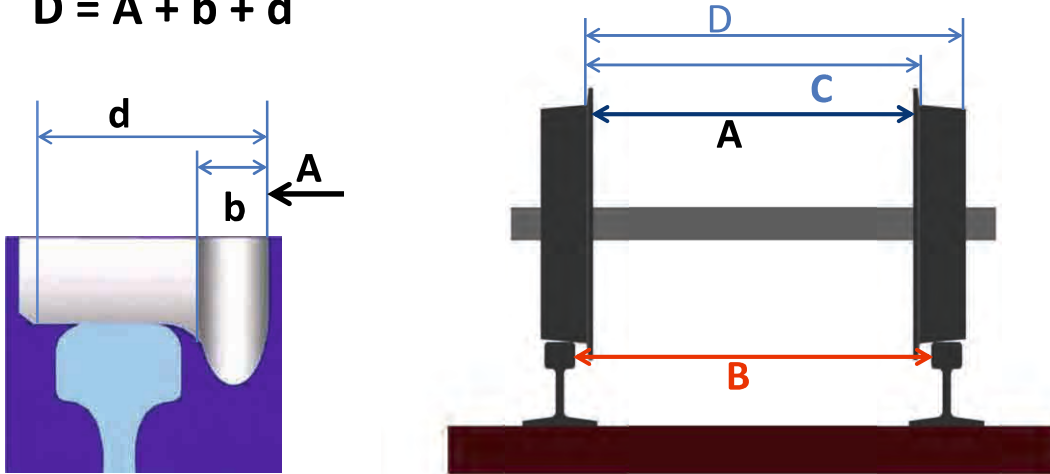

Study for Operation and Management of Railway in the Republic of Ghana

- Set a standard number of A, C, d, appropriately considering B; track gauge; including deterioration and slack
- $B = 1067 \pm 14 + \text{slack } (0 \sim 25) : 1053 \sim 1106$
- A ; 989 ~ 994, C ; 1032 ~ 1054, d ; 120 ~ 150,
- D ; 1109 ~ 1144,



- $C: 1032 \sim 1054 < 1053 \sim 1106 : B$
- $D: 1109 \sim 1144 > 1053 \sim 1106 : B$
- $b = (C - A)/2 = 19 \sim 32.5$

Study for Operation and Management of Railway in the Republic of Ghana

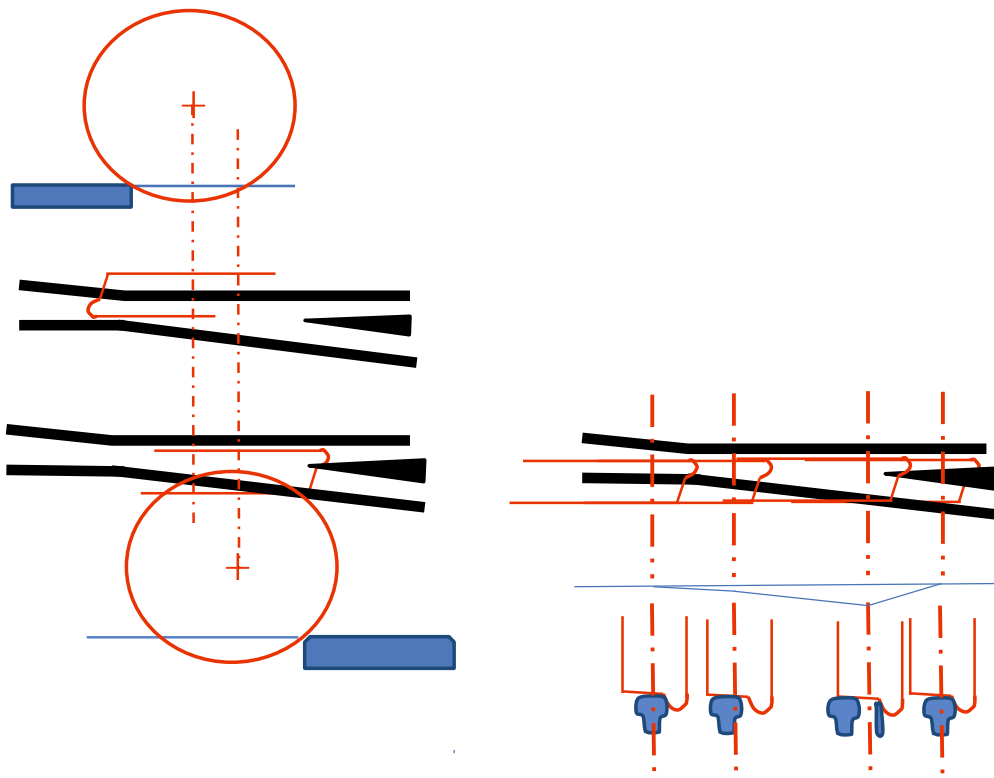
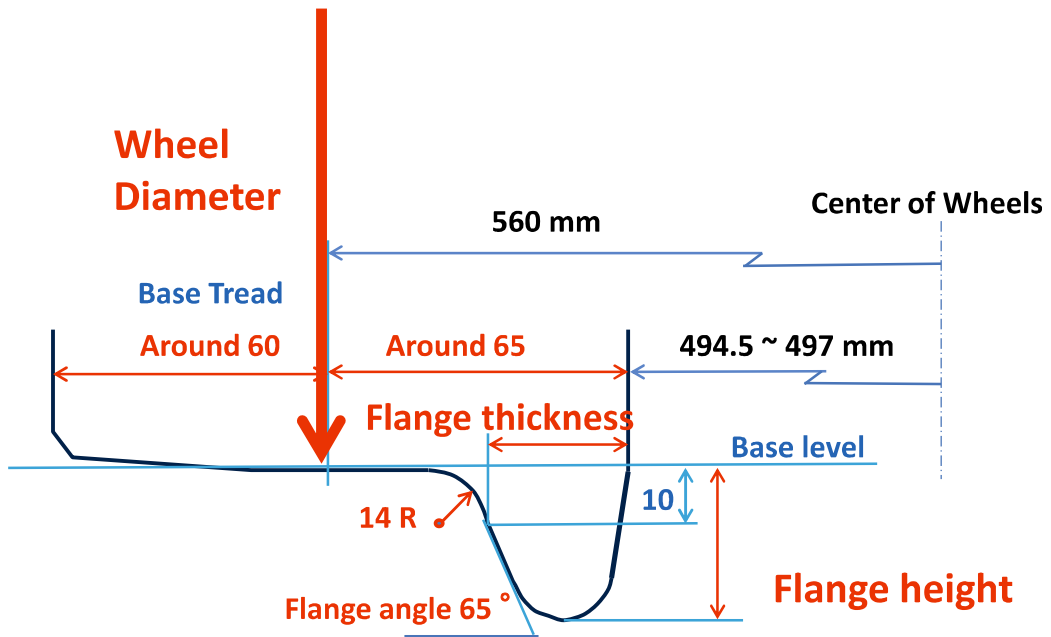

- Wheel Diameter : 680 ~
- Flange Height : 25 ~ 35
- Flange thickness : 26 ~ 32.5

- Risk of small Diameter
 - Increasing probability of irruption into wrong direction on crossing frog.
 - Increasing wheel sinking on crossing
 - Increasing wheel rotation
 - Increasing contact pressure between wheel and rail

- Risk of High/Low Flange Height
 - Low Height less guard derailment
 - High Height may touch something to fasten

- Risk of thin/thick Flange
 - Thin Flange increase probability of irruption into wrong direction on crossing.
 - Thick Flange may invade guard rail

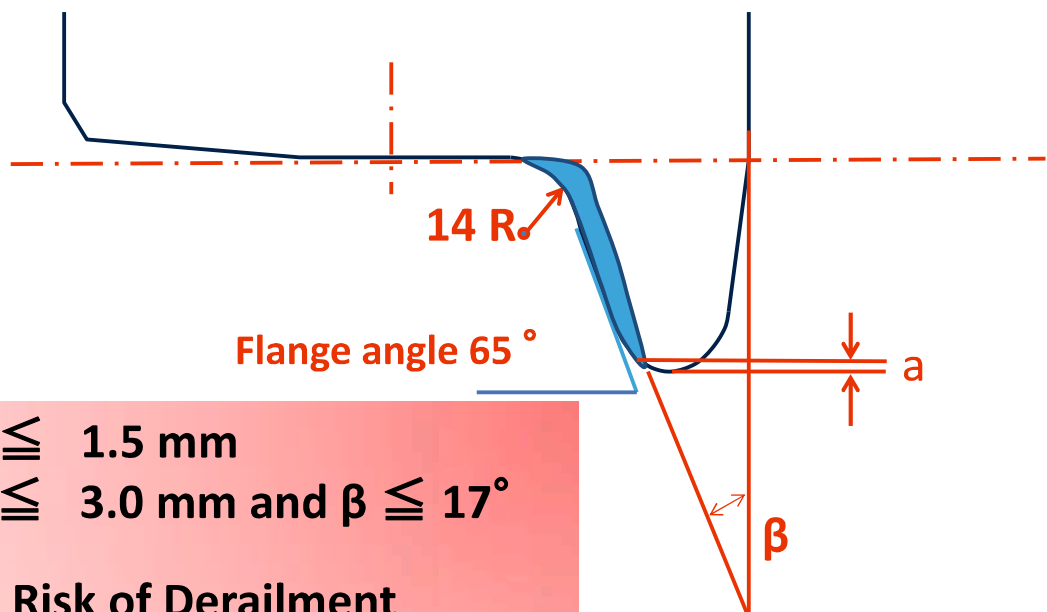

- $a \leq 1.5 \text{ mm}$
- $a \leq 3.0 \text{ mm}$ and $\beta \leq 17^\circ$

High Risk of Derailment

Test items and outline of test

Mar. 10, 2014

1. Brake pipe leakage test

Seal pressurized air in BP and measure pressure drop of BP.

2. Slow depressurization test

Charge pressurized air into BP and depressurize slowly, and confirm that brake cylinder piston comes out.

3. Slow pressurization test

Charge pressurized air into BP and depressurize, and pressurize slowly and confirm that brake cylinder begins to be loosened.

4. Quick depressurization test

Charge pressurized air into BP and depressurize quickly, and confirm that it does not cause the emergency brake operation.

5. Emergency brake operation test

Charge pressurized air into BP and perform emergency depressurization, and confirm that emergency brake is activated.

6. Release test after emergency brake operation

Charge pressurized air into BP and confirm that the brake is released completely.

Class and period of the inspection of wagon (Japan)

Mar. 5, 2014

Class	Content	Period
Daily inspection	<ul style="list-style-type: none"> ➤ Exchange of consumables. ➤ Inspect a state and action such as running gears, electric apparatus, a brake system and a body from the outside. 	Dead period between operation
Monthly inspection	<ul style="list-style-type: none"> ➤ Inspect a state and action and the function such as running gears, electric apparatus, a brake system and a body being not dismantled 	Less than 90 days
Yearly inspection (Important devices inspection)	<ul style="list-style-type: none"> ➤ Inspect such as running gears, brake system and other important devices. 	Less than 30 mouths
General inspection	<ul style="list-style-type: none"> ➤ Inspect about the whole of wagon. 	Less than 60 months
Running inspection	<ul style="list-style-type: none"> ➤ Inspect dynamic states such as the vibration and a function while driving 	As needed
Extra inspection	<ul style="list-style-type: none"> ➤ Breakdown ➤ Accident ➤ Construction • Remodeling ➤ Out-of-service car ➤ By other needed 	

Portable type brake tester for single car Instruction manual

August 2013

Nabtesco Corporation
Railroad Products Company
Engineering Department



DOC.No	2945-AS20904-00E	cover2
--------	------------------	--------

REVISION SYMBOL	REVISION HISTORY	DATE	PREPARED	CHECKED	APPROVED
	• Newly established	Aug. 7, 2013	J. Morita	T. Kibe	A. Hayashi





[For safe use]

Read through this instruction manual before use and follow the precautions for proper use of the product.

Explanation of marks attached to precautions

Warning term	Meaning of warning term
 Warning	• Failure to follow the warning may result in death or serious injury to the user.
 Caution	• Failure to follow the caution may result in medium or light injury. • Failure to follow the caution may result in improper test operation or failure of the equipment.

Cautions on product

 Warning	Be sure to fix the car using scotch blocks, etc. before connecting the tester with the car and performing test operation. Failure to fix the car may result in death or serious injury such as broken bones due to being hit by the car.
 Caution	Do not move your face close to air outlet port or tip of hose. Sudden blowoff could harm your eyes or ears.
 Caution	Be sure to check the pressure gauge to confirm that pressure has been released before removal of the air hose. Sudden blowoff could result in injury caused by the hose.
 Caution	Confirm that the air hose is properly connected to the air source and the car. If the hose is disconnected due to improper connection, you could be injured.

Contents

1.	Introduction.....	1
2.	Explanation of structure and devices.....	1
2-1.	Structure (Refer to Picture-1 and Figure-1).....	1
2-2.	Actions and throttle hole diameter at each handle position	2
3.	Test operation	2
3-1.	Preparation for test.....	2
3-2.	Test operation procedure	2
4.	Maintenance.....	3
4-1.	Daily maintenance/inspection.....	3
4-2.	Function test (recommendation: every year).....	3
4-3.	Maintenance/repair (refer to Figure-1)	4

TITLE	R.R.C. ENGINEERING DEPT.			
	DATE	PREPARED	CHECKED	APPROVED
Portable type brake tester for single car Instruction manual	August 7, 2013	J. Morita	T. Kibe	A. Hayashi

1. Introduction

This tester is used to check operation of automatic brake for single car (freight car) manually (Refer to Table-1).

[Table-1]

No.	Type	Product No.	Car model to be tested
1	For freight car	1009-3199256-01	2-shaft freight car • bogie freight car

2. Explanation of structure and devices

2-1. Structure (Refer to Picture-1 and Figure-1)

Rotary valve is turned by handle to open or close the hole between rotary valve and fixed valve seat, so as to flow upstream (Air source side) air to downstream (brake pipe of car), release downstream air to atmosphere or seal in downstream air. The tester is connected to brake pipe (BP) hose of car. The tester is portable and easy to carry.

The connection is screwed and can be connected with either a coupler or a car coupler.

* Hoses for BP connection and air source connection are not attached to the tester.



Whole view of the tester (Picture-1)

2-2. Actions and throttle hole diameter at each handle position

[Table-2]

Handle position	Actions	Air passage diameter [mm]	Remarks
Position 1	Supply	6.35	
Position 2	Slow supply	0.7	
Position 3	Lap	-	
Position 4	Slow exhaust	0.9	
Position 5	Quick exhaust	1.8	
Position 6	Quick exhaust	3.5	Emergency brake

3. Test operation

3-1. Preparation for test

- [1] Set the handle of the tester at position 3 and connect air source hose. (Side on which nameplate indicates MR)
- [2] Supply air source. (Dry and clean air adjusted to 490 kPa)
- [3] Turn the handle to position 4, 5 and 6 in this order and confirm that hose coupler and exhaust port of the tester are free from leakage.
- [4] Connect BP hose of car and the tester to BP side.

3-2. Test operation procedure

(1) Brake pipe leakage test

- [1] Set the handle at position 1, charge 490 kPa of air into BP, move the handle to position 5 to reduce pressure of BP by 100 kPa (to 390 kPa) and then move the handle to position 3.
- [2] Confirm that pressure drop of BP during in one minute is within 15 kPa.

(2) Slow application test

- [1] Set the handle at position 1 and charge 490 kPa of air into BP.
- [2] Move the handle to position 4 to reduce pressure of BP and confirm that pressure reduction of BP is within 40 kPa and brake cylinder piston comes out.

(3) Slow charging test

- [1] Set the handle at position 1 and charge 490 kPa of air into BP.
- [2] Set the handle at position 5 to reduce pressure of BP by 40 kPa (to 450 kPa) and then move the handle to position 3.
- [3] Move the handle to position 2 after stabilization of pressure gauge needle and confirm that brake cylinder begins to be loosened before BP pressure increases by 20 kPa.

(4) Ser. Stability application test

- [1] Set the handle at position 1 and charge 490 kPa of air into BP.
- [2] Set the handle at position 5 to reduce pressure of BP by 135 kPa (to 355 kPa) and then move the handle to position 3.
- [3] Confirm that it does not cause emergency brake operation.

(5) Emergency brake operation test

- [1] Set the handle at position 1 and charge 490 kPa of air into BP.
- [2] Confirm that emergency brake is activated when BP is depressurized by setting the handle at position 6.

(6) Release test after emergency brake operation

- [1] Confirm that the brake is released completely when the handle is moved from position 6 to position 1 after emergency brake operation test.

(7) Gradual release test

This test applies to cars equipped with A control valve, KU control valve and E control valve or triple valve featuring gradual release function. (Cars equipped with K control valve do not have this function)

- [1] Set the handle at position 1 and charge 490 kPa of air into BP.
- [2] Set the handle at position 5 to reduce pressure of BP by 135 kPa (to 355 kPa) and then return the handle to position 3.
- [3] Move the handle to position 1 to increase pressure of BP by 20 to 30 kPa, and then move the handle quickly to position 3. (Lapping of release)
Repeat this operation (position 1 ⇔ position 3), and confirm that release is hold at least three times.

* The tester is for simplified brake operation test of car. The tester is not intended for detailed tests of control valve functions/performance. Use testers such as 3T (3TN), AB (ABN) and HSC for function/performance tests of control valve units.

4. Maintenance

The following maintenance/inspection are required to keep the tester at proper condition.

4-1. Daily maintenance/inspection

Check for flaws on connection port of the tester
(Check couplers and hoses used for connection at the same time. Flaws on them could cause air leakage.)

4-2. Function test (recommendation: every year)

(1) Preparation for test

- [1] Connect 15-liter air reservoir to BP side (right side).
- [2] Connect air source to air source side (left side). (Dry and clean air)
- [3] Adjust pressure of air source at 490 kPa.
- [4] Move the handle back and forth between position 1 and positions 4, 5 and 6 several times and return it to position 1 to charge 490 kPa of air into air reservoir.
- [5] Confirm that air reservoir and hose joints are free from leakage. (Check by noise and soap water)

(2) Leakage inspection [continued from (1)]

- [1] Set the handle at position 1, charge 490 kPa of air into 15-liter air reservoir and stabilize for 5 minutes.
During this period, apply soap water on entire area of the tester and exhaust port to confirm that they are free from leakage.
- [2] Move the handle to position 3 and confirm that pressure drop in 10 minutes is within 10 kPa, using pressure gauge of the tester.

(3) Capacity test [continued from (1)]

Accuracy of the tester's throttle hole diameter (refer to Table-2) is checked by this inspection.

- [1] Operate the handle and use the pressure gauge of the tester to measure the time for charging 15-liter air reservoir (position 2) and the time for depressurizing the air reservoir (positions 4, 5 and 6). Before measurement of depressurizing time, charge the air reservoir with 490 kPa of air. Refer to Table-3 for ranges of pressure for measurement and judgment criteria (time).

[Table-3]

Handle position	Range of pressure for measurement [kPa] (15-liter air reservoir)		Acceptable range (second)
Position 2	0 → 195	Charge (Supply)	65 to 85
Position 4	490 → 355	Depressurize (Exhaust)	25 to 35
Position 5	490 → 355	Depressurize (Exhaust)	7 to 9
Position 6	490 → 195	Depressurize (Exhaust)	5 to 7

4-3. Maintenance/repair (refer to Figure-1)

To be performed periodically or when leakage is detected, car test cannot be done smoothly or handle resistance is high.

- (1) Calibration of pressure gauge (Recommended replacement cycle: 1 year)
- (2) Replacement of pressure gauge packing (Recommended replacement cycle: 2 years)

[Table-4]

No.	Packing P/N	Remarks
1	1084-4090628-03	

- (3) Inspection/maintenance of single car testing device

<<Major items>>

- [1] Disassemble/cleaning
- [2] Replacement of gasket for rotary valve cap (Recommended replacement cycle: 2 years)

[Table-5]

No.	Gasket P/N	Remarks
1	1009-3199256-01	

- [3] Applying grease: Apply multi-purpose grease [Dynamax No.2 (Cosmo Oil) or equivalent] used for brake parts to areas between rotary valve and rotary valve seat, rotary valve key and rotary valve seat and handle positioning steel balls.
- [4] Grinding (rotary valve)
 Perform after leakage inspection or when leakage cannot be stopped. (Experience is required to perform this operation.)
 Be sure to perform inspection after completion of inspection/maintenance operations explained above (refer to section 4-1)

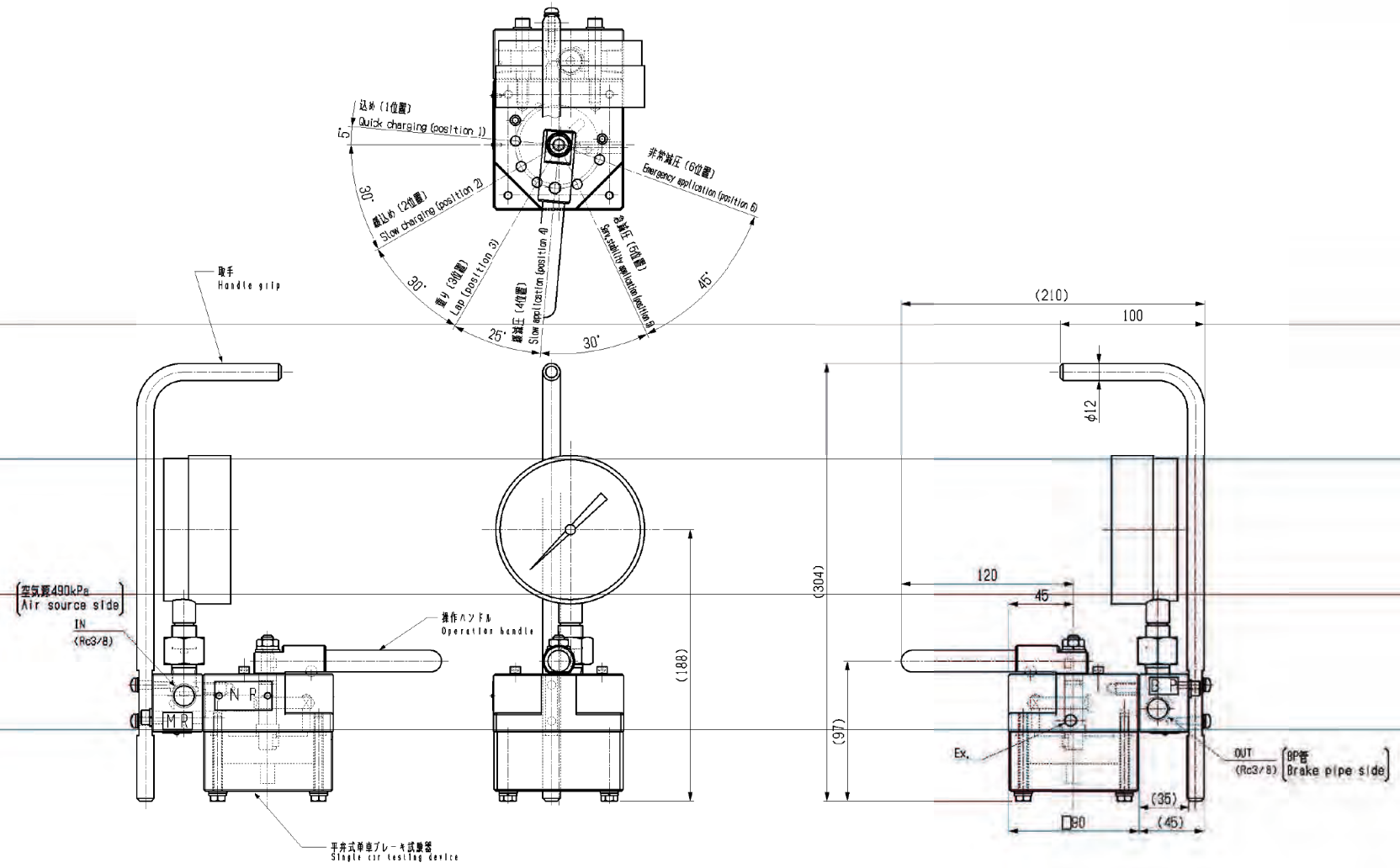

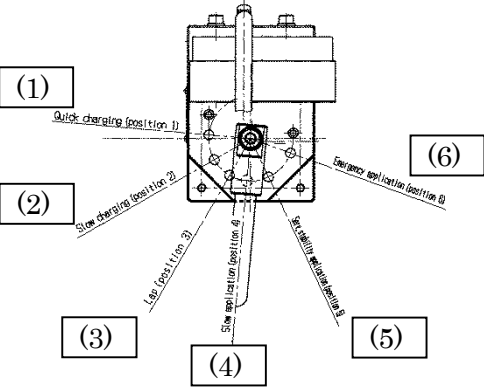

Figure-1 External view of Portable type brake tester for single car

Date	1. Mar 2014	Item	Air Brake Test Manual	1/2
------	-------------	------	-----------------------	-----

Test	Remarks
<p>1. Preparation for test</p> <p>(1) Set the handle of the tester at position 3 and connect air source hose to the MR side of the tester.</p> <p>(2) Supply air source (Dry and clean air adjusted to 490kPa: 5kgf/cm²)</p> <p>(3) Turn the handle to position 4,5 and 6 and confirm that hose coupler and exhaust port of the tester have no leakage.</p> <p>(4) Connect BP hose of the wagon and the BP side of the tester.</p> <p>2. Test operation procedure</p> <p>(1) Brake pipe leakage test</p> <p>[1] Set the handle at position 1 and charge pressurized air into BP to 490kPa, move the handle to position 5 and reduce the pressure to 390kPa, then move the handle to position 3.</p> <p>[2] Confirm that the pressure drop in one minute is within 15 kPa.</p> <p>(2) Slow depressurization test</p> <p>[1] Set the handle at position 1 and charge pressurized air into BP to 490kPa, move the handle to position 4 and reduce the pressure</p> <p>[2] Confirm that the brake cylinder starts working within 40kPa of the pressure reduction.</p>	<div data-bbox="1688 268 2011 703" data-label="Image"> </div> <div data-bbox="1666 708 2011 746" data-label="Caption"> <p>Portable brake tester</p> </div> <div data-bbox="1592 762 2085 1129" data-label="Diagram"> </div> <div data-bbox="1644 1193 2063 1347" data-label="List-Group"> <ul style="list-style-type: none"> Position (1) Quick charging Position (2) Slow charging Position (3) Lap Position (4) Slow depressurization Position (5) Quick depressurization Position (6) Emergency depressurization </div>

Test	Remarks
<p>(3) Slow pressurization test</p> <p>[1] Set the handle at position 1 and charge pressurized air into BP to 490kPa, move the handle to position 5 and reduce the pressure to 450kPa, then move the handle to position 3.</p> <p>[2] After the pressure is stabilized, move the handle to position 2, confirm that the brake starts releasing within 20kPa of the pressure increase.</p> <p>(4) Quick depressurization test</p> <p>[1] Set the handle at position 1 and charge pressurized air into BP to 490kPa, move the handle to position 5 and reduce the pressure to 355kPa, then move the handle to position 3.</p> <p>[2] Confirm that the emergency brake is not acted.</p> <p>[3] Confirm the piston stroke of brake cylinder.</p> <p>(5) Emergency brake operation test</p> <p>[1] Set the handle at position 1 and charge pressurized air into BP to 490kPa, then move the handle to position 6.</p> <p>[2] Confirm that the emergency brake is acted.</p> <p>[3] Confirm the piston stroke of brake cylinder.</p> <p>(6) Release test after the emergency brake operation</p> <p>[1] Move the handle from position 6 to position 1 after the emergency brake operation test</p> <p>[2] Confirm that the brake is released completely.</p>	 <p style="text-align: center;">Portable brake tester</p>  <p>Position (1) Quick charging Position (2) Slow charging Position (3) Lap Position (4) Slow depressurization Position (5) Quick depressurization Position (6) Emergency depressurization</p>

20E12M011 Ver1.1

TY-50 Type Diameter Gauge for the Wheel

(Measuring range : between 760 and 920 mm)

YOSHIDA SEIKI

SHINYEI TECHNOLOGY CO. LTD. Engineering Department
(Brand name: **YOSHIDA SEIKI**)

Shiba 2 Chome Bldg. 11F, 2-28-8, Shiba, Minato-ku, Tokyo 105-0014 Japan

TEL: +81-3-5443-1562 FAX: +81-3-5443-1566

URL : <http://www.shinyei.co.jp/stc/> (SHINYEI TECHNOLOGY)

<http://www.yoshida-seiki.co.jp/> (YOSHIDA SEIKI)

This is a dial gauge for measuring the wheel diameter, derived from a new concept which allows the direct read on the gauge simply applying it on the wheel tread.

Measurement can be made without any error caused by the observer and is simple for all kinds of wheels, some of which having been found difficult in measurement by conventional measuring instruments.

This new gauge is an instrument of notable faculty incorporated numerous ideas for the practical use with regard not only to its construction but also small components.

Characteristics

1. Measuring range : between 760 and 920 mm
2. Measuring accuracy : within ± 0.5 mm
3. Dial gauge : $\phi 80$ and graduations on both sides
4. Division : Direct read of the diameter in 1mm graduation
5. Location of the diameter measurement : 65 mm from the flange side
(Any other version is available upon request)
6. Maximum measurable height of the flange : 37 mm
7. Holding system of the measuring condition : the gauge is fixed side on the flange by the attractive force of magnets
8. Weight : 2.1 kg

Features

1. The wheel diameter can be read directly on the dial gauge
It is valid for wheel diameters ranging from 760mm to 920mm indicating accurately by 1mm unit from the relative location of 3 different points on the tread.
2. The dial gauge is provided with graduations on both sides
As the dial gauge is large enough ($\phi 80$) and is provided with graduations on both sides, reading of the indicated values is easy even when the observer is in a limited space and no matter what posture he takes.
3. The dial gauge can be fixed at designated positions by magnet
No error will be incurred by the observer's handling of the dial gauge, as its datum plane is tightly attached with the aid of magnets to the side of flange which serves as the reference plane of measurements.
4. Small and light-weight
It is 326mm long, 112mm wide and 235mm high weighing about 2kg.
It can be used by single hand even in a limited measuring site.
5. Assurance of the accuracy
The whole gauge surface contacting with the wheel is sufficiently hardened by heat treatment and fixed contact elements at its extremities as well as the contact area of its tips are large enough to prevent any error in measurement due to their wear. A metal cover protects the dial gauge from direct shocks.
A test piece corresponding to a wheel diameter of 700mm is provided for checking the accuracy.

Method to Use

- The flange side serves as the datum plane. Therefore when it is heavily filthy, wipe the dirt off with wastes.
- The dial gauge is applied on any location of a wheel and is fixed on the flange side by the attractive force of magnets. In case of new wheel, the flange side is wide enough to hold the gauge parallel to the center line of the tread. However when it is a used wheel reprofiled several times, it is not always fixed on the flange side parallel to the center line of the latter, because the contact area has been reduced. Accordingly it is advisable to see if the gauge is parallel.
- To make sure, push the fixed contact elements onto the tread. Then the graduation of the dial gauge will directly indicate the wheel diameter. In reading the indicated value, it should be kept in mind that the order of graduation on one side of the gauge is totally opposed to that of the other side. Therefore read the value in accordance with the direction shown by an arrow.
- The wheel diameter should be determined by the mean value of at least 3 measurements on different locations of the wheel tread as there may exist certain partial flaws or any local flat on the tread.
- The dial gauge is protected by a metal cover and its base is so constructed as to render it a high rigidity. Accuracy of the measurement is maintained throughout the usual handling, but in the event of dropping it or when it suffers a strong shock during the operation, the value may be erroneously indicated. In order to assure the accuracy, it is to be handled with care considering that it is a precision measuring instrument and its needle multiplies every movement of the spindle by a factor of about 30.

Accuracy Check

- Though the fixed contact elements and the spindle tips of the dial gauge as well as the contact area of flange side, etc. are all made of hard steel of sufficient hardness and the main body made of aluminum casting renders its structure such a high rigidity that a long service with a stable accuracy be assured, it is probable that the measuring precision be reduced be case of its unintentional dropping during the operation or its wear. It is, therefore, advisable to check the dial gauge in the following manner:
- Place the fixed contact elements at the extremities of the dial gauge on a smooth-surfaced plate of high plane level and put the test piece corresponding to a 700mm diameter under them. If there exist any error serious enough to be amended in the indicated values, then loosen the locking nut which holds the contact elements by using a rod of 2mm in diameter so as the indicating value comes to coincident with the graduation. As it is a fine regulation in which 1mm division corresponds to a displacement of the spindle about 0.03mm, extreme care should be paid.
- In the calibration by a test piece, if any error in the indicated value exceeding $\pm 3\text{mm}$ before regulation is found, then there is doubt that the distance between two fixed contact elements ($300 \pm \text{less than } 0.1\text{mm}$) has been altered by shock, etc. In this case, please get in contact with us for its amendment.

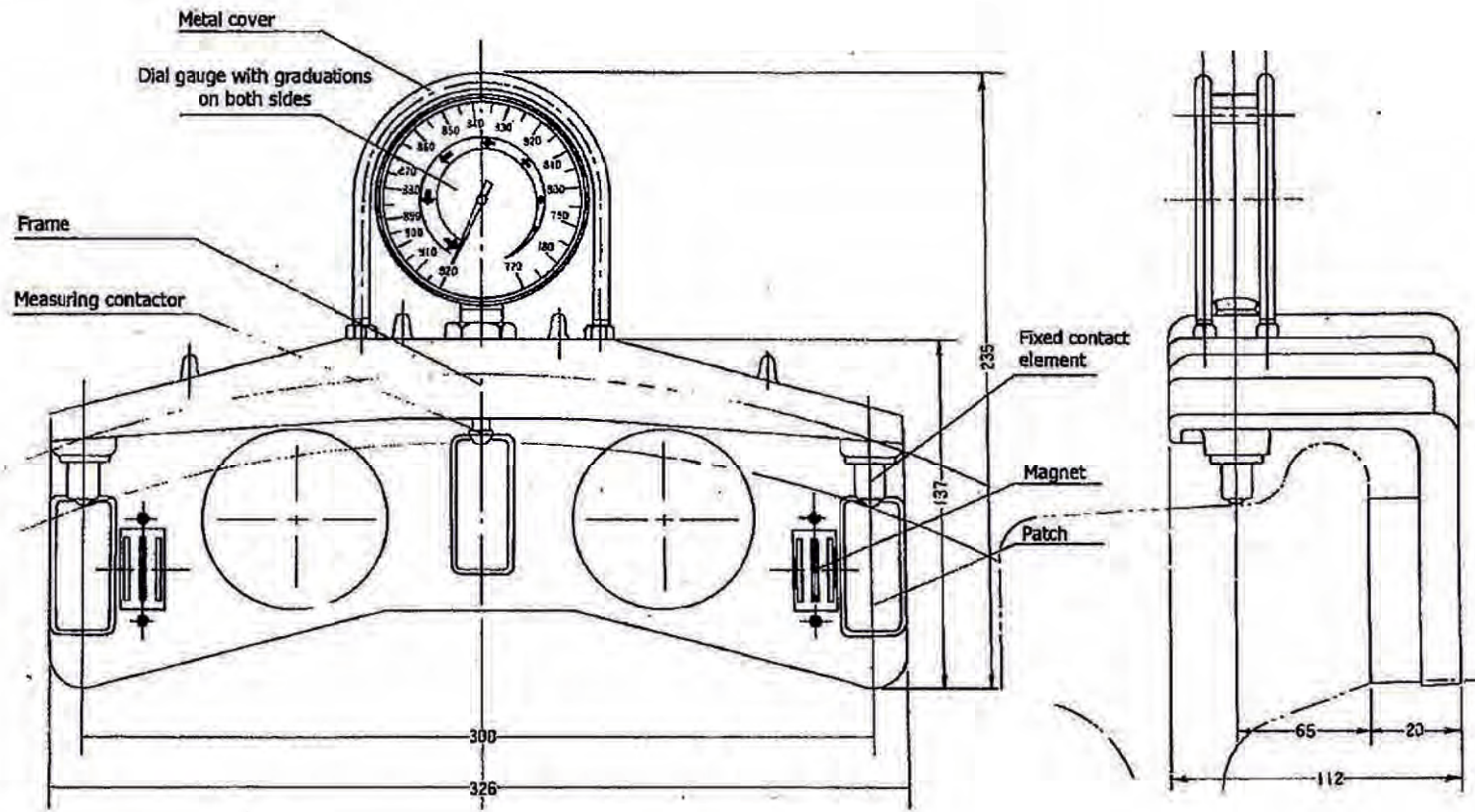

Instruction Manual

for Tread-Wear Measuring Device TS-3D

SHINYEI TECHNOLOGY CO., LTD. Engineering Department
(Brand name: **YOSHIDA SEIKI**)

Shiba 2 Chome Bldg. 11F, 2-28-8, Shiba, Minato-ku, Tokyo 105-0014 Japan

TEL: +81-3-5443-1562 FAX: +81-3-5443-1566

URL : <http://www.shinyei.co.jp/stc/> (SHINYEI TECHNOLOGY)

<http://www.yoshida-seiki.co.jp/> (YOSHIDA SEIKI)

YOSHIDA SEIKI

Introduction

This instruction manual describes the information on the TS-3D and its operation methods.

You are, therefore, requested to read this manual to fully understand the performance and functions before using the instrument.

Store this manual within your reach in the course of using the instrument.

Contents of the text

- The text of this manual is described based on the standard specifications.

Brands

- The product names and other proper nouns being described in this manual are the registered brands or brands of individual companies.

General cautions

- No part of the contents of this manual can be reproduced in any form without permission.
- For the contents of this manual, alteration is reserved without notice.
- This manual has been prepared by making assurance doubly sure. We are not responsible for any damage that might have happened in regard to the contents. If you should have found an obscure point, an error, a description skip, or the like, please contact our company.

User support

Periodical calibration

You are recommended to calibrate the instrument for confirming the performance once every year. Please contact us.

Reference

SHINYEI TECHNOLOGY CO., LTD. Engineering Department
(Brand name: **YOSHIDA SEIKI**)

Shiba 2 Chome Bldg. 11F, 2-28-8, Shiba, Minato-ku, Tokyo 105-0014 Japan

TEL: +81-3-5443-1562 FAX: +81-3-5443-1566

E-mail: sales@stc.shinyei.co.jp

For inquiries through a telephone

Monday ~ Friday (excluding festivals)

09:00 hours ~ 17:30 hours

Home pages

The guides and the latest information about the products now being manufactured and sold by our company as well as this product are described in our home pages.

URL : <http://www.shinyei.co.jp/stc/> (Shinyei Technology)

<http://www.yoshida-seiki.co.jp/> (YOSHIDA SEIKI)

Others

If you have any question about the operation method and other measuring instruments, please contact us readily.

Contents

§1 SUMMARY	1
§2 TECHNICAL DETAILS	2
§3 OPERATION METHOD.....	3
3-1 FITTING TO THE WHEEL	3
3-2 MEASUREMENT	5
§4 STRUCTURE	9

§1 Summary

The tread of a wheel, when it is worn, may sometimes lead to a catastrophic accident like derailment of a train.

Its profile needs measurement and inspection all the time.

The tread-wear measuring device can simply and fully measure and record the vehicle and brought to the plant but also as fitted to the vehicle on the track.

- 1-1 It can be easily and accurately fitted to the wheel to be measured.
- 1-2 With the measuring needle and the recording pen directly linked together, it produces no difference between the original profile and the profile recorded.
- 1-3 Being fitted at right angles to the wheel, it causes no error in the profile of tread after measurement.
- 1-4 Replacement of the recording pen is easy, because a commercial ball-point pen is employed.

§2 Technical details

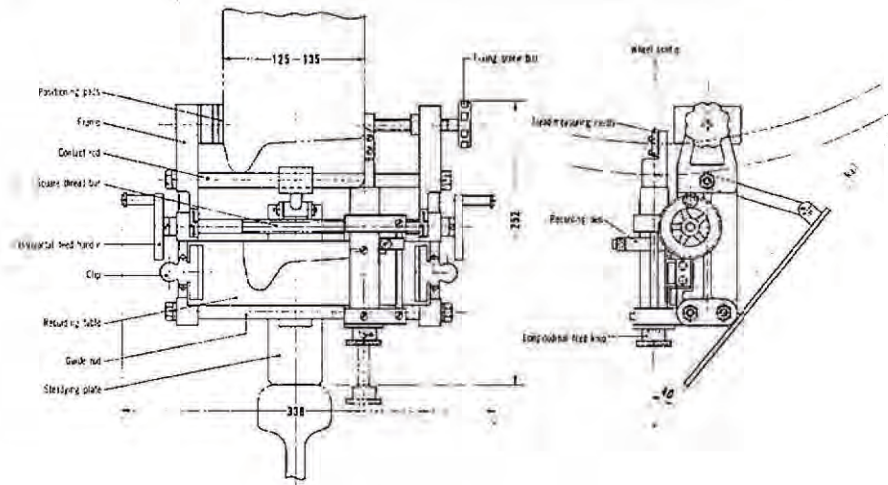

Wheel diameter	800~950mm
Wheel width	125~135mm
Volume	338x252x200mm
Weight	4.0kg

§3 Operation Method

The following steps should be taken in fitting it to the wheel and measuring the tread profile.

3-1 Fitting to the wheel

- The device is put in the state ready for fitting to the wheel, with the tread profile measuring needle set at down position and the recording pen lifted a bit above the table by turning the knob counterclockwise three to four times.
- The steadying plate of it is placed on the rail and it is drawn so close to the wheel that the contact rod touches the top of wheel flange.
- The recording paper is laid out on the recording table.

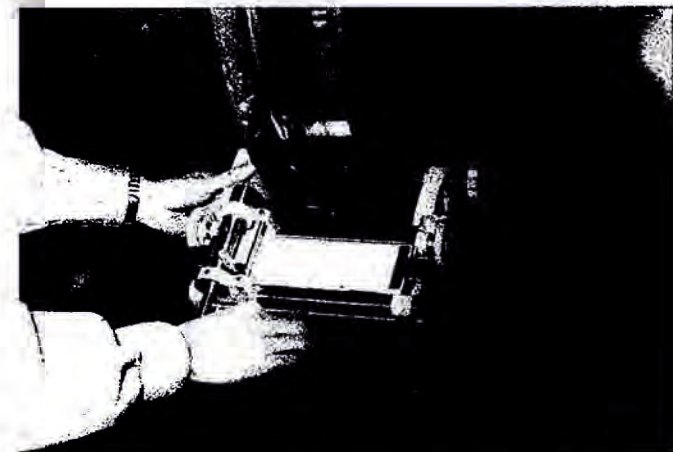

Drawn so close to the wheel that the contact rod touches the flange top.

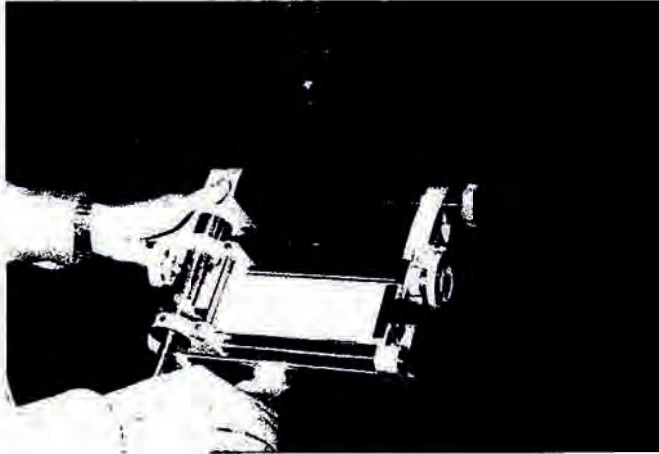

Set on the rail top



Clamped to the wheel

3-2 Measurement

- First turn the horizontal feed handle until the center of the measuring needle touches the flange top. Thereupon turn the longitudinal feed knob to set the measuring needle in forward position.
- Turn the recording pen knob clockwise to make the pen nib touch the recording paper.
- Recording is done from the opposite side to the tread (it may be started from any side). The relation between the direction of the needle and its horizontal shift in the recording operation is illustrated in Fig. 1.
- Next, the recording pen is lifted a bit above the paper; the needle is lowered by the longitudinal feed knob, turned 90° , horizontally shifted to the flange top position and again it is caused to touch the flange top.
- When the pen nib comes to touch the paper, the horizontal feed handle is gently turned to trace and record the tread profile. The relation between the direction of the needle and its horizontal shift in this operation is illustrated in Fig. 2.
- With this the operation for recording the wheel tread profile is finished. Thereupon the recording paper is taken off the table, with the necessary entries made; and then the whole device is unfitted from the wheel.

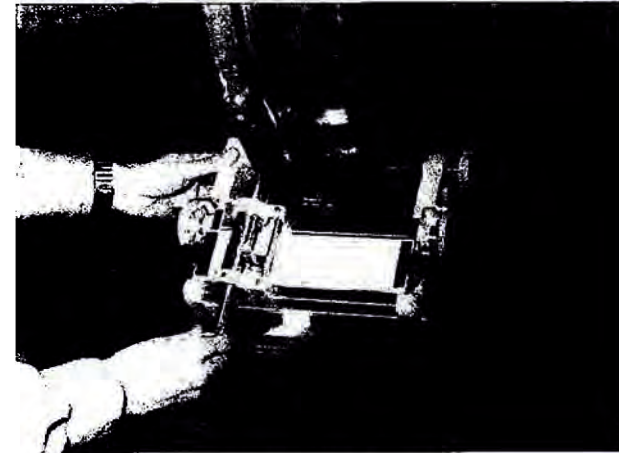
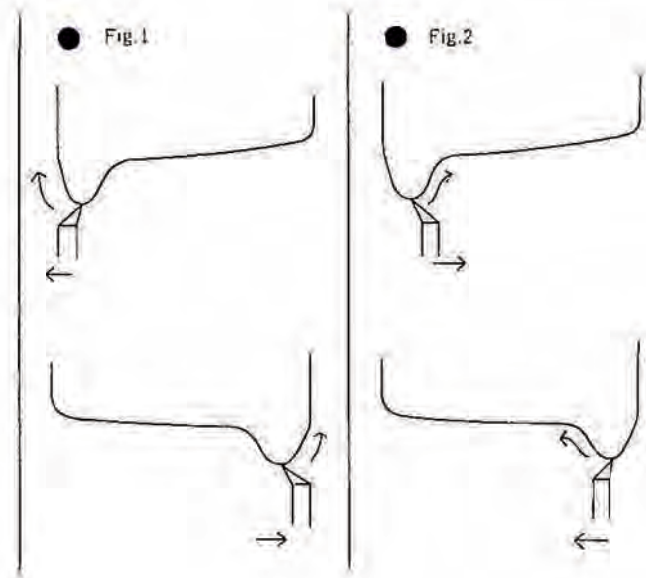

Needle set against the flange top

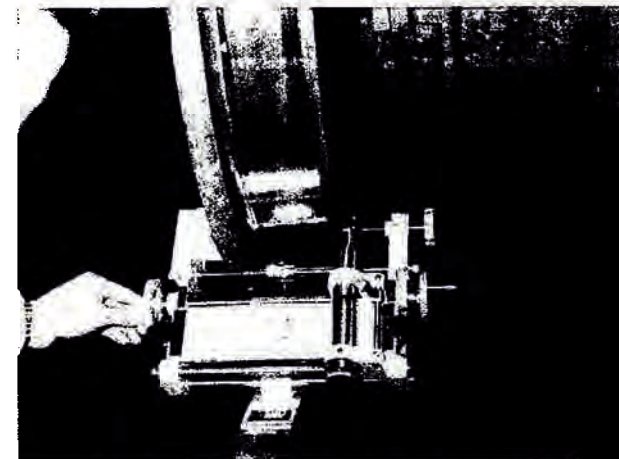

Inside surface of flange traced for recording

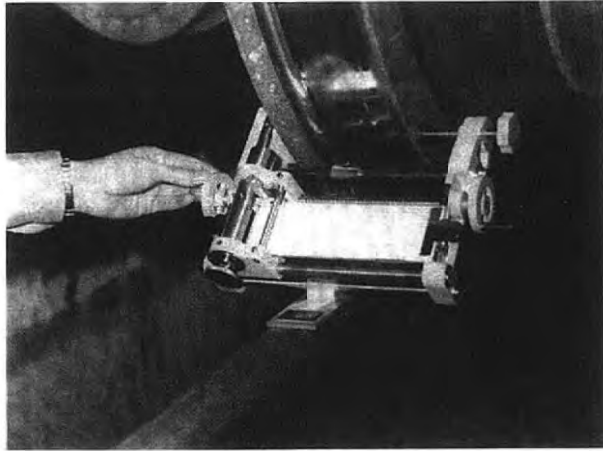

Next, tread surface traced for recording

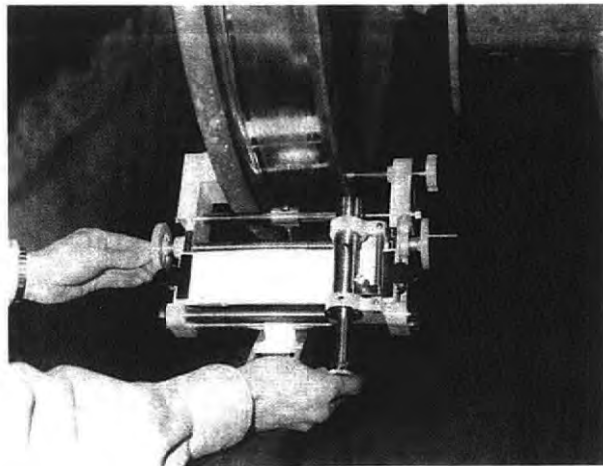

The recording pen lifted above the paper, turned 90° and clamped

§4 Structure

The device is rigidly framed on both sides. The frames are linked together by means of three fixing bars.

These frames on both sides are equipped with a screw bar for fixing to the wheel and positioning pads with wide area.

On the top side come the table on which to lay out the recording paper and clips and on the underside is fitted the steadying plate for stabilizing the wheel fitting angle.

The tread profile recording unit is guided by one of the fixing bars and horizontally moved along the tread surface by another of them which is a square thread bar.

Moreover, one rod slides toward the wheel center at right angles to the horizontal shift.

Since the profile recording needle and the recording pen are fixed to this rod, the movement of the needle is faithfully duplicated by the recording pen.

Thus direct recording of tread profile is accomplished.

This sliding rod is all the time pressed by the force of a spring toward the wheel center, and the measuring needle can rotate 360° around the rod to trace the tread surface.

When the needle is lowered at 90° position, the needle and the paper are properly set.

Accessories:

(1) Spare recording pen	1
(2) Recording paper	100 sheets (one package)
(3) Holding case	1

Instruction Manual

for Digital Tire Measuring Instrument Type TOD-400Ⅲ

SHINYEI TECHNOLOGY CO., LTD. Engineering Department
(Brand name: **YOSHIDA SEIKI**)

Shiba 2 Chome Bldg. 11F, 2-28-8, Shiba, Minato-ku, Tokyo 105-0014 Japan

TEL: +81-3-5443-1562 FAX: +81-3-5443-1566

URL : <http://www.shinyei.co.jp/stc/> (SHINYEI TECHNOLOGY)

<http://www.yoshida-seiki.co.jp/> (YOSHIDA SEIKI)

YOSHIDA SEIKI

Introduction

This instruction manual describes the information on the TOD-400 III type and its operation methods.

You are, therefore, requested to read this manual to fully understand the performance and functions before using the instrument.

Store this manual within your reach in the course of using the instrument.

Contents of the text

- The text of this manual is described based on the standard specifications.
- The instrument may be different from the description contents, depending upon the measurement reference point and measuring positions.

Brands

- The product names and other proper nouns being described in this manual are the registered brands or brands of individual companies.

General cautions

- No part of the contents of this manual can be reproduced in any form without permission.
- For the contents of this manual, alteration is reserved without notice.
- This manual has been prepared by making assurance doubly sure. We are not responsible for any damage that might have happened in regard to the contents. If you should have found an obscure point, an error, a description skip, or the like, please contact our company.

User support

Periodical calibration

You are recommended to calibrate the instrument for confirming the performance once every year. Please contact us.

Reference

SHINYEI TECHNOLOGY CO., LTD. Engineering Department
(Brand name: **YOSHIDA SEIKI**)

Shiba 2 Chome Bldg. 11F, 2-28-8, Shiba, Minato-ku, Tokyo 105-0014 Japan

TEL: +81-3-5443-1562 FAX: +81-3-5443-1566

E-mail: sales@stc.shinyei.co.jp

For inquiries through a telephone

Monday ~ Friday (excluding festivals)

09:00 hours ~ 17:30 hours

Home pages

The guides and the latest information about the products now being manufactured and sold by our company as well as this product are described in our home pages.

URL : <http://www.shinyei.co.jp/stc/> (Shinyei Technology)

<http://www.yoshida-seiki.co.jp/> (YOSHIDA SEIKI)

Others

If you have any question about the operation method and other measuring instruments, please contact us readily.

Contents

§1 SUMMARY	1
§2 NAMES AND FUNCTIONS OF COMPONENT PARTS	3
2-1 [POWER/MEASURING] SWITCH	3
2-2 [CAR No.] SWITCH.....	3
2-3 [WHEEL No.] SWITCH.....	3
2-4 [TRANSFER] SWITCH	3
2-5 [CLEAR] SWITCH	4
2-6 LED DISPLAY.....	4
2-7 [USB] CONNECTOR	5
2-8 [CHARGING] CONNECTOR.....	6
§3 OPERATION METHOD.....	7
3-1 MEASUREMENT (DIRECT READING AND STORAGE INTO MEMORY OF MEASURED VALUES).....	7
3-2 MEASUREMENT (DIRECT READING OF A MEASURED VALUE ONLY).....	10
3-3 STORED DATA READING	12
§4 SPECIFICATIONS	13

§1 Summary

In the course of striving for securing a safe run of various railway vehicles day and night, the necessity of high-precision measuring instruments more and more increases together with the improvement of study and training technologies TOD-400 measuring instrument indicates measured values, saves them into memory, and transfers stored data through a USB cable.

1-1 Red 7-segments LED indicator

A red 7-segments LED indicator is used for indicating measured values and also indicating and setting the measured wheels, so that it can read measured values even at a dark place.

The [Car No.] switch is used for setting vehicle numbers, and its display is switched to 01-02-03 ...16 sequentially, each time this switch is pressed once. The [Wheel No.] switch is used for setting the wheel number and the display is switched to 1-2-3...8 sequentially, each time this switch is pressed once.

1-2 Measured value lock function and memory function are provided

The move quantity of the measuring stylus is detected by a no-contact type linear encoder, the output pulses are counted by introducing them into the CPU, and then, the measured value is automatically saved every wheel of each vehicle together with its display.

Measured values can be stored up to max. 128 data (16 vehicles x 8 wheels), and they remain stored into memory until the clear switch is pressed. Accordingly, measured values can be read at any time and at any place.

- 1-3 A USB communication unit is mounted
Storage data consisting of car No., wheel No., and measured values can be transferred through an AB type USB cable simply by pressing the transfer switch.
By using the option communication software (Excel macro), data can be transferred to the PC and tabulated.
- 1-4 A 30-second auto OFF timer is mounted
An auto OFF timer is mounted to prevent the power switch from being turned on continuously by mistake. Thirty seconds after turning on the power supply, the display disappears, and the power supply is turned off automatically.
- 1-5 A battery alarm is provided
The battery voltage is monitored, and when its voltage becomes lower than an appropriate battery power voltage (approx. 4.8V), the dot (decimal point) of a measured value flickers to call operator's attention.
- 1-6 A chargeable batteries are mounted as a built-in power supply.
An exclusive power supply pack containing 4 nickel hydrogen chargeable batteries, size AA is mounted as a built in power supply. After charging them for about 4 hours by the exclusive charger BQ-908, measurement can be done for longer than 6 hours continuously.

§2 Names and Functions of Component Parts

- 2-1 [Power/measuring] switch
- 1) By pressing this switch, power is fed to the CPU and sensor, and car No, wheel No., flange thickness, and flange height are displayed as stored data.
 - 2) By pressing this switch again, the measured values being indicated by the display are stored into memory as the measured wheel data.
 - 3) The power supply is turned off by the auto OFF timer after 30 seconds. By pressing either [Car No.] switch or [Wheel No.] switch within 30 seconds, the auto OFF timer is started again.
- 2-2 [Car No.] switch
Car number increases by +1 and returns to "01" when it reaches maximum value 16. This display is switched sequentially as 01-02-03 ... 16, each time this switch is pressed once.
- 2-3 [Wheel No.] switch
Wheel number increases by +1 and returns to "1" when it reaches maximum value 8. This display is switched sequentially as 1-2-3 ... 8, each time this switch is pressed once.
- 2-4 [Transfer] switch
By pressing this switch long for 2 seconds, stored data into memory are output by USB.

2-5 [Clear] switch

By pressing this switch long for 2 seconds, stored data are erased.

The memory address returns to "01" in case of car No. or "1" in case of wheel No.

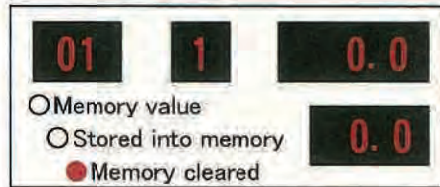

2-6 LED display

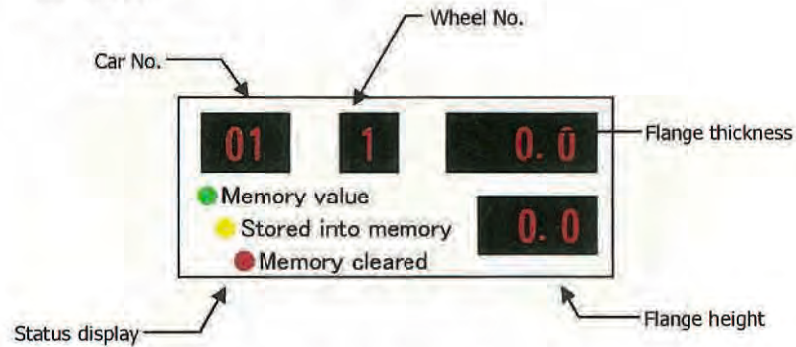

- 1) By pressing [Power/measuring] switch, the "data in memory" LED lights green. For the [Flange thickness] and [Flange height], "0.0" or data in memory is displayed.
- 2) By pressing [Power/measuring] switch again, the "stored into memory" LED lights yellow. For the [Flange thickness] and [Flange height], their measured values are displayed.

- 3) [Car No.] and [Wheel No.] display are switched by +1, each time their switches are pressed once.
- 4) By pressing [Clear] switch, the "Memory cleared" LED lights red. All memory values are reset to "0.0".
- 5) The [Flange thickness] indicating LED displays "- - - -" during the data transfer.
- 6) When the battery voltage becomes lower than approx. 4.8V, the dot (decimal point) of its measured value flickers.

2-7 [USB] connector

Connect the AB type USB cable when transferring stored data into the PC,

- 1) By pressing [Transfer] switch long for 2 seconds, stored data into memory are output by USB. During the transfer, the [Flange thickness] LED displays "...".
- 2) Communication specifications
 - ① Baud rate : 9600bps
 - ② Parity : None
 - ③ Stop bit : 1
 - ④ Data length : 8 bits
- 3) Communication format

Car No. - Wheel No., Flange thickness, Flange height (line feed code)

01 - 1 , 31.0 , 27.0

2-8 [Charging] connector

Charging is started by inserting the plug of the exclusive charger BQ-908 into the charging connector.

This charger is exclusively used for the built-in charging pack.

Charging can be done in about 4 hours, and the charging condition is informed by LED. This LED lights orange during the charging, and it lights green and an alarm sounds when charging ends.

During charging, no power is fed to the circuits to cause the measurement to be impossible.

§3 Operation Method

3-1 Measurement (Direct reading and storage into memory of measured values)

Car No. and wheel No. must be set every measurement.

Measured values are stored to the preset wheel No.

Stored data are displayed first, and then, measured values are displayed after moving the measuring stylus.

1) Press [Power/measuring] switch

① Stored data are displayed. If stored data have already been cleared, "0.0" is displayed.

If not yet, the last measured values are displayed.

② After 30 seconds, the power supply is turned off automatically by the auto OFF timer.

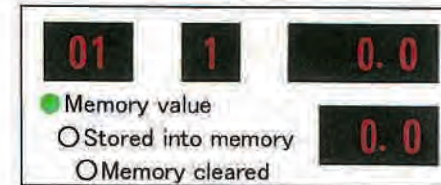

2) Set the measuring wheel No.

① Press [Car No.] and [Wheel No.] switches. Display is switched by +1, each time these switches are pressed once.

② When these switches are pressed, the auto OFF timer is started again.

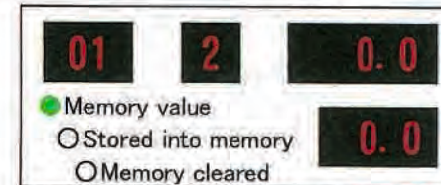

3) Set the measuring instrument to the wheel.

- ① Fix the fixed contact to the tread by closely fitting the scale ruler part for measuring the tire thickness to the internal face of the wheel tire, while facing the scale ruler part toward the wheel center.
- ② Since the [Flange height] measuring stylus is pushed out at all times, it is drawn simultaneously when setting the measuring instrument to the wheel, and the indicator is switched by the above move to display the measuring value.
- ③ [Flange height] indicates a measured value, while [Flange thickness] indicates an initial value

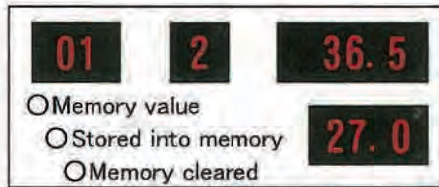

4) Push the [Flange thickness] measuring stylus against the wheel.

- ① Apply the measuring stylus to the internal face of the flange by pressing the measurement knob.
- ② [Flange thickness] indicates its measured value.

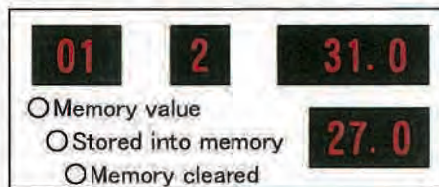

5) Press [Power/measuring] switch to save the measured value into memory.

- ① Check if the measured value is correct before pressing the switch.
The "Stored into memory" LED lights and the measured value is stored into memory.
- ② This display continues holding for 30 seconds by the auto OFF timer.

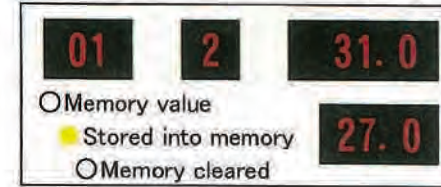

6) Measurement transfers to the next wheel to be measured, and the measured value is stored into memory.

- ① After setting the measuring instrument to the wheel, repeat saving its measured value to the set wheel by [Power/measuring] switch.
- ② By pressing [Car No.] switch or [Wheel No.] switch before the power supply has been turned off by the auto OFF timer, measurement can be done earlier. When the power supply has been turned off, start the operation with [Power/measuring] switch.

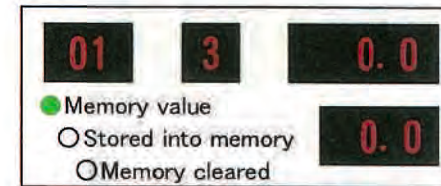

3-2 Measurement (Direct reading of a measured value only)

Fix the setting of car No. and wheel No. Since a measured value is always over-written, it must be noted down each time. Stored data are displayed first, and then, a measured value is displayed after the measuring stylus has moved.

1) Press [Power/measuring] switch.

- ① Stored data are displayed. If stored data have already been cleared, "0.0" is displayed. If not yet, the last measured value is displayed.
- ② After 30 seconds, the power supply is turned off automatically by the auto OFF timer.

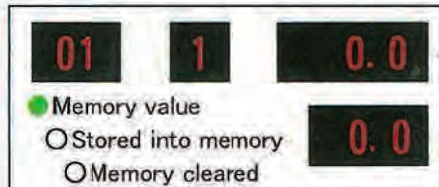

2) Set the measuring instrument to the wheel.

- ① Fix the fixed contact to the tread by closely fitting the scale ruler part for measuring the tire thickness to the internal face of the wheel tire, while facing the scale ruler part toward the wheel center.
- ② Since the [Flange height] measuring stylus is pushed out at all times, it is drawn simultaneously when setting the measuring instrument to the wheel, and the indicator is switched by the above move to display the measuring value.
- ③ [Flange height] indicates a measured value, while [Flange thickness] indicates an initial value.

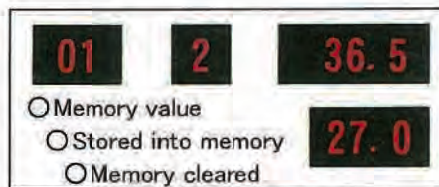

3) Push the [Flange thickness] measuring stylus against the wheel.

- ① Apply the measuring stylus to the internal face of the flange by pressing the measurement knob.
- ② [Flange thickness] indicates its measured value.

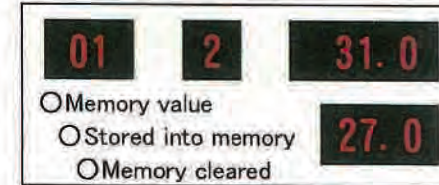

4) Press [Power/measuring] switch to hold the measured value

- ① Check if the measured value is correct before pressing the switch.
- ② This display continues holding for 30 seconds by the auto OFF timer. Note the measured value.

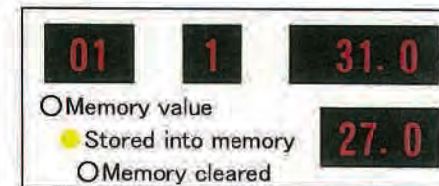

5) Transfers to the next wheel to be measured, and press [Power/measuring] switch.

- ① The last measured value is displayed. This measured value is over-written in the next measurement.
- ② After setting the measuring instrument to the wheel, hold its measured value by pressing [Power/measuring] switch. Repeat this operation.

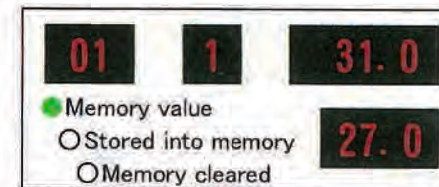

3-3 Stored data reading

Stored data into memory are displayed every measured wheel.

1) Press [Power/measuring] switch.

- ① Stored data are displayed.
- ② By the auto OFF timer, the power supply is turned off automatically after passing 30 seconds.



2) Press [Car No.] or [Wheel No.] switch.

- ① The display is selected by +1, each time the switch is pressed one, and these stored data are displayed.
- ② Each time this switch is pressed once, the auto OFF timer is started again.

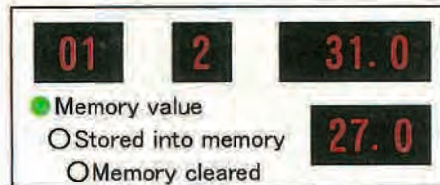

54 Specifications

4-1	Maximum measuring distance	15mm
4-2	Measuring range	15mm
	Flange height	25 ~ 40mm
	Flange thickness	[type III] 21 ~ 36mm
4-3	Tire thickness	25~125mm
		Scale direct reading system
4-4	Reference point	65mm
		from the internal face of the wheel tire
4-5	Measuring position	10mm
		from the tread at the reference point
4-6	Measuring sensor	Optical linear encoder
4-7	Measuring resolution	0.1mm
4-8	Display	Red 7-segments LED display
4-9	Display	Car No. 01 ~ 16
	Wheel No.	1 ~ 8
	Flange thickness	4 digits (Minimum unit 0.1mm)
	Flange height	3 digits (Minimum unit 0.1mm)
4-10	Storage data	16 vehicles x 6 wheels = 128 data

4-11	LSB output	Car No, Wheel No., Flange thickness, Flange height
4-12	Continuous working time	6 hours minimum
4-13	Power supply	A. Built-in power pack B. Nickel-hydrogen charging battery, size AA, 4 pieces
4-14	Dimensions	235mm long x 145mm wide x 45mm high
4-15	Weight	Approx. 950g
4-16	Options	Charger BQ-908 (Power pack exclusive charger) Communication software Excel Macro, USB cable (AB type) Master gauge TOD-300M

4-17 Dimensions drawing

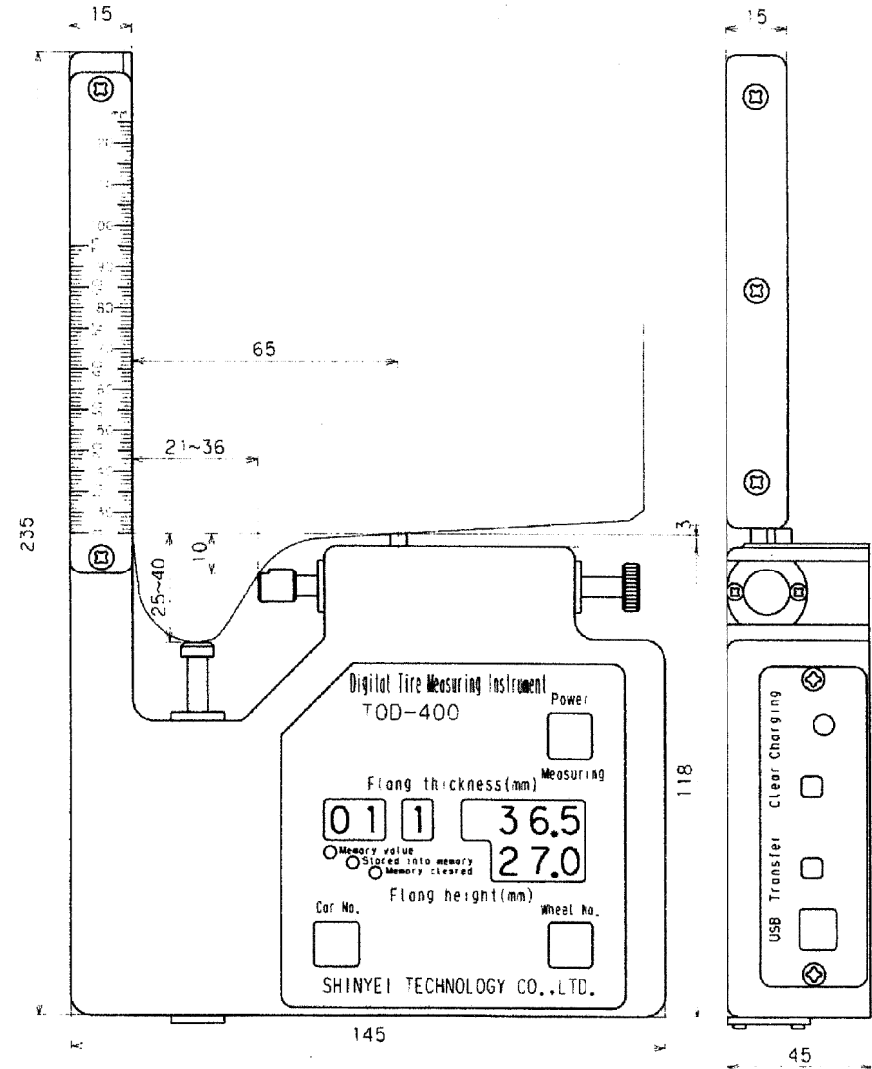

APPENDIX 7

Wrap up Meeting Material



Wrap-up Meeting

Study for Safety Operation and Management of Railway in the Republic of Ghana

18 March 2014

JICA Study Team

0

Study for Safety Operation and Management of Railway in the Republic of Ghana 2012 to 2013

Outline of our study

1

Study for Safety Operation and Management of Railway in the Republic of Ghana 2012 to 2013



1. Objective and Activities of the study



Objective of the Study

- Create **appropriate maintenance** for railway system
- Reduce of accidents, **delay** and **suspension** of train operation

Activities

- To grasp and analyze the present situation of the railway in Ghana
- To set up **the improvement goals** for maintenance of track and rolling stock
- To **update the O&M plan**
- To support **the implementation of O&M plan**

2

Study for Safety Operation and Management of Railway in the Republic of Ghana 2012 to 2013



2. Project Area



3

Study for Safety Operation and Management of Railway in the Republic of Ghana 2012 to 2013

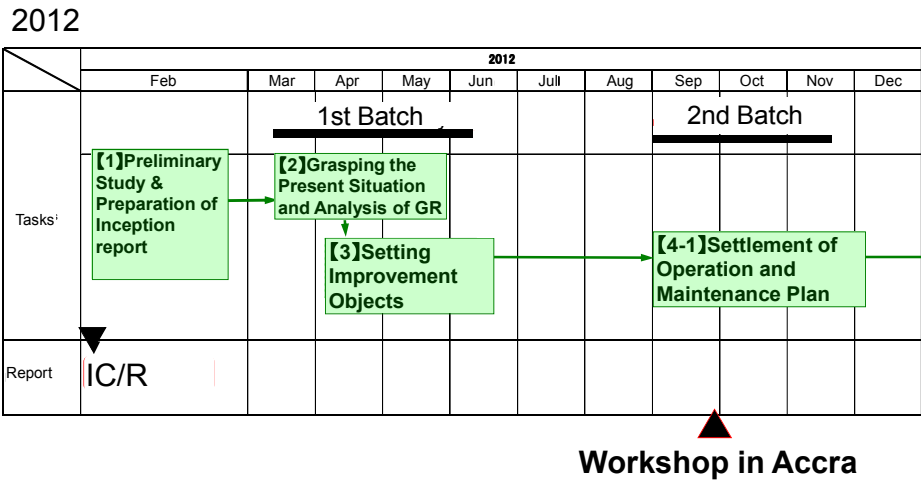

[2] To Grasp and Analyze the present situation of the railway in Ghana

- **Signaling and communications** : Through the exchange of votes between the train driver and the stationmaster and using a mobile phone for communication.
Due to cable signal theft and lack of spare parts, signaling systems are disabled, therefore mobile phones are use at stations for communication.
- **Rail crossing** : Train guard is blocked road traffic (only the main road)

[2] To Grasp and Analyze the present situation of the railway in Ghana

- **Operation** : 24 May 2011 Suspension of Operations
- **Track** : The rail is going to lose its functions, as almost all sleepers have corroded and there is a lack of fastening devices.
- **Track Bed** : The top of the embankment is experiencing subsidence. Unevenness of ballasts are causing many puddles at level crossings.
- Transportation of bauxite from Awaso is carried transported by truck only, in which the conditions of the roads are bad.
- **Considerable expenses and time are required for the resumption of operations.**



4. 1st Batch -1 (4)



Special train for field survey



Interior of train



Signaling Office



Railroad switch level

8

4. 1st Batch -1 (6)



Corroded sleepers



Dirt and garbage in the crossing ditch



Track transfer the mineral resources



Puddle caused by subsidence

10

4. 1st Batch -1 (5)



Decrepit bridge



Trail of the flange run on the rail

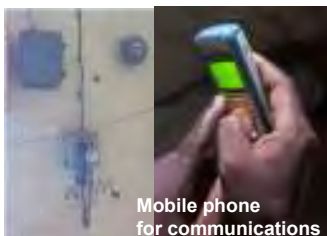

Mobile phone for communications



Railroad crossing system (Not used at present)



Signaling System (Not used at present)

9

4. 1st Batch -1 (7)



Entrance at Tarkwa Station



Marshaling yard



Crane (railroad)



Lifting jack and crane

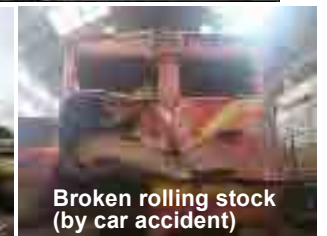

Broken rolling stock (by car accident)

11

4. 1st Batch -1 (8)



Maintenance manuals



Output meter

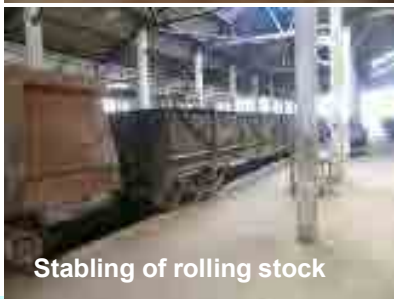

Stabling of rolling stock



Spare parts for locomotives

12

4. 1st Batch -1 (10)



Car wheel lathe



Attaching of tire



Attaching of axle-box



Boring lathes for wheel

14

4. 1st Batch -1 (9)



Automatic rotary washing equipment (Not used at present)



Insulation of in pregnant equipment for motor (Not used at present)



Welder



Cutting machine (by Japanese Aid)

13

4. 1st Batch -1 (11)

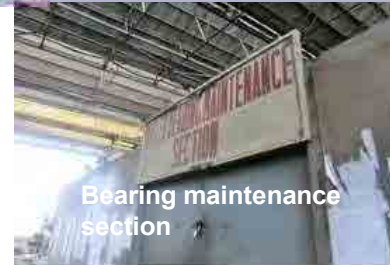

Bearing maintenance section



Inside of bearing maintenance section



Vacuum brake booster cylinder



Cast iron boiler for brake shoe

15

4. 1st Batch -1 (12)



Wood working shop



Sleepers

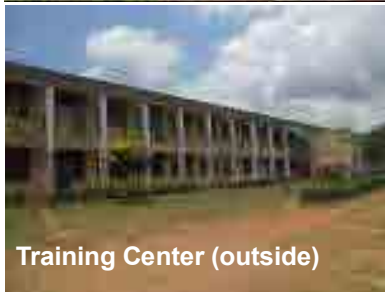

Training Center (outside)



Training Center (inside)

16

Study for Safety Operation and Management of Railway in the Republic of Ghana 2012 to 2013

5. 1st Batch-2

(3) To set up the improvement goals for maintenance of track and rolling stock

Setting improvement goals

- No accidents due to causes that are the responsibility of the railway
- Reduction of transport disorder (suspension, delay etc)
- Improvement of safety consciousness

Holding Workshop

- Sharing the recognition of the present situation and challenges with GRDA/GRCL
- Setting goals for safety improvement and an enforcement system
- Introduction of railway operation in Japan and India

17

Study for Safety Operation and Management of Railway in the Republic of Ghana 2012 to 2013

6. 2nd Batch - Workshop Agenda

【Work Shop / 27th September 2012】

◆Agenda:

- About Workshop
- Outline of the JICA study

Session 1: Organization and Management

Session 2: Train operation

Session 3: Track

Session 4: Civil structures/Bridges

Session 5: Rolling Stock

- Introduction of Indian railway system on safety operation



18

Study for Safety Operation and Management of Railway in the Republic of Ghana 2012 to 2013

6. 2nd Batch – Workshop / Summary

【4-1】Settlement of Operation and Maintenance Plan

Present situation and challenges

- Because maintenance is not fully carried out, obsolescence of railway assets and the rolling stock is progressing.
- Maintenance expenses are not fully secured, but the inspection system of railway assets is also inadequate. As the result, derailments occur frequently.
- Although the rehabilitation project of the Western Line will start in the end of 2012, possibility to become impossible to maintain safety train operation is high, not to be able to maintain before completing the project.
- The rehabilitation of rolling stock, especially locomotive, is required because the existing rolling stocks will be used for the moment after the rehabilitation project.

19

Study for Safety Operation and Management of Railway in the Republic of Ghana 2012 to 2013

[4-1] Settlement of Operation and Maintenance Plan

Points as required for maintenance of sustainable operation

- Importance to **secure maintenance budget**
- **Measures required** securing train operation, especially manganese train operation from Nsuta to Takoradi, for the moment.
- Recommendation of the **maintenance management** which can be applied after the completion of the rehabilitation project.



20

[4-2] Review of Action Plan / 30th January 2013

- **General**
 - The **roles and responsibilities** of each stakeholder will become clear to advance the implementation of the Action Plan.
 - Confirmation will be required in terms of **the method for securing the budget** for the implementation of the Action Plan.
- **Rolling Stock**
 - Listed parts mainly consist of **consumable items** which need continuous replacement.
 - The **requirement is reasonable** because the average maintenance cost per one rolling stock as same as Japan.

22

2013 to 2014

	2013					2014					
	Jan	Feb	Mar	to	Dec	Jan	Feb	Mar	Apr	May	Jun
	3rd Batch					4th Batch		5th Batch		6th Batch	
Tasks	[4-2] Review of the Action Plan		Waiting for approval of the Action Plan budget			[4-3] Preperation of training		[5] Implementation of Operation and Maintenance Training		[6] Preparation of Final Report	
Report						IT/R				DF/R	F/R

Stakeholder Meeting in Accra

21

[4-2] Review of Action Plan / 30th January 2013

- **Track bed and Bridges**
 - The report shows the **minimum items** for maintenance required urgently.
- **Track**
 - Although the **locations** for track improvement are not identified, the locations where realignment is necessary shall be also listed. → Done by GRCL
 - Action Plan's item shall be sorted out **between budget-required item and no budget-required item** → Done by GRCL
 - The requirement seems reasonable for maintenance required urgently.

23



9. 4th Batch(1)



[4-3] Preparation of training

Purpose and Expected Outcome of Training:

- This training program aims at **improving technical skills of the maintenance**. It will lead carrying out the maintenance of minimum required facilities for safety operation from Takoradi to Nusta, **being away from severe accidents**, such as derailment.

24

Study for Safety Operation and Management of Railway in the Republic of Ghana 2012 to 2013



9. 4th Batch(2)



[4-3] Preparation of training

■ Training Program Contents

1. Lecture for "Organization and Operation"
2. Lecture for "Safety Operation"
3. Rolling Stock Maintenance Activities
4. Track Maintenance Activities
5. Bridge and Road Bed Maintenance Activities

25

Study for Safety Operation and Management of Railway in the Republic of Ghana 2012 to 2013

5th Batch

Training Program for GRDA and GRCL

March 2014

26

Study for Safety Operation and Management of Railway in the Republic of Ghana 2012 to 2013



10. 5th Batch - Maintenance Training (1)



[5] Implementation of Operation and Maintenance Training



Lecture Program for Railway Organization and Operation



- **Date**: 14th in Takoradi, 19th and 20th March, 2014 in Accra
- **Staff**: GRDA, Chief Managers of GRCL and all staff concerned operation works between Takoradi and Nusta.
- **Contents**: Introduce the **privatization procedure and Non-railway business** of Japan Railway Company. Discuss the possibility of Non-Railway Business of Ghana railway.

27

Study for Safety Operation and Management of Railway in the Republic of Ghana 2012 to 2013



10. 5th Batch - Maintenance Training (2)



[5] Implementation of Operation and Maintenance Training



Lecture Program for Safety Operation



- **Date:** 18th to 21st in Accra, 25th and 27th March, 2014 in Takoradi
- **Staff:** GRDA, Chief Managers and all staff concerned train operation and safety operation as well as the handling accidents.
- **Contents:** Introduce for the **safety operation system** and the approaches to reduce number of train accidents in Japan Railway Company. Lecture on “Kaizen” method for **managing the train accident report** and its simplified database

28

Study for Safety Operation and Management of Railway in the Republic of Ghana 2012 to 2013



10. 5th Batch - Maintenance Training (3)



[5] Implementation of Operation and Maintenance Training



Track Maintenance Training Program

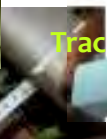

- **Date:** 14th and 27th March, 2014 in Takoradi
- **Staff:** About 20 people from Superintendent of Track Department or Inspect of Works Department.
- **Contents:** Implement the **inspection of track conditions** and the **measurement of the track irregularities**. Set out the **Work Plan** by analyzing the track conditions. Implement the **replacements** of defective sleepers and materials as well as the **investigation of gauge irregularities** in accordance with the Work Plan

29

Study for Safety Operation and Management of Railway in the Republic of Ghana 2012 to 2013



10. 5th Batch - Maintenance Training (4)



[5] Implementation of Operation and Maintenance Training



Civil Structure Maintenance Training Program



- **Date:** 14th and 27th March, 2014 in Takoradi
- **Staff:** About 20 people from Superintendent of Track Department or Inspect of Works Department.
- **Contents:** Lecture on the **civil structure maintenance method** and the **management of civil structure inspection result** as well as the bridge maintenance system using **bridge ledger**. Implement the **inspection** of civil structure conditions and the **measurement** of the concrete crack and make an inspection reports.

30

Study for Safety Operation and Management of Railway in the Republic of Ghana 2012 to 2013



10. 5th Batch - Maintenance Training (5)



[5] Implementation of Operation and Maintenance Training



Rolling Stock Maintenance Training Program



- **Date:** 24th and 27th March, 2014 in Takoradi
- **Staff:** Electrical and Mechanical Engineer from Electrical and Mechanical Engineering Division. (Including the staff of Running Shed and Work shop.)
- **Contents:** Lecture on the operation of **basic measuring instruments**. Implementation of hands- on training of **axel, wheels and brake system maintenance**.

31

Study for Safety Operation and Management of Railway in the Republic of Ghana 2012 to 2013



11. Output of the study



Draft Final Report

- **Result** of the training maintenance activities
- **Operation and Maintenance Manuals**
- **Issue and suggestion** for safety operation

Submit to GRDA at Middle of May, 2014

Comment from GRDA within 1 month

Final Report

Submit to JICA and GRDA at Middle of June, 2014

32

Study for Safety Operation and Management of Railway
in the Republic of Ghana 2012 to 2013



12. Positive Development of Ghana Railway (2012~)



■ New Line, Rehabilitation:

- Expansion of Tema Line (Tema – Tema Community 1)
- Rehabilitation of the Western Line (Takoradi - Secondi)
(Ghana Fund)

■ Procurement of Wagons, Track Materials:

- 70 Wagons including spare parts, track materials etc
(Indian Loan)

■ Traffic Volume:

- Incensement of traffic volume of manganese transportation

33

Study for Safety Operation and Management of Railway
in the Republic of Ghana 2012 to 2013

Introduction of Technical Assistance for Myanmar Railway

34

Study for Safety Operation and Management of Railway
in the Republic of Ghana 2012 to 2013



35

Study for Safety Operation and Management of Railway
in the Republic of Ghana 2012 to 2013



36

Myanma Railway also used to be poor maintenance for railway facilities such as civil structure, track, rolling stocks.



However, the Government of Myanmar decided to put high priority for railway maintenance and allocated budget, human resources.



Such self-effort has attracted foreign cooperation.



Myanma Railway has been improving railway facilities gradually.



Japan International Cooperation Agency

38



37

Training of Track maintenance used by equipments of MR



39

Training of Track maintenance used by equipments of MR



Study for Safety Operation and Management of Railway in the Republic of Ghana 2012 to 2013

40

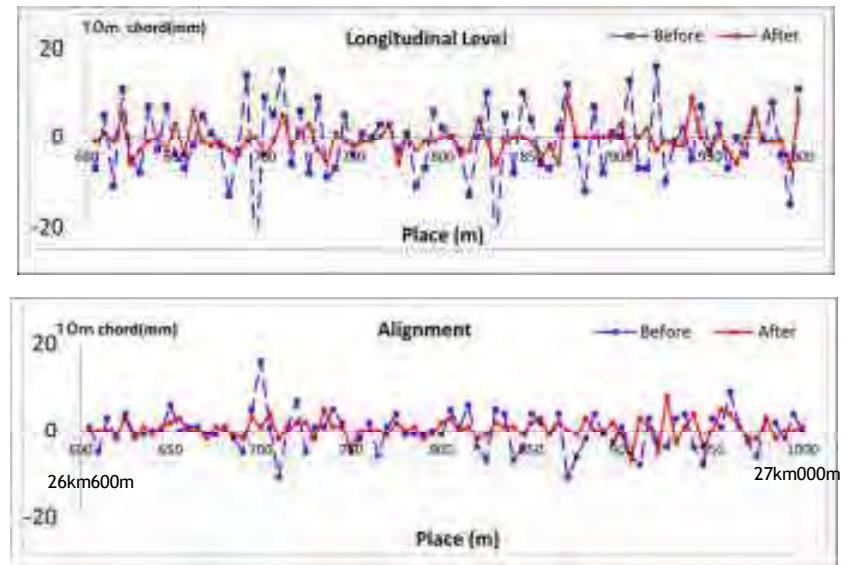

Up Line 26k600m~27k000m,
Comparison of Longitudinal Level and Alignment
Before and After the Maintenance work

Study for Safety Operation and Management of Railway in the Republic of Ghana 2012 to 2013

Training of track maintenance after the arrival of equipments from Japan



Practice on the track in Yangon Sta.



Track maintenance
used by Hand Tie Tamper



Track maintenance
used by jack



Track maintenance
used by standard gauge

Study for Safety Operation and Management of Railway in the Republic of Ghana 2012 to 2013

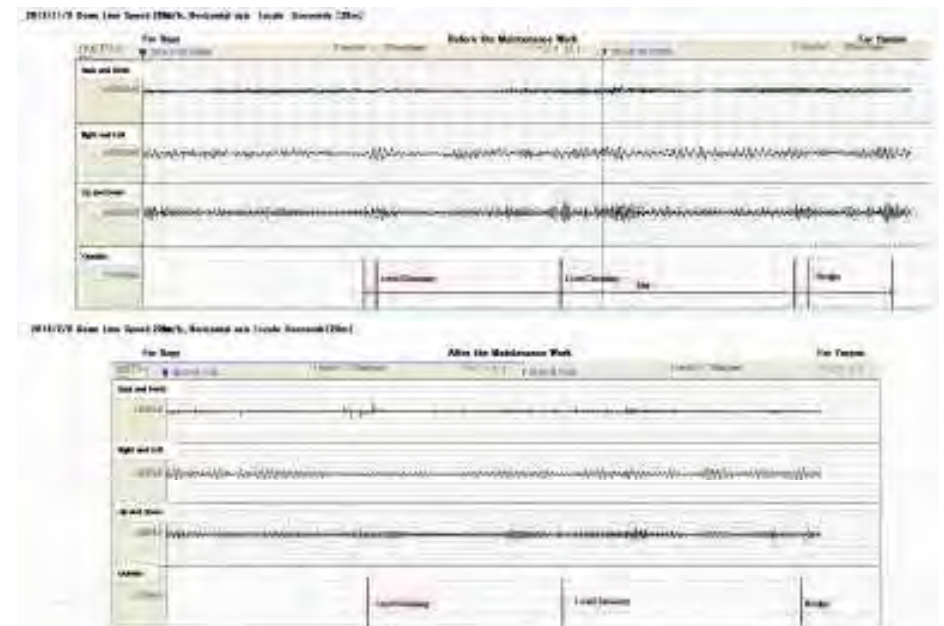

Comparison of Vehicle Vibration Acceleration Before and After the Track Maintenance Work (Down Line 12k200m~13k500m)

Study for Safety Operation and Management of Railway in the Republic of Ghana 2012 to 2013



44

Donation Equipment

45



13. Donation Equipment



Obligation of Recipient

- All equipment are donated from JICA to GRDA after training.
- GRDA is responsible for all donated equipments, but GRCL will use almost equipments.
- GRCL should keep all equipments better condition with suitable maintenance budget.
- GRDA should supervise the status of all donated equipments every year.

46



13. Donation Equipment List (1)



■ Rolling Stock Maintenance :

- Portable type brake tester for single car and Compressor
- Back gauge
- Digital diameter gauge
- Flange gauge
- Tread-Wear measuring device
- Vernier caliper
- Digital multi meter (Tester)
- Insulation Resistance Taster
- Friction sawing machine
- Air pressure gauge
- Inspection Hammer
- Calipers



47



13. Donation Equipment List (2)



■ Safety Operation:

- 3 Desk top computers
- Multiple printer



■ Track and Civil structure Maintenance:

- Fiber-Reinforced Plastic Standard Gage for 1,067mm,
- Measurement for Leveling Defect (Coma),
- Constant Tension Device for Level Measurement (vam tension)
- Auger drill
- 2 Desk top computers.



- **Others** : Hard Hats, Desk top computer, Inkjet printer, Video Camera etc.

48



13. Flow of Donation Equipment

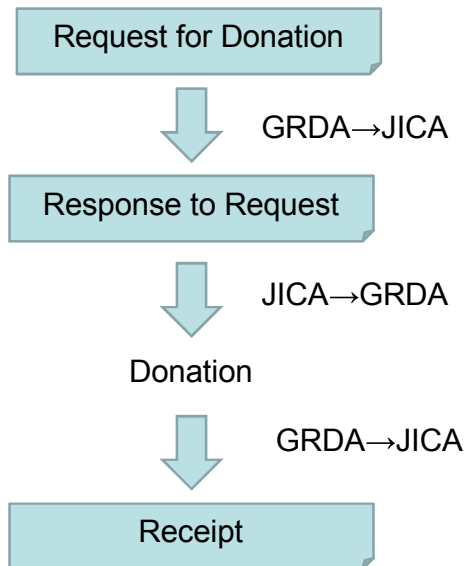

49

Thank you

Japan International Cooperation Agency (JICA)

Oriental Consultants Co., Ltd.

Japan International Consultants for Transportation Co., Ltd.



Oriental Consultants Co., Ltd.



Japan International Consultants for Transportation Co., Ltd.

50