

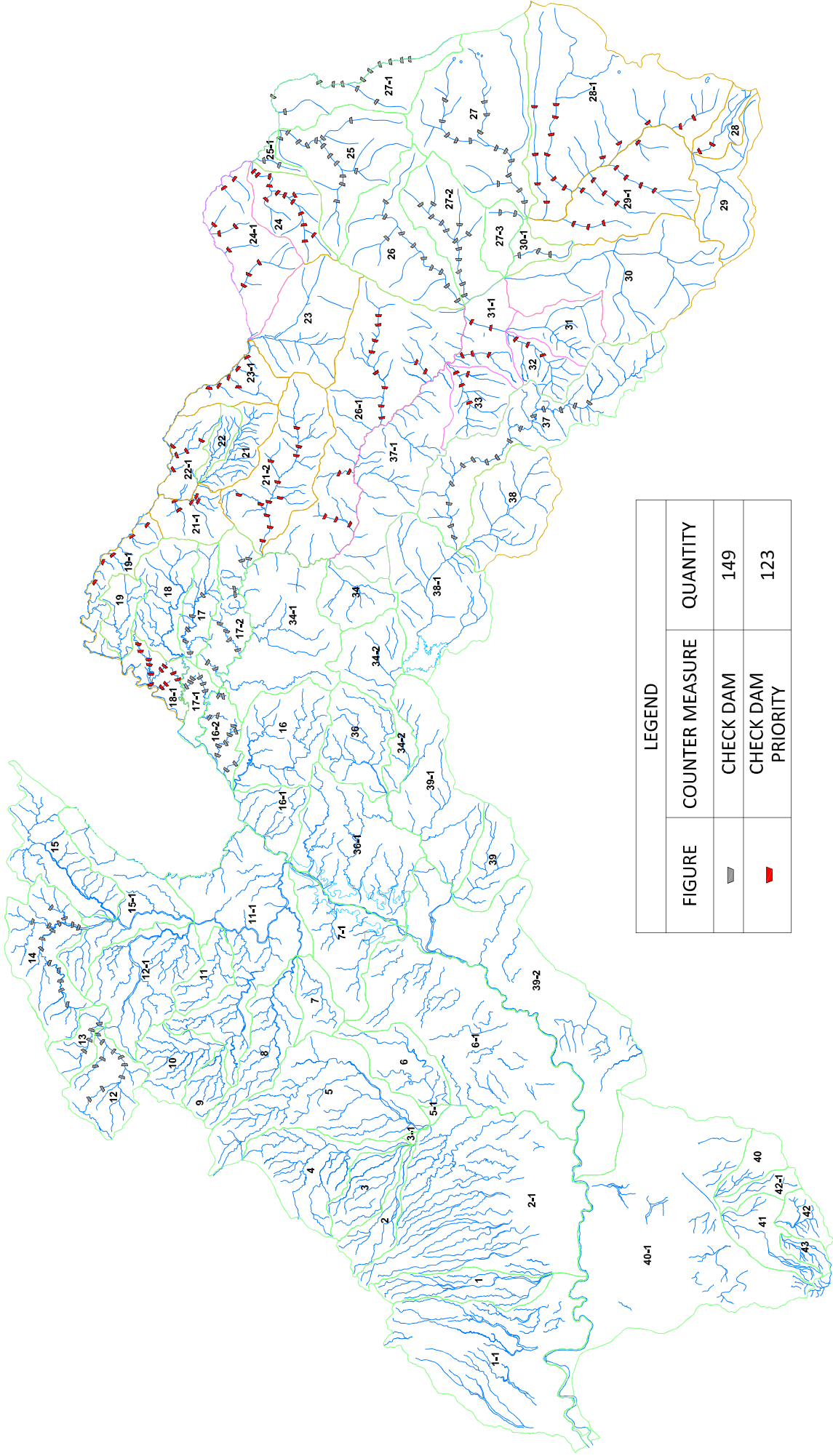

卷末資料  
砂防施設配置計画





LEGEND		
FIGURE	COUNTER MEASURE	QUANTITY
	CHECK DAM	149
	CHECK DAM PRIORITY	123



ARRANGEMENT PLAN OF COUNTERMEASURE

CHIRA BASIN  
SCALE 1:500 000

# CHIRA RIVER

## SUB BASIN 28-1

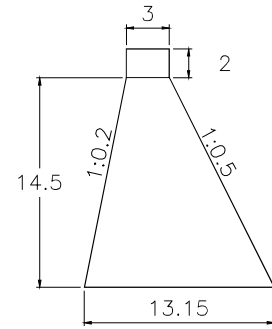
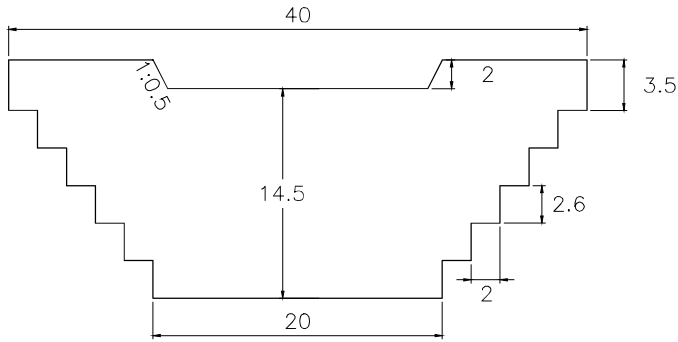

VOLUME: 3,512.70m<sup>3</sup>

QUANTITY: 15

## SUB BASIN 29-1

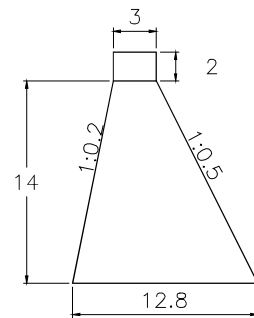
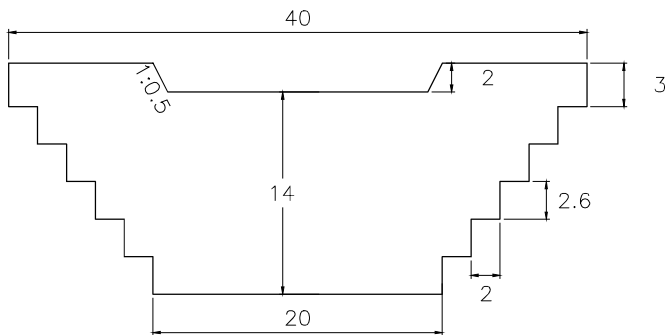

VOLUME: 3,318.00m<sup>3</sup>

QUANTITY: 12

## SUB BASIN 30-1

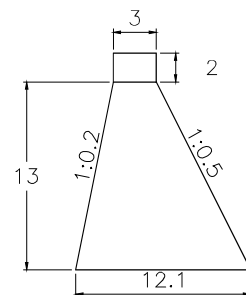
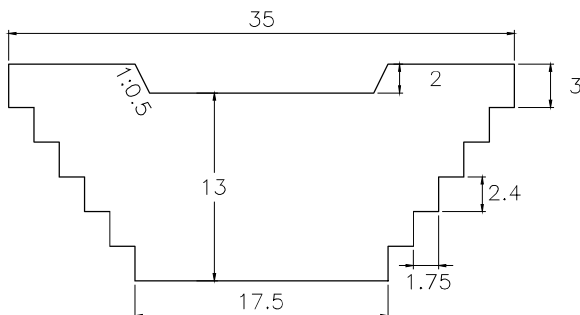

VOLUME: 2,576.44m<sup>3</sup>

QUANTITY: 3

### CHECK DAM

SCALE 1:500

# CHIRA RIVER

## SUB BASIN 31-1

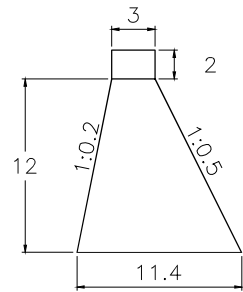
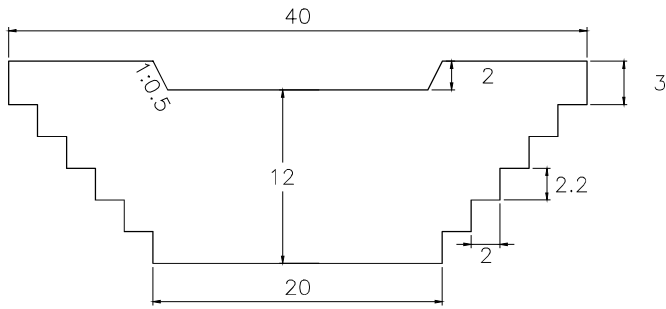

VOLUME: 2,592.00m<sup>3</sup>

QUANTITY: 5

## SUB BASIN 32

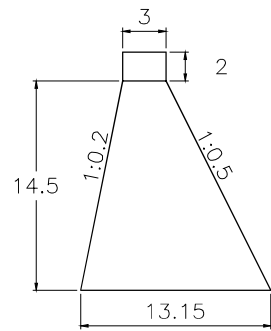
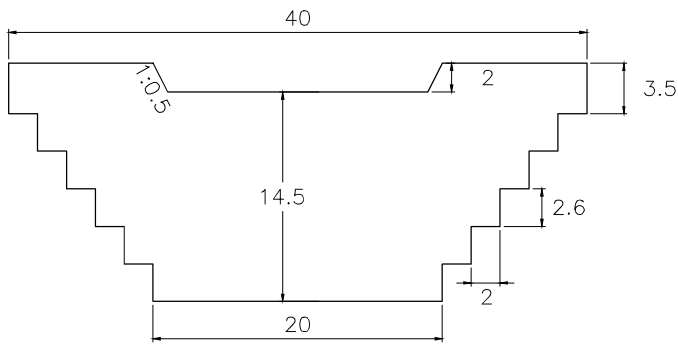

VOLUME: 3,512.70m<sup>3</sup>

QUANTITY: 3

## SUB BASIN 33

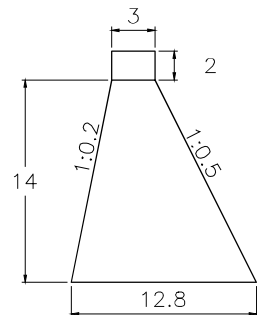
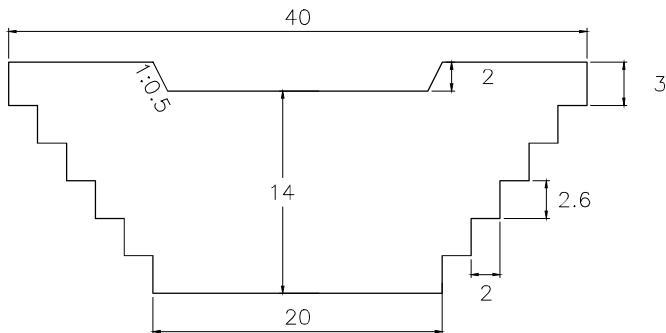

VOLUME: 3,318.00m<sup>3</sup>

QUANTITY: 4

### CHECK DAM

SCALE 1:500

# CHIRA RIVER

## SUB BASIN 37

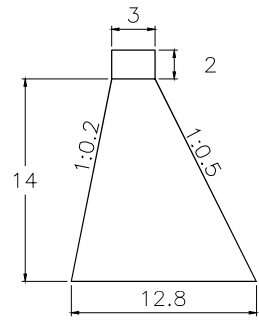
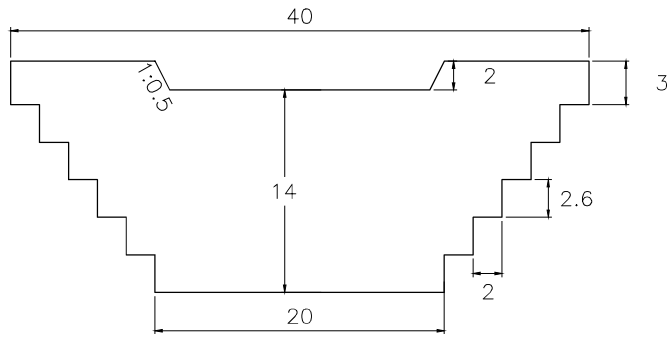

VOLUME: 3,318.00m<sup>3</sup>

QUANTITY: 15

### CHECK DAM

SCALE 1:500

# CHIRA RIVER

## SUB BASIN 12

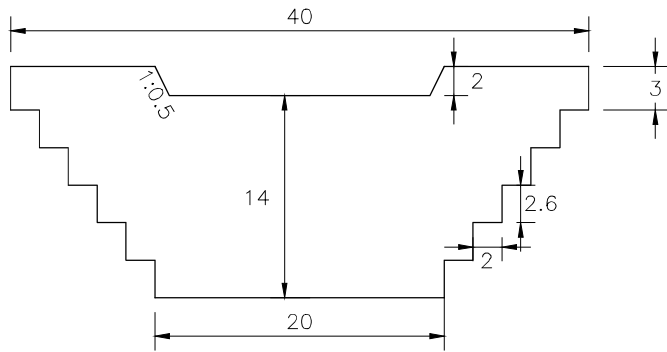

VOLUME: 3,318.00m<sup>3</sup>

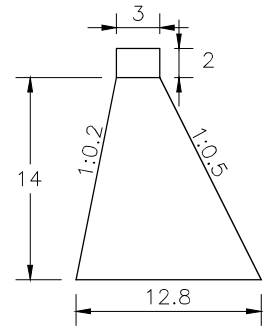

QUANTITY: 10

## SUB BASIN 13

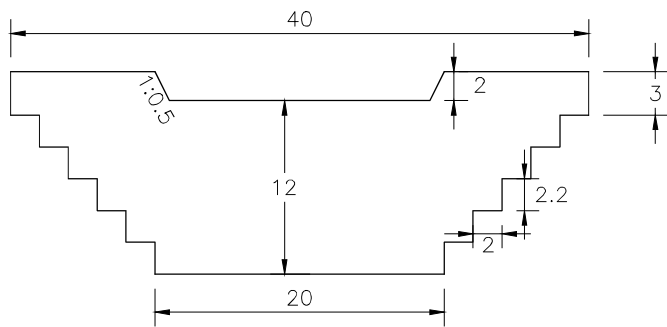

VOLUME: 2,592.00m<sup>3</sup>

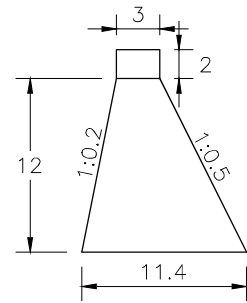

QUANTITY: 4

## SUB BASIN 14

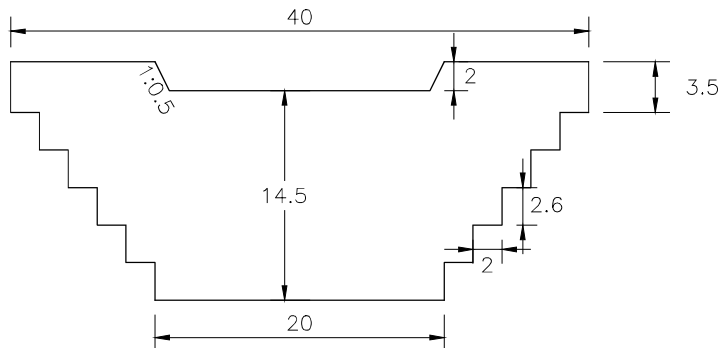

VOLUME: 3,512.70m<sup>3</sup>

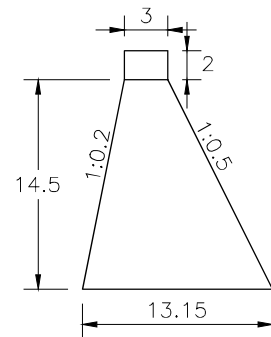

QUANTITY: 15

### CHECK DAM

SCALE 1:500

# CHIRA RIVER

## SUB BASIN 16-2

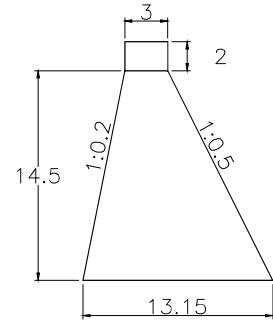
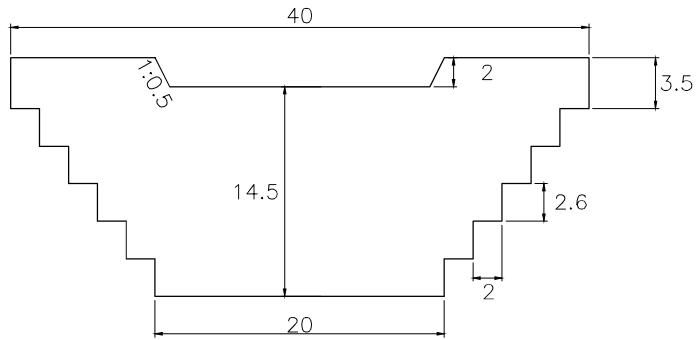

VOLUME: 3,512.70m<sup>3</sup> QUANTITY: 12

## SUB BASIN 17

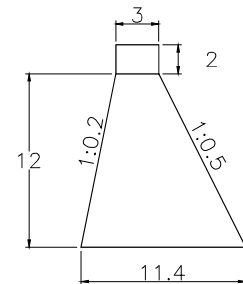
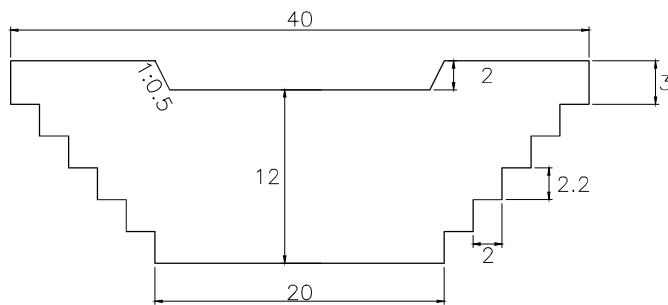

VOLUME: 2,592.00m<sup>3</sup> QUANTITY: 5

## SUB BASIN 17-1

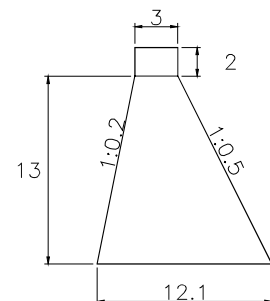
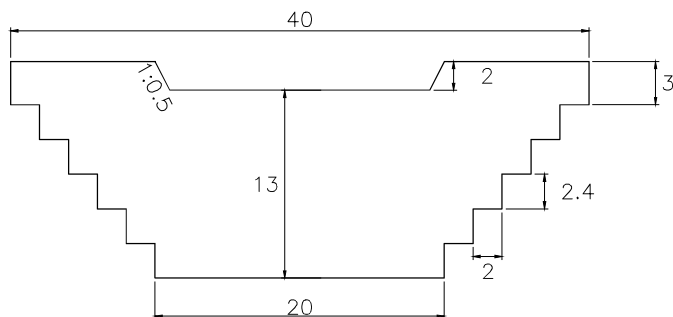

VOLUME: 2,944.50m<sup>3</sup> QUANTITY: 6

### CHECK DAM

SCALE 1:500



# CHIRA RIVER

## SUB BASIN 17-2

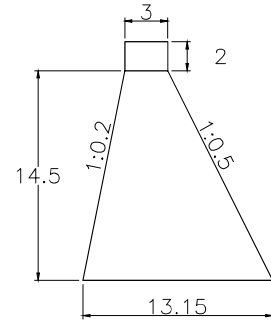
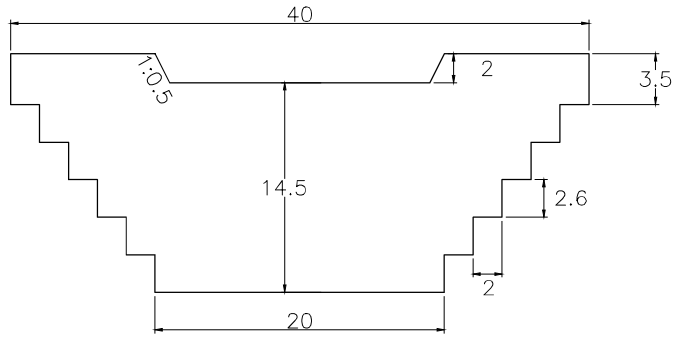

VOLUME: 3,512.70m<sup>3</sup> QUANTITY: 10

## SUB BASIN 18-1

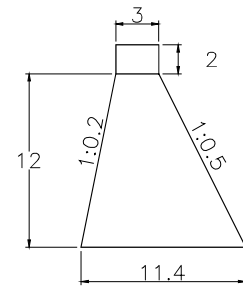
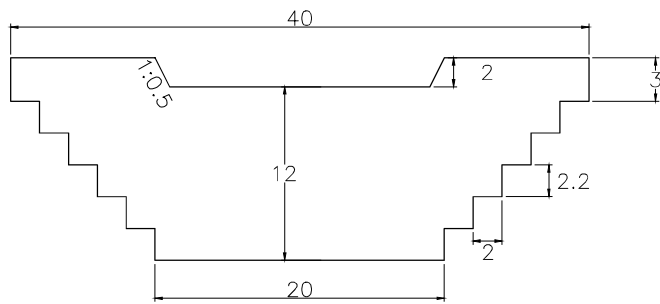

VOLUME: 2,592.00m<sup>3</sup> QUANTITY: 12

## SUB BASIN 19-1

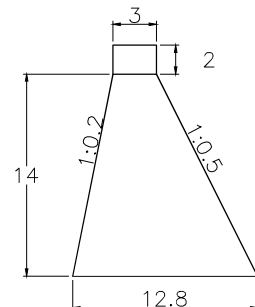
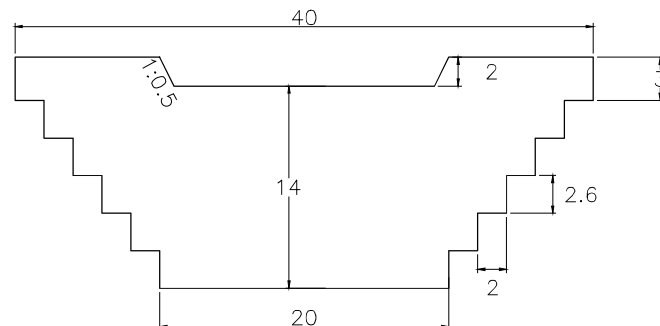

VOLUME: 3,318.0m<sup>3</sup> QUANTITY: 5

### CHECK DAM

SCALE 1:500

# CHIRA RIVER

## SUB BASIN 23-1

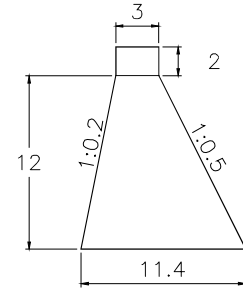
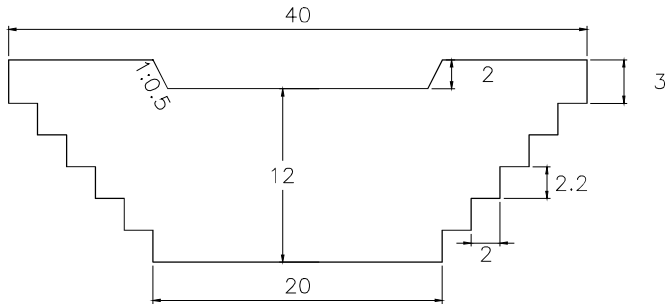

VOLUME: 2,592.00m<sup>3</sup>

QUANTITY: 6

## SUB BASIN 24

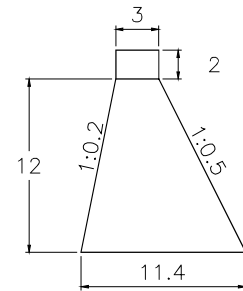
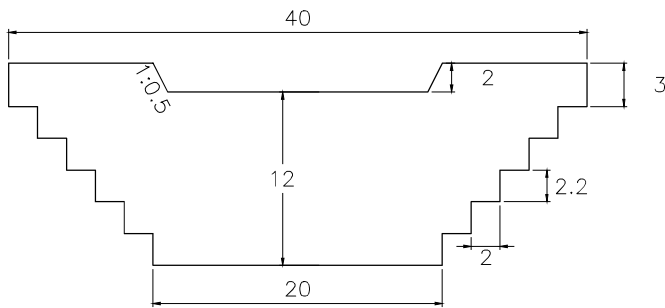

VOLUME: 2,592.00m<sup>3</sup>

QUANTITY: 13

## SUB BASIN 24-1

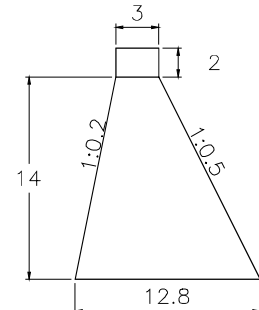
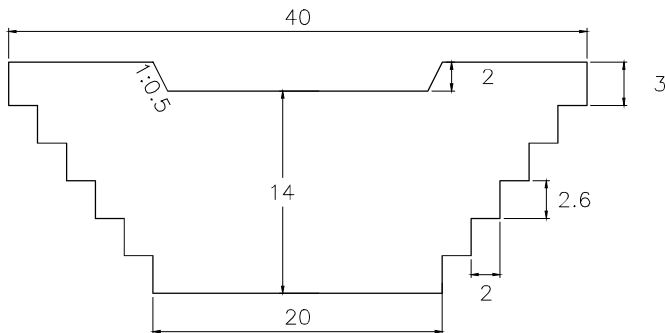

VOLUME: 3,318.00m<sup>3</sup>

QUANTITY: 9

**CHECK DAM**

SCALE 1:500

# CHIRA RIVER

## SUB BASIN 21-1

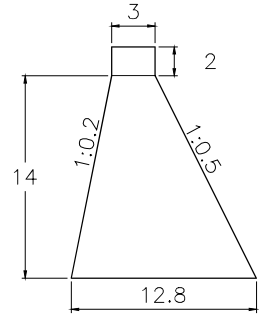
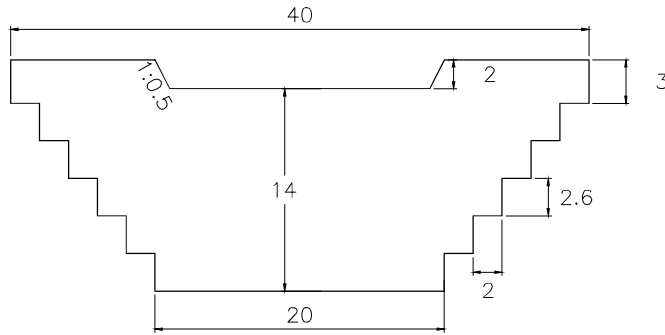

VOLUME: 3,318.00m<sup>3</sup> QUANTITY: 5

## SUB BASIN 21-2

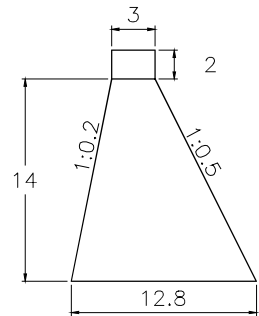
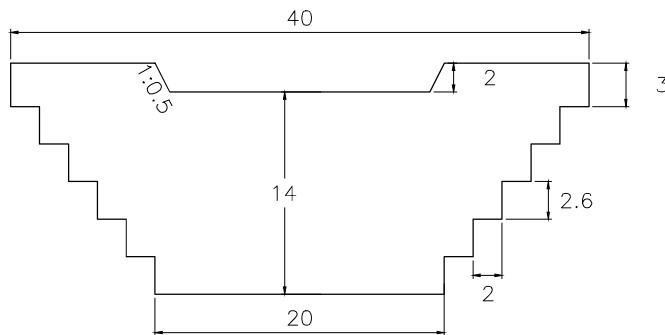

VOLUME: 3,318.00m<sup>3</sup> QUANTITY: 12

## SUB BASIN 22-1

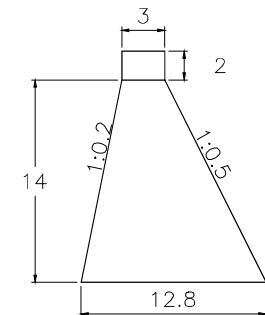
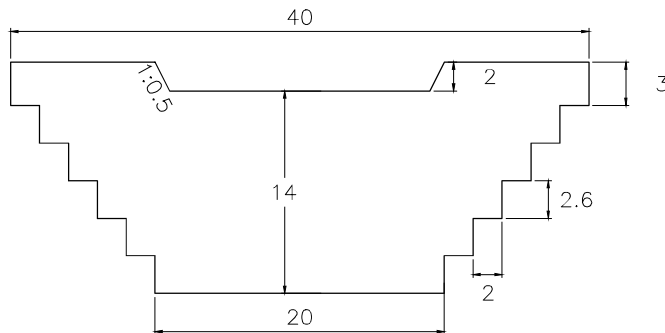

VOLUME: 3,318.00m<sup>3</sup> QUANTITY: 5

## CHECK DAM

SCALE 1:500

# CHIRA RIVER

## SUB BASIN 25

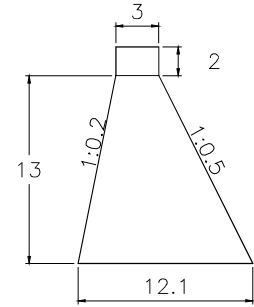
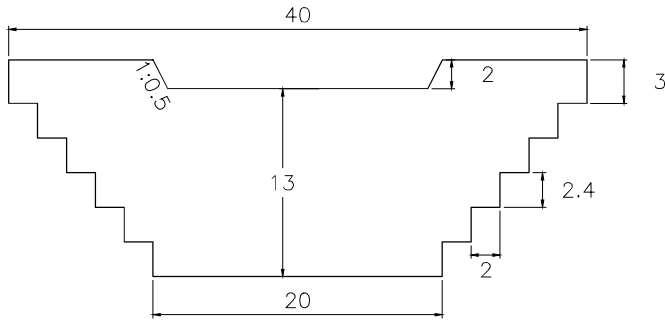

VOLUME: 2,944.50m<sup>3</sup>

QUANTITY: 14

## SUB BASIN 25-1

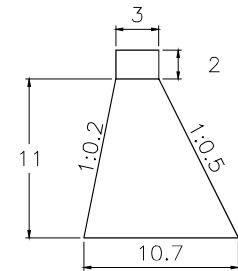
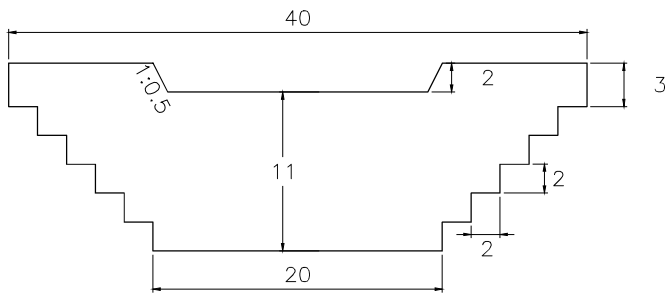

VOLUME: 2,260.50m<sup>3</sup>

QUANTITY: 2

## SUB BASIN 26

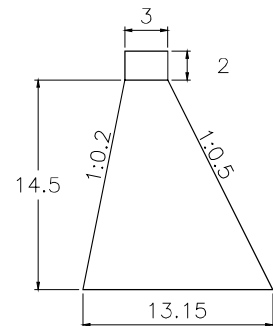
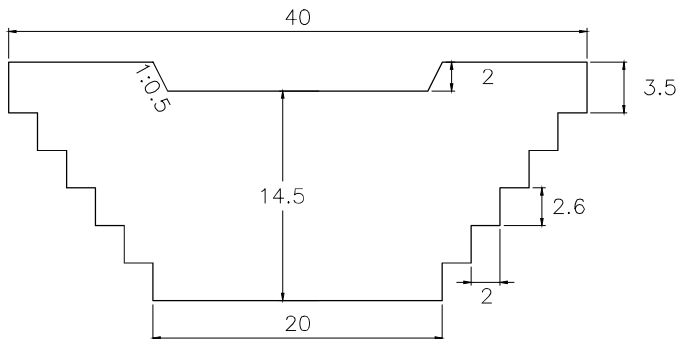

VOLUME: 3,512.70m<sup>3</sup>

QUANTITY: 10

# CHECK DAM

SCALE 1:500

# CHIRA RIVER

## SUB BASIN 26-1

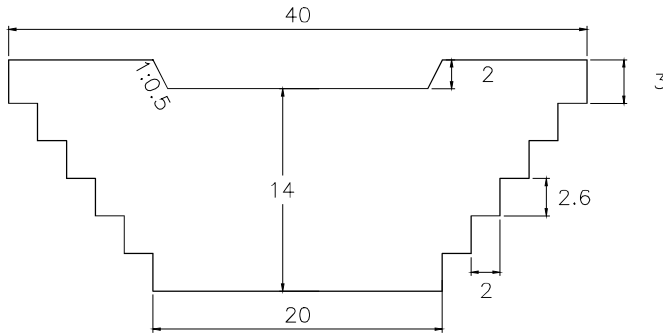

VOLUME: 3,318.00m<sup>3</sup>

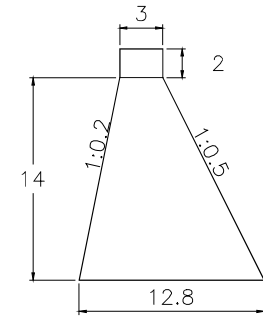

QUANTITY: 15

## SUB BASIN 27

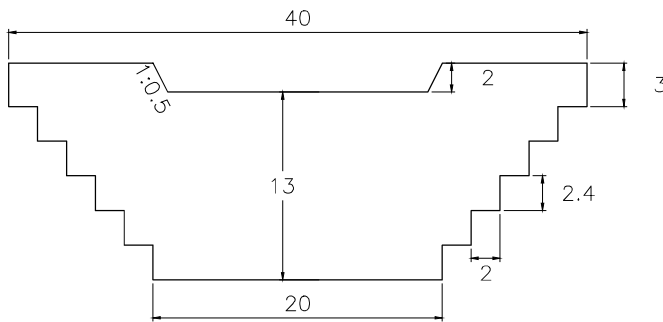

VOLUME: 2,944.50m<sup>3</sup>

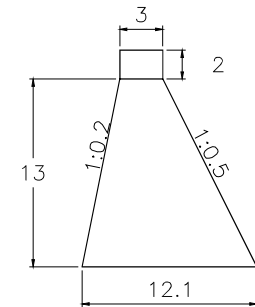

QUANTITY: 15

## SUB BASIN 27-1

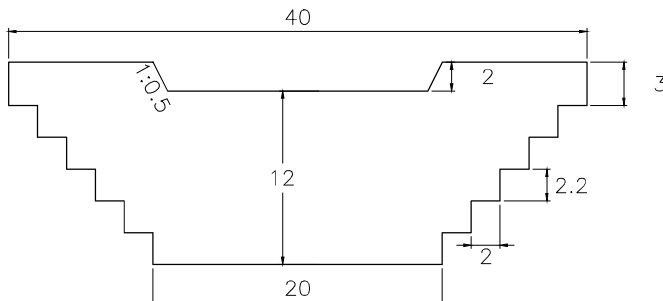

VOLUME: 2,592.00m<sup>3</sup>

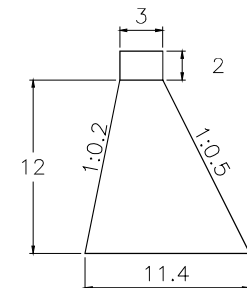

QUANTITY: 13

**CHECK DAM**

SCALE 1:500

# CHIRA RIVER

## SUB BASIN 27-2

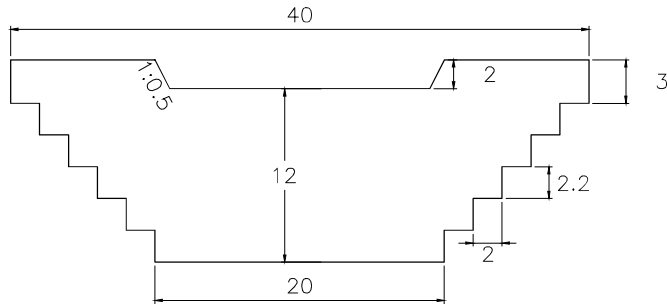

VOLUME: 2,592.00m<sup>3</sup>

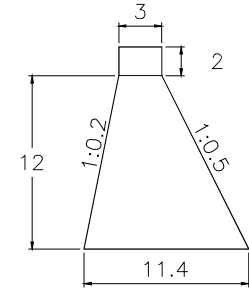

QUANTITY: 13

## SUB BASIN 27-3

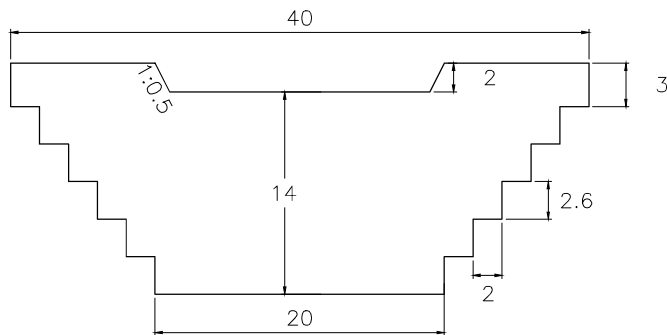

VOLUME: 3,318.00m<sup>3</sup>

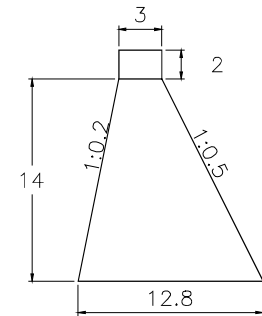

QUANTITY: 2

## SUB BASIN 28

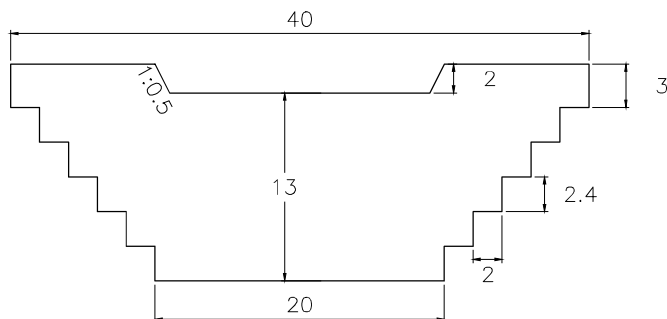



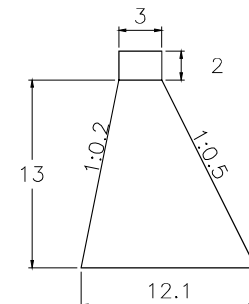

VOLUME: 2,944.50m<sup>3</sup>



QUANTITY: 2

**CHECK DAM**

SCALE 1:500

LEGEND		
FIGURE	COUNTER MEASURE	QUANTITY
	CHECK DAM	42
	CHECK DAM PRIORITY	159
	REVENT WORK	324.53 km
	CENOZOIC ZONE	

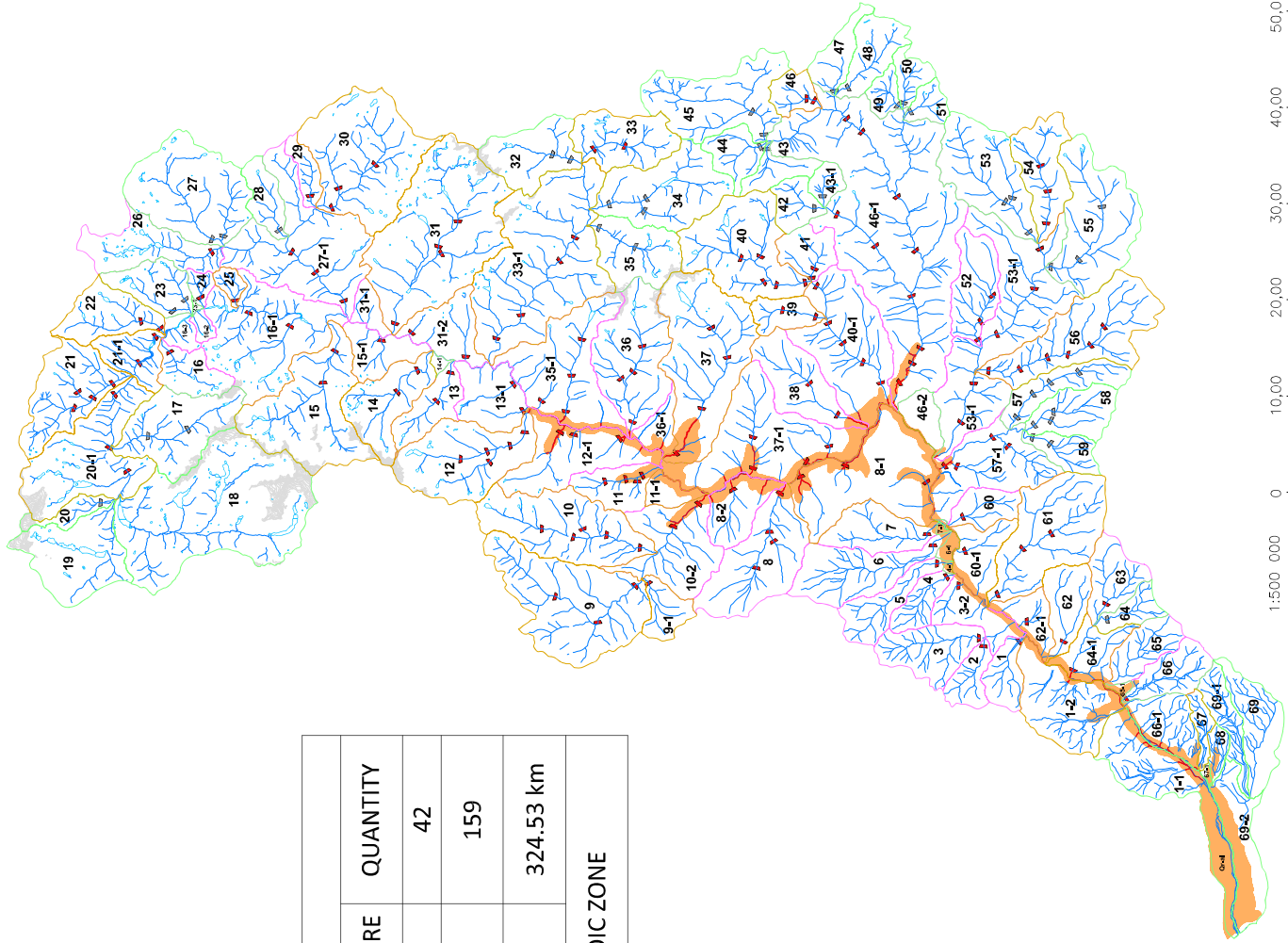

# CAÑETE RIVER

## SUB BASIN 1

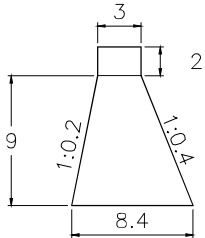
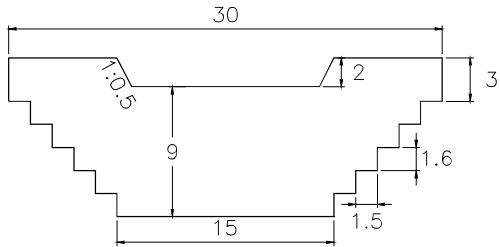

VOLUME: 1,154.25m<sup>3</sup> QUANTITY: 1

## SUB BASIN 2

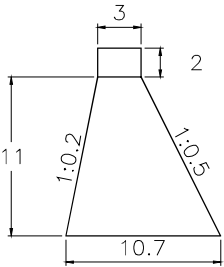
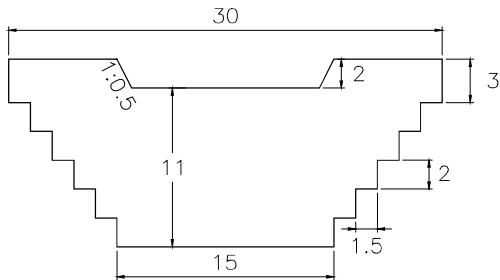

VOLUME: 1,695.38m<sup>3</sup> QUANTITY: 1

## SUB BASIN 3

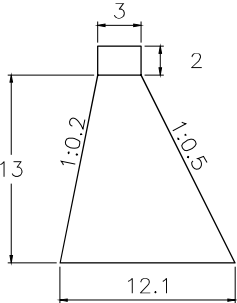
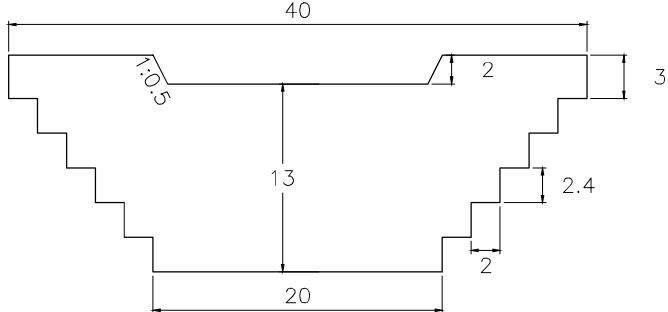

VOLUME: 2,944.50m<sup>3</sup> QUANTITY: 1

# CHECK DAM

SCALE 1:500



# CAÑETE RIVER

## SUB BASIN 3-2

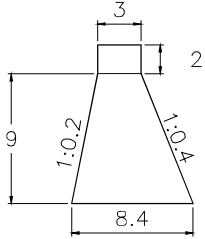
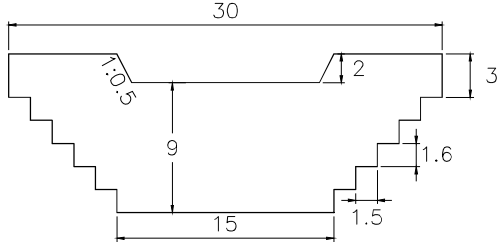

VOLUME: 1,154.25m<sup>3</sup> QUANTITY: 1

## SUB BASIN 4

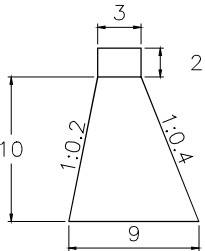
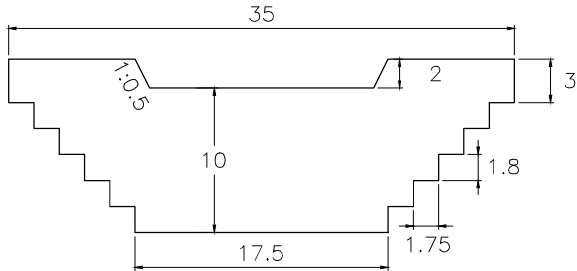

VOLUME: 1,575.00m<sup>3</sup> QUANTITY: 1

## SUB BASIN 5

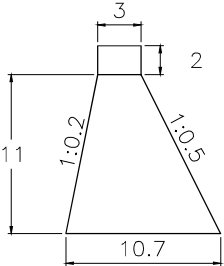
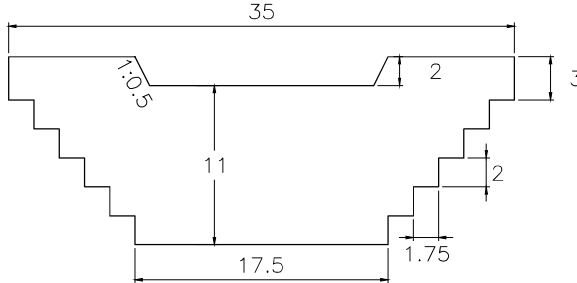

VOLUME: 1,977.94m<sup>3</sup> QUANTITY: 1

# CHECK DAM

SCALE 1:500

# CAÑETE RIVER

## SUB BASIN 6

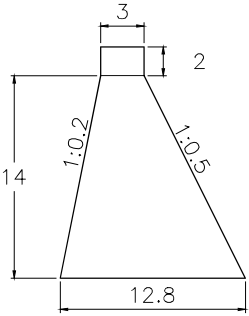
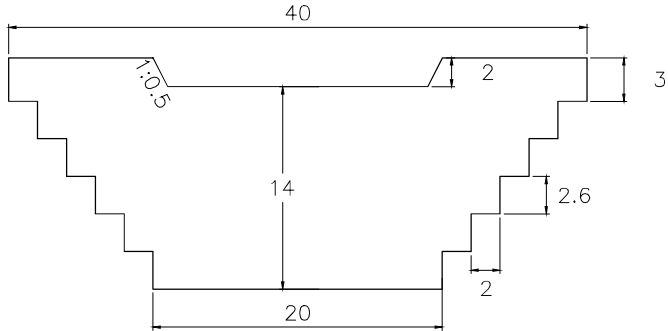

VOLUME: 3,318.00m<sup>3</sup>    QUANTITY: 1

## SUB BASIN 7

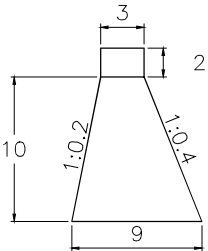
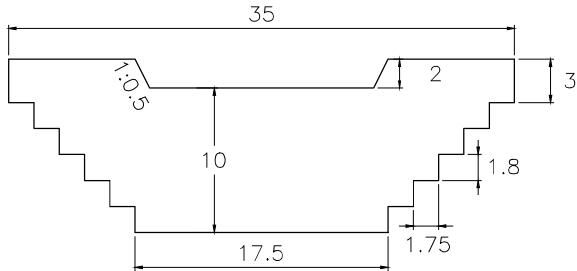

VOLUME: 1,575.00m<sup>3</sup>    QUANTITY: 1

## SUB BASIN 8

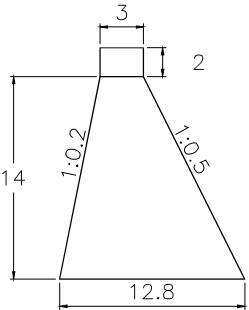
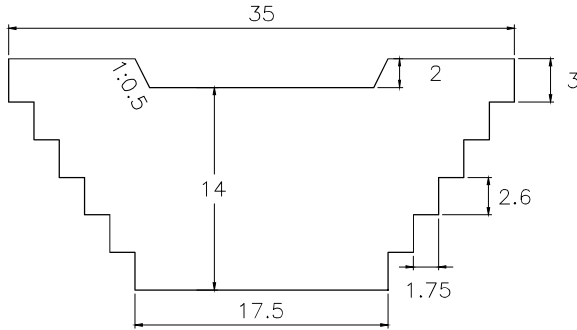

VOLUME: 2,903.25m<sup>3</sup>    QUANTITY: 4

# CHECK DAM

SCALE 1:500

# CAÑETE RIVER

## SUB BASIN 8-1

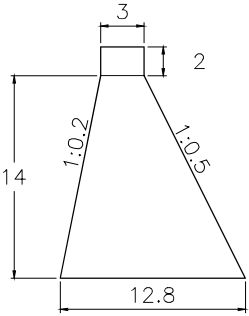
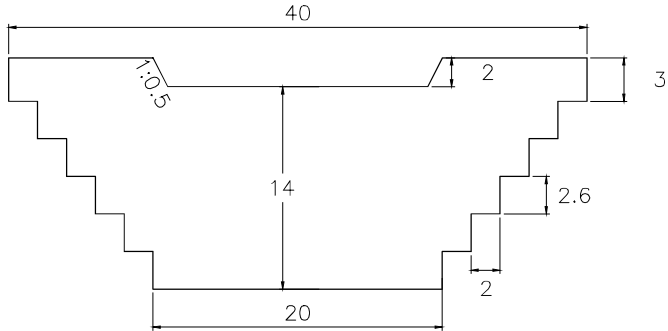

VOLUME: 3,318.00m<sup>3</sup> QUANTITY: 3

## SUB BASIN 8-2

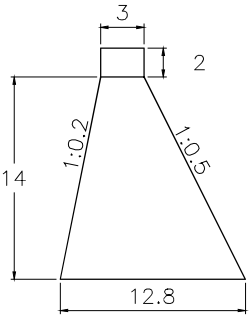
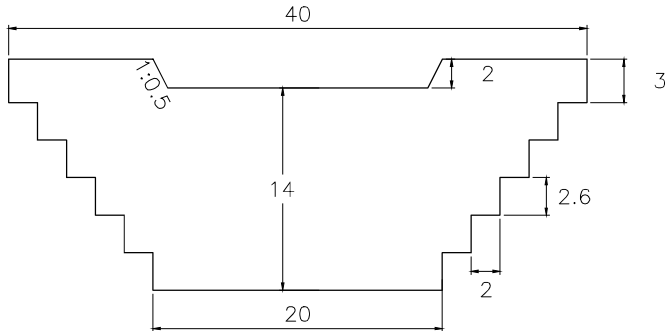

VOLUME: 3,318.00m<sup>3</sup> QUANTITY: 1

## SUB BASIN 9

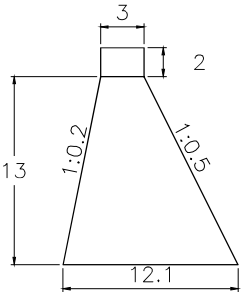
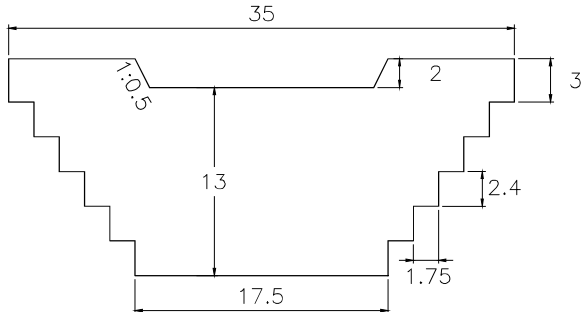

VOLUME: 2,576.44m<sup>3</sup> QUANTITY: 3

# CHECK DAM

SCALE 1:500

# CAÑETE RIVER

## SUB BASIN 9-1

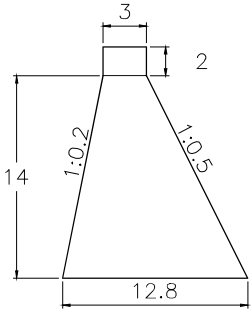
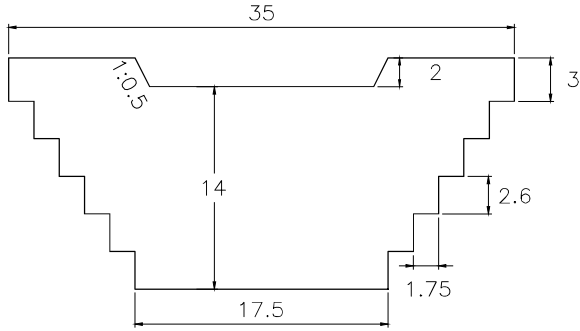

VOLUME: 2,903.25m3    QUANTITY: 1

## SUB BASIN 10

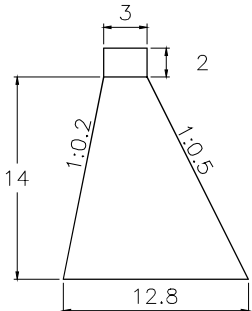
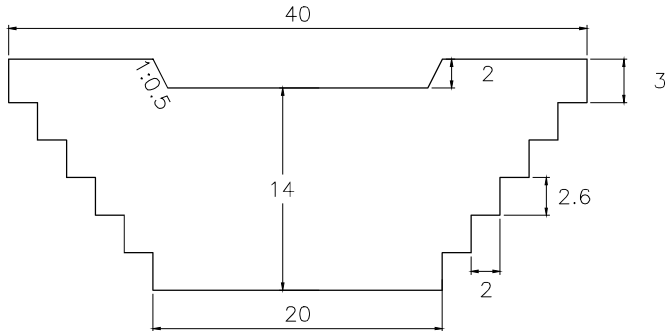

VOLUME: 3,318.00m3    QUANTITY: 5

## SUB BASIN 10-2

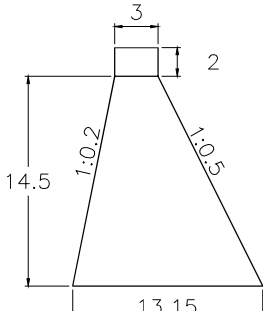
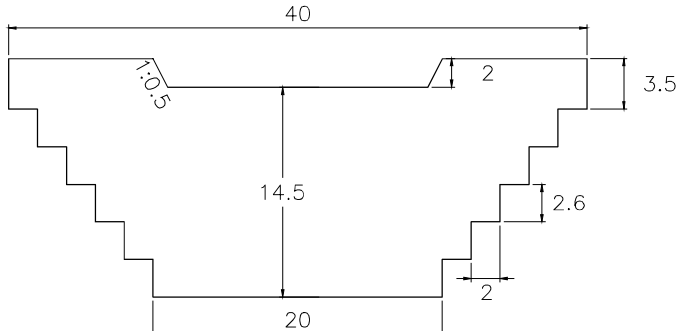

VOLUME: 3,512.70m3    QUANTITY: 2

# CHECK DAM

SCALE 1:500

# CAÑETE RIVER

## SUB BASIN 11

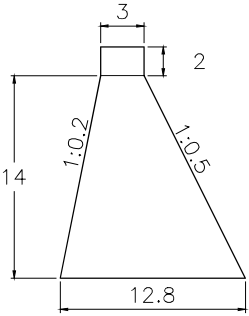
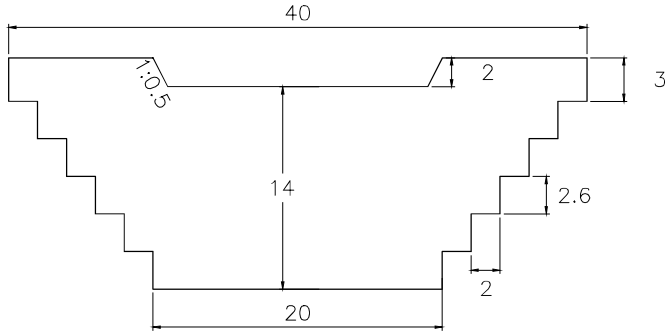

VOLUME: 3,318.00m<sup>3</sup> QUANTITY: 4

## SUB BASIN 12

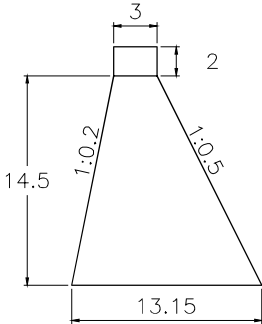
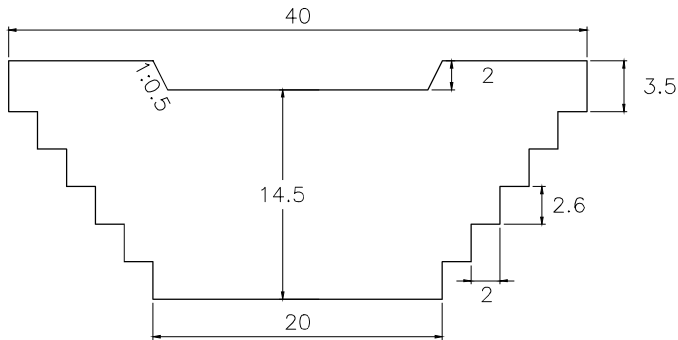

VOLUME: 3,512.70m<sup>3</sup> QUANTITY: 5

## SUB BASIN 12-1

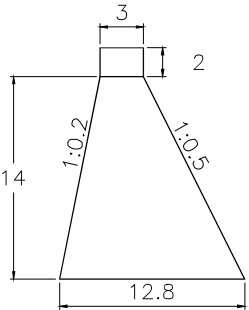
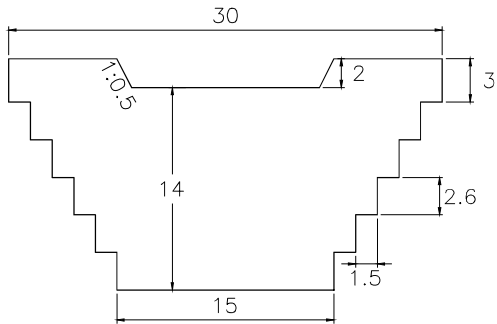

VOLUME: 2,488.50m<sup>3</sup> QUANTITY: 3

# CHECK DAM

SCALE 1:500

# CAÑETE RIVER

## SUB BASIN 13

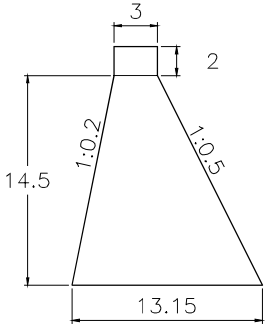
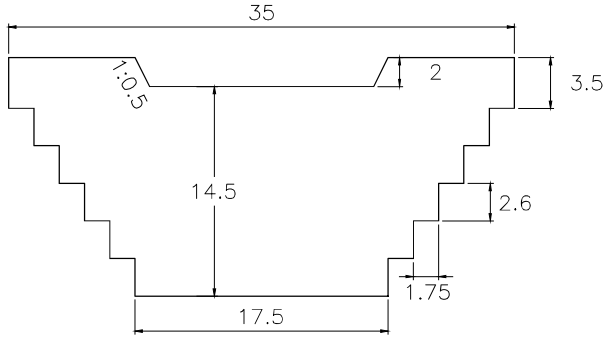

VOLUME: 3,073.61m<sup>3</sup>    QUANTITY: 2

## SUB BASIN 13-1

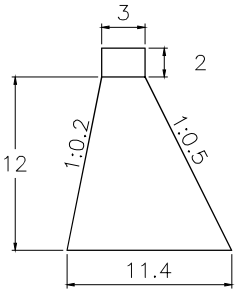
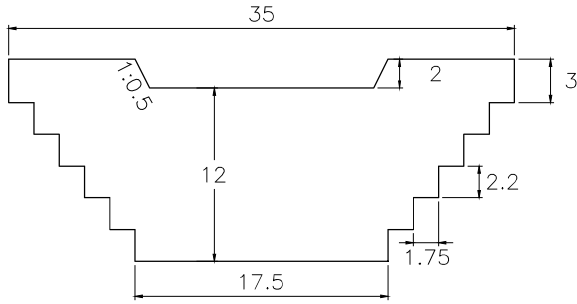

VOLUME: 2,268.00m<sup>3</sup>    QUANTITY: 2

## SUB BASIN 14

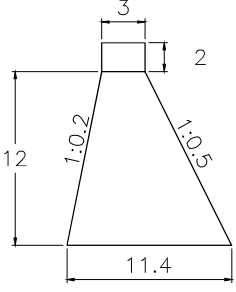
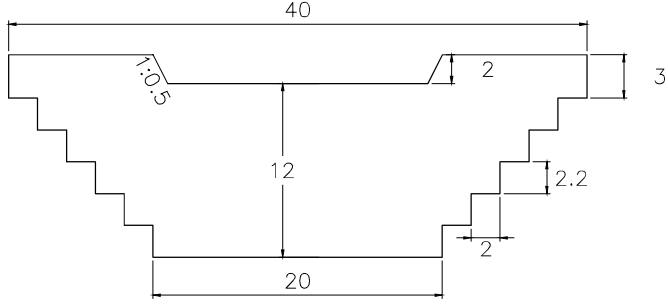

VOLUME: 2,592.00m<sup>3</sup>    QUANTITY: 2

# CHECK DAM

SCALE 1:500

# CAÑETE RIVER

## SUB BASIN 15

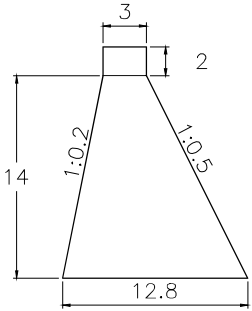
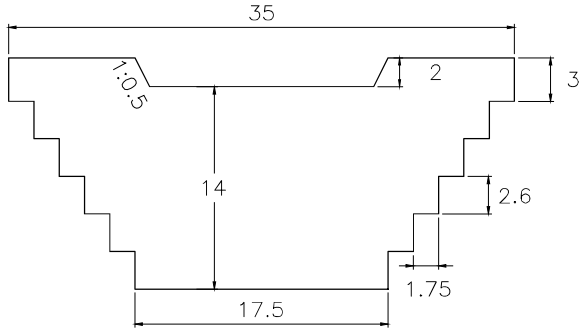

VOLUME: 2,903.25m<sup>3</sup>    QUANTITY: 2

## SUB BASIN 15-1

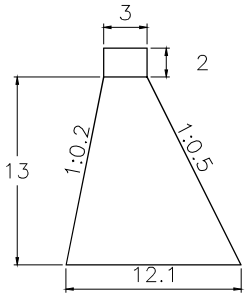
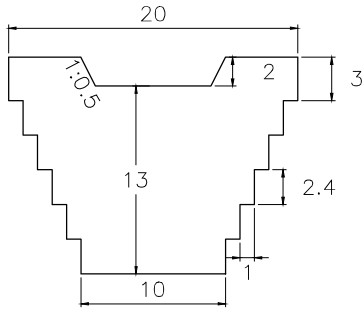

VOLUME: 1,472.25m<sup>3</sup>    QUANTITY: 1

## SUB BASIN 16

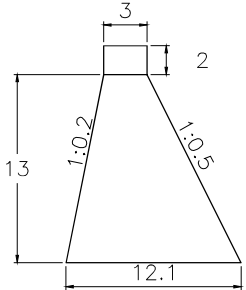
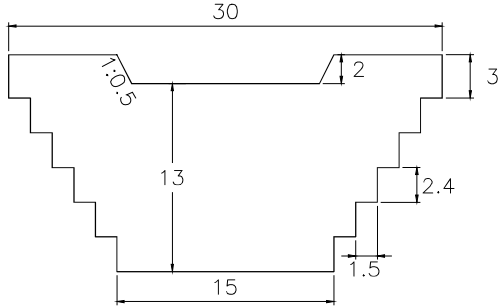

VOLUME: 2,208.38m<sup>3</sup>    QUANTITY: 1

# CHECK DAM

SCALE 1:500

# CAÑETE RIVER

## SUB BASIN 16-1

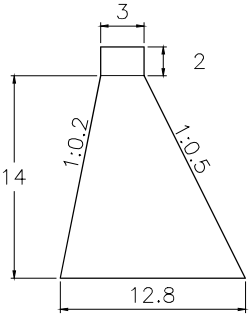
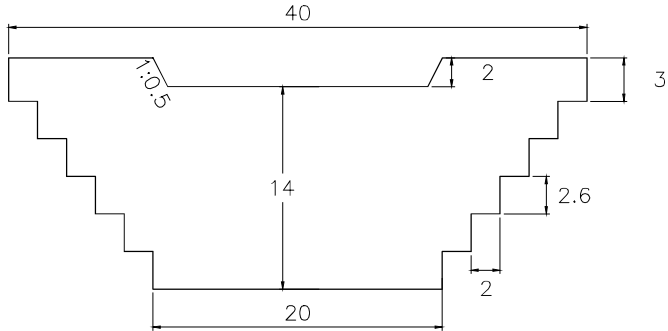

VOLUME: 3,318.00m<sup>3</sup> QUANTITY: 2

## SUB BASIN 17

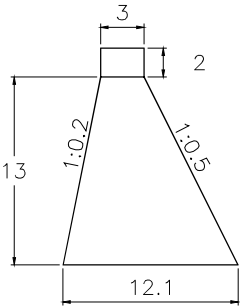
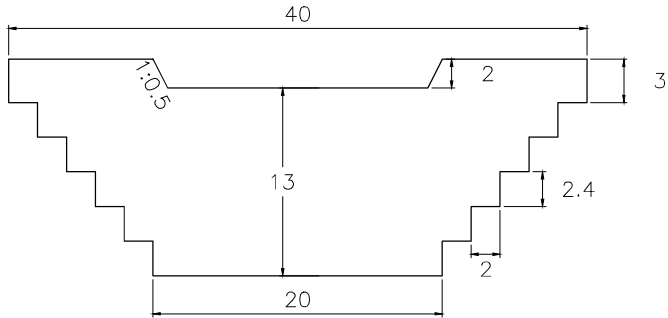

VOLUME: 2,944.50m<sup>3</sup> QUANTITY: 2

## SUB BASIN 20

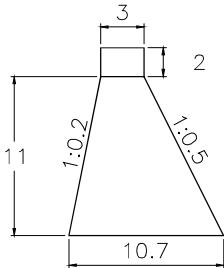
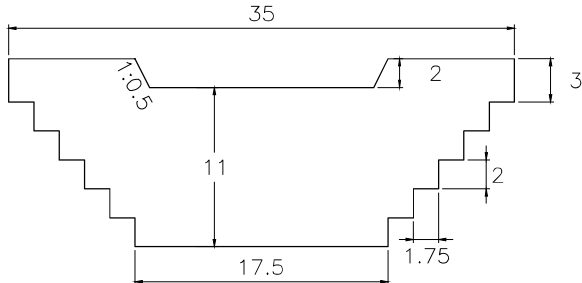

VOLUME: 1,977.94m<sup>3</sup> QUANTITY: 1

# CHECK DAM

SCALE 1:500



# CAÑETE RIVER

SUB BASIN 20-1

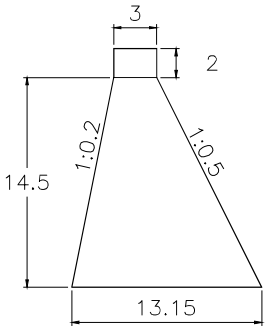
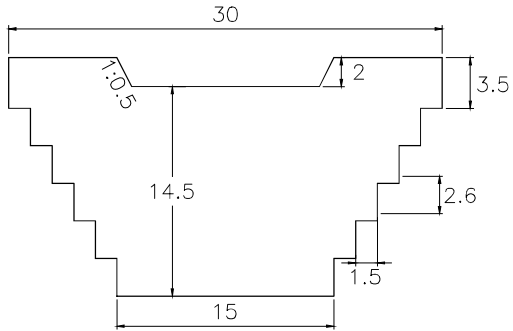

VOLUME: 2,634.53m<sup>3</sup> QUANTITY: 3

SUB BASIN 21

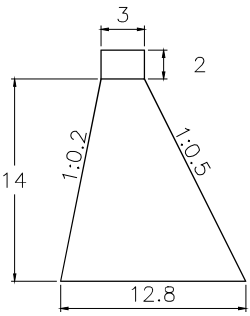
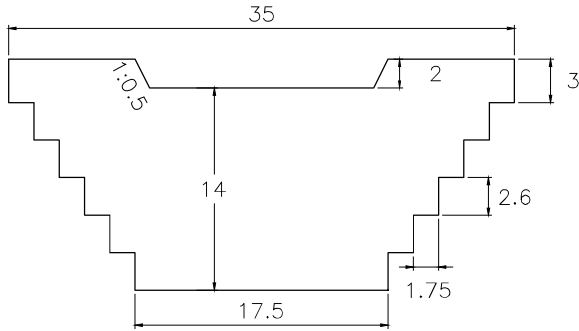

VOLUME: 2,903.25m<sup>3</sup> QUANTITY: 4

SUB BASIN 21-1

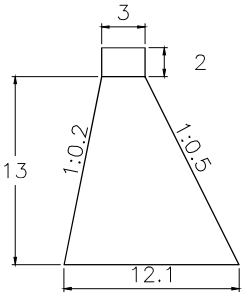
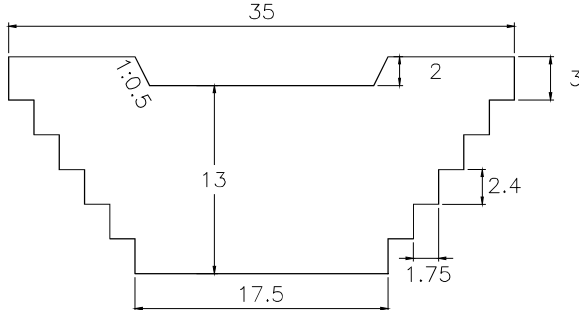

VOLUME: 2,576.44m<sup>3</sup> QUANTITY: 2

## CHECK DAM

SCALE 1:500

# CAÑETE RIVER

## SUB BASIN 22

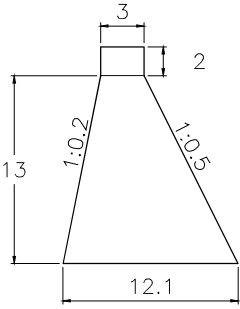
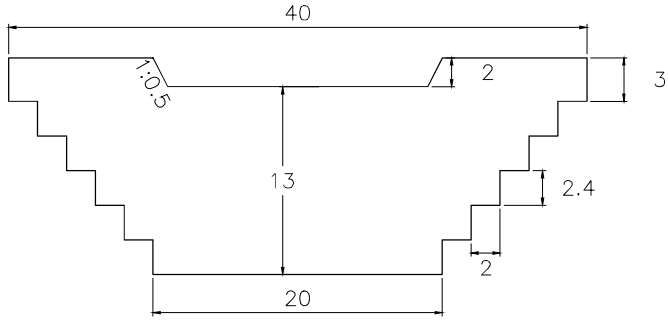

VOLUME: 2,944.50m<sup>3</sup> QUANTITY: 2

## SUB BASIN 23

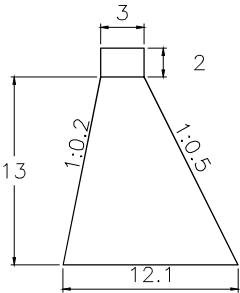
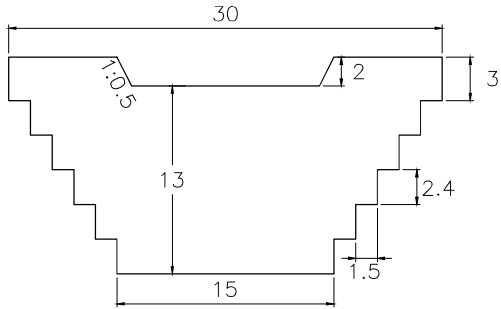

VOLUME: 2,208.38m<sup>3</sup> QUANTITY: 2

## SUB BASIN 24

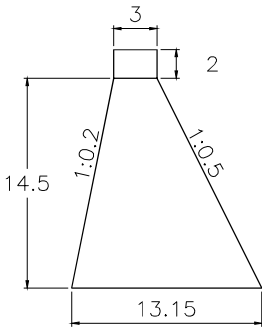
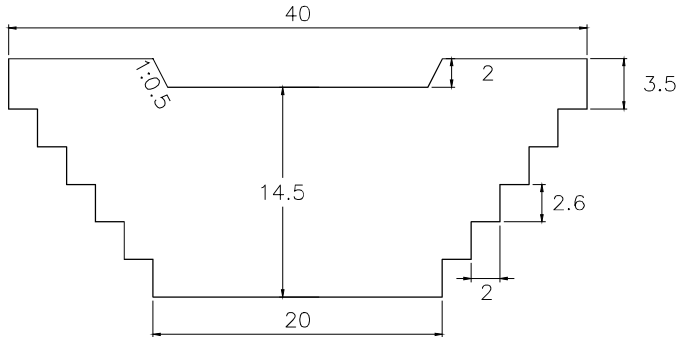

VOLUME: 3,512.70m<sup>3</sup> QUANTITY: 1

# CHECK DAM

SCALE 1:500

# CAÑETE RIVER

## SUB BASIN 25

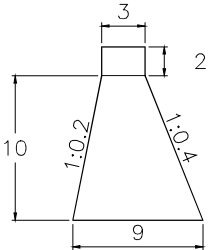
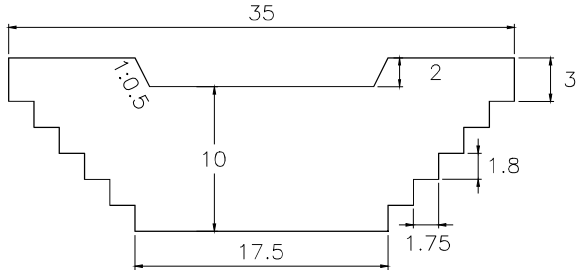

VOLUME: 1,575.00m<sup>3</sup>    QUANTITY: 1

## SUB BASIN 26

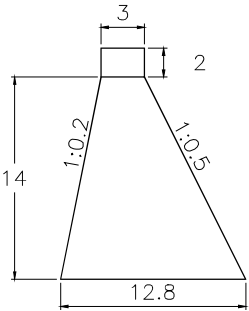
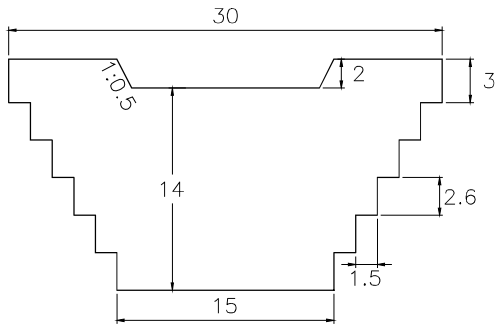

VOLUME: 2,488.50m<sup>3</sup>    QUANTITY: 1

## SUB BASIN 27

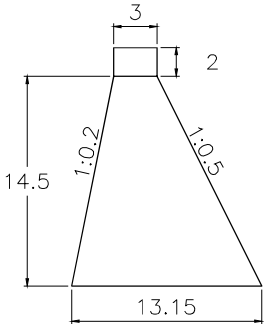
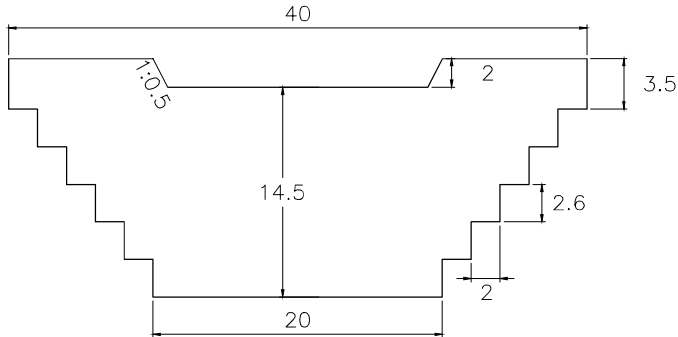

VOLUME: 3,512.70m<sup>3</sup>    QUANTITY: 2

# CHECK DAM

SCALE 1:500

# CAÑETE RIVER

## SUB BASIN 27-1

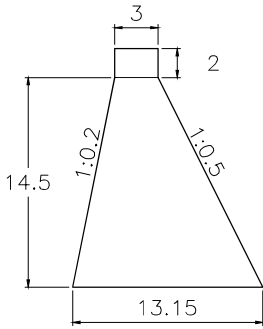
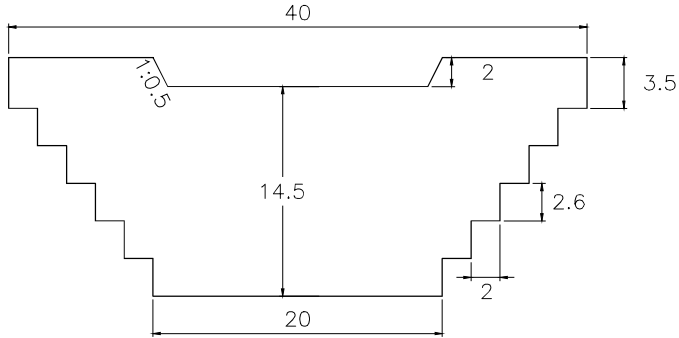

VOLUME: 3,512.70m<sup>3</sup>    QUANTITY: 3

## SUB BASIN 28

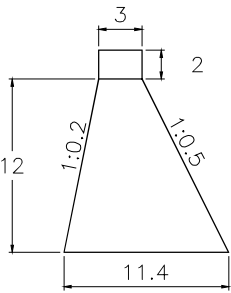
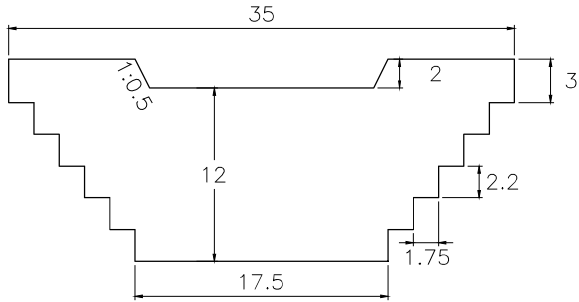

VOLUME: 2,268.00m<sup>3</sup>    QUANTITY: 1

## SUB BASIN 29

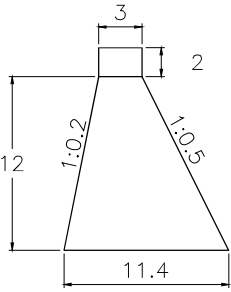
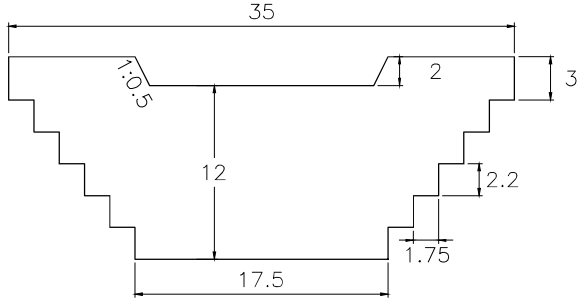

VOLUME: 2,268.00m<sup>3</sup>    QUANTITY: 1

# CHECK DAM

SCALE 1:500

# CAÑETE RIVER

## SUB BASIN 30

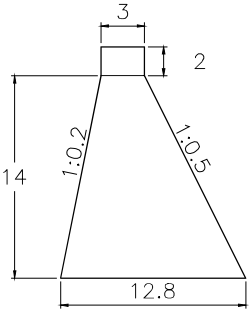
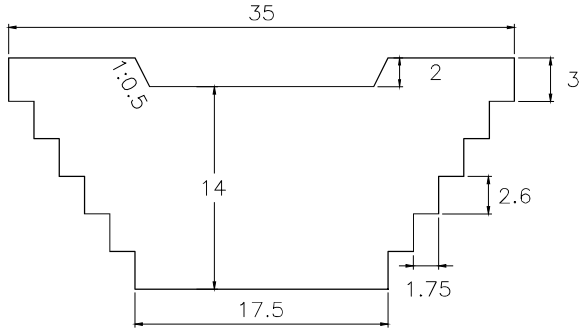

VOLUME: 2,903.25m<sup>3</sup>    QUANTITY: 3

## SUB BASIN 31

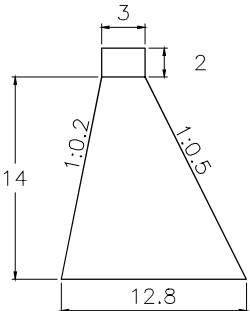
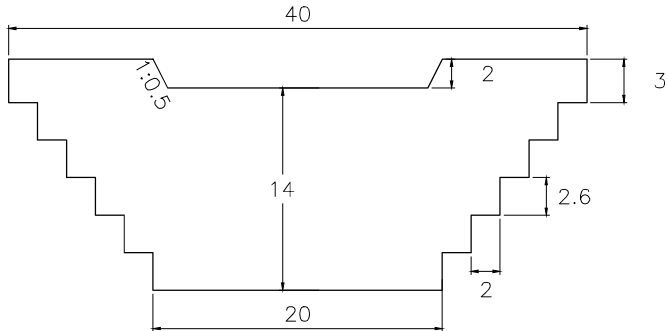

VOLUME: 3,318.00m<sup>3</sup>    QUANTITY: 4

## SUB BASIN 31-2

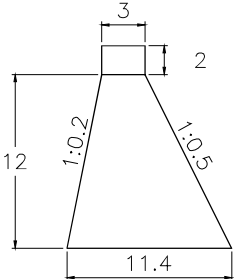
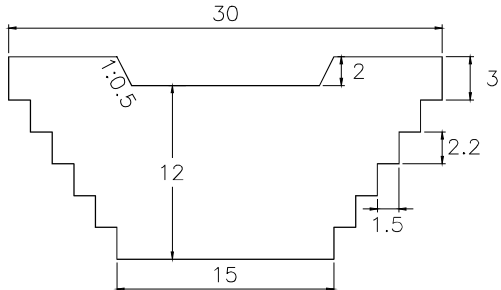

VOLUME: 1,944.00m<sup>3</sup>    QUANTITY: 2

## CHECK DAM

SCALE 1:500

# CAÑETE RIVER

## SUB BASIN 32

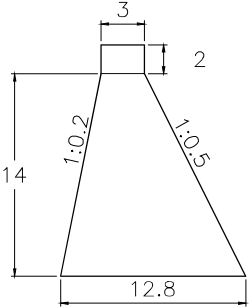
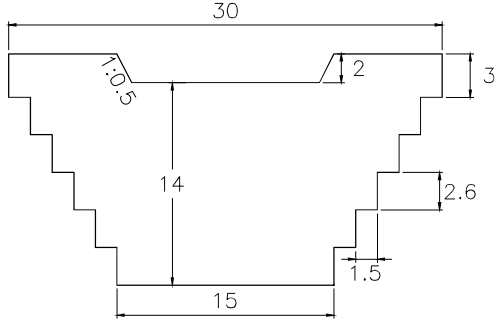

VOLUME: 2,488.50m<sup>3</sup> QUANTITY: 2

## SUB BASIN 33

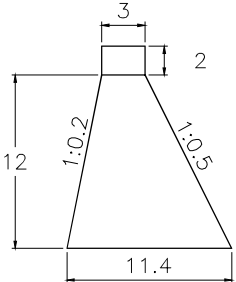
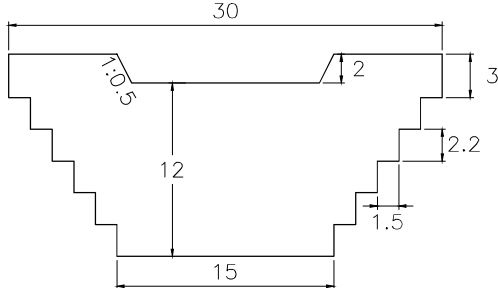

VOLUME: 1,944.00m<sup>3</sup> QUANTITY: 2

## SUB BASIN 33-1

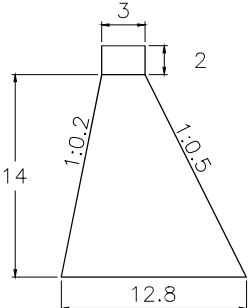
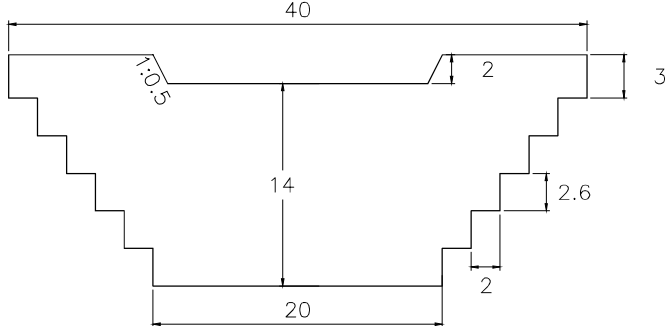

VOLUME: 3,318.00m<sup>3</sup> QUANTITY: 4

# CHECK DAM

SCALE 1:500

# CAÑETE RIVER

## SUB BASIN 34

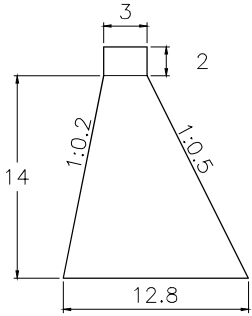
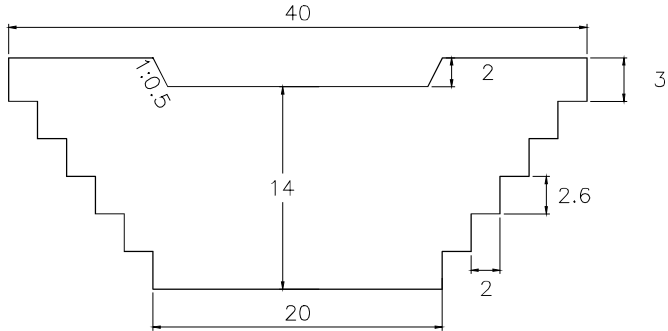

VOLUME: 3,318.00m<sup>3</sup> QUANTITY: 3

## SUB BASIN 35

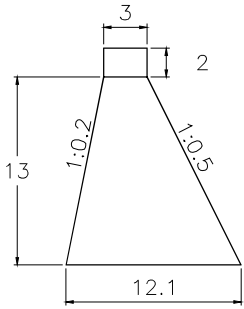
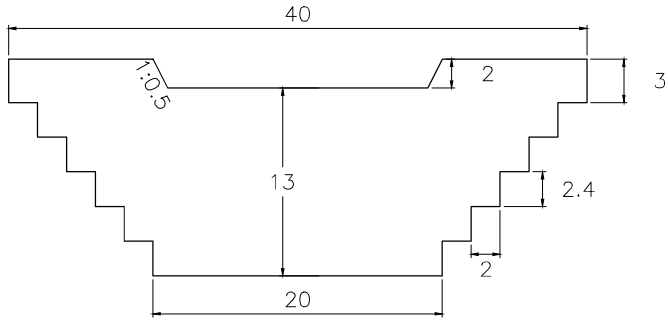

VOLUME: 2,944.50m<sup>3</sup> QUANTITY: 2

## SUB BASIN 35-1

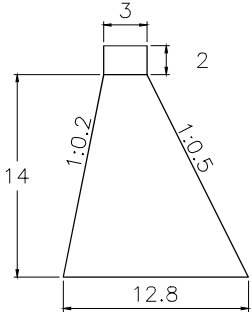
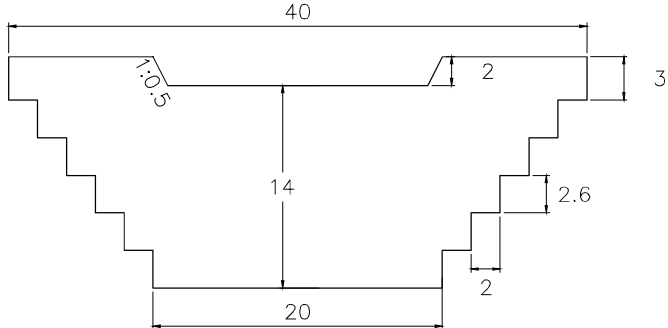

VOLUME: 3,318.00m<sup>3</sup> QUANTITY: 4

# CHECK DAM

SCALE 1:500

# CAÑETE RIVER

SUB BASIN 36

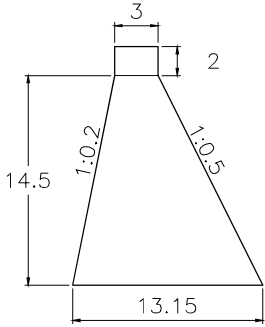
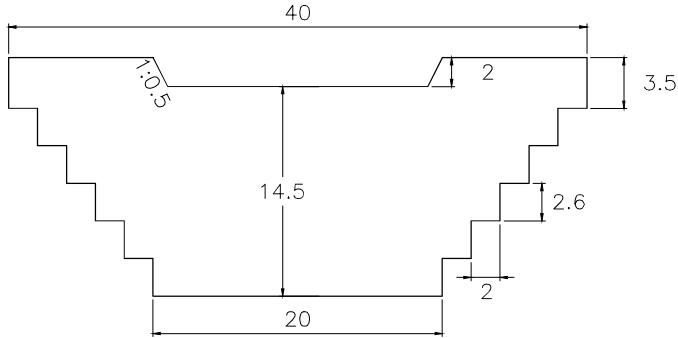

VOLUME: 3,512.70m<sup>3</sup>    QUANTITY: 4

SUB BASIN 37

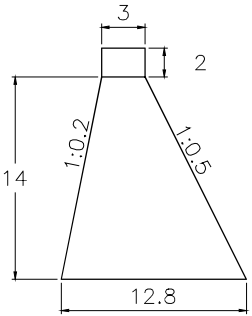
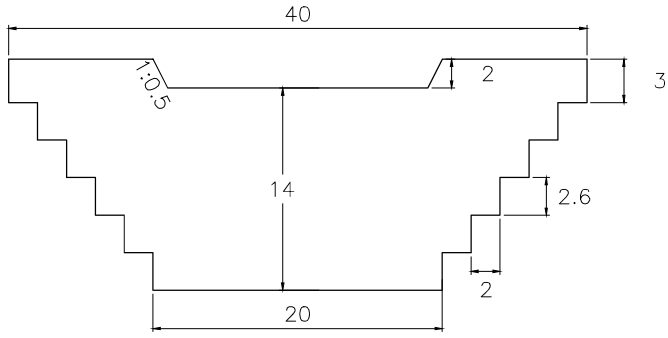

VOLUME: 3,318.00m<sup>3</sup>    QUANTITY: 4

SUB BASIN 37-1

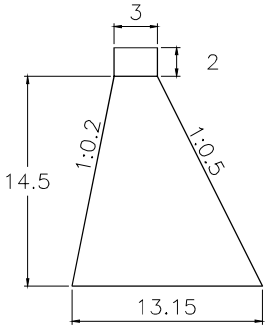
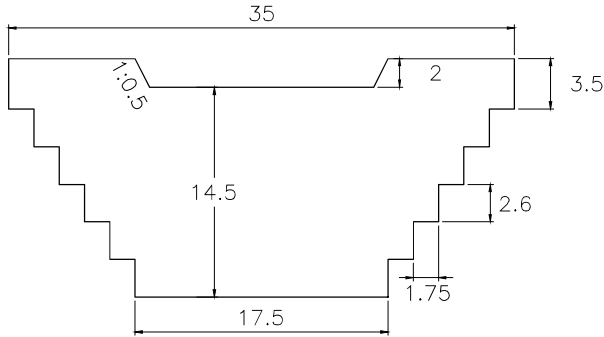

VOLUME: 3,073.61m<sup>3</sup>    QUANTITY: 4

## CHECK DAM

SCALE 1:500



# CAÑETE RIVER

## SUB BASIN 38

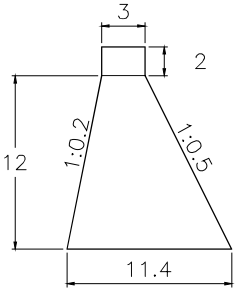
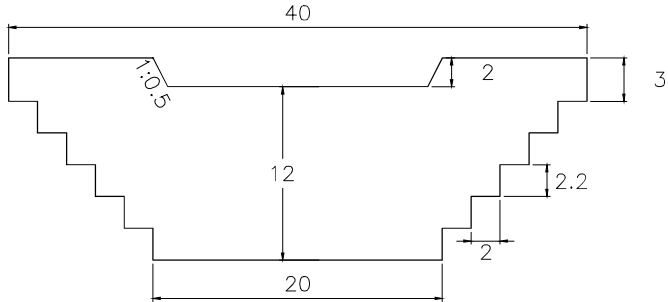

VOLUME: 2,592.00m<sup>3</sup>    QUANTITY: 2

## SUB BASIN 39

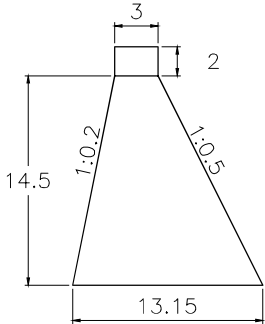
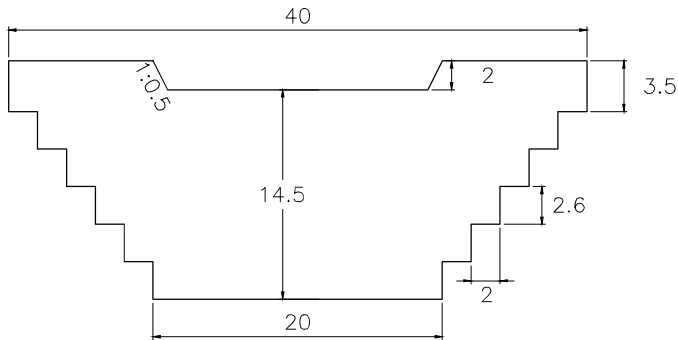

VOLUME: 3,512.70m<sup>3</sup>    QUANTITY: 2

## SUB BASIN 40

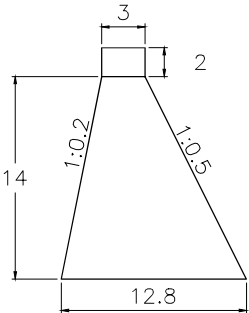
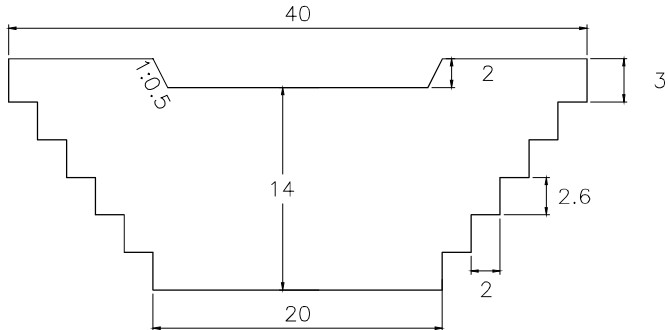

VOLUME: 3,318.00m<sup>3</sup>    QUANTITY: 5

# CHECK DAM

SCALE 1:500

# CAÑETE RIVER

## SUB BASIN 40-1

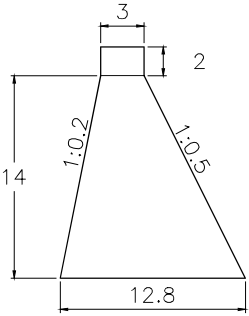
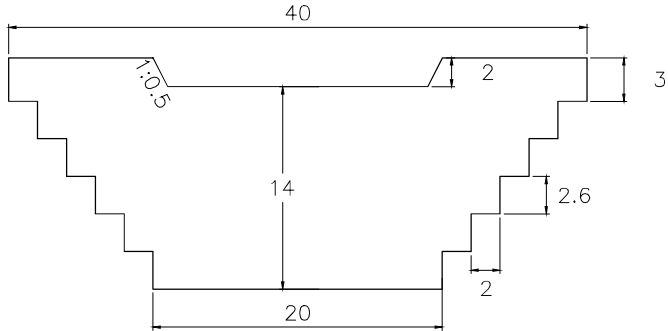

VOLUME: 3,318.00m3    QUANTITY: 5

## SUB BASIN 41

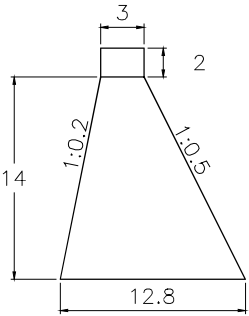
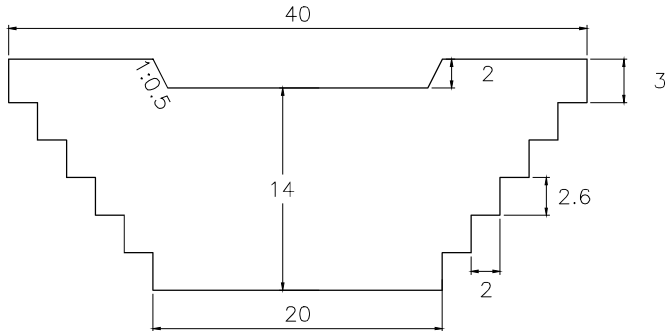

VOLUME: 3,318.00m3    QUANTITY: 2

## SUB BASIN 42

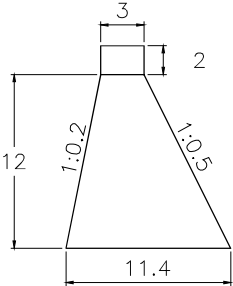
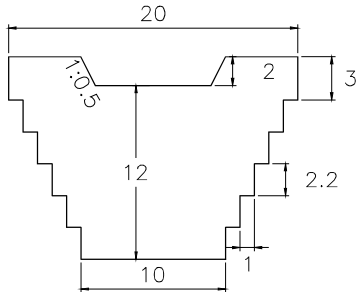

VOLUME: 1,296.00m3    QUANTITY: 1

# CHECK DAM

SCALE 1:500

# CAÑETE RIVER

## SUB BASIN 43

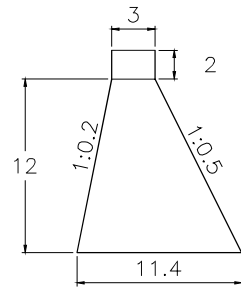
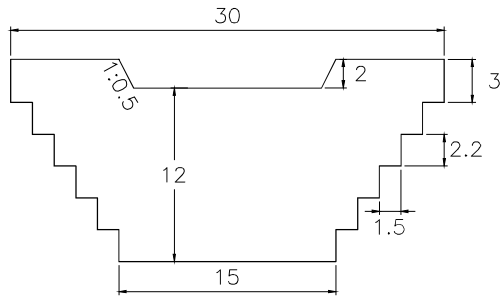

VOLUME: 1,944.00m<sup>3</sup> QUANTITY: 1

## SUB BASIN 43-1

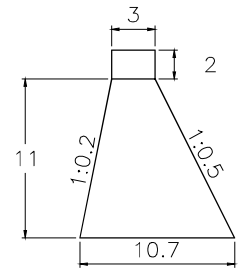
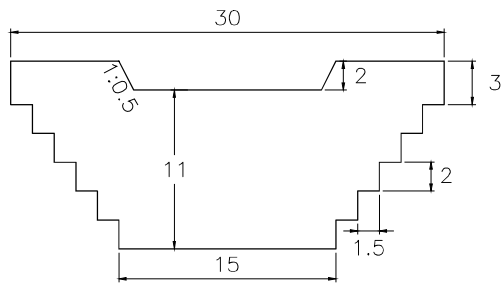

VOLUME: 1,695.38m<sup>3</sup> QUANTITY: 1

## SUB BASIN 44

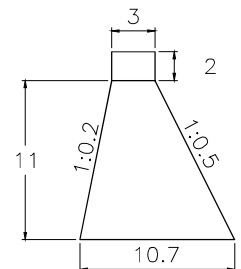
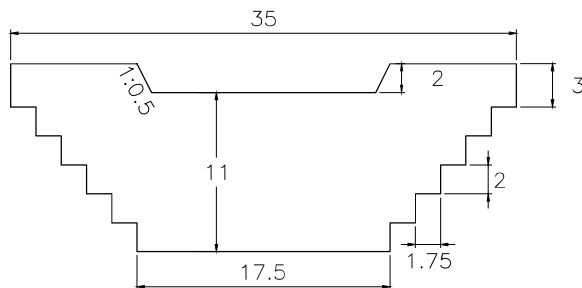

VOLUME: 1,977.94m<sup>3</sup> QUANTITY: 1

**CHECK DAM**

SCALE 1:500

# CAÑETE RIVER

## SUB BASIN 45

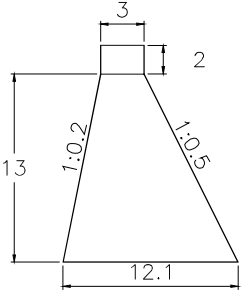
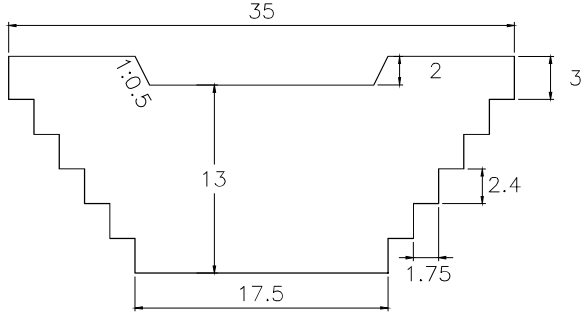

VOLUME: 2,576.44m3    QUANTITY: 2

## SUB BASIN 46

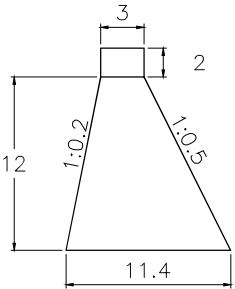
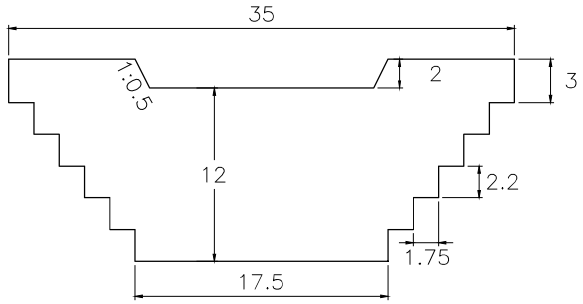

VOLUME: 2,268.00m3    QUANTITY: 2

## SUB BASIN 46-1

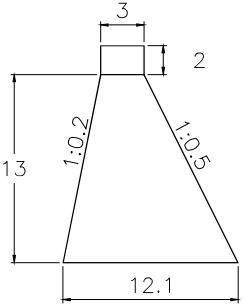
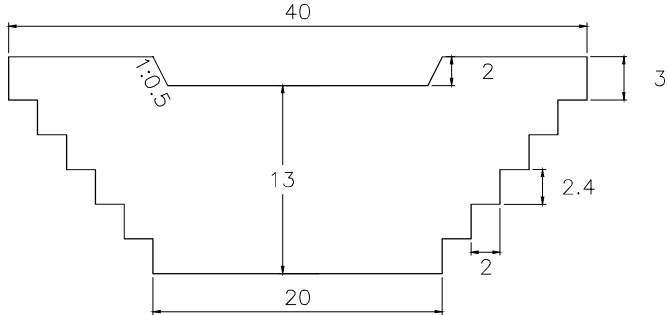

VOLUME: 2,944.50m3    QUANTITY: 10

# CHECK DAM

SCALE 1:500

# CAÑETE RIVER

## SUB BASIN 47

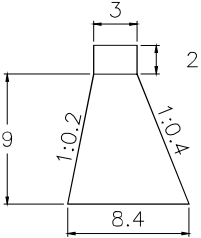
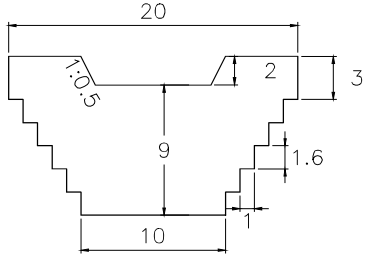

VOLUME: 769.50m<sup>3</sup>    QUANTITY: 1

## SUB BASIN 48

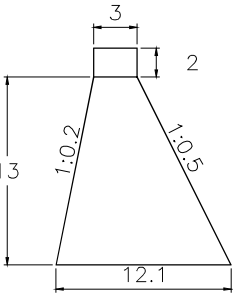
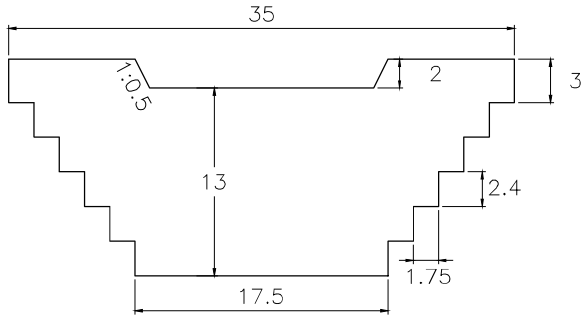

VOLUME: 2,576.44m<sup>3</sup>    QUANTITY: 1

## SUB BASIN 49

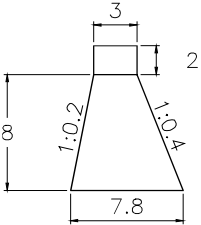
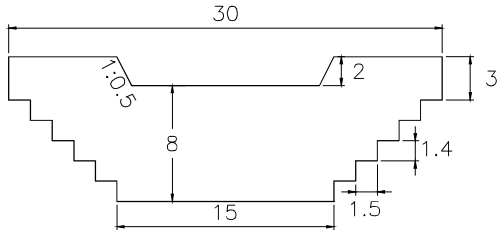

VOLUME: 972.00m<sup>3</sup>    QUANTITY: 1

# CHECK DAM

SCALE 1:500

# CAÑETE RIVER

## SUB BASIN 50

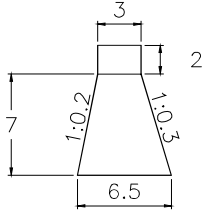
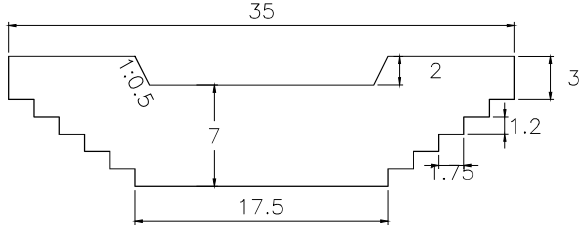

VOLUME: 872.81m<sup>3</sup>    QUANTITY: 1

## SUB BASIN 51

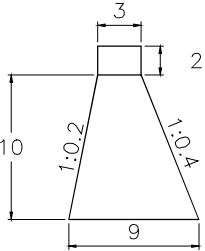
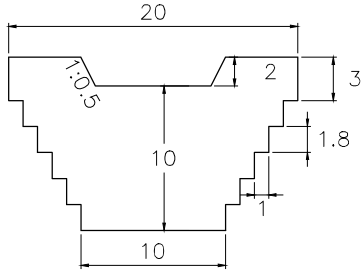

VOLUME: 900.00m<sup>3</sup>    QUANTITY: 1

## SUB BASIN 52

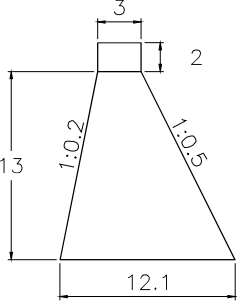
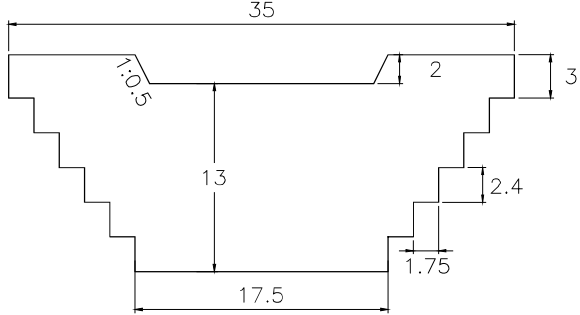

VOLUME: 2,576.44m<sup>3</sup>    QUANTITY: 3

# CHECK DAM

SCALE 1:500

# CAÑETE RIVER

## SUB BASIN 53

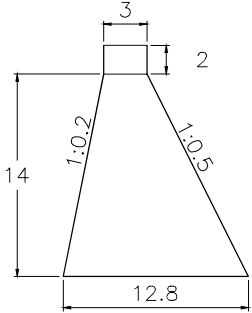
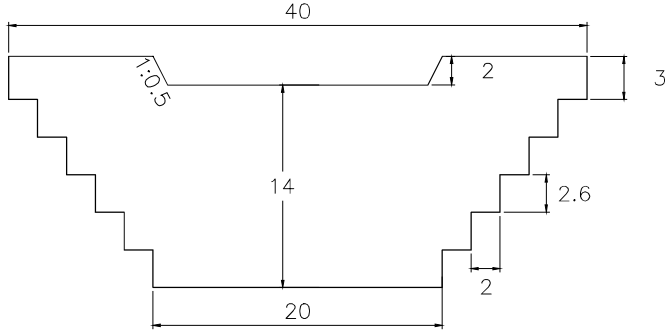

VOLUME: 3,318.00m3    QUANTITY: 3

## SUB BASIN 53-1

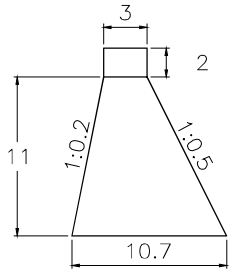
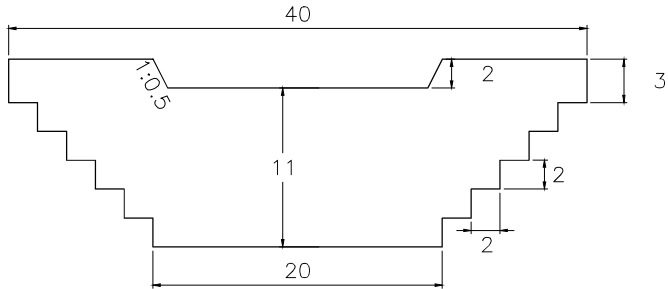

VOLUME: 2,260.50m3    QUANTITY: 5

## SUB BASIN 54

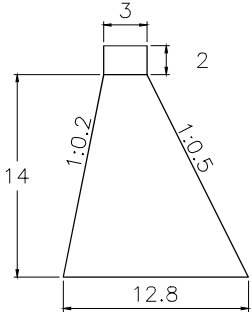
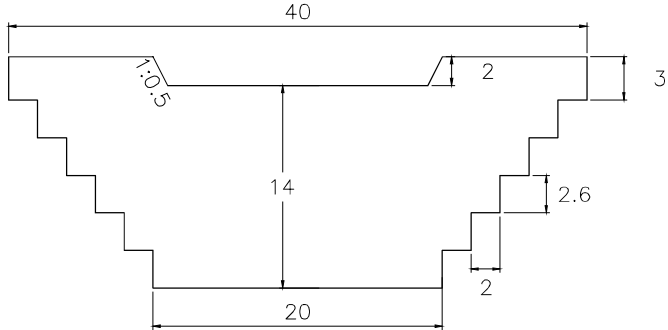

VOLUME: 3,318.00m3    QUANTITY: 3

# CHECK DAM

SCALE 1:500

# CAÑETE RIVER

## SUB BASIN 55

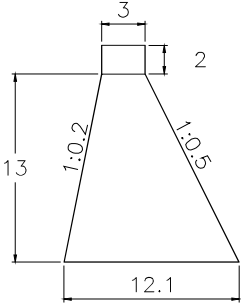
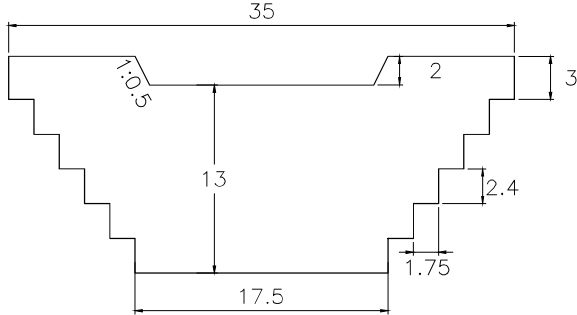

VOLUME: 2,576.44m3    QUANTITY: 3

## SUB BASIN 56

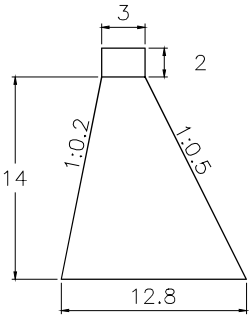
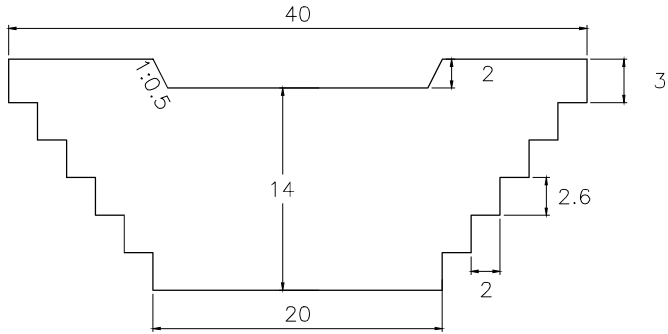

VOLUME: 3,318.00m3    QUANTITY: 6

## SUB BASIN 57

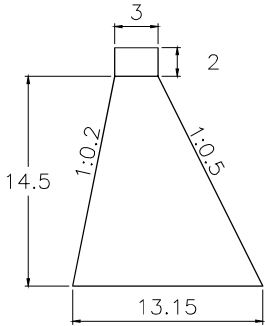
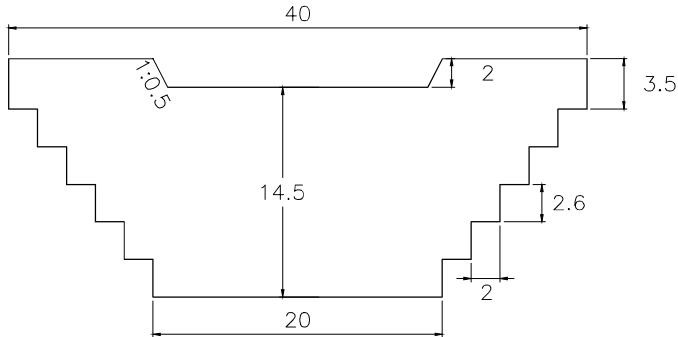

VOLUME: 3,512.70m3    QUANTITY: 4

# CHECK DAM

SCALE 1:500



# CAÑETE RIVER

## SUB BASIN 57-1

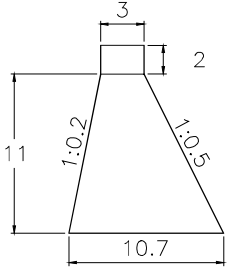
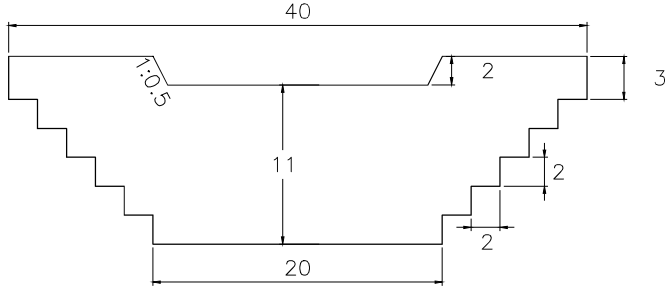

VOLUME: 2,260.50m<sup>3</sup> QUANTITY: 4

## SUB BASIN 58

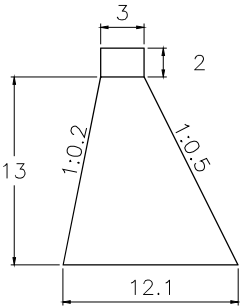
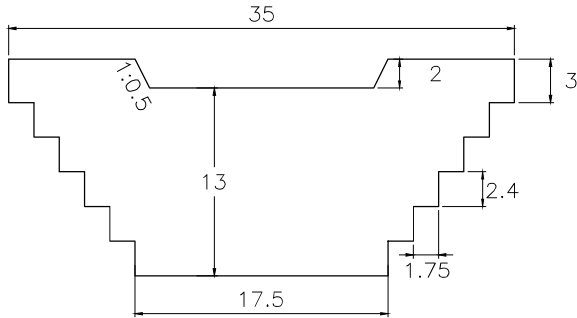

VOLUME: 2,576.44m<sup>3</sup> QUANTITY: 3

## SUB BASIN 59

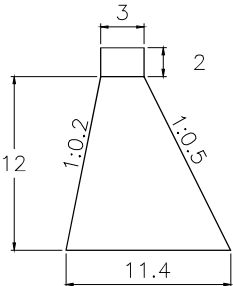
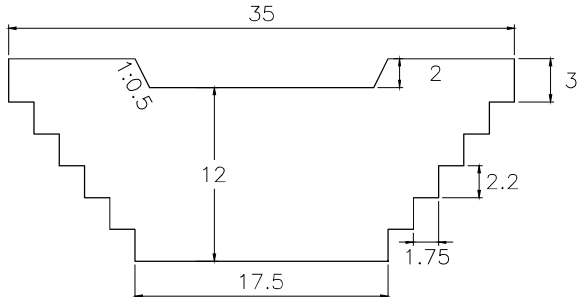

VOLUME: 2,268.00m<sup>3</sup> QUANTITY: 2

# CHECK DAM

SCALE 1:500

# CAÑETE RIVER

## SUB BASIN 60

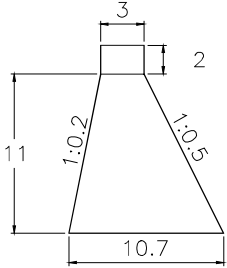
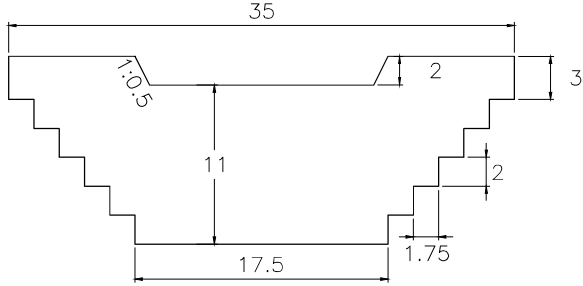

VOLUME: 1,977.94m<sup>3</sup>    QUANTITY: 1

## SUB BASIN 60-1

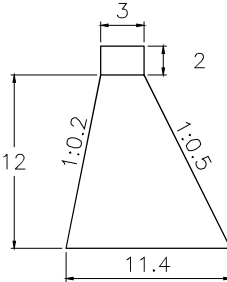
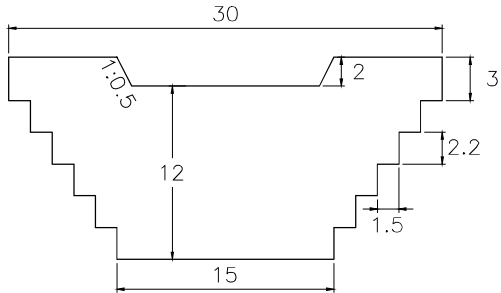

VOLUME: 1,944.00m<sup>3</sup>    QUANTITY: 1

## SUB BASIN 61

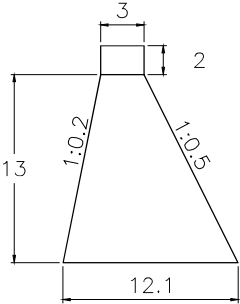
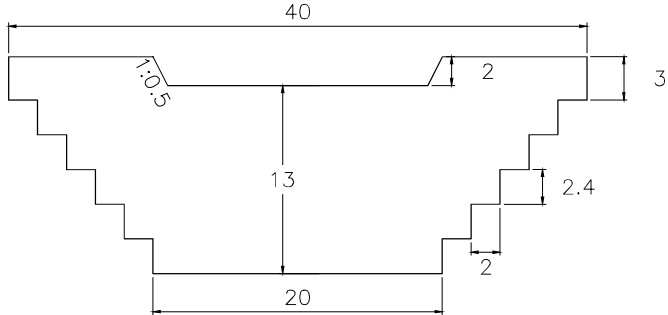

VOLUME: 2,944.50m<sup>3</sup>    QUANTITY: 3

# CHECK DAM

SCALE 1:500

# CAÑETE RIVER

## SUB BASIN 62

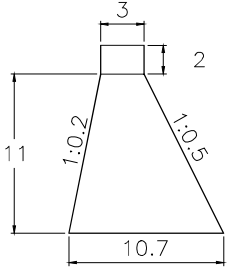
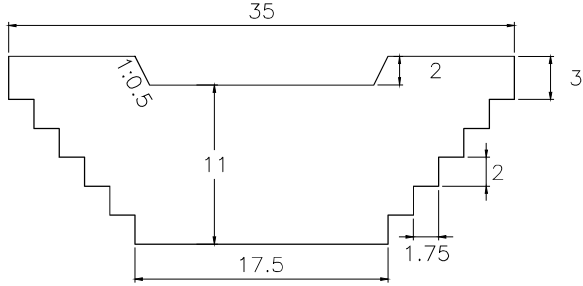

VOLUME: 1,977.94m3    QUANTITY: 1

## SUB BASIN 62-1

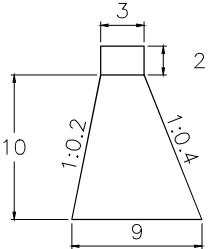
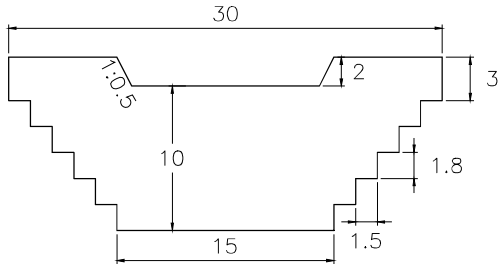

VOLUME: 1,350.00m3    QUANTITY: 1

## SUB BASIN 63

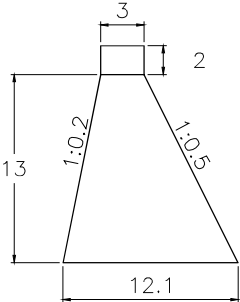
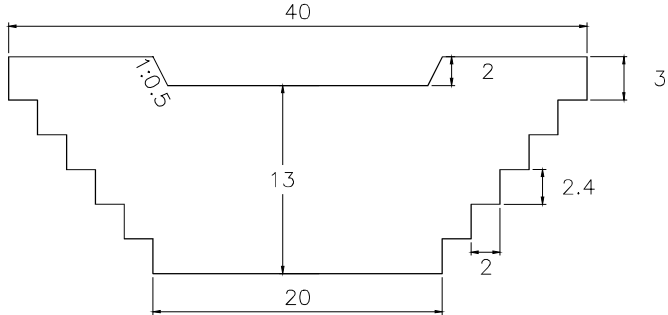

VOLUME: 2,944.50m3    QUANTITY: 1

# CHECK DAM

SCALE 1:500

# CAÑETE RIVER

## SUB BASIN 64

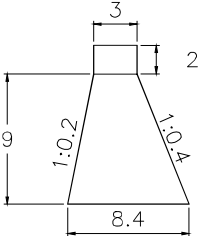
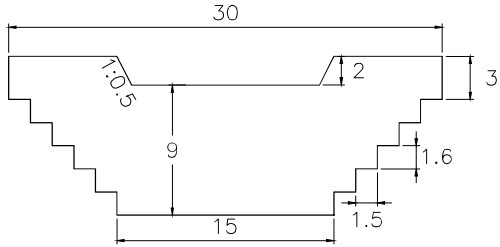

VOLUME: 1,154.25m<sup>3</sup>    QUANTITY: 1

## SUB BASIN 64-1

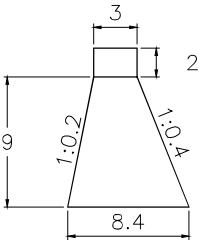
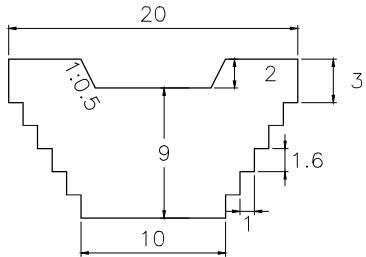

VOLUME: 769.50m<sup>3</sup>    QUANTITY: 1



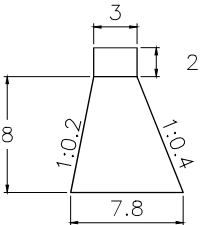
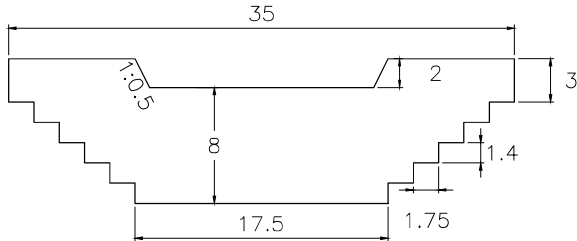

## SUB BASIN 66



VOLUME: 1,134.00m<sup>3</sup>    QUANTITY: 1

# CHECK DAM

SCALE 1:500

LEGEND		
FIGURE	COUNTER MEASURE	QUANTITY
	CHECK DAM	45
	CHECK DAM PRIORITY	66
	REVENT WORK	380.93 km
	CENOZOIC ZONE	
	Qr-s1	

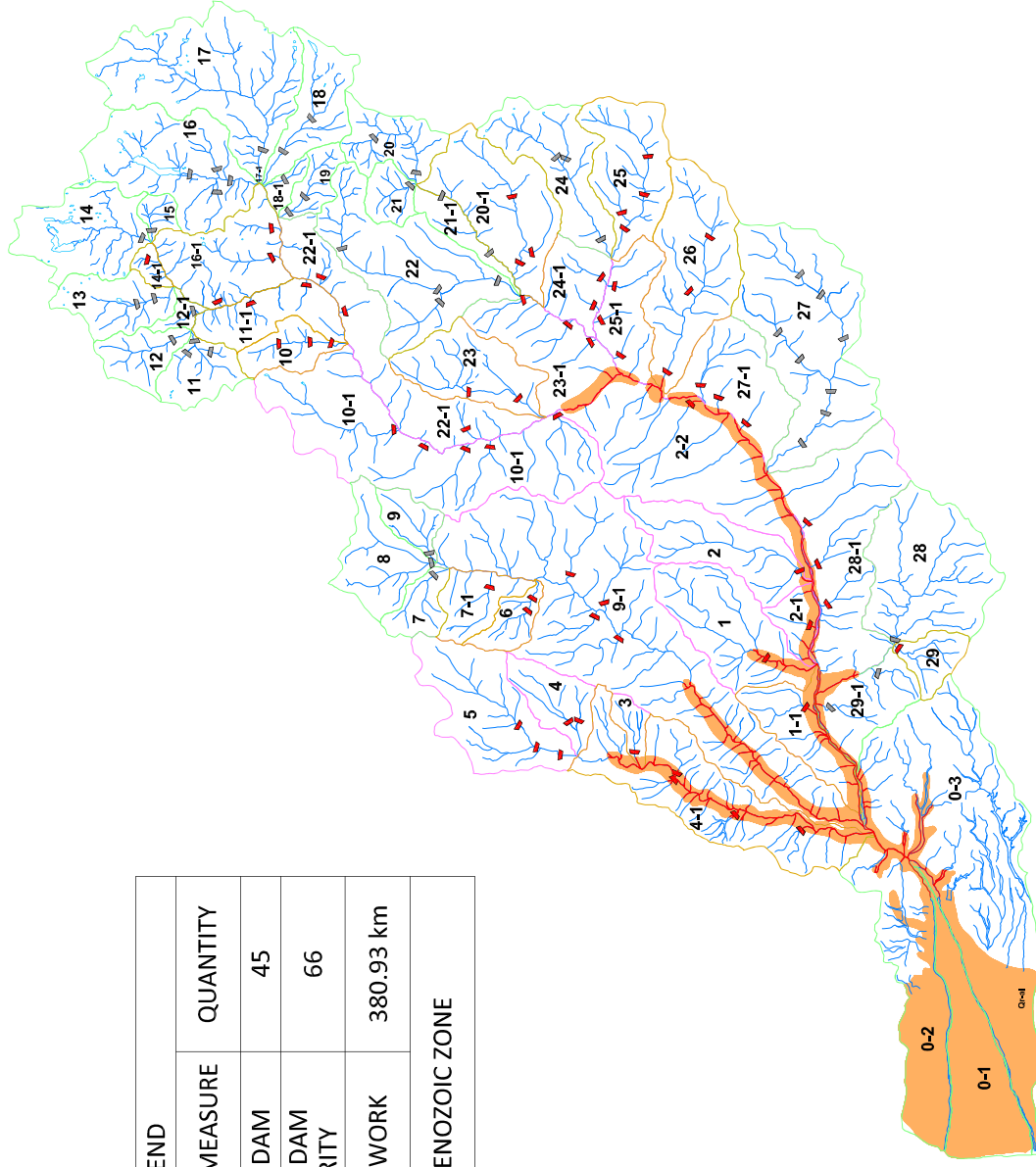

ARRANGEMENT PLAN OF COUNTERMEASURE

CHINCHA BASIN

SCALE 1:400 000

1:400 000

0

8,00

16,00

24,00

32,00

40,00 km

# CHINCHA RIVER

## SUB BASIN 1

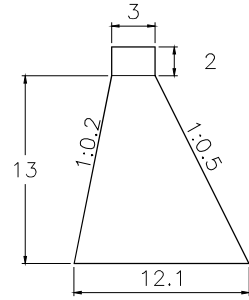
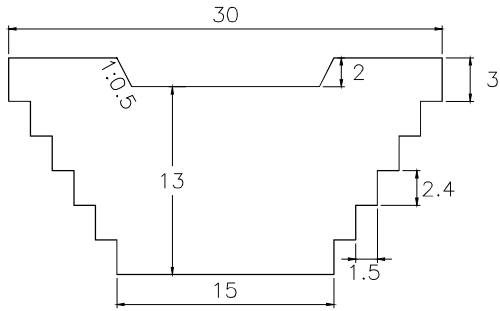

VOLUME: 2,208.38m<sup>3</sup> QUANTITY: 1

## SUB BASIN 1-1

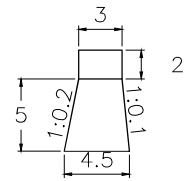
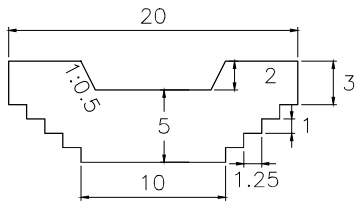

VOLUME: 281.25m<sup>3</sup> QUANTITY: 1

## SUB BASIN 2

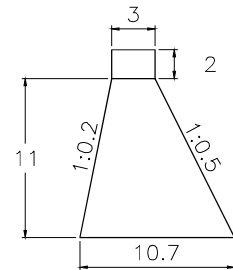
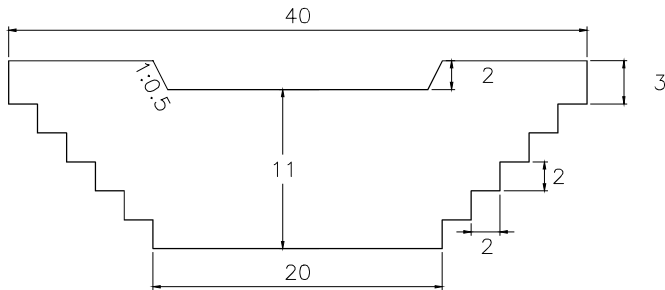

VOLUME: 2,260.50m<sup>3</sup> QUANTITY: 1

**CHECK DAM**

SCALE 1:500

# CHINCHA RIVER

## SUB BASIN 2-1

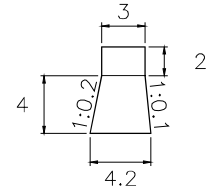
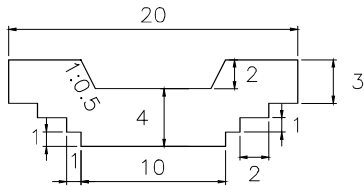

VOLUME: 216.00m<sup>3</sup> QUANTITY: 1

## SUB BASIN 2-2

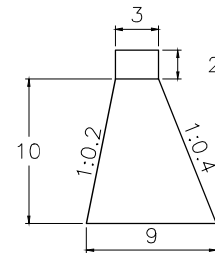
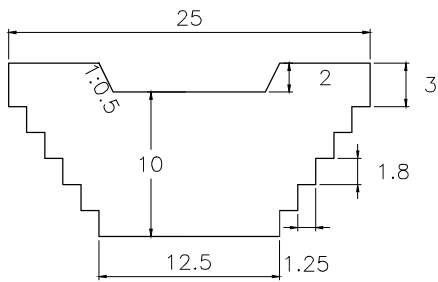

VOLUME: 1,125.00m<sup>3</sup> QUANTITY: 1

## SUB BASIN 3

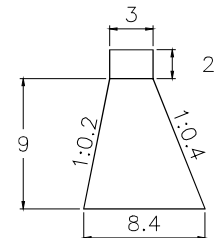
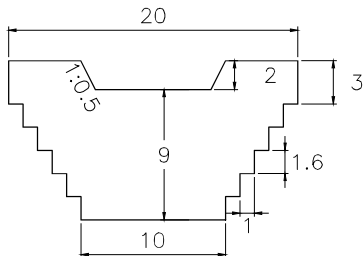

VOLUME: 769.50m<sup>3</sup> QUANTITY: 1

**CHECK DAM**

SCALE 1:500

# CHINCHA RIVER

## SUB BASIN 4

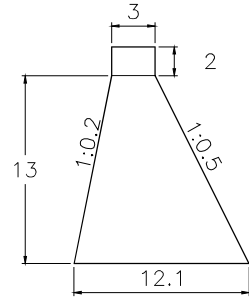
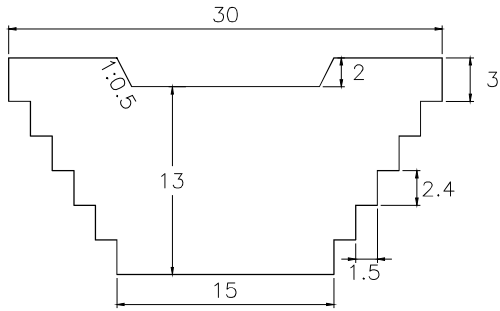

VOLUME: 2,208.38m<sup>3</sup> QUANTITY: 2

## SUB BASIN 4-1

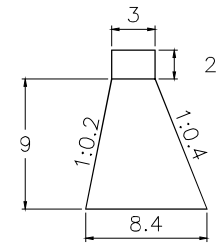
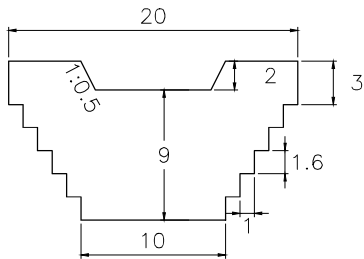

VOLUME: 769.50m<sup>3</sup> QUANTITY: 4

## SUB BASIN 5

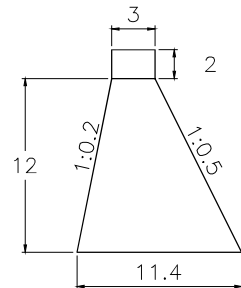
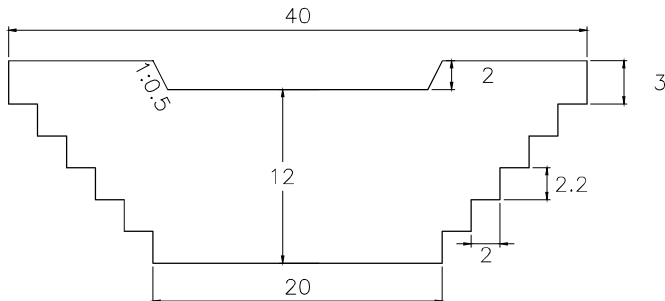

VOLUME: 2,592.00m<sup>3</sup> QUANTITY: 3

**CHECK DAM**

SCALE 1:500



# CHINCHA RIVER

## SUB BASIN 6

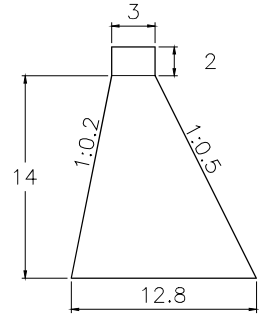
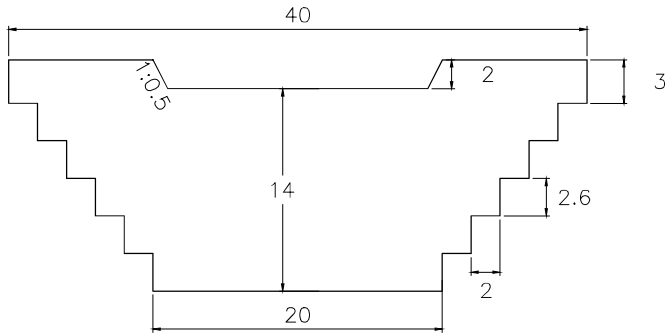

VOLUME: 3,318.00m<sup>3</sup> QUANTITY: 2

## SUB BASIN 7

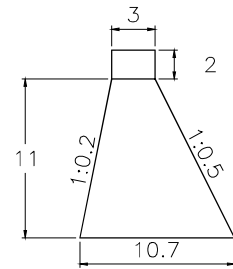
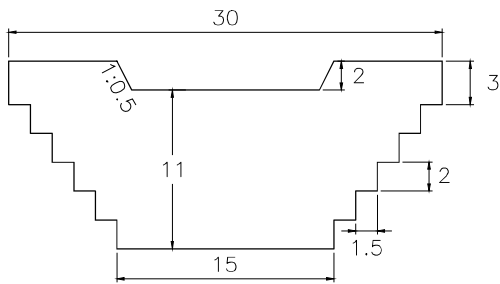

VOLUME: 1,695.38m<sup>3</sup> QUANTITY: 1

## SUB BASIN 7-1

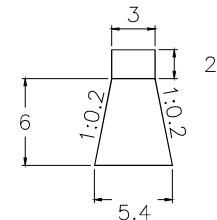
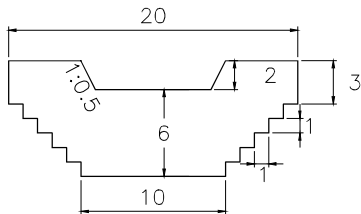

VOLUME: 378.00m<sup>3</sup> QUANTITY: 1

CHECK DAM

SCALE 1:500

# CHINCHA RIVER

## SUB BASIN 8

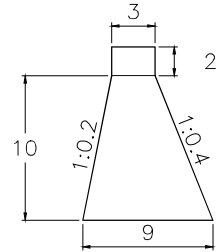
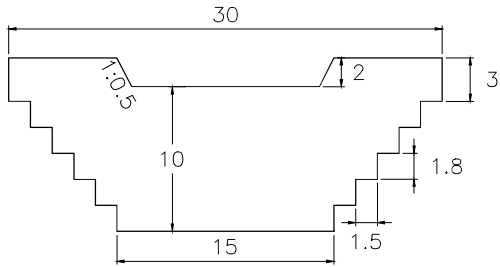

VOLUME: 1,350.00m<sup>3</sup> QUANTITY: 1

## SUB BASIN 9

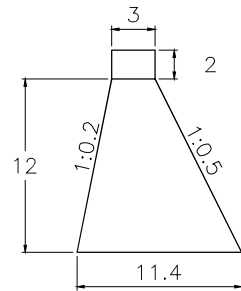
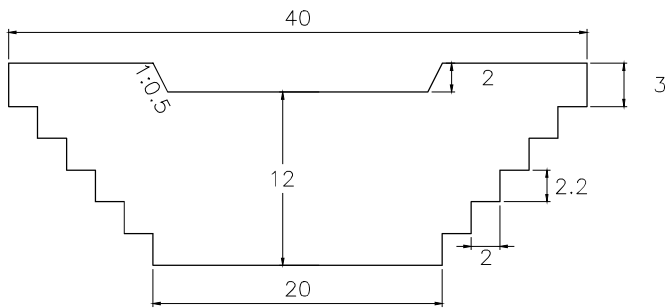

VOLUME: 2,592.00m<sup>3</sup> QUANTITY: 1

## SUB BASIN 9-1

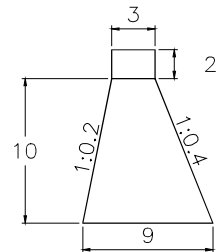
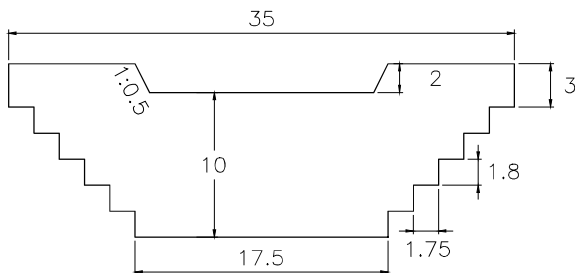

VOLUME: 1,575.00m<sup>3</sup> QUANTITY: 4

**CHECK DAM**

SCALE 1:500

# CHINCHA RIVER

## SUB BASIN 10

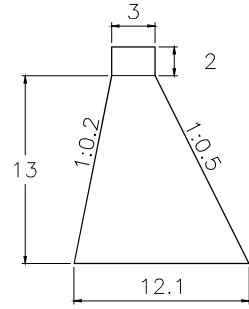
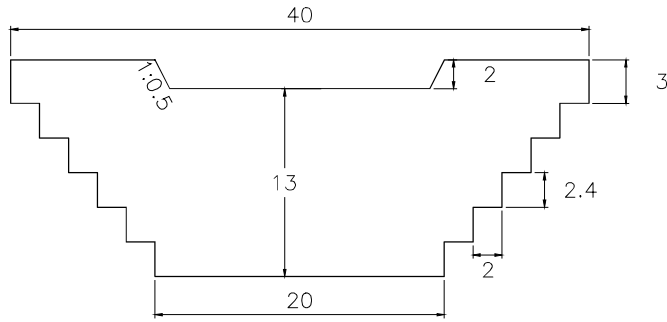

VOLUME: 2,944.50m<sup>3</sup> QUANTITY: 3

## SUB BASIN 10-1

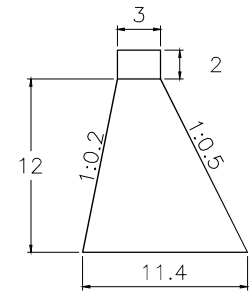
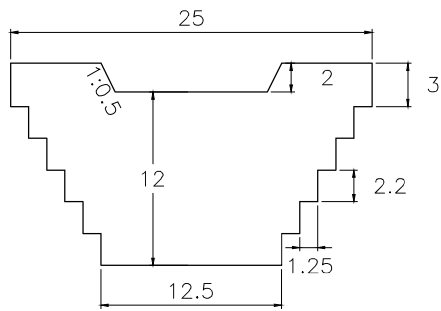

VOLUME: 1,620.00m<sup>3</sup> QUANTITY: 5

## SUB BASIN 11

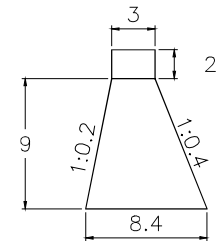
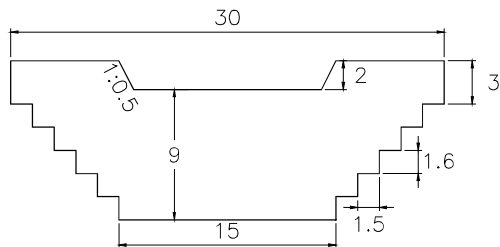

VOLUME: 1,154.25m<sup>3</sup> QUANTITY: 3

**CHECK DAM**

SCALE 1:500

# CHINCHA RIVER

## SUB BASIN 11-1

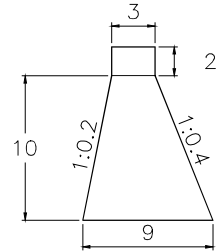
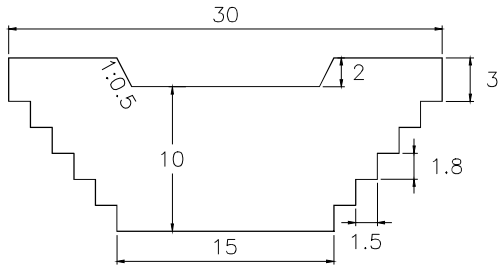

VOLUME: 1,350.00m<sup>3</sup> QUANTITY: 2

## SUB BASIN 12

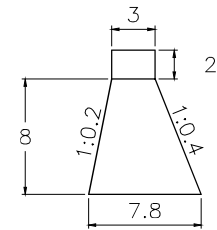
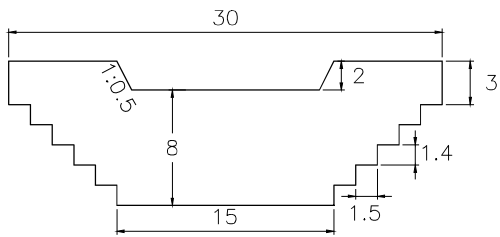

VOLUME: 972.00m<sup>3</sup> QUANTITY: 1

## SUB BASIN 12-1

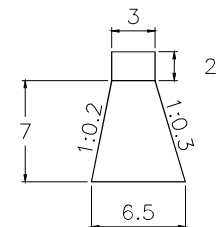
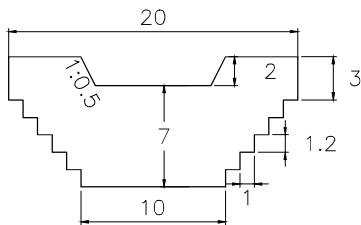

VOLUME: 498.75m<sup>3</sup> QUANTITY: 1

# CHECK DAM

SCALE 1:500

# CHINCHA RIVER

## SUB BASIN 13

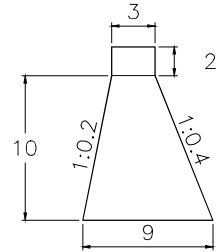
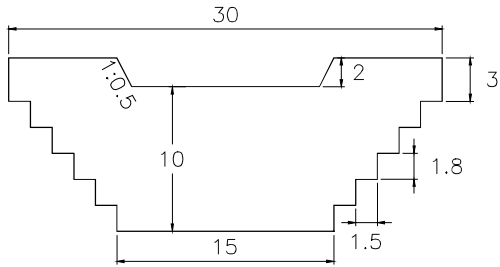

VOLUME: 1,350.00m<sup>3</sup> QUANTITY: 2

## SUB BASIN 14

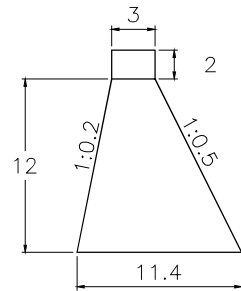
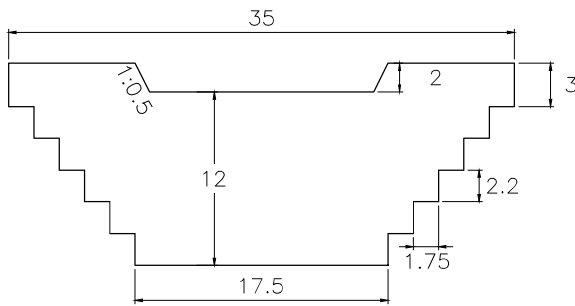

VOLUME: 2,268.00m<sup>3</sup> QUANTITY: 1

## SUB BASIN 14-1

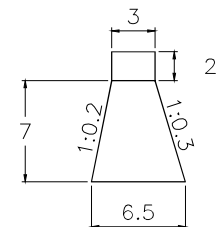
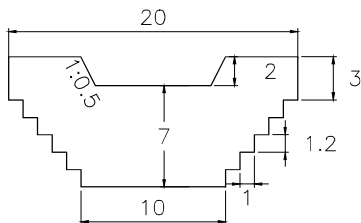

VOLUME: 498.75m<sup>3</sup> QUANTITY: 1

**CHECK DAM**

SCALE 1:500

# CHINCHA RIVER

## SUB BASIN 15

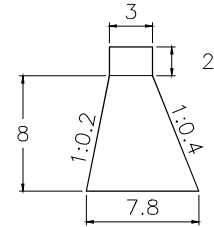
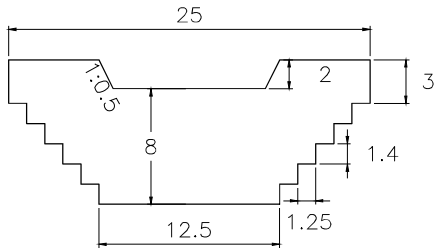

VOLUME: 810.00m<sup>3</sup> QUANTITY: 1

## SUB BASIN 16

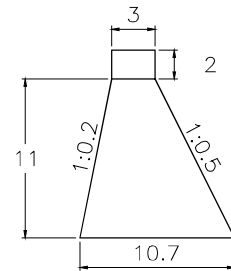
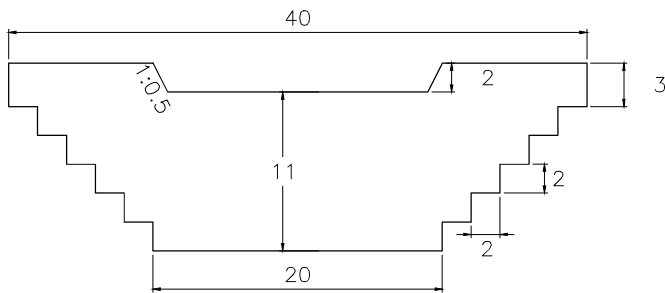

VOLUME: 2,260.50m<sup>3</sup> QUANTITY: 4

## SUB BASIN 16-1

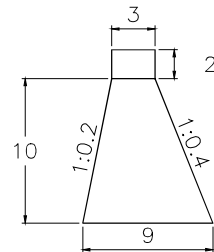
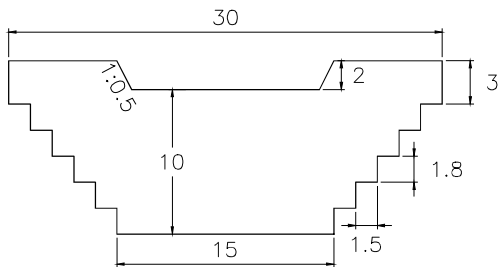

VOLUME: 1,350.00m<sup>3</sup> QUANTITY: 3

**CHECK DAM**

SCALE 1:500

# CHINCHA RIVER

## SUB BASIN 17

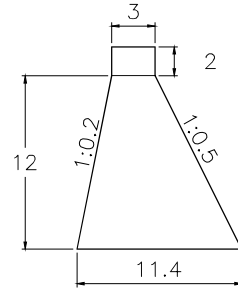
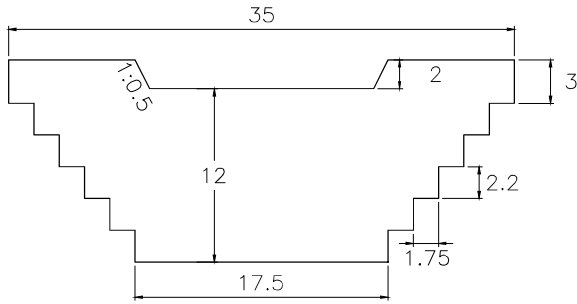

VOLUME: 2,268.00m<sup>3</sup> QUANTITY: 1

## SUB BASIN 18

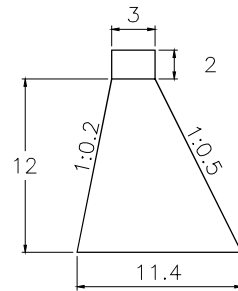
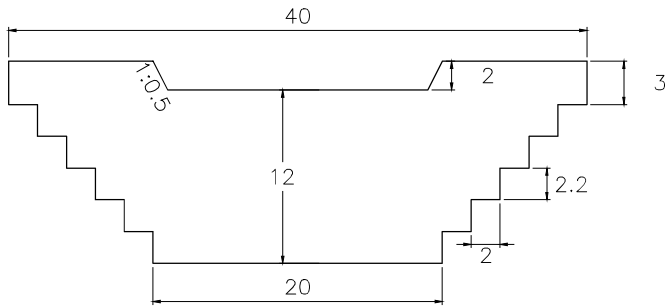

VOLUME: 2,592.00m<sup>3</sup> QUANTITY: 2

## SUB BASIN 18-1

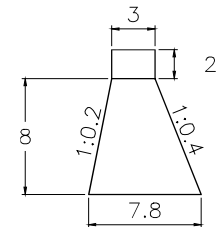
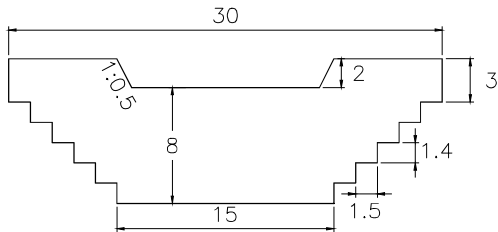

VOLUME: 972.00m<sup>3</sup> QUANTITY: 1

**CHECK DAM**

SCALE 1:500

# CHINCHA RIVER

## SUB BASIN 19

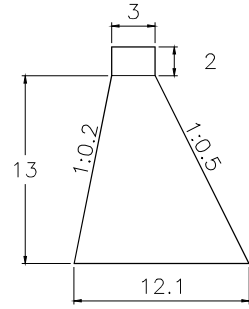
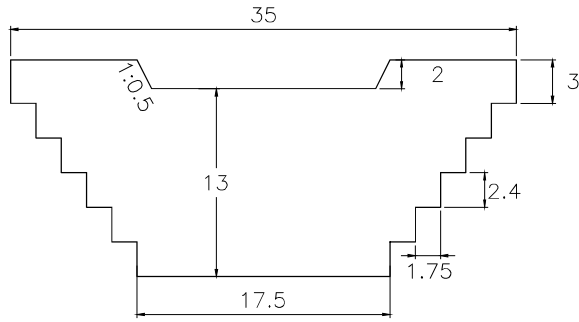

VOLUME: 2,576.44m<sup>3</sup> QUANTITY: 2

## SUB BASIN 20

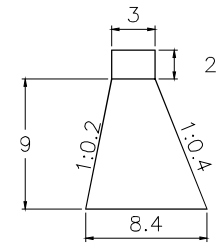
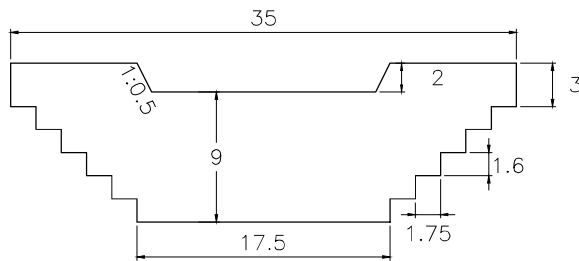

VOLUME: 1,346.63m<sup>3</sup> QUANTITY: 2

## SUB BASIN 20-1

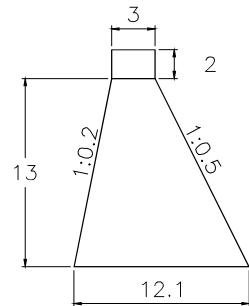
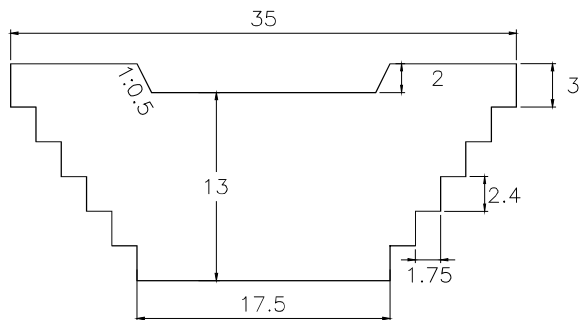

VOLUME: 2,576.44m<sup>3</sup> QUANTITY: 3

**CHECK DAM**

SCALE 1:500



# CHINCHA RIVER

## SUB BASIN 21

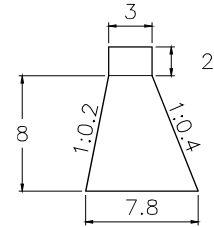
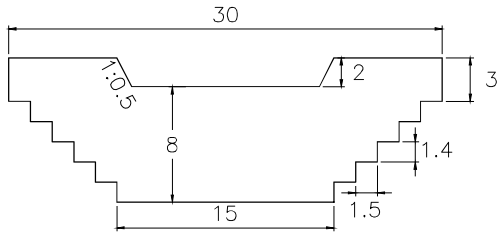

VOLUME: 972.00m<sup>3</sup> QUANTITY: 1

## SUB BASIN 21-1

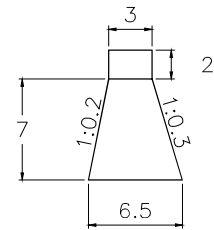
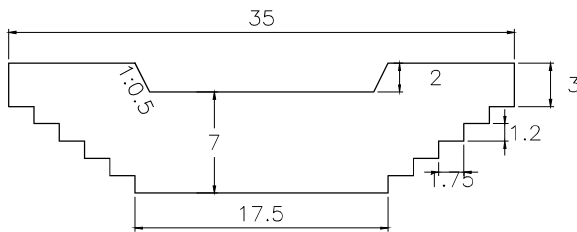

VOLUME: 872.81m<sup>3</sup> QUANTITY: 2

## SUB BASIN 22

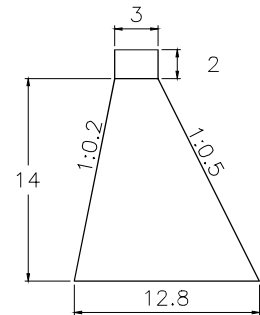
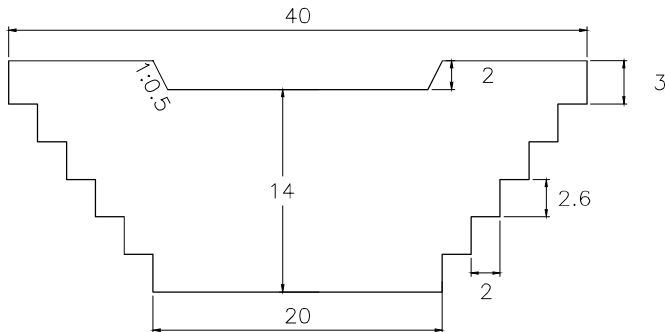

VOLUME: 3,318.00m<sup>3</sup> QUANTITY: 4

**CHECK DAM**

SCALE 1:500

# CHINCHA RIVER

## SUB BASIN 22-1

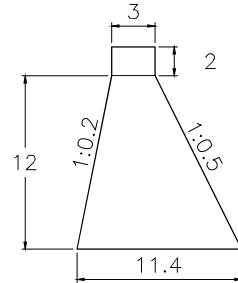
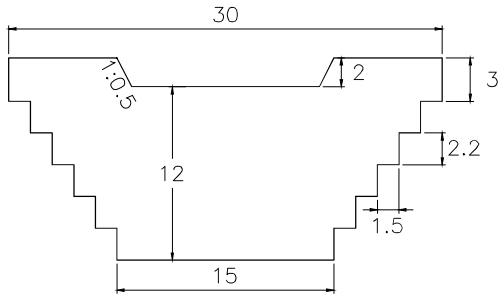

VOLUME: 1,944.00m<sup>3</sup> QUANTITY: 3

## SUB BASIN 23

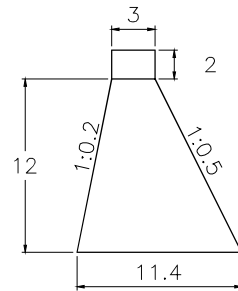
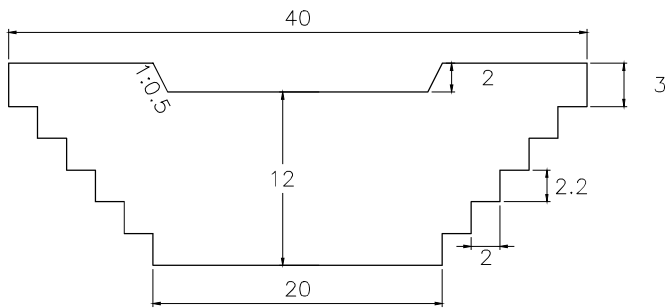

VOLUME: 2,592.00m<sup>3</sup> QUANTITY: 2

## SUB BASIN 23-1

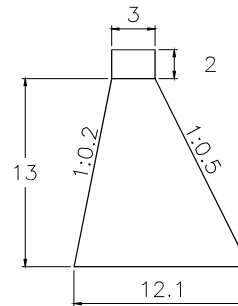
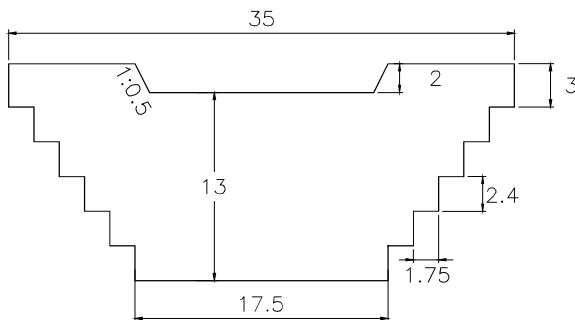

VOLUME: 2,576.44m<sup>3</sup> QUANTITY: 3

**CHECK DAM**

SCALE 1:500

# CHINCHA RIVER

## SUB BASIN 25

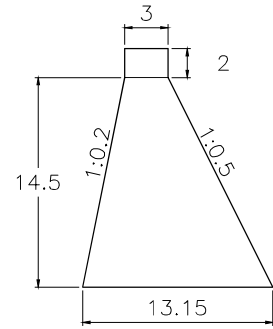
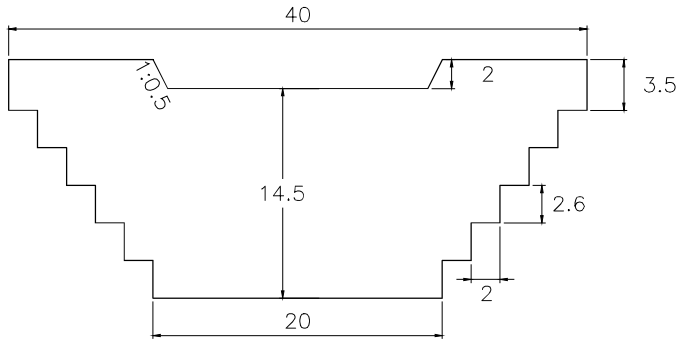

VOLUME: 3,512.70m<sup>3</sup> QUANTITY: 4

## SUB BASIN 25-1

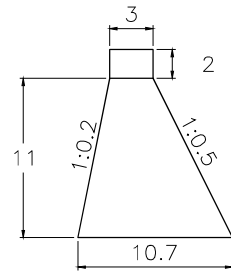
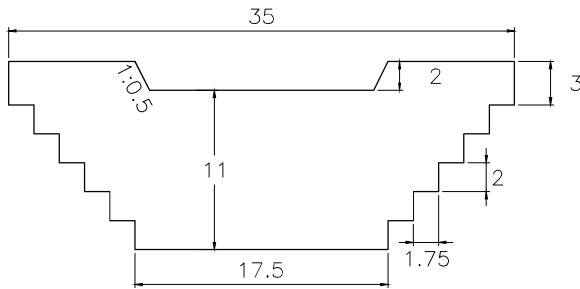

VOLUME: 1,977.94m<sup>3</sup> QUANTITY: 3

## SUB BASIN 26

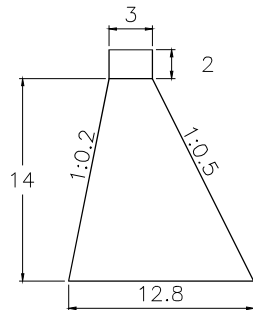
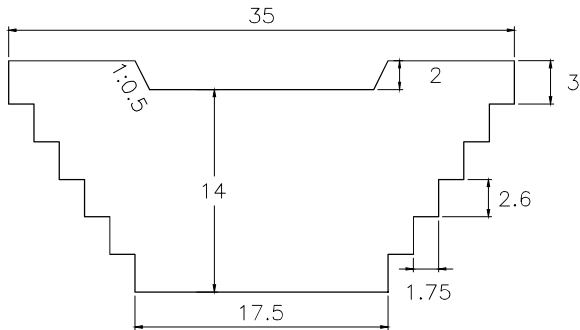

VOLUME: 2,903.25m<sup>3</sup> QUANTITY: 3

**CHECK DAM**

SCALE 1:500

# CHINCHA RIVER

## SUB BASIN 27

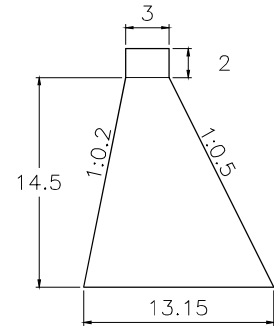
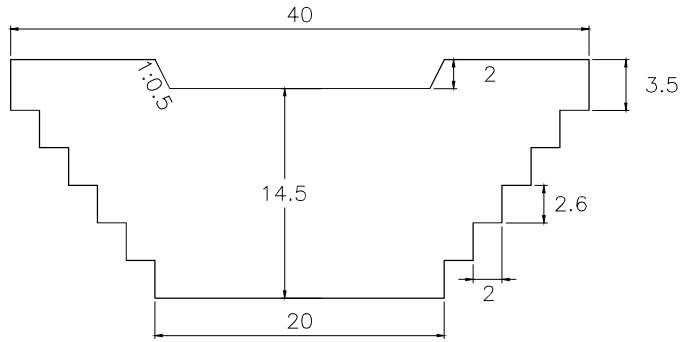

VOLUME: 3,512.70m<sup>3</sup> QUANTITY: 8

## SUB BASIN 27-1

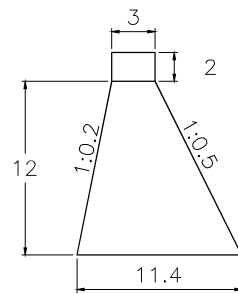
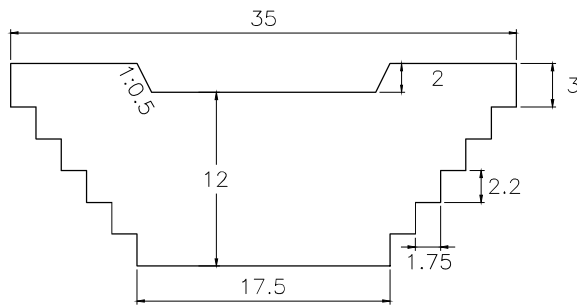

VOLUME: 2,268.00m<sup>3</sup> QUANTITY: 3

## SUB BASIN 28

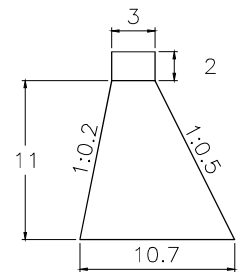
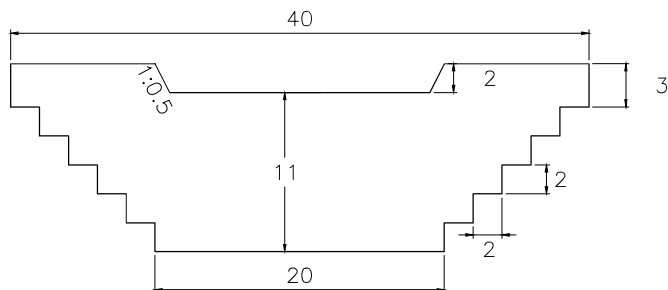

VOLUME: 2,260.50m<sup>3</sup> QUANTITY: 1

**CHECK DAM**

SCALE 1:500

# CHINCHA RIVER

## SUB BASIN 28-1

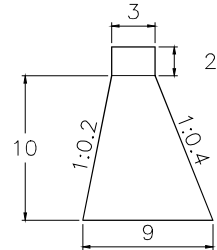
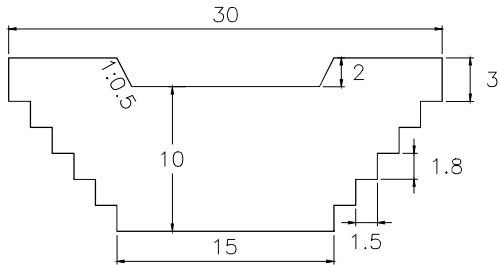

VOLUME: 1,350.00m<sup>3</sup> QUANTITY: 3

## SUB BASIN 29

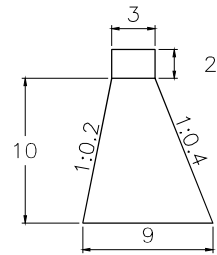
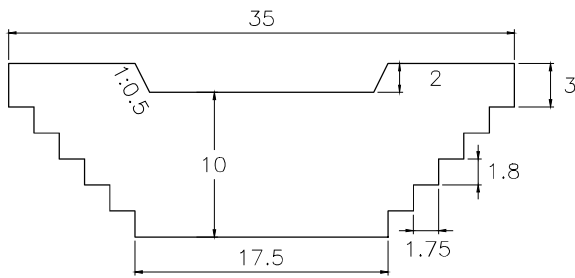

VOLUME: 1,575.00m<sup>3</sup> QUANTITY: 1



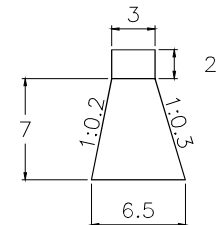
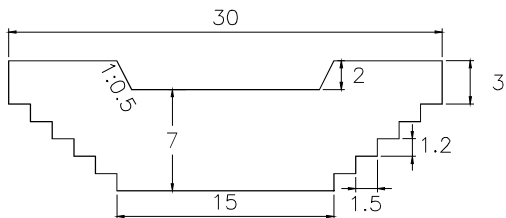

## SUB BASIN 29-1



VOLUME: 748.13m<sup>3</sup> QUANTITY: 2

**CHECK DAM**

SCALE 1:500

LEGEND		
FIGURE	COUNTER MEASURE	QUANTITY
	CHECK DAM	72
	CHECK DAM PRIORITY	106
	REVENT WORK	268.62 km
	CENOZOIC ZONE	

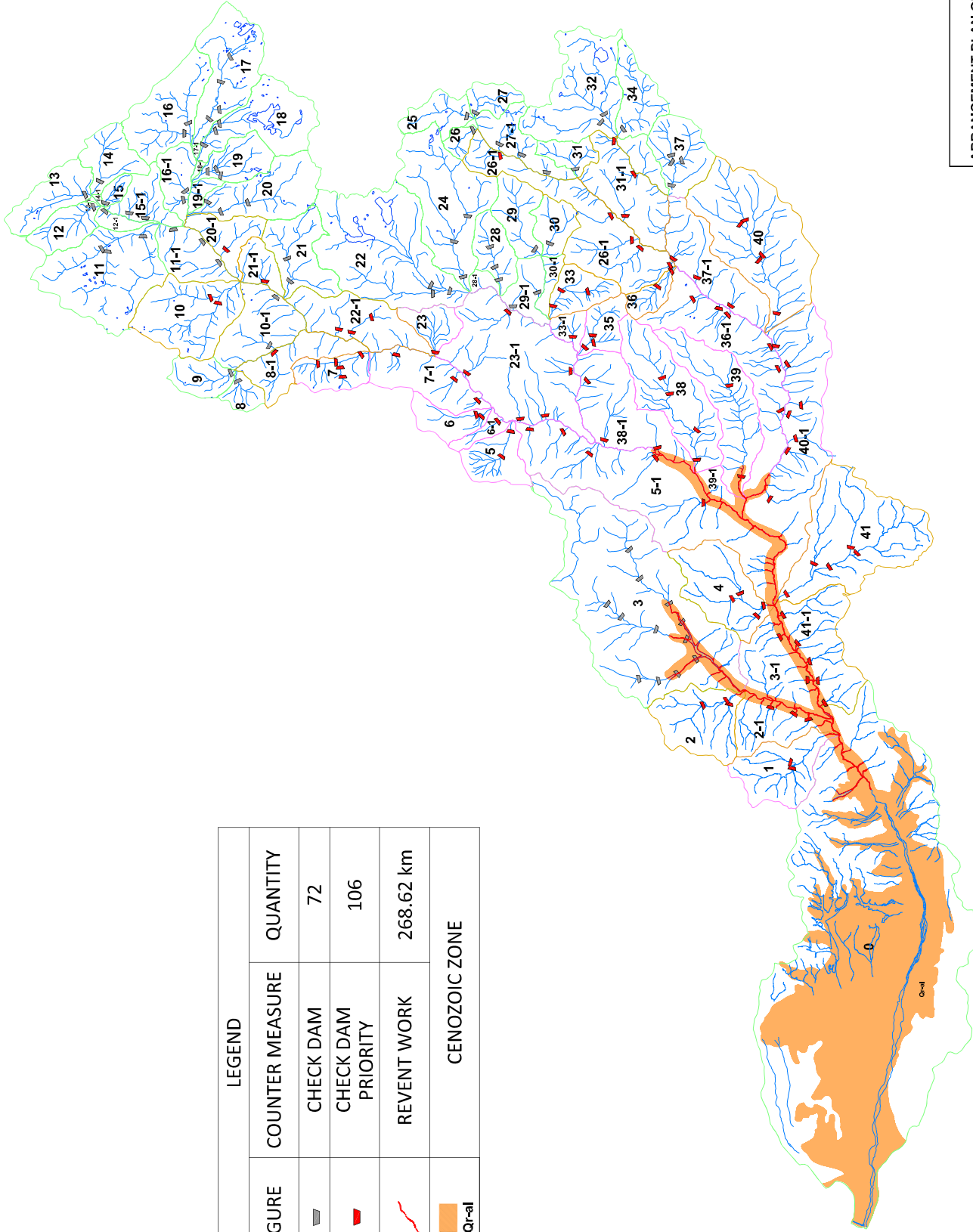

ARRANGEMENT PLAN OF COUNTERMEASURE  
 PISCO BASIN  
 SCALE 1:400 000

1:400 000 0 8,00 16,00 24,00 32,00 40,00 km