

7. その他資料・情報

資料 7-1 貫入試験結果

(1) コンセプション地点

本調査では、発電所計画位置にて、簡易の土質試験（貫入試験）を実施した。

実施日：2012年8月27日 実施場所：発電所計画位置（既設エアレーター南側）

使用規格：ASTM1586



コンセプション発電所地点 No.1



貫入試験用機材



貫入試験用機材



コア 0~0.5m



コア 0~3.0m

コンセプション発電所地点 No.2



貫入試験用機材



貫入試験用機材



コア 0~0.5m



表層の風化岩

Cliente: **NEW JEC**

Proyecto: **CASA DE MAQUINAS REPRESA LA CONCEPCION**

PERFORACION No. 1

Localizacion: **RES. VILLAS DE CONCEPCION, TEGUCIGALPA, HONDURAS.**

Hoja: **1**

Ubicacion:

Jefe de Perforacion: **NAHUN RIVERA**

Angulo de perforacion: **VERTICAL**

Fecha: **17 / 09 / 2012**

Perforado por: **WILSON ORDONEZ**

Longitud total: **3.00 M**

Hoja: **1**

Perforadora: **ACKER 2**

Ademe: **NO**

| Profundidad (m) | Nivel Freatico | Simbologia | Descripcion | Grafico SPT N60 | | | | Golpes | Limite Liquido | Limite Plastico | Indice de Plasticidad | % Humedad |
|-----------------|----------------|------------|---|-----------------|----|----|-----|--------|----------------|-----------------|-----------------------|-----------|
| | | | | 20 | 40 | 60 | 80 | | | | | |
| 0.00 | | | <p>SC Arena con traza de grava y con finos plásticos de color rosado, con consistencia muy densa, húmeda. Peso específico = 1653kg/m³ Angulo de fricción = 32° Cohesión = 0.15kg/cm²</p> | | | | | | | | | |
| 0.50 | | | <p>土の種類 : SC (小石交じりの砂、粘土粉、赤色) 打撃回数 : 88 回 密度 : 1.65g/cm³ 摩擦角 : 32°、粘着力 : 0.15kg/cm² 含水比 : 12%</p> | | | | 88 | 44 | 23 | 21 | 12 | |
| 1.00 | | | | | | | | | | | | |
| 1.50 | | | | | | | | | | | | |
| 2.00 | | | | | | | | | | | | |
| 2.50 | | | | | | | | | | | | |
| 3.00 | | | | | | | | | | | | |
| 0.00 | | | <p>SP Arena con grava y con traza de finos no plásticos de color rosado, con consistencia muy densa, con poca humedad. Peso específico = 1735kg/m³ Angulo de fricción = 34°</p> | | | | | | | | | |
| 0.50 | | | <p>土の種類 : SP (砂と小石、赤色) 打撃回数 : 100 回 密度 : 1.73g/cm³ 摩擦角 : 34°</p> | | | | 100 | 44 | 23 | 21 | 12 | |
| 1.00 | | | | | | | | | | | | |
| 1.50 | | | | | | | | | | | | |
| 2.00 | | | | | | | | | | | | |
| 2.50 | | | | | | | | | | | | |
| 3.00 | | | | | | | | | | | | |
| 3.50 | | | | | | | | | | | | |
| 4.00 | | | | | | | | | | | | |
| 4.50 | | | | | | | | | | | | |
| 5.00 | | | | | | | | | | | | |
| 5.50 | | | | | | | | | | | | |
| 6.00 | | | | | | | | | | | | |
| 6.50 | | | | | | | | | | | | |
| 7.00 | | | | | | | | | | | | |
| 7.50 | | | | | | | | | | | | |
| 8.00 | | | | | | | | | | | | |
| 8.50 | | | | | | | | | | | | |
| 9.00 | | | | | | | | | | | | |
| 9.50 | | | | | | | | | | | | |
| 10.00 | | | | | | | | | | | | |
| 10.50 | | | | | | | | | | | | |
| 11.00 | | | | | | | | | | | | |
| 11.50 | | | | | | | | | | | | |
| 12.00 | | | | | | | | | | | | |
| 12.50 | | | | | | | | | | | | |
| 13.00 | | | | | | | | | | | | |
| 13.50 | | | | | | | | | | | | |
| 14.00 | | | | | | | | | | | | |
| 14.50 | | | | | | | | | | | | |
| 15.00 | | | | | | | | | | | | |
| 15.50 | | | | | | | | | | | | |
| 16.00 | | | | | | | | | | | | |
| 16.50 | | | | | | | | | | | | |
| 17.00 | | | | | | | | | | | | |
| 17.50 | | | | | | | | | | | | |
| 18.00 | | | | | | | | | | | | |
| 18.50 | | | | | | | | | | | | |
| 19.00 | | | | | | | | | | | | |
| 19.50 | | | | | | | | | | | | |
| 20.00 | | | | | | | | | | | | |
| 20.50 | | | | | | | | | | | | |
| 21.00 | | | | | | | | | | | | |
| 21.50 | | | | | | | | | | | | |
| 22.00 | | | | | | | | | | | | |
| 22.50 | | | | | | | | | | | | |
| 23.00 | | | | | | | | | | | | |
| 23.50 | | | | | | | | | | | | |
| 24.00 | | | | | | | | | | | | |
| 24.50 | | | | | | | | | | | | |
| 25.00 | | | | | | | | | | | | |
| 25.50 | | | | | | | | | | | | |
| 26.00 | | | | | | | | | | | | |
| 26.50 | | | | | | | | | | | | |
| 27.00 | | | | | | | | | | | | |
| 27.50 | | | | | | | | | | | | |
| 28.00 | | | | | | | | | | | | |
| 28.50 | | | | | | | | | | | | |
| 29.00 | | | | | | | | | | | | |
| 29.50 | | | | | | | | | | | | |
| 30.00 | | | | | | | | | | | | |
| 30.50 | | | | | | | | | | | | |
| 31.00 | | | | | | | | | | | | |
| 31.50 | | | | | | | | | | | | |
| 32.00 | | | | | | | | | | | | |
| 32.50 | | | | | | | | | | | | |
| 33.00 | | | | | | | | | | | | |
| 33.50 | | | | | | | | | | | | |
| 34.00 | | | | | | | | | | | | |
| 34.50 | | | | | | | | | | | | |
| 35.00 | | | | | | | | | | | | |
| 35.50 | | | | | | | | | | | | |
| 36.00 | | | | | | | | | | | | |
| 36.50 | | | | | | | | | | | | |
| 37.00 | | | | | | | | | | | | |
| 37.50 | | | | | | | | | | | | |
| 38.00 | | | | | | | | | | | | |
| 38.50 | | | | | | | | | | | | |
| 39.00 | | | | | | | | | | | | |
| 39.50 | | | | | | | | | | | | |
| 40.00 | | | | | | | | | | | | |
| 40.50 | | | | | | | | | | | | |
| 41.00 | | | | | | | | | | | | |
| 41.50 | | | | | | | | | | | | |
| 42.00 | | | | | | | | | | | | |
| 42.50 | | | | | | | | | | | | |
| 43.00 | | | | | | | | | | | | |
| 43.50 | | | | | | | | | | | | |
| 44.00 | | | | | | | | | | | | |
| 44.50 | | | | | | | | | | | | |
| 45.00 | | | | | | | | | | | | |
| 45.50 | | | | | | | | | | | | |
| 46.00 | | | | | | | | | | | | |
| 46.50 | | | | | | | | | | | | |
| 47.00 | | | | | | | | | | | | |
| 47.50 | | | | | | | | | | | | |
| 48.00 | | | | | | | | | | | | |
| 48.50 | | | | | | | | | | | | |
| 49.00 | | | | | | | | | | | | |
| 49.50 | | | | | | | | | | | | |
| 50.00 | | | | | | | | | | | | |
| 50.50 | | | | | | | | | | | | |
| 51.00 | | | | | | | | | | | | |
| 51.50 | | | | | | | | | | | | |
| 52.00 | | | | | | | | | | | | |
| 52.50 | | | | | | | | | | | | |
| 53.00 | | | | | | | | | | | | |
| 53.50 | | | | | | | | | | | | |
| 54.00 | | | | | | | | | | | | |
| 54.50 | | | | | | | | | | | | |
| 55.00 | | | | | | | | | | | | |
| 55.50 | | | | | | | | | | | | |
| 56.00 | | | | | | | | | | | | |
| 56.50 | | | | | | | | | | | | |
| 57.00 | | | | | | | | | | | | |
| 57.50 | | | | | | | | | | | | |
| 58.00 | | | | | | | | | | | | |
| 58.50 | | | | | | </ | | | | | | |

Ciente: **NEW JEC**

Proyecto: **CASA DE MAQUINAS REPRESA LA CONCEPCION**

PERFORACION No. 2

Localizacion: **RES. VILLAS DE CONCEPCION, TEGUCIGALPA, HONDURAS.**

Hoja: **1**

Ubicacion:

Jefe de Perforacion: **NAHUN RIVERA**

Angulo de perforacion: **VERTICAL**

Fecha: **17 / 09 / 2012**

Perforado por: **WILSON ORDONEZ**

Longitud total: **3.00 M**

Hoja: **1**

Perforadora: **ACKER 2**

Ademe: **NO**

| Profundidad (m) | Nivel Freatico | Simbologia | Descripcion | Grafico SPT N60 | | | | Golpes | Limite Liquido | Limite Plastico | Indice de Plasticidad | % Humedad |
|-----------------|----------------|------------|---|-----------------|----|----|----|--------|----------------|-----------------|-----------------------|-----------|
| | | | | 20 | 40 | 60 | 80 | | | | | |
| 0 | | | <p>SM Arena con grava y con finos plásticos de color rosado, con consistencia media, húmeda. Peso específico = 1748kg/m³ Angulo de fricción = 30° Cohesión = 0.14kg/cm²</p> <p>土の種類 : SM (小石交じりの砂、粘土粉、赤色) 打撃回数 : 31 回 密度 : 1.75g/cm³ 摩擦角 : 30°、粘着力 : 0.14kg/cm² 含水比 : 19%</p> | | | | | | | | | |
| 1 | | | <p>SP-SM Arena con traza de grava y con finos no plásticos de color rosado, con consistencia muy densa, húmeda. Peso específico = 1572kg/m³ Angulo de fricción = 33°</p> <p>土の種類 : SP-SM (小石交じりの砂、赤色) 打撃回数 : 100 回 密度 : 1.57g/cm³ 含水比 : 6% 摩擦角 : 33°</p> | | | | | 31 | 48 | 31 | 17 | 19 |
| 2 | | | <p>TOBA Roca suave de color rosado siendo clasificada como toba volcánica.</p> <p>凝灰岩 打撃回数 : 100 回 深度 2.00m で凝灰岩が出た。</p> | | | | | 100 | NP | NP | NP | 6 |
| 3 | | | | | | | | 100 | | | | |

(2) ピカチヨ地点

本調査では、発電所計画位置にて、簡易の土質試験（貫入試験）を実施した。

実施日：2012年8月28日

実施場所：発電所計画位置（浄水場からの配水管 L22 路線近く）

使用規格：ASTM1586



| Sondeo | Ubicación | |
|--------|------------------|------------------|
| 1 | N 14° 06' 52.46" | W 87° 11' 38.18" |
| 2 | N 14° 06' 52.64" | W 87° 11' 38.19" |

ピカチヨ発電所地点 No.1



貫入試験用機材



貫入試験用機材



コア 0~0.5m



コア 1~1.5m

ピカチヨ発電所地点 No.2



貫入試験用機材



貫入試験用機材



コア 0~0.5m



コア 1~1.5m

Cliete: **NEW JEC**

Proyecto: **CASA DE MAQUINAS EL PICACHO**

PERFORACION No. 1

Localizacion: **SUBIDA A CASAMATA, FINAL LINEA DE CONDUCCION EL PICACHO**

Hoja: **1**

Ubicacion:

Jefe de Perforacion: **NAHUN RIVERA**

Angulo de perforacion: **VERTICAL**

Fecha: **17 / 09 / 2012**

Perforado por: **WILSON ORDONEZ**

Longitud total: **3.00 M**

Hoja: **1**

Perforadora: **SPT**

Ademe: **NO**

| Profundidad (m) | Nivel Freatico | Simbologia | Descripcion | Grafico SPT N60 | | | | Golpes | Limite Liquido | Limite Plastico | Indice de Plasticidad | % Humedad |
|-----------------|----------------|------------|---|-----------------|----|----|----|--------|----------------|-----------------|-----------------------|-----------|
| | | | | 20 | 40 | 60 | 80 | | | | | |
| 0 | | | <p>SM Arena con traza de grava y con finos plasticos de color café, con consistencia muy suelta, muy húmeda. Peso especifico = 1844kg/m³</p> <p>土の種類 : SM (小石交じりの砂、粘土粉、褐色) 打撃回数 : 2回 密度 : 1.84g/cm³ 含水比 : 30%</p> | | | | | | | | | |
| 1 | | | <p>SC Arena con traza de grava y con finos plasticos de color café, con consistencia muy densa, muy húmeda. Peso especifico = 1668kg/m³ Angulo de fricción = 33° Cohesión = 0.11kg/cm²</p> <p>土の種類 : SC (小石交じりの砂、粘土粉、褐色) 打撃回数 : 70回 密度 : 1.67g/cm³ 含水比 : 18% 摩擦角 : 33°、粘着力 : 0.11kg/cm²</p> | | | | | 2 | 46 | 31 | 15 | 30 |
| 2 | | | <p>TOBA Roca suave de color blanco siendo clasificada como toba volcanica.</p> <p>凝灰岩、打撃回数 : 100回 深度 1.8m で、凝灰岩が出た。</p> | | | | | 70 | 53 | 27 | 26 | 18 |
| 3 | | | | | | | | 100 | | | | |

Cliente: **NEW JEC**

Proyecto: **CASA DE MAQUINAS EL PICACHO**

PERFORACION No. 2

Localizacion: **SUBIDA A CASAMATA, FINAL LINEA DE CONDUCCION EL PICACHO**

Hoja: 1

Ubicacion:

Jefe de Perforacion: **NAHUN RIVERA**

Angulo de perforacion: **VERTICAL**

Fecha: **17 / 09 / 2012**

Perforado por: **WILSON ORDONEZ**

Longitud total: **3.00 M**

Hoja: 1

Perforadora: **SPT**

Ademe: **NO**

| Profundidad (m) | Nivel Freatico | Simbologia | Descripcion | Grafico SPT N60 | | | | Golpes | Limite Liquido | Limite Plastico | Indice de Plasticidad | % Humedad |
|-----------------|----------------|------------|--|-----------------|----|----|----|--------|----------------|-----------------|-----------------------|-----------|
| | | | | 20 | 40 | 60 | 80 | | | | | |
| 0.0 - 0.8 | | | SM Arena con traza de grava y con finos plásticos de color café, con consistencia suelta, muy húmeda. Peso específico = 1796kg/m³ Clasificación = SM 土の種類 : SM (小石交じりの粘土粉、褐色) 打撃回数 : 6 回 密度 : 1.80g/cm³ 含水比 : 24% | | | | | 6 | 51 | 33 | 18 | 24 |
| 0.8 - 1.55 | | | SC Arena con traza de grava y con finos plásticos de color café claro, con consistencia muy densa, muy húmeda. Peso específico = 1780kg/m³ Angulo de fricción = 32° Cohesión = 0.14kg/cm² 土の種類 : SC (小石交じりの砂、粘土粉、褐色) 打撃回数 : 64 回 密度 : 1.78g/cm³ 含水比 : 22%、 摩擦角 : 32°、粘着力 : 0.14kg/cm² | | | | | 64 | 48 | 26 | 22 | 22 |
| 1.55 - 3.00 | | | TOBA Roca suave de color blanco siendo clasificada como toba volcánica. 凝灰岩、打撃回数 : 100 回 深度 1.55m で、凝灰岩が出た。 | | | | | 100 | | | | |

資料 7-2 水圧試験結果（コンセプション地点）

2011年11月に行われた事前調査で、管路全長約6km（管径1,100mm、900mm）の導水路では、管路終点近く、発電所設置予定箇所で水圧が大きく減少することが指摘されている。今回の調査では、それを確認するため、既設導水路上の4箇所と同時に水圧測定を行った。

コンセプション 水圧テスト

1.実施日 2012/8/23

2.測定位置：添付図参照

| No. | Location | Point (km) | Remark |
|-----|-----------|------------|--------------------|
| P1 | Aerator | (+5+500) | φ900 |
| P2 | PI-69BN | (+4+400) | φ900 |
| P3 | PI-64AN | (+3+600) | φ900 |
| - | Manhole 2 | (+3+100) | Divert Option No.2 |
| - | PI-58 | (+2+950) | φ900 start point |
| - | PC | (+2+700) | Divert Option No.1 |
| P4 | PI-46 | (+2+200) | φ1,100 |

3.実施者：SANAA

4.実施結果 2012/8/23

| | Pressure (Bar) | | | | Remark | 2011/11/17 |
|------------------|----------------|----------|----------|----------|--------------|----------------|
| | Aerator | PI-69BN | PI-64AN | PI-46 | | Pressure (Bar) |
| Flow (lit./sec.) | Point 1 | Point 2 | Point 3 | Point 4 | | Aerator |
| distance in m | 6,243 | 4,306 | 3,592 | 2,172 | | Point 1 |
| diameter in mm | 900 | 900 | 900 | 1,100 | | 900 |
| EL in m | 1,117.78 | 1,117.00 | 1,116.35 | 1,081.25 | | 1,117.78 |
| 0 | 3.55 | 3.40 | 3.10 | 6.50 | バルブ隙間から漏れ有り。 | 3.60 |
| 200 | 3.50 | 3.40 | 3.10 | 6.40 | | |
| 400 | 3.40 | 3.20 | 3.00 | 6.40 | | 3.50 |
| 600 | 3.00 | 2.90 | 2.70 | 6.30 | | 3.10 |
| 800 | 2.35 | 2.40 | 2.40 | 6.20 | | 2.70 |
| 1,000 | 1.65 | 1.90 | 2.00 | 6.10 | | |
| 1,200 | 1.20 | 1.70 | 1.80 | 6.10 | | 0.95 |
| 1,300 | 1.10 | 1.60 | 1.80 | 6.10 | | |
| 1,500 | 0.10 | 0.90 | 1.30 | 5.40 | | 0.00 |



貫入試験の状況（コンセプション地点）



水圧0（発電所計画地点。流量：1,500ℓ/sec.）
（コンセプション地点）

Fig Discharge vs Head Loss at ST3600 (Existing pipeline)

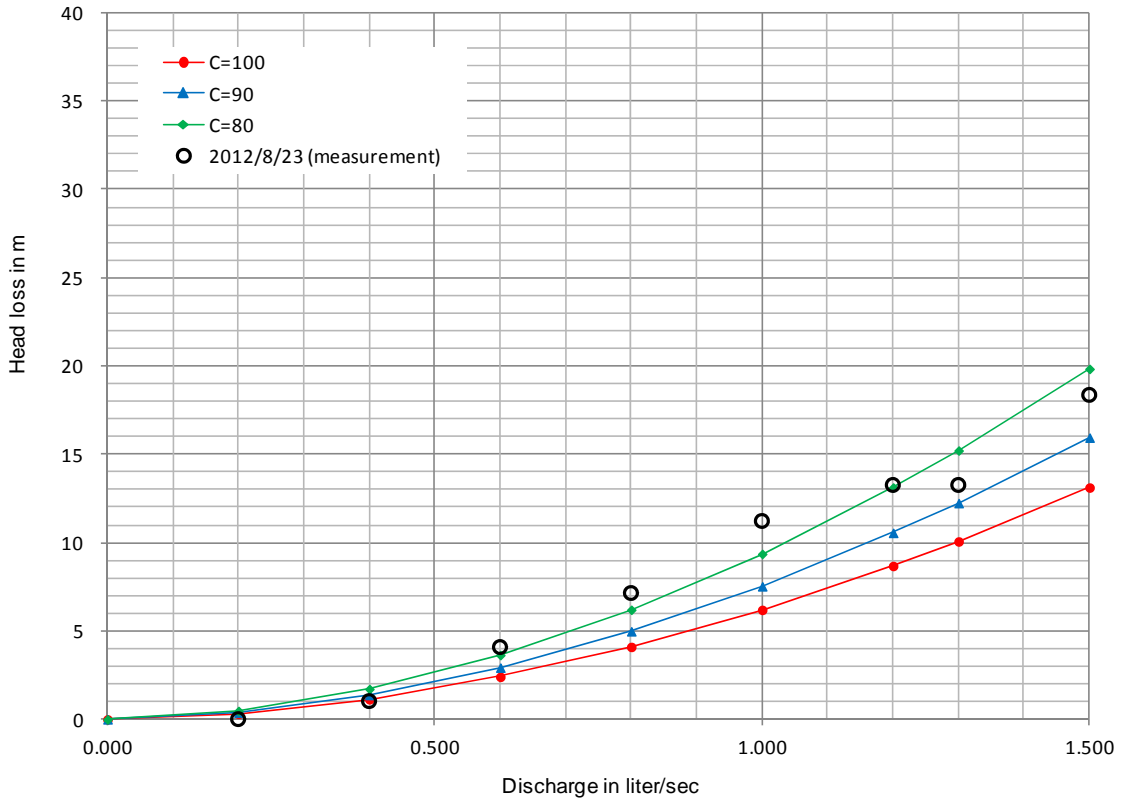
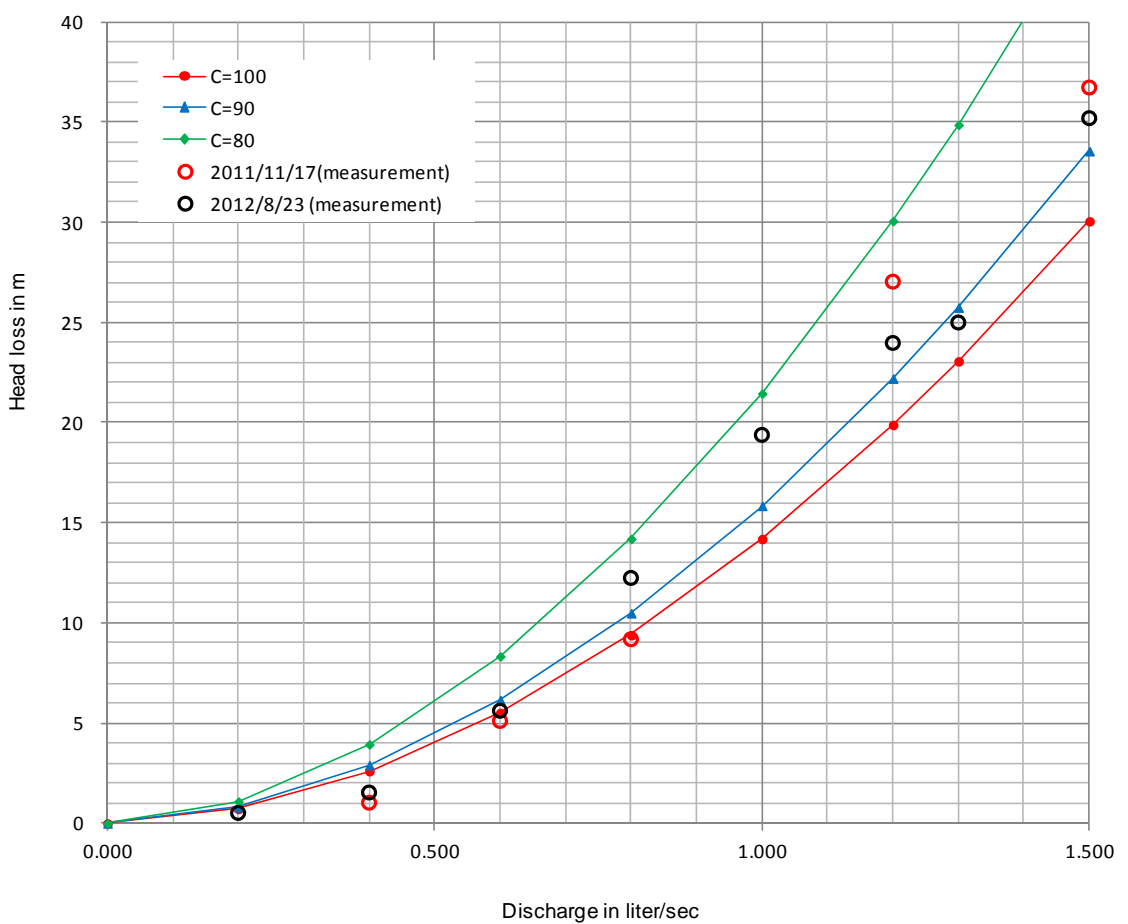

Fig Discharge vs Total Head Loss at Aearator (Existing pipeline)



資料 7-3 流量及び圧力測定結果（ピカチヨ地点）

ピカチヨ浄水場から送水している配水管のうち L22 系統管路（管径φ400mm）を使って発電する計画である。2011 年 11 月に実施された事前調査では L22 系統管路で流量測定が行われていない。今回の調査で L22 系統管路の送水量を確認するため、流量測定を実施した。SANAA には、各配水系統毎の配水量のデータが残されていない。通常の送水量の調整は、浄水場のマニホールドのバルブを調整して行っている。また、浄水場流出部には、各配水系統に流量計が設置されているが、調査時にはキャリブレーションがされておらず測定不能であった。

- 1.日時 2012 年 8 月 24 日（金）16 時～17 時
- 2.場所 リンデロ配水池入口
- 3.測定者 SANAA（水量測定ラボ業者の立会い）
- 4.測定関連 器具：超音波流量計 PT878（メーカーGE）
測定管：ダクタイル鋳鉄管 φ300（12 インチ）
測定位置：配水池流入前の直線区間（管 1 本分（6m）以上）

5.測定結果

| 時間 | 流速 (m/s) | 流量(m ³ /hr) | 流量(lit./sec) | ピカチヨ浄水場バルブ回転数 |
|-------|----------|------------------------|--------------|---------------|
| 16:07 | 1.85 | 472.81 | 131.34 | 12 |
| 16:08 | 1.83 | 466.75 | 129.65 | 12 |
| 16:09 | 1.83 | 466.30 | 129.53 | 12 |
| 16:10 | 1.87 | 474.41 | 131.78 | 12 |
| 16:11 | 1.92 | 487.93 | 135.54 | 12 |
| 16:12 | 1.94 | 494.13 | 137.26 | 12 |
| 16:13 | 2.00 | 508.45 | 141.24 | 12 |
| 16:15 | 2.16 | 549.84 | 152.73 | 12 |
| | | mean | 136.13 | |
| | | max | 152.73 | |
| | | min | 129.53 | |
| 16:27 | 1.69 | 430.38 | 119.55 | 8 |
| 16:28 | 1.63 | 408.95 | 113.60 | 8 |
| 16:29 | 1.50 | 381.41 | 105.95 | 8 |
| 16:31 | 1.48 | 375.60 | 104.33 | 8 |
| 16:32 | 1.42 | 363.62 | 101.01 | 8 |
| 16:33 | 1.34 | 340.98 | 94.72 | 8 |
| 16:34 | 1.31 | 334.49 | 92.91 | 8 |
| | | mean | 104.58 | |
| | | max | 119.55 | |
| | | min | 92.91 | |

ピカチヨ取水量（800liter/sec. ホーターによる）←全水量の 1/3 を 22 系統管路に流すとする事前報告書からすると少ない。浄水場水位は 1301.44m



超音波流量計の設置状況
(リンデロ配水池 ピカチヨ地点)



超音波流量計の測定状況
(リンデロ配水池 ピカチヨ地点)

ここで、配水バルブの回転数 (8,12 回転) は、SANAA オペレーターの長年の経験により決められた回転数である。通常、SANAA では、L22 系統管路を使用し、下図に示す主に 2つのエリアに配水している (8 回転時：リンデロ配水池、12 回転時：エスペランサ地区)。

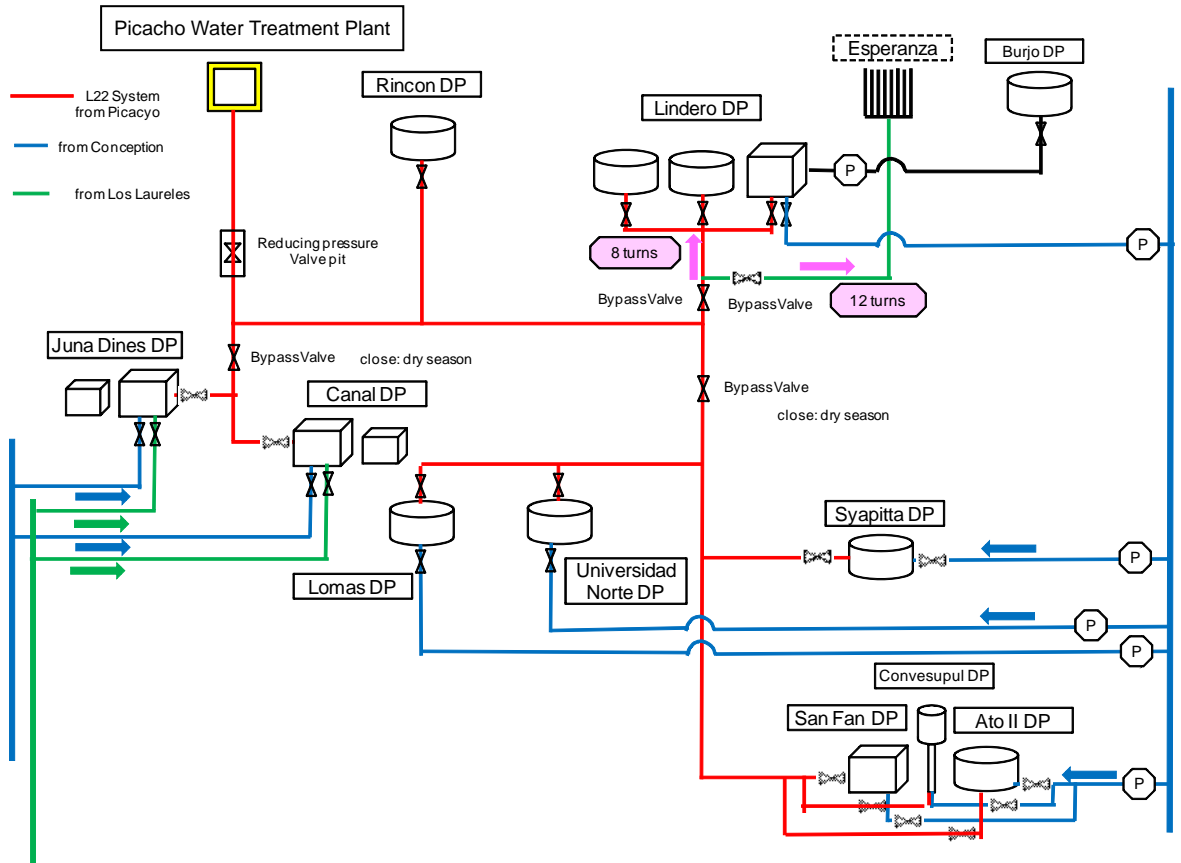

L22 配水系統システム (SANAA 運転主任からの聞き取り)

L22 系統管路は、ピカチヨ浄水場のメイン系統の一つであり、複数の配水池に送水している。但し、雨季と乾季によって、送水時間が異なり、雨季では、2 日間(48 時間)で、30~36 時間(60~75%)、乾季には、19~26 時間 (41~54%) の配水となっている。

| 乾季 | | 雨季 | |
|---------|----------------|----------|----------------|
| 年月 | 配水時間 / 1サイクル時間 | 年月 | 配水時間 / 1サイクル時間 |
| 2009. 3 | - | 2009. 10 | 34 / 48 hours |
| 2010. 3 | 19 / 48 hours | 2010. 10 | 30 / 48 hours |
| 2011. 3 | 20 / 48 hours | 2011. 10 | 30 / 48 hours |
| 2012. 3 | 26 / 48 hours | 2012. 8 | 34 / 48 hours |
| | | 2012. 9 | 36 / 48 hours |

水頭については、8 月 29 日に減圧弁の前後での圧力測定を SANAA が実施した。SANAA が行っている現状の水運用 (120~150 litter/sec) では、減圧弁の手前では圧力値が 60~70psi 程度=4~5bar (40~50m 程度) しかないとの測定結果となった。

事前調査では、ピカチヨ浄水場と減圧弁ピットの静落差は 160m 以上あるので、下流に 90m 残圧を確保しても 70m 近くは確保できるとの結果となっている。しかし、今回の調査結果では、流量が少ない場合は、配水池の弁を全開にして、浄水池のマニホールドの入口弁で各配水量を調整する SANAA の運用では満管にならず、圧力がなくなっているのではないかと想定される。この場合は、発電ができないことになる。ちなみに、20 回転で約 400 litter/sec を流した時は、圧力が 150psi まで上昇する結果となっている。おそらく、浄水場からの水の方が多い場合は満管となって想定の圧力が生じたのではないかと考えられる。

現在の SANAA の運用は、基本的に浄水場の入口バルブで調整し、配水池のバルブは全開とし調整は行っていない。管路の途中にあるバイパスバルブの開閉操作で、2 地域 (リンデロ配水池とこれ以外の配水池) への流量の振分けを行っている。各配水池への配水量を管理しておらず、彼らの経験で配水池への送水が行われているのが実情である。

このように、配水池のバルブを調整して、浄水池からの送水量を管理していないため、流量が少ない場合は、管路が満管となっていないことが考えられる。送水が必要なバルブのみを開くのであれば、満管となり減圧弁の前後で圧力差が生じて発電ができるが、このように各配水池のバルブの開閉を調整するのは、SANAA がこれまで行ったことのない運用で担当者も、今の方法をかえるのは非常に困難であるとのことである。

L22 系統管路の配水池の状況調査

タンクの状況



リンデロから見たエルペランサWD

レベルスイッチ

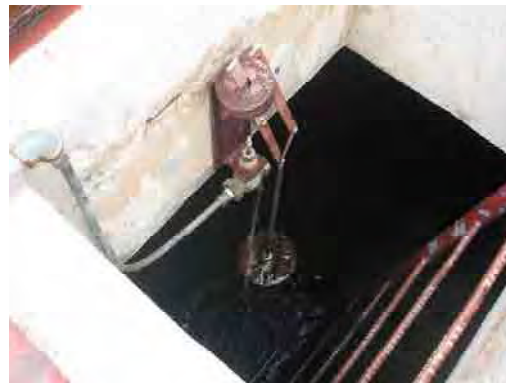

スペイン納入の流量計(正しい表示をしていないと思われる)

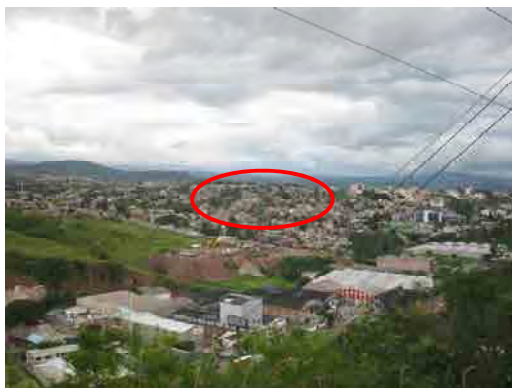

HATO II、Covesupl, San Juan

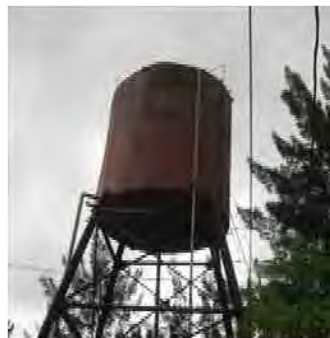

運転管理員(24 時間勤務)によると、ピカチヨ浄水場からの送水のバルブは閉じている。開にしても水はこない。

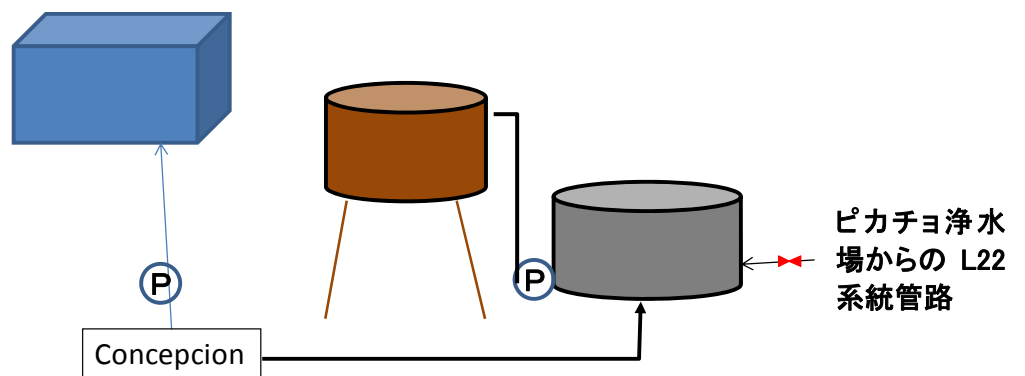

SAN MIGUEL

乾季はCLOSE、雨季はOPEN



マンホール



周辺の状況

配管布設に伴い、整備。

SUYAPITTA



運転管理員(24時間)4人体制
8時間(昼)、16時間(夜)

ピカチヨより22系統
現在CLOSE

コンセプション浄水場
から送水されている。



タンク内部
レベルスイッチなし

The Preparatory Survey for the Project of Micro-Hydroelectric Power Generation in Metropolitan Area of Tegucigalpa in the Republic of Honduras

Brief on First Field Survey

1. Schedule of the Study

| Item \ Year | 2012 | | | | | | 2013 | | |
|---|------|--------|------|------|------|--------|------|------|-------|
| | Jul. | Aug. | Sep. | Oct. | Nov. | Dec. | Jan. | Feb. | Mar. |
| Preparation of the survey in Japan | □ | | | | | | | | |
| First Field Survey in Honduras | | | | | | | | | |
| Analysis in Japan (Preparation of Draft report in Japan) | | | | □ | □ | □ | | | |
| Second Field Survey in Honduras | | | | | | ■ | | | |
| Preparation and Submission of F/R | | | | | | | □ | □ | □ |
| Submission of each report to JICA | | ▼ Ic/R | | | | ▼ Df/R | | | F/R ▼ |

Remarks: □ work in Japan, ■ work in Honduras, ▼ Submission of Ic/R, Df/R, F/R to JICA
Ic/R: Inception Report, Df/R: Draft final Report, F/R: Final Report

2. Licenses / Permission / Approval for Required for Power Generation Business

Existing condition and forecasts/problems for Licenses / Permission / Approval for Required for Power Generation Business are summarized in the following tables.

3. Study Results

3.1 Concepcion Site

The following essential data for power generation plan are collected

- Daily intake water data for 10 years
- Daily dam level data for 10 years
- Booster pump operation condition
- Pressure measurement for various discharge at several points
- Final drawings of existing pipe line, intake, dam etc.

The following study will be conducted according to flow chart of optimum study.

- Selection of new pipeline, steel pipe vs PVC pipe
- Optimum diameter of new pipeline
- Location of connecting point of existing and new pipe line s

The Concepcion site has no difficulties for power generation plan and basic design.

The new pipeline route are basically located along the road and the connecting point of existing and new pipe lines are determined according to the topographic condition and around the boundary from 1100mm diameter to 900mm diameter pipes.

Licenses / Permission / Approval for Required for Power Generation Business

| Required Licensing | Applicant | Acknowledge of licensing | Existing Conditions | Forecasts / Problems |
|--|---------------|---------------------------|--|---|
| Power Generation Operation License | SERNA (SANAA) | Cabinet | SANAA is confirming the procedures regarding the power generation operation license to CNE. | SERNA is to submit the documents for the cabinet approval with Environmental license and Water Right. |
| Water Contract | - | - | SANAA has water right utilized for water supply at Concepcion and Picacho sites. So SANAA understands it is not necessary to obtain further water right for power generation utilization. | SERNA shall confirm its water right. |
| Environmental License | SANAA | SERNA or Tegucigalpa city | Picacho site has high possibility to fall under Category 1 (low impact projects), which applies to Hydroelectric Power projects less than 3MW. Picacho powerhouse site is not inside national park areas and is properties of several private land owners. Concepcion site is not inside the protected area and is located in the public roads and private lands partly. | After submission of F01 for Category 1, the license will be issued within 15 days. F01 is to be fulfilled after the submission of Study report (Dec. 2012) and acquisition of necessary lands. The lands of Picacho powerhouse area are private ones not property of national park. The license will be obtained before E/N. |
| Renewable Resource Law Application | Contractor | SANAA | Not necessary | |
| Power Selling Agreement | SERNA (SANAA) | CNE | SANAA is confirming the procedures regarding the power selling agreement to CNE under guidance of ENEE. The electricity generated by the Hydroelectric Power plants is to be sold to ENEE. | SANAA is to submit the relevant document to SERNA. SERNA is to submit the documents for the approval of ENEE. |
| Construction License | Contractor | Tegucigalpa city | Construction license requires Environmental license and construction plan including environmental measures. | The Contractor will obtain the license before construction |
| Grid Connection / System Interconnection | SERNA (SANAA) | ENEE | SANAA and ENEE agreed that the powerhouse is to be connected directly to the nearby ENEE grid. E/M Equipment can be connected to ENEE system by review and approval by ENEE. SANAA is preparing draft documents regarding the grid connection. | SANAA is to submit the relevant document to SERNA, then SERNA will submit it for approval from ENEE |
| Tax Exemption | Contractor | SANAA | The procedures of tax exemption to such as import duties, VAT were obtained. | The Contractor shall apply to tax exemption according to the procedures. |
| Land Acquisition | SANAA | Land Owner | Picacho powerhouse site is the land of several land owners. Powerhouse and part of water pipeline are located in the lands of private owners in Concepcion site. Most of pipeline portion is under the existing roads. | The land actuation by SANAA shall be completed until construction of the Work. |
| Road Space Occupation Permission | Contractor | Tegucigalpa city | The road occupation approval during construction period is responsible for the Tegucigalpa city. | The Contractor shall submit the permission to the Tegucigalpa city before the construction |

*CNE: Comisión Nacional de Energía

Power Generation Plan of Concepcion Site

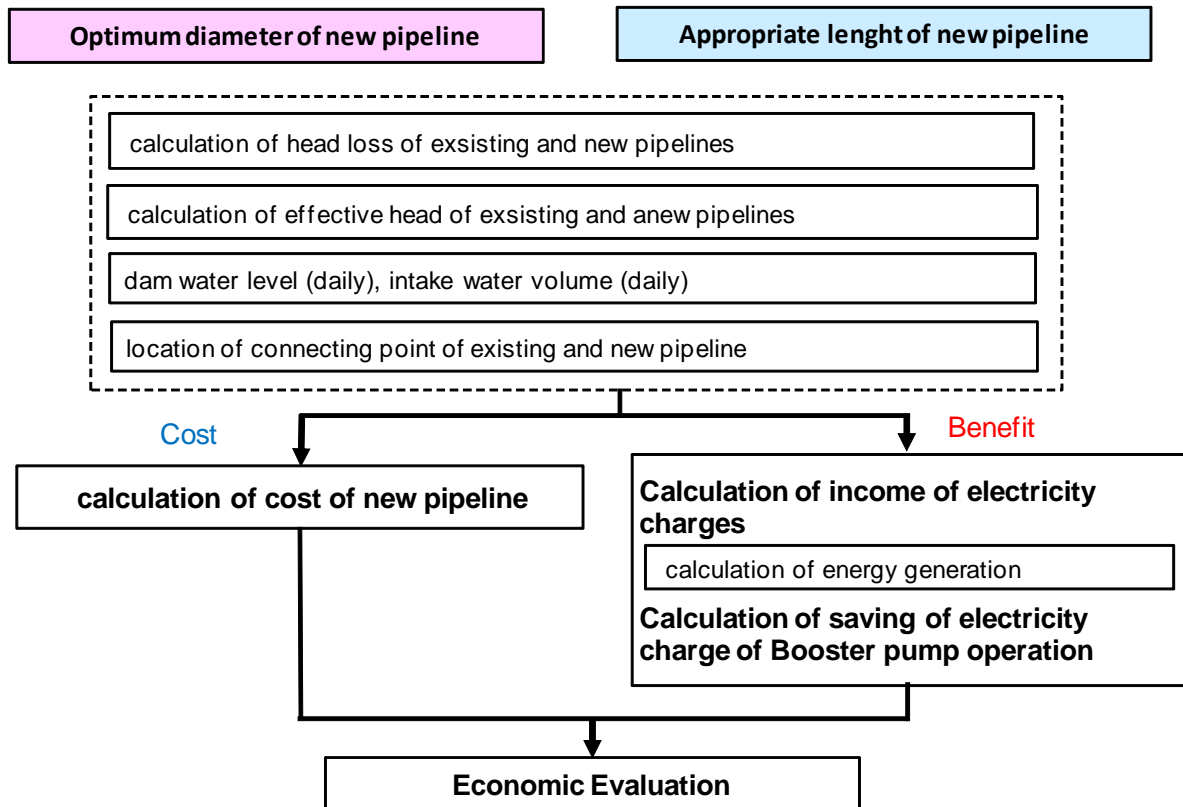

Flow Chart of Optimum Study

$$P_{max} = 9.8 \eta Q_{pmax} H_e$$

where, P_{max} :Max Output (kW)
 Q_{pmax} :MaxPower discharge(m³/sec)
 H_e :Effective head in case of Maxdischarge(m)
 η :efficiency(=0.8, turbine-generator)

$$E = \sum 9.8 \eta(i) Q_p(i) H_e(i) h$$

where, E:Energy Generation(kWh)
 $Q_p(i)$:power discharge (m³/sec)
 h :hour

Calculation of Max. Power Output and Energy Generation

Fluctuation of Daily Dam Water Level

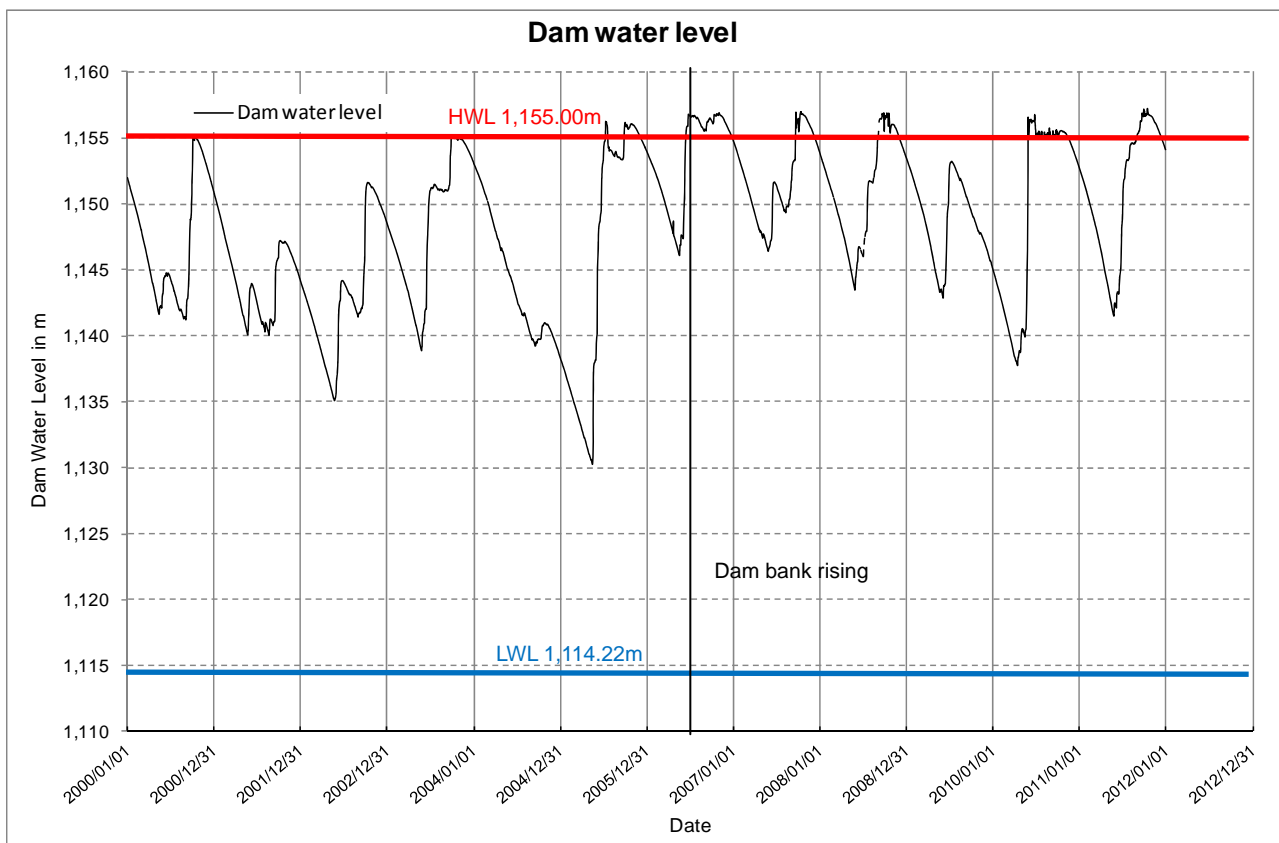

Annual Maximum/Minimum/Average Dam Water Level

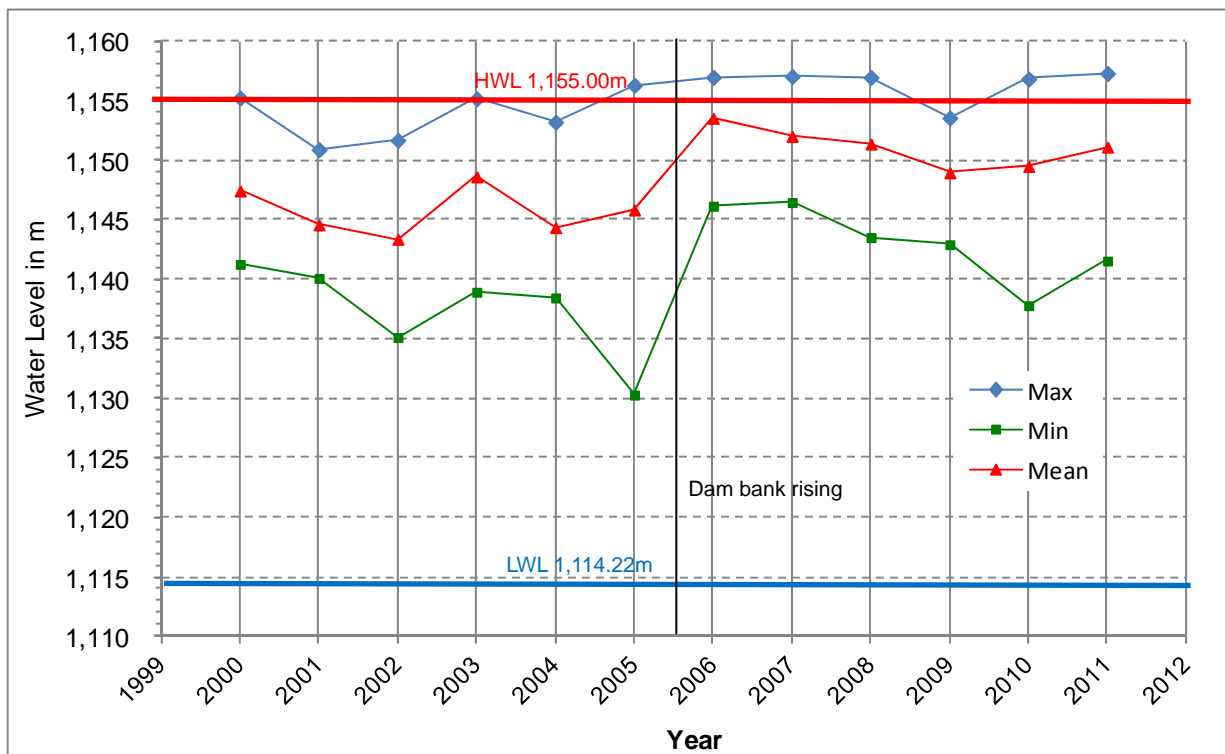

Fluctuation of Dam Water Level

Fluctuation of Daily Dam Intake Water

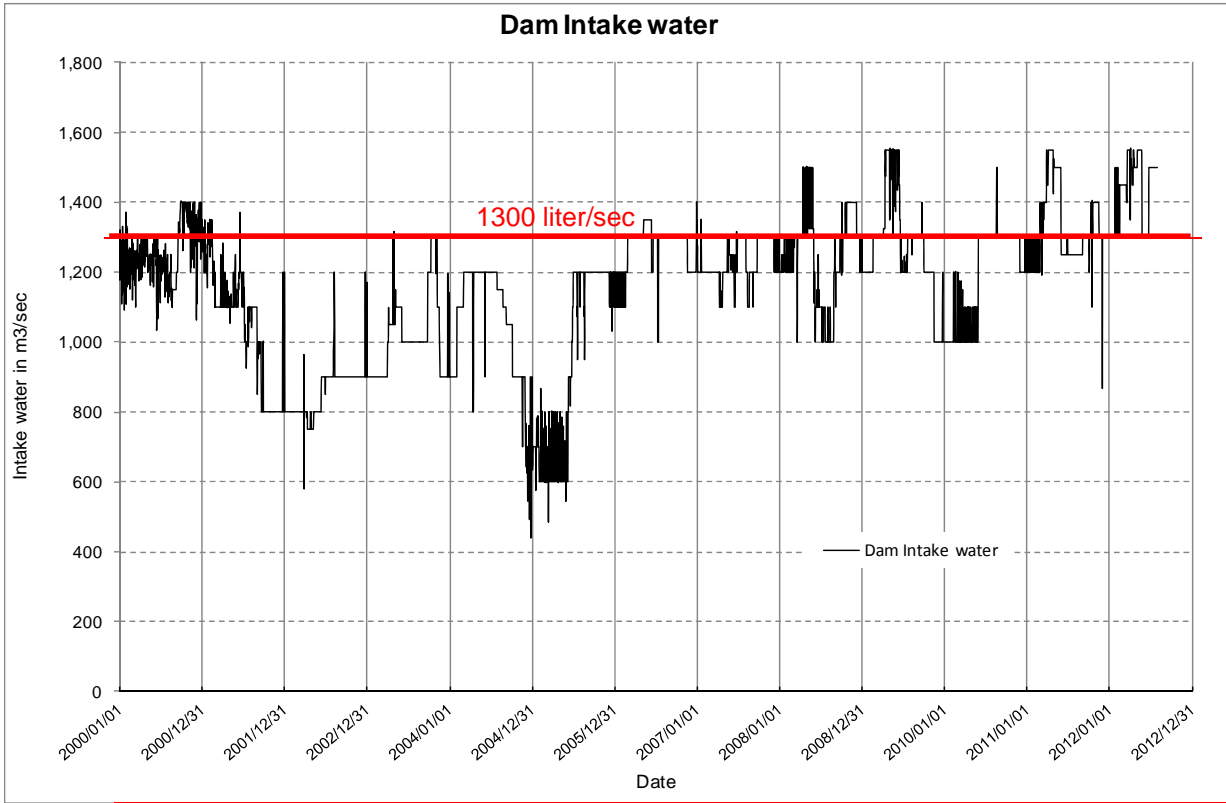

Annual Maximum/Minimum/Average Intake Water

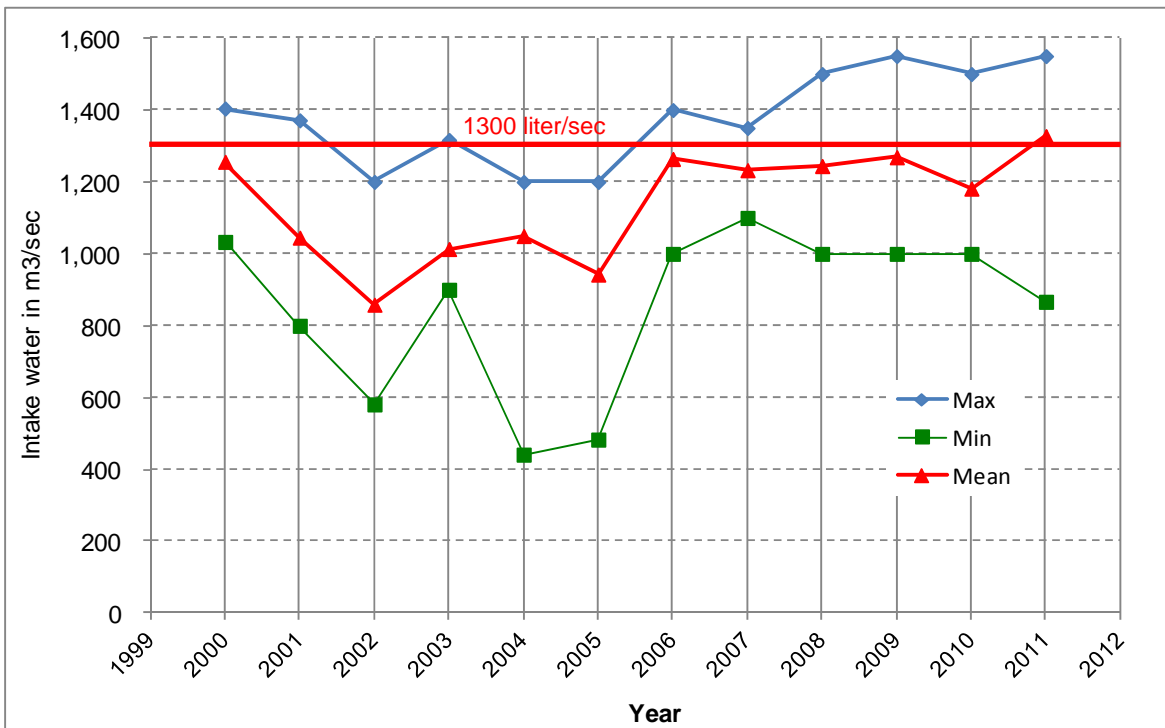

Fluctuation of Intake Water Volume

Duration Curve (2000-2007)

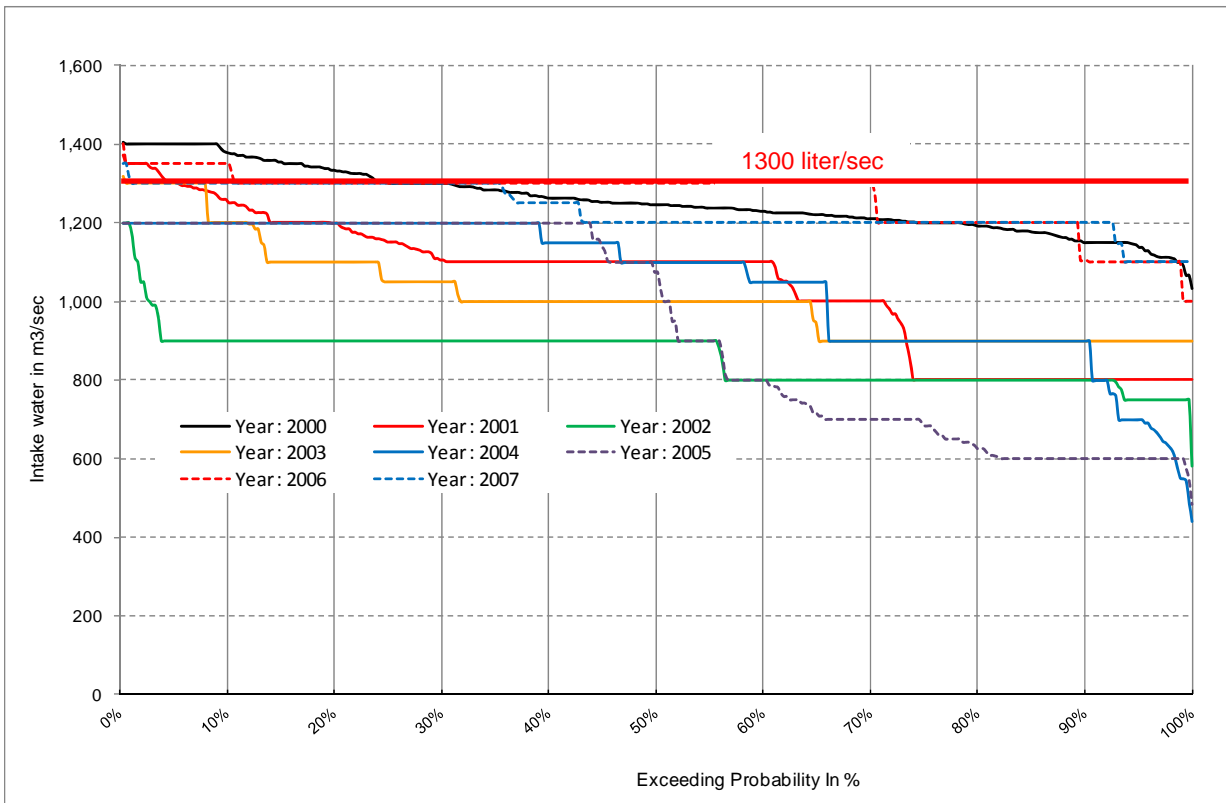

Duration Curve (2008-2011)

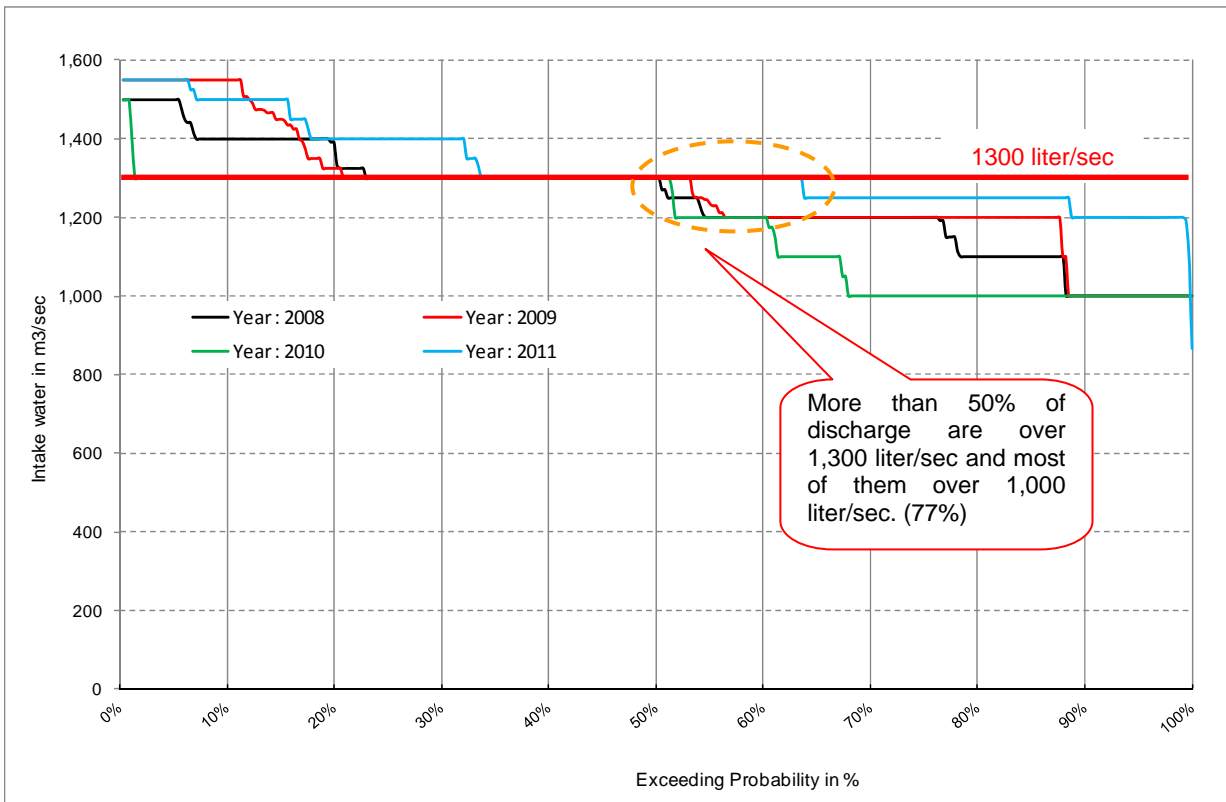

Fluctuation of Discharge Data

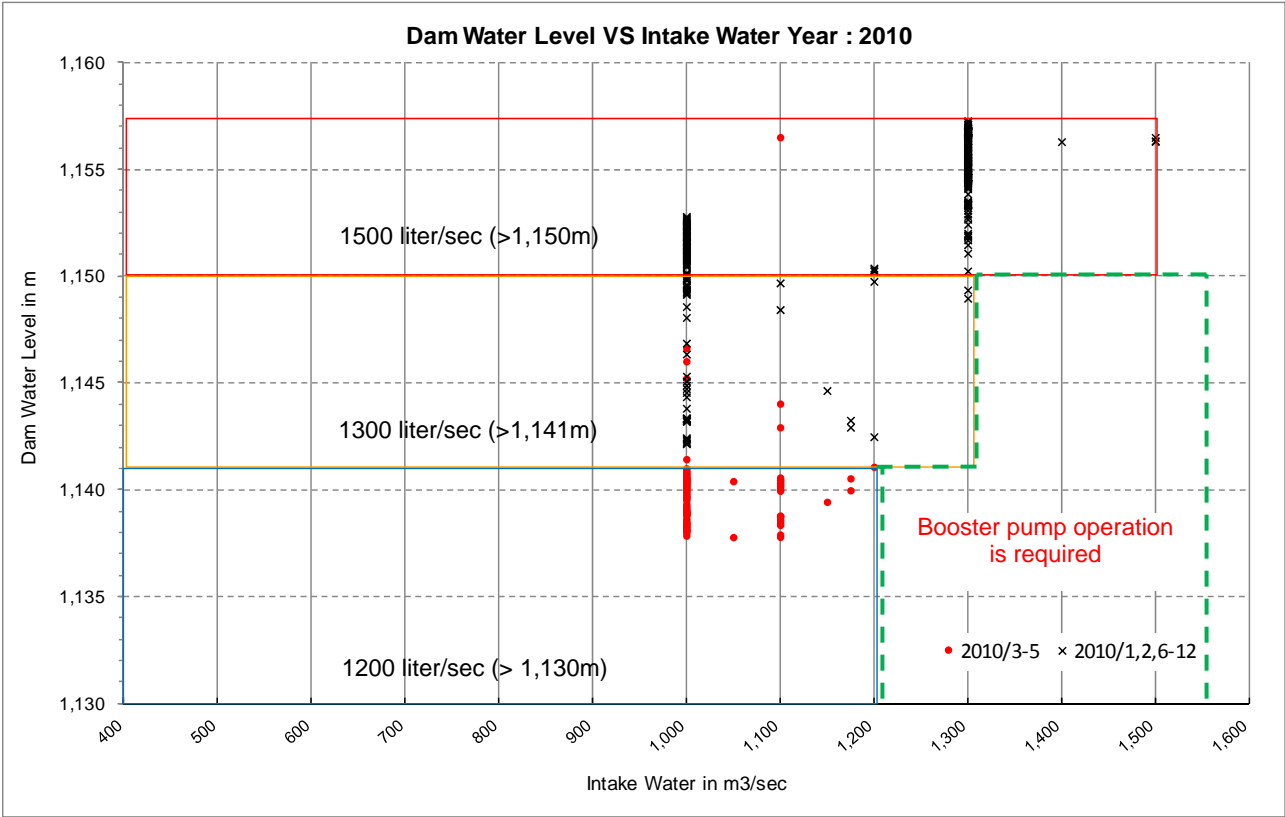
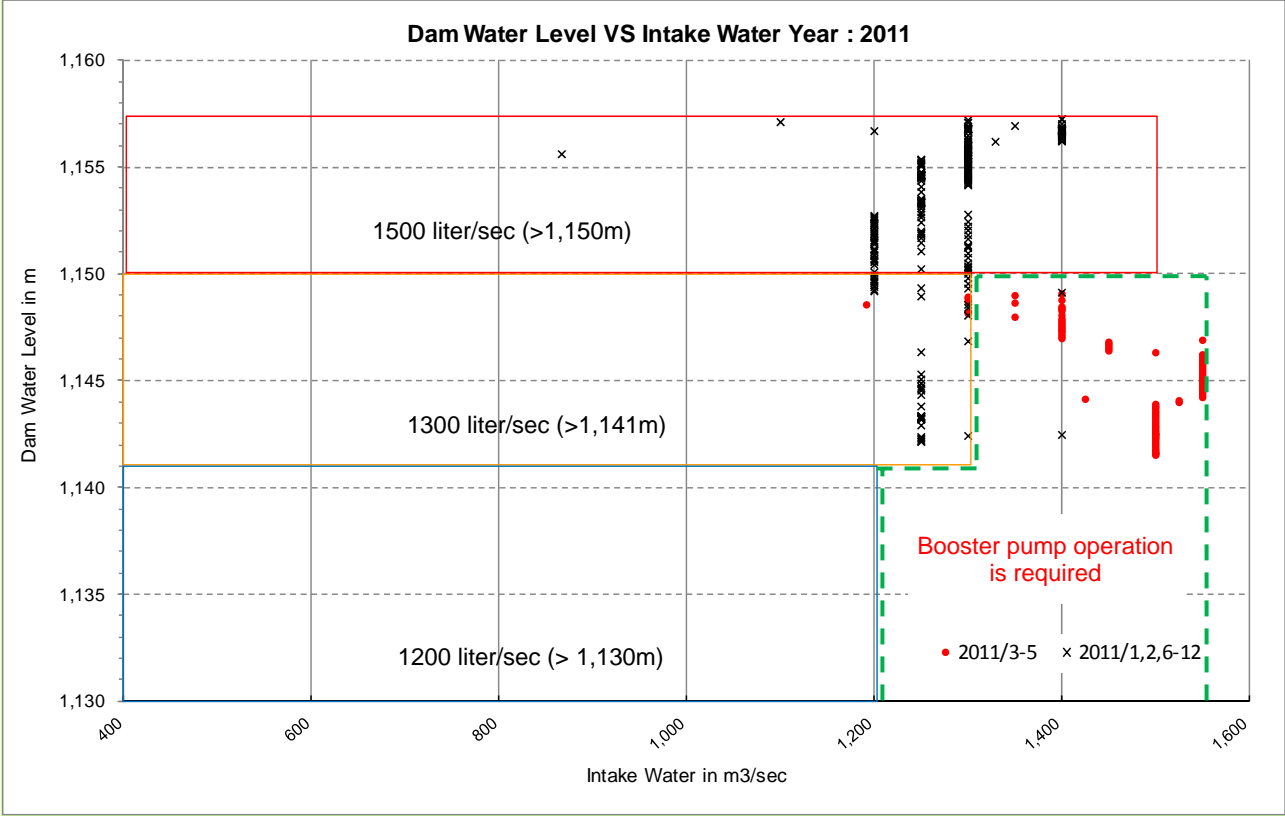

Booster Pump Operation Condition

Head vs Discharge at Aerator (ST 5,500m)

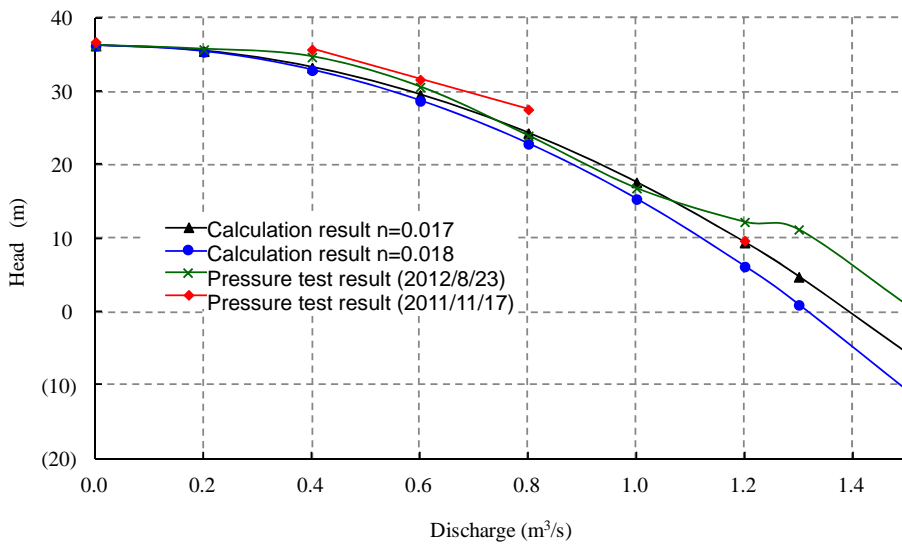

Head vs Discharge at P-2 (ST 4,400m)

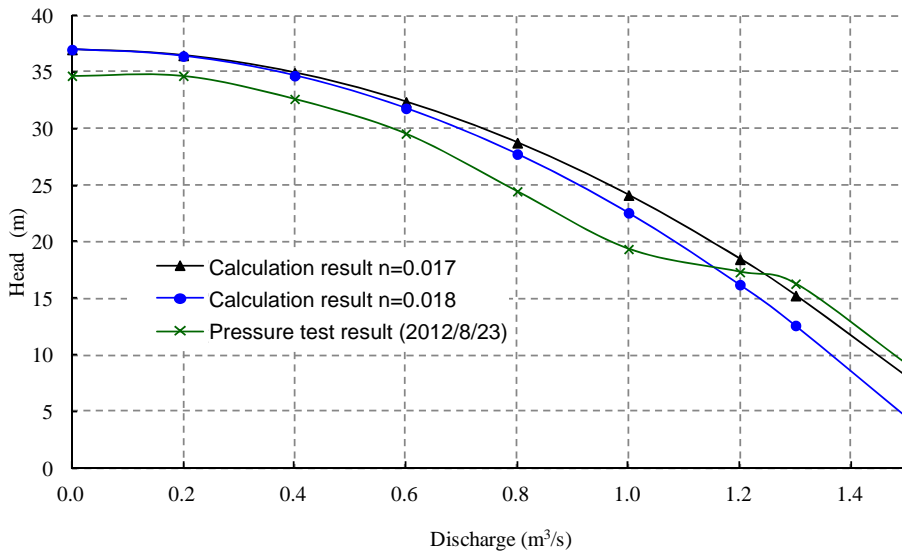

Head loss vs Discharge at Aerator (ST 5,500m)

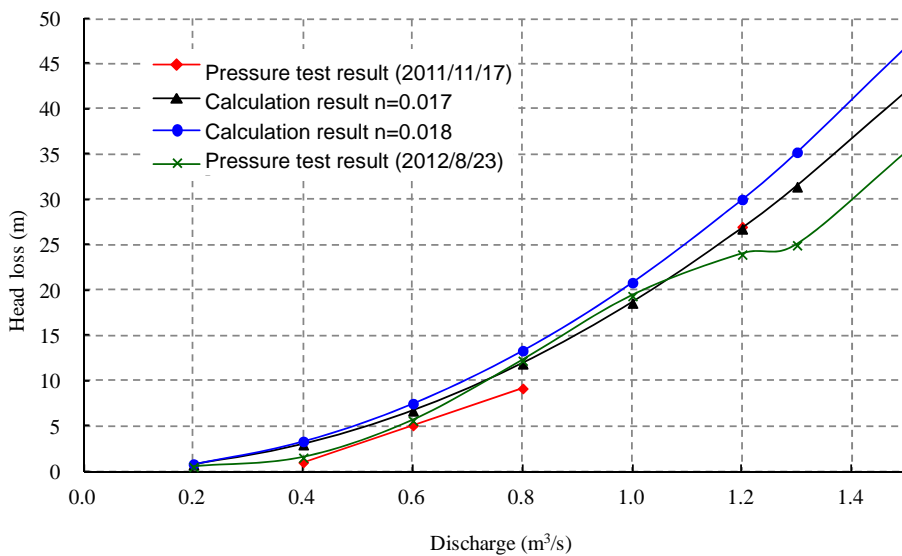

Pressure Measurement Results along the Pipe line



Aerator



Concepcion Powerhouse Site

Conception Site : New Pipeline Route



Aerator-PI87

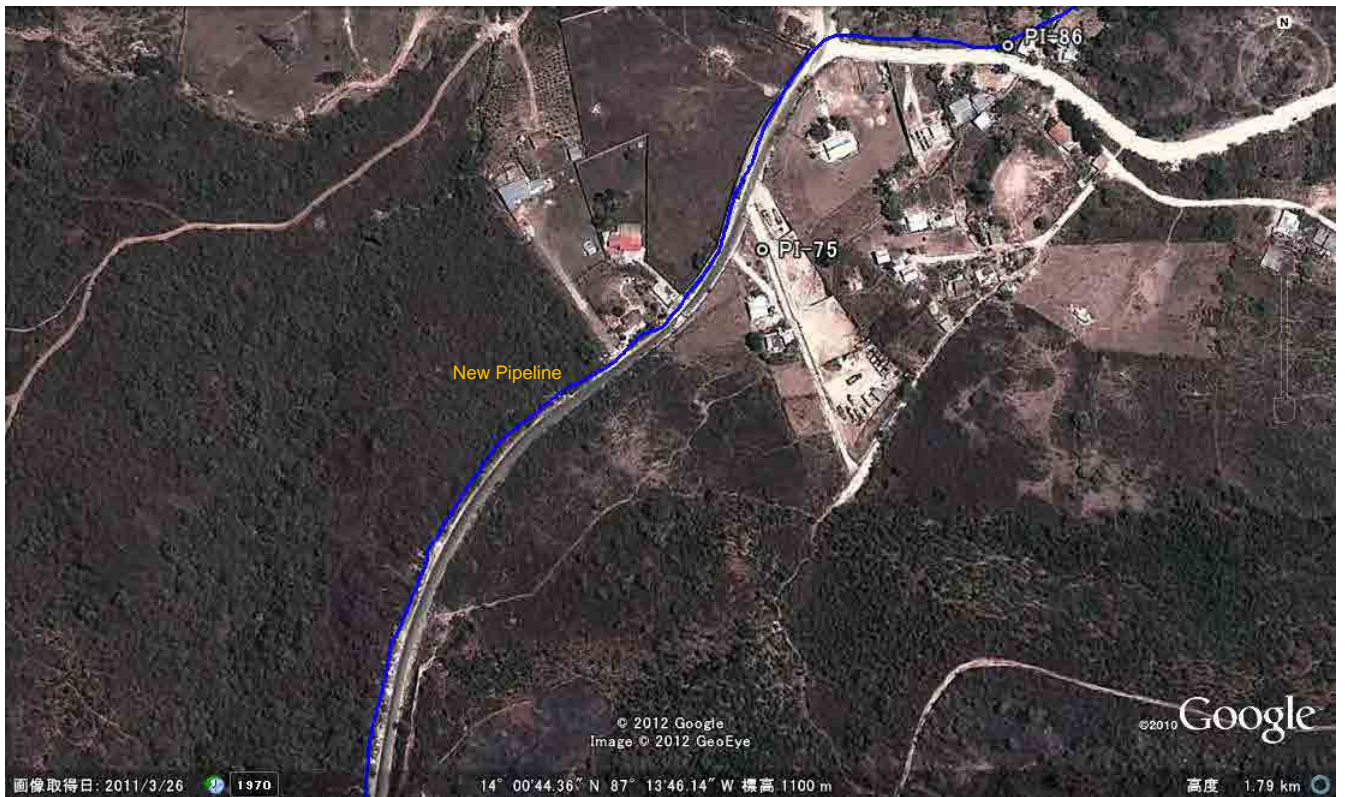

PI87 – P73

Conception Site : New Pipeline Route

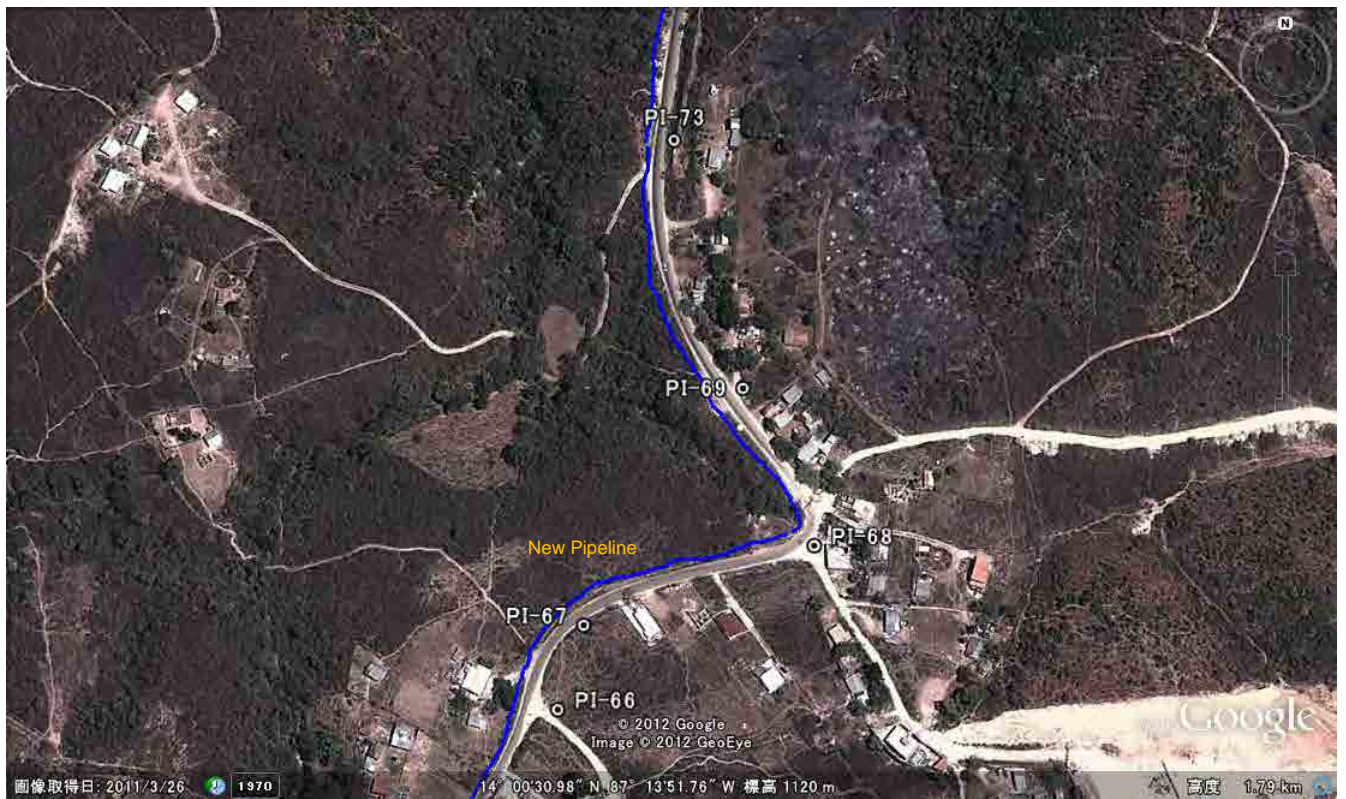

PI73 - PI66



PI67 - PI65

Conception Site : New Pipeline Route

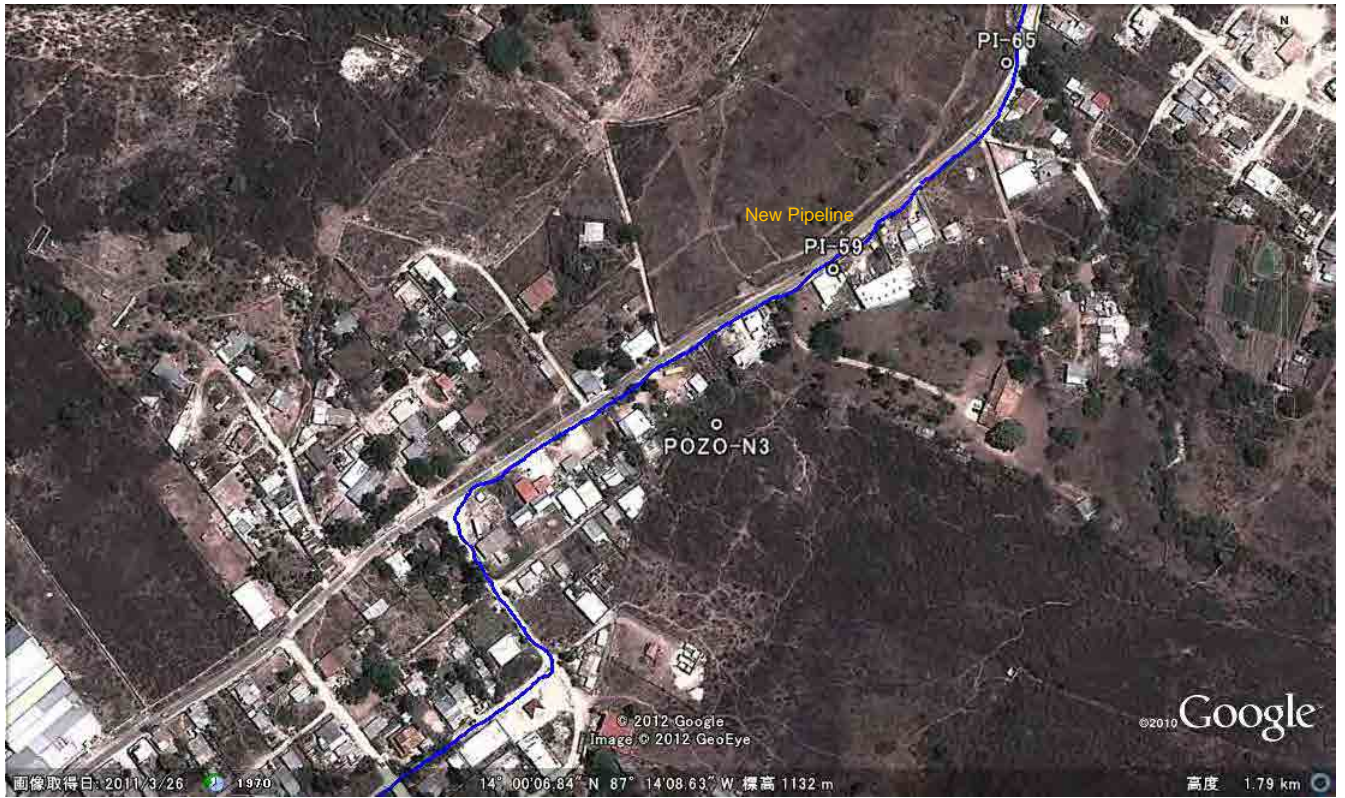

PI65 – Manhole No.3



Manhole No.2 – Manhole No.1



PI-89⇒PI-87



PI-89⇒PI-87⇒PI-86



PI-87⇒PI-86



PI-86⇒PI-75



PI-86⇒PI-75



PI-75⇒PI-73



PI-75⇒PI-73



PI-69⇒PI-68

Concepcion Site Pipeline Route



PI-69⇒PI-68



PI-68⇒PI-67



PI-67⇒PI-66



PI-67⇒PI-66⇒PI-65

3



PI-66⇒PI-65



PI-66⇒PI-65



PI-66⇒PI-65⇒PI-59



PI-65⇒PI-59

Concepcion Site Pipeline Route

3.2 Picacho Site

The essential data for power generation plan such as discharge data and effective head is not reliable.

The following points shall be decided immediately for further study.

- Design and maximum distribution water volume of L22 system
- Future distribution water plan of L22 system and forecast
- Set pressure value of pressure reducing valve

The Picacho site has difficulties for power generation plan due to very small amounts of water in addition to pressure degradation and aeration into the pipe.

The present valve operation for L22 pipeline at the treatment plant is to be changed and water regulating valve installed at the downstream of the turbine is to be operated for water distribution. Valve operation at each distribution pond is not changed. To avoid cavitation of the turbine, the minimum power discharge is required.

Power Generation Plan of Picacho Site

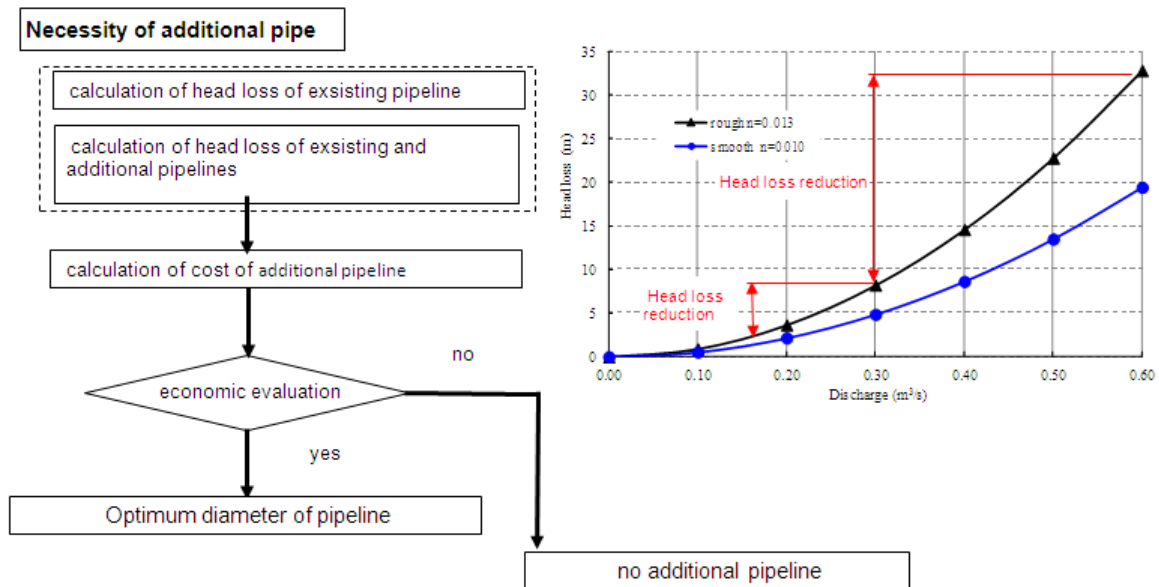

Study on Necessity of Additional Pipe

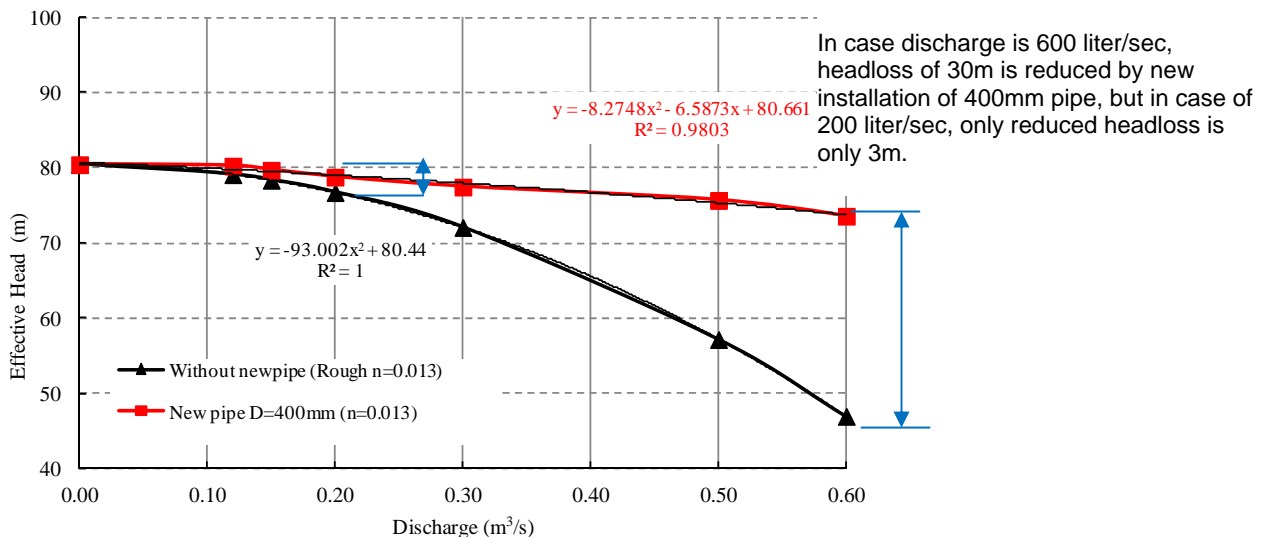

Calculated Effective Head of L22 Pipeline with new pipe for Various Discharges

Water Distribution Pattern of L22 Pipeline in the rainy season (September 2012)

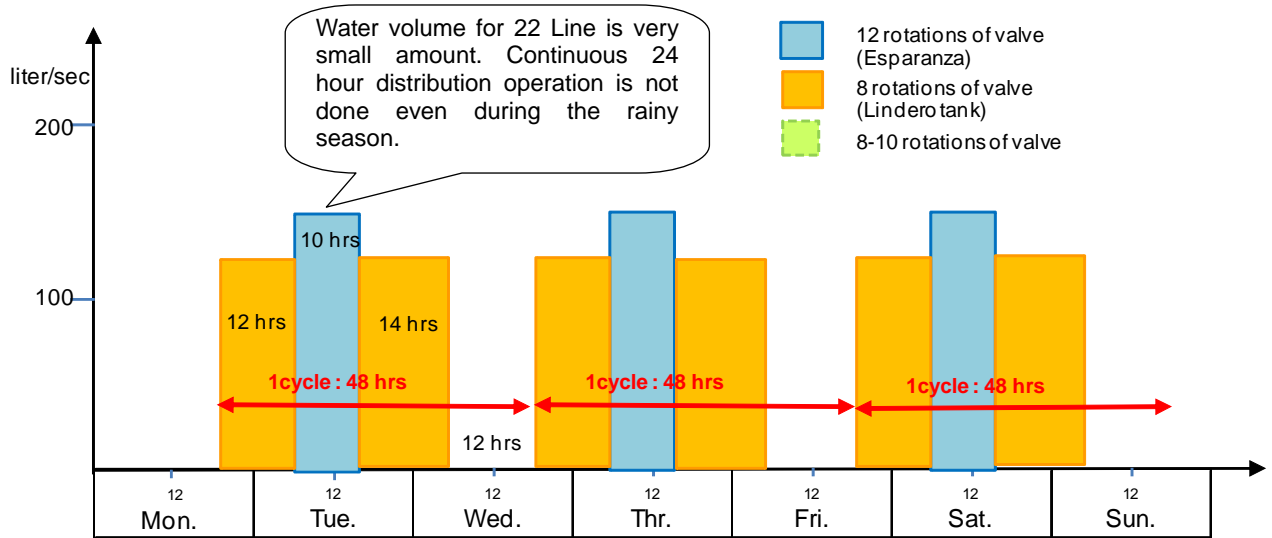

Water Distribution Pattern of L22 Pipeline in the dry season (March 2012)

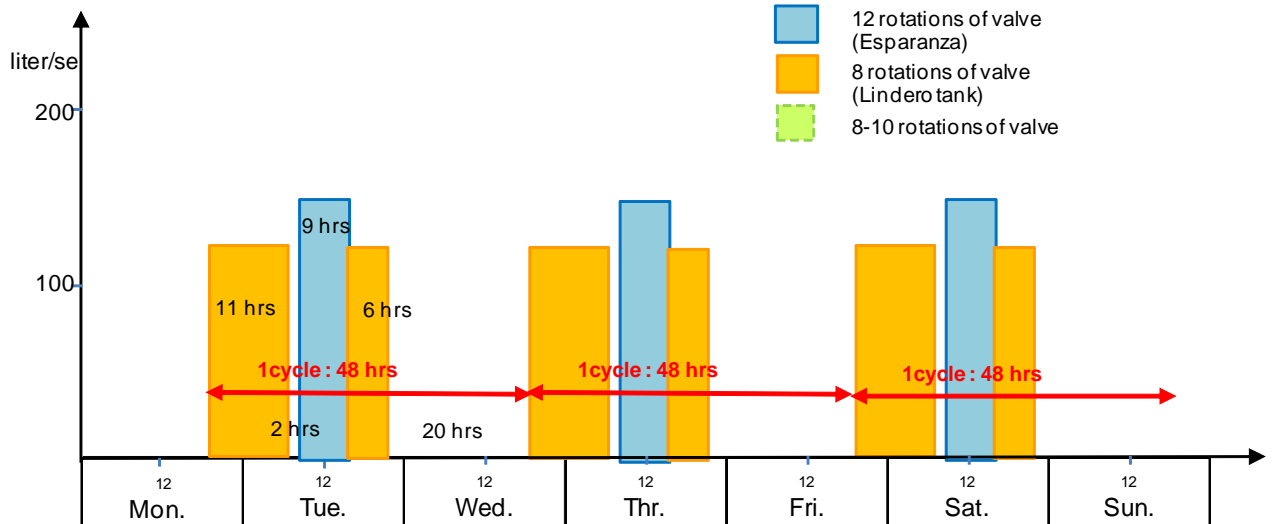

L22 System Water Distribution Typical Pattern in the rainy and dry seasons

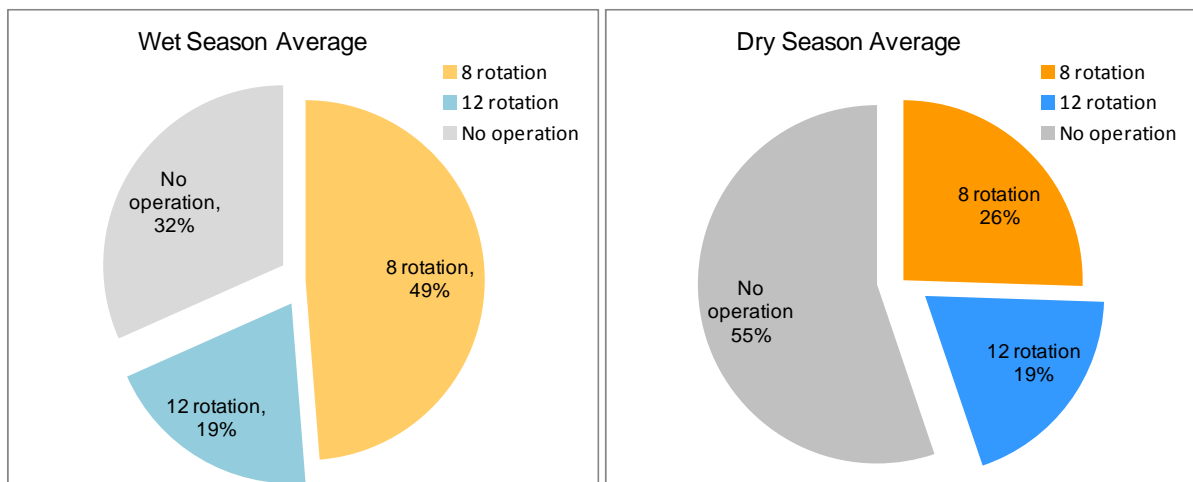

Water Distribution Pattern of L22 Distribution System

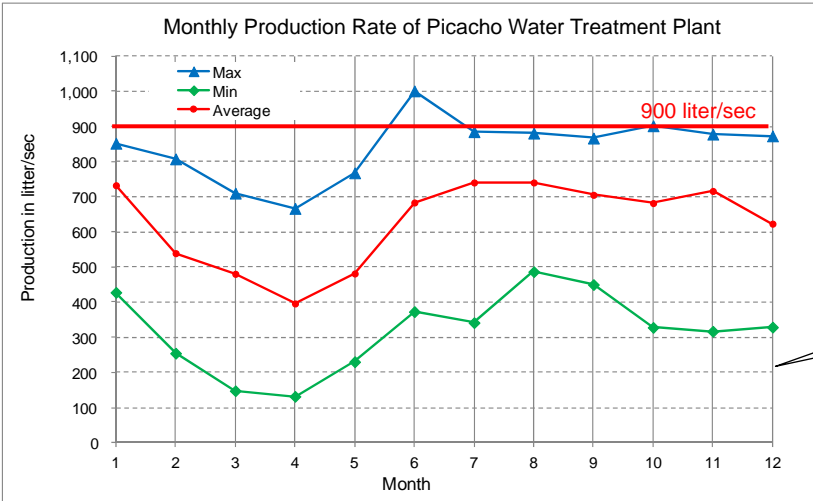
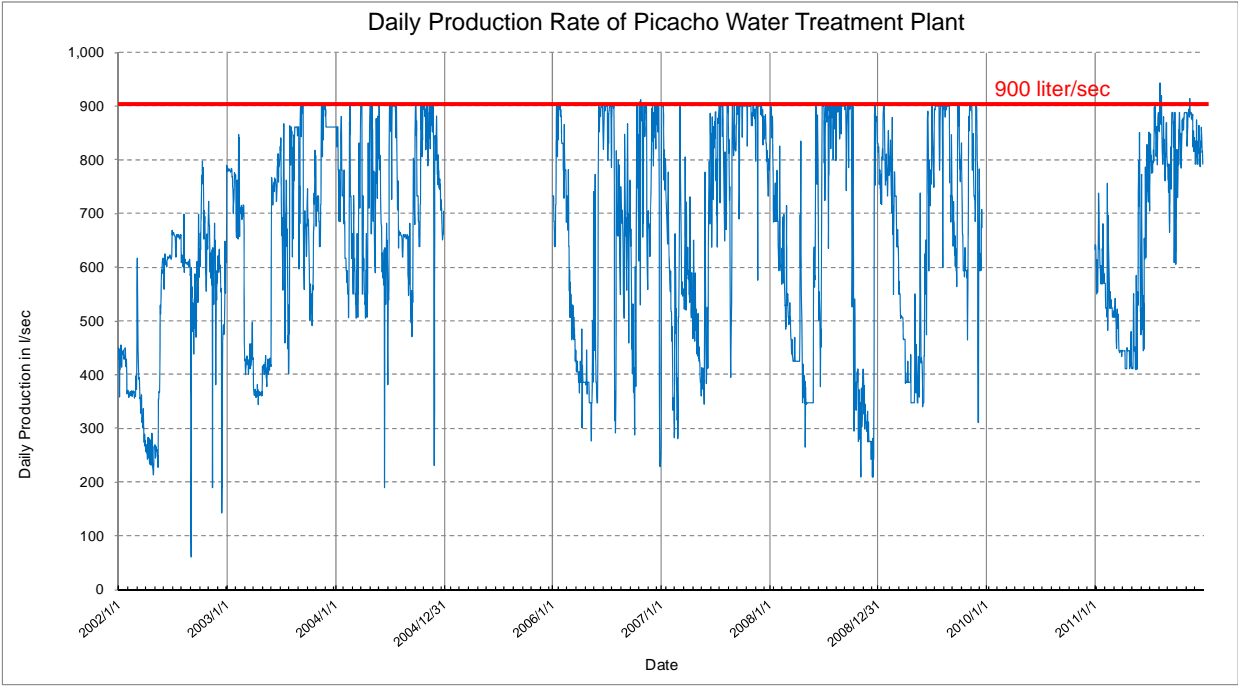

Large fluctuation between water in the rainy season and one in the dry season exists, max. 900 liter/sec and min. 300 liter/sec, it is 3 times.

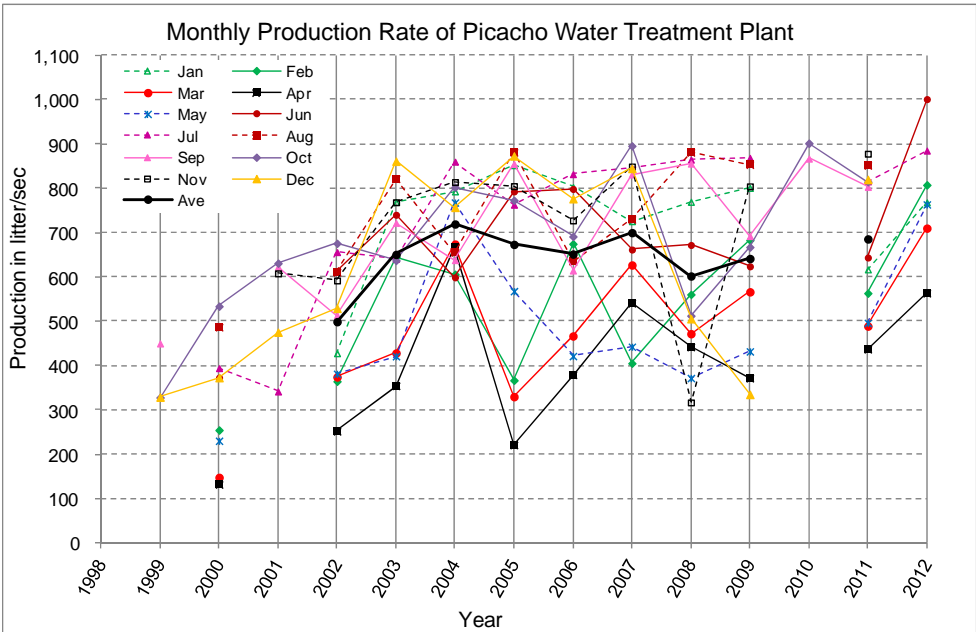

Water Production Rate of Picacho Treatment Plant

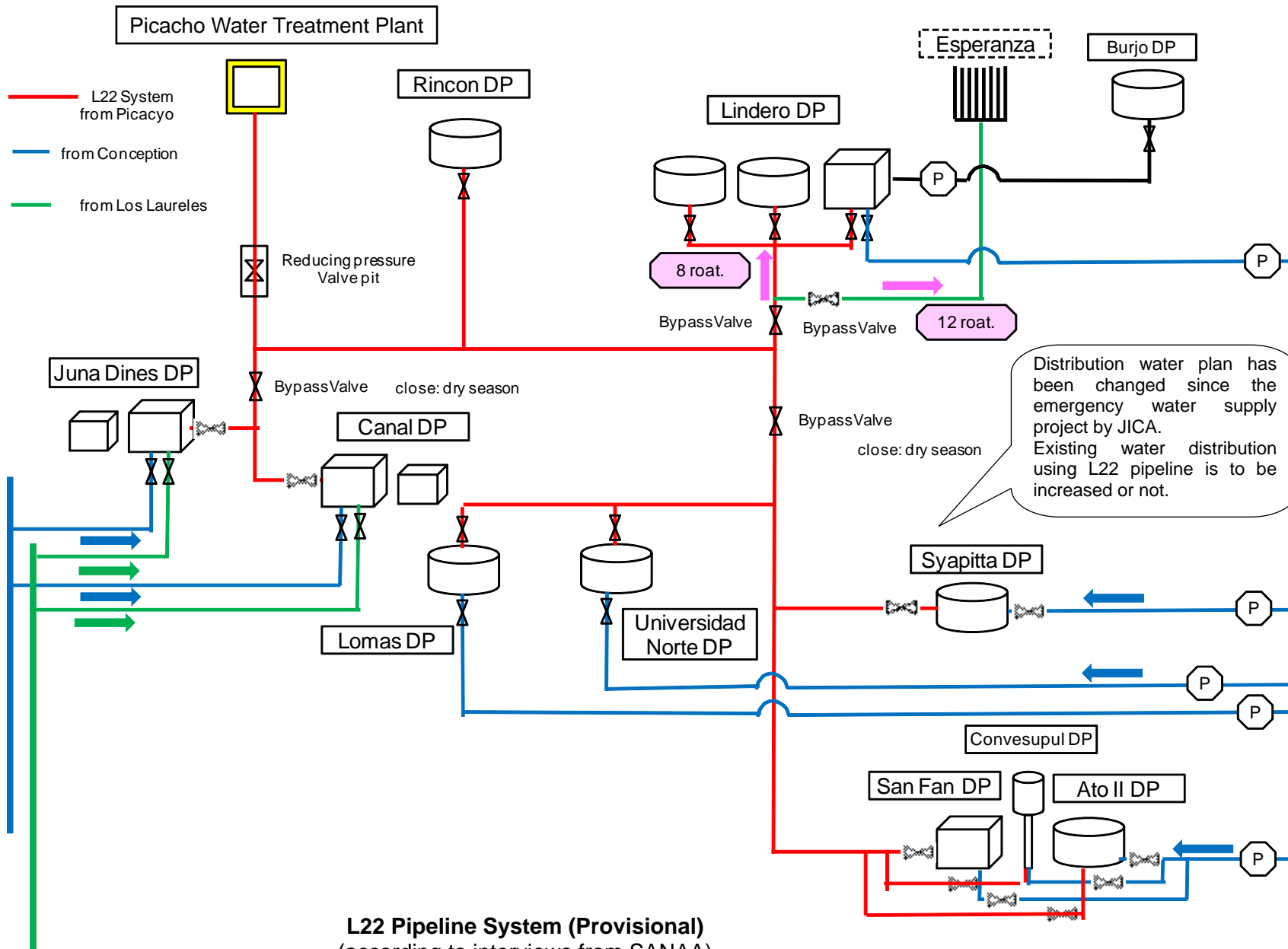

L22 Pipeline System (Provisional)
 (according to interviews from SANAA)

Effective Head Calculation

The pressure in the downstream of reducing valve is to be set to 90m according to JICA Study results. The high pressure will act on downstream pipes located in lower elevation. The location of powerhouse is around 10m higher than the existing pit.

Picacho Water
Treatment Plant

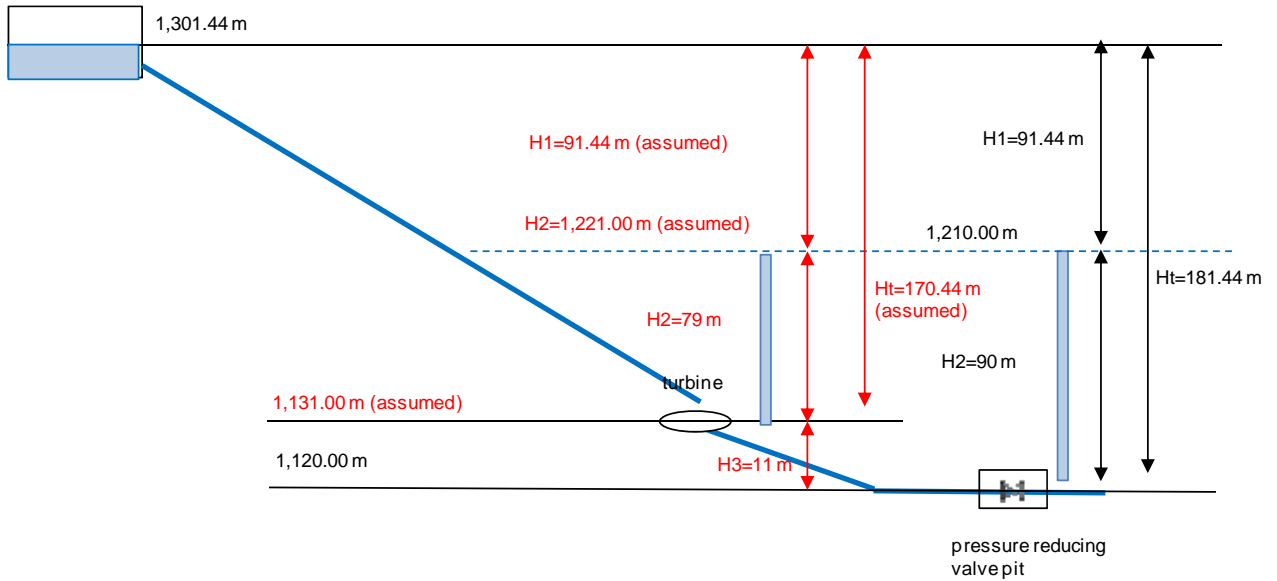

| Turbine Discharge (Q_{max}) | Gross Head (H_g) | Effective Head (H_e) |
|---------------------------------|----------------------|--------------------------|
| 0.12 m ³ /s | 91.44 m | 90.29 m |
| 0.15 m ³ /s | 91.44 m | 89.64 m |
| 0.30 m ³ /s | 91.44 m | 84.22 m |

* 10% increase of total friction loss, Manning roughness coefficient: $n=0.014$

Discharge Measurement at L22 System and Pressure Test at Pressure Reducing Valve

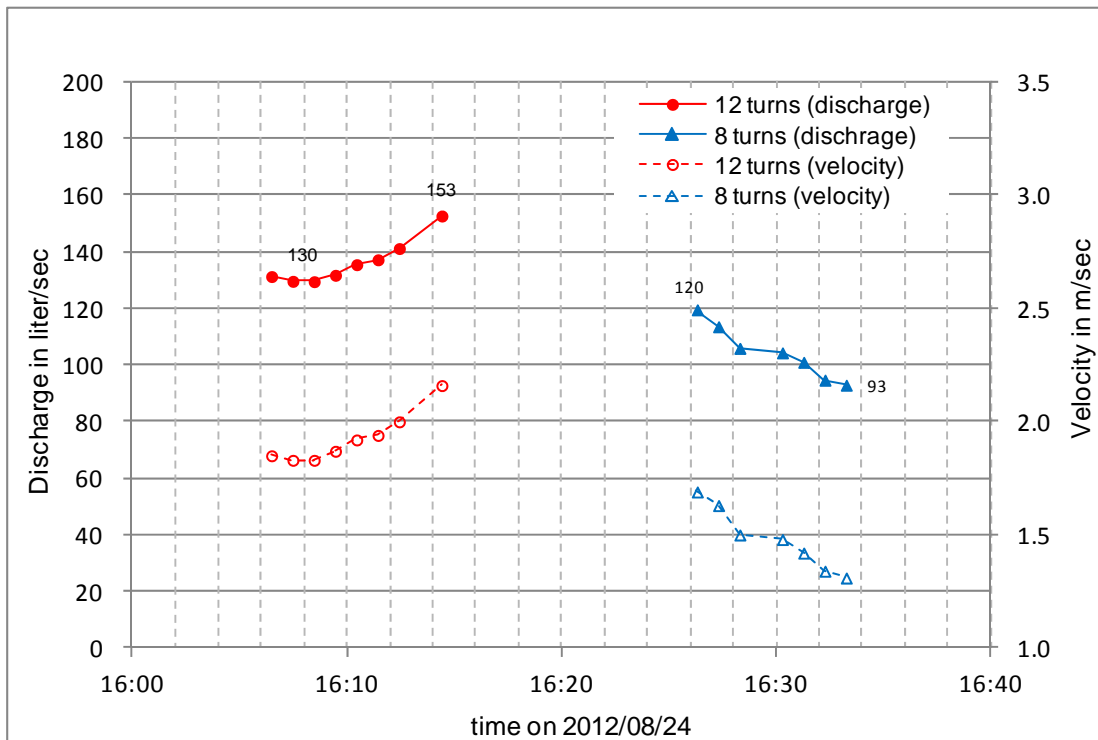

Discharge measurement results

Unit: liter/sec

| Date | | mean | max | min | remarks |
|------------|----------|------|-----|-----|-------------------------------------|
| 2012/08/24 | 12 turns | 136 | 153 | 130 | Lindero distribution reservoir |
| | 8 turns | 105 | 120 | 93 | |
| 2012/08/29 | 8 turns | 120 | | | L22 pipeline upstream the valve pit |
| | 20 turns | | 480 | 405 | |

Pressure measurement results

Unit: bar

| Date | | upstream | downstream | remarks |
|------------|----------|-------------------|-------------------|-------------------------------------|
| 2012/08/29 | 8 turns | 4.827 (70 psi) | 4.068 (59 psi) | L22 pipeline upstream the valve pit |
| | 15 turns | 6.843 | 6.843 | |
| | 20 turns | 15.393 | 15.393 | |

*: It is judged that pressure reducing valve must not be functioned properly.



Picacho Powerhouse Site

PREPARATORY SURVEY FOR THE PROJECT OF MICRO-HYDROELECTRIC POWER GENERATION IN METROPOLITAN AREA OF TEGUCIGALPA IN THE REPUBLIC OF HONDURAS

December, 2012

NEWJEC Inc.
JAPAN TECHNO Co., Ltd.

Location Map of Concepcion & Picacho Hydroelectric Power Plants



General Plan & Profile of Concepcion Hydroelectric Power Plant

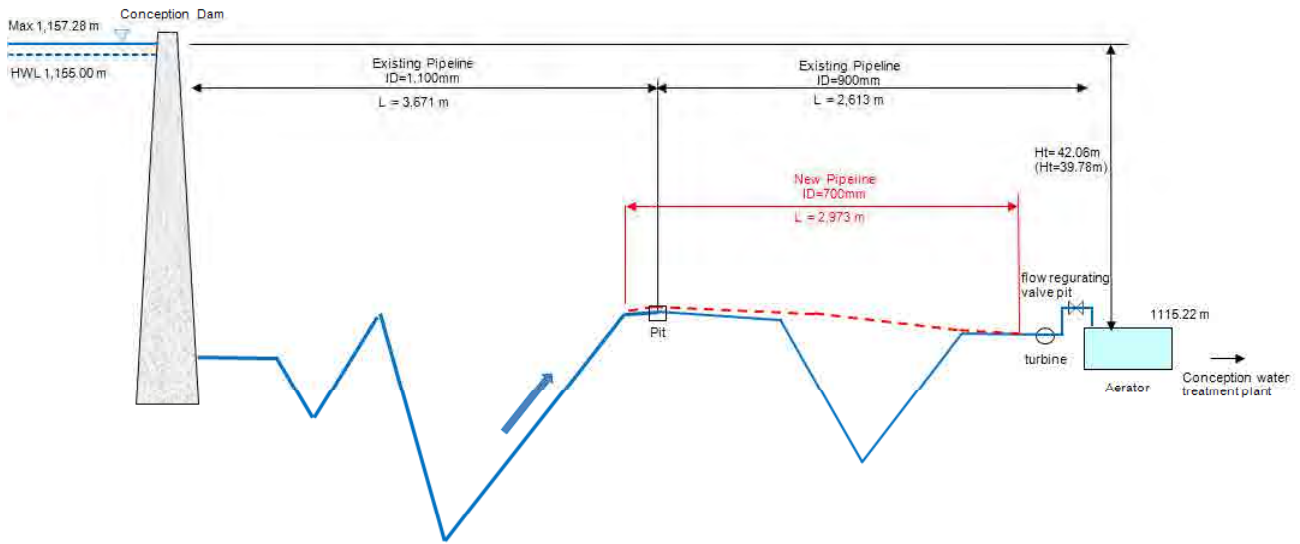

| item | value |
|-----------------------------------|-------------------------|
| Max. Power discharge | 1.5 m ³ /sec |
| Max. dam WL | 1,157.28m |
| Tail water WL | 1,115.22m |
| Max. gross head | 42.06m |
| Power discharge at rated capacity | 1.2m ³ /sec |

| item | value |
|----------------------------------|--------|
| Effective head at rated capacity | 26.52m |
| Rated capacity | 273kW |
| Installed capacity | 250kW |

3

Daily Dam water level & Intake water of Concepcion Hydroelectric Power Plant

From 2006 to 2011

Dam Water Level: Max 1,157.3m – Min 1,137.8m Ave. 1,151.0m

Dam intake water : Max 1,550 – Min 866.7 liter/sec Ave 1,253.1 liter/sec

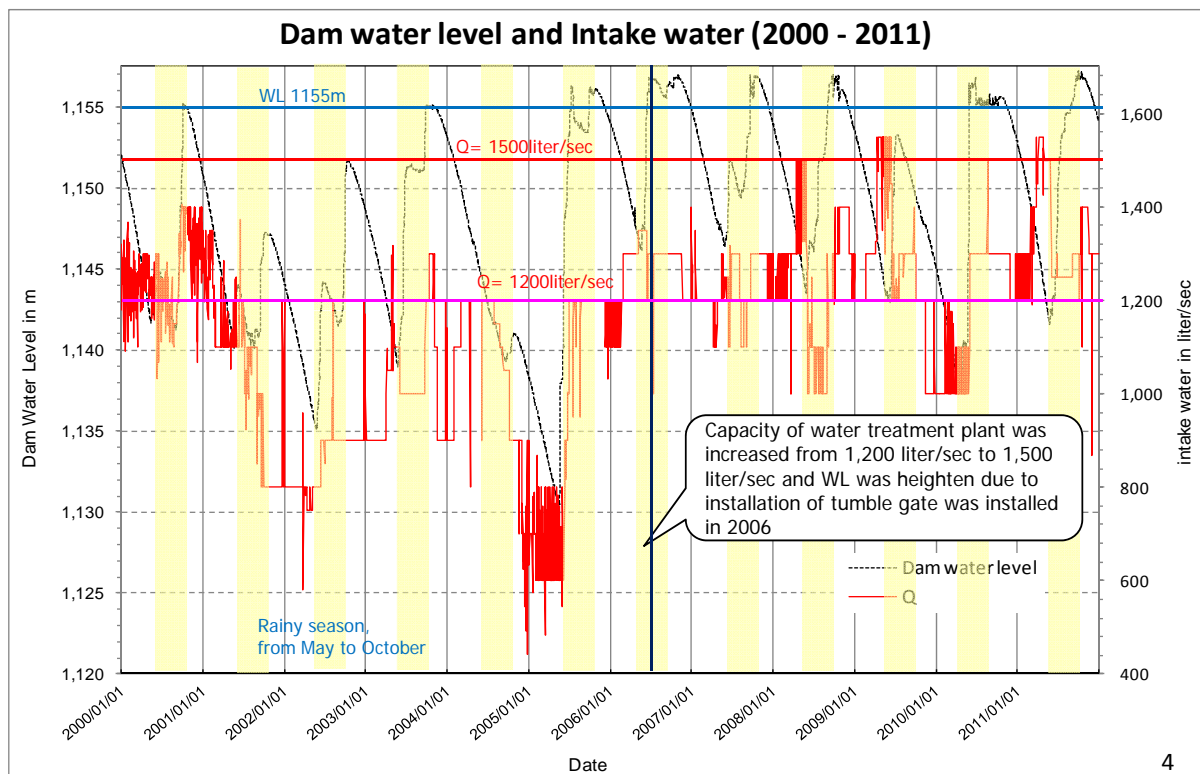

4

Duration Curve of Intake water of Concepcion Hydroelectric Power Plant

To utilize Intake water as much as possible for power generation

Max Intake water = Max Power discharge (Q_{pmax}) = 1,500 liter/sec

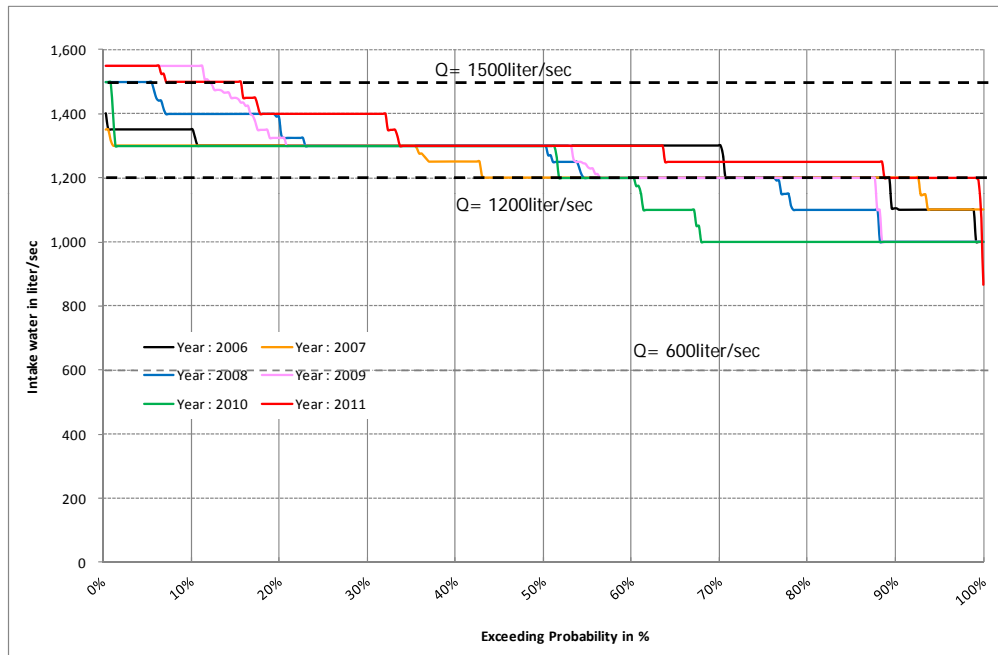

5

Head loss and Effective head of Concepcion Hydroelectric Power Plant

Head loss of Existing steel pipe

| Intake water m^3/sec | Friction Head loss (m) | | | | Total head loss |
|---------------------------|------------------------|----------|------------------|----------|-----------------|
| | ID 1,100mm section | | ID 900mm section | | |
| | L=3,671m | | L=2,613 m | | |
| | Sub-total | Per 100m | Sub-total | Per 100m | |
| 0.4 | 1.10 | 0.030 | 2.07 | 0.079 | 3.17 |
| 0.8 | 3.95 | 0.108 | 7.47 | 0.286 | 11.42 |
| 1.0 | 5.97 | 0.163 | 11.29 | 0.432 | 17.26 |
| 1.2 | 8.36 | 0.228 | 15.82 | 0.605 | 24.18 |
| 1.3 | 9.70 | 0.264 | 18.34 | 0.702 | 28.04 |
| 1.5 | 12.64 | 0.344 | 23.90 | 0.915 | 36.54 |

Existing steel pipe ID 1,100mm Existing steel pipe ID 900mm

Large head loss occurs in ID900mm section, so new pipe shall be installed in ID 900mm section.

Total Head loss after installation of new ID 700mm ductile cast-iron pipe (L=2,973m)

| Intake water m^3/sec | Total Head loss (m) | Decreasing head loss due to new pipe (m) | Effective Head at Max WL (m) |
|---------------------------|---------------------|--|------------------------------|
| 0.0 | 0.00 | - | 42.06 |
| 0.4 | 2.01 | 1.16 | 40.05 |
| 0.8 | 6.88 | 4.54 | 35.18 |
| 1.0 | 10.38 | 6.88 | 31.68 |
| 1.2 | 14.60 | 9.58 | 27.46 |
| 1.3 | 16.98 | 11.06 | 25.08 |
| 1.5 | 22.27 | 14.27 | 19.79 |

To increase electric energy due to installation of new ductile pipe.

New ductile cast-iron pipe ID 700mm

(Reference: Hazen-Williams formula existing steel pipe $C=90$, new ductile pipe $C=110$)

6

Economic Parameters for Optimization of Pipe Diameter at Concepcion Hydroelectric Power Plant

Optimum diameter of new ductile pipe is ID 700mm because of the lowest unit construction cost per kWh (material cost + installation cost)

| Economic parameter | Period for calculation | 500mm | 600mm | 700mm |
|--|------------------------|-------|-------|-------|
| Unit Pipe Construction Cost per kWh yen/kWh | 2006 – 2011 Average | 179 | 168 | 163 |
| | 2000 – 2011 Average | 206 | 186 | 182 |
| B-C a million yen/year | 2006 – 2011 Average | 3.98 | 5.52 | 6.85 |
| | 2000 – 2011 Average | 3.10 | 4.66 | 5.71 |
| B/C | 2006 – 2011 Average | 2.45 | 2.60 | 2.68 |
| | 2000 – 2011 Average | 1.95 | 2.12 | 2.14 |

B: Annual income of electricity selling (0.13695 US\$/kWh)

C: Annual capitation cost of ductile pipe installation in case of 40 year life time of the pipe (51,000US\$/year)

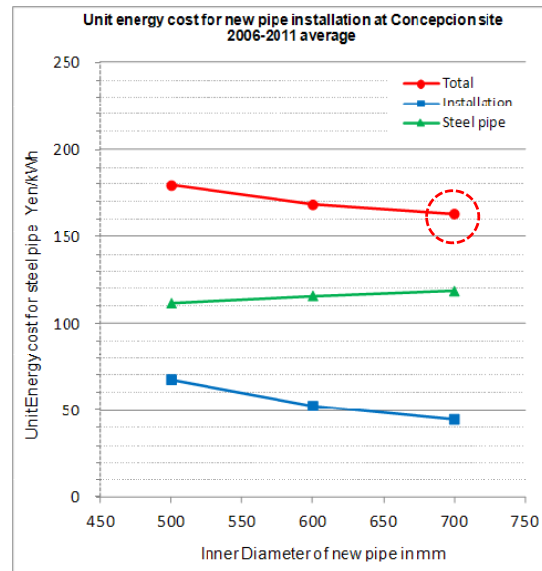
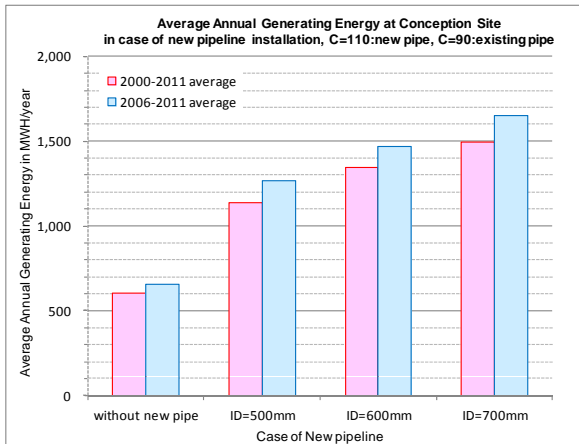

7

Annual Electric Energy of Concepcion Hydroelectric Power Plant

Mean annual electric energy with new installation of ID 700 mm ductile pipe is 1.650 GWh/year (Assumed income of selling electricity : 230,000US\$/year = 18 million yen/year (0.13695 US\$/kWh))

| Period For calculation | | Mean Annual Electric Energy | Maximum Annual Electric Energy | Minimum Annual Electric Energy |
|------------------------|----------|-----------------------------|--------------------------------|--------------------------------|
| 2006 – 2011 | GWh/year | 1.650 | 1.910 | 1.349 |
| | PF | 75% | 87% | 62% |
| 2000 - 2011 | GWh/year | 1.495 | 1.910 | 1.201 |
| | PF | 68% | 87% | 55% |

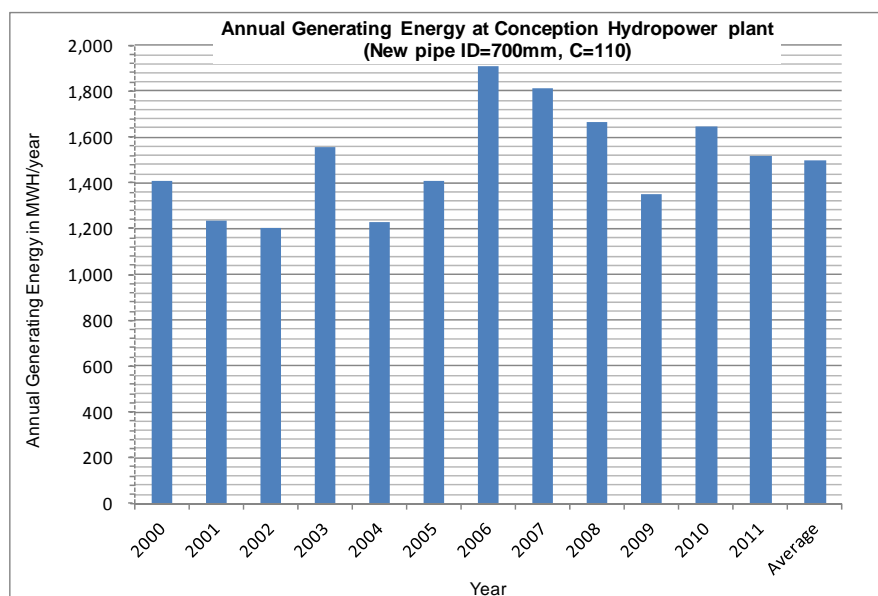

8

Concepcion Hydroelectric Power Plant

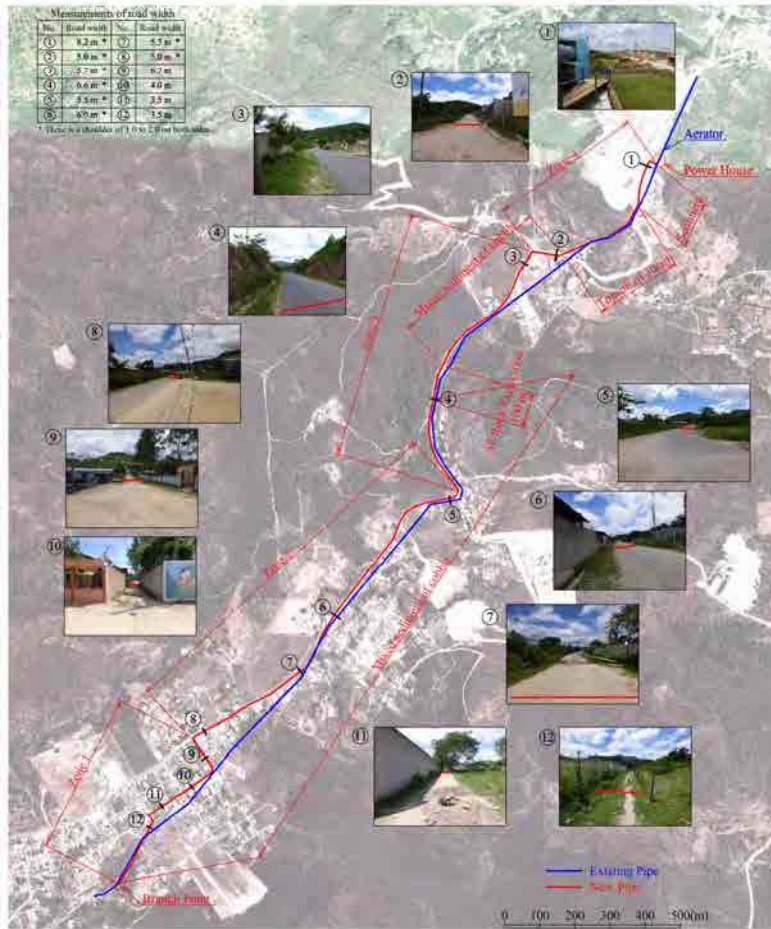

New pipeline is to be installed under ground along the existing road.

Kind : Ductile cast-iron pipe

Diameter : 700 mm

Total length : 2,973m

9

Concepcion Hydroelectric Power Plant



10

Concepcion Hydroelectric Power Plant



11

Concepcion Hydroelectric Power Plant

Section a-a

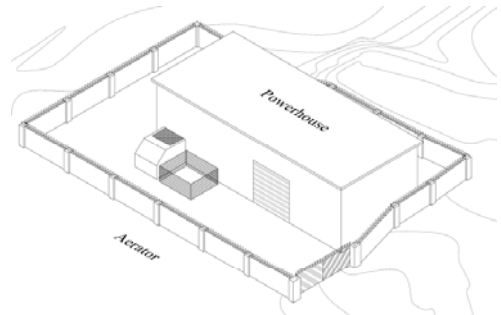
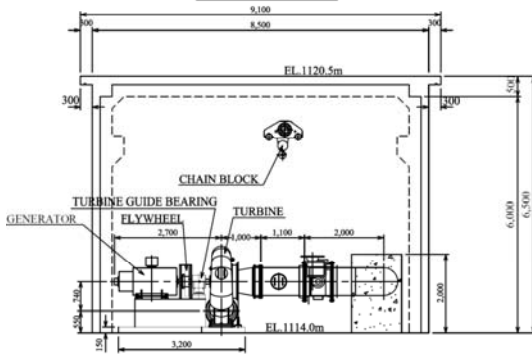

Section b-b

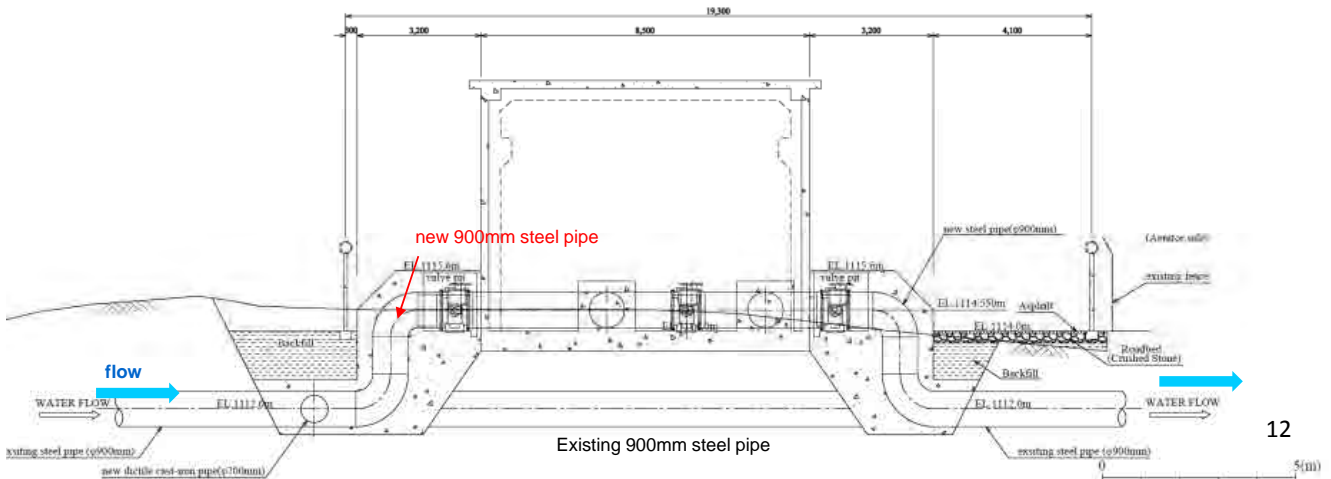

12

General Profile of Picacho Hydroelectric Power Plant

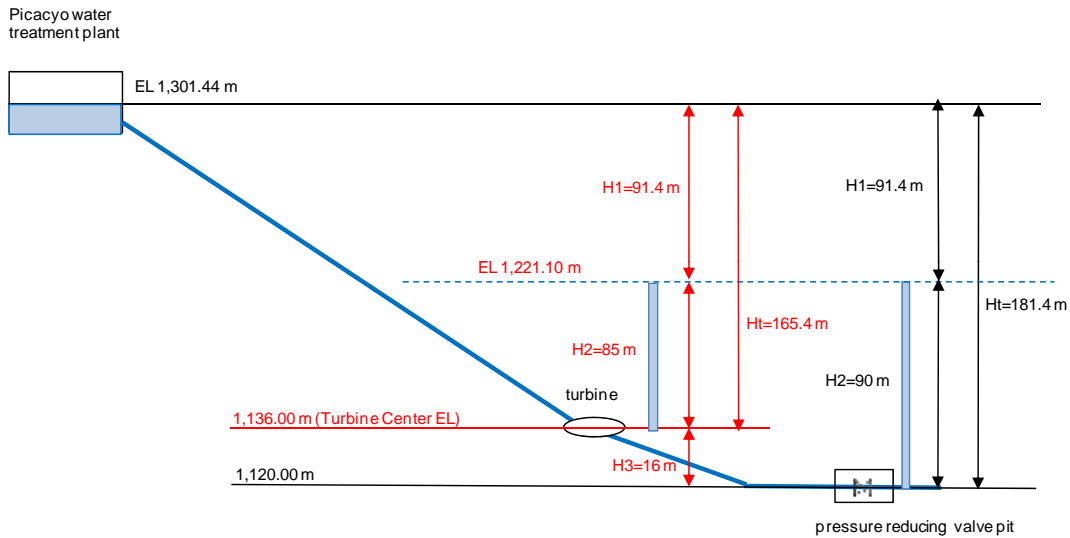

| item | value |
|----------------------------------|-------------------------|
| Max. Power discharge | 0.3 m ³ /sec |
| Picacho water treatment plant WL | 1,301.44m |
| Tail water WL | 1,210.00m |
| Max. gross head | 91.44m |
| Effective head at rated capacity | 86.16m |
| Rated capacity | 204kW |
| Installed capacity | 180kW |

to distribute 120liter/sec water to Lindero pond and distribute 150liter/sec to Esperanza community (actual measurement).
Max design distribution water 225 liter/sec

Water Distribution Operation Pattern of L22 pipeline of Picacho Water Treatment Pplant

Water Distribution Pattern of L22 in the wet season (September 2012)

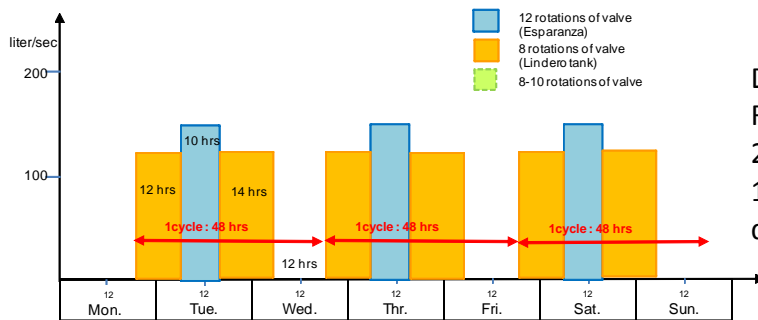

Distribution operation pattern in the Rainy season :
26 hour-operation with 120liter/sec, 10 hour-operation with 150liter/sec during 48 hours (total 75% operation)

Water Distribution Pattern of L22 in the dry season (March 2012)

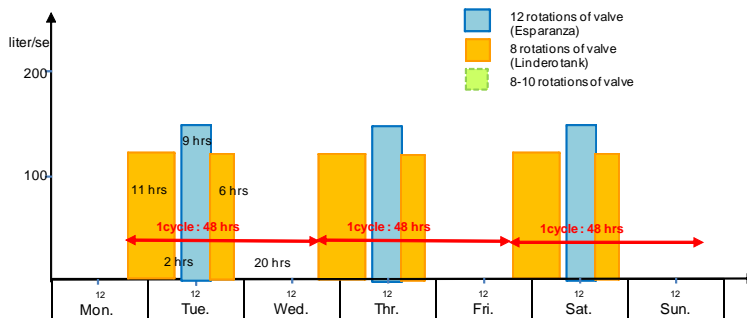

Distribution operation pattern in the Dry season :
17 hour-operation with 120liter/sec, 9 hour-operation with 150liter/sec during 48 hours (total 54% operation)

Annual Electric Energy of Picacho Hydroelectric Power Plant

Annual electric energy is 0.52GWh/year under existing water distribution condition, however, considering max design distribution water of 225 liter/sec for L22 pipeline , more energy can be generated under effective water distribution schedule.

(Assumed income of selling electricity : 71,000US\$/year = 5.6 million yen/year (0.13695 US\$/kWh))

Picacho Hydroelectric Power Plant



15

Picacho Hydroelectric Power Plant

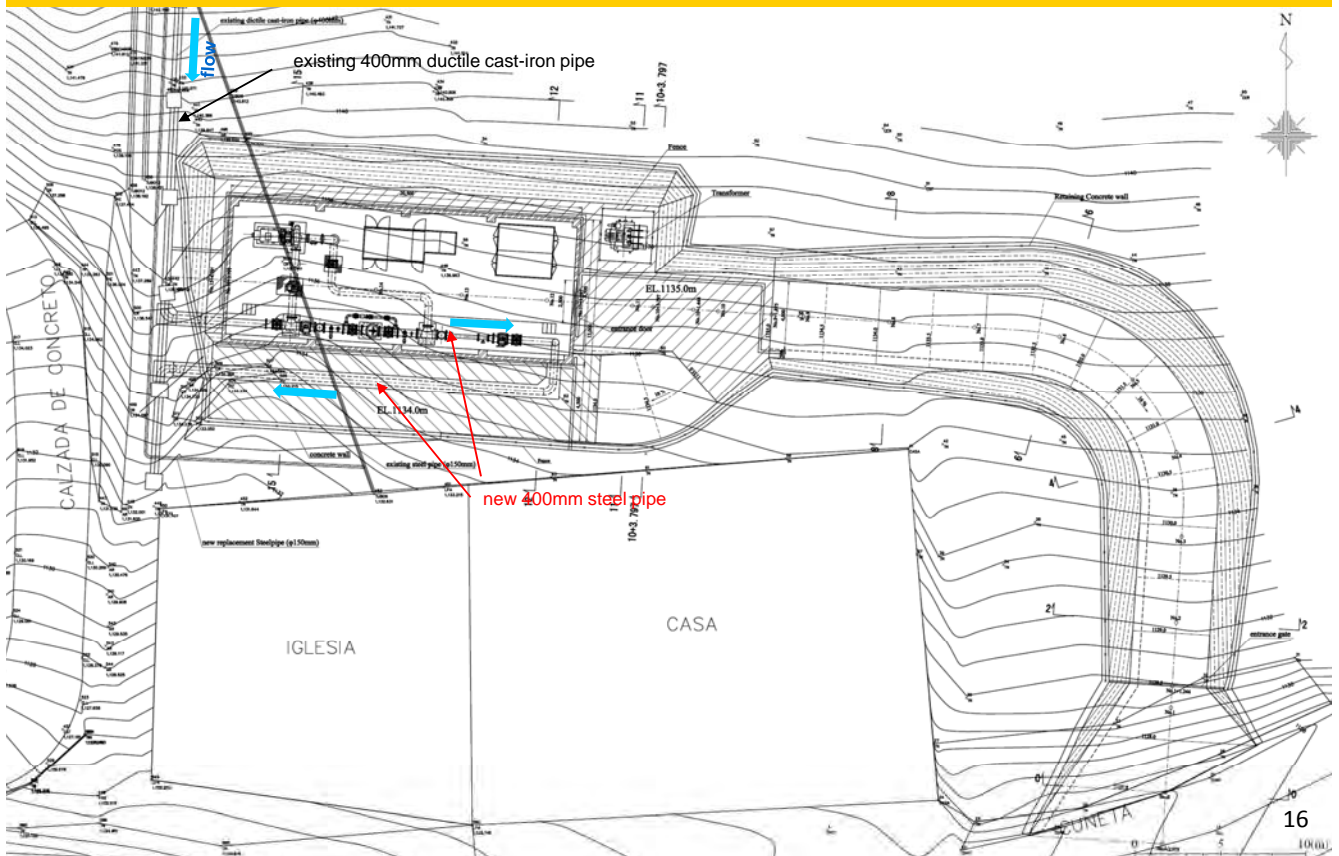

16

Picacho Hydroelectric Power Plant

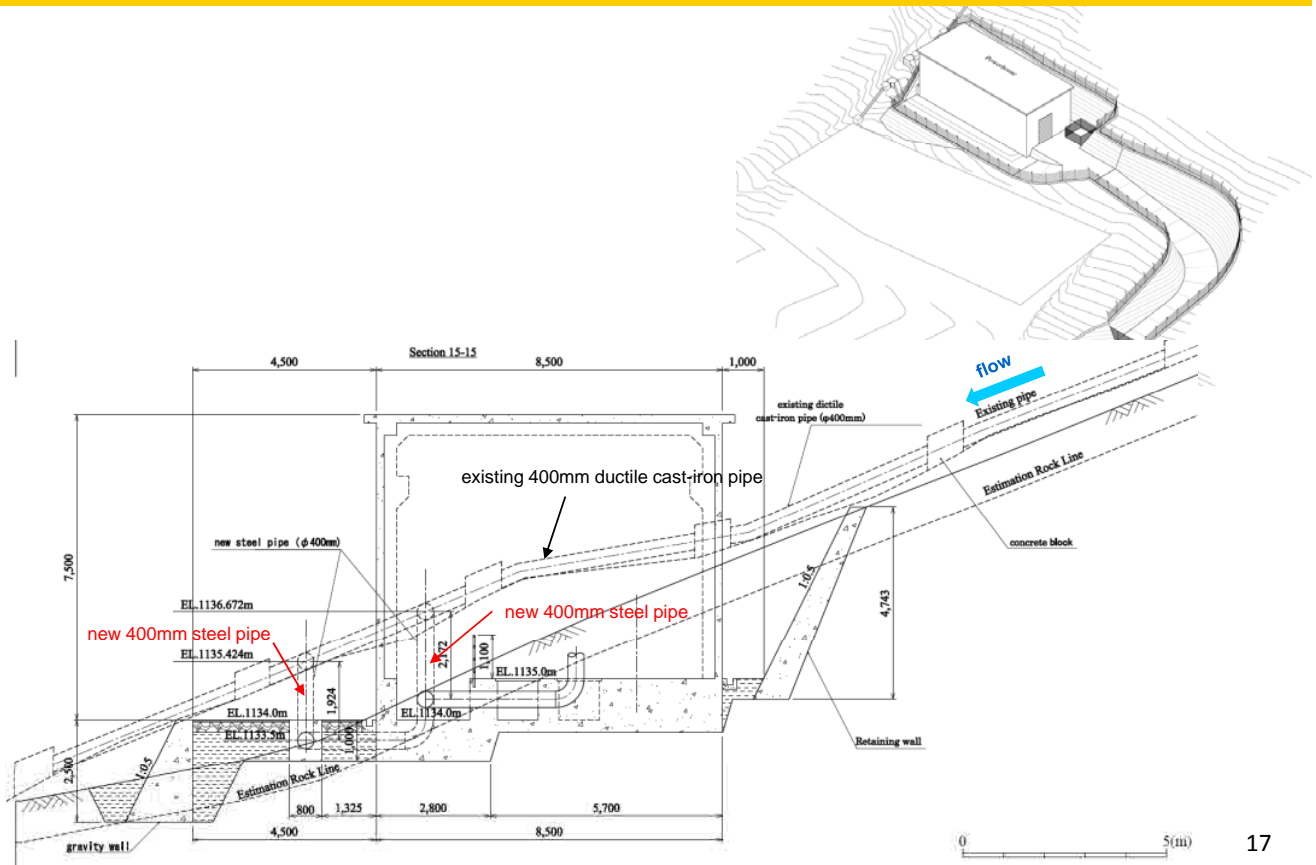

Concepcion Hydroelectric Power Plant (250kW)

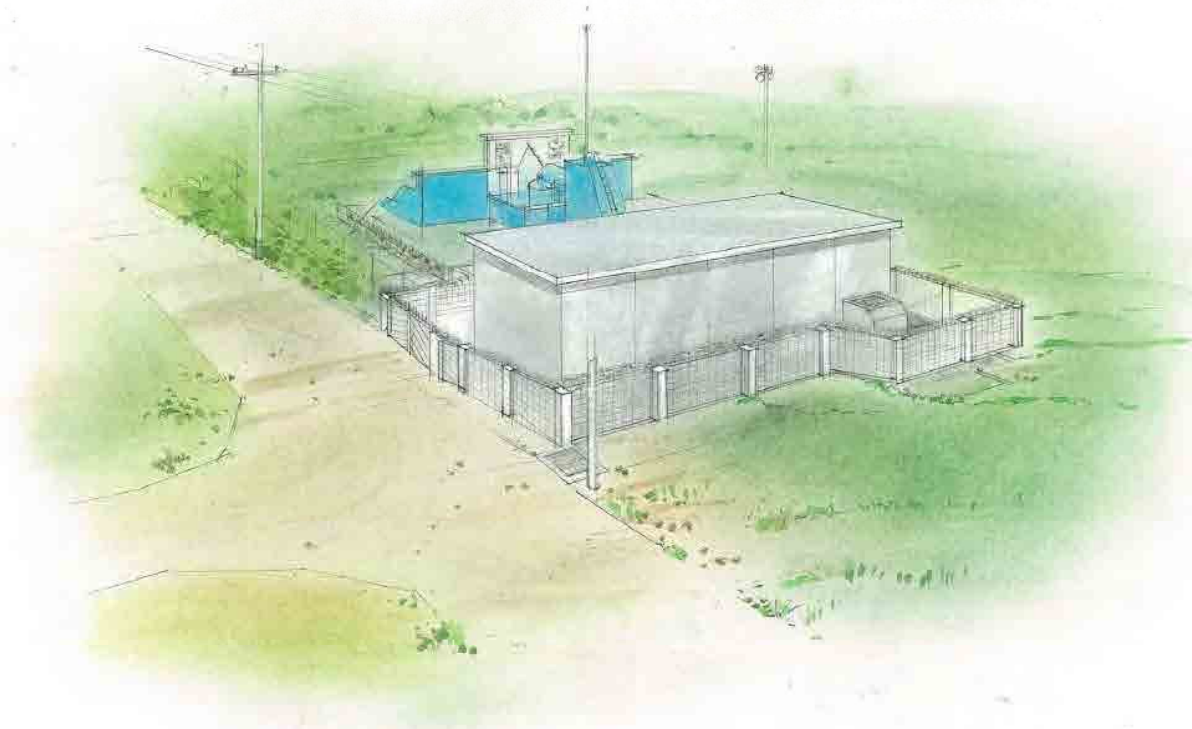

Picacho Hydroelectric Power Plant (180 kW)

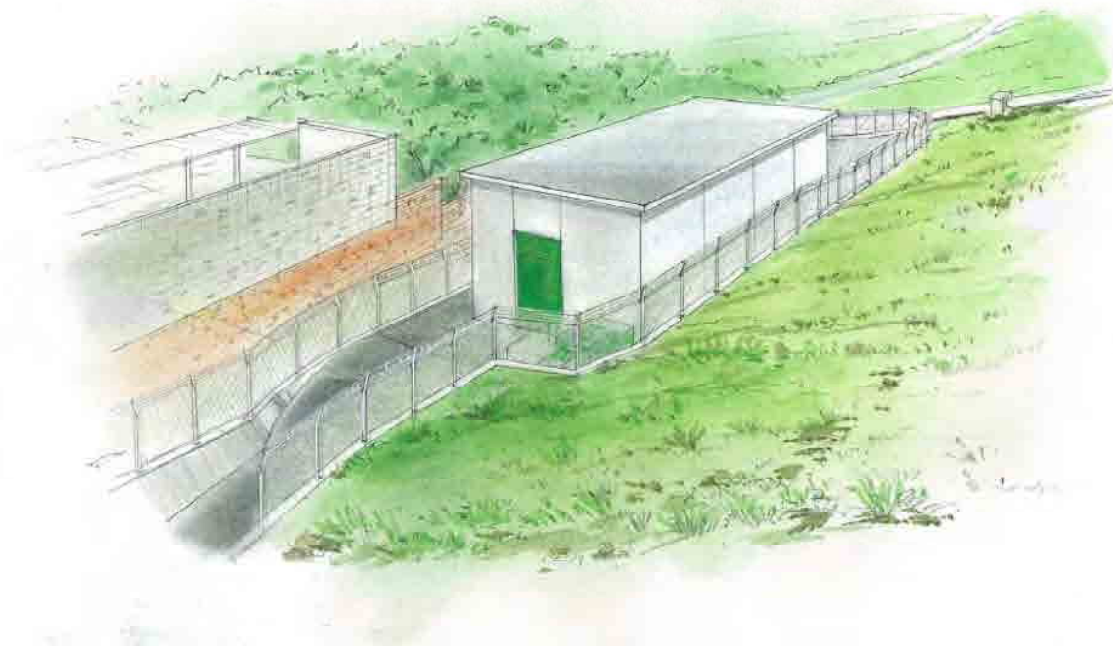

19

Operation & Maintenance of Concepcion & Picacho Hydroelectric Power Plants

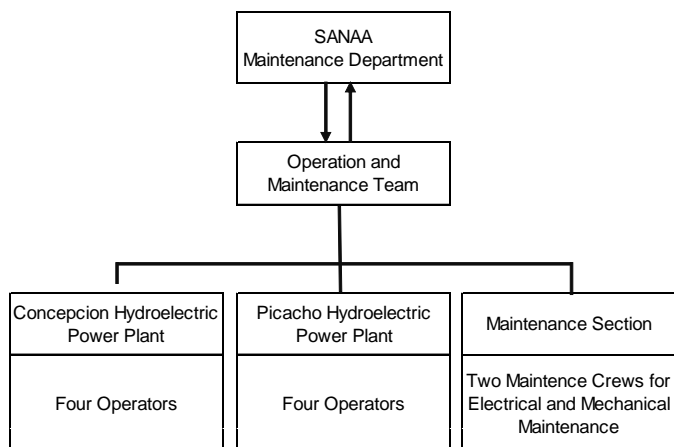

Periodic Inspection and Deterioration Diagnosis

| Daily Patrol Inspection | | Periodic Inspection and Deterioration Diagnosis | | |
|---|--------------|---|-------------------------|----------------------------|
| Facility | Frequency | Facility | Item | Frequency |
| Turbine, Generator and Electrical Equipment | one time/day | Turbine, Generator and Electrical Equipment | Periodic Inspection | one time/three years |
| | | | Deterioration Diagnosis | |
| | | | Detailed Inspection | an abnormality is observed |

Overhaul of Turbine and Valves

| Item | Frequency |
|--------------------------|--------------------------|
| Overhaul after Operation | One year after operation |
| Overhaul | a time/ten years |

20

TURBINE, GENERATOR AND ELECTRICAL EQUIPMENT

21

Concepcion Hydroelectric Power Plant (250kW)

22

Concepcion Hydroelectric Power Plant

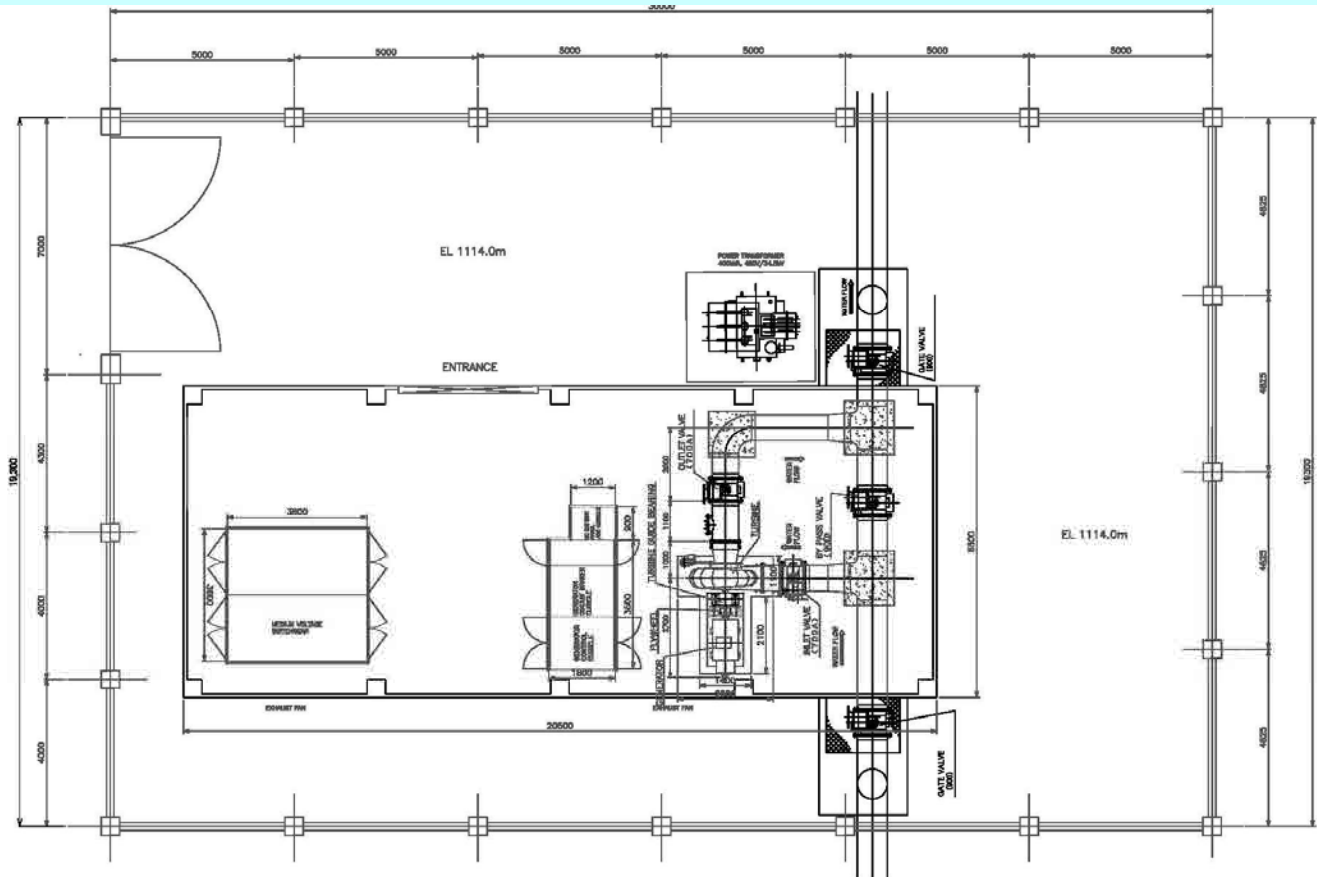

23

General Feature of Generating Equipment (Concepcion Site)

1. Hydraulic Turbine
 - a. Quantity 1
 - b. Type Horizontal-shaft, Francis
 - c. Power 273kW
 - d. Speed 900rpm
 - e. Discharge 1.50m³/s
 - f. Rated head 27.46m

2. Synchronous Generator
 - a. Quantity 1
 - b. Type Horizontal-shaft, synchronous
 - c. Power 314kVA
 - d. Power factor 80%
 - e. Voltage 480V, three (3) phases
 - f. Speed 900rpm
 - g. Frequency 60Hz

3. Power Transformer
 - a. Quantity 1
 - b. Type Oil immersed, outdoor
 - c. Power 400kVA
 - d. Voltage 0.48/34.5kV, three (3) phases

4. 34.5kV Medium Voltage Switchgear
 - a. Quantity 1

24

Concepcion Hydroelectric Power Plant

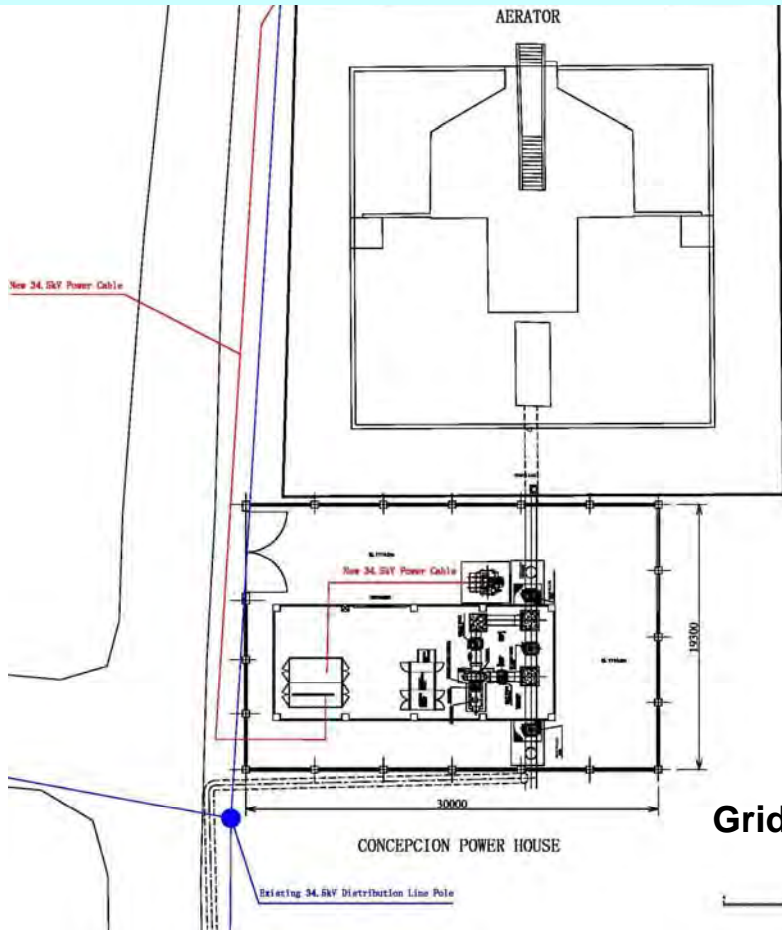

Grid-interconnection Scheme

Concepcion Hydroelectric Power Plant

Operation Scheme (Concepcion Site)

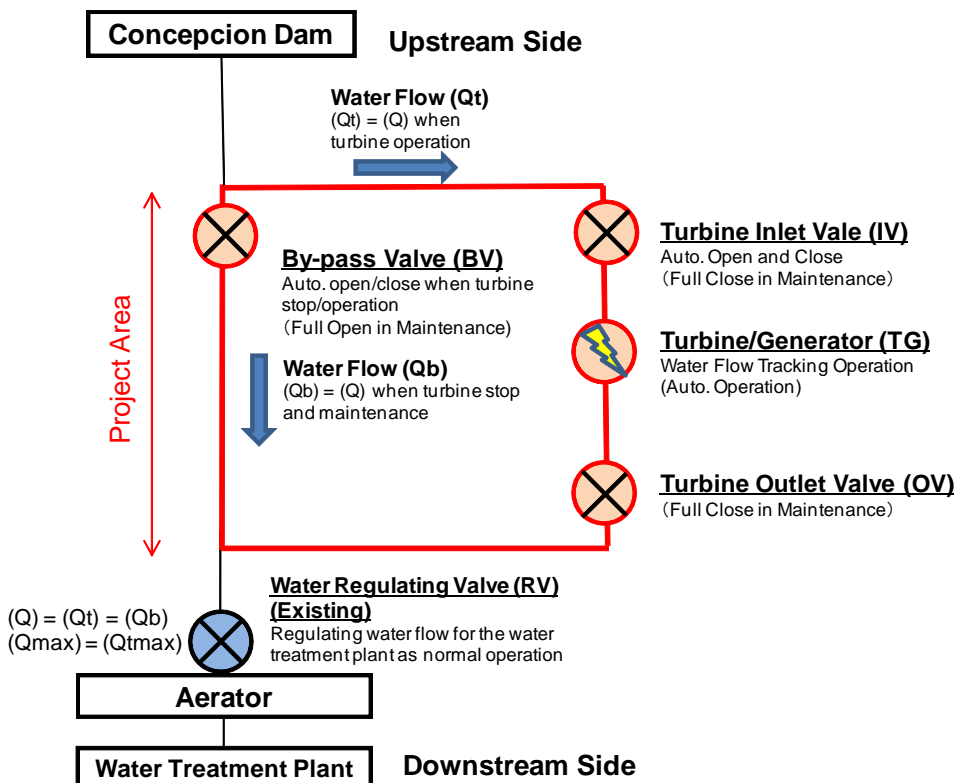

Picacho Hydroelectric Power Plant (180kW)

Picacho Hydroelectric Power Plant

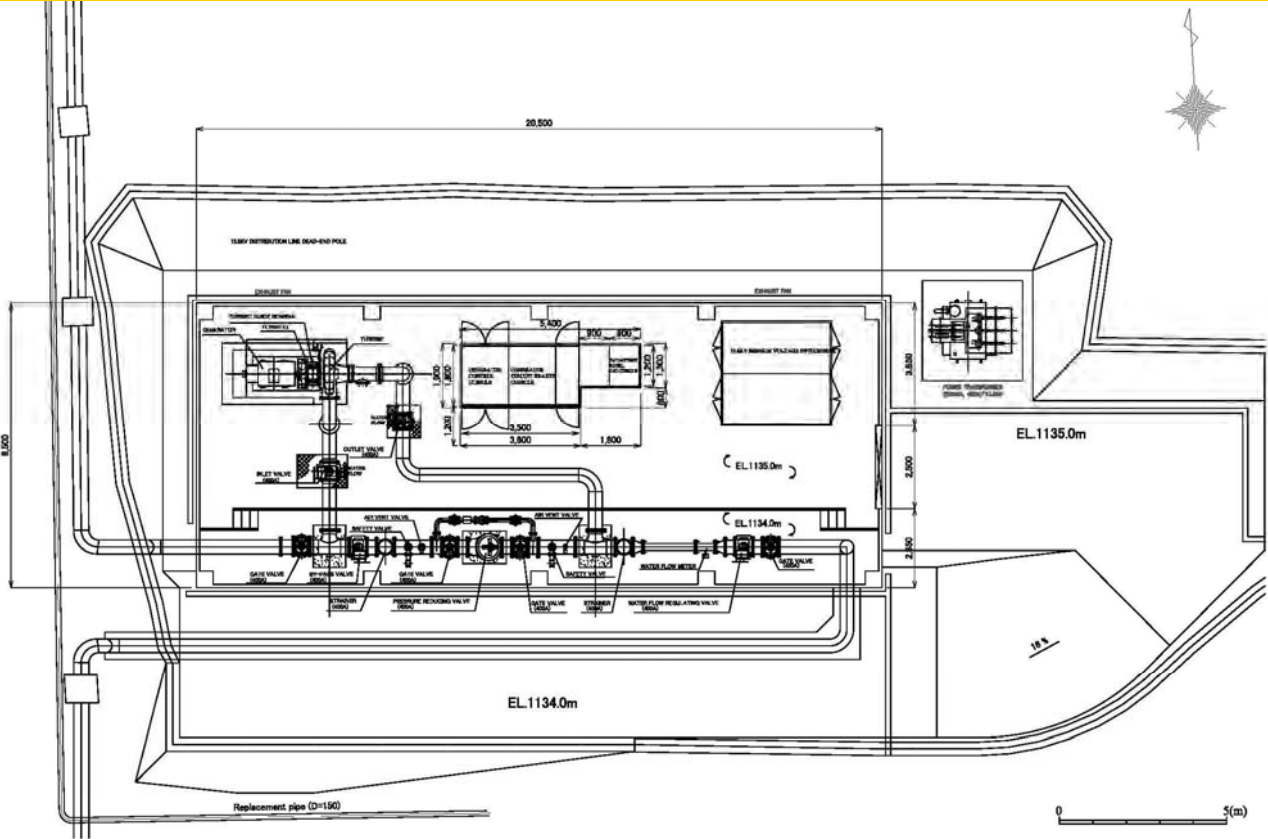

General Feature of Generating Equipment (Picacho Site)

- | | |
|-------------------------------------|-------------------------------|
| 1. Hydraulic Turbine | |
| a. Quantity | 1 |
| b. Type | Horizontal-shaft, Francis |
| c. Power | 204kW |
| d. Speed | 1,200rpm |
| e. Discharge | 0.30m ³ /s |
| f. Rated head | 88.16m |
| 2. Synchronous Generator | |
| a. Quantity | 1 |
| b. Type | Horizontal-shaft, synchronous |
| c. Power | 235kVA |
| d. Power factor | 80% |
| e. Voltage | 480V, three (3) phases |
| f. Speed | 1,200rpm |
| g. Frequency | 60Hz |
| 3. Power Transformer | |
| a. Quantity | 1 |
| b. Type | Oil immersed, outdoor |
| c. Power | 250kVA |
| d. Voltage | 0.48/13.8kV, three (3) phases |
| 4. 13.8kV Medium Voltage Switchgear | |
| a. Quantity | 1 |

29

Picacho Hydroelectric Power Plant

Grid-interconnection Scheme

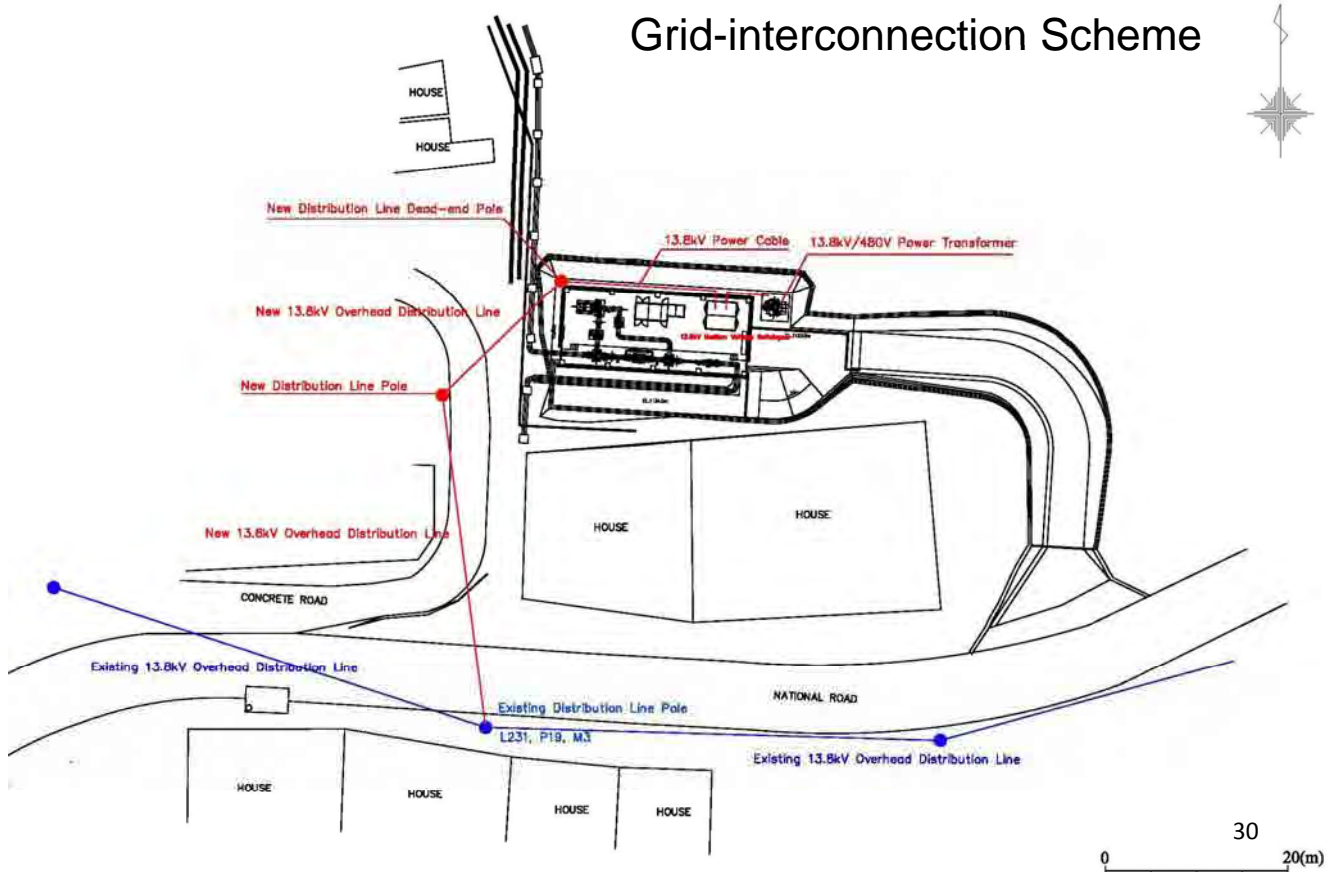

Picacho Hydroelectric Power Plant

Operation Scheme (Picacho Site)

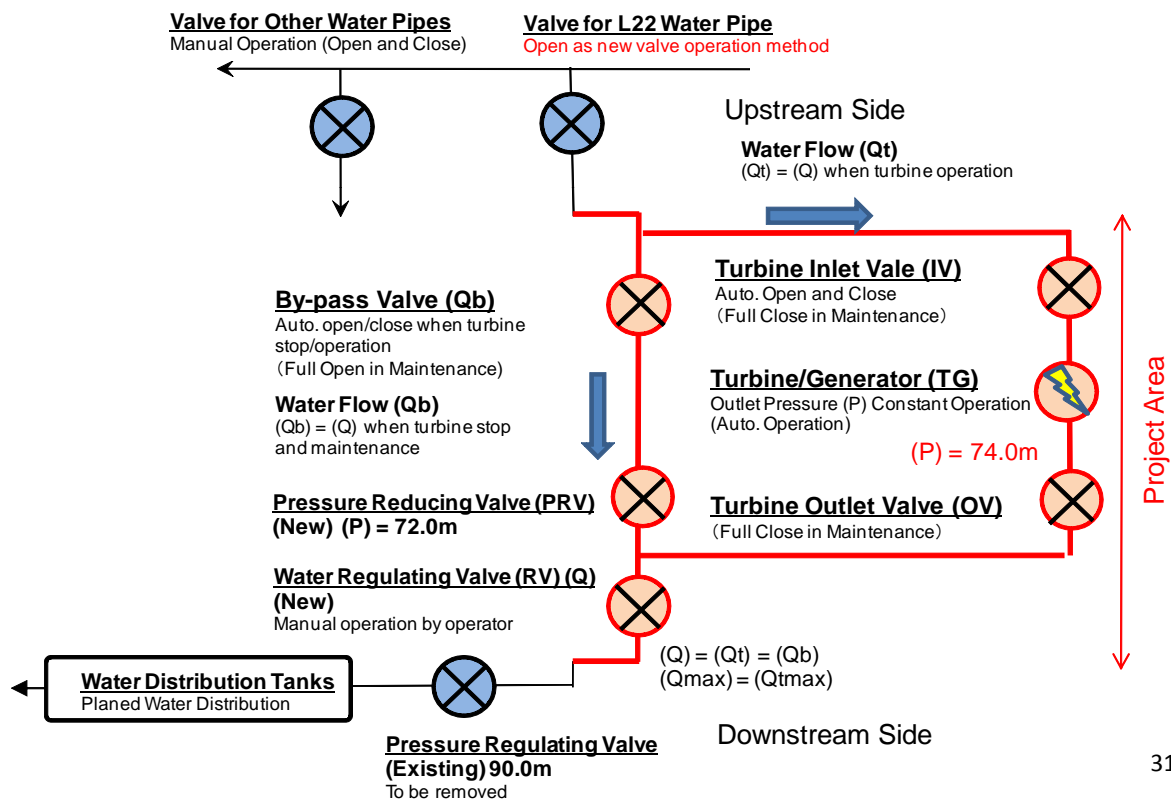

31

Equipment & Material Procurement

The country of origin for the equipment being procured for the Project shall be fundamentally considered as shown in the following Table.

| ITEM | Origin | | |
|---|--------|----------|-------|
| | Japan | Honduras | Other |
| Small-Scale Hydroelectric Power equipment | | | |
| Turbine | ○ | | |
| Generator | ○ | | |
| Turbine/generator Control System | ○ | | |
| Low Voltage Distribution Cubicle | ○ | | |
| Control System | ○ | | |
| Medium Voltage Switchgear | | | ○ |
| Power Transformer | | | ○ |
| Construction Materials | | | |
| Ready-Mix-Concrete | | ○ | |
| Cement | | ○ | |
| Sand·Aggregate | | ○ | |
| Deformed bar | | ○ | |
| Wood | | ○ | |
| Ductile Iron Pipe, Steel Pipe (more than $\phi 200$ mm) | | | ○ |
| Valves | | | ○ |
| Electric line pole | | ○ | |
| Construction Machines | | | |
| Crane | | ○ | |
| Backhoe | | ○ | |
| Dump Truck | | ○ | |
| Bulldozer | | ○ | |

Main components of the small-scale Hydroelectric Power generation, such as a turbine, dynamos, and an operator control panel etc, are premised on Japanese-made supply.

32

Local Equipment & Material

Construction material



Concrete plant



Construction machine



Transportation of Equipment from Japan

The small-scale-Hydroelectric Power related electrical items procured in Japan will arrive at the sole international port in El Salvador, Acajutla. The target sites are located in Tegucigalpa, which is located about 400km from the port. However, there are many experienced transport companies in Tegucigalpa and the access roads from the port to the sites are well maintained. Therefore, there is no concern related to the local transport of the materials from Japan.

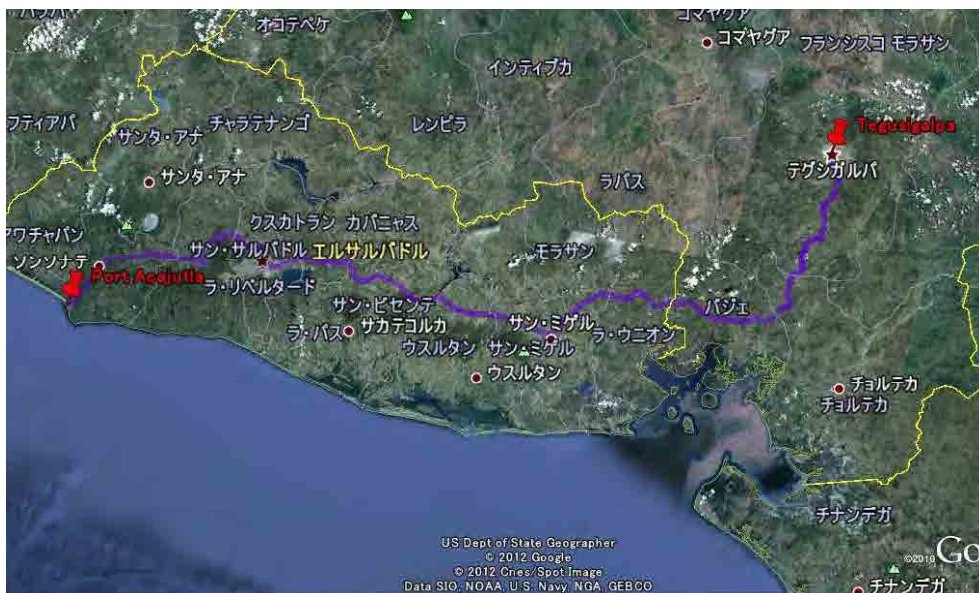

Concepcion Construction Site

Powerhouse site



New pipeline route



Picacho Construction Site



35

Implementation Schedule

Based on the grant aide scheme of Japan, preliminary implementation schedule is drawn up as shown below.

| Pre-Implementation | | Total Seven Months | | | | | | | | | | | | | | | | | |
|--------------------|--|--------------------|---|---|---|---|---|---|---|---|----|----|----|----|----|----|----|----|--|
| | | 1 | 2 | 3 | 4 | 5 | 6 | 7 | 8 | 9 | 10 | 11 | 12 | 13 | 14 | 15 | 16 | 17 | |
| Contract | | █ | | | | | | | | | | | | | | | | | |
| Field Survey | | | █ | | | | | | | | | | | | | | | | |
| Desk Study | | | | █ | | | | | | | | | | | | | | | |
| Bidding Process | | | | | █ | | | | | | | | | | | | | | |

| Implementation | | Total Sixteen Months | | | | | | | | | | | | | | | | |
|---------------------------------------|--|----------------------|---|---|---|---|---|---|---|---|----|----|----|----|----|----|----|----|
| | | 1 | 2 | 3 | 4 | 5 | 6 | 7 | 8 | 9 | 10 | 11 | 12 | 13 | 14 | 15 | 16 | 17 |
| Manufacturing/ Transportation | | █ | | | | | | | | | | | | | | | | |
| Installation Works (include test run) | | | | | | | | | | | | | | █ | | | | |
| Civil Works | | | | | █ | | | | | | | | | | | | | |

In this project, the time necessary for completion is mainly determined by the process of manufacture and delivery of small-scale Hydroelectric Power equipment, installation, and adjustment works. The other construction works, such as pipeline works, proceed in parallel with the manufacture and delivery of the small-scale Hydroelectric Power equipment. 36

Allocation of Chief Responsibility

| No. | Items | To be covered by Grant Aid | To be covered by Recipient Side |
|-----|---|----------------------------|---------------------------------|
| 1 | Acquisition and free provision of land necessary for the project | | ● |
| 2 | Acquisition and free provision of land necessary for the temporary works and the land clearance | | ● |
| 3 | Provision of waste disposal sites | | ● |
| 4 | To construct roads within the sites | ● | |
| 5 | To maintain the roads outside of the sites | | ● |
| 6 | Procurement of Small-Scale Hydroelectric Power equipment | ● | |
| 7 | Installation of Small-Scale Hydroelectric Power equipment | ● | |
| 8 | New Bypass Pipeline Construction (Concepcion) | ● | |
| 9 | To connect the new power line to the existing infrastructures | ● | |
| 10 | Provision of free water for the construction works | | ● |
| 11 | To bear the following commissions applied by the bank in Japan for banking services based upon the Bank Arrangement (B/A): 1) Payment of bank commission | | ● |
| 12 | Application and acquisition of permits and licenses required for the construction works | | ● |
| 13 | To ensure all the expense and prompt execution of unloading and customs clearance at the port of disembarkation in the recipient country | | |
| | 1) Marine or air transportation of the products from Japan or third countries to the recipient | ● | |
| | 2) To ensure all the expense and prompt execution of unloading, tax exemption and customs clearance of the products at the port of disembarkation | | ● |
| 14 | 3) Internal transportation from the port of disembarkation to the project site | ● | |
| | To accord Japanese nationals and/or nationals of third countries, including persons employed by the agent whose services may be required in connection with the Components such facilities as may be necessary for their entry into recipient country and stay therein for the performance of their work. | | ● |
| 15 | To ensure that customs duties, internal taxes and other fiscal levies which may be imposed in the recipient country with respect to the purchase of the Components and to the employment of the Agent will be exempted by the Government of recipient country. | | ● |
| 16 | To maintain and use properly and effectively the facilities that are constructed and the equipment that is provided under the Grant. | | ● |
| 17 | To bear all the expenses, other than those covered by the Grant and its accrued interest, necessary for the purchase of the Components as well as for the agent's fees. | | ● |
| 18 | To ensure environmental and social consideration for the Programme. | | ● 1 |

Obligations of Honduras Side and the Allocation of Responsibilities

| | Obligations | Allocation of responsibilities |
|----|--|---|
| 1 | Acquisition and free provision of land necessary for the project | The SANAA |
| 2 | Acquisition and free provision of land necessary for the temporary works and the land clearance | The SANAA |
| 3 | Provision of waste disposal sites | The SANAA with Tegucigalpa municipality |
| 4 | To maintain the roads outside of the sites | The SANAA with Tegucigalpa municipality |
| 5 | Provision of free water for the construction works | The SANAA |
| 6 | To bear the commissions applied by the bank in Japan for banking services based upon the Bank Arrangement (B/A) (ex; Payment of bank commission) | The SANAA |
| 7 | Application, acquisition of permits and licenses required for the construction works | The SANAA with relevant institutions and Tegucigalpa municipality |
| 8 | To ensure all the expenses and prompt execution of unloading and customs clearance at the port of disembarkation in the recipient country | The SANAA |
| 9 | To accord Japanese nationals and/or nationals of third countries , including persons employed by the agent whose services may be required in connection with the components such facilities as may be necessary for their entry into recipient country and stay therein for their works | The SANAA |
| 10 | To ensure that customs duties, internal taxes and other fiscal levies which may be imposed in the recipient country with respect to the purchase of the Components and to the employment of Agent will be exempted by the Government of recipient country | The SANAA with relevant institutions |
| 11 | To maintain and use properly and effectively, the facilities that are constructed and the equipment that are provided under the Grant | The SANAA |
| 12 | To bear all the expenses, other than those covered by the Grant and its accrued interest, necessary for the purchase of the components as well as the agent's fees. | The SANAA |
| 13 | To ensure environmental and social consideration for the Programme | The SANAA with relevant institutions |

Operation and Maintenance Cost

(1) Labor Cost of Operation and Maintenance

| | Name | Number of staff | Salary |
|----|-------------------|-------------------------------------|--|
| 1) | Operators | 4 personnel × 2 Sites = 8 personnel | Lp.15,000/month × 8 personnel= Lp.120, 000 |
| 2) | Maintenance Crews | 2 personnel | Lp.20, 000/month × 2 personnel= Lp.40, 000 |
| | | | Lp.160,000/month |

(2) Purchase Cost of Spare Parts

| | item | amount |
|----|--|-----------------|
| 1) | a regular basis is a kind of valve seals and turbine shaft water seal packing. | Lps.24,000/year |

(3) Other Direct Costs (Consumables)

| | item | amount |
|----|---|-----------------|
| 1) | Consumables such as printer cartridges of the printers for the control system, grease for the generator and office supplies | Lps.12,000/year |

(4) Overhaul Costs, etc.

| | item | amount |
|----|--|---------------------|
| 1) | The overhaul of the turbine and the generator in every 10 years The replacement of turbine water seal packing and the valve seals | Lps.718,000/10years |

Necessary spare parts are delivered in this Project. If spares are used in the repairing work, it is necessary to purchase and keep them for future maintenance.

3

Land Acquisition for the Project

| | Location | Required area | Remarks |
|-----------------|--|--|---|
| Concepcion site | Powerhouse site | Powerhouse site : 30m x 19.3m | Excluding space between the boundary and anterior road, neighboring aerator |
| | Buried pipeline route (garden of private house) | Pipe length :about 30m | |
| | Buried pipeline route (community land) | Pipe length :about 100m | |
| Picacho site | Powerhouse site (including Access road) | Powerhouse site: 600m ² Access road: 430m ² | Excluding space between the boundary and private house below. |

Others

- Relocation of existing distribution water pipeline, which cross the powerhouse site to be constructed (steel pipe ID 150mm, length 48m) at Picacho site
- water stoppage to bifurcation of new pipe from existing pipeline
Concepcion site: 4 locations, 2 along the existing pipeline, 2 in powerhouse
Picacho site : 2 locations in powerhouse

4

Land Acquisition for the Project

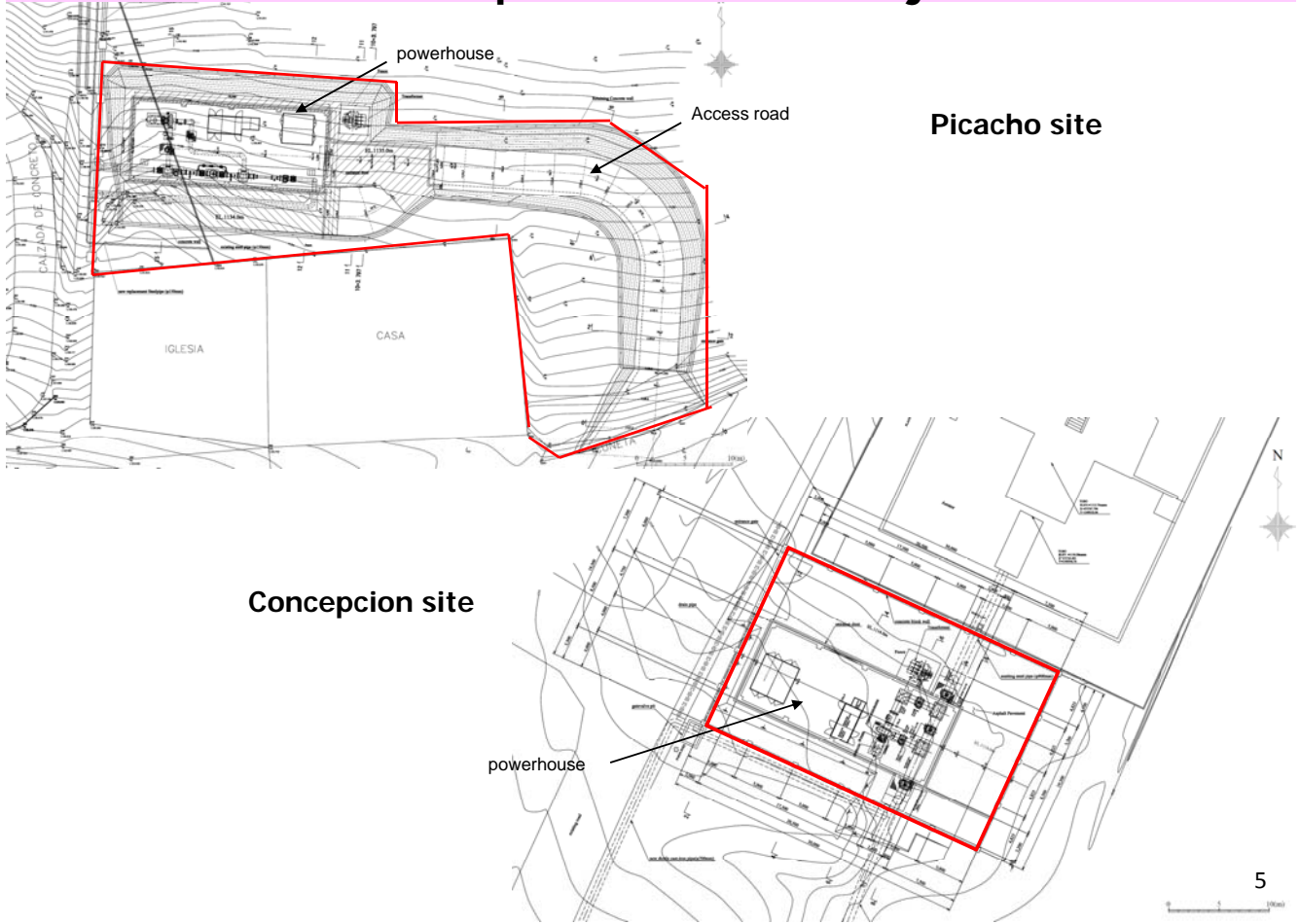

Construction required for Water Stoppage

