

**KHẢO SÁT CHUẨN BỊ
CHO
DỰ ÁN ĐƯỜNG CAO TỐC TRUNG LƯƠNG – MỸ THUẬN
Ở
VIỆT NAM**

BÁO CÁO CUỐI KỲ

PHỤ LỤC

- Phụ lục -A1 Danh sách các đối tác tư nhân tham gia vào các
Dự án đường bộ tại Việt Nam
- Phụ lục -A2 Thiết kế hướng tuyến cao tốc TL-MT
- A2-1: Hướng tuyến trên bình đồ
- A2-2: Trắc dọc
- Phụ lục -A3 Lịch trình xây dựng
- Phụ lục -A4 Kết quả của dự báo chất lượng không khí
- Phụ lục -A5 Tài liệu họp
- A5-1: Hợp báo cáo đầu kỳ với BEDC
- A5-2: Hợp tiến độ (lần 5) với BEDC
- A5-3: Hợp với Bộ GTVT để khôi phục dự án
- A5-4: Hợp khởi động để khôi phục dự án với CL CIPM
- A5-5: Hợp báo cáo giữa kỳ với CL CIPM
- A5-6: Hợp dự thảo báo cáo cuối kỳ với Bộ GTVT
- Phụ lục -A6 Biên bản / Ghi chú cuộc họp
- A6-1: Hợp báo cáo đầu kỳ với BEDC
- A6-2: Hợp tiến độ (lần 5) với BEDC
- A6-3: Hợp với Bộ GTVT để khôi phục dự án
- A6-4: Hợp khởi động để khôi phục dự án với CL CIPM
- A6-5: Hợp báo cáo giữa kỳ với CL CIPM
- A6-6: Hợp với tổ công tác của Bộ GTVT (lần 1)
- A6-7: Hợp dự thảo báo cáo cuối kỳ với Bộ GTVT

Phụ lục -A1 Danh sách các đối tác tư nhân tham gia
vào các Dự án đường bộ tại Việt Nam

Table The List of Private Sector Participated Projects in Road Sector in Vietnam

(As of July 10 2012)

No.	Name	Investor	Location	Scope	Investment capital	Status
1.	Rach Mieu Bridge, National Highway 60	Rach Mieu Bridge BOT Limited Liability. (joint venture among CIENCO1, CIENCO5 and CIENCO6)	Connecting Tien Giang & Ben Tre Provinces	Length: 8.3 km	988 billion VND	Construction is complete. Toll collection is being conducted at Rach Mieu Bridge Toll Collection Station. Toll collection period: 18 years and 5 months, starting from April 2009.
2.	New Dong Nai Bridge and Route at two ends of the bridge	Construction Corporation No. 1 – One member Liability Limited Company (CCI) <i>(no further information available about members of CCI)</i>	Dong Nai Province	Length: 460m Width: 20m 5 lanes	187 billion VND	The section of Dong Nai Bridge has been in operation since Dec 2009. <i>(no information available about toll collection period)</i> The remaining items of the route at two ends of the bridge are supposed to be completed by March 2012, but is currently behind schedule.
3.	National Highway 1 Detour Road Bien Hoa City	Dong Thuan Investment Joint Stock Company	Dong Nai Province	Length: 12.2 km	751 billion VND	A section of 4.38 km is currently under construction. The site of the remaining length of 7.82 km has not been cleared.
4.	Renovation and expansion of some sections on National Highway No. 20	Partnership among Company 7/5 (Ministry of National Defence), Hung Phat Limited Liability Company and Dai Phat Investment and Development Limited Liability Company	Madaguoi Town, Lam Dong Province	Length: 130 km	Not known	Construction is complete. Toll collection is being conducted at Toll Collection Station Dinh Quan and Bao Loc. Toll collection period: 16 years and 6 months, starting from 16 Oct 2010.
5.	Expansion of detour route National Highway No. 1A – Section crossing Phan Giang – Thap Cham City	Joint venture between 577 Investment Joint Stock Company and HCM City Economic Infrastructure Investment Joint Stock Company Project enterprise: Ninh Thuan Construction Investment and	Ninh Thuan Province	Length: 8.3 km	365.8 billion VND	- Construction started on 14 April 2009. - Date of completion stipulated in the contract: 14 Oct 2011. - Currently operating as of July 2012.

No.	Name	Investor	Location	Scope	Investment capital	Status
		Development Joint Stock Company (Company 577: 36%, HCMC City Economic Infrastructure Investment JSC: 64%)				
6.	National Highway 1A, Hoa Cam – Hoa Phuoc Section	Civil Engineering Construction Joint Stock Company No. 545	Hoa Cam – Hoa Phuoc Section.	Length: 8.4km	370 billion VND	Construction is complete, toll collection is being conducted. <i>(no information available about toll collection period)</i>
			Tu Cau – Vinh Dien Section (additional)	Length: 5 km		Construction has recently started. (Contract schedule was signed in Feb 2012).
7.	Expansion of National Highway 1A, Section from Dong Ha City – Quang Tri	Joint venture among Investment Joint Stock Company No. 577 & HCM City Economic Infrastructure Investment Joint Stock Company Project enterprise: Ninh Thuan Construction Investment and Development Joint Stock Company.	Quang Tri Province	Length: 12.9 km	616 billion VND	Construction started in Oct 2008 and is planned to complete in Dec 2010. As of April 2012, only 50% of the construction is complete.
8.	Highway 1A Detour Road Dong Hoi City	BOT Dong Hoi Detour Road Limited Liability. Company	Quang Binh Province	Length: 19.3 km 4 lanes	657 billion VND	Construction is complete. Toll collection is being conducted. <i>(no information available about toll collection period)</i>
9.	Road tunnel through Deo Ngang	Song Da Corporation	Ha Tinh – Quang Binh Province	Length: 2.8 km	150 billion VND	Construction started in May 2003 and is complete. Toll collection is being conducted. [<i>(no information available about toll collection period)</i>
10.	Renovation and	Dai Duong Development Joint Stock	Quang Ninh	Length: 30.1 km	1500 billion VND	Construction started in Oct 2011, and is expected to complete in 14

No.	Name	Investor	Location	Scope	Investment capital	Status
	upgrade of National Highway 18, Section from Uong Bi City to Ha Long City	Company	Province	Width: 11.5 m Height: 7.5 m		months. Completed choosing Contractors. Site is being cleared.
11.	Yen Lenh Bridge	Partnership between Thang Long Construction Corporation and Transport Engineering Construction Joint Stock Company No. 4	Connecting Hung Yen and Ha Nam Provinces	Length: 2.2 km Width: 15m	340 billion VND	Construction is complete. The bridge has been operating for 7 years. Toll collection is being conducted at Yen Lenh Bridge Toll Collection Station. <i>(no information available about toll collection period)</i>
12.	Expansion of Nam Cau Gie Toll Collection Station	Hai Chau Limited Liability. Company	Ha Nam Province	Toll collection station	Not known	The proposal of expansion has been approved the Department of Road, Ministry of Transport on 24 October 2011.
13.	Renovation and upgrade of National Highway 10, Section from La Uyen Bridge to Tan De Bridge	Tasco Joint Stock Company	Thai Binh Province	Length: 5.5km	432 billion VND	- Site is cleared. Section is under construction. - Under construction as of March 2012.
14.	Construction of National Highway 2, Detour Road Vinh Yen City	Vietracimex 8 BOT Joint Stock Company	Vinh Yen	Length: 21.9 km Width: 23m 4 lanes Speed limit: 80 km/h	616 billion VND	The road was brought into operation on 29 December 2010 <i>(no information available about toll collection period)</i>
15.	National Highway 1A, Detour Road	Detour Road Thanh Hoa City Limited Liability. Company	Thanh Hoa	Speed limit : 80 km/h Width: 26 m	820 billion VND	- Stage 1 & 2 are basically complete and have been brought into operation since 2009. Toll collection started in 1 Jan 2009. Directorate

No.	Name	Investor	Location	Scope	Investment capital	Status
	Thanh Hoa City			Length: 9.98 km		for Roads of Vietnam is currently discussing with the investor to lower the toll. <i>(no information available about toll collection period)</i>
16.	Construction of National Highway 1A, Detour Road Ha Tinh City	Detour Road Thanh Hoa City Limited Liability. Company	Ha Tinh province	Main route length: 16.3 km Thach thuong - Thach Ngoc Branch: 1.56 km. Provincial Road 17 Branch: 3.5 km	Not known	Construction started in Nov 2005. Main route is complete and brought into operation since Dec 2008. Toll collection is being conducted at Cau Rac Toll Collection Station since 1 Jan 2009. <i>(no information available about toll collection period)</i>
17.	Renovation and upgrade of National Highway 2, Section from Noi Bai to Vinh Yen	Highway 2 BOT Joint Stock Company <i>(no information about the investors)</i>	Hanoi – Vinh Phuc	Speed limit: 80 Km/h Width: 26m Length: 21.9 km.	713 billion VND	21.68 km was completed as of March 2012. The Ministry of Transport has encouraged the contractor and investor to finalise the remaining part (around 320 m).
18.	Construction of National Highway 1A, Detour Road Vinh City	Transport Works Construction Corporation No. 4	Nghe An	Width: 12m Length: 25.8 km.	Not known	Construction is complete. Toll collection is being conducted. <i>(no information available about toll collection period)</i>
19.	Phu Gia, Phuoc Tuong Road Tunnel	Currently under selection	Thua Thien Hue	Length: 17.9 Km	1,186 billion VND	Investor is being selected as of March 2012 <i>(no information available about expected timeframe for selection)</i> . Currently there are two contenders: - Mien Trung Construction Corporation, Cienco8 and Phu Thinh

No.	Name	Investor	Location	Scope	Investment capital	Status
						Construction and Investment Joint Stock Company; and - HCM City Technology and Infrastructure Development Investment Joint Stock Company and Trading and Construction Joint Stock Company No. 591.
20.	Road for Transportation of Construction Materials at Phuoc Tan and Tam Phuoc Villages, Bien Hoa City	Currently under selection	Dong Nai Province	Length: 7.5 km	107 billion VND	Proposal has been approved. Investor is being selected. <i>(no information available about expected timeframe for selection)</i>
21.	Bien Hoa – Vung Tau Railroad	Not known	Bien Hoa, Vung Tau	Length: 78 km	80 million USD	Construction is expected to start in 2012.
22.	Trang Bom-Hoa Hung Highline Railroad	Not known	Dong Nai-HCMC	Length: 49 km	575 million USD	Feasibility Study has been approved by the PM of the Gov. <i>(no information available about construction period)</i>
23.	TPHCM-Long Thanh-Dau Day and Long Thanh-Vung Tau Freeway	Freeway Development and Investment Corporation of Vietnam	HCMC, Dong Nai, Ba Ria-Vung Tau	4-6 lanes Length: 103 km	400 million USD Stage 2: 250 million USD	Construction is expected to be completed in Oct 2013.
24.	Freeway TPHCM-My	Cuu Long Corporation for Investment,	TPHCM, Can	Length: 176 km	785 million USD	Feasibility Study is being conducted.

No.	Name	Investor	Location	Scope	Investment capital	Status
	Thuan- Can Tho	Development and Project Management of Infrastructure	Tho	4-6 lanes	Stage 2: 414 million USD	
25.	Noi Bai-Ha Long-Mong Duong Freeway	Not known	Hanoi, Hạ Long	Length: 146 km 4 lanes	220 million USD	Feasibility Study is being conducted.
26.	Da Nang-Quang Ngai Freeway	Freeway Development and Investment Corporation of Vietnam	Da Nang, Quang Nam, Quang Ngai.	Length: 130 km 4 lanes	500 million USD	Pending
27.	Highline across Nhieu Loc-Thi Nghe Channel; Hoang Van Thu Road Route-Dan Chu Works	Not known	HCMC	Length: 8.44km	14.95 billion VND	Project Plan is being considered.
28.	HCM City inner urban Railroad	Not known	HCMC	7 metro routes: 114km 3 subway routes: 32.5 km	800 million USD	The Council has not approved due to infeasibility of the site clearance costs.
29.	Dak Nong-Chon Thanh-Thi Vai Railroad	Not known	Dac Nong, Bien Hoa, BR-VT	Length: 305 km	590 million USD	Feasibility Study is being conducted.
30.	Hanoi- Hai Phong Railroad	Not known	<u>Hanoi, Hai Phong</u>	Length: 105 km	320 million USD	Not known
31.	<u>Hanoi-Hai Phong Freeway</u>	Vietnam Infrastructure Development and Financial Investment Corporation	<u>Hanoi, Hai Phong</u>	Length: 95 km 4 lanes	240 million USD	Site clearance is due to be completed in June 2012. <i>(no more information available as of July 2012)</i>
32.	<u>Hanoi Inner-urban Railroad</u>	Vietnam Railway Administration (a body under Hanoi OC)	<u>Hanoi</u>	Length: 12 km (8.5km above the ground and	300 million USD	Construction is expected to start in September 2012, but site clearance is encountering a lot of difficulties.

No.	Name	Investor	Location	Scope	Investment capital	Status
				4km underground)		
33.	Trung Luong-Can Tho Freeway	Cuu Long Corporation for Investment, Development and Project Management of Infrastructure	Tien Giang, Vinh Long, Can Tho	Length: 80 km 4-6 lanes	1.61 billion USD	Seeking sources of financing.
34.	Expansion of Highway 1A through Quang Nam	CIENCO 5	Quang Nam	Length: 78.65 km	596 billion VND	The Ministry approved the proposal in March 2012 and ordered Cienco 5 and related bodies to proceed preparation in order to commence construction in September 2012.

Phụ lục -A2 Thiết kế hướng tuyến đường cao tốc

TL-MT

A2-1 Hướng tuyến trên bình đồ

Table Horizontal Alignment of TL-MT Expressway

No.		Station	Coordinate		Beginning Radius	Clothoid Parameter	Ending Radius	Length (km)
			X	Y				
1	BP	49+620.000	534143.273	1154920.306	0.000		0	9.150
2	TS	49+629.150	534137.930	1154913.175	0.000	565.685	2000.000	160.000
3	SC	49+789.150	534040.291	1154786.435	2000.000		2000.000	1548.710
4	CS	51+337.860	532715.024	1154061622	2000.000	567.685	0.000	160.000
5	ST	51+497.860	532555.635	1154047.789	0.000		0.000	1634.370
6	TS	53+131.980	530925.894	1153928.217	0.000	1341.641	4000.000	450.000
7	SC	53+581.980	530476.625	1153903.714	4000.000		4000	731.870
8	CS	54+313.850	529747.804	1153958.108	4000.000	1341.64	0.000	450.000
9	ST	54+763.850	529307.150	1154049.031	0.000		0.000	248.960
10	TS	55+012.810	529064.313	1154103.902	0.000	1341.641	-4000.000	450.000
11	SC	55+462.810	528623.660	1154194.825	-4000		-4000.000	1469.050
12	CS	56+931.860	527163.080	1154169.041	-4000.000	1341.641	0.000	450.000
13	ST	57+381.860	526725.909	1154062.621	0.000		0.000	3001.610
14	TS	60+383.470	523823.287	1153298.124	0.000	2000.000	10000.000	400.000
15	SC	60+783.470	523435.815	1153198.829	10000.000		10000	1144.900
16	CS	61+928.370	522310.089	1152993.646	10000.000	2000.000	0.000	400.000
17	ST	62+328.370	521912.501	1152949.850	0.000.000		0.000	2965.860
18	TS	65+294.230	518962.337	1152644.776	0.000.000	2000.000	10000.000	400.000
19	SC	65+694.230	518564.200	1152606.285	10000.000		10000.000	1034.220
20	CS	66+728.450	517530.956	1152573.901	10000.000	2000.000	0.000	400.000
21	ST	67+128.450	517131.190	1152587.382	0.000		0.000	1298.360
22	TS	68+426.810	515833.886	1152657.716	0.000	2449.490	15000.000	400.000
23	SC	68+826.810	515434.291	1152657.716	15000.000		15000.000	580.650
24	CS	69+407.460	514855.224	1152700.088	15000.000	2449.490	0.000	400.000
25	ST	69+807.460	514457.279	1152740.558	0.000		0.000	956.010.
26	TS	70+763.470	513506.614	1152841.472	0.000	1341.641	-4000.000	450.000
27	SC	71+213.470	513058.380	1152880.599	-4000.000		-4000.000	416.090
28	CS	71+629.560	512642.470	1152879.709	-4000.000	1341.641	0.000	450.000
29	ST	72+079.560	512194.447	1152838.184	0.000		0.000	828.400
30	SC	72+907.960	511371.120	1152746.612	0.000	1549.193	6000.000	400.000
31	CS	73+307.960	510973.127	1152706.780	6000.000		6000.000	369.960
32	ST	73+677.920	510603.620	1152689.707	6000.000	1549.193	0.000	400.000
33	TS	74+077.920	510204.388	1152692.152	0.000		0.000	549.240
34	SC	74+627.160	509654.498	1152701.810	0.000	1024.695	-3000.000	350.000
35	CS	74+977.160	509304.552	1152701.137	-3000.000		-3000.000	453.580
36	ST	75+430.740	508854.462	1152648.581	-3000.000	1024.695	0.000	350.000
37	SC	75+780.740	508513.807	1152568466	0.000		0.000	2033.050

38	CS	77+813.790	506544.105	1152064.891	0.000	1549.193	8000.000	300.000
39	ST	78+113.790	506252.978	1151992.490	8000.000		8000.000	739.960
40	TS	78+853.750	505525.966	1151856.101	8000.000	1549.193	0.000	300.000
41	SC	79+153.750	505228.368	1151818.254	0.000		0.000	1705.990
42	CS	80+859.740	503534.711	1151613.512	0.000	1024.695	-3000.000	350.000
43	ST	81+209.740	503188.174	1151564.767	-3000.000		-3000.000	880.980
44	SC	82+090.720	502356.451	1151284.079	-3000.000	1024.695	0.000	350.000
45	CS	82+440.720	502051.235	1151112.888	0.000		0.000	2640.610
46	ST	85+081.330	499773.731	1149776.537	0.000	1732.051	15000.000	200.000
47	TS	85+281.330	499601.009	1149675.706	15000.000		15000.000	715.320
48	SC	85+996.650	498973.359	1149332.724	15000.000	1732.051	0.000	200.000
49	CS	86+196.650	498795.212	1149241.821	0.000		0.000	1260.570
50	ST	87+457.020	497633.107	1148652.085	0.000	2000.000	-20000.000	200.000
51	SC	87+657.020	497454.790	1148561750 9	-20000.000		-20000.000	557.200
52	CS	88+214.220	497000.276	1148320.673	-20000.000	2000.000	0.000	200.000
53	ST	88+414.220	496825.759	1148320.673	0.000		0.000	1322.620
54	TS	89+736.840	495667.970	1147583.556	0.000	2000.000	20000.000	200.000
55	SC	89+936.840	495492.806	1147487.029	20000.000		2000.000	643.160
56	CS	90+577.000	494926.289	1147188.975	20000.000	2000.000	0.000	200.000
57	ST	90+777.000	494747.523	1147099.294	0.000		0.000	585.320
58	TS	91+365.320	494221.188	1146836.342	0.000	2000.000	-20000.000	200.000
59	SC	91+565.320	494041.861	1146747.871	-20000.000 0		-20000.000	582.980
60	CS	92+148.300	493526.170	1146475.992	-20000.000	2000.00	0.000	200.000
61	ST	92+348.300	493350.731	1146379.962	0.000		0.000	1444.820
62	TS	93+793.120	492084.489	1145684.154	0.000	2449.490	-20000.000	300.000
63	SC	94+093.120	491823.204	1145536.772	-20000.000		-20000.00	475.220
64	CS	94+568.340	491427.932	1145273.350	-20000.000	2449.490	0.000	300.000
65	ST	94+868.340	491191.827	1145088.273	0.000		0.000	4561.420
66	TS	99+429.760	487629.929	1142238.775	0.000	670.820	-1500.000	300.000
67	SC	99+729.760	487402.155	1142043.760	-1500.000		-1500.000	1798.700
68	CS	101+528.46 0	487071.651	1140383.486	-1500.00	670.820	0.000	300.000
69	ST	101+828.46 0	487207.388	1140116.096	0.000		0.000	2104.540
70	EP	103+933.00 0	488222.035	1138272.266				0.000

Source: TL-MT D/D

Phụ lục -A2 Thiết kế hướng tuyến đường cao tốc

TL-MT

A2-2 Trắc dọc

Table Vertical Alignment of TL-MT Expressway

VIP	Station (KM)	Crest/Sag	EL(m)	Grade(%)	V. Curve	
					Length(m)	Radius(m)
VIP1	49+620.000		5.50	-0.74		
VIP2	49+880.000	Sag	3.55	0.00	119.100	16000.000
VIP3	50+583.130	Crest	3.55	-0.03		
VIP4	50+883.130	Sag	3.47	2.45	231.780	9360.000
VIP5	51+293.000	Crest	13.51	-2.45	558.000	12000.000
VIP6	51+702.680	Sag	3.45	0.00	231.600	9452.000
VIP7	53+743.000	Sag	3.49	1.67	166.460	10000.000
VIP8	54+043.000	Crest	8.48	-1.46	375.260	12000.000
VIP9	54+343.000	Sag	4.10	-0.20	101.260	8000.000
VIP10	54+643.000	Sag	3.50	0.00	117.600	60000.000
VIP11	54+983.590	Sag	3.51	2.00	197.600	9881.000
VIP12	55+325.600	Crest	10.35	-2.00	480.000	12000.000
VIP13	55+667.610	Sag	3.51	0.00	199.980	10000.000
VIP14	56+393.000	Sag	3.51	0.52	130.060	25000.000
VIP15	56+693.000	Crest	5.07	-0.52	156.080	15000.000
VIP16	56+993.000	Sag	3.51	0.00	130.060	25000.000
VIP17	57+537.400	Sag	3.51	3.00	165.600	5521.000
VIP18	57+980.000	Crest	16.79	-3.00	720.00	12000.000
VIP19	58+421.940	Sag	3.53	0.00	164.26	5475.000
VIP20	59+771.000	Sag	3.54	0.60	148.960	25000.000
VIP21	60+071.000	Crest	5.33	-0.60	202.840	17000.000
VIP22	60+371.000	Sag	3.54	0.63	146.640	12000.000
VIP23	60+671.000	Crest	5.42	-0.77	237.460	17000.000
VIP24	60+971.000	Sag	3.10	0.50	305.240	24000.000
VIP25	61+404.500	Crest	5.27	-0.50	200.200	20000.000
VIP26	61+744.880	Sag	3.57	0.00	175200	35000.000
VIP27	62+396.020	Sag	3.57	2.00	199.920	10000.000
VIP28	62+740.000	Crest	10.45	-2.00	479.860	12000.000
VIP29	63+083.000	Sag	3.59	0.00	199.920	10000.000
VIP30	64+380.130	Sag	3.59	0.16	113.840	70000.000
VIP31	64+693.200	Crest	4.10	-0.16	113.840	35000.000
VIP32	64+993.200	Sag	3.61	0.00	114.140	70000.000
VIP33	65+360.100	Sag	3.61	2.00	199.920	9997.000
VIP34	65+700.000	Crest	10.41	-2.00	480.000	12000.000
VIP35	66+020.400	Sag	4.00	0.00	123.400	100000.000
VIP36	66+320.400	Crest	4.00	-0.12	123.400	100000.000
VIP37	66+620.400	Sag	3.63	0.00	123.400	10000.000
VIP38	66+979.670	Sag	3.64	2.50	192.900	7717.000
VIP39	67+376.000	Crest	13.54	-2.50	600.000	12000.000
VIP40	67+772.000	Sag	3.64	0.00	192.240	7688.000
VIP41	69+001.860	Sag	3.65	2.00	225.080	11254.000
VIP42	69+354.300	Crest	10.70	-2.00	480.020	12000.000
VIP43	69+706.020	Sag	3.67	0.00	223.560	11171.000
VIP44	70+105.700	Sag	3.67	1.00	119.820	12000.000
VIP45	70+451.000	Crest	7.12	-1.00	240.000	12000.000
VIP46	70+795.640	Sag	3.68	0.00	120.120	12000.000
VIP47	71+483.400	Sag	3.68	3.00	156.540	5221.000
VIP48	71+921.490	Crest	16.82	-3.00	720.000	12000.000
VIP49	72+359.280	Sag	3.69	0.00	155.960	5198.000

VIP50	73+659.000	Sag	3.71	1.93	171.880	8923.000
VIP51	73+959.000	Crest	9.49	-1.64	428.220	12000.000
VIP52	74+310.770	Sag	3.72	0.00	106.740	6500.000
VIP53	75+355.780	Sag	3.73	1.64	106.580	6500.000
VIP54	75+708.000	Crest	9.51	-1.93	428.100	12000.000
VIP55	76+008.000	Sag	3.73	0.00	172.020	8924.000
VIP56	76+376.850	Sag	3.73	2.50	201.040	8047.000
VIP57	76+777.250	Crest	13.74	-2.50	600.000	12000.000
VIP58	77+177.000	Sag	3.74	0.00	199.700	7950.000
VIP59	78+597.390	Sag	3.91	1.65	171.880	10493.000
VIP60	78+945.000	Crest	9.65	-1.65	396.000	12000.000
VIP61	79+257.910	Sag	4.48	1.40	229.880	7537.000
VIP62	79+580.000	Crest	8.99	-1.40	336.000	12000.000
VIP63	79+580.000	Sag	4.30	1.50	312.620	10780.000
VIP64	80+251.490	Crest	9.34	-1.50	360.000	12000.000
VIP65	80+597.900	Sag	4.15	1.50	332.900	11097.000
VIP66	80+960.000	Crest	9.58	-1.50	360.000	12000.000
VIP67	81+398.000	Sag	3.01	1.50	360.000	12000.000
VIP68	81+834.000	Crest	9.55	-1.50	1360.000	12000.000
VIP69	82+161.040	Sag	4.65	2.00	288.080	8231.000
VIP70	82+545.000	Crest	12.32	-2.00	480.000	12000.000
VIP71	82+959.000	Sag	4.05	-0.10	227.580	12000.000
VIP72	83+259.000	Sag	3.75	0.25	103.520	30000.000
VIP73	83+559.000	Crest	4.49	-0.25	202.820	41000.000
VIP74	83+859.000	Sag	3.74	0.00	110.820	45000.000
VIP75	84+178.810	Sag	3.74	2.70	144.640	5355.000
VIP76	84+575.000	Crest	14.43	-2.70	648.000	12000.000
VIP77	84+971.780	Sag	3.72	0.00	145.820	5404.000
VIP78	86+892.600	Sag	3.70	3.00	195.080	6502.000
VIP79	87+349.940	Crest	17.42	-3.00	720.000	12000.000
VIP80	87+807.580	Sag	3.69	0.00	195.660	6526.000
VIP81	88+230.800	Sag	3.69	0.54	136.340	25000.000
VIP82	88+530.800	Crest	5.31	-0.55	130.880	12000.000
VIP83	88+830.800	Sag	3.68	0.00	136.340	25000.000
VIP84	89+305.000	Sag	3.68	1.17	140.460	12000.000
VIP85	89+605.000	Crest	7.19	-1.17	280.920	12000.000
VIP86	89+905.000	Sag	3.71	0.00	140.340	12000.000
VIP87	90+900.610	Sag	3.65	2.00	204.740	10227.000
VIP88	91+242.940	Crest	10.50	-2.00	480.040	12000.000
VIP89	91+585.720	Sag	3.64	0.00	205.640	10288.000
VIP90	91+960.000	Sag	3.64	2.23	268.080	12000.000
VIP91	92+384.340	Crest	13.09	2.37	552.140	12000.000
VIP92	92+712.120	Sag	5.35	-0.57	101.920	5685.000
VIP93	93+012.120	Sag	3.63	0.00	114.860	20000.000
VIP94	93+862.000	Sag	3.62	0.56	112.400	20000.000
VIP95	94+163.000	Crest	5.30	-0.56	134.600	12000.000
VIP96	94+587.060	Sag	2.93	1.75	372.000	16100.000
VIP97	94+982.760	Crest	9.86	-1.75	420.000	12000.000
VIP98	95+362.130	Sag	3.22	0.99	163.860	6000.000
VIP99	95+926.440	Crest	8.81	0.30	137.320	20000.000
VIP100	97+212.150	Crest	12.66	-2.26	512.840	20000.000
VIP101	97+612.300	Sag	3.57	0.00	287.660	12716.000
VIP102	98+202.760	Sag	3.56	2.10	144.600	6880.000
VIP103	98+527.000	Crest	10.36	-2.10	504.000	12000.000

VIP104	98+851.860	Sag	3.54	0.00	145.860	6950.000
VIP105	99+665.000	Sag	3.53	0.96	144.160	15000.000
VIP106	99+965.000	Crest	6.43	-0.90	223.520	12000.000
VIP107	100+265.000	Sag	3.70	0.00	135.000	15000.000
VIP108	101+298.870	Sag	3.69	0.35	105.000	30000.000
VIP109	101+598.870	Crest	4.73	0.00	103.720	30000.000
VIP110	101+898.870	Sag	4.76	2.60	138.500	5328.000
VIP111	102+280.000	Crest	14.64	-2.60	624.000	12000.000
VIP112	102+709.260	Sag	3.48	0.00	234.800	9039.000
VIP113	103+138.000	Sag	3.48	0.55	137.500	25000.000
VIP114	103+438.000	Crest	5.11	-0.55	154.020	14000.000
VIP115	103+438.000	Sag	3.46		137.500	25000.000

Source: TL-MT D/D

Phụ lục -3 Lịch trình xây dựng

Phụ lục -4 Kết quả của dự báo chất lượng không khí

Results of the Prediction of Air Quality

1. Trung Luong - Cai Lay

Southwest monsoon with wind velocity $V_{min} = 2.5$ m/s

Trung Luong – Cai Lay ($V_{min} = 2.5$ m/s)

Year	Distance	TSP ($\mu\text{g}/\text{m}^3$)	SO ₂ ($\mu\text{g}/\text{m}^3$)	CO ($\mu\text{g}/\text{m}^3$)	NO _x ($\mu\text{g}/\text{m}^3$)	HC ($\mu\text{g}/\text{m}^3$)
2020	20m	103.1	151.0	11374.3	1753.3	1222.9
	30m	66.8	97.8	7365.5	1135.4	791.9
	40m	47.2	69.1	5205.3	802.4	559.6
	50m	35.5	51.9	3912.7	603.1	420.7
	60m	27.9	40.8	3074.2	473.9	330.5
	70m	22.6	33.1	2496.0	384.8	268.4
	80m	18.8	27.6	2078.4	320.4	223.5
	90m	16.0	23.4	1765.4	272.1	189.8
	100m	13.8	20.2	1523.8	234.9	163.8
	110m	12.1	17.7	1332.8	205.4	143.3
	120m	10.7	15.7	1178.8	181.7	126.7
	130m	9.5	14.0	1052.3	162.2	113.1
2025	20m	145.3	212.8	16024.8	2470.1	1722.9
	30m	94.1	137.8	10376.9	1599.6	1115.7
	40m	66.5	97.4	7333.6	1130.4	788.5
	50m	50.0	73.2	5512.4	849.7	592.7
	60m	39.3	57.5	4331.0	667.6	465.6
	70m	31.9	46.7	3516.5	542.1	378.1
	80m	26.6	38.9	2928.1	451.4	314.8
	90m	22.6	33.0	2487.2	383.4	267.4
	100m	19.5	28.5	2146.8	330.9	230.8
	110m	17.0	24.9	1877.8	289.4	201.9
	120m	15.1	22.0	1660.7	256.0	178.5
	130m	13.4	19.7	1482.6	228.5	159.4
2030	20m	188.8	276.5	20822.6	3209.7	2238.7
	30m	122.3	179.0	13483.8	2078.5	1449.7
	40m	86.4	126.5	9529.2	1468.9	1024.5
	50m	64.9	95.1	7162.9	1104.1	770.1
	60m	51.0	74.7	5627.8	867.5	605.1
	70m	41.4	60.7	4569.4	704.4	491.3
	80m	34.5	50.5	3804.8	586.5	409.1
	90m	29.3	42.9	3231.8	498.2	347.5
	100m	25.3	37.0	2789.6	430.0	299.9
	110m	22.1	32.4	2440.0	376.1	262.3
	120m	19.6	28.7	2157.9	332.6	232.0
	130m	17.5	25.6	1926.5	297.0	207.1
QCVN 05: 2009/BTNMT		300	350	30000	250	-

QCVN 06: 2009/BTNMT		-	-	-	5000

Trung Luong – Cai Lay ($V_{max} = 3 \text{ m/s}$)

Year	Distance	TSP ($\mu\text{g}/\text{m}^3$)	SO ₂ ($\mu\text{g}/\text{m}^3$)	CO ($\mu\text{g}/\text{m}^3$)	NO _x ($\mu\text{g}/\text{m}^3$)	HC ($\mu\text{g}/\text{m}^3$)
2020	20m	103.1	151.0	11374.3	1753.3	1222.9
	30m	66.8	97.8	7365.5	1135.4	791.9
	40m	47.2	69.1	5205.3	802.4	559.6
	50m	35.5	51.9	3912.7	603.1	420.7
	60m	27.9	40.8	3074.2	473.9	330.5
	70m	22.6	33.1	2496.0	384.8	268.4
	80m	18.8	27.6	2078.4	320.4	223.5
	90m	16.0	23.4	1765.4	272.1	189.8
	100m	13.8	20.2	1523.8	234.9	163.8
	110m	12.1	17.7	1332.8	205.4	143.3
	120m	10.7	15.7	1178.8	181.7	126.7
	130m	9.5	14.0	1052.3	162.2	113.1
	2025	20m	145.3	212.8	16024.8	2470.1
30m		94.1	137.8	10376.9	1599.6	1115.7
40m		66.5	97.4	7333.6	1130.4	788.5
50m		50.0	73.2	5512.4	849.7	592.7
60m		39.3	57.5	4331.0	667.6	465.6
70m		31.9	46.7	3516.5	542.1	378.1
80m		26.6	38.9	2928.1	451.4	314.8
90m		22.6	33.0	2487.2	383.4	267.4
100m		19.5	28.5	2146.8	330.9	230.8
110m		17.0	24.9	1877.8	289.4	201.9
120m		15.1	22.0	1660.7	256.0	178.5
130m		13.4	19.7	1482.6	228.5	159.4
2030		20m	188.8	276.5	20822.6	3209.7
	30m	122.3	179.0	13483.8	2078.5	1449.7
	40m	86.4	126.5	9529.2	1468.9	1024.5
	50m	64.9	95.1	7162.9	1104.1	770.1
	60m	51.0	74.7	5627.8	867.5	605.1
	70m	41.4	60.7	4569.4	704.4	491.3
	80m	34.5	50.5	3804.8	586.5	409.1
	90m	29.3	42.9	3231.8	498.2	347.5
	100m	25.3	37.0	2789.6	430.0	299.9
	110m	22.1	32.4	2440.0	376.1	262.3
	120m	19.6	28.7	2157.9	332.6	232.0
	130m	17.5	25.6	1926.5	297.0	207.1

Northeast monsoon with wind velocity $V_{\min} = 3.5$ m/s

Year	Distance	TSP ($\mu\text{g}/\text{m}^3$)	SO ₂ ($\mu\text{g}/\text{m}^3$)	CO ($\mu\text{g}/\text{m}^3$)	NO _x ($\mu\text{g}/\text{m}^3$)	HC ($\mu\text{g}/\text{m}^3$)
2020	20m	73.7	107.9	8124.5	1252.4	873.5
	30m	47.7	69.9	5261.1	811.0	565.6
	40m	33.7	49.4	3718.1	573.1	399.7
	50m	25.3	37.1	2794.8	430.8	300.5
	60m	19.9	29.2	2195.8	338.5	236.1
	70m	16.2	23.7	1782.9	274.8	191.7
	80m	13.5	19.7	1484.6	228.8	159.6
	90m	11.4	16.7	1261.0	194.4	135.6
	100m	9.9	14.5	1088.4	167.8	117.0
	110m	8.6	12.6	952.0	146.7	102.4
	120m	7.6	11.2	842.0	129.8	90.5
	130m	73.7	107.9	751.7	115.9	80.8
	2025	20m	103.8	152.0	11446.3	1764.4
30m		67.2	98.4	7412.1	1142.5	796.9
40m		47.5	69.5	5238.3	807.5	563.2
50m		35.7	52.3	3937.5	606.9	423.3
60m		28.1	41.1	3093.6	476.9	332.6
70m		22.8	33.3	2511.8	387.2	270.1
80m		19.0	27.8	2091.5	322.4	224.9
90m		16.1	23.6	1776.6	273.8	191.0
100m		13.9	20.4	1533.5	236.4	164.9
110m		12.2	17.8	1341.3	206.7	144.2
120m		10.8	15.7	1186.2	182.8	127.5
130m		9.6	14.1	1059.0	163.2	113.9
2030		20m	134.9	197.5	14873.3	2292.6
	30m	87.3	127.9	9631.3	1484.6	1035.5
	40m	61.7	90.4	6806.6	1049.2	731.8
	50m	46.4	67.9	5116.3	788.7	550.1
	60m	36.4	53.4	4019.8	619.6	432.2
	70m	29.6	43.3	3263.9	503.1	350.9
	80m	24.6	36.1	2717.7	418.9	292.2
	90m	20.9	30.6	2308.5	355.8	248.2
	100m	18.1	26.5	1992.6	307.1	214.2
	110m	15.8	23.1	1742.8	268.6	187.4
	120m	14.0	20.5	1541.4	237.6	165.7
	130m	12.5	18.3	1376.1	212.1	147.9

Northeast monsoon with wind velocity $V_{max} = 4$ m/s

Year	Distance	TSP ($\mu\text{g}/\text{m}^3$)	SO ₂ ($\mu\text{g}/\text{m}^3$)	CO ($\mu\text{g}/\text{m}^3$)	NO _x ($\mu\text{g}/\text{m}^3$)	HC ($\mu\text{g}/\text{m}^3$)
2020	20m	64.5	94.4	7109.0	1095.8	764.3
	30m	41.7	61.1	4603.4	709.6	494.9
	40m	29.5	43.2	3253.3	501.5	349.8
	50m	22.2	32.5	2445.4	377.0	262.9
	60m	17.4	25.5	1921.3	296.2	206.6
	70m	14.1	20.7	1560.0	240.5	167.7
	80m	11.8	17.2	1299.0	200.2	139.7
	90m	10.0	14.6	1103.4	170.1	118.6
	100m	8.6	12.6	952.4	146.8	102.4
	110m	7.6	11.1	833.0	128.4	89.6
	120m	6.7	9.8	736.7	113.6	79.2
	130m	6.0	8.7	657.7	101.4	70.7
2025	20m	90.8	133.0	10015.5	1543.8	1076.8
	30m	58.8	86.1	6485.6	999.7	697.3
	40m	41.6	60.9	4583.5	706.5	492.8
	50m	31.2	45.7	3445.3	531.1	370.4
	60m	24.5	35.9	2706.9	417.3	291.0
	70m	19.9	29.2	2197.8	338.8	236.3
	80m	16.6	24.3	1830.1	282.1	196.8
	90m	14.1	20.6	1554.5	239.6	167.1
	100m	12.2	17.8	1341.8	206.8	144.3
	110m	10.6	15.6	1173.6	180.9	126.2
	120m	9.4	13.8	1037.9	160.0	111.6
	130m	8.4	12.3	926.6	142.8	99.6
2030	20m	118.0	172.8	13014.1	2006.1	1399.2
	30m	76.4	111.9	8427.4	1299.0	906.1
	40m	54.0	79.1	5955.8	918.1	640.3
	50m	40.6	59.4	4476.8	690.1	481.3
	60m	31.9	46.7	3517.4	542.2	378.2
	70m	25.9	37.9	2855.9	440.2	307.0
	80m	21.6	31.6	2378.0	366.6	255.7
	90m	18.3	26.8	2019.9	311.4	217.2
	100m	15.8	23.1	1743.5	268.8	187.4
	110m	13.8	20.2	1525.0	235.1	164.0
	120m	12.2	17.9	1348.7	207.9	145.0
	130m	10.9	16.0	1204.1	185.6	129.5

2. Cai Lay – Cai Be

Southwest monsoon with wind velocity $V_{\min} = 2.5$ m/s

Year	Distance	TSP ($\mu\text{g}/\text{m}^3$)	SO ₂ ($\mu\text{g}/\text{m}^3$)	CO ($\mu\text{g}/\text{m}^3$)	NO _x ($\mu\text{g}/\text{m}^3$)	HC ($\mu\text{g}/\text{m}^3$)
2020	20m	78.5	115.0	8658.2	1334.6	930.9
	30m	50.8	74.4	5606.7	864.2	602.8
	40m	35.9	52.6	3962.3	610.8	426.0
	50m	27.0	39.5	2978.4	459.1	320.2
	60m	21.2	31.1	2340.1	360.7	251.6
	70m	17.2	25.2	1900.0	292.9	204.3
	80m	14.3	21.0	1582.1	243.9	170.1
	90m	12.2	17.8	1343.8	207.1	144.5
	100m	10.5	15.4	1159.9	178.8	124.7
	110m	9.2	13.5	1014.6	156.4	109.1
	120m	8.1	11.9	897.3	138.3	96.5
	130m	7.3	10.6	801.0	123.5	86.1
2025	20m	114.2	167.2	12590.5	1940.8	1353.6
	30m	73.9	108.2	8153.1	1256.8	876.6
	40m	52.2	76.5	5761.9	888.2	619.5
	50m	39.3	57.5	4331.1	667.6	465.6
	60m	30.9	45.2	3402.9	524.5	365.9
	70m	25.1	36.7	2762.9	425.9	297.0
	80m	20.9	30.5	2300.6	354.6	247.3
	90m	17.7	25.9	1954.1	301.2	210.1
	100m	15.3	22.4	1686.7	260.0	181.3
	110m	13.4	19.6	1475.3	227.4	158.6
	120m	11.8	17.3	1304.8	201.1	140.3
	130m	10.6	15.5	1164.9	179.6	125.2
2030	20m	148.4	217.3	16363.0	2522.3	1759.2
	30m	96.1	140.7	10596.0	1633.3	1139.2
	40m	67.9	99.4	7488.4	1154.3	805.1
	50m	51.0	74.7	5628.8	867.7	605.2
	60m	40.1	58.7	4422.5	681.7	475.5
	70m	32.6	47.7	3590.8	553.5	386.1
	80m	27.1	39.7	2989.9	460.9	321.5
	90m	23.0	33.7	2539.7	391.5	273.0
	100m	19.9	29.1	2192.2	337.9	235.7
	110m	17.4	25.5	1917.4	295.6	206.1
	120m	15.4	22.5	1695.7	261.4	182.3
	130m	13.7	20.1	1513.9	233.4	162.8

Southwest monsoon with wind velocity $V_{max} = 3 \text{ m/s}$

Năm	Khoảng cách	TSP ($\mu\text{g}/\text{m}^3$)	SO ₂ ($\mu\text{g}/\text{m}^3$)	CO ($\mu\text{g}/\text{m}^3$)	NO _x ($\mu\text{g}/\text{m}^3$)	HC ($\mu\text{g}/\text{m}^3$)
2020	20m	65.4	95.8	7215.2	1112.2	775.7
	30m	42.4	62.0	4672.2	720.2	502.3
	40m	29.9	43.8	3301.9	509.0	355.0
	50m	22.5	33.0	2482.0	382.6	266.8
	60m	17.7	25.9	1950.1	300.6	209.7
	70m	14.4	21.0	1583.3	244.1	170.2
	80m	12.0	17.5	1318.4	203.2	141.7
	90m	10.2	14.9	1119.8	172.6	120.4
	100m	8.8	12.8	966.6	149.0	103.9
	110m	7.7	11.2	845.5	130.3	90.9
	120m	6.8	9.9	747.7	115.3	80.4
	130m	6.1	8.9	667.5	102.9	71.8
2025	20m	95.1	139.3	10492.1	1617.3	1128.0
	30m	61.6	90.2	6794.2	1047.3	730.5
	40m	43.5	63.8	4801.6	740.1	516.2
	50m	32.7	47.9	3609.2	556.3	388.0
	60m	25.7	37.7	2835.7	437.1	304.9
	70m	20.9	30.6	2302.4	354.9	247.5
	80m	17.4	25.5	1917.2	295.5	206.1
	90m	14.8	21.6	1628.5	251.0	175.1
	100m	12.7	18.7	1405.6	216.7	151.1
	110m	11.1	16.3	1229.4	189.5	132.2
	120m	9.9	14.4	1087.3	167.6	116.9
	130m	8.8	12.9	970.7	149.6	104.4
2030	20m	123.6	181.0	13635.9	2101.9	1466.0
	30m	80.1	117.2	8830.0	1361.1	949.3
	40m	56.6	82.9	6240.3	961.9	670.9
	50m	42.5	62.3	4690.7	723.0	504.3
	60m	33.4	48.9	3685.4	568.1	396.2
	70m	27.1	39.7	2992.3	461.2	321.7
	80m	22.6	33.1	2491.6	384.1	267.9
	90m	19.2	28.1	2116.4	326.2	227.5
	100m	16.6	24.3	1826.8	281.6	196.4
	110m	14.5	21.2	1597.8	246.3	171.8
	120m	12.8	18.8	1413.1	217.8	151.9
	130m	11.4	16.8	1261.6	194.5	135.6

Northeast monsoon with wind velocity $V_{\min} = 3.5$ m/s

Year	Distance	TSP ($\mu\text{g}/\text{m}^3$)	SO ₂ ($\mu\text{g}/\text{m}^3$)	CO ($\mu\text{g}/\text{m}^3$)	NO _x ($\mu\text{g}/\text{m}^3$)	HC ($\mu\text{g}/\text{m}^3$)
2020	20m	56.1	82.1	6184.4	953.3	664.9
	30m	36.3	53.2	4004.8	617.3	430.6
	40m	25.7	37.6	2830.2	436.3	304.3
	50m	19.3	28.2	2127.4	327.9	228.7
	60m	15.2	22.2	1671.5	257.6	179.7
	70m	12.3	18.0	1357.1	209.2	145.9
	80m	10.2	15.0	1130.0	174.2	121.5
	90m	8.7	12.7	959.9	148.0	103.2
	100m	7.5	11.0	828.5	127.7	89.1
	110m	6.6	9.6	724.7	111.7	77.9
	120m	5.8	8.5	640.9	98.8	68.9
	130m	5.2	7.6	572.2	88.2	61.5
2025	20m	81.5	119.4	8993.2	1386.3	966.9
	30m	52.8	77.3	5823.6	897.7	626.1
	40m	37.3	54.6	4115.6	634.4	442.5
	50m	28.1	41.1	3093.6	476.9	332.6
	60m	22.0	32.3	2430.6	374.7	261.3
	70m	17.9	26.2	1973.5	304.2	212.2
	80m	14.9	21.8	1643.3	253.3	176.7
	90m	12.7	18.5	1395.8	215.2	150.1
	100m	10.9	16.0	1204.8	185.7	129.5
	110m	9.6	14.0	1053.8	162.4	113.3
	120m	8.5	12.4	932.0	143.7	100.2
	130m	7.5	11.0	832.0	128.3	89.5
2030	20m	106.0	155.2	11687.9	1801.6	1256.6
	30m	68.6	100.5	7568.6	1166.7	813.7
	40m	48.5	71.0	5348.8	824.5	575.1
	50m	36.5	53.4	4020.6	619.8	432.3
	60m	28.6	41.9	3158.9	486.9	339.6
	70m	23.3	34.1	2564.8	395.4	275.8
	80m	19.4	28.4	2135.7	329.2	229.6
	90m	16.4	24.1	1814.1	279.6	195.0
	100m	14.2	20.8	1565.8	241.4	168.3
	110m	12.4	18.2	1369.6	211.1	147.2
	120m	11.0	16.1	1211.2	186.7	130.2
	130m	9.8	14.4	1081.3	166.7	116.3

Northeast monsoon with wind velocity $V_{max} = 4 \text{ m/s}$

Year	Distance	TSP ($\mu\text{g}/\text{m}^3$)	SO ₂ ($\mu\text{g}/\text{m}^3$)	CO ($\mu\text{g}/\text{m}^3$)	NO _x ($\mu\text{g}/\text{m}^3$)	HC ($\mu\text{g}/\text{m}^3$)
2020	20m	49.1	71.8	5411.4	834.1	581.8
	30m	31.8	46.5	3504.2	540.1	376.7
	40m	22.5	32.9	2476.5	381.7	266.3
	50m	16.9	24.7	1861.5	286.9	200.1
	60m	13.3	19.4	1462.5	225.4	157.2
	70m	10.8	15.8	1187.5	183.0	127.7
	80m	9.0	13.1	988.8	152.4	106.3
	90m	7.6	11.2	839.9	129.5	90.3
	100m	6.6	9.6	725.0	111.7	77.9
	110m	5.7	8.4	634.1	97.7	68.2
	120m	5.1	7.4	560.8	86.4	60.3
	130m	4.5	6.6	500.7	77.2	53.8
2025	20m	71.4	104.5	7869.1	1213.0	846.0
	30m	46.2	67.7	5095.7	785.5	547.8
	40m	32.7	47.8	3601.2	555.1	387.2
	50m	24.5	35.9	2706.9	417.3	291.0
	60m	19.3	28.2	2126.8	327.8	228.7
	70m	15.7	22.9	1726.8	266.2	185.7
	80m	13.0	19.1	1437.9	221.6	154.6
	90m	11.1	16.2	1221.3	188.3	131.3
	100m	9.6	14.0	1054.2	162.5	113.3
	110m	8.4	12.2	922.1	142.1	99.1
	120m	7.4	10.8	815.5	125.7	87.7
	130m	6.6	9.7	728.0	112.2	78.3
2030	20m	92.7	135.8	10226.9	1576.4	1099.5
	30m	60.0	87.9	6622.5	1020.8	712.0
	40m	42.4	62.1	4680.2	721.4	503.2
	50m	31.9	46.7	3518.0	542.3	378.2
	60m	25.1	36.7	2764.0	426.1	297.2
	70m	20.3	29.8	2244.2	345.9	241.3
	80m	16.9	24.8	1868.7	288.1	200.9
	90m	14.4	21.1	1587.3	244.7	170.7
	100m	12.4	18.2	1370.1	211.2	147.3
	110m	10.9	15.9	1198.4	184.7	128.8
	120m	9.6	14.1	1059.8	163.4	113.9
	130m	8.6	12.6	946.2	145.8	101.7

3. Cai Be – My Thuan

Southwest monsoon with wind velocity $V_{\min} = 2.5$ m/s

Year	Distance	TSP ($\mu\text{g}/\text{m}^3$)	SO ₂ ($\mu\text{g}/\text{m}^3$)	CO ($\mu\text{g}/\text{m}^3$)	NO _x ($\mu\text{g}/\text{m}^3$)	HC ($\mu\text{g}/\text{m}^3$)
2020	20m	295.3	23.4	1763.4	271.8	189.6
	30m	191.2	15.2	1141.9	176.0	122.8
	40m	135.1	10.7	807.0	124.4	86.8
	50m	101.6	8.1	606.6	93.5	65.2
	60m	79.8	6.3	476.6	73.5	51.2
	70m	64.8	5.1	387.0	59.6	41.6
	80m	54.0	4.3	322.2	49.7	34.6
	90m	45.8	3.6	273.7	42.2	29.4
	100m	39.6	3.1	236.2	36.4	25.4
	110m	34.6	2.7	206.6	31.9	22.2
	120m	30.6	2.4	182.7	28.2	19.6
	130m	27.3	2.2	163.1	25.1	17.5
2025	20m	195.7	35.3	2660.0	410.0	286.0
	30m	126.7	22.9	1722.5	265.5	185.2
	40m	89.6	16.2	1217.3	187.6	130.9
	50m	67.3	12.1	915.0	141.0	98.4
	60m	52.9	9.5	718.9	110.8	77.3
	70m	43.0	7.8	583.7	90.0	62.8
	80m	35.8	6.5	486.0	74.9	52.3
	90m	30.4	5.5	412.8	63.6	44.4
	100m	26.2	4.7	356.4	54.9	38.3
	110m	22.9	4.1	311.7	48.0	33.5
	120m	20.3	3.7	275.7	42.5	29.6
	130m	18.1	3.3	246.1	37.9	26.5
2030	20m	152.0	152.0	45.5	3424.7	527.9
	30m	98.4	98.4	29.4	2217.7	341.8
	40m	69.6	69.6	20.8	1567.3	241.6
	50m	52.3	52.3	15.6	1178.1	181.6
	60m	41.1	41.1	12.3	925.6	142.7
	70m	33.4	33.4	10.0	751.5	115.8
	80m	27.8	27.8	8.3	625.8	96.5
	90m	23.6	23.6	7.1	531.5	81.9
	100m	20.4	20.4	6.1	458.8	70.7
	110m	17.8	17.8	5.3	401.3	61.9
	120m	15.8	15.8	4.7	354.9	54.7
	130m	14.1	14.1	4.2	316.8	48.8

Southwest monsoon with wind velocity $V_{max} = 3 \text{ m/s}$

Year	Distance	TSP ($\mu\text{g}/\text{m}^3$)	SO ₂ ($\mu\text{g}/\text{m}^3$)	CO ($\mu\text{g}/\text{m}^3$)	NO _x ($\mu\text{g}/\text{m}^3$)	HC ($\mu\text{g}/\text{m}^3$)
2020	20m	246.0	19.5	1469.5	226.5	158.0
	30m	159.3	12.6	951.6	146.7	102.3
	40m	112.6	8.9	672.5	103.7	72.3
	50m	84.6	6.7	505.5	77.9	54.3
	60m	66.5	5.3	397.2	61.2	42.7
	70m	54.0	4.3	322.5	49.7	34.7
	80m	45.0	3.6	268.5	41.4	28.9
	90m	38.2	3.0	228.1	35.2	24.5
	100m	33.0	2.6	196.9	30.3	21.2
	110m	28.8	2.3	172.2	26.5	18.5
	120m	25.5	2.0	152.3	23.5	16.4
	130m	22.8	1.8	136.0	21.0	14.6
2025	20m	163.1	29.4	2216.6	341.7	238.3
	30m	105.6	19.1	1435.4	221.3	154.3
	40m	74.6	13.5	1014.4	156.4	109.1
	50m	56.1	10.1	762.5	117.5	82.0
	60m	44.1	8.0	599.1	92.3	64.4
	70m	35.8	6.5	486.4	75.0	52.3
	80m	29.8	5.4	405.0	62.4	43.5
	90m	25.3	4.6	344.0	53.0	37.0
	100m	21.9	3.9	297.0	45.8	31.9
	110m	19.1	3.4	259.7	40.0	27.9
	120m	16.9	3.0	229.7	35.4	24.7
	130m	15.1	2.7	205.1	31.6	22.0
2030	20m	126.7	37.9	2853.9	439.9	306.8
	30m	82.0	24.5	1848.1	284.9	198.7
	40m	58.0	17.3	1306.0	201.3	140.4
	50m	43.6	13.0	981.7	151.3	105.5
	60m	34.2	10.2	771.3	118.9	82.9
	70m	27.8	8.3	626.3	96.5	67.3
	80m	23.1	6.9	521.5	80.4	56.1
	90m	19.7	5.9	442.9	68.3	47.6
	100m	17.0	5.1	382.3	58.9	41.1
	110m	14.8	4.4	334.4	51.5	36.0
	120m	13.1	3.9	295.8	45.6	31.8
	130m	11.7	3.5	264.0	40.7	28.4

Northeast monsoon with wind velocity $V_{\min} = 3.5$ m/s

Year	Distance	TSP ($\mu\text{g}/\text{m}^3$)	SO ₂ ($\mu\text{g}/\text{m}^3$)	CO ($\mu\text{g}/\text{m}^3$)	NO _x ($\mu\text{g}/\text{m}^3$)	HC ($\mu\text{g}/\text{m}^3$)
2020	20m	210.9	16.7	1259.6	194.2	135.4
	30m	136.6	10.8	815.6	125.7	87.7
	40m	96.5	7.7	576.4	88.9	62.0
	50m	72.5	5.8	433.3	66.8	46.6
	60m	57.0	4.5	340.4	52.5	36.6
	70m	46.3	3.7	276.4	42.6	29.7
	80m	38.5	3.1	230.2	35.5	24.7
	90m	32.7	2.6	195.5	30.1	21.0
	100m	28.3	2.2	168.7	26.0	18.1
	110m	24.7	2.0	147.6	22.8	15.9
	120m	21.9	1.7	130.5	20.1	14.0
	130m	19.5	1.5	116.5	18.0	12.5
2025	20m	139.8	25.2	1900.0	292.9	204.3
	30m	90.5	16.3	1230.3	189.7	132.3
	40m	64.0	11.5	869.5	134.0	93.5
	50m	48.1	8.7	653.6	100.7	70.3
	60m	37.8	6.8	513.5	79.2	55.2
	70m	30.7	5.5	416.9	64.3	44.8
	80m	25.5	4.6	347.2	53.5	37.3
	90m	21.7	3.9	294.9	45.5	31.7
	100m	18.7	3.4	254.5	39.2	27.4
	110m	16.4	3.0	222.6	34.3	23.9
	120m	14.5	2.6	196.9	30.4	21.2
	130m	12.9	2.3	175.8	27.1	18.9
2030	20m	108.6	32.5	2446.2	377.1	263.0
	30m	70.3	21.0	1584.0	244.2	170.3
	40m	49.7	14.9	1119.5	172.6	120.4
	50m	37.4	11.2	841.5	129.7	90.5
	60m	29.3	8.8	661.1	101.9	71.1
	70m	23.8	7.1	536.8	82.7	57.7
	80m	19.8	5.9	447.0	68.9	48.1
	90m	16.9	5.0	379.7	58.5	40.8
	100m	14.5	4.4	327.7	50.5	35.2
	110m	12.7	3.8	286.6	44.2	30.8
	120m	11.3	3.4	253.5	39.1	27.3
	130m	10.0	3.0	226.3	34.9	24.3

Northeast monsoon with wind velocity $V_{max} = 4 \text{ m/s}$

Year	Distance	TSP ($\mu\text{g}/\text{m}^3$)	SO ₂ ($\mu\text{g}/\text{m}^3$)	CO ($\mu\text{g}/\text{m}^3$)	NO _x ($\mu\text{g}/\text{m}^3$)	HC ($\mu\text{g}/\text{m}^3$)
2020	20m	184.5	14.6	1102.1	169.9	118.5
	30m	119.5	9.5	713.7	110.0	76.7
	40m	84.5	6.7	504.4	77.7	54.2
	50m	63.5	5.0	379.1	58.4	40.8
	60m	49.9	4.0	297.9	45.9	32.0
	70m	40.5	3.2	241.9	37.3	26.0
	80m	33.7	2.7	201.4	31.0	21.7
	90m	28.6	2.3	171.1	26.4	18.4
	100m	24.7	2.0	147.6	22.8	15.9
	110m	21.6	1.7	129.1	19.9	13.9
	120m	19.1	1.5	114.2	17.6	12.3
	130m	17.1	1.4	102.0	15.7	11.0
2025	20m	122.3	22.1	1662.5	256.3	178.7
	30m	79.2	14.3	1076.6	165.9	115.7
	40m	56.0	10.1	760.8	117.3	81.8
	50m	42.1	7.6	571.9	88.2	61.5
	60m	33.1	6.0	449.3	69.3	48.3
	70m	26.8	4.8	364.8	56.2	39.2
	80m	22.4	4.0	303.8	46.8	32.7
	90m	19.0	3.4	258.0	39.8	27.7
	100m	16.4	3.0	222.7	34.3	23.9
	110m	14.3	2.6	194.8	30.0	20.9
	120m	12.7	2.3	172.3	26.6	18.5
	130m	11.3	2.0	153.8	23.7	16.5
2030	20m	95.0	28.4	2140.4	329.9	230.1
	30m	61.5	18.4	1386.0	213.7	149.0
	40m	43.5	13.0	979.5	151.0	105.3
	50m	32.7	9.8	736.3	113.5	79.2
	60m	25.7	7.7	578.5	89.2	62.2
	70m	20.9	6.2	469.7	72.4	50.5
	80m	17.4	5.2	391.1	60.3	42.0
	90m	14.7	4.4	332.2	51.2	35.7
	100m	12.7	3.8	286.8	44.2	30.8
	110m	11.1	3.3	250.8	38.7	27.0
	120m	9.8	2.9	221.8	34.2	23.8
	130m	8.8	2.6	198.0	30.5	21.3

Phụ lục -5 Tài liệu hợp

A5-1: Hợp báo cáo đầu kỳ với BEDC

THE PREPARATORY SURVEY ON TRUNG LUONG – MY THUAN EXPRESSWAY PROJECT IN VIETNAM

Inception Report

September 2011

Nippon Koei Co., Ltd.
Marubeni Corp.
KRI International Corp.

Table of Contents

1. Background of the Survey
2. Work Plan
3. Basic Approach for the Survey
4. Survey Flow
5. Draft Contents of the Final Report

1.1 Background of the Survey

- Policy on Expressway Development utilizing BOT/PPP by GOV
 - Expressway network development plan in Vietnam
 - Governmental Initiative for promoting BOT/PPP project
 - The Trung Luong - My Thuan Expressway Project (the Project) is a part of the North-South Expressway and is prioritized to develop in form of BOT before 2015.
 - Issues on current BOT Scope and Scheme of the Project
- Assistance Policy on Expressway Development utilizing BOT/PPP by GOJ
 - JICA's role for assistance policy by GOJ
 - Measuring the possibility of private investment in the Project and propose profitable project scope and scheme so that the Project can be realized under BOT/PPP scheme

3

1.2 Objectives of the Survey

- a. To evaluate the private investment possibility for the Project by confirmation of;
 - ✓private investment environment
 - ✓examination of demarcation between public scope and private scope
 - ✓technical verification
 - ✓environmental and social considerations
 - ✓financial structure analysis
 - ✓risk analysis
 - ✓proposal of government supports menu
 - ✓market sounding study
- b. To propose profitable BOT/PPP scheme
- c. To prepare draft term sheets for BOT Contract and Government Guarantee and Undertaking(GGU)

4

Location Map of the Project

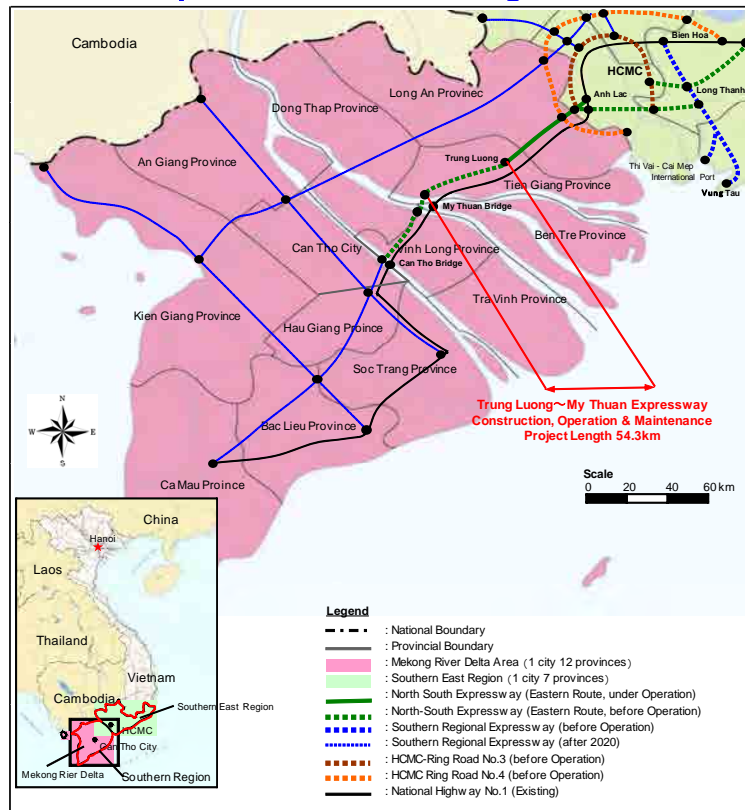

5

2.1 Work Schedule

The Survey period is approximately 8 months from end of August 2011 and final report will be submitted at middle of April 2012.

Year/ Month	2011					2012			
	August	September	October	November	December	January	February	March	April
Survey Schedule	Approach and Methodology		Preliminary Evaluation of Project Scope			Detailed Evaluation of Project Scope and Scheme			
			Engineering Work (Review of D/D, Update of Traffic Demand Forecast etc.)			BOT/GGU Term Sheet Draft			
	IC/R		IT/R			DF/R		F/R	

6

2.2 Organization of the Survey Team

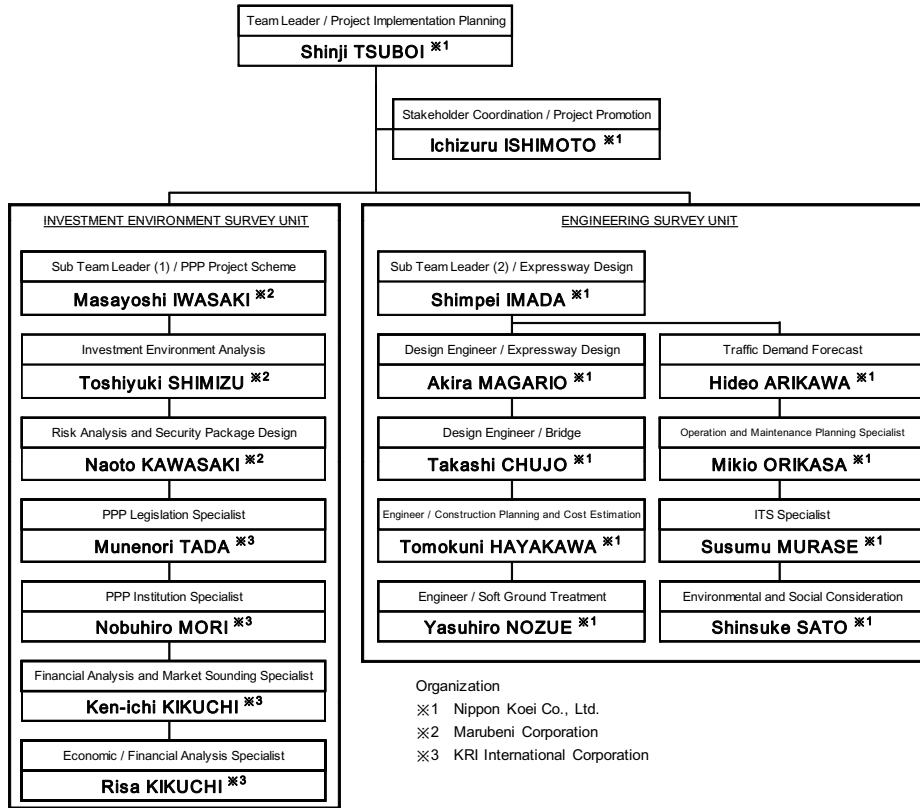

7

2.3 Assignment Schedule

Position	Name	CY 2011					CY 2012				M/M	
		Aug	Sep	Oct	Nov	Dec	Jan	Feb	Mar	Apr	VN	JP
Team Leader / Project Implementation Planning	Shinji TSUBOI		■	■	■	■	■	■	■	■	3.0	0.6
Stakeholder Coordination / Project Promotion	Ichizuru ISHIMOTO		■	■	■	■	■	■	■	■	0.9	
Sub Team Leader (1) / PPP Project Scheme	Masayoshi IWASAKI		■	■	■	■	■	■	■	■	1.5	0.3
Investment Environment Analysis Specialist	Toshiyuki SHIMIZU		■	■	■	■	■	■	■	■	1.5	
Risk Analysis and Security Package Design Specialist	Naoto KAWASAKI		■	■	■	■	■	■	■	■	1.0	1.4
PPP Legislation Specialist	Munenori TADA				■	■	■	■	■	■	1.0	0.6
PPP Institution Specialist	Nobuhiro MORI				■	■	■	■	■	■	1.0	0.5
Financial Analysis and Market Sounding Specialist	Ken-ichi KIKUCHI			■	■	■	■	■	■	■	2.1	0.5
Economic / Financial Analysis Specialist	Risa KIKUCHI		■	■	■	■	■	■	■	■	2.1	0.5
Sub Team Leader (2) / Expressway Design	Shimpei IMADA		■	■	■	■	■	■	■	■	4.3	0.4
Traffic Demand Forecast	Hideo ARIKAWA		■	■	■	■	■	■	■	■	3.5	
Design Engineer / Expressway Design	Akira MAGARIO		■	■	■	■	■	■	■	■	2.0	
Design Engineer / Bridge	Takashi CHUJO		■	■	■	■	■	■	■	■	1.7	
Engineer / Construction Planning and Cost Estimation	Tomokuni HAYAKAWA		■	■	■	■	■	■	■	■	2.5	
Engineer / Soft Ground Treatment	Yasuhiro NOZUE		■	■	■	■	■	■	■	■	1.8	
Operation and Maintenance Planning Specialist	Mikio ORIKASA		■	■	■	■	■	■	■	■	2.0	
ITS Specialist	Susumu MURASE		■	■	■	■	■	■	■	■	2.0	
Environmental and Social Consideration	Shinsuke SATO		■	■	■	■	■	■	■	■	1.7	0.6
											35.6	5.4
Reports and Date of Submission			▲		▲		▲		▲			
			Inception Report (IC/R)		Interim Report (IT/R)		Draft Final Report (DF/R)		Final Report (FR)			

□ Study in Japan ■ Study in Vietnam

8

3. Basic Approach of the Survey

[Approach 1]

Options of Viable Project Scope

[Approach 2]

Reliable Traffic Demand Forecast,

Review of Detailed Design taking into account of Life Cycle Cost,

Appropriate O&M Plan and Environmental/Social Considerations

[Approach 3]

Selection of Profitable Project Scope and Scheme

[Approach 4]

Design of Bankable Financial Structures for Implementation of the Project

11

Approach 1

Options of Viable Project Scope

- BEDC obtained two concessions;
 - A) O&M concession for Ho Chi Minh-Trung Luong (HCM-TL) Expressway
 - B) BOT concession for Trung Luong – My Thuan (TL-MT) Expressway
- Preliminary evaluation of Cash flow for the each above two concessions
- Extraction of options of the project scope by;
 - Cost down such as phasing by section
 - Consideration of government support such as subsidiary of land acquisition fee
 - Sharing between public sector and private etc.

For the public sector portion, possibility of application of loans from potential Overseas Aid will be examined.

12

Approach 1

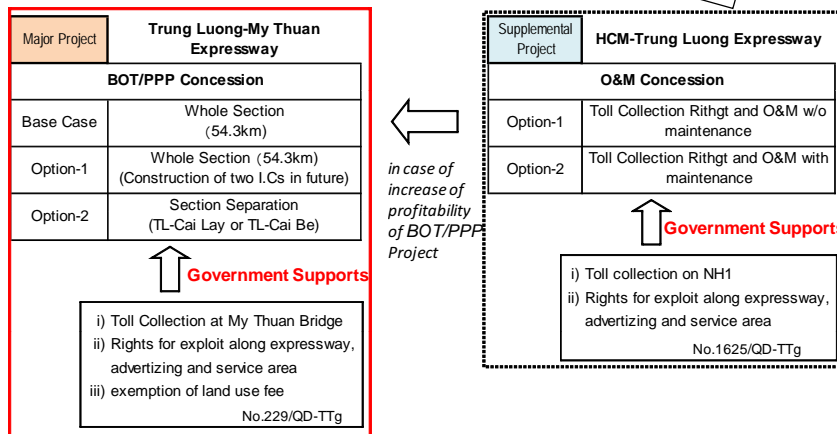
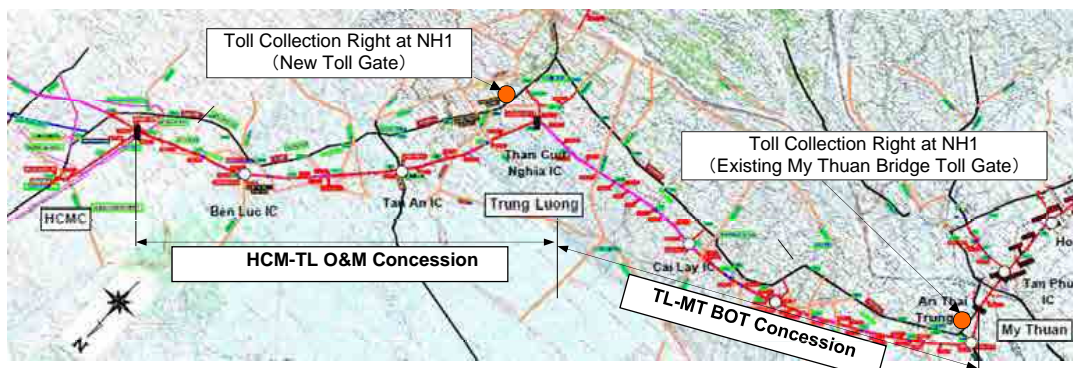

13

Approach 2

Reliable Traffic Demand Forecast

- Practical forecasting based on the supplemental traffic surveys from the viewpoint of the investor
- Development traffic will not be directly counted.
- But it can be assumed to be included normal traffic.
- Future traffic will be forecasted based on the growth of GDP.

Review of Detailed Design taking into account of Life Cycle Cost

- Review of D/D from the viewpoint of minimization of risks such as increase of construction cost and delay of construction work
- Selection of suitable soft soil treatment based on policy (avoidance, prevention, mitigation) against the extracted risks
- For the parts required revision of the D/D, basic design and preliminary cost estimate will be done.
- Revision in D/D level will propose to be conducted by BEDC.

14

Approach 2

Appropriate O&M Plan

- Examination of O&M Plan referring not only actual circumstances in Vietnam Expressways but also Japanese institution and standards
- Study of introduction of ITS referring to JICA's studies and recent Vietnamese plans such as traffic control center for southern region

Appropriate Environmental/Social Considerations

- Review of EIA in accordance with Vietnamese regulations and JICA Guidelines for Environmental and Social Considerations
- In case that supplemental survey is necessitated, contents and implementation program of the supplemental survey will be recommended to BEDC.

15

Approach 3

Selection of Profitable Project Scope and Scheme

To be selected based on due evaluation of following options:

- Examination of options described in Approach 1 and possibility of support from public
- Phasing by section, e.g. TL- Cai Be section as Phase-1 and remaining section to be constructed by public as Phase-2
- Cooperation finance with ADB for Phase-2 section
- Combination of reduction of investment cost and lease finance scheme based on BIDV re-lending scheme
- Phased opening plan of TL-MT expressway with toll revenue of NH1A and functional sharing of the traffic between expressway and NH1A

16

Approach 4

Design of Bankable Financial Structures for Implementation of the Project

□ From the viewpoints of both equity and debt providers, following issues to be discussed:

- Optimal allocation of the major risks,
- Government support for strengthen and stabilization of the project cash-flow,
- Guarantee provided by international donors.

Finalization of the financial structures considering to feedbacks from project owner, potential investors and lenders, and Vietnamese relevant authorities.

□ Then, formulation of the above contents into Draft Term Sheets:

- For the BOT contract,
- For Government Guarantee and Undertaking.

17

4. Survey Flow

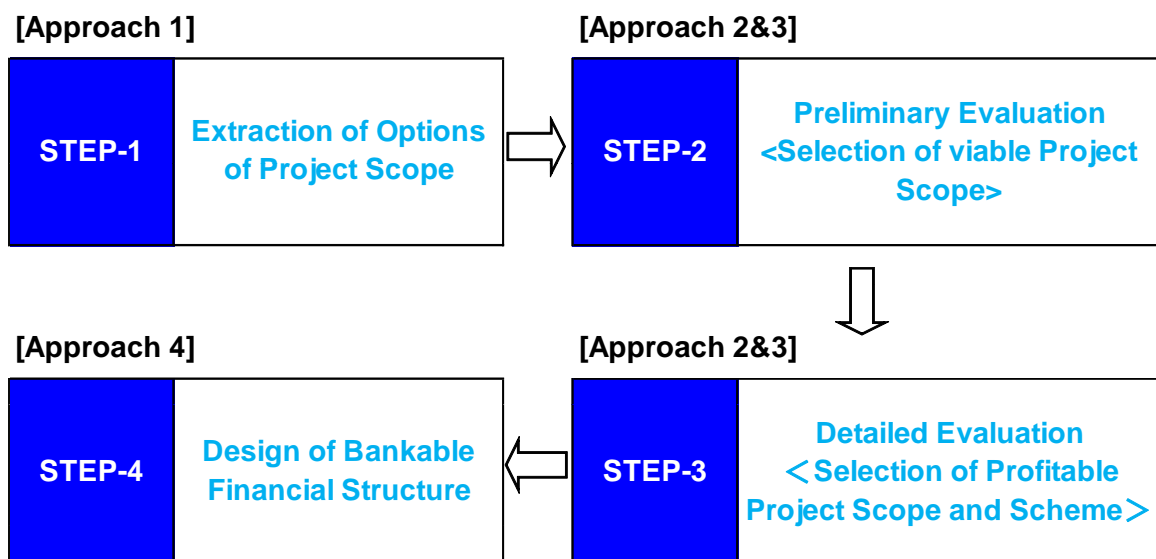

18

4. Survey Flow : STEP-1

[Approach 1]

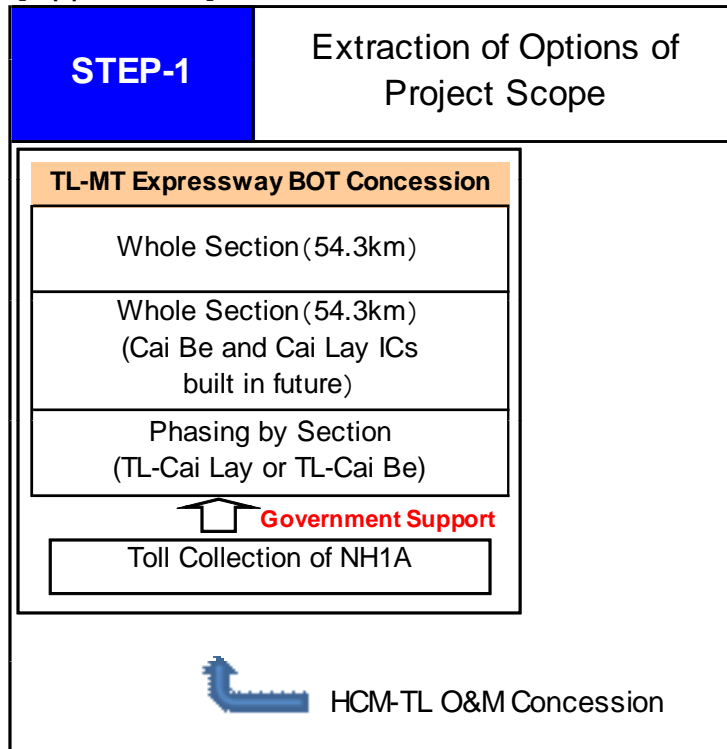

19

4. Survey Flow : STEP-2

[Approach 2&3]

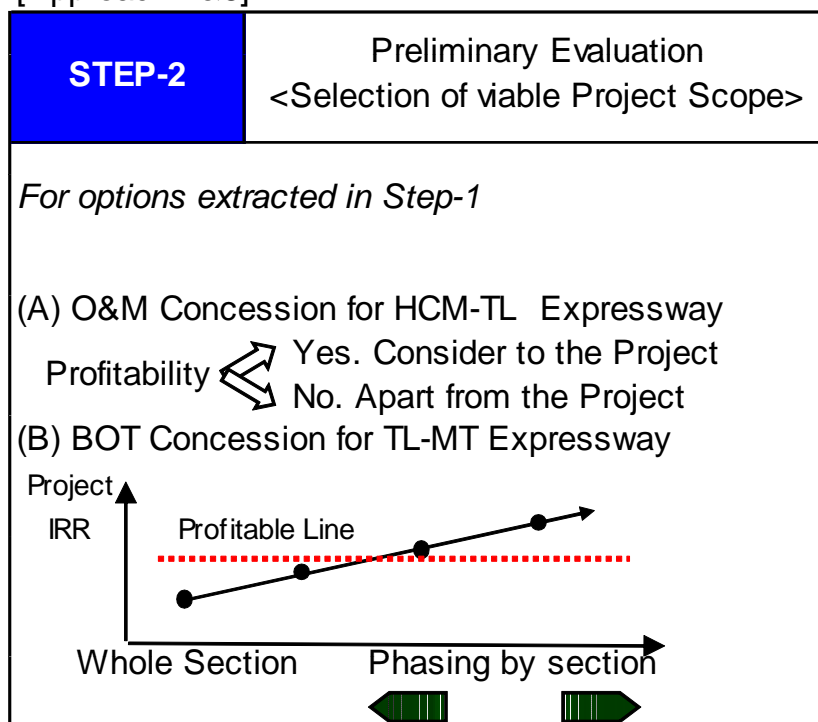

20

4. Survey Flow : STEP-3

[Approach 2&3]

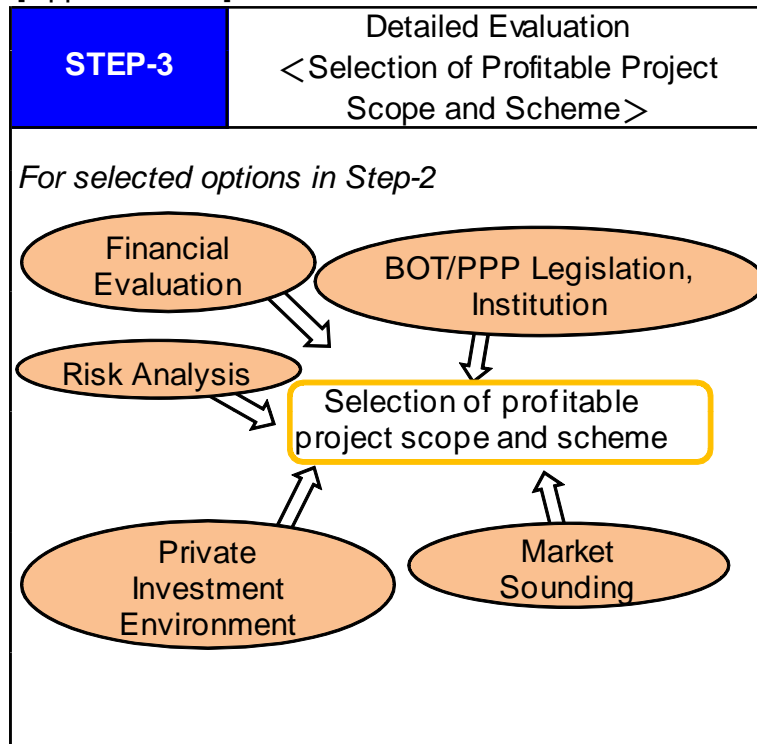

21

4. Survey Flow : STEP-4

[Approach 4]

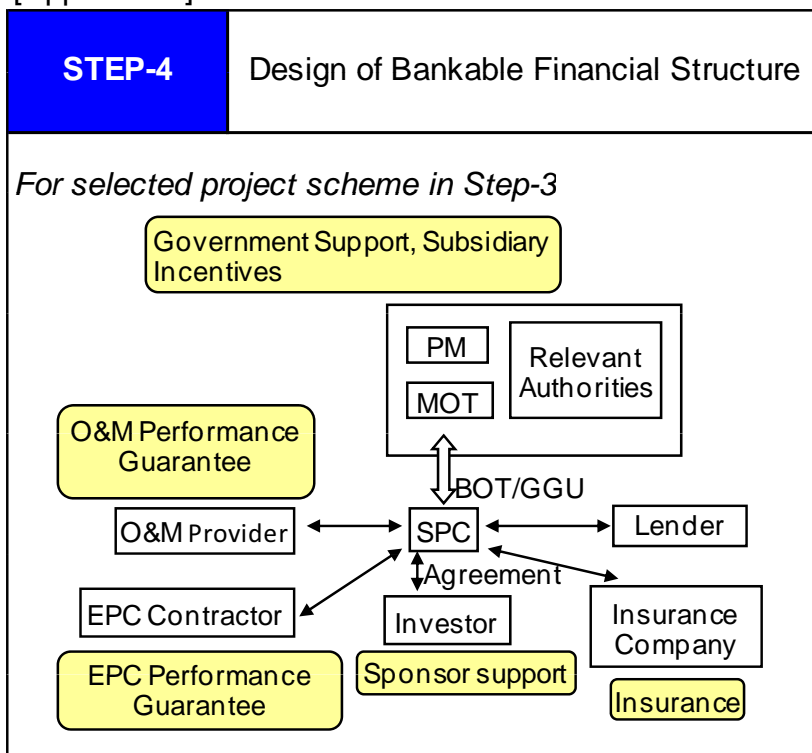

22

5. Draft Contents of the Final Report

CHAPTER 1	INTRODUCTION
CHAPTER 2	PROJECT BACKGROUND AND NECESSITY
CHAPTER 3	ANALYSIS OF BOT/PPP LEGAL SYSTEMS AND ORGANIZATION
CHAPTER 4	STUDY OF EXISTING PROJECT SCHEME
CHAPTER 5	REVIEW OF TRAFFIC DEMAND FORECAST
CHAPTER 6	REVIEW AND ADDITIONAL STUDY OF THE PROJECT PLAN
CHAPTER 7	RECOMMENDATION FOR PROJECT SCOPE AND PROJECT SCHEME
CHAPTER 8	DESIGN AND RECOMMENDATION FOR SECURITY PACKAGE
CHAPTER 9	EVALUATION AND FEASIBILITY OF THE PROJECT
CHAPTER 10	CONCLUSION
APPENDIX	DRAFT TERM SHEETS FOR BOT CONTRACT AND FOR GGU

23



Thank you very much for your attention.

24

Phụ lục -5 Tài liệu họp

A5-2: Họp tiến độ (lần 5) với BEDC



THE PREPARATORY SURVEY ON TRUNG LUONG – MY THUAN EXPRESSWAY PROJECT IN VIETNAM

Progress Meeting (5)

7 December 2011

Nippon Koei Co., Ltd.
Marubeni Corp.
KRI International Corp.

Table of Contents

1. Progress of the Study
2. Traffic Demand Forecast
3. Phase-wise Construction Plan
4. Construction Plan
5. Updated Project Cost
6. O&M Plan
7. Environmental and Social Considerations

1. Progress of the Study

Schedule		Private Investment Part		Engineering Part	
Sept	Kick-Off (22 nd) P.M1 (23 rd)	Preliminary Evaluation of Project Scope and Scheme	<ul style="list-style-type: none"> Extraction of options of project scope 	Engineering Work <ul style="list-style-type: none"> Review of D/D (propose design change, update project cost) Update of Traffic Demand Forecast O&M, ITS Plan Environment and Social Considerations 	
Oct	T.M with DD Consultant (6 th) P.M2 (7 th) P.M3 (14 th)		<ul style="list-style-type: none"> Preliminary selection and evaluation of viable project scope and scheme by Project IRR and Equity IRR based on F/S traffic volume and the cost 		
Nov	P.M4(17 th)				
Dec	P.M5(7 th) Progress Report	Detailed Evaluation	Design of Bankable Financial Structure	Suspension of the Study	
2012 Jan					<ul style="list-style-type: none"> Evaluation of bankable scheme by using updated traffic volume and cost Market Sounding Security Package BOT/GG Term Sheet
Feb					
Mar					<ul style="list-style-type: none"> Project Implementation Program

P.M: Progress Meeting
T.M: Technical Meeting

3

2. Traffic Demand Forecast

Methodology

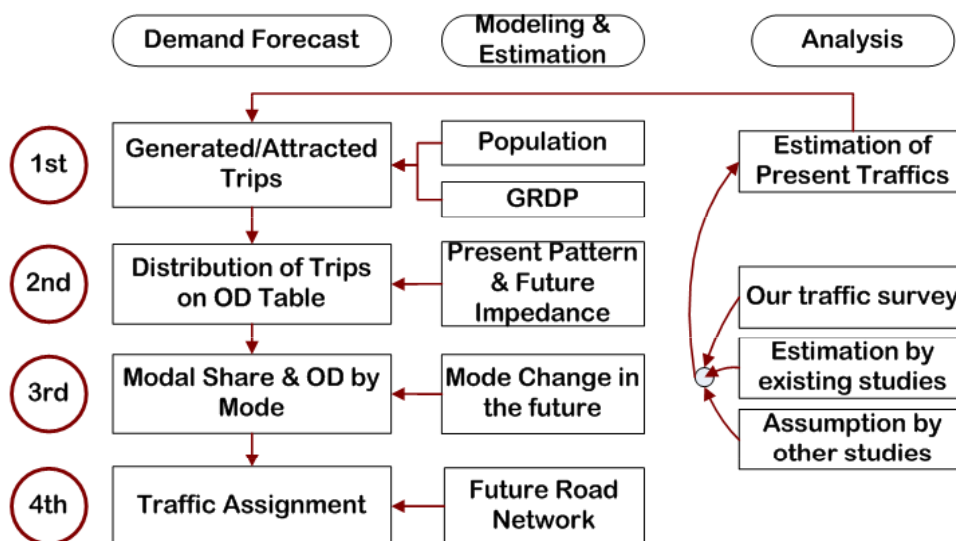

4

2. Traffic Demand Forecast

Traffic Survey Zone & Traffic Survey



5

2. Traffic Demand Forecast

Expanded OD Interview Result

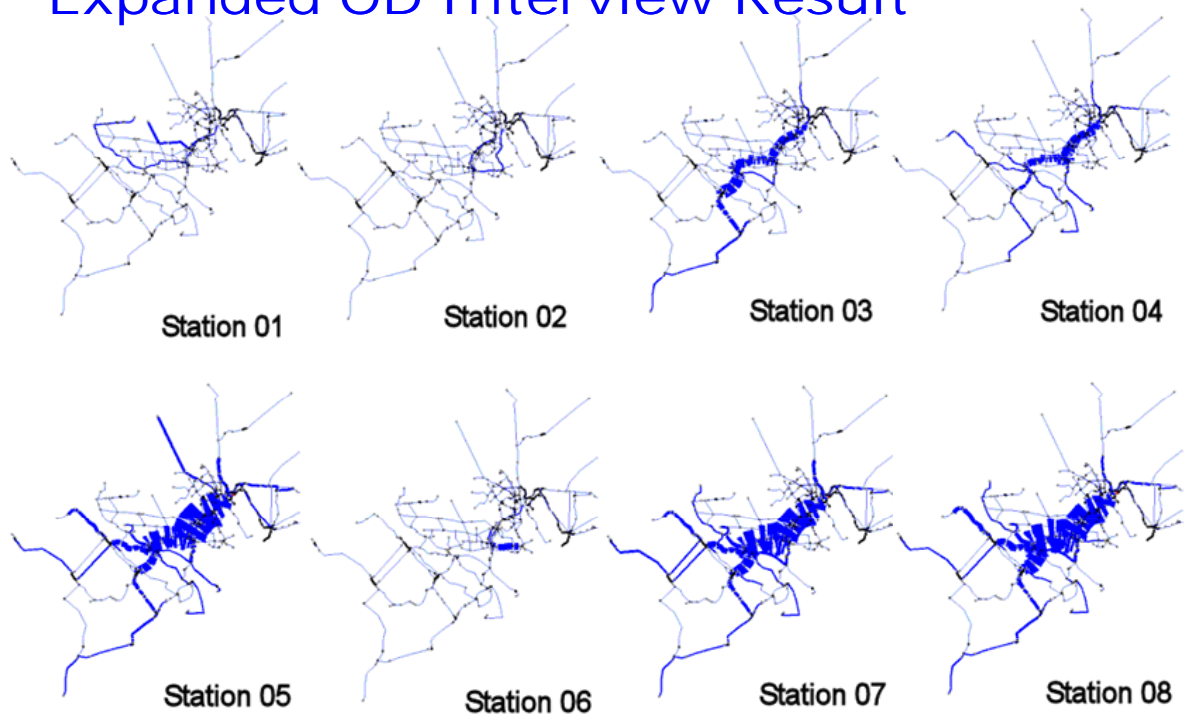

2. Traffic Demand Forecast

Trip Character of Person Trips

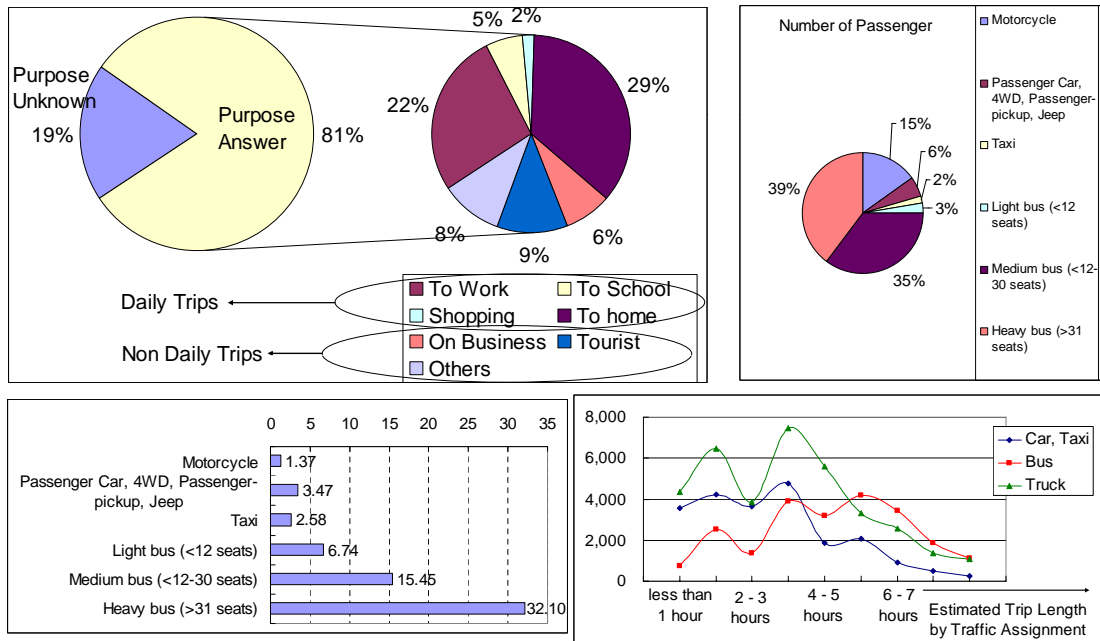

7

2. Traffic Demand Forecast

Trip Character of Cargo Trips

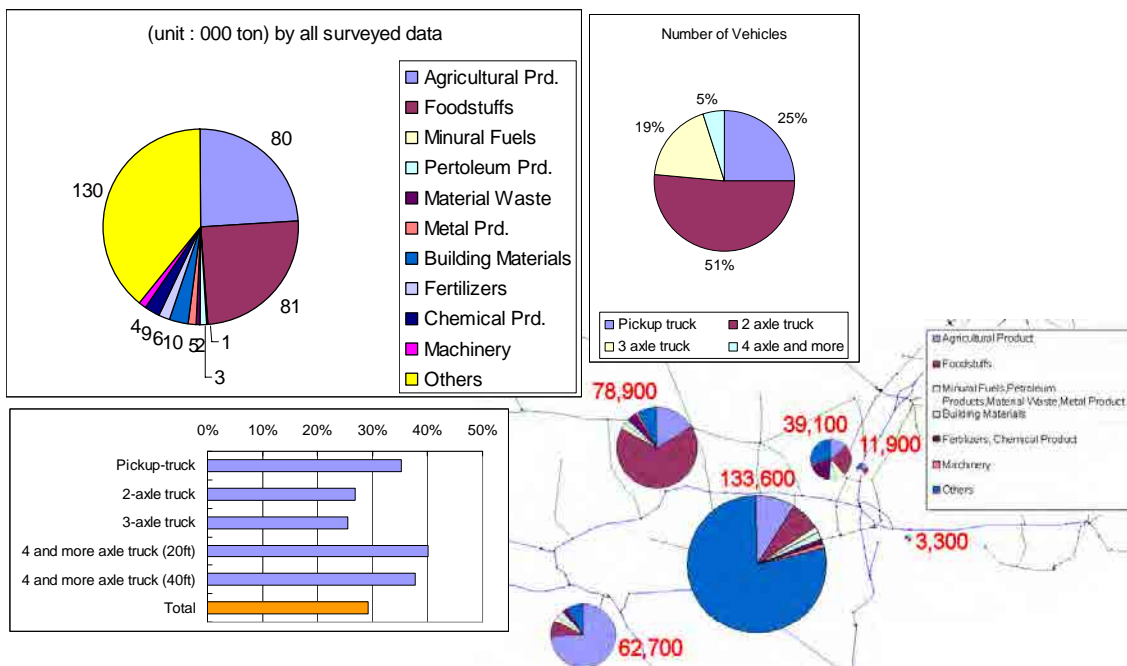

8

2. Traffic Demand Forecast

Estimation of Present OD

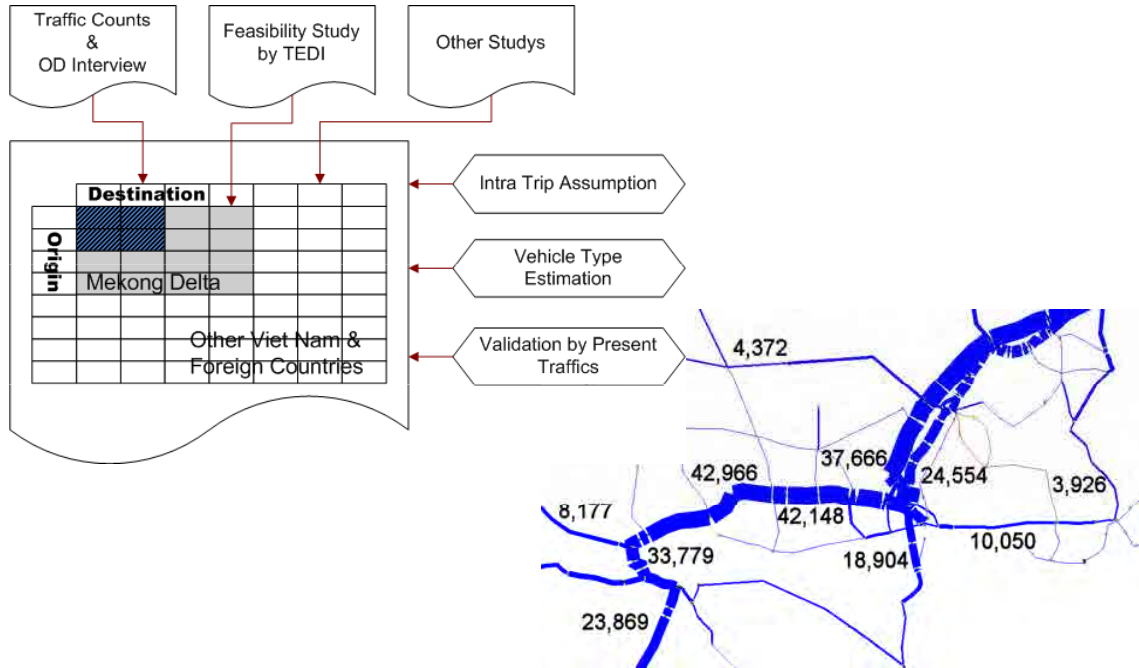

9

2. Traffic Demand Forecast

Generated/Attracted Vehicle Trips

(1) Personal unit type

$$\text{Trips} = a \times (k + m \times \text{Log-e}(\text{GDP per capita})) \times \text{Population} + b$$

$k + m \times \text{Log-e}(\text{GDP per capita})$: Generated trips per person

(2) Economic growth type

$$\text{Trips} = a \times (\text{GRDP per capita}) + b \times (\text{Population}) + c$$

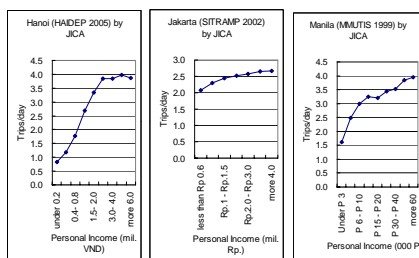

Vehicle Type	$a*(k+m*LN(\text{GDP p.c.})*\text{Pop} + b)$			$a*\text{GDP p.c.} + b*\text{Pop} + c$			
	a	b	R2	a	b	c	R2
1Motorcycle	0.6231	4758.30	0.29	551.957	0.00560	969.62186	0.54
2Car	0.4980	121.11	0.43	42.093	0.00055	-189.082	0.68
3Taxi	0.3055	112.41	0.40	21.365	0.00036	-45.846	0.63
4Small Bus	0.0127	41.65	0.64	11.269	0.00020	-42.174	0.75
5Medium Bus				25.566	0.00046	-136.430	0.80
6Large Bus				8.751	0.00014	-27.440	0.76
7Pickup	0.9568	118.95	0.43	17.319	0.00024	-8.079	0.65
82 axle truck				37.270	0.00053	-118.367	0.69
93 axle truck				9.539	0.00014	-25.509	0.71
104 axle more				3.790	0.00003	-11.514	0.58

*) personal unit type

*) economic growth type

10

2. Traffic Demand Forecast

Future Socio Economic Framework

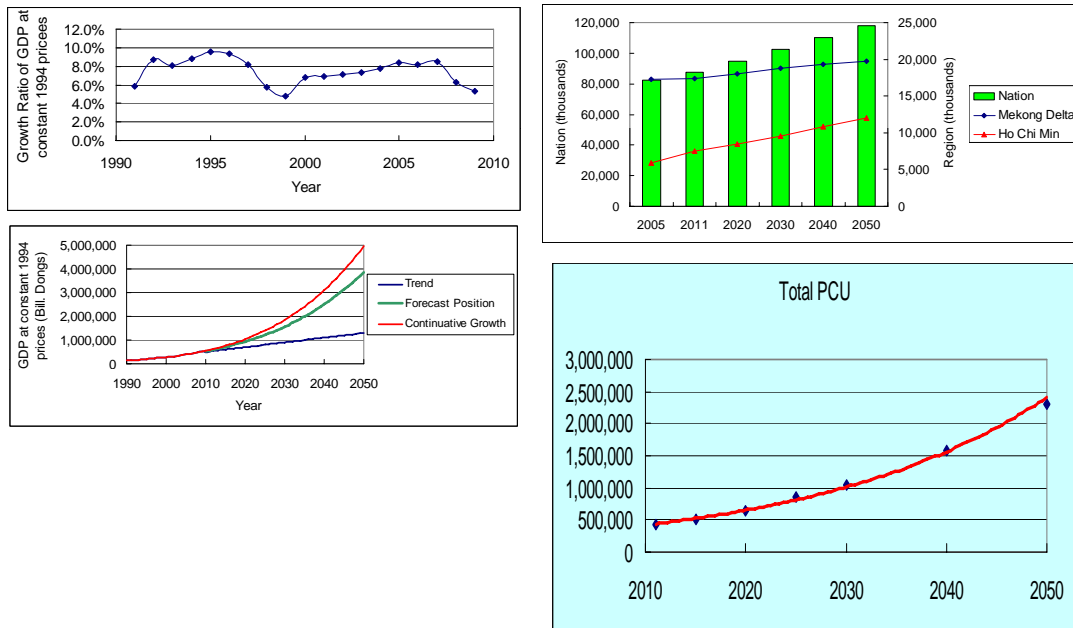

11

2. Traffic Demand Forecast

Traffic Assignment by STRADA

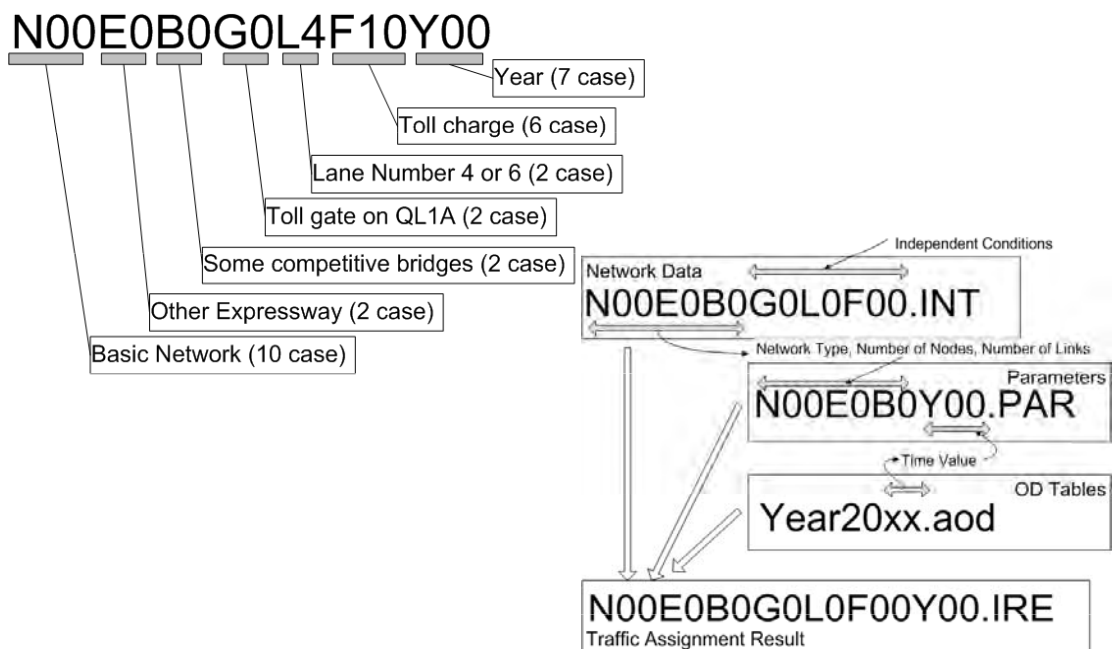

12

2. Traffic Demand Forecast

Conversion to Toll by Time Value

Type of vehicle	Regulated toll rate (VND)	Type of vehicle	Proposed toll rate (VND/km)
<12 seats vehicle	10,000	Car (< 12 seats), Truck (<2tons), mass transit bus	1,000
12 – 30 seats bus	15,000	Car (12-30 seats), Truck (2-4 tons)	1,500
> 30 seats bus	22,000	Car (> 30 seats), Truck (4 - 10 tons)	2,200
Light truck (weight<4 tones)	15,000	Truck (10-18 tons, and 20ft container)	4,000
Medium truck (weight= 4 - 10 tones)	22,000	Truck (>18 tons and over 40ft container)	8,000
Heavy truck (weight=10 - 18 tones)	40,000		
Special truck (trailer>18 tones)	80,000		

min/1000 Dong	2011	2015	2020	2025	2030	2040	2050
Car	0.94294	0.81813	0.68509	0.57062	0.47529	0.33949	0.25058
Taxi	0.47147	0.40906	0.34254	0.28531	0.23764	0.16974	0.12529
Small Bus	2.09249	1.81554	1.52030	1.26628	1.05472	0.75336	0.55608
Medium Bus	0.72623	0.63011	0.52764	0.43948	0.36606	0.26147	0.19299
Large Bus	0.43935	0.38120	0.31922	0.26588	0.22146	0.15818	0.11676
Pickup	1.36547	1.18474	0.99208	0.82632	0.68826	0.49161	0.36287
2 axle truck	0.73101	0.63426	0.53111	0.44238	0.36847	0.26319	0.19427
3 axle truck	0.73101	0.63426	0.53111	0.44238	0.36847	0.26319	0.19427
Container	0.41473	0.35983	0.30132	0.25098	0.20904	0.14932	0.11021

13

2. Traffic Demand Forecast

Traffic Assignment (1)

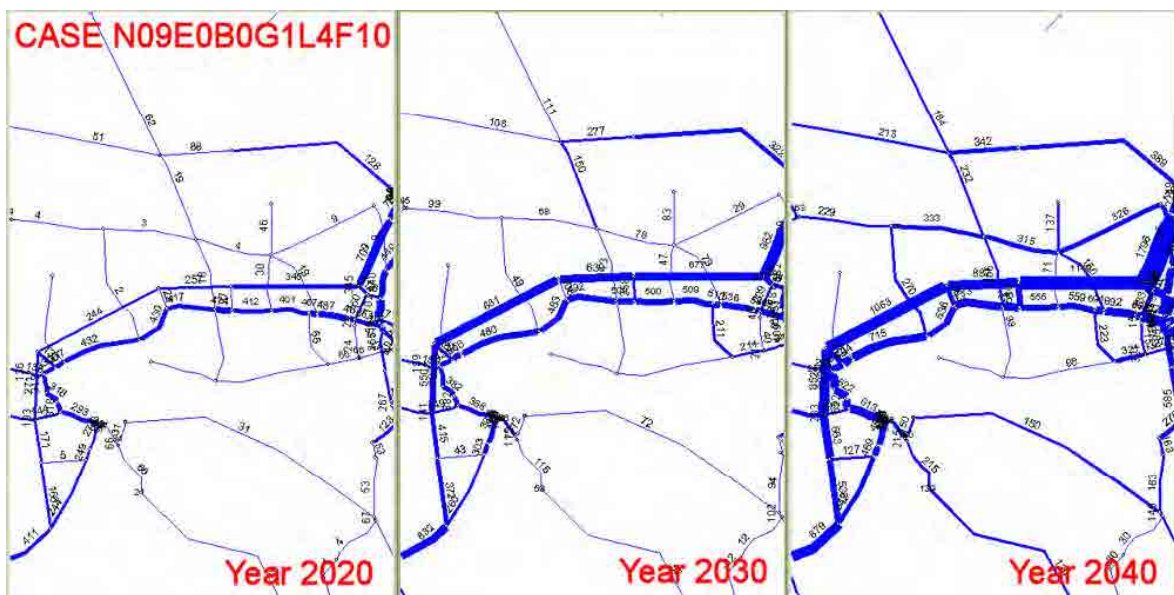

14

2. Traffic Demand Forecast

Traffic Assignment (2)

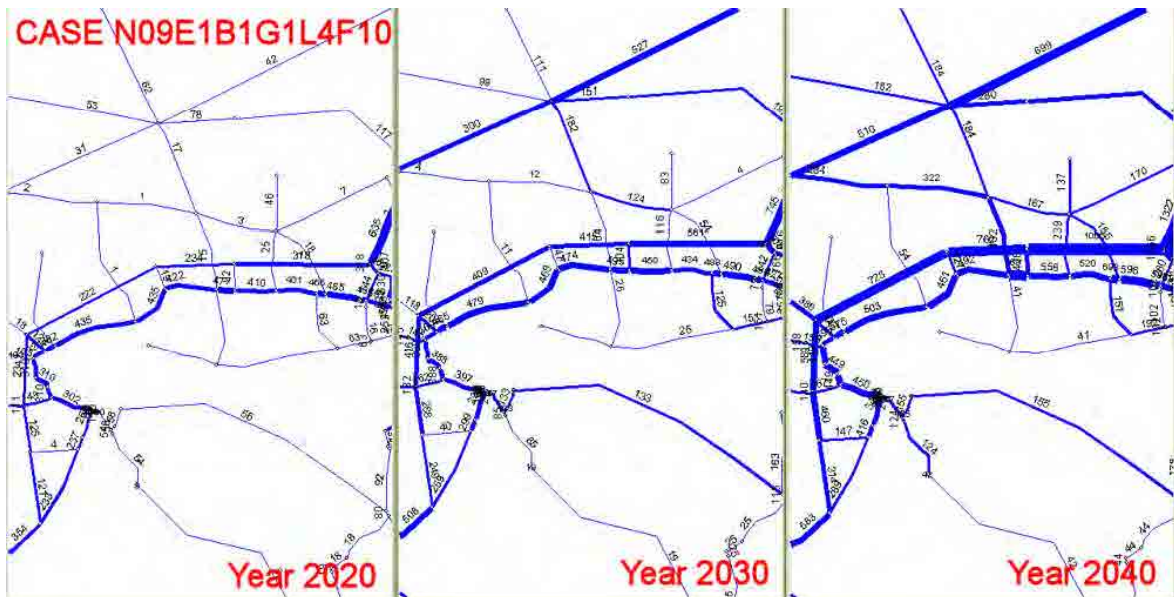

15

2. Traffic Demand Forecast

Comparison with Other Studies

PCU	Year 2020					
	TEDI		METI & JETRO		This Study (N09E0B0G1L4F10)	
	QL1A	Ex-way	QL1A	Ex-way	QL1A	Ex-way
Trung Luong - Cai Lay	23,242	62,088	41,010	39,119	41,236	34,514
Cai Lay - My Thuan	33,756	45,969	25,746	29,460	43,194	24,352
My Thuan - Can Tho	14,600	38,756	24,536	23,657	27,406	17,145

PCU	Year 2030					
	TEDI		METI & JETRO		This Study (N09E0B0G1L4F10)	
	QL1A	Ex-way	QL1A	Ex-way	QL1A	Ex-way
Trung Luong - Cai Lay	41,154	93,392	56,567	67,751	50,047	67,657
Cai Lay - My Thuan	60,932	74,200	37,226	49,657	48,041	63,056
My Thuan - Can Tho	36,804	48,759	34,519	41,418	30,469	41,527

One of our scenarios

Year	Year 2015	Year 2020	Year 2025	Year 2030	Year 2040	Year 2050
Case	N03E0B0G1L4F10Y15	N09E1B0G1L4F10Y20	N09E1B1G1L4F10Y25	N09E1B1G1L4F10Y30	N09E1B1G1L6F10Y40	N09E1B1G1L6F10Y50
Than Cuu Nohia - Cai Lay	17,200	31,300	44,300	56,100	131,100	197,600
Cail Lai - Cai Be	9,700	22,700	34,100	41,500	106,900	168,500
Cai Be - An Thai Trung	7,500	21,300	33,500	40,900	96,700	158,000
Hoa Khanh - Tan Phu	-	23,200	33,300	41,600	61,000	115,000
Tan Phu - Hoa Phu	-	12,600	20,600	28,800	45,800	97,300
Hoa Phu - Tra Va	-	12,300	18,800	24,900	30,200	62,200
Section	Trung Luong - My Thuan	Trung Luong - Can Toh (4 lanes)		Trung Luong - Can Toh (6 lanes)		
Other Expressways	Not yet		Completed			
Other Bridges	Not yet		Completed			

16

3. Phase-wise Construction Plan

3.1 Plan in F/S and D/D

F/S

Standard		2010	2020	2025	2030
Traffic Volume (PCU/day)		45,464	57,036	76,034	97,355
TCVN5729-97		4	4	6	8
Highway Capacity Manual	4-lane	LOS C	LOS D	LOS F	-
	6-lane	-	-	LOS C/D	LOS D/E

LOS: Level of Service

4-lane operation Up to 2020
 Widening to 6-lane after 2020 ➔ MOT Approved

D/D

Phase-1: Construction of 4-lane Expressway for whole section
 Land Acquisition for 6-lane
 PC box girder and foundation of simple span bridges for 6-lane
 Phase-2: Investment cost of widening stage is not considered 17

3. Phase-wise Construction Plan

3.2 Proposed Phase-wise Construction Plan

(1) Traffic Demand Forecast for Determination of Required Number of Lanes

Average Daily Traffic (vehicle/day) at TL-Cai Lay section

Vehicle Type	2017	2027	2032	2037	2047
Car	4,171	13,394	18,130	26,493	43,452
Taxi	830	1,291	1,446	1,775	1,840
Small Bus	174	345	580	1,071	1,308
Medium Bus	2,395	4,816	5,847	7,621	10,553
Large Bus	1,227	2,462	2,834	3,490	4,646
Pickup	1,321	2,027	2,763	4,326	5,927
2 axle truck	2,891	5,263	6,632	9,130	12,284
3 axle truck	596	1,085	1,580	2,748	4,909
Container	185	329	489	788	1,600
Total	13,790	31,012	40,301	57,442	86,519

Estimated under the scenario of development of road network:

- ❑ Traffic Open of TL-MT Expressway Year 2017
- ❑ Extension to Can Tho Year 2020
- ❑ Completion of HCM Highway Route Year 2025
- ❑ Completion of bridges (Co Chiein, Dai Nghai) along NH60 Year 2035

3. Phase-wise Construction Plan

(2) Required Number of Lanes based on the various Standards

Standard	Traffic Open			Design Year		
	2017	2027	2032	2037	2047	
TCVN5729-97	4	4	6	8	10	
Japan Road Structure Ordinance	4	4	4	6	8	
Highway Capacity Manual (HCM)	4-lane	LOS A	LOS C	LOS D	-	
	6-lane	-	LOS B	LOS B	LOS C	
	8-lane	-	-	-	-	LOS D
	10-lane	-	-	-	LOS B	LOS C

Recommend to apply HCM for determination of required number of lanes from viewpoints of;

- ✓ standard based on traffic characteristics accumulated for a long term
- ✓ high flexibility so that the project owner can select the level of service
- ➔ suitable for BOT scheme

3. Phase-wise Construction Plan

(3) Required Number of Lane and Timing of Widening by HCM

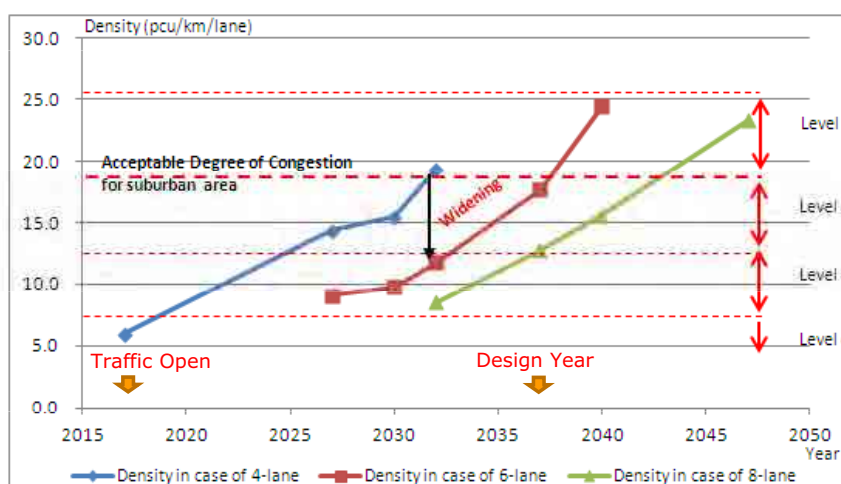

TL-MT Expressway requires 6-Lane

For efficient investment

4-Lane Construction initial phase is recommended

Widening to 6-Lane before 2032

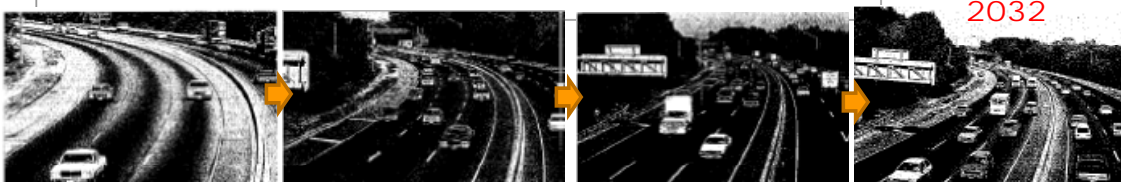

Level of Service A
Free flow

Level of Service B
Reasonably free flow

Level of Service C
Stable flow

Level of Service D
Approaching unstable flow

4. Construction Plan

Presumptions

1. Construction works can start from any places / packages.
2. Amount of materials, manpower, construction machines to throw are unlimited.



21

4. Construction Plan

Construction Speed

Item	Construction Speed	Remarks
Highway		
Soft Soil Treatment (PVD)	1 km/3 month	Issue (2)
Embankment	18 months	Step-by-step construction Issue (3)
Bridges		
Substructure (Piles, Abutment, Pier)	2 months/nos	Issue (1)
Superstructure	1 km/month	Including slab, barrier, pavement

22

4. Construction Plan

Issue (1)

1. Construction of piles of abutment shall be latter than embankment around them.

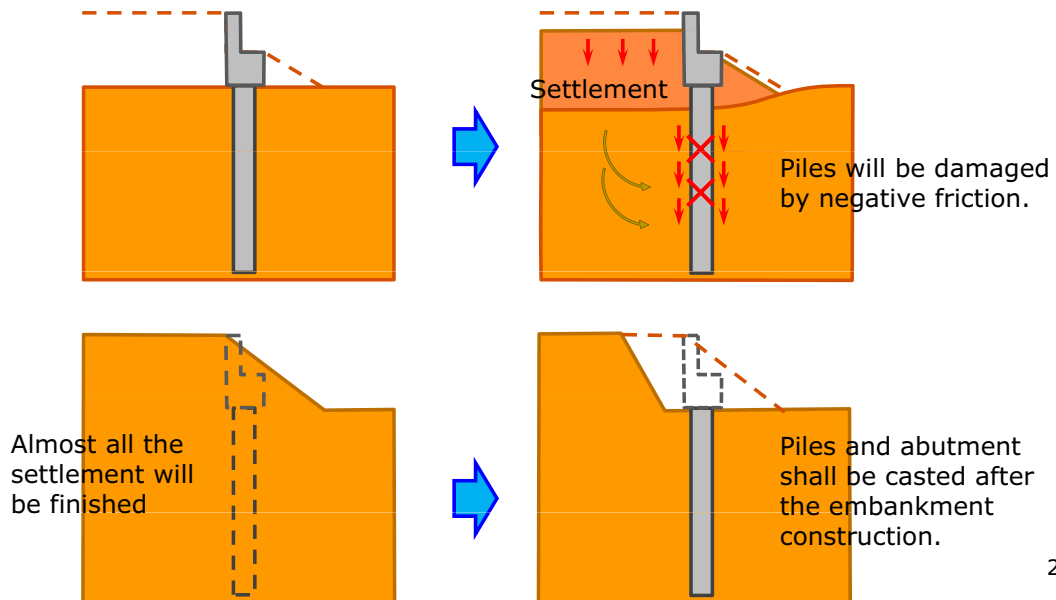

23

4. Construction Plan

Issue (2)

2. Driving PVD takes time and construction machines.

Driving speed 30cm/s -> 150 nos/d
-> 4~5m (longitudinal)/d
-> 100m (Longitudinal)/month/machine
-> 1 km/3 months/3 machine/package

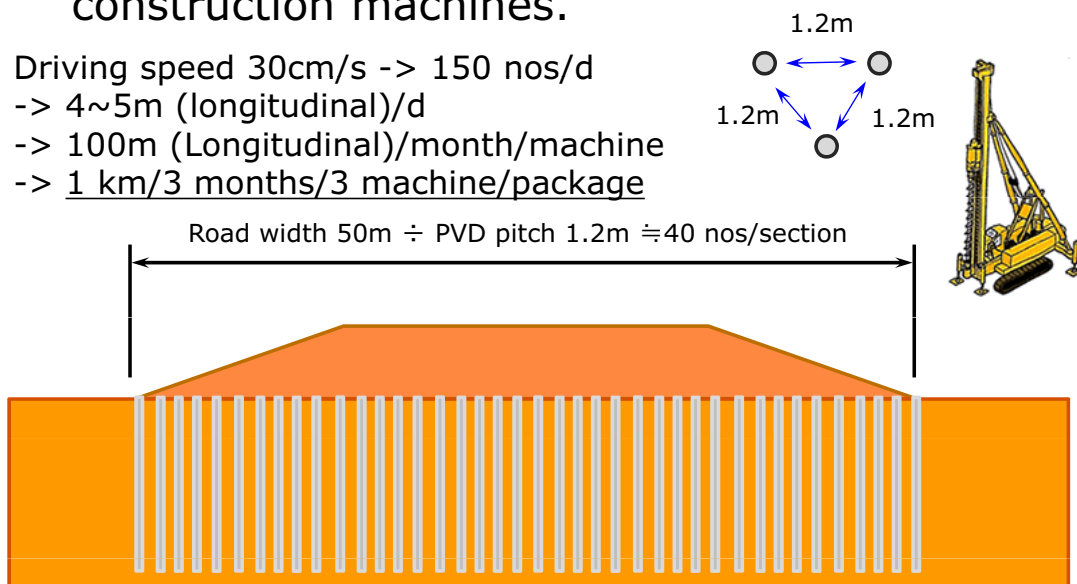

24

4. Construction Plan

Issue (3)-1

3. Because the volume of embankment is big, the supply of sand becomes important.

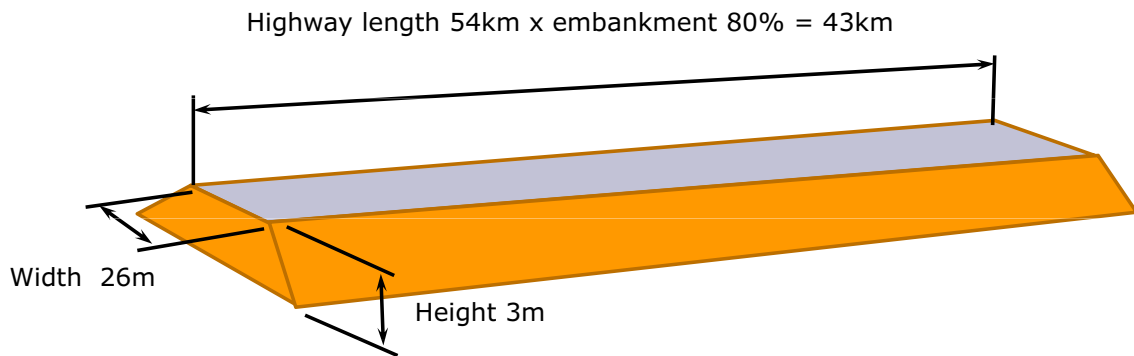

The amount of sand for embankment will be $\frac{1}{2} \times (26+39) \times 3 \times 43,000 = 4,128,000 \text{ m}^3$

25

4. Construction Plan

Issue (3)-2

$4,128,000 \text{ m}^3$ / construction period 15 months
/ 20 working days per month
= $13,760 \text{ m}^3$ /day
= 860 m^3 /day/ package

a. Material supply



860 m^3 /day



b. Material transfer



100 m^3 /ship
x 9 ships/day



c. Embankment construction



860 m^3 /day

For every 16 packages

26

4. Construction Plan

Recommendations

1. Construction TL~MT Expressway within 3 years is possible, but it needs sufficient materials, construction machines, and/or new construction method.
2. Soft soil treatment (PVD) is the most critical work. Balance of quality and construction speed is important in case of settlement.

27

5. Updated Project Cost

Total Construction cost (Billion VND)

Construction cost	15,220
Engineering cost	1,065
Project management	609
Other cost	609
SPC establishment	178
Land acquisition	2,254
VAT	1,646
Total	21,582

Incl. physical contingency(10%), price contingency(8%)
Some cost should be revised (ITS cost etc.)

28

Cost analysis

	Cost (Bil. VND)	Rate (%)	Remarks
Total Civil Work	12,699	100.0	
Highway	4,800	37.8	Soft soil 1,615 (12.7%) Pavement 1,232 (9.7%)
Bridge (Simple)	3,965	31.2	
Bridge (Continuous)	1,287	10.1	
Overpass	558	4.4	
Interchange	1,505	11.8	
Access road to NH1	92	0.7	
Lighting System	109	0.9	
Equipment	383	3.0	

Physical contingency, price contingency are not included.
Some cost should be revised (ITS cost etc.)

29

Annual Disbursement (Billion VND)

	Total	2012	2013	2014	2015	2016
Total	21,582	1,140	2,270	4,884	5,492	7,795
(Billion JPY)	79.9	4.2	8.4	18.1	20.3	28.9
Construction	15,220	0	1	4,006	4,559	6,653
Other Cost	2,461	360	717	461	461	461
Land Acquisition	2,254	751	1,503	0	0	0
VAT	1,646	29	50	416	471	681

Incl. physical contingency(10%), price contingency(8%)
Some cost should be revised (ITS cost etc.)

30

6. O&M Plan

6.1 O&M Plan (Expressway)

1) Basic Policy Concerning the Expressway's O&M

1-1) Legislations Related to The Expressway's O&M

1-2) To Decide The Basic Policy of O&M for TL-MT Expressway
Based on The Legislation, and Actual O&M Works as Reference

2) O&M Plan

2-1) Actual O&M Works of HCMC-TL Expressway

2-2) To Propose The Concrete O&M Plan of TL-MT Expressway

3) O&M Cost

3-1) O&M Initial Cost

3-2) O&M Operation Cost by F/S of The TL-MT Expressway Project

3-3) Verification of The Above Mentioned Cost by The
Comparison with Other Roads and Bridges' O&M Cost

31

1) Basic Policy Concerning the Expressway's O&M

1-1) Legislations Related to The Expressway's O&M

Road Maintenance and Traffic Management:

“Temporary Regulation on the Maintenance of HCMC - Trung Luong Expressway” 2011 /Feb. 17, 266/Qd-BGTVT, Decision by MOT



However, the content is insufficient though the whole items are covered, but toll collection works are not mentioned.

Toll Collection:

“Instruction for collection, remittance, management and usage of fee, charges in Road transportation” 2004/Jul. 29, 76/2004/TT-BTC, Circular by MOF



The whole items regarding the toll collection works for roads and bridges in Vietnam are covered, but the expressway's toll collection is not referred.



In the Formal O&M Regulation, it is necessary to add the insufficient contents of works and toll collection works.

32

1-2) To Decide The Basic Policy of O&M Based on The Legislation, and Actual O&M Works as Reference

General Idea of the O&M Basic Policy ↔ “Level of Service”

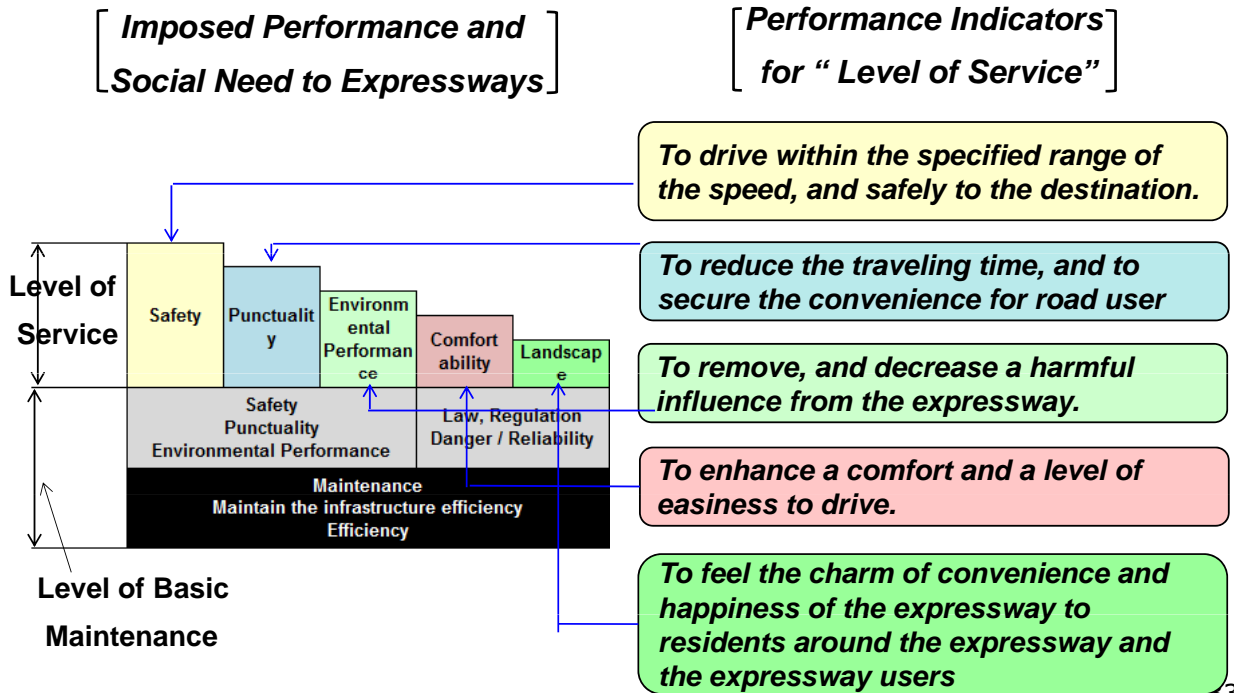

“ Level of Service” of HCMC-TL-MT Expressway

kind of Performance	Example of Setting Performance Indicators	“Level of Service”	
		HCMC - TL	TL - MT
Safety	Number of traffic accidents, Traffic accident ratio		
	Pavement evaluation condition: Rutting depth(25mm), Skid resistance (0.25), longitudinal profile (8m profile 90(PrI)), cracking ratio(20%), Size of pothole(D=20cm)		
Punctuality	Vehicle speed is secured 80 km/h at normal hours Vehicle speed is secured 60 km/h at peak hours		
	How to reduce the congestion hours		
Environmental Performance	Noise from the road traffic is limited.		
	Amount of poisonous substances generated by the road traffic is decreased.		
	Vibration, light, and stink (The influence on air, the soil, and water is considered).		
Comfort ability	The stress is given to the road user by reducing the comfort ability, and the influence of the minus is given to the driving operation.		
	IRI is the indicator		
Landscape	Evaluation from road users		
	Evaluation from residents around expressway		

- There is no concept of LOS in the O&M works now.
- Therefore, these performance indicators are not regulated.
- In the O&M works, setting LOS is important.
- In the Formal O&M Regulation, concept of LOS is needed to introduce.

2) O&M Plan

2-1) Actual O&M Works of HCMC-TL Expressway

O&M Organization of HCMC- TL Expressway

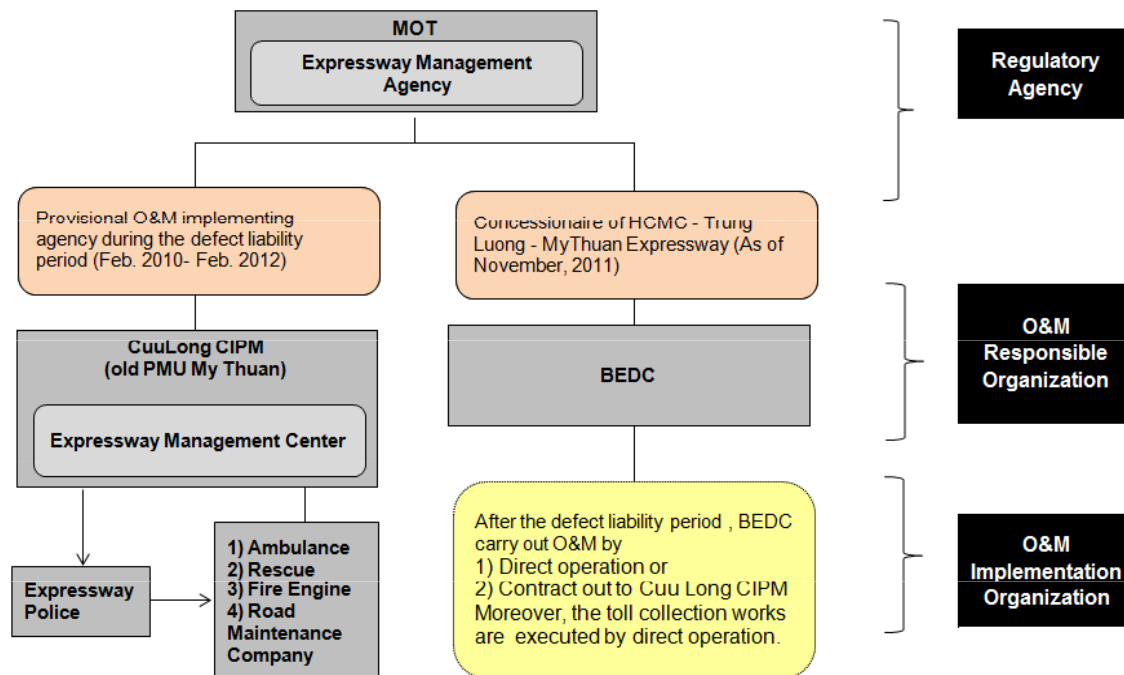

35

Actual O&M Works

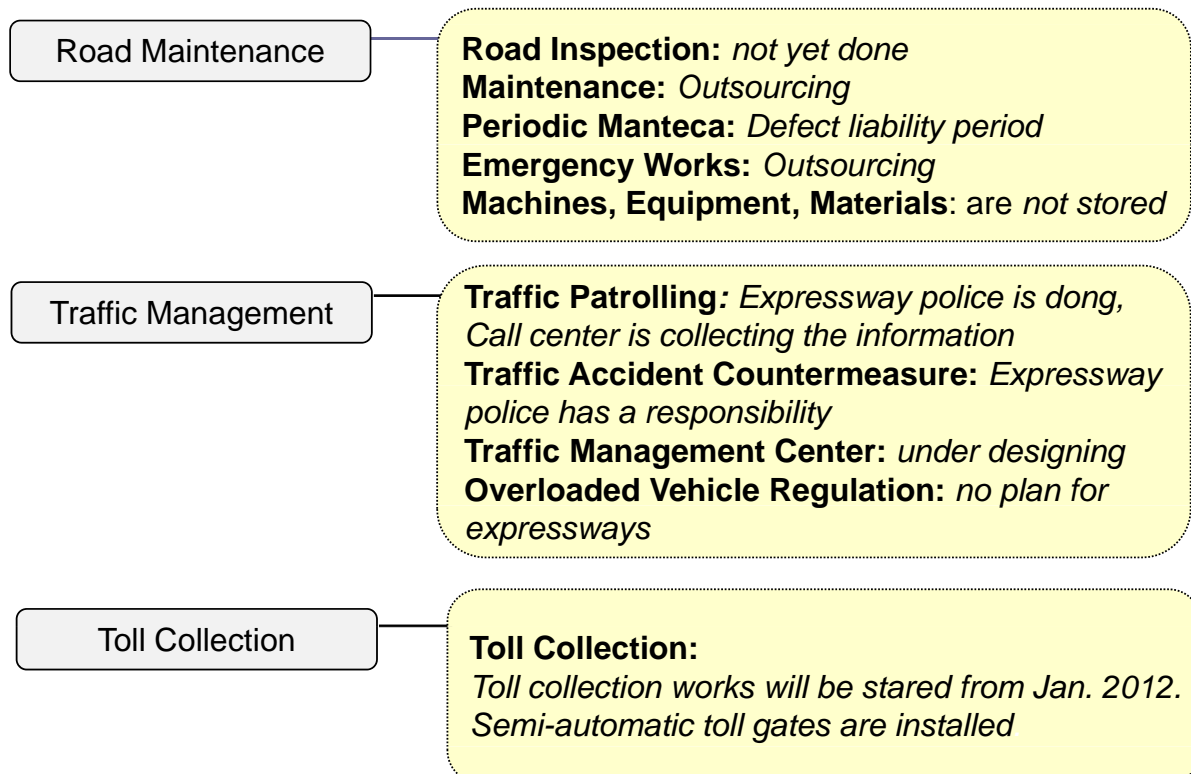

36

2-2) To Propose The Concrete O&M Plan of TL-MT Expressway

O&M Execution Plan

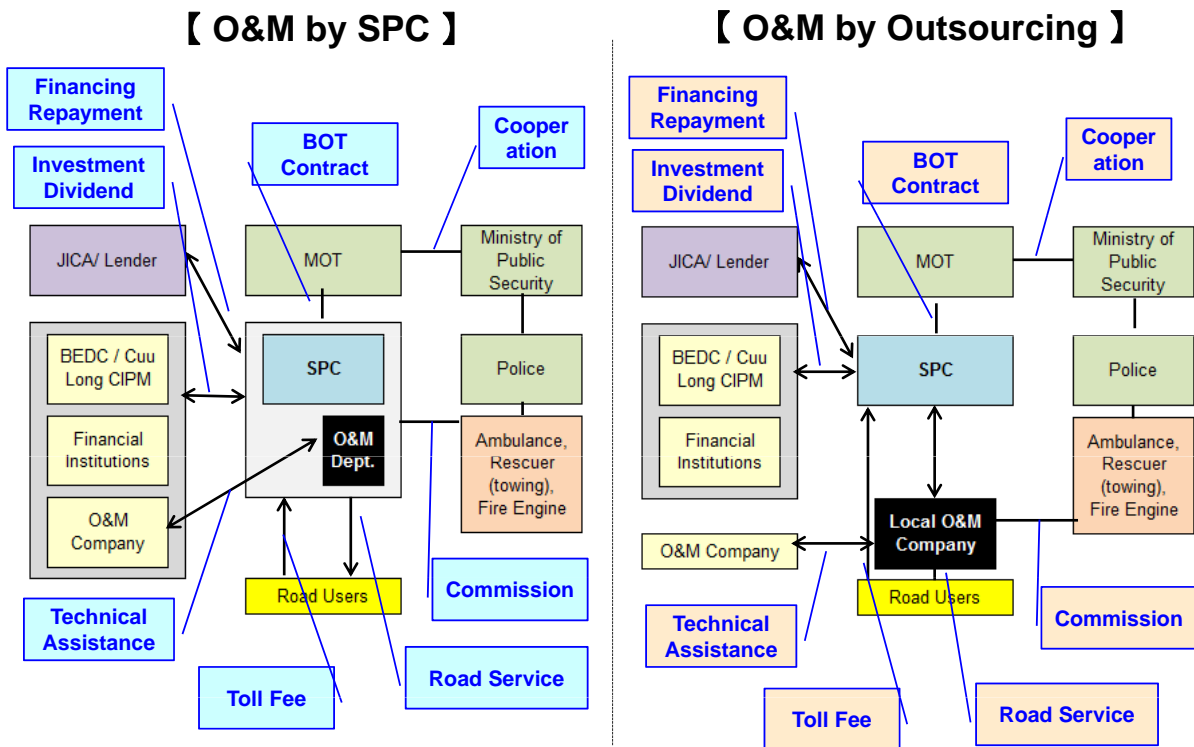

37

Proposed Organization of Expressway Management Center

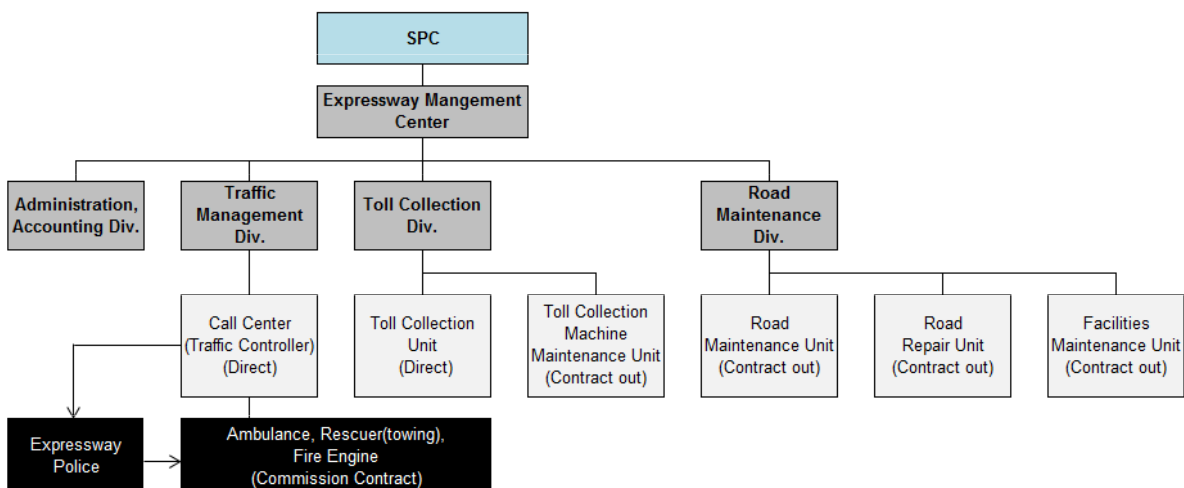

O&M works (road maintenance, traffic management, toll collection) will be conducted by the outsourcing, however appropriate number of staff must be assigned according to the Technical Norm will be defined these.

38

Proposed Expressway Management Center

【 Number of Staff 】

	Position	Present	Future
1	Director	1	1
2	Vice-Director	0	2
3	Administration Accounting	4	8
4	Traffic Management	8	16
5	Toll Collection	0	3
6	Road Facilities Maintenance	3	6
7	Others	3	3
	Sub Total	19	39
	(person/km)	0.48	0.41
7	Road maintenance	n/a	n/a
8	Facility Maintenance	n/a	n/a
9	Traffic Patrol	n/a	n/a
10	Emergency works	n/a	n/a
11	Toll Collection	n/a	n/a
	Sub Total	n/a	n/a
	(person/km)	n/a	n/a
	Total	n/a	n/a
	(person/km)	n/a	n/a

【 Vehicle and Equipment 】

Kind of Works	Vehicle	Unit	Quantity
Road Cleaning	Sweeper	Vehicle	1
Road Cleaning	Watering truck	Vehicle	1
All-Purpose Car	Unimog	Vehicle	1
Truck	Track with crane	Vehicle	2
Traffic Patrol	Patrol car	Vehicle	4
Traffic Regulation	Track with sign	Vehicle	4
Traffic Regulation	Equipment regulation	set	2
Contact Vehicle	Passenger car	Vehicle	4
Total			17

39

Assumed O&M Works

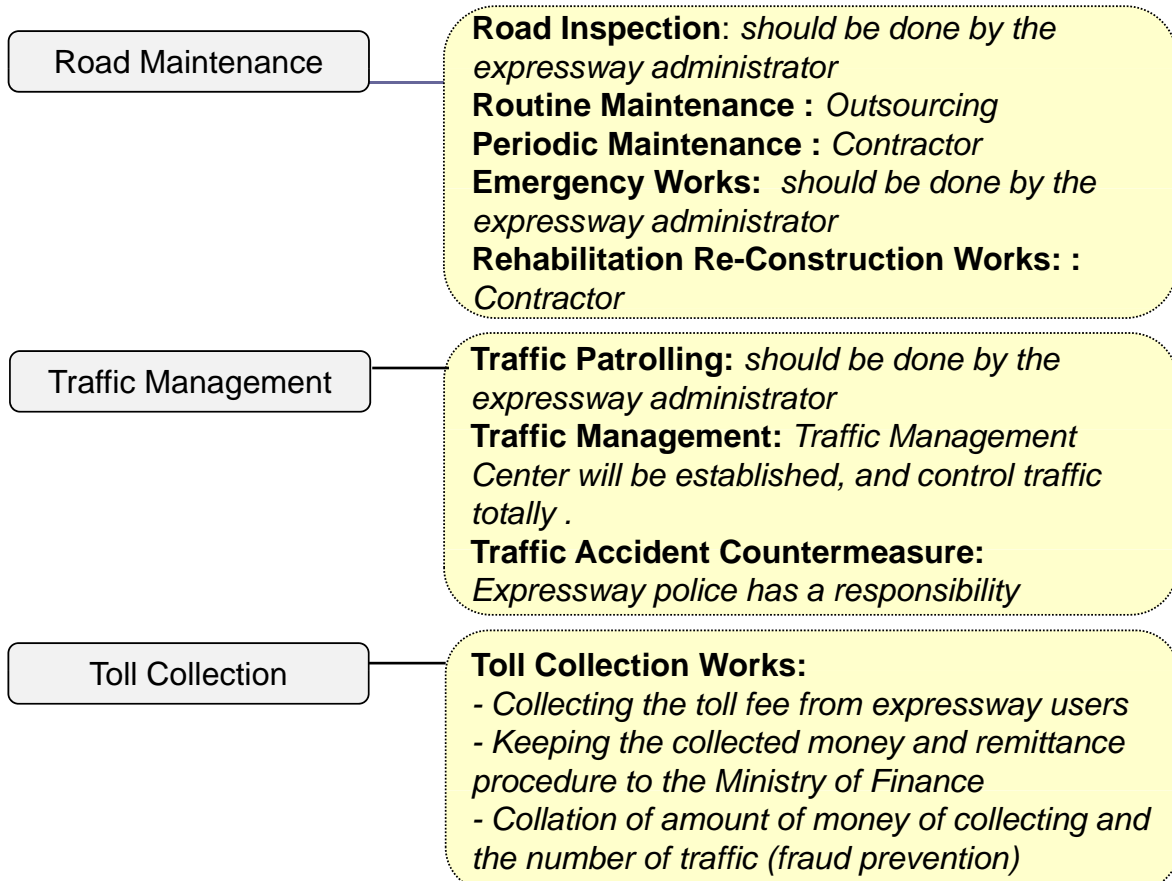

40

3) O&M Cost

3-1) O&M Initial Cost

Expressway O&M Initial Cost

Category	Kind of Works	Vehicle	Unit	Quantity	Cost (mil yen)
Road Maintenance	Road Cleaning	Sweeper	Vehicle	1	---
	Road Cleaning	Watering truck	Vehicle	1	---
	All-Purpose Car	Unimog	Vehicle	1	---
	Truck	Track with crane	Vehicle	2	---
Traffic Management	Traffic Patrol	Patrol car	Vehicle	4	---
	Traffic Regulation	Track with sign	Vehicle	4	---
	Traffic Regulation	Equipment regulation	set	2	---
	Contact Vehicle	Passenger car	Vehicle	4	---
Total			Vehicle	17	About 200

About 53 bil VND

The total cost of these vehicles are roughly estimated about 200mil yen by our experience in Japan.

41

3-2) O&M Operation Cost by F/S of The TL-MT Expressway Project

Calculation Standard for Road Maintenance

Type of Works	Cost for Road Maintenance	Cost for Bridge Maintenance
Annual maintenance	0,55% cost of road construction	0,1% cost of bridge construction
Repair (5 years/time)	5,1% cost of road construction	1% cost of bridge construction
Major repair (15 years/time)	42% cost of road construction	2% cost of bridge construction

Calculation Standard for Road Maintenance

Layer of pavement	Period (year)		Rate of Maintenance Cost and Previous Capital		
	Major Repair	Repair	Major Repair	Repair	Regular Repair
Asphalt Concrete	15	5	42	5.1	0.55
Ballast Mixed Asphalt	12	4	48.7	7.9	0.98
Asphalt	10	4	49.6	8.7	1.92
Ballast	5	3	53.1	9	1.6
Aggregate	5	3	55	10	1.8
Cement Concrete	25	8	34.2	4.1	0.32

However, these criteria are currently not used.

42

Calculation Result by F/S of the TL-MT Expressway Project

Items	Type of Works	Unit	Cost	Remarks
Maintenance Cost	Routine	bil VND	580.125	
-ditto	Periodic	bil VND	396.13	
O&M Cost	Routine	Bil VND	2,569.70	
-ditto	Periodic	bil VND	121.877	
Total		bil VND	3,667.83	35 years, 54.3km
Unit Cost		bil VND /km/year	1.93	
		USD /km/year	92,654	

(1 bil VND=48,008.8USD)

O&M cost for 35 years is estimated by the fixed cost of the first year of O&M cost calculated in F/S.

43

3-3) Verification of The Above Mentioned Cost by The Comparison with Other Roads and Bridges' O&M Cost

Other Roads and Bridges' O&M Cost

Case No.	Name of Case	Cost (/km/year)		Remarks
		Mil VND	USD	
Original	Calculation Result by F/S of the Trung Luong – My Thuan Expressway Project	1,930	92,654	
Case-1	Calculation Result by the F/S of HCMC - Trung Luong Expressway Project	1,048	50,298	
Case-2	Actual O&M Cost of HCMC - Trung Luong Expressway	2,412	115,797	
Case-3	Calculation Result by applying the O&M cost of Lach Huyen Port Development Project (Road and Bridge Portion)	1,384	66,297	
Case-4	Actual O&M Cost of Ordinary Roads and Long Bridges in Vietnam	1.027	49,305	
Case-5	Actual O&M Cost of Expressways in Japan	13,018 (1,301)	625,000 (62,500)	

44

Verification of Calculation Results by F/S of the TL- MT Expressway Project

O&M Cost of TL-MT Expressway= 1,930 mil VND (92,654 USD) /km/year

- ◆ Generally, the O&M cost of national highways in Vietnam is calculated about one million yen/km/year. This is about 1/10 of the O&M cost of national highways, managed by MLIT (Ministry of Land, Infrastructure, Transport and Tourism) in Japan.
- ◆ The O&M cost of expressways (road maintenance, traffic management, toll collection) is assumed about 50 - 70 million yen/ km/year in NEXCO of Japan.
- ◆ According to the idea that the O&M cost of Vietnam is 1/10 of Japanese one, O&M cost of expressways in Vietnam is assumed about 5 - 7 million yen/year.

Calculated amount of 1,930 mil VND (92,654 USD=7,140,149 yen) /km/year of Trung Luong - My Thuan Expressway

- ◆ is almost same with the actual O&M cost of HCMC - Trung Luong Expressway, and
- ◆ There is no big difference with the assumed O&M cost from the expressway in Japan.

Then, the estimated amount by F/S can generally be judged appropriate.

45

6.2 ITS Plan

6.2.1 Vietnamese Regulation

6.2.2 Planning of other expressway

6.2.3 Comparison

6.2.4 Proposal of ITS Plan

6.2.5 Cost

46

6.2.1 Vietnamese Regulation

Table 1. Vietnamese Regulation

ITS Facility	Regulation	
CCTV Monitoring	Pan-Tilt and Zoom IP Camera (PTZ Camera)	MOT Decision 2530/BGTVT -KHCN
Vehicle Detection	Image recognition type (traffic detection, traffic volume and traffic flow speed)	
Automatic Toll Collection (ETC)	Passive RFID type (*1)	
Manual Toll Collection (Semi-auto)	Barcode ticket system	TCCS01: 2008/VRA
Variable Message Sign(VMS)	Not specified	
Heavy Truck Control	Not specified	

(*1) It will be revised by MoT

47

6.2.2 Planning of other expressway

Table 2. ITS Planning of other expressway

Expressway	Status for ITS Plan	
TL – MT expressway	Basic design is completed	Jun. 2010
HCM – TL expressway	IC/R of FEED (*1)	Oct. 2011
HCM – Dau Giay expressway	Bidding stage	At present

(*1) FEED :Front End Engineering Design

48

6.2.3 Comparison

Table 3. Comparison of ITS Facility

ITS Facility	Reg.	TL - MT	HCM – TL	HCM - DG
CCTV Monitoring	PTZ Camera	No plan	No plan	PTZ Camera
		Along the expressway, Tollgate	2km intervals, Tollgate	Tollgate, Merging and Diverging section
Vehicle Detection	Image Recognition type	Ultrasonic typ.	Image Rec. typ.	Ultrasonic typ.
		Merging and Diverging section	2km intervals	2km intervals
ETC	Passive RFID type	Waiting revised specific.		Active DSRC (One lane each IC)
VMS	Not specified	Tollgate and IC (Entrance and Exit)		
Heavy Truck Control	Not specified	No plan	No plan	Tollgates

49

6.2.4 Proposal of ITS Plan

Table 4. Proposal of ITS Plan

ITS Facility	Reg.	TL - MT	HCM – TL	HCM - DG
CCTV Monitoring	PTZ Camera	No plan	No plan	PTZ Camera
		Along the expressway, Tollgate	2km intervals, Tollgate	Merging and Diverging section
Vehicle Detection	Image Recognition type	Ultrasonic typ.	Image Rec. typ.	Ultrasonic typ.
		Merging and Diverging section	2km intervals	2km intervals
ETC	Active DSRC	Waiting revised specific.		Active DSRC (One lane each IC)
VMS	Not specified	Tollgate and IC (Entrance and Exit)		
Heavy Truck Control	Not specified	No plan	No plan	Tollgates

(*1) It will be revised by MoT

50

6.2.5 Proposal of ITS Cost

Table 5. Summary of ITS Cost

ITS Facility		Sub-Total
CCTV Monitoring	PTZ Camera	288,000 (USD)
	Merging and Diverging section	833 (million VND)
Vehicle Detection	Image Recognition type	192,000 (USD)
	Between ICs	2,212 (million VND)
VMS	High intensity LED type	2,242,000 (USD)
	On/OFF Ramps	5,134 (million VND)
Mobile Radio	Dedicated radio system for operation & maintenance of expressway	867,000 (USD)
		432 (million VND)
Weather Monitoring	Anemometer, Thermometer, Rainfall, etc.	97,000 (USD)
		223 (million VND)
Traffic control	System server, Display, Console, etc.	3,029,000 (USD)
		11,827 (million VND)
Communication Network	Fiber optic facility, IP-PBX, IP-Phone, etc.	2,531,000 (USD)
		21,954 (million VND)
Toll collection	Lane camera, ETC, Server, etc.	Not yet
Electrical facility	Transformer, Switchgear, Generator, etc.	

Proposed ITS Cost (without Toll collection & Electrical) : 9,246,000 USD + 42,615 million VND⁵¹

7. Environmental and Social Considerations

7.1 Validity of EIA

- EIA Report for the Project “Trung Luong-My Thuan-Can Tho Expressway Construction” was approved on October 2008 (Decision No. 2140/QD-BTNMT) excluding:
 - Operation of groundwater,
 - Operation of soil and sand supplying, and
 - Resettlement of affected households

1) Validity of EIA Report

2) Supplementary provisions in the MONRE's Approval letter

3) Progress of Land Acquisition and Resettlement

1) Validity of EIA Report

Clause 3 of Article 12 of Decree No. 29/2011/ND-CP stipulated the terms of the conditions of EIA report after the approval as follows:

3. *The report on environmental impact assessment has to be refurbished in the following cases:*

- a) Change of project implementation location;*
- b) Failure to implement the project within thirty-six (36) months from the time of issuance of the decision approving the report on environmental impact assessment;*
- c) Change of the size, capacity or technology that increases the degree of negative impacts on environment or affected scope caused by this change.*



BEDC and MONRE's Opinion (in verbal)

It has been more than thirty-six (36) months since the EIA Report was approved by MONRE without implementation of construction work of the Project.

However, the EIA Report is still valid, and BEDC needs not implement supplementary or additional EIA.

53

1) Validity of EIA Report

The reasons why the EIA Report is still valid:

- a) The project location is not changed from that of mentioned in the EIA Report.
- b) Following activities relating to the Project were already implemented:
 - Measurement Survey, Technical Design and Capital budgeting activities,
 - Ground-breaking ceremony for construction of Than Cuu Nghia IC,
 - People's Committee of Tien Giang Province established the compensation council.
- c) No drastic design change to increase the degree of negative impacts on environment.

54

2) Supplementary provisions in the MONRE's Approval letter

The approval letter of the EIA Report (No. 2140/QD-BTNMT) stipulates three supplementary items as follows:

*Article 1: Approve the content of EIA Report of the "Trung Luong - My Thuan - Can Tho Expressway Project in BOT scheme (Phase 1)" at Tien Giang, Vinh Long and Dong Thap Provinces of BIDV Expressway Development Company which was passed by Appraisal Council on June 30th 2008. **This approved report excludes contents of EIA for operation of underground water, operation of soil and sand supplying for the Project, either resettlement of affected households by the Project.***



MONRE's Opinion on the reasons why the approval of EIA report excludes three items (in verbal)

- ❑ People's committee is the organization assigned by the Government for land acquisition, compensation, support and resettlement.
- ❑ Measurements for operation of groundwater and operation of soil and sand supplying should be dealt with under the scheme of Environmental Protection Commitment (EPC). 55

3) Progress of Land Acquisition and Resettlement

JICA Study Team is collecting data/information on the current status of RAPs and Land acquisition from Tien Giang PPC and 4 District level PCs through BEDC including:

- Affected houses
- Total cost for compensation and lands acquisition
- Progress of establishment of compensation council, Preparation of Inventory of Loss (IOL), RAPs, Measuring land for acquisition and amending the land use right
- Construction schedule of resettlement area etc.

Preliminary information to be provided by People's Committee:

- Land acquisition cost has risen from VND785 bil. (F/S stage) to VND1,910 bil. (Oct. 2011).

7. Environmental and Social Considerations

7.2(Land Acquisition, Compensation, Supporting and Resettlement)

Summary of Land Acquisition and Resettlement (1)

Item					
A	GENERAL INFORMATION				
1	Road length	About 53km			
2	Province(s)	Tien Giang Province			
3	District	Chau Thanh	Tan Phuoc	Cai Lay	Cai Be
4	Formal name of agency (which is responsible for land acquisition and compensations activities)	Center of lands development	Center of lands development	Center of lands development	Center of lands development
		Organization under the district level People's Committee. Each district level Compensation, Support and Resettlement Council has been established under the Center of lands development of each district.			
5	Legal basis of Establishment of compensation council	Decision No. 3444/QĐ-UBND	Decision No. 576/QĐ-UBND	Decision No. 9967/QĐ-UBND	Decision No. 4118/QĐ-UBND (17/01/2011)
6	Communes affected by the Project	Tam Hiep Long Dinh Nhi Binh Diem Hy	Phuoc Lap	Tan Phu Tan Hoi <i>Nhi My (not finish)</i> Tan Binh Binh Phu Phu Nhuan My Thanh Nam	My Hoi Hau My Phu Hau Thanh Hoa Khanh <i>Hoa Hung (not finish)</i> Thien Tri My Duc Dong My Duc Tay An Thoi Dong An Thoi Trung An Huu
7	Number of communes affected by the Project	4	1	7	11

57

Summary of Land Acquisition and Resettlement (2)

Item					
District		Chau Thanh	Tan Phuoc	Cai Lay	Cai Be
8	Areas of land acquisition (ha)	76	18.9	1,202.3 (Excluding Nhi My commune)	163.5 (Excluding Hoa Hung commune)
		1,460.7 ha Total (ha): Width of land acquisition areas: Average 70m (35m from the center line)			
9	Number of household affected by the Project	320	99	869	1,068
		Total: 2,356 (excluding households located in the areas of intersections of Than Cuu Nghia, Cai Lay and Cai Be)			
10	Current status of land acquisition (as of end of November 2011)	Area of Than Cuu Nghia intersection is not finished	Finished	Area of Cai lay intersection is not finished	Area of Cai Be intersection is not finished
11	Resettlement plan	Not finished	No households required resettlement	Resettlement plan is approved (by District People's committee)	Hired consultant for making resettlement plan
12	Number of household 100% clearance	45 (Excluding households in the area of Than Cuu Nghia intersection)	26	199 (141 households have moved to resettlement areas. Excluding households of the area of Cai lay intersection)	218 (Excluding households of the areas of Cai Be intersection)

58

Summary of Land Acquisition and Resettlement (3)

Item					
District		Chau Thanh	Tan Phuoc	Cai Lay	Cai Be
13	Measuring land	4/4 communes	1/1 communes	6/7 communes	10/11 communes
Total: 21/23 communes					
14	Site inventory (Making up of IOL: land, house, construction, crop...)	2/4 communes	1/1 communes, 99/99 household (Feb, 2011)	6/7 communes	10/11 communes, 1,068 households
Total: 2,110/2,356 households					
15	Total money for land acquisition, compensation, support and resettlement (Billion VND)	179.8	62.0	393.4 (as of Nov. 2010)	1,298.3
Total: 1,933.5					
16	Number of households which have enough eligibility for compensation, support and resettlement	Not finished	26	128 (6/7 communes)	180 (10/11 communes)
17	Consultation with local stakeholders	Meeting (19 th Mar, 2011)	Meeting (13 th Aug, 2011)	Questionnaire Survey	Issue notice for land acquisition
18	Survey for price of land acquisition		<i>Finished</i>		

59

Summary of Land Acquisition and Resettlement (4)

Item					
District		Chau Thanh	Tan Phuoc	Cai Lay	Cai Be
B	LAND ACQUISITION AND RAP				
19	RAPs		not implement (No households required resettlement)		
20	Content of RAPs			3,23 ha 168 land lots 38,1 billion VND	6,6 ha
21	Construction schedule of resettlement areas	Not yet implemented (as of Dec. 2011)			
22	Approval of compensation price (by district level compensation council)	Not yet implemented (as of Dec. 2011)			
23	Approval of compensation price (Tieng Giang Province compensation council)	Not yet implemented (as of Dec. 2011)			
24	Inform compensation price to households to get their opinions	Not yet implemented (as of Dec. 2011)			
25	Review of compensation price	Not yet implemented (as of Dec. 2011)			
26	Final approval by People's committee	Not yet implemented (as of Dec. 2011)			

60



□ Thank you very much!

Cám ơn.

Phụ lục -5 Tài liệu họp

A5-3: Họp với Bộ GTVT để khôi phục dự án

THE PREPARATORY SURVEY ON TRUNG LUONG - MY THUAN EXPRESSWAY PROJECT IN VIETNAM

15th MAY 2012

JICA Study Team;

Nippon Koei Co., Ltd.

Marubeni Corp.

KRI International Corp.



2

Contents

- A) Location Map
- B) Project History
- C) JICA Preparatory Survey - Suspended in Dec 2011
- D) Outcomes of JICA Preparatory Survey before Suspension
 - 1. Traffic Demand Forecast
 - 2. Engineering Work
 - 3. Preliminary Evaluation of Project Scope and Scheme
 - 4. Findings in JICA Survey before Suspension
- E) Resumption of the JICA Preparatory Survey

- HCMC – Trung Luong
(Completed in 2010)
□ 39.8(km)
- Trung Luong – My Thuan
(D/D completed, JICA
Preparatory Survey suspended)
□ 54.3(km)
- My Thuan – Can Tho
(F/S completed)
□ 24.5(km)

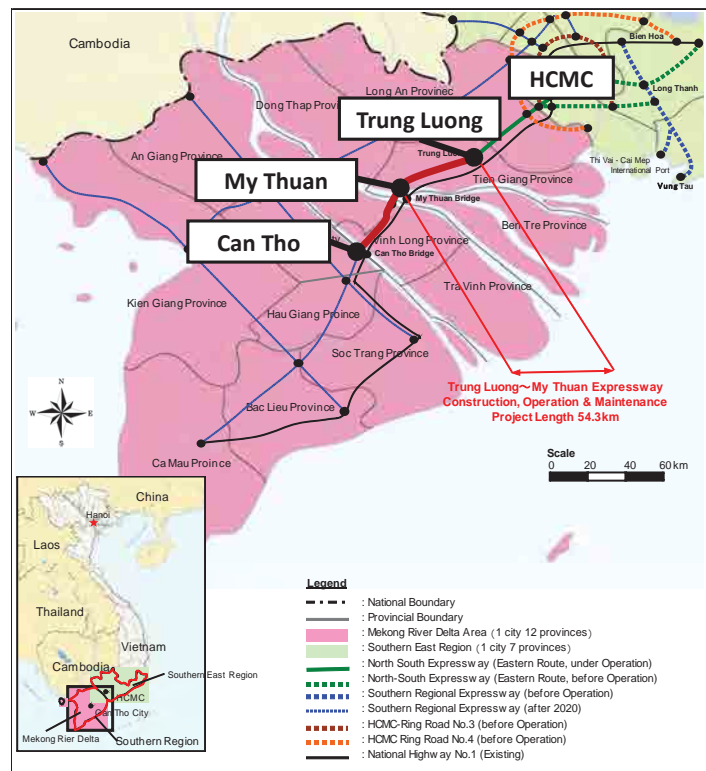

- 2007. Nov: BEDC was established and granted BOT concession for TL-MT-CT Expressway.
- 2008. Feb: F/S approved by MOT & EIA approved by MONRE
- 2009. May: Concession of MT - CT section transferred to PMU My Thuan (present Cuu Long CIPM)
- 2009. Sept: BEDC was granted O&M concession for HCMC – TL Expressway.
- 2011. Nov: BEDC proposed returning concessions to MOT.
- 2011. Dec: Detailed Design (KCI+TEDIS) was mostly completed by BEDC.
- 2012. Feb: Prime Minister approved to transfer the concessions to MOT from BEDC in Feb. 2012.

■ Objective

- To evaluate the possibility of private investment for the Project
- To propose feasible BOT/PPP scheme
- To prepare Draft Term Sheet for BOT Contract and Government Guarantee and Undertaking (GGU)

■ Progress of the Study

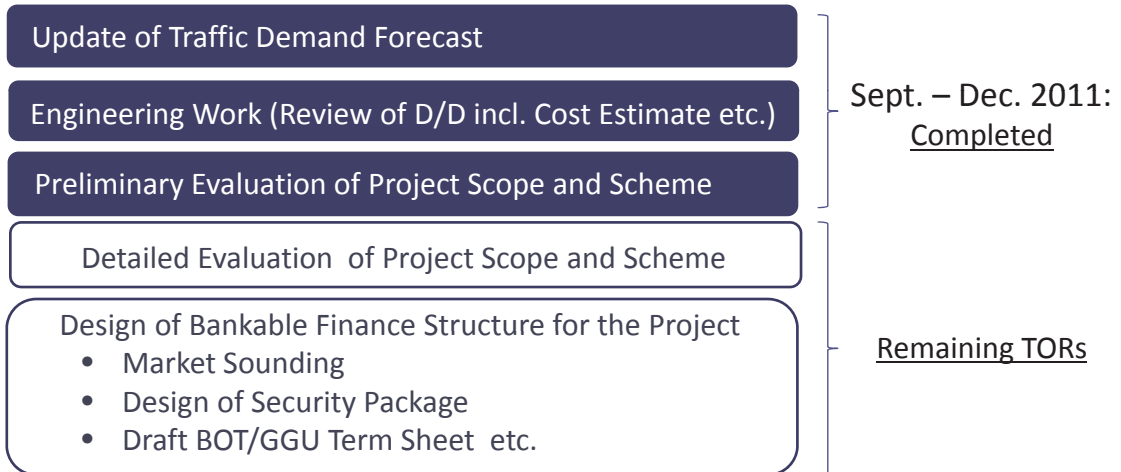

1. Traffic Demand Forecast

- ❑ Traffic demand forecast is updated based on the supplemental traffic surveys and referring to other studies.
- ❑ The results of traffic demand forecast by F/S, METI/JETRO and the Survey are compared in PCU in 2020.

Section	PCU in Year 2020								
	F/S (TEDI)			METI/JETRO			JICA Survey		
	NH1A	Ex-way	Total	NH1A	Ex-way	Total	NH1A	Ex-way	Total
Trung Luong-Cai Lay	23,242	62,088	85,330	41,010	39,119	80,129	41,236	34,514	75,750
Cai Lay - My Thuan	33,756	45,969	79,725	25,746	29,460	55,206	43,194	24,352	67,546
My Thuan - Can Tho	14,600	38,756	53,356	24,536	23,657	48,193	27,406	17,145	44,551

- ✓ Total volume of NH1A and the expressway is not so much different.
- ✓ Diversion ratio of the traffic from NH1A to the expressway is different which might come from different precondition of time value (resistance by toll).
- ✓ Referring to the recent actual traffic trend in HCM-TL Expressway, it is found that F/S is similar diversion ratio in case before start toll collection, METI and JICA Survey are similar diversion ratio in case with collection of toll.

The JICA Survey result is enough acceptable.

2. Engineering Work (1/2)

Review of the D/D was carried out in order to improve safety of the expressway and to reduce the construction cost.

Several design improvements were proposed such as

- Bridge Widening Method
- Expressway over Provincial Road
- Alternative for Deep Cement Mixing etc.

Stage	Time of Cost Estimate	Civil Work Cost with VAT (bil.VND)	Ratio
F/S	June 2010	11,159	1.00
D/D	July 2011	15,646	1.40
JICA Survey	July 2011	14,736	1.32

Note: exclusive of equipment cost

2. Engineering Work (2/2)

Section	Length (km)	Project Cost*(billion VND)
Whole Section	54.3	24,573
Trung Luong- Cai Lay	18.5	8,372
Cai Lay- Cai Be	12.7	5,747
Trung Luong- Cai Be	31.2	14,119
Cai Be- My Thuan	23.1	10,454

- Project cost is included land acquisition cost, SPC establish cost and VAT etc. but exclusive of O&M cost during operation. The cost is present value as of 2011
- The cost each section is divided proportionally by the length.



3. Preliminary Evaluation of Project Scope and Scheme (1/5)

■ Basic Option:

- BOT for TL-MT Section
- Revenue from whole section of TL-MT and NH1A (My Thuan Bridge) toll collection
- Toll level is 1,000VND/km (as of 2012 year)

➤ **Project IRR: 6.4%**

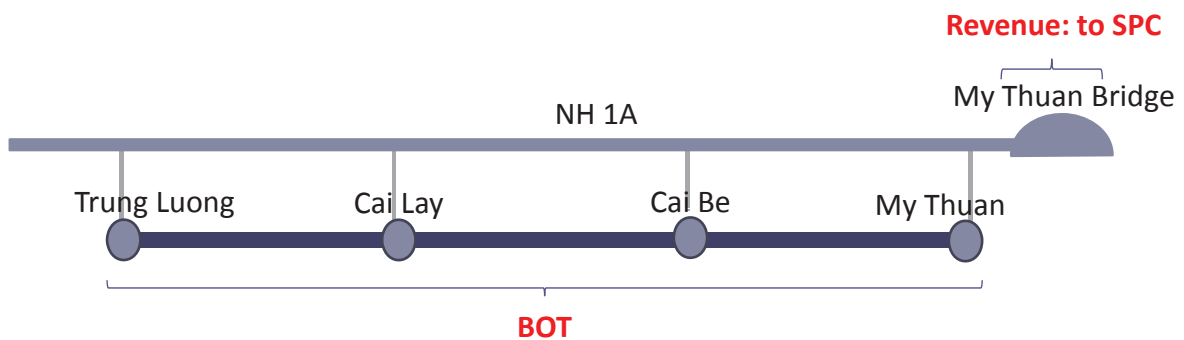

3. Preliminary Evaluation of Project Scope and Scheme (2/5)

■ Option-1:

- BOT only TL-Cai Be Section
- Revenue from whole section of TL-MT and NH1A (My Thuan Bridge)
- Subsidy for land acquisition and VAT
- Toll level is 1,000VND/km (as of 2012 year)

➤ **Project IRR: 9.2%** (13.6% in case 2,000VND/km)

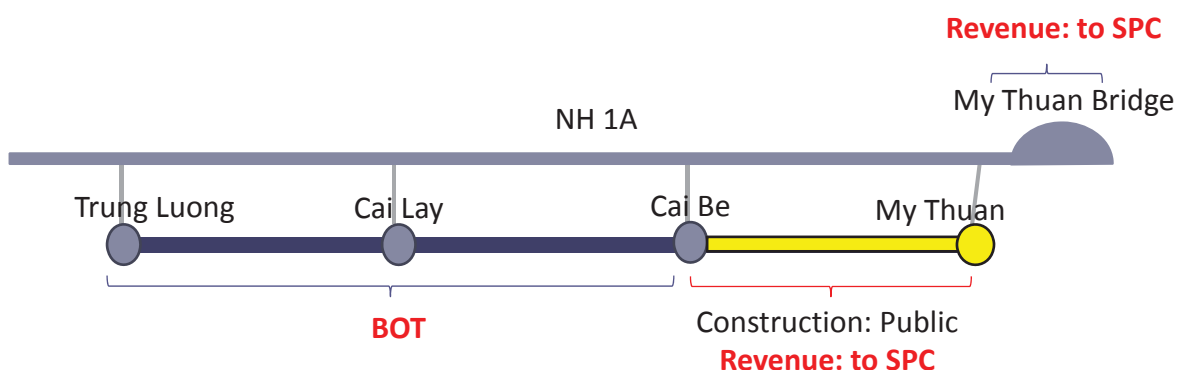

3. Preliminary Evaluation of Project Scope and Scheme (3/5)

■ Option-2:

- BOT for whole section TL-My Thuan
- All revenue from HCM-TL, TL-MT & NH1A (My Thuan Bridge and KM1953+200)
- Subsidy for land acquisition and VAT
- Concessional condition for the payment of HCM-TL concession fee with 20 years deferred payment (paid to MOF)
- Toll level is 1,000VND/km (as of 2012 year)

➤ **Project IRR: 7.8%** (12.6% in case 2,000VND/km)

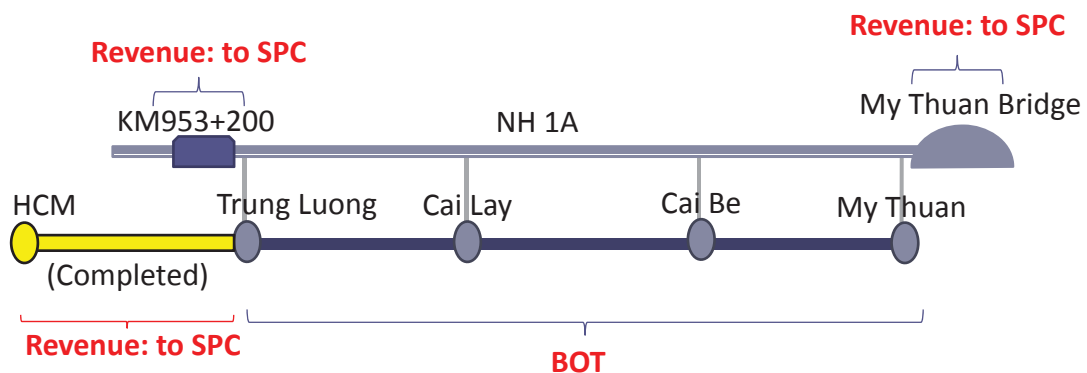

3. Preliminary Evaluation of Project Scope and Scheme (4/5)

■ Option-3:

- BOT only TL-Cai Be Section
- All revenue from HCM-TL, TL-MT & NH1A (My Thuan Bridge and KM1953+200) toll collections
- Subsidy for land acquisition and VAT
- Concessional condition for the payment of HCM-TL concession fee with 20 years deferred payment (paid to MOF)
- Toll level is 1,000VND/km (as of 2012 year)

➤ **Project IRR: 9.8%** (15.5% in case 2,000VND/km for TL-MT)
(17.6% in case 2,000VND/km for HCM-MT)

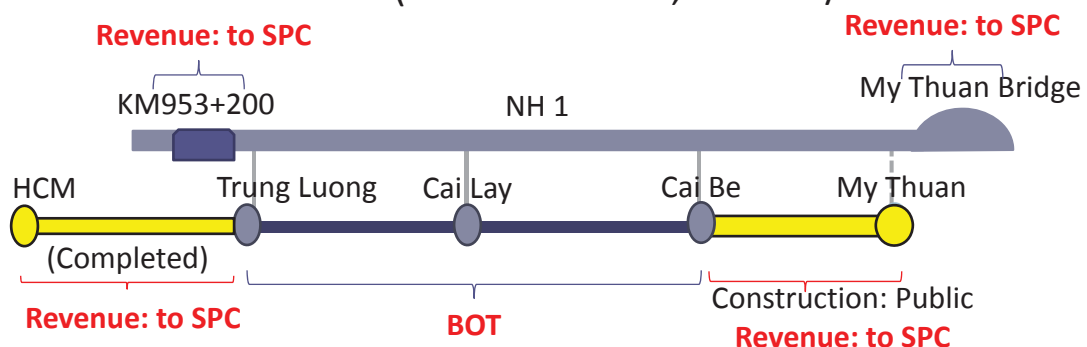

3. Preliminary Evaluation of Project Scope and Scheme (5/5)

■ Option-4:

- BOT only TL-Cai Lay Section
- All revenue from HCM-TL, TL-MT & NH1A (My Thuan Bridge and KM1953+200) toll collections
- Subsidy for land acquisition and VAT
- Concessional condition for the payment of HCM-TL concession fee with 20 years deferred payment (paid to MOF)
- Toll level is 1,000VND/km (as of 2012 year)

- **Project IRR: 11.3%** (17.7% in case 2,000VND/km for TL-MT)
(20.8% in case 2,000VND/km for HCM-MT)

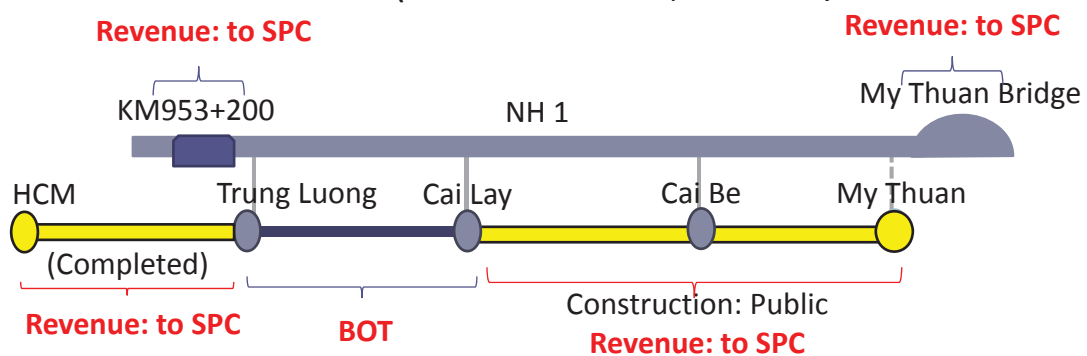

4. Findings in JICA Survey before suspension

- 1) The updated traffic demand forecast on expressway is reasonable taking into accounts of other study result and present actual traffic trend of HCM-TL Expressway,
- 2) As the result of review of the D/D from the viewpoints of improvement of safety of the expressway and reduction of the civil work cost, the civil work cost can be possible to reduce to VND14,736 billion from VND15,646billion of D/D's cost.

4. Findings in JICA Survey before suspension

3) Despite various supports from the government and cut of the project scope, the project is not still feasible as BOT project (*) because of high project cost (whole section softsoil treatment), low traffic volume and low toll fee level etc., if the toll level is fixed as the current level.

(*) Generally more than 18.0 (%) of FIRR is at least required to invite private investment

3) For proceeding the project, following alternatives might be considerable:

- I. Vertical separation method
- II. Start the Project when traffic volume increases enough for making feasible
- III. Higher Traffic Tariff

Draft Schedule and Procedure for Resumption of JICA Preparatory Survey

Procedure	2012							
	February	March	April	May	June	July	August	
1 PM Decision on Transfer of the BOT concession (217/TTG-KTN dated 20 Feb. 2012)	█							
2 Preliminary Discussion/confirmation on transfer of the concession between JICA and Cuu Long CIPM		█	█	█				
3 Meeting among JICA, Cuu Long CIPM/MOT, Study Team (15 May, 2012)				█				
4 JICA Internal Procedure				█	█			
5 Sign of M/D between JICA and Cuu Long CIPM/MOT					█			
6 Request for Amendment of the Proposal (JICA → Survey Team)						█		
7 Submission of Amendment of the Proposal						█		
8 Evaluation of the Proposal							█	
9 Submission of Draft Amendment Contract (Study Team → JICA)							█	
10 JICA Approval								█
11 Sign of Amendment of the Contract								█
12 Resumption of the JICA Survey								█

[Report Submission Schedule]
 Interim Report: end of August 2012
 Draft Final Report: end of October 2012
 Final Report: beginning of December 2012

Survey period is assumed from August 2012 to end of December 2012 for 5 months.

Thank you very much!

Traffic Volume

Comparison of Traffic Volume of **HCM-TL Expressway** between Forecast and Actual

1. Traffic Forecast

1) F/S

Traffic volume forecast (PCU/day)				
2006	2010	2015	2020	2025
49,547	69,302	97,883	138,275	191,987

source: F/S for Trung Luong - My Thuan Expressway (August 2007)

2) JICA PPP F/S Forecast

Traffic volume forecast (PCU/day)				
	2011	2015		
-	21,996	37,265	-	-

source: JICA survey team

2. Actual Traffic Volume

Actual Traffic Volume (PCU/day)	
Nov. 2011	Mar.2012
before toll collection	after toll collection (1,000VND/km)
45,842	27,987

source: data provided by Cuu Long CIPM

3. Comparison between Forecast and Actual

Data	Traffic Volume (PCU/day)	Ratio	Ratio
F/S	69,302	100%	248%
JICA PPP F/S Forecast	21,996	32%	79%
Actual Traffic Volume	27,987	40%	100%



- ✓Traffic volume forecasted in F/S is much overestimated. Therefore, 40% of traffic volume for HCM-TL section is used for calculation of Project IRR in this study.
- ✓Traffic volume forecasted in JICA PPP F/S is a little underestimate, but it is reasonable.

Civil Work Cost

Comparison of Civil Work Cost of Expressways in Southern of Vietnam

Project	HCM-Trung Luong Expressway Project	HCM-Long Thanh-Dou Giay Expressway Project	Trung Luong - My Thuan Expressway Project	
Basic information	completed in 2010	under construction	detailed design completed	
Total Length	39.8km	55km	54.3km	
Nos. of lane	4-lane	4-lane	4-lane	
Viaduct section	16.3km	6.8km	2.6km	
Bridge Section	3.8km	5.5km	10.1km	
Embankment Section	19.7km	42.7km	41.6km	
(softground treatment section)	(39.8km)	(23km)	(54.3km)	
Total Cost	*actual cost	*D/D cost	*D/D cost	
Total Civil Work Cost	6,667billion VND	9,765billion VND	14,353billion VND	
Viaduct Cost	3,741billion VND	2,764billion VND	929billion VND	
Bridge Cost		3,535billion VND	6,451billion VND	
Road Cost (Embankment Section)	2,926billion VND	3,466billion VND	6,973billion VND incl. 2,390 of softsoil treatment cost	
Km cost				
Whole section	168billion VND/km	178billion VND/km	264billion VND/km	1,057million JPY/km
Viaduct section	230billion VND/km	406billion VND/km	357billion VND/km	1,429million JPY/km
Bridge Section	billion VND/km	643billion VND/km	639billion VND/km	2,555million JPY/km
Road (Embankment Section)	125*no breakdown available	81billion VND/km	168billion VND/km	670million JPY/km
embankment cost only for softground section except bridge&viaduct		148billion VND/km	168billion VND/km	incl. 57billion VND/km of softsoil treatment cost

Revenue

Section	Length (km)	Revenue in 2017* (billion VND/year)
HCM-Trung Luong	39.8	388
Trung Luong- Cai Lay	18.5	189
Cai Lay- Cai Be	12.7	97
Cai Be- My Thuan	23.1	106
My Thuan Bridge	-	164
Can Tho Bridge	-	103

Note:

- 1) 2017 year is assumed as traffic open.
- 2) Toll level (passenger car) is 1,300VND/km for expressway, and 13,000VND/km for MT Bridge and CT Bridge.

Phụ lục -5 Tài liệu họp

A5-4: Họp khởi động để khôi phục dự án với CL CIPM

THE PREPARATORY SURVEY ON TRUNG LUONG - MY THUAN EXPRESSWAY PROJECT IN VIETNAM

KICK-OFF MEETING FOR RESUMPTION



20th JUNE 2012

JICA Study Team;

Nippon Koei Co., Ltd.
Marubeni Corp.
KRI International Corp.



2

Contents

1. Location Map
2. JICA Preparatory Survey - Objective & Progress -
3. Outcomes of JICA Preparatory Survey before Suspension
 - 1) Traffic Demand Forecast
 - 2) Engineering Work
 - 3) Preliminary Evaluation of Project Scope and Scheme
 - 4) Findings in JICA Survey before Suspension
4. Work Schedule
 - 1) Overall Work Schedule
 - 2) Flow Chart
5. Organization of the JICA Study Team
6. Assignment Schedule
7. Proposed Working Group
8. Deliverables (Reporting)
9. Draft Contents of the Final Report

- HCMC – Trung Luong
(Operating from 2010)
 □ 39.8(km)
- Trung Luong – My Thuan
(D/D completed, JICA
Preparatory Survey)
 □ 54.3(km)
- My Thuan – Can Tho
(F/S completed)
 □ 24.5(km)

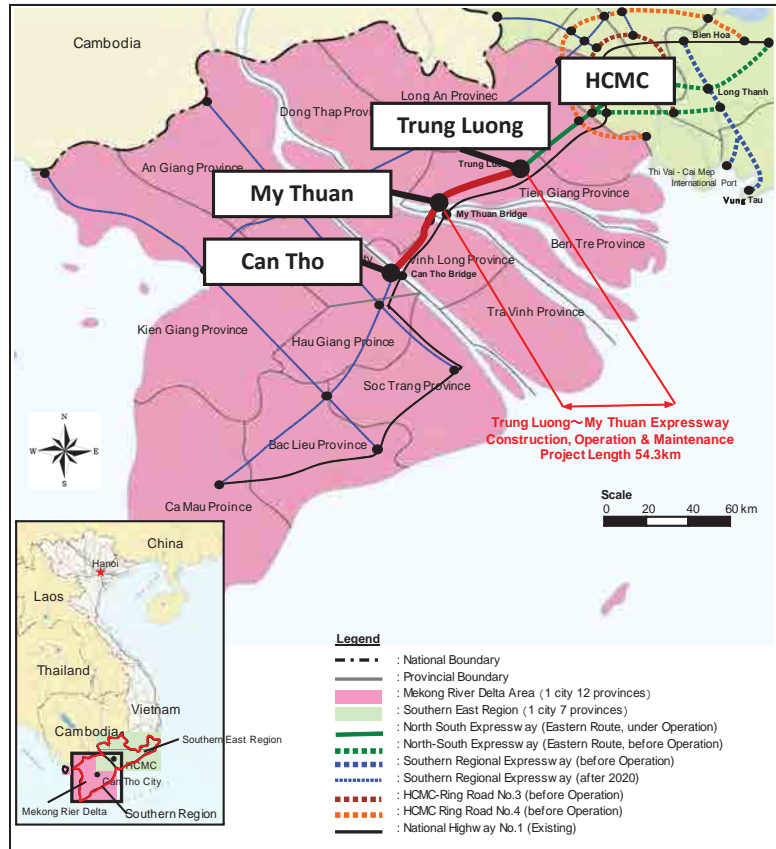

- Basis of Implementation and Resumption of the Survey
 - The Minutes of Meeting (M/D) signed between BEDC and JICA in July 2011
 - Prime Minister’s approval to transfer the concessions to MOT from BEDC in February 2012
 - MOT’s Notice and Cuu Long CIPM’s Request for Resumption to JICA in May 2012
 - Notice of Resumption from JICA to Cuu Long CIPM in June 2012
- Objective
 - To evaluate the possibility of private investment for the Project
 - To propose feasible BOT/PPP scheme
 - To prepare Draft Term Sheet for BOT Contract and Government Guarantee and Undertaking (GGU)

Revision of TOR should be considered in case of low feasible for BOT and/or high sharing from public is required, especially cancellation of design of security package and term sheet of BOT contract and GGU.

■ Progress of the Study

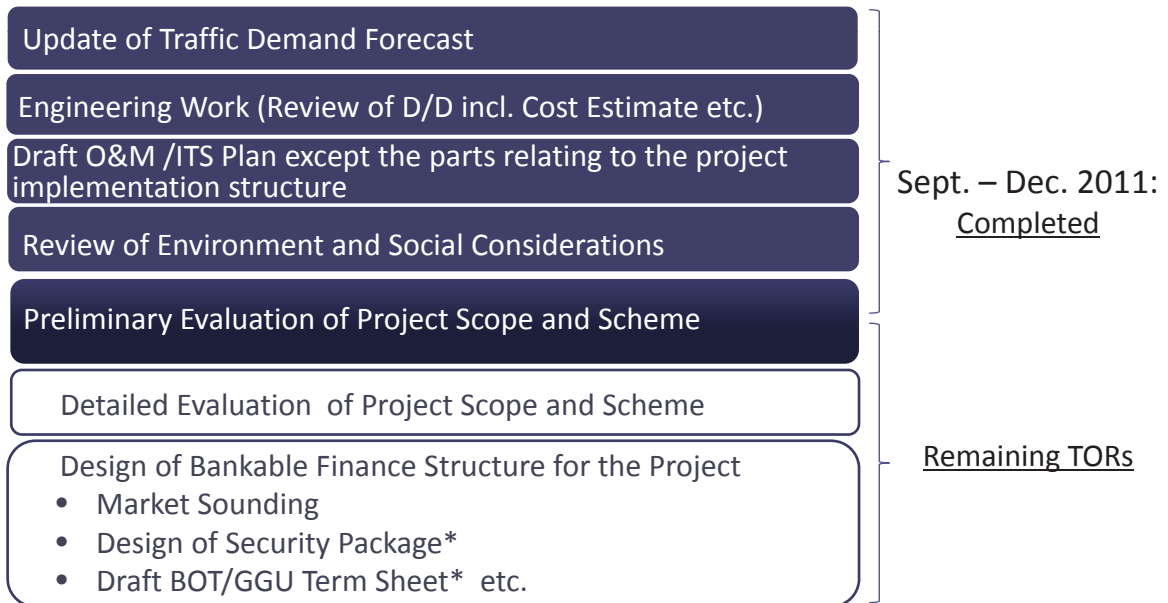

* might be cancelled depending on results of IT/R

1) Traffic Demand Forecast

- ❑ Traffic demand forecast is updated based on the supplemental traffic surveys and referring to other studies.
- ❑ The results of traffic demand forecast by F/S, METI/JETRO and the Survey are compared in PCU in 2020.

Section	PCU in Year 2020								
	F/S (TED)			METI/JETRO			JICA Survey		
	NH1A	Ex-way	Total	NH1A	Ex-way	Total	NH1A	Ex-way	Total
Trung Luong-Cai Lay	23,242	62,088	85,330	41,010	39,119	80,129	41,236	34,514	75,750
Cai Lay - My Thuan	33,756	45,969	79,725	25,746	29,460	55,206	43,194	24,352	67,546
My Thuan - Can Tho	14,600	38,756	53,356	24,536	23,657	48,193	27,406	17,145	44,551

- ✓ Total volume of NH1A and the expressway is not so much different.
- ✓ Diversion ratio of the traffic from NH1A to the expressway is different which might come from different precondition of time value (resistance by toll).
- ✓ Referring to the recent actual traffic trend in HCM-TL Expressway, it is found that F/S is similar diversion ratio in case before start toll collection, METI and JICA Survey are similar diversion ratio in case with collection of toll.

2) Engineering Work (1/2)

Review of the D/D was carried out in order to improve safety of the expressway and to reduce the construction cost.

Several design changes were proposed such as

- Application of phased construction of bridge widening
- Change to the direct connection type of deceleration lane at interchange/parking area instead of parallel type
- Application of Vacuum Consolidation Method etc. instead of Deep Cement Mixing etc.

Stage	Time of Cost Estimate	Civil Work Cost with VAT (bil.VND)	Ratio
F/S	June 2010	11,159	1.00
D/D	July 2011	15,646	1.40
JICA Survey	July 2011	14,736	1.32

Note: exclusive of equipment cost

2) Engineering Work (2/2)

Section	Length (km)	Project Cost*(billion VND)
Whole Section	54.3	24,573
Trung Luong- Cai Lay	18.5	8,372
Cai Lay- Cai Be	12.7	5,747
Trung Luong- Cai Be	31.2	14,119
Cai Be- My Thuan	23.1	10,454

- Project cost is included land acquisition cost, SPC establish cost and VAT etc. but exclusive of O&M cost during operation. The cost is present value as of 2011 (Q.2)
- The cost each section is divided proportionally by the length.



3) Preliminary Evaluation of Project Scope and Scheme (1/2)

■ Basic Option:

- BOT for TL-MT Section
- Revenue from whole section of TL-MT and NH1A (My Thuan Bridge) toll collection
- Toll level is 1,000VND/km (as of 2012 year)

➤ **Project IRR: 6.4%**

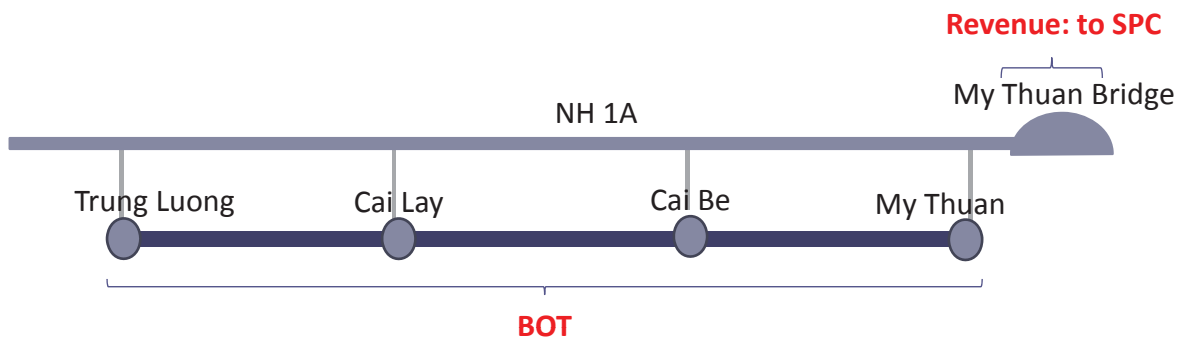

3) Preliminary Evaluation of Project Scope and Scheme (2/2)

■ One of Possible Options:

- BOT only TL-Cai Lay Section
- All revenue from HCM-TL, TL-MT & NH1A (My Thuan Bridge and KM1953+200) toll collections
- Subsidy for land acquisition and VAT
- Concessional condition for the payment of HCM-TL concession fee with 20 years deferred payment (paid to MOF)
- Toll level is 1,000VND/km (as of 2012 year)

➤ **Project IRR: 11.3%** (17.7% in case 2,000VND/km for TL-MT)
(20.8% in case 2,000VND/km for HCM-MT)

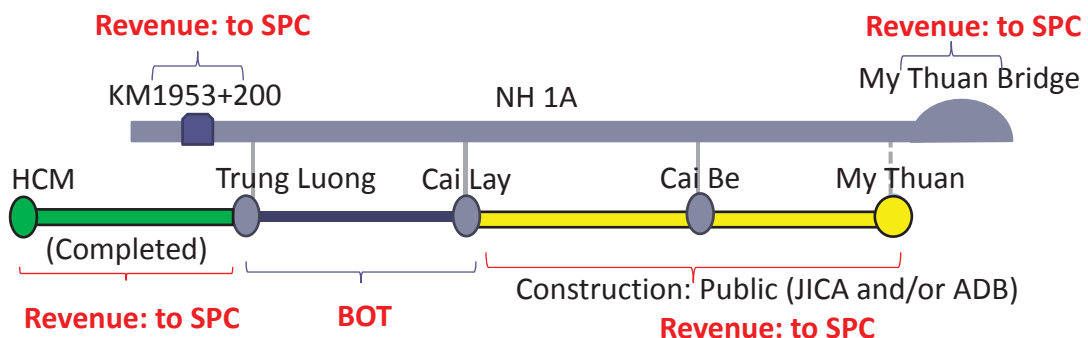

4) Findings in JICA Survey before suspension

- (1) The traffic demand forecast on the expressway was updated, which shows that of F/S is overestimated.
- (2) As the result of review of the D/D from the viewpoints of improvement of safety of the expressway and reduction of the civil work cost, the civil work cost can be possible to reduce to VND14,736 billion from VND15,646 billion of D/D's cost.
- (3) Despite various supports from the government and cut of the project scope, the project is not still feasible as BOT project because of high project cost (whole section softsoil treatment), low traffic volume and low toll fee level etc.
- (4) For proceeding the project, following alternatives might be considerable:
 - I. Vertical separation method
 - II. Start the Project when traffic volume increases enough for making feasible
 - III. Higher Traffic Tariff

1) Overall Work Schedule

Schedule		Private Investment Part	Engineering Part
Sept	Kick-Off (22 nd) P.M1 (23 rd)	Preliminary Evaluation of Project Scope and Scheme <ul style="list-style-type: none"> • Extraction of options of project scope • Preliminary selection and evaluation of viable project scope and scheme by Project IRR and Equity IRR based on F/S traffic volume and the cost 	Engineering Work <ul style="list-style-type: none"> • Review of D/D (propose design change, update project cost, preliminary review of construction plan) • Update of Traffic Demand Forecast • O&M, ITS Plan • Environment and Social Considerations
Oct	T.M with DD Consultant (6 th) P.M2 (7 th) P.M3 (14 th)		
Nov	P.M4 (17 th)		
Dec	P.M5 (7 th) Progress Report		
2012			
June	Kick-Off for resumption	Detailed Evaluation Design of Bankable Financial Structure <ul style="list-style-type: none"> • Evaluation of bankable scheme by using updated traffic volume and cost • Project Implementation Program • Market Sounding • Security Package * • BOT/GGU Term Sheet * 	<ul style="list-style-type: none"> • Detailed evaluation of Construction Plan • Update of project cost • O&M Implementation Structure • Update information of EIA/RAP
July	Interim Report		
Aug	W.G1		
Sept	W.G2		
Oct	W.G3		
Nov	Draft Final Report		
Dec	Report		
		<div style="border: 1px solid black; padding: 2px; display: inline-block;">* might be cancelled depending on results of IT/R</div>	

P.M: Progress Meeting W.G: Working Group organized by JICA, MOT, Cuu Long CIPM and Study Team (ADB, if necessary)
T.M: Technical Meeting

2) Survey Flow (1/3)

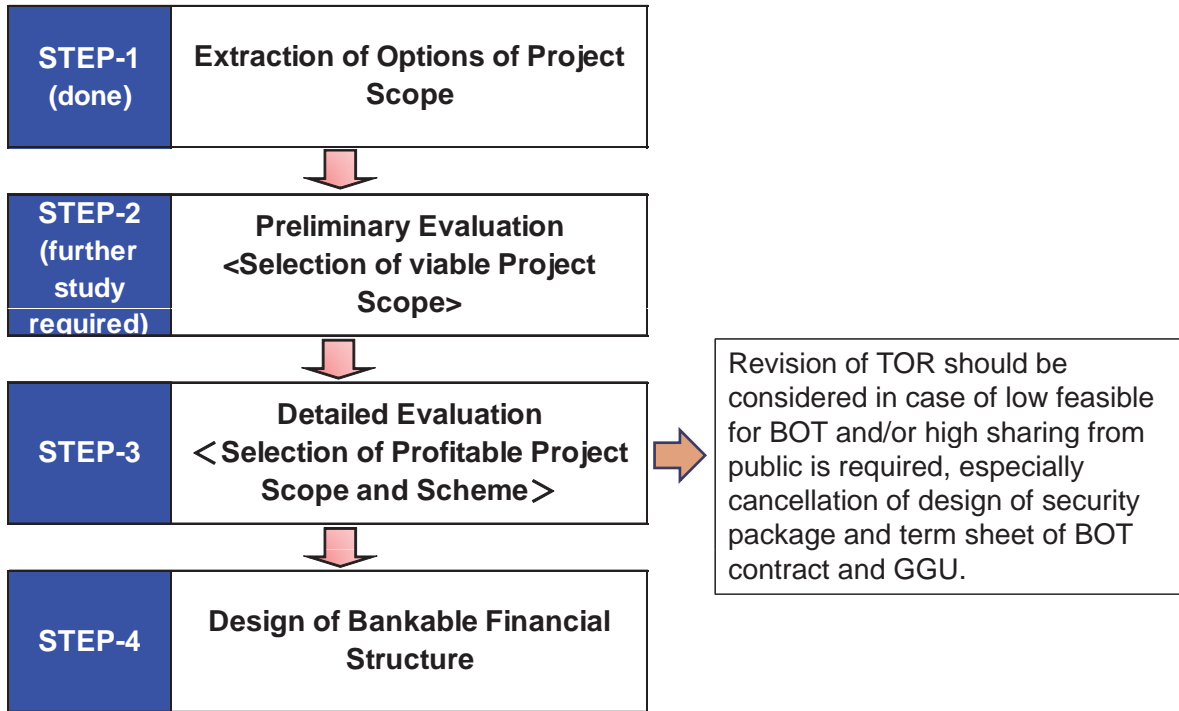

2) Survey Flow (2/3)

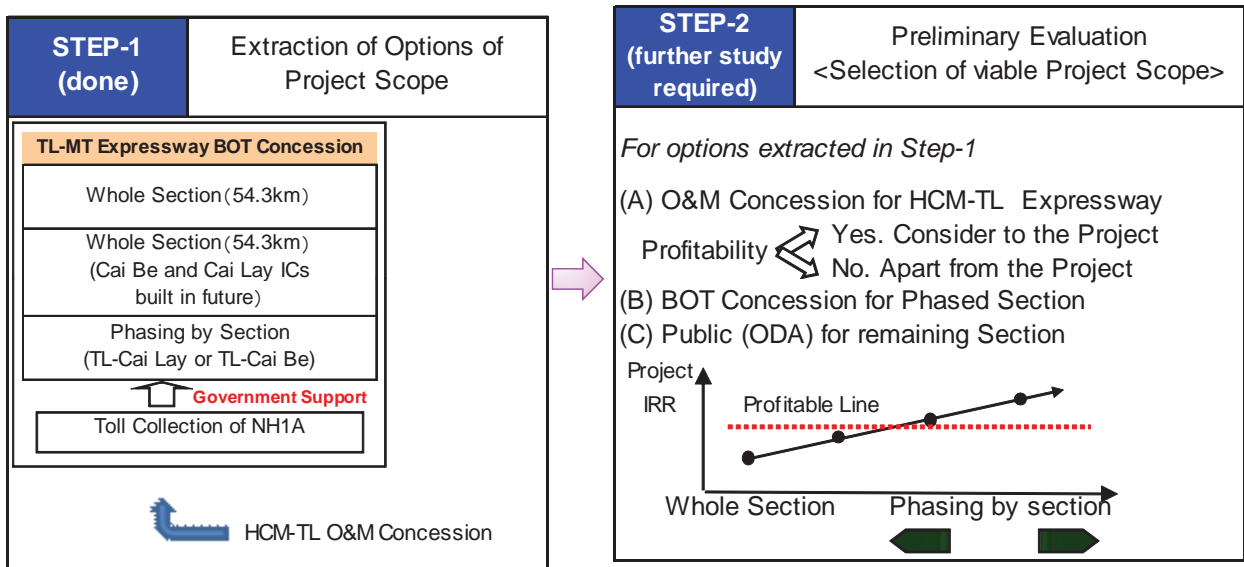

2) Survey Flow (3/3)

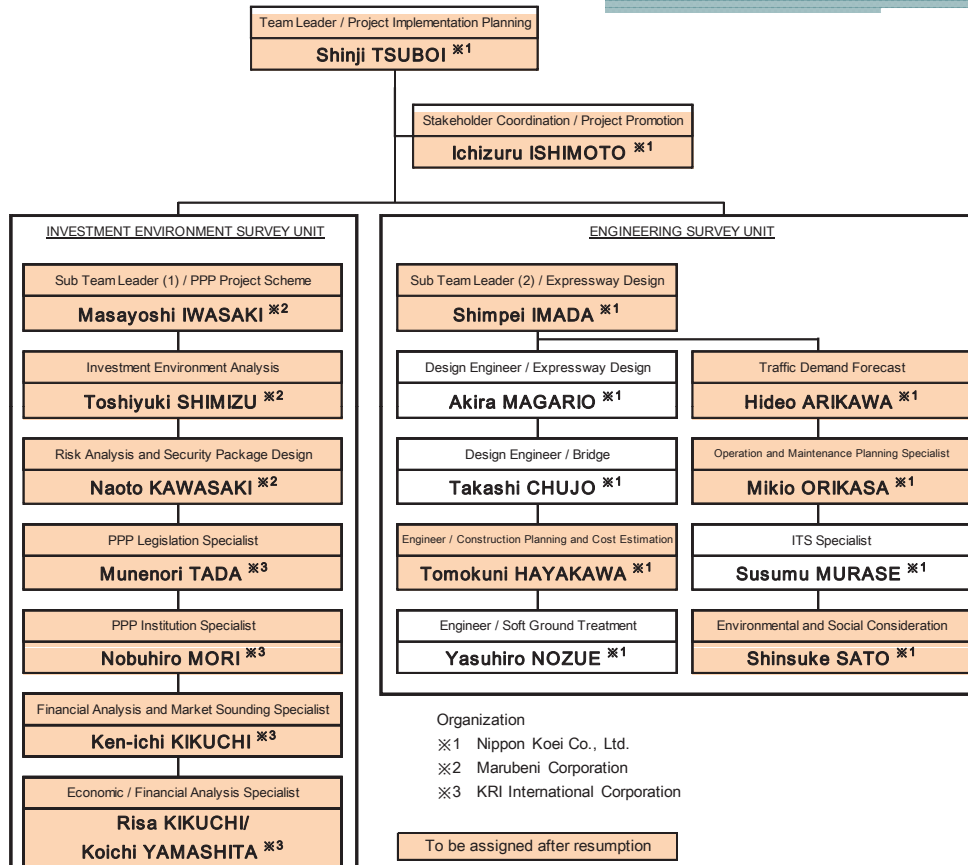
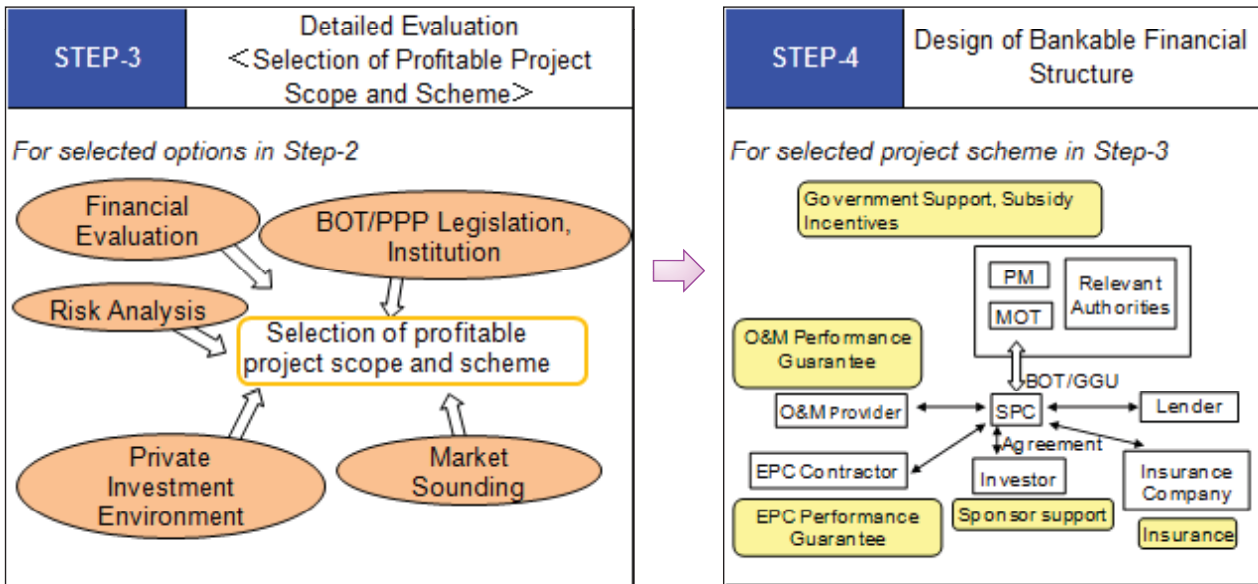

Position	Name	CY 2011					CY 2012						MM			
		Aug	Sep	Oct	Nov	Dec	May	June	July	August	September	October	November	December	VN	JP
Team Leader / Project Implementation Planning	Shinji TSUBOI	■	■	■	■	■	■	■	■	■	■	■	■	■	3.00	0.63
Stakeholder Coordination / Project Promotion	Ichizuru ISHIMOTO		■					■							0.90	
Sub Team Leader (1) / PPP Project Scheme	Masayoshi IWASAKI	■	■					■	■	■	■	■	■	■	1.50	0.30
Investment Environment Analysis Specialist	Toshiyuki SHIMIZU	■					■		■	■	■	■	■	■	1.50	
Risk Analysis and Security Package Design Specialist	Nato KAWASAKI	■	■					■		■	■	■	■	■	1.00	1.40
PPP Legislation Specialist	Munenori TADA								■	■	■	■	■	■	0.33	0.33
PPP Institution Specialist	Nobuhiro MORI				■				■	■	■	■	■	■	1.00	0.50
Financial Analysis and Market Sounding Specialist	Ken-ichi KIKUCHI			■			■	■	■	■	■	■	■	■	0.90	0.50
Economic / Financial Analysis Specialist	Risa KIKUCHI/ Kaichi YAMASHITA	■	■	■	■	■	■	■	■	■	■	■	■	■	1.77	2.27
Sub Team Leader (2) / Expressway Design	Shimpei IMADA	■	■	■	■	■	■	■	■	■	■	■	■	■	4.30	0.40
Traffic Demand Forecast	Hideo ARIKAWA	■	■	■	■	■									3.50	
Design Engineer / Expressway Design	Akira MAGARIO	■	■	■	■	■									2.00	
Design Engineer / Bridge	Takashi CHUJO	■	■	■	■	■									1.70	
Engineer / Construction Planning and Cost Estimation	Tomokuni HAYAKAWA	■	■	■	■	■			■						2.50	
Engineer / Soft Ground Treatment	Yasuhiro NOZUE	■	■	■	■	■									1.80	
Operation and Maintenance Planning Specialist	Mikio ORIKASA	■	■	■	■	■					■				2.23	
ITS Specialist	Susumu MURASE	■	■	■	■	■									1.70	
Environmental and Social Consideration	Shinsuke SATO	■	■	■	■	■				■	■				1.70	0.30
													33.33	6.63		

Reports and Date of Submission	Inception Report (IC/R)	Progress Report (PR/R)	Interim Report (IT/R)	Draft Final Report (DF/R)	Final Report (FR)
	▲	▲	▲	▲	▲

Study in Japan
 Study in Vietnam

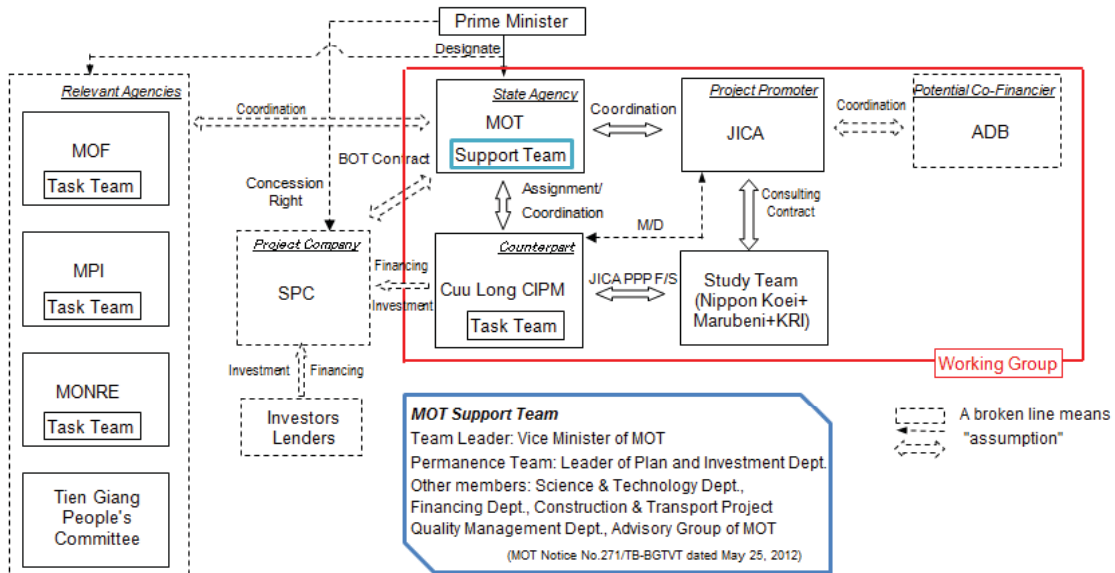

Stakeholder Chart and WG Members

Proposed Schedule of WG

Date	Agenda of Working Group	Location
Middle of Aug. 2012	- Detailed Evaluation of Project Scope and Scheme (1)	Hanoi
Middle of Sept. 2012	- Detailed Evaluation of Project Scope and Scheme (2) - Project Implementation Program	Hanoi
Beginning of Nov. 2012	- Security Package - Draft of BOT/GGU Term Sheet	Hanoi

Report	Main Contents	Submission Date	Number of Copy
Inception Report	<ul style="list-style-type: none"> •Outline of the Survey •Work Plan •Necessary Data and Questionnaires 	Submitted in Sept. 2011	20 nos. in EN 10 nos. in VN
Progress Report	<ul style="list-style-type: none"> •Update of Traffic Demand Forecast •Review Result of D/D •Draft O&M/ITS Plan •Review Result of EIA 	Submitted in Dec. 2011	2 nos. in EN
Interim Report	<i>in addition to the above</i> <ul style="list-style-type: none"> •Preliminary Evaluation of Project Scope and Scheme •Detailed Evaluation of Project Scope and Scheme (1) 	Middle of July 2012	20 nos. in EN
Draft Final Report	<i>in addition to the above</i> <ul style="list-style-type: none"> •Detailed Evaluation of Project Scope and Scheme (2) •Project Implementation Program •Security Package* •Draft of BOT/GGU Term Sheet* 	Middle of Nov. 2012	20 nos. in EN
Final Report	<i>include all study results</i>	beginning of Jan. 2013	20 nos. in EN 10 nos. in VN

*might be cancelled depending on results of IT/R

- Chapter 1** Introduction
- Chapter 2** Project background and necessity
- Chapter 3** Analysis of BOT/PPP legal systems and organization
- Chapter 4** Study of existing project scheme
- Chapter 5** Update of traffic demand forecast
- Chapter 6** Review and additional study of the project plan
- Chapter 7** Recommendation for project scope and project scheme
- Chapter 8** Design and recommendation for security package*
- Chapter 9** Evaluation and feasibility of the project
- Chapter 10** Conclusions
- Appendix** Draft term sheets for BOT contract and GGU*

* might be cancelled depending on results of IT/R

Thank you very much!

APPENDIX

- a. Other options of Preliminary Evaluation of Project Scope and Scheme
- b. Project Implementation Structure
- c. Tentative Implementation Schedule
- d. Traffic Volume
- e. Civil Work Cost
- f. Revenue

Other options of Preliminary Evaluation of Project Scope and Scheme

■ Option-1:

- BOT only TL-Cai Be Section
- Revenue from whole section of TL-MT and NH1A (My Thuan Bridge)
- Subsidy for land acquisition and VAT
- Toll level is 1,000VND/km (as of 2012 year)

➤ **Project IRR: 9.2%** (13.6% in case 2,000VND/km)

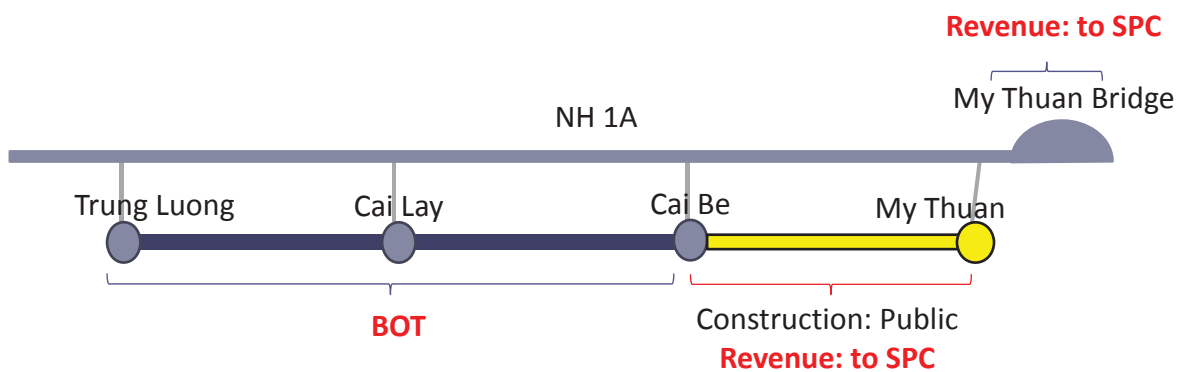

Other options of Preliminary Evaluation of Project Scope and Scheme

■ Option-2:

- BOT for whole section TL-My Thuan
- All revenue from HCM-TL, TL-MT & NH1A (My Thuan Bridge and KM1953+200)
- Subsidy for land acquisition and VAT
- Concessional condition for the payment of HCM-TL concession fee with 20 years deferred payment (paid to MOF)
- Toll level is 1,000VND/km (as of 2012 year)

➤ **Project IRR: 7.8%** (12.6% in case 2,000VND/km)

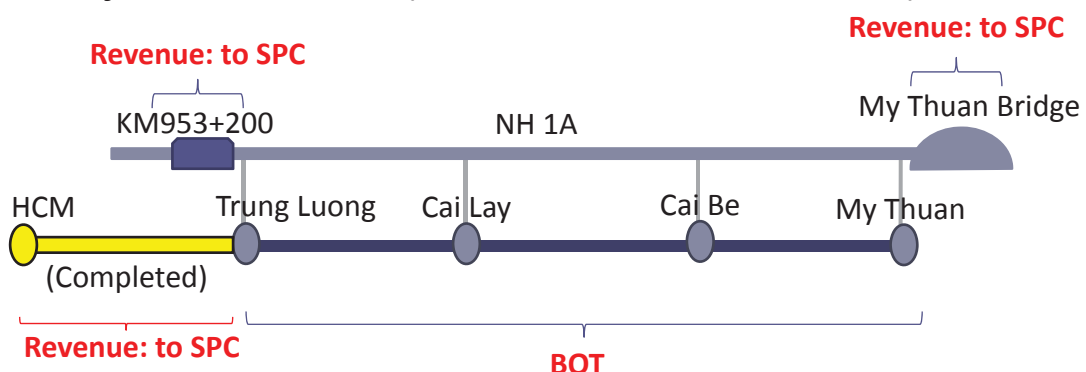

Other options of Preliminary Evaluation of Project Scope and Scheme

■ Option-3:

- BOT only TL-Cai Be Section
- All revenue from HCM-TL, TL-MT & NH1A (My Thuan Bridge and KM1953+200) toll collections
- Subsidy for land acquisition and VAT
- Concessional condition for the payment of HCM-TL concession fee with 20 years deferred payment (paid to MOF)
- Toll level is 1,000VND/km (as of 2012 year)

➤ **Project IRR: 9.8%** (15.5% in case 2,000VND/km for TL-MT)
 (17.6% in case 2,000VND/km for HCM-MT)

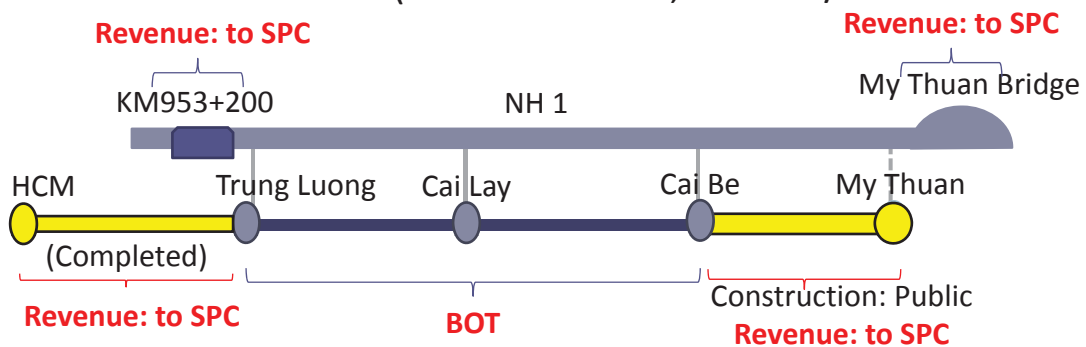

Project Implementation Structure (Source: Final Report on the Study on Measuring the Possibility of Private Investments in Expressway Project in Southern Vietnam, JICA in June 2011)

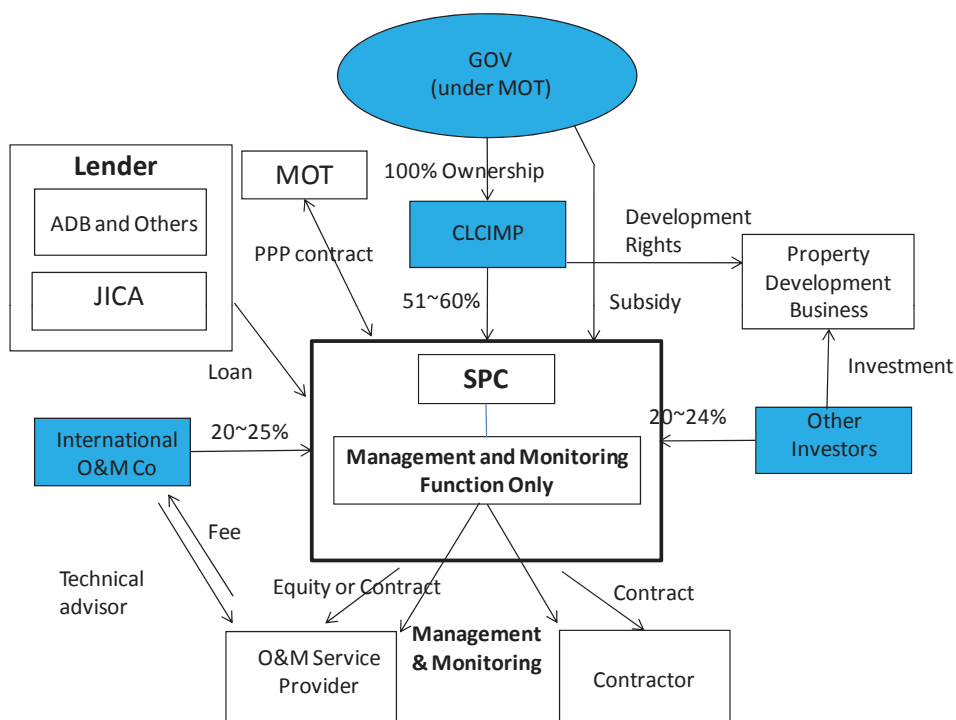

Project Implementation Structure (Hypothetical)

Civil Work Cost

Comparison of Civil Work Cost of Expressways in Southern of Vietnam

Project	HCM-Trung Luong Expressway Project	HCM-Long Thanh-Dau Giay Expressway Project	Trung Luong - My Thuan Expressway Project	
Basic information	completed in 2010	under construction	detailed design completed	
Total Length	39.8km	55km	54.3km	
Nos. of lane	4-lane	4-lane	4-lane	
Viaduct section	16.3km	6.8km	2.6km	
Bridge Section	3.8km	5.5km	10.1km	
Embankment Section (soft soil section)	19.7km (39.8km)	42.7km (23km)	41.6km (54.3km)	
Total Cost	*actual cost	*D/D cost	*D/D cost	
Total Civil Work Cost	6,667billion VND	9,765billion VND	14,353billion VND	
Viaduct Cost	3,741billion VND	2,764billion VND	929billion VND	
Bridge Cost		3,535billion VND	6,451billion VND	
Road Cost (Embankment Section)	2,926billion VND	3,466billion VND	6,973billion VND	incl. 2,390 of softsoil treatment cost
Km cost				
Whole section	168billion VND/km	178billion VND/km	264billion VND/km	1,057million JPY/km
Viaduct section	230billion VND/km	406billion VND/km	357billion VND/km	1,429million JPY/km
Bridge Section	billion VND/km	643billion VND/km	639billion VND/km	2,555million JPY/km
Road (Embankment Section)	125*no breakdown available	81billion VND/km	168billion VND/km	670million JPY/km
embankment cost only for softsoil section except bridge&viaduct		148billion VND/km	168billion VND/km	incl. 57billion VND/km of softsoil treatment cost

Revenue

Section	Length (km)	Revenue in 2017* (billion VND/year)
HCM-Trung Luong	39.8	388
Trung Luong- Cai Lay	18.5	189
Cai Lay- Cai Be	12.7	97
Cai Be- My Thuan	23.1	106
My Thuan Bridge	-	164
Can Tho Bridge	-	103

Note:

- 1) 2017 year is assumed as traffic open.
- 2) Toll level (passenger car) is 1,300VND/km for expressway, and 13,000VND/km for My Thuan Bridge and Can Tho Bridge.

Phụ lục -5 Tài liệu họp

A5-5: Họp báo cáo giữa kỳ với CL CIPM

THE PREPARATORY SURVEY ON TRUNG LUONG – MY THUAN EXPRESSWAY PROJECT IN VIETNAM

INTERIM REPORT



20th July 2012

JICA Study Team;

Nippon Koei Co., Ltd.
Marubeni Corp.
KRI International Corp.



Contents

2

1. **Location Map**
2. **JICA Preparatory Survey - Objective and Progress-**
3. **Cuu Long CIPM's Business and Financial Conditions**
4. **Selection of Project Scope and Scheme**
 - 4.1 Assumptions of Financial Analysis
 - 1) Traffic Demand Forecast
 - 2) Project Cost
 - 4.2 Financial Analysis of Base Case
 - 1) Results of Financial Analysis of Base Case
 - 2) Impact of Tariff Increase to Project IRR
 - 3) Assumptions for Cashflow Analysis
 - 4.3 Hurdle Rate
 - 4.4 Evaluation of Project Scope and Scheme
 - 1) Option Setting
 - 2) Evaluation of Options by Project IRR
 - 3) Project Scheme of Option 4 (Horizontal Separation PPP)
 - 4.5 Legal Background for Project Implementation
 - 4.6 Risk Analysis: Private Sector's Perspective
 - 1) Why Do You Need PPP/BOT?
 - 2) Major Risks for Privately Financed Expressway Project
 - 3) Major Issues
 - 4) Is Security Package Workable?
 - 5) Security Package for Option 4
 - 4.7 Proposed Direction
5. **Proposed Working Group Schedule and Contents**
6. **Deliverables and Contents of the Interim Report**

- HCMC – Trung Luong
(Operating from 2010)
 □ 39.8(km)
- Trung Luong – My Thuan
(D/D completed, JICA
Preparatory Survey)
 □ 54.3(km)
- My Thuan – Can Tho
(F/S completed)
 □ 24.5(km)

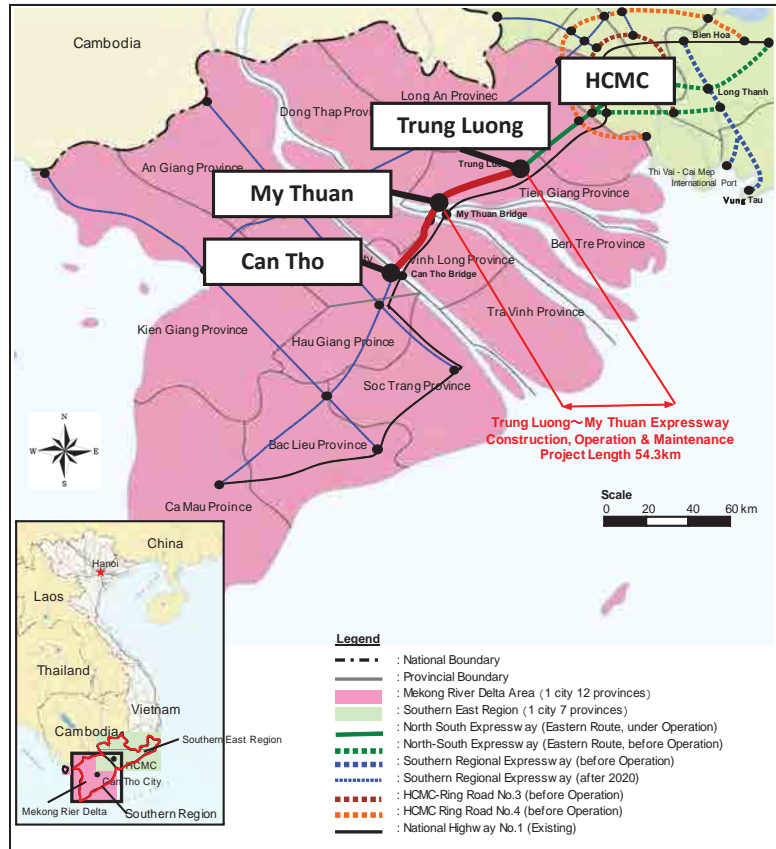

■ Basis of Implementation of the Survey

- The Minutes of Meeting (M/D) signed between BEDC and JICA in July 2011
- Prime Minister’s approval to transfer the concessions to MOT from BEDC in February 2012
- MOT’s Notice and Cuu Long CIPM’s Request for Resumption to JICA in May 2012
- Notice of Resumption from JICA to Cuu Long CIPM in June 2012
- Kick-Off Meeting for Resumption on 20th June 2012

■ Objective

- To evaluate the possibility of private investment for the Project
- To propose feasible BOT/PPP scheme
- To prepare Draft Term Sheet for BOT Contract and Government Guarantee and Undertaking (GGU)

■ Progress of the Study

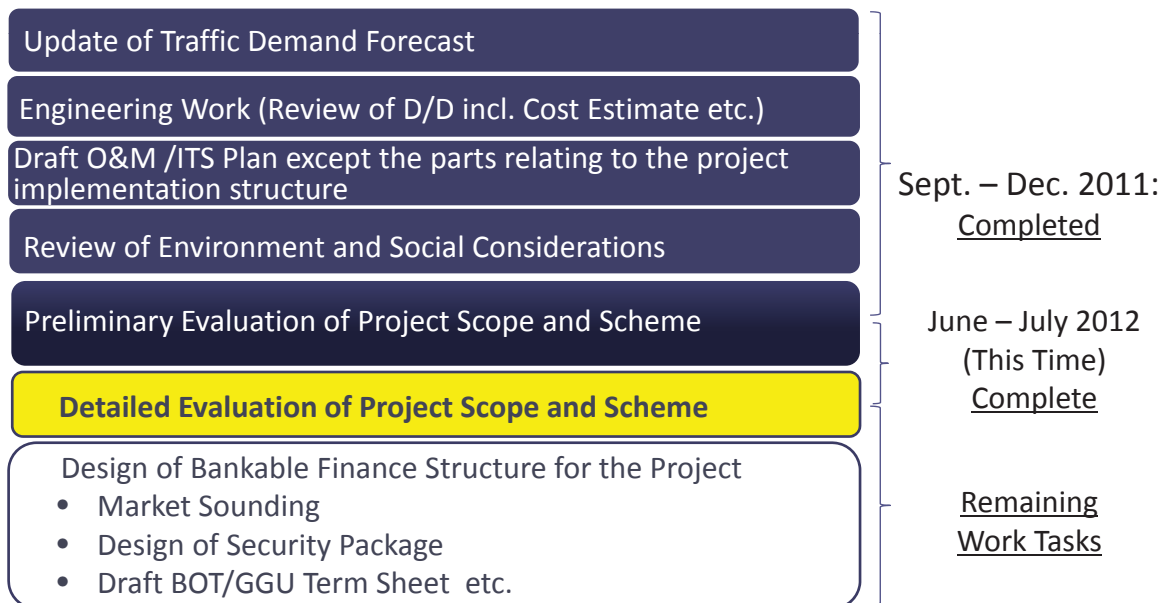

- Established in July 2011 as state-owned enterprise (SOE), reorganizing My Thuan PMU (retained), 715 Company, and Can Tho Bridge Company into one entity.
- The charter capital is VDN 1,500 billion.
- Main business areas include investment/development of infrastructure, project management, operation and maintenance of transport infrastructures, and project concession (ownership).
- Organized into a headquarters 13 divisions (92 staff), 2 dependable accounting units (6 staff), and two subsidiary companies, Can Tho Bridge (184 staff) and 715 Company (127 staff), totalling 409 staff.
- Budgetary base looks robust due to status of state business agency

Organization of Cuu Long CIPM

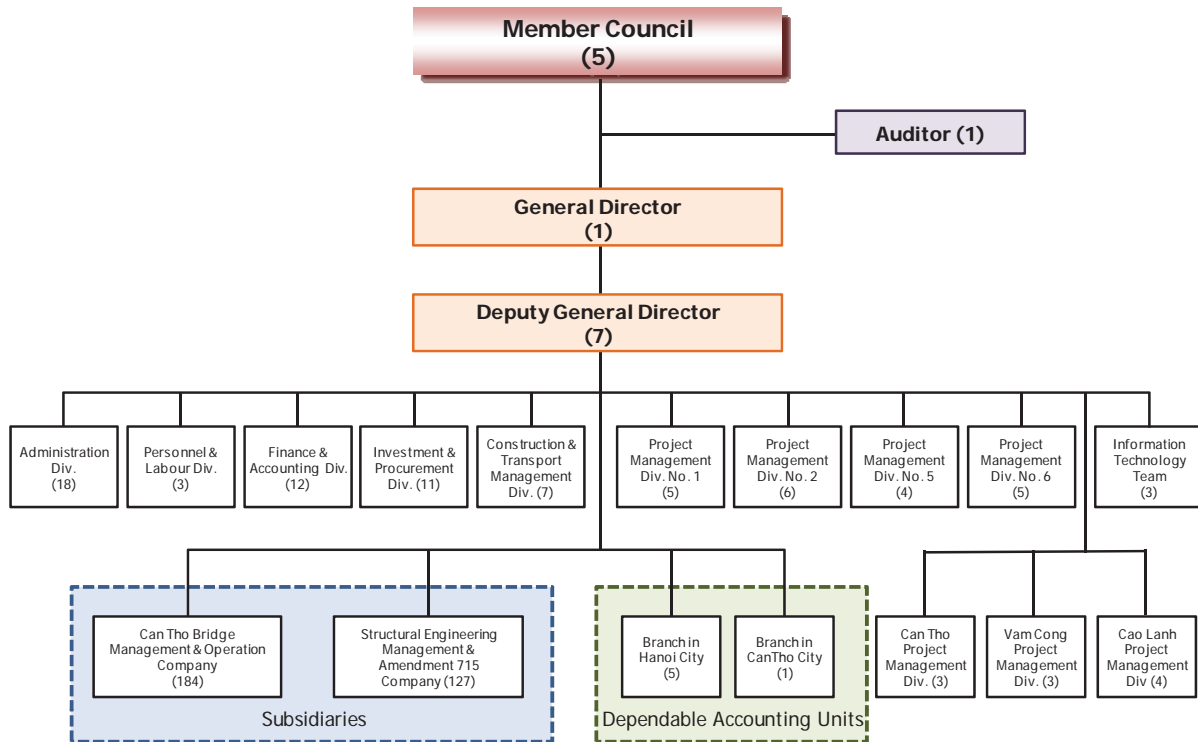

Notes: () indicates number of staff
As of June 20, 2012

4.1 Assumptions of Financial Analysis

1) Traffic Demand Forecast (see Annex)

Traffic decreased to less than 50% from BOT FS by BEDC

Unit: PCU/day

Section of <u>Expressway</u>	Year 2020	Year 2025	Year 2030
Trung Luong-Cai Lay	29,475	41,528	53,959
Cai Lay – Cai Be	21,461	31,208	40,559
Cai Be – My Thuan	20,106	30,329	39,048
Average between TL-MT	23,681	34,355	44,522
Ratio against BEDC's FS	41%	47%	48%

source: JICA PPP Study (2011)

Unit: PCU/day

Section of <u>NH1A</u>	Year 2020	Year 2025	Year 2030
My Thuan Bridge	35,410	16,651	17,778
Can Tho Bridge	21,049	25,403	29,423

source: JICA PPP Study (2011)

Major scenario for traffic demand forecast of JICA Study:

- Traffic open of TL-MT section in 2017
- HCM Highway with Cao Lanh Bridge and Vam Cong Bridge open in 2017
- Extension to MT-CT section including 2nd My Thuan Bridge in 2020
- Toll Fee increases 30% per 5 years from base level of 1,000VND/km in 2012

Unit: PCU/day

Section of <u>Expressway</u>	Year 2020	Year 2025	Year 2030
Trung Luong-My Thuan (average)	58,088	73,654	93,392

source: BOT F/S by BEDC (2010)

4.1 Assumptions of Financial Analysis

2) Project Cost (see Annex)

Component of Project Cost

- Civil work construction cost is reduced (16,209 -> 15,524 billion VND) because of engineering review.
- Total Project cost (excluding price escalation) reaches approximately VND20 trillion.

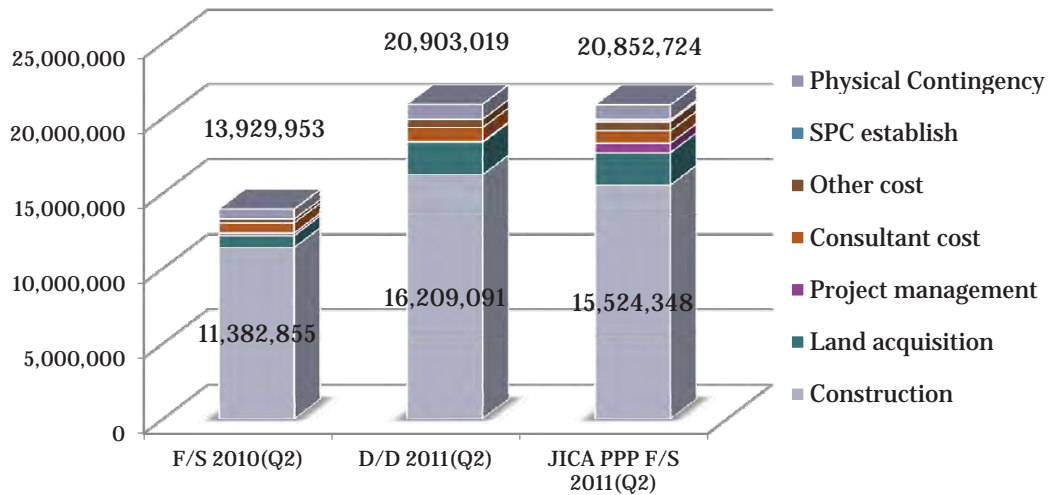

4.1 Assumptions of Financial Analysis

2) Project Cost

Project Cost by Sections

Section	Length (km)	Project Cost*(billion VND)
Whole Section	54.3	20,853
Trung Luong- Cai Lay	18.5	7,426
Cai Lay- Cai Be	12.7	6,695
Cai Be- My Thuan	23.1	6,732

- Project cost is included land acquisition cost, SPC establish cost and physical contingency etc. but exclusive of VAT, price escalation during construction and O&M cost during operation. The cost is present value as of 2011 (Q.2)



4.2 Financial Analysis of Base Case

1) Results of Financial Analysis of Base Case

- **Project IRR (Base Case) = 4.3%**
- **Project IRR (Base Case + NH1A*) = 5.6%**

(cf. 9.64% in BEDC's F/S in June 2010)

* revenue from toll plaza at NH1A (My Thuan Bridge + Can Tho Bridge)

Traffic network scenario (newly added to the previous analysis):

- In 2017, traffic Open for TL-MT expressway with 1,000VND/km/pcu (price of 2012)
- In 2017, completion of HCMC Highway route with Cao Lanh Bridge and Vam Cong Bridge
- In 2020, extension to Can Tho
- In 2030, completion of Co Chien Bridge and Dai Nghai Bridge along NH60.

Reasons for low Project IRR

- Traffic forecast is optimistic in BEDC's F/S (see page 8 and Annex)
- Construction cost is high due to softsoil treatment (see Annex)
- Toll Tariff is low (see next page)

4.2 Financial Analysis of Base Case

2) Impact of Toll Tariff Increase to Project IRR

Toll Tariff (in price of 2012, 30%up every 5yrs)	Project IRR*	
	Base Case	+ NH1A**
1,000VND/km	4.3%	5.6%
2,000VND/km	7.9%	9.8%
3,000VND/km	9.6%	12.2%

* each Project IRR is calculated by corresponding traffic demand forecasted by the traffic network software "STRADA", by considering the effect of lower traffic volume due to higher tariff.

** Toll plaza at My Thuan Bridge and Can Tho Bridge

- Immediate and significant impact is confirmed for the toll tariff increase.
- If GOV approve 3,000VND/km, the Project IRR of Base Case + NH1A becomes as high as 12.2%.

4.2 Financial Analysis of Base Case

3) Assumptions for Cashflow Analysis

Trung Luong - My Thuan Expressway
Assumptions for cashflow projection

nominal price - with inflation

Contract schedule	year	
Study year	2011	
BOT section	N03	(N03: TL-MT, N08: TL-CL, N11: O&M+)
1st year of operation(BOT)	2017	
Last year of operation(BOT)	2047	
1st year of operation (ODA)		(blank if there is no ODA)

SPC: Sources & uses of funds (nominal)		VND bil	
Uses	Sources		%
Construction (initial)	Loan Tr.1 (JICA)	19,786	70%+IDC
	Equity	8,480	30%
Total	Total	28,266	100%+IDC
subsidy for land acquisition		0	(yes=1, no=0)

IDC: Interest payment During the Construction period

Terms & Conditions for financings	
Loan	JICA(PSIF)
Upfront fee	0.3%
Interest rate	3.0%
Grace period	5 years
Maturity	25 years
Repayment	linear amortisation

- Forex risk for JICA loan in JPY

Prov.* for Forex loss (JPY/VND)	2	(Choose "1" or "2" below)
	1	7%of outstanding loan amount
	2	20%of interest & principle repayment

* assumed immediate write-off with cash payment

Project IRR = 4.3% Negative cash amount at B/S

Case for traffic forecast*					
2011N03	E0	B0	G0	L4	F10
2015N03	E0	B0	G0	L4	F10
2020N09	E0	B0	G0	L4	F10
2025N09	E1	B0	G0	L4	F10
2030N09	E1	B1	G0	L4	F10
2040N09	E1	B1	G0	L4	F10
2050N09	E1	B1	G0	L4	F10

* see detail of cases in the Report(traffic demand) of JICA study team

Expand to 6 lanes (yes=1, no=0)

Other revenue (yes=1, no=0)			Revenue from Toll Plaza	HCMC-TL
KM1953+200	MT bridge	CT bridge		0
0	0	0		90%of F/S(MOF) revenue
				1,000VND/km/pcu

Inflation switch	
Inflation for capex & cost (yes=1, no=0)	1
Toll price increase % (every 5 yrs) (MOF decree, Document No.77 / BC-BTC)	30%

Corporate income tax	
Standard tax rate	25%
- Preferential exemption	15 yrs 10%
100% exemption period	4 yrs
50% exemption period	9 yrs

Inflation		
From	To	%
2015		8.4%
2016	2020	7.5%
2021	2025	7.0%
2026	2030	6.5%
2031	2035	6.5%
2036	2040	6.5%
2041	2045	6.5%
2046	2050	6.5%
developed countries		0.0%

4.3 Hurdle Rate

Hurdle Rate:
14-16%

JICA Loan (on yen basis, Tentative) 3%

JICA Loan (on VND basis, based on on-lending rate, Tentative) 15%

BIDV 17-19%

Equity 25-30%

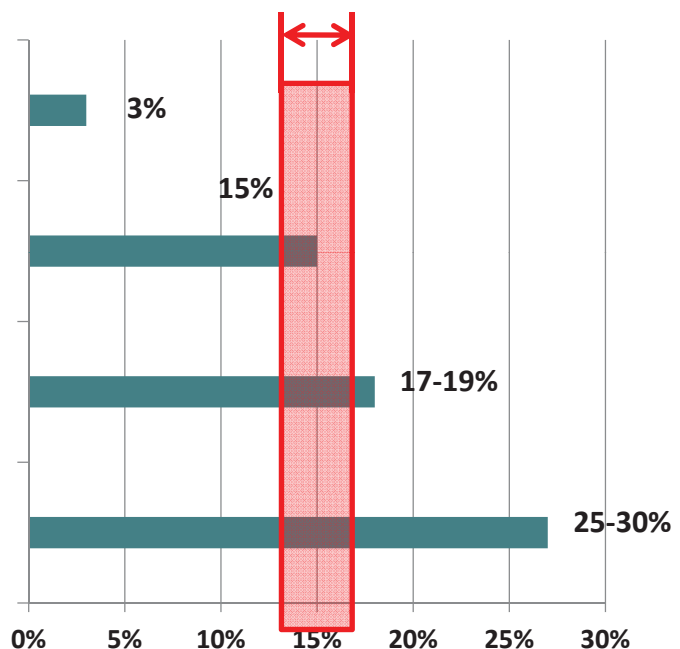

4.4 Evaluation of Project Scope and Scheme

1) Option Setting

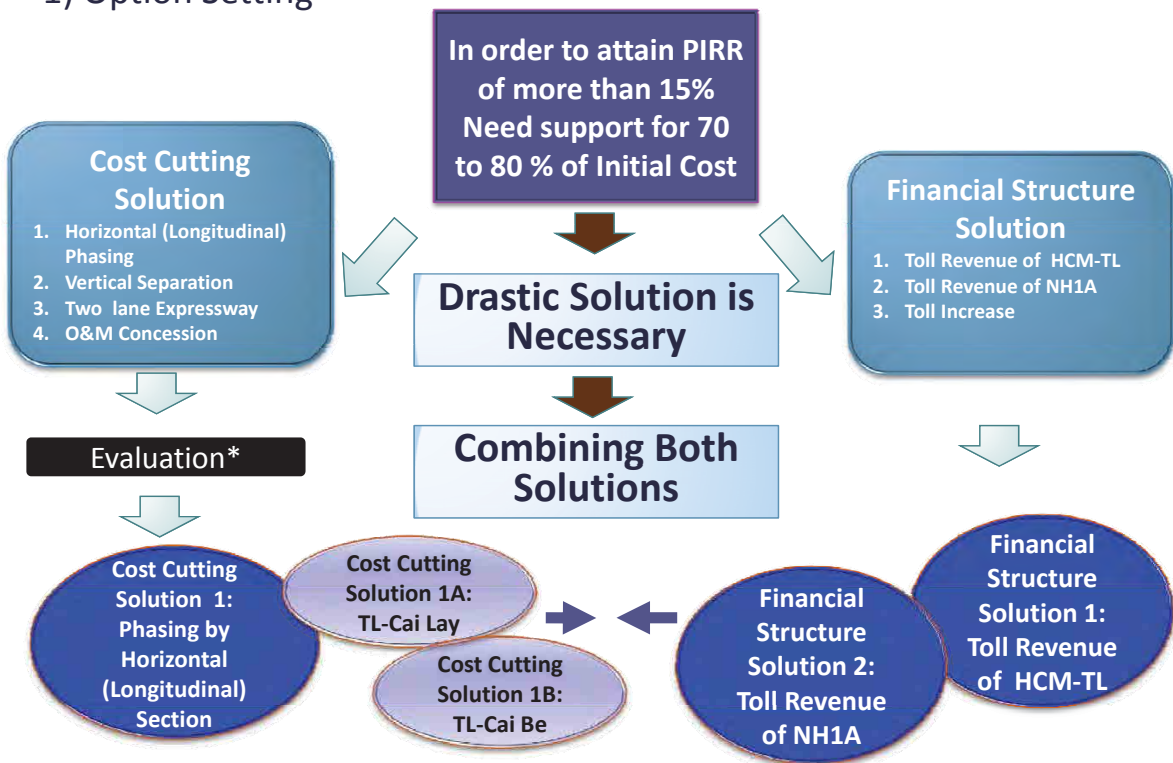

*see Annex

4.4 Evaluation of Project Scope and Scheme

Option-1:

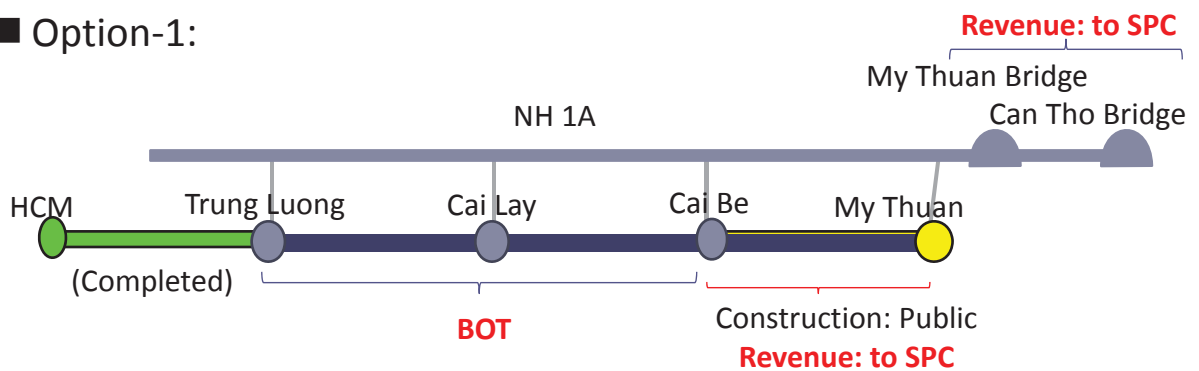

Option-2:

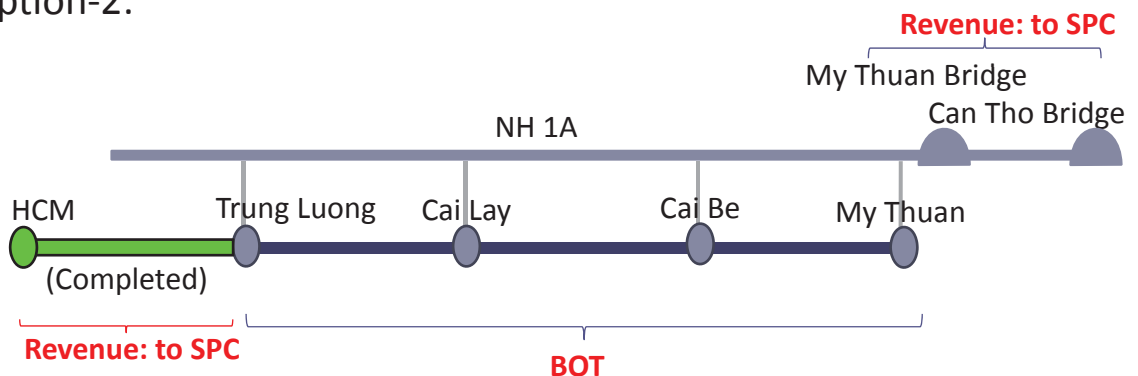

4.4 Evaluation of Project Scope and Scheme

■ Option-3:

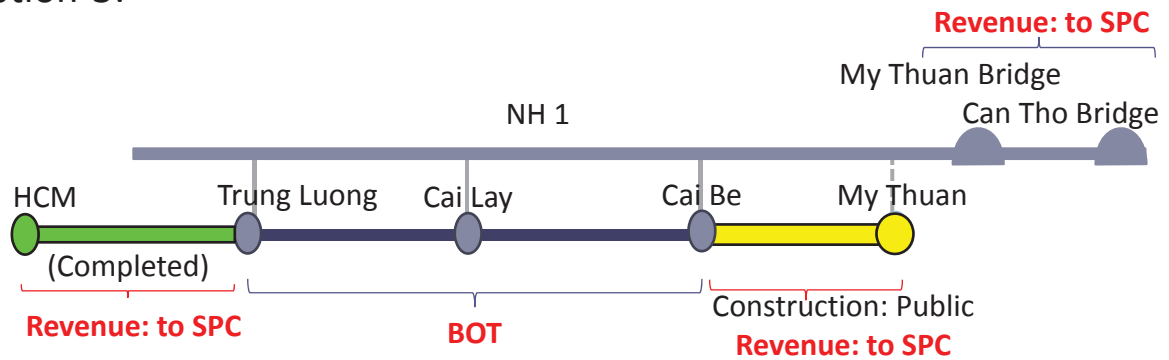

■ Option 4:

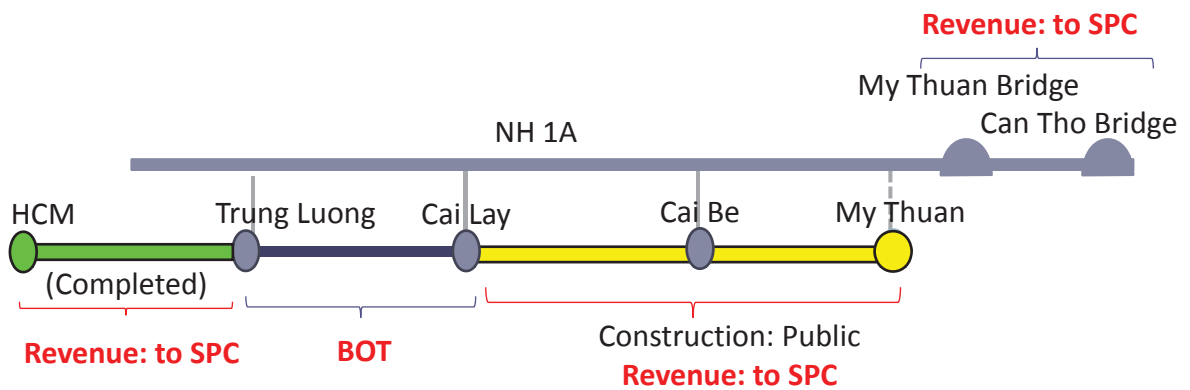

4.4 Evaluation of Project Scope and Scheme

2) Evaluation of Options by Project IRR

BOT Base Case	Project IRR	CAPEX Investment (billion)
TL-MT	4.3%	VND25,672
Options	Project IRR	Investment
Op1: TL-Cai Be + NH1A	8.5%	VND16,019
Op2: HCM-TL + TL-MT + NH1A	7.3%	VND25,672
Op3: HCM-TL + TL-Cai Be + NH1A	10.2 %	VND16,019
Op4: HCM-TL + TL-Cai Lay + NH1A	14.8%	VND9,026

4.4 Evaluation of Project Scope and Scheme

3) Project Scheme of Option 4 (Horizontal Separation PPP)

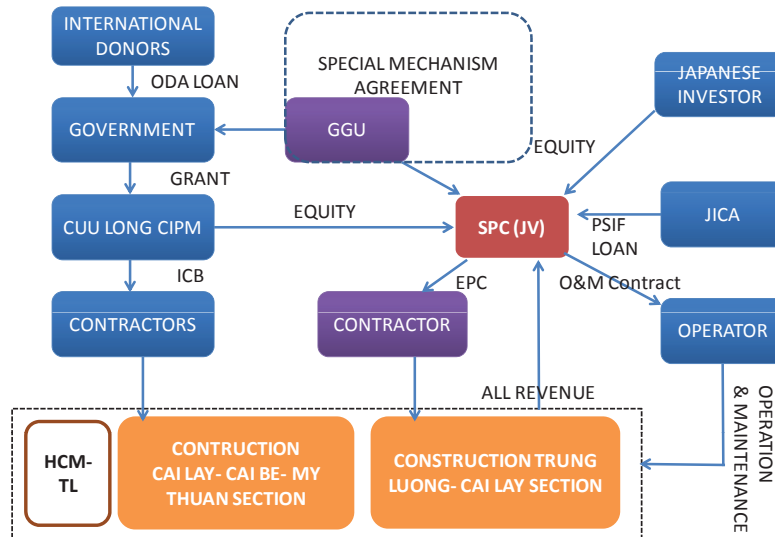
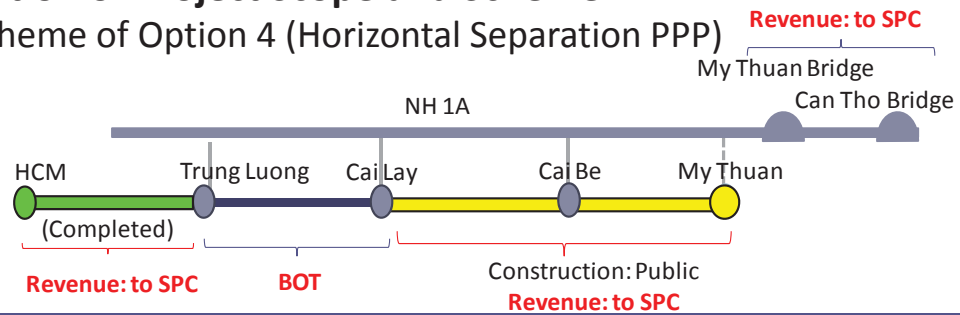

4.5 Legal Background for Project Implementation

- Concession for Project Implementation of TL-MT section
=> The concession is currently with MOT, CL CIPM was “assigned to study and propose” the implementation of the project (PM Decision No.217/TTg-KTN in Feb, 2012)
- Special Mechanism
=> Special mechanism based on PM’s approval is to be proposed for the implementation framework of the project instead of being based on the current BOT Law (Government Decree No.108/2009/ND-CP) or Pilot PPP Regulation (PM Decision No.71/2010/QD-TTg)

4.6 Risk Analysis: Private Sector's Perspective

1) Why Do You Need PPP/BOT?

- PPP/BOT is not an objective, but a means to deliver a project. It is one of various procurement alternatives.
- Merits/Advantages of PPP(BOT):
 - Life-cycle costing;
 - Efficiency gains;
 - Risk transfer to those who best manage risks;
 - Public spending in installment over the economic life of the asset.
- Demerits/Disadvantages of PPP(BOT):
 - Higher financing cost;
 - Risks to be priced higher unless properly structured;
 - Complex security package;
 - Contingent liability for the government.
- PPP/BOT option is to be taken when merits \gg demerits, i.e. positive value-for-money.
- Is TL-MT Expressway a suitable case for PPP/BOT application? If so, how should it be applied?

2) Major Risks for Privately Financed Expressway Project

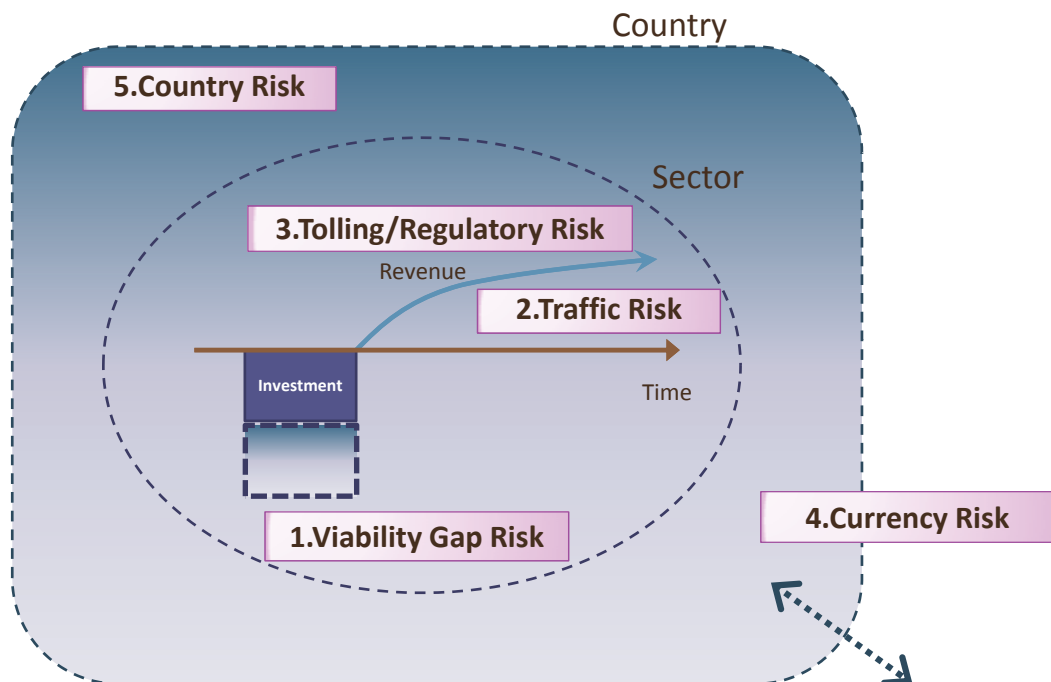

3) Private Sector's Perspective - Major Issues

Major Issue 1: Traffic Risk

- Toll collection is the main source of revenues for toll road projects.
- Toll revenues = $\text{Traffic} \times \text{Toll rates}$
- Traffic forecast for green-field projects is challenging even in advanced countries.
- It is more difficult in countries where a tolling regime/track record has not been well established - Difficulty in measuring users' appreciation of time saving.
- Possible solutions to mitigate/reduce traffic risks for investors/financiers:
 - Availability payment;
 - Shadow toll;
 - Minimum traffic guarantee;
 - Traffic risk sharing, e.g. cap & floor.

3) Private Sector's Perspective - Major Issues

Major Issue 2: Tolling Risk

- Toll revenues = $\text{Traffic} \times \text{Toll rates}$
- The toll level should be set to allow cost recovery and revised regularly vis-à-vis inflation; OR it could be set at a subsidized level for economic/social consideration. \Rightarrow Need subsidy for TL-MT.
- The current toll levels in Vietnam appear to be set below users' affordability to pay.
- The current norm for toll revision in Vietnam, i.e. 30% increase every 5 years, translates to 5.5% increase per annum \ll historical CPI.
- The regulatory risk in connection with approval of toll revisions affects Project viability.

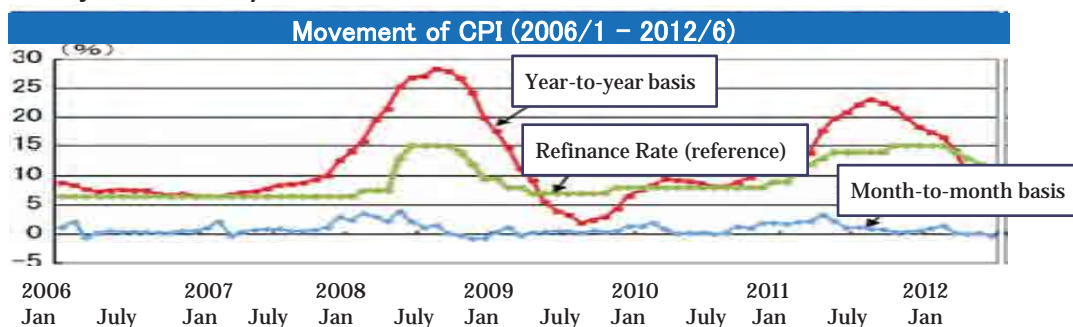

3) Private Sector's Perspective - Major Issues

Major Issue 3: Currency Risk

Hard currency revenue generating projects, e.g. IPP and refinery projects, could organize finance with relative ease (but still many issues...). Toll road financing, however, will face a much higher hurdle, due to the mismatch between the revenue currency (VND) and the financing currency (US\$ or J¥).

The absence of local currency financing suitable for infrastructure finance, i.e. shorter tenor and prohibitive interest cost in VND, necessitates hard currency loan financing.

The government undertaking for the exchange rate guarantee is now limited (e.g. to 30% of revenues). Depreciation of VND will squeeze the Project cash flow.

Exchange rate variation could be passed through to tolls by way of an escalation formula. But in case of sharp devaluation of VND, it's difficult to pass this risk entirely to users (socially not acceptable).

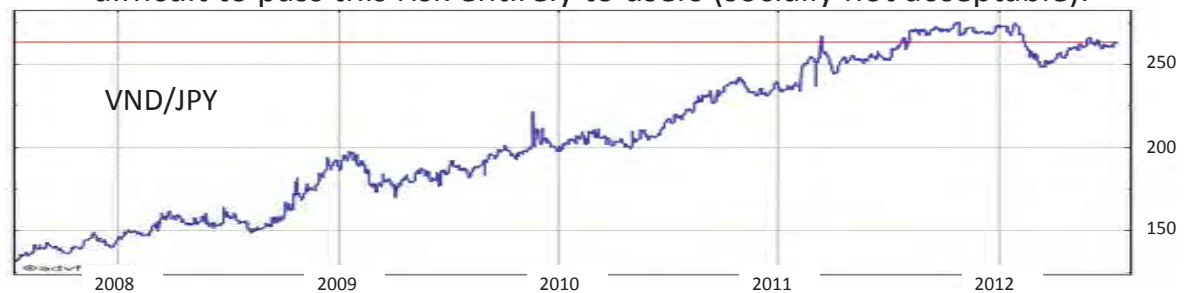

4) Private Sector's Perspective – Is Security Package Workable?

Option 4 would require the following government undertakings:

Toll rates:

- Assurance of the revision of the initial toll rates (at 1,000VND/km for HCM-TL-MT, 2012 price) in a pre-agreed percentage and frequency;
- Allowance to accelerate toll increase in case of hyper-inflation.

Minimum traffic guarantee (cap & floor type risk sharing)

Land acquisition for TL - Cai Lay (BOT section) under the full responsibility of the government for funding and timely acquisition.

Subsidy for the Project:

- Appropriation of revenues from HCM-TL; Cai Lay - MT; NH1A (MT Bridge & CT Bridge);

HCM-TL Concession Fee:

- Agreement on the deferred payment with a 20-year amortization schedule

Construction:

- Completion of the construction of Cai Lay - Cai Be - MT with public finance;
- Assumption of all interface risks, e.g. timely completion, defect liability, which affect the appropriation of the revenues from the publicly financed sections for the Project;
- Construction of the BOT section shall commence only after a set of prescribed milestones on the implementation of the public-financed sections are achieved.

Exchange rate guarantee from VND to financing currencies.

Buy-out guarantee for private sector's debt balance + α in case of termination due to GOV and force majeure default.

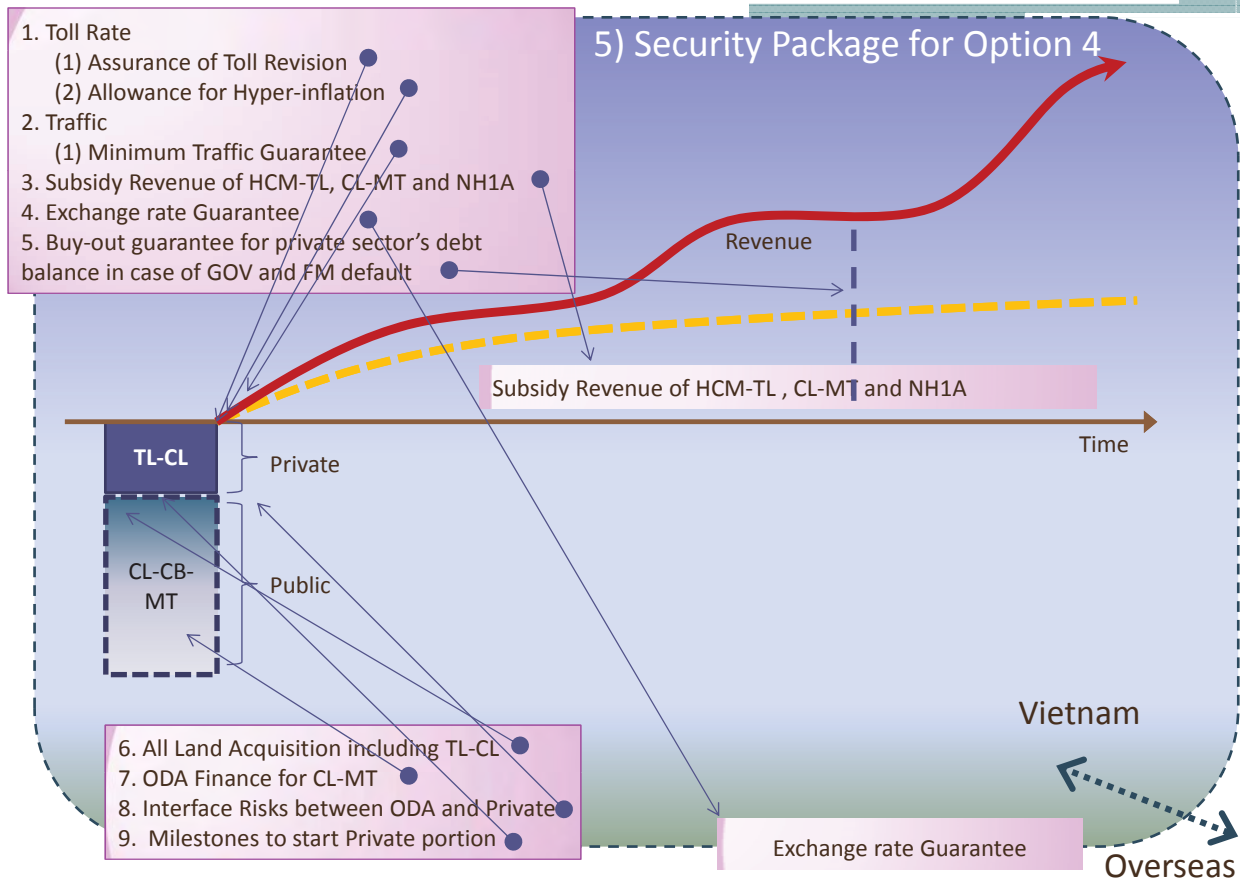

4.7 Proposed Direction

■ Viable PPP option is difficult, because:

- Risks are priced high and supporting security package becomes so complex that it seems to be difficult to materialize

=> It will be rather high risk for Private sector investor to expose large sum of money in these conditions.

- **Small Benefit (value for money) for GOV**

=> 2/3 of Capital Investment should be borne by GOV and All revenue will go to the private sector

■ Proposed Direction

- **Seek for Public Funding Route with limited participation of private sector**

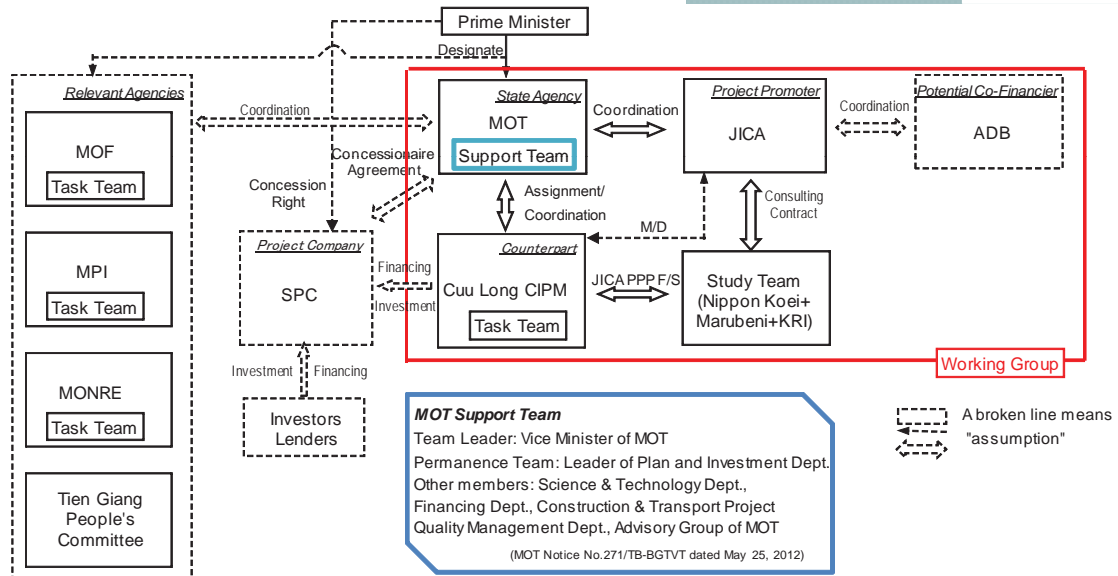

Stakeholder Chart and WG Members

Proposed Schedule of WG

Date	Agenda of Working Group	Location
17 Aug. 2012	- Detailed Evaluation of Project Scope and Scheme (1)	Hanoi
Middle of Sept. 2012	- Detailed Evaluation of Project Scope and Scheme (2) - Project Implementation Program	Hanoi
Beginning of Nov. 2012	- Security Package - Draft of BOT/GGU Term Sheet	Hanoi

Report	Main Contents	Submission Date	Number of Copy
Inception Report	<ul style="list-style-type: none"> Outline of the Survey Work Plan Necessary Data and Questionnaires 	Submitted in Sept. 2011	20 nos. in EN 10 nos. in VN
Progress Report	<ul style="list-style-type: none"> Update of Traffic Demand Forecast Review Result of D/D Draft O&M/ITS Plan Review Result of EIA 	Submitted in Dec. 2011	2 nos. in EN
Interim Report	<i>in addition to the above</i> <ul style="list-style-type: none"> Preliminary Evaluation of Project Scope and Scheme Detailed Evaluation of Project Scope and Scheme (1) 	Middle of August 2012	20 nos. in EN
Draft Final Report	<i>in addition to the above</i> <ul style="list-style-type: none"> Detailed Evaluation of Project Scope and Scheme (2) Project Implementation Program Security Package Draft of BOT/GGU Term Sheet 	Middle of Nov. 2012	20 nos. in EN
Final Report	<i>include all study results</i>	beginning of Jan. 2013	20 nos. in EN 10 nos. in VN

Chapter 1	Introduction
Chapter 2	Background and necessity of the Project
Chapter 3	PRESENT STATUS OF BOT/PPP PROJECT
Chapter 4	Existing project scheme
Chapter 5	Traffic demand forecast
Chapter 6	Project plan
Chapter 7	Project scope and project scheme
Chapter 8	Security package*
Chapter 9	Overall Evaluation*
Chapter 10	Conclusions*

** To be reported in Final Report*

Thank you very much!

Traffic Volume (1/2)

- ❑ Traffic demand forecast is updated based on the supplemental traffic surveys and referring to other studies.
- ❑ The results of traffic demand forecast by F/S, METI/JETRO and the Survey are compared in PCU in 2020.

Section	PCU in Year 2020								
	F/S (TEDI)			METI/JETRO			JICA Survey		
	NH1A	Ex-way	Total	NH1A	Ex-way	Total	NH1A	Ex-way	Total
Trung Luong-Cai Lay	23,242	62,088	85,330	41,010	39,119	80,129	38,141	29,475	67,616
Cai Lay - My Thuan	33,756	45,969	79,725	25,746	29,460	55,206	40,401	21,461	61,862
My Thuan - Can Tho	14,600	38,756	53,356	24,536	23,657	48,193	41,941	20,106	62,047

- ✓ Total volume of NH1A and the expressway is not so much different.
- ✓ Diversion ratio of the traffic from NH1A to the expressway is different which might come from different precondition of time value (resistance by toll).
- ✓ Referring to the recent actual traffic trend in HCM-TL Expressway, it is found that F/S is similar diversion ratio in case before start toll collection (79%), METI and JICA Survey are similar diversion ratio in case with collection of toll(49%).

Traffic Volume (2/2)

Comparison of Traffic Volume of HCM-TL Expressway between Forecast and Actual

1. Traffic Forecast

1) F/S

Traffic volume forecast (PCU/day)				
2006	2010	2015	2020	2025
49,547	69,302	97,883	138,275	191,987

source: BOT F/S for Trung Luong - My Thuan Expressway (2010)

2) JICA PPP F/S Forecast

Traffic volume forecast (PCU/day)				
	2011	2015		
-	21,996	37,265	-	-

source: JICA study team

2. Actual Traffic Volume

Actual Traffic Volume (PCU/day)	
Nov. 2011	Mar.2012
before toll collection	after toll collection (1,000VND/km)
45,842	27,987

source: data provided by Cuu Long CIPM

3. Comparison between Forecast and Actual

Data	Traffic Volume (PCU/day)	Ratio against actual traffic after toll collection
BOT F/S by BEDC	69,302	248%
JICA PPP F/S Forecast	21,996	79%
Actual Traffic Volume before Toll Collection	45,842	164%
Actual Traffic Volume after Toll Collection	27,987	100%



- ✓ Traffic volume forecasted in BEDC's F/S is much overestimated comparing actual traffic volume.
- ✓ Traffic volume forecasted in JICA PPP F/S is a little underestimate but only 20% different.

Civil Work Cost

Comparison of Civil Work Cost of Expressways in Southern of Vietnam

Project	HCM-Trung Luong Expressway Project	HCM-Long Thanh-Dau Giay Expressway Project	Trung Luong - My Thuan Expressway Project	
Basic information	completed in 2010	under construction	detailed design completed	
Total Length	39.8km	55km	54.3km	
Nos. of lane	4-lane	4-lane	4-lane	
Viaduct section	16.3km	6.8km	2.6km	
Bridge Section	3.8km	5.5km	10.1km	
Embankment Section (soft soil section)	19.7km (39.8km)	42.7km (23km)	41.6km (54.3km)	
Total Cost	*actual cost	*D/D cost	*D/D cost	
Total Civil Work Cost	6,667billion VND	9,765billion VND	14,353billion VND	
Viaduct Cost	3,741billion VND	2,764billion VND	929billion VND	
Bridge Cost		3,535billion VND	6,451billion VND	
Road Cost (Embankment Section)	2,926billion VND	3,466billion VND	6,973billion VND incl. 2,390 of softsoil treatment cost	
Km cost				
Whole section	168billion VND/km	178billion VND/km	264billion VND/km	1,057million JPY/km
Viaduct section	230billion VND/km	406billion VND/km	357billion VND/km	1,429million JPY/km
Bridge Section	billion VND/km	643billion VND/km	639billion VND/km	2,555million JPY/km
Road (Embankment Section)	125*no breakdown available	81billion VND/km	168billion VND/km	670million JPY/km
embankment cost only for softsoil section except bridge&viaduct		148billion VND/km	168billion VND/km	incl. 57billion VND/km of softsoil treatment cost

Revenue

Section	Length (km)	Revenue in 2017* (billion VND/year)
HCM-Trung Luong	39.8	960
Trung Luong- Cai Lay	18.5	173
Cai Lay- Cai Be	12.7	92
Cai Be- My Thuan	23.1	107
My Thuan Bridge	-	109
Can Tho Bridge	-	125

Note:

- 1) 2017 year is assumed as traffic open.
- 2) Toll level (passenger car) is 1,000VND/km for expressway, 10,000VND/trip/pcu for My Thuan Bridge and 15,000VND/trip/pcu for Can Tho Bridge in 2012.

