

<p style="text-align: center;">Weekly Meeting (101) Apr 23, 2012 JICA Expert Team For Strengthening the Capacity for Solid Waste Management in Ulaanbaatar City</p> <hr/> <p style="text-align: right;">1</p>	<p style="text-align: center;">Agenda</p> <ol style="list-style-type: none"> 1. Work Progress 2. Schedule for This Week 3. Subjects to be Discussed 4. Material Needed <hr/> <p style="text-align: right;">2</p>	<p style="text-align: center;">1. Progress from 16 to 22 April 2012</p> <ol style="list-style-type: none"> 1. Preparation of Revised M/P <ul style="list-style-type: none"> <input type="checkbox"/> To summarize Plan and Achievement for Implementing SWM M/P <input type="checkbox"/> Analysis for proper operation of RPF plant 2. Implementation of PP1 Phase II by EPWMD <ul style="list-style-type: none"> <input type="checkbox"/> Distribution of 3R booklet and brochure <input type="checkbox"/> Distribution of broadcasting 3R TV program <input type="checkbox"/> AOU meeting at EPWMD 3. Improvement of WB Operation <ul style="list-style-type: none"> <input type="checkbox"/> MUB Web Site? WB record at web site. 4. Analysis of POS answers in Excel Form 5. Operation & Maintenance of machineries <ul style="list-style-type: none"> <input type="checkbox"/> Preparation for Technical Workshop on hydraulic system for TUKs on 23rd (Mon) <input type="checkbox"/> To research the solution for radiator issue 6. Printing Progress report no.5 <hr/> <p style="text-align: right;">3</p>															
<p style="text-align: center;">2. Schedule from 23 to 29 April 2012</p> <ol style="list-style-type: none"> 1. Preparation of Revised M/P <ul style="list-style-type: none"> <input type="checkbox"/> To summarize Plan and Achievement for Implementing SWM M/P <input type="checkbox"/> Analysis for proper operation of RPF plant 2. Implementation of PP1 Phase II by EPWMD <ul style="list-style-type: none"> <input type="checkbox"/> Distribution of 3R booklet and brochure <input type="checkbox"/> Distribution of broadcasting 3R TV program <input type="checkbox"/> AOU meeting at BZD#15 3. Improvement of WB Operation <ul style="list-style-type: none"> <input type="checkbox"/> Video which introduce Japanese SWM history is under translation <input type="checkbox"/> MUB Web Site? WB record at web site. 4. Analysis of POS answers in Excel Form 5. Operation & Maintenance of machineries <ul style="list-style-type: none"> <input type="checkbox"/> Technical Workshop on hydraulic system for TUKs on 23rd (Mon) <input type="checkbox"/> To research the solution for radiator issue 6. Printing Progress report no.5 <hr/> <p style="text-align: right;">4</p>	<p style="text-align: center;">3. Subjects to be Discussed</p> <ol style="list-style-type: none"> a. Progress of Work for EPWMD b. Progress of Work for CMPUA c. Progress of 3R PR tool d. Operation & Maintenance <hr/> <p style="text-align: right;">5</p>	<p style="text-align: center;">a. Progress of Work for EPWMD Apr 9 – 15 , 2012 By EPWMD staff</p> <hr/>															
<p style="text-align: center;">b. Progress of Work for CMPUA Apr 9 – 15 , , 2012 By CMPUA staff</p> <hr/>	<p style="text-align: center;">Content of work conducted last week</p> <ol style="list-style-type: none"> 1. Regular landfill operations at NEDS and MDDS <ul style="list-style-type: none"> <input type="checkbox"/> Preparation for RPF trial tests begin from 17 April 2012. <input type="checkbox"/> New mechanic has been assigned to NEDS <input type="checkbox"/> Main waste receiving face at the landfill site is being covered with soil while waste is being received at the reserve working face. <input type="checkbox"/> Fire occurred at the reserve working face on April 16 and it was down on 18th. <input type="checkbox"/> A request was made by the Faculty of Environment Engineering of the Science and Technology Graduate School of ChuoU to make a presentation for the workshop on "Waste is Product" <input type="checkbox"/> JICA volunteers visited NEDS on April 19 2. Regular waste collection operations in 15 khoroos of BZD <hr/>	<p style="text-align: center;">Weekly Disposal Amount (ton) 2012 IV/6-19</p> <table border="1"> <thead> <tr> <th></th> <th>(IV/6-12)</th> <th>(IV/13-19)</th> </tr> </thead> <tbody> <tr> <td>NEDS / weekly</td> <td>8,215</td> <td>8,842</td> </tr> <tr> <td>NEDS / daily average</td> <td>1,174</td> <td>1,263</td> </tr> <tr> <td>MDDS / weekly</td> <td>436</td> <td>921</td> </tr> <tr> <td>MDDS / daily average</td> <td>62</td> <td>132</td> </tr> </tbody> </table> <hr/>		(IV/6-12)	(IV/13-19)	NEDS / weekly	8,215	8,842	NEDS / daily average	1,174	1,263	MDDS / weekly	436	921	MDDS / daily average	62	132
	(IV/6-12)	(IV/13-19)															
NEDS / weekly	8,215	8,842															
NEDS / daily average	1,174	1,263															
MDDS / weekly	436	921															
MDDS / daily average	62	132															

Schedule for next week

1. Regular landfill operations at NEDS and MDDS
* (Solution of problem for electricity supply to WB in MDDS)
2. Regular waste collection operations in 15 khorooos of BZD

10

AOU meeting

District	Khoroo	Date	Status
KhUD	2	4/6	finished
BZD	15		
ChD	4	4/10	finished

13

1. Problems concerning the radiator of D65 bulldozer



c. Progress of 3R PR tool

* Official letter signed with Bat city general manager, which express request of that they broadcast our 3R PR video in voluntary base, has been delivered to all broadcasting company in UB.

According to the letter, as of 20th Apr., we have learned that our video is being on air "MNB", "SCH" and "Mongolia television".

d. Operation & Maintenance by Uzawa



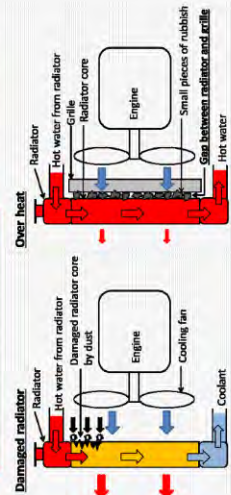

- ### Content
1. Problems concerning the radiator of D65 bulldozer
 2. Workshop for analysis and evaluation of O&M report
 3. Periodic service
 4. Practical training for TUKs
 5. Concerning of waste collection trucks

Causes of overheat and its prevention



17

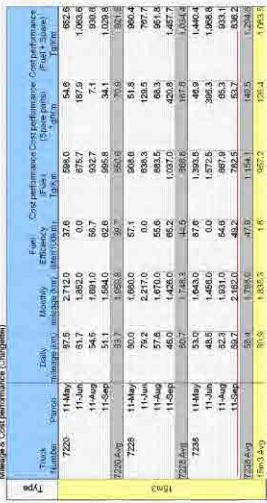

<p>Wind direction (Outside→Inside)</p> 	<p>Request to KOMIT</p> <ol style="list-style-type: none"> 1. Easy removable grille 2. Fine net to protect grille 3. Material of engine room sealing <p style="text-align: right;">20</p>	<p>Expected service life of radiator</p> <table border="1" data-bbox="300 237 517 741"> <thead> <tr> <th>No.</th> <th>Grill</th> <th>Direction of air from the reversible fan</th> <th>sealing of the engine room</th> <th>Expected service life</th> </tr> </thead> <tbody> <tr> <td>1</td> <td>detached</td> <td>Fixed (engine's side-outside)</td> <td>No sealing</td> <td>Less than 3 years</td> </tr> <tr> <td>2</td> <td>detached</td> <td>Changeable Summer (engine's side-outside) Winter (outside-engine's side)</td> <td>No sealing</td> <td>4 to 5 years</td> </tr> <tr> <td>3</td> <td>attached</td> <td>Changeable Summer (engine's side-outside) Winter (outside-engine's side)</td> <td>Sealing</td> <td>6 to 8 years</td> </tr> </tbody> </table> <p>1 radiator costs 13,721,220Tg, about 900,000 yen 1 grille costs 3,039,660Tg, about 189,000 yen</p> <p style="text-align: right;">21</p>	No.	Grill	Direction of air from the reversible fan	sealing of the engine room	Expected service life	1	detached	Fixed (engine's side-outside)	No sealing	Less than 3 years	2	detached	Changeable Summer (engine's side-outside) Winter (outside-engine's side)	No sealing	4 to 5 years	3	attached	Changeable Summer (engine's side-outside) Winter (outside-engine's side)	Sealing	6 to 8 years
No.	Grill	Direction of air from the reversible fan	sealing of the engine room	Expected service life																		
1	detached	Fixed (engine's side-outside)	No sealing	Less than 3 years																		
2	detached	Changeable Summer (engine's side-outside) Winter (outside-engine's side)	No sealing	4 to 5 years																		
3	attached	Changeable Summer (engine's side-outside) Winter (outside-engine's side)	Sealing	6 to 8 years																		
<p>Engine room sealing</p> 	<p>2. Workshop for analysis and evaluation of O&M report</p> <p>Date: Apr. 13th (Fri.), 2012 Place: Japan Mongolia culture center Time: 11:00 - 12:30 Participants: 14 participants •CMPUA CWS manager accountant •CMPUA NEDS accountant •6TUKs director or accountant</p> <p style="text-align: right;">23</p>	<p>Present condition</p> <p>Drivers TUK CMPUA EPWMD Daily report Monthly report O&M report</p> <p>Drivers TUK CMPUA EPWMD</p> <p>Motivation = useful, easy for TUKs = analysis and evaluation</p>																				
<p>Excel calculation and Pivot table</p> 		<p>3. Periodic service 2012 April</p> <p>Started date: Apr. 18th (Wed.), 2012 Place: CMPUA CWS Schedule: •ChD Apr. 18 5trucks •BGD Apr. 19 8trucks •SKhd Apr. 20 4trucks •KhUD Apr. 23 2trucks</p> <p style="text-align: right;">27</p>																				

Schedule and contents

Contents of periodic service

Date	Version 2						2803/2012
	Engine oil filter	Fuel filter	Air filter	Transmission Differential Oil	Hydraulic Oil	Power Steering oil	
Replacement interval	6	6	12	12	24	24	36
4/2011	✓	✓	✓	✓	✓	✓	✓
10/2011	✓	✓	✓	✓	✓	✓	✓
4/2012	✓	✓	✓	✓	✓	✓	✓
10/2012	✓	✓	✓	✓	✓	✓	✓
4/2013	✓	✓	✓	✓	✓	✓	✓
10/2013	✓	✓	✓	✓	✓	✓	✓
4/2014	✓	✓	✓	✓	✓	✓	✓
10/2014	✓	✓	✓	✓	✓	✓	✓
4/2015	✓	✓	✓	✓	✓	✓	✓
10/2015	✓	✓	✓	✓	✓	✓	✓
4/2016	✓	✓	✓	✓	✓	✓	✓
10/2016	✓	✓	✓	✓	✓	✓	28

4. Practical training for TUKs

Date: Apr. 23th (Mon.), 2012
Place: CMPUA CWS
Time: 14:00 - 16:00
Participants: CMS and 6TUKs engineer, mechanics, drivers

Contents of Practical training The unit of pressure

Tire pressure
 $2.2\text{kgf/cm}^2 = 220\text{KPa} = 31.0\text{PSI}$
 $1\text{kgf/cm}^2 = 98,000\text{Pa}$
 $98,000\text{Pa} = 98\text{KPa} \quad K=\text{Kilo}(1,000) = 100\text{KPa}$
 Tire pressure = 200 - 700 kPa (2~7kgf/cm²)
 Hydraulic pressure = 10 - 30 MPa (100~300kgf/cm²)



Objectives

- To understand the piping diagram of a hydraulic system
 - Confirming the hydraulic flow on a piping diagram by running a hydraulic system
- To utilize the spare parts catalogue of the hydraulic system
 - Finding required spare part / spare part number in a catalogue
- To adjust a valve switch timing
 - Detecting incorrect valve switch timing
 - Adjusting the valve switch timing
- To understand how to use an oil pressure gauge
 - Detecting problems by using an oil pressure gauge

Hydraulic circuit diagram

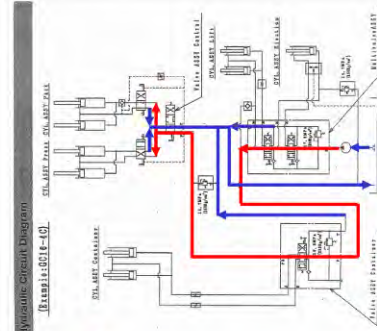

Concerning

No payment: SBD

Budget for 2012 October

Schedule

Topic	Expositor	Time
Opening address	Director of EPWMD	14:00 - 14:10
1. Contents of the workshop	JICA expert	14:10 - 14:15
2. Hydraulic system (Piping diagram, parts catalogue)	JOCV senior volunteer and JICA expert	14:15 - 14:45
3. Questions and comments	All participants	14:45 - 15:00
4. Practical training	All engineer and mechanics	15:00 - 16:00
5. Closing		16:00 -

5. Concerning of waste collection trucks



Condition of Trucks

Drivers and Operators

Information

- Mr. Uzawa and Oda will leave on 24th April 2012
- Mr. Kono will arrive on 30th April





Next Weekly Meeting

- 30 April 2012 at 8 AM

<p>Weekly Meeting (102) May 7, 2012 JICA Expert Team For Strengthening the Capacity for Solid Waste Management in Ulaanbaatar City</p> <p>1</p>	<p>Agenda</p> <ol style="list-style-type: none"> 1. Work Progress 2. Schedule for This Week 3. Subjects to be Discussed 4. Material Needed <p>2</p>	<p>1. Progress from April 30 to May 6</p> <ol style="list-style-type: none"> 1. Preparation of Revised M/P <ul style="list-style-type: none"> Summarize plan and achievement for implementing SWM M/P Analysis for proper operation of RPF plant 2. Implementation of PP1 Phase II by EPWMD <ul style="list-style-type: none"> Distribution of 3R booklet and brochure 3R TV program Video which introduce Japanese SWM history is under translation 3. Improvement of WB Operation <ul style="list-style-type: none"> MUB Web Server (temporary address: http://202.179.31.40/EW/) Permanent address: https://tuk.ulaanbaatar.mn 4. Analysis of POS answers in Excel Form 5. Investigation of large scale illegal dump sites 6. Submission of Progress Report No.5 <p>3</p>															
<p>2. Schedule from May 7 to 13</p> <ol style="list-style-type: none"> 1. Preparation of Revised M/P <ul style="list-style-type: none"> Summarize plan and achievement for implementing SWM M/P Finalize revised M/P 2. Implementation of PP1 Phase II by EPWMD <ul style="list-style-type: none"> Distribution of 3R booklet and brochure AOU meeting at BZD#15 Video which introduce Japanese SWM history is under translation 3. Improvement of WB Operation <ul style="list-style-type: none"> MUB Web Server (temporary address: http://202.179.31.40/EW/) Permanent address: https://tuk.ulaanbaatar.mn 4. Final Assessment of the Technical Cooperation Project <p>4</p>	<p>3. Subjects to be Discussed</p> <ol style="list-style-type: none"> a. Progress of Work for EPWMD b. Progress of Work for CMPUA c. Final Assessment of the Project d. Preparation of Revised M/P e. Proposal for Major Maintenance Work for Mitsubishi 15m3 CT <p>5</p>	<p>a. Progress of Work for EPWMD Apr 30 – May 6, 2012 By EPWMD staff</p>															
<p>b. Progress of Work for CMPUA Apr 30 – May 6, 2012 By CMPUA staff</p>	<p>Content of work conducted last week</p> <ol style="list-style-type: none"> 1. Regular landfill operations at NEDS and MDDS <ul style="list-style-type: none"> Daily soil covering operations are being conducted. There were two fires which informed promptly. Due to fuel line supply issue and heavy work load on only one bulldozer operator, the area was not covered. Cause of the fire is under investigation. Cleaning operation was completed on April 26. All staff attended. All staff meeting was held. Representatives of Japanese company visited NEDS together with Deputy Director and representatives of JICA volunteers visited NEDS on April 27. Inspectors from Capital City Inspection Agency visited and inspected the operations of NEDS, MDDS, RPF facility and Element LLC on May 1. Regular waste collection operations were conducted by the officials of Capital City Inspection Agency on May 1. 2. Regular waste collection operations in 15 khoroos of BZD 	<p>Weekly Disposal Amount (ton) 2012 IV/20-V/3</p> <table border="1"> <thead> <tr> <th></th> <th>(IV/20-26)</th> <th>(IV/27-V/3)</th> </tr> </thead> <tbody> <tr> <td>NEDS / weekly</td> <td>11,625</td> <td>9,621</td> </tr> <tr> <td>NEDS / daily average</td> <td>1,660</td> <td>1,374</td> </tr> <tr> <td>MDDS / weekly</td> <td>2,134</td> <td>618</td> </tr> <tr> <td>MDDS / daily average</td> <td>305</td> <td>88</td> </tr> </tbody> </table>		(IV/20-26)	(IV/27-V/3)	NEDS / weekly	11,625	9,621	NEDS / daily average	1,660	1,374	MDDS / weekly	2,134	618	MDDS / daily average	305	88
	(IV/20-26)	(IV/27-V/3)															
NEDS / weekly	11,625	9,621															
NEDS / daily average	1,660	1,374															
MDDS / weekly	2,134	618															
MDDS / daily average	305	88															

<p>Schedule for next week</p> <ul style="list-style-type: none"> 1. Regular landfill operations at NEDS and MDDS * (Solution of problem for electricity supply to WB in MDDS) 2. Regular waste collection operations in 15 khoroos of BZD <p style="text-align: right;">16</p>	<p>c. Final Assessment of the Project</p>	<p>Background</p> <ul style="list-style-type: none"> □ JICA Technical Cooperation Project receives two times evaluations. □ One is mid term evaluation which was conducted in May 2011. □ Second is final evaluation which will be conducted from 7 May to 19 May. □ Objective is to evaluate PDM is appropriate and Output is achieved according to PDM or not. 																																		
<p>Contents of Evaluation</p> <ul style="list-style-type: none"> □ Interview to CP and Stakeholders based on the pre-prepared questionnaire sheets. □ Field visit to Pilot Project Sites □ Presentation of outcome of the Project by CP 	<p>Contents of the Evaluation</p> <table border="1"> <thead> <tr> <th>Items</th> <th>Date</th> <th>Remarks</th> </tr> </thead> <tbody> <tr> <td>Interview to CP and Stakeholders</td> <td>7,8 May PM</td> <td>EPNWD and CMPUA</td> </tr> <tr> <td>Field visit to Pilot Project Sites</td> <td>9 May</td> <td>SBD7, Khud2, ???</td> </tr> <tr> <td>Presentation of outcome of the Project by CP</td> <td>15 May AM</td> <td>EPNWD and CMPUA</td> </tr> <tr> <td>Field visit to disposal NEDS and MDDS</td> <td>15 May PM</td> <td>CMPUA</td> </tr> <tr> <td>JCC No6 Presentation of evaluation results</td> <td>18 May AM</td> <td>Evaluation Team</td> </tr> </tbody> </table>	Items	Date	Remarks	Interview to CP and Stakeholders	7,8 May PM	EPNWD and CMPUA	Field visit to Pilot Project Sites	9 May	SBD7, Khud2, ???	Presentation of outcome of the Project by CP	15 May AM	EPNWD and CMPUA	Field visit to disposal NEDS and MDDS	15 May PM	CMPUA	JCC No6 Presentation of evaluation results	18 May AM	Evaluation Team	<p>Presentation of Outcome of the Project by CP</p> <table border="1"> <thead> <tr> <th>Item</th> <th>Presenter</th> </tr> </thead> <tbody> <tr> <td>OP1: Policy and Planning</td> <td>Mr. Ariguun</td> </tr> <tr> <td>OP2: O&M of Equipment</td> <td>Mr. Ariguun</td> </tr> <tr> <td>OP3: Operation of Disposal Site</td> <td>Mr. Amgalan</td> </tr> <tr> <td>OP4: SWM including Financial Aspects</td> <td>Ms. Mungunzul</td> </tr> <tr> <td>OP5: Public Awareness Raising</td> <td>Mr. Babilleg</td> </tr> <tr> <td>OP6: Recycling and Waste Separation1</td> <td>Mr. Odjargal</td> </tr> <tr> <td>: Recycling and Waste Separation2</td> <td>Mr. Iderchuluun</td> </tr> </tbody> </table>	Item	Presenter	OP1: Policy and Planning	Mr. Ariguun	OP2: O&M of Equipment	Mr. Ariguun	OP3: Operation of Disposal Site	Mr. Amgalan	OP4: SWM including Financial Aspects	Ms. Mungunzul	OP5: Public Awareness Raising	Mr. Babilleg	OP6: Recycling and Waste Separation1	Mr. Odjargal	: Recycling and Waste Separation2	Mr. Iderchuluun
Items	Date	Remarks																																		
Interview to CP and Stakeholders	7,8 May PM	EPNWD and CMPUA																																		
Field visit to Pilot Project Sites	9 May	SBD7, Khud2, ???																																		
Presentation of outcome of the Project by CP	15 May AM	EPNWD and CMPUA																																		
Field visit to disposal NEDS and MDDS	15 May PM	CMPUA																																		
JCC No6 Presentation of evaluation results	18 May AM	Evaluation Team																																		
Item	Presenter																																			
OP1: Policy and Planning	Mr. Ariguun																																			
OP2: O&M of Equipment	Mr. Ariguun																																			
OP3: Operation of Disposal Site	Mr. Amgalan																																			
OP4: SWM including Financial Aspects	Ms. Mungunzul																																			
OP5: Public Awareness Raising	Mr. Babilleg																																			
OP6: Recycling and Waste Separation1	Mr. Odjargal																																			
: Recycling and Waste Separation2	Mr. Iderchuluun																																			
<p>d. Preparation for Revised M/P</p>	<p>Achievement of M/P for Institutional System by March 2012 (1)</p> <p>1. M/P: Improvement of SWM Administration System = > ○</p> <p>Achievement:</p> <ul style="list-style-type: none"> □ Improvement of SWM Administration System of MUB => EPWMD (Plan & Control) & CMPUA (Operation) □ Improvement of SWM Administration System of District => District/PSD (Plan & Control) & TUK, etc. (Operation) <p style="text-align: right;">17</p>	<p>Achievement of M/P for Institutional System by March 2012(2)</p> <p>2. M/P: Capacity Development (CD) of Organization responsible for SWM => ○</p> <p>Achievement:</p> <ul style="list-style-type: none"> □ CD of EPWMD □ CD of CMPUA □ CD of PSDs <p style="text-align: right;">18</p>																																		

<p>Achievement of M/P for Institutional System by March 2012 (3)</p> <p>3. M/P: Promotion of Private Company Entry into SWM Services => ○</p> <p>Achievement:</p> <ul style="list-style-type: none"> <input type="checkbox"/> Entry of Private Companies into Waste Collection Service => TUK, TsY, etc. <input type="checkbox"/> Entry of Private Companies into Hazardous/ Infectious Healthcare Waste Management Service => Element Co. Ltd. <p style="text-align: right;">19</p>	<p>Achievement of M/P for Institutional System by March 2012 (4)</p> <p>4. M/P: Establishment of Systematic Monitoring and Information Management System for SWM => ○</p> <p>Achievement:</p> <ul style="list-style-type: none"> <input type="checkbox"/> Guideline on Estimation of Waste Collection Fee for Contractor <input type="checkbox"/> Management of Weighbridge Data of NEDS <input type="checkbox"/> Environment Monitoring of Disposal Site <p style="text-align: right;">20</p>	<p>Achievement of M/P for Institutional System by March 2012 (5)</p> <p>5. M/P: Development of Personnel Capacity Development Program => ○</p> <p>Achievement:</p> <ul style="list-style-type: none"> <input type="checkbox"/> Collection System Planning <input type="checkbox"/> Management of CMPUA Central Workshop <input type="checkbox"/> Final Disposal Site Management <input type="checkbox"/> Environmental Education <p style="text-align: right;">21</p>
<p>Achievement of M/P for Institutional System by March 2012 (6)</p> <p>6. M/P: Improvement of Legal Systems => ○</p> <p>Achievement:</p> <ul style="list-style-type: none"> <input type="checkbox"/> National Level <input type="checkbox"/> City Level <p style="text-align: right;">22</p>	<p>Achievement of M/P for Institutional System by March 2012 (7)</p> <p>7. M/P: Improvement of Collection and Management of Waste Collection Fee => △</p> <p>Achievement:</p> <ul style="list-style-type: none"> <input type="checkbox"/> Improvement of Waste Collection Fee Management <input type="checkbox"/> Improvement of Waste Fee Collection System in Ger Area <input type="checkbox"/> Improvement of Financial Management System on Waste Collection Service <p style="text-align: right;">23</p>	<p>Achievement of M/P for Institutional System by March 2012 (8)</p> <p>1. M/P: Establishment of Hazardous Waste Management => ○</p> <p>Achievement:</p> <ul style="list-style-type: none"> <input type="checkbox"/> Establishment of Hazardous/ Infectious Healthcare Waste Management <input type="checkbox"/> Improvement of Hazardous Industrial Waste Management <input type="checkbox"/> Improvement of Hazardous Household Waste Management <p style="text-align: right;">24</p>
<p>e. Major Maintenance Work for Mitsubishi 15m3 C/T</p>	<p>Background</p> <ul style="list-style-type: none"> <input type="checkbox"/> It has passed 3.5 years since Japanese GA equipment started to use. <input type="checkbox"/> It has experienced 4 times severe winter conditions. <input type="checkbox"/> It is required major repairing works in order to use in coming few years. <input type="checkbox"/> These preventive measures will prolong the life time of trucks. <input type="checkbox"/> New trucks have arrived and it is good timing to conduct this operation. <input type="checkbox"/> Mr. Matsuda will leave for Japan in November 2012 <input type="checkbox"/> This repairing work will be conducted at CMPUA CWS under the control of Mr. Matsuda, before his leave. 	<p>Hydraulic Cylinder: dismantling, cleaning, replacing oil seal, change hydraulic oil.</p>     <p>Back cylinder Tighten and Anti loosen agent will be applied</p> <p>Oil is leaked severely</p> <p>Press cylinder</p> <p>Dismantle and change oil seal</p>

<p>Reinforcement of Connection at Chassis Frame and Body</p>  <p>Insert Steel Plate and tighten bolt</p>	<p>Grease Ejection Cylinder</p>  <p>Grease</p> <p>Broken Pin Base</p>	<p>Top of Hopper</p>  <p>Reinforce by Welding</p> <p>Preventive Measures Keep truck in Warm Garaged</p> <p>Steel has brittle fracture in severe winter in UBC. No car manufacturer guarantee car under -30°C</p>	<p>f. 2nd Inspection on NEDS Landfilling Operation</p>	<p>Regular Inspection</p> <ul style="list-style-type: none"> <input type="checkbox"/> EPWMD has issued a guideline to inspect operation of NEDS in Aug 2010. <input type="checkbox"/> According to guideline, 1st inspection was carried out by 20 Oct 2010. <input type="checkbox"/> According to guideline, inspection shall be carried out every twice a year. <input type="checkbox"/> But there is no inspection after that. <input type="checkbox"/> When is the next inspection? 	<p>Information</p> <ul style="list-style-type: none"> <input type="checkbox"/> Mr. Oda will arrive on 7th May
<p>Next Weekly Meeting</p> <ul style="list-style-type: none"> <input type="checkbox"/> 14 May 2012 at 8 AM 		<p style="text-align: right;">34</p>			

Weekly Meeting (103)

May 21, 2012
JICA Expert Team
For Strengthening the Capacity
for Solid Waste Management in
Ulaanbaatar City

1

2. Schedule from May 20 to

1. Revised M/P
 - Finalization
2. Preparation for Separate Collection at Khud#2
3. Preparation for Strategic Plan for Public Awareness Raising on SWM
4. Recommendation Paper on Waste Separation and Recycling based on the Results of Pilot Project
5. Continuation of Major Repair Works for 23 Mitsubishi Compactor Trucks

4

Background

- 1st POS was conducted on Nov 2009 in order to investigate satisfaction level of the people on environment and sanitary conditions in UBC including SWM.
- 2nd POS was conducted on March 2012 in order to investigate the changes of the people's satisfaction level after the Project.

Agenda

1. Work Progress
2. Schedule for This Week
3. Subjects to be Discussed
4. Material Needed

2

3. Subjects to be Discussed

- a. Results of POS conducted on March 2012.
- b. Revised Master Plan
- c. Proposed Monthly Technical Meeting (MTM)
- d. Schedule

5

About Interviewee

400 from apartment area and 400 from ger area

Age	male	female	(Blank)	Total
16-23	1.5%	2.5%	0.0%	4.0%
24-29	4.5%	6.5%	0.0%	11.0%
30-35	4.6%	8.0%	0.0%	12.6%
36-41	5.3%	8.0%	0.1%	13.4%
42-47	5.0%	8.2%	0.0%	13.2%
48 above	16.5%	25.2%	0.4%	44.1%
(Blank)	0.0%	0.1%	1.6%	1.7%
Total	36.3%	36.6%	2.1%	100.0%

1. Progress from May 7 to May 20

1. Preparation of Revised M/P
 - Summarize plan and achievement for implementing SWM M/P
 - Finalize revised M/P
2. Implementation of PP1 Phase II by EPWMD
 - Distribution of 3R booklet and brochure
 - Distribution of 3R TV program
 - Video which introduce Japanese SWM history is under translation
3. Improvement of WB Operation
 - MUB Web Server (temporary address: <http://202.179.31.50/EVJ>)
 - Permanent address: <http://tuk.ulaanbaatar.mn>
4. Final Assessment of Technical Cooperation Project
 - May 14, Monitoring of NEDS Operations
5. May 16, Start of Major Repair Works for 23 Mitsubishi Compactor Trucks
6. May 18, JCC No6

3

a. Results of POS conducted on March 2012

Comparison of POS results in Nov 2009 and March 2012

Are you satisfied with urban environment and sanitary conditions in Ulaanbaatar City?

0-1-1	Apartment area			Ger area			Total		
	2009	2012	Change	2009	2012	Change	2009	2012	Change
1. Yes, it is very good	2.2%	1.1%	-1.1%	1.2%	0.3%	-0.9%	1.7%	0.6%	-1.1%
2. Yes, it is good	5.9%	4.5%	-1.4%	5.1%	3.0%	-2.1%	5.3%	3.9%	-1.4%
3. Yes, but it is average	35.8%	37.2%	1.4%	34.0%	33.8%	-0.2%	35.1%	36.4%	1.3%
4. No, it is poor	32.5%	34.2%	1.7%	38.6%	36.5%	-2.3%	35.8%	35.3%	-0.5%
5. No, it is very poor	22.6%	20.1%	-2.5%	18.6%	23.9%	4.8%	20.6%	21.8%	1.2%
(Blank)	1.0%	2.4%	1.4%	1.0%	3.0%	2.0%	1.0%	3.0%	2.0%
Total	100.0%	100.0%	0.0%	100.0%	100.0%	0.0%	100.0%	100.0%	0.0%
Share of ratings above average	43.6%	43.3%	-0.3%	40.8%	37.5%	-3.3%	42.1%	39.9%	-2.2%

Comparison of POS results in Nov 2009 and March 2012

Changes of rating in each district (Apartment Area)

Q1-1	BGD	BZD	CHD	KNUD	SBD	SKVD	Total
1. Yes, it is very good conditions	-1.0	1.5	2.0	-1.5	-6.3	-1.4	-1.1
2. Yes, it is good conditions	-1.0	-7.2	-1.8	8.6	-0.3	-4.2	0.3
3. Yes, but it is average conditions	-13.9	-19.4	-9.3	-2.8	-14.2	35.9	1.4
4. No, it is poor conditions	-5.5	-26.0	-2.7	4.3	0.4	-12.2	1.2
5. No, it is very poor conditions	-8.4	-2.3	3.3	-8.5	17.6	-16.8	-2.5
(Blank)	1.9	1.5	8.6	0.0	2.9	-1.4	1.9
Answers with ratings above average	11.9	-25.1	-9.1	4.3	-20.8	30.3	-0.5

Are you satisfied with Solid Waste Management services?

Changes in the shares in Apartment Area

Q2-1	BGD	BZD	CHD	KNUD	SBD	SKVD	Total
1. Yes, it is very good service	5.7	-1.4	2.0	-1.4	-3.3	0.0	0.1
2. Yes, it is good service	6.5	-11.8	-10.3	10.0	-9.9	-2.8	-3.0
3. Yes, it is average service	1.1	-16.5	0.9	-8.6	-6.6	4.2	-4.1
4. No, it is poor service	-12.3	12.7	1.0	-5.7	11.3	1.2	1.1
5. No, it is very poor service	6.8	16.8	-5.1	1.4	10.4	-1.2	2.9
(I do not know)	3.8	0.1	2.6	5.7	1.4	0.1	2.3
(Blank)	1.9	0.0	10.0	-1.5	-3.3	-1.4	6.6
Share of answers with ratings above average	13.3	-28.5	-7.4	8.0	-19.8	1.5	-7.6

Why aren't you satisfied with waste collection services

Q2-3	Apartment area	Ger area	Total
1. Waste collection manner is poor	25.5%	46.0%	24.3
2. Frequency of waste collection is not enough	16.6%	22.9%	15.0
3. Waste collection is not possible in the area	19.7%	13.4%	14.7
4. Waste collection is not possible in the area	9.3%	5.5%	7.4
5. Waste is not collected	2.4%	3.1%	2.8
6. Some people do not pay waste collection fee	15.9%	2.3%	10.6
7. Others	7.5%	2.3%	5.6
(Blank)	1.8%	1.8%	1.1
Total	100.0%	100.0%	100.0%

Comparison of POS results in Nov 2009 and March 2012

Changes in the share of answers in each district (Ger Area)

Q1-1	BGD	BZD	CHD	KNUD	SBD	SKVD	Total
1. Yes, it is very good conditions	-1.4	0.0	0.0	-4.3	0.0	0.1	-1.0
2. Yes, it is good conditions	-1.5	-2.8	-5.0	-2.9	0.4	0.2	-2.1
3. Yes, but it is average conditions	16.0	-2.4	2.3	-7.2	-7.8	-5.1	-0.7
4. No, it is poor conditions	-4.3	-6.7	-2.1	2.9	-8.2	4.3	-2.3
5. No, it is very poor conditions	-13.1	13.3	5.5	11.4	10.3	2.1	4.9
(Blank)	4.3	-1.4	0.2	0.0	5.5	-1.4	1.1
Share of ratings above average	13.1	-5.2	-3.7	-14.4	-7.5	-4.9	-3.8

Are you satisfied with Solid Waste Management services?

Changes in the shares in Ger Area

Q2-1	BGD	BZD	CHD	KNUD	SBD	SKVD	Total
1. Yes, it is very good service	0.0	-1.4	0.0	-2.3	0.0	-5.8	-1.7
2. Yes, it is good service	0.0	-21.4	-22.7	-7.1	-5.4	-9.9	-11.0
3. Yes, it is average service	-4.4	-31.3	4.3	-21.5	-20.5	1.0	-22.2
4. No, it is poor service	1.4	39.3	14.5	12.9	-1.0	9.9	12.8
5. No, it is very poor service	6.4	20.5	8.4	18.6	24.7	3.3	13.3
(I do not know)	-4.3	1.4	-1.5	0.0	3.2	1.5	0.1
(Blank)	2.8	-7.1	-3.0	0.0	-9.6	0.0	-1.4
Share of ratings above average	4.3	-54.1	-18.4	-31.5	-26.6	-14.7	-24.6

How do you evaluate waste management services of your Khoroos

Q2-6	Apartment area	Ger area	Total
1. very poor	1.7%	4.5%	2.8
2. poor	8.0%	5.9%	7.0%
3. average	38.0%	36.1%	37.7%
4. good	42.3%	38.8%	40.6%
5. very good	2.4%	3.7%	3.1%
(Blank)	7.9%	11.0%	9.5%
Subtotal	100.0%	100.0%	100.0%
Answers above average	62.7%	75.6%	69.2%

Comparison of POS results in Nov 2009 and March 2012

Are you satisfied with Solid Waste Management services?

Q2-1	Apartment area		Ger area		Total	
	2009	2012	2009	2012	2009	2012
1. Yes, it is very good service	1.5%	1.6%	0.1	2.2%	0.8%	4.7
2. Yes, it is good service	16.2%	7.2%	-9.0	13.7%	2.9%	-11.9
3. Yes, it is average service	45.1%	38.0%	-4.1	42.2%	30.9%	-12.2
4. No, it is poor service	33.1%	34.2%	1.1	28.4%	41.3%	12.8
5. No, it is very poor service	10.5%	13.6%	2.9	9.2%	22.5%	13.3
6. I do not know	1.2%	3.5%	2.3	1.4%	1.5%	0.1
(Blank)	1.5%	2.1%	0.6	2.9%	1.5%	-1.4
Total	100.0%	100.0%	100.0%	100.0%	100.0%	100.0%
Share of answers with ratings above average	53.9%	46.8%	-7.6	58.1%	43.3%	-24.9

What is the most serious problem on SWM in UBC

Q2-2	Apartment area		Ger area		Total	
	2009	2012	2009	2012	2009	2012
1. People's waste discharge manners are poor	38.3%	65.6%	29.3	35.9%	60.6%	24.7
2. Waste collection services are poor	6.5%	11.6%	5.0	12.4%	19.7%	7.3
3. Waste management is not appropriate	9.8%	9.1%	-0.7	5.7%	6.2%	0.5
4. There are no waste treatment facilities like an incineration	11.4%	4.3%	-7.1	10.9%	4.9%	-9.0
5. There are not enough SWM to conduct waste separation and recycling activities	16.9%	5.7%	-13.8	14.1%	4.3%	-9.6
6. Waste collection services are not enough	10.1%	1.4%	-8.7	11.7%	3.2%	-8.5
7. Public education activities are not enough	6.6%	1.7%	-4.3	8.3%	0.7%	-7.6
8. Others	1.0%	0.8%	-0.2	1.1%	0.1%	-1.0
(Blank)	0.5%	0.5%	0.0	0.3%	0.3	0.4
Total	100.0%	100.0%	100.0%	100.0%	100.0%	100.0%

How do you evaluate waste management services of your District

Q2-8	Apartment area	Ger area	Total
1. very poor	4.8%	4.5%	4.6
2. poor	13.6%	12.0%	12.8
3. average	50.9%	49.7%	50.3
4. good	18.2%	19.7%	19.0
5. very good	0.2%	2.1%	1.1
(Blank)	12.2%	12.8%	12.5
Subtotal	100.0%	100.0%	100.0%
Answers above average	69.8%	70.6%	70.2%

How do you evaluate waste management services of your City

Obj 6	Apartment area			General area			Total		
	2009	2012	change	2009	2012	change	2009	2012	change
1. very poor	14.2%	9.1%	-2.1	6.7%	15.0%	7.3	8.9%	12.7%	2.8
2. poor	20.2%	16.0%	-4.2	13.3%	16.8%	3.5	16.7%	16.4%	-0.3
3. average	41.1%	43.2%	1.9	39.8%	35.5%	-4.3	40.4%	39.1%	-1.3
4. good	9.7%	14.8%	4.7	15.7%	9.3%	-6.5	12.7%	14.8%	2.9
5. very good	32.8%	17.9%	-14.9	24.5%	20.9%	-3.6	24.5%	18.1%	-6.4
Subtotal	100.0%	100.0%	0	100.0%	100.0%	0	100.0%	100.0%	0
Absence above average	51.0%	59.4%	8.4	50.0%	46.8%	-3.2	51.5%	52.9%	1.4

Findings -2

- The number of serious problems existing in SWM of UBC has decreased from 4 to 2 since 2009. The most serious problems in SWM of UBC are (1) residents' poor discharge manner and (2) insufficiency of collection service.
- Residents' degree of satisfaction on waste collection service decreased by 16.9 points since 2009 as they have been demanding improvements in waste collection manner, collection frequency and reliability of the service provided by the collection companies

Achievement of M/P for Institutional System by March 2012 (1)

- 1. **M/P: Improvement of SWM Administration System =>** ○
Achievement:
□ Improvement of SWM Administration System of MUB => EPWMD (Plan & Control) & CMPUA (Operation)
□ Improvement of SWM Administration System of District => District/PSD (Plan & Control) & TUK, etc. (Operation)

25

Do you want to cooperate for separating your waste into "Recyclables and Non-Recyclables" in our house?

Obj 7	Apartment area			General area			Total		
	2009	2012	change	2009	2012	change	2009	2012	change
1. Yes, very much	16.6%	36.1%	20.5%	12.5	61.7%	49.2%	10.0	65.1%	55.1%
2. Yes, some extent	4.1%	6.7%	2.6	3.6%	7.6%	4.0	3.9%	7.2%	3.3
3. Not much	1.2%	0.9%	-0.3	1.0%	2.6%	1.6	1.1%	2.5%	1.4
4. Not at all	3.0%	0.8%	-2.2	8.4%	16.6%	8.2%	2.0	5.3%	3.3
5. (do not know)	2.2%	5.4%	3.2	4.2	4.3%	0.1	2.0	8.5%	6.5
Total	100.0%	100.0%	0	100.0%	100.0%	0	100.0%	100.0%	0
Withdrawn to companies	16.6%	70.7%	54.1	12.1	82.7%	70.6%	10.2	85.7%	75.5%

Conclusion

- MUB should pay attention to declining trend of residents' degree of satisfaction on SWM of UBC.
- It is essential to improve the quality of the SWM activities including collection, treatment and disposal by increasing collection frequency, introducing "Fixed-time and Fixed-point collections" and promoting 3Rs and recycling.

Achievement of M/P for Institutional System by March 2012(2)

- 2. **M/P: Capacity Development (CD) of Organization responsible for SWM =>** ○
Achievement:
□ CD of EPWMD
□ CD of CMPUA
□ CD of PSDs

26

Findings - 1

- Generally, residents' degree of satisfaction on urban environment and public sanitation has not been changed.
- The most serious problem in UBC is still air pollution. The next serious problems are solid waste issues and traffic congestions.
- Residents' degree of satisfaction on SWM activities decreased by 16.1 points as the indicator decreased drastically (by 24.9 points) in ger areas.

b. Revised Master Plan

Achievement of M/P for Institutional System by March 2012 (3)

- 3. **M/P: Promotion of Private Company Entry into SWM Services =>** ○
Achievement:
□ Entry of Private Companies into Waste Collection Service => TUK, Tsy, etc.
□ Entry of Private Companies into Hazardous/ Infectious Healthcare Waste Management Service => Element Co. Ltd.

27

<p>Achievement of M/P for Institutional System by March 2012 (4)</p> <p>4. M/P: Establishment of Systematic Monitoring and Information Management System for SWM => ○</p> <p>Achievement:</p> <ul style="list-style-type: none"> <input type="checkbox"/> Guideline on Estimation of Waste Collection Fee for Contractor <input type="checkbox"/> Management of Weighbridge Data of NEDS <input type="checkbox"/> Environment Monitoring of Disposal Site <p style="text-align: right;">28</p>	<p>Achievement of M/P for Institutional System by March 2012 (5)</p> <p>5. M/P: Development of Personnel Capacity Development Program => ○</p> <p>Achievement:</p> <ul style="list-style-type: none"> <input type="checkbox"/> Collection System Planning Workshop <input type="checkbox"/> Management of CMPUA Central <input type="checkbox"/> Final Disposal Site Management <input type="checkbox"/> Environmental Education <p style="text-align: right;">29</p>	<p>Achievement of M/P for Institutional System by March 2012 (6)</p> <p>6. M/P: Improvement of Legal Systems => ○</p> <p>Achievement:</p> <ul style="list-style-type: none"> <input type="checkbox"/> National Level <input type="checkbox"/> City Level <p style="text-align: right;">30</p>
<p>Achievement of M/P for Institutional System by March 2012 (7)</p> <p>7. M/P: Improvement of Collection and Management of Waste Collection Fee => △</p> <p>Achievement:</p> <ul style="list-style-type: none"> <input type="checkbox"/> Improvement of Waste Collection Fee Management <input type="checkbox"/> Improvement of Waste Fee Collection System in Ger Area <input type="checkbox"/> Improvement of Financial Management System on Waste Collection Service <p style="text-align: right;">31</p>	<p>Achievement of M/P for Institutional System by March 2012 (8)</p> <p>1. M/P: Establishment of Hazardous Waste Management => ○</p> <p>Achievement:</p> <ul style="list-style-type: none"> <input type="checkbox"/> Establishment of Hazardous/Infectious Healthcare Waste Management <input type="checkbox"/> Improvement of Hazardous Industrial Waste Management <input type="checkbox"/> Improvement of Hazardous Household Waste Management <p style="text-align: right;">32</p>	<p>c. Monthly Technical Meeting on SWM</p>
<p>Background</p> <ul style="list-style-type: none"> <input type="checkbox"/> Weekly meetings were held 103 times since Oct 26 2009. <input type="checkbox"/> This meeting is the last regular weekly meeting. <input type="checkbox"/> Monthly Technical Meeting (MTM) will be proposed for the persons who are interested to participate. <input type="checkbox"/> Chief Advisor is Mr. Sakata 	<p>Mr. Sakata's Background</p> <ul style="list-style-type: none"> <input type="checkbox"/> University graduate of Mechanical and Building Engineering <input type="checkbox"/> Joined Kajima Corporation which is one of biggest construction company <input type="checkbox"/> Head of New business development department <input type="checkbox"/> Development of waste transportation and treatment co. <input type="checkbox"/> Director of Municipal waste transportation co. <input type="checkbox"/> Establish private financed Incineration plant <input type="checkbox"/> Establish co. to produce recycled construction material <input type="checkbox"/> Chairman of ERS (Environmental Consultant) for 6 years <input type="checkbox"/> Expert of Japanese Archery 5 dan 	<p>Objective of the MTM</p> <ul style="list-style-type: none"> <input type="checkbox"/> Recognition of each duties <input type="checkbox"/> Mutual Cooperation <input type="checkbox"/> Think from Broader Point of View <input type="checkbox"/> Study New Technology <input type="checkbox"/> Study Management Know How

<p>Procedure for MTM</p> <ul style="list-style-type: none"> <input type="checkbox"/> Once a Month <input type="checkbox"/> Informant, Chairman, Clerk will be appointed from Participants. <input type="checkbox"/> Find problems by yourself and try to find solution by yourself. <input type="checkbox"/> Informant should prepare and distribute materials one week before MTM. 	<p>Fix Participants</p> <ul style="list-style-type: none"> <input type="checkbox"/> Please inform to JET project office by 25th May 2012 (Fri) <input type="checkbox"/> Venue: <input type="checkbox"/> Date: <input type="checkbox"/> Time: 	<p>d. Remaining Assignment</p>
<p>Information</p> <ul style="list-style-type: none"> <input type="checkbox"/> Mr. Kono will leave on 22nd May <input type="checkbox"/> Mr. Oda will leave on 30th May 	<p>Next Weekly Meeting</p> <ul style="list-style-type: none"> <input type="checkbox"/> Thank you for attending 103 weekly meetings and handing over to Monthly Technical Meeting <input type="checkbox"/> Scheduled to be on ??? Jun 2012. 	

K.2 Meeting Record

<p>Minutes of TCP Weekly Meeting (98) 8:00, 2 April 2012, at EPWMD</p> <p>Participants: Baatarsogt, Ariguun, Enkh-Amgalar, Batbileg, Mungunzul, Chantsalnurmaa EPWMD: Purevdorj, Enkhjargal CMPUA: Minami, Matsuda, Sakata, Kinoshita JICA: Kono, Shimura, Oda, Timujin, Enkhbadoral JET:</p> <p>Slide 4: Progress Kono clarified about the dates of the commencement of UB server for the WBD website operation and the POS data collection progress. Ariguun answered that the UB server is going to commence within one week. As for the POS, Batbileg answered that BZD has finished and SBD is going to finish this week.</p> <p>Slide 6: EPWMD progress EPWMD members are working in their respective responsible districts. EPWMD is collecting the waste collection reports from collection organizations on daily basis.</p> <p>Slide 7: CMPUA progress Enkhjargal informed that due to the bulldozers' engine overheating problems, the landfill operations has worsened significantly. The landfill site is full with non pushed waste. There were some improvements made over the weekend. It can be checked from today whether those improvements work or not. The audit inspection team worked at NEDS two times on Tuesday and Friday. Also, they have visited the WPS' Children welfare center (local NGO).</p> <p>Slide 11: Waste Fee Collection Rate in Ger area after introduction of New Fee Collection System Kono clarified about 23% fee deducted by the Power Distribution Company. Ariguun answered that the rate has been changed from 20 to 23 percent from 1 January 2012. The MUB was under pressure by Power Distribution Company that threatened to withdraw unless the fees are raised.</p> <p>Ariguun requested JET to conduct the Excel calculations in order to learn how the JET calculated the appropriate level for the waste collection and discharge fees. Ariguun needs those calculations to conduct negotiations with directors of collection organizations that complain that they cannot increase the number of waste collection trips even with the supply of new equipment since the amount of financing is not changing. Kono said that it can be possible (to increase number of trips) if cross subsidy between apartment and ger areas introduced. However, you have to negotiate with actual figures and not just having oral discussions. Ariguun said that according to the directors of collection organizations, even with the full collection of waste discharge fees from households and business entities it is not enough. That why, Ariguun needs those calculations to renegotiate with the directors of collection organizations who may have, for example, allocating too high profit for them.</p> <p>Slide 22: Basic Plan for Future Landfill Operation at TDDS Ariguun asked whether linear is needed at TDDS to protect soil from leachate. Kono replied you may install leachate collection pipe at the bottom of the fist embankment. NEDS has a concrete wall to collect leachate instead of installation of linear. The soil investigation survey is needed by drilling borehole to investigate the depth of concrete wall. As for the linear, it is not appropriate to install it for the cold climate conditions such as UB when the linear can break up easily. Ariguun asked</p>	<p>is it possible to landfill waste of illegally dumping nearby those sites. Shimura answered that it depends on nearby residential and manufacturing areas, water wells and etc.</p> <p>Purevdorj added that CMPUA has an understanding that TDDS is assigned as a final disposal site by the city government decision after the approval of the EIA report. As for the construction of TDDS, CMPUA is planning to rehabilitate a former dam surrounding the site made by previous brick factory to protect their site against water flow. The net fence shall be constructed phase by phase according to the amount of the budget approved.</p> <p>Baatarsogt expressed his appreciation for JET that responded to his request and worked together with CMPUA to prepare a landfill plan for TDDS. Kono said that the JET has received a request from Govi-Sumber aiming to cooperate on SWM of that aiming and Kono asked whether it is possible to cooperate. Baatarsogt replied it is possible to cooperate.</p> <p style="text-align: right;">Recorded by Enkhbadoral</p>
---	---

<p>Having informed this situation, Ms. Enkhjargal requested the JET to allow the CMPUA to remove radiator protection grills.</p> <p>As the JET considered that the first priority was to ensure normal condition at NEDS, the JET allowed to remove the grills and to operate two bulldozers. Mr. Uzawa emphasized that the utilization period of bulldozers would be shortened to 3 years if operating them without the grills and expressed his intention to continue finding solutions for the issue.</p> <p>Slide 11 to 14: Progress of 3R PR tool</p> <p>Mr. Oda presented the topic based on the slides.</p> <p>Slide 15: Calculation for Waste Collection Tariff</p> <p>As Mr. Ariguum, who had been decided to present the topic, attended the MUB meeting, the topic was not presented.</p> <p>Slide 16 to 20: Financial Analysis (Income & Expenditure) of Collection Service for Apartment and Ger Area</p> <p>Mr. Shimura presented the topic. The purpose of the topic was to provide EPWMD members with information about unit cost and unit income in order for them to explain the real condition in ger area collection to residents.</p> <p>Slide 21 to 26: Proposed A/P of SWM in MUB from 2013 to 2016</p> <p>Mr. Shimura presented the contents of the action plan. He requested the members to report the JET about any amendments made by the department.</p>	<p>Minutes of TCP Weekly Meeting (99)</p> <p>8:00, 9 Apr 2012, at EPWMD</p> <p>Participants: EPWMD: Ms. Chantsalurnmaa, Mr. Batbileg, Mr. Odjargal CMPUA: Mr. Purevdorj, Ms. Enkhjargal JICA: Mr. Matsuda, Mr. Sakata JOCV: Mr. Kinoshita JET: Mr. Shimura, Mr. Uzawa, Mr. Timujin, Mr. Gantumur</p> <p>Items discussed prior to the commencement of the meeting was the following:</p> <p>(1) Progress of POS: According to the EPWMD members, the filled questionnaires of the POS were collected. EPWMD will input the data and send it to the JET through email.</p> <p>(2) RPF facility: The RPF facility has not been handed over to the MUB. The KOICA experts will come on 15 Apr and hand it over to the MUB after conducting test-run. Based on the information, the JET decided not to visit the facility before the KOICA experts come to Mongolia.</p> <p>(3) Date for O&M training: The training on O&M of collection vehicles was planned on 19 Apr (Thu). Mr. Oda inquired whether the date was proper or not. Mr. Purevdorj considered that the date would be proper.</p> <p>Slide 6: Progress of Work Conducted by EPWMD</p> <p>Mr. Odjargal presented the progress of the work conducted by EPWMD last week. The contents of his presentation were as follows:</p> <p>Organization of cleaning campaigns: The Mayor of UBC ordered to conduct cleaning campaign "UBC without waste" for 2 months with his ordinance #229. During this campaign, districts will compete with their performance in cleaning, renovation of green facilities, maintenance of street lighting and road curbs. At the end of May, a district with best performance will be selected and awarded by the Mayor. As the campaign is overlapped with the elections planned for the election in terms of implementation period, the relevant cleaning activities will be organized every weekend during the 2 months. For the campaign, the MUB transferred necessary budgets to the districts. Socks, masks and gloves will be distributed to the participants on the spot during the implementation of the activities.</p> <p>All staffs of EPWMD have been working on organization of these activities.</p> <p>Participation in inspection of flood prevention facility: EPWMD members participated in an inspection on flood prevention facilities conducted by the Engineering Facility Department of the Mayor's Office last week.</p> <p>Mr. Oda requested EPWMD to allow Mr. Kinoshita to participate in the activities of the campaign.</p> <p>Slides 7 to 10: Progress of Work Conducted by CMPUA</p> <p>The NEDS operation was not normal last week. According to Ms. Enkhjargal, NEDS was not able to operate two bulldozers as engine overheating was resulted by the radiator grills. Since only one bulldozer operated at the site, waste leveling and soil coverage was not conducted sufficiently. As a result, fire broke out at the landfill site last Saturday and the NEDS have not distinguished the fire yet. The smoke limited the visibility making the bulldozer operation difficult. At the same time, the excavator was broke on Sunday and the cause of the breakdown was not clear.</p>
--	---

Recorded by Gantumur. B

<p>Minutes of TCP Weekly Meeting (100)</p> <p>8:00, 17 Apr 2012, at EPWMD</p> <p>Participants: EPWMD: Ms. Chantsalhurmaa, Mr. Batbileg, Mr. Ojijargal, Mr. Ariguan, Ms. Munganzul CMPUA: Mr. Purevdorj, Ms. Enkhjargal JICA: Ms. Solongo SV: Mr. Matsuda, Mr. Sakata JOCV: Mr. Kinoshita JET: Mr. Shimura, Mr. Uzawa, Mr. Oda, Mr. Timujiin, Mr. Gantumur</p> <p>Slide 6: Progress of Work Conducted by EPWMD</p> <p>Mr. Ojijargal presented the contents of work conducted by the department last week. The major activities were the following:</p> <ul style="list-style-type: none"> Preparation for cleaning campaign. In relation to the ordinance #229 by the City Mayor, the EPWMD members are conducting preparatory work for the cleaning campaign to be organized on 21 Apr 2012. According to Mr. Ojijargal, military units, their headquarters, schools and universities will participate in the activity. Distribution plan of trucks procured by Clean Air Foundation: According to Mr. Ariguan, Clean Air Foundation purchased 24 collection trucks for the MUB apart from the 163 that the MUB is procuring. The suppliers are Hyundai Motors Mongolia and Nomin Motors Company. The types of the trucks are compactor, dump and skip loader. EPWMD prepared a plan to distribute the trucks to the districts. EPWMD will send the plan to the JET later. All the trucks will be used in ger area collection, according to Mr. Ariguan. Mr. Shimura explained that the skip loader is not suitable for unpaved roads in ger area. Progress of the vehicle procurement: The contractors were already selected by each district. Currently, 14 vehicles have already been procured. 2 of them were received by CHD while the rest by SKHD. According to Mr. Ariguan, all the trucks will be supplied by the contractors by 20 May 2012. <p>Slides 7 to 10: Progress of Work Conducted by CMPUA</p> <p>As CMPUA members did not attend the meeting, Mr. Timujiin presented the contents of the slides about the contents of activities conducted by CMPUA.</p> <p>Slide 11 to 13: Progress of 3R PR Tool</p> <p>Mr. Oda presented the contents. He asked the EPWMD members about the expected schedule for the AOU meeting of BZD-15. According to Mr. Batbileg, he will try to organize the meeting this week. However, considering the convenience of Iboroo office, the meeting might be organized next week.</p> <p>Slide 14 to 17: Problem of Cross-subsidy from Apartment to Ger Area</p> <p>Mr. Shimura presented the topic.</p> <p>According to Mr. Ariguan, fee collection pattern where AOU collects waste fee exists mainly in newly developed apartments areas. According to laws and regulations, AOUs are not authorized to collect waste fee since this fee is considered as a part of local budget and the authorized organization is WSF. As WSFs are disbanded, the only way of</p>	<p>fee collection is through OSNAAG. Since the fee collection by OSNAAG is a practice in UBC, the problem in SKHD (faced by TUT) can be solved by a decision of the district government to collect fees through OSNAAG.</p> <p>Mr. Shimura emphasized that this kind of manner by AOU will be the biggest problem for UBC. EPWMD should not allow such kind of manner in order to ensure cross-subsidy to ger area collection. In his opinion, a possible countermeasure is to re-establish WSF. According to Mr. Ariguan, the MUB is intending to re-establish the WSF, and therefore, reflected a relevant provision in the draft of Law on Waste. However, the WSFs will be established after new parliament is formed this year. Although the law requires establishment of the WSF, selection and financing collection companies will be regulated by an independent regulation, according to Mr. Ariguan.</p> <p>Mr. Shimura advised EPWMD members to be careful about the current financial conditions of apartment and ger area collection when talking to other AOU in order to avoid possible problems in implementation of cross-subsidy from apartment to ger area. However, the members should introduce the condition to decision makers based on the relevant calculations as waste collection in ger area will not improve unless subsidized (even if number of collection trucks increase). If they understand the real condition, they will consider subsidizing ger area collection.</p> <p>Mr. Ariguan informed that EPWMD director had presented the condition to the city mayor. The mayor ordered EPWMD (Mr. Baatarsogt and Ms. Munganzul) to prepare necessary calculations for financing ger area losses. According to Mr. Ariguan, the mayor understands that the waste fee in ger have been set lower than the service cost; and therefore, he supports the idea financing ger area collection with tax system (Eko-tax or Municipal tax).</p> <p>Mr. Shimura expressed that the JET was willing to support Ms. Munganzul on the preparation of the calculations.</p> <p>Slide 18 to 27: Proposed Operation Plan for RPF Facility and Separate Collection</p> <p>Mr. Shimura presented the topic. He emphasized that the members should verify the capacities of equipments when KOICA experts arrive as the indicators are critical in planning. He presented the operation plan for RPF facility and expressed his willingness to answer any questions by the members related to the operation of the facility.</p> <p>Slide 28 to 36: Achievement of M/P for Institutional System by March 2012</p> <p>Due to the insufficient time left, the topic was not presented.</p> <p>Recorded by Gantumur. B</p>
---	---

Minutes of TCP Weekly Meeting (101)	8:00, 23 Apr 2012, at EPMWD
<p>The waste amount is increasing since TUKS' collection capacity improved. 314 vehicles worked on Saturday, conducted 559 trips and transported 2600 ton waste. 3 dispatchers worked at the weighbridge since number of vehicles worked on the day was many. On the day, NEDS operated until 3:00 a.m., Sunday.</p> <p>The MUB requests the CMPUA to operate NEDS 24 hours a day. However, NEDS has not been operating 24 hours a day since lighting at the landfill site is not sufficient (It operates until 11 p.m. to 00 a.m.). She requested the EPWMD to improve the lighting as soon as possible.</p> <p>Slide 11 to 13: Progress of 3R PR Tool</p> <p>Mr. Oda presented the topic. He asked when the AOU meeting would be organized in BGD-15 khoroo. Mr. Ariguun answered that the meeting would be organized this week.</p> <p>Slide 14 to 38: Operation and Maintenance</p> <p>Mr. Uzawa presented the topic.</p> <p>At the end of the meeting, Mr. Oda reminded Mr. Ariguun to send the file of POS to the JET as soon as possible. Mr. Ariguun promised to send the file on the day of the meeting (23 Apr 2012).</p> <p>Recorded by Gantumur. B</p>	<p>Participants: EPWMD: Ms. Chantsalnurmaa, Mr. Ariguun CMPUA: Ms. Enkhjargal JICA: Ms. Minami JET: Mr. Uzawa, Mr. Oda, Mr. Timujijn, Mr. Gantumur</p> <p>Mr. Oda asked the progress of the improvement of the server for the MUB website. Although Mr. Ariguun could not contacted with Mr. Bayaraa, he hoped that the task had been finished.</p> <p>In relation to the Japanese documentary video on SWM, Mr. Ariguun inquired whether the documentary reflects the current conditions of SWM in Japan. Mr. Kinoshita informed that the video does not include the current conditions. However, Mr. Sakata informed that a video showing the current condition was already given to Mr. Batarartsogt. Mr. Ariguun requested the JET to translate this video together with the documentary video.</p> <p>Mr. Ariguun informed that he could not attend the workshop on O&M of collection vehicles scheduled on 22 Apr 2012. He thought that he should be in his office since Mr. Batarartsogt would be absent. Mr. Oda asked him to appoint a member who will facilitate the workshop. Mr. Ariguun suggested that Mr. Luvsandagva, the chief of the central workshop, facilitates the workshop.</p> <p>Slide 6: Progress of Work Conducted by EPWMD</p> <p>Organization of cleaning campaign: All members worked on cleaning campaign last Saturday. The activity was effective. However, the wind was strong after the cleaning so that the result of the cleaning might have been affected.</p> <p>Calculation of necessary subsidy for ger area collection: In order to operate the 163 vehicles (that the MUB has been purchasing) normally for the second half of 2012, the department is trying to ensure necessary subsidy. As the Municipal budget for 2012 is amended in May, the department prepared necessary calculation for the subsidy and submitted to the State Treasury Department.</p> <p>As the subsidy is for ger area collection, the department considered that a vehicle conducts 1 trip on a day in the calculation. Operation costs were based on the calculations by Districts/TUKs.</p> <p>Mr. Fujita's guideline was not employed in the calculation. Mr. Ariguun considers that the cost will be high if it was used in the calculation. In order to get the budget approved by the City Council, the cost should not be so high. Therefore, the calculation was based on the proposals submitted by districts.</p> <p>Mr. Oda requested Mr. Ariguun to send a copy of the calculation to the JET. Mr. Ariguun accepted his request and decided to send the file after the meeting.</p> <p>Slides 7 to 10: Progress of Work Conducted by CMPUA</p> <p>Operation of NEDS was normal. Radiator grills were removed. As wind is strong, the agency is trying to conduct soil coverage daily.</p>

<p style="text-align: center;">Minutes of TCP Weekly Meeting (102)</p> <p style="text-align: center;">8:00, 7 May 2012, at EPMWD</p> <p>Participants: EPWMD: Mr. Baatarsogt, Ms. Chamsalnurmaa, Mr. Batbileg, Mr. Arigunuu, Mr. Odjargal CMPUA: Mr. Purevdorj, Ms. Enkhjargal JICA: SY: Mr. Matsuda, Mr. Sakata JET: Mr. Kono, Mr. Timujin, Mr. Gantumur</p> <p>In relation to the progress of the project activities Mr. Kono inquired when AOU meeting will be organized in BZD-15 khoroo. BZD meeting will be organized this week, according to Mr. Bilgee. Mr. Kono requested him to fix the date and inform to the JET.</p> <p>Any detailed info on web? If users access the web, will they get information now? Mr. Bilgee does not know.</p> <p>Mr. Kono requested EPWMD to distribute progress reports from those handed to the department by the JET.</p> <p>Slide 6: Progress of Work Conducted by EPWMD</p> <p>Mr. Batbileg presented the contents of the work conducted by the department. According to him, the department paid much attention on monitoring and organization of cleaning campaigns and removal of illegally dumped accumulated waste on weekends. Last weekend, cleaning of river beds was organized.</p> <p>EPWMD in cooperation with Municipal Specialized Inspection Department (MSID) and Mongolian National Broadcaster (MNB=TV) has been preparing a promotion video or TV program on illegal dumping. According to Mr. Batbileg, the department intends to catch illegal dumping on the spot, get the MSID taken penalty on the illegal dumping and reflect the conditions in the program.</p> <p>Mr. Batbileg informed that the MONET and district governments had signed a cooperation contract on elimination of illegal dump sites and the MONET donated necessary fund to the districts for cleaning of illegally dumped waste.</p> <p>Regarding the cleaning activity, Mr. Kono asked how the cleaning campaigns were financed. According to Mr. Batbileg, cleaning campaigns are usually financed from district budgets.</p>	<p>Slide 11 to 15: Final Assessment of the Project</p> <p>Mr. Kono presented the topic based on the slides. He explained how the assessment would be implemented and presented the schedule of the assessment team. He also reminded the EPWMD members to fill and send the questionnaire of the final assessment.</p> <p>In relation to C/P presentation on 15 May, Mr. Kono presented the agenda of the meeting, presentations to be done and person in charge of each presentation.</p> <p>Slide 16 to 24: Preparation for Revised M/P</p> <p>The topic was not presented.</p> <p>Slide 25 to 30: Major Maintenance Work for Mitsubishi 15 m3 CT</p> <p>Mr. Kono presented the topic. According to him, the decision was made based on the results of the periodic inspection conducted last Apr at the central workshop. Mr. Matsuda will take initiative in the maintenance. As his assignment will end in Sep 2012, this maintenance should be done during his stay in UBC.</p> <p>He emphasized that the central workshop was built during the grant aid. The purpose of the facility was to conduct maintenance for all collection vehicles of UBC. As the MUB has been purchasing vehicles from other countries than Japan, these vehicles should also be maintained at the workshop based on a schedule.</p> <p>At the end of the presentation, Mr. Kono informed that the Project would bear of maintenance cost of the 1st truck. Based on this, the JET will estimate all types of maintenance costs including the workmanship of CMPUA and prepare maintenance plan.</p> <p>The target vehicles will be Mitsubishi 15 m3 compactor trucks, according to Mr. Kono.</p> <p>Mr. Kono presented the contents of the maintenance based on the slides.</p> <p>Slide 31 to 32: 2nd Inspection on NEDS Landfilling Operation</p> <p>Mr. Baatarsogt suggested that the department should conduct monitoring shortly and present the results of the monitoring during the meetings scheduled in this May. Mr. Kono and Mr. Baatarsogt discussed and decided to present the results of the monitoring on the JCC meeting on 18 May. Mr. Odjargal from EPWMD and Mr. Purevdorj from CMPUA will be in charge of monitoring.</p> <p>Mr. Kono informed that CMPUA has been receiving huge amount of waste currently, therefore, EPWMD should allow the agency to push the current waste and conduct monitoring just before 18 May. In Mr. Baatarsogt's opinion, conducting monitoring after improving the current condition of the site is not good. On contrary, the monitoring should be organized shortly in order to identify necessary improvement measures. However, Mr. Baatarsogt recommended Mr. Purevdorj to decide the date of monitoring.</p> <p>Mr. Purevdorj considers that the monitoring should be organized in order to improve the operation of final disposal sites and expressed his willingness to participate in the monitoring. He considers that the monitoring should be organized around the middle of May as Mr. Odjargal recommends. As he reported there were several issues that should be solved such as electricity supply at MDDS and lighting at landfill site at NEDS.</p> <p>The JET and the members decided to organize monitoring on 14 May.</p> <p>Although the guideline of the monitoring was approved on 2010, Mr. Baatarsogt recommended this guideline should be updated. Mr. Kono requested Mr. Baatarsogt to inform the JET about any items that needs updating. Mr. Baatarsogt agreed.</p> <p>Mr. Baatarsogt recommended CMPUA to prepare a list of spare parts that are needed for the future. Before the completion of the project, we had better to submit official request to Japanese side to supply the spare parts. Even it was impossible, we still needs to try. Mr. Kono explained that supplying spare parts under the technical cooperation project is quite difficult. However, we will try to lengthen the utilization period of the equipment. The maintenance of the vehicles should be paid by TUKs since these organizations are making profit using these trucks. As I mentioned before, Kokusai Kogyo Company, but not JICA, will bear the 1st truck.</p> <p style="text-align: right;">Recorded by Gantumur. B</p>
<p>Slides 7 to 10: Progress of Work Conducted by CMPUA</p> <p>Ms. Enkhjargal presented the topic. According to her, fire broke out at NEDS last Sunday. The main reasons for the outbreak of the fire are (1) waste that is received during the nights includes fire in it, and (2) dry season. Although bulldozer and water truck worked at the site and distinguished the fire, smoke still remains.</p> <p>Smoke at MDDS has existed since the beginning of the winter. Although the agency sent water truck to MDDS last weekend, they could not distinguish the smoke as the water truck could not approach the spot.</p> <p>Although CMPUA was intending to conduct soil coverage at NEDS last weekend, they could not manage to complete the task. The agency is intending to conduct soil coverage today.</p> <p>Mr. Kono pointed out that 1,500 tons of waste came to the final disposal sites daily, and therefore, the disposal site operations might be influenced by this increased amount of waste. In that case, 3 bulldozers have to work according to the plan. As the agency is in short of bulldozer operators, he recommended CMPUA to train operators by themselves for their operation.</p> <p>Mr. Kono emphasized that MSID worked at NEDS last week and asked whether the department inspects the landfill site regularly. According to Ms. Enkhjargal, the inspection was not conducted last year. As she understands, the department inspected the operation of Element Co., and checked the NEDS at the same time.</p>	

Minutes of TCP Weekly Meeting (103)

8:00, 21 May 2012, at EPMWD

Participants

EPWMD: Mr. Bazarzorig, Ms. Chantsalnurmaa, Mr. Ariguun
CMPUA: Ms. Enkijjargal
JICA: Ms. Minami **SY:** Mr. Matsuda, Mr. Sakata
JET: Mr. Kono, Mr. Oda, Mr. Timuijin, Mr. Gantumur

JOCY: Mr. Kinoshita

In the beginning of the meeting, Mr. Kono informed that C/P members did not need to present the contents of work conducted by their organizations last week as the time for the meeting is not sufficient for the prepared topics.

The contents of the presentations and relevant discussions were the following:

Slide 5 to 22: Results of POS conducted in Mar 2012

Mr. Kono introduced the results of the POS based on the slides.

Slide 23 to 31: Revised Master Plan

Mr. Kono presented the contents of the revised M/P and requested the members to let him know their opinions of adjustments.

Slide 32 to 37: Monthly Technical Meeting on SWM

Mr. Kono informed that the weekly meeting of the TCP would be finished with this meeting, and instead of it, he recommended that the C/P members to organize monthly technical meeting with the support of Mr. Sakata, a JICA's senior volunteer.

He introduced Mr. Sakata's background and purposes and principles of the monthly technical meetings. He requested the C/P members to decide venue, date and time of the monthly meeting and inform the results to the JET. Mr. Ariguun said that it is possible to organize this meeting at the meeting room of the Mayor's Office. The date and time will be fixed two or three days before the meeting.

Mr. Ariguun asked whether the JET interpreters would participate in the monthly meeting. Mr. Kono informed that JET interpreters would participate in these meetings.

Slide 38: Remaining Assignment

Mr. Kono presented the assignment table of the JET. He recommended the members to ask Mr. Shimura in August if they have any questions on revised M/P.

Other:

Mr. Ariguun asked if it is possible you prepare a guideline for estimating the required number of trucks for waste collection in UBC. Mr. Kono replied that method of calculation for identification of appropriate number of vehicles had already been reflected in the guideline for calculation of appropriate collection fee. Mr. Oda will explain the detailed methodology next week.

Recorded by Gantumur. B