

5. Field Report

**PREPARATORY SURVEY
ON
THE PROJECT
FOR
IMPROVEMENT OF THE POWER DISTRIBUTION SYSTEM
IN
THE REPUBLIC OF GHANA**

THE SECOND FIELD SURVEY

FIELD REPORT

February 21st, 2011

Presented and submitted by:

Mr. Masatsugu KOMIYA
JICA Study Team
Chief Consultant
Japan International Cooperation Agency
(JICA)

Confirmed by:

Mr. Kirk Koffi
Deputy Chief Executive
Volta River Authority (VRA)

Witness

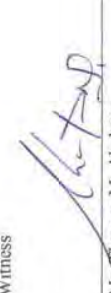
Mr. Thomas M. Akabzaa
Chief Director
Ministry of Energy (MOE)
Republic of Ghana

1. Introduction

In order to build mutual understanding between the Ghanaian side and the Second Preparatory Survey Team (hereinafter referred to as "the Team") for the Project for Improvement of the Distribution System in the Republic of Ghana (hereinafter referred to as "the Project") on the technical and engineering aspects, this Field Report has been prepared based on the results of the second field survey and discussions with the Ghanaian side, i.e., Volta River Authority - Northern Electricity Department (VRA-NED) and Ministry of Energy (MOE).

It has been confirmed by the Ghanaian side and the Team that the candidate components of the Project are as shown as follows in the Minutes of Discussions (M/D) signed by both parties on 28th January, 2011. However, the final components of the Project will be decided by the Government of Japan.

Table 1 Summary of the Project

	Improvement of Tamale distribution system	Improvement of Sunyani distribution system
Procurement and Installation	<p>(1) Construction of UDS Primary Substation</p> <ul style="list-style-type: none"> ➢ 1 set of 34.5/11.5kV Transformer, 7.5MVA ➢ 2 sets of 34.5kV Switchgear Cubicle ➢ 5 sets of 11.5kV Switchgear Cubicle ➢ 11.5/0.433kV Station Transformer, 100kVA ➢ Substation Building (Approx. 260m²) <p>(2) Installation of a 34.5 kV Sub-transmission Line from Tamale BSP to UDS Primary Substation (Approx. 19km including 5km underground cable)</p> <p>(3) Installation of 11.5kV Distribution Lines from UDS Primary Substation for connection with the existing lines:</p> <ul style="list-style-type: none"> 1. UDS Feeder Approx. 0.2km 2. Tolon Feeder Approx. 0.7km 3. Sheshagna Feeder Approx. 0.3km <p>(4) Extension of 34.5kV Switchgear in Tamale BSP</p> <ul style="list-style-type: none"> ➢ 3 sets of 34.5kV Switchgear Cubicle 	<p>(1) Construction of Kokokrom Primary Substation</p> <ul style="list-style-type: none"> ➢ 1 set of 34.5/11.5kV Transformer, 7.5MVA ➢ 2 sets of 34.5kV Switchgear Cubicle ➢ 5 sets of 11.5kV Switchgear Cubicle ➢ 11.5/0.433kV Station Transformer, 100kVA ➢ Substation Building (Approx. 260m²) <p>(2) Installation of a 34.5 kV Sub-transmission Line from Sunyani BSP to Kokokrom Primary Substation (Approx. 8.5km including 0.5km underground cable)</p> <p>(3) Installation of 11.5 kV Distribution Lines from Kokokrom Primary Substation for connection with the existing lines:</p> <ul style="list-style-type: none"> 1. Hospital Feeder Approx. 4.3km 2. New Dormma Feeder Approx. 0.6km 3. Chiraa Feeder Approx. 0.7km <p>(4) Extension of 34.5kV Switchgear in Sunyani BSP</p> <ul style="list-style-type: none"> ➢ 3 sets of 34.5kV Switchgear Cubicle <p>(5) 11.5 kV Ring Main Unit at Sunyani Regional Hospital</p> <p>(1) Maintenance equipment and tools</p> <ul style="list-style-type: none"> ➢ 1 set of Cable fault detector ➢ 1 unit of Truck with an aerial bucket ➢ Spare parts and maintenance tools
Procurement	<p>(1) Maintenance equipment and tools</p> <ul style="list-style-type: none"> ➢ 1 set of Cable fault detector ➢ 1 unit of Truck with an aerial bucket ➢ Spare parts and maintenance tools 	<p>(1) Maintenance equipment and tools</p> <ul style="list-style-type: none"> ➢ 1 set of Cable fault detector ➢ 1 unit of Truck with an aerial bucket ➢ Spare parts and maintenance tools

2. Project Site Information

2.1 Project Site Locations

The new primary substation, i.e., UDS primary substation, will be located near the UDS (University of Development Study) in western area of Tamale District, where severe voltage drop in 11.5kV lines is expected by increase of demand in Distribution System Master Plan Study prepared by JICA.

The new primary substation, i.e., Kotokrom primary substation, will be located in eastern area of Sunyani District and will contribute to improvement of power supply to north-eastern half of the Sunyani District.

The Project Site Locations are shown as Fig. 1.

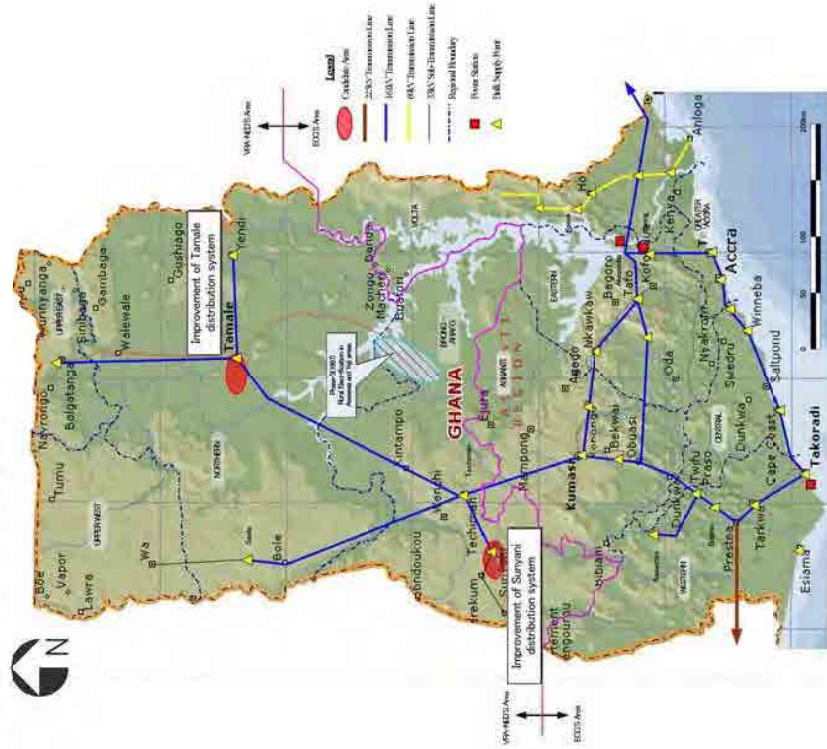

Fig. 1 Project Site Locations

2.2 Beneficiary of the Project

2.2.1 Tamale

(1) Primary beneficiaries

1) Consumers

- The existing consumers: 5,084 households
- The waiting consumers: 3,916 households
- Total beneficiaries: 9,000 households (approximately 66,600 populations¹⁾)

2) Public Facilities

(a) Hospitals

- First beneficiaries: 4,498 patients/month (accumulated) of three medical centers
- Second beneficiaries: 36 medical staffs of three medical centers. They will be relieved from risks of medical accidents because the blackout, fluctuation, low voltage and the damages on the medical equipment will decrease with the stable electric supply by the Project.

Table 2 Major Beneficiaries of Hospitals in the Tamale Project (Monthly)

No.	Name of Hospital	Outpatient	Inpatient	Surgery	Emergency	Total*	Medical staff
1	God Cares Community Hospital	1,500	500	6	40	2,046	1 doctor 3 parttime doctors 5 nurses 2 midwives 8 nurse assistants
2	Tolon Health Center	1,250	-	-	20	1,270	1 medical assistant 2 nurses 8 community nurses
3	Nyankpala Health Center	1,167	-	-	15	1,182	2 midwives 4 community nurses
4	Total	3,917	500	6	40	4,498	36 medical staffs

Note: * Accumulated figure

(b) Schools

- First beneficiaries: 2,095 students (Boarders using more electricity in the night)
- Second beneficiaries: 2,872 students (higher educational students before getting jobs, excluding the boarders)
- Third beneficiaries: 17,959 students (lower educational: primary and secondary school students)
- Total beneficiaries: 22,926 students

¹ Mean household size of 7.4 persons of Northern Region by the Census 2000

Table 3 Major Beneficiaries of Schools in the Tamale Project

No.	Name	No. of Students	No. of Boarders	No. of Teachers
1	University Development of Study (UDS)/Faculty of Agriculture	2,300	1,000	78
2	Grich Business College	100	90	10
3	Tamale Vocational Training Institute	180	45	11
4	Bisco High School	1,600	800	68
5	Tolon High School	787	160	32
6	Subtotal	4,967	2,095	199
7	The other Primary/Secondary Schools	17,959	-	-
8	Total	22,926	2,095	199

(2) Secondary beneficiaries

- Communities supported by Nyanaspala and Tolon Health Centers outreach service including immunization: 79 communities (approximately 75,200 populations)
- Students including boarders and teachers close to the Project feeder: 10,863 students. The schools in Table 4 are out of the Project feeder but they can also obtain benefit because their feeder line's electric load will be reduced with the Project.

Table 4 Secondary Beneficiaries of Schools in the Tamale Project

No.	Name	No. of Students	No. of Boarders	No. of Teachers
1	TACE Training School (for Teachers)	850	567	43
2	Batco Training School (for teachers)	830	500	48
3	Tamale Polytechnic	6,500	877	250
4	Tamasco High School	2,583	2,583	104
5	Ghana Institute of Language	100	-	7
6	Total	10,863	2,583	452

2.2.2 Sunyani

(1) Primary beneficiaries

1) Consumers

- The existing consumers: 4,577 households
- The waiting consumers: 4,380 households
- Total beneficiaries: 8,957 households (approximately 47,500 populations²)

2) Public Facilities

(a) Hospitals

- First beneficiaries: 20,807 patients/month (accumulated) of two medical centers
- Second beneficiaries: 366 medical staffs of two medical centers. They will be relieved from risks of medical accidents because the blackout, fluctuation, low voltage and the damages on the medical equipment will decrease with the stable electric supply by the

² Mean household size of 5.3 persons of Brong-Ahafo Region by the Census/2000

Project:

Table 4 Major Beneficiaries of Hospitals in the Sunyani Project (Monthly)

No.	Name of Hospital	Outpatient	Inpatient	Surgery	Emergency	Total*	Medical staff
1	Sunyami Regional Hospital	17,800	1,368	300	410	19,878	58 doctors 294 nurses
2	Chiraa Health Center	929	-	-	-	929	1 medical assistant 10 community nurses
3	Total	18,729	1,368	300	410	20,807	366 medical staffs

Note: * Accumulated figure

(b) Schools

- First beneficiaries: 969 students (Boarders using more electricity in the night)
- Second beneficiaries: 2,313 students (higher educational students before getting jobs, excluding the boarders)
- Third beneficiaries: 23,310 students (lower educational: primary/secondary school students)
- Total beneficiaries: 26,592 students

Table 5 Major Beneficiaries of Students and Boarders of the Sunyani Project

No.	Name	No. of Students	No. of Boarders	No. of Teachers
1	Nurse Training School Sunyani	437	300	12
2	Catholic Technical Institute (Electrical Installation)	65	49	5
3	Sunyami Business School	450	300	20
4	Chiraa High School	1,010	320	34
5	Twene Amanfo High School	1,320	-	-
6	Subtotal	3,282	969	71
7	The other Primary/Secondary Schools	23,310	-	-
8	Total	26,592	969	71

(2) Secondary beneficiaries

- Communities supported by Sunyani Regional Hospital outreach service: 169 communities (approximately 600,000 populations) are subjected.
- Sunyani Regional Hospital outreaches other areas for medical cares. They daily dispatches a team consist of doctors and nurses for several hospitals to assist them. They also hold training workshops for midwives and nurses working in rural areas. Some graduates of Nurse Training School Sunyani will also be allocated for community healthcare facilities.

3.1.2 Environmental Permit (EP)

VRA will register respective regional offices of Environmental Protection Agency (EPA) the Project attaching necessary documents to obtain an Environmental Permit (EP). EPA will assess the documents and decide to issue the EP, to require EIA or Preliminary Environmental Report (PER). According to the Environmental Impact Assessment Guideline for the Energy Sector, the PER will be expected to obtain the EP for the Project. The Environmental Department of VRA will be in charged for the EP matter.

3. Design Conditions and Technical Specifications

3.1 Design Conditions

Design conditions to be applied to the Project are described as follows.

3.1.1 Climatic Conditions

Natural conditions for the equipment and facilities design are described as follows.

Table 8 Climatic Conditions

Region	Northern and Brong-Ahafo	
Altitude	Less than 1,000m	
Ambient Temperature	Maximum	40°C
	Minimum	10°C
	Mean	30°C
Maximum Humidity	85%	
Max. Wind Velocity	34m/sec.	
Rainfall	800mm/year	
Seismic Force	Horizontal 0.1G	
Soil Bearing Capacity	5 ton/m ²	

3.1.2 Basic Electrical Design Conditions

Basic conditions for designing electrical equipment and materials are described as follows.

Table 9 Basic Electrical Design Conditions

Item	Distribution System	Station Service Power
Nominal Voltage	34.5kV	11.5kV AC 415/240V DC 125V
Maximum Voltage	36 kV	12kV AC 435/252V DC 131V
Frequency	50Hz	
Rated Short-time Withstand Current	25kA (1sec.)	12.5kA (1sec.)
Lightning Impulse Withstand Voltage (LIWV)	170 kV	75kV
Earthing System	Effective Earthing System	
		N/A

Item	Distribution System		Station Service Power
	Outdoor: IP43	Indoor: IP20	
Protection Class (IP)			
Minimum Creepage Distance of Insulator	25mmkV	N/A	N/A
Minimum Clearance of Bare Conductor			
Phase to Phase (mm)	370	315	N/A
Phase to Ground (mm)	320	220	N/A
Minimum Height of Bare Conductor	above the Ground Level		
Road side (m)	6	6	N/A
Road crossing (m)	7	7	N/A

3.1.3 Applicable Codes / Standards and Units

With regard to the Project design, relevant international standards such as IEC, ISO and Japanese standards are applied to the major functions of equipment and facilities in conformity with the existing electrical equipment and facilities in Ghana. For the system of units, the International System of Units (SI) is applied.

- International Electrotechnical Commission (IEC): Applied to major functions of electrical products in general
- International Standardization Organization (ISO): Applied to performance evaluation of industrial products in general
- Japanese Industrial Standard (JIS): Applied to industrial products in general
- Japanese Electrotechnical Commission (JEC): Applied to electrical products in general
- Standards for Japan Electrical Manufacturer's Association (JEM): Same as above
- Japanese Electrical Wire and Cable Maker's Association (JCS): Applied to electric wire and cables
- Relevant Technical Standards on Electrical Installation: Applied to electrical work in general

3.2 Basic Plans of Components

3.2.1 Improvement of Tamale distribution system in Northern Region

(1) Construction of UDS Primary Substation

One (1) set of new step down transformer (34.5/11.5kV, 7.5MVA with On Load Tap Changer) shall be installed in outdoor. The 34.5kV switchgear cubicles, 11.5kV switchgear cubicles, Low voltage AC panel and DC power system shall be installed in the substation building.

36kV and 12kV aluminum conductors armored type cables shall be directly buried under the ground about 1.2 meter depth. Low voltage and control cables copper conductor shall be installed inside cable

conduits.

The earthing resistance of the substation is supposed to be less than 1 ohm.

(2) Installation of a 34.5kV Sub-transmission Line from Tamale BSP to UDS Primary Substation

1) 34.5kV Sub-transmission Line

A 34.5kV sub-transmission line of approx. 19km (approx. 5km is underground cable, approx. 14km is overhead line.) shall be constructed between Tamale BSP and UDS Primary Substation.

A 34.5kV sub-transmission line shall be passed beside Stadium Road, Old Runway Road and Nyankpala Road to the direction of UDS Primary Substation.

The conductor size of a 34.5kV feeder line is AAAC 120mm². The conductor size of cable is 185mm².

2) 34.5kV Switchgear in Tamale BSP

In order to supply 34.5kV power from Tamale BSP to UDS primary substation, new 34.5kV switchgears shall be installed and connected to the existing 34.5kV switchgear (Buipe / Yape) inside the existing 34.5kV switchgear room in Tamale BSP.

(3) Installation of 11.5kV Distribution Lines from UDS Primary Substation to 11.5kV distribution lines

1) 11.5kV Distribution Line

The following three (3) 11.5kV distribution lines shall be installed. The conductor size of 11.5kV feeder line is AAAC 120mm².

- From UDS primary substation to the UDS feeder (Overhead line: approx. 200m)
- From UDS primary substation to the Tolon feeder (Overhead line: approx. 300m and underground cable: approx. 400m)
- From UDS primary substation to Sheshegu feeder (Overhead line: approx. 300m and underground cable: approx 30m)

3.2.2 Improvement of Sunyani distribution system in Brong-Ahafo Region

(1) Construction of Kotokrom Primary Substation

One (1) set of new step down transformer (34.5/11.5kV, 7.5MVA with On Load Tap Changer) shall be installed in outdoor. The 34.5kV switchgear cubicles, 11.5kV switchgear cubicles, Low voltage AC panel and DC power system shall be installed in the substation building.

36kV and 12kV aluminum conductor armored type cables shall be directly buried under the ground about 1.2 meter depth. Low voltage and control cables copper conductor shall be installed inside cable conduits.

The earthing resistance of the substation is supposed to be less than 1 ohm.

(2) Installation of a 34.5kV Sub-transmission Line from Sunyani BSP to Kotokrom Primary Substation

1) 34.5kV Sub-transmission Line

A 34.5kV sub-transmission line of approx. 8.5km (approx. 0.5km is under ground cable, approx 8.0km is overhead line.) shall be constructed between Sunyani BSP and Kotokrom Primary Substation.

A 34.5kV sub-transmission line shall be passed inside way leave of 161kV transmission line (Teehiman line) from tower No. 157 to tower No. 144 and turn to the direction of Kotokrom Primary Substation.

The conductor size of a 34.5kV feeder line is AAAC 120mm². The conductor size of cable is 185mm².

2) 34.5kV Switchgear in Sunyani BSP

In order to supply 34.5kV power from Sunyani BSP to Kotokrom primary substation, new 34.5kV switchgears shall be installed and connected to the existing 34.5kV switchgear (Berekum feeder) inside the existing 34.5kV switchgear room in Sunyani BSP.

(3) Installation of 11.5kV Distribution Lines from Kotokrom Primary Substation to 11.5kV distribution lines

1) 11.5kV Distribution Line

The following three (3) 11.5kV distribution lines shall be installed.

- From Kotokrom primary substation to the Hospital feeder (Overhead line: approx. 4.3km and underground cable: approx 30m)
- From Kotokrom primary substation to the New Dormaa feeder (Overhead line: approx. 600m and underground cable: approx. 30m)
- From Kotokrom primary substation to the Chiraa feeder (Overhead line: approx. 700m and underground cable: approx 30m)

2) 11.5kV Ring Main Unit in Sunyani Regional Hospital

In order to supply reliable and stable electricity to Sunyani Regional Hospital, new Ring Main Unit (RMU) shall be installed outside near the existing electrical pole inside premise of the Hospital.

New RMU shall have three (3) feeders (one for outgoing to the existing RMU inside electrical room in the Hospital, one for incoming from Sunyani BSP (Feeder No. 27F8B) and one for incoming from Kotokrom Primary Substation).

A mechanical interlock both incoming feeders is provided.

3.3 Procurement Plan of Equipment and Materials

3.3.1 Improvement of Tamale distribution system in Northern Region

Technical specifications for Improvement of Tamale distribution system in Northern Region are shown in Table 10, Table 11 and Table 12.

The network diagram, single line diagrams, arrangement at the bulk supply points, general layouts of substations and route maps for distribution lines for Improvement of Tamale distribution system are shown in Part 1 of the attached "Drawings" in the end of this field report as follows.

- 34.5 / 11.5 kV network diagram in the area improved under the Project
- Single line diagram of the primary substation installed under the Project
- Single line diagram in the BSP
- General layout in the primary substation installed under the Project
- Layout in the BSP control building
- Route Maps for the distribution lines installed under the Project

Table 10 Construction of UDS Primary Substation

No.	Item/Equipment	Specification	Quantity
1	34.5/11.5kV Transformer 1) Type 2) Rated primary voltage 3) Rated secondary voltage 4) Rated Capacity 5) Cooling type 6) Number of phases 7) Frequency 8) Tap voltage 9) Number of taps 10) Step voltage 11) Winding connection and vector symbol 12) Impedance 13) Cable cover	Outdoor, oil immersed, with on-load tap changer 34.5kV 11.5kV 7.5MVA ONAN 3 50Hz 34.5kV +10% to -10% 17 taps 1.25% Primary winding: Delta Secondary winding: Star (neutral lead out) Dyn11 About 6% Elephant type cable duct with bottom cover	1 set
2	34.5kV Switchgear Cubicles 1) Type 2) Component of Switchgear Cubicles 2.1) Incoming feeder switchgear cubicle a) Number of cubicle b) Circuit breaker (CB) - Type of CB - Rated voltage of CB	Indoor type cubicle VCB, withdrawal type 36kV	1 set

No.	Item/Equipment	Specification	Quantity
3	11.5kV Switchgear Cubicles 1) Type 2) Component of Switchgear Cubicles 2.1) Transformer feeder switchgear cubicle a) Number of cubicle b) Bus bar current c) Circuit breaker (CB) - Type of CB - Rated voltage of CB - Rated current of CB - Rated short-time withstand current d) Earthing switch (ES) - Type of ES e) Current transformer for metering - Current ratio - Accuracy class - Burden f) Current transformer for protection - Current ratio - Accuracy class - Burden g) Potential transformer - Voltage ratio - Accuracy class - Burden h) Metering i) Protection relay	630A 25kA (1 sec.) Mechanical interlock with CB Primary: 200-100A Secondary: 5A CL: 0.5 50VA Primary: 200-100A Secondary: 5A CL: 5P20 50VA Primary: 34.5/√3kV Secondary: 115/√3V CL: 0.5 100VA Multi-meter (V, A, W, VA, VAR, PF, Hz and WH) Under voltage relay, Over current relay, Over current ground relay and transformer differential relay Indoor type cubicle 800A VCB, withdrawal type 12kV 630A 12.5kA (1 sec.) Mechanical interlock with CB Primary: 400-200A Secondary: 5A CL: 0.5 50VA Primary: 400-200A Secondary: 5A CL: 5P20 50VA Primary: 11.5/√3kV Secondary: 115/√3V CL: 0.5 100VA Multi-meter (V, A, W, VA, VAR, PF, Hz and WH) Under voltage relay, Over voltage relay, Over current ground relay and Auto voltage relay 1 set	1 set

No.	Item/Equipment	Specification	Quantity
4	<p>2.2) Outgoing feeder switchgear cubicle</p> <p>a) Number of cubicle</p> <p>b) Circuit breaker (CB)</p> <ul style="list-style-type: none"> - Type of CB - Rated voltage of CB - Rated current of CB - Rated short-time withstand current <p>c) Earthing switch (ES)</p> <ul style="list-style-type: none"> - Type of ES <p>d) Current transformer for metering</p> <ul style="list-style-type: none"> - Current ratio - Accuracy class - Burden <p>e) Current transformer for protection</p> <ul style="list-style-type: none"> - Current ratio - Accuracy class - Burden <p>f) Metering</p> <p>g) Protection relay</p> <p>2.3) Station transformer feeder switchgear cubicle</p> <p>a) Number of cubicle</p> <p>b) Circuit breaker (CB)</p> <ul style="list-style-type: none"> - Type of CB - Rated voltage of CB - Rated current of CB - Rated short-time withstand current <p>c) Earthing switch (ES)</p> <ul style="list-style-type: none"> - Type of ES <p>d) Current transformer for metering</p> <ul style="list-style-type: none"> - Current ratio - Accuracy class - Burden <p>e) Current transformer for protection</p> <ul style="list-style-type: none"> - Current ratio - Accuracy class - Burden <p>f) Metering</p> <p>g) Protection relay</p>	<p>VCB, withdrawal type</p> <p>12kV</p> <p>630A</p> <p>12.5kA (1 sec.)</p> <p>Mechanical interlock with CB</p> <p>Primary: 200-100A Secondary: 5A</p> <p>CL: 0.5</p> <p>50VA</p> <p>Primary: 200-100A Secondary: 5A</p> <p>CL: 5P20</p> <p>50VA</p> <p>Multi-meter (V, A, W, VA, VAR, PF, Hz and WH)</p> <p>Over current relay, Over current ground relay and Auto reclosing relay</p> <p>VCB, withdrawal type</p> <p>12kV</p> <p>630A</p> <p>12.5kA (1 sec.)</p> <p>Mechanical interlock with CB</p> <p>Primary: 200-100A Secondary: 5A</p> <p>CL: 0.5</p> <p>50VA</p> <p>Primary: 200-100A Secondary: 5A</p> <p>CL: 5P20</p> <p>50VA</p> <p>Multi-meter (V, A, W, VA, VAR, PF, Hz and WH)</p> <p>Over current relay, Over current ground relay and Auto reclosing relay</p> <p>Outdoor, oil immersed type</p> <p>11.5kV±2.5% and ±5% taps (off-load tap changer)</p> <p>433-250V</p> <p>100kVA</p> <p>3</p> <p>50Hz</p> <p>Primary winding: Delta</p> <p>Secondary winding: Star (neutral lead out)</p> <p>Dyn11</p> <p>About 5%</p> <p>Primary: 100-50A Secondary: 5A</p> <p>CL: 10P10</p> <p>25VA</p> <p>E: ephram type cable duct with bottom cover</p>	<p>3 sets</p>
4	<p>Station Transformer (STR)</p> <p>1) Type of STR</p> <p>2) Rated primary voltage and tap</p> <p>3) Rated secondary voltage</p> <p>4) Rated capacity</p> <p>5) Number of phases</p> <p>6) Frequency</p> <p>7) Winding connection and vector symbol</p> <p>8) Impedance</p> <p>9) Current transformer for protection</p> <ul style="list-style-type: none"> - Current ratio - Accuracy class - Burden <p>10) Cable cover</p>	<p>1 set</p>	

No.	Item/Equipment	Specification	Quantity
5	<p>LV Service panel</p> <p>1) Number of panel</p> <p>2) Type of panel</p> <p>3) Rated voltage (Number of phase and wire)</p> <p>4) Type of breakers</p> <p>5) Current transformer for metering</p> <ul style="list-style-type: none"> - Current ratio - Accuracy class - Burden <p>6) Metering</p> <p>7) Protection relay</p>	<p>Indoor, self-standing type</p> <p>AC 415/240V (3 phase 4 wires)</p> <p>Earth leakage circuit breaker (ELCB), 4 poles, 400AF/400AT</p> <p>Primary: 200A Secondary: 5A</p> <p>CL: 1.0</p> <p>25VA</p> <p>Ammeter with change-over switch</p> <p>Over current ground relay</p>	<p>1 set</p>
6	<p>DC Service panel and battery charger</p> <p>1) Number of panel</p> <p>2) Type of panel</p> <p>3) Rated voltage</p> <p>4) Type of breaker</p> <p>5) Battery charger</p>	<p>Indoor, self-standing type</p> <p>DC 125V</p> <p>Earth leakage circuit breaker (ELCB)</p> <p>Battery charger has floating and equalizing function</p>	<p>1 set</p>
7	<p>Battery</p> <p>1) Number of battery</p> <p>2) Type of battery</p> <p>3) Rated voltage (voltage per cell)</p> <p>4) Number of battery cell</p> <p>5) Discharge time (AC black-out time)</p> <p>6) Capacity of battery</p>	<p>Lead acid type</p> <p>12.5V (2V per cell)</p> <p>58 cells</p> <p>12 hours</p> <p>Minimum 150Ah/10hrs (battery capacity is to be decided subject to during 12hours black out.)</p>	<p>1 lot</p>
8	<p>34.5kV disconnecting switch pole</p> <p>1) Number of pole</p> <p>2) Type</p> <p>3) Equipment mounted on pole</p> <ul style="list-style-type: none"> - Lightning arresters - Disconnecting switch 	<p>Double steel poles with lightning arresters and disconnecting switch</p> <p>36kV, 10kA, zinc-oxide gapless type</p> <p>36kV, 630A, 25kA (1 sec.)</p>	<p>1 set</p>
9	<p>11.5kV disconnecting switch pole</p> <p>1) Number of pole</p> <p>2) Type</p> <p>3) Equipment mounted on pole</p> <ul style="list-style-type: none"> - Lightning arresters - Disconnecting switch 	<p>Double steel poles with lightning arresters and disconnecting switch</p> <p>12kV, 10kA, zinc-oxide gapless type</p> <p>12kV, 400A, 12.5kA (1 sec.)</p>	<p>3 sets</p>
10	<p>36kV Cables</p> <p>1) Type</p> <p>2) Conductor, insulation and sheath</p> <p>3) No. of core and size</p>	<p>Armored type cables for directly buried under the ground</p> <p>Aluminum conductor, XLPE insulation, aluminum wire armored and PVC sheath</p> <p>1 core, 185mm², 1 cable per phase</p> <p>(from 34.5kV disconnecting switch pole to 34.5kV switchgear and from 34.5kV switchgear to transformer 34.5kV side)</p>	<p>1 lot</p>
11	<p>12kV Cables</p> <p>1) Type</p> <p>2) Conductor, insulation and sheath</p> <p>3) No. of core and size</p>	<p>Armored type cables for directly buried under the ground</p> <p>Aluminum conductor, XLPE insulation, aluminum wire armored and PVC sheath</p> <p>1 core, 185mm², 3cables per phase</p> <p>(from transformer 11.5kV side to 11.5kV switchgear)</p> <p>1 core, 185mm², 1 cable per phase</p>	<p>1 lot</p>

No.	Item/Equipment	Specification	Quantity
		(from 11.5kV switchgear to 11.5kV disconnecting switch pole) 1 core, 185mm ² , 1 cable per phase (from 11.5kV switchgear to station transformer 11.5kV side)	

Table 11 Installation of 34.5kV Sub-transmission Line from Tamale BSP to UDS Primary Substation

No.	Item/Equipment	Specification	Quantity
1	34.5kV Sub-transmission Line	Line angle 0-5 deg. Line angle 5-20 deg. Line angle 20-60 deg. Line angle 60-90 deg. Line angle 90 deg.	1 lot
2	34.5kV Switchgear Cubicles in Tamale BSP 1) Type 2) Number of cubicle 3) Bus bar current 4) Circuit Breaker 5) Metering 6) Protection 7) AC control source 8) DC control source 9) Number of cable termination kit	AAAC 120mm ² Indoor type, SF6 gas insulated cubicle Three (3) cubicles - One (1): connection to existing switchgear (former Bupe/Yapei feeder) - One (1): outgoing feeder (Bupe/Yapei) - One (1): outgoing feeder (UDS) 1,250A 36kV, 800A, 25kA (1sec.) Multi-meter (V, A, W, VA, VAR, PF, Hz and WH) Over current relay, Over current ground relay and Auto reclosing relay To be supplied from the existing LV Panel (AC 3 phase 4 wires, 415/240V) To be supplied from the existing DC Panel (DC 125V) 3 feeders - Existing switchgear connection feeder (new cables: 36kV, XLPE, copper conductor, 1 core, 240mm ² , 2 cables per phase) - Bupe/Yapei feeder (existing cables: 36kV, XLPE, aluminum conductor, 1 core, 185mm ² , 1 cable per phase, with aluminum wire armoured type) - UDS feeder (new cables: 36kV, XLPE, aluminum conductor, 1 core, 185mm ² , 1 cable per phase, with aluminum wire armoured type)	1 lot
3	36kV Cables 1) Specifications	Copper conductor, XLPE insulation, 1 core, 240mm ² PVC sheath, 2 cables per phase	1 lot

No.	Item/Equipment	Specification	Quantity
		(from existing 34.5kV switchgear (former Bupe/Yapei feeder) to new 34.5kV switchgear) Aluminum conductor, XLPE insulation, 185mm ² , aluminum wire armoured and PVC sheath 1 cable per phase (from new 34.5kV switchgear cubicle to 34.5kV disconnecting switch pole for UDS primary substation)	

Table 12 Installation of 11.5kV Distribution Line from UDS Substation

No.	Item/Equipment	Specification	Quantity
1	11.5kV Distribution Line	Line angle 0-5 deg. Line angle 5-20 deg. Line angle 20-60 deg. Line angle 60-90 deg. Line angle 90 deg.	1 lot
3	12kV Cables 1) Type 2) Conductor, insulation and sheath 3) No. of core and size	AAAC 120mm ² Armored type cables for directly buried under the ground Aluminum conductor, XLPE insulation, aluminum wire armoured and PVC sheath 1 core, 185mm ² (from new 11.5kV disconnecting switch pole (Tolon feeder) to existing section pole) 1 core, 185mm ² (from new 11.5kV disconnecting switch pole (Sheshegu feeder) to existing pole)	1 lot

3.3.2 Improvement of Sunyani distribution system in Brong-Ahafo Region

Technical specifications for Improvement of Sunyani distribution system in Northern Region are shown in Table 13, Table 14 and Table 15.

The network drawings, single line diagrams, arrangements at the bulk supply points, general layouts of substations and route maps for distribution lines for Improvement of Tamale distribution system are shown in Part 2 of the attached "Drawings" in the end of this field report as follows.

- 34.5 / 11.5 kV network drawings in the area improved under the Project
- Single line diagram of the primary substation installed under the Project
- Single line diagram for arrangement in the BSP
- General layout in the primary substation
- General Layout in the BSP
- Route Maps for the distribution lines installed under the Project

No.	Item/Equipment	Specification	Quantity
4	<ul style="list-style-type: none"> - Rated short-time withstand current e) Earthing switch (ES) <ul style="list-style-type: none"> - Type of ES d) Current transformer for metering <ul style="list-style-type: none"> - Current ratio - Accuracy class - Burden e) Current transformer for protection <ul style="list-style-type: none"> - Current ratio - Accuracy class - Burden f) Metering g) Protection relay 	<p>12.5kA (1 sec.)</p> <p>Mechanical interlock with CB</p> <p>Primary: 200-100A Secondary: 5A CL: 0.5 50VA</p> <p>Primary: 200-100A Secondary: 5A CL: 5P20 50VA</p> <p>Multi-meter (V, A, W, VA, VAR, PF, Hz and WH)</p> <p>Over current relay, Over current ground relay and Auto reclosing relay</p> <p>Outdoor, oil immersed type 11.5kV\pm2.5%, and\pm5% taps (off-load tap changer) 433-250V 100kVA 3 50Hz</p> <p>Primary winding: Delta Secondary winding: Star (neutral lead out) Dyn11 About 5%</p> <p>Primary: 100-50A Secondary: 5A CL: 10P10 25VA</p> <p>Elephant type cable duct with bottom cover</p>	1 set
5	<ul style="list-style-type: none"> 10) Cable cover LV Service panel <ul style="list-style-type: none"> 1) Number of panel 2) Type of panel 3) Rated voltage (Number of phase and wire) 4) Type of breakers 5) Current transformer for metering <ul style="list-style-type: none"> - Current ratio - Accuracy class - Burden 6) Metering 7) Protection relay 	<p>Indoor, self-standing type AC: 415/240V (3 phase 4 wires)</p> <p>Earth leakage circuit breaker (ELCB), 4 poles, 400AF/400AT</p> <p>Primary: 200A Secondary: 5A CL: 1.0 25VA</p> <p>Ammeter with change-over switch Over current ground relay</p> <p>Indoor, self-standing type DC 125V Earth leakage circuit breaker (ELCB) Battery charger has floating and equalizing function</p>	1 set
6	<ul style="list-style-type: none"> DC Service panel and battery charger <ul style="list-style-type: none"> 1) Number of panel 2) Type of panel 3) Rated voltage 4) Type of breaker 5) Battery charger 	<p>Lead acid type 125V (2V per cell) 58 cells 12 hours Minimum 150Ah/10hrs (battery capacity is to be decided subject to during 12hours black</p>	1 lot
7	<ul style="list-style-type: none"> Battery <ul style="list-style-type: none"> 1) Number of battery 2) Type of battery 3) Rated voltage (voltage per cell) 4) Number of battery cell 5) Discharge time (AC back-out time) 6) Capacity of battery 		1 lot

No.	Item/Equipment	Specification	Quantity
8	<ul style="list-style-type: none"> 34.5kV disconnecting switch pole 1) Number of pole 2) Type 3) Equipment mounted on pole <ul style="list-style-type: none"> - Lightning arresters - Disconnecting switch 	<p>out.)</p> <p>Double steel poles with lightning arresters and disconnecting switch</p> <p>36kV, 10kA, zinc-oxide gapless type 36kV, 630A, 25kA (1 sec.)</p>	1 set
9	<ul style="list-style-type: none"> 11.5kV disconnecting switch pole 1) Number of pole 2) Type 3) Equipment mounted on pole <ul style="list-style-type: none"> - Lightning arresters - Disconnecting switch 	<p>Double steel poles with lightning arresters and disconnecting switch</p> <p>12kV, 10kA, zinc-oxide gapless type 12kV, 400A, 12.5kA (1 sec.)</p>	3 sets
10	<ul style="list-style-type: none"> 36kV Cables 1) Type 2) Conductor, insulation and sheath 3) No. of core and size 	<p>Armored type cables for directly buried under the ground</p> <p>Aluminum conductor, XLPE insulation, aluminum wire armored and PVC sheath 1 core, 185mm², 1 cable per phase (from 34.5kV disconnecting switch pole to 34.5kV switchgear and from 34.5kV switchgear to transformer 34.5kV side)</p>	1 lot
11	<ul style="list-style-type: none"> 12kV Cables 1) Type 2) Conductor, insulation and sheath 3) No. of core and size 	<p>Armored type cables for directly buried under the ground</p> <p>Aluminum conductor, XLPE insulation, aluminum wire armored and PVC sheath 1 core, 185mm², 3 cables per phase (from transformer 11.5kV side to 11.5kV switchgear)</p> <p>1 core, 185mm², 1 cable per phase (from 11.5kV switchgear to 11.5kV disconnecting switch pole)</p> <p>1 core, 185mm², 1 cable per phase (from 11.5kV switchgear to station transformer 11.5kV side)</p>	1 lot

Table 14 Installation of 34.5kV Sub-transmission Line from Sunyani BSP to Kotokrom Primary

No.	Item/Equipment	Specification	Quantity
1	<ul style="list-style-type: none"> 34.5kV Sub-transmission Line 	<p>1) Type of electrical pole</p> <ul style="list-style-type: none"> a) 3A (Intermediate pole) b) 3B (Light angle pole) c) 3C (Medium angle pole) d) 3D (Heavy angle pole) e) 3E (Cross pole) f) 3F (Section pole) g) 3K (Disconnecting switch pole) <p>2) Type of conductor</p> <p>34.5kV Switchgear Cubicles in Sunyani BSP</p> <ul style="list-style-type: none"> 1) Type 2) Number of cubicle 	1 lot
2	<ul style="list-style-type: none"> 34.5kV Switchgear Cubicles in Sunyani BSP 1) Type 2) Number of cubicle 	<p>AAAC 120mm²</p> <p>Indoor type, SF₆ gas insulated cubicle Tree (3) cubicles</p>	1 lot

No.	Item/Equipment	Specification	Quantity
3	<ul style="list-style-type: none"> 3) Bus bar current 4) Circuit Breaker 5) Metering 6) Protection 7) AC control source 8) DC control source 9) Number of cable termination kit 	<ul style="list-style-type: none"> - One (1): connection to existing switchgear (former Bereikum feeder) - One (1): outgoing feeder (Bereikum) - One (1): outgoing feeder (Kotokrom) 800A 36kV, 800A, 25kA (1sec.) Multi-meter (V, A, W, VA, VAR, PF, Hz and WH) Over current relay, Over current ground relay and Auto reclosing relay To be supplied from the existing LV Panel (AC 3 phase 4 wires, 415/240V) To be supplied from the existing DC Panel (DC 125V) 3 feeders - Existing switchgear connection feeder (new cables: 34.5kV, XLPE, aluminum conductor, 1 core, 185mm², 2 cables per phase, with aluminum wire armoured type) - Bereikum feeder (existing cables: 34.5kV, XLPE, aluminum conductor, 1 core, 185mm², 1 cable per phase, with aluminum wire armoured type) - Kotokrom feeder (new cables: 34.5kV, XLPE, aluminum conductor, 1 core, 185mm², 1 cable per phase, with aluminum wire armoured type) 	1 lot
3	<ul style="list-style-type: none"> 36kV Cables 1) Specifications 	<ul style="list-style-type: none"> Copper conductor, XLPE insulation, 1 core, 240mm² PVC sheath, 2 cables per phase (from existing 34.5kV switchgear (former Bupe/Yapei feeder) to new 34.5kV switchgear) Aluminum conductor, XLPE insulation, 185mm², aluminum wire armoured and PVC sheath 1 cable per phase (from new 34.5kV switchgear cable to 34.5kV disconnecting switch pole for UDS primary substation) 	1 lot

Table 15 Installation of 11.5kV Distribution Line from Kotokrom Substation

No.	Item/Equipment	Specification	Quantity
1	<ul style="list-style-type: none"> 11.5kV Distribution Line 1) Type of electrical pole <ul style="list-style-type: none"> a) 1A (Intermediate pole) b) 1B (Light angle pole) c) 1C (Medium angle pole) d) 1D (Heavy angle pole) e) 1E (Cross pole) f) 1F (Section pole) g) 1K (Disconnecting switch pole) 2) Type of conductor 	<ul style="list-style-type: none"> Line angle 0-5 deg. Line angle 5-20 deg. Line angle 20-60 deg. Line angle 60-90 deg. Line angle 90 deg. AAAC 120mm² 	1 lot
2	<ul style="list-style-type: none"> 11.5kV Ring Main Unit (RMU) 1) Type 2) Number of feeder 	<ul style="list-style-type: none"> Outdoor type, SF6 gas Incoming: 2 feeders with earthing switch Outgoing: 1 feeder with earthing switch 	1 set

No.	Item/Equipment	Specification	Quantity
3	<ul style="list-style-type: none"> 3) Rated voltage 4) Rated current 5) Rated short-time withstand current 6) Mechanical interlock 7) Number of cable termination 	<ul style="list-style-type: none"> 12kV 630A 12.5kA (1sec.) Mechanical interlock shall be provided for incoming two (2) feeders (to be confirmed in Japan) 3 feeders (cables: 12kV, XLPE, aluminum conductor, 3 cores, 185mm² with steel wire armoured type) 	1 lot
3	<ul style="list-style-type: none"> 12kV Cables 1) Type 2) Conductor, insulation and sheath 3) No. of core and size 	<ul style="list-style-type: none"> Armored type cables for directly buried under the ground Aluminum conductor, XLPE insulation, steel wire armoured and PVC sheath 3 cores, 185mm² (from new 11.5kV disconnecting switch pole (Hospital feeder) to RMU) 3 cores, 185mm² (from new 11.5kV disconnecting switch pole (Chiraa feeder) to existing section pole) 3 cores, 185mm² (from new 11.5kV disconnecting switch pole (New Dormaa feeder) to existing section pole) 	1 lot

3.3.3 Drawings and Other Relevant Documents

The pole dressings for the distribution lines for the Project are shown in Part 2 of the attached "Drawings" in the end of this field report as follows.

3.4 Procurement Plan of Spare Parts and Maintenance Tools

The testing tools, maintenance tools, replacement parts, emergency spare parts and consumables for the Project are shown as Table 16.

Table 16 Spare Parts and Maintenance Tools

No.	Description	Qty
1	Testing Instruments	1 lot
(1)	Oil Insulation Tester	2 sets
(2)	Cable Earth Fault Locator	2 sets
(3)	Single Phase Protection Relay Tester	2 sets
(4)	3 Phase Protection Relay Tester	2 sets
(5)	Analog Tester	2 sets
(6)	Phase Rotation Meter	2 sets
(7)	Voltage Deictor (AC3-35 kV)	2 sets
(8)	Voltage Deictor (AC 600 V)	2 sets
(9)	Insulation Resistance Tester (Megger) 500 V	2 sets
(10)	Insulation Resistance Tester (Megger) 1,000 V	2 sets

No.	Description	Qty
(11)	DC Dielectric (0-100 kV)	2 sets
(12)	Portable Earth Resistance Tester	2 sets
(13)	Digital-type Multi-meter	2 sets
(14)	Clip-on Meter	2 sets
2	Maintenance Tools	1 lot
(1)	Compression Tool with Dices	2 sets
(2)	Crimping Tool (10 to 250 mm2)	2 sets
(3)	Cable Cutter	2 sets
(4)	Industrial Tool for Electrical Work	2 sets
(5)	Lifter for Drawing 36kV Circuit Breaker	2 sets
(6)	Lifter for Drawing 12kV Circuit Breaker	2 sets
(7)	Torch for Cable Terminal Treatment	2 sets
(8)	Truck with Aerial Bucket	2 units
3	Replacement Parts	1 lot
3.1	For 34.5/11.5kV Transformer	1 lot
(1)	Gasket	2 sets
(2)	Buchholz Relay	2 sets
(3)	Oil Temperature Meter	2 sets
(4)	Oil Level Meter	2 sets
(5)	34.5kV Bushing	2 sets
(6)	11.5kV Bushing	2 sets
3.2	For 34.5kV Switchgear	1 lot
(1)	Various Lamps or LEDs (100%)	2 sets
(2)	Various Fuses	2 sets
(3)	Various MCCBs	2 sets
(4)	Various Protection Relays	2 sets
(5)	Various Auxiliary Relays	2 sets
(6)	Space Heater	2 sets
(7)	Various Meters	2 sets
(8)	Various CTs	2 sets
(9)	Various VTs	2 sets
(10)	Various Switches	2 sets
3.3	For 11.5kV Switchgear	1 lot
(1)	Various Lamps or LEDs (100%)	2 sets
(2)	Various Fuses	2 sets
(3)	Various MCCBs	2 sets

No.	Description	Qty
(4)	Various Protection Relays	2 sets
(5)	Various Auxiliary Relays	2 sets
(6)	Space Heater	2 sets
(7)	Various Meters	2 sets
(8)	Various CTs	2 sets
(9)	Various VTs	2 sets
(10)	Various Switches	2 sets
3.4	For Low Voltage Distribution Pane	1 lot
(1)	Various Lamps or LEDs (100%)	2 sets
(2)	Various Fuses	2 sets
(3)	Various MCCBs	2 sets
(4)	Various Meters	2 sets
3.5	DC Supply System	1 lot
(1)	Various Lamps or LEDs (100%)	2 sets
(2)	Various Fuses	2 sets
(3)	Various MCCBs	2 sets
(4)	Various Meters	2 sets
3.6	Cable Termination Kit	1 lot
(1)	36kV Outdoor Type	2 sets
(2)	36kV Indoor Type	2 sets
(3)	36kV Indoor Socket Type for GIS	2 sets
(4)	12kV Outdoor Type	2 sets
(5)	12kV Indoor Type	2 sets
(6)	12kV Indoor Socket Type for RMU	1 set
4	Emergency Spare Parts	1 lot
(1)	36kV Circuit Breaker	2 sets
(2)	12kV Circuit Breaker	2 sets

Note: A word "set" means a group for three phase.

3.5 Tentative Implementation Schedule of the Project

The tentative implementation schedule is shown as Table 17. In case that the Project is decided by the Japanese Government, the Project will proceed as follows in case of the earliest scenario, as shown as Table 17. Both installation work of Tamale and Suniyami will start at the same time in February, 2012.

- The Exchange of Notes between the Ghanaian and Japanese Government will be signed in August, 2011.
- The Tender Opening will be held in December 2011.
- Installation work of the Project will start in January, 2012.
- Commissioning of the Project will be in May, 2013.

Table 17 Tentative Implementation Schedule

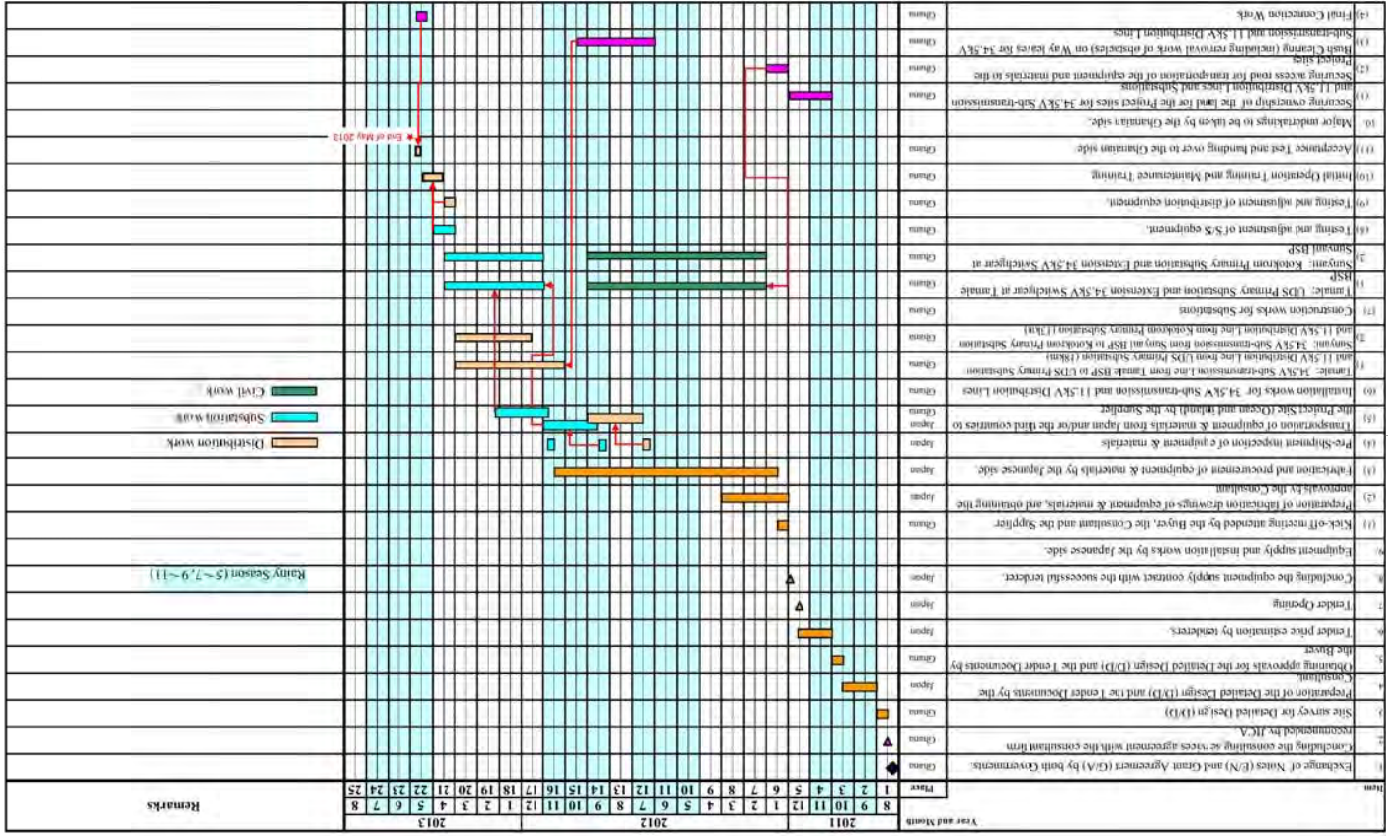

4. Work Demarcations for Both Parties

In the implementation of the Grant Aid Project, the recipient country is required to undertake such necessary measures as shown as Table 18.

Table 18 Work Demarcations for Both Parties

No.	Undertakings	To be covered by		Notes	Item No. on M/D
		Japan	Ghana		
1	(1) Securing of lands of the Project sites (New substations and routes of 34.5KV sub-transmission lines and 11.5KV distribution lines) (2) Land leveling and preparation, bush clearing and removal of obstacles in the Project sites		<input type="checkbox"/>	Including a land in the Sunyani Regional Hospital for the new Ring Main Unit to be provided by the Japanese side.	1
2	Installation of fences and gates in and around the new substations		<input type="checkbox"/>	Including relocation of a temporary market on the route of sub-transmission or distribution lines	2
	(1) Temporary fences and gates during construction period	<input type="checkbox"/>			
	(2) Permanent fences, gates and guard house	<input type="checkbox"/>			
3	Road works	<input type="checkbox"/>			2
	(1) Road within the Project sites	<input type="checkbox"/>			
	(2) Access road to the Project sites	<input type="checkbox"/>			
4	Building service facilities for the new substations		<input type="checkbox"/>		3
	(1) Electrical works				
	a) Extension work to the new substations				
	b) Internal wiring	<input type="checkbox"/>		Station transformer will be installed.	
	(2) Water supply works				
	a) Primary connection work to the new substations		<input type="checkbox"/>		
	b) Piping work after primary connection and installation of water tank	<input type="checkbox"/>			
	(3) Drainage works				
	a) Outside the substation	<input type="checkbox"/>			
	b) Inside the substation	<input type="checkbox"/>			
5	Transportation of the Equipment, customs procedures and tax procedures		<input type="checkbox"/>		4, 5
	(1) Marine/air transportation to a port of disembarkation in Ghana	<input type="checkbox"/>			
	(2) Procedures for tax exemption and customs clearance at the port of disembarkation	<input type="checkbox"/>			
	(3) Internal transportation from the port of disembarkation to the Project sites	<input type="checkbox"/>		Delivery point: VRA's Commercial Yard at BSIPs of Tamale and Sunyani	
	(4) Exemption or payment of value-added tax (VAT) on locally procured items	<input type="checkbox"/>			
6	Procedures necessary to obtain the following permits for the Japanese Consultant and Contractor: - Permits required for installation works - Permits to access restricted areas		<input type="checkbox"/>	The permits shall be obtained before project implementation.	6
7	Proper operation and maintenance of facilities and the Equipment after the Project		<input type="checkbox"/>	Including bush clearing and removal of obstacles along 34.5KV sub-transmission lines and 11.5KV distribution lines.	7
8	Other expenses that are not covered by grant aid		<input type="checkbox"/>		8
9	Payment of the following fees based on the Banking Arrangement: (1) A/P advising commission (2) Payment commission		<input type="checkbox"/>	Approx. 10,000 Japanese Yen 0.1% of the grant aid amount	9

No.	Undertakings	To be covered by		Notes	Item No. on M/D
		Japan	Ghana		
10	Giving due environmental and social considerations in the implementation of the Project.		<input type="checkbox"/>		10
11	Securing of land of temporary material storage yard with fence and gate		<input type="checkbox"/>	To be utilized VRA's Commercial Yard at BSIPs of Tamale and Sunyani	
12	Securing parking space during construction period		<input type="checkbox"/>		
13	Site offices	<input type="checkbox"/>		For the Japanese Consultant and Contractor	
14	Proper storage and safety management of the Equipment at temporary material storage yard	<input type="checkbox"/>			
15	Securing of working space along routes of 34.5KV sub-transmission lines and 11.5KV distribution lines and traffic control		<input type="checkbox"/>		
16	Relocation of existing overhead/underground cables or pipes of power, telephone, water supply/drainage, etc. and obtaining necessary permissions		<input type="checkbox"/>	When necessary.	
17	Obtaining permissions on Road crossing during underground cabling work.		<input type="checkbox"/>	When necessary.	
18	Providing of disposal site of soil and discharged water caused by the construction work		<input type="checkbox"/>		
19	Manufacturing and procurement of the Equipment	<input type="checkbox"/>		"The Equipment" is defined as the equipment and materials to be provided the Japanese side under the Project.	
20	Installation of the Equipment, adjust and testing	<input type="checkbox"/>		The Ghanaian side is required to lend test equipment and tools to be provided on the Project to the Japanese Contractor during construction.	
21	Temporary power cut during construction		<input type="checkbox"/>		
22	Re-connection work of the existing cables from the existing cable to the new one on extension of 34.5KV feeder in Tamale and Sunyani BSIPs		<input type="checkbox"/>	Cable termination kit shall be provided by the Japanese side.	
23	Modification of a cross arm and shifting jumper wires on the existing pole at the connection point of 11.5KV Tolon Feeder in Tamale		<input type="checkbox"/>	Including necessary materials	
24	Installation of cables onto the existing pole at the connection point of 11.5KV Sleshegu Feeder in Tamale		<input type="checkbox"/>	Cables and cable termination kit shall be provided by the Japanese side.	
25	Final connection to the existing 11.5KV distribution lines		<input type="checkbox"/>		
26	Provision of materials for the above mentioned final connection	<input type="checkbox"/>			
27	Provision of trainings for initial operation and maintenance of the Equipment	<input type="checkbox"/>			
28	Installation of Low voltage distribution network fed from the 11.5KV distribution lines		<input type="checkbox"/>		
29	Assuring security for personnel in the Project sites		<input type="checkbox"/>	When necessary	
30	Managing any dispute from customers regarding temporary power cut for construction work including compensation for customers		<input type="checkbox"/>	If necessary	
31	Public notice of scheduled power cut and safety measures for the consumers during the implementation stage		<input type="checkbox"/>		

Remarks: * is described in the "Minutes of Discussion" signed between the Ghanaian and Japanese side

DRAWINGS

PART 1 Improvement of Tamale Distribution System in Northern Region

1. 34.5/11.5 kV Network Diagram
 - DWG No. GE-T01 Tamale 34.5/11.5 kV Network Diagram
2. Single Line Diagram
 - DWG No. E-T01 Single Line Diagram of UDS Primary Substation
 - DWG No. E-T02 Single Line Diagram of Tamale Bulk Supply Point
3. General Layout
 - DWG No. GA-T01 General Layout of UDS Primary Substation
 - DWG No. GA-T02 Layout of Tamale Bulk Supply Point Control Building
 - DWG No. GA-T03 Cable Route of Tamale Bulk Supply Point
4. Route Map of Distribution System
 - DWG No. R-T01 ~ T15 Route Map of Tamale Distribution System

PART 2 Improvement of Sunyani Distribution System in Brong-Ahafo Region

1. 34.5/11.5 kV Network Diagram
 - DWG No. GE-S01 Sunyani 34.5/11.5 kV Network Diagram
2. Single Line Diagram
 - DWG No. E-S01 Single Line Diagram of Kotokrom Primary Substation
 - DWG No. E-S02 Single Line Diagram of Sunyani Bulk Supply Point
3. General Layout
 - DWG No. GA-S01 General Layout of Kotokrom Primary Substation
 - DWG No. GA-S02 Layout of Sunyani Bulk Supply Point
 - DWG No. GA-S03 Cable Route of Sunyani Bulk Supply Point
 - DWG No. GA-S04 Location of RMU2 [VRA] Sunyani Regional Hospital
4. Route Map of Distribution System
 - DWG No. R-S01 ~ S12 Route Map of Sunyani Distribution System

PART 3 Pole Assembly Drawing for Distribution Line

DWG No. TPA-A	11.5 / 34.5kV Intermediate Pole (Line Angle 0 to 5 degrees)	[1A / 3A]
DWG No. TPA-B	11.5 / 34.5kV Light angle Pole (Line Angle 5 to 20 degrees)	[1B / 3B]
DWG No. TPA-C	11.5 / 34.5kV Medium angle Pole (Line Angle 20 to 60 degrees)	[1C / 3C]
DWG No. TPA-D	11.5 / 34.5kV Heavy angle Pole (Line Angle 60 to 90 degrees)	[1D / 3D]
DWG No. TPA-E	11.5 / 34.5kV Cross Pole (Line Angle 90 degrees)	[1E / 3E]
DWG No. TPA-F	11.5 / 34.5kV Section Pole	[1F / 3F]
DWG No. TPA-G	11.5 / 34.5kV T-off Pole	[1G / 3G]
DWG No. TPA-H	11.5 / 34.5kV Terminal Pole	[1H / 3H]
DWG No. TPA-J	11.5 / 34.5kV Disconnecting Switch Pole (Horizontal Type)	[1J / 3J]
DWG No. TPA-K	11.5 / 34.5kV Disconnecting Switch Pole (Vertical Dend End Type)	[1K / 3K]
DWG No. TPA-M	11.5 / 34.5kV Disconnecting Switch Pole (Vertical Section Type)	[1M / 3M]
DWG No. TPA-Z	Material Composition of Assembly Parts	

GE-T01: Tamale 34.5/11.5KV Network Diagram

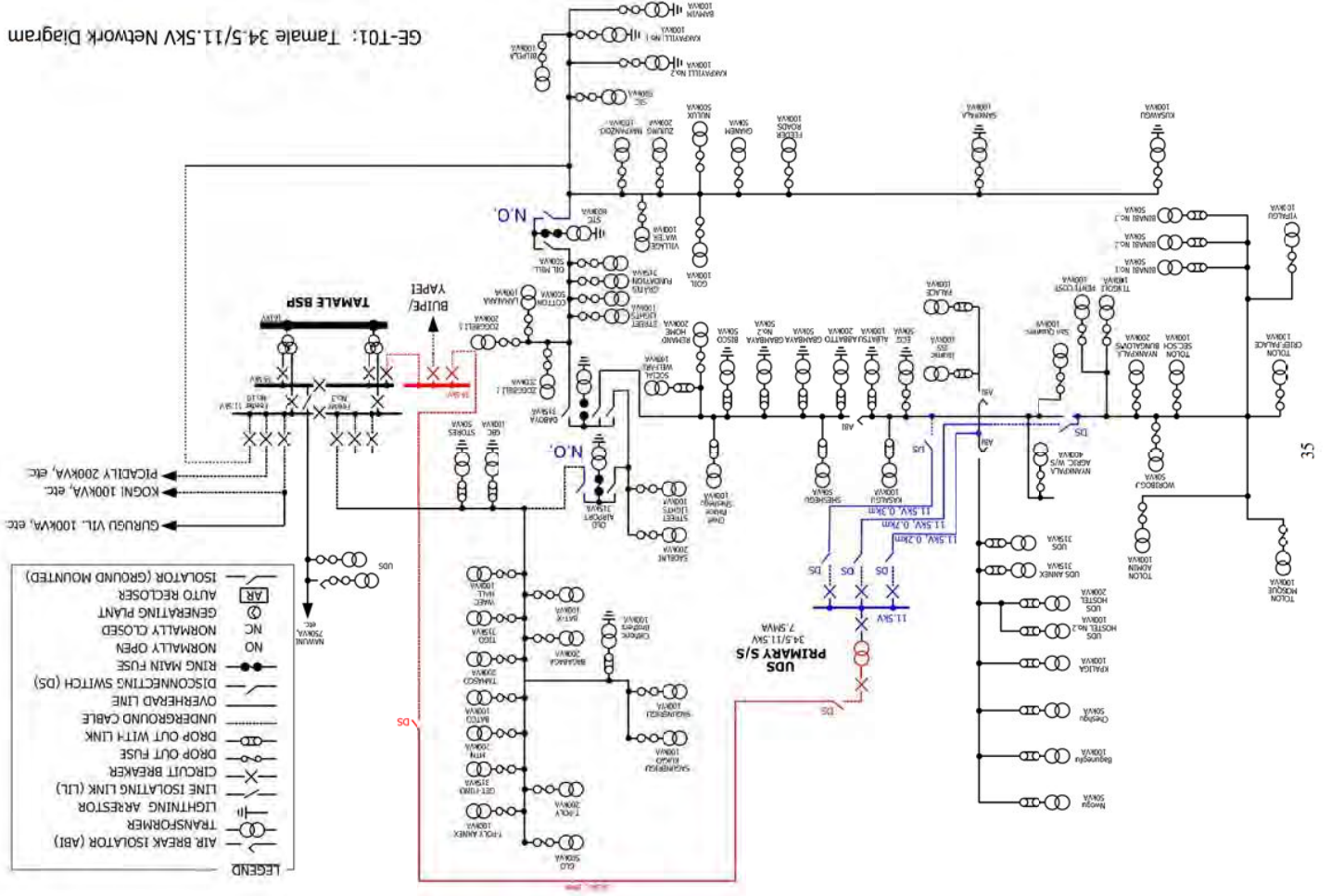

DRAWINGS

PART 1 Improvement of Tamale Distribution System in Northern Region

1. 34.5/11.5 kV Network Diagram

DRAWINGS

PART 1 Improvement of Tamale Distribution System in Northern Region

2. Single Line Diagram

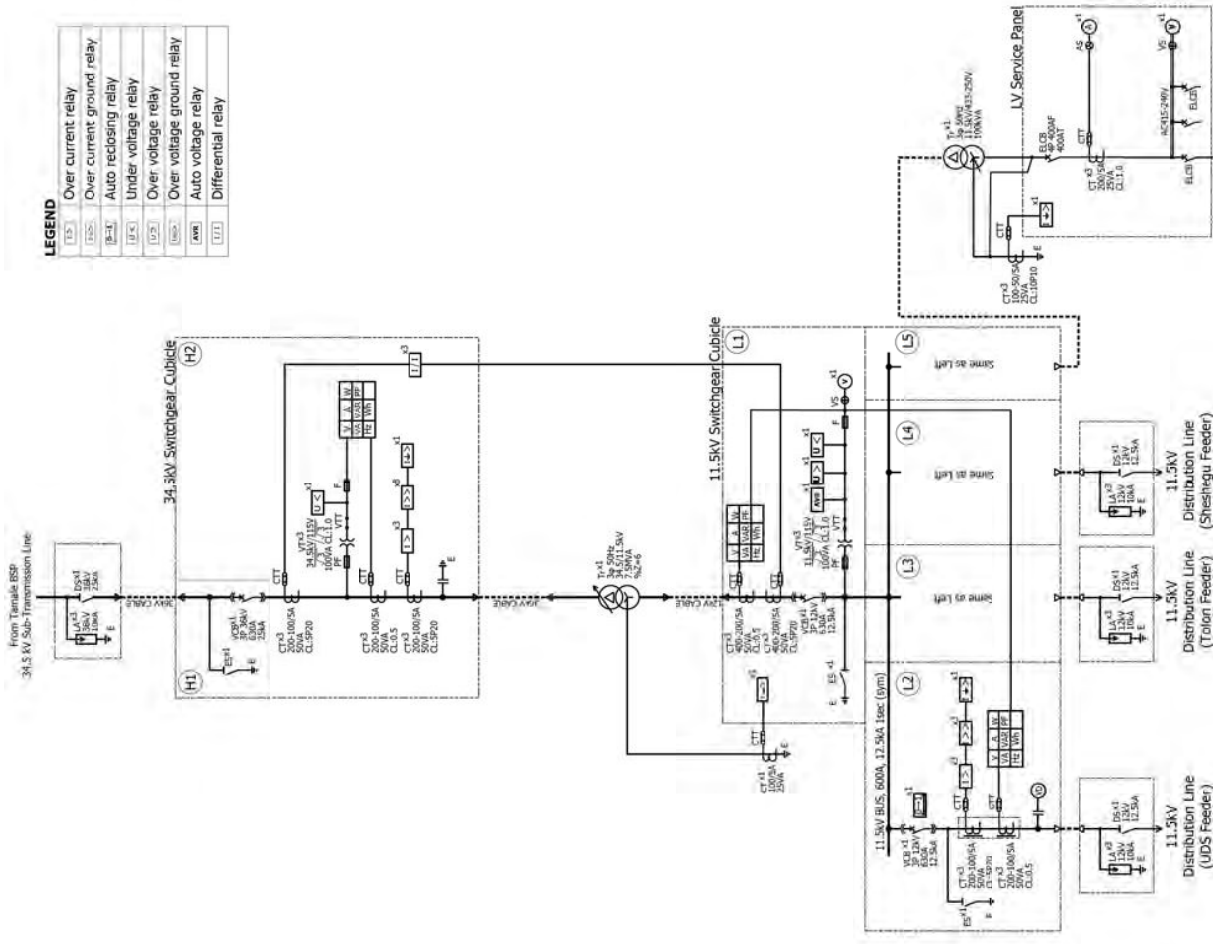

LEGEND

L1	Over current relay
L2	Over current ground relay
L3	Auto reclosing relay
L4	Under voltage relay
L5	Over voltage ground relay
L6	Over voltage relay
L7	Auto voltage relay
L8	Differential relay

E-T01: Single Line Diagram of UDS Primary Substation

LEGEND

11.1	Over current relay
11.2	Over current ground relay
11.3	Auto reclosing relay

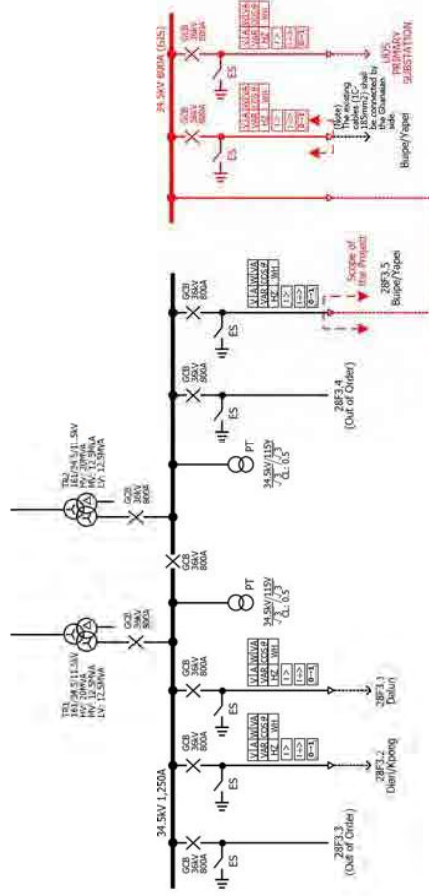

DRAWINGS

PART 1 Improvement of Tamale Distribution System in Northern Region

3. General Layout

E-T02: Single Line Diagram of Tamale BSP (Extension of 34.5 kV Feeder)

LAYOUT OF TAMALE BULK SUPPLY POINT CONTROL BUILDING 1/200

REMARKS	
①	11KV Control Panels
②	11.5KV Switchgear Cubicles
③	34.5KV Switchgear Cubicles
④	LV Panel [AC415/240V]
⑤	DC Panel [DC125V]
⑥	New 34.5KV Switchgear Cubicles
[Scope of the Project]	

34.5KV Switchgear Room Details	
Room Height	H: 5.055m
Beam Bottom Height	H: 4.675m
Door wide	W: 1.970m
Door Height	H: 2.270m

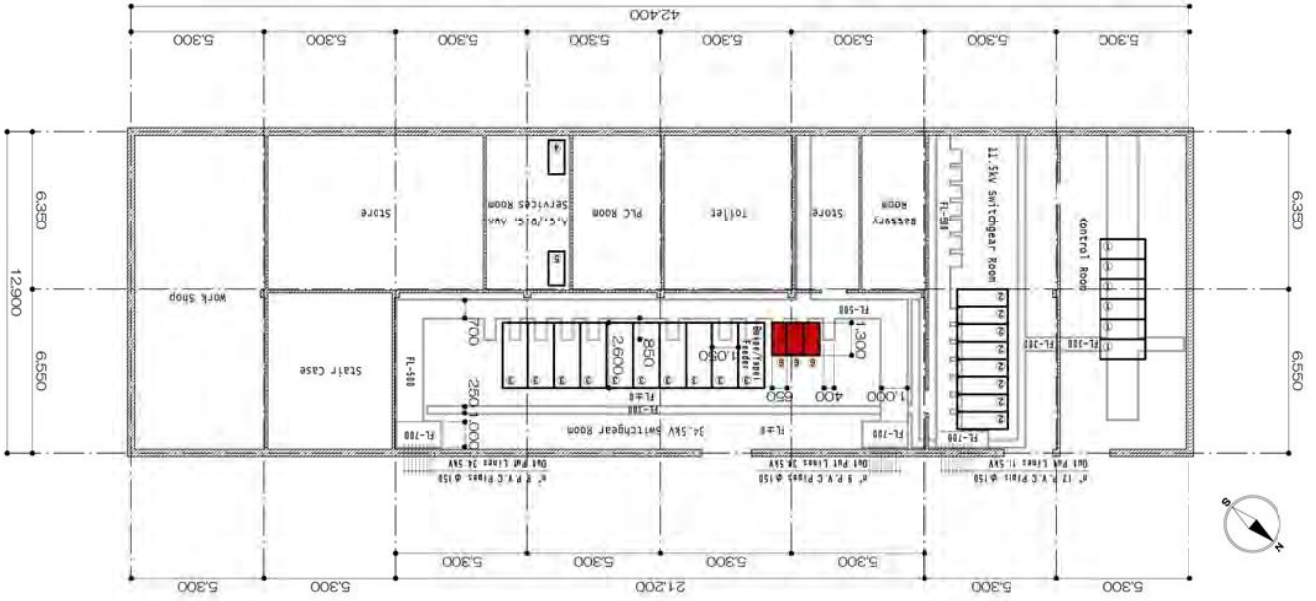

1F

GENERAL LAYOUT OF UDS PRIMARY SUBSTATION 1/200

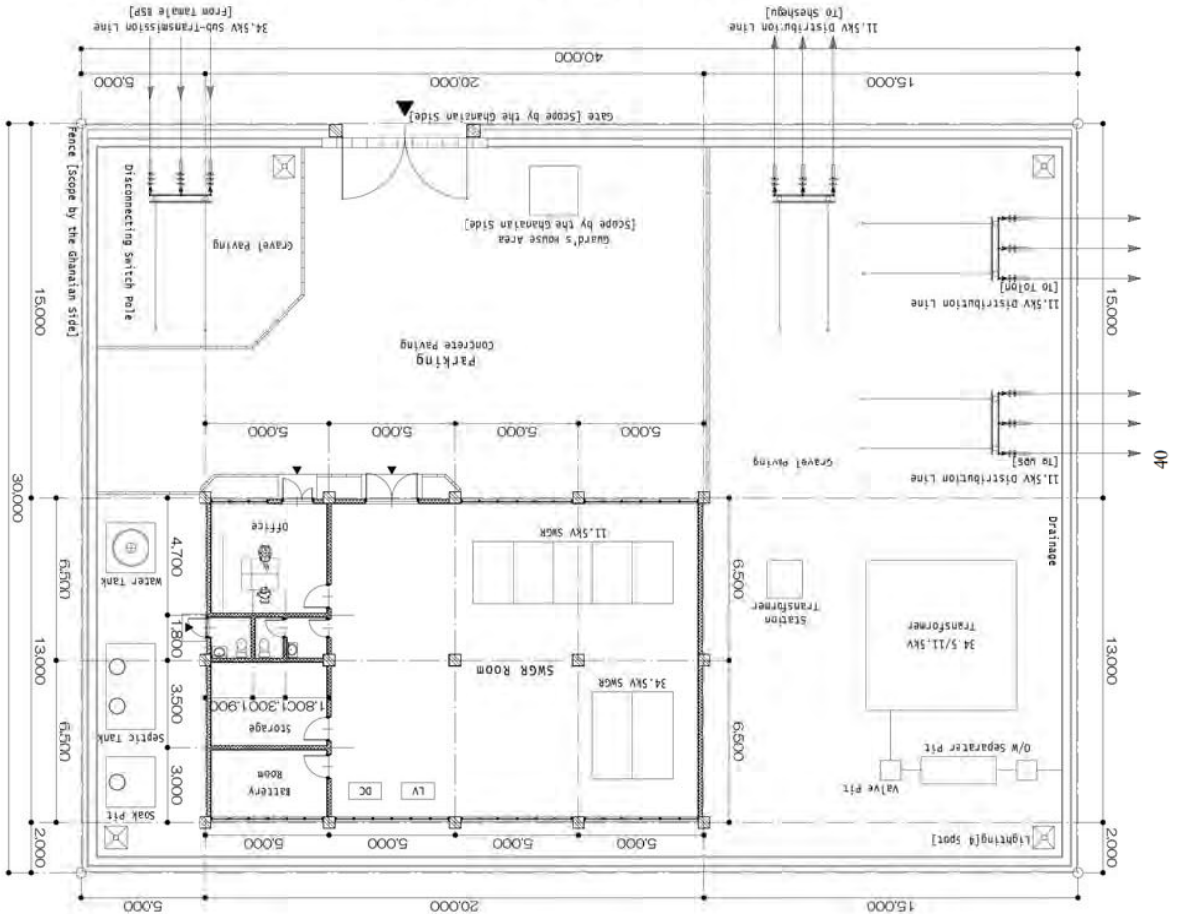

CABLE ROUTE OF TAMALE BULK SUPPLY POINT 1/1000

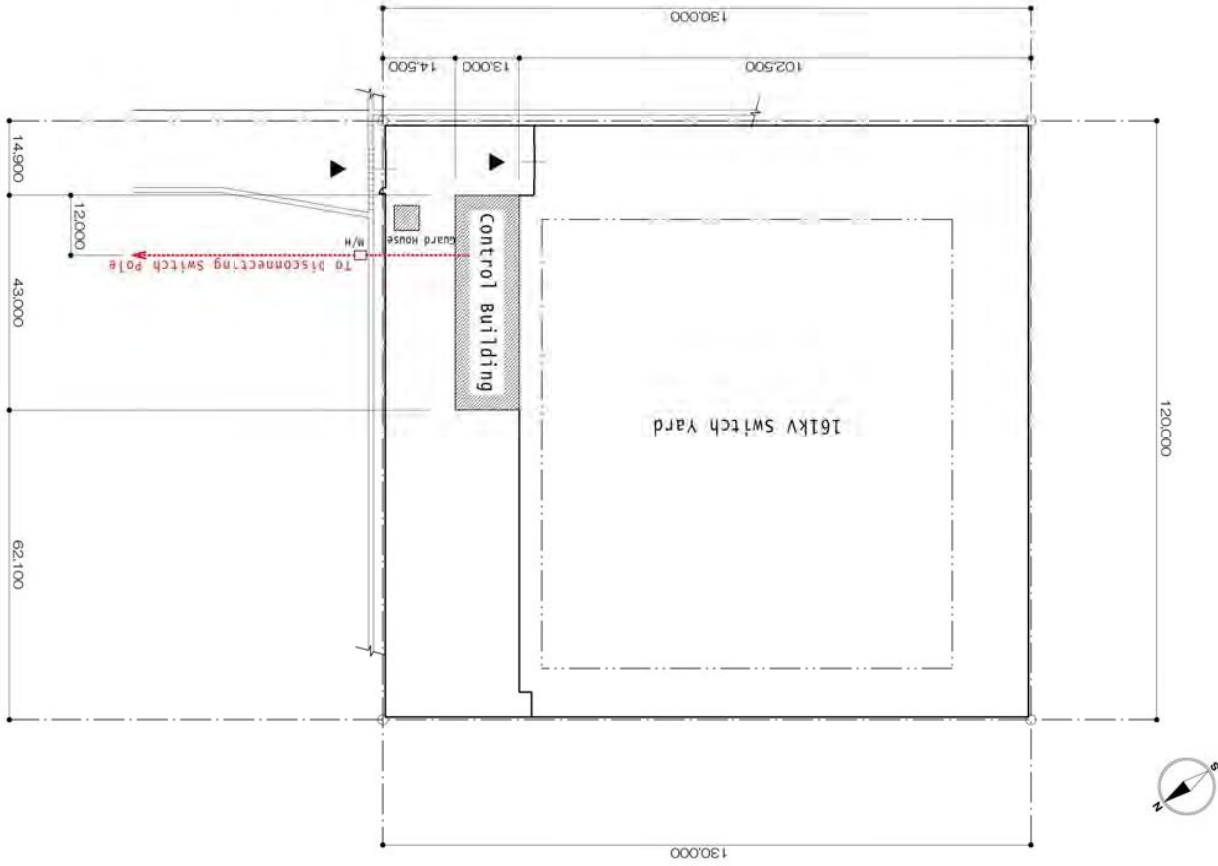

DRAWINGS

**PART 1 Improvement of Tamale Distribution System
in Northern Region**

4. Route Map of Distribution System

Route Map of Tamale Distribution System

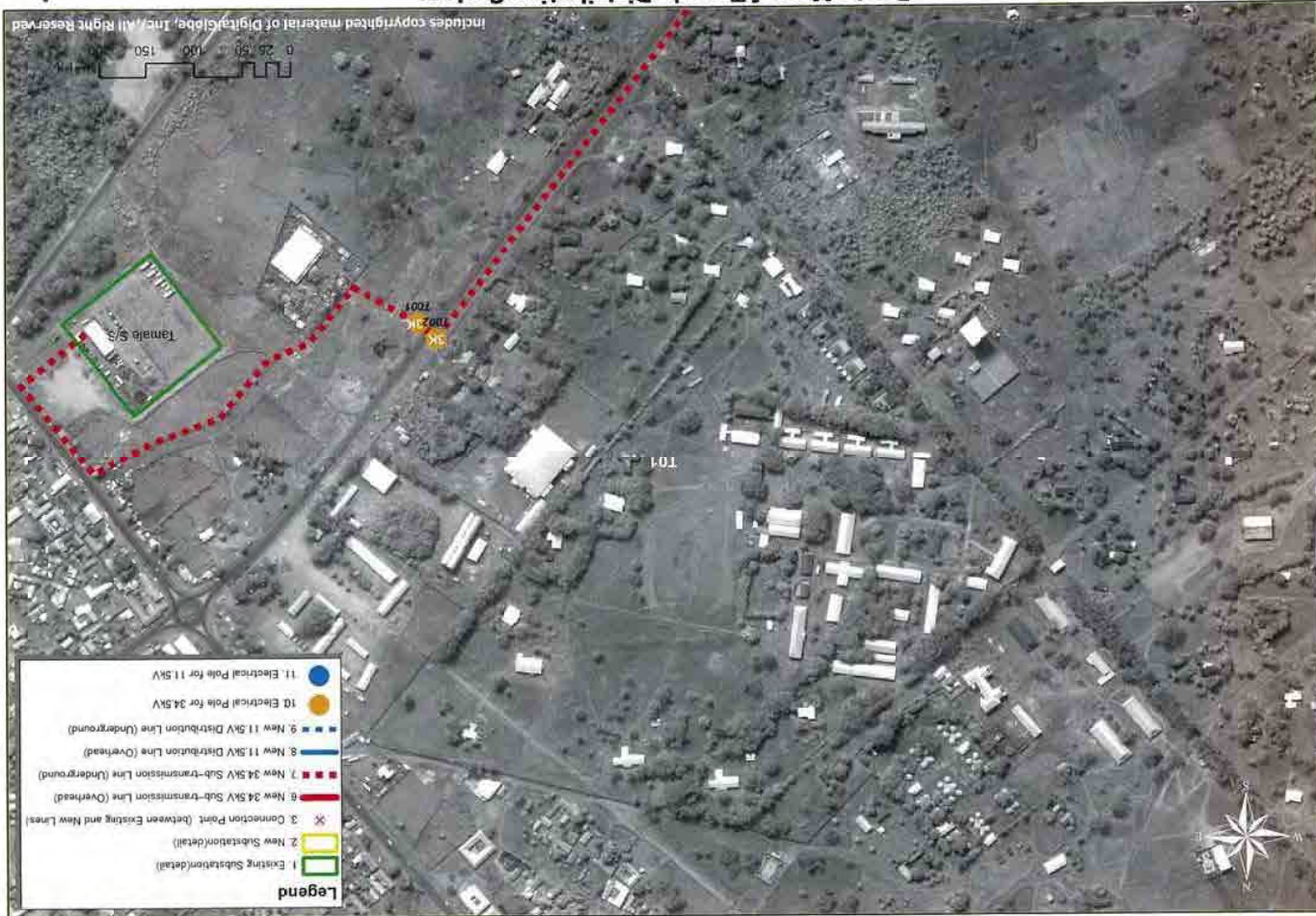

Route Map of Tamale Distribution System

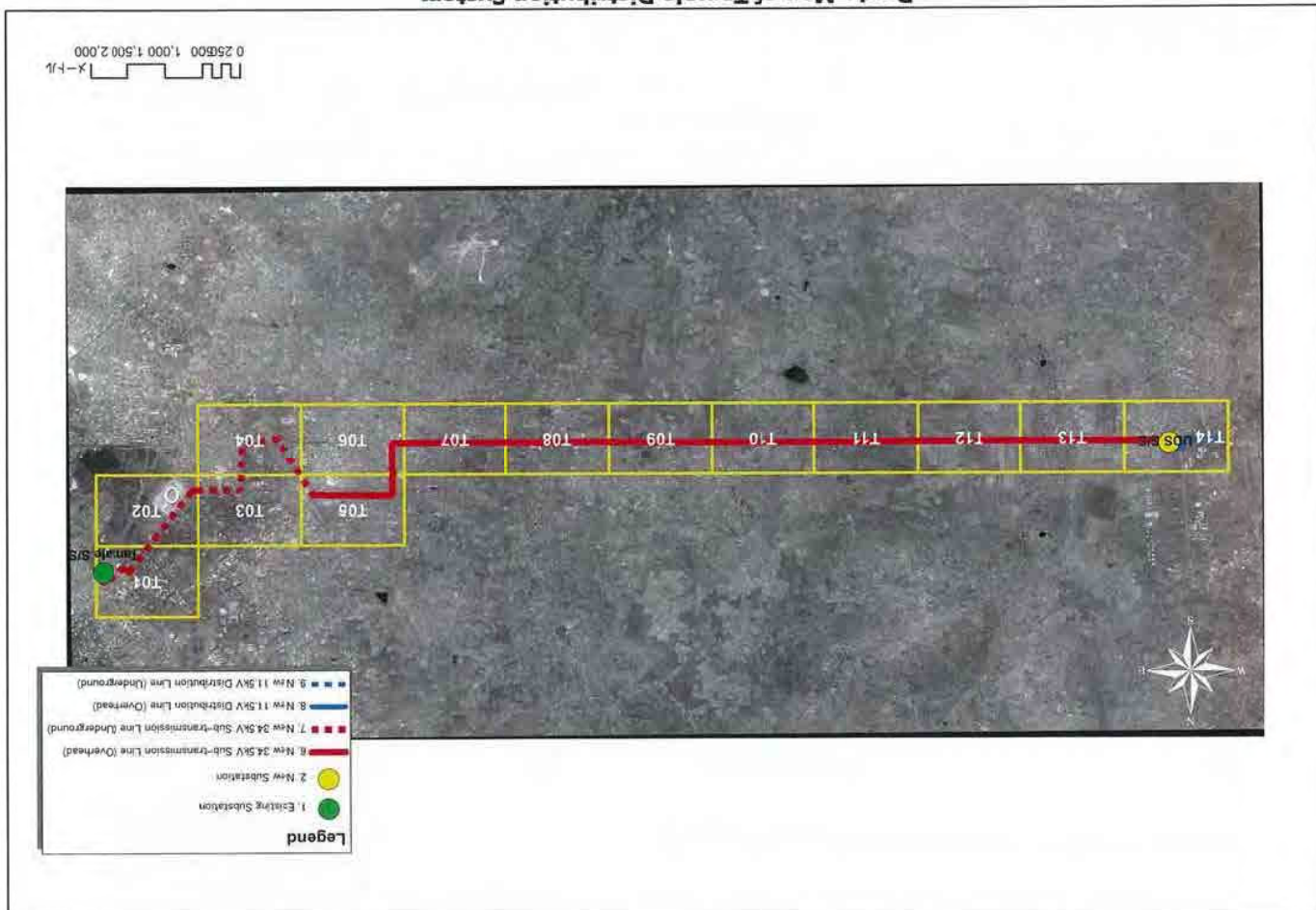

Route Map of Tamale Distribution System

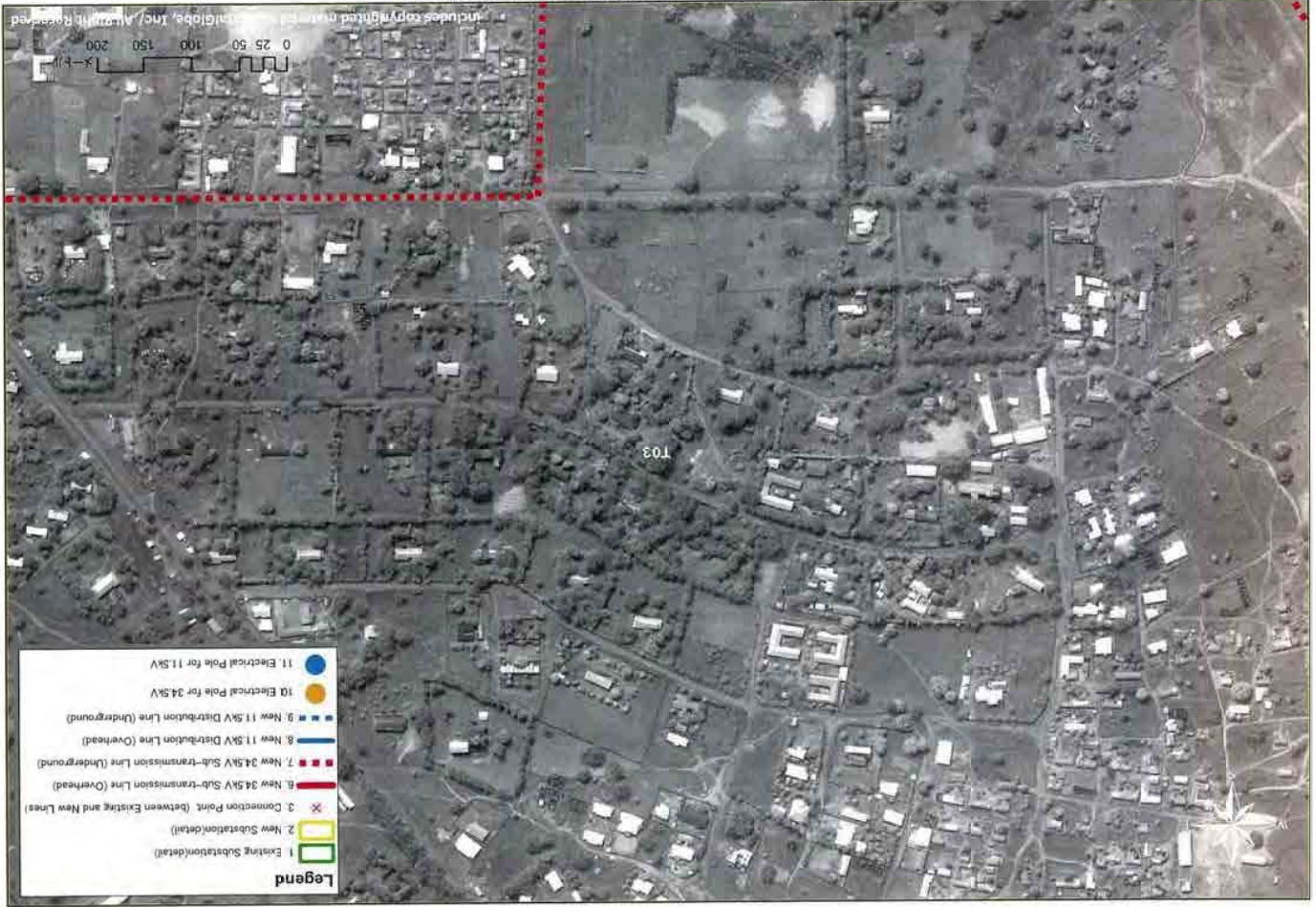

Route Map of Tamale Distribution System



Route Map of Tamale Distribution System



Route Map of Tamale Distribution System

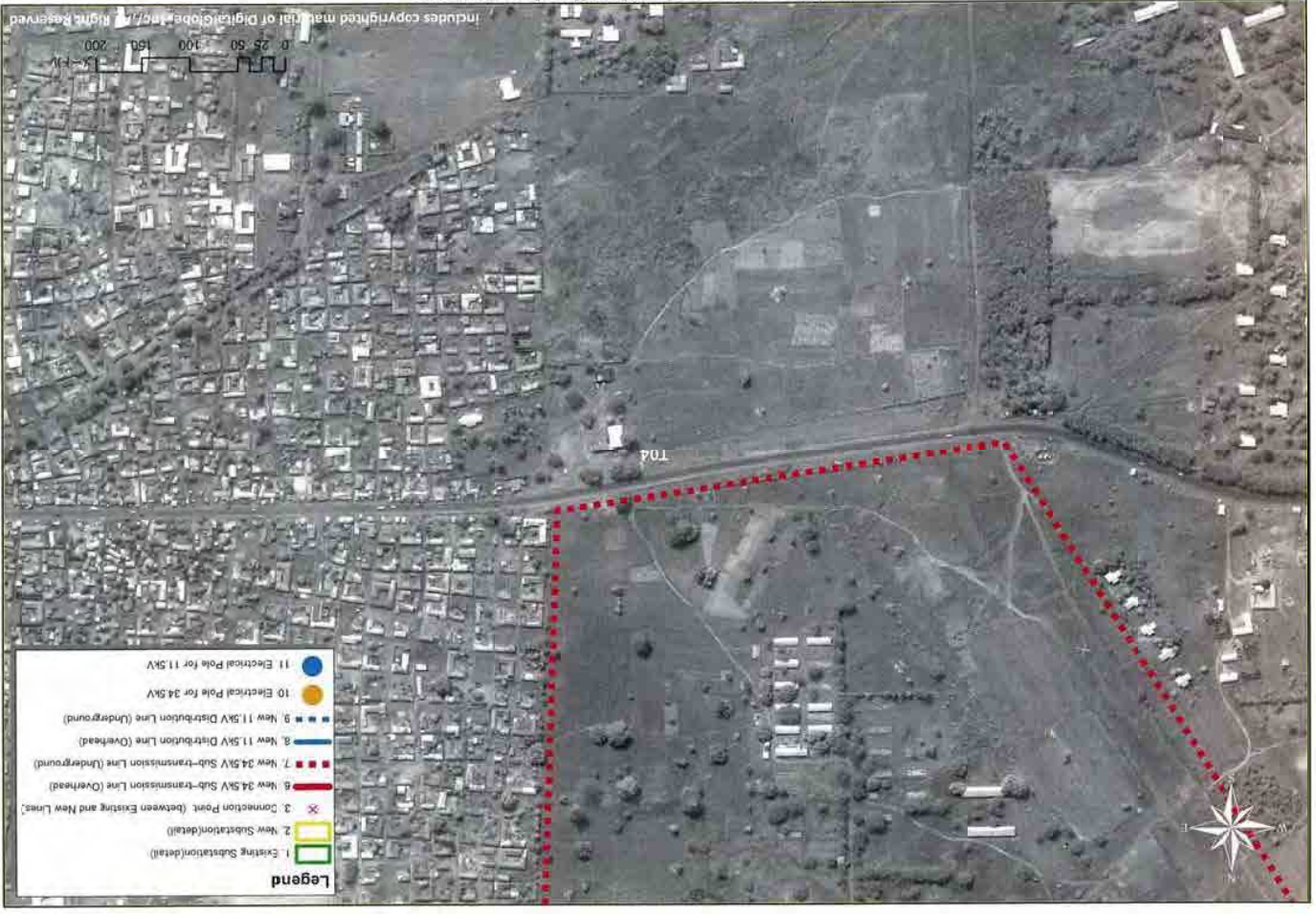

Route Map of Tamale Distribution System

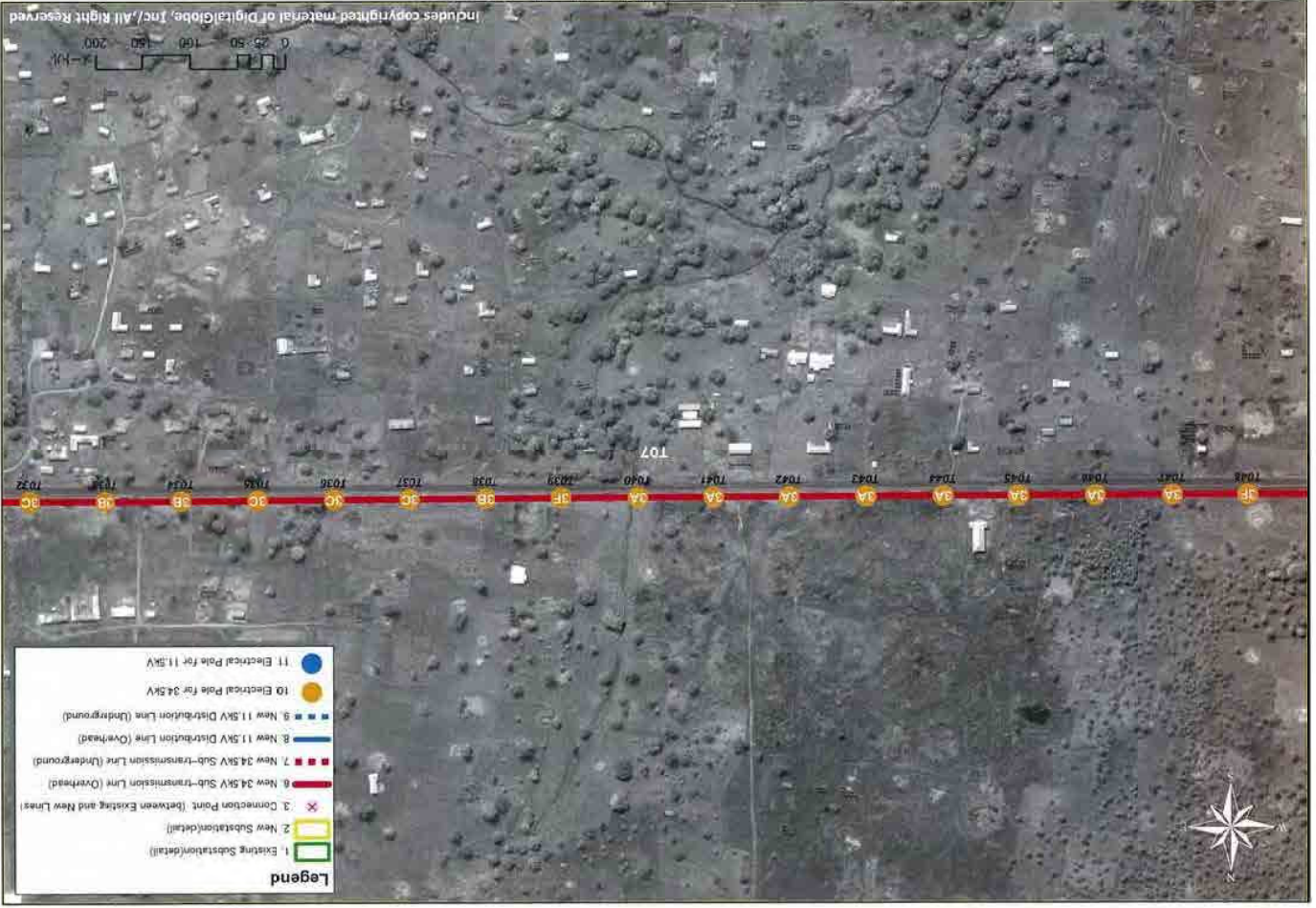

51

Route Map of Tamale Distribution System



50

Route Map of Tamale Distribution System



53

Route Map of Tamale Distribution System



52

Route Map of Tamale Distribution System

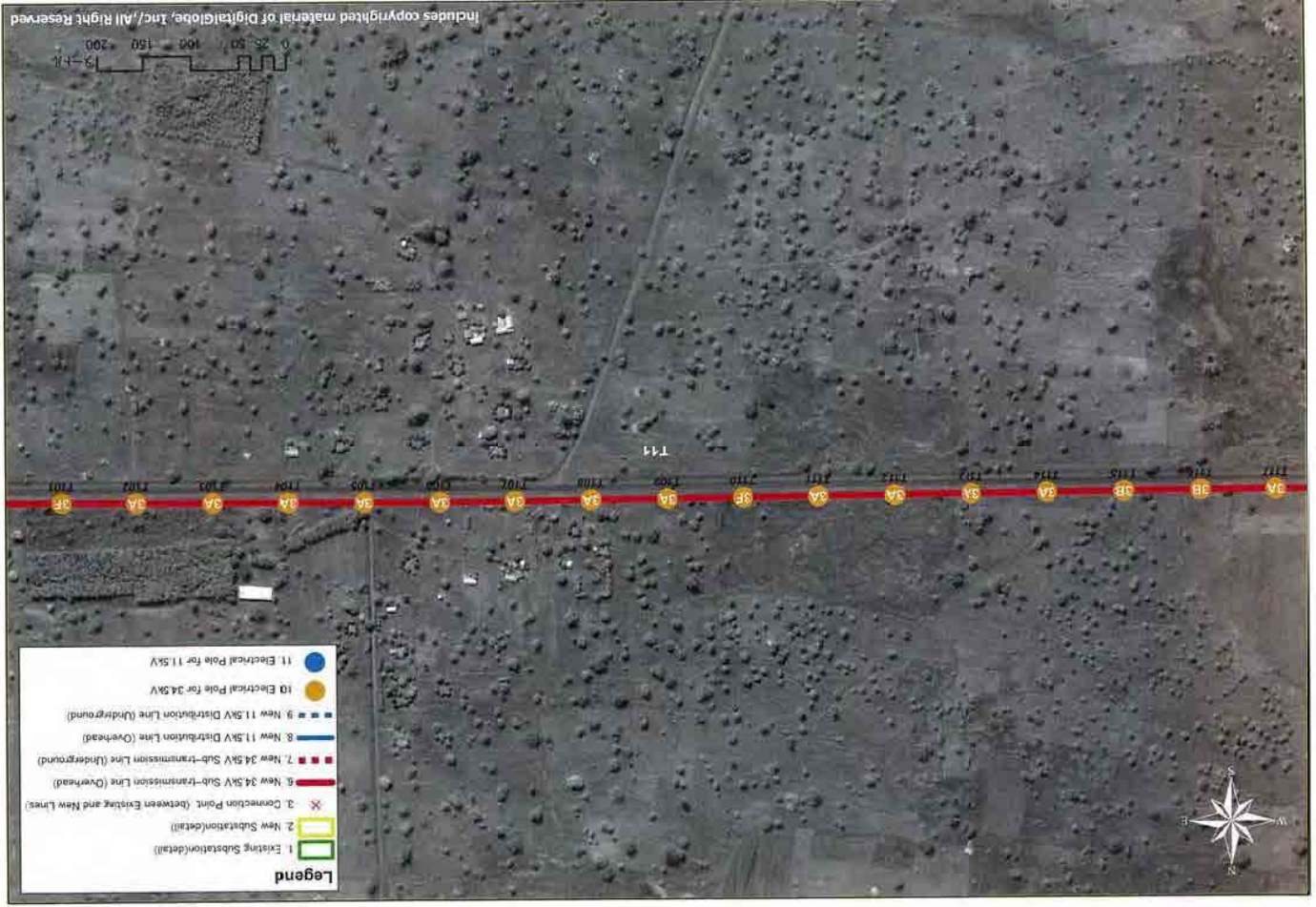

Route Map of Tamale Distribution System

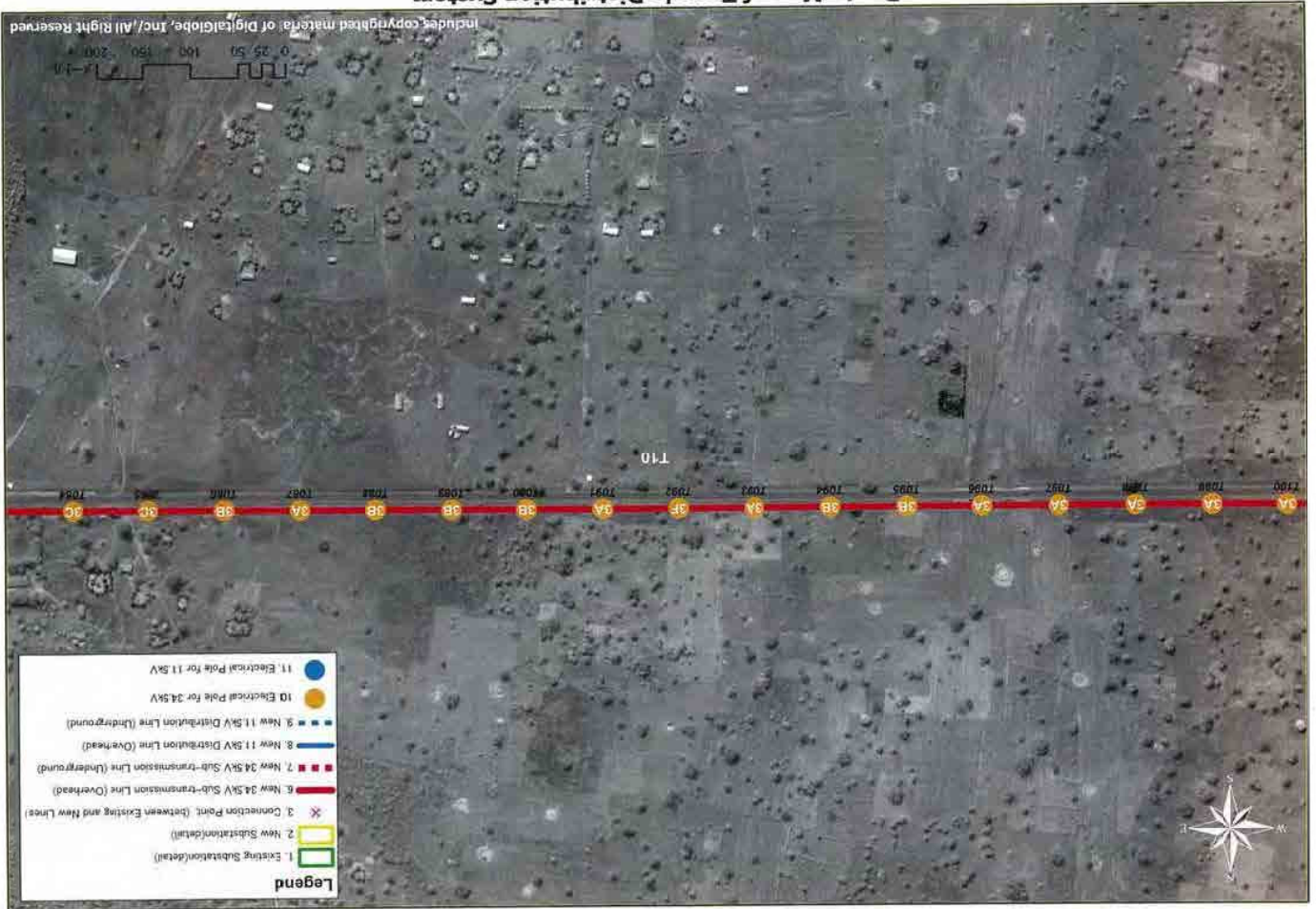

Route Map of Tamale Distribution System



Route Map of Tamale Distribution System

