

(8) Pavement Condition Survey Result

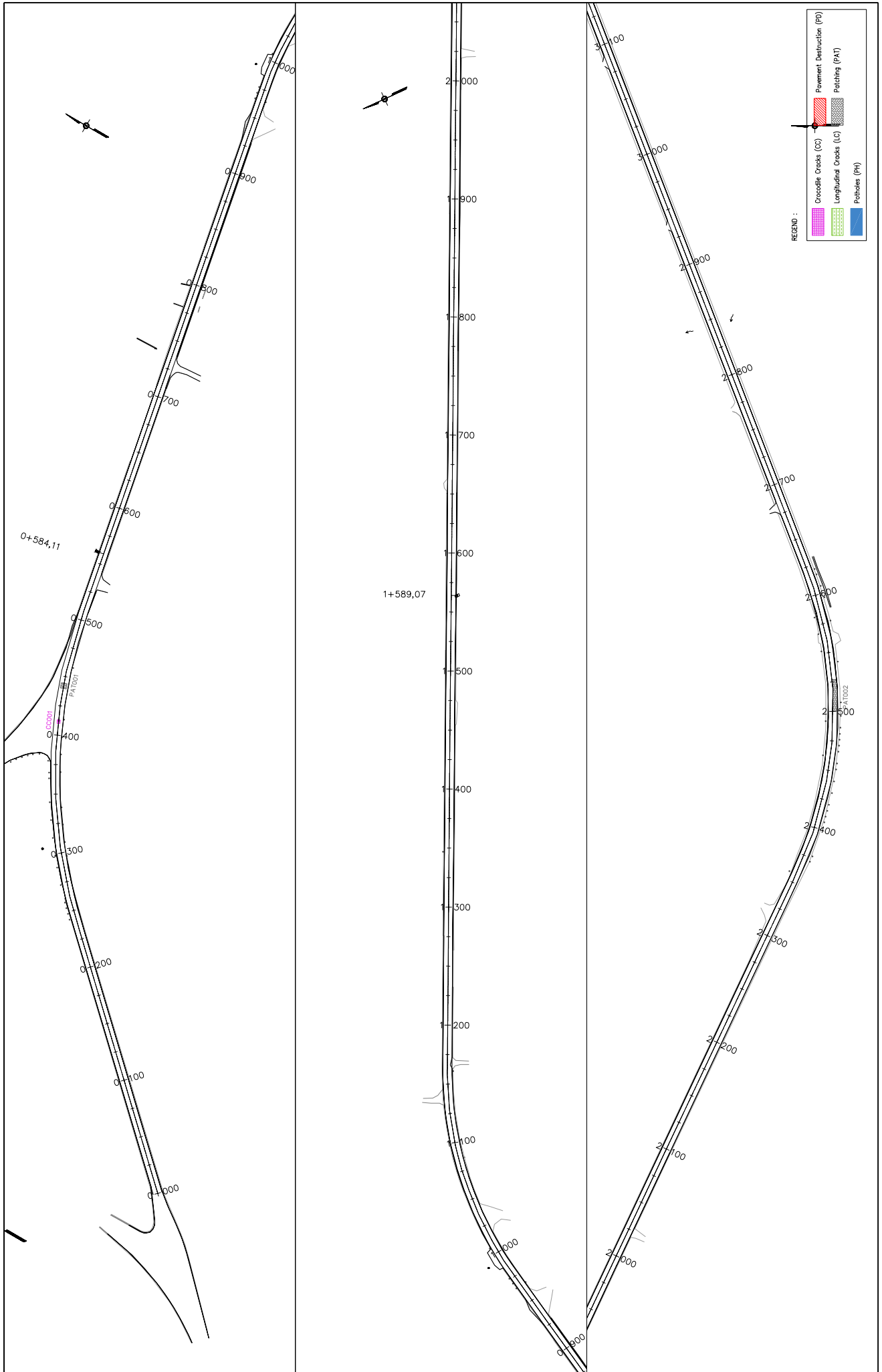

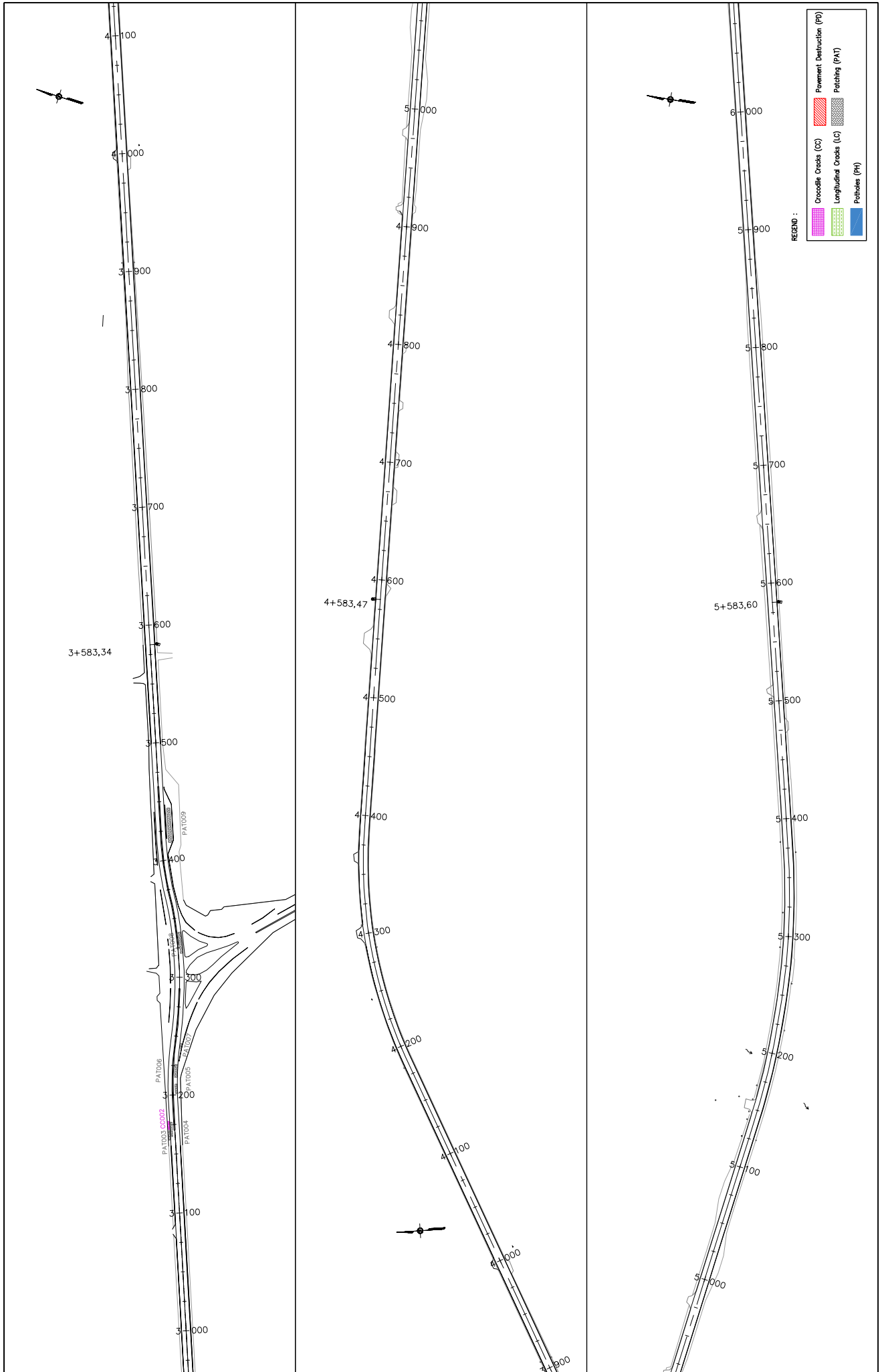

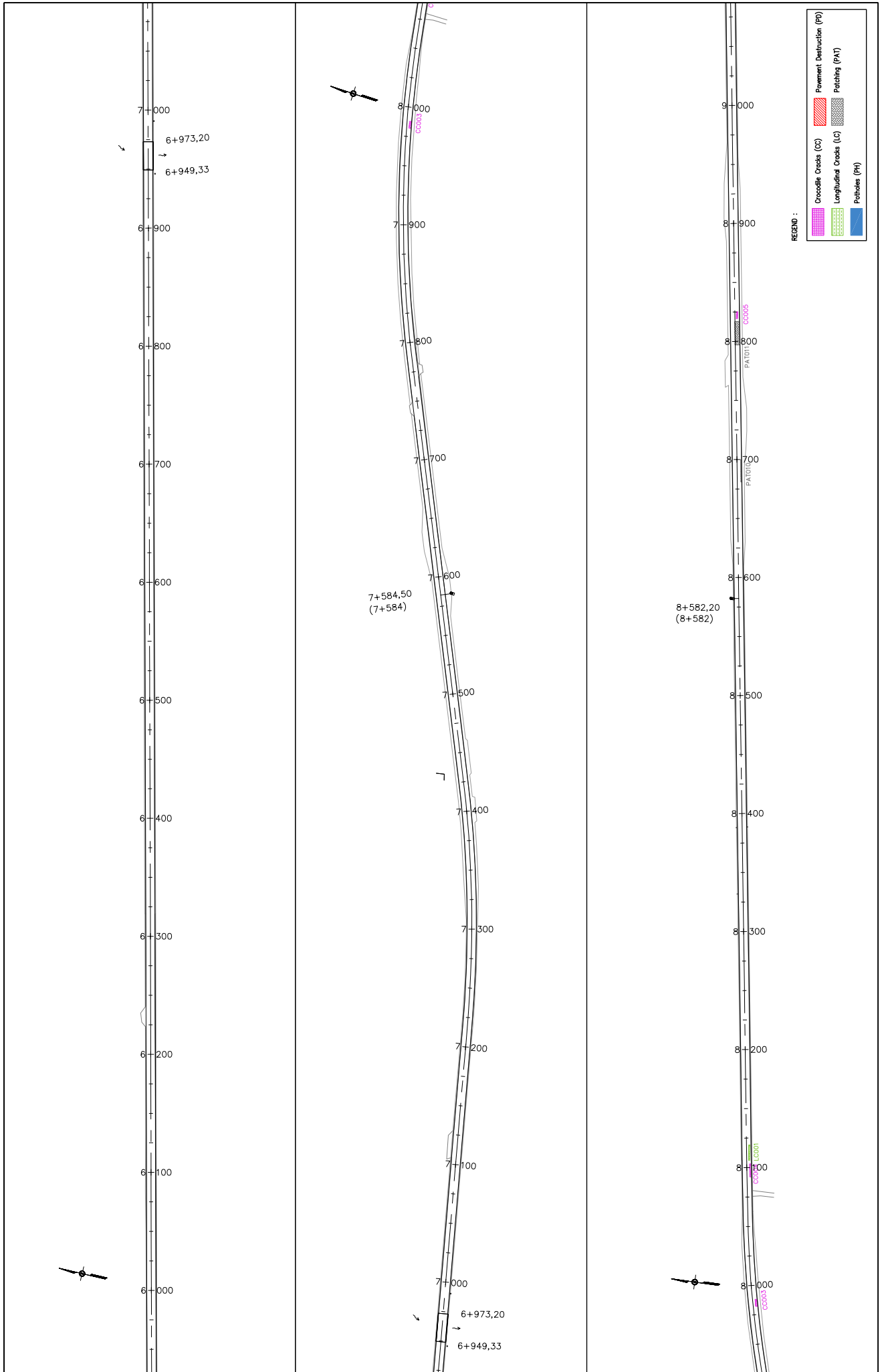

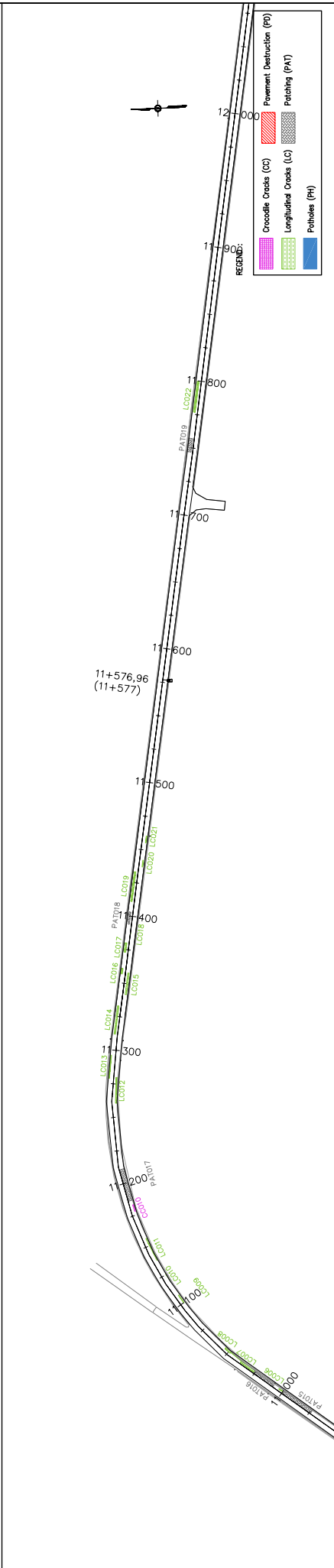
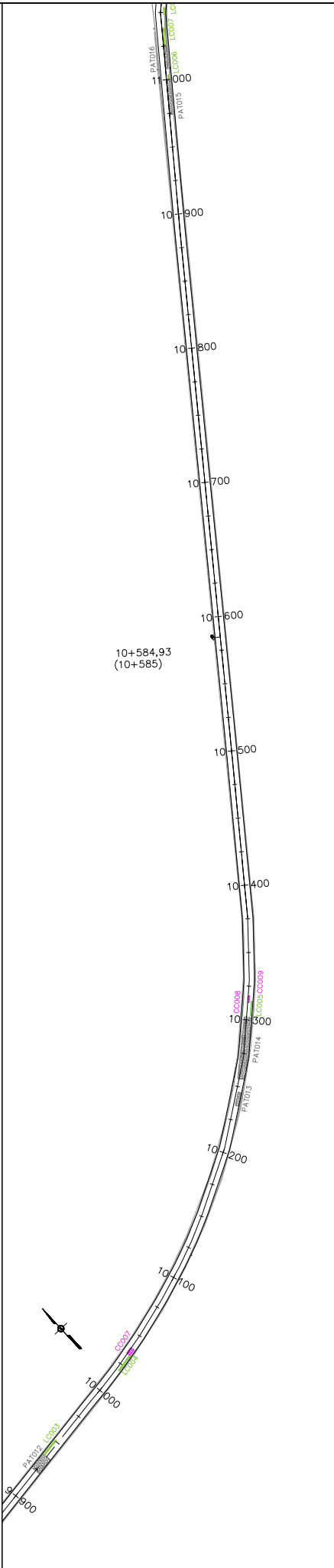
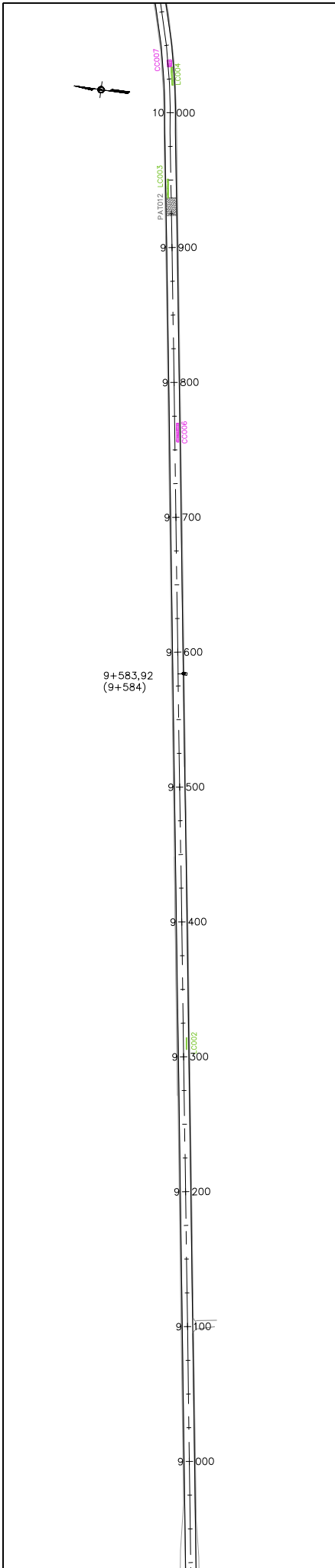

REGRIND:

	Crocodile Croads (CC)		Pavement Destruction (PD)
	Longitudinal Croads (LC)		Patching (PAT)
	Potholes (PH)		



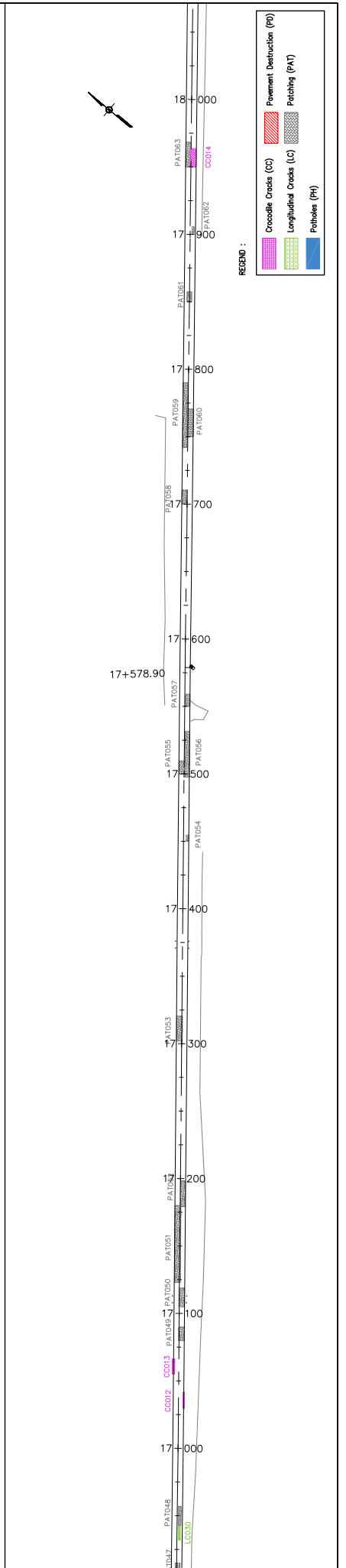
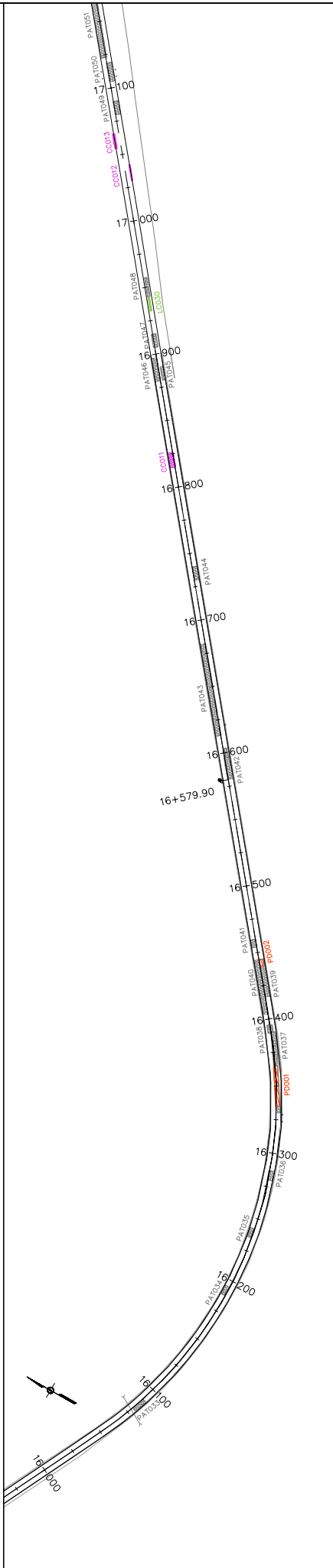
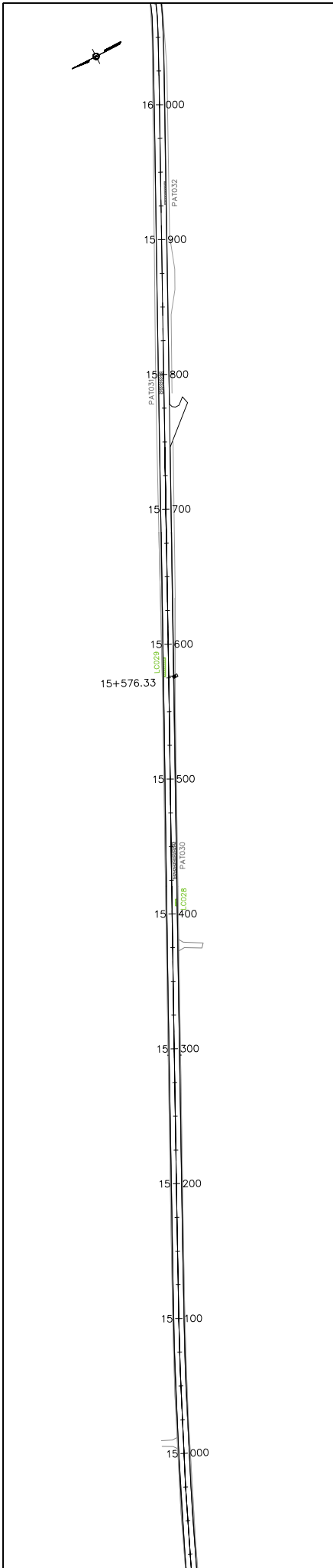

REGENO :

	Crocodile Cracks (CC)		Pavement Destruction (PD)
	Longitudinal Cracks (LC)		Patching (PAT)
	Potholes (PH)		

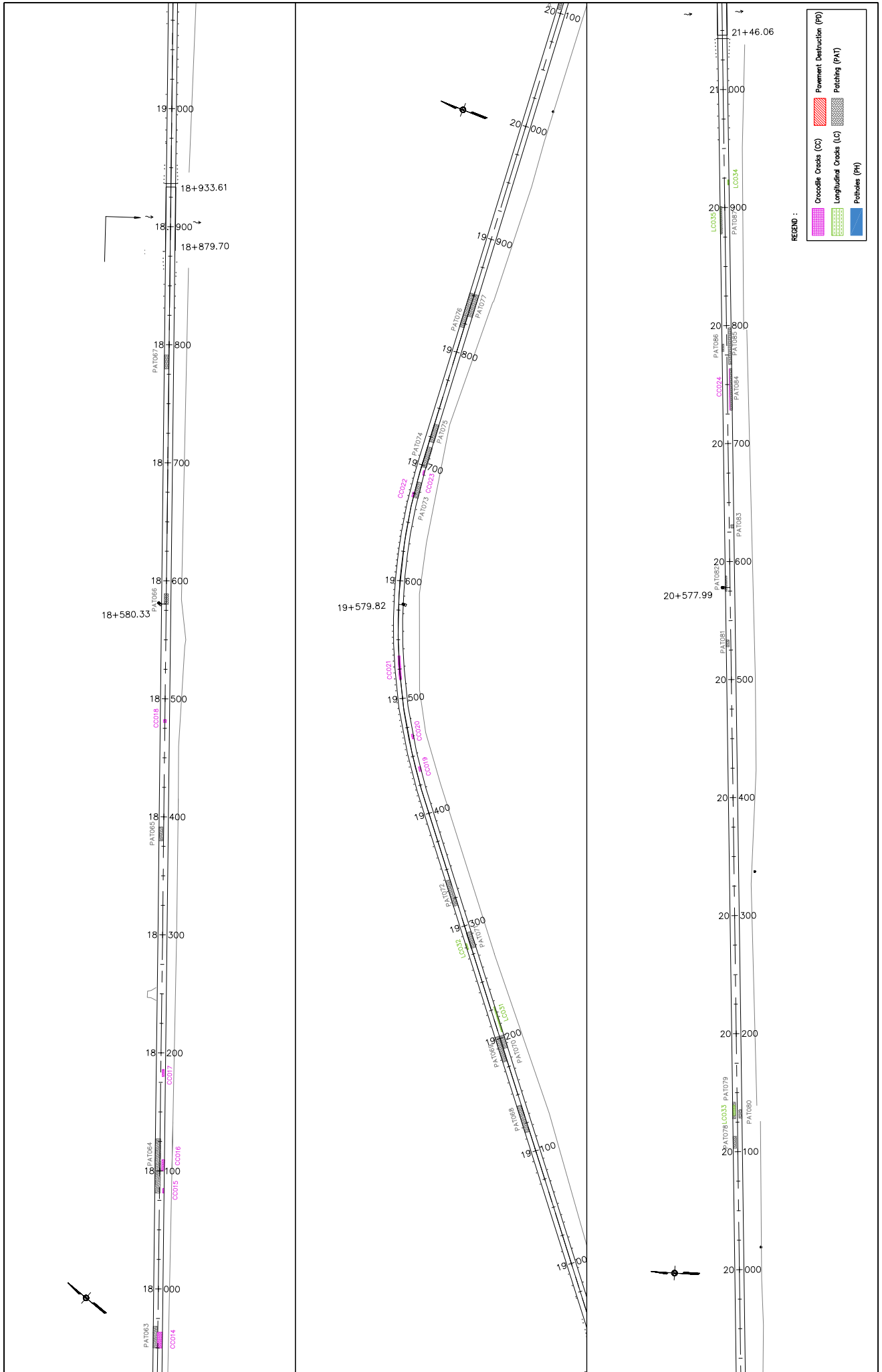

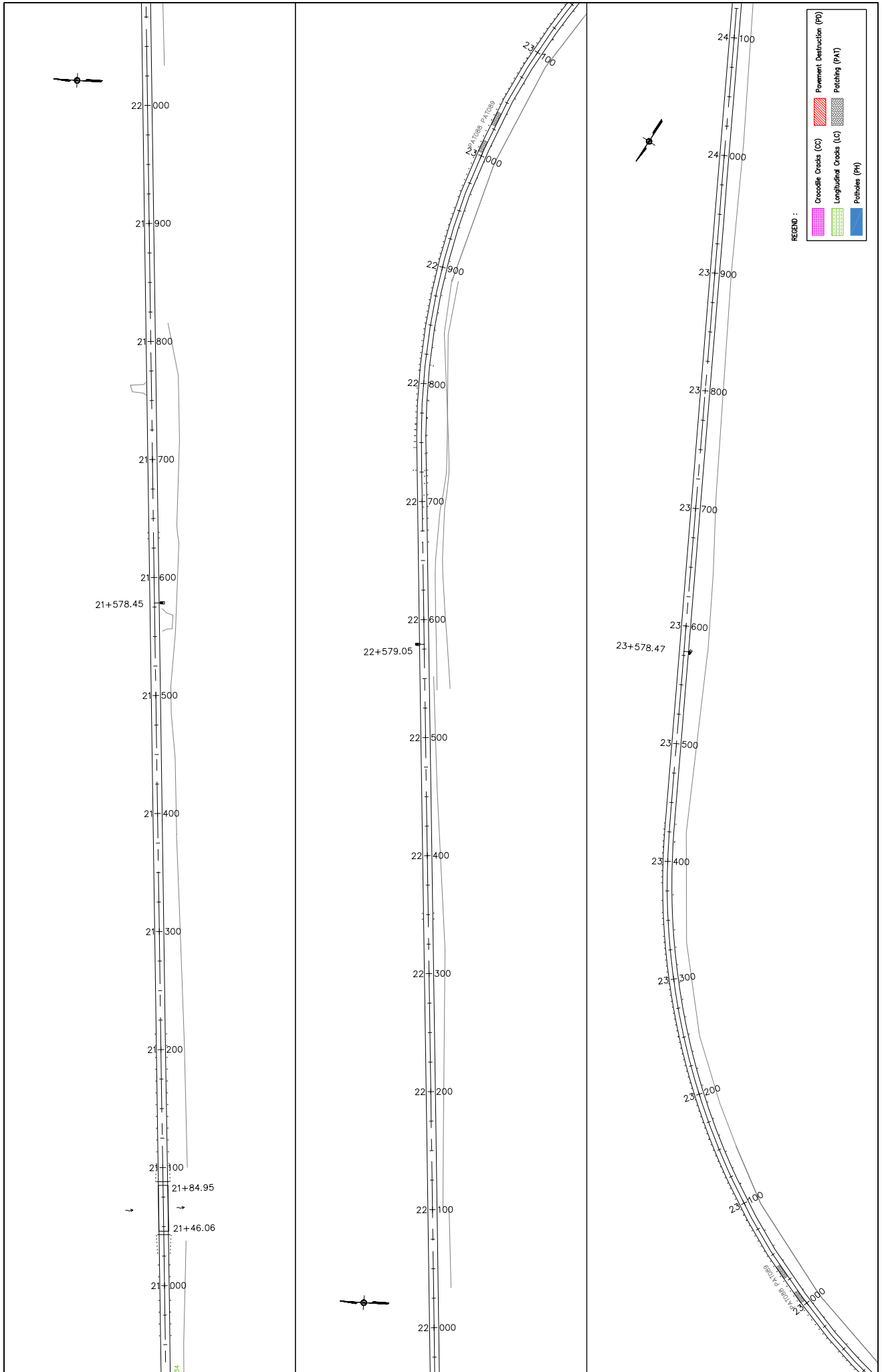

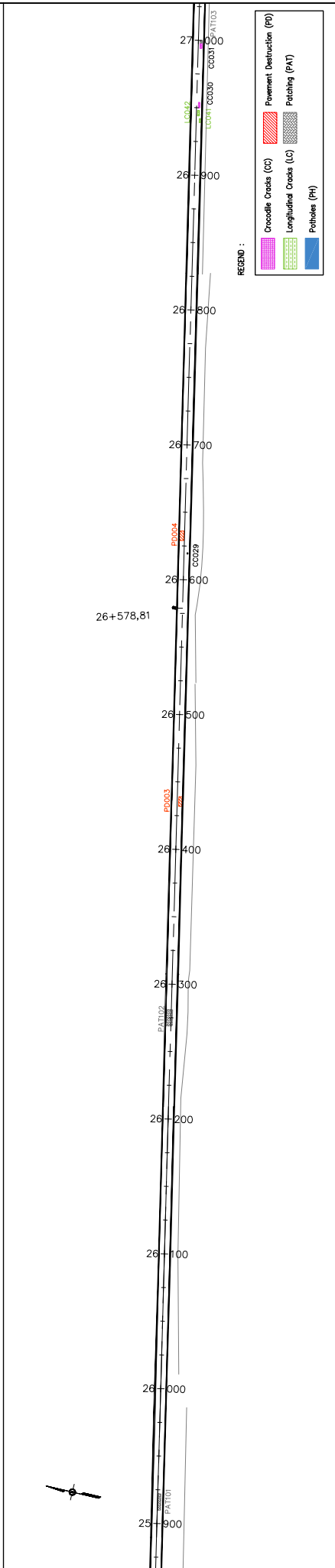
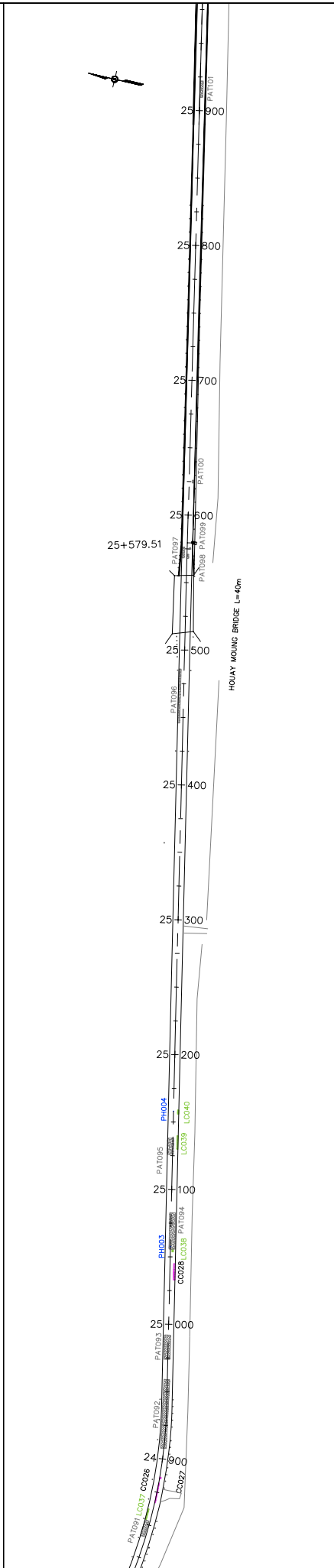
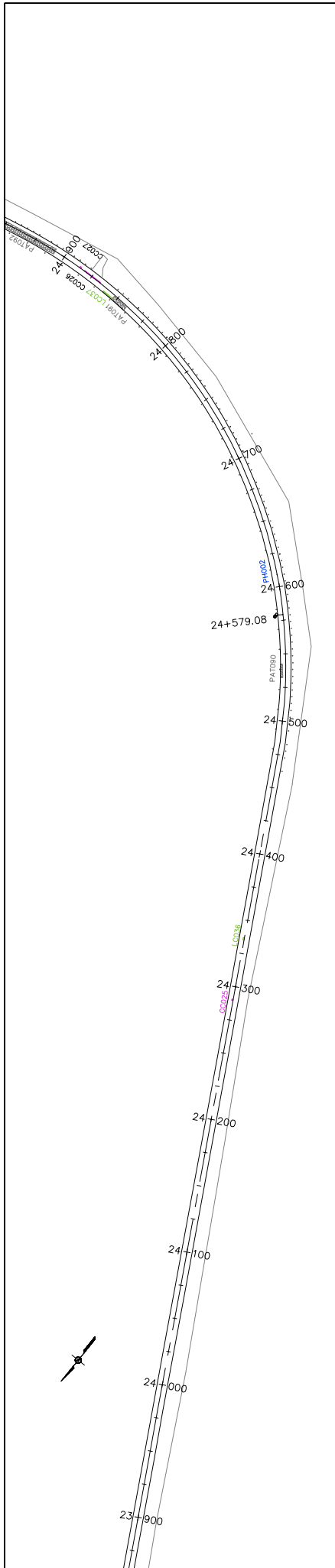

REGENO :

	Crocodile Cracks (CC)		Pavement Destruction (PD)
	Longitudinal Cracks (LC)		Patching (PAT)
	Potholes (PH)		

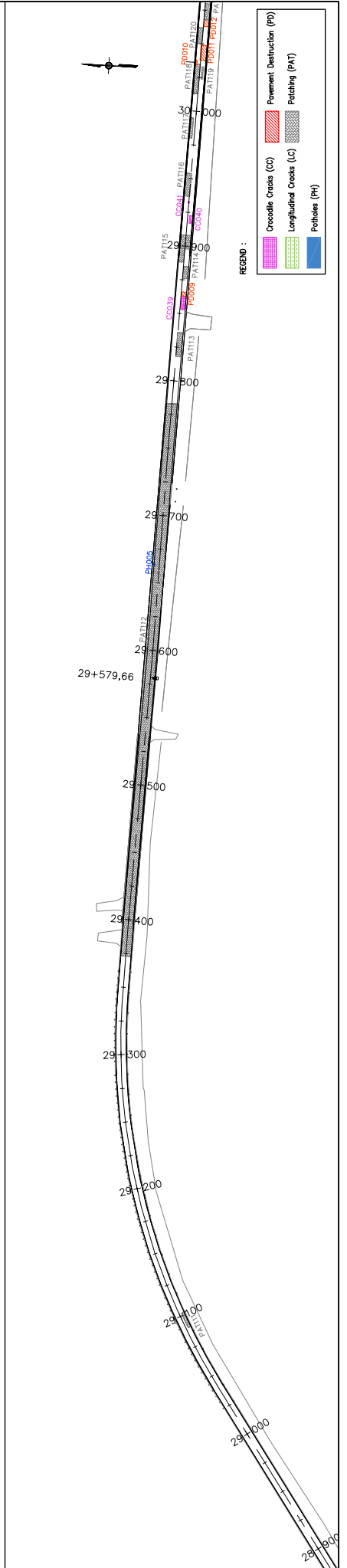
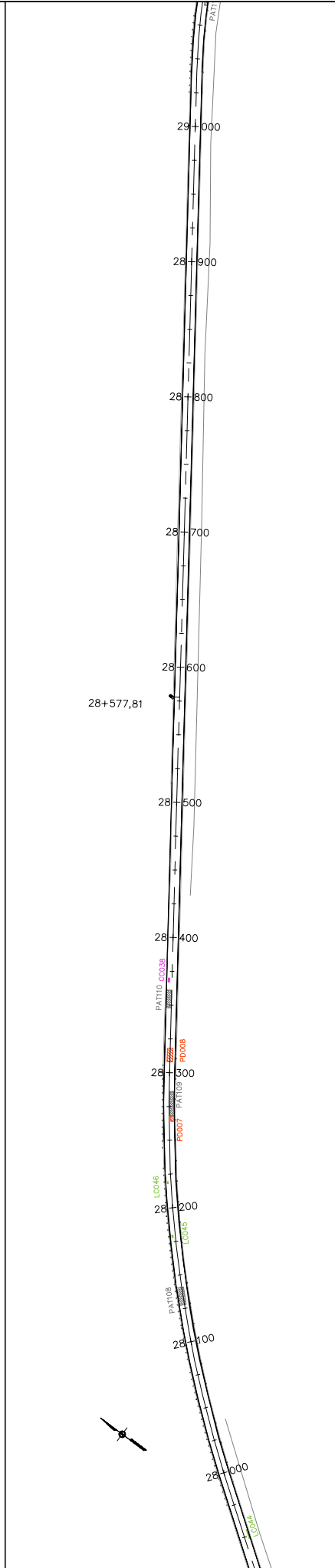

REGENO :

	Crocodile Cracks (CC)		Pavement Destruction (PD)
	Longitudinal Cracks (LC)		Patching (PAT)
	Potholes (PH)		



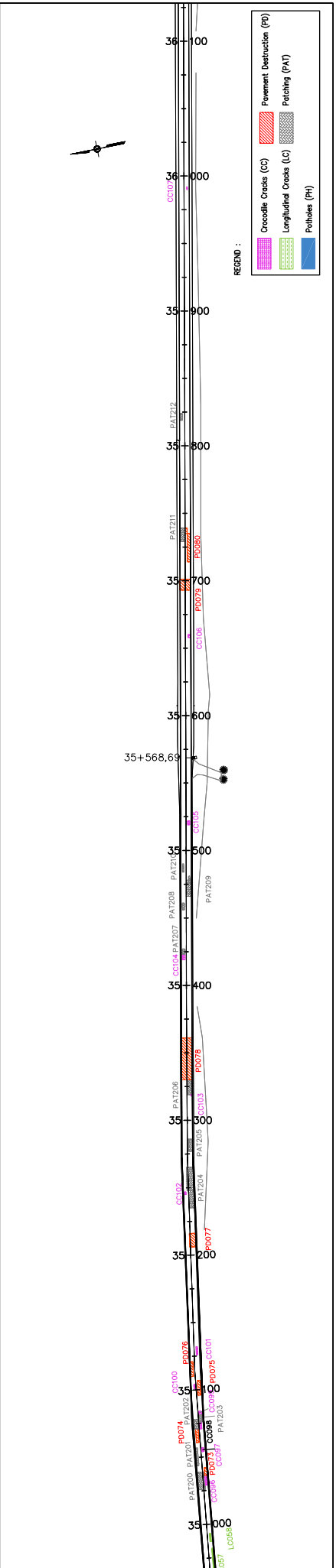
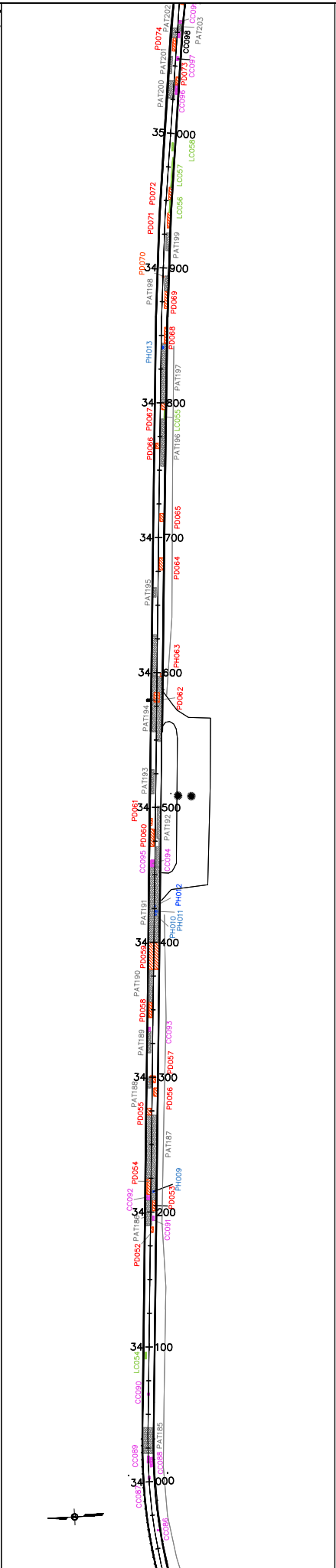
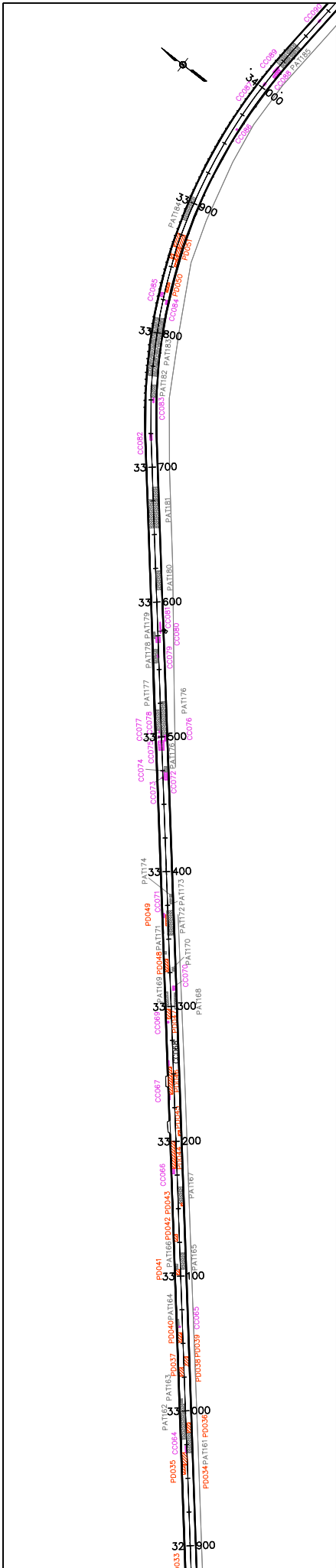

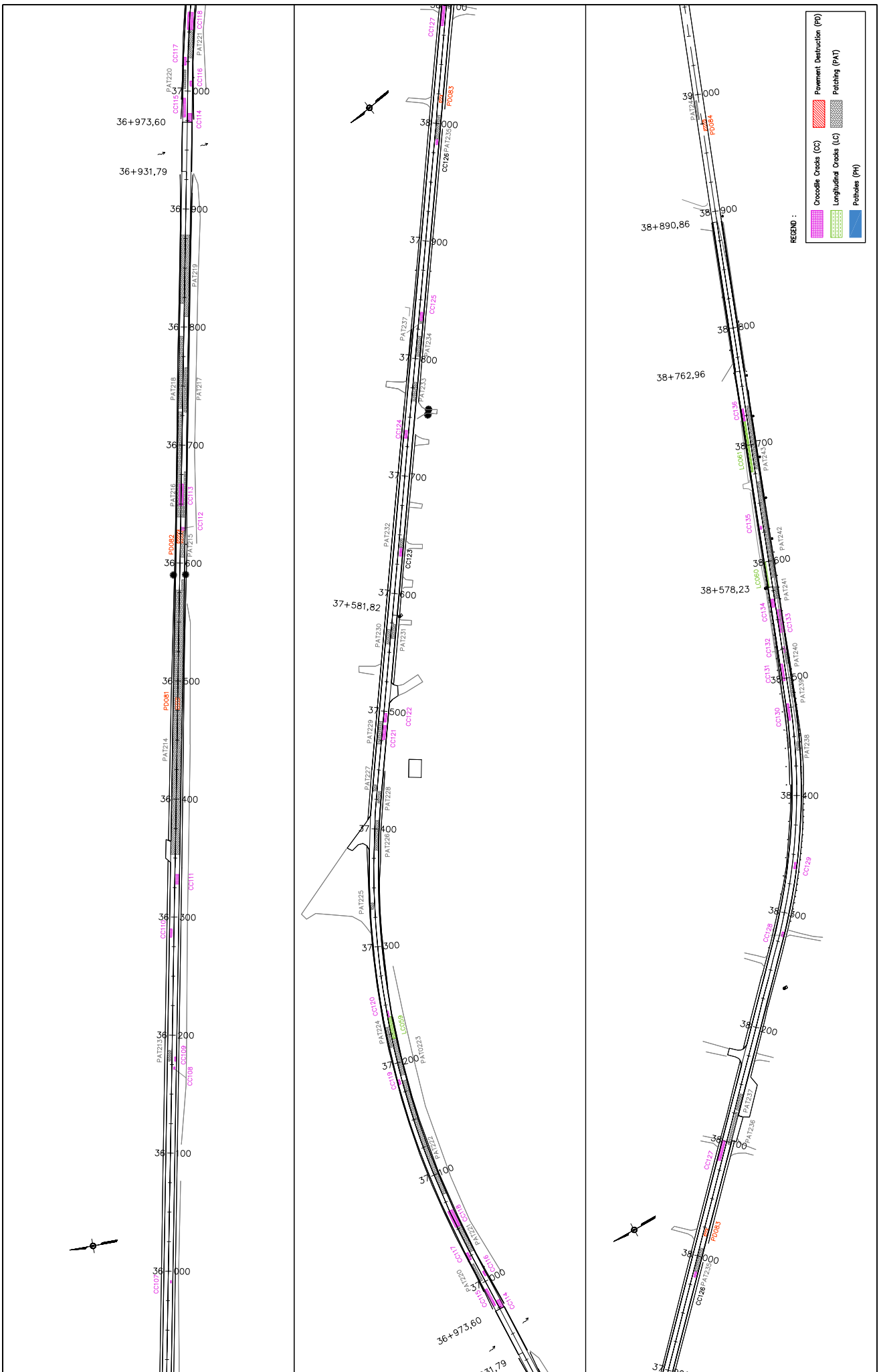

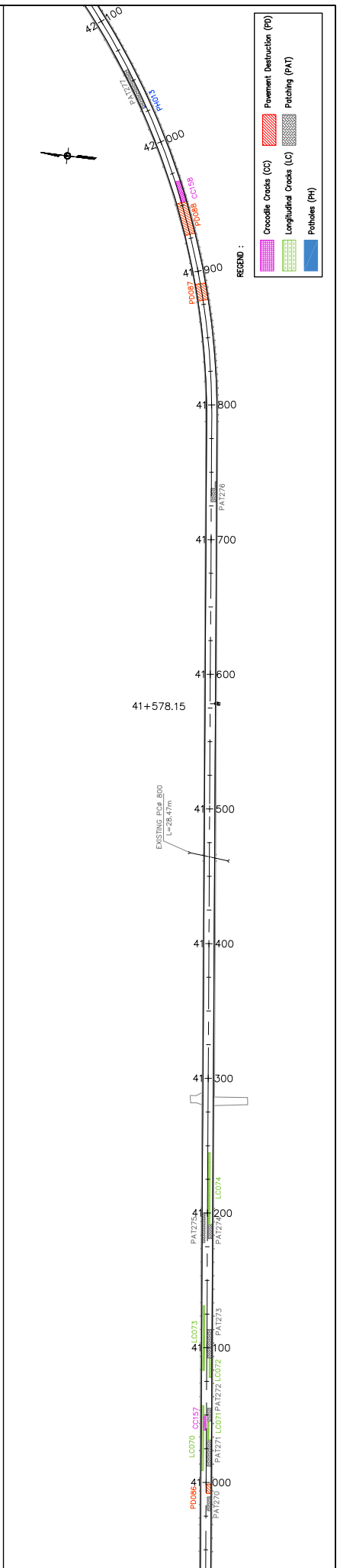
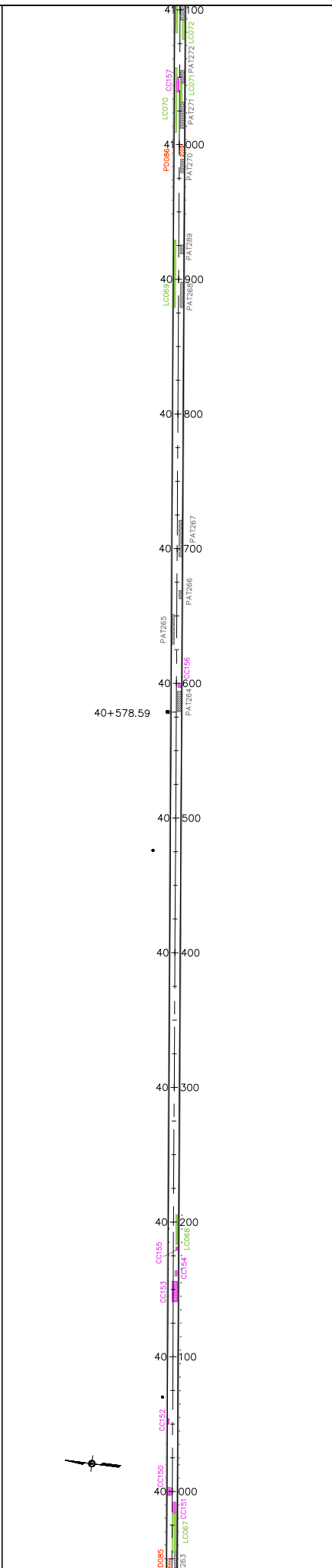
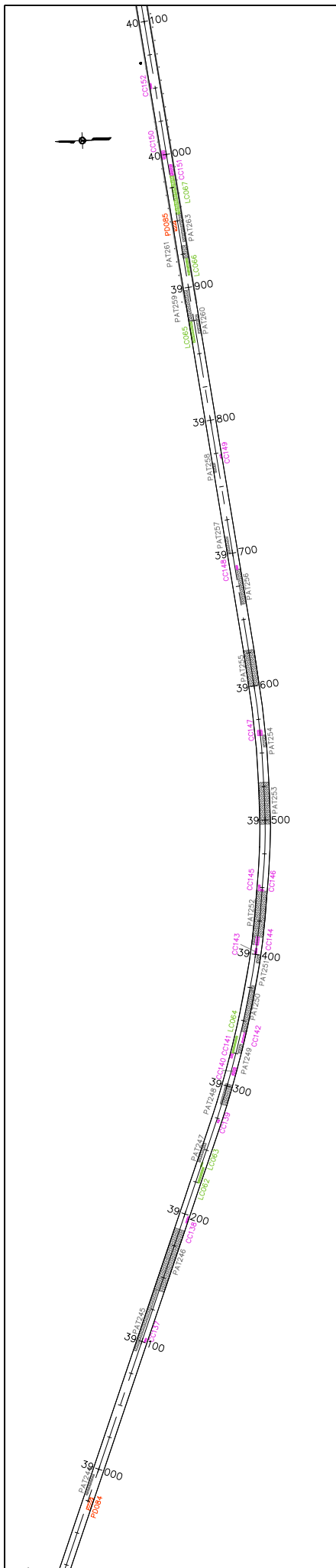

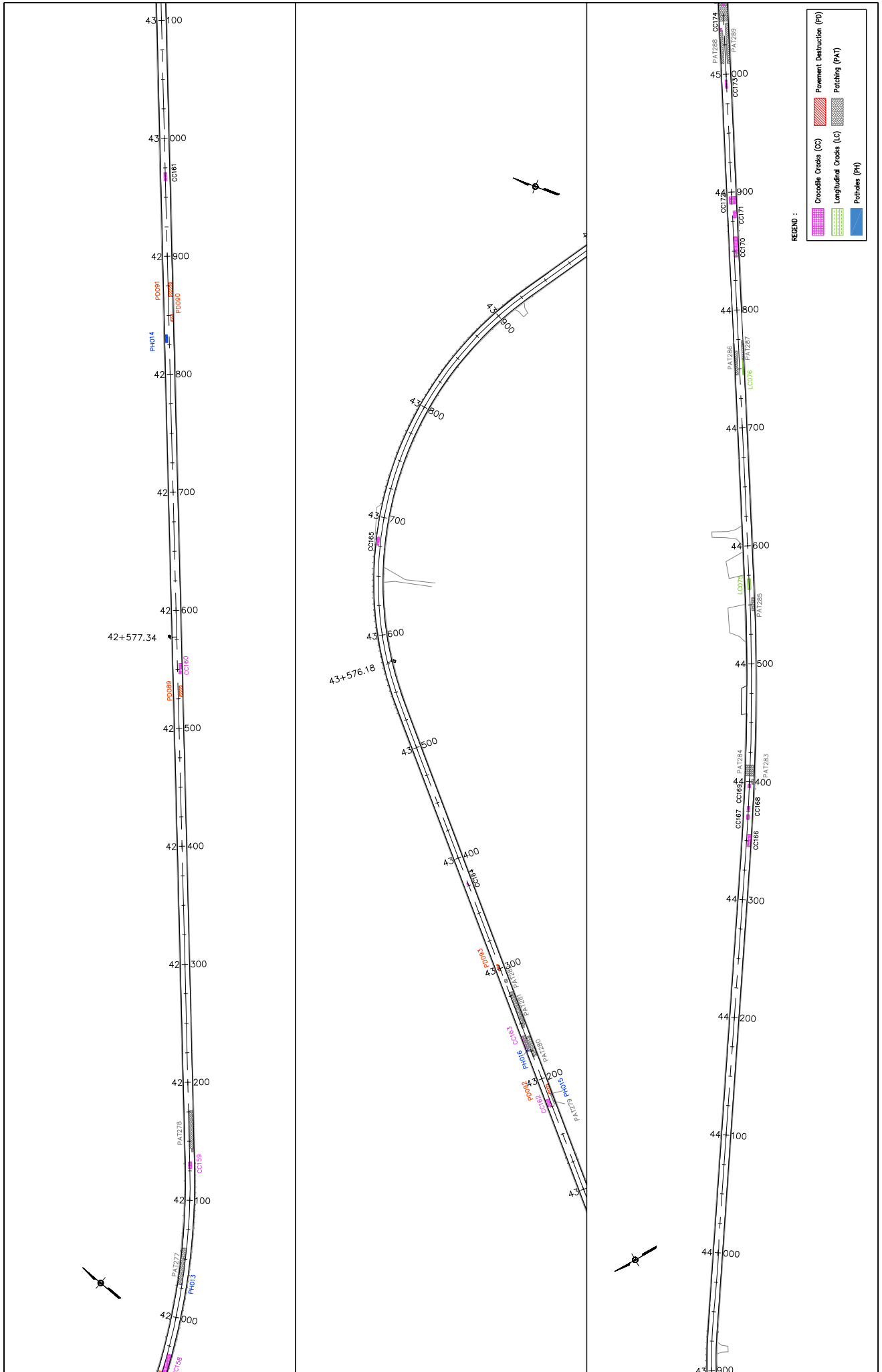

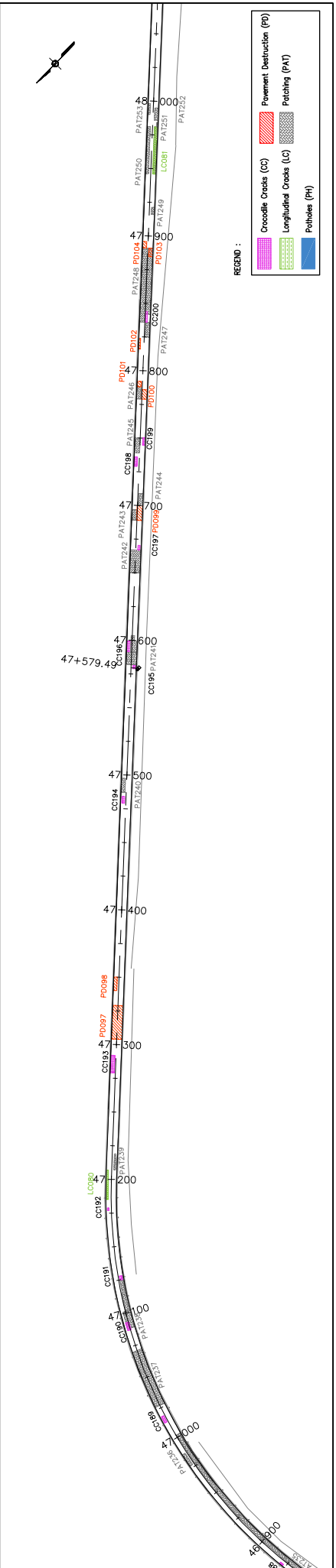
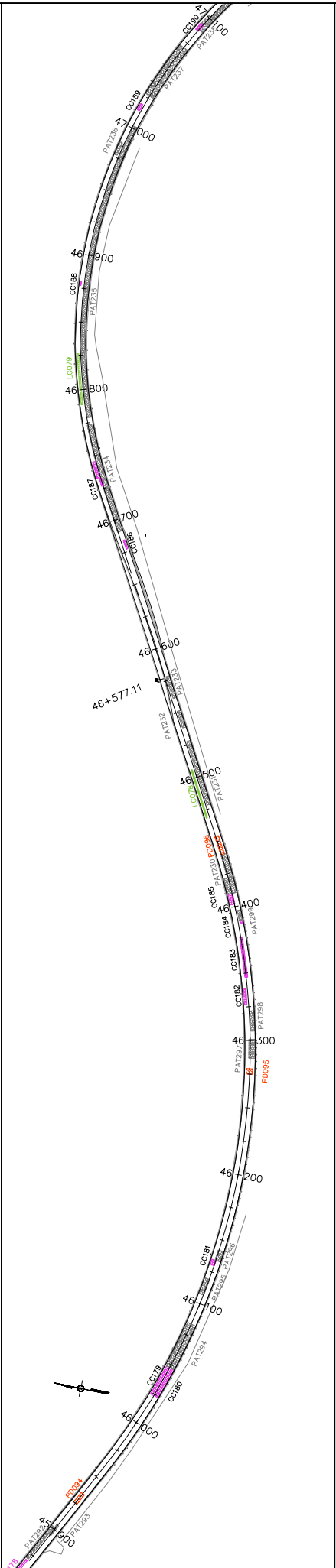
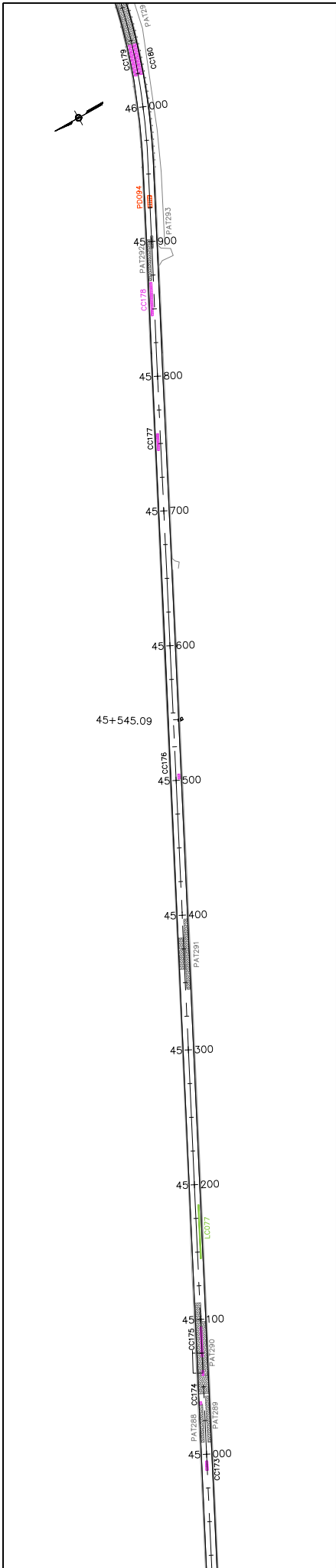

LEGEND :

	Crocodile Croads (CC)		Pavement Destruction (PD)
	Longitudinal Croads (LC)		Patching (PAT)
	Potholes (PH)		

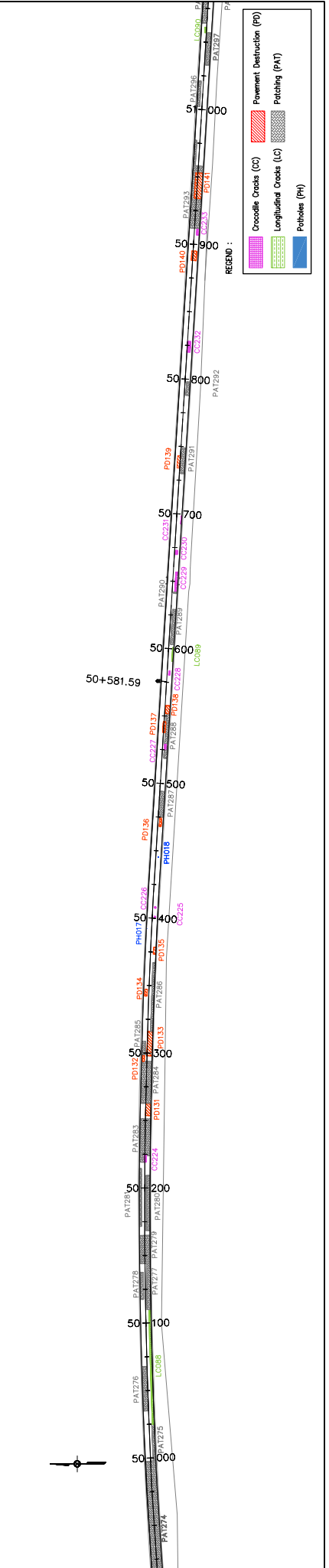
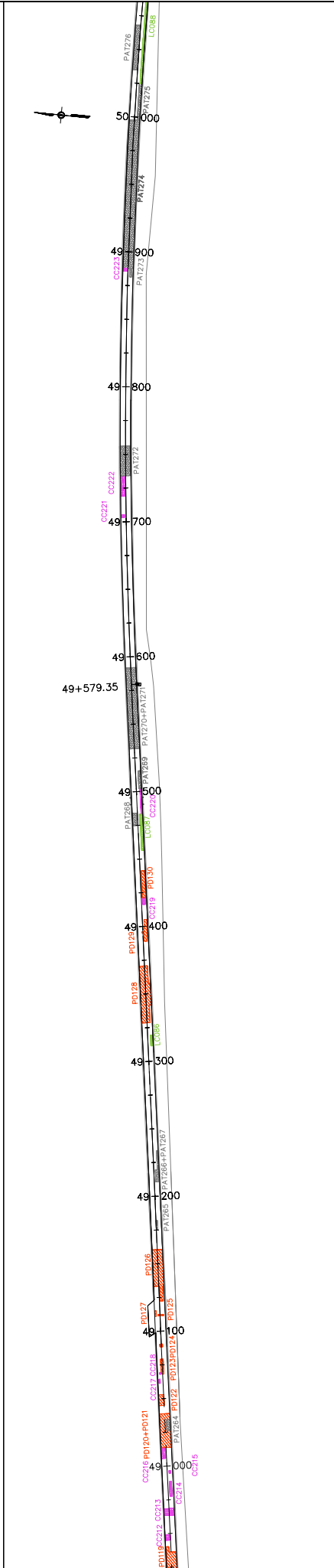
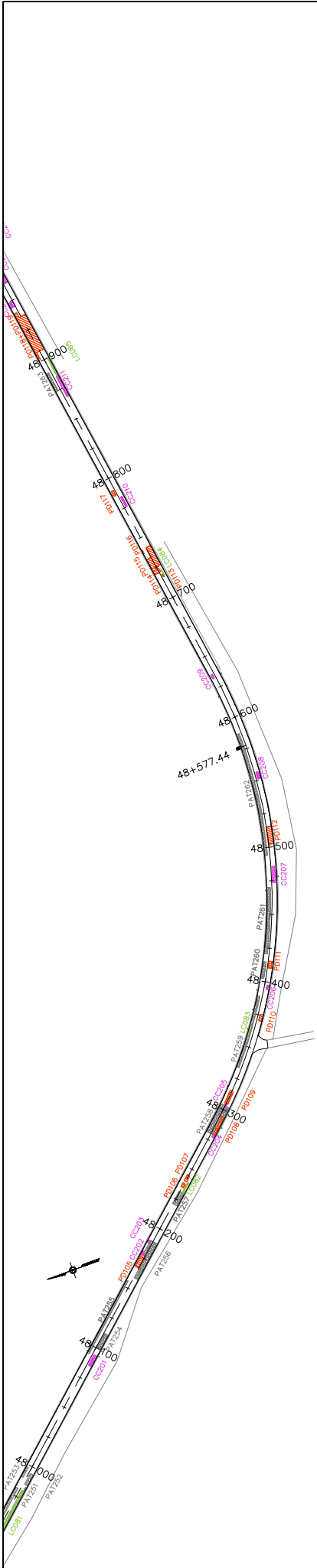

LEGEND :

- Pavement Destruction (PD)
- Patching (PAT)
- Crocodile Cracks (CC)
- Longitudinal Cracks (LC)
- Potholes (PH)

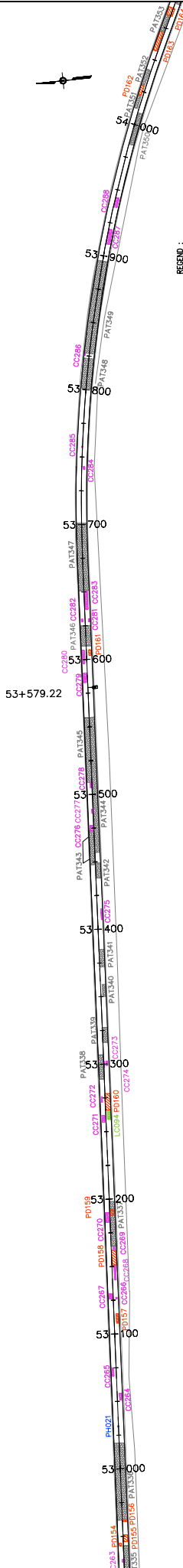
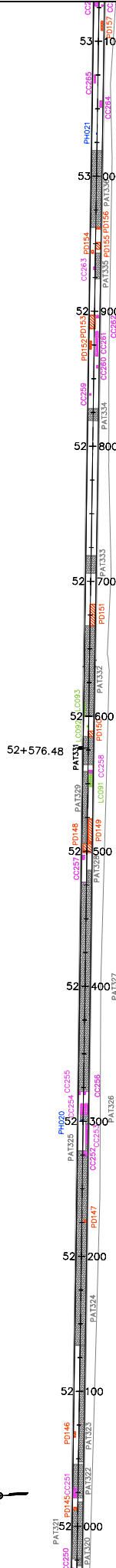
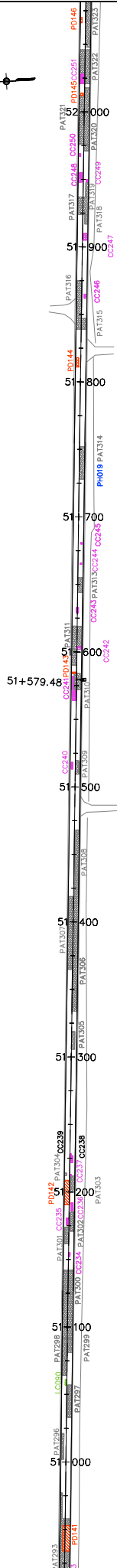



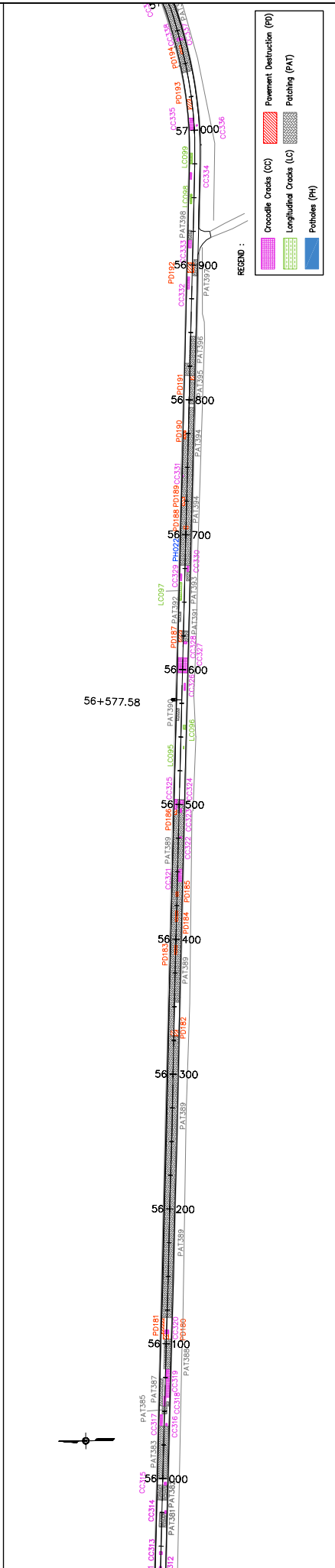
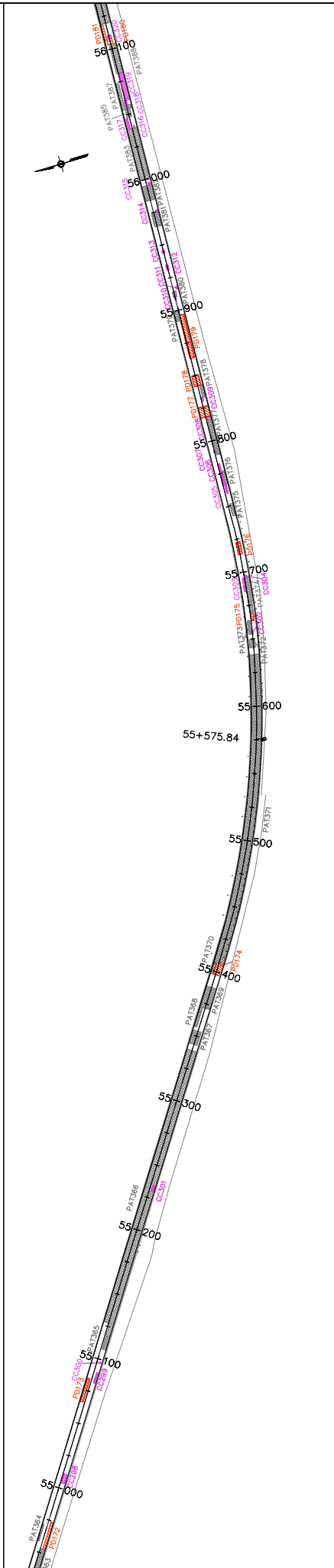
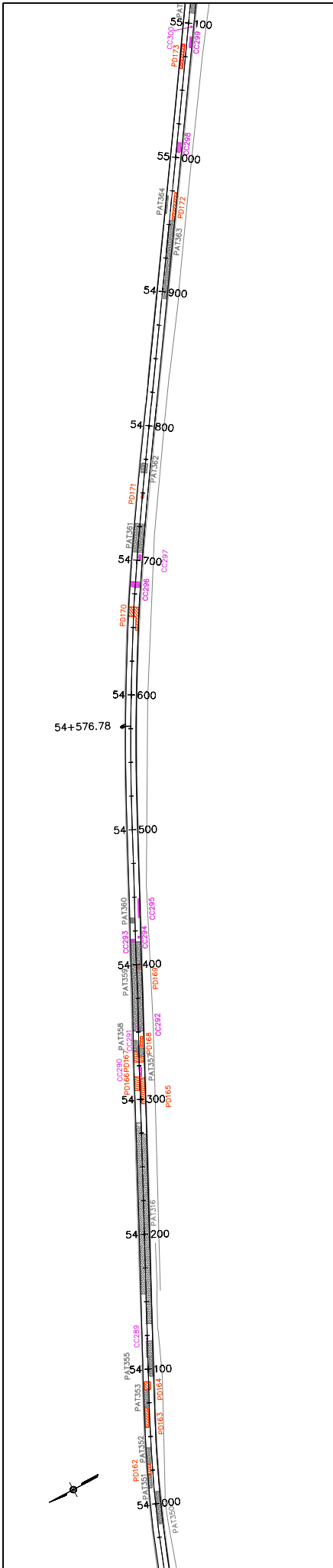

LEGEND :

- Crocodile Croads (CC) [Pattern]
- Longitudinal Croads (LC) [Pattern]
- Potholes (PH) [Pattern]
- Pavement Destruction (PD) [Pattern]
- Patching (PAT) [Pattern]



LEGEND :

	Potholes (PH)
	Longitudinal Cracks (LC)
	Crocodile Cracks (CC)
	Patching (PAT)
	Pavement Destruction (PD)

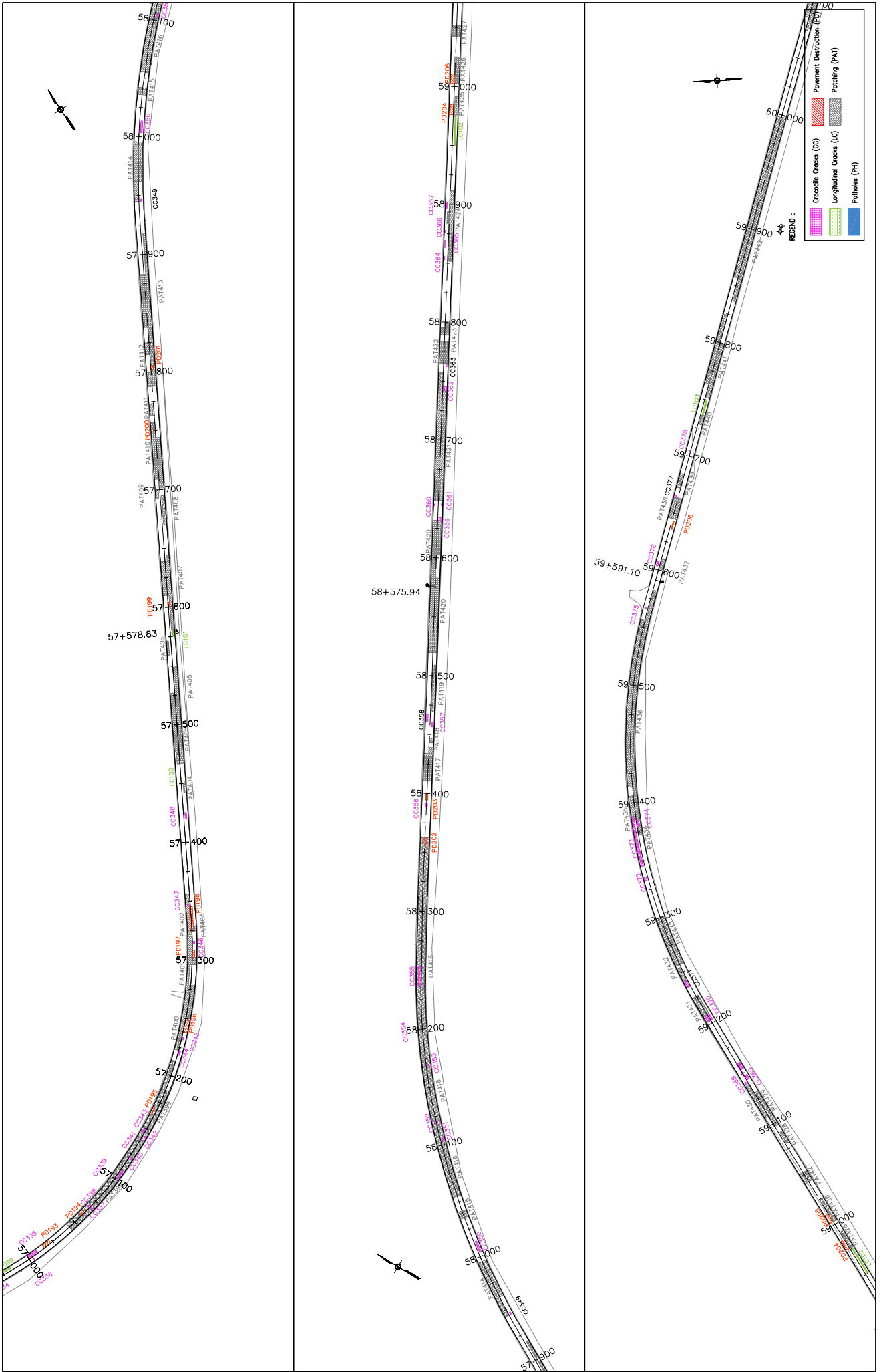

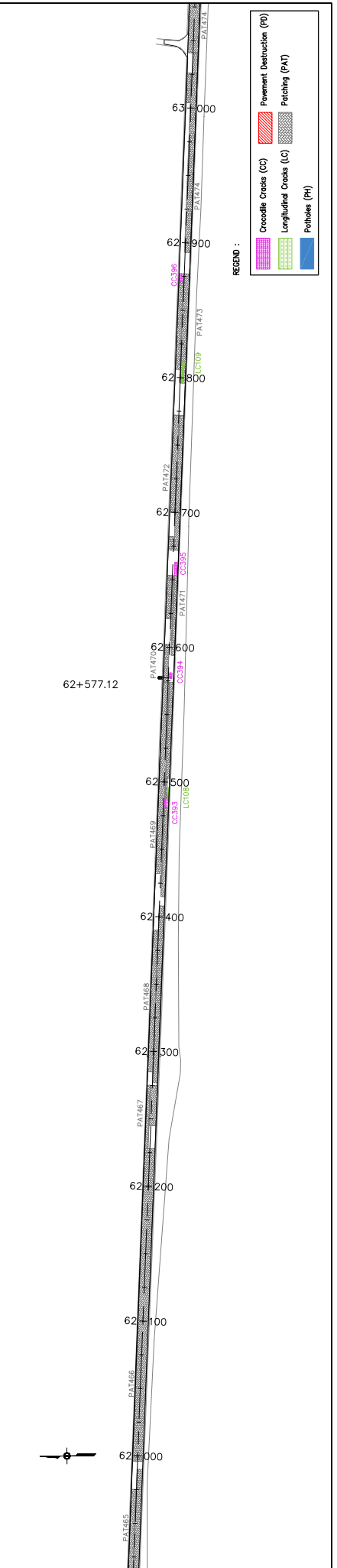
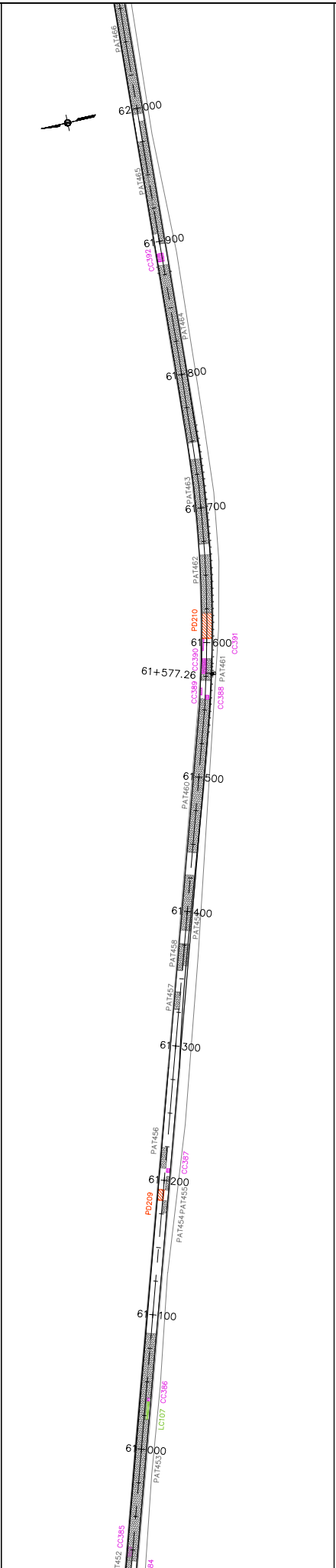
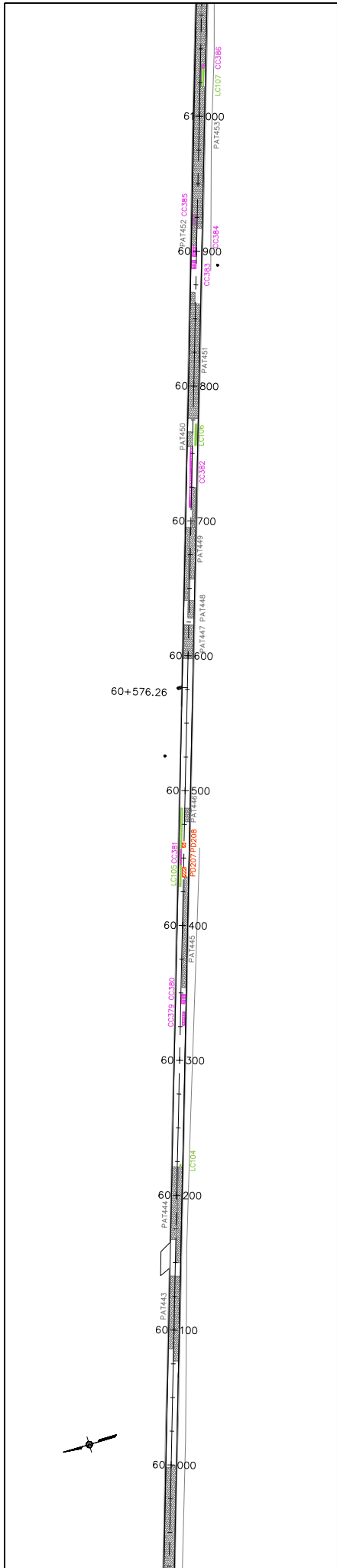

LEGEND :

	Crocodile Croads (CC)		Pavement Destruction (PD)
	Longitudinal Croads (LC)		Patching (PAT)
	Potholes (PH)		



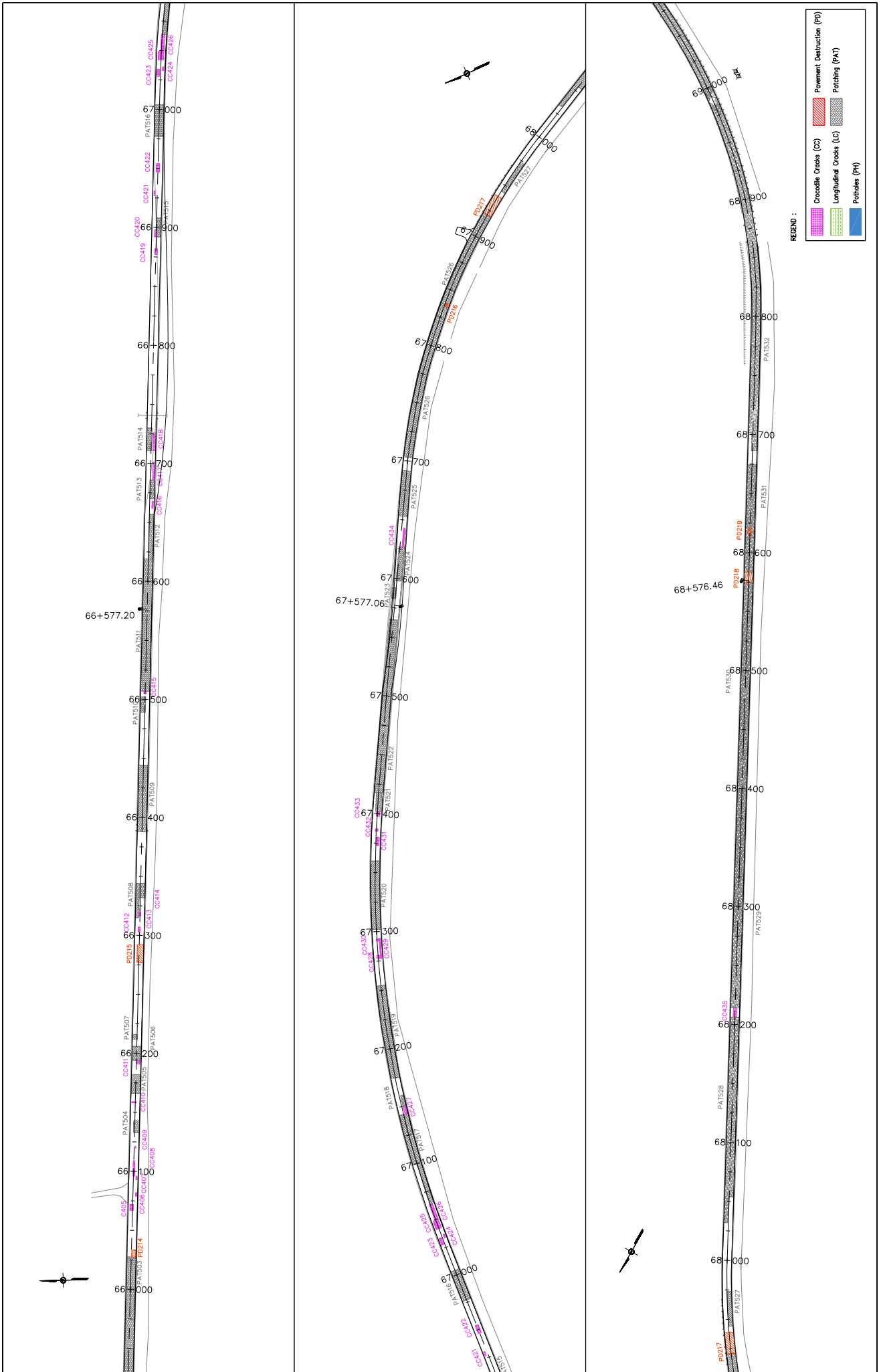

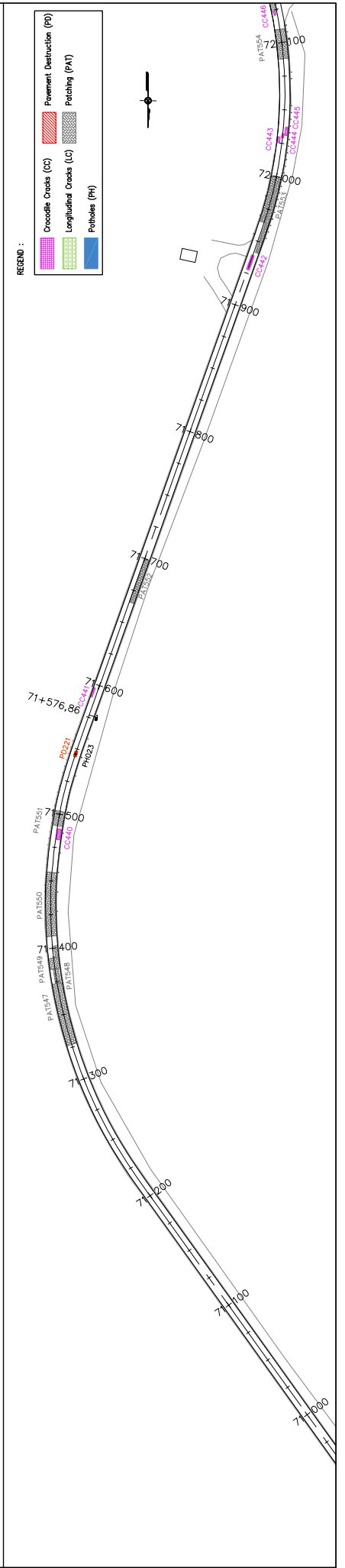
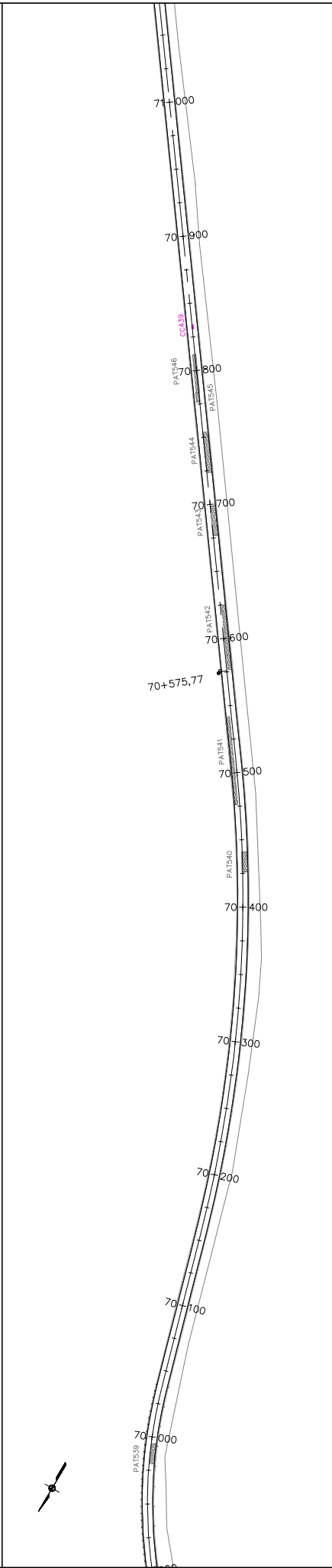
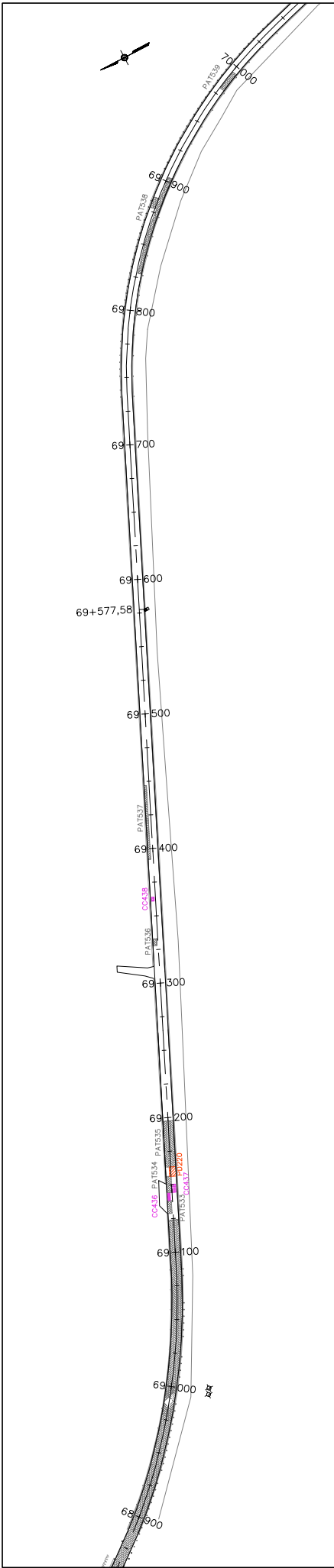

LEGEND :

	Crocodile Cracks (CC)		Pavement Destruction (PD)
	Longitudinal Cracks (LC)		Patching (PAT)
	Potholes (PH)		

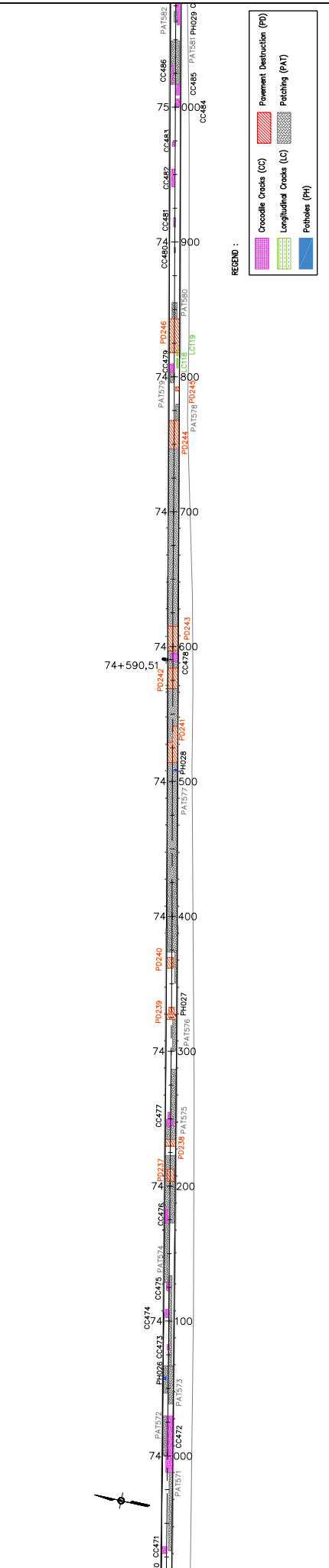
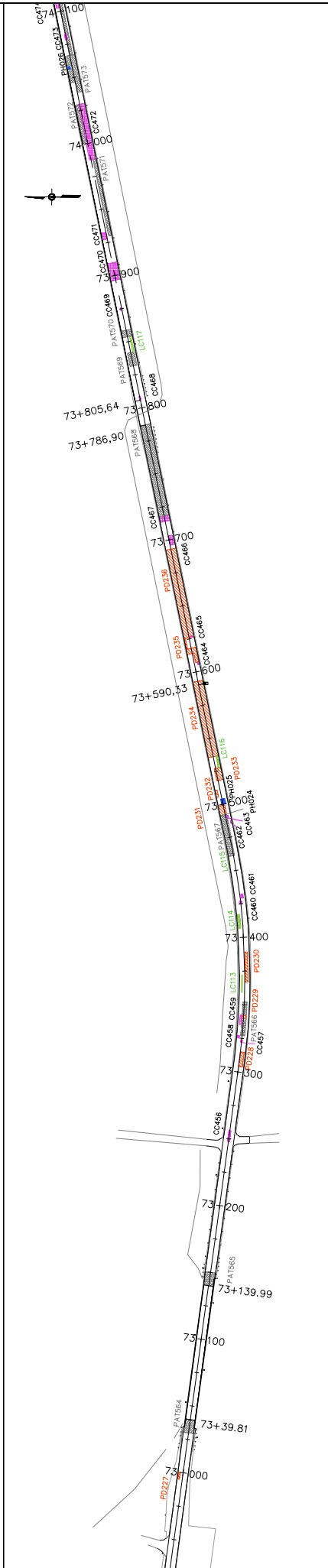
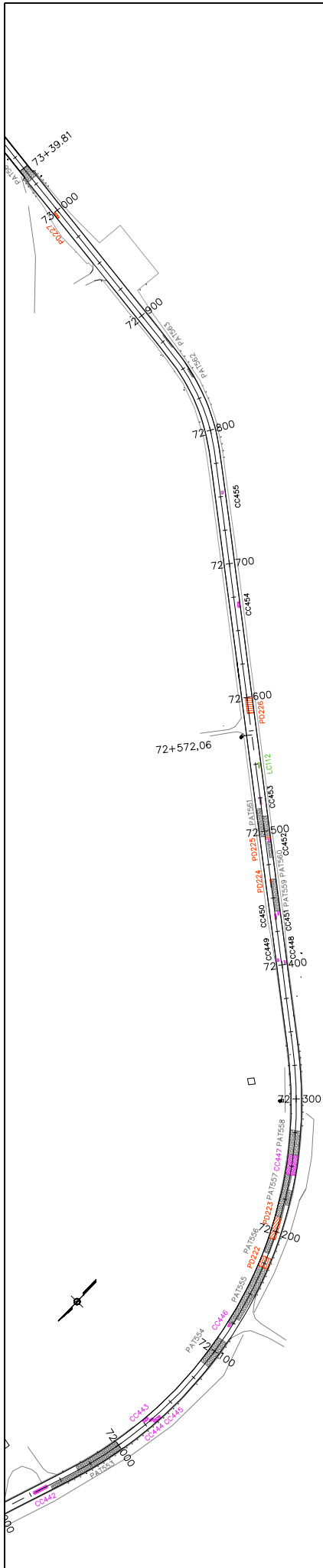

LEGEND :

- Crocodile Cross (CC)
- Pavement Destruction (PD)
- Longitudinal Cross (LC)
- Potholes (PH)
- Patching (PAT)