

(第二次現地調査)

Minutes of Discussions
on 2nd Preparatory Survey on the Project for
Rehabilitation of Substation and Transmission Line in Kilimanjaro Region
in the United Republic of Tanzania

In response to the request from the Government of the United Republic of Tanzania (hereinafter referred to as "Tanzania"), the Japan International Cooperation Agency (hereinafter referred to as "JICA"), in consultation with the Government of Japan, decided to conduct a Preparatory Survey (hereinafter referred to as "the Survey") on the Project for Rehabilitation of Substation and Transmission Line in Kilimanjaro Region (hereinafter referred to as "the Project").

JICA sent to Tanzania the 2nd Preparatory Survey Team (hereinafter referred to as "the Team"), headed by Mr. Tetsuya TAKIMOTO, Deputy Director for Electric Power Division, Industrial Development Department, JICA. The Team is scheduled to stay in the country from June 7 to July 2, 2010.

The Team held discussions with the officials of Tanzanian authorities concerned (hereinafter referred to as "Tanzania side"). In the course of the discussions, both sides have confirmed the main items described in the sheets attached hereto.

Dar es Salaam, June 15, 2010



Tetsuya Takimoto
Deputy Director
Electric Power Division
Industrial Development Department
Japan International Cooperation Agency



Bashir J. Mrindoko
Commissioner for Energy and Petroleum Affairs
Ministry of Energy and Minerals
The United Republic of Tanzania



Felchesmi Mramba
For Managing Director
Tanzania Electric Supply Company Ltd.
The United Republic of Tanzania

Witnessed by :

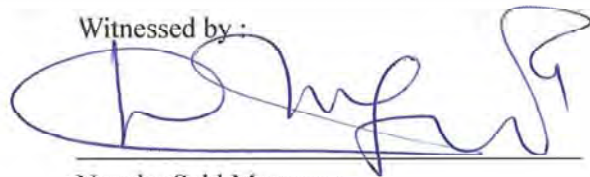

Ngosha Said Magonya
Commissioner for External Finance
Ministry of Finance and Economic Affairs
The United Republic of Tanzania

ATTACHMENT

1. Objective of the Project

The objective of the Project is to rehabilitate the substations and transmission/distribution network in Kilimanjaro Region.

2. Project Site

The Project sites which are selected through the 1st Preparatory Survey and the analysis in Japan based on the request from the Tanzania side are located in Kilimanjaro Region as shown in Annex-1.

3. Result of Analysis on 1st Preparatory Survey

JICA explained the result of analysis on 1st Preparatory Survey in Japan to Tanzania side. Based on the analysis, JICA selected the following component for the Project, and detailed contents of the components are described in Annex-2.

- (1) Upgrading of existing 33/11kV substations at YMCA, Lawati and Machame
- (2) Construction of 33/11kV substation at KCMC
- (3) Installation of 33kV outgoing bay at Trade School substation
- (4) Installation of 33kV distribution line from Trade School to KCMC substation
- (5) Construction of 66/33kV substation at Makuyuni
- (6) Installation of 66kV transmission line from Kiyungi to Makyuni and outgoing bay at Kiyungi substation
- (7) Installation of 132/66kV transformer at Kiyungi substation

Tanzania side understood the result of analysis on 1st Preparatory Survey in Japan and accepted the selected components to be covered by the Project.

4. Japan's Grant Aid Scheme

- (1) JICA confirmed that Tanzania side understood Japan's Grant Aid Scheme explained by the Team at the 1st Preparatory Survey as described in Annex-3.
- (2) The Tanzania side will take the necessary measures, as described in Annex-4, for smooth implementation of the Project as prerequisites for the Japan's Grant Aid to be implemented.



5. Schedule of the 2nd Preparatory Survey

The Team will continue the Survey in Tanzania until July 2, 2010. Based on the results of the Survey, JICA will send the mission to explain the Draft Final Report in November, 2010.

6. Other Relevant Issues

- (1) Status of the 2nd Preparatory Survey

The Team explained that the purpose of the Survey is to collect information and data necessary for the outline design and cost calculation of the Project components which are selected through the 1st Preparatory Survey and the analysis in Japan.

2



(2) Coordination among relevant donors and agencies

The Team requested the Tanzania side to ensure coordination among relevant donors and agencies for smooth implementation of the Project.

(3) Environmental and Social Considerations

- a) The Team requested the Tanzania side to ensure access to the site and undertake expropriation if necessary in order to secure the project site.
- b) The Team requested the Tanzania side to conduct the required environmental works, and obtain approval on environmental clearance for implementation of the Project
- c) The Tanzania side agreed to comply with the JICA Guidelines for Environmental and Social Considerations (hereinafter referred to as "JICA Guidelines") as well as Tanzanian laws and regulations, and requested to prepare Environmental Checklist and Monitoring Form which are designated by JICA Guidelines for an outline design. The Tanzania side agreed to make necessary arrangements with governmental organizations concerned in order to secure funding for and execution of the above environmental matters in a schedule as required for smooth execution of the Project.

(4) Counterpart Personnel

The Team requested the Tanzania side that necessary number of counterpart personnel shall be assigned to the Team and necessary arrangements with related organizations be made during the Survey in Tanzania.

(5) Major Undertakings to be taken by the Tanzania Side

The Tanzania side agreed to undertake the following particular items out of general undertakings described in Annex-4.

- a) To install 33kV feeder lines to connect Makuyuni substation and the existing 33kV distribution lines by the completion of the work by the Japanese side.
- b) To allocate a budget for the above mentioned work.
- c) To construct temporary roads necessary for the construction of 66kV transmission line between Kiyungi and Makuyuni (approx. 20km) by the commencement of the work by the Japanese side.
- d) To obtain permission from land owners necessary for the construction work by the Japanese side by the end of October 2010.
- e) To secure a storage yard with the area of 150m x 150m by the commencement of the work by the Japanese side.
- f) To remove obstacles from the Project sites such as obsolete reactors, outdoor cubicles and foundation at Kiyungi substation, trees, bush and crops on the wayleave of transmission and distribution lines to be installed under the Project, etc. by the commencement of the work by the Japanese side.

(End)

- Annex-1 Project site
Annex-2 Selected Components to be Covered by the Project
Annex-3 Japan's Grant Aid Scheme
Annex-4 Major Undertakings to be taken by Each Government

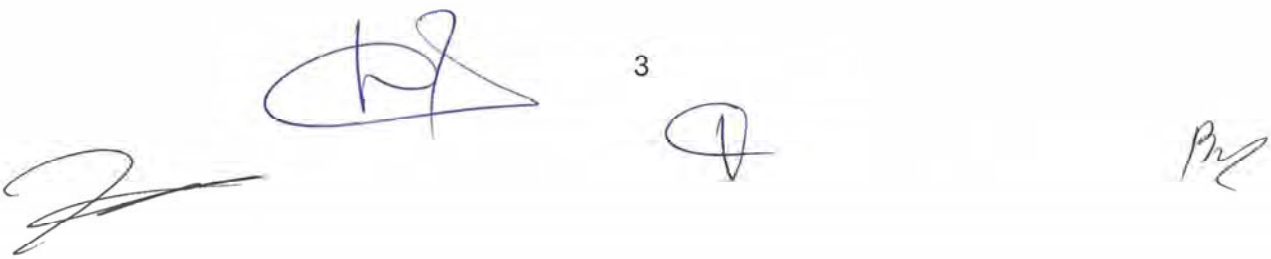

The bottom of the page features several handwritten signatures in blue ink. A large, stylized signature is on the left. In the center, there is a smaller signature above the page number '3'. To the right of the page number is another signature, and further right is a fourth signature. The page number '3' is printed in a small, black font.

[Handwritten signature]

[Handwritten mark]

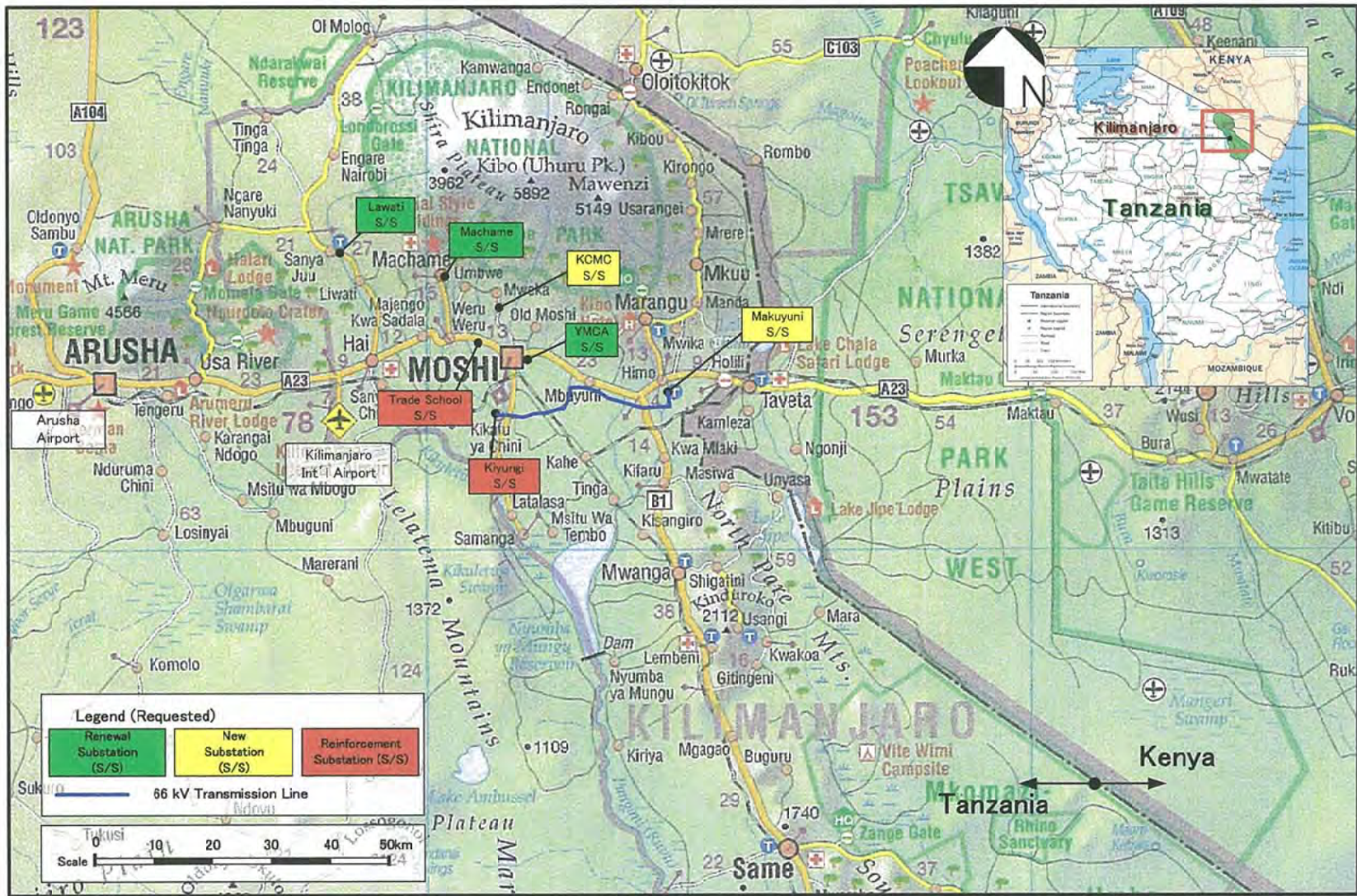

Project Sites

[Handwritten mark]

Selected Components to be Covered by the Project

- A. 33/11kV, 15MVA Transformer Substation at YMCA**
- a) 33kV Incoming switchgear panel with VCB (1 No.)
 - b) 33/11kV, 15MVA Transformer with On-load Tap-changer (1 No.)
 - c) 11kV switchgear panel (6 Nos.)
 - Transformer secondary (1 No.)
 - Line feeder (3 Nos.)
 - Station supply transformer (1 No.)
 - LV supply and control (1 No.)
 - d) 33kV Cable and end treatment material (1 Lot)
 - e) 11kV Cable and end treatment material (1 Lot)
 - f) Miscellaneous (1 Lot)
 - g) Civil and Installation work (1 Lot)
- B. 33/11kV, 10MVA Transformer Substation at Lawati**
- a) 33kV Incoming switchgear panel with VCB (1 No.)
 - b) 33/11kV, 10MVA Transformer with On-load Tap-changer (1 No.)
 - c) 11kV switchgear panel (6 Nos.)
 - Transformer secondary (1 No.)
 - Line feeder (3 Nos.)
 - Station supply transformer (1 No.)
 - LV supply and control (1 No.)
 - d) 33kV Cable and end treatment material (1 Lot)
 - e) 11kV Cable and end treatment material (1 Lot)
 - f) Miscellaneous (1 Lot)
 - g) Civil and Installation work (1 Lot)
- C. 33/11kV, 10MVA Transformer Substation at Machame**
- a) 33kV Incoming switchgear panel with VCB (1 No.)
 - b) 33/11kV, 10MVA Transformer with On-load Tap-changer (1 No.)
 - c) 11kV switchgear panel (6 Nos.)
 - Transformer secondary (1 No.)
 - Line feeder (3 Nos.)
 - Station supply transformer (1 No.)
 - LV supply and control (1 No.)
 - d) 33kV Cable and end treatment material (1 Lot)
 - e) 11kV Cable and end treatment material (1 Lot)
 - f) Miscellaneous (1 Lot)
 - g) Civil and Installation work (1 Lot)

D. 33/11kV, 5MVA Transformer Substation at KCMC

- a) 33kV incoming switchgear panel with VCB (3 Nos.)
- b) 33/11kV, 5MVA Transformer with On-load Tap-changer (1 No.)
- c) 11kV switchgear panel (6 Nos.)
 - Transformer secondary (1 No.)
 - Line feeder (3 Nos.)
 - Station supply transformer (1 No.)
 - LV supply and control (1 No.)
- d) 33kV Cable and end treatment material (1 Lot)
- e) 11kV Cable and end treatment material (1 Lot)
- f) Miscellaneous (1 Lot)
- g) Civil and Installation work (1 Lot)

E. 33kV Outgoing bay at Trade School substation

- a) 33kV Outgoing switchgear panel with VCB (1 No.)
- b) 33kV Cable and end treatment material (1 Lot)
- c) Civil and Installation work (1 Lot)

F. Installation of 33kV distribution line from Trade School to KCMC (3.7km)

G. 66/33kV, 20MVA Transformer Substation at Makuyuni

- a) 66kV Incoming line bay with GCB, etc. (1 Lot)
- b) 66kV Transformer bay (2 Lots)
- c) 66/33kV, 10MVA Transformer with On-load Tap-changer (2 Nos.)
- d) 33kV switchgear panel (7 Nos.)
 - Transformer secondary (2 Nos.)
 - Line feeder (4 Nos.)
 - Station supply transformer (1 No.)
- e) 66kV Control and protection panel (3 Nos.)
- f) 33kV Control and protection panel (6 Nos.)
- g) DC Supply Equipment (1 Set)
- h) 66kV Conductor (1 Lot)
- i) 33kV Cable and end treatment material (1 Lot)
- j) Miscellaneous (1 Lot)
- k) Civil, Building and Installation work (1 Lot)

Remarks: Excluding SCADA and data transfer system for Makuyuni substation

H. 66kV Outgoing bay at Kiyungi

- a) 66kV transmission line with GCB (1 Lot)
- b) 66kV Control panel (1 No.)
- c) Civil and Installation work (1 Lot)

I. Installation of New 66kV transmission line from Kiyungi to Makuyuni (34km)



6



J. Installation of 132/66kV, 20MVA transformer at Kiyungi substation

- a) 132/66kV, 20MVA transformer with On-load tap changer (1 No.)
- b) 132kV switch gear (1 Lot)
- c) 66kV switch gear (1 Lot)
- d) 132kV Control and Protection panel (1 No.)
- e) 66kV Control and Protection panel (1 No.)
- f) Miscellaneous (1 Lot)
- g) Civil and Installation work (1 Lot)

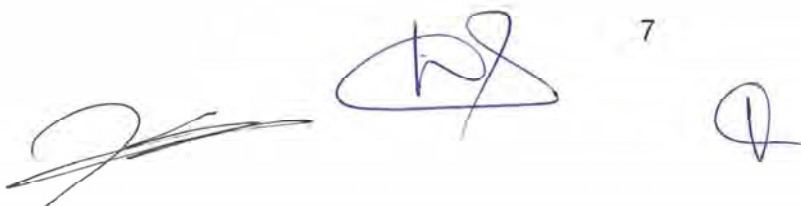
The image shows several handwritten signatures and initials in blue ink. On the left, there is a long, horizontal signature. In the center, there is a circular signature with a stylized 'K' or 'H' inside. To the right of this is a small number '7'. Further right is a circular signature with a stylized 'Q' inside. On the far right, there are the initials 'PC'.

Handwritten signatures and scribbles on the left side of the page.

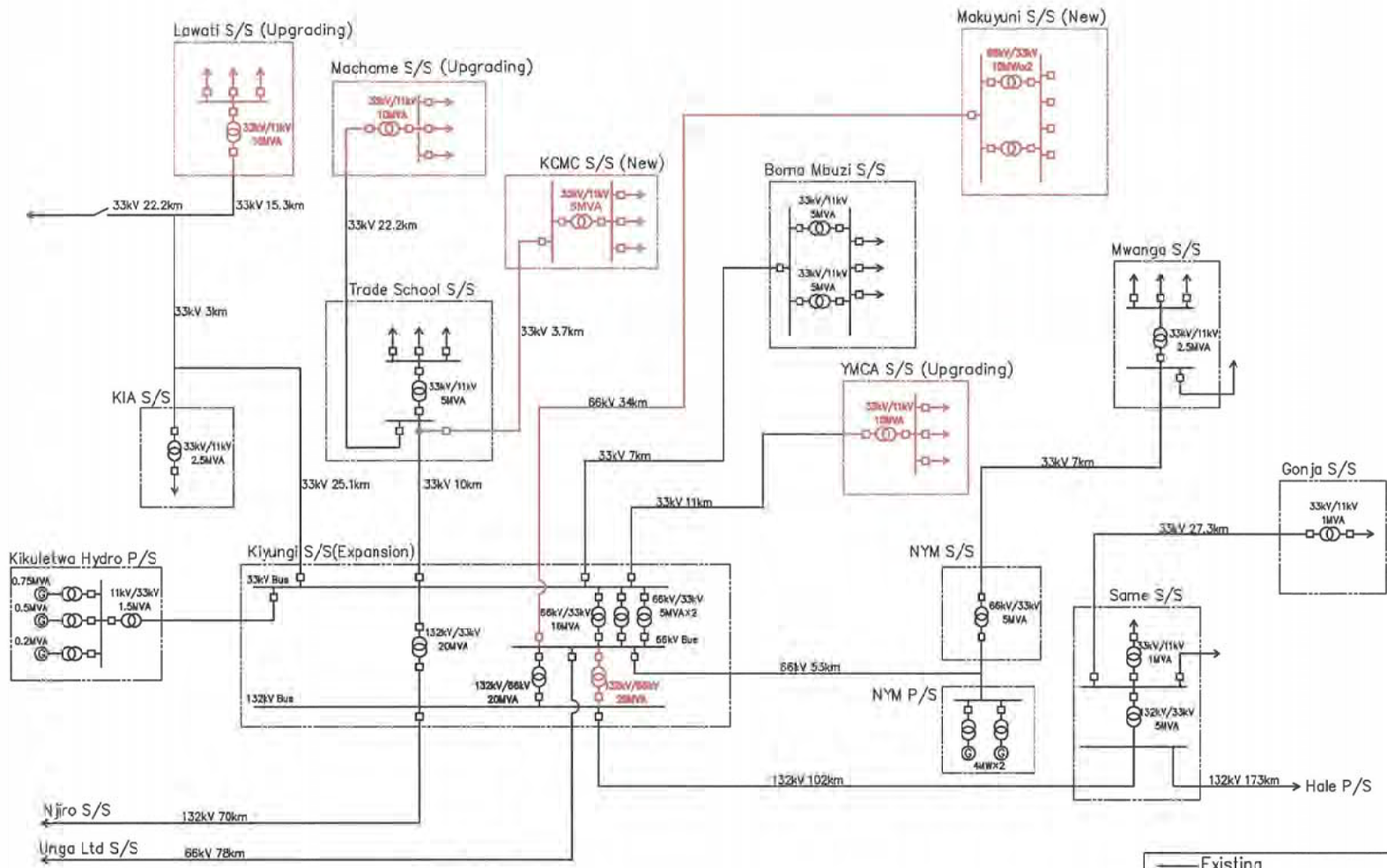

Components to be Covered by the Project

— Existing
 — Scope of the Project

Handwritten signature or initials at the bottom left.

JAPAN'S GRANT AID

The Government of Japan (hereinafter referred to as “the GOJ”) is implementing the organizational reforms to improve the quality of ODA operations, and as a part of this realignment, a new JICA law was entered into effect on October 1, 2008. Based on the law and the decision of the Government of Japan (hereinafter referred to as “the GOJ”), JICA has become the executing agency of the Grant Aid for General Projects, for Fisheries and for Cultural Cooperation, etc.

The Grant Aid is non-reimbursable fund to a recipient country to procure the facilities, equipment and services (engineering services and transportation of the products, etc.) for economic and social development of the country under principles in accordance with the relevant laws and regulations of Japan. The Grant Aid is not supplied through the donation of materials as such.

1. Grant Aid Procedures

The Japanese Grant Aid is conducted as follows-

- Preparatory Survey (hereinafter referred to as “the Survey”)
 - The Survey conducted by JICA
- Appraisal & Approval
 - Appraisal by The GOJ and JICA, and Approval by the Japanese Cabinet
- Determination of Implementation
 - The Notes exchanged between the GOJ and a recipient country
- Grant Agreement (hereinafter referred to as “the G/A”)
 - Agreement concluded between JICA and a recipient country
- Implementation
 - Implementation of the Project on the basis of the G/A

2. Preparatory Survey

(1) Contents of the Survey

The aim of the Survey is to provide a basic document necessary for the appraisal of the Project by JICA and the GOJ. The contents of the Survey are as follows:

- Confirmation of the background, objectives, and benefits of the Project and also institutional capacity of agencies concerned of the recipient country necessary for the implementation of the Project.
- Evaluation of the appropriateness of the Project to be implemented under the Grant Aid Scheme from a technical, financial, social and economic point of view.
- Confirmation of items agreed on by both parties concerning the basic concept of the Project.
- Preparation of a basic design of the Project.
- Estimation of costs of the Project.

The contents of the original request by the recipient country are not necessarily approved in their initial form as the contents of the Grant Aid project. The Basic Design of the Project is confirmed considering the guidelines of the Japan's Grant Aid scheme.

JICA requests the Government of the recipient country to take whatever measures are necessary to ensure its self-reliance in the implementation of the Project. Such measures must be guaranteed

9

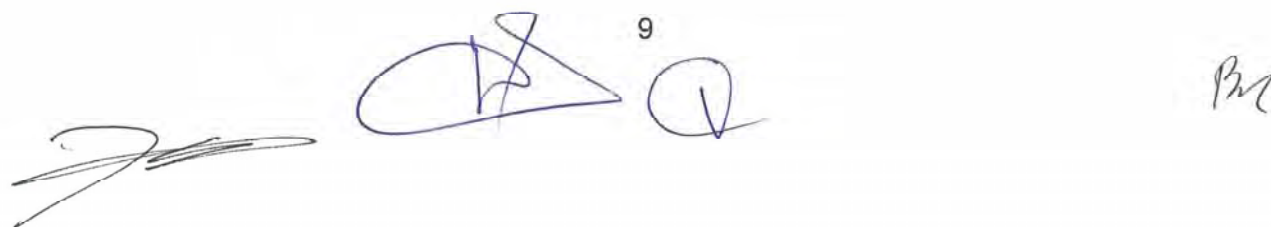

even though they may fall outside of the jurisdiction of the organization in the recipient country actually implementing the Project. Therefore, the implementation of the Project is confirmed by all relevant organizations of the recipient country through the Minutes of Discussions.

(2) Selection of Consultants

For smooth implementation of the Survey, JICA uses (a) registered consulting firm(s). JICA selects (a) firm(s) based on proposals submitted by interested firms.

(3) Result of the Survey

The Report on the Survey is reviewed by JICA, and after the appropriateness of the Project is confirmed, JICA recommends the GOJ to appraise the implementation of the Project.

3. Japan's Grant Aid Scheme

(1) The E/N and the G/A

After the Project is approved by the Cabinet of Japan, the Exchange of Notes(hereinafter referred to as "the E/N") will be signed between the GOJ and the Government of the recipient country to make a plea for assistance, which is followed by the conclusion of the G/A between JICA and the Government of the recipient country to define the necessary articles to implement the Project, such as payment conditions, responsibilities of the Government of the recipient country, and procurement conditions.

(2) Selection of Consultants

The consultant firm(s) used for the Survey will be recommended by JICA to the recipient country to also work on the Project's implementation after the E/N and the G/A, in order to maintain technical consistency.

(3) Eligible source country

Under the Japanese Grant Aid, in principle, Japanese products and services including transport or those of the recipient country are to be purchased. When JICA and the Government of the recipient country or its designated authority deem it necessary, the Grant Aid may be used for the purchase of the products or services of a third country. However, the prime contractors, namely, constructing and procurement firms, and the prime consulting firm are limited to "Japanese nationals".

(4) Necessity of "Verification"

The Government of the recipient country or its designated authority will conclude contracts denominated in Japanese yen with Japanese nationals. Those contracts shall be verified by JICA. This "Verification" is deemed necessary to secure accountability to Japanese taxpayers.

(5) Major undertakings to be taken by the Government of the Recipient Country

In the implementation of the Grant Aid Project, the recipient country is required to undertake such necessary measures as Annex-4.

10

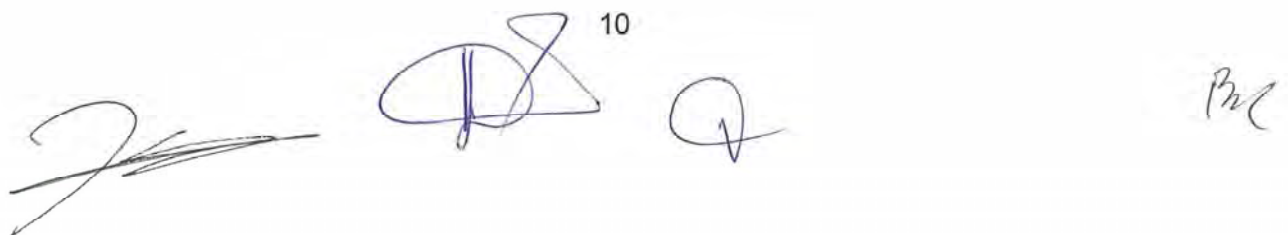

The bottom of the page features several handwritten signatures and initials. On the left is a large, stylized signature. In the center is a signature with a large loop, followed by the number '10'. To the right of '10' is a smaller signature. On the far right is a set of initials, possibly 'PNC'.

(6) "Proper Use"

The Government of the recipient country is required to maintain and use the facilities constructed and the equipment purchased under the Grant Aid properly and effectively and to assign staff necessary for this operation and maintenance as well as to bear all the expenses other than those covered by the Grant Aid.

(7) "Export and Re-export"

The products purchased under the Grant Aid should not be exported or re-exported from the recipient country.

(8) Banking Arrangements (B/A)

- a) The Government of the recipient country or its designated authority should open an account in the name of the Government of the recipient country in a bank in Japan (hereinafter referred to as "the Bank"). JICA will execute the Grant Aid by making payments in Japanese yen to cover the obligations incurred by the Government of the recipient country or its designated authority under the Verified Contracts.
- b) The payments will be made when payment requests are presented by the Bank to JICA under an Authorization to Pay (A/P) issued by the Government of the recipient country or its designated authority.





(9) Authorization to Pay (A/P)

The Government of the recipient country should bear an advising commission of an Authorization to Pay and payment commissions to the Bank.

(10) Social and Environmental Considerations

A recipient country must ensure the social and environmental considerations for the Project and must follow the environmental regulation of the recipient country and JICA socio-environmental guideline.

(End)

  11  

(概略設計概要説明)

Minutes of Discussions
on 3rd Preparatory Survey on the Project for
Rehabilitation of Substation and Transmission Line in Kilimanjaro Region
in the United Republic of Tanzania

(Explanation on Draft Final Report)

In response to the request from the Government of the United Republic of Tanzania (hereinafter referred to as “Tanzania”), the Japan International Cooperation Agency (hereinafter referred to as “JICA”), in consultation with the Government of Japan, decided to conduct a Preparatory Survey (hereinafter referred to as “the Survey”) on the Project for Rehabilitation of Substation and Transmission Line in Kilimanjaro Region (hereinafter referred to as “the Project”).

In order to explain and to consult with the officials of Tanzanian authorities concerned (hereinafter referred to as “Tanzanian side”) on the components of the Draft Final Report, JICA sent to Tanzania the 3rd Preparatory Survey Team (hereinafter referred to as “the Team”), headed by Mr. Toshihisa HASEGAWA, Senior Representative of JICA Tanzania office, from November 21, 2010 to November 30, 2010.

In the course of the discussions, both sides have confirmed the main items described in the sheets attached hereto.

Dar es Salaam, November 29, 2010

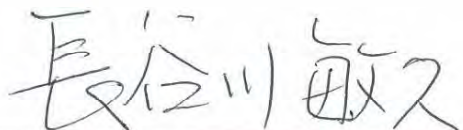

Toshihisa HASEGAWA
 Senior Representative
 Tanzania Office
 Japan International Cooperation Agency



Bashir J. Mrindoko
 Commissioner for Energy and Petroleum Affairs
 Ministry of Energy and Minerals
 The United Republic of Tanzania

Witnessed by :



William G. Mhando
 Managing Director
 Tanzania Electric Supply Company Ltd.
 The United Republic of Tanzania



Ngosha Said Magonya
 Commissioner for External Finance
 Ministry of Finance and Economic Affairs
 The United Republic of Tanzania

ATTACHMENT

1. Objective of the Project

The objective of the Project is to rehabilitate the substations and transmission/distribution network in Kilimanjaro Region so as to improve the living environment of the people in the region by stable and sufficient electricity supply.

2. Contents of the Draft Final Report

The Ministry of Energy and Minerals (hereinafter referred to as "MEM") and Tanzania Electric Supply Company Ltd. (hereinafter referred to as "TANESCO") accepted in principle the contents of the Draft Final Report explained by the Team. The Tanzanian side shall inform the Team in writing of the comments on the Draft Final Report and the Draft Technical Specifications by December 17, 2010. The Final Report will be sent to the Tanzanian side around April 2011.

3. Components of the Project

The following (1) to (7) are the outline of the Project components selected through 1st and 2nd Preparatory Survey. Annex-1 and 2 show the location and detailed contents of the components, respectively.

- (1) Upgrading of existing 33/11kV substations at YMCA, Lawati and Machame
- (2) Construction of 33/11kV substation at KCMC
- (3) Installation of 33kV outgoing bay at Trade School substation
- (4) Installation of 33kV distribution line from Trade School to KCMC substation
- (5) Construction of 66/33kV substation at Makuyuni
- (6) Installation of 66kV transmission line from Kiyungi to Makuyuni and outgoing bay at Kiyungi substation
- (7) Installation of 132/66kV transformer at Kiyungi substation

However, if it is difficult to acquire an enough budget to cover all the components above, one component might be excluded from the scope of the Project. Both sides agreed that Machame substation is a candidate for further exclusion in such an occasion. The final decision will be made through the consultation with and due consideration by the Government of Japan.

4. Japan's Grant Aid Scheme

- (1) JICA confirmed that the Tanzanian side understood Japan's Grant Aid Scheme explained by the Team at the 1st Preparatory Survey as described in Annex-3.
- (2) The Tanzanian side will take necessary measures, as described in Annex-4, for smooth implementation of the Project as prerequisites for the Japan's Grant Aid to be implemented.

5. Project Cost

The Tanzanian side agreed that the cost for the Project should not exceed the upper limit of amount agreed on E/N. The Tanzanian side also agreed that the cost for the Project contains procurement cost of equipment, transportation cost up to the Project site, installation cost and the Consultant fee.



1

A-4-28



6. Confidentiality of the Project

(1) Detailed specifications of the Facilities and Equipment

JICA and the Tanzanian side agreed that all the information related to the Project including detailed drawings and specifications of the facilities and equipment and other technical information shall not be disclosed to any outside parties (i.e. outside of JICA and Tanzanian side) before the conclusion of all contract(s) for the Project.

(2) Confidentiality of the Cost Estimation

The Team explained the estimated cost of the Project as described in Annex-5. JICA and Tanzanian side agreed that the estimated cost for the Project should never be duplicated or disclosed to any outside parties (i.e. outside of JICA and Tanzanian side) before tender for the Project. Tanzanian side understood that the estimated cost for the Project attached as Annex-5 is not final and is subject to change as a result of examination through revision of the Outline Design Study.

7. Other Relevant Issues

(1) Status of the 3rd Preparatory Survey

The Team explained that the purpose of the Survey is to explain and to consult with Tanzanian side on the components of the Draft Final Report.

(2) Coordination among relevant donors and agencies

The Team requested the Tanzanian side to ensure coordination among relevant donors and agencies for smooth implementation of the Project.

(3) Environmental and Social Considerations

- a) The Team requested the Tanzanian side to ensure access to the site and undertake expropriation if necessary in order to secure the project site.
- b) The Team requested the Tanzanian side to conduct the required environmental works, and obtain approval on environmental clearance for implementation of the Project
- c) The Tanzanian side agreed to comply with the JICA Guidelines for Environmental and Social Considerations (hereinafter referred to as "JICA Guidelines") as well as Tanzanian laws and regulations, and requested to prepare Environmental Checklist and Monitoring Form which are designated by JICA Guidelines for an outline design. The Tanzanian side agreed to make necessary arrangements with governmental organizations concerned in order to secure funding for and execution of the above environmental matters in a schedule as required for smooth execution of the Project.

(4) Counterpart Personnel

The Team requested the Tanzanian side that necessary number of counterpart personnel shall be assigned to the Team and necessary arrangements with related organizations be made during the Survey and implementing stage in Tanzania.

(5) Customs Duties and Tax Exemption

The Tanzanian side agreed that the Government of Tanzania shall take necessary arrangement for the exemption of all customs duties, tax, levies and duties incurred in Tanzania for the implementation of the Project.

(e)

2

A-4-29





(6) Major Undertakings to be taken by the Tanzanian side

The Tanzanian side agreed to undertake the following particular items out of general undertakings described in Annex-4.

- a) To install 33kV feeder lines to connect Makuyuni substation and the existing 33kV distribution lines by the completion of the work by the Japanese side.
- b) To allocate a budget for the above mentioned work.
- c) To construct temporary roads necessary for the construction of 66kV transmission line between Kiyungi and Makuyuni (approx. 34km) by the commencement of the work by the Japanese side.
- d) To complete compensation for land owners necessary for the construction work by the Japanese side by the end of January 2011.
- e) To secure a storage yard with the area of 150m x 150m by the commencement of the work by the Japanese side.
- f) To remove obstacles from the Project sites such as obsolete reactors, outdoor cubicles and foundation at Kiyungi substation, trees, bush and crops on the way leave of transmission and distribution lines to be installed under the Project, etc. by the commencement of the work by the Japanese side.
- g) To procure and install OPGW (Optical Grounding Wire) for 66kV transmission line in a timely manner.

(End)

Annex-1	Project sites
Annex-2	Detailed Contents of Components to be Covered by the Project
Annex-3	Japan's Grant Aid Scheme
Annex-4	Major Undertakings to be taken by Each Government
Annex-5	Project Cost Estimation