

Location Map (VLP)

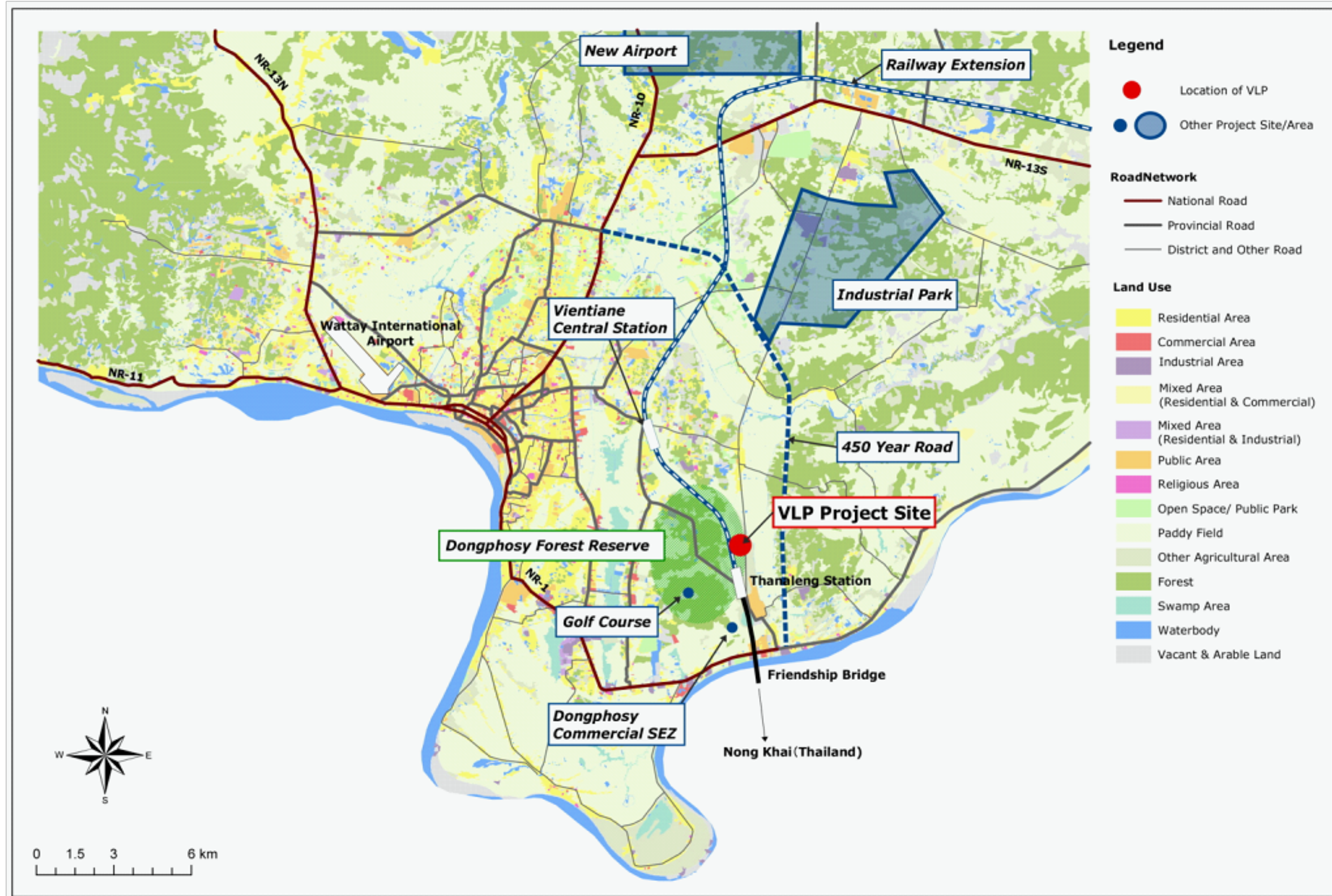

Overall Layout (VLP)

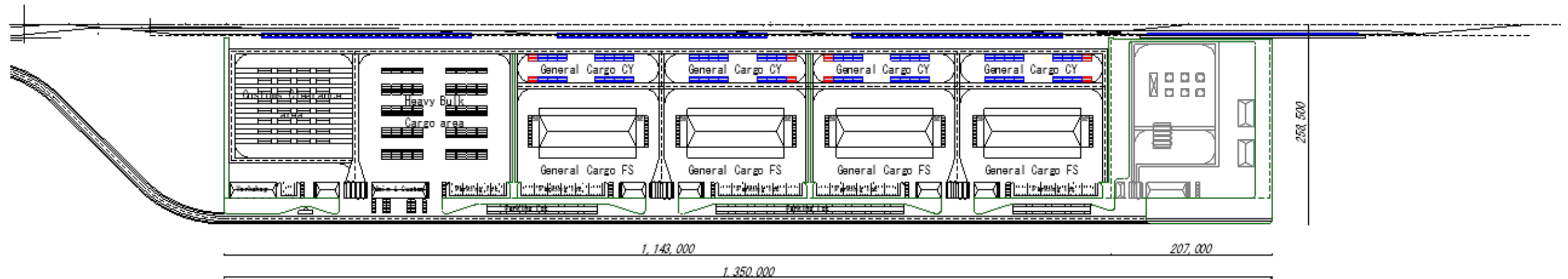

Japan International
Cooperation Agency (JICA)

International
Development
Center of Japan

Project: the Comprehensive
Study on Logistics System in
LAO PDR

Overall Layout (VLP)

| Drawing: | | Engineer | | Description | REV. NO. |
|----------|---------|----------|---------|-------------|----------|
| Date | Checked | Date | Checked | | |
| | | | | | |
| | | | | | |

General Cargo Warehouse/VLP

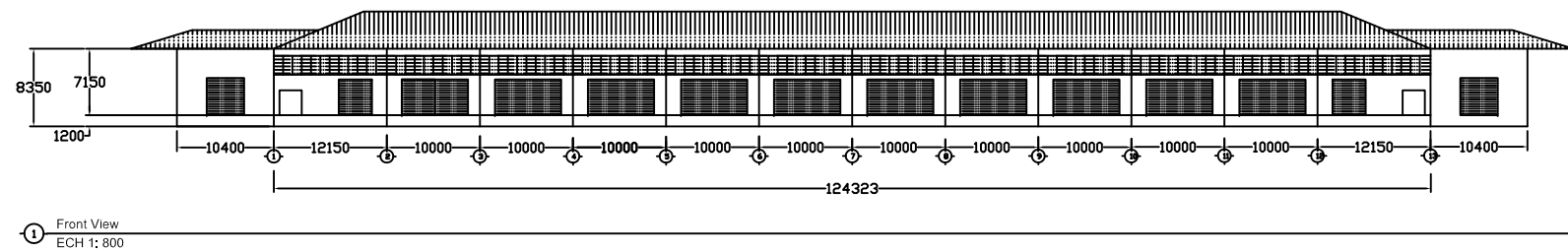
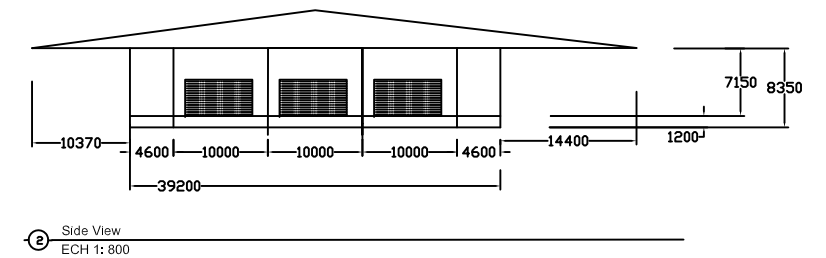
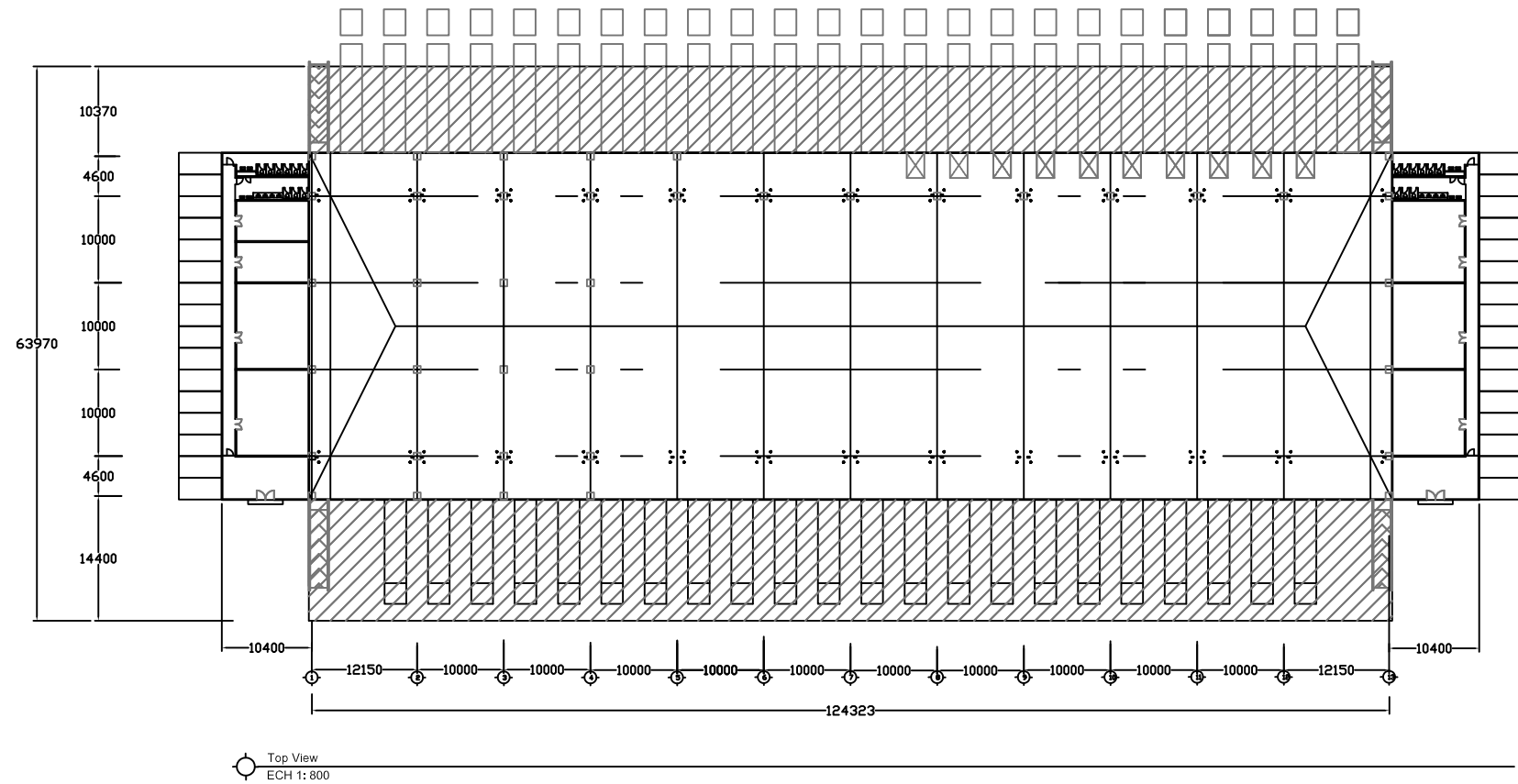

Japan Internation Cooperation Agency (JICA)

International Development Center of Japan

Project: The Comprehensive Study on Logistics System in LAO PDR

Plan and Profile (VLP) General Cargo Warehouse

| Drawing: | | Engineer | | Description | REV. NO. |
|----------|---------|----------|---------|-------------|----------|
| Date | Checked | Date | Checked | | |
| | | | | | |
| | | | | | |

Administration and Custom's Office/VLP

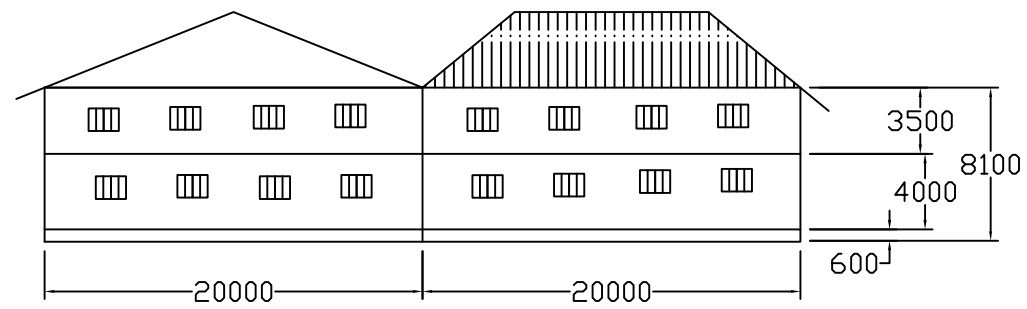

② Side View
ECH 1: 400

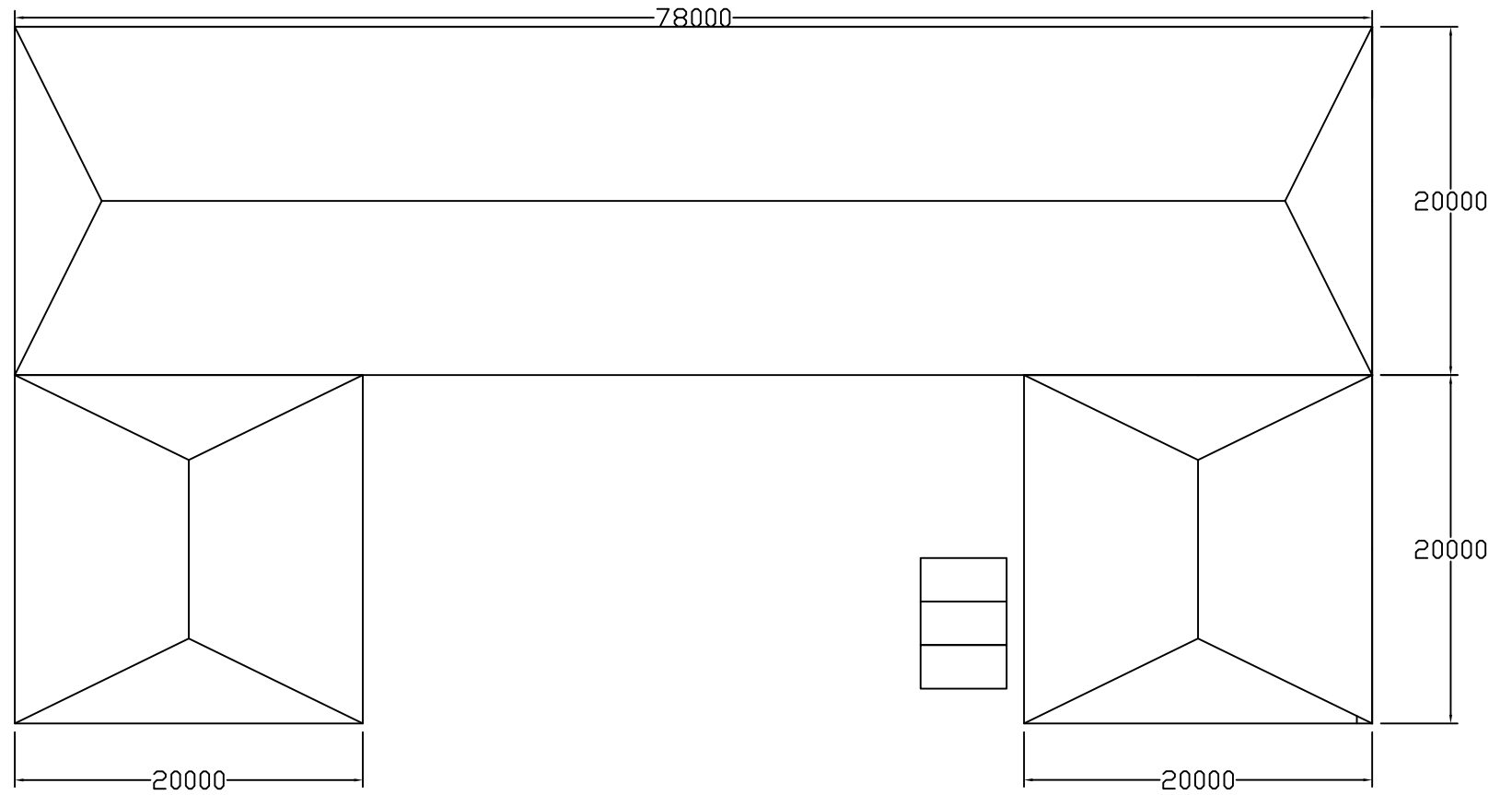

○ Top View
ECH 1: 400

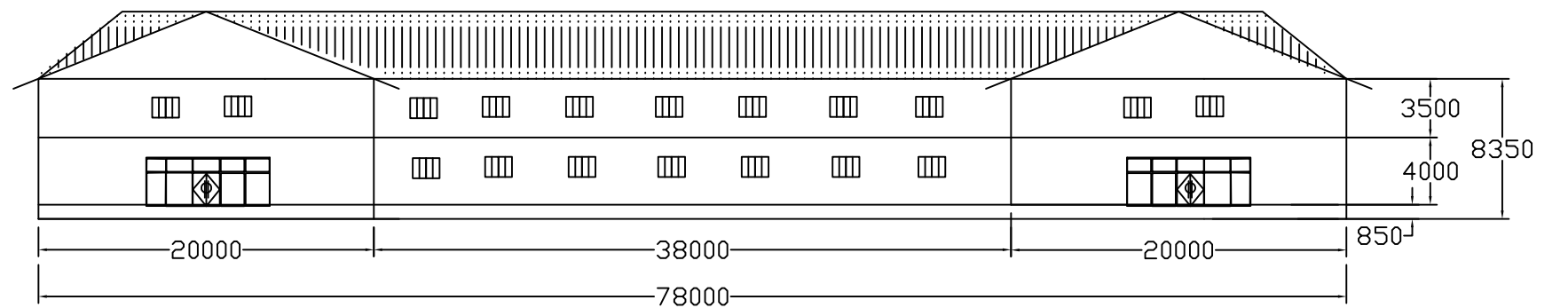

① Front View
ECH 1: 400

Operator's Office/VLP

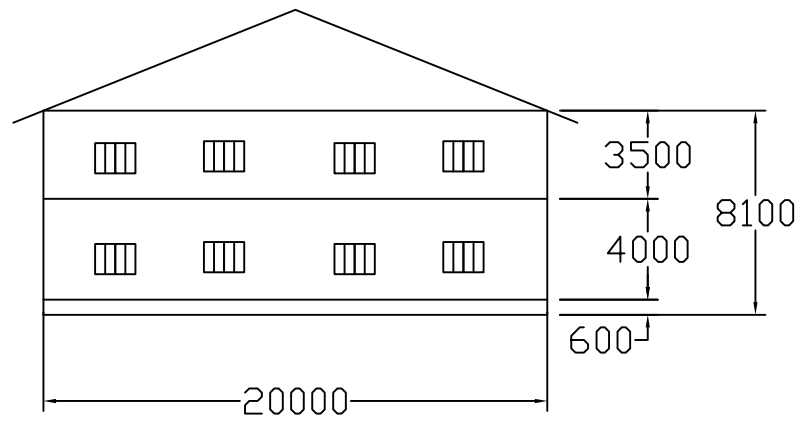

② Side View
ECH 1: 300

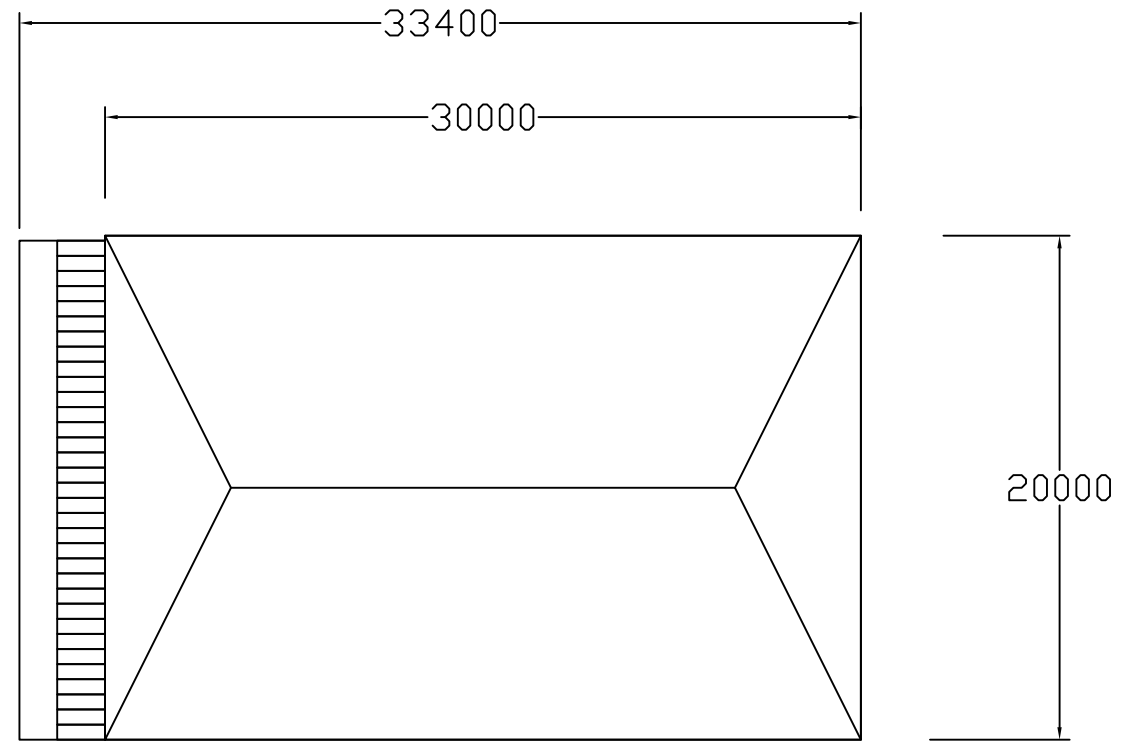

⊙ Top View
ECH 1: 300

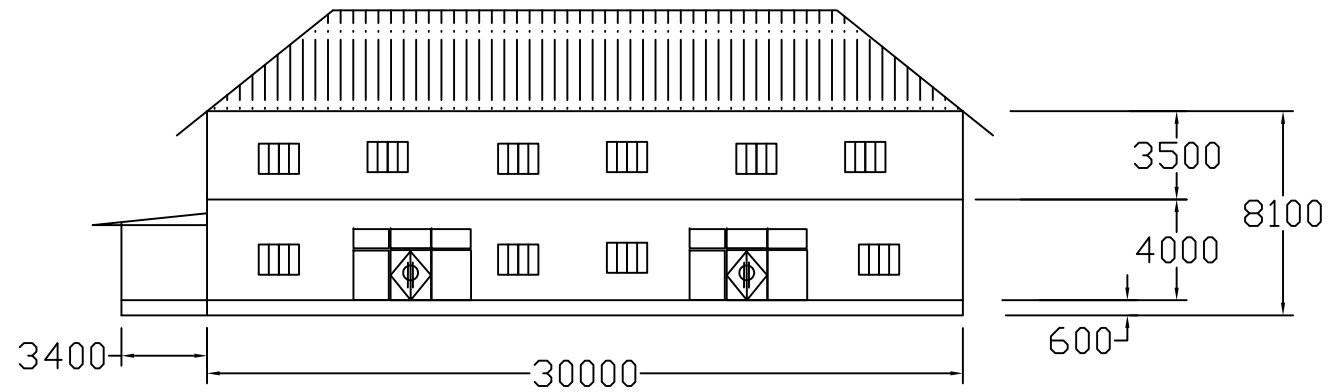

① Front View
ECH 1: 300

Maintenance Workshop/VLP

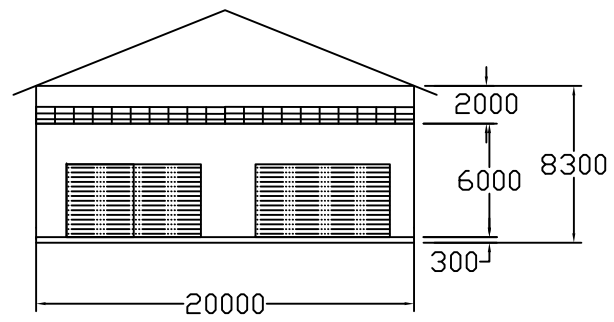

② Side View
ECH 1: 400

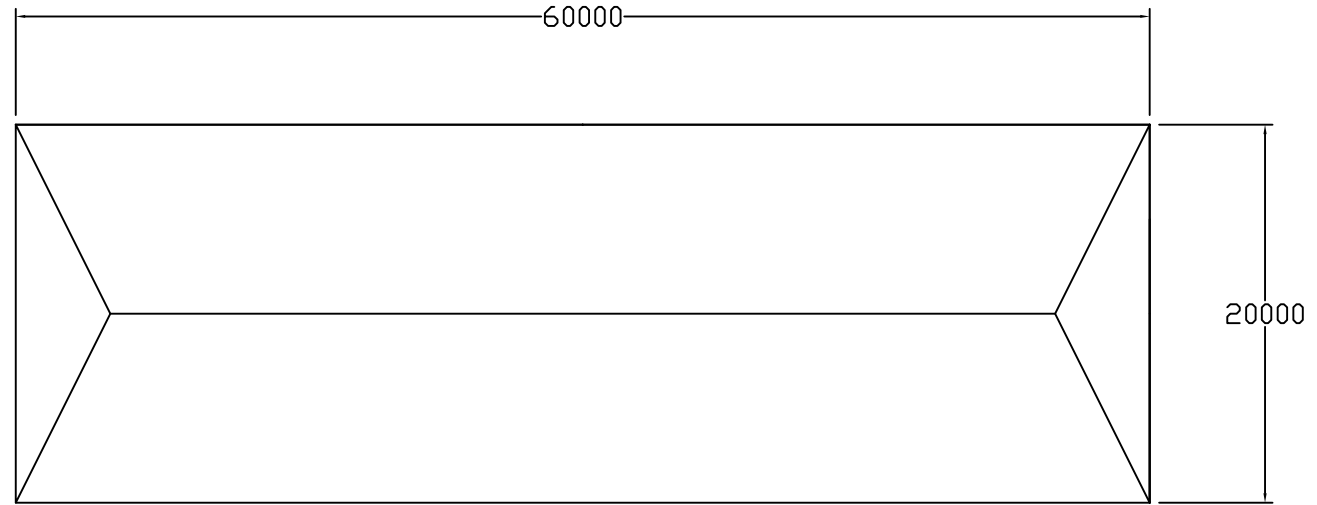

⊙ Top View
ECH 1: 400

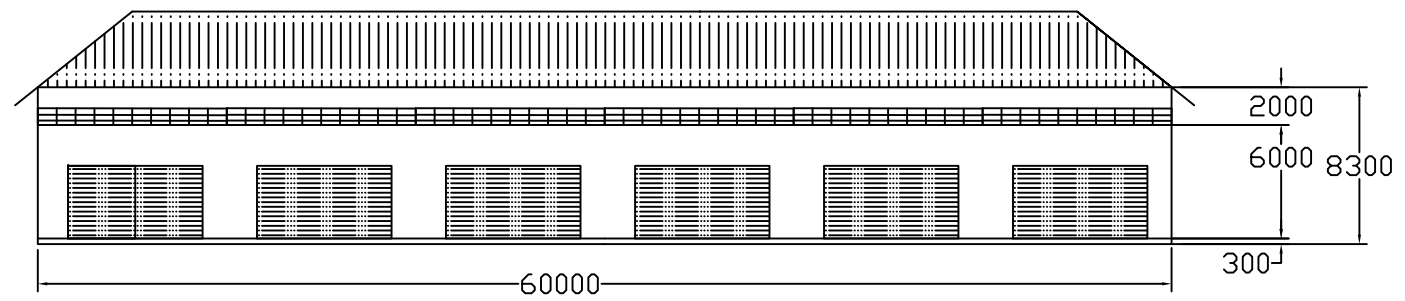

① Front View
ECH 1: 400

Gate and Weight Station/VLP

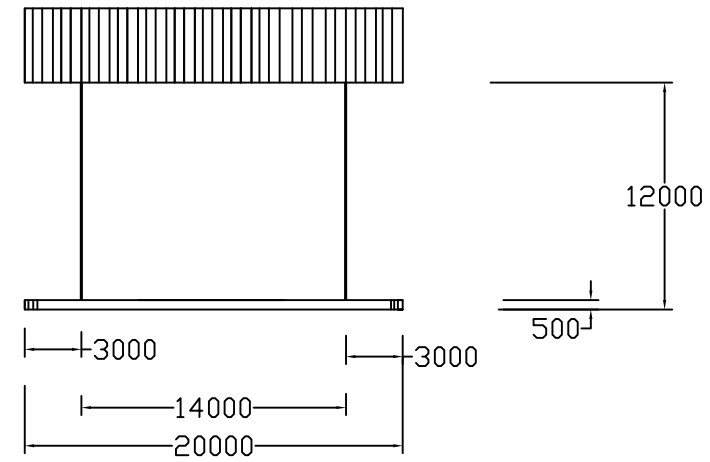

② Side View
ECH 1: 400

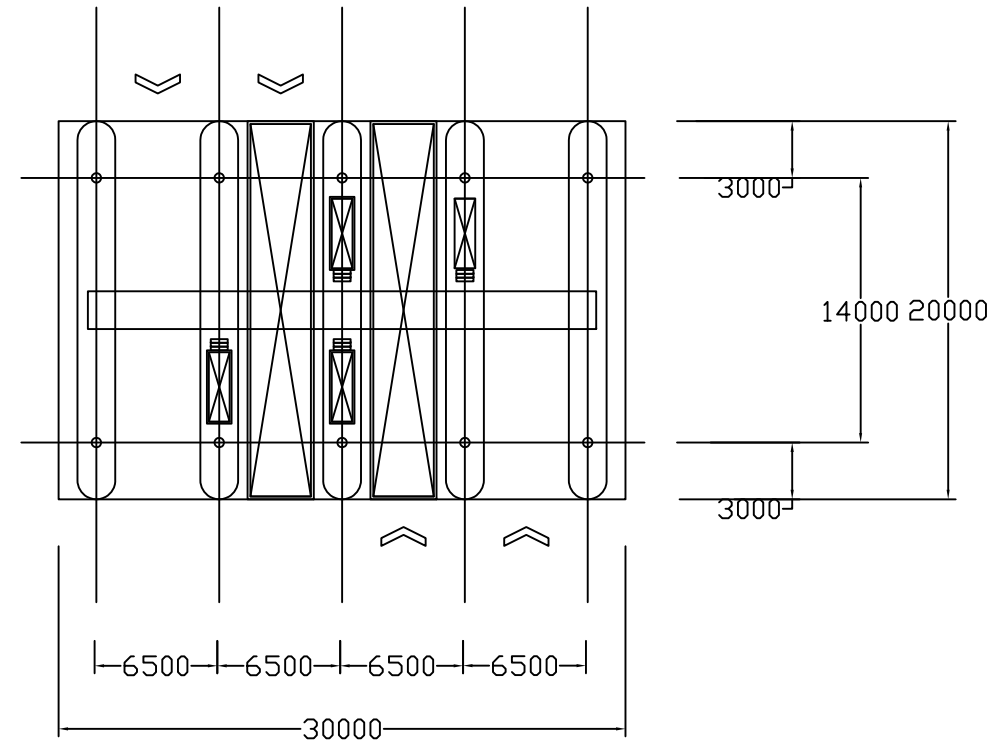

① Top View
ECH 1: 400

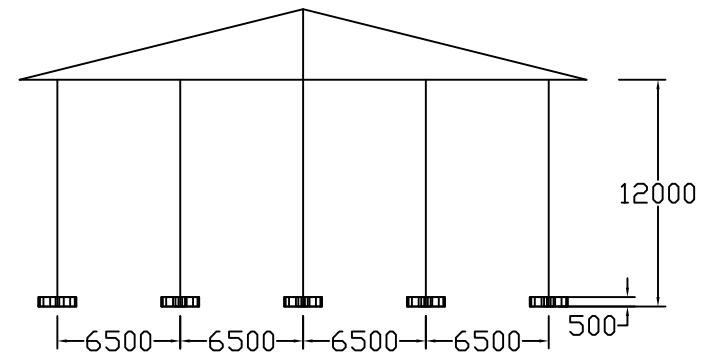

① Front View
ECH 1: 400

Approach Road/VLP

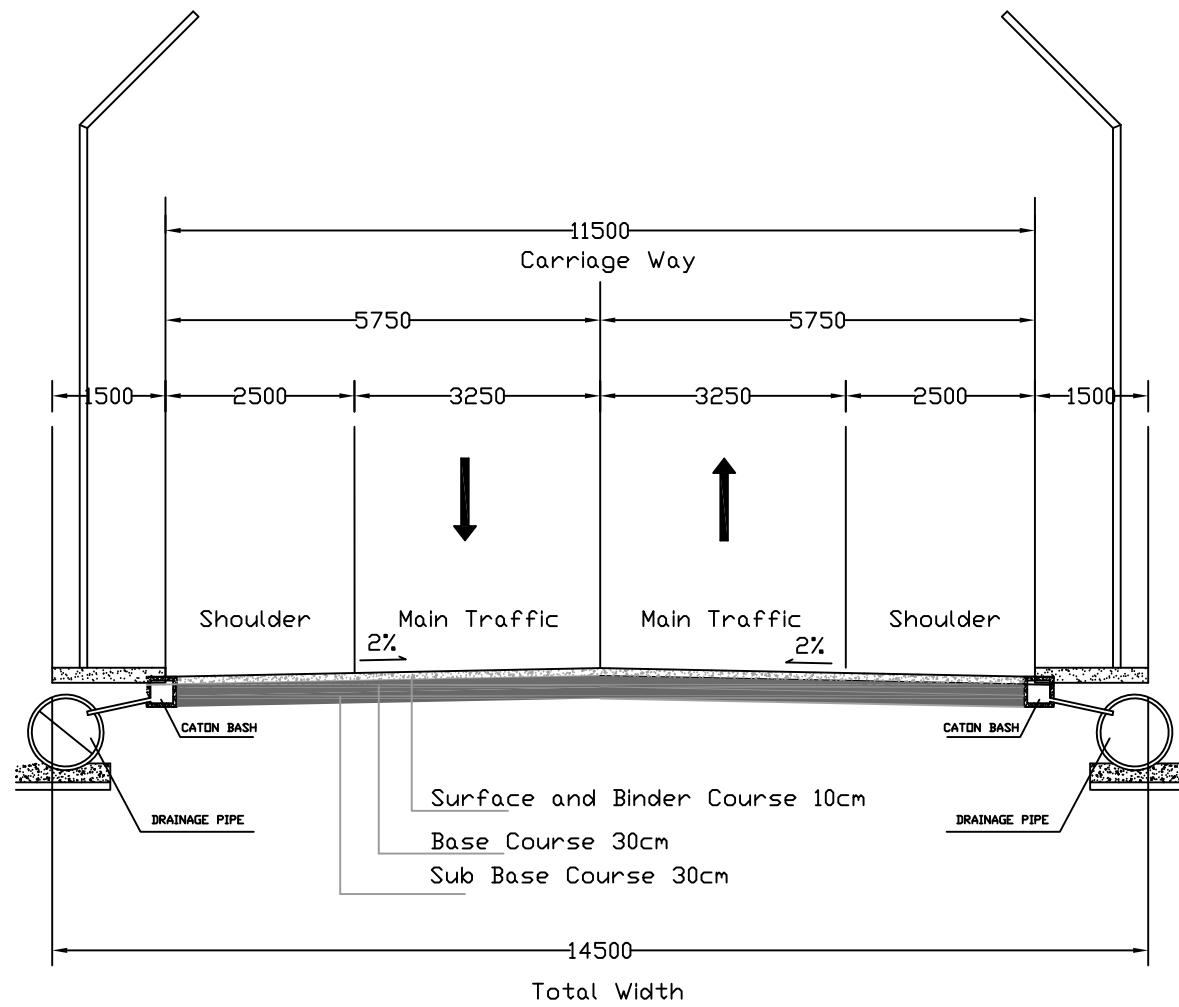

Section I

ECH 1/100

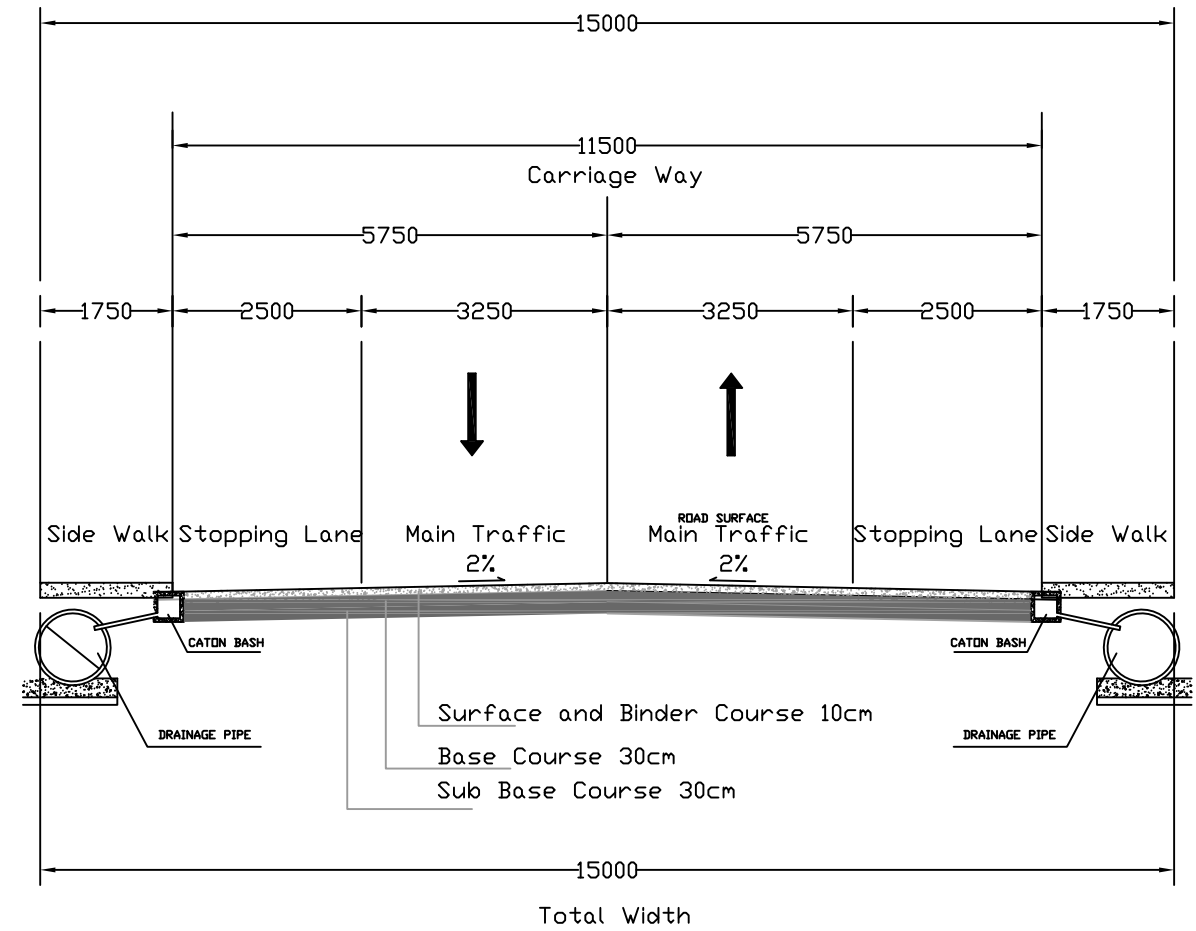

Section II

ECH 1/100

| | | | | | | | | | |
|---|---|---|---|----------|---------|----------|---------|-------------|----------|
| Japan International Cooperation Agency (JICA) | International Development Center of Japan | Project: the Comprehensive Study on Logistics System in LAO PDR | Typical Cross Section Approach Road/VLP | Drawing: | | Engineer | | Description | REV. NO. |
| | | | | Date | Checked | Date | Checked | | |
| | | | | | | | | | |

Railway Track/VLP

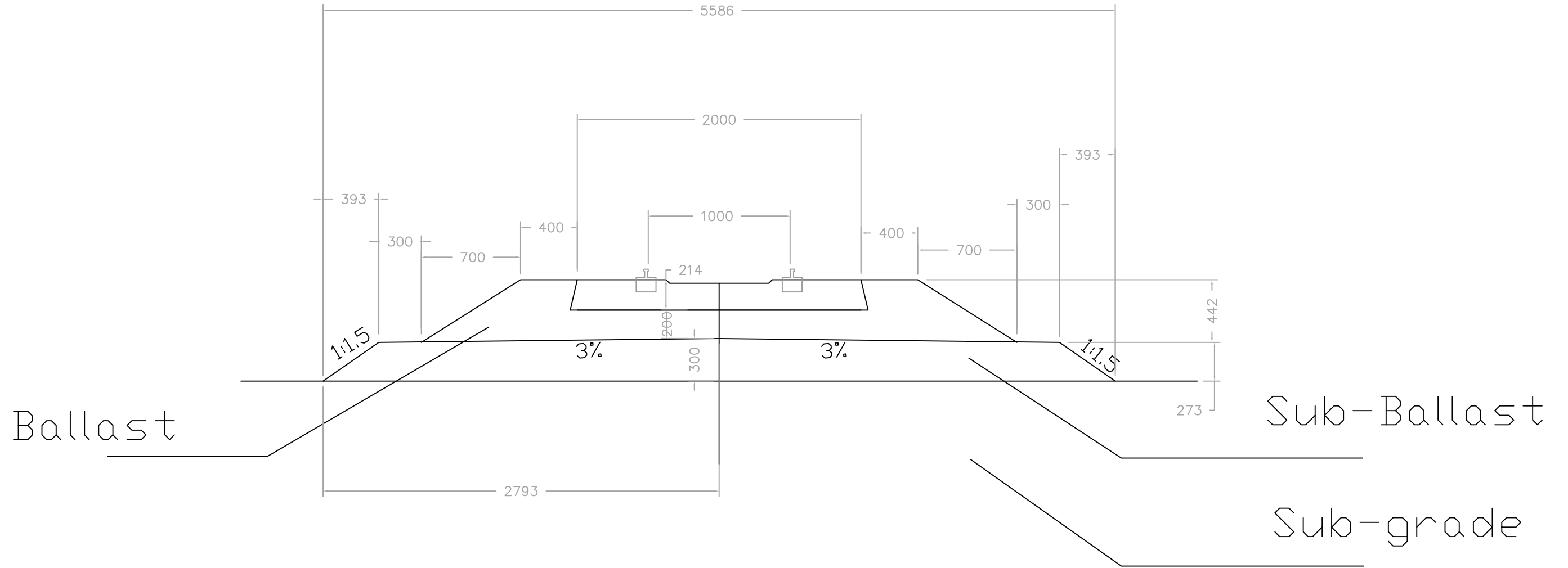

Typical Cross Section of Railway Track

ECH 1/30

| | | | | | | | | | |
|---|---|---|--|----------|---------|----------|---------|-------------|----------|
| Japan International Cooperation Agency (JICA) | International Development Center of Japan | Project: the Comprehensive Study on Logistics System in LAO PDR | Typical Cross Section of Railway (VLP) | Drawing: | | Engineer | | Description | REV. NO. |
| | | | | Date | Checked | Date | Checked | | |
| | | | | | | | | | |

Track Schematic Diagram

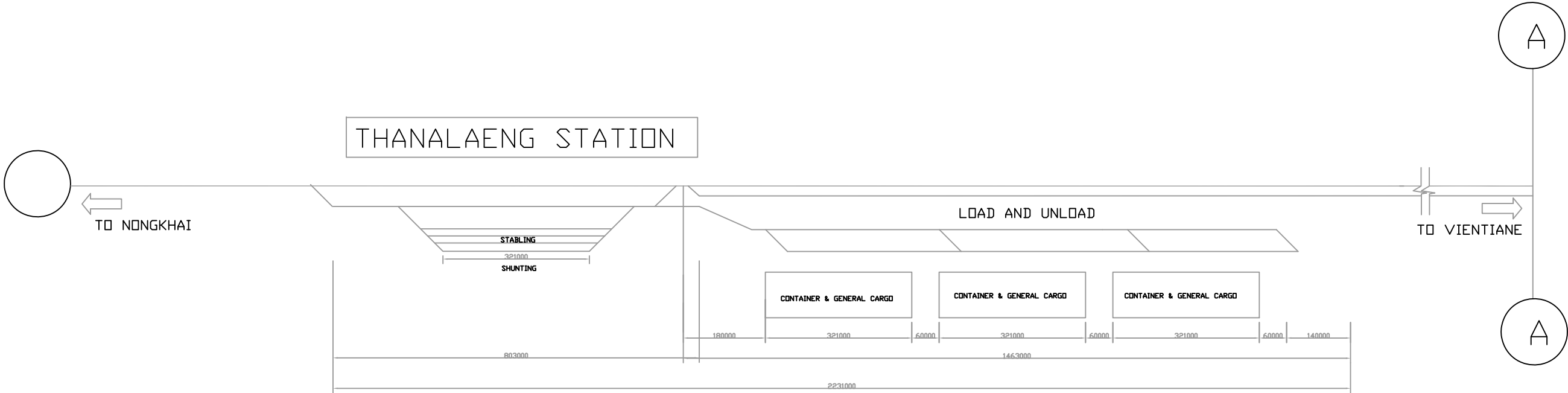

TRACK SCHEMATIC DIAGRAM

ECH 1/10000

| | | | | | | | | | |
|---|---|---|-------------------------------|----------|---------|----------|---------|-------------|----------|
| Japan International Cooperation Agency (JICA) | International Development Center of Japan | Project: the Comprehensive Study on Logistics System in LAO PDR | Track Schematic Diagram (VLP) | Drawing: | | Engineer | | Description | REV. NO. |
| | | | | Date | Checked | Date | Checked | | |
| | | | | | | | | | |

Perspective (SLP)



Japan International
Cooperation Agency (JICA)

International
Development
Center of Japan

Project: the Comprehensive
Study on Logistics System in
LAO PDR

Perspective (SLP)

| Drawing: | | Engineer | | Description | REV. NO. |
|----------|---------|----------|---------|-------------|----------|
| Date | Checked | Date | Checked | | |
| | | | | | |
| | | | | | |