

独立行政法人 国際協力機構
インド国電力省
インド火力発電公社

インド国 火力発電所運用改善計画調査

ファイナルレポート Volume V

平成 22 年 11 月
(2010 年)

電源開発株式会社
九州電力株式会社
中国電力株式会社

TABLE OF CONTENTS

CONCLUSION AND RECOMMENDATION

Conclusion	1
Recommendation	5

CHAPTER 1 INTRODUCTION

1.1 Background of the Study	1-1
1.2 Purpose of the Study	1-1
1.3 Schedule of the Study	1-1
1.4 Scope of the Study	1-2
1.5 Outline of the Study	1-3
1.6 Basic Policy of the Study	1-3
1.7 Counterpart Agencies	1-6
1.8 Study Team Member	1-8

CHAPTER 2 POWER SECTOR IN INDIA

2.1 Government Policy	2-1
2.1.1 Law/Regulation	2-1
2.1.2 Power Sector Structure	2-1
2.1.3 Power Demand and Supply	2-7
2.1.4 Policy and Development Plan and MEGA Project	2-12
2.1.5 Tariff	2-15
2.1.6 Assistance Policy and Present Situation of Project Formation Proposed by Other Donors	2-19

CHAPTER 3 PERFORMANCE IMPROVEMENT IN NTPC POWER PLANTS

3.1 NTPC Limited Power Plant	3-1
3.2 Statuses of Operation	3-5
3.3 Former Performance Improvement in NTPC	3-7

CHAPTER 4 WORK IN INDIA

4.1 #1 Kick off Meeting	4-1
4.2 #2 Kick off Meeting	4-1
4.3 #1 Field Work	4-3
4.4 #2 Field Work	4-9
4.5 #3 Field Work	4-9
4.6 #4 Field Work	4-9
4.7 #5 Field Work	4-9

Vol. I

4.8 #6 Field Work	4-9
CHAPTER 5 SELECTION OF CANDIDATE UNITS OF NTPC AND STUDY SCOPE	
5.1 Selected Units and Study Scope	5-1
5.2 Present Operation Condition of the Selected Units	5-9
CHAPTER 6 STUDY RESULT AND RECOMMENDATION	
6.1 Diagnosis of Boiler Problem	6-1
6.2 Combustion Simulation	6-11
6.2.1 Introduction	6-11
6.2.2 Outline of the Combustion Simulation and the Subject in this Project	6-11
6.2.3 The Mesh Pattern and the Simulation Cases	6-12
6.2.4 Results	6-13
6.2.5 Additional Case study for the Effect of the Air and Fuel Bias	6-16
6.3 Boiler Remaining Life Assessment	6-21
6.3.1 Overview	6-21
6.3.2 Procedure.....	6-23
6.3.3 Report.....	6-23
6.4 Air Heater (AH) Performance Improvement.....	6-26
6.4.1 Korba #6.....	6-26
6.4.2 Singrauli Unit 4	6-29
6.4.3 Efficiency Improvement Proposals	6-33
6.5 Turbine RLA.....	6-42
6.6 Condenser Leak Buster.....	6-51
6.7 Pump Assessment	6-52
6.8 Seal Fin Replacement	6-55
6.9 Control System Assessment	6-59
6.9.1 Overview	6-59
6.9.2 Details	6-59
6.9.3 Evaluation	6-59
6.9.4 Improvement Proposals and Effects.....	6-60
6.10 BFP Turbine Parameter Assessment.....	6-60
6.11 Generator Assessment	6-62
6.11.1 Target Generator for Assessment and the Procedure.....	6-62
6.11.2 Korba#6 Generator Assessment	6-63
6.11.3 Rihand#2 Generator Assessment.....	6-64
6.11.4 Singrauli#4 Generator Assessment.....	6-65

6.12 Generator Transformer Assessment.....	6-66
6.12.1 Target Transformers for Assessment and the Procedure	6-66
6.12.2 Korba #6 GT Assessment	6-68
6.12.3 Rihand#2 GT Assessment	6-69
6.12.4 Singrauli#6 (R-Phase) GT Assessment	6-71
6.12.5 Korba #6 GT Assessment (3 rd year: 2010)	6-72
6.13 Analysis of Current Performance and Performance Degradation	6-73
6.13.1 General	6-73
6.13.2 Boiler Performance Test	6-77
6.13.3 Turbine Performance Test	6-90
6.14 Review and Improvement of Past and Present O&M Procedure	6-99
6.14.1 Current Conditions of Thermal Power Station Operations	6-99
6.14.2 Current Conditions of Operation	6-99
6.14.3 Outline of a Power Station Management System.....	6-100
6.14.4 Power Generation Equipment Operating States in Each Power Station	6-114
6.14.5 Issues and Countermeasures about Operation of Power Generation Equipment	6-115
6.14.6 Provided Reports and Instructions	6-122
6.15 Economic and Financial Analysis.....	6-124
6.15.1 Concept	6-124
6.15.2 Scope	6-124
6.15.3 Method	6-125
6.15.4 Economic and Financial Analysis - Case Study.....	6-135
6.15.5 Environmental Value Added Analysis.....	6-181
6.16 Application of CDM.....	6-198
6.16.1 Outline of CDM	6-198
6.16.2 Implementation of preparation of PDD Draft	6-202
6.16.3 Summary of PDD Draft	6-203
6.16.4 Planning of schedule of preparatory works for CDM procedure for submission and approval	6-220
6.17 Recommendation.....	6-224

CHAPTER 7 TRAINING PROGRAM



7.1 Periodic Inspection, Efficiency Management, Facility Condition Monitoring and Diagnostic Technology Training.....	7-1
7.1.1 Periodic Inspection Training Course.....	7-2
7.1.2 Efficiency Management Training Course.....	7-4
7.1.3 Facility Condition Monitoring and Diagnostic Technology Training Course	7-5

7.2	Boiler Residual Life Assessment Technique Training.....	7-6	}	Vol. I		
7.2.1	Boiler Residual Life Assessment Technique Training Course	7-7				
7.3	Boiler Combustion Simulation Training.....	7-8				
7.3.1	Boiler Combustion Simulation Training Course	7-9				
7.4	Evaluation of the Trainings	7-10				
7.4.1	Evaluation of Training Programs	7-10				
7.4.2	Evaluation of Training Program and Implementation.....	7-10				
CHAPTER 8 ATTACHMENT						
8.1	Minutes of Meeting (MOM)				}	Vol. I
8.1.1	MoM of First Steering Committee					
8.1.2	MoM of Second Steering Committee					
8.1.3	MoM of Third Steering Committee					
8.1.4	MoM of Fourth Steering Committee		}	Vol. II		
8.2	Presentation Slides					
8.2.1	#1 Work Shop		}	Vol. III		
8.2.2	Other work shop and seminar					
8.3	Survey Sheets for the Selection of the Candidate Units					
8.4	Assessment / Test procedure and report					
8.4.1	Boiler RLA					
8.4.2	Condenser Leak Buster					
8.4.3	Pump Test					
8.4.4	Control System Assessment					
8.4.5	Generator Assessment					
8.4.6	Generator Transformer Assessment					
8.4.7	Performance Test					
8.4.8	Combustion Simulation		}	Vol. IV		
8.4.9	BFPT Parameter Assessment					
8.4.10	Preparation of PDD Draft					
8.4.11	Turbine RLA		}	Vol. V		



Volume- II

**RLA & Stress Analysis
of Critical Pipings.**

	CLIENT	J-Power (Electric Power Development Co. Ltd.)
	PROJECT	Turbine and System Assessment for NTPC-KORBA Unit # 4
	ORDER NO.	CGP10028C
	CONTRACTOR	ALSTOM K. K. NASL LTD. (Nominated Sub-Contractor in India)
	DOCUMENT	FINAL REPORT VOL - II (PIPING ASSESSMENT)

INDEX

CHAPTER - 1	INTRODUCTION	3
CHAPTER - 2	OBJECTIVE.....	4
CHAPTER - 3	METHODOLOGIES FOR NDT TESTS & ANALYSIS:	5
CHAPTER - 4	METHODOLOGIES FOR FINITE ELEMENT ANALYSIS USING ABAQUS/FESAFE	6
CHAPTER - 5	THE METHODOLOGIES FOR STRESS ANALYSIS (USING CAESAR II).....	7
CHAPTER - 6	THE METHODOLOGIES FOR REMAINING LIFE CALCULATION	8
CHAPTER - 7	ASSUMPTIONS.....	9
CHAPTER - 8	SUMMARY OF OBSERVATIONS & RECOMMENDATION.....	10
CHAPTER - 9	FIELD NDT ANALYSIS	14
9.1.0	Main Steam Line	14
9.2.0	HP By Pass Line	20
9.3.0	Cold Reheat piping system	22
9.4.0	LP By Pass Line	25
9.5.0	Hot Reheat piping system (Including LPBP Line)	28
9.6.0	Boiler Feed Discharge Piping system	35
CHAPTER - 10	FINITE ELEMENT ANALYSIS.....	37
10.1.0	Overview of the Piping systems of Unit #4 of Korba,STPS	37
10.2.0	Background of the Study of Critical Steam and BFP pipes.	37
10.3.0	Design Parameters of Critical Steam Pipes	38
10.4.0	Load cases	38
10.5.0	Material specification	38
10.6.0	Stress Analysis Using CAESAR II:	45
10.6.1	Main Steam (including HPBP).....	48
10.6.2	Cold Reheat Piping	53
10.6.3	Hot Reheat piping	56
10.6.4	Boiler Feed Discharge Piping.....	61
10.6.5	Piping Report- Salient Points:	69
10.6.6	Conclusions of the report.....	70
10.6.7	CAESAR II REPORT	71
10.7.0	Stress Analysis & Remaining Life Calculation using ABAQUS/FESAFE	82
10.7.1	MS, CRH and HPBP	82
10.7.2	HRH and LPBP.....	105
10.7.3	BFD	126
10.7.4	Remaining Life Calculation Using LMP Methods:	133
10.7.5	Conclusion of FEA USING ABAQUS/FESAFE	133
10.7.6	Overall Conclusions:.....	134

ALSTOM	CLIENT	J-Power (Electric Power Development Co. Ltd.)
	PROJECT	Turbine and System Assessment for NTPC-KORBA Unit # 4
	ORDER NO.	CGP10028C
NTPC ALSTOM Power Services Pvt. Ltd.	CONTRACTOR	ALSTOM K. K. NASL LTD. (Nominated Sub-Contractor in India)
	DOCUMENT	FINAL REPORT VOL - II (PIPING ASSESSMENT)

10.7.7	Recommendations on MS Line hot points:.....	135
CHAPTER - 11	PHOTOGRAPHS.....	136



479

The ALSTOM logo is located in the top left corner of the page. It consists of the word "ALSTOM" in a bold, sans-serif font. The letter "O" is stylized with a red circle around it.

Volume- II
Chapter – 01

Introduction

NTPC ALSTOM
Power Services Pvt. Ltd.

	CLIENT	J-Power (Electric Power Development Co. Ltd.)
	PROJECT	Turbine and System Assessment for NTPC-KORBA Unit # 4
	ORDER NO.	CGP10028C
	CONTRACTOR	ALSTOM K. K. NASL LTD. (Nominated Sub-Contractor in India)
	DOCUMENT	FINAL REPORT VOL - II (PIPING ASSESSMENT)

CHAPTER - 1 INTRODUCTION

RLA ,Stress Analysis & FEA studies was carried out for Critical pipings viz Main Steam, CRH, HRH, and BFP discharge of NTPC Korba, 500 MW Unit # 4.

The above Pipelines and associated supports/hangers, interconnecting Boiler and turbine, operate at high Pressure and Temperature and are subjected to deterioration mainly due to Creep & fatigue. Accordingly their useful life is affected subject to the condition of the metal parts exposed to varying parameters viz pressure, temperature.

This report contains the data and analysis of various NDT/other studies carried out to identify the deterioration, assessment of remaining life and recommendation thereof in the above pipeline.

The process included data collection through field survey of the piping systems in hot and cold condition, recording current and historical O & M parameters, drawings and documents. Analysis part included Stress Analysis through Software CAESAR II, NDT methodologies and Finite Element Analysis. Results and conclusions are brought out in terms of remaining life and other corrective actions in the piping system.



The ALSTOM logo is located in the top left corner of the page. It consists of the word "ALSTOM" in a bold, sans-serif font. The letters "ALST" are in blue, and "OM" is in red. The letter "O" has a white circle inside it.

ALSTOM

Volume- II
Chapter – 02

Objective

NTPC ALSTOM
Power Services Pvt. Ltd.

	CLIENT	J-Power (Electric Power Development Co. Ltd.)
	PROJECT	Turbine and System Assessment for NTPC-KORBA Unit # 4
	ORDER NO.	CGP10028C
	CONTRACTOR	ALSTOM K. K. NASL LTD. (Nominated Sub-Contractor in India)
	DOCUMENT	FINAL REPORT VOL - II (PIPING ASSESSMENT)

CHAPTER - 2 OBJECTIVE

Objectives of this study are as below:

1. To assess the present condition of the piping system.
2. To identify failure prone areas and provide recommendations thereof.
3. To predict the remaining life of the piping system.





ALSTOM

Volume- II
Chapter – 03

Methodologies for NDT & Analysis

NTPC ALSTOM
Power Services Pvt. Ltd.

	CLIENT	J-Power (Electric Power Development Co. Ltd.)
	PROJECT	Turbine and System Assessment for NTPC-KORBA Unit # 4
	ORDER NO.	CGP10028C
	CONTRACTOR	ALSTOM K. K. NASL LTD. (Nominated Sub-Contractor in India)
	DOCUMENT	FINAL REPORT VOL - II (PIPING ASSESSMENT)

CHAPTER - 3 METHODOLOGIES FOR NDT TESTS & ANALYSIS:

Following NDT techniques have been applied:

- In situ metallography to assess the metallurgical condition.
- DPT to assess the defects open to surface.
- MPI to detect surface/ subsurface defects in ferrous materials.
- Ultrasonic testing to detect surface/subsurface defect.

Test analysis is carried out to assess:

- Level of degradation and reveal the presence of defects.
- Remaining life.

For Detail Methodologies & Remaining Life calculation please refer Vol 1A Chapter 6.





ALSTOM

Volume- II
Chapter – 04
Methodologies for FEA Using
ABAQUS/FESAFE

NTPC ALSTOM
Power Services Pvt. Ltd.

424

	CLIENT	J-Power (Electric Power Development Co. Ltd.)
	PROJECT	Turbine and System Assessment for NTPC-KORBA Unit # 4
	ORDER NO.	CGP10028C
	CONTRACTOR	ALSTOM K. K. NASL LTD. (Nominated Sub-Contractor in India)
	DOCUMENT	FINAL REPORT VOL - II (PIPING ASSESSMENT)

CHAPTER - 4 METHODOLOGIES FOR FINITE ELEMENT ANALYSIS USING ABAQUS/FESAFE

Computer simulation using powerful numerical technique, Finite Element Method, is used to analyze piping system subjected to thermal and mechanical loading.

Thermal and mechanical loading (gravity + internal pressure) cycle is analysed using non-linear, elasto-plastic FEM analysis, to identify the critical failure locations and residual life of piping.

Following steps are followed for FEA using ABAQUS/FESAFE

- Create 3D CAD model of piping components and assembly (using CATIA V5).
- Create finite element mesh (using ABAQUS).
- A deck is created for finite element modeling and analysis of piping.
- Impose boundary conditions (Operating conditions, loading parts etc, cyclic loading, thermal etc.).
- Physical operating conditions are mimicked for computer simulation.
- Do finite element analysis (thermo– mechanical using ABAQUS).
- Conduct thermo-mechanical fatigue analysis (using FESAFE\hand calculation).
- Conduct creep analysis to predict the plastic deformation of the pipe.



FEA analysis is carried out to assess

1. Stresses, strains (elastic and plastic), temperatures and deflections at all points in the assembly.
2. Fatigue hot spot, and number of cycles for fatigue crack initiation.
3. Remaining Life.

ALSTOM

Volume- II
Chapter – 05
Methodologies for Stress Analysis
Using CAESAR II

NTPC ALSTOM
Power Services Pvt. Ltd.

	CLIENT	J-Power (Electric Power Development Co. Ltd.)
	PROJECT	Turbine and System Assessment for NTPC-KORBA Unit # 4
	ORDER NO.	CGP10028C
	CONTRACTOR	ALSTOM K. K. NASL LTD. (Nominated Sub-Contractor In India)
	DOCUMENT	FINAL REPORT VOL - II (PIPING ASSESSMENT)

CHAPTER - 5 THE METHODOLOGIES FOR STRESS ANALYSIS (USING CAESAR II)

The methodology adopted for CAESAR II analysis:

- Based on drawings and design documents CAESAR II Analysis generates the Hanger Load & Travel, Forces & Moments at the equipment connections and identify the stress point in the piping system.
- Spring hanger positions of the piping systems were noted to assess movement from hot to cold. These hanger travel values can be compared with the design value available in the design documents and as established in the CAESAR II Output Report.



Outcome of CAESAR II Analysis

- Recommend change for the Hanger Loading & Travels.
- Identifying high stress points in the piping for NDT/Monitoring and corrective actions.

The ALSTOM logo is located in the top left corner of the page. It consists of the word "ALSTOM" in a bold, sans-serif font. The letter "O" is stylized with a red circle around it. The entire page is framed by a decorative border with a repeating geometric pattern.

Volume- II
Chapter – 06
Methodologies for Remaining Life
Calculation

NTPC ALSTOM
Power Services Pvt. Ltd.

	CLIENT	J-Power (Electric Power Development Co. Ltd.)
	PROJECT	Turbine and System Assessment for NTPC-KORBA Unit # 4
	ORDER NO.	CGP10028C
	CONTRACTOR	ALSTOM K. K. NASL LTD. (Nominated Sub-Contractor in India)
	DOCUMENT	FINAL REPORT VOL - II (PIPING ASSESSMENT)

CHAPTER - 6 THE METHODOLOGIES FOR REMAINING LIFE CALCULATION

Following Remaining Life Calculation techniques have been applied:

- LMP.
- VBG Guidelines.
- FEA Analysis using ABAQUS/FESAFE/CAESAR II.



For Detail Methodologies of Remaining Life calculation please refer Vol 1A Chapter 6.



ALSTOM

Volume- II
Chapter – 7
Assumptions

NTPC ALSTOM
Power Services Pvt. Ltd.

	CLIENT	J-Power (Electric Power Development Co. Ltd.)
	PROJECT	Turbine and System Assessment for NTPC-KORBA Unit # 4
	ORDER NO.	CGP10028C
	CONTRACTOR	ALSTOM K. K. NASL LTD. (Nominated Sub-Contractor In India)
	DOCUMENT	FINAL REPORT VOL - II (PIPING ASSESSMENT)

CHAPTER - 7 ASSUMPTIONS

Following are the assumptions made during the FEA using ABAQUS/FESAFE

- Hanger stiffness data has been derived from the CAESAR II Analysis, wherever not available.
- Piping assembly is made of 1D Pipe element for faster solution convergence.
- Material properties are taken from relevant Codes & Standards.
- Insulation mass is added to the pipe mass.
- Major pipes circuit temperature is considered uniform.
- Only Cold Start condition of the pipeline is applicable for analysis .In order to evaluate total number of cold start, the available data for 15 years of plant has been extrapolated for 25 years (running years).Total number of cold start is evaluated to be 50 Nos.

Following are the assumptions made during the CAESAR II analysis

- HPBP line from Valve II to CRH, BFD Discharge Line from Heater 5A to 6A, HRH Strainer to Control Valves are unavailable for modeling. However based on site observation of the piping layout, a complete model of the respective piping systems have been prepared.
- Scope relates to assessment of external piping.Hense Steam Piping has been analysed from the Boiler Header Connecting Point upto the Control Valve of Main Steam & HRH at the Turbine End and Turbine Casing for CRH Piping.





ALSTOM

Volume- II
Chapter – 08
Summary of Observations
& Recommendation

NTPC ALSTOM
Power Services Pvt. Ltd.

134

	CLIENT	J-Power (Electric Power Development Co. Ltd.)
	PROJECT	Turbine and System Assessment for NTPC-KORBA Unit # 4
	ORDER NO.	CGP10028C
	CONTRACTOR	ALSTOM K. K. NASL LTD. (Nominated Sub-Contractor in India)
	DOCUMENT	FINAL REPORT VOL - II (PIPING ASSESSMENT)

CHAPTER - 8 SUMMARY OF OBSERVATIONS & RECOMMENDATION

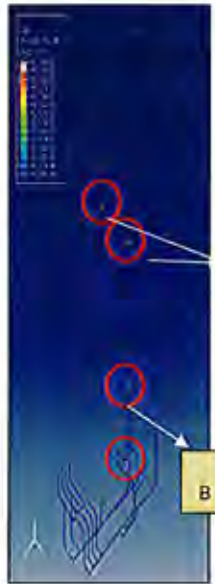
RESIDUAL LIFE ASSESSMENT AND ACTION PROPOSED REPORT RLA of IP/LP Turbines of Unit#4at NTPC-Korba.				
Unit : # 4				
Sl. No	Component	Testing	Key Observations/ Findings/ condition assessment	Remarks/ Action Proposed
1	Main Steam Line. & HP Bypass	VI	Hard scaling is observed on the main steam line at exposed area. Minor external scale is observed on the HP By pass line steam line.	<p>Run-Component fit for further operation and re-inspection of the component is recommended after 5 years of further operation to monitor the extent and trend in service induced damage and assess its fitness for further service.</p> <p>Repair / Replace- Below hangers/supports are required to be corrected.</p> <p>No.MST-18: The hanger scale is damaged.</p> <p>No. HPBP-02: The spring is topped out.</p> <p>No. HPBP-18: The spring casing is missing.</p>
		UT	No recordable indication observed.	
		MPI	No surface or sub surface indication.	
		Replica	<p>Parent Metal :</p> <p><u>MS</u> Microstructure shows decomposed Bainite with ferrite and with carbides at the grain boundary. Diffusional degradation level IVL is observed. Expeded Creep life fraction is 0.20.</p> <p><u>HPBP</u> Microstructure shows fine tempered bainite and ferrite with spherodisation of carbides. Diffusional degradation level IIL is observed. Expeded Creep life fraction is 0.10.</p>	
		Hardness	<p><u>MS</u> W-161-169BHN. PM-122-131BHN.</p> <p><u>HPBP</u> PM-138-142 BHN. WELD-218-222 BHN.</p>	
		OD	MS - 544mm - 548 mm HPBP - 298mm-300 mm.	
		Thickness	MS - 99.33 mm - 99.95 mm. HPBP - 54.6mm-55.5 mm.	
		CAESAR II Analysis	The maximum risk node points having highest stress components are marked.	
		FEA	The maximum risk node points having highest stress components (point A) & creep strain (Point B) are marked.	
			 <p>CAESAR II Hot Spots</p>	 <p>FEA Hot Spots</p>



ALSTOM	CLIENT	J-Power (Electric Power Development Co. Ltd.)
	PROJECT	Turbine and System Assessment for NTPC-KORBA Unit # 4
	ORDER NO.	CGP10028C
NTPC ALSTOM Power Services Pvt. Ltd.	CONTRACTOR	ALSTOM K. K. NASL LTD. (Nominated Sub-Contractor In India)
	DOCUMENT	FINAL REPORT VOL - II (PIPING ASSESSMENT)



RESIDUAL LIFE ASSESSMENT AND ACTION PROPOSED REPORT
RLA of IP/LP Turbines of Unit#4at NTPC-Korba.



Unit : # 4



Sl. No	Component	Testing	Key Observations/ Findings/ condition assessment	Remarks/ Action Proposed
2	COLD RE HEAT LINE	VI	Minor external scale is observed on the CRH steam line	Run-Component fit for further operation and re-inspection of the component is recommended after 5 years of further operation to monitor the extent and trend in service induced damage and assess its fitness for further service.
		UT	No record able indication observed.	
		MPI	No surface or sub surface indication	
		Replica	Microstructure shows tempered bainite with spherodisation of the carbides. Degradation Level- IVL. Expeded Creep life fraction is 0.20	Repair / Replace- Below hangers/supports are required to be corrected.
		Hardness	W-160-178 BHN. PM- 137-141 BHN.	No. CRH-17: No load on the spring.
		OD	563mm-564 mm	No. CRH-20: found missing
		Thickness	22.10mm-22.34 mm	
		CAESAR II Analysis	Marked in Model with MS-CRH-HPBP	
		FEA	Marked in Model with MS-CRH-HPBP	
3	HOT REHEAT LINE.	VI	Hard scaling is observed on the Hot reheat line at exposed area.	Run-Component fit for further operation and re-inspection of the component is recommended after 5 years of further operation to monitor the extent and trend in service induced damage and assess its fitness for further service.
		UT	No recordable indication observed.	
		MPI	No surface or sub surface indication	
		Replica	Parent Metal : Microstructure shows decomposed Bainite with ferrite and with carbides at the grain boundary. Diffusional degradation level IVL is observed. Expeded Creep life fraction is 0.20	Repair / Replace- Below hangers/supports are required to be corrected.
		Hardness	W-201-212 HB PM-151-169BHN.	A horizontal restraint provided between LPBH13 and LPBPH-14 is in dismantled condition. Bolts to be tightened.
		OD	678mm-679 mm	
		Thickness	40.85mm – 41.86 mm	
		CAESAR II Analysis	The maximum risk node points having highest stress components are marked.	

9/6/10

	CLIENT	J-Power (Electric Power Development Co. Ltd.)
	PROJECT	Turbine and System Assessment for NTPC-KORBA Unit # 4
	ORDER NO.	CGP10028C
	CONTRACTOR	ALSTOM K. K. NASL LTD. (Nominated Sub-Contractor in India)
	DOCUMENT	FINAL REPORT VOL - II (PIPING ASSESSMENT)

RESIDUAL LIFE ASSESSMENT AND ACTION PROPOSED REPORT RLA of IP/LP Turbines of Unit#4at NTPC-Korba.				
Unit : # 4				
Sl. No	Component	Testing	Key Observations/ Findings/ condition assessment	Remarks/ Action Proposed
		FEA	The maximum risk node points having highest stress components & creep strain are marked.	  <div style="display: flex; justify-content: space-around;"> <div style="border: 1px solid black; padding: 5px;">CAESAR II Hot Spots</div> <div style="border: 1px solid black; padding: 5px;">FEA Hot Spots</div> </div>
4	FEED WATER LINE	VI	No significant indication observed.	Run-Component fit for further operation and re-inspection of the component is recommended after 5 years of further operation to monitor the extent and trend in service induced damage and assess its fitness for further service. Repair- No. Replace- No.
		UT	No recordable indication observed.	
		MPI	No surface or sub surface indication observed.	
		OD	361mm - 363mm.	
		Thickness	45.64mm – 45.77 mm.	
		CAESAR II Analysis	The maximum risk node points having highest stress components are marked.	
		FEA	The maximum risk node points having highest stress components (Point A) are marked.	

	CLIENT	J-Power (Electric Power Development Co. Ltd.)
	PROJECT	Turbine and System Assessment for NTPC-KORBA Unit # 4
	ORDER NO.	CGP10028C
	CONTRACTOR	ALSTOM K. K. NASL LTD. (Nominated Sub-Contractor In India)
	DOCUMENT	FINAL REPORT VOL - II (PIPING ASSESSMENT)

RESIDUAL LIFE ASSESSMENT AND ACTION PROPOSED REPORT RLA of IP/LP Turbines of Unit#4at NTPC-Korba.				
Unit : # 4				
Sl. No	Component	Testing	Key Observations/ Findings/ condition assessment	Remarks/ Action Proposed
				<div style="display: flex; justify-content: space-around;"> <div style="text-align: center;">  <p>CAESAR II Hot Spots</p> </div> <div style="text-align: center;">  <p>FEA Hot Spots</p> </div> </div>

698





ALSTOM

Volume- II
Chapter – 09
Field NDT Analysis

NTPC ALSTOM
Power Services Pvt. Ltd.

647

	CLIENT	J-Power (Electric Power Development Co. Ltd.)
	PROJECT	Turbine and System Assessment for NTPC-KORBA Unit # 4
	ORDER NO.	CGP10028C
	CONTRACTOR	ALSTOM K. K. NASL LTD. (Nominated Sub-Contractor in India)
	DOCUMENT	FINAL REPORT VOL - II (PIPING ASSESSMENT)

CHAPTER - 9 FIELD NDT ANALYSIS

9.1.0 Main Steam Line



- INTRODUCTION
- VISUAL INSPECTION
- NON DESTRUCTIVE TESTING
- INSITU METALLOGRAPHY & HARDNESS MEASUREMENT

INTRODUCTION

Main steam from the Boiler at pressure of 187 Kg/cm² and at temperature of 545° C is carried away through two pipes called main steam piping. These pipes are extended up to steam turbine and steam is allowed to pass through four strainers and valves.

VISUAL INSPECTION

- Hard scaling is observed on the main steam line at exposed area. Continuous operation at an elevated temperature, the pipeline outer surface under insulation develops a hard scale, which is not abnormal.

	CLIENT	J-Power (Electric Power Development Co. Ltd.)
	PROJECT	Turbine and System Assessment for NTPC-KORBA Unit # 4
	ORDER NO.	CGP10028C
	CONTRACTOR	ALSTOM K. K. NASL LTD. (Nominated Sub-Contractor in India)
	DOCUMENT	FINAL REPORT VOL - II (PIPING ASSESSMENT)

DIMENSIONAL MEASUREMENT

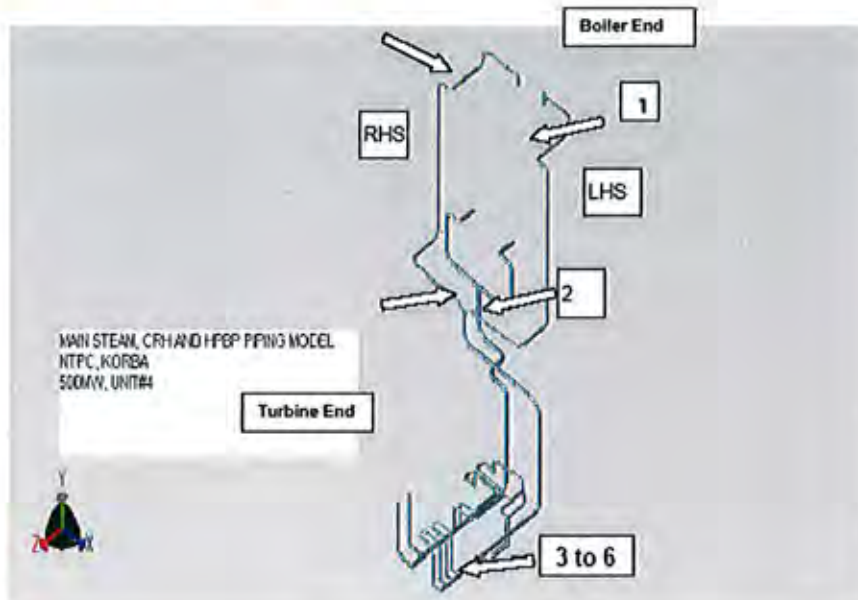

Outer Diameter and thickness readings recorded at critical locations are as below.

Loc. No. /Elevation	Name of pipe	Design Values (mm) (w.r.t drwg.)	Outside Diameter	Thickness	Remarks
1. (Elevation-76 meter)	MS pipe	OD=540.24 THK.=85.3(Pipe) THK.=97.4 (Bend) Drg.-0-80-500-01221	Near boiler MSSV LHS 544-545 mm	Near boiler MSSV LHS 99.51-99.95 mm 84.00-84.79 mm	Values are within the tolerance limit as per ASTM specifications.
			Near boiler MSSV RHS 545-548 mm	Near boiler MSSV RHS 99.33-99.90 mm 87.12-87.90 mm	
2. Y joint (37 Meter)	MS pipe	OD=536.5 THK.=95.5 Drg.-0-80-502-01223	Left 540-541 mm	Left 99.45,99.86,99.66 mm	Values are within the tolerance limit as per ASTM specifications.
			Right 540-542 mm	Right 98.50,98.65,98.99 mm	Values are within the tolerance limit as per ASTM specifications.
3. Near strainer	MS pipe 1	OD=372.7 THK.=61.9	371-373 mm	65.19,65.30,65.40 mm	Values are within the tolerance limit as per

105

ALSTOM	CLIENT	J-Power (Electric Power Development Co. Ltd.)
	PROJECT	Turbine and System Assessment for NTPC-KORBA Unit # 4
	ORDER NO.	CGP10028C
NTPC ALSTOM Power Services Pvt. Ltd.	CONTRACTOR	ALSTOM K. K. NASL LTD. (Nominated Sub-Contractor in India)
	DOCUMENT	FINAL REPORT VOL - II (PIPING ASSESSMENT)

Loc. No. /Elevation	Name of pipe	Design Values (mm) (w.r.t drwg.)	Outside Diameter	Thickness	Remarks
(5.5 Meter)		Drg.-0-80-505-1595			ASTM specifications.
4. Near strainer (5.5 Meter)	MS pipe 2	OD=372.7 THK.=61.9 Drg.-0-80-505-1595	372-373 mm	64.29,63.91,63.60 mm	Values are within the tolerance limit as per ASTM specifications.
5. Near strainer (5.5 Meter)	MS pipe 3	OD=372.7 THK.=61.9 Drg.-0-80-505-1595	371-373 mm	64.50,64.15,63.95 mm	Values are within the tolerance limit as per ASTM specifications.
6. Near strainer (5.5 Meter)	MS pipe 4	OD=372.7 THK.=61.9 Drg.-0-80-505-1595	372-373 mm	64.45,64.25,64.10 mm	Values are within the tolerance limit as per ASTM specifications.

MAGNETIC PARTICLE INSPECTION

MPI was performed on weld joints. There was no significant indication on all tested weld joint locations.

(Refer Report 7.2 of Vol 1B Report No. NASL/KKALSTOM/MPT/02)



ULTRASONIC INSPECTION

Ultrasonic Inspection was performed on weld joints. No recordable indication observed.

(Refer Report 7.3 of Vol 1B Report No- NASL/KK ALSTOM/UT/ 04)

IN-SITU METALLOGRAPHY & HARDNESS MEASUREMENT

(Refer report 7.4 of Vol 1B)

	CLIENT	J-Power (Electric Power Development Co. Ltd.)
	PROJECT	Turbine and System Assessment for NTPC-KORBA Unit # 4
	ORDER NO.	CGP10028C
 Power Services Pvt. Ltd.	CONTRACTOR	ALSTOM K. K. NASL LTD. (Nominated Sub-Contractor in India)
	DOCUMENT	FINAL REPORT VOL - II (PIPING ASSESSMENT)



Replicas were taken on pipes of Main steam line at various locations as mentioned in the below table.

Partial Bainite and Pearlite Degradation were observed in Main Steam lines. The spheroidisation level observed is II-L to IVL. No creep cavities have been observed.

Component ID & Location	Observations	Degradation Level	Hardness	Reference	Remarks
Main Steam Line # 1(LHS) External Surface (76 Mtr)	Parent Metal : Microstructure shows fine tempered bainite and ferrite with spheroidisation of carbides.	Diffusional degradation level IIL is observed.	138-142 BHN	Fig: 29 of Chapter 7.4 of Vol 1B.	Expended Creep life fraction is 0.10
	Weld Metal : Microstructure shows fine tempered bainite and ferrite.	Diffusional degradation level IIL is observed.	165-169 BHN	Fig: 27 of Chapter 7.4 of Vol 1B.	Expended Creep life fraction is 0.10
Main Steam Line # 2(RHS) External Surface (76 Mtr)	Parent Metal : Microstructure shows decomposed Bainite with ferrite and with carbides at the grain boundary.	Diffusional degradation level IVL is observed.	142-148 BHN	Fig: 26 of Chapter 7.4 of Vol 1B.	Expended Creep life fraction is 0.20
	Weld Metal : Microstructure shows fine tempered bainite and with spheroidisation of the carbides.	Diffusional degradation level IIL is observed.	163-174 BHN	Fig: 24 of Chapter 7.4 of Vol 1B.	Expended Creep life fraction is 0.10
Main Steam at strainer housing # 1 External Surface (5.5 Meter)	Parent Metal : Microstructure shows decomposed Bainite with ferrite and with carbides at the grain boundary.	Diffusional degradation level IVL is observed.	122-130 BHN	Fig: 59 of Chapter 7.4 of Vol 1B.	Expended Creep life fraction is 0.20
	Weld Metal : Microstructure shows fine tempered bainite and ferrite with spheroidisation of carbides.	Diffusional degradation level IIL is observed.	151-158 BHN	Fig: 57 of Chapter 7.4 of Vol 1B.	Expended Creep life fraction is 0.10
Main Steam at strainer housing # 2 External Surface (5.5 Meter)	Parent Metal : Microstructure shows decomposed Bainite with ferrite and with carbides at the grain boundary.	Diffusional degradation level IVL is observed.	111-121 BHN	Fig: 62 of Chapter 7.4 of Vol 1B.	Expended Creep life fraction is 0.20

ALSTOM	CLIENT	J-Power (Electric Power Development Co. Ltd.)
	PROJECT	Turbine and System Assessment for NTPC-KORBA Unit # 4
	ORDER NO.	CGP10028C
NTPC ALSTOM Power Services Pvt. Ltd.	CONTRACTOR	ALSTOM K. K. NASL LTD. (Nominated Sub-Contractor in India)
	DOCUMENT	FINAL REPORT VOL - II (PIPING ASSESSMENT)

	Weld Metal : Microstructure shows fine tempered bainite and ferrite with spheroidisation of carbides.	Diffusional degradation level IIL is observed.	152-156 BHN	Fig: 60 of Chapter 7.4 of Vol 1B.	Expended Creep life fraction is 0.10
Main Steam at strainer housing # 3 External Surface (5.5 Meter)	Parent Metal : Microstructure shows decomposed Bainite with ferrite and with carbides at the grain boundary.	Diffusional degradation level IVL is observed.	113-120 BHN	Fig: 65 of Chapter 7.4 of Vol 1B.	Expended Creep life fraction is 0.20
	Weld Metal : Microstructure shows fine tempered bainite and ferrite with spheroidisation of carbides.	Diffusional degradation level IIL is observed.	151-158 BHN	Fig: 63 of Chapter 7.4 of Vol 1B.	Expended Creep life fraction is 0.10
Main Steam at strainer housing # 4 Internal Surface (5.5 Meter)	Parent Metal : Microstructure shows decomposed Bainite with ferrite and with carbides at the grain boundary.	Diffusional degradation level IVL is observed.	114-120 BHN	Fig: 68 of Chapter 7.4 of Vol 1B.	Expended Creep life fraction is 0.20
	Weld Metal : Microstructure shows fine tempered bainite and ferrite with spheroidisation of carbides.	Diffusional degradation level IIL is observed.	149-151 BHN	Fig: 66 of Chapter 7.4 of Vol 1B.	Expended Creep life fraction is 0.10
Main Steam at 'Y' joint Internal Surface (37 Meter)	Parent Metal : Microstructure shows decomposed Bainite with ferrite and with carbides at the grain boundary.	Diffusional degradation level IVL is observed.	132-138 BHN	Fig: 50 of Chapter 7.4 of Vol 1B.	Expended Creep life fraction is 0.20
	Weld Metal : Microstructure shows decomposed Bainite with ferrite and with carbides at the grain boundary.	Diffusional degradation level IVL is observed.	178-179 BHN	Fig: 48 of Chapter 7.4 of Vol 1B.	Expended Creep life fraction is 0.20
Main Steam at 'Y' joint Internal Surface (37 Meter)	Parent Metal : Microstructure shows decomposed Bainite with ferrite and with carbides at the grain boundary.	Diffusional degradation level IVL is observed.	129-131 BHN	Fig: 53 of Chapter 7.4 of Vol 1B.	Expended Creep life fraction is 0.20
	Weld Metal : Microstructure shows fine tempered bainite and ferrite with spheroidisation of carbides.	Diffusional degradation level IIL is observed.	181-189 BHN	Fig: 51 of Chapter 7.4 of Vol 1B.	Expended Creep life fraction is 0.10
Main steam at HP inlet as HP integral piping. (8 Mtr)	Parent Metal : Microstructure shows decomposed Bainite with ferrite and with carbides at the grain boundary.	Diffusional degradation level IVL is observed.	128-138 BHN 130-134 BHN	Fig: 88/89 of Chapter 7.4 of Vol 1B.	Expended Creep life fraction is 0.20

	CLIENT	J-Power (Electric Power Development Co. Ltd.)
	PROJECT	Turbine and System Assessment for NTPC-KORBA Unit # 4
	ORDER NO.	CGP10028C
	CONTRACTOR	ALSTOM K. K. NASL LTD. (Nominated Sub-Contractor in India)
	DOCUMENT	FINAL REPORT VOL - II (PIPING ASSESSMENT)

ANALYSIS OF FINDING

Visual Observation does not show any surface damage. During Magnetic particle Inspection and Ultrasonic Inspection no significant defect was observed.

Partial Bainite and Pearlite Degradation were observed in Main steam pipe lines. The spheroidisation level (Diffusional degradation) observed is II-L to IV L. No creep cavities have been observed.

REMAINING LIFE

Based on the microstructure and the dimensional details available the remaining life of the main steam line is more than 20 years subject to operation of the unit with recommended operating & maintenance practice.

ALSTOM	CLIENT	J-Power (Electric Power Development Co. Ltd.)
	PROJECT	Turbine and System Assessment for NTPC-KORBA Unit # 4
	ORDER NO.	CGP10028C
NTPC ALSTOM Power Services Pvt. Ltd.	CONTRACTOR	ALSTOM K. K. NASL LTD. (Nominated Sub-Contractor in India)
	DOCUMENT	FINAL REPORT VOL - II (PIPING ASSESSMENT)

9.2.0 HP By Pass Line

- VISUAL INSPECTION
- NON DESTRUCTIVE TESTING
- INSITU METALLOGRAPHY & HARDNESS MEASUREMENT

VISUAL INSPECTION

Minor external scale is observed on the HPBP line which is acceptable.

DIMENSIONAL MEASUREMENT

Outer Diameter and thickness readings recorded at critical locations are as below:

Loc. No./ Elevation	Name of pipe	Design values w.r.t drwg.	Outside Diameter	Thickness	Remarks
01 (8 Meter)	HP By pass pipe	OD=298.3 Thk=55.13 0-80-510-01226	LHS 298-300 mm	LHS 54.6-54.9 mm	Values are within the tolerance limit as per ASTM specifications.
			RHS 299-300 mm	RHS 54.8-55.5 mm	Values are within the tolerance limit as per ASTM specifications.

MAGNETIC PARTICLE INSPECTION



Magnetic particle Inspection was performed on weld joints of HP By Pass line. There was no significant indication on all tested weld joint locations.

(Refer Report 7.2 of Vol 1B / Report No. NASL/KKALSTOM/MPT/02)

ULTRASONIC INSPECTION

Ultrasonic Inspection was performed on weld joints of HP BY PASS line. No recordable indication observed.

(Refer Report 7.3 of Vol 1B / Report No. NASL/KKALSTOM/UT/04)

	CLIENT	J-Power (Electric Power Development Co. Ltd.)
	PROJECT	Turbine and System Assessment for NTPC-KORBA Unit # 4
	ORDER NO.	CGP10028C
	CONTRACTOR	ALSTOM K. K. NASL LTD. (Nominated Sub-Contractor in India)
	DOCUMENT	FINAL REPORT VOL - II (PIPING ASSESSMENT)

IN-SITU METALLOGRAPHY & HARDNESS MEASUREMENT

(Refer report 7.4 of Vol 1B)

Replicas were taken on pipes of HP Bypass line at various locations as mentioned in the below table.

Partial Bainite and Pearlite Degradation was observed in HP Bypass lines. The spheroidisation level observed is II-L. No creep cavities have been observed.

Component ID & Location	Observations	Degradation Level	Hardness	Reference	Remarks
HP By Pass Line External Surface (8 Mtr)	Parent Metal : Microstructure shows fine tempered bainite and ferrite with spheroidisation of carbides.	Diffusional degradation level IIL is observed.	131-142 BHN	Fig: 56 of Chapter 7.4 of Vol 1B.	Expended Creep life fraction is 0.10
	Weld Metal : Microstructure shows fine tempered bainite and ferrite with spheroidisation of carbides.	Diffusional degradation level IIL is observed.	218-222 BHN	Fig: 54 of Chapter 7.4 of Vol 1B.	Expended Creep life fraction is 0.10

ANALYSIS OF FINDING

Visual Observation does not show any surface damage. During Magnetic particle Inspection and Ultrasonic Inspection no significant defect was observed.



Partial Bainite and Pearlite Degradation was observed in HP By Pass pipe lines. The spheroidisation level (Diffusional degradation) observed is II-L. No creep cavities have been observed.

Based on the microstructure and the dimensional details available the remaining life of the HP By Pass Line is more than 25 years subject to operation of the unit with recommended operating & maintenance practice.

Hanger Survey:

There are a total of 43 Hanger supports in the Main Steam pipe. An additional, 24 hangers are provided in the HPBP system. Types of hangers are Variable, Constant and Rigid types.

The hanger components show evidence of corrosion. In the Boiler area, corrosion of Hanger components is severe, due to the presence of Ash.

	CLIENT	J-Power (Electric Power Development Co. Ltd.)
	PROJECT	Turbine and System Assessment for NTPC-KORBA Unit # 4
	ORDER NO.	CGP10028C
	CONTRACTOR	ALSTOM K. K. NASL LTD. (Nominated Sub-Contractor in India)
	DOCUMENT	FINAL REPORT VOL - II (PIPING ASSESSMENT)

In pipe support No.MST-18,the hanger scale is damaged. In HPBP-02 the spring is topped out. In HPBP-18 the spring casing is missing.

During Cold and hot survey, spring Hanger positions were marked/noted. (Ref Annexure I,Table 1).

Recommendation:

All spring Hangers to be Cold set as per design values specified in drawings .Hangers to be marked with respective Tag nos. for easy identification.

Inspection, pipe thickness measurement, NDT, DPT of welds on pipes, where deemed necessary have been carried out and is reported separately.

Insulation and cladding are found damaged in several places and need to be attended immediately.

9.3.0 Cold Reheat piping system



- INTRODUCTION
- VISUAL INSPECTION
- NON DESTRUCTIVE TESTING
- INSITU METALLOGRAPHY & HARDNESS MEASUREMENT

INTRODUCTION

Steam from the HP turbine at pressure of 56.49 Kg/cm² and at temperature of 370° C is returned back to get reheated from the boiler. These pipes carrying the cold steam for re heating is called Cold Re Heat Line.

As these pipes are operating under hoop stress at high temperature and fatigue under load variations.

5/28

	CLIENT	J-Power (Electric Power Development Co. Ltd.)
	PROJECT	Turbine and System Assessment for NTPC-KORBA Unit # 4
	ORDER NO.	CGP10028C
	CONTRACTOR	ALSTOM K. K. NASL LTD. (Nominated Sub-Contractor in India)
	DOCUMENT	FINAL REPORT VOL - II (PIPING ASSESSMENT)

VISUAL INSPECTION

Minor external scale is observed on the CRH steam line which is acceptable.

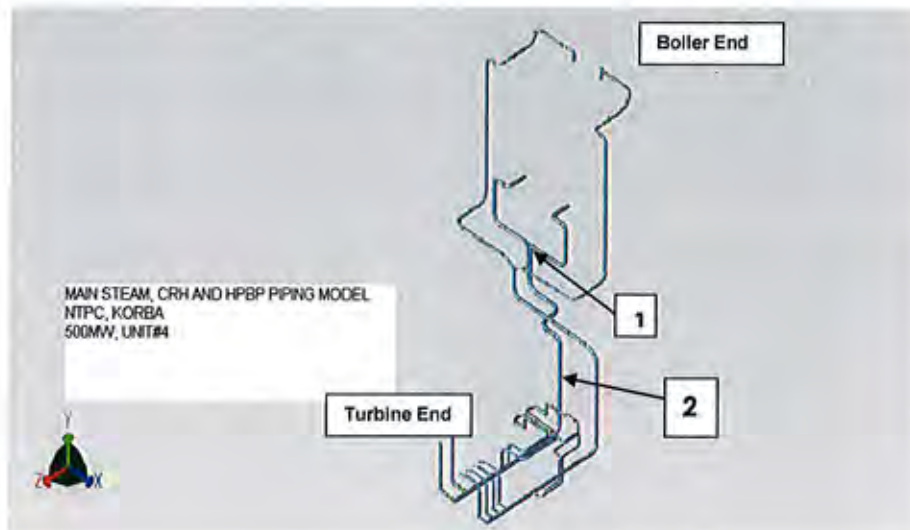



DIMENSIONAL MEASUREMENT

Outer Diameter and thickness readings recorded at critical locations are as below:

Loc. No. / Elevation	Name of pipe	Design Values w.r.t Drwg.	Outside Diameter	Thickness	Remarks
01 51 Meter Near T-Joints	CRH pipe		LHS 563-564 mm	LHS 22.10-22.16 mm	Values are within the tolerance limit as per ASTM specifications.
			RHS 563-564 mm	RHS 22.16-22.34 mm	Values are within the tolerance limit as per ASTM specifications.
02 49 Meter (Spray Nozzle)	CRH stub joint	NA	LHS D1 72-73 mm	LHS t1 7.7-8.4 mm	Values are within the tolerance limit as per ASTM specifications.
			LHS D2 122-123 mm	LHS t2 11.74-12.6 mm	
			RHS D1 74-75 mm	RHS t1 7.45-7.88 mm	Values are within the tolerance limit as per ASTM specifications.
			RHS D2 124-125 mm	RHS t2 12.16-12.40 mm	

509

	CLIENT	J-Power (Electric Power Development Co. Ltd.)
	PROJECT	Turbine and System Assessment for NTPC-KORBA Unit # 4
	ORDER NO.	CGP10028C
 Power Services Pvt. Ltd.	CONTRACTOR	ALSTOM K. K. NASL LTD. (Nominated Sub-Contractor in India)
	DOCUMENT	FINAL REPORT VOL - II (PIPING ASSESSMENT)

MAGNETIC PARTICLE INSPECTION

Magnetic particle Inspection was performed on weld joints of Cold Reheat Steam line. There was no significant indication on all tested weld joint locations.

(Refer Report 7.2 of Vol 1B / Report No. NASL/KKALSTOM/MPT/02)

ULTRASONIC INSPECTION

Ultrasonic Inspection was performed on weld joints of CRH line. No recordable indication observed.

(Refer Report 7.3 of Vol 1B / Report No. NASL/KKALSTOM/UT/04)

IN-SITU METALLOGRAPHY & HARDNESS MEASUREMENT



(Refer report 7.4 of Vol 1B)

Replicas were taken on pipes of CRH steam line at various locations as mentioned in the below table.

Partial Bainite and Pearlite Degradation was observed in CRH lines. The spherodisation level observed is I-L to II L. No creep cavities have been observed.

Component ID & Location	Observations	Degradation Level	Hardness	Reference	Remarks
CRH Steam Line # 1 External Surface (51 Mtr)	Parent Metal : Microstructure shows fine tempered bainite and ferrite with spherodisation of carbides.	Diffusional degradation level IIL is observed.	PM- 121-128 BHN	Fig: 38 of Chapter 7.4 of Vol 1B.	Expended Creep life fraction is 0.10
	Weld Metal : Microstructure shows fine tempered bainite and ferrite with spherodisation of carbides.	Diffusional degradation level IIL is observed.	169-178 BHN	Fig: 36 of Chapter 7.4 of Vol 1B.	Expended Creep life fraction is 0.10
CRH Steam Line # 2 External Surface (51 Mtr)	Parent Metal : Microstructure shows fine tempered bainite and ferrite with spherodisation of carbides.	Diffusional degradation level IIL is observed.	129-131 BHN	Fig: 41 of Chapter 7.4 of Vol 1B.	NO significant degradation in microstructure
	Weld Metal : Microstructure shows fine tempered bainite and ferrite with spherodisation of carbides.	Diffusional degradation level IIL is observed.	160-168 BHN	Fig: 39 of Chapter 7.4 of Vol 1B.	Expended Creep life fraction is 0.10

5/10

	CLIENT	J-Power (Electric Power Development Co. Ltd.)
	PROJECT	Turbine and System Assessment for NTPC-KORBA Unit # 4
	ORDER NO.	CGP10028C
	CONTRACTOR	ALSTOM K. K. NASL LTD. (Nominated Sub-Contractor In India)
	DOCUMENT	FINAL REPORT VOL - II (PIPING ASSESSMENT)

Component ID & Location	Observations	Degradation Level	Hardness	Reference	Remarks
CRH Steam Line at HP External Surface (49 Mtr)	Parent Metal : Microstructure shows fine tempered bainite and ferrite with spherodisation of carbides.	Diffusional degradation level IIL is observed.	151-168 BHN	Fig: 83 of Chapter 7.4 of Vol 1B.	Expended Creep life fraction is 0.10
	Weld Metal : Microstructure shows fine tempered bainite and ferrite with spherodisation of carbides.	Diffusional degradation level IIL is observed.	208-212 BHN	Fig: 81 of Chapter 7.4 of Vol 1B.	Expended Creep life fraction is 0.10

ANALYSIS OF FINDING

Visual Observation does not show any surface damage. During Magnetic particle Inspection and Ultrasonic Inspection no significant defect was observed.

Partial Bainite and Pearlite Degradation was observed in COLD re Heat steam pipe lines. The spherodisation level (Diffusional degradation) observed is II L. No creep cavities have been observed.

9.4.0 LP By Pass Line

1. VISUAL INSPECTION
2. NON DESTRUCTIVE TESTING
3. INSITU METALLOGRAPHY & HARDNESS MEASUREMENT

VISUAL INSPECTION

Minor external scale is observed on the LP by Pass line which is acceptable.

DIMENSIONAL MEASUREMENT

Outer Diameter and thickness readings recorded at critical locations are as below:

ALSTOM	CLIENT	J-Power (Electric Power Development Co. Ltd.)
	PROJECT	Turbine and System Assessment for NTPC-KORBA Unit # 4
	ORDER NO.	CGP10028C
NTPC ALSTOM Power Services Pvt. Ltd.	CONTRACTOR	ALSTOM K. K. NASL LTD. (Nominated Sub-Contractor In India)
	DOCUMENT	FINAL REPORT VOL - II (PIPING ASSESSMENT)

Loc. No./ Elevation	Name of pipe	Design values w.r.t drwg.	Outside Diameter	Thickness	Remarks
01 8 Meter	LP By pass pipe	OD=557.7 Thk=28.5	560-561 mm	31.7-31.8 mm	Values are within the tolerance limit as per ASTM specifications.
			560-561.5 mm	31.7-31.9 mm	Values are within the tolerance limit as per ASTM specifications.

MAGNETIC PARTICLE INSPECTION

Magnetic particle Inspection was performed on weld joints of LP By Pass line. There was no significant indication on all tested weld joint locations.

(Refer Report 7.2 of Vol 1B / Report No. NASL/KKALSTOM/MPT/02)

ULTRASONIC INSPECTION

Ultrasonic Inspection was performed on weld joints of LP BY PASS line. No recordable indication observed.



(Refer Report 7.3 of Vol 1B / Report No. NASL/KKALSTOM/UT/04)

IN-SITU METALLOGRAPHY & HARDNESS MEASUREMENT

(Refer report 7.4 of Vol 1B)

Replicas were taken on pipes of LP Bypass line at various locations as mentioned in the below table.

Partial Bainite and Pearlite degradation were observed in LP Bypass lines. The spheroidisation level observed is II-L. No creep cavities have been observed.

	CLIENT	J-Power (Electric Power Development Co. Ltd.)
	PROJECT	Turbine and System Assessment for NTPC-KORBA Unit # 4
	ORDER NO.	CGP10028C
	CONTRACTOR	ALSTOM K. K. NASL LTD. (Nominated Sub-Contractor in India)
	DOCUMENT	FINAL REPORT VOL - II (PIPING ASSESSMENT)

Component ID & Location	Observations	Degradation Level	Hardness	Reference	Remarks
LP By Pass Line External Surface (8 Mtr)	Parent Metal : Microstructure shows fine tempered bainite and ferrite with spherodisation of carbides.	Diffusional degradation level IIL is observed.	171-181 BHN	Fig: 94 of Chapter 7.4 of Vol 1B.	Expended Creep life fraction is 0.10
	Parent Metal : Microstructure shows fine tempered bainite and ferrite with spherodisation of carbides.	Diffusional degradation level IIL is observed.	191-201 BHN	Fig: 95 of Chapter 7.4 of Vol 1B.	Expended Creep life fraction is 0.10

ANALYSIS OF FINDING

Visual Observation does not show any surface damage. During Magnetic particle Inspection and Ultrasonic Inspection no significant defect was observed.

Partial Bainite and Pearlite Degradation was observed in LP By Pass pipe lines. The spherodisation level (Diffusional degradation) observed is II-L. No creep cavities have been observed.



Hanger Survey :

There are a total of 34 Hanger supports in the CRH Steam pipe. The hanger types include Variable, Constant and Rigid supports.

The hanger components show evidence of corrosion. In the Boiler area, corrosion of Hanger components is severe, due to the presence of Ash.

Hanger no CRH-17 has no load on the spring. Hanger no CRH-20 is found missing.

During cold and hot survey, accessible spring Hanger positions were marked/noted. (Ref Annexure I Table 2).

	CLIENT	J-Power (Electric Power Development Co. Ltd.)
	PROJECT	Turbine and System Assessment for NTPC-KORBA Unit # 4
	ORDER NO.	CGP10028C
	CONTRACTOR	ALSTOM K. K. NASL LTD. (Nominated Sub-Contractor in India)
	DOCUMENT	FINAL REPORT VOL - II (PIPING ASSESSMENT)

Recommendation:

All spring Hangers to be Cold set as per design values specified in drawings .Hangers to be marked with respective Tag nos. for easy identification.

Inspection, pipe thickness measurement, NDT, DPT of welds on pipes, where deemed necessary have been carried out and is reported separately.

Insulation and cladding are found damaged in several places and need to be attended immediately.

9.5.0 Hot Reheat piping system (Including LPBP Line)

- INTRODUCTION
- VISUAL INSPECTION
- NON DESTRUCTIVE TESTING
- INSITU METALLOGRAPHY & HARDNESS MEASUREMENT

INTRODUCTION



Re heated steam from the Boiler at pressure of 51.4 Kg/cm² and at temperature of 545 ° C is carried away through two pipes called HOT Re heat steam piping. These pipes are extended up to steam turbine and steam is allowed to pass through four strainers and valves.

As these pipes are operating under hoop stress at high temperature and fatigue under load variations.

VISUAL INSPECTION

Hard scaling is observed on the Hot reheat line at exposed area. Continuous operation at an elevated temperature, the pipeline outer surface under insulation develops a hard scale, which is not abnormal.

514

	CLIENT	J-Power (Electric Power Development Co. Ltd.)
	PROJECT	Turbine and System Assessment for NTPC-KORBA Unit # 4
	ORDER NO.	CGP10028C
 Power Services Pvt. Ltd.	CONTRACTOR	ALSTOM K. K. NASL LTD. (Nominated Sub-Contractor in India)
	DOCUMENT	FINAL REPORT VOL - II (PIPING ASSESSMENT)

DIMENSIONAL MEASUREMENT

Outer Diameter and thickness readings recorded at critical locations are as below

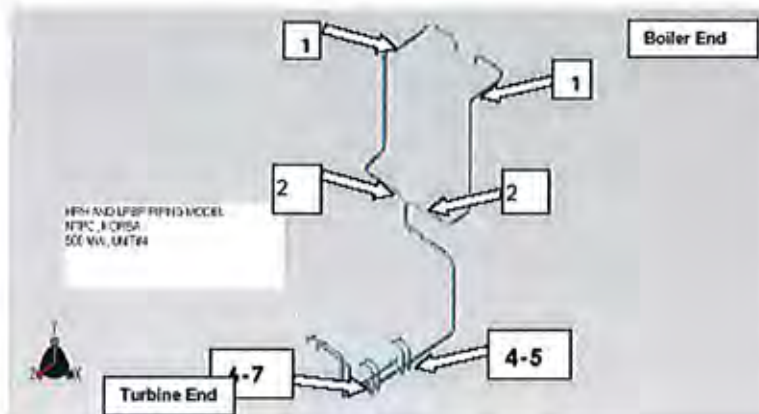

Loc. No./ Elevation	Name of pipe	Design Values(mm) w.r.t drwg.	Outside Diameter	Thickness	Remarks
01 75 Meter	HRH pipe	OD=680 THK=41.00 (0-80-512-01228)	Near boiler MSSV LHS 682-683 mm	Near boiler MSSV LHS 42.19-43.49 mm	Values are within the tolerance limit as per ASTM specifications.
			Near boiler MSSV RHS 684-685 mm	Near boiler MSSV RHS 42.67-43.67 mm	Values are within the tolerance limit as per ASTM specifications.
02 Y joint 39 Meter	HRH pipe	OD=675 THK=39.0 (0-80-512-01228)	Left 678-679 mm	Left 40.85 – 41.85 mm	Values are within the tolerance limit as per ASTM specifications.
			Right 678-679 mm	Right 41.55 – 41.86 mm	Values are within the tolerance limit as per ASTM specifications.
03 Turbine floor	IP integral pipe		LHS 560-561 mm	LHS 32.8-33.2 mm	Values are within the tolerance limit as per ASTM specifications.
			RHS 556-557 mm	RHS 31.6-31.9 mm	Values are within the tolerance limit as per ASTM specifications.
04 Near strainer 6 Meter	HRH pipe 1	OD=635.6 THK=33.27 (1-80-515-01789)	631-633 mm	35.30,35.41,35.55 mm	Values are within the tolerance limit as per ASTM specifications.
05 Near strainer 6 Meter	HRH pipe 2	OD=635.6 THK=33.27 (1-80-515-01789)	632-634 mm	35.27,35.49,35.24 mm	Values are within the tolerance limit as per ASTM specifications.

ALSTOM	CLIENT	J-Power (Electric Power Development Co. Ltd.)
	PROJECT	Turbine and System Assessment for NTPC-KORBA Unit # 4
	ORDER NO.	CGP10028C
NTPC ALSTOM Power Services Pvt. Ltd.	CONTRACTOR	ALSTOM K. K. NASL LTD. (Nominated Sub-Contractor In India)
	DOCUMENT	FINAL REPORT VOL - II (PIPING ASSESSMENT)

Loc. No./ Elevation	Name of pipe	Design Values(mm) w.r.t drwg.	Outside Diameter	Thickness	Remarks
06 Near strainer 6 Meter	HRH pipe 3	OD=635.6 THK=33.27 (1-80-515-01789)	636-637 mm	35.12,35.17, 35.60 mm	Values are within the tolerance limit as per ASTM specifications.
07 Near strainer 6 Meter	HRH pipe 4	OD=635.6 THK=33.27 (1-80-515-01789)	635-636 mm	35.10,35.52, 35.60 mm	Values are within the tolerance limit as per ASTM specifications.

MAGNETIC PARTICLE INSPECTION

MPI was performed on weld joints.

Magnetic particle Inspection was performed on weld joints. There was no significant indication on all tested weld joint locations.

(Refer Report 7.2 of Vol 1B / Report No. NASL/KKALSTOM/MPT/02)

ULTRASONIC INSPECTION

Ultrasonic Inspection was performed on weld joints of HRH line. No recordable indication observed.

(Refer Report 7.3 of Vol 1B / Report NoNASL/KKALSTOM/UT/04)

IN-SITU METALLOGRAPHY & HARDNESS MEASUREMENT

(Refer report 7.4 of Vol 1B)

Replicas were taken on pipes of Hot reheat steam line at various locations as mentioned in the below table.

Partial Bainite and Pearlite Degradation were observed in Hot Re Heat lines. The spheroidisation level observed is II-L to IVL. No creep cavities have been observed.

ALSTOM	CLIENT	J-Power (Electric Power Development Co. Ltd.)
	PROJECT	Turbine and System Assessment for NTPC-KORBA Unit # 4
	ORDER NO.	CGP10028C
NTPC ALSTOM Power Services Pvt. Ltd.	CONTRACTOR	ALSTOM K. K. NASL LTD. (Nominated Sub-Contractor in India)
	DOCUMENT	FINAL REPORT VOL - II (PIPING ASSESSMENT)

Component ID & Location	Observations	Degradation Level	Hardness	Reference	Remarks
HRH Steam Line # 1(LHS) External Surface (75 Meter)	Parent Metal : Microstructure shows decomposed Bainite with ferrite and with carbides at the grain boundary.	Diffusional degradation level IVL is observed.	151-161 BHN	Fig: 35 of Chapter 7.4 of Vol 1B.	Expended Creep life fraction is 0.20
	Weld Metal : Microstructure shows fine tempered bainite and ferrite with spherodisation of carbides.	Diffusional degradation level IIL is observed.	200-212 BHN	Fig: 33 of Chapter 7.4 of Vol 1B.	Expended Creep life fraction is 0.10
HRH Steam Line # 2(RHS) External Surface (75 Meter)	Parent Metal : Microstructure shows fine tempered bainite and ferrite with spherodisation of carbides.	Diffusional degradation level IIL is observed.	151-169 BHN	Fig: 32 of Chapter 7.4 of Vol 1B.	Expended Creep life fraction is 0.10
	Weld Metal : Microstructure shows fine tempered bainite and ferrite with spherodisation of carbides.	Diffusional degradation level IIL is observed.	199-201 BHN	Fig: 30 of Chapter 7.4 of Vol 1B.	Expended Creep life fraction is 0.10
HRH Steam at strainer housing # 1 External Surface (6 Meter)	Parent Metal : Microstructure shows decomposed Bainite with ferrite and with carbides at the grain boundary.	Diffusional degradation level IVL is observed.	120-132 BHN	Fig: 71 of Chapter 7.4 of Vol 1B.	Expended Creep life fraction is 0.20
	Weld Metal : Microstructure shows decomposed Bainite with ferrite and with carbides at the grain boundary.	Diffusional degradation level IVL is observed.	180-186 BHN	Fig: 61 of Chapter 7.4 of Vol 1B.	Expended Creep life fraction is 0.20
HRH steam line at strainer housing # 2 Internal Surface (6 Meter)	Parent Metal : Microstructure shows decomposed Bainite with ferrite and with carbides at the grain boundary.	Diffusional degradation level IVL is observed.	131-134 BHN	Fig: 74 of Chapter 7.4 of Vol 1B.	Expended Creep life fraction is 0.20

ALSTOM	CLIENT	J-Power (Electric Power Development Co. Ltd.)
	PROJECT	Turbine and System Assessment for NTPC-KORBA Unit # 4
	ORDER NO.	CGP10028C
NTPC ALSTOM Power Services Pvt. Ltd.	CONTRACTOR	ALSTOM K. K. NASL LTD. (Nominated Sub-Contractor in India)
	DOCUMENT	FINAL REPORT VOL - II (PIPING ASSESSMENT)

Component ID & Location	Observations	Degradation Level	Hardness	Reference	Remarks
	Weld Metal : Microstructure shows decomposed Bainite with ferrite and with carbides at the grain boundary.	Diffusional degradation level IVL is observed.	180-186 BHN	Fig: 72 of Chapter 7.4 of Vol 1B.	Expended Creep life fraction is 0.20
HRH Steam at strainer housing # 3 External Surface (6 Meter)	Parent Metal : Microstructure shows decomposed Bainite with ferrite and with carbides at the grain boundary.	Diffusional degradation level IVL is observed.	130-135 BHN	Fig: 77 of Chapter 7.4 of Vol 1B.	Expended Creep life fraction is 0.20
	Weld Metal : Microstructure shows decomposed Bainite with ferrite and with carbides at the grain boundary.	Diffusional degradation level IVL is observed.	186-189 BHN	Fig: 75 of Chapter 7.4 of Vol 1B.	Expended Creep life fraction is 0.20
HRH Steam at strainer housing # 4 Internal Surface (6 Meter)	Parent Metal : Microstructure shows decomposed Bainite with ferrite and with carbides at the grain boundary.	Diffusional degradation level IVL is observed.	136-140 BHN	Fig: 80 of Chapter 7.4 of Vol 1B.	Expended Creep life fraction is 0.20
	Weld Metal : Microstructure shows decomposed Bainite with ferrite and with carbides at the grain boundary.	Diffusional degradation level IVL is observed.	181-190 BHN	Fig: 78 of Chapter 7.4 of Vol 1B.	Expended Creep life fraction is 0.20
HRH Steam at 'Y' joint Internal Surface (39 Meter)	Parent Metal : Microstructure shows decomposed Bainite with ferrite and with carbides at the grain boundary.	Diffusional degradation level IVL is observed.	129-131 BHN	Fig: 44 of Chapter 7.4 of Vol 1B.	Expended Creep life fraction is 0.20
	Weld Metal : Microstructure shows fine tempered bainite and ferrite with spherodisation of carbides.	Diffusional degradation level IIL is observed.	171-181 BHN	Fig: 42 of Chapter 7.4 of Vol 1B.	Expended Creep life fraction is 0.10

ALSTOM	CLIENT	J-Power (Electric Power Development Co. Ltd.)
	PROJECT	Turbine and System Assessment for NTPC-KORBA Unit # 4
	ORDER NO.	CGP10028C
NTPC ALSTOM Power Services Pvt. Ltd.	CONTRACTOR	ALSTOM K. K. NASL LTD. (Nominated Sub-Contractor In India)
	DOCUMENT	FINAL REPORT VOL - II (PIPING ASSESSMENT)

Component ID & Location	Observations	Degradation Level	Hardness	Reference	Remarks
HRH Steam at 'Y' joint Internal Surface (39 Meter)	Parent Metal : Microstructure shows decomposed Bainite with ferrite and with carbides at the grain boundary.	Diffusional degradation level IVL is observed.	121-123 BHN	Fig: 47 of Chapter 7.4 of Vol 1B.	Expended Creep life fraction is 0.20
	Weld Metal : Microstructure shows decomposed Bainite with ferrite and with carbides at the grain boundary.	Diffusional degradation level IVL is observed.	181-183 BHN	Fig: 45 of Chapter 7.4 of Vol 1B.	Expended Creep life fraction is 0.20
Main steam at IP inlet as IP integral piping (8 Mtr)	Parent Metal : Microstructure shows decomposed Bainite with ferrite and with carbides at the grain boundary.	Diffusional degradation level IVL is observed.	158-162 BHN	Fig: 86 of Chapter 7.4 of Vol 1B.	Expended Creep life fraction is 0.20
	Weld Metal : Microstructure shows fine tempered bainite and ferrite with spherodisation of carbides.	Diffusional degradation level IIL is observed.	180-186 BHN	Fig: 84 of Chapter 7.4 of Vol 1B.	Expended Creep life fraction is 0.10



ANALYSIS OF FINDING

Visual Observation does not show any surface damage. During Magnetic particle Inspection and Ultrasonic Inspection no significant defect was observed.

Partial Bainite and Pearlite Degradation was observed in HOT re Heat steam pipe lines. The spherodisation level (Diffusional degradation) observed is II-L to III L. No creep cavities have been observed.

REMAINING LIFE

Based on the microstructure and the dimensional details available the remaining life of the Hot Re heat line is more than 20 years subject to operation of the unit with recommended operating & maintenance practice.

	CLIENT	J-Power (Electric Power Development Co. Ltd.)
	PROJECT	Turbine and System Assessment for NTPC-KORBA Unit # 4
	ORDER NO.	CGP10028C
	CONTRACTOR	ALSTOM K. K. NASL LTD. (Nominated Sub-Contractor in India)
	DOCUMENT	FINAL REPORT VOL - II (PIPING ASSESSMENT)

Hanger Survey

There are a total of 48 Hanger supports in the HRH Steam pipe. An additional 16 nos Hanger supports are in the LPBP system. The hanger types include Variable, Constant and Rigid supports.

The hanger components show evidence of corrosion. In the Boiler area, corrosion of Hanger components is severe, due to the presence of Ash.

A horizontal restraint provided between LPBH13 and LPBPH-14 is in dismantled condition. Bolts to be tightened.



During cold survey, spring Hanger positions were marked/noted. (Ref Annexure I Table 3).

Recommendation

All spring Hangers to be Cold set as per design values specified in drawings Hangers to be marked with respective Tag nos. for easy identification.

Inspection, pipe thickness measurement, NDT, DPT of welds on pipes, where deemed necessary have been carried out and is reported separately.

520

	CLIENT	J-Power (Electric Power Development Co. Ltd.)
	PROJECT	Turbine and System Assessment for NTPC-KORBA Unit # 4
	ORDER NO.	CGP10028C
	CONTRACTOR	ALSTOM K. K. NASL LTD. (Nominated Sub-Contractor in India)
	DOCUMENT	FINAL REPORT VOL - II (PIPING ASSESSMENT)

9.6.0 Boiler Feed Discharge Piping system

- VISUAL INSPECTION
- NON DESTRUCTIVE TESTING

VISUAL INSPECTION



Minor external scale is observed on the Feed Water line which is acceptable.

DIMENSIONAL MEASUREMENT

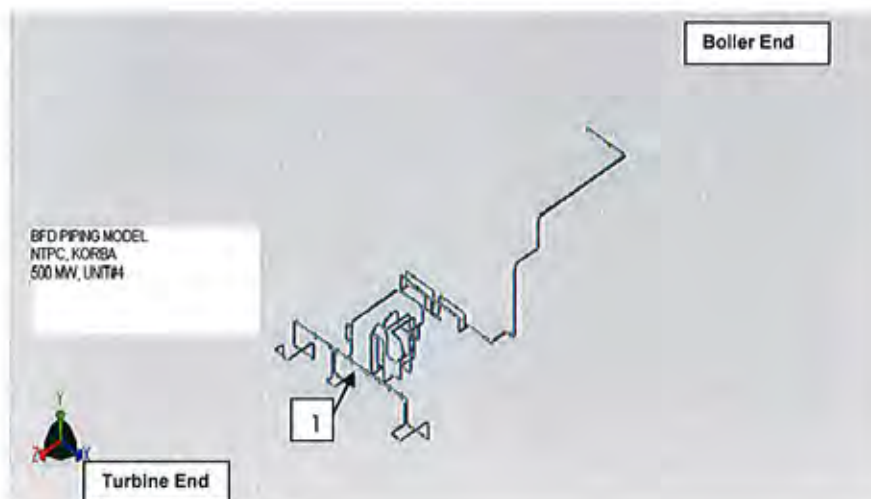
Outer Diameter and thickness readings recorded at critical locations are as below:



Loc. No./ Elevation	Name of pipe	Design values w.r.t drwg.	Outside Diameter	Thickness	Remarks
01 9 meter	Feed water pipe	OD=362 Thk.=43.5 1-80-530-01596.	LHS D1 361 - 362mm	LHS t1 45.64 - 45.77 mm	Values are within the tolerance limit as per ASTM specifications.
			RHS D2 362 - 363 mm	RHS t2 45.75 - 47.71 mm	Values are within the tolerance limit as per ASTM specifications.

	CLIENT	J-Power (Electric Power Development Co. Ltd.)
	PROJECT	Turbine and System Assessment for NTPC-KORBA Unit # 4
	ORDER NO.	CGP10028C
	CONTRACTOR	ALSTOM K. K. NASL LTD. (Nominated Sub-Contractor in India)
	DOCUMENT	FINAL REPORT VOL - II (PIPING ASSESSMENT)

MAGNETIC PARTICLE INSPECTION

Magnetic particle Inspection was performed on weld joints of Feed Water line. There was no significant indication on all tested weld joint locations.

(Refer Report 7.2 of Vol 1B / Report No. NASL/KKALSTOM/MPT/02)

ULTRASONIC INSPECTION

Ultrasonic Inspection was performed on weld joints of Feed Water line. No recordable indication observed.

(Refer Report 7.3 of Vol 1B / Report No. NASL/KKALSTOM/UT/04)

ANALYSIS OF FINDING

Visual Observation does not show any surface damage. During Magnetic particle Inspection and Ultrasonic Inspection no significant defect was observed.

Hanger Survey

There are a total of 90 Hanger supports in the BFP discharge piping which includes Variable, Constant Hangers, Restraints and Bottom supports.

The hanger components show evidence of corrosion. In the Boiler area, corrosion of Hanger components is severe, due to the presence of Ash.

During cold and Hot survey, spring Hanger positions were marked/noted. (Ref Annexure I Table No 4)

Spring supports below the Feed control station at about 20 M elev are not accessible for hanger measurements. However, visual inspection in this region shows no broken Tie rods or damaged springs.

Recommendation

All spring Hangers to be Cold set as per design values specified in drawings. Hangers to be marked with respective Tag nos. for easy identification.



Inspection, pipe thickness measurement, NDT, DPT of welds on pipes, where deemed necessary have been carried out and is reported separately.

Insulation and cladding are found damaged in several places and need to be attended immediately.

The ALSTOM logo is located in the top left corner of the page. It consists of the word "ALSTOM" in a bold, blue, sans-serif font. The letter "O" is stylized with a red circle around it.

Volume-II
Chapter – 10
FEA Analysis

NTPC ALSTOM
Power Services Pvt. Ltd.

	CLIENT	J-Power (Electric Power Development Co. Ltd.)
	PROJECT	Turbine and System Assessment for NTPC-KORBA Unit # 4
	ORDER NO.	CGP10028C
	CONTRACTOR	ALSTOM K. K. NASL LTD. (Nominated Sub-Contractor in India)
	DOCUMENT	FINAL REPORT VOL - II (PIPING ASSESSMENT)

CHAPTER - 10 FINITE ELEMENT ANALYSIS

10.1.0 Overview of the Piping systems of Unit #4 of Korba,STPS

The Critical Steam Pipes namely Main Steam, CRH and HRH operates at High temp. and High pressure. Each piping system is double lead layout at the Boiler end and connects their respective Boiler Header to the Turbine end. The piping is routed with long radius bends and has loops provided to give flexibility to the system to accommodate thermal expansion of the pipe. The HRH and MS pipes from the Boiler are connected through a Y-piece to a common pipe to the Turbine. Similarly the CRH pipe is connected thru' a T-piece to a common pipe from the Turbine.

The Boiler Feed discharge piping connects the two motor driven Boiler feed pumps and one Steam Turbine driven BFP discharge through a common header to the economiser inlet header of the Boiler..

All piping Hangers are of Mannesmann / Lisega make. The types of Hangers and Supports Include Variable spring, Constant load and Restraints.

Selection of each hanger has been carried out ,at the time of erection, based on the actual load which the hanger is to support. And the amount and directions of the pipeline thermal movement from cold/installed conditions to the hot/operating conditions.

The steam piping systems are free floating with Anchors at the Boiler Steam Header and Turbine Casing / Stop Valve terminals.

Constant Load hangers Constant hangers are provided to compensate for vertical movement caused by thermal expansion. Via constant hangers, the respective piping loads are kept constant in Hot and Cold conditions. Otherwise significant deviations in load would act as harmful and uncontrolled extra loads in the system. Due to which, Equipment connection points would be at risk because of unacceptable forces and moments.

Variable Spring hangers Variable hangers compensate for slight vertical displacements in the piping. The functioning of these hangers is based on a variable supporting load of a maximum of 25%, over the whole range of movement corresponding to the given spring characteristics.

The Critical Steam and BFD piping systems have been erected without any Cold pulls.

Y-piece pipe Elements have been erected in the MS and HRH Lines.

10.2.0 Background of the Study of Critical Steam and BFP pipes.

Failure of piping leads to serious consequences in terms of safety, lead time required for replacement and secondary damages. In general, the locations of high stress will be at elbows,

ALSTOM	CLIENT	J-Power (Electric Power Development Co. Ltd.)
	PROJECT	Turbine and System Assessment for NTPC-KORBA Unit # 4
	ORDER NO.	CGP10028C
NTPC ALSTOM Power Services Pvt. Ltd.	CONTRACTOR	ALSTOM K. K. NASL LTD. (Nominated Sub-Contractor In India)
	DOCUMENT	FINAL REPORT VOL - II (PIPING ASSESSMENT)

Tees, welded attachments to pipe and circumferential girth butt welds, at tapered regions such as pipe nozzle, flange and valves.

Improper Hanger positions will result in additional system stress. Main Steam, Hot and Cold Reheat Steam piping components operate under creep regime. These are also subjected to thermal fatigue mainly due to transients in Steam temp.

10.3.0 Design Parameters of Critical Steam Pipes

The Design parameters of the critical steam pipes namely, Live Steam, Cold Reheat and Hot Reheat and FW piping are as tabulated in Table-5, below.

500 MW Unit #4 DESIGN PARAMETERS OF CRITICAL STEAM AND BFP PIPES

Sl. No.	Description	Live Steam	Hot Reheat	Cold Reheat	FW AT ECON
1	Design Press. kg/cm ² (g)	187	51.4	56.49	300
2	Design Temp. (deg.C)	545	545	370	265
3	Material	A 335 P 22	A 335 P 22	SA106GrC	SA106GrC
4	Pipe Size (mm)	345.44 ID x 85.3 WT	595 IDx 34.74 WT	762 OD x22.23 WT	351.5 IDx 55.03 WT
5	Bend Radius, mm	1524	1981,3302	2286 ,1143	686

10.4.0 Load cases

Following Table No 6 shows the different load cases to be analyzed.

1. Cold condition (the gravity of the pipe will act).
2. Hot condition (gravity, the temperature and pressure of steam will act).



Load case specifications

1	Thermo-mechanical Loading
2	Creep Loading
3	Fatigue Loading

10.5.0 Material specification

The MST pipe line is of SA-335 P-22 material and CRH is of SA-106 Gr-C. Table 7 gives the list of temperature dependent material properties SA335, P22 (2-1/4Cr-1Mo). All the above material

525

	CLIENT	J-Power (Electric Power Development Co. Ltd.)
	PROJECT	Turbine and System Assessment for NTPC-KORBA Unit # 4
	ORDER NO.	CGP10028C
	CONTRACTOR	ALSTOM K. K. NASL LTD. (Nominated Sub-Contractor in India)
	DOCUMENT	FINAL REPORT VOL - II (PIPING ASSESSMENT)

properties are taken from "The Grade 22 Low Alloy Steel Handbook." Other details are taken from open source.

Material properties for SA-335-P22 at room temperature

Property	Metric
Specific gravity	7.83
Density	
Thermal coefficient of expansion	$14.1 \times 10^{-6} \text{ } ^\circ\text{C}^{-1}$ (21–538°C)
Modulus of elasticity at room temperature	212 GPa
Modulus of rigidity or shear modulus at room temperature	82 GPa
Specific heat	442 J/kg/°K at 23°C 688 J/kg/°K at 527°C 969 J/kg/°K at 727°C
Thermal conductivity	36.3 (W/m-°C [20°C])
Poisson's Ratio at room temperature	0.288

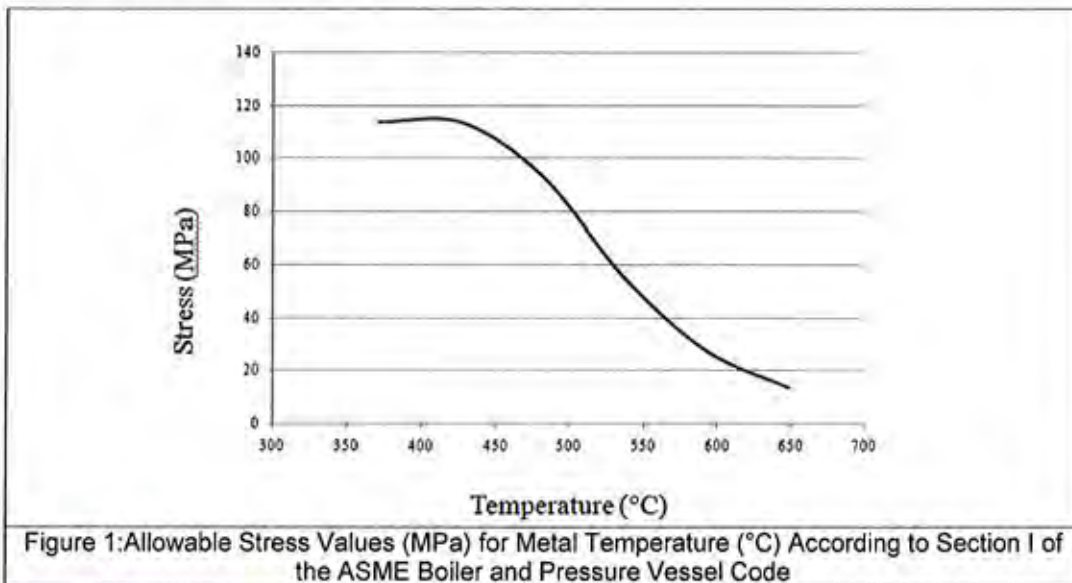

Allowable Stress Values (MPa) for Metal Temperature (°C) According to Section I of the ASME Boiler and Pressure Vessel Code is given in figure 1



Chemical Composition

The chemical composition of steel Grade 22, as specified by ASME SA-335 P22, is given in Table 8. The basic requirements have remained similar since these steels were first introduced over 50 years ago. However, improvements in steelmaking practice have allowed greater control on trace

526

	CLIENT	J-Power (Electric Power Development Co. Ltd.)
	PROJECT	Turbine and System Assessment for NTPC-KORBA Unit # 4
	ORDER NO.	CGP10028C
	CONTRACTOR	ALSTOM K. K. NASL LTD. (Nominated Sub-Contractor In India)
	DOCUMENT	FINAL REPORT VOL - II (PIPING ASSESSMENT)

elements, such as phosphorus and Sulphur, resulting in improvements in steel toughness and less susceptibility to embrittlement.



Composition for SA-335-P22

Element	Composition
Carbon	0.05–0.15 maximum
Manganese	0.30–0.60
Phosphorus	0.025 maximum
Sulphur	0.025 maximum
Silicon	0.5
Chromium	1.9–2.60
Molybdenum	0.87–1.13

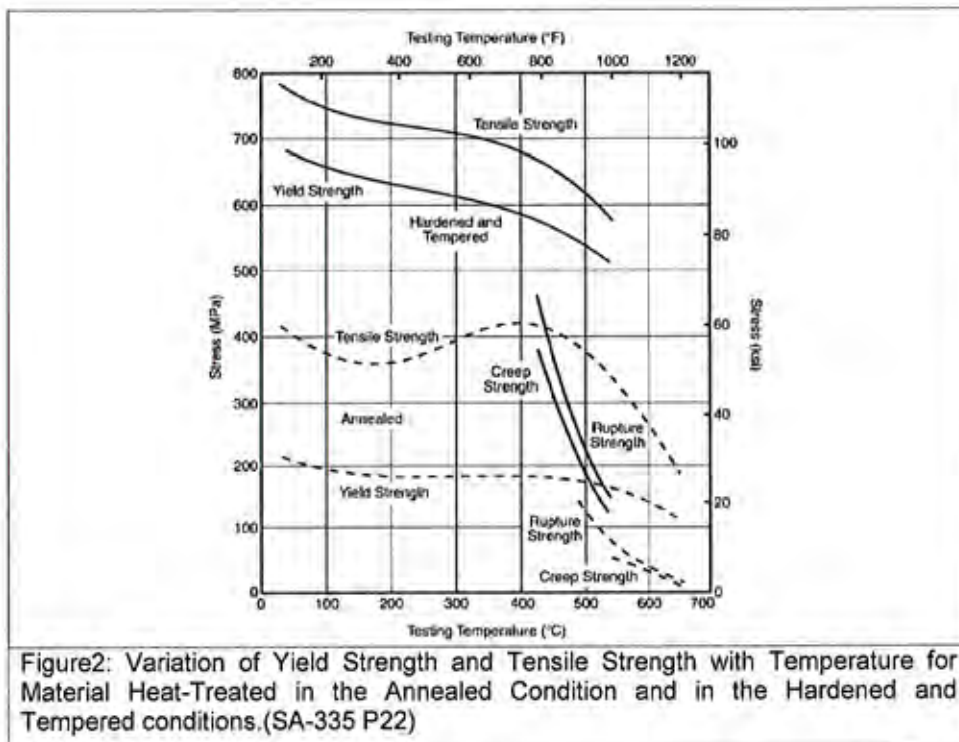
Variation of Yield Strength and Tensile Strength



625

	CLIENT	J-Power (Electric Power Development Co. Ltd.)
	PROJECT	Turbine and System Assessment for NTPC-KORBA Unit # 4
	ORDER NO.	CGP10028C
	CONTRACTOR	ALSTOM K. K. NASL LTD. (Nominated Sub-Contractor in India)
	DOCUMENT	FINAL REPORT VOL - II (PIPING ASSESSMENT)

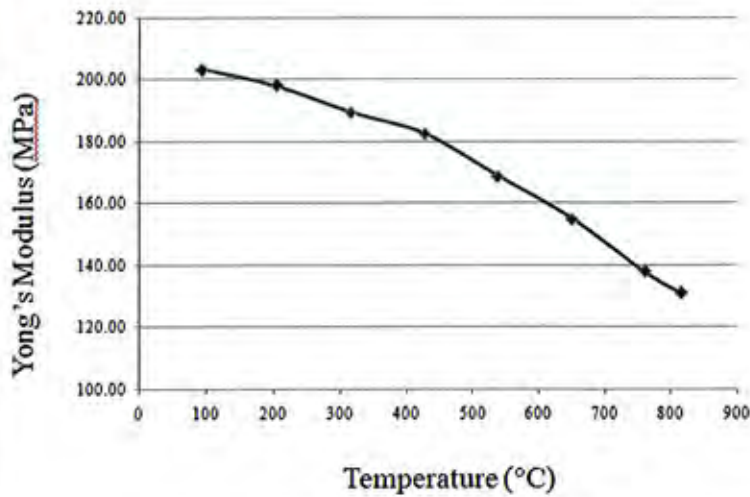

Figure 3: Variation of Young's modulus with Temperature. (SA-335 P22)

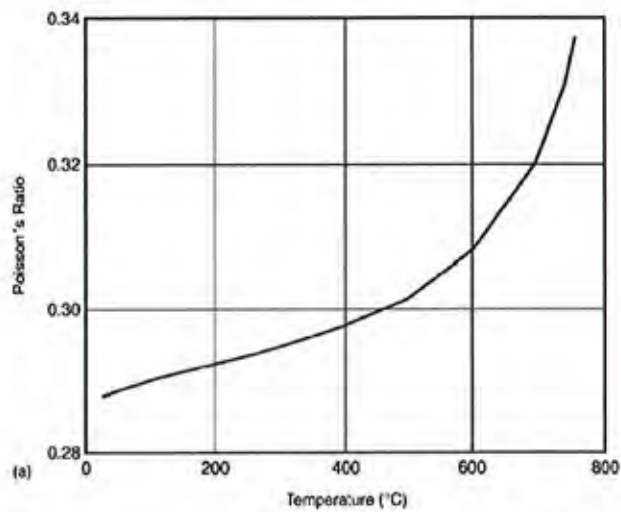



Figure 4: Variation of Poisson's ratio with Temperature. (SA-335 P22)

528

	CLIENT	J-Power (Electric Power Development Co. Ltd.)
	PROJECT	Turbine and System Assessment for NTPC-KORBA Unit # 4
	ORDER NO.	CGP10028C
 Power Services Pvt. Ltd.	CONTRACTOR	ALSTOM K. K. NASL LTD. (Nominated Sub-Contractor In India)
	DOCUMENT	FINAL REPORT VOL - II (PIPING ASSESSMENT)

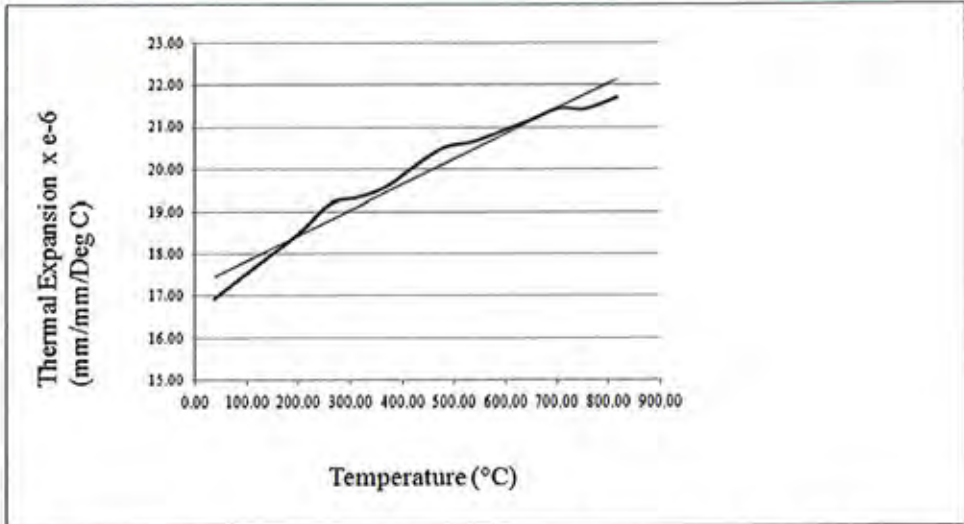

Figure 5: Variation of Thermal expansion with Temperature. (SA-335 P22)

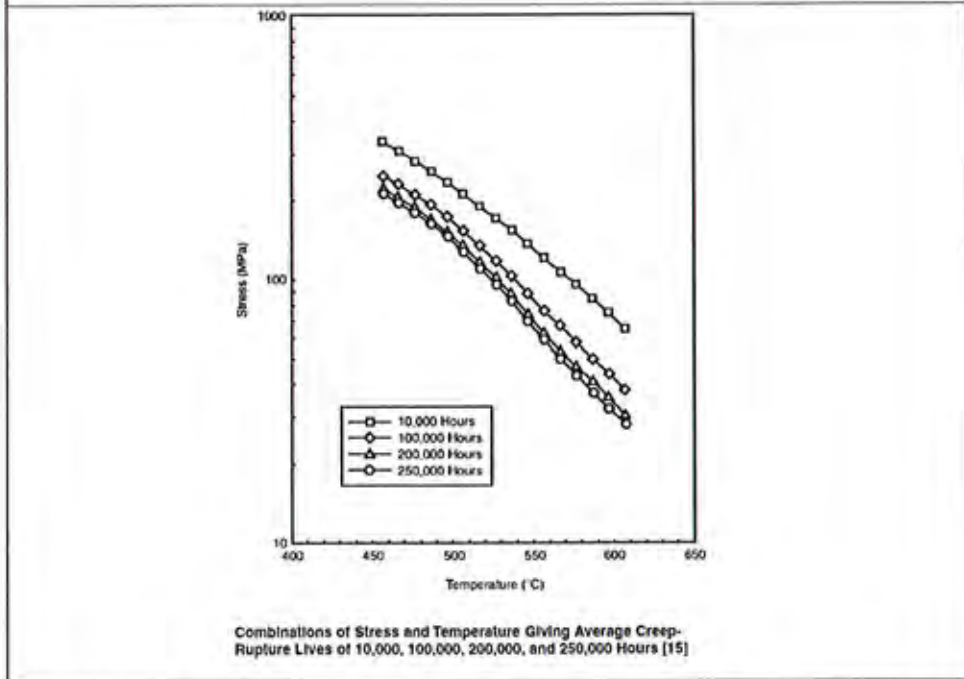

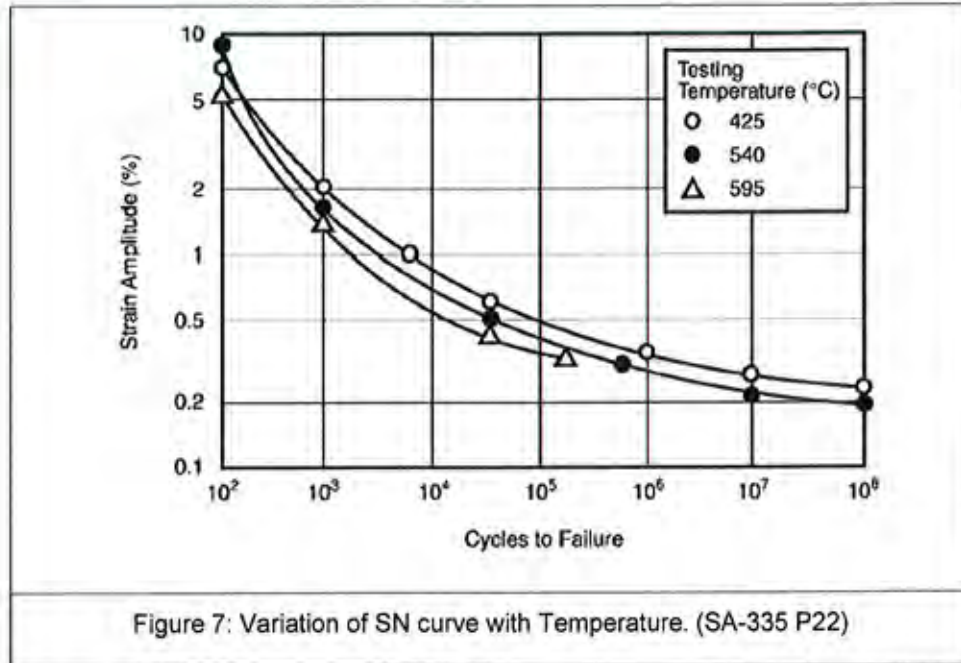

Figure 6: Variation of creep rupture life with Temperature. (SA-335 P22)

525

	CLIENT	J-Power (Electric Power Development Co. Ltd.)
	PROJECT	Turbine and System Assessment for NTPC-KORBA Unit # 4
	ORDER NO.	CGP10028C
	CONTRACTOR	ALSTOM K. K. NASL LTD. (Nominated Sub-Contractor In India)
	DOCUMENT	FINAL REPORT VOL - II (PIPING ASSESSMENT)



Power law creep model is considered to predict the creep strain. The operating loading condition is considered to develop creep.

$$\epsilon = c\sigma^n$$



Where σ = stress

ϵ = creep strain

n = power law multiplier

Table 9: Creep properties. (SA-335 P22)

Coefficient	Value
A (Power law multiplier)	2.5003E-59
n (equivalent stress order)	6.62
m (time order)	0.0

	CLIENT	J-Power (Electric Power Development Co. Ltd.)
	PROJECT	Turbine and System Assessment for NTPC-KORBA Unit # 4
	ORDER NO.	CGP10028C
	CONTRACTOR	ALSTOM K. K. NASL LTD. (Nominated Sub-Contractor in India)
	DOCUMENT	FINAL REPORT VOL - II (PIPING ASSESSMENT)

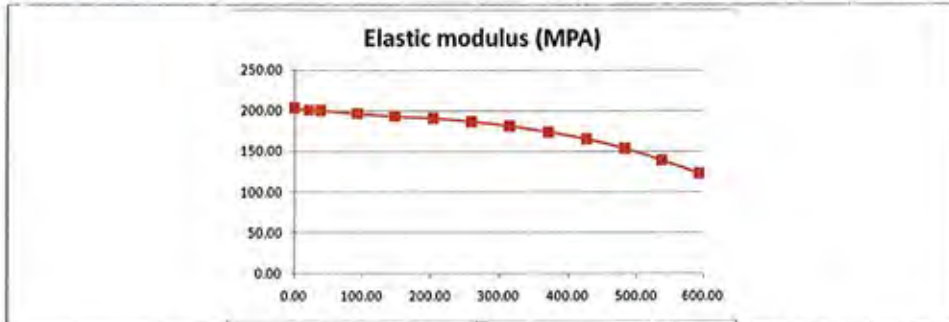

Figure 8: Variation of Young's modulus with Temperature. (SA-106 Gr.C)

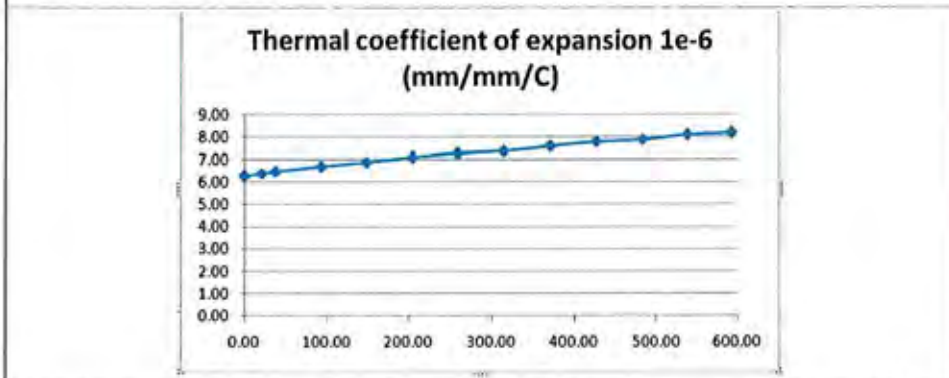

Figure 9 Variation of Thermal coefficient of expansion with Temperature.(SA-106 Gr.C)

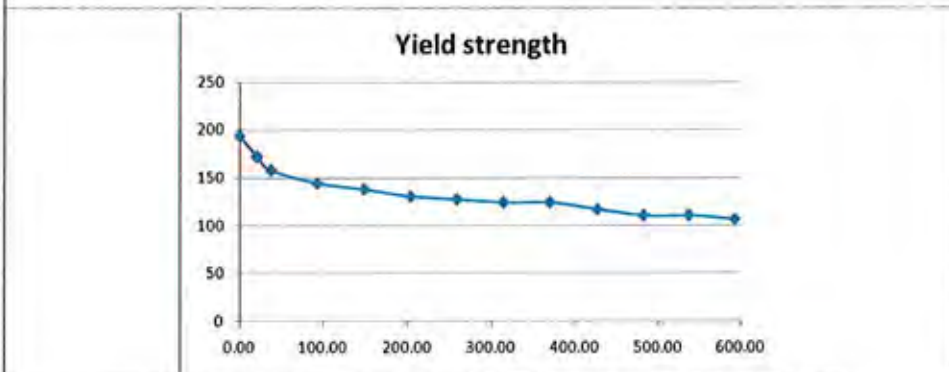

Figure 9: Yield strength (MPa) with Temperature.(SA-106 Gr.C)

ALSTOM	CLIENT	J-Power (Electric Power Development Co. Ltd.)
	PROJECT	Turbine and System Assessment for NTPC-KORBA Unit # 4
	ORDER NO.	CGP10028C
NTPC ALSTOM Power Services Pvt. Ltd.	CONTRACTOR	ALSTOM K. K. NASL LTD. (Nominated Sub-Contractor in India)
	DOCUMENT	FINAL REPORT VOL - II (PIPING ASSESSMENT)

Creep properties. (SA-106 Gr C)

Coefficient	Value
A (Power law multiplier)	2.60E-59
n (equivalent stress order)	6.6
m (time order)	0

10.6.0 Stress Analysis Using CAESAR II:

Provide a high degree of detail for load determination. This is necessary as undetected additional loads from external forces, which substantially reduce the calculated life, are not recorded or even evaluated.

Stress Analysis Calculations of piping will help in the following manner

Localizes and identifies points subject to high loads, which can be prepared for NDT or destructive tests.

Detect structural weak points and subsequent studies can work out to overcome these by improvements in support system and pipe line layout.

Reveals system related loads, which help in theoretical life determination.

Piping flexibility analysis assume elastic behaviour of the entire piping system.

The Turbine supplier specifies the Allowable limits for the combined forces and moments of all piping connections or of any individual piping connections acting on the Turbine Casing.

Calculations for thermal expansion stress range, has been based on the modulus of elasticity at room temperature. Thermal expansion data and moduli of elasticity has been determined from piping code.



Technical Conditions for Design and Analysis:

The piping models have been built for analysis , wherein, the Isometric model has been prepared as per the existing layout drawings for Unit # 4..And Hanger points have been marked as per existing location at site. Piping material, size and thickness values are as available in erection drawings. Pressure and Temperature ratings have been considered as per Design values.

Two types of stresses have been analysed in the report.

Force Induced (Sustained) Stress due to Pipe weight

Displacement induced (expansion) stress due to thermal expansion induced deformation.

	CLIENT	J-Power (Electric Power Development Co. Ltd.)
	PROJECT	Turbine and System Assessment for NTPC-KORBA Unit # 4
	ORDER NO.	CGP10028C
	CONTRACTOR	ALSTOM K. K. NASL LTD. (Nominated Sub-Contractor In India)
	DOCUMENT	FINAL REPORT VOL - II (PIPING ASSESSMENT)

Two types of Spring Hangers used are Variable Spring hangers and Constant Load Hangers. In Variable spring Hangers, Hot Load and Cold Load variation is within 25%.

A particular hanger model is selected after ascertaining that Hot and Cold loads are within its working load and travel range.

Constant load hangers are designed such that the Loading in Cold condition and Hot condition is constant. It allows vertical movement due to expansion.

Other than spring Hangers, restraints have been used, in which movement is restricted in a particular direction. ex tie rods restrain displacements in the vertical direction.

Equipment nozzle connections are considered as pipe anchors.

Some of the important points covered in the analysis include,

- a) The dead weights of the Steam lines must be absorbed within the pipe hanger and support system. It is not permissible to transfer component weight loads to the turbine nozzles.
- b) The rated Steam temperatures have been used to calculate the pipe reactions (forces and moments) acting on the Turbine nozzles.

Forces arising from deflection of the pipe hangers as a result of Thermal expansion are included in the analysis of the pipe reactions on the turbine nozzles.

Y-piece pipe elements erected in the MS and HRH lines, are typical items, for which the Stress Intensity Factor (SIF) is not specified in the ASME 31.1, piping code. Assumptions have been made regarding the same., while carrying out the stress analysis..



Good piping design practice ensures that Sag between two supports should be limited to 2 mm. And the expansion stresses in the operating case, preferably, should not exceed 80% of the allowable Code stress value.

Lisega Hanger Load and Travel data of spring hangers in the Isometrics, has been compared with calculated values.

Computer Output results of Hanger load and Stress analysis

The piping models have been analysed as per Power piping Code ANSIB31.1. The following output results are detailed in the report.

Identification of maximum stress points (code stress) on pipe forces and moments on equipment connections hanger load and travel report ,displacement and stress reports at every node point.

	CLIENT	J-Power (Electric Power Development Co. Ltd.)
	PROJECT	Turbine and System Assessment for NTPC-KORBA Unit # 4
	ORDER NO.	CGP10028C
	CONTRACTOR	ALSTOM K. K. NASL LTD. (Nominated Sub-Contractor in India)
	DOCUMENT	FINAL REPORT VOL - II (PIPING ASSESSMENT)

Code Stress Definition: In CAESAR II output report, the code stress is the stress obtained using the particular code's equation as per ASME B 31.1 under clause no 104.8 for particular load cases ie sustained or expansion stress range.

The stress equation specified in the code are derived from theoretical and substantiated by investigative work.

The effect of pressure, weight and other **sustained mechanical load** must meet the requirements of the following equation as per code:

$$S_L = \frac{P D_o}{(1000) 4 t_n} + \frac{(0.75 i) M_A}{Z} \leq S_h$$

Where

S_L = Sum of longitudinal stresses due to pressure, weight and other sustained loads, (KPa).

i = Stress Intensification factor (ref. Appendix D-1 of ASME B 31.1).

M_A = resultant moment due to weight and sustained loads, (mm- N).

Z = Section Modulus, (mm³).

t_n = Nominal Thickness, (mm).

S_h = Basic allowable stress at the operating temp. (KPa)

The effects of **thermal expansion** must meet the requirements of the following equation:



$$S_E = \frac{i M_c}{Z} \leq S_A$$

Where

S_E = Expansion Stress Range. (KPa)

M_c = Range of resultant moment due to thermal expansion. (mm- N)

S_A = Allowable stress range. (KPa)

	CLIENT	J-Power (Electric Power Development Co. Ltd.)
	PROJECT	Turbine and System Assessment for NTPC-KORBA Unit # 4
	ORDER NO.	CGP10028C
	CONTRACTOR	ALSTOM K. K. NASL LTD. (Nominated Sub-Contractor in India)
	DOCUMENT	FINAL REPORT VOL - II (PIPING ASSESSMENT)

10.6.1 Main Steam (including HPBP)

The Live steam pipe and CRH routing is of conventional double lead, parallel type. The MS line starts from super heater outlet header of boiler to high pressure turbine inlet valves. 'Y' connections are provided in a vertical section of the piping.

The HPBP line interconnects the Live steam and CRH lines. As observed at site, the piping layout and Hanger locations have been erected as per the isometric drawings.

The live steam piping has been modelled along with the CRH line, and HPBP line from Main steam line to the CRH. Hanger locations have been marked as per the isometric drawings, while preparing the model of the piping system.

Basic Assumptions

Boiler terminal point data, specifying the allowable Movements are available and have been considered as input boundary conditions. (Ref BHEL Dwg 1-00-020-70113 for Terminal Point details.

Materials used in the Live Steam piping is, an alloy steel material ASTMA 335 Gr. P22 Allowable stresses at operating temperatures for ASTMA 335 Gr. P22 material have been considered for the stress analysis.

Comprehensive Stress analysis calculations by CAESAR II have taken into account available data as per drawings and documents.

There is no information regarding the piping stress and flexibility analysis results for unit # 4 as predicted during the project planning / installation stage. However, partial information is available regarding the Hanger design loads and the same have been used as a comparison.

Due to age of the plant, (piping system has been in operation for over 25 years). The following factors will affect the safety of the system.

Condition of the pipe regarding degree of corrosion / erosion

Steam hammer may occur, in MS lines, due to Turbine trip. High Loads are possible at single supports.

Thinning of pipe wall thickness.

Excursions in operating Pressure and Temp. of Steam.

535

ALSTOM	CLIENT	J-Power (Electric Power Development Co. Ltd.)
	PROJECT	Turbine and System Assessment for NTPC-KORBA Unit # 4
	ORDER NO.	CGP10028C
NTPC ALSTOM Power Services Pvt. Ltd.	CONTRACTOR	ALSTOM K. K. NASL LTD. (Nominated Sub-Contractor in India)
	DOCUMENT	FINAL REPORT VOL - II (PIPING ASSESSMENT)

Findings and Recommendations of the Analysis

Detailed Hanger Load and Stress Analysis outputs are listed in Chapter 10.6.7

The analysis has been carried out with available input, as mentioned earlier.

Listed below in Table 5 are the loads analysed, for each Hanger point. The same is tabulated and compared with available design values.

For ease of identification Node numbers have been shown, as listed in the Isometric drawing

For detailed results refer , Chapter 10.6.7 which gives Hanger Report.

TABLE 5 Korba, LIVE STEAM, Hanger Loads # 4

Hanger Tag No.	As per Design data of Hangers (Ref . Hanger Dwgs)			Node No.	AS PER STRESS ANALYSIS Calculations unit # 4			Remarks
	Cold Load (Kg)	Hot Load (kgs)	Travel (mm) -ve is down		Cold Load(kgs)	Hot Load(kgs)	Travel (mm)	
MST-001				40	5990.3	5351.4	15.972	
MST-002				45	8615.5	7294.4	9.908	
MST-003				60	5146.5	6295.6	-10.774	
MST-004				65				Tie Rod
MST-005	2x5559.3		+10	80	7157.3	5846.7	12.288	
MST-006	26652		Dy=0	95				Tie Rod
MST-007	2x6334	2x6334	-79	100	10636.7	10636.7	-80.386	
MST-008	2x9633	2x9633	-161	105	17033.8	17033.8	-164.6	
MST-009	2x4190	2x4190	-228	115	7684.5	7684.5	-225.99	
MST-010	7954	7954	-187	125	7487.8	7487.8	-175.382	
MST-011	6444	6444	-150	135	6085.9	6085.9	-128.056	
MST-012	7849	7849	-142	145	7285.1	7285.1	-104.382	
MST-013	2x8321	2x8321	-181	160	13112.6	13112.6	-139.708	
MST-014	10074	10074	-197	175	9177.7	9177.7	-157.532	
MST-015	10345	10345	-131	185	9694.1	9694.1	-100.867	
MST-016	10154	10154	-55	190	9527.9	9527.9	-33.154	
MST-017	10651	10651	+27	195	9520.6	9520.6	+40.70	
MST-018	11389	11389	+109	210	10482.5	10482.5	+116.186	

9/15

ALSTOM	CLIENT	J-Power (Electric Power Development Co. Ltd.)
	PROJECT	Turbine and System Assessment for NTPC-KORBA Unit # 4
	ORDER NO.	CGP10028C
NTPC ALSTOM Power Services Pvt. Ltd.	CONTRACTOR	ALSTOM K. K. NASL LTD. (Nominated Sub-Contractor in India)
	DOCUMENT	FINAL REPORT VOL - II (PIPING ASSESSMENT)

Hanger Tag No.	As per Design data of Hangers (Ref . Hanger Dwgs)			Node No.	AS PER STRESS ANALYSIS Calculations unit # 4			Remarks
	Cold Load (Kg)	Hot Load (kgs)	Travel (mm) -ve is down		Cold Load(kgs)	Hot Load(kgs)	Travel (mm)	
MST-019	2x8261	2x8261	+120	225	15436.3	15436.3	+118.678	
MST-020				230	9989.4	9989.4	+80.395	
MST-021				235	9144	9144	+31.392	
MST-022				260	2x6088.7	2x6088.7	-74.939	
MST-023				265	8028.1	8028.1	-107.356	
MST-024				275	2x5247.2	2x5247.2	-149.455	
MST-025				290	8973.8	8973.8	-187.297	
MST-026				300	10836.7	10836.7	-228.6	
MST-027				320	6923.5	6923.5	-272.991	
MST-028				7000	1184.4	1184.4	-253.801	
MST-029				7005	3337.6	3337.6	-265.379	
MST-030				7010	1938	1938	-280.642	
MST-031				7015	178	178	-299.583	
MST-032				540	5931.2	5173.1	9.476	
MST-033				555	7882.3	6993.8	16.662	
MST-034				570	6417.3	6077	3.19	
MST-035				580				Tie Rod
MST-036				595	2x2684	2x2800.3	-2.181	
MST-037				615				Tie Rod
MST-038				620	10194	10194	-50.086	
MST-039				625	16275.2	16275.2	-102.558	
MST-040				645	7464	7464	-172.59	
MST-041				660	7192.1	7192.1	-188.314	
MST-042				670	5811.6	5811.6	-171.088	
MST-043				680	7045.6	7045.6	-138.518	
MST-044				25	3800	3487.7	5.857	At SHO outlet
MST-045				520	3154.9	3175.4	-0.384	At SHO outlet
MST-046				205				X- restraint
MST-047				245				Tie Rod
MST-048				270				Z- restraint
MST-049								Z-snubber

ALSTOM	CLIENT	J-Power (Electric Power Development Co. Ltd.)
	PROJECT	Turbine and System Assessment for NTPC-KORBA Unit # 4
	ORDER NO.	CGP10028C
NTPC ALSTOM Power Services Pvt. Ltd.	CONTRACTOR	ALSTOM K. K. NASL LTD. (Nominated Sub-Contractor in India)
	DOCUMENT	FINAL REPORT VOL - II (PIPING ASSESSMENT)

Hanger Tag No.	As per Design data of Hangers (Ref . Hanger Dwgs)			Node No.	AS PER STRESS ANALYSIS Calculations unit # 4			Remarks
	Cold Load (Kg)	Hot Load (kgs)	Travel (mm) -ve is down		Cold Load(kgs)	Hot Load(kgs)	Travel (mm)	
MST-050								Z-snubber
H-8	2x9338			7045	8085.8	8085.8	-248.026	Turbine integral piping supports
H-7	2014			7055	2678.5	2678.5	-288.949	do
H-4	2x9338			805	8692.2	8692.2	-266.967	do
H-3	2014			8025	2676.9	2676.9	-307.890	do
H-12	2x9338			7115	7663.9	7663.9	-232.763	do
H-11	2014			7125	2679.7	2679.7	-273.686	do
H-16	2x9338			9015	8314	8314	-221.185	do
H-15	2014			9025	2677.9	2677.9	-262.108	do
HP BYPASS								
HPBP-01	2561		-10	2005	2006.4	2006.4	-161.549	
HPBP-02	1770		+1	2025	1617.5	1617.5	-113.704	
HPBP-03	2x1852	2x1852	+39	2050	3151.6	3151.6	-43.536	
HPBP-04	2780		+8	2070	1995.9	2548.5	-41.456	
HPBP-05	2x801	2x801	+12	2085	764.9	764.9	1.849	
HPBP-06	1386		+18	2105	3873.4	3290.9	10.922	
HPBP-07	2897		+9	2134	4560.8	3932.7	7.851	
HPBP-08	1191		-7	1010	1001.7	1001.7	-129.938	
HPBP-09	2X2052		+24	1040	2x1756.3	2x1756.3	-69.044	
HPBP-10	2X1352	2X1352	+57	1065	2477.6	2477.6	-5.653	
HPBP-11	2143	2143	+59	1080	1719	1719	2.546	
HPBP-12	2221		+26	1100	2930.2	2929.5	0.013	
HPBP-13	2786		+12	1145	4539.8	4047.9	6.149	
HPBP-14	1468		-7	1175	1009.1	1230.6	-8.307	
HPBP-15	2259		-6	1185	1608.3	1707.9	-3.738	
HPBP-16	1447		-10	15000	1703.7	1644.2	2.23	
HPBP-17	1615		-56	15010	855.1	936.4	-6.103	
HPBP-18	2x1417	2x1417	-23	15030	1416.6	1630	-32.046	
				15045		742.3	-63.965	
HPBP-19	1176		-8	2160	841.2	1089.9	-9.326	
HPBP-20	2085		-7	2170	1853.1	1979.6	-4.743	

ALSTOM	CLIENT	J-Power (Electric Power Development Co. Ltd.)
	PROJECT	Turbine and System Assessment for NTPC-KORBA Unit # 4
	ORDER NO.	CGP10028C
NTPC ALSTOM Power Services Pvt. Ltd.	CONTRACTOR	ALSTOM K. K. NASL LTD. (Nominated Sub-Contractor in India)
	DOCUMENT	FINAL REPORT VOL - II (PIPING ASSESSMENT)

Hanger Tag No.	As per Design data of Hangers (Ref . Hanger Dwgs)			Node No.	AS PER STRESS ANALYSIS Calculations unit # 4			Remarks
	Cold Load (Kg)	Hot Load (kgs)	Travel (mm) -ve is down		Cold Load(kgs)	Hot Load(kgs)	Travel (mm)	
HPBP-21	2415		-3	2180	2888.8	2347	10.161	
HPBP-22	1489		-14	2185	1474.7	1395.4	-2.974	
HPBP-23	2x1721		-1	2195	1397.6	1605.2	-15.575	
HPBP-24	3623		-52	2205	2x1375.4	2x1375.4	-58.262	
HPBP-25			-	2139				ANC
				1160				ANC

For Main Steam piping, Forces and Moments have been obtained at the Boiler terminal

(Node 10 and 505) .Also Ref Chapter 10.6.7 of Stress Analysis results.

Noted below (Table 6) are the , max loads at the Boiler terminal connections. These values are within acceptable values of those specified by OEM.



TABLE- 6 Main Steam- Loading at Boiler

	Allowable loads, as specified in BHEL dw (Kg)			Calculated Max load as per stress analysis report.(Kg)		
	Fx	Fy	Fz	Fx	Fy	Fz
SHO header						
Node 10	5450	5450	5450	544.9	3076.6	1409.6
Node 505	5450	5450	5450	317.4	1419.1	391.4

Due to non availability of allowable movements input data for the CV at the Turbine inlet, the connection points have not been modeled as a restraint. As such we are unable to evaluate the Forces and moments which may occur at the Turbine end of the MS pipe.

The report giving the Hanger Hot load /Travel as per calculations is Tabulated with available OEM data (Ref Table 5)

Stress check shows a failure at Tee point at Node 1200, which is a connection for the HPBP piping to the CRH line. This may be attributed to layout of this section for which drawing was not available but was generated as per site observation..

	CLIENT	J-Power (Electric Power Development Co. Ltd.)
	PROJECT	Turbine and System Assessment for NTPC-KORBA Unit # 4
	ORDER NO.	CGP10028C
	CONTRACTOR	ALSTOM K. K. NASL LTD. (Nominated Sub-Contractor in India)
	DOCUMENT	FINAL REPORT VOL - II (PIPING ASSESSMENT)

Due to age of the plant, the piping system has already undergone number of Thermal cycles during the course of operation. The safety of the system will be effected by Steam hammer, in the MS lines.. This will lead to High Loads at single supports. It is recommended to take operational precautions such that Thermal shocks are avoided.

10.6.2 Cold Reheat Piping

The Cold Reheat steam pipe routing is of conventional double lead, parallel type starting from the Turbine HP casing to the Boiler.

Basic Assumptions

- Boiler terminal point data, specifying the allowable Movements are available and have been considered as input boundary conditions.(Ref BHEL Dwg 1-00-020-70113 for Terminal Point details)
- Materials used in the CRH Steam piping is, an carbon steel material ASTMA 106Gr C. Allowable stresses at operating temperatures for ASTMA 106Gr C material have been considered for the stress analysis.
- Comprehensive Stress analysis calculations by CAESAR II have taken into account available data as per drawings and documents.
- There is no information regarding the piping stress and flexibility analysis results for unit # 4 as predicted during the project planning / installation stage. However, partial information is available regarding the Hanger design loads and the same have been used as a comparison..
- Due to age of the plant,(piping system has been in operation for over 25 years). The following factors will affect the safety of the system.

Condition of the pipe regarding degree of corrosion / erosion



Steam hammer may occur, in MS lines, due to Turbine trip. High Loads are possible at single supports.

Thinning of pipe wall thickness.

Excursions in operating Pressure and Temp. of Steam.

Findings and Recommendations of the Analysis

Detailed Hanger Load and Stress Analysis outputs are listed in Chapter 10.6.7

	CLIENT	J-Power (Electric Power Development Co. Ltd.)
	PROJECT	Turbine and System Assessment for NTPC-KORBA Unit # 4.
	ORDER NO.	CGP10028C
 Power Services Pvt. Ltd.	CONTRACTOR	ALSTOM K. K. NASL LTD. (Nominated Sub-Contractor In India)
	DOCUMENT	FINAL REPORT VOL - II (PIPING ASSESSMENT)

The analysis has been carried out with available input, as mentioned earlier.

Listed below in Table 7 are the loads analysed, for each Hanger point. The same is tabulated and compared with available design values.

For ease of identification Node numbers have been shown, as listed in the Isometric drawing

For detailed results refer , Chapter 10.6.7 which gives Hanger Report.

TABLE 7 Korba, CRH HANGER Hanger Loads # 4

Hanger Tag No.	As per Design data of Hangers (Ref . Hanger Dwg schedule)			Node No.	AS PER STRESS ANALYSIS Calculations unit #4			Remarks
	Cold Load (Kg)	Hot Load (kgs)	Travel (mm) -ve is down		Cold Load(kgs)	Hot Load(kgs)	Travel (mm)	
CRH -01	2384.8	2384.8	-127	1420	2219.7	2219.7	-126.44	
CRH -02	2298	2298	-127	1405	2188	2188	-127.47	
CRH -03	2x3350	2x3350	-142	1390	5650.8	5650.8	-143.44	
CRH -04	3119	3119	-164	1370	3020.1	3020.1	-167.70	
CRH -05	3015	3015	-156	1360	2652.5	2652.5	-159.04	
CRH -06	2x3662	2x3662	-170	1340	5642.7	5642.7	-171.36	
CRH -07	3053	3053	-115	1310	2946.3	2946.3	-120.21	
CRH -08	2x2079	2x2079	-37	1285	3490.9	3490.9	-47.36	
CRH -09	2x2832		-12	1250	2x1021.1	2x1192.7	-12.874	
CRH -10	2x2394		-37	1245	2x1476	2x1730.9	-39.099	
CRH -11	2x3362	2x3362	-66	1240	2x1470.5	2x1730.9	-69.615	
CRH -12	1827	1827	-99	1225	3721.8	3721.8	-107.39	
CRH -13	4012	4012	-88	1210	4037.6	4037.6	-99.35	
CRH -14	4909	4909	-76	1205	2865.2	2865.2	-85.102	
CRH -15	3502	3502	-64	2215	3037.3	3037.3	-66.268	
CRH -16	3594	3594	-54	2220	2949.5	2949.5	-44.468	
CRH -17	2x2821	2x2821	-47	2235	3801.5	3801.5	-20.311	
CRH -18	3001		-52	3000	2703.7	3248.9	-40.898	
CRH -19	2960		-54	3015	2426.6	3187.6	-57.093	
CRH -20	2x2800		-21	3025	2x1961.9	2x2445.4	-36.275	
CRH -21	4242		-52	4010	3675.9	4480	-40.208	
CRH -22	2x2690		-21	4020	2x1781.7	2x2349.5	-21.301	

165

ALSTOM	CLIENT	J-Power (Electric Power Development Co. Ltd.)
	PROJECT	Turbine and System Assessment for NTPC-KORBA Unit # 4
	ORDER NO.	CGP10028C
NTPC ALSTOM Power Services Pvt. Ltd.	CONTRACTOR	ALSTOM K. K. NASL LTD. (Nominated Sub-Contractor in India)
	DOCUMENT	FINAL REPORT VOL - II (PIPING ASSESSMENT)

Hanger Tag No.	As per Design data of Hangers (Ref . Hanger Dwg schedule)			Node No.	AS PER STRESS ANALYSIS Calculations unit #4			Remarks
	Cold Load (Kg)	Hot Load (kgs)	Travel (mm) -ve is down		Cold Load(kgs)	Hot Load(kgs)	Travel (mm)	
CRH -23	2399.5	2399.5	-127	1495	2220	2220	-126.67	
CRH -24	2290	2290	-125	1485	2185.1	2185.1	-125.76	
CRH -25	2x3255	2x3255	-132	1475	5658.4	5758.4	-131.95	
CRH -26	3117	3117	-166	1455	3016.9	3016.9	-168.12	
CRH -27	2941	2941	-169	1450	2607.7	2607.7	-161.35	
CRH -28	2906	2906	-179	1325	2806.1	2806.1	-184.19	
CRH -29	3843	3843	-75	1300	3586.7	3586.7	-83.784	
CRH -30				1415				Y snubbers
CRH -31				1493				Y snubbers
CRH -32	4830		Dx=0	1365				X restraint
CRH -33	11003		Dy=0	1255				Y restraint
CRH -34	16350		Dz=0	2230				Z restraint

- For CRH Steam piping, Forces and Moments have been obtained at the Boiler terminal (Node 1435 and 1510) .Also Chapter 10.6.7of Stress Analysis results.

Noted below (Table 8) are the, max loads at the Boiler terminal connections. These values are within acceptable values of those specified by OEM except at Fy load at Node 1435.

542



	CLIENT	J-Power (Electric Power Development Co. Ltd.)
	PROJECT	Turbine and System Assessment for NTPC-KORBA Unit # 4
	ORDER NO.	CGP10028C
	CONTRACTOR	ALSTOM K. K. NASL LTD. (Nominated Sub-Contractor In India)
	DOCUMENT	FINAL REPORT VOL - II (PIPING ASSESSMENT)

TABLE- 8 CRH Steam- Loading at Boiler

	Allowable loads, as specified in BHEL dwg(Kg)			Calculated Max load as per stress analysis report.(Kg)		
	Fx	Fy	Fz	Fx	Fy	Fz
RH header						
Node 1435	3400	3400	3400	1250.6	4643.8	1560.4
Node 1510	3400	3400	3400	2652.9	3318	1320.2

Due to non availability of allowable movements input data for the Casing at the Turbine outlet,

The connection points have not been modeled as a restraint. As such we are unable to Evaluate the Forces and moments which may occur at the Turbine end of the CRH pipe.

- The report giving the Hanger Hot load /Travel as per calculations is Tabulated with available OEM data (Ref Table 7)
- Due to age of the plant, the piping system has already undergone number of Thermalcycles during the course of operation The safety of the system will be effected by Steam hammer, in the MS lines.. This will lead to High Loads at single supports. It is recommended to take operational precautions such that Thermal shocks are avoided.



10.6.3 Hot Reheat piping

The Hot Reheat steam pipe routing is of conventional double lead, parallel type starting from Reheater outlet header on boiler to IP turbine inlet valves. 'Y' connections are provided in a vertical section of the piping .

Basic Assumptions

- Boiler terminal point data, specifying the allowable Movements are available and have been considered as input boundary conditions.(Ref BHEL Dwg 1-00-020-70113 for Terminal Point details)
- Materials used in the HRH Steam piping is, an alloy steel material ASTMA 335 Gr. P22 Allowable stresses at operating temperatures for ASTMA 335 Gr. P22 material have been considered for the stress analysis.

543

	CLIENT	J-Power (Electric Power Development Co. Ltd.)
	PROJECT	Turbine and System Assessment for NTPC-KORBA Unit # 4
	ORDER NO.	CGP10028C
	CONTRACTOR	ALSTOM K. K. NASL LTD. (Nominated Sub-Contractor in India)
	DOCUMENT	FINAL REPORT VOL - II (PIPING ASSESSMENT)

Comprehensive Stress analysis calculations by CAESAR II have taken into account available data as per drawings and documents.

There is no information regarding the piping stress and flexibility analysis results for unit # 4 as predicted during the project planning / installation stage. However, partial information is available regarding the Hanger design loads and the same have been used as a comparison.

Due to age of the plant, (piping system has been in operation for over 25 years). The following factors will affect the safety of the system.

Condition of the pipe regarding degree of corrosion / erosion

Steam hammer may occur, in MS lines, due to Turbine trip. High Loads are possible at single supports.

Thinning of pipe wall thickness.

Excursions in operating Pressure and Temp. of Steam

Findings and Recommendations of the Analysis

Detailed Hanger Load and Stress Analysis outputs are listed in Chapter 10.6.7

The analysis has been carried out with available input, as mentioned earlier.

Listed below in Table 9 are the loads analysed, for each Hanger point. The same is tabulated and compared with available design values.

For ease of identification Node numbers have been shown, as listed in the Isometric drawing

For detailed results refer, Chapter 10.6.7 which gives Hanger Report.

TABLE 9 Hanger Loads # 4, 500 MW Korba HRH, Steam, (Including LP Bypass)

Hanger Tag No.	As per Design data of Hangers (Ref. Hanger dwgs)			Node No.	AS PER STRESS ANALYSIS Calculations unit #4			Remarks
	Cold Load (Kg)	Hot Load (kgs)	Travel (mm) -ve is down		Cold Load (kgs)	Hot Load (kgs)	Travel (mm)	
HRH-001	3931.8		+17	530	4407.9	3669.8	18.452	
HRH-002	5840		+19	540	6864.2	5508	25.432	
HRH-003	2x2995		+7	560	2x3316	2x2716.4	11.243	
HRH-004	19779		Dy=0	570				Tie Rod
HRH-005	4005		+3	580	3415.9	3607.9	-3.6	

589

ALSTOM	CLIENT	J-Power (Electric Power Development Co. Ltd.)
	PROJECT	Turbine and System Assessment for NTPC-KORBA Unit # 4
	ORDER NO.	CGP10028C
NTPC ALSTOM Power Services Pvt. Ltd.	CONTRACTOR	ALSTOM K. K. NASL LTD. (Nominated Sub-Contractor in India)
	DOCUMENT	FINAL REPORT VOL - II (PIPING ASSESSMENT)

Hanger Tag No.	As per Design data of Hangers (Ref. Hanger dwgs)			Node No.	AS PER STRESS ANALYSIS Calculations unit #4			Remarks
	Cold Load (Kg)	Hot Load (kgs)	Travel (mm) -ve is down		Cold Load (kgs)	Hot Load (kgs)	Travel (mm)	
HRH-006	14712		Dy=0	597				Tie Rod
HRH-007	2x4749	2x4749	-97	600	7810.4	7810.4	-97.303	
HRH-008	2x5166	2x5166	-180	605	8653.8	8653.8	-181.51	
HRH-009	2x3248	2x3248	-254	615	5803.3	5803.3	-258.16	
HRH-010	6269	6269	-251	625	5796	5796	-259.7	
HRH-011	3004	3004	-210	635	2701	2701	-221.24	
HRH-012	4113	4113	-170	640	1884.9	1884.9	-182.27	
HRH-013	2X 9272	2X 9272	-154	160	13868.7	13868.7	-164.21	
HRH-014	6689	6689	-156	175	6242.6	6242.6	-165.18	
HRH-015	7780	7780	-78	185	6042.1	6042.1	-85.62	
HRH-016	6033	6033	+7	190	5509.2	5509.2	0.807	
HRH-017	8285	8285	+91	200	7659.1	7659.1	89.215	
HRH-018	2X6380	2X6380	+120	215	10700.6	10700.6	121.31	
HRH-019	2X6150	2X6150	+79	220	7001.1	7001.1	79.22	
HRH-020	2X7062		+31	225	6039.2	6039.2	30.234	
HRH-021	2x4169		-30	245	2x3199.2	2x3763.6	-42.345	
HRH-022	2x3996		-36	255	2x2800.5	2x3666.1	-64.936	
HRH-023	2x3971		-37	260	2x3513.4	2x3513.4	-81.002	
HRH-024	9589		-37	270	6349.5	6349.5	-81.002	
HRH-025	8275		-39	285	7448.3	7448.3	-79.429	
HRH-026	9198		-45	290	2x3474	2x3474	-74.594	
HRH-027	6080		-44	300	3130.2	3130.2	-70.411	
HRH-028	2X2670		-28	340	2x1730.5	2x1730.5	-67.309	
HRH-029	2X2738		-28	330	2x1693.8	2x1693.8	-66.512	
HRH-030	2X2327		-35	320	2x1356.5	2x1356.5	-58.929	
HRH-031	2X2389		-37	310	2x1382.9	2x1382.9	-56.598	
HRH-032	3931		+14	35	4281.1	3684.9	+14.904	
HRH-033	5838		+2	40	5360.2	5532.7	-2.157	
HRH-034	2x3001		-15	60	4680.6	5475.3	-19.87	
HRH-035	19776		Dy=0	70				Tie Rod
HRH-036	4000		+13	80	3618.1	4219.8	+15.042	
HRH-037	16711		nil	95				Tie Rod

ALSTOM	CLIENT	J-Power (Electric Power Development Co. Ltd.)
	PROJECT	Turbine and System Assessment for NTPC-KORBA Unit # 4
	ORDER NO.	CGP10028C
NTPCALSTOM Power Services Pvt. Ltd.	CONTRACTOR	ALSTOM K. K. NASL LTD. (Nominated Sub-Contractor In India)
	DOCUMENT	FINAL REPORT VOL - II (PIPING ASSESSMENT)

Hanger Tag No.	As per Design data of Hangers (Ref . Hanger dwgs)			Node No.	AS PER STRESS ANALYSIS Calculations unit #4			Remarks
	Cold Load (Kg)	Hot Load (kgs)	Travel (mm) -ve is down		Cold Load (kgs)	Hot Load (kgs)	Travel (mm)	
HRH-038	2x4749	2x4749	-97	100	7810.4	7810.4	-97.27	
HRH-039	2x5157	2x5157	-180	105	8632.5	8632.5	-181.45	
HRH-040	3931.8		-240	115	5822.7	5822.7	-242.11	
HRH-041	6764	6764	--184	125	5826.5	5826.5	-187.07	
HRH-042	2989	2989	-126	135	2463.2	2463.2	-133.72	
HRH-043	4174	4174	-106	140	3941.4	3941.4	-113.08	
HRH-044	Fz=4663		Dz=0	65				Z- restraint
HRH-045	Fz=7150		Dz=0	565				Z- restraint
HRH-046	17390		Dy=o	235				Y- restraint
HRH-047				185				snubber
HRH-048				290				snubber
H-6	2X7679		4	5013	2x3699.7	2x3910	-3.944	Turbine integral piping support
H-5	1591		9	5023	3116.1	3705.4	-22.10	-do-
H-11	7963X2		6	6013	2x3552.1	2x4035.6	-6.044	do
H-10	1041		12	6023	2225.7	2563.3	-25.331	do
H-22	8252X2		15	7013	6242.4	7710.7	-13.767	do
H-21	1126		18	7025	2120.3	2589.4	-35.18	do
H-16	8116X2			8013	2x3200.3	2x4223.7	-12.792	do
H-15	1792		15	8023	2218.4	2589.8	-27.861	do
LPBPH-1	2x2799	2x2799	-57	7510	4592.3	4592.3	-110.79	
LPBPH-2	3152	3152	-61	8510	3138.8	3138.8	-85.363	
LPBPH-3	3344	3344	-56	8515	3184.3	3184.3	-40.029	
LPBPH-4	2x744	2x744	-51	8520	1292.9	1292.9	-4.151	
LPBPH-5	4951	4951	-48	8535	4546.3	4546.3	-2.756	
LPBPH-6	11692		Dy=o	8550				Y- restraint
LPBPH-7	2x977		+7	8565	2x957.3	2x1097.2	-21.009	
				8585	2x2513.7	2x3063.3	-41.235	LPBP Valve support
LPBPH-8	2x1389		+4	8575	2x892.6	2x1121.3	-34.344	
LPBPH-9	2x250	2x250	-5	8605	1578.4	1578.4	-67.139	
LPBPH-10	2x2970		-57	6510	2x2512.6	2x2512.6	-84.97	
LPBPH-11	2x3977		+3	5515	2x2952.3	2x3695.7	-13.939	

ALSTOM	CLIENT	J-Power (Electric Power Development Co. Ltd.)
	PROJECT	Turbine and System Assessment for NTPC-KORBA Unit # 4
	ORDER NO.	CGP10028C
NTPC ALSTOM Power Services Pvt. Ltd.	CONTRACTOR	ALSTOM K. K. NASL LTD. (Nominated Sub-Contractor in India)
	DOCUMENT	FINAL REPORT VOL - II (PIPING ASSESSMENT)

Hanger Tag No.	As per Design data of Hangers (Ref . Hanger dwgs)			Node No.	AS PER STRESS ANALYSIS Calculations unit #4			Remarks
	Cold Load (Kg)	Hot Load (kgs)	Travel (mm) -ve is down		Cold Load (kgs)	Hot Load (kgs)	Travel (mm)	
LPBPH-12	2x3977		+2	5530	2x2876.2	2x3614.8	-13.85	
LPBPH-13	3326	3326	-55	5545	3035.7	3035.7	-63.267	
LPBPH-14	9717		Dy=0	5560				Y- restraint
LPBPH-15	3573		+5	5570	3554.5	3554.5	39.859	
				5575		2x2870.6	54.682	LPBP Valve support
LPBPH-16	2x251		-5	5595	2x869.5	2x869.5	52.2	LPBP Valve support
LPBPH-17	2x1506		+10	8560	2x1172.9	2x1172.1	.031	
LPBPH-18	12209		Dz=0					Z- restraint (in dismantled condn)
LPBPH-21				5550				snubber

- For HRH Steam piping, Forces and Moments have been obtained at the Boiler terminal

(Node 10 and 505) Also Chapter 10.6.7 of Stress Analysis results.



Noted below (Table 10) are the max loads at the Boiler terminal connections. These values are within acceptable values of those specified by OEM.

TABLE- 10 HRH Steam- Loading at Boiler

	Allowable loads, as specified in BHEL dwg Kg)			Calculated Max load as per stress analysis report.(Kg)		
	Fx	Fy	Fz	Fx	Fy	Fz
RHO header						
Node 10	5400	5400	5400	741	3148.9	2589
Node 505	5400	5400	5400	1921.6	3490.5	2389.4

Due to non availability of allowable movements input data for the CV at the Turbine end, The connection points have not been modeled as a restraint. As such we are unable to Evaluate the Forces and moments which may occur at the Turbine end of the CRH pipe.

6/5

	CLIENT	J-Power (Electric Power Development Co. Ltd.)
	PROJECT	Turbine and System Assessment for NTPC-KORBA Unit # 4
	ORDER NO.	CGP10028C
	CONTRACTOR	ALSTOM K. K. NASL LTD. (Nominated Sub-Contractor in India)
	DOCUMENT	FINAL REPORT VOL - II (PIPING ASSESSMENT)

- The report giving the Hanger Hot load /Travel as per calculations is Tabulated with available OEM data (Ref Table 9)
- Stress check shows that the piping stress limits are acceptable as per piping code.
- Due to age of the plant, the piping system has already undergone number of Thermal cycles during the course of operation The safety of the system will be effected by Steam hammer, in the MS lines.. This will lead to High Loads at single supports. It is recommended to take operational precautions such that Thermal shocks are avoided.

10.6.4 Boiler Feed Discharge Piping

The pipe is of Carbon Steel Material between the Boiler Feed Discharge to the Economiser inlet header. The piping operates at a temp. of 265 deg.C (max) and pressure of 300 bar. The piping connects the Three BFPs, thru' a common header to the economiser inlet header. The piping is routed, with connections to the HP heaters and has loops provided to give flexibility to the system to accommodate thermal expansion of the pipe.



The piping system has a Feed control station.

Basic Assumptions

- Boiler terminal point data, specifying the allowable Movements are available and have been considered as input boundary conditions.(Ref BHEL Dwg 1-00-020-70113 for Terminal Point details)
- Materials used in the BFD piping is, carbon steel material ASTMA 106Gr C.
- Allowable stresses at operating temperatures for ASTMA 106Gr C material have been considered for the stress analysis.
- Comprehensive Stress analysis calculations by CAESAR II have taken into account available data as per drawings and documents.
- d) There is no information regarding the piping stress and flexibility analysis results for unit # 4 as predicted during the project planning / installation stage However, partial information is available regarding the Hanger design loads and the same have been used as a comparison.
- Due to age of the plant,(piping system has been in operation for over 25 years). The following factors will affect the safety of the system.

Condition of the pipe regarding degree of corrosion / erosion

548

	CLIENT	J-Power (Electric Power Development Co. Ltd.)
	PROJECT	Turbine and System Assessment for NTPC-KORBA Unit # 4
	ORDER NO.	CGP10028C
	CONTRACTOR	ALSTOM K. K. NASL LTD. (Nominated Sub-Contractor in India)
	DOCUMENT	FINAL REPORT VOL - II (PIPING ASSESSMENT)

Steam hammer may occur, in MS lines, due to Turbine trip. High Loads are possible at single supports.

Thinning of pipe wall thickness.

Excursions in operating Pressure and Temp. of Steam

Findings and Recommendations of the Analysis

Detailed Hanger Load and Stress Analysis outputs are listed in Annexure IV

The analysis has been carried out with available input, as mentioned earlier.

Listed below in Table 11 are the loads analysed, for each Hanger point. The same is tabulated and compared with available design values.

For ease of identification Node numbers have been shown, as listed in the Isometric drawing



For detailed results refer , Chapter 10.6.7 which gives Hanger Report.

TABLE 11 Korba, Boiler Feed Discharge Piping #4



Hanger Tag No.	As per Design data of Hangers (Ref . Hanger Dwgs)			Node No.	AS PER STRESS ANALYSIS Calculations unit #4			Remarks	
	Cold Load (Kg)	Hot Load (kgs)	Travel (mm) -ve is down		Cold (kgs)	Load (kgs)	Hot Load (kgs)		Travel (mm)
BFD-1				305	2x610		2x584.3	1.933	
BFD-2				320	2412.8		2241.5	3.212	
BFD-3				330	1850.6		1837.4	0.498	
BFD-4				340	2x973.1		2x1110.5	-5.153	
BFD-5				360	831.1		1065	-8.774	
BFD-6				375	389.6		519.1	-9.711	
BFD-7				385	2x548.5		2x632.5	-6.296	
BFD-8				395					Tie rod
BFD-9				400					Tie rod
BFD-10				405					Tie rod
BFD-11				205	2x808.6		2x901.2	-6.946	
BFD-12				220	1149.4		1442.1	-10.98	
BFD-13				230	1041.6		1300.3	-9.704	
BFD-14				240	2x844.5		2x985.4	-10.565	
BFD-15				257	824.9		976.8	-11.392	

ALSTOM	CLIENT	J-Power (Electric Power Development Co. Ltd.)
	PROJECT	Turbine and System Assessment for NTPC-KORBA Unit # 4
	ORDER NO.	CGP10028C
NTPC ALSTOM Power Services Pvt. Ltd.	CONTRACTOR	ALSTOM K. K. NASL LTD. (Nominated Sub-Contractor in India)
	DOCUMENT	FINAL REPORT VOL - II (PIPING ASSESSMENT)

Hanger Tag No.	As per Design data of Hangers (Ref . Hanger Dwgs)			Node No.	AS PER STRESS ANALYSIS Calculations unit #4					Remarks
	Cold Load (Kg)	Hot Load (kgs)	Travel (mm) -ve is down		Cold (kgs)	Load	Hot (kgs)	Load	Travel (mm)	
BFD-16				270	848.1		982.2		-10.059	
BFD-17				500						Tie rod
BFD-18				510						Tie rod
BFD-19				515						Tie rod
BFD-20				10	2x819.7		2x912.3		-6.947	
BFD-21				25	1883		2204.9		-6.021	
BFD-22				35	1899.1		1981.9		-3.108	
BFD-23				45	1196.3		1288.9		-3.475	
BFD-24				65	918.2		1199.4		-10.547	
BFD-25				80	434.4		574.6		-10.521	
BFD-26				90	2x919.4		2x953.4		-2.553	
BFD-27				100						Tie rod
BFD-28				105						Tie rod
BFD-29				110						Tie rod
BFD-30				540	2x3495.2		2x2988.1		19.022	
BFD-31				715	2x2351.9		2x2085.6		19.98	
BFD-32				735	663.7		753.6		-6.744	
BFD-33				750	2x2462.1		2x2338.7		2.313	
BFD-34				565	2x2576.1		2x2095.7		18.021	
BFD-35				585	607.5		737.3		-9.731	
BFD-36				600	2036.9		2x2296.6		-4.871	
BFD-37				9065	1705.7		1478		17.081	
BFD-38				9055	1898.4		1772.9		9.414	
BFD-39				9045						Tie rod
BFD-40				9035	973		1252.4		-20.959	
BFD-41				9020	3300.4		4193.6		-22.332	
BFD-42				5015	1668.9		1432.7		17.72	
BFD-43				5025	1892.5		1777.6		8.618	
BFD-44				5035						Tie rod
BFD-45				5045	1000.6		1240.4		-17.989	
BFD-46				5060	4165.4		4208.1		-1.107	
BFD-47				8040	880.7		938.2		-4.311	
BFD-48				8030	2x792		2x931.8		-10.486	

	CLIENT	J-Power (Electric Power Development Co. Ltd.)
	PROJECT	Turbine and System Assessment for NTPC-KORBA Unit # 4
	ORDER NO.	CGP10028C
 Power Services Pvt. Ltd.	CONTRACTOR	ALSTOM K. K. NASL LTD. (Nominated Sub-Contractor in India)
	DOCUMENT	FINAL REPORT VOL - II (PIPING ASSESSMENT)

Hanger Tag No.	As per Design data of Hangers (Ref. Hanger Dwgs)			Node No.	AS PER STRESS ANALYSIS Calculations unit #4					Remarks
	Cold Load (Kg)	Hot Load (kgs)	Travel (mm) -ve is down		Cold (kgs)	Load	Hot (kgs)	Load	Travel (mm)	
BFD-49				8010	1287.9		1557.9		-10.128	
BFD-50				6050	1452.9		1559.1		-3.983	
BFD-51				6030	2x993.1		2x931.1		9.314	
BFD-52				6020	1165		960.8		15.324	
BFD-53				835	2x984		2x870.8		16.993	
BFD-54				820	2x1849.7		2x1644		15.425	
BFD-55				860	2484.7		2x2194.1		21.802	
BFD-56				865	2537		2240.3		22.261	
BFD-57				870	1936.7		1647.1		21.727	
BFD-58				880	2273.4		1845.9		8.017	
BFD-59				6075	3128.2		3498.5		-6.943	
BFD-60				900	1686.3		1857.7		-6.428	
BFD-61				923	9324		1080.8		-22.282	
BFD-62				1005	2x968		2x1063.4		-3.577	
BFD-63				1025	1204.6		1013.2		14.356	
BFD-64				1040	1212.2		1035.9		26.478	
BFD-65				1060	2x1197.1		2x998.2		29.866	
BFD-66				2000	2x625.8		2x532.1		28.139	
BFD-67				2020	872.7		715.7		23.567	
BFD-68				2045	882.8		747.3		10.165	
BFD-69				2065	2x529.8		2x644.8		-8.627	
BFD-70				7075	2X916.3		2X1196.2		-10.500	
BFD-71				7095	941.8		1138.7		-14.768	
BFD-72				7110	891.5		1099.9		-31.229	
BFD-73				7130	2x571		2x571		-50.469	
BFD-74				7005	2704.6		2704.6		-53.191	
BFD-75				7025	3340.1		4030.6		-34.527	
BFD-76				7040	1869.6		2382.8		-19.251	
BFD-77				7060	2x801.3		2x1009.5		-15.619	
BFD-78				1090	3923.4		3489.5		16.275	
BFD-79				1095	3924.5		4492.4		-14.196	
BFD-80				1100	3054.1		3658.9		-45.371	
BFD-81				1110	4314		4314		-80.508	

	CLIENT	J-Power (Electric Power Development Co. Ltd.)
	PROJECT	Turbine and System Assessment for NTPC-KORBA Unit # 4
	ORDER NO.	CGP10028C
 Power Services Pvt. Ltd.	CONTRACTOR	ALSTOM K. K. NASL LTD. (Nominated Sub-Contractor in India)
	DOCUMENT	FINAL REPORT VOL - II (PIPING ASSESSMENT)

Hanger Tag No.	As per Design data of Hangers (Ref. Hanger Dwgs)			Node No.	AS PER STRESS ANALYSIS Calculations unit #4			Remarks
	Cold Load (Kg)	Hot Load (kgs)	Travel (mm) -ve is down		Cold Load (kgs)	Hot Load (kgs)	Travel (mm)	
BFD-82				1120	2318.6	2318.6	-95.140	
BFD-83				1135	5902.5	5902.5	-91.179	
BFD-84				1140	4861.7	4861.7	-62.304	
BFD-85				1150	2754.6	2745.6	-63.437	
BFD-86				1160	4284.9	4284.9	-67.466	
BFD-87				1170	4835.1	4835.1	-63.08	
BFD-88				1175	5926.4	5926.4	-105.51	
BFD-89				1180	4785.9	4785.9	-145.49	
BFD-90				1190	3783.5	3783.5	-166.39	
-				1215	4102.7	4102.7	-171.67	Hanger at Bir. Econ inlet

- For BFD Steam piping, Forces and Moments have been obtained at the Boiler terminal (Node 1225) .Also Chapter 10.6.7 of Stress Analysis results.

Noted below (Table 12) are the , max loads at the Boiler terminal connections. These values are within acceptable values of those specified by OEM.

ALSTOM	CLIENT	J-Power (Electric Power Development Co. Ltd.)
	PROJECT	Turbine and System Assessment for NTPC-KORBA Unit # 4
	ORDER NO.	CGP10028C
NTPC ALSTOM Power Services Pvt. Ltd.	CONTRACTOR	ALSTOM K. K. NASL LTD. (Nominated Sub-Contractor in India)
	DOCUMENT	FINAL REPORT VOL - II (PIPING ASSESSMENT)

TABLE- 12 BFD- Loading at Boiler

	Allowable loads, as specified in BHEL dwg(Kg)			Calculated Max load as per stress analysis report.(Kg)		
	Fx	Fy	Fz	Fx	Fy	Fz
Econ inlet						
Node 1225	4540	4540	4540	286	761.9	687.6

Due to non availability of allowable Forces and moments at the BFP disch end, we are unable to evaluate the Forces and moments which occur at the BFP.

- The report giving the Hanger Hot load /Travel as per calculations is Tabulated in Table 11.
- Stress check shows that the piping stress limits are acceptable as per piping code.
- Due to age of the plant, the piping system has already undergone number of Thermal cycles during the course of operation The safety of the system will be effected by Steam hammer, in the MS lines.. This will lead to High Loads at single supports. It is recommended to take operational precautions such that Thermal shocks are avoided.

POSSIBLE DAMAGES DUE TO HANGER MISALIGNMENTS IN CRITICAL STEAM PIPES

Creep damage

Critical Steam piping components in power stations are subject to creep processes which limit their life time. As steam piping systems age and operate well beyond their original design life, susceptibility to deterioration and failure increases.



Hanger misalignments result in increased dead weight moments and thus in increased creep relevant primary stresses

In a free-floating steam-piping system, with no anchors, over designed and / or under designed hangers create problems. Normally, plant personnel make travel adjustments to the hanger, which restore the hanger to a working range again but do not change the hanger load applied to the pipe. As a result, after several adjustments build up of localised creep strain produces a failure at some point Hanger travel adjustments may provide a temporary fix but if the problem is hanger related, future adjustments are inevitable. This can be detrimental to the piping system.

Causes for additional stresses due to Support Problems are summarised below.

Misaligned hangers due to:

459

	CLIENT	J-Power (Electric Power Development Co. Ltd.)
	PROJECT	Turbine and System Assessment for NTPC-KORBA Unit # 4
	ORDER NO.	CGP10028C
	CONTRACTOR	ALSTOM K. K. NASL LTD. (Nominated Sub-Contractor in India)
	DOCUMENT	FINAL REPORT VOL - II (PIPING ASSESSMENT)

Additional dead weight

Choice of hanger

Changed spring rate or suspension force by ageing blocked spring and constant force hangers.

Assembly of Turbine

The stability of the Turbine cylinder at the major inspection is selected as a limiting criterion for determining the permissible pipe reactions. Stability is based on the supported residual weight of the Turbine cylinder at the pipe connection.

Where extraneous weight components are transferred complete from the piping system, reliable conclusions cannot be drawn with regard to the residual strength. The residual strength is however, absolutely essential for performance of alignment work in the sensitive region between the rotor and turbine casing

Recommended R&M Works and Replacement / Repairs

The recommendations listed below are Short Term measures and Long Term.

Recommended Scope of R&M works



Sl. No.	Equipment/ Assembly/ System	Recommendation as per study	Scope of work(based on LE study carried out)
1	Live Steam, CRH, and HPBP	<p>As per highest Stress points in Chapter 10.6.7, Stress summary identifies the highest risk node points. These elements should be tested by NDT methods.</p> <p>During Hot and Cold survey it was observed that the Hanger spring travel was not consistent with the design values furnished by BHEL. Short Term, immediate measure should ensure that the Hanger supports are properly maintained. Each support to be Tag marked, with Cold load position, clearly identified. Necessary adjustments to be made, to ensure that hanger operating loads and travel are as close as possible (within 5%) to their design.</p> <p>Creep Strain - Periodic strain measurements may be taken on the pipes to monitor the pipe OD and ID variations, if any. This will identify piping locations, which are effected due to creep stresses.</p>	Stress Report Analysis

ALSTOM	CLIENT	J-Power (Electric Power Development Co. Ltd.)
	PROJECT	Turbine and System Assessment for NTPC-KORBA Unit # 4
	ORDER NO.	CGP10028C
NTPC ALSTOM Power Services Pvt. Ltd.	CONTRACTOR	ALSTOM K. K. NASL LTD. (Nominated Sub-Contractor in India)
	DOCUMENT	FINAL REPORT VOL - II (PIPING ASSESSMENT)

Sl. No.	Equipment/ Assembly/ System	Recommendation as per study	Scope of work(based on LE study carried out)
2	Hot Reheat and LPBP	-do-	-do-
3	BFP Discharge	-do-	-do-

Details regarding Replacement/ Repairs

Sl. No.	Supply /Material (Replacement)		Repairs	
	Items/Quantity	Technical Particulars	Activity	Methodology adopted
1	Live Steam, CRH, and HPBP	<p>The analysis shows that the Hanger Hot load /Travel as per calculations varies with respect to the BHEL design</p> <p>At least 25% of total number of Spring hangers have shown a travel which is in deviation from design. Possible cause for this is changes in layout, due to the effect of Creep and loss of elasticity of the piping.</p> <p>Misaligned hangers could also cause additional stresses on the piping, leading to early creep failures.</p>	<p>Long term recommendation- It is recommended to get a layout mapping done at the earliest to determine the changes in the piping layout.</p>	<p>Comprehensive reanalysis after incorporating actual layout changes in the stress analysis model</p> <p>Then resize, redesign hanger supports so that new support loads can obtain the most favorable distribution of support loads to minimize further creep distortions</p>
2	Hot Reheat and LPBP	-do-	-do-	-do-
3	BFP Discharge	-do-	-do-	-do-

	CLIENT	J-Power (Electric Power Development Co. Ltd.)
	PROJECT	Turbine and System Assessment for NTPC-KORBA Unit # 4
	ORDER NO.	CGP10028C
	CONTRACTOR	ALSTOM K. K. NASL LTD. (Nominated Sub-Contractor in India)
	DOCUMENT	FINAL REPORT VOL - II (PIPING ASSESSMENT)

10.6.5 Piping Report- Salient Points:

The piping systems have been analyzed using CAESAR II software. Piping flexibility analysis assume elastic behavior of the entire piping system.

The analysis used the traditional ASME B31.1 Code for Pressure and Power Piping, for safe design and construction. The intent of this analysis is to develop a better understanding of elastic behavior of the piping system, when subjected to all relevant loadings in the hot operating condition.

The power plant steam piping is a free floating system, with Anchors at the Turbine and Boiler connections.

Necessary input data for carrying out the stress runs, is the boundary condition allowable movements at the equipment connection, as specified by the Boiler and Turbine OEMs.

Computer Output results of the stress run on CAESAR II include the following reports.

Forces and moments on equipment connections

Hanger load and travel report

Limitations of the Report

Input data of Allowable movements at the Turbine and other equipments, like, HP Heaters and Boiler Feed pump discharge terminals are not available. However, allowable input data at the Boiler connections are available.

There is also no information available regarding the piping stress and flexibility analysis results as predicted during the project planning / installation stage.

Hanger load and travel data for Main steam hangers MST-001 to MST-004 and MST-020 to MST-048 and BFD hangers BFD-1 to BFD-90 are not available.

Due to non availability of allowable movements input data at the piping connection of MS and HRH Turbine CVs and CRH casing connection, these points have not been modeled as restraints. Whereas, the Boiler connections have been modeled as restraints.

As such, Computer Output results of the stress run on CAESAR II have the following limitations.

Hanger load and travel values will differ from the design stage values of the hangers.

We are unable to evaluate the Forces and moments which occur at the Turbine end and ensure that the dead weights of the Steam lines are being absorbed within the pipe hanger and support system and are not being transferred to the turbine nozzles.

ALSTOM	CLIENT	J-Power (Electric Power Development Co. Ltd.)
	PROJECT	Turbine and System Assessment for NTPC-KORBA Unit # 4.
	ORDER NO.	CGP10028C
NTPC ALSTOM Power Services Pvt. Ltd.	CONTRACTOR	ALSTOM K. K. NASL LTD. (Nominated Sub-Contractor in India)
	DOCUMENT	FINAL REPORT VOL - II (PIPING ASSESSMENT)

10.6.6 Conclusions of the report



Based on Hanger readings noted during Hot and Cold surveys we are able to identify the hangers where deviation in Cold and Hot conditions exist.

The piping Isometric models are prepared as per the existing layout drawings and Hanger points and type have been marked as per existing arrangement.

The output results identifies the maximum stress points on pipe and displacement and stress reports at every node point.

Recommendation for change in Hanger Load/travels based upon stress analysis and FEA, is not made conclusively due to non availability of allowable input movement, forces & moments at the Turbine connections.

657

	CLIENT	J-Power (Electric Power Development Co. Ltd.)
	PROJECT	Turbine and System Assessment for NTPC-KORBA Unit # 4
	ORDER NO.	CGP10028C
	CONTRACTOR	ALSTOM K. K. NASL LTD. (Nominated Sub-Contractor in India)
	DOCUMENT	FINAL REPORT VOL - II (PIPING ASSESSMENT)



10.6.7 CAESAR II REPORT

ALSTOM	CLIENT	J-Power (Electric Power Development Co. Ltd.)
	PROJECT	Turbine and System Assessment for NTPC-KORBA Unit # 4
	ORDER NO.	CGP10028C
NTPC ALSTOM Power Services Pvt. Ltd.	CONTRACTOR	ALSTOM K. K. NASL LTD. (Nominated Sub-Contractor in India)
	DOCUMENT	FINAL REPORT VOL - II (PIPING ASSESSMENT)

HANGER LOAD AND STRESS ANALYSIS REPORT

NTPC, KORBA 500 MW Unit #4

559

	CLIENT	J-Power (Electric Power Development Co. Ltd.)
	PROJECT	Turbine and System Assessment for NTPC-KORBA Unit # 4
	ORDER NO.	CGP10028C
	CONTRACTOR	ALSTOM K. K. NASL LTD. (Nominated Sub-Contractor in India)
	DOCUMENT	FINAL REPORT VOL - II (PIPING ASSESSMENT)

MAIN STEAM, CRH AND HPBP



HANGER LOAD AND STRESS ANALYSIS REPORT (ANNEXURE II)

ALSTOM	CLIENT	J-Power (Electric Power Development Co. Ltd.)
	PROJECT	Turbine and System Assessment for NTPC-KORBA Unit # 4
	ORDER NO.	CGP10028C
NTPC ALSTOM Power Services Pvt. Ltd.	CONTRACTOR	ALSTOM K. K. NASL LTD. (Nominated Sub-Contractor in India)
	DOCUMENT	FINAL REPORT VOL - II (PIPING ASSESSMENT)

MAIN STEAM, CRH AND HPBP

PIPING MODEL

195

	CLIENT	J-Power (Electric Power Development Co. Ltd.)
	PROJECT	Turbine and System Assessment for NTPC-KORBA Unit # 4
	ORDER NO.	CGP10028C
	CONTRACTOR	ALSTOM K. K. NASL LTD. (Nominated Sub-Contractor in India)
	DOCUMENT	FINAL REPORT VOL - II (PIPING ASSESSMENT)

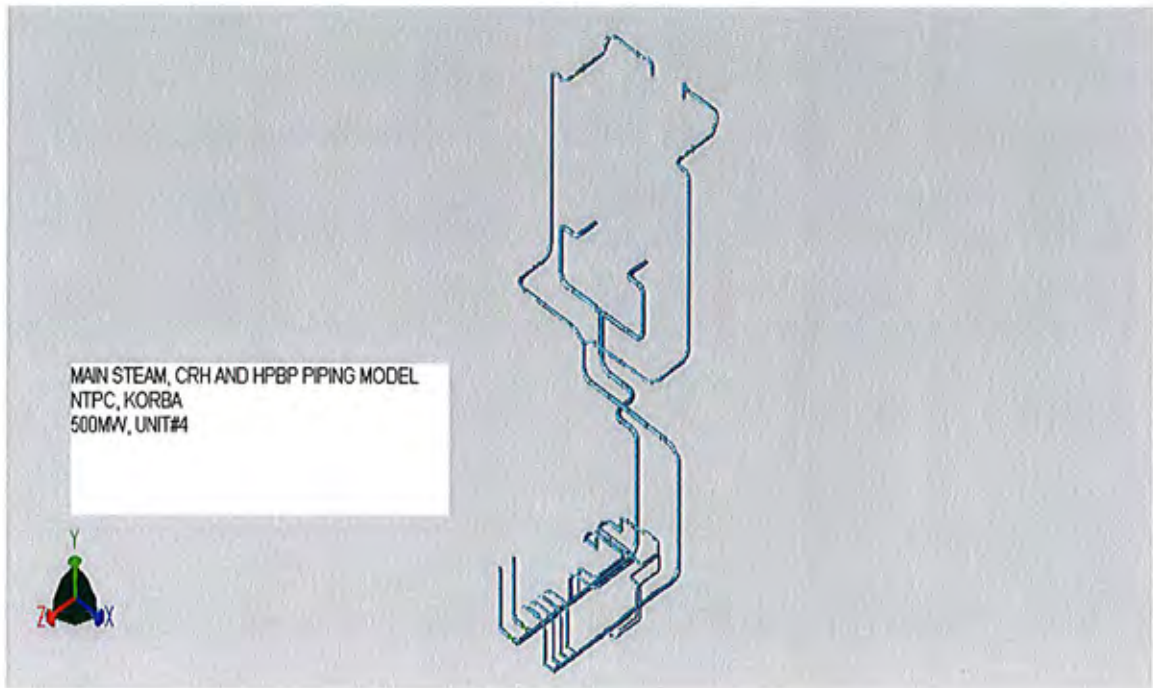

ALSTOM	CLIENT	J-Power (Electric Power Development Co. Ltd.)
	PROJECT	Turbine and System Assessment for NTPC-KORBA Unit # 4
	ORDER NO.	CGP10028C
NTPC ALSTOM Power Services Pvt. Ltd.	CONTRACTOR	ALSTOM K. K. NASL LTD. (Nominated Sub-Contractor in India)
	DOCUMENT	FINAL REPORT VOL - II (PIPING ASSESSMENT)

HRH AND LPBP PIPING SYSTEMS



HANGER LOAD AND STRESS ANALYSIS REPORT (ANNEXURE III)

ALSTOM	CLIENT	J-Power (Electric Power Development Co. Ltd.)
	PROJECT	Turbine and System Assessment for NTPC-KORBA Unit # 4
	ORDER NO.	CGP10028C
NTPC ALSTOM Power Services Pvt. Ltd.	CONTRACTOR	ALSTOM K. K. NASL LTD. (Nominated Sub-Contractor in India)
	DOCUMENT	FINAL REPORT VOL - II (PIPING ASSESSMENT)

HRH AND LPBP



PIPING MODEL

564

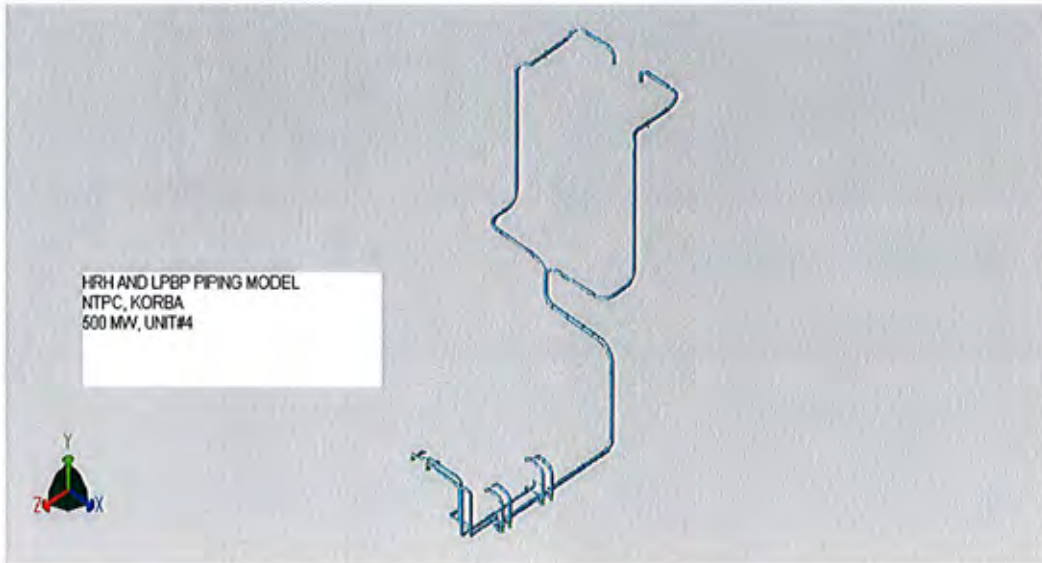
	CLIENT	J-Power (Electric Power Development Co. Ltd.)
	PROJECT	Turbine and System Assessment for NTPC-KORBA Unit # 4
	ORDER NO.	CGP10028C
	CONTRACTOR	ALSTOM K. K. NASL LTD. (Nominated Sub-Contractor in India)
	DOCUMENT	FINAL REPORT VOL - II (PIPING ASSESSMENT)





595

	CLIENT	J-Power (Electric Power Development Co. Ltd.)
	PROJECT	Turbine and System Assessment for NTPC-KORBA Unit # 4
	ORDER NO.	CGP10028C
	CONTRACTOR	ALSTOM K. K. NASL LTD. (Nominated Sub-Contractor in India)
	DOCUMENT	FINAL REPORT VOL - II (PIPING ASSESSMENT)

BFD PIPING



HANGER LOAD AND STRESS ANALYSIS REPORT (ANNEXURE IV)

	CLIENT	J-Power (Electric Power Development Co. Ltd.)
	PROJECT	Turbine and System Assessment for NTPC-KORBA Unit # 4
	ORDER NO.	CGP10028C
	CONTRACTOR	ALSTOM K. K. NASL LTD. (Nominated Sub-Contractor In India)
	DOCUMENT	FINAL REPORT VOL - II (PIPING ASSESSMENT)

BFD

PIPING MODEL

195

	CLIENT	J-Power (Electric Power Development Co. Ltd.)
	PROJECT	Turbine and System Assessment for NTPC-KORBA Unit # 4
	ORDER NO.	CGP10028C
	CONTRACTOR	ALSTOM K. K. NASL LTD. (Nominated Sub-Contractor in India)
	DOCUMENT	FINAL REPORT VOL - II (PIPING ASSESSMENT)

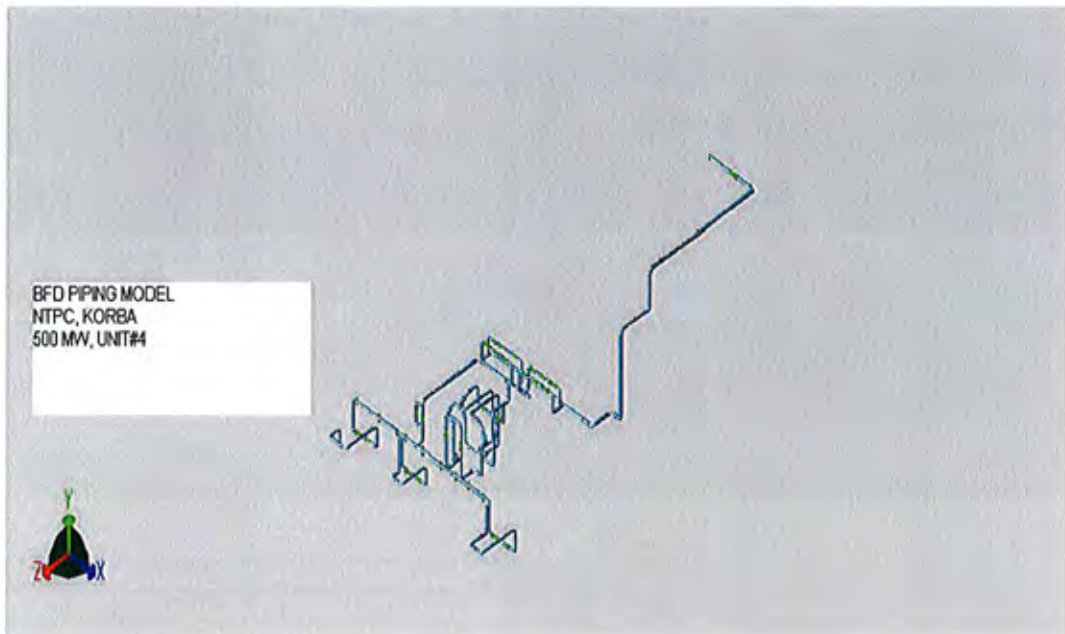

ALSTOM	CLIENT	J-Power (Electric Power Development Co. Ltd.)
	PROJECT	Turbine and System Assessment for NTPC-KORBA Unit # 4
	ORDER NO.	CGP10028C
NTPC ALSTOM Power Services Pvt. Ltd.	CONTRACTOR	ALSTOM K. K. NASL LTD. (Nominated Sub-Contractor in India)
	DOCUMENT	FINAL REPORT VOL - II (PIPING ASSESSMENT)

10.7.0 Stress Analysis & Remaining Life Calculation using ABAQUS/FESAFE

10.7.1 MS, CRH and HPBP

CAD Model Details



The CAD modeling of piping is carried out in CATIA V5 R18 Software. The snap shot of assembly and positions of the hangers are shown in Fig 10.1 and Fig 10.2. Table 10.1 gives list of drawings considered for the modeling of the main steamline. The pipes are modeled as line and the appropriate thickness and diameters are defined in the FE analysis. The hangers considered as springs.

Table 10-1: List of drawings.

DRAWINGS/DOCUMENTS LIST		
SR NO	DESCRIPTION	DRG/DOC NO.
PIPING		
MST & HPBP		
1	Main Steam Line from Boiler Stop Valve to Common Header (Left)	0-80-502-01223
2	Main Steam Line to High Pressure Bypass Valve-II	0-80-511-01227
3	High Pressure Bypass Valve I to Cold Reheat Line	0-80-528-01237
4	Main Steamline to High Pressure Bypass Valve-I	0-80-510-01226
5	MS from Strainer to Turbine Bottom Left	1-80-508-015-43
6	MS Header From HP Bypass Tap off to Strainer	MSE-1-80-505-1595/Bhel-1-88-505-1595
7	MS from Strainer to Turbine	PE-1-052-141-001
8	Main Steam Line up to Boiler Stop valve (Right)	0-80-501-01222
9	G Piping & Hanger(MS)	0-80-504-01225
10	Main Steam Line from Boiler Stop Valve to Common Header (Right)	0-80-503-01224
11	Main Steam Line up to Boiler Stop valve (Left)	0-80-500-01221
12	Main Steam Piping SH 1 of 2	TCE-790-ME-SK-37
13	Layout of MS HRH & LP Bypass Piping (BHEL Scope)	PE-1-052-141-001
CRH		
1	Cold Reheat From Common Header to Reheater (left)	0-80-526-01235

ALSTOM	CLIENT	J-Power (Electric Power Development Co. Ltd.)
	PROJECT	Turbine and System Assessment for NTPC-KORBA Unit # 4
	ORDER NO.	CGP10028C
NTPC ALSTOM Power Services Pvt. Ltd.	CONTRACTOR	ALSTOM K. K. NASL LTD. (Nominated Sub-Contractor in India)
	DOCUMENT	FINAL REPORT VOL - II (PIPING ASSESSMENT)

2	Cold Reheat From Common Header to Reheater (left)	0-80-526-01235
3	Cold Reheat Beyond High Pressure By pass Tap-off	0-80-525-01234
4	Cold Reheat From Common Header to Reheater (right)	0-80-527-01236
5	Cold Reheat Piping	TCE-790-ME-SK-38
6	Cold Reheat From Turbine Out Let (Left)	1-80-522-01786
7	Cold Reheat From Turbine Out Let (Right)	1-80-523-01787
8	Cold Reheat between Turbine and HP Bypass Tap off	1-80-524-01788
9	Cold Reheat from Common Header to reheater Right	0-80-527-01236

	CLIENT	J-Power (Electric Power Development Co. Ltd.)
	PROJECT	Turbine and System Assessment for NTPC-KORBA Unit # 4
	ORDER NO.	CGP10028C
	CONTRACTOR	ALSTOM K. K. NASL LTD. (Nominated Sub-Contractor in India)
	DOCUMENT	FINAL REPORT VOL - II (PIPING ASSESSMENT)

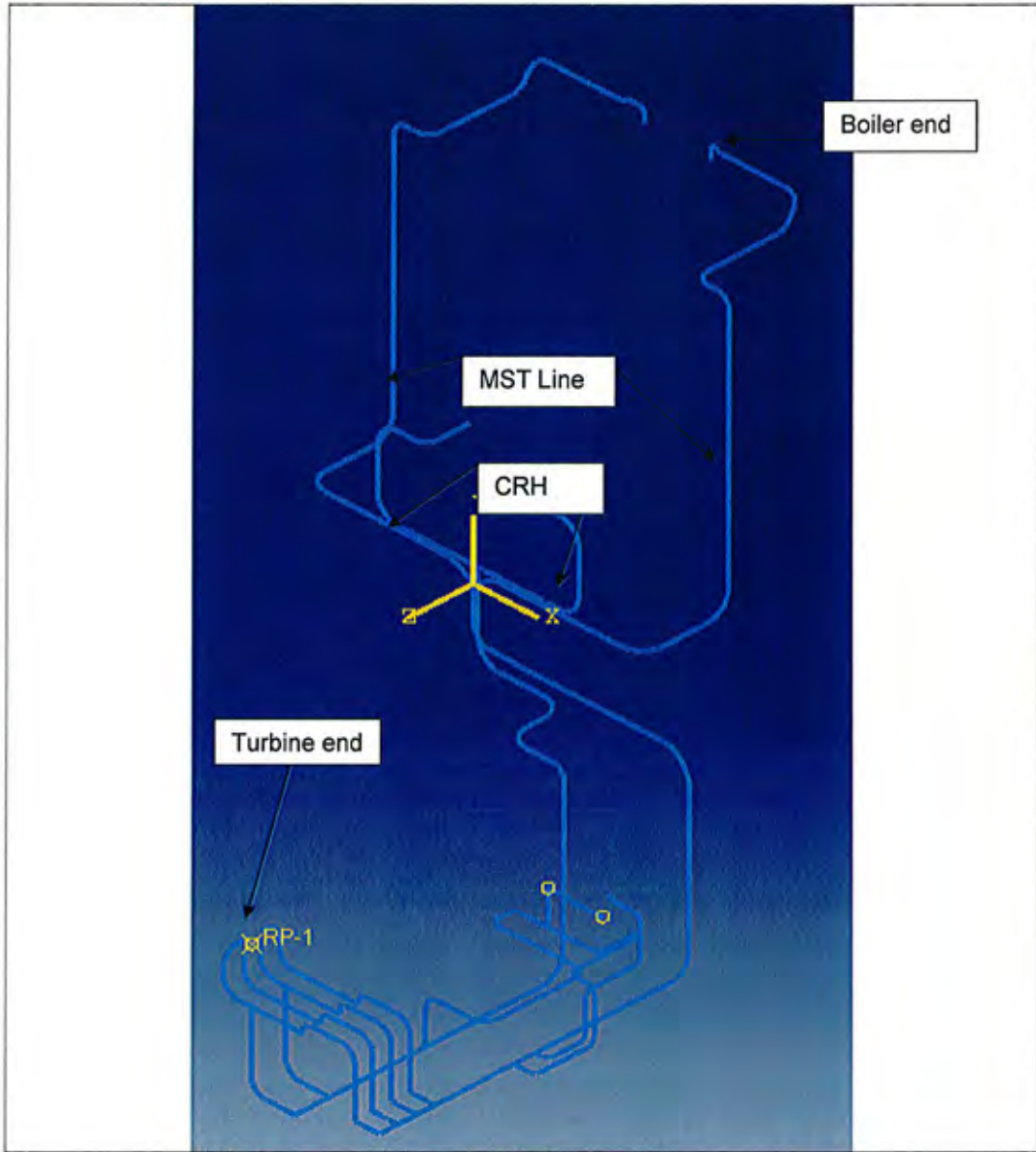

Figure 10:1: CAD model of MST-CRH-HPBP

571



	CLIENT	J-Power (Electric Power Development Co. Ltd.)
	PROJECT	Turbine and System Assessment for NTPC-KORBA Unit # 4
	ORDER NO.	CGP10028C
	CONTRACTOR	ALSTOM K. K. NASL LTD. (Nominated Sub-Contractor in India)
	DOCUMENT	FINAL REPORT VOL - II (PIPING ASSESSMENT)

Table 10-2: spring stiffness for MST

Sl no.	Hanger #	Operating (cold)	Preset - cold (mm)	Preset - Hot (mm)	Spring rate X 1.0e3 (KN/mm)
1	MST-001			-	
2	MST-002			-	
3	MST-003			-	
4	MST-004			-	
5	MST-005 TVH	111.1186	109	99	11.1119
6	MST-006 DYR	266.52			
7	MST-007 TCH	126.68	0	79	1.6035
8	MST-008 TCH	192.66	0	161	1.1966
9	MST-009 TCH	83.8	0	228	0.3675
10	MST-010 SCH	79.54	0	187	0.4253
11	MST-011 SCH	64.44	0	150	0.4296
12	MST-012 SCH	78.49	0	142	0.5527
13	MST-013 TCH	166.42	0	181	0.9194
14	MST-014 SCH	100.74	0	197	0.5114
15	MST-015 SCH	103.45	0	131	0.7897
16	MST-016 SCH	101.54	0	55	1.8462
17	MST-017 SCH	106.51	80	53	3.9448
18	MST-018 SCH	113.89	160	51	1.0449
19	MST-019 TCH	165.22	250	130	1.3768
20	MST-020			-	
21	MST-021			-	
22	MST-022			-	
23	MST-023			-	
24	MST-024			-	
25	MST-025			-	
26	MST-026			-	
27	MST-027			-	
28	MST-028			-	
29	MST-029			-	

592

ALSTOM	CLIENT	J-Power (Electric Power Development Co. Ltd.)
	PROJECT	Turbine and System Assessment for NTPC-KORBA Unit # 4
	ORDER NO.	CGP10028C
NTPC ALSTOM Power Services Pvt. Ltd.	CONTRACTOR	ALSTOM K. K. NASL LTD. (Nominated Sub-Contractor In India)
	DOCUMENT	FINAL REPORT VOL - II (PIPING ASSESSMENT)

Sl no.	Hanger #	Operating (cold)	Preset - cold (mm)	Preset - Hot (mm)	Spring rate X 1.0e3 (KN/mm)
30	MST-030			-	
31	MST-031			-	
32	MST-032			-	
33	MST-033			-	
34	MST-034			-	
35	MST-035			-	
36	MST-036			-	
37	MST-037			-	
38	MST-038			-	
39	MST-039			-	
40	MST-040			-	
41	MST-041			-	
42	MST-042			-	

Table 10-3: spring stiffness for CRH



Sl no.	Hanger #	Operating (cold)	Preset - cold (mm)	Preset - Hot (mm)	Spring rate X 1.0e3 (KN/mm)
1	CRH-001 SCH	23.848	0	127	0.1878
2	CRH-002 SCH	22.98	0	127	0.1809
3	CRH-003 TCH	67	0	142	0.4718
4	CRH-004 SCH	31.19	0	164	0.1902
5	CRH-005 SCH	30.15	0	156	0.1933
6	CRH-006 TCH	73.24	0	170	0.4308
7	CRH-007 SCH	30.53	0	115	0.2655
8	CRH-008 TCH	40.58	50	87	1.0968
9	CRH-009 TVH	56.64	112	124	4.7200
10	CRH-010 TVH	47.88	80	117	1.2941
11	CRH-011 TCH	67.24	0	66	1.0188
12	CRH-012 TCH	18.27	0	99	0.1845
13	CRH-013 SCH	40.12	0	88	0.4559

593

ALSTOM	CLIENT	J-Power (Electric Power Development Co. Ltd.)
	PROJECT	Turbine and System Assessment for NTPC-KORBA Unit # 4
	ORDER NO.	CGP10028C
NTPC ALSTOM Power Services Pvt. Ltd.	CONTRACTOR	ALSTOM K. K. NASL LTD. (Nominated Sub-Contractor in India)
	DOCUMENT	FINAL REPORT VOL - II (PIPING ASSESSMENT)

SI no.	Hanger #	Operating (cold)	Preset - cold (mm)	Preset - Hot (mm)	Spring rate X 1.0e3 (KN/mm)
14	CRH-014 SCH	49.09	0	76	0.6459
15	CRH-015 SCH	35.2	0	64	0.5500
16	CRH-016 SCH	35.29	0	54	0.6535
17	CRH-017 TCH	61.88	0	47	1.3166
18	CRH-018 SVH	36.71	84	136	0.7060
19	CRH-019 SVH	37.57	88	142	0.6957
20	CRH-020 TVH	55.86	109.5	130.5	2.6600
21	CRH-021 SVH	53.76	102	154	1.0338
22	CRH-022 TVH	52.74	98	119	2.5114
23	CRH-023 SCH	23.995	0	127	0.1889
24	CRH-024 SCH	22.9	0	125	0.1832
25	CRH-025 TCH	65.1	0	132	0.4932
26	CRH-026 SCH	31.17	0	166	0.1878
27	CRH-027 SCH	29.41	0	169	0.1740
28	CRH-028 SCH	29.06	0	179	0.1623
29	CRH-029 SCH	38.43	0	75	0.5124
30	CRH-030 SAR	127.53	-	-	-
31	CRH-031 SAR	127.53	-	-	-
32	CRH-032 DXR	48.3	-	-	-
33	CRH-033 DYR	-	-	-	-
34	CRH-034 DZR	163.5	-	-	-
35	CRH-041 SCH	11.485	0	99	0.1160
36	CRH-042 TCH	13.406	0	75	0.1787
37	CRH-043 SCH	4.325	0	69	0.0627
38	CRH-044 SCH	7.479	0	50	0.1496
39	CRH-045 SVH	6.565	130	150	0.3283
40	CRH-046 SVH	3.759	126	141	0.2506
41	CRH-047 SVH	3.239	94	102	0.4049
42	CRH-048 TVH	7.028	18	16	3.5140
43	CRH-049 SVH	3.765	63	47	0.2353

574

	CLIENT	J-Power (Electric Power Development Co. Ltd.)
	PROJECT	Turbine and System Assessment for NTPC-KORBA Unit # 4
	ORDER NO.	CGP10028C
 Power Services Pvt. Ltd.	CONTRACTOR	ALSTOM K. K. NASL LTD. (Nominated Sub-Contractor in India)
	DOCUMENT	FINAL REPORT VOL - II (PIPING ASSESSMENT)

Sl no.	Hanger #	Operating (cold)	Preset - cold (mm)	Preset - Hot (mm)	Spring rate X 1.0e3 (KN/mm)
44	CRH-050 SVH	3.189	91	110	0.1678
45	CRH-051 TVH	6.852	53	40	0.5271
46	CRH-052 SVH	3.65	60	53	0.5214



Table 10-4: spring stiffness for HPBP

Sl no.	Hanger #	Operating (cold)	Preset - cold (mm)	Preset - Hot (mm)	Spring rate X 1.0e3 (KN/mm)
1	HPB 001 SVH	25.81	92	102	2.5810
2	HPB 002 SVH	17.7	8	7	17.7000
3	HPB 003 TCH	37.04	100	81	1.9495
4	HPB 004 SVH	27.8	54	48	4.6333
5	HPB 005 TVH	16.02	70	58	1.3350
6	HPB 006 SVH	13.86	49	31	0.7700
7	HPB 007 SVH	28.97	117	108	3.2189
8	HPB 008 SVH	11.91	39	46	1.7014
9	HPB 009 TVH	41.04	54	30	1.7100
10	HPB 010 TCH	27.04	110	53	0.4744
11	HPB 011 SCH	21.43	110	51	0.3632
12	HPB 012 SVH	22.21	67	41	0.8542
13	HPB 013 SVH	27.85	109	97	2.3208
14	HPB 014 SVH	14.88	120	127	2.1257
15	HPB 015 SVH	22.59	70	76	3.7650
16	HPB 016 SVH	16.47	59	69	1.6470
17	HPB 017 SCH	18.15	0	58	0.3129
18	HPB 018 TCH	28.34	50	63	2.1800
19	HPB 019 SVH	11.76	57	68	1.0691
20	HPB 020 SVH	20.85	56	63	2.9786
21	HPB 021 SVH	24.15	81	84	8.0500
22	HPB 022 SVH	14.89	62	76	1.0636

575



ALSTOM	CLIENT	J-Power (Electric Power Development Co. Ltd.)
	PROJECT	Turbine and System Assessment for NTPC-KORBA Unit # 4
	ORDER NO.	CGP10028C
NTPC ALSTOM Power Services Pvt. Ltd.	CONTRACTOR	ALSTOM K. K. NASL LTD. (Nominated Sub-Contractor in India)
	DOCUMENT	FINAL REPORT VOL - II (PIPING ASSESSMENT)

Sl no.	Hanger #	Operating (cold)	Preset - cold (mm)	Preset – Hot (mm)	Spring rate X 1.0e3 (KN/mm)
23	HPB 023 SVH	17.04	28	55	0.6311
24	HPB 024 TCH	36.23	0	62	0.5844

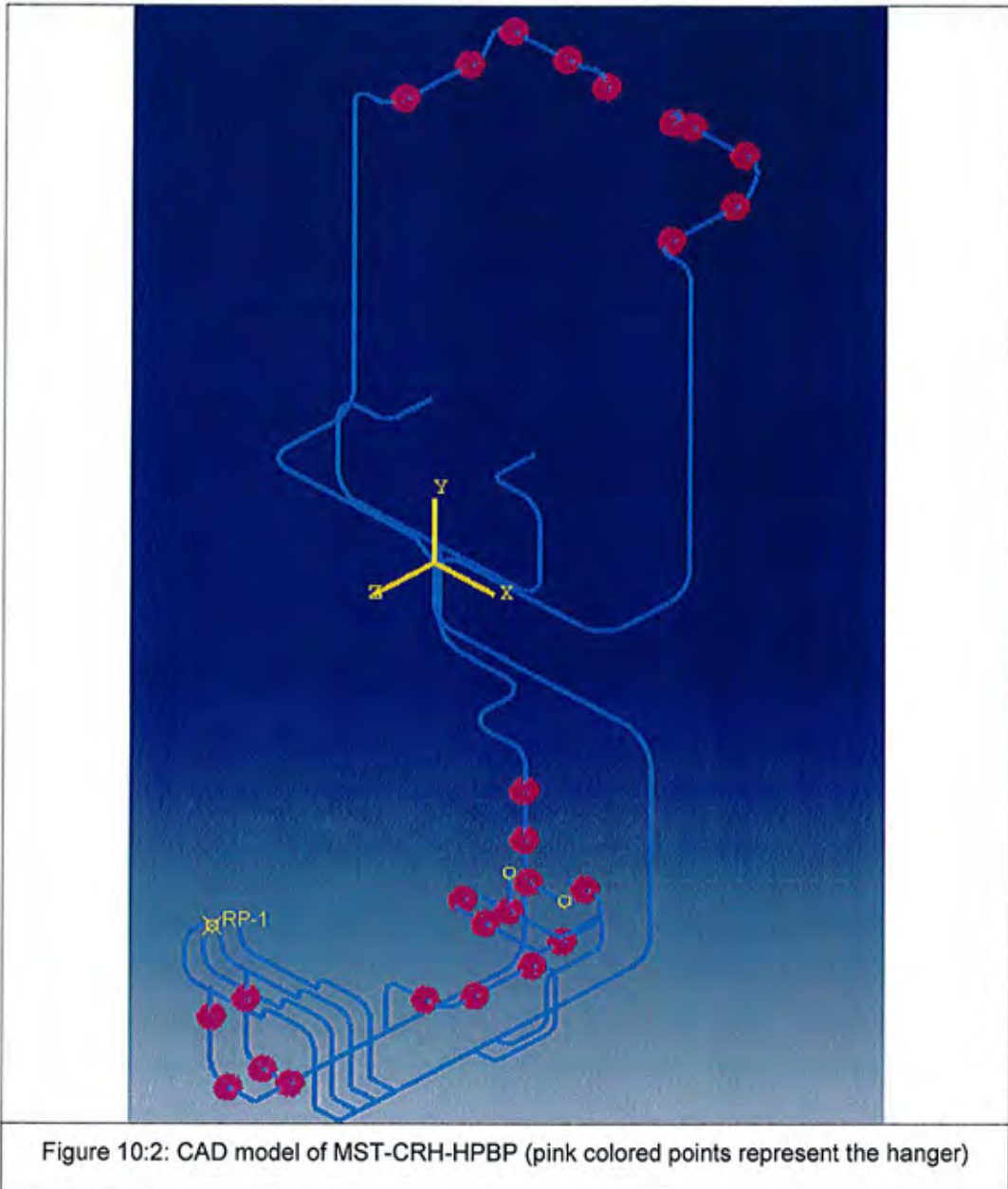
	CLIENT	J-Power (Electric Power Development Co. Ltd.)
	PROJECT	Turbine and System Assessment for NTPC-KORBA Unit # 4
	ORDER NO.	CGP10028C
	CONTRACTOR	ALSTOM K. K. NASL LTD. (Nominated Sub-Contractor in India)
	DOCUMENT	FINAL REPORT VOL - II (PIPING ASSESSMENT)



545

	CLIENT	J-Power (Electric Power Development Co. Ltd.)
	PROJECT	Turbine and System Assessment for NTPC-KORBA Unit # 4
	ORDER NO.	CGP10028C
 Power Services Pvt. Ltd.	CONTRACTOR	ALSTOM K. K. NASL LTD. (Nominated Sub-Contractor in India)
	DOCUMENT	FINAL REPORT VOL - II (PIPING ASSESSMENT)

Mesh Model Details

The meshing of the piping assembly is carried out in ABAQUS software. Pipe elements are used in the analysis to capture the effect of internal pressure. PIPE31: A 2-node linear pipe elements are used in the analysis. Total number of elements in the MS, CRH, HPBP piping assembly is 6944. Maximum element length is 100mm.

FE Analysis and Results



The piping assembly analysis is carried out for thermal and mechanical loads. The model is meshed with 2 noded pipe elements. The elastic and plastic effects are taken into account.

The loading, boundary conditions, thermo-mechanical loading and results for each case is discussed in the following pages.

Piping Assembly - Mechanical & Thermal Loading



The piping assembly is analysed for gravity and thermal loading conditions. Also internal pressure of 18.407MPa (184.07 Kg/cm²) on MST, 5.54 MPa on CRH, HPBP, pipeline is applied. The hangers are modeled as spring elements with spring rate. Some of the regions are constrained in a particular direction as given in the drawing

598

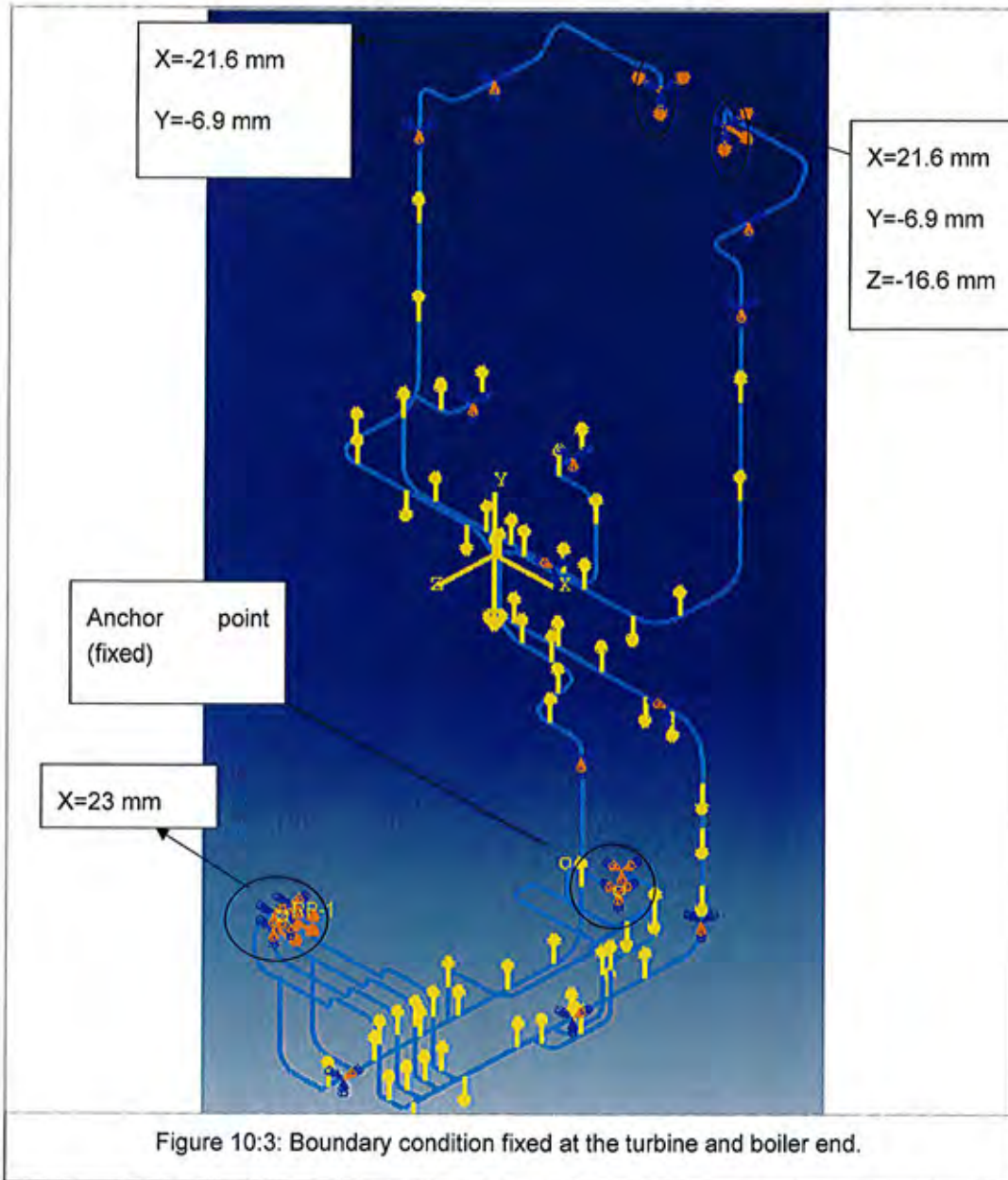
	CLIENT	J-Power (Electric Power Development Co. Ltd.)
	PROJECT	Turbine and System Assessment for NTPC-KORBA Unit # 4
	ORDER NO.	CGP10028C
	CONTRACTOR	ALSTOM K. K. NASL LTD. (Nominated Sub-Contractor in India)
	DOCUMENT	FINAL REPORT VOL - II (PIPING ASSESSMENT)



579

	CLIENT	J-Power (Electric Power Development Co. Ltd.)
	PROJECT	Turbine and System Assessment for NTPC-KORBA Unit # 4
	ORDER NO.	CGP10028C
 Power Services Pvt. Ltd.	CONTRACTOR	ALSTOM K. K. NASL LTD. (Nominated Sub-Contractor in India)
	DOCUMENT	FINAL REPORT VOL - II (PIPING ASSESSMENT)

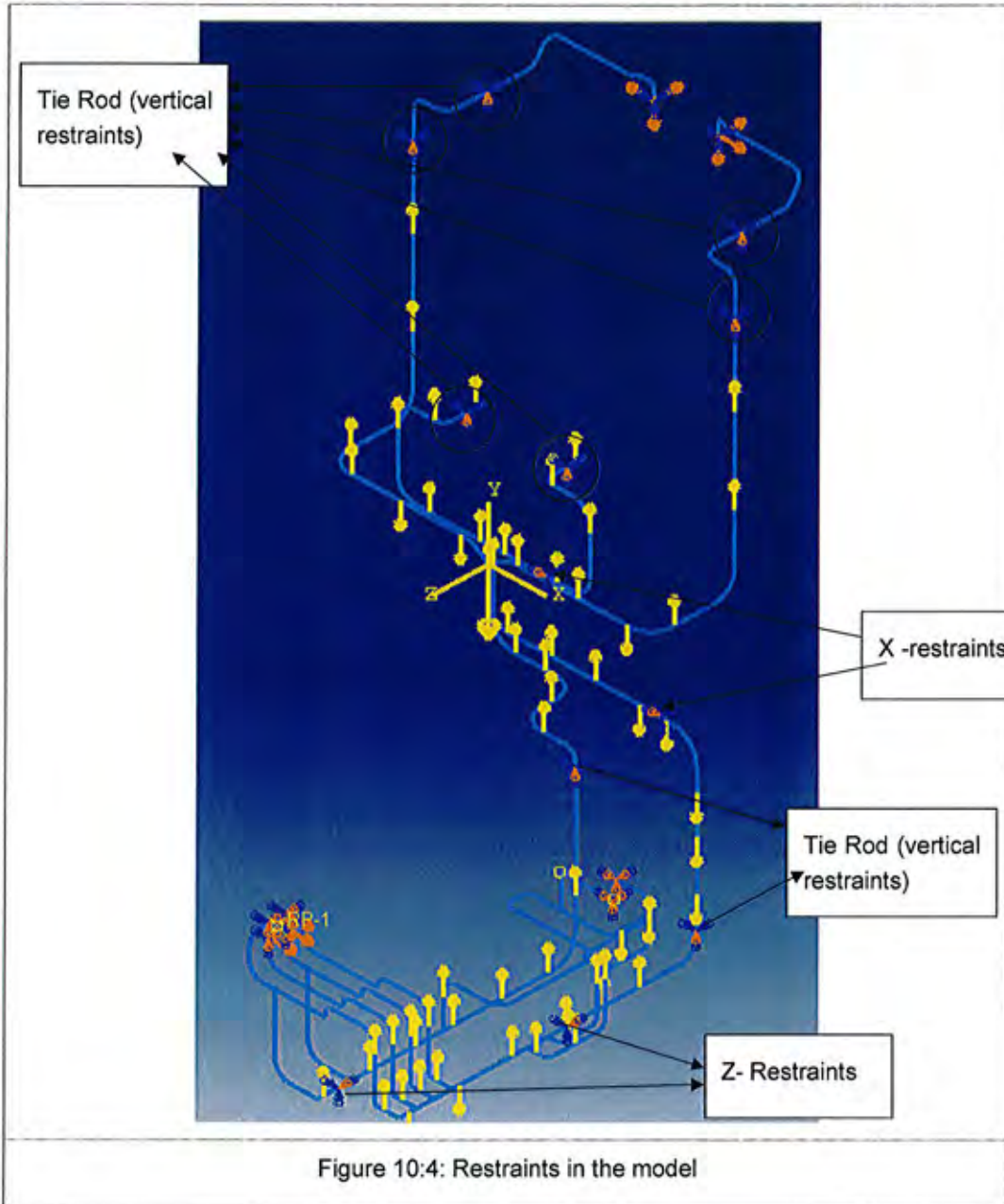

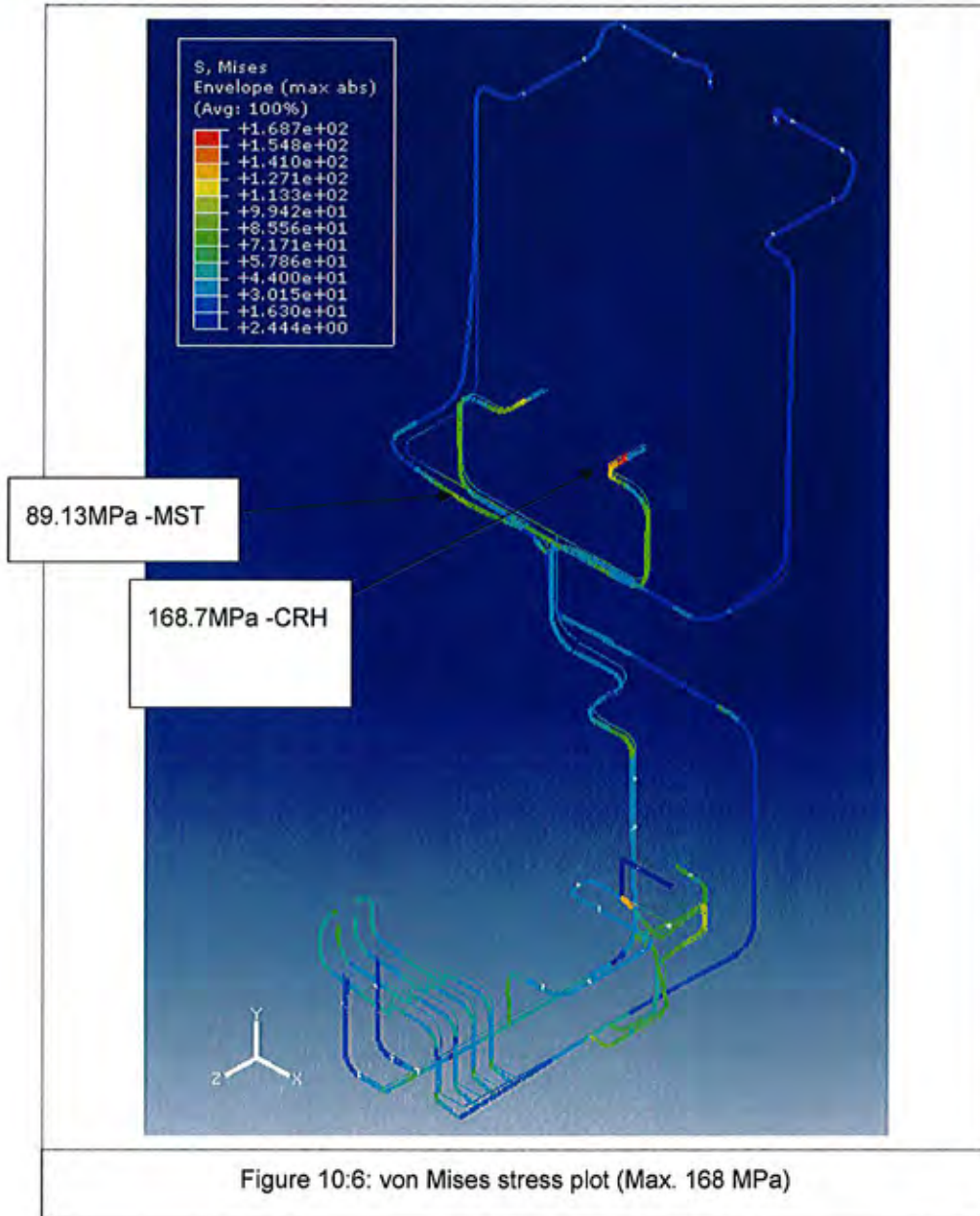

Figure 10:4: Restraints in the model

580

	CLIENT	J-Power (Electric Power Development Co. Ltd.)
	PROJECT	Turbine and System Assessment for NTPC-KORBA Unit # 4
	ORDER NO.	CGP10028C
	CONTRACTOR	ALSTOM K. K. NASL LTD. (Nominated Sub-Contractor in India)
	DOCUMENT	FINAL REPORT VOL - II (PIPING ASSESSMENT)



FE analysis Results



185

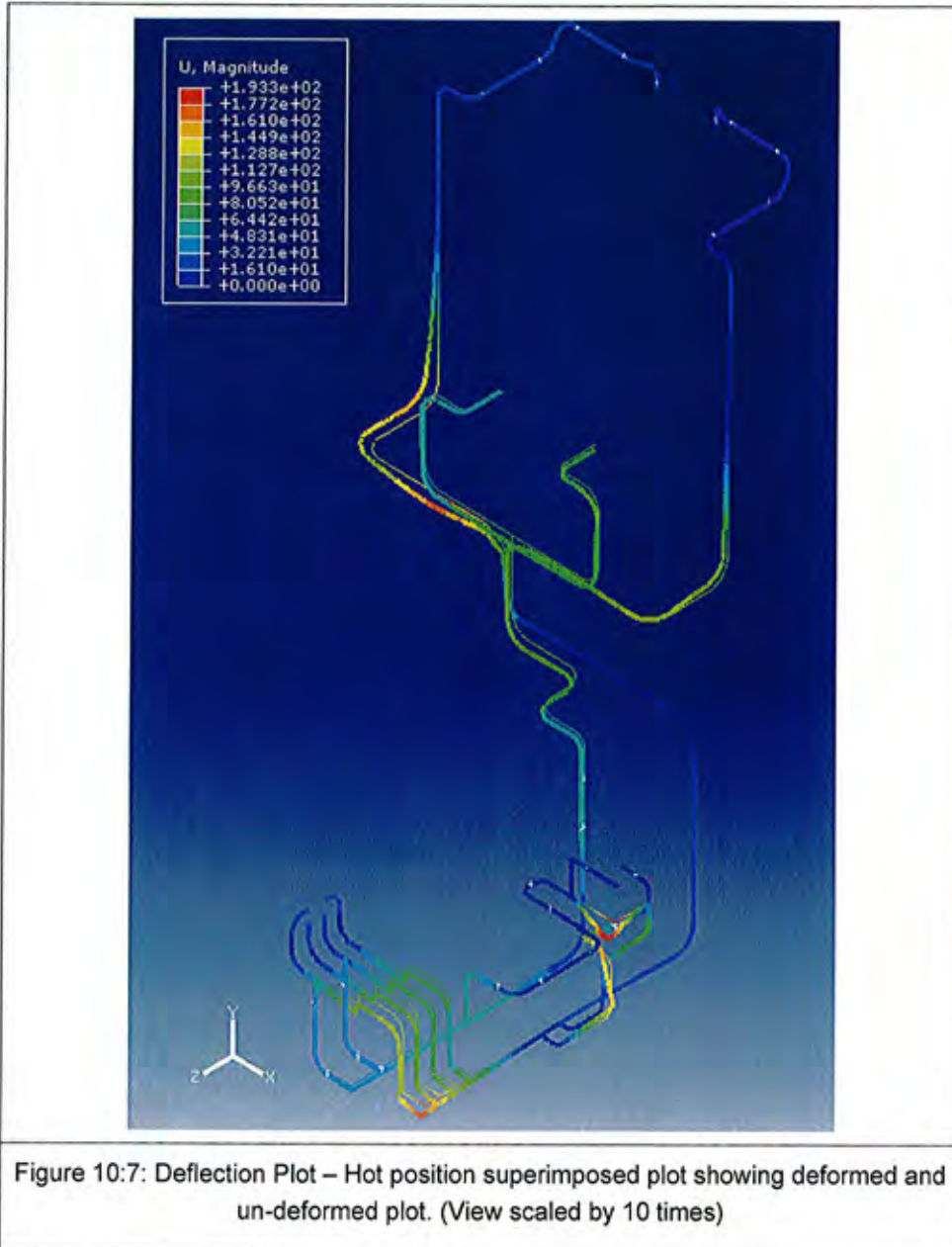

CLIENT	J-Power (Electric Power Development Co. Ltd.)
PROJECT	Turbine and System Assessment for NTPC-KORBA Unit # 4
ORDER NO.	CGP10028C
CONTRACTOR	ALSTOM K. K. NASL LTD. (Nominated Sub-Contractor in India)
DOCUMENT	FINAL REPORT VOL - II (PIPING ASSESSMENT)

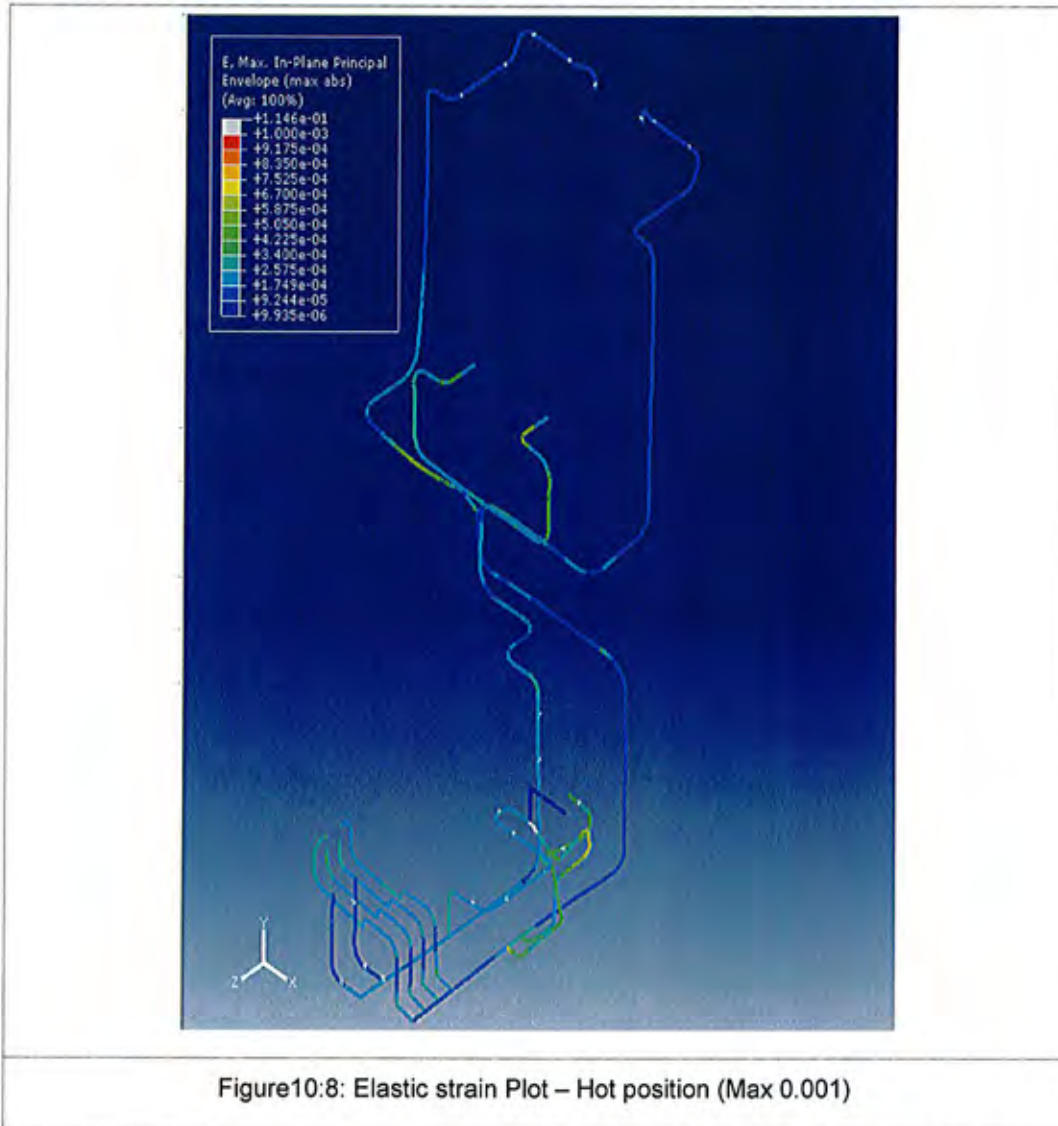

	CLIENT	J-Power (Electric Power Development Co. Ltd.)
	PROJECT	Turbine and System Assessment for NTPC-KORBA Unit # 4
	ORDER NO.	CGP10028C
 Power Services Pvt. Ltd.	CONTRACTOR	ALSTOM K. K. NASL LTD. (Nominated Sub-Contractor in India)
	DOCUMENT	FINAL REPORT VOL - II (PIPING ASSESSMENT)



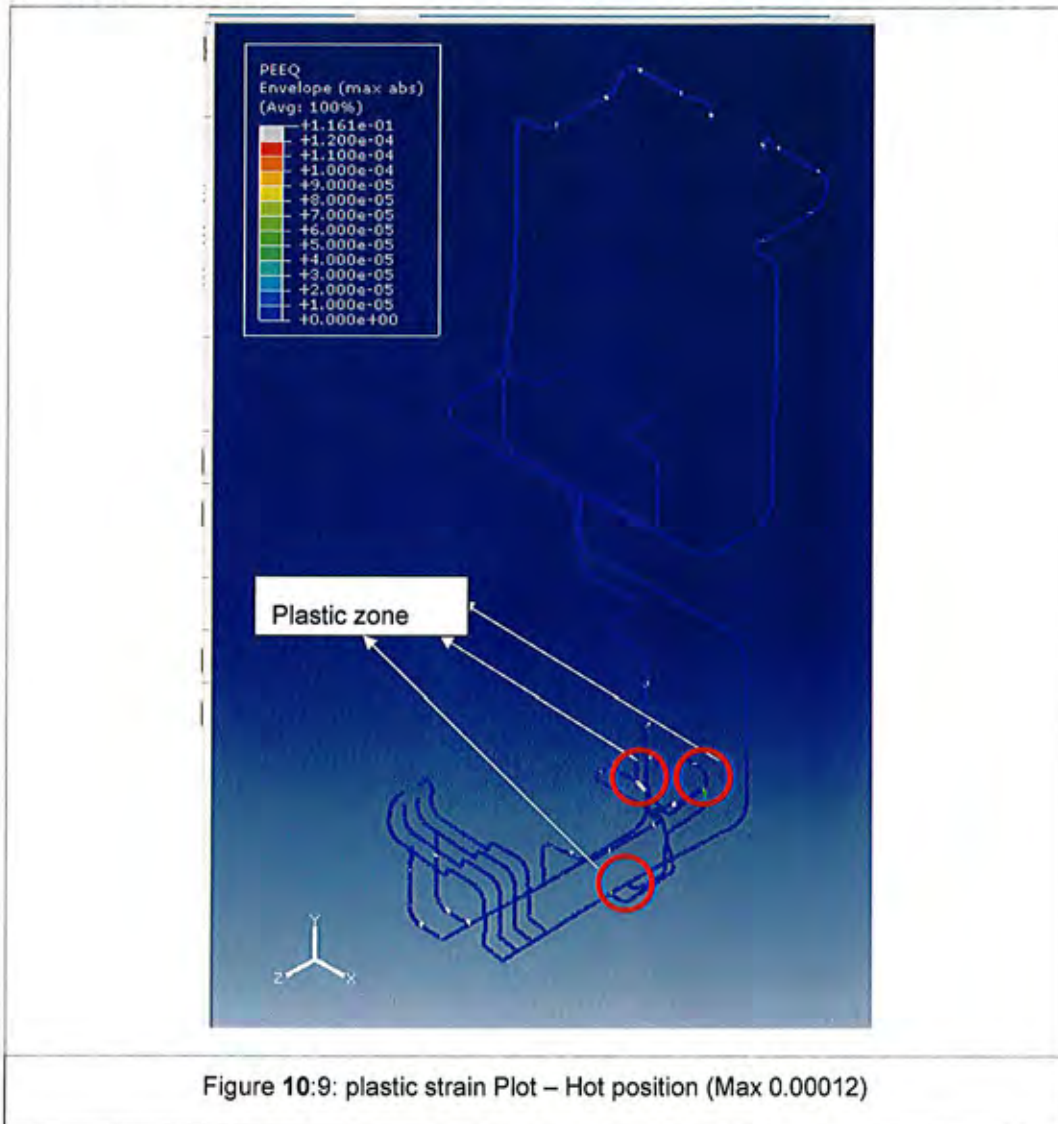

583

	CLIENT	J-Power (Electric Power Development Co. Ltd.)
	PROJECT	Turbine and System Assessment for NTPC-KORBA Unit # 4
	ORDER NO.	CGP10028C
	CONTRACTOR	ALSTOM K. K. NASL LTD. (Nominated Sub-Contractor in India)
	DOCUMENT	FINAL REPORT VOL - II (PIPING ASSESSMENT)



A total of 0.00112 strain will occur.

504

	CLIENT	J-Power (Electric Power Development Co. Ltd.)
	PROJECT	Turbine and System Assessment for NTPC-KORBA Unit # 4
	ORDER NO.	CGP10028C
 Power Services Pvt. Ltd.	CONTRACTOR	ALSTOM K. K. NASL LTD. (Nominated Sub-Contractor in India)
	DOCUMENT	FINAL REPORT VOL - II (PIPING ASSESSMENT)

Piping assembly creep analysis

Creep analysis is carried out considering the operating load for a period of 25 years and predicted the amount of permanent plastic deformation. Figure 10.10 shows the creep strain and stress

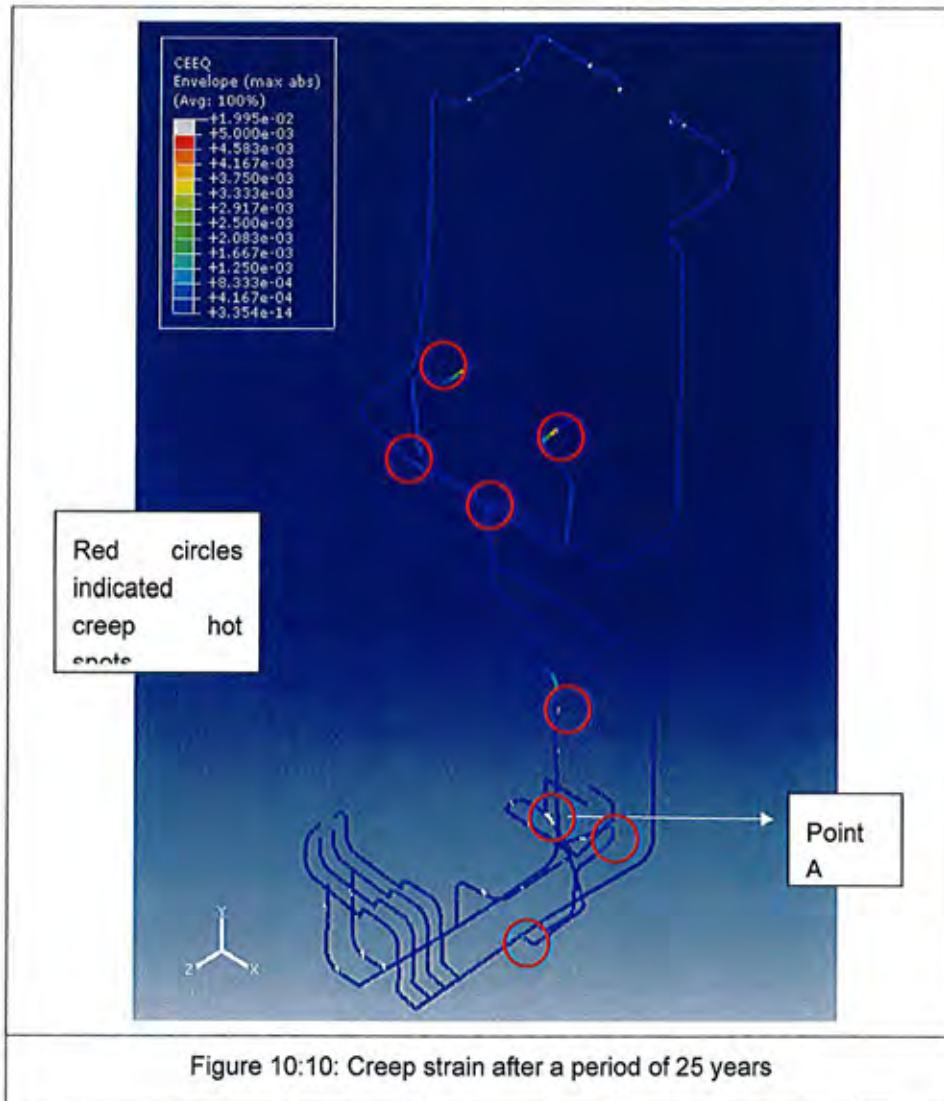

585

 NTPC ALSTOM Power Services Pvt. Ltd.	CLIENT	J-Power (Electric Power Development Co. Ltd.)
	PROJECT	Turbine and System Assessment for NTPC-KORBA Unit # 4
	ORDER NO.	CGP10028C
	CONTRACTOR	ALSTOM K. K. NASL LTD. (Nominated Sub-Contractor in India)
	DOCUMENT	FINAL REPORT VOL - II (PIPING ASSESSMENT)

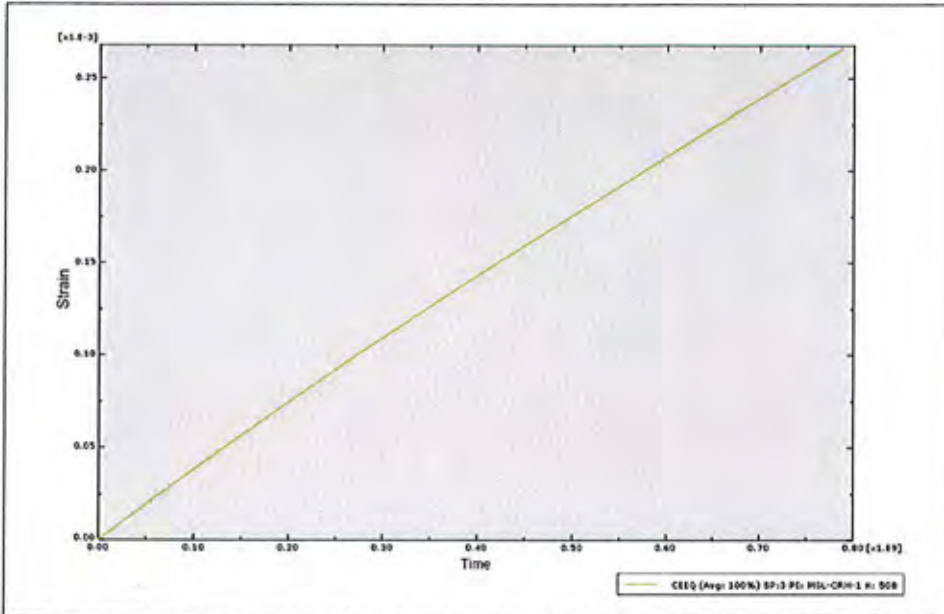

Figure 10:11: Creep strain accumulated over a period of 25 years (point A indicated in figure 10.10)

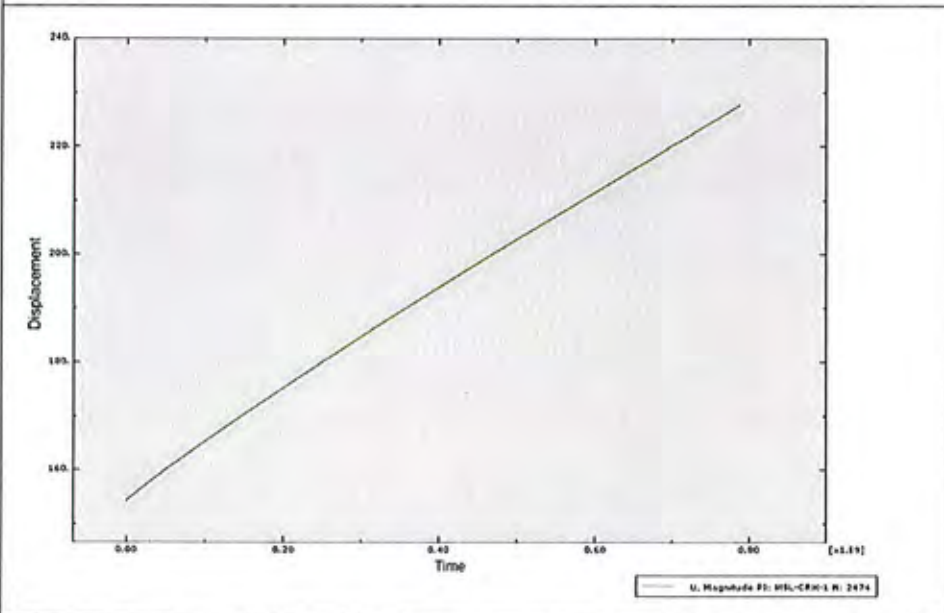



Figure 10:12: Permanent deformation occurring due to creep after 25 years of operation (Point A) ~ 80 mm deformation

	CLIENT	J-Power (Electric Power Development Co. Ltd.)
	PROJECT	Turbine and System Assessment for NTPC-KORBA Unit # 4
	ORDER NO.	CGP10028C
	CONTRACTOR	ALSTOM K. K. NASL LTD. (Nominated Sub-Contractor in India)
	DOCUMENT	FINAL REPORT VOL - II (PIPING ASSESSMENT)

Reaction force after creep deformation

Reaction forces at the fixed locations are listed table 10.5. Figure 10.13 shows the list of nodes and node number.

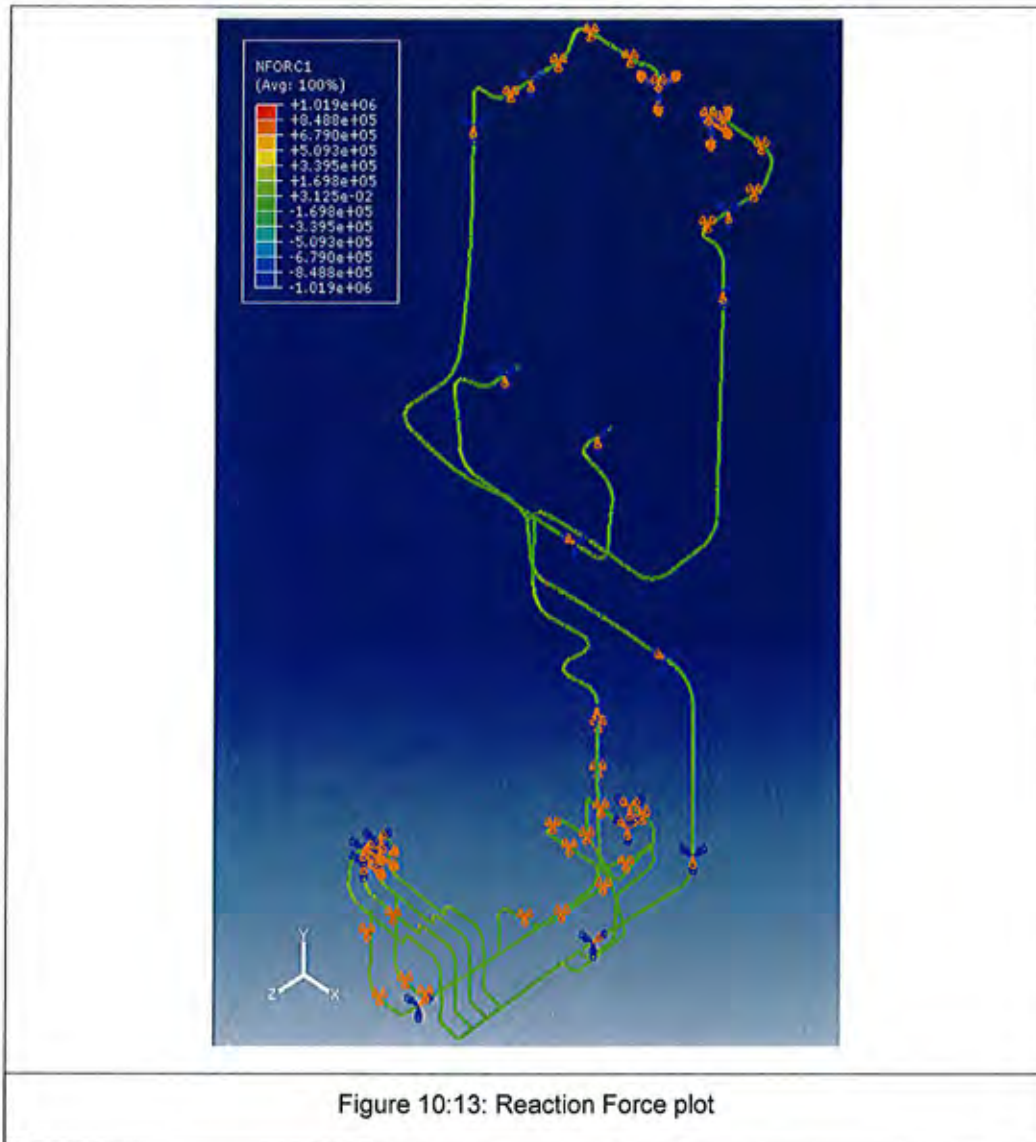

Figure 10:13: Reaction Force plot



684

ALSTOM	CLIENT	J-Power (Electric Power Development Co. Ltd.)
	PROJECT	Turbine and System Assessment for NTPC-KORBA Unit # 4
NTPC ALSTOM Power Services Pvt. Ltd.	ORDER NO.	CGP10028C
	CONTRACTOR	ALSTOM K. K. NASL LTD. (Nominated Sub-Contractor In India)
	DOCUMENT	FINAL REPORT VOL - II (PIPING ASSESSMENT)

Table 10-5: Reaction force acting on the hanger as after 25 years of operation

	Hanger Number	Node No	Reaction Force X	Reaction force Y	Reaction force Z
1	CRH009	11	-	20.1115	-
2	CRH010	12	-	24.0263	-
3	CRH018	22	-	5.83E+04	-
4	CRH019	23	-	5.66E+04	-
5	CRH020	26	-	5.55E+04	-
6	CRH021	24	-	9.35E+04	-
7	CRH022	25	-	8.05E+04	-
8	CRH030	235	-	3.48E+05	-
9	CRH031	232	-	3.49E+05	-
10	CRH032	192	1.30E+03	-	-
11	CRH034	52	-	-	1.31E+03
12	HPB004	18	-	-7.40E+03	-
13	HPB006	17	-	2.67E+04	-
14	HPB007	13	-	1.49E+04	-
15	HPB012	14	-	1.90E+04	-
16	HPB019	15	-	1.22E+04	-
17	HPB020	16	-	1.62E+04	-
18	HPB021	19	-	1.02E+04	-
19	HPB022	20	-	2.03E+04	-
20	HPB023	21	-	3.83E+04	-
21	MST001	2	-	2.45E+04	-
22	MST002	3	-	4.39E+04	-
23	MST003	4	-	1.84E+04	-
24	MST004	5	-	1.18E+04	-
25	MST004	268	-	3.69E+04	-
26	MST006	81	-	5.20E+05	-
27	MST006	250	-	-5.42E+04	-
28	MST032	6	-	3.25E+04	-
29	MST033	7	-	3.16E+04	-
30	MST034	8	-	2.86E+04	-
31	MST035	9	-	7.30E+03	-
32	MST035	163	1.49E+03	-1.37E+03	256.715
33	MST037	249	-	-5.16E+04	-
34	MST044	10	-	3.66E+04	-
35	MST045	27	-	3.66E+04	-
36	MST046	133	1.23E+04	-	-
37	MST047	85	-	8.10E+05	-
38	MST049	56	-	-	5.01E+03

335

 	CLIENT	J-Power (Electric Power Development Co. Ltd.)
	PROJECT	Turbine and System Assessment for NTPC-KORBA Unit # 4
	ORDER NO.	CGP10028C
	CONTRACTOR	ALSTOM K. K. NASL LTD. (Nominated Sub-Contractor in India)
	DOCUMENT	FINAL REPORT VOL - II (PIPING ASSESSMENT)

Displacement of hangers

Following figure shows the displacement of hangers over a period of 25 years. Figure 10.14 shows that most of hangers are moved by 10 to 15 mm but a 6 of them have moved more than 60 mm. Following Table 10.7 shows the movement of the hanger after 25 years.

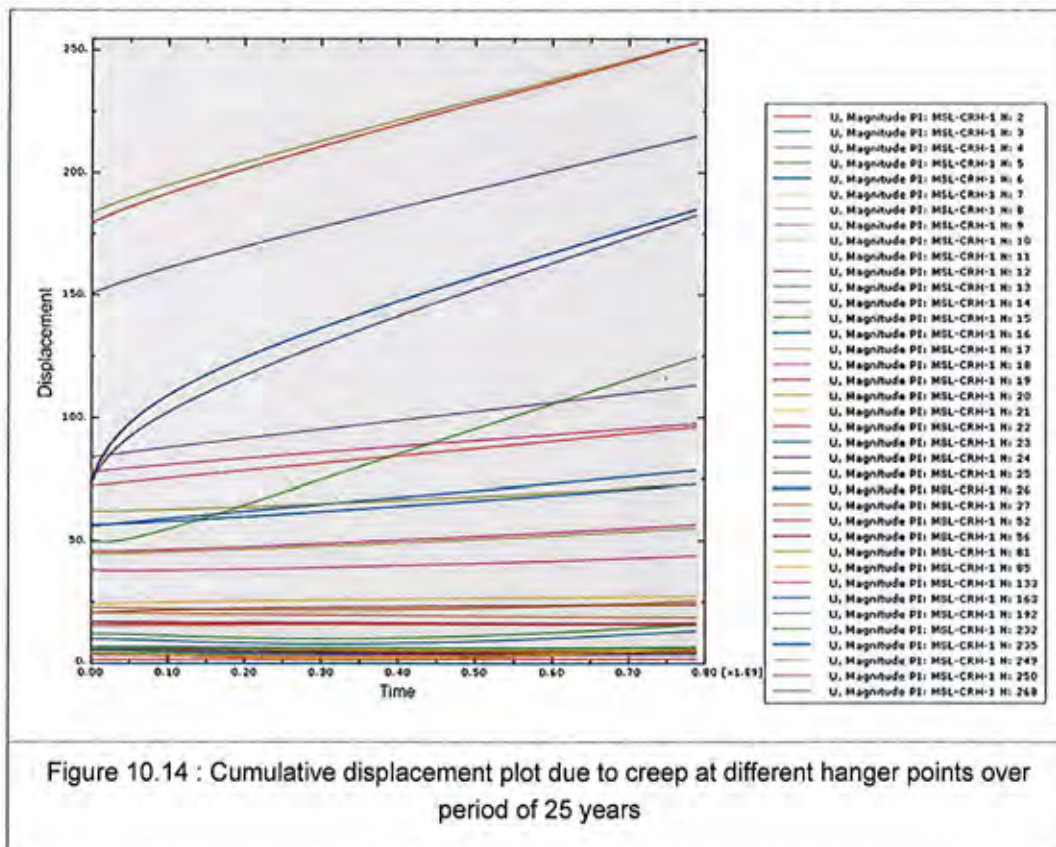

685





	CLIENT	J-Power (Electric Power Development Co. Ltd.)
	PROJECT	Turbine and System Assessment for NTPC-KORBA Unit # 4
	ORDER NO.	CGP10028C
 Power Services Pvt. Ltd.	CONTRACTOR	ALSTOM K. K. NASL LTD. (Nominated Sub-Contractor in India)
	DOCUMENT	FINAL REPORT VOL - II (PIPING ASSESSMENT)

Table 10-7: Hanger travel after 25 years of operation

	Hanger Number	Node No	0 year	25 years	Travel
1	CRH009	11	6.56	5.55	1.01
2	CRH010	12	179	253	74
3	CRH018	22	72.3	96.31	24.01
4	CRH019	23	9.8	13.2	3.4
5	CRH020	26	56.73	77.94	21.21
6	CRH021	24	83.88	113.18	29.3
7	CRH022	25	11.9	15.79	3.89
8	CRH030	235	73.4	184.9	111.5
9	CRH031	232	50.72	124.4	73.68
10	CRH032	192	73.4	182	108.6
11	CRH034	52	45.95	56.65	10.7
12	HPB004	18	38.42	43.93	5.51
13	HPB006	17	3.8	4.9	1.1
14	HPB007	13	6.8	6.3	0.5
15	HPB012	14	150.5	214.88	64.38
16	HPB019	15	6.14	6.55	0.41
17	HPB020	16	55.88	78.52	22.64
18	HPB021	19	3.99	5.55	1.56
19	HPB022	20	44.94	55.12	10.18
20	HPB023	21	4.2	5.8	1.6
21	MST001	2	1.73718	1.96	0.22282
22	MST002	3	0	0	0
23	MST003	4	3.56	3.73	0.17
24	MST004	5	4.38	4.96	0.58
25	MST004	268	16.5	16.8	0.3
26	MST006	81	62	73.8	11.8
27	MST006	250	17.19	16.29	0.9
28	MST032	6	5.37	3.77	1.6
29	MST033	7	5.9	4.4	1.5
30	MST034	8	77.95	97.62	19.67
31	MST035	9	6.23	5.04	1.19
32	MST035	163	0	0	0
33	MST037	249	20.78	18.88	1.9
34	MST044	10	183.67	253	69.33
35	MST045	27	22.8	25.6	2.8
36	MST046	133	15.5	16.5	1
37	MST047	85	25.3	27.5	2.2
38	MST049	56	20.6	24.3	3.7

596

	CLIENT	J-Power (Electric Power Development Co. Ltd.)
	PROJECT	Turbine and System Assessment for NTPC-KORBA Unit # 4
	ORDER NO.	CGP10028C
	CONTRACTOR	ALSTOM K. K. NASL LTD. (Nominated Sub-Contractor in India)
	DOCUMENT	FINAL REPORT VOL - II (PIPING ASSESSMENT)

Remaining Life Analysis

Fatigue analysis

Carried out on the piping considering the start and stop of the boiler. Due to the thermal loading, stresses will be developed. These cycles are repeated to predict the life of the piping system.

In the piping side the fatigue loading will occur due to shut down of the boiler. Due to this there will not be any hot start and warm start.

From the plant we have got 15 years (1995-2010) of operation. In fifteen years the piping system is shut down for 13 times (only cold start is considered). Assuming the piping system is shut down for 50 times in the past 25 years of operation since commissioning.

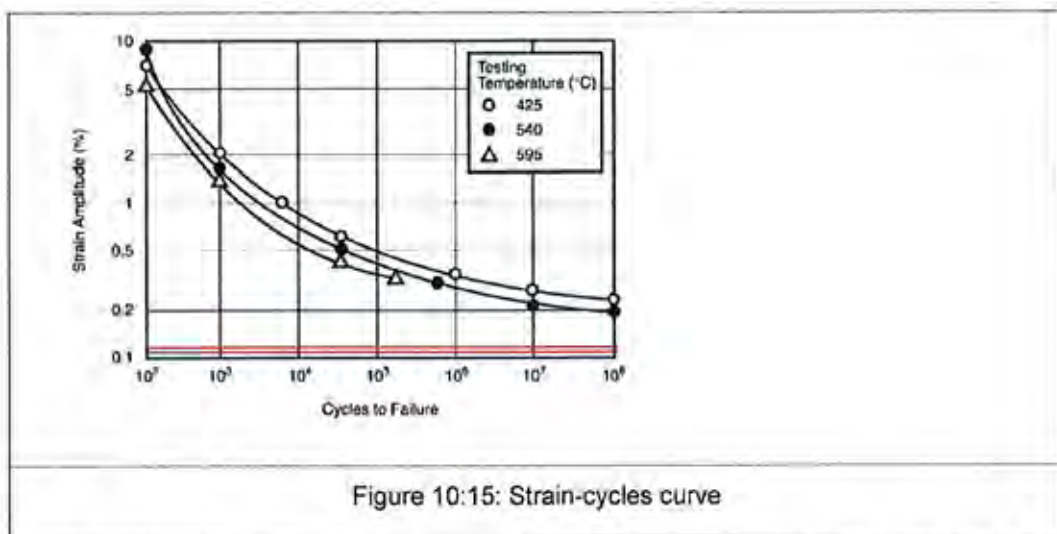



The maximum stress observed in CRH is 168 MPa and strain observed in 0.00112. From the figure 10:15 the number of cycles for failure is 1e6 cycles. The remaining life is 1e6 cycles

The maximum stress observed in MST is 89.13 MPa and strain observed in 0.00055. From the figure 10.15 the number of cycles for failure is about 1e6 cycles.

Creep analysis:

The maximum operating stress observed in the MST piping is (on an average) 65 MPa and operating temperature 545 Deg C. From the creep rupture graph shown in Figure 6 of Chapter 10 the creep life is 48 years.

	CLIENT	J-Power (Electric Power Development Co. Ltd.)
	PROJECT	Turbine and System Assessment for NTPC-KORBA Unit # 4
	ORDER NO.	CGP10028C
	CONTRACTOR	ALSTOM K. K. NASL LTD. (Nominated Sub-Contractor in India)
	DOCUMENT	FINAL REPORT VOL - II (PIPING ASSESSMENT)

In CRH creep will not occur as the temperature is 370 Deg C only. Hence creep damage will not occur.

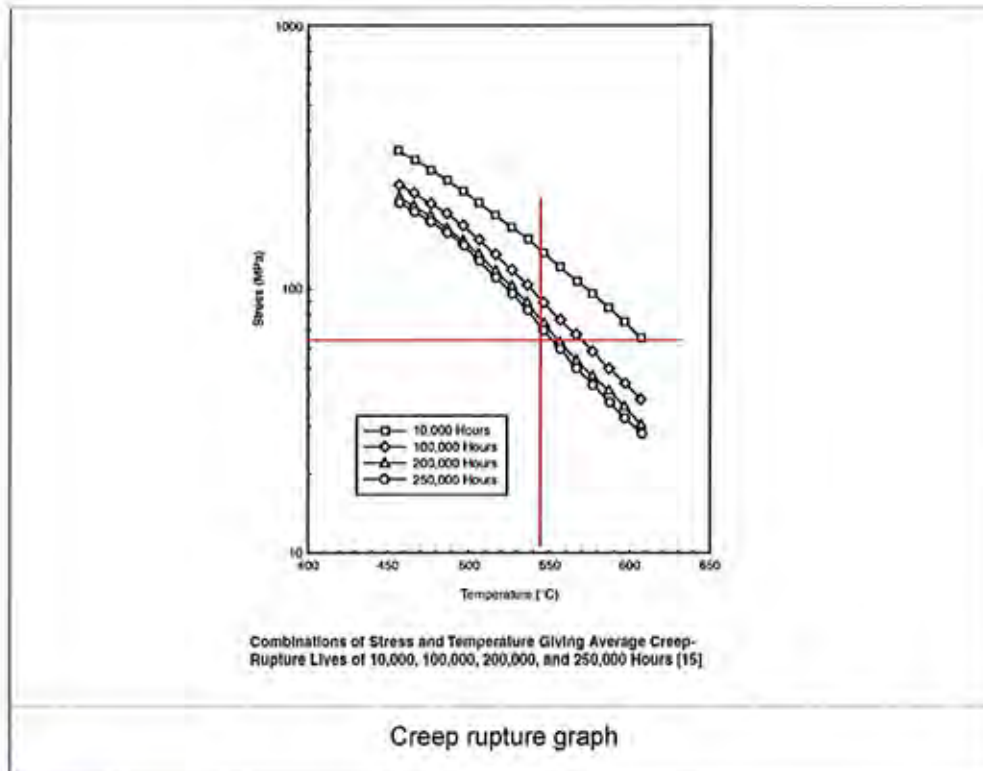



Observations

1. The results due to thermo-mechanical loads for the operating conditions show the maximum deflection is around 250 mm and a maximum stress is 168 MPa.
2. The creep has caused maximum of 111 mm permanent deformation.
3. The life of the MST piping system subjected to fatigue loading is 1e6 cycles.
4. The life of the CRH piping system subjected to fatigue loading is 1e6 cycles.
5. The creep life of the MST pipe line is 48 years

10.7.2 HRH and LPBP

CAD Model Details

The CAD modeling of piping is carried out in CATIA V5 R18 Software. The snap shot of assembly and positions of the hangers are shown in Figure 11.1 Table 11.1 gives list of drawings considered



	CLIENT	J-Power (Electric Power Development Co. Ltd.)
	PROJECT	Turbine and System Assessment for NTPC-KORBA Unit # 4
	ORDER NO.	CGP10028C
	CONTRACTOR	ALSTOM K. K. NASL LTD. (Nominated Sub-Contractor in India)
	DOCUMENT	FINAL REPORT VOL - II (PIPING ASSESSMENT)

for the modeling of the HRH. The pipes are modeled as line and the appropriate thickness and diameters are defined in the FE analysis. The hangers are modeled as springs.

Table 11-1: List of drawings.

DRAWINGS/DOCUMENTS LIST		
SR NO	DESCRIPTION	DRG/DOC NO.
PIPING		
HRH & LBP		
1	Hot Reheat Piping From Turbine Inlet Manifold to Strainer	1-80-515-01789
2	Hot Reheat from Reheater to Common Header (Left)	0-80-512-01228
3	Hot Reheat Header upto Turbine Inlet Manifold	0-80-514-01230
4	Hot Reheat Piping	TCE-790-ME-SK-36
5	HRH from Strainer to Turbine TOP Right	1-80-517-01546
6	HRH from Strainer to Turbine TOP Left	1-80-516-01545
7	HRH from Strainer to Turbine Bottom Right	1-80-519-01548
8	Hot Reheat Piping from Reheater to Common Header (Right)	0-80-513-01229
9	HRH from Strainer to Turbine Bottom Left	0-80-518-01547

53

	CLIENT	J-Power (Electric Power Development Co. Ltd.)
	PROJECT	Turbine and System Assessment for NTPC-KORBA Unit # 4
	ORDER NO.	CGP10028C
	CONTRACTOR	ALSTOM K. K. NASL LTD. (Nominated Sub-Contractor in India)
	DOCUMENT	FINAL REPORT VOL - II (PIPING ASSESSMENT)

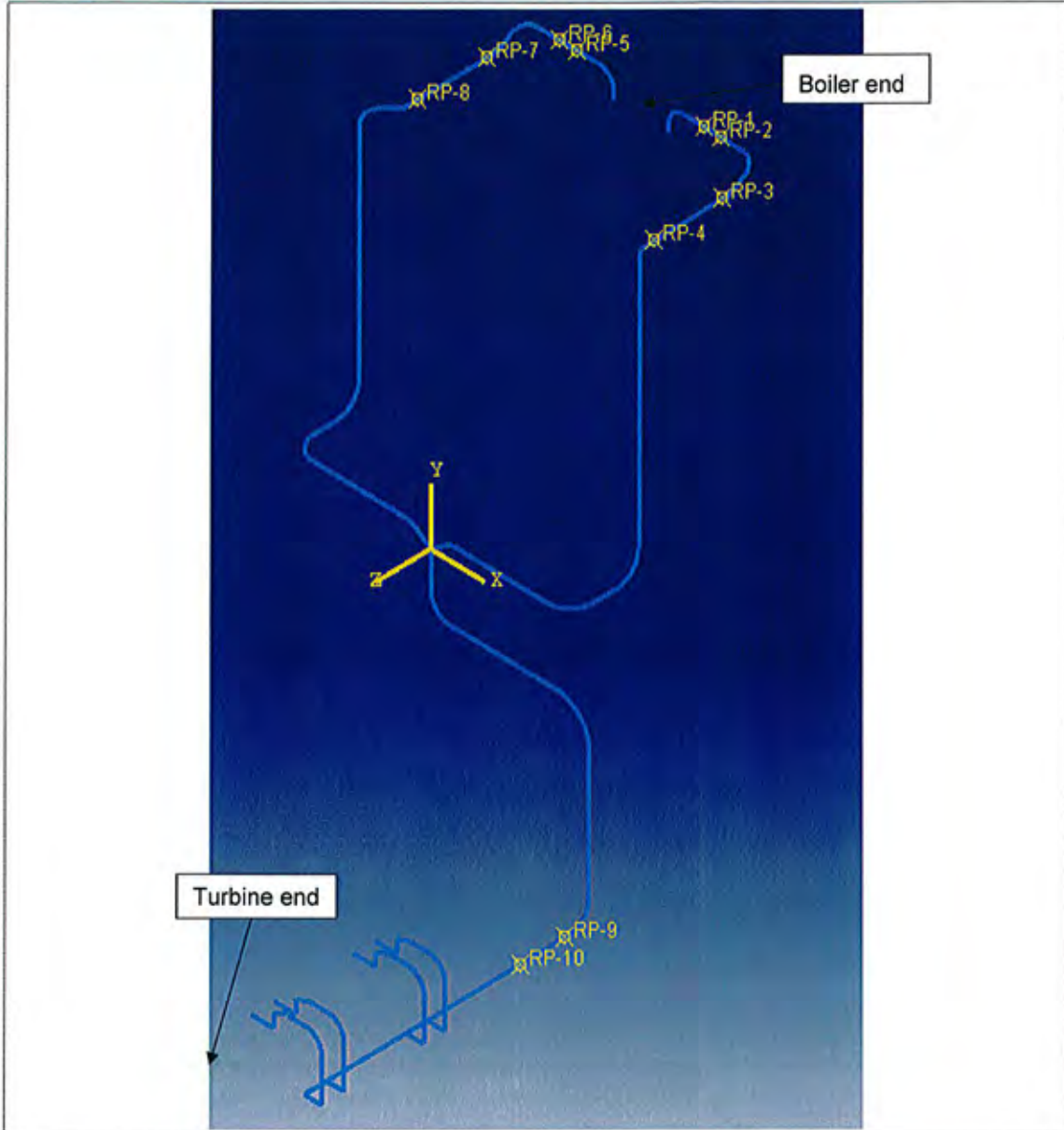

Figure 13:5: CAD model of HRH-LPBP

594





	CLIENT	J-Power (Electric Power Development Co. Ltd.)
	PROJECT	Turbine and System Assessment for NTPC-KORBA Unit # 4
	ORDER NO.	CGP10028C
 Power Services Pvt. Ltd.	CONTRACTOR	ALSTOM K. K. NASL LTD. (Nominated Sub-Contractor In India)
	DOCUMENT	FINAL REPORT VOL - II (PIPING ASSESSMENT)

Table 11-2: spring stiffness for HRH

SI no.	Hanger #	Operating (cold)	Preset - cold (mm)	Preset - Hot (mm)	Spring rate X 1.0e3 (KN/mm)
1	HRH-001-SVH	39.318	48	-	-
2	HRH-002-SVH	58.4	119	100	3.0737
3	HRH-003 TVH	59.9	25	18	8.5571
4	HRH-004 SYR	197.79			
5	HRH-005 SVH	40.05	50	47	13.3500
6	HRH-006 DYP	147.12			
7	HRH-007 TCH	94.98	0	97	0.9792
8	HRH-008 TCH	103.28	0	180	0.5738
9	HRH-009 TCH	64.96	0	254	0.2557
10	HRH-010 SCH	62.69	0	251	0.2498
11	HRH-011 SCH	30.04	0	210	0.1430
12	HRH-012 SCH	41.13	0	170	0.2419
13	HRH-013 TCH	185.44	0	154	1.2042
14	HRH-014 SCH	66.89	0	156	0.4288
15	HRH-015 SCH	77.8	0	78	0.9974
16	HRH-016 SCH	60.33	80	73	8.6186
17	HRH-017 SCH	82.85	160	69	0.9104
18	HRH-018 TCH	127.6	160	40	1.0633
19	HRH-019 TCH	83	112	33	1.0506
20	HRH-020 TVH	141.24	165	134	4.5561
21	HRH-021 TVH	83.38	108	138	2.7793
22	HRH-022 TVH	79.92	100	136	2.2200
23	HRH-023 TVH	79.42	99	136	2.1465
24	HRH-024 SVH	95.89	80	117	2.5916
25	HRH-025 SVH	82.75	148	187	2.1218
26	HRH-026 SVH	91.98	72	117	2.0440
27	HRH-027 SVH	60.8	128	172	1.3818
28	HRH-028 TVH	53.7	100	128	1.9179
29	HRH-029 TVH	54.76	105	133	1.9557
30	HRH-030 TVH	46.54	75	110	1.3297

595

	CLIENT	J-Power (Electric Power Development Co. Ltd.)
	PROJECT	Turbine and System Assessment for NTPC-KORBA Unit # 4
	ORDER NO.	CGP10028C
 Power Services Pvt. Ltd.	CONTRACTOR	ALSTOM K. K. NASL LTD. (Nominated Sub-Contractor In India)
	DOCUMENT	FINAL REPORT VOL - II (PIPING ASSESSMENT)

Sl no.	Hanger #	Operating (cold)	Preset - cold (mm)	Preset - Hot (mm)	Spring rate X 1.0e3 (KN/mm)
31	HRH-031 TVH	47.78	79	116	1.2914
32	HRH-032 SVH	39.31	48	34	2.8079
33	HRH-033 SVH	58.38	30	28	29.1900
34	HRH-034 TVH	60.02	25	40	4.0013
35	HRH-035 SYR	197.76			
36	HRH-036 SVH	40	50	37	3.0769
37	HRH-037 DYR	167.11	-	-	-
38	HRH-038 TCH	94.98	0	97	0.9792
39	HRH-039 TCH	103.14	0	180	0.5730
40	HRH-040 TCH	65.14	0	240	0.2714
41	HRH-041 SCH	62.64	0	184	0.3404
42	HRH-042 SCH	29.89	0	126	0.2372
43	HRH-043 SCH	41.74	0	104	0.4013
44	HRH-044 DZR	46.63	-	-	-
45	HRH-045 DZR	71.5	-	-	-
46	HRH-046 DYR	173.9	-	-	-
47	HRH-047 DSX	92.32	-	-	-
48	HRH-048 DZS	160.86	-	-	-



Table 11-3: spring stiffness for LPBP

Sl no.	Hanger #	Operating (cold)	Preset - cold (mm)	Preset - Hot (mm)	Spring rate X 1.0e3 (KN/mm)
1	LPB H1	55.98	0	57	0.9821
2	LPB H2	31.52	0	61	0.5167
3	LPB H3	33.44	0	56	0.5971
4	LPB H4	14.88	0	51	0.2918
5	LPB H5	49.51	0	48	1.0315
6	LPB H6	116.92	-	-	-
7	LPB H7	19.54	47	40	2.7914
8	LPB H8	27.78	54	50	6.9450
9	LPB H9	5	13	18	1.0000

ALSTOM	CLIENT	J-Power (Electric Power Development Co. Ltd.)
	PROJECT	Turbine and System Assessment for NTPC-KORBA Unit # 4
	ORDER NO.	CGP10028C
NTPC ALSTOM Power Services Pvt. Ltd.	CONTRACTOR	ALSTOM K. K. NASL LTD. (Nominated Sub-Contractor in India)
	DOCUMENT	FINAL REPORT VOL - II (PIPING ASSESSMENT)

Sl no.	Hanger #	Operating (cold)	Preset - cold (mm)	Preset - Hot (mm)	Spring rate X 1.0e3 (KN/mm)
10	LPB H10	59.4	0	57	1.0421
11	LPB H11	79.54	99	96	26.5133
12	LPB H12	78.74	48	46	39.3700
13	LPB H13	33.26	0	55	0.6047
14	LPB H14	97.17			
15	LPB H15	35.73	17	12	7.1460
16	LPB H16	5.02	13	18	1.0040
17	LPB H17	30.12	126	116	3.0120
18	LPB H18	122.09	-	-	-
19	LPB H21 SX	28.988	-	-	-

151

	CLIENT	J-Power (Electric Power Development Co. Ltd.)
	PROJECT	Turbine and System Assessment for NTPC-KORBA Unit # 4
	ORDER NO.	CGP10028C
	CONTRACTOR	ALSTOM K. K. NASL LTD. (Nominated Sub-Contractor in India)
	DOCUMENT	FINAL REPORT VOL - II (PIPING ASSESSMENT)

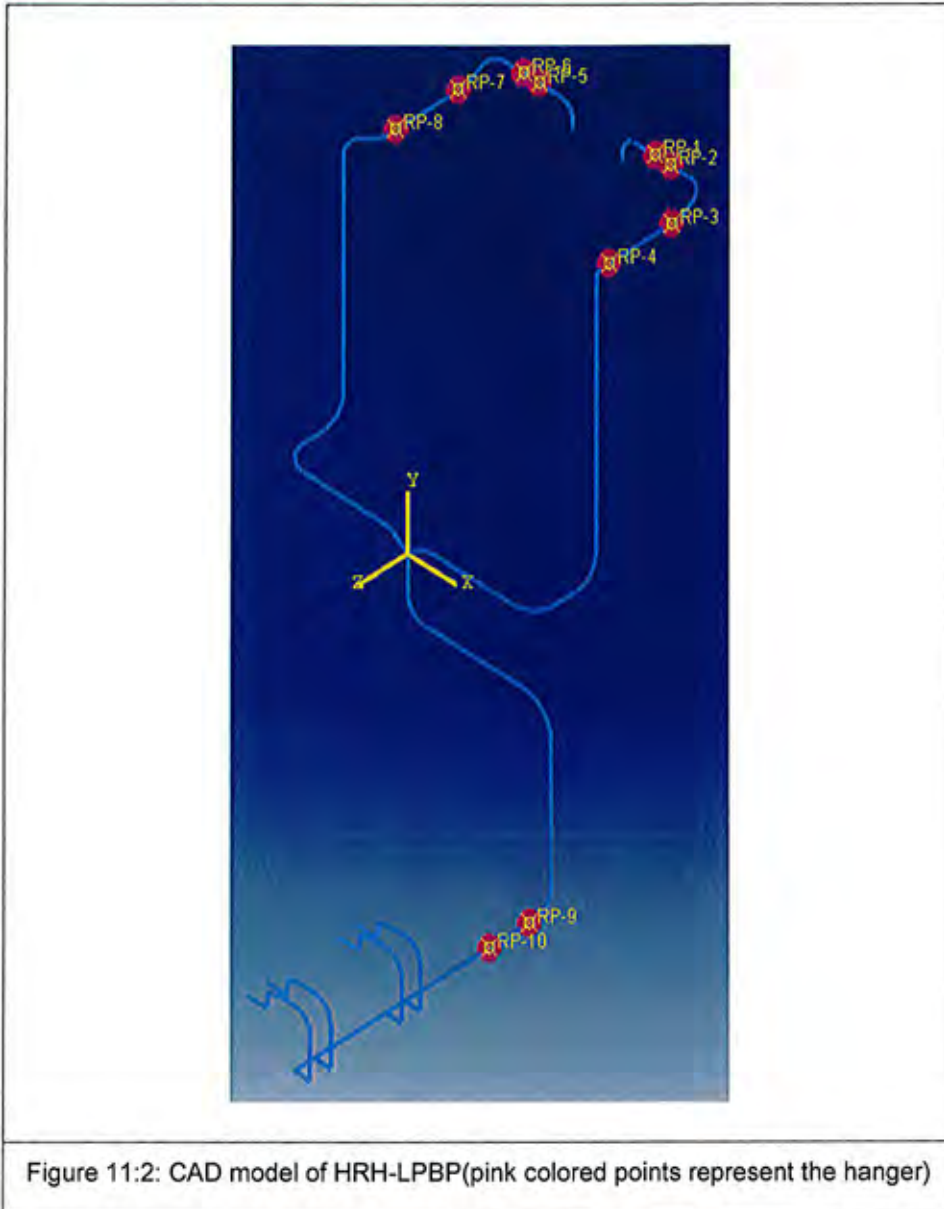



Figure 11:2: CAD model of HRH-LPBP(pink colored points represent the hanger)

Mesh Model Details

The meshing of the piping assembly is carried out in ABAQUS software. Pipe elements are used in the analysis to capture the effect of internal pressure. PIPE31: A 2-node linear pipe elements are used in the analysis. Total number of elements in the piping assembly is 3711. Maximum element length is 100mm.

	CLIENT	J-Power (Electric Power Development Co. Ltd.)
	PROJECT	Turbine and System Assessment for NTPC-KORBA Unit # 4
	ORDER NO.	CGP10028C
	CONTRACTOR	ALSTOM K. K. NASL LTD. (Nominated Sub-Contractor in India)
	DOCUMENT	FINAL REPORT VOL - II (PIPING ASSESSMENT)

FE Analysis and Results

The piping assembly analysis is carried out for thermal and mechanical loads. The model is meshed with 2 noded pipe elements. The elastic and plastic effects are taken into account.

The loading, boundary conditions, thermo-mechanical loading and results for each case is discussed in the following pages.

Piping Assembly - Mechanical & Thermal Loading

The piping assembly is analysed for gravity and thermal loading conditions. Also internal pressure of 5.034 MPa on HRP and LPBP pipeline is applied. The hangers are modeled as spring elements with spring rate. The piping at the boiler end and the turbine ends are fixed as shown in Figure 13.3.

Some of the regions are constrained in a particular direction as given in the drawing.

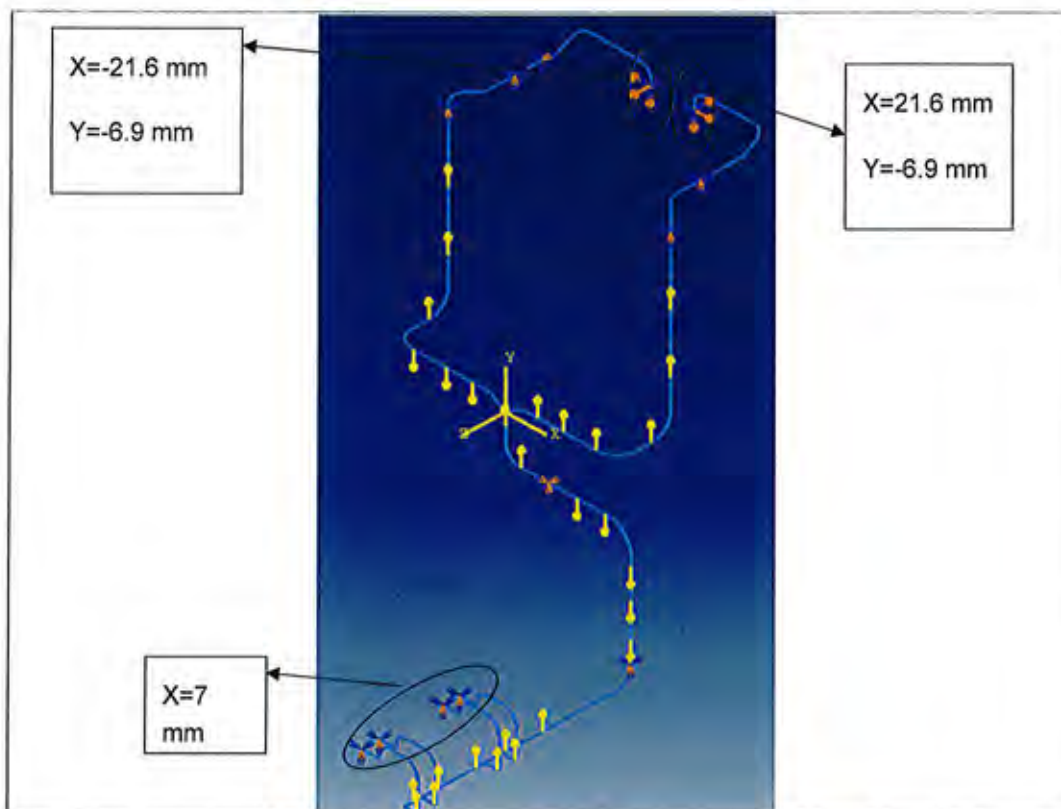



Figure 11.3: Boundary condition fixed at the turbine and boiler end.

667

	CLIENT	J-Power (Electric Power Development Co. Ltd.)
	PROJECT	Turbine and System Assessment for NTPC-KORBA Unit # 4
	ORDER NO.	CGP10028C
	CONTRACTOR	ALSTOM K. K. NASL LTD. (Nominated Sub-Contractor in India)
	DOCUMENT	FINAL REPORT VOL - II (PIPING ASSESSMENT)

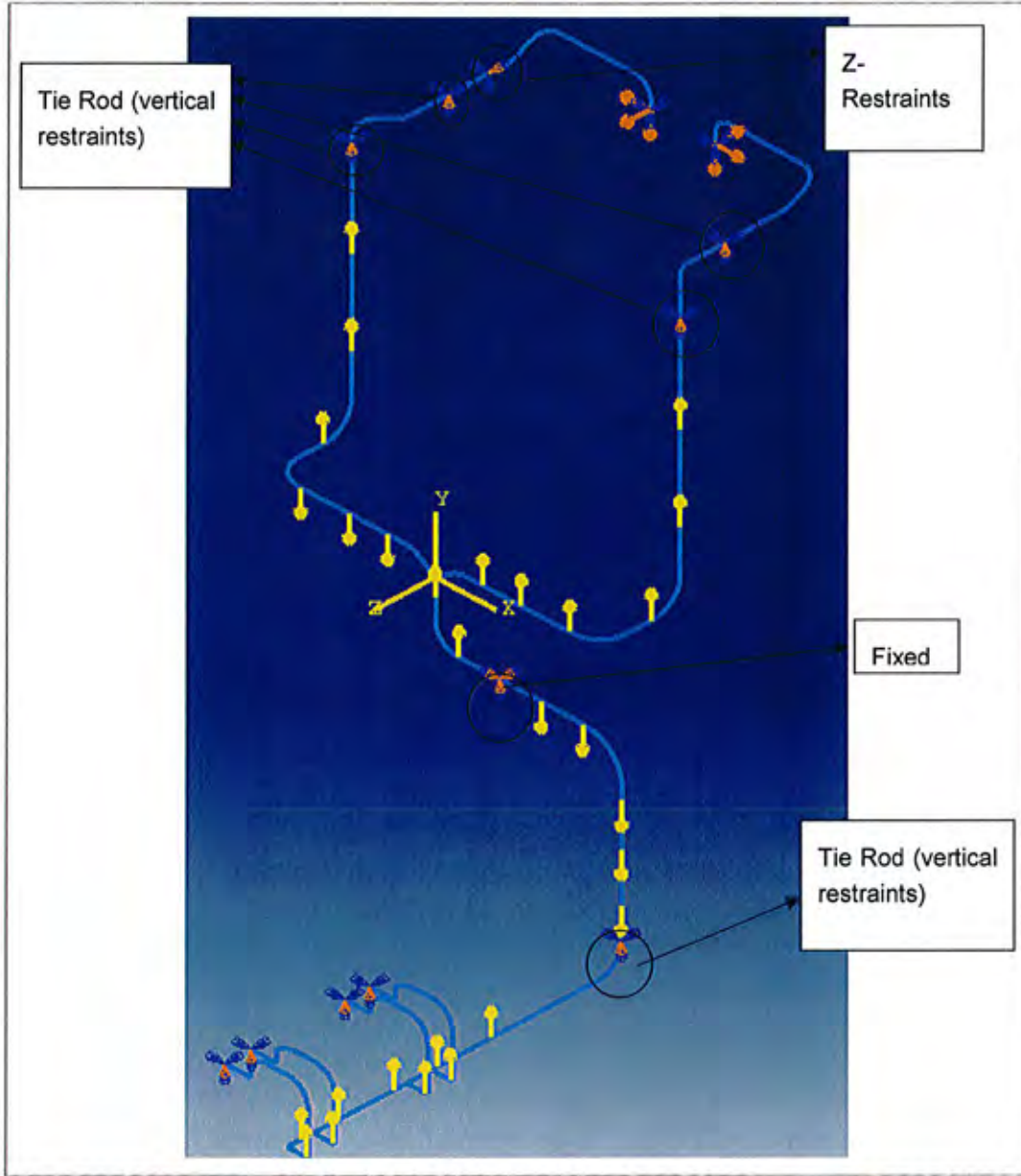

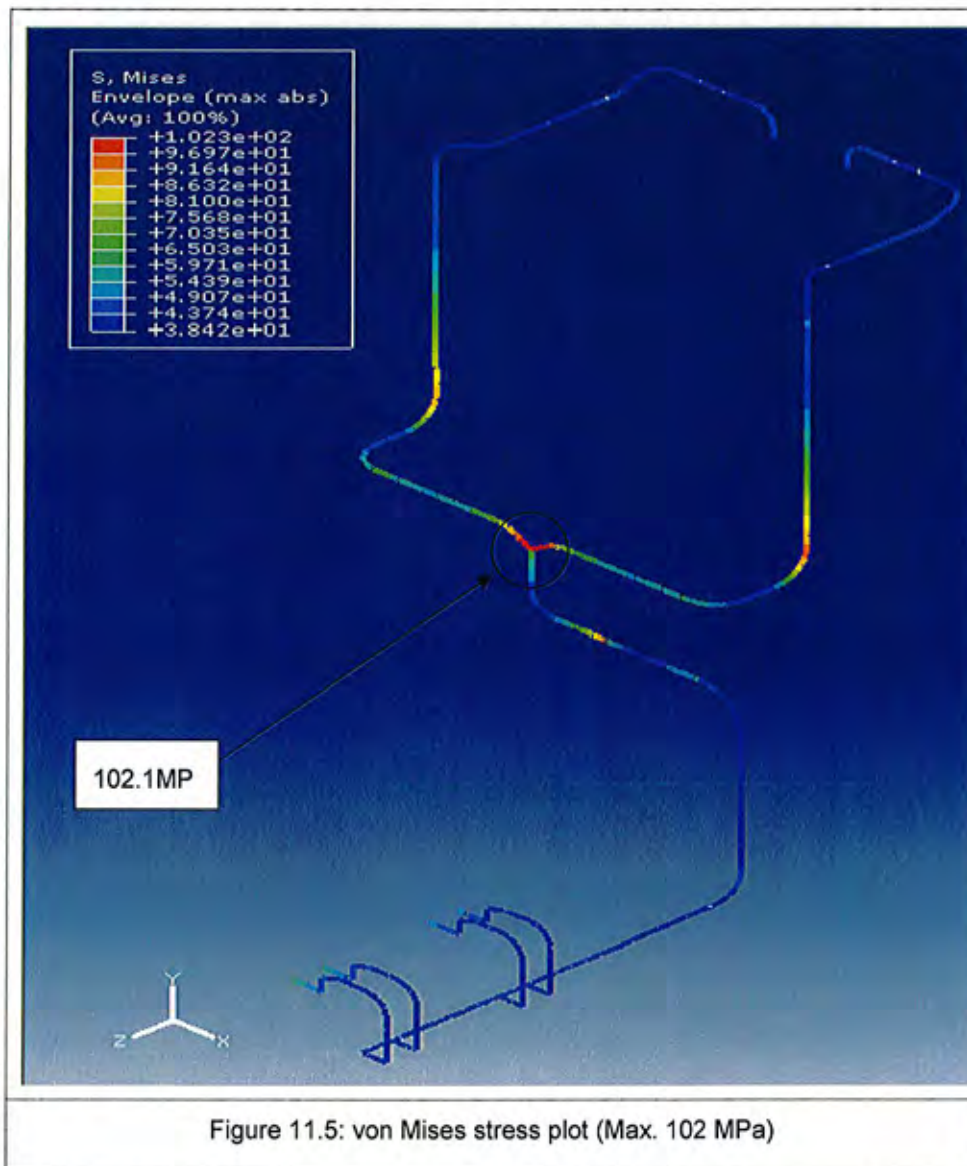



Figure 11.4: Restraints in the model

	CLIENT	J-Power (Electric Power Development Co. Ltd.)
	PROJECT	Turbine and System Assessment for NTPC-KORBA Unit # 4
	ORDER NO.	CGP10028C
 Power Services Pvt. Ltd.	CONTRACTOR	ALSTOM K. K. NASL LTD. (Nominated Sub-Contractor in India)
	DOCUMENT	FINAL REPORT VOL - II (PIPING ASSESSMENT)



FE analysis Results



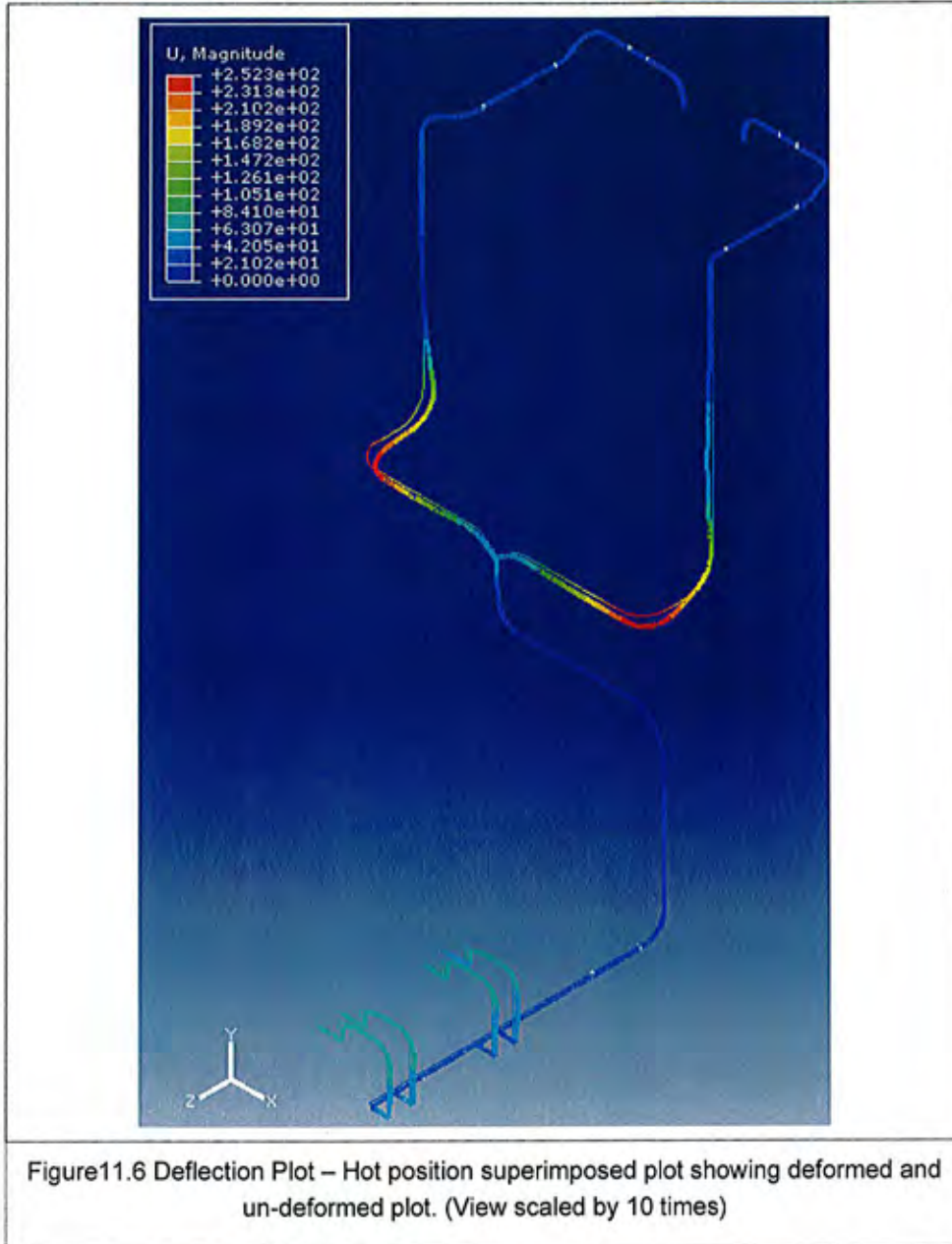

601

	CLIENT	J-Power (Electric Power Development Co. Ltd.)
	PROJECT	Turbine and System Assessment for NTPC-KORBA Unit # 4
	ORDER NO.	CGP10028C
	CONTRACTOR	ALSTOM K. K. NASL LTD. (Nominated Sub-Contractor In India)
	DOCUMENT	FINAL REPORT VOL - II (PIPING ASSESSMENT)

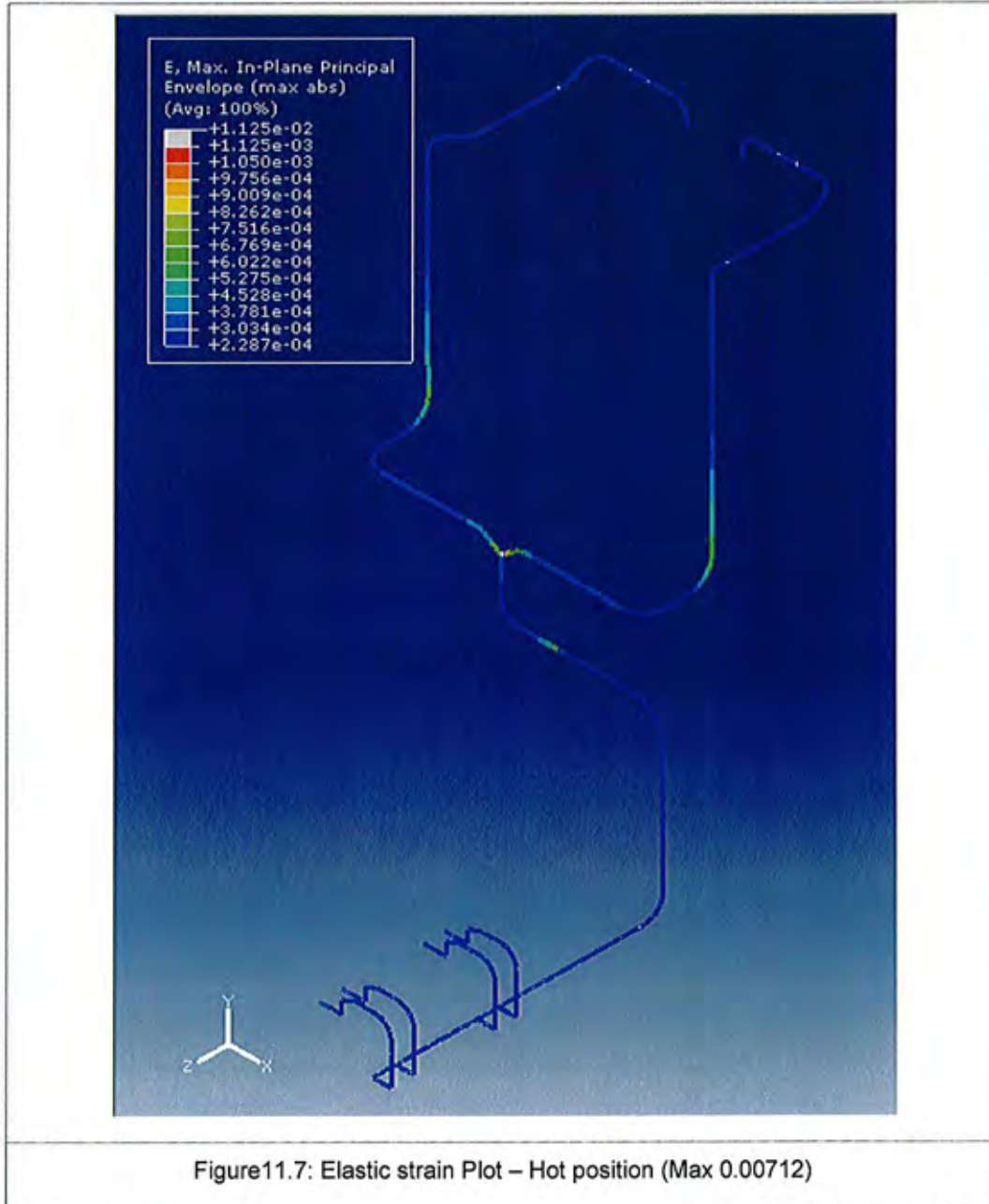

	CLIENT	J-Power (Electric Power Development Co. Ltd.)
	PROJECT	Turbine and System Assessment for NTPC-KORBA Unit # 4
	ORDER NO.	CGP10028C
	CONTRACTOR	ALSTOM K. K. NASL LTD. (Nominated Sub-Contractor In India)
	DOCUMENT	FINAL REPORT VOL - II (PIPING ASSESSMENT)



	CLIENT	J-Power (Electric Power Development Co. Ltd.)
	PROJECT	Turbine and System Assessment for NTPC-KORBA Unit # 4
	ORDER NO.	CGP10028C
	CONTRACTOR	ALSTOM K. K. NASL LTD. (Nominated Sub-Contractor in India)
	DOCUMENT	FINAL REPORT VOL - II (PIPING ASSESSMENT)

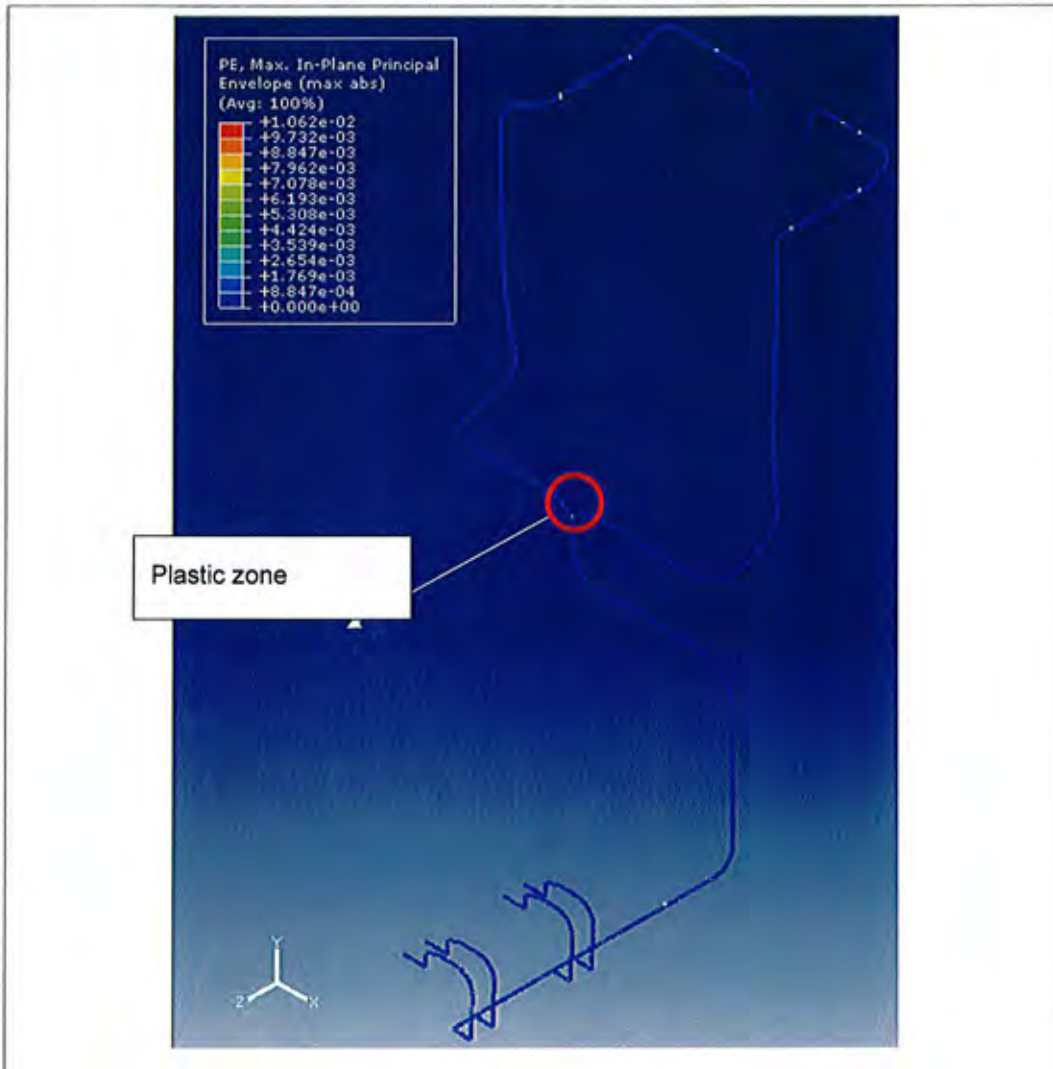



Figure 11.8: plastic strain Plot – Hot position (Max 0.00106)

A total of 0.00818 strain will occur.

Piping assembly creep analysis



Creep analysis is carried out considering the operating load for a period of 25 years and predicted the amount of permanent plastic deformation. Figure 11.9 shows the creep strain and stress.

604

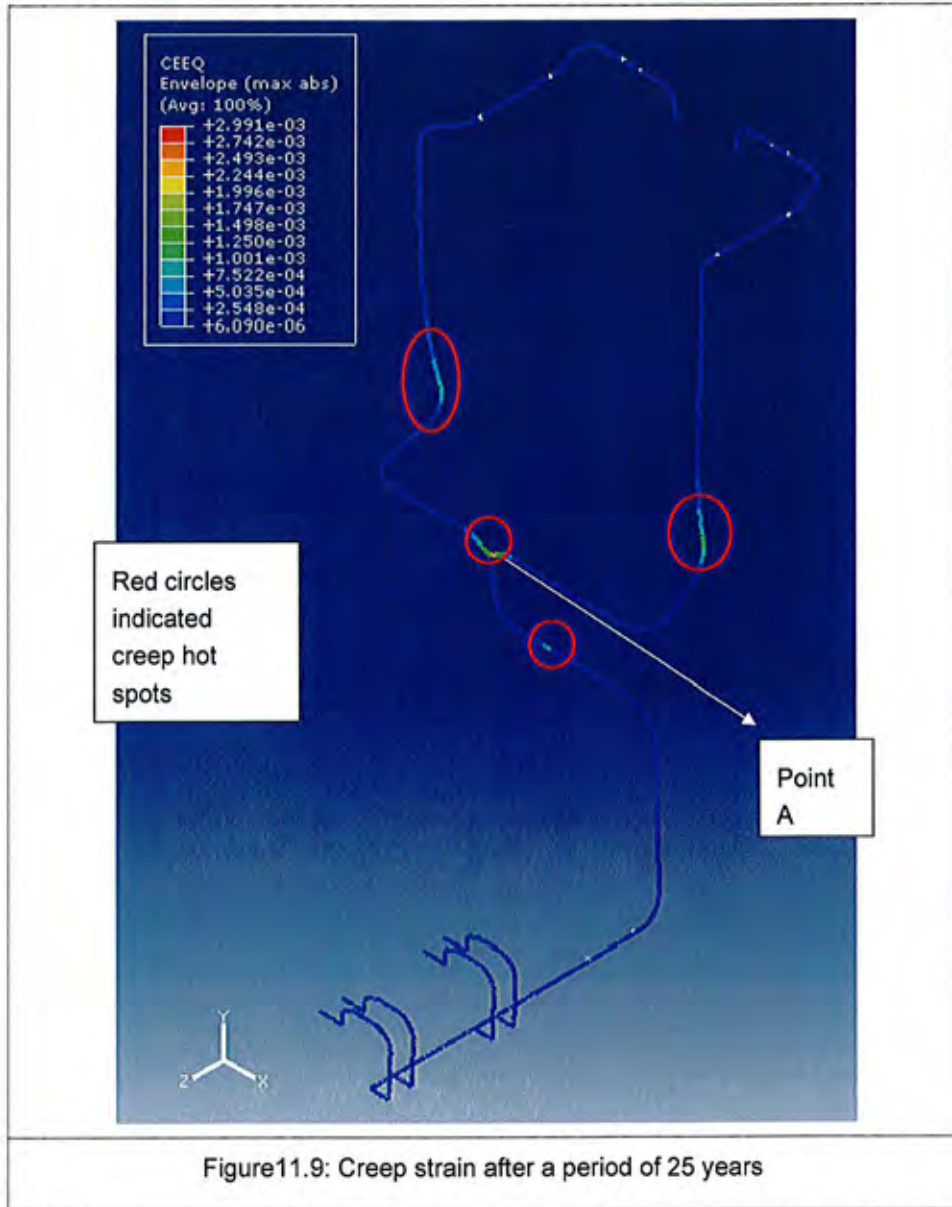
	CLIENT	J-Power (Electric Power Development Co. Ltd.)
	PROJECT	Turbine and System Assessment for NTPC-KORBA Unit # 4
	ORDER NO.	CGP10028C
 Power Services Pvt. Ltd.	CONTRACTOR	ALSTOM K. K. NASL LTD. (Nominated Sub-Contractor in India)
	DOCUMENT	FINAL REPORT VOL - II (PIPING ASSESSMENT)



505

	CLIENT	J-Power (Electric Power Development Co. Ltd.)
	PROJECT	Turbine and System Assessment for NTPC-KORBA Unit # 4
	ORDER NO.	CGP10028C
	CONTRACTOR	ALSTOM K. K. NASL LTD. (Nominated Sub-Contractor in India)
	DOCUMENT	FINAL REPORT VOL - II (PIPING ASSESSMENT)

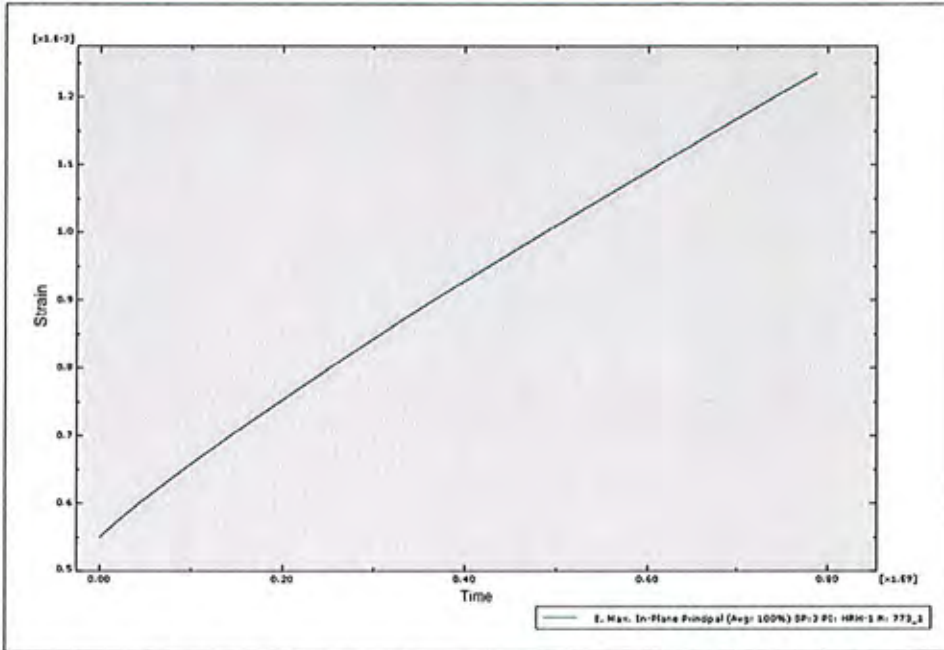

Figure 11.10: Creep strain accumulated over a period of 25 years (point A indicated in figure 11.9)

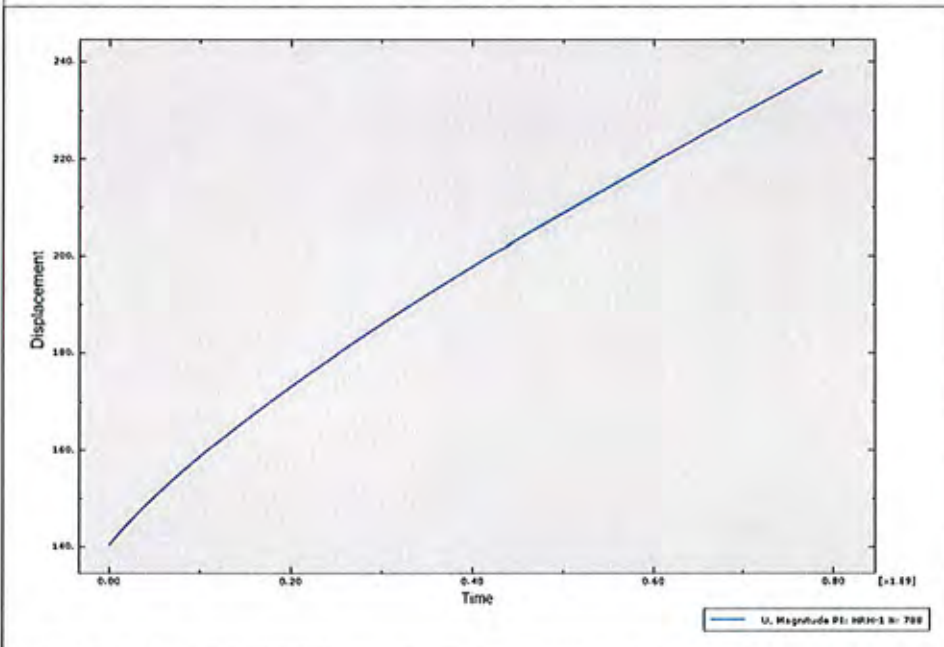



Figure 11.11: Permanent deformation occurring due to creep after 25 years of operation (Point A) ~ 100 mm deformation

606

	CLIENT	J-Power (Electric Power Development Co. Ltd.)
	PROJECT	Turbine and System Assessment for NTPC-KORBA Unit # 4
	ORDER NO.	CGP10028C
	CONTRACTOR	ALSTOM K. K. NASL LTD. (Nominated Sub-Contractor in India)
	DOCUMENT	FINAL REPORT VOL - II (PIPING ASSESSMENT)

Reaction force after creep deformation

Reaction forces at the fixed locations are listed table 11.4.

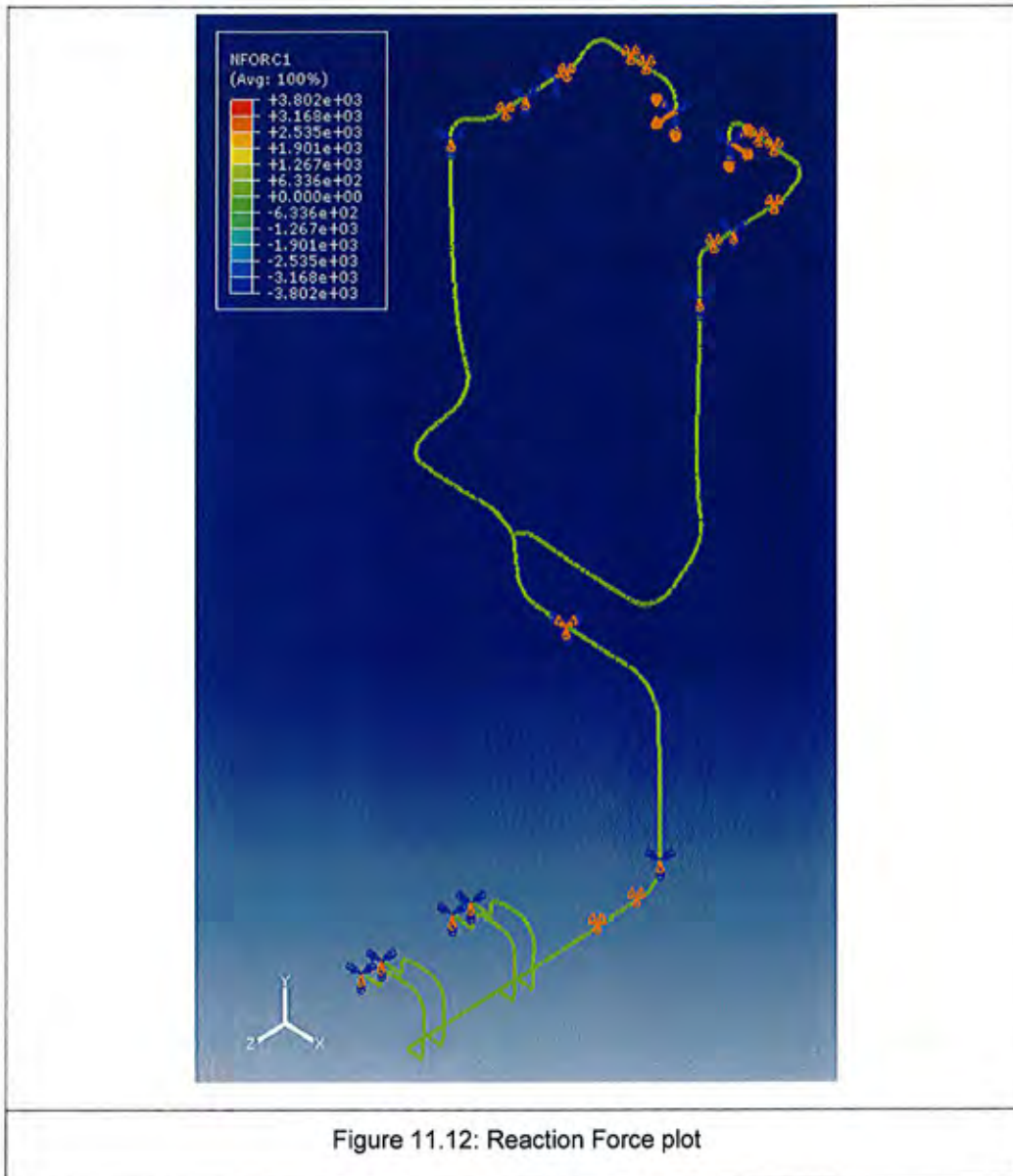

Figure 11.12: Reaction Force plot



607

ALSTOM	CLIENT	J-Power (Electric Power Development Co. Ltd.)
	PROJECT	Turbine and System Assessment for NTPC-KORBA Unit # 4
	ORDER NO.	CGP10028C
NTPC ALSTOM Power Services Pvt. Ltd.	CONTRACTOR	ALSTOM K. K. NASL LTD. (Nominated Sub-Contractor in India)
	DOCUMENT	FINAL REPORT VOL - II (PIPING ASSESSMENT)

Table 11.5: Reaction force acting on the hanger after 25 years of operation

Hanger Number	Node No	Reaction Force X	Reaction force Y	Reaction force Z
HRH001	5	-	2.16E+04	-
HRH002	6	-	2.42E+04	-
HRH003	7	-	6.90E+03	-
HRH004	73	-	8.69E+04	-
HRH005	8	-	2.08E+03	-
HRH006	61	-	3.56E+05	-
HRH021	9	-	3.58E+03	-
HRH022	10	-	1.06E+04	-
HRH031	1	-	2.39E+04	-
HRH032	2	-	5.03E+04	-
HRH034	3	-	1.55E+04	-
HRH035	11	-	5.87E+04	-
HRH036	4	-	1.57E+03	-
HRH037	18	-	3.62E+05	-
HRH045	75	-	-	-4.71E+04
HRH046	58	-	4.66E+05	-
HRH047	42	-3.80E+03	2.08E+05	5.42E+04

609

	CLIENT	J-Power (Electric Power Development Co. Ltd.)
	PROJECT	Turbine and System Assessment for NTPC-KORBA Unit # 4
	ORDER NO.	CGP10028C
	CONTRACTOR	ALSTOM K. K. NASL LTD. (Nominated Sub-Contractor in India)
	DOCUMENT	FINAL REPORT VOL - II (PIPING ASSESSMENT)

Displacement of hangers

Following figure shows the displacement of hangers over a period of 25 years. Figure 11.13 shows that most of hangers are moved by 10 to 15 mm but a 6 of them have moved more than 60 mm. Following Table 11.6 shows the movement of the hanger after 25 years.

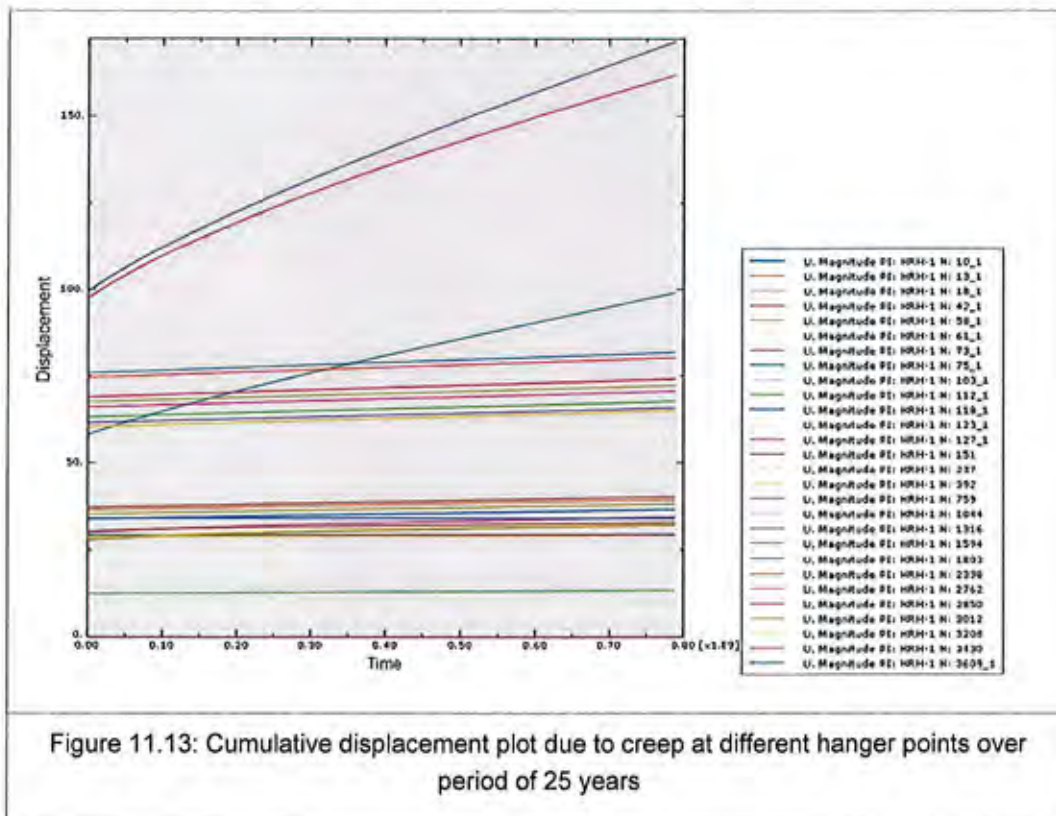

Table 11.6: Hanger travel after 25 years of operation

Hanger Number	Node No	0 year	25 years	Travel
HRH001	5	27.3	27.6	0.3
HRH002	6	24.67	24.5	0.17
HRH003	7	28.8	29.12	0.32
HRH004	73	29.02	29.7	0.68
HRH005	8	28	29.17	1.17
HRH006	61	28.69	29.15	0.46
HRH021	9	35	37.5	2.5

609

ALSTOM	CLIENT	J-Power (Electric Power Development Co. Ltd.)
	PROJECT	Turbine and System Assessment for NTPC-KORBA Unit # 4
	ORDER NO.	CGP10028C
NTPC ALSTOM Power Services Pvt. Ltd.	CONTRACTOR	ALSTOM K. K. NASL LTD. (Nominated Sub-Contractor in India)
	DOCUMENT	FINAL REPORT VOL - II (PIPING ASSESSMENT)

Hanger Number	Node No	0 year	25 years	Travel
HRH022	10	36	38.8	2.8
HRH032	1	25	23.5	1.5
HRH033	2	23	23.3	0.3
HRH034	3	32	31.3	0.7
HRH035	11	27.72	32.02	4.3
HRH036	4	36	32.32	3.68
HRH037	18	29.7	34.3	4.6
HRH045	75	29.1	29.3	0.2
HRH046	58	35.19	38.142	2.952
HRH047	42	0	0	0

Remaining Life analysis

Fatigue analysis

Carried out on the piping considering the start and stop of the boiler. Due to the thermal loading, stresses will be developed. These cycles are repeated to predict the life of the piping system.

In the piping side the fatigue loading will occur due to shut down of the boiler. Due to this there will not be any hot start and warm start.

From the plant we have got 15 years (1995-2010) of operation. In fifteen years the piping system is shut down for 13 times. Assuming the piping system is shut down for 50 times in the past 25 years of operation.

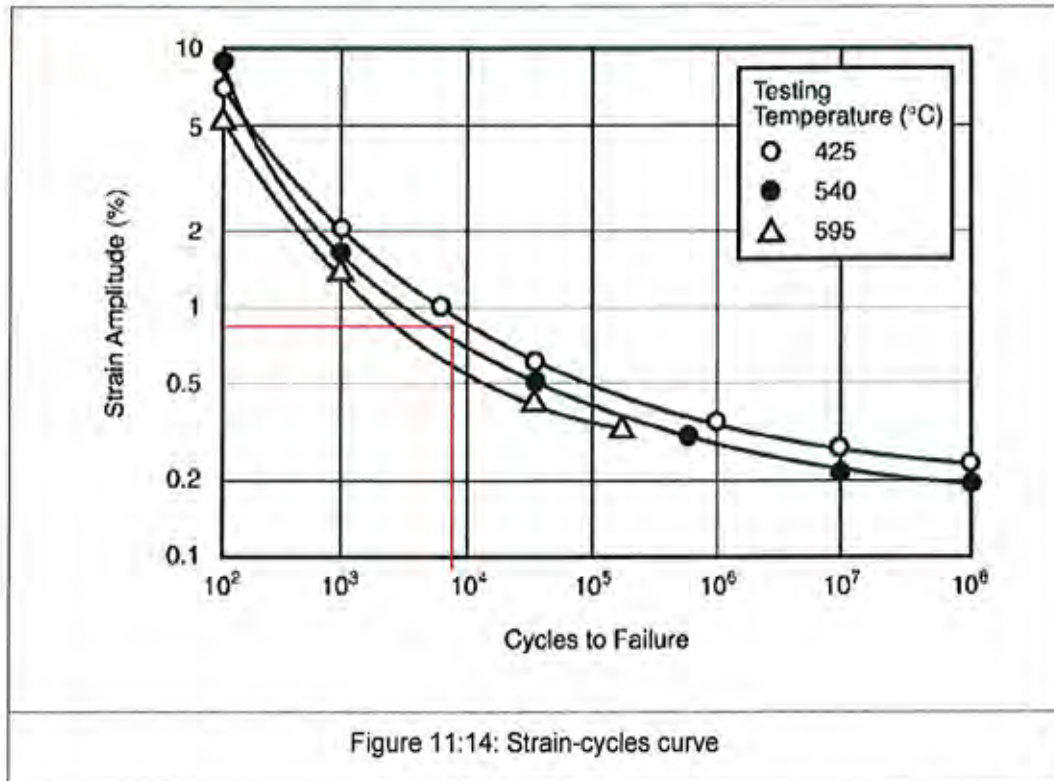

ALSTOM NTPC ALSTOM Power Services Pvt. Ltd.	CLIENT	J-Power (Electric Power Development Co. Ltd.)
	PROJECT	Turbine and System Assessment for NTPC-KORBA Unit # 4
	ORDER NO.	CGP10028C
	CONTRACTOR	ALSTOM K. K. NASL LTD. (Nominated Sub-Contractor In India)
	DOCUMENT	FINAL REPORT VOL - II (PIPING ASSESSMENT)



The maximum stress observed is 102 MPa and strain observed in 0.00812. From the figure 11.14 the number of cycles for crack initiation is about 8500 cycles. The remaining life of the piping system is $8500 - 50 = 8450$ cycles.

Creep analysis

The maximum operating stress observed in the HRH piping is (on an average) 72 MPa and operating temperature 545 Deg C. From the creep rupture graph shown in Figure 6 of Chapter 10 the creep life is 39 years.

	CLIENT	J-Power (Electric Power Development Co. Ltd.)
	PROJECT	Turbine and System Assessment for NTPC-KORBA Unit # 4
	ORDER NO.	CGP10028C
 Power Services Pvt. Ltd.	CONTRACTOR	ALSTOM K. K. NASL LTD. (Nomlnated Sub-Contractor In India)
	DOCUMENT	FINAL REPORT VOL - II (PIPING ASSESSMENT)

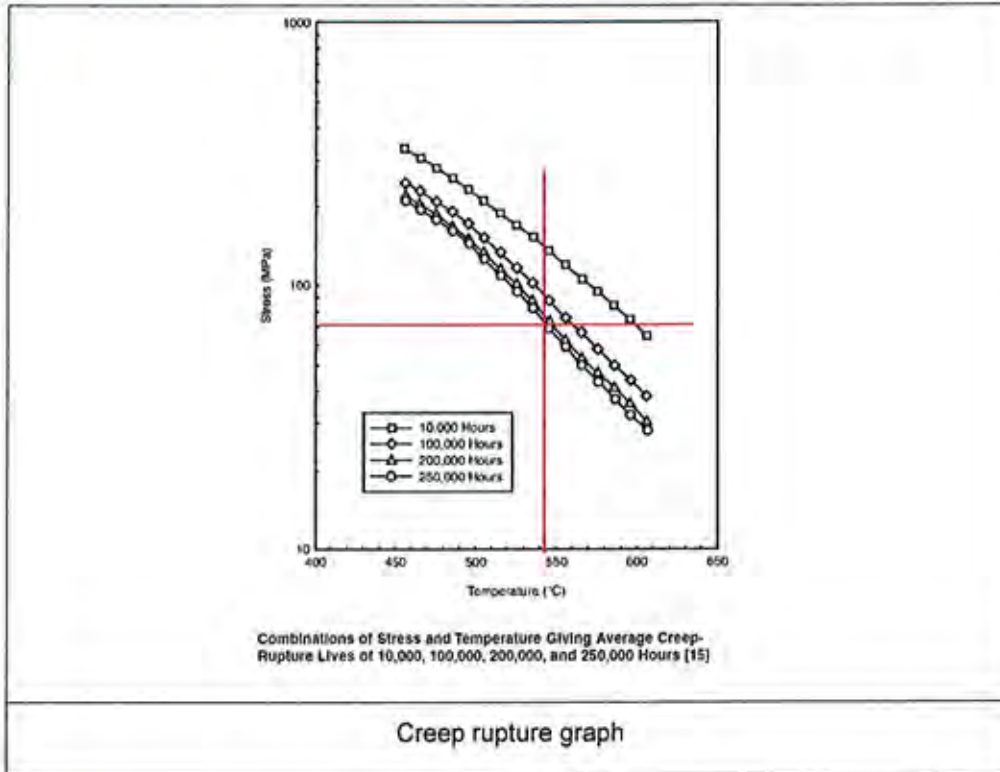

Observation

1. The results due to thermo-mechanical loads for the operating conditions show the maximum deflection is around 250 mm and a maximum stress is 102 MPa.
2. The creep has caused maximum of 60 mm permanent deformation.
3. The fatigue life of the piping system subjected to fatigue loading is 8500 cycles.
4. The remaining life of the HRH line is 8450 cycles.
5. Creep life of the HRH piping system is 36 years.

6/2

ALSTOM	CLIENT	J-Power (Electric Power Development Co. Ltd.)
	PROJECT	Turbine and System Assessment for NTPC-KORBA Unit # 4
	ORDER NO.	CGP10028C
NTPC ALSTOM Power Services Pvt. Ltd.	CONTRACTOR	ALSTOM K. K. NASL LTD. (Nominated Sub-Contractor in India)
	DOCUMENT	FINAL REPORT VOL - II (PIPING ASSESSMENT)

10.7.3 BFD

CAD Model Details

The CAD modeling of piping is carried out in CATIA V5 R18 Software. The snap shot of assembly and positions of the hangers are shown in figure12:1. Table 12.1 gives list of drawings considered for the modeling of the BFD. The pipes are modeled as line and the appropriate thickness and diameters are defined in the FE analysis.

Table 12-1: List of drawings.

DRAWINGS/DOCUMENTS LIST		
SR NO	DESCRIPTION	DRG/DOC NO.
PIPING		
BFD		
1	Boiler Feed Discharge Header UP to Heaters and Bypass Line	0-80-533-01239
2	BFD from Heaters to SG Terminal Point	1-80-536-01815
3	BFP Discharge From Pump A to Header	1-80-530-01596
4	BFP Discharge From Pump B to Header	1-80-531-01597
5	Boiler Feed Discharge Line Through Heaters 5B & 6B	1-80-535-01600
6	BFP Discharge from Pump C to Header	1-80-532-01598
7	Boiler Feed Discharge line from Heaters to Steam Generator Terminal Point	0-80-536-01240
8	Boiler Feed Discharge Line Through Heaters 5B & 6B	1-80-535-01600
9	Boiler Feed Discharge Header UP to Heaters and Bypass Line	0-80-533-01239

ALSTOM	CLIENT	J-Power (Electric Power Development Co. Ltd.)
	PROJECT	Turbine and System Assessment for NTPC-KORBA Unit # 4
	ORDER NO.	CGP10028C
NTPC ALSTOM Power Services Pvt. Ltd.	CONTRACTOR	ALSTOM K. K. NASL LTD. (Nominated Sub-Contractor in India)
	DOCUMENT	FINAL REPORT VOL - II (PIPING ASSESSMENT)

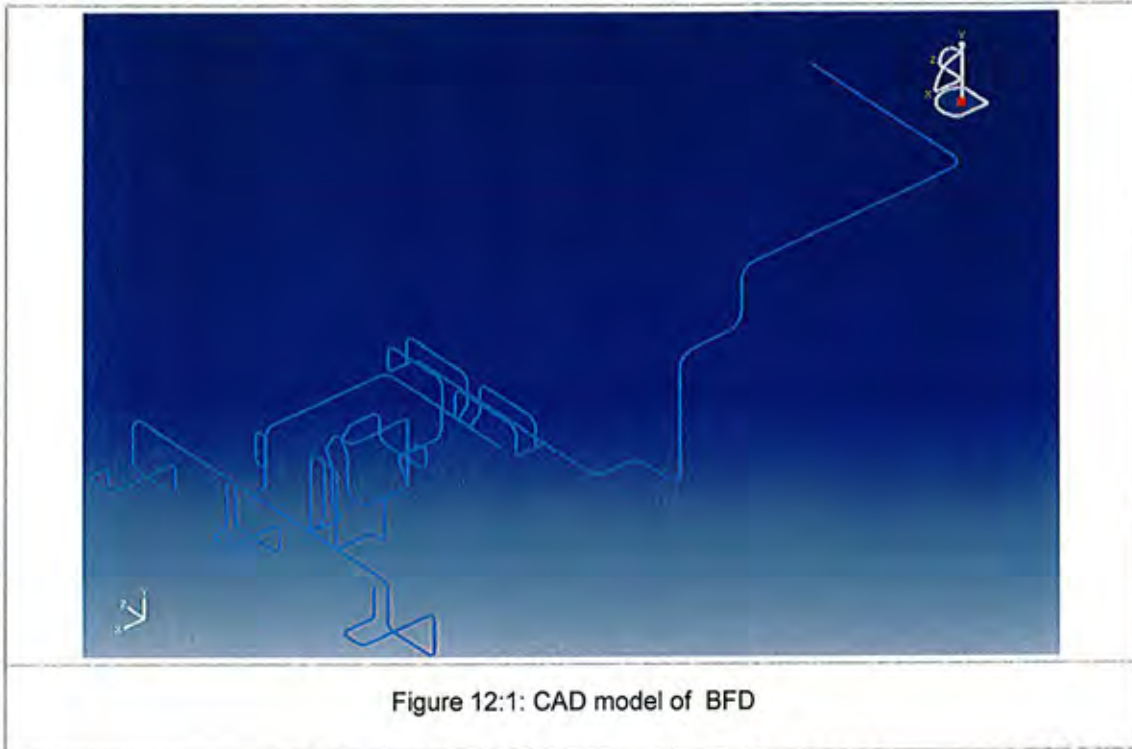

Figure 12-1: CAD model of BFD



Table 12-2: spring stiffness for BFD

Sl no.	Hanger #	Operating (cold)	Preset - cold (mm)	Preset - Hot (mm)	Spring rate X 1.0e3 (KN/mm)
1	BFD 023 TVH	34.42	34.42	44	45
2	BFD 054 TVH	74.1	74.1	39	36

Mesh Model Details

The meshing of the piping assembly is carried out in ABAQUS software. Pipe elements are used in the analysis to capture the effect of internal pressure. PIPE31: A 2-node linear pipe elements are used in the analysis. Total number of elements in the piping assembly is 4421. Maximum element length is 100mm.

614

	CLIENT	J-Power (Electric Power Development Co. Ltd.)
	PROJECT	Turbine and System Assessment for NTPC-KORBA Unit # 4
	ORDER NO.	CGP10028C
	CONTRACTOR	ALSTOM K. K. NASL LTD. (Nominated Sub-Contractor in India)
	DOCUMENT	FINAL REPORT VOL - II (PIPING ASSESSMENT)

FE Analysis Results

The piping assembly analysis is carried out for thermal and mechanical loads. The model is meshed with 2 noded pipe elements. The elastic and plastic effects are taken into account.

The loading, boundary conditions, thermo-mechanical loading and results for each case is discussed in the following pages.

Piping Assembly - Mechanical & Thermal Loading

The piping assembly is analysed for gravity and thermal loading conditions. Also internal pressure of 29.42 MPa (300 Kg/cm²) on BFD pipeline is applied. The hangers are modeled as spring elements with spring rate. The piping at the boiler end and the turbine ends are fixed as shown in Figure 12.3. Some of the regions are constrained in a particular direction as given in the drawing.

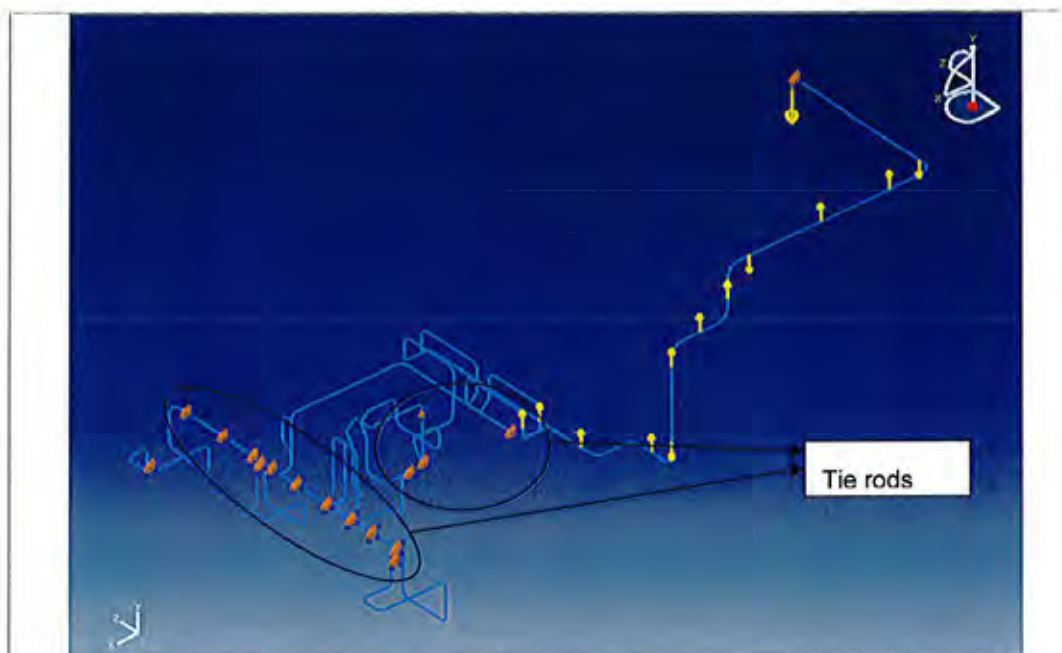



Figure 12.3: Boundary condition

	CLIENT	J-Power (Electric Power Development Co. Ltd.)
	PROJECT	Turbine and System Assessment for NTPC-KORBA Unit # 4
	ORDER NO.	CGP10028C
	CONTRACTOR	ALSTOM K. K. NASL LTD. (Nominated Sub-Contractor in India)
	DOCUMENT	FINAL REPORT VOL - II (PIPING ASSESSMENT)

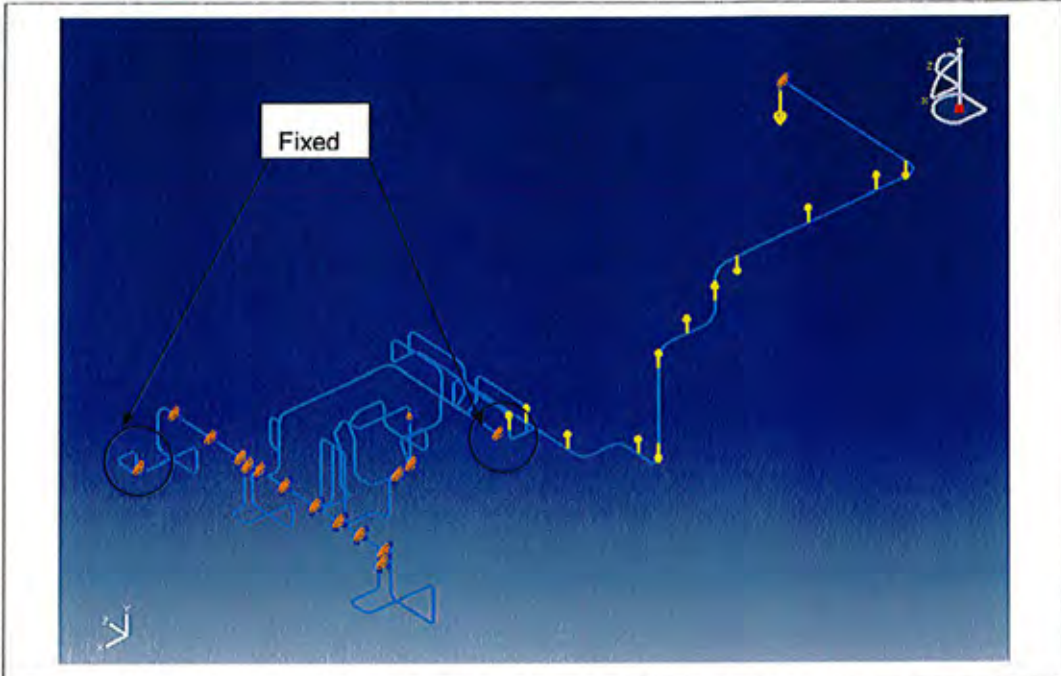

Figure 12:46: Restraints in the model

FE analysis and results

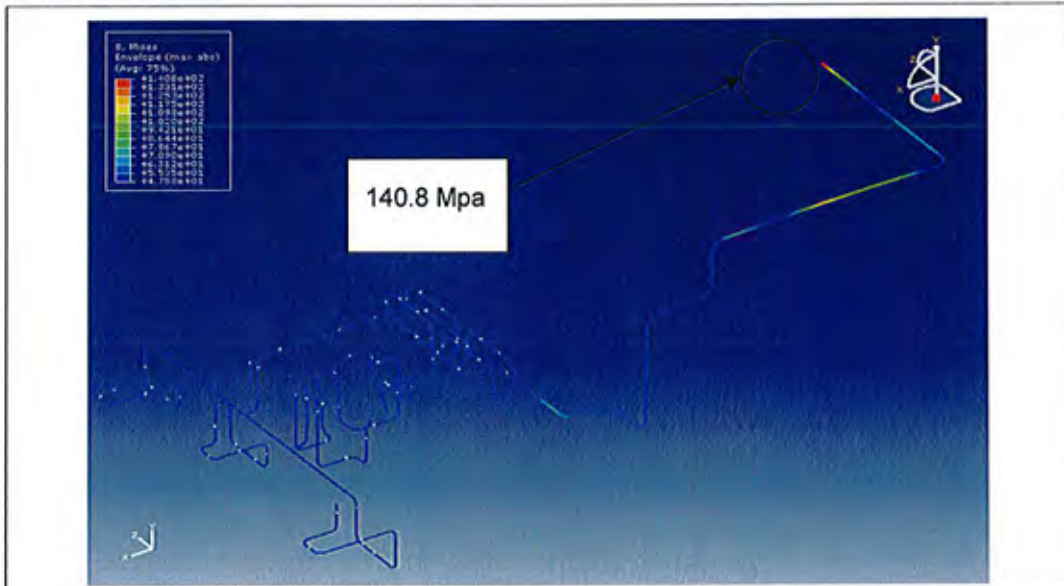



Figure 12:5: von Mises stress plot (Max. 140.8 MPa)

	CLIENT	J-Power (Electric Power Development Co. Ltd.)
	PROJECT	Turbine and System Assessment for NTPC-KORBA Unit # 4
	ORDER NO.	CGP10028C
 Power Services Pvt. Ltd.	CONTRACTOR	ALSTOM K. K. NASL LTD. (Nominated Sub-Contractor in India)
	DOCUMENT	FINAL REPORT VOL - II (PIPING ASSESSMENT)

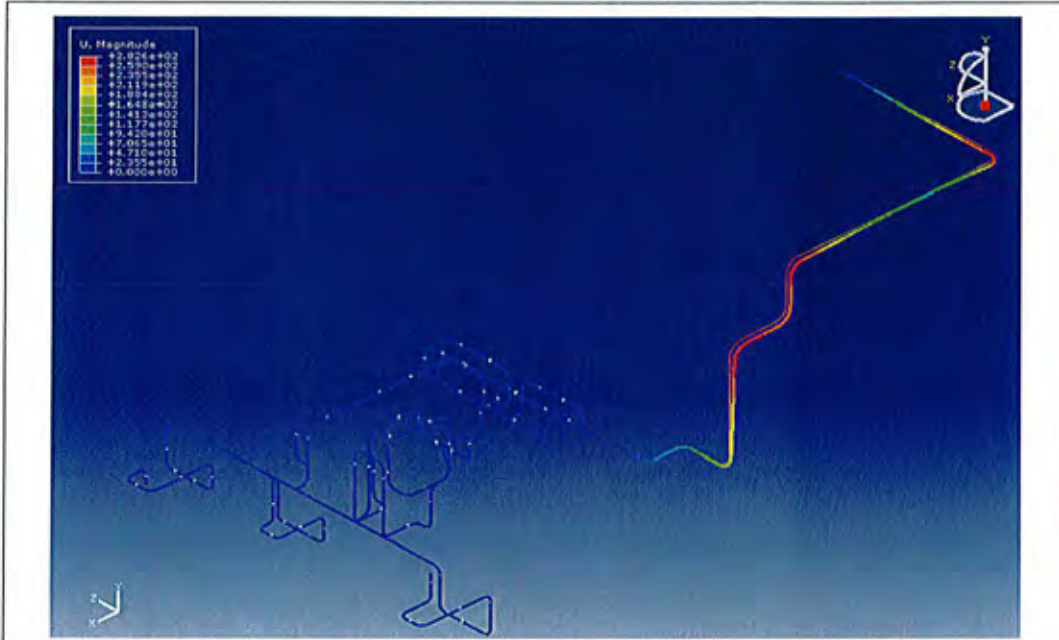



Figure 12.6: Deflection Plot – Hot position superimposed plot showing deformed and undeformed plot. (View scaled by 2 times)



Figure 12.7: Elastic strain Plot – Hot position (Max 0.00066)

617

	CLIENT	J-Power (Electric Power Development Co. Ltd.)
	PROJECT	Turbine and System Assessment for NTPC-KORBA Unit # 4
	ORDER NO.	CGP10028C
 Power Services Pvt. Ltd.	CONTRACTOR	ALSTOM K. K. NASL LTD. (Nominated Sub-Contractor in India)
	DOCUMENT	FINAL REPORT VOL - II (PIPING ASSESSMENT)

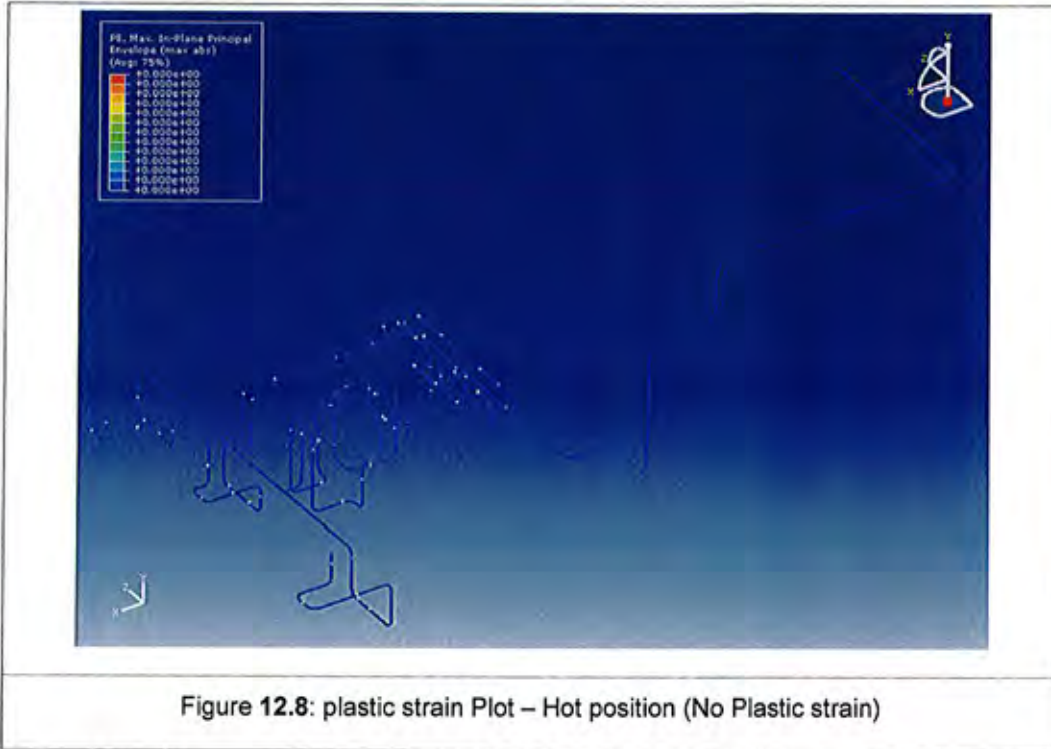



A total of 0.00066 strain is observed in the pipe line.

Piping assembly fatigue analysis

Fatigue analysis carried out on the piping considering the start and stop of the boiler. Due to the thermal and pressure loading, stresses are developed. These cycles are repeated to predict the life of the piping system.

The maximum stress observed is 140.8 MPa and strain observed in 0.00066 From the graph the piping has infinite life.

	CLIENT	J-Power (Electric Power Development Co. Ltd.)
	PROJECT	Turbine and System Assessment for NTPC-KORBA Unit # 4
	ORDER NO.	CGP10028C
 Power Services Pvt. Ltd.	CONTRACTOR	ALSTOM K. K. NASL LTD. (Nominated Sub-Contractor In India)
	DOCUMENT	FINAL REPORT VOL - II (PIPING ASSESSMENT)

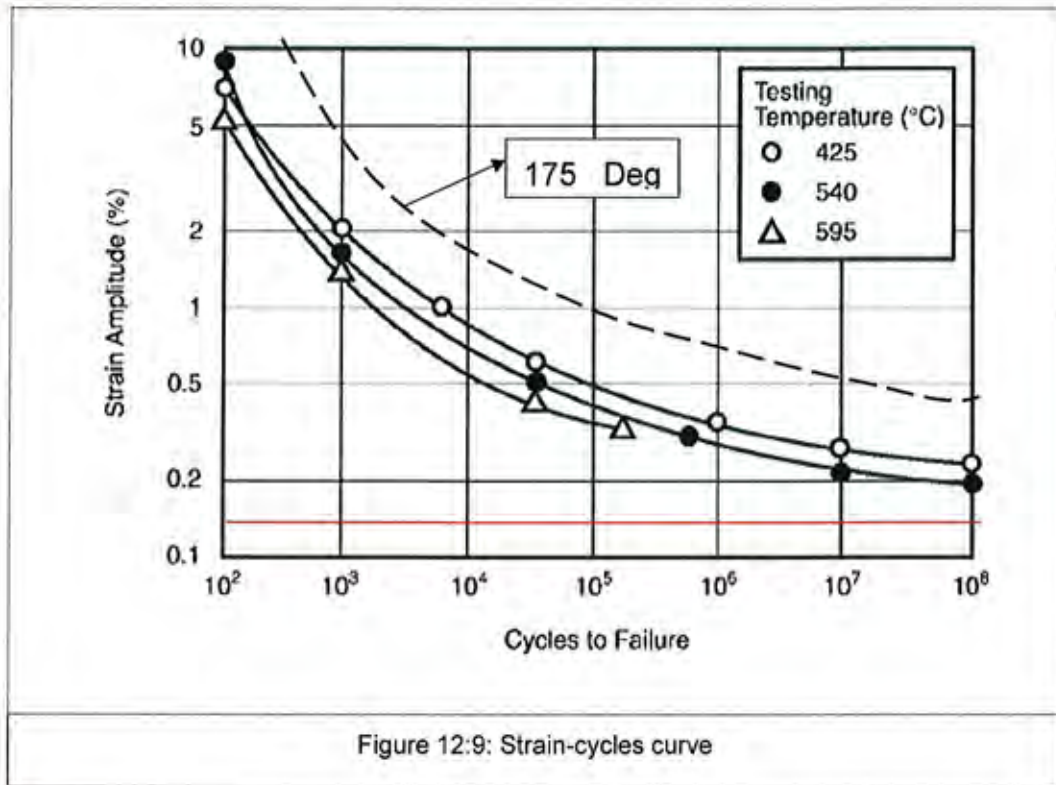

Observations

- The results due to thermo-mechanical loads for the operating conditions show the maximum deflection is around 280 mm and a maximum stress is 140.8 MPa.
- The life of the piping system subjected to fatigue loading is 1e6 cycles.

619

ALSTOM	CLIENT	J-Power (Electric Power Development Co. Ltd.)
	PROJECT	Turbine and System Assessment for NTPC-KORBA Unit # 4
	ORDER NO.	CGP10028C
NTPC ALSTOM Power Services Pvt. Ltd.	CONTRACTOR	ALSTOM K. K. NASL LTD. (Nominated Sub-Contractor in India)
	DOCUMENT	FINAL REPORT VOL - II (PIPING ASSESSMENT)

10.7.4 Remaining Life Calculation Using LMP Methods:



	Pressure Kg/cm ²	OD cm	Thickness s cm	Hoop Stress Mpa	Hoop Stress Kg/cm ² (PD/2t)	A	B	LMP	T,°K	Log tr	t rupture, hours	Remaining life in hours,	Remaini ng life in years,
MS- operating (without factor of safety)	170	54.5	8.4	54.067	551.488	26890	3413	20946	813	5.800	631102	433102	49.44
MS- operating (with 1.25 factor of safety)	212	54.5	8.4	67.425	687.738	26890	3413	20648	813	5.398	249787	51787	5.91
MS- operating (with 1.10 factor of safety)	187	54.5	8.4	59.474	606.637	26890	3413	20834	813	5.626	422999	224999	25.68
HRH operating	63.75	68.5	4.08	52.466	535.156	26890	3413	21020	813	5.655	707000	509000	58.11
CRH operating	56.2	56.0	2.20	70.630	720.360	26890	3413	20560	643	12.005	infinite life		

Please refer Clause No 6.4.1 of Vol 1A of Chapter 6 for detail methodology for remaining life calculation using LMP.

10.7.5 Conclusion of FEA USING ABAQUS/FESAFE

1. The results due to thermo-mechanical loads for the operating conditions show the maximum deflection is around 250 mm and a maximum stress is 168MPa in CRH. And 171 mm deflection in MST and maximum stress of 89.13MPa.
2. Creep life of the MST piping is 48 years.
3. The creep has caused maximum of 111 mm permanent deformation.
4. The fatigue life of the CRH piping system subjected to fatigue loading is 1e6 cycles.
5. The fatigue life of the MST piping system subjected to fatigue loading is 1e6 cycles.
6. The fatigue life of the HRH piping is 8500.
7. Creep life of the HRH piping is 36 years.

By using Miner's damage rule and combining the fatigue damage

	CLIENT	J-Power (Electric Power Development Co. Ltd.)
	PROJECT	Turbine and System Assessment for NTPC-KORBA Unit # 4
	ORDER NO.	CGP10028C
 Power Services Pvt. Ltd.	CONTRACTOR	ALSTOM K. K. NASL LTD. (Nominated Sub-Contractor in India)
	DOCUMENT	FINAL REPORT VOL - II (PIPING ASSESSMENT)

N1 =Fatigue life of the piping system in years.

N2 = Creep life of the piping system in years.

The power plant has completed 25 years of operation

N = Total life of the piping due to fatigue and creep

$$=(25/N) = (25/N1)+(25/N2)$$

Piping component	Fatigue life (Years) (considering 2 cycles/yr)	Creep life (years)	creep + fatigue life (Years) =N	Remaining life (Years) =(N-25)
Minors damage (rule)	N1	N2	25/N=(25/N1+25/N2)	
MST & HPBP	500000	48	48	23
CRH	500000	-	-	-
HRH and LPBP	4250	36	38.6	13.6
BFD	500000	-	-	-

10.7.6 Overall Conclusions:

The wide difference between the evaluated remaining life for MS Line between LMP and FEA is due to a conservative approach taken in LMP methodology. A safety factor of 1.25 upon operating pressure is taken - to cover the probability of variation in operation, undue stresses due to change in loading pattern & spent life of the pipe. It may be noted that probability of failure is generally located in the hot spot zone as identified in FE analysis. However evaluated life changes drastically to 25 yrs if 10 % safety factor is taken or in other words if pressure does not rise above design pressure.

Based upon above result, we conclude that the expected remaining life for MS Line could be prolonged up to 20 years under strict compliance of the following:

- 1) Operating pressure will not exceed design pressure
- 2) Corrective action of resetting the hangers and supports are taken (refer to Chapter 8)
- 3) Close monitoring of weak zones are carried out as recommended in the next section.

Based on the overall analysis, it can be concluded that:

1. Remaining life of MS-CRH-HPBP Line is evaluated to be > 20 years.
2. Remaining life of HRH-LPBP Line is evaluated to be 13.6 years.
3. Remaining Life of BFD is evaluated to be > 20 years.

ALSTOM	CLIENT	J-Power (Electric Power Development Co. Ltd.)
	PROJECT	Turbine and System Assessment for NTPC-KORBA Unit # 4
	ORDER NO.	CGP10028C
NTPC ALSTOM Power Services Pvt. Ltd.	CONTRACTOR	ALSTOM K. K. NASL LTD. (Nominated Sub-Contractor in India)
	DOCUMENT	FINAL REPORT VOL - II (PIPING ASSESSMENT)

10.7.7 Recommendations on MS Line hot points:

It is suggested that the critical locations identified be subjected to the following tests in every annual overhauling, mandatory at next annual overhauling:



- a. In situ Metallography (IM) to know the material degradation level,
- b. Thickness Survey,
- c. Online line monitoring systems using the installation of the High temperature strain gauges at identified hot spot locations & thus the real time strain data will be acquired and used for further life estimations.
- d. EMAT - Electromagnetic acoustic transducer test / high frequency (20MHz) small diameter probe UT can be implemented to check the state of steam side surface corrosion. / pitting of the main steam pipe in the critical locations.

The ALSTOM logo is located in the top left corner of the page. It consists of the word "ALSTOM" in a bold, blue, sans-serif font. The letter "O" is stylized with a red circle around it.

Volume-II
Chapter – 11
Photographs

NTPC ALSTOM
Power Services Pvt. Ltd.

529

	CLIENT	J-Power (Electric Power Development Co. Ltd.)
	PROJECT	Turbine and System Assessment for NTPC-KORBA Unit # 4
	ORDER NO.	CGP10028C
	CONTRACTOR	ALSTOM K. K. NASL LTD. (Nominated Sub-Contractor In India)
	DOCUMENT	FINAL REPORT VOL - II (PIPING ASSESSMENT)

CHAPTER - 11 PHOTOGRAPHS



PHOTO 1- Bent supporting flange of I-beam at Y-restraint



PHOTO 2- Dismantled Horz restraint in LPBP piping

624

The ALSTOM logo is located in the top left corner of the page. It consists of the word "ALSTOM" in a bold, sans-serif font. The letters "ALST" are in blue, and "OM" is in red. The letter "O" has a white center with a red outline.

Volume-II
Annexure-I

NTPC ALSTOM
Power Services Pvt. Ltd.



	CLIENT	J-Power (Electric Power Development Co. Ltd.)
	PROJECT	Turbine and System Assessment for NTPC-KORBA Unit # 4
	ORDER NO.	CGP10028C
 Power Services Pvt. Ltd.	CONTRACTOR	ALSTOM K. K. NASL LTD. (Nominated Sub-Contractor In India)
	DOCUMENT	FINAL REPORT VOL - II (PIPING ASSESSMENT)



Table No: 1 Hanger Movements, at Korba Unit # 4, 500 MW

Hanger Tag No.	As per Design data of Hangers (Ref. Hanger dwgs)			Site Readings of Hangers			Observations at Site during Cold survey Dt. 20.5.10 to 24.5.10 Hot Survey-22.06.10 to 24.06.10
	Hot position (mm)	Cold Pos. (mm)	Travel (mm)	Hot Survey(mm)	Cold Survey(mm)	Travel (mm)	
MST-001				60	70		
MST-002				120	140		
MST-003				90/88	90/92		
MST-004					-		Tie Rod
MST-005	99	109	+10	70/60	80/70		
MST-006	-						Tie Rod
MST-007	79	0	-79	40/90	0/20		
MST-008	161	0	-161	138/140	20/0		
MST-009	228	0	-228	Not Approachable	0/-		Not approachable
MST-010	187	0	-187	108	54		
MST-011	150	0	-150	90	120		
MST-012	142	0	-142	72	84		
MST-013	181	0	-181	90/90	60/60		
MST-014	197	0	-197	120	78		
MST-015	131	0	-131	108	96		
MST-016	55	0	-55	40	72		
MST-017	53	80	+27	20	100		
MST-018	51	160	+109	Scale damage	-		Scale damaged
MST-019	130	250	+120	120/110	12/18		
MST-020				110/110	160/160		
MST-021				120/100	120/120		
MST-022				190/160	170/110		
MST-023				80/85	60/60		
MST-024				170/170	130/125		
MST-025				140/150	90/100		
MST-026				180/180	140/140		
MST-027				140/140	75/75		
MST-028				65	20		
MST-029				95	55		
MST-030				60	30		

626

ALSTOM	CLIENT	J-Power (Electric Power Development Co. Ltd.)
	PROJECT	Turbine and System Assessment for NTPC-KORBA Unit # 4
	ORDER NO.	CGP10028C
NTPC ALSTOM Power Services Pvt. Ltd.	CONTRACTOR	ALSTOM K. K. NASL LTD. (Nominated Sub-Contractor in India)
	DOCUMENT	FINAL REPORT VOL - II (PIPING ASSESSMENT)

Hanger Tag No.	As per Design data of Hangers (Ref . Hanger dwgs)			Site Readings of Hangers			Observations at Site during Cold survey Dt. 20.5.10 to 24.5.10 Hot Survey-22.06.10 to 24.06.10
	Hot position (mm)	Cold Pos. (mm)	Travel (mm)	Hot Survey(mm)	Cold Survey(mm)	Travel (mm)	
MST-031				150	110		
MST-032				50	60		
MST-033				135	150		
MST-034				100/100	100/100		
MST-035				Tie	-		Tie Rod
MST-036				80/70	85/80		
MST-037				Tie	-		Tie Rod
MST-038				55/80	0/0		
MST-039				120/160	25/0		
MST-040				Not Approachable			Not approachable
MST-041				150/150	100/80		
MST-042				140	70		
MST-043				90	72		
MST-046							X- restraint
MST-049					-		
MST-050							
HPBP-01				100	80		
HPBP-02				25			Spring topped out. Requires cold setting
HPBP-03				50/60	100/100		
HPBP-04				70	60		
HPBP-05				50/75	75/75		
HPBP-06				40	55		
HPBP-07				80	95		
HPBP-08				40	60/60		
HPBP-09				80/100	116		
HPBP-10				100/100	120/130		
HPBP-11				116			
HPBP-12				70	80		

	CLIENT	J-Power (Electric Power Development Co. Ltd.)
	PROJECT	Turbine and System Assessment for NTPC-KORBA Unit # 4
	ORDER NO.	CGP10028C
 Power Services Pvt. Ltd.	CONTRACTOR	ALSTOM K. K. NASL LTD. (Nominated Sub-Contractor in India)
	DOCUMENT	FINAL REPORT VOL - II (PIPING ASSESSMENT)

Hanger Tag No.	As per Design data of Hangers (Ref. Hanger dwgs)			Site Readings of Hangers			Observations at Site during Cold survey Dt. 20.5.10 to 24.5.10 Hot Survey-22.06.10 to 24.06.10
	Hot position (mm)	Cold Pos. (mm)	Travel (mm)	Hot Survey(mm)	Cold Survey(mm)	Travel (mm)	
HPBP-13					120		
HPBP-14					100		
HPBP-15				60	90		
HPBP-16				120	80		
HPBP-17				70	100		
HPBP-18				No Scale	0/-		Spring casing missing.
HPBP-19				70	65		
HPBP-20				60	60		
HPBP-21				70	60		
HPBP-22					95		
HPBP-23					130		
HPBP-24				160/160	160/160		

ALSTOM	CLIENT	J-Power (Electric Power Development Co. Ltd.)
	PROJECT	Turbine and System Assessment for NTPC-KORBA Unit # 4
	ORDER NO.	CGP10028C
NTPC ALSTOM Power Services Pvt. Ltd.	CONTRACTOR	ALSTOM K. K. NASL LTD. (Nominated Sub-Contractor In India)
	DOCUMENT	FINAL REPORT VOL - II (PIPING ASSESSMENT)

Table No 2: CRH Hanger Movements, at Korba Unit #4, 500 MW

Hanger Tag No.	As per Design data of Hangers (Ref . Hanger dwgs)			Site Readings of Hangers			Observations at Site during Cold survey Dt. 20.5.10 to 24.5.10 Hot Survey-22.06.10 to 24.06.10
	Hot position (mm)	Cold Position (mm)	Travel (mm)	Hot Survey (mm)	Cold Survey (mm)	Travel (mm)	
CRH -01	127	0	-127	138	12		
CRH -02	127	0	-127	108	60		
CRH -03	142	0	-142	132/138	72/125		
CRH -04	164	0	-164	126	48		
CRH -05	156	0	-156	150	72		
CRH -06	170	0	-170	180/198	102/120		
CRH -07	115	0	-115	120	70		
CRH -08	87	50	-37	70/70	90/50		
CRH -09	124	112	-12	130/125	125/125		
CRH -10	117	80	-37	110/120	90/95		
CRH -11	66	0	-66	80/70	0/0		
CRH -12	99	0	-99	85/100	0/0		
CRH -13	88	0	-88	110	70		
CRH -14	76	0	-76	100	60		
CRH -15	64	0	-64	100	70		
CRH -16	54	0	-54	80	60		
CRH -17	47	0	-47	20/20	12/-		No load on spring
CRH -18	177	125	-52	170	170		
CRH -19	176	122	-54	155	115		
CRH -20	131	110	-21				Hanger is missing
CRH -21	164	112	-52	150	115		
CRH -22	123	102	-21				
CRH -23	127	0	-127	112	6		
CRH -24	125	0	-125	120	60		
CRH -25	132	0	-132	140/160	24/36		
CRH -26	166	0	-166	125	60		
CRH -27	169	0	-169	144	72		
CRH -28	179	0	-179	210	90		
CRH -29	75	0	-75	100	70		
CRH -30					-		Y- restraint
CRH -31							
CRH -32					-		Horz restraint
CRH -33				Restraint	-		Y- restraint

649

ALSTOM	CLIENT	J-Power (Electric Power Development Co. Ltd.)
	PROJECT	Turbine and System Assessment for NTPC-KORBA Unit # 4
	ORDER NO.	CGP10028C
NTPC ALSTOM Power Services Pvt. Ltd.	CONTRACTOR	ALSTOM K. K. NASL LTD. (Nominated Sub-Contractor in India)
	DOCUMENT	FINAL REPORT VOL - II (PIPING ASSESSMENT)

Hanger Tag No.	As per Design data of Hangers (Ref . Hanger dwgs)			Site Readings of Hangers			Observations at Site during Cold survey Dt. 20.5.10 to 24.5.10 Hot Survey-22.06.10 to 24.06.10
	Hot position (mm)	Cold Position (mm)	Travel (mm)	Hot Survey (mm)	Cold Survey (mm)	Travel (mm)	
CRH -34					-		Horz Restraint



Table No 3 :HRH,Steam,(Including LP Bypass)

Hanger Movements, at Korba Unit #4, 500 MW

Hanger Tag No.	As per Design data of Hangers (Ref . Hanger dwgs)			Site Readings of Hangers			Observations at Site during Cold survey Dt. 20.5.10 to 24.5.10 Hot Survey-22.06.10 to 24.06.10
	Hot position (mm)	Cold Position (mm)	Travel (mm)	Hot Survey(mm)	Cold Survey (mm)	Travel (mm)	
HRH-001	31	48	+17	48	55		
HRH-002	100	119	+19	120	120		
HRH-003	18	25	+7	30/40	30/30		
HRH-004				Tie	-		Tie Rod
HRH-005	47	50	+3	50	60		
HRH-006				Tie	-		Tie Rod
HRH-007	97	0	-97	70/100	10/10		
HRH-008	180	0	-180	180/192	0/30		
HRH-009	254	0	-254	Not Approachable	-		Not approachable
HRH-010	251	0	-251	200	50		
HRH-011	210	0	-210	80	20		
HRH-012	170	0	-170	30	0		
HRH-013	154	0	-154	30/0	0/0		
HRH-014	156	0	-156	18	0		
HRH-015	78	0	-78	0	0		
HRH-016	73	80	+7	20	72		
HRH-017	69	160	+91	52	52		
HRH-018	40	160	+120	60/60	160/160		
HRH-019	33	112	+79	50	110/110		
HRH-020	134	165	+31	110/110	140/140		

ALSTOM	CLIENT	J-Power (Electric Power Development Co. Ltd.)
	PROJECT	Turbine and System Assessment for NTPC-KORBA Unit # 4
	ORDER NO.	CGP10028C
NTPC ALSTOM Power Services Pvt. Ltd.	CONTRACTOR	ALSTOM K. K. NASL LTD. (Nominated Sub-Contractor In India)
	DOCUMENT	FINAL REPORT VOL - II (PIPING ASSESSMENT)

Hanger Tag No.	As per Design data of Hangers (Ref . Hanger dwgs)			Site Readings of Hangers			Observations at Site during Cold survey Dt. 20.5.10 to 24.5.10 Hot Survey-22.06.10 to 24.06.10
	Hot position (mm)	Cold Position (mm)	Travel (mm)	Hot Survey(mm)	Cold Survey (mm)	Travel (mm)	
HRH-021	138	108	-30	120/120	95/95		
HRH-022	136	100	-36	160/150	110/110		
HRH-023	136	99	-37	150/155	100/100		
HRH-024	117	80	-37	40	120		
HRH-025	187	148	-39	60	130		
HRH-026	117	72	-45	180	70		
HRH-027	172	128	-44	90	110		
HRH-028	128	100	-28	100	95/95		
HRH-029	133	105	-28	110/110	110/115		
HRH-030	110	75	-35	140/140	80/80		
HRH-031	116	79	-37	110/	85/85		
HRH-032	34	48	+14	50	55		
HRH-033	28	30	+2	40	50		
HRH-034	40	25	-15	38/35	35/40		
HRH-035				Tie	-		Tie Rod
HRH-036	37	50	+13	40	60		
HRH-037					-		Tie Rod
HRH-038	97	0	-97	70/100	0/20		
HRH-039	180	0	-180	165/170	0/30		
HRH-040	240	0	-240	Not Approachable	0/-		Not approachable
HRH-041	184	0	--184	120	30		
HRH-042	126	0	-126	54	12		
HRH-043	106	0	-106	0	0		
HRH-044							Z- restraint
HRH-045							Z- restraint
HRH-046							Y- restraint
HRH-047							Restraint
HRH-048							Restraint
LPBPH-1				20/20	0/0		
LPBPH-2				35	0		
LPBPH-3				50	10		
LPBPH-4				70/70	10/10		
LPBPH-5				60	0		
LPBPH-6				45/35	-		

	CLIENT	J-Power (Electric Power Development Co. Ltd.)
	PROJECT	Turbine and System Assessment for NTPC-KORBA Unit # 4
	ORDER NO.	CGP10028C
 Power Services Pvt. Ltd.	CONTRACTOR	ALSTOM K. K. NASL LTD. (Nominated Sub-Contractor in India)
	DOCUMENT	FINAL REPORT VOL - II (PIPING ASSESSMENT)

Hanger Tag No.	As per Design data of Hangers (Ref . Hanger dwgs)			Site Readings of Hangers			Observations at Site during Cold survey Dt. 20.5.10 to 24.5.10 Hot Survey-22.06.10 to 24.06.10
	Hot position (mm)	Cold Position (mm)	Travel (mm)	Hot Survey(mm)	Cold Survey (mm)	Travel (mm)	
LPBPH-7				95/90	105/105		
							Y- restraint
LPBPH-8				50/40	45/45		
					25/25		LPBP Valve support
LPBPH-9				18/18	10/10		
LPBPH-10				30/35	0		
LPBPH-11				20/20	80/80		
LPBPH-12				75/80	40/40		
LPBPH-13				40	0		
					-		Horz restraint in dismantled condition. Bolts to be tightened.
LPBPH-14					-		Tie Rod
LPBPH-15				0	0		
							LPBP Valve support
LPBPH-16				18/18	10/10		

**Table No 4 : Boiler Feed Discharge Piping
Hanger Movements, at Korba Unit#4, 500 MW**

Hanger Tag No.	As per Design data of Hangers (Ref . Hanger dwgs)			Site Readings of Hangers			Observations at Site during Cold survey Dt. 20.5.10 to 24.5.10 Hot Survey-22.06.10 to 24.06.10
	Hot position (mm)	Cold Position (mm)	Travel (mm)	Hot Survey (mm)	Cold Survey (mm)	Travel (mm)	
BFD-01				No Load			No load on hanger
BFD-02				75	50		
BFD-03					-		Tie rod
BFD-04				20/20	20/20		
BFD-05				Topped Spring	20		
BFD-06				30	15		
BFD-07				30/30	30/30		
BFD-08					-		Tie rod

ALSTOM**NTPC ALSTOM**
Power Services Pvt. Ltd.

CLIENT	J-Power (Electric Power Development Co. Ltd.)
PROJECT	Turbine and System Assessment for NTPC-KORBA Unit # 4
ORDER NO.	CGP10028C
CONTRACTOR	ALSTOM K. K. NASL LTD. (Nominated Sub-Contractor in India)
DOCUMENT	FINAL REPORT VOL - II (PIPING ASSESSMENT)

Hanger Tag No.	As per Design data of Hangers (Ref. Hanger dwgs)			Site Readings of Hangers			Observations at Site during Cold survey Dt. 20.5.10 to 24.5.10 Hot Survey-22.06.10 to 24.06.10
	Hot position (mm)	Cold Position (mm)	Travel (mm)	Hot Survey (mm)	Cold Survey (mm)	Travel (mm)	
BFD-09					-		Tie rod
BFD-10					-		Tie rod
BFD-11				60/40	30/40		
BFD-12				80	70		
BFD-13				40	30		
BFD-14				30/30	40/15		
BFD-15				75	60		
BFD-16				Topped spring	-		
BFD-17				Tie rod	-		Tie rod
BFD-18				Tie rod	-		Tie rod
BFD-19				Tie rod			
BFD-20				60/60	50/50		
BFD-21				50	45		
BFD-22				55	35		
BFD-23				50/40	40/40		
BFD-24				70	40		
BFD-25				60	40		
BFD-26				60/70	80/80		
BFD-27					-		Tie rod
BFD-28					-		Tie rod
BFD-29					-		Tie rod
BFD-30				90/90	80/80		
BFD-31				50/75	40/60		
BFD-32				30	35		
BFD-33				35/35	35/35		
BFD-34				90/70	30/50		
BFD-35				40	30		
BFD-36				50/50	40/45		
BFD-37				50	49		
BFD-38					-		Tie rod
BFD-39				70	35		
BFD-40				70/70	50/50		
BFD-41				52			
BFD-42				50	50		

ALSTOM	CLIENT	J-Power (Electric Power Development Co. Ltd.)
	PROJECT	Turbine and System Assessment for NTPC-KORBA Unit # 4
	ORDER NO.	CGP10028C
NTPC ALSTOM Power Services Pvt. Ltd.	CONTRACTOR	ALSTOM K. K. NASL LTD. (Nominated Sub-Contractor In India)
	DOCUMENT	FINAL REPORT VOL - II (PIPING ASSESSMENT)

Hanger Tag No.	As per Design data of Hangers (Ref . Hanger dwgs)			Site Readings of Hangers			Observations at Site during Cold survey Dt. 20.5.10 to 24.5.10 Hot Survey-22.06.10 to 24.06.10
	Hot position (mm)	Cold Position (mm)	Travel (mm)	Hot Survey (mm)	Cold Survey (mm)	Travel (mm)	
BFD-43				50	45		
BFD-44					-		Tie rod
BFD-45				100	60		
BFD-46				50/50	50		
BFD-47				70	75		
BFD-48				80	75		
BFD-49				75	80		
BFD-50				70	60		
BFD-51				40/30	30/30		
BFD-52				70	80		
BFD-53				30/30	30/30		
BFD-54				20/30	25/30		
BFD-55				40	55		
BFD-56				50	50		
BFD-57							
BFD-58							
BFD-59							
BFD-60							
BFD-61							
BFD-62							
BFD-63							
BFD-64							
BFD-65							
BFD-66							
BFD-67							
BFD-68							
BFD-69							
BFD-70							
BFD-71							
BFD-72							
BFD-73							
BFD-74							
BFD-75							
BFD-76							

ALSTOM	CLIENT	J-Power (Electric Power Development Co. Ltd.)
	PROJECT	Turbine and System Assessment for NTPC-KORBA Unit # 4
	ORDER NO.	CGP10028C
NTPC ALSTOM Power Services Pvt. Ltd.	CONTRACTOR	ALSTOM K. K. NASL LTD. (Nominated Sub-Contractor in India)
	DOCUMENT	FINAL REPORT VOL - II (PIPING ASSESSMENT)

Hanger Tag No.	As per Design data of Hangers (Ref . Hanger dwgs)			Site Readings of Hangers			Observations at Site during Cold survey Dt. 20.5.10 to 24.5.10 Hot Survey-22.06.10 to 24.06.10
	Hot position (mm)	Cold Position (mm)	Travel (mm)	Hot Survey (mm)	Cold Survey (mm)	Travel (mm)	
BFD-77							
BFD-78							
BFD-79							
BFD-80							
BFD-81							
BFD-82				35	8		
BFD-83				60/40	36/20		
BFD-84				0	0/0		
BFD-85				40	56		
BFD-86				12/12	16/18		
BFD-87				100	100		
BFD-88				100	50		
BFD-89				110	30		
BFD-90				110	0		



ALSTOM

Volume-II
Annexure-II

NTPC ALSTOM
Power Services Pvt. Ltd.

CAESAR II Ver.5.10.00, (Build 070917) Date: JUL 19, 2010 Time: 16:42
Job: C:\DOCUMENTS AND SETTINGS\ABC\MY DOCUMENTS\ST...MS_CRH_LPBP
Licensed To: DEALR/EVAL COPY -- ID #4369

Table of Contents

LISTING OF STATIC LOAD CASES FOR THIS ANALYSIS 2

.....

Restraint Summary : Multiple..... 3

Displacements : 3 (OPE) W+D1+T1+P1+H 20

Displacements : 4 (SUS) W+P1+H..... 30

Stress Summary : Multiple..... 40

HANGER REPORT ((TABLE DATA FROM DESIGN RUNS))..... 41

CAESAR II Ver.5.10.00, (Build 070917) Date: JUL 19, 2010 Time: 16:42
Job: C:\DOCUMENTS AND SETTINGS\ABC\MY DOCUMENTS\IST...MS_CRH_LPBP
Licensed To: DEALR/EVAL COPY -- ID #4369

LISTING OF STATIC LOAD CASES FOR THIS ANALYSIS

- 1 (HGR) CASE NOT ACTIVE
- 2 (HGR) CASE NOT ACTIVE
- 3 (OPE) W+D1+T1+P1+H
- 4 (SUS) W+P1+H
- 5 (EXP) L5=L3-L4

CAESAR II Ver.5.10.00, (Build 070917) Date: JUL 19, 2010 Time: 16:42
 Job: C:\DOCUMENTS AND SETTINGS\ABC\MY DOCUMENTS\IST...MS_CRH_LPBP
 Licensed To: DEALR/EVAL COPY -- ID #4369

RESTRAINT SUMMARY REPORT: Loads On Restraints
 Various Load Cases

LOAD CASE DEFINITION KEY

CASE 3 (OPE) W+D1+T1+P1+H
 CASE 4 (SUS) W+P1+H
 CASE 5 (EXP) L5=L3-L4

NODE	Load Case	FX N. Displ. Reaction	FY N.	FZ N.	MX N.m.	MY N.m.	MZ N.m.
10	3 (OPE)	-5078	-28037	-14036	-74294	63624	-95979
	4 (SUS)	371	2729	60	-4113	3265	13527
	5 (EXP)	-5449	-30766	-14096	-70181	60359	-109506
	MAX	-5449/5	-30766/5	-14096/5	-74294/3	63624/3	-109506/5
		Prog Design VSH					
25	3 (OPE)	0	-34877	0	0	0	0
	4 (SUS)	0	-38000	0	0	0	0
	5 (EXP)	0	3123	0	0	0	0
	MAX		-38000/4				
		Prog Design VSH					
40	3 (OPE)	0	-53514	0	0	0	0
	4 (SUS)	0	-59797	0	0	0	0
	5 (EXP)	0	6283	0	0	0	0
	MAX		-59797/4				
		Prog Design VSH					
45	3 (OPE)	0	-72945	0	0	0	0
	4 (SUS)	0	-85699	0	0	0	0
	5 (EXP)	0	12753	0	0	0	0
	MAX		-85699/4				
		Prog Design VSH					
60	3 (OPE)	0	-62957	0	0	0	0
	4 (SUS)	0	-51647	0	0	0	0
	5 (EXP)	0	-11310	0	0	0	0
	MAX		-62957/3				
		Prog Design VSH					
65	3 (OPE)	0	90965	0	0	0	0
	4 (SUS)	0	-10803	0	0	0	0
	5 (EXP)	0	101768	0	0	0	0
	MAX		101768/5				
		Rigid Y					
80		Prog Design VSH					

CAESAR II Ver.5.10.00, (Build 070917) Date: JUL 19, 2010 Time: 16:42
 Job: C:\DOCUMENTS AND SETTINGS\ABC\MY DOCUMENTS\ST...MS_CRH_LPBP
 Licensed To: DEALR/EVAL COPY -- ID #4369

RESTRAINT SUMMARY REPORT: Loads On Restraints
 Various Load Cases

NODE	Load Case	FX N.	FY N.	FZ N.	MX N.m.	MY N.m.	MZ N.m.
	3 (OPE)	0	-58466	0	0	0	0
	4 (SUS)	0	-70983	0	0	0	0
	5 (EXP)	0	12517	0	0	0	0
	MAX		-70983/4				
95		Rigid Y					
	3 (OPE)	0	-148858	0	0	0	0
	4 (SUS)	0	-105107	0	0	0	0
	5 (EXP)	0	-43752	0	0	0	0
	MAX		-148858/3				
100		Prog Design CSH					
	3 (OPE)	0	-106367	0	0	0	0
	4 (SUS)	0	-106367	0	0	0	0
	5 (EXP)	0	0	0	0	0	0
	MAX		-106367/3				
105		Prog Design CSH					
	3 (OPE)	0	-170338	0	0	0	0
	4 (SUS)	0	-170338	0	0	0	0
	5 (EXP)	0	0	0	0	0	0
	MAX		-170338/3				
115		Prog Design CSH					
	3 (OPE)	0	-76845	0	0	0	0
	4 (SUS)	0	-76845	0	0	0	0
	5 (EXP)	0	0	0	0	0	0
	MAX		-76845/3				
125		Prog Design CSH					
	3 (OPE)	0	-74878	0	0	0	0
	4 (SUS)	0	-74878	0	0	0	0
	5 (EXP)	0	0	0	0	0	0
	MAX		-74878/3				
135		Prog Design CSH					
	3 (OPE)	0	-60859	0	0	0	0
	4 (SUS)	0	-60859	0	0	0	0
	5 (EXP)	0	0	0	0	0	0
	MAX		-60859/3				
145		Prog Design CSH					
	3 (OPE)	0	-72851	0	0	0	0
	4 (SUS)	0	-72851	0	0	0	0

CAESAR II Ver.5.10.00, (Build 070917) Date: JUL 19, 2010 Time: 16:42
 Job: C:\DOCUMENTS AND SETTINGS\ABC\MY DOCUMENTS\IST...MS_CRH_LPBP
 Licensed To: DEALR/EVAL COPY -- ID #4369

RESTRAINT SUMMARY REPORT: Loads On Restraints
 Various Load Cases

NODE	Load Case	FX N.	FY N.	FZ N.	MX N.m.	MY N.m.	MZ N.m.
	5 (EXP)	0	0	0	0	0	0
	MAX		-72851/3				
160		Prog Design CSH					
	3 (OPE)	0	-131126	0	0	0	0
	4 (SUS)	0	-131126	0	0	0	0
	5 (EXP)	0	0	0	0	0	0
	MAX		-131126/3				
175		Prog Design CSH					
	3 (OPE)	0	-91777	0	0	0	0
	4 (SUS)	0	-91777	0	0	0	0
	5 (EXP)	0	0	0	0	0	0
	MAX		-91777/3				
185		Prog Design CSH					
	3 (OPE)	0	-96941	0	0	0	0
	4 (SUS)	0	-96941	0	0	0	0
	5 (EXP)	0	0	0	0	0	0
	MAX		-96941/3				
190		Prog Design CSH					
	3 (OPE)	0	-95279	0	0	0	0
	4 (SUS)	0	-95279	0	0	0	0
	5 (EXP)	0	0	0	0	0	0
	MAX		-95279/3				
195		Prog Design CSH					
	3 (OPE)	0	-95206	0	0	0	0
	4 (SUS)	0	-95206	0	0	0	0
	5 (EXP)	0	0	0	0	0	0
	MAX		-95206/3				
205		Rigid X					
	3 (OPE)	-7499	1854	1275	0	0	0
	4 (SUS)	-604	-4	181	0	0	0
	5 (EXP)	-6895	1858	1093	0	0	0
	MAX	-7499/3	1858/5	1275/3			
210		Prog Design CSH					
	3 (OPE)	0	-104825	0	0	0	0
	4 (SUS)	0	-104825	0	0	0	0
	5 (EXP)	0	0	0	0	0	0
	MAX		-104825/3				

CAESAR II Ver.5.10.00, (Build 070917) Date: JUL 19, 2010 Time: 16:42
 Job: C:\DOCUMENTS AND SETTINGS\ABC\MY DOCUMENTS\IST...MS_CRH_LPBP
 Licensed To: DEALR/EVAL COPY -- ID #4369

RESTRAINT SUMMARY REPORT: Loads On Restraints
 Various Load Cases

NODE	Load Case	FX N.	FY N.	FZ N.	MX N.m.	MY N.m.	MZ N.m.
225	Prog Design CSH						
	3 (OPE)	0	-154363	0	0	0	0
	4 (SUS)	0	-154363	0	0	0	0
	5 (EXP)	0	0	0	0	0	0
	MAX		-154363/3				
230	Prog Design CSH						
	3 (OPE)	0	-99894	0	0	0	0
	4 (SUS)	0	-99894	0	0	0	0
	5 (EXP)	0	0	0	0	0	0
	MAX		-99894/3				
235	Prog Design CSH						
	3 (OPE)	0	-91440	0	0	0	0
	4 (SUS)	0	-91440	0	0	0	0
	5 (EXP)	0	0	0	0	0	0
	MAX		-91440/3				
245	Rigid Y						
	3 (OPE)	0	-177559	0	0	0	0
	4 (SUS)	0	-136234	0	0	0	0
	5 (EXP)	0	-41325	0	0	0	0
	MAX		-177559/3				
260	Prog Design CSH						
	3 (OPE)	0	-121774	0	0	0	0
	4 (SUS)	0	-121774	0	0	0	0
	5 (EXP)	0	0	0	0	0	0
	MAX		-121774/3				
265	Prog Design CSH						
	3 (OPE)	0	-80281	0	0	0	0
	4 (SUS)	0	-80281	0	0	0	0
	5 (EXP)	0	0	0	0	0	0
	MAX		-80281/3				
270	Rigid Z						
	3 (OPE)	1883	-1157	7368	0	0	0
	4 (SUS)	-151	-342	-1247	0	0	0
	5 (EXP)	2035	-815	8615	0	0	0
	MAX	2035/5	-1157/3	8615/5			
275	Prog Design CSH						

CAESAR II Ver.5.10.00, (Build 070917) Date: JUL 19, 2010 Time: 16:42
 Job: C:\DOCUMENTS AND SETTINGS\ABC\MY DOCUMENTS\ST...MS_CRH_LPBP
 Licensed To: DEALR/EVAL COPY -- ID #4369

RESTRAINT SUMMARY REPORT: Loads On Restraints
 Various Load Cases

NODE	Load Case	FX N.	FY N.	FZ N.	MX N.m.	MY N.m.	MZ N.m.
	3 (OPE)	0	-104944	0	0	0	0
	4 (SUS)	0	-104944	0	0	0	0
	5 (EXP)	0	0	0	0	0	0
	MAX		-104944/3				
290	Prog Design CSH						
	3 (OPE)	0	-89738	0	0	0	0
	4 (SUS)	0	-89738	0	0	0	0
	5 (EXP)	0	0	0	0	0	0
	MAX		-89738/3				
300	Prog Design CSH						
	3 (OPE)	0	-108367	0	0	0	0
	4 (SUS)	0	-108367	0	0	0	0
	5 (EXP)	0	0	0	0	0	0
	MAX		-108367/3				
320	Prog Design CSH						
	3 (OPE)	0	-69235	0	0	0	0
	4 (SUS)	0	-69235	0	0	0	0
	5 (EXP)	0	0	0	0	0	0
	MAX		-69235/3				
505	Displ. Reaction						
	3 (OPE)	-3174	-11872	-2397	19454	-112225	-62299
	4 (SUS)	-1152	2319	1517	8614	9907	-33332
	5 (EXP)	-2023	-14191	-3914	10840	-122132	-28967
	MAX	-3174/3	-14191/5	-3914/5	19454/3	-122132/5	-62299/3
520	Prog Design VSH						
	3 (OPE)	0	-31754	0	0	0	0
	4 (SUS)	0	-31549	0	0	0	0
	5 (EXP)	0	-205	0	0	0	0
	MAX		-31754/3				
540	Prog Design VSH						
	3 (OPE)	0	-51731	0	0	0	0
	4 (SUS)	0	-58865	0	0	0	0
	5 (EXP)	0	7135	0	0	0	0
	MAX		-58865/4				
555	Prog Design VSH						
	3 (OPE)	0	-69938	0	0	0	0

CAESAR II Ver.5.10.00, (Build 070917) Date: JUL 19, 2010 Time: 16:42
 Job: C:\DOCUMENTS AND SETTINGS\ABC\MY DOCUMENTS\ST...MS_CRH_LPBP
 Licensed To: DEALR/EVAL COPY -- ID #4369

RESTRAINT SUMMARY REPORT: Loads On Restraints
 Various Load Cases

NODE	Load Case	FX N.	FY N.	FZ N.	MX N.m.	MY N.m.	MZ N.m.
	4 (SUS)	0	-77559	0	0	0	0
	5 (EXP)	0	7622	0	0	0	0
	MAX		-77559/4				
570	Prog Design VSH						
	3 (OPE)	0	-60770	0	0	0	0
	4 (SUS)	0	-62341	0	0	0	0
	5 (EXP)	0	1571	0	0	0	0
	MAX		-62341/4				
580	Rigid Y						
	3 (OPE)	-2245	7498	136	0	0	0
	4 (SUS)	1879	-7758	-1373	0	0	0
	5 (EXP)	-4124	15256	1509	0	0	0
	MAX	-4124/5	15256/5	1509/5			
595	Prog Design VSH						
	3 (OPE)	0	-56006	0	0	0	0
	4 (SUS)	0	-54701	0	0	0	0
	5 (EXP)	0	-1306	0	0	0	0
	MAX		-56006/3				
615	Rigid Y						
	3 (OPE)	0	-120720	0	0	0	0
	4 (SUS)	0	-109073	0	0	0	0
	5 (EXP)	0	-11647	0	0	0	0
	MAX		-120720/3				
620	Prog Design CSH						
	3 (OPE)	0	-101941	0	0	0	0
	4 (SUS)	0	-101941	0	0	0	0
	5 (EXP)	0	0	0	0	0	0
	MAX		-101941/3				
625	Prog Design CSH						
	3 (OPE)	0	-162752	0	0	0	0
	4 (SUS)	0	-162752	0	0	0	0
	5 (EXP)	0	0	0	0	0	0
	MAX		-162752/3				
645	Prog Design CSH						
	3 (OPE)	0	-74640	0	0	0	0
	4 (SUS)	0	-74640	0	0	0	0
	5 (EXP)	0	0	0	0	0	0
	MAX		-74640/3				

CAESAR II Ver.5.10.00, (Build 070917) Date: JUL 19, 2010 Time: 16:42
 Job: C:\DOCUMENTS AND SETTINGS\ABC\MY DOCUMENTS\ST...MS_CRH_LPBP
 Licensed To: DEALR/EVAL COPY -- ID #4369

RESTRAINT SUMMARY REPORT: Loads On Restraints
 Various Load Cases

NODE	Load Case	FX N.	FY N.	FZ N.	MX N.m.	MY N.m.	MZ N.m.
660	Prog Design CSH						
	3 (OPE)	0	-71921	0	0	0	0
	4 (SUS)	0	-71921	0	0	0	0
	5 (EXP)	0	0	0	0	0	0
	MAX		-71921/3				
670	Prog Design CSH						
	3 (OPE)	0	-58116	0	0	0	0
	4 (SUS)	0	-58116	0	0	0	0
	5 (EXP)	0	0	0	0	0	0
	MAX		-58116/3				
680	Prog Design CSH						
	3 (OPE)	0	-70456	0	0	0	0
	4 (SUS)	0	-70456	0	0	0	0
	5 (EXP)	0	0	0	0	0	0
	MAX		-70456/3				
1010	Prog Design CSH						
	3 (OPE)	0	-10017	0	0	0	0
	4 (SUS)	0	-10017	0	0	0	0
	5 (EXP)	0	0	0	0	0	0
	MAX		-10017/3				
1040	Prog Design CSH						
	3 (OPE)	0	-35125	0	0	0	0
	4 (SUS)	0	-35125	0	0	0	0
	5 (EXP)	0	0	0	0	0	0
	MAX		-35125/3				
1065	Prog Design CSH						
	3 (OPE)	0	-24776	0	0	0	0
	4 (SUS)	0	-24776	0	0	0	0
	5 (EXP)	0	0	0	0	0	0
	MAX		-24776/3				
1080	Prog Design CSH						
	3 (OPE)	0	-17190	0	0	0	0
	4 (SUS)	0	-17190	0	0	0	0
	5 (EXP)	0	0	0	0	0	0
	MAX		-17190/3				

CAESAR II Ver.5.10.00, (Build 070917) Date: JUL 19, 2010 Time: 16:42
 Job: C:\DOCUMENTS AND SETTINGS\ABC\MY DOCUMENTS\ST...MS_CRH_LPBP
 Licensed To: DEALR/EVAL COPY -- ID #4369

RESTRAINT SUMMARY REPORT: Loads On Restraints
 Various Load Cases

NODE	Load Case	FX N.	FY N.	FZ N.	MX N.m.	MY N.m.	MZ N.m.
1100		Prog Design VSH					
	3 (OPE)	0	-29299	0	0	0	0
	4 (SUS)	0	-29259	0	0	0	0
	5 (EXP)	0	-41	0	0	0	0
	MAX		-29299/3				
1145		Prog Design VSH					
	3 (OPE)	0	-40480	0	0	0	0
	4 (SUS)	0	-45243	0	0	0	0
	5 (EXP)	0	4763	0	0	0	0
	MAX		-45243/4				
1160		Rigid ANC					
	3 (OPE)	28168	-17380	-12698	31432	-47449	4228
	4 (SUS)	267	-1349	1581	940	-3431	22342
	5 (EXP)	27901	-16030	-14278	30492	-44018	-18114
	MAX	28168/3	-17380/3	-14278/5	31432/3	-47449/3	22342/4
1175		Prog Design VSH					
	3 (OPE)	0	-12296	0	0	0	0
	4 (SUS)	0	-10197	0	0	0	0
	5 (EXP)	0	-2100	0	0	0	0
	MAX		-12296/3				
1185		Prog Design VSH					
	3 (OPE)	0	-17079	0	0	0	0
	4 (SUS)	0	-16131	0	0	0	0
	5 (EXP)	0	-948	0	0	0	0
	MAX		-17079/3				
1205		Prog Design CSH					
	3 (OPE)	0	-28652	0	0	0	0
	4 (SUS)	0	-28652	0	0	0	0
	5 (EXP)	0	0	0	0	0	0
	MAX		-28652/3				
1210		Prog Design CSH					
	3 (OPE)	0	-40376	0	0	0	0
	4 (SUS)	0	-40376	0	0	0	0
	5 (EXP)	0	0	0	0	0	0
	MAX		-40376/3				
1225		Prog Design CSH					

CAESAR II Ver.5.10.00, (Build 070917) Date: JUL 19, 2010 Time: 16:42
 Job: C:\DOCUMENTS AND SETTINGS\ABC\MY DOCUMENTS\ST...MS_CRH_LPBP
 Licensed To: DEALR/EVAL COPY -- ID #4369

RESTRAINT SUMMARY REPORT: Loads On Restraints
 Various Load Cases

NODE	Load Case	FX N.	FY N.	FZ N.	MX N.m.	MY N.m.	MZ N.m.
	3 (OPE)	0	-37218	0	0	0	0
	4 (SUS)	0	-37218	0	0	0	0
	5 (EXP)	0	0	0	0	0	0
	MAX		-37218/3				
1240		Prog Design CSH					
	3 (OPE)	0	-58522	0	0	0	0
	4 (SUS)	0	-58522	0	0	0	0
	5 (EXP)	0	0	0	0	0	0
	MAX		-58522/3				
1245		Prog Design VSH					
	3 (OPE)	0	-34617	0	0	0	0
	4 (SUS)	0	-29410	0	0	0	0
	5 (EXP)	0	-5207	0	0	0	0
	MAX		-34617/3				
1250		Prog Design VSH					
	3 (OPE)	0	-23854	0	0	0	0
	4 (SUS)	0	-20422	0	0	0	0
	5 (EXP)	0	-3432	0	0	0	0
	MAX		-23854/3				
1255		Rigid Y					
	3 (OPE)	19584	-66815	-4272	0	0	0
	4 (SUS)	-528	-30896	2360	0	0	0
	5 (EXP)	20112	-35919	-6632	0	0	0
	MAX	20112/5	-66815/3	-6632/5			
1285		Prog Design CSH					
	3 (OPE)	0	-34909	0	0	0	0
	4 (SUS)	0	-34909	0	0	0	0
	5 (EXP)	0	0	0	0	0	0
	MAX		-34909/3				
1300		Prog Design CSH					
	3 (OPE)	0	-35867	0	0	0	0
	4 (SUS)	0	-35867	0	0	0	0
	5 (EXP)	0	0	0	0	0	0
	MAX		-35867/3				
1310		Prog Design CSH					
	3 (OPE)	0	-29463	0	0	0	0
	4 (SUS)	0	-29463	0	0	0	0

CAESAR II Ver.5.10.00, (Build 070917) Date: JUL 19, 2010 Time: 16:42
 Job: C:\DOCUMENTS AND SETTINGS\ABC\MY DOCUMENTS\ST...MS_CRH_LPBP
 Licensed To: DEALR/EVAL COPY -- ID #4369

RESTRAINT SUMMARY REPORT: Loads On Restraints
 Various Load Cases

NODE	Load Case	FX N.	FY N.	FZ N.	MX N.m.	MY N.m.	MZ N.m.
	5 (EXP)	0	0	0	0	0	0
	MAX		-29463/3				
1325		Prog Design CSH					
	3 (OPE)	0	-28061	0	0	0	0
	4 (SUS)	0	-28061	0	0	0	0
	5 (EXP)	0	0	0	0	0	0
	MAX		-28061/3				
1340		Prog Design CSH					
	3 (OPE)	0	-56427	0	0	0	0
	4 (SUS)	0	-56427	0	0	0	0
	5 (EXP)	0	0	0	0	0	0
	MAX		-56427/3				
1360		Prog Design CSH					
	3 (OPE)	0	-26525	0	0	0	0
	4 (SUS)	0	-26525	0	0	0	0
	5 (EXP)	0	0	0	0	0	0
	MAX		-26525/3				
1365		Rigid X					
	3 (OPE)	216	-65	4	0	0	0
	4 (SUS)	72	-16	-15	0	0	0
	5 (EXP)	144	-49	19	0	0	0
	MAX	216/3	-65/3	19/5			
1370		Prog Design CSH					
	3 (OPE)	0	-30201	0	0	0	0
	4 (SUS)	0	-30201	0	0	0	0
	5 (EXP)	0	0	0	0	0	0
	MAX		-30201/3				
1390		Prog Design CSH					
	3 (OPE)	0	-56508	0	0	0	0
	4 (SUS)	0	-56508	0	0	0	0
	5 (EXP)	0	0	0	0	0	0
	MAX		-56508/3				
1405		Prog Design CSH					
	3 (OPE)	0	-21880	0	0	0	0
	4 (SUS)	0	-21880	0	0	0	0
	5 (EXP)	0	0	0	0	0	0
	MAX		-21880/3				

CAESAR II Ver.5.10.00, (Build 070917) Date: JUL 19, 2010 Time: 16:42
 Job: C:\DOCUMENTS AND SETTINGS\ABC\MY DOCUMENTS\ST...MS_CRH_LPBP
 Licensed To: DEALR/EVAL COPY -- ID #4369

RESTRAINT SUMMARY REPORT: Loads On Restraints
 Various Load Cases

NODE	Load Case	FX N.	FY N.	FZ N.	MX N.m.	MY N.m.	MZ N.m.
1420		Prog Design CSH					
	3 (OPE)	0	-22197	0	0	0	0
	4 (SUS)	0	-22197	0	0	0	0
	5 (EXP)	0	0	0	0	0	0
	MAX		-22197/3				
1435		Displ. Reaction					
	3 (OPE)	-12506	46438	-15604	-46179	-46188	61934
	4 (SUS)	-396	2852	-85	1121	-1888	1270
	5 (EXP)	-12110	43587	-15519	-47300	-44300	60664
	MAX	-12506/3	46438/3	-15604/3	-47300/5	-46188/3	61934/3
1450		Prog Design CSH					
	3 (OPE)	0	-26077	0	0	0	0
	4 (SUS)	0	-26077	0	0	0	0
	5 (EXP)	0	0	0	0	0	0
	MAX		-26077/3				
1455		Prog Design CSH					
	3 (OPE)	0	-30169	0	0	0	0
	4 (SUS)	0	-30169	0	0	0	0
	5 (EXP)	0	0	0	0	0	0
	MAX		-30169/3				
1475		Prog Design CSH					
	3 (OPE)	0	-56584	0	0	0	0
	4 (SUS)	0	-56584	0	0	0	0
	5 (EXP)	0	0	0	0	0	0
	MAX		-56584/3				
1485		Prog Design CSH					
	3 (OPE)	0	-21851	0	0	0	0
	4 (SUS)	0	-21851	0	0	0	0
	5 (EXP)	0	0	0	0	0	0
	MAX		-21851/3				
1495		Prog Design CSH					
	3 (OPE)	0	-22200	0	0	0	0
	4 (SUS)	0	-22200	0	0	0	0
	5 (EXP)	0	0	0	0	0	0
	MAX		-22200/3				

CAESAR II Ver.5.10.00, (Build 070917) Date: JUL 19, 2010 Time: 16:42
 Job: C:\DOCUMENTS AND SETTINGS\ABC\MY DOCUMENTS\ST...MS_CRH_LPBP
 Licensed To: DEALR/EVAL COPY -- ID #4369

RESTRAINT SUMMARY REPORT: Loads On Restraints
 Various Load Cases

NODE	Load Case	FX N.	FY N.	FZ N.	MX N.m.	MY N.m.	MZ N.m.
1510		Displ. Reaction					
	3 (OPE)	-26112	33180	-13202	17876	-144320	-177743
	4 (SUS)	418	2588	-53	818	2179	-1426
	5 (EXP)	-26529	30592	-13149	17058	-146498	-176317
	MAX	-26529/5	33180/3	-13202/3	17876/3	-146498/5	-177743/3
2005		Prog Design CSH					
	3 (OPE)	0	-20064	0	0	0	0
	4 (SUS)	0	-20064	0	0	0	0
	5 (EXP)	0	0	0	0	0	0
	MAX		-20064/3				
2025		Prog Design CSH					
	3 (OPE)	0	-16175	0	0	0	0
	4 (SUS)	0	-16175	0	0	0	0
	5 (EXP)	0	0	0	0	0	0
	MAX		-16175/3				
2050		Prog Design CSH					
	3 (OPE)	0	-31516	0	0	0	0
	4 (SUS)	0	-31516	0	0	0	0
	5 (EXP)	0	0	0	0	0	0
	MAX		-31516/3				
2070		Prog Design VSH					
	3 (OPE)	0	-25487	0	0	0	0
	4 (SUS)	0	-20554	0	0	0	0
	5 (EXP)	0	-4933	0	0	0	0
	MAX		-25487/3				
2085		Prog Design CSH					
	3 (OPE)	0	-7649	0	0	0	0
	4 (SUS)	0	-7649	0	0	0	0
	5 (EXP)	0	0	0	0	0	0
	MAX		-7649/3				
2105		Prog Design VSH					
	3 (OPE)	0	-32911	0	0	0	0
	4 (SUS)	0	-37180	0	0	0	0
	5 (EXP)	0	4269	0	0	0	0
	MAX		-37180/4				
2134		Prog Design					

CAESAR II Ver.5.10.00, (Build 070917) Date: JUL 19, 2010 Time: 16:42
 Job: C:\DOCUMENTS AND SETTINGS\ABC\MY DOCUMENTS\ST...MS_CRH_LPBP
 Licensed To: DEALR/EVAL COPY -- ID #4369

RESTRAINT SUMMARY REPORT: Loads On Restraints
 Various Load Cases

NODE	Load Case	FX N.	FY N.	FZ N.	MX N.m.	MY N.m.	MZ N.m.
		VSH					
	3 (OPE)	0	-39327	0	0	0	0
	4 (SUS)	0	-45001	0	0	0	0
	5 (EXP)	0	5674	0	0	0	0
	MAX		-45001/4				
2139		Rigid ANC					
	3 (OPE)	10636	-11200	-9962	63227	9548	9196
	4 (SUS)	39	452	1474	12741	-7792	40852
	5 (EXP)	10597	-11651	-11436	50486	17339	-31656
	MAX	10636/3	-11651/5	-11436/5	63227/3	17339/5	40852/4
2160		Prog Design VSH					
	3 (OPE)	0	-10903	0	0	0	0
	4 (SUS)	0	-8945	0	0	0	0
	5 (EXP)	0	-1959	0	0	0	0
	MAX		-10903/3				
2170		Prog Design VSH					
	3 (OPE)	0	-19799	0	0	0	0
	4 (SUS)	0	-18347	0	0	0	0
	5 (EXP)	0	-1452	0	0	0	0
	MAX		-19799/3				
2180		Prog Design VSH					
	3 (OPE)	0	-23503	0	0	0	0
	4 (SUS)	0	-25213	0	0	0	0
	5 (EXP)	0	1710	0	0	0	0
	MAX		-25213/4				
2185		Prog Design VSH					
	3 (OPE)	0	-14063	0	0	0	0
	4 (SUS)	0	-15193	0	0	0	0
	5 (EXP)	0	1131	0	0	0	0
	MAX		-15193/4				
2195		Prog Design VSH					
	3 (OPE)	0	-16125	0	0	0	0
	4 (SUS)	0	-15207	0	0	0	0
	5 (EXP)	0	-918	0	0	0	0
	MAX		-16125/3				
2205		Prog Design CSH					
	3 (OPE)	0	-27507	0	0	0	0

CAESAR II Ver.5.10.00, (Build 070917) Date: JUL 19, 2010 Time: 16:42
 Job: C:\DOCUMENTS AND SETTINGS\ABC\MY DOCUMENTS\IST...MS_CRH_LPBP
 Licensed To: DEALR/EVAL COPY -- ID #4369

RESTRAINT SUMMARY REPORT: Loads On Restraints
 Various Load Cases

NODE	Load Case	FX N.	FY N.	FZ N.	MX N.m.	MY N.m.	MZ N.m.
	4 (SUS)	0	-27507	0	0	0	0
	5 (EXP)	0	0	0	0	0	0
	MAX		-27507/3				
2215	Prog Design CSH						
	3 (OPE)	0	-30373	0	0	0	0
	4 (SUS)	0	-30373	0	0	0	0
	5 (EXP)	0	0	0	0	0	0
	MAX		-30373/3				
2220	Prog Design CSH						
	3 (OPE)	0	-29495	0	0	0	0
	4 (SUS)	0	-29495	0	0	0	0
	5 (EXP)	0	0	0	0	0	0
	MAX		-29495/3				
2230	Rigid Z						
	3 (OPE)	-1782	-18825	63030	0	0	0
	4 (SUS)	-6	-1360	-4532	0	0	0
	5 (EXP)	-1776	-17465	67562	0	0	0
	MAX	-1782/3	-18825/3	67562/5			
2235	Prog Design CSH						
	3 (OPE)	0	-38015	0	0	0	0
	4 (SUS)	0	-38015	0	0	0	0
	5 (EXP)	0	0	0	0	0	0
	MAX		-38015/3				
3000	Prog Design VSH						
	3 (OPE)	0	-32619	0	0	0	0
	4 (SUS)	0	-30533	0	0	0	0
	5 (EXP)	0	-2087	0	0	0	0
	MAX		-32619/3				
3015	Prog Design VSH						
	3 (OPE)	0	-31965	0	0	0	0
	4 (SUS)	0	-27915	0	0	0	0
	5 (EXP)	0	-4050	0	0	0	0
	MAX		-31965/3				
3025	Prog Design VSH						
	3 (OPE)	0	-48988	0	0	0	0
	4 (SUS)	0	-46901	0	0	0	0
	5 (EXP)	0	-2087	0	0	0	0

CAESAR II Ver.5.10.00, (Build 070917) Date: JUL 19, 2010 Time: 16:42
 Job: C:\DOCUMENTS AND SETTINGS\ABC\MY DOCUMENTS\ST...MS_CRH_LPBP
 Licensed To: DEALR/EVAL COPY -- ID #4369

RESTRAINT SUMMARY REPORT: Loads On Restraints
 Various Load Cases

NODE	Load Case	FX N.	FY N.	FZ N.	MX N.m.	MY N.m.	MZ N.m.
	MAX		-48988/3				
4010	Prog Design VSH						
	3 (OPE)	0	-44982	0	0	0	0
	4 (SUS)	0	-42900	0	0	0	0
	5 (EXP)	0	-2081	0	0	0	0
	MAX		-44982/3				
4020	Prog Design VSH						
	3 (OPE)	0	-47264	0	0	0	0
	4 (SUS)	0	-52423	0	0	0	0
	5 (EXP)	0	5159	0	0	0	0
	MAX		-52423/4				
7000	Prog Design CSH						
	3 (OPE)	0	-11844	0	0	0	0
	4 (SUS)	0	-11844	0	0	0	0
	5 (EXP)	0	0	0	0	0	0
	MAX		-11844/3				
7005	Prog Design CSH						
	3 (OPE)	0	-33376	0	0	0	0
	4 (SUS)	0	-33376	0	0	0	0
	5 (EXP)	0	0	0	0	0	0
	MAX		-33376/3				
7010	Prog Design CSH						
	3 (OPE)	0	-19380	0	0	0	0
	4 (SUS)	0	-19380	0	0	0	0
	5 (EXP)	0	0	0	0	0	0
	MAX		-19380/3				
7015	Prog Design CSH						
	3 (OPE)	0	-1782	0	0	0	0
	4 (SUS)	0	-1782	0	0	0	0
	5 (EXP)	0	0	0	0	0	0
	MAX		-1782/3				
7045	Prog Design CSH						
	3 (OPE)	0	-80858	0	0	0	0
	4 (SUS)	0	-80858	0	0	0	0
	5 (EXP)	0	0	0	0	0	0
	MAX		-80858/3				

CAESAR II Ver.5.10.00, (Build 070917) Date: JUL 19, 2010 Time: 16:42
 Job: C:\DOCUMENTS AND SETTINGS\ABC\MY DOCUMENTS\ST...MS_CRH_LPBP
 Licensed To: DEALR/EVAL COPY -- ID #4369

RESTRAINT SUMMARY REPORT: Loads On Restraints
 Various Load Cases

NODE	Load Case	FX N.	FY N.	FZ N.	MX N.m.	MY N.m.	MZ N.m.
7055		Prog Design CSH					
	3 (OPE)	0	-26785	0	0	0	0
	4 (SUS)	0	-26785	0	0	0	0
	5 (EXP)	0	0	0	0	0	0
	MAX		-26785/3				
7115		Prog Design CSH					
	3 (OPE)	0	-76639	0	0	0	0
	4 (SUS)	0	-76639	0	0	0	0
	5 (EXP)	0	0	0	0	0	0
	MAX		-76639/3				
7125		Prog Design CSH					
	3 (OPE)	0	-26797	0	0	0	0
	4 (SUS)	0	-26797	0	0	0	0
	5 (EXP)	0	0	0	0	0	0
	MAX		-26797/3				
8015		Prog Design CSH					
	3 (OPE)	0	-86922	0	0	0	0
	4 (SUS)	0	-86922	0	0	0	0
	5 (EXP)	0	0	0	0	0	0
	MAX		-86922/3				
8025		Prog Design CSH					
	3 (OPE)	0	-26769	0	0	0	0
	4 (SUS)	0	-26769	0	0	0	0
	5 (EXP)	0	0	0	0	0	0
	MAX		-26769/3				
9015		Prog Design CSH					
	3 (OPE)	0	-83140	0	0	0	0
	4 (SUS)	0	-83140	0	0	0	0
	5 (EXP)	0	0	0	0	0	0
	MAX		-83140/3				
9025		Prog Design CSH					
	3 (OPE)	0	-26779	0	0	0	0
	4 (SUS)	0	-26779	0	0	0	0
	5 (EXP)	0	0	0	0	0	0
	MAX		-26779/3				

CAESAR II Ver.5.10.00, (Build 070917) Date: JUL 19, 2010 Time: 16:42
 Job: C:\DOCUMENTS AND SETTINGS\ABC\MY DOCUMENTS\ST...MS_CRH_LPBP
 Licensed To: DEALR/EVAL COPY -- ID #4369

RESTRAINT SUMMARY REPORT: Loads On Restraints
 Various Load Cases

NODE	Load Case	FX N.	FY N.	FZ N.	MX N.m.	MY N.m.	MZ N.m.
15000	Prog Design VSH						
	3 (OPE)	0	-16500	0	0	0	0
	4 (SUS)	0	-17582	0	0	0	0
	5 (EXP)	0	1083	0	0	0	0
	MAX		-17582/4				
15010	Prog Design VSH						
	3 (OPE)	0	-9416	0	0	0	0
	4 (SUS)	0	-9335	0	0	0	0
	5 (EXP)	0	-81	0	0	0	0
	MAX		-9416/3				
15030	Prog Design VSH						
	3 (OPE)	0	-16329	0	0	0	0
	4 (SUS)	0	-14895	0	0	0	0
	5 (EXP)	0	-1434	0	0	0	0
	MAX		-16329/3				
15045	Prog Design CSH						
	3 (OPE)	0	-14846	0	0	0	0
	4 (SUS)	0	-14846	0	0	0	0
	5 (EXP)	0	0	0	0	0	0
	MAX		-14846/3				

05

CAESAR II Ver.5.10.00, (Build 070917) Date: JUL 19, 2010 Time: 16:42
 Job: C:\DOCUMENTS AND SETTINGS\ABC\MY DOCUMENTS\ST...MS_CRH_LPBP
 Licensed To: DEALR/EVAL COPY -- ID #4369

DISPLACEMENTS REPORT: Nodal Movements
 CASE 3 (OPE) W+D1+T1+P1+H

NODE	DX mm.	DY mm.	DZ mm.	RX deg.	RY deg.	RZ deg.
10	21.600	-6.900	-16.600	-0.0000	0.0000	-0.0000
15	21.612	-3.967	-16.610	-0.0026	0.0030	-0.0036
20	21.637	-1.670	-16.630	-0.0046	0.0054	-0.0064
25	21.813	5.857	-16.750	-0.0090	0.0118	-0.0142
28	22.033	11.472	-16.884	-0.0116	0.0165	-0.0203
29	23.892	15.817	-16.162	-0.0135	0.0200	-0.0257
30	27.941	17.440	-14.199	-0.0160	0.0228	-0.0311
34	37.649	16.787	-9.766	-0.0233	0.0282	-0.0415
35	40.693	16.488	-9.566	-0.0253	0.0294	-0.0439
40	45.250	15.972	-9.879	-0.0283	0.0309	-0.0475
42	48.478	15.581	-10.108	-0.0305	0.0317	-0.0497
43	89.732	10.360	-13.000	-0.0646	0.0236	-0.0454
45	93.865	9.907	-13.208	-0.0673	0.0212	-0.0444
48	97.596	9.496	-13.374	-0.0698	0.0187	-0.0432
49	105.575	6.011	-11.472	-0.0753	0.0117	-0.0364
50	108.520	-0.641	-6.170	-0.0819	0.0019	-0.0255
53	108.117	-8.061	0.323	-0.0925	-0.0097	-0.0121
54	107.911	-11.361	5.428	-0.1001	-0.0164	-0.0029
55	107.660	-11.617	11.524	-0.1080	-0.0219	0.0070
60	107.470	-10.774	15.135	-0.1126	-0.0246	0.0128
62	107.269	-9.936	18.597	-0.1173	-0.0272	0.0184
65	104.613	0.000	48.827	-0.1947	-0.0507	0.0798
70	103.251	5.220	60.254	-0.2191	-0.0576	0.1030
75	101.886	10.386	71.069	-0.2191	-0.0576	0.1031
80	101.379	12.289	74.882	-0.2161	-0.0590	0.1093
85	111.227	21.788	89.586	-0.1738	-0.0661	0.1334
88	101.196	12.952	76.230	-0.2146	-0.0595	0.1115
89	103.470	17.822	84.960	-0.1986	-0.0625	0.1262
90	134.258	15.887	96.072	-0.1022	-0.0909	0.0937
91	128.869	23.285	93.323	-0.1233	-0.0796	0.1157
92	119.666	24.351	90.898	-0.1493	-0.0708	0.1298
93	135.405	10.055	97.353	-0.0908	-0.0974	0.0789
95	136.852	-0.000	99.164	-0.0679	-0.1113	0.0476
100	124.655	-80.386	100.287	0.0301	-0.2224	-0.1715
105	74.345	-164.600	97.522	-0.0293	-0.3387	-0.3425
107	25.717	-220.083	108.640	-0.1589	-0.4154	-0.4223
108	17.977	-228.049	111.705	-0.1792	-0.4245	-0.4300
109	-1.215	-239.090	123.525	-0.2199	-0.4396	-0.4430
110	-20.947	-237.402	140.219	-0.2545	-0.4511	-0.4572
112	-27.246	-233.883	146.291	-0.2635	-0.4554	-0.4635
115	-41.036	-225.993	159.370	-0.2717	-0.4657	-0.4799
117	-56.303	-217.482	173.543	-0.2652	-0.4753	-0.4977
118	-64.871	-212.888	181.386	-0.2590	-0.4790	-0.5058
119	-85.906	-198.560	188.977	-0.2343	-0.4846	-0.5208
120	-106.214	-179.499	179.547	-0.1902	-0.4860	-0.5199
125	-109.788	-175.371	175.659	-0.1787	-0.4857	-0.5154
130	-112.146	-172.671	173.092	-0.1711	-0.4853	-0.5119
135	-156.276	-128.045	126.121	0.0011	-0.4538	-0.3695

CAESAR II Ver.5.10.00, (Build 070917) Date: JUL 19, 2010 Time: 16:42
 Job: C:\DOCUMENTS AND SETTINGS\ABC\MY DOCUMENTS\ST...MS_CRH_LPBP
 Licensed To: DEALR/EVAL COPY -- ID #4369

DISPLACEMENTS REPORT: Nodal Movements
 CASE 3 (OPE) W+D1+T1+P1+H

NODE	DX mm.	DY mm.	DZ mm.	RX deg.	RY deg.	RZ deg.
140	-212.129	-104.176	74.316	0.2198	-0.3493	0.0275
145	-214.024	-104.371	72.789	0.2260	-0.3453	0.0435
148	-216.520	-104.700	70.826	0.2341	-0.3399	0.0649
149	-222.075	-106.804	65.928	0.2535	-0.3261	0.1158
150	-226.450	-111.074	60.571	0.2729	-0.3099	0.1682
155	-234.586	-127.793	45.562	0.3241	-0.2598	0.3228
160	-225.174	-139.698	36.613	0.3349	-0.2454	0.3711
165	-212.345	-153.773	25.680	0.3462	-0.2284	0.4291
168	-203.972	-162.069	19.089	0.3508	-0.2204	0.4567
169	-187.198	-168.223	12.271	0.3565	-0.2096	0.4984
170	-170.466	-159.816	13.560	0.3625	-0.2012	0.5379
175	-168.535	-157.521	14.395	0.3636	-0.2000	0.5434
180	-159.253	-146.170	18.337	0.3686	-0.1946	0.5697
185	-126.150	-100.856	31.405	0.3912	-0.1760	0.6714
190	-83.182	-33.144	46.775	0.4201	-0.1644	0.7596
195	-40.105	40.708	61.672	0.4487	-0.1671	0.8004
200	-6.321	99.931	73.892	0.4710	-0.1791	0.7998
205	-0.000	110.960	76.286	0.4744	-0.1817	0.7967
210	3.004	116.189	77.439	0.4761	-0.1831	0.7947
213	5.822	121.076	78.528	0.4776	-0.1844	0.7926
214	37.854	145.718	77.748	0.4892	-0.1971	0.7754
215	77.159	140.539	60.623	0.4974	-0.2138	0.7541
220	92.705	131.438	50.277	0.4996	-0.2216	0.7447
225	114.152	118.678	35.697	0.5022	-0.2346	0.7301
230	176.227	80.395	-8.236	0.5026	-0.2736	0.6951
235	252.231	31.392	-63.684	0.4869	-0.3236	0.6697
240	293.129	4.479	-93.089	0.4706	-0.3510	0.6650
245	299.917	-0.000	-97.882	0.4680	-0.3546	0.6649
248	309.424	-6.276	-104.548	0.4642	-0.3597	0.6650
249	322.664	-22.446	-111.737	0.4554	-0.3694	0.6668
250	320.245	-38.725	-105.327	0.4449	-0.3769	0.6696
255	313.306	-46.917	-97.262	0.4379	-0.3808	0.6713
260	288.070	-74.956	-68.601	0.4166	-0.3933	0.6785
265	257.164	-107.382	-34.302	0.4054	-0.3984	0.6872
270	226.284	-139.049	0.000	0.3971	-0.3928	0.6959
275	216.143	-149.493	11.435	0.3978	-0.3885	0.6989
280	209.450	-156.490	19.058	0.3991	-0.3851	0.7008
285	192.894	-174.005	38.116	0.3994	-0.3804	0.7024
290	180.384	-187.346	52.618	0.4000	-0.3804	0.7021
295	148.291	-221.609	89.824	0.3987	-0.3804	0.7015
300	141.477	-228.660	97.651	0.3997	-0.3804	0.7014
305	134.903	-235.491	105.202	0.4007	-0.3804	0.7012
310	120.163	-250.786	122.127	0.3998	-0.3804	0.7008
315	105.435	-266.028	139.044	0.3984	-0.3804	0.7012
320	98.615	-273.064	146.874	0.3985	-0.3804	0.7014
325	90.707	-281.255	155.961	0.3989	-0.3804	0.7018
505	-21.600	-6.900	-16.600	0.0000	-0.0000	-0.0000
510	-21.593	-5.073	-16.598	0.0007	-0.0054	-0.0023
515	-21.576	-3.652	-16.593	0.0013	-0.0096	-0.0042
520	-21.506	-0.384	-16.570	0.0025	-0.0174	-0.0077

CAESAR II Ver.5.10.00, (Build 070917) Date: JUL 19, 2010 Time: 16:42
 Job: C:\DOCUMENTS AND SETTINGS\ABC\MY DOCUMENTS\ST...MS_CRH_LPBP
 Licensed To: DEALR/EVAL COPY -- ID #4369

DISPLACEMENTS REPORT: Nodal Movements
 CASE 3 (OPE) W+D1+T1+P1+H

NODE	DX mm.	DY mm.	DZ mm.	RX deg.	RY deg.	RZ deg.
523	-21.459	1.115	-16.555	0.0031	-0.0209	-0.0093
524	-23.202	6.349	-15.600	0.0064	-0.0345	-0.0167
525	-27.919	8.727	-13.620	0.0104	-0.0458	-0.0256
530	-27.988	8.730	-13.594	0.0104	-0.0459	-0.0257
533	-29.302	8.809	-13.110	0.0112	-0.0483	-0.0278
534	-31.190	8.950	-12.704	0.0123	-0.0515	-0.0305
535	-33.123	9.142	-12.824	0.0133	-0.0547	-0.0330
540	-35.947	9.477	-13.414	0.0146	-0.0595	-0.0363
545	-37.982	9.735	-13.870	0.0156	-0.0628	-0.0388
550	-63.765	15.765	-22.189	0.0307	-0.1123	-0.0952
555	-66.348	16.662	-23.267	0.0319	-0.1160	-0.0986
558	-68.682	17.491	-24.271	0.0330	-0.1193	-0.1018
559	-75.007	17.467	-25.749	0.0351	-0.1269	-0.1120
560	-80.258	13.588	-24.776	0.0360	-0.1344	-0.1237
563	-84.250	7.987	-22.462	0.0363	-0.1423	-0.1359
564	-86.980	5.004	-20.195	0.0365	-0.1466	-0.1438
565	-89.463	3.525	-16.752	0.0373	-0.1507	-0.1529
570	-90.717	3.190	-14.534	0.0382	-0.1533	-0.1586
575	-91.954	2.853	-12.382	0.0390	-0.1558	-0.1641
580	-103.663	0.000	6.291	0.0342	-0.1801	-0.2240
585	-108.502	-0.959	13.339	0.0338	-0.1877	-0.2466
590	-113.174	-1.878	20.006	0.0339	-0.1878	-0.2467
595	-114.820	-2.182	22.391	0.0368	-0.1893	-0.2528
598	-115.402	-2.297	23.230	0.0379	-0.1899	-0.2550
599	-121.133	-1.023	26.874	0.0467	-0.1931	-0.2697
600	-127.786	3.788	25.345	0.0570	-0.1957	-0.2820
603	-133.043	9.303	21.559	0.0660	-0.1978	-0.2907
604	-140.486	12.710	17.261	0.0751	-0.1993	-0.2971
605	-148.242	9.898	14.215	0.0826	-0.2010	-0.3002
610	-152.244	6.264	13.086	0.0872	-0.2025	-0.3014
615	-159.182	-0.000	10.977	0.0966	-0.2059	-0.3034
620	-214.025	-50.086	-12.785	0.1586	-0.2327	-0.2851
625	-261.826	-102.558	-47.406	0.1976	-0.2608	-0.2018
630	-281.926	-137.135	-73.211	0.2087	-0.2793	-0.1112
633	-283.832	-142.099	-77.006	0.2092	-0.2815	-0.0985
634	-290.186	-153.314	-80.030	0.2091	-0.2877	-0.0714
635	-300.010	-163.374	-74.277	0.2079	-0.2922	-0.0380
640	-304.038	-166.271	-70.544	0.2084	-0.2925	-0.0241
645	-312.699	-172.588	-62.514	0.2154	-0.2921	0.0121
650	-322.062	-179.771	-53.786	0.2237	-0.2899	0.0515
653	-327.182	-183.803	-48.976	0.2253	-0.2883	0.0694
654	-332.568	-189.851	-36.805	0.2305	-0.2838	0.1032
655	-327.608	-189.330	-24.560	0.2395	-0.2786	0.1278
660	-325.400	-188.308	-22.348	0.2414	-0.2775	0.1317
665	-323.952	-187.626	-20.902	0.2427	-0.2767	0.1341
670	-296.580	-171.080	5.614	0.2714	-0.2636	0.2044
675	-262.560	-140.772	37.159	0.3070	-0.2572	0.2915
680	-260.393	-138.508	39.138	0.3089	-0.2572	0.2939
683	-258.823	-136.845	40.587	0.3102	-0.2572	0.2956
684	-254.605	-133.514	43.307	0.3134	-0.2574	0.3003

CAESAR II Ver.5.10.00, (Build 070917) Date: JUL 19, 2010 Time: 16:42
 Job: C:\DOCUMENTS AND SETTINGS\ABC\MY DOCUMENTS\ST...MS_CRH_LPBP
 Licensed To: DEALR/EVAL COPY -- ID #4369

DISPLACEMENTS REPORT: Nodal Movements
 CASE 3 (OPE) W+D1+T1+P1+H

NODE	DX mm.	DY mm.	DZ mm.	RX deg.	RY deg.	RZ deg.
685	-249.558	-131.521	44.515	0.3164	-0.2579	0.3058
1000	213.745	-149.548	22.673	0.4105	-0.3536	0.7166
1003	215.101	-147.326	23.749	0.4141	-0.3438	0.7212
1004	220.424	-138.802	25.161	0.4241	-0.3116	0.7354
1005	224.770	-131.811	22.289	0.4305	-0.2820	0.7501
1010	225.854	-129.979	20.502	0.4324	-0.2710	0.7563
1015	227.037	-127.879	18.460	0.4342	-0.2589	0.7633
1020	233.972	-111.582	2.816	0.4377	-0.1625	0.8333
1025	225.383	-97.065	-0.225	0.4182	-0.1262	0.8651
1026	232.888	-102.764	-2.492	0.4275	-0.1395	0.8562
1027	234.941	-108.500	-0.159	0.4347	-0.1523	0.8434
1030	217.420	-93.041	3.571	0.4103	-0.1134	0.8713
1035	172.183	-70.380	23.546	0.3687	-0.0190	0.8658
1040	169.616	-69.077	24.638	0.3676	-0.0148	0.8636
1045	152.922	-55.823	25.959	0.3610	0.0190	0.8283
1046	156.389	-60.917	28.592	0.3627	0.0082	0.8454
1047	164.361	-66.400	26.874	0.3655	-0.0063	0.8582
1050	152.685	-53.292	22.975	0.3601	0.0236	0.8168
1055	150.214	-27.881	-8.883	0.2919	-0.0092	0.6537
1060	142.350	-16.591	-14.314	0.2295	-0.0551	0.6111
1061	147.968	-21.632	-14.895	0.2557	-0.0342	0.6261
1062	150.238	-25.864	-11.876	0.2789	-0.0185	0.6419
1063	136.855	-12.595	-12.330	0.2065	-0.0760	0.5950
1065	127.799	-5.677	-9.474	0.1567	-0.1234	0.5521
1067	125.116	-3.518	-8.740	0.1416	-0.1382	0.5370
1068	121.460	-0.484	-7.816	0.1259	-0.1541	0.5198
1069	116.098	3.180	-5.078	0.1033	-0.1791	0.4888
1070	112.440	4.082	-0.647	0.0825	-0.1991	0.4504
1075	110.482	3.488	3.373	0.0660	-0.2114	0.4158
1080	101.097	2.524	20.476	0.0146	-0.2492	0.2220
1085	100.076	2.503	22.238	0.0135	-0.2503	0.2020
1088	97.817	2.469	26.134	0.0119	-0.2506	0.1681
1089	93.720	1.909	29.288	0.0137	-0.2485	0.1301
1090	88.606	0.888	28.684	0.0165	-0.2438	0.0990
1095	85.660	0.334	27.066	0.0167	-0.2401	0.0812
1100	64.166	0.005	16.455	0.0184	-0.1892	-0.0336
1105	52.698	1.518	11.988	0.0195	-0.1512	-0.0724
1110	50.178	1.992	11.133	0.0196	-0.1460	-0.0785
1115	45.962	2.844	9.754	0.0197	-0.1407	-0.0849
1120	45.222	-0.985	9.582	0.0197	-0.1406	-0.0849
1125	28.036	3.279	4.620	0.0178	-0.0841	-0.0996
1130	23.829	4.316	3.748	0.0176	-0.0787	-0.0965
1135	22.440	4.651	3.472	0.0176	-0.0779	-0.0958
1140	18.234	5.644	2.658	0.0175	-0.0741	-0.0919
1145	16.007	6.148	2.246	0.0174	-0.0710	-0.0878
1148	5.756	8.137	0.590	0.0170	-0.0556	-0.0701
1149	1.870	7.128	0.142	0.0096	-0.0290	-0.0421
1150	0.092	3.563	0.010	0.0011	-0.0158	-0.0128
1155	0.090	3.511	0.010	0.0011	-0.0157	-0.0127
1160	0.000	-0.000	-0.000	0.0000	-0.0000	0.0000

CAESAR II Ver.5.10.00, (Build 070917) Date: JUL 19, 2010 Time: 16:42
 Job: C:\DOCUMENTS AND SETTINGS\ABC\MY DOCUMENTS\IST...MS_CRH_LPBP
 Licensed To: DEAL/REVAL COPY -- ID #4369

DISPLACEMENTS REPORT: Nodal Movements
 CASE 3 (OPE) W+D1+T1+P1+H

NODE	DX mm.	DY mm.	DZ mm.	RX deg.	RY deg.	RZ deg.
1165	0.294	-6.444	-0.120	0.0069	0.0006	0.0210
1168	-15.142	-8.292	0.430	0.0133	0.0298	0.0378
1169	-18.021	-8.596	-0.024	0.0155	0.1096	0.0371
1170	-20.582	-8.559	-2.048	0.0231	0.2086	0.0347
1175	-23.190	-8.272	-5.332	0.0249	0.2284	0.0344
1178	-25.621	-8.012	-8.138	0.0272	0.2478	0.0341
1179	-27.525	-7.531	-12.050	0.0482	0.3948	0.0404
1180	-26.687	-6.910	-17.580	0.0601	0.5437	0.0520
1185	-11.201	-3.739	-51.122	0.0916	0.6310	0.0675
1190	4.219	0.811	-87.811	0.1222	0.6623	0.1108
1195	31.937	3.148	-106.648	0.1329	0.5927	0.2138
1198	7.870	2.337	-96.644	0.1284	0.6617	0.1242
1199	18.122	4.126	-106.865	0.1280	0.6413	0.1799
1200	118.407	-82.524	-69.884	-0.1529	-0.4820	0.4605
1205	127.429	-85.334	-75.009	-0.1515	-0.4905	0.4547
1210	180.111	-99.382	-103.725	-0.1124	-0.5161	0.4227
1215	223.559	-106.356	-126.971	-0.0490	-0.5100	0.3993
1218	229.166	-106.821	-130.003	-0.0386	-0.5075	0.3962
1220	234.779	-107.169	-133.053	-0.0278	-0.5047	0.3932
1225	238.826	-107.345	-135.262	-0.0199	-0.5024	0.3909
1228	244.729	-107.494	-138.503	-0.0077	-0.4987	0.3877
1229	254.831	-102.039	-146.070	0.1317	-0.4617	0.3860
1230	248.490	-90.973	-143.087	0.2698	-0.4377	0.3841
1235	236.794	-82.629	-134.360	0.2997	-0.4190	0.3834
1240	218.470	-69.615	-119.030	0.3408	-0.3870	0.3885
1245	173.156	-39.099	-77.514	0.3900	-0.3118	0.4308
1250	128.727	-12.874	-40.121	0.3794	-0.2472	0.5010
1255	104.087	-0.000	-22.704	0.3563	-0.2155	0.5469
1260	99.262	2.391	-19.600	0.3507	-0.2096	0.5564
1264	87.249	2.605	-15.767	0.2879	-0.2130	0.7112
1265	77.779	-7.923	-17.072	0.2719	-0.1896	0.8555
1270	77.622	-8.383	-17.170	0.2713	-0.1894	0.8561
1275	74.742	-16.824	-18.955	0.2618	-0.1856	0.8648
1278	71.494	-26.440	-20.928	0.2507	-0.1818	0.8737
1280	68.244	-36.146	-22.864	0.2396	-0.1786	0.8813
1285	64.576	-47.172	-25.012	0.2281	-0.1759	0.8878
1288	62.483	-53.504	-26.226	0.2216	-0.1746	0.8908
1289	55.053	-79.774	-35.015	0.1805	-0.1624	0.9253
1290	55.502	-86.807	-45.690	0.1411	-0.1455	0.9302
1295	55.810	-86.452	-46.349	0.1406	-0.1449	0.9297
1300	58.221	-83.640	-51.632	0.1384	-0.1393	0.9258
1303	59.481	-82.125	-54.507	0.1388	-0.1353	0.9236
1304	58.549	-89.121	-64.399	0.1781	-0.0756	0.9025
1305	49.865	-114.232	-69.169	0.2237	-0.0111	0.8377
1310	47.829	-120.177	-69.210	0.2295	-0.0079	0.8331
1315	43.400	-132.994	-69.220	0.2422	-0.0017	0.8209
1320	30.397	-169.278	-68.779	0.2792	0.0108	0.7689
1325	24.759	-184.213	-68.444	0.2952	0.0134	0.7395
1328	23.789	-186.722	-68.381	0.2980	0.0137	0.7341
1329	7.154	-203.080	-63.401	0.3337	0.0297	0.5147

CAESAR II Ver.5.10.00, (Build 070917) Date: JUL 19, 2010 Time: 16:42
 Job: C:\DOCUMENTS AND SETTINGS\ABC\MY DOCUMENTS\ST...MS_CRH_LPBP
 Licensed To: DEALR/EVAL COPY -- ID #4369

DISPLACEMENTS REPORT: Nodal Movements
 CASE 3 (OPE) W+D1+T1+P1+H

NODE	DX mm.	DY mm.	DZ mm.	RX deg.	RY deg.	RZ deg.
1330	-8.789	-200.065	-51.492	0.3856	0.0369	0.2798
1335	-16.530	-191.650	-39.412	0.3967	0.0323	0.2252
1340	-28.481	-171.484	-9.508	0.4078	0.0204	0.1060
1345	-31.748	-160.048	7.526	0.4028	0.0136	0.0536
1350	-28.713	-159.525	7.440	0.4016	0.0094	0.0379
1355	-25.796	-159.202	7.406	0.4001	0.0047	0.0198
1360	-24.599	-159.130	7.407	0.3993	0.0023	0.0106
1365	0.000	-164.823	9.149	0.3830	-0.0282	-0.1233
1370	5.989	-167.705	9.874	0.3790	-0.0306	-0.1431
1375	6.900	-168.181	9.988	0.3784	-0.0308	-0.1458
1378	14.298	-172.299	10.920	0.3739	-0.0308	-0.1603
1379	24.051	-173.954	15.999	0.3635	-0.0179	-0.1812
1380	32.258	-168.375	26.022	0.3383	-0.0040	-0.1739
1385	35.762	-162.824	32.840	0.3318	0.0013	-0.1703
1390	47.115	-143.420	55.215	0.2940	0.0213	-0.1460
1395	52.044	-133.628	65.308	0.2671	0.0315	-0.1274
1399	51.785	-129.298	68.622	0.1876	0.0124	-0.0592
1400	48.150	-127.329	69.681	0.1588	0.0009	-0.0019
1405	38.855	-127.463	69.778	0.1188	0.0031	0.0058
1408	37.153	-127.509	69.800	0.1115	0.0030	0.0059
1409	33.301	-127.128	68.214	0.0829	-0.0032	0.0216
1410	31.809	-126.609	64.326	0.0161	-0.0104	0.0362
1415	32.143	-126.405	55.947	0.0012	-0.0102	0.0249
1420	32.315	-126.443	51.178	-0.0033	-0.0087	0.0185
1425	32.415	-126.509	47.926	-0.0044	-0.0071	0.0142
1430	32.480	-126.571	45.007	-0.0035	-0.0042	0.0078
1435	32.500	-126.600	43.000	-0.0000	-0.0000	0.0000
1440	-34.791	-160.644	7.734	0.4009	0.0164	0.0569
1445	-37.714	-161.252	7.966	0.3985	0.0196	0.0604
1450	-38.913	-161.513	8.071	0.3973	0.0211	0.0620
1455	-69.462	-168.273	12.140	0.3657	0.0375	0.0459
1460	-70.369	-168.419	12.277	0.3648	0.0373	0.0442
1463	-77.736	-169.362	13.343	0.3578	0.0348	0.0273
1464	-85.029	-165.767	18.182	0.3422	0.0130	-0.0623
1465	-85.061	-157.002	27.418	0.3102	-0.0057	-0.1526
1470	-81.796	-151.451	33.655	0.3029	-0.0126	-0.1670
1475	-68.505	-132.041	53.908	0.2638	-0.0391	-0.2001
1478	-61.205	-122.237	62.934	0.2375	-0.0525	-0.2037
1479	-56.773	-119.547	65.996	0.1634	-0.0372	-0.1927
1480	-51.834	-120.480	67.337	0.1385	-0.0348	-0.1624
1485	-42.532	-125.790	68.636	0.1002	-0.0402	-0.1472
1488	-40.828	-126.704	68.890	0.0932	-0.0408	-0.1436
1489	-36.706	-127.874	67.921	0.0835	-0.0455	-0.1005
1490	-34.499	-127.584	64.327	0.0331	-0.0374	-0.0943
1493	-33.420	-126.877	55.948	0.0157	-0.0304	-0.0620
1495	-32.934	-126.678	51.179	0.0085	-0.0235	-0.0436
1500	-32.680	-126.614	47.926	0.0048	-0.0176	-0.0311
1505	-32.535	-126.596	45.008	0.0014	-0.0076	-0.0127
1510	-32.500	-126.600	43.000	0.0000	-0.0000	-0.0000
2000	197.190	-167.072	41.621	0.4132	-0.3363	0.7119

CAESAR II Ver.5.10.00, (Build 070917) Date: JUL 19, 2010 Time: 16:42
 Job: C:\DOCUMENTS AND SETTINGS\ABC\MY DOCUMENTS\ST...MS_CRH_LPBP
 Licensed To: DEALR/EVAL COPY -- ID #4369

DISPLACEMENTS REPORT: Nodal Movements
 CASE 3 (OPE) W+D1+T1+P1+H

NODE	DX mm.	DY mm.	DZ mm.	RX deg.	RY deg.	RZ deg.
2005	200.551	-161.595	44.068	0.4240	-0.3029	0.7157
2010	203.285	-157.131	45.871	0.4328	-0.2764	0.7176
2015	214.760	-136.656	44.982	0.4589	-0.1945	0.7238
2016	211.198	-143.810	48.213	0.4505	-0.2238	0.7216
2017	206.202	-152.353	47.638	0.4399	-0.2554	0.7194
2020	216.283	-132.499	41.152	0.4651	-0.1714	0.7264
2025	220.205	-113.744	24.388	0.4743	-0.0621	0.7407
2030	220.693	-94.405	6.596	0.4545	0.0116	0.7552
2033	220.512	-91.243	3.622	0.4508	0.0178	0.7570
2034	217.303	-85.350	1.322	0.4439	0.0258	0.7586
2035	210.111	-79.565	3.748	0.4362	0.0336	0.7585
2040	203.213	-75.573	7.687	0.4303	0.0405	0.7572
2045	152.399	-44.870	36.815	0.4164	0.1103	0.6744
2050	150.404	-43.567	38.051	0.4173	0.1126	0.6696
2053	146.337	-40.883	40.610	0.4196	0.1172	0.6592
2054	138.595	-39.260	45.007	0.4241	0.1245	0.6400
2055	132.017	-43.344	47.884	0.4306	0.1315	0.6192
2057	128.916	-47.521	48.860	0.4357	0.1370	0.6052
2058	123.357	-54.730	50.735	0.4478	0.1518	0.5736
2059	115.473	-61.801	51.750	0.4583	0.1704	0.5432
2060	112.009	-59.487	48.385	0.4611	0.1817	0.5236
2061	120.359	-58.475	51.823	0.4528	0.1588	0.5613
2065	110.304	-55.341	44.542	0.4620	0.1898	0.5063
2070	104.020	-41.470	31.456	0.4366	0.2109	0.4289
2075	88.888	-12.589	-0.807	0.3305	0.1646	0.2371
2078	87.776	-10.333	-3.768	0.3210	0.1560	0.2236
2079	85.548	-5.681	-6.622	0.3048	0.1420	0.2050
2080	83.188	-0.431	-5.544	0.2874	0.1234	0.1881
2085	82.236	1.844	-4.077	0.2789	0.1127	0.1786
2088	79.809	8.329	-0.124	0.2568	0.0823	0.1487
2089	76.834	11.919	2.482	0.2437	0.0633	0.1256
2095	72.287	12.597	3.938	0.2290	0.0483	0.1035
2100	69.279	11.972	4.253	0.2180	0.0389	0.0909
2105	63.101	10.920	4.706	0.1955	0.0215	0.0717
2110	51.582	9.761	4.849	0.1407	-0.0123	0.0212
2115	49.038	9.691	4.777	0.1341	-0.0155	0.0132
2120	44.810	9.649	4.627	0.1275	-0.0183	0.0047
2125	44.851	5.820	3.515	0.1275	-0.0183	0.0047
2130	27.681	6.742	2.329	0.0633	-0.0313	-0.0384
2131	23.477	7.140	1.989	0.0580	-0.0313	-0.0383
2132	22.090	7.271	1.878	0.0572	-0.0313	-0.0381
2133	17.886	7.657	1.541	0.0537	-0.0309	-0.0363
2134	15.661	7.851	1.365	0.0509	-0.0305	-0.0341
2135	0.039	3.564	0.059	0.0084	-0.0056	-0.0051
2136	1.660	7.207	0.271	0.0281	-0.0144	-0.0154
2137	0.039	3.511	0.058	0.0084	-0.0055	-0.0051
2138	5.417	8.557	0.601	0.0380	-0.0270	-0.0255
2139	0.000	-0.000	-0.000	0.0000	0.0000	0.0000
2140	0.169	-6.443	-0.133	0.0083	0.0158	0.0136
2143	-15.276	-7.832	2.027	0.0200	0.0709	0.0321

CAESAR II Ver.5.10.00, (Build 070917) Date: JUL 19, 2010 Time: 16:42
 Job: C:\DOCUMENTS AND SETTINGS\ABC\MY DOCUMENTS\ST...MS_CRH_LPBP
 Licensed To: DEALR/EVAL COPY -- ID #4369

DISPLACEMENTS REPORT: Nodal Movements
 CASE 3 (OPE) W+D1+T1+P1+H

NODE	DX mm.	DY mm.	DZ mm.	RX deg.	RY deg.	RZ deg.
2144	-17.300	-8.300	4.218	0.0277	0.1776	0.0479
2145	-16.137	-8.830	7.627	0.0418	0.2904	0.0561
2153	-9.277	-9.810	13.710	0.0460	0.3250	0.0624
2154	-4.683	-10.030	14.740	0.0496	0.4289	0.0660
2160	-12.534	-9.343	10.907	0.0441	0.3093	0.0595
2165	-0.305	-9.565	11.285	0.0479	0.5228	0.0798
2170	15.186	-4.755	-19.824	0.0540	0.5670	0.0937
2172	40.153	5.493	-70.841	0.0628	0.5292	0.1473
2173	43.807	7.483	-77.803	0.0638	0.5147	0.1565
2174	52.600	10.227	-84.695	0.0588	0.4344	0.1912
2175	62.023	10.626	-82.712	0.0606	0.3394	0.2088
2180	64.802	10.099	-80.446	0.0628	0.3255	0.2148
2182	67.825	9.466	-77.866	0.0651	0.3095	0.2218
2185	89.110	2.568	-48.562	0.0515	0.0742	0.3126
2187	89.993	1.780	-44.477	0.0480	0.0379	0.3253
2188	90.378	0.928	-39.630	0.0426	-0.0005	0.3382
2189	87.139	-2.484	-35.182	0.0282	-0.1320	0.3518
2190	80.707	-9.580	-36.788	0.0215	-0.2545	0.3773
2192	77.098	-14.688	-40.356	0.0146	-0.2786	0.3853
2195	76.098	-16.125	-41.404	0.0124	-0.2858	0.3880
2197	65.658	-31.657	-53.748	-0.0105	-0.3480	0.4099
2198	62.001	-37.262	-58.559	-0.0175	-0.3619	0.4147
2199	60.252	-47.328	-65.562	-0.0241	-0.4003	0.4334
2200	66.435	-55.843	-68.037	-0.0522	-0.4140	0.4501
2205	71.059	-58.642	-67.466	-0.0609	-0.4215	0.4525
2207	74.541	-60.742	-66.975	-0.0683	-0.4271	0.4541
2210	101.667	-76.923	-60.351	-0.1666	-0.4769	0.4602
2215	75.513	-66.830	-45.330	-0.1974	-0.4741	0.4597
2220	28.933	-45.407	-18.405	-0.2316	-0.4711	0.4588
2225	6.750	-34.325	-5.538	-0.2374	-0.4706	0.4584
2230	-2.791	-29.491	0.000	-0.2382	-0.4705	0.4583
2235	-18.279	-21.648	8.997	-0.2376	-0.4705	0.4583
2240	-26.096	-17.712	13.538	-0.2372	-0.4705	0.4583
3000	2.147	-41.878	-13.377	-0.2374	-0.4706	0.4585
3005	1.429	-43.058	-14.598	-0.2374	-0.4706	0.4585
3010	-6.567	-56.186	-28.214	-0.2374	-0.4706	0.4585
3015	-7.527	-57.759	-29.848	-0.2374	-0.4706	0.4586
3018	-14.032	-68.450	-40.925	-0.2374	-0.4706	0.4589
3019	-19.639	-72.570	-47.777	-0.2374	-0.4706	0.4585
3020	-26.516	-71.548	-52.970	-0.2374	-0.4706	0.4583
3025	-85.134	-36.575	-83.340	-0.2374	-0.4706	0.4583
3030	-108.218	-22.811	-95.300	-0.2374	-0.4706	0.4583
3035	-113.114	-19.892	-97.836	-0.2374	-0.4706	0.4583
4000	-31.427	-26.461	4.462	-0.2372	-0.4705	0.4571
4005	-39.423	-39.548	-9.152	-0.2372	-0.4705	0.4570
4010	-40.382	-41.114	-10.786	-0.2372	-0.4705	0.4572
4014	-52.482	-55.878	-28.695	-0.2372	-0.4705	0.4582
4015	-59.357	-54.856	-33.885	-0.2372	-0.4705	0.4581
4020	-114.723	-21.812	-62.547	-0.2372	-0.4705	0.4581
4025	-141.013	-6.131	-76.157	-0.2372	-0.4705	0.4581

CAESAR II Ver.5.10.00, (Build 070917) Date: JUL 19, 2010 Time: 16:42
 Job: C:\DOCUMENTS AND SETTINGS\ABC\MY DOCUMENTS\ST...MS_CRH_LPBP
 Licensed To: DEALR/EVAL COPY -- ID #4369

DISPLACEMENTS REPORT: Nodal Movements
 CASE 3 (OPE) W+D1+T1+P1+H

NODE	DX mm.	DY mm.	DZ mm.	RX deg.	RY deg.	RZ deg.
4030	-145.907	-3.212	-78.691	-0.2372	-0.4705	0.4581
7000	123.416	-253.860	95.244	0.4019	-0.3804	0.7025
7005	110.973	-265.443	114.160	0.4008	-0.3804	0.7012
7010	96.245	-280.711	131.077	0.3993	-0.3804	0.7020
7015	79.220	-299.655	146.002	0.4001	-0.3804	0.7032
7030	87.439	-294.824	123.442	0.4003	-0.3804	0.7037
7035	77.220	-288.452	129.255	0.4003	-0.3804	0.7037
7040	22.213	-254.222	160.577	0.4031	-0.3804	0.7070
7045	12.338	-248.093	166.207	0.4034	-0.3804	0.7075
7048	7.398	-245.030	169.025	0.4036	-0.3804	0.7077
7049	-11.268	-241.978	174.194	0.4043	-0.3804	0.7075
7050	-26.615	-252.979	169.727	0.4051	-0.3805	0.7041
7055	-49.206	-289.007	150.136	0.4070	-0.3805	0.6985
7058	-51.771	-293.094	147.912	0.4072	-0.3805	0.6991
7059	-53.980	-296.496	146.454	0.4073	-0.3805	0.6994
7060	-56.491	-300.152	145.617	0.4074	-0.3805	0.6995
7065	-64.133	-311.002	144.142	0.4075	-0.3805	0.6996
7100	102.167	-279.555	106.525	0.4017	-0.3804	0.7039
7105	91.946	-273.183	112.359	0.4017	-0.3804	0.7039
7110	36.931	-238.955	143.796	0.4045	-0.3804	0.7071
7115	27.055	-232.825	149.447	0.4049	-0.3804	0.7075
7118	22.115	-229.763	152.275	0.4051	-0.3804	0.7078
7119	3.449	-226.711	157.475	0.4058	-0.3804	0.7076
7120	-11.899	-237.712	153.021	0.4066	-0.3805	0.7041
7125	-34.489	-273.740	133.430	0.4085	-0.3805	0.6985
7128	-37.055	-277.827	131.205	0.4087	-0.3805	0.6991
7129	-39.264	-281.229	129.747	0.4088	-0.3805	0.6993
7130	-41.774	-284.888	128.911	0.4089	-0.3805	0.6995
7135	-49.416	-295.748	127.435	0.4090	-0.3805	0.6996
8000	70.414	-313.771	138.368	0.4011	-0.3804	0.7035
8005	60.198	-307.400	144.192	0.4011	-0.3804	0.7035
8010	5.202	-273.167	175.576	0.4039	-0.3804	0.7070
8015	-4.673	-267.038	181.218	0.4042	-0.3804	0.7074
8018	-9.612	-263.975	184.040	0.4044	-0.3804	0.7077
8019	-28.277	-260.923	189.226	0.4051	-0.3804	0.7075
8020	-43.624	-271.923	184.767	0.4059	-0.3805	0.7041
8025	-66.215	-307.952	165.176	0.4078	-0.3805	0.6985
8028	-68.780	-312.039	162.951	0.4080	-0.3805	0.6991
8029	-70.989	-315.442	161.493	0.4081	-0.3805	0.6994
8030	-73.500	-319.099	160.656	0.4082	-0.3805	0.6995
8035	-81.142	-329.955	159.181	0.4083	-0.3805	0.6996
9000	114.609	-267.975	87.609	0.4028	-0.3804	0.7037
9005	104.392	-261.603	93.459	0.4028	-0.3804	0.7037
9010	49.389	-227.372	124.981	0.4056	-0.3804	0.7070
9015	39.514	-221.243	130.647	0.4060	-0.3804	0.7075
9018	34.574	-218.180	133.482	0.4062	-0.3804	0.7077
9019	15.908	-215.128	138.705	0.4069	-0.3804	0.7075
9020	0.561	-226.129	134.261	0.4077	-0.3805	0.7041
9025	-22.029	-262.157	114.670	0.4095	-0.3805	0.6985
9028	-24.595	-266.244	112.445	0.4098	-0.3805	0.6991

CAESAR II Ver.5.10.00, (Build 070917) Date: JUL 19, 2010 Time: 16:42
 Job: C:\DOCUMENTS AND SETTINGS\ABC\MY DOCUMENTS\ST...MS_CRH_LPBP
 Licensed To: DEALR/EVAL COPY -- ID #4369

DISPLACEMENTS REPORT: Nodal Movements
 CASE 3 (OPE) W+D1+T1+P1+H

NODE	DX mm.	DY mm.	DZ mm.	RX deg.	RY deg.	RZ deg.
9029	-26.804	-269.648	110.987	0.4099	-0.3805	0.6994
9030	-29.314	-273.308	110.151	0.4100	-0.3805	0.6995
9035	-36.956	-284.175	108.675	0.4101	-0.3805	0.6996
15000	36.847	2.015	-104.387	0.1355	0.5834	0.2261
15005	42.337	0.694	-101.814	0.1379	0.5714	0.2400
15010	68.740	-6.489	-88.312	0.1352	0.4665	0.3245
15015	75.477	-8.518	-84.238	0.1294	0.4248	0.3496
15018	82.676	-10.787	-79.402	0.1200	0.3767	0.3754
15019	86.139	-15.905	-72.271	0.0942	0.1958	0.4029
15020	82.119	-24.655	-68.318	0.0800	0.0123	0.4491
15025	78.519	-30.758	-68.427	0.0662	-0.0257	0.4621
15030	77.522	-32.483	-68.548	0.0617	-0.0373	0.4662
15035	76.612	-34.343	-68.732	0.0569	-0.0491	0.4703
15038	72.964	-40.815	-69.645	0.0428	-0.0833	0.4812
15039	71.833	-52.297	-72.639	0.0385	-0.1974	0.5148
15040	79.527	-61.445	-74.827	0.0028	-0.2550	0.5251
15045	84.908	-64.245	-74.797	-0.0103	-0.2819	0.5238
15050	88.930	-66.345	-74.682	-0.0212	-0.3022	0.5216

CAESAR II Ver.5.10.00, (Build 070917) Date: JUL 19, 2010 Time: 16:42
 Job: C:\DOCUMENTS AND SETTINGS\ABC\MY DOCUMENTS\ST...MS_CRH_LPBP
 Licensed To: DEALR/EVAL COPY -- ID #4369

DISPLACEMENTS REPORT: Nodal Movements
 CASE 4 (SUS) W+P1+H

NODE	DX mm.	DY mm.	DZ mm.	RX deg.	RY deg.	RZ deg.
10	0.000	0.000	0.000	-0.0000	0.0000	0.0000
15	-0.002	0.000	-0.001	-0.0002	0.0002	0.0005
20	-0.005	0.000	-0.002	-0.0003	0.0003	0.0009
25	-0.030	0.001	-0.009	-0.0006	0.0006	0.0020
28	-0.060	0.000	-0.018	-0.0008	0.0008	0.0028
29	-0.089	0.014	-0.031	-0.0010	0.0011	0.0036
30	-0.099	0.055	-0.046	-0.0012	0.0013	0.0043
34	-0.082	0.178	-0.076	-0.0011	0.0016	0.0051
35	-0.080	0.216	-0.087	-0.0009	0.0017	0.0049
40	-0.080	0.265	-0.105	-0.0005	0.0018	0.0038
42	-0.080	0.288	-0.119	-0.0002	0.0019	0.0030
43	-0.079	0.385	-0.379	0.0042	0.0036	-0.0037
45	-0.079	0.342	-0.414	0.0045	0.0037	-0.0062
48	-0.080	0.275	-0.447	0.0048	0.0039	-0.0085
49	-0.137	0.062	-0.557	0.0052	0.0042	-0.0111
50	-0.282	-0.074	-0.671	0.0045	0.0047	-0.0116
53	-0.451	-0.116	-0.744	0.0030	0.0051	-0.0118
54	-0.515	-0.139	-0.768	0.0021	0.0053	-0.0119
55	-0.489	-0.160	-0.775	0.0015	0.0055	-0.0121
60	-0.445	-0.170	-0.775	0.0015	0.0056	-0.0122
62	-0.403	-0.185	-0.775	0.0016	0.0056	-0.0122
65	-0.010	-0.000	-0.772	-0.0079	0.0062	-0.0132
70	0.146	0.237	-0.768	-0.0097	0.0063	-0.0136
75	0.293	0.473	-0.764	-0.0096	0.0063	-0.0136
80	0.347	0.553	-0.764	-0.0081	0.0062	-0.0137
85	0.531	0.385	-0.927	-0.0048	0.0061	-0.0114
88	0.366	0.576	-0.764	-0.0075	0.0062	-0.0137
89	0.483	0.582	-0.812	-0.0053	0.0062	-0.0133
90	0.361	-0.003	-1.076	-0.0046	0.0058	-0.0057
91	0.474	0.044	-1.118	-0.0047	0.0059	-0.0067
92	0.531	0.188	-1.043	-0.0048	0.0060	-0.0089
93	0.288	-0.003	-1.015	-0.0046	0.0057	-0.0053
95	0.177	-0.000	-0.911	-0.0045	0.0056	-0.0045
100	-0.183	0.000	-0.188	-0.0033	0.0044	-0.0001
105	-0.116	0.000	0.274	-0.0014	0.0031	0.0001
107	-0.225	-0.024	0.348	0.0003	0.0023	-0.0021
108	-0.267	-0.025	0.342	0.0005	0.0022	-0.0025
109	-0.331	-0.032	0.326	0.0000	0.0021	-0.0034
110	-0.319	0.000	0.334	-0.0019	0.0019	-0.0045
112	-0.294	0.031	0.334	-0.0020	0.0018	-0.0050
115	-0.249	0.054	0.335	0.0025	0.0014	-0.0063
117	-0.215	-0.136	0.333	0.0069	0.0008	-0.0076
118	-0.205	-0.257	0.332	0.0062	0.0005	-0.0082
119	-0.202	-0.290	0.331	0.0031	-0.0002	-0.0091
120	-0.211	-0.056	0.312	0.0020	-0.0009	-0.0064
125	-0.212	-0.008	0.304	0.0020	-0.0011	-0.0045
130	-0.212	0.010	0.298	0.0021	-0.0012	-0.0032
135	-0.210	-0.154	0.033	0.0027	-0.0041	0.0049

CAESAR II Ver.5.10.00, (Build 070917) Date: JUL 19, 2010 Time: 16:42
 Job: C:\DOCUMENTS AND SETTINGS\ABC\MY DOCUMENTS\IST...MS_CRH_LPBP
 Licensed To: DEALR/EVAL COPY -- ID #4369

DISPLACEMENTS REPORT: Nodal Movements
 CASE 4 (SUS) W+P1+H

NODE	DX mm.	DY mm.	DZ mm.	RX deg.	RY deg.	RZ deg.
140	-0.208	-0.323	-0.732	0.0035	-0.0080	-0.0020
145	-0.208	-0.314	-0.767	0.0035	-0.0081	-0.0012
148	-0.208	-0.313	-0.813	0.0036	-0.0082	-0.0001
149	-0.206	-0.325	-0.931	0.0036	-0.0086	0.0013
150	-0.196	-0.346	-1.058	0.0037	-0.0090	0.0018
155	-0.162	-0.394	-1.425	0.0037	-0.0101	0.0013
160	-0.125	-0.393	-1.527	0.0038	-0.0104	0.0014
165	-0.080	-0.396	-1.649	0.0039	-0.0109	0.0014
168	-0.054	-0.396	-1.722	0.0039	-0.0111	0.0013
169	-0.020	-0.383	-1.705	0.0040	-0.0114	0.0013
170	-0.005	-0.348	-1.457	0.0042	-0.0117	0.0010
175	-0.005	-0.344	-1.407	0.0042	-0.0117	0.0008
180	-0.005	-0.339	-1.165	0.0043	-0.0118	0.0003
185	-0.004	-0.253	-0.279	0.0048	-0.0124	0.0009
190	-0.002	-0.187	0.914	0.0055	-0.0128	0.0006
195	-0.001	-0.129	2.130	0.0062	-0.0129	0.0007
200	-0.000	-0.091	3.081	0.0067	-0.0128	0.0014
205	-0.000	-0.069	3.258	0.0068	-0.0128	0.0012
210	0.000	-0.060	3.342	0.0068	-0.0127	0.0009
213	0.000	-0.058	3.420	0.0069	-0.0127	0.0006
214	0.013	-0.038	3.817	0.0071	-0.0125	0.0013
215	0.095	-0.005	3.727	0.0074	-0.0122	0.0022
220	0.143	-0.004	3.572	0.0075	-0.0120	0.0023
225	0.212	0.000	3.349	0.0078	-0.0118	0.0025
230	0.442	0.000	2.619	0.0090	-0.0110	0.0028
235	0.756	0.000	1.509	0.0110	-0.0099	0.0028
240	0.926	-0.000	0.793	0.0124	-0.0094	0.0027
245	0.954	-0.000	0.666	0.0126	-0.0093	0.0027
248	0.992	-0.001	0.484	0.0129	-0.0092	0.0027
249	0.964	-0.143	0.147	0.0129	-0.0090	0.0026
250	0.763	-0.459	0.012	0.0112	-0.0088	0.0024
255	0.601	-0.651	0.011	0.0095	-0.0087	0.0023
260	0.041	-1.112	0.008	0.0078	-0.0084	0.0020
265	-0.608	-1.925	0.004	0.0118	-0.0082	0.0016
270	-1.246	-2.818	-0.000	0.0097	-0.0081	0.0011
275	-1.459	-3.068	-0.001	0.0104	-0.0081	0.0010
280	-1.601	-3.265	-0.002	0.0113	-0.0081	0.0009
285	-1.957	-3.747	-0.005	0.0105	-0.0082	0.0007
290	-2.230	-4.094	-0.007	0.0112	-0.0082	0.0005
295	-2.929	-5.022	-0.011	0.0098	-0.0082	-0.0002
300	-3.075	-5.198	-0.011	0.0108	-0.0082	-0.0003
305	-3.216	-5.399	-0.010	0.0118	-0.0082	-0.0004
310	-3.531	-5.846	-0.008	0.0109	-0.0082	-0.0008
315	-3.847	-6.232	-0.006	0.0095	-0.0082	-0.0005
320	-3.992	-6.397	-0.005	0.0097	-0.0082	-0.0002
325	-4.162	-6.604	-0.004	0.0100	-0.0082	0.0001
505	-0.000	0.000	0.000	0.0000	0.0000	-0.0000
510	0.004	0.000	0.001	0.0003	0.0005	-0.0012
515	0.013	0.000	0.003	0.0005	0.0008	-0.0022
520	0.050	0.000	0.012	0.0009	0.0015	-0.0041

CAESAR II Ver.5.10.00, (Build 070917) Date: JUL 19, 2010 Time: 16:42
 Job: C:\DOCUMENTS AND SETTINGS\ABC\MY DOCUMENTS\ST...MS_CRH_LPBP
 Licensed To: DEALR/EVAL COPY -- ID #4369

DISPLACEMENTS REPORT: Nodal Movements
 CASE 4 (SUS) W+P1+H

NODE	DX mm.	DY mm.	DZ mm.	RX deg.	RY deg.	RZ deg.
523	0.075	0.000	0.018	0.0011	0.0018	-0.0049
524	0.207	0.043	0.060	0.0015	0.0028	-0.0084
525	0.311	0.194	0.125	0.0024	0.0035	-0.0118
530	0.312	0.197	0.126	0.0024	0.0035	-0.0119
533	0.320	0.245	0.142	0.0027	0.0037	-0.0126
534	0.330	0.321	0.166	0.0033	0.0040	-0.0133
535	0.333	0.413	0.194	0.0039	0.0042	-0.0137
540	0.331	0.558	0.239	0.0048	0.0046	-0.0136
545	0.330	0.657	0.274	0.0055	0.0048	-0.0134
550	0.316	2.214	0.800	0.0159	0.0058	-0.0169
555	0.315	2.370	0.853	0.0167	0.0057	-0.0153
558	0.314	2.489	0.901	0.0175	0.0056	-0.0137
559	0.249	2.653	0.876	0.0190	0.0053	-0.0125
560	0.091	2.568	0.600	0.0196	0.0048	-0.0129
563	-0.110	2.352	0.225	0.0199	0.0043	-0.0134
564	-0.201	2.161	0.033	0.0202	0.0041	-0.0137
565	-0.199	1.892	-0.041	0.0213	0.0039	-0.0140
570	-0.170	1.718	-0.044	0.0223	0.0038	-0.0142
575	-0.142	1.535	-0.046	0.0233	0.0037	-0.0144
580	0.092	-0.000	-0.067	0.0185	0.0039	-0.0163
585	0.191	-0.436	-0.073	0.0157	0.0042	-0.0170
590	0.289	-0.820	-0.079	0.0157	0.0042	-0.0170
595	0.326	-0.958	-0.079	0.0164	0.0043	-0.0172
598	0.339	-1.009	-0.079	0.0167	0.0043	-0.0173
599	0.420	-1.196	-0.045	0.0172	0.0043	-0.0181
600	0.454	-0.975	0.037	0.0165	0.0043	-0.0197
603	0.454	-0.580	0.120	0.0156	0.0043	-0.0212
604	0.284	-0.172	0.083	0.0146	0.0041	-0.0216
605	-0.112	-0.004	-0.152	0.0138	0.0039	-0.0203
610	-0.375	-0.003	-0.332	0.0133	0.0038	-0.0192
615	-0.789	-0.000	-0.626	0.0124	0.0036	-0.0169
620	-2.429	-0.000	-2.308	0.0065	0.0021	-0.0019
625	-1.752	-0.000	-3.250	0.0039	0.0005	0.0079
630	-0.521	-0.023	-3.738	0.0041	-0.0005	0.0111
633	-0.317	-0.024	-3.813	0.0042	-0.0006	0.0113
634	0.029	-0.079	-3.944	0.0037	-0.0009	0.0116
635	0.149	-0.162	-3.985	0.0019	-0.0012	0.0118
640	0.133	-0.184	-3.985	0.0018	-0.0014	0.0119
645	0.087	-0.274	-3.986	0.0064	-0.0019	0.0120
650	0.017	-0.586	-3.989	0.0107	-0.0027	0.0122
653	-0.032	-0.774	-3.990	0.0100	-0.0031	0.0123
654	-0.137	-0.881	-3.946	0.0068	-0.0040	0.0121
655	-0.187	-0.610	-3.808	0.0053	-0.0049	0.0088
660	-0.187	-0.543	-3.768	0.0053	-0.0051	0.0069
665	-0.186	-0.512	-3.741	0.0053	-0.0053	0.0055
670	-0.186	-0.491	-3.086	0.0047	-0.0078	-0.0033
675	-0.186	-0.484	-1.997	0.0040	-0.0097	0.0042
680	-0.185	-0.452	-1.921	0.0039	-0.0098	0.0030
683	-0.185	-0.440	-1.865	0.0039	-0.0098	0.0021
684	-0.183	-0.426	-1.744	0.0038	-0.0099	0.0008

CAESAR II Ver.5.10.00, (Build 070917) Date: JUL 19, 2010 Time: 16:42
 Job: C:\DOCUMENTS AND SETTINGS\ABC\MY DOCUMENTS\ST...MS_CRH_LPBP
 Licensed To: DEALR/EVAL COPY -- ID #4369

DISPLACEMENTS REPORT: Nodal Movements
 CASE 4 (SUS) W+P1+H

NODE	DX mm.	DY mm.	DZ mm.	RX deg.	RY deg.	RZ deg.
685	-0.180	-0.420	-1.649	0.0038	-0.0099	0.0005
1000	-1.601	-3.257	0.077	0.0121	-0.0080	0.0009
1003	-1.601	-3.254	0.102	0.0124	-0.0080	0.0009
1004	-1.570	-3.194	0.178	0.0132	-0.0080	0.0011
1005	-1.495	-3.063	0.212	0.0134	-0.0080	0.0010
1010	-1.461	-3.007	0.213	0.0132	-0.0080	0.0009
1015	-1.423	-2.946	0.214	0.0129	-0.0080	0.0007
1020	-1.130	-2.436	0.224	0.0154	-0.0081	-0.0005
1025	-0.954	-2.138	0.405	0.0116	-0.0082	-0.0012
1026	-0.995	-2.190	0.285	0.0141	-0.0082	-0.0010
1027	-1.073	-2.329	0.226	0.0153	-0.0081	-0.0007
1030	-0.942	-2.138	0.501	0.0092	-0.0082	-0.0014
1035	-0.836	-2.131	0.537	-0.0074	-0.0085	-0.0028
1040	-0.828	-2.131	0.514	-0.0081	-0.0085	-0.0028
1045	-0.656	-2.285	0.314	-0.0114	-0.0085	-0.0035
1046	-0.748	-2.174	0.361	-0.0114	-0.0085	-0.0032
1047	-0.810	-2.132	0.460	-0.0095	-0.0085	-0.0030
1050	-0.597	-2.361	0.312	-0.0101	-0.0086	-0.0037
1055	0.051	-1.543	0.325	0.0305	-0.0089	-0.0064
1060	0.323	-0.935	0.707	0.0258	-0.0090	-0.0071
1061	0.224	-1.045	0.449	0.0294	-0.0090	-0.0069
1062	0.113	-1.329	0.328	0.0309	-0.0090	-0.0066
1063	0.389	-0.934	0.925	0.0222	-0.0091	-0.0073
1065	0.508	-0.932	1.213	0.0144	-0.0092	-0.0078
1067	0.547	-0.932	1.278	0.0119	-0.0093	-0.0079
1068	0.602	-0.933	1.352	0.0094	-0.0093	-0.0081
1069	0.643	-0.959	1.422	0.0055	-0.0094	-0.0083
1070	0.589	-0.989	1.438	0.0014	-0.0095	-0.0086
1075	0.504	-0.985	1.438	-0.0021	-0.0095	-0.0089
1080	0.136	-0.701	1.432	-0.0062	-0.0098	-0.0104
1085	0.097	-0.680	1.432	-0.0047	-0.0098	-0.0106
1088	0.012	-0.648	1.431	-0.0032	-0.0098	-0.0109
1089	-0.077	-0.579	1.392	-0.0024	-0.0099	-0.0114
1090	-0.113	-0.460	1.299	-0.0021	-0.0098	-0.0122
1095	-0.112	-0.377	1.233	-0.0020	-0.0098	-0.0126
1100	-0.105	0.081	0.777	-0.0008	-0.0085	0.0032
1105	-0.109	-0.178	0.571	-0.0002	-0.0071	0.0088
1110	-0.109	-0.225	0.531	-0.0001	-0.0069	0.0068
1115	-0.110	-0.279	0.466	-0.0001	-0.0067	0.0038
1120	-0.077	-0.279	0.466	-0.0001	-0.0067	0.0038
1125	-0.079	0.002	0.227	0.0004	-0.0041	-0.0083
1130	-0.079	0.089	0.184	0.0005	-0.0039	-0.0066
1135	-0.079	0.113	0.170	0.0005	-0.0039	-0.0063
1140	-0.079	0.174	0.130	0.0005	-0.0037	-0.0039
1145	-0.079	0.193	0.109	0.0005	-0.0035	-0.0013
1148	-0.079	0.089	0.027	0.0006	-0.0028	0.0059
1149	-0.052	0.022	0.006	0.0003	-0.0014	0.0061
1150	-0.012	0.002	0.000	0.0000	-0.0008	0.0019
1155	-0.012	0.002	0.000	0.0000	-0.0008	0.0019
1160	0.000	-0.000	0.000	0.0000	-0.0000	0.0000

CAESAR II Ver.5.10.00, (Build 070917) Date: JUL 19, 2010 Time: 16:42
 Job: C:\DOCUMENTS AND SETTINGS\ABC\MY DOCUMENTS\IST...MS_CRH_LPBP
 Licensed To: DEALR/EVAL COPY -- ID #4369

DISPLACEMENTS REPORT: Nodal Movements
 CASE 4 (SUS) W+P1+H

NODE	DX mm.	DY mm.	DZ mm.	RX deg.	RY deg.	RZ deg.
1165	0.079	-0.003	-0.006	0.0008	-0.0006	0.0067
1168	0.079	-0.584	-0.110	0.0047	-0.0041	0.0099
1169	0.115	-0.628	-0.182	0.0075	-0.0120	0.0041
1170	0.270	-0.544	-0.240	0.0120	-0.0208	0.0012
1175	0.527	-0.395	-0.240	0.0124	-0.0220	-0.0001
1178	0.759	-0.270	-0.239	0.0128	-0.0232	-0.0011
1179	1.013	-0.133	-0.129	0.0177	-0.0311	-0.0008
1180	1.144	-0.068	0.199	0.0199	-0.0381	-0.0012
1185	1.143	-0.181	2.442	0.0301	-0.0408	-0.0043
1190	1.140	-0.450	4.670	0.0403	-0.0386	-0.0014
1195	0.359	-1.582	6.034	0.0551	-0.0244	0.0083
1198	1.140	-0.456	5.173	0.0424	-0.0376	0.0007
1199	0.879	-0.716	5.819	0.0453	-0.0314	0.0071
1200	1.330	-12.213	-0.005	0.0536	-0.0059	0.0279
1205	1.439	-11.220	0.003	0.0521	-0.0062	0.0270
1210	2.114	-6.105	0.044	0.0446	-0.0070	0.0222
1215	2.700	-2.624	0.073	0.0384	-0.0071	0.0186
1218	2.777	-2.200	0.076	0.0375	-0.0070	0.0182
1220	2.853	-1.784	0.079	0.0363	-0.0070	0.0177
1225	2.909	-1.492	0.082	0.0352	-0.0070	0.0174
1228	2.990	-1.088	0.085	0.0336	-0.0069	0.0169
1229	2.998	-0.231	0.414	0.0205	-0.0071	0.0151
1230	2.663	-0.015	0.865	0.0084	-0.0075	0.0120
1235	2.311	-0.013	1.077	0.0056	-0.0072	0.0111
1240	1.815	-0.006	1.238	0.0014	-0.0067	0.0098
1245	0.875	-0.005	0.982	-0.0052	-0.0055	0.0072
1250	0.257	-0.002	0.355	-0.0072	-0.0045	0.0058
1255	-0.003	-0.000	0.013	-0.0070	-0.0040	0.0053
1260	-0.049	-0.000	-0.048	-0.0069	-0.0039	0.0052
1264	-0.125	-0.029	-0.171	-0.0053	-0.0032	0.0037
1265	-0.145	-0.068	-0.242	-0.0044	-0.0019	0.0013
1270	-0.145	-0.068	-0.243	-0.0044	-0.0019	0.0013
1275	-0.145	-0.079	-0.262	-0.0043	-0.0018	0.0011
1278	-0.145	-0.090	-0.283	-0.0041	-0.0017	0.0011
1280	-0.145	-0.099	-0.302	-0.0040	-0.0016	0.0012
1285	-0.146	-0.112	-0.323	-0.0038	-0.0016	0.0016
1288	-0.146	-0.127	-0.335	-0.0037	-0.0015	0.0019
1289	-0.134	-0.251	-0.376	-0.0025	-0.0009	0.0019
1290	-0.117	-0.303	-0.386	-0.0004	-0.0003	0.0007
1295	-0.116	-0.304	-0.386	-0.0004	-0.0003	0.0007
1300	-0.111	-0.308	-0.387	-0.0008	-0.0002	0.0005
1303	-0.109	-0.322	-0.387	-0.0012	-0.0002	0.0004
1304	-0.108	-0.372	-0.388	-0.0009	0.0002	-0.0005
1305	-0.111	-0.330	-0.377	-0.0001	0.0004	-0.0016
1310	-0.111	-0.317	-0.374	-0.0001	0.0005	-0.0014
1315	-0.110	-0.301	-0.367	0.0000	0.0005	-0.0012
1320	-0.109	-0.235	-0.344	0.0002	0.0005	-0.0017
1325	-0.109	-0.197	-0.333	0.0003	0.0005	-0.0015
1328	-0.109	-0.193	-0.331	0.0004	0.0005	-0.0014
1329	-0.099	-0.170	-0.309	0.0006	0.0005	-0.0009

5/20

CAESAR II Ver.5.10.00, (Build 070917) Date: JUL 19, 2010 Time: 16:42
 Job: C:\DOCUMENTS AND SETTINGS\ABC\MY DOCUMENTS\ST...MS_CRH_LPBP
 Licensed To: DEALR/EVAL COPY -- ID #4369

DISPLACEMENTS REPORT: Nodal Movements
 CASE 4 (SUS) W+P1+H

NODE	DX mm.	DY mm.	DZ mm.	RX deg.	RY deg.	RZ deg.
1330	-0.067	-0.155	-0.279	0.0009	0.0005	-0.0008
1335	-0.045	-0.153	-0.251	0.0009	0.0005	-0.0007
1340	-0.010	-0.141	-0.177	0.0010	0.0004	-0.0003
1345	-0.000	-0.141	-0.133	0.0010	0.0003	-0.0002
1350	-0.000	-0.142	-0.136	0.0010	0.0002	-0.0002
1355	-0.000	-0.142	-0.138	0.0010	0.0002	-0.0004
1360	-0.000	-0.143	-0.139	0.0010	0.0002	-0.0006
1365	0.000	-0.147	-0.142	0.0010	-0.0001	0.0014
1370	-0.000	-0.113	-0.139	0.0010	-0.0001	0.0007
1375	-0.000	-0.113	-0.139	0.0010	-0.0001	0.0004
1378	-0.000	-0.119	-0.135	0.0010	-0.0001	-0.0002
1379	-0.005	-0.113	-0.119	0.0010	-0.0002	0.0008
1380	-0.030	-0.101	-0.089	0.0010	-0.0001	0.0005
1385	-0.038	-0.099	-0.069	0.0010	-0.0001	0.0003
1390	-0.044	-0.088	-0.006	0.0008	-0.0001	-0.0001
1395	-0.041	-0.090	0.021	0.0007	-0.0001	-0.0000
1399	-0.042	-0.091	0.026	0.0003	-0.0002	-0.0000
1400	-0.041	-0.086	0.024	0.0001	-0.0003	-0.0007
1405	-0.041	-0.058	0.011	-0.0000	-0.0004	-0.0003
1408	-0.041	-0.059	0.009	-0.0001	-0.0004	-0.0001
1409	-0.038	-0.076	0.003	-0.0003	-0.0005	0.0012
1410	-0.031	-0.079	-0.000	0.0012	-0.0005	0.0007
1415	-0.015	-0.034	-0.000	0.0015	-0.0005	0.0005
1420	-0.008	-0.007	-0.000	0.0010	-0.0004	0.0004
1425	-0.003	-0.001	-0.000	0.0005	-0.0003	0.0003
1430	-0.001	0.001	-0.000	0.0002	-0.0002	0.0002
1435	-0.000	0.000	-0.000	0.0000	-0.0000	0.0000
1440	-0.000	-0.139	-0.130	0.0010	0.0003	-0.0001
1445	-0.000	-0.136	-0.126	0.0010	0.0003	0.0002
1450	-0.000	-0.136	-0.125	0.0010	0.0003	0.0004
1455	-0.000	-0.092	-0.078	0.0008	0.0005	-0.0007
1460	-0.000	-0.091	-0.076	0.0008	0.0005	-0.0005
1463	-0.000	-0.096	-0.063	0.0008	0.0005	0.0001
1464	0.005	-0.089	-0.040	0.0007	0.0005	-0.0009
1465	0.030	-0.076	-0.016	0.0006	0.0004	-0.0005
1470	0.038	-0.074	-0.003	0.0006	0.0004	-0.0003
1475	0.043	-0.063	0.032	0.0004	0.0004	0.0001
1478	0.041	-0.065	0.044	0.0003	0.0004	0.0000
1479	0.043	-0.067	0.043	-0.0001	0.0005	-0.0001
1480	0.042	-0.063	0.035	-0.0002	0.0006	0.0006
1485	0.042	-0.040	0.016	-0.0004	0.0006	0.0002
1488	0.042	-0.042	0.012	-0.0004	0.0006	-0.0001
1489	0.038	-0.062	0.004	-0.0006	0.0006	-0.0013
1490	0.030	-0.068	-0.000	0.0010	0.0005	-0.0008
1493	0.014	-0.028	-0.000	0.0013	0.0005	-0.0005
1495	0.007	-0.004	-0.000	0.0008	0.0004	-0.0003
1500	0.003	0.000	-0.000	0.0004	0.0003	-0.0002
1505	0.001	0.001	-0.000	0.0001	0.0001	-0.0001
1510	0.000	0.000	-0.000	0.0000	0.0000	-0.0000
2000	-1.957	-3.736	0.079	0.0057	-0.0090	0.0005

CAESAR II Ver.5.10.00, (Build 070917) Date: JUL 19, 2010 Time: 16:42
 Job: C:\DOCUMENTS AND SETTINGS\ABC\MY DOCUMENTS\IST...MS_CRH_LPBP
 Licensed To: DEALR/EVAL COPY -- ID #4369

DISPLACEMENTS REPORT: Nodal Movements
 CASE 4 (SUS) W+P1+H

NODE	DX mm.	DY mm.	DZ mm.	RX deg.	RY deg.	RZ deg.
2005	-1.957	-3.736	0.151	0.0020	-0.0097	-0.0017
2010	-1.957	-3.756	0.213	-0.0010	-0.0104	-0.0036
2015	-1.791	-3.930	0.440	-0.0091	-0.0133	-0.0000
2016	-1.911	-3.844	0.393	-0.0070	-0.0121	-0.0028
2017	-1.957	-3.784	0.285	-0.0035	-0.0110	-0.0041
2020	-1.669	-4.015	0.439	-0.0099	-0.0143	0.0024
2025	-1.014	-4.492	0.431	-0.0172	-0.0195	0.0165
2030	-0.126	-5.266	0.421	-0.0139	-0.0242	0.0314
2033	0.039	-5.353	0.419	-0.0115	-0.0247	0.0333
2034	0.133	-5.444	0.383	-0.0078	-0.0257	0.0361
2035	-0.116	-5.469	0.328	-0.0042	-0.0269	0.0386
2040	-0.476	-5.468	0.304	-0.0011	-0.0277	0.0406
2045	-4.051	-5.462	1.468	0.0360	-0.0360	0.0621
2050	-4.236	-5.461	1.577	0.0373	-0.0363	0.0628
2053	-4.625	-5.462	1.813	0.0401	-0.0369	0.0643
2054	-5.236	-5.714	2.066	0.0454	-0.0382	0.0666
2055	-5.503	-6.338	1.894	0.0517	-0.0394	0.0674
2057	-5.511	-6.804	1.627	0.0561	-0.0397	0.0669
2058	-5.524	-7.619	1.144	0.0663	-0.0403	0.0641
2059	-5.386	-8.328	0.516	0.0767	-0.0405	0.0602
2060	-5.016	-7.814	0.372	0.0814	-0.0404	0.0578
2061	-5.531	-8.042	0.882	0.0706	-0.0404	0.0625
2065	-4.664	-7.076	0.381	0.0845	-0.0403	0.0553
2070	-3.476	-4.462	0.412	0.0832	-0.0395	0.0444
2075	-0.697	1.506	0.483	0.0844	-0.0356	0.0175
2078	-0.457	2.080	0.490	0.0839	-0.0352	0.0156
2079	-0.188	2.854	0.817	0.0817	-0.0343	0.0128
2080	-0.165	3.165	1.563	0.0780	-0.0333	0.0105
2085	-0.217	3.165	1.962	0.0760	-0.0329	0.0094
2088	-0.334	3.166	3.044	0.0705	-0.0318	0.0064
2089	-0.385	3.147	3.566	0.0666	-0.0306	0.0047
2095	-0.402	3.107	3.544	0.0621	-0.0294	0.0050
2100	-0.402	3.069	3.350	0.0590	-0.0288	0.0071
2105	-0.404	2.915	2.963	0.0528	-0.0274	0.0172
2110	-0.412	2.192	2.313	0.0376	-0.0229	0.0293
2115	-0.414	2.024	2.185	0.0357	-0.0223	0.0277
2120	-0.417	1.766	1.977	0.0339	-0.0216	0.0251
2125	-0.199	1.766	1.681	0.0339	-0.0216	0.0250
2130	-0.196	1.133	0.885	0.0170	-0.0142	0.0109
2131	-0.195	1.017	0.737	0.0156	-0.0135	0.0120
2132	-0.195	0.975	0.689	0.0154	-0.0133	0.0123
2133	-0.194	0.841	0.548	0.0145	-0.0128	0.0141
2134	-0.194	0.759	0.477	0.0138	-0.0124	0.0162
2135	-0.029	0.002	0.014	0.0020	-0.0023	0.0044
2136	-0.121	0.049	0.072	0.0074	-0.0053	0.0150
2137	-0.028	0.002	0.013	0.0020	-0.0023	0.0044
2138	-0.191	0.229	0.180	0.0104	-0.0102	0.0208
2139	0.000	0.000	0.000	0.0000	-0.0000	0.0000
2140	0.124	-0.003	-0.025	0.0024	-0.0005	0.0105
2143	0.125	-1.073	-0.103	0.0106	-0.0030	0.0236

CAESAR II Ver.5.10.00, (Build 070917) Date: JUL 19, 2010 Time: 16:42
 Job: C:\DOCUMENTS AND SETTINGS\ABC\MY DOCUMENTS\IST...MS_CRH_LPBP
 Licensed To: DEALR/EVAL COPY -- ID #4369

DISPLACEMENTS REPORT: Nodal Movements
 CASE 4 (SUS) W+P1+H

NODE	DX mm.	DY mm.	DZ mm.	RX deg.	RY deg.	RZ deg.
2144	0.099	-1.382	-0.155	0.0151	-0.0086	0.0318
2145	-0.012	-1.699	-0.197	0.0241	-0.0148	0.0364
2153	-0.366	-2.270	-0.196	0.0272	-0.0169	0.0394
2154	-0.553	-2.395	-0.114	0.0309	-0.0236	0.0405
2160	-0.197	-1.996	-0.197	0.0258	-0.0159	0.0380
2165	-0.650	-2.109	0.137	0.0305	-0.0298	0.0466
2170	-0.626	0.693	1.911	0.0359	-0.0329	0.0500
2172	-0.581	5.800	4.848	0.0448	-0.0308	0.0683
2173	-0.573	6.730	5.247	0.0460	-0.0299	0.0711
2174	-0.764	7.777	5.757	0.0478	-0.0249	0.0768
2175	-1.161	7.392	5.925	0.0593	-0.0193	0.0752
2180	-1.313	6.892	5.921	0.0624	-0.0186	0.0750
2182	-1.478	6.280	5.916	0.0659	-0.0177	0.0747
2185	-2.755	-1.673	5.852	0.0781	-0.0077	0.0712
2187	-2.852	-2.863	5.842	0.0796	-0.0065	0.0707
2188	-2.946	-4.281	5.830	0.0793	-0.0053	0.0702
2189	-2.995	-6.275	5.793	0.0747	-0.0015	0.0684
2190	-2.986	-8.106	5.780	0.0714	0.0013	0.0663
2192	-2.979	-8.989	5.794	0.0700	0.0017	0.0666
2195	-2.977	-9.235	5.799	0.0695	0.0018	0.0669
2197	-2.959	-11.817	5.860	0.0646	0.0020	0.0645
2198	-2.953	-12.675	5.880	0.0631	0.0017	0.0622
2199	-2.520	-13.741	5.418	0.0608	0.0007	0.0515
2200	-1.650	-14.112	4.314	0.0576	-0.0001	0.0423
2205	-1.224	-14.111	3.727	0.0570	-0.0007	0.0408
2207	-0.915	-14.113	3.291	0.0566	-0.0012	0.0397
2210	1.127	-14.121	-0.004	0.0555	-0.0057	0.0292
2215	0.816	-17.236	-0.003	0.0580	-0.0057	0.0295
2220	0.259	-22.988	-0.001	0.0577	-0.0056	0.0300
2225	-0.007	-25.700	-0.000	0.0565	-0.0056	0.0302
2230	-0.121	-26.834	-0.000	0.0557	-0.0056	0.0286
2235	-0.307	-28.651	-0.000	0.0557	-0.0056	0.0261
2240	-0.400	-29.587	-0.000	0.0561	-0.0056	0.0248
3000	-0.012	-26.223	-0.085	0.0565	-0.0056	0.0327
3005	-0.012	-26.310	-0.098	0.0565	-0.0056	0.0331
3010	-0.021	-27.264	-0.245	0.0565	-0.0056	0.0331
3015	-0.023	-27.376	-0.263	0.0565	-0.0056	0.0333
3018	-0.030	-28.175	-0.382	0.0565	-0.0056	0.0342
3019	-0.206	-28.590	-0.164	0.0565	-0.0056	0.0346
3020	-0.622	-28.762	0.489	0.0565	-0.0056	0.0345
3025	-5.041	-28.748	7.714	0.0565	-0.0056	0.0345
3030	-6.781	-28.751	10.559	0.0565	-0.0056	0.0345
3035	-7.150	-28.751	11.162	0.0565	-0.0056	0.0345
4000	-0.405	-30.037	-0.098	0.0561	-0.0056	0.0211
4005	-0.410	-30.639	-0.245	0.0561	-0.0056	0.0209
4010	-0.411	-30.707	-0.263	0.0561	-0.0056	0.0207
4014	-0.511	-31.416	-0.165	0.0561	-0.0056	0.0184
4015	-0.729	-31.505	0.482	0.0561	-0.0056	0.0180
4020	-2.907	-31.489	7.260	0.0561	-0.0056	0.0180
4025	-3.941	-31.492	10.478	0.0561	-0.0056	0.0180

CAESAR II Ver.5.10.00, (Build 070917) Date: JUL 19, 2010 Time: 16:42
 Job: C:\DOCUMENTS AND SETTINGS\ABC\MY DOCUMENTS\IST...MS_CRH_LPBP
 Licensed To: DEALR/EVAL COPY -- ID #4369

DISPLACEMENTS REPORT: Nodal Movements
 CASE 4 (SUS) W+P1+H

NODE	DX mm.	DY mm.	DZ mm.	RX deg.	RY deg.	RZ deg.
4030	-4.134	-31.492	11.077	0.0561	-0.0056	0.0180
7000	-3.216	-5.399	-0.225	0.0130	-0.0082	0.0008
7005	-3.531	-5.808	-0.180	0.0119	-0.0082	-0.0005
7010	-3.847	-6.220	-0.178	0.0104	-0.0082	0.0004
7015	-4.162	-6.635	-0.219	0.0112	-0.0082	0.0016
7030	-3.847	-6.250	-0.343	0.0114	-0.0082	0.0021
7035	-3.877	-6.250	-0.177	0.0114	-0.0082	0.0021
7040	-4.168	-6.236	0.819	0.0142	-0.0082	0.0054
7045	-4.247	-6.233	1.020	0.0146	-0.0082	0.0059
7048	-4.289	-6.233	1.122	0.0148	-0.0082	0.0061
7049	-4.421	-6.289	1.367	0.0154	-0.0083	0.0059
7050	-4.465	-6.382	1.329	0.0162	-0.0083	0.0025
7055	-4.465	-6.285	0.899	0.0181	-0.0083	-0.0032
7058	-4.465	-6.269	0.851	0.0183	-0.0083	-0.0026
7059	-4.470	-6.270	0.813	0.0185	-0.0083	-0.0023
7060	-4.484	-6.293	0.778	0.0185	-0.0083	-0.0021
7065	-4.540	-6.395	0.681	0.0186	-0.0083	-0.0020
7100	-3.531	-5.837	-0.344	0.0129	-0.0082	0.0022
7105	-3.564	-5.837	-0.158	0.0129	-0.0082	0.0022
7110	-3.863	-5.823	0.953	0.0156	-0.0082	0.0054
7115	-3.942	-5.821	1.175	0.0160	-0.0082	0.0059
7118	-3.984	-5.821	1.287	0.0162	-0.0082	0.0061
7119	-4.117	-5.877	1.563	0.0169	-0.0083	0.0059
7120	-4.161	-5.971	1.537	0.0177	-0.0083	0.0025
7125	-4.161	-5.873	1.108	0.0196	-0.0083	-0.0032
7128	-4.161	-5.857	1.059	0.0198	-0.0083	-0.0026
7129	-4.166	-5.858	1.022	0.0199	-0.0083	-0.0023
7130	-4.180	-5.885	0.987	0.0200	-0.0083	-0.0021
7135	-4.236	-5.996	0.890	0.0201	-0.0083	-0.0020
8000	-4.162	-6.668	-0.384	0.0122	-0.0082	0.0019
8005	-4.189	-6.668	-0.207	0.0122	-0.0082	0.0019
8010	-4.470	-6.651	0.851	0.0150	-0.0082	0.0053
8015	-4.548	-6.648	1.063	0.0154	-0.0082	0.0058
8018	-4.589	-6.649	1.171	0.0156	-0.0082	0.0060
8019	-4.720	-6.704	1.432	0.0162	-0.0083	0.0059
8020	-4.764	-6.797	1.401	0.0170	-0.0083	0.0024
8025	-4.764	-6.700	0.972	0.0189	-0.0083	-0.0032
8028	-4.764	-6.685	0.923	0.0191	-0.0083	-0.0026
8029	-4.769	-6.686	0.886	0.0192	-0.0083	-0.0023
8030	-4.783	-6.711	0.851	0.0193	-0.0083	-0.0021
8035	-4.839	-6.818	0.754	0.0194	-0.0083	-0.0020
9000	-3.216	-5.431	-0.390	0.0139	-0.0082	0.0020
9005	-3.245	-5.430	-0.187	0.0139	-0.0082	0.0020
9010	-3.533	-5.415	1.009	0.0167	-0.0082	0.0054
9015	-3.611	-5.412	1.245	0.0171	-0.0082	0.0058
9018	-3.653	-5.413	1.366	0.0173	-0.0082	0.0061
9019	-3.784	-5.468	1.664	0.0180	-0.0083	0.0059
9020	-3.828	-5.561	1.648	0.0188	-0.0083	0.0024
9025	-3.828	-5.464	1.219	0.0207	-0.0083	-0.0032
9028	-3.828	-5.448	1.170	0.0209	-0.0083	-0.0026

5/2

CAESAR II Ver.5.10.00, (Build 070917) Date: JUL 19, 2010 Time: 16:42
 Job: C:\DOCUMENTS AND SETTINGS\ABC\MY DOCUMENTS\IST...MS_CRH_LPBP
 Licensed To: DEALR/EVAL COPY -- ID #4369

DISPLACEMENTS REPORT: Nodal Movements
 CASE 4 (SUS) W+P1+H

NODE	DX mm.	DY mm.	DZ mm.	RX deg.	RY deg.	RZ deg.
9029	-3.833	-5.451	1.133	0.0210	-0.0083	-0.0023
9030	-3.848	-5.479	1.097	0.0211	-0.0083	-0.0021
9035	-3.904	-5.597	1.001	0.0212	-0.0083	-0.0020
15000	0.161	-2.046	6.031	0.0575	-0.0234	0.0091
15005	-0.055	-2.607	6.026	0.0603	-0.0223	0.0100
15010	-1.001	-5.885	5.988	0.0695	-0.0162	0.0154
15015	-1.229	-6.942	5.960	0.0706	-0.0145	0.0171
15018	-1.469	-8.197	5.950	0.0700	-0.0128	0.0188
15019	-1.658	-9.630	5.863	0.0659	-0.0076	0.0201
15020	-1.702	-10.536	5.750	0.0635	-0.0037	0.0234
15025	-1.699	-10.856	5.698	0.0620	-0.0032	0.0251
15030	-1.699	-10.949	5.685	0.0615	-0.0031	0.0259
15035	-1.691	-11.050	5.657	0.0610	-0.0030	0.0266
15038	-1.689	-11.426	5.614	0.0594	-0.0028	0.0282
15039	-1.455	-11.978	5.113	0.0568	-0.0023	0.0299
15040	-0.896	-12.209	4.064	0.0536	-0.0025	0.0295
15045	-0.594	-12.209	3.519	0.0531	-0.0029	0.0294
15050	-0.368	-12.209	3.112	0.0528	-0.0032	0.0293

CAESAR II Ver.5.10.00, (Build 070917) Date: JUL 19, 2010 Time: 16:42
 Job: C:\DOCUMENTS AND SETTINGS\ABC\MY DOCUMENTS\ST...MS_CRH_LPBP
 Licensed To: DEALR/EVAL COPY -- ID #4369

**STRESS SUMMARY REPORT: Highest Stresses Mini Statement
 Various Load Cases**

LOAD CASE DEFINITION KEY

CASE 3 (OPE) W+D1+T1+P1+H
 CASE 4 (SUS) W+P1+H
 CASE 5 (EXP) L5=L3-L4

Piping Code: B31.1 = B31.1 -2004, December 15, 2006

NO CODE STRESS CHECK PROCESSED: LOADCASE 3 (OPE) W+D1+T1+P1+H

Highest Stresses: (KPa) LOADCASE 3 (OPE) W+D1+T1+P1+H
 OPE Stress Ratio (%): 0.0 @Node 1200
 OPE Stress: 309451.4 Allowable: 0.0
 Axial Stress: 46225.6 @Node 2235
 Bending Stress: 240322.3 @Node 1345
 Torsion Stress: 19088.7 @Node 15050
 Hoop Stress: 95189.1 @Node 2210
 3D Max Intensity: 294869.8 @Node 1345

CODE STRESS CHECK PASSED : LOADCASE 4 (SUS) W+P1+H

Highest Stresses: (KPa) LOADCASE 4 (SUS) W+P1+H
 CodeStress Ratio (%): 58.5 @Node 2140
 Code Stress: 66913.2 Allowable: 114453.0
 Axial Stress: 46404.7 @Node 1340
 Bending Stress: 39489.7 @Node 2140
 Torsion Stress: 2896.0 @Node 2058
 Hoop Stress: 95189.1 @Node 2210
 3D Max Intensity: 106980.5 @Node 2225

CODE STRESS CHECK FAILED : LOADCASE 5 (EXP) L5=L3-L4

Highest Stresses: (KPa) LOADCASE 5 (EXP) L5=L3-L4
 CodeStress Ratio (%): 109.4 @Node 1200
 Code Stress: 272580.7 Allowable: 249269.6
 Axial Stress: 1239.6 @Node 1264
 Bending Stress: 240400.0 @Node 1345
 Torsion Stress: 18799.1 @Node 15050
 Hoop Stress: 0.0 @Node 15
 3D Max Intensity: 247557.0 @Node 1345

CAESAR II Ver.5.10.00, (Build 070917) Date: JUL 19, 2010 Time: 16:42
 Job: C:\DOCUMENTS AND SETTINGS\ABC\MY DOCUMENTS\ST...MS_CRH_LPBP
 Licensed To: DEALR/EVAL COPY -- ID #4369

HANGER REPORT
 (TABLE DATA FROM DESIGN RUNS)

NO. NODE	FIG. REQD NO.	VERTICAL SIZE	MOVEMENT (mm.)	HOT LOAD	THEORETICAL INSTALLED LOAD	ACTUAL INSTALLED LOAD	SPRING RATE	HORIZONTAL MOVEMENT (mm.)
25	1	2161	5.857	34877.	38000.	0.	5333.	27.502
	LISEGA						LOAD VARIATION =	9%
40	1	2172	15.972	53514.	59903.	0.	4000.	46.316
	LISEGA						LOAD VARIATION =	12%
45	1	2191	9.908	72944.	86155.	0.	13333.	94.790
	LISEGA						LOAD VARIATION =	18%
60	1	2181	-10.774	62956.	51465.	0.	10666.	108.532
	LISEGA						LOAD VARIATION =	18%
80	1	2181	12.288	58467.	71573.	0.	10666.	126.037
	LISEGA						LOAD VARIATION =	22%
100	0		-80.386	106367.	*****	CONSTANT	EFFORT	SUPPORT *****
105	0		-164.600	170338.	*****	CONSTANT	EFFORT	SUPPORT *****
115	0		-225.999	76845.	*****	CONSTANT	EFFORT	SUPPORT *****
125	0		-175.382	74878.	*****	CONSTANT	EFFORT	SUPPORT *****
135	0		-128.056	60859.	*****	CONSTANT	EFFORT	SUPPORT *****
145	0		-104.382	72851.	*****	CONSTANT	EFFORT	SUPPORT *****
160	0		-139.708	131126.	*****	CONSTANT	EFFORT	SUPPORT *****
175	0		-157.532	91777.	*****	CONSTANT	EFFORT	SUPPORT *****
185	0		-100.867	96941.	*****	CONSTANT	EFFORT	SUPPORT *****
190	0		-33.154	95279.	*****	CONSTANT	EFFORT	SUPPORT *****
195	0		40.700	95206.	*****	CONSTANT	EFFORT	SUPPORT *****
210	0		116.186	104825.	*****	CONSTANT	EFFORT	SUPPORT *****
225	0		118.678	154363.	*****	CONSTANT	EFFORT	SUPPORT *****
230	0		80.395	99894.	*****	CONSTANT	EFFORT	SUPPORT *****
235	0		31.392	91440.	*****	CONSTANT	EFFORT	SUPPORT *****
260	2		-74.939	60887.	*****	CONSTANT	EFFORT	SUPPORT *****
265	1		-107.356	80281.	*****	CONSTANT	EFFORT	SUPPORT *****

CAESAR II Ver.5.10.00, (Build 070917) Date: JUL 19, 2010 Time: 16:42
 Job: C:\DOCUMENTS AND SETTINGS\ABC\MY DOCUMENTS\ST...MS_CRH_LPBP
 Licensed To: DEALR/EVAL COPY -- ID #4369

HANGER REPORT
 (TABLE DATA FROM DESIGN RUNS)

NO. NODE	FIG. REQD NO.	SIZE	VERTICAL MOVEMENT	HOT LOAD	THEORETICAL INSTALLED LOAD	ACTUAL INSTALLED LOAD	SPRING RATE	HORIZONTAL MOVEMENT
275	2		-149.455	52472.	*****	CONSTANT EFFORT SUPPORT	*****	
290	0		-187.297	89738.	*****	CONSTANT EFFORT SUPPORT	*****	
300	0		-228.600	108367.	*****	CONSTANT EFFORT SUPPORT	*****	
320	0		-272.991	69235.	*****	CONSTANT EFFORT SUPPORT	*****	
520	1	2161	-0.384	31754.	31549.	0.	5333.	27.149
		LISEGA					LOAD VARIATION =	1%
540	1	2171	9.476	51731.	59312.	0.	8000.	38.371
		LISEGA					LOAD VARIATION =	15%
555	1	2182	16.662	69938.	78823.	0.	5333.	70.315
		LISEGA					LOAD VARIATION =	13%
570	1	2181	3.190	60770.	64173.	0.	10666.	91.888
		LISEGA					LOAD VARIATION =	6%
595	2	2161	-2.181	28003.	26840.	0.	5333.	117.016
		LISEGA					LOAD VARIATION =	4%
620	0		-50.086	101941.	*****	CONSTANT EFFORT SUPPORT	*****	
625	0		-102.558	162752.	*****	CONSTANT EFFORT SUPPORT	*****	
645	0		-172.590	74640.	*****	CONSTANT EFFORT SUPPORT	*****	
660	0		-188.314	71921.	*****	CONSTANT EFFORT SUPPORT	*****	
670	0		-171.088	58116.	*****	CONSTANT EFFORT SUPPORT	*****	
680	0		-138.518	70456.	*****	CONSTANT EFFORT SUPPORT	*****	
1010	0		-129.938	10017.	*****	CONSTANT EFFORT SUPPORT	*****	
1040	2		-69.044	17563.	*****	CONSTANT EFFORT SUPPORT	*****	
1065	0		-5.653	24776.	*****	CONSTANT EFFORT SUPPORT	*****	
1080	0		2.546	17190.	*****	CONSTANT EFFORT SUPPORT	*****	
1100	1	2161	0.013	29295.	29302.	0.	5333.	66.239
		LISEGA					LOAD VARIATION =	0%
1145	1	2171	6.149	40479.	45398.	0.	8000.	16.163
		LISEGA					LOAD VARIATION =	12%
1175	1	2151	-8.307	12306.	10091.	0.	2666.	23.811
		LISEGA					LOAD VARIATION =	18%

CAESAR II Ver.5.10.00, (Build 070917) Date: JUL 19, 2010 Time: 16:42
 Job: C:\DOCUMENTS AND SETTINGS\ABC\MY DOCUMENTS\ST...MS_CRH_LPBP
 Licensed To: DEALR/EVAL COPY -- ID #4369

HANGER REPORT
 (TABLE DATA FROM DESIGN RUNS)

NO. NODE	FIG. REQD NO.	SIZE	VERTICAL MOVEMENT	HOT LOAD	THEORETICAL INSTALLED LOAD	ACTUAL INSTALLED LOAD	SPRING RATE	HORIZONTAL MOVEMENT
1185	1	2151	-3.738	17079.	16083.	0.	2666.	52.407
	LISEGA						LOAD VARIATION =	6%
1205	0		-85.102	28652.	*****	CONSTANT	EFFORT	SUPPORT *****
1210	0		-99.350	40376.	*****	CONSTANT	EFFORT	SUPPORT *****
1225	0		-107.395	37218.	*****	CONSTANT	EFFORT	SUPPORT *****
1240	0		-69.615	58522.	*****	CONSTANT	EFFORT	SUPPORT *****
1245	2	2153	-39.099	17309.	14705.	0.	666.	188.525
	LISEGA						LOAD VARIATION =	15%
1250	2	2152	-12.874	11927.	10211.	0.	1333.	133.073
	LISEGA						LOAD VARIATION =	14%
1285	0		-47.360	34909.	*****	CONSTANT	EFFORT	SUPPORT *****
1300	1		-83.784	35867.	*****	CONSTANT	EFFORT	SUPPORT *****
1310	0		-120.214	29463.	*****	CONSTANT	EFFORT	SUPPORT *****
1325	0		-184.193	28061.	*****	CONSTANT	EFFORT	SUPPORT *****
1340	0		-171.365	56427.	*****	CONSTANT	EFFORT	SUPPORT *****
1360	0		-159.049	26525.	*****	CONSTANT	EFFORT	SUPPORT *****
1370	0		-167.709	30201.	*****	CONSTANT	EFFORT	SUPPORT *****
1390	0		-143.441	56508.	*****	CONSTANT	EFFORT	SUPPORT *****
1405	0		-127.479	21880.	*****	CONSTANT	EFFORT	SUPPORT *****
1420	0		-126.446	22197.	*****	CONSTANT	EFFORT	SUPPORT *****
1450	0		-161.359	26077.	*****	CONSTANT	EFFORT	SUPPORT *****
1455	0		-168.124	30169.	*****	CONSTANT	EFFORT	SUPPORT *****
1475	0		-131.951	56584.	*****	CONSTANT	EFFORT	SUPPORT *****
1485	0		-125.764	21851.	*****	CONSTANT	EFFORT	SUPPORT *****
1495	0		-126.675	22200.	*****	CONSTANT	EFFORT	SUPPORT *****
2005	0		-161.549	20064.	*****	CONSTANT	EFFORT	SUPPORT *****
2025	1		-113.704	16175.	*****	CONSTANT	EFFORT	SUPPORT *****
2050	0		-43.536	31516.	*****	CONSTANT	EFFORT	SUPPORT *****

CAESAR II Ver.5.10.00, (Build 070917) Date: JUL 19, 2010 Time: 16:42
 Job: C:\DOCUMENTS AND SETTINGS\ABC\MY DOCUMENTS\ST...MS_CRH_LPBP
 Licensed To: DEALR/EVAL COPY -- ID #4369

HANGER REPORT
 (TABLE DATA FROM DESIGN RUNS)

NO. NODE	FIG. REQD NO.	VERTICAL SIZE	MOVEMENT	HOT LOAD	THEORETICAL INSTALLED LOAD	ACTUAL INSTALLED LOAD	SPRING RATE	HORIZONTAL MOVEMENT
2070	1 LISEGA	2163	-41.456	25485.	19959.	0.	1333.	108.690 LOAD VARIATION = 22%
2085	0		1.849	7649.	***** CONSTANT EFFORT SUPPORT *****			
2105	1 LISEGA	2161	10.922	32909.	38734.	0.	5333.	63.275 LOAD VARIATION = 18%
2134	1 LISEGA	2171	7.851	39327.	45608.	0.	8000.	15.720 LOAD VARIATION = 16%
2160	1 LISEGA	2151	-9.326	10899.	8412.	0.	2666.	16.608 LOAD VARIATION = 23%
2170	1 LISEGA	2151	-4.743	19796.	18531.	0.	2666.	25.017 LOAD VARIATION = 6%
2180	1 LISEGA	2161	10.161	23470.	28888.	0.	5333.	103.360 LOAD VARIATION = 23%
2185	1 LISEGA	2151	2.974	13954.	14747.	0.	2666.	101.368 LOAD VARIATION = 6%
2195	1 LISEGA	2152	-15.575	16052.	13976.	0.	1333.	86.461 LOAD VARIATION = 13%
2205	2		-58.262	13754.	***** CONSTANT EFFORT SUPPORT *****			
2215	0		-66.268	30373.	***** CONSTANT EFFORT SUPPORT *****			
2220	0		-44.468	29495.	***** CONSTANT EFFORT SUPPORT *****			
2235	0		-20.311	38015.	***** CONSTANT EFFORT SUPPORT *****			
3000	1 LISEGA	2163	-40.898	32489.	27037.	0.	1333.	13.585 LOAD VARIATION = 17%
3015	1 LISEGA	2163	-57.093	31876.	24266.	0.	1333.	30.748 LOAD VARIATION = 24%
3025	2 LISEGA	2163	-36.275	24454.	19619.	0.	1333.	120.358 LOAD VARIATION = 20%
4010	1 LISEGA	2173	-40.208	44800.	36759.	0.	2000.	41.627 LOAD VARIATION = 18%
4020	2 LISEGA	2162	-21.301	23495.	17817.	0.	2666.	131.969 LOAD VARIATION = 24%
7000	0		-253.801	11844.	***** CONSTANT EFFORT SUPPORT *****			

005

CAESAR II Ver.5.10.00, (Build 070917) Date: JUL 19, 2010 Time: 16:42
 Job: C:\DOCUMENTS AND SETTINGS\ABC\MY DOCUMENTS\ST...MS_CRH_LPBP
 Licensed To: DEALR/EVAL COPY -- ID #4369

HANGER REPORT
 (TABLE DATA FROM DESIGN RUNS)

NO. NODE	FIG. REQD NO.	SIZE	VERTICAL MOVEMENT	HOT LOAD	THEORETICAL INSTALLED LOAD	ACTUAL INSTALLED LOAD	SPRING RATE	HORIZONTAL MOVEMENT
7005	0		-265.379	33376.	*****	CONSTANT EFFORT SUPPORT	*****	
7010	0		-280.642	19380.	*****	CONSTANT EFFORT SUPPORT	*****	
7015	0		-299.583	1782.	*****	CONSTANT EFFORT SUPPORT	*****	
7045	0		-248.026	80858.	*****	CONSTANT EFFORT SUPPORT	*****	
7055	0		-288.949	26785.	*****	CONSTANT EFFORT SUPPORT	*****	
7115	0		-232.763	76639.	*****	CONSTANT EFFORT SUPPORT	*****	
7125	0		-273.686	26797.	*****	CONSTANT EFFORT SUPPORT	*****	
8015	0		-266.967	86922.	*****	CONSTANT EFFORT SUPPORT	*****	
8025	0		-307.890	26769.	*****	CONSTANT EFFORT SUPPORT	*****	
9015	0		-221.185	83140.	*****	CONSTANT EFFORT SUPPORT	*****	
9025	0		-262.108	26779.	*****	CONSTANT EFFORT SUPPORT	*****	
15000	1	2151	2.230	16442.	17037.	0.	2666.	110.764
	LISEGA						LOAD VARIATION =	4%
15010	1	2141	-6.103	9364.	8551.	0.	1333.	111.879
	LISEGA						LOAD VARIATION =	9%
15030	1	2153	-32.046	16300.	14166.	0.	666.	103.383
	LISEGA						LOAD VARIATION =	13%
15045	2		-63.965	7423.	*****	CONSTANT EFFORT SUPPORT	*****	



ALSTOM

Volume-II
Annexure-III

NTPC ALSTOM
Power Services Pvt. Ltd.

CAESAR II Ver.5.10.00, (Build 070917) Date: JUL 18, 2010 Time: 23:14
Job: C:\DOCUMENTS AND SETTINGS\ABC\MY DOCUMENTS\STRES...HRH_LPBP
Licensed To: DEALR/EVAL COPY -- ID #4369

Table of Contents

LISTING OF STATIC LOAD CASES FOR THIS ANALYSIS2
Restraint Summary : Multiple.....2
Displacements : 3 (OPE) W+D1+T1+P1+H13
Displacements : 4 (SUS) W+P1+H19
Stress Summary : Multiple.....25
HANGER REPORT ((TABLE DATA FROM DESIGN RUNS)).....26

43

CAESAR II Ver.5.10.00, (Build 070917) Date: JUL 18, 2010 Time: 23:14
 Job: C:\DOCUMENTS AND SETTINGS\ABC\MY DOCUMENTS\STRES...HRH_LPBP
 Licensed To: DEALR/EVAL COPY -- ID #4369

RESTRAINT SUMMARY REPORT: Loads On Restraints
 Various Load Cases

LOAD CASE DEFINITION KEY

CASE 3 (OPE) W+D1+T1+P1+H

CASE 4 (SUS) W+P1+H

CASE 5 (EXP) L5=L3-L4

NODE	Load Case	FX N.	FY N.	FZ N.	MX N.m.	MY N.m.	MZ N.m.
10		Displ. Reaction					
	3 (OPE)	-7113	-31489	-25890	-132540	192154	-183037
	4 (SUS)	297	-12915	-15	-10976	2482	-13453
	5 (EXP)	-7410	-18574	-25876	-121564	189672	-169584
	MAX	-7410/5	-31489/3	-25890/3	-132540/3	192154/3	-183037/3
35		Prog Design VSH					
	3 (OPE)	0	-36850	0	0	0	0
	4 (SUS)	0	-42891	0	0	0	0
	5 (EXP)	0	6042	0	0	0	0
	MAX		-42891/4				
40		Prog Design VSH					
	3 (OPE)	0	-55340	0	0	0	0
	4 (SUS)	0	-55045	0	0	0	0
	5 (EXP)	0	-296	0	0	0	0
	MAX		-55340/3				
60		Prog Design VSH					
	3 (OPE)	0	-54762	0	0	0	0
	4 (SUS)	0	-47580	0	0	0	0
	5 (EXP)	0	-7182	0	0	0	0
	MAX		-54762/3				
65		Rigid Z					
	3 (OPE)	608	-81	2044	0	0	0
	4 (SUS)	-54	-212	730	0	0	0
	5 (EXP)	661	131	1314	0	0	0
	MAX	661/5	-212/4	2044/3			
70		Rigid Y					
	3 (OPE)	0	82134	0	0	0	0
	4 (SUS)	0	-32986	0	0	0	0
	5 (EXP)	0	115121	0	0	0	0
	MAX		115121/5				
80		Prog Design VSH					

CAESAR II Ver.5.10.00, (Build 070917) Date: JUL 18, 2010 Time: 23:14
 Job: C:\DOCUMENTS AND SETTINGS\ABC\MY DOCUMENTS\STRES...HRH_LPBP
 Licensed To: DEALR/EVAL COPY -- ID #4369

RESTRAINT SUMMARY REPORT: Loads On Restraints
 Various Load Cases

NODE	Load Case	FX N.	FY N.	FZ N.	MX N.m.	MY N.m.	MZ N.m.
	3 (OPE)	0	-36175	0	0	0	0
	4 (SUS)	0	-41918	0	0	0	0
	5 (EXP)	0	5742	0	0	0	0
	MAX		-41918/4				
95	Rigid Y						
	3 (OPE)	0	-93749	0	0	0	0
	4 (SUS)	0	-65382	0	0	0	0
	5 (EXP)	0	-28367	0	0	0	0
	MAX		-93749/3				
100	Prog Design CSH						
	3 (OPE)	0	-78104	0	0	0	0
	4 (SUS)	0	-78104	0	0	0	0
	5 (EXP)	0	0	0	0	0	0
	MAX		-78104/3				
105	Prog Design CSH						
	3 (OPE)	0	-86325	0	0	0	0
	4 (SUS)	0	-86325	0	0	0	0
	5 (EXP)	0	0	0	0	0	0
	MAX		-86325/3				
115	Prog Design CSH						
	3 (OPE)	0	-58227	0	0	0	0
	4 (SUS)	0	-58227	0	0	0	0
	5 (EXP)	0	0	0	0	0	0
	MAX		-58227/3				
125	Prog Design CSH						
	3 (OPE)	0	-58265	0	0	0	0
	4 (SUS)	0	-58265	0	0	0	0
	5 (EXP)	0	0	0	0	0	0
	MAX		-58265/3				
135	Prog Design CSH						
	3 (OPE)	0	-24632	0	0	0	0
	4 (SUS)	0	-24632	0	0	0	0
	5 (EXP)	0	0	0	0	0	0
	MAX		-24632/3				
140	Prog Design CSH						
	3 (OPE)	0	-39414	0	0	0	0
	4 (SUS)	0	-39414	0	0	0	0

685

CAESAR II Ver.5.10.00, (Build 070917) Date: JUL 18, 2010 Time: 23:14
 Job: C:\DOCUMENTS AND SETTINGS\ABC\MY DOCUMENTS\STRES...HRH_LPBP
 Licensed To: DEALR/EVAL COPY -- ID #4369

RESTRAINT SUMMARY REPORT: Loads On Restraints
 Various Load Cases

NODE	Load Case	FX N.	FY N.	FZ N.	MX N.m.	MY N.m.	MZ N.m.
	5 (EXP)	0	0	0	0	0	0
	MAX		-39414/3				
160	Prog Design CSH						
	3 (OPE)	0	-138687	0	0	0	0
	4 (SUS)	0	-138687	0	0	0	0
	5 (EXP)	0	0	0	0	0	0
	MAX		-138687/3				
175	Prog Design CSH						
	3 (OPE)	0	-62426	0	0	0	0
	4 (SUS)	0	-62426	0	0	0	0
	5 (EXP)	0	0	0	0	0	0
	MAX		-62426/3				
185	Prog Design CSH						
	3 (OPE)	0	-60421	0	0	0	0
	4 (SUS)	0	-60421	0	0	0	0
	5 (EXP)	0	0	0	0	0	0
	MAX		-60421/3				
190	Prog Design CSH						
	3 (OPE)	0	-55092	0	0	0	0
	4 (SUS)	0	-55092	0	0	0	0
	5 (EXP)	0	0	0	0	0	0
	MAX		-55092/3				
200	Prog Design CSH						
	3 (OPE)	0	-76591	0	0	0	0
	4 (SUS)	0	-76591	0	0	0	0
	5 (EXP)	0	0	0	0	0	0
	MAX		-76591/3				
215	Prog Design CSH						
	3 (OPE)	0	-107006	0	0	0	0
	4 (SUS)	0	-107006	0	0	0	0
	5 (EXP)	0	0	0	0	0	0
	MAX		-107006/3				
220	Prog Design CSH						
	3 (OPE)	0	-70011	0	0	0	0
	4 (SUS)	0	-70011	0	0	0	0
	5 (EXP)	0	0	0	0	0	0

CAESAR II Ver.5.10.00, (Build 070917) Date: JUL 18, 2010 Time: 23:14
 Job: C:\DOCUMENTS AND SETTINGS\ABC\MY DOCUMENTS\STRES...\HRH_LPBP
 Licensed To: DEALR/EVAL COPY -- ID #4369

RESTRAINT SUMMARY REPORT: Loads On Restraints
 Various Load Cases

NODE	Load Case	FX N.	FY N.	FZ N.	MX N.m.	MY N.m.	MZ N.m.
	MAX		-70011/3				
225	Prog Design CSH						
	3 (OPE)	0	-60392	0	0	0	0
	4 (SUS)	0	-60392	0	0	0	0
	5 (EXP)	0	0	0	0	0	0
	MAX		-60392/3				
235	Rigid Y						
	3 (OPE)	26859	-147430	-35139	0	0	0
	4 (SUS)	-931	-87285	4637	0	0	0
	5 (EXP)	27790	-60145	-39777	0	0	0
	MAX	27790/5	-147430/3	-39777/5			
245	Prog Design VSH						
	3 (OPE)	0	-75273	0	0	0	0
	4 (SUS)	0	-64737	0	0	0	0
	5 (EXP)	0	-10537	0	0	0	0
	MAX		-75273/3				
255	Prog Design VSH						
	3 (OPE)	0	-73323	0	0	0	0
	4 (SUS)	0	-58067	0	0	0	0
	5 (EXP)	0	-15256	0	0	0	0
	MAX		-73323/3				
260	Prog Design CSH						
	3 (OPE)	0	-70269	0	0	0	0
	4 (SUS)	0	-70269	0	0	0	0
	5 (EXP)	0	0	0	0	0	0
	MAX		-70269/3				
270	Prog Design CSH						
	3 (OPE)	0	-63495	0	0	0	0
	4 (SUS)	0	-63495	0	0	0	0
	5 (EXP)	0	0	0	0	0	0
	MAX		-63495/3				
285	Prog Design CSH						
	3 (OPE)	0	-74483	0	0	0	0
	4 (SUS)	0	-74483	0	0	0	0
	5 (EXP)	0	0	0	0	0	0
	MAX		-74483/3				

CAESAR II Ver.5.10.00, (Build 070917) Date: JUL 18, 2010 Time: 23:14
 Job: C:\DOCUMENTS AND SETTINGS\ABC\MY DOCUMENTS\STRES...HRH_LPBP
 Licensed To: DEALR/EVAL COPY -- ID #4369

RESTRAINT SUMMARY REPORT: Loads On Restraints
 Various Load Cases

NODE	Load Case	FX N.	FY N.	FZ N.	MX N.m.	MY N.m.	MZ N.m.
290	Prog Design CSH						
	3 (OPE)	0	-69480	0	0	0	0
	4 (SUS)	0	-69480	0	0	0	0
	5 (EXP)	0	0	0	0	0	0
	MAX		-69480/3				
300	Prog Design CSH						
	3 (OPE)	0	-31302	0	0	0	0
	4 (SUS)	0	-31302	0	0	0	0
	5 (EXP)	0	0	0	0	0	0
	MAX		-31302/3				
310	Prog Design CSH						
	3 (OPE)	0	-27658	0	0	0	0
	4 (SUS)	0	-27658	0	0	0	0
	5 (EXP)	0	0	0	0	0	0
	MAX		-27658/3				
320	Prog Design CSH						
	3 (OPE)	0	-27131	0	0	0	0
	4 (SUS)	0	-27131	0	0	0	0
	5 (EXP)	0	0	0	0	0	0
	MAX		-27131/3				
330	Prog Design CSH						
	3 (OPE)	0	-33877	0	0	0	0
	4 (SUS)	0	-33877	0	0	0	0
	5 (EXP)	0	0	0	0	0	0
	MAX		-33877/3				
340	Prog Design CSH						
	3 (OPE)	0	-34700	0	0	0	0
	4 (SUS)	0	-34700	0	0	0	0
	5 (EXP)	0	0	0	0	0	0
	MAX		-34700/3				
505	Displ. Reaction						
	3 (OPE)	19216	-34905	-23646	12099	-157406	-90534
	4 (SUS)	103	-3872	248	21768	4925	-62949
	5 (EXP)	19113	-31033	-23894	-9669	-162331	-27585
	MAX	19216/3	-34905/3	-23894/5	21768/4	-162331/5	-90534/3
530	Prog Design						

CAESAR II Ver.5.10.00, (Build 070917) Date: JUL 18, 2010 Time: 23:14
 Job: C:\DOCUMENTS AND SETTINGS\ABC\MY DOCUMENTS\STRES...HRH_LPBP
 Licensed To: DEALR/EVAL COPY -- ID #4369

RESTRAINT SUMMARY REPORT: Loads On Restraints
 Various Load Cases

NODE	Load Case	FX N.	FY N.	FZ N.	MX N.m.	MY N.m.	MZ N.m.
		VSH					
	3 (OPE)	0	-36701	0	0	0	0
	4 (SUS)	0	-43751	0	0	0	0
	5 (EXP)	0	7050	0	0	0	0
	MAX		-43751/4				
540		Prog Design VSH					
	3 (OPE)	0	-55088	0	0	0	0
	4 (SUS)	0	-66084	0	0	0	0
	5 (EXP)	0	10996	0	0	0	0
	MAX		-66084/4				
560		Prog Design VSH					
	3 (OPE)	0	-54331	0	0	0	0
	4 (SUS)	0	-62032	0	0	0	0
	5 (EXP)	0	7702	0	0	0	0
	MAX		-62032/4				
565		Rigid Z					
	3 (OPE)	-1111	69	-3710	0	0	0
	4 (SUS)	120	1319	-4416	0	0	0
	5 (EXP)	-1231	-1250	706	0	0	0
	MAX	-1231/5	1319/4	-4416/4			
570		Rigid Y					
	3 (OPE)	-12597	43656	3584	0	0	0
	4 (SUS)	1983	-6623	-130	0	0	0
	5 (EXP)	-14579	50279	3714	0	0	0
	MAX	-14579/5	50279/5	3714/5			
580		Prog Design VSH					
	3 (OPE)	0	-36079	0	0	0	0
	4 (SUS)	0	-34696	0	0	0	0
	5 (EXP)	0	-1383	0	0	0	0
	MAX		-36079/3				
595		Rigid Y					
	3 (OPE)	-24514	-90099	11388	0	0	0
	4 (SUS)	-1409	-82582	4879	0	0	0
	5 (EXP)	-23105	-7517	6509	0	0	0
	MAX	-24514/3	-90099/3	11388/3			
600		Prog Design CSH					
	3 (OPE)	0	-78104	0	0	0	0
	4 (SUS)	0	-78104	0	0	0	0
	5 (EXP)	0	0	0	0	0	0

CAESAR II Ver.5.10.00, (Build 070917) Date: JUL 18, 2010 Time: 23:14
 Job: C:\DOCUMENTS AND SETTINGS\ABC\MY DOCUMENTS\STRES...HRH_LPBP
 Licensed To: DEALR/EVAL COPY -- ID #4369

RESTRAINT SUMMARY REPORT: Loads On Restraints
 Various Load Cases

NODE	Load Case	FX N.	FY N.	FZ N.	MX N.m.	MY N.m.	MZ N.m.
	MAX		-78104/3				
605	Prog Design CSH						
	3 (OPE)	0	-86538	0	0	0	0
	4 (SUS)	0	-86538	0	0	0	0
	5 (EXP)	0	0	0	0	0	0
	MAX		-86538/3				
615	Prog Design CSH						
	3 (OPE)	0	-58033	0	0	0	0
	4 (SUS)	0	-58033	0	0	0	0
	5 (EXP)	0	0	0	0	0	0
	MAX		-58033/3				
625	Prog Design CSH						
	3 (OPE)	0	-57960	0	0	0	0
	4 (SUS)	0	-57960	0	0	0	0
	5 (EXP)	0	0	0	0	0	0
	MAX		-57960/3				
635	Prog Design CSH						
	3 (OPE)	0	-27010	0	0	0	0
	4 (SUS)	0	-27010	0	0	0	0
	5 (EXP)	0	0	0	0	0	0
	MAX		-27010/3				
640	Prog Design CSH						
	3 (OPE)	0	-18849	0	0	0	0
	4 (SUS)	0	-18849	0	0	0	0
	5 (EXP)	0	0	0	0	0	0
	MAX		-18849/3				
645	Prog Design CSH						
	3 (OPE)	0	-20384	0	0	0	0
	4 (SUS)	0	-20384	0	0	0	0
	5 (EXP)	0	0	0	0	0	0
	MAX		-20384/3				
5013	Prog Design VSH						
	3 (OPE)	0	-78200	0	0	0	0
	4 (SUS)	0	-83857	0	0	0	0
	5 (EXP)	0	5657	0	0	0	0
	MAX		-83857/4				

CAESAR II Ver.5.10.00, (Build 070917) Date: JUL 18, 2010 Time: 23:14
 Job: C:\DOCUMENTS AND SETTINGS\ABC\MY DOCUMENTS\STRES...\HRH_LPBP
 Licensed To: DEALR/EVAL COPY -- ID #4369

RESTRAINT SUMMARY REPORT: Loads On Restraints
 Various Load Cases

NODE	Load Case	FX N.	FY N.	FZ N.	MX N.m.	MY N.m.	MZ N.m.
5023	Prog Design VSH						
	3 (OPE)	0	-37051	0	0	0	0
	4 (SUS)	0	-34611	0	0	0	0
	5 (EXP)	0	-2440	0	0	0	0
	MAX		-37051/3				
5515	Prog Design VSH						
	3 (OPE)	0	-73912	0	0	0	0
	4 (SUS)	0	-73548	0	0	0	0
	5 (EXP)	0	-364	0	0	0	0
	MAX		-73912/3				
5530	Prog Design VSH						
	3 (OPE)	0	-72295	0	0	0	0
	4 (SUS)	0	-69828	0	0	0	0
	5 (EXP)	0	-2467	0	0	0	0
	MAX		-72295/3				
5545	Prog Design CSH						
	3 (OPE)	0	-30357	0	0	0	0
	4 (SUS)	0	-30357	0	0	0	0
	5 (EXP)	0	0	0	0	0	0
	MAX		-30357/3				
5560	Rigid Y						
	3 (OPE)	0	-62056	0	0	0	0
	4 (SUS)	0	-53781	0	0	0	0
	5 (EXP)	0	-8275	0	0	0	0
	MAX		-62056/3				
5570	Prog Design CSH						
	3 (OPE)	0	-35545	0	0	0	0
	4 (SUS)	0	-35545	0	0	0	0
	5 (EXP)	0	0	0	0	0	0
	MAX		-35545/3				
5575	Prog Design CSH						
	3 (OPE)	0	-57411	0	0	0	0
	4 (SUS)	0	-57411	0	0	0	0
	5 (EXP)	0	0	0	0	0	0
	MAX		-57411/3				
5595	Prog Design						

CAESAR II Ver.5.10.00, (Build 070917) Date: JUL 18, 2010 Time: 23:14
 Job: C:\DOCUMENTS AND SETTINGS\ABC\MY DOCUMENTS\STRES...HRH_LPBP
 Licensed To: DEALR/EVAL COPY -- ID #4369

RESTRAINT SUMMARY REPORT: Loads On Restraints
 Various Load Cases

NODE	Load Case	FX N.	FY N.	FZ N.	MX N.m.	MY N.m.	MZ N.m.
		CSH					
	3 (OPE)	0	-17390	0	0	0	0
	4 (SUS)	0	-17390	0	0	0	0
	5 (EXP)	0	0	0	0	0	0
	MAX		-17390/3				
6013		Prog Design VSH					
	3 (OPE)	0	-80714	0	0	0	0
	4 (SUS)	0	-86669	0	0	0	0
	5 (EXP)	0	5955	0	0	0	0
	MAX		-86669/4				
6023		Prog Design VSH					
	3 (OPE)	0	-25632	0	0	0	0
	4 (SUS)	0	-23995	0	0	0	0
	5 (EXP)	0	-1637	0	0	0	0
	MAX		-25632/3				
6510		Prog Design CSH					
	3 (OPE)	0	-50251	0	0	0	0
	4 (SUS)	0	-50251	0	0	0	0
	5 (EXP)	0	0	0	0	0	0
	MAX		-50251/3				
7013		Prog Design VSH					
	3 (OPE)	0	-77115	0	0	0	0
	4 (SUS)	0	-74611	0	0	0	0
	5 (EXP)	0	-2504	0	0	0	0
	MAX		-77115/3				
7025		Prog Design VSH					
	3 (OPE)	0	-25893	0	0	0	0
	4 (SUS)	0	-23150	0	0	0	0
	5 (EXP)	0	-2743	0	0	0	0
	MAX		-25893/3				
7510		Prog Design CSH					
	3 (OPE)	0	-45923	0	0	0	0
	4 (SUS)	0	-45923	0	0	0	0
	5 (EXP)	0	0	0	0	0	0
	MAX		-45923/3				
8013		Prog Design VSH					

CAESAR II Ver.5.10.00, (Build 070917) Date: JUL 18, 2010 Time: 23:14
 Job: C:\DOCUMENTS AND SETTINGS\ABC\MY DOCUMENTS\STRES...HRH_LPBP
 Licensed To: DEALR/EVAL COPY -- ID #4369

RESTRAINT SUMMARY REPORT: Loads On Restraints
 Various Load Cases

NODE	Load Case	FX N.	FY N.	FZ N.	MX N.m.	MY N.m.	MZ N.m.
	3 (OPE)	0	-84482	0	0	0	0
	4 (SUS)	0	-82639	0	0	0	0
	5 (EXP)	0	-1844	0	0	0	0
	MAX		-84482/3				
8023		Prog Design VSH					
	3 (OPE)	0	-25897	0	0	0	0
	4 (SUS)	0	-24066	0	0	0	0
	5 (EXP)	0	-1831	0	0	0	0
	MAX		-25897/3				
8510		Prog Design CSH					
	3 (OPE)	0	-31388	0	0	0	0
	4 (SUS)	0	-31388	0	0	0	0
	5 (EXP)	0	0	0	0	0	0
	MAX		-31388/3				
8515		Prog Design CSH					
	3 (OPE)	0	-31843	0	0	0	0
	4 (SUS)	0	-31843	0	0	0	0
	5 (EXP)	0	0	0	0	0	0
	MAX		-31843/3				
8520		Prog Design CSH					
	3 (OPE)	0	-12929	0	0	0	0
	4 (SUS)	0	-12929	0	0	0	0
	5 (EXP)	0	0	0	0	0	0
	MAX		-12929/3				
8525		Rigid Z					
	3 (OPE)	2745	-5718	68646	0	0	0
	4 (SUS)	-87	1783	-5949	0	0	0
	5 (EXP)	2832	-7501	74594	0	0	0
	MAX	2832/5	-7501/5	74594/5			
8535		Prog Design CSH					
	3 (OPE)	0	-45463	0	0	0	0
	4 (SUS)	0	-45463	0	0	0	0
	5 (EXP)	0	0	0	0	0	0
	MAX		-45463/3				
8550		Rigid Y					
	3 (OPE)	0	-49919	0	0	0	0
	4 (SUS)	0	-48178	0	0	0	0
	5 (EXP)	0	-1740	0	0	0	0

CAESAR II Ver.5.10.00, (Build 070917) Date: JUL 18, 2010 Time: 23:14
 Job: C:\DOCUMENTS AND SETTINGS\ABC\MY DOCUMENTS\STRES...\HRH_LPBP
 Licensed To: DEALR/EVAL COPY -- ID #4369

RESTRAINT SUMMARY REPORT: Loads On Restraints
 Various Load Cases

NODE	Load Case	FX N.	FY N.	FZ N.	MX N.m.	MY N.m.	MZ N.m.
	MAX		-49919/3				
8560	Prog Design VSH						
	3 (OPE)	0	-23442	0	0	0	0
	4 (SUS)	0	-26396	0	0	0	0
	5 (EXP)	0	2954	0	0	0	0
	MAX		-26396/4				
8565	Prog Design VSH						
	3 (OPE)	0	-21945	0	0	0	0
	4 (SUS)	0	-21440	0	0	0	0
	5 (EXP)	0	-505	0	0	0	0
	MAX		-21945/3				
8575	Prog Design VSH						
	3 (OPE)	0	-22426	0	0	0	0
	4 (SUS)	0	-21626	0	0	0	0
	5 (EXP)	0	-800	0	0	0	0
	MAX		-22426/3				
8585	Prog Design VSH						
	3 (OPE)	0	-61266	0	0	0	0
	4 (SUS)	0	-59956	0	0	0	0
	5 (EXP)	0	-1310	0	0	0	0
	MAX		-61266/3				
8605	Prog Design CSH						
	3 (OPE)	0	-15784	0	0	0	0
	4 (SUS)	0	-15784	0	0	0	0
	5 (EXP)	0	0	0	0	0	0
	MAX		-15784/3				

CAESAR II Ver.5.10.00, (Build 070917) Date: JUL 18, 2010 Time: 23:14
 Job: C:\DOCUMENTS AND SETTINGS\ABC\MY DOCUMENTS\STRES...HRH_LPBP
 Licensed To: DEALR/EVAL COPY -- ID #4369

DISPLACEMENTS REPORT: Nodal Movements
 CASE 3 (OPE) W+D1+T1+P1+H

NODE	DX mm.	DY mm.	DZ mm.	RX deg.	RY deg.	RZ deg.
10	21.600	-6.900	-25.300	-0.0000	0.0000	-0.0000
15	21.630	-3.095	-25.327	-0.0050	0.0099	-0.0073
20	21.753	1.591	-25.413	-0.0102	0.0214	-0.0160
28	21.785	2.437	-25.435	-0.0109	0.0232	-0.0174
29	27.152	12.761	-26.377	-0.0307	0.0521	-0.0567
30	38.656	15.259	-28.447	-0.0424	0.0837	-0.0956
35	40.213	14.903	-28.749	-0.0432	0.0856	-0.0981
37	48.651	12.813	-30.486	-0.0479	0.0943	-0.1105
40	94.290	-2.173	-41.688	-0.0792	0.1082	-0.1668
45	96.214	-2.931	-42.162	-0.0805	0.1072	-0.1691
48	106.357	-7.038	-44.577	-0.0863	0.1010	-0.1764
49	116.853	-12.947	-42.500	-0.0953	0.0789	-0.1841
50	120.373	-18.012	-32.684	-0.1129	0.0537	-0.1886
53	119.163	-20.711	-22.628	-0.1226	0.0424	-0.1883
54	118.836	-21.173	-18.667	-0.1306	0.0351	-0.1896
55	118.868	-20.556	-14.706	-0.1386	0.0276	-0.1903
60	118.984	-19.892	-12.497	-0.1408	0.0255	-0.1904
63	119.323	-17.371	-4.397	-0.1503	0.0181	-0.1910
65	119.448	-15.917	0.000	-0.1578	0.0135	-0.1913
70	118.877	0.000	37.013	-0.2419	-0.0184	-0.1941
75	117.629	11.216	56.638	-0.2676	-0.0306	-0.1955
80	117.109	15.057	63.151	-0.2655	-0.0333	-0.1959
83	116.797	17.215	66.859	-0.2624	-0.0347	-0.1961
84	117.429	20.020	72.808	-0.2479	-0.0389	-0.1977
85	120.247	21.192	78.054	-0.2291	-0.0434	-0.2036
88	124.504	21.392	83.275	-0.2129	-0.0464	-0.2067
89	128.874	16.334	93.516	-0.1518	-0.0565	-0.2450
90	124.985	4.659	99.838	-0.0765	-0.0657	-0.2937
95	121.812	-0.000	100.567	-0.0616	-0.0700	-0.3031
97	117.976	-5.451	101.223	-0.0449	-0.0750	-0.3140
100	31.650	-97.270	85.061	0.1528	-0.1780	-0.4978
105	-74.864	-181.452	57.570	0.0944	-0.2725	-0.6011
107	-119.586	-213.429	53.452	0.0121	-0.3083	-0.6240
108	-134.397	-223.796	53.498	-0.0173	-0.3185	-0.6288
109	-165.584	-240.459	62.948	-0.0916	-0.3370	-0.6371
110	-190.457	-242.937	82.606	-0.1444	-0.3524	-0.6431
115	-192.538	-242.109	85.153	-0.1472	-0.3538	-0.6439
117	-196.928	-240.341	90.493	-0.1515	-0.3566	-0.6454
118	-204.988	-237.021	100.189	-0.1557	-0.3617	-0.6487
119	-234.262	-217.767	119.552	-0.1251	-0.3702	-0.6519
120	-258.942	-190.239	112.029	-0.0638	-0.3639	-0.6206
121	-211.392	-234.390	107.810	-0.1545	-0.3647	-0.6509
125	-261.289	-187.045	110.136	-0.0558	-0.3626	-0.6149
130	-269.311	-176.381	103.715	-0.0286	-0.3569	-0.5926
135	-307.415	-133.663	75.396	0.1200	-0.2984	-0.4023
140	-343.781	-113.015	54.378	0.2624	-0.1994	-0.0916
145	-351.034	-112.255	51.205	0.2909	-0.1744	-0.0132
148	-358.858	-112.826	48.212	0.3178	-0.1492	0.0648

CAESAR II Ver.5.10.00, (Build 070917) Date: JUL 18, 2010 Time: 23:14
 Job: C:\DOCUMENTS AND SETTINGS\ABC\MY DOCUMENTS\STRES...\HRH_LPBP
 Licensed To: DEALR/EVAL COPY -- ID #4369

DISPLACEMENTS REPORT: Nodal Movements
 CASE 3 (OPE) W+D1+T1+P1+H

NODE	DX mm.	DY mm.	DZ mm.	RX deg.	RY deg.	RZ deg.
149	-365.875	-115.935	45.020	0.3435	-0.1173	0.1625
150	-370.908	-122.488	40.760	0.3688	-0.0829	0.2659
155	-377.015	-146.371	29.541	0.4319	0.0041	0.4955
160	-355.566	-164.123	11.685	0.4486	0.0322	0.5651
165	-343.506	-173.196	2.326	0.4556	0.0465	0.6020
168	-328.063	-184.113	-9.095	0.4613	0.0608	0.6396
169	-298.789	-189.012	-25.864	0.4769	0.0850	0.7549
170	-272.814	-168.272	-36.095	0.4867	0.1127	0.8615
175	-271.130	-165.110	-36.550	0.4872	0.1139	0.8663
180	-257.813	-139.539	-40.303	0.4912	0.1229	0.9014
185	-231.246	-85.564	-48.521	0.5007	0.1382	0.9674
190	-191.226	0.846	-61.945	0.5147	0.1454	1.0187
195	-163.207	62.745	-71.328	0.5243	0.1391	1.0205
200	-151.167	89.235	-75.201	0.5279	0.1343	1.0131
203	-149.413	93.074	-75.755	0.5284	0.1334	1.0116
204	-101.515	137.652	-95.385	0.5355	0.1109	0.9695
205	-39.011	134.848	-127.665	0.5353	0.0808	0.9118
210	-19.111	125.189	-139.441	0.5331	0.0695	0.8956
215	-11.236	121.318	-144.148	0.5318	0.0644	0.8885
220	70.684	79.220	-194.144	0.5053	0.0088	0.8220
225	159.231	30.234	-247.577	0.4455	-0.0559	0.7683
230	198.792	7.386	-269.836	0.4071	-0.0861	0.7520
235	211.424	-0.000	-276.601	0.3956	-0.0942	0.7486
238	216.911	-3.220	-279.489	0.3904	-0.0977	0.7472
239	240.344	-22.938	-285.638	0.3299	-0.1189	0.7311
240	246.098	-39.071	-275.192	0.2642	-0.1462	0.7184
245	244.275	-42.348	-269.692	0.2538	-0.1507	0.7155
250	241.317	-47.215	-261.110	0.2378	-0.1577	0.7110
255	225.644	-64.941	-221.572	0.1537	-0.1957	0.6858
260	203.265	-76.847	-175.696	0.0726	-0.2378	0.6566
265	182.599	-80.772	-139.543	0.0197	-0.2694	0.6336
270	176.927	-81.003	-130.546	0.0086	-0.2771	0.6279
275	170.347	-81.025	-121.911	-0.0029	-0.2856	0.6215
280	154.952	-80.205	-99.021	-0.0226	-0.2951	0.6143
285	146.701	-79.427	-86.887	-0.0280	-0.2951	0.6098
290	111.721	-74.589	-35.450	-0.0480	-0.2951	0.5907
295	96.031	-71.829	-12.375	-0.0525	-0.2952	0.5821
300	88.410	-70.405	-1.163	-0.0536	-0.2951	0.5796
305	82.921	-69.371	6.911	-0.0539	-0.2952	0.5778
310	92.685	-56.596	13.485	-0.0553	-0.2957	0.5692
315	102.066	-44.528	19.811	-0.0566	-0.2961	0.5598
320	105.794	-58.927	-5.801	-0.0544	-0.2956	0.5771
325	115.175	-46.645	0.525	-0.0562	-0.2961	0.5729
330	164.711	-66.514	-92.363	-0.0340	-0.3057	0.6148
335	174.087	-53.381	-85.690	-0.0450	-0.3208	0.6142
340	180.115	-67.313	-115.465	-0.0142	-0.2963	0.6106
345	189.501	-54.372	-108.990	-0.0250	-0.3117	0.6015
505	-21.600	-6.900	-25.300	0.0000	-0.0000	-0.0000
510	-21.583	-3.095	-25.301	0.0006	-0.0073	-0.0031
515	-21.528	1.590	-25.292	0.0021	-0.0168	-0.0066

CAESAR II Ver.5.10.00, (Build 070917) Date: JUL 18, 2010 Time: 23:14
 Job: C:\DOCUMENTS AND SETTINGS\ABC\MY DOCUMENTS\STRES...HRH_LPBP
 Licensed To: DEALR/EVAL COPY -- ID #4369

DISPLACEMENTS REPORT: Nodal Movements
 CASE 3 (OPE) W+D1+T1+P1+H

NODE	DX mm.	DY mm.	DZ mm.	RX deg.	RY deg.	RZ deg.
523	-21.514	2.437	-25.289	0.0024	-0.0183	-0.0071
524	-25.678	13.358	-25.479	0.0102	-0.0397	-0.0187
525	-36.256	18.354	-26.630	0.0197	-0.0625	-0.0290
530	-37.816	18.446	-26.857	0.0213	-0.0640	-0.0297
535	-46.274	18.988	-28.170	0.0297	-0.0708	-0.0350
540	-92.075	25.417	-36.440	0.0834	-0.0748	-0.1001
545	-94.008	25.844	-36.771	0.0856	-0.0735	-0.1031
548	-104.202	28.322	-38.420	0.0957	-0.0660	-0.1195
549	-116.117	28.545	-36.492	0.1015	-0.0454	-0.1624
550	-123.550	22.763	-28.897	0.1045	-0.0296	-0.2014
553	-126.487	15.632	-21.399	0.1063	-0.0167	-0.2331
554	-127.413	13.290	-18.224	0.1069	-0.0135	-0.2461
555	-127.822	11.816	-14.564	0.1074	-0.0093	-0.2589
560	-127.886	11.241	-12.375	0.1076	-0.0079	-0.2662
563	-128.071	9.120	-4.354	0.1068	-0.0038	-0.2932
565	-128.145	7.984	-0.000	0.1049	-0.0018	-0.3106
570	-128.664	0.000	36.610	0.0652	-0.0040	-0.4566
575	-129.443	-2.755	56.001	0.0509	-0.0152	-0.5341
580	-129.826	-3.601	62.435	0.0522	-0.0188	-0.5552
583	-130.071	-4.102	66.098	0.0540	-0.0210	-0.5672
584	-131.655	-3.400	71.824	0.0600	-0.0285	-0.5866
585	-135.340	0.361	76.498	0.0652	-0.0356	-0.6066
588	-140.484	6.263	80.831	0.0763	-0.0390	-0.6247
589	-155.408	11.410	86.703	0.1014	-0.0536	-0.6572
590	-175.459	4.661	86.463	0.1395	-0.0641	-0.6901
595	-182.829	-0.000	84.937	0.1468	-0.0655	-0.6968
597	-191.540	-5.453	83.060	0.1548	-0.0673	-0.7043
600	-345.644	-97.303	38.231	0.2521	-0.1028	-0.7244
605	-468.612	-181.514	-9.910	0.2314	-0.1354	-0.5202
607	-501.899	-213.502	-25.600	0.1960	-0.1477	-0.3869
608	-510.547	-223.872	-30.089	0.1832	-0.1512	-0.3435
609	-524.984	-244.347	-29.571	0.1506	-0.1581	-0.2310
610	-534.619	-257.373	-14.269	0.1301	-0.1564	-0.1060
615	-535.529	-258.143	-11.738	0.1296	-0.1553	-0.0895
617	-537.411	-259.764	-6.432	0.1291	-0.1526	-0.0550
618	-540.705	-262.696	3.202	0.1290	-0.1447	0.0168
619	-540.702	-268.322	30.543	0.1471	-0.1066	0.1916
620	-524.209	-261.173	41.381	0.1804	-0.0712	0.2958
621	-543.149	-265.009	10.774	0.1303	-0.1376	0.0661
625	-521.892	-259.642	41.726	0.1845	-0.0681	0.3038
630	-513.960	-254.115	42.787	0.1985	-0.0579	0.3301
635	-476.034	-221.171	45.359	0.2753	-0.0147	0.4487
640	-439.357	-182.189	45.061	0.3489	0.0074	0.5056
645	-431.975	-173.935	44.814	0.3637	0.0095	0.5088
648	-423.986	-164.969	44.513	0.3776	0.0107	0.5100
649	-415.180	-157.627	43.237	0.3908	0.0113	0.5095
650	-404.626	-153.203	40.041	0.4037	0.0108	0.5071
5000	91.125	-35.952	18.704	-0.0566	-0.2961	0.5596
5005	86.899	-32.627	18.274	-0.0570	-0.2964	0.5564
5010	59.461	-10.993	15.508	-0.0553	-0.2964	0.5570

CAESAR II Ver.5.10.00, (Build 070917) Date: JUL 18, 2010 Time: 23:14
 Job: C:\DOCUMENTS AND SETTINGS\ABC\MY DOCUMENTS\STRES...HRH_LPBP
 Licensed To: DEALR/EVAL COPY -- ID #4369

DISPLACEMENTS REPORT: Nodal Movements
 CASE 3 (OPE) W+D1+T1+P1+H

NODE	DX mm.	DY mm.	DZ mm.	RX deg.	RY deg.	RZ deg.
5013	50.516	-3.944	14.624	-0.0547	-0.2964	0.5572
5014	23.937	5.903	8.933	-0.0532	-0.2964	0.5570
5015	4.114	-5.185	-0.492	-0.0519	-0.2964	0.5552
5016	45.828	-0.254	14.165	-0.0545	-0.2964	0.5573
5020	-2.885	-14.036	-5.220	-0.0512	-0.2964	0.5550
5023	-9.257	-22.094	-9.524	-0.0506	-0.2964	0.5555
5029	-14.388	-27.994	-12.079	-0.0499	-0.2964	0.5572
5030	-17.252	-29.975	-11.525	-0.0494	-0.2964	0.5577
5035	-18.895	-30.790	-10.726	-0.0494	-0.2964	0.5577
5040	-22.078	-32.369	-9.174	-0.0494	-0.2964	0.5577
5498	55.354	-73.505	-4.612	-0.1100	-0.3027	0.3677
5499	54.352	-70.513	-4.507	-0.0994	-0.3046	0.3977
5500	55.690	-67.532	-3.188	-0.0955	-0.3047	0.4303
5505	63.440	-83.439	-2.015	-0.1194	-0.3060	0.3454
5508	32.193	-70.284	43.110	-0.1331	-0.3059	0.2503
5509	29.403	-68.157	45.801	-0.1181	-0.2962	0.2377
5510	27.029	-64.798	46.311	-0.0994	-0.2864	0.2053
5515	8.021	-13.937	37.230	-0.0573	-0.2864	0.1228
5518	2.216	10.880	34.569	-0.0368	-0.2864	0.0825
5519	0.516	13.743	33.563	-0.0203	-0.2814	0.0447
5520	-2.602	14.825	31.595	-0.0138	-0.2764	0.0075
5523	-17.014	14.935	22.517	0.0017	-0.2764	-0.0126
5524	-20.127	13.856	20.584	0.0082	-0.2814	-0.0382
5525	-21.731	10.963	19.661	0.0246	-0.2864	-0.0613
5530	-25.881	-13.848	17.687	0.0452	-0.2864	-0.0854
5533	-41.809	-74.652	7.937	0.0956	-0.2864	-0.1445
5534	-42.063	-77.375	5.951	0.1149	-0.2805	-0.1638
5535	-40.621	-77.755	2.565	0.1336	-0.2747	-0.1714
5538	-29.178	-71.858	-15.625	0.1436	-0.2746	-0.1944
5539	-28.528	-70.248	-19.430	0.1522	-0.2747	-0.2025
5540	-30.759	-68.325	-22.572	0.1576	-0.2748	-0.2190
5545	-40.621	-63.265	-28.745	0.1576	-0.2748	-0.2232
5550	-50.169	-58.340	-34.723	0.1575	-0.2748	-0.2240
5553	-53.558	-56.586	-36.845	0.1575	-0.2748	-0.2241
5554	-55.927	-53.784	-38.279	0.1575	-0.2748	-0.2241
5555	-55.634	-50.128	-37.976	0.1575	-0.2748	-0.2230
5560	-30.328	-0.000	-19.995	0.1574	-0.2748	-0.2202
5563	-27.040	6.556	-17.642	0.1574	-0.2748	-0.2198
5564	-26.778	10.194	-17.340	0.1574	-0.2748	-0.2189
5565	-29.159	12.959	-18.772	0.1573	-0.2748	-0.2200
5570	-80.265	39.854	-50.772	0.1572	-0.2748	-0.2300
5575	-108.513	54.675	-68.458	0.1572	-0.2748	-0.2265
5580	-113.117	45.753	-71.654	0.1572	-0.2748	-0.2265
5585	-108.694	48.219	-78.824	0.1573	-0.2748	-0.2265
5590	-105.799	49.837	-83.410	0.1574	-0.2748	-0.2265
5595	-101.584	52.193	-90.086	0.1571	-0.2748	-0.2265
5600	-94.489	56.142	-101.326	0.1569	-0.2748	-0.2265
6000	103.976	-38.068	-0.574	-0.0562	-0.2961	0.5728
6005	99.642	-34.743	-1.002	-0.0567	-0.2963	0.5715
6010	71.433	-13.094	-3.784	-0.0561	-0.2963	0.5724

CAESAR II Ver.5.10.00, (Build 070917) Date: JUL 18, 2010 Time: 23:14
 Job: C:\DOCUMENTS AND SETTINGS\ABC\MY DOCUMENTS\STRES...HRH_LPBP
 Licensed To: DEALR/EVAL COPY -- ID #4369

DISPLACEMENTS REPORT: Nodal Movements
 CASE 3 (OPE) W+D1+T1+P1+H

NODE	DX mm.	DY mm.	DZ mm.	RX deg.	RY deg.	RZ deg.
6013	62.241	-6.046	-4.682	-0.0558	-0.2963	0.5727
6014	35.088	3.594	-10.429	-0.0552	-0.2963	0.5726
6015	15.074	-7.953	-19.882	-0.0547	-0.2963	0.5704
6016	57.443	-2.371	-5.150	-0.0557	-0.2963	0.5728
6020	8.067	-17.053	-24.614	-0.0544	-0.2963	0.5697
6023	1.696	-25.322	-28.918	-0.0542	-0.2963	0.5697
6029	-3.435	-31.363	-31.472	-0.0539	-0.2963	0.5704
6030	-6.299	-33.377	-30.918	-0.0537	-0.2963	0.5706
6035	-7.942	-34.202	-30.119	-0.0537	-0.2963	0.5706
6040	-11.125	-35.799	-28.567	-0.0536	-0.2963	0.5706
6048	68.442	-72.526	-22.457	-0.0949	-0.3046	0.4775
6049	67.189	-75.722	-23.777	-0.0988	-0.3046	0.4348
6500	68.347	-78.783	-23.885	-0.1093	-0.3027	0.3936
6505	76.830	-88.582	-21.342	-0.1184	-0.3061	0.3667
6510	67.450	-84.964	-7.805	-0.1193	-0.3064	0.3518
7000	177.745	-45.795	-109.481	-0.0251	-0.3122	0.6014
7005	173.198	-42.472	-109.681	-0.0262	-0.3208	0.6016
7010	143.512	-20.823	-110.956	-0.0255	-0.3208	0.6022
7013	133.842	-13.775	-111.364	-0.0253	-0.3208	0.6023
7014	105.567	-4.497	-116.249	-0.0247	-0.3208	0.6020
7015	85.193	-16.911	-126.051	-0.0241	-0.3208	0.5996
7016	128.796	-10.099	-111.575	-0.0252	-0.3208	0.6024
7020	78.178	-26.489	-131.179	-0.0239	-0.3208	0.5989
7025	71.807	-35.181	-135.837	-0.0236	-0.3208	0.5989
7028	69.449	-38.402	-137.561	-0.0235	-0.3208	0.5991
7029	66.656	-41.559	-138.643	-0.0233	-0.3208	0.5996
7030	63.697	-43.806	-138.184	-0.0231	-0.3208	0.5998
7035	61.982	-44.772	-137.426	-0.0231	-0.3208	0.5998
7040	58.656	-46.643	-135.956	-0.0231	-0.3208	0.5998
7498	130.679	-100.595	-153.198	-0.1006	-0.4777	0.5688
7499	129.657	-104.308	-155.263	-0.1190	-0.4367	0.5498
7500	131.442	-107.620	-155.462	-0.1547	-0.4126	0.5216
7505	142.135	-116.885	-151.917	-0.1885	-0.3698	0.4799
7510	130.908	-110.790	-138.299	-0.2075	-0.3670	0.4423
8000	162.079	-44.804	-86.572	-0.0452	-0.3213	0.6142
8005	157.430	-41.480	-86.925	-0.0464	-0.3298	0.6110
8010	127.301	-19.846	-89.192	-0.0457	-0.3298	0.6116
8013	117.479	-12.798	-89.924	-0.0454	-0.3298	0.6118
8014	79.016	3.406	-96.406	-0.0446	-0.3298	0.6116
8015	58.524	-9.292	-106.718	-0.0441	-0.3298	0.6092
8016	102.528	-2.079	-91.031	-0.0451	-0.3298	0.6120
8020	51.510	-19.023	-111.990	-0.0438	-0.3298	0.6085
8023	45.138	-27.854	-116.779	-0.0436	-0.3298	0.6085
8029	39.975	-34.306	-119.680	-0.0433	-0.3298	0.6092
8030	36.981	-36.512	-119.256	-0.0431	-0.3298	0.6094
8035	35.238	-37.435	-118.515	-0.0431	-0.3298	0.6094
8040	31.861	-39.223	-117.074	-0.0431	-0.3298	0.6094
8498	114.506	-96.922	-133.252	-0.1855	-0.4218	0.3958
8499	113.435	-93.911	-133.185	-0.1486	-0.4457	0.4033
8500	114.774	-90.938	-131.139	-0.1298	-0.4855	0.4253

CAESAR II Ver.5.10.00, (Build 070917) Date: JUL 18, 2010 Time: 23:14
 Job: C:\DOCUMENTS AND SETTINGS\ABC\MY DOCUMENTS\STRES...HRH_LPBP
 Licensed To: DEALR/EVAL COPY -- ID #4369

DISPLACEMENTS REPORT: Nodal Movements
 CASE 3 (OPE) W+D1+T1+P1+H

NODE	DX mm.	DY mm.	DZ mm.	RX deg.	RY deg.	RZ deg.
8505	123.085	-106.322	-128.976	-0.2209	-0.3802	0.4165
8510	92.817	-85.365	-95.127	-0.3200	-0.4087	0.3850
8515	41.382	-40.033	-41.528	-0.4153	-0.4362	0.3352
8520	4.246	-4.151	-4.236	-0.4321	-0.4426	0.3007
8525	0.016	-0.033	0.000	-0.4314	-0.4426	0.2968
8528	-9.542	9.248	9.547	-0.4289	-0.4426	0.2880
8529	-13.836	11.354	11.328	-0.4252	-0.4427	0.2850
8530	-18.115	10.615	9.548	-0.4254	-0.4428	0.2754
8535	-39.422	-2.754	-11.919	-0.4118	-0.4428	0.2746
8538	-64.544	-18.881	-37.234	-0.3958	-0.4427	0.2790
8539	-66.292	-21.938	-41.523	-0.3914	-0.4428	0.2741
8540	-64.478	-25.402	-45.796	-0.3810	-0.4428	0.2703
8543	-46.033	-41.157	-63.935	-0.3749	-0.4428	0.2679
8544	-43.722	-42.502	-68.037	-0.3741	-0.4434	0.2672
8545	-44.288	-40.543	-71.890	-0.3756	-0.4440	0.2652
8550	-68.590	-0.000	-106.732	-0.3789	-0.4440	0.2611
8553	-72.656	6.842	-112.645	-0.3795	-0.4440	0.2604
8554	-75.688	9.127	-116.526	-0.3811	-0.4445	0.2580
8555	-79.441	8.623	-120.678	-0.3817	-0.4450	0.2557
8560	-94.364	0.031	-135.831	-0.3833	-0.4450	0.2560
8565	-130.834	-21.009	-172.867	-0.3872	-0.4450	0.2554
8568	-155.545	-35.255	-197.963	-0.3899	-0.4450	0.2548
8569	-157.518	-35.908	-199.305	-0.3901	-0.4450	0.2545
8570	-159.852	-35.881	-199.791	-0.3904	-0.4450	0.2543
8575	-169.679	-34.344	-199.880	-0.3905	-0.4450	0.2549
8578	-181.051	-32.585	-199.983	-0.3907	-0.4450	0.2556
8579	-183.384	-32.562	-200.469	-0.3910	-0.4450	0.2553
8580	-185.357	-33.217	-201.811	-0.3913	-0.4450	0.2549
8585	-199.319	-41.235	-215.991	-0.3928	-0.4450	0.2544
8590	-194.147	-50.156	-208.004	-0.3928	-0.4450	0.2544
8595	-186.855	-56.640	-214.896	-0.3931	-0.4450	0.2544
8600	-182.067	-60.898	-219.423	-0.3932	-0.4450	0.2544
8605	-175.090	-67.140	-225.904	-0.3935	-0.4450	0.2544
8610	-163.440	-77.481	-237.032	-0.3938	-0.4450	0.2544

CAESAR II Ver.5.10.00, (Build 070917) Date: JUL 18, 2010 Time: 23:14
 Job: C:\DOCUMENTS AND SETTINGS\ABC\MY DOCUMENTS\STRES...HRH_LPBP
 Licensed To: DEALR/EVAL COPY -- ID #4369

DISPLACEMENTS REPORT: Nodal Movements
 CASE 4 (SUS) W+P1+H

NODE	DX mm.	DY mm.	DZ mm.	RX deg.	RY deg.	RZ deg.
10	0.000	-0.000	-0.000	-0.0000	0.0000	-0.0000
15	0.002	-0.000	-0.002	-0.0004	0.0001	-0.0005
20	0.011	-0.001	-0.009	-0.0009	0.0003	-0.0011
28	0.014	-0.001	-0.011	-0.0010	0.0003	-0.0012
29	0.074	-0.031	-0.068	-0.0032	0.0009	-0.0039
30	0.124	-0.172	-0.138	-0.0048	0.0016	-0.0084
35	0.124	-0.202	-0.144	-0.0050	0.0017	-0.0089
37	0.122	-0.401	-0.177	-0.0060	0.0018	-0.0109
40	0.112	-1.804	-0.420	-0.0128	0.0030	-0.0192
45	0.111	-1.893	-0.433	-0.0130	0.0030	-0.0203
48	0.107	-2.410	-0.503	-0.0143	0.0032	-0.0231
49	0.008	-2.872	-0.506	-0.0160	0.0035	-0.0247
50	-0.220	-2.751	-0.326	-0.0190	0.0036	-0.0248
53	-0.433	-2.362	-0.102	-0.0197	0.0038	-0.0251
54	-0.487	-2.200	-0.034	-0.0195	0.0039	-0.0252
55	-0.485	-2.031	-0.010	-0.0187	0.0039	-0.0254
60	-0.467	-1.936	-0.008	-0.0183	0.0039	-0.0255
63	-0.402	-1.618	-0.003	-0.0172	0.0040	-0.0257
65	-0.366	-1.450	0.000	-0.0170	0.0040	-0.0259
70	-0.061	-0.000	0.025	-0.0154	0.0041	-0.0275
75	0.095	0.560	0.034	-0.0102	0.0039	-0.0283
80	0.144	0.701	0.036	-0.0085	0.0038	-0.0285
83	0.172	0.764	0.038	-0.0077	0.0038	-0.0286
84	0.216	0.775	0.029	-0.0065	0.0036	-0.0288
85	0.253	0.628	0.003	-0.0067	0.0035	-0.0285
88	0.290	0.395	-0.034	-0.0073	0.0034	-0.0279
89	0.085	0.088	0.004	-0.0103	0.0032	-0.0248
90	-0.463	-0.001	0.268	-0.0127	0.0032	-0.0222
95	-0.697	-0.000	0.405	-0.0131	0.0031	-0.0218
97	-0.965	-0.002	0.571	-0.0136	0.0031	-0.0213
100	-4.453	-0.001	4.012	-0.0179	0.0025	-0.0125
105	-6.265	-0.001	7.259	-0.0147	0.0020	-0.0068
107	-6.703	-0.012	8.231	-0.0117	0.0018	-0.0053
108	-6.823	-0.014	8.496	-0.0107	0.0017	-0.0049
109	-6.978	0.137	8.882	-0.0082	0.0016	-0.0041
110	-6.983	0.384	9.002	-0.0024	0.0014	-0.0034
115	-6.976	0.398	9.002	-0.0012	0.0013	-0.0033
117	-6.960	0.391	9.002	0.0011	0.0013	-0.0031
118	-6.934	0.327	9.002	0.0033	0.0011	-0.0027
119	-6.888	0.195	9.010	0.0012	0.0004	-0.0018
120	-6.886	0.199	9.008	0.0011	-0.0005	0.0030
121	-6.917	0.262	9.001	0.0035	0.0010	-0.0024
125	-6.886	0.184	9.005	0.0013	-0.0007	0.0040
130	-6.884	0.074	8.989	0.0018	-0.0011	0.0071
135	-6.871	-0.682	8.775	0.0047	-0.0041	0.0088
140	-6.860	-1.338	8.265	0.0076	-0.0083	0.0078
145	-6.857	-1.477	8.117	0.0081	-0.0093	0.0081
148	-6.855	-1.621	7.939	0.0087	-0.0103	0.0073

CAESAR II Ver.5.10.00, (Build 070917) Date: JUL 18, 2010 Time: 23:14
 Job: C:\DOCUMENTS AND SETTINGS\ABC\MY DOCUMENTS\STRES...HRH_LPBP
 Licensed To: DEALR/EVAL COPY -- ID #4369

DISPLACEMENTS REPORT: Nodal Movements
 CASE 4 (SUS) W+P1+H

NODE	DX mm.	DY mm.	DZ mm.	RX deg.	RY deg.	RZ deg.
149	-6.837	-1.732	7.730	0.0092	-0.0116	0.0057
150	-6.801	-1.806	7.472	0.0097	-0.0129	0.0040
155	-6.733	-1.901	6.724	0.0107	-0.0158	0.0028
160	-6.619	-1.896	6.278	0.0114	-0.0167	0.0028
165	-6.561	-1.898	6.040	0.0117	-0.0171	0.0028
168	-6.493	-1.900	5.743	0.0122	-0.0176	0.0027
169	-6.403	-1.865	5.562	0.0134	-0.0182	0.0028
170	-6.360	-1.764	5.981	0.0144	-0.0189	0.0027
175	-6.360	-1.753	6.049	0.0145	-0.0189	0.0026
180	-6.359	-1.686	6.597	0.0153	-0.0192	0.0026
185	-6.355	-1.504	7.706	0.0173	-0.0196	0.0032
190	-6.348	-1.177	9.393	0.0203	-0.0197	0.0046
195	-6.342	-0.863	10.557	0.0224	-0.0193	0.0061
200	-6.339	-0.692	11.048	0.0232	-0.0190	0.0063
203	-6.338	-0.669	11.119	0.0233	-0.0190	0.0063
204	-6.145	-0.264	11.559	0.0253	-0.0180	0.0098
205	-5.476	-0.003	10.487	0.0274	-0.0167	0.0134
210	-5.174	-0.000	9.877	0.0281	-0.0162	0.0140
215	-5.048	0.001	9.627	0.0284	-0.0160	0.0143
220	-3.525	0.001	6.717	0.0324	-0.0135	0.0173
225	-1.434	0.000	2.791	0.0381	-0.0107	0.0200
230	-0.362	-0.001	0.727	0.0412	-0.0094	0.0211
235	-0.005	-0.000	0.026	0.0420	-0.0090	0.0213
238	0.151	-0.001	-0.283	0.0424	-0.0089	0.0214
239	0.778	-0.632	-1.781	0.0461	-0.0079	0.0226
240	0.860	-2.223	-2.443	0.0477	-0.0066	0.0235
245	0.780	-2.824	-2.446	0.0479	-0.0064	0.0238
250	0.660	-3.772	-2.450	0.0477	-0.0060	0.0241
255	0.208	-7.714	-2.468	0.0386	-0.0042	0.0262
260	-0.101	-10.982	-2.483	0.0238	-0.0020	0.0287
265	-0.174	-12.469	-2.489	0.0115	-0.0001	0.0306
270	-0.175	-12.670	-2.488	0.0089	0.0003	0.0311
275	-0.165	-12.850	-2.486	0.0060	0.0009	0.0316
280	-0.107	-12.976	-2.485	-0.0008	0.0015	0.0324
285	-0.070	-12.914	-2.486	-0.0028	0.0015	0.0334
290	0.083	-12.077	-2.490	-0.0102	0.0015	0.0379
295	0.151	-11.544	-2.493	-0.0103	0.0015	0.0399
300	0.184	-11.277	-2.494	-0.0102	0.0015	0.0405
305	0.208	-11.091	-2.495	-0.0100	0.0015	0.0408
310	0.208	-10.165	-2.529	-0.0083	0.0016	0.0420
315	0.208	-9.261	-2.565	-0.0068	0.0017	0.0435
320	0.151	-10.641	-2.526	-0.0095	0.0015	0.0404
325	0.151	-9.781	-2.557	-0.0088	0.0014	0.0406
330	-0.106	-12.274	-2.524	-0.0011	0.0022	0.0302
335	-0.106	-11.655	-2.581	-0.0014	0.0033	0.0290
340	-0.165	-12.139	-2.510	0.0054	0.0015	0.0324
345	-0.166	-11.436	-2.550	0.0048	0.0025	0.0353
505	0.000	-0.000	0.000	0.0000	0.0000	-0.0000
510	0.010	-0.000	0.003	0.0008	0.0002	-0.0023
515	0.050	0.000	0.017	0.0018	0.0005	-0.0052

CAESAR II Ver.5.10.00, (Build 070917) Date: JUL 18, 2010 Time: 23:14
 Job: C:\DOCUMENTS AND SETTINGS\ABC\MY DOCUMENTS\STRES...HRH_LPBP
 Licensed To: DEALR/EVAL COPY -- ID #4369

DISPLACEMENTS REPORT: Nodal Movements
 CASE 4 (SUS) W+P1+H

NODE	DX mm.	DY mm.	DZ mm.	RX deg.	RY deg.	RZ deg.
523	0.060	0.000	0.021	0.0019	0.0006	-0.0056
524	0.347	0.145	0.132	0.0061	0.0018	-0.0181
525	0.565	0.723	0.267	0.0094	0.0031	-0.0265
530	0.564	0.820	0.278	0.0097	0.0032	-0.0268
535	0.560	1.348	0.341	0.0118	0.0035	-0.0285
540	0.533	4.798	0.781	0.0247	0.0051	-0.0302
545	0.532	4.925	0.803	0.0253	0.0052	-0.0291
548	0.527	5.549	0.921	0.0277	0.0054	-0.0261
549	0.447	5.894	0.900	0.0305	0.0056	-0.0245
550	0.265	5.472	0.568	0.0328	0.0057	-0.0248
553	0.092	4.810	0.186	0.0343	0.0059	-0.0254
554	0.053	4.529	0.068	0.0360	0.0059	-0.0256
555	0.073	4.212	0.023	0.0382	0.0060	-0.0258
560	0.101	4.020	0.019	0.0390	0.0060	-0.0259
563	0.204	3.272	0.007	0.0409	0.0061	-0.0263
565	0.261	2.858	-0.000	0.0409	0.0062	-0.0266
570	0.752	-0.000	-0.049	0.0239	0.0064	-0.0289
575	1.010	-0.819	-0.064	0.0140	0.0059	-0.0301
580	1.088	-1.007	-0.067	0.0124	0.0056	-0.0305
583	1.130	-1.110	-0.069	0.0117	0.0054	-0.0307
584	1.191	-1.167	-0.058	0.0090	0.0046	-0.0312
585	1.236	-1.016	-0.028	0.0063	0.0038	-0.0321
588	1.274	-0.725	0.010	0.0046	0.0033	-0.0321
589	0.998	-0.215	0.036	0.0017	0.0027	-0.0316
590	0.285	-0.001	0.032	0.0004	0.0026	-0.0280
595	-0.008	-0.000	0.028	0.0001	0.0025	-0.0272
597	-0.340	-0.002	0.029	-0.0003	0.0023	-0.0262
600	-4.070	-0.001	0.721	-0.0052	-0.0016	-0.0105
605	-5.155	-0.001	1.660	-0.0036	-0.0052	-0.0018
607	-5.208	-0.012	1.855	-0.0016	-0.0066	0.0001
608	-5.200	-0.014	1.884	-0.0008	-0.0070	0.0005
609	-5.290	-0.019	1.884	0.0009	-0.0078	0.0012
610	-5.599	-0.123	1.853	0.0058	-0.0087	0.0017
615	-5.650	-0.157	1.853	0.0070	-0.0089	0.0017
617	-5.759	-0.261	1.851	0.0091	-0.0091	0.0019
618	-5.966	-0.497	1.849	0.0109	-0.0097	0.0021
619	-6.581	-1.031	2.031	0.0077	-0.0118	0.0027
620	-6.788	-1.072	2.542	0.0068	-0.0134	-0.0010
621	-6.137	-0.691	1.847	0.0108	-0.0102	0.0023
625	-6.788	-1.077	2.612	0.0068	-0.0136	-0.0020
630	-6.790	-1.148	2.857	0.0071	-0.0140	-0.0047
635	-6.798	-1.646	4.124	0.0082	-0.0158	-0.0053
640	-6.803	-1.933	5.443	0.0093	-0.0164	-0.0017
645	-6.803	-1.961	5.711	0.0095	-0.0164	-0.0018
648	-6.804	-1.995	6.002	0.0097	-0.0164	-0.0014
649	-6.806	-2.009	6.249	0.0099	-0.0163	-0.0000
650	-6.799	-1.998	6.421	0.0102	-0.0162	0.0016
5000	-0.642	-9.261	-2.696	-0.0067	0.0017	0.0435
5005	-0.975	-9.260	-2.746	-0.0063	0.0018	0.0444
5010	-3.248	-9.251	-3.014	-0.0046	0.0018	0.0478

703

CAESAR II Ver.5.10.00, (Build 070917) Date: JUL 18, 2010 Time: 23:14
 Job: C:\DOCUMENTS AND SETTINGS\ABC\MY DOCUMENTS\STRES...HRH_LPBP
 Licensed To: DEALR/EVAL COPY -- ID #4369

DISPLACEMENTS REPORT: Nodal Movements
 CASE 4 (SUS) W+P1+H

NODE	DX mm.	DY mm.	DZ mm.	RX deg.	RY deg.	RZ deg.
5013	-4.025	-9.248	-3.084	-0.0041	0.0018	0.0489
5014	-5.937	-9.876	-3.189	-0.0025	0.0018	0.0513
5015	-6.566	-11.392	-3.162	-0.0012	0.0018	0.0509
5016	-4.439	-9.249	-3.117	-0.0038	0.0018	0.0495
5020	-6.566	-12.201	-3.133	-0.0005	0.0018	0.0509
5023	-6.566	-12.941	-3.107	0.0001	0.0018	0.0516
5029	-6.564	-13.505	-3.088	0.0008	0.0018	0.0532
5030	-6.557	-13.720	-3.081	0.0013	0.0018	0.0537
5035	-6.552	-13.816	-3.078	0.0013	0.0018	0.0537
5040	-6.541	-14.004	-3.072	0.0013	0.0018	0.0537
5498	-0.800	-12.460	-2.585	0.0087	0.0010	0.0173
5499	-0.904	-12.415	-2.553	0.0054	0.0020	0.0250
5500	-0.962	-12.268	-2.556	0.0041	0.0030	0.0334
5505	-0.468	-12.459	-2.812	0.0114	0.0008	0.0120
5508	-0.385	-13.532	-2.818	0.0072	0.0008	-0.0013
5509	-0.370	-13.586	-2.794	0.0098	0.0021	-0.0031
5510	-0.326	-13.617	-2.710	0.0145	0.0035	-0.0076
5515	1.224	-13.596	-0.395	0.0255	0.0035	-0.0192
5518	2.467	-13.602	1.201	0.0309	0.0035	-0.0248
5519	2.655	-13.521	1.442	0.0352	0.0048	-0.0303
5520	2.748	-13.290	1.584	0.0369	0.0061	-0.0368
5523	2.748	-11.999	1.786	0.0410	0.0061	-0.0418
5524	2.614	-11.687	1.705	0.0427	0.0048	-0.0488
5525	2.254	-11.540	1.408	0.0470	0.0035	-0.0550
5530	-1.035	-11.535	-1.403	0.0524	0.0035	-0.0613
5533	-10.605	-11.556	-9.578	0.0656	0.0035	-0.0768
5534	-11.167	-11.358	-10.048	0.0709	0.0051	-0.0819
5535	-11.445	-10.846	-10.255	0.0768	0.0066	-0.0839
5538	-11.701	-7.553	-10.238	0.0812	0.0066	-0.0900
5539	-11.742	-6.720	-10.216	0.0843	0.0066	-0.0922
5540	-11.756	-5.825	-10.166	0.0855	0.0066	-0.0957
5545	-11.745	-3.658	-10.008	0.0855	0.0066	-0.0949
5550	-11.735	-1.618	-9.855	0.0855	0.0066	-0.0930
5553	-11.732	-0.900	-9.801	0.0855	0.0066	-0.0927
5554	-11.468	-0.269	-9.510	0.0855	0.0066	-0.0912
5555	-10.845	-0.011	-8.903	0.0855	0.0066	-0.0899
5560	-0.740	-0.000	0.851	0.0854	0.0066	-0.0871
5563	0.558	-0.002	2.127	0.0854	0.0066	-0.0867
5564	1.150	0.241	2.733	0.0853	0.0065	-0.0858
5565	1.396	0.830	3.023	0.0853	0.0065	-0.0869
5570	1.462	11.869	3.846	0.0852	0.0065	-0.0969
5575	1.498	17.927	4.301	0.0851	0.0065	-0.0934
5580	-0.401	17.927	2.570	0.0851	0.0065	-0.0934
5585	-0.527	19.312	2.552	0.0853	0.0065	-0.0934
5590	-0.609	20.221	2.541	0.0853	0.0065	-0.0934
5595	-0.728	21.545	2.524	0.0851	0.0065	-0.0934
5600	-0.930	23.758	2.496	0.0848	0.0065	-0.0934
6000	-0.642	-9.781	-2.728	-0.0088	0.0014	0.0406
6005	-0.950	-9.780	-2.794	-0.0086	0.0013	0.0408
6010	-3.033	-9.771	-3.199	-0.0079	0.0013	0.0436

CAESAR II Ver.5.10.00, (Build 070917) Date: JUL 18, 2010 Time: 23:14
 Job: C:\DOCUMENTS AND SETTINGS\ABC\MY DOCUMENTS\STRES...HRH_LPBP
 Licensed To: DEALR/EVAL COPY -- ID #4369

DISPLACEMENTS REPORT: Nodal Movements
 CASE 4 (SUS) W+P1+H

NODE	DX mm.	DY mm.	DZ mm.	RX deg.	RY deg.	RZ deg.
6013	-3.741	-9.768	-3.324	-0.0076	0.0013	0.0445
6014	-5.474	-10.336	-3.587	-0.0070	0.0013	0.0462
6015	-6.038	-11.690	-3.632	-0.0065	0.0013	0.0449
6016	-4.116	-9.768	-3.387	-0.0075	0.0013	0.0450
6020	-6.038	-12.401	-3.611	-0.0062	0.0013	0.0444
6023	-6.038	-13.042	-3.592	-0.0060	0.0013	0.0445
6029	-6.036	-13.515	-3.578	-0.0057	0.0013	0.0451
6030	-6.031	-13.670	-3.572	-0.0055	0.0013	0.0453
6035	-6.027	-13.733	-3.570	-0.0055	0.0013	0.0454
6040	-6.020	-13.853	-3.566	-0.0055	0.0013	0.0454
6048	-0.940	-12.024	-2.733	-0.0006	0.0008	0.0216
6049	-0.901	-12.120	-2.729	0.0003	0.0006	0.0177
6500	-0.821	-12.154	-2.735	0.0025	0.0001	0.0151
6505	-0.502	-12.152	-2.810	0.0041	0.0006	0.0134
6510	-0.479	-12.313	-2.811	0.0087	0.0007	0.0125
7000	-0.858	-11.436	-2.458	0.0047	0.0025	0.0354
7005	-1.133	-11.435	-2.423	0.0044	0.0031	0.0370
7010	-3.051	-11.429	-2.189	0.0051	0.0031	0.0408
7013	-3.715	-11.426	-2.105	0.0053	0.0031	0.0420
7014	-5.367	-11.972	-1.856	0.0059	0.0031	0.0445
7015	-5.912	-13.284	-1.690	0.0065	0.0031	0.0437
7016	-4.069	-11.427	-2.061	0.0054	0.0031	0.0426
7020	-5.912	-13.977	-1.641	0.0067	0.0031	0.0432
7025	-5.912	-14.602	-1.597	0.0070	0.0031	0.0434
7028	-5.912	-14.836	-1.581	0.0071	0.0031	0.0435
7029	-5.908	-15.080	-1.564	0.0073	0.0031	0.0440
7030	-5.896	-15.282	-1.552	0.0075	0.0031	0.0442
7035	-5.887	-15.381	-1.547	0.0075	0.0031	0.0442
7040	-5.869	-15.572	-1.537	0.0075	0.0031	0.0442
7498	-1.116	-15.532	-1.429	-0.0349	0.0097	0.0320
7499	-1.060	-15.673	-1.311	-0.0372	0.0077	0.0247
7500	-0.953	-15.719	-1.093	-0.0437	0.0079	0.0190
7505	-0.579	-15.718	-0.112	-0.0486	0.0029	0.0172
7510	-0.508	-14.202	-0.104	-0.0472	0.0021	0.0170
8000	-0.672	-11.656	-2.609	-0.0015	0.0034	0.0290
8005	-0.892	-11.655	-2.620	-0.0017	0.0040	0.0292
8010	-2.399	-11.648	-2.689	-0.0010	0.0040	0.0319
8013	-2.918	-11.645	-2.704	-0.0008	0.0040	0.0328
8014	-4.766	-12.081	-2.679	0.0000	0.0040	0.0352
8015	-5.195	-13.107	-2.557	0.0005	0.0040	0.0338
8016	-3.734	-11.648	-2.720	-0.0005	0.0040	0.0340
8020	-5.195	-13.640	-2.493	0.0008	0.0040	0.0333
8023	-5.195	-14.120	-2.434	0.0010	0.0040	0.0334
8029	-5.189	-14.483	-2.391	0.0013	0.0040	0.0340
8030	-5.173	-14.622	-2.376	0.0015	0.0040	0.0342
8035	-5.161	-14.686	-2.369	0.0016	0.0040	0.0342
8040	-5.138	-14.810	-2.355	0.0016	0.0040	0.0342
8498	-0.806	-13.234	-1.067	-0.0429	0.0085	0.0146
8499	-0.866	-13.213	-1.286	-0.0378	0.0089	0.0091
8500	-0.881	-13.181	-1.414	-0.0362	0.0119	0.0051

CAESAR II Ver.5.10.00, (Build 070917) Date: JUL 18, 2010 Time: 23:14
 Job: C:\DOCUMENTS AND SETTINGS\ABC\MY DOCUMENTS\STRES...HRH_LPBP
 Licensed To: DEALR/EVAL COPY -- ID #4369

DISPLACEMENTS REPORT: Nodal Movements
 CASE 4 (SUS) W+P1+H

NODE	DX mm.	DY mm.	DZ mm.	RX deg.	RY deg.	RZ deg.
8505	-0.460	-13.232	-0.098	-0.0467	0.0027	0.0168
8510	-0.299	-9.179	-0.075	-0.0555	0.0014	0.0174
8515	-0.201	-1.804	-0.033	-0.0635	0.0002	0.0183
8520	-0.193	3.370	-0.004	-0.0598	-0.0001	0.0190
8525	-0.192	3.939	-0.000	-0.0589	-0.0001	0.0190
8528	-0.192	5.194	0.006	-0.0565	-0.0001	0.0192
8529	-0.192	5.502	0.008	-0.0490	-0.0001	0.0217
8530	-0.191	5.473	0.009	-0.0452	-0.0002	0.0261
8535	-0.184	3.998	0.012	-0.0328	-0.0001	0.0396
8538	-0.169	1.060	0.012	-0.0182	-0.0001	0.0586
8539	-0.166	0.580	0.011	-0.0173	-0.0002	0.0644
8540	-0.161	0.295	0.012	-0.0107	-0.0003	0.0649
8543	-0.136	0.010	0.013	-0.0044	-0.0002	0.0747
8544	-0.357	-0.010	0.006	-0.0024	0.0022	0.0779
8545	-0.934	-0.015	-0.010	-0.0025	0.0047	0.0862
8550	-9.671	-0.000	-0.282	-0.0034	0.0047	0.1030
8553	-11.299	-0.000	-0.336	-0.0035	0.0047	0.1058
8554	-12.059	-0.319	-0.348	-0.0040	0.0046	0.1154
8555	-12.400	-1.147	-0.329	-0.0041	0.0045	0.1251
8560	-12.420	-5.509	-0.177	-0.0046	0.0045	0.1332
8565	-12.472	-17.216	0.193	-0.0056	0.0045	0.1473
8568	-12.510	-25.657	0.443	-0.0063	0.0045	0.1516
8569	-12.509	-26.221	0.460	-0.0062	0.0045	0.1528
8570	-12.502	-26.693	0.474	-0.0057	0.0045	0.1538
8575	-12.460	-28.340	0.524	-0.0056	0.0045	0.1551
8578	-12.411	-30.277	0.581	-0.0057	0.0045	0.1564
8579	-12.404	-30.761	0.595	-0.0058	0.0045	0.1566
8580	-12.403	-31.343	0.612	-0.0059	0.0045	0.1569
8585	-12.426	-36.321	0.753	-0.0075	0.0045	0.1567
8590	-9.240	-36.321	0.905	-0.0075	0.0045	0.1567
8595	-9.280	-36.447	0.906	-0.0078	0.0045	0.1567
8600	-9.307	-36.531	0.908	-0.0079	0.0045	0.1567
8605	-9.317	-36.653	0.911	-0.0082	0.0045	0.1567
8610	-9.410	-36.874	0.912	-0.0084	0.0045	0.1567

CAESAR II Ver.5.10.00, (Build 070917) Date: JUL 18, 2010 Time: 23:14
 Job: C:\DOCUMENTS AND SETTINGS\ABC\MY DOCUMENTS\STRES...HRH_LPBP
 Licensed To: DEALR/EVAL COPY -- ID #4369

**STRESS SUMMARY REPORT: Highest Stresses Mini Statement
 Various Load Cases**

LOAD CASE DEFINITION KEY

CASE 3 (OPE) W+D1+T1+P1+H
 CASE 4 (SUS) W+P1+H
 CASE 5 (EXP) L5=L3-L4

Piping Code: B31.1 = B31.1 -2004, December 15, 2006

NO CODE STRESS CHECK PROCESSED: LOADCASE 3 (OPE) W+D1+T1+P1+H

Highest Stresses: (KPa) LOADCASE 3 (OPE) W+D1+T1+P1+H
 OPE Stress Ratio (%): 0.0 @Node 8005
 OPE Stress: 163555.5 Allowable: 0.0
 Axial Stress: 22302.1 @Node 5515
 Bending Stress: 145147.6 @Node 8005
 Torsion Stress: 26756.6 @Node 618
 Hoop Stress: 44544.9 @Node 7510
 3D Max Intensity: 164292.5 @Node 8005

CODE STRESS CHECK PASSED : LOADCASE 4 (SUS) W+P1+H

Highest Stresses: (KPa) LOADCASE 4 (SUS) W+P1+H
 CodeStress Ratio (%): 71.8 @Node 275
 Code Stress: 33543.3 Allowable: 46718.9
 Axial Stress: 22070.3 @Node 5515
 Bending Stress: 20336.8 @Node 7005
 Torsion Stress: 2421.5 @Node 8539
 Hoop Stress: 44544.9 @Node 7510
 3D Max Intensity: 53893.2 @Node 8539

CODE STRESS CHECK PASSED : LOADCASE 5 (EXP) L5=L3-L4

Highest Stresses: (KPa) LOADCASE 5 (EXP) L5=L3-L4
 CodeStress Ratio (%): 82.9 @Node 8005
 Code Stress: 152868.1 Allowable: 184341.6
 Axial Stress: 1930.2 @Node 8500
 Bending Stress: 152435.3 @Node 8005
 Torsion Stress: 26664.1 @Node 618
 Hoop Stress: 0.0 @Node 15
 3D Max Intensity: 157608.9 @Node 8005

707

CAESAR II Ver.5.10.00, (Build 070917) Date: JUL 18, 2010 Time: 23:14
 Job: C:\DOCUMENTS AND SETTINGS\ABC\MY DOCUMENTS\STRES...HRH_LPBP
 Licensed To: DEALR/EVAL COPY -- ID #4369

HANGER REPORT
 (TABLE DATA FROM DESIGN RUNS)

NO.	FIG.	VERTICAL	HOT	THEORETICAL	ACTUAL	SPRING	HORIZONTAL
NODE	REQD NO.	MOVEMENT	LOAD	INSTALLED	INSTALLED	RATE	MOVEMENT
				LOAD	LOAD		
		(mm.)	(N.)	(N.)	(N.)	(N./cm.)	(mm.)
35	1	2172	14.904	36849.	42811.	0. 4000.	49.430
	LISEGA					LOAD VARIATION =	16%
40	1	2171	-2.157	55327.	53602.	0. 8000.	103.091
	LISEGA					LOAD VARIATION =	3%
60	1	2172	-19.870	54753.	46806.	0. 4000.	119.663
	LISEGA					LOAD VARIATION =	15%
80	1	2172	15.042	36181.	42198.	0. 4000.	133.126
	LISEGA					LOAD VARIATION =	17%
100	0	-97.270	78104.	*****	CONSTANT	EFFORT	SUPPORT *****
105	0	-181.452	86325.	*****	CONSTANT	EFFORT	SUPPORT *****
115	0	-242.111	58227.	*****	CONSTANT	EFFORT	SUPPORT *****
125	0	-187.073	58265.	*****	CONSTANT	EFFORT	SUPPORT *****
135	0	-133.719	24632.	*****	CONSTANT	EFFORT	SUPPORT *****
140	0	-113.085	39414.	*****	CONSTANT	EFFORT	SUPPORT *****
160	0	-164.206	138687.	*****	CONSTANT	EFFORT	SUPPORT *****
175	0	-165.184	62426.	*****	CONSTANT	EFFORT	SUPPORT *****
185	0	-85.621	60421.	*****	CONSTANT	EFFORT	SUPPORT *****
190	0	0.807	55092.	*****	CONSTANT	EFFORT	SUPPORT *****
200	0	89.215	76591.	*****	CONSTANT	EFFORT	SUPPORT *****
215	0	121.318	107006.	*****	CONSTANT	EFFORT	SUPPORT *****
220	0	79.220	70011.	*****	CONSTANT	EFFORT	SUPPORT *****
225	0	30.234	60392.	*****	CONSTANT	EFFORT	SUPPORT *****
245	2	2163	-42.345	37636.	31992.	0. 1333.	364.402
	LISEGA					LOAD VARIATION =	15%
255	2	2163	-64.936	36661.	28005.	0. 1333.	316.736
	LISEGA					LOAD VARIATION =	24%
260	2	-76.843	35134.	*****	CONSTANT	EFFORT	SUPPORT *****
270	1	-81.002	63495.	*****	CONSTANT	EFFORT	SUPPORT *****

264

CAESAR II Ver.5.10.00, (Build 070917) Date: JUL 18, 2010 Time: 23:14
 Job: C:\DOCUMENTS AND SETTINGS\ABC\MY DOCUMENTS\STRES...HRH_LPBP
 Licensed To: DEALR/EVAL COPY -- ID #4369

HANGER REPORT
 (TABLE DATA FROM DESIGN RUNS)

NO. NODE	FIG. REQD NO.	VERTICAL MOVEMENT	HOT LOAD	THEORETICAL INSTALLED LOAD	ACTUAL INSTALLED LOAD	SPRING RATE	HORIZONTAL MOVEMENT
285	1	-79.429	74483.	*****	CONSTANT EFFORT SUPPORT	*****	
290	2	-74.594	34740.	*****	CONSTANT EFFORT SUPPORT	*****	
300	1	-70.411	31302.	*****	CONSTANT EFFORT SUPPORT	*****	
310	2	-56.598	13829.	*****	CONSTANT EFFORT SUPPORT	*****	
320	2	-58.929	13565.	*****	CONSTANT EFFORT SUPPORT	*****	
330	2	-66.512	16938.	*****	CONSTANT EFFORT SUPPORT	*****	
340	2	-67.309	17350.	*****	CONSTANT EFFORT SUPPORT	*****	
530	1 LISEGA	2172	18.452	36698.	44079.	0. 4000.	46.387 LOAD VARIATION = 20%
540	1 LISEGA	2182	25.432	55080.	68642.	0. 5333.	99.033 LOAD VARIATION = 25%
560	2 LISEGA	2161	11.243	27164.	33160.	0. 5333.	128.347 LOAD VARIATION = 22%
580	1 LISEGA	2161	-3.600	36079.	34159.	0. 5333.	143.530 LOAD VARIATION = 5%
600	0	-97.303	78104.	*****	CONSTANT EFFORT SUPPORT	*****	
605	0	-181.514	86538.	*****	CONSTANT EFFORT SUPPORT	*****	
615	0	-258.160	58033.	*****	CONSTANT EFFORT SUPPORT	*****	
625	0	-259.701	57960.	*****	CONSTANT EFFORT SUPPORT	*****	
635	0	-221.248	27010.	*****	CONSTANT EFFORT SUPPORT	*****	
640	0	-182.274	18849.	*****	CONSTANT EFFORT SUPPORT	*****	
645	0	-174.020	20384.	*****	CONSTANT EFFORT SUPPORT	*****	
5013	2 LISEGA	2161	-3.944	39100.	36997.	0. 5333.	52.803 LOAD VARIATION = 5%
5023	1 LISEGA	2162	-22.103	37054.	31161.	0. 2666.	13.150 LOAD VARIATION = 16%
5515	2 LISEGA	2161	-13.939	36957.	29523.	0. 5333.	38.088 LOAD VARIATION = 20%
5530	2 LISEGA	2161	-13.850	36148.	28762.	0. 5333.	31.224 LOAD VARIATION = 20%

709

CAESAR II Ver.5.10.00, (Build 070917) Date: JUL 18, 2010 Time: 23:14
 Job: C:\DOCUMENTS AND SETTINGS\ABC\MY DOCUMENTS\STRES...\HRH_LPBP
 Licensed To: DEALR/EVAL COPY -- ID #4369

HANGER REPORT
 (TABLE DATA FROM DESIGN RUNS)

NO.	FIG.	VERTICAL	HOT	THEORETICAL	ACTUAL	SPRING	HORIZONTAL
NODE	REQD	MOVEMENT	LOAD	INSTALLED	INSTALLED	RATE	MOVEMENT
	NO.	SIZE		LOAD	LOAD		
5545	0		-63.267	30357.	*****	CONSTANT	EFFORT SUPPORT *****
5570	0		39.859	35545.	*****	CONSTANT	EFFORT SUPPORT *****
5575	2		54.682	28706.	*****	CONSTANT	EFFORT SUPPORT *****
5595	2		52.200	8695.	*****	CONSTANT	EFFORT SUPPORT *****
6013	2	2171	-6.044	40356.	35521.	0.	8000. 62.656
		LISEGA					LOAD VARIATION = 12%
6023	1	2163	-25.331	25633.	22257.	0.	1333. 28.989
		LISEGA					LOAD VARIATION = 13%
6510	2		-84.973	25126.	*****	CONSTANT	EFFORT SUPPORT *****
7013	1	2181	-13.767	77107.	62424.	0.	10666. 174.441
		LISEGA					LOAD VARIATION = 19%
7025	1	2163	-35.186	25894.	21203.	0.	1333. 153.865
		LISEGA					LOAD VARIATION = 18%
7510	0		-110.799	45923.	*****	CONSTANT	EFFORT SUPPORT *****
8013	2	2171	-12.792	42237.	32003.	0.	8000. 148.247
		LISEGA					LOAD VARIATION = 24%
8023	1	2163	-27.861	25898.	22184.	0.	1333. 125.345
		LISEGA					LOAD VARIATION = 14%
8510	0		-85.363	31388.	*****	CONSTANT	EFFORT SUPPORT *****
8515	0		-40.029	31843.	*****	CONSTANT	EFFORT SUPPORT *****
8520	0		-4.151	12929.	*****	CONSTANT	EFFORT SUPPORT *****
8535	0		-2.756	45463.	*****	CONSTANT	EFFORT SUPPORT *****
8560	2	2151	0.031	11721.	11729.	0.	2666. 165.599
		LISEGA					LOAD VARIATION = 0%
8565	2	2153	-21.009	10972.	9573.	0.	666. 217.109
		LISEGA					LOAD VARIATION = 13%
8575	2	2153	-34.344	11213.	8926.	0.	666. 262.597
		LISEGA					LOAD VARIATION = 20%
8585	2	2163	-41.235	30633.	25137.	0.	1333. 294.381
		LISEGA					LOAD VARIATION = 18%
8605	1		-67.139	15784.	*****	CONSTANT	EFFORT SUPPORT *****

0/0

CAESAR II Ver.5.10.00, (Build 070917) Date: JUL 18, 2010 Time: 23:14
Job: C:\DOCUMENTS AND SETTINGS\ABC\MY DOCUMENTS\STRES...\HRH_LPBP
Licensed To: DEALR/EVAL COPY -- ID #4369

HANGER REPORT
(TABLE DATA FROM DESIGN RUNS)

NO.	FIG.	VERTICAL	HOT	THEORETICAL	ACTUAL	SPRING	HORIZONTAL
NODE	REQD	SIZE	LOAD	INSTALLED	INSTALLED	RATE	MOVEMENT
	NO.			LOAD	LOAD		



ALSTOM

Volume-II
Annexure-IV

NTPC ALSTOM
Power Services Pvt. Ltd.

Table of Contents

LISTING OF STATIC LOAD CASES FOR THIS ANALYSIS	2
Restraint Summary : Multiple.....	3
Displacements : 3 (OPE) W+D1+T1+P1+H.....	17
Displacements : 4 (SUS) W+P1+H.....	26
Stress Summary : Multiple.....	35
HANGER REPORT ((TABLE DATA FROM DESIGN RUNS)).....	36

CAESAR II Ver.5.10.00, (Build 070917) Date: JUL 18, 2010 Time: 19:43
Job: C:\DOCUMENTS AND SETTINGS\ABC\MY DOCUM...\KORBA_BFD_#4_500MW
Licensed To: DEALR/EVAL COPY -- ID #4369

LISTING OF STATIC LOAD CASES FOR THIS ANALYSIS

- 1 (HGR) CASE NOT ACTIVE
- 2 (HGR) CASE NOT ACTIVE
- 3 (OPE) W+D1+T1+P1+H
- 4 (SUS) W+P1+H
- 5 (EXP) L5=L3-L4

7/16

CAESAR II Ver.5.10.00, (Build 070917) Date: JUL 18, 2010 Time: 19:43
 Job: C:\DOCUMENTS AND SETTINGS\ABC\MY DOCUM...KORBA_BFD_#4_500MW
 Licensed To: DEALR/EVAL COPY -- ID #4369

RESTRAINT SUMMARY REPORT: Loads On Restraints
 Various Load Cases

LOAD CASE DEFINITION KEY

CASE 3 (OPE) W+D1+T1+P1+H

CASE 4 (SUS) W+P1+H

CASE 5 (EXP) L5=L3-L4

NODE	Load Case	FX N.	FY N.	FZ N.	MX N.m.	MY N.m.	MZ N.m.
5		Displ. Reaction					
	3 (OPE)	11048	-6075	3663	-11087	-14502	55401
	4 (SUS)	-316	-12612	-517	12320	406	-5571
	5 (EXP)	11363	6537	4180	-23407	-14908	60972
	MAX	11363/5	-12612/4	4180/5	-23407/5	-14908/5	60972/5
10		Prog Design VSH					
	3 (OPE)	0	-18247	0	0	0	0
	4 (SUS)	0	-16395	0	0	0	0
	5 (EXP)	0	-1851	0	0	0	0
	MAX		-18247/3				
25		Prog Design VSH					
	3 (OPE)	0	-22040	0	0	0	0
	4 (SUS)	0	-20033	0	0	0	0
	5 (EXP)	0	-2007	0	0	0	0
	MAX		-22040/3				
35		Prog Design VSH					
	3 (OPE)	0	-19819	0	0	0	0
	4 (SUS)	0	-19718	0	0	0	0
	5 (EXP)	0	-101	0	0	0	0
	MAX		-19819/3				
45		Prog Design VSH					
	3 (OPE)	0	-25778	0	0	0	0
	4 (SUS)	0	-25257	0	0	0	0
	5 (EXP)	0	-521	0	0	0	0
	MAX		-25778/3				
65		Prog Design VSH					
	3 (OPE)	0	-11994	0	0	0	0
	4 (SUS)	0	-9512	0	0	0	0
	5 (EXP)	0	-2483	0	0	0	0
	MAX		-11994/3				
80		Prog Design VSH					

CAESAR II Ver.5.10.00, (Build 070917) Date: JUL 18, 2010 Time: 19:43
 Job: C:\DOCUMENTS AND SETTINGS\ABC\MY DOCUM...\KORBA_BFD_#4_500MW
 Licensed To: DEALR/EVAL COPY -- ID #4369

RESTRAINT SUMMARY REPORT: Loads On Restraints
 Various Load Cases

NODE	Load Case	FX N.	FY N.	FZ N.	MX N.m.	MY N.m.	MZ N.m.
	3 (OPE)	0	-5746	0	0	0	0
	4 (SUS)	0	-4405	0	0	0	0
	5 (EXP)	0	-1341	0	0	0	0
	MAX		-5746/3				
90	Prog Design VSH						
	3 (OPE)	0	-19069	0	0	0	0
	4 (SUS)	0	-18439	0	0	0	0
	5 (EXP)	0	-630	0	0	0	0
	MAX		-19069/3				
100	Rigid Y						
	3 (OPE)	0	-22862	0	0	0	0
	4 (SUS)	0	-18913	0	0	0	0
	5 (EXP)	0	-3949	0	0	0	0
	MAX		-22862/3				
105	Rigid Y						
	3 (OPE)	0	-242	0	0	0	0
	4 (SUS)	0	-9771	0	0	0	0
	5 (EXP)	0	9529	0	0	0	0
	MAX		-9771/4				
110	Rigid Y						
	3 (OPE)	0	-23827	0	0	0	0
	4 (SUS)	0	-12964	0	0	0	0
	5 (EXP)	0	-10863	0	0	0	0
	MAX		-23827/3				
200	Displ. Reaction						
	3 (OPE)	-4081	-5008	1055	1370	7470	-20231
	4 (SUS)	351	-15661	-507	6925	-161	-8085
	5 (EXP)	-4432	10653	1561	-5554	7632	-12146
	MAX	-4432/5	-15661/4	1561/5	6925/4	7632/5	-20231/3
205	Prog Design VSH						
	3 (OPE)	0	-18025	0	0	0	0
	4 (SUS)	0	-16174	0	0	0	0
	5 (EXP)	0	-1851	0	0	0	0
	MAX		-18025/3				
220	Prog Design VSH						
	3 (OPE)	0	-14421	0	0	0	0
	4 (SUS)	0	-11877	0	0	0	0
	5 (EXP)	0	-2545	0	0	0	0
	MAX		-14421/3				

CAESAR II Ver.5.10.00, (Build 070917) Date: JUL 18, 2010 Time: 19:43
 Job: C:\DOCUMENTS AND SETTINGS\ABC\MY DOCUM...\KORBA_BFD_#4_500MW
 Licensed To: DEALR/EVAL COPY -- ID #4369

RESTRAINT SUMMARY REPORT: Loads On Restraints
 Various Load Cases

NODE	Load Case	FX N.	FY N.	FZ N.	MX N.m.	MY N.m.	MZ N.m.
230	Prog Design VSH						
	3 (OPE)	0	-13003	0	0	0	0
	4 (SUS)	0	-11039	0	0	0	0
	5 (EXP)	0	-1964	0	0	0	0
	MAX		-13003/3				
240	Prog Design VSH						
	3 (OPE)	0	-19708	0	0	0	0
	4 (SUS)	0	-17558	0	0	0	0
	5 (EXP)	0	-2149	0	0	0	0
	MAX		-19708/3				
257	Prog Design VSH						
	3 (OPE)	0	-9768	0	0	0	0
	4 (SUS)	0	-8405	0	0	0	0
	5 (EXP)	0	-1363	0	0	0	0
	MAX		-9768/3				
270	Prog Design VSH						
	3 (OPE)	0	-9822	0	0	0	0
	4 (SUS)	0	-8520	0	0	0	0
	5 (EXP)	0	-1302	0	0	0	0
	MAX		-9822/3				
300	Displ. Reaction						
	3 (OPE)	-9827	-3465	1517	3286	23859	12024
	4 (SUS)	-184	-651	382	-3	-19	680
	5 (EXP)	-9643	-2814	1135	3289	23878	11344
	MAX	-9827/3	-3465/3	1517/3	3289/5	23878/5	12024/3
305	Prog Design VSH						
	3 (OPE)	0	-11685	0	0	0	0
	4 (SUS)	0	-12200	0	0	0	0
	5 (EXP)	0	515	0	0	0	0
	MAX		-12200/4				
320	Prog Design VSH						
	3 (OPE)	0	-22415	0	0	0	0
	4 (SUS)	0	-24064	0	0	0	0
	5 (EXP)	0	1650	0	0	0	0
	MAX		-24064/4				

CAESAR II Ver.5.10.00, (Build 070917) Date: JUL 18, 2010 Time: 19:43
 Job: C:\DOCUMENTS AND SETTINGS\ABC\MY DOCUM...KORBA_BFD_#4_500MW
 Licensed To: DEALR/EVAL COPY -- ID #4369

RESTRAINT SUMMARY REPORT: Loads On Restraints
 Various Load Cases

NODE	Load Case	FX N.	FY N.	FZ N.	MX N.m.	MY N.m.	MZ N.m.
330	Prog Design VSH						
	3 (OPE)	0	-18374	0	0	0	0
	4 (SUS)	0	-18828	0	0	0	0
	5 (EXP)	0	455	0	0	0	0
	MAX		-18828/4				
340	Prog Design VSH						
	3 (OPE)	0	-22209	0	0	0	0
	4 (SUS)	0	-20656	0	0	0	0
	5 (EXP)	0	-1554	0	0	0	0
	MAX		-22209/3				
360	Prog Design VSH						
	3 (OPE)	0	-10650	0	0	0	0
	4 (SUS)	0	-8602	0	0	0	0
	5 (EXP)	0	-2048	0	0	0	0
	MAX		-10650/3				
375	Prog Design VSH						
	3 (OPE)	0	-5191	0	0	0	0
	4 (SUS)	0	-3928	0	0	0	0
	5 (EXP)	0	-1263	0	0	0	0
	MAX		-5191/3				
385	Prog Design VSH						
	3 (OPE)	0	-12649	0	0	0	0
	4 (SUS)	0	-10966	0	0	0	0
	5 (EXP)	0	-1684	0	0	0	0
	MAX		-12649/3				
395	Rigid Y						
	3 (OPE)	0	-25504	0	0	0	0
	4 (SUS)	0	-25909	0	0	0	0
	5 (EXP)	0	405	0	0	0	0
	MAX		-25909/4				
400	Rigid Y						
	3 (OPE)	0	-11888	0	0	0	0
	4 (SUS)	0	-20556	0	0	0	0
	5 (EXP)	0	8669	0	0	0	0
	MAX		-20556/4				
405	Rigid Y						
	3 (OPE)	0	-26394	0	0	0	0
	4 (SUS)	0	-19884	0	0	0	0

CAESAR II Ver.5.10.00, (Build 070917) Date: JUL 18, 2010 Time: 19:43
 Job: C:\DOCUMENTS AND SETTINGS\ABC\MY DOCUM...KORBA_BFD_#4_500MW
 Licensed To: DEALR/EVAL COPY -- ID #4369

RESTRAINT SUMMARY REPORT: Loads On Restraints
 Various Load Cases

NODE	Load Case	FX N.	FY N.	FZ N.	MX N.m.	MY N.m.	MZ N.m.
	5 (EXP)	0	-6511	0	0	0	0
	MAX		-26394/3				
500		Rigid Y					
	3 (OPE)	0	-25102	0	0	0	0
	4 (SUS)	0	-24947	0	0	0	0
	5 (EXP)	0	-155	0	0	0	0
	MAX		-25102/3				
510		Rigid Y					
	3 (OPE)	0	-31716	0	0	0	0
	4 (SUS)	0	-29920	0	0	0	0
	5 (EXP)	0	-1796	0	0	0	0
	MAX		-31716/3				
515		Rigid Y					
	3 (OPE)	0	-30825	0	0	0	0
	4 (SUS)	0	-17746	0	0	0	0
	5 (EXP)	0	-13080	0	0	0	0
	MAX		-30825/3				
540		Prog Design VSH					
	3 (OPE)	0	-59763	0	0	0	0
	4 (SUS)	0	-68710	0	0	0	0
	5 (EXP)	0	8947	0	0	0	0
	MAX		-68710/4				
565		Prog Design VSH					
	3 (OPE)	0	-41914	0	0	0	0
	4 (SUS)	0	-50619	0	0	0	0
	5 (EXP)	0	8704	0	0	0	0
	MAX		-50619/4				
585		Prog Design VSH					
	3 (OPE)	0	-7373	0	0	0	0
	4 (SUS)	0	-5999	0	0	0	0
	5 (EXP)	0	-1373	0	0	0	0
	MAX		-7373/3				
600		Prog Design VSH					
	3 (OPE)	0	-45932	0	0	0	0
	4 (SUS)	0	-43210	0	0	0	0
	5 (EXP)	0	-2722	0	0	0	0
	MAX		-45932/3				
715		Prog Design					

CAESAR II Ver.5.10.00, (Build 070917) Date: JUL 18, 2010 Time: 19:43
 Job: C:\DOCUMENTS AND SETTINGS\ABC\MY DOCUM...KORBA_BFD_#4_500MW
 Licensed To: DEALR/EVAL COPY -- ID #4369

RESTRAINT SUMMARY REPORT: Loads On Restraints
 Various Load Cases

NODE	Load Case	FX N.	FY N.	FZ N.	MX N.m.	MY N.m.	MZ N.m.
		VSH					
	3 (OPE)	0	-41711	0	0	0	0
	4 (SUS)	0	-46297	0	0	0	0
	5 (EXP)	0	4586	0	0	0	0
	MAX		-46297/4				
735		Prog Design VSH					
	3 (OPE)	0	-7536	0	0	0	0
	4 (SUS)	0	-6238	0	0	0	0
	5 (EXP)	0	-1298	0	0	0	0
	MAX		-7536/3				
750		Prog Design VSH					
	3 (OPE)	0	-46775	0	0	0	0
	4 (SUS)	0	-44927	0	0	0	0
	5 (EXP)	0	-1848	0	0	0	0
	MAX		-46775/3				
820		Prog Design VSH					
	3 (OPE)	0	-32881	0	0	0	0
	4 (SUS)	0	-36480	0	0	0	0
	5 (EXP)	0	3599	0	0	0	0
	MAX		-36480/4				
835		Prog Design VSH					
	3 (OPE)	0	-17416	0	0	0	0
	4 (SUS)	0	-19306	0	0	0	0
	5 (EXP)	0	1890	0	0	0	0
	MAX		-19306/4				
860		Prog Design VSH					
	3 (OPE)	0	-21941	0	0	0	0
	4 (SUS)	0	-24116	0	0	0	0
	5 (EXP)	0	2175	0	0	0	0
	MAX		-24116/4				
865		Prog Design VSH					
	3 (OPE)	0	-22403	0	0	0	0
	4 (SUS)	0	-23489	0	0	0	0
	5 (EXP)	0	1086	0	0	0	0
	MAX		-23489/4				
870		Prog Design VSH					

CAESAR II Ver.5.10.00, (Build 070917) Date: JUL 18, 2010 Time: 19:43
 Job: C:\DOCUMENTS AND SETTINGS\ABC\MY DOCUM...KORBA_BFD_#4_500MW
 Licensed To: DEALR/EVAL COPY -- ID #4369

RESTRAINT SUMMARY REPORT: Loads On Restraints
 Various Load Cases

NODE	Load Case	FX N.	FY N.	FZ N.	MX N.m.	MY N.m.	MZ N.m.
	3 (OPE)	0	-16471	0	0	0	0
	4 (SUS)	0	-16874	0	0	0	0
	5 (EXP)	0	403	0	0	0	0
	MAX		-16874/4				
880	Prog Design VSH						
	3 (OPE)	0	-18459	0	0	0	0
	4 (SUS)	0	-18526	0	0	0	0
	5 (EXP)	0	68	0	0	0	0
	MAX		-18526/4				
900	Prog Design VSH						
	3 (OPE)	0	-18577	0	0	0	0
	4 (SUS)	0	-17814	0	0	0	0
	5 (EXP)	0	-763	0	0	0	0
	MAX		-18577/3				
923	Prog Design VSH						
	3 (OPE)	0	-10808	0	0	0	0
	4 (SUS)	0	-10342	0	0	0	0
	5 (EXP)	0	-466	0	0	0	0
	MAX		-10808/3				
1005	Prog Design VSH						
	3 (OPE)	0	-21268	0	0	0	0
	4 (SUS)	0	-22604	0	0	0	0
	5 (EXP)	0	1337	0	0	0	0
	MAX		-22604/4				
1025	Prog Design VSH						
	3 (OPE)	0	-10132	0	0	0	0
	4 (SUS)	0	-11772	0	0	0	0
	5 (EXP)	0	1640	0	0	0	0
	MAX		-11772/4				
1040	Prog Design VSH						
	3 (OPE)	0	-10359	0	0	0	0
	4 (SUS)	0	-11328	0	0	0	0
	5 (EXP)	0	969	0	0	0	0
	MAX		-11328/4				
1060	Prog Design VSH						
	3 (OPE)	0	-19963	0	0	0	0

CAESAR II Ver.5.10.00, (Build 070917) Date: JUL 18, 2010 Time: 19:43
 Job: C:\DOCUMENTS AND SETTINGS\ABC\MY DOCUM...KORBA_BFD_#4_500MW
 Licensed To: DEALR/EVAL COPY -- ID #4369

RESTRAINT SUMMARY REPORT: Loads On Restraints
 Various Load Cases

NODE	Load Case	FX N.	FY N.	FZ N.	MX N.m.	MY N.m.	MZ N.m.
	4 (SUS)	0	-21273	0	0	0	0
	5 (EXP)	0	1310	0	0	0	0
	MAX		-21273/4				
1090	Prog Design VSH						
	3 (OPE)	0	-34895	0	0	0	0
	4 (SUS)	0	-35013	0	0	0	0
	5 (EXP)	0	118	0	0	0	0
	MAX		-35013/4				
1095	Prog Design VSH						
	3 (OPE)	0	-44924	0	0	0	0
	4 (SUS)	0	-42078	0	0	0	0
	5 (EXP)	0	-2845	0	0	0	0
	MAX		-44924/3				
1100	Prog Design VSH						
	3 (OPE)	0	-36589	0	0	0	0
	4 (SUS)	0	-34278	0	0	0	0
	5 (EXP)	0	-2311	0	0	0	0
	MAX		-36589/3				
1110	Prog Design CSH						
	3 (OPE)	0	-43140	0	0	0	0
	4 (SUS)	0	-43140	0	0	0	0
	5 (EXP)	0	0	0	0	0	0
	MAX		-43140/3				
1120	Prog Design CSH						
	3 (OPE)	0	-23186	0	0	0	0
	4 (SUS)	0	-23186	0	0	0	0
	5 (EXP)	0	0	0	0	0	0
	MAX		-23186/3				
1135	Prog Design CSH						
	3 (OPE)	0	-59025	0	0	0	0
	4 (SUS)	0	-59025	0	0	0	0
	5 (EXP)	0	0	0	0	0	0
	MAX		-59025/3				
1140	Prog Design CSH						
	3 (OPE)	0	-48617	0	0	0	0
	4 (SUS)	0	-48617	0	0	0	0

CAESAR II Ver.5.10.00, (Build 070917) Date: JUL 18, 2010 Time: 19:43
 Job: C:\DOCUMENTS AND SETTINGS\ABC\MY DOCUM...\KORBA_BFD_#4_500MW
 Licensed To: DEALR/EVAL COPY -- ID #4369

RESTRAINT SUMMARY REPORT: Loads On Restraints
 Various Load Cases

NODE	Load Case	FX N.	FY N.	FZ N.	MX N.m.	MY N.m.	MZ N.m.
	5 (EXP)	0	0	0	0	0	0
	MAX		-48617/3				
1150	Prog Design CSH						
	3 (OPE)	0	-27456	0	0	0	0
	4 (SUS)	0	-27456	0	0	0	0
	5 (EXP)	0	0	0	0	0	0
	MAX		-27456/3				
1160	Prog Design CSH						
	3 (OPE)	0	-42849	0	0	0	0
	4 (SUS)	0	-42849	0	0	0	0
	5 (EXP)	0	0	0	0	0	0
	MAX		-42849/3				
1170	Prog Design CSH						
	3 (OPE)	0	-48351	0	0	0	0
	4 (SUS)	0	-48351	0	0	0	0
	5 (EXP)	0	0	0	0	0	0
	MAX		-48351/3				
1175	Prog Design CSH						
	3 (OPE)	0	-59264	0	0	0	0
	4 (SUS)	0	-59264	0	0	0	0
	5 (EXP)	0	0	0	0	0	0
	MAX		-59264/3				
1180	Prog Design CSH						
	3 (OPE)	0	-47859	0	0	0	0
	4 (SUS)	0	-47859	0	0	0	0
	5 (EXP)	0	0	0	0	0	0
	MAX		-47859/3				
1190	Prog Design CSH						
	3 (OPE)	0	-37835	0	0	0	0
	4 (SUS)	0	-37835	0	0	0	0
	5 (EXP)	0	0	0	0	0	0
	MAX		-37835/3				
1215	Prog Design CSH						
	3 (OPE)	0	-41027	0	0	0	0
	4 (SUS)	0	-41027	0	0	0	0
	5 (EXP)	0	0	0	0	0	0

CAESAR II Ver.5.10.00, (Build 070917) Date: JUL 18, 2010 Time: 19:43
 Job: C:\DOCUMENTS AND SETTINGS\ABC\MY DOCUM...KORBA_BFD_#4_500MW
 Licensed To: DEALR/VAL COPY -- ID #4369

RESTRAINT SUMMARY REPORT: Loads On Restraints
 Various Load Cases

NODE	Load Case	FX N.	FY N.	FZ N.	MX N.m.	MY N.m.	MZ N.m.
	MAX		-41027/3				
1225		Displ. Reaction					
	3 (OPE)	2860	-738	-6234	-76802	107836	58157
	4 (SUS)	148	-7619	642	26433	3026	-22392
	5 (EXP)	2712	6881	-6876	-103235	104810	80549
	MAX	2860/3	-7619/4	-6876/5	-103235/5	107836/3	80549/5
2000		Prog Design VSH					
	3 (OPE)	0	-10643	0	0	0	0
	4 (SUS)	0	-11135	0	0	0	0
	5 (EXP)	0	493	0	0	0	0
	MAX		-11135/4				
2020		Prog Design VSH					
	3 (OPE)	0	-7157	0	0	0	0
	4 (SUS)	0	-7924	0	0	0	0
	5 (EXP)	0	766	0	0	0	0
	MAX		-7924/4				
2045		Prog Design VSH					
	3 (OPE)	0	-7473	0	0	0	0
	4 (SUS)	0	-8681	0	0	0	0
	5 (EXP)	0	1209	0	0	0	0
	MAX		-8681/4				
2065		Prog Design VSH					
	3 (OPE)	0	-12895	0	0	0	0
	4 (SUS)	0	-12678	0	0	0	0
	5 (EXP)	0	-217	0	0	0	0
	MAX		-12895/3				
5015		Prog Design VSH					
	3 (OPE)	0	-14327	0	0	0	0
	4 (SUS)	0	-16392	0	0	0	0
	5 (EXP)	0	2064	0	0	0	0
	MAX		-16392/4				
5025		Prog Design VSH					
	3 (OPE)	0	-17776	0	0	0	0
	4 (SUS)	0	-18864	0	0	0	0
	5 (EXP)	0	1088	0	0	0	0
	MAX		-18864/4				

CAESAR II Ver.5.10.00, (Build 070917) Date: JUL 18, 2010 Time: 19:43
 Job: C:\DOCUMENTS AND SETTINGS\ABC\MY DOCUM...\KORBA_BFD_#4_500MW
 Licensed To: DEALR/EVAL COPY -- ID #4369

RESTRAINT SUMMARY REPORT: Loads On Restraints
 Various Load Cases

NODE	Load Case	FX N.	FY N.	FZ N.	MX N.m.	MY N.m.	MZ N.m.
5035		Rigid Y					
	3 (OPE)	0	-38338	0	0	0	0
	4 (SUS)	0	-39137	0	0	0	0
	5 (EXP)	0	799	0	0	0	0
	MAX		-39137/4				
5045		Prog Design VSH					
	3 (OPE)	0	-12404	0	0	0	0
	4 (SUS)	0	-10170	0	0	0	0
	5 (EXP)	0	-2233	0	0	0	0
	MAX		-12404/3				
5060		Prog Design VSH					
	3 (OPE)	0	-42081	0	0	0	0
	4 (SUS)	0	-40116	0	0	0	0
	5 (EXP)	0	-1965	0	0	0	0
	MAX		-42081/3				
6020		Prog Design VSH					
	3 (OPE)	0	-9608	0	0	0	0
	4 (SUS)	0	-11156	0	0	0	0
	5 (EXP)	0	1549	0	0	0	0
	MAX		-11156/4				
6030		Prog Design VSH					
	3 (OPE)	0	-18622	0	0	0	0
	4 (SUS)	0	-19200	0	0	0	0
	5 (EXP)	0	578	0	0	0	0
	MAX		-19200/4				
6050		Prog Design VSH					
	3 (OPE)	0	-15591	0	0	0	0
	4 (SUS)	0	-14745	0	0	0	0
	5 (EXP)	0	-846	0	0	0	0
	MAX		-15591/3				
6075		Prog Design VSH					
	3 (OPE)	0	-34985	0	0	0	0
	4 (SUS)	0	-31844	0	0	0	0
	5 (EXP)	0	-3141	0	0	0	0
	MAX		-34985/3				
7005		Prog Design					

CAESAR II Ver.5.10.00, (Build 070917) Date: JUL 18, 2010 Time: 19:43
 Job: C:\DOCUMENTS AND SETTINGS\ABC\MY DOCUM...KORBA_BFD_#4_500MW
 Licensed To: DEALR/EVAL COPY -- ID #4369

RESTRAINT SUMMARY REPORT: Loads On Restraints
 Various Load Cases

NODE	Load Case	FX N.	FY N.	FZ N.	MX N.m.	MY N.m.	MZ N.m.
		CSH					
	3 (OPE)	0	-54092	0	0	0	0
	4 (SUS)	0	-54092	0	0	0	0
	5 (EXP)	0	0	0	0	0	0
	MAX		-54092/3				
7025		Prog Design VSH					
	3 (OPE)	0	-40306	0	0	0	0
	4 (SUS)	0	-39284	0	0	0	0
	5 (EXP)	0	-1022	0	0	0	0
	MAX		-40306/3				
7040		Prog Design VSH					
	3 (OPE)	0	-23828	0	0	0	0
	4 (SUS)	0	-24065	0	0	0	0
	5 (EXP)	0	236	0	0	0	0
	MAX		-24065/4				
7060		Prog Design VSH					
	3 (OPE)	0	-20190	0	0	0	0
	4 (SUS)	0	-19479	0	0	0	0
	5 (EXP)	0	-711	0	0	0	0
	MAX		-20190/3				
7075		Prog Design VSH					
	3 (OPE)	0	-23925	0	0	0	0
	4 (SUS)	0	-24310	0	0	0	0
	5 (EXP)	0	386	0	0	0	0
	MAX		-24310/4				
7095		Prog Design VSH					
	3 (OPE)	0	-11387	0	0	0	0
	4 (SUS)	0	-11994	0	0	0	0
	5 (EXP)	0	607	0	0	0	0
	MAX		-11994/4				
7110		Prog Design VSH					
	3 (OPE)	0	-10999	0	0	0	0
	4 (SUS)	0	-10908	0	0	0	0
	5 (EXP)	0	-91	0	0	0	0
	MAX		-10999/3				
7130		Prog Design CSH					

CAESAR II Ver.5.10.00, (Build 070917) Date: JUL 18, 2010 Time: 19:43
 Job: C:\DOCUMENTS AND SETTINGS\ABC\MY DOCUM...\KORBA_BFD_#4_500MW
 Licensed To: DEALR/EVAL COPY -- ID #4369

RESTRAINT SUMMARY REPORT: Loads On Restraints
 Various Load Cases

NODE	Load Case	FX N.	FY N.	FZ N.	MX N.m.	MY N.m.	MZ N.m.
	3 (OPE)	0	-11420	0	0	0	0
	4 (SUS)	0	-11420	0	0	0	0
	5 (EXP)	0	0	0	0	0	0
	MAX		-11420/3				
8010	Prog Design VSH						
	3 (OPE)	0	-15579	0	0	0	0
	4 (SUS)	0	-14484	0	0	0	0
	5 (EXP)	0	-1095	0	0	0	0
	MAX		-15579/3				
8030	Prog Design VSH						
	3 (OPE)	0	-18636	0	0	0	0
	4 (SUS)	0	-19013	0	0	0	0
	5 (EXP)	0	378	0	0	0	0
	MAX		-19013/4				
8040	Prog Design VSH						
	3 (OPE)	0	-9382	0	0	0	0
	4 (SUS)	0	-10540	0	0	0	0
	5 (EXP)	0	1158	0	0	0	0
	MAX		-10540/4				
9020	Prog Design VSH						
	3 (OPE)	0	-41936	0	0	0	0
	4 (SUS)	0	-38692	0	0	0	0
	5 (EXP)	0	-3245	0	0	0	0
	MAX		-41936/3				
9035	Prog Design VSH						
	3 (OPE)	0	-12524	0	0	0	0
	4 (SUS)	0	-10263	0	0	0	0
	5 (EXP)	0	-2261	0	0	0	0
	MAX		-12524/3				
9045	Rigid Y						
	3 (OPE)	0	-43064	0	0	0	0
	4 (SUS)	0	-42679	0	0	0	0
	5 (EXP)	0	-386	0	0	0	0
	MAX		-43064/3				
9055	Prog Design VSH						
	3 (OPE)	0	-17729	0	0	0	0
	4 (SUS)	0	-18887	0	0	0	0

CAESAR II Ver.5.10.00, (Build 070917) Date: JUL 18, 2010 Time: 19:43
 Job: C:\DOCUMENTS AND SETTINGS\ABC\MY DOCUM...\KORBA_BFD_#4_500MW
 Licensed To: DEALR/EVAL COPY -- ID #4369

RESTRAINT SUMMARY REPORT: Loads On Restraints
 Various Load Cases

NODE	Load Case	FX N.	FY N.	FZ N.	MX N.m.	MY N.m.	MZ N.m.
	5 (EXP)	0	1158	0	0	0	0
	MAX		-18887/4				
9065		Prog Design VSH					
	3 (OPE)	0	-14780	0	0	0	0
	4 (SUS)	0	-16851	0	0	0	0
	5 (EXP)	0	2071	0	0	0	0
	MAX		-16851/4				

CAESAR II Ver.5.10.00, (Build 070917) Date: JUL 18, 2010 Time: 19:43
 Job: C:\DOCUMENTS AND SETTINGS\ABC\MY DOCUM...KORBA_BFD_#4_500MW
 Licensed To: DEALR/EVAL COPY -- ID #4369

DISPLACEMENTS REPORT: Nodal Movements
 CASE 3 (OPE) W+D1+T1+P1+H

NODE	DX mm.	DY mm.	DZ mm.	RX deg.	RY deg.	RZ deg.
5	1.000	-0.000	0.000	-0.0000	-0.0000	0.0000
10	3.396	-6.947	0.385	-0.0081	-0.0339	0.0640
13	3.702	-7.468	0.423	-0.0078	-0.0364	0.0659
14	4.044	-8.180	0.773	-0.0065	-0.0405	0.0692
15	3.950	-8.444	1.520	-0.0057	-0.0467	0.0708
18	0.492	-8.123	7.108	-0.0068	-0.0991	0.0838
19	0.083	-7.848	8.144	-0.0057	-0.1191	0.0856
20	0.470	-7.264	9.302	-0.0041	-0.1399	0.0869
25	2.054	-6.021	11.460	-0.0006	-0.1623	0.0861
28	3.734	-4.735	14.089	0.0030	-0.1847	0.0847
29	5.002	-4.166	15.060	0.0050	-0.2027	0.0852
30	6.698	-3.892	14.898	0.0078	-0.2191	0.0860
35	20.393	-3.108	8.667	0.0162	-0.2584	0.0906
39	38.707	-2.093	0.582	0.0216	-0.2187	0.0952
40	39.915	-2.764	0.139	0.0212	-0.2070	0.0934
45	40.513	-3.475	0.004	0.0211	-0.1972	0.0924
48	43.821	-7.869	-0.902	0.0265	-0.1369	0.0693
49	43.938	-8.766	-1.436	0.0286	-0.1254	0.0563
50	43.349	-9.391	-2.293	0.0305	-0.1118	0.0418
55	41.477	-9.928	-4.024	0.0373	-0.0938	0.0218
60	39.307	-10.353	-5.856	0.0374	-0.0937	0.0217
65	37.832	-10.547	-7.023	0.0427	-0.0823	0.0083
70	36.670	-10.583	-7.840	0.0470	-0.0740	-0.0016
75	34.500	-10.550	-9.286	0.0470	-0.0739	-0.0018
80	33.823	-10.521	-9.725	0.0495	-0.0702	-0.0074
85	32.608	-9.274	-10.050	0.0586	-0.0552	-0.0328
87	32.724	-10.076	-10.265	0.0547	-0.0608	-0.0225
88	33.402	-10.487	-9.987	0.0510	-0.0679	-0.0109
90	35.307	-2.553	-6.252	0.0630	-0.0142	-0.0445
93	35.659	-1.649	-5.742	0.0619	-0.0087	-0.0410
94	35.607	-0.819	-5.354	0.0602	-0.0037	-0.0337
95	34.962	-0.323	-5.195	0.0587	0.0020	-0.0251
100	33.090	-0.000	-5.097	0.0539	0.0090	-0.0124
105	26.313	-0.000	-4.089	0.0369	0.0200	0.0024
110	20.505	-0.000	-3.187	0.0222	0.0115	0.0006
115	18.886	-0.025	-3.054	0.0181	0.0062	0.0013
200	1.000	-0.000	0.000	0.0000	0.0000	-0.0000
205	0.128	-6.946	-0.146	0.0059	0.0174	-0.0232
208	-0.284	-8.824	-0.267	0.0086	0.0222	-0.0250
209	-0.386	-9.582	-0.028	0.0109	0.0244	-0.0250
210	-0.284	-9.964	0.670	0.0130	0.0275	-0.0247
213	0.037	-10.117	1.899	0.0146	0.0310	-0.0244
214	0.557	-10.285	2.536	0.0166	0.0358	-0.0245
215	1.389	-10.493	2.585	0.0184	0.0412	-0.0248
220	3.504	-10.980	1.721	0.0230	0.0497	-0.0273
223	3.876	-11.073	1.553	0.0238	0.0512	-0.0281
224	4.456	-11.198	0.894	0.0256	0.0572	-0.0302
225	4.361	-11.106	0.003	0.0281	0.0629	-0.0317

CAESAR II Ver.5.10.00, (Build 070917) Date: JUL 18, 2010 Time: 19:43
 Job: C:\DOCUMENTS AND SETTINGS\ABC\MY DOCUM...\KORBA_BFD_#4_500MW
 Licensed To: DEALR/EVAL COPY -- ID #4369

DISPLACEMENTS REPORT: Nodal Movements
 CASE 3 (OPE) W+D1+T1+P1+H

NODE	DX mm.	DY mm.	DZ mm.	RX deg.	RY deg.	RZ deg.
230	1.343	-9.704	-4.776	0.0350	0.0749	-0.0407
233	-1.661	-8.300	-9.168	0.0360	0.0749	-0.0490
234	-2.286	-8.366	-9.996	0.0353	0.0732	-0.0504
235	-2.821	-9.001	-10.527	0.0341	0.0714	-0.0517
240	-3.559	-10.565	-10.999	0.0329	0.0679	-0.0525
243	-4.586	-12.747	-11.633	0.0318	0.0629	-0.0513
244	-5.220	-13.341	-11.673	0.0316	0.0609	-0.0494
245	-6.083	-13.326	-11.367	0.0316	0.0584	-0.0473
250	-7.182	-12.865	-10.799	0.0313	0.0563	-0.0457
255	-9.352	-11.972	-9.699	0.0313	0.0562	-0.0457
257	-10.825	-11.392	-8.976	0.0309	0.0526	-0.0410
260	-11.987	-10.986	-8.441	0.0306	0.0495	-0.0365
265	-14.157	-10.272	-7.473	0.0306	0.0495	-0.0365
270	-14.835	-10.059	-7.177	0.0304	0.0474	-0.0330
273	-15.256	-9.938	-6.999	0.0303	0.0461	-0.0309
274	-15.915	-9.456	-6.628	0.0297	0.0416	-0.0238
275	-16.085	-8.667	-6.326	0.0289	0.0379	-0.0173
280	-15.689	-0.008	-4.326	0.0206	0.0003	0.0001
300	1.000	-0.000	0.000	0.0000	0.0000	0.0000
305	0.956	1.933	0.013	0.0013	0.0155	0.0036
308	0.931	2.644	0.022	0.0015	0.0212	0.0036
309	0.979	3.369	0.337	0.0017	0.0284	0.0017
310	1.194	3.660	1.072	0.0009	0.0381	-0.0009
313	2.422	3.687	3.811	-0.0039	0.0637	-0.0070
314	3.192	3.700	4.339	-0.0067	0.0803	-0.0086
315	4.156	3.657	4.053	-0.0089	0.0980	-0.0108
320	7.471	3.212	0.486	-0.0180	0.1412	-0.0209
323	9.731	2.700	-2.701	-0.0243	0.1719	-0.0275
324	9.956	2.441	-4.196	-0.0267	0.1915	-0.0292
325	8.931	2.176	-5.466	-0.0289	0.2103	-0.0301
330	-3.944	0.498	-11.407	-0.0350	0.2624	-0.0341
333	-18.836	-1.490	-17.542	-0.0329	0.2676	-0.0383
334	-20.688	-2.002	-18.186	-0.0311	0.2626	-0.0382
335	-21.650	-2.816	-18.289	-0.0296	0.2577	-0.0373
340	-22.396	-5.153	-17.696	-0.0264	0.2439	-0.0317
343	-22.922	-7.338	-17.212	-0.0225	0.2311	-0.0201
344	-23.327	-8.031	-16.453	-0.0191	0.2257	-0.0098
345	-24.075	-8.306	-14.942	-0.0161	0.2191	0.0008
350	-25.949	-8.433	-11.320	-0.0107	0.2099	0.0139
355	-28.119	-8.706	-7.218	-0.0106	0.2098	0.0140
360	-28.604	-8.774	-6.308	-0.0092	0.2071	0.0175
365	-29.821	-9.016	-4.076	-0.0057	0.2000	0.0261
370	-31.991	-9.527	-0.167	-0.0056	0.2000	0.0262
375	-32.712	-9.711	1.117	-0.0035	0.1953	0.0306
378	-33.055	-9.809	1.717	-0.0025	0.1931	0.0327
379	-33.891	-9.749	2.956	-0.0008	0.1843	0.0410
380	-34.490	-9.138	3.452	0.0012	0.1770	0.0481
385	-35.848	-6.296	3.551	0.0061	0.1520	0.0555
388	-38.115	-1.517	3.933	0.0107	0.1100	0.0441
389	-38.079	-0.681	3.722	0.0121	0.1024	0.0354

CAESAR II Ver.5.10.00. (Build 070917) Date: JUL 18, 2010 Time: 19:43
 Job: C:\DOCUMENTS AND SETTINGS\ABC\MY DOCUM... \KORBA_BFD_#4_500MW
 Licensed To: DEALR/EVAL COPY -- ID #4369

DISPLACEMENTS REPORT: Nodal Movements
 CASE 3 (OPE) W+D1+T1+P1+H

NODE	DX mm.	DY mm.	DZ mm.	RX deg.	RY deg.	RZ deg.
390	-37.437	-0.178	3.114	0.0132	0.0933	0.0252
395	-36.533	-0.000	2.377	0.0135	0.0875	0.0178
400	-26.271	-0.000	-3.010	0.0171	0.0327	-0.0033
405	-17.751	-0.000	-4.298	0.0201	0.0034	0.0007
410	-17.217	-0.001	-4.311	0.0203	0.0021	-0.0001
415	-16.479	-0.005	-4.321	0.0205	0.0010	-0.0002
500	-13.753	-0.000	-4.297	0.0193	-0.0034	0.0000
505	-8.912	-0.016	-3.973	0.0162	-0.0108	-0.0002
508	-8.722	0.216	-6.755	0.0145	-0.0143	-0.0061
509	-8.596	0.808	-7.928	0.0129	-0.0176	-0.0093
510	-4.100	-0.000	-3.679	0.0160	-0.0113	0.0000
515	10.174	-0.000	-3.001	0.0153	-0.0037	-0.0004
520	14.344	-0.032	-2.966	0.0151	0.0010	-0.0013
525	16.551	-0.037	-2.994	0.0164	0.0034	0.0002
530	17.658	-0.034	-3.018	0.0170	0.0045	0.0007
533	14.322	0.236	-6.380	0.0142	0.0012	-0.0039
534	14.329	1.000	-7.887	0.0139	0.0009	-0.0054
535	14.380	2.605	-8.416	0.0131	0.0006	-0.0073
540	15.678	19.022	-8.064	-0.0115	-0.0016	-0.0237
545	16.230	22.871	-8.413	-0.0225	-0.0020	-0.0291
550	18.899	22.427	-8.374	-0.0292	-0.0030	-0.0316
555	20.122	22.212	-8.352	-0.0341	-0.0034	-0.0331
559	21.232	21.478	-8.215	-0.0436	-0.0048	-0.0379
560	21.467	20.161	-7.875	-0.0546	-0.0058	-0.0427
565	20.945	18.021	-7.181	-0.0642	-0.0058	-0.0468
570	19.534	12.965	-5.143	-0.0829	-0.0056	-0.0556
575	18.448	9.371	-3.522	-0.0830	-0.0056	-0.0556
580	13.105	-6.963	2.515	-0.0882	-0.0051	-0.0712
581	13.263	-5.869	3.485	-0.0917	-0.0051	-0.0703
582	13.709	-4.401	3.375	-0.0939	-0.0053	-0.0691
585	13.317	-9.731	-3.803	-0.0751	-0.0068	-0.0752
588	13.332	-9.882	-4.179	-0.0743	-0.0069	-0.0754
589	13.885	-10.555	-5.370	-0.0693	-0.0080	-0.0758
590	15.119	-11.236	-5.816	-0.0649	-0.0088	-0.0762
593	17.370	-12.173	-5.706	-0.0579	-0.0086	-0.0769
594	18.790	-12.180	-5.800	-0.0536	-0.0080	-0.0780
595	19.808	-11.184	-6.114	-0.0489	-0.0072	-0.0795
600	22.630	-4.871	-7.618	-0.0405	-0.0015	-0.0853
605	24.075	-1.822	-8.278	-0.0397	0.0013	-0.0889
610	26.164	1.262	-9.007	-0.0409	0.0039	-0.0926
611	25.419	0.619	-8.821	-0.0404	0.0033	-0.0917
612	24.870	-0.195	-8.629	-0.0400	0.0026	-0.0908
615	27.285	1.992	-9.252	-0.0418	0.0049	-0.0932
620	28.359	2.689	-9.495	-0.0428	0.0059	-0.0932
700	13.560	23.302	-8.436	-0.0265	-0.0012	-0.0305
705	12.331	23.510	-8.442	-0.0294	-0.0008	-0.0317
710	10.285	22.120	-8.095	-0.0418	0.0017	-0.0384
711	11.029	23.230	-8.353	-0.0351	0.0006	-0.0352
715	9.822	19.980	-7.574	-0.0475	0.0024	-0.0410
720	9.042	16.636	-6.635	-0.0554	0.0035	-0.0447

CAESAR II Ver.5.10.00, (Build 070917) Date: JUL 18, 2010 Time: 19:43
 Job: C:\DOCUMENTS AND SETTINGS\ABC\MY DOCUM...KORBA_BFD_#4_500MW
 Licensed To: DEALR/EVAL COPY -- ID #4369

DISPLACEMENTS REPORT: Nodal Movements
 CASE 3 (OPE) W+D1+T1+P1+H

NODE	DX mm.	DY mm.	DZ mm.	RX deg.	RY deg.	RZ deg.
725	8.169	13.042	-5.553	-0.0554	0.0035	-0.0447
730	3.443	-4.753	-1.346	-0.0627	0.0093	-0.0524
731	3.645	-3.834	-0.304	-0.0646	0.0089	-0.0523
732	4.013	-2.441	-0.231	-0.0657	0.0084	-0.0521
735	3.126	-6.744	-7.659	-0.0560	0.0094	-0.0527
738	3.108	-6.856	-8.035	-0.0557	0.0094	-0.0527
739	2.548	-7.065	-9.222	-0.0537	0.0089	-0.0530
740	1.316	-6.857	-9.667	-0.0519	0.0080	-0.0533
743	-0.936	-6.203	-9.576	-0.0492	0.0067	-0.0533
744	-2.002	-5.352	-9.668	-0.0476	0.0050	-0.0525
745	-2.161	-4.001	-9.962	-0.0460	0.0034	-0.0514
750	-0.441	2.313	-11.490	-0.0440	-0.0045	-0.0491
753	0.801	6.988	-12.626	-0.0459	-0.0104	-0.0487
754	0.917	7.890	-12.852	-0.0465	-0.0115	-0.0488
755	0.795	8.792	-13.080	-0.0472	-0.0125	-0.0491
760	0.475	9.985	-13.391	-0.0483	-0.0139	-0.0503
765	0.175	11.130	-13.696	-0.0489	-0.0146	-0.0512
766	-0.658	14.505	-14.624	-0.0510	-0.0169	-0.0559
800	-8.470	2.051	-8.349	0.0112	-0.0205	-0.0133
805	-7.949	7.402	-8.078	0.0078	-0.0300	-0.0227
810	-7.527	10.695	-7.943	0.0073	-0.0334	-0.0245
815	-7.047	14.288	-7.801	0.0073	-0.0335	-0.0245
820	-6.893	15.425	-7.756	0.0071	-0.0347	-0.0252
825	-6.394	18.908	-7.627	0.0066	-0.0383	-0.0275
828	-9.176	19.295	-8.194	0.0058	-0.0369	-0.0248
829	-10.451	18.954	-8.448	0.0053	-0.0359	-0.0243
830	-11.112	17.811	-8.579	0.0049	-0.0352	-0.0245
835	-11.221	16.993	-8.600	0.0048	-0.0348	-0.0246
840	-11.324	16.225	-8.620	0.0047	-0.0345	-0.0247
845	-11.806	12.632	-8.712	0.0047	-0.0345	-0.0247
848	-12.197	9.755	-8.789	0.0052	-0.0331	-0.0254
849	-11.859	8.451	-8.735	0.0059	-0.0324	-0.0258
850	-10.699	7.767	-8.538	0.0066	-0.0314	-0.0253
853	-6.253	19.814	-7.594	0.0067	-0.0399	-0.0296
854	-5.928	21.040	-8.049	0.0070	-0.0429	-0.0351
855	-5.534	21.590	-9.236	0.0073	-0.0465	-0.0398
860	-3.964	21.802	-14.910	0.0034	-0.0552	-0.0572
865	4.011	22.261	-34.803	0.0017	-0.0941	-0.1184
870	12.142	21.727	-48.281	-0.0163	-0.1281	-0.1599
873	12.746	21.648	-49.138	-0.0180	-0.1305	-0.1625
874	14.128	21.068	-49.981	-0.0218	-0.1371	-0.1671
875	15.718	19.889	-49.556	-0.0246	-0.1439	-0.1720
880	27.645	8.017	-39.013	-0.0435	-0.1823	-0.1982
885	34.935	-0.325	-31.261	-0.0551	-0.2092	-0.2211
890	36.163	-1.810	-29.853	-0.0563	-0.2121	-0.2233
895	37.270	-3.158	-28.571	-0.0569	-0.2137	-0.2246
900	39.901	-6.428	-25.450	-0.0576	-0.2220	-0.2323
905	42.083	-9.222	-22.776	-0.0581	-0.2283	-0.2379
910	44.695	-12.643	-19.485	-0.0578	-0.2346	-0.2430
915	47.306	-16.124	-16.111	-0.0576	-0.2400	-0.2467

CAESAR II Ver.5.10.00, (Build 070917) Date: JUL 18, 2010 Time: 19:43
 Job: C:\DOCUMENTS AND SETTINGS\ABC\MY DOCUM... \KORBA_BFD_#4_500MW
 Licensed To: DEALR/EVAL COPY -- ID #4369

DISPLACEMENTS REPORT: Nodal Movements
 CASE 3 (OPE) W+D1+T1+P1+H

NODE	DX mm.	DY mm.	DZ mm.	RX deg.	RY deg.	RZ deg.
920	49.918	-19.644	-12.682	-0.0571	-0.2425	-0.2488
923	51.869	-22.282	-10.109	-0.0571	-0.2425	-0.2487
925	53.573	-24.587	-7.862	-0.0571	-0.2425	-0.2487
998	42.189	-6.502	-21.382	-0.0602	-0.2300	-0.2395
999	42.453	-5.813	-21.191	-0.0607	-0.2303	-0.2399
1000	43.158	-5.102	-21.279	-0.0612	-0.2307	-0.2404
1005	45.154	-3.577	-21.790	-0.0619	-0.2315	-0.2412
1008	53.497	2.732	-23.963	-0.0649	-0.2348	-0.2451
1009	54.614	4.612	-25.035	-0.0661	-0.2357	-0.2470
1010	54.079	6.745	-26.770	-0.0672	-0.2368	-0.2492
1015	52.953	8.275	-28.222	-0.0680	-0.2373	-0.2504
1020	49.359	13.170	-32.860	-0.0680	-0.2373	-0.2504
1025	48.490	14.356	-33.983	-0.0686	-0.2377	-0.2509
1030	46.253	17.416	-36.882	-0.0702	-0.2389	-0.2526
1035	41.902	23.393	-42.535	-0.0702	-0.2389	-0.2526
1040	39.666	26.478	-45.450	-0.0718	-0.2403	-0.2540
1045	38.796	27.679	-46.587	-0.0724	-0.2408	-0.2544
1050	35.202	32.653	-51.295	-0.0724	-0.2408	-0.2544
1053	34.076	34.215	-52.773	-0.0732	-0.2416	-0.2554
1054	32.168	35.400	-54.166	-0.0741	-0.2431	-0.2571
1055	29.971	34.893	-54.339	-0.0751	-0.2444	-0.2584
1060	22.872	29.866	-52.250	-0.0775	-0.2491	-0.2605
1063	20.810	28.411	-51.634	-0.0782	-0.2505	-0.2609
1064	19.776	26.965	-51.627	-0.0791	-0.2519	-0.2614
1065	20.787	25.945	-52.655	-0.0794	-0.2536	-0.2617
1070	22.276	25.518	-53.717	-0.0794	-0.2544	-0.2620
1075	24.024	25.019	-54.959	-0.0792	-0.2551	-0.2622
1080	25.601	24.571	-56.078	-0.0792	-0.2554	-0.2623
1083	27.181	24.122	-57.198	-0.0792	-0.2559	-0.2627
1084	30.050	22.565	-57.869	-0.0796	-0.2572	-0.2635
1085	32.525	20.060	-56.335	-0.0802	-0.2585	-0.2649
1090	35.122	16.275	-52.651	-0.0811	-0.2595	-0.2673
1095	55.858	-14.196	-22.781	-0.0884	-0.2658	-0.2706
1100	76.591	-45.371	7.595	-0.0956	-0.2684	-0.2760
1105	84.953	-58.191	19.898	-0.0985	-0.2684	-0.2807
1110	100.051	-80.508	41.382	-0.0916	-0.2463	-0.2585
1113	104.702	-87.031	47.511	-0.0894	-0.2341	-0.2504
1114	107.073	-89.459	48.829	-0.0877	-0.2252	-0.2419
1115	109.602	-91.047	48.046	-0.0848	-0.2160	-0.2340
1120	120.114	-95.140	38.496	-0.0725	-0.1896	-0.1935
1123	120.470	-95.276	38.150	-0.0721	-0.1888	-0.1921
1124	122.703	-96.538	37.230	-0.0673	-0.1813	-0.1837
1125	124.906	-98.294	38.095	-0.0625	-0.1736	-0.1731
1128	127.542	-100.708	40.534	-0.0569	-0.1662	-0.1632
1129	129.644	-101.398	41.716	-0.0538	-0.1579	-0.1515
1130	131.519	-100.358	41.822	-0.0503	-0.1507	-0.1401
1135	137.703	-91.179	39.559	-0.0423	-0.1128	-0.1085
1140	148.630	-62.304	31.181	-0.0807	0.0067	-0.0381
1143	149.381	-58.349	29.313	-0.0934	0.0231	-0.0319
1144	149.533	-57.135	27.826	-0.1040	0.0311	-0.0270

CAESAR II Ver.5.10.00, (Build 070917) Date: JUL 18, 2010 Time: 19:43
 Job: C:\DOCUMENTS AND SETTINGS\ABCIMY\DOCUM...\KORBA_BFD_#4_500MW
 Licensed To: DEALR/EVAL COPY -- ID #4369

DISPLACEMENTS REPORT: Nodal Movements
 CASE 3 (OPE) W+D1+T1+P1+H

NODE	DX mm.	DY mm.	DZ mm.	RX deg.	RY deg.	RZ deg.
1145	149.317	-57.414	25.879	-0.1141	0.0404	-0.0230
1150	146.779	-63.437	17.079	-0.1394	0.0652	-0.0076
1155	141.906	-70.227	4.111	-0.1649	0.0976	0.0155
1156	142.355	-71.225	6.145	-0.1604	0.0924	0.0114
1157	143.149	-70.532	8.275	-0.1564	0.0860	0.0077
1160	141.647	-67.466	1.602	-0.1698	0.1048	0.0187
1165	137.759	-54.556	-16.669	-0.2274	0.1504	0.0310
1166	139.125	-53.319	-14.321	-0.2164	0.1448	0.0299
1167	139.877	-54.138	-11.878	-0.2056	0.1399	0.0284
1170	132.186	-63.080	-23.249	-0.2542	0.1618	0.0331
1175	104.886	-105.511	-51.780	-0.2867	0.1846	0.0424
1180	78.676	-145.496	-78.824	-0.2446	0.1669	0.0510
1183	66.173	-163.354	-93.711	-0.1907	0.1409	0.0557
1184	64.343	-165.116	-94.804	-0.1771	0.1341	0.0552
1185	62.305	-166.194	-94.343	-0.1661	0.1268	0.0552
1190	61.639	-166.394	-93.886	-0.1622	0.1251	0.0555
1195	55.702	-168.175	-90.116	-0.1270	0.1076	0.0516
1200	51.691	-169.215	-87.917	-0.1032	0.0935	0.0427
1205	49.557	-169.711	-86.832	-0.1031	0.0934	0.0427
1210	46.349	-170.455	-85.203	-0.1030	0.0933	0.0426
1215	39.931	-171.679	-82.458	-0.0650	0.0629	0.0295
1220	30.304	-172.680	-80.538	-0.0079	0.0084	0.0046
1225	28.700	-172.700	-80.500	-0.0000	0.0000	0.0000
2000	30.635	28.139	-57.603	-0.0779	-0.2517	-0.2568
2003	37.583	33.166	-59.702	-0.0755	-0.2465	-0.2520
2004	39.124	33.541	-59.576	-0.0746	-0.2455	-0.2509
2005	40.476	32.722	-58.570	-0.0740	-0.2442	-0.2495
2010	42.542	29.929	-55.834	-0.0725	-0.2427	-0.2473
2015	45.478	25.980	-51.958	-0.0725	-0.2427	-0.2473
2020	47.275	23.567	-49.592	-0.0711	-0.2416	-0.2471
2025	47.974	22.626	-48.674	-0.0706	-0.2412	-0.2473
2030	48.552	21.849	-47.917	-0.0700	-0.2407	-0.2472
2035	52.081	17.102	-43.296	-0.0700	-0.2407	-0.2472
2040	52.659	16.326	-42.540	-0.0694	-0.2403	-0.2467
2045	57.266	10.165	-36.541	-0.0659	-0.2385	-0.2464
2050	58.640	8.319	-34.761	-0.0649	-0.2381	-0.2472
2055	61.575	4.371	-30.959	-0.0649	-0.2381	-0.2472
2058	64.059	1.036	-27.746	-0.0630	-0.2376	-0.2469
2059	64.442	-0.484	-26.508	-0.0622	-0.2373	-0.2475
2060	63.634	-1.831	-25.756	-0.0612	-0.2370	-0.2484
2065	54.426	-8.627	-23.554	-0.0581	-0.2359	-0.2485
2068	52.079	-10.367	-23.008	-0.0575	-0.2356	-0.2475
2069	51.330	-10.806	-22.769	-0.0572	-0.2355	-0.2468
2070	50.459	-11.121	-22.381	-0.0570	-0.2353	-0.2462
5000	1.956	16.853	-15.291	-0.0562	-0.0215	-0.0637
5003	5.294	19.569	-16.191	-0.0657	-0.0275	-0.0729
5004	6.173	19.940	-16.324	-0.0689	-0.0282	-0.0763
5005	2.828	17.555	-15.529	-0.0582	-0.0229	-0.0660
5010	7.124	19.806	-16.277	-0.0718	-0.0291	-0.0796
5015	11.684	17.720	-15.523	-0.0865	-0.0311	-0.0889

CAESAR II Ver.5.10.00, (Build 070917) Date: JUL 18, 2010 Time: 19:43
 Job: C:\DOCUMENTS AND SETTINGS\ABC\MY DOCUM...\KORBA_BFD_#4_500MW
 Licensed To: DEALR/EVAL COPY -- ID #4369

DISPLACEMENTS REPORT: Nodal Movements
 CASE 3 (OPE) W+D1+T1+P1+H

NODE	DX mm.	DY mm.	DZ mm.	RX deg.	RY deg.	RZ deg.
5018	12.540	17.300	-15.378	-0.0893	-0.0311	-0.0907
5019	13.833	16.433	-15.672	-0.0941	-0.0310	-0.0948
5020	14.533	15.528	-16.794	-0.0991	-0.0307	-0.0976
5025	16.471	8.618	-28.443	-0.1182	-0.0325	-0.1160
5028	17.703	4.005	-35.139	-0.1302	-0.0366	-0.1266
5029	17.596	2.640	-35.980	-0.1331	-0.0381	-0.1287
5030	16.848	1.071	-35.595	-0.1358	-0.0394	-0.1311
5035	16.080	-0.000	-34.800	-0.1370	-0.0405	-0.1323
5038	-0.804	-22.126	-18.294	-0.1268	-0.0645	-0.1445
5039	-1.937	-22.999	-16.968	-0.1223	-0.0661	-0.1447
5040	-2.772	-22.706	-15.427	-0.1179	-0.0678	-0.1448
5045	-5.710	-17.989	-7.696	-0.1032	-0.0722	-0.1442
5048	-6.108	-17.422	-6.681	-0.1007	-0.0726	-0.1442
5049	-7.083	-16.378	-5.675	-0.0956	-0.0734	-0.1437
5050	-8.488	-15.171	-5.662	-0.0916	-0.0743	-0.1434
5053	-13.665	-11.095	-7.820	-0.0770	-0.0785	-0.1429
5054	-14.481	-9.659	-8.546	-0.0733	-0.0809	-0.1411
5055	-14.061	-8.071	-9.233	-0.0691	-0.0829	-0.1386
5060	-8.943	-1.107	-11.630	-0.0587	-0.0953	-0.1322
5063	-6.070	2.928	-12.880	-0.0556	-0.1025	-0.1296
5064	-5.571	3.880	-13.207	-0.0552	-0.1041	-0.1291
5065	-5.339	4.928	-13.642	-0.0547	-0.1056	-0.1289
5070	-5.217	6.326	-14.270	-0.0542	-0.1077	-0.1290
5075	-5.098	7.717	-14.899	-0.0539	-0.1094	-0.1296
6000	-4.615	11.998	-16.834	-0.0538	-0.1149	-0.1333
6005	-0.810	13.660	-16.626	-0.0559	-0.1204	-0.1376
6010	0.508	14.216	-16.550	-0.0568	-0.1221	-0.1390
6013	3.121	15.303	-16.405	-0.0596	-0.1263	-0.1424
6014	4.901	15.708	-16.833	-0.0621	-0.1290	-0.1465
6015	6.360	15.516	-18.016	-0.0656	-0.1322	-0.1500
6020	6.740	15.324	-18.545	-0.0664	-0.1329	-0.1512
6023	10.217	13.512	-23.252	-0.0730	-0.1398	-0.1620
6024	10.695	12.521	-24.251	-0.0762	-0.1431	-0.1649
6025	9.991	11.104	-24.237	-0.0795	-0.1458	-0.1684
6030	8.337	9.314	-23.452	-0.0816	-0.1497	-0.1713
6033	3.859	4.605	-21.306	-0.0853	-0.1598	-0.1782
6034	3.177	2.904	-20.299	-0.0866	-0.1629	-0.1813
6035	3.890	1.201	-18.978	-0.0874	-0.1664	-0.1838
6040	3.907	1.184	-18.962	-0.0874	-0.1664	-0.1838
6045	7.501	-2.410	-15.709	-0.0874	-0.1664	-0.1839
6050	9.068	-3.983	-14.283	-0.0880	-0.1678	-0.1855
6055	9.780	-4.705	-13.631	-0.0882	-0.1683	-0.1862
6060	11.009	-5.953	-12.504	-0.0885	-0.1688	-0.1865
6065	12.116	-7.076	-11.487	-0.0886	-0.1690	-0.1865
6068	23.336	-12.240	-23.111	-0.0727	-0.1860	-0.2054
6069	25.657	-12.183	-24.904	-0.0674	-0.1913	-0.2089
6070	28.113	-10.858	-26.093	-0.0630	-0.1958	-0.2131
6075	32.707	-6.943	-27.384	-0.0589	-0.2049	-0.2187
7000	80.107	-56.403	23.206	-0.0988	-0.2705	-0.2849
7005	85.123	-53.191	21.487	-0.0977	-0.2766	-0.2898

CAESAR II Ver.5.10.00, (Build 070917) Date: JUL 18, 2010 Time: 19:43
 Job: C:\DOCUMENTS AND SETTINGS\ABC\MY DOCUM...KORBA_BFD_#4_500MW
 Licensed To: DEALR/EVAL COPY -- ID #4369

DISPLACEMENTS REPORT: Nodal Movements
 CASE 3 (OPE) W+D1+T1+P1+H

NODE	DX mm.	DY mm.	DZ mm.	RX deg.	RY deg.	RZ deg.
7008	93.145	-48.165	18.869	-0.0928	-0.2861	-0.2966
7009	94.604	-46.143	17.484	-0.0897	-0.2885	-0.2998
7010	94.215	-43.659	15.335	-0.0869	-0.2911	-0.3039
7015	93.968	-43.250	14.944	-0.0863	-0.2914	-0.3044
7020	90.374	-37.299	9.248	-0.0863	-0.2914	-0.3045
7025	88.706	-34.527	6.599	-0.0827	-0.2921	-0.3044
7030	86.261	-30.491	2.711	-0.0773	-0.2923	-0.3041
7035	81.910	-23.294	-4.207	-0.0773	-0.2923	-0.3041
7040	79.465	-19.251	-8.081	-0.0720	-0.2898	-0.3015
7045	77.796	-16.532	-10.702	-0.0683	-0.2876	-0.2978
7050	74.209	-10.722	-16.314	-0.0683	-0.2875	-0.2977
7053	73.962	-10.322	-16.700	-0.0677	-0.2870	-0.2971
7054	71.954	-8.887	-18.394	-0.0651	-0.2824	-0.2908
7055	69.564	-9.310	-18.742	-0.0622	-0.2783	-0.2840
7060	60.120	-15.619	-16.724	-0.0566	-0.2588	-0.2665
7063	57.908	-17.157	-16.253	-0.0563	-0.2541	-0.2624
7064	56.800	-17.772	-15.923	-0.0562	-0.2518	-0.2593
7065	55.518	-18.213	-15.383	-0.0562	-0.2492	-0.2562
7068	47.361	-13.406	-14.696	-0.0582	-0.2482	-0.2517
7069	47.620	-12.734	-14.501	-0.0584	-0.2501	-0.2529
7070	48.345	-12.038	-14.579	-0.0585	-0.2519	-0.2544
7075	50.482	-10.500	-15.069	-0.0589	-0.2561	-0.2568
7078	59.496	-4.191	-17.154	-0.0635	-0.2734	-0.2692
7079	61.784	-3.725	-16.827	-0.0657	-0.2771	-0.2747
7080	63.747	-5.050	-15.170	-0.0677	-0.2813	-0.2798
7085	65.627	-7.932	-12.275	-0.0709	-0.2846	-0.2835
7090	69.221	-13.473	-6.711	-0.0709	-0.2847	-0.2835
7095	70.058	-14.768	-5.411	-0.0723	-0.2857	-0.2852
7100	73.127	-19.576	-0.614	-0.0775	-0.2887	-0.2900
7105	77.478	-26.438	6.218	-0.0776	-0.2887	-0.2900
7110	80.547	-31.299	11.042	-0.0827	-0.2889	-0.2926
7115	81.554	-32.906	12.626	-0.0845	-0.2888	-0.2935
7120	85.148	-38.644	18.271	-0.0845	-0.2888	-0.2935
7123	86.624	-41.001	20.586	-0.0870	-0.2877	-0.2936
7124	87.033	-43.433	22.714	-0.0892	-0.2859	-0.2936
7125	85.602	-45.443	24.087	-0.0916	-0.2843	-0.2936
7130	77.588	-50.469	26.657	-0.0956	-0.2776	-0.2919
7133	75.212	-51.968	27.440	-0.0962	-0.2756	-0.2908
7134	74.052	-53.441	27.574	-0.0968	-0.2739	-0.2891
7135	75.060	-54.580	26.629	-0.0974	-0.2720	-0.2876
7140	76.378	-55.053	25.737	-0.0977	-0.2713	-0.2864
7145	78.189	-55.706	24.508	-0.0982	-0.2708	-0.2855
8000	13.223	-8.193	-10.474	-0.0888	-0.1678	-0.1851
8005	14.459	-9.428	-9.353	-0.0893	-0.1660	-0.1834
8010	15.165	-10.128	-8.720	-0.0897	-0.1644	-0.1823
8015	16.745	-11.687	-7.322	-0.0905	-0.1612	-0.1807
8020	20.339	-15.218	-4.172	-0.0906	-0.1611	-0.1807
8024	22.042	-15.907	-3.369	-0.0915	-0.1591	-0.1820
8025	23.747	-15.195	-3.542	-0.0920	-0.1577	-0.1843
8030	28.523	-10.486	-5.884	-0.0898	-0.1537	-0.1885

CAESAR II Ver.5.10.00, (Build 070917) Date: JUL 18, 2010 Time: 19:43
 Job: C:\DOCUMENTS AND SETTINGS\ABC\MY DOCUM...KORBA_BFD_#4_500MW
 Licensed To: DEALR/EVAL COPY -- ID #4369

DISPLACEMENTS REPORT: Nodal Movements
 CASE 3 (OPE) W+D1+T1+P1+H

NODE	DX mm.	DY mm.	DZ mm.	RX deg.	RY deg.	RZ deg.
8033	30.366	-8.695	-6.750	-0.0876	-0.1522	-0.1897
8034	31.207	-7.256	-6.817	-0.0840	-0.1509	-0.1912
8035	30.748	-6.216	-5.839	-0.0794	-0.1495	-0.1924
8040	26.964	-4.311	-1.133	-0.0657	-0.1475	-0.1958
8043	26.542	-4.122	-0.604	-0.0636	-0.1474	-0.1962
8044	25.361	-4.432	0.944	-0.0540	-0.1468	-0.1976
8045	24.434	-5.997	2.209	-0.0449	-0.1460	-0.1996
8050	23.434	-9.168	3.530	-0.0358	-0.1475	-0.2020
8055	22.920	-10.789	4.174	-0.0325	-0.1483	-0.2033
9000	21.353	-15.550	5.974	-0.0241	-0.1512	-0.2089
9005	16.343	-16.516	4.922	-0.0178	-0.1523	-0.2147
9010	14.610	-16.831	4.536	-0.0160	-0.1524	-0.2158
9013	12.185	-17.270	3.983	-0.0133	-0.1525	-0.2169
9014	11.527	-17.480	3.869	-0.0122	-0.1527	-0.2170
9015	10.946	-17.854	3.848	-0.0111	-0.1527	-0.2170
9020	5.647	-22.332	4.062	-0.0075	-0.1531	-0.2178
9023	-2.654	-29.294	4.368	-0.0108	-0.1536	-0.2213
9024	-4.610	-29.898	4.032	-0.0139	-0.1534	-0.2231
9025	-6.427	-28.933	3.069	-0.0169	-0.1527	-0.2250
9028	-11.647	-22.546	-1.195	-0.0280	-0.1480	-0.2275
9029	-12.468	-21.139	-2.658	-0.0312	-0.1442	-0.2263
9030	-12.044	-20.750	-4.255	-0.0362	-0.1397	-0.2244
9035	-11.281	-20.959	-5.272	-0.0389	-0.1377	-0.2233
9038	-5.866	-23.149	-13.013	-0.0660	-0.1203	-0.2146
9039	-4.512	-23.120	-14.426	-0.0775	-0.1145	-0.2125
9040	-2.812	-22.131	-15.482	-0.0897	-0.1096	-0.2099
9045	20.589	-0.000	-30.880	-0.1479	-0.0358	-0.1745
9048	21.599	1.071	-31.742	-0.1479	-0.0322	-0.1721
9049	22.633	2.677	-32.215	-0.1474	-0.0280	-0.1673
9050	22.923	4.143	-31.415	-0.1463	-0.0228	-0.1634
9055	22.407	9.414	-24.722	-0.1372	-0.0075	-0.1424
9058	22.663	17.452	-13.080	-0.1134	0.0129	-0.1059
9059	23.263	17.905	-11.916	-0.1069	0.0160	-0.1022
9060	24.520	17.536	-11.532	-0.1008	0.0185	-0.0985
9065	25.377	17.081	-11.621	-0.0968	0.0193	-0.0974
9068	29.936	14.733	-12.125	-0.0756	0.0203	-0.0920
9069	30.678	14.081	-12.128	-0.0714	0.0200	-0.0905
9070	30.999	13.150	-11.962	-0.0668	0.0199	-0.0893
9075	31.249	9.855	-11.248	-0.0566	0.0159	-0.0881
9080	31.347	8.593	-10.999	-0.0539	0.0145	-0.0883
9085	31.497	4.752	-10.272	-0.0471	0.0096	-0.0906

CAESAR II Ver.5.10.00, (Build 070917) Date: JUL 18, 2010 Time: 19:43
 Job: C:\DOCUMENTS AND SETTINGS\ABC\MY DOCUM...KORBA_BFD_#4_500MW
 Licensed To: DEALR/EVAL COPY -- ID #4369

DISPLACEMENTS REPORT: Nodal Movements
 CASE 4 (SUS) W+P1+H

NODE	DX mm.	DY mm.	DZ mm.	RX deg.	RY deg.	RZ deg.
5	-0.000	-0.000	-0.000	0.0000	0.0000	-0.0000
10	-0.293	-0.002	-0.659	0.0205	0.0009	-0.0090
13	-0.336	-0.003	-0.759	0.0219	0.0010	-0.0096
14	-0.401	-0.070	-0.915	0.0254	0.0010	-0.0111
15	-0.426	-0.248	-0.987	0.0277	0.0011	-0.0123
18	-0.341	-1.541	-0.987	0.0204	0.0026	-0.0201
19	-0.323	-1.723	-0.995	0.0178	0.0031	-0.0212
20	-0.314	-1.912	-1.018	0.0158	0.0037	-0.0228
25	-0.314	-2.257	-1.074	0.0121	0.0041	-0.0263
28	-0.314	-2.687	-1.139	0.0082	0.0044	-0.0293
29	-0.326	-2.865	-1.169	0.0063	0.0046	-0.0299
30	-0.357	-2.912	-1.181	0.0046	0.0046	-0.0298
35	-0.606	-2.728	-1.182	0.0006	0.0039	-0.0274
39	-0.851	-2.530	-1.210	0.0111	0.0002	-0.0242
40	-1.008	-2.498	-1.290	0.0130	-0.0005	-0.0237
45	-1.159	-2.497	-1.376	0.0138	-0.0011	-0.0234
48	-2.050	-2.501	-2.016	0.0182	-0.0045	-0.0214
49	-2.188	-2.444	-2.153	0.0194	-0.0052	-0.0207
50	-2.244	-2.309	-2.245	0.0204	-0.0061	-0.0207
55	-2.244	-1.954	-2.355	0.0223	-0.0069	-0.0218
60	-2.244	-1.529	-2.491	0.0223	-0.0069	-0.0218
65	-2.244	-1.235	-2.586	0.0238	-0.0072	-0.0218
70	-2.244	-1.009	-2.662	0.0250	-0.0074	-0.0215
75	-2.244	-0.589	-2.806	0.0250	-0.0074	-0.0215
80	-2.244	-0.458	-2.851	0.0257	-0.0073	-0.0210
85	-2.068	-0.195	-2.689	0.0282	-0.0065	-0.0178
87	-2.190	-0.247	-2.852	0.0271	-0.0069	-0.0193
88	-2.244	-0.379	-2.878	0.0262	-0.0072	-0.0207
90	-1.201	-0.191	-0.776	0.0355	-0.0045	-0.0112
93	-1.113	-0.190	-0.482	0.0368	-0.0042	-0.0105
94	-1.048	-0.164	-0.245	0.0387	-0.0038	-0.0093
95	-1.023	-0.107	-0.161	0.0404	-0.0032	-0.0078
100	-1.023	-0.000	-0.210	0.0439	-0.0025	-0.0039
105	-1.024	-0.000	-0.245	0.0567	0.0020	0.0007
110	-1.024	-0.000	0.015	0.0677	0.0084	-0.0004
115	-1.024	-0.001	0.153	0.0708	0.0106	-0.0001
200	0.000	-0.000	-0.000	0.0000	-0.0000	-0.0000
205	-0.477	-0.003	-0.356	0.0108	-0.0004	-0.0157
208	-0.781	-0.005	-0.560	0.0132	-0.0005	-0.0203
209	-0.927	-0.045	-0.652	0.0146	-0.0008	-0.0237
210	-1.001	-0.144	-0.693	0.0147	-0.0012	-0.0266
213	-1.015	-0.304	-0.693	0.0132	-0.0014	-0.0306
214	-1.025	-0.472	-0.689	0.0104	-0.0016	-0.0331
215	-1.030	-0.726	-0.677	0.0076	-0.0020	-0.0356
220	-1.030	-1.435	-0.634	-0.0001	-0.0027	-0.0385
223	-1.030	-1.566	-0.625	-0.0014	-0.0028	-0.0388
224	-1.021	-1.835	-0.605	-0.0044	-0.0035	-0.0393
225	-0.996	-1.982	-0.594	-0.0070	-0.0041	-0.0389

335

CAESAR II Ver.5.10.00, (Build 070917) Date: JUL 18, 2010 Time: 19:43
 Job: C:\DOCUMENTS AND SETTINGS\ABC\MY DOCUM...KORBA_BFD_#4_500MW
 Licensed To: DEALR/EVAL COPY -- ID #4369

DISPLACEMENTS REPORT: Nodal Movements
 CASE 4 (SUS) W+P1+H

NODE	DX mm.	DY mm.	DZ mm.	RX deg.	RY deg.	RZ deg.
230	-0.778	-2.338	-0.595	-0.0079	-0.0058	-0.0344
233	-0.534	-2.532	-0.595	0.0002	-0.0063	-0.0302
234	-0.573	-2.518	-0.602	0.0040	-0.0064	-0.0294
235	-0.746	-2.504	-0.641	0.0074	-0.0065	-0.0285
240	-1.140	-2.504	-0.772	0.0111	-0.0065	-0.0275
243	-1.667	-2.505	-1.038	0.0159	-0.0064	-0.0263
244	-1.838	-2.435	-1.170	0.0188	-0.0066	-0.0257
245	-1.907	-2.267	-1.267	0.0211	-0.0068	-0.0256
250	-1.907	-2.013	-1.334	0.0240	-0.0066	-0.0259
255	-1.907	-1.508	-1.464	0.0241	-0.0066	-0.0259
257	-1.907	-1.166	-1.548	0.0280	-0.0061	-0.0252
260	-1.907	-0.908	-1.609	0.0311	-0.0056	-0.0241
265	-1.907	-0.437	-1.718	0.0312	-0.0056	-0.0241
270	-1.907	-0.292	-1.751	0.0330	-0.0051	-0.0229
273	-1.907	-0.207	-1.770	0.0341	-0.0048	-0.0221
274	-1.851	-0.070	-1.701	0.0365	-0.0036	-0.0196
275	-1.731	-0.019	-1.459	0.0395	-0.0024	-0.0172
280	-1.024	-0.013	2.401	0.0604	0.0063	-0.0003
300	-0.000	-0.000	0.000	-0.0000	-0.0000	0.0000
305	-0.003	0.000	-0.000	-0.0001	-0.0000	0.0003
308	-0.005	-0.000	-0.001	-0.0002	-0.0000	0.0004
309	-0.008	0.000	-0.003	-0.0005	-0.0000	0.0005
310	-0.010	0.006	-0.005	-0.0015	-0.0000	0.0006
313	-0.009	0.083	-0.004	-0.0050	0.0001	0.0009
314	-0.008	0.125	-0.005	-0.0067	0.0003	0.0011
315	-0.007	0.153	-0.007	-0.0078	0.0005	0.0010
320	-0.007	0.119	-0.032	-0.0119	0.0013	-0.0059
323	-0.007	-0.078	-0.067	-0.0147	0.0022	-0.0117
324	-0.014	-0.203	-0.083	-0.0157	0.0029	-0.0129
325	-0.036	-0.346	-0.092	-0.0164	0.0035	-0.0135
330	-0.294	-1.208	-0.092	-0.0175	0.0059	-0.0161
333	-0.670	-2.142	-0.091	-0.0124	0.0075	-0.0188
334	-0.773	-2.215	-0.062	-0.0101	0.0078	-0.0192
335	-0.922	-2.241	-0.003	-0.0081	0.0080	-0.0197
340	-1.344	-2.239	0.134	-0.0048	0.0085	-0.0203
343	-1.749	-2.240	0.198	-0.0015	0.0089	-0.0208
344	-1.887	-2.183	0.225	0.0006	0.0089	-0.0212
345	-1.945	-2.042	0.280	0.0024	0.0089	-0.0220
350	-1.945	-1.658	0.432	0.0064	0.0090	-0.0236
355	-1.945	-1.197	0.607	0.0064	0.0090	-0.0236
360	-1.945	-1.093	0.647	0.0074	0.0089	-0.0235
365	-1.945	-0.839	0.744	0.0100	0.0087	-0.0231
370	-1.945	-0.388	0.914	0.0100	0.0087	-0.0231
375	-1.945	-0.240	0.971	0.0116	0.0085	-0.0223
378	-1.945	-0.171	0.997	0.0123	0.0084	-0.0218
379	-1.889	-0.033	1.087	0.0140	0.0081	-0.0197
380	-1.768	0.018	1.209	0.0162	0.0078	-0.0172
385	-1.393	0.020	1.678	0.0204	0.0063	-0.0121
388	-1.046	0.021	2.697	0.0267	0.0038	-0.0041
389	-1.027	0.015	2.868	0.0283	0.0032	-0.0020

CAESAR II Ver.5.10.00, (Build 070917) Date: JUL 18, 2010 Time: 19:43
 Job: C:\DOCUMENTS AND SETTINGS\ABC\MY DOCUM...KORBA_BFD_#4_500MW
 Licensed To: DEALR/EVAL COPY -- ID #4369

DISPLACEMENTS REPORT: Nodal Movements
 CASE 4 (SUS) W+P1+H

NODE	DX mm.	DY mm.	DZ mm.	RX deg.	RY deg.	RZ deg.
390	-1.024	0.008	2.928	0.0296	0.0025	-0.0012
395	-1.024	-0.000	2.909	0.0309	0.0022	-0.0021
400	-1.024	-0.000	2.765	0.0460	0.0018	0.0014
405	-1.024	-0.000	2.512	0.0586	0.0055	-0.0000
410	-1.024	-0.003	2.485	0.0593	0.0058	-0.0005
415	-1.024	-0.009	2.445	0.0600	0.0061	-0.0006
500	-1.024	-0.000	2.280	0.0641	0.0075	0.0007
505	-1.024	0.009	1.895	0.0733	0.0102	-0.0009
508	-1.187	1.166	1.895	0.0786	0.0115	-0.0100
509	-1.230	1.694	2.115	0.0812	0.0121	-0.0146
510	-1.024	-0.000	1.619	0.0733	0.0109	-0.0009
515	-1.024	-0.000	0.717	0.0731	0.0122	0.0012
520	-1.024	0.008	0.438	0.0730	0.0124	-0.0005
525	-1.024	0.002	0.294	0.0721	0.0116	-0.0004
530	-1.024	-0.000	0.225	0.0716	0.0112	-0.0003
533	-1.266	1.372	0.438	0.0728	0.0137	-0.0026
534	-1.375	1.982	0.689	0.0703	0.0147	-0.0036
535	-1.392	2.226	1.268	0.0665	0.0154	-0.0049
540	-0.574	2.241	6.286	0.0467	0.0231	-0.0138
545	-0.260	2.240	7.220	0.0426	0.0249	-0.0162
550	-0.260	1.999	6.853	0.0403	0.0257	-0.0170
555	-0.260	1.884	6.679	0.0387	0.0263	-0.0179
559	-0.314	1.757	6.401	0.0357	0.0277	-0.0216
560	-0.471	1.695	6.103	0.0319	0.0287	-0.0260
565	-0.798	1.696	5.753	0.0281	0.0308	-0.0301
570	-1.755	1.690	5.112	0.0185	0.0356	-0.0393
575	-2.524	1.690	4.750	0.0185	0.0356	-0.0394
580	-7.317	1.498	4.640	-0.0228	0.0523	-0.0651
581	-6.805	1.636	4.586	-0.0180	0.0504	-0.0627
582	-6.265	1.681	4.487	-0.0123	0.0488	-0.0596
585	-9.162	0.573	4.634	-0.0302	0.0561	-0.0753
588	-9.275	0.510	4.634	-0.0305	0.0563	-0.0759
589	-9.646	0.092	4.477	-0.0324	0.0574	-0.0783
590	-9.802	-0.523	4.095	-0.0338	0.0584	-0.0809
593	-9.802	-1.527	3.373	-0.0356	0.0593	-0.0833
594	-9.571	-2.083	2.881	-0.0368	0.0602	-0.0861
595	-8.993	-2.320	2.470	-0.0382	0.0609	-0.0893
600	-5.767	-2.318	1.104	-0.0412	0.0634	-0.0989
605	-4.085	-2.321	0.411	-0.0423	0.0646	-0.1038
610	-2.170	-2.589	-0.520	-0.0430	0.0657	-0.1085
611	-2.648	-2.390	-0.210	-0.0428	0.0655	-0.1074
612	-3.155	-2.322	0.034	-0.0427	0.0652	-0.1062
615	-1.556	-2.945	-0.976	-0.0432	0.0661	-0.1095
620	-0.965	-3.287	-1.415	-0.0433	0.0664	-0.1099
700	-0.260	2.483	7.582	0.0413	0.0250	-0.0173
705	-0.260	2.601	7.749	0.0403	0.0250	-0.0179
710	-0.440	2.778	7.633	0.0362	0.0259	-0.0199
711	-0.311	2.725	7.808	0.0385	0.0255	-0.0192
715	-0.675	2.779	7.224	0.0340	0.0262	-0.0204
720	-1.053	2.775	6.639	0.0304	0.0267	-0.0213

CAESAR II Ver.5.10.00, (Build 070917) Date: JUL 18, 2010 Time: 19:43
 Job: C:\DOCUMENTS AND SETTINGS\ABC\MY DOCUM...\KORBA_BFD_#4_500MW
 Licensed To: DEALR/EVAL COPY -- ID #4369

DISPLACEMENTS REPORT: Nodal Movements
 CASE 4 (SUS) W+P1+H

NODE	DX mm.	DY mm.	DZ mm.	RX deg.	RY deg.	RZ deg.
725	-1.469	2.775	6.044	0.0304	0.0267	-0.0213
730	-3.999	2.840	4.161	0.0064	0.0299	-0.0282
731	-3.728	2.792	4.182	0.0088	0.0295	-0.0274
732	-3.469	2.765	4.249	0.0117	0.0292	-0.0265
735	-5.032	2.995	4.161	0.0028	0.0308	-0.0314
738	-5.095	3.000	4.162	0.0025	0.0309	-0.0316
739	-5.298	3.100	4.246	0.0012	0.0313	-0.0323
740	-5.383	3.317	4.454	0.0002	0.0318	-0.0331
743	-5.383	3.728	4.846	-0.0015	0.0323	-0.0338
744	-5.291	3.952	5.054	-0.0026	0.0327	-0.0337
745	-5.071	4.043	5.122	-0.0038	0.0330	-0.0330
750	-3.974	4.046	4.930	-0.0072	0.0351	-0.0308
753	-3.213	4.042	4.717	-0.0094	0.0366	-0.0290
754	-3.077	4.059	4.695	-0.0098	0.0369	-0.0287
755	-2.951	4.110	4.718	-0.0103	0.0372	-0.0285
760	-2.791	4.202	4.780	-0.0108	0.0377	-0.0290
765	-2.635	4.291	4.839	-0.0111	0.0379	-0.0295
766	-2.152	4.569	5.005	-0.0119	0.0385	-0.0325
800	-1.148	1.918	2.655	0.0827	0.0126	-0.0202
805	-0.366	1.920	5.102	0.0854	0.0161	-0.0334
810	0.256	1.922	6.640	0.0864	0.0175	-0.0360
815	0.959	1.922	8.330	0.0864	0.0175	-0.0360
820	1.184	1.923	8.865	0.0868	0.0179	-0.0366
825	1.896	1.922	10.521	0.0880	0.0193	-0.0384
828	1.896	2.476	10.809	0.0879	0.0188	-0.0360
829	1.799	2.710	10.692	0.0878	0.0184	-0.0356
830	1.565	2.807	10.165	0.0877	0.0182	-0.0358
835	1.406	2.807	9.774	0.0877	0.0180	-0.0359
840	1.256	2.806	9.409	0.0876	0.0179	-0.0360
845	0.553	2.806	7.697	0.0876	0.0179	-0.0360
848	-0.015	2.805	6.331	0.0871	0.0174	-0.0367
849	-0.263	2.701	5.701	0.0866	0.0171	-0.0372
850	-0.367	2.451	5.348	0.0862	0.0167	-0.0365
853	2.089	1.922	10.956	0.0884	0.0199	-0.0401
854	2.311	2.164	11.540	0.0893	0.0205	-0.0442
855	2.298	2.753	11.784	0.0898	0.0213	-0.0476
860	1.595	5.484	11.791	0.0844	0.0246	-0.0613
865	-1.801	14.117	11.813	0.0732	0.0395	-0.1095
870	-5.142	18.704	11.825	0.0548	0.0527	-0.1422
873	-5.388	18.954	11.825	0.0535	0.0536	-0.1442
874	-5.747	18.896	11.676	0.0508	0.0562	-0.1477
875	-5.901	18.047	11.297	0.0492	0.0588	-0.1512
880	-5.901	7.891	7.040	0.0393	0.0726	-0.1641
885	-5.901	1.155	3.984	0.0332	0.0816	-0.1733
890	-5.901	-0.006	3.435	0.0326	0.0825	-0.1739
895	-5.901	-1.053	2.936	0.0322	0.0831	-0.1742
900	-5.901	-3.566	1.738	0.0310	0.0844	-0.1773
905	-5.901	-5.688	0.730	0.0300	0.0854	-0.1800
910	-5.901	-8.253	-0.490	0.0300	0.0864	-0.1807
915	-5.901	-10.820	-1.726	0.0297	0.0875	-0.1804

CAESAR II Ver.5.10.00, (Build 070917) Date: JUL 18, 2010 Time: 19:43
 Job: C:\DOCUMENTS AND SETTINGS\ABC\MY DOCUM...\KORBA_BFD_#4_500MW
 Licensed To: DEALR/EVAL COPY -- ID #4369

DISPLACEMENTS REPORT: Nodal Movements
 CASE 4 (SUS) W+P1+H

NODE	DX mm.	DY mm.	DZ mm.	RX deg.	RY deg.	RZ deg.
920	-5.901	-13.377	-2.973	0.0300	0.0881	-0.1796
923	-5.901	-15.281	-3.909	0.0300	0.0881	-0.1795
925	-5.901	-16.945	-4.726	0.0300	0.0881	-0.1795
998	-2.901	-6.008	1.051	0.0280	0.0848	-0.1859
999	-2.152	-6.065	1.136	0.0277	0.0850	-0.1877
1000	-1.406	-6.085	1.236	0.0275	0.0850	-0.1896
1005	0.176	-6.084	1.464	0.0274	0.0849	-0.1919
1008	6.913	-6.085	2.394	0.0268	0.0845	-0.2000
1009	8.236	-5.536	2.800	0.0266	0.0843	-0.2024
1010	8.790	-4.197	3.427	0.0265	0.0842	-0.2047
1015	8.790	-2.939	3.942	0.0263	0.0841	-0.2057
1020	8.790	1.082	5.587	0.0263	0.0841	-0.2057
1025	8.790	2.056	5.985	0.0262	0.0841	-0.2057
1030	8.790	4.555	7.007	0.0260	0.0840	-0.2056
1035	8.790	9.421	8.995	0.0260	0.0840	-0.2056
1040	8.790	11.921	10.017	0.0258	0.0839	-0.2048
1045	8.790	12.888	10.413	0.0257	0.0839	-0.2044
1050	8.790	16.883	12.053	0.0257	0.0839	-0.2044
1053	8.791	18.135	12.567	0.0255	0.0838	-0.2042
1054	8.235	19.477	13.049	0.0254	0.0838	-0.2037
1055	6.898	20.031	13.110	0.0252	0.0838	-0.2030
1060	1.357	20.033	12.427	0.0248	0.0836	-0.2025
1063	-0.245	20.032	12.232	0.0246	0.0835	-0.2027
1064	-1.831	20.101	12.069	0.0245	0.0835	-0.2032
1065	-2.931	20.266	12.004	0.0251	0.0837	-0.2038
1070	-3.379	20.411	12.008	0.0257	0.0838	-0.2042
1075	-3.905	20.584	12.012	0.0262	0.0840	-0.2045
1080	-4.380	20.743	12.016	0.0266	0.0841	-0.2047
1083	-4.855	20.903	12.021	0.0269	0.0843	-0.2050
1084	-5.529	20.415	11.729	0.0276	0.0849	-0.2054
1085	-5.816	18.770	11.009	0.0280	0.0857	-0.2063
1090	-5.828	15.832	9.785	0.0285	0.0863	-0.2080
1095	-5.918	-7.083	-0.303	0.0330	0.0912	-0.1945
1100	-6.000	-28.032	-10.916	0.0376	0.0955	-0.1736
1105	-6.031	-35.923	-15.331	0.0394	0.0971	-0.1698
1110	-6.083	-49.063	-23.368	0.0513	0.0967	-0.1538
1113	-6.098	-52.995	-25.825	0.0550	0.0960	-0.1536
1114	-6.442	-54.101	-26.645	0.0567	0.0954	-0.1511
1115	-7.257	-54.138	-26.983	0.0593	0.0948	-0.1486
1120	-12.130	-50.852	-26.983	0.0654	0.0927	-0.1361
1123	-12.305	-50.729	-26.983	0.0653	0.0927	-0.1357
1124	-13.093	-50.647	-27.310	0.0655	0.0919	-0.1332
1125	-13.418	-51.539	-28.092	0.0659	0.0912	-0.1300
1128	-13.418	-53.382	-29.394	0.0661	0.0904	-0.1272
1129	-12.979	-54.447	-29.924	0.0664	0.0895	-0.1246
1130	-11.934	-54.880	-29.674	0.0667	0.0887	-0.1225
1135	-5.965	-54.876	-26.314	0.0681	0.0849	-0.1167
1140	11.038	-54.875	-14.903	0.0789	0.0728	-0.1001
1143	13.171	-54.876	-13.181	0.0812	0.0712	-0.0980
1144	13.751	-54.587	-12.482	0.0831	0.0705	-0.0966

CAESAR II Ver.5.10.00, (Build 070917) Date: JUL 18, 2010 Time: 19:43
 Job: C:\DOCUMENTS AND SETTINGS\ABC\MY DOCUM...\KORBA_BFD_#4_500MW
 Licensed To: DEALR/EVAL COPY -- ID #4369

DISPLACEMENTS REPORT: Nodal Movements
 CASE 4 (SUS) W+P1+H

NODE	DX mm.	DY mm.	DZ mm.	RX deg.	RY deg.	RZ deg.
1145	13.497	-53.870	-12.184	0.0854	0.0697	-0.0954
1150	10.257	-49.624	-12.167	0.0908	0.0667	-0.0895
1155	7.400	-44.070	-10.988	0.0967	0.0617	-0.0811
1156	6.923	-44.409	-11.810	0.0959	0.0625	-0.0825
1157	7.164	-45.221	-12.150	0.0947	0.0635	-0.0836
1160	8.607	-44.069	-9.532	0.0973	0.0604	-0.0797
1165	14.385	-42.829	-1.088	0.1038	0.0519	-0.0709
1166	14.577	-43.711	-1.456	0.1029	0.0529	-0.0719
1167	14.146	-44.072	-2.328	0.1017	0.0537	-0.0732
1170	12.592	-39.158	-1.074	0.0996	0.0493	-0.0670
1175	5.965	-23.060	-1.010	0.1024	0.0367	-0.0499
1180	1.627	-9.569	-0.956	0.0835	0.0226	-0.0338
1183	0.153	-3.773	-0.933	0.0647	0.0141	-0.0249
1184	0.041	-3.148	-0.886	0.0610	0.0122	-0.0234
1185	0.000	-2.745	-0.788	0.0572	0.0105	-0.0207
1190	0.000	-2.670	-0.751	0.0558	0.0101	-0.0200
1195	0.000	-2.089	-0.479	0.0437	0.0069	-0.0182
1200	0.000	-1.669	-0.350	0.0355	0.0050	-0.0207
1205	0.000	-1.429	-0.292	0.0355	0.0050	-0.0207
1210	0.000	-1.068	-0.205	0.0355	0.0050	-0.0207
1215	0.000	-0.392	-0.073	0.0224	0.0027	-0.0149
1220	0.000	-0.008	-0.001	0.0027	0.0003	-0.0016
1225	0.000	-0.000	0.000	0.0000	0.0000	-0.0000
2000	-0.435	20.743	12.538	0.0271	0.0838	-0.2021
2003	5.063	20.742	13.290	0.0278	0.0834	-0.2003
2004	6.004	20.352	13.259	0.0280	0.0833	-0.2000
2005	6.393	19.412	12.922	0.0282	0.0832	-0.1995
2010	6.393	17.175	11.987	0.0284	0.0831	-0.1985
2015	6.393	14.006	10.660	0.0284	0.0831	-0.1985
2020	6.393	12.062	9.848	0.0287	0.0831	-0.1999
2025	6.393	11.299	9.532	0.0288	0.0831	-0.2008
2030	6.393	10.667	9.270	0.0289	0.0831	-0.2015
2035	6.393	6.798	7.675	0.0289	0.0831	-0.2015
2040	6.393	6.165	7.414	0.0290	0.0831	-0.2016
2045	6.393	1.097	5.327	0.0296	0.0834	-0.2041
2050	6.393	-0.435	4.704	0.0298	0.0835	-0.2053
2055	6.393	-3.714	3.370	0.0298	0.0835	-0.2053
2058	6.393	-6.473	2.240	0.0301	0.0838	-0.2030
2059	5.999	-7.424	1.787	0.0303	0.0841	-0.2014
2060	5.056	-7.815	1.480	0.0305	0.0843	-0.1998
2065	-2.205	-7.813	0.335	0.0315	0.0855	-0.1922
2068	-4.011	-7.814	0.036	0.0317	0.0858	-0.1896
2069	-4.449	-7.830	-0.045	0.0319	0.0860	-0.1881
2070	-4.729	-7.876	-0.114	0.0319	0.0863	-0.1868
5000	-1.595	4.247	4.458	-0.0127	0.0393	-0.0375
5003	-0.817	3.797	3.753	-0.0139	0.0403	-0.0425
5004	-0.670	3.649	3.567	-0.0144	0.0407	-0.0443
5005	-1.390	4.128	4.266	-0.0130	0.0395	-0.0388
5010	-0.614	3.439	3.359	-0.0147	0.0411	-0.0459
5015	-0.614	2.234	2.328	-0.0164	0.0420	-0.0521

CAESAR II Ver.5.10.00, (Build 070917) Date: JUL 18, 2010 Time: 19:43
 Job: C:\DOCUMENTS AND SETTINGS\ABC\MY DOCUM...KORBA_BFD_#4_500MW
 Licensed To: DEALR/EVAL COPY -- ID #4369

DISPLACEMENTS REPORT: Nodal Movements
 CASE 4 (SUS) W+P1+H

NODE	DX mm.	DY mm.	DZ mm.	RX deg.	RY deg.	RZ deg.
5018	-0.614	1.986	2.131	-0.0167	0.0422	-0.0534
5019	-0.730	1.577	1.853	-0.0173	0.0425	-0.0561
5020	-1.013	1.306	1.737	-0.0173	0.0429	-0.0576
5025	-3.828	0.460	1.742	-0.0114	0.0451	-0.0693
5028	-5.522	0.058	1.744	-0.0082	0.0468	-0.0760
5029	-6.042	0.012	1.762	-0.0055	0.0476	-0.0775
5030	-6.685	-0.000	1.788	-0.0028	0.0482	-0.0792
5035	-7.150	-0.000	1.801	-0.0016	0.0486	-0.0801
5038	-17.884	-0.017	0.621	0.0203	0.0567	-0.0990
5039	-18.387	-0.076	0.481	0.0221	0.0571	-0.1010
5040	-18.285	-0.228	0.419	0.0234	0.0575	-0.1027
5045	-15.802	-1.234	0.423	0.0246	0.0594	-0.1121
5048	-15.470	-1.372	0.424	0.0251	0.0596	-0.1133
5049	-15.072	-1.228	0.588	0.0255	0.0601	-0.1150
5050	-14.904	-0.533	0.986	0.0256	0.0606	-0.1173
5053	-14.890	2.850	2.720	0.0267	0.0620	-0.1213
5054	-14.557	3.648	3.202	0.0271	0.0627	-0.1214
5055	-13.762	3.977	3.552	0.0275	0.0632	-0.1206
5060	-9.250	3.981	4.623	0.0291	0.0660	-0.1177
5063	-6.686	3.978	5.274	0.0303	0.0676	-0.1158
5064	-6.137	4.050	5.461	0.0306	0.0679	-0.1154
5065	-5.629	4.260	5.722	0.0308	0.0682	-0.1151
5070	-5.006	4.619	6.104	0.0312	0.0686	-0.1152
5075	-4.387	4.979	6.487	0.0315	0.0689	-0.1155
6000	-2.443	6.057	7.664	0.0325	0.0699	-0.1180
6005	-0.563	4.972	7.543	0.0337	0.0711	-0.1206
6010	0.088	4.594	7.503	0.0341	0.0715	-0.1214
6013	1.384	3.846	7.430	0.0353	0.0725	-0.1236
6014	1.896	3.533	7.395	0.0361	0.0728	-0.1259
6015	1.711	3.601	7.380	0.0364	0.0733	-0.1280
6020	1.498	3.706	7.380	0.0364	0.0734	-0.1288
6023	-0.417	4.637	7.376	0.0364	0.0749	-0.1361
6024	-1.288	4.876	7.276	0.0361	0.0759	-0.1384
6025	-2.413	4.973	7.041	0.0354	0.0768	-0.1412
6030	-3.799	4.974	6.700	0.0347	0.0776	-0.1434
6033	-7.545	4.972	5.833	0.0329	0.0798	-0.1492
6034	-8.535	4.560	5.402	0.0320	0.0803	-0.1521
6035	-8.952	3.550	4.785	0.0312	0.0810	-0.1546
6040	-8.952	3.536	4.777	0.0312	0.0810	-0.1546
6045	-8.952	0.513	3.194	0.0312	0.0810	-0.1546
6050	-8.952	-0.811	2.502	0.0303	0.0814	-0.1564
6055	-8.952	-1.420	2.186	0.0299	0.0816	-0.1571
6060	-8.952	-2.474	1.640	0.0294	0.0818	-0.1576
6065	-8.952	-3.424	1.147	0.0292	0.0819	-0.1577
6068	-14.121	-1.464	1.154	0.0339	0.0829	-0.1664
6069	-14.231	-1.174	1.275	0.0341	0.0829	-0.1677
6070	-13.096	-1.055	1.562	0.0336	0.0828	-0.1694
6075	-9.464	-1.053	2.268	0.0328	0.0829	-0.1718
7000	-4.281	-36.620	-15.331	0.0393	0.0973	-0.1729
7005	-1.229	-36.617	-14.649	0.0388	0.0974	-0.1765

CAESAR II Ver.5.10.00, (Build 070917) Date: JUL 18, 2010 Time: 19:43
 Job: C:\DOCUMENTS AND SETTINGS\ABC\MY DOCUM...KORBA_BFD_#4_500MW
 Licensed To: DEALR/EVAL COPY -- ID #4369

DISPLACEMENTS REPORT: Nodal Movements
 CASE 4 (SUS) W+P1+H

NODE	DX mm.	DY mm.	DZ mm.	RX deg.	RY deg.	RZ deg.
7008	3.653	-36.620	-13.599	0.0378	0.0976	-0.1800
7009	4.840	-36.129	-13.087	0.0372	0.0976	-0.1811
7010	5.335	-34.933	-12.344	0.0367	0.0976	-0.1835
7015	5.335	-34.686	-12.212	0.0366	0.0976	-0.1839
7020	5.335	-31.092	-10.305	0.0366	0.0976	-0.1839
7025	5.335	-29.414	-9.419	0.0360	0.0975	-0.1840
7030	5.335	-26.976	-8.125	0.0351	0.0972	-0.1846
7035	5.335	-22.607	-5.825	0.0351	0.0972	-0.1846
7040	5.335	-20.137	-4.537	0.0342	0.0966	-0.1847
7045	5.335	-18.469	-3.662	0.0336	0.0961	-0.1833
7050	5.335	-14.892	-1.787	0.0336	0.0961	-0.1833
7053	5.335	-14.646	-1.658	0.0335	0.0960	-0.1831
7054	4.839	-13.446	-1.119	0.0330	0.0952	-0.1816
7055	3.651	-12.952	-1.075	0.0325	0.0946	-0.1800
7060	-2.478	-12.950	-2.167	0.0313	0.0914	-0.1779
7063	-3.965	-12.951	-2.428	0.0311	0.0906	-0.1780
7064	-4.535	-12.973	-2.538	0.0309	0.0903	-0.1782
7065	-4.891	-13.035	-2.632	0.0308	0.0898	-0.1785
7068	-2.880	-11.146	-1.400	0.0288	0.0884	-0.1813
7069	-2.154	-11.203	-1.313	0.0289	0.0888	-0.1817
7070	-1.443	-11.224	-1.210	0.0292	0.0891	-0.1821
7075	0.082	-11.223	-0.964	0.0295	0.0898	-0.1826
7078	6.385	-11.225	0.075	0.0311	0.0925	-0.1846
7079	7.602	-11.730	0.029	0.0317	0.0930	-0.1853
7080	8.108	-12.951	-0.498	0.0322	0.0937	-0.1856
7085	8.108	-14.850	-1.460	0.0330	0.0943	-0.1856
7090	8.108	-18.477	-3.302	0.0330	0.0943	-0.1856
7095	8.108	-19.322	-3.732	0.0333	0.0945	-0.1859
7100	8.108	-22.433	-5.316	0.0345	0.0952	-0.1861
7105	8.108	-26.837	-7.570	0.0345	0.0952	-0.1861
7110	8.108	-29.932	-9.164	0.0358	0.0957	-0.1852
7115	8.108	-30.948	-9.689	0.0362	0.0959	-0.1850
7120	8.108	-34.564	-11.563	0.0362	0.0959	-0.1850
7123	8.108	-36.044	-12.333	0.0368	0.0960	-0.1838
7124	7.610	-37.248	-13.067	0.0373	0.0963	-0.1821
7125	6.417	-37.743	-13.577	0.0380	0.0965	-0.1807
7130	1.515	-37.741	-14.636	0.0393	0.0969	-0.1778
7133	0.069	-37.741	-14.958	0.0397	0.0971	-0.1769
7134	-1.355	-37.632	-15.221	0.0402	0.0971	-0.1756
7135	-2.471	-37.366	-15.331	0.0403	0.0971	-0.1745
7140	-2.942	-37.170	-15.331	0.0401	0.0972	-0.1738
7145	-3.592	-36.902	-15.331	0.0398	0.0972	-0.1733
8000	-8.952	-4.370	0.654	0.0293	0.0819	-0.1571
8005	-8.952	-5.422	0.104	0.0295	0.0818	-0.1566
8010	-8.952	-6.022	-0.210	0.0297	0.0818	-0.1566
8015	-8.952	-7.369	-0.912	0.0302	0.0817	-0.1568
8020	-8.952	-10.433	-2.510	0.0302	0.0817	-0.1568
8024	-8.522	-11.469	-2.966	0.0306	0.0820	-0.1588
8025	-7.469	-11.904	-2.986	0.0310	0.0822	-0.1613
8030	-3.271	-11.902	-2.184	0.0316	0.0831	-0.1664

CAESAR II Ver.5.10.00, (Build 070917) Date: JUL 18, 2010 Time: 19:43
 Job: C:\DOCUMENTS AND SETTINGS\ABC\MY DOCUM...KORBA_BFD_#4_500MW
 Licensed To: DEALR/EVAL COPY -- ID #4369

DISPLACEMENTS REPORT: Nodal Movements
 CASE 4 (SUS) W+P1+H

NODE	DX mm.	DY mm.	DZ mm.	RX deg.	RY deg.	RZ deg.
8033	-1.642	-11.902	-1.876	0.0316	0.0835	-0.1682
8034	-0.304	-11.988	-1.668	0.0315	0.0839	-0.1703
8035	0.716	-12.194	-1.582	0.0314	0.0844	-0.1721
8040	2.902	-13.001	-1.578	0.0326	0.0845	-0.1777
8043	3.147	-13.096	-1.578	0.0330	0.0845	-0.1783
8044	3.284	-13.565	-1.773	0.0346	0.0843	-0.1801
8045	2.481	-14.259	-2.253	0.0361	0.0841	-0.1822
8050	0.541	-15.378	-3.156	0.0377	0.0838	-0.1844
8055	-0.452	-15.955	-3.622	0.0383	0.0837	-0.1854
9000	-3.397	-17.654	-5.000	0.0404	0.0835	-0.1893
9005	-6.412	-15.915	-4.894	0.0426	0.0838	-0.1930
9010	-7.452	-15.310	-4.864	0.0435	0.0839	-0.1937
9013	-8.910	-14.467	-4.832	0.0450	0.0840	-0.1941
9014	-9.346	-14.286	-4.855	0.0457	0.0839	-0.1940
9015	-9.813	-14.224	-4.940	0.0465	0.0838	-0.1938
9020	-14.526	-14.221	-6.126	0.0510	0.0835	-0.1929
9023	-21.820	-14.223	-8.206	0.0591	0.0829	-0.1926
9024	-23.084	-13.701	-8.379	0.0620	0.0826	-0.1929
9025	-23.613	-12.435	-8.012	0.0644	0.0821	-0.1935
9028	-23.635	-6.946	-5.711	0.0733	0.0812	-0.1946
9029	-23.863	-5.462	-5.181	0.0755	0.0806	-0.1941
9030	-24.397	-4.428	-4.965	0.0775	0.0800	-0.1931
9035	-24.843	-3.996	-4.967	0.0780	0.0797	-0.1922
9038	-28.210	-0.703	-4.980	0.0758	0.0788	-0.1853
9039	-28.231	-0.213	-4.781	0.0716	0.0790	-0.1840
9040	-27.240	-0.021	-4.326	0.0663	0.0792	-0.1823
9045	-6.554	-0.000	0.221	0.0071	0.0803	-0.1594
9048	-5.630	-0.000	0.253	0.0039	0.0803	-0.1580
9049	-4.386	0.002	0.257	-0.0032	0.0801	-0.1549
9050	-3.440	0.048	0.242	-0.0102	0.0798	-0.1523
9055	-0.501	0.725	0.238	-0.0238	0.0792	-0.1400
9058	4.467	2.755	0.228	-0.0404	0.0751	-0.1185
9059	4.962	2.710	0.024	-0.0420	0.0739	-0.1159
9060	5.164	2.073	-0.459	-0.0426	0.0727	-0.1138
9065	5.164	1.546	-0.796	-0.0427	0.0722	-0.1134
9068	5.164	-1.243	-2.562	-0.0434	0.0703	-0.1109
9069	5.027	-1.755	-2.834	-0.0436	0.0698	-0.1098
9070	4.655	-2.127	-2.922	-0.0438	0.0693	-0.1088
9075	3.140	-3.003	-2.864	-0.0438	0.0682	-0.1076
9080	2.563	-3.336	-2.840	-0.0438	0.0680	-0.1075
9085	0.772	-4.290	-2.711	-0.0436	0.0672	-0.1088

CAESAR II Ver.5.10.00, (Build 070917) Date: JUL 18, 2010 Time: 19:43
 Job: C:\DOCUMENTS AND SETTINGS\ABC\MY DOCUM...\KORBA_BFD_#4_500MW
 Licensed To: DEALR/EVAL COPY -- ID #4369

**STRESS SUMMARY REPORT: Highest Stresses Mini Statement
 Various Load Cases**

LOAD CASE DEFINITION KEY

CASE 3 (OPE) W+D1+T1+P1+H
 CASE 4 (SUS) W+P1+H
 CASE 5 (EXP) L5=L3-L4

Piping Code: B31.1 = B31.1 -2004, December 15, 2006

NO CODE STRESS CHECK PROCESSED: LOADCASE 3 (OPE) W+D1+T1+P1+H

Highest Stresses: (KPa) LOADCASE 3 (OPE) W+D1+T1+P1+H
 OPE Stress Ratio (%): 0.0 @Node 1195
 OPE Stress: 74019.5 Allowable: 0.0
 Axial Stress: 45336.1 @Node 766
 Bending Stress: 24907.9 @Node 895
 Torsion Stress: 6578.3 @Node 40
 Hoop Stress: 103999.8 @Node 765
 3D Max Intensity: 152888.9 @Node 766

CODE STRESS CHECK PASSED : LOADCASE 4 (SUS) W+P1+H

Highest Stresses: (KPa) LOADCASE 4 (SUS) W+P1+H
 CodeStress Ratio (%): 35.6 @Node 1175
 Code Stress: 49128.1 Allowable: 137895.1
 Axial Stress: 45359.2 @Node 766
 Bending Stress: 10949.1 @Node 805
 Torsion Stress: 2608.8 @Node 508
 Hoop Stress: 103999.8 @Node 765
 3D Max Intensity: 152888.9 @Node 765

CODE STRESS CHECK PASSED : LOADCASE 5 (EXP) L5=L3-L4

Highest Stresses: (KPa) LOADCASE 5 (EXP) L5=L3-L4
 CodeStress Ratio (%): 13.1 @Node 1195
 Code Stress: 38820.9 Allowable: 296803.4
 Axial Stress: 282.8 @Node 535
 Bending Stress: 24078.9 @Node 895
 Torsion Stress: 8057.0 @Node 1185
 Hoop Stress: 0.0 @Node 10
 3D Max Intensity: 25803.7 @Node 1220

CAESAR II Ver.5.10.00, (Build 070917) Date: JUL 18, 2010 Time: 19:43
 Job: C:\DOCUMENTS AND SETTINGS\ABC\MY DOCUM...\KORBA_BFD_#4_500MW
 Licensed To: DEALR/EVAL COPY -- ID #4369

HANGER REPORT
 (TABLE DATA FROM DESIGN RUNS)

NO. NODE	FIG. REQD NO.	VERTICAL MOVEMENT	HOT LOAD	THEORETICAL INSTALLED LOAD	ACTUAL INSTALLED LOAD	SPRING RATE	HORIZONTAL MOVEMENT
		(mm.)	(N.)	(N.)	(N.)	(N./cm.)	(mm.)
10	2 LISEGA	2141 -6.947	9123.	8197.	0.	1333.	3.417 LOAD VARIATION = 10%
25	1 LISEGA	2161 -6.021	22040.	18830.	0.	5333.	11.642 LOAD VARIATION = 15%
35	1 LISEGA	2151 -3.108	19819.	18991.	0.	2666.	22.158 LOAD VARIATION = 4%
45	2 LISEGA	2151 -3.475	12889.	11963.	0.	2666.	40.513 LOAD VARIATION = 7%
65	1 LISEGA	2151 -10.547	11994.	9182.	0.	2666.	38.478 LOAD VARIATION = 23%
80	1 LISEGA	2141 -10.521	5746.	4344.	0.	1333.	35.193 LOAD VARIATION = 24%
90	2 LISEGA	2141 -2.553	9534.	9194.	0.	1333.	35.856 LOAD VARIATION = 4%
205	2 LISEGA	2141 -6.946	9012.	8086.	0.	1333.	0.194 LOAD VARIATION = 10%
220	1 LISEGA	2151 -10.980	14421.	11494.	0.	2666.	3.904 LOAD VARIATION = 20%
230	1 LISEGA	2151 -9.704	13003.	10416.	0.	2666.	4.962 LOAD VARIATION = 20%
240	2 LISEGA	2141 -10.565	9854.	8445.	0.	1333.	11.560 LOAD VARIATION = 14%
257	1 LISEGA	2141 -11.392	9768.	8249.	0.	1333.	14.062 LOAD VARIATION = 16%
270	1 LISEGA	2141 -10.059	9822.	8481.	0.	1333.	16.480 LOAD VARIATION = 14%
305	2 LISEGA	2141 1.933	5843.	6100.	0.	1333.	0.956 LOAD VARIATION = 4%
320	1 LISEGA	2161 3.212	22415.	24128.	0.	5333.	7.487 LOAD VARIATION = 8%
330	1 LISEGA	2151 0.498	18374.	18506.	0.	2666.	12.070 LOAD VARIATION = 1%
340	2	2151 -5.153	11105.	9731.	0.	2666.	28.544

CAESAR II Ver.5.10.00, (Build 070917) Date: JUL 18, 2010 Time: 19:43
 Job: C:\DOCUMENTS AND SETTINGS\ABC\MY DOCUM...\KORBA_BFD_#4_500MW
 Licensed To: DEALR/EVAL COPY -- ID #4369

HANGER REPORT
 (TABLE DATA FROM DESIGN RUNS)

NO. NODE	FIG. REQD NO.	VERTICAL MOVEMENT	HOT LOAD	THEORETICAL INSTALLED LOAD	ACTUAL INSTALLED LOAD	SPRING RATE	HORIZONTAL MOVEMENT
							LOAD VARIATION = 12%
360	1	2151	-8.774	10650.	8311.	0. 2666.	29.291
	LISEGA						LOAD VARIATION = 22%
375	1	2141	-9.711	5191.	3896.	0. 1333.	32.731
	LISEGA						LOAD VARIATION = 25%
385	2	2141	-6.296	6325.	5485.	0. 1333.	36.023
	LISEGA						LOAD VARIATION = 13%
540	2	2162	19.022	29881.	34952.	0. 2666.	17.631
	LISEGA						LOAD VARIATION = 17%
565	2	2162	18.021	20957.	25761.	0. 2666.	22.142
	LISEGA						LOAD VARIATION = 23%
585	1	2141	-9.731	7373.	6075.	0. 1333.	13.850
	LISEGA						LOAD VARIATION = 18%
600	2	2161	-4.871	22966.	20369.	0. 5333.	23.878
	LISEGA						LOAD VARIATION = 11%
715	2	2163	19.980	20856.	23519.	0. 1333.	12.403
	LISEGA						LOAD VARIATION = 13%
735	1	2141	-6.744	7536.	6637.	0. 1333.	8.273
	LISEGA						LOAD VARIATION = 12%
750	2	2161	2.313	23387.	24621.	0. 5333.	11.499
	LISEGA						LOAD VARIATION = 5%
820	2	2152	15.425	16440.	18497.	0. 1333.	10.377
	LISEGA						LOAD VARIATION = 13%
835	2	2142	16.993	8708.	9840.	0. 666.	14.138
	LISEGA						LOAD VARIATION = 13%
860	1	2163	21.802	21941.	24847.	0. 1333.	15.428
	LISEGA						LOAD VARIATION = 13%
865	1	2163	22.261	22403.	25370.	0. 1333.	35.034
	LISEGA						LOAD VARIATION = 13%
870	1	2152	21.727	16471.	19367.	0. 1333.	49.785
	LISEGA						LOAD VARIATION = 18%
880	1	2161	8.017	18459.	22734.	0. 5333.	47.815
	LISEGA						LOAD VARIATION = 23%
900	1	2151	-6.428	18577.	16863.	0. 2666.	47.327
	LISEGA						LOAD VARIATION = 9%

CAESAR II Ver.5.10.00, (Build 070917) Date: JUL 18, 2010 Time: 19:43
 Job: C:\DOCUMENTS AND SETTINGS\ABC\MY DOCUM...KORBA_BFD_#4_500MW
 Licensed To: DEALR/EVAL COPY -- ID #4369

HANGER REPORT
 (TABLE DATA FROM DESIGN RUNS)

NO. NODE	FIG. REQD NO.	VERTICAL SIZE	MOVEMENT	HOT LOAD	THEORETICAL INSTALLED LOAD	ACTUAL INSTALLED LOAD	SPRING RATE	HORIZONTAL MOVEMENT
923	1 LISEGA	2153	-22.282	10808.	9324.	0.	666.	52.845 LOAD VARIATION = 14%
1005	2 LISEGA	2151	-3.577	10634.	9680.	0.	2666.	50.137 LOAD VARIATION = 9%
1025	1 LISEGA	2152	14.356	10132.	12046.	0.	1333.	59.212 LOAD VARIATION = 19%
1040	1 LISEGA	2153	26.478	10359.	12122.	0.	666.	60.325 LOAD VARIATION = 17%
1060	2 LISEGA	2153	29.866	9982.	11971.	0.	666.	57.037 LOAD VARIATION = 20%
1090	1 LISEGA	2162	16.275	34895.	39234.	0.	2666.	63.290 LOAD VARIATION = 12%
1095	1 LISEGA	2172	-14.196	44924.	39245.	0.	4000.	60.324 LOAD VARIATION = 13%
1100	1 LISEGA	2163	-45.371	36589.	30541.	0.	1333.	76.967 LOAD VARIATION = 17%
1110	1		-80.508	43140.	*****	CONSTANT	EFFORT	SUPPORT *****
1120	0		-95.140	23186.	*****	CONSTANT	EFFORT	SUPPORT *****
1135	0		-91.179	59025.	*****	CONSTANT	EFFORT	SUPPORT *****
1140	0		-62.304	48617.	*****	CONSTANT	EFFORT	SUPPORT *****
1150	0		-63.437	27456.	*****	CONSTANT	EFFORT	SUPPORT *****
1160	0		-67.466	42849.	*****	CONSTANT	EFFORT	SUPPORT *****
1170	0		-63.080	48351.	*****	CONSTANT	EFFORT	SUPPORT *****
1175	0		-105.511	59264.	*****	CONSTANT	EFFORT	SUPPORT *****
1180	0		-145.496	47859.	*****	CONSTANT	EFFORT	SUPPORT *****
1190	0		-166.394	37835.	*****	CONSTANT	EFFORT	SUPPORT *****
1215	1		-171.679	41027.	*****	CONSTANT	EFFORT	SUPPORT *****
2000	2 LISEGA	2143	28.139	5321.	6258.	0.	333.	65.243 LOAD VARIATION = 18%
2020	1 LISEGA	2142	23.567	7157.	8727.	0.	666.	68.515 LOAD VARIATION = 22%

756

CAESAR II Ver.5.10.00, (Build 070917) Date: JUL 18, 2010 Time: 19:43
 Job: C:\DOCUMENTS AND SETTINGS\ABC\MY DOCUM...KORBA_BFD_#4_500MW
 Licensed To: DEALR/EVAL COPY -- ID #4369

HANGER REPORT
 (TABLE DATA FROM DESIGN RUNS)

NO. NODE	FIG. REQD NO.	VERTICAL SIZE	MOVEMENT	HOT LOAD	THEORETICAL INSTALLED LOAD	ACTUAL INSTALLED LOAD	SPRING RATE	HORIZONTAL MOVEMENT
2045	1 LISEGA	2141	10.165	7473.	8828.	0.	1333.	67.932 18%
2065	2 LISEGA	2141	-8.627	6448.	5298.	0.	1333.	59.304 18%
5015	1 LISEGA	2152	17.720	14327.	16689.	0.	1333.	19.429 16%
5025	1 LISEGA	2152	8.618	17776.	18925.	0.	1333.	32.868 6%
5045	1 LISEGA	2152	-17.989	12404.	10006.	0.	1333.	9.583 19%
5060	1 0080 BHEL	11	-1.107	42081.	41654.	0.	3862.	14.670 1%
6020	1 LISEGA	2152	15.324	9608.	11650.	0.	1333.	19.732 21%
6030	2 LISEGA	2142	9.314	9311.	9931.	0.	666.	24.889 7%
6050	1 LISEGA	2151	-3.983	15591.	14529.	0.	2666.	16.918 7%
6075	1 LISEGA	2161	-6.943	34985.	31282.	0.	5333.	42.658 11%
7005	2		-53.191	27046.	***** CONSTANT EFFORT SUPPORT *****			
7025	1 LISEGA	2173	-34.527	40306.	33401.	0.	2000.	88.951 17%
7040	1 LISEGA	2162	-19.251	23828.	18696.	0.	2666.	79.875 22%
7060	2 LISEGA	2152	-15.619	10095.	8013.	0.	1333.	62.402 21%
7075	2 LISEGA	2151	-10.500	11962.	9163.	0.	2666.	52.684 23%
7095	1 LISEGA	2152	-14.768	11387.	9418.	0.	1333.	70.267 17%
7110	1 LISEGA	2153	-31.299	10999.	8915.	0.	666.	81.300 19%
7130	2		-50.469	5710.	***** CONSTANT EFFORT SUPPORT *****			

CAESAR II Ver.5.10.00, (Build 070917) Date: JUL 18, 2010 Time: 19:43
 Job: C:\DOCUMENTS AND SETTINGS\ABC\MY DOCUM...\KORBA_BFD_#4_500MW
 Licensed To: DEALR/EVAL COPY -- ID #4369

HANGER REPORT
 (TABLE DATA FROM DESIGN RUNS)

NO. NODE	FIG. REQD NO.	SIZE	VERTICAL MOVEMENT	HOT LOAD	THEORETICAL INSTALLED LOAD	ACTUAL INSTALLED LOAD	SPRING RATE	HORIZONTAL MOVEMENT
8010	1	2151	-10.128	15579.	12879.	0.	2666.	17.493
	LISEGA						LOAD VARIATION =	17%
8030	2	2141	-10.486	9318.	7920.	0.	1333.	29.124
	LISEGA						LOAD VARIATION =	15%
8040	1	2141	-4.311	9382.	8807.	0.	1333.	26.988
	LISEGA						LOAD VARIATION =	6%
9020	1	2172	-22.332	41936.	33004.	0.	4000.	6.956
	LISEGA						LOAD VARIATION =	21%
9035	1	2152	-20.959	12524.	9730.	0.	1333.	12.452
	LISEGA						LOAD VARIATION =	22%
9055	1	2152	9.414	17729.	18984.	0.	1333.	33.366
	LISEGA						LOAD VARIATION =	7%
9065	1	2152	17.081	14780.	17057.	0.	1333.	27.911
	LISEGA						LOAD VARIATION =	15%



ALSTOM

THE END

NTPC ALSTOM
Power Services Pvt. Ltd.



ALSTOM

Volume- III
Chapter – 01

Introduction of SPA

NTPC ALSTOM
Power Services Pvt. Ltd.

ALSTOM	Client	J-Power (Electric Power Development Co. Ltd.,)
	Project	Turbine and System Assessment for NTPC-Korba Unit #4
	Order No.	CGP10028C
	Contractor	ALSTOM K.K. NASL Ltd. (Nominated subcontractor in India)
NTPC ALSTOM Power Services Pvt. Ltd.	Document	FINAL REPORT VOL. III (STEAM PATH AUDIT)

1. INTRODUCTION

1.1 Purpose of the Audit

The purpose of the steam path audit was to assess the thermal performance of the steam turbine. The results of this audit identified specific problem areas and quantified the impact of the problems in order to assist the Korba Super Thermal Power Station, Unit # 4, 500 Mw, in making decisions whether to repair or replace steam path components.

A valves-wide-open turbine heat balance to characterize the unit's performance in its new-and-clean condition. Steam path audit data were taken during the outage to determine the condition of the steam path.



1.2 Description of the Audit

Basic concept of the audit is to examine the entire turbine steam path in detail and compare the as-found condition with the new-and-clean condition of the machine to quantify the losses in the components & stages at the time of inspection.

The steps involved are:

- Data collection & Model Preparation,
- Detailed inspection of the stationary and rotating steam path components
- Accounting of performance losses on a stage-by-stage basis
- Analysis and presentation of losses in power and heat rate

The new-and-clean condition of the unit was modeled in eSTPE using the cross-section. This model was used for comparison purposes since it represents the turbine as it is

	Client	J-Power (Electric Power Development Co. Ltd.,)
	Project	Turbine and System Assessment for NTPC-Korba Unit #4
	Order No.	CGP10028C
	Contractor	ALSTOM K.K. NASL Ltd. (Nominated subcontractor in India)
	Document	FINAL REPORT VOL. III (STEAM PATH AUDIT)

expected to operate. This model provides a representative condition to be used as a basis for comparisons.

The eSTPE program accepts the measured data collected during the on-site investigation and calculates the resulting power loss and heat rate degradation for each loss category, independent of other losses, at each turbine stage. The results of solid particle erosion, foreign object damage, and deposits are combined, however, to best represent the conditions of the unit at the time of the audit.

eSTPE compares as-found data collected during the audit with the new-and-clean condition characterized in the software "Design" section. The Design portion of the eSTPE computer program calculates the turbine geometric properties, the thermodynamic and fluid dynamic conditions at each stage, efficiency margins, and other operation and design dependent properties using the turbine cross-section and the heat balance. Although complete restoration to the new-and-clean condition is generally not possible, it provides a fixed standard for comparisons.

eSTPE evaluates losses on a stage-by-stage basis but recognizes that some losses in early stages can be recovered down stream. Two important considerations are: first, the regain to steam flowing to downstream stages due to increases in downstream available energy and second, the reduced heat input required by the boiler resulting from losses that occur above a reheat point. The analysis used in eSTPE accounts for both of these effects when calculating stage losses.

2010

The ALSTOM logo is located in the top left corner of the page. It consists of the word "ALSTOM" in a bold, sans-serif font. The letter "O" is stylized with a red circle around it.

Volume- III
Chapter – 02

Objective of SPA

NTPC ALSTOM
Power Services Pvt. Ltd.

ALSTOM	Client	J-Power (Electric Power Development Co. Ltd.,)
	Project	Turbine and System Assessment for NTPC-Korba Unit #4
	Order No.	CGP10028C
	Contractor	ALSTOM K.K. NASL Ltd. (Nominated subcontractor in India)
NTPC ALSTOM Power Services Pvt. Ltd.	Document	FINAL REPORT VOL. III (STEAM PATH AUDIT)

2. OBJECTIVE

The objective of the audit was to assess the condition of the turbine steam path to identify degradation in thermal performance of the unit and to point out the cause and location of power and efficiency losses.

The eSTPE program creates a computer model of the turbine steam cycle and uses it to calculate power loss and heat rate degradation from data collected during the turbine on-site inspection. The software calculates losses for the turbine, casings, and each turbine stage for each of nine loss categories. These loss categories are:

- Interstage Packing
- Tip Spill Strips
- End Packing
- Miscellaneous Leakages
- Flow Path Damage
- Surface Roughness
- Cover Deposits
- Trailing Edge Thickness
- Other (Hand Calculations)

17/8





ALSTOM

Volume- III
Chapter – 03

Methodologies Adopted

NTPC ALSTOM
Power Services Pvt. Ltd.

	Client	J-Power (Electric Power Development Co. Ltd.,)
	Project	Turbine and System Assessment for NTPC-Korba Unit #4
	Order No.	CGP10028C
	Contractor	ALSTOM K.K. NASL Ltd. (Nominated subcontractor in India)
	Document	FINAL REPORT VOL. III (STEAM PATH AUDIT)

3.0.0 METHODOLOGIES

Following methodologies are used to carry out Steam Path Audit :

3.1.0 Create Model

A soft model of turbine design using eSTPE tool is created. The following docs/drgs of the Turbine under study are used to create the model:

- a. Design heat balance (VWO)
- b. Turbine cross section
- c. Clearance and steam seal system diagram
- d. First stage shell pressure curve

3.2.0 Field Measurements :

Measurements are carried out in the following identified area of losses in the steam path:

- Measure leakage areas
- Measurement of geometry at required locations,
- Measure clearances in seals/packing ,
- Create a photographic record of the steam path ,
- Surface finish (roughness)
- Solid particle erosion
- Mechanical damage
- Cover deposits
- Miscellaneous leakages

ALSTOM	Client	J-Power (Electric Power Development Co. Ltd.,)
	Project	Turbine and System Assessment for NTPC-Korba Unit #4
	Order No.	CGP10028C
	Contractor	ALSTOM K.K. NASL Ltd. (Nominated subcontractor in India)
NTPC ALSTOM Power Services Pvt. Ltd.	Document	FINAL REPORT VOL. III (STEAM PATH AUDIT)

September

3.2.1 Leakages

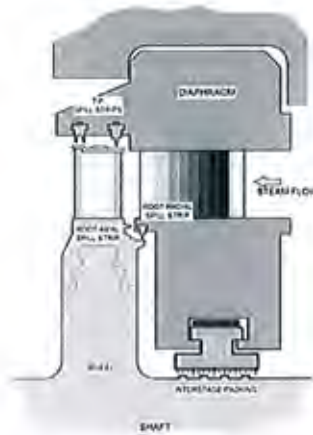

Leakages are steam flows that bypass either stationary or rotating turbine components. Leakage flows include flows through leakage control devices such as interstage packing or end packing (labyrinth-type packing), and tip spill strips as well as other miscellaneous leakages past expansion joints, stationary blade carrier seals, or leakages along the horizontal joint.

3.2.2 Shaft Packings/seals:

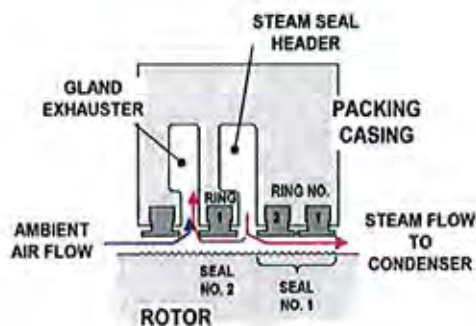

Labyrinth-type packing control leakage between stationary and rotating parts in the machine. These packing include:

196

ALSTOM	Client	J-Power (Electric Power Development Co. Ltd.,)
	Project	Turbine and System Assessment for NTPC-Korba Unit #4
	Order No.	CGP10028C
	Contractor	ALSTOM K.K. NASL Ltd. (Nominated subcontractor in India)
NTPC ALSTOM Power Services Pvt. Ltd.	Document	FINAL REPORT VOL. III (STEAM PATH AUDIT)

S

- Inter-stage Packing located at the inside diameter of the stationary blading and root spill strips located near the root of the rotating blading,
- End Packing located where rotors emerge from casings, and
- Tip Spill Strips located at the tips of the rotating blades.

To calculate packing losses, the auditor determines the difference in leakage area calculated from the original design clearances. Wear is determined by subtracting the height of the worn tooth from that of the design tooth. The wear is then added to the design clearance to estimate the clearance in the running condition. To estimate clearances at the top and bottom of the rotor, the auditor measures tooth heights at the horizontal joint and at the top and bottom of the packing. The auditor then makes four additional tooth height measurements at locations around the casing circumference: the upper left, the upper right, the lower left, and the lower right. eSTPE calculates an average clearance and leakage area from these measurements and compares it to the design value.

The eSTPE program also applies a tooth condition to all packing. A "rounded" set of teeth will exhibit a greater flow passing capability than a sharp set of teeth. Rubbing of steam packing causes the packing tooth to "mushroom" out at the tip, causing a rounded tooth tip.

Tooth rounding may also be caused by solid particle erosion of the tip of the packing tooth. Sharpening any packing tooth that is rounded will result in a performance benefit by reducing the flow through the packing.

After determining the change in leakage area and tooth condition, eSTPE uses Martin's flow formula to calculate the change in leakage flow from design. Important inputs to this calculation are the pressures on each side of the packing and the upstream specific volume. The auditor can determine these parameters readily for end packing, from the heat balance, but since these parameters are functions of the reaction at the root and tip of each stage more information is needed to determine flows past stationary and rotating blading. For this purpose, eSTPE uses the Design section of the program that calculates root, pitch, and tip reactions of each stage. Other important inputs to the calculation of packing flows are the number of teeth currently in place, compared with the expected or design value, and the

11/2

ALSTOM	Client	J-Power (Electric Power Development Co. Ltd.,)
	Project	Turbine and System Assessment for NTPC-Korba Unit #4
	Order No.	CGP10028C
	Contractor	ALSTOM K.K. NASL Ltd. (Nominated subcontractor in India)
NTPC ALSTOM Power Services Pvt. Ltd.	Document	FINAL REPORT VOL. III (STEAM PATH AUDIT)

condition of those teeth. Losing teeth in service and increasing the flow coefficient due to packing rubbing can both increase packing leakage?

The packing GAP is the distance between the packing land (usually on the rotor or rotating blade cover) and the base of the measured tooth. The gap (GAP) is calculated from the left and right measured clearances and the left and right measured tooth heights.

$$GAP = \frac{1}{2} [(C_R + t_R) + (C_L + t_L)] \quad (1)$$

The average measured clearance (C_{ave}) is calculated from the average packing GAP and the eight measured tooth heights.

$$C_{ave} = \frac{1}{8} \sum_{i=1}^8 GAP_{ave} - t_i \quad (2)$$

The Horizontal Gap Variance (HGV) is calculated as one half the difference between the left and the right GAP.

$$HGV = \frac{GAP_L - GAP_R}{2} \quad (3)$$

Where:

- HGV = Horizontal Gap Variance
- GAP = radial distance between packing land and tooth base
- C_{ave} = average clearance
- t = tooth height
- c = clearance
- L = left side of turbine while facing the generator
- R = right side of turbine while facing the generator

eSTPE uses this method to calculate average clearance and the horizontal gap variance for inter-stage packing, end packing, and tip spill strips.

1. Differences in temperature between the top and bottom of the turbine casing causing distortion during hot or still-warm starts and during stops, and
2. Differences between the vertical thermal expansions of the casing supports and of the rotor.

ALSTOM	Client	J-Power (Electric Power Development Co. Ltd.,)
	Project	Turbine and System Assessment for NTPC-Korba Unit #4
	Order No.	CGP10028C
	Contractor	ALSTOM K.K. NASL Ltd. (Nominated subcontractor in India)
NTPC ALSTOM Power Services Pvt. Ltd.	Document	FINAL REPORT VOL. III (STEAM PATH AUDIT)

3.2.3 Surface Finish Degradation

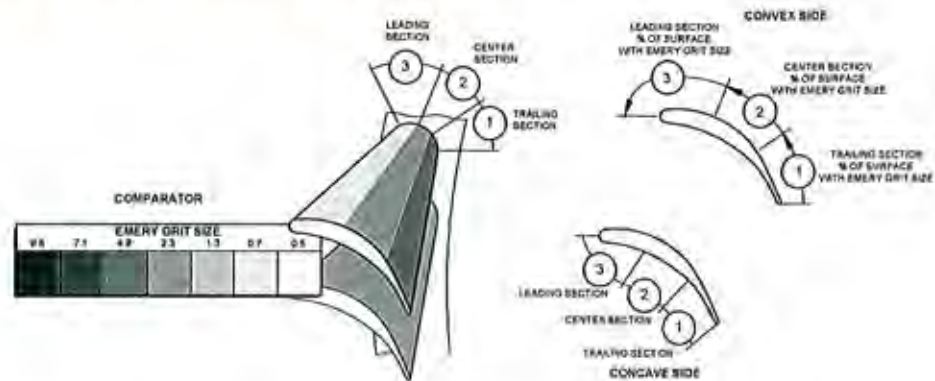

The method for quantifying the impact of surface finish degradation makes use of laboratory data on cascade efficiencies developed by V.T. Forster. The auditor uses a surface roughness comparator to evaluate each surface of each stationary and rotating blade row in the turbine. The surface roughness comparator uses the standard grades of emery paper Mr. Forster used in his tests.

eSTPE uses "Emery Grit Size" to compare as-found surface finish to that when the machine originally went into service. It then calculates stage efficiencies for the assumed new condition (32 or 64 micro inch center line average) and modified stage efficiency for the observed existing surface finish. The modified stage efficiencies are then used to calculate a resulting power and heat rate loss for each stage.

The impact of water droplet erosion on turbine efficiency is often negligible, but is an important factor to consider when it threatens the unit's mechanical integrity. The main change in flow path efficiency attributable to water droplet erosion is an increase in surface roughness of the leading edge of the blades in the low pressure areas where Reynolds numbers are small. Forster and others determined in laboratory tests that increased leading edge surface roughness has relatively little effect on cascade efficiency.

17/11

ALSTOM	Client	J-Power (Electric Power Development Co. Ltd.,)
	Project	Turbine and System Assessment for NTPC-Korba Unit #4
	Order No.	CGP10028C
	Contractor	ALSTOM K.K. NASL Ltd. (Nominated subcontractor in India)
NTPC ALSTOM Power Services Pvt. Ltd.	Document	FINAL REPORT VOL. III (STEAM PATH AUDIT)

3.2.4 Solid Particle Erosion

To evaluate area changes caused by solid particle erosion, the auditor measures the geometry of the cascade and the amount of the partition trailing edge that is removed. eSTPE uses the geometry of the cascade and the trailing edge cutback to calculate a change in nozzle area and a change in the velocity diagram between the stationary and rotating components.

3.2.5 Mechanical Damage

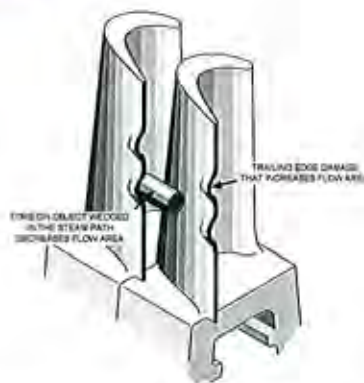

Foreign objects, deposits, corrosion, and other mechanical damage to the steam path can cause an increase in flow area or a flow blockage. To determine the performance degradation caused by the damage, the auditor estimates the change in flow area for each stage. eSTPE then uses this area change information to calculate changes in the stage flow coefficients and determines the impact on adjacent stages resulting from a change in pressure ratios and stage energies.

765

ALSTOM	Client	J-Power (Electric Power Development Co. Ltd.,)
	Project	Turbine and System Assessment for NTPC-Korba Unit #4
	Order No.	CGP10028C
	Contractor	ALSTOM K.K. NASL Ltd. (Nominated subcontractor in India)
NTPC ALSTOM Power Services Pvt. Ltd.	Document	FINAL REPORT VOL. III (STEAM PATH AUDIT)

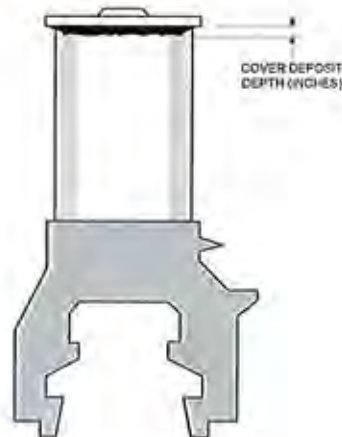

3.2.6 Rotating Blade Cover Deposits



Solid particles that travel through the steam path are subjected to centrifugal force from the rotating elements in the turbine. Steam carries these particles through the turbine where they may impact on the stationary blading and cause solid particle erosion. As these particles lose momentum they move outward toward the tips of the rotating blading. The particles then either travel through the tip spill strip, causing spill strip erosion, or lodge underneath the rotating blade covers.

The deposits under the rotating blade covers cause a flow disturbance that affects the rotating blade velocity coefficient for a short radial portion of the rotating blade.

The auditor measures the average depth of deposits under the rotating blade covers. eSTPE uses this data along with the recorded turbine geometry to determine the impact of the deposits on turbine power and heat rate.

	Client	J-Power (Electric Power Development Co. Ltd.,)
	Project	Turbine and System Assessment for NTPC-Korba Unit #4
	Order No.	CGP10028C
	Contractor	ALSTOM K.K. NASL Ltd. (Nominated subcontractor in India)
	Document	FINAL REPORT VOL. III (STEAM PATH AUDIT)

3.2.7 Increased and Decreased Flow Area

Damage to the turbine blading can cause the flow area of a stationary or rotating blade row to increase or decrease from design. Changes in flow path area are caused primarily by solid particle erosion, mechanical damage, or deposits result in increased heat rate.

3.2.8 Flow Path Damage



eSTPE addresses changes in cascade flow area in a section titled "Flow Path Damage". Data are entered into the Solid Particle Erosion, Deposits, and Mechanical Damage subsections for flow path damage analysis. Each of these three sections calculates a change in area and flow coefficients from the data input into each section. The areas and coefficients from each of the three sections listed above are then combined together to calculate single area and flow coefficient change for each stationary and rotating blade row. These changes are then used to calculate an efficiency change for each damaged stage and the associated power and heat rate losses.

Changes in the cascade flow area not only affect the stage with the observed area change, but also affect interstage pressures before and after the damaged stage and the distribution of energy between the stages. The effect of area changes may cause power and heat rate losses several stages before and after the affected stage. Power loss due to change in flow, pressure, and available energy on undamaged stages appear in the casing and turbine loss summaries under the heading "Flow Change Impact".

3.2.9 Miscellaneous leakages

eSTPE calculates miscellaneous leakages on an individual or case-by-case basis. The auditor calculates the leakage area from leakage site geometric data input. The auditor also determines and inputs the expected flow coefficient for the type of leakage found. The miscellaneous leakage flow is then calculated by applying the equations for flow through orifices.

650

	Client	J-Power (Electric Power Development Co. Ltd.,)
	Project	Turbine and System Assessment for NTPC-Korba Unit #4
	Order No.	CGP10028C
	Contractor	ALSTOM K.K. NASL Ltd. (Nominated subcontractor in India)
	Document	FINAL REPORT VOL. III (STEAM PATH AUDIT)

3.2.10 Deposits

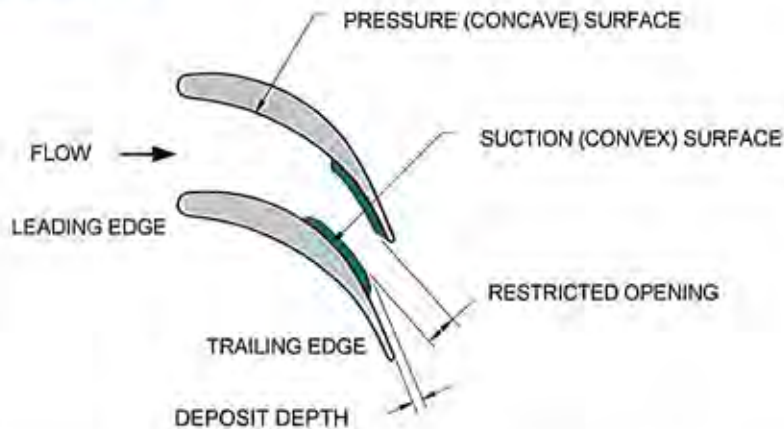

Deposits on the turbine steam path both increase the flow path surface roughness and may, if thick enough, decrease the flow area of the cascade. To determine the performance degradation caused by thick deposits, the auditor measures the deposit thickness and the design nozzle area to determine the change in flow area caused by the deposition.

eSTPE uses the nozzle exit area and the deposit thickness information to calculate changes in cascade flow passing ability and changes in the velocity coefficient for the cascade.

3.2.11 Increased Trailing Edge Thickness

The trailing edges of stationary blades are typically 15 to 30 mils thick by design to satisfy aerodynamic and mechanical concerns. This thickness is limited to minimize flow separation at the nozzle discharge. Partition weld repairs to correct solid particle erosion and mechanical damage often leave trailing edges thicker than design. The thickened trailing edges introduce a flow disturbance at the nozzle exit. This flow disturbance is reflected in the velocity coefficient of the steam leaving the interstage blading and causes a velocity diagram efficiency loss.

168

ALSTOM	Client	J-Power (Electric Power Development Co. Ltd.,)
	Project	Turbine and System Assessment for NTPC-Korba Unit #4
	Order No.	CGP10028C
	Contractor	ALSTOM K.K. NASL Ltd. (Nominated subcontractor in India)
NTPC ALSTOM Power Services Pvt. Ltd.	Document	FINAL REPORT VOL. III (STEAM PATH AUDIT)

To determine the power and heat rate impacts caused by increased trailing edge thickness the auditor measures the average trailing edge thickness and the nozzle opening. eSTPE then compares the measured trailing edge thickness to the design trailing edge thickness of 20 mils.

3.3.0 Result Calculation

Field measurement data is used in to the eSTPE based software Model of the Turbine for evaluating the opening and closing audit of the Turbine.

The Change in Power Loss is the calculated decrease in gross output power, including generator and mechanical losses, for the stage or casing noted on the report. The Change in Heat Rate is the degradation in the gross turbine heat rate for the unit.

The Total Change in Power Loss is a summation of the stage power losses from individual loss categories. The Total Change In Heat Rate is not, however, a summation of the heat rate changes from individual categories. The change in heat rate is a function of the power loss. This function is non-linear with respect to power and, therefore, cannot be summed in a linear manner. The Change in Heat Rate is the degradation in the gross turbine heat rate resulting from the specific power loss and change in boiler duty, if any.

3.4.0 Result and Recommendations

Based on the observations and analysis of all measured data, a summary result and recommendations was prepared which emphasizes :

- Quantification of losses measured in pre-outage test
- Quality check on maintenance performed during the outage
- Performance improvement resulting from individual maintenance actions
- Expected return-to-service performance



ALSTOM

Volume- III
Chapter – 04

*Assumption and other
remarks*

NTPC ALSTOM
Power Services Pvt. Ltd.

ALSTOM	Client	J-Power (Electric Power Development Co. Ltd.,)
	Project	Turbine and System Assessment for NTPC-Korba Unit #4
	Order No.	CGP10028C
NTPC ALSTOM Power Services Pvt. Ltd.	Contractor	ALSTOM K.K. NASL Ltd. (Nominated subcontractor in India)
	Document	FINAL REPORT VOL. III (STEAM PATH AUDIT)

4. ASSUMPTIONS

Following assumptions are carried out Steam Path Audit.

- **SURFACE ROUGHNESS:**

Surface of blade for both sides is divided into three sections as shown in figure during Surface roughness measurement due to change in erosion pattern of the surface.

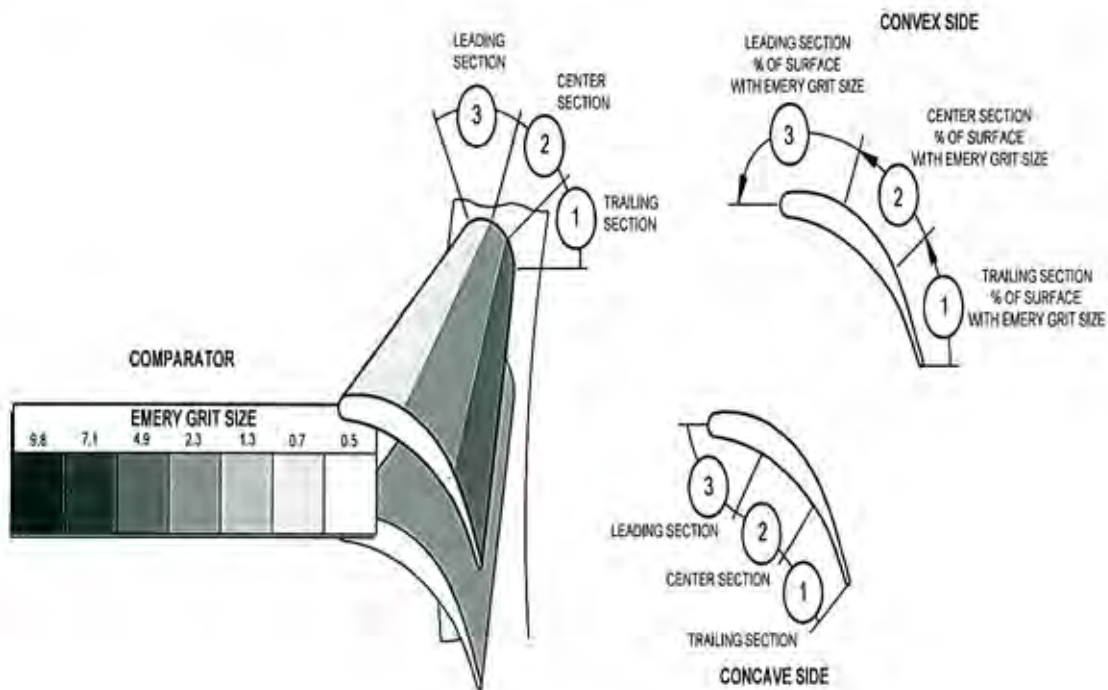

- **TOOTH HEIGHT FOR TIP SPILL STRIP:**

8 measurements for tooth height are taken in one stage of the tip spill strip to average the height of the tooth.

77/

ALSTOM	Client	J-Power (Electric Power Development Co. Ltd.,)
	Project	Turbine and System Assessment for NTPC-Korba Unit #4
	Order No.	CGP10028C
	Contractor	ALSTOM K.K. NASL Ltd. (Nominated subcontractor in India)
NTPC ALSTOM Power Services Pvt. Ltd.	Document	FINAL REPORT VOL. III (STEAM PATH AUDIT)

- **TOOTH HEIGHT FOR END PACKING:**

8 measurements for tooth height are taken in one seal of end packing to average the height of the tooth.

- **TOOTH HEIGHT FOR INTERSTAGE PACKING:**

2 measurements for tooth height are taken in one stage of interstage packing to average the height of the tooth.



ALSTOM

Volume- III
Chapter – 05
SUMMARY OF
OBSERVATIONS &
RECOMMENDATION OF EACH
COMPONENT.

NTPC ALSTOM
Power Services Pvt. Ltd.



ALSTOM	Client	J-Power (Electric Power Development Co. Ltd.,)
	Project	Turbine and System Assessment for NTPC-Korba Unit #4
	Order No.	CGP10028C
	Contractor	ALSTOM K.K. NASL Ltd. (Nominated subcontractor in India)
NTPC ALSTOM Power Services Pvt. Ltd.	Document	FINAL REPORT VOL. III (STEAM PATH AUDIT) CONDITIONAL HEALTH ASSESSMENT STUDY.

5.0 Summary of SPA findings for IP/LP Turbines.

SI No	Component	Testing	Key Observations/ Findings/ condition assessment	Photos / Sketch
1. IP Turbine				
1.1	Blade of Rotor/ casing	Surface Roughness measurement	<p>Opening Audit Losses: 3350.3 kW & heat rate was 50.86 kJ/kWh.</p> <p>Closing Audit losses: 1756.9 kW and heat rate was 26.63 kJ/kWh.</p> <p>Total Recovery: 1593.4 kW and 24.23 kJ/kWh</p>	 <p>Surface roughness in 14th Stage- TP Generator Side</p>
1.2	Interstage Packing	Clearance of Interstage Packing	<p>Opening Audit Losses: -7.7 kW & Heat rate was -0.11 kJ/kWh</p> <p>Closing Audit losses: -138.3 kW & heat rate was -2.09 kJ/kWh</p> <p>Total Recovery: 130.6 kW and 1.98 kJ/kWh are recovered</p>	 <p>Clearance of interstage packing</p>
1.3	Cover Deposits	Interstage fin height measurement	Fin of Interstage was worn and bend	 <p>Height of fin</p>

ALSTOM	Client	J-Power (Electric Power Development Co. Ltd.,)
	Project	Turbine and System Assessment for NTPC-Korba Unit #4
	Order No.	CGP10028C
	Contractor	ALSTOM K.K. NASL Ltd. (Nominated subcontractor in India)
NTPC ALSTOM Power Services Pvt. Ltd.	Document	FINAL REPORT VOL. III (STEAM PATH AUDIT) CONDITIONAL HEALTH ASSESSMENT STUDY.

5.0 Summary of SPA findings for IP/LP Turbines.

SI No	Component	Testing	Key Observations/ Findings/ condition assessment	Photos / Sketch
		Cover Deposit measurement	<p>Opening Audit Losses: 186.7 kW and heat rate was 2.83 kJ/kWh</p> <p>Closing Audit losses: Due to the blasting cover deposit have been removed</p> <p>Total Recovery: 186.7 kW and 2.83 kJ/kWh.</p>	 <p style="text-align: center;">Cover deposit</p>
1.4	Tip Spill Strip	Clearance of Tip Spill Strips	<p>Opening Audit Losses: -210.2 kW and heat rate was -3.18 kJ/kWh</p> <p>Closing Audit losses: -104.3 kW and heat rate is -1.58 kJ/kWh.</p> <p>Total Recovery: -105.9 kW and -1.6 kJ/kWh.</p>	 <p style="text-align: center;">Clearance of Tip spill strip</p>

ALSTOM	Client	J-Power (Electric Power Development Co. Ltd.,)
	Project	Turbine and System Assessment for NTPC-Korba Unit #4
	Order No.	CGP10028C
	Contractor	ALSTOM K.K. NASL Ltd. (Nominated subcontractor in India)
NTPC ALSTOM Power Services Pvt. Ltd.	Document	FINAL REPORT VOL. III (STEAM PATH AUDIT) CONDITIONAL HEALTH ASSESSMENT STUDY.

5.0 Summary of SPA findings for IP/LP Turbines.

SI No	Component	Testing	Key Observations/ Findings/ condition assessment	Photos / Sketch
1.5	End Packing	Clearance measurement	<p>Opening Audit Losses: 64.2 kW and heat rate was 0.97 kJ/kWh</p> <p>Closing Audit losses: 26.2 kW and heat rate was 0.40 kJ/kWh.</p> <p>Total Recovery: 38.0 kW and 0.57 kJ/kWh</p>	

2. LP Turbine

2.1	Blade of Rotor/ Casing	Surface Roughness Test	<p>Opening Audit Losses: 3585.0 kW and heat rate was 54.45 kJ/kWh</p> <p>Closing Audit losses: 1140.9 kW and heat rate was 17.28 kJ/kWh</p> <p>Total Recovery: 2444.1 kW and 37.17 kJ/kWh</p>	<p>LP Rotating - Blade-Surface Roughness</p>
-----	------------------------	------------------------	---	--

ALSTOM	Client	J-Power (Electric Power Development Co. Ltd.,)
	Project	Turbine and System Assessment for NTPC-Korba Unit #4
	Order No.	CGP10028C
	Contractor	ALSTOM K.K. NASL Ltd. (Nominated subcontractor in India)
NTPC ALSTOM Power Services Pvt. Ltd.	Document	FINAL REPORT VOL. III (STEAM PATH AUDIT) CONDITIONAL HEALTH ASSESSMENT STUDY.

5.0 Summary of SPA findings for IP/LP Turbines.

Sl No	Component	Testing	Key Observations/ Findings/ condition assessment	Photos / Sketch
2.2	Interstage Packing	Clearance of Interstage Packing	<p>The opening audit loss due to Interstage packing was 245.3 kW and an increase in heat rate 3.71 kJ/kWh and in closing loss was 212.5 kW and heat rate was 3.21 kJ/kWh.</p> <p>Total of 32.8 kW and 0.50 kJ/kWh are recovered</p>	<p>A cross-sectional diagram of a turbine stage. It shows a balance hole on the left, a wheel in the middle, and interstage packing on the right, all mounted on a shaft. Labels include 'BALANCE HOLE', 'WHEEL', 'INTERSTAGE PACKING', and 'SHAFT'.</p>
2.3	End Packing	Clearance measurement	<p>The opening audit loss due to end packing was 2.3 kW and an increase in heat rate 0.03 kJ/kWh and in closing loss was -3.2 kW and heat rate was -0.05 kJ/kWh.</p> <p>Total of 5.5 kW and 0.08 kJ/kWh are recovered</p>	<p>A cross-sectional diagram of the end packing area. It shows a gland exhauster, a steam seal header, a packing casing, a rotor, and two seals (Seal No. 1 and Seal No. 2). Labels include 'GLAND EXHAUSTER', 'STEAM SEAL HEADER', 'PACKING CASING', 'ROTOR', 'SEAL NO. 2', 'SEAL NO. 1', 'RING NO.', 'AMBIENT AIR FLOW', and 'STEAM FLOW TO CONDENSER'.</p>
2.4	Tip Spill Strip	Clearance measurement	<p>The opening audit loss due to end packing was 161.3 kW and an increase in heat rate 2.44 kJ/kWh and in closing loss was 122.5 kW and heat rate was 1.85 kJ/kWh.</p> <p>Total of 38.8 kW and 0.59 kJ/kWh are recovered</p>	<p>A cross-sectional diagram of a tip spill strip on a rotor. It shows the tip of the rotor and the spill strip. Labels include 'Tip', 'Spill Strip', and 'ROTOR'.</p>

777



ALSTOM

Volume- III
Chapter – 06

Field measurement data

NTPC ALSTOM
Power Services Pvt. Ltd.

ALSTOM	Client	J-Power (Electric Power Development Co. Ltd.,)
	Project	Turbine and System Assessment for NTPC-Korba Unit #4
	Order No.	CGP10028C
	Contractor	ALSTOM K.K. NASL Ltd. (Nominated subcontractor in India)
NTPC ALSTOM Power Services Pvt. Ltd.	Document	FINAL REPORT VOL. III (STEAM PATH AUDIT)

6. FIELD MEASUREMENT DATA

For Field measurement data for opening and closing SPA audit refer annexure 1 & 2 respectively.

086/

Annexure 1

done (OK)

Encotech™ Steam Turbine Performance Evaluation

OWNER: NTPC
STATION: Korba TPS

UNIT NO: 4

INVESTIGATOR: PAUL ROEDIGER
DATE: VINAY SINGH
PROJECT NO: MAY 21, 2010
Opening Audit

TURBINE GEOMETRY DATA SHEET

Casing: **IP Turb**

Stage Number	Stationary Blading					Rotating Blading					Balance Holes						
	Axial Width (in.)	Axial Width Adjustment	Axial Width Adjustment	Blade Height (in.)	Root Diameter (in.)	Axial Width (in.)	Axial Width Adjustment	Axial Width Adjustment	Blade Height (in.)	Root Diameter (in.)	Qty Holes	Location Wheel or Root	Qty Bends	Axial Length (in.)	Radial Position (in.)	Major Axis (in.)	Minor Axis (in.)
TURB	✓✓			✓✓	✓✓	✓✓			✓✓	✓✓							
1	1.337	—	—	3 13/16	31 9/16	1.424	—	—	3.938	32.0625	2						
2	1.076	—	—	3 13/16	32 2/16	1.431	—	—	4.062	32.9375	3						
3	1.070	—	—	4 4/16	30 1/16	1.390	—	—	4.250	33.0625	4						
4	1.076	—	—	4 5/16	39	1.290	—	—	4.375	34.625	5						
5	1.062	—	—	4 6/16	34 17/16	1.135	—	—	4.563	35.250	6						
6	1.083	—	—	4 9/16	35 8/16	1.129	—	—	4.750	36.125	7						
7	1.058	—	—	4 12/16	36 5/16	1.130	—	—	4.938	36.875	8						
8	1.073	—	—	5	37 1/16	1.442	—	—	5.000	38.375	9						
9	1.039	—	—	4 15/16	38 19/16	1.123	—	—	4.938	39.250	10						
10	1.061	—	—	4 15/16	39 5/16	1.111	—	—	5.063	39.875	11						
11	1.073	—	—	5	40 2/16	1.132	—	—	5.188	40.69375	12						
12	1.071	—	—	5 1/16	40 13/16	1.139	—	—	5.375	41.5625	13						
13	1.118	—	—	5 5/16	41 11/16	1.156	—	—	5.438	42.4375	14						
14	1.159	—	—	5 7/16	42 7/16	1.190	—	—	5.625	42.5625							

Notes:

Encotech™ Steam Turbine Performance Evaluation

OWNER: NTPC
STATION: Korba TPS

UNIT NO: 4

INVESTIGATOR:
DATE:
PROJECT NO:

PAUL ROEDIGER
VINCE SIOGEL
MAY 20, 2010
Opening Audit

TURBINE GEOMETRY DATA SHEET

Casing: IP Gen

Stage Number	Stationary Blading					Rotating Blading					Balance Holes						
	Axial Width (in.)	Axial Width Adjustment	Axial Width Adjustment	Blade Height (in.)	Root Diameter (in.)	Axial Width (in.)	Axial Width Adjustment	Axial Width Adjustment	Blade Height (in.)	Root Diameter (in.)	Qty Holes	Location Wheel or Root	Qty Bends	Axial Length (in.)	Radial Position (in.)	Major Axis (in.)	Minor Axis (in.)
Gen	✓			W	W	✓			✓	31 9/16	2						
1	1.337	-	-	3 13/16	31 9/16	1.424	-	-	3 15/16	32 1/16	2						
2	1.076	-	-	3 13/16	32 3/16	1.431	-	-	4 1/16	32 15/16	3						
3	1.070	-	-	4 1/16	33 1/16	1.590	-	-	4 1/4	33 1/16	4						
4	1.075	-	-	5 5/16	34	1.290	-	-	4 9/16	34 10/16	5						
5	1.062	-	-	4 6/16	35 1/16	1.135	-	-	4 9/16	35 4/16	6						
6	1.083	-	-	4 9/16	35 8/16	1.129	-	-	4 12/16	36 7/16	7						
7	1.058	-	-	4 11/16	36 5/16	1.130	-	-	4 13/16	36 4/16	8						
8	1.073	-	-	5	37 1/16	1.442	-	-	5	38 7/16	9						
9	1.039	-	-	5 15/16	38 9/16	1.123	-	-	4 15/16	39 4/16	10						
10	1.061	-	-	4 15/16	39 5/16	1.111	-	-	5 1/16	39 19/16	11						
11	1.073	-	-	5	40 2/16	1.132	-	-	5 3/16	40 1/16	12						
12	1.071	-	-	5 1/16	40 13/16	1.139	-	-	5 6/16	41 7/16	13						
13	1.118	-	-	5 5/16	41 11/16	1.156	-	-	5 7/16	42 7/16	14						
14	1.119	-	-	5 7/16	42 7/16	1.190	-	-	5 19/16								

Notes:

Encotech™ Steam Turbine Performance Evaluation

OWNER: NTPC
STATION: Korba TPS

UNIT NO: 4

INVESTIGATOR:
DATE:
PROJECT NO:

PAUL ROEDIGER
VINAY SINGH
MAY 18, 2010
Opening Audit

16.1
100
96
40
32
27

TURBINE GEOMETRY DATA SHEET

Casing: LP

Stage Number	Stationary Blading					Rotating Blading					Balance Holes						
	Axial Width (in.)	Axial Width Adjustment	Axial Width Adjustment	Blade Height (in.)	Root Diameter (in.)	Axial Width (in.)	Axial Width Adjustment	Axial Width Adjustment	Blade Height (in.)	Root Diameter (in.)	Qty Holes	Location Wheel or Root	Qty Bends	Axial Length (in.)	Radial Position (in.)	Major Axis (in.)	Minor Axis (in.)
TURB	✓	✓	✓	✓	✓	✓	✓	✓	✓								
1	1.288	—	—	4 1/16	63 9/16	1.719	—	—	4.65								
2	1.700	—	—	5 9/16	63 9/16	2.177	—	—	6 7/16								
3	2.057	—	—	7 10/16	63 7/16	2 3/8	—	—	9 1/4								
4	3 10/16	-.127	—	11 1/2	63 9/16	4	—	—	15 1/16								
5	5 1/2	-.127	—	20 14/16	63 7/16	5	—	—	25 9/16								
6	6 7/16	-.127	—	37 7/8	61 10/16	6 1/4	—	—	41 13/16								
Gen	✓	✓	✓	✓	✓	✓	✓	✓	✓								
1	1.288	—	—	4.062	63.375	1.726	—	—	4 3/4								
2	1.700	—	—	5.375	63.375	2.185	—	—	6 5/16								
3	2.057	—	—	7.625	63.438	2.78	—	—	9 4/16								
4	3.625	-.127	—	11.500	63.375	4	—	—	15 1/16								
5	5.5	-.127	—	20.875	63.438	5	—	—	25 9/16								
6	6.438	-.127	—	37.125	61.625	6 1/4	—	—	41 13/16								

Notes:

Encotech™ Steam Turbine Performance Evaluation

OWNER: NTPC
STATION: Korba TPS

UNIT NO: 4

INVESTIGATOR: Viraj & Paul
DATE: MAY 18, 2010
PROJECT NO: **Opening Audit**

INTERSTAGE PACKINGS DATA SHEET

Casing: **IP Turb**

Stage Number	Tooth		Clearance		Condn	Tooth Heights							Out of Round			Additional Info			
	Type	Active Number	Left (in.)	Right (in.)	Top/Bot Round (%)	Left (in.)	Bottom Left (in.)	Bottom (in.)	Bottom Right (in.)	Right (in.)	Top Right (in.)	Top (in.)	Top Left (in.)	Tops On Diameter		Tops Off Diameter	Tooth Meas	Side US/DS	
														Horz	Vert	Horz			
TURB	✓	✓	✓	✓	✓		✓	✓		✓									
1	HL	A	024	034	φ		223	231	=	.227								2	
2	STP	3	025	032	φ		203	212	=	.208								2	DS
3	STP	3	027	031	φ		208	202	=	.205								2	DS
4	STP	3	027	031	φ		207	207	=	.207								2	DS
5	STP	3	030	035	φ		210	211	=	.211								2	DS
6	STP	3	030	029	φ		210	205	=	.208								2	DS
7	STP	3	032	035	φ		211	206	=	.208								2	DS
8	STP	3	031	034	φ		213	208	=	.211								2	DS
9	STP	3	029	035	φ		210	207	=	.209								2	DS
10	STP	3	032	033	φ		211	209	=	.210								2	DS
11	STP	3	025	034	φ		212	214	=	.213								2	DS
12	STP	3	030	030	φ		208	214	=	.211								2	DS
13	STP	3	030	030	φ		214	216	=	.215								2	DS
14	STP	3	029	029	φ		198	218	=	.208								2	DS

Packing Types: No Tooth Single Axial Single Radial Double Straight Two Single Straight-Smooth
 HoneyComb Double & Single Step HiLo Labyrinth Slant-Slant Slant-Smooth Alternate

Encotech Steam Turbine Performance Evaluation

OWNER: NTPC
STATION: Korba TPS

UNIT NO: 4

INVESTIGATOR:
DATE:
PROJECT NO:

PAUL ROEDIGER
VINAY SINGH
MAY 20, 2010
Opening Audit

INTERSTAGE PACKINGS DATA SHEET

Casing: IP Gen

Stage Number	Tooth		Clearance		Condn	Tooth Heights							Out of Round			Additional Info		
	Type	Active Number	Left (in.)	Right (in.)	Top/Bot Round (%)	Left (in.)	Bottom		Bottom Right (in.)	Right (in.)	Top Right (in.)	Top (in.)	Top Left (in.)	Tops On Diameter		Tops Off Diameter Horiz	Tooth Meas	Side US/DS
							Left (in.)	Right (in.)						Horiz	Vert			
Gen	✓	✓	✓	✓	✓		✓	✗		✓								
1	HL	4	025	035	10		223	226	=	.225							2	
2	STP	3	025	031	10		199	203	=	.201							2	DS
3	STP	3	027	033	10		195	202	=	.199							2	DS
4	STP	3	030	032	10		197	206	=	.202							2	DS
5	STP	3	031	032	10		198	207	=	.203							2	DS
6	STP	3	030	035	10		193	211	=	.202							2	DS
7	STP	3	031	033	10		202	205	=	.204							2	DS
8	STP	3	023	032	10		207	212	=	.210							2	DS
9	STP	3	030	035	10		201	203	=	.202							2	DS
10	STP	3	030	032	10		203	209	=	.206							2	DS
11	STP	3	027	030	10		209	212	=	.211							2	DS
12	STP	3	027	033	10		210	213	=	.212							2	DS
13	STP	3	026	030	10		214	214	=	.214							2	DS
14	STP	3	020	031	10		215	215	=	.215							2	DS

Packing Types: No Tooth Single Axial Ingle Axial Double Straight Two Single Straight-Smooth
 HoneyComb Double & Single Step Hi o Labyrinth Slant-Stant Slant-Smooth Alternate

Encotech™ Steam Turbine Performance Evaluation

OWNER: NTPC
STATION: Korba TPS



UNIT NO: 4

INVESTIGATOR: VINAY SINGH & PAUL ROEDIGER
DATE: MAY 18, 2010
PROJECT NO: Opening Audit

INTERSTAGE PACKINGS DATA SHEET

Casing: LP

Stage Number	Tooth		Clearance		Condtn Round (%)	Tooth Heights							Out of Round		Additional Info		
	Type	Active Number	Left (in.)	Right (in.)		Left (in.)	Bottom Left (in.)	Bottom (in.)	Bottom Right (in.)	Right (in.)	Top Right (in.)	Top (in.)	Top Left (in.)	Tops On Diameter		Tooth Meas	Side US/DS
			Horiz	Vert													
TURB	✓	✓	✓	✓	✓		✓	✓		✓							
1	STSM	3	—	—	+	—	—	—	—	—	—	—	—	—	—	—	—
2	STSM	9	069	047	50		042	043	=	043							4 DS
3	STSM	11	055	045	50		058	061	=	060							4 DS
4	STSM	7	057	035	50		052	052	=	052							6 DS
5	STSM	8	060	053	50		084	090	=	087							6 DS
6	STSM	8	077	040	50		056	060	=	058							5 DS
Gen	✓	✓	✓	✓	✓		✓	✓		✓							
1	STSM	3	—	—	+	—	—	—	—	—	—	—	—	—	—	—	—
2	STSM	9	074	042	50		052	069	=	060							6 DS
3	STSM	11	060	042	50		069	068	=	069							6 DS
4	STSM	7	061	037	50		070	064	=	067							6 DS
5	STSM	8	092	036	50		066	066	=	066							6 DS
6	STSM	8	075	053	50		062	058	=	060							6 DS

Packing Types: No Tooth Single Axial Single Radial Double Straight Two Single Straight-Smooth
HoneyComb Double & Single Step HiLo Labyrinth Slant-Slant Slant-Smooth Alternate

936

done

Encotech™ Steam Turbine Performance Evaluation

OWNER: NTPC
STATION: Korba TPS

UNIT NO: 4

INVESTIGATOR:
DATE:
PROJECT NO:

VINAY SINGH
PAUL ROEDIGER
MAY 20, 2010
Opening Audit

OK

TIP SPILL STRIP DATA SHEET

EXTRACTION STAGE 9

Casing: IP Turb

Stage Number	Tooth		Clearance		Condn	Tooth Heights							Out of Round			Additional Info		
	Type	Active Number	Left (in.)	Right (in.)	% Round (%)	Left (in.)	Bottom Left (in.)	Bottom (in.)	Bottom Right (in.)	Right (in.)	Top Right (in.)	Top (in.)	Top Left (in.)	Tops On Diameter		Tops Off Diameter	Tooth Meas	Side US/DS
														Horiz	Vert	Horz		
TURB	✓	✓	✓	✓	✓	✓	✓	✓	✓	✓	✓	✓	✓					
1	HL	4	025	036	100/100	059	078	067	063	038	068	057	077				2	DS
2	HL	4	040	036	100/100	047	065	069	064	039	067	065	064				2	DS
3	HL	4	028	042	100/100	068	083	072	073	023	069	063	077				2	DS
4	HL	4	031	035	100/100	059	083	068	063	048	066	063	074				2	DS
5		3	031	035	100/100	063	074	068	064	045	070	067	074				2	DS
6		3	039	036	100/100	055	085	076	078	044	067	070	075				2	DS
7		3	031	036	100/100	065	081	078	066	044	067	075	075				2	DS
8	HILD	4	033	036	100/100	059	085	083	071	042	079	079	069				2	DS
9		3	030	035	100/100	062	081	080	065	045	068	078	071				2	DS
10		3	030	035	100/100	061	085	084	066	041	068	072	071				2	DS
11		3	030	034	100/100	065	083	084	066	047	068	080	077				2	DS
12		3	031	032	100/100	065	092	087	073	047	068	083	081				2	DS
13		3	033	034	100/100	060	086	083	075	052	070	085	082				2	DS
14		3	039	036	100/100	064	079	086	070	055	067	085	070				2	DS

Packing Types: No Tooth Single Axial Single Radial Double Straight Two Single Straight-Smooth
 HoneyComb Double & Single Step HiLo Labyrinth Slant-Slant Slant-Smooth Alternate

Encotech™ Steam Turbine Performance Evaluation

OWNER: NTPC
STATION: Korba TPS

UNIT NO: 4

INVESTIGATOR: PAUL ROEDIGER
DATE: VINAY SINGH
PROJECT NO: MAY 20, 2010
Opening Audit

TIP SPILL STRIP DATA SHEET

DESIGN 2010

done $2.5 + "$
 $6 = .023$
 $14 = .0157$ $.015 = 1/64$ "

Casing: **IP Gen**

Stage Number	Tooth		Clearance		Condn % Round (%)	Tooth Heights							Out of Round		Additional Info		
	Type	Active Number	Left (in.)	Right (in.)		Left (in.)	Bottom Left (in.)	Bottom (in.)	Bottom Right (in.)	Right (in.)	Top Right (in.)	Top (in.)	Top Left (in.)	Tops On Diameter		Tooth Meas	Side US/DS
													Horiz	Vert	Diameter Horz		
Gen	✓	✓	✓	✓	✓	✓	✓	✓	✓	✓	✓	✓	✓				
1	HL	4	031	039	100/100	066	071	068	048	038	068	050	066				Z DS
2	HL	4	032	036	100/100	065	077	060	033	048	066	058	071				Z DS
3	HL	4	035	036	100/100	046	064	066	053	046	076	068	065				Z DS
4	HL	4	025	037	100/100	074	083	058	067	047	072	062	074				Z DS
5	STP	3	029	038	100/100	076	085	068	064	050	067	055	065				Z DS
6	STP	3	027	036	100/100	065	086	073	065	051	074	069	077				Z DS
7	STP	3	022	036	100/100	070	084	079	069	045	070	073	069				Z DS
8	HL	4	022	036	100/100	068	082	078	069	039	073	069	070				Z DS
9	STP	3	022	037	100/100	067	080	071	063	047	074	074	075				Z DS
10	STP	3	022	036	100/100	068	071	074	068	046	068	078	076				Z DS
11	STP	3	024	035	100/100	075	086	085	074	045	076	083	080				Z DS
12	STP	3	023	034	100/100	075	086	077	080	049	074	074	073				Z DS
13	STP	3	022	039	100/100	074	088	083	077	048	073	075	078				Z DS
14	STP	3	024	047	100/100	081	085	085	079	059	075	072	080				Z DS

Packing Types: No Tooth Single Axial Single Radial Double Straight Two Single Straight-Smooth
 HoneyComb Double & Single Step HiLo Labyrinth Slant-Slant Slant-Smooth Alternate

Korba

Encotech™ Steam Turbine Performance Evaluation

OWNER: NTPC
STATION: Korba TPS

UNIT NO: 4

INVESTIGATOR: VINAY & PAUL
DATE: MAY 18, 2010
PROJECT NO: Opening Audit

TIP SPILL STRIP DATA SHEET

Casing: LP

Stage Number	Tooth		Clearance		Condn % Round (%)	Tooth Heights							Out of Round			Additional Info		
	Type	Active Number	Left (in.)	Right (in.)		Left (in.)	Bottom Left (in.)	Bottom (in.)	Bottom Right (in.)	Right (in.)	Top Right (in.)	Top (in.)	Top Left (in.)	Tops On Diameter		Tops Off Diameter	Tooth Meas	Side US/DS
														Horiz	Vert	Horz		
TURB	✓	✓	✓	✓	✓	✓	✓	✓	✓	✓	✓	✓	✓					
1	STSM	9	050	035	φ130	080	085	081	091	043	068	068	075					6
2	STSM	11	055	030	530	059	073	071	076	080	058	058	101					6
3	—	—	—	—	+	—	—	—	—	—	—	—	—	—	—	—	—	—
4	—	—	—	—	/	—	—	—	—	—	—	—	—	—	—	—	—	—
5	—	—	—	—	/	—	—	—	—	—	—	—	—	—	—	—	—	—
6	—	—	—	—	/	—	—	—	—	—	—	—	—	—	—	—	—	—
Gen	✓	✓	✓	✓	✓	✓	✓	✓	✓	✓	✓	✓	✓					
1	STSM	9	046	037	10/60	065	080	083	093	058	083	085	086					6
2	STSM	11	047	035	φ160	068	081	070	089	058	077	087	080					6
3	—	—	—	—	+	—	—	—	—	—	—	—	—	—	—	—	—	—
4	—	—	—	—	/	—	—	—	—	—	—	—	—	—	—	—	—	—
5	—	—	—	—	/	—	—	—	—	—	—	—	—	—	—	—	—	—
6	—	—	—	—	/	—	—	—	—	—	—	—	—	—	—	—	—	—

Packing Types: No Tooth Single Axial Single Radial Double Straight Two Single Straight-Smooth
 HoneyComb Double & Single Step HiLo Labyrinth Slant-Slant Slant-Smooth Alternate

Encotech™ Steam Turbine Performance Evaluation

OWNER: NTPC
STATION: Korba TPS

UNIT NO: 4

INVESTIGATOR: PAUL ROEDIGER
DATE: MAY 20, 2010
PROJECT NO: Opening Audit

CLEARANCE DATA SHEET - DESIGN

Casing: IP Turb

Stage Number	Interstage Packings				Root Spill Strips			Tip Spill Strips			End Packings							
	Type	Active Number	Design Clearance (in.)	Shaft Diameter (in.)	Type	Active Number	Design Clearance (in.)	Type	Active Number	Design Clearance (in.)	Desc/ Seal	Ring Number	Source	Return	Type ✓	Active Number ✓	Design Clearance (in.) ✓	Shaft Diameter (in.) ✓
TURB	✓	✓	✓	✓				✓	✓	✓							.6	RAMACOR DIAM 5
1	HL	4	.9	31 19/16				HL	4	.9	SZ				ALT	14	.6	27 7/16
2	STP	3	.9	31 9/16				HL	4	.9	Z				ALT	14	.6	27 7/16
3	STP	3	.9	32 7/16				HL	4	.9	3				ALT	14	.6	27 7/16
4	STP	3	.9	33 5/16				HL	4	.9	SZ				ALT	14	.6	27 7/16
5	STP	3	1.0	34 3/16				STP	3	1.0								
6	STP	3	1.0	34 14/16				STP	3	1.0								
7	STP	3	1.0	35 19/16				STP	3	1.0								
8	STP	3	1.0	36 5/16				STP	4	1.0								
9	STP	3	1.0	37 13/16				STP	3	1.0								
10	STP	3	1.0	38 10/16				STP	3	1.0								
11	STP	3	1.0	39 7/16				STP	3	1.0								
12	STP	3	1.0	40 4/16				STP	3	1.0								
13	STP	3	1.0	40 15/16				STP	3	1.0								
14	STP	3	1.0	41 19/16				STP	3	1.0								
			.6 =	52.3														

Packing Types: No Tooth Single Axial Single Radial Double Straight Two Single Straight-Smooth
 HoneyComb Double & Single Step HiLo Labyrinth Slant-Slant Slant-Smooth Alternate

→ semi low clearance
 → pointing clearance
 → clearance conforming

789

Encotech™ Steam Turbine Performance Evaluation

OWNER: NTPC
STATION Korba TPS

UNIT NO: 4

INVESTIGATOR: PAUL ROEDIGER
DATE: MAY 20, 2010
PROJECT NO: Opening Audit

CLEARANCE DATA SHEET - DESIGN

Casing: IP Gen

Stage Number	Interstage Packings				Root Spill Strips			Tip Spill Strips			End Packings								
	Type	Active Number	Design Clearance (in.)	Shaft Diameter (in.)	Type	Active Number	Design Clearance (in.)	Type	Active Number	Design Clearance (in.)	Desc/ Seal	Ring Number	Source	Return	Type	Active Number	Design Clearance (in.)	Shaft Diameter (in.)	
Gen	✓	✓	✓					✓	✓	✓									
1	HL	4	.9		X			HL	4	.9	S1	1	EXH	SSH	ALT	8	.6	27 7/16	
2	STP	3	.9						HL	4	.9		2	EXH	SSH	ALT	8	.6	27 7/16
3	STP	3	.9						HL	4	.9		3	EXH	SSH	ALT	8	.6	27 7/16
4	STP	3	.9						HL	4	.9	S2	1	EXH	GEH	ALT	8	.6	27 7/16
5	STP	3	1.0						STP	3	1.0								
6	STP	3	1.0						STP	3	1.0								
7	STP	3	1.0						STP	3	1.0								
8	STP	3	1.0						HL	4	1.0								
9	STP	3	1.0						STP	3	1.0								
10	STP	3	1.0						STP	3	1.0								
11	STP	3	1.0						STP	3	1.0								
12	STP	3	1.0						STP	3	1.0								
13	STP	3	1.0						STP	3	1.0								
14	STP	3	1.0						STP	3	1.0								
			.65	-126.7															
			.42																

Packing Types: No Tooth Single Axial Single Radial Double Straight Two Single Straight-Smooth
 HoneyComb Double & Single Step HiLo Labyrinth Slant-Slant Slant-Smooth Alternate

Encotech™ Steam Turbine Performance Evaluation

OWNER: NTPC
STATION Korba TPS

UNIT NO: 4

INVESTIGATOR: PAUL ROEDIGER
DATE: VINAY SINGH
MAY 19, 2010
PROJECT NO: Opening Audit

CLEARANCE DATA SHEET - DESIGN

Casing: LP

Stage Number	Interstage Packings				Root Spill Strips			Tip Spill Strips			End Packings								
	Type	Active Number	Design Clearance (in.)	Shaft Diameter (in.)	Type	Active Number	Design Clearance (in.)	Type	Active Number	Design Clearance (in.)	Desc/ Seal	Ring Number	Source	Return	Type	Active Number	Design Clearance (in.)	Shaft Diameter (in.)	
TURB	✓	✓	✓	✓				✓	✓	✓	✓	✓	✓	✓	✓	✓	✓	✓	✓
1	—	—	—	—				STSM	9	.9	S1	1	EXH	SSH	STSM	20	.6	33 9/16	
2	STSM	9	2.0	63 1/16				STSM	11	.9		2	EXH	SSH	STSM	20	.6	33 9/16	
3	STSM	11	2.0	63 1/16				—	—	—		3	EXH	GCH	STSM	20	.6	33 9/16	
4	STSM	7	2.0	62 9/16				—	—	—	S2	1	EXH	GEN	STSM	20	.6	33 9/16	
5	STSM	8	2.0	56 9/16				—	—	—									
6	STSM	8	2.0	55				—	—	—									
Gen	✓	✓	✓	✓				✓	✓	✓	✓	✓	✓	✓	✓	✓	✓	✓	
1	—	—	—	—				STSM	9	.9	S1	1	EXH	SSH	STSM	20	.6	33 9/16	
2	STSM	9	2.0	63 1/16				STSM	11	.9		2	EXH	SSH	STSM	20	.6	33 9/16	
3	STSM	11	2.0	63 1/16				—	—	—		3	EXH	SSH	STSM	20	.6	33 9/16	
4	STSM	7	2.0	62 9/16				—	—	—	S2	1	EXH	GEN	STSM	20	.6	33 9/16	
5	STSM	8	2.0	56 9/16				—	—	—									
6	STSM	8	2.0	55				—	—	—									

RAMAGUNOON #5

Packing Types: No Tooth Single Axial Single Radial Double Straight Two Single Straight-Smooth
HoneyComb Double & Single Step HiLo Labyrinth Slant-Slant Slant-Smooth Alternate

266

of

done

✓

Encotech™ Steam Turbine Performance Evaluation

OWNER: NTPC
STATION: Korba TPS

UNIT NO: 4

INVESTIGATOR: PAUL ROEDIGER
DATE: MAY 20, 2010
PROJECT NO: Opening Audit

END PACKINGS DATA SHEET

Casing: IP Turb

Location and Ring Number	Tooth		Clearance		Condn	Tooth Heights							Out of Round			Additional Info			
	Type	Active Number	Left (in.)	Right (in.)	% Round	Left (in.)	Bottom Left (in.)	Bottom (in.)	Bottom Right (in.)	Right (in.)	Top Right (in.)	Top (in.)	Top Left (in.)	Tops On Diameter		Tops Off Diameter	Tooth Meas	Side	
	✓	✓	✓	✓	✓	✓	✓	✓	✓	✓	✓	✓	✓	Horiz	Vert	Horz		US/DS	
S 1	ALT	14	027	027	7/8	084	087	082	087	091	098	096	104				2	DS	5
2	ALT	14	021	031	5/10	129	111	110	128	139	090	095	106				2	DS	4
3	ALT	14	025	033	5/10	081	097	085	101	105	095	098	101				2	DS	3
S 2	ALT	14	020	035	7/8	098	089	073	085	080	101	104	116				2	DS	2
					/														
					/														
					/														
					/														
					/														
					/														
					/														
					/														
					/														
					/														
					/														
					/														
					/														
					/														
					/														
					/														
					/														
					/														

4 S17C
4 S18C
2 R1A ✓
LR145 ✓
LR312 ✓
LR314 ✓
LR315 ✓
LR316 ✓
LR317 ✓
LR318 ✓
LR319 ✓
LR320 ✓
LR321 ✓
LR322 ✓
LR323 ✓
LR324 ✓
LR325 ✓
LR326 ✓
LR327 ✓
LR328 ✓
LR329 ✓
LR330 ✓
LR331 ✓
LR332 ✓
LR333 ✓
LR334 ✓
LR335 ✓
LR336 ✓
LR337 ✓
LR338 ✓
LR339 ✓
LR340 ✓
LR341 ✓
LR342 ✓
LR343 ✓
LR344 ✓
LR345 ✓
LR346 ✓
LR347 ✓
LR348 ✓
LR349 ✓
LR350 ✓
LR351 ✓
LR352 ✓
LR353 ✓
LR354 ✓
LR355 ✓
LR356 ✓
LR357 ✓
LR358 ✓
LR359 ✓
LR360 ✓
LR361 ✓
LR362 ✓
LR363 ✓
LR364 ✓
LR365 ✓
LR366 ✓
LR367 ✓
LR368 ✓
LR369 ✓
LR370 ✓
LR371 ✓
LR372 ✓
LR373 ✓
LR374 ✓
LR375 ✓
LR376 ✓
LR377 ✓
LR378 ✓
LR379 ✓
LR380 ✓
LR381 ✓
LR382 ✓
LR383 ✓
LR384 ✓
LR385 ✓
LR386 ✓
LR387 ✓
LR388 ✓
LR389 ✓
LR390 ✓
LR391 ✓
LR392 ✓
LR393 ✓
LR394 ✓
LR395 ✓
LR396 ✓
LR397 ✓
LR398 ✓
LR399 ✓
LR400 ✓
LR401 ✓
LR402 ✓
LR403 ✓
LR404 ✓
LR405 ✓
LR406 ✓
LR407 ✓
LR408 ✓
LR409 ✓
LR410 ✓
LR411 ✓
LR412 ✓
LR413 ✓
LR414 ✓
LR415 ✓
LR416 ✓
LR417 ✓
LR418 ✓
LR419 ✓
LR420 ✓
LR421 ✓
LR422 ✓
LR423 ✓
LR424 ✓
LR425 ✓
LR426 ✓
LR427 ✓
LR428 ✓
LR429 ✓
LR430 ✓
LR431 ✓
LR432 ✓
LR433 ✓
LR434 ✓
LR435 ✓
LR436 ✓
LR437 ✓
LR438 ✓
LR439 ✓
LR440 ✓
LR441 ✓
LR442 ✓
LR443 ✓
LR444 ✓
LR445 ✓
LR446 ✓
LR447 ✓
LR448 ✓
LR449 ✓
LR450 ✓
LR451 ✓
LR452 ✓
LR453 ✓
LR454 ✓
LR455 ✓
LR456 ✓
LR457 ✓
LR458 ✓
LR459 ✓
LR460 ✓
LR461 ✓
LR462 ✓
LR463 ✓
LR464 ✓
LR465 ✓
LR466 ✓
LR467 ✓
LR468 ✓
LR469 ✓
LR470 ✓
LR471 ✓
LR472 ✓
LR473 ✓
LR474 ✓
LR475 ✓
LR476 ✓
LR477 ✓
LR478 ✓
LR479 ✓
LR480 ✓
LR481 ✓
LR482 ✓
LR483 ✓
LR484 ✓
LR485 ✓
LR486 ✓
LR487 ✓
LR488 ✓
LR489 ✓
LR490 ✓
LR491 ✓
LR492 ✓
LR493 ✓
LR494 ✓
LR495 ✓
LR496 ✓
LR497 ✓
LR498 ✓
LR499 ✓
LR500 ✓

Packing Types: No Tooth Single Axial Single Radial Double Straight Two Single Straight-Smooth
HoneyComb Double & Single Step HiLo Labyrinth Slant-Slant Slant-Smooth Alternate

Encotech™ Steam Turbine Performance Evaluation

OWNER: NTPC
STATION: Korba TPS

UNIT NO: 4

INVESTIGATOR: PAUL ROEDIGER

VINAY SINGH

DATE: MAY 20 2010

Opening Audit

S1 PROJECT NO: 52

TURBINE

END PACKINGS DATA SHEET

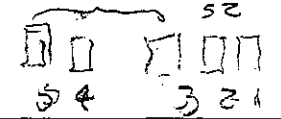
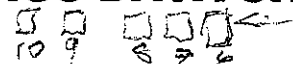

Casing: **IP Gen** S2 S1

Location and Ring Number	Tooth		Clearance		Cond'n	Tooth Heights							Out of Round		Additional Info				
	Type	Active Number	Left (in.)	Right (in.)	% Round	Left (in.)	Bottom Left (in.)	Bottom (in.)	Bottom Right (in.)	Right (in.)	Top Right (in.)	Top Left (in.)	Top (in.)	Tops On Diameter		Tops Off Diameter	Tooth Meas	Side US/DS	
	✓	✓	✓	✓	✓	✓	✓	✓	✓	✓	✓	✓	✓	Horiz	Vert	Horz			
S1	ALT	8	017	033	52/100	096	092	083	082	083	090	092	093					2	DS
2	ALT	8	023	031	52/100	097	088	085	098	096	091	102	100					2	DS
3	ALT	8	020	030	52/100	095	091	087	096	098	088	103	095					2	DS
S2	ALT	8	020	025	50/100	096	098	090	094	092	083	095	092					2	DS
					/														
					/														
					/														
					/														
					/														
					/														
					/														
					/														
					/														
					/														
					/														
					/														
					/														
					/														
					/														
					/														
					/														
					/														
					/														

Packing Types: No Tooth, Single Axial, Single Radial, Double Straight, Two Single, Straight-Smooth
 HoneyComb, Double & Single, Step, HiLo Labyrinth, Slant-Slant, S ant-tooth, Alternate

6
7
8
9

Encotech™ Steam Turbine Performance Evaluation

For Surface Roughness

done

OWNER: NTPC
STATION: Korba TPS

UNIT NO: 4

OK

ELECTRONIC PROFLOWMETER
INVESTIGATOR: VINAY SINGH
PAUL ROEDIGER
DATE: MAY 21, 2010
PROJECT NO: Opening Audit

SURFACE ROUGHNESS for STATIONARY BLADING

Casing: IP Turb		Stationary - Convex						Stationary - Concave					
Stage Number	Trailing Section		Center Section		Leading Section		Stage Number	Trailing Section		Center Section		Leading Section	
	Equivalent Grain Size	Percent of Surface	Equivalent Grain Size	Percent of Surface	Equivalent Grain Size	Percent of Surface		Equivalent Grain Size	Percent of Surface	Equivalent Grain Size	Percent of Surface	Equivalent Grain Size	Percent of Surface
TURB	✓	✓	✓	✓	✓	✓	TURB	✓	✓	✓	✓	✓	✓
1	1.8	30	—	—	0.7	70	1	155	95	—	—	0.6	5
2	1.8	30	0.7	60	0.85	10	2	155	95	—	—	0.6	5
3	1.3	30	0.7	60	0.85	10	3	155	95	—	—	0.6	5
4	1.0	30	0.7	60	0.85	10	4	0.8	25	155	70	0.65	5
5	0.9	30	0.7	60	0.85	10	5	0.8	25	155	70	0.65	5
6	0.8	30	0.7	60	0.85	10	6	0.8	25	155	70	0.65	5
7	0.75	30	0.7	60	0.85	10	7	1.60	95	—	—	1.65	5
8	0.7	30	0.7	60	0.85	10	8	0.70	95	—	—	1.65	5
9	0.7	30	1.3	50	1.70	20	9	155	10	1.8	85	1.80	5
10	0.7	30	1.4	50	1.70	20	10	155	10	1.85	85	1.80	5
11	0.7	20	1.5	50	1.70	20	11	155	5	1.9	85	1.80	10
12	0.7	30	1.4	50	1.71	20	12	1.6	5	1.9	85	1.80	10
13	0.8	15	1.5	75	1.70	10	13	1.6	5	1.13	85	1.80	10
14	0.9	15	1.6	75	1.70	10	14	1.6	5	1.18	85	1.80	10

Encotech™ Steam Turbine Performance Evaluation

OWNER: NTPC
STATION: Korba TPS

UNIT NO: 4

OK

INVESTIGATOR: VINAY SINGH
PAUL ROEDIGER
DATE: MAY 21, 2010
PROJECT NO: Opening Audit

SURFACE ROUGHNESS for STATIONARY BLADING

Casing: IP Gen		Stationary - Convex						Stationary - Concave					
Stage Number	Trailing Section		Center Section		Leading Section		Stage Number	Trailing Section		Center Section		Leading Section	
	Equilavent Grain Size	Percent of Surface	Equilavent Grain Size	Percent of Surface	Equilavent Grain Size	Percent of Surface		Equilavent Grain Size	Percent of Surface	Equilavent Grain Size	Percent of Surface	Equilavent Grain Size	Percent of Surface
Gen	✓	✓	✓	✓	✓	✓	Gen	✓	✓	✓	✓	✓	✓
1	1.8	30	—	—	.7	70	1	.55	95	—	—	.6	5
2	1.8	30	.7	60	.85	10	2	.55	95	—	—	.6	5
3	1.3	30	.7	60	.85	10	3	.55	95	—	—	.6	5
4	1.0	30	.7	60	.85	10	4	.8	25	.55	70	.65	5
5	.9	30	.7	60	.85	10	5	.8	25	.55	70	.65	5
6	.8	30	.7	60	.85	10	6	.8	25	.55	70	.65	5
7	.75	30	.7	60	.85	10	7	.6	95	—	—	.65	5
8	.7	30	.7	60	.85	10	8	.7	95	—	—	.65	5
9	.7	30	1.3	50	.7	20	9	.55	10	.8	85	.8	5
10	.7	30	1.4	50	.7	20	10	.55	10	.85	85	.8	5
11	.7	30	1.5	50	.7	20	11	.55	5	.9	85	.8	10
12	.7	30	1.4	50	.7	20	12	.6	5	.9	85	.8	10
13	.8	15	1.5	75	.7	10	13	.6	5	1.3	85	.8	10
14	.9	15	1.6	75	.7	10	14	.6	5	1.8	85	.8	10

Encotech™ Steam Turbine Performance Evaluation

OWNER: NTPC
STATION: Korba TPS

UNIT NO: 4

INVESTIGATOR: PAUL ROEDIGER

DATE: MAY 19, 2010

PROJECT NO: Opening Audit

SURFACE ROUGHNESS for STATIONARY BLADING

Casing: LP		Stationary - Convex						Stationary - Concave					
Stage Number	Trailing Section		Center Section		Leading Section		Stage Number	Trailing Section		Center Section		Leading Section	
	Equivalent Grain Size	Percent of Surface	Equivalent Grain Size	Percent of Surface	Equivalent Grain Size	Percent of Surface		Equivalent Grain Size	Percent of Surface	Equivalent Grain Size	Percent of Surface	Equivalent Grain Size	Percent of Surface
TURB							TURB						
1	.9	10	2.3	80	2.0	10	1	.6	10	—	—	3.0	90
2	3.0	45	4.9	20	1.3	35	2	.6	50	.8	30	.7	20
3	.9	60	1.8	20	.7	20	3	.6	55	—	—	.5	45
4	1.6	30	9.3	30	1.3	40	4	.8	40	1.3	30	2.0	30
5	.9	10	4.9	40	1.3	50	5	.8	95	—	—	1.6	5
6	1.1	70	3.0	10	1.3	20	6	.8	95	—	—	1.3	5
Gen							Gen						
1	1.6	75	2.0	20	.5	5	1	.5	5	3.0	70	.6	5
2	3.0	45	4.9	20	1.3	35	2	.6	95	—	—	2.3	5
3	.9	60	1.8	20	.7	20	3	.6	55	—	—	.5	40
4	1.3	25	9.3	30	1.3	45	4	.6	15	1.3	75	.9	10
5	.9	50	4.9	40	1.3	10	5	.8	95	—	—	1.6	5
6	1.1	70	3.0	10	1.3	20	6	.8	95	—	—	1.3	5

OK

266

done

Encotech™ Steam Turbine Performance Evaluation

OWNER: NTPC
STATION: Korba TPS

UNIT NO: 4

INVESTIGATOR:
DATE:
PROJECT NO:

*PAUL J
Vinay*
20.05.10
Opening Audit

SURFACE ROUGHNESS for ROTATING BLADING

Casing: IP Turb													
Stage Number	Stationary - Convex						Stage Number	Stationary - Concave					
	Trailing Section		Center Section		Leading Section			Trailing Section		Center Section		Leading Section	
	Equivalent Grain Size	Percent of Surface	Equivalent Grain Size	Percent of Surface	Equivalent Grain Size	Percent of Surface		Equivalent Grain Size	Percent of Surface	Equivalent Grain Size	Percent of Surface	Equivalent Grain Size	Percent of Surface
TURB							TURB						
1	1.8	10	0.9	85	4.9	5	1	0.7	60			0.65	40
2	1.8	10	0.9	85	4.9	5	2	1.7	66			0.65	40
3	1.7	10	0.9	85	4.9	5	3	0.65	90			0.70	10
4	1.6	10	0.7	85	4.9	5	4	0.65	90			0.70	10
5	1.5	10	0.7	85	3.3	5	5	0.65	90			0.70	10
6	1.4	5	0.7	90	2.3	5	6	0.65	90			0.70	10
7	1.3	5	0.9	90	2.3	5	7	0.65	90			0.70	10
8	0.8	20	1.3	75	2.3	5	8	0.6	90			0.65	10
9	0.8	30	1.0	55	2.3	15	9	0.65	80			0.70	20
10	0.8	30	1.0	55	2.3	15	10	0.65	80			0.70	20
11	0.8	30	1.0	55	2.3	15	11	0.65	80			0.70	20
12	0.9	10	1.8	75	2.3	15	12	0.65	80			0.70	20
13	0.9	5	3.8	80	2.3	15	13	0.7	90			1.8	10
14	0.9	5	3.8	80	2.3	15	14	0.70	90			1.8	10

Encotech™ Steam Turbine Performance Evaluation

OWNER: NTPC
STATION: Korba_TPS

UNIT NO: 4

INVESTIGATOR: PAUL ROEDIGER
VIWAY SINGH
DATE: MAY 20, 2010
PROJECT NO: Opening Audit

SURFACE ROUGHNESS for ROTATING BLADING

Casing: IP Gen													
Stage Number	Stationary - Convex						Stage Number	Stationary - Concave					
	Trailing Section		Center Section		Leading Section			Trailing Section		Center Section		Leading Section	
	Equivalent Grain Size	Percent of Surface	Equivalent Grain Size	Percent of Surface	Equivalent Grain Size	Percent of Surface		Equivalent Grain Size	Percent of Surface	Equivalent Grain Size	Percent of Surface	Equivalent Grain Size	Percent of Surface
Gen							Gen						
1	1.8	10	.9	85	4.9	5	1	.7	60			.65	40
2	1.8	10	.9	85	4.9	5	2	.7	60			.65	40
3	1.7	10	.9	85	4.9	5	3	.65	90			.7	10
4	1.6	10	.7	85	4.9	5	4	.65	90			.7	10
5	1.5	10	.7	85	3.8	5	5	.65	90			.7	10
6	1.4	5	.7	90	2.3	5	6	.65	90			.7	10
7	1.3	5	.9	90	2.3	5	7	.65	90			.7	10
8	.8	20	1.3	75	2.3	5	8	.6	90			.65	10
9	.8	30	1.0	55	2.3	15	9	.65	80			.7	20
10	.8	30	1.0	55	2.3	15	10	.65	80			.7	20
11	.8	30	1.0	55	2.3	15	11	.65	80			.7	20
12	.9	10	1.8	75	2.3	15	12	.65	80			.7	20
13	.9	5	3.8	80	2.3	15	13	.7	90			1.8	10
14	.9	5	3.8	80	2.3	15	14	.7	90			1.8	10

Encotech™ Steam Turbine Performance Evaluation

OWNER: NTPC
STATION: Korba TPS

UNIT NO: 4

INVESTIGATOR: VINAY A PAUL
DATE: 18.05.10
PROJECT NO: Opening Audit

SURFACE ROUGHNESS for ROTATING BLADING

Casing: LP		Stationary - Convex						Stationary - Concave					
Stage Number	Trailing Section		Center Section		Leading Section		Stage Number	Trailing Section		Center Section		Leading Section	
	Equivalent Grain Size	Percent of Surface	Equivalent Grain Size	Percent of Surface	Equivalent Grain Size	Percent of Surface		Equivalent Grain Size	Percent of Surface	Equivalent Grain Size	Percent of Surface	Equivalent Grain Size	Percent of Surface
TURB							TURB						
1	1.3	45	0.9	50	4.9	5	1	0.55	95			0.6	5
2	1.8	40	2.8	20	1.3	40	2	0.65	60	1.8	30	1.3	10
3	0.5	30	1.8	40	0.8	30	3	0.9	1			0.7	99
4	3.8	80			1.0	20	4	3.8	30	0.7	60	4.2	10
5	2.3	79	2.8	20	7.1	1	5	0.7	95			0.8	5
6	0.7	97			9.8	3	6	0.7	100				
Gen							Gen						
1	1.8	45	0.9	50	4.9	5	1	0.55	95			0.6	5
2	1.8	40	2.8	20	1.3	40	2	0.65	60	1.8	30	1.3	10
3	0.5	30	1.8	40	0.8	30	3	0.9	1			0.7	99
4	3.8	80			1.0	20	4	3.8	30	0.7	60	4.2	10
5	2.3	79	2.8	20	7.1	1	5	0.7	95			0.8	5
6	0.7	97			9.8	3	6	0.7	100				

Encotech™ Steam Turbine Performance Evaluation

OWNER: NTPC
STATION: Korba TPS

UNIT NO: 4

(off)

INVESTIGATOR: PAUL ROEDIGER
VINAY SINGH
DATE: MAY 20, 2010
PROJECT NO: Opening Audit

DEPOSITS & MISCELLANEOUS LOSSES DATA SHEET

IP Gen	Blade Deposits						Cover Deposits	Trailing Edge Thickness		Hand Calculations		Notes
	Stationary Blading			Rotating Blading				Depth of Deposit Under Blade Cover (in.)	Audit T.E. Thick. (in.)	Design Throat Width	Power Loss kW	
Stage Number	Design Throat Width	Convex Surface (in.)	Concave Surface (in.)	Design Throat Width	Convex Surface (in.)	Concave Surface (in.)						
Gen							✓					
1							~.001					COULD NOT SEE OR PHOTO
2							~.09					ROUGH GUESS BASED ON
3							~.09					MEASUREMENT OF BEAD AND
4							~.09					FEEEL. DEPOSITS WITHIN A
5							~.09					STAGE ARE NOT CONSISTANT
6							~.09					
7							~.09					
8							~.09					
9							~.09					
10							~.001					
11							~.001					
12							~.001					
13							~.001					
14							~.001					

Notes:

Annexure 2

Encotech™ Steam Turbine Performance Evaluation

OWNER: NTPC - ALSTOM POWER SERVICES PVT. LTD.

INVESTIGATOR: _____

STATION: _____ UNIT NO: _____

DATE: _____

PROJECT NO: _____

INTERSTAGE PACKINGS DATA SHEET

Casing: *IP Turbine*

Stage Number	Tooth		Clearance		Condn Top/Bot Round (%)	Tooth Heights						Out of Round			Additional Info			
	Type	Active Number	Left (in.)	Right (in.)		Left (in.)	Bottom Left (in.)	Bottom (in.)	Bottom Right (in.)	Right (in.)	Top Right (in.)	Top (in.)	Top Left (in.)	Taps On Diameter		Tops Off Diameter Horz	Tooth Meas	Side US/DS
														Horz	Vert			
1	HiLo	4	024	032	0		223	231	=	227								
2	STP	3	024	032	0		205	212	=	208								
3	STP	3	025	030	0		208	202	=	205								
4	STP	3	026	030	0		207	207	=	207								
5	"	3	028	033	0		210	211	=	211								
6	"	3	029	028	0		210	205	=	208								
7	"	3	031	033	0		211	206	=	208								
8	"	3	030	034	0		213	208	=	211								
9	"	3	029	035	0		210	207	=	207								
10	"	3	030	034	0		211	209	=	210								
11	"	3	025	033	0		212	214	=	213								
12	"	3	029	029	0		208	214	=	211								
13	"	3	029	029	0		214	216	=	215								
14	"	3	029	028	0		198	218	=	208								

Packing Types: No Tooth Single Axial Single Radial Double Straight Two Single Straight-Smooth
 HoneyComb Double & Single Step HiLo Labyrinth Slant-Slant Slant-Smooth Alternate

Encotech™ Steam Turbine Performance Evaluation

OWNER: NTPC - ALSTOM POWER SERVICES PVT. LTD.

STATION: UNIT NO: 4

INVESTIGATOR: _____

DATE: _____

PROJECT NO: _____

INTERSTAGE PACKINGS DATA SHEET

Casing: IP GEN

Stage Number	Tooth		Clearance		Condn Top/Bot Round (%)	Tooth Heights							Out of Round			Additional Info		
	Type	Active Number	Left (in.)	Right (in.)		Left (in.)	Bottom Left (in.)	Bottom (in.)	Bottom Right (in.)	Right (in.)	Top Right (in.)	Top (in.)	Top Left (in.)	Tops On Diameter		Tops Off Diameter Horz	Tooth Meas	Side US/DS
														Horiz	Vert			
1	FILE	4	025	034				0209	223	226	=	225						
2	STP	3	024	030				210	223	203	=	201						
3	STP	3	026	032					199	202	=	199						
4	STP	3	029	032					195	206	=	202						
5	STP	3	029	031					197	207	=	203						
6	STP	3	030	033					198	211	=	202						
7	STP	3	031	031					193	205	=	204						
8	STP	3	023	031					202	212	=	210						
9		3	029	031					207	203	=	202						
10		3	028	030					201	209	=	206						
11		3	026	032					203	212	=	211						
12		3	026	028					209	213	=	212						
13		3	025	031					210	214	=	214						
14	*	3	024	039					215	215	=	215						

Packing Types: No Tooth Single Axial Single Radial Double Straight Two Single Straight-Smooth
 HoneyComb Double & Single Step HiLo Labyrinth Slant-Slant Slant-Smooth Alternate

805

Encotech™ Steam Turbine Performance Evaluation

OWNER: **NTPC - ALSTOM POWER SERVICES PVT. LTD.**
 STATION: _____ UNIT NO: _____

INVESTIGATOR: Vinay K. Singh
 DATE: _____
 PROJECT NO: _____

INTERSTAGE PACKINGS DATA SHEET

Casing: LP

Stage Number	Tooth		Clearance		Condn	Tooth Heights						Out of Round		Additional Info			
	Type	Active Number	Left (in.)	Right (in.)	Top/Bot Round (%)	Left (in.)	Bottom		Right (in.)	Top Right (in.)	Top (in.)	Top Left (in.)	Tops On Diameter		Tops Off Diameter Horz	Tooth Meas	Side US/DS
							Left (in.)	Right (in.)					Horz	Vert			
2	STSM	9	.100	.100	80		042	043	=	043						4	DS
3	STSM	11	095	095	80		058	061	=	066						4	↓
4	STSM	7	101	101	80		052	052	=	052						6	↓
5	STSM	8	069	069	80		082	090	=	087						6	↓
6	STSM	8	095	095	80		056	060	=	058						5	↓
2	STSM	9	095	095	80		054	069	=	060						6	DS
3	STSM	11	085	085	80		067	068	=	069						6	↓
4	STSM	7	087	087	80		070	064	=	067						6	↓
5	STSM	8	090	090	80		066	066	=	066						6	↓
6	STSM	8	093	093	80		062	058	=	060						6	↓

LP
IM

LP
SM

Packing Types: **No Tooth** **Single Axial** **Single Radial** **Double Straight** **Two Single** **Straight-Smooth**
 HoneyComb **Double & Single** **Step** **HiLo Labyrinth** **Slant-Slant** **Slant-Smooth** **Alternate**

Encotech™ Steam Turbine Performance Evaluation

OWNER: NTPC - ALSTOM POWER SERVICES PVT. LTD.
 STATION: UNIT NO: _____

INVESTIGATOR: Vinay K. Singh
 DATE: _____
 PROJECT NO: _____

TIP SPILL STRIP DATA SHEET

Casing: ~~HIP~~ IP Turb

Stage Number	Tooth		Clearance		Condtn % Round	Tooth Heights							Out of Round		Additional Info			
	Type	Active Number	Left (in.)	Right (in.)		Left (in.)	Bottom Left (in.)	Bottom (in.)	Bottom Right (in.)	Right (in.)	Top Right (in.)	Top (in.)	Top Left (in.)	Tops On Diameter		Tops Off Diameter	Tooth Meas	Side US/DS
			Horiz	Vert	Horz													
1	HILo	4	030	032	90	059	078	067	063	066	066	057	077				2	DS
2	HILo	4	031	033	90	047	065	069	064	067	067	065	064				2	DS
3	HILo	4	031	034	90	068	085	072	073	069	069	063	077				2	DS
4	HILo	4	025	033	90	059	088	068	063	066	066	063	074				2	DS
5	STP	3	029	035	90	063	074	068	064	070	071	067	074				2	DS
6	STP	3	026	035	90	058	085	076	078	067	067	070	075				2	DS
7	STP	3	022	035	90	065	081	078	066	067	067	075	075				2	DS
8	HILo	4	022	036	90	059	085	083	071	079	079	079 069					2	DS
9	STP	3	022	036	90	062	081	080	068	068	068	078	071				2	DS
10	STP	3	022	035	90	061	085	084	066	068	068	072	071				2	DS
11	STP	3	023	034	90	065	089	089	066	068	068	080	077				2	DS
12	STP	3	022	033	90	065	090	087	073	068	068	083	081				2	DS
13	STP	3	021	034	90	060	086	083	075	070	070	085	082				2	DS
14	STP	3	022	040	90	064	079	081	070	067	067	085	070				2	DS

Packing Types: No Tooth Single Axial Single Radial Double Straight Two Single Straight-Smooth
 HoneyComb Double & Single Step HiLo Labyrinth Slant-Slant Slant-Smooth Alternate

207

Encotech™ Steam Turbine Performance Evaluation

OWNER: NTPC - ALSTOM POWER SERVICES PVT. LTD.
 STATION: UNIT NO: _____

INVESTIGATOR: _____
 DATE: _____
 PROJECT NO: _____

TIP SPILL STRIP DATA SHEET

Casing: ~~IP~~ IP Gen.

Stage Number	Tooth		Clearance		Condn % Round (%)	Tooth Heights							Out of Round			Additional Info		
	Type	Active Number	Left (in.)	Right (in.)		Left (in.)	Bottom Left (in.)	Bottom (in.)	Bottom Right (in.)	Right (in.)	Top Right (in.)	Top (in.)	Top Left (in.)	Tops On Diameter		Tops Off Diameter Horz	Tooth Meas	Side US/DS
														Horiz	Vert			
1	HIL0	4	030	032	90	066	071	068	048	038	068	050	066				2	DS
2	HIL0	4	031	033	90	068	077	060	033	048	066	058	071				2	DS
3	HIL0	4	031	034	90	046	064	068	053	046	076	068	065				2	
4	HIL0	4	025	033	90	074	083	058	067	047	072	062	074				2	
5	STR	3	024	035	90	074	085	068	064	050	067	055	065				2	
6	STR	3	026	035	90	068	086	073	065	051	074	069	077				2	
7	STR	3	022	035	90	070	084	079	069	045	070	073	069				2	
8	HIL0	4	022	036	90	068	082	078	063	035	073	069	070				2	
9	STR	3	022	036	90	067	080	071	068	047	074	074	075				2	
10	STR	3	022	035	90	068	071	074	074	046	068	078	076				2	
11	STR	3	023	034	90	075	086	085	080	048	076	083	080				2	
12	STR	3	022	033	90	075	086	077	080	049	074	074	073				2	
13	STR	3	04	034	90	074	088	083	077	048	073	075	078				2	
14	STR	3	022	040	90	081	085	085	074	059	075	072	080				2	

Packing Types: No Tooth Single Axial Single Radial Double Straight Two Single Straight-Smooth
 HoneyComb Double & Single Step HiLo Labyrinth Slant-Slant Slant-Smooth Alternate

Encotech™ Steam Turbine Performance Evaluation

OWNER: NTPC - ALSTOM POWER SERVICES PVT. LTD.

INVESTIGATOR: _____

STATION: _____ UNIT NO: _____

DATE: _____

PROJECT NO: _____

TIP SPILL STRIP DATA SHEET

Casing: ~~LP~~ LP

Stage Number	Tooth		Clearance		Condn	Tooth Heights							Out of Round		Additional Info			
	Type	Active Number	Left (in.)	Right (in.)	% Round (%)	Left (in.)	Bottom Left (in.)	Bottom (in.)	Bottom Right (in.)	Right (in.)	Top Right (in.)	Top (in.)	Top Left (in.)	Horiz	Vert	Tops Off Diameter Horz	Meas	Side US/DS
1	SFSM	9	075	0100	15	080	085	081	091	043	088	068	075					6
2	SFSM	11	095	075	20	059	073	071	075	086	058	058	101					6
1	SFSM	7	043	037	0	065	088	083	093	058	083	085	086					6
2	SFSM	11	046	033	0	068	081	070	089	058	077	087	080					6

Packing Types: No Tooth Single Axial Single Radial Double Straight Two Single Straight-Smooth
 HoneyComb Double & Single Step HiLo Labyrinth Slant-Slant Slant-Smooth Alternate

809

Encotech™ Steam Turbine Performance Evaluation

OWNER: NTPC - ALSTOM POWER SERVICES PVT. LTD.
 STATION: UNIT NO: _____

INVESTIGATOR: _____
 DATE: _____
 PROJECT NO: T2387; LOA No. 25021

END PACKINGS DATA SHEET

Casing: ~~IP Turb~~ IP Turb & IT Gen

Location and Ring Number	Tooth		Clearance		Condn	Tooth Heights							Out of Round		Additional Info			
	Type	Active Number	Left	Right	% Round	Left	Bottom Left	Bottom	Bottom Right	Right	Top Right	Top	Top Left	Tops On Diameter		Tops Off Diameter	Tooth Meas	Side US/DS
	(in.)	(in.)	(in.)	(in.)	(%)	(in.)	(in.)	(in.)	(in.)	(in.)	(in.)	(in.)	(in.)	Horiz	Vert	Horz		
S 1	ALF	14	026	025	0	084	087	082	087	091	098	096	104				2	DS
	ALF	14	021	026	0	129	111	110	128	139	099	095	106				2	
	ALF	14	024	029	0	081	097	085	087	095	095	098	101				2	
S 1	ALF	14	024	030	0	098	088	073	085	080	101	104	116				2	
S 1	ALI	8	020	030	0	096	092	083	082	083	090	092	099				2	DS
	ALI	8	021	030	0	097	088	095	098	096	091	100	100				2	
	ALI	8	021	030	0	095	091	089	096	098	088	103	095				2	
	ALI	8	020	025	0	096	092	090	094	092	083	095	092				2	

Packing Types: No Tooth Single Axial Single Radial Double Straight Two Single Straight-Smooth
 HoneyComb Double & Single Step HiLo Labyrinth Slant-Slant Slant-Smooth Alternate

Encotech™ Steam Turbine Performance Evaluation

OWNER: NTPC - ALSTOM POWER SERVICES PVT. LTD.
 STATION: UNIT NO: _____

INVESTIGATOR: Vijay K. Singh
 DATE: _____
 PROJECT NO: T2387; LOA No. 25021

END PACKINGS DATA SHEET

Casing: **HP/IP LP Tur / LP Gen.**

Location and Ring Number	Tooth		Clearance		Condn	Tooth Heights							Out of Round		Additional Info				
	Type	Active Number	Left	Right	% Round	Left	Bottom Left	Bottom	Bottom Right	Right	Top Right	Top	Top Left	Tops On Diameter		Tops Off Diameter	Tooth Meas	Side US/DS	
	(in.)	(in.)	(%)	(in.)	(in.)	(in.)	(in.)	(in.)	(in.)	(in.)	(in.)	(in.)	(in.)	Horiz	Vert	Horz			
LP Tur	S 1	STSM	20	047	035	90	068	090	101	110	112	034	016	055				2	DS
	2	STSM	20	039	032	90	080	083	089	100	091	068	022	026				2	
	3	STSM	20	042	037	90	080	083	085	096	093	065	031	056				2	
	S 1	STSM	20	047	035	40	060	068	069	081	070	085	043	058				2	
LP Gen	S 1	STSM	20	039	034	100	095	090	103	094	084	049	022	045				2	DS
	2	STSM	20	035	027	100	099	094	089	085	088	032	024	040				2	
	3	STSM	20	036	027	50	091	092	093	083	089	045	038	058				2	
	S 1	STSM	20	034	028	40	101	089	096	088	088	045	031	047				2	

Packing Types: No Tooth Single Axial Single Radial Double Straight Two Single Straight-Smooth
 HoneyComb Double & Single Step HiLo Labyrinth Slant-Slant Slant-Smooth Alternate

8/11

Encotech™ Steam Turbine Performance Evaluation

OWNER: NTPC - ALSTOM POWER SERVICES PVT. LTD.
STATION: UNIT NO: _____

INVESTIGATOR: _____
DATE: _____
PROJECT NO: _____

SURFACE ROUGHNESS for ROTATING BLADING

Turbine

Casing: <i>IP</i>		Rotating - Convex								Rotating Concave							
Stage Number	Trailing Section		Trailing Center		Leading Center		Leading Section		Trailing Section		Trailing Center		Leading Center		Leading Section		
	Equivalent Grain Size	Percent of Surface	Equivalent Grain Size	Percent of Surface	Equivalent Grain Size	Percent of Surface	Equivalent Grain Size	Percent of Surface	Equivalent Grain Size	Percent of Surface	Equivalent Grain Size	Percent of Surface	Equivalent Grain Size	Percent of Surface	Equivalent Grain Size	Percent of Surface	
	1	.65	90					.8	10	.8	20	.7	60			.65	20
2	.65	90					.7	10	.8	20	.7	60			.65	20	
3	.6	90					.7	10	.8	20	.7	60			.65	20	
4	.6	90					.7	10	.7	20	.45	20			.65	60	
5	.6	90					.7	10	.7	20	.45	10			.6	70	
6	.65	90					.7	10	.65	30	.5	10			.55	60	
7	.65	90					.7	10	.9	5	.45	15			.65	80	
8	.6	90					.7	10	.9	5	.45	15			.65	80	
9	.55	80	.65	5			.6	15	.55	10	.5	10			.65	80	
10	.55	80	.65	5			.6	15	.55	10	.5	10			.65	80	
11	.55	80	.65	5			.6	15	.45	10	.5	10			.65	80	
12	.55	80	.65	5			.6	15	.75	15	.7	5			.6	80	
13	.55	80	.65	5			.6	15	.6	15	.45	5			.8	80	
14	.5	80	.65	5			.6	15	.6	15	.45	5			.8	80	

NTPC - ALSTOM - Steam Turbine Performance Evaluation

OWNER: NTPC
 STATION: ~~XXXX~~ Korba

UNIT NO: 4

INVESTIGATOR: _____
 DATE: _____
 PROJECT NO: ~~XXXXXXXXXXXXXXXXXXXX~~

SURFACE ROUGHNESS for ROTATING BLADING

Casing: <i>IP Gen</i>		Stationary - Convex								Stationary - Concave							
Stage Number	IP Section	Trailing Section		Trailing Center		Leading Center		Leading Section		Trailing Section		Trailing Center		Leading Center		Leading Section	
		Equivalent Grain Size	Percent of Surface	Equivalent Grain Size	Percent of Surface	Equivalent Grain Size	Percent of Surface	Equivalent Grain Size	Percent of Surface	Equivalent Grain Size	Percent of Surface	Equivalent Grain Size	Percent of Surface	Equivalent Grain Size	Percent of Surface	Equivalent Grain Size	Percent of Surface
	1	.65	90					.8	10	.8	20	.7	60			.65	20
	2	.65	90					.7	10	.8	20	.7	60				20
	3	.60	90					.7	10	.8	20	.7	60				20
	4	.60	90					.7	10	.7	20	.45	20				60
	5	.65	90					.7	10	.7	20	.45	10				70
	6	.65	90					.7	10	.65	30	.5	10				60
	7	.60	90					.7	10	.9	5	.45	15				80
	8	.55	90					.7	10	.9	5	.45	15				80
	9	.55	80	.65	5			.6	15	.55	10	.5	10				80
	10	.55	80	.65	5			.6	15	.55	10	.5	10				80
	11	.55	80	.65	5			.6	15	.55	10	.5	10			.65	80
	12	.55	80	.65	5			.6	15	.75	15	.7	5			.6	80
	13	.55	80	.65	5			.6	15	.6	15	.45	5			.8	80
	14	.5	80	.65	5			.6	15	.6	15	.45	5			.8	80

Encotech™ Steam Turbine Performance Evaluation

OWNER: NTPC - ALSTOM POWER SERVICES PVT. LTD.
 STATION: UNIT NO: _____

INVESTIGATOR: _____
 DATE: _____
 PROJECT NO: _____

SURFACE ROUGHNESS for ROTATING BLADING

Casing: LP		Rotating - Convex								Rotating Concave							
Stage Number		Trailing Section		Trailing Center		Leading Center		Leading Section		Trailing Section		Trailing Center		Leading Center		Leading Section	
		Equivalent Grain Size	Percent of Surface	Equivalent Grain Size	Percent of Surface	Equivalent Grain Size	Percent of Surface	Equivalent Grain Size	Percent of Surface	Equivalent Grain Size	Percent of Surface	Equivalent Grain Size	Percent of Surface	Equivalent Grain Size	Percent of Surface	Equivalent Grain Size	Percent of Surface
		LP Tr	1	1.3	20	.7	60			1.1	20	.7	95				
	2	.8	80	-	-			1.1	20	.9	90					1.1	10
	3	.8	80	-	-			.9	20	.8	90					1.1	10
	4	2.3	10	.5	20			.65	20	.7	95					2.3	5
	5	.8	100	-	-			-	-	.75	100					-	-
	6	.8	100	-	-			-	-	.75	100					-	-
	/	/	/	/	/	/	/	/	/	/	/	/	/	/	/	/	/
LP Gen	1	1.3	20	.7	60			1.1	20	.7	95					0.9	5
	2	.8	80	-	-			1.1	20	.85	90					1.1	10
	3	.8	80	-	-			.9	20	.8	90					1.0	10
	4	2.3	10	.5	20			.65	70	.7	95					2.3	5
	5	.8	100	-	-			-	-	.75	100					-	-
	6	.8	100	-	-			-	-	.75	100					-	-

Encotech™ Steam Turbine Performance Evaluation

OWNER: NTPC - ALSTOM POWER SERVICES PVT. LTD.
 STATION: UNIT NO: _____

INVESTIGATOR: _____
 DATE: _____
 PROJECT NO: _____

SURFACE ROUGHNESS for STATIONARY BLADING

Casing: <i>IP Turbine</i>		Stationary - Convex								Stationary - Concave							
Stage Number	Trailing Section		Trailing Center		Leading Center		Leading Section		Trailing Section		Trailing Center		Leading Center		Leading Section		
	Equilavent Grain Size	Percent of Surface	Equilavent Grain Size	Percent of Surface	Equilavent Grain Size	Percent of Surface	Equilavent Grain Size	Percent of Surface	Equilavent Grain Size	Percent of Surface	Equilavent Grain Size	Percent of Surface	Equilavent Grain Size	Percent of Surface	Equilavent Grain Size	Percent of Surface	
	1	.45	95					.5	5	.65	50	.13	5			.7	45
2	.45	95					.5	5	.65	50	.13	5			.65	45	
3	.45	95					.5	5	.65	50	.13	5			.7	45	
4	.5	95					.55	5	.65	50	.17	5			.7	45	
5	.5	95					.55	5	.7	50	.9	5			.7	45	
6	.5	95					.6	5	.65	50	.9	5			.7	45	
7	.5	95					.5	5	.7	50	.9	5			.65	45	
8	.45	95					.5	5	.7	60	-				.6	40	
9	.45	5	.48	90			.5	5	.7	60	-				.6	40	
10	.45	5	.45	90			.55	5	.6	20	.17	20			.6	10	
11	.45	95					.5	5	.6	20	.17	20			.6	10	
12	.45	95					.5	5	.6	20	.17	20			.65	20	
13	.45	95					.6	5	.7	75	.19	20			.6	5	
14	.45	95					.5	5	.6	85	-				.7	15	

8/5

NTPC - ALSTOM™ Steam Turbine Performance Evaluation

OWNER: NTPC
 STATION: ~~XXXX~~ Kurba.

UNIT NO: 4

INVESTIGATOR: Veray Krishna Singh
 DATE: _____
 PROJECT NO: _____

SURFACE ROUGHNESS for STATIONARY BLADING

Casing: <u>IP low</u>		Stationary - Convex								Stationary - Concave							
Stage	Number	Trailing Section		Trailing Center		Leading Center		Leading Section		Trailing Section		Trailing Center		Leading Center		Leading Section	
MP Section		Equivalent Grain Size	Percent of Surface	Equivalent Grain Size	Percent of Surface	Equivalent Grain Size	Percent of Surface	Equivalent Grain Size	Percent of Surface	Equivalent Grain Size	Percent of Surface	Equivalent Grain Size	Percent of Surface	Equivalent Grain Size	Percent of Surface	Equivalent Grain Size	Percent of Surface
1	1	.44	55					.5	5	.65	50	1.3	5			.7	45
1	2	.43	45					.5	5	.65	50	1.1	5			.65	45
1	3	.65	35					.5	5	.65	50	1.3	5			.7	45
1	4	.5	95					.55	5	.65	50	0.9	5			.7	45
1	5	.5	95					.55	5	.7	50	0.9	5			.7	45
1	6	.5	95					.6	5	.65	50	0.9	5			.7	45
1	7	.5	95					.5	5	.7	50	0.9	5			.65	45
1	8	.45	95					.5	5	.7	60	1			.6	40	
1	9	.45	5	.48	90			.5	5	.7	60	1			.6	40	
1	10	.45	5	.45	90			.55	5	.6	20	.7	70			.6	10
1	11	.45	95					.5	5	.6	20	.7	70			.6	10
1	12	.5	95					.5	5	.6	20	.7	60			.65	20
2	13	.5	95					.60	5	.7	75	.9	20			.6	5
2	14	.45	95					.5	5	.6	85					.7	15

Encotech™ Steam Turbine Performance Evaluation

OWNER: NTPC - ALSTOM POWER SERVICES PVT. LTD.
 STATION: UNIT NO: _____

INVESTIGATOR: _____
 DATE: _____
 PROJECT NO: _____

SURFACE ROUGHNESS for STATIONARY BLADING

Casing: LP		Stationary - Convex								Stationary - Concave							
Stage Number		Trailing Section		Trailing Center		Leading Center		Leading Section		Trailing Section		Trailing Center		Leading Center		Leading Section	
		Equilavent Grain Size	Percent of Surface	Equilavent Grain Size	Percent of Surface	Equilavent Grain Size	Percent of Surface	Equilavent Grain Size	Percent of Surface	Equilavent Grain Size	Percent of Surface	Equilavent Grain Size	Percent of Surface	Equilavent Grain Size	Percent of Surface	Equilavent Grain Size	Percent of Surface
LP-Twr	1	0.05	5	.48	90	-	-	0.5	5	1	90	-	-	0.5	10		
	2	.6	30	.55	65	-	-	.65	5	0.6	50	-	-	.55	50		
	3	.65	10	.55	85	-	-	.6	5	.65	60	-	-	.5	40		
	4	.65	60	-	-	-	-	.7	40	.65	80	-	-	.6	20		
	5	.7	40	.5	20	-	-	.65	40	.65	80	-	-	.6	20		
	6	.6	95	-	-	-	-	.7	5	.5	10	.65	80	.55	10		
LP-Gen	1	.6	5	.48	90	-	-	.55	5	1.5	90	-	-	0.5	10		
	2	.65	30	.55	65	-	-	.65	5	.6	50	-	-	.55	50		
	3	.65	10	.65	65	-	-	.6	5	.65	60	-	-	.5	40		
	4	.65	60	-	-	-	-	.9	40	.7	80	-	-	.6	20		
	5	.7	40	-	-	-	-	.7	40	.65	80	-	-	.5	20		
	6	.65	95	-	-	-	-	.75	5	.5	10	.65	80	.65	10		

817



ALSTOM

Volume- III
Chapter – 7
Analysis

NTPC ALSTOM
Power Services Pvt. Ltd.



ALSTOM	Client	J-Power (Electric Power Development Co. Ltd.,)
	Project	Turbine and System Assessment for NTPC-Korba Unit #4
	Order No.	CGP10028C
	Contractor	ALSTOM K.K. NASL Ltd. (Nominated subcontractor in India)
NTPC ALSTOM Power Services Pvt. Ltd.	Document	FINAL REPORT VOL. III (STEAM PATH AUDIT)

7. 0.0 ANALYSIS DATA

This section is organized in accordance with the nine loss eSTPE loss categories. These loss categories are:

- Inter-stage Packing
- End Packing
- Tip Spill Strips
- Miscellaneous Leakages
- Flow Path Damage
- Surface Roughness
- Trailing Edge Thickness
- Cover Deposits
- Other (Hand Calculations)

The following sections discuss the audit results for each of the loss categories listed above. Each eSTPE report page shows the power loss in kW and the heat rate loss in kJ/kWh.

	Client	J-Power (Electric Power Development Co. Ltd.,)
	Project	Turbine and System Assessment for NTPC-Korba Unit #4
	Order No.	CGP10028C
	Contractor	ALSTOM K.K. NASL Ltd. (Nominated subcontractor in India)
	Document	FINAL REPORT VOL. III (STEAM PATH AUDIT)

7.1.1 THE INTERSTAGE PACKING

The opening audit loss due to increased inter-stage packing clearances was 237.6 kW and the heat rate degraded 3.6 kJ/kWh. Most of the tooth circumference, of both inter stage of the IP, LP stages, was found with a rounded tooth profile, which passes more flow. The closing audit loss when compared to original design clearances was 74.3 kW and the heat rate degraded 1.12 kJ/kWh.

eSTPE uses the design clearances as the basis for the calculations of all losses. Packing clearances that are at design have no loss associated with them. Clearances that are larger than design introduce a loss to the system. Clearances that are smaller than design result in a performance improvement provided they do not rub in-service.

For Interstage packing, refer photo no 20 for opening audit and stage losses for IP and LP mention in Page 3 to 8.

ALSTOM	Client	J-Power (Electric Power Development Co. Ltd.,)
	Project	Turbine and System Assessment for NTPC-Korba Unit #4
	Order No.	CGP10028C
	Contractor	ALSTOM K.K. NASL Ltd. (Nominated subcontractor in India)
NTPC ALSTOM Power Services Pvt. Ltd.	Document	FINAL REPORT VOL. III (STEAM PATH AUDIT)

Steam Turbine Performance Evaluation Program

NTPC Korba unit # 4 May-2010 final

Audit Results:

Opening May 2010:

Interstage Packings Totals

Description	Power Loss kW	Change In
		G.T.H.R. kJ/kWh
IP TE	-0.1	0
IP GE	-7.6	-0.11
LP TE	135.3	2.05
LP GE	110	1.66
Turbine Total	237.6	3.6

Audit Results:

Opening May 2010:

Interstage Packings IP-TE

Description	Leakage Flow kg/s	Average Clearance mm	Corrected		Stage		Change In G.T.H.R. kJ/kWh
			Average Clearance mm	Wear mm	Efficiency Loss %	Power Loss kW	
Stage 1	1.3739	0.737	0.737	0.152	0.07	1.4	0.02
Stage 2	1.3376	0.724	0.724	0.165	0.01	0.3	0
Stage 3	1.3349	0.737	0.737	0.152	0.02	0.5	0.01
Stage 4	1.357	0.737	0.737	0.152	0.02	0.6	0.01
Stage 5	1.4528	0.825	0.825	0.165	0.03	0.8	0.01
Stage 6	1.2908	0.749	0.749	0.241	-0.04	-1.1	-0.02
Stage 7	1.4009	0.851	0.851	-0.14	0.05	1.5	0.02
Stage 8	1.3297	0.825	0.825	0.165	0.03	0.9	0.01

120

ALSTOM	Client	J-Power (Electric Power Development Co. Ltd.,)
	Project	Turbine and System Assessment for NTPC-Korba Unit #4
	Order No.	CGP10028C
	Contractor	ALSTOM K.K. NASL Ltd. (Nominated subcontractor In India)
NTPC ALSTOM Power Services Pvt. Ltd.	Document	FINAL REPORT VOL. III (STEAM PATH AUDIT)

Stage 9	1.3406	0.813	0.813	0.187	0.01	0.4	0.01
Stage 10	1.2604	0.825	0.825	0.175	0.02	0.8	0.01
Stage 11	1.0649	0.749	0.749	0.251	-0.04	-1.7	-0.03
Stage 12	0.995	0.762	0.762	0.238	-0.03	-1.3	-0.02
Stage 13	0.9045	0.762	0.762	0.238	-0.03	-1.2	-0.02
Stage 14	0.773	0.737	0.737	0.263	-0.04	-1.9	-0.03
Total						-0.1	0

Audit Results:
Opening May 2010:
Interstage Packings **IP-GE**

Description	Leakage Flow kg/s	Average Clearance mm	Corrected	Stage Efficiency Loss %	Power Loss kW	Change In G.T.H.R. kJ/kWh	
			Average Clearance mm				Wear mm
Stage 1	1.4022	0.762	0.762	0.127	0.09	1.7	0.03
Stage 2	1.3151	0.711	0.711	0.178	0	0	0
Stage 3	1.3787	0.762	0.762	0.127	0.05	1	0.02
Stage 4	1.4459	0.787	0.787	0.102	0.07	1.8	0.03
Stage 5	1.4105	0.8	0.8	0.191	0.01	0.2	0
Stage 6	1.4151	0.825	0.825	0.165	0.03	0.8	0.01
Stage 7	1.3416	0.813	0.813	0.178	0.02	0.5	0.01
Stage 8	1.1337	0.698	0.698	0.292	-0.08	-2.6	-0.04
Stage 9	1.3604	0.825	0.825	0.175	0.03	0.9	0.01
Stage 10	1.2051	0.787	0.787	0.213	-0.01	-0.4	-0.01
Stage 11	1.0303	0.724	0.724	0.276	-0.07	-2.5	-0.04

ALSTOM	Client	J-Power (Electric Power Development Co. Ltd.,)
	Project	Turbine and System Assessment for NTPC-Korba Unit #4
	Order No.	CGP10028C
	Contractor	ALSTOM K.K. NASL Ltd. (Nominated subcontractor In India)
NTPC ALSTOM Power Services Pvt. Ltd.	Document	FINAL REPORT VOL. III (STEAM PATH AUDIT)

Stage 12	0.995	0.762	0.762	0.238	-0.03	-1.3	-0.02
Stage 13	0.8466	0.711	0.711	0.289	-0.07	-2.9	-0.04
Stage 14	0.683	0.648	0.648	0.352	-0.1	-4.7	-0.07
Total						-7.6	-0.11

Audit Results:
Opening May 2010:
Interstage Packings **LP-TE**

Description	Leakage Flow kg/s	Average Clearance mm	Corrected		Stage		Change In G.T.H.R. kJ/kWh
			Average Clearance mm	Wear mm	Efficiency Loss %	Power Loss kW	
			Stage 2	2.9713	2.896	2.896	
Stage 3	1.7583	2.464	2.464	0.464	0.28	40.3	0.61
Stage 4	1.0334	2.667	2.667	0.667	0.15	20.3	0.31
Stage 5	0.4758	1.778	1.778	0.222	0	0.5	0.01
Stage 6	0.2315	2.515	2.515	0.515	0.03	9.9	0.15
Total						135.3	2.05

Audit Results:
Opening May 2010:
Interstage Packings **LP-GE**

Description	Leakage Flow kg/s	Average Clearance mm	Corrected		Stage		Change In G.T.H.R. kJ/kWh
			Average Clearance mm	Wear mm	Efficiency Loss %	Power Loss kW	
			Stage 2	2.7466	2.464	2.464	
Stage 3	1.6672	2.235	2.235	0.235	0.2	29	0.44
Stage 4	0.9655	2.286	2.286	0.286	0.1	13.2	0.2

823

ALSTOM	Client	J-Power (Electric Power Development Co. Ltd.,)
	Project	Turbine and System Assessment for NTPC-Korba Unit #4
	Order No.	CGP10028C
	Contractor	ALSTOM K.K. NASL Ltd. (Nominated subcontractor in India)
NTPC ALSTOM Power Services Pvt. Ltd.	Document	FINAL REPORT VOL. III (STEAM PATH AUDIT)

Stage 5	0.5526	2.311	2.311	0.311	0.08	14.5	0.22
Stage 6	0.2297	2.464	2.464	0.464	0.03	9.4	0.14
Total						110	1.66

Steam Turbine Performance Evaluation Program

NTPC korba unit#4 May-2010 final

Audit Results: Closing May 2010: Interstage Packings

Totals

Description	Power Loss kW	Change In G.T.H.R. kJ/kWh
IP GE	-71.6	-1.08
LP TE	112.5	1.7
LP GE	100	1.51
Turbine Total	74.2	1.12

Audit Results: Closing May 2010: Interstage Packings

IP-TE

Description	Leakage Flow kg/s	Corrected Average Clearance mm	Stage Average Clearance mm	Wear mm	Stage Efficiency Loss %	Power Loss kW	Change In G.T.H.R. kJ/kWh
Stage 2	1.0603	0.711	0.711	-0.178	-0.14	-2.9	-0.04
Stage 3	1.023	0.698	0.698	-0.191	-0.15	-3.2	-0.05
Stage 4	1.0579	0.711	0.711	-0.178	-0.14	-3.4	-0.05
Stage 5	1.1045	0.775	0.775	-0.216	-0.16	-4.1	-0.06
Stage 6	1.0071	0.724	0.724	-0.267	-0.2	-5.3	-0.08
Stage 7	1.084	0.813	0.813	-0.178	-0.13	-3.6	-0.05
Stage 8	1.0583	0.813	0.813	-0.178	-0.13	-4	-0.06

ALSTOM	Client	J-Power (Electric Power Development Co. Ltd.,)
	Project	Turbine and System Assessment for NTPC-Korba Unit #4
	Order No.	CGP10028C
	Contractor	ALSTOM K.K. NASL Ltd. (Nominated subcontractor in India)
NTPC ALSTOM Power Services Pvt. Ltd.	Document	FINAL REPORT VOL. III (STEAM PATH AUDIT)

Stage 9	1.0828	0.813	0.813	-0.187	-0.15	-5.2	-0.08
Stage 10	1.0032	0.813	0.813	-0.187	-0.14	-5.1	-0.08
Stage 11	0.8447	0.737	0.737	-0.263	-0.18	-7.1	-0.11
Stage 12	0.7766	0.737	0.737	-0.263	-0.17	-7.1	-0.11
Stage 13	0.7059	0.737	0.737	-0.263	-0.16	-7	-0.11
Stage 14	0.6128	0.737	0.737	-0.276	-0.14	-6.8	-0.1
Total						-66.7	-1.01

Audit Results: Closing May 2010: Interstage Packings

IP-GE

Description	Leakage Flow kg/s	Average Clearance mm	Corrected	Stage Efficiency Loss %	Power Loss kW	Change In G.T.H.R. kJ/kWh	
			Average Clearance mm				Wear mm
Stage 1	1.1193	0.749	0.749	-0.14	-0.08	-1.5	-0.02
Stage 2	1.0234	0.686	0.686	-0.203	-0.16	-3.3	-0.05
Stage 3	1.0772	0.737	0.737	-0.152	-0.12	-2.6	-0.04
Stage 4	1.1494	0.775	0.775	-0.114	-0.09	-2.2	-0.03
Stage 5	1.087	0.762	0.762	-0.229	-0.17	-4.3	-0.07
Stage 6	1.1098	0.8	0.8	-0.191	-0.14	-3.8	-0.06
Stage 7	1.0512	0.787	0.787	-0.203	-0.14	-4.2	-0.06
Stage 8	0.8972	0.686	0.686	-0.305	-0.22	-6.8	-0.1
Stage 9	1.0172	0.762	0.762	-0.238	-0.2	-6.6	-0.1
Stage 10	0.9119	0.737	0.737	-0.263	-0.2	-7.2	-0.11
Stage 11	0.8447	0.737	0.737	-0.263	-0.18	-7.1	-0.11
Stage 12	0.7243	0.686	0.686	-0.314	-0.2	-8.5	-0.13
Stage 13	0.6822	0.711	0.711	-0.289	-0.17	-7.7	-0.12
Stage 14	0.6441	0.762	0.762	-0.238	-0.12	-5.8	-0.09
Total						-71.6	-1.08

Audit Results: Closing May 2010: Interstage Packings

LP-TE

52

ALSTOM	Client	J-Power (Electric Power Development Co. Ltd.,)
	Project	Turbine and System Assessment for NTPC-Korba Unit #4
	Order No.	CGP10028C
	Contractor	ALSTOM K.K. NASL Ltd. (Nominated subcontractor in India)
NTPC ALSTOM Power Services Pvt. Ltd.	Document	FINAL REPORT VOL. III (STEAM PATH AUDIT)

Description	Leakage Flow kg/s	Average Clearance mm	Corrected	Wear mm	Stage	Power Loss kW	Change In
			Average Clearance mm		Efficiency Loss %		G.T.H.R. kJ/kWh
Stage 2	2.7874	2.54	2.54	0.54	0.4	47.6	0.72
Stage 3	1.7391	2.413	2.413	0.413	0.26	38	0.57
Stage 4	1.0159	2.565	2.565	0.565	0.14	18.5	0.28
Stage 5	0.4714	1.753	1.753	-0.247	0	-0.3	-0.01
Stage 6	0.2278	2.413	2.413	0.413	0.03	8.8	0.13
Total						112.5	1.43

**Audit Results: Closing May
2010: Interstage Packings**

LP-GE

Description	Leakage Flow kg/s	Average Clearance mm	Corrected	Wear mm	Stage	Power Loss kW	Change In
			Average Clearance mm		Efficiency Loss %		G.T.H.R. kJ/kWh
Stage 2	2.7183	2.413	2.413	0.413	0.34	41.3	0.63
Stage 3	1.6339	2.159	2.159	0.159	0.17	24.8	0.38
Stage 4	0.95	2.21	2.21	0.21	0.09	11.6	0.18
Stage 5	0.5496	2.286	2.286	0.286	0.07	14	0.21
Stage 6	0.2258	2.362	2.362	0.362	0.03	8.3	0.13
Total						100	1.51

Audit Results: Closing audit 2010: Interstage Packings: Graphs : LP Turb

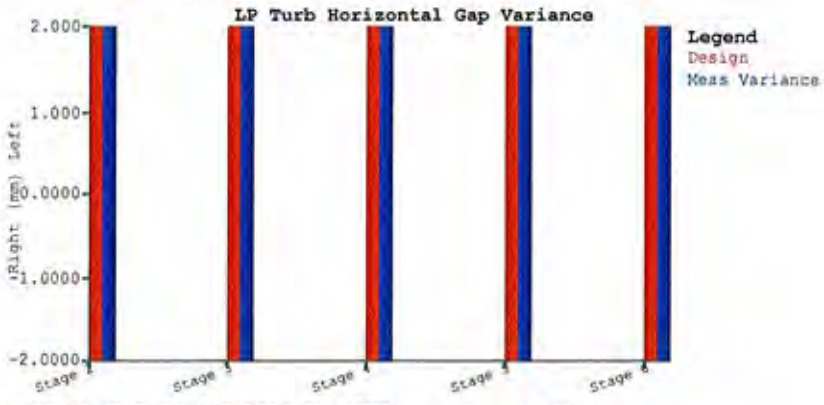
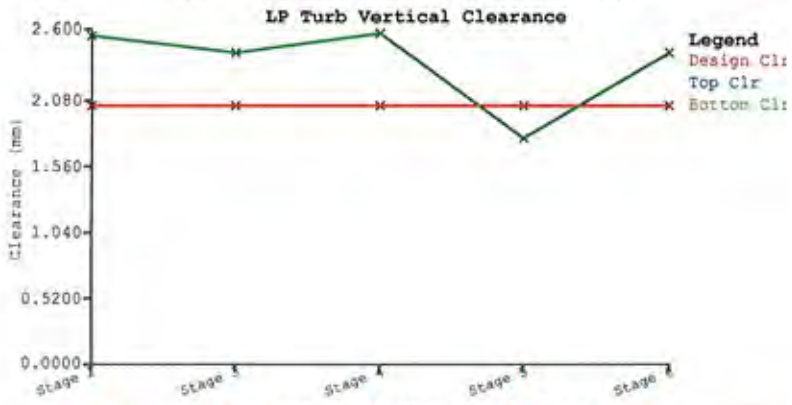
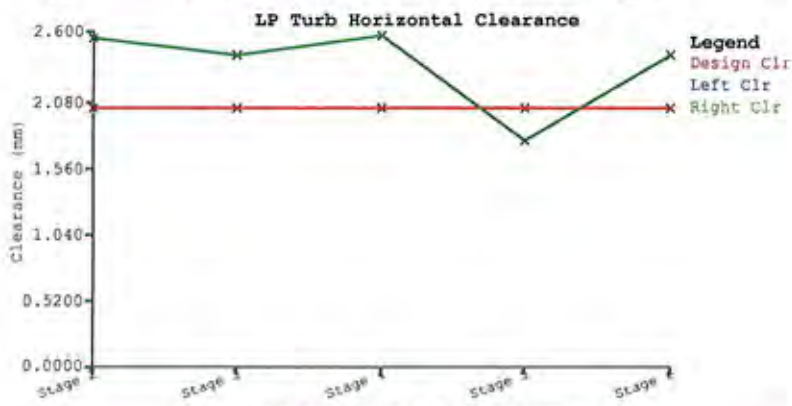
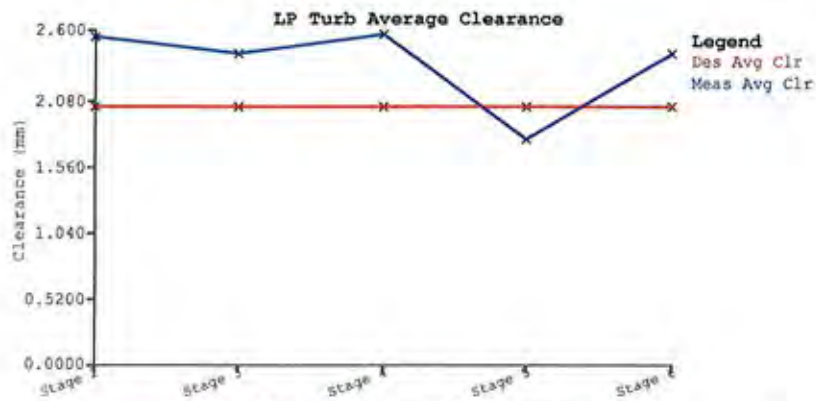

027

Audit Results: Closing audit 2010: Interstage Packings: Graphs : IP Gen

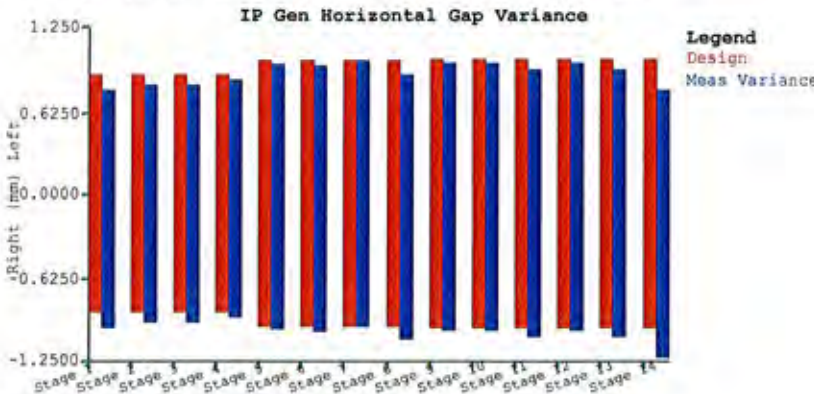
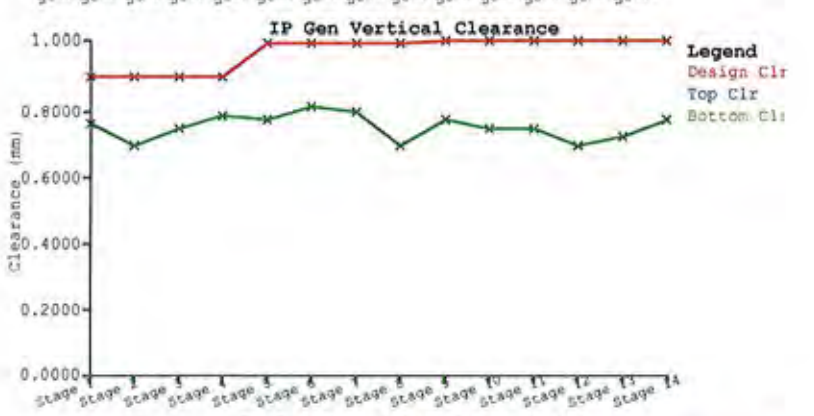
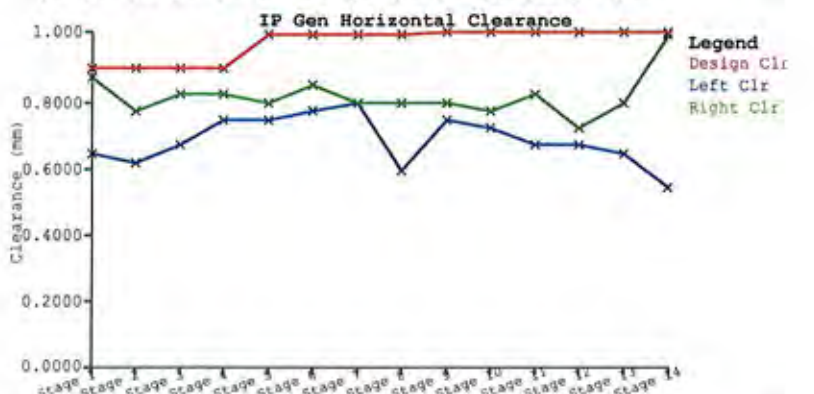
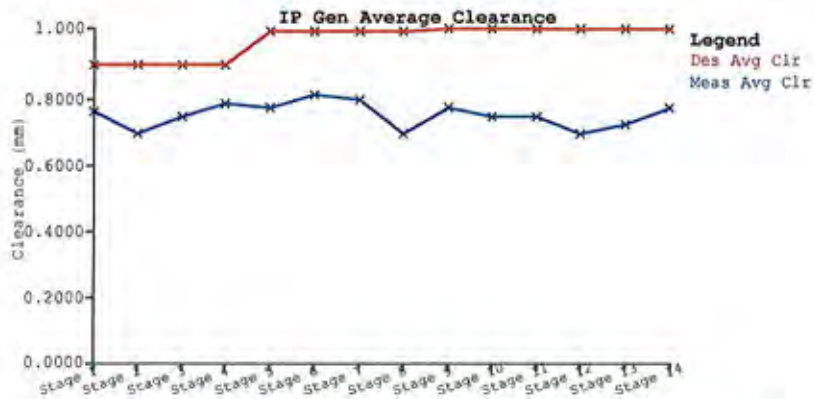

878

Audit Results: Closing audit 2010: Interstage Packings: Graphs : IP Turb

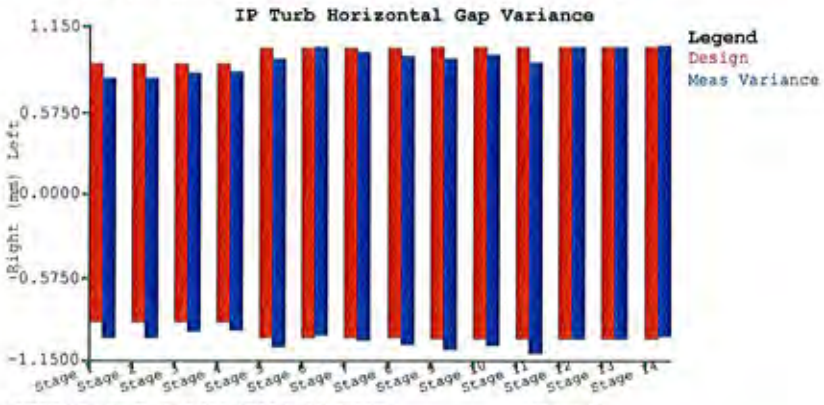
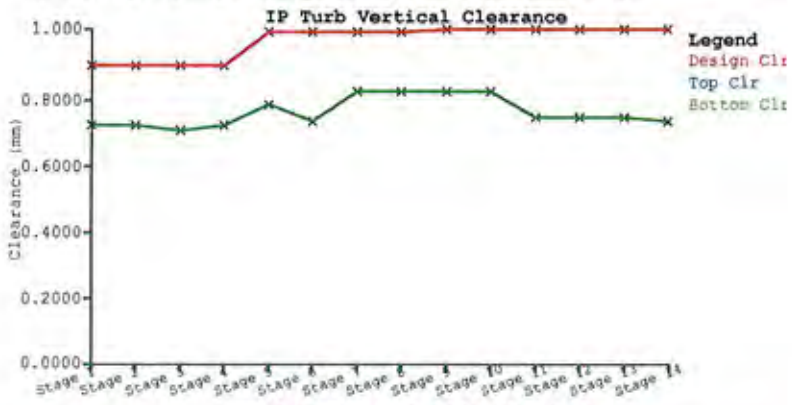
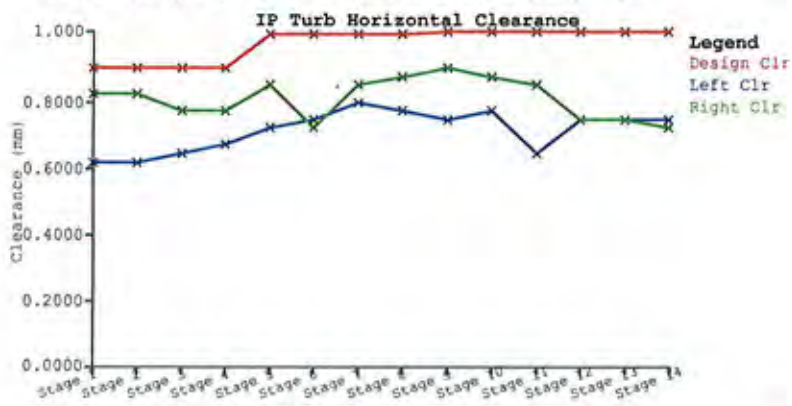
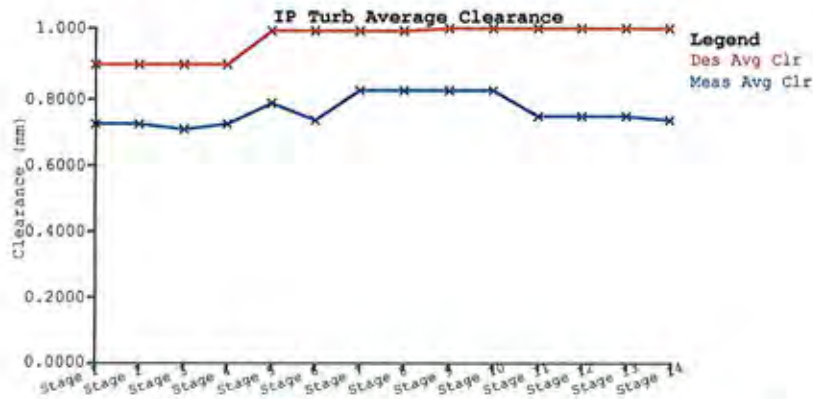

829

Audit Results: Closing audit 2010: Interstage Packings: Graphs : LP Gen

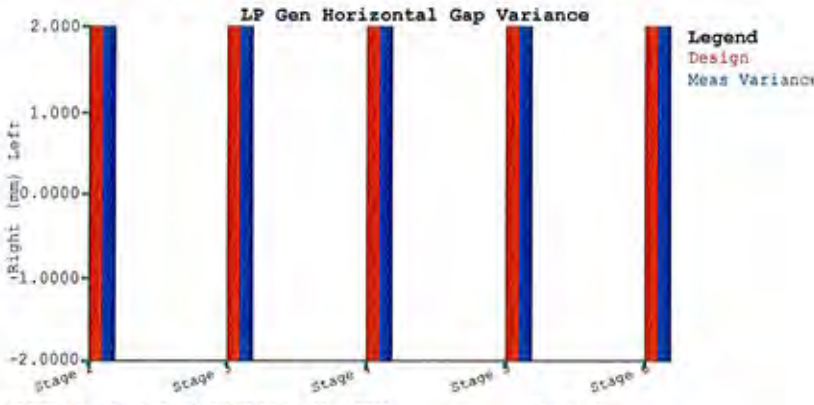
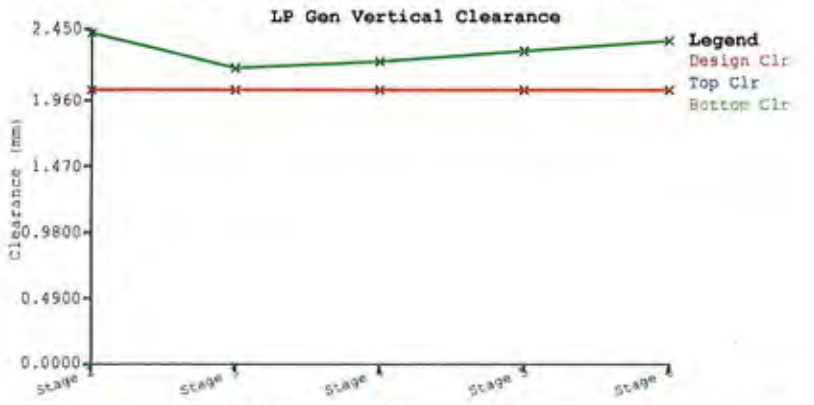
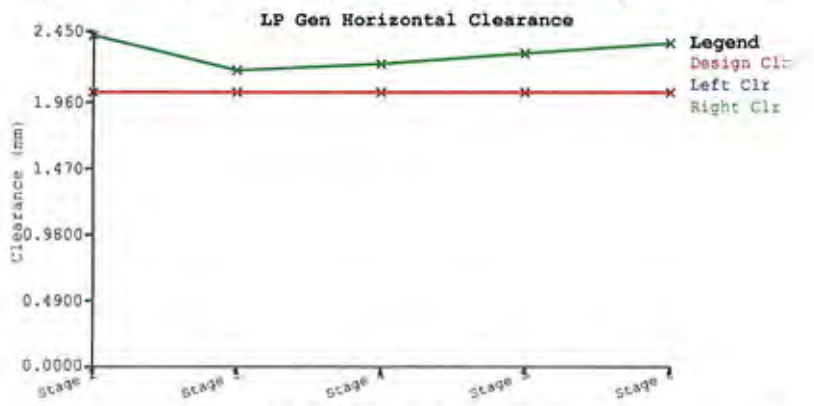
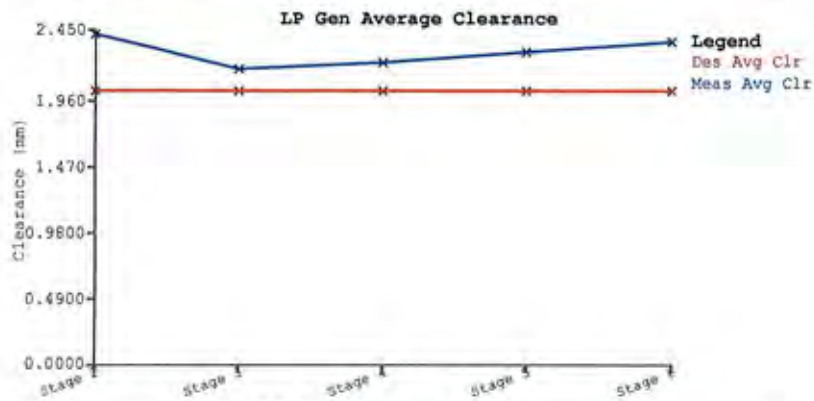

830

ALSTOM	Client	J-Power (Electric Power Development Co. Ltd.,)
	Project	Turbine and System Assessment for NTPC-Korba Unit #4
	Order No.	CGP10028C
	Contractor	ALSTOM K.K. NASL Ltd. (Nominated subcontractor in India)
NTPC ALSTOM Power Services Pvt. Ltd.	Document	FINAL REPORT VOL. III (STEAM PATH AUDIT)

7.1.2 END PACKING

Increased leakages from shaft end packing and their impact on heat rate and power output are summarized in the Shaft End Packing Audit Results Report. The loss reports provide the calculated leakage flow, measured average clearances, the packing wear, and the loss for each packing seal.

The opening audit loss due to increased end packing clearances was 66.5 kW and the total heat rate degraded 1.01 kJ/kWh. The closing audit loss due to increased end packing clearances was 23 kW and the total heat rate degraded 0.35 kJ/kWh.

Stage losses of IP and LP turbine for Shaft End packing shown in Page 10 to 13.

ALSTOM	Client	J-Power (Electric Power Development Co. Ltd.,)
	Project	Turbine and System Assessment for NTPC-Korba Unit #4
	Order No.	CGP10028C
	Contractor	ALSTOM K.K. NASL Ltd. (Nominated subcontractor in India)
NTPC ALSTOM Power Services Pvt. Ltd.	Document	FINAL REPORT VOL. III (STEAM PATH AUDIT)

Steam Turbine Performance Evaluation Program

NTPC korba unit#4 May-2010 final

**Audit Results: Opening
May 2010: Shaft End
Packings**

Totals

Description	Power Loss kW	Change In G.T.H.R. kJ/kWh
IP TE	35.8	0.54
IP GE	28.4	0.43
LP TE	5.4	0.08
LP GE	-3.1	-0.05
Turbine Total	66.5	1.01

**Audit Results: Opening
May 2010: Shaft End
Packings**

IP TE

Packing Description	Seal	Leakage Flow kg/s	Corrected		Wear mm	Power Loss kW	Change In G.T.H.R. kJ/kWh
			Average Clearance mm	Average Clearance mm			
Exhaust	1	0.2348	0.817	0.817	0.207	36.3	0.55
	2	0.0376	0.594	0.594	-0.016	-0.5	-0.01
Total						35.8	0.54
Total						35.8	0.54

**Audit Results: Opening
May 2010: Shaft End
Packings**

IP GE

Packing Description	Seal	Leakage Flow	Corrected		Wear	Power Loss	Change In G.T.H.R.
			Average Clearance	Average Clearance			
September 2010							

ALSTOM	Client	J-Power (Electric Power Development Co. Ltd.,)
	Project	Turbine and System Assessment for NTPC-Korba Unit #4
	Order No.	CGP10028C
	Contractor	ALSTOM K.K. NASL Ltd. (Nominated subcontractor in India)
NTPC ALSTOM Power Services Pvt. Ltd.	Document	FINAL REPORT VOL. III (STEAM PATH AUDIT)

		kg/s	mm	mm	mm	kW	kJ/kWh
Exhaust	1	0.2747	0.693	0.693	0.084	29.3	0.44
	2	0.0509	0.61	0.61	0	-0.9	-0.01
	Total					28.4	0.43
Total						28.4	0.43

**Audit Results: Opening
May 2010: Shaft End
Packings**

LP TE

		Leakage	Average	Corrected Average	Wear	Power Loss	Change In G.T.H.R.
	Seal	Flow	Clearance	Clearance			
		kg/s	mm	mm	mm	kW	kJ/kWh
Exhaust	1	-0.1535	1.229	1.229	0.619	9.2	0.14
	2	0.1282	0.791	0.791	0.181	-3.7	-0.06
	Total					5.4	0.08
Total						5.4	0.08

**Audit Results: Opening
May 2010: Shaft End
Packings**

LP GE

		Leakage	Average	Corrected Average	Wear	Power Loss	Change In G.T.H.R.
	Seal	Flow	Clearance	Clearance			
		kg/s	mm	mm	mm	kW	kJ/kWh
Exhaust	1	-0.1791	1.491	1.491	0.882	13	0.2
	2	0.2112	1.584	1.584	0.975	-16.1	-0.24
	Total					-3.1	-0.05
Total						-3.1	-0.05

ALSTOM	Client	J-Power (Electric Power Development Co. Ltd.,)
	Project	Turbine and System Assessment for NTPC-Korba Unit #4
	Order No.	CGP10028C
	Contractor	ALSTOM K.K. NASL Ltd. (Nominated subcontractor in India)
NTPC ALSTOM Power Services Pvt. Ltd.	Document	FINAL REPORT VOL. III (STEAM PATH AUDIT)

Steam Turbine Performance Evaluation Program
Audit Results: Closing May 2010: Shaft End
Packings

NTPC korba unit#4 May-2010 final

Totals

Description	Power Loss kW	Change In G.T.H.R. kJ/kWh
IP TE	15.7	0.24
IP GE	10.5	0.16
LP TE	-2.4	-0.04
LP GE	-0.8	-0.01
Turbine Total	23	0.35

Audit Results: Closing May 2010: Shaft End
Packings

IP TE

Packing Description	Seal	Leakage Flow kg/s	Average Clearance mm	Corrected		Power Loss kW	Change In G.T.H.R. kJ/kWh
				Average Clearance mm	Wear mm		
Exhaust	1	0.1983	0.762	0.762	0.152	15.3	0.23
	2	0.0313	0.543	0.543	0.067	0.4	0.01
Total						15.7	0.24
Total						15.7	0.24

Audit Results: Closing May 2010: Shaft End
Packings

IP GE

Packing Description	Seal	Leakage Flow kg/s	Average Clearance mm	Corrected		Power Loss kW	Change In G.T.H.R. kJ/kWh
				Average Clearance mm	Wear mm		
Exhaust	1	0.2411	0.685	0.685	0.075	10.5	0.16
	2	0.0447	0.61	0.61	0	0	0

ALSTOM	Client	J-Power (Electric Power Development Co. Ltd.,)
	Project	Turbine and System Assessment for NTPC-Korba Unit #4
	Order No.	CGP10028C
	Contractor	ALSTOM K.K. NASL Ltd. (Nominated subcontractor in India)
NTPC ALSTOM Power Services Pvt. Ltd.	Document	FINAL REPORT VOL. III (STEAM PATH AUDIT)

	Total	10.5	2.93
Total		10.5	2.93

Audit Results: Closing May 2010: Shaft End Packings

LP TE

	Seal	Leakage Flow kg/s	Average Clearance mm	Corrected		Power Loss kW	Change In G.T.H.R. kJ/kWh
				Average Clearance mm	Wear mm		
Exhaust	1	-0.189	1.47	1.47	0.86	14.5	0.22
	2	0.2161	1.584	1.584	0.975	-16.9	-0.26
	Total					-2.4	-0.04
Total						-2.4	-0.04

Audit Results: Closing May 2010: Shaft End Packings

LP GE

	Seal	Leakage Flow kg/s	Average Clearance mm	Corrected		Power Loss kW	Change In G.T.H.R. kJ/kWh
				Average Clearance mm	Wear mm		
Exhaust	1	-0.11738	1.326	1.326	0.716	12.2	0.18
	2	0.1901	1.33	1.33	0.721	-13	-0.2
	Total					-0.8	-0.01
Total						-0.8	-0.01

Audit Results: Closing audit 2010: Shaft End Packings: Graphs : IP Turb

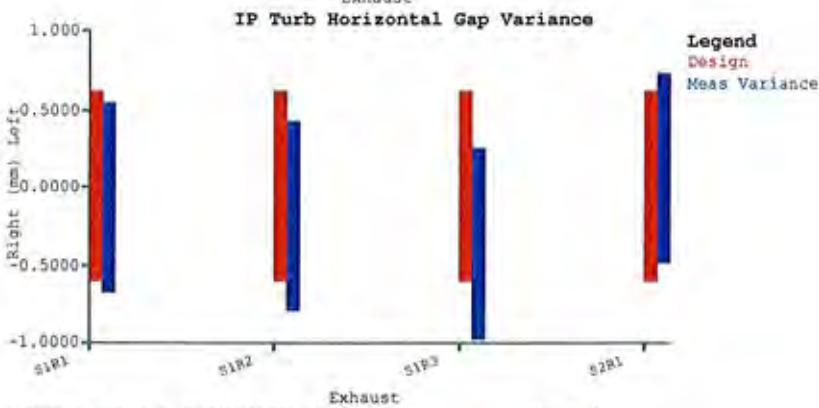
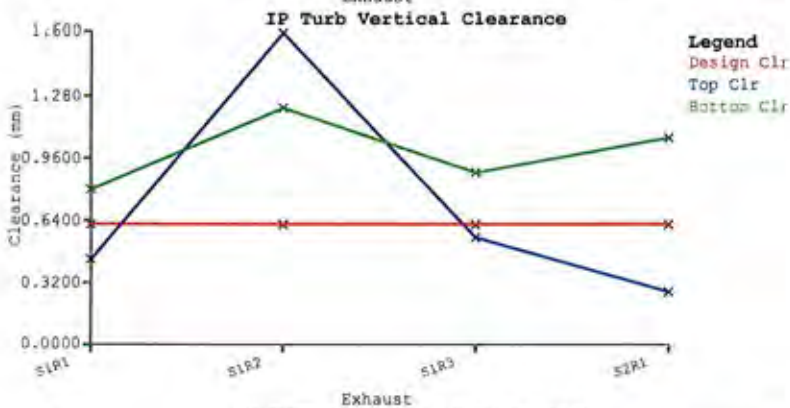
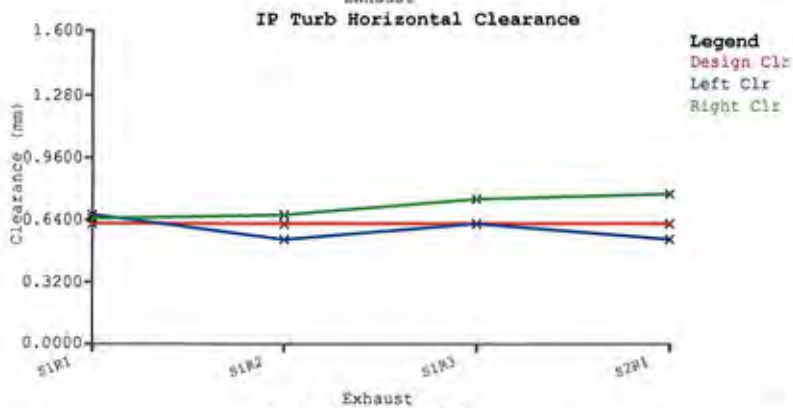
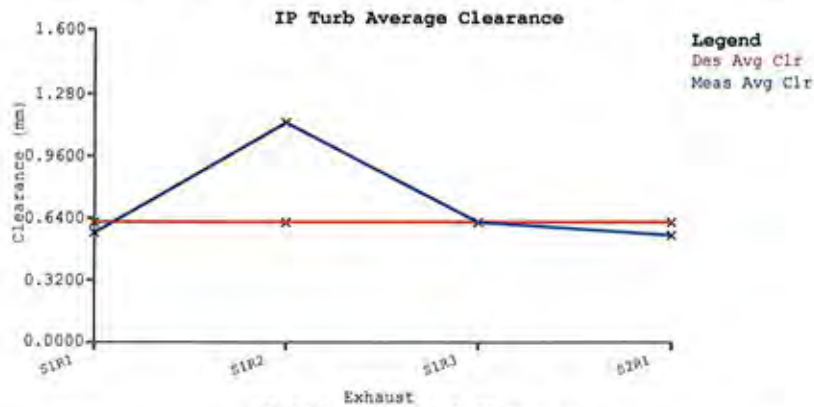

236

Audit Results: Closing audit 2010: Shaft End Packings: Graphs : IP Gen

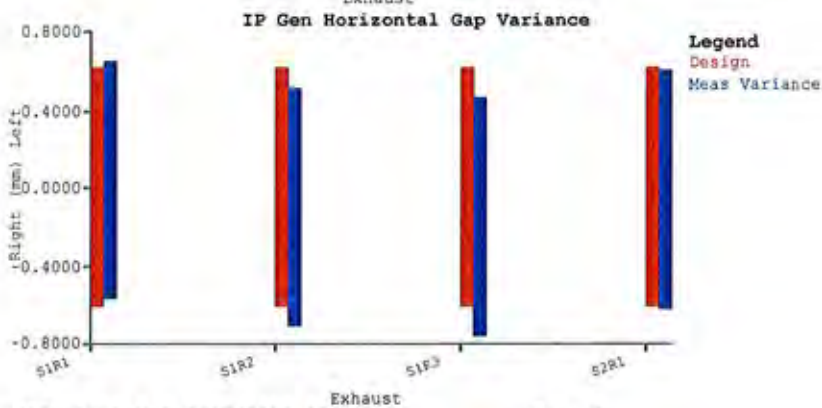
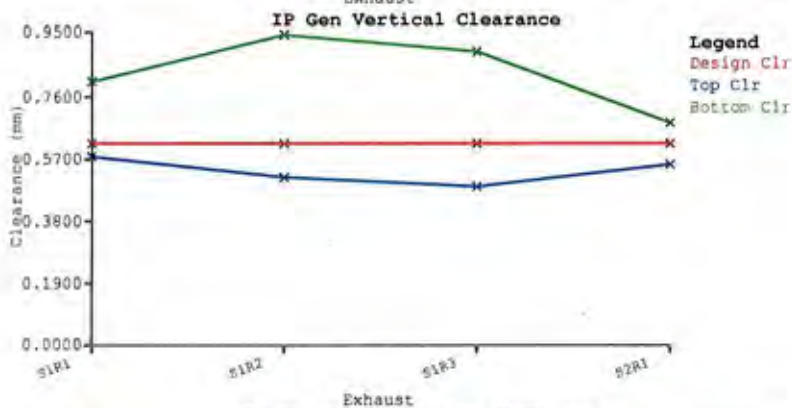
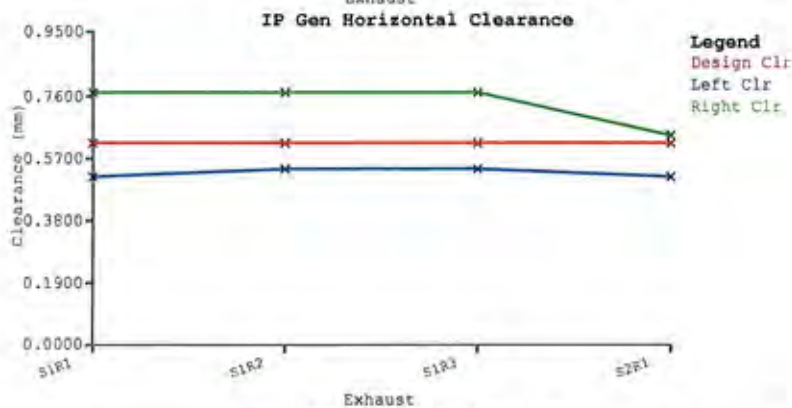
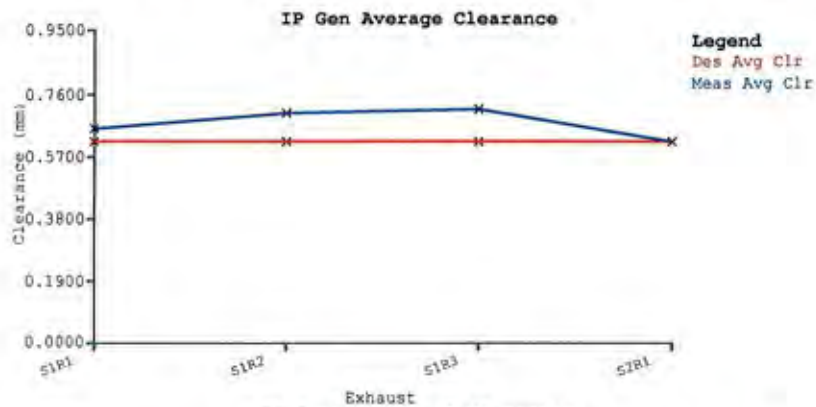

837

Audit Results: Closing audit 2010: Shaft End Packings: Graphs : LP Turb

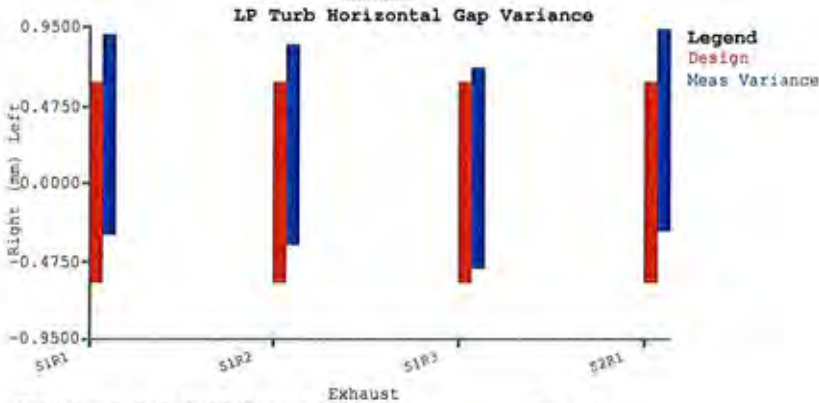
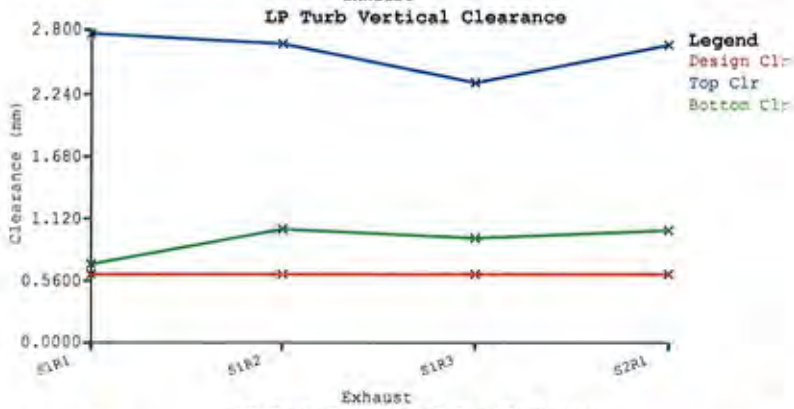
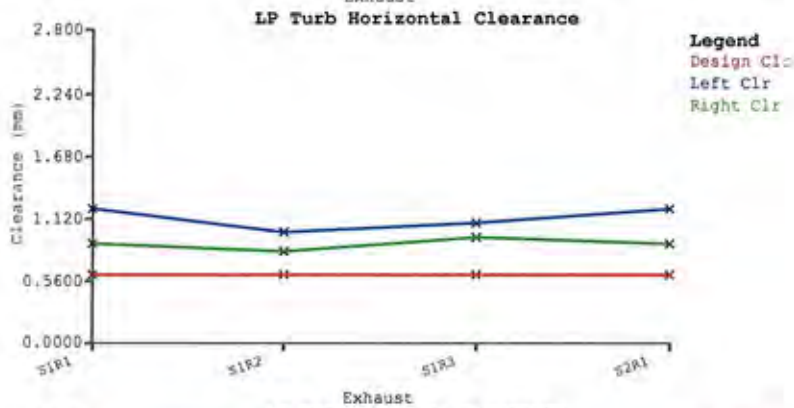
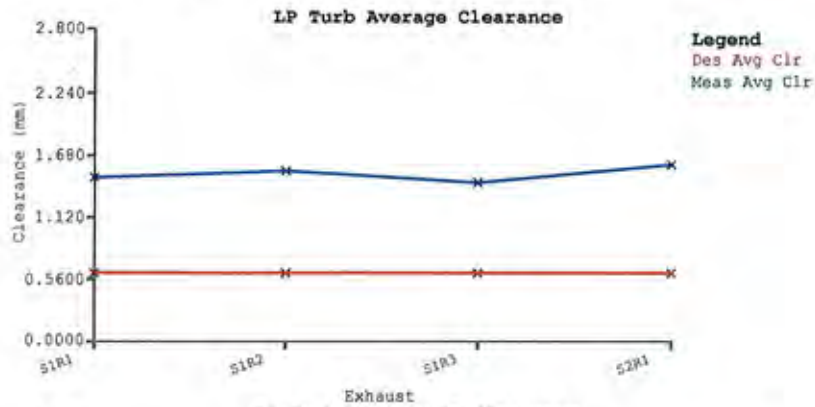

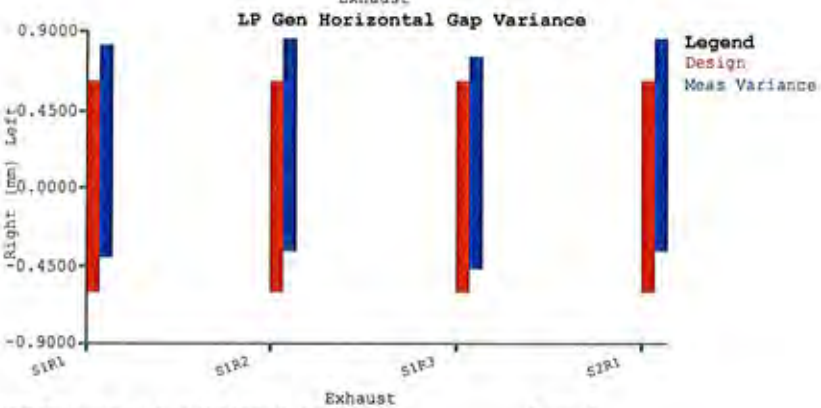
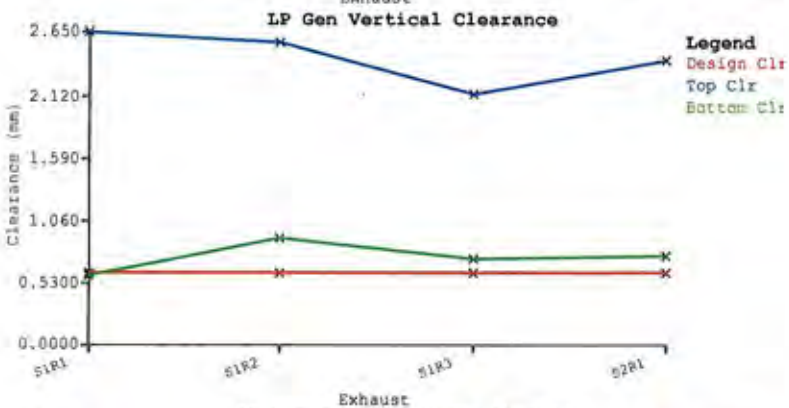
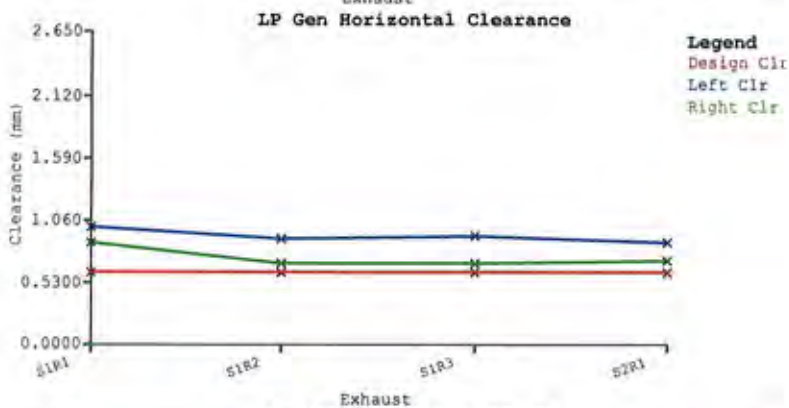
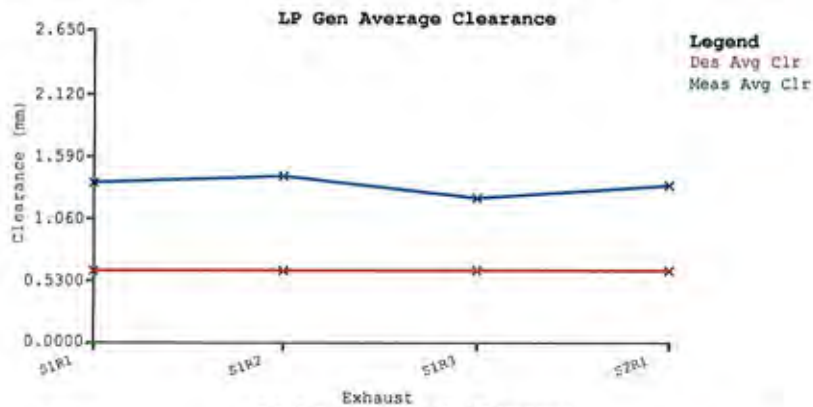

88

Audit Results: Closing audit 2010: Shaft End Packings: Graphs : LP Gen



839

	Client	J-Power (Electric Power Development Co. Ltd.,)
	Project	Turbine and System Assessment for NTPC-Korba Unit #4
	Order No.	CGP10028C
	Contractor	ALSTOM K.K. NASL Ltd. (Nominated subcontractor in India)
	Document	FINAL REPORT VOL. III (STEAM PATH AUDIT)

7.1.3 TIP SPILL STRIPS

The Tip Spill Strips Audit Results Report summarizes the power output and heat rate degradation resulting from increased leakage past rotating blading and leakage losses for each turbine stage.

The opening audit loss due to increased Tip Spill Strips clearances was -48.8 kW and the heat rate degraded -0.74 kJ/kWh. The closing audit loss due to increased Tip Spill strip clearances was 18.1 kW and the total heat rate degraded 0.27 kJ/kWh.

Stage losses of IP & LP turbine for Tip spill strip shown in Page 15 to 20.

For Tip spill strip, refer photo 15 & 18 (for opening audit) and for closing audit refer photo 19 & 20.

ALSTOM	Client	J-Power (Electric Power Development Co. Ltd.,)
	Project	Turbine and System Assessment for NTPC-Korba Unit #4
	Order No.	CGP10028C
	Contractor	ALSTOM K.K, NASL Ltd. (Nominated subcontractor in India)
NTPC ALSTOM Power Services Pvt. Ltd.	Document	FINAL REPORT VOL. III (STEAM PATH AUDIT)

Steam Turbine Performance Evaluation Program

NTPC korba unit#4 May-2010 final

Audit Results:

Opening May 2010:

Tip Spill Strips

Totals

Description	Power Loss kW	Change In G.T.H.R. kJ/kWh
IP TE	-74.1	-1.12
IP GE	-136.1	-2.06
LP TE	184.8	2.8
LP GE	-23.5	-0.36
Turbine Total	-48.8	-0.74

Audit Results:

Opening May 2010:

Tip Spill Strips

IP TE

Description	Leakage Flow kg/s	Average Clearance mm	Corrected Average Clearance mm	Stage Wear mm	Stage Efficiency Loss %	Power Loss kW	Change In G.T.H.R. kJ/kWh
Stage 1	1.326	0.516	0.516	-0.373	-0.1	-1.9	-0.03
Stage 2	1.7908	0.797	0.797	-0.092	0.11	2.3	0.03
Stage 3	1.2042	0.479	0.479	-0.41	-0.12	-2.6	-0.04
Stage 4	1.6096	0.698	0.698	-0.191	0.04	1	0.02
Stage 5	1.7486	0.743	0.743	-0.248	-0.05	-1.3	-0.02
Stage 6	1.4299	0.622	0.622	-0.368	-0.17	-4.6	-0.07
Stage 7	1.1177	0.505	0.505	-0.486	-0.28	-8.1	-0.12
Stage 8	1.0845	0.467	0.467	-0.524	-0.16	-5	-0.08
Stage 9	1.0599	0.518	0.518	-0.482	-0.29	-9.7	-0.15
Stage 10	0.9673	0.511	0.511	-0.489	-0.27	-9.7	-0.15

841

ALSTOM	Client	J-Power (Electric Power Development Co. Ltd.,)
	Project	Turbine and System Assessment for NTPC-Korba Unit #4
	Order No.	CGP10028C
	Contractor	ALSTOM K.K. NASL Ltd. (Nominated subcontractor in India)
NTPC ALSTOM Power Services Pvt. Ltd.	Document	FINAL REPORT VOL. III (STEAM PATH AUDIT)

Stage 11	0.6718	0.384	0.384	-0.616	-0.36	-13.9	-0.21
Stage 12	0.834	0.518	0.518	-0.482	-0.22	-9.4	-0.14
Stage 13	0.7123	0.489	0.489	-0.511	-0.22	-10	-0.15
Stage 14	0.9246	0.756	0.756	-0.244	-0.03	-1.3	-0.02
Total						-74.1	-1.12

Audit Results:
Opening May 2010:
Tip Spill Strips

IP GE

Description	Leakage Flow kg/s	Average Clearance mm	Corrected	Wear mm	Stage	Power Loss kW	Change In G.T.H.R. kJ/kWh
			Average		Efficiency		
			Clearance		Loss		
Stage 1	1.405	0.556	0.556	-0.333	-0.06	-1.2	-0.02
Stage 2	1.2699	0.487	0.487	-0.402	-0.12	-2.5	-0.04
Stage 3	1.0104	0.375	0.375	-0.514	-0.2	-4.4	-0.07
Stage 4	1.3471	0.544	0.544	-0.345	-0.07	-1.7	-0.03
Stage 5	1.3075	0.556	0.556	-0.435	-0.24	-6.2	-0.09
Stage 6	0.7804	0.34	0.34	-0.651	-0.46	-12.3	-0.19
Stage 7	0.8735	0.395	0.395	-0.596	-0.39	-11.1	-0.17
Stage 8	0.6105	0.219	0.219	-0.772	-0.37	-11.6	-0.18
Stage 9	0.7412	0.362	0.362	-0.629	-0.44	-14.7	-0.22
Stage 10	0.5526	0.292	0.292	-0.698	-0.47	-16.8	-0.25
Stage 11	0.6329	0.362	0.362	-0.629	-0.37	-14.3	-0.22
Stage 12	0.4093	0.254	0.254	-0.737	-0.43	-17.9	-0.27
Stage 13	0.4579	0.314	0.314	-0.676	-0.34	-15.4	-0.23
Stage 14	0.7146	0.584	0.584	-0.406	-0.13	-5.9	-0.09
Total						-136.1	-2.06

2/2

ALSTOM	Client	J-Power (Electric Power Development Co. Ltd.,)
	Project	Turbine and System Assessment for NTPC-Korba Unit #4
	Order No.	CGP10028C
	Contractor	ALSTOM K.K. NASL Ltd. (Nominated subcontractor in India)
NTPC ALSTOM Power Services Pvt. Ltd.	Document	FINAL REPORT VOL. III (STEAM PATH AUDIT)

**Audit Results:
Opening May 2010:
Tip Spill Strips**

LP TE

Description	Leakage Flow kg/s	Average Clearance mm	Corrected	Wear mm	Stage	Power Loss kW	Change In G.T.H.R. kJ/kWh
			Average		Efficiency		
			Clearance		Loss		
Stage 1	3.6345	2.111	2.111	1.222	0.99	102.4	1.55
Stage 2	2.4551	2.162	2.162	1.273	0.68	82.4	1.25
Total						184.8	2.8

**Audit Results:
Opening May 2010:
Tip Spill Strips**

LP GE

Description	Leakage Flow kg/s	Average Clearance mm	Corrected	Wear mm	Stage	Power Loss kW	Change In G.T.H.R. kJ/kWh
			Average		Efficiency		
			Clearance		Loss		
Stage 1	1.4341	0.581	0.581	-0.308	-0.17	-17.8	-0.27
Stage 2	1.0642	0.708	0.708	-0.184	-0.05	-5.7	-0.09
Total						-23.5	-0.36

Steam Turbine Performance Evaluation Program

NTPC korba unit#4 May-2010 final

Audit Results: Closing May 2010:

Totals

September 2010

Technical Report No: SPA-KB-527-01

Page 17 of 37

8/43

ALSTOM	Client	J-Power (Electric Power Development Co. Ltd.,)
	Project	Turbine and System Assessment for NTPC-Korba Unit #4
	Order No.	CGP10028C
	Contractor	ALSTOM K.K. NASL Ltd. (Nominated subcontractor in India)
NTPC ALSTOM Power Services Pvt. Ltd.	Document	FINAL REPORT VOL. III (STEAM PATH AUDIT)

Tip Spill Strips

Description	Power Loss kW	Change In G.T.H.R. kJ/kWh
IP TE	3.9	0.06
IPGE	-108.2	-1.64
LP TE	162.8	2.46
LP GE	-40.3	-0.61
Turbine Total	18.1	0.27

Audit Results: Closing May 2010: Tip Spill Strips

Description	Leakage Flow kg/s	Average Clearance mm	IP-TE Corrected			Stage Efficiency Loss %	Power Loss kW	Change In G.T.H.R. kJ/kWh
			Average Clearance mm	Wear mm				
Stage 1	1.1089	0.41	0.41	-0.479	-0.19	-3.7	-0.06	
Stage 2	1.046	0.381	0.381	-0.508	-0.22	-4.5	-0.07	
Stage 3	0.8281	0.298	0.298	-0.591	-0.28	-6.1	-0.09	
Stage 4	1.094	0.416	0.416	-0.473	-0.18	-4.3	-0.07	
Stage 5	1.1935	0.518	0.518	-0.473	-0.29	-7.4	-0.11	
Stage 6	0.7076	0.314	0.314	-0.676	-0.49	-13.2	-0.2	
Stage 7	0.7784	0.359	0.359	-0.632	-0.43	-12.3	-0.19	
Stage 8	0.5983	0.219	0.219	-0.772	-0.37	-11.8	-0.18	
Stage 9	0.7009	0.349	0.349	-0.651	-0.46	-15.7	-0.24	
Stage 10	0.4827	0.26	0.26	-0.74	-0.51	-18.3	-0.28	
Stage 11	0.555	0.324	0.324	-0.676	-0.42	-16.1	-0.24	
Stage 12	0.3559	0.225	0.225	-0.775	-0.46	-19.2	-0.29	
Stage 13	7.7658	5.42	5.42	4.42	3.25	146.1	2.21	
Stage 14	0.5633	0.47	0.47	-0.53	-0.2	-9.7	-0.15	
Total						3.9	0.06	

Audit Results: Closing May 2010: Tip Spill Strips

IP-GE

2/3/8

ALSTOM	Client	J-Power (Electric Power Development Co. Ltd.,)
	Project	Turbine and System Assessment for NTPC-Korba Unit #4
	Order No.	CGP10028C
	Contractor	ALSTOM K.K. NASL Ltd. (Nominated subcontractor in India)
NTPC ALSTOM Power Services Pvt. Ltd.	Document	FINAL REPORT VOL. III (STEAM PATH AUDIT)

Description	Leakage Flow kg/s	Average Clearance mm	Corrected			Stage		Change In G.T.H.R. kJ/kWh
			Average Clearance mm	Wear mm	Efficiency Loss %	Power Loss kW		
Stage 1	1.5205	0.638	0.638	-0.251	-0.01	-0.2	0	
Stage 2	1.6743	0.743	0.743	-0.146	0.06	1.2	0.02	
Stage 3	1.2055	0.495	0.495	-0.394	-0.12	-2.5	-0.04	
Stage 4	1.4361	0.61	0.61	-0.279	-0.03	-0.8	-0.01	
Stage 5	1.6331	0.708	0.708	-0.283	-0.1	-2.6	-0.04	
Stage 6	1.1152	0.495	0.495	-0.495	-0.31	-8.4	-0.13	
Stage 7	0.8955	0.413	0.413	-0.578	-0.38	-10.9	-0.16	
Stage 8	0.8421	0.34	0.34	-0.651	-0.27	-8.4	-0.13	
Stage 9	0.9112	0.454	0.454	-0.537	-0.35	-11.9	-0.18	
Stage 10	0.677	0.365	0.365	-0.625	-0.41	-14.6	-0.22	
Stage 11	0.555	0.324	0.324	-0.667	-0.41	-15.8	-0.24	
Stage 12	0.6669	0.422	0.422	-0.568	-0.3	-12.6	-0.19	
Stage 13	0.4986	0.349	0.349	-0.641	-0.32	-14.5	-0.22	
Stage 14	0.7003	0.584	0.584	-0.406	-0.13	-6.3	-0.09	
Total						-108.2	-1.64	

**Audit Results: Closing May 2010:
Tip Spill Strips**

LP-TE

Description	Leakage Flow kg/s	Average Clearance mm	Corrected			Stage		Change In G.T.H.R. kJ/kWh
			Average Clearance mm	Wear mm	Efficiency Loss %	Power Loss kW		
Stage 1	3.3086	1.908	1.908	1.019	0.81	84.6	1.28	
Stage 2	2.3885	2.099	2.099	1.21	0.65	78.2	1.18	
Total						162.8	2.46	

PH

ALSTOM	Client	J-Power (Electric Power Development Co. Ltd.,)
	Project	Turbine and System Assessment for NTPC-Korba Unit #4
	Order No.	CGP10028C
	Contractor	ALSTOM K.K. NASL Ltd. (Nominated subcontractor in India)
NTPC ALSTOM Power Services Pvt. Ltd.	Document	FINAL REPORT VOL. III (STEAM PATH AUDIT)

**Audit Results: Closing May 2010:
Tip Spill Strips**

LP-GE

Description	Leakage Flow kg/s	Average Clearance mm	Corrected Average		Stage Efficiency		Change In G.T.H.R. kJ/kWh
			Clearance mm	Wear mm	Loss %	Power Loss kW	
Stage 1	1.2539	0.543	0.543	-0.346	-0.27	-27.6	-0.42
Stage 2	0.9538	0.667	0.667	-0.222	-0.11	-12.7	-0.19

Audit Results: Closing audit 2010: Tip Spill Strips: Graphs : IP Turb

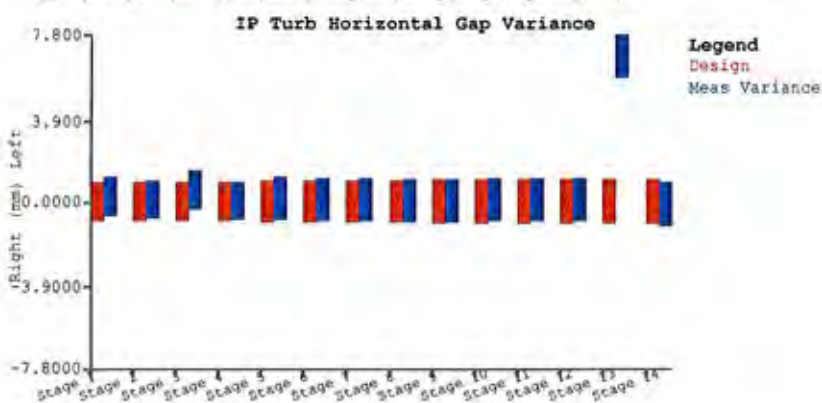
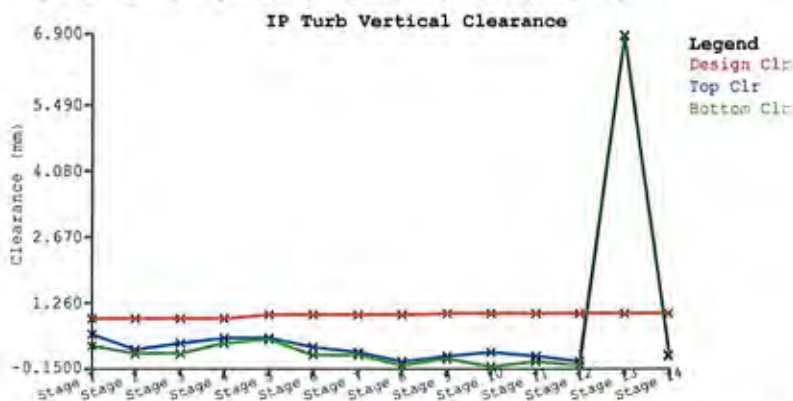
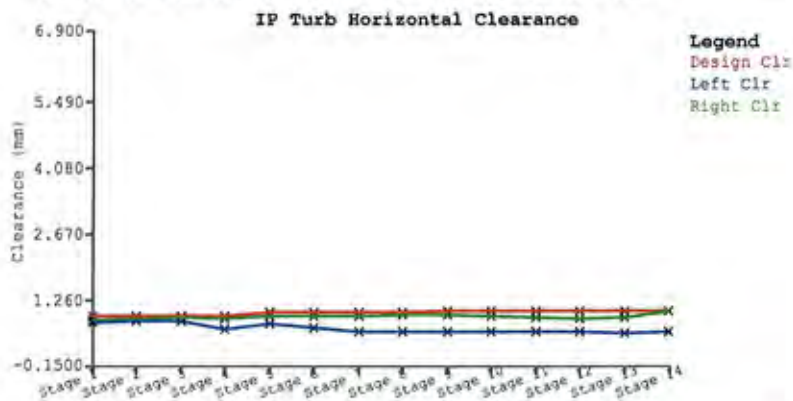
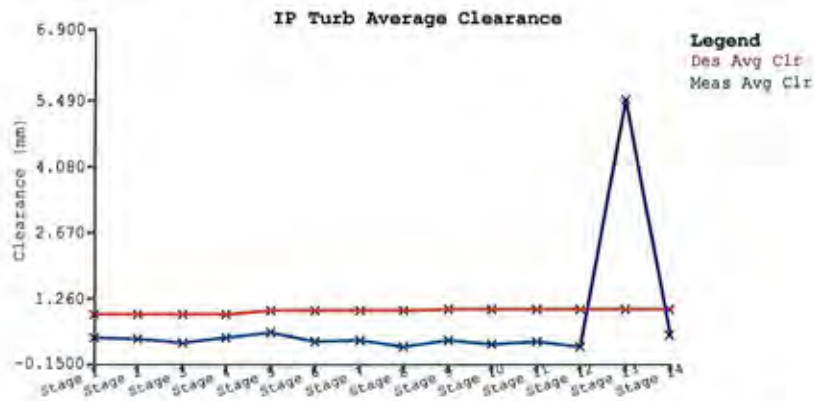

847

Audit Results: Closing audit 2010: Tip Spill Strips: Graphs : IP Gen

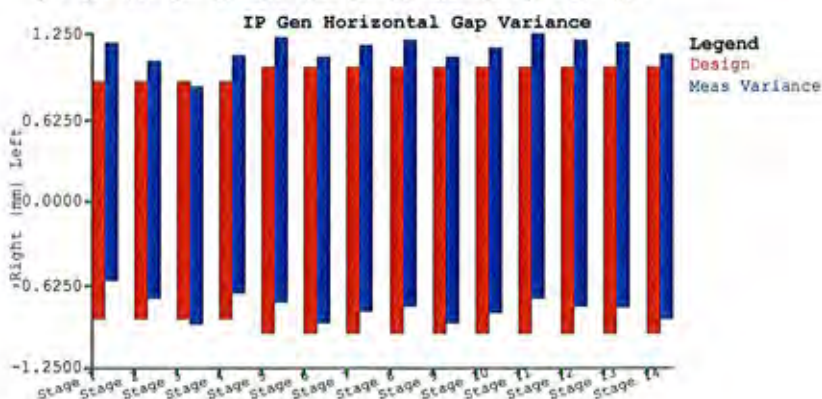
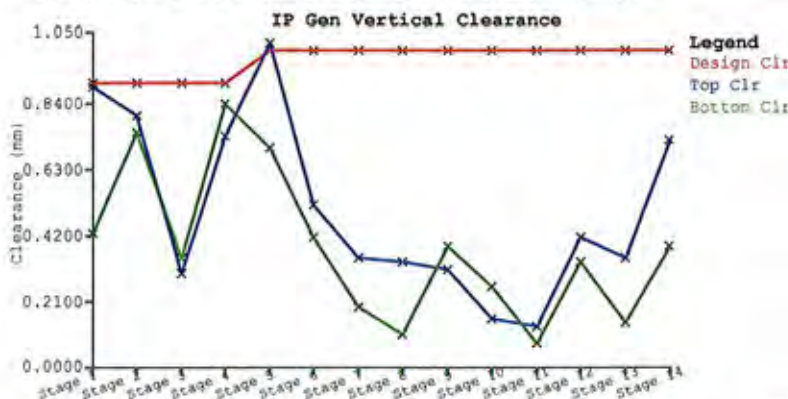
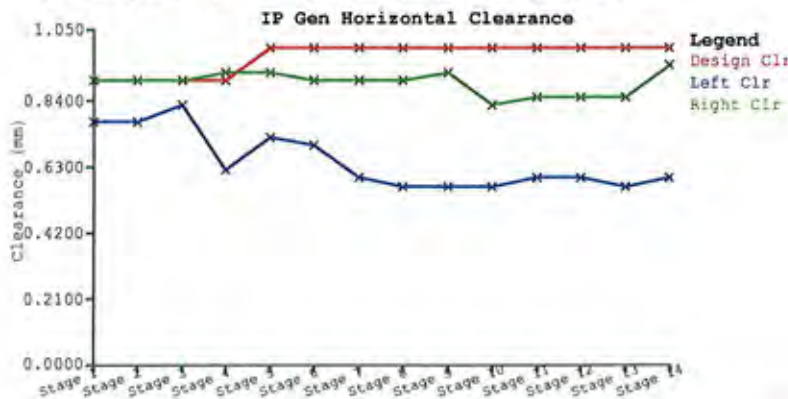

218

Audit Results: Closing audit 2010: Tip Spill Strips: Graphs : LP Turb

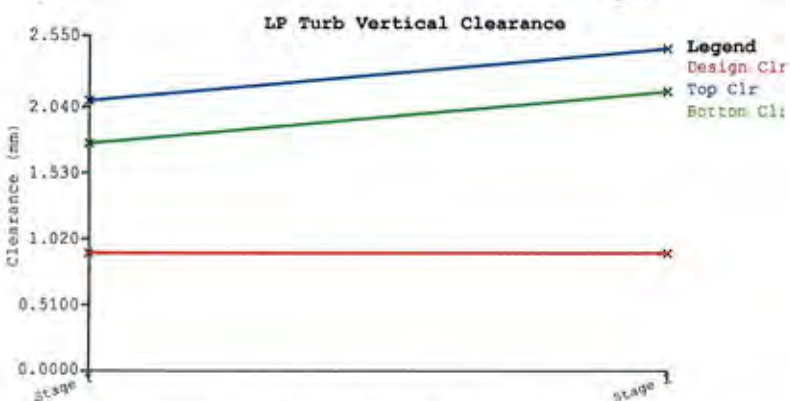
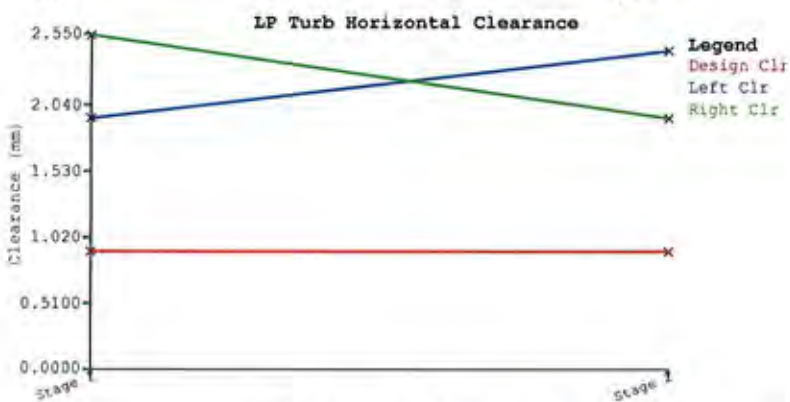
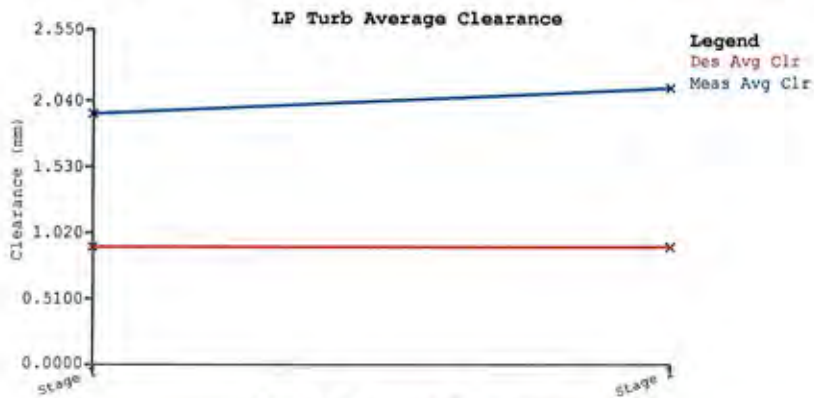

859

Audit Results: Closing audit 2010: Tip Spill Strips: Graphs : LP Gen

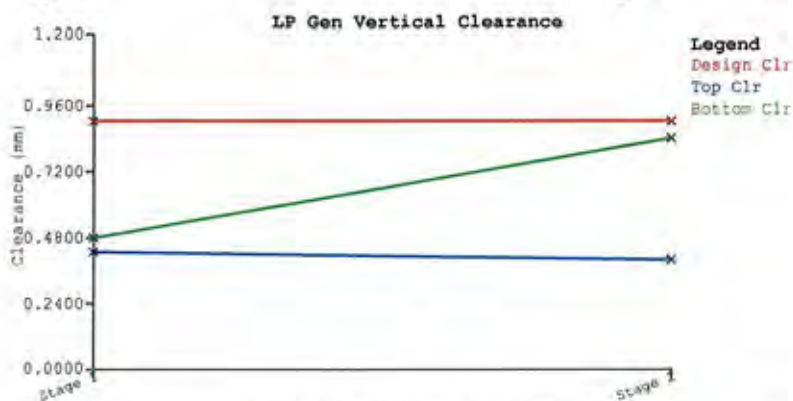
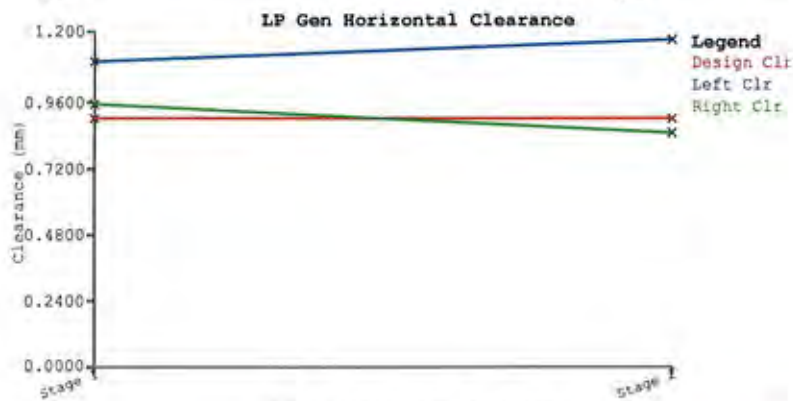
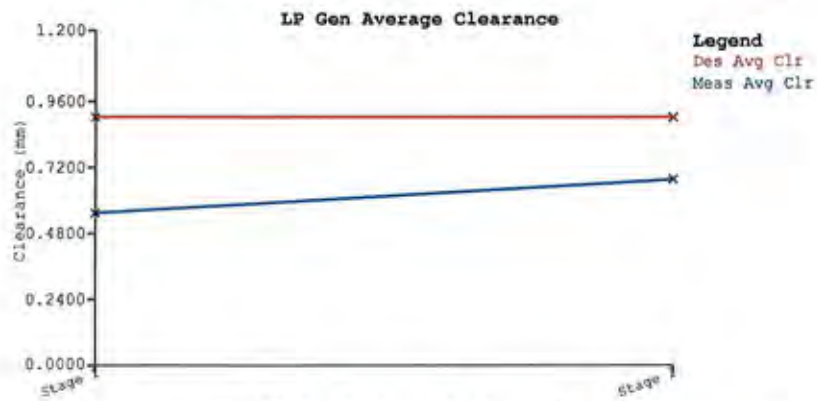



858

ALSTOM	Client	J-Power (Electric Power Development Co. Ltd.,)
	Project	Turbine and System Assessment for NTPC-Korba Unit #4
	Order No.	CGP10028C
	Contractor	ALSTOM K.K. NASL Ltd. (Nominated subcontractor in India)
NTPC ALSTOM Power Services Pvt. Ltd.	Document	FINAL REPORT VOL. III (STEAM PATH AUDIT)

7.1.4 MISCELLANEOUS LEAKAGES

Miscellaneous leakages are those leakages that result in steam bypassing any turbine stage or group of stages that is not accounted for in the Inter-stage Packing, End Packing, or Tip Spill Strip loss categories.

No miscellaneous leakages were identified during the opening audit.

	Client	J-Power (Electric Power Development Co. Ltd.,)
	Project	Turbine and System Assessment for NTPC-Korba Unit #4
	Order No.	CGP10028C
	Contractor	ALSTOM K.K. NASL Ltd. (Nominated subcontractor in India)
	Document	FINAL REPORT VOL. III (STEAM PATH AUDIT)

7.1.5 FLOW PATH DAMAGE

The types of degradation evaluated in the Flow Path Damage section are:

- Solid Particle Erosion
- Deposits
- Mechanical Damage

A characteristic that differentiates the above losses from other types of losses is a change in the stage flow area. The program uses the combined change in area and velocity profile from the three damage sections to determine the flow path damage loss. The changes in area also result in corresponding changes in machine flow and pressure distribution on the stage with the observed condition and in adjacent stages.

eSTPE calculates three different types of losses for observed flow path damages. These losses are shown on the opening audit flow path damage Turbine Loss Reports.

1. **Directly affected stage losses** - These are losses occurring at the stage where the degradation was noted. The direct losses for the opening audit are 44.5kW. **Indirectly affected stage losses** - These are losses occurring at stages that have no degradation but are affected by the change in flow and pressure distribution. There was no Flow Change Impact for the opening audit
2. **Net Losses** - Net losses are the summation of the directly and indirectly affected stage losses. The net turbine impact for the opening audit is 44.5 kW.

The Flow Path Damage section evaluates only the impact of area changes brought about by solid particle erosion, deposits, and mechanical damage. Changes in surface finish, spill strip erosion, and other types of damage that also result from solid particle erosion, deposits, and mechanical damage are evaluated separately in the appropriate sections of the audit program.

ALSTOM	Client	J-Power (Electric Power Development Co. Ltd.,)
	Project	Turbine and System Assessment for NTPC-Korba Unit #4
	Order No.	CGP10028C
	Contractor	ALSTOM K.K. NASL Ltd. (Nominated subcontractor in India)
NTPC ALSTOM Power Services Pvt. Ltd.	Document	FINAL REPORT VOL. III (STEAM PATH AUDIT)

7.1.6 SURFACE ROUGHNESS

The Surface Roughness Turbine loss report summarizes the power output and heat rate degradation resulting from increased partition surface roughness and losses for each turbine stage.

Light deposits, solid particle erosion and mechanical damage all contributed to an increase in surface roughness.

The opening audit evaluation of the surface roughness showed a loss of 6935.4 kW and an increase in heat rate of 106.35 kJ/kWh.

Surface roughness of closing audit loss when compared to original design was 2897.9 kW and an increase in heat rate of 44.10 kJ/kWh is recovered 4037.5 kW and improved heat rate 62.25 kJ/kWh. This is a recovery of 58.21% of the opening power loss and 58.53 % of the Heat rate of the opening heat rate degradation.

Stage losses of IP & LP turbine for Surface roughness, shown in Page 24 to 29.

For Tip spill strip, refer photo no 1 to 18 (opening audit) and for closing audit refer photo no 1 to 17.

ALSTOM	Client	J-Power (Electric Power Development Co. Ltd.,)
	Project	Turbine and System Assessment for NTPC-Korba Unit #4
	Order No.	CGP10028C
	Contractor	ALSTOM K.K. NASL Ltd. (Nominated subcontractor in India)
NTPC ALSTOM Power Services Pvt. Ltd.	Document	FINAL REPORT VOL. III (STEAM PATH AUDIT)

Steam Turbine Performance Evaluation Program

NTPC korba unit#4 May-2010 final

**Audit Results: Opening May 2010:
Surface Roughness**

Totals

Description	Power Loss kW	Change In
		G.T.H.R. kJ/kWh
IP TE	1675.1	25.43
IP GE	1675.1	25.43
LP TE	1849.9	28.1
LP GE	1735.1	26.35
Turbine Total	6935.4	106.35

**Audit Results: Opening May 2010:
Surface Roughness**

IP TE

Description	Stage		Change In G.T.H.R. kJ/kWh
	Efficiency	Power Loss	
	Loss %	kW	
Stage 1	2.88	55.8	0.84
Stage 2	3.2	66.5	1.01
Stage 3	3.1	66.4	1.01
Stage 4	2.78	66.1	1
Stage 5	3.03	76.2	1.15
Stage 6	2.84	76.7	1.16
Stage 7	3.09	89	1.35
Stage 8	2.93	92.7	1.4
Stage 9	3.58	121.3	1.84
Stage 10	3.62	130.4	1.97

452

ALSTOM	Client	J-Power (Electric Power Development Co. Ltd.,)
	Project	Turbine and System Assessment for NTPC-Korba Unit #4
	Order No.	CGP10028C
	Contractor	ALSTOM K.K. NASL Ltd. (Nominated subcontractor in India)
NTPC ALSTOM Power Services Pvt. Ltd.	Document	FINAL REPORT VOL. III (STEAM PATH AUDIT)

Stage 11	3.66	141.4	2.14
Stage 12	4.19	174.7	2.64
Stage 13	5.59	251.1	3.8
Stage 14	5.66	266.9	4.04
Total		1675.1	25.43

**Audit Results: Opening May 2010:
Surface Roughness**

IP GE

Description	Stage		
	Efficiency		Change In
	Loss	Power Loss	G.T.H.R.
	%	kW	kJ/kWh
Stage 1	2.88	55.8	0.84
Stage 2	3.2	66.4	1.01
Stage 3	3.1	66.4	1.01
Stage 4	2.78	66.1	1
Stage 5	3.03	76.3	1.15
Stage 6	2.84	76.7	1.16
Stage 7	3.09	89	1.35
Stage 8	2.93	92.7	1.4
Stage 9	3.58	121.3	1.84
Stage 10	3.62	130.4	1.97
Stage 11	3.66	141.4	2.14
Stage 12	4.19	174.7	2.64
Stage 13	5.59	251.1	3.8
Stage 14	5.66	266.9	4.04
Total		1675.2	25.43

55

ALSTOM	Client	J-Power (Electric Power Development Co. Ltd.,)
	Project	Turbine and System Assessment for NTPC-Korba Unit #4
	Order No.	CGP10028C
	Contractor	ALSTOM K.K. NASL Ltd. (Nominated subcontractor in India)
NTPC ALSTOM Power Services Pvt. Ltd.	Document	FINAL REPORT VOL. III (STEAM PATH AUDIT)

**Audit Results: Opening May 2010:
Surface Roughness**

LP TE

Description	Stage		Change In G.T.H.R. kJ/kWh
	Efficiency	Power Loss	
	Loss %	kW	
Stage 1	4	415.3	6.29
Stage 2	4.05	487.2	7.38
Stage 3	1.56	225.3	3.41
Stage 4	3.65	484.6	7.34
Stage 5	1.25	234.5	3.55
Stage 6	0.01	2.9	0.04
Total		1849.9	28.1

**Audit Results: Opening May 2010:
Surface Roughness**

LP GE

Description	Stage		Change In G.T.H.R. kJ/kWh
	Efficiency	Power Loss	
	Loss %	kW	
Stage 1	4.1	425.3	6.44
Stage 2	4.04	486.2	7.37
Stage 3	1.56	225	3.41
Stage 4	3.65	484.6	7.34
Stage 5	0.59	111.1	1.68
Stage 6	0.01	2.9	0.04

ALSTOM	Client	J-Power (Electric Power Development Co. Ltd.,)
	Project	Turbine and System Assessment for NTPC-Korba Unit #4
	Order No.	CGP10028C
	Contractor	ALSTOM K.K. NASL Ltd. (Nominated subcontractor in India)
NTPC ALSTOM Power Services Pvt. Ltd.	Document	FINAL REPORT VOL. III (STEAM PATH AUDIT)

Total **1735.1** **26.35**

Steam Turbine Performance Evaluation Program

NTPC korba unit#4 May-2010 final

Audit Results: Closing May 2010: Surface Roughness

Totals



Description	Power Loss kW	Change In
		G.T.H.R. kJ/kWh
IP TE	882.2	13.37
IPGE	874.7	13.26
LP TE	507.1	7.68
LP GE	633.8	9.6
Turbine Total	2897.9	44.1

Audit Results: Closing May 2010: Surface Roughness

IP TE

Description	Stage Efficiency		Change In
	Loss %	Power Loss kW	G.T.H.R. kJ/kWh
Stage 1	1.64	31.8	0.48
Stage 2	1.95	40.4	0.61
Stage 3	1.99	42.7	0.65
Stage 4	1.87	44.5	0.67
Stage 5	2.2	55.2	0.84
Stage 6	1.98	53.4	0.81
Stage 7	2.27	65.4	0.99
Stage 8	1.93	61.2	0.93
Stage 9	2.22	75.1	1.14
Stage 10	2.08	74.9	1.13
Stage 11	2.01	77.7	1.18
Stage 12	2.08	86.9	1.32
Stage 13	2.11	94.9	1.44
Stage 14	1.65	78	1.18
Total		882.2	13.37

456

	Client	J-Power (Electric Power Development Co. Ltd.,)
	Project	Turbine and System Assessment for NTPC-Korba Unit #4
	Order No.	CGP10028C
	Contractor	ALSTOM K.K. NASL Ltd. (Nominated subcontractor in India)
	Document	FINAL REPORT VOL. III (STEAM PATH AUDIT)

Audit Results: Closing May 2010: Surface Roughness

IP GE

Description	Stage Efficiency		Change In G.T.H.R. kJ/kWh
	Loss %	Power Loss kW	
Stage 1	1.64	31.7	0.48
Stage 2	1.82	37.8	0.57
Stage 3	1.84	39.3	0.59
Stage 4	1.89	44.9	0.68
Stage 5	2.22	55.9	0.85
Stage 6	2	53.9	0.82
Stage 7	2.22	63.9	0.97
Stage 8	1.92	60.8	0.92
Stage 9	2.03	68.7	1.04
Stage 10	2.08	74.9	1.13
Stage 11	2.01	77.7	1.18
Stage 12	2.08	86.9	1.32
Stage 13	2.08	93.3	1.41
Stage 14	1.8	84.9	1.28
Total		874.7	13.26

Audit Results: Closing May 2010: Surface Roughness

LP TE

Description	Stage Efficiency		Change In G.T.H.R. kJ/kWh
	Loss %	Power Loss kW	
Stage 1	1.73	179.8	2.72

ALSTOM	Client	J-Power (Electric Power Development Co. Ltd.,)
	Project	Turbine and System Assessment for NTPC-Korba Unit #4
	Order No.	CGP10028C
	Contractor	ALSTOM K.K. NASL Ltd. (Nominated subcontractor in India)
NTPC ALSTOM Power Services Pvt. Ltd.	Document	FINAL REPORT VOL. III (STEAM PATH AUDIT)

Stage 2	1.01	122	1.85
Stage 3	0.77	111.4	1.69
Stage 4	0.61	81	1.23
Stage 5	0.07	12.9	0.19
Stage 6	0	0	
Total		507.1	7.68

Audit Results: Closing May 2010: Surface Roughness

LP GE

Description	Stage	Efficiency		Change In
	Loss	Power Loss	G.T.H.R.	
	%	kW	kJ/kWh	
Stage 1	2.81	291.5	4.41	
Stage 2	1.05	126.6	1.92	
Stage 3	0.85	122.2	1.85	
Stage 4	0.6	80.2	1.21	
Stage 5	0.07	13.3	0.2	
Stage 6	0	0	0	
Total		633.8	9.6	

ALSTOM	Client	J-Power (Electric Power Development Co. Ltd.,)
	Project	Turbine and System Assessment for NTPC-Korba Unit #4
	Order No.	CGP10028C
	Contractor	ALSTOM K.K. NASL Ltd. (Nominated subcontractor in India)
NTPC ALSTOM Power Services Pvt. Ltd.	Document	FINAL REPORT VOL. III (STEAM PATH AUDIT)

7.1.7 COVER DEPOSITS

Cover deposit observed on IP Turbine & removed by sand blasting. (Refer photo no 25 in opening Audit).

7.1.8 TRAILING EDGE THICKNESS



Trailing edge thickness that is greater than design introduces a flow disturbance at the nozzle exit. This flow disturbance is reflected in the velocity coefficient of the steam leaving the inter-stage blading and causes a velocity diagram efficiency loss.

No thickened trailing edges were identified during the opening audit

7.1.9 HAND CALCULATIONS

Hand calculations can be used to evaluate items that are not normally reported by the eSTPE program.

No hand calculations were necessary for opening & closing audits

	Client	J-Power (Electric Power Development Co. Ltd.,)
	Project	Turbine and System Assessment for NTPC-Korba Unit #4
	Order No.	CGP10028C
	Contractor	ALSTOM K.K. NASL Ltd. (Nominated subcontractor in India)
	Document	FINAL REPORT VOL. III (STEAM PATH AUDIT)

7.2.0 COMPARISON WITH PRELIMINARY RESULTS

Following a partial examination and analysis of the turbine steam path, and preliminary results were discussed with site personnel.

While comparing the opening audit with closing audit results we observe about the recovery of the power loss, which is 4408.5 kW and degradation in Heat rate valve is 67.74 kJ/kWh.

ALSTOM	Client	J-Power (Electric Power Development Co. Ltd.,)
	Project	Turbine and System Assessment for NTPC-Korba Unit #4
	Order No.	CGP10028C
	Contractor	ALSTOM K.K. NASL Ltd. (Nominated subcontractor in India)
NTPC ALSTOM Power Services Pvt. Ltd.	Document	FINAL REPORT VOL. III (STEAM PATH AUDIT)

Steam Turbine Performance Evaluation Program

NTPC Korba unit # 4 May-2010 final

Audit Results:

Comparison

Base Audit:

Opening May 2010

Current Audit:

Closing May 2010

Audit Category	Base Audit		Current Audit		Base Audit		Current Audit		Difference	
	Power Loss	Power Loss	Difference	G.T.H.R.	G.T.H.R.	Difference	G.T.H.R.	G.T.H.R.	Difference	
	kW	kW	kW	kJ/kWh	kJ/kWh	kJ/kWh	kcal/kWh	kcal/kWh	kcal/kWh	
Interstage Packings	237.6	74.3	163.3	3.6	1.12	2.48	0.86	0.27	0.59	
Tip Spill Strips	-48.8	18.1	-66.9	-0.74	0.27	-1.01	-0.18	0.06	-0.24	
Shaft End Packings	66.5	23	43.5	1.01	0.35	0.66	0.24	0.08	0.16	
Steam Seal System Loss	0	0	0	0	0	0	0.00	0.00	0.00	
Miscellaneous Leakages	0	0	0	0	0	0	0.00	0.00	0.00	
Flow Path Damages	44.5	0	44.5	0.37	0	0.37	0.09	0.00	0.09	
Flow Change Impact	0	0	0	0	0	0	0.00	0.00	0.00	
Surface Roughness	6935.4	2897.9	4037.5	106.35	44.1	62.25	25.40	10.53	14.87	
Trailing Edge Thickness	0	0	0	0	0	0	0.00	0.00	0.00	
Cover Deposits	186.7	0	186.7	2.83	0	2.83	0.68	0.00	0.68	
Hand Calculations	0	0	0	0	0	0	0.00	0.00	0.00	
							0.00	0.00	0.00	

ALSTOM	Client	J-Power (Electric Power Development Co. Ltd.,)
	Project	Turbine and System Assessment for NTPC-Korba Unit #4
	Order No.	CGP10028C
	Contractor	ALSTOM K.K. NASL Ltd. (Nominated subcontractor in India)
NTPC ALSTOM Power Services Pvt. Ltd.	Document	FINAL REPORT VOL. III (STEAM PATH AUDIT)

Turbine Total 7421.8 3013.3 4408.5 113.61 45.87 67.74 27.14 10.96 16.18

**Audit Results:
Comparison**

IP TE

Base Audit: Opening May 2010

Current Audit: Closing May 2010

Audit Category	Base Audit	Current Audit	Difference	Base Audit	Current Audit	Difference	Base Audit	Current Audit	Difference
				Change In	Change In		Change In	Change In	
	Power Loss kW	Power Loss kW		G.T.H.R. kJ/kWh	G.T.H.R. kJ/kWh		G.T.H.R. kcal/kWh	G.T.H.R. kcal/kWh	
Interstage Packings	-0.1	-66.7	66.6	0	-1.01	1.01	0.00	-0.24	0.24
Tip Spill Strips	-74.1	3.9	-78	-1.12	0.06	-1.18	-0.27	0.01	-0.28
Shaft End Packings	35.8	15.7	20.1	0.54	0.24	0.3	0.13	0.06	0.07
Miscellaneous Leakages	0	0	0	0	0	0	0.00	0.00	0.00
Flow Path Damages	0	0	0	0	0	0	0.00	0.00	0.00
Surface Roughness	1675.1	882.2	792.9	25.43	13.37	12.06	6.07	3.19	2.88
Trailing Edge Thickness	0	0	0	0	0	0	0.00	0.00	0.00
Cover Deposits	108.4	0	108.4	1.64	0	1.64	0.39	0.00	0.39
Hand Calculations	0	0	0	0	0	0	0.00	0.00	0.00
Total	1745.2	835.1	910.1	26.5	12.66	13.84	6.33	3.02	3.31
True Subdivision Efficiency Change	3.66	1.75	1.91						

ALSTOM	Client	J-Power (Electric Power Development Co. Ltd.,)
	Project	Turbine and System Assessment for NTPC-Korba Unit #4
	Order No.	CGP10028C
	Contractor	ALSTOM K.K. NASL Ltd. (Nominated subcontractor in India)
NTPC ALSTOM Power Services Pvt. Ltd.	Document	FINAL REPORT VOL. III (STEAM PATH AUDIT)

True Subdivision
Efficiency 88.39 90.14 -1.75
Apparent Subdivision
Efficiency 3.66 1.75 1.91
Audit Results:
Comparison IP GE
Base Audit: Opening May 2010
Current Audit: Closing May 2010

Audit Category	Base Audit	Current Audit	Difference	Base Audit	Current Audit	Difference	Base Audit	Current Audit	Difference
	Power Loss	Power Loss		Change In	Change In		Change In	Change In	
	kW	kW		G.T.H.R.	G.T.H.R.		G.T.H.R.	G.T.H.R.	
Interstage Packings	-7.6	-71.6	64	-0.11	-1.08	0.97	-0.03	-0.26	0.23
Tip Spill Strips	-136.1	-108.2	-27.9	-2.06	-1.64	-0.42	-0.49	-0.39	-0.10
Shaft End Packings	28.4	10.5	17.9	0.43	0.16	0.27	0.10	0.04	0.06
Miscellaneous Leakages	0	0	0	0	0	0	0.00	0.00	0.00
Flow Path Damages	0	0	0	0	0	0	0.00	0.00	0.00
Surface Roughness	1675.2	874.7	800.5	25.43	13.26	12.17	6.07	3.17	2.91
Trailing Edge Thickness	0	0	0	0	0	0	0.00	0.00	0.00
Cover Deposits	78.3	0	78.3	1.19	0	1.19	0.28	0.00	0.28
Hand Calculations	0	0	0	0	0	0	0.00	0.00	0.00
Total	1638.2	705.4	932.8	24.87	10.69	14.18	5.94	2.55	3.39

ALSTOM	Client	J-Power (Electric Power Development Co. Ltd.,)
	Project	Turbine and System Assessment for NTPC-Korba Unit #4
	Order No.	CGP10028C
	Contractor	ALSTOM K.K. NASL Ltd. (Nominated subcontractor in India)
NTPC ALSTOM Power Services Pvt. Ltd.	Document	FINAL REPORT VOL. III (STEAM PATH AUDIT)

True Subdivision Efficiency Change	3.45	1.49	1.96
True Subdivision Efficiency	88.59	90.39	-1.8
Apparent Subdivision Efficiency	3.45	1.49	1.96

**Audit Results:
Comparison**

LP TE

Base Audit: Opening May 2010

Current Audit: Closing May 2010

Audit Category	Base Audit	Current Audit	Difference	Base Audit	Current Audit	Difference	Base Audit	Current Audit	Difference
	Power Loss	Power Loss		Change In	Change In		Change In	Change In	
	kW	kW	kW	G.T.H.R.	G.T.H.R.	kJ/kWh	kcal/kWh	kcal/kWh	kcal/kWh
Interstage Packings	135.3	112.5	22.8	2.05	1.7	0.35	0.49	0.41	0.08
Tip Spill Strips	184.8	162.8	22	2.8	2.46	0.34	0.67	0.59	0.08
Shaft End Packings	5.4	-2.4	7.8	0.08	-0.04	0.12	0.02	-0.01	0.03
Miscellaneous Leakages	0	0	0	0	0	0	0.00	0.00	0.00
Flow Path Damages	22.2	0	22.2	0.18	0	0.18	0.04	0.00	0.04
Surface Roughness	1849.9	507.1	1342.8	28.1	7.68	20.42	6.71	1.83	4.88
Trailing Edge Thickness	0	0	0	0	0	0	0.00	0.00	0.00
Cover Deposits	0	0	0	0	0	0	0.00	0.00	0.00
Hand Calculations	0	0	0	0	0	0	0.00	0.00	0.00
Total	2197.7	780.1	1417.6	33.25	11.82	21.43	7.94	2.82	5.12

ALSTOM	Client	J-Power (Electric Power Development Co. Ltd.,)
	Project	Turbine and System Assessment for NTPC-Korba Unit #4
	Order No.	CGP10028C
	Contractor	ALSTOM K.K. NASL Ltd. (Nominated subcontractor in India)
NTPC ALSTOM Power Services Pvt. Ltd.	Document	FINAL REPORT VOL. III (STEAM PATH AUDIT)

True Subdivision Efficiency Change	2.13	0.76	1.37
True Subdivision Efficiency	85.22	86.42	-1.19
Apparent Subdivision Efficiency	2.13	0.76	1.37



**Audit Results:
Comparison**

LP GE



Base Audit: Opening May 2010

Current Audit: Closing May 2010

Audit Category	Base Audit	Current Audit	Difference	Base Audit	Current Audit	Difference	Base Audit	Current Audit	Difference
	Power Loss	Power Loss		Change In	Change In		Change In	Change In	
	kW	kW		G.T.H.R.	G.T.H.R.		G.T.H.R.	G.T.H.R.	
	kW	kW	kW	kJ/kWh	kJ/kWh	kJ/kWh	kcal/kWh	kcal/kWh	kcal/kWh
Interstage Packings	110	100	10	1.66	1.51	0.15	0.40	0.36	0.04
Tip Spill Strips	-23.5	-40.3	16.8	-0.36	-0.61	0.25	-0.09	-0.15	0.06
Shaft End Packings	-3.1	-0.8	-2.3	-0.05	-0.01	-0.04	-0.01	0.00	-0.01
Miscellaneous Leakages	0	0	0	0	0	0	0.00	0.00	0.00
Flow Path Damages	22.3	0	22.3	0.19	0	0.19	0.05	0.00	0.05
Surface Roughness	1735.1	633.8	1101.3	26.35	9.6	16.75	6.29	2.29	4.00
Trailing Edge Thickness	0	0	0	0	0	0	0.00	0.00	0.00

	Client	J-Power (Electric Power Development Co. Ltd.,)
	Project	Turbine and System Assessment for NTPC-Korba Unit #4
	Order No.	CGP10028C
	Contractor	ALSTOM K.K. NASL Ltd. (Nominated subcontractor in India)
	Document	FINAL REPORT VOL. III (STEAM PATH AUDIT)

Cover Deposits	0	0	0	0	0	0	0.00	0.00	0.00
Hand Calculations	0	0	0	0	0	0	0.00	0.00	0.00
Total	1840.7	692.7	1148	27.8	10.5	17.3	6.64	2.51	4.13
True Subdivision Efficiency Change	1.79	0.68	1.12						
True Subdivision Efficiency Apparent Subdivision Efficiency	85.52	86.49	-0.98						
	1.79	0.68	1.12						

	Client	J-Power (Electric Power Development Co. Ltd.,)
	Project	Turbine and System Assessment for NTPC-Korba Unit #4
	Order No.	CGP10028C
	Contractor	ALSTOM K.K. NASL Ltd. (Nominated subcontractor in India)
	Document	FINAL REPORT VOL. III (STEAM PATH AUDIT)

Korba Power Generating Station Unit No 4

Summary of Power Loss/ Recovery

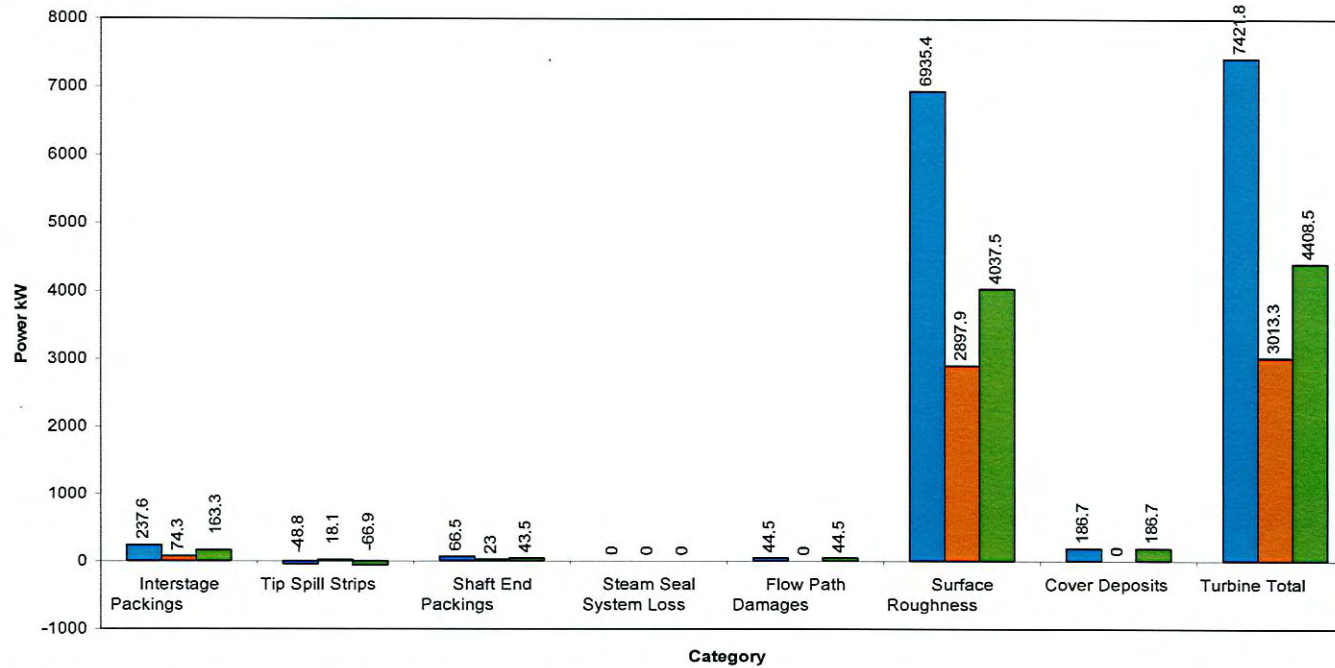



Figure 1 Changes in Total Power



	Client	J-Power (Electric Power Development Co. Ltd.,)
	Project	Turbine and System Assessment for NTPC-Korba Unit #4
	Order No.	CGP10028C
	Contractor	ALSTOM K.K. NASL Ltd. (Nominated subcontractor in India)
	Document	FINAL REPORT VOL. III (STEAM PATH AUDIT)

Korba Power Generating Station Unit No 4

Summary of Heat Rate Loss/ Recovery Total

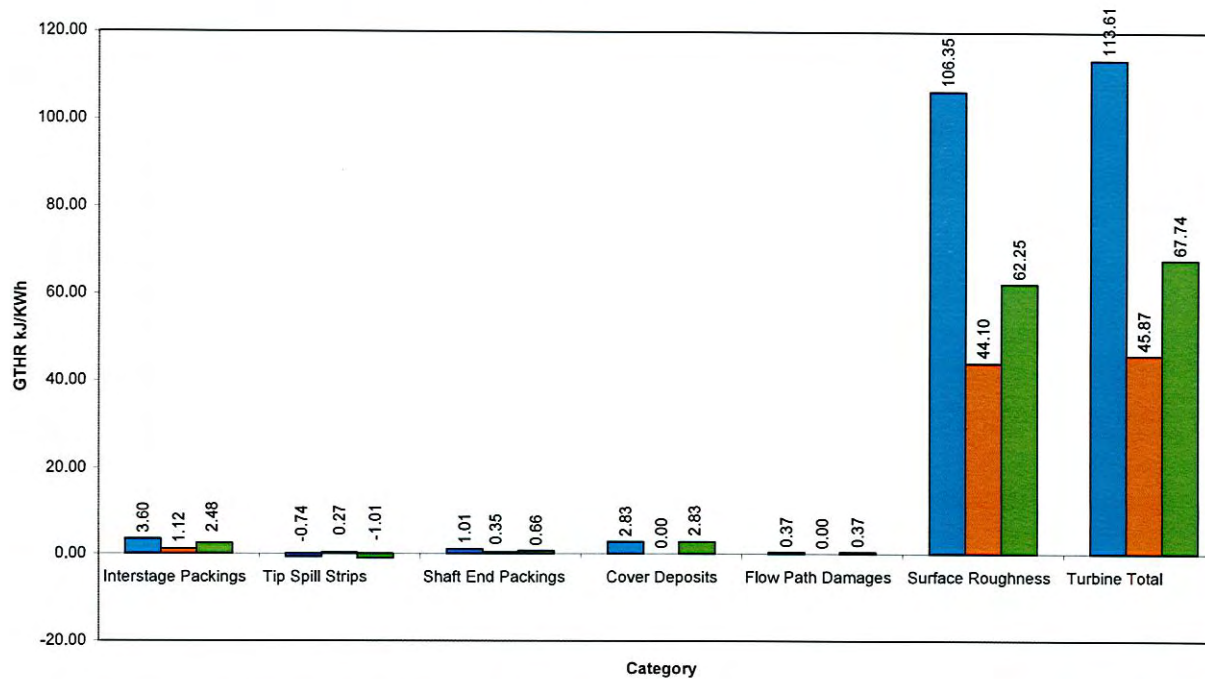



Figure 2 Changes in Total Heat Rate



869

	Client	J-Power (Electric Power Development Co. Ltd.,)
	Project	Turbine and System Assessment for NTPC-Korba Unit #4
	Order No.	CGP10028C
	Contractor	ALSTOM K.K. NASL Ltd. (Nominated subcontractor in India)
	Document	FINAL REPORT VOL. III (STEAM PATH AUDIT)

Korba Power Generating Station Unit No 4

Summary Power Loss/Recovery IP Turbine

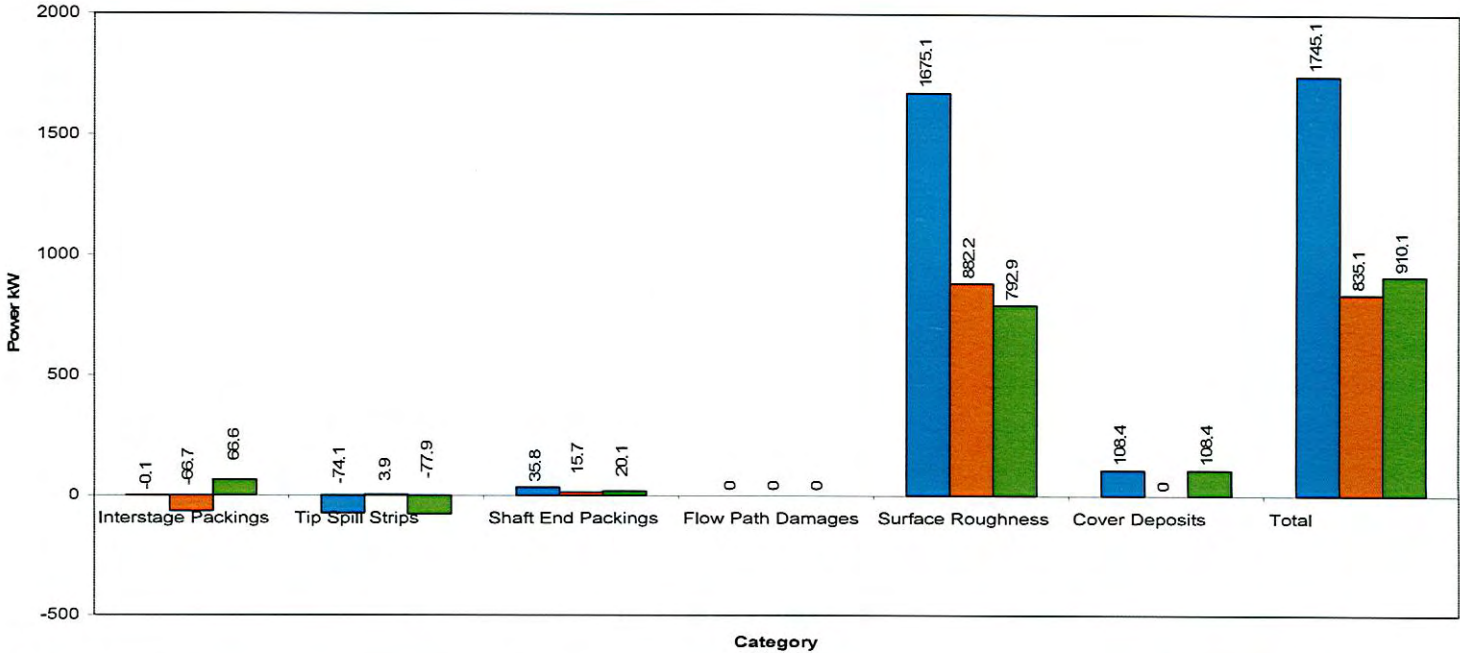



Figure 3 Changes in Power – IP Turbine

█ Opening
█ Closing
█ Recovery

	Client	J-Power (Electric Power Development Co. Ltd.,)
	Project	Turbine and System Assessment for NTPC-Korba Unit #4
	Order No.	CGP10028C
	Contractor	ALSTOM K.K. NASL Ltd. (Nominated subcontractor in India)
	Document	FINAL REPORT VOL. III (STEAM PATH AUDIT)

Korba Power Generating Station Unit No 4

Summary of Heat Rate Loss/ Recovery IP Turbine

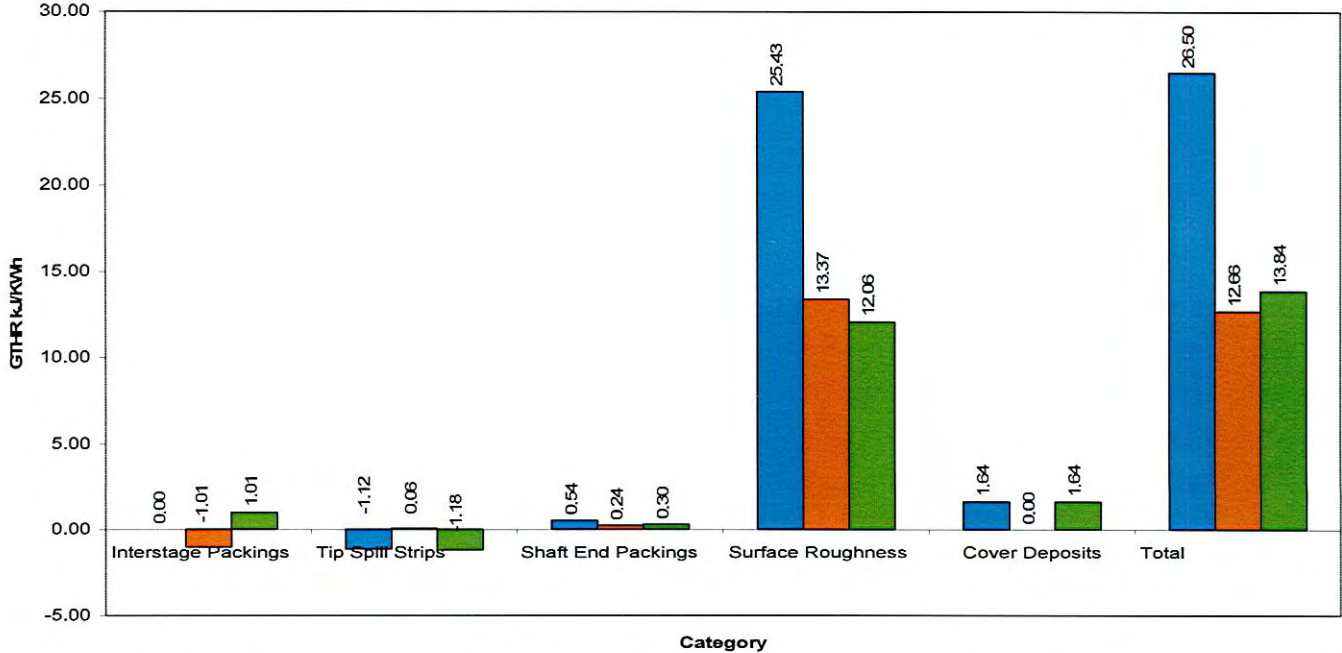



Figure 4 Changes in Heat Rate – IP Turbine

- Opening
- Closing
- Recovery

871

	Client	J-Power (Electric Power Development Co. Ltd.,)
	Project	Turbine and System Assessment for NTPC-Korba Unit #4
	Order No.	CGP10028C
	Contractor	ALSTOM K.K. NASL Ltd. (Nominated subcontractor in India)
	Document	FINAL REPORT VOL. III (STEAM PATH AUDIT)

Korba Power Generating Station Unit No 4

Summary Power Loss/Recovery IP Generator

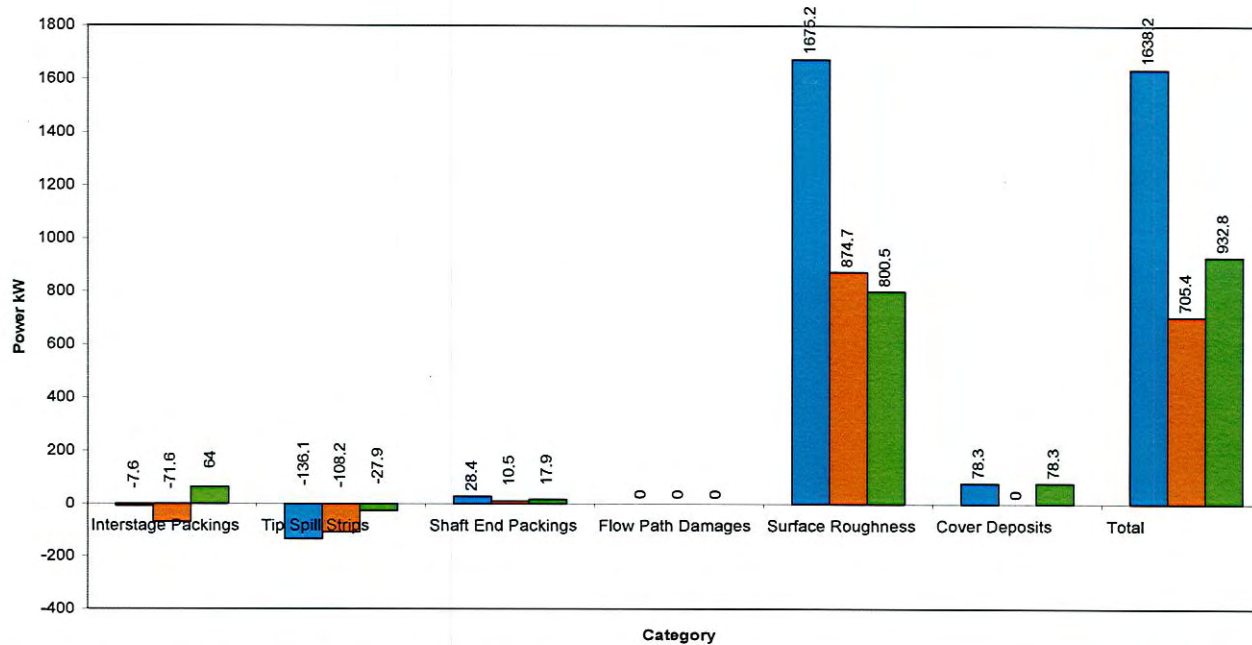



Figure 5 Changes in Power – IP Generator

■ Opening
■ Closing
■ Recovery

	Client	J-Power (Electric Power Development Co. Ltd.)
	Project	Turbine and System Assessment for NTPC-Korba Unit #4
	Order No.	CGP10028C
	Contractor	ALSTOM K.K. NASL Ltd. (Nominated subcontractor in India)
	Document	FINAL REPORT VOL. III (STEAM PATH AUDIT)

Korba Power Generating Station Unit No 4

Summary of Heat Rate Loss/ Recovery IP Generator

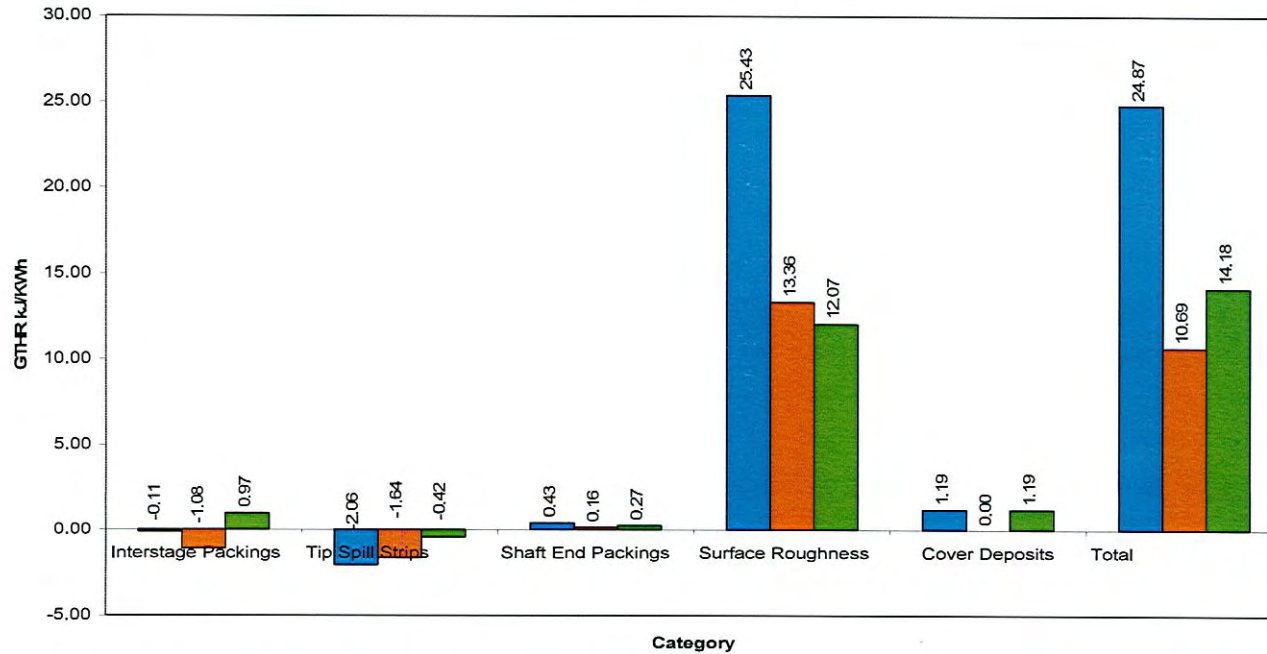



Figure 6 Changes in Heat Rate – IP Generator

■ Opening
■ Closing
■ Recovery

	Client	J-Power (Electric Power Development Co. Ltd.,)
	Project	Turbine and System Assessment for NTPC-Korba Unit #4
	Order No.	CGP10028C
	Contractor	ALSTOM K.K. NASL Ltd. (Nominated subcontractor in India)
	Document	FINAL REPORT VOL. III (STEAM PATH AUDIT)

Korba Power Generating Station Unit No 4

Summary Power Loss/Recovery LP Turbine

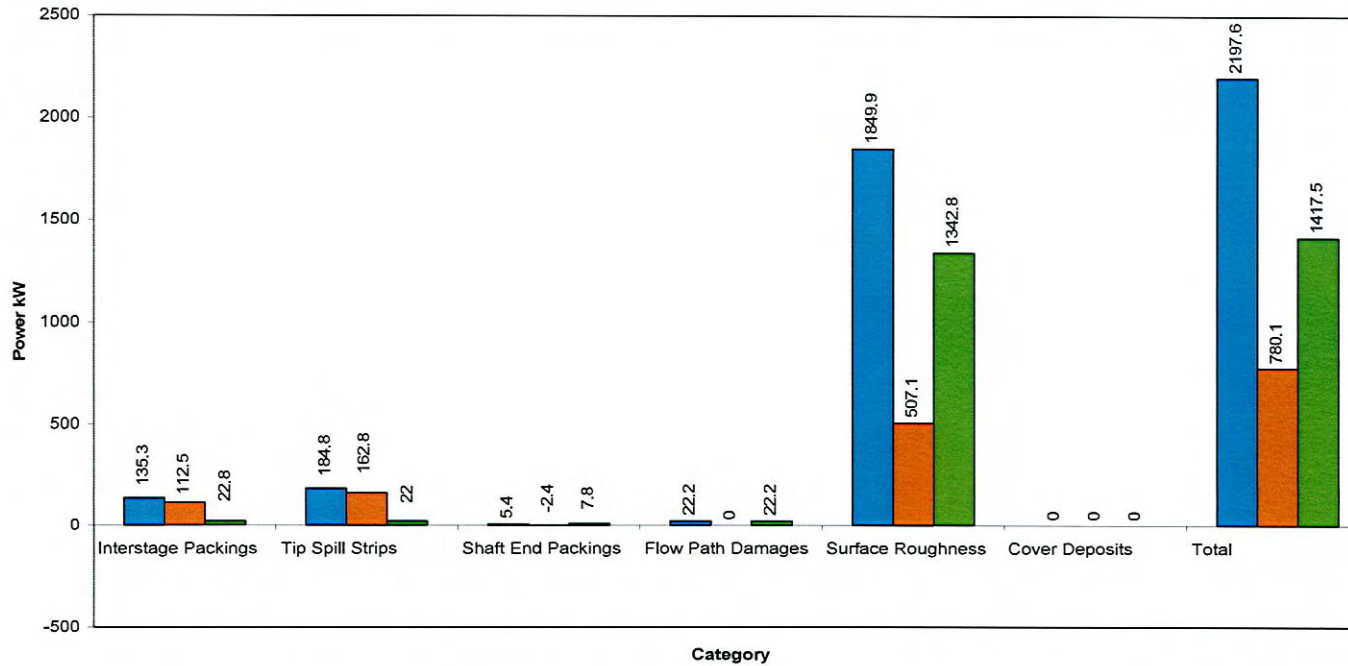



Figure 7 Changes in Power – LP Turbine

■ Opening
■ Closing
■ Recovery

	Client	J-Power (Electric Power Development Co. Ltd.,)
	Project	Turbine and System Assessment for NTPC-Korba Unit #4
	Order No.	CGP10028C
	Contractor	ALSTOM K.K. NASL Ltd. (Nominated subcontractor in India)
	Document	FINAL REPORT VOL. III (STEAM PATH AUDIT)

Korba Power Generating Station Unit No 4

Summary of Heat Rate Loss/ Recovery LP Turbine

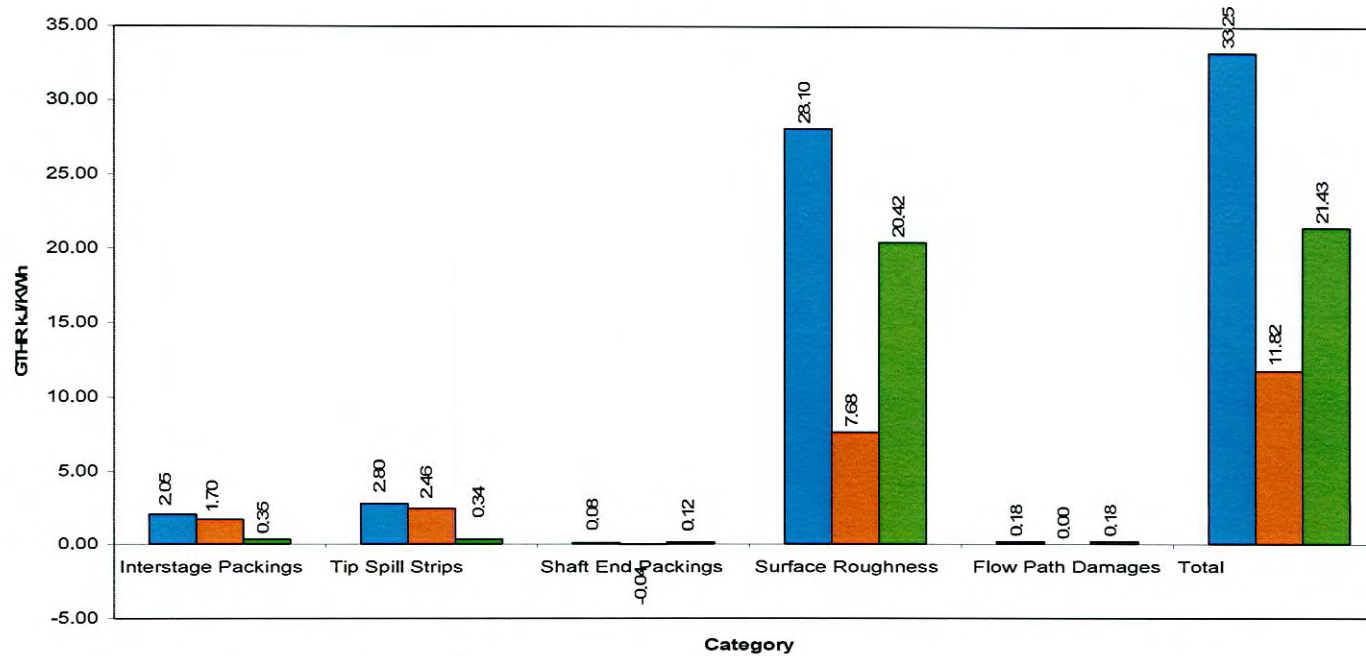



Figure 8 Changes in Heat Rate – LP Turbine



835

	Client	J-Power (Electric Power Development Co. Ltd.,)
	Project	Turbine and System Assessment for NTPC-Korba Unit #4
	Order No.	CGP10028C
	Contractor	ALSTOM K.K. NASL Ltd. (Nominated subcontractor in India)
	Document	FINAL REPORT VOL. III (STEAM PATH AUDIT)

Korba Power Generating Station Unit No 4

Summary Power Loss/Recovery LP Generator

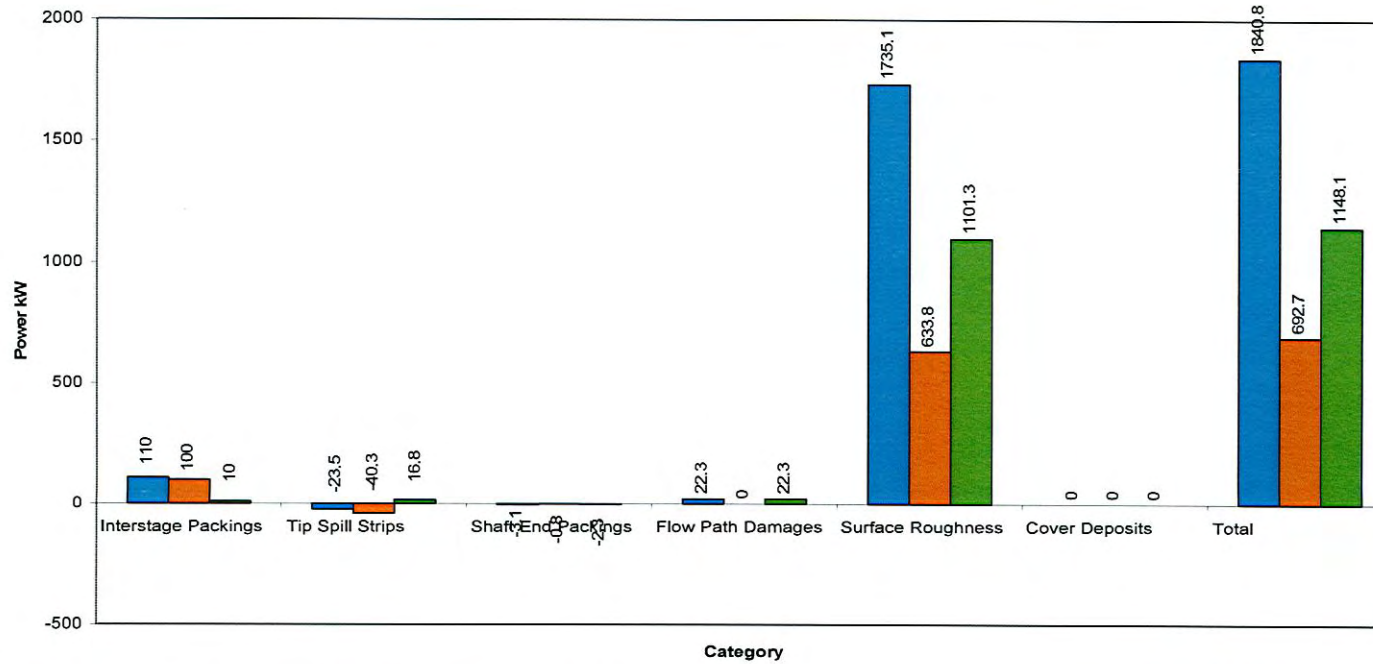



Figure 9 Changes in Power – LP Generator

■ Opening
■ Closing
■ Recovery

	Client	J-Power (Electric Power Development Co. Ltd.,)
	Project	Turbine and System Assessment for NTPC-Korba Unit #4
	Order No.	CGP10028C
	Contractor	ALSTOM K.K. NASL Ltd. (Nominated subcontractor in India)
	Document	FINAL REPORT VOL. III (STEAM PATH AUDIT)

Korba Power Generating Station Unit No 4

Summary of Heat Rate Loss/ Recovery LP Generator

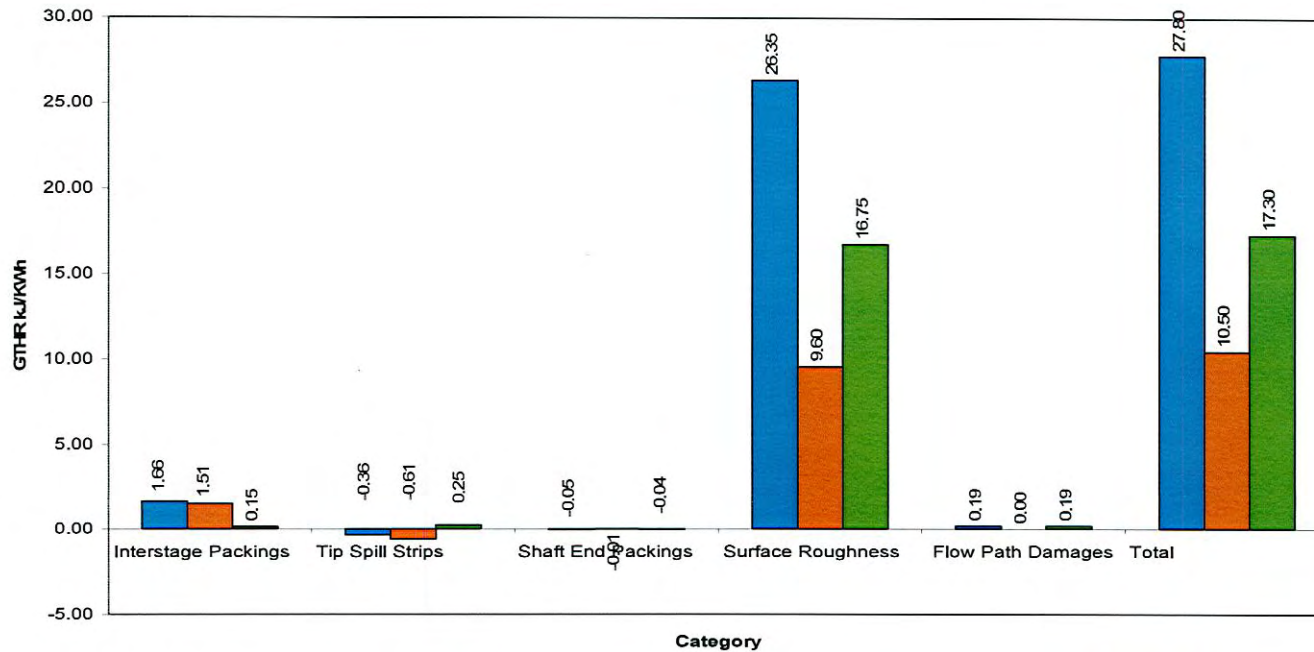

Figure 10 Changes in Heat Rate – LP Generator

■ Opening
■ Closing
■ Recovery

857

The ALSTOM logo is located in the top left corner of the page. It consists of the word "ALSTOM" in a bold, sans-serif font. The letters "ALSTO" are in blue, and the letter "M" is in red. The entire page is framed by a decorative border with a repeating geometric pattern.

Volume- III
Chapter – 08
Photographs

NTPC ALSTOM
Power Services Pvt. Ltd.

ALSTOM	Client	J-Power (Electric Power Development Co. Ltd.,)
	Project	Turbine and System Assessment for NTPC-Korba Unit #4
	Order No.	CGP10028C
	Contractor	ALSTOM K.K. NASL Ltd. (Nominated subcontractor in India)
NTPC ALSTOM Power Services Pvt. Ltd.	Document	FINAL REPORT VOL. III

S

PHOTOGRAPHS OF OPENING AUDIT

This Section contains an accumulation of IP and LP Turbine Opening Audit photographs taken after the unit was opened.

Photo 1	IP Rotating Blade – Surface Roughness of 1 st Stage
Photo 2	IP Rotating Blade – Surface Roughness of 2 nd Stage
Photo 3	IP Rotating Blade – Surface Roughness of 3 rd Stage
Photo 4	IP Rotating Blade – Surface Roughness of 4 th Stage
Photo 5	IP Rotating Blade – Surface Roughness of 5 th Stage
Photo 6	IP Rotating Blade – Surface Roughness of 6 th Stage
Photo 7	IP Rotating Blade – Surface Roughness of 7 th Stage
Photo 8	IP Rotating Blade – Surface Roughness of 8 th Stage
Photo 9	IP Rotating Blade – Surface Roughness of 9 th Stage
Photo 10	IP Rotating Blade – Surface Roughness of 10 th Stage
Photo 11	IP Rotating Blade – Surface Roughness of 11 th Stage
Photo 12	IP Rotating Blade – Surface Roughness of 12 th Stage
Photo 13	IP Rotating Blade – Surface Roughness of 13 th Stage
Photo 14	IP Rotating Blade – Surface Roughness of 14 th Stage
Photo 15	IP –Condition of Tip spill strip in 1 st & 2 nd stage
Photo 16	IP –Condition of Tip spill strip in 3 rd , 4 th , 5 th stage
Photo 17	IP –Condition of Tip spill strip in 4 th , 5 th , 6 th & 7 th stage
Photo 18	IP –Condition of Tip spill strip fins in 3 rd , 4 th , 5 th stage
Photo 19	IP Turbine
Photo 20	IP-Interstage packing 5 th stage
Photo 21	LP Rotating Blade – Surface Roughness
Photo 22	LP Stationary Blade – Surface Roughness 5 th stage
Photo 23	LP Stationary Blade – Surface Roughness 6 th stage
Photo 24	LP Stationary Blade – Surface Roughness
Photo 25	Cover Deposit

899



	Client	J-Power (Electric Power Development Co. Ltd.,)
	Project	Turbine and System Assessment for NTPC-Korba Unit #4
	Order No.	CGP10028C
	Contractor	ALSTOM K.K. NASL Ltd. (Nominated subcontractor in India)
	Document	FINAL REPORT VOL. III



Photo 1
IP Rotating Blade – Surface Roughness of 1st Stage



Photo 2
IP Rotating Blade – Surface Roughness of 2nd Stage



	Client	J-Power (Electric Power Development Co. Ltd.,)
	Project	Turbine and System Assessment for NTPC-Korba Unit #4
	Order No.	CGP10028C
	Contractor	ALSTOM K.K. NASL Ltd. (Nominated subcontractor in India)
	Document	FINAL REPORT VOL. III



Photo 3
IP Rotating Blade – Surface Roughness of 3rd Stage



Photo 4
IP Rotating Blade – Surface Roughness of 4th Stage



	Client	J-Power (Electric Power Development Co. Ltd.,)
	Project	Turbine and System Assessment for NTPC-Korba Unit #4
	Order No.	CGP10028C
	Contractor	ALSTOM K.K. NASL Ltd. (Nominated subcontractor in India)
	Document	FINAL REPORT VOL. III



Photo 5
IP Rotating Blade – Surface Roughness of 5th Stage

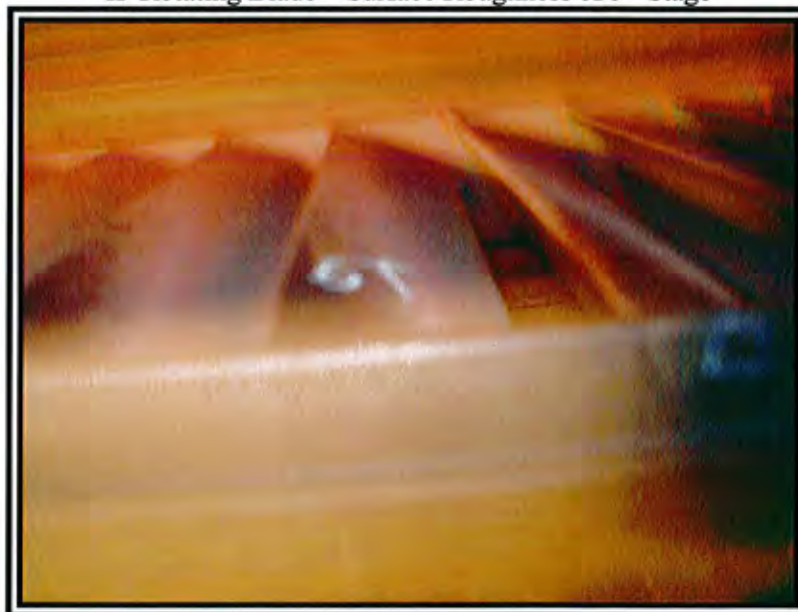

Photo 6
IP Rotating Blade – Surface Roughness of 6th Stage

882



	Client	J-Power (Electric Power Development Co. Ltd.,)
	Project	Turbine and System Assessment for NTPC-Korba Unit #4
	Order No.	CGP10028C
	Contractor	ALSTOM K.K. NASL Ltd. (Nominated subcontractor in India)
	Document	FINAL REPORT VOL. III



Photo 7
IP Rotating Blade – Surface Roughness of 7th Stage



Photo 8
IP Rotating Blade – Surface Roughness of 8th Stage



	Client	J-Power (Electric Power Development Co. Ltd.,)
	Project	Turbine and System Assessment for NTPC-Korba Unit #4
	Order No.	CGP10028C
	Contractor	ALSTOM K.K. NASL Ltd. (Nominated subcontractor in India)
	Document	FINAL REPORT VOL. III



Photo 9
IP Rotating Blade – Surface Roughness of 9th Stage



Photo 10
IP Rotating Blade – Surface Roughness of 10th Stage

528

ALSTOM	Client	J-Power (Electric Power Development Co. Ltd.,)
	Project	Turbine and System Assessment for NTPC-Korba Unit #4
	Order No.	CGP10028C
	Contractor	ALSTOM K.K. NASL Ltd. (Nominated subcontractor in India)
NTPC ALSTOM Power Services Pvt. Ltd.	Document	FINAL REPORT VOL. III



Photo 11
IP Rotating Blade – Surface Roughness of 11th Stage



Photo 12
IP Rotating Blade – Surface Roughness of 12th Stage

ALSTOM	Client	J-Power (Electric Power Development Co. Ltd.,)
	Project	Turbine and System Assessment for NTPC-Korba Unit #4
	Order No.	CGP10028C
	Contractor	ALSTOM K.K. NASL Ltd. (Nominated subcontractor in India)
NTPC ALSTOM Power Services Pvt. Ltd.	Document	FINAL REPORT VOL. III



Photo 13
IP Rotating Blade – Surface Roughness of 13th Stage



Photo 14
IP Rotating Blade – Surface Roughness of 14th Stage



	Client	J-Power (Electric Power Development Co. Ltd.,)
	Project	Turbine and System Assessment for NTPC-Korba Unit #4
	Order No.	CGP10028C
	Contractor	ALSTOM K.K. NASL Ltd. (Nominated subcontractor in India)
	Document	FINAL REPORT VOL. III



Photo 15
IP –Condition of Tip spill strip in 1st & 2nd stage



Photo 16
IP –Condition of Tip spill strip in 3rd, 4th, 5th stage



	Client	J-Power (Electric Power Development Co. Ltd.,)
	Project	Turbine and System Assessment for NTPC-Korba Unit #4
	Order No.	CGP10028C
	Contractor	ALSTOM K.K. NASL Ltd. (Nominated subcontractor in India)
	Document	FINAL REPORT VOL. III



Photo 17
IP –Condition of Tip spill strip in 4th, 5th, 6th & 7th stage

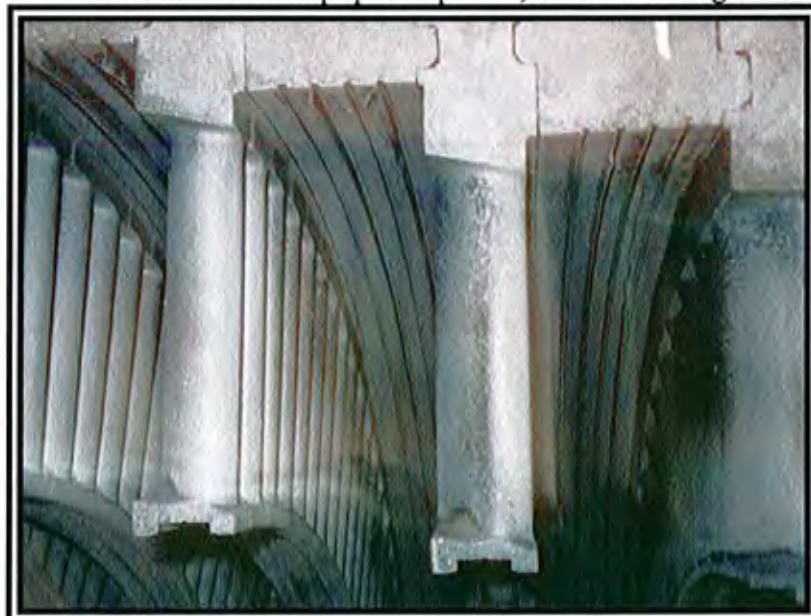



Photo 18
IP –Condition of Tip spill strip fins in 3rd, 4th, 5th stage

	Client	J-Power (Electric Power Development Co. Ltd.,)
	Project	Turbine and System Assessment for NTPC-Korba Unit #4
	Order No.	CGP10028C
	Contractor	ALSTOM K.K. NASL Ltd. (Nominated subcontractor in India)
	Document	FINAL REPORT VOL. III

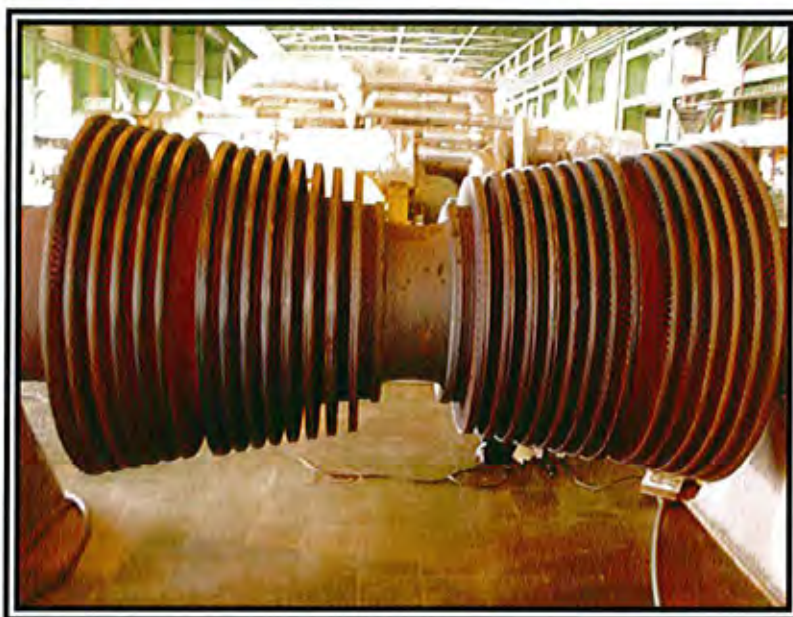

Photo 19
IP Turbine



Photo 20
IP-Interstage packing 5th stage

ALSTOM	Client	J-Power (Electric Power Development Co. Ltd.,)
	Project	Turbine and System Assessment for NTPC-Korba Unit #4
	Order No.	CGP10028C
	Contractor	ALSTOM K.K. NASL Ltd. (Nominated subcontractor in India)
NTPC ALSTOM Power Services Pvt. Ltd.	Document	FINAL REPORT VOL. III



Photo-21
LP Rotating Blade – Surface Roughness



Photo-22
LP Stationary Blade – Surface Roughness 5th stage



	Client	J-Power (Electric Power Development Co. Ltd.,)
	Project	Turbine and System Assessment for NTPC-Korba Unit #4
	Order No.	CGP10028C
	Contractor	ALSTOM K.K. NASL Ltd. (Nominated subcontractor in India)
	Document	FINAL REPORT VOL. III



Photo-23
LP Stationary Blade – Surface Roughness 6th stage



Photo-24
LP Stationary Blade – Surface Roughness

ALSTOM	Client	J-Power (Electric Power Development Co. Ltd.,)
	Project	Turbine and System Assessment for NTPC-Korba Unit #4
	Order No.	CGP10028C
	Contractor	ALSTOM K.K. NASL Ltd. (Nominated subcontractor in India)
NTPC ALSTOM Power Services Pvt. Ltd.	Document	FINAL REPORT VOL. III

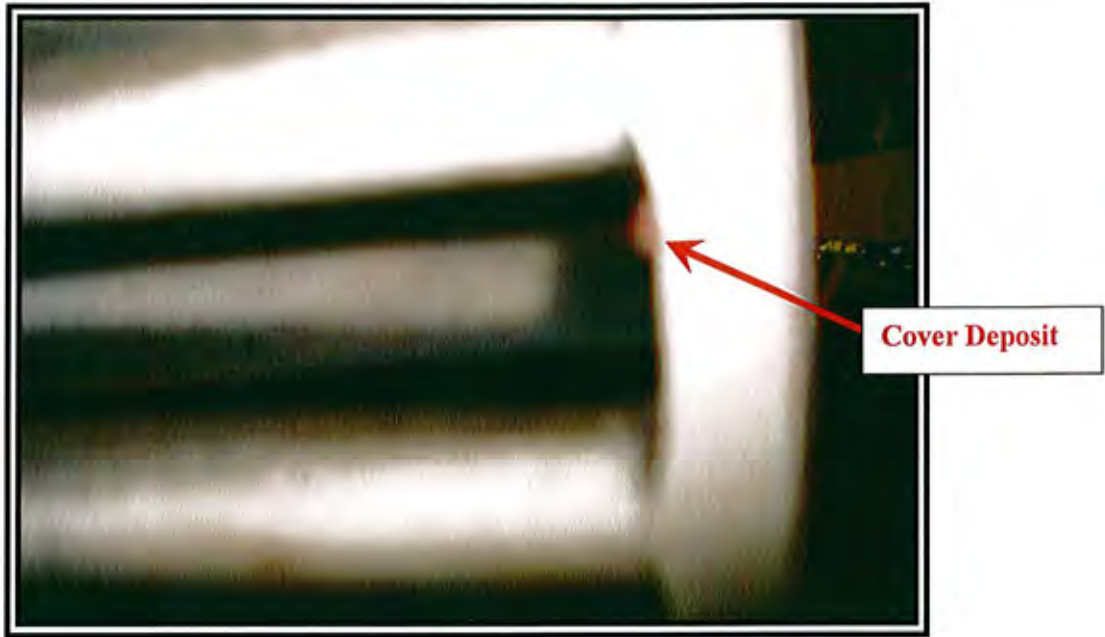



Photo-25
Cover deposit in IP Turbine

	Client	J-Power (Electric Power Development Co. Ltd.,)
	Project	Turbine and System Assessment for NTPC-Korba Unit #4
	Order No.	CGP10028C
	Contractor	ALSTOM K.K. NASL Ltd. (Nominated subcontractor in India)
	Document	FINAL REPORT VOL. III

PHOTOGRAPHS OF CLOSING AUDIT

This Section contains an accumulation of IP and LP Turbine Closing Audit photographs.

Photo 1	IP Rotating Blade – Surface Roughness of 1 st Stage
Photo 2	IP Rotating Blade – Surface Roughness of 2 nd Stage
Photo 3	IP Rotating Blade – Surface Roughness of 3 rd Stage
Photo 4	IP Rotating Blade – Surface Roughness of 4 th Stage
Photo 5	IP Rotating Blade – Surface Roughness of 5 th Stage
Photo 6	IP Rotating Blade – Surface Roughness of 6 th Stage
Photo 7	IP Rotating Blade – Surface Roughness of 7 th Stage
Photo 8	IP Rotating Blade – Surface Roughness of 8 th Stage
Photo 9	IP Rotating Blade – Surface Roughness of 9 th Stage
Photo 10	IP Rotating Blade – Surface Roughness of 10 th Stage
Photo 11	IP Rotating Blade – Surface Roughness of 11 th Stage
Photo 12	IP Rotating Blade – Surface Roughness of 12 th Stage
Photo 13	IP Rotating Blade – Surface Roughness of 13 th Stage
Photo 14	IP Rotating Blade – Surface Roughness of 14 th Stage
Photo 15	LP Rotating Blade – Surface Roughness of 1 st Stage
Photo 16	LP Rotating Blade – Surface Roughness of 2 nd Stage
Photo 17	LP Rotating Blade – Surface Roughness of 3 rd Stage
Photo 18	IP bottom Casing - after Sand Blasting
Photo 19	IP – condition of Tip spill strip in 6 th & 7 th stage
Photo 20	IP – condition of Tip spill strip in 3 rd , 4 th & 5 th stage
Photo 21	LP Rotor



	Client	J-Power (Electric Power Development Co. Ltd.,)
	Project	Turbine and System Assessment for NTPC-Korba Unit #4
	Order No.	CGP10028C
	Contractor	ALSTOM K.K. NASL Ltd. (Nominated subcontractor in India)
	Document	FINAL REPORT VOL. III



Photo 1
IP Rotating Blade – Surface Roughness of 1st Stage

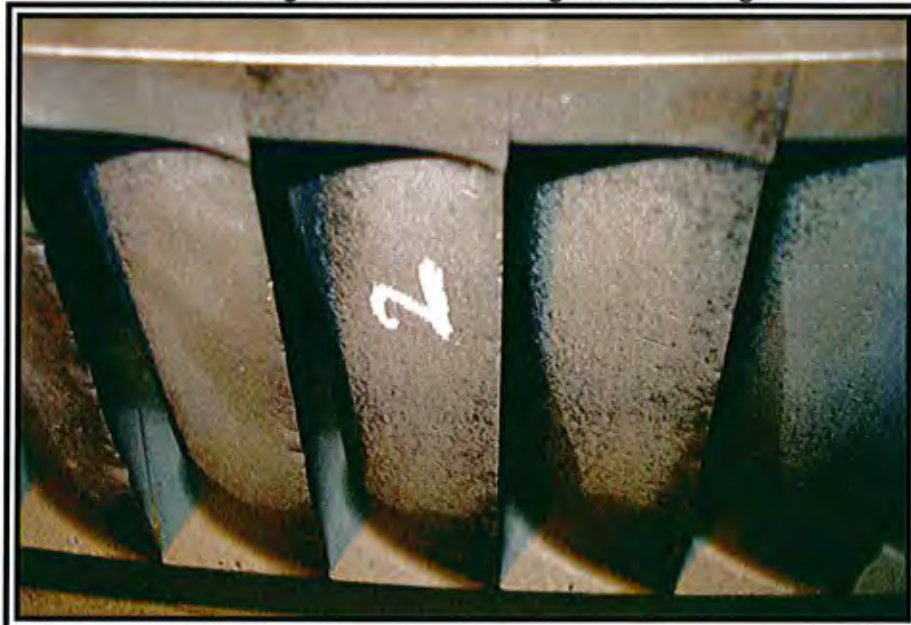

Photo 2
IP Rotating Blade – Surface Roughness of 2nd Stage

462



	Client	J-Power (Electric Power Development Co. Ltd.,)
	Project	Turbine and System Assessment for NTPC-Korba Unit #4
	Order No.	CGP10028C
	Contractor	ALSTOM K.K. NASL Ltd. (Nominated subcontractor in India)
	Document	FINAL REPORT VOL. III



Photo 3
IP Rotating Blade – Surface Roughness of 3rd Stage



Photo 4
IP Rotating Blade – Surface Roughness of 4th Stage



	Client	J-Power (Electric Power Development Co. Ltd.,)
	Project	Turbine and System Assessment for NTPC-Korba Unit #4
	Order No.	CGP10028C
	Contractor	ALSTOM K.K. NASL Ltd. (Nominated subcontractor in India)
	Document	FINAL REPORT VOL. III



Photo 5
IP Rotating Blade – Surface Roughness of 5th Stage



Photo 6
IP Rotating Blade – Surface Roughness of 6th Stage

ALSTOM	Client	J-Power (Electric Power Development Co. Ltd.,)
	Project	Turbine and System Assessment for NTPC-Korba Unit #4
	Order No.	CGP10028C
	Contractor	ALSTOM K.K. NASL Ltd. (Nominated subcontractor in India)
NTPC ALSTOM Power Services Pvt. Ltd.	Document	FINAL REPORT VOL. III



Photo 7
IP Rotating Blade – Surface Roughness of 7th Stage



Photo 8
IP Rotating Blade – Surface Roughness of 8th Stage



	Client	J-Power (Electric Power Development Co. Ltd.,)
	Project	Turbine and System Assessment for NTPC-Korba Unit #4
	Order No.	CGP10028C
	Contractor	ALSTOM K.K. NASL Ltd. (Nominated subcontractor in India)
	Document	FINAL REPORT VOL. III



Photo 9
IP Rotating Blade – Surface Roughness of 9th Stage



Photo 10
IP Rotating Blade – Surface Roughness of 10th Stage

ALSTOM	Client	J-Power (Electric Power Development Co. Ltd.,)
	Project	Turbine and System Assessment for NTPC-Korba Unit #4
	Order No.	CGP10028C
	Contractor	ALSTOM K.K. NASL Ltd. (Nominated subcontractor in India)
NTPC ALSTOM Power Services Pvt. Ltd.	Document	FINAL REPORT VOL. III



Photo 11
IP Rotating Blade – Surface Roughness of 11th Stage



Photo 12
IP Rotating Blade – Surface Roughness of 12th Stage

ALSTOM	Client	J-Power (Electric Power Development Co. Ltd.,)
	Project	Turbine and System Assessment for NTPC-Korba Unit #4
	Order No.	CGP10028C
	Contractor	ALSTOM K.K. NASL Ltd. (Nominated subcontractor in India)
NTPC ALSTOM Power Services Pvt. Ltd.	Document	FINAL REPORT VOL. III



Photo 13
IP Rotating Blade – Surface Roughness of 13th Stage



Photo 14
IP Rotating Blade – Surface Roughness of 14th Stage

900



	Client	J-Power (Electric Power Development Co. Ltd.,)
	Project	Turbine and System Assessment for NTPC-Korba Unit #4
	Order No.	CGP10028C
	Contractor	ALSTOM K.K. NASL Ltd. (Nominated subcontractor in India)
	Document	FINAL REPORT VOL. III



Photo 15
LP Rotating Blade – Surface Roughness of 1st Stage



Photo 16
LP Rotating Blade – Surface Roughness of 2nd Stage

ALSTOM	Client	J-Power (Electric Power Development Co. Ltd.,)
	Project	Turbine and System Assessment for NTPC-Korba Unit #4
	Order No.	CGP10028C
	Contractor	ALSTOM K.K. NASL Ltd. (Nominated subcontractor in India)
NTPC ALSTOM Power Services Pvt. Ltd.	Document	FINAL REPORT VOL. III





Photo 17
LP Rotating Blade – Surface Roughness of 3rd Stage



Photo 18
IP bottom Casing - after Sand Blasting

902

	Client	J-Power (Electric Power Development Co. Ltd.,)
	Project	Turbine and System Assessment for NTPC-Korba Unit #4
	Order No.	CGP10028C
	Contractor	ALSTOM K.K. NASL Ltd. (Nominated subcontractor in India)
	Document	FINAL REPORT VOL. III

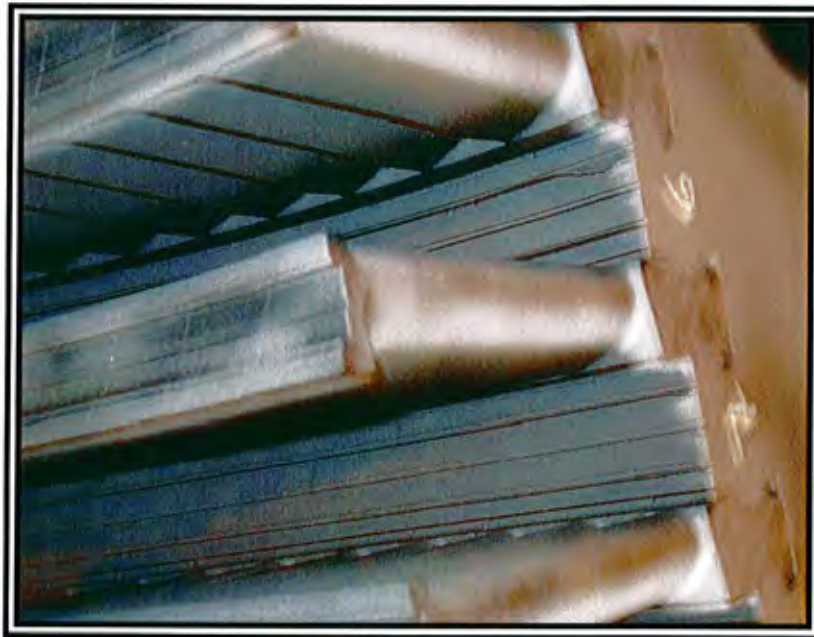

Photo - 19
IP – condition of Tip spill strip in 6th & 7th stage



Photo - 19
IP – condition of Tip spill strip in 3rd, 4th & 5th stage



	Client	J-Power (Electric Power Development Co. Ltd.,)
	Project	Turbine and System Assessment for NTPC-Korba Unit #4
	Order No.	CGP10028C
	Contractor	ALSTOM K.K. NASL Ltd. (Nominated subcontractor in India)
	Document	FINAL REPORT VOL. III



Photo – 20
LP Rotor

The ALSTOM logo is located in the top left corner of the page. It consists of the word "ALSTOM" in a bold, blue, sans-serif font. The letter "O" is stylized with a red circle around it.

2.0

List of Instruments Used

NTPC ALSTOM
Power Services Pvt. Ltd.

ALSTOM	Client	J-Power (Electric Power Development Co. Ltd.,)
	Project	Turbine and System Assessment for NTPC-Korba Unit #4
	Order No.	CGP10028C
	Contractor	ALSTOM K.K. NASL Ltd. (Nominated subcontractor in India)
NTPC ALSTOM Power Services Pvt. Ltd.	Document	FINAL REPORT

Testing Equipment list

Sr. No.	Name of the Equipment	Make	Equipment Sr. No.	Cali. Due Date
1	Ultraviolet black light BL100F with accessories	K- Electronic	168 - 99	25/03/2011
2	Ultraviolet black light BL100F with accessories	Parikh Ind.	MNF03J08	25/03/2011
3	Ultraviolet black light ZB100F with accessories	Magnaflux	2007092378	25/03/2011
5	Coil MPI Machine	K- Electronic	B-P-01	03/05/2011
6	Magnetic particle tester - yoke with accessories	K- Electronic	2074 - 99	25/03/2011
7	Magnetic particle tester - yoke with accessories	Magnaflux	2007082107	25/03/2011
8	Outside Micrometer (50 to 150 mm)	Mitutoyo	3039737	15/09/2010
9	Outside Micrometer (200 to 300 mm)	Mitutoyo	86292275	25/09/2010
10	Outside Micrometer (300 to 400 mm)	Mitutoyo	-----	15/09/2010
11	Outside Micrometer (100 to 200 mm)	Mitutoyo	4429119	15/09/2010
12	Outside Micrometer (400 to 500 mm)	Mitutoyo	1359463	15/09/2010
13	Ultrasonic Thickness Meter	EEC	ENL/49	26/03/2011
14	Ultrasonic Thickness Meter	Modsonic	10038-1002	15/09/2011
15	Ultrasonic Thickness Meter	Pulse Echo	2287	26/03/2011
16	Ultrasonic Thickness meter step block	Pulse Echo	-----	26/03/2011
17	Digital Vernier Caliper	Mitutoyo	0000992	15/09/2010
18	Standard Calibration Block for Ultrasonic flow detector	Krautkammer	-----	15/09/2011
19	Portable hardness tester TH170 with accessories	Time	-----	25/09/2010
20	Standard Calibration Block for Portable hardness tester	Time	VL2508-244	24/09/2011
21	Ultrasonic flaw detector DS322 with accessories	EEC	-----	01/04/2011
22	Eddy Current Test System	INSIS-EX	INSIS EX-06	30/12/2011

906



ALSTOM

3.0

*Calibration certificates of
the Instruments*

NTPC ALSTOM
Power Services Pvt. Ltd.



ELECTRICAL RESEARCH AND DEVELOPMENT ASSOCIATION

ERDA Road, Makarpura Industrial Estate, Vadodara-390 010, India. Gram : ELECSEARCH
EPABX : +91 (0265) 2642942, 2642964, 2642377, 3043133, 3043128, 3043129, 3043130, 3043131.
Fax : +91 (0265) 2638382.
E-mail : erda@erda.org , dir@erda.org , phv@erda.org , ins@erda.org , plv@erda.org , mtd@erda.org
tdc@erda.org , ene@erda.org



TEST REPORT

SHEET 01 OF 01

NAME & ADDRESS OF CUSTOMER: NDT Section, Materials Technology Division, ERDA, Vadodara.		Report No: MNDD/INT/108-1/09-10 Date: 25/03/2010			
		Internal Ref. No. & Date: MNDD/01 dated: 25/03/2010			
		Date of sample Receipt	Date of Testing		
		25/03/2010	25/03/2010		
SAMPLE DESCRIPTION: Ultra violet black light use in Fluorescent NDT testing Model - PLK-125 Make - K- electronic		SAMPLE IDENTIFICATION: Equipment Sr. No.: 168 - 99 ERDA Sr. No.: 11077-1			
TEST DETAILS: Ultra violet black light intensity measurement		TEST SPECIFICATION: 1) ASTM E-709 2) ASTM E-165 3) ASME Sec V			
Sr. No.	Cl. No.	Test Details	Requirement	Obtained Value	Remark
1.0	-	Ultra violet black light intensity measurement			
		Distance - 300 mm* Line Voltage - 230±20V	Min. 1000 microW /cm ²	Measured 1800 microW /cm ²	Conforms
		Distance - 380 mm* Line Voltage - 230±20V		Measured 1430 microW /cm ²	Conforms
Remarks: 1) Ultra violet black light conforms to the requirement of specification and compatible for use in Fluorescent NDT testing 2) * Distance between UV black light bulb and Intensity meter on test surface. 3) Measurement was done using black light intensity meter, make- L T Tutron; ERDA Sr. No. 11226 4) Valid - One year					
 PREPARED BY		 CHECKED BY		 APPROVED BY	
NOTE: 1) This report relates only to the particular sample(s) received for testing in good condition at ERDA. 2) This report cannot be reproduced in part under any circumstances. 3) Publication of this report requires prior permission in writing from Director, ERDA. 4) Only the tests asked for by the customer have been carried out.					

I 0187611



906

ELECTRICAL RESEARCH AND DEVELOPMENT ASSOCIATION

ERDA Road, Makarpura Industrial Estate, Vadodara-390 010, India. Gram : ELECSEARCH
EPABX : +91 (0265) 2642942, 2642964, 2642377, 3043133, 3043128, 3043129, 3043130, 3043131.
Fax : +91 (0265) 2638382.
E-mail : erda@erda.org , dir@erda.org , phv@erda.org, ins@erda.org, plv@erda.org, mtd@erda.org
tdc@erda.org, ene@erda.org



TEST REPORT

SHEET 01 OF 01

NAME & ADDRESS OF CUSTOMER: NDT Section, Materials Technology Division, ERDA, Vadodara.		Report No: MNDDT/INT/108-2/09-10 Date: 25/03/2010			
		Internal Ref. No. & Date: MNDDT/01 dated: 25/03/2010			
		Date of sample Receipt	Date of Testing		
		25/03/2010	25/03/2010		
SAMPLE DESCRIPTION: Ultra violet black light use in Fluorescent NDT testing Model - BL-100F Make - PI		SAMPLE IDENTIFICATION: Equip. Sr. No.: MNF03J08 ERDA Sr. No.: 11149-1			
TEST DETAILS: Ultra violet black light intensity measurement		TEST SPECIFICATION: 1) ASTM E-709 2) ASTM E-165 3) ASME Sec V			
Sr. No.	Cl. No.	Test Details	Requirement	Obtained Value	Remark
1.0	-	Ultra violet black light intensity measurement			
		Distance - 300 mm* Line Voltage - 230±20V	Min. 1000 microW /cm ²	Measured 3720 microW /cm ²	Conforms
		Distance - 380 mm* Line Voltage - 230±20V		Measured 2550 microW /cm ²	Conforms
Remarks: 1) Ultra violet black light conforms to the requirement of specification and compatible for use in Fluorescent NDT testing 2) * Distance between UV black light bulb and Intensity meter on test surface. 3) Measurement was done using black light intensity meter, make- L T Tutron; ERDA Sr. No. 11226 4) Valid - One year					
 PREPARED BY		 CHECKED BY		 APPROVED BY	
NOTE: 1) This report relates only to the particular sample(s) received for testing in good condition at ERDA. 2) This report cannot be reproduced in part under any circumstances. 3) Publication of this report requires prior permission in writing from Director, ERDA. 4) Only the tests asked for by the customer have been carried out.					



606
• I 0187612



ELECTRICAL RESEARCH AND DEVELOPMENT ASSOCIATION

ERDA Road, Makarpura Industrial Estate, Vadodara-390 010, India. Gram : ELECSEARCH
EPABX : +91 (0265) 2642942, 2642964, 2642377, 3043133, 3043128, 3043129, 3043130, 3043131.
Fax : +91 (0265) 2638382.
E-mail : erda@erda.org , dir@erda.org , phv@erda.org , ins@erda.org , plv@erda.org , mtd@erda.org
tdc@erda.org , ene@erda.org

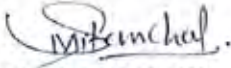

TEST REPORT

SHEET 01 OF 01

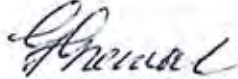
NAME & ADDRESS OF CUSTOMER: NDT Section, Materials Technology Division, ERDA, Vadodara.		Report No: MNDT/INT/108-3/09-10 Date: 25/03/2010			
		Internal Ref. No. & Date: MNDT/01 dated: 25/03/2010			
		Date of sample Receipt		Date of Testing	
		25/03/2010		25/03/2010	
SAMPLE DESCRIPTION: Ultra violet black light use in Fluorescent NDT testing Model - ZB-100F Make - Magnaflux		SAMPLE IDENTIFICATION: Equip. Sr. No.: 2007092378 ERDA Sr. No.: 11236			
TEST DETAILS: Ultra violet black light intensity measurement		TEST SPECIFICATION: 1) ASTM E-709 2) ASTM E-165 3) ASME Sec V			
Sr. No.	Cl. No.	Test Details	Requirement	Obtained Value	Remark
1.0	-	Ultra violet black light intensity measurement			
		Distance - 300 mm* Line Voltage - 230±20V	Min. 1000 microW /cm ²	Measured 3920 microW /cm ²	Conforms
		Distance - 380 mm* Line Voltage - 230±20V		Measured 3050 microW /cm ²	Conforms
Remarks: 1) Ultra violet black light conforms to the requirement of specification and compatible for use in Fluorescent NDT testing 2) * Distance between UV black light bulb and Intensity meter on test surface. 3) Measurement was done using black light intensity meter, make- L T Tutron; ERDA Sr. No. 11226 4) Valid - One year					
 PREPARED BY		 CHECKED BY		 APPROVED BY	
NOTE: 1) This report relates only to the particular sample(s) received for testing in good condition at ERDA. 2) This report cannot be reproduced in part under any circumstances. 3) Publication of this report requires prior permission in writing from Director, ERDA. 4) Only the tests asked for by the customer have been carried out.					

I 0187609



K - ELECTRONICS

THE MAGNETIC PEOPLE™

G-11 RAJMAHAL, 55 E, M. VASANJI ROAD, ANDHERI (EAST),
MUMBAI (BOMBAY) - 400 069, MAHARASHTRA, INDIA.
TEL.: (91-22) 26833600 / 26830781 / 26847581 FAX: (91-22) 268318 91
e-mail : kelec@bom5.vsnl.net.in / kelectronics@vsnl.com

REF : KE/ERDA/MT-6000/CAL/01/09

D: 04/11/2009

ELECTRICAL RESEARCH AND DEVELOPMENT ASSOCIATION.
ERDA ROAD, MAKARPURA INDUSTRIAL ESTATE,
VADODARA -390010, GUJARAT.

MANUFACTURER'S CALIBRATION CERTIFICATE

EQUIPMENT : MAGNATEST MT- 6000 AC / HWDC
K-ELECTRONICS, BILIMORA MAKE,
SR. NO. B-P-01

THIS IS TO CERTIFY THAT AMMETER ON MPT MACHINE HAVING THE ABOVE
DETAILS ON NAME PLATE HAS BEEN CALIBRATED BY US BY COMPARING
THE AMPERAGE WITH STANDARD AMMETER CLASS I AS PER BS-6072.

<u>METER ON EQUIPMENT</u>		<u>MASTER METER</u>		<u>%</u>	<u>%</u>
<u>(AMPS)</u>		<u>(AMPS)</u>		<u>ERROR</u>	<u>ERROR</u>
HWDC	<u>AC</u>	HWDC	AC	HWDC	AC
1500	1500	1500	1545	0.0	3
3000	3000	3000	3030	0.0	1
4000	4000	4000	4040	0.0	1
6000	6000	6000	6000	0.0	0.0

THE RESULTS ARE WELL WITHIN THE LIMITS AS PER IS-1248, ASTM E
709 & BS-6072. MASTER METERS USED FOR CALIBRATION ARE DULY
CERTIFIED BY RECOGNIZED INSTITUTE,

FOR K-ELECTRONICS

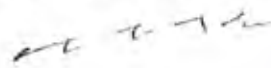
(ANIL B. PARIKH)
PROPRIETOR

K-ELECTRONICS



Plot No.: 240, Phase-III,
G.I.D.C , Ar talia,
BILIMORA, Dist. Navsari,
Gujarat, Pin - 396 325

VALID UPTO D: 03/05/2010

ELECTRICAL RESEARCH AND DEVELOPMENT ASSOCIATION

ERDA Road, Makarpura Industrial Estate, Vadodara-390 010, India. Gram : ELECSEARCH
 EPABX : +91 (0265) 2642942, 2642964, 2642377, 3043133, 3043128, 3043129, 3043130, 3043131.
 Fax : +91 (0265) 2638382.
 E-mail : erda@erda.org , dir@erda.org , phv@erda.org, ins@erda.org, plv@erda.org, mtd@erda.org
 tdc@erda.org, ene@erda.org

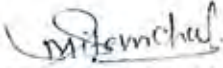
**TEST REPORT****SHEET 01 F**

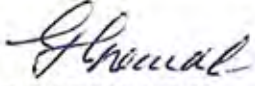
NAME & ADDRESS OF CUSTOMER: NDT Section, Materials Technology Division, ERDA, Vadodara.			Report No: MNMT/INT/107-1/09-10				
			Date: 25/03/2010			Internal Ref. No. & Date: MNMT/01 dated: 25/03/2010	
			Date of sample Receipt		Date of Testing		
		25/03/2010		25/03/2010			
SAMPLE DESCRIPTION: Magnetic particle tester [Yoke type] Model - Magic Master MT-200 Make - K-electronic			SAMPLE IDENTIFICATION: Equip. Sr. No.: 2074-99 ERDA Sr. No. 11077				
TEST DETAILS: Yoke Lifting Force			TEST SPECIFICATION: 1) ASTM E-709 2) ASME Sec V				
Sr. No.	Cl. No.	Test Details	Requirement	Obtained Value	Remark		
1.0	-	Yoke lifting force					
		Type of current	Yoke pole leg spacing				
		AC	50mm - 100mm	Min. Yoke lifting force 45N [4.59kg]	Lifted 5.13kg (50.3N)	Conforms	
		DC	50mm - 100mm	Min. Yoke lifting force 135N [13.77kg]	Lifted 14.58kg (143.0N)	Conforms	
DC	100mm - 150mm	Min. Yoke lifting force 225N [22.9 kg]	Lifted 23.3kg (228.5N)	Conforms			
Remarks: 1) Magnetic particle tester conforms to the requirement of specification and compatible for use in magnetic particle testing. 2) Calibrated dead weights ERDA Sr. No. 11202-1 to 11202-3 were used for measuring yoke lifting force. 3) Validity - One Year							
 PREPARED BY		 CHECKED BY		 APPROVED BY			
NOTE: 1] This report relates only to the particular sample(s) received for testing in good condition at ERDA. 2] This report cannot be reproduced in part under any circumstances. 3] Publication of this report requires prior permission in writing from Director, ERDA. 4] Only the tests asked for by the customer have been carried out.							



I 0187603

ELECTRICAL RESEARCH AND DEVELOPMENT ASSOCIATION

ERDA Road, Makarpura Industrial Estate, Vadodara-390 010, India. Gram : ELECSEARCH
 EPABX : +91 (0265) 2642942, 2642964, 2642377, 3043133, 3043128, 3043129, 3043130, 3043131.
 Fax : +91 (0265) 2638382.
 E-mail : erda@erda.org , dir@erda.org , phv@erda.org, ins@erda.org, plv@erda.org, mtd@erda.org
 ldc@erda.org, ene@erda.org

**TEST REPORT****SHEET 01 OF 01**

NAME & ADDRESS OF CUSTOMER: NDT Section, Materials Technology Division, ERDA, Vadodara.		Report No: MNMT/INT/107-2/09-10 Date: 25/03/2010 .				
		Internal Ref. No. & Date: MNMT/01 dated: 25/03/10				
		Date of sample Receipt		Date of Testing		
		25/03/2010		25/03/2010		
SAMPLE DESCRIPTION: Magnetic particle tester [Yoke type] Make - Magna flux		SAMPLE IDENTIFICATION: Equip. Sr. No.: 2007082107 ERDA Sr. No. 11237				
TEST DETAILS: Yoke Lifting Force		TEST SPECIFICATION: 1) ASTM E-709 2) ASME Sec V				
Sr. No.	Cl. No.	Test Details		Requirement	Obtained Value	Remark
1.0	-	Yoke lifting force				
		Type of current	Yoke pole leg spacing			
		AC	50mm - 100mm	Min. Yoke lifting force 45N [4.59kg]	Lifted 5.13kg (50.3N)	Conforms
		DC	50mm - 100mm	Min. Yoke lifting force 135N [13.77kg]	Lifted 14.58kg (143.0N)	Conforms
		DC	100mm - 150mm	Min. Yoke lifting force 225N [22.9 kg]	Lifted 23.3kg (228.5N)	Conforms
Remarks: 1) Magnetic particle tester conforms to the requirement of specification and compatible for use in magnetic particle testing. 2) Calibrated dead weights ERDA Sr. No. 11202-1 to 11202-3 were used for measuring yoke lifting force 3) Validity - One Year						
<i>V. K. Patel</i> PREPARED BY		<i>Patel</i> CHECKED BY		<i>Sharma</i> APPROVED BY		
NOTE: 1) This report relates only to the particular sample(s) received for testing in good condition at ERDA. 2) This report cannot be reproduced in part under any circumstances. 3) Publication of this report requires prior permission in writing from Director, ERDA. 4) Only the tests asked for by the customer have been carried out.						



I 0188618

ELECTRICAL RESEARCH AND DEVELOPMENT ASSOCIATION

ERDA Road, Makarpura Industrial Estate, Vadodara-390 010, India. Gram : ELECSEARCH
EPABX : +91 (0265) 2642942, 2642964, 2642377, 3043133, 3043128, 3043129, 3043130, 3043131.
Fax : +91 (0265) 2638382.
E-mail : erda@erda.org , dir@erda.org , phv@erda.org , ins@erda.org , plv@erda.org , mtd@erda.org
tdc@erda.org , ene@erda.org



CALIBRATION CERTIFICATE OF OUTSIDE MICROMETER

Sheet: 01 of 02

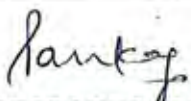
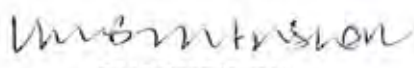
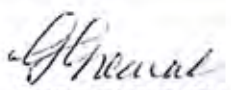
Certificate No.: MMET/INT/CAL/116/09-10 Date : 25-09-2009	No. of Sheets : 2 Calibrated on : 25-09-2009 Recommended Recalibration Date : 24-09-2010	
1.0 Name & Address of Customer :	N. D. T Section	
2.0 Customer's Reference No. :	Internal note dt. 11-09-2009	
3.0 Sample Received on :	25-09-2009	
4.0 Description & Identification of Item :	Name : Outside Micrometer Make : Mitutoyo Model : 104 - 141 A Range : 200 to 300 mm L.C. : 0.01 mm Accuracy : ± 0.03 mm Eqpt. Sr. No. : 86292275 ERDA Sr. No. : 11256	
5.0 Amb. Temp. : $21.7 \pm 1^\circ \text{C}$	Relative Humidity : $50 \pm 3\%$	
6.0 Major Equipment used for Calibration :	Name : Slip Gauge Set (M88/1) Range : 0.5 mm to 100 mm ERDA Sr. No. : 11188	
7.0 Procedure :	ERDA Calibration Procedure No. MT/06/10	
 PREPARED BY	 CHECKED BY	 APPROVED BY
Note: 1. This Certificate relates only to the particular item received for calibration in good condition at ERDA. 2. This Certificate shall not be reproduced, except in full, without permission of the Director ERDA. 3. The calibration results reported in the certificate are valid at the time of and under stated conditions of measurements.		

I 0187915

D:\Desktop Items\Calibration\Internal Calibration services provided\Internal Calibration services provided\Division Wise
Report\MTD\NDT Section .doc



9/14

ELECTRICAL RESEARCH AND DEVELOPMENT ASSOCIATION

ERDA Road, Makarpura Industrial Estate, Vadodara-390 010, India. Gram : ELECSEARCH
EPABX : +91 (0265) 2642942, 2642964, 2642377, 3043133, 3043128, 3043129, 3043130, 3043131.
Fax : +91 (0265) 2638382.
E-mail : erda@erda.org , dir@erda.org , phv@erda.org , ins@erda.org , plv@erda.org , mtd@erda.org
ldc@erda.org, ene@erda.org



Certificate No.: MMET/INT/CAL/116/09-10

Date : 25-09-2009

Sheet : 02 of 02

8.0 Results:

Sr. No.	Reference Standard Size, mm	Micrometer's Reading, mm	Deviation, mm
1.	200.00	200.00	0.00
2.	233.50	233.52	+ 0.02
3.	260.00	260.00	0.00
4.	286.50	286.52	+ 0.02
5.	300.00	300.01	+ 0.01

- Note:** 1] Standard used for calibration is calibrated with reference traceable to National Standard vide Report No. SG/07/274, dt. 18-12-2007 (Valid up to 17-12-2009)
2] Uncertainty of measurement : ± 0.027 mm.
3] The above results are an average of three readings.
4] The reported expanded uncertainty in measurement is stated as the standard uncertainty in measurement multiplied by the coverage factor $k=2$, which for a normal distribution corresponds to a coverage probability of approximately 95%.
5] A Sticker indicating, 'Calibration Status' as shown below has been fixed on the box of instrument.

Mfg. Spec.	Users Spec.	Full Cal.	Partial Cal.	Within Cal.	Out of Spec.	Use Cal. Value
-	√	√	-	√	-	-

Santosh
PREPARED BY

mmet/ntd
CHECKED BY



5/16
I 0187916

ELECTRICAL RESEARCH AND DEVELOPMENT ASSOCIATION

ERDA Road, Makarpura Industrial Estate, Vadodara-390 010, India, Gram : ELECSEARCH
EPABX : +91 (0265) 2642942, 2642964, 2642377, 3043133, 3043128, 3043129, 3043130, 3043131.
Fax : +91 (0265) 2638382.
E-mail : erda@erda.org , dir@erda.org , phv@erda.org, ins@erda.org, plv@erda.org, mtd@erda.org
tdc@erda.org, ene@erda.org



Certificate No.: MMET/INT/CAL/105/09-10

Date : 16-09-2009

Sheet : 02 of 02

8.0 RESULTS:

Sr. No.	Reference Standard Size, mm	Micrometer's Reading, mm	Deviation, mm
1.	300.00	300.02	+ 0.02
2.	333.50	333.51	+ 0.01
3.	360.00	360.02	+ 0.02
4.	386.50	386.51	+ 0.01
5.	400.00	400.02	+ 0.02

- Note:** 1] Standards used for calibration are calibrated with reference traceable to National Standard vide Report Nos. I) SG/07/274, dt. 18-12-2007 (Valid up to 17-12-2009) II) SG/07/276, dt 18-12-2007 (Valid up to 17-12-2009)
2] Uncertainty of measurement : ± 0.027 mm.
3] The above results are an average of three readings.
4] The reported expanded uncertainty in measurement is stated as the standard uncertainty in measurement multiplied by the coverage factor $k=2$, which for a normal distribution corresponds to a coverage probability of approximately 95%.
5] A Sticker indicating, 'Calibration Status' as shown below has been fixed on the box of instrument.

Mfg. Spec.	Users Spec.	Full Cal.	Partial Cal.	Within Cal.	Out of Spec.	Use Cal. Value
-	√	√	-	√	-	-

Santosh
PREPARED BY

Mubinsian
CHECKED BY



0187912

ELECTRICAL RESEARCH AND DEVELOPMENT ASSOCIATION

ERDA Road, Makarpura Industrial Estate, Vadodara-390 010, India. Gram : ELECSEARCH
EPABX : +91 (0265) 2642942, 2642964, 2642377, 3043133, 3043128, 3043129, 3043130, 3043131.
Fax : +91 (0265) 2638382.
E-mail : erda@erda.org , dir@erda.org , phv@erda.org , ins@erda.org , plv@erda.org , mtd@erda.org
tdc@erda.org , ene@erda.org



CALIBRATION CERTIFICATE OF OUTSIDE MICROMETER

Sheet: 01 of 02

Certificate No.: MMET/INT/CAL/108/09-10 Date : 16-09-2009	No. of Sheets : 2 Calibrated on : 16-09-2009 Recommended Recalibration Date : 15-09-2010												
1.0 Name & Address of Customer :	N. D. T Section												
2.0 Customer's Reference No. :	Internal note dt. 11-09-2009												
3.0 Sample Received on :	16-09-2009												
4.0 Description & Identification of Item :	Name : Outside Micrometer Make: Mitutoyo Model : 104 - 143 Range : 400 to 500 mm L. C.: 0.01 mm Accuracy : ± 0.03 mm Eqpt. Sr. No. : 1359463 ERDA Sr. No. : 11119												
5.0 Amb. Temp. : $22.0 \pm 1^\circ \text{C}$	Relative Humidity: $50 \pm 3\%$												
6.0 Major Equipment used for Calibration :	<table border="0"><thead><tr><th></th><th>I</th><th>II</th></tr></thead><tbody><tr><td>Name :</td><td>Slip Gauge Set (M88/1)</td><td>Slip Gauge</td></tr><tr><td>Range :</td><td>0.5 mm to 100 mm</td><td>250 mm</td></tr><tr><td>ERDA Sr. No. :</td><td>11188</td><td>11061</td></tr></tbody></table>		I	II	Name :	Slip Gauge Set (M88/1)	Slip Gauge	Range :	0.5 mm to 100 mm	250 mm	ERDA Sr. No. :	11188	11061
	I	II											
Name :	Slip Gauge Set (M88/1)	Slip Gauge											
Range :	0.5 mm to 100 mm	250 mm											
ERDA Sr. No. :	11188	11061											
7.0 Procedure :	ERDA Calibration Procedure No. MT/06/10												
<i>Santosh</i> PREPARED BY	<i>M. S. M. S. S. S.</i> CHECKED BY	<i>A. G. P. S. S.</i> APPROVED BY											
Note: 1. This Certificate relates only to the particular item received for calibration in good condition at ERDA. 2. This Certificate shall not be reproduced, except in full, without permission of the Director ERDA. 3. The calibration results reported in the certificate are valid at the time of and under stated conditions of measurements.													

D:\Desktop Items\Calibration\Internal Calibration services provided\Internal Calibration services provided\Division Wise Report\MTD\NDT Section .doc



I 0187913

9/8

ELECTRICAL RESEARCH AND DEVELOPMENT ASSOCIATION

ERDA Road, Makarpura Industrial Estate, Vadodara-390 010, India. Gram : ELECSEARCH
EPABX : +91 (0265) 2642942, 2642964, 2642377, 3043133, 3043128, 3043129, 3043130, 3043131.
Fax : +91 (0265) 2638382.
E-mail : erda@erda.org , dir@erda.org , phv@erda.org, ins@erda.org, plv@erda.org, mtd@erda.org
tdc@erda.org, ene@erda.org



Certificate No.: MMET/INT/CAL/108/09-10

Date : 16-09-2009

Sheet : 02 of 02

8.0 RESULTS:

Sr. No.	Reference Standard Size, mm	Micrometer's Reading, mm	Deviation, mm
1.	400.00	400.00	0.00
2.	433.50	433.51	+ 0.01
3.	460.00	460.01	+ 0.01
4.	486.50	486.50	0.00
5.	500.00	500.00	0.00

- Note:** 1] Standards used for calibration are calibrated with reference traceable to National Standard vide Report Nos. I) SG/07/274, dt. 18-12-2007 (Valid up to 17-12-2009) II) SG/07/276, dt 18-12-2007 (Valid up to 17-12-2009)
2] Uncertainty of measurement : ± 0.027 mm.
3] The above results are an average of three readings.
4] The reported expanded uncertainty in measurement is stated as the standard uncertainty in measurement multiplied by the coverage factor $k=2$, which for a normal distribution corresponds to a coverage probability of approximately 95%.
5] A Sticker indicating, 'Calibration Status' as shown below has been fixed on the box of instrument.

Mfg. Spec.	Users Spec.	Full Cal.	Partial Cal.	Within Cal.	Out of Spec.	Use Cal. Value
-	√	√	-	√	-	-

Hankaj
PREPARED BY

Munishwar
CHECKED BY





ELECTRICAL RESEARCH AND DEVELOPMENT ASSOCIATION

ERDA Road, Makarpura Industrial Estate, Vadodara-390 010, India. Gram : ELECSEARCH
EPABX : +91 (0265) 2642942, 2642964, 2642377, 3043133, 3043128, 3043129, 3043130, 3043131.
Fax : +91 (0265) 2638382.
E-mail : erda@erda.org , dir@erda.org , phv@erda.org , ins@erda.org , plv@erda.org , mtd@erda.org
tdc@erda.org , ene@erda.org

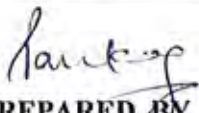
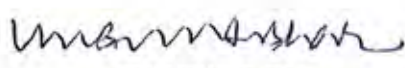

CALIBRATION CERTIFICATE OF ULTRASONIC THICKNESS METER

Sheet : 01 of 02

Certificate No.: MMET/INT/CAL/288/08-09	No. of Sheets	: 2
Date : 27-03-2009	Calibrated on	: 27-03-2009
	Recommended Recalibration Date	: 26-03-2011
1.0 Name & Address of Customer	:	N. D. T. Section
2.0 Customer's Reference No.	:	Internal note dt. 27-03-2009
3.0 Sample Received on	:	27-03-2009
4.0 Description & Identification of Item	:	
	Name	: Ultrasonic Thickness Meter
	Make	: EEC
	Type / Model	: ETM-1
	Range	: 2 to 150 mm
	Accuracy	: ± 0.5 mm
	Equipment Sr. No.	: ENL/49
	ERDA Sr. No.	: 11078-1
		L.C.: 0.1 mm
5.0 Ambient Temperature : $21.8 \pm 1^\circ \text{C}$	Relative Humidity	: $58 \pm 3\%$
6.0 Major Equipment used for Calibration :	I	II
	Name : Slip gauge set (M-11)	Ref. std. gauges
	Range : 3.1 to 100 mm	25 to 200 mm
	ERDA Sr. No. : 1138	11213
7.0 Procedure	:	ERDA Calibration Procedure No. MTL/01/53
 PREPARED BY	 CHECKED BY	 APPROVED BY
Note:		
1. This Certificate relates only to the particular item received for calibration in good condition at ERDA.		
2. This Certificate shall not be reproduced, except in full, without permission of the Director ERDA.		
3. The calibration results reported in the certificate are valid at the time of and under stated conditions of measurements.		



D:\Desktop Items\Calibration\Internal Calibration services provided\Division Wise Report\MTD\NDT Section .doc

I 0188623

920



ELECTRICAL RESEARCH AND DEVELOPMENT ASSOCIATION

ERDA Road, Makarpura Industrial Estate, Vadodara-390 010, India. Gram : ELECSEARCH
 EPABX : +91 (0265) 2642942, 2642964, 2642377, 3043133, 3043128, 3043129, 3043130, 3043131.
 Fax : +91 (0265) 2638382.
 E-mail : erda@erda.org , dir@erda.org , phv@erda.org, ins@erda.org, plv@erda.org, mtd@erda.org
 tdc@erda.org, ene@erda.org

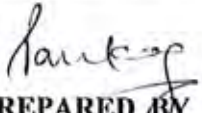
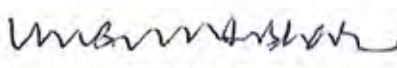

CALIBRATION CERTIFICATE OF ULTRASONIC THICKNESS METER

Sheet : 01 of 02

Certificate No.: MMET/INT/CAL/288/08-09	No. of Sheets : 2
Date : 27-03-2009	Calibrated on : 27-03-2009
	Recommended Recalibration Date : 26-03-2011
1.0 Name & Address of Customer :	N. D. T. Section
2.0 Customer's Reference No. :	Internal note dt. 27-03-2009
3.0 Sample Received on :	27-03-2009
4.0 Description & Identification of Item :	
Name :	Ultrasonic Thickness Meter
Make :	EEC
Type / Model :	ETM-1
Range :	2 to 150 mm
Accuracy :	± 0.5 mm
Equipment Sr. No. :	ENL/49
ERDA Sr. No. :	11078-1
L.C.:	0.1 mm
5.0 Ambient Temperature :	21.8 ± 1° C
Relative Humidity:	58 ± 3%
6.0 Major Equipment used for Calibration :	
Name :	I Slip gauge set (M-11)
Range :	3.1 to 100 mm
ERDA Sr. No. :	1138
II	Ref. std. gauges
ERDA Sr. No. :	25 to 200 mm
II	11213
7.0 Procedure :	ERDA Calibration Procedure No. MTL/01/53
 PREPARED BY	 CHECKED BY
	 APPROVED BY
Note:	
1. This Certificate relates only to the particular item received for calibration in good condition at ERDA.	
2. This Certificate shall not be reproduced, except in full, without permission of the Director ERDA.	
3. The calibration results reported in the certificate are valid at the time of and under stated conditions of measurements.	



D:\Desktop Items\Calibration\Internal Calibration services provided\Division Wise Report\MTD\NDT Section .doc

I 0188623

ELECTRICAL RESEARCH AND DEVELOPMENT ASSOCIATION

ERDA Road, Makarpura Industrial Estate, Vadodara-390 010, India. Gram : ELECSEARCH
EPABX : +91 (0265) 2642942, 2642964, 2642377, 3043133, 3043128, 3043129, 3043130, 3043131.
Fax : +91 (0265) 2638382.
E-mail : erda@erda.org , dir@erda.org , phv@erda.org , ins@erda.org , plv@erda.org , mtd@erda.org
tdc@erda.org , ene@erda.org



Certificate No: MMET/INT/CAL/288/08-09

Date : 27-03-2009

Sheet : 02 of 02

8.0 RESULTS:

Sr. No.	Reference Standard Size, mm	Obtained value of UUC, mm	Deviation, mm
1.	3.1	3.2	+0.1
2.	6.5	6.5	0.0
3.	9.7	9.6	-0.1
4.	12.5	12.4	-0.1
5.	15.8	15.7	-0.1
6.	25.0	24.8	-0.2
7.	50.0	50.1	+0.1
8.	75.0	75.2	+0.2
9.	100.0	100.0	0.0
10.	125.0	124.9	-0.1
11.	150.0	149.8	-0.2

Note:

- Standards used for calibration are calibrated with reference traceable to National Standard vide Report No. 1] SG/107/275 dt. 18-12-2007 (Valid up to 17-12-2009).
2] MMET/INT/CAL/275/08-09 dt.28-02-2009 (Valid up to 27-02-2011).
- Uncertainty of measurement : ± 0.067 mm
- The above results are an average of three readings.
- The reported expanded uncertainty in measurement is stated as the standard uncertainty in measurement multiplied by the coverage factor $k=2$, which for a normal distribution corresponds to a coverage probability of approximately 95 %.
- Sticker indicating "Calibration status" as given below has been fixed on the box of the instrument.

Mfg. Spec.	Users Spec.	Full Cal.	Partial Cal.	Within Cal.	Out of Spec.	Use Cal. Value
-	√	√	-	√	-	-

[Signature]
PREPARED BY

[Signature]
CHECKED BY



D:\Desktop Items\Calibration\Internal Calibration services provided\Division Wise Report\MTD\NDT Section .doc

I 0188624

922

ELECTRICAL RESEARCH AND DEVELOPMENT ASSOCIATION

ERDA Road, Makarpura Industrial Estate, Vadodara-390 010, India. Gram : ELECSEARCH
EPABX : +91 (0265) 2642942, 2642964, 2642377, 3043133, 3043128, 3043129, 3043130, 3043131.
Fax : +91 (0265) 2638382.
E-mail : erda@erda.org , dir@erda.org , phv@erda.org , ins@erda.org , plv@erda.org , mtd@erda.org
tdc@erda.org , ene@erda.org



Certificate No: MMET/INT/CAL/106/09-10

Date : 16-09-2009

Sheet : 02 of 02

8.0 RESULTS:

Sr. No.	Nomenclature	Required Dimension, mm	Tolerance, mm	Obtained Dimensions, mm	Deviation, mm
1.	A	100	± 0.1	100.06	+0.06
2.	B	30	± 0.1	30.04	+0.04
3.	C	15	± 0.1	15.08	+0.08
4.	d ₁	50	± 0.2	50.06	+0.06
5.	d ₂	1.5	± 0.02	1.51	+0.01
6.	E	35	± 0.1	35.01	+0.01
7.	F	200	± 0.1	200.03	+0.03
8.	G	91	± 0.1	91.07	+0.07
9.	H	25	± 0.1	25.06	+0.06
10.	I	2	± 0.1	2.03	+0.03
11.	J	6	± 0.1	6.02	+0.02
12.	r ₁	100	± 0.2	100.03	+0.03

DIMENSION MEASUREMENT OF THE MARKING FROM THE EDGE

13.	60°	86.96	± 0.1	86.95	-0.01
14.	70°	117.42	± 0.1	117.40	-0.02
15.	74°	87.30	± 0.1	87.27	-0.03
16.	80°	120.07	± 0.1	120.02	-0.04
17.	40°	93.74	± 0.1	93.69	-0.05
18.	50°	118.42	± 0.1	118.42	0.0
19.	60°	156.24	± 0.1	156.26	+0.02

Note: 1] Standard used for calibration is calibrated with reference traceable to National Standard vide report no. MMET/INT/CAL/166/08-09 dt. 24-11-2008 (Valid up to 23-11-2009)

2] Uncertainty of measurement: ± 0.02 mm.

3] The above results are an average of three readings.

4] The reported expanded uncertainty in measurement is stated as the standard uncertainty in measurement multiplied by the coverage factor k=2, which for a normal distribution corresponds to a coverage probability of approximately 95 %.

5] Sticker indicating "Calibration Status" as given below has been fixed on the box of the instrument

Mfg. Spec.	Users Spec.	Full Cal.	Partial Cal.	Within Cal.	Out of Spec.	Use Cal. Value
-	√	√	-	√	-	-

Sankar
PREPARED BY

Umesh
CHECKED BY



D:\Desktop Items\Calibration\Internal Calibration services provided\Division Wise Report\MTD\NDT Section .doc

I 0187305

924

ELECTRICAL RESEARCH AND DEVELOPMENT ASSOCIATION

ERDA Road, Makarpura Industrial Estate, Vadodara-390 010, India.

EPABX: +91 (0265) 2642942, 2642964, 2642377, 3043128 / 29 / 30 / 31 / 33,

Fax : +91 (0265) 2638382,

E-mail : erda@erda.org

Web : http://www.erda.org



CALIBRATION CERTIFICATE OF PORTABLE HARDNESS TESTER

Sheet 01 of 02

Certificate No.: MMET/INT/CAL/118/09-10	No. of Sheets : 02	
Date : 25-09-2009	Calibrated on : 25-09-2009	
	Recommended Recalibration Date : 24-09-2011	
1.0 Name & Address of Customer :	NDT Section	
2.0 Customer's Reference No. :	Internal note dt. 24-09-2009	
3.0 Sample Received on :	25-09-2009	
4.0 Description & Identification of Item :		
	Name : Portable Hardness Tester	
	Make : Time	
	Type / Model : TH-170	
	Range : HLD Scale (Hardness 200-900 HLD)	
	Range calibrated : Calibrated for Brinell & Vickers Hardness scale	
	Accuracy : Not mentioned	
	ERDA Sr. No. : 11212-1	
5.0 Amt Temperature : 21.5 ± 1° C	Relative Humidity: 54±3 %	
6.0 Major Equipment used for Calibration :		
	Name : Standard Hardness block for portable hardness tester	
	Range : 581 HBW 2.5/187.5 & 571 HV5	
	ERDA Sr. No. : 11212-2	
7.0 Procedure :	ERDA Calibration Procedure No. MTL:02/15	
PREPARED BY	CHECKED BY	APPROVED BY
Note:		
1. This Certificate relates only to the particular item received for calibration in good condition at ERDA.		
2. This Certificate shall not be reproduced, except in full, without permission of the Director ERDA.		
3. The calibration results reported in the certificate are valid at the time of and under stated conditions of measurements.		



ELECTRICAL RESEARCH AND DEVELOPMENT ASSOCIATION

ERDA Road, Makarpura Industrial Estate, Vadodara-390 010, India.

EPABX: +91 (0265) 2642942, 2642964, 2642377, 3043128 / 29 / 30 / 31 / 33,

Fax : +91 (0265) 2638382,

E-mail : erda@erda.org

Web : http://www.erda.org



Certificate No.: MMET/INT/CAL/118/09-10

Date : 25-09-2009

Sheet : 02 of 02

8.0 RESULTS:

Sr. No.	Particulars	Hardness Readings	Average hardness Value	%
01.	Brinell Hardness Measurement	576,578,578,576,577 HB	577 HB	- 0.69
02.	Vickers Hardness Measurement	594,601,597, 602, 592 HV	597 HV	+ 4.55

Note:

- 1] Standard used for calibration is calibrated with reference traceable to National Standard vide Report No. MMET/INT/CAL/117/09-10, dt. 25/09/2009 (Valid up to 24-09-2011)
- 2] Uncertainty of measurement :
 - i. For Brinell scale : $\pm 2.5\%$
 - ii. For Vickers scale : $\pm 2.9\%$
- 3] The reported expanded uncertainty in measurement is stated as the standard uncertainty in measurement multiplied by the coverage factor $k=2$, which for a normal distribution corresponds to a coverage probability of approximately 95 %.
- 4] Sticker indicating "Calibration status" as given below has been fixed on the instrument

Mfg. Spec.	Users Spec.	Full Cal.	Partial Cal.	Within Cal.	Out of Spec.	Use Cal. Value
-	√	--	√	√	-	-

Sanjay
PREPARED BY

Mubanshan
CHECKED BY



I 0386684

ELECTRICAL RESEARCH AND DEVELOPMENT ASSOCIATION

ERDA Road, Makarpura Industrial Estate, Vadodara-390 010, India.

EPABX: +91 (0265) 2642942, 2642964, 2642377, 3043128 / 29 / 30 / 31 / 33,

Fax : +91 (0265) 2638382,

E-mail : erda@erda.org

Web : http://www.erda.org



CALIBRATION CERTIFICATE OF STANDARD BLOCK FOR PORTABLE HARDNESS TESTER

Sheet 01 of 02

Certificate No.: MMET/INT/CAL/117/09-10	No. of Sheets : 02												
Date : 25-09-2009	Calibrated on : 25-09-2009												
	Recommended Recalibration Date : 24-09-2011												
1.0 Name & Address of Customer : NDT Section													
2.0 Customer's Reference No. : Internal note dt. 24-09-2009													
3.0 Sample Received on : 25-09-2009 (Calibrated in Metallurgy Section)													
4.0 Description & Identification of Item :													
	Name : Standard Block for Portable Hardness Tester												
	Make : Time												
	Range : HLD Scale (Hardness 882 HLD)												
	Range calibrated : Calibrated for Brinell & Vickers Hardness scale												
	Accuracy : Not mentioned												
	Equipment Sr. No. : VL2508-244												
	ERDA Sr. No. : 11212-2												
5.0 Ambient Temperature : 21.5 ± 1°C													
6.0 Major Equipment used for Calibration :													
	<table border="1"><thead><tr><th></th><th>I</th><th>II</th></tr></thead><tbody><tr><td>Name</td><td>Brinell Hardness testing Machine</td><td>Vickers Hardness testing Machine</td></tr><tr><td>Range</td><td>1839 N (187.5 kgf) test force</td><td>49 N (5 kgf) test force</td></tr><tr><td>ERDA Sr. No.</td><td>1190</td><td>1190</td></tr></tbody></table>		I	II	Name	Brinell Hardness testing Machine	Vickers Hardness testing Machine	Range	1839 N (187.5 kgf) test force	49 N (5 kgf) test force	ERDA Sr. No.	1190	1190
	I	II											
Name	Brinell Hardness testing Machine	Vickers Hardness testing Machine											
Range	1839 N (187.5 kgf) test force	49 N (5 kgf) test force											
ERDA Sr. No.	1190	1190											
7.0 Procedure : ERDA Calibration Procedure No. MTL:02/14.													
PREPARED BY <i>Sanku</i>	CHECKED BY <i>mmmmmmmm</i>	APPROVED BY <i>Shival</i>											
Note:													
1. This Certificate relates only to the particular item received for calibration in good condition at ERDA.													
2. This Certificate shall not be reproduced, except in full, without permission of the Director ERDA.													
3. The calibration results reported in the certificate are valid at the time of and under stated conditions of measurements.													



ELECTRICAL RESEARCH AND DEVELOPMENT ASSOCIATION

ERDA Road, Makarpura Industrial Estate, Vadodara-390 010, India.

EPABX: +91 (0265) 2642942, 2642964, 2642377, 3043128 / 29 / 30 / 31 / 33,

Fax : +91 (0265) 2638382,

E-mail : erda@erda.org

Web : http://www.erda.org



Certificate No.: MMET/INT/CAL/117/09-10

Date : 25-09-2009

Sheet : 02 of 02

8.0 RESULTS:

Sr. No.	Particulars	Hardness Readings	Average hardness Value
01.	Brinell Hardness Measurement at 1839 N (187.5 kgf) Test force.	573,594,573,573,594 HBW	581 HBW 2.5/187.5
02.	Vickers Hardness Measurement at 49 N (5 kgf) Test force.	584,575,566,566,566 HV5	571 HV5

Note:

- Standards used for calibration are calibrated with reference traceable to National Standard vide Report Nos.
 - MMET/INT/CAL/230/08-09 dt. 27-01-2009 (Valid up to 26-01-2010)
 - MMET/INT/CAL/172/08-09 dt. 04-12-2008 (Valid up to 03-12-2009)
- Uncertainty of measurement:
 - For Brinell Hardness testing m/c.: $\pm 2.5\%$
 - For Vickers Hardness testing m/c.: $\pm 2.9\%$
- The reported expanded uncertainty in measurement is stated as the standard uncertainty in measurement multiplied by the coverage factor $k=2$, which for a normal distribution corresponds to a coverage probability of approximately 95 %.
- Sticker indicating "Calibration status" as given below has been fixed on the instrument

Mfg. Spec.	Users Spec.	Full Cal.	Partial Cal.	Within Cal.	Out of Spec.	Use Cal. Value
-	√	--	√	--	-	√

Santosh
PREPARED BY

Umesh
CHECKED BY



I 0386682



ELECTRONIC & ENGINEERING SERVICES PVT. LTD.

C-7, Dalia Indl. Estate, New Link Road, Opp Laxmi Indl. Estate, Andheri (W), Mumbai - 400 053. India.
Tel : 91-22-6692 5941 / 2673 0651 Fax : 91-22-2673 0650 E-mail : ees@vsnl.net

CALIBRATION CERTIFICATE

CERTIFICATE NO. / DATE: -EES/13/ 02.04.2010

THIS IS CERTIFY THAT, ULTRASONIC FLAW DETECTOR

MODEL: - DS-322

COMPANY NAME: - Electrical Research Development Association

Sr. No.: DSH012

HAS BEEN CALIBRATED AND TESTED AS PER OUR PROCEDURE

NO. SERVO 31, WHICH MEET THE REQUIREMENTS OF THE EQUIPMENTS

SPECIFICATIONS & ASTM-E317-06a.

DATE : 02/04/ 2010

VALID UP TO : 01/ 04/ 2011

PLACE : VADODARA

AUTHORISED SIGNATORY

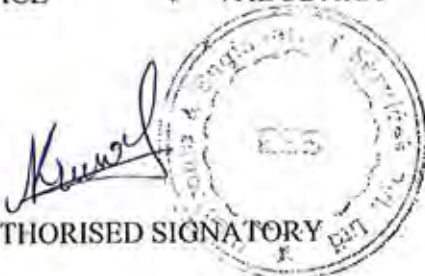

Branch Office: - 359/A/6 G.I.D.C Makarpura,

VADODARA-10 Ph. (0265) 2634460 RIM. 9327270533, Telefax 2634460

626



TECHNOFOUR

THE NDT TECHNOCRATS

NDT House, 45 Ambedkar Road,
Near Sangam Bridge,
Pune 411001, India.
Tel. : +91-20-2605 8080 / 61 / 62
Fax : +91-20-2605 8070
Email : info@technofour.com
Website : www.technofour.com

31/01/2010

Calibration Certificate

for Eddy Current Test System INSIS-EX (Sr.No.INSIS-EX-06)

This is to certify that Eddy Current Test System INSIS-EX (Sr.No.INSIS-EX-06) is calibrated for modes of testing and is found to be working satisfactory confirming to the following specifications :

- * Frequency : 55 Hz to 6 MHz
- * Gain : 0 to 86 db in 0.5 db step
- * Phase : 0 to 359 deg. in 1 deg step
- * No. of Channels : 4 simultaneous (2 Diff + 2 Abs)
(32 Multiplexed)

This calibration is valid from 31/01/2010 to 30/12/2011.

For **TECHNOFOUR**

Asunil

PARTNER

To,
VIBRANT NDT SERVICES
Module No.107 & 110,
SIDCO, AIEMA TOWER,
1st Main Road,
Ambattur Industrial Estate,
Chennai – 600 058



ELECTRONIC & ENGINEERING SERVICES PVT. LTD.

C-7, Dalia Indl. Estate, New Link Road, Opp Laxmi Indl. Estate, Andheri (W), Mumbai - 400 053, India.
Tel : 91-22-6692 5941 / 2673 0651 Fax : 91-22-2673 0650 E-mail : ees@vsnl.net

CALIBRATION CERTIFICATE

CERTIFICATE NO. / DATE: -EES/13/ 02.04.2010

THIS IS CERTIFY THAT, ULTRASONIC FLAW DETECTOR

MODEL: - DS-322

COMPANY NAME: - Electrical Research Development Association

Sr. No.: DSH012

HAS BEEN CALIBRATED AND TESTED AS PER OUR PROCEDURE

NO. SERVO 31, WHICH MEET THE REQUIREMENTS OF THE EQUIPMENTS

SPECIFICATIONS & ASTM-E317-06a.

DATE : 02/04/ 2010

VALID UP TO : 01/ 04/ 2011

PLACE : VADODARA

AUTHORISED SIGNATORY

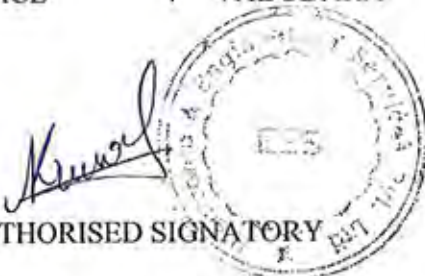

Branch Office: - 359/A/6 G.I.D.C Makarpura,

VADODARA-10 Ph. (0265) 2634460 RIM. 9327270533, Telefax 2634460

The ALSTOM logo is located in the top left corner of the page. It consists of the word "ALSTOM" in a bold, sans-serif font. The letters "ALST" are in blue, and the "OM" is in red. The letter "O" has a small white circle inside it.

4.0

Our Associates

NTPC ALSTOM
Power Services Pvt. Ltd.

933

Our Associates:-

Dr. S. Shamasundar Dr. B. Sreehari Kumar B. M. Sachin (Design Engineer) P. Senapathi (Design Engineer)	 <small>engineering your designs</small> ProSIM R&D Pvt. Ltd., Bangalore, INDIA.
Dr. G. S. Grewal (Metallurgist) R. N. Patil (Metallurgist)	 Electrical Research & Development Association, Vadodara, INDIA.
Paul Roediger Fredrick (Steam Path Auditor)	Encotech USA
Samir Sahay (Piping Stress Analyst)	Consultant