

Appendix 1.D

Explanatory Materials for Technical Assistance on System Planning (Voltage Stability)

Voltage Control in TEPCO

June 2010

Voltage Collapse of TEPCO's System in 1987 (1/2)

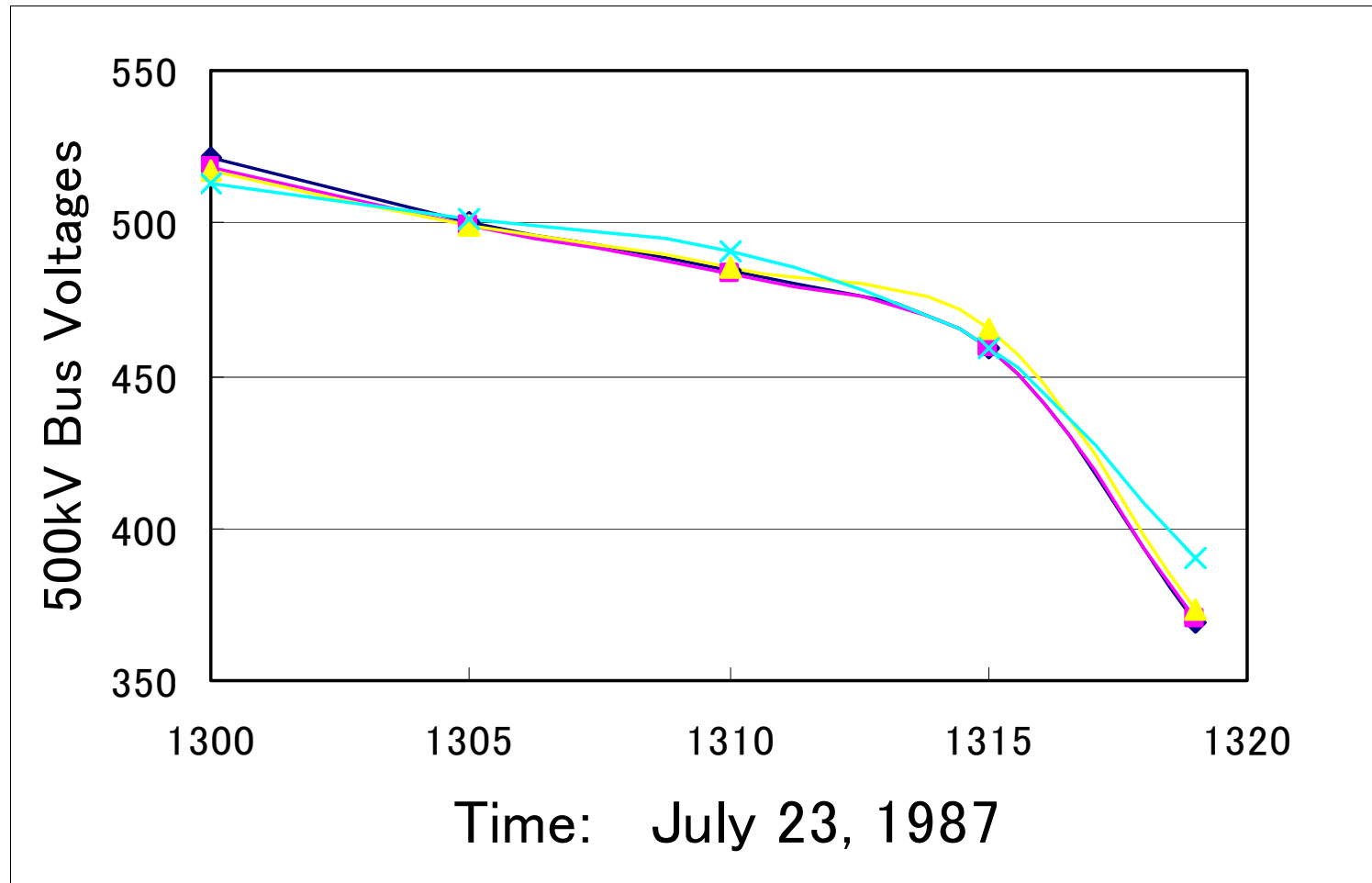

Voltage Collapse of TEPCO's System in 1987 (2/2)

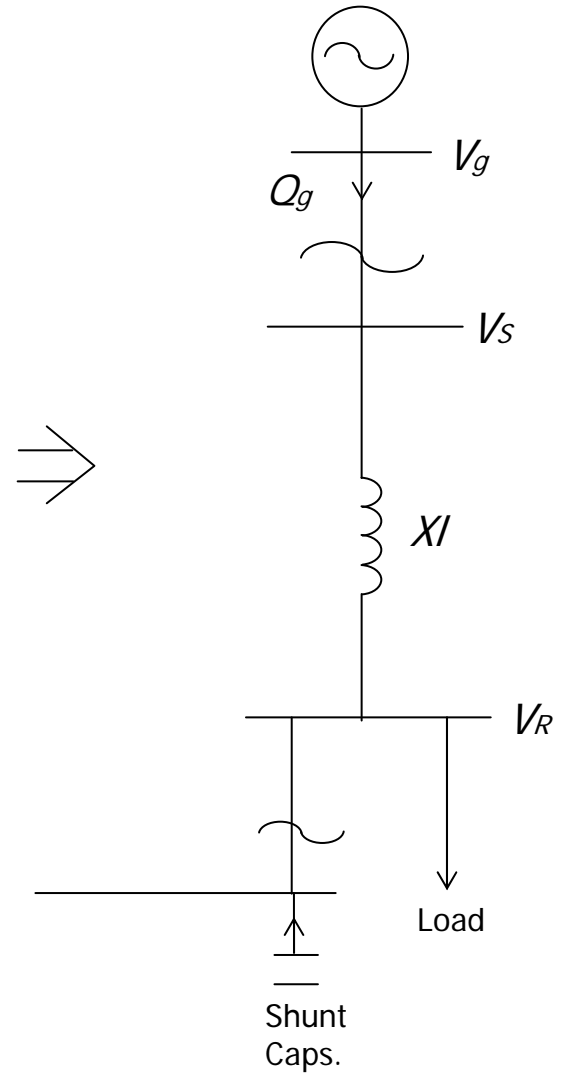
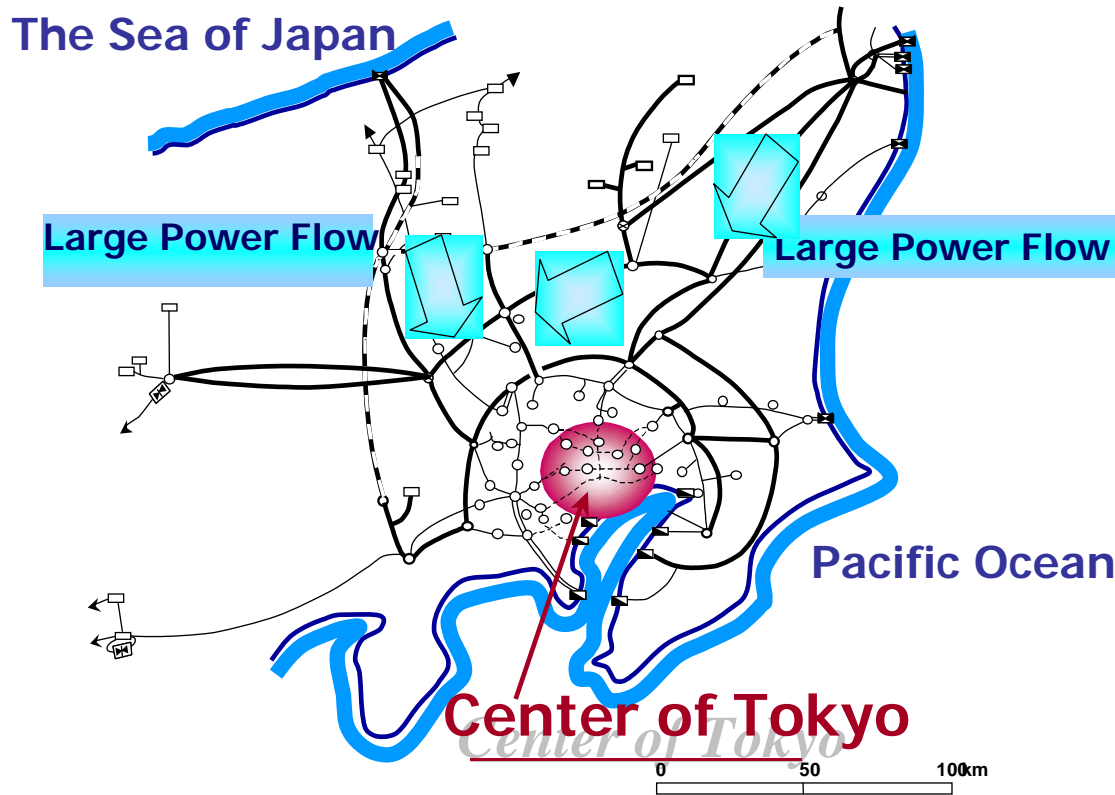

Heavy Load -> Too much Loss of Reactive Power

Evaluation of Voltage Stability by P-V Curve

Image of P-V Curve (or Nose Curve)

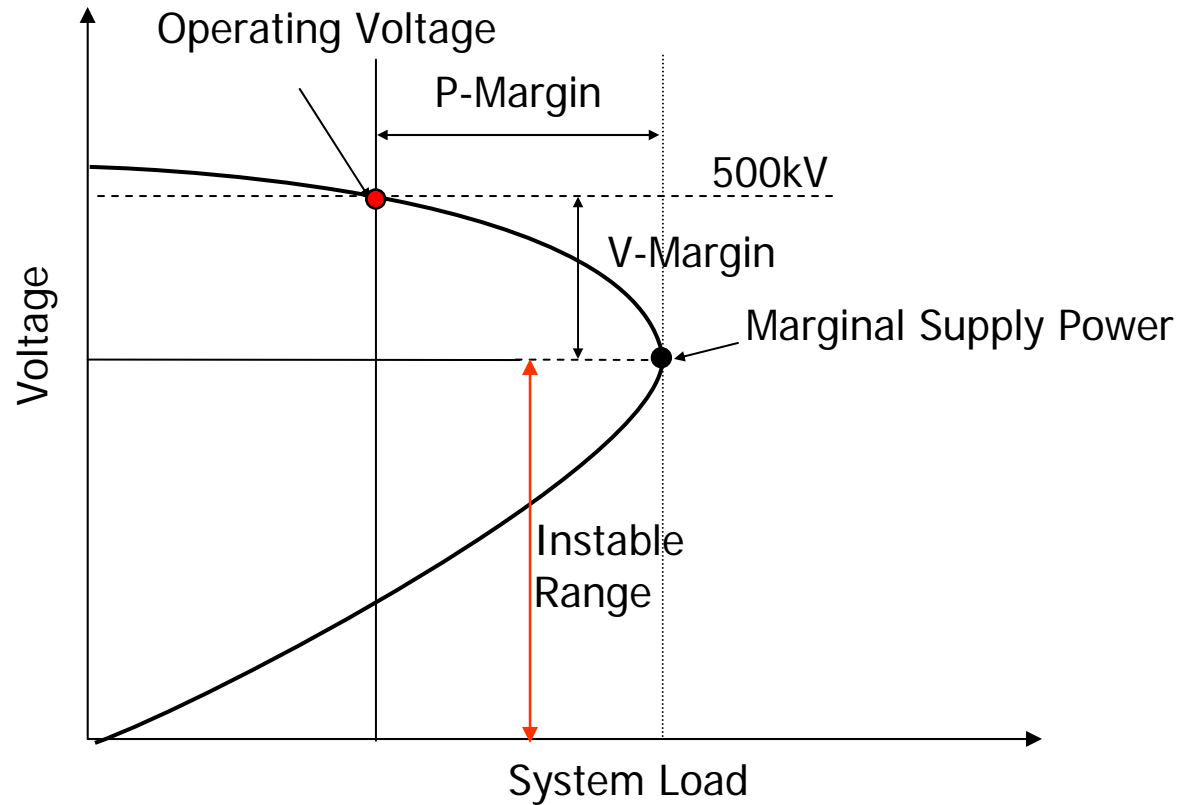

How the Collapse Happened in 1987 (1/3)

➤ Conceptual explanation by P-V Curve

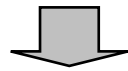
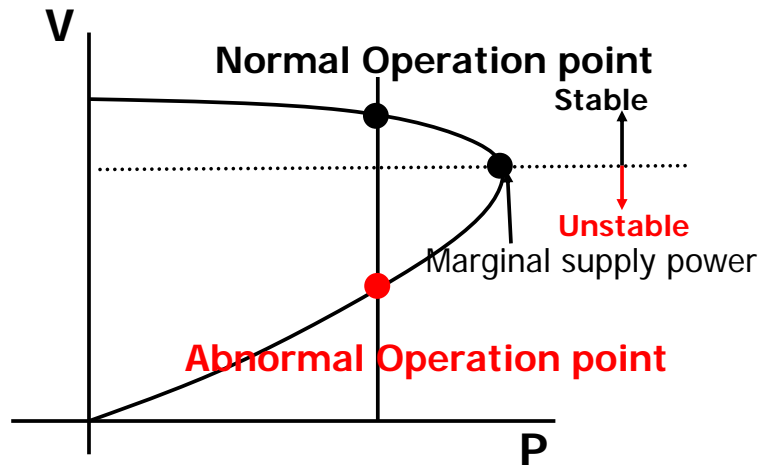

➤ Increasing Demand

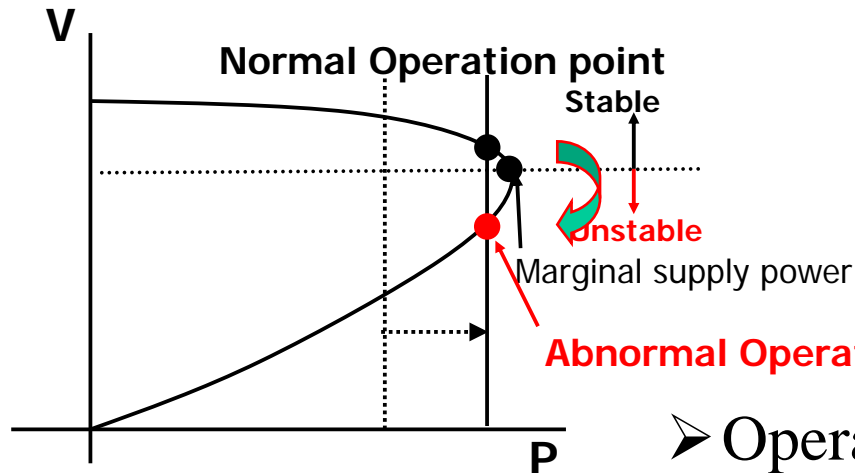

➤ Operation point moved to lower part of the curve

How the Collapse Happened in 1987 (2/3)

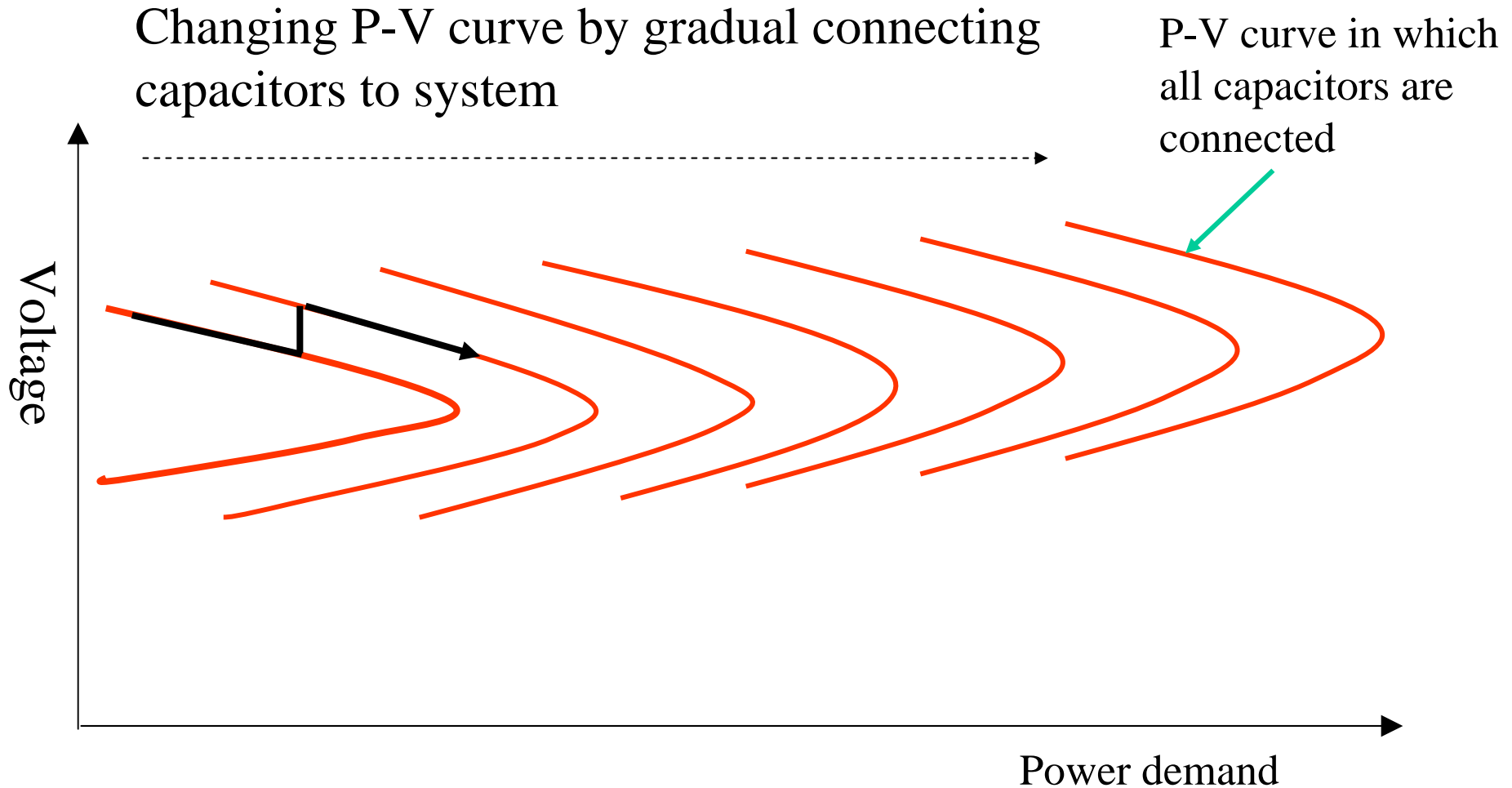

How the Collapse Happened in 1987 (3/3)

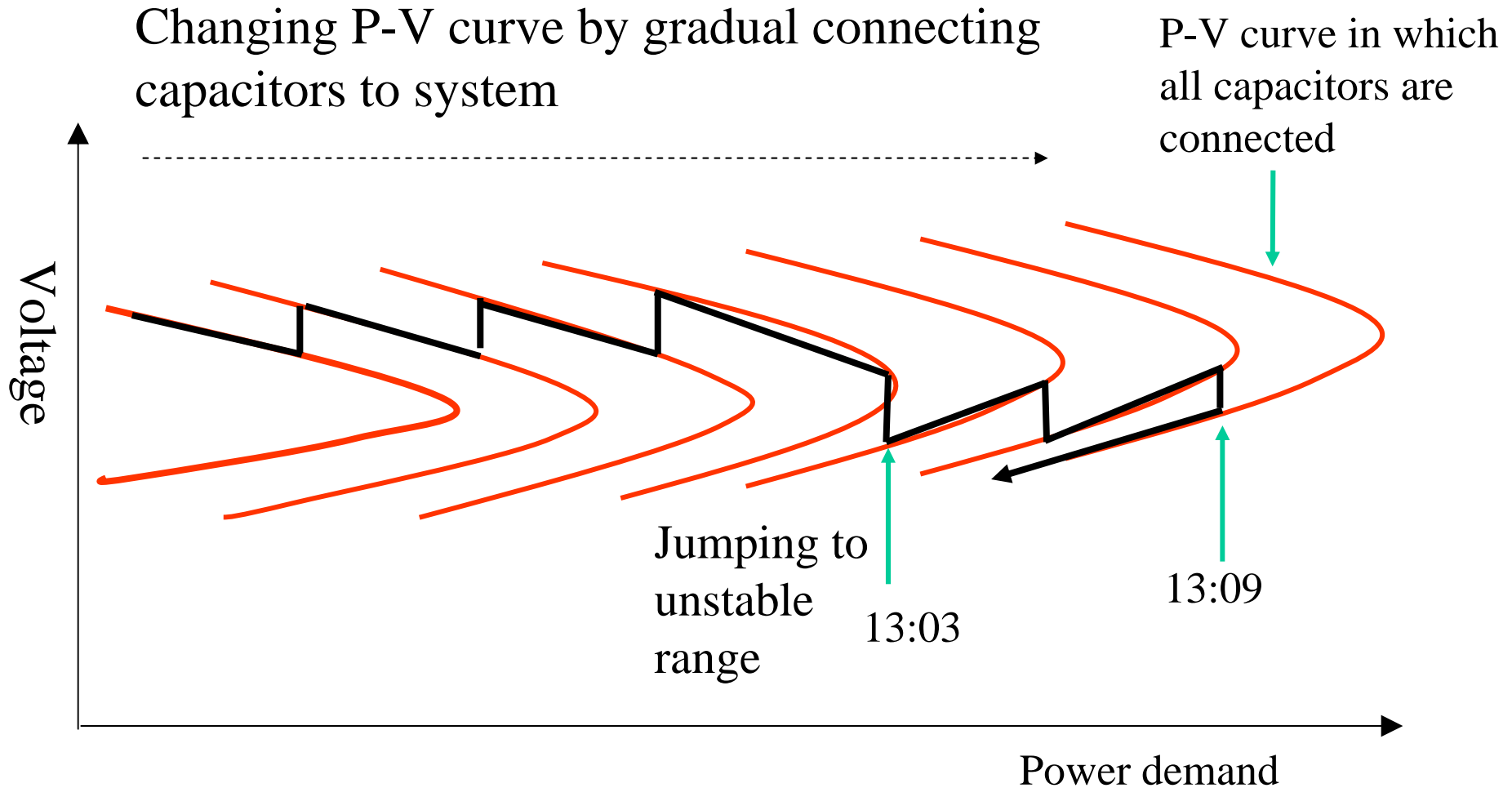

Other Voltage Collapse Events

Date	Location, Time frame
860413	Winnipeg, Canada, Nelson River HVDC link Transient, 1 s
861130	SE Brazil, Paraguay, Itaipu HVDC link Transient, 2 s
850517	S Florida, USA Transient, 4 s
870822	W Tennessee, USA Transient, 10 s
960702	Western USA Longer term? 35 s
831227	Sweden Longer term, 55 s
820902	Florida, USA Longer term, 1-3 min
821126	Florida, USA Longer term, 1-3 min
821228	Florida, USA Longer term, 1-3 min
821230	Florida, USA Longer term, 1-3 min
770922	Jacksonville, Florida Longer term, minutes
820804	Belgium Longer term, 4-5 min
870112	Western France Longer term, 6-7 min
651209	Bretagne, France Longer term
761110	Bretagne, France Longer term
870723	Tokyo, Japan Longer term, 20 min
781219	France Longer term, 26 min
700822	Japan Longer term, 30 min

<http://www.iea.lth.se/~ielolof/stability/Seminar5.pdf>

Countermeasure against Voltage Stability

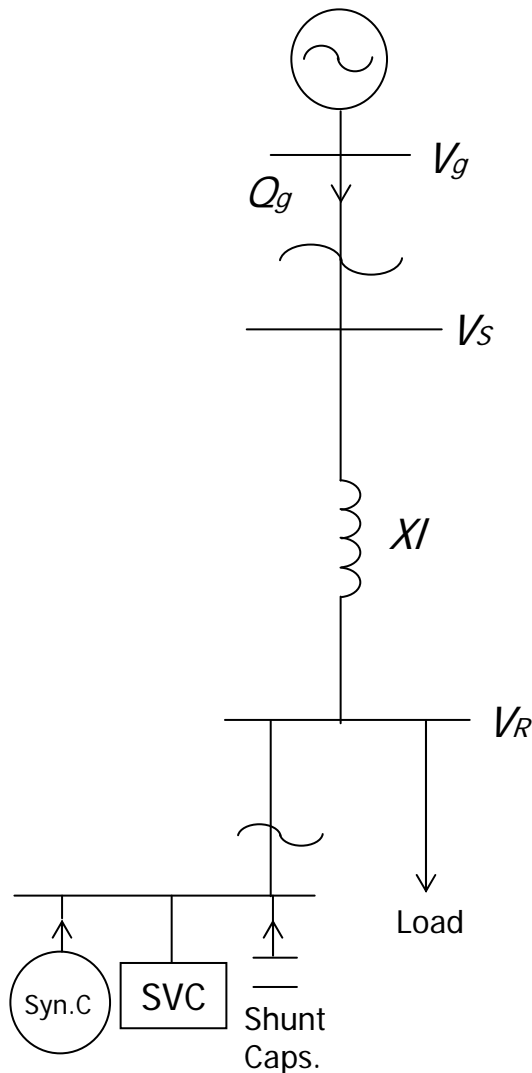

- Shunt capacitors
- SVC (Static Var Compensator)
- Synchronous Capacitor
- Automatic Controllers
 - Intelligent Automatic Voltage-Var controller (VQC)
 - Power System Voltage Regulator (PSVR)
 - Determination of coordinated settings among VQC, PSVR, Synchronous capacitor and SVC based on extensive off-line simulations

Rapid and Accurate Switching of Shunt Capacitors

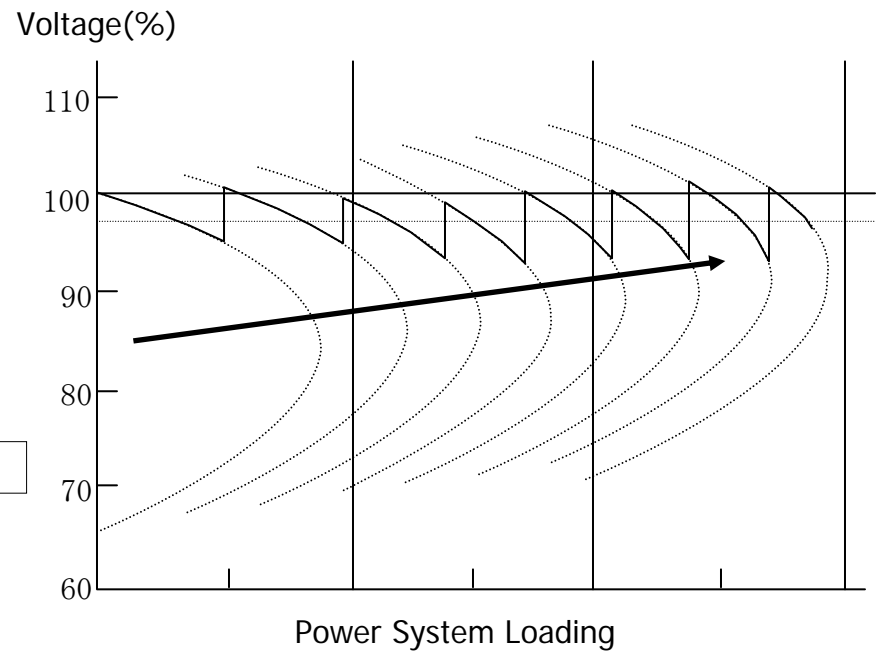
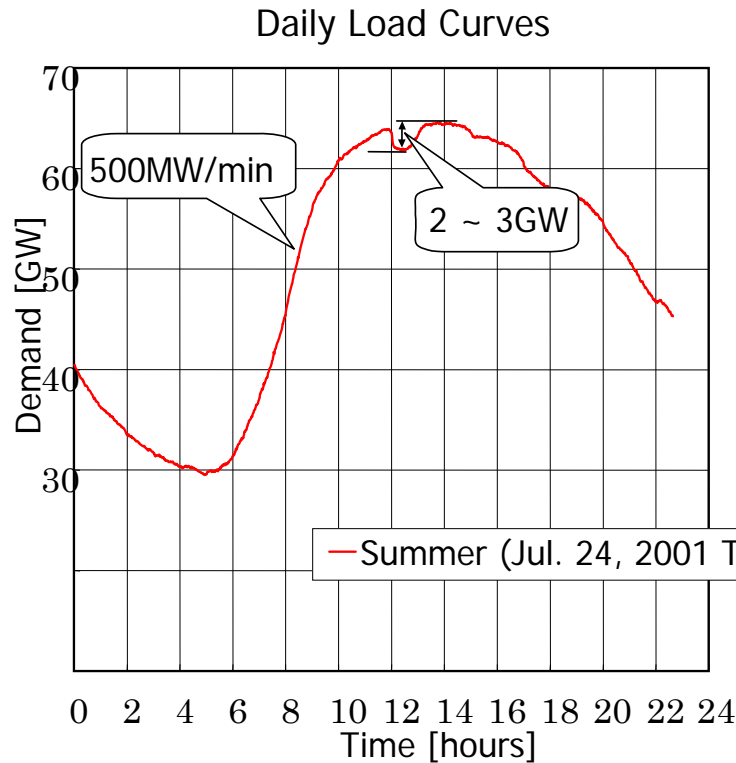

VQC

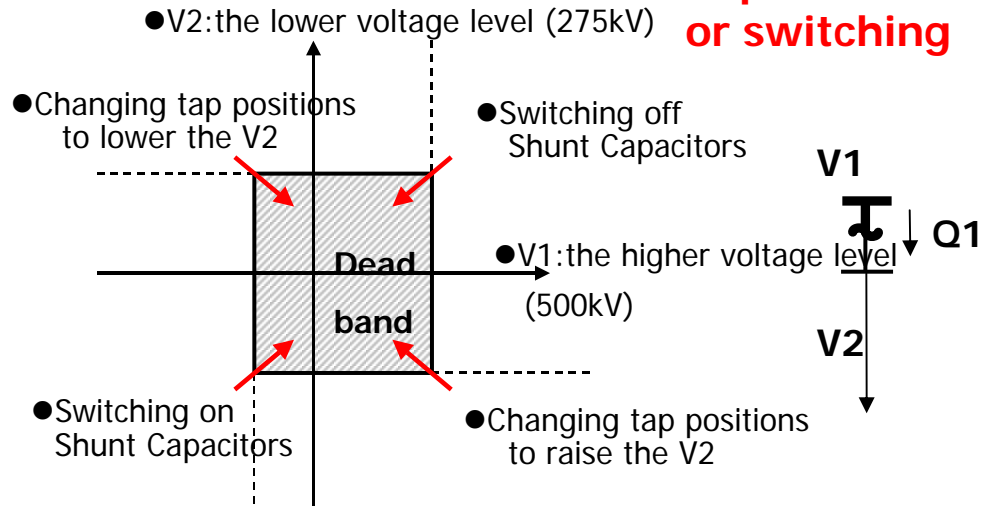
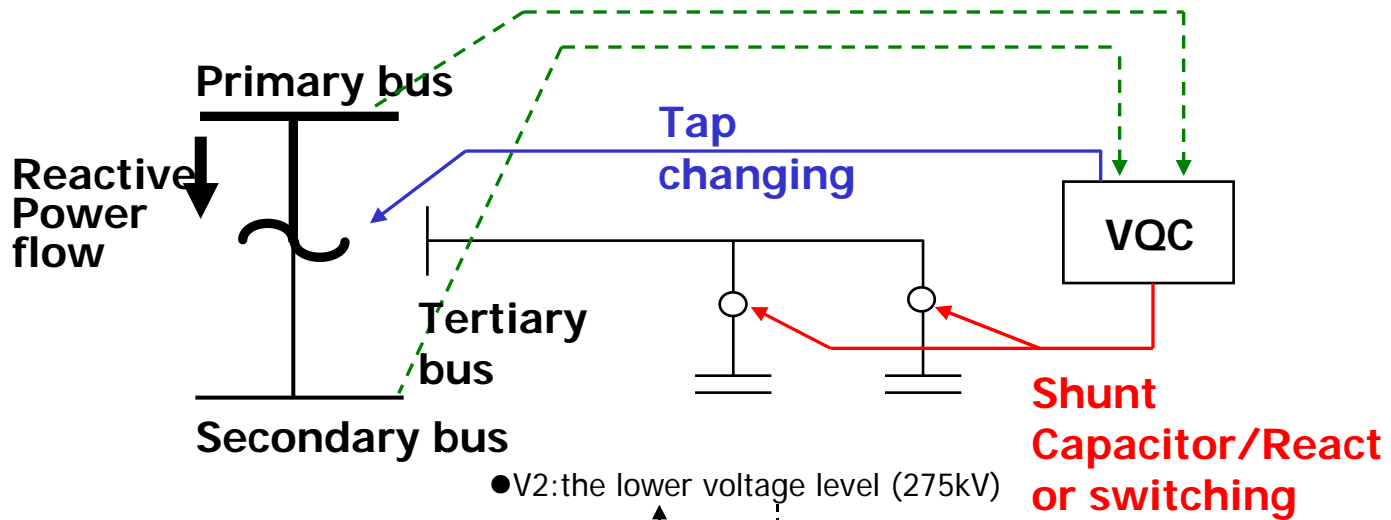

Power System Voltage Regulator

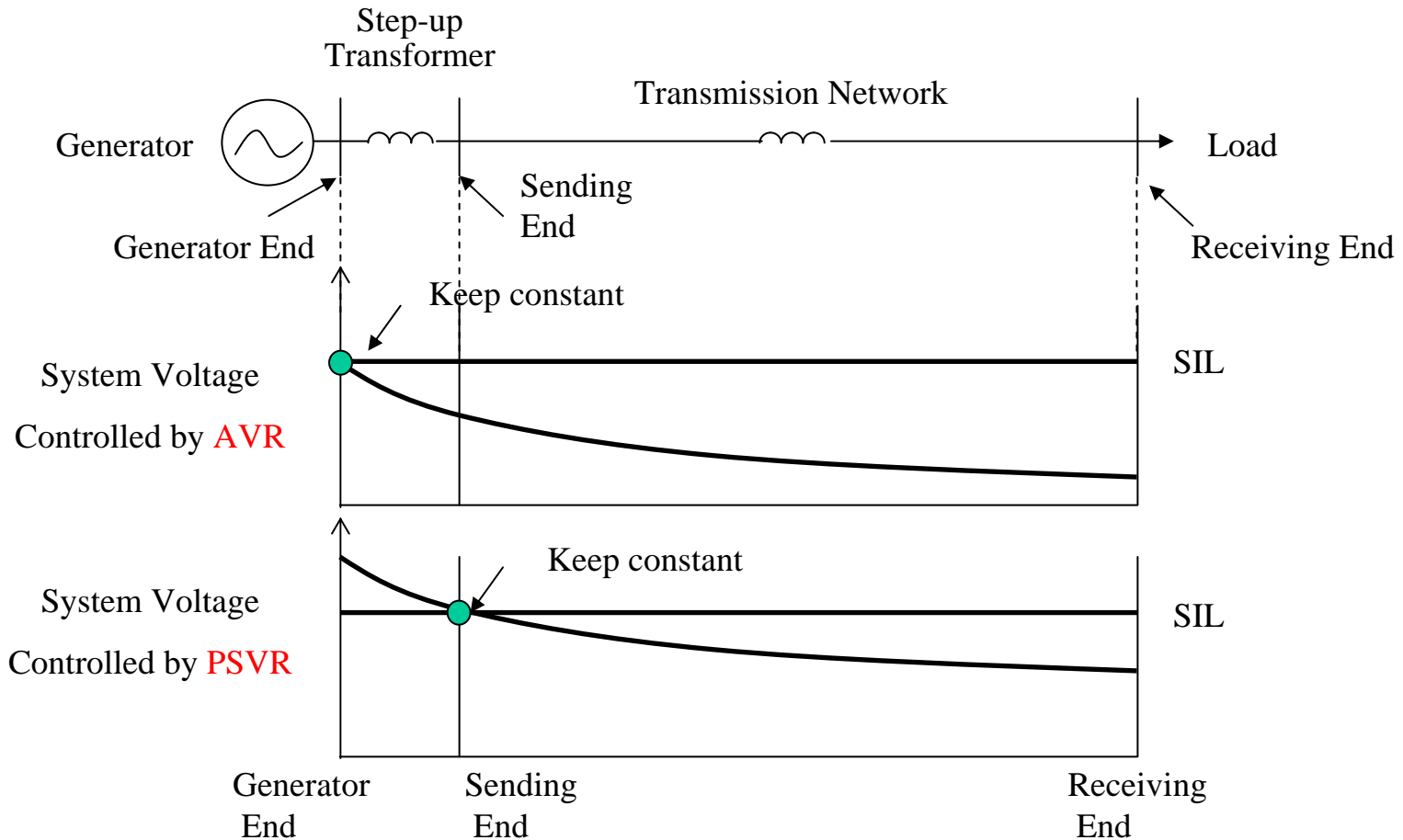

Phase Modifying Equipment

	Shunt Capacitor	Shunt Reactor	Sync C	SVC
Adjustment	Lead, Stepwise *1	Lag, Stepwise *1	Lead/Lag Continuously adjusted	
Power loss	Small	Relatively small	Large	Relatively Large
Regulating Voltage Ability	Small	Small	Large	Large
Maintenance	Easy	Easy	Cumbersome	Relatively Cumbersome
Cost	Inexpensive	Inexpensive	Expensive	Expensive

<http://www.jeea.or.jp/course/contents/03301/>

*1 Maximum capacity per unit can be limited by voltage change

Reactive Power Sources in Substation

	Voltage (kV)	Capacity (MVA/Unit)
Shunt Capacitors	154	-
	66	20, 30, 40, 60, 80, 120
	22	20, 30
	6.6	6, (4)
Shunt Reactors	500	-
	275	150, 200
	66	30, 40, 80
	22	20, 30

Standard Specifications for Transformers

	Voltage (kV)	Capacity of Transformers (MVA)	Capacity at Tertiary Side (%)	Number of Transformers
Underground System	500/275	1,500	30	3
	275/154	450, (300)	30	3
	275/66	300, (200)	30	3
		300	30	6
	(154/66)	(200)	30	3
	(154/22)	60, (45)	30	3
	66/22	60, (45)	30	3
Overhead System	500/275	1,500	30	4
		(1,000)	30	4
	500/154	750	50	4
	275/154	450, (300)	30	4
	275/66	300, (200)	50	4
	154/66	200, (100)	50	4

Reactive Power Compensation for Cable System: Installed Location of Shunt Reactors

	Advantage	Disadvantage
Directly connected to the cable	<ul style="list-style-type: none">- Can limit the overvoltage when one side of the cable is opened	<ul style="list-style-type: none">- Cannot be used for voltage control when the cable is not-in-service (Some exceptions exist.)- May cause DC offset current when the cable is energized
Connected to substation buses	<ul style="list-style-type: none">- Can be shared by multiple cable routes- Cheaper (tertiary side)	<ul style="list-style-type: none">- May cause reactive power imbalance during switching operations

For long cables, shunt reactors are often directly connected to the cables due to the concern for the overvoltage and voltage variation.

275kV Underground Cable System of TEPCO

System configuration in the metropolitan area

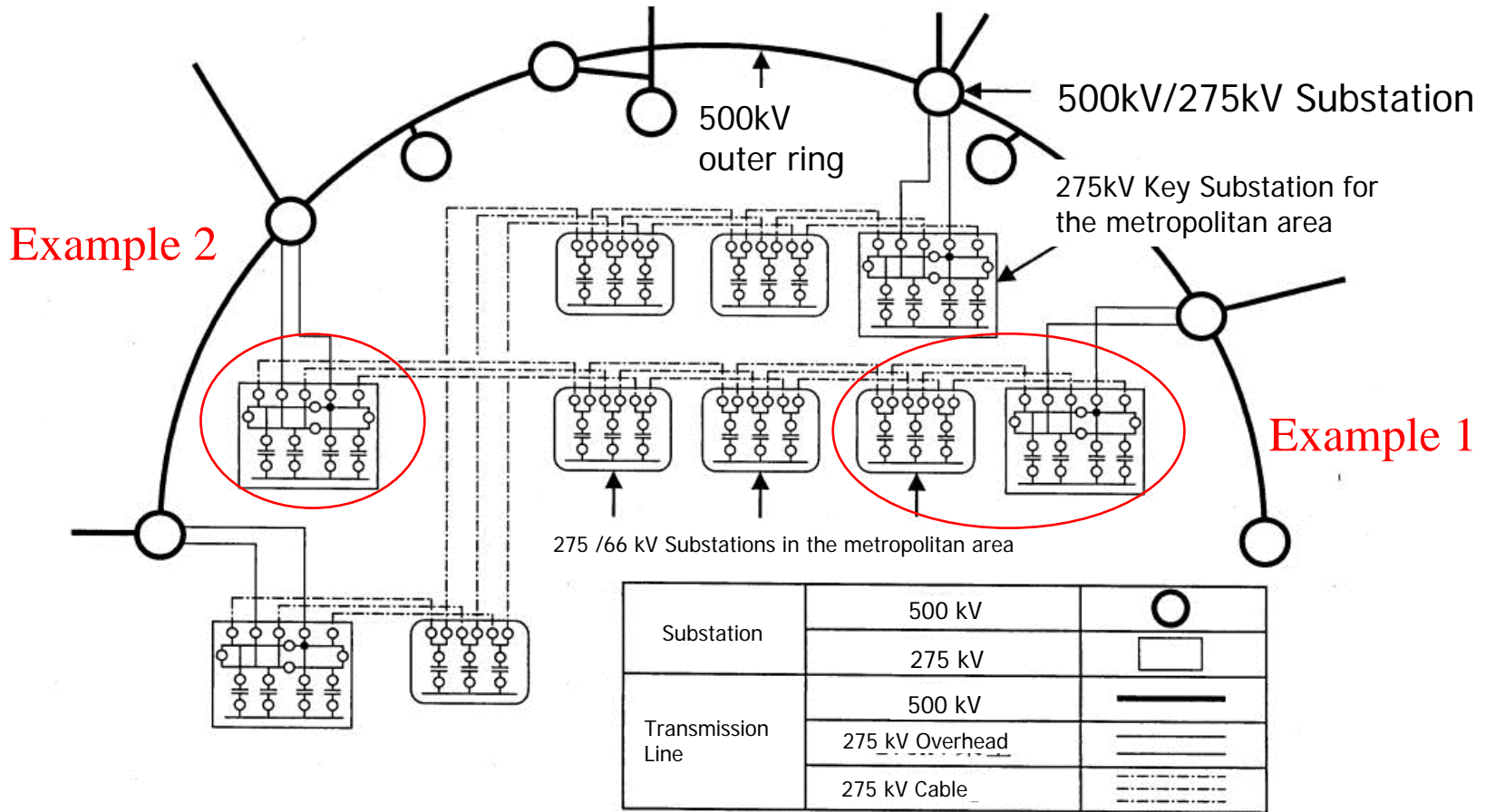

Reactive Power Compensation for HV Long cable

- Appropriate amount of shunt reactors will be found from the voltage profile in off-peak demand
- If the length of the cable is very long, necessity of shunt reactor stations (or switching stations) along the length of the cables will be found from the following aspects:
 - a. Voltage around the center of the cable
 - b. Impact on the transmission capacity
 - c. Active power loss in the cables

Reactive Power Compensation for HV Long cable:

a. Voltage around the center of the cable

- ✓ Example of voltage profile with shunt reactor stations

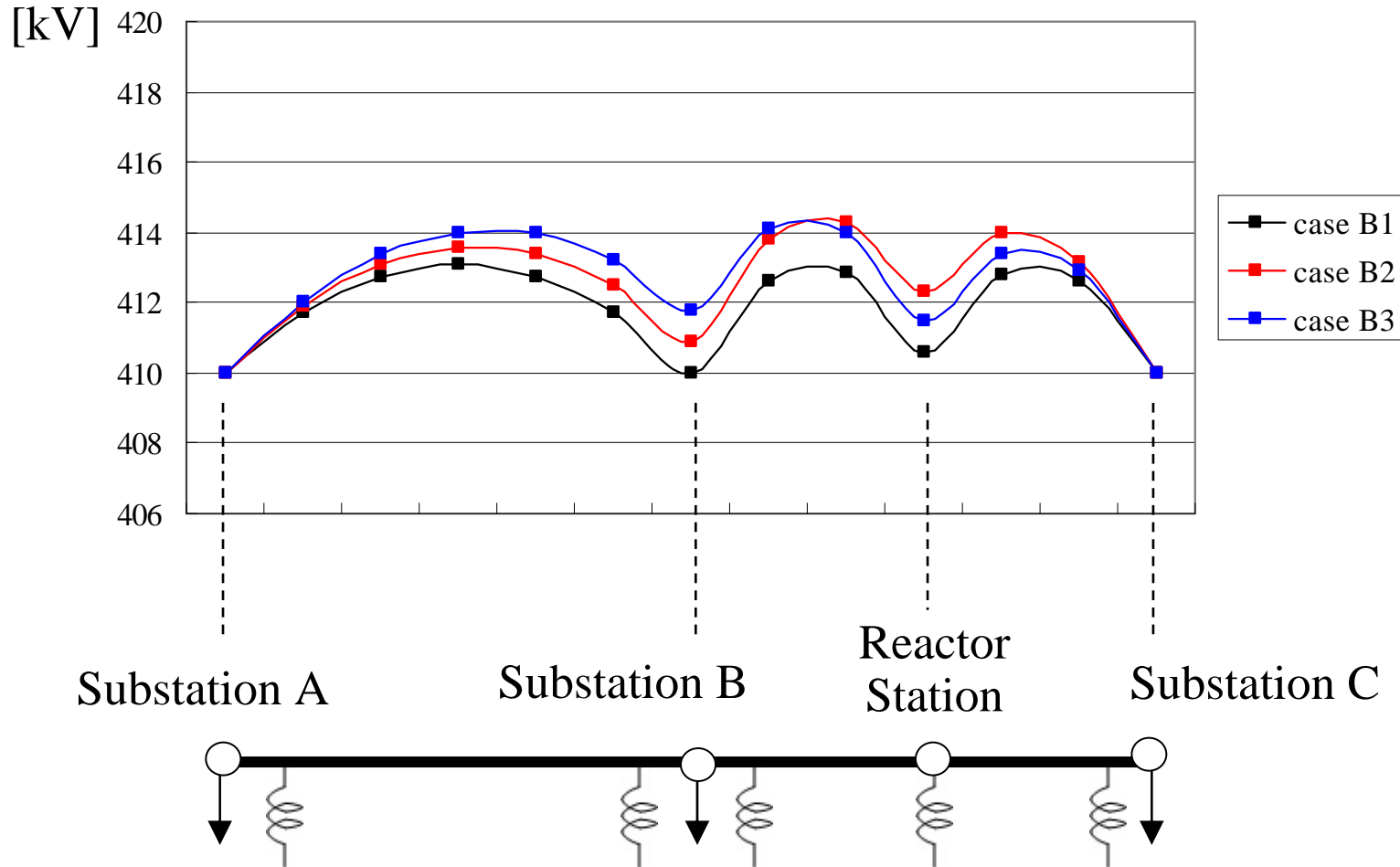

Reactive Power Compensation for HV Long cable:

b. Impact on the transmission capacity

✓ Difference between with shunt reactor station and without it

- Condition: 100% Compensation by shunt reactors directly connected to a cable
Reactive power loss in the cable is omitted.
PF = 100% at the center of the cable
- Flow of reactive power (Q: Charging capacity of the cable)

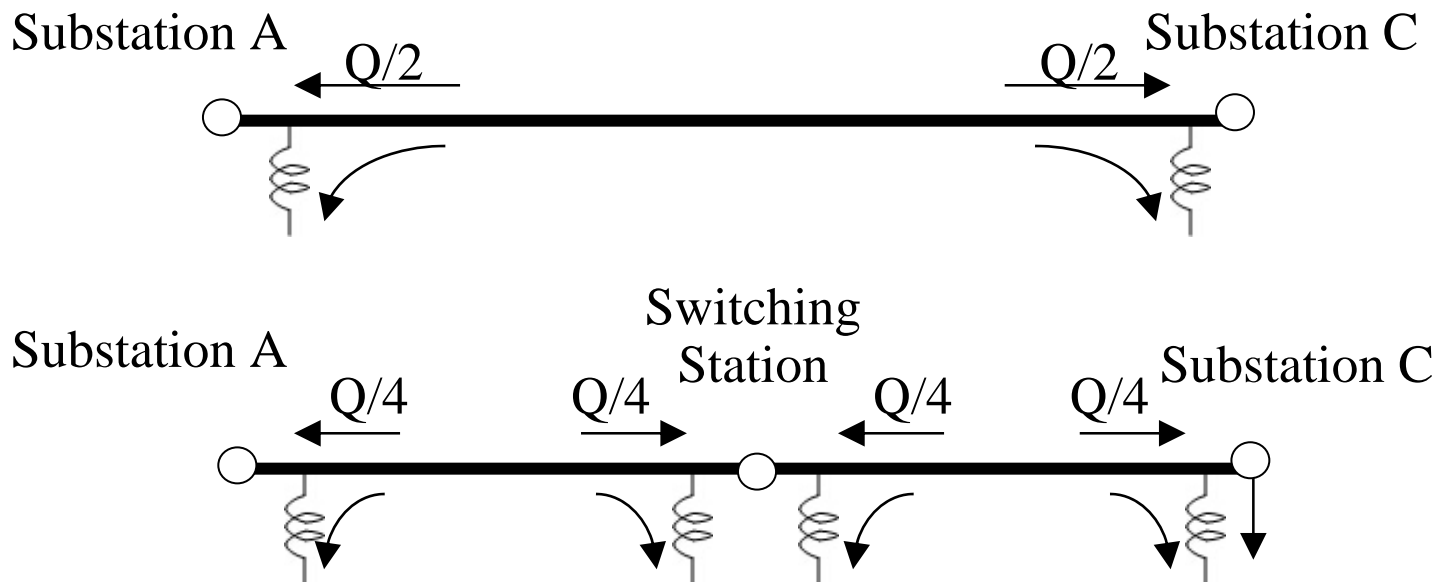

Reactive Power Compensation for HV Long cable:

b. Impact on the transmission capacity

✓ Impact on the transmission capacity

➤ Condition:

Pf= 100% at center or at the sending end of the cable

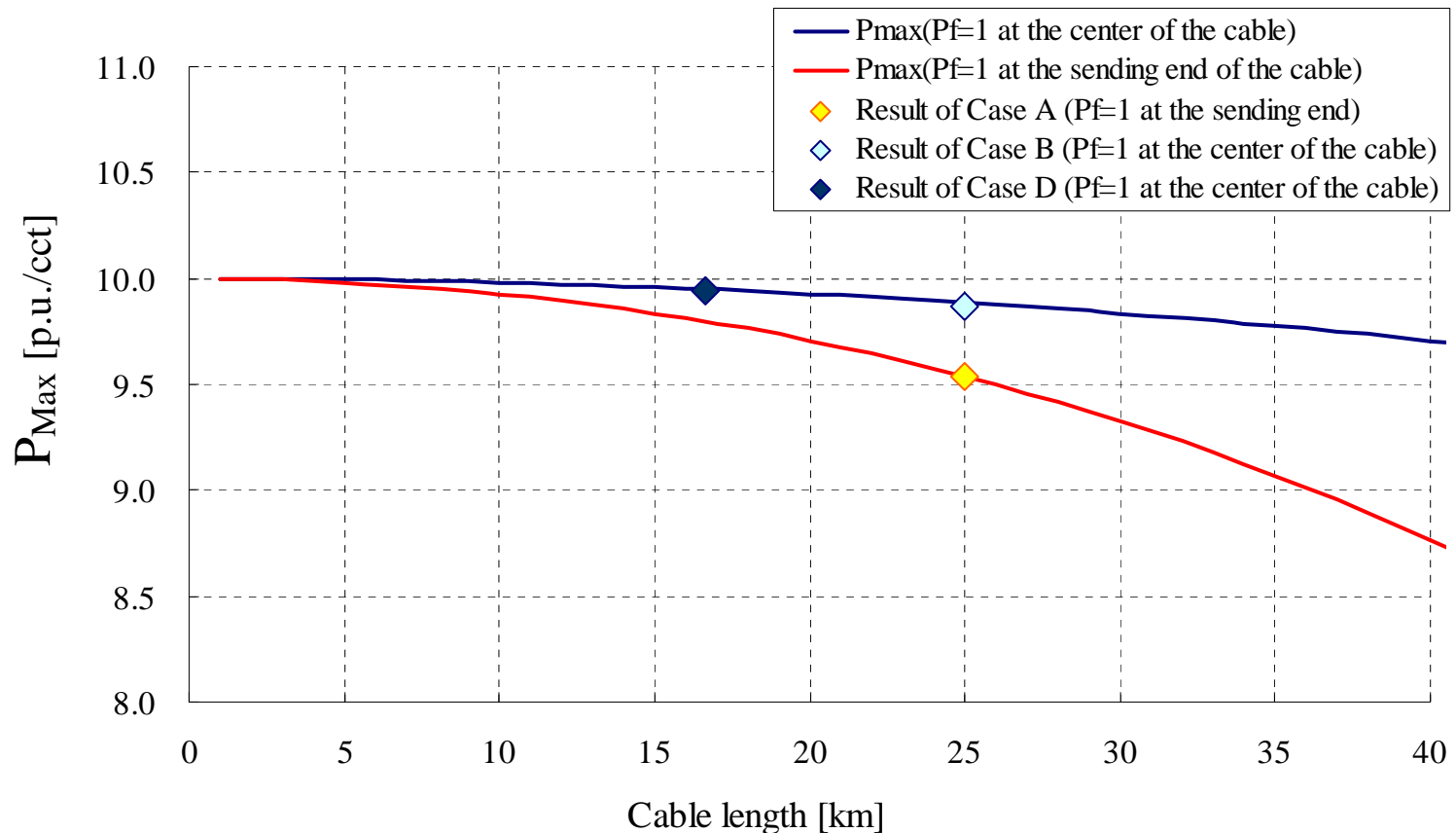

Thank you for your attention.

Appendix 1.E

Stakeholders Meeting Materials (The TA Team)

Technical Assistance for Power Development Plan 7 in Vietnam

Stakeholders Meeting

August 3, 2010 in Hanoi, Vietnam

Technical Assistance of Power Network System Analysis and Planning for PDP7

JICA TA Team/TEPCO

TA Team Member / Schedule

Position/ Area of expertise	Name
1. Team Leader/ System Planning	Masaharu YOGO
2. Demand Forecast A	Tomoyuki INOUE
3. Demand Forecast B	Tateyuki ASAKURA
4. Power System Analysis A	Makoto KAMIBAYASHI
5. Power System Analysis B	Yasuharu SATO
6. Economic & Financial Analysis	Keiichi FUJITANI
7. Environmental and Social Considerations	Hidehiro FUKUI

- 1st Mission (27th of January 2010 - 6th of February 2010)
- 4th Mission (16 th of May 2010 - 19 th of June 2010)
- 3rd Mission (11 th of April 2010 - 28 th of April 2010)
- 4th Mission (16 th of May 2010 - 19 th of June 2010)
- 5th Mission (18 th of July 2010 - 7 th of August 2010)

Requirements for Power Transmission from Nuclear Power Stations to Ho Chi Min City

- Power Transmission with 250 to 300km
- Efficiently, Stably and Environmental friendly

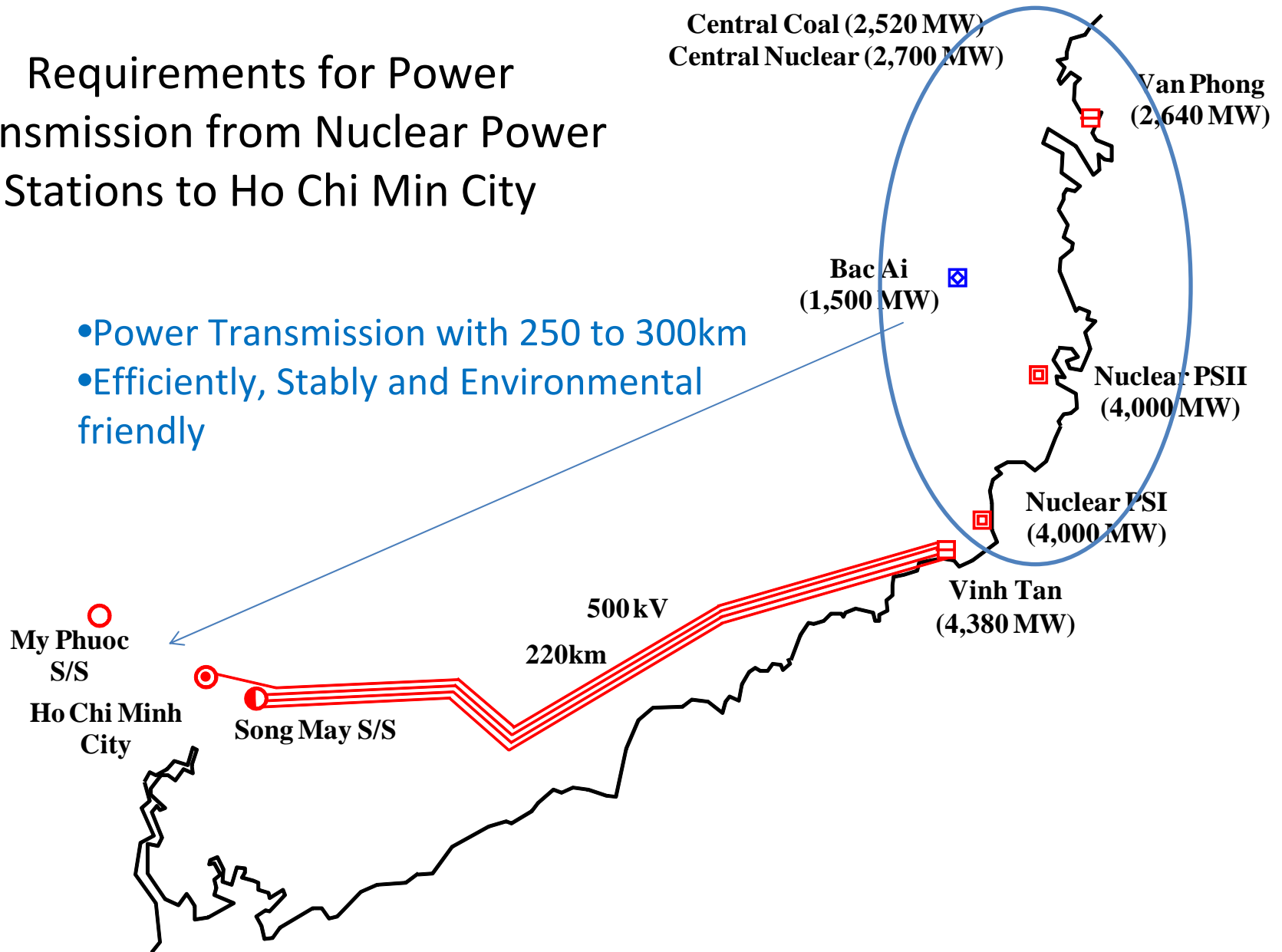

* This presentation reflects the latest power development plan in July. Draft Final Report that was based on the power generation plan as of June 2010 should be revised.

Option UHV(1,100 kV) Designed Tower

Interval around 500 m

Height: around 120 m



Assumptions for Comparison between 500 kV and UHV

	500 kV	1,100 kV
Conductor	ACSR 410 mm ² x 4	ACSR 810 mm ² x 8
Stable Capacity for around 300 km	1,200 MW for remaining circuits when N-1 faults (Surge Impedance Load=1.1 GW)	5,000 MW for remaining circuits when N-1 faults Surge Impedance Load=5.1 GW)
Unit Capacity of a 1,100/500 kV Transformer	-	2,000 MVA
Cost of T/L (Approximate value in Vietnam to be precisely determined)	0.5 million USD/km/cct	1.25 million USD/km/cct
Cost of UHV substation (Approximate value in Vietnam to be precisely determined)	-	0.0406 million USD/MVA

500 kV System Configuration

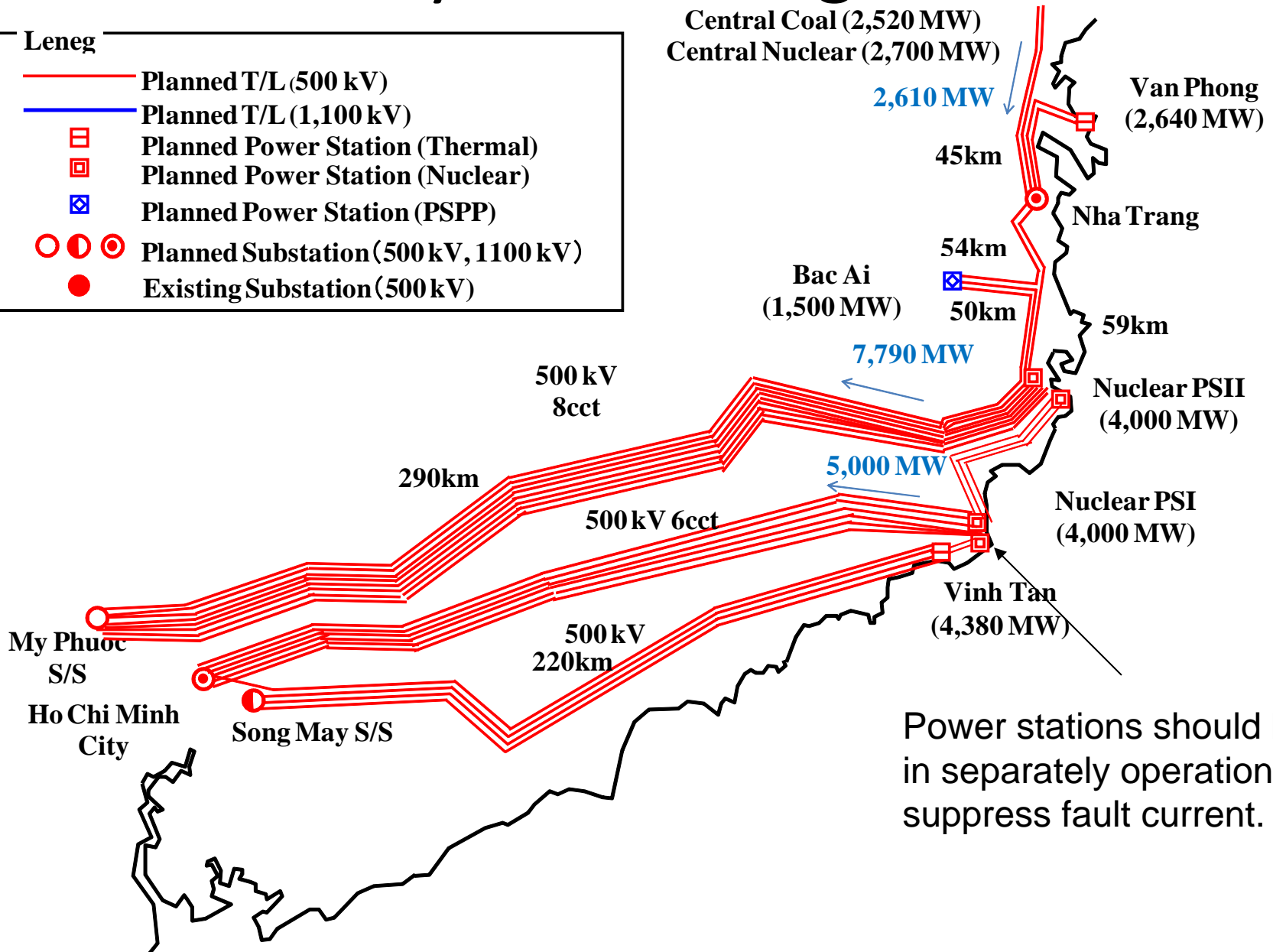
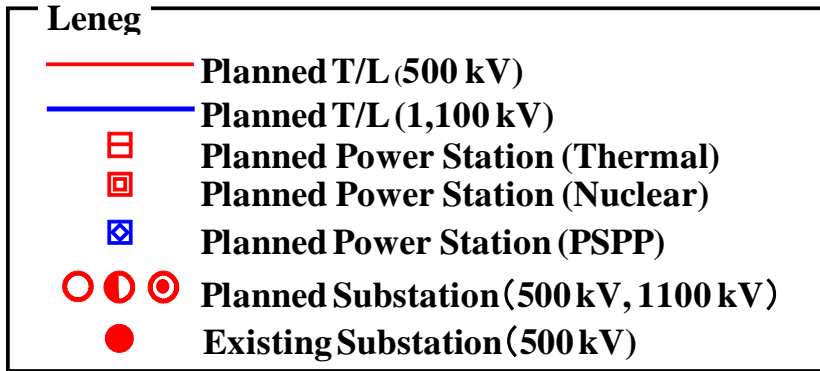

Power stations should be in separately operation to suppress fault current.

1,100 kV System Configuration

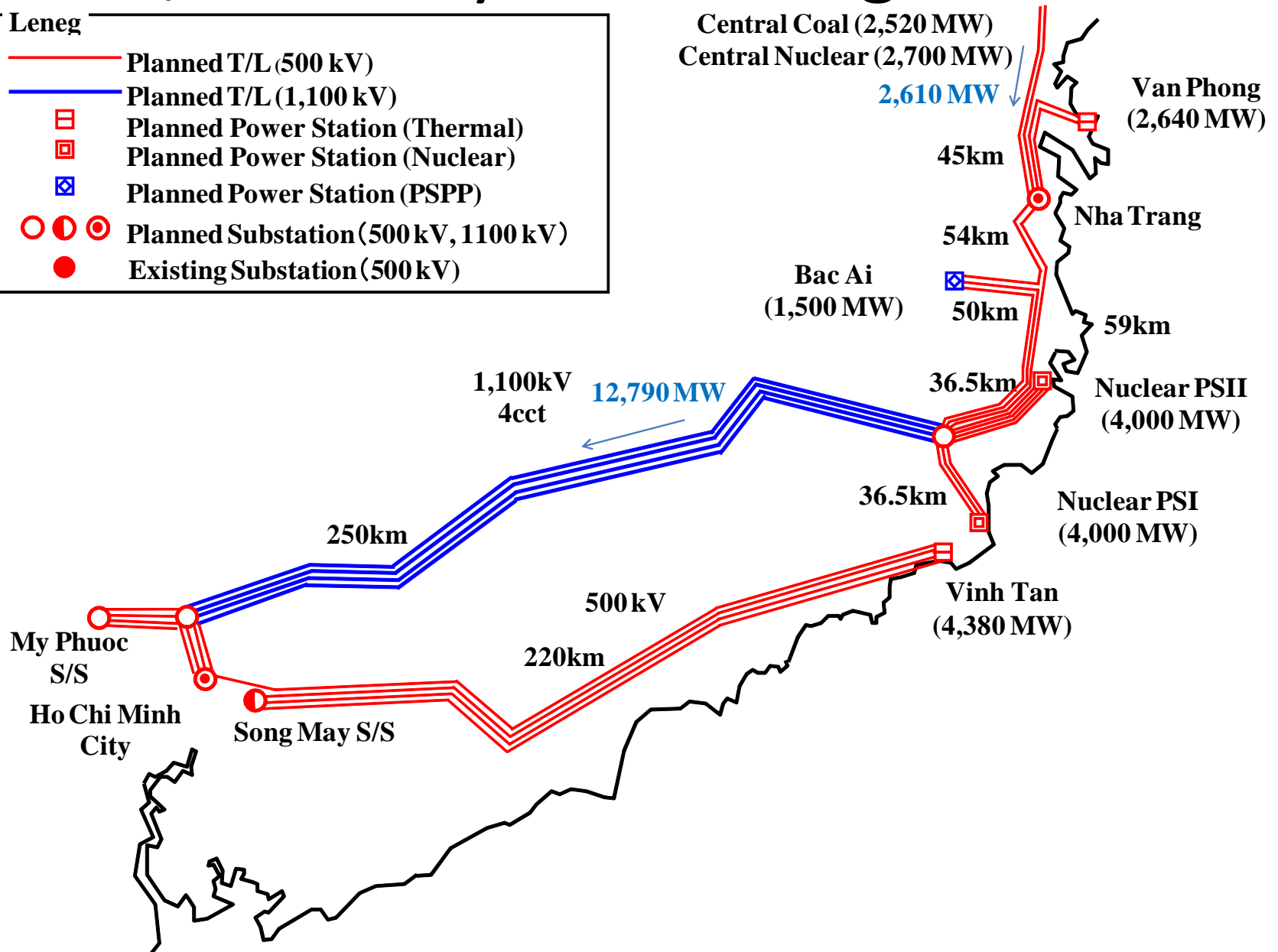
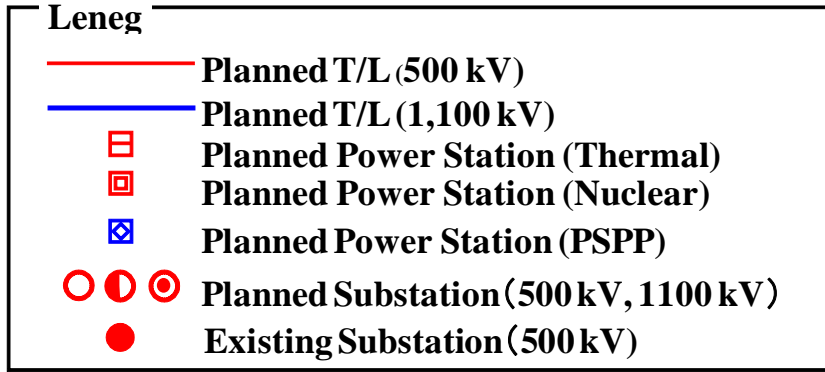

Summary of Comparison between 500 kV and UHV

	500 kV	UHV
Number of Circuits (Number of Circuits in 2030)	Large (14)	Small (4)
Total Cost	Almost same as UHV	Almost same as 500 kV
Investment, O&M and Right of Way (Initial 5 years)	Small 1,642 million USD (1,121 million USD)	Large 2,457 million USD (1,785 million USD)
Power Transmission Loss	Large 1,151 million USD	Small 358 million USD

- The total cost of the case with the UHV was not so much different than the case with 500 kV.
- However, the case with the UHV would have the advantage of possessing minimal influence on the environment by reducing the required number of transmission line circuits and losses.
- **It will be required to carry out a detailed continual study on the UHV design, its construction costs, the methodology of its implementation and fund raising.**

Low CO₂
emission



Power Supply System Planning of Ho Chi Minh City

- 500 kV system surrounding Ho Chi Minh City constructed into a ring-shaped configuration.
- Operation as a loop configuration makes the fault currents of the 500 kV and the 220 kV system in Ho Chi Minh in 2030 considerably increase

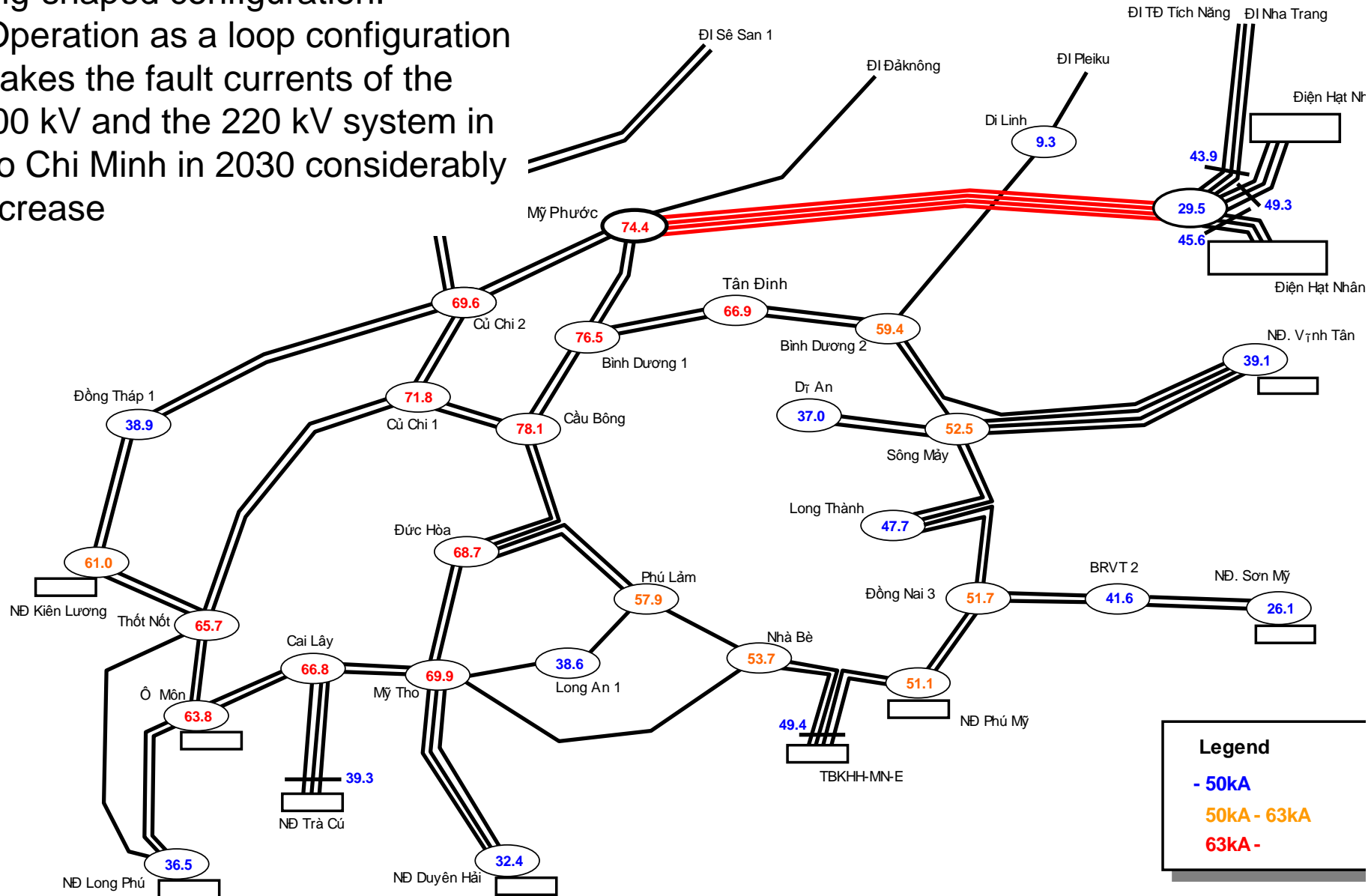

Ho Chi Minh City Supply System in 2030 without Countermeasures

Three Phase Short Circuit Fault Current in Ho Chi Minh Area in 2030

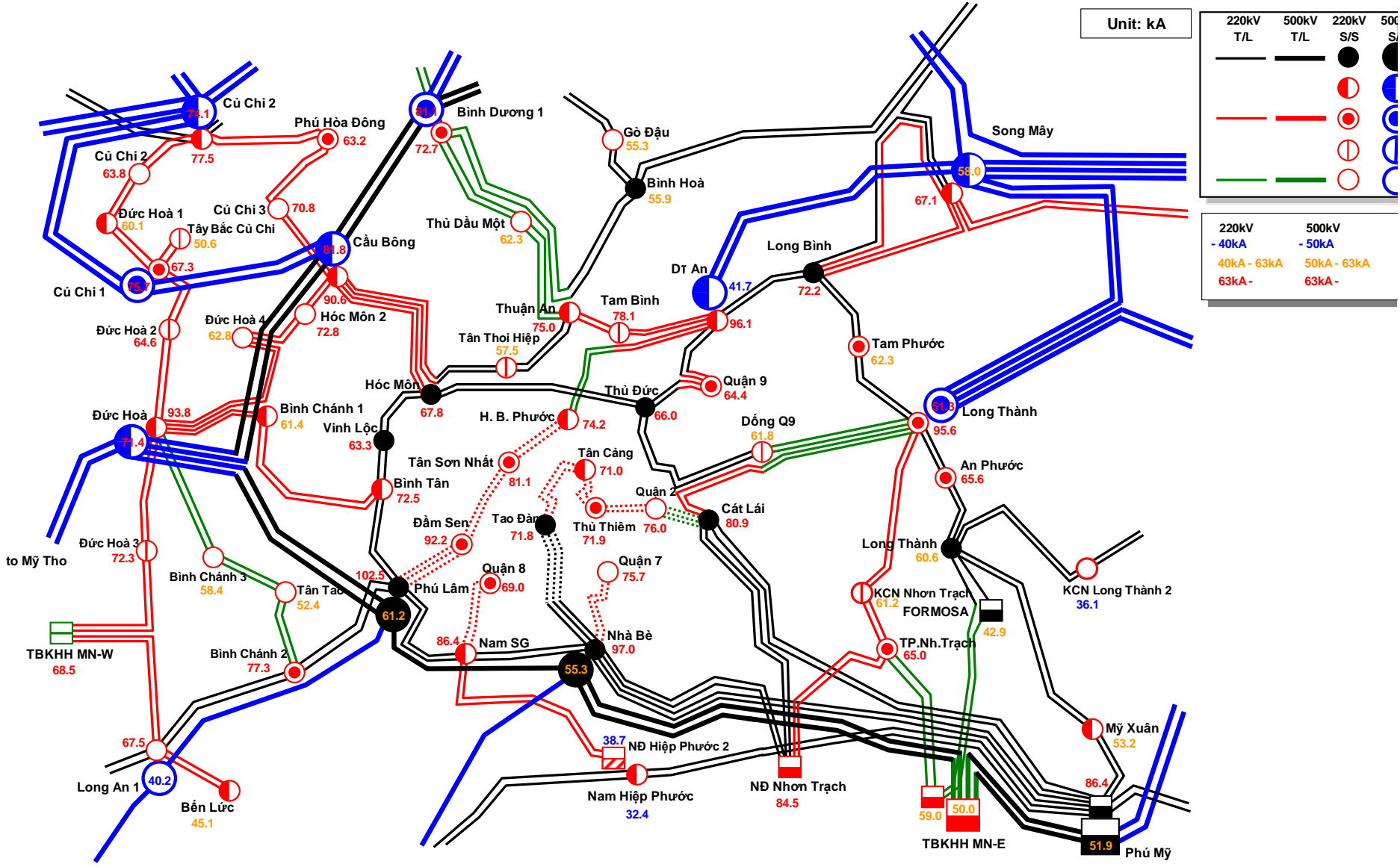

Parallel or Splitting System Operation

Parallel System Operation

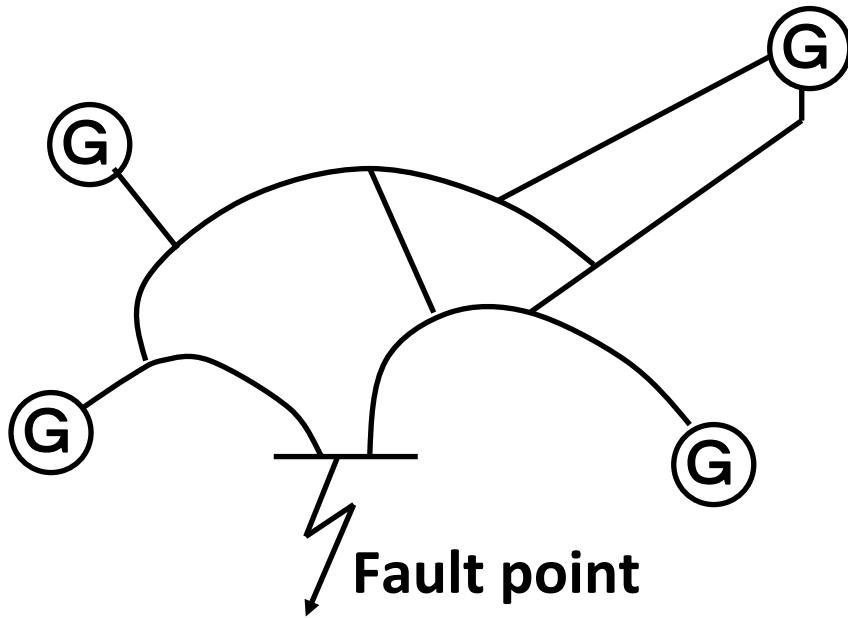

Fault current : large

Splitting System Operation

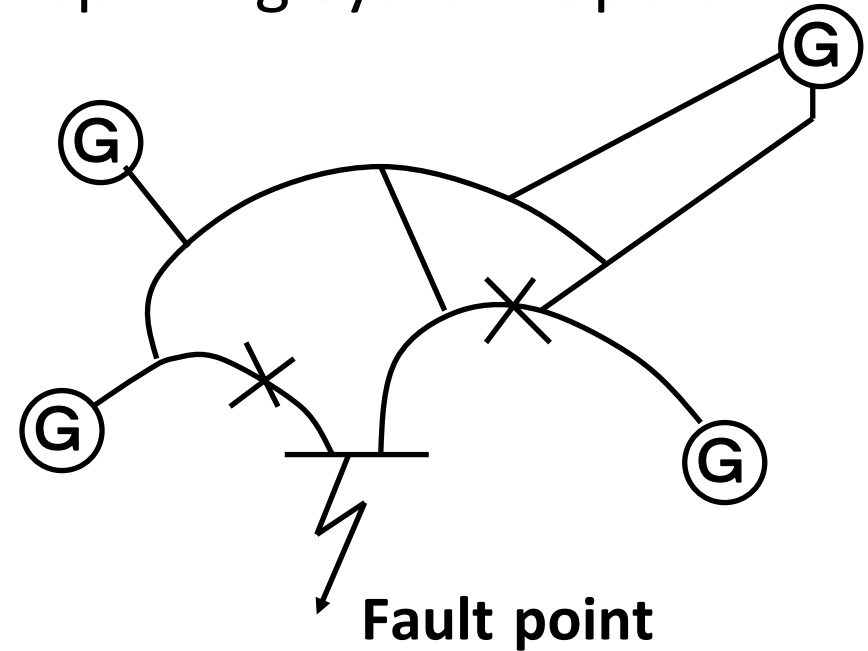

Fault current : small

- We recommend 220 kV transmission lines feeding power to the Ho Chi Minh City should be separately operated as the radial form to reduce fault currents. (like Tokyo, Shanghai, Beijing)

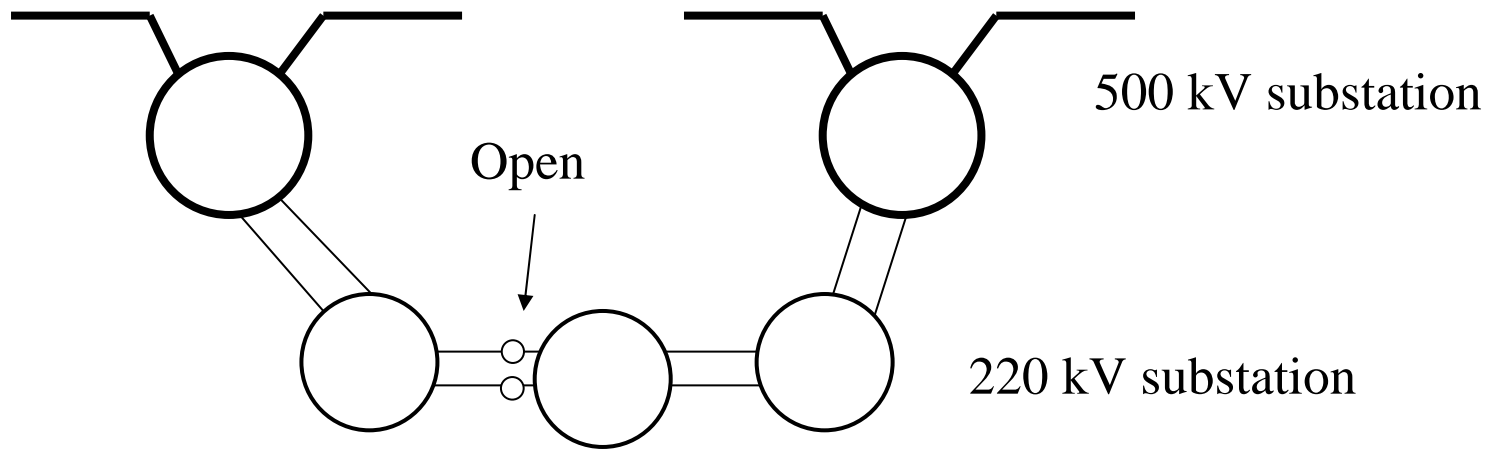

Three Phase Short Circuit Fault Current in Ho Chi Minh Area in 2030 (System separation for fault current reduction)

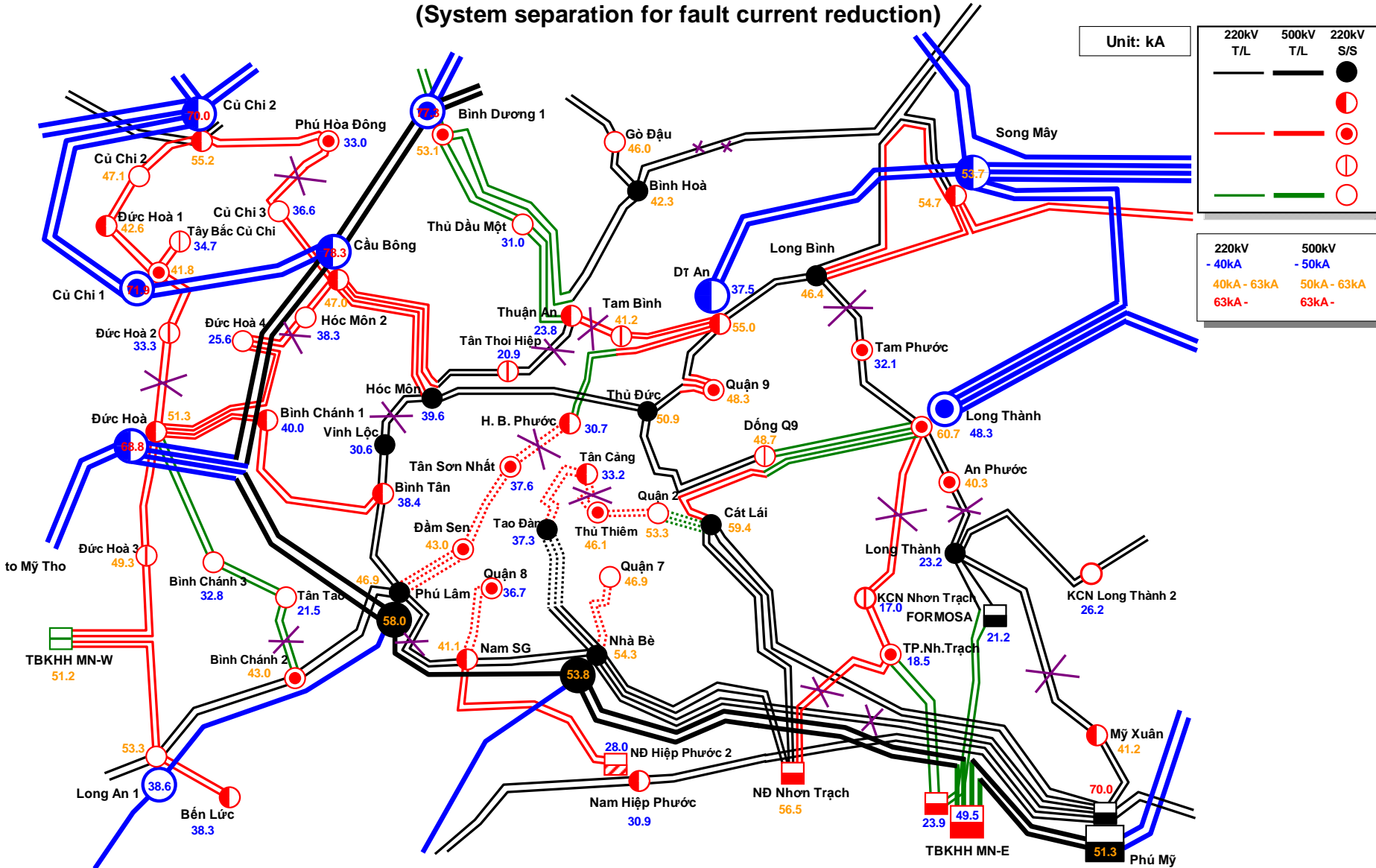

To determine the system configuration, it is considered necessary to conduct a detailed study taking into account the actual situation of facilities, power flow and voltage drops.

Policy on 500 kV Interconnections in Vietnam

- The power generation should be planned so as to maintain the regional power supply-demand balance.
- However, the 500 kV interconnection between the central to the south will need to be reinforced because the surplus power in those regions be supplied to the southern area.

Configuration of Power Generation

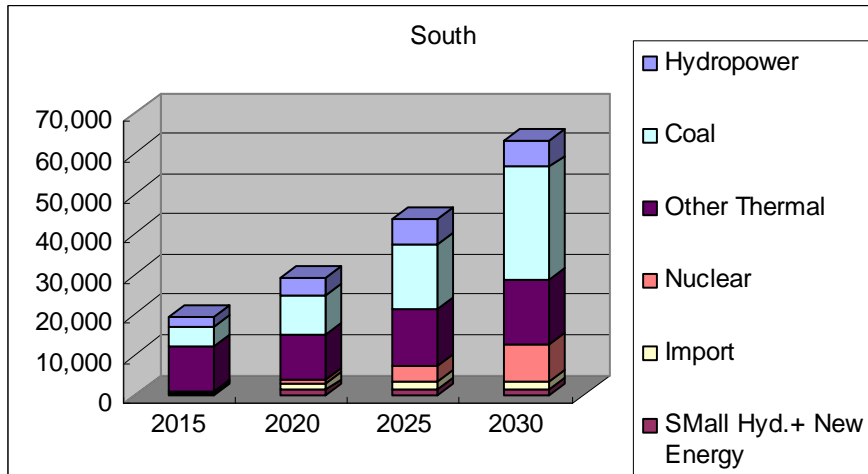
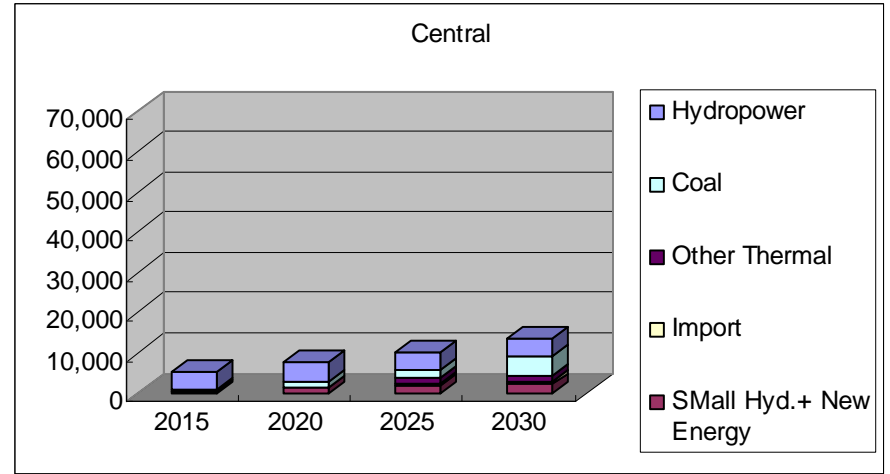
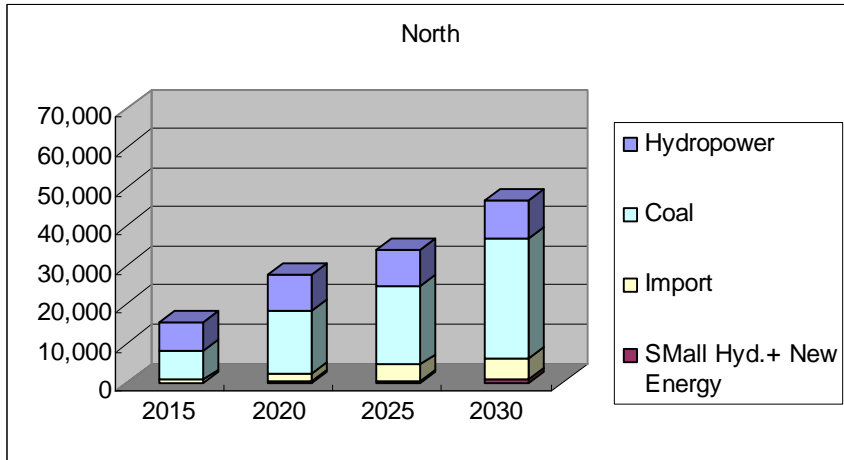

Investors

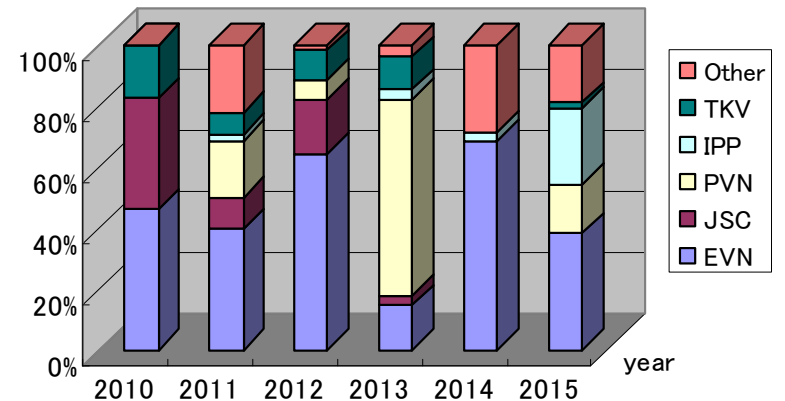

Reinforcement between Central and South

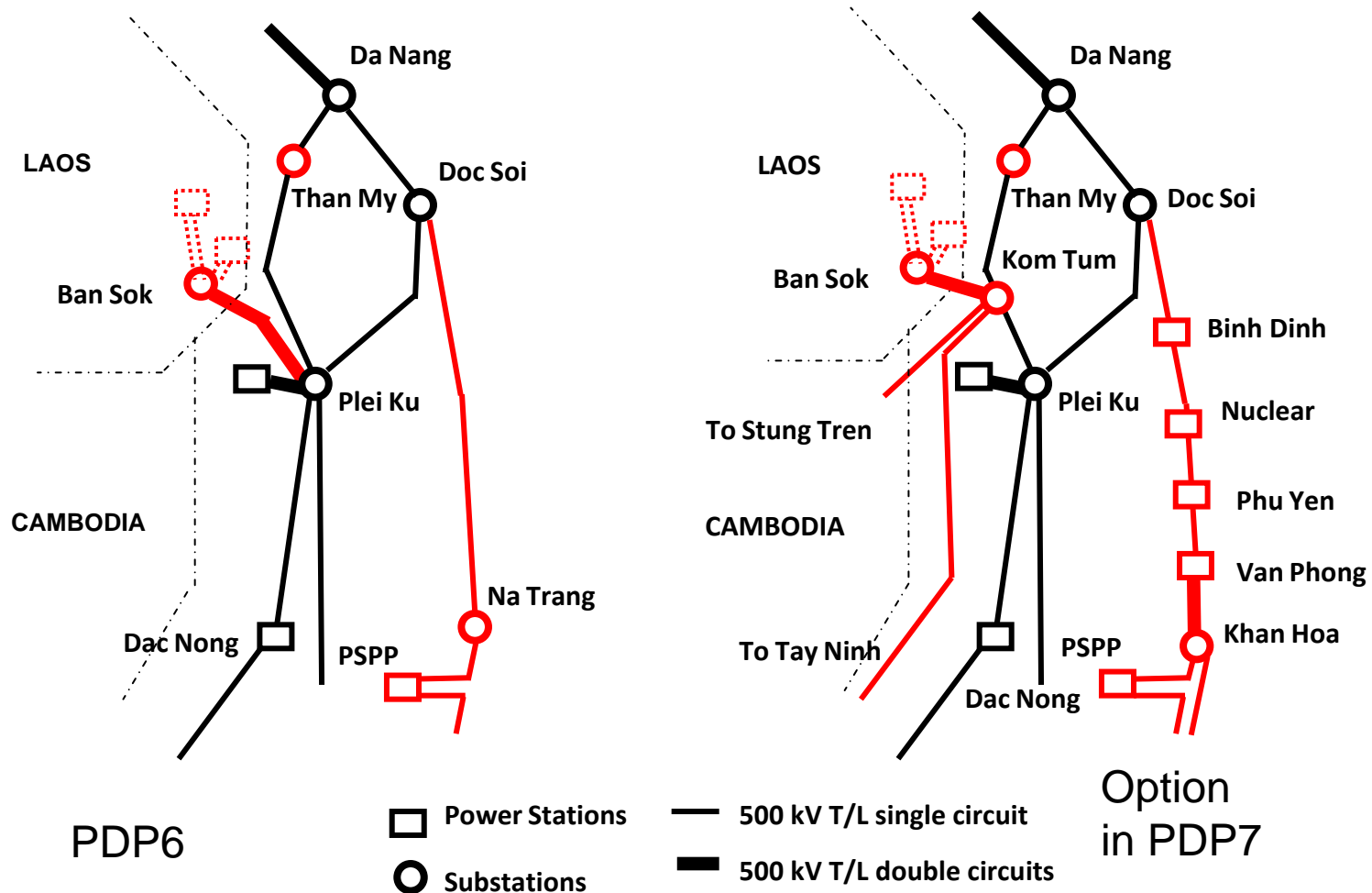

Risk Analysis Regarding Development of Power Network System

- Causes of delay of power network construction
 - Unexpected power demands.
 - Lack of investment and issues regarding its management
 - Land acquisition issues
- The power network system should be planned and constructed in consideration of N-1 criteria.
- The redundancy of the capacity of transmission lines can not only maintain the high power supply reliability level but also reduce the power loss and sometimes cost quite effectively.
- Land acquisition negotiations should be started earlier with a sure grasp of the points of the issues.

Way to Avoid the Power Shortage When Nuclear Power Plants Delayed

- Alternatives: Large Hydropower, Importing Power or Large Scaled Thermal
 - Reservoir type hydropower stations will reach a limit
 - Uncertainty regarding importing power energy from foreign countries
- A considerable amount of the **thermal power stations** as countermeasures



1. It would be desirable to study the adoption of not only the coal but also **other fuels** including LNG for the thermal power plants. (Otherwise, coal thermal power plants would share 60 -70 %)
2. The **parallel development of multiple sites** keeping a room for increasing the number of their power units would be also effective countermeasures.

Technical Study Items Introduced in This TA

- **Overvoltage study items for underground cable system**
- Cable systems will expand in the future.
- Overvoltage analyses and abnormal phenomena such as resonance overvoltage will be needed.

- **Introduction of efficient utilization of underground in Tokyo**
- Power system facilities equipped underground as examples of efficient utilization of underground space, and technologies, which reduced the total costs for the facilities while maintaining safety and reliability

- **Voltage stability**
- 1987 system collapse which occurred at TEPCO due to voltage instability

- **Conductors used for Bulk Power Transmission Lines**
- For the Ho Chi Minh City supply system application of larger size conductors

Other Issues to be Studied

- **Study of Power System Stability**
- Long term oscillation of power generator angles would occur with expansion of the international interconnections and the domestic bulk power system.
- Installation of the PSS (power system stabilizer) is an effective way to suppress this

- **Losses of Power Transmission Lines and Distribution Systems**
- Costs of transmission line losses in Vietnam were relatively high. (low cost of the power network system facilities)
- There is a high possibility of an effective power network loss reduction by revising the conductor specifications such as applying the large size conductors.
- It is recommended that the methodologies for loss reduction be studied.

Thank you.

Appendix 1.F

Stakeholders Meeting Materials (IE)

stakeholder meeting IN POWER DEVELOPMENT PLAN VII

BRIEF INTRODUCTION OF POWER DEVELOPMENT PLAN PERIOD 2011 – 2020 WITH OUTLOOK TO 2030 (PDP7)

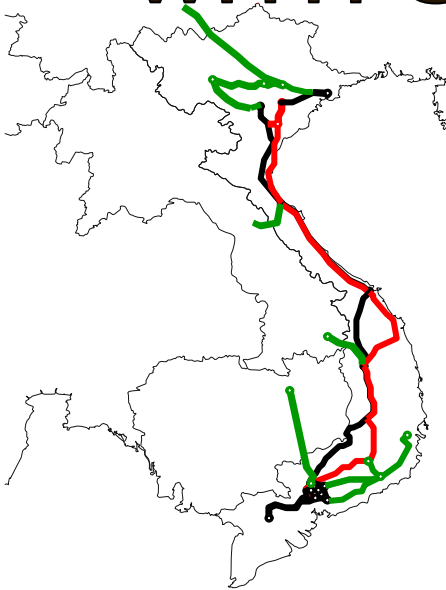

INSTITUTE OF ENERGY

Hanoi, August 2010

1. Current status of vietnam power system

Installed capacity - 2009

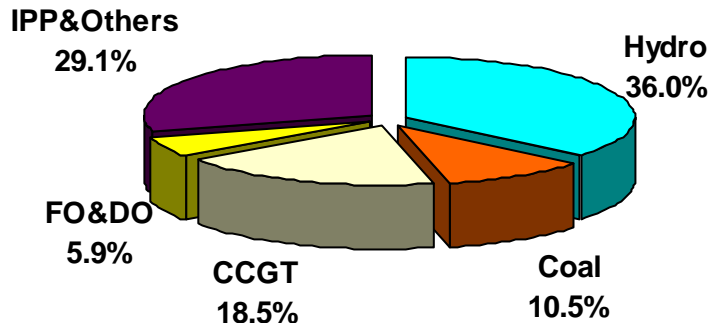

Installed capacity and electricity production in 2009

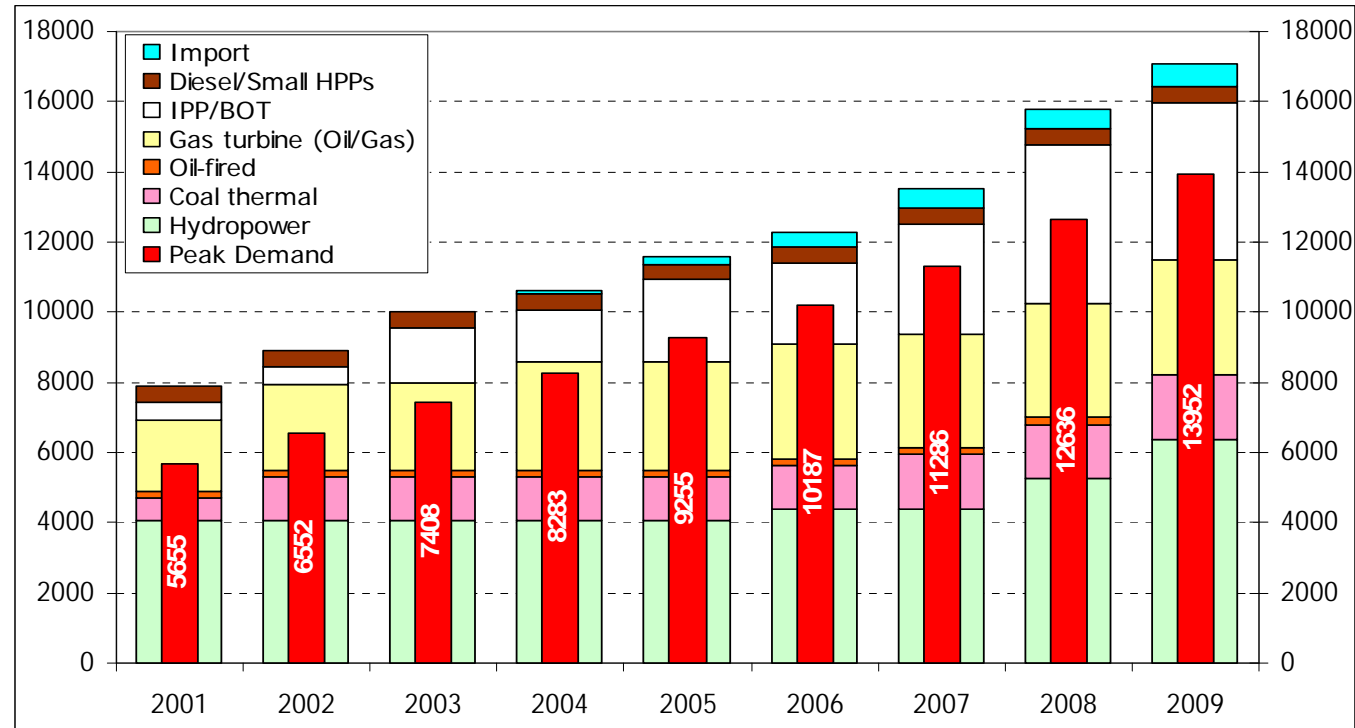

Average capacity growth rate is 11.1%/year in 2006-2009: (including power imported from China) 2

Volume of transmission network as of 2009

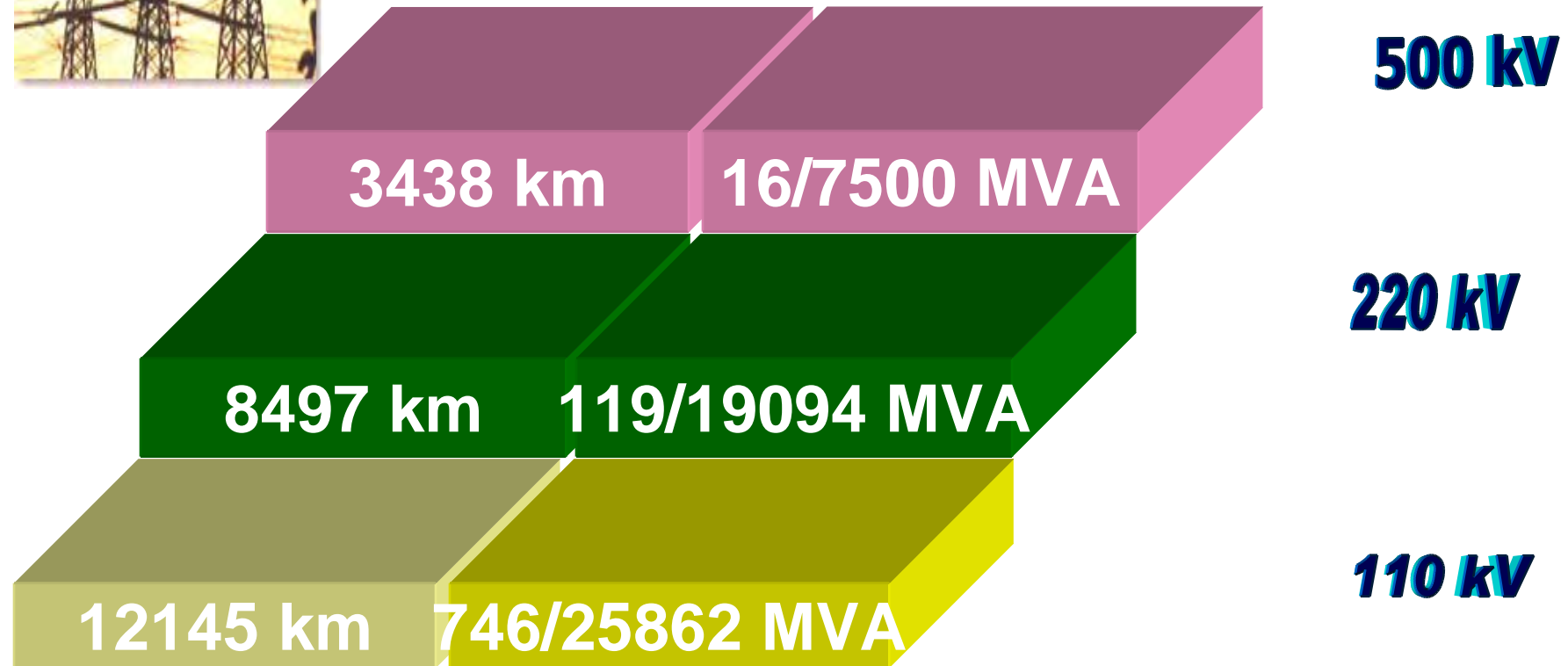

500 kV

220 kV

110 kV



Rate of rural electrification as of end of 2009

- 100% districts have electricity from national grid or local system
- 97.6% communes (8880/9101 communes); and
- 95,1% rural households have electricity from grid (13.95/14.67 mill. households)

Electricity production in 2001–2009

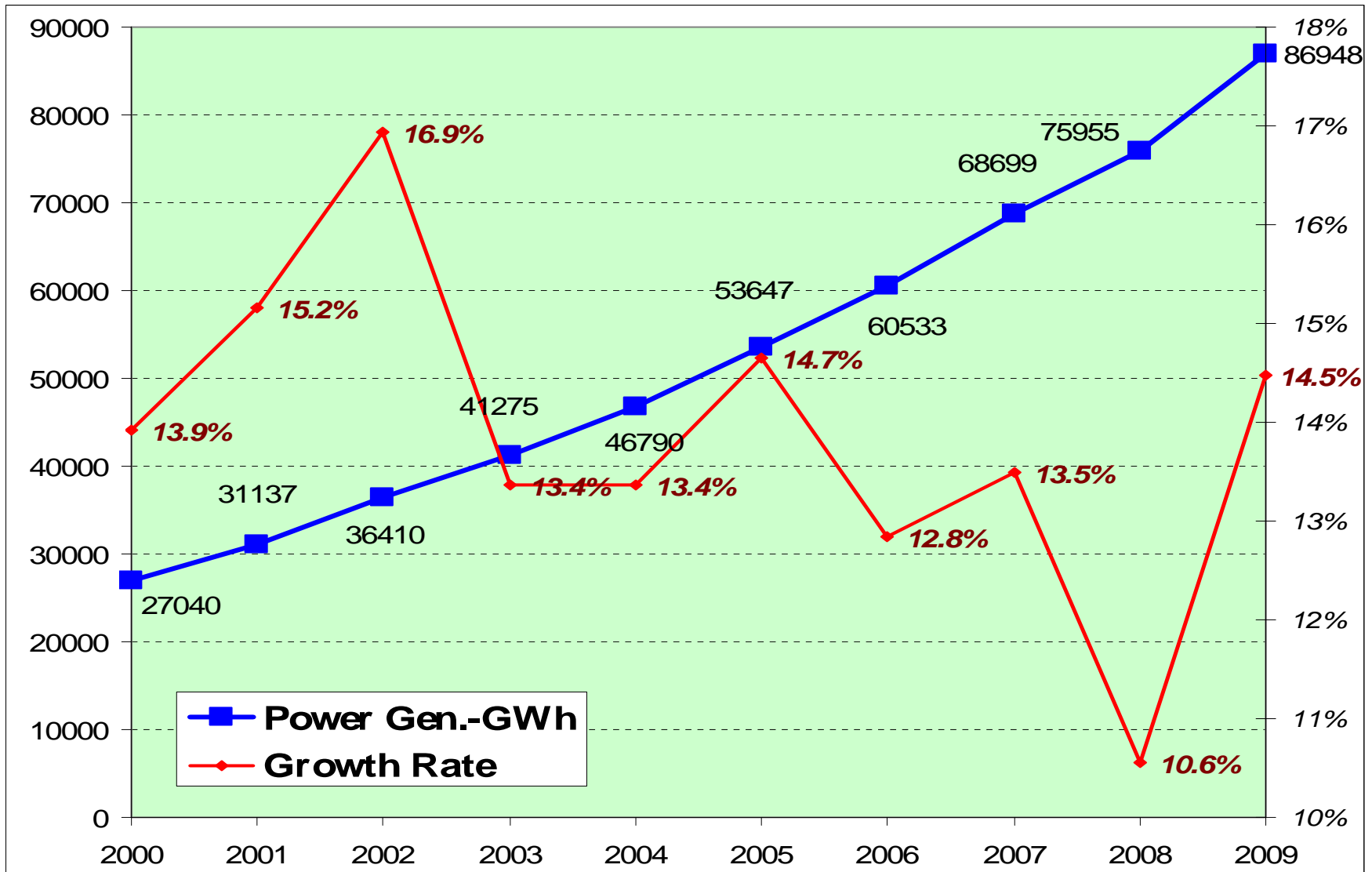

Average growth rate of electricity is 12.8%/year in 2006–2009 (including electricity from China).

Assessment of pdp vi implementation

Nhu cầu điện 2001-2009

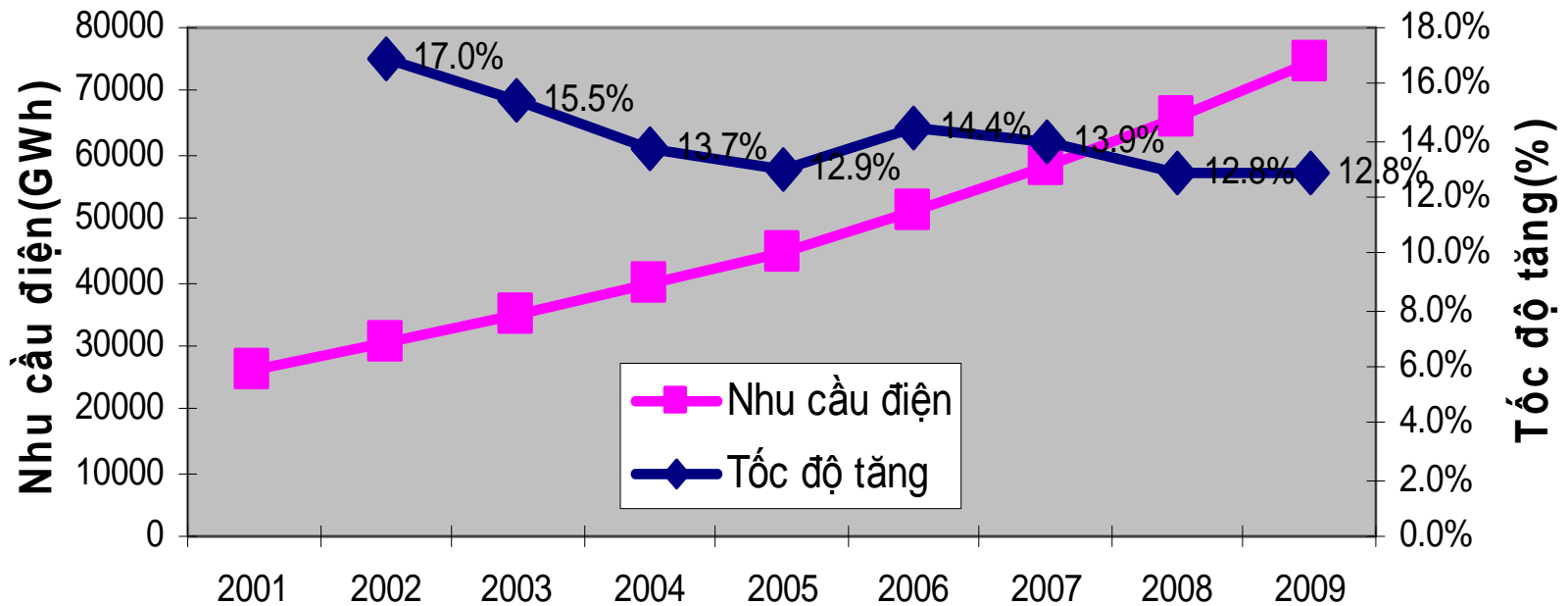

year 2009

Electricity sales (TWh): 76

Electricity production (TWh): 87

Pmax(MW): 13867

Growth rate in 2001-2009: 14.5%/year

2006-2009: 13.6%/year

Electricity consumption structure 2001 – 2009

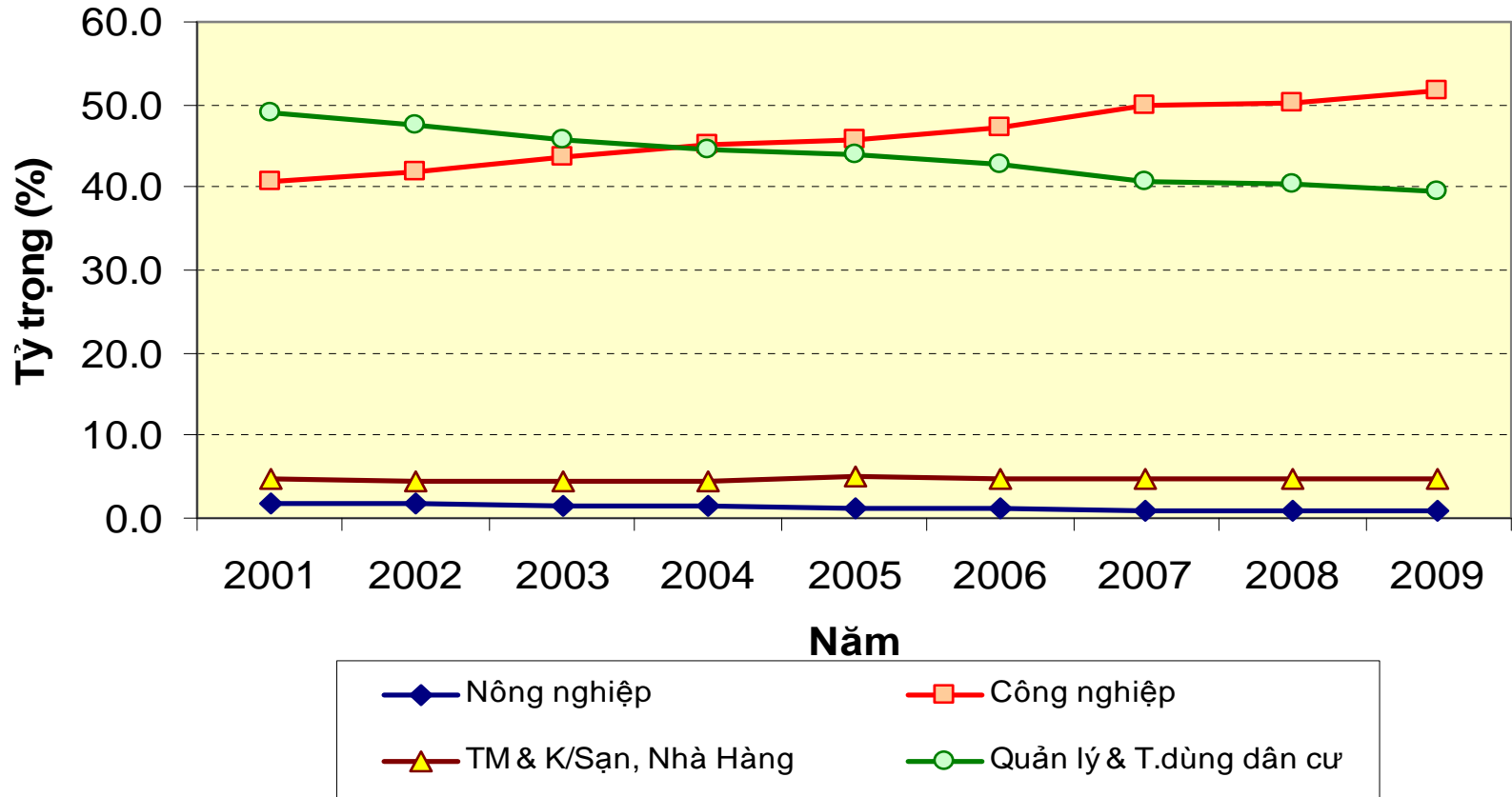

Electricity growth rate by sector in 2001-2009:

Total electricity sales: increase 14.5%
In which: -Industry- Construction: 17.6%
-Management & residential: 11.6%
-Commercial & hotel, restaurants: 13.9%

GDP growth rate & electricity demand in 2001-2009

GDP	electricity sales	elasticity
7.3%	14.5%	1,8

ASSESSMENT OF PDP VI IMPLEMENTATION

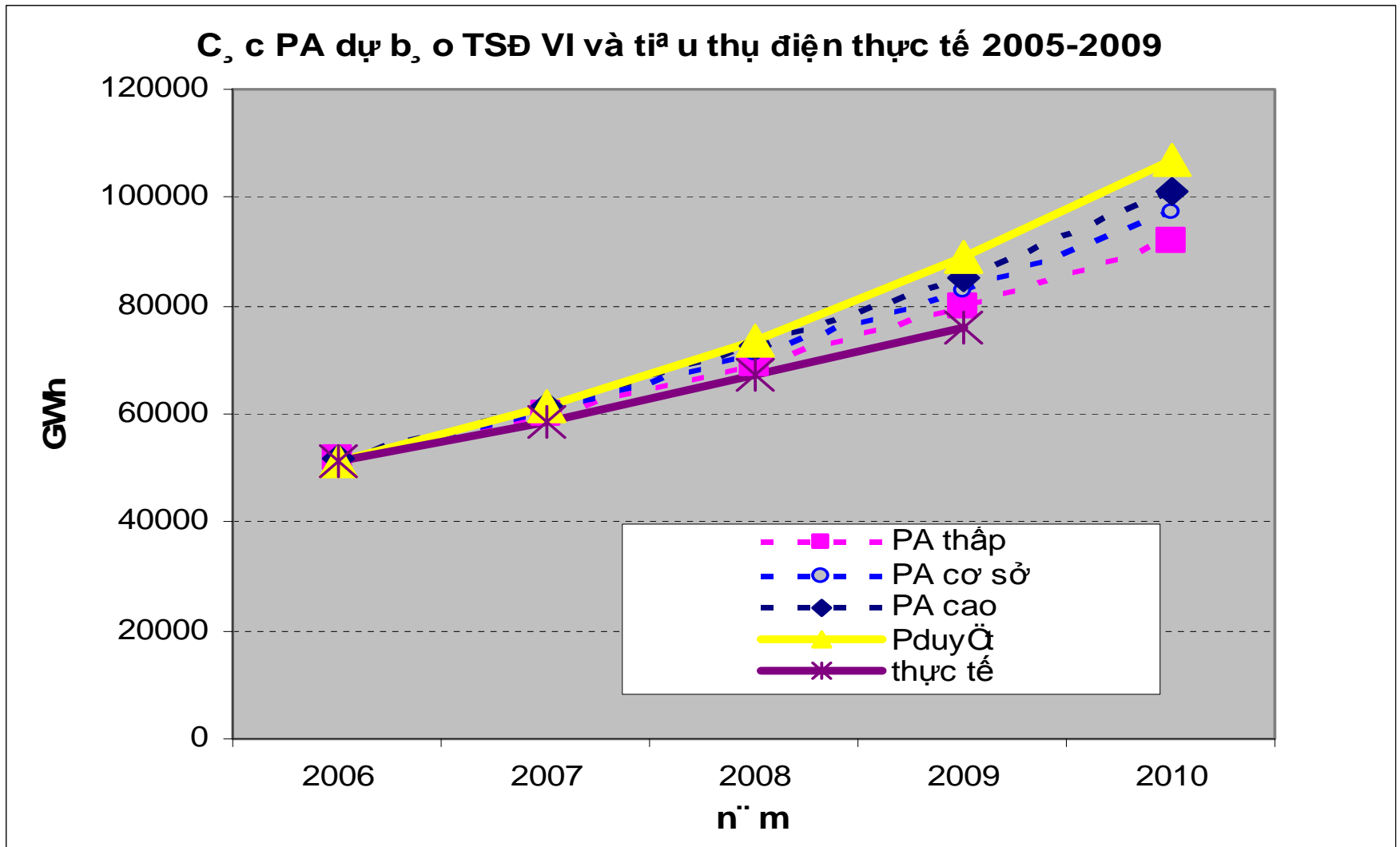

Actual electricity consumption in 2006-2009 is lower than forecast in alternatives . Growth rate of electricity sales in 2006-2009: 13.6%/year

Assessment of pdpvi implementation

Electricity growth rate in some provinces in 2001-2009

	<u>2001-2005</u>	<u>2006-2009</u>	<u>2008-2009</u>
<i>HCM CT</i>	12,2%/năm	7,8%	6,95%
<i>Şàng Nai</i>	19,3%/năm	14,9%	9,4%
<i>Bxnh D-ng</i>	37%/năm	17,2%	11,3%
<i>Vòng Tmu</i>	21,6%/năm	20,4%	15,5%
<i>Long An</i>	20,6%/năm	17,3%	19,9%
<i>Hµ Néi</i>	12,0%/năm	18,6%*	15,6%
<i>Hqi Phbng</i>	10,4%/năm	20,1%	15,0%
<i>Hqi D-ng</i>	12,4%/năm	14,0%	8,3%
<i>Ninh Bxnh</i>	24,6%/năm	21,0%	17,4%
<i>Qutng Ninh</i>	17,3%/năm	18,9%	26,8%

Construction of power plants in 2006-2009

	2006	2007	2008	2009	Est. 2010	2006- 2010
- Approved capacity MW	861	2096	3271	3393	4960	14,581
-Implemented - MW	756	1297	2251	1879	3416	9,599
- % Implemented	87.8%	61.9%	68.8%	55.4%	68.9%	65.8%

Transmission network

(2006 -:- -íc 2010)	Planned		Implemented		(%)	
	number	MVA-km	number	MVA-km	number	capacity
Substation 500kV						
New and expanded	16	8400	12	5850	75%	69.6%
lines 500kV						
New and upgraded	12	1339	6	593	50%	44.3%
Substation 220kV						
New and expanded	89	19326	63	13001	70.8%	66.8%
Lines 220kV						9
New and upgraded	121	4666	66	3238	54.5%	68.5%

Reasons

- *Many project are implemented at same time. Some investors have not enough finance*
- => *lack of capital, lborrow procedures neding long time*
- => *Weakness and lack of experience in :*
 - *bidding procedures,*
 - *Bidders, consultants*
 - *Project management units*
- *Impacts of global economic crisis =. Demand increase of 14%/year in comparision to anticipated 17%/year (~82%)*
- *high prices of equipment, fuels*
- *Not yet importing coal for TPPs in South*
- *Project area clearance, compensation works are not consistent with local plans ...*

Delay construction of TPPs will be continuous

2. Power demand forecast

Power forecasting methods

Siminar to methods applied in PDP-VI :

+ **Direct method**: demand forecast for whole country, each region, power companies, provinces in **period to 2015 and 2020**

+ **Indirect method**:

- **Main method**: multi-regretion analysis (Simple-E)

- **Other methods (for checking forecast results)**:

Ⓜ **Electricity intensity/GDP**

Ⓜ **ELasticity**

Ⓜ **Comparison to international practices**

National Economic development scenarios

GDP growth rate in 2000 – 2010(%)

	2000	2005	2006	2007	2008	2009	2010
GDP	6,79	8,4	8,2	8,48	6,23	5,3	6,5
Agriculture	4,63	4,0	3,7	3,4	3,79	1,8	2,8
Industry-Construction	10,07	10,6	10,4	10,6	6,33	5,5	7,0
Service	5,32	8,5	8,3	8,7	7,2	6,6	7,5

GDP growth rate forecast for 2011 – 2030 (%)

	2011 - 2015	2016 - 2020	2021 - 2030
High case	7.96	8.44	8.64
Base case	7.5	8.0	7.83
Low case	6.96	7.0	7.22

(according to directive 751 by PM, GDP growth rate in 2011 – 2015 shall be 7 – 8 %/year)

Scenarios prepared by economists team

input data

Population increase in 2009 – 2030

Year	2009	2010	2015	2020	2030
Population (mil.)	87093	88038	92499	97187	102421

Energy saving

Electricity saving rate: 1-3%/year, various by sector and period

Electricity tariff

- *Electricity tariff forecasting: was present, based on the oil price change ...*
- *Elasticity of electricity ptariff: -0.01->-0.02*

Electricity demand forecasting by power corporation

Electricity demand forecast by power corporation up to 2020

	Đơn vị	2010	2015	2020
Chỉ số tổng hợp	GWh	85932	159202	251763
<i>TC Ty 1</i>	GWh	24256	45970	69669
<i>TC Ty 2</i>	GWh	28506	57026	90270
<i>TC Ty 3</i>	GWh	8489	16451	27634
<i>TC Ty § L Hμ NéI</i>	GWh	9152	15566	26917
<i>TC Ty § L TPHCM</i>	GWh	14746	25413	40007
Pmax Tổng quốc	MW	15731	28876	45197
<i>TC Ty 1</i>	MW	5035	9416	14053
<i>TC Ty 2</i>	MW	5059	10154	16015
<i>TC Ty 3</i>	MW	1616	3060	4890
<i>TC Ty § L Hμ NéI</i>	MW	1850	3110	5080
<i>TC Ty § L TPHCM</i>	MW	2656	4496	6955

long term demand forecast in scenarios

Year	2010	2015	2020	2025	2030
<u>Base case</u>					
Production (GWh)	100.88 0	194.304	309.888	456.425	643.048
Pmax (MW)	16.048	30.803	48.956	71.857	101.955
Sales (GWh)	87.665	169.821	272.701	401.654	569.098
<u>High case</u>					
Production (GWh)	100.88 0	210.852	361.943	561.506	833.817
Pmax (MW)	16.048	33.426	57.180	88.401	132.201
Sales (GWh)	87.665	184.284	318.511	494.126	737.928

growth rates in scenarios

Growth rate of electricity sales in whole country

Growth rate/year	2006-2010	2011-2015	2016-2020	2021-2025	2026-2030
High case		16.0%	11.6%	9.2%	8.4%
Base case	14.0%	14.1%	11.3%	8.2%	7.4%

Elasticity

	2011-2015	2016-2020	2021-2025	2026-2030
Base case	1.89	1.41	1.06	0.95

4. Electricity demand forecast for 2011–2030

H'ng môc	2009		2010		2015		2020		2025		2030	
	GWh	%	GWh	%	GWh	%	GWh	%	GWh	%	GWh	%
Kl h bñ n CAO												
N«ng l«m nghiÖp & Thuû sñ n	700	0.92	789	0.90	1659	0.90	2040	0.64	2147	0.43	2233	0.30
C«ng nghiÖp & x«y dùng	38501	50.63	44708	51.00	97454	52.88	169962	53.36	255253	51.66	368694	49.96
Th- ñng nghiÖp & kh, ch s' n nhþ hþng	3512	4.62	4181	4.77	10057	5.46	15605	4.90	22930	4.64	34337	4.65
Quñ n lý & tiª u dĩ ng d«n c-	30534	40.15	34585	39.45	66319	35.99	113728	35.71	184501	37.34	286051	38.76
C, c ho¹ t ®éng kh, c	2799	3.68	3402	3.88	8796	4.77	17177	5.39	29295	5.93	46612	6.32
§ iÖn th- ñng phËm	76046	100	87665	100	184284	100	318511	100	494126	100	737928	100
Tæn thËt T/D		9.70		10.0		9.0		8.0		7.5		7.0
Tự dùng		3.0		3.1		3.6		4.0		4.5		4.5
§ iÖn sñ n xuËt	87109		100880		210852		361945		561506		833817	
C«ng suËt (MW)	13867		16048		33426		57180		88401		132201	
Kl h bñ n C« S«												
N«ng l«m nghiÖp & Thuû sñ n	700	0.92	789	0.90	1528	0.90	1843	0.68	1951	0.49	2046	0.36
C«ng nghiÖp & x«y dùng	38501	50.63	44708	51.00	89805	52.88	145052	53.19	210596	52.43	294039	51.67
Th- ñng nghiÖp & kh, ch s' n nhþ hþng	3512	4.62	4181	4.77	9268	5.46	12939	4.74	16858	4.20	22267	3.91
Quñ n lý & tiª u dĩ ng d«n c-	30534	40.15	34585	39.45	61114	35.99	98122	35.98	148965	37.09	216290	38.01
C, c ho¹ t ®éng kh, c	2799	3.68	3402	3.88	8106	4.77	14745	5.41	23284	5.80	34456	6.05
§ iÖn th- ñng phËm	76046	100	87665	100	169821	100	272701	100	401654	100	569098	100
Tæn thËt T/D		9.70		10.0		9.0		8.0		7.5		7.0
Tự dùng		3.0		3.1		3.6		4.0		4.5		4.5
§ iÖn sñ n xuËt	87109		100880		194304		309888		456425		643048	
C«ng suËt (MW)	13867		16048		30803		48956		71857		101955	

Elasticity and electricity intensity

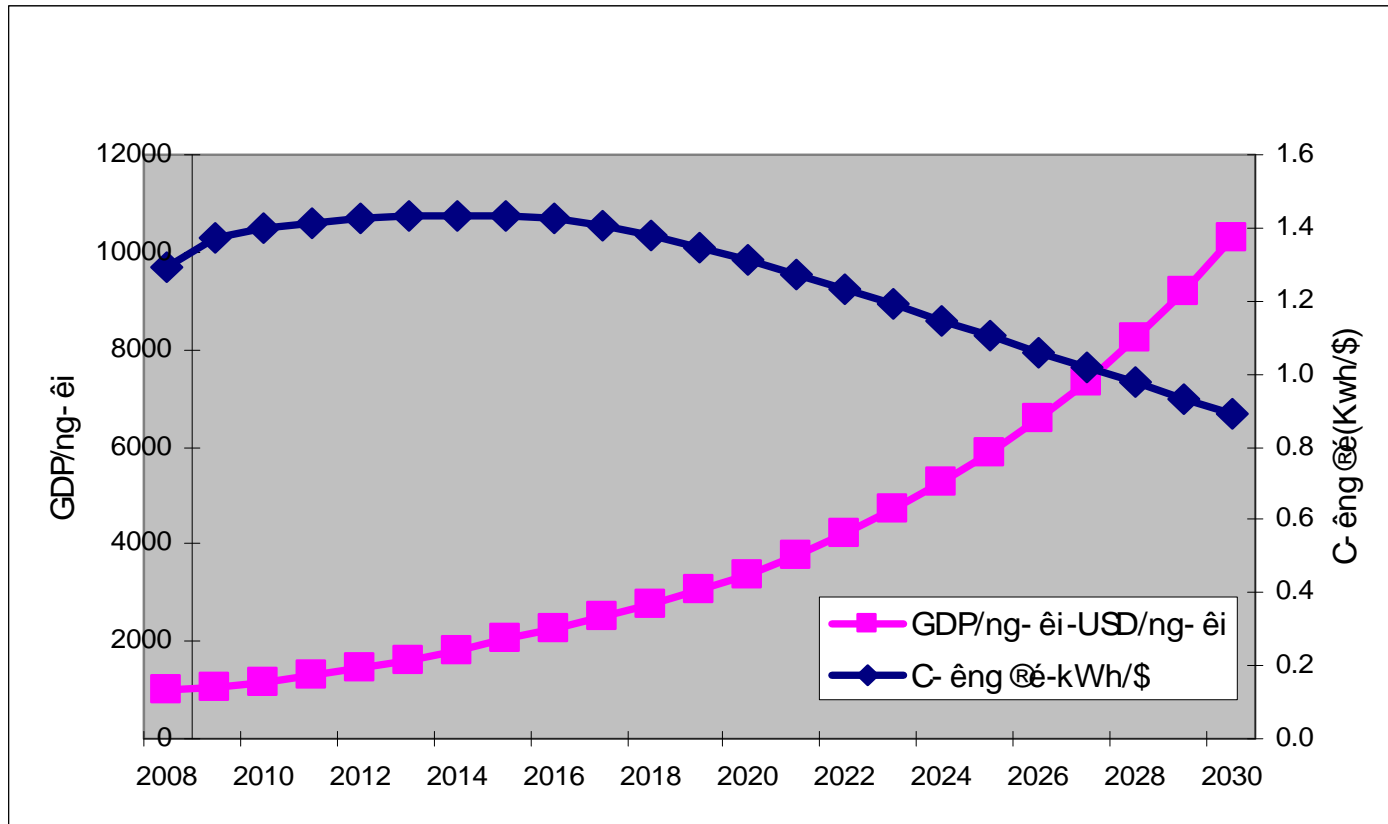

Electricity intensity, GDP/person, Consumption/person

	2010	2015	2020	2025	2030
kWh/USD(2005)	1,44	1,52	1,41	1,16	0,92
USD/person	1221	2023	3350	5000	9890
kWh/person/year	996	1836	2800	4020	5560

Comparison to the forecast in pdp-vi

Số lượng TSS VII & TSS VI

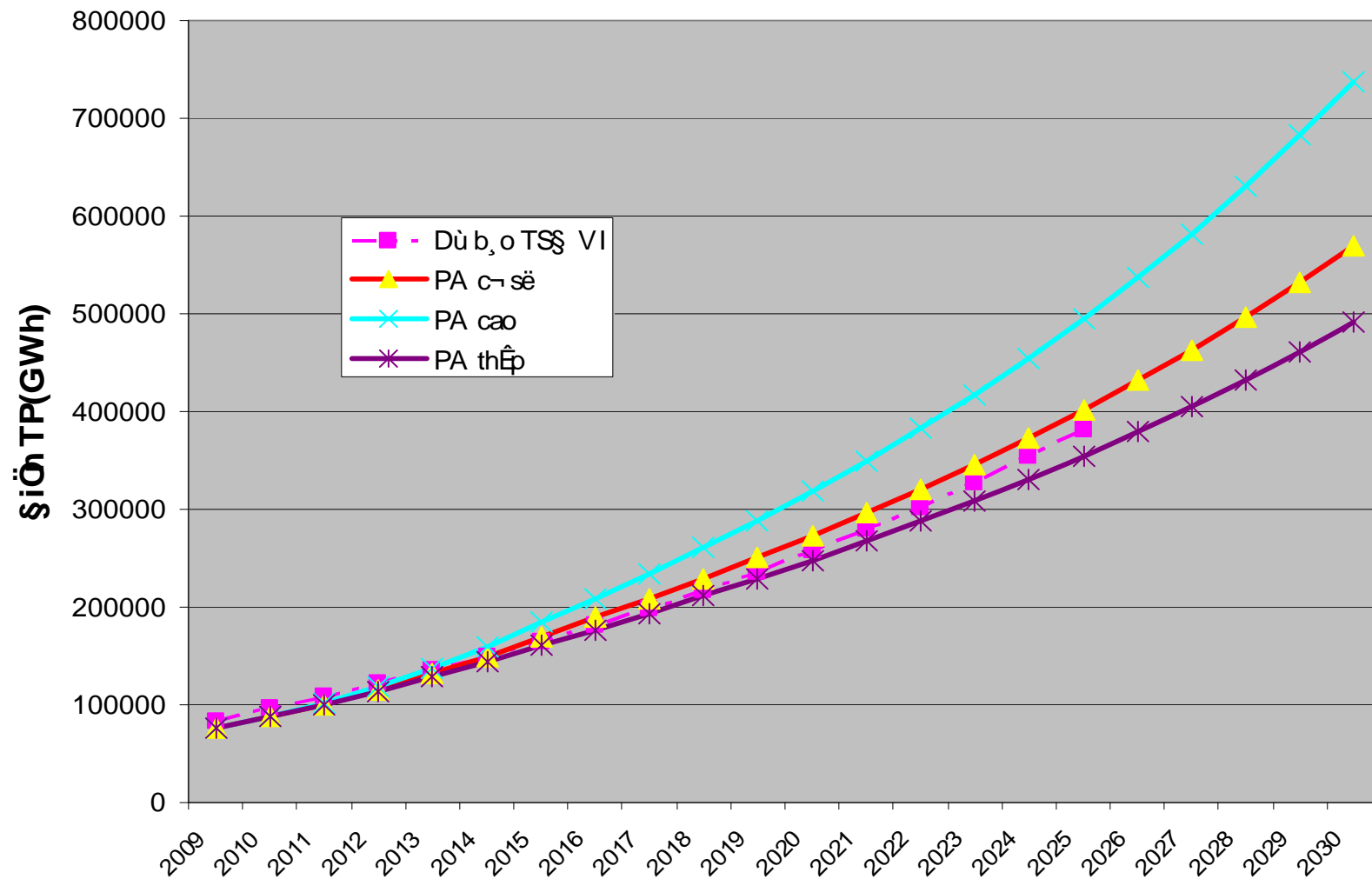

Forecasting fuels for electricity generation

	2010	2015	2020	2025	2030
Domestic coal *					
Dust 4b (1000.VND/ton)	648	916,5	1.012	1.117,3	1.233,5
Dust 5 (1000.VND/ton)	520	800,0	883	975,0	1.076,5
Imported coal *					
(USD/T)	71	78	87	96	106
Natural gas (USD/triÖu BTU)	3,55	6,37	7,65	8,90	10,72
DO (USD/ton)	874	964	1.065	1.176	1.298
FO (USD/ton)	703	776	857	946	1.044
Imported fuel rods					
Price (US cent/kWh)	0,70	0,70	0,773	0,853	0,942

* Not included transport cost to power plants, about 2-5 \$/T (North) and 10-11 \$/T (South)

Assessment of primary energy resources - exploitation

- **Hydropower:** Economic-technical potential ~75 - 80 billion kWh (20.000MW); 70,8 billion kWh on main rivers (not more than PDPVI):
 - 51.6% in North
 - 31.9% in Central, and
 - 16.4% in South
- **Coal:** according to coal development plan up to 2030:
 - 2015: 60-61 MT/ann.
 - 2020: 83-85 MT/ann.
 - 2025: 108-124 MT/ann.
 - 2030: 109-133 MT/ann.

coal supply for electricity generation:

- 2015: 31-32 MT
- 2020: 47-48 MT
- 2025: 63-78 MT
- 2030: 56-79 MT

Need to find coal source for import

5. Assessment of primary energy resources - exploitation

Base

N ^o m	2011	2012	2013	2014	2015	2016	2017	2018	2019	2020	2021	2022	2023	2024	2025	2026	2027	2028	2029	2030	
MiOn Tr ung																					
Khả n^o ng cấ p (khả kh^o)						0.48	0.81	1.05	1.05	1.05	1.05	1.05	1.05	1.05	1.05	1.05	1.05	1.05	1.05	1.05	1.05
MiOn § « ng Nam																					
Khả n^o ng cấ p (khả kh^o)	6.23	6.75	8.15	9.02	7.79	7.59	7.46	8.33	7.97	7.45	6.95	6.47	6.19	5.91	5.35	4.8	4.8	4.8	4.8	4.8	4.5
MiOn T@y Nam																					
Khả n^o ng cấ p (khả kh^o)	1.96	1.96	1.96	2.61	4.65	5.68	5.68	5.68	5.69	5.68	5.57	5.45	5.1	4.85	4.66	4.0	4.0	4.0	4.0	4.0	4.0
Tổng m.Trung vụ Nam	8.19	8.71	10.11	11.63	12.44	13.75	13.95	15.06	14.71	14.18	13.57	12.97	12.34	11.81	11.06	9.85	9.85	9.85	9.85	9.85	9.55
Tỷ trọng giữa các vùng																					
Miền trung						3.5%	5.8%	7.0%	7.1%	7.4%	7.7%	8.1%	8.5%	8.9%	9.5%	10.7%	10.7%	10.7%	10.7%	10.7%	11.0%
Miền Đông	76%	77%	81%	78%	63%	55%	53%	55%	54%	53%	51%	50%	50%	50%	48%	49%	49%	49%	49%	49%	47%
Miền Tây	24%	23%	19%	22%	37%	41%	41%	38%	39%	40%	41%	42%	41%	41%	42%	41%	41%	41%	41%	41%	42%

High

N ^o m	2011	2012	2013	2014	2015	2016	2017	2018	2019	2020	2021	2022	2023	2024	2025	2026	2027	2028	2029	2030	
MiOn Tr ung																					
Khả n^o ng cấ p (khả kh^o)						0.48	0.81	1.05	1.59	2.31	3.25	3.62	3.66	3.66	3.66	3.66	3.66	3.66	3.66	3.66	3.66
MiOn § « ng Nam																					
Khả n^o ng cấ p (khả kh^o)	6.23	6.75	8.15	9.08	7.98	8.01	8.26	9.44	9.5	9.34	9.21	8.72	8.45	8.16	7.6	7.2	7	6.5	6	5.5	
MiOn T@y Nam																					
Khả n^o ng cấ p (khả kh^o)	1.96	1.96	1.96	2.61	4.65	6.36	7.04	7.95	7.95	7.95	7.84	7.71	7.37	7.12	6.93	5.66	5.26	4.96	4.46	4.26	
Tổng m.Trung vụ Nam	8.19	8.71	10.11	11.69	12.63	14.85	16.11	18.44	19.04	19.60	20.30	20.05	19.48	18.94	18.19	16.52	15.92	15.12	14.12	13.42	
Tỷ trọng giữa các vùng																					
Miền trung						3.2%	5.0%	5.7%	8.4%	11.8%	16.0%	18.1%	18.8%	19.3%	20.1%	22.2%	23.0%	24.2%	25.9%	27.3%	
Miền Đông	76%	77%	81%	78%	63%	54%	51%	51%	50%	48%	45%	43%	43%	43%	42%	44%	44%	43%	42%	41%	
Miền Tây	24%	23%	19%	22%	37%	43%	44%	43%	42%	41%	39%	38%	38%	38%	38%	34%	33%	33%	32%	32%	

Consider import LNG when natural gas supply is reduction

Potential of renewable power resources

1. At present: about 150MW of co-generation using biomass (at sugar plants), 7.5MW of wind power (Tuy Phong-Ninh Thuan) and about 1.15MW of solar power.

2. Potential development / anticipated development:

- **Small hydropower**: 4000MW / 2400MW
- **Geothermal power**: 200MW / 0 (not efficient)
- **Biomass power**: 300 -:- 400MW
- **Wind power**: 3500MW / 2100MW
- **Solar power**: 4 -:- 6MW

❖ Total potential / anticipated RE capacity to be developed:

- 7800 -:- 8000MW / 4900MW

- 2015: Cả thỐ x©y dùng ~1600MW nguồn NL t_l t_o (~ 5,7 TWh);

- 2020: 3200MW (~11,2 TWh); vµ

- 2025: 4700MW (16,2 TWh)

- 2030: 4900MW (~17 TWh)

Updates

- According to the transmission project of 3 countries in Indochina (IE is entrusted with task by EVN) :
 - **In Northern Laos:** HPP Luong Prabang through 500kV line to Nho Quan (420km). Option with XÇm N-a substation is not feasible because HPP Nam Sum will send power to Vietnam on 220kV line, HPP NĚm Đt is not economically viable: not certain schedule of Luong Pra bang HPP.
 - **In Southern Laos:** Some HPP projects are less effective (Dak Emuele, Sekaman2); not yet agreement with project owner (Se Kong 4) => total capacity anticipated through Ban Sok - Pleiku line in 2015-2016 is lower than that in MOU between VN and Laos (reduced from 1500MW to ~800MW); added HPP Nam Theun 1 - 400MW
 - **In Northern Cambodia:** HPP Se San 1; located in eco-protection zone (Prekliang); changed investors (Srepok 5,6,8&9); Sambor, Not clear capacity of Strung Treng
- ⇒ Total anticipated imported capacity is reduced (Laos:3000MW instead of 5000MW, Cambodia: 1200MW instead of 2500MW)
- **In China:** maintaining import through 220kV line, but delaying import through 500kV lines

6. Power generation development program

Planning criteria

1. Methodologies – criteria for power generation development

- Concentrated planning
- Solving least cost planning problem
- Using advanced software, equivalent to regional level: STRATEGIST, PDPAT
- Technical zoning: 3 systems: North – Central – South interconnected by two 500kV lines
- Using comments of JICA experts
- Priority given to sites near load centers, reduction of far transmission

Inputs

- Reserve capacity ensure power supply shortage not exceeding 24h/year by each regional system in period 2021-2030
- Not served electricity value: 0.7 USD/kWh
- Transmission limit on 500kV line:
 - North <-> Central: 1800MW (to 2015), 2000MW (from 2016 to 2025) and 2500MW (from 2026)
 - Central <-> SOut: 1800MW (to 2012), 2500MW (from 2013 onwards)
 - **500kV line from Pleiku -> Cau Bong to be completed in 2013, enhancing supply reliability for the South in 2013 – 2015; importing electricity from Laos**
- Southern PSHPP: unit #1:300MW- 2019, increased to 3600MW; North: unit #1: 300MW- 2021, total capacity 1200MW
- Wind power plants are stimulated as one equivalent power plant with capacity of 50MW (~87GWh/yr); Wind power tariff: average ~9US cent/kWh
- Pmax in Central: 4700 – 5800MW in 2020 and 6800 – 9000MW in 2025 => simulated uniy capacity lower than that in the sourh and north (coal TPP: 300MW, GTCC: 450MW)
- Nuclear power: *Base case: 2020: unit #1; 2025: 4x1000MW; 2030: added 2x1350MW*
High case: 2020: unit #1; 2025:4x1000+2x1350MW; 2030: added 6x1350MW
- In additions to planned SHPPs, othe SHPPs after 2010 are cimulated as one equivalent HPP with capacity of ~100MW

Updated and anticipated generation
Development in 2010-2012

TT	Tên nhà máy	Công suất (MW)	Tiến độ theo QHĐ-VI	Chủ đầu tư
	Công trình dự kiến v/h 2010	2962		
1	TĐ Sơn La #1	400	2010	EVN
2	TĐ Cửa Đạt	2x48.5	2009	CTCPTĐ Cửa Đạt
3	TĐ Bản Vẽ	2x150	2009	EVN
5	TĐ Srêpok 3	2x110	2100	EVN
6	TĐ Sê San 4 #3	120	2010	EVN
7	TĐ Sông Tranh 2 #1	1x95	2010	EVN
8	TĐ Preikrong #2	50	2010	EVN
9	TĐ Đồng Nai 3#1&2	2x90	2009	EVN
10	NĐ than Sơn Động	2x110	2008	TKV
11	NĐ Hải Phòng I #1	300	2009	CTCPNĐ Hải Phòng
12	NĐ Cẩm Phả I	300	2009	TKV
12	NĐ Quảng Ninh I	2x300	2009	CTCPNĐ Quảng Ninh
13	TĐ Sre Pok 4	2x40	2012	CTCP Điện Đại Hải
	Vào vận hành năm 2011	3762		
1	Sơn La #2,3	2x400	2011	EVN
2	Nậm Chiến	2x100	2011	S.Đà
3	Nho Quế 3	2x55	2013	CTCP Bitexco
4	TĐ Na Le (Bắc Hà)	2x45	2010	LICOGI/IPP
5	Khe Bô #1	50	2011	CTCPDL
6	TĐ Sông Tranh 2 #2	1x95	2010	EVN
7	TĐ An Khê #2	80	2008	EVN
8	Sê San 4a	63	2010	CTCPTĐ Sê San 4a
9	Đak My 4	2x74+2x21	2011	IDICO
10	Se Kaman 3	2x125	2010	CTCP Việt Lào
11	DakR tih	2x41+2x31	2010	TCTXD số 1
12	Đồng Nai 4	2x170	2010	EVN
13	NĐ Hải Phòng I #2	300	2009	CTCPNĐ Hải Phòng
14	NĐ Cẩm Phả II	300	2009	TKV
15	Nhơn Trạch 2	3x250	2011	PVN
	Vào vận hành năm 2012	2970		
1	Sơn La #4,5,6	3x400	2012	EVN
2	Bản Chất	2x110	2011	EVN
3	Hủa Na	180	2012	PVN
4	Khe Bô #2	50	2011	CTCPDL
5	A Lưới	2x85	2011	CP điện MT
7	NĐ Nông Sơn	30	2009	TKV
6	Mạo Khê #1	220	2009-2010	TKV 27
8	Uông Bí MR #2	300	2011	EVN
9	Quảng Ninh II	2x300	2009	CTCPNĐ Quảng Ninh

...updated and
anticipated

Generation 2013 - 2015

In total 22,160 MW
put in 2010-2015,
EVN 's power plants
12,926MW (58.3%)

2016-`17 of added 14,300MW
4380MW is under EVN
(30.6%):

Lai Chau HPP, Mong Duong
II#2 TPP,
Thị bình I, D.Hải III TPPs,
HPP H¹ S.San 2

TT	Tên nhà máy	Công suất (MW)	Tiến độ theo QHĐ-VI	Chủ đầu tư
Vào vận hành năm 2013		1507		
1	Bá Thước I	40	-	
2	Bá Thước II	80	-	
3	Srê Pok 4a	64	-	
4	Đak Rinh	2x62.5	2011	PVN
5	Đồng Nai 2	78	2012	IPP
6	Hải Phòng 2 #1	300	2009-2010	EVN
7	Mạo Khê #2	220	2009-2010	TKV
8	Vũng Áng I #1	600	2010	PVN
Vào vận hành năm 2014		6795		
1	Huội Quảng	2x260	2012	EVN
2	Nậm Mô (Lào)	95	2012	IPP
3	Se Ka man 1 (Lào)	290	2012	CTCP Việt Lào
4	Hải Phòng 2 #2	300	2009-2010	EVN
5	Mông Dương 1 #1	500	2011-2012	EVN
6	Mông Dương 2 #1	600	2011-2012	AES (BOT)
7	Nghi Sơn 1	2x300	2011-2012	EVN
8	Vũng Áng I #2	600	2010	PVN
9	NĐ Lục Nam #1	50	-	IPP
10	Vĩnh Tân 2 #1,2	2x600	2013-2014	EVN
11	Duyên Hải (Trà Vinh) 1 #1	600	2012-2013	EVN
12	Ô Môn I #2	300	2010	EVN
13	Hiệp Phước 2 #1	390	-	Hiệp Phước PC (đề nghị)
14	Ô Môn III (TBKHH)	3x250	2014	EVN
Vào vận hành năm 2015		7126		
1	Trung Sơn	250	2012	EVN
2	Thượng Kon tum	220	2013	CP VS-S.Hình
3	Sông Bung 4	156	2012	EVN
4	Sông Bung 2	100	2013	EVN
5	Đồng Nai 5	140	2012	TKV
7	Mông Dương 1 #2	500	2011-2012	EVN
9	Hải Dương #1	600	-	Jak Behad (BOT)
10	Thái Bình II #1	600	-	PVN
11	Vĩnh Tân 1	2x600	2011	CSG (BOT)
12	Ô Môn II (TBKHH)	3x250	2013-2015	BOT
13	Ô Môn IV (TBKHH)	3x250	2014	EVN
14	Duyên Hải (Trà Vinh) 1 #2	600	2012-2013	EVN
15	Long Phú (Sóc Trăng) 1 #1	600	2013-2014	PVN
16	Vân Phong 1	660	-	Sumitomo-BOT

Calculation results of generation - loads in base case

Generation	2010	2015	2020
Electricity production	100.9 TWh	194.3 TWh	329.4 TWh
Pmax whole country:	16,048 MW	30,803 MW	52,040 MW
Total installed capacity:	19,937 MW	43,050 MW	69,433 MW
<i>Total reserve:</i>	<i>3,889 MW</i>	<i>12,247 MW</i>	<i>17,393 MW</i>
<i>In which:</i>			
<i>HPP&PSPP</i>	<i>7,726MW (38.8%)</i>	<i>14,351 (33.3%);</i>	<i>17,455 (25.1%)</i>
<i>Oil&Gas TPPs:</i>	<i>7,703MW(38.6%);</i>	<i>10,582 (24.6%)</i>	<i>13,625 (19.6%)</i>
<i>Coal TPPs:</i>	<i>3,231MW (16.2%)</i>	<i>15,365 (35.7%);</i>	<i>32,385 (46.6%)</i>
<i>Import:</i>	<i>750MW (3.8%);</i>	<i>1,073 (2.5%)</i>	<i>1,839 (2.6%)</i>
<i>RE</i>	<i>527MW (2.6%)</i>	<i>1,679(3.9%)</i>	<i>3,129 (4.5%)</i>
<i>NPP</i>			<i>1,000 (1.4%)</i>
System max monthly reserve	19.5%	39.8%	33.4%
in 2025 capacity of RE ~4,800MW, accounting for 5% of 97,900MW installed capacity			

Calculation results of generation development alternative (RE increase)

Generation mix 2020

(base case / RE increased case)

Electricity production	329.4 TWh	
Pmax whole country :	52,040 MW	
Total installed capacity :	69,433 MW	69,823 MW
<i>Total reserve:</i>	<i>17,393 MW</i>	<i>17,783 MW</i>
<i>In which:</i>		
<i>HPP&PSPP</i>	<i>17,445 MW (25.1%)</i>	<i>17,455 (25.0%)</i>
<i>Oil&Gas TPPs :</i>	<i>13,625 MW (19.6%)</i>	<i>13,565 (19.4%)</i>
<i>Coal TPPs :</i>	<i>32,385 MW (46.6%)</i>	<i>32,385 (46.4%)</i>
<i>Import:</i>	<i>1,839 MW (2.6%)</i>	<i>1,839 (2.6%)</i>
<i>RE</i>	<i>3,129 MW (4.5%)</i>	<i>3,579 (5.1%)</i>
<i>NPP</i>	<i>1,000 MW (1.4%)</i>	<i>1,000 (1.4%)</i>

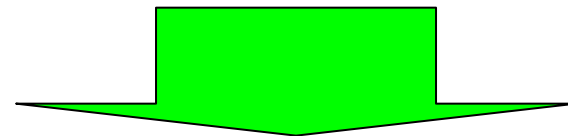

In 2025 RE capacity ~5,700MW,
(of which SHPP 3100MW, wind, solar , biogas 2600MW)
accounting for 5.8% of 98,100MW installed capacity

Balancing coal for electricity production

Domestic coal consumption	2011	2012	2013	2014	2015	2016	2017	2018	2019	2020
North - Domestic coal	10.8	12.7	16.0	18.9	21.0	25.1	28.3	30.2	34.0	37.0
<i>North - Import</i>	0	0	0	0	0	0	0	1.5	1.3	3.3
Central – Domestic coal	0	0.07	0.07	0.08	0.08	0.07	0.07	0.06	0.06	0.07
Central - Import	0	0	0	0	0	0	0.9	2.3	3.1	3.3
South - Domestic coal	0.0	0.0	0.0	3.4	9.0	9.6	9.5	9.3	9.6	9.6
South - Import	0.4	0.4	0.5	0.4	1.98	7.6	13.8	17.5	21.4	23.9
Demand of whole country	11.2	13.2	16.5	22.8	32.0	42.4	52.6	60.8	69.5	77.1
Total import	0.38	0.42	0.46	0.43	2.0	7.6	14.7	21.3	25.8	30.5
Domestic				22.4	30.0	34.8	37.9	39.6	43.7	46.6
Supply possibility according to VINACOMIN					37.4					50.4

Coal consumption – mill.	2021	2022	2023	2024	2025	2026	2027	2028	2029	2030
North - Domestic coal	41.1	44.1	47.9	52.5	53.6	57.2	59.8	59.9	58.6	57.5
<i>Miền Bắc-Nhập khẩu</i>	2.7	3.3	3.3	3.5	7.1	7.5	9.9	16.6	25.3	34.4
<i>North - Import</i>	0.08	0.08	0.08	0.09	0.09	0.09	0.08	0.07	0.07	0.116
Central – Domestic coal	4.3	4.4	4.3	5.3	6.5	8.7	10.6	9.7	9.8	9.0
South - Domestic coal	9.5	9.3	9.2	9.0	8.9	9.0	8.9	8.8	8.7	8.6
South - Import	26.8	28.6	31.4	35.4	40.1	44.5	50.9	58.0	68.3	78.5
Demand of whole country	84.4	89.8	96.2	105.8	116.4	126.9	140.2	153.0	170.8	188.1
Total import	33.7	36.2	39.1	44.2	53.8	60.6	71.4	84.2	103.5	121.9
Domestic	50.6	53.6	57.1	61.6	62.7	66.2	68.8	68.8	67.3	66.2
Supply possibility according to VINACOMIN					68.8					31

Balancing gas for electricity generation-(base gas scenarios)

Year	2011	2012	2013	2014	2015	2016	2017	2018	2019	2020	2025	2030
Central												
Gas for electricity										0.381	1.16	1.13
Gas for other industrial uses						0.06	0.06	0.22	0.22	0.22	0.22	0.22
Total demand for Central						0.06	0.06	0.22	0.22	0.60	1.38	1.35
Supply possibility						0.50	0.85	1.10	1.10	1.10	1.10	1.10
Balancing for Central	0	0	0	0	0	0.44	0.79	0.88	0.88	0.50	-0.28	-0.25
South												
Total demand for South-East	6.77	7.61	7.95	8.03	7.47	6.86	6.74	7.13	7.18	7.25	7.41	3.47
Gas for TPPs	5.77	6.59	6.90	6.96	6.36	5.72	5.57	5.93	5.94	5.98	5.92	1.71
Gas for Urea	0.5	0.5	0.5	0.5	0.5	0.5	0.5	0.5	0.5	0.5	0.5	0.5
Gas for other industries	0.50	0.53	0.55	0.58	0.61	0.64	0.67	0.70	0.74	0.78	0.99	1.26
Supply possibility (dry gas)	6.23	6.75	8.15	9.02	7.79	7.59	7.46	8.33	7.97	7.45	5.35	4.5
Balancing for South-East	-0.54	-0.86	0.20	0.99	0.32	0.73	0.72	1.20	0.79	0.20	-2.06	1.03
South-West												
Total demand for South-West	2.28	2.32	2.44	3.85	4.11	4.63	4.50	4.82	5.11	5.11	4.92	4.43
Gas for TPPs	2.28	2.32	2.44	3.35	3.61	4.13	4.00	4.32	4.61	4.61	4.42	3.93
Gas for Urea				0.5	0.5	0.5	0.5	0.5	0.5	0.5	0.5	0.5
Gas for other industries												
Supply possibility (dry gas)	1.96	1.96	1.96	2.61	4.65	5.68	5.68	5.68	5.69	5.68	4.66	4.0
Balancing for South-West	-0.32	-0.36	-0.48	-1.24	0.54	1.05	1.18	0.86	0.59	0.57	-0.26	-0.43
Supply possibility	8.19	8.71	10.11	11.63	12.44	13.77	13.99	15.11	14.76	14.23	11.11	9.60
Total demand	9.05	9.93	10.40	11.89	11.58	11.55	11.31	12.17	12.51	12.96	13.71	9.24
For electricity	8.05	8.90	9.35	10.31	9.97	9.85	9.58	10.25	10.55	10.59	11.50	6.76
For other industries	1.00	1.03	1.05	1.58	1.61	1.64	1.67	1.70	1.74	1.78	1.99	2.26
Whole country balance	-0.9	-1.2	-0.3	-0.3	0.9	2.2	2.7	2.9	2.3	1.3	-2.6	0.4
LNG import							0	0	0.77	1.89	5.42	10.35

Balancing gas for electricity generation-(high gas scenarios)

N ^o m	2011	2012	2013	2014	2015	2016	2017	2018	2019	2020	2025	2030
Central												
Gas for electricity										0.38	1.15	1.13
Gas for other industrial uses						0.06	0.06	0.22	0.22	0.22	0.22	0.22
Total demand for Central						0.06	0.06	0.22	0.22	0.60	1.37	1.35
Supply possibility						0.48	0.81	1.05	1.59	2.31	3.66	3.66
Balancing for Central	0	0	0	0	0	0.42	0.75	0.83	1.37	1.71	2.29	2.31
South												
Total demand for South-East	6.77	7.61	7.95	8.03	7.47	6.86	6.87	7.42	8.34	9.13	10.75	10.73
Gas for TPPs	5.77	6.59	6.90	6.96	6.36	5.72	5.70	6.22	7.10	7.85	9.26	8.97
Gas for Urea	0.5	0.5	0.5	0.5	0.5	0.5	0.5	0.5	0.5	0.5	0.5	0.5
Gas for other industries	0.50	0.53	0.55	0.58	0.61	0.64	0.67	0.70	0.74	0.78	0.99	1.26
Supply possibility (dry gas)	6.23	6.75	8.15	9.08	7.98	8.01	8.26	9.44	9.5	9.34	7.6	5.5
Balancing for South-East	-0.54	-0.86	0.20	1.05	0.51	1.15	1.39	2.02	1.17	0.22	-3.15	-5.23
South-West												
Total demand for South-West	2.28	2.32	2.44	3.85	4.11	4.63	4.45	4.56	4.74	5.01	4.89	4.48
Gas for TPPs	2.28	2.32	2.44	3.35	3.61	4.13	3.95	4.06	4.24	4.51	4.39	3.98
Gas for Urea				0.5	0.5	0.5	0.5	0.5	0.5	0.5	0.5	0.5
Gas for other industries												
Supply possibility (dry gas)	1.96	1.96	1.96	2.61	4.65	6.36	7.04	7.95	7.95	7.95	6.93	4.26
Balancing for South-West	-0.32	-0.36	-0.48	-1.24	0.54	1.73	2.59	3.39	3.21	2.94	2.04	-0.22
Supply possibility	8.19	8.71	10.11	11.69	12.63	14.85	16.11	18.44	19.04	19.60	18.19	13.42
Total demand	9.05	9.93	10.40	11.89	11.58	11.49	11.32	11.98	13.08	14.52	16.79	16.33
For electricity	8.05	8.90	9.35	10.31	9.97	9.85	9.65	10.27	11.34	12.36	14.80	14.07
For other industries	1.00	1.03	1.05	1.58	1.61	1.64	1.67	1.70	1.74	1.78	1.99	2.26
Whole country balance	-0.9	-1.2	-0.3	-0.2	1.1	3.4	4.8	6.5	6.0	5.1	1.4	-2.9
LNG nhập khẩu									0	0.00	1.86	2.36

7. Transmission development program (Ch.8)

Viewpoints and design standard for 500kV network

- **Balance of supply and demand in North, Central and South, reducing far transmission lines;**
- **Interconnection of 3 regions in order to exchange electricity and optimal operation of power systems**
- **Balance of supply and demand in each province, area, big load center (Hanoi, HCMCT): design power systems for divided areas.**
- **Focus on safe design power networks for big load centers (Hanoi, HCMCT...)**
- **Ensuring electricity quality, simple network, flexible operation**
- **Lines:**
 - **Applying criterion (N-1), design with loop or double circuit 500kV line with conductor 1300 - 2400 mm², or bigger for cities.**
 - **Using multi-circuit towers** **Số đông §Z cét nhiều m'ch, xem xĐt kh¶ n'ng số đông, considering re-using existing routes of lines 110kV, 220kV..., by rehabilitation to multi-voltage levels, multi-circuit towers.**
- **Substation:**
 - **In HCMCT, Hanoi: 2 – 4 MBA/substation, 900-2000 MVA/ transformer, in other areas: 2 – 3 MBA/substation, 450 – 2000 MVA/ transformer.**
 - **Expansion of existing 500kV substations: considering possibility of changing switchyards by using GIS to increase number of feeders.**

Zoning of electricity systems

Whole country system

consisting of 3 regional interconnected systems

- **North system:** northern provinces to Ha Tinh.
- **Central system:** North-central provinces, central coastal provinces to Khanh Hoa and 4 provinces in highland: Kon Tum, Gia Lai, $\frac{3}{4}$ L $\frac{3}{4}$ C, $\frac{3}{4}$ N \ll ng
- **South system:** Southern provinces, B \times nh Thu \ddot{E} n, Ninh Thu \ddot{E} n, L \odot m \S \grave{a} ng

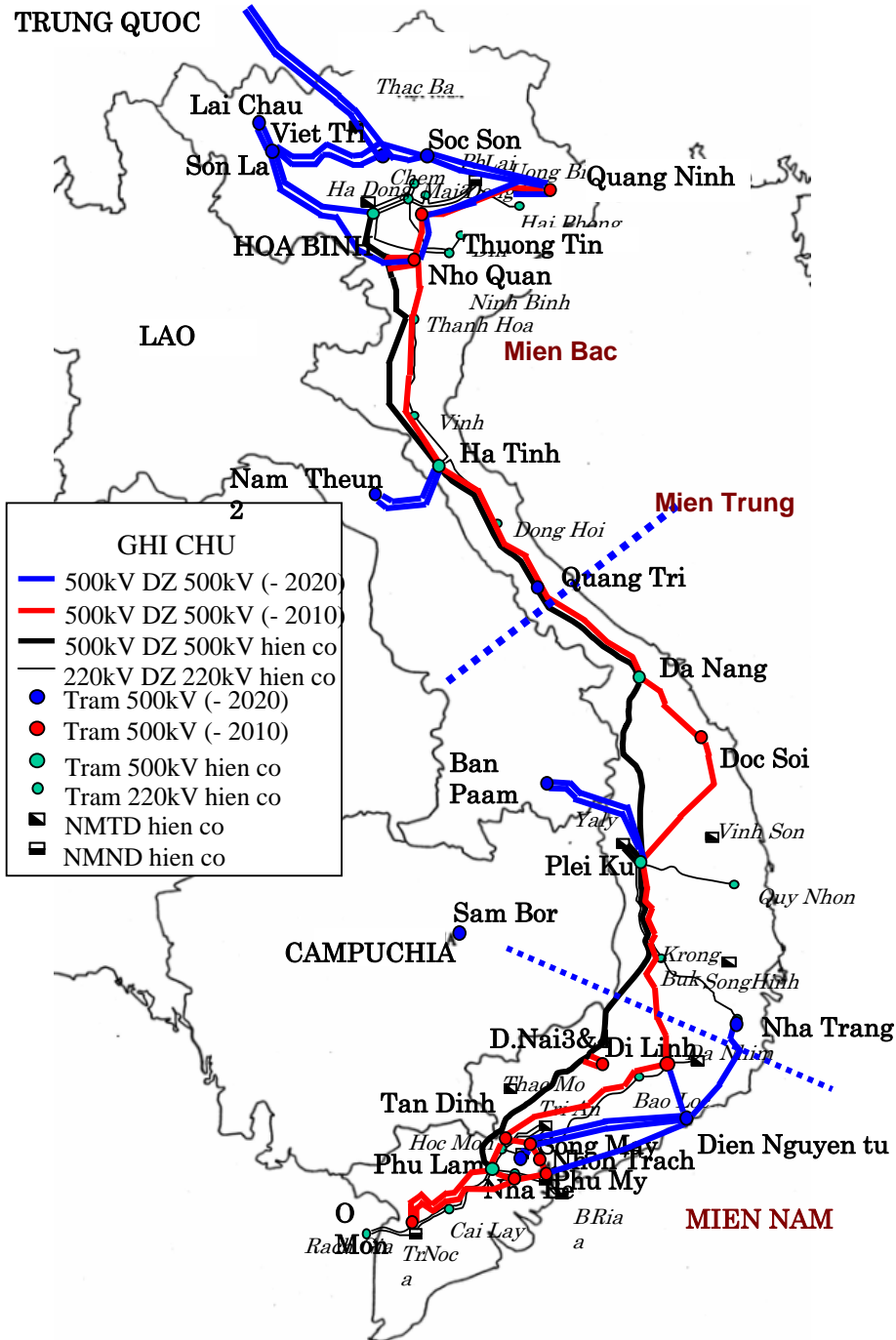

North system

Central system

South system

HỒ THẲNG ĐIỆN 500KV

khuvàc miền B^{3/4}C
& B^{3/4}C Trung bé

năm 2020

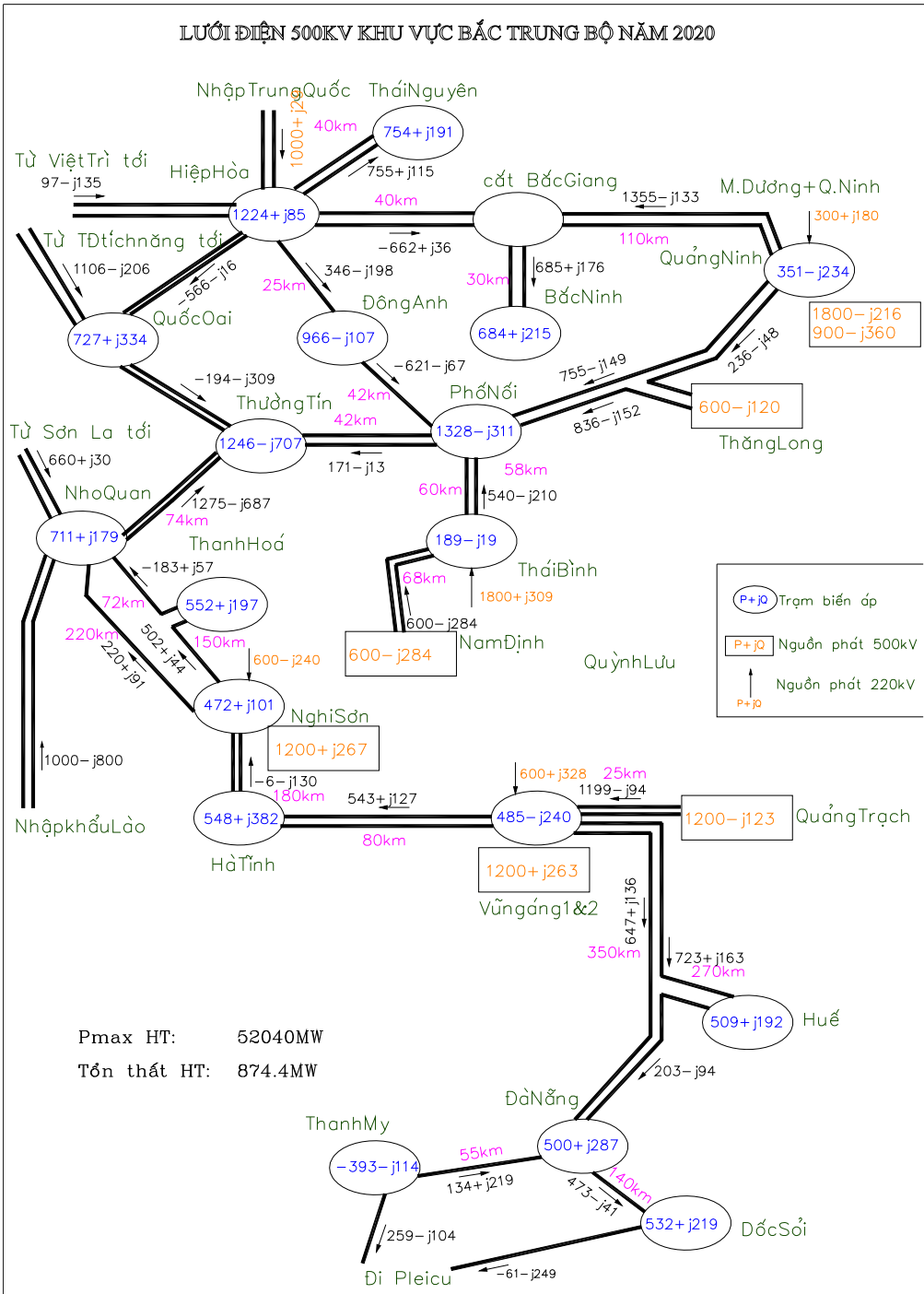

Southeast 500kV system in 2020

LUỚI ĐIỆN 500KV MIỀN ĐÔNG NAM BỘ NĂM 2020

Pmax HT: 52040MW

Tổn thất HT: 874.4MW

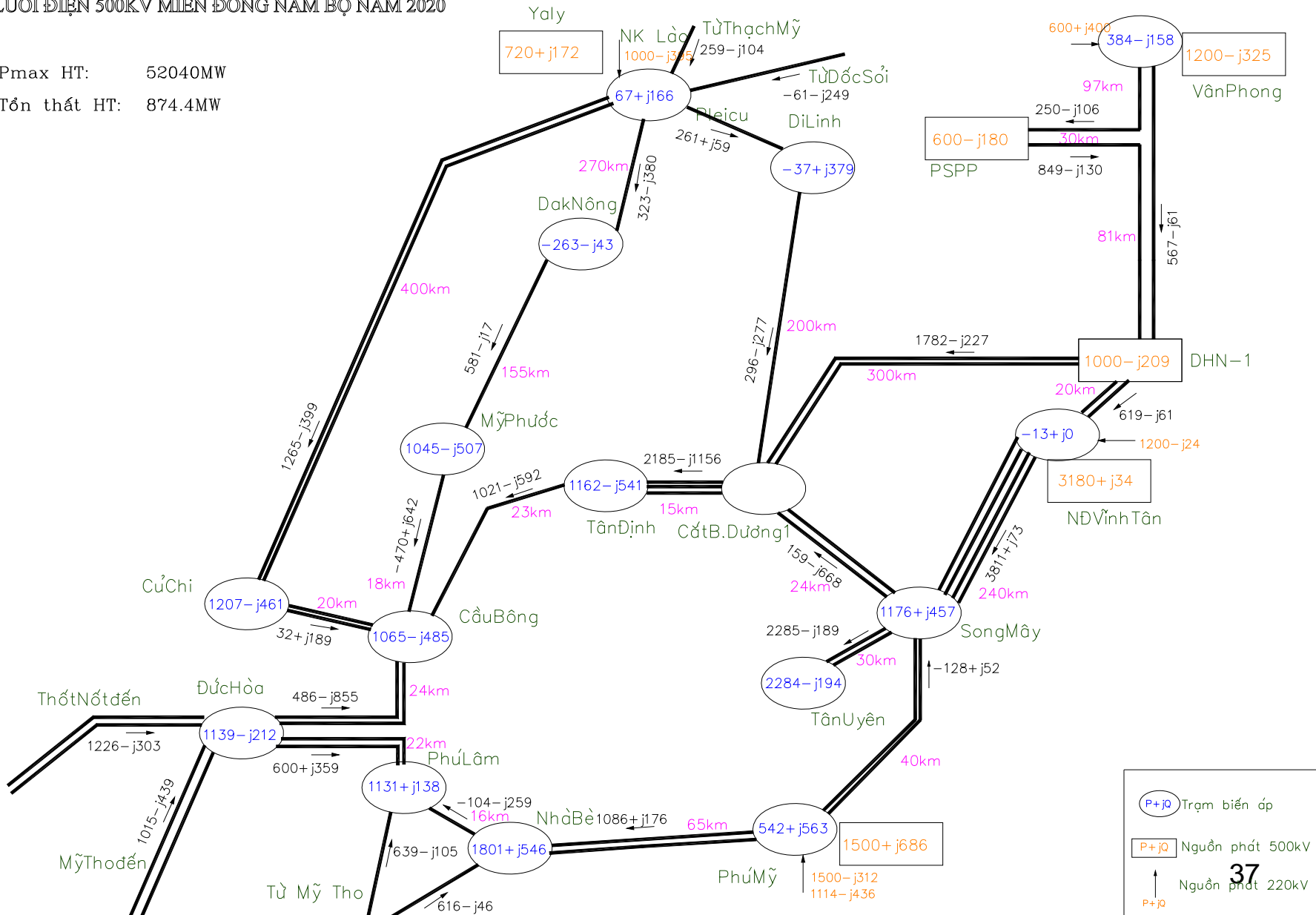

Southwest 500kV system in 2020

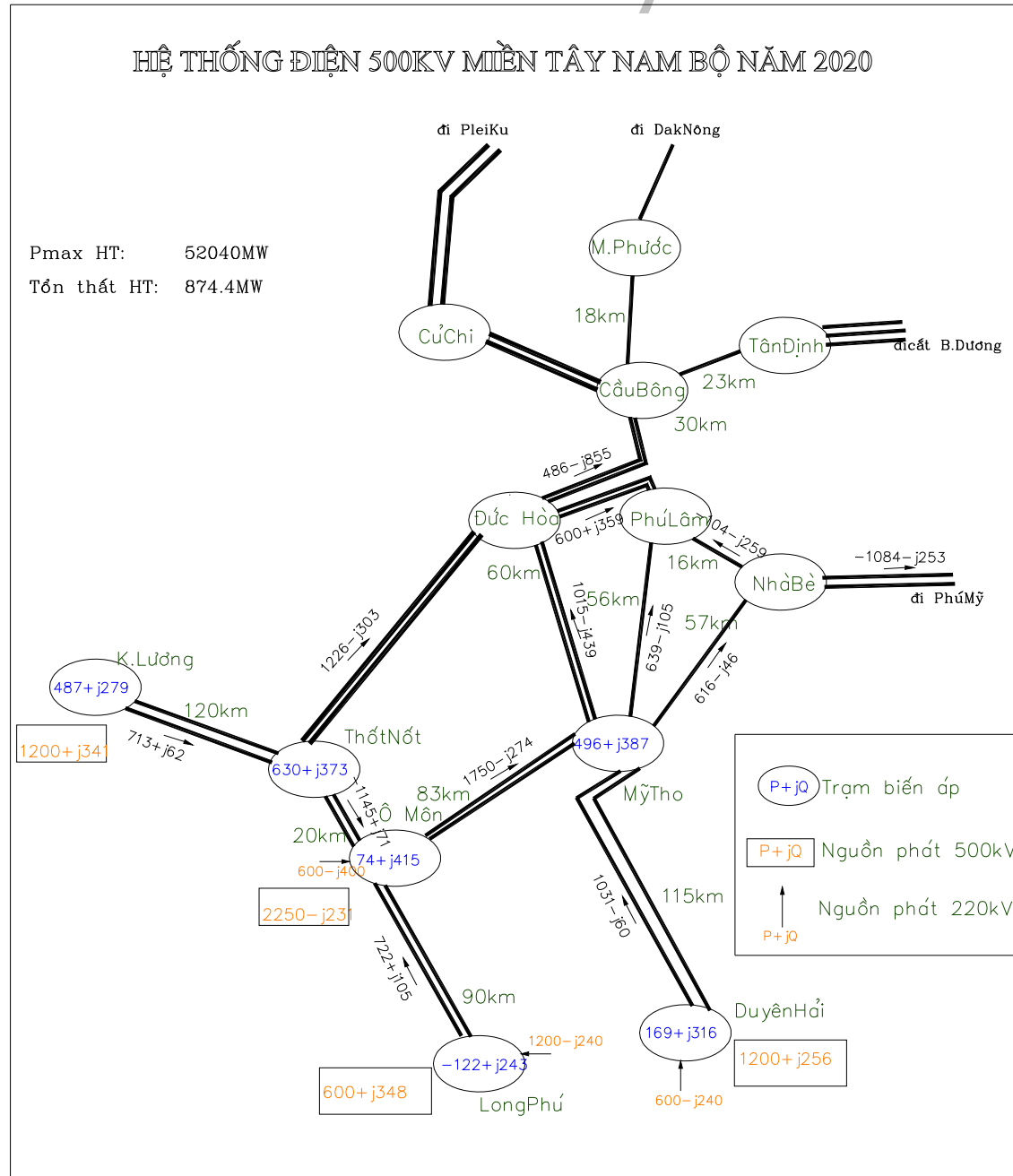

Northern & north Central 500kV system in 2030

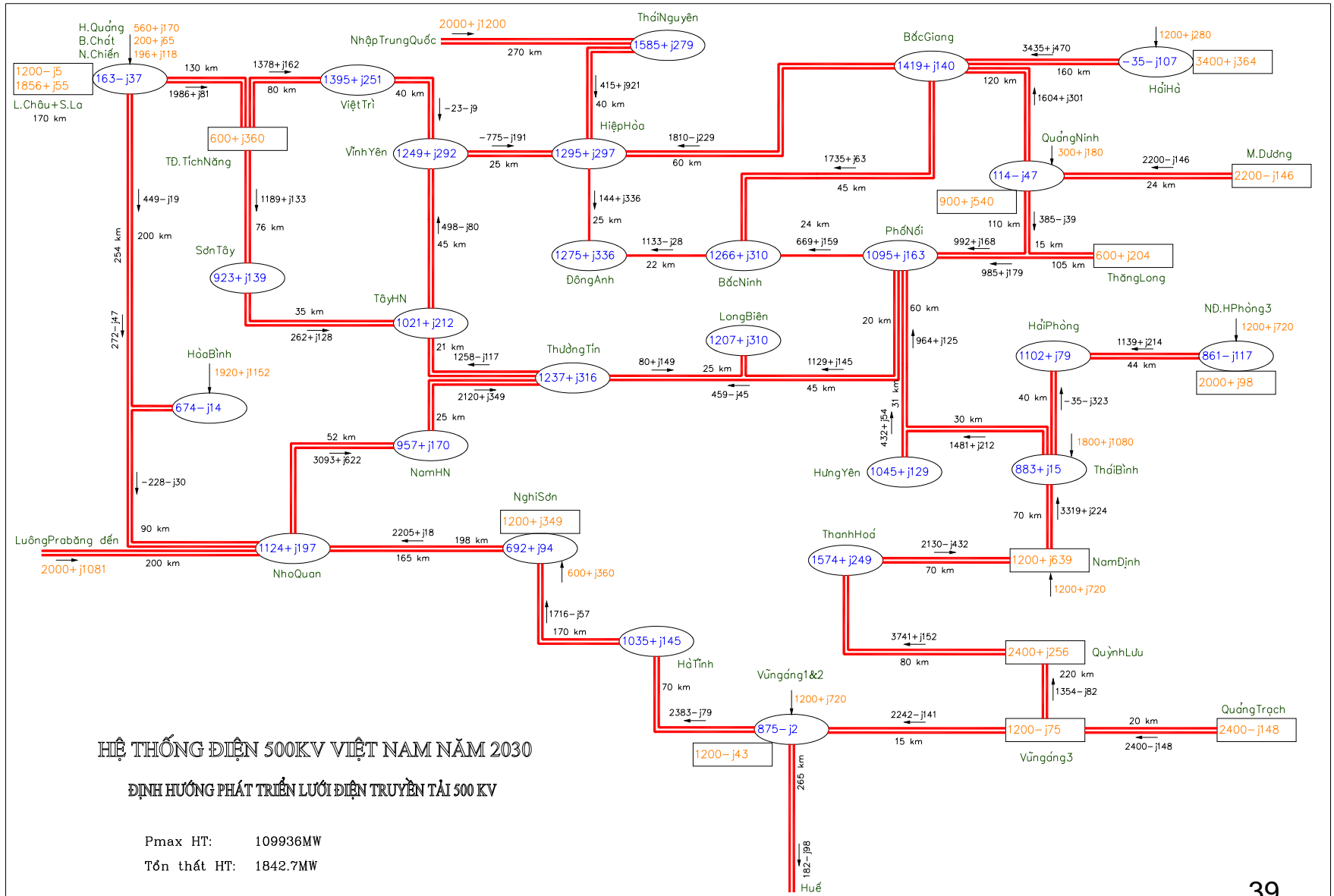

Southern 500kV system in 2030

QUY HOẠCH PHÁT TRIỂN ĐIỆN LỰC QUỐC GIA GIAI ĐOẠN 2011-2020 CÓ XÉT ĐẾN 2030
VIỆT NAM POWER SYSTEM MASTER PLAN PERIOD 2011-2020 WITH VIEW 2030

HỆ THỐNG ĐIỆN 500KV NĂM 2030 / 500KV POWER SYSTEM THE YEAR 2030
 Chế độ phụ tải cực đại / Maximum Load situation
 Điều kiện vận hành bình thường / Normal operating condition
 Pmax Hệ thống / Pmax(system): 109936MW
 Tồn thất hệ thống / System Losses: 1842.7MW

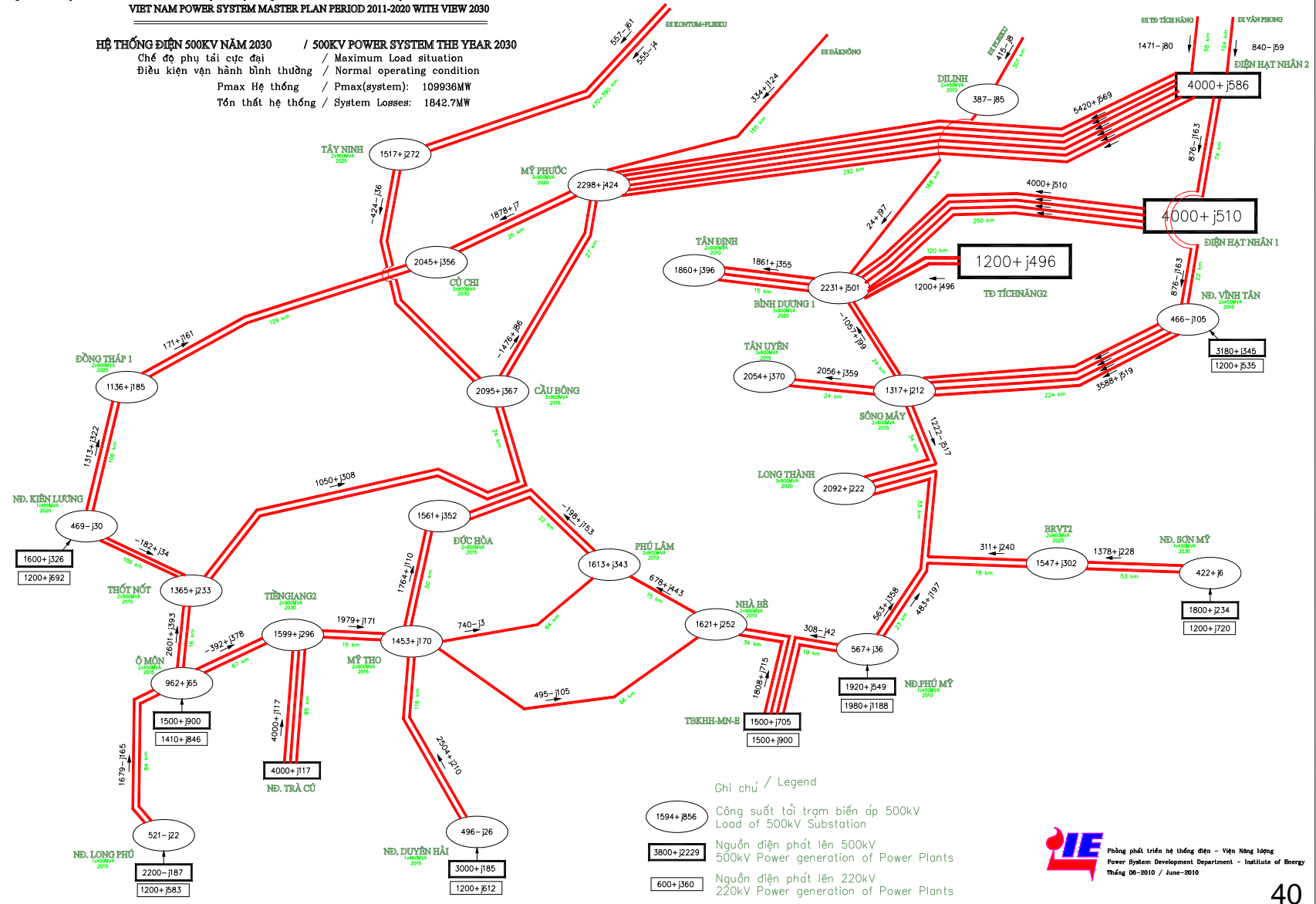

...transmission development program

Design standards for 220kV network in HCM city and Hanoi city

- **Substation:** HCM city, Hanoi area: 2(3)x250MVA, or 1-phase 2x(3x100) MVA transformers.
- **220kV network:** In Hanoi and HCM city : open operation, one substation 500/220kV feeds to 2-3 substations 220kV; Double circuit lines 2x610 (810)mm²

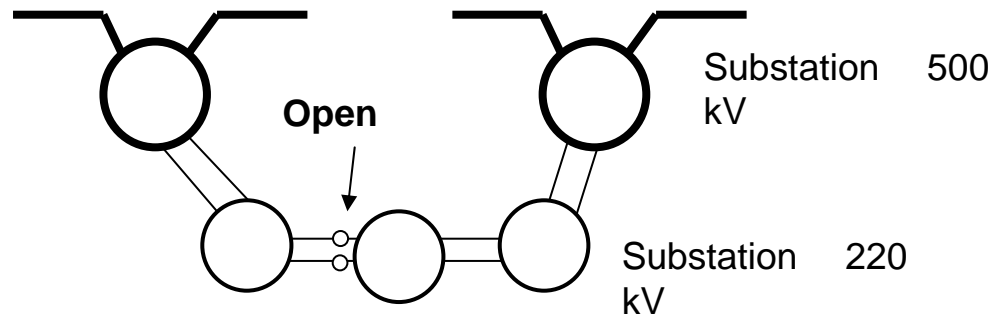

Design standards for other areas

- **Substation :** 1 (2)x125(250)MVA.
- **220kV network:** double circuit line with conductor 1(2) cores, 330-400 -600mm².

...transmission development plan

Item	Unit	2011-2015	2016-2020	2021-2025	2026-2030	Notes
500kV substation	MVA	15,750	26,850	27,450	22,800	New constructed and up-graded capacity of substation
220kV substation	MVA	37,250	36,075	41,950	54,000	New constructed and up-graded capacity of substation
500kV lines	km	1,651	2,384	1,374	980	
220kV lines	km	5,291	2,027	937	714	

Installed capacity					
Item	Unit	2015	2020	2025	2030
500kV substations	MVA	30,600	55,350	75,750	83,550
North	MVA	10,350	20,550	32,850	37,950
Central	MVA	4,950	7,350	8,250	1,050
South	MVA	15,300	27,450	34,650	44,550
220kV substations	MVA	69,271	90,087	128,633	176,139
North	MVA	24,868	39,359	55,255	73,386
Central	MVA	5,875	9,750	13,125	18,000
South	MVA	38,529	40,978	60,253	84,753

9. SEA report

Works have been being done

1. **Establishment of SEA team consisting of members from IE and other organizations**
2. **Information collection: technical-social information, natural conditions, status of national environment, forest area, reservation planning**
3. **Determining core environmental elements; development of environmental assessment matrix for PDP 7**
4. **Development of detailed SEA report**

Works to be done

1. **Getting opinions from localities with projects**
2. **Selecting typical sites for survey**
3. **Using model for ranking priority project**
4. **Feedbacks on draft alternatives in PDP-VII**
5. **Coordinating with ADB experts to perform: social survey, scenario design**
...
6. **Development of supervision of implementation according to the recommendations of SEA**

Recommendations of some solutions

1. In 2011-2014 total added capacity is ~15,000MW, of which ~8,900MW in the North, 2,100MW in the Central, but only < 4000MW in South => electricity shortage risk in 2013 -:- 2014, especially in South
2. => Focus on speeding up power plants in the south (up to 2015): thermal power complexes of α M_{αn}, V_{Ünh T_{©n}}, Duy^an Hải, 01 GTCC 390MW in Hi_{Öp Ph-íc} by late 2014;
3. Promoting HPP projects in Laos & Cambodia * transmission network for importing electricity from Laos, Cambodia to Vietnam.
4. Calculation of investment in GTCC power plants in East area using LNG instead of investment in TPP as α M_{αn V}
5. Song Hau TPP will be considered with capacity of 2x600MW
6. Starting importing coal
7. Consider PSHPP in area of Ch_{©u Th_{αn}-Ngh_Ö An}, near to large TPPs.

Recommendations of some solutions

8. Soon construction of line 500kV Pleiku – Cau Bong;
9. Ensuring construction of transmission network in harmony with power plants; upgrading series capacitors along 500kV lines; Construction of 220kV lines such as ĐakNông-Bình Long-Phước Long, Vũng Áng-Đồng Hới-Huế.
10. Considering construction of switchgear substation 500kV Bình Định 2 (in harmony with NPP 1)
11. Calculation balancing demand-supply according to base case (2011-2015:14.1%/yr), implementing development of generation according to high case (2011-2015: 16%/yr)

Thank you for attention