

THE PREPARATORY STUDY FOR
 SECTOR LOAN ON
 DISASTER RISK MANAGEMENT
 CTI Engineering International Co., Ltd.
 Nippon Koei Co., Ltd

図 7.5 (1/6)
 洪水氾濫計算結果
 (Without Project)

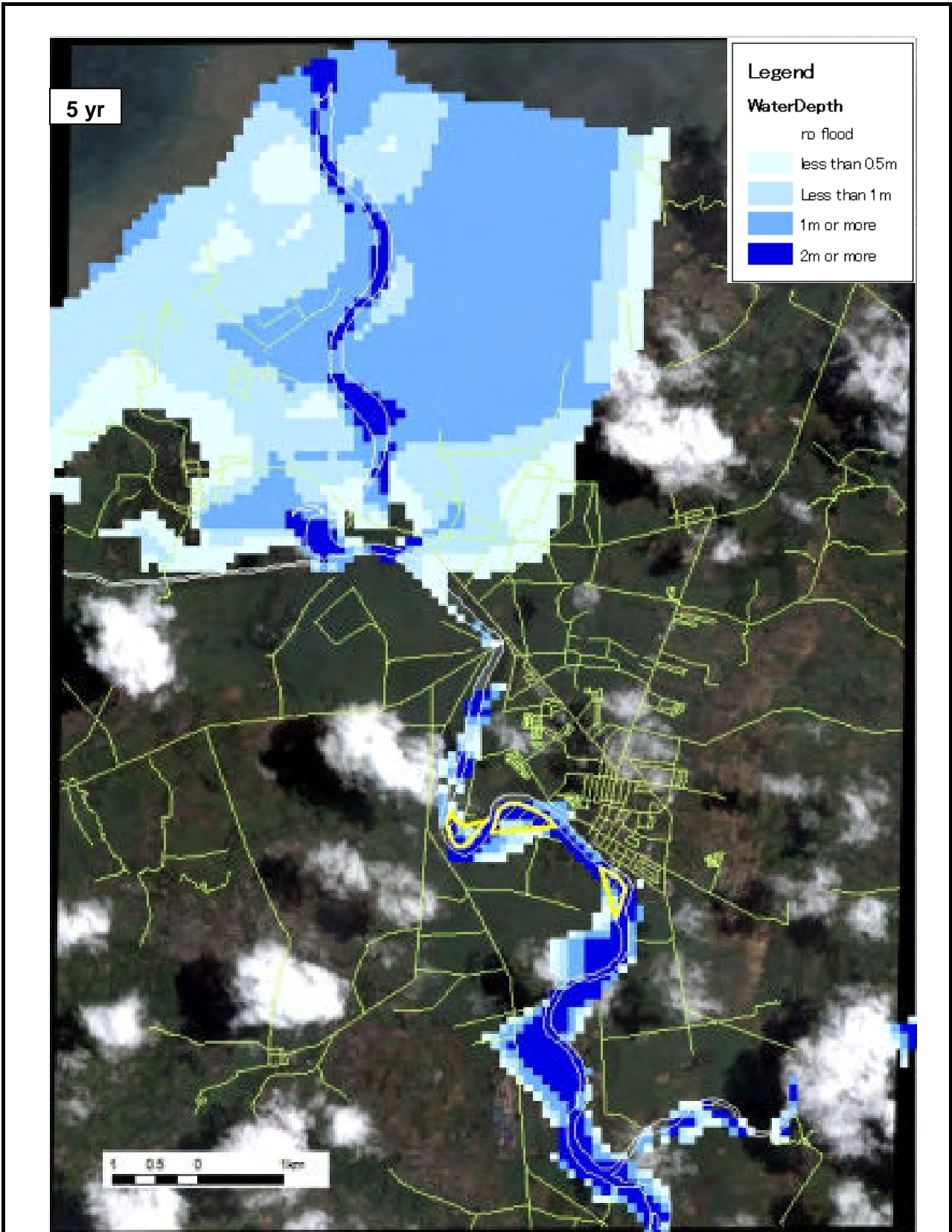

THE PREPARATORY STUDY FOR
 SECTOR LOAN ON
 DISASTER RISK MANAGEMENT
 CTI Engineering International Co., Ltd.
 Nippon Koei Co., Ltd

図 7.5 (2/6)
 洪水氾濫計算結果
 (Without Project)

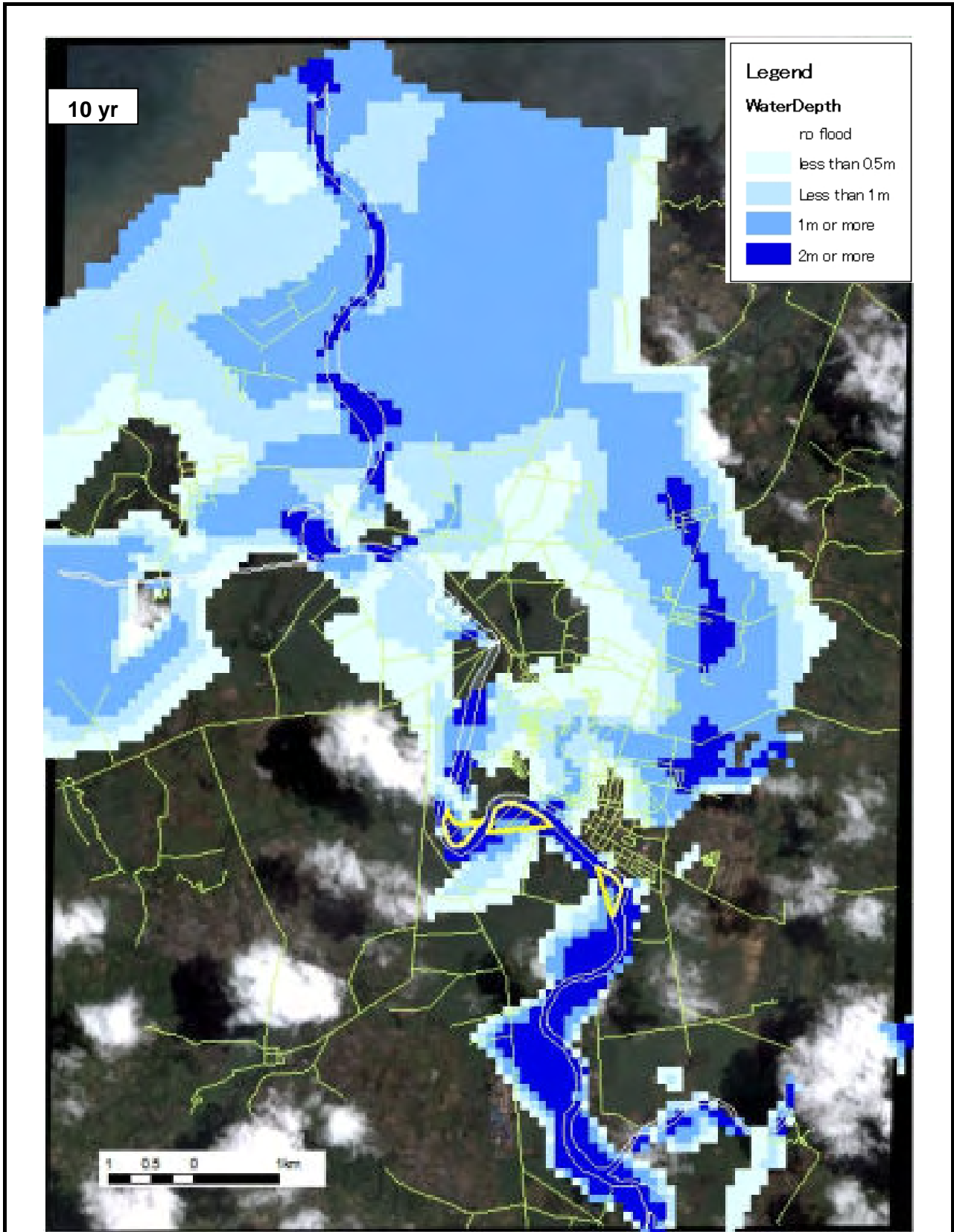

THE PREPARATORY STUDY FOR
SECTOR LOAN ON
DISASTER RISK MANAGEMENT

CTI Engineering International Co., Ltd.
Nippon Koei Co., Ltd

図 7.5 (3/6)
洪水氾濫計算結果
(Without Project)

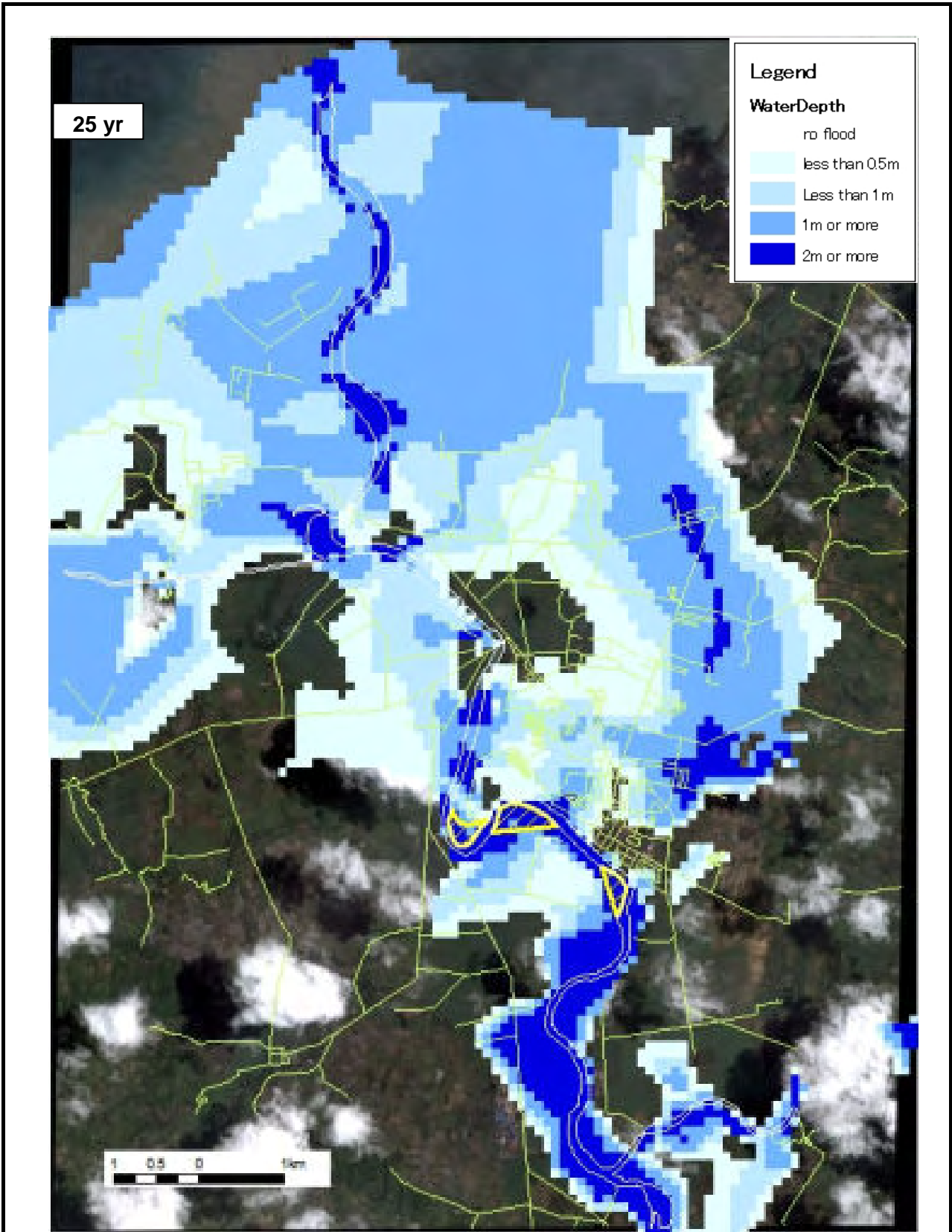

THE PREPARATORY STUDY FOR
 SECTOR LOAN ON
 DISASTER RISK MANAGEMENT
 CTI Engineering International Co., Ltd.
 Nippon Koei Co., Ltd

図 7.5 (4/6)
 洪水氾濫計算結果
 (Without Project)

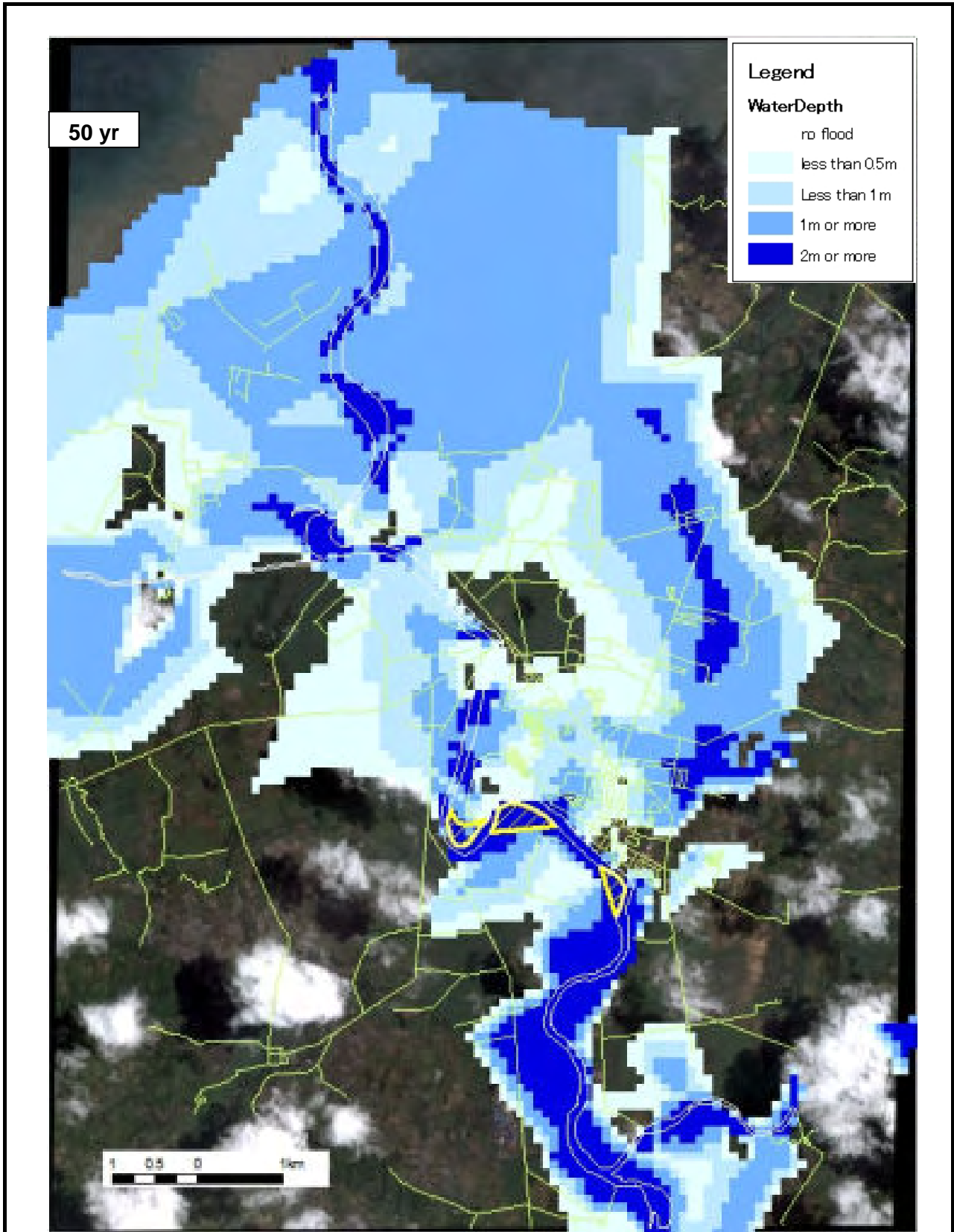

THE PREPARATORY STUDY FOR
SECTOR LOAN ON
DISASTER RISK MANAGEMENT

CTI Engineering International Co., Ltd.
Nippon Koei Co., Ltd

図 7.5 (5/6)
洪水氾濫計算結果
(Without Project)

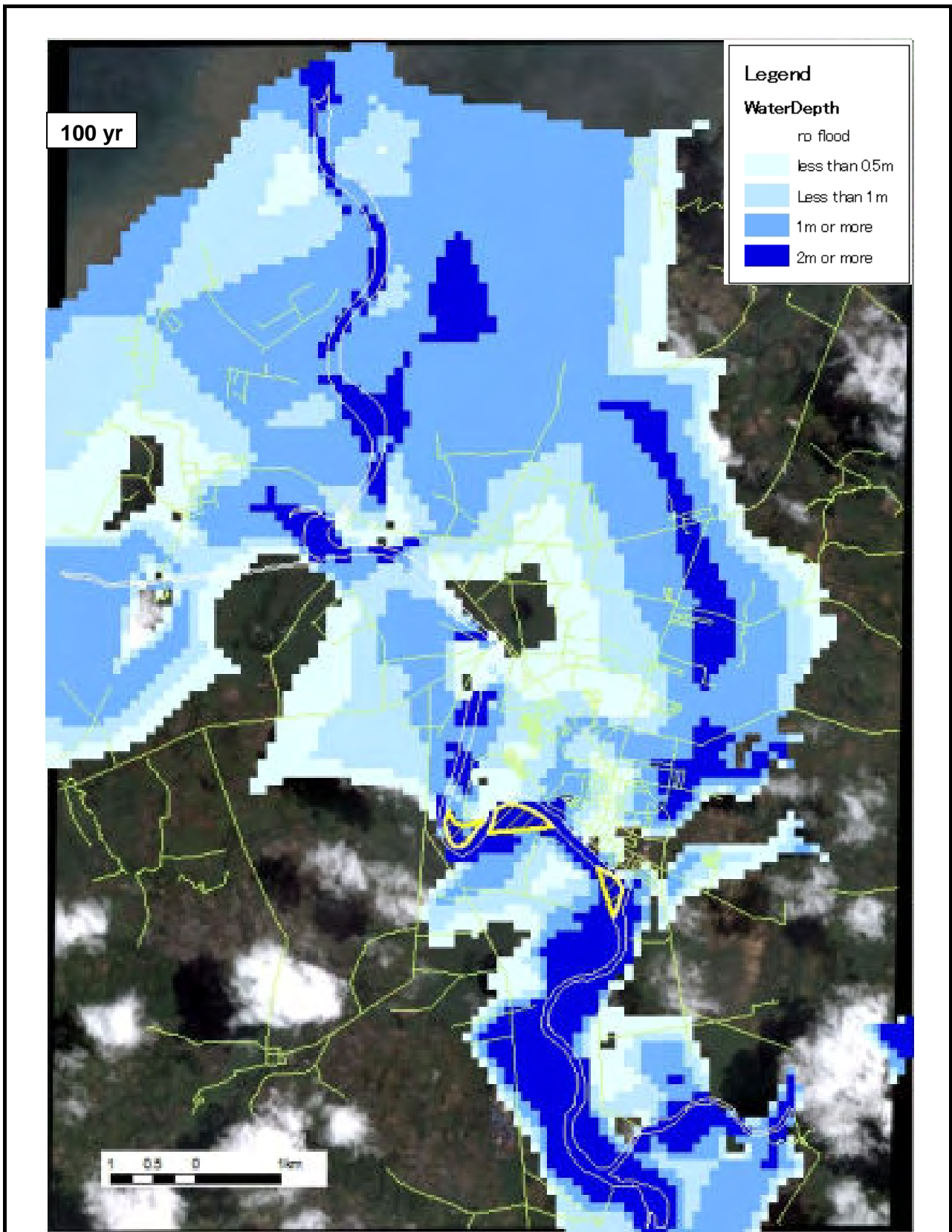

THE PREPARATORY STUDY FOR
 SECTOR LOAN ON
 DISASTER RISK MANAGEMENT
 CTI Engineering International Co., Ltd.
 Nippon Koei Co., Ltd

図 7.5 (6/6)
 洪水氾濫計算結果
 (Without Project)

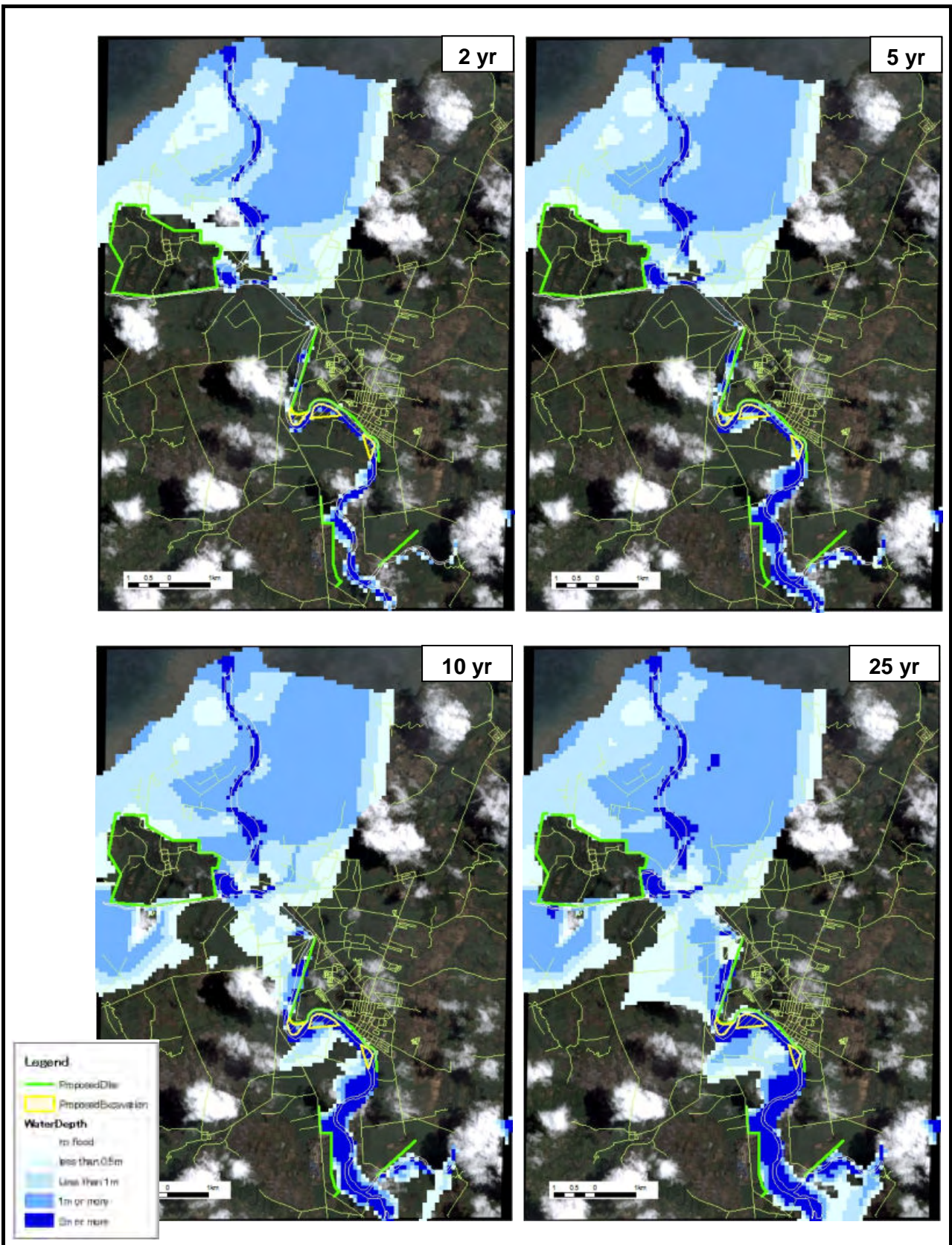

THE PREPARATORY STUDY FOR
 SECTOR LOAN ON
 DISASTER RISK MANAGEMENT

CTI Engineering International Co., Ltd.
 Nippon Koei Co., Ltd

図 7.6
 洪水氾濫計算結果
 (With Alt-I2)

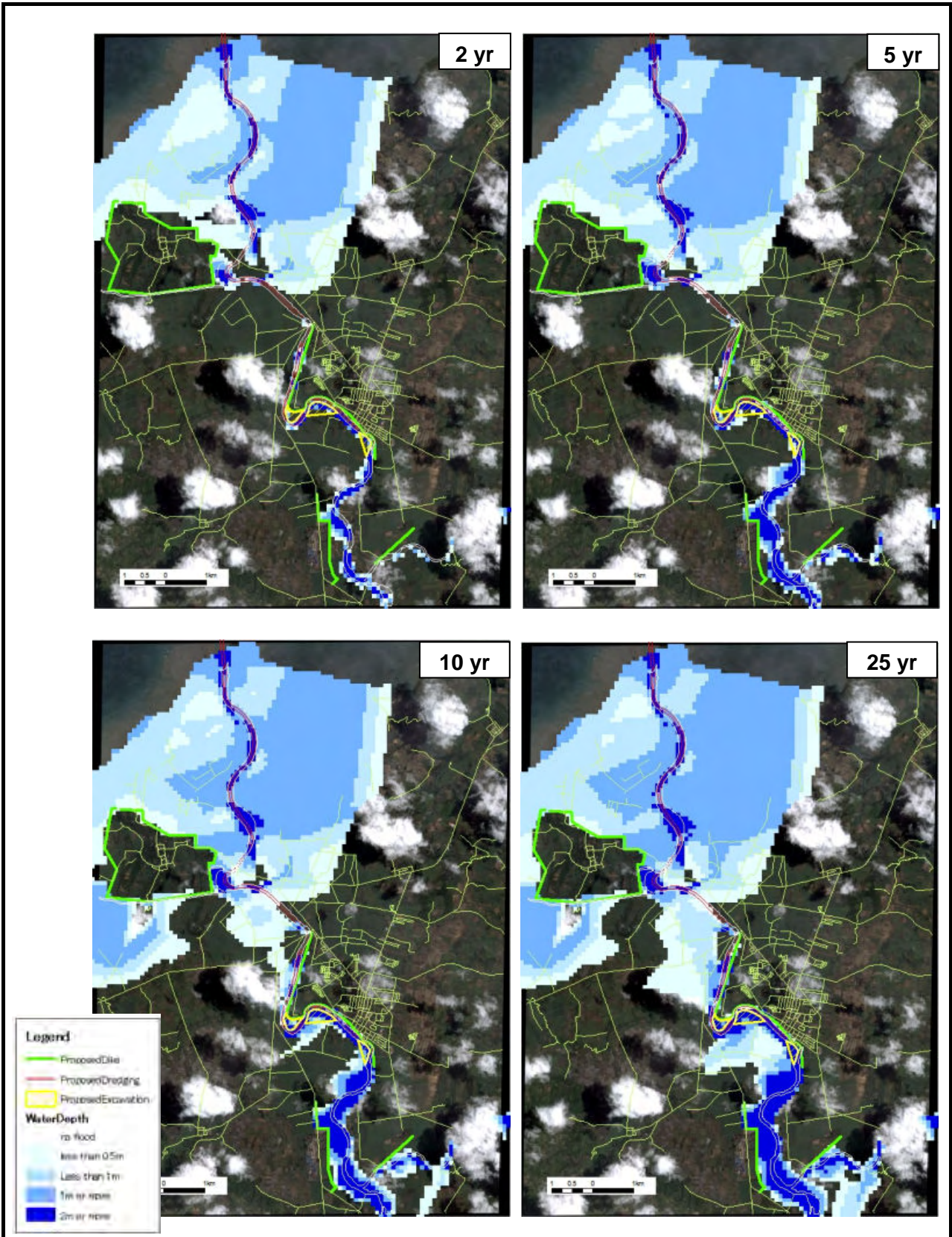

THE PREPARATORY STUDY FOR
 SECTOR LOAN ON
 DISASTER RISK MANAGEMENT

CTI Engineering International Co., Ltd.
 Nippon Koei Co., Ltd

図 7.7
 洪水氾濫計算結果
 (With Alt-I3)

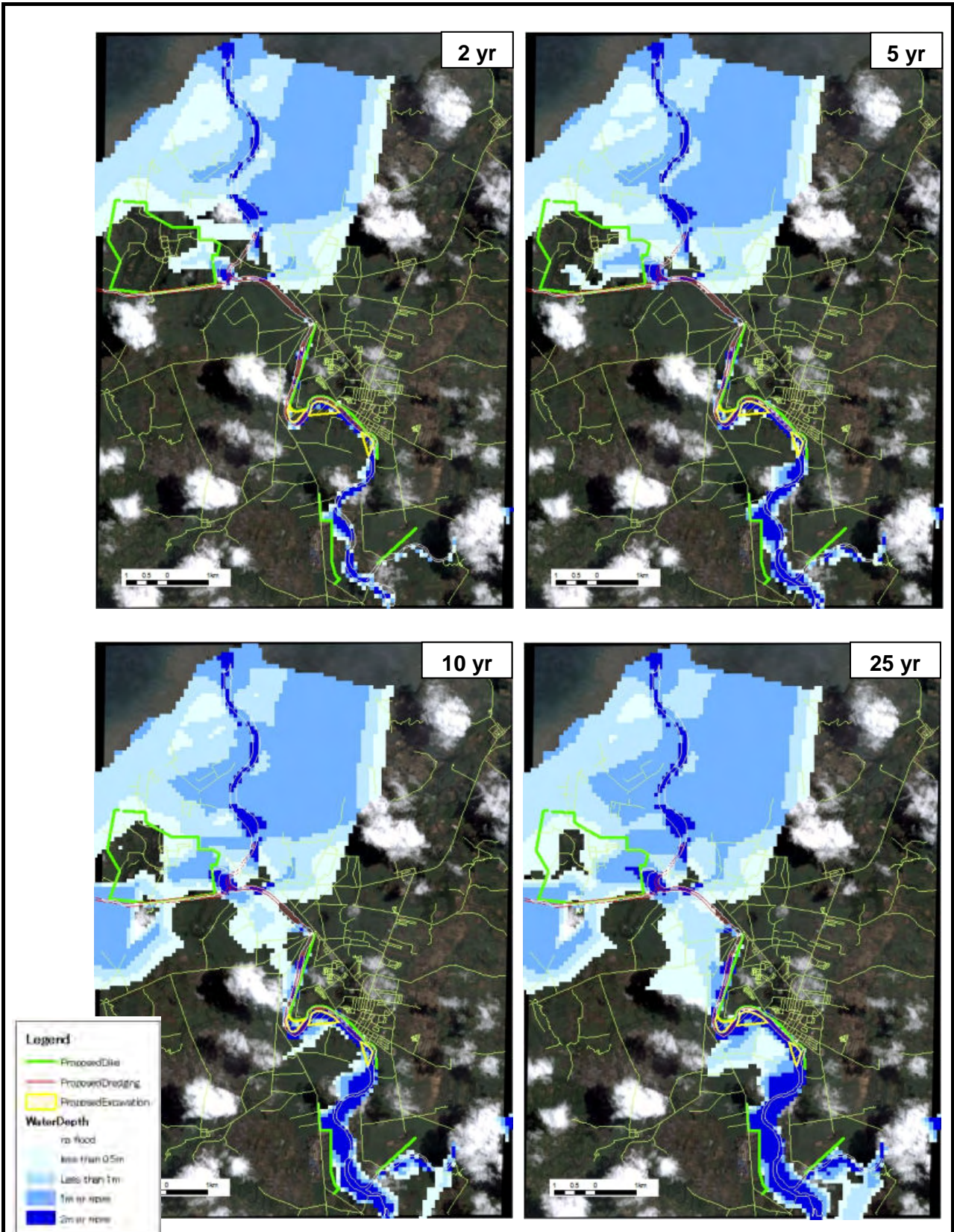

THE PREPARATORY STUDY FOR
 SECTOR LOAN ON
 DISASTER RISK MANAGEMENT

CTI Engineering International Co., Ltd.
 Nippon Koei Co., Ltd

図 7.8
 洪水氾濫計算結果
 (With Alt-I4)

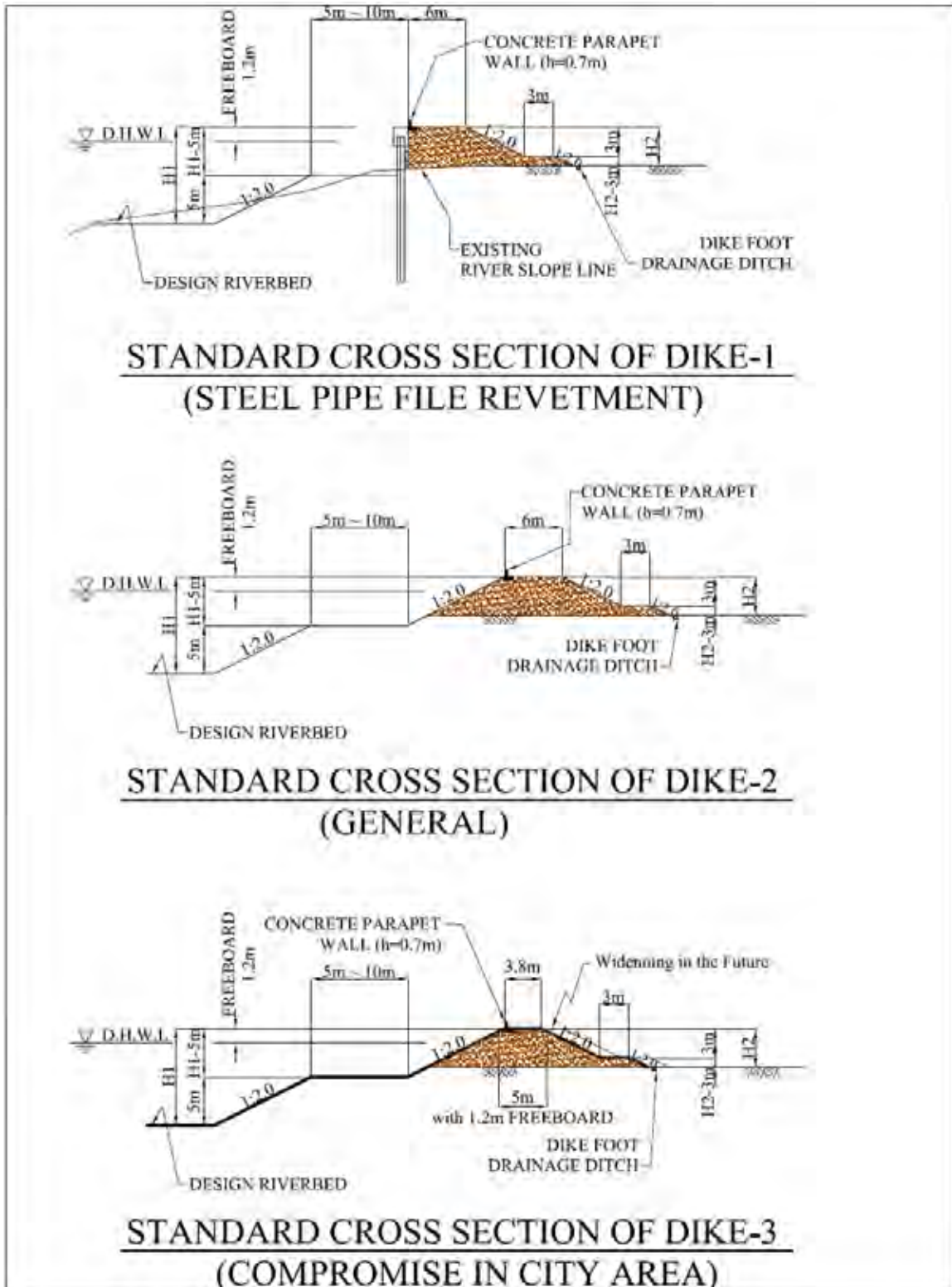

THE PREPARATORY STUDY FOR
SECTOR LOAN FOR
DISASTER RISK MANAGEMENT

CTI Engineering International Co., Ltd.
Nippon Koei Co., Ltd

図 7.9
Ilog-Hilabangan 川治水対策で提案する
河川堤防の標準断面

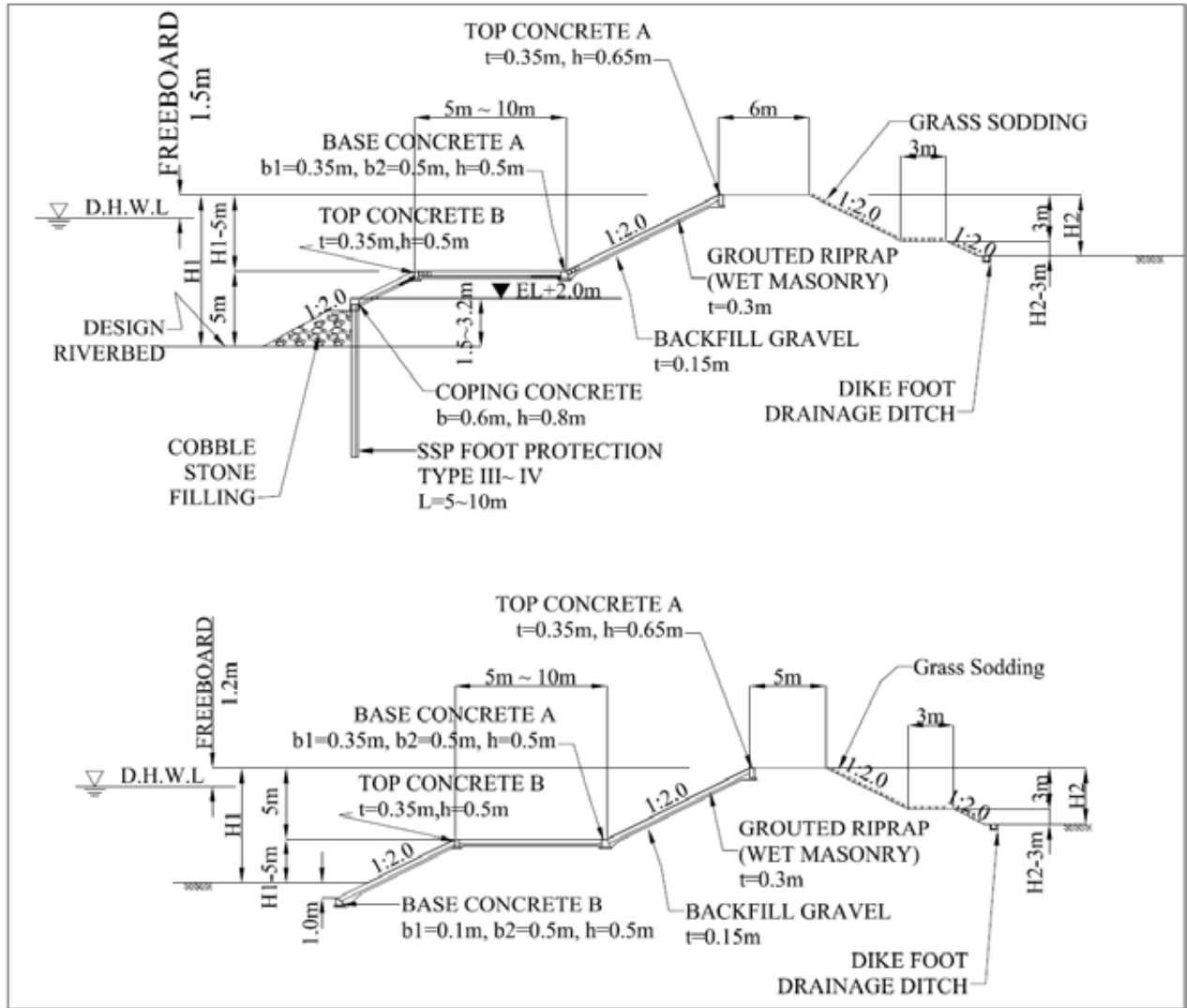

THE PREPARATORY STUDY FOR
SECTOR LOAN FOR
DISASTER RISK MANAGEMENT

CTI Engineering International Co., Ltd.
Nippon Koei Co., Ltd

図 7.10

Ilog-Hilabangan 川治水対策で提案する
護岸及び法面保護の標準断面

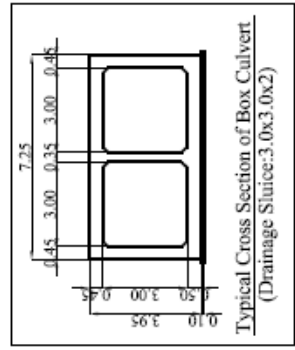
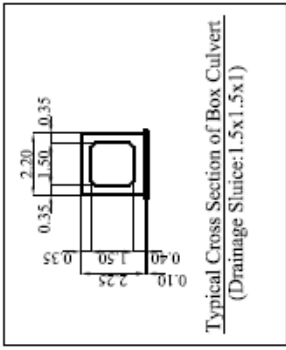
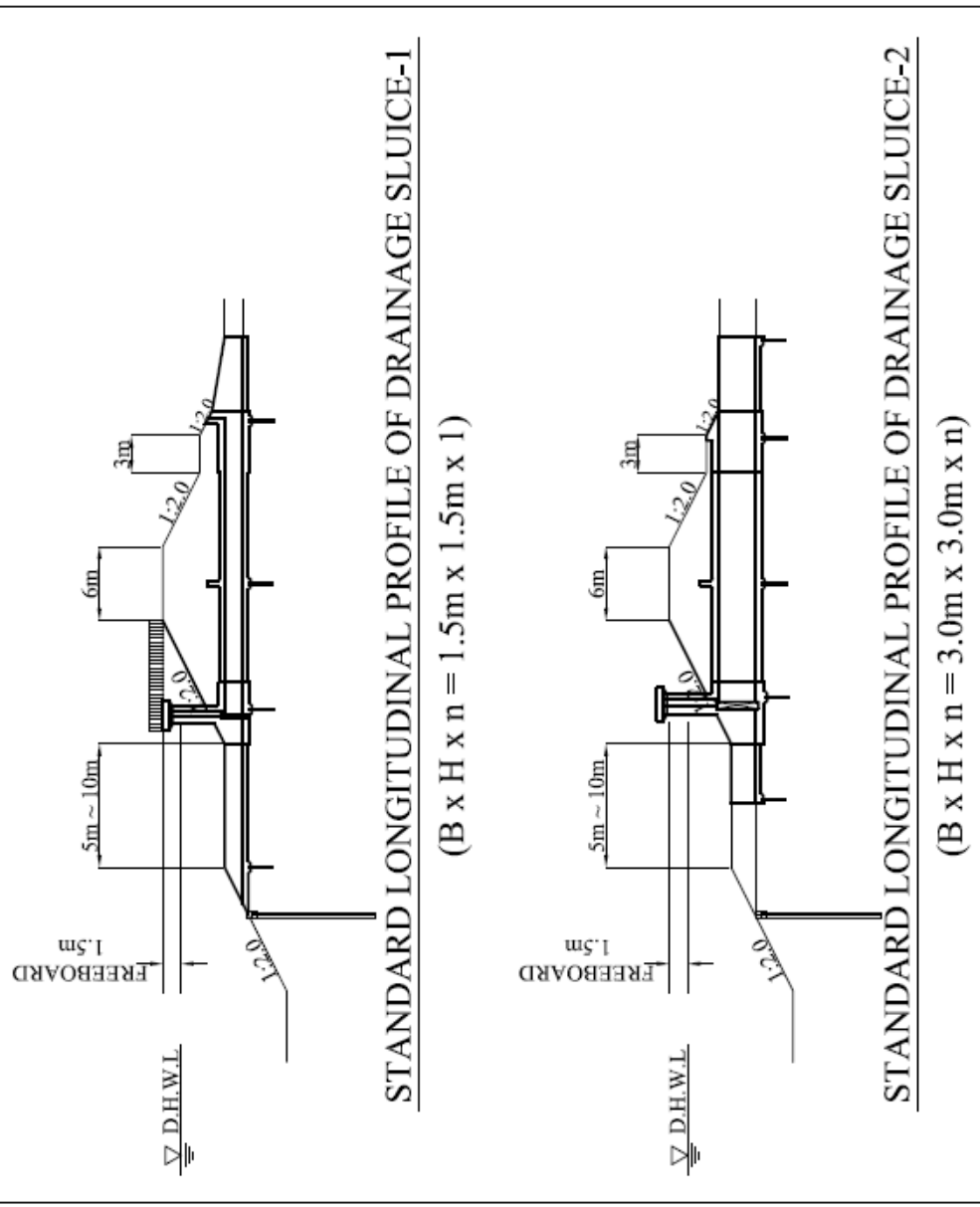

THE PREPARATORY STUDY FOR
SECTOR LOAN FOR
DISASTER RISK MANAGEMENT

CTI Engineering International Co., Ltd.
Nippon Koei Co., Ltd

図 7.11
Ilog-Hilabangan 川治水対策で提案する
排水樋門の標準図

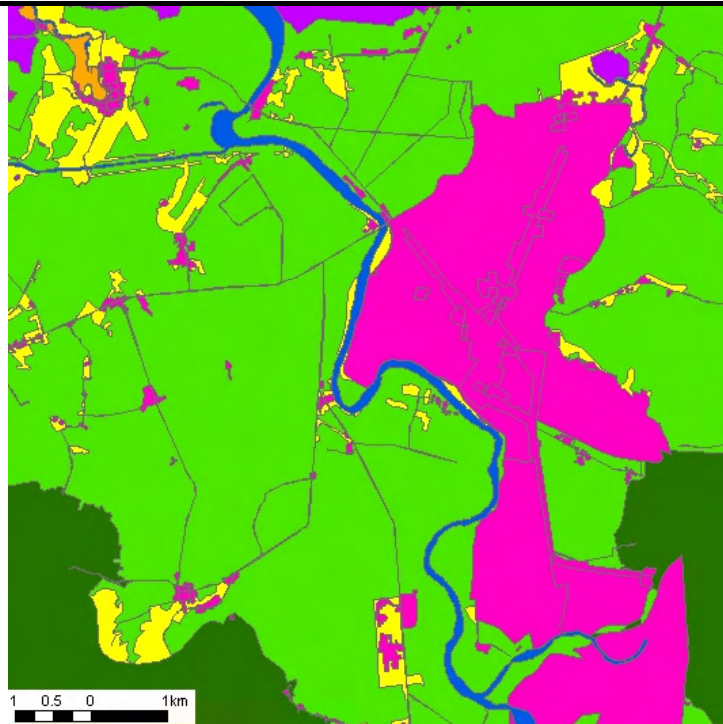

Future Land Use Condition (Newly Developed Area: 13.7km²)

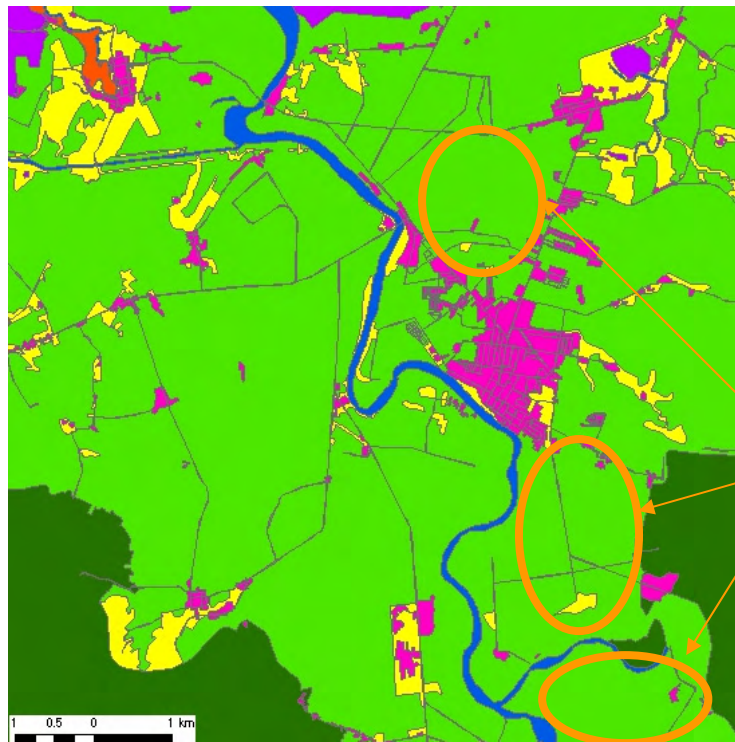

Expected
Disposal
Site

Existing Land Use Condition with Expected Disposal Site for Surplus Soils

THE PREPARATORY STUDY FOR
SECTOR LOAN FOR
DISASTER RISK MANAGEMENT
CTI Engineering International Co., Ltd.
Nippon Koei Co., Ltd

図 7.12
Ilog-Hilabangan 川治水対策の
余剰土砂の土捨て場候補地

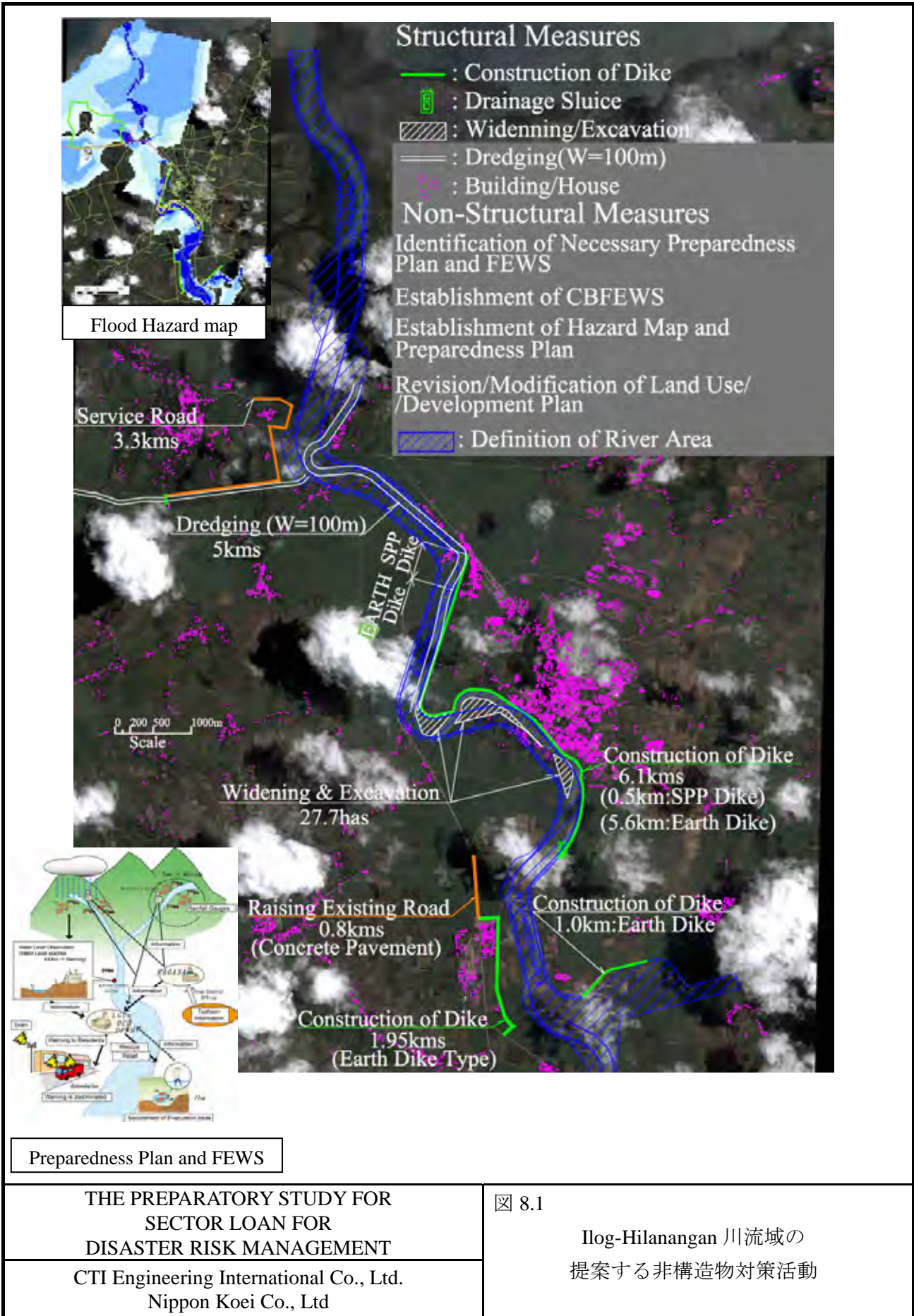

THE PREPARATORY STUDY FOR
SECTOR LOAN FOR
DISASTER RISK MANAGEMENT

CTI Engineering International Co., Ltd.
Nippon Koei Co., Ltd

図 8.1 Ilog-Hilanangan 川流域の提案する非構造物対策活動

