

6. PRELIMINARY ENGINEERING DESIGN

6.1 Road Design

6.1.1 Road Design Condition

(1) Design Standards

Design standards applicable to the project are the Ugandan Road Design Manual, comprising of four (4) volumes: i.e. Geometric design manual, Hydrology and hydraulics design manual, Pavement design manual and Bridge design manual.

The Ugandan road design manuals are based on the SATCC standards, and as such the SATCC Standard is applicable for the road design of the Project if found to be necessary. Additionally, the AASHTO Standard which is recognized worldwide as the most popular and authorized design standard for road designs will also be used as reference in certain cases.

(2) Design Criteria for the Road Study

The road study was determined to fall under Class Ib Paved Road thus satisfying international road design standard which is compatible with the design Class of the Bugiri-Jinja Road. The design parameters as shown in Table 6.1 were formulated based on the foregoing.

Table 6.1 Design Parameters

Parameters	Unit	Applied	AASHTO	SATCC		Uganda			Remarks
Design Speed	km/h	80	100-120	80	100	80	100	120	-
Design Vehicle	m	Semi trailer combination large* W=2.6, L=16.7, H=4.1	-	WB-15 (Semi-Trailer) W=2.6, L=17, H=4.1		Semi trailer combination large* W=2.6, L=16.7, H=4.1			*Second largest vehicle (DV-4) Maximum legal freight is 4.0m (refer to 5.1 in the design manual)
Lane Width	m	3.5	3.6	-	-	3.5*	3.5*	3.65*	Less relationship to the design speed
Shoulder	m	2.0	Min 1.25	-	-	2.0	2.0	2.5	-
Min .R. of Horizontal Curve	m	240	280*	250	400	240	415	710	*In case of 4% of crossfall
Min. Curve Length	m	-	Not specified	300 (absolute 150)		Not specified			-
Min. R. of Curve for omitting Transition	m	1200	-	-		1200*	2300*	4000*	*R < (Design Speed) ³ / 432 : Rounded
Stopping Sight Distance	m	115	110	115	155	115	160	205	-
Max. Grade	%	6.0	4.0	5.0% (Flat)	4.0% (Flat)	6.0-8.0	4.5-6.5	3.0-4.0	-
Critical Length of Steep Section	m	-	-	240	300	Not specified			5% for 450m
Min. R. of Sag Curve	m	2500	2600	2500	3600	2500*	3700*	5000*	*Assumed from stopping sight distance
Min. R. of Crest Curve	m	2100	2600	3300	6000	3200*	8000*	10300*	*Assumed from stopping sight distance
Max. Superelevation	%	4.0	-	-	-	7.0 (4.0)*	7.0	7.0	*4.0% is applied for urban area.
Pavement Crossfall	%	2.5	-	-	-	2.5	2.5	2.5	-
Height Clearance	m	5.0	-	-	-	5.0			-
Right of Way	m	-	-	-	-	50-60	60	60	-

Source: JICA Study Team

6.1.2 Preliminary Road Design

(1) Geometrical Design

Horizontal Alignment Design

The horizontal alignment design is outlined in Figure 6.1.

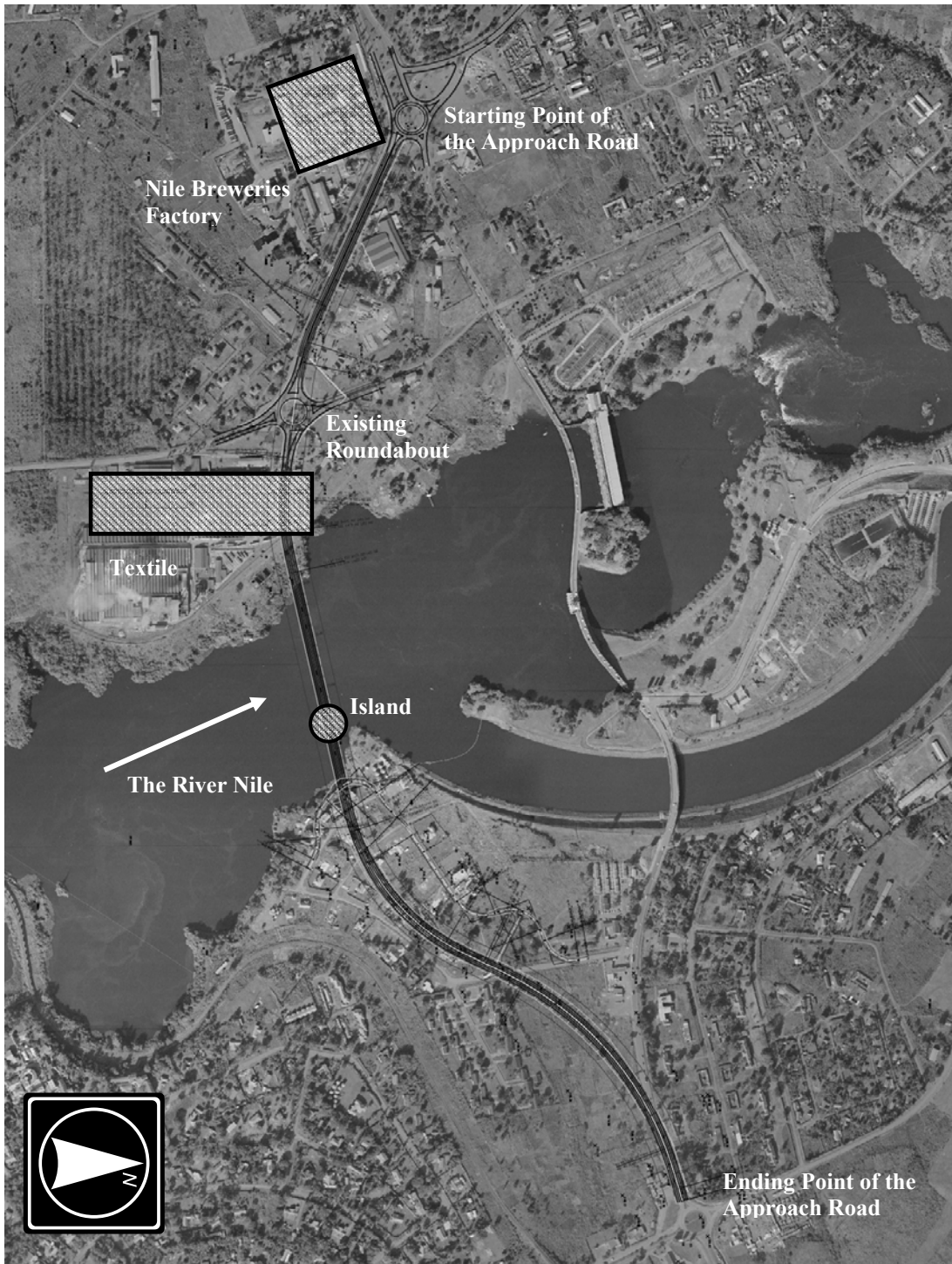

Source: JICA Study Team

Figure 6.1 Outline of Horizontal Alignment Design

Typical Cross Section Design

The project is divided into 5 segments composing of No.0- No.5, No.5-No.7+85, No, 7+85-No.13+10 and No.13+10-No.14+91 and No.14+91-No.23+53.698(ending point) as shown in Figure 6.2 below.

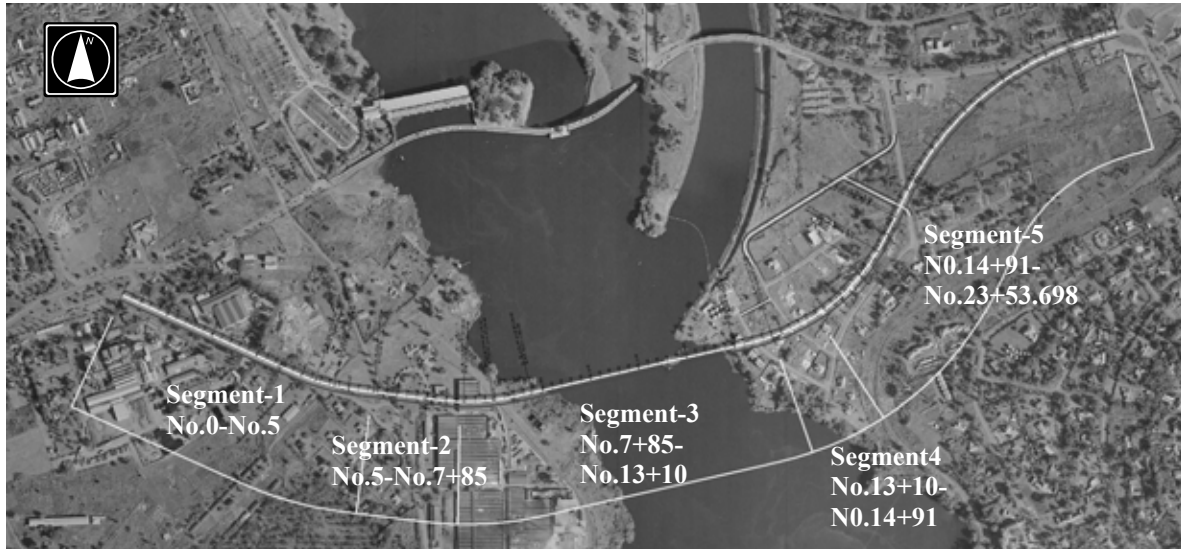

Source: JICA Study Team

Figure 6.2 Segments for Cross Section

Cross-section designs are based on geometric design standard and land uses along route of the project. The typical cross sections for segments 1, 3 and 5 are formulated as shown in Figures 6.3 through 6.5.

◆ **No.0- No.5 (Segment-1): Njeru Town**

The cross section for this segment was conceived to minimize areas from being affected by the development of the Project. to curtail land acquisition cost..

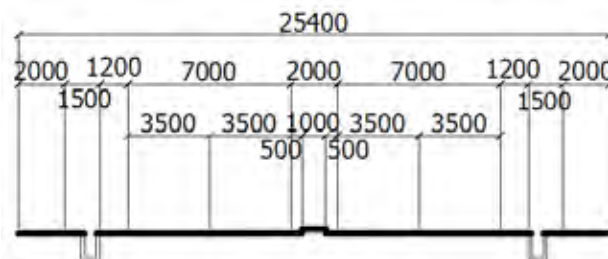

Figure 6.3 Cross Section for Segment-1

◆ **No.7+85-No.13+10 (Segment -3): Bridge**

This segment is the bridge section. Median width is set at 2.3m to cover the space needed for the installation of cables for the bridge.

Pedestrian lane, 2.25 wide including the space for safety facility at 0.25m in width will be provided on both sides of the bridge.

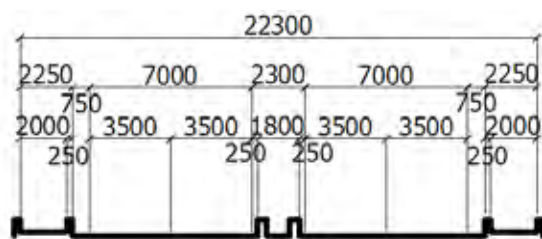

Figure 6.4 Cross Section for Segment-3

◆ No14+91-No.23+ 53.698 (Segment -5): Jinja City

The cross section of this segment satisfies the standard requirement for Class Ib Paved Road. It is also compatible with the Bugiri-Jinja road as a continuation of the project road.

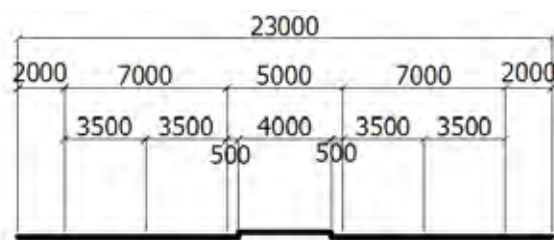

Figure 6.5 Cross Section for Segment-5

(2) Pavement Design

Subgrade Design

“Black Cotton Soil” is observed to exist along the project road. The black cotton soil will be replaced with 1 m thick of good borrowed materials to improve the subsoil conditions. The subgrade value will depend on the quality of borrow materials to attain CBR of more than 15% based on Ugandan Standard. Based on the above, the subgrade design value shall satisfy CBR 15%.

Design Pavement Layer Thickness

It is desirable to adopt the same materials and pavement thickness as used for the Bugiri-Jinja Road. As such the pavement design thickness adopted for this Project is as shown in Table 6.2 hereunder.

Table 6.2 Pavement Design Thickness

Material	Layer Coefficient (L)	Thickness (T) mm	LxT
AC	0.35	60	21.0
Dense Bitumen Macadam Binder Course	0.20	150	30.0
Graded Crushed Stone Base	0.14	175	24.5
Crushed Stone Subbase	0.11	200	22.0
		$\Sigma L.C.x T=25.4$	3.8

Source: JICA Study Team,

(3) Intersection Design and Feeder Road

Based on the selected project alignment, six (6) intersections with the existing road network are identified as shown in Figure 6.6.



Source: JICA Study Team,

Figure 6.6 Intersections with Existing Road Network

Njeru Town

On the Njeru side, there are two (2) existing intersection points with roundabout type of crossings. Two (2) options are being considered for the intersections and these are the junction and the roundabout types. Comparisons between the two options for each point were made based on various aspects including Speed of Mobility, Safety, Local Access, Resettlement, Maintenance and Construction Cost. Consequently, the roundabout type intersection was adopted for both Points No.1 and 2 as shown in Figure 6.7 below.



Adopted Roundabout at No.1



Adopted Roundabout at No. 2

Figure 6.7 Intersection Types to be Adopted for Points No.1 and 2

Jinja City

Four (4) intersection points were identified with the existing roads. Intersection point No.6, however, should remain as it is. The intersections at points No.3 and 4 should be consolidated with point No.5 by providing a feeder road crossing facility passing under the New Nile Bridge as shown in Figure 6.8.



Source: JICA Study Team

Figure 6.8 Feeder Road Plan in Jinja City (Consolidated Plan for Intersection Points No.3, 4 and No)

For intersection No.5, the junction was conceived not to allow the crossing of traffic with the proposed road, and for this reason the median of the study road is un-opened at the junction.

(4) Local Traffic Management

Given the above intersection and feeder road arrangements, local traffic will be managed as shown in Figure 6.9.

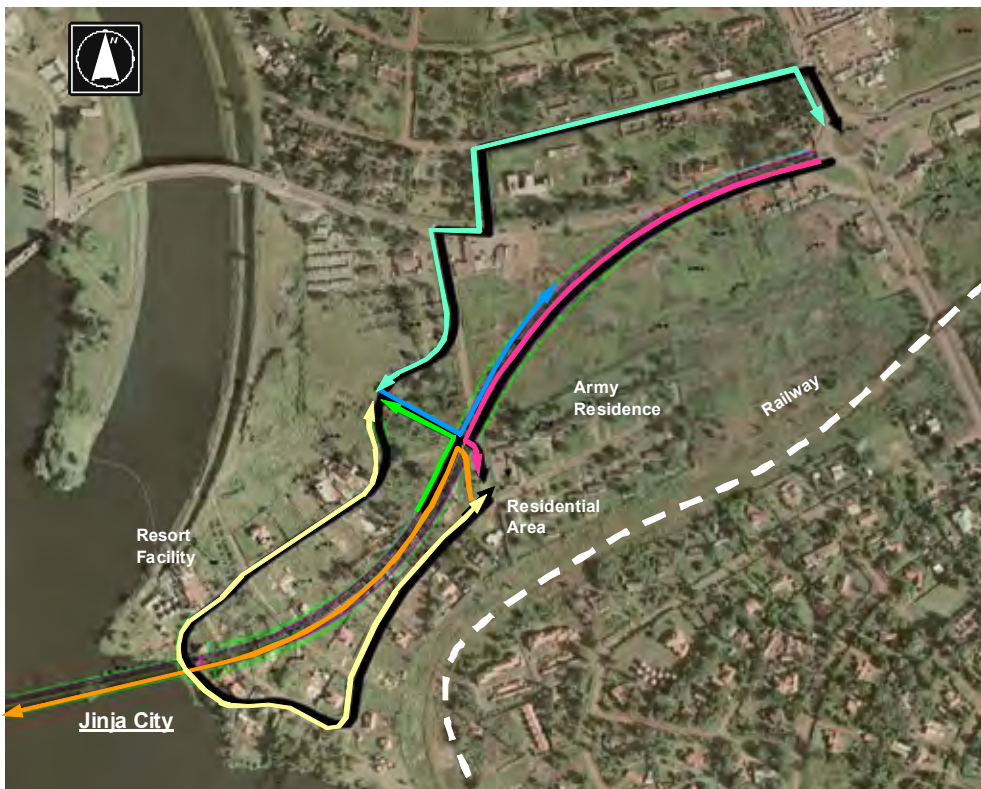
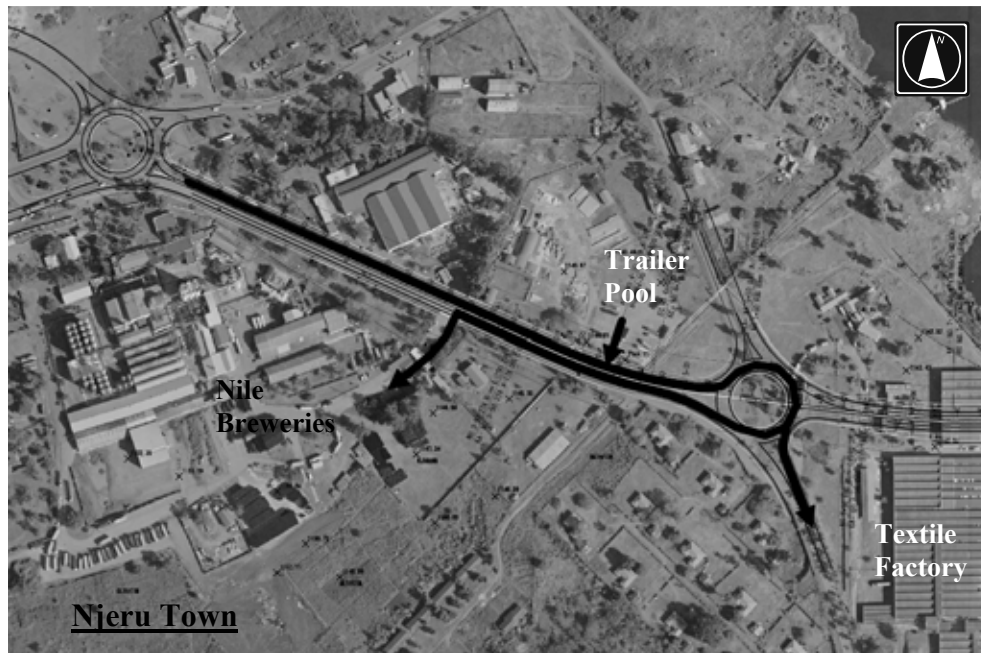

Source: JICA Study Team

Figure 6.9 Local Traffic Management

6.2 Bridge Design

6.2.1 Design Conditions for the Bridge

Based on the result of the discussions with UNRA and MOWT, the standards to be used for the design of the bridge are listed as follows:

Main Standard

- Road Design Manual Volume 4 : Bridge Design, Ministry of Works, Housing and Communications, 2005

Secondary Standard

- Latest British Standard BS 5400
- BS 8002:1994, Earth retaining structures
- BS8004: 1986, Foundations
- AASHTO LRFD 2007, Section 3

Regarding the obstacle aviation restrictions of Jinja airfield, it was officially confirmed that the development of the bridge should follow the regulation restrictions in accordance with the results of the discussions with CAA (Civil Aviation Authority) and relevant agencies.

6.2.2 Preliminary Bridge Design

(1) Introduction

The preliminary designs of the bridge were based on the chosen structures of the study for Optimum solution to Cross the River Nile at Jinja.

1. Prestressed concrete three-span cable-stayed bridge, with 290m main span, 100m left hand side span and 135m right hand side span, for a total bridge length of 525m.
2. The structure of 100m left side span will be the semi-underground beam type.
3. The structure will be provided with Inverted Y shape Pylons.
4. Spread type of footing will be used for the foundations on land (P1).
5. Cast in Place Concrete Pile with Steel Casing for foundations will be used on the island (P2).

(2) River Characteristics

The maximum water depth at flood condition at the Location of the Bridge was estimated at 25.5m, based on the flood water level as determined by the dam operation rules shown in Table 6.3 below.

Table 6.3 Flood Water Level at Bridge Location

Flood Water Level	1135.0 m
Riverbed Level	1109.5 m
Flood Water Depth	25.5 m

Source: JICA Study Team

(3) Geological Conditions

Figure 6.10 shows the location of pits carried out for the drilling investigations. As shown the investigations were conducted on both sides of the river. A trial pit was excavated on the island to determine the geological conditions.

Figure 6.11 shows the profile layers of the subsoil conditions the results of the drilling and trial pit investigations.

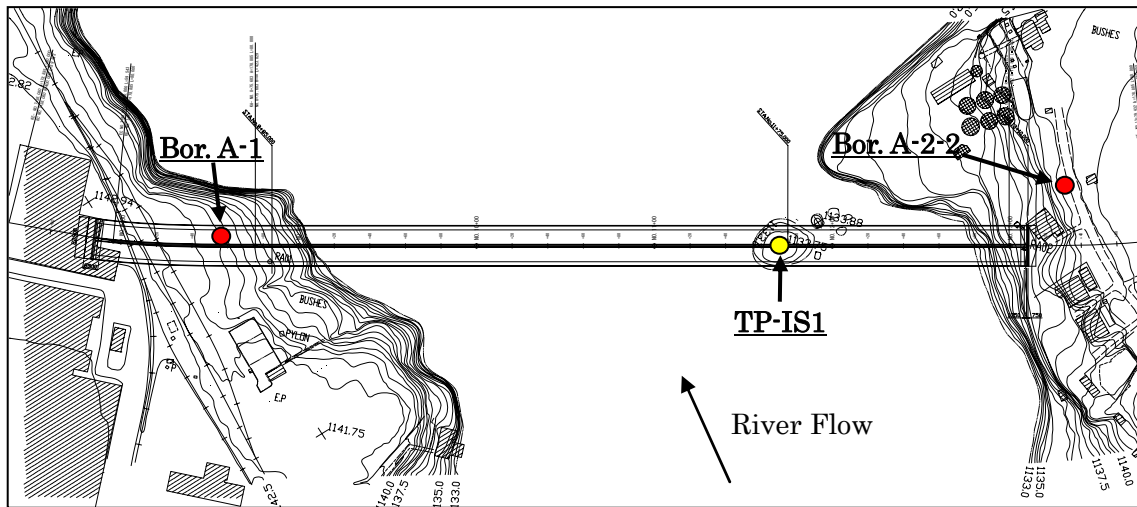
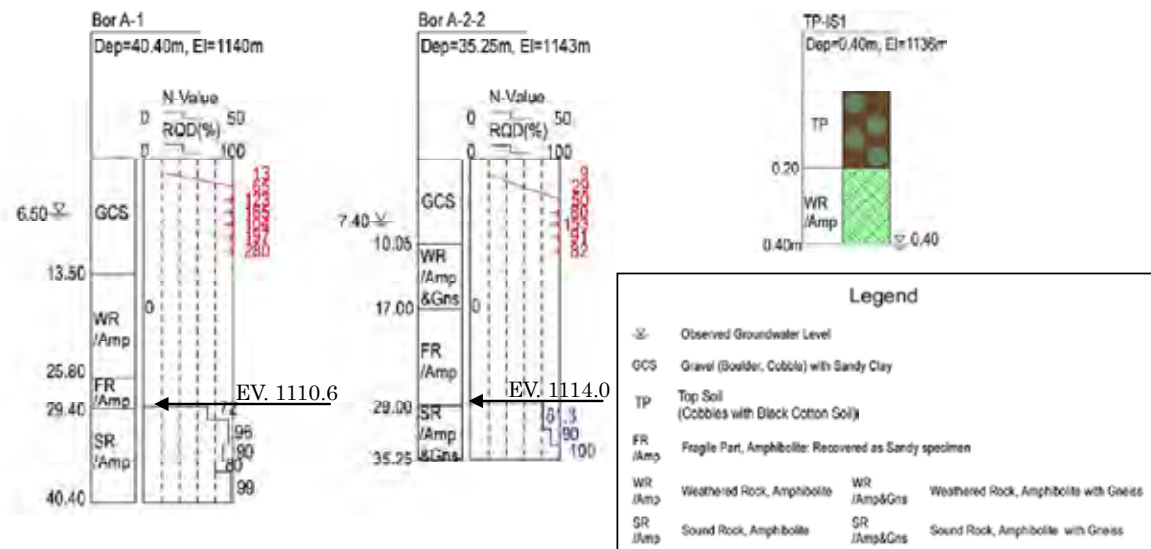

Figure 6.10 Location of Drilling and Trial Pit



Source: JICA Study Team

Figure 6.11 Boring Logs and Trial Pit

Figure 6.12 shows the assumed geological profiles at the Bridge Location based on the drilling and trial pit results. The assumed design parameters are shown in Table 6.4.

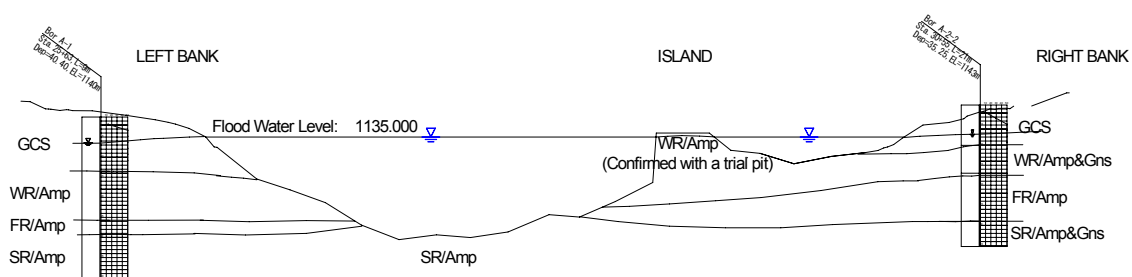

Figure 6.12 Assumed Geological Profiles

Table 6.4 List of Assumed Design Parameters

Symbols for Strata	Rock (Soil) Type	γ Mg/m ³	C kN/m ²	ϕ °	Remarks	
CS	Sandy Clay	1.8	50	-	Average values from NSPT	
GCS	Gravel (Boulder Cobble) with Sandy Clay	2.1	-	35	Assuming Inter Rocking Gravelly Layer	
			120	-	Assuming Matrix Supported Gravelly Layer, Average values from NSPT	
Lat	Lateritic Soil	2.0	110	-	Average values from NSPT	
Lat/Sap	Lateritic Soil with Sapprolitic Layer	2.0	200	-	Average values from NSPT	
FR/Amp	Fragile	Amphibolite	2.6	50	8	RMR10 (BIENIAWSKI) qu<5Mpa (Supposed)
HWR/Amp	Highly Weathered		2.6	50	8	RMR10 (BIENIAWSKI) qu<5Mpa (Supposed)
WR/Amp	Weathered		3.0	195	22	RMR39 (BIENIAWSKI), qu=24Mpa (Average Values from Lab Test)
SR/Amp	Sound Rock		3.0	265	29	RMR53 (BIENIAWSKI) qu=50Mpa (Average Values from Lab Test)

Source: JICA Study Team

(4) Basic Configurations of Proposed Nile Bridge

A comparison of basic configurations was carried out prior to the carrying out of the preliminary design.

Table 6.5 and Figure 6.13 show the characteristics of the 3 alternatives and the general views respectively.

Table 6.5 Characteristics of 3 Alternatives

	Alternative 1	Alternative 2	Alternative 3
Front View of Pylon a			
Pylon Shape	Inverted Y Shape	I Shape	H Shape
Stay Cable	Single Plane	Single Plane	Double Planes
Cross-section of Girder			

Source: JICA Study Team

Alternative 1 (Inverted Y Shape Pylon & Single Plane Stay Cable)



Front View



Alternative 2 (I Shape Pylon & Single Plane Stay Cable)



Front View



Alternative 3 (H Shape Pylon & Double Plane Stay Cable)



Front View



Source: JICA Study Team

Figure 6.13 General View of Each Alternatives

Evaluation summary and recommendation

Table 6.6 shows the summary evaluation of the 3 Alternatives. The construction and maintenance cost of Alternative 1 is lower than the other Alternatives, merits for additional advantages in safety and security aspects, in comparison with Alternative 3. For this reason, Alternative 1 (Inverted Y Shape Pylon & Single Plane Stay Cable) is recommended to be adopted as the basic configuration for the proposed Nile Bridge.

Relative to the foregoing, it is noted that the Steering Committee in the meeting held on 13 May 2009 accepted that Alternative 1 (Inverted Y Shape Pylon & Single Plane Stay Cable) be adopted for the basic configuration of the proposed Nile Bridge.

Table 6.6 Evaluation Summary and Recommendation

		Alternative 1	Alternative 2	Alternative 3
1) Bridge User's feeling	Driver's view	Open feeling		Confined feeling
	Outside view of cable	Simple		Interlace
2) Design (Structural characteristics)	Applicability	Applicable		
	Wind resistance	Possible		
	Stability of pylon	Slightly better	Slightly poorer	Slightly better
	Diameter/number of cable	72 Cables and Anchors Ave. ϕ 200mm	72 Cables and Anchors Ave. ϕ 200mm	144 Cables and Anchors Ave. ϕ 150mm
	Width of girder	Narrowest (22.9m)	Widest (25.7m)	Medium (24.8m)
	Substructure width	34.0m	26.0m	35.0m
3) Construction (Constructability)	Girder erection	Same method		
	Pylon erection	A little difficult	A little easier	A little difficult
	Cable erection	A little better		
	Construction period	3.5 years		
	Construction cost	1.00	1.02	1.03
4) Maintenance	Maintenance work	Easy to access		Difficult to access
	Maintenance cost	1.00	1.00	1.03
5) Safety	Users (vehicles)	Guarded by concrete wall or guardrail		
	Users (pedestrians)	Protected by guardrail		by concrete wall
	Protection of cable against vehicle collision	Protected by concrete wall with sufficient rigidity		
	Cable Protection from fire	Cables in 10m high are tubed into the steel pipe		
	Cable Protection from vandalism	Impossible for pedestrians to access		Possible for pedestrians to access
6) Security	Entire bridge	Bridge will be guarded by army		
	Cables	Not easy for anybody to access		Easy to access
	Cable anchors	Doors or hatches to enter box girder or pylon should be checked every morning and evening		
Recommendation		Most Recommendable	—	—

Source: JICA Study Team

(5) Preliminary Bridge Design

1) Bridge Layout

Three-Span continuous span arrangement comprising of a main span 290m long, left side span of 100m long and right side span of 135m long, for a total bridge length of 525m, has been adopted for the preliminary design. The span arrangement and plan of the project bridge are shown in Figures 6.14 and 6.15 respectively.

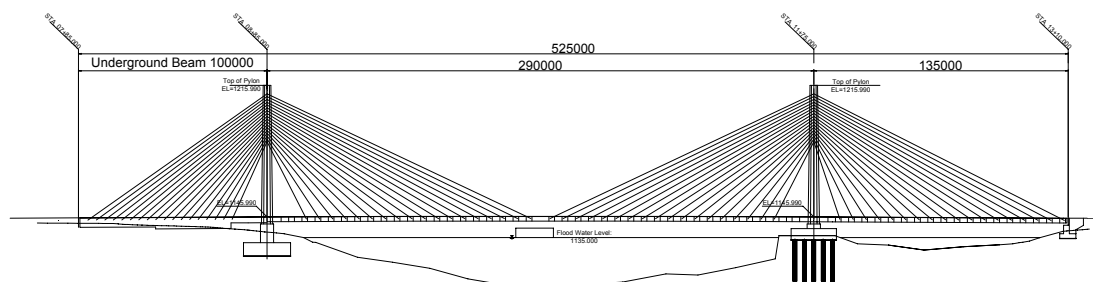
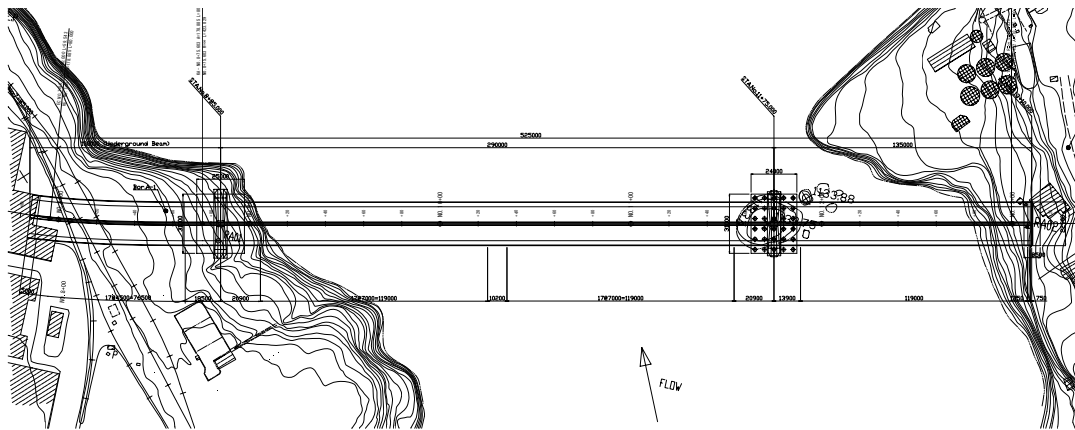

Figure 6.14 Profile of the New Nile Bridge



Source: JICA Study Team

Figure 6.15 Plan of the New Nile Bridge

2) Superstructure

Structural Dimensions

The typical cross-section of the bridge which is shown in Figure 6.16 is provided with cell box girder with depth of 2.5m.

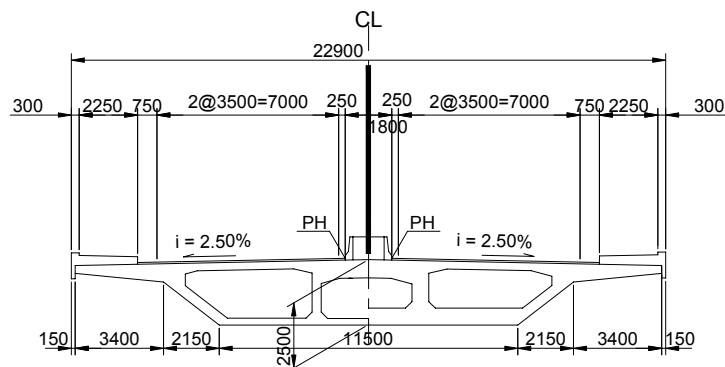

Source: JICA Study Team

Figure 6.16 Typical Cross Section of the New Nile Bridge

Stay Cables and Anchors

Multi Strand (MS type) stay cable is suitable for the prestressed concrete structure of the bridge to be constructed in a remote area from the factory.

Pylons

Figure 6.17 shows the general view of the pylon. Arrangement of stay cables is the semi-fan pattern suited for the construction of cable anchors in concrete pylons.

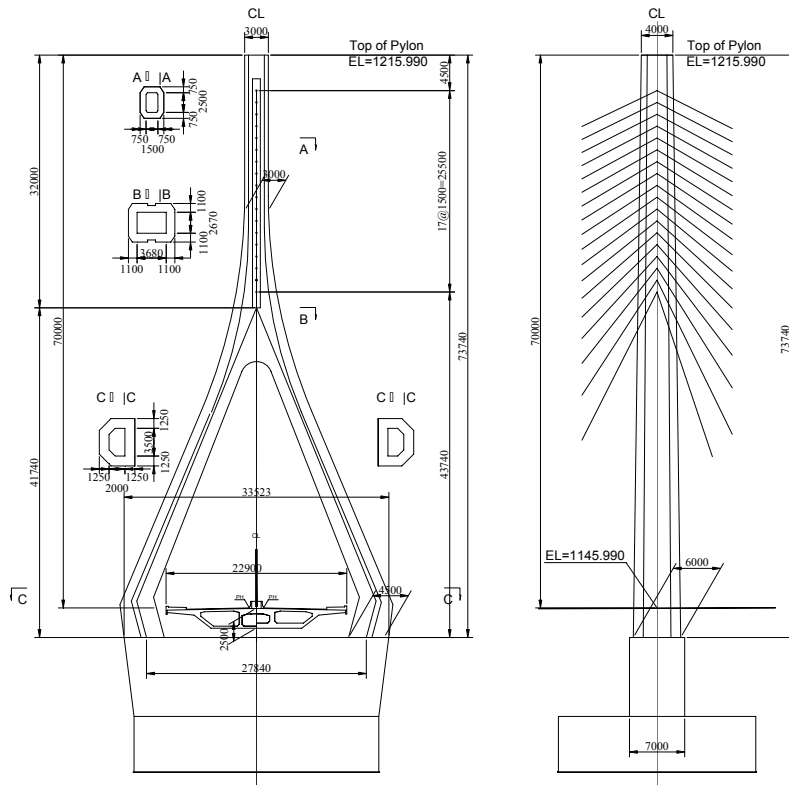

Source: JICA Study Team

Figure 6.17 General View of the Pylon (P1)

3) Substructure

Foundations

The P1 spread footing will have a dimension of 25 m x 31 m x 7 m.

Cast-in-place concrete piles partly encased with steel are considered appropriate for the foundations of P2 pylons based on the geological information and constructability of the structure in the small island. Figure 6.18 shows the pile foundation of P2.

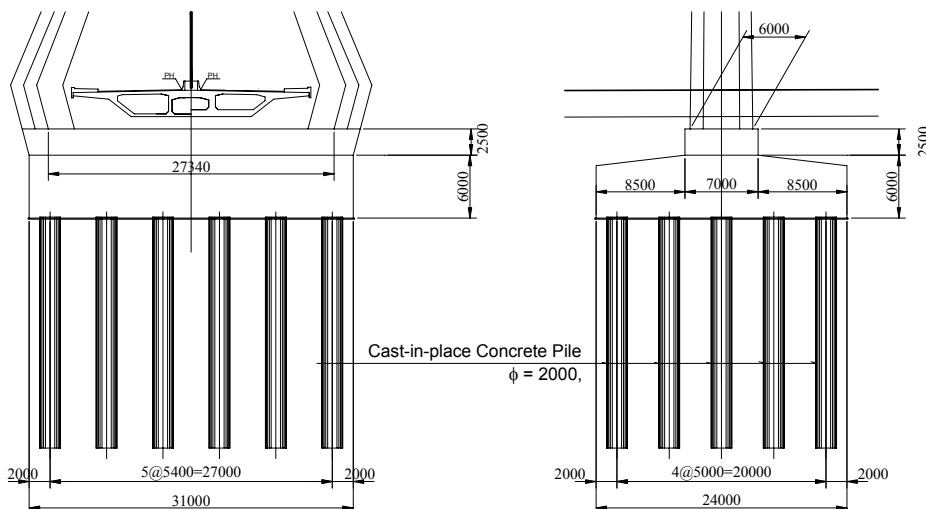

Source: JICA Study Team

Figure 6.18 Arrangement of Pile for P2

Semi-underground Beam

Since the 100m long left side span is located on land, a semi-underground beam was adopted. The design bending moment of the left side span will balance the weight of the 3 m high underground beam.

Figure 6.19 shows the typical cross section of the semi-underground beam.

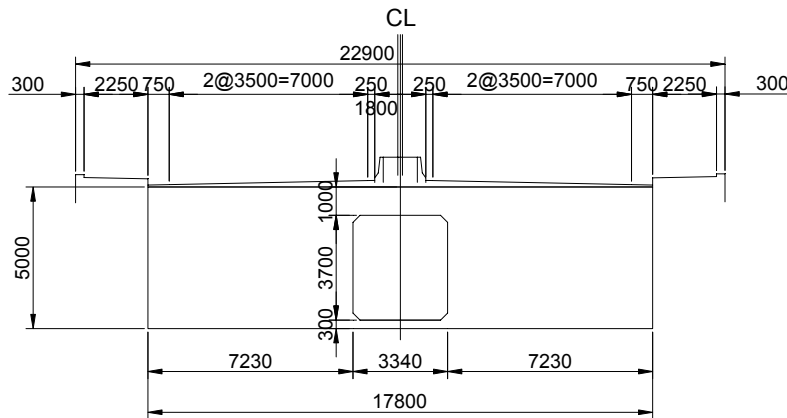

Source: JICA Study Team

Figure 6.19 Typical Cross Section of the Semi-Underground Beam

4) Miscellaneous Facilities

The major appurtenant facilities to be provided for the project for traffic safety include the following:

- a. Lighting facilities for the bridge
- b. Aircraft warning light
- c. Lightning rod (conductor)

Deck Drainage

Vertical drainage pipes with catch-basin will be installed between the carriageway and walkway at both sides of the bridge for the draining of rain water from the bridge deck.

Appurtenant Facilities to be installed on the Bridge

Utilities including water supply pipe, and cables for fibre optics and power distribution are normally installed on deck of bridges to convey basic necessities over a river. With this in consideration, future plans will be examined to determine if these utilities work are needed so that the corresponding space will be provided to accommodate these lifelines. This scheme will be considered during the preparation of the detailed engineering designs.

7. CONSTRUCTION PLANNING AND COST ESTIMATES

7.1 Construction Procedure

Figure 7.1 shows the construction method for the proposed bridge and approach roads..

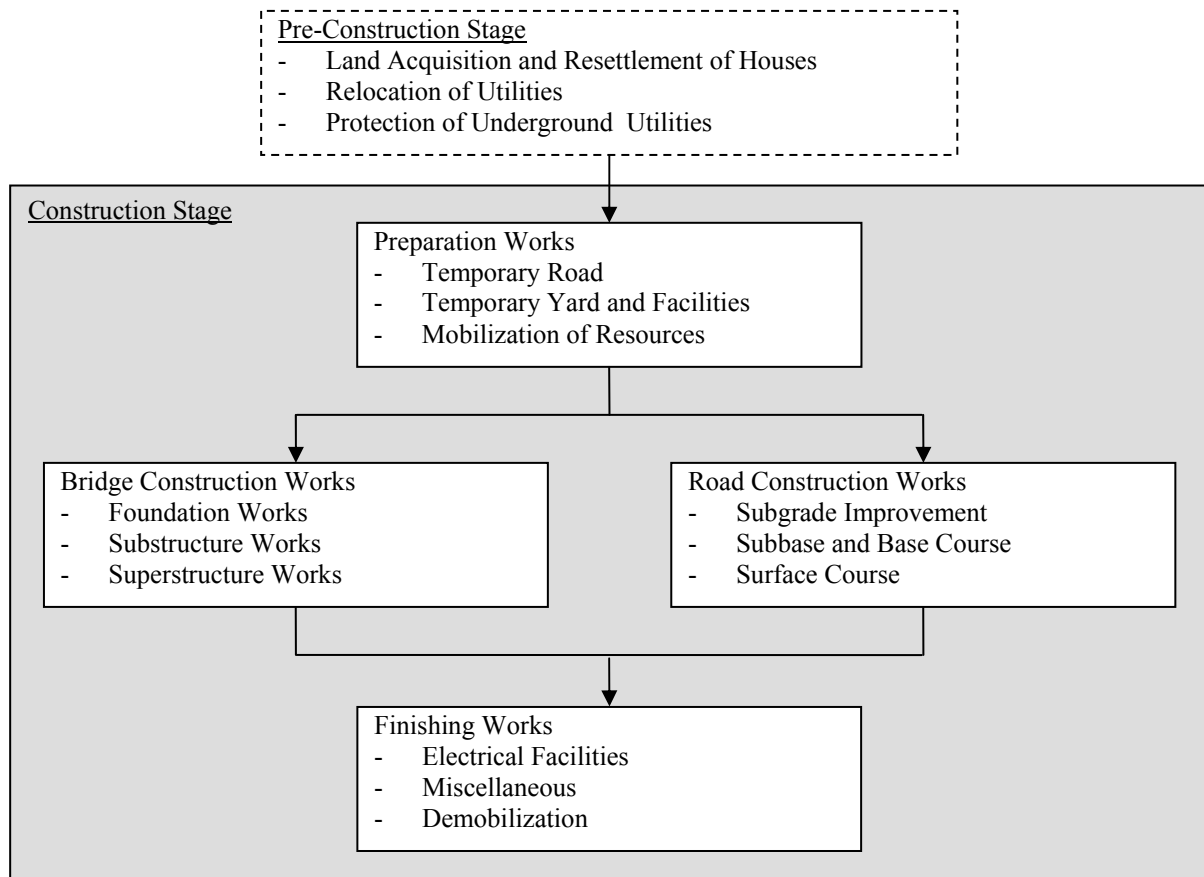

Figure 7.1 Construction Method of the Proposed Nile Bridge

7.2 Preparatory Works

Figures 7.2 and 7.3 show the proposed locations of temporary roads and yards at Njeru side and Jinja side respectively.

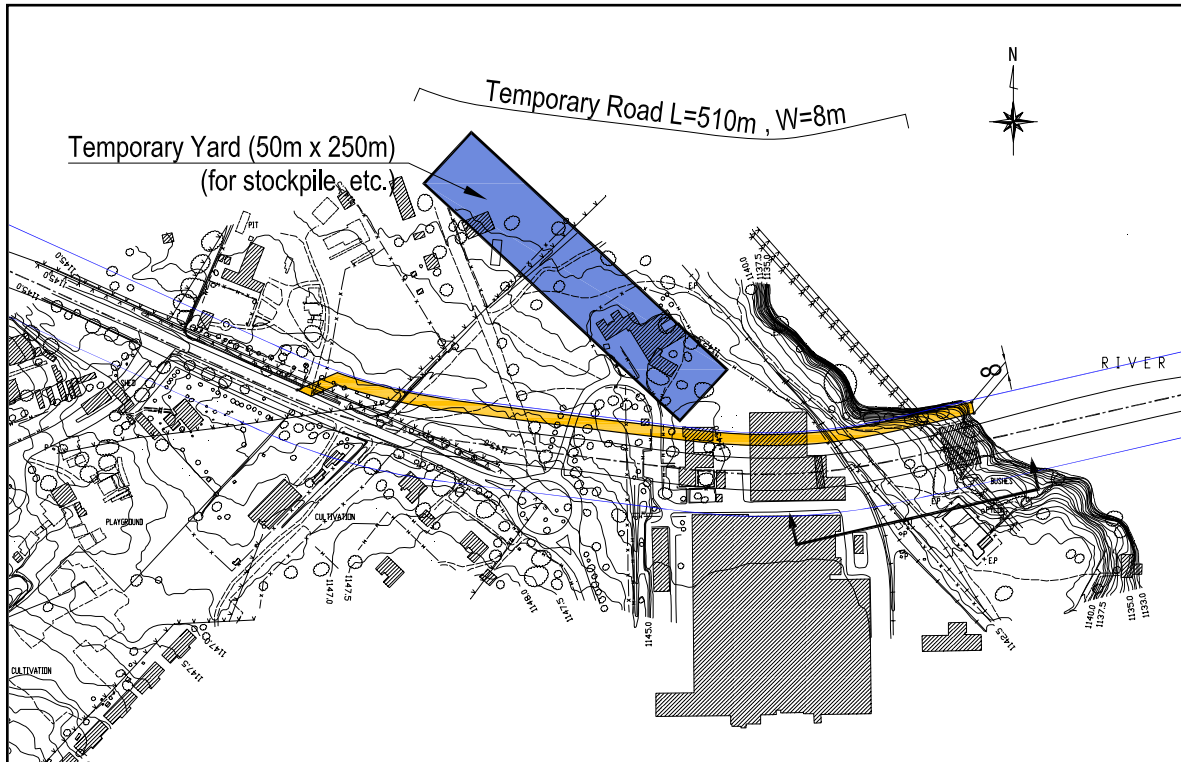

Figure 7.2 Location of Temporary Road and Yard at Njeru side

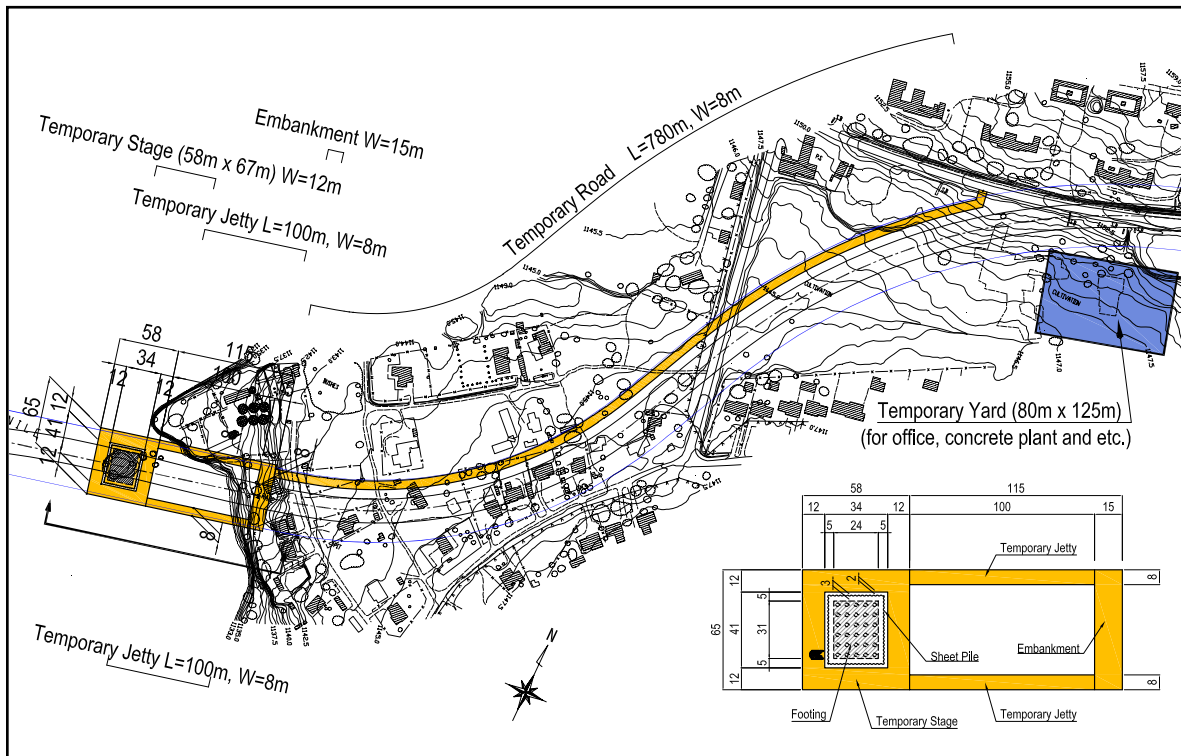

Figure 7.3 Location of Temporary Road and Yard at Njeru side

7.3 Construction Works for the Bridge

(1) Foundation Works

Excavation for the semi-underground beam and Pier 1 will be done by “open cut method” but cofferdam will be provided for the excavation of Pier 1.

Piles will be driven for the foundation of Pier 2 of the Jinja side. The method to excavate the foundation for the Jinja side is shown in Figure 7.4.

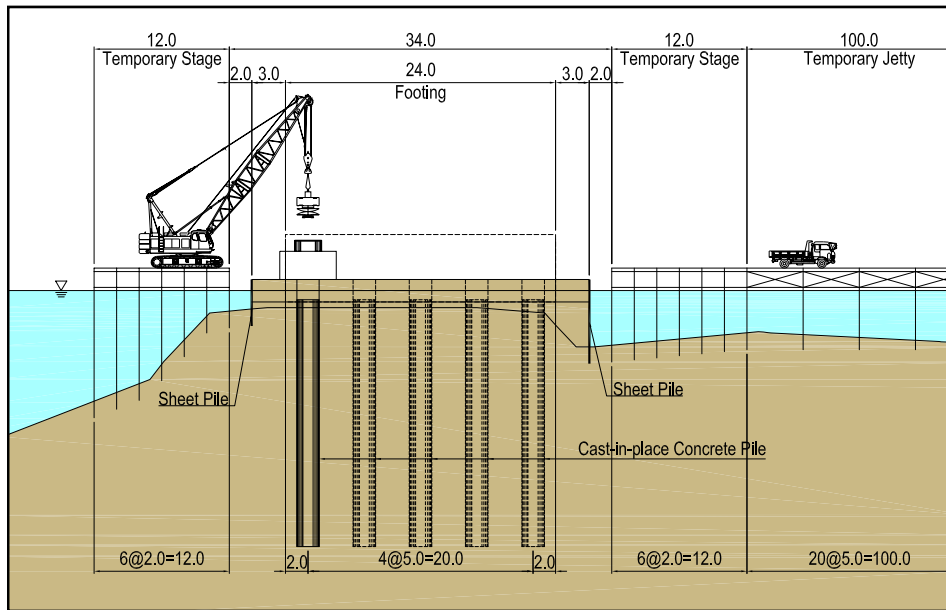

Figure 7.4 Methodology for the Construction of the Foundation for the Jinja Side

(2) Substructure Works

Regarding the placing of mass concrete footings for Piers 1 and 2, the height per lift should not exceed 1.5 m to comply with the capacities of existing concrete plants.

The lifting height for placing of concreting will be around 2 m for both piers considering the productivity capacities of the concrete plants.

(3) Superstructure Works

The pylon will be constructed based on the “whole scaffolding method”. The height of one lift will be around 2.5 m (which is 30 lifts in total) to synchronize with the timing of erection of the girders.

Erection of the PC girder erection for each segment is estimated to take 13 days for the formulation of the construction period. One longitudinal segment of the PC girder is either 3m long (if provided with cable stay anchor) or 4 m (without cable stay anchor) long. Based on this consideration, the total period for girder erection is estimated as follows: 13 days x 38 segments = 494 working days (or about 20 months), except for the duration required to prepare the Wagen (Travelling form for the cantilever PC girder).

The stay cable should comply to:

- JIS G3536-1999 SWPR7BL or BS5896-1980, D=15.2mm 7-wire strand with Epoxy Coating Thickness: 0.400-0.900mm.

7.4 Construction Works for the Road

Subgrade for the proposed approach roads should be improved by replacing the poor “black cotton soil” with 1 m thick of approved fill materials.

Subbase should be well graded crushed stones passing no. 200 mm sieve, except in certain part of the subbase for the shoulder, in which 175mm of Natural Gravel can be used. The layers of placement should be compacted by Vibratory Roller (of 7 - 8.5 ton capacity).

Base course also should be constructed of well graded crashed stone, 150mm in size (for the walkway), 175mm thick (for the carriageway and shoulder), to be compacted by Road Roller Macadam 12 ton in capacity and Pneumatic Tire Roller (8 - 20 ton in capacity).

The wearing course thickness for the pavement varies from 30 mm to 70 mm depending on the location of use. For the bridge pavement, 70 mm of wearing course will be applied and compacted by Road Roller Macadam 12 ton in capacity and Pneumatic Tire Roller (8 – 20 ton in capacity). A 30 mm wearing course will be applied for the walkway and compacted by Hand Guide Roller (0.8-1.1 ton in capacity).

Double surface treatment will be applied to the shoulder, while single surface treatment will be applied to the walkway.

7.5 Construction Schedule

The construction period will be 3.5 years (42 months) including mobilization and demobilization as shown in Table 7.1

Table 7.1 Construction Schedule of the Project

Description	1st Year												2nd Year												3rd Year												4th Year											
	1	2	3	4	5	6	7	8	9	10	11	12	1	2	3	4	5	6	7	8	9	10	11	12	1	2	3	4	5	6	7	8	9	10	11	12	1	2	3	4	5	6	7	8	9	10	11	12
Mobilization																																																
Material Order																																																
Oversea Transportation																																																
Custom & Inland Transportation																																																
Site Office																																																
Sub contract with local contractor																																																
Demobilization																																																
Temporary Works (Kampala side)																																																
Temporary Works (Jinja side)																																																
Temporary Works (for Plants)																																																
Temporary Yard for Plants																																																
Crusher Plant assemble																																																
Concrete Plant assemble and test																																																
Asphalt Plant																																																
Main Bridge Work																																																
Main Pier (P1)																																																
Excavation (Rock)																																																
Footing																																																
Column																																																
Tower (74.07m)																																																
Girder & Stay Cable																																																
PC Box Girder																																																
Main Pier (P2)																																																
Excavation (Rock)																																																
Piling Work																																																
Footing																																																
Column																																																
Tower (74.07m)																																																
Girder & Stay Cable																																																
PC Box Girder																																																
Abutment (A1 & A2)																																																
Excavation																																																
Footing																																																
Wall																																																
Pavement & Accessory																																																
Road Work																																																
Earthwork & Structures																																																
Pavement & Traffic Facilities																																																

7.6 Cost Estimation

This section is omitted due to the confidentiality.

8. MAINTENANCE, OPERATION AND IMPLEMENTATION PLANS

8.1 Inspection and Maintenance

Procedure of Inspection for Maintenance (Repair) of the Facility

Generally, bridges are administered by Bridge Management System comprising mainly of activities for the “Preparation of Inventory Data”, “Inspection”, and “Rating and Prioritization based on the inspection results for actual implementation of Maintenance (Repair) works”, also including the documentation of all maintenance work activities.

Figure 8.1 shows the procedure of the maintenance works commencing from Inspection up to completion. Maintenance operation includes Repair Works, Routine and Periodic Maintenance Works.

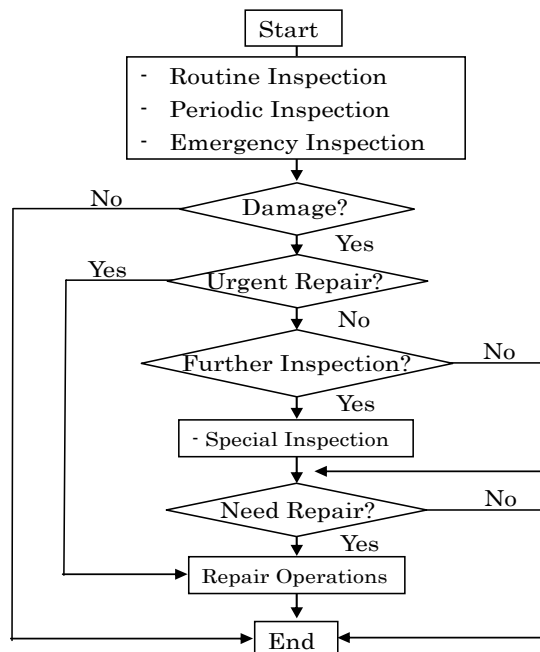

Figure 8.1 Procedure of Maintenance (Repairs) Operations

Bridge Inspection

Classification of inspections for the New Nile Bridge is proposed in Table 8.1. Inspection works are categorized into 3 types including Routine inspection, Periodic and spontaneous inspections.

Table 8.1 Classification of Inspection Works

Inspection Type		Major objects	Purpose	Methods
Routine	Daily	Once or twice	Road surface	Road safety
		Morning & evening	Doors / hatches of girder & pylon	Security
	Every 3 months	Cable surface	Damage	Visual inspection from vehicle-on board
		Cable anchor	Water leakage	Visual and touch inspection on foot
				Visual inspection inside girder & pylon

Periodic	Every 1 year	All components	Damage and Safety	Visual inspection by min. equipment (crack scale, hand tape, etc.)
	Every 3 years	All components	Damage and Safety	Visual inspection by equipment
Non-periodic	Emergency (at the time of accident/disaster)	All damaged components	Damage and Safety	Visual inspection by equipment
	Special (as required)	Defective portions Discovered by above inspections	<ul style="list-style-type: none"> •to grasp detailed behavior of defects/ actions needed •to monitor progress of damage •to investigate cause of damage 	<ul style="list-style-type: none"> •Visual inspection •Inspection using equipment •Testing (by equipment)

Source: JICA Study Team

Table 8.2 shows the proposed plan for inspection works of relevant responsible organizations, who will assume the daily inspection to be undertaken by Jinja Station. The 3-month interval inspection work will be conducted by the joint cooperation of UNRA headquarters and Jinja Station. Other associated inspection activities will also be done by the above two UNRA organizations together with hired consultants.

Table 8.2 Proposed Plan for Inspection Works and Responsible Organizations

Inspection Type		UNRA		Consultant (hired)	Remarks
		Station	Headquarter		
Routine	Daily	✓	—	—	In-house
	Every 3 months	✓	✓	—	
Periodic	Every 1 year	✓	✓	✓	Out-sourcing
	Every 3 Years	✓	✓	✓	
Non-periodic	Emergency	✓	✓	✓	
	Special	✓	✓	✓	

Source: JICA Study Team

Road Inspection

Road inspection works are generally categorized as routine, periodic and urgent as detailed in Table 8.3.

Table 8.3 Road Inspection Items

Inspection Type		Major objects	Purpose	Methods
Routine	Daily	Road surface, Slope condition	Road safety	Visual inspection from vehicle
Periodic	Yearly	Structures other than bridge: culvert retaining wall etc.	Soundness of structure	Visual inspection on foot with min. equipments (crack scale, hand tape etc.)
Urgent	In the event of occurrence of accident/disaster	Damaged components	Magnitude of damage	Visual inspection with the use of Equipments

Maintenance

After the completion of the proposed Bridge, maintenance (repair) works will be planned and conducted based on rating and prioritization of maintenance activities in accordance with the inspection results.

Cost of Inspection and Maintenance

The costs for inspection and repair of the proposed bridge after completion are estimated and listed in Table 8.4 below.

Table 8.4 Costs of Inspection and Maintenance Works of Project

Maintenance Items	Maint. Interval (years)	Costs (Ushs Mil.)
Approach Road		
Routine Maintenance	Every year	9
Periodic Maintenance	5	515
Rehabilitation	20	2,061
Bridge		
Routine Inspection	Every year	145
Periodic Inspection	3	11
Pavement Resurface	20	669
Replacement Joints	20	315
Replacement Shoes	40	704
Replacement Stay Cable	75	5,068

Source: JICA Study Team

8.2 Outlook of the Toll Operation

There are several ambiguities, incomplete legislative background and inconsistency for concerning international treaty on tolling issues, and making it difficult to provide conclusive actions at the soonest time possible. Those problems and issues, which are listed in Table 8.5, if not acted accordingly, will become the primary contributory factors to the delay in commencing the implementation of the project.

Ultimately, the introduction of tolling system to the project needs more discussions and preparation of legislative actions and consensus of users on principles of the tolling system, including the necessity of alternative route when a toll system is introduced.

Table 8.5 Problems and Issues on Introduction of Tolling System to the Proposed Bridge and Road Project

Toll Option	Road Administrator	Financing Aspect	Legal Aspect	Social Aspect
Toll Free Option	<ul style="list-style-type: none"> Road Maintenance Plan should be authorized to secure future maintenance fund. 	<ul style="list-style-type: none"> GOU is responsible to prepare funds for the maintenance required by the Road Maintenance Plan. 	<ul style="list-style-type: none"> Legal as well as institutional frameworks should be established to assure the fund required by the Road Maintenance Plan. 	<ul style="list-style-type: none"> Toll free is socially agreeable and economically encouraging transport and industrial activities.
Tolling Option	<ul style="list-style-type: none"> Additional operation facilities are required (installation of 3 toll booths, administrative office will cost about Ushs 3 billion). Method of operation should be determined, i.e. Force Account, Subcontracting, Leasing, Special Purpose Company. Method to determine a level of toll should be established, for instance, based on beneficiaries-to-pay, cost recovery, willingness-to-pay principles. It should be decided who should pay the toll in order to mitigate complaints from frequent bridge users for their daily lives (Only heavy trucks should pay?) Toll collection measures need to be invented, if some vehicles are exempted from paying toll. Preventive measures against illegalities of toll collection should be taken including additional devices and facility requirements. Argument and preparation about the tolling will cause the delay in the new bridge construction, and eventually bring about another cost of rehabilitation and long traffic queue at the existing Nalbaale Dam Bridge. 	<ul style="list-style-type: none"> GOU is responsible to prepare funds which can not cover by the toll revenue. Demarcation between public and private sectors should be clarified for financing the initial investment costs. It is necessary to examine whether or not a shadow toll should be introduced in order to assure the operational profit and to attract private sector eventually. 	<ul style="list-style-type: none"> It is necessary to establish an entity that is authorized to collect toll and appropriate the toll revenue to the relevant bridge and road maintenance. Legal as well as institutional frameworks should be prepared to enable the GOU to introduce such PFI schemes as BOT, Leasing, PPP and SPC. Justification is required to collect toll besides Road User Charges of Road Fund. Consent by the Parliament may be required to infringe the vested right of crossing the River freely. Law enforcement is required to prevent illegal toll collection and cheating toll. Compatibility with EAC and COMESA treaties are required. 	<ul style="list-style-type: none"> A sentiment of double charging, i.e. toll and fuel levy, is raised. A sentiment of infringement of vested right to cross the River freely will arise. Complaints from frequent users such as shoppers, pupils/students, commuters will be voiced. Complaints of no alternative choice other than the toll bridge will be raised. Inconvenience to stop, pay and re-start at toll booth will take place. Tolling will discourage community activities to cross the River. Additional barrier of toll booth will obstruct regional and international traffics.

8.3 Implementation Plan

Because huge initial investment is required, the Proposed Nile Bridge Project will have to rely primarily on the financial assistance from either international or bilateral donor agencies. Japanese ODA Loan or co-financing by both Japan and other international/bilateral agency is considered as the most conceivable scheme to finance the proposed project.

The implementation plan was based solely on pre-construction and construction activities for which the construction period was already analyzed and discussed in Chapter 7 of this Report. In this connection, the construction period at 3.5 years, could hardly be reduced based on experience of projects similar in nature worldwide.

Differences in loan application procedure between the Japanese Government and other international/bilateral lending institutions is that these agencies might require project cost data based on the Detailed Design while Japanese ODA Loan will be able to determine the loan amount based on the result of the Feasibility Study. Hence, application for loan assistance through other international/bilateral lending institution will need the completion of Detailed Engineering Studies prior to loan application, which is usually undertaken by the borrowing country.

Japanese ODA loan on the other is able to provide loan funds for both the Detailed Engineering Studies and Construction of the Project (including construction supervision services), based on the loan agreements which will be provided separately for the respective stages.

Assuming that International Competitive Bidding (ICB) method will be adopted to both the Detailed Design and Construction of the Project, the time required for the procurement will be more or less the same when compared with the financing scheme of the GOU (Detailed Design) with one international/bilateral lending institution (for the Construction of the

Project) and the Japanese Lending Institution (for the Detailed Design and Construction of the Project based on separate bidding exercises). Therefore, reference was made to experiences from Japanese ODA scheme for projects similar in nature worldwide. Consequently, the milestones for the implementation plan of the Project are depicted as follows:

- E/N and L/A for DD consultant procurement will be concluded by the end of March 2010 based on 4 months of EIA approval.
- 7 months for the selection of DD consultants
- L/A for SV consultant and contractor procurement will be concluded by the end of March 2011
- Preparation of DD including topographic surveys, geological investigations and preparation of tender documents: 1 year (12 months)
- 15 months for selection of contractor
- Construction for the proposed Nile Bridge will commence by February 2013
- The construction of Proposed Nile Bridge will be completed by the end of July 2016

As a recapitulation, the total implementation schedule will commence with the approval of the Loan Agreement for DD by March 2010 for which the construction will be completed by July 2016 as detailed in Table 8.6 hereunder.

Moreover, the detailed design of the Proposed Nile Bridge including the approach roads could be undertaken within the ROW determined by the Feasibility Study. This will enable UNRA to proceed with the land acquisition and compensation of affected houses and entities immediately after the completion of the Study.

Table 8.6 Implementation Plan for Project

	2008				2009				2010				2011				2012				2013				2014				2015				2016			
	1	2	3	4	1	2	3	4	1	2	3	4	1	2	3	4	1	2	3	4	1	2	3	4	1	2	3	4	1	2	3	4	1	2	3	4
Feasibility Study																																				
EIA and Approval by NEMA																																				
Loan Agreement																																				
Selection of Consultant for D/D and Teder Assistance																																				
Request for EOI (Expression of Interest)																																				
JICA's Concurrence of Short List and RFP																																				
Proposal Evaluation																																				
JICA's Concurrence of Consultant Contract																																				
Detailed Design																																				
Design and Cost Estimates																																				
PQ and Tender Documents																																				
Tendering Procedure																																				
JICA's Concurrence of PQ Document																																				
PQ Period																																				
PQ Evaluation																																				
JICA's Concurrence of PQ Evaluation																																				
JICA's Concurrence of Tender Document																																				
Tender Period																																				
Tender Evaluation																																				
JICA's Concurrence of Tender Evaluation																																				
Negotiation of Contract																																				
JICA's Concurrence of Contract																																				
Signing on Contract / LC Opening																																				
Selection of Consultant for S/V																																				
Request for EOI (Expression of Interest)																																				
JICA's Concurrence of Short List and RFP																																				
Proposal Evaluation																																				
JICA's Concurrence of Consultant Contract																																				
Construction Works																																				
Land Acquisition / Resettlement																																				

Source: JICA Study Team

9. ECONOMIC AND FINANCIAL EVALUATION

9.1 Economic Evaluation

Major quantifiable economic benefits derived from the proposed project composed mainly composed of savings in vehicle operating cost and travel time cost. The project EIRR for the base case resulted to an EIRR of 17.1 %. The sensitivity analysis based on 20% reduced traffic demand and increase in project cost by 20 %, resulted to an EIRR of 13.7 % thereby ensuring the economic viability of the project, the breakdown of which is shown in Table 9.1.

In addition to the quantifiable benefits, unquantifiable benefits also suggest the importance of improving the infrastructure network, particularly the trunk road such the Trans-African Highway 8 connecting the capital cities of Central Africa.

Table 9.1 Summary of the Economic Evaluation Results

			Project Cost		
			Base Case	10% Increase	20% Increase
Traffic Demand	Base Case	EIRR	17.1%	16.3%	15.5%
		NPV	49,191	43,444	37,698
		B/C	1.86	1.69	1.55
	10% Decrease	EIRR	16.2%	15.4%	14.7%
		NPV	38,879	33,132	27,385
		B/C	1.68	1.52	1.40
	20% Decrease	EIRR	15.3%	14.5%	13.7%
		NPV	28,567	22,820	17,073
		B/C	1.50	1.36	1.25

Source: JICA Study Team

Note: Unit of NPV is 000US\$ discounted at 12%

9.2 Financial Evaluation

This section is omitted due to the confidentiality.

10. NATURAL AND SOCIAL ENVIRONMENTAL STUDIES

10.1 Natural Environmental Study

Firstly, the current baseline environmental condition regarding the natural environment surrounding the study site was collected. The information collection focused mainly on technical site inspections, reviews of current reports and discussions with local researchers/or scientists around the study site.

Thereafter, based on the collected baseline environmental information and the engineering features for each alternative of this study, an IEE was carried out. Basically, the IEE took the following two steps. The first step, involved preliminary IEE for two scenarios, i.e., (i) Do-Nothing scenario, and (ii) Do-Project scenario of all the completed alignment alternatives (i.e., Alignments A, B and C). By using more specific engineering information, a more detailed, route-specific IEE was carried out, to identify possible negative environmental impacts to be caused during and/after the construction of the Project for each of the alternative alignment option. Major findings obtained from this IEE are described as follows:

- Conservation Area (100 meters away from the high water level of the River Nile) exist at both riversides of the River Nile, and all Alignment Options A, B and C will pass through the conserved areas. In Alignment A and B Options, the caisson construction site may be set up along the shoreline of Lake Victoria (which is, also a protected area). Alignment C will pass through Kimaka Forest Reserve, located on the eastside of the River Nile.
- It was discovered that several IUCN-CR (critically Endangered), EN (Endangered), VL (Vulnerable), NT (Near Threatened) and LC (Least concern) species exists inside and around the River Nile for all Alignment Options.
- Alignment C has the longest-distance approach roads on both sides of the River Nile, so that it is expected to have the largest volume of construction wastes, as compared with Alignments A and B. By the same token, the negative impacts on the regional drainage brought about by the construction of Alignment C would be significant, as compared with those of Alignments A and B.
- Alignment B will be provided with two bridge piers to be constructed inside of the River Nile, so that the order of the magnitude of water quality degradation to be incurred during the construction of the Project would be significant, as compared with Alignments A and C.
- The bridge section of Alignment C is located at the downstream side of Owen Falls Dam Complex, so that the potential risk of the dam breach cannot be ignored.

From this IEE study, it can be said that the order of the magnitude of potential negative impacts on the natural environment associated with Alignment A will be less significant, but not for Alignments B and C.

Hence, in order to prepare a study based on UNRA's ESIA/RAP guidelines a more comprehensive, site-specific (i.e., carry out ESIA/RAP studies based on the latest engineering results of the selected alignment, the design, the construction schedule and others) compatible to JICA Guidelines for Environmental and Social Considerations. Relevant technical support program from the JICA Study Team was also be developed by reviewing the ToR attached to UNRA's tender documents. Similarly, appropriate interactions between the JICA Study Team and UNRA-selected Consultants were developed. It is noted in this connection that COWI UGANDA was selected by UNRA as ESIA/RAP Consultant in early March of 2009.

Based on the interaction scheme and technical support system, several assistances such as the roadside air quality and noise studies were provided from the JICA Study Team to UNRA. Also, technical transfer seminars on roadside air quality, noise and CO₂ emission studies were provided to UNRA for the capacity building of the environmental work, associated with the transport planning. The D/F Report for this ESIA/RAP studies were submitted to UNRA for review and comments in the mid of September, 2009. Thereafter, the official examination of submitted reports will be initiated by NEMA, and the environmental permit for the construction of the proposed project is expected to be approved in late November 2009.

10.2 Social Environmental Study

10.2.1 General

A social environmental study of the project area was carried out to determine the optimum alignment for crossing the River Nile. Firstly, the socio-economic profiles of the two towns were broadly assessed using data from various sources to be supplemented with field survey to be conducted by the Study Team. Secondly, the characteristics of the social aspects of the alternative alignments were outlined in terms of anticipated negative impacts including involuntary resettlement.

For the initial environmental examination (IEE) of the three alignment alternatives, firstly, the social environmental parameters were selected using scoping matrix pertinent to JICA Guidelines. Based on the results of the scoping, the assessment revealed the project's negative impacts on each environmental parameter by grading system: "grade A" to "D" for each alternative alignment. Based on the results of the grading system, a comparative analysis of the negative impacts provided the basis to comprehensively evaluate the alternative alignments.

10.2.2 Results of Social IEE for Selected Optimum Alignment A

The negative impacts to be assessed along the chosen optimum Alignment A are summarized in Table 10.1. The IEE results show that Alignment A will bring about minor impacts on the social environment of the concerned area.

Table 10.1 Initial Social Environmental Evaluation (Alignment A)

Environmental Parameters	Evaluation	Description
Involuntary Resettlement	B	Number of affected buildings are 26 including those under construction
Local economy such as employment and livelihood, etc.	B	Some buildings of the textile factory will be affected
Land use and Utilization of local Resources	D	Length of the approach road is short.
Existing social infrastructures and services	D	Only distribution lines (9: Jinja<3>and Njeru<6>) will be crossed by the ROW.
Water Usage or Water Rights and Rights of Common	B	Although water intakes for the textile factory at the upstream of the River and the Brewery plant at the downstream of the River will be affected by the project, the impact on water quality could be mitigated.
Risk of spread of infectious diseases such as HIV/AIDS	B	Labour migration to the Project area might cause the spread of infectious diseases including AIDS and HIV during the construction of the Project

10.2.3 Draft ESIA Results on Social Environment by UNRA's Consultant

The draft ESIA report was provided to the JICA Study Team on the 7th of August. The draft ESIA report was reviewed from the viewpoint of social environmental considerations for the project.

That study has identified several negative impacts to be brought about by the construction of the project. Table 10.2 hereunder summarises the negative impacts which have been identified and the proposed mitigation measures to avert the possible occurrence of harmful effects to the social environment.

Table 10.2 Summary of the Negative Impacts and Mitigation Measures

Negative Impact	Description	Mitigation Measure
Land acquisition	About 72,000m ² of land is to be acquired for the ROW of the approach road.	<ul style="list-style-type: none"> ● Conducting adequate RAP study for fair and appropriate compensation ● Engineering design will be pursued considering the need to reduce the area of ROW
Involuntary Resettlement	The actual number of buildings that require resettlement is 26 consisting of 16 houses (either partially or completely built), 2 commercial and 8 industrial buildings.	<ul style="list-style-type: none"> ● Adequate, fair and prompt compensation under the RAP ● Consideration on issues of restoring peoples' livelihoods following disruptions from project activities ● Establishment of the mechanism for resettlement of some of PAPs relative to their demand
HIV/AIDS Concern	Influx of labours from the outside might cause the prevalence of Sexually Transmitted Diseases (STDs) and HIV/AIDS.	<ul style="list-style-type: none"> ● Preparation of comprehensive HIV/AIDS mitigation programme for the staffs and laborers
Social conflict and Crime Issues	The increased influx of workers is likely to lead to conflict over housing, water resources and related social services.	<ul style="list-style-type: none"> ● Encouraging the recruiting of local labour force from within the immediate communities
Occupational Safety and Health(OSH) for the Workers	There will be a number of health and safety concerns relating to the site preparation and construction.	<ul style="list-style-type: none"> ● Preparation of OSH plan by contractor based on OSH Statute of 2006r
Public Health and Human Safety	The project might facilitate the incorporation of certain hazardous materials that could not have been envisaged in the ESIA study.	<ul style="list-style-type: none"> ● Preparation of a comprehensive plan for the management of potential hazardous materials in conjunction with the Ministry of Health and the Uganda National Bureau of Standards(UNBS)
Risk due to Project related Traffic	There will be some disruption to local traffic movement during the construction of the proposed approach roads	<ul style="list-style-type: none"> ● Preparation of traffic management control in close liaison with traffic police
Loss of access route to properties	The construction of the approach road will inhibit traffic flow for some of the roads in the eastern side.	<ul style="list-style-type: none"> ● Provision of alternative alignment for the inhabitants

Source: JICA Study Team compiled from the Draft ESIA report

10.3 Resettlement Action Plan

The resettlement action plan (RAP) should be prepared in accordance with the Resettlement/Land Acquisition Policy Framework (Nov. 2001) which provides institutional/legal framework and compensation system for resettlement/land acquisition. The overall objectives of the RAP is the provision of all findings and results of land acquisition preparatory exercises and based on the outcome RAP should propose the land procedure to be taken for the acquisition process for project implementation.

RAP preparation for the Project has been conducted as part of the ESIA study. All the field works for the preparation of RAP including measurement surveys has been completed on

August 07, 2009 for which the draft RAP report is under preparation. RAP will be submitted to the Ministry of Land in the middle of September after the review of the Chief Government Valuer.

The measurement survey revealed that approximately 72,000 m² of land need to be acquired as the ROW of the approach road and the actual number of buildings that require resettlement is 26 consisting of 16 houses (either partially or completely built), 2 commercial and 8 industrial buildings.

The preliminary implementation schedule based on discussion with the Land acquisition specialist of UNRA is shown in Table 10.3

Table 10.3 Preliminary Implementation Schedule for Land Acquisition/Compensation

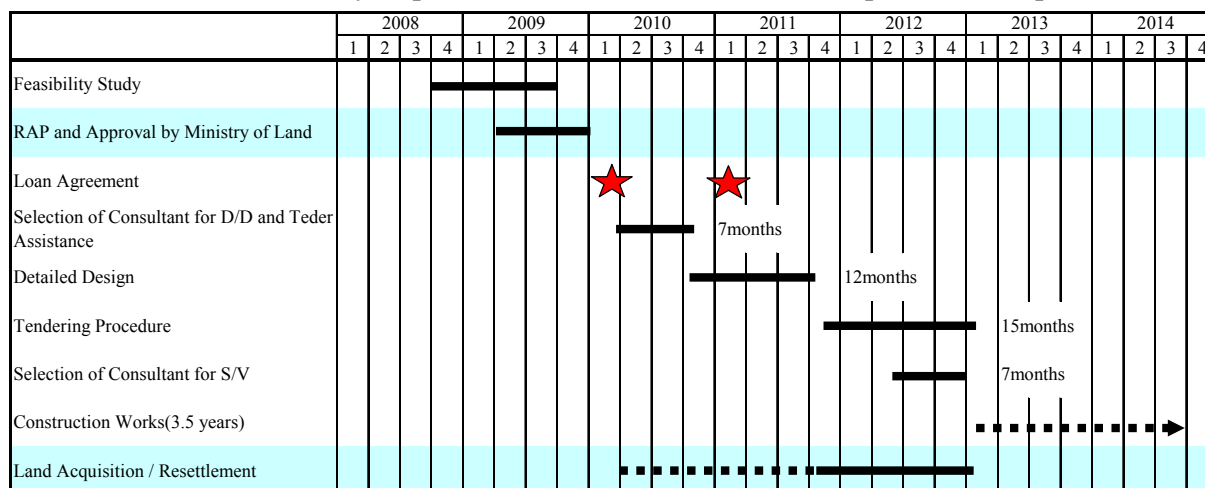

Source: JICA Study Team

10.4 Assistance to Public Consultation

Information disclosure through public consultations is one of the integral parts of the basic principle of the JICA Guidelines. TOR for the Feasibility Study specified the holding of at least three (3) public consultations during the study period. Additionally to public consultations “Focus Group Discussion (FGD)” was held once as shown in Table 10.4.

A series of the meetings were conducted successfully with active commitment of UNRA. The summary of the public consultation is shown in the below table.

Table 10.4 Schedule and Main Topics of Public Consultations

Public Consultation(PC)	Date and Venue	Main Topics
1st PC	December 12, 2008 in Kampala	Introduction of the outline of the Project and presentation of the Study schedule
Focus Group Discussion	March 6, 2009 in Jinja	Presentation of the Project to Focus group directly affected by the Project
2nd PC	April 3, 2009. in Kampala	Establishment of basic agreement on the optimum alignment and bridge type of the Project.
3rd PC	September 8, 2009 in Seeta	Presentation of the results of the Feasibility Study and opinion exchange

11. TECHNICAL TRANSFER

Technical transfer program scheduled for bridge planning is shown in Table 11.1. All subjects of the technical transfer program that have been implemented were discussed with UNRA personnel.

Table 11.1 Technical Transfer Program Schedule for Bridge Planning

No.	Subject	Contents	Date	Presenter	No. of Attendees
1	Natural condition survey	Topographic Survey Geological Investigation Hydrologic & Meteorological Survey	13 th March	Mr. Ohshita Mr. Kawamura Mr. Okabe	18
2	Design Standard	Geometric Standard Navigation Clearance Aviation Limitation Wind/Seismic Design Design Load & Combinations	2nd April	Mr. Urano	10
3	Bridge Planning	Bridge Types & Application Outline of Selection of Optimum Bridge Type	6th May	Mr. Konishi	17
4	Bridge Maintenance	Maintenance Procedure for Selected Bridge Type	29th May	Mr. Konishi	16
5	Bridges in Japan	Presentation of Bridges in Japan	17th June	Dr. Tatsumi	10

Besides the above program, roadside noise and air quality studies were carried out both in the field and class room having participants from relevant counterpart agencies.

12. CONCLUSION AND RECOMMENDATIONS

12.1 Conclusion

As the consequence of the study, it concludes that:

- The project is technically and economically feasible and environmentally sound.
- Hence, it is justified to implement the project for national and people's benefits.
- An optimum location of the project should lie on the Alignment A which begins at Nile Brewery junction and passes by Nytil Textile Factory before crossing the River Nile and which further extends to Nalufenya roundabout after the River.
- A bridge type should be a PC Cable-stayed bridge with inverted Y-shape Pylon and Single Plane Stayed-Cable.
- Introduction of Toll System to the Project should be carefully examined again during the Detailed Design stage involving stakeholders not only the service providers but also users.

12.2 Recommendations

12.2.1 Natural Environmental Considerations

Throughout this EIA study on the natural environment, it was found that potential impacts regarding the water quality, regional drainage, and waste treatment would be critical for the implementation of the construction of the proposed bridge. In particular, there are several water intake points (detailed descriptions about this water intake are summarized in the social environmental study section) around the project site and the biodiversity around the current riverine condition is good. So, special care shall be taken for the prevention of the water quality degradation.

Also, it was found that several important fish species with IUCN "Endangered" status occur around the project site of the River Nile, so the conservation of those species is one of important and challenging points, though the proposed project will not cause direct, significant negative impacts on those species. Note that key components of the local fauna/flora conservation of the protection zone of the River Nile are to establish a well-coordinated link with a basin-wide Lake Victoria management program, supervised by LVFO and/or Nile Basin Initiative and to undertake education concerning biodiversity conservation for the general community.

Key directions and/or principles for the development of a comprehensive EMP, which are discussed within this study, and engineering results of D/D to be held after this feasibility study should help to prepare an action plan for the implementation of EMP before the construction starts. NaFIRRI, one of key inland freshwater fishery resources institutes, has a great knowledge about the aquatic eco-system of the upper Victoria Nile. Therefore, the participation of this institute in executing the EMP can be useful for the successful implementation of EMP for the natural environment.

12.2.2 Social Environmental Considerations

Land acquisition and involuntary resettlement are considered as major negative impacts on social environment caused by the Project. The ESIA study conducted by UNRA's consultant reveals that approximately 72,000m² of land is to be taken as the ROW for the approach road and the actual number of buildings that require resettlement is 26 consisting of 16 houses (either partially or completely built), 2 commercial and 8 industrial buildings. These negative

impacts could be minimized with adequate, fair, and prompt compensation and resettlement of communities based on the on-going RAP process.

It is therefore recommended to consider in the next project phase (detailed design) that:

- Monitoring of the compensation procedures

All compensation procedures including payment and relocation of affected properties should be completed before commencement of the construction activities. In order to conduct appropriate compensation, monitoring of the compensation procedures based on the RAP is indispensable.

- Loss of access route to properties

The construction of approach roads to the bridge will cut off some of the roads in the eastern (Jinja side) and this will imply loss of access to some properties. This has multiple effects with respect to increased travel time and distance for the people travelling to/from their homes. In order to solve this issue, more detailed plan on substitutive access roads for the residents should be prepared in the detailed design.

- Potential business loss

The approach road alignment passing through the sections in the industrial area will affect, in terms of disturbing access, such factories as Nile Breweries, East African Packaging Solutions, Nytil/Picfare in Njeru side. Also, two fuel stations (IGAR and TOTAL) in the Jinja side will be affected due to loss of business after completion of the approach road. In the detailed design, those potential business losses will have to be considered.

- Establishment of grievance procedure and redress system

It is envisaged that a number of issues (grievances) will come up as a result of land acquisition by the Project. A system must be put in place to settle these issues amicably through recognized institutions such as local councils, land boards and land tribunals to the satisfaction of involved parties. In order to address the concern, it should be encouraged that UNRA communicate closely with the relevant parties through the branch office in Jinja.