

	Turbine Discharge (m ³ /s)	Effective Head (m)	Speed (min ⁻¹)	Rated Capacity (kVA)
Seasir	0.04	218.0	1800	70



JAPAN INTERNATIONAL COOPERATION AGENCY

PROJECT & LOCATION:

Preparatory Survey on the Project for Promotion of
Production Activities by Clean Energy in the North Villages
The Republic of Guatemala

SHEET CONTENTS

Seasir Micro Hydro power Project
Layout Plan in the powerhouse

DRAWING NO.

S-E-001

(S=1:60)

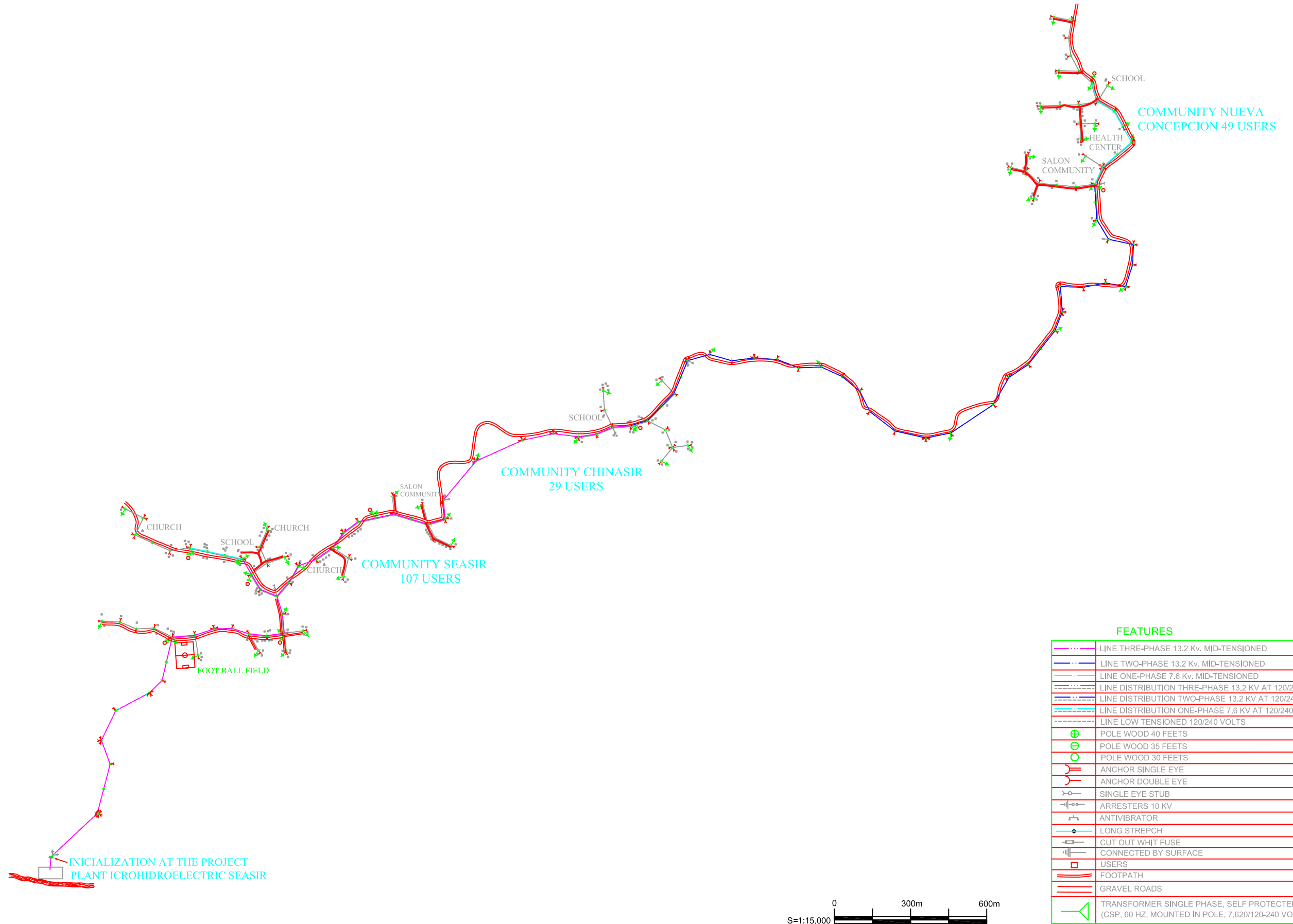
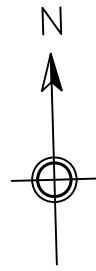

FEATURES

	LINE THREE-PHASE 13.2 Kv. MID-TENSIONED
	LINE TWO-PHASE 13.2 Kv. MID-TENSIONED
	LINE ONE-PHASE 7.6 Kv. MID-TENSIONED
	LINE DISTRIBUTION THREE-PHASE 13.2 KV AT 120/240 V.
	LINE DISTRIBUTION TWO-PHASE 13.2 KV AT 120/240 VOLTS
	LINE DISTRIBUTION ONE-PHASE 7.6 KV AT 120/240 VOLTS
	LINE LOW TENSIONED 120/240 VOLTS
	POLE WOOD 40 FEETS
	POLE WOOD 35 FEETS
	POLE WOOD 30 FEETS
	ANCHOR SINGLE EYE
	ANCHOR DOUBLE EYE
	SINGLE EYE STUB
	ARRESTERS 10 KV
	ANTIVIBRATOR
	LONG STREPC
	CUT OUT WHIT FUSE
	CONNECTED BY SURFACE
	USERS
	FOOTPATH
	GRAVEL ROADS
	TRANSFORMER SINGLE PHASE, SELF PROTECTED (CSP, 60 HZ, MOUNTED IN POLE, 7.620/120-240 VOLTS)

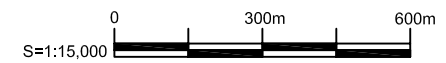

JAPAN INTERNATIONAL COOPERATION AGENCY

PROJECT & LOCATION:

Preparatory Survey on the Project for Promotion of Production Activities by Clean Energy in the North Villages The Republic of Guatemala

SHEET CONTENTS

Seasir Micro Hydropower Project
Transmission Line Plan
(Scale: 1:15,000)

DRAWING NO.

S-E-002

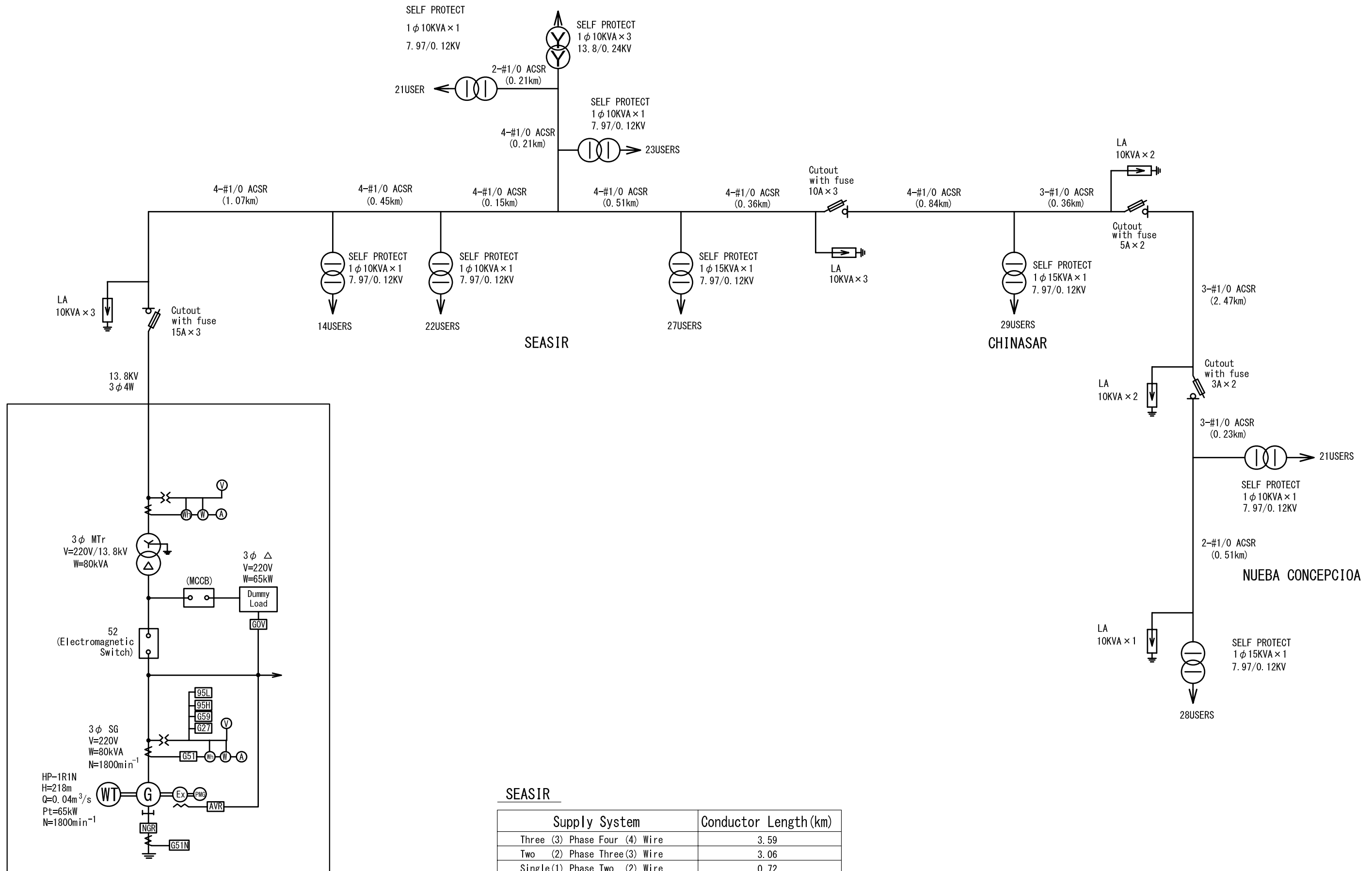

Seasir Power Station

SEASIR

Supply System	Conductor Length (km)
Three (3) Phase Four (4) Wire	3.59
Two (2) Phase Three(3) Wire	3.06
Single(1) Phase Two (2) Wire	0.72
Total	7.37



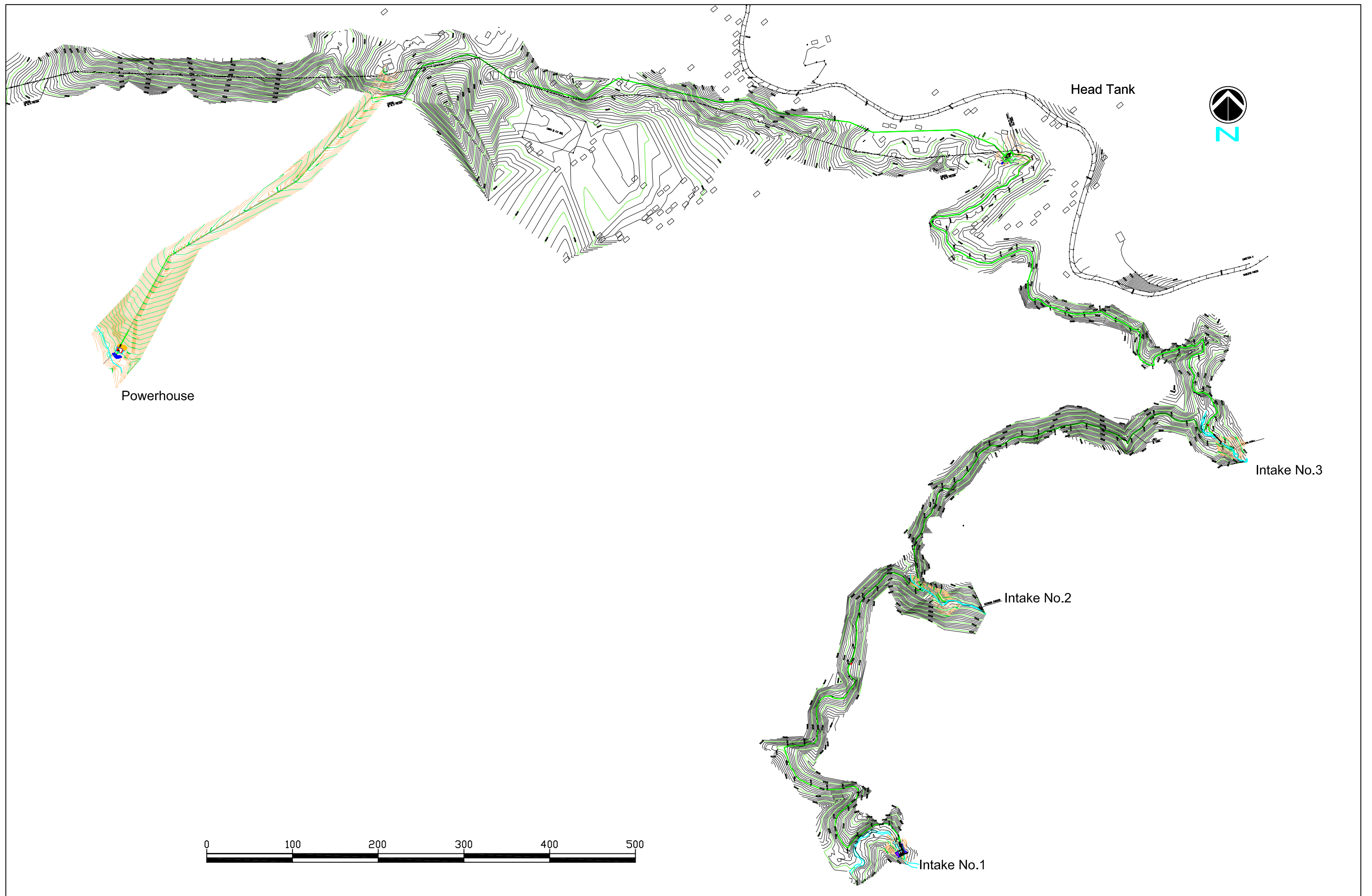

JAPAN INTERNATIONAL COOPERATION AGENCY

PROJECT & LOCATION:

Preparatory Survey on the Project for Promotion of
Production Activities by Clean Energy in the North Villages
The Republic of Guatemala

SHEET CONTENTS

Seasir Micro Hydropower Project
Plan View
(Scale: 1:4,000)

DRAWING NO.

S-G-001

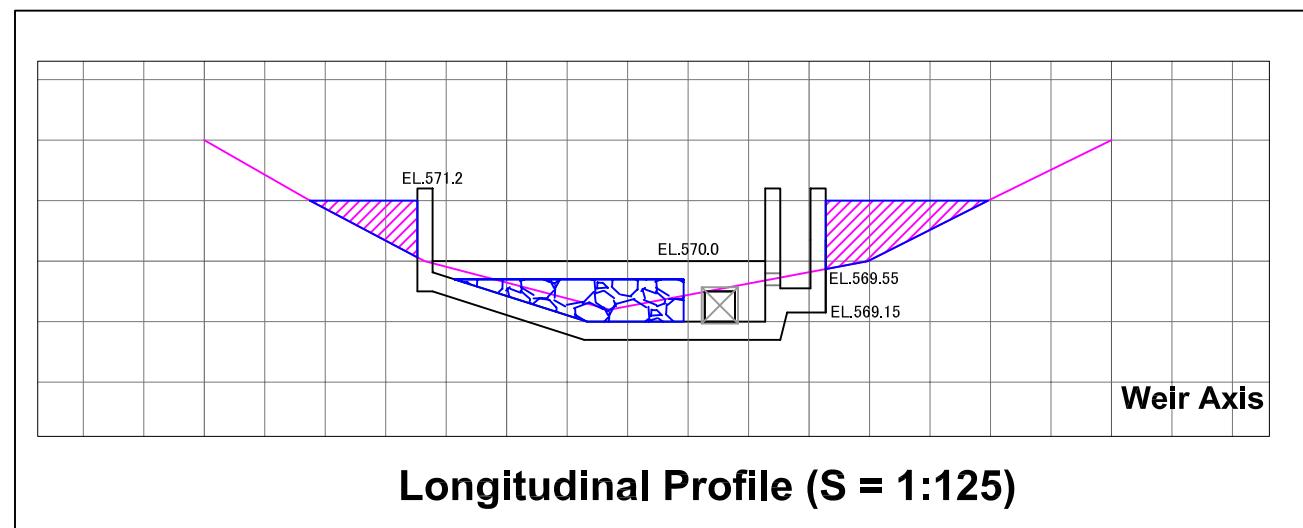
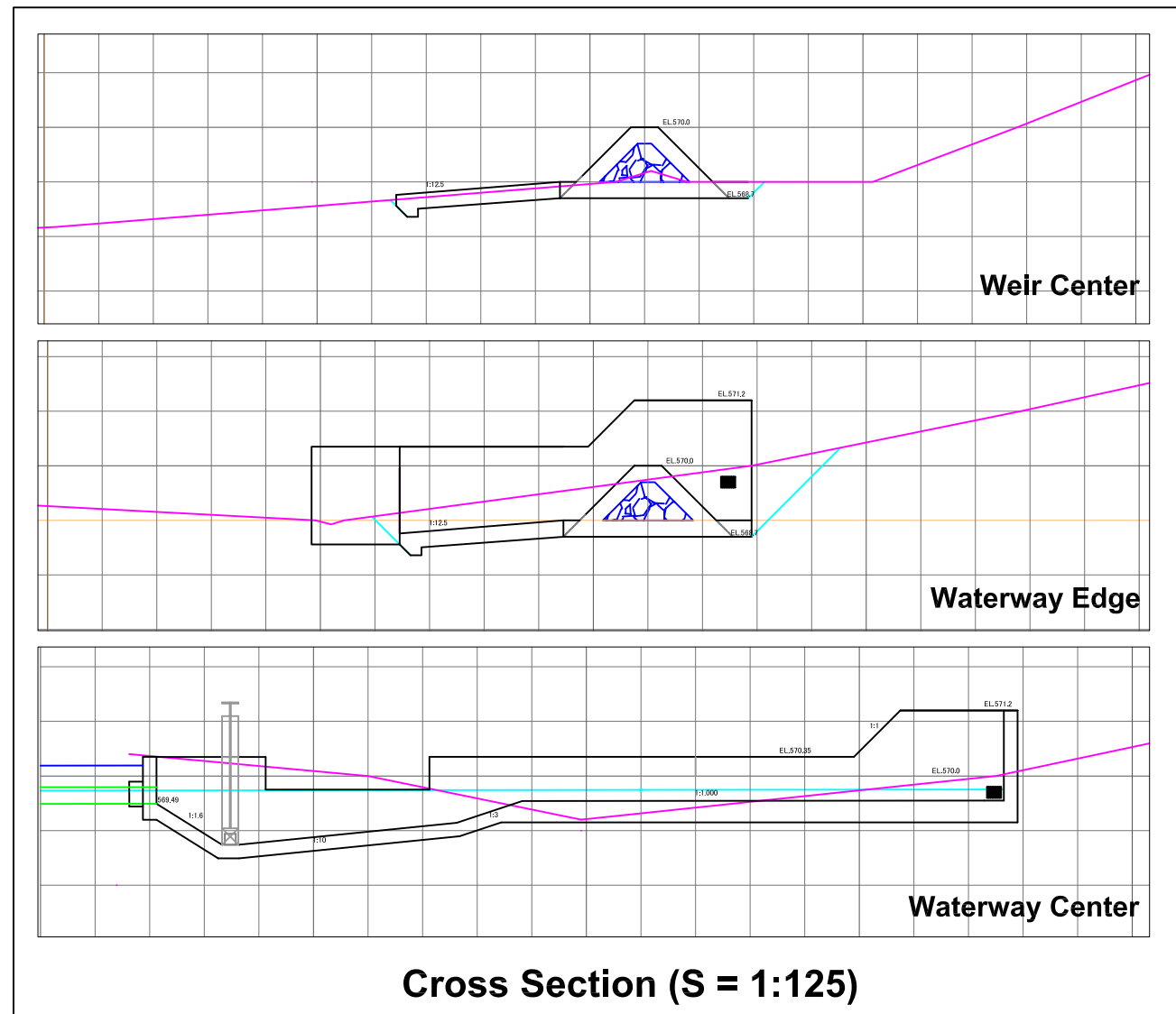
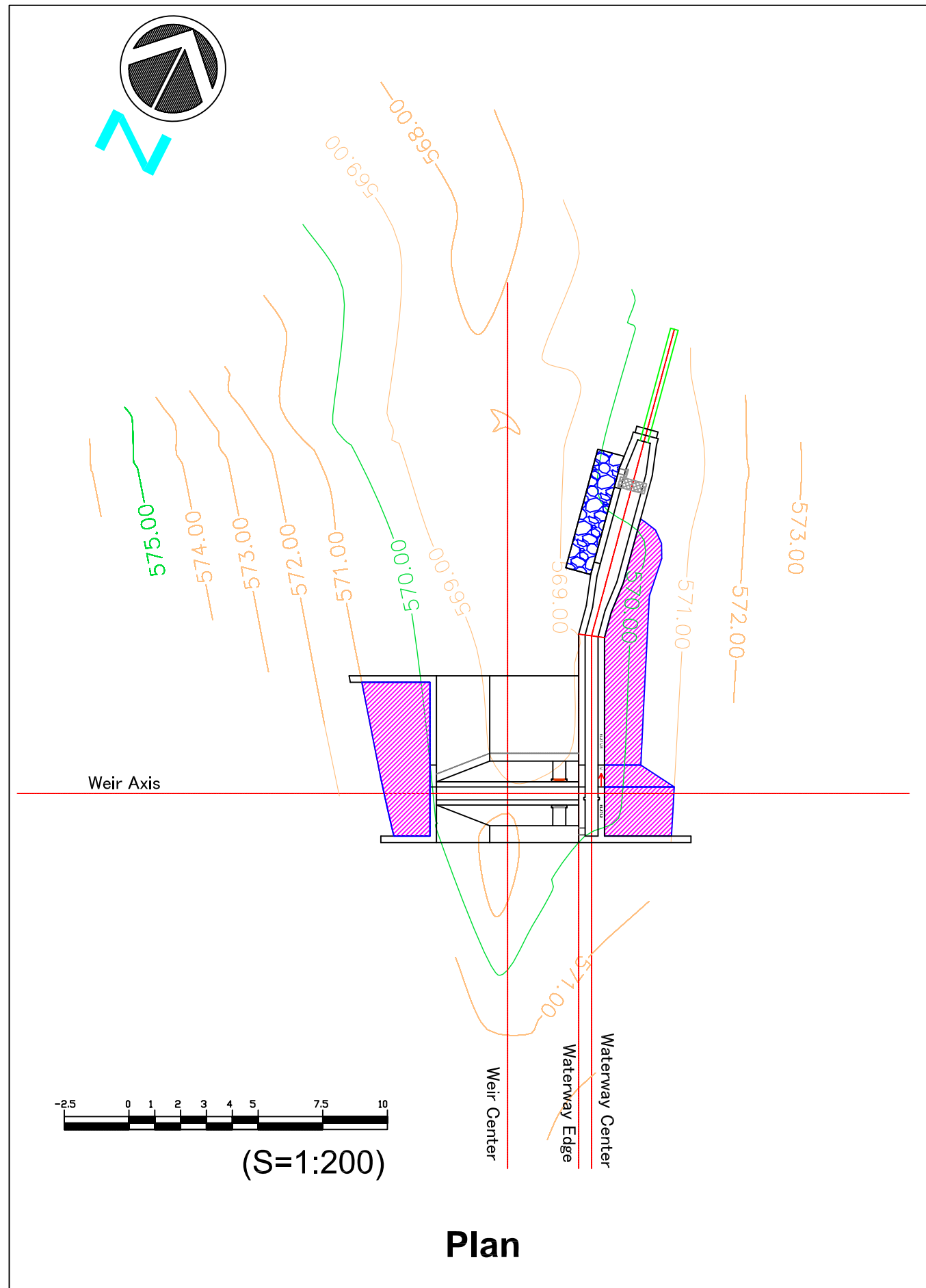

JAPAN INTERNATIONAL COOPERATION AGENCY

PROJECT & LOCATION:
Preparatory Survey on the Project for Promotion of
Production Activities by Clean Energy in the North Villages
The Republic of Guatemala

SHEET CONTENTS
Seasir Micro Hydropower Project
Intake No.1
(Scale: As Drawing)

DRAWING NO.
S-C-001

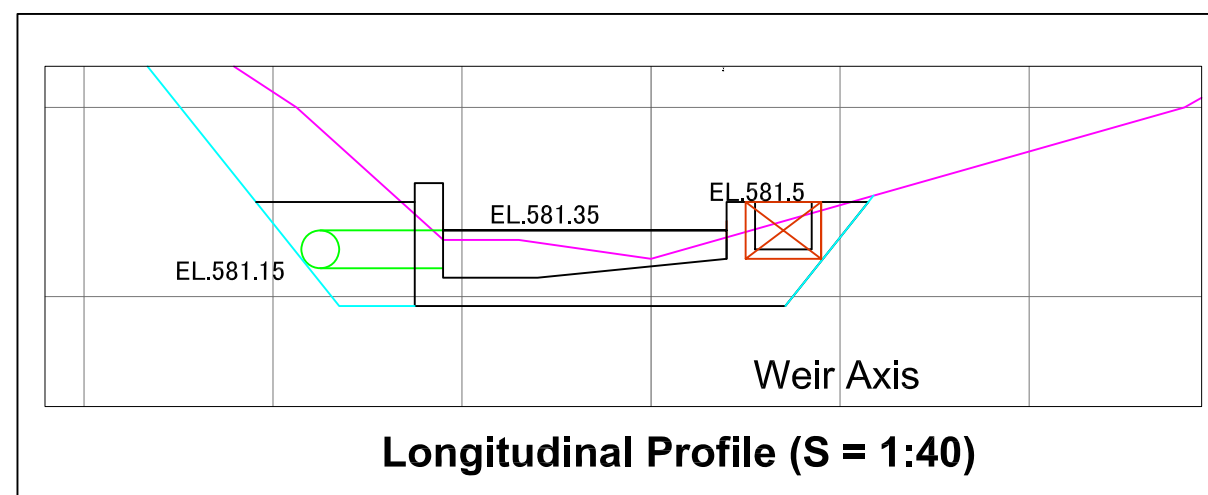
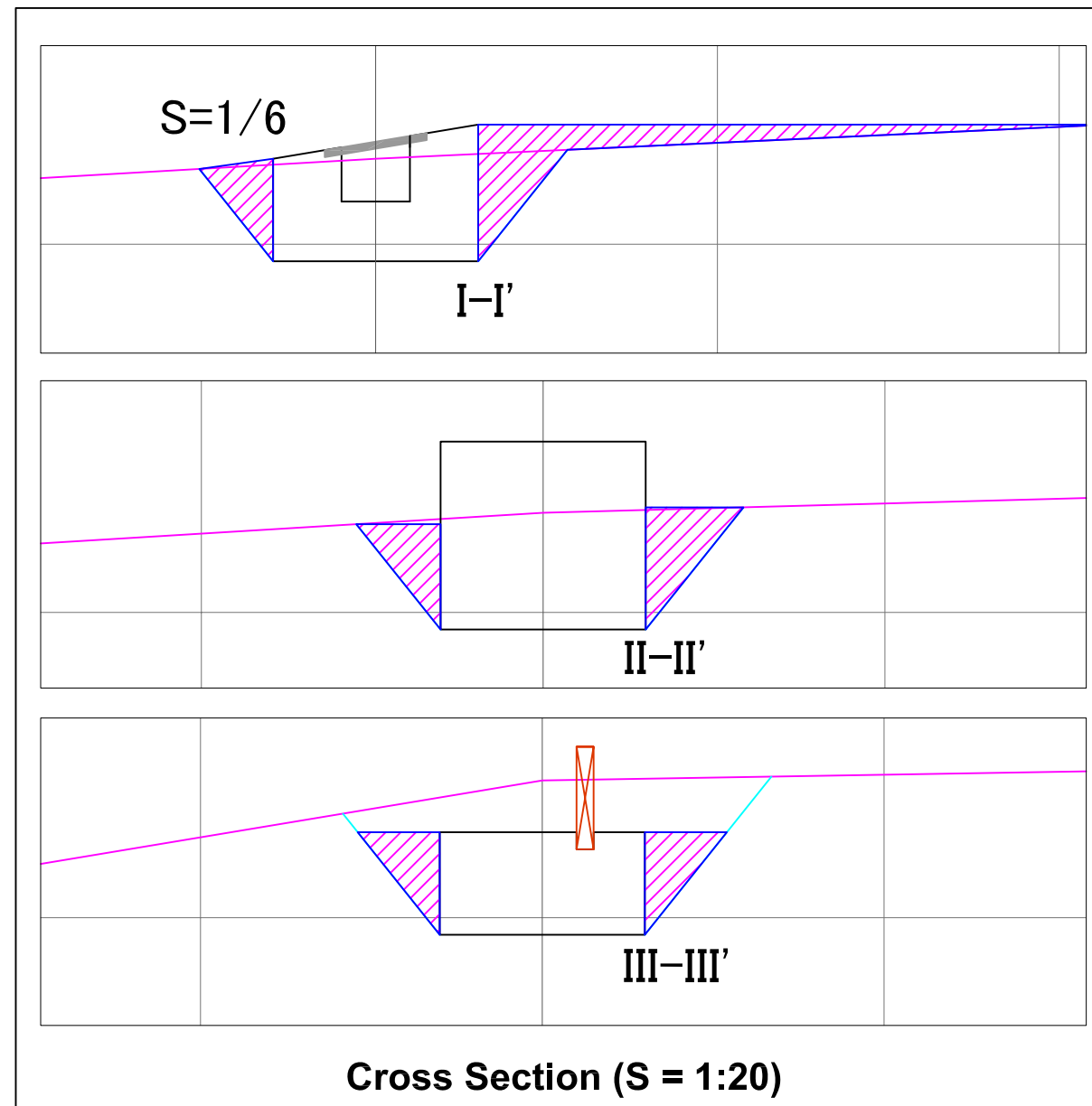
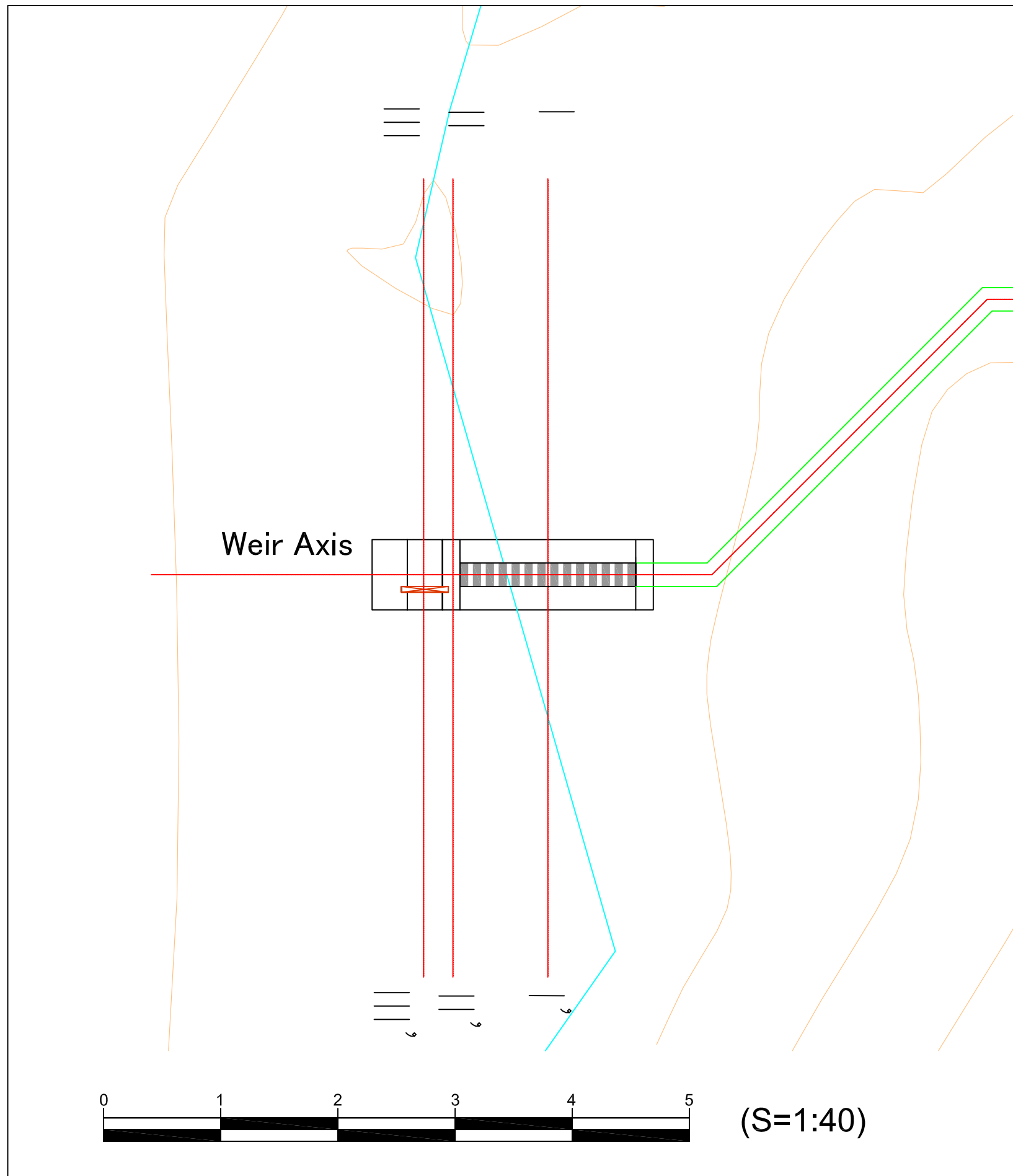

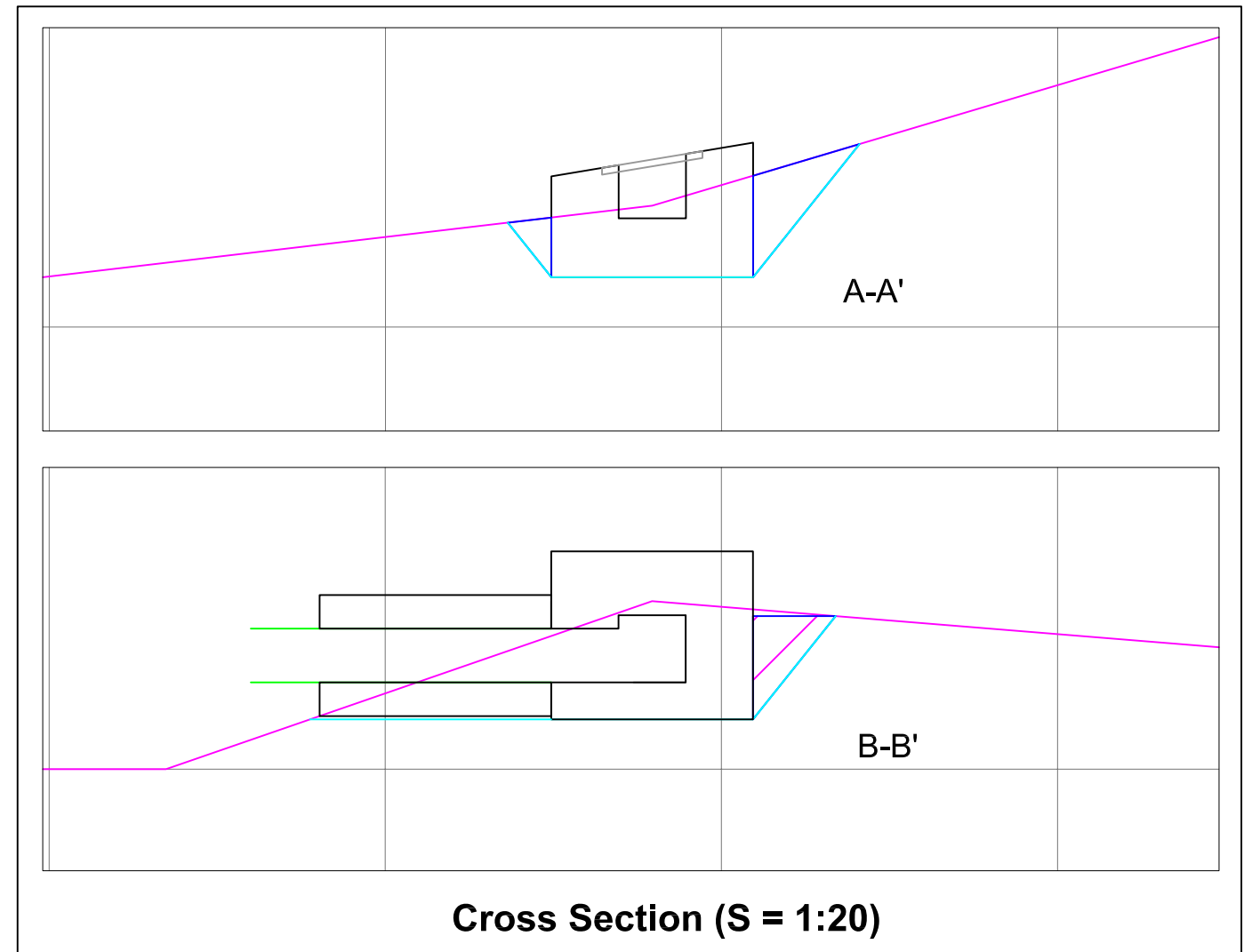
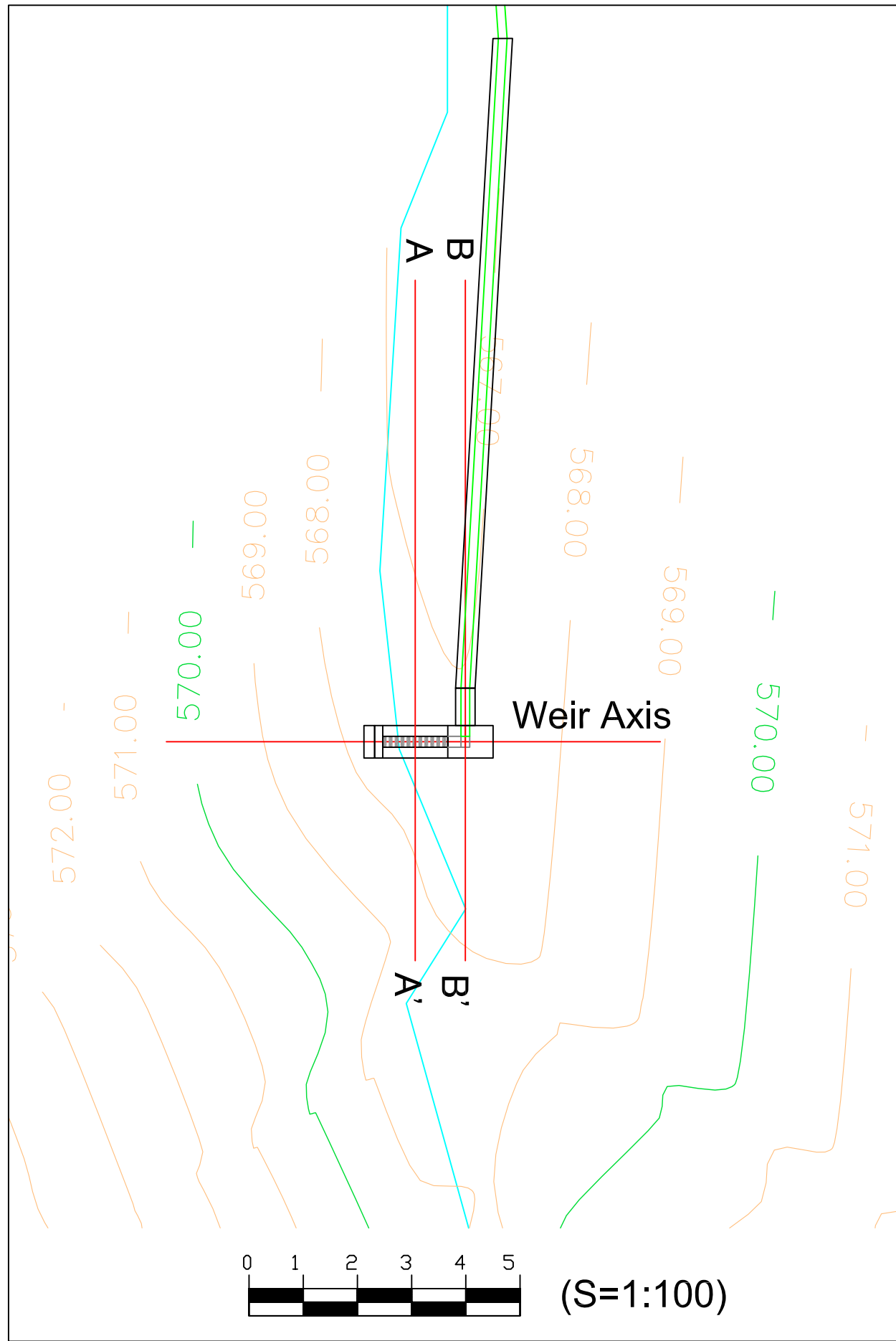

Cross Section (S = 1:20)

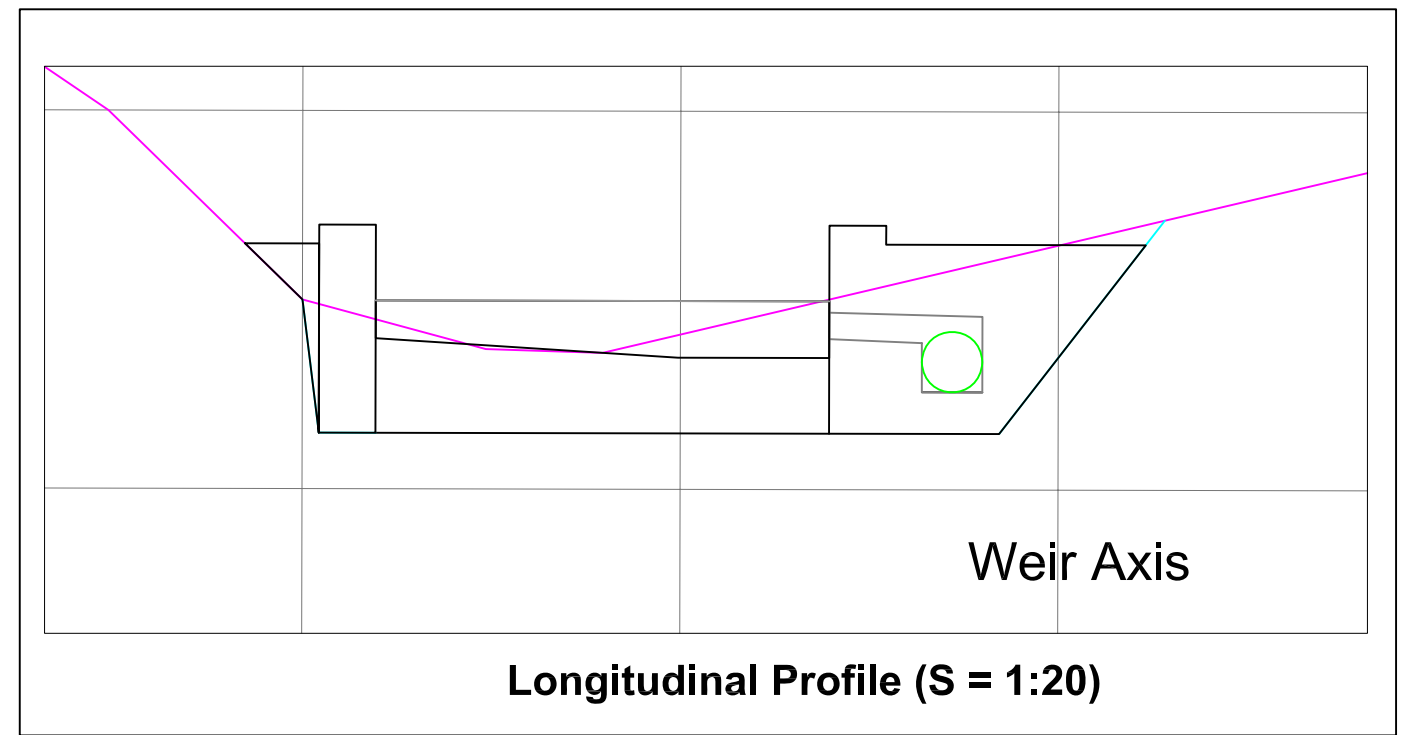

Longitudinal Profile (S = 1:20)



JAPAN INTERNATIONAL COOPERATION AGENCY

PROJECT & LOCATION:	SHEET CONTENTS	DRAWING NO.
Preparatory Survey on the Project for Promotion of Production Activities by Clean Energy in the North Villages The Republic of Guatemala	Seasir Micro Hydropower Project Intake No.3 (Scale: As Drawing)	S-C-003

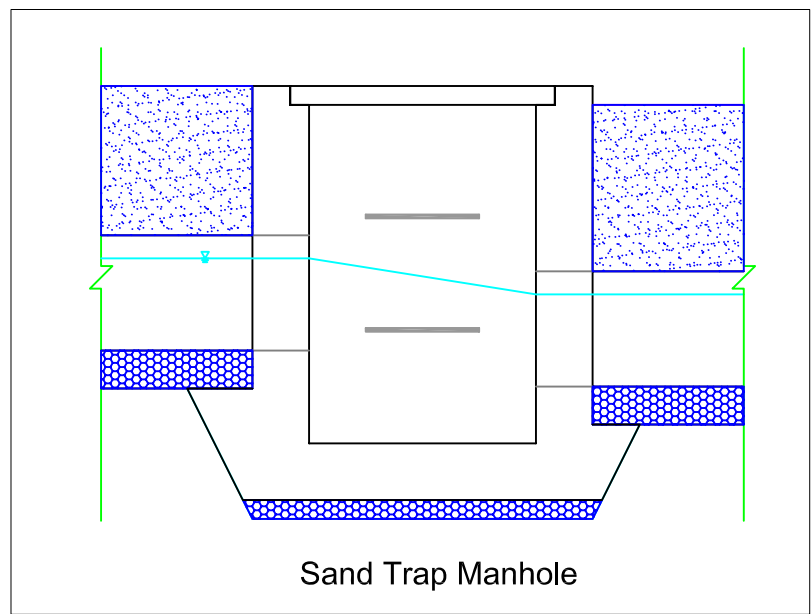
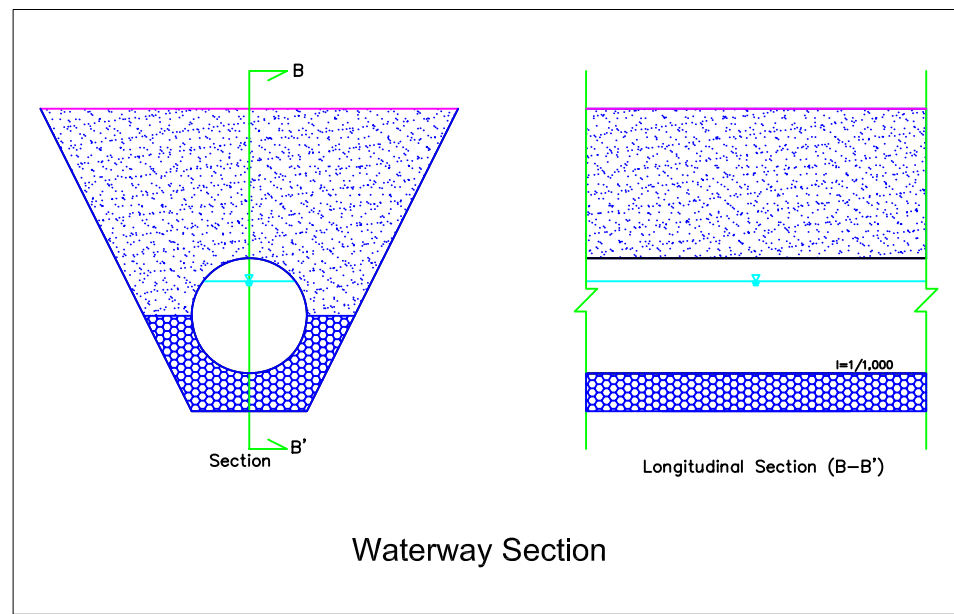
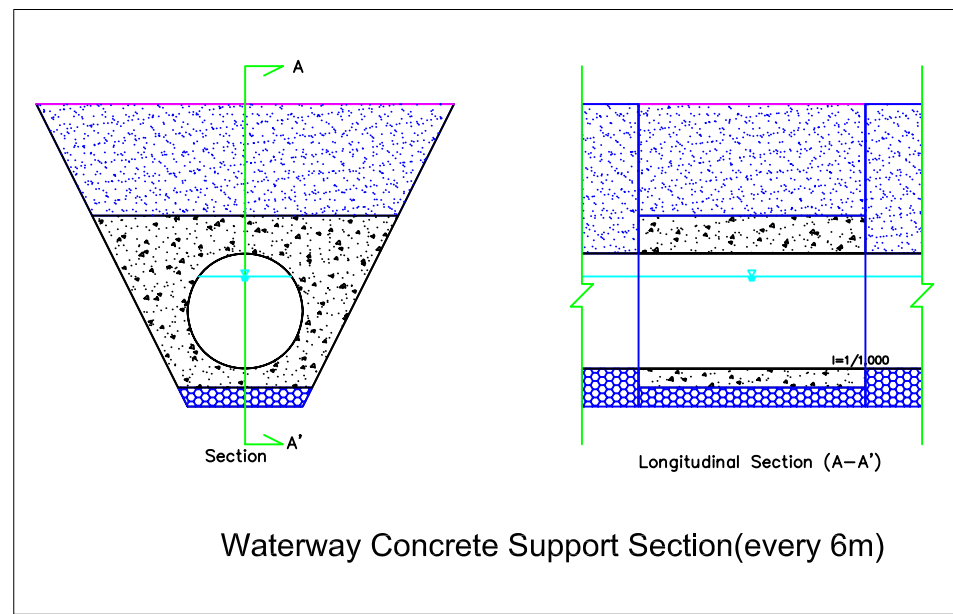
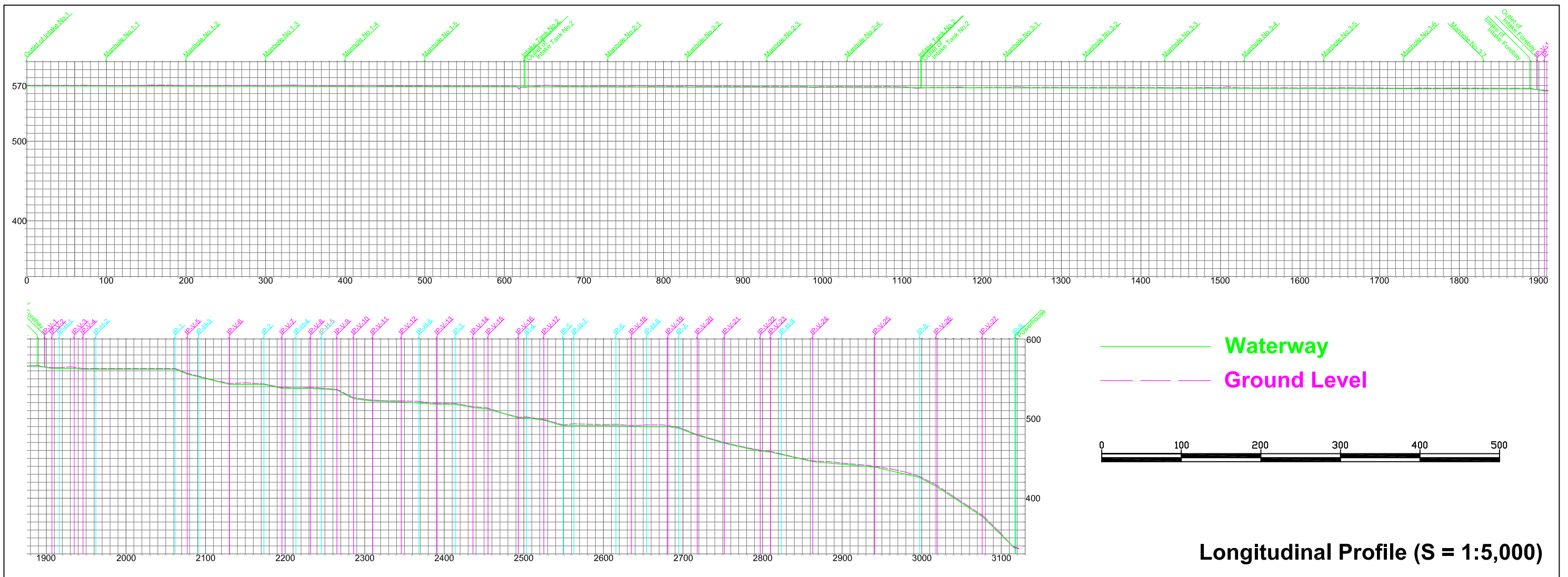

Cross Section (S = 1:200)



JAPAN INTERNATIONAL COOPERATION AGENCY

PROJECT & LOCATION:

Preparatory Survey on the Project for Promotion of Production Activities by Clean Energy in the North Villages The Republic of Guatemala

SHEET CONTENTS

Seasir Micro Hydropower Project Waterway (Scale: As Drawing)

DRAWING NO.

S-C-004

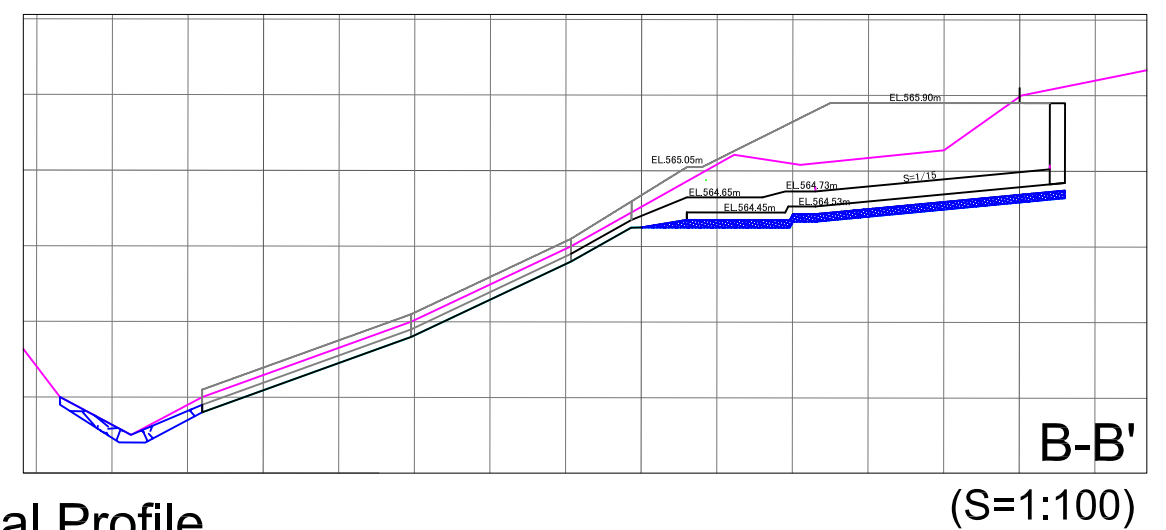
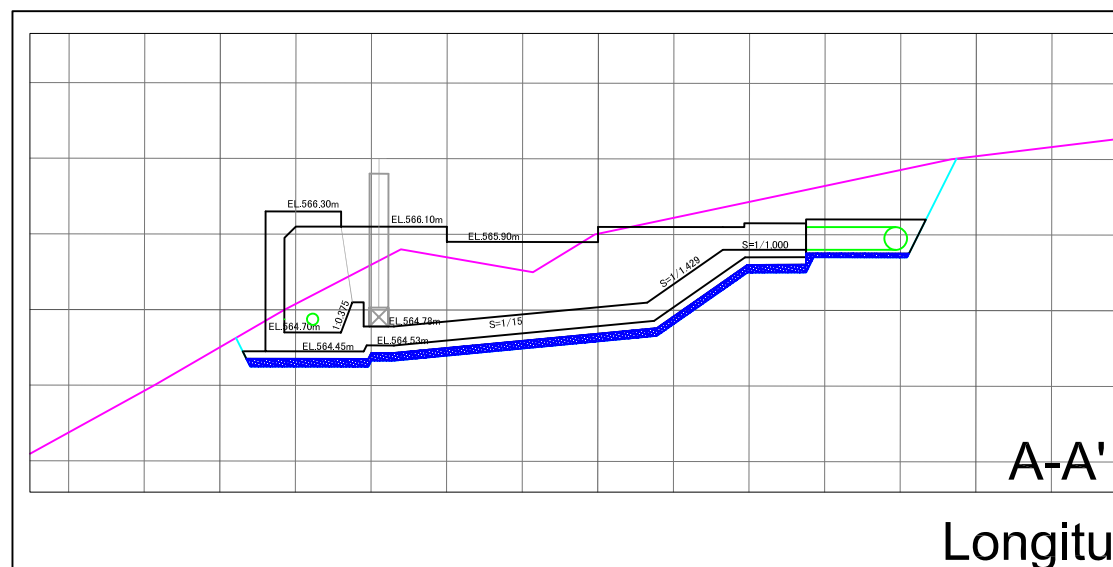
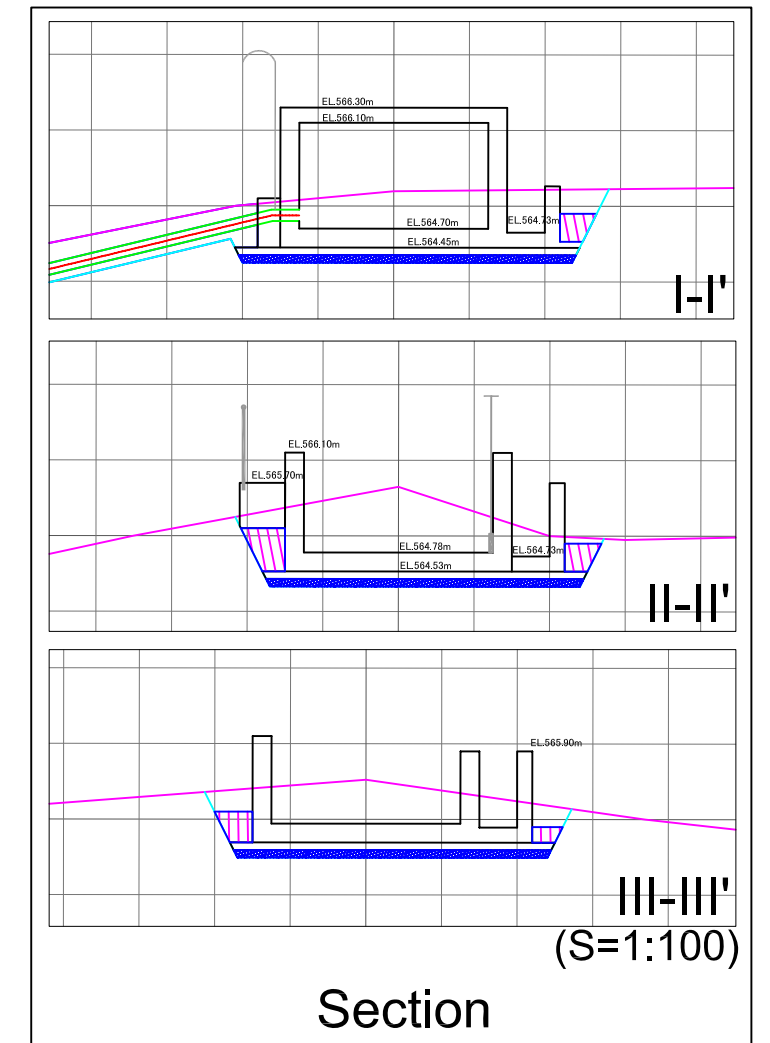
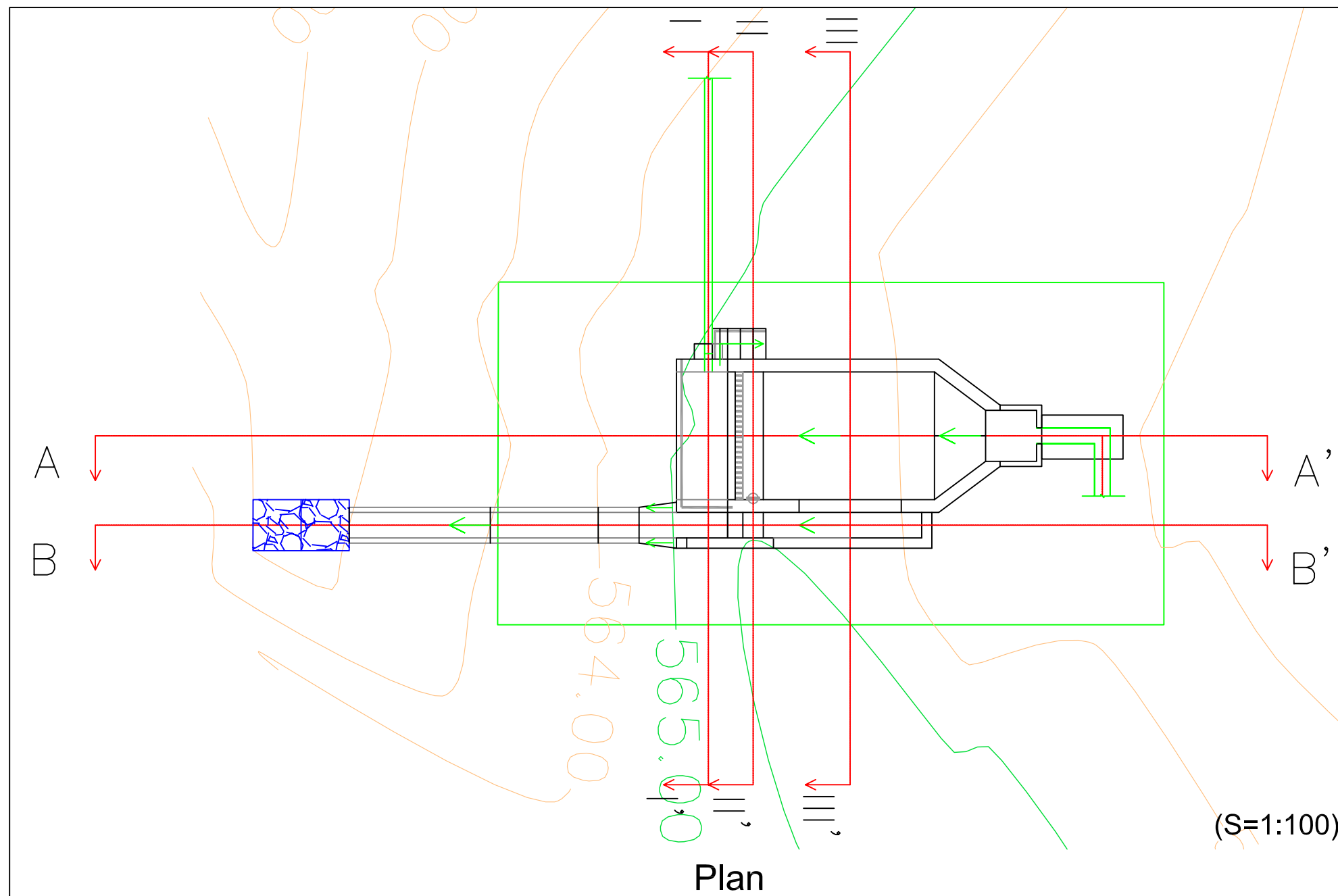

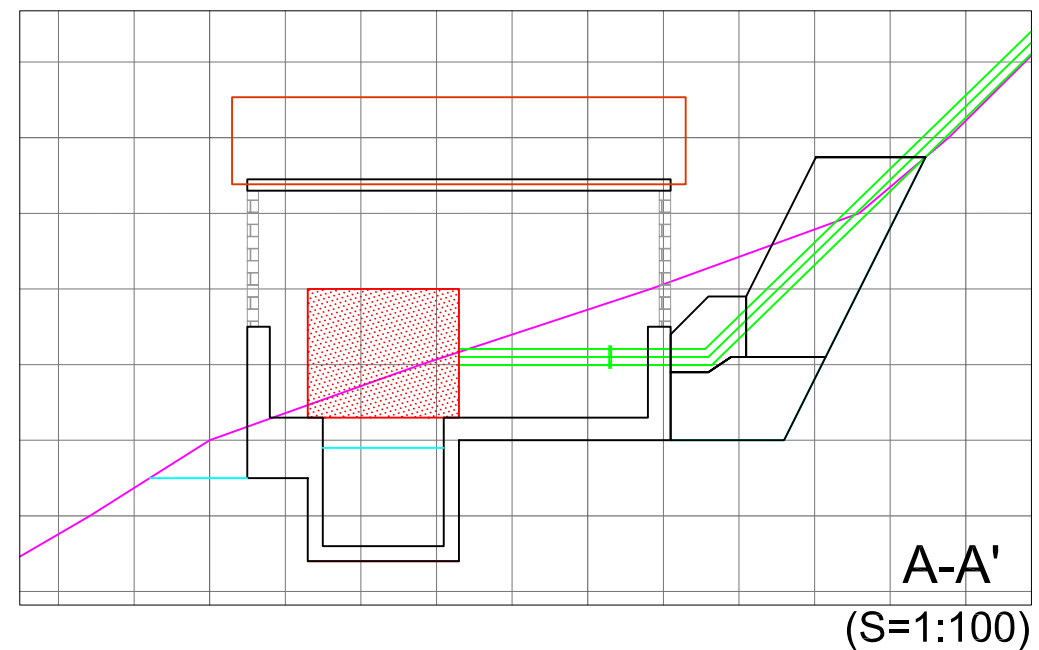
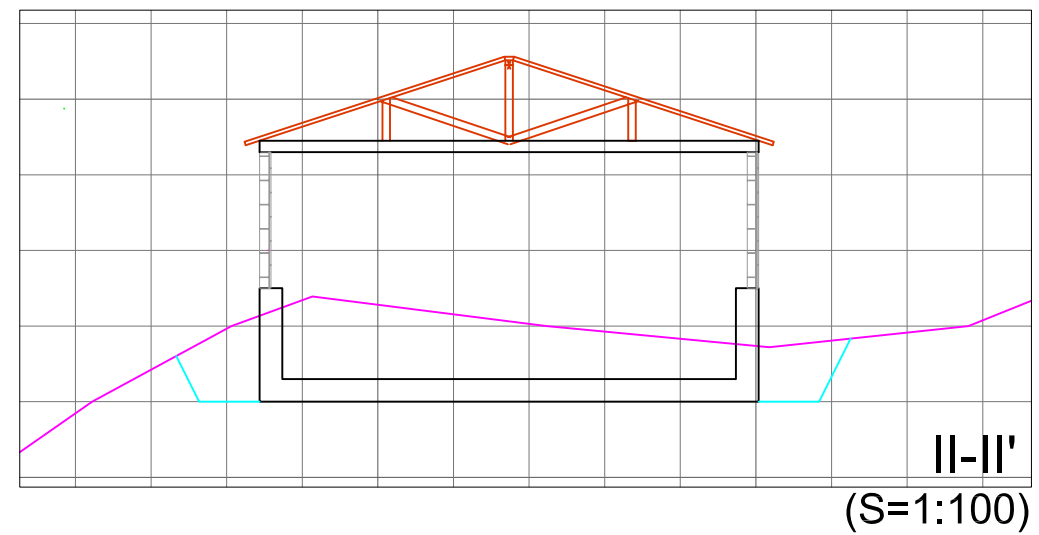
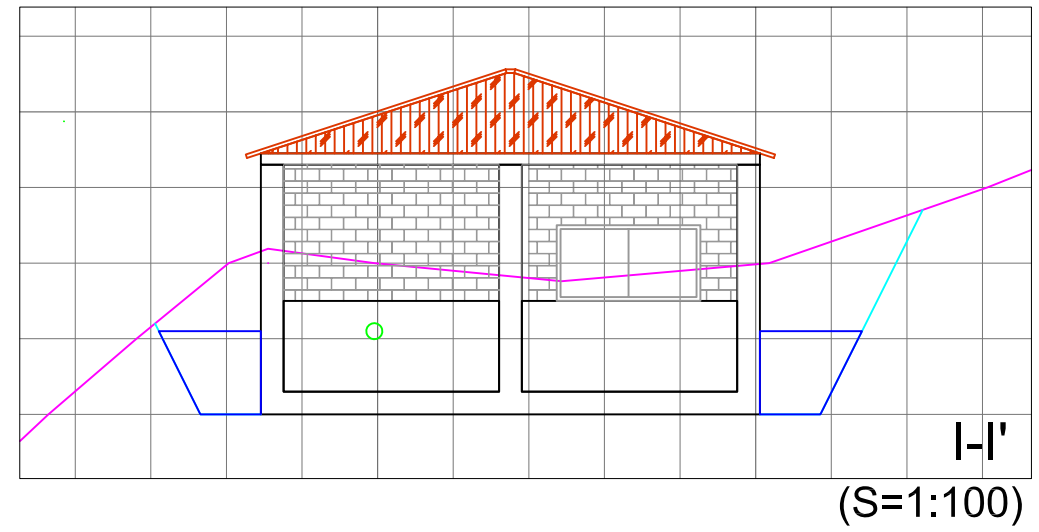
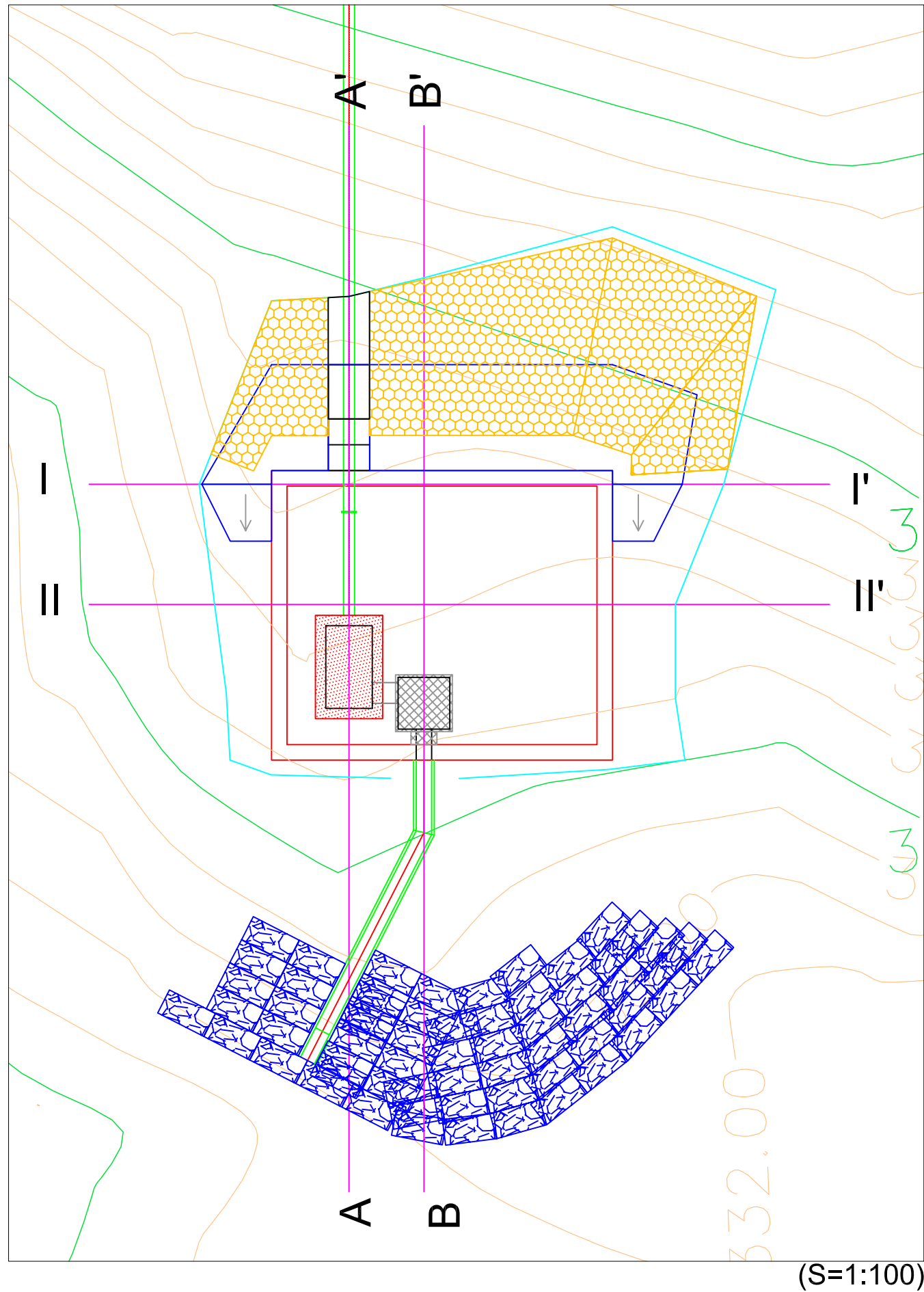

JAPAN INTERNATIONAL COOPERATION AGENCY

PROJECT & LOCATION:

Preparatory Survey on the Project for Promotion of
Production Activities by Clean Energy in the North Villages
The Republic of Guatemala

SHEET CONTENTS

Seasir Micro Hydropower Project
Powerhouse
(Scale: S=1:100)

DRAWING NO.

S-C-006

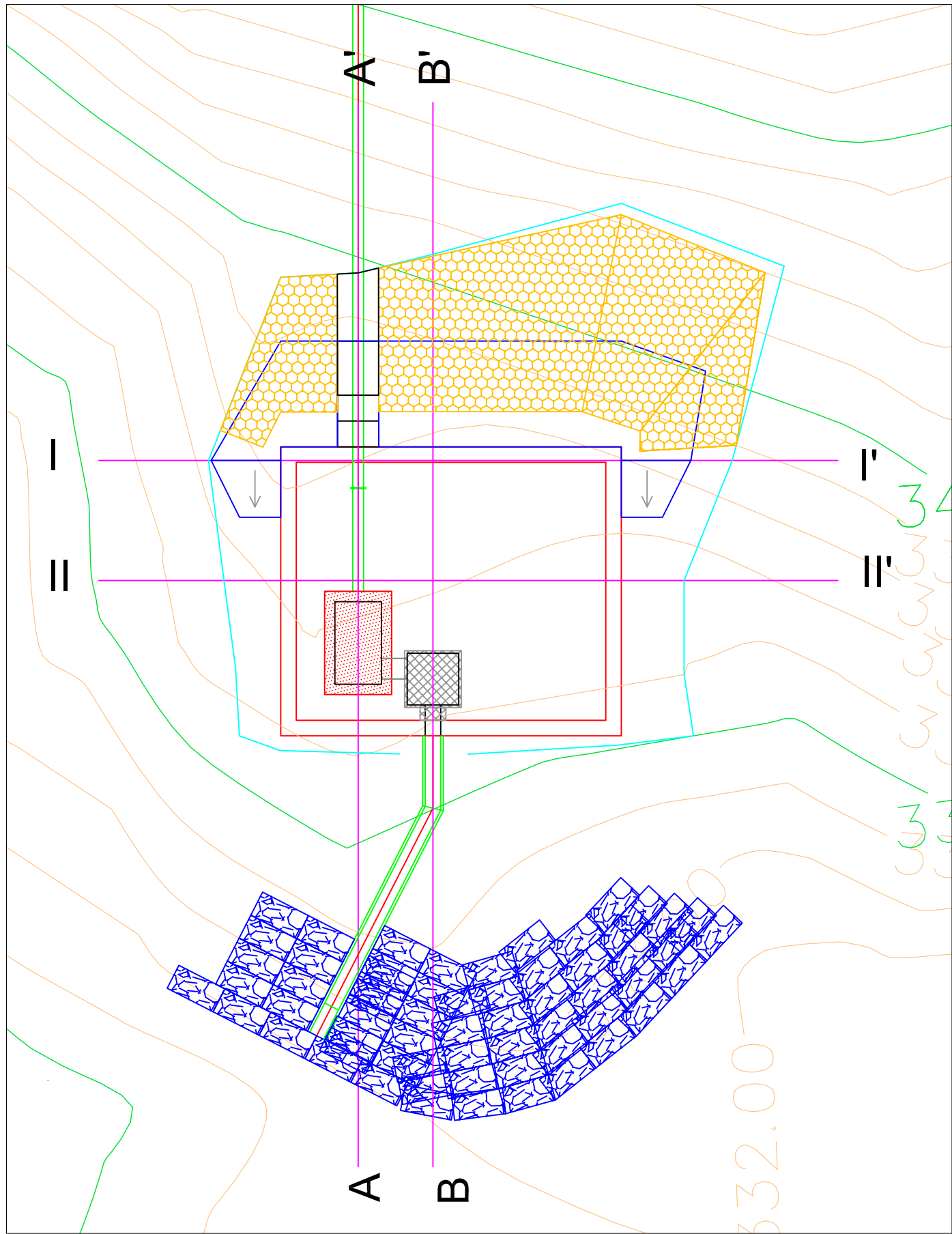

(S=1:100)

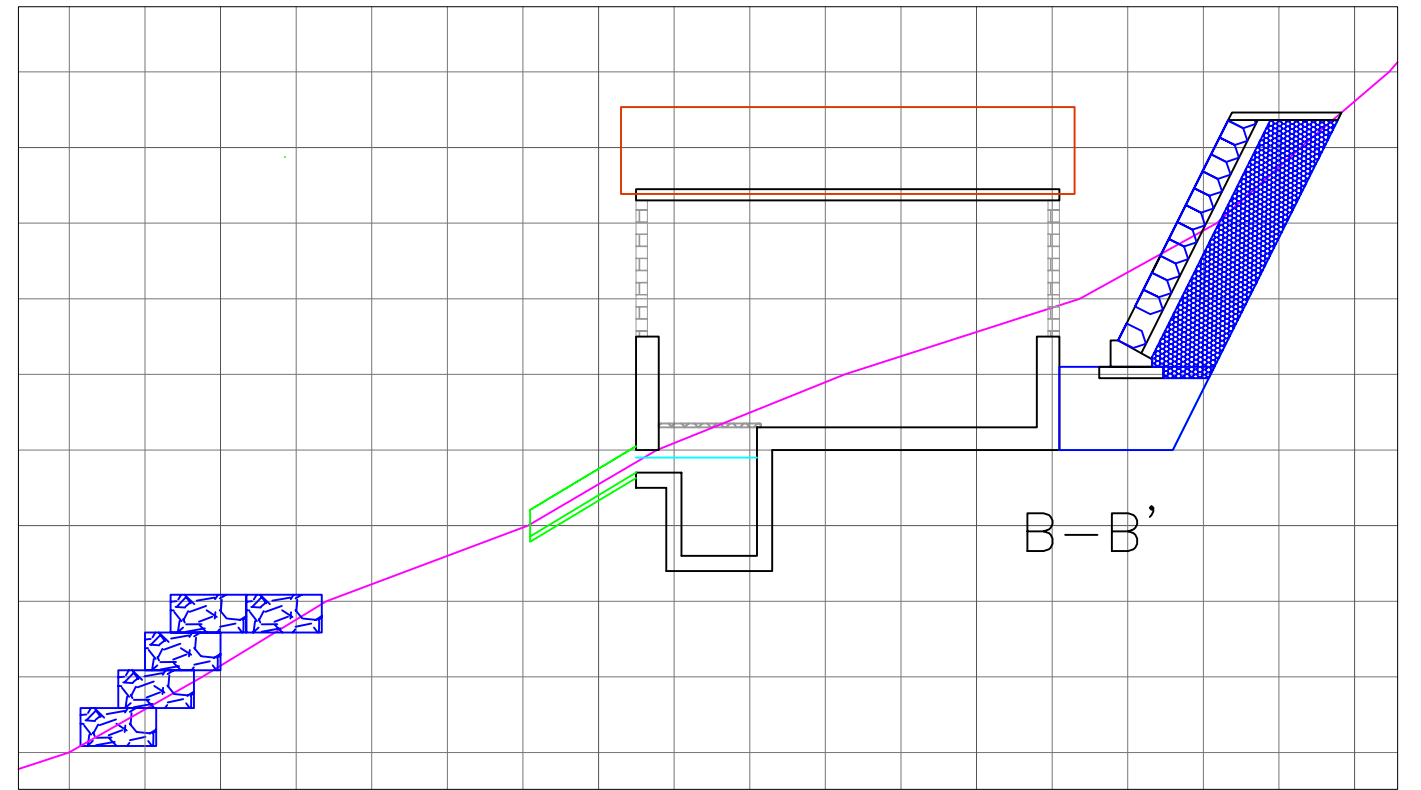

(S=1:100)

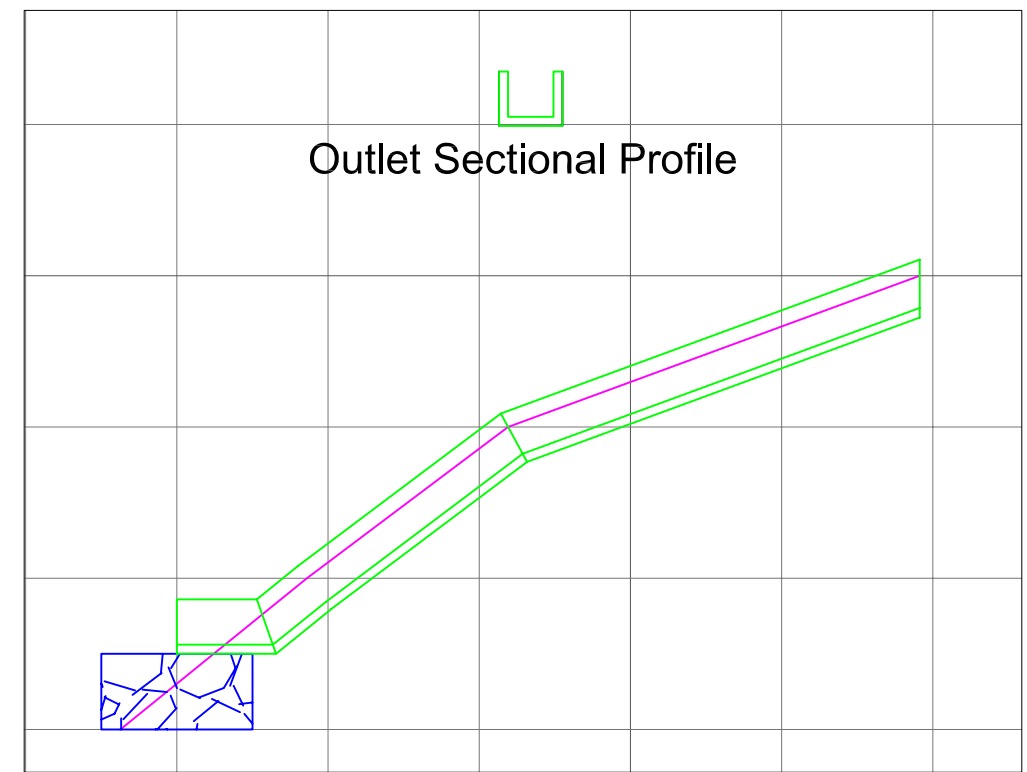

(S=1:50)



JAPAN INTERNATIONAL COOPERATION AGENCY

PROJECT & LOCATION:

Preparatory Survey on the Project for Promotion of
Production Activities by Clean Energy in the North Villages
The Republic of Guatemala

SHEET CONTENTS

Seasir Micro Hydropower Project
Outlet
(Scale: As Drawings)

DRAWING NO.

S-C-007

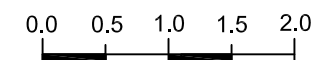
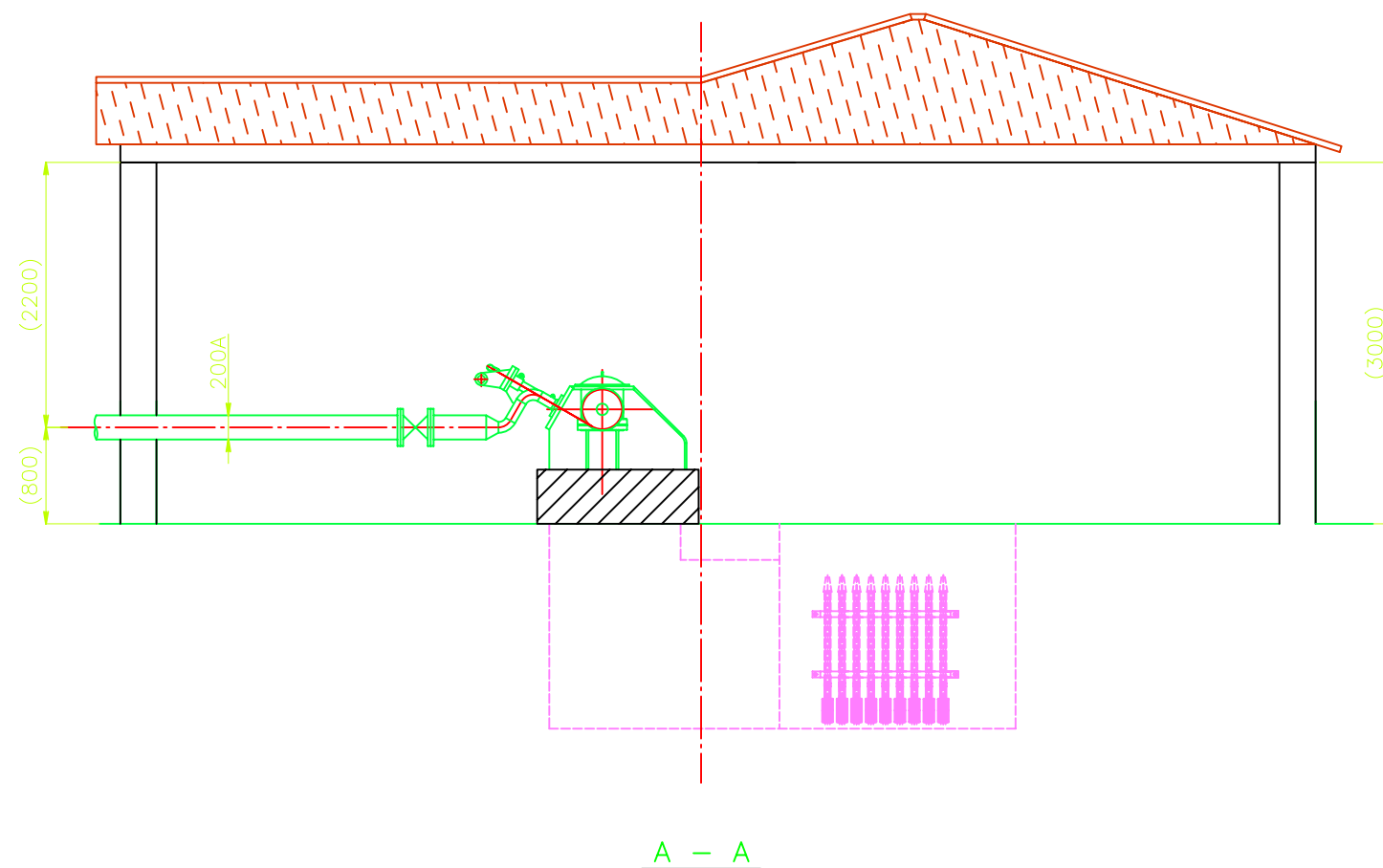
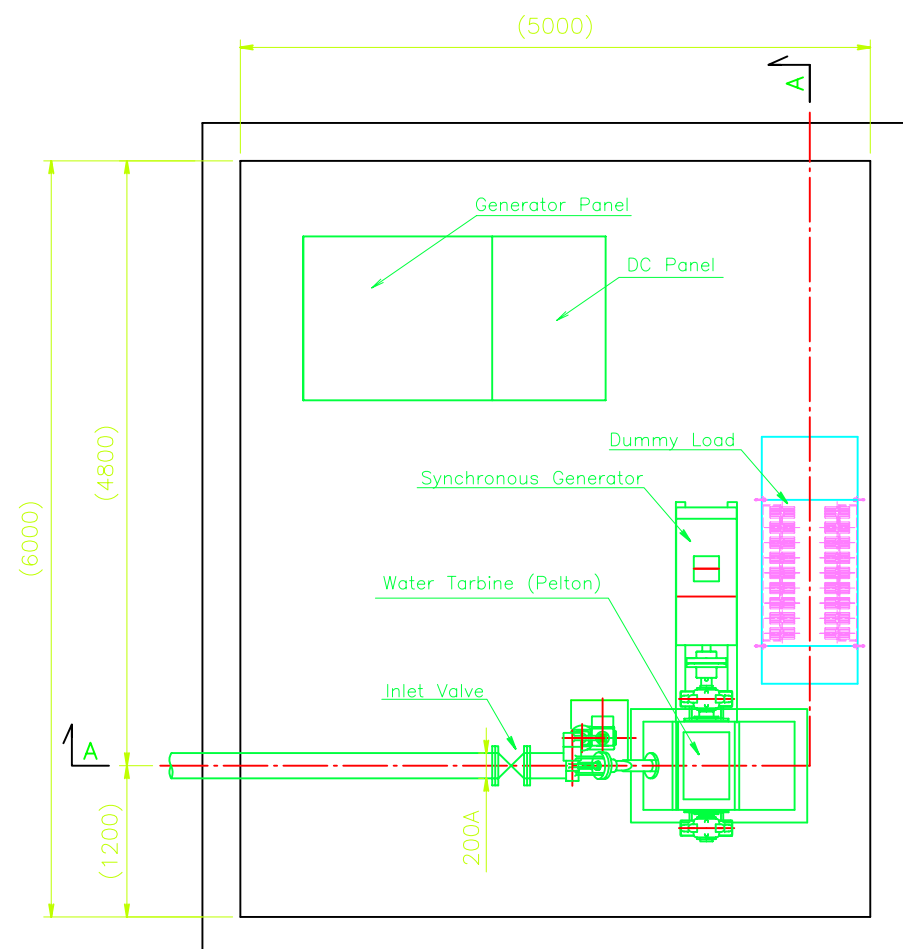
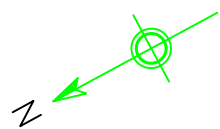

	Turbine Discharge (m ³ /s)	Effective Head (m)	Speed (min ⁻¹)	Rated Capacity (kVA)
Seasir	0.04	218.0	1800	70



JAPAN INTERNATIONAL COOPERATION AGENCY

PROJECT & LOCATION:

Preparatory Survey on the Project for Promotion of
Production Activities by Clean Energy in the North Villages
The Republic of Guatemala

SHEET CONTENTS

Seasir Micro Hydro power Project
Layout Plan in the powerhouse

DRAWING NO.

S-E-001

(S=1:60)

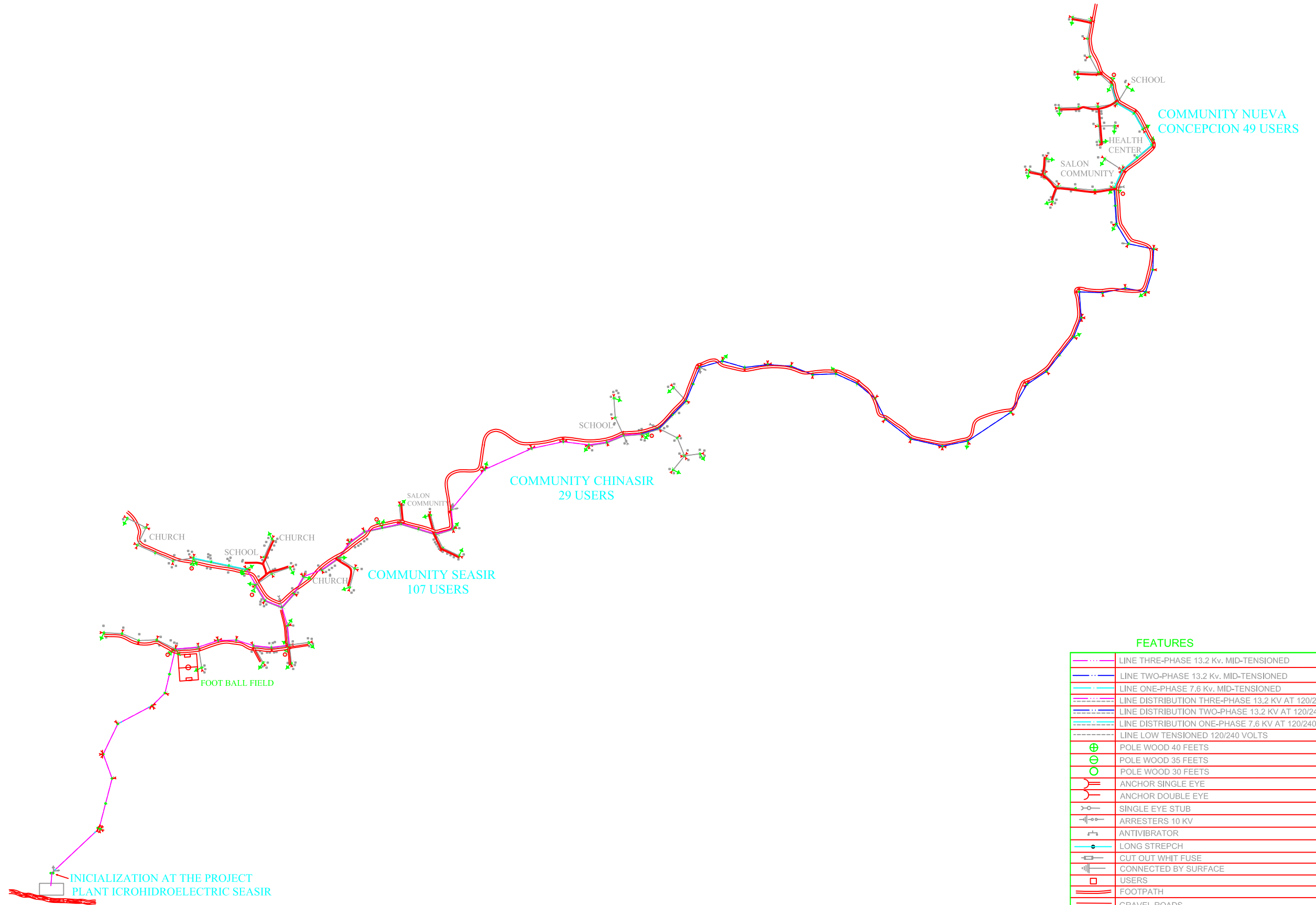
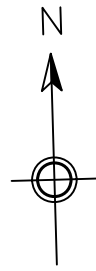

INICIALIZACION AT THE PROJECT
PLANT ICROHIDROELECTRIC SEASIR

COMMUNITY CHINASIR
29 USERS

COMMUNITY SEASIR
107 USERS

COMMUNITY NUEVA
CONCEPCION 49 USERS

FEATURES

	LINE THREE-PHASE 13.2 Kv. MID-TENSIONED
	LINE TWO-PHASE 13.2 Kv. MID-TENSIONED
	LINE ONE-PHASE 7.6 Kv. MID-TENSIONED
	LINE DISTRIBUTION THREE-PHASE 13.2 KV AT 120/240 V.
	LINE DISTRIBUTION TWO-PHASE 13.2 KV AT 120/240 VOLTS
	LINE DISTRIBUTION ONE-PHASE 7.6 KV AT 120/240 VOLTS
	LINE LOW TENSIONED 120/240 VOLTS
	POLE WOOD 40 FEETS
	POLE WOOD 35 FEETS
	POLE WOOD 30 FEETS
	ANCHOR SINGLE EYE
	ANCHOR DOUBLE EYE
	SINGLE EYE STUB
	ARRESTERS 10 KV
	ANTIVIBRATOR
	LONG STREPC
	CUT OUT WHIT FUSE
	CONNECTED BY SURFACE
	USERS
	FOOTPATH
	GRAVEL ROADS
	TRANSFORMER SINGLE PHASE, SELF PROTECTED (CSP, 60 HZ, MOUNTED IN POLE, 7.620/120-240 VOLTS)

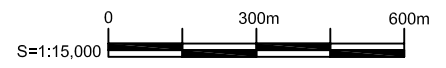

JAPAN INTERNATIONAL COOPERATION AGENCY

PROJECT & LOCATION:

Preparatory Survey on the Project for Promotion of
Production Activities by Clean Energy in the North Villages
The Republic of Guatemala

SHEET CONTENTS

Seasir Micro Hydropower Project
Transmission Line Plan
(Scale: 1:15,000)

DRAWING NO.

S-E-002

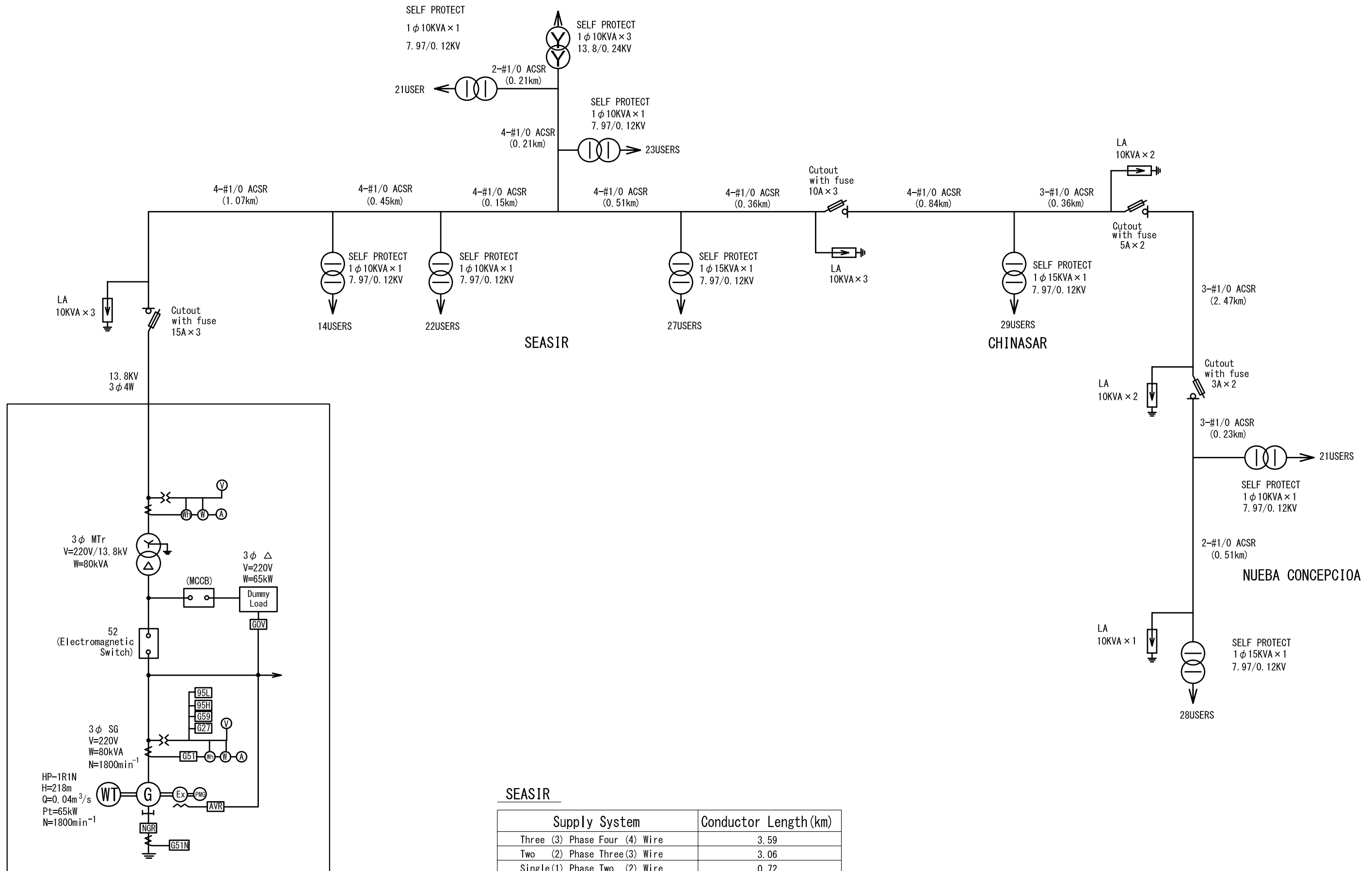

Seasir Power Station

SEASIR

Supply System	Conductor Length (km)
Three (3) Phase Four (4) Wire	3.59
Two (2) Phase Three(3) Wire	3.06
Single(1) Phase Two (2) Wire	0.72
Total	7.37

