

## **LAMPIRAN**

# LAMPIRAN

1. Hasil Survey *Benchmark*

### (1) Department of Export Promotion (DEP) in Thailand

<p>a)</p> <p>Mission / priority, and position in export policy</p>	<ul style="list-style-type: none"> <li>- Mission or major policy issues</li> <li>- Priority industries and commodities for export</li> <li>- Position and roles of export promotion organization in the export policy</li> </ul>	<ul style="list-style-type: none"> <li>- i) promote and expand the market for Thai exports by penetrating new markets and preserving existing ones, ii) develop and perform activities that promote trade and increase the competitiveness, iii) reinforce the ability of Thai exporters to deliver goods and services, iv) build a positive image of Thai goods and services in terms of quality and prompt delivery.</li> <li>- Sub-sectors or commodities are not designated in particular.</li> <li>- Within Ministry of Commerce, DEP functions as one of its department specialized in export promotion and are also responsible for policy formulation and licensing, not only promotion. In line with the policy direction of Ministry of Commerce, DEP can propose any relevant activities / programs, but which are subject to approval of the Minister on an annual basis.</li> </ul>
<p>b)</p> <p>Organizational set-up and staffing</p>	<ul style="list-style-type: none"> <li>- Establishment and brief history</li> <li>- Organizational status (government-owned including a department of government, agency, public corporation, or else)</li> <li>- Divisions in organization, the staffing by division for major function</li> <li>- Status of staff, recruit system (including requirements for academic background and major</li> <li>- Recruitment from private sector, system to accept seconded staff from private (with or without, and degree)</li> <li>- Salary level of staff (compared to government officer and private sector)</li> </ul>	<ul style="list-style-type: none"> <li>- Established in 1952, and named as Department of Economic Relations under the Ministry of Commerce.</li> <li>- One of the departments within and under supervision of Ministry of Commerce.</li> <li>- In the Ministry of Commerce, there are secretariat, public relations division, eight offices for functional services, three centers for information, consulting, &amp; training, and 56 overseas foreign trade promotion offices and 5 regional export promotion centers. Total staff amounts to 957 as of July 2007, out of which 786 are assigned for domestic operations and the rest including the locally hired assigned for overseas operation.</li> <li>- Of the total staff, 393 are officers, the rest are permanent staffs and temporary staffs. Officers and permanent staffs are government employees. Personnel matters are handled in accordance to the government personnel system.</li> <li>- Not applicable, since DEP is a ministry's department</li> <li>- Same as the level applied to other central government officers.</li> </ul>
<p>c)</p> <p>Human resource development (HRD)</p>	<ul style="list-style-type: none"> <li>- Personnel evaluation system, career-path planning</li> <li>- Features and appealing points in HRD (staff training) system</li> <li>- Staff dispatch (seconded or OJT) to private sector and industrial associations (with or without, and degree)</li> <li>- Services and programs</li> </ul>	<ul style="list-style-type: none"> <li>- In accordance with the personnel system of the central government.</li> <li>- Annual training plan is internally compiled and approved by HRD Committee (prepared in DEP). Around 16 training courses are annually designed and conducted. Training theme covers project management skill, customer-care skill, languages &amp; business manner, financial management, export marketing &amp; procedure, overseas trade fair and etc.</li> <li>- Not practiced.</li> </ul>
<p>d)</p> <p>Services and programs</p> <ul style="list-style-type: none"> <li>: Market intelligence</li> <li>: Product development</li> <li>: Export promotion</li> </ul>	<ul style="list-style-type: none"> <li>- Services and programs</li> </ul>	<ul style="list-style-type: none"> <li>- Major services and programs are as follows:</li> <li>a) Market information: Intelligence service, web-site (Thai, English, Japanese), directory services (10,000 exporters &amp; 100,000 foreign importers listed)</li> <li>b) Product (design) development: One-village One-Product program, design / branding support programs, design contests</li> </ul>

	<ul style="list-style-type: none"> <li>- Manuals to prescribe the standard process of each service and function (with or without, or ISO accreditation), and their use by staff</li> <li>- Performance and indicators of each service and function (with or without, contents)</li> <li>- Process and practice to reflect the needs of users (export industries) into the planning and revision of services and functions</li> <li>- Relation between the international promotion posts and headquarter, main activities of international promotion posts</li> <li>- Exporters training programs and memberships</li> </ul>	<p>c) Export promotion: exhibition &amp; mission, in-store promotion, Prime Minister's Export Award, client service (inquiry and consultation through visit or Call Center)</p> <ul style="list-style-type: none"> <li>- Not known for manuals for the delivery of each service, and not accredited with ISO.</li> <li>- Indicators are set to represent the performance of DEP services and programs in terms of no. of users and deals made, and reported in the annual report.</li> <li>- Every project is followed by questionnaire. Furthermore, interviews with clients / users are undertaken if necessary to reflect for the betterment of services and programs. In 2006, the poll (evaluation study) on DEP performance was done for the first time.</li> <li>- Representatives of overseas promotion offices are appointed by the Committee of MOC, and their staffs (junior position) are internally appointed by DEP. Major roles include i) assist trade mission and fairs, ii) collect and report market and buyers' information to local traders, and iii) invite buyers to visit fairs.</li> <li>- Exporter training is available at the International Trade Training Institute with focus on pre-exporter and pre-trading companies, amounts to 93 courses with 8,692 participants (2005).</li> <li>- Membership system exists with free of charge. Member exporters can update their own data through access to the web-site.</li> </ul>
e)	<ul style="list-style-type: none"> <li>- Origins of operational budget</li> <li>- Operational revenue (with or without), discretions on such revenue use</li> <li>- Structure of expenditure (ratio of personnel expense, fixed charge ratio, etc.)</li> <li>- Excess or deficiency of budget</li> </ul>	<ul style="list-style-type: none"> <li>- Almost all funded by the national government.</li> <li>- Out of revenue 1,978 mil. Baht, in 2006, 1,964 mil is financed by the government budget. Fees collected from users are quite nominal and used for the programs of DEP. Once the budget plan is approved on an annual basis, DEP can have discretion over the use in flexible manner.</li> <li>- About 70% of the budget goes to salary and fixed items, and the rest for activities and programs.</li> <li>- Always balanced.</li> </ul>
f)	<ul style="list-style-type: none"> <li>- Meeting (regular or irregular) with industrial sector, association (with or without), participatory organizations, the role of TPO in the meeting</li> <li>- Overlapping of services and functions with other ministries and agencies</li> <li>- Business partnership with other related organizations (with or without)</li> </ul>	<ul style="list-style-type: none"> <li>- No special dialogue is set, but frequently communicated with private institutions such as Chamber of Commerce to listen to their needs and opinions for export promotion.</li> <li>- One of the major functions by DEP is to handle trade permit and licensing. In Thai, at least eleven public institutions are involved in this field. To realize access-friendly service, One-Stop Service Center was established in 2002 in DEP by the initiative of Prime Minister Office and now functions as single window for trade permit and licensing.</li> <li>- DEP has partnership agreements with seven financial institutions including Export-Import Bank and SME Bank to facilitate financial support for exporters. DEP has also cooperated with global retail chains such as Carrefour for the In-store Promotion program.</li> </ul>
g)	<ul style="list-style-type: none"> <li>- Large-scale restructuring and reform of organization and service line during the last ten years (after Asian currency crisis) (with or without)</li> <li>- Success or failure, and evaluation of restructuring and reform</li> </ul>	<ul style="list-style-type: none"> <li>- Organizational change was made under the concept of "Global Dynamics" in 2006 in view of encouraging i) Thai companies to promote overseas operation (outbound investment, M&amp;A, JV and franchising and licensing, ii) global sourcing of raw materials, machinery and equipment, iii) trade logistic efficiency.</li> <li>- The above organizational reform is still underway.</li> </ul>

**Major Figures for Organization and Operation**

Number of employee	957 in total	Domestic: 786 Overseas: 171 inc. local
Number of domestic office	5 (region) + 1 HQ	
Number of overseas office	56	
Companies listed in TPO's directory	Exporter: app. 10,000	Buyer: app. 100,000
Number of membership company	n.a	
Number of consulting services / year	n.a	
Number of inquiry services / year	Exporter: n.a	Buyer: n.a
Number of successful matching / year	n.a	
Number of website visitor	1,126,964 (2005 in multiple), 271,217 (single hit)	
Number of product / company listed at web exhibition	553 companies (as of Jul. 2007)	
Number of trade fairs organized and sponsored / year	Overseas: 90	Domestic: 18
Number of participating companies / year	Overseas: 3,157	Domestic: 8,524
Number of material held in library	n.a	
Annual budget	64.1 million US\$ (FY2006)	
Languages in home website	Thai, English and Japanese	

## Highlights of Department of Export Promotion (DEP) of Thailand

Organization Chart of DEP of Thailand\_as of 2006



- 1) **One-Stop Export/Import Service Center contributes to facilitating the access of the customers and users to the programs and services of DEP.** Located on the first floor of DEP, One Stop Export-Import Service Center allows traders to consolidate and streamline export processing in one location by giving priority to providing convenience in issuing and certifying export documents and reducing unnecessary processes to save cost and time. The center provides services to exporters such as issuing food quality certificate and certificate of origin, issuing various certificate of guarantee, and providing export procedures information. In 2006, the center issued 76,106 certifications while 52,354 people sought services. In 2006, DEP received an "outstanding award" from the Working System Development Commission for the largest intra-governmental network. The concept of One-Stop service Center can be learned further. This service materializes not only quick services to traders, but also joint work of various government agencies and the private sectors.
- 2) **DEP has focused on the raising of pre-exporters and export potential identification in the regions.** Since 2000, DEP commenced "Inter-Trader" program which raises traders to identify potential products and exporters in the regions and act as agents on behalf (such as license processing). This five-year program has completed in 2006, bringing about almost 3,000 of inter-trader. From 2007, in linking to the activity of inter-trader, DEP launches the exporter training program to enhance the exporting capacity particularly in the regions, which targets pre (potential) exporters and companies. DEP expects that those exporters who participate in the training be followed up and further facilitated by the inter-trader for export realization.
- 3) **DEP has assisted exporter development in the neighboring countries through its training institute.** In accordance with the economic cooperation strategy of Thai Government, DEP provides international training course for exporters in Cambodia, Laos and Myanmar at its attached International Trade Training Institute (ITTI). The course helps develop their capability in planning of export strategy, financial management, procedure, shipping, and other skills. This effort has fostered the network in these countries, as well as created a potential for trade development.

## (2) Malaysian External Trade Promotion Corporation (MATRADE)

a)	Mission / priority, and position in export policy	<ul style="list-style-type: none"> <li>- Mission or major policy issues</li> <li>- Priority industries and commodities for export</li> <li>- Position and roles of export promotion organization in the export policy</li> </ul>	<ul style="list-style-type: none"> <li>- Along with Third Industry Master Plan ('06-'20) prepared by Ministry of Industry &amp; Trade (MITI) and Matrade (for trade parts), Matrade shall i) formulate and implement export marketing strategies and trade promotion activities, ii) undertake intelligence and market research and create a database of trade information, &amp; iii) organize training programs.</li> <li>- Identified 10 important export industries. Special focus is made to helping SMEs which have the export capacity. West &amp; Central Asia is increasingly focused.</li> <li>- MITI formulates policies and regulations, organize the high-level coordination body for the external trade sector, while MATRADE is responsible for the actual development and delivery of export promotion programs within the portfolio of MITI.</li> </ul>
b)	Organizational set-up and staffing	<ul style="list-style-type: none"> <li>- Establishment and brief history</li> <li>- Organizational status (government-owned including a department of government, agency, public corporation, or else)</li> <li>- Divisions in organization, the staffing by division for major function</li> <li>- Status of staff, recruit system (including requirements for academic background and major</li> <li>- Recruitment from private sector, system to accept seconded staff from private (with or without, and degree)</li> <li>- Salary level of staff (compared to government officer and private sector)</li> </ul>	<ul style="list-style-type: none"> <li>- Established in March 1993 as the external trade promotion arm of MITI by the Matrade Act.</li> <li>- Statutory public corporation under the Matrade Act 1992 (Act 490).</li> <li>- Comprised of six divisions: i) International Networking &amp; Trade Support, ii) Exporter Development, iii) Product &amp; Services Development, iv) Strategic Planning, v) Information Technology, and vi) Management. It has 32 overseas and 3 domestic offices.</li> <li>- The present number of workforce in total amounts to 479, comprising of 193 for management &amp; professional, 52 for executive officers, 110 for supporting staff, and 124 for locally recruited staff (e.g. marketing officers, clerks and drivers).</li> <li>- Government employee under the framework of Malaysian Public Service. All the employees except for one, who is a deputy CEO (seconded from MITI), are employed by Matrade. 64% of the staff has tertiary qualification, of which 78% are degree holders and 22% are diploma holders. No particular requirements for major exist.</li> <li>- Actively recruits from private companies, and there's no system to accept seconded staff from private companies.</li> <li>- Being a public corporation attached to MITI, the salary level of Matrade staff is based on that of government officers.</li> </ul>
c)	Human resource development (HRD)	<ul style="list-style-type: none"> <li>- Personnel evaluation system, career-path planning</li> <li>- Features and appealing points in HRD (staff training) system</li> <li>- Staff dispatch (seconded or OJT) to private sector and industrial associations (with or without, and degree)</li> </ul>	<ul style="list-style-type: none"> <li>- Introduced the evaluation system for the home employees, which is made firstly by the direct boss and then by division head, so that fair / objective evaluation can be achieved.</li> <li>- Takes various steps to enhance the quantity and quality of its human resources through a wide-range of training menu. The capacity and competency enhancement programs are available to improve the skill and knowledge of Matrade staffs.</li> <li>- Theme of HRD programs includes i) leadership and organizational change, ii) corporate team integration, iii) export promotion policy, iv) international negotiation, v) information technology applications, vi) problem solving skill, vii) marketing communication skill, viii) financial analysis and etc. In total, 164 capacity building programs were carried out in 2005.</li> <li>- Not practiced.</li> </ul>

d)	<p>Services and programs</p> <ul style="list-style-type: none"> <li>. Market intelligence</li> <li>. Product development</li> <li>. Export promotion</li> </ul>	<p>Services and programs</p> <ul style="list-style-type: none"> <li>- Manuals to prescribe the standard process of each service and function (with or without, or ISO accreditation), and their use by staff</li> <li>- Performance and indicators of each service and function (with or without, contents)</li> <li>- Process and practice to reflect the needs of users (export industries) into the planning and revision of services and functions</li> <li>- Relation between the international promotion posts and headquarter, main activities of international promotion posts</li> <li>- Exporters training programs and memberships</li> </ul>	<ul style="list-style-type: none"> <li>- Four major functions include i) trade information, ii) trade promotion, iii) trade matching, and iv) export development. Matrade stressed the trade fair support as most effective measure. The service users can access to Matrade through its Client Help Desk.</li> <li>a) Trade information: Intelligence on overseas markets and business opportunities, database of suppliers and foreign buyers, updating &amp; publication of trade directories, exporter guidebooks, trade bulletins and leads, and research studies.</li> <li>b) Trade promotion: support for international trade fair (50 in 2005) &amp; mission (7 in 2005), specialized marketing mission (8 in 2005), Malaysian (solo) product exhibition, and overseas in-store promotion with global chain stores.</li> <li>c) Trade matching: dissemination of trade enquiries from foreign buyers, business meeting (12,050 times in 2005), inward buying mission (745 buyers from 93 countries). As a result, 7,135 cases are successfully matched through Matrade's support.</li> <li>d) Export development: Market Development Grants for SMEs, coaching and advice to SMEs, and seminars &amp; workshops for exporters.</li> <li>- Matrade is accredited with ISO9002. Procedures to render each service are well documented in accordance with requirements of ISO.</li> <li>- Indicators are set to represent the performance of Matrade services and programs (no. of participant in the trade promotion activities, no. and amount of deals made, etc.).</li> <li>- Collects feedbacks from its member exporters and consults frequently with industrial associations in order to reflect their voices into the planning for the future programs. Matrade now prepares to conduct Client Service Survey to systemize the communication process with individual exporters.</li> <li>- Overseas promotion post (trade commissioner) is directly appointed by Matrade. Minimum duty of trade commissioner includes i) market information such as market alert (24 times per year), monthly report and market research (6 per year). In addition, they are expected to help find buyers abroad and assists in trade fair &amp; mission participations.</li> <li>- Organizes seminars and workshops to nurture and update exporters on trade developments and business opportunities in international markets.</li> <li>- Membership service is available with free of charge. No. of member has grown to as many as 12,000 companies.</li> </ul>
e)	<p>Budget and revenue source</p>	<ul style="list-style-type: none"> <li>- Origins of operational budget</li> <li>- Operational revenue (with or without), discretions on such revenue use</li> <li>- Structure of expenditure (ratio of personnel expense, fixed charge ratio, etc.)</li> <li>- Excess or deficiency of budget</li> </ul>	<ul style="list-style-type: none"> <li>- Mostly financed by the government through MITI. Of the total budget (FY2005) of RM 106.1 mil. (US\$ 35 mil.), MITI budget accounts for 93.5% (99.2 mil.).</li> <li>- Small portion of RM 6.9 mil. came from own revenue (FY2005). Including the use of this own revenue, Matrade needs to have all intending programs (budget use) approved on an annual basis from the minister. Diversion of funds is possible without MITI's approval.</li> <li>- Matrade covers its own personnel expenses. Salary expense accounts for 27% of total. Around 40% goes to the service &amp; program delivery, and the rest to fixed type charges. And two-thirds of total expenses are spent overseas.</li> <li>- Slightly deficient, and un-piled from its asset in case of deficit.</li> </ul>



f)	<p>Communication and networking with other related organizations</p> <ul style="list-style-type: none"> <li>- Meeting (regular or irregular) with industrial sector, association (with or without), participatory organizations, the role of TPO in the meeting</li> <li>- Overlapping of services and functions with other ministries and agencies</li> <li>- Business partnership with other related organizations (with or without)</li> </ul>	<ul style="list-style-type: none"> <li>- Held dialogues with private (manufactures federation, major industrial associations) and public (investment, industrial development &amp; SME agencies) institutions to draw the inputs for Matrade's strategy building and promotional measures.</li> <li>- Basically export promotion functions by the public sector are consolidated into Matrade.</li> <li>- Matrade hold the Matrade Open-Day to strengthen communication with other governments.</li> <li>- Works closely with other public institutions such as SME agency, Export-Import Bank and Technology Development Corporation to make up the resources and services in lack internally and to realize comprehensive support arms for exporters.</li> </ul>
g)	<p>Restructuring and reform of organization and service line</p> <ul style="list-style-type: none"> <li>- Large-scale restructuring and reform of organization and service line during the last ten years (after Asian currency crisis) (with or without)</li> </ul>	<ul style="list-style-type: none"> <li>- From the previous five division operation (trade fair, R&amp;D, trade information, etc.), Matrade now re-organize itself to the one which can respond to each major product &amp; service industry. Matrade has also established the division for information technology to accelerate the utilization of ICT for the service operation of Matrade. Matrade presently seeks to strengthen the funding base from private sector.</li> </ul>

### Major Figures for Organization and Operation

Number of employee	479 in total (the latest)	Home staff: 355 Local staff: 124
Number of domestic office	3 (region) + 1 HQ	
Number of overseas office	32 (in 28 countries/areas)	
Companies listed in TPO's directory	Exporter: 13,764	Buyer: n.a.
Number of membership company	About 12,000 (the latest, 90% are SMEs)	
Number of consulting services / year	n.a	
Number of inquiry services / year	Head office: 7,551 ('05)	Overseas: 13,784 ('05)
Number of successful matching / year	7,135 (2005)	
Number of website visitor	737,805 (2005)	
Number of product / company listed at web exhibition	n.a	
Number of trade fairs organized and sponsored / year	Overseas: 50 (2005)	Domestic: 2 (2005)
Number of participating companies / year	Overseas: n.a	Domestic: n.a
Number of material held in library	About 12,000 volumes (latest, any material types)	
Annual budget	35 million US\$ (FY2005)	
Languages in home website	English, Japanese	

## Highlights of Malaysian External Trade Development Corporation (MATRADE)

### Organization Chart of MATRADE\_as of June 2007

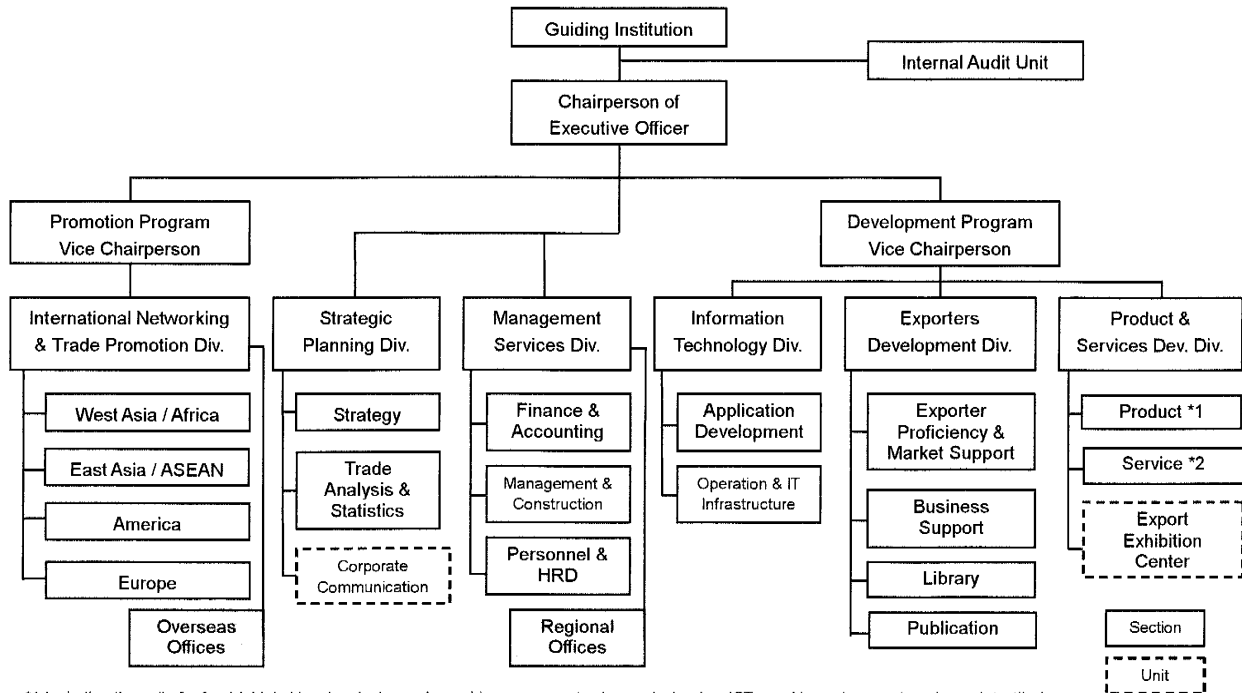

\*1 Including the units for food / drink, bio, chemical, wooden, rubber, paper, petro / gas, electronics, ICT, machinery, transport equipment, textile / garment, shoe, handicraft, plastic, sport product, others.

\*2 Including the unit for training, education, health, printing, publication, professional services, franchise, transport, etc.

- 1) **Matrade has arranged SME focused-programs in a sequenced manner.** Matrade has Trade Outreach Program (MTO) which serves as a platform to identify SME exporters that have the potential to market their products and services overseas. Under MTO, Matrade provides business clinics to give potential SMEs guidance and coaching on the benefits of exporting, basic marketing skills, export opportunities and trade regulations and practices. If identified SMEs become interested in working out for exporting as a result of business clinics, Matrade then can offer the program of Market Development Grant (MDG) to assist SMEs to undertake their own export promotion activities. Under MDG, SMEs can obtain a 50% matching grant on the approved cost of the eligible activities, which include the followings;

- Participation in international trade fairs
- Participation in trade mission and specialized marketing mission
- Participation in overseas hypermarkets and retail outlets such as overseas "in-store" promotion
- Participation in overseas business conferences
- Preparation of promotional materials
- Establishment of overseas marketing offices
- Export market research, etc.

MDG scheme received 337 applications in the first quarter of 2007.

- 2) **Product & Services Development Division is actively liaise with private sector.** Matrade is quite active in communicating with each major exporting industrial association to draw their strategy and needs for export promotion and feedback them into the future programs of export promotion by Matrade. In Matrade, the Product & Services Development Division is responsible for routine communication with these industrial sectors. Particularly in July, when private sector starts preparing the budget for the next year, Matrade announces the draft outline of the programs for the next year and holds discussions with major industrial associations. Each staff in the division is assigned for the particular industry, draw the strategy and needs held by the assigned

industry, and works out for designing and concreting the promotion programs for the industry. Suggested programs for each major exporting industry then would be reported to the division heads and selected for implementation.

Before annual dialogue between Ministry of Industry & Trade (MITI) and stakeholder institutions, Matrade would lead the hearing to each major exporting industry, and summarize issues, proposals and Matrade views, and request the concerning stakeholder institutions to solve the identified issues at the annual dialogue.

- 3) **Matrade has prepared “Client’s Charter” to assure a certain level of promotion services and programs** Its Client’s Charter prescribes Matrade to organize at least 30 trade promotion activities, to entertain, answer and distribute information on trade opportunities within 4 days, to inform the results to the applicants for participation in the trade fairs and mission within 1 week after the application closing date, to ensure the release of publication (online news-every 2 weeks, trade leads-every week, upcoming events-every month, magazine-every 2 months), to update the website within 2 days from the receipt of the update information, and to review all market development grant applications and to give the results to applicants within 10 days.
- 4) **Matrade enhanced the capacity of trade data analysis.** Matrade regularly analyzes trade statistics in depth (by nine digit level) to reveal very detailed picture of Malaysian trade performance by the smallest category of the products. The analysis result has been feed to the determination of promotion targets (countries and products).
- 5) **Matrade is certified with International Standard Organization 9002 for quality management of its service delivery.** Matrade has been accredited for ISO9002, and documented the procedures and formats for its service delivery process. For example, the minimum duties and activities of overseas offices (trade commissioners) are well fixed (e.g., the reporting duty on kind, content and frequency), and the assigned staffs basically comply with such duties. In addition, the performance indicators linked with personnel evaluation system is also set along with the quality management system. For example again, the performance of trade commissioners are to be judged in terms of the no. of foreign buyers invited for trade fair participation, no. of buyers mission visited to Malaysia, and no. of trade matches supported during and after the events and so on.
- 6) **Matrade minimizes the resource input on international trade fairs and missions.** Owing to dedicated support by overseas offices, Matrade basically dispatches only one accompanying staff for each international trade fair and mission, and sometimes zero in case that overseas offices can provide more support at site. Saving resources for such conventional typed trade promotion event, Matrade can shift their resources to more custom-made programs such as specialized marketing mission, reception for foreign buyer mission (inbound buying mission) and market development grant.
- 7) **Matrade supports branding efforts by local exporters through grant scheme.** Matrade introduced the Brand Promotion Grant to develop and promote in the international market, brand names owned by Malaysian companies for products and services. Companies are eligible for grants on the approved cost of the activities related to brand development and promotion with a maximum grant of RM 2 million per company. When applying for the grant, company must submit the proposal containing the development and promotion plan of the brand.
- 8) **Matrade highlights the promotion support for the service industries.** Matrade views the service industries as growing and promising potentials for export development. The target service industries include professional services (doctor, finance, accountant, engineer, etc.), construction, education, franchise, healthcare, ICT industry, petroleum, oil & gas, and printing & publication. In cooperation with the related institutions and associations of the said industries, Matrade formulates the export promotion programs (such as specialized marketing mission, exhibition support). Particularly for construction and engineering sectors, Matrade started the Promotion of Service Export Fund since 2006 to help them to participate into international bidding.

### (3) Korea Trade-Investment Promotion Agency (KOTRA)

a)	Mission / priority, and position in export policy	<ul style="list-style-type: none"> <li>- Mission or major policy issues</li> <li>- Priority industries and commodities for export</li> <li>- Position and roles of export promotion organization in the export policy</li> </ul>	<ul style="list-style-type: none"> <li>- i) pursue twin mandates (trade and investment promotions) for the goal to be the business and economic hub of Northeast Asia. ii) assist import of capital and raw materials, necessary for export from Korea. iii) serve all interested parties worldwide to do business with Korea. Products are not specified in particular. Mainly targeted for but not limited to SMEs.</li> <li>- KOTRA plays the role of an executor for trade promotion measures, receiving the policy direction from the government, mainly from Ministry of Foreign Affairs and Trade.</li> </ul>
b)	Organizational set-up and staffing	<ul style="list-style-type: none"> <li>- Establishment and brief history</li> <li>- Organizational status (government-owned including a department of government, agency, public corporation, or else)</li> <li>- Divisions in organization, the staffing by division for major function</li> <li>- Status of staff, recruit system (including requirements for academic background and major)</li> <li>- Recruitment from private sector, system to accept seconded staff from private (with or without, and degree)</li> <li>- Salary level of staff (compared to government officer and private sector)</li> </ul>	<ul style="list-style-type: none"> <li>- Founded in 1962 as Korea Trade Promotion Corporation as a national trade promotion organization, and renamed as KOTRA in August 1995 to add the function of investment promotion by the special legislation for the agency.</li> <li>- A statutory (independent) agency, which reports to the Ministry of Foreign Affairs &amp; Trade.</li> <li>- KOTRA has an extensive network of overseas Korea Trade Centers, presently amounting to 100 ones (in 73 countries), and 14 domestic offices. KOTRA separately operates Invest KOREA as an investment arm of KOTRA).</li> <li>- Total staff amounts to over 1,000, as of 2002, out of which 393 are officers, the rest are permanent staffs and temporary staffs. Officers and permanent staffs are government staff.</li> <li>- Government employee, but KOTRA can operate its own personnel and recruiting system.</li> <li>- N.A.</li> <li>- There are two bases for payroll and bonus for HQ staff and for locally hired staff).</li> </ul>
c)	Human resource development (HRD)	<ul style="list-style-type: none"> <li>- Personnel evaluation system, career-path planning</li> <li>- Features and appealing points in HRD (staff training) system</li> <li>- Staff dispatch (seconded or OJT) to private sector and industrial associations (with or without, and degree)</li> <li>- Services and programs</li> </ul>	<ul style="list-style-type: none"> <li>- Have adopted personnel evaluation system to create competitive culture. Evaluation system is linked to the bonus payment. In case of payment for export marketing and research staffs, quantitative assessment accounts for 80% of total performance score and qualitative does for 20% (subject to the results of customer satisfaction survey).</li> <li>- N.A.</li> <li>- Not practiced.</li> </ul>
d)	Services and programs : Market intelligence : Product development : Export promotion	<ul style="list-style-type: none"> <li>- Services and programs</li> </ul>	<ul style="list-style-type: none"> <li>- Functions are categorized into the followings;             <ol style="list-style-type: none"> <li>1) International Trade Facilitation: business matching, overseas trade fairs, Cyber Business Center (for on-line trade dealing, business meeting), specialized marketing support (for IT and cultural industries)</li> <li>2) Foreign Investment Promotion (by Invest Korea): one-stop window services for inbound investors and investment ombudsman service (for trouble shooting).</li> <li>3) Market Information Service: in-depth market research and seminar, trade information library, support for outbound investment support.</li> </ol> </li> </ul>

	<ul style="list-style-type: none"> <li>- Manuals to prescribe the standard process of each service and function (with or without, or ISO accreditation), and their use by staff</li> <li>- Performance and indicators of each service and function (with or without, contents)</li> <li>- Process and practice to reflect the needs of users (export industries) into the planning and revision of services and functions</li> <li>- Relation between the international promotion posts and headquarter, main activities of international promotion posts</li> <li>- Exporters training programs and memberships</li> </ul>	<p>4) Building Trade-Investment Infrastructure: to provide fully supportive environments for corporations. KOTRA engages in cooperation with other TPOs and care for foreign missions, training service provision through KOTRA Academy, support for other ministries.</p> <p>5) Provision of Buyers Virtual Access to Korea: through utilizing ICT, KOTRA operates on-line trade matching &amp; e-commerce site such as Cybermart Korea, Buy Korea (since 2004), and Invest Korea (since 2003) to access to investment opportunities.</p> <ul style="list-style-type: none"> <li>- Not known for availability of manuals for each service delivery, not accredited with ISO.</li> <li>- Although not known for indicator setting for each service &amp; function, KOTRA sets overall management indicators like customer satisfaction level, access improvement to local exporters, and financial independence (from government).</li> <li>- Evaluation over the performance of KOTRA is regularly done by the Evaluation Board which composes of government, academic and private sector. Scope of evaluation is decided each year. Qualitative evaluation through the customer survey becomes more important.</li> <li>- Through a series of meeting with Chamber of Commerce and industrial associations, and customer needs survey (linked with satisfaction survey). KOTRA formed a team for customer survey.</li> <li>- The basic role of overseas post is to conduct intelligence and to organize trade mission and fairs. For overseas operation, KOTRA adopts regional headquarter system where overseas centers are grouped into eight regional groups. Each regional HQ is given more autonomy to decide their activities and budgets concerning promotion &amp; intelligence work, and recruit local staffs. Previously, all instruction and decision were given by Seoul.</li> <li>- Launched KOTRA Academy in 2003 as a professional learning and training center for international business.</li> <li>- Membership service is available.</li> </ul>
e)	<ul style="list-style-type: none"> <li>- Origins of operational budget</li> <li>- Operational revenue (with or without), discretions on such revenue use</li> <li>- Structure of expenditure (ratio of personnel expense, fixed charge ratio, etc.)</li> <li>- Excess or deficiency of budget</li> </ul>	<ul style="list-style-type: none"> <li>- Mainly budgeted by the government (undisclosed).</li> <li>- There are chargeable services to the users, including contracted research (on buyer, supplier and market trend, service charge for non-SMEs is twice) and contracted sales support (for one year).</li> <li>- Undisclosed.</li> <li>- Undisclosed.</li> </ul>
f)	<ul style="list-style-type: none"> <li>- Meeting (regular or irregular) with industrial sector, association (with or without), participatory organizations, the role of TPO in the meeting</li> <li>- Overlapping of services and functions with other ministries and agencies</li> <li>- Business partnership with other related organizations (with or without)</li> </ul>	<ul style="list-style-type: none"> <li>- Holds the regular meeting with Korean Chamber of Commerce, major industrial associations to exchange the issues relating to export and overseas business operation. Main topics identified through the meetings are reported to the concerned ministries.</li> <li>- N.A.</li> <li>- Has tightened the partnership with institutions such as Korean Chamber of Commerce, Korea Export Assistant Center, and JETRO.</li> </ul>

g)	<p>Restructuring and reform of organization and service line</p> <p>- Large-scale restructuring and reform of organization and service line during the last ten years (after Asian currency crisis) (with or without)</p>	<p>- In 1997, KOTRA began a management reform that consists of result-oriented personnel assessment, decentralized operations and competence-oriented human resources, through changes of corporate status (to corporation), culture (to customer-oriented operation) and technology (to ICT based operation). Concretely, KOTRA has i) introduced a team (task)-based structure, ii) transferred staff (25%) from headquarter to domestic &amp; overseas offices, and iii) delegated more autonomy to overseas operation.</p>
----	---	--

### Major Figures for Organization and Operation

Number of employee	Total: over 1,000 (as of 2002)	Domestic: n.a Overseas: n.a
Number of domestic office	14 (region) + 1 HQ	
Number of overseas office	100 (in 73 countries)	
Companies listed in TPO's directory	Exporter: 5,346 ('07)	Buyer: n.a
Number of membership company	n.a	
Number of consulting services / year	n.a	
Number of inquiry services / year	Exporter: n.a	Buyer: n.a
Number of successful matching / year	n.a	
Number of website visitor	Over 2 million (the latest)	
Number of product / company listed at web exhibition	8,696 products/3,756 companies, but at Buy Korea (Jul. 2007)	
Number of trade fairs organized and sponsored / year	Overseas: n.a	Domestic: n.a
Number of participating companies / year	Overseas: n.a	Domestic: n.a
Number of material held in library	n.a	
Annual budget	Undisclosed	
Languages in home website	Korean, English, Chinese and Japanese	

## Highlights of Korea Trade-Investment Promotion Agency (KOTRA)

- 1) **Evaluation system for job performance successfully seems to stimulate the motivation of staff.** KOTRA has adopted a personnel evaluation system to create competitive culture in the organization. Evaluation system is linked to the bonus payment. In case of payment for export marketing and research staffs, quantitative assessment accounts for 80% of total performance score and qualitative one does for 20%. Their payment is also determined by the results of customer satisfaction survey. The system generates about twice disparity of bonus.
- 2) **Enhanced ICT utilization enables KOTRA to strengthen a direct communication between local exporters and overseas promotion centers.** KOTRA developed ICT-based Enterprise Knowledge (intranet system) which composes of a centralized knowledge management system (to share their know-how, experience, and information), a customer relationship management system (to respond to customers / users more promptly and accurately) and a management control system (to centrally control budget and program performance). As a result of such enhanced intranet facilities, the direct communication between local exporters (and KOTRA's domestic offices) and overseas promotion centers has been largely enhanced. Owing also to the decentralized operation of overseas centers (under the regional headquarter system), overseas centers can now deliver prompt and dedicated response for each exporter's demand. Notably, every transaction and communication made between overseas centers and local exporters are monitored so that headquarter in Seoul can trace them for follow-up.

## Export Promotion Activities of KOTRA

**International Trade Facilitation:** KOTRA serves as a bridge between Korean exporters and overseas buyers through;

### (1) Trade matchmaking

- To introduce, on request, overseas buyers to the most appropriate Korean partners through their wide-ranging inquiry network as well as business meetings held year round.
- To provide buyers visiting Korea with assistance in arranging business meetings with Korean companies and collecting information on products and suppliers.
- To dispatch groups of Korean exporters abroad to explore global markets with the overseas promotion centers.

### (2) International exhibitions

- To organize international exhibitions in Korea as well as large-scale Korean product shows in strategic markets abroad.
- To arrange the participation of domestic companies in similar events overseas through its "Korea Pavilions".
- To make the occasions more specialized and sophisticated.

### (3) e-Trade

- To operate Cyber Business Center where overseas buyers can hold online business meetings and interactions with domestic suppliers.

### (4) IT / cultural industry marketing

- To maintain the lead in promoting trade in such software and service as IT, music and movies.

**Market Information Service:** KOTRA provides such hands-on information as local business practices, market conditions through;

### (1) In-depth research and seminars

- To draw insightful findings on a variety of trade issues through the analysis of the information gathered by domestic and overseas networks.
- To issue publications as well as hold seminars on world trade regimes and regional market conditions, with the overseas promotion centers at home and abroad.

### (2) Trade information library

- To offer current information on each country's market conditions gathered through overseas promotion centers.
- To provide an extensive range of resources such as business directories, tariff schedules, periodicals and much more.

**Virtual access to the Korean market:** KOTRA operates Buy Korea / CyberMart, the leading Korean internet trade port.

- To promote cyber marketing and provide customers with a one-click search function for up-to-the-minute trade information such as product offers, company profiles and product catalogues.
- To offer an interactive web service, through which global traders can develop a mutually-rewarding business community based on the sharing of information and the free conduct of e-Commerce.



#### (4) Taiwan External Trade Development Council (TAITRA)

a)	Mission / priority, and position in export policy	<ul style="list-style-type: none"> <li>- Mission or major policy issues</li> <li>- Priority industries and commodities for export</li> <li>- Position and roles of export promotion organization in the export policy</li> </ul>	<ul style="list-style-type: none"> <li>- TAITRA assists Taiwan businesses and manufacturers to reinforce their international competitiveness and to cope with the challenges faced in the foreign markets. In addition, it undertakes many initiatives to help foreign businesses establish a wider presence in Taiwan.</li> <li>- Sub-sectors or commodities are not designated in particular.</li> <li>- Mainly sponsored by the Bureau of Foreign Trade, Ministry of Economic Affairs (MOEA), and TAITRA functions as an executor of trade promotion in a non-profit-based operation.</li> </ul>
b)	Organizational set-up and staffing	<ul style="list-style-type: none"> <li>- Establishment and brief history</li> <li>- Organizational status (government-owned including a department of government, agency, public corporation, or else)</li> <li>- Divisions in organization, the staffing by division for major function</li> <li>- Status of staff, recruit system (including requirements for academic background and major)</li> <li>- Recruitment from private sector, system to accept seconded staff from private (with or without, and degree)</li> <li>- Salary level of staff (compared to government officer and private sector)</li> </ul>	<ul style="list-style-type: none"> <li>- Founded in 1970 as CETRA (China External Trade Development Council) to help promote foreign trade and later renamed as TAITRA.</li> <li>- A non-profit trade promotion organization jointly sponsored by the government and the industrial as well as commercial associations.</li> <li>- TAITRA comprises of Market Development Dept., Strategic Marketing Dept., Exhibition Dept., Planning &amp; Finance Dept., General Administration Dept., Service Industry Promotion Center, International Trade Information Center, Taipei International Exhibition Center, Nangang International Exhibition Center, Taipei International Convention Center (TICC), International Trade Institute, TaitraNet Center, and 44 overseas &amp; 4 domestic branch offices.</li> <li>- Over 730 staffs, stationed in its headquarters (438 management/technical staff +116 support staff), four local (20+7) and overseas branches (57+93).</li> <li>- N.A.</li> <li>- N.A.</li> <li>- N.A.</li> </ul>
c)	Human resource development (HRD)	<ul style="list-style-type: none"> <li>- Personnel evaluation system, career-path planning</li> <li>- Features and appealing points in HRD (staff training) system</li> <li>- Staff dispatch (seconded or OJT) to private sector and industrial associations (with or without, and degree)</li> </ul>	<ul style="list-style-type: none"> <li>- N.A.</li> <li>- N.A.</li> <li>- N.A.</li> </ul>
d)	Services and programs : Market intelligence : Product development : Export promotion	<ul style="list-style-type: none"> <li>- Services and programs</li> </ul>	<ul style="list-style-type: none"> <li>- Major functions include i) market research &amp; information services, ii) market and product development, iii) exhibition &amp; convention service, iv) buyers' service (including exporters/importers directory, v) trade education, and vi) web-based service.</li> <li>- <u>Market information service</u> conducts 59 surveys in total in 2005.</li> <li>- <u>Market development</u> emphasizes commodities sourcing services through alliance development with multi-national global retailers and corporations under the International Sourcing Center project.</li> <li>- <u>Product &amp; brand development</u> including International Brand Alliance (IBA) project, &amp; Product Image Enhancement Program (IEP, support for product and packaging design).</li> </ul>

<p><u>Strategic marketing including investment promotion program (both inbound and outbound), Food and Agricultural Products Promotion for local agricultural industry, foreign tender participation support, etc.</u></p> <p>Exhibitions &amp; convention services including trade missions (103 times in 2005) and participation in overseas trade fairs (50 times in 2005, 1,044 of participants), trade meetings &amp; seminars (145 times in 2005).</p>		<p>- Manuals to prescribe the standard process of each service and function (with or without, or ISO accreditation), and their use by staff</p> <p>- Performance and indicators of each service and function (with or without, contents)</p> <p>- Process and practice to reflect the needs of users (export industries) into the planning and revision of services and functions</p> <p>- Relation between the international promotion posts and headquarter, main activities of international promotion posts</p> <p>- Exporters training programs and memberships</p>	<p>- N.A.</p> <p>- Performance is evaluated regular and systematic manners. Indicators including trade deals target are also set for each major promotion projects and services.</p> <p>- Basically, home and local staffs visit local industries (1,796 times in 2005) to exchange information and needs on export promotion and other useful topics with domestic business community.</p> <p>- The overseas offices would i) assist trade mission and fair, ii) initiate and facilitate procurement for international firms in Taiwan, iii) collect and report market and buyers' information to local traders, and iv) invite buyers to visit Taipei's international exhibitions.</p> <p>- Training programs are offered through training institute for international business management and marketing, language. Membership service is available.</p>
<p>e) Budget and revenue source</p>	<p>- Origins of operational budget (revenue sources)</p> <p>- Operational revenue (with or without), discretions on such revenue use</p> <p>- Structure of expenditure (ratio of personnel expense, fixed charge ratio, etc.)</p> <p>- Excess or deficiency of budget</p>	<p>- Largely financed by the government budget, Trade Promotion Fund of MOEA (over 60%), and the rest by charges to customer / user and other revenues (exhibition hall fees, etc.).</p> <p>- N.A.</p> <p>- N.A.</p> <p>- N.A.</p>	<p>- Largely financed by the government budget, Trade Promotion Fund of MOEA (over 60%), and the rest by charges to customer / user and other revenues (exhibition hall fees, etc.).</p> <p>- N.A.</p> <p>- N.A.</p> <p>- N.A.</p>
<p>f) Communication and networking with other related organizations</p>	<p>- Meeting (regular or irregular) with industrial sector, association (with or without)</p> <p>- Overlapping of services and functions with other ministries and agencies</p> <p>- Business partnership with other related organizations (with or without)</p>	<p>- TAITRA has frequent communication and meeting with local industries through direct visits and contacts, and also has meeting opportunities with local government offices, industrial parks, industry promotion associations, and export zones for the program design / review.</p> <p>- N.A.</p>	<p>- TAITRA has frequent communication and meeting with local industries through direct visits and contacts, and also has meeting opportunities with local government offices, industrial parks, industry promotion associations, and export zones for the program design / review.</p> <p>- N.A.</p>
<p>g) Restructuring and reform of organization and service line</p>	<p>- Large-scale restructuring and reform of organization and service line during the last ten years (after Asian currency crisis) (with or without)</p> <p>- Success or failure, and evaluation of restructuring and reform</p>	<p>- Many partnership building program available, business alliance program with global corporation and chain store to connect local suppliers with global supply chains in particular.</p> <p>- N.A.</p> <p>- N.A.</p>	<p>- Many partnership building program available, business alliance program with global corporation and chain store to connect local suppliers with global supply chains in particular.</p> <p>- N.A.</p> <p>- N.A.</p>

### Major Figures for Organization and Operation

Number of employee	Over 731 in total (the latest)	Domestic: 581 Overseas: 150 inc. local
Number of domestic office	4 (region) + 1 HQ	
Number of overseas office	44	
Companies listed in TPO's directory	Exporter: 76,150 (2005)	Buyer: 80,798 (2005)
Number of membership company	43,888 (as of end 2005)	
Number of consulting services / year	n.a	
Number of inquiry services / year	Exporter: 410,000 ('05)	Buyer: n.a
Number of successful matching / year	5,089 (2005, under International Sourcing Center)	
Number of website visitor	10,430,170 (2005, e-business platform)	
Number of product / company listed at web exhibition	n.a	
Number of trade fairs organized and sponsored / year	Overseas: 50 (2005)	Domestic: 25 (2005)
Number of participating companies / year	Overseas: 1,044 (2005)	Domestic: 9,278 (2005)
Number of material held in library	3,923 books, 15,042 other materials (as of end '05)	
Annual budget	n.a	
Languages in home website	Chinese, English and Japanese	

## Highlights of Taiwan External Trade Development Council (TAITRA)

### Organization Chart of TAITRA\_as of 2006

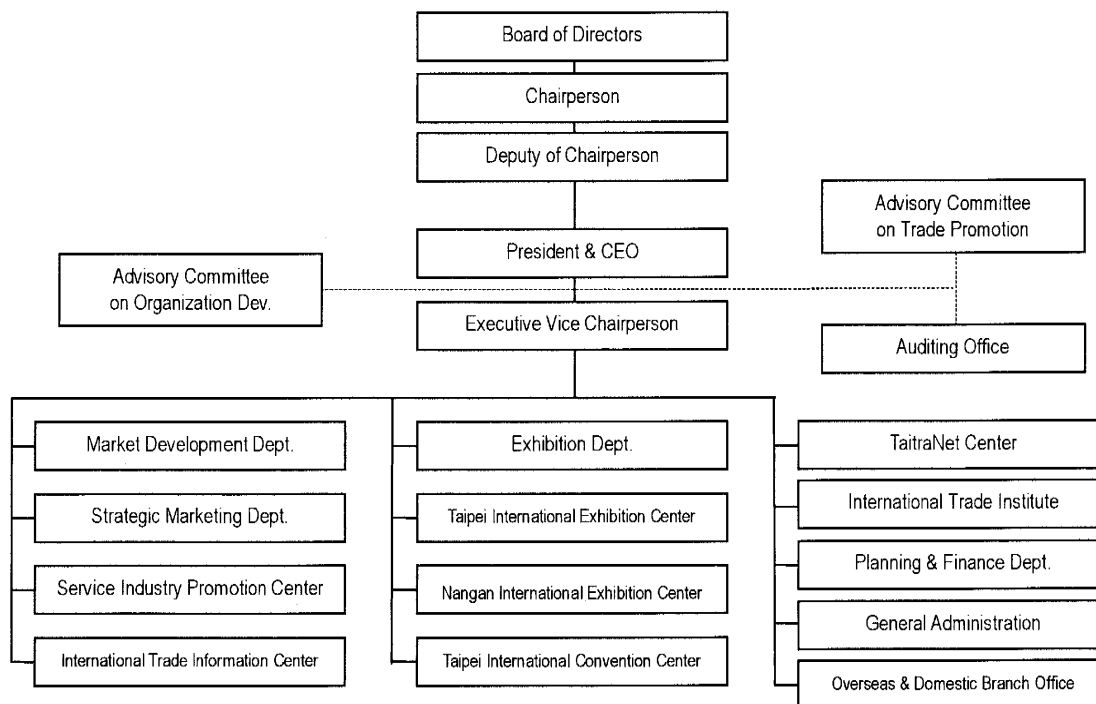

- 1) **Not only traditional outbound promotion, TAITRA enhances inbound promotion like “global sourcing supports” through alliance building with global corporations.** In 1997, TAITRA launched the International Sourcing Center (ISC) project to assist foreign firms in selecting appropriate Taiwan manufacturers, and to achieve matching and strategic alliance between local suppliers and foreign buyers. For the past years, many multinational corporations, including GE, Siemens, Fujitsu, Hitachi, Nortel, BMW, and Renault, have recognized the value of ISC services in fulfilling their procurement in Taiwan. To date, ISC has created around US\$3.6 billion worth of business opportunities, and has assisted nearly 1,700 multinational corporations.

#### **Sourcing Service for Chain Stores**

TAITRA is presently assisting numerous chain stores in establishing, developing, and even expanding their existing direct-sourcing capabilities in Asia, through its "Commodities Sourcing Services for Chain Stores" program. The Program has been established to provide chain stores with unlimited sourcing information on products and services from every potential Taiwan manufacturer. During the past years, multinational corporations that have utilized TAITRA's services included Wal-mart, OfficeMax, Home Depot, Costco, IKEA and many others. Multinational large-scale chain stores fulfilled their product requirements from 2,949 local Taiwan suppliers, initiating over USD100 million on-the-spots transactions in 2005.

- 2) **TAITRA prepares abundant menus of export promotion services and programs.** Services and programs for export promotion currently held by TAITRA include International Market Development (IMD) Project (for individual exporters in overseas), Provisional Overseas Branch (POB) Project, assisting companies with mergers and acquisitions of international brands and channels, International Brand Alliance (IBA) Project, International Sourcing Center (ISC) Project, Commodities Sourcing Services for Chain Stores, Taiwan Machinery Distribution Channel Promotion (TMP) Project, Large-scale Global Forums, domestic trade exhibition (25 times), overseas trade exhibitions (50 times), trade missions (29 times), convention service (697 conferences), and other internet-based service.

- 3) **TAITRA enhances the use of internet-based services.** Internet-based services by TAITRA include e-business platform which offers trade information, internet marketing, and business opportunity services (recording 410,000 buyers' inquiries to local suppliers and 10 million site visitors in 2005). Other notables one is "Online Exhibitions" which offer services throughout all stages of trade fairs. One such a case is created for International Automobile Parts Exhibition, known as AMPA-Online. For example, before an exhibition begins, AMPA-Online provides local exhibitors with corporate website marketing services. During the exhibition, AMPA-Online then introduces itself and matches buyer interests with vendors. Afterwards, it follows up with buyers to further track and develop business opportunities. Another one is "Online Trade Mission Service. Using this, mission participants can present their products in advance, and buyers can pre-arrange meetings with them. In 2005, 11 cases were fulfilled as 1,768 buyers made 5,711 appointments with 311 participants.
- 4) **TAITRA focuses on specialized promotion programs through strategic marketing function.** Besides the numerous programs organized each year, TAITRA is able to furnish a wide range of highly specialized promotion programs. Such programs include i) Business Alliance program which provides counseling and match-making services to foreign buyers to visit Taiwan, ii) Food and Agricultural Products Promotion which comprehensively integrate the promotion measures and coordinates specialized supports from farmers' associations and agricultural related industries, iii) outbound investment support for Taiwan investors to set up a branch, liaison, representative, factory and/or warehouse in overseas markets, and iv) other series of specialized forums, seminars and consulting services to improves a firm's marketing and operational capabilities.
- 5) **TAITRA holds investment promotion function (inbound and outbound) through the cooperation with Investment Promotion Service (Taipei World Trade Center-IBC).** TWTC-IBC in cooperation with TAITRA has prepared a package service for investigating and pursuing investment opportunities, through provision of Professional Investment Consulting, Industrial Information Counseling, Executive Secretary, and Facility Rental services. Support for local industry to promote investment overseas is also available through TAITRA under the support for Outbound Investment Planning.
- 6) **Call Center is established to strengthen the platform function with customers.** A new call center dedicated to TAITRA's customer service system has been launched to add a new platform to strengthen TAITRA's integrated marketing services. Inbound calls amount to an average of 143 calls every day.

### (5) Australian Trade Commission (AUSTRADE)

<p>a) Mission / priority, and position in export policy</p>	<ul style="list-style-type: none"> <li>- Mission or major policy issues</li> <li>- Priority industries and commodities for export</li> <li>- Position and roles of export promotion organization in the export policy</li> </ul>	<ul style="list-style-type: none"> <li>- i) achieve a fair deal for Australia in the international marketplace and ensure better trade conditions for Australian products, ii) help more businesses to become exporters, and increase export value, iii) adds more jobs, more choice for living for all Australians.</li> <li>- Basically responds to individual needs of private sector, commodities are not designated for priority support. But the priority regions for market development are set for India, China.</li> <li>- Within Dept. of Foreign Affairs &amp; Trade (DFAT) portfolio, Australian Trade Commission (Austrade) is supposed to execute the support programs and activities for export development of Australian businesses, while DFAT is engaged in trade environment improvement through negotiations on Free Trade Agreements.</li> </ul>
<p>b) Organizational set-up and staffing</p>	<ul style="list-style-type: none"> <li>- Establishment and brief history</li> <li>- Organizational status (government-owned including a department of government, agency, public corporation, or else)</li> <li>- Divisions in organization, the staffing by division for major function</li> </ul>	<ul style="list-style-type: none"> <li>- Australian Trade Commission (Austrade), established in 1985.</li> <li>- Statutory agency within Dept. of Foreign Affairs &amp; Trade portfolio, reporting to the Minister of Trade. Upon the annual Statement of Expectations from the Minister, Austrade replies with a Statement of Intent, which outlines how to meet the expectations and activity plan.</li> <li>- On-shore operation is structured to deliver services to new, irregular and established exporters through two divisions: Exporter Development and Client Services (as of 2006). Offshore is structured into four regions: Americas; Europe, Middle East and Africa; North East Asia; and South East Asia, South Asia and Pacific. The regions' focus is to identify opportunities and work with businesses in overseas markets to capture export business. Austrade is represented in 142 overseas locations in 64 countries, and 18 domestic offices. Support for onshore and offshore activities is provided by four enabling areas: human resource, finance &amp; information, government &amp; corporate services, analysis &amp; planning.</li> <li>- At 30 June 2006, Austrade employed 1,072 staff comprising 527 Aus-based staff and 545 overseas-engaged staff. Of the total number of Aus-based staff, 80 work in an offshore location as trade commissioner.</li> <li>- Government employee under the framework of Australian Public Service. Overseas-engaged staffs are contracted employee. No particular requirements for major exist.</li> <li>- Majority are recruited on mid-career basis, having experienced private sector business. This is more apparent for overseas staff. Seconded staff from private sector is not accepted.</li> <li>- Applied to basic salary standard of Australian Public Service. For incentive pay, overseas-engaged employees are eligible to receive a bonus pay ranging from 2 to 12% of their base salary, depending on performance. Australia-based employees with an 'exceptional' rating are eligible to receive a bonus pay of up to 5% of their base salary.</li> </ul>
<p>c) Human resource development (HRD)</p>	<ul style="list-style-type: none"> <li>- Personnel evaluation system, career-path planning</li> </ul>	<ul style="list-style-type: none"> <li>- Introduced and expanded on-line performance management system called as "Partnering?Perform", which covers the four stages of performance management: self-assessment, development planning, performance planning and performance review in order to determine the range of performance pay. In addition, Austrade recognizes exceptional contributions by individuals and teams through the presentation of Awards.</li> </ul>

		<ul style="list-style-type: none"> <li>- Features and appealing points in HRD (staff training) system</li> <li>- Staff dispatch (seconded or OJT) to private sector and industrial associations (with or without, and degree)</li> <li>- Services and programs</li> <li>- Manuals to prescribe the standard process of each service and function (with or without, or ISO accreditation), and their use by staff</li> <li>- Performance and indicators of each service and function (with or without, contents)</li> <li>- Process and practice to reflect the needs of users (export industries) into the planning and revision of services and functions</li> <li>- Relation between the international promotion posts and headquarter, main activities of international promotion posts</li> <li>- Exporters training programs and memberships</li> </ul>	<p>Started career management effort since 2005, initially focusing on frontline marketing and administration staff. This included a review of staff classification structure, staff mobility and career pathways. Another work also began to upgrade the existing human resources management information system to provide the better data on workforce status.</p> <ul style="list-style-type: none"> <li>- Among the training programs, training for export advisers on export facilitation capabilities is highlighted. Online courses via Austrade Institute are also available.</li> <li>- Not practiced.</li> </ul>
d)	<ul style="list-style-type: none"> <li>Services and programs</li> <li>: Market intelligence</li> <li>: Product development</li> <li>: Export promotion</li> </ul>	<ul style="list-style-type: none"> <li>- Client service, Trade start service, Marketing campaign, Exhibition &amp; mission support (only technical), Export award, Market information provision, Web-sited trade matching (Opportunities Online), Export Market Development Grants (EMDG), New Exporter Development Program (NEDP), Suppliers directory service, Business matching (Business Club), Export education.</li> <li>- Guidelines for each service and program are prepared, but not accredited with ISO.</li> <li>- Indicators are set to represent the performance of Austrade services and programs, and annually reported to the minister. For EMDG and NEDP, the performance review and evaluation is made.</li> <li>- One of the key tools includes Client Service Improvement Study to reveal the clients' satisfaction for Austrade and its major program like EMDG and NEDP.</li> <li>- Overseas promotion posts are directly appointed by Austrade. Activities include i) answering inquires &amp; trade matching, ii) assisting &amp; arranging promotion activities, iii) arranging buyers visit, and iv) collecting and updating market brief, and customized survey.</li> <li>- Not functioned as training provider. Membership service is available with free of charge.</li> </ul>	<ul style="list-style-type: none"> <li>- Federal government budget allocation (81.8%), followed by sales of goods / services (15.0%), interest, other minor revenue.</li> <li>- Upon the statement of expectations from the supervising minister, Austrade can plan and propose any relevant programs. But all intending programs need approval on an annual basis from the supervising minister through the statement of intent.</li> <li>- Austrade covers its own personnel expenses. Ratio of personnel expense (47.9%), fixed charge ratio (53.0%).</li> <li>- Slightly deficient in the past few years, but compensated by the federal government.</li> <li>- Although industrial team in HQ has the regular communication with major industries, Austrade as a whole responds to individual needs of exporters through various channels.</li> <li>- A least. Other governments, if concerned with export development of its sector, assign Austrade to engage in export marketing and strategy planning for such sectors.</li> <li>- Tradestart is a program using national network of trade related offices, partnerships between Austrade and regional governments, industry associations and etc., amounting to 54 offices in Australia. Tradestart offers a package of free services through New Exporter Development</li> </ul>
e)	<ul style="list-style-type: none"> <li>Budget and revenue source</li> </ul>	<ul style="list-style-type: none"> <li>- Origins of operational budget</li> <li>- Operational revenue (with or without), discretions on such revenue use</li> <li>- Structure of expenditure (ratio of personnel expense, fixed charge ratio, etc.)</li> <li>- Excess or deficiency of budget</li> </ul>	<ul style="list-style-type: none"> <li>- Federal government budget allocation (81.8%), followed by sales of goods / services (15.0%), interest, other minor revenue.</li> <li>- Upon the statement of expectations from the supervising minister, Austrade can plan and propose any relevant programs. But all intending programs need approval on an annual basis from the supervising minister through the statement of intent.</li> <li>- Austrade covers its own personnel expenses. Ratio of personnel expense (47.9%), fixed charge ratio (53.0%).</li> <li>- Slightly deficient in the past few years, but compensated by the federal government.</li> <li>- Although industrial team in HQ has the regular communication with major industries, Austrade as a whole responds to individual needs of exporters through various channels.</li> <li>- A least. Other governments, if concerned with export development of its sector, assign Austrade to engage in export marketing and strategy planning for such sectors.</li> <li>- Tradestart is a program using national network of trade related offices, partnerships between Austrade and regional governments, industry associations and etc., amounting to 54 offices in Australia. Tradestart offers a package of free services through New Exporter Development</li> </ul>
f)	<ul style="list-style-type: none"> <li>Communication and networking with other related organizations</li> </ul>	<ul style="list-style-type: none"> <li>- Meeting (regular or irregular) with industrial sector, association (with or without), participatory organizations, the role of TPO in the meeting</li> <li>- Overlapping of services and functions with other ministries and agencies</li> <li>- Business partnership with other related organizations (with or without)</li> </ul>	<ul style="list-style-type: none"> <li>- Although industrial team in HQ has the regular communication with major industries, Austrade as a whole responds to individual needs of exporters through various channels.</li> <li>- A least. Other governments, if concerned with export development of its sector, assign Austrade to engage in export marketing and strategy planning for such sectors.</li> <li>- Tradestart is a program using national network of trade related offices, partnerships between Austrade and regional governments, industry associations and etc., amounting to 54 offices in Australia. Tradestart offers a package of free services through New Exporter Development</li> </ul>

			<p>Program (NEDP) including the provision of advice, coaching and information on export), and intends to assist SMEs develop their business overseas and make their first export sale.</p> <ul style="list-style-type: none"> <li>- Corporate Partnership Program: by partnering with private sector and other parties. Austrade seeks to extend the range of and deepen the contents of international business services available to assist Australian businesses succeed in exporting. Austrade enters into non-exclusive agreements to work with leading financial, legal and logistics organizations.</li> <li>- In the early 1990s, a big organizational reform was made to realize decentralized operation (to downsize the home operation and grant the larger authority to overseas offices).</li> <li>- Started Export Development Grant Scheme (EDMG) since 1997 and NEDP in the early 2000s to focus on the promotion of new and SME exporters. EDMG to assist overseas marketing activity of Australian business aims at efficiently answering various needs and options for export promotion of individual business.</li> <li>- EDMG is annually reviewed and evaluated as successful, and the minister decided to extend the scheme period.</li> </ul>
g)	Restructuring and reform of organization and service line	<ul style="list-style-type: none"> <li>- Large-scale restructuring and reform of organization and service line during the last ten years (after Asian currency crisis) (with or without)</li> <li>- Success or failure, and evaluation of restructuring and reform</li> </ul>	

#### Major Figures for Organization and Operation

Number of employee	Over 1,072 in total (as of Jul. 2006)	Domestic: 527 Overseas: 545
Number of domestic office	18 (region) + 1 HQ	
Number of overseas office	142 (in 64 countries)	
Companies listed in TPO's directory	Exporter: over 10,000	Buyer: n.a
Number of membership company	n.a	
Number of consulting services / year	16,219 (2006, total service receiver)	
Number of inquiry services / year	Exporter: n.a	Buyer: n.a
Number of successful matching / year	5,098 (2006, those who achieved export success)	
Number of website visitor	n.a	
Number of product / company listed at web exhibition	No corresponding site.	
Number of trade fairs organized and sponsored / year	Overseas: n.a	Domestic: n.a
Number of participating companies / year	Overseas: n.a	Domestic: n.a
Number of material held in library	n.a	
Annual budget	275.6 million US\$ (FY2006)	
Languages in home website	Mainly English, and various for international site	



## Highlights of Australian Trade Commission (Austrade)

### Organization Chart of Austrade as of 2006

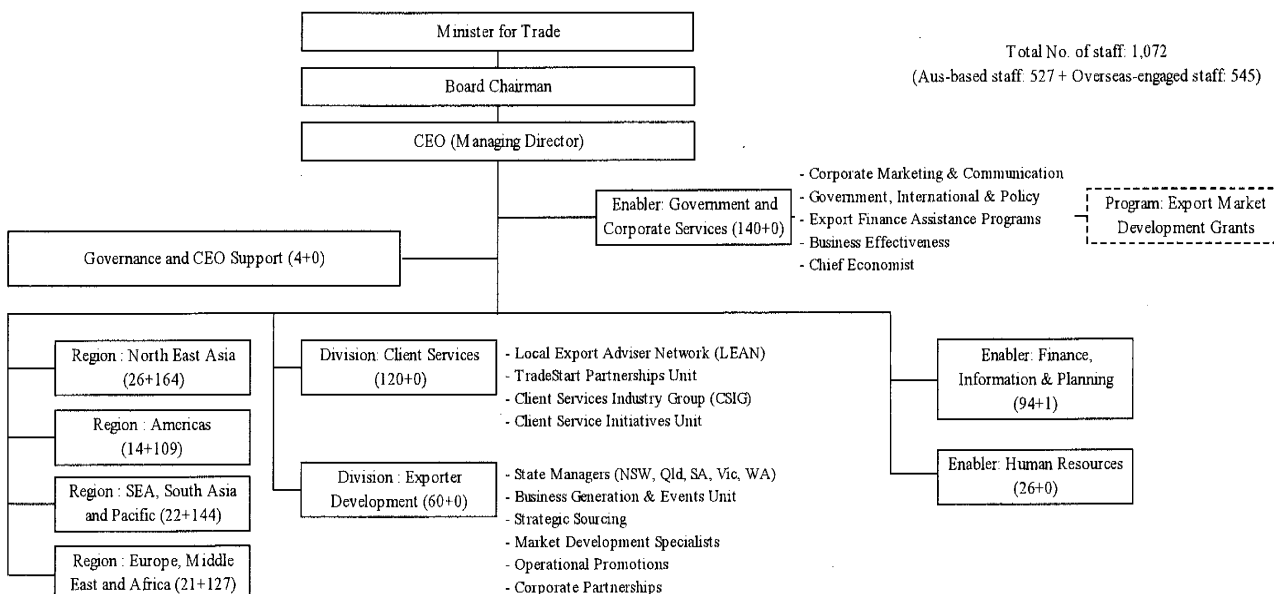

- 1) **Clients are categorized into new and irregular exporter, and established exporter for fine-tuning the export services into the needs of each category.** Austrade considers that new or irregular exporters require intensive coaching and assistance to make them begin regular exporting. New Exporter Development Program (NEDP) as a package of export services through TradeStart and Austrade offices would answer such needs. New and irregular exporters (SMEs) work alongside the export advisers (Local Export Advisor Network) to develop their capabilities and knowledge required to achieve overseas sales and become regular exporters. Austrade also works with established exporters who require assistance to expand in their current export markets or to enter new ones through Client Service Industry Group.

#### TradeStart office

TradeStart is an extensive national network that provides the resources, advice and expertise to help Australian businesses export successfully, with a particular focus on new and irregular exporters and SMEs, especially in regional and rural Australia. Austrade assigns the private sectors to manage and provide services of TradeStart, and periodically conduct tender to renew the contracts. In 2005-06 TradeStart assisted 854 Australian businesses achieve export sales worth \$353.1 million.

- 2) **Austrade promotes the Corporate Partnerships Program to extend the range of and deepen the contents of international business services available for Australian businesses through partnering with private sector and others.** Austrade enters into non-exclusive agreements to work with leading financial, legal and logistics organizations. The program offers partners the opportunity to outreach their international advisory services to existing and potential clients, through Professional Development Program, Cooperative Marketing and Media Activities. In 2005-06, the program delivered *Going International* sessions to 116 partner advisers and undertook 65 joint marketing activities with partner organizations. Corporate Partners reported 601 international business successes achieved by their clients. Austrade also opens its knowledge and advisory resources through comprehensive agreement to enable partnering private sector to access to Austrade's global network of market and industry specialists.
- 3) **Austrade has institutionalized the outcome-based corporate management by setting Key Performance Indicators (KPI).** Austrade supports utmost desired national outcome, "Australians succeed in international business with widespread support". Austrade's services and programs are categorized into output groups where external evaluators measure the end results. While Austrade targets these outputs, it recognizes that these measures are largely driven by the efforts of Australian business.

Austrade thus serves as the lead agency of the collective efforts of regional governments, businesses and industry associations vital to the achievement of such shared outputs.

**Outcome - Australians succeed in international business with widespread support**

Indicator Measures	Target
Quantity	--
- The total number of Australian goods and services exporters	
- The proportion of Australians who believe exports make a major contribution to the economy	80%

The external measure of the **total number of Australian goods and services exporters** is provided annually by the Australian Bureau of Statistics (ABS). The **proportion of Australians who believe exports make a major contribution to the economy** is measured as part of a survey of company attitudes to trade, which is conducted annually by News poll on behalf of Austrade and DFAT. According to 2006 survey, 83 per cent of those surveyed thought exports made a positive contribution to the Australian economy against a target of 80 per cent.

**Output 1.1 Awareness raising:** Community Commitment to trade and investment, understanding of the Australian Government's export assistance programs and a positive business image of Australia overseas

Indicator Measures	Target
Quality	
- Client satisfaction - Minister's office	
Quantity	80%
- Proportion of Australians who believe exports make a contribution to the economy	
- Community awareness of the importance of the Australian Government's trade and international business facilitation activities through Austrade	75%
- Number of positive net media mentions	2,500
Cost (A\$m)	18.9

**Output 1.2 Government advice and coordination:** Advice to the Australian Government and coordination of Australia's export activities

Indicator Measures	Target
Quality	
- Client satisfaction - Minister's office	
Quantity	575
- Number of briefs (including submissions and ministerial correspondence) provided to ministers, Parliament, public sector agencies	
- Percentage of material prepared within agreed timeframe	100%
Cost (A\$m)	13.3

**Output 1.3 Services and opportunities:** Export and investment services and opportunities for Australians through a national and global network

Indicator Measures	Target
Quality	85%
- Client satisfaction with Austrade's services	
Quantity	5,000
- Total number of clients achieving export success with Austrade's assistance	
- Number of new and irregular exporters achieving export success with Austrade assistance	1,800
- Number of established exporter clients achieving export success with Austrade assistance	3,200
- Dollar value of export success achieved with Austrade assistance	A\$17.5b
- Total number of clients achieving outward investment success with Austrade assistance	120
- Dollar value of outward investment success achieved with Austrade assistance	A\$1.26b
- Number of businesses achieving export success indirectly through Austrade	400
- Number of clients receiving services from Austrade	15,000
Cost (A\$m)	153.9

**Output 1.4 Austrade administered grants and Loans: Administering Export Market Development Grants (EMDG) for SMEs, and managing the closures of the loans program under the International Trade Enhancement Scheme (ITES)**

Indicator Measures		Target
Quantity	- Number of EMDG applicants	3,750
	- Number of EMDG recipients	3,470
	- Number of first-time EMDG applicants	1,350
	- Number of first-time EMDG recipients	1,180
	- Number of dollar amount of financial facilities under management (number and amount of loans to be repaid at the end of fiscal year)	4 & A\$1.6m
Cost (A\$ m)		153.9

- 4) **Austrade adopts region-wide organization to have them to focus on off-shore operation.** The regions' primary focus is to proactively identify opportunities and work with Australian businesses in overseas markets to capture export business. On the other hand, on-shore operations are handled by two divisions: Client Services and Exporter Development. The division's focus is to provide the consultation, advisory service, support for strategy planning, and other related services to new, irregular and established exporters through Export Market Development Grants, New Exporter Development Program and TradeStart. Accordingly, market intelligence operation is shared by all these regions and divisions. In addition, organizational support for onshore and offshore operation is provided by four enabling areas including human resources development, finance and information and planning, and government and corporate service. Management of market information and data is handled by information section.
- 5) **Austrade has the function of business development service internally.** For example, Austrade is engaged by the state-led Wine and Brandy Corporation to develop strategies and undertake marketing and promotion activities in a number of markets under the comprehensive agreement with Department of Agriculture.
- 6) **Austrade is quite serious for receiving the feedbacks from its client and user for continuous improvement of its services and programs.** This is through Client Service Improvement Study which reveals the clients' satisfaction for Austrade and its major program like EMDG and NEDP. In addition, Austrade institutionalizes Staff Feedback Program (Austrade Climate Survey) to gather perceptions of collaboration and information sharing within Austrade.
- 7) **Austrade introduces "on-line supported performance management system" called as "Partnering2Perform",** which covers the four stages of performance management: self-assessment, development planning, performance planning and performance review in order to determine the range of performance pay.
- 8) **Austrade is legally allowed to charge its services to the client for specifically tailored advice and consultation.** Such specifically tailored services are provided based on a quote in advance, and fees are based on an hourly rate of advisors.
- 9) **Austrade is eager to promote awareness building on importance of export development.** The awareness of community on export development is made through Export for the Future Program, where a number of documents and success cases of export development are disseminated to the universities and other academic institutions for class-room and thesis materials. Experts on export education are also dispatched upon demand.

### (6) International Enterprise Singapore (IE Singapore)

<p>a) Mission / priority, and position in export policy</p>	<ul style="list-style-type: none"> <li>- Mission or major policy issues</li> <li>- Priority industries and commodities for export</li> <li>- Position and roles of export promotion organization in the export policy</li> </ul>	<ul style="list-style-type: none"> <li>- Basic trade policy is to extend Singaporean access to the global market and strengthen its economic ties with key trading partners. The mission of IE Singapore is to promote the overseas growth of Singapore-based enterprises and international trade, and to make Singapore a thriving trading hub with global enterprises and leading international traders.</li> <li>- Not specifically mentioned.</li> <li>- Ministry of Trade &amp; Industry (MTI) is responsible for overall trade policy of Singapore. IE Singapore is an implementing agency for trade promotion under MTI spearheading Singapore's efforts to develop its external economic activities.</li> </ul>
<p>b) Organizational set-up and staffing</p>	<ul style="list-style-type: none"> <li>- Establishment and brief history</li> <li>- Organizational status (government-owned including a department of government, agency, public corporation, or else)</li> <li>- Divisions in organization, the staffing by division for major function</li> <li>- Status of staff, recruit system (including requirements for academic background and major)</li> <li>- Recruitment from private sector, system to accept seconded staff from private (with or without, and degree)</li> <li>- Salary level of staff (compared to government officer and private sector)</li> </ul>	<ul style="list-style-type: none"> <li>- Originally established as the Singapore Trade Development Board in 1983, and transformed into the International Enterprise Singapore (IE Singapore) in 2002.</li> <li>- A statutory board under MTI under the IE Singapore Board Act (2002).</li> <li>- Comprised of six groups, i) Trade Group, ii) International Operations Group, iii) Corporate Group, iv) Capability Development Group, v) Enterprise Group, and vi) Support (management) Group. On the top of these groups, IE Singapore establishes management board which has a certain level of the discretion over its management. IE Singapore's Board comprises 12 members including representatives from private sector, so that interests of private sector would be reflected in its strategy building and programs.</li> <li>- IE Singapore has a network of overseas center staffed by Honorary Business Representatives and Business Advisors in 35 locations world wide.</li> <li>- IE Singapore does not follow the government regulation for personnel. The present number of workforce in total amounts to 450, comprising of 330 domestic staff and 120 overseas staff (including locally hired staff). Recruitment is done by each vacant post, and done every year for 50 to 70 officers are for replacement. The turnover ratio is quite high.</li> <li>- IE Singapore principally recruits mid-career officers who have experience in actual business. For some posts such as researchers, new graduates are recruited. There is no system to accept seconded staff from private companies.</li> <li>- IE Singapore offers the wage system which is higher than the public sector, because IE Singapore does not have to follow the government regulations</li> </ul>
<p>c) Human resource development (HRD)</p>	<ul style="list-style-type: none"> <li>- Personnel evaluation system, career-path planning</li> <li>- Features and appealing points in HRD (staff training) system</li> </ul>	<ul style="list-style-type: none"> <li>- Personnel evaluation is done by the management board by objectives. At the beginning of fiscal year, each officer makes a working plan which is evaluated twice a year for its target achievement. Performance is rated by four grades. The result of evaluation affects the level of bonus. Average receives bonus equivalent of 2 months salary. Good one receives 3-4 months equivalent and bad receives 0.5-1 month.</li> <li>- The Human Resource Development Committee is responsible for human capital planning of IE Singapore and its immediate subsidiaries. It meets twice a year for monitoring &amp; evaluation of the human capital plan.</li> </ul>

	<ul style="list-style-type: none"> <li>- Staff dispatch (seconded or OJT) to private sector and industrial associations (with or without, and degree)</li> <li>- Services and programs</li> </ul>	<ul style="list-style-type: none"> <li>- Not practiced.</li> <li>- IE Singapore offers a wide range of services by using a "3C" framework of assistance; Competency, Connections and Capital. <ul style="list-style-type: none"> <li>a) Capital - Facilitating access to finance: provides the credit (through partnership with commercial financial institutions), grant (for market development activities), and tax incentives to help exporters access capital, defray costs and build their financial capability.</li> <li>b) Connections - Enhancing market access: offers the right channels to get enterprises connected to the global markets, through business matching support, network facilitation (with China, India and Indonesia), trade fairs &amp; missions, International Marketing Assistance Program and Pathfinder Scheme for Distribution (helping nascent exporters by leveraging "pathfinders" such as agents and distributors).</li> <li>c) Competency - Developing capabilities: offers a wide range of supporting services and resources such as branding &amp; design development, manpower support, distribution support, advice on intellectual property, alliance formation support, library &amp; information access.</li> </ul> </li> <li>- As for trade fairs, IE Singapore provides funds to associations to hold exhibitions (does not hold its own fairs). IE Singapore out-sources detailed market studies. Activity of IE Singapore is limited to delivery (with free of charge) of trade program opportunities, data on foreign buyers and local suppliers. IE Singapore considers that information on overseas markets can be available in the internet, and charges fee for market studies if wanted.</li> <li>- IE Singapore is accredited with ISO9002. Procedures to render each service are well documented in accordance with requirements of ISO.</li> <li>- IE Singapore introduced Balanced Scorecard three years ago, and currently sets Key Performance Indicators (KPIs) at the board, division and group levels, and plans to introduce KPIs to the individual level in the future.</li> <li>- IE Singapore periodically evaluates the customer satisfaction at the board and activity level, and collects feedbacks from customers for all the activities, which are to be reflected in the next review of activities.</li> <li>- Overseas post is directly appointed by IE Singapore and report to International Operations Group. Major function is "Connections" i.e., on-the-ground business facilitation services, and not obliged to send periodic market report.</li> <li>- IE Singapore has subsidiaries International Trade Institute of Singapore for training and e-learning provision (not only training also business consultation &amp; facilitation). An online e-learning portal offers new or aspiring exporters to learn about exporting fundamentals.</li> <li>- Membership (ieConnect) service is available with free of charge.</li> <li>- Mainly financed from government. Total budgeted expenditure is S\$ 101.2 mil. (FY2007).</li> <li>- There is own revenue sources but minimal. There is flexibility in budget use even after it is approved.</li> <li>- Of the total, S\$ 80.6 mil. is spent for operating expenditure, and the rest goes to grant fund.</li> </ul>
<p>d)</p> <ul style="list-style-type: none"> <li>Services and programs</li> <li>: Market intelligence</li> <li>: Product development</li> <li>: Export promotion</li> </ul>	<ul style="list-style-type: none"> <li>- Manuals to prescribe the standard process of each service and function (with or without, or ISO accreditation), and their use by staff</li> <li>- Performance and indicators of each service and function (with or without, contents)</li> <li>- Process and practice to reflect the needs of users (export industries) into the planning and revision of services and functions</li> <li>- Relation between the international promotion posts and headquarter, main activities of international promotion posts</li> <li>- Exporters training programs and memberships</li> </ul>	
<p>e)</p> <ul style="list-style-type: none"> <li>Budget and revenue source</li> </ul>	<ul style="list-style-type: none"> <li>- Origins of operational budget</li> <li>- Operational revenue (with or without), discretions on such revenue use</li> <li>- Structure of expenditure (ratio of personnel expense, fixed charge ratio)</li> </ul>	

	- Excess or deficiency of budget	- Undisclosed.
f)	<ul style="list-style-type: none"> <li>- Communication and networking with other related organizations</li> <li>- Meeting (regular or irregular) with industrial sector, association (with or without), participatory organizations, the role of TPO in the meeting</li> <li>- Overlapping of services and functions with other ministries &amp; agencies</li> <li>- Business partnership with other related organizations (with or without)</li> </ul>	<ul style="list-style-type: none"> <li>- Corporate and Enterprise Group function to communicate with industrial sectors and SMEs and work with them to develop the customized programs for their global trade and operation.</li> <li>- Not overlapped.</li> <li>- IE Singapore and commercial financial institutions have jointly created and sponsored the credit program for exporters, known as the Enterprise Fund. Through this fund, IE Singapore provides an alternate channel of financing to exporters that have encountered difficulties with traditional bank financing. This fund is independently managed by private partners.</li> </ul>
g)	<ul style="list-style-type: none"> <li>- Restructuring and reform of organization and service line</li> <li>- Large-scale restructuring and reform of organization and service line during the last ten years (after Asian currency crisis) (with or without)</li> </ul>	<ul style="list-style-type: none"> <li>- Since reorganization to IE Singapore in 2002, the focus has shifted to help Singapore companies build up expertise and grow the presence in overseas, moving beyond mere trade promotion. IE Singapore recently restructured its organization (2007) to enhance the channels to customers by setting Enterprise Group and customer call (service) center.</li> </ul>

#### Major Figures for Organization and Operation

Number of employee	450 in total (the latest)	Home: 330 Local: 120 inc. local.
Number of domestic office	1 HQ	
Number of overseas office	35 (in 21 countries)	
Companies listed in TPO's directory	Exporter: 12,000 (07)	Buyer: n.a.
Number of membership company	n.a.	
Number of consulting services / year	15 to 20 per day (05/06)	
Number of inquiry services / year	Entire: app. 50,000 (05/06)	--
Number of successful matching / year	n.a.	
Number of website visitor	5 mil. hits per year (05/06)	
Number of product / company listed at web exhibition	92,281 companies (the latest, in BuySingapore)	
Number of trade fairs organized and sponsored / year	Overseas: 100 (05/06)	Domestic: n.a.
Number of participating companies / year	Overseas: 2,400 (05/06)	Domestic: n.a.
Number of material held in library	About 10,000 title (latest, any material types)	
Annual budget	66.7 million US\$ (FY2007)	
Languages in home website	English, Chinese	

**Highlights of International Enterprise Singapore (IE Singapore)**

**Organization Chart of IE Singapore\_as of June 2007**

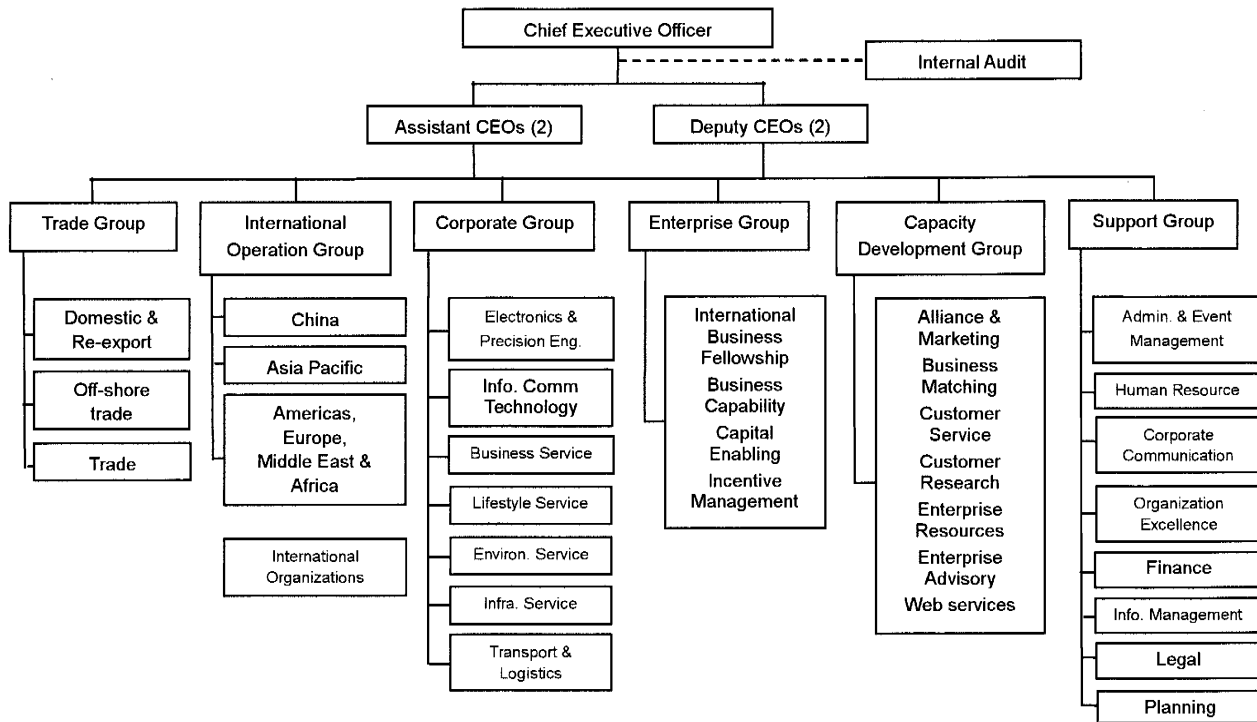

- 1) **IE Singapore advanced its management system in a modern way.** IE Singapore has introduced the Zero Defects initiative using the methodology of Six Sigma. IE Singapore evaluates the customer satisfaction at the Board level and activity level and collects the feedbacks from customers for all the activities. IE Singapore has also introduced the Balanced Scorecard (BSC) three years ago, currently sets KPIs at the board, division and group levels, and plans to introduce KPIs to the individual level in the future. Customer-orientation is an important issue in BSC. It is also noted that IE Singapore did the benchmark survey in order to improve its management system. Citibank, McDonalds, hospital, zoo, etc. were surveyed. Empowerment at Citibank served as most useful reference, and their practices were reflected in reviewing the procedure of credit provision programs by IE Singapore.
  
- 2) **IE Singapore has actively worked for facilitation of financial services to exporters.** IE Singapore provides the following credit provision programs to help companies access to capital, defray costs and build up their financial capabilities in building alliance with commercial financial institutions:
  - Enterprise Fund: IE Singapore and Hong Leong Finance have jointly created and sponsor the Enterprise Fund. Through this Fund, IE Singapore provides an alternate channel of financing to companies that have encountered difficulties with traditional bank financing. Enterprise Fund is independently managed by Crest Capital Partners Ltd.
  - Internationalization Finance Scheme: the Internationalization Finance Scheme is designed to help Singapore-based companies support their expansion overseas.
  - Loan Insurance Scheme: a variable-cost financing program that meets a company's working capital needs in Singapore and overseas. Loan Insurance Scheme offers loans that are partially insured against the borrowers' default risks. The government co-shares the premium cost with borrowers.
  - Trade Credit Insurance Program: IE Singapore has partnered with two credible underwriters to offer trade credit insurance at very attractive premium rates. By pooling demand for trade credit insurance, thereby generating economies of scale and diversification of risks, this program is able to offer premium rates normally available only to companies with significant trade volumes.
  
- 3) **IE Singapore has developed subsidiary operation for the particular functions.** Singapore Information Services Pty Ltd. (SIS) was formed in 1989 to undertake the trade directory publishing and sales, as a wholly-owned subsidiary of IE Singapore,

which gives them incentive to make directories attractive. SIS publishes the product directory of 12,000 companies and develops the website which offers a comprehensive database of Singapore companies and their goods and services.

International Trade Institute of Singapore (ITIS), as wholly owned subsidiaries of IE Singapore, was also set up in July 2000 as a result of the merger and corporatization of two business units of the former Singapore Trade Development Board (STDB), namely Export Institute of Singapore (EIS) and Singapore Trade Development Board Consulting Group (STDBC). ITIS is a premier training, consulting and research institute, specializing in trade and economic development and international business. Its main clientele includes both public and private sector organizations across Asia, Africa and the Middle East.

#### 4) **Reorganization experiences by IE Singapore**

Reorganization to IE Singapore: Reorganized to IE Singapore in April 2002 with the major purpose to start stepped-up efforts in view of spreading Singapore government's external economic arms in the global sphere. The focus has shifted to help Singapore-based companies build up expertise and grow overseas, moving beyond mere trade promotion.

The latest reorganization (strengthening the customer channel): In July 2007, IE Singapore implemented an organizational change. Two assistant CEOs are newly added to two deputy CEOs. These four deputy and assistant CEOs share the management of groups. Before the organizational change, groups were categorized into three areas, i.e., International Operations, Corporate Resources and Singapore Operations. Under the new organization, IE Singapore expanded the groups to six, adding Trade Group, Capability Development Group and Enterprise Group. Of the new groups, Enterprise Group was set particularly to take care of SMEs (while Corporate Group focuses on large enterprises) and to enhance communication channels to the customers. Through Enterprise Group, IE Singapore enhanced consultation function to its smaller customers. Consultation service consists of call center (customer service center), website and face-to-face advice. Enterprise Group allocated experienced staffs (master-degree holders) that are familiar to IE Singapore's activities to the customer service center. The customer service center monthly handles 2,000 - 3,000 inquires. Frequent topics of inquires are concerning IE Singapore's programs such as credit programs and overseas contacts. If necessary, inquirers are referred to website services and/or face-to-face consultation desk. Seven staff members are posted at the consultation desk. Call center is a useful tool to offer consultancy to customers at remote areas.

Global Business Insights: IE Singapore established a subsidiary company, Global Business Insights (GBI) in November 2003. GBI offered services in two key areas: market strategy services (MSSs) and business support offices (BSOs). MSSs provided market researches and marketing consultancy services for a fee. BSOs aimed at helping companies who make their initial foray into international markets, and provided physical and virtual office facilities and support services. BSOs are available in 12 locations around the world. IE Singapore indicated that it limits consultancy liability by establishing GBI, and that it seeks eventually to make GBI self-sustaining. However, IE Singapore has closed GBI's operation. This is partly because they considered that the government sector should withdrawn from the marketing research and consulting business where the private sector is doing business according to a "yellow page rule." Secondary, the customers' requirements became severe because GBI charged fees. For a governmental agency, market research and consultancy on a commercial base is difficult due to the limited capabilities and "yellow page rule".



## (7) Japan External Trade Organization (JETRO)

<p>a) Mission / priority, and position in export policy</p>	<ul style="list-style-type: none"> <li>- Mission or major policy issues</li> <li>- Priority industries and commodities for export</li> <li>- Position and roles of export promotion organization in the export policy</li> </ul>	<ul style="list-style-type: none"> <li>- Aimed to increase trade and investment, develop closer economic relationships with other countries and expand its involvement in international economic cooperation.</li> <li>- Sub-sectors or commodities are not designated in particular, but the presently Japanese government put an emphasis on the export of agricultural products.</li> <li>- Within Ministry of Economy and Industry (MOEI) portfolio, JETRO is supposed to i) to conduct activities to promote international trade and investment, ii) help Japanese companies (especially SMEs) build stronger business ties in ASEAN, China, India, and the rest of East Asia, iii) to improve intellectual property protection and help promote free trade agreements in corporation with government, v) promote foreign direct investment in Japan, vi) carry out economic research overseas and collect economic and market information.</li> </ul>
<p>b) Organizational set-up and staffing</p>	<ul style="list-style-type: none"> <li>- Establishment and brief history</li> <li>- Organizational status (government-owned including a department of government, agency, public corporation, or else)</li> <li>- Divisions in organization, the staffing by division for major function</li> <li>- Status of staff, recruit system (including requirements for academic background and major)</li> <li>- Recruitment from private sector, system to accept seconded staff from private (with or without, and degree)</li> <li>- Salary level of staff (compared to government officer and private sector)</li> </ul>	<ul style="list-style-type: none"> <li>- Originally established in 1958 to promote exports abroad (trade fairs and market research), and gradually transformed to accommodate investment and import promotion according to the changes in economic environments.</li> <li>- Government-incorporated Administrative Agency since 2002 within Ministry of Economy and Industry (MOEI) portfolio.</li> <li>- The network comprises of HQ office, the Institute of Developing Economies (IDE), 36 local offices, and 73 overseas (in 54 countries) offices. The number of staffs amounts to 1,680 (630 domestic and 850 overseas) as of present</li> <li>- Staffs are government employee of the incorporated administrative agency. Most of them are recruited annually from the university graduates (38 in 2007). There are also many seconded staffs from supervising ministry, MOET.</li> <li>- Also intermediately recruits from private sector.</li> <li>- Salary level is set as average between government officials and private companies.</li> </ul>
<p>c) Human resource development (HRD)</p>	<ul style="list-style-type: none"> <li>- Personnel evaluation system, career-path planning</li> <li>- Features and appealing points in HRD (staff training) system</li> <li>- Staff dispatch (seconded or OJT) to private sector and industrial associations (with or without, and degree)</li> <li>- Services and programs</li> </ul>	<ul style="list-style-type: none"> <li>- Personnel evaluation system was introduced since 2003, and is done by each designated evaluators (immediate manager) every year. The system is linked with the performance management system which comprises of objective setting, self-assessment, and performance review. Career-path planning is also adopted.</li> <li>- HRD system structures of career stage-wide training (from freshman training to management one), language training (at overseas), business management training, and training for required skills (writing trade / market report, and business documents, etc.)</li> <li>- Not practiced. But JETRO receives trainees of trade promotion staff from regional governments for their international experience.</li> </ul>
<p>d) Services and programs : Market intelligence : Product development : Export promotion</p>	<ul style="list-style-type: none"> <li>- Services and programs</li> </ul>	<ul style="list-style-type: none"> <li>- Major services and functions include; <ul style="list-style-type: none"> <li>a) Promotion of Foreign Direct Investment into Japan</li> <li>b) Assistance for SME export by experienced advisors from the private companies</li> </ul> </li> </ul>

	<ul style="list-style-type: none"> <li>c) Collection &amp; dissemination of foreign economic information through various medias</li> <li>d) Trade Tie-up Promotion Program (TPP) for free on-line business matching site</li> <li>e) Promotion of high-tech industry tie-ups between Japanese and foreign firms (incubation and start-up support service in US for high-tech industry)</li> <li>f) Support for intellectual property protection</li> <li>g) Research for developing economies</li> <li>h) Support for Official Development Assistance</li> <li>i) Support for Economic Revitalization of regions in Japan (regional economic programs)</li> <li>- Not known for guidelines for execution of each service and program. No ISO accredited.</li> <li>- Major performance indicators are set and linked with the customer satisfaction level.</li> <li>- Customer survey through questionnaire is done for each project / program which can clearly identify customers.</li> <li>- Staff of overseas centers is internally appointed from JETRO except for some cases where MOE requests its staff to be seconded. Frequency of contact is countless. Meeting among overseas centers is held annually with HQ attendance.</li> <li>- Export training course is available on trade practices and such. Membership is available, presently counting 3,836 members, and requires annual membership fee of US\$ 650.</li> <li>- Government budget allocation (26.6 billion yen, 70.7%), followed by sales of goods &amp; services (10.8 billion yen, 28.7%), and other minor revenues (FY2006).</li> <li>- Sales of goods (publication, etc.) and services account for 28.7% of total revenue. Including the use of this operational revenue, all the use of operational budget need an approval on an annual basis from the supervising minister.</li> <li>- N.A.</li> <li>- Deficiency is to be compensated from accumulation fund.</li> </ul>	<ul style="list-style-type: none"> <li>- Manuals to prescribe the standard process of each service and function (with or without, or ISO accreditation), and their use by staff</li> <li>- Performance and indicators of each service and function (with or without, contents)</li> <li>- Process and practice to reflect the needs of users (export industries) into the planning and revision of services and functions</li> <li>- Relation between the international promotion posts and headquarter, main activities of international promotion posts</li> <li>- Exporters training programs and memberships</li> <li>- Origins of operational budget</li> <li>- Operational revenue (with or without), discretions on such revenue use</li> <li>- Structure of expenditure (ratio of personnel expense, fixed charge ratio, etc.)</li> <li>- Excess or deficiency of budget</li> </ul>	
e)	<ul style="list-style-type: none"> <li>- Meeting (regular or irregular) with industrial sector, association (with or without), participatory organizations, the role of TPO in the meeting</li> <li>- Overlapping of services and functions with other ministries and agencies</li> <li>- Business partnership with other related organizations (with or without)</li> </ul>		
f)	<ul style="list-style-type: none"> <li>- Chairman and executive directors are posted for other governments and industrial associations, thus ensuring communication channel with private sector. Overseas centers serve as key member in the Japanese Chamber of Commerce and Japan Society to keep close communication with the corporations working at overseas.</li> <li>- None. Other governments concerned with export development of its sector, assign JETRO to engage in export marketing and strategy planning for such sectors. For the Ministry of Agriculture, JETRO plays the secretariat role for the Committee of Overseas Market Development for Japanese Foods and give advice on agro-export promotion strategy.</li> <li>- Closely coordinated with other Trade Fair Committees and Convention Bureaus.</li> <li>- Local JETRO offices are established jointly between JETRO and regional governments in cooperation with local industry associations.</li> </ul>		

g)	<ul style="list-style-type: none"> <li>- Restructuring and reform of organization and service line during the last ten years (after Asian currency crisis) (with or without)</li> <li>- Success or failure, and evaluation of restructuring and reform</li> </ul>	<ul style="list-style-type: none"> <li>- In 2003, JETRO was reorganized as incorporated administrative agency from the status of a non-profit government organization. Reorganization is accorded with the government policy to decrease the number of government organizations, thereby lessening financial burden of government.</li> <li>- It is considered as too early to assess the results of reorganization.</li> </ul>
----	---	---

#### Major Figures for Organization and Operation

Number of employee	1,680 in total (the latest)	Domestic: 830 Overseas: 850
Number of domestic office	36 (region) + 2 HQ	
Number of overseas office	73 (in 54 countries)	
Companies listed in TPO's directory	Exporter: n.a	Buyer: n.a
Number of membership company	3,836 (as of Apr. 2007)	
Number of consulting services / year	33,013 (2005, No. of export business confab)	
Number of inquiry services / year	Exporter: n.a	Buyer: n.a
Number of successful matching / year	6,733 (2005, No. of closed deal after confab)	
Number of website visitor	103.31 million (2005, No. of page view)	
Number of product / company listed at web exhibition	n.a	
Number of trade fairs organized and sponsored / year	Overseas: n.a	Domestic: n.a
Number of participating companies / year	Overseas: n.a	Domestic: n.a
Number of material held in library	n.a	
Annual budget	313.3 million US\$ (FY2006)	
Languages in home website	English and Japanese	

## Highlights of Japan External Trade Organization (JETRO)

Organization Chart of JETRO\_as of 2007

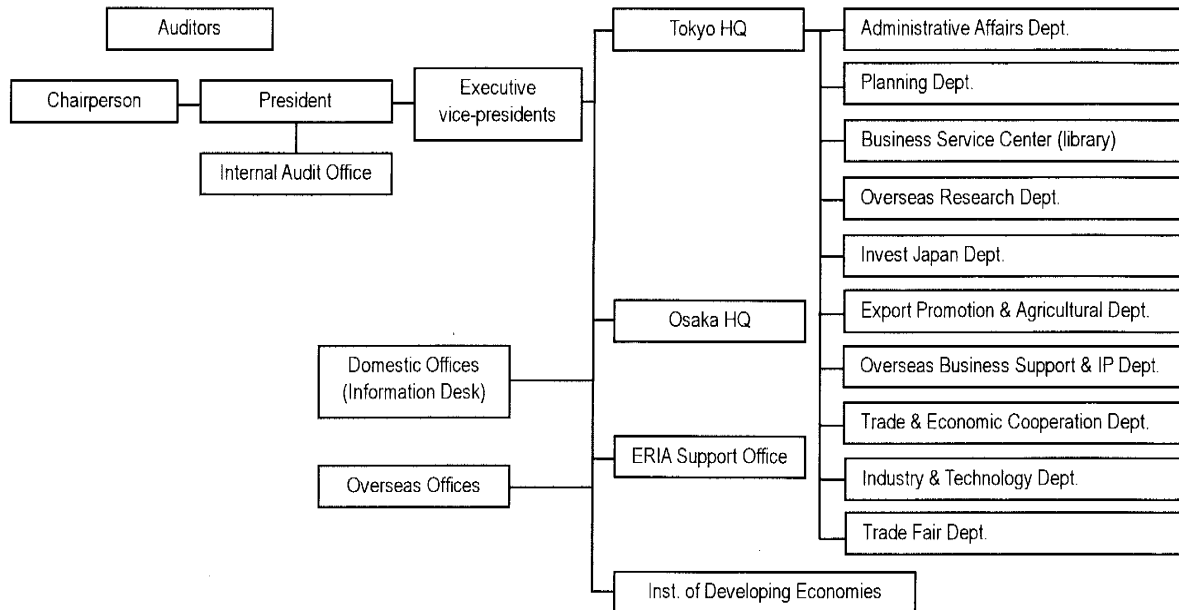

Missions of JETRO have been shifted from export promotion to investment and import promotions in accordance with the changes in economic relations with foreign countries, and industrial structure of Japan. Present activity of JETRO focuses more on investment promotion and improvement of overseas business environment, on-the-ground support for Japanese corporations in overseas, etc. Accordingly, this section highlights the service operation of JETRO in the past, when export promotion was agenda of JETRO.

### Brief History of JETRO

- 1958 : Established as a non profit government organization by the special law and with 100% of government finance.
- 1960s : Growing JETRO's domestic and overseas network rapidly, and scaled-up export promotion activities.
- 1970s : Enhanced assistance for overseas investment of Japanese corporations, and expanded activities of overseas PR for Japanese products.
- 1980s : Started and activated import promotion activities in the cooperation with foreign industries and developing countries.
  - 1987 : Instigated the Asian Trade Promotion Forum (ATPF) among 10 Asian countries
- 1990s : Established import promotion dept., and import business support center.
- 2000s : Started promotion of investment entering Japan and support for globalization of regional economies.
  - 2002 : Resumed export promotion programs.
  - 2003 : Expanded "Invest in Japan" promotion through establishment of Invest in Japan business support center.

### History during Export Promotion Era

#### (1) Establishment of JETRO

JETRO was established in 1958. Japanese government took the lead in promoting exports in order to put the economy back upon its feet after the war. From early 1950s to 1960s, Japanese industry severely lacked economic and trade information on the overseas markets, particularly in its campaigns for export of textiles, craft / daily goods and wares. Most private companies lacked the resources to gather such information on their own. Therefore, JETRO was assigned to assist business sectors to collect overseas trade information, and started with 239 employees in Japan and 53 employees in its 37 overseas offices.

#### (2) Began collecting and disseminating trade information

JETRO Trade Centers in overseas conducted a numerous market studies and surveys, concentrating on information relating to overseas importers, export and import systems, pricing, distribution channels, and other trade fundamentals. This information was subsequently channeled back to potential Japanese exporters through its trade libraries and trade publications. Overseas centers also served for Japanese businessmen through functioning as the bases on their business trips abroad.

(3) Started comprehensive export promotion activities

In the 1960s, Japan entered a period of rapid trade expansion. Accordingly, JETRO turned to more comprehensive export promotion activities, and began making detailed studies of overseas market, held overseas exhibitions for Japanese products. It also expanded publication activity for Japanese products and started business consultation and trade inquiry services.

(4) Gradually shifted from export promotion to globalization support

After the first oil crisis of 1973, Japanese companies began investing overseas, and securing resources and energy. Along with this, JETRO shifted its focus from export promotion to import promotion and economic cooperation with developing countries.

### **Export Promotion Activities by JETRO in the 1950s and 1960s**

(1) Market research

For a general overview of the market, JETRO started at first research on the economic trends of the target countries or regions, and collection of information concerning on import system, import channel, trading port, customs clearance procedure, and transportation channel after customs, etc. To more specific level, JETRO gradually enlarged the scopes to the credit ratings of importers and overseas wholesalers and retailers, and their trade practices. The demand trends for individual commodities were also examined, including the import share of Japanese products, the condition of production and its distribution, the profile of manufactures and sales companies, the purchasing power by income bracket, and demand forecasts.

(2) Dissemination of information

JETRO Trade Library housed collections of business directories of countries around the world, "Yellow page" telephone directories, trade statistics, catalogs of foreign products, tables of customs tariffs, and other information. All of these collections were available for reviewing by the general public.

(3) Trade exhibitions

JETRO hosted overseas fairs on its own and participates in numerous international fairs to assist the overseas market development of Japanese firms.

(4) PR

JETRO publicized the superiority of Japanese products and industry through publications and newsletters. Also PR films were produced. Contacts with foreign media were also taken seriously by JETRO staffs.

(5) Trade inquiry and business consultation

JETRO offered trade consultation service and helped introduce business prospects especially for SMEs and overseas business.

(6) Publications

JETRO published a daily trade bulletin which contained national economic report, and commodity and industrial information, compiled by each overseas office.

(7) Overseas office

JETRO's overseas offices offered valuable information, and facilities and conveniences for Japanese businessmen traveling overseas for market survey and business negotiations.

### **Other Highlights**

- 1) **JETRO shows a good model of cooperation with regional governments and private sector in the regions.** Budget necessary for the operation of local offices of JETRO is shared by JETRO HQ (central government) and regional governments. Experts for trade consultation are usually recruited from the private sector such as regional chamber of commerce and industry. Local offices

frequently hold the seminars to provide local businesses with overseas market information, and are active for organizing trade fairs and business confab in cooperation with regional government and chamber of commerce and industry. With the strong cooperation of regional government and private sector, JETRO realizes sufficient regional arms of promotion services with establishment of 36 local offices.

- 2) **JETRO has an extensive network of human resources with private sector.** JETRO has actively utilized the human resources held by the private sector in offering advice and consultation services. In overseas centers (Asia in particular) and local offices, JETRO assigns the experts for overseas marketing and investment recruited from private sector (who have worked for trading companies, global manufactures, and etc.). The scope of advising and consulting topics is broad enough, ranging from trade and investment issues, overseas business management, legal and taxation issues, labor issues, intellectual property protection, etc.
- 3) **JETRO provides incubator functions.** A number of Japanese high-tech firms possess cutting-edge products and services, but often lack the resources and information to develop overseas operation. To help meet this need, JETRO can send the promising high-tech firms to business incubation centers in US in order to nurture their business or technology "seeds". JETRO covers the cost of incubation, including use of office space and professionals, and supports for drawing-up business plans in English.

## LAMPIRAN

2. Hasil Survey Kepuasan Pengguna Layanan BPEN (Disubkontrakkan)

Customer Satisfaction Survey  
for the Service of  
National Agency for Export Development (NAFED)



**TRIASA BAHARTHA RIZKI**

**2007**

**Jl. Ulujami Raya no. 27 Pesanggrahan  
Jakarta Selatan 12250 – Telp. 021-7365189 Fax. 7377185  
Email:triasa\_bahartha\_rizki@yahoo.com Website:www.triasabaharharizki.com**



# Table of Contents

<b>Table of Contents</b> .....	2
<b>I. Background</b> .....	3
<b>II. Survey Program</b> .....	3
<b>III. Result of Questionnaire Survey</b> .....	4
3.1 Distribution of Respondents .....	4
3.2 Profile of Respondents .....	5
3.3 Operational Status of Respondent .....	7
A. Overall.....	7
B. Export performance .....	10
3.4 Use and Evaluation of NAFED Services.....	13
A. Market information service .....	13
B. Export promotion service: overseas trade fair / exhibition.....	15
C. Export promotion service: domestic trade fair / exhibition.....	16
D. Export promotion service: inquiry and matching service.....	18
E. Web-site service.....	19
F. Product (design) development service .....	21
3.5 Overall Evaluation on NAFED Performance .....	23
<b>IV. Result of Interview Survey</b> .....	24
4.1 Interview with KADIN.....	24
4.2 Interview with Industrial Associations (export-oriented) .....	25
4.3 Interview with Selected Exporters .....	26
<b>Attachments</b>	
- Interview sheets for KADIN	
- Interview sheets for Industrial Association	
- Interview sheets for exporter	
- Questionnaire sheet for exporter	

# **Customer Satisfaction Survey for the Service of National Agency for Export Development (NAFED)**

## **Survey Report**

### **I. Background**

The export promotion by strengthening competitiveness of Indonesian industries is one of the major issues for the sustainable development of Indonesia's economy as well as foreign investment promotion through investment environment improvement. For the export promotion, the Ministry of Trade (MOT) of Indonesia proposes such actions as i) to diversify of export products by upgrading added value and productivity, ii) to bolster exports to the traditional market, iii) to penetrate non-traditional markets, iv) to expand market development activities including effective export promotion activities and trade missions, etc.

Under these circumstances, the National Agency for Export Development (NAFED), affiliate agency of MOT, functions as a government agency specialized in export promotion. The strengthening of NAFED's capabilities is regarded as an urgent issue in order to reinforce the export competitiveness. Responding to this situation, the Government of the Republic of Indonesia (GOI) requested Japan International Cooperation Agency (JICA) to carry out the Study with the purpose of formulating a master plan to strengthen the organization and function of NAFED.

To complement the said Study, the Questionnaire and Interview Survey to Private Export Industries (customer satisfaction survey for the services of NAFED) (hereafter referred to **the Survey**) is implemented on a sub-contract basis. The JICA Study Team consigned the Survey to a local consulting firm, Triasa Baharta Rizki (TBR) as a survey contractor.

### **II. Survey Program**

The survey consists of two parts (questionnaire and interview surveys), and each survey was conducted by the team of experts.

The interview survey team conducted the survey by visiting respondents on a door to door basis. Targets of interview survey included;

- i. Seven (7) KADIN in seven (7) provinces
- ii. Fifteen (15) export-oriented industrial associations in seven (7) provinces
- iii. Thirty (30) exporting (and potentially exporting) enterprises in seven (7) provinces

The questionnaire survey team visited the respondents on a door to door basis. Target number of the respondent was set as 140. To achieve the target number, the team visited over 180 respondents, which included the following sub sectors: a) leather product, b) footwear, c) furniture, d) textile product, e) food processing, f) medicinal herb, g) electronics, h) medical equipment, i) automotive component, j) cocoa, k) coffee, l) palm oil, m) rubber product, n) shrimp, o) essential oil, p) fish product, q) handicraft, r) jewelry, s) spice, t) stationery, u) other products.

The survey conducted in two months period cover seven provinces, they were: Jakarta, East Java (Surabaya), Central Java (Semarang), West Java (Bandung), South Sulawesi (Makassar), North Sumatra (Medan), and South Kalimantan (Banjarmasin).

### III. Result of Questionnaire Survey

#### 3.1 Distribution of Respondents

The sector distribution of the questionnaire respondents (who returned the questionnaire to the survey team) is as follows;

a) Leather product	: 9
b) Footwear	: 7
c) Furniture	: 20
d) Textile product	: 19
e) Food processing	: 23
f) Medicinal herb	: 13
g) Electronic	: 2
h) Medical equipment	: 9
i) Automotive component	: 5
j) Cocoa	: 1
k) Palm oil	: 1
l) Rubber product	: 3
m) Essential oil	: 3
n) Fish product	: 5
o) Handicraft	: 15
p) Jewelry	: 3
q) Stationery	: 2
r) Others	: 6

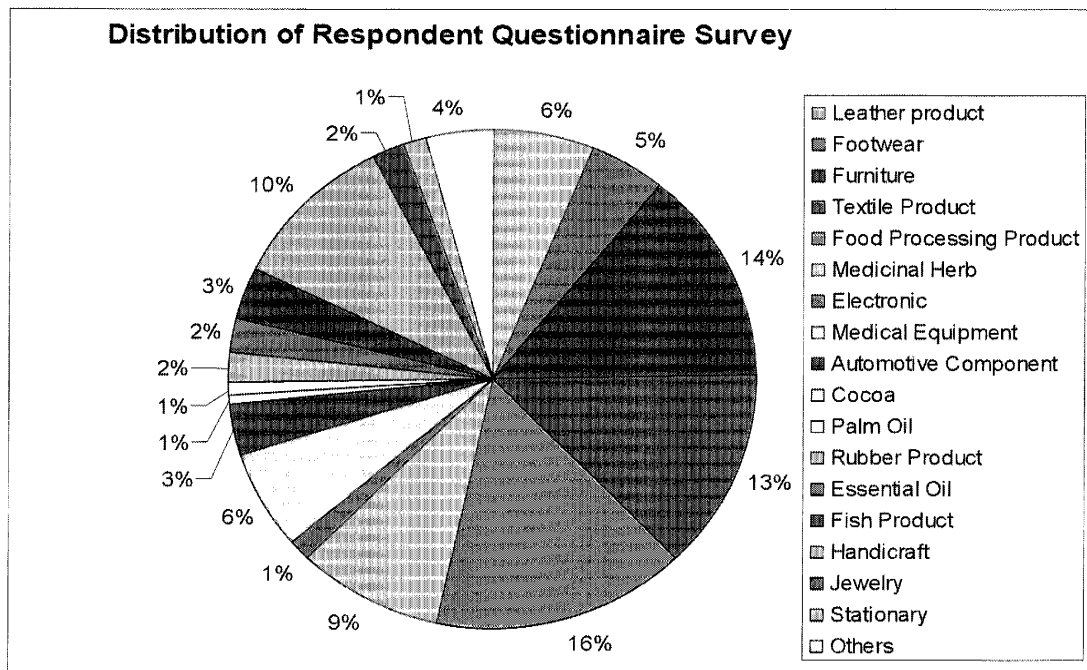

The respondents are classified in terms of size as follows;

i. Small industries	: 95 enterprises
ii. Medium industries	: 33 enterprises
iii. Large industries	: 18 enterprises

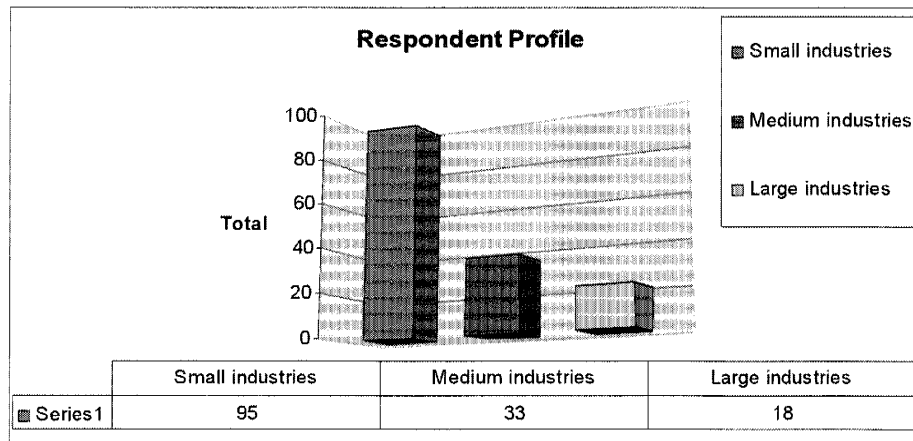

Of the respondents, the enterprises who are exporting amounted to 117 (79.6%) and the rests of 30 (20.4%) were the prospective or potential exporters.

### 3.2 Profile of Respondents

#### 1) Total asset value

The range of total asset value among small enterprises is shown as follows (80 of total disclosed and 15 did not disclose the data);

Rp. 10 million to Rp. 500 million	: 32 enterprises
Rp. 501 million to Rp. 1,000 million	: 9 enterprises
Rp. 1,001 million to Rp. 5,000 million	: 30 enterprises
Rp. 5,001 million to Rp. 10,000 million	: 5 enterprises
≥ Rp. 10,000 million	: 4 enterprises

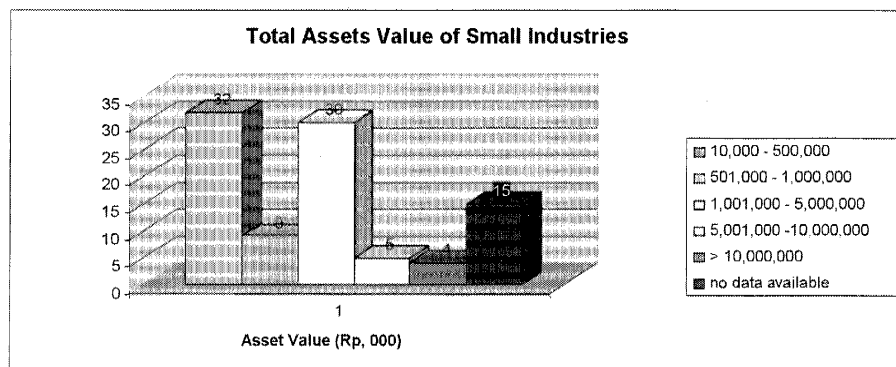

The range of total asset value among medium enterprises is shown as follows (21 of total disclosed and 12 did not disclose the data);

Rp. 100 million to Rp. 500 million	: 10 enterprises
Rp. 5,001 million to Rp. 9,000 million	: 4 enterprises
Rp. 9,001 million to Rp. 25,000 million	: 3 enterprises
≥ Rp. 25,000 million	: 4 enterprises

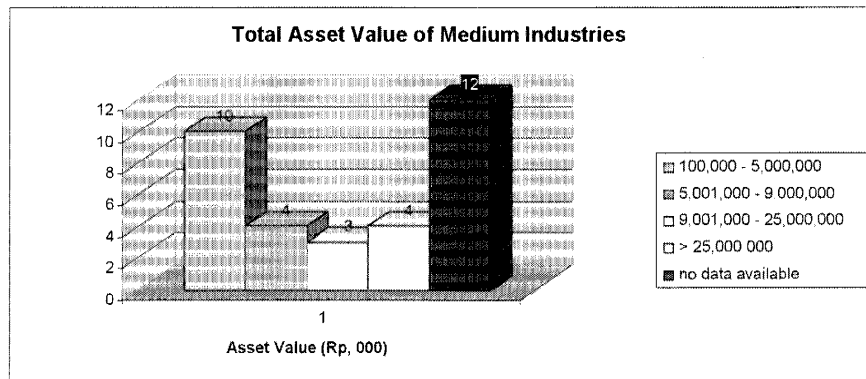

The range of total asset value among medium enterprises is shown as follows (17 of total disclosed and one did not disclose the data):

Rp.100 million to Rp.25, 000 million	: 10 enterprises
Rp.25, 001 million to Rp.200, 000million	: 4 enterprises
≥ Rp.201, 000 million	: 3 enterprises

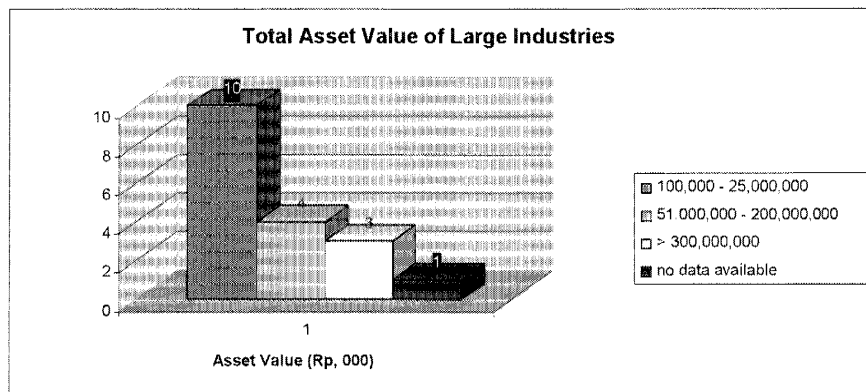

## 2) Date of establishment

The range of establishment year of the respondents is shown as follows (142 of total disclosed and 4 did not disclose the data):

1900 to 1940	: 2 enterprises
1941 to 1970	: 8 enterprises
1971 to 1990	: 56 enterprises
1991 to 2000	: 45 enterprises
> 2000	: 31 enterprises

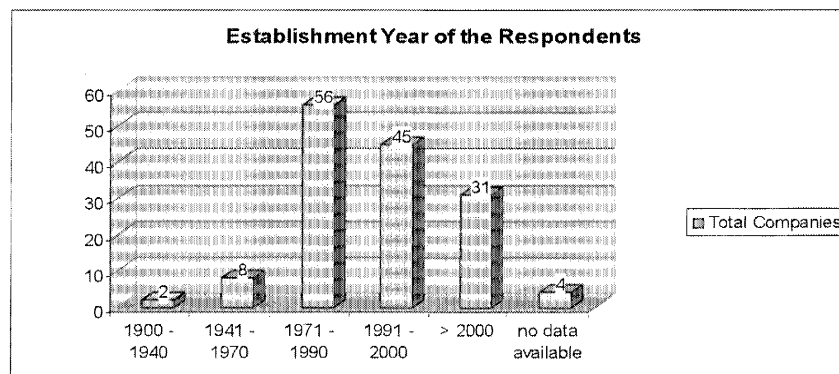

## 3.3 Operational Status of the Respondents

## A. Overall

### 1) Annual turnover

Of the total small enterprise respondents, the annual turnovers (for the year 2006) of around the half of the respondents are increasing, 26.6% of them constant, but 19.2% declining. The respondents, who did not disclose, account for 6.4% of total.

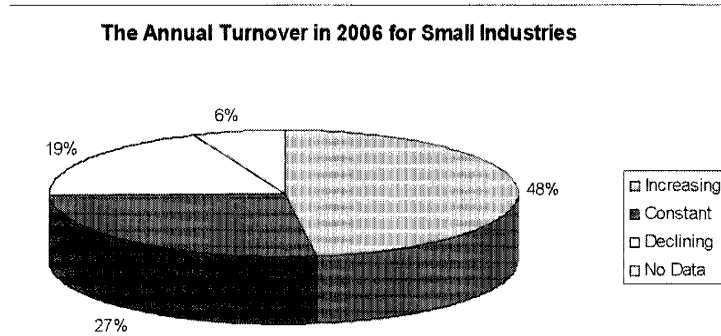

Of the total medium enterprise respondents, the annual turnovers (for the year 2006) of 25.0% of the respondents are increasing, 21.8% of them constant, but 21.8% declining. The respondents, who did not disclose, account for 31.3% of total.

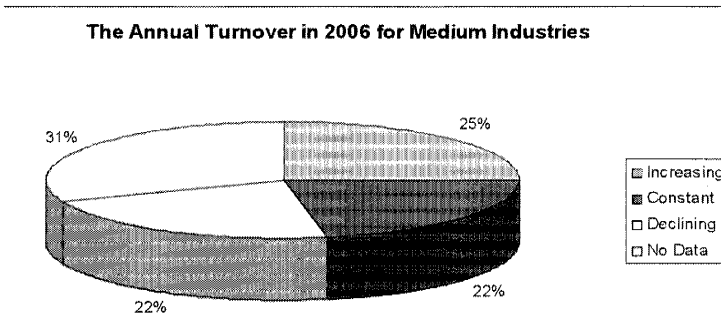

Of the total large enterprise respondents, the annual turnovers (for the year 2006) of 28.5% of the respondents are increasing, 19.1% of them constant, but 23.8% declining. The respondents, who did not disclose, account for 33.3% of total.

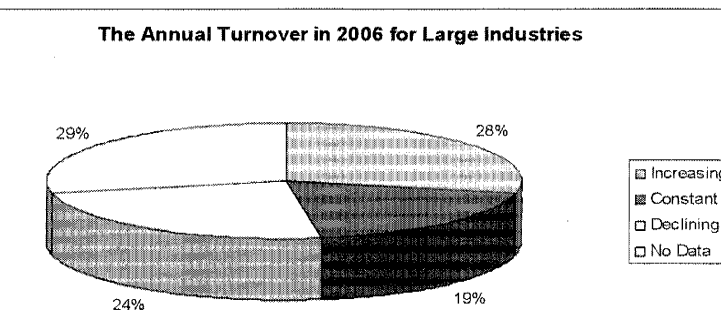

### 2) Profit

Of the total small enterprise respondents, the annual profits (before tax for the year 2006) of 38.3% of the respondents are increasing, 27.6% of them constant, but 23.4% declining. The respondents, who did not disclose, account for 10.6% of total.

**Profit Before Tax for the year 2006 of Small Indust.**

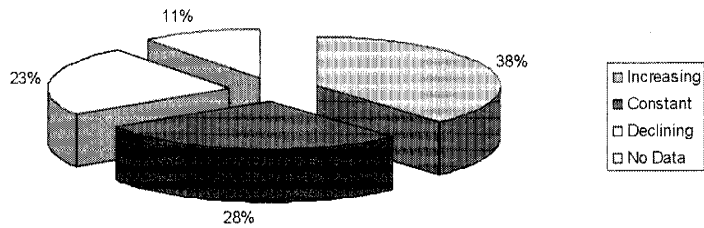

Of the total medium enterprise respondents, the annual profits (before tax for the year 2006) of 25.0% of the respondents are increasing, 21.8% of them constant, but 21.8% declining. The respondents, who did not disclose, account for 31.3% of total.

**Profit Before Tax for the year 2006 of Medium Indust.**

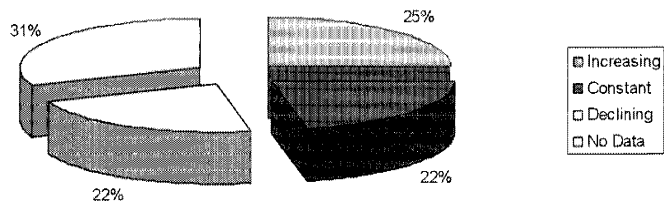

Of the total large enterprise respondents, the annual profits (before tax for the year 2006) of 23.8% of the respondents are increasing, 4.8% of them constant, but 38.1% declining. The respondents, who did not disclose, account for 33.3% of total.

**Profit Before Tax for the year 2006 of Large Indust.**

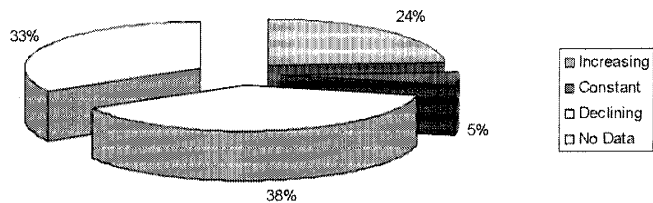

3) Number of employee / worker

Number of employee / worker by size of respondent is shown in the following chart:

**Number of Employee / Worker for Small Industries**

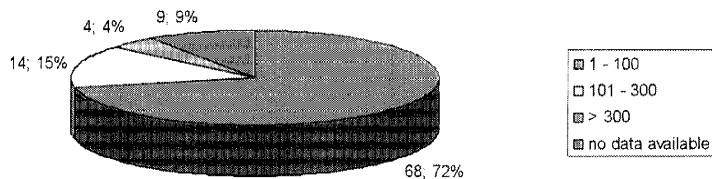

**Number of Employee / Worker for Medium Industries**

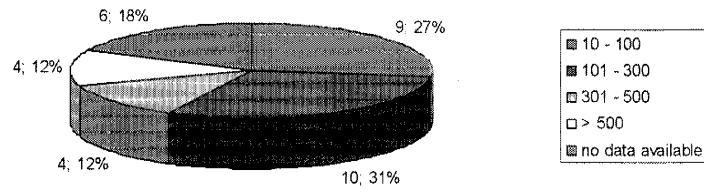

**Number of Employee / Worker for Large Industries**

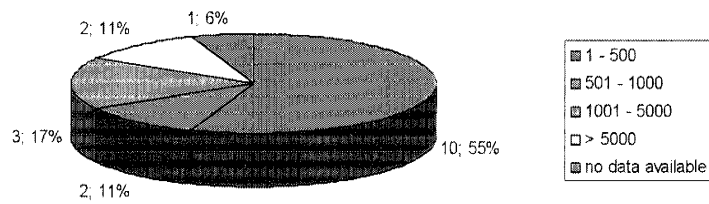

4) Present operational status

Of the total small enterprise respondents, 32% of them indicated that the operation is growing, 54% indicated constant, 11% indicated facing difficulties, whereas 0% was going to non-operational. The respondents who did not answer the status account for 3% of total.

**The Present Operational Status for Small Industries**

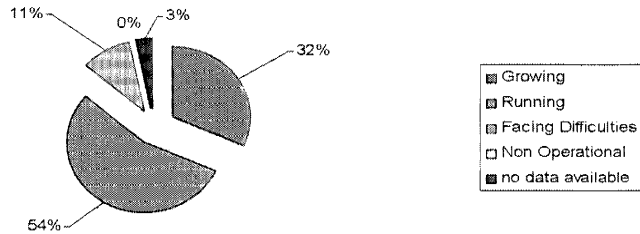

Of the total medium enterprise respondents, 18% of them indicated that the operation is growing, 61% indicated constant, 6% indicated facing difficulties, whereas 0% was going to non-operational. The respondents who did not answer the status account for 15% of total.

**The Present Operational Status for Medium Industries**

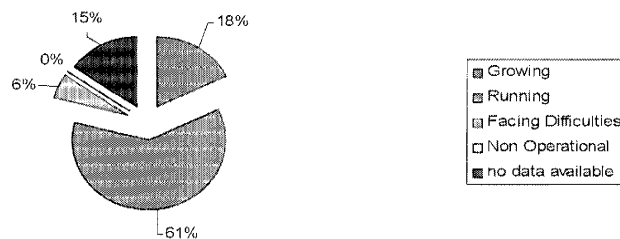

Of the total large enterprise respondents, 45% of them indicated that the operation is growing, 44% indicated constant, 11% indicated facing difficulties, whereas 0% was going to non-operational.



The Present Operational Status for Large Industries

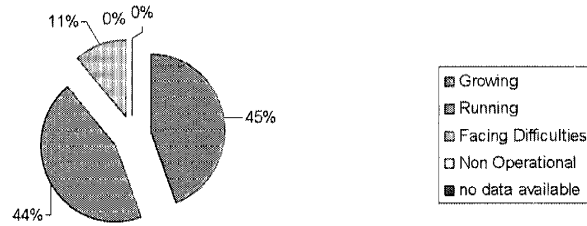

## B. Export performance

### 1) Annual export value

Total value of export for the year 2006 of 97 responded exporters was Rp. 564.3 billion. Trend of annual export value showed that 32% of the respondents were increasing, 18% of them were constant, 21% were decreasing, but 20% of them did not present the data.

Trend of Annual Export Value

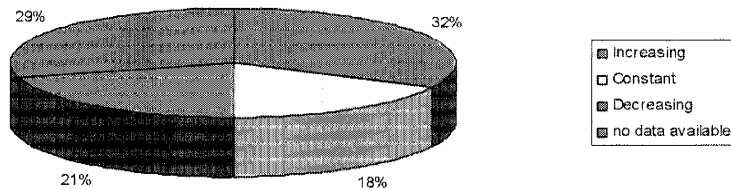

### 2) Share of export value in total turnover

The share of export value in total turnover differs among the respondents as follows;

1% to 25%	: 43 enterprises
26% to 50%	: 12 enterprises
51% to 75%	: 8 enterprises
≥ 75%	: 44 enterprises
No data available	= 39 enterprises

Share of Export Value in the Total Turnover  
(Total Respondents = 146)

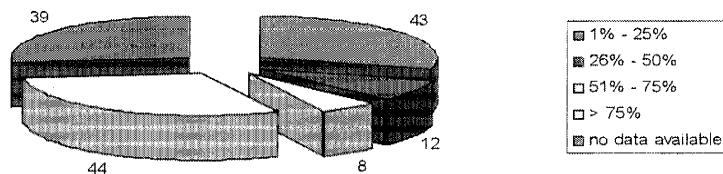

### 3) Existing export market destinations

The export destination concentrates on Malaysia (34% of total respondents), Japan (32%), and USA (30%).

### 4) Support providers for export market development

The exporters tend to develop their export market via: the support by trader and trading agent (21%), the support by business association and group (14%), the support by importing customer and buyer (24%), and the support by public sector (20%). Some 16% of the respondents mentioned no needs for support.

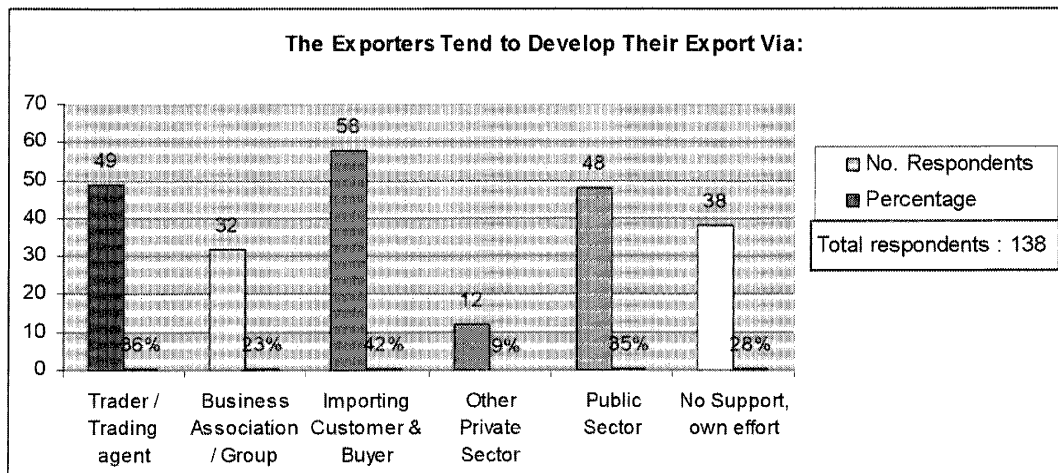

The frequently named private support providers included IWAPI and Indessota. The public sector providers named were NAFED, Regional Government (Industry, Trade and Cooperative Office).

5) Issues and constraints of export market development

Some problems arise in the course of export development. Majority of the respondents (115) indicated weak and little market channels (115 of total), poor product quality which does not meet the requirements (101), vulnerability against price fluctuation (95), and lack of capacity to answer the volume of order (80). Some half of the respondents raised the lack of market information and data (64) and out-dated product design (56) as major issues and constraints of export development. In addition, many (60) observed poor financial access as a constraint.

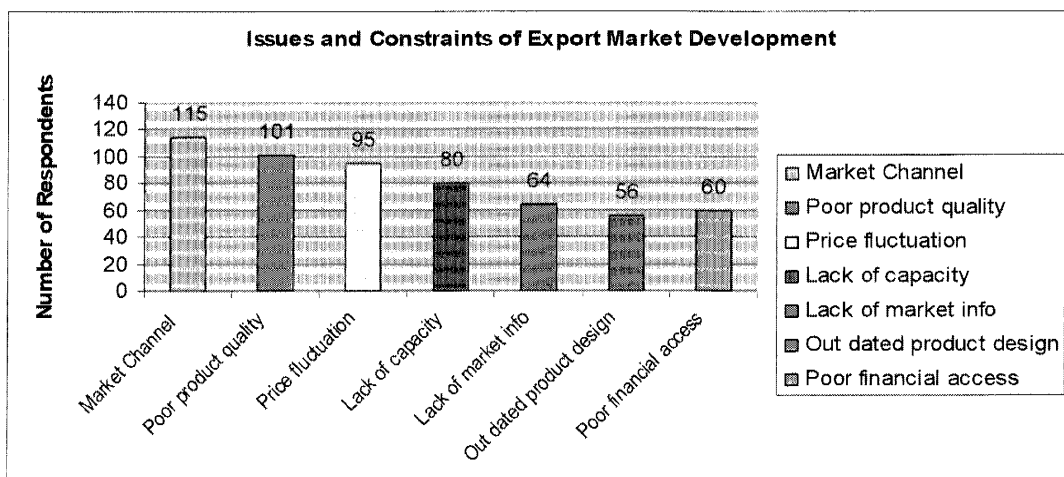

6) Support needs for export market development

In order to expand the export volume and diversify the markets and buyers, the responded exporters frequently raised the followings as areas required for supports;

Market information and data	: 83 %
Exploration of market and buyers	: 68 %
Finance for investment capital	: 36 %

Finance for working capital : 36 %  
 Quality control : 27 %  
 Design development : 20 %

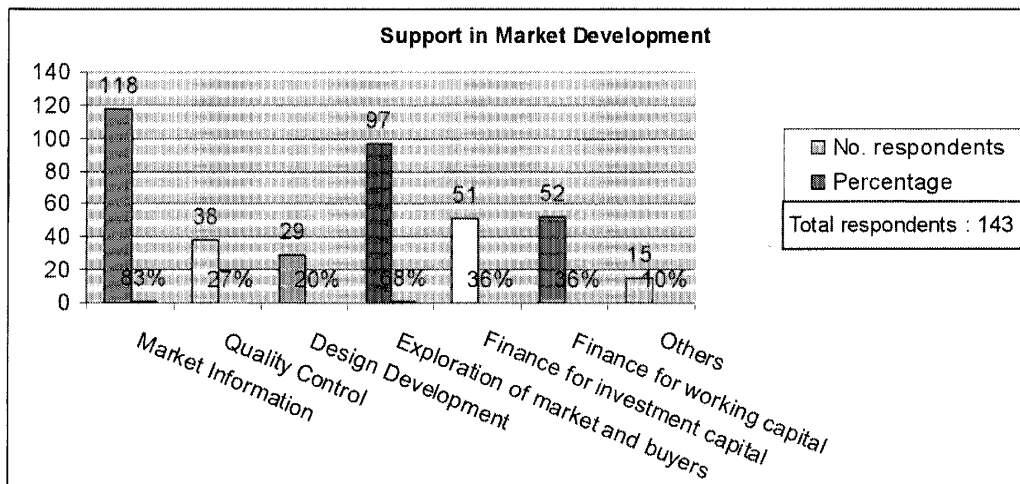

7) Countries and regions to be developed

From the total of 146 respondents, some 137 of them answered the questionnaire. The respondents raised Malaysia, Japan and USA as major destinations to be developed in the future, and the following regions received the larger attentions from the respondents as potential destinations for export development.

Middle East : 48 respondents or 35 %  
 Western Europe : 42 respondents or 31 %  
 South East Asia : 35 respondents or 26 %  
 North America : 34 respondents or 25 %

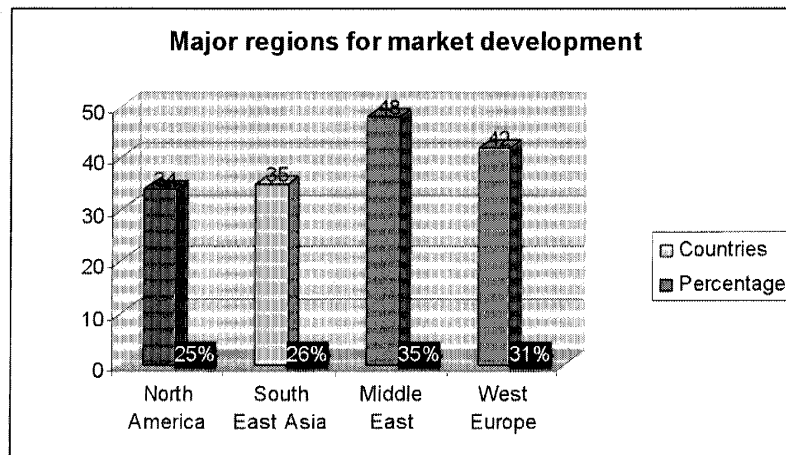

### 3.4 Use and Evaluation of NAFED Services

#### A. Market information service

##### 1) Use of NAFED service

Many exporters need market information for their export development, but unfortunately some parts of them were less familiar with NAFED service. There were 88 respondents or 60% of the total access to the information delivered by NAFED, whereas 57 respondents or 39% have not used NAFED resource.

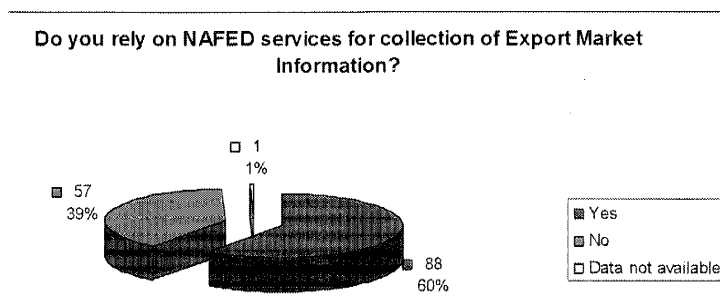

The applicable means of collection of export market information are as follows, in case that the respondents use NAFED resource;

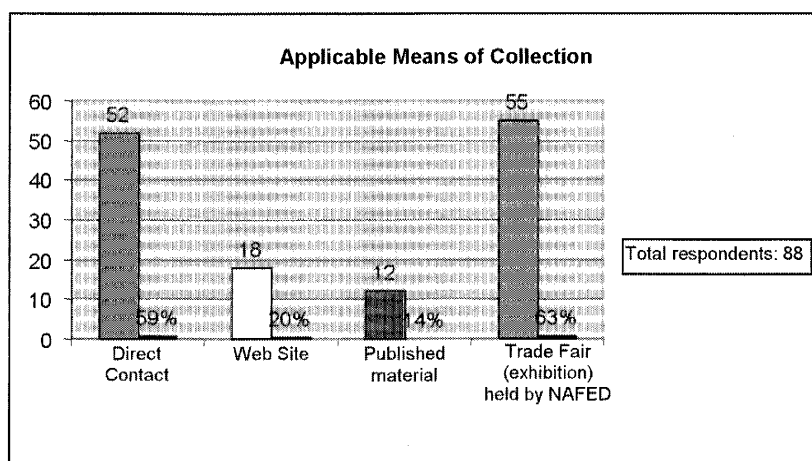

##### 2) Access to other sources for collection of export market information

In case that the respondent accesses to other sources other than NAFED for collection of export market information, they obtain from such as;

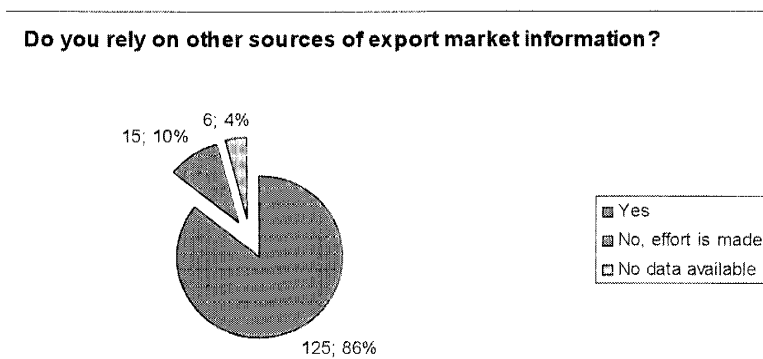

Trader / trading agent	: 46 %
Trade fair	: 47 %
Importing customer / buyer	: 47 %
Industrial association / group	: 35 %
Public sector	: 22 %
Website	: 23 %

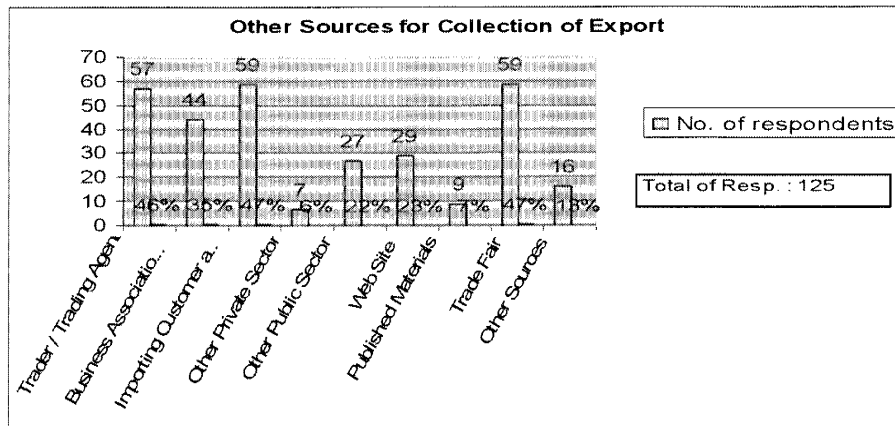

### 3) Reasons not to use NAFED service

The respondents who answered this question were 57 from the total of 146 and the reason did not use NAFED service is as follows;

50 respondents or 88 %	: Do not know the service
13 respondents or 23 %	: Timing does not match
10 respondents or 18 %	: Have no interest
8 respondents or 12 %	: Service cost is expensive
7 respondents or 12 %	: Considered that it is useless
14 respondents or 25 %	: Others

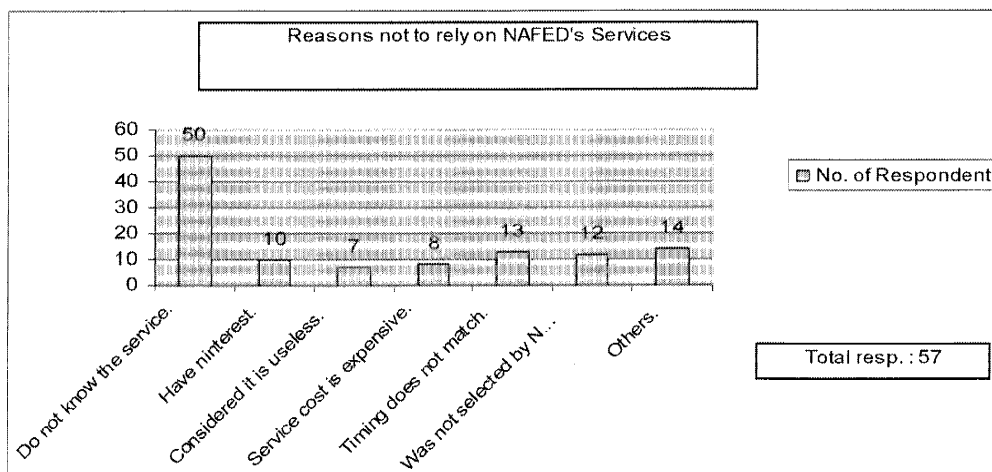

### 3) Type of information collected from NAFED

The respondents searched the following types of information from NAFED;

Total numbers of respondents who answered the questionnaire were 88 and among of them required the following information.

66 respondents or 75%	: Buyers' directory and their information
54 respondents or 61%	: Country data information
55 respondents or 63%	: Consumer's preference and requirement

52 respondents or 59% : Market and other regulations  
 34 respondents or 39% : Price information

4) Satisfaction with the market information service of NAFED

The respondents have judged the information and data delivered by NAFED as satisfactory (11%), fair (61%), not satisfactory (21%), not interest (7%). In general, the respondents who established their companies before the economic crisis indicated that NAFED service is satisfactory or fair.

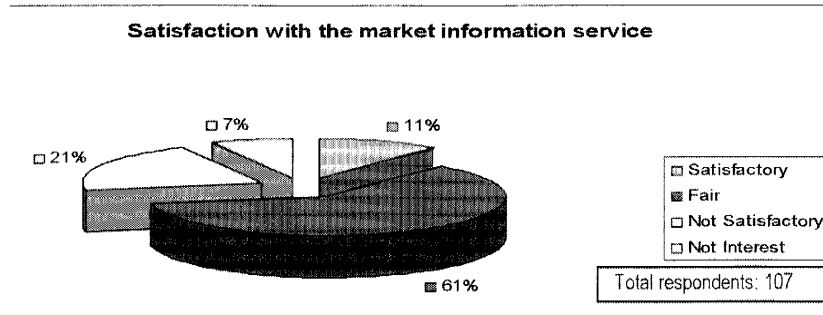

**B. Export promotion service: overseas trade fair / exhibition**

1) Participation

Around two-thirds of respondents have participated in the overseas trade exhibitions, but the others have not participated yet. The respondents that have participated in the overseas trade exhibition account for 92 or 63%, whereas 52 respondents or 35% have not participated yet.

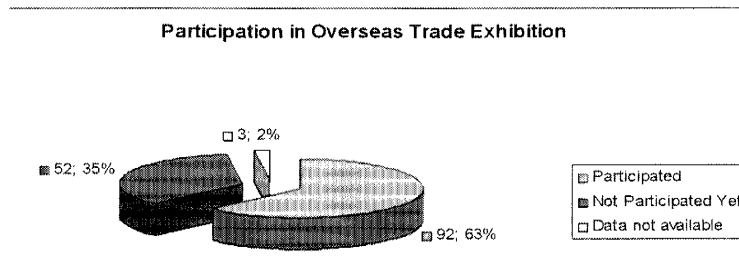

2) Sponsoring organizations of the trade exhibitions participated

The respondents that have participated in the overseas trade exhibitions were sponsored by the following organizations:

50 respondents or 54% : NAFED  
 25 respondents or 27% : Others  
 12 respondents or 13% : Regional Government  
 8 respondents or 9% : Industrial association  
 7 respondents or 8% : State Ministry of Cooperatives, Ministry of Agriculture  
 6 respondents or 7% : Private sector

3) Reasons not to participate in overseas trade exhibition

From the total number of 146 respondents, 52 respondents have not participated in overseas exhibition because of the following reasons:

33 respondents or 63% : Cost is expensive  
 22 respondents 42% : Do not know the service  
 19 respondents 37% : Was not selected  
 8 respondents 15% : Timing does not match

- 2 respondents 4% : Have no interest
- 2 respondents 4% : Considered useless
- 8 respondents 15% : Others

- 4) Results from participation in overseas trade exhibition  
 Some of 62 respondents or 67% of the total participating enterprises said that they obtained good results from participation in overseas trade exhibition, while 30 respondents or 33% of them said no good result.

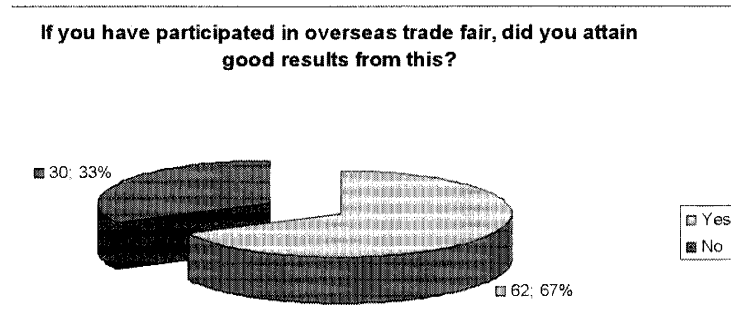

- 5) Satisfaction with the arrangements and operation of trade exhibition sponsored by NAFED  
 The respondents judged the results from participation in the overseas trade exhibition (sponsored by NAFED) as satisfactory (7%), fair (74%), and not satisfactory (19%). The reasons of satisfaction included;
- Cost-attractiveness (the cost of stand was subsidized).
  - The design of stand was attractive.
  - Exhibitions created the buyers to deal with.

- Whereas the reason of no satisfaction included;
- The arrangements before and after the exhibition was less appropriate.
  - Exhibition cost was too high.
  - Coordination in preparing exhibition was lacking.
  - Promotional arrangements were not sufficiently made (such as buyer invitations).
  - Sufficient market information was not complemented.

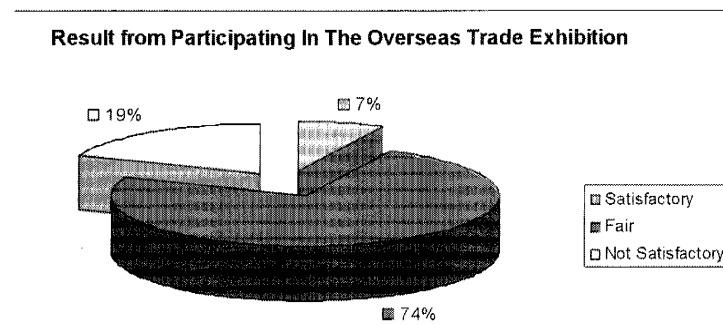

**C. Export promotion service: domestic trade fair / exhibition**

- 1) Participation  
 Around three-fourths of respondents have participated in the domestic trade exhibitions, but the others have not participated yet (they are exporters of raw material products in most cases). The respondents that have participated in the domestic trade exhibitions account for 109 respondents or 75%, whereas 36 respondents or 24% have not participated yet.

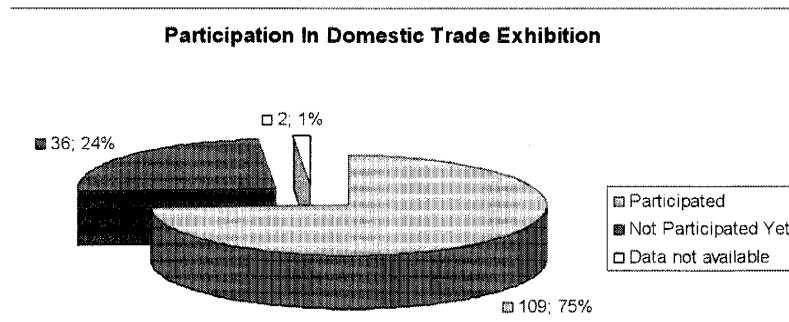

- 2) Sponsoring organizations of the trade exhibition participated  
The respondents that have participated in the overseas trade exhibitions were sponsored by the following organizations;

56 respondents or 51% : NAFED  
 37 respondents or 34% : Regional Government  
 22 respondents or 20% : Industrial association  
 18 respondents or 17% : Ministry of Industry, Cooperatives and Agriculture  
 18 respondents or 17% : Private sector such as Kompasindo, Pamerindo, Debindo  
 22 respondents or 20% : Others, e.g., ASEAN Center, PERTAMINA, PT. POS Indonesia

- 3) Reasons not to participate in domestic trade exhibition  
Some respondents have not participated in overseas exhibition because of the following reasons;

10 respondents or 28% : Cost is expensive  
 9 respondents or 25% : Do not know the service  
 7 respondents or 19% : Was not selected  
 5 respondents or 14% : Timing does not match  
 5 respondents or 14% : Have no interest  
 7 respondents or 19% : Considered useless  
 8 respondents or 22% : Others

- 4) Results from participation in domestic trade exhibition  
Some of 76 respondents or 68% of the total said that they obtained good results from participation in domestic trade exhibition, and 35 respondents or 32% said no good result.

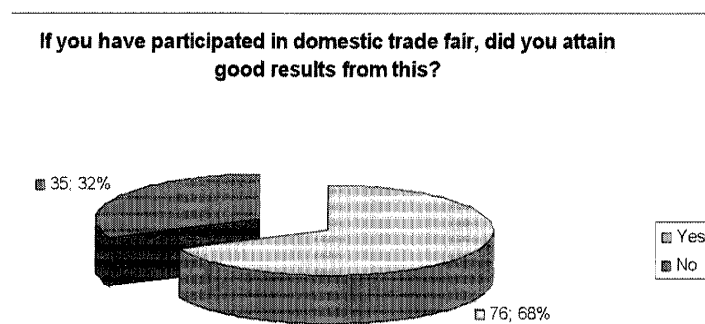

- 5) Satisfaction with the arrangements and operation of trade exhibition sponsored by NAFED  
The respondents judged the results from participation in the domestic trade exhibitions (sponsored by NAFED) as satisfactory (19%), fair (55%), and not satisfactory (26%). The reasons of satisfaction included;
- Could find the potential buyers.
  - Improved the product knowledge.
  - Widened market and realized more orders coming.



Whereas the reason of no satisfaction included;

- Less than expected number of buyer.
- Less than expected publicity of exhibition.
- NAFED never subsidized the cost of domestic exhibition.

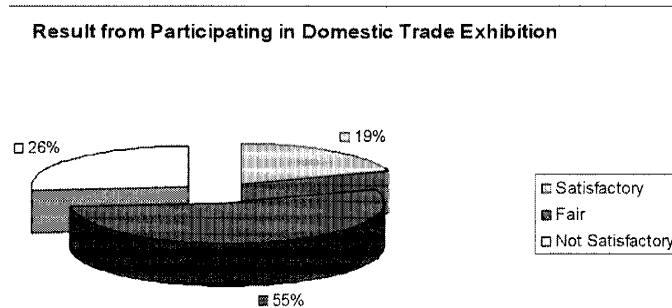

#### D. Export promotion service: inquiry and matching service

##### 1) Whom to ask, if you want inquiry on export and introduction of buyers

From the total of 146 respondents, 136 of them answered this question. The respondents usually approached the following organizations if they ask for inquiry on export or want international buyers introduced;

76 respondents or 56%	: NAFED/RETPC
9 respondents or 7%	: Central Ministries
20 respondents or 15%	: Regional Government
8 respondents or 6%	: Private Sector
23 respondents or 17%	: Industrial association or KADIN

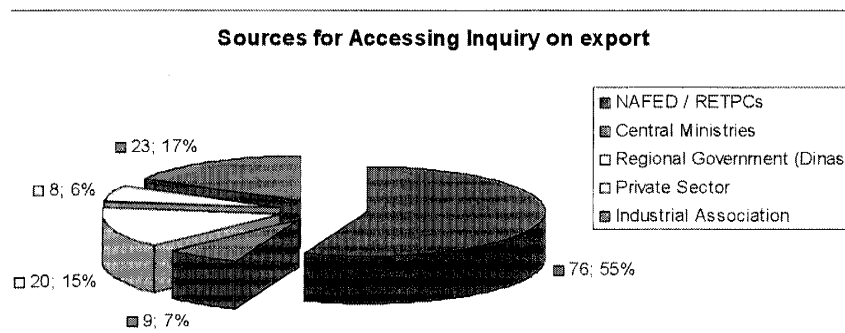

##### 2) Reasons not to ask NAFED (or RETPC)

There were 60 respondents who do not ask NAFED / RETPCs for inquiry services have the following reasons:

49 respondents or 82%	: Not know that such services are offered by NAFED
20 respondents or 33%	: No access to NAFED (or RETPC)
13 respondents or 22%	: Already have good relation with others
10 respondents or 17%	: Others are more dedicative and quick to response
2 respondents or 3%	: Others have more information and knowledge
15 respondents or 25%	: Other reasons

##### 3) Use of inquiry and matching service by NAFED

Around one-fourth of respondents (39 respondents or 27%) have ever asked inquiry or buyer-matching service to NAFED (or RETPCs), but partly 103 respondents or 73% not used the services. The frequent topics of inquiry or consultation among other things are as follows;

- Distributor development
- Importer list and database
- Prospective buyer data
- Technique of negotiations

4) Result of inquiry and matching service by NAFED

Some respondents (23 respondents or 59% of total) said they attained good results, while 16 respondents (or 41% of total) said no good result.

Good results include;

- Increased list of potential buyer or customers
- Realized opportunities to export
- Could communicate with new buyers

5) Satisfaction with inquiry and matching service by NAFED

The respondents who asked inquiry or matching service to NAFED revealed their satisfactory level over the services as follows;

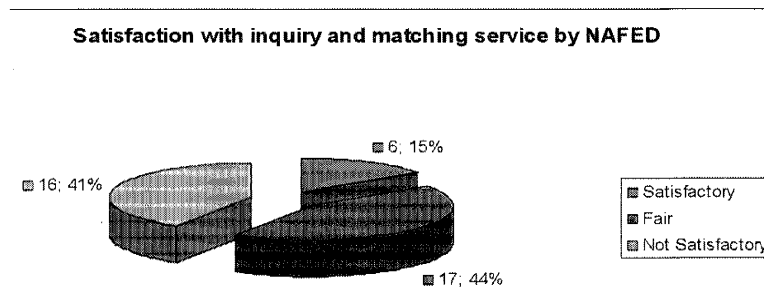

They were satisfied because of;

- Received market opportunity information.
- Service is good enough and their request takes more attention.
- Responded fast and friendly, and the staff were ready to assist.

They were not satisfied because of;

- Provided inaccurate and out-dated buyer data.
- Never had a good response.
- No deal with recommended prospective buyer.

**E. Web-site service**

Generally speaking, the web-site displayed by NAFED is evaluated as less interesting. Many respondents complaint that the quality and quantity of information and data presented does not meet their requirements.

1) Access to the web-site

Frequency of access by the respondents to NAFED web-site is shown as follows:

- 24 % : Often
- 23 % : Sometime
- 17 % : Rare
- 15 % : Not accessed, but I know
- 21 % : Do not know the web

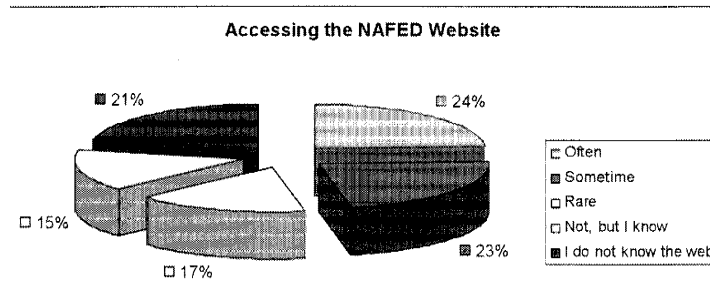

The respondents also stated about the design of the web-site as follows;

23 respondents or 26% : User friendly  
 55 respondents or 55% : Fair  
 12 respondents or 13% : Not user-friendly

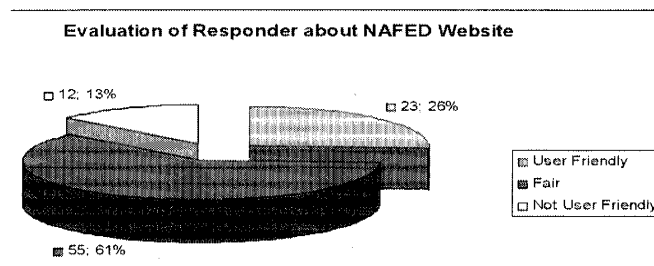

2) Web-site section of interest

From the number of 146 respondents only 97 respondents answered this question. The respondents have the interests in the following sections of the web-site;

65 respondents or 67% : Global promotion events  
 54 respondents or 56% : Inquiry  
 49 respondents or 51% : Trade database  
 31 respondents or 32% : Publication  
 18 respondents or 19% : Market intelligence  
 17 respondents or 18% : Brand development  
 16 respondents or 16% : Digital market place  
 12 respondents or 12% : Statistics  
 11 respondents or 11% : Export awards

3) Satisfaction and expectations for web-site

The respondents revealed their satisfaction level with the information and data of the web-site as follows;

12 % of the respondents : Yes, mostly  
 73 % of the respondents : Yes, a little  
 15 % of the respondents : Not satisfied

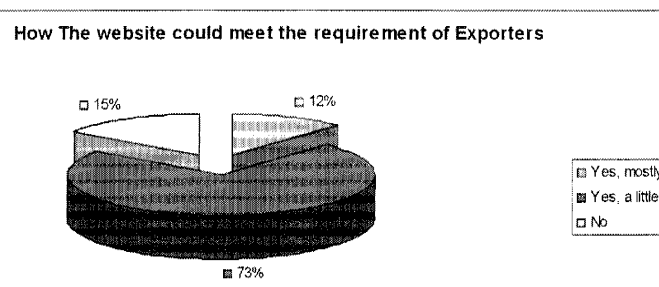

Major requirements and expectations were as follows;

- Information and data should be up-dated in due course at least.
- Quality of information and data should contribute to the export promotion activities of SME.
- NAFED should contain more information and data about potential buyers.

## F. Product (Design) development service

### 1) Experiences in product (design) development

Majority (132) of the respondents have experienced some kinds of design and development of their products in order to compete in the global markets. The respondents usually engage in the product (design) development through or upon:

- 52 % : Their own efforts
- 37 % : Requests from the buyers or traders
- 7 % : Collaboration with outside institutions
- 4 % : With other product design provider

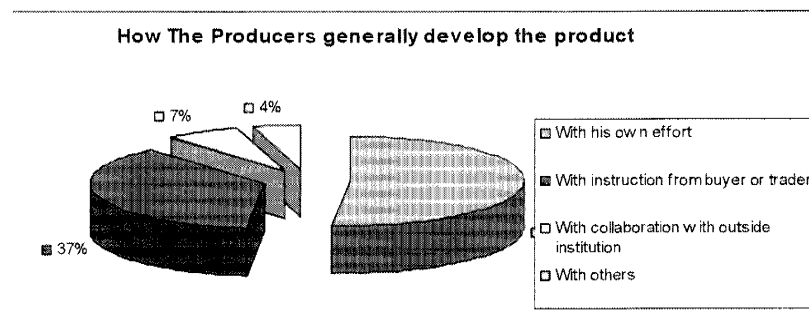

### 2) Information required for design development

From the total 146 respondents, 132 of them answered this question. The respondents obtained the information required for design development of their products through or from:

- 82 respondents or 62% : Design catalogue and book
- 72 respondents or 55% : Participation in exhibitions
- 62 respondents or 47% : Visiting stores and shops
- 57 respondents or 43% : Web-site
- 50 respondents or 36% : Designer or consultant (local)
- 12 respondents or 9% : Designer or consultant (foreign)
- 26 respondents or 20% : Others

### 3) Supports for design development

Some of 36 respondents (or 27% of the total respondents) have received some kinds of support for design development of their products, but 98 respondents or 73% have not received the support. The kinds of support included:

- Design idea
- Product innovation training
- Quality improvement training
- Technical information from buyer
- Design and packaging training
- Learning about the copyrights for design

**Have you ever received any supports for design development of your product?**

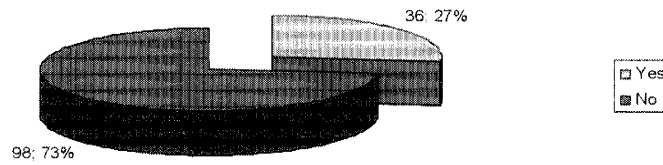

The organizations which supported the respondents included NAFED (or RETPC) (23% of the supported respondents), central ministries (such as Health, Industry, Trade) (10% of them), regional government (19% of them), and others such as foreign institutions, ASSOMAC, IKAPPEI, customers or buyers (38%). No one mentioned Indonesian Design Center as a support provider.

The respondents judged the supports received for design development as satisfactory (21% of the supported respondents), fair (68% of them), and not satisfactory (11%).

**The Grade of Satisfactory for Design Development Support**

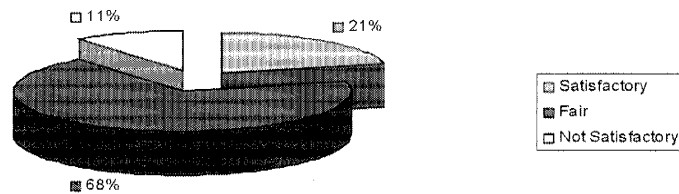

Satisfaction mostly came from;

- Improved understanding of the global pictures about the product design.
- Good explanation about the material in relation with finished product.

On the other hand, no satisfaction is pointed out as follows;

- The design suggested was far from the expectation.
- The contents of support itself were less interesting, nor could not meet the requirements.

**4) Result of design development**

By the above supports, some of the respondents attained good results. The respondents who realized good results account for 58%, but 42% of them reported no good results. Good results came from;

- Production of more attractive products to consumers.
- Improved global picture to develop product and design.
- Improved product quality, and increased sales.

### 3.5. Overall Evaluation on NAFED performance

1) Which service do you expect NAFED (or RETPCs) to strengthen most?

From the total of 146 respondents, some 141 of them answered this question. The respondents expected NAFED to strengthen the following services;

- 90 respondents or 63% : Market information service
- 21 respondents or 15% : Inquiry and buyer-matching service
- 29 respondents or 21% : Trade fair (exhibition) and mission service
- 1 respondents or 1% : Product (design) development service

2) For the expected services, how should NAFED (or RETPCs) strengthen this?

The respondents stated that the expected services will be strengthened by NAFED in the following manners;

- Provision of more accurate and up-dated information and data (like potential buyers).
- Effective and intensive dissemination of information and data to the exporters.
- Covering and searching for the broader area of markets.
- Replacement of the inactive and discouraging officers.
- Introduction of the professional culture and professional-based operation.

3) Do you want new services or supports of export promotion by NAFED (or RETPCs)?

Small number (only 10%) of the respondents gave the answer of 'yes', and stated the services such as holding of business meetings, teleconference-based programs.

4) Impressions about NAFED (or RETPCs) and its staff

The respondents' impressions about NAFED (or RETPCs) and its staff are as follows;

- 21% of the respondents : Very dedicative and supportive
- 55% of the respondents : Fair
- 12% of the respondents : Not really dedicative or supportive
- 12% of the respondents : Don't know NAFED (or RETPC) and its staff

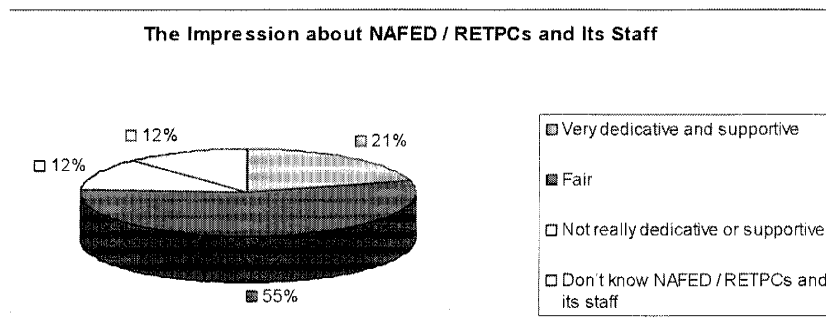

5) Suggestions to improve the service of NAFED (or RETPCs)

To improve the role and to create good image of NAFED, some suggestions are raised by the respondents. According to the respondents, NAFED should;

- Be more active to look for information and directly disseminate information to exporters.
- Provide more accurate and up-dated information about market, promotion and training opportunities.
- Emphasize more on facilitation of internet access by SME exporters.
- Deliver the services in more professional manner.

#### **IV. Result of Interview Survey**

The interview survey was conducted to complement the questionnaire survey. The objective of the survey was to obtain clear pictures on both strengths and weaknesses of NAFED and its relations with private sectors.

##### **4.1. Interview with KADIN**

During the course of survey, eight (8) KADINs were interviewed.

- KADIN Indonesia
- KADIN DKI Jakarta
- KADIN East Java
- KADIN Central Java
- KADIN Bandung, West Java
- KADIN North Sumatera
- KADIN South Kalimantan
- KADIN South Sulawesi

The results of interview for the above KADINs are summarized as follows;

- a) **Programs and activities to boost export**  
All of KADIN interviewed said they have the program to boost export by organizing business meeting, seminar/panel discussion, and training locally as well as abroad.
- b) **Market information service**  
All of KADIN provided market information service to their members, but it depends on where their offices were located. KADINs outside Jakarta presented the market information in the form of leaflets, magazines or brochures, whereas KADIN in Jakarta presented in their website.
- c) **Cooperation with NAFED (or RETPC)**  
There is cooperation between KADIN and RETPC in provinces where RETPC exist except in South Sulawesi. Yet in provinces with no RETPC, KADIN did not make any cooperation neither with NAFED nor RETPC.
- d) **Overseas trade exhibition**  
Every KADIN provided and facilitated the opportunities to their members to participate in overseas exhibitions, but in most cases all expenses incurred were to be borne by participants.
- e) **Overseas trade mission**  
Every KADIN provided and facilitated the opportunities to their members to participate in overseas trade missions, mostly through the cooperation and coordination with NAFED, except KADIN in Jakarta.
- f) **Inquiry service**  
Inquiry service was rendered by each KADIN through leaflets, brochures or magazines. KADIN cooperated with NAFED (or RETPC), except KADIN Central Java, West Java, and Jakarta.
- g) **Product and design development**  
Only KADIN Jakarta did not provide the product or design development service. The others provide the service by organizing special training or providing information to their members, in cooperation with NAFED (or RETPC).
- h) **Collaboration and communication with NAFED (or RETPC)**

KADINs that have the cooperation with NAFED (or RETPC) said that the communication between them was a little ineffective and it should be improved.

- i) Indonesian Trade Promotion Center  
Only KADIN South Kalimantan has not utilized the service provided by ITPC. Others access the service by telephone or internet.
- j) Regular meeting with NAFED (or RETPC)  
All of KADIN claimed that there was no regular meeting held by NAFED (or RETPC) to listen to their suggestions or requests.
- k) Suggestion to improve the future role of NAFED  
During the interview, KADIN gave recommendations to improve the future role of NAFED which can be concluded as follows:
  - i) A good communication between NAFED and industries is needed to design and conduct more effective export promotion measures.
  - ii) NAFED should improve the ways of socializing their roles and functions.
  - iii) NAFED should be more active in developing exportable product from the existing potential ones in regions.
  - iv) The persons who are assigned as representatives abroad should have a business sense and ability to collect overseas business information.

#### **4.2. Interview with Industrial Association (export-oriented)**

During the course of survey, fifteen (15) industrial associations were interviewed.

- GAPMMI (Food and Beverage Association), Jakarta
- API (Indonesian Textile Association), Jakarta
- APKA (Agro Commodity Trader Association), Bandung
- APRISINDO (Footwear Association), Jakarta
- APRISINDO (Footwear Association), Surabaya
- ASBUMI (Pearl Breeder Association), Jakarta
- ASIONI (Association of Sport Utilities Product), Jakarta
- ASMINDO (Furniture and Handicraft Association), Jakarta
- ASMINDO (Furniture and Handicraft Association), Surabaya
- ASPAKI (Medical Equipment Association), Surabaya
- HIMPI (Handicraft Association), Bandung
- KUPMI (SME Association), Bandung
- GAPEKSI (Exporter Association), Surabaya
- GP Jamu (Medicinal Herb Association), Jakarta
- GP Jamu (Medicinal Herb Association), Semarang

The results of interview for the above industrial associations are summarized as follows;

- a) Programs and activities to boost export  
Each of the associations has a program to boost the export except Medicinal Herb Association. In general, the program consists of participation in seminars, socialization of the market condition, and discussion forums among members.
- b) Market information service  
All of the associations provide market information service to members through news letter distributions or magazine publications. Mostly they got the information from NAFED, Department of Foreign Affair, ITPC, internet, or overseas importer.
- c) Cooperation with NAFED or RETPC



Majority of the associations have cooperated with NAFED (or RETPC), except five of them which are; Handicraft Association in Bandung, Footwear Association in East Java, Medicinal Herb Association in Central Java, Furniture and Handicraft Association in East Java, and Medical Equipment in Jakarta.

- d) Overseas trade exhibition  
Every association provided and facilitated the opportunities to its members to participate in the overseas trade exhibitions either borne by the association or by the participants. It was depended on the policy of each association. Most of these opportunities were given in cooperation with NAFED (or RETPC), or by their own efforts.
- e) Overseas trade mission  
All the associations except the exporter association provided and facilitated opportunities to their members to participate in the overseas trade missions under the coordination of NAFED, but partly under their own initiative.
- f) Inquiry service  
Only two associations which have not rendered inquiry service they come from Medicinal Herb Association. The others rendered inquiry service, but five of them have not cooperated with NAFED (or RETPC).
- g) Product and design development  
Among of the 15 associations, two who had no product and design development program, and they were the Exporter Association in East Java and Medicinal Herb Association in Central Java. The others have the program, but only four of them cooperated with NAFED (or RETPC). The four were Pearl Breeder Association in Jakarta, Furniture and Handicraft Association in Jakarta and in East Java, Food and Beverage Association in Jakarta.
- h) Collaboration and Communication with NAFED (or RETPC)  
The associations who have cooperated with NAFED (or RETPC) said that the communication between them had not yet optimized and should be improved.
- i) Indonesian Trade Promotion Center  
There were eleven associations who were familiar and utilized with the ITPC services, while the rest had no any access to the service. The associations made communication through telephone conversation or email to ITPC to get buyer market information or trade exhibitions, if any.
- j) Regular meeting with NAFED (or RETPC)  
There was no regular meeting with NAFED (or RETPC), but with the Regional Government of East Java, Central Java, and West Java.
- k) Suggestion to improve the future role of NAFED  
To improve the future role of NAFED, the 17 associations recommended as follows;
  - i) NAFED should be professional.
  - ii) It is expected that no more officer shall take the self-advantage.
  - iii) NAFED should improve the facility for overseas trade exhibition.
  - iv) It is recommended that NAFED officers should understand products knowledge against the product to be promoted.

#### **4.3. Interview with Selected Exporters**

The results of interview for thirty (30) of the selected exporters are summarized as follows;

- a) Major reasons of increasing in their export

- i) Participate in overseas trade exhibitions and could find more overseas buyers.
- ii) Cost reduction of the product and could maintain price competitiveness.
- iii) Maintain the quality in good order and match with the buyer requirements.

While, main reasons of decrease in their export

- i) The marketing strategy was little ineffective.
- ii) Lack of working capital and raw material, so they could not fulfill the overseas order.
- iii) Could not compete with the price of Chinese and Vietnamese products.

- b) Difficulties in developing export market and accessing international market  
Some exporters got difficulties to develop export market and to access international market because:
  - i) Little government supports in organizing overseas trade exhibitions, NAFED and Minister of Trade in this case
  - ii) Increasingly complicating procedure to obtain the approval or license for export of the certain products.
  - iii) Little government supports to help access international market.
- c) Whom to ask to solve such difficulties  
Almost 60% of respondents asked the assistant of NAFED (or RETPC), Regional Trade Office or Regional Government when they got some difficulties, 35% of respondents solved such difficulties by themselves. They usually contacted their overseas agent, or overseas buyer through internet, and the rest had no idea.
- d) Result of problem solving  
Many respondents indicated the results of problem solving for the difficulties were less than expected, and only a little respondents had the results according to their expectation.
- e) Difficulties in obtaining and accessing to the overseas market information and data  
Almost all exporters said there had no difficulty in obtaining and accessing data, the problem only from the data itself, less accurate and not up to date.
- f) Whom to ask to solve such difficulties  
About 57% of respondents asked the assistance by NAFED (or RETPC), Regional Trade Office or Regional Government to solve such difficulties, and the rest by their own effort through communication with their overseas buyer, their business partner, or browsing to internet.
- g) Result of the above effort  
There were 13 (43%) respondents said the result were under the expectation, 12 (40%) respondents said the result were within the expectation, and the rest 5 (17%) respondents said the result were satisfactory.
- h) When you have questions and problem in export, whom to usually ask  
About 63% of exporters asked the advice to NAFED or Regional Trade Office, when they had problem in export, 23% solved by their own effort through accessing to internet, 13% of exporters asked the advice to Shipping Agent, 10 % of exporters asked the advice to their association, and the rest never had the problem.
- i) How do you evaluate their answer and support?  
Almost all exporters said that the response was fully support and good enough.
- j) Most important thing in exhibition and trade fair to be arranged by sponsor and organizer  
Some exporters said that if willing to organize the exhibition, the following aspects should be taken into consideration:

- i) Organizer should provide the proper and attractive stands.
  - ii) Organizer should invite more prospective buyers.
  - iii) Product to be promoted should be in line one to another.
  - iv) Information about cost borne by participant should be informed earliest.
- k) How do you work for product and design development (for export) of your product, whom to ask for the support and advice?  
 Many exporters said that they developed the product and design through:
- i) Imitating the products shown in the internet or imported with a little innovation.
  - ii) Matching to the buyer request.
  - iii) Conducting the research.
- l) Are there any other difficulties like legal matter, logistics, and finance in relation to your export development?  
 The exporters of furniture product had a difficulty in securing raw materials, whereas the exporters of leather product had a difficulty in obtaining license for export. The exporters of medicinal herb had a difficulty in registering their brands to sell them in overseas markets. In general, exporters had the problems of expensive freight costs compared to other countries.
- m) Necessary support and advice on export development  
 Almost all exporters claim that the export development should depend also on the supports from government, not only on the efforts by the private sector. Whatever hard effort done by the exporters, it may be less effective, unless there are government supports. Therefore, the exporters propose that NAFED should;
- i) Provide more opportunity of the overseas exhibitions.
  - ii) Be more realistic to see exporters' problems and give them the better solutions.
  - iii) Lead the public supports for exporters from the upstream to the downstream to make their products more competitive and attractive.
  - iv) Enhance the communications between the government and SME exporters.
  - v) Look for more potential buyer.
  - vi) Regularly provide more complete and accurate information, about the market, promotion and training opportunities and directly disseminate information to exporters.
  - vii) Provide more information and data about overseas trade regulations.

**Summary Results of  
Customer Satisfaction Survey  
for the Service of  
National Agency for  
Export Development (NAFED)**

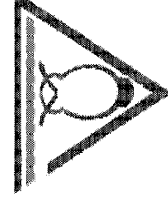

Prepared by **TRIASA BHARTHA RIZKI**

**September 2007**

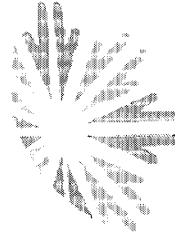

**jica**

# Outline of the Survey

## Interview

- Central & Regional KADINs (7)
- Export-oriented Industrial Associations (15)
- Exporters (30)

## Questionnaire: 146 exporters

### Survey area

- DKI Jakarta
- East Java (Surabaya)
- Central Java (Semarang)
- West Java (Bandung)
- South Sulawesi (Makassar)
- North Sumatra (Medan)
- South Kalimantan (Banjarmasin)

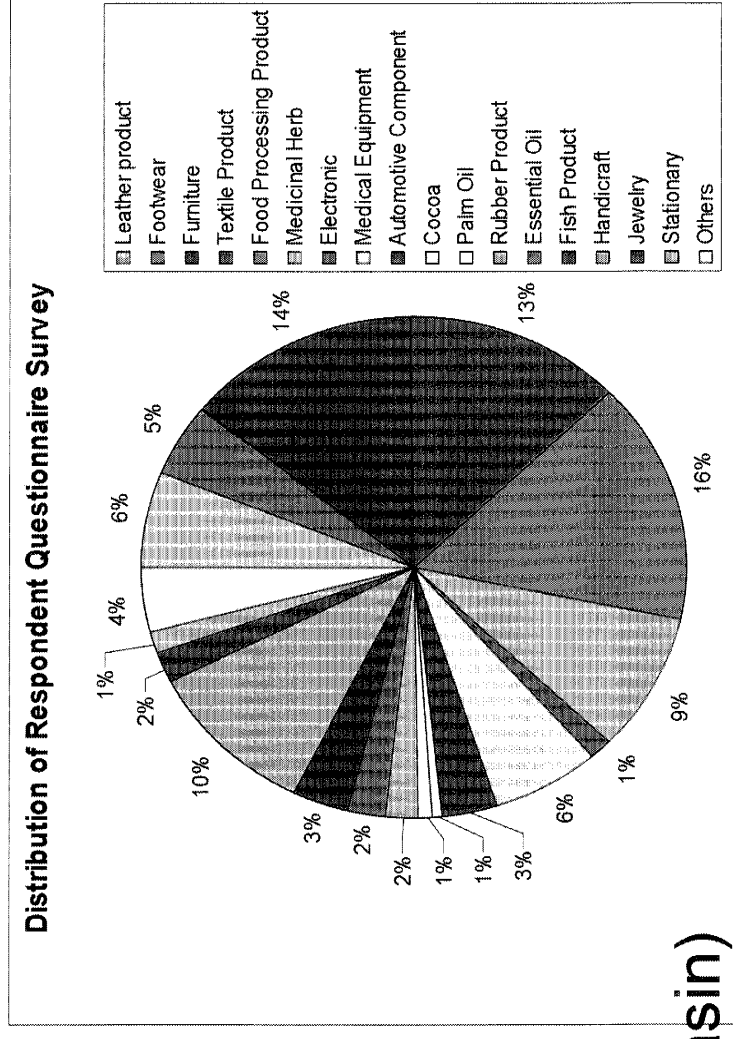

# Issues & constraints of export development

Issues and Constraints of Export Market Development

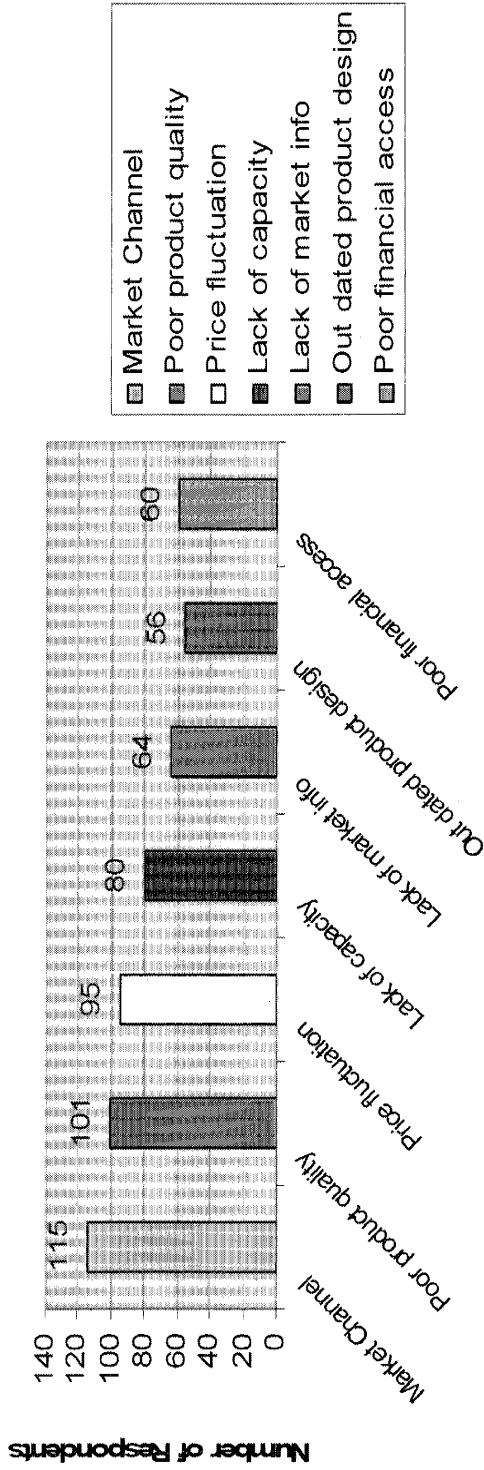

# Support needs for export development

Support in Market Development

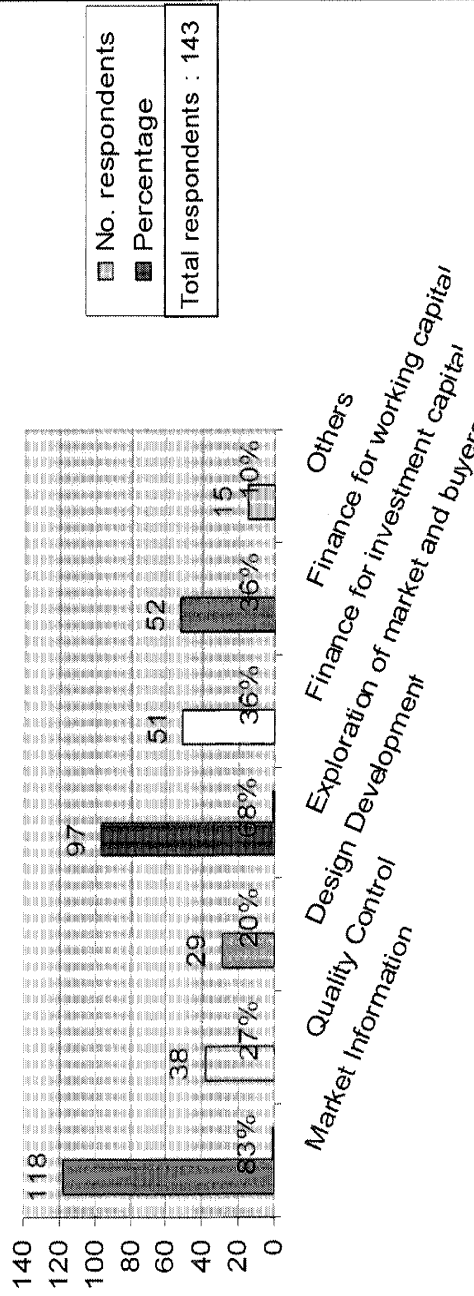

## Present support providers for export development

Respondent exporters tend to develop their export market via;

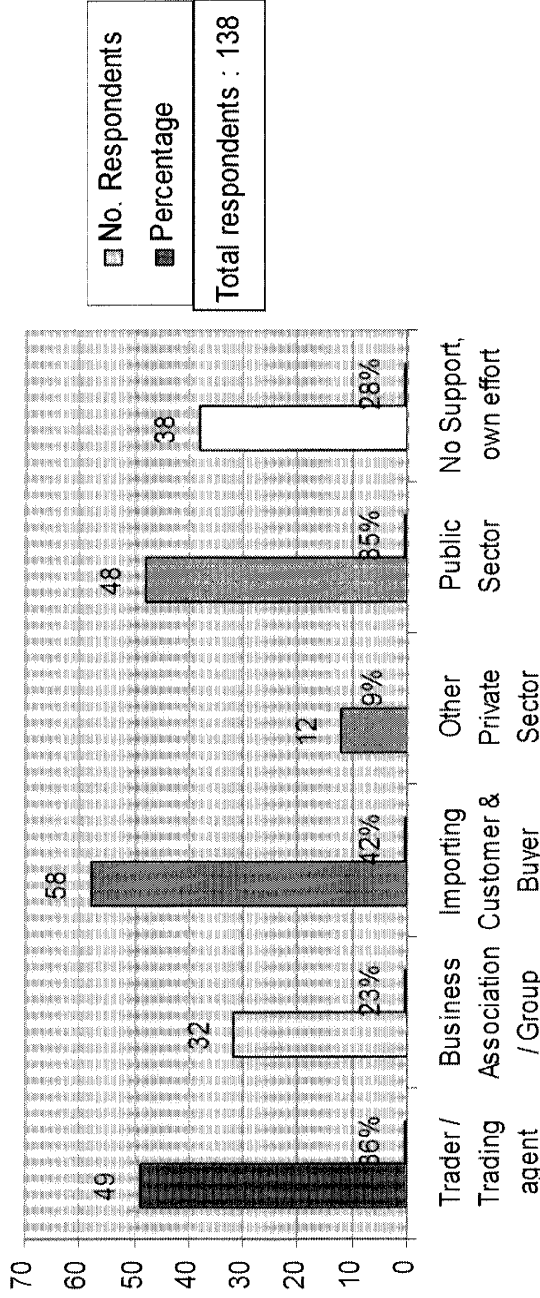

## Regions to be developed for export

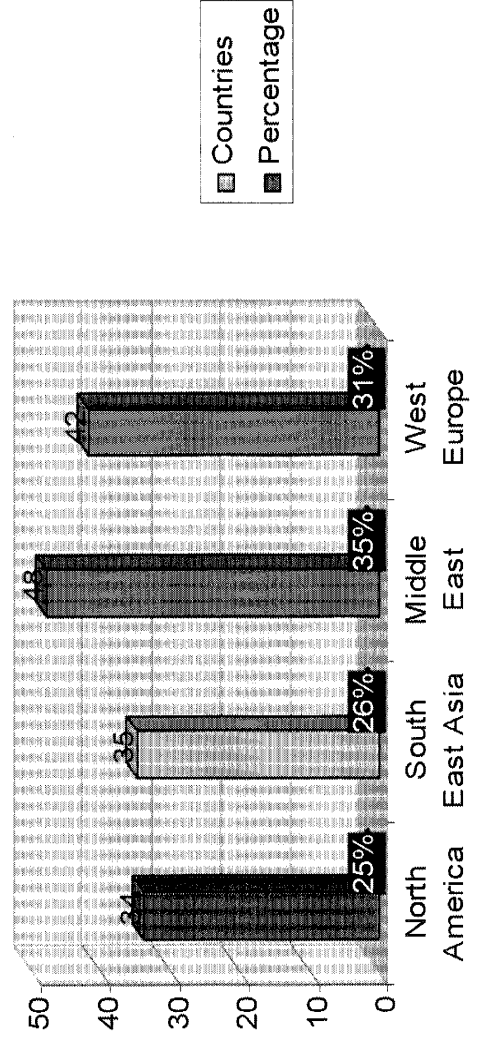

# Market Information Service

## Access to NAFED resource

Some 60% of the respondents have accessed to NAFED for market information.

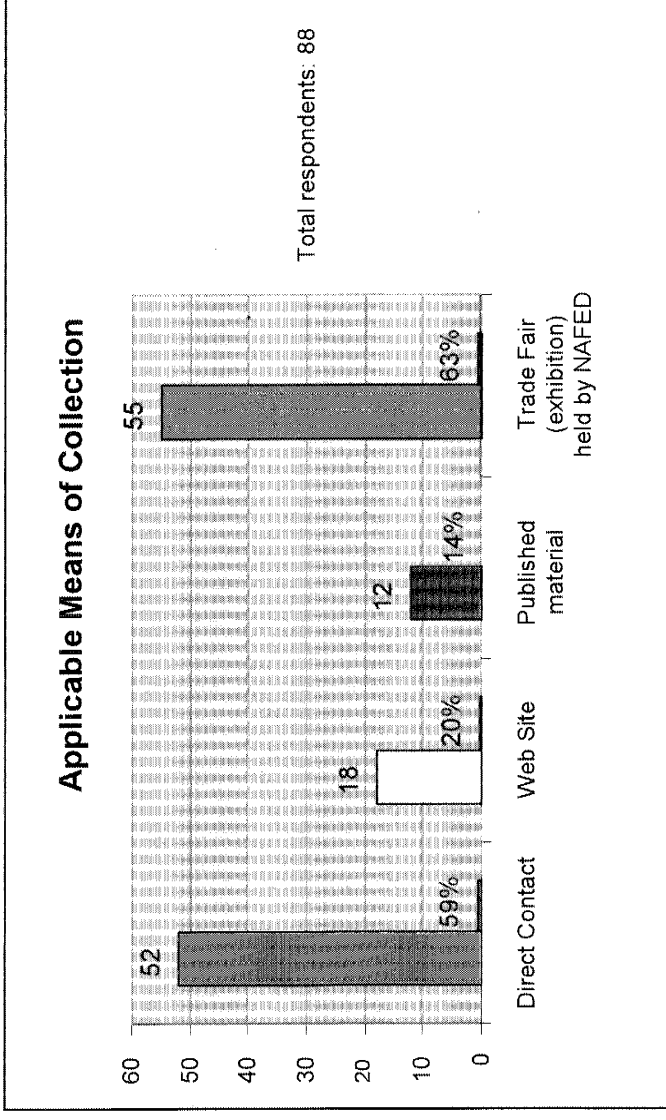

The above respondents have sought the following types of information;

- 66 respondents or 75% : Buyers' directory and their information
- 54 respondents or 20% : Country data information
- 55 respondents or 20% : Consumer's preference and requirement
- 52 respondents or 19% : Market and other regulations
- 34 respondents or 12% : Price information



## Satisfaction with market information service of NAFED

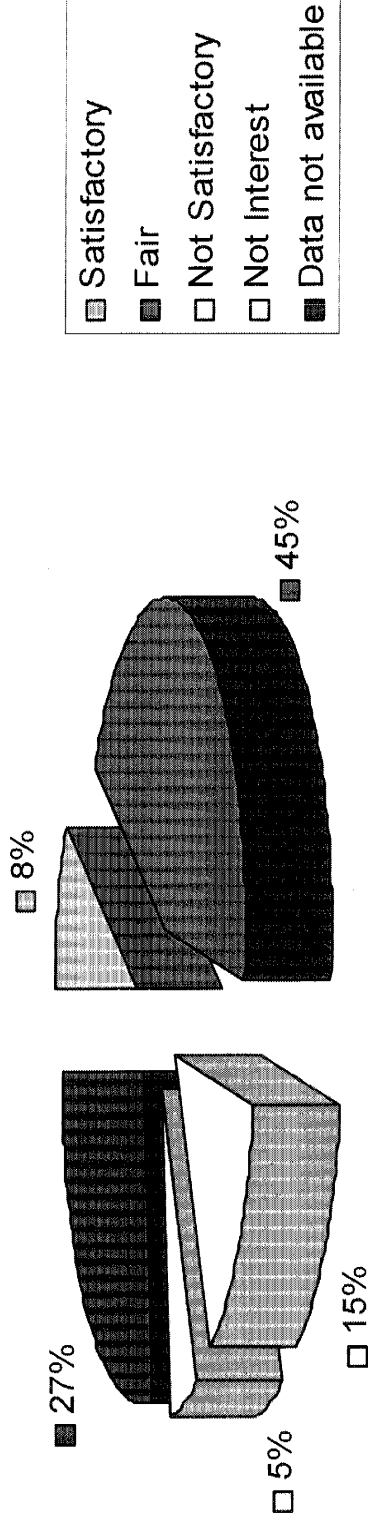

## Reasons not to access to NAFED resource

50 respondents or 88% : Don't know the service

12 respondents or 21% : No opportunity to obtain (not selected for trade fairs)

10 respondents or 18% : Not interested

7 respondents or 12% : Considered as useless

14 respondents or 25% : Other reasons

# Overseas Trade Exhibition

## Participation in overseas trade exhibition

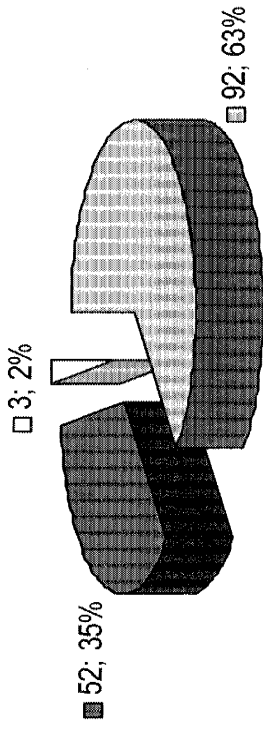

Among the respondents who participated in, 50 of them are sponsored by NAFED.

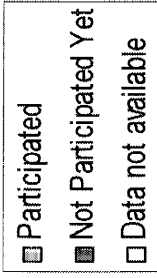

## Results of the participants

If you have participated in overseas trade fair, did you attain good results from this?

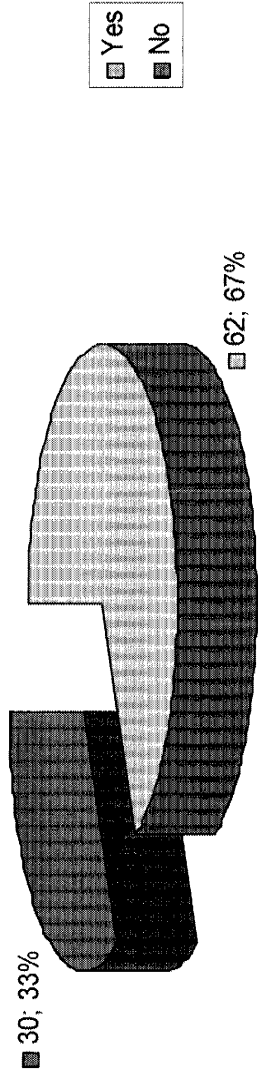

Non-participants indicated their reasons as follows;

33 respondents or 63% : Cost is expensive

22 respondents or 42% : Don't know the service

19 respondents or 37% : Not selected

## **Satisfaction with the arrangements and operation of overseas trade exhibition sponsored by NAFED**

The respondents judged the participation in NAFED-sponsored trade exhibition as satisfactory (7%), fair (74%), and not satisfactory (19%).

The reasons of satisfaction included;

- Cost-attractiveness (cost of stand was subsidized).
- The design of stand was attractive.
- Exhibition created the buyers to deal.

The reasons of non-satisfaction included;

- The arrangements before and after the exhibition was less appropriate.
- Exhibition cost was too high.
- Coordination in preparing exhibition was lacking.
- Promotional arrangements were not sufficiently made (such as buyer invitations).
- Sufficient market information was not complemented.

# Domestic Trade Exhibition

## Participation in domestic trade exhibition

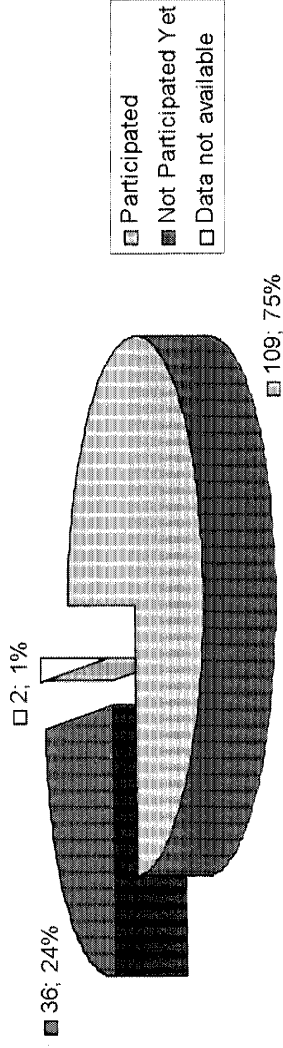

Among the respondents who participated in, 56 of them are sponsored by NAFED.

## Results of the participants

If you have participated in domestic trade fair, did you attain good results from this?

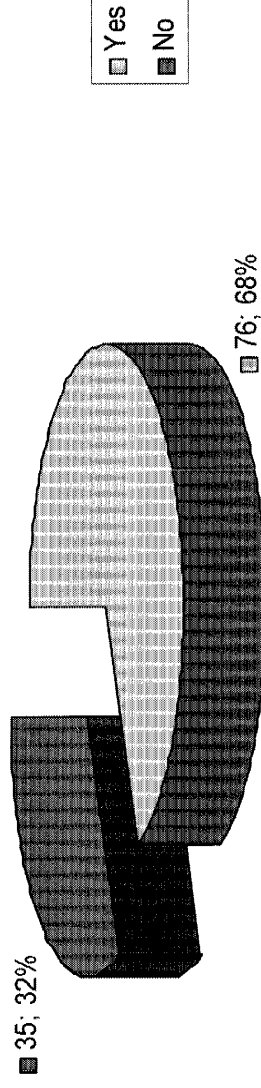

Non-participants indicated their reasons as follows;

- 10 respondents or 28% : Cost is expensive
- 9 respondents or 25% : Don't know the service
- 7 respondents or 19% : Not selected

## **Satisfaction with the arrangements and operation of overseas trade exhibition sponsored by NAFED**

The respondents judged the participation in NAFED-sponsored trade exhibition as satisfactory (19%), fair (55%), and not satisfactory (26%).

The reasons of satisfaction included;

- Widened the market and realized more orders coming.
- Improved the knowledge on the products.
- Found the potential buyers to deal.

The reasons of non-satisfaction included;

- Less than expected number of buyer.
- Less than expected publicity of exhibitions.
- NAFED never subsidized the cost of participation.

# Inquiry & Matching Service

**Whom to ask, if you want inquiry on export and introduction of buyers.**

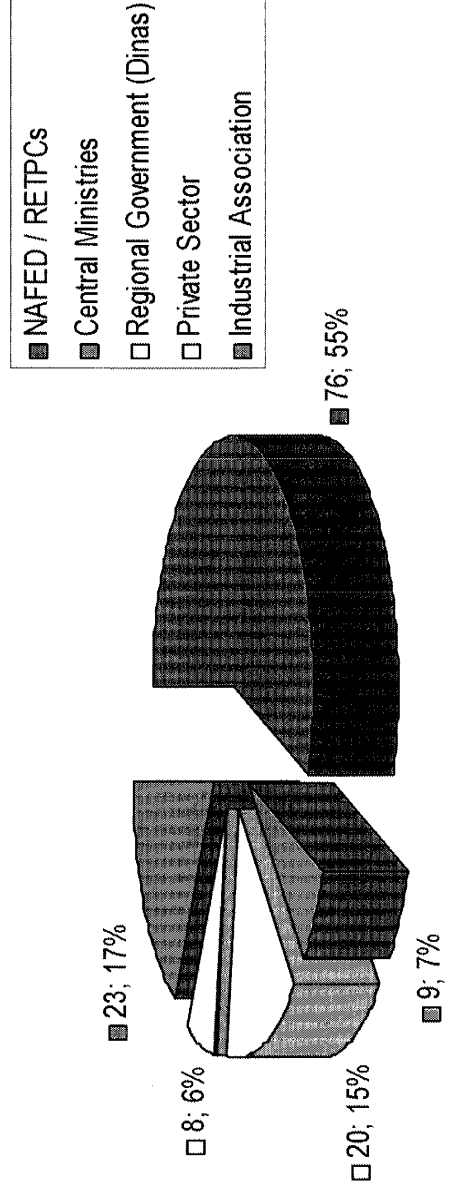

## Reasons not to ask NAFED (or RETPCs)

- 49 respondents or 82% : Not know that such services are offered by NAFED
- 20 respondents or 33% : No access to NAFED (or RETPC)
- 13 respondents or 22% : Already have good relation with others
- 10 respondents or 17% : Others are more dedicative and quick to response

# Satisfaction with inquiry & matching service by NAFED

Results from inquiry or buyer matching to NAFED (or RETPCs)

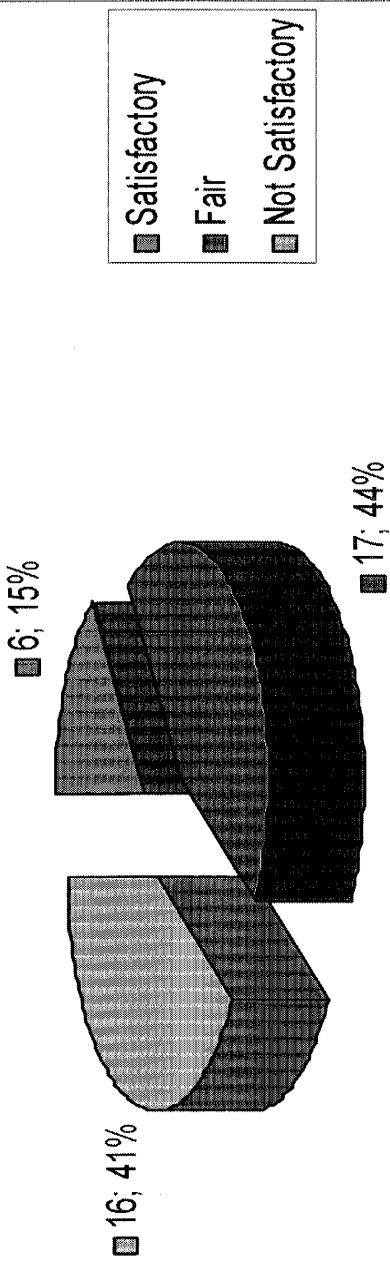

The reasons of satisfaction included;

- Received market opportunity information.
- Service is good enough and their request takes more attention.
- Responded fast and friendly, and the staff were ready to assist.

The reasons of non-satisfaction included;

- Provided inaccurate and out-dated buyer data.
- Never had a good response.
- No deal with recommended prospective buyer.

# Web-site service

## Access to the web-site

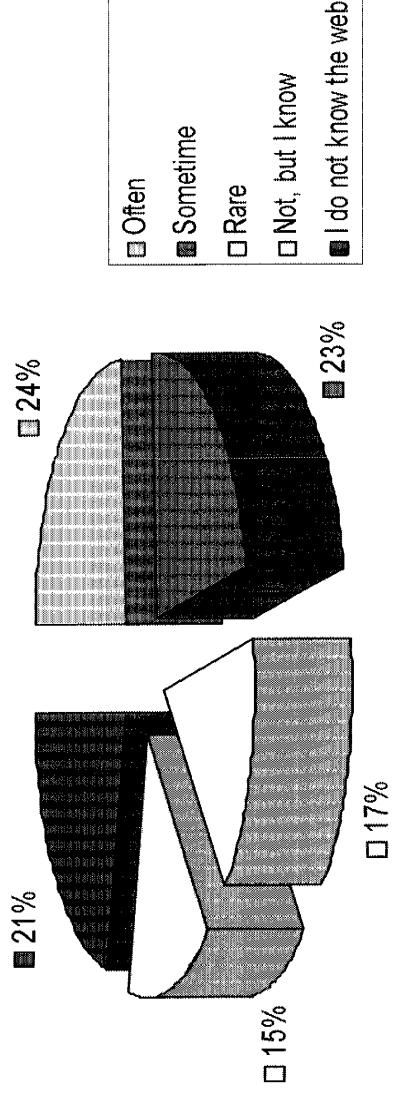

## Web-site section of interest

65 respondents or 67% : Global promotion events

54 respondents or 56% : Inquiry / trade matching

49 respondents or 51% : Trade database

On the other hand,

18 respondents or 19% : Market intelligence

17 respondents or 18% : Brand development

16 respondents or 16% : Digital market place

## Satisfaction: how the web-site meet the requirements of exporters?

12%: Yes, mostly, 73%: Yes, a little, 15%: Not satisfied

- Information and data should be up-dated in due course at least.

- NAFED should contain more information and data about potential buyers.



# Product Development

Almost all respondents (132 in total) have experienced some kinds of product (design) development of their products to compete in the global markets, and usually engage in the product (design) development through or upon;

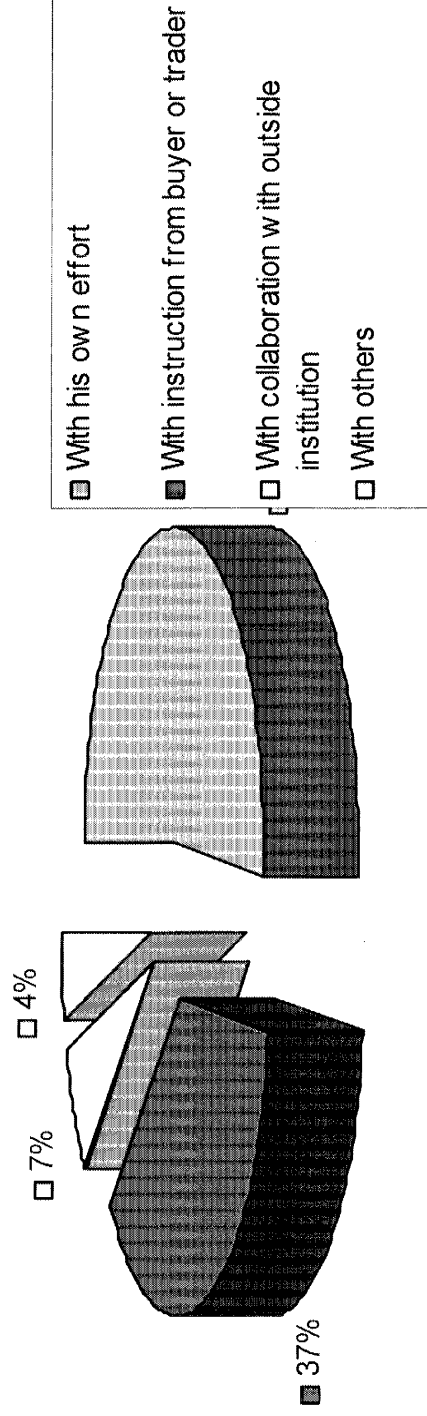

The above respondents obtained the information required for design development of their products through or from;

82 respondents or 62% : Design catalogue and design book

72 respondents or 55% : Participation in exhibition

62 respondents or 47% : Visiting stores and shops

57 respondents or 43% : Web-sites

50 respondents or 36% : Designer or consultant (local)

# Overall Evaluation on NAFED Performance

Most expected services to be strengthened

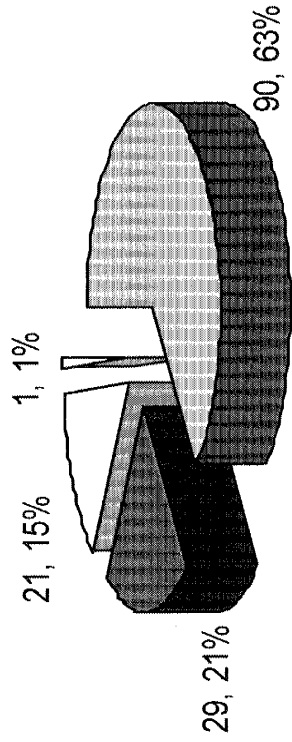

- Market information service
- Trade fair (exhibition) and mission service
- Inquiry and buyer-matching service
- Product (design) development service

Impressions about NAFED staff

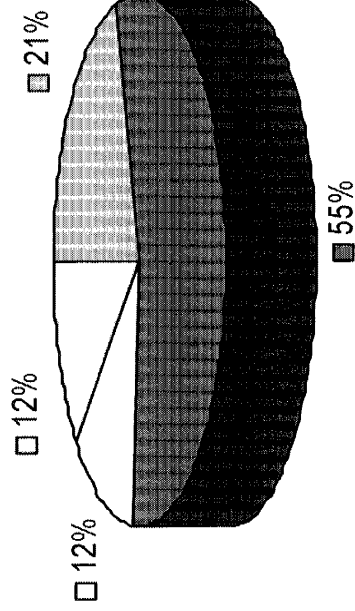

- Very dedicative and supportive
- Fair
- Not really dedicative or supportive
- Don't know NAFED / RETPCs and its staff

# **Voices from Associations & KADINS**

To strengthen the roles and functions, and create good image of NAFED, the following suggestions are raised;

- A good cooperation between NAFED and industry is needed to design and conduct more effective promotion measures.
- NAFED should deepen the knowledge of products and industry in order to design more effective promotion measures.
- NAFED should improve the facility for overseas trade exhibitions.
- NAFED should improve the way of socializing its roles & programs.
- NAFED should be more active in developing exportable products from the existing potential ones in regions.
- The staffs to be assigned as overseas representative should have a business sense and ability to collect overseas business information.
- NAFED staff should be professional, and no more officers shall take the self-advantage.

# **Voices from Individual Exporters**

Responded exporters propose that NAFED should;

- provide more opportunity of overseas trade exhibition.
- Be more realistic to see exporters' problems and give them the better solutions.
- lead the public supports for exporters from the upstream to the downstream to make their products more competitive and attractive.
- Look for more potential buyers.
- regularly provide more complete and accurate information, about the market, promotion and training opportunities.
- provide more information and data about overseas trade regulations.
- directly disseminate information to exporters and facilitate the internet access by SME exporters.