

資料 8 概略設計図

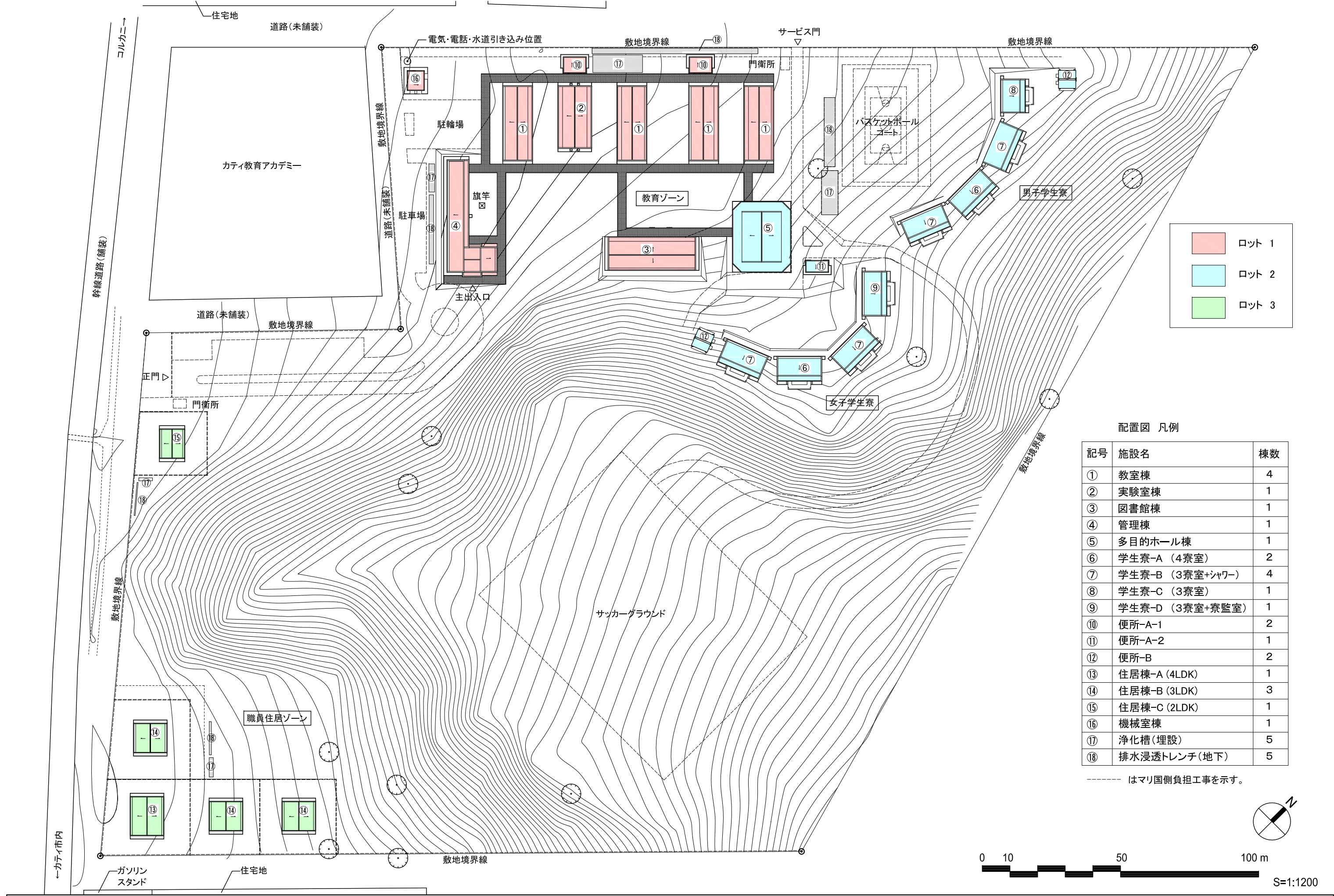

ロット 1
 ロット 2
 ロット 3

配置図 凡例

記号	施設名	棟数
①	教室棟	4
②	実験室棟	1
③	図書館棟	1
④	管理棟	1
⑤	多目的ホール棟	1
⑥	学生寮-A (4寮室)	2
⑦	学生寮-B (3寮室+シャワー)	4
⑧	学生寮-C (3寮室)	1
⑨	学生寮-D (3寮室+寮監室)	1
⑩	便所-A-1	2
⑪	便所-A-2	1
⑫	便所-B	2
⑬	住居棟-A (4LDK)	1
⑭	住居棟-B (3LDK)	3
⑮	住居棟-C (2LDK)	1
⑯	機械室棟	1
⑰	浄化槽(埋設)	5
⑱	排水浸透トレンチ(地下)	5

----- はマリ国側負担工事を示す。

0 10 50 100 m
 S=1:1200

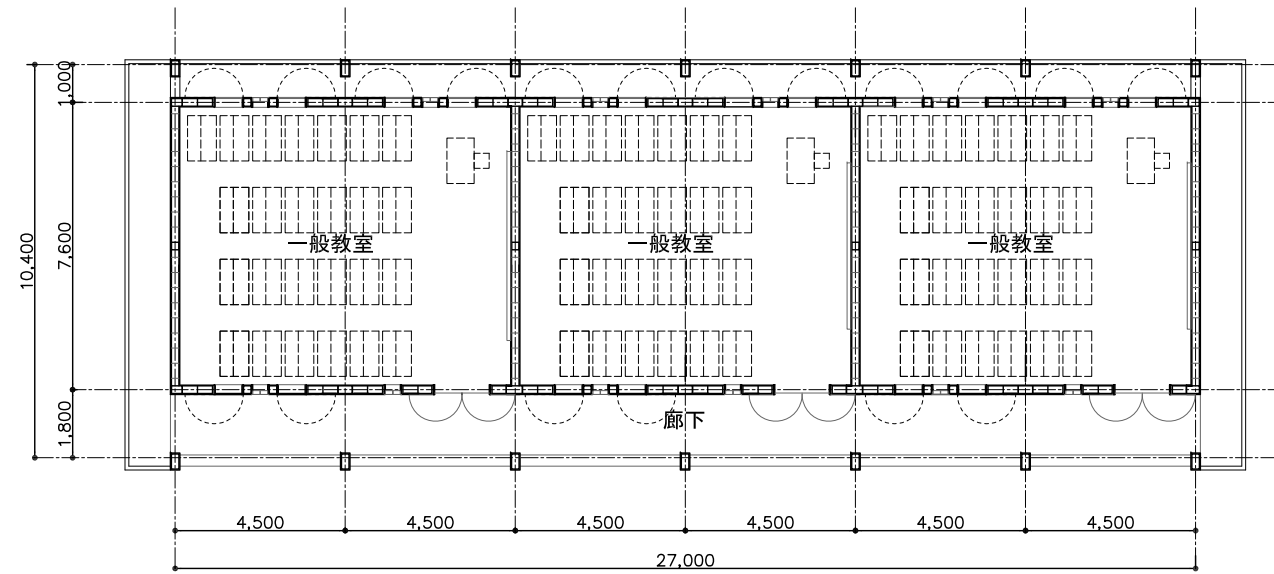

1階平面図

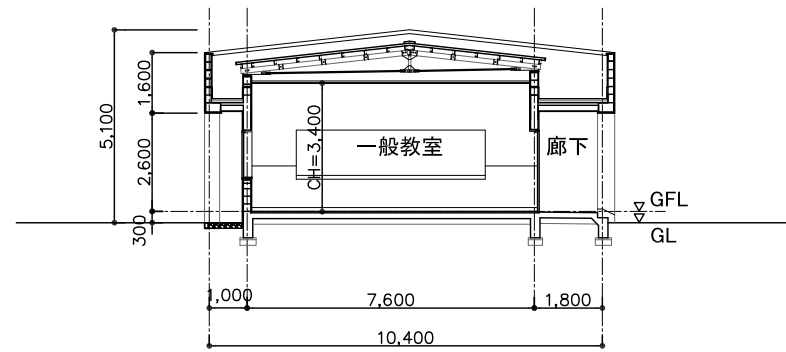

断面図 (短辺方向)

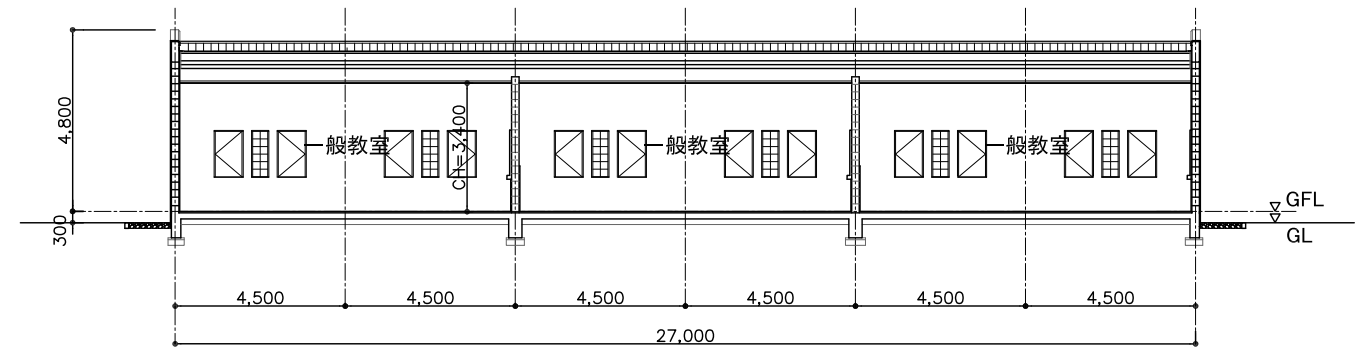

断面図 (長辺方向)

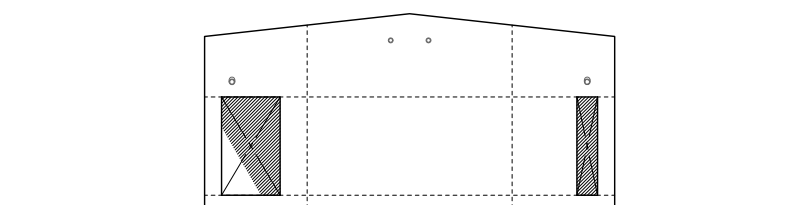

側面立面図-1

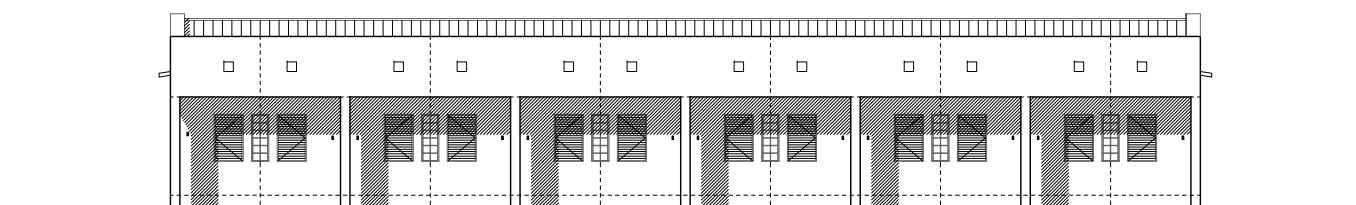

立面図 (教室側)

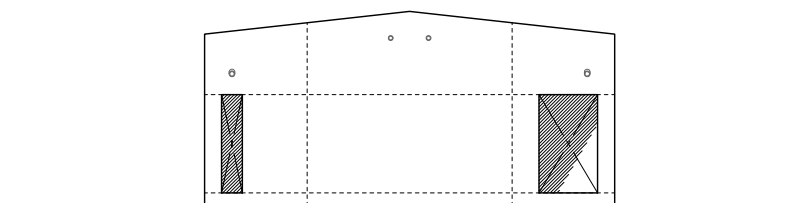

側面立面図-2

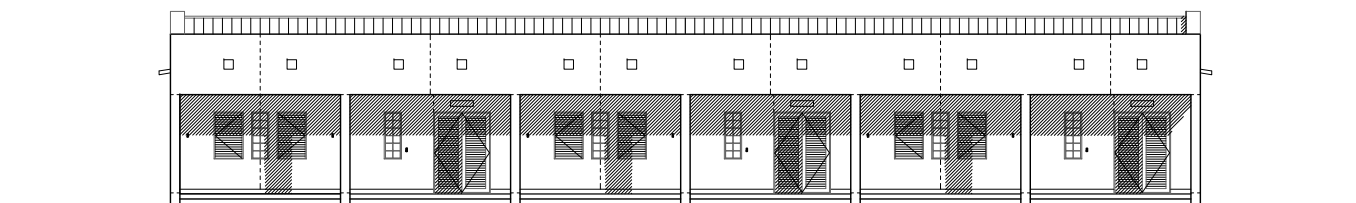

立面図 (廊下側)

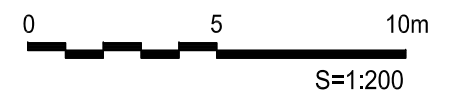

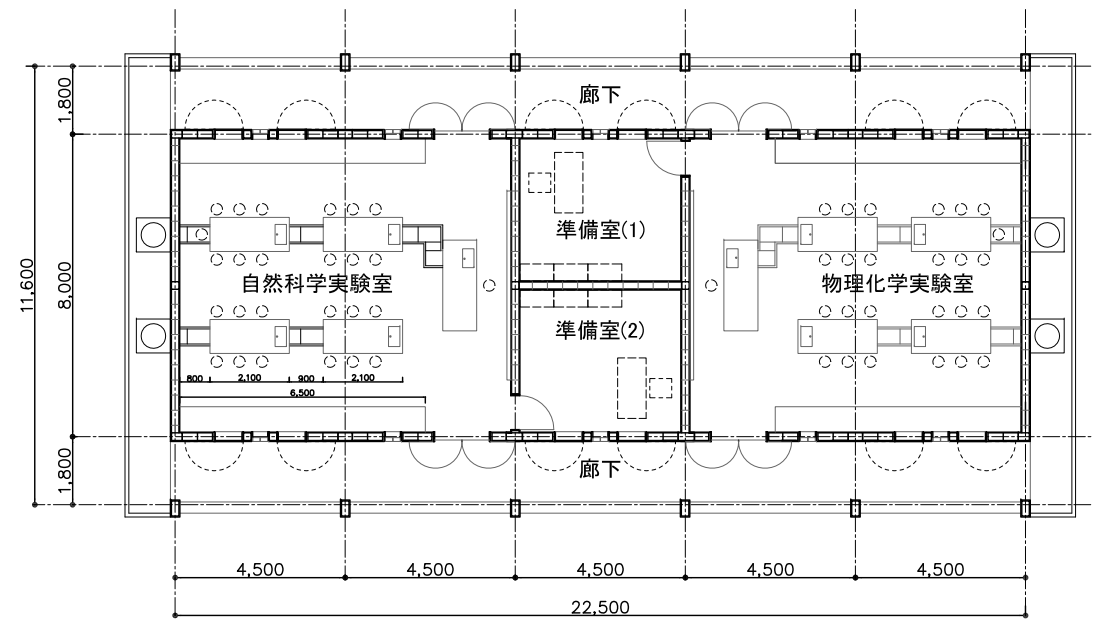

1階平面図

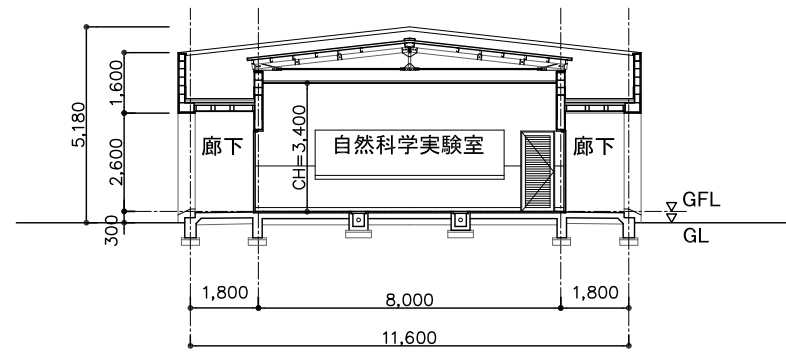

断面図 (短辺方向)

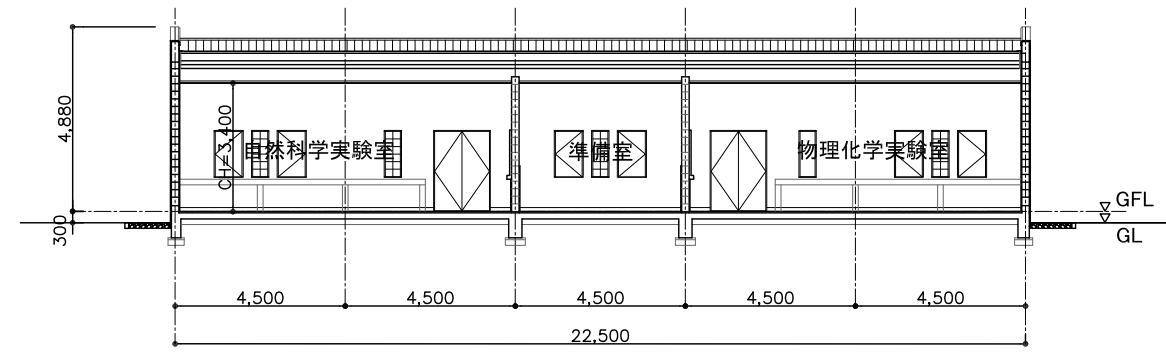

断面図 (長辺方向)

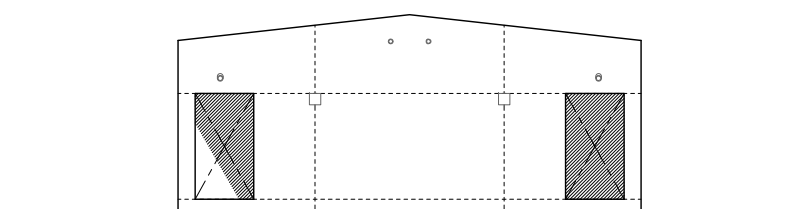

側面立面図 (南東面)

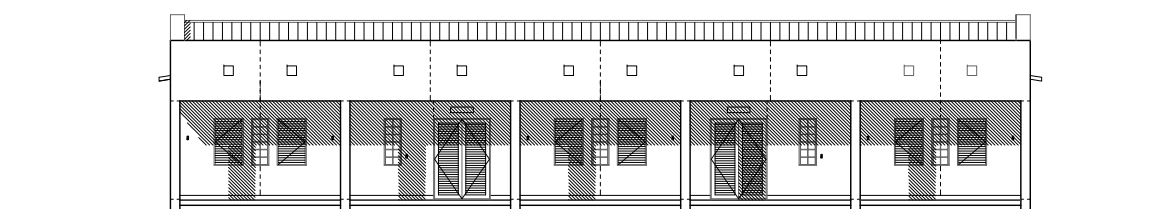

立面図 (北東面)

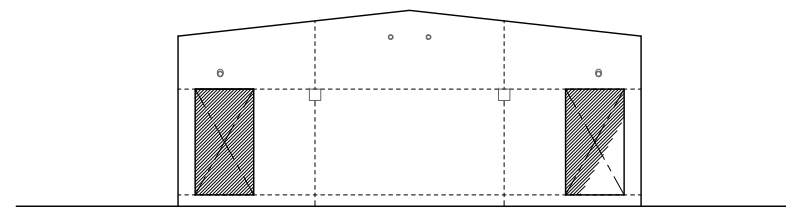

側面立面図 (北西面)

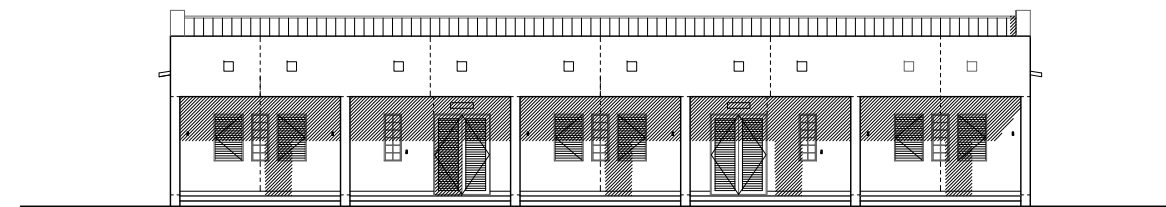

立面図 (南西面)

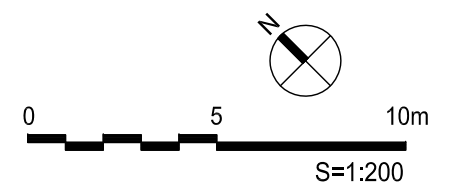

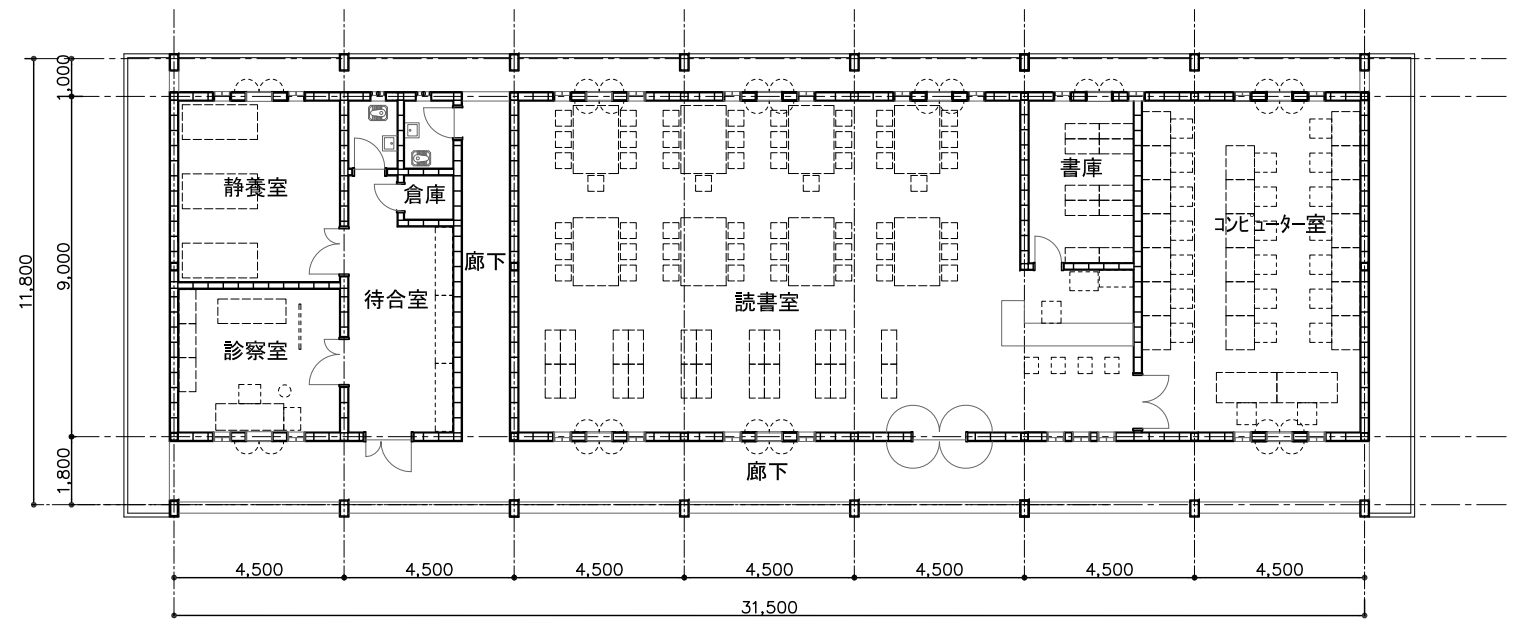

1階平面図

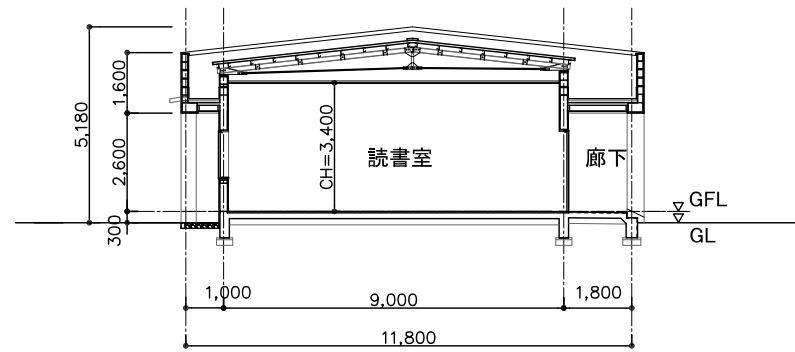

断面図(短辺方向)

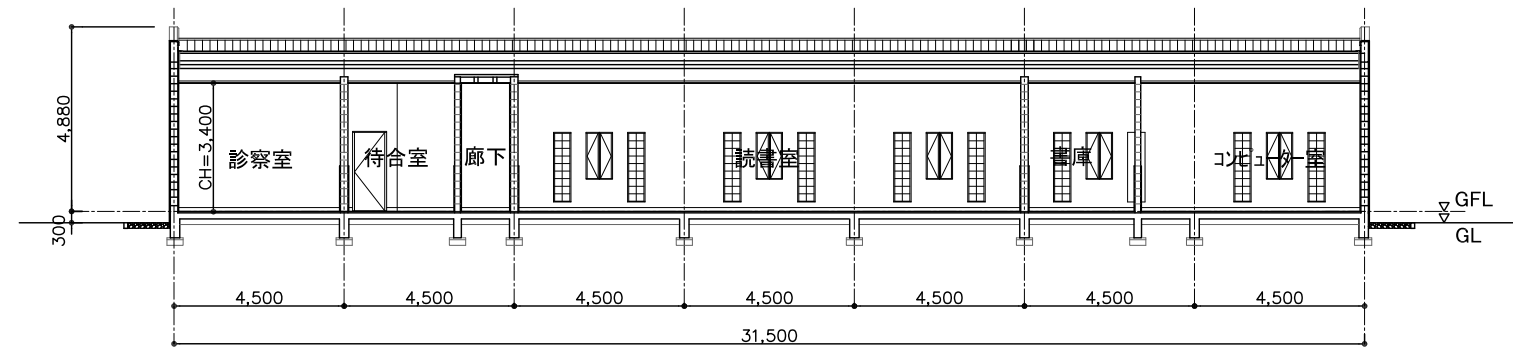

断面図(長辺方向)

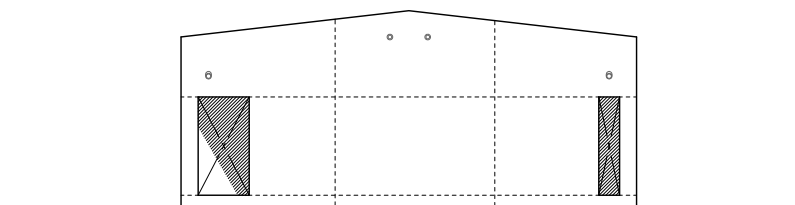

側面立面図(南西面)

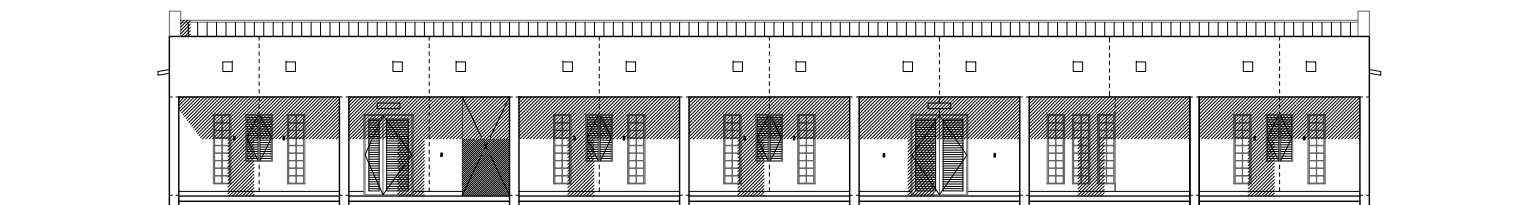

立面図(北西面)

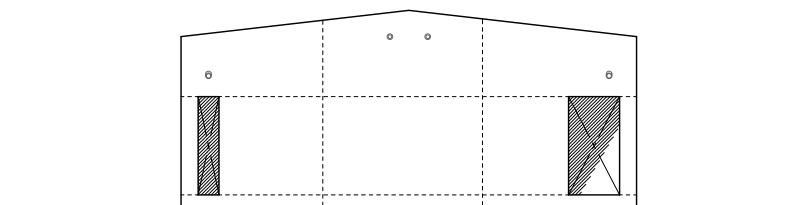

側面立面図(北東面)

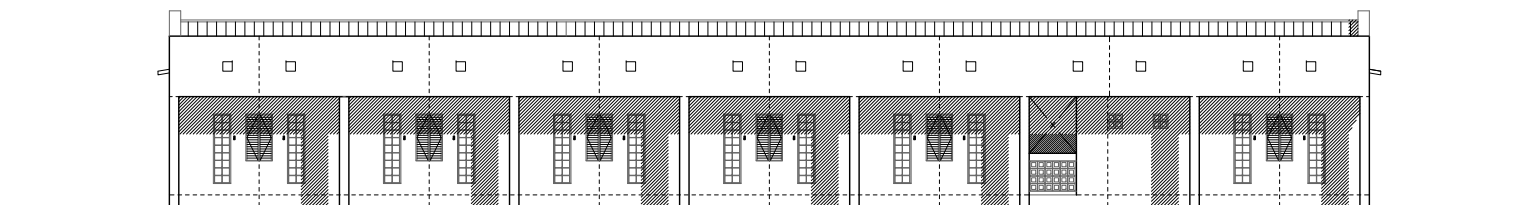

立面図(南東面)

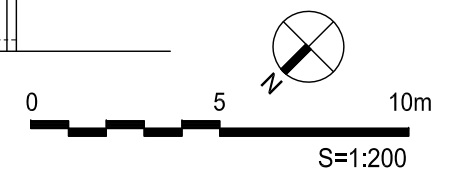

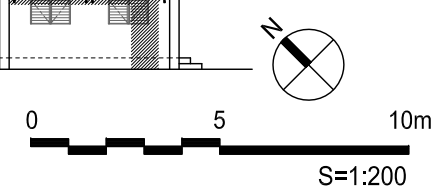
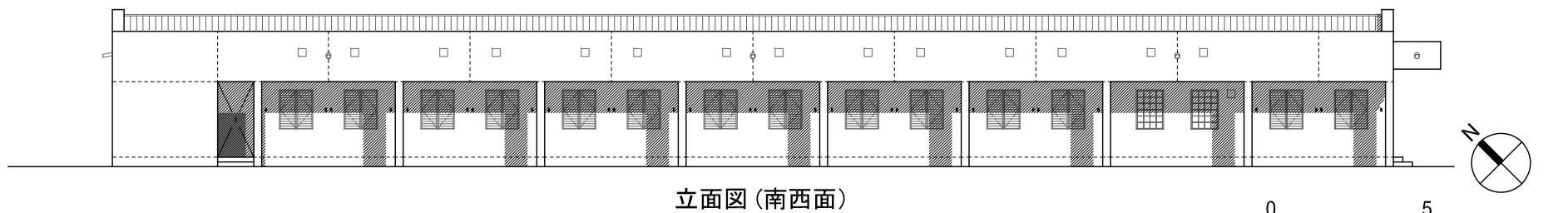
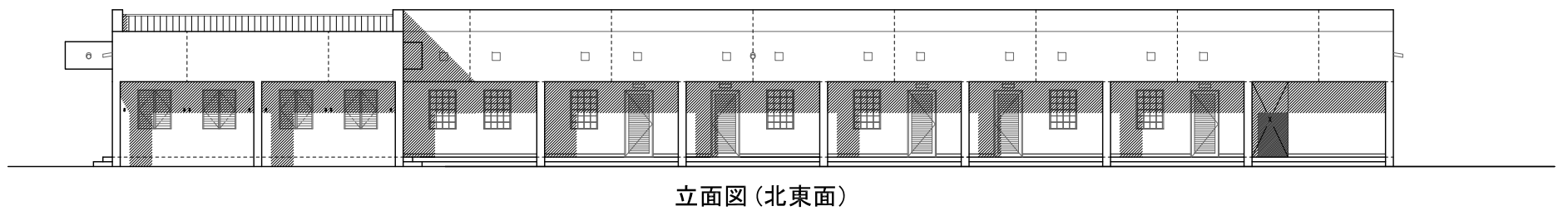
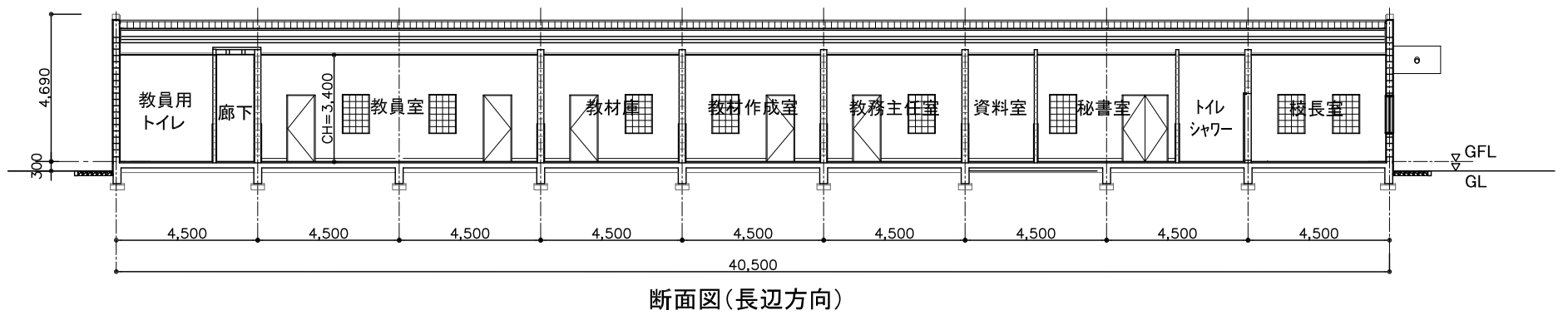
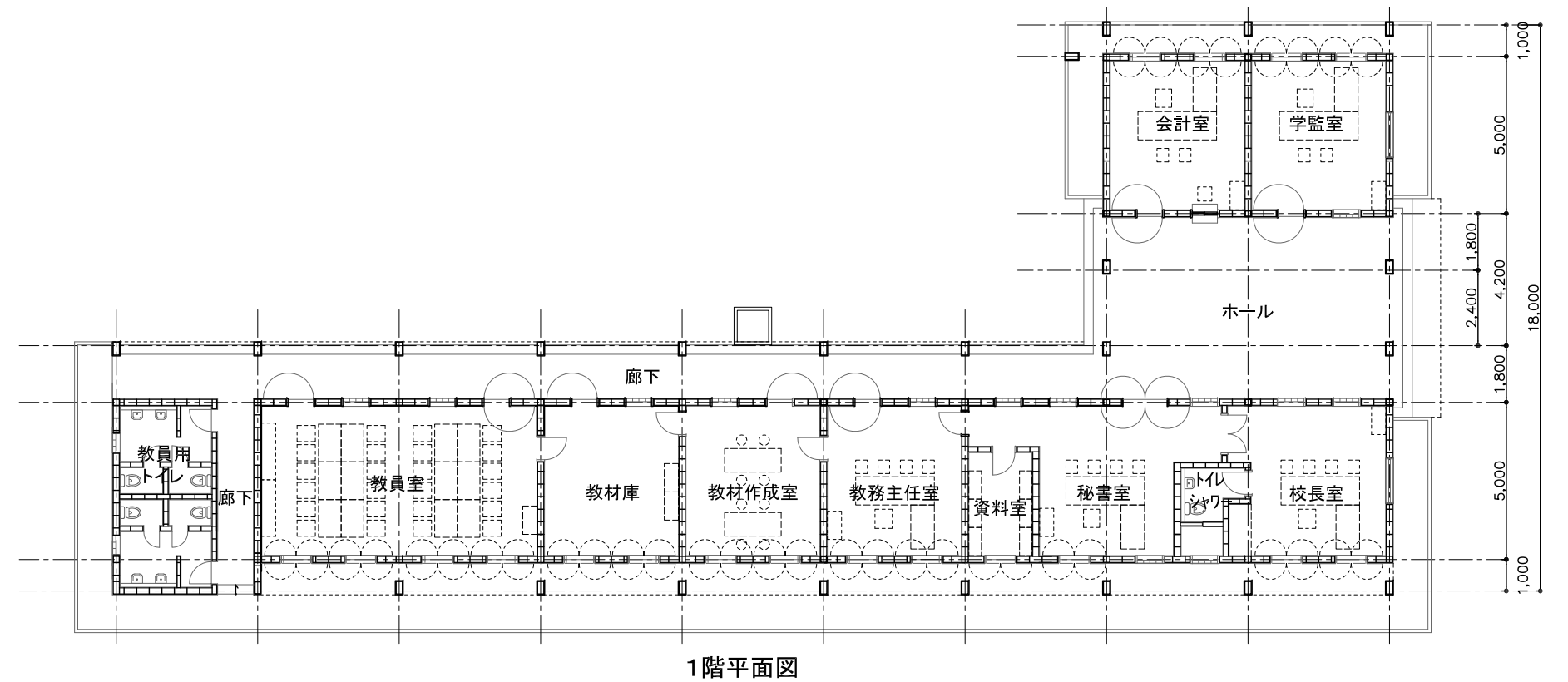
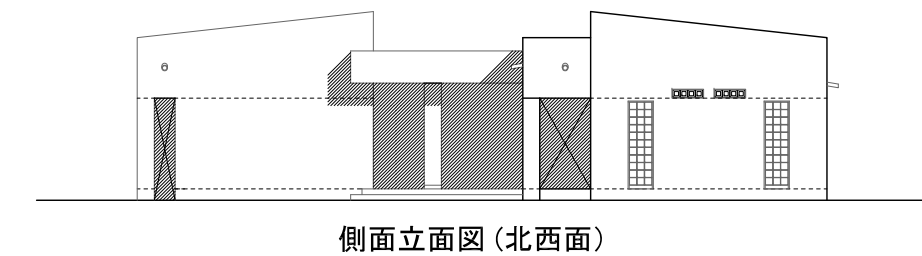
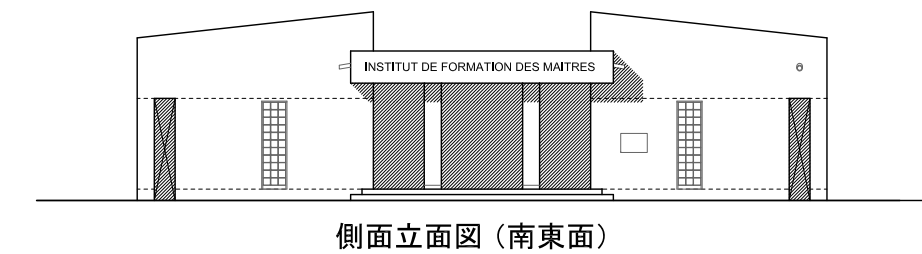
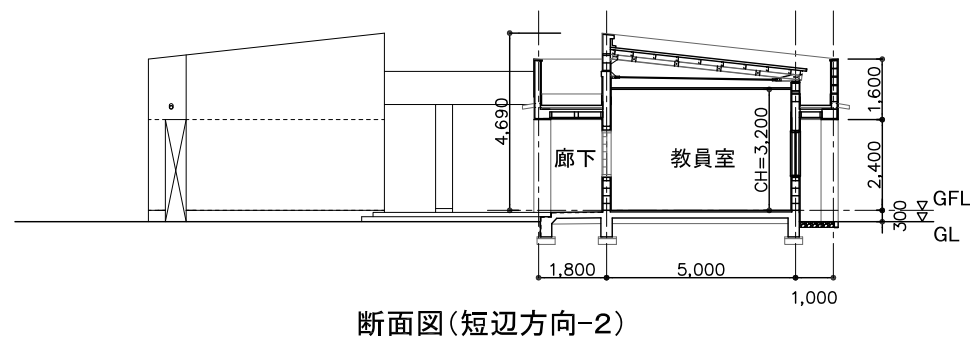
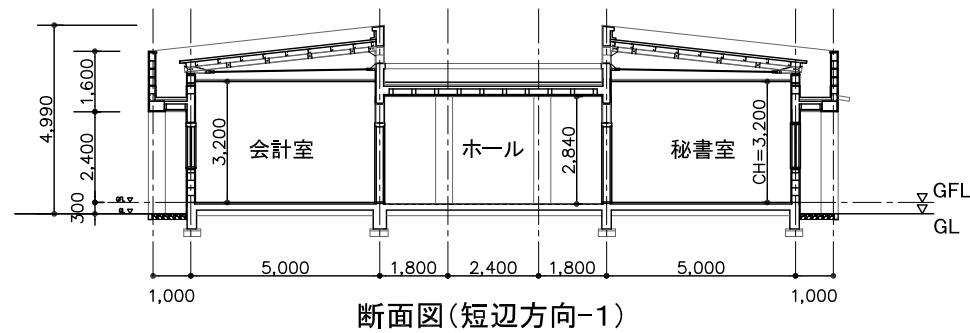

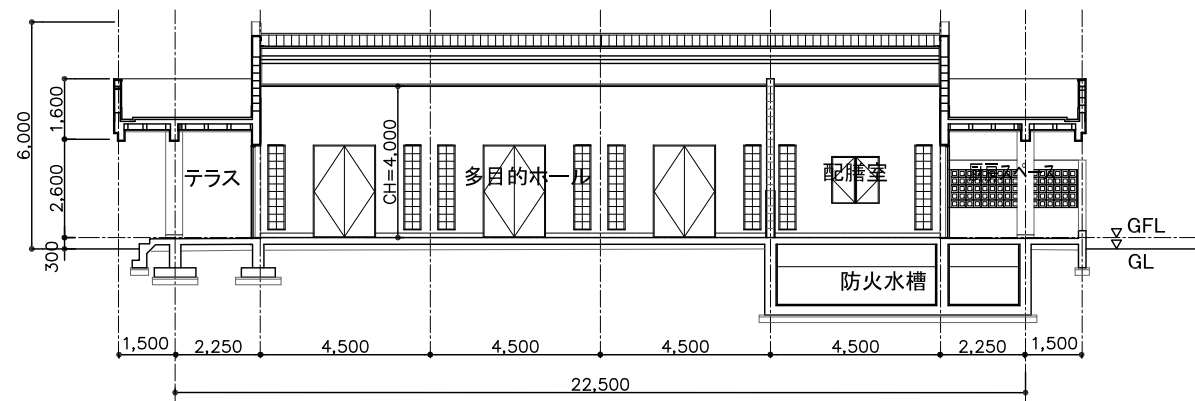

断面図 (長辺方向)

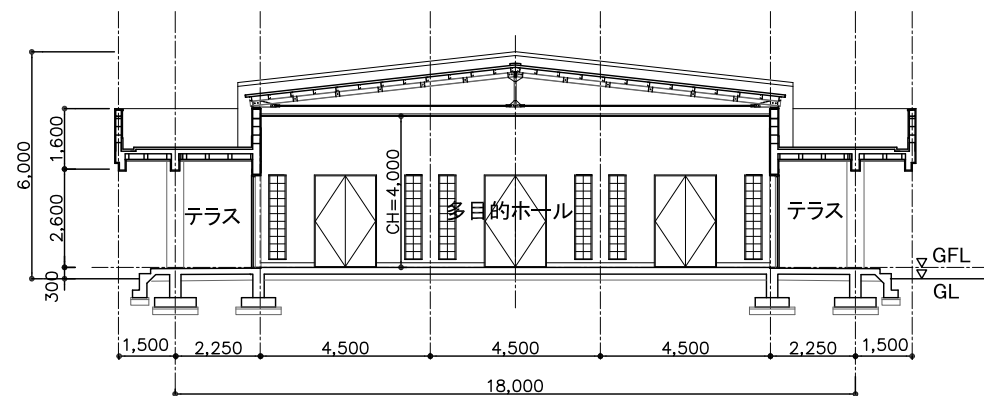

断面図 (短辺方向)

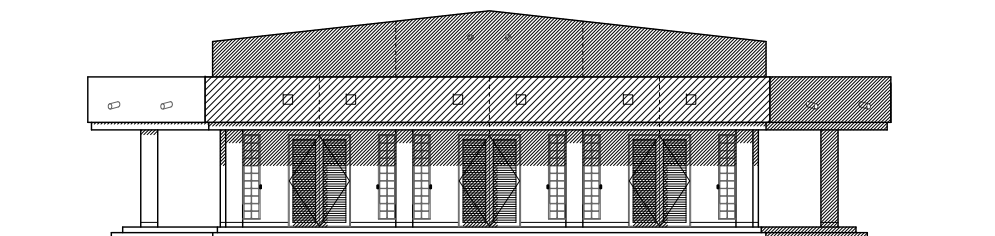

立面図 (北西面)

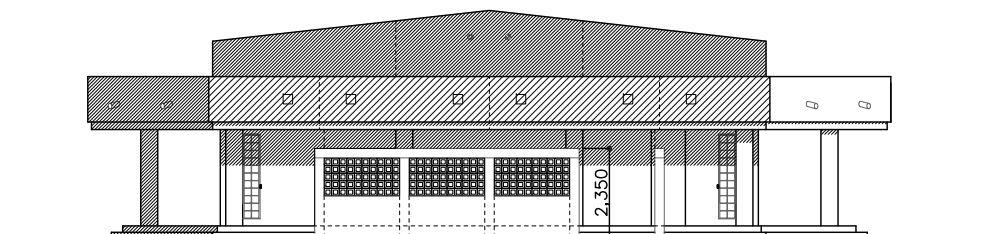

立面図 (南東面)

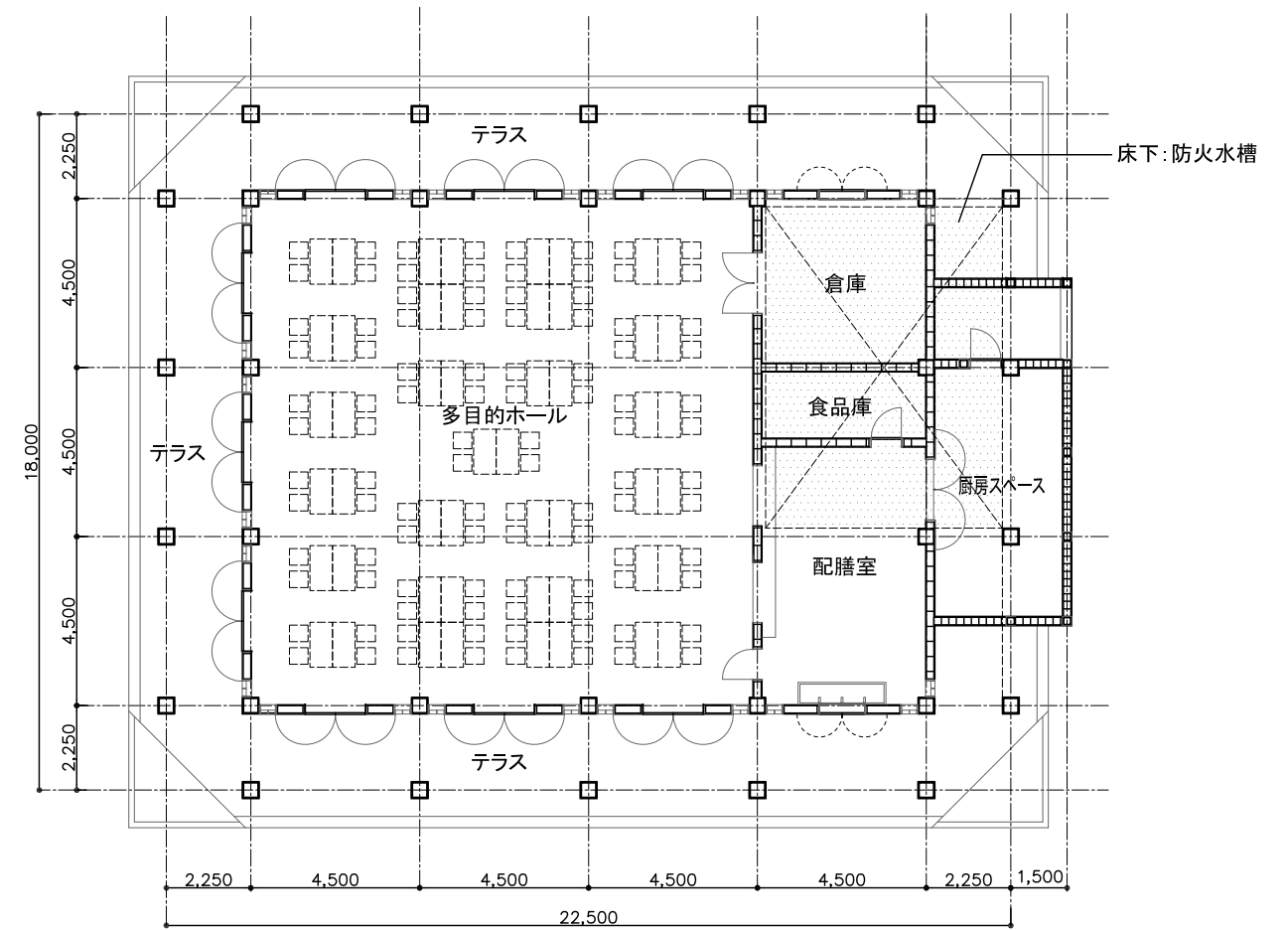

1階平面図

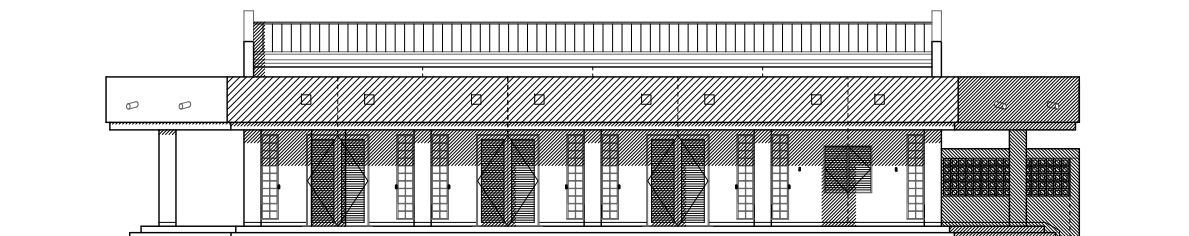

立面図 (北東面)

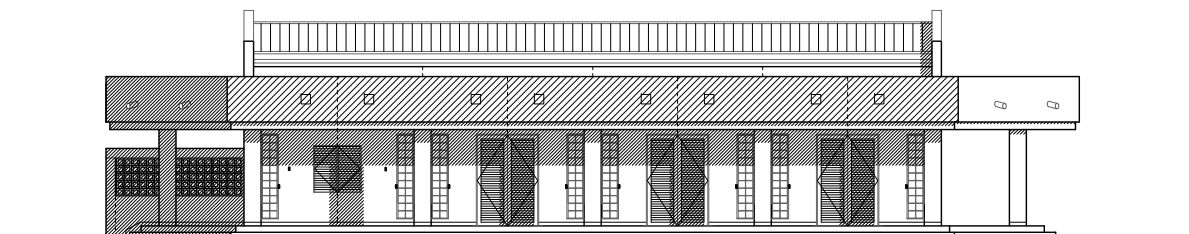

立面図 (南西面)

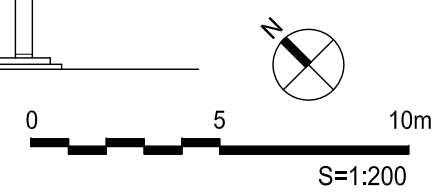

学生寮 Aタイプ

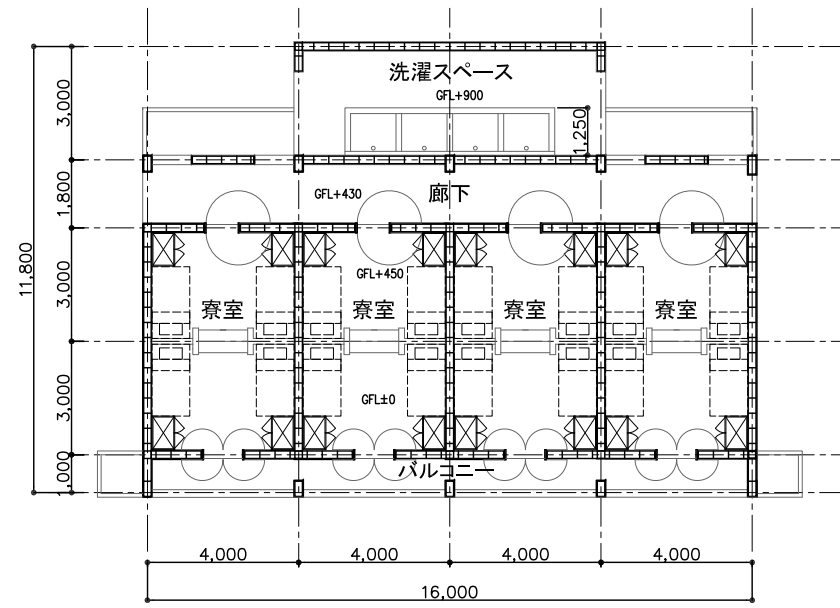

1階平面図

学生寮 Bタイプ

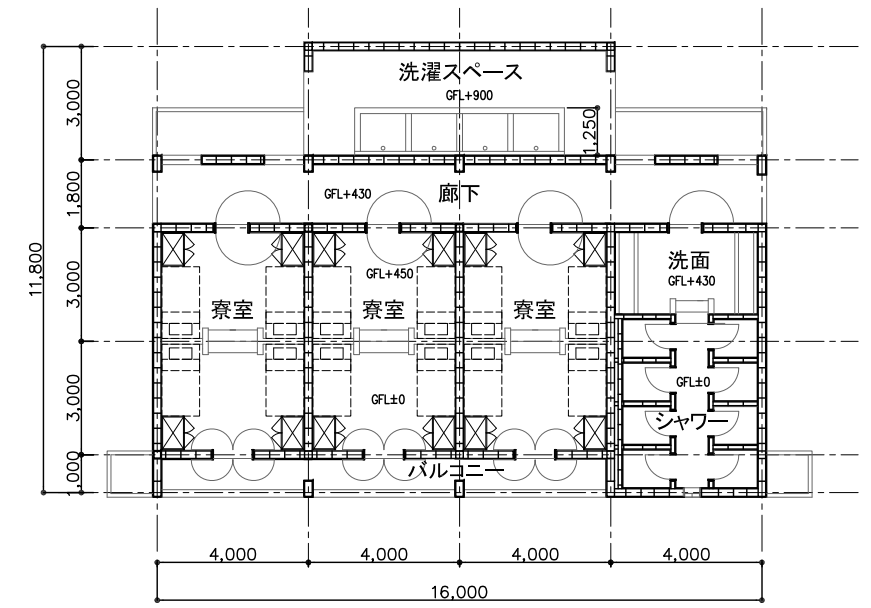

1階平面図

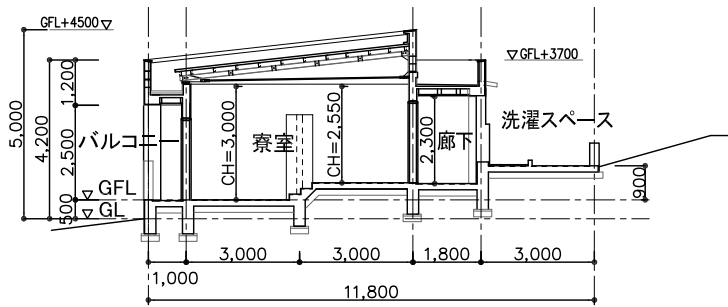

断面図 (短辺方向)

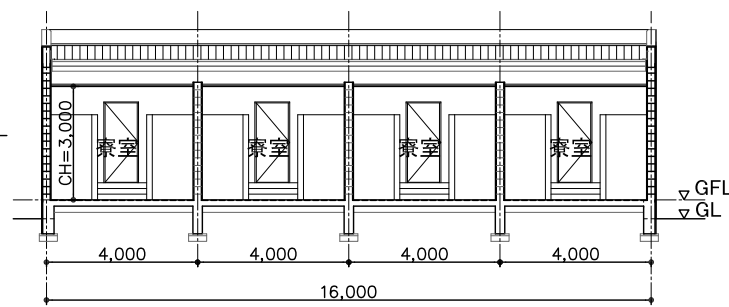

断面図 (長辺方向)

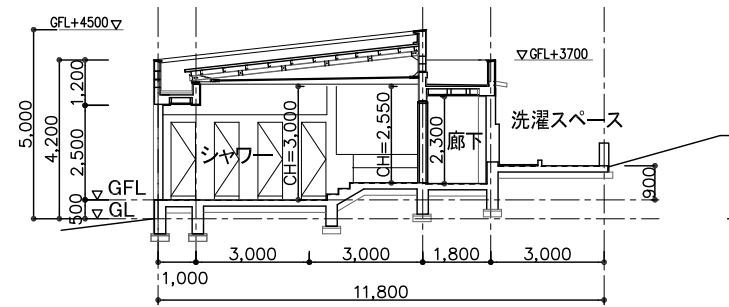

断面図 (短辺方向)

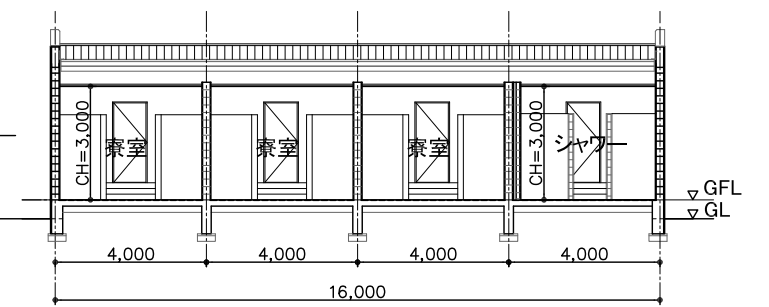

断面図 (長辺方向)

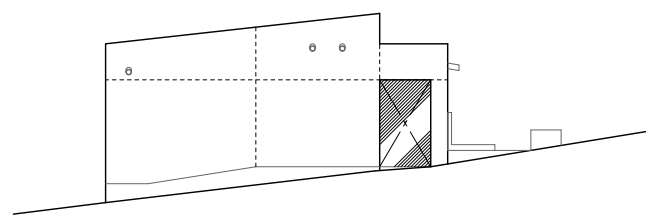

側面立面図 -1

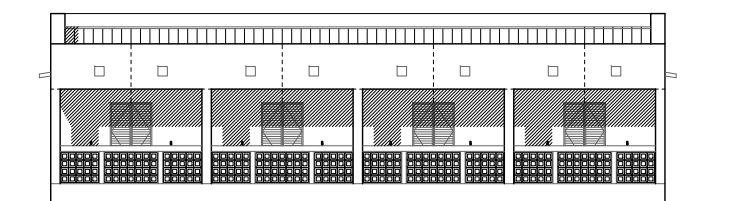

立面図 (バルコニー側)

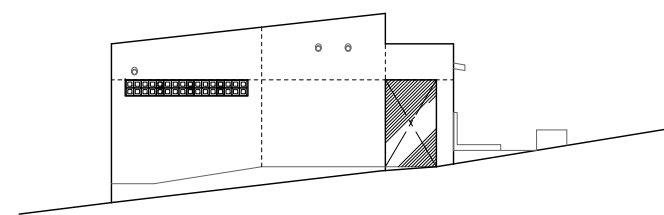

側面立面図 -1

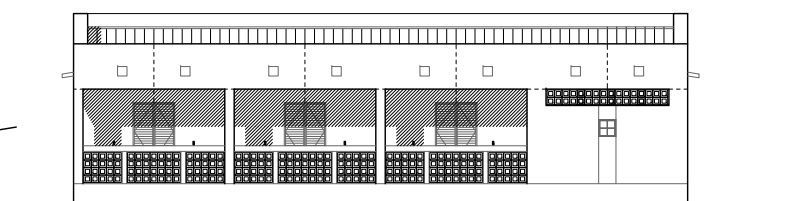

立面図 (バルコニー側)

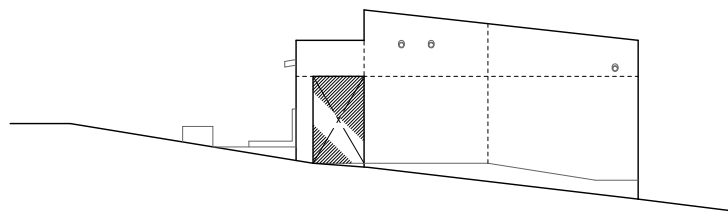

側面立面図 -2

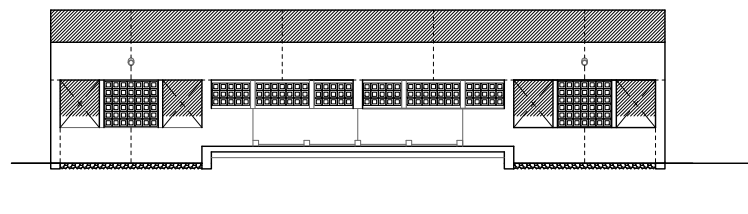

立面図 (廊下側)

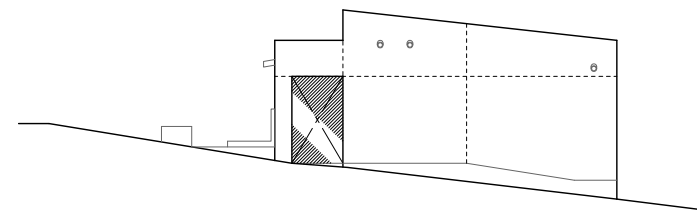

側面立面図 -2

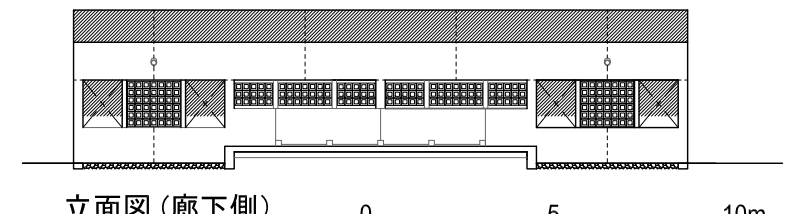

立面図 (廊下側)

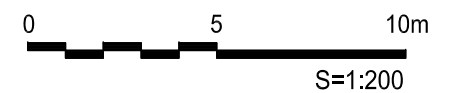

学生寮 Cタイプ

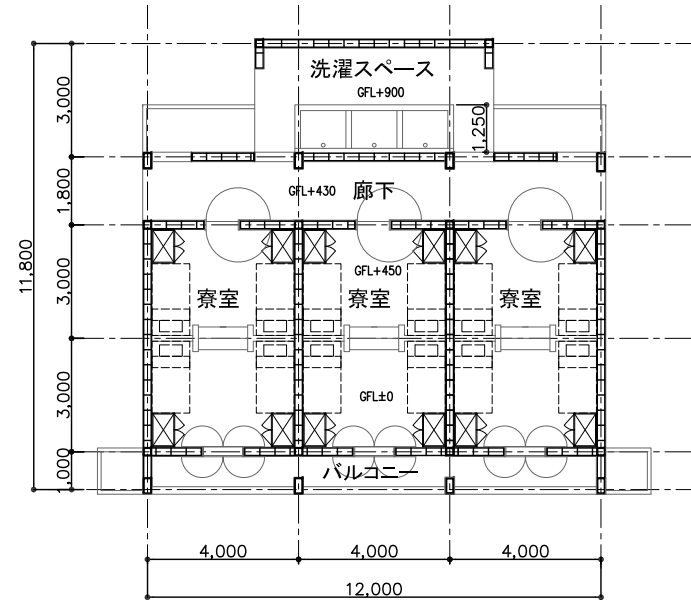

1階平面図

学生寮 Dタイプ

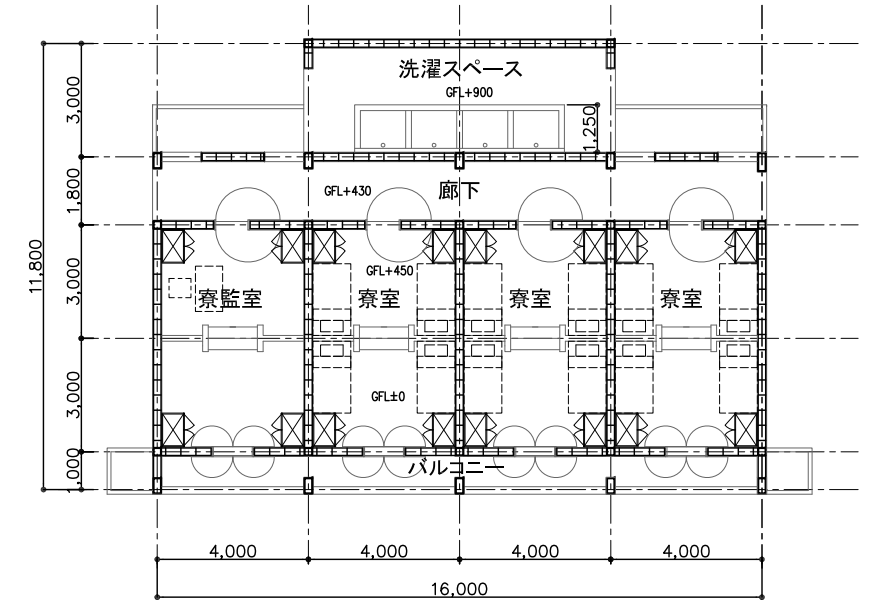

1階平面図

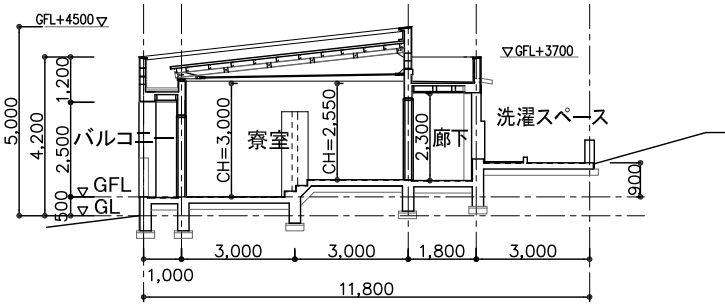

断面図 (短辺方向)

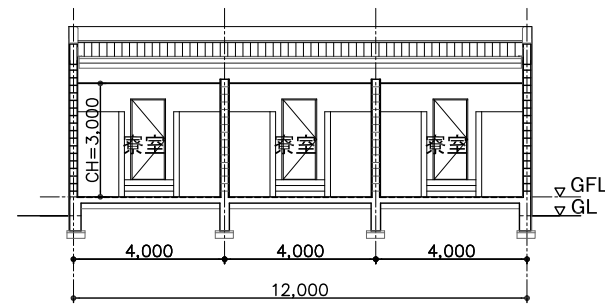

断面図 (長辺方向)

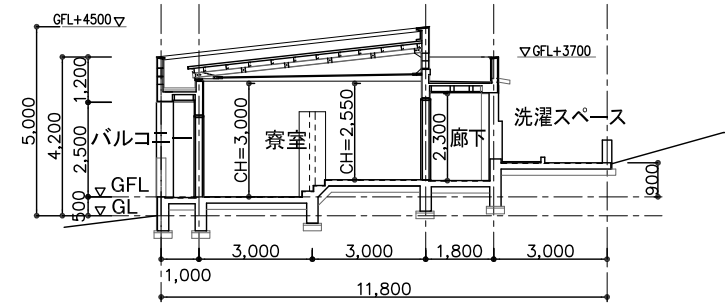

断面図 (短辺方向)

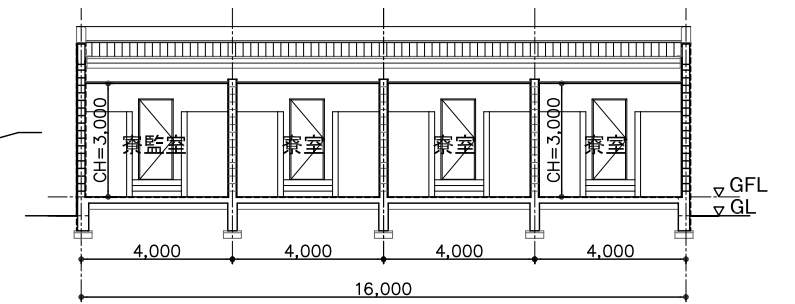

断面図 (長辺方向)

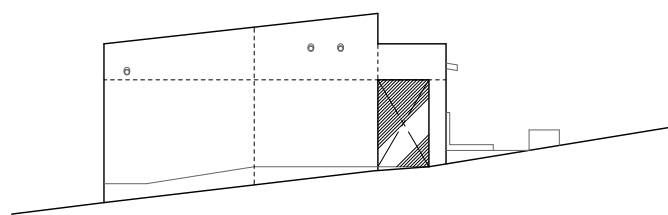

側面立面図 -1

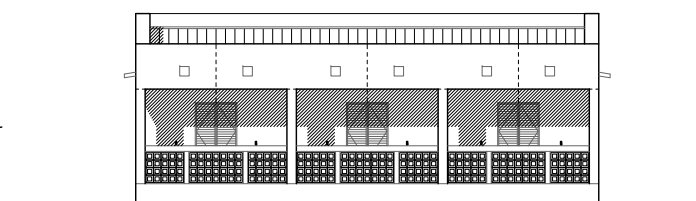

立面図 (バルコニー側)

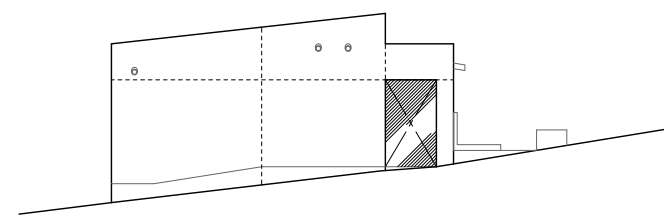

側面立面図 -1

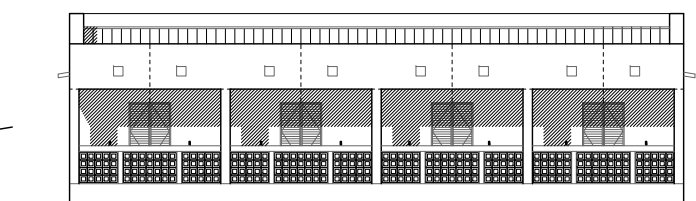

立面図 (バルコニー側)

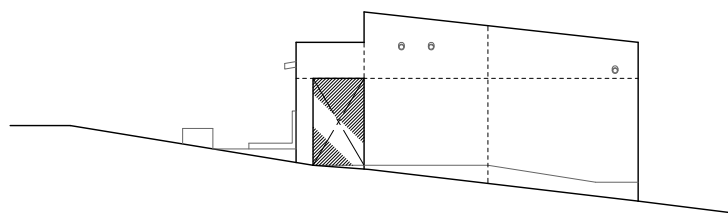

側面立面図 -2

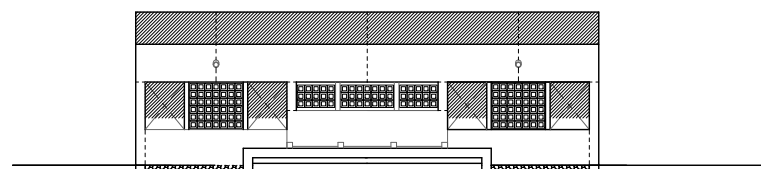

立面図 (廊下側)

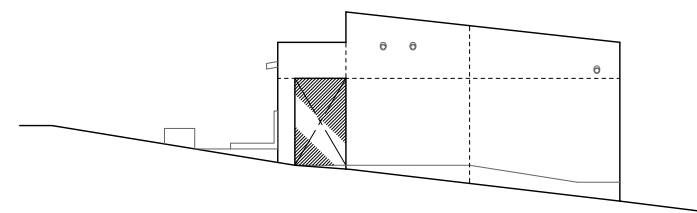

側面立面図 -2

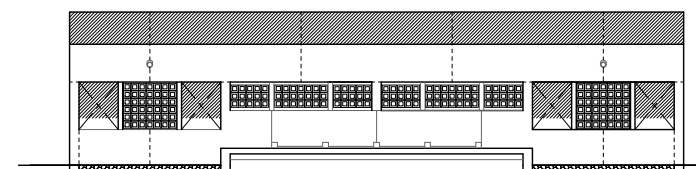

立面図 (廊下側)

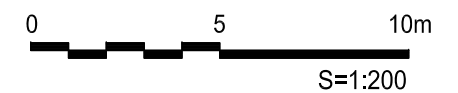

A-1タイプ

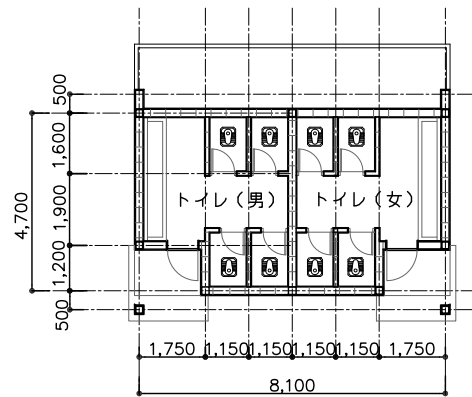

1階平面図

A-2タイプ

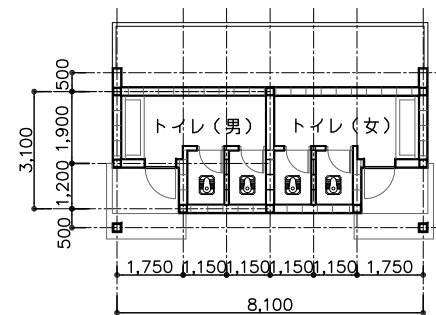

1階平面図

Bタイプ

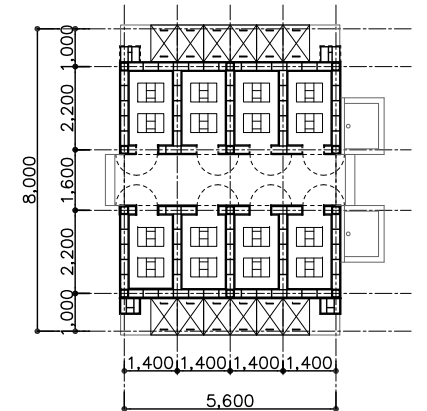

1階平面図

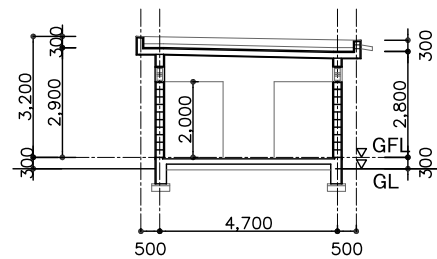

断面図 (短辺方向)

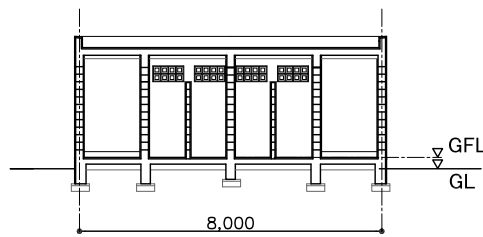

断面図 (長辺方向)

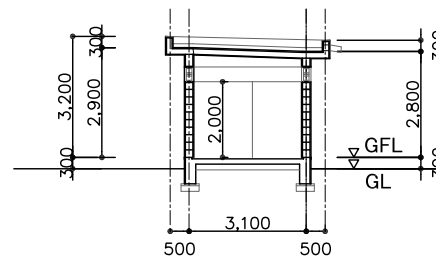

断面図 (短辺方向)

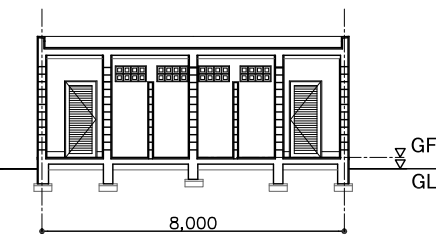

断面図 (長辺方向)

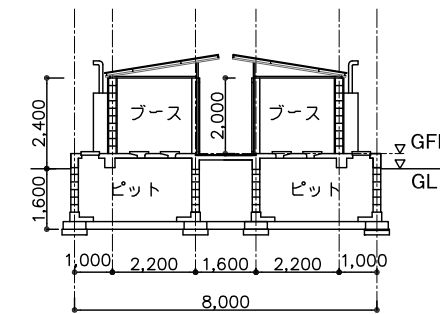

断面図 (長辺方向)

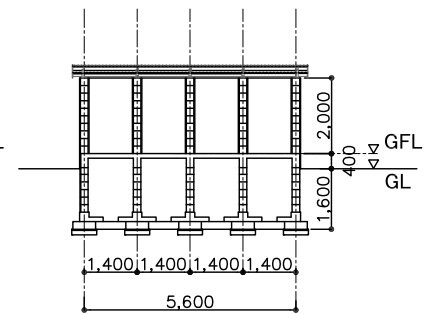

断面図 (短辺方向)

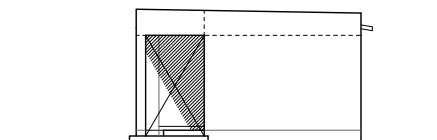

立面図 (側面)

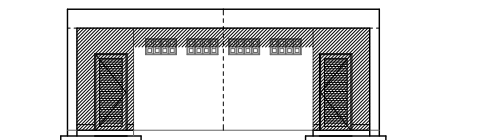

立面図 (正面)

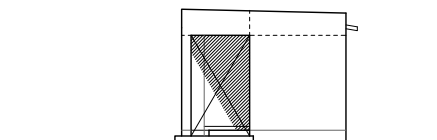

立面図 (側面)

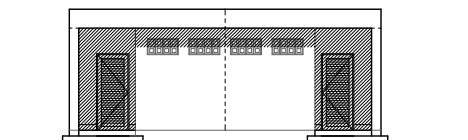

立面図 (正面)

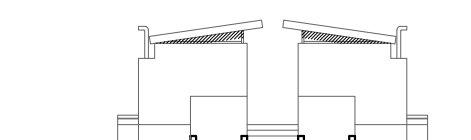

立面図 (正面)

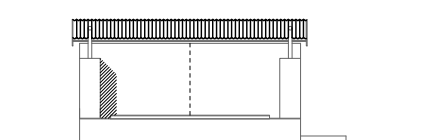

立面図 (側面)

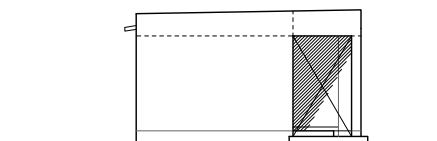

立面図 (側面)

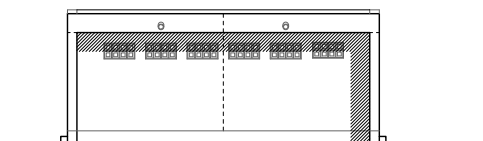

立面図 (背面)

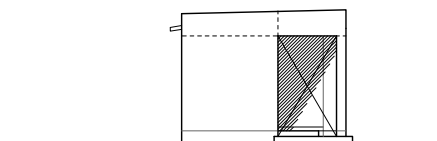

立面図 (側面)

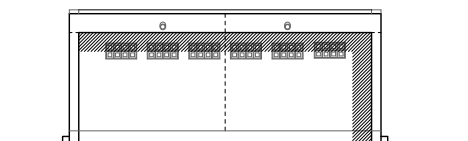

立面図 (背面)

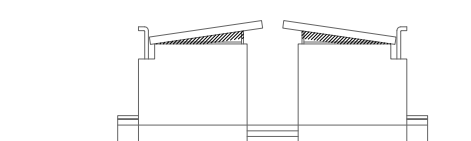

立面図 (背面)

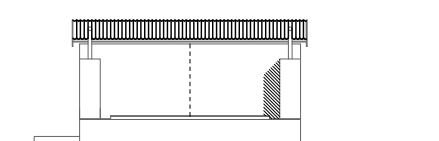

立面図 (側面)

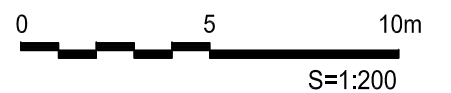

住居棟Aタイプ

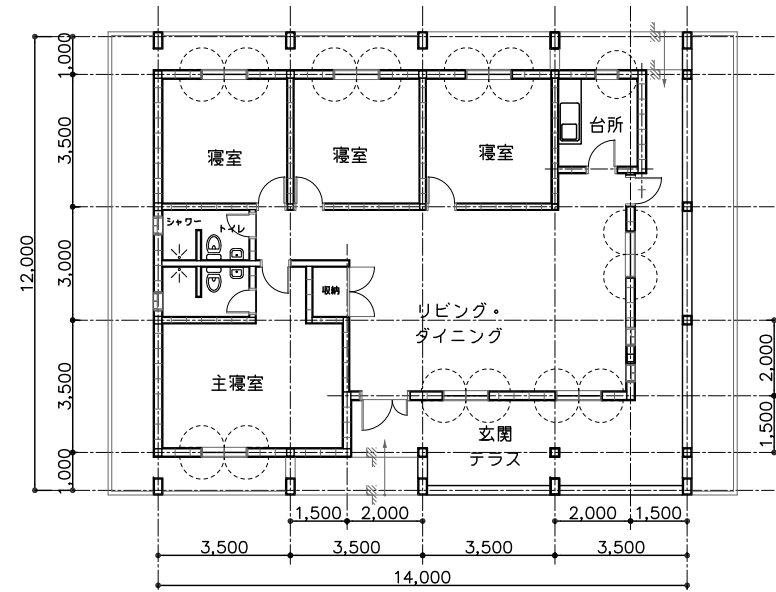

1階平面図

住居棟Bタイプ

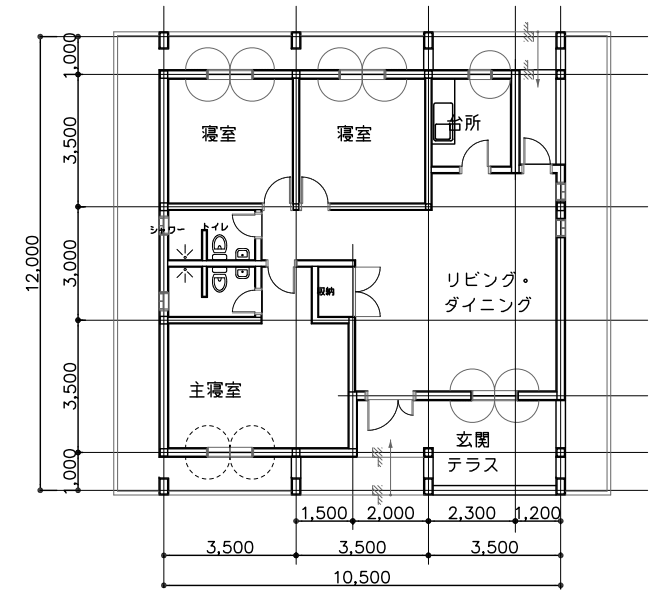

1階平面図

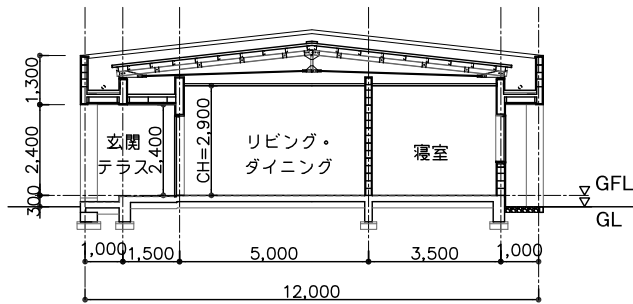

断面図 (短辺方向)

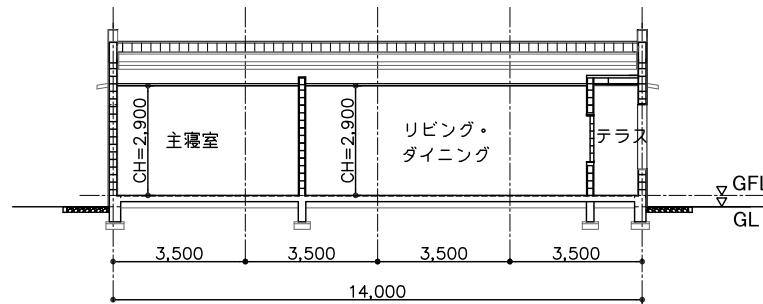

断面図 (長辺方向)

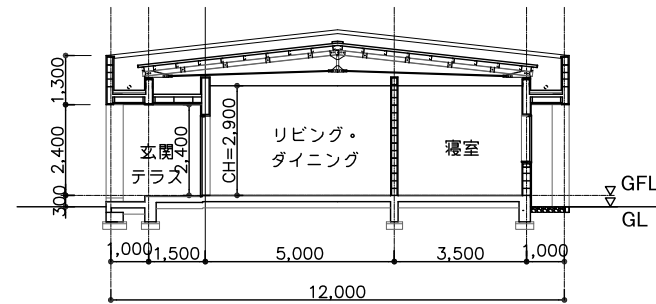

断面図 (長辺方向)

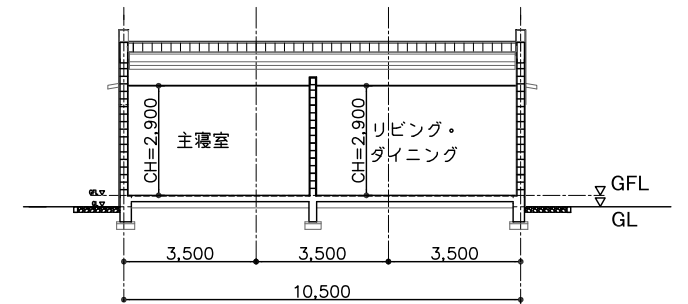

断面図 (短辺方向)

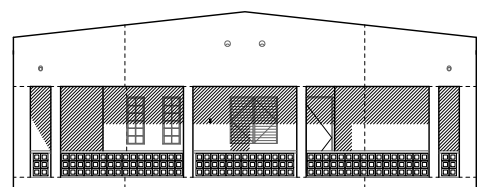

側面立面図 (南東面)

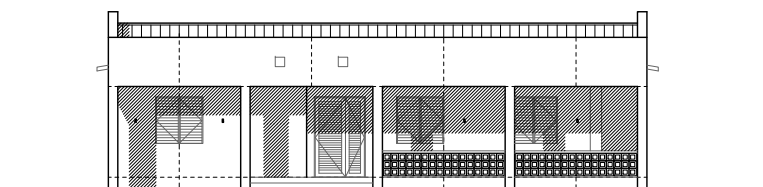

立面図 (南西面)

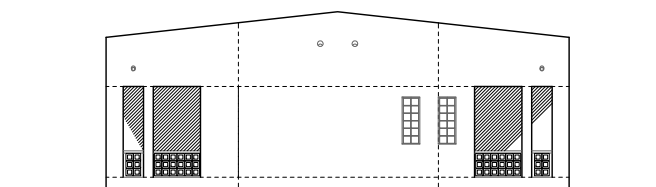

側面立面図 (南東面)

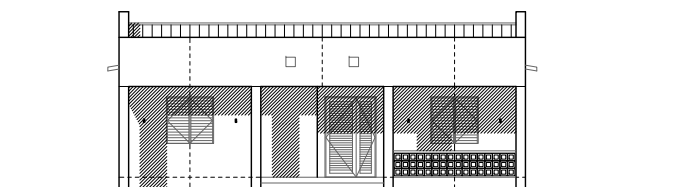

立面図 (南西面)

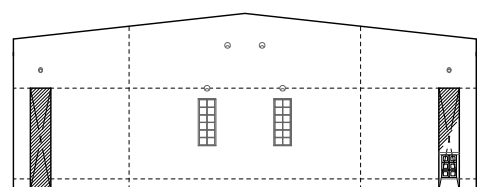

側面立面図 (北西面)

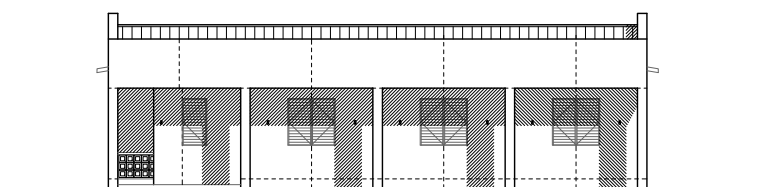

立面図 (北東面)

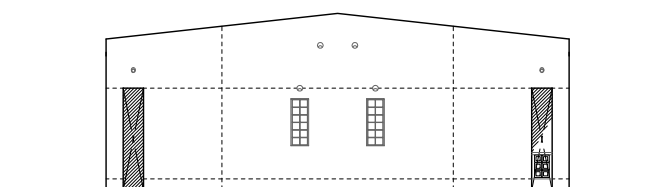

側面立面図 (北西面)

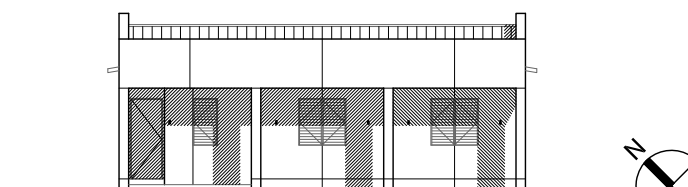

立面図 (北東面)

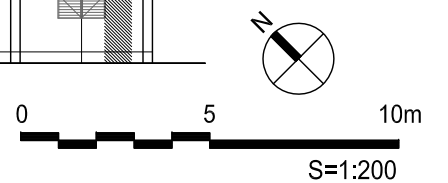

住居棟Cタイプ

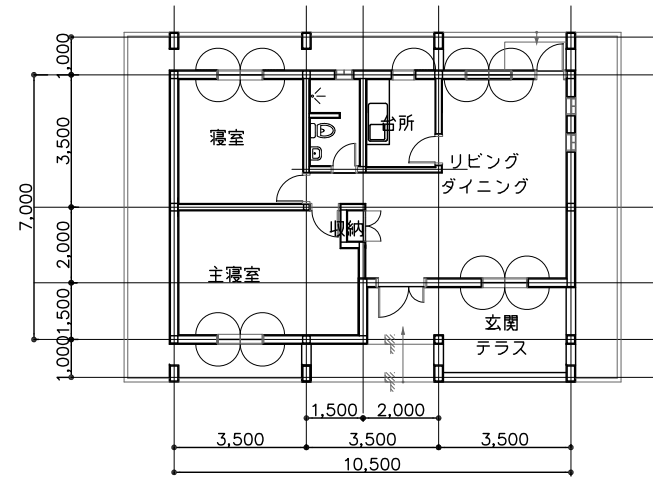

1階平面図

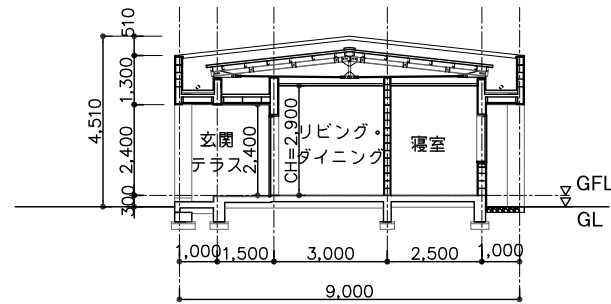

断面図 (短辺方向)

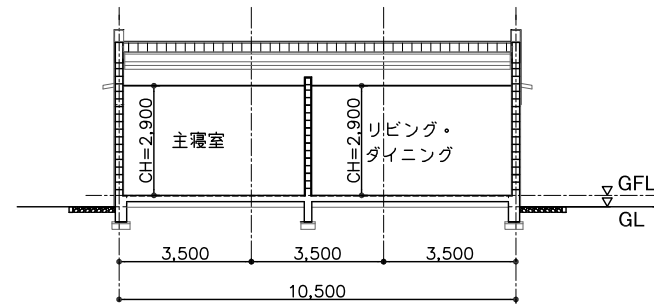

断面図 (長辺方向)

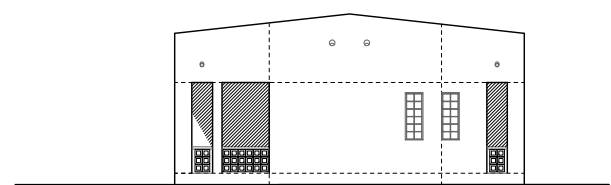

側面立面図 (南東面)

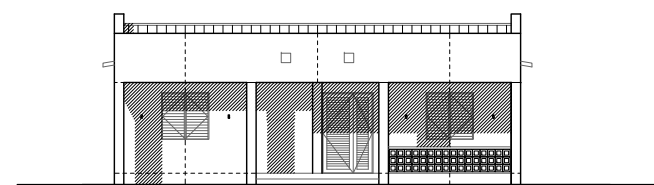

立面図 (南西面)

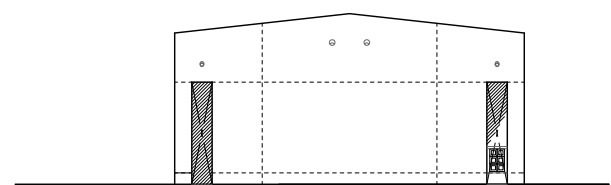

側面立面図 (北西面)

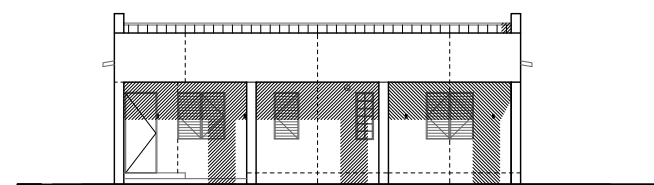

立面図 (北東面)

機械室棟

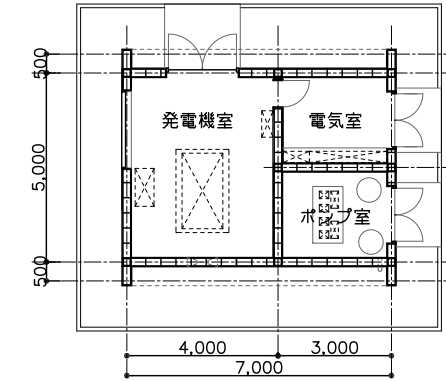
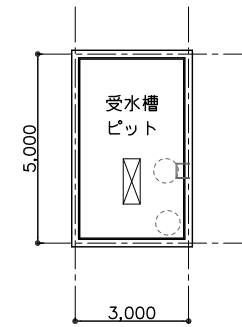

1階平面図

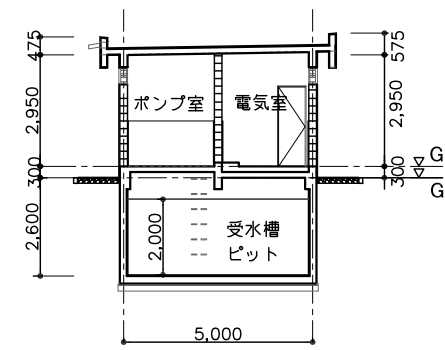

断面図 (短辺方向)

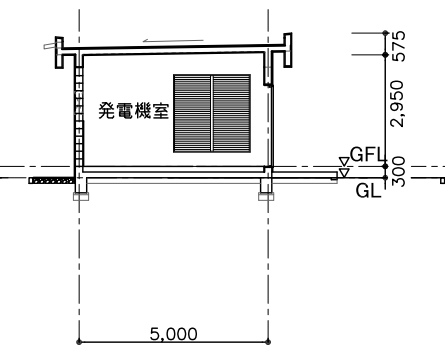

断面図 (短辺方向)

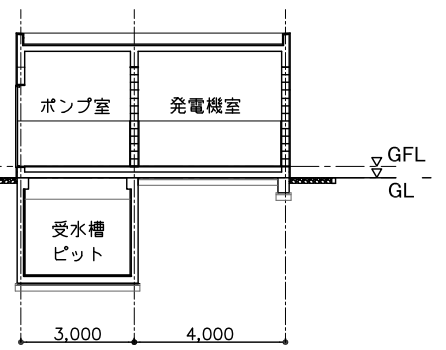

断面図 (長辺方向)

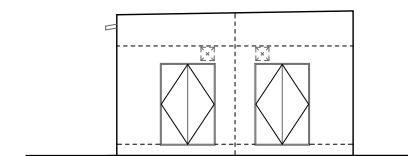

側面立面図 (南東面)

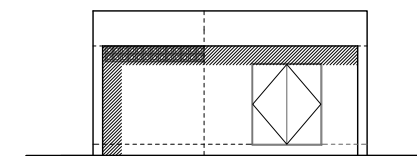

立面図 (北東面)

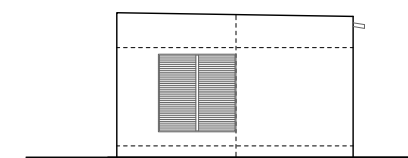

側面立面図 (北西面)

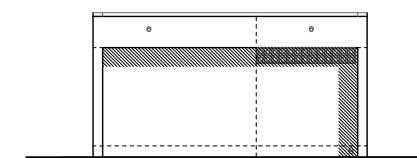

立面図 (南西面)

