

Bagian II Studi Kelayakan
Gambar-Gambar

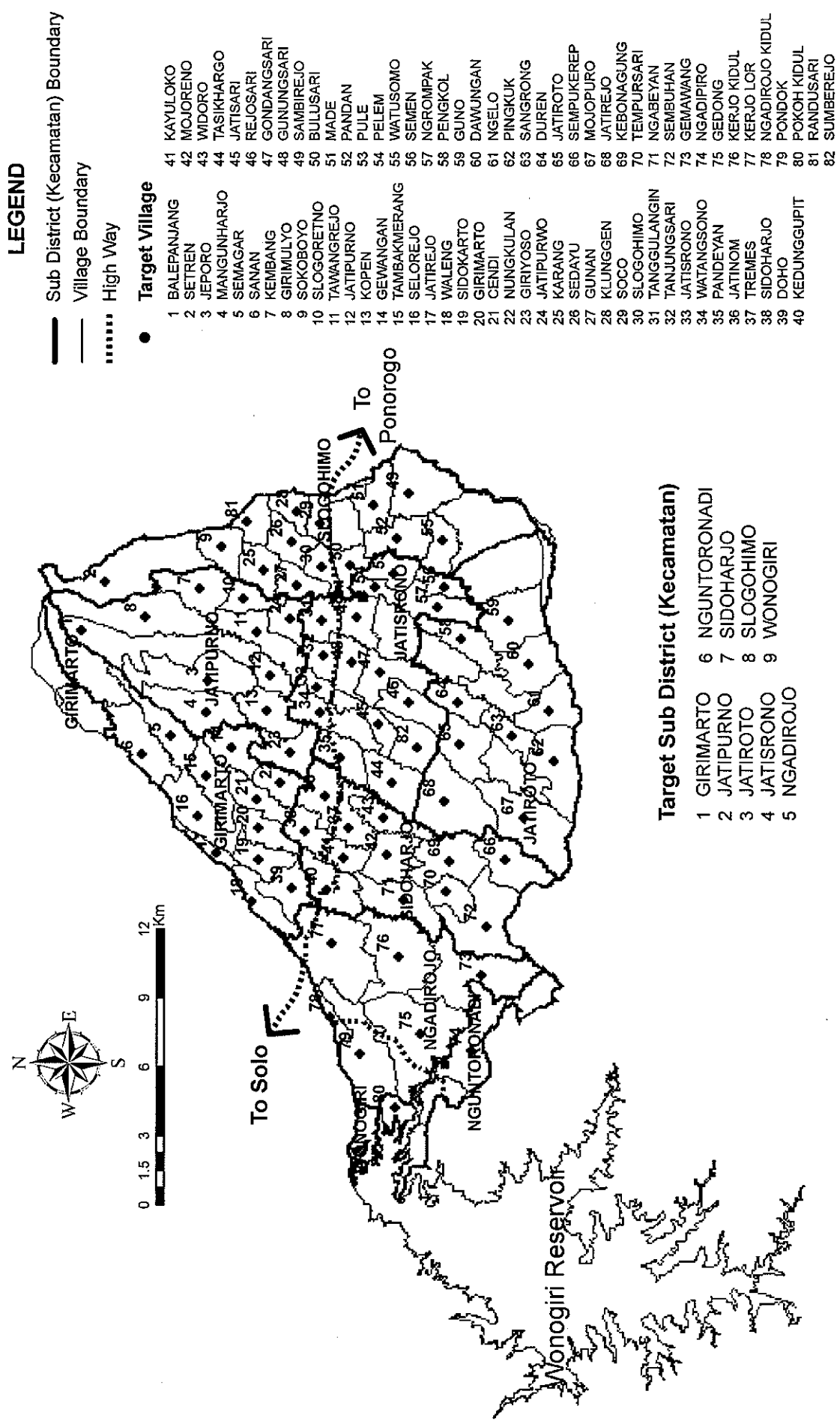

Gambar 2.1.1 Batas Administrasi DAS Keduang

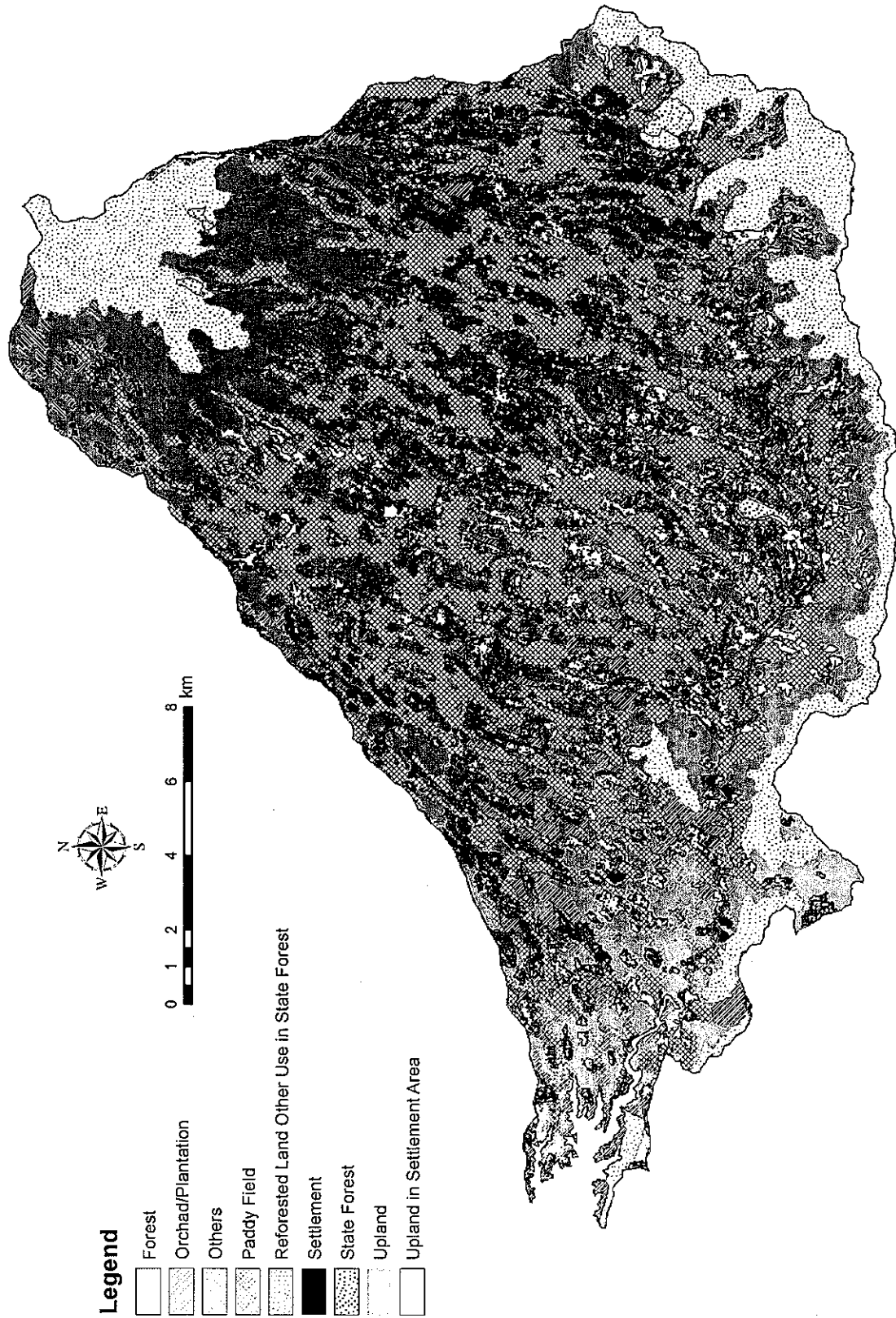

Gambar 2.3.1 Pemanfaatan Lahan DAS Keduang pada Saat Ini

SHFD(4,000m³/s) B=250m

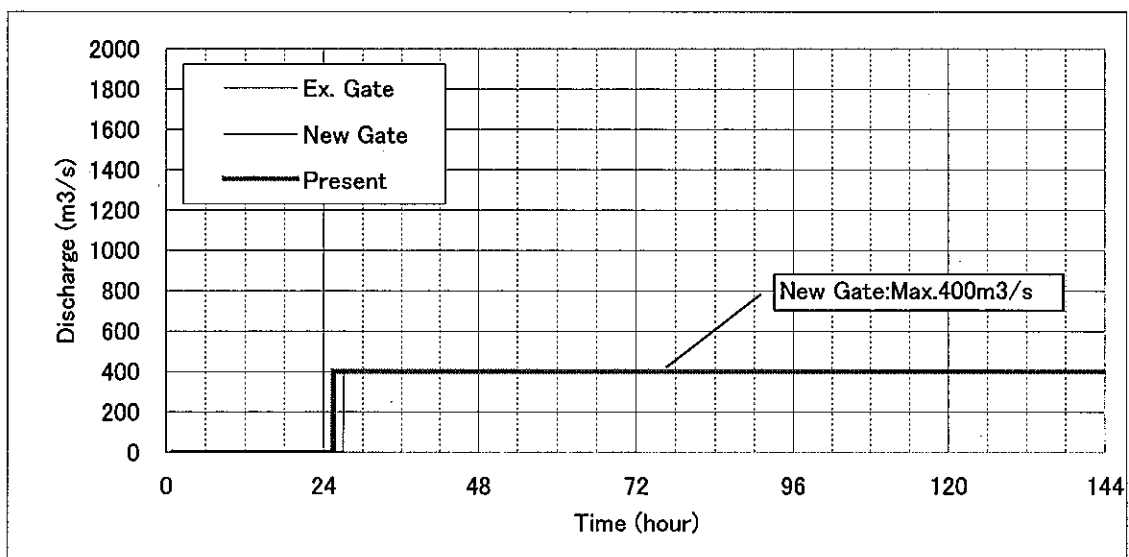
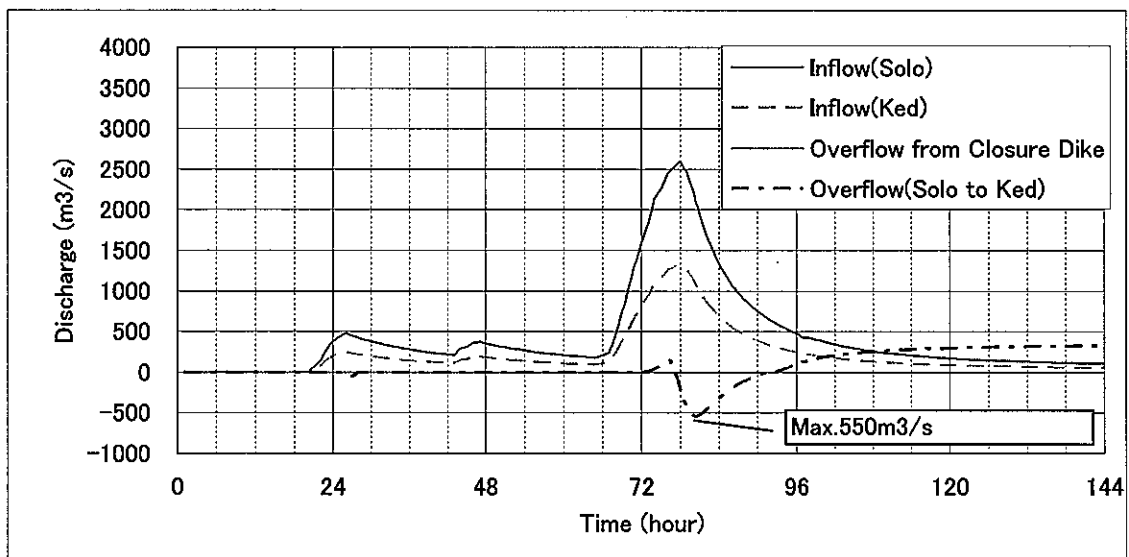
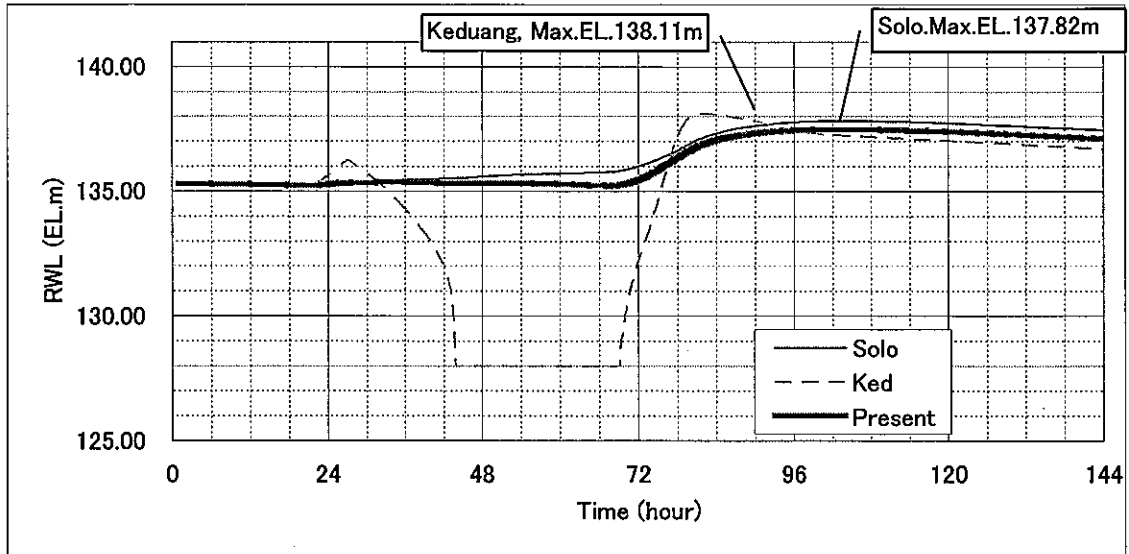

Source: JICA Study Team

Gambar 3.1.8 Banjir Rutin untuk Tinggi Standar Debit Banjir

Spillway Design Discharge (5,100m³/s)

B=250m

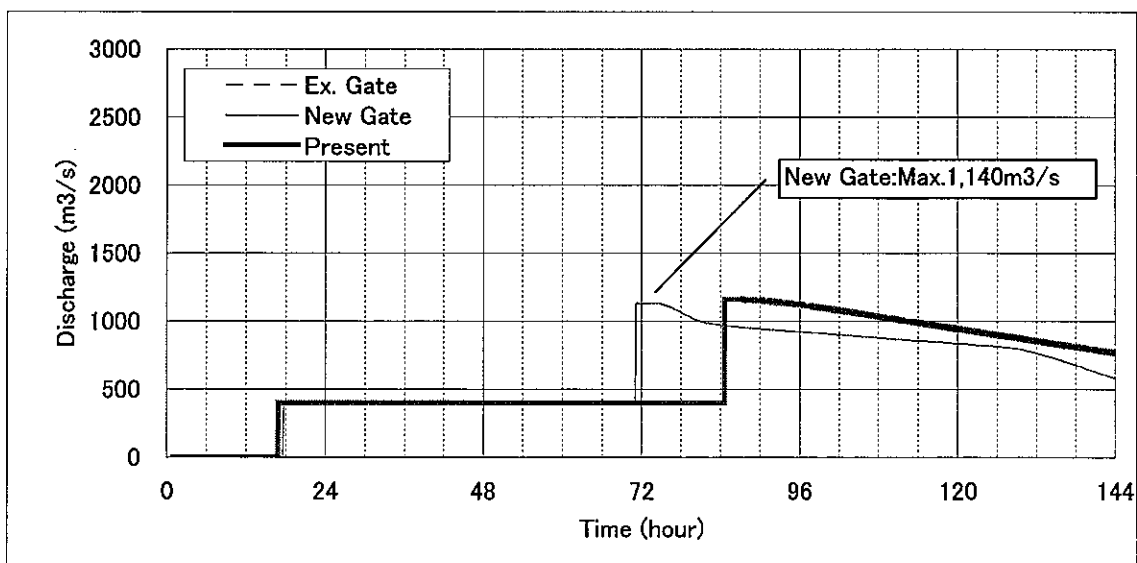
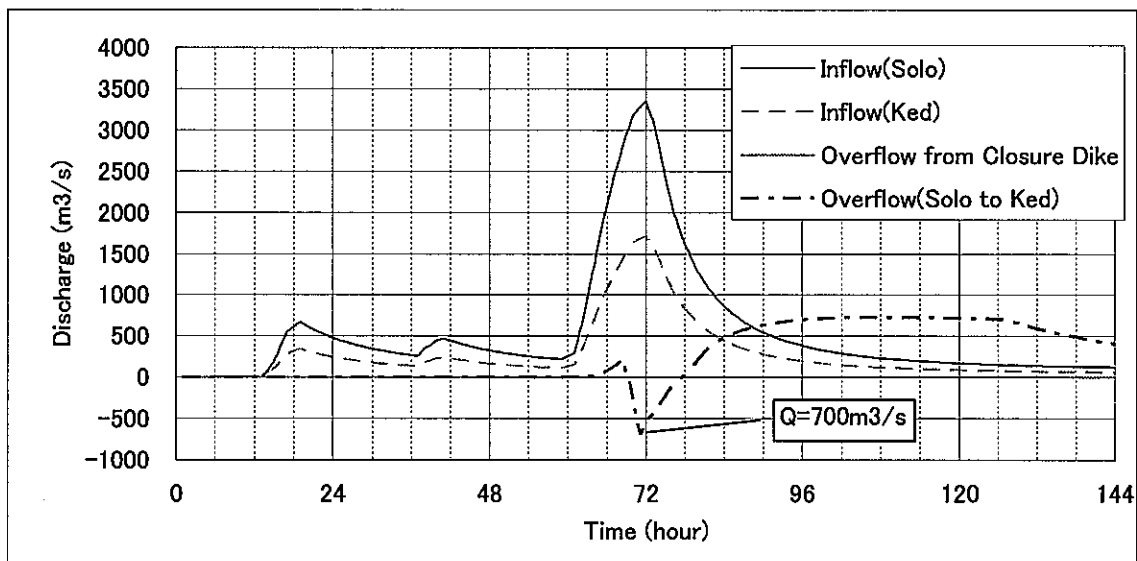
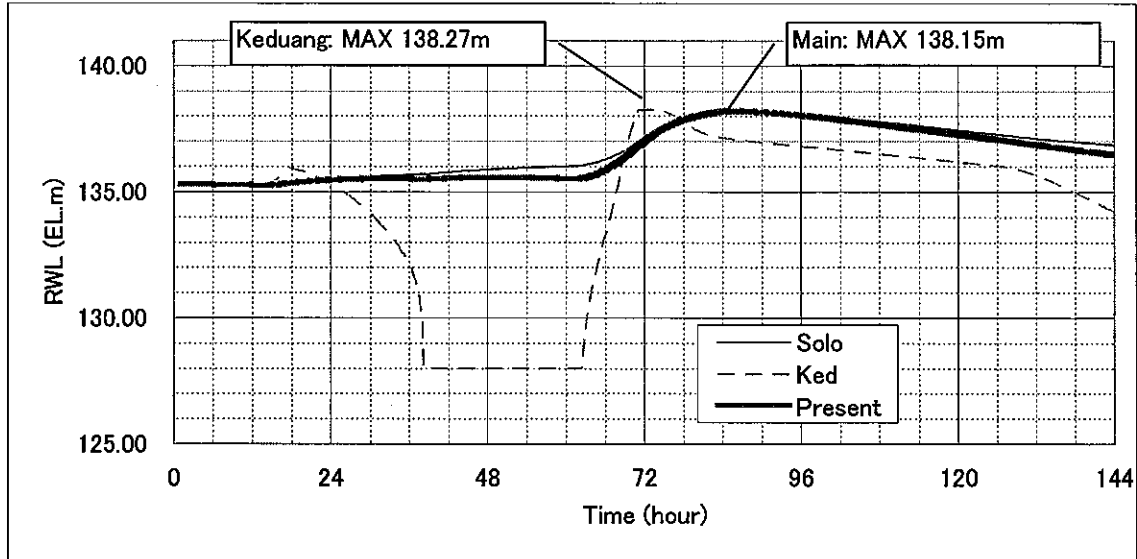

Source: JICA Study Team

Gambar 3.1.9 Banjir Rutin untuk Desain Debit Spillway

PMF(9,600m³/s)

B=250m

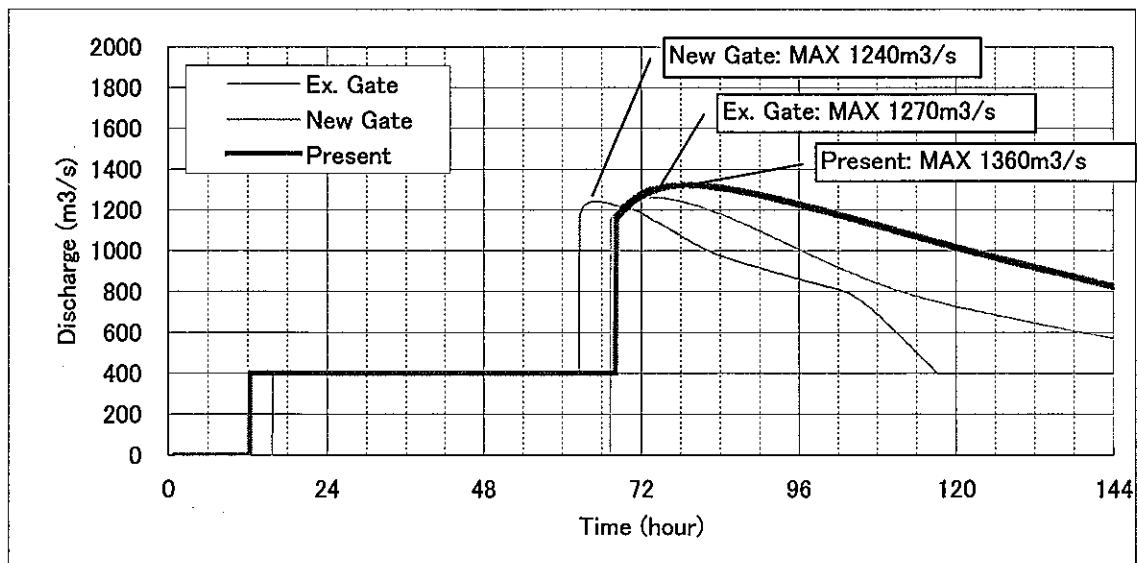
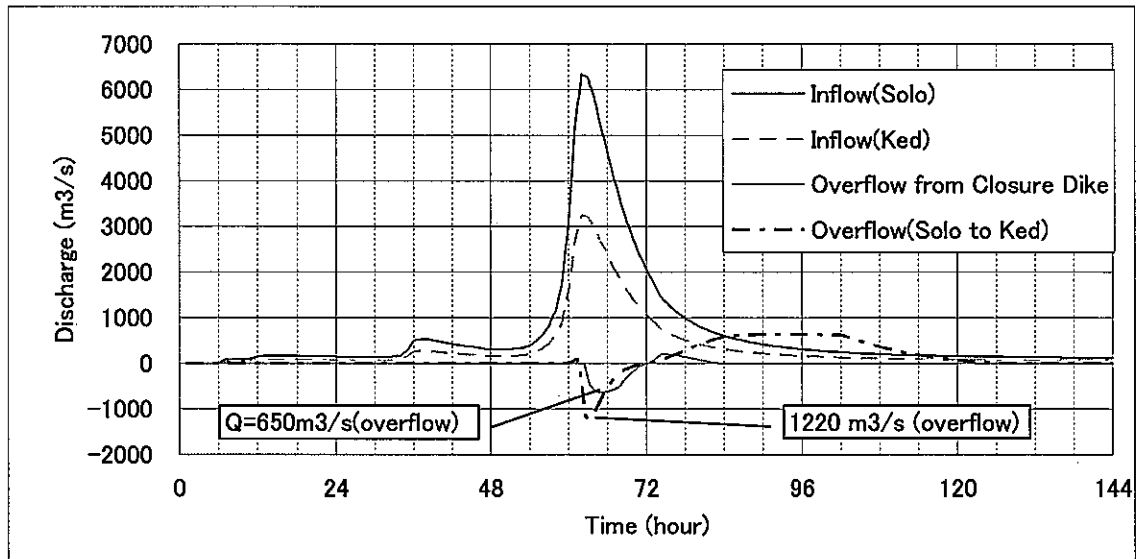
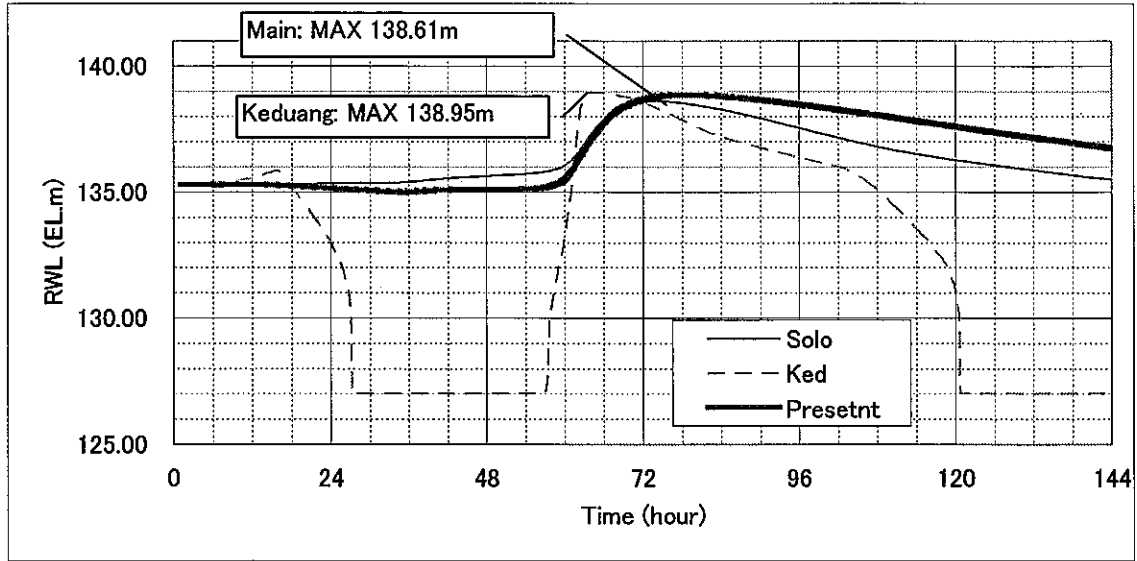

Source: JICA Study Team

Gambar 3.1.10 Banjir Rutin untuk Kemungkinan Banjir Maksimum

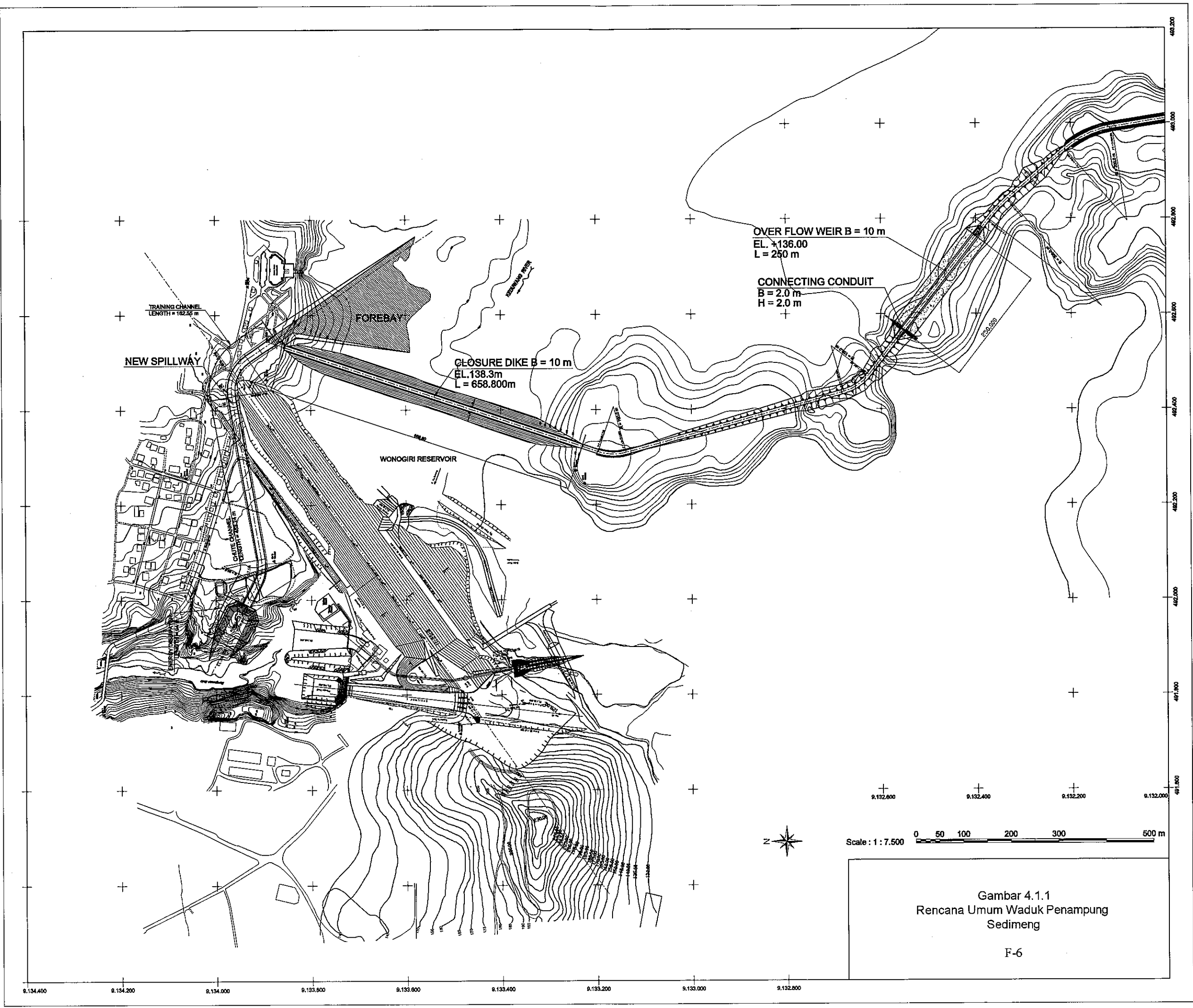

Gambar 4.1.1
Rencana Umum Waduk Penampung
Sedimeng

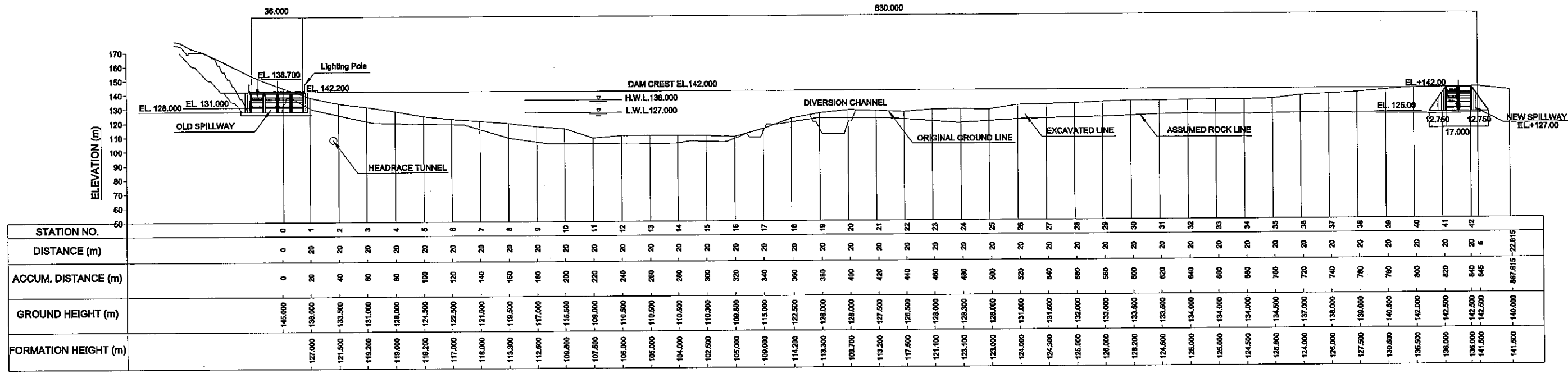

LONGITUDINAL PROFILE DAM CREST

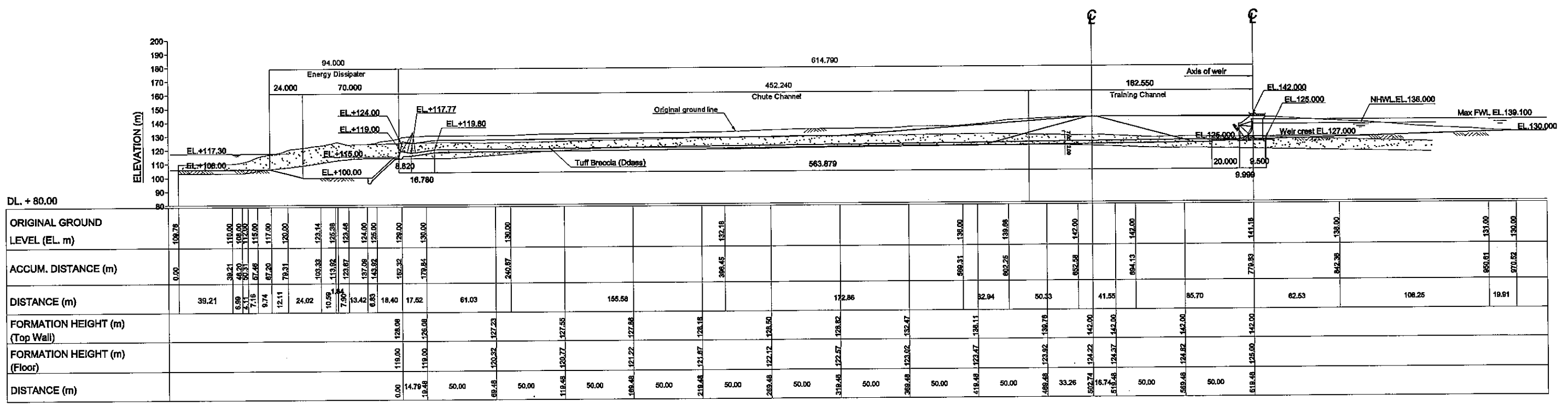

LONGITUDINAL PROFILE OF NEW SPILLWAY

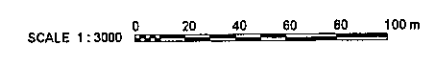

Gambar 4.2.2
Profil Spillway Baru

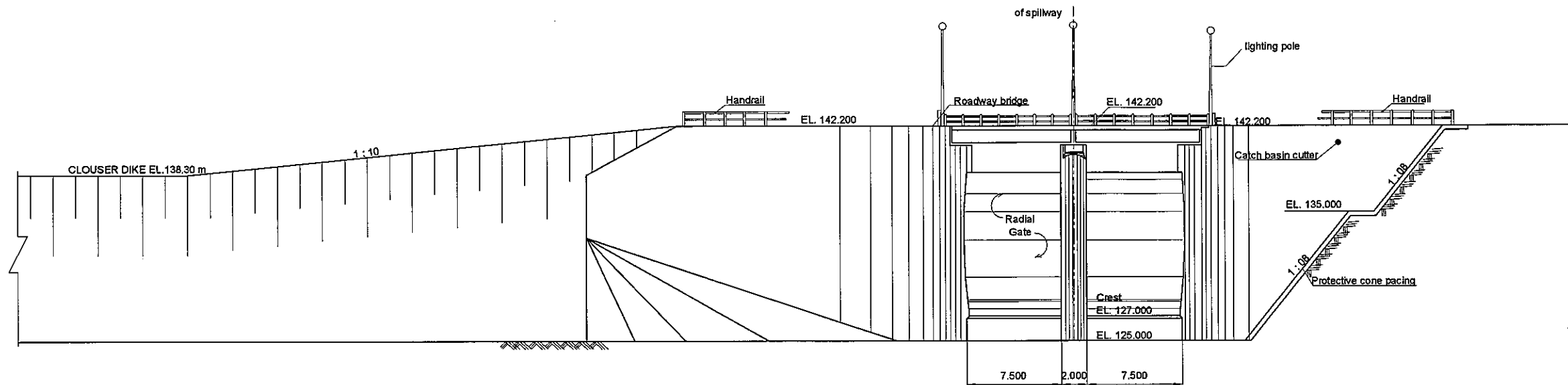

FRONT

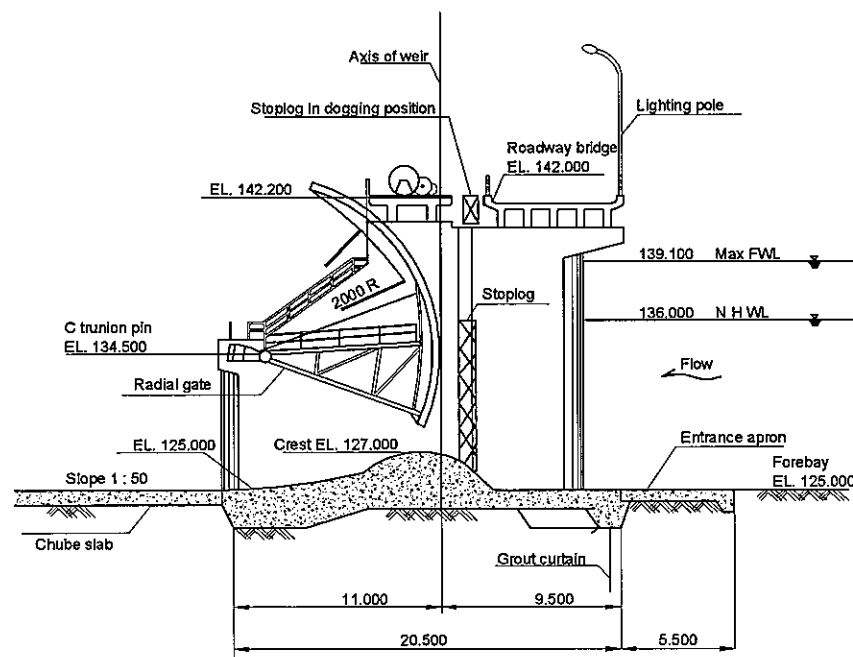

SECTION

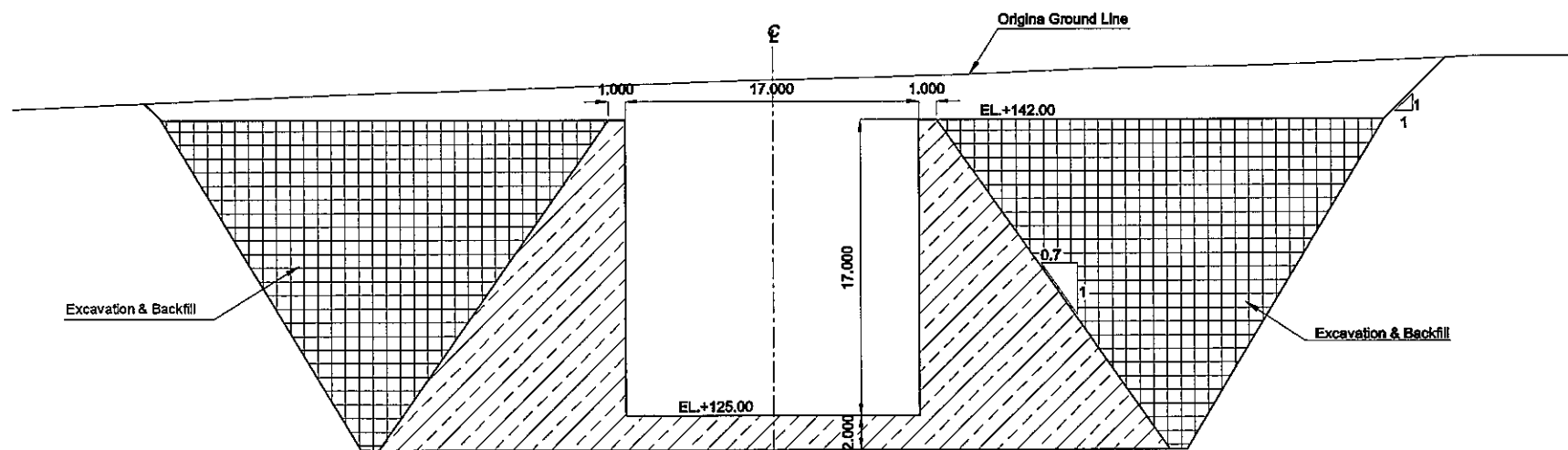

TYPICAL-2 SPILLWAY
P.7- P.12

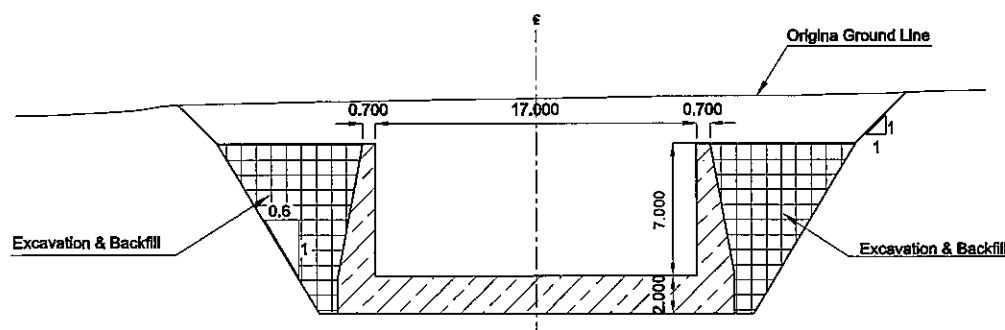

TYPICAL-1 SPILLWAY
P.0 - P.6

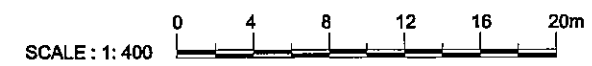

Gambar 4.2.5
Pintu Baru dan Tipe Potongan Melintang Spillway

PLAN OF CLOSURE DIKE
SCALE : 1 : 3000

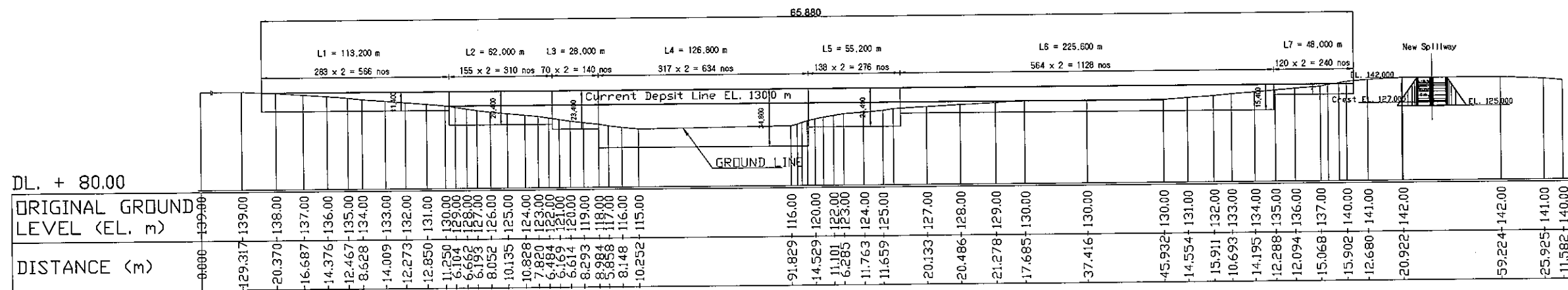
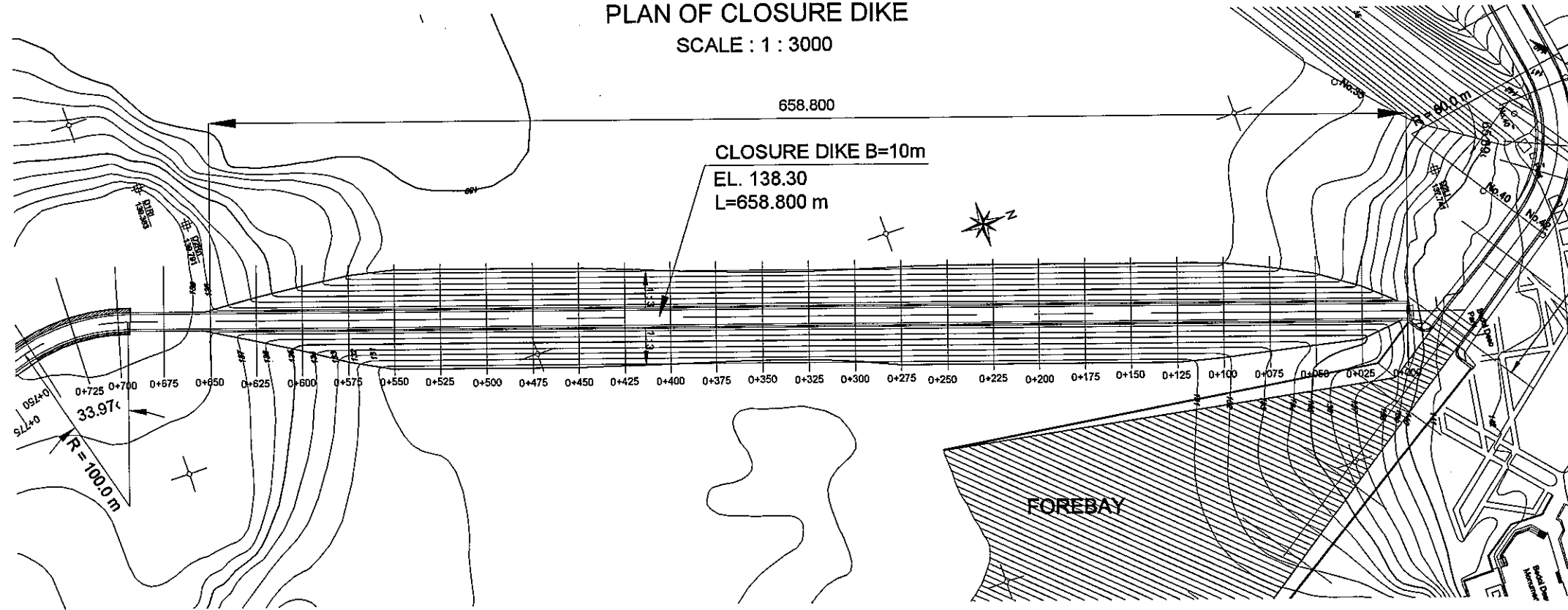

LONGITUDINAL PROFILE OF CLOSURE DIKE
Scale : 1 : 2500

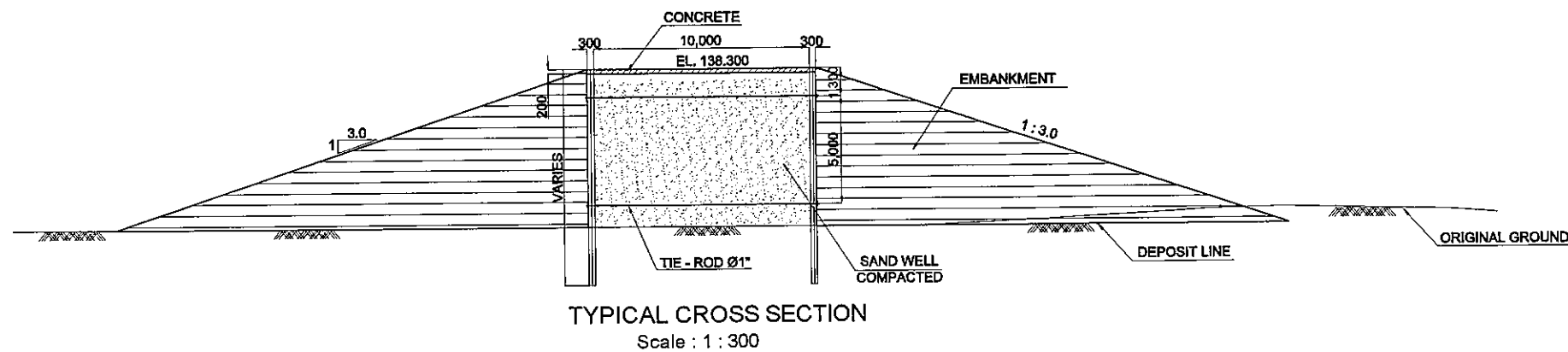

Scale : 1 : 2500 0 10 20 40 60 80 100 m

Gambar 4.3.1
Rencana dan Konstruksi Waduk Penutup

PLAN OF OVERFLOW DIKE
Scale : 1 : 2000

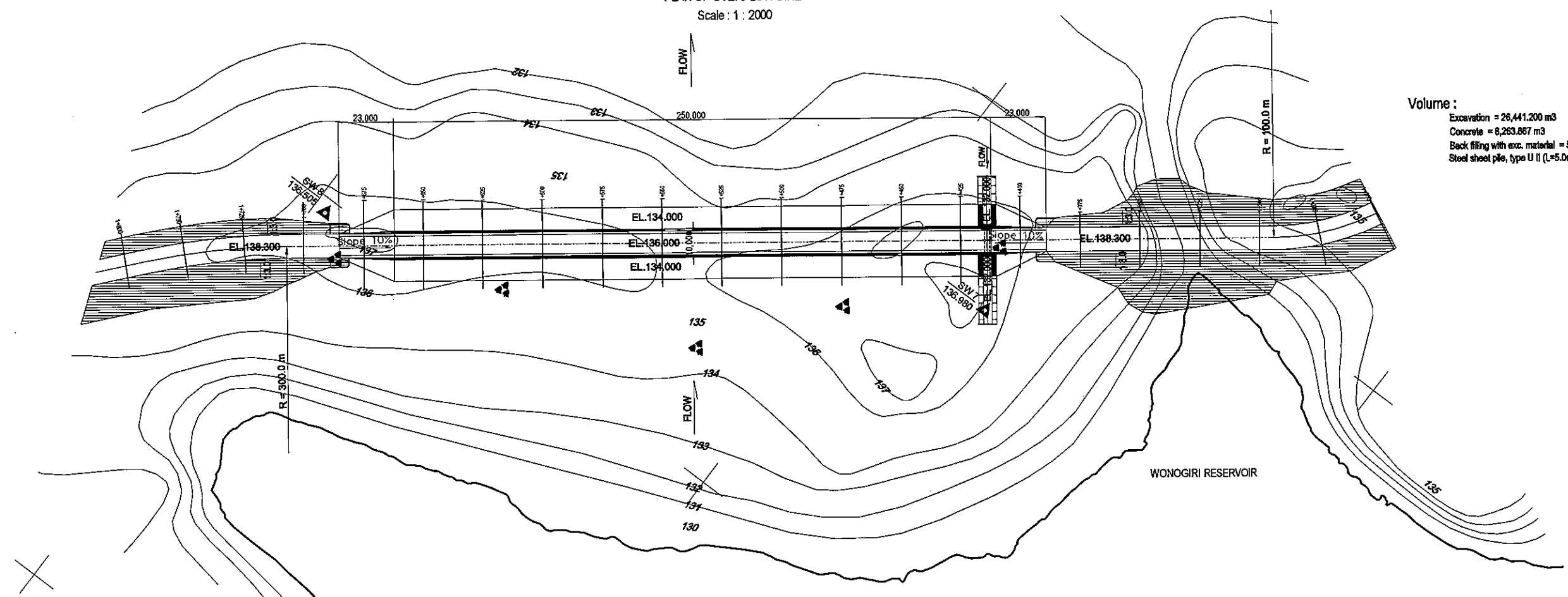

Volume :
Excavation = 26,441.200 m³
Concrete = 6,263.867 m³
Back filling with exc. material = 5,321.500 m³
Steel sheet pile, type U II (L=5.0m) = 592.0 m²

LONGITUDINAL PROFILE OVER FLOW DIKE

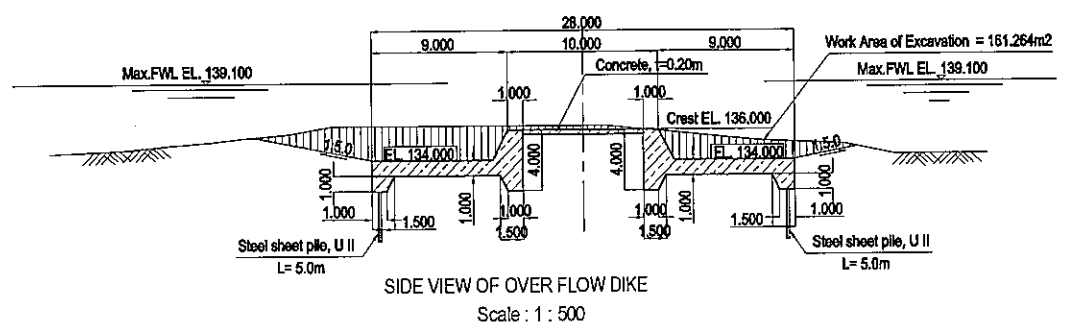
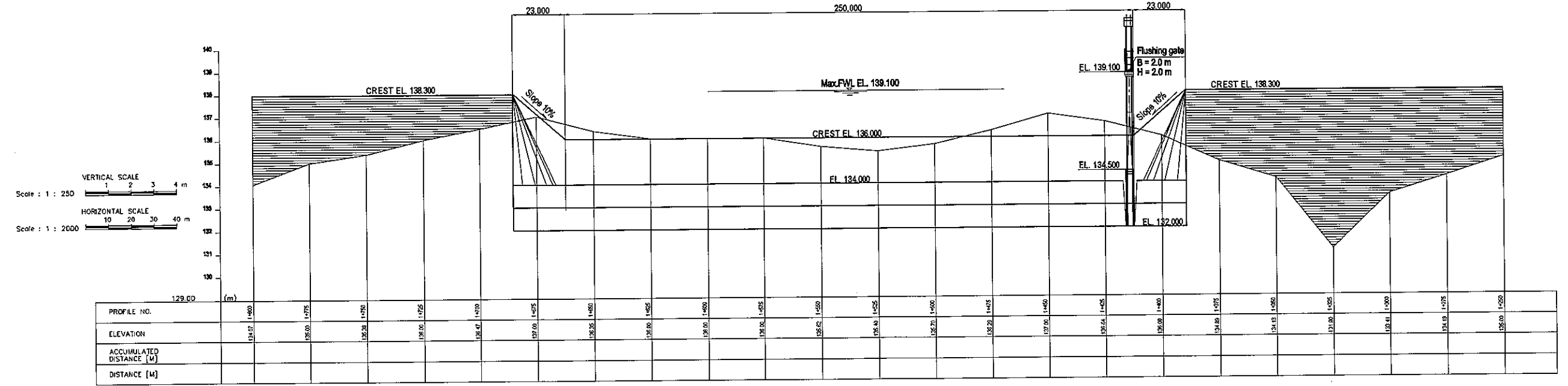

Gambar 4.4.1
Rencana dan Konstruksi Waduk Pelimpah
F-11

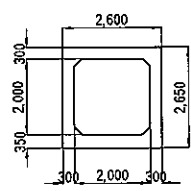
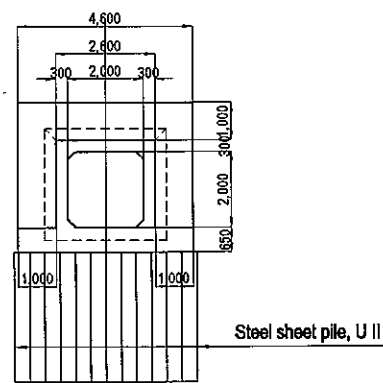
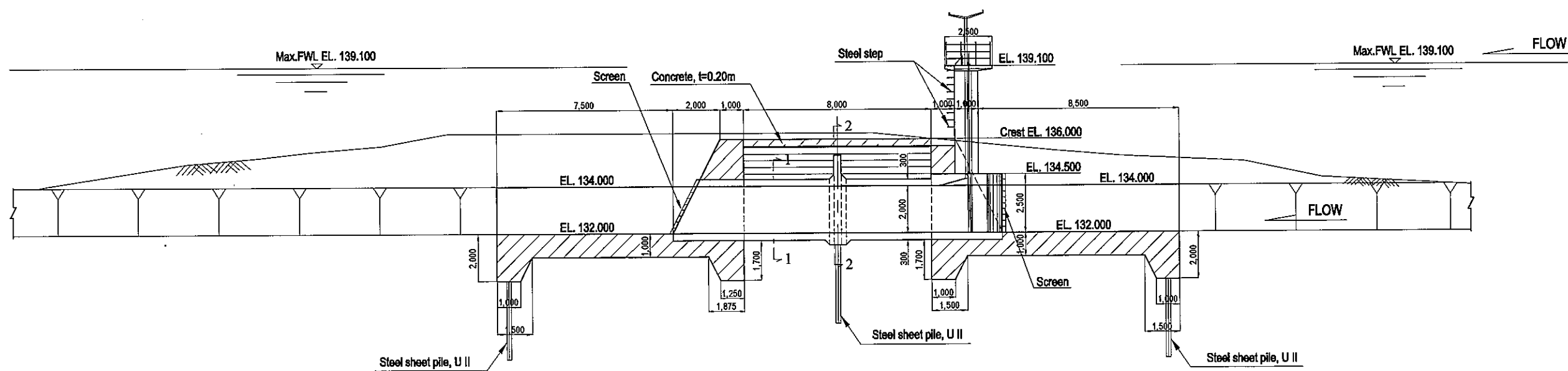
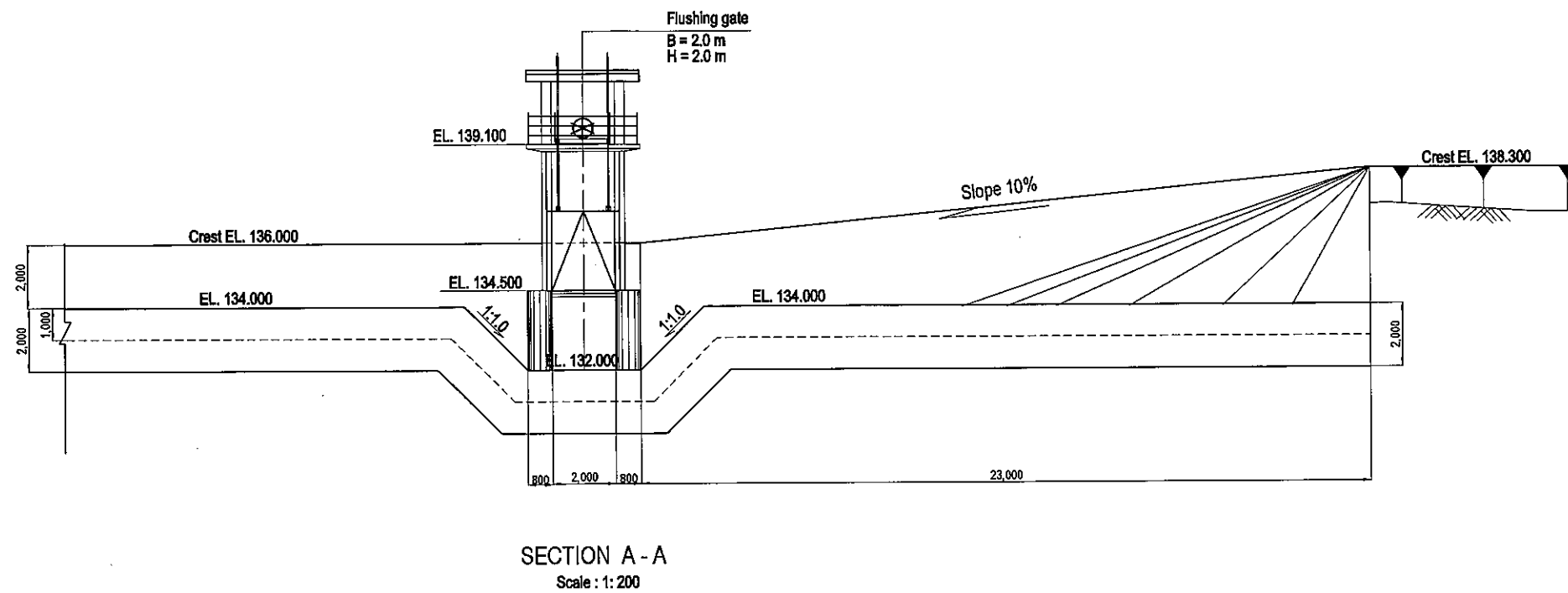
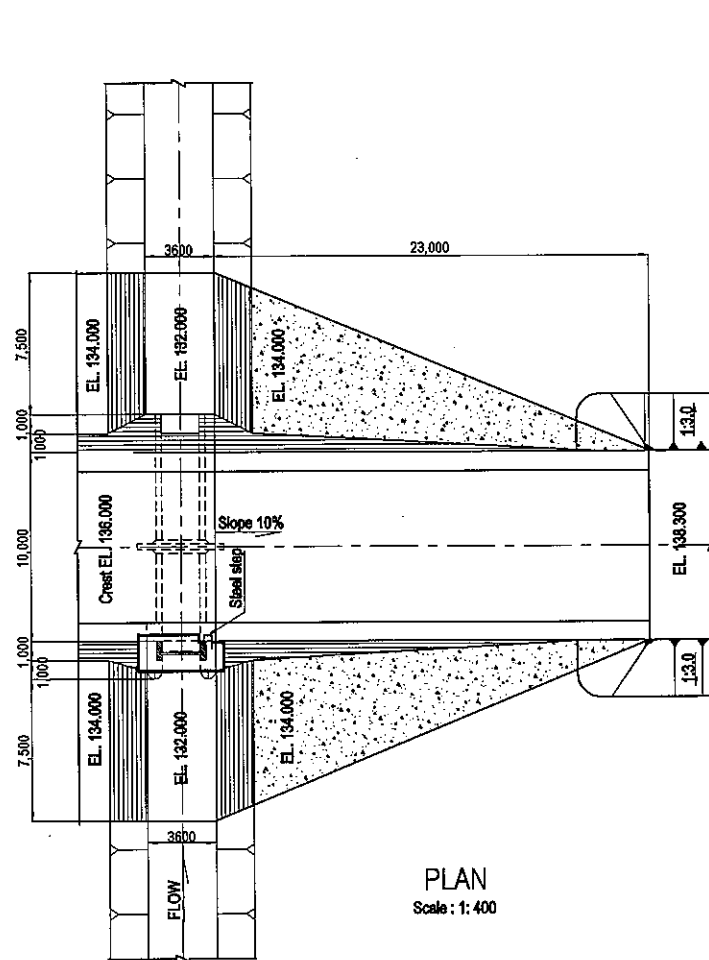

Gambar 4.4.3
Rencana dan Penampang Waduk Pelimpah
F-12

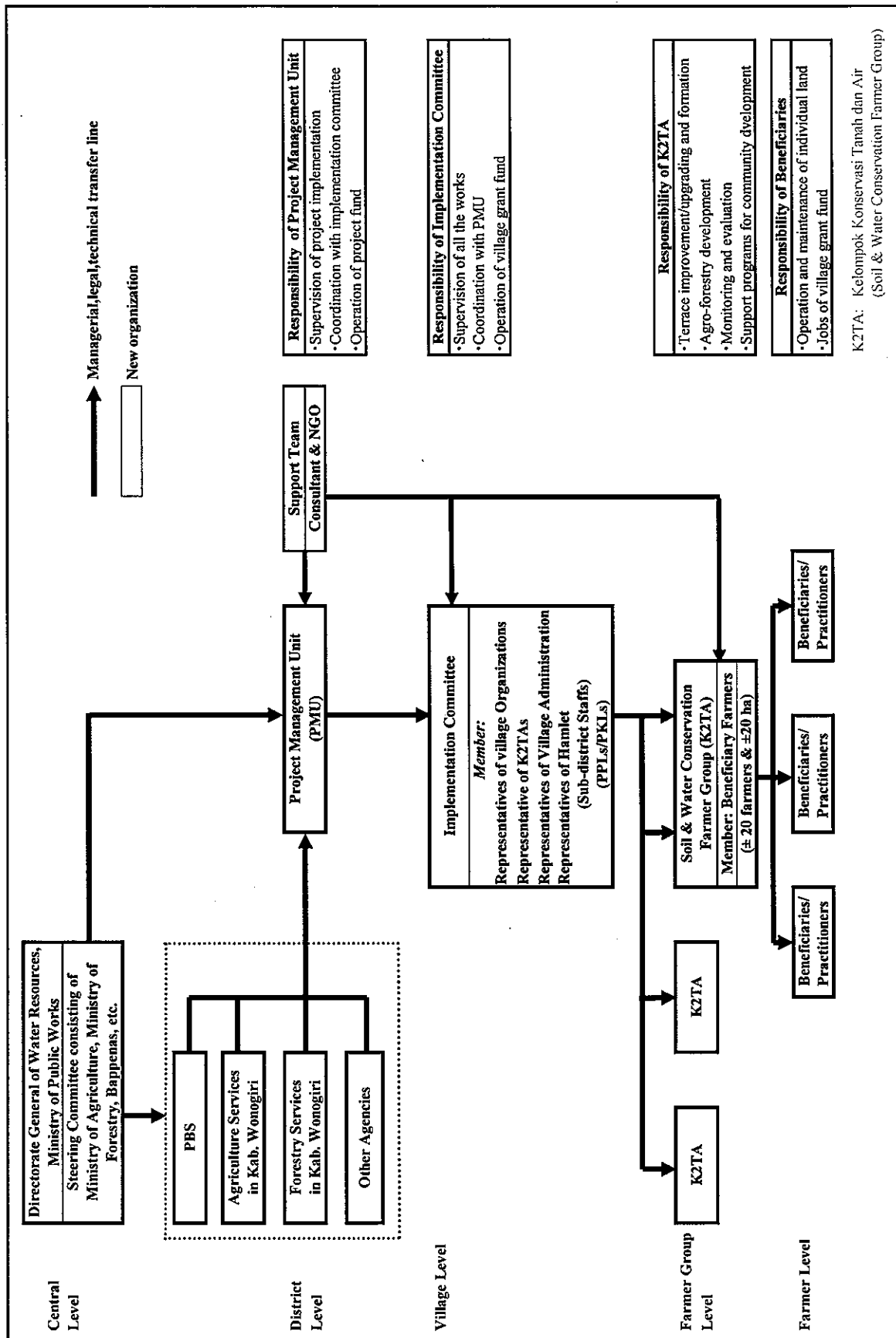

Gambar 9.4.1 Pembentukan Organisasi di Tingkat Desa dan Lapangan untuk Pelaksanaan Pengerjaan Konservasi DAS

Lampiran

Lampiran 1	Scope of Work
Lampiran 2	Minutes of Meeting on Scope of Work
Lampiran 3	Minutes of Meeting on Inception Report
Lampiran 4	Minutes of Meeting on Progress Report (1)
Lampiran 5	Minutes of Meeting on Progress Report (2)
Lampiran 6	Minutes of Meeting on Progress Report (3)
Lampiran 7	Minutes of Meeting on Interim Report
Lampiran 8	Minutes of Meeting on Draft Final Report
Lampiran 9	Minutes of Meeting on Draft Final Report

Lampiran 1

Scope of Work

*Scope of Work
For the Study
on
Countermeasures for Sedimentation
in the Wonogiri Multipurpose Dam Reservoir*

AGREED UPON BETWEEN

Ministry of Settlement and Regional Infrastructure

AND

Japan International Cooperation Agency

Jakarta, March 9, 2003



Dr. Ir. Moch. BASUKI H, M.Sc
Director General,
Directorate General of Water Resources,
Ministry of Settlement and Regional
Infrastructure

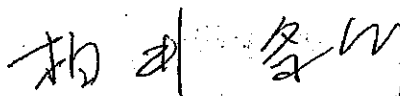

Mr. Josuke KASHIWAI
Leader of Preparatory Study Team,
Japan International Cooperation Agency

I. INTRODUCTION

In response to the official request of the government of the Republic of Indonesia (hereinafter referred to as "Government of Indonesia"), the Government of Japan decided to conduct the Study on Countermeasures for Sedimentation in the Wonogiri Multipurpose Dam Reservoir (hereinafter referred to as "the Study") in accordance with the relevant laws and regulations in force in Japan.

Accordingly, the Japan International Cooperation Agency (hereinafter referred to as "JICA"), the official agency responsible for the implementation of the technical cooperation programs of the Government of Japan, will undertake the Study in close cooperation with the authorities concerned of the Government of Indonesia (hereinafter referred to as "Indonesian side").

The present document sets forth the Scope of Work with regard to the Study.

II. OBJECTIVES OF THE STUDY

The objectives of the Study are:

1. To formulate a master plan for sustainable countermeasures for sedimentation problems in the Wonogiri multipurpose dam reservoir,
2. To conduct a feasibility study of the selected priority project(s), and
3. To transfer technology to counterpart personnel in the course of the Study.

III. STUDY AREA

The study area will cover the entire catchment of the Wonogiri dam and downstream reach of the Solo from the Wonogiri dam to the confluence of the Madiun River.

IV. SCOPE OF THE STUDY

In order to achieve the objectives mentioned above, the Study will cover the following items:

1. Formulation of master plan
 - 1.1 Ensuring the function of the water intake of the Wonogiri dam
 - 1.1.1 Sediment removal system
 - 1.2 Countermeasure for sedimentation of the whole Wonogiri dam reservoir
 - 1.2.1 Watershed conservation
 - 1.2.2 Structural countermeasures
 - 1.2.3 Operational countermeasures
 - 1.3 Institutional plan
 - 1.3.1 Operation and Maintenance plan of the Wonogiri dam and watershed conservation facilities
 - 1.3.2 Institutional strengthening plan of watershed management and the Wonogiri dam management
 - 1.3.3 Financial plan of watershed management and the Wonogiri dam management
 - 1.4 Cost estimation
 - 1.5 Project Evaluation
 - 1.5.1 Technical evaluation
 - 1.5.2 Financial evaluation

- 1.5.3 Economic evaluation
 - 1.5.4 Environmental and Social evaluation (Initial Environmental Examination Level)
 - 1.6 Selection of Master Plan project
 - 1.7 Implementation Schedule
 - 1.8 Monitoring and Evaluation Plan
 - 1.9 Selection of Priority Project(s) for Feasibility Study
- 2 Feasibility Study on the selected priority project(s)
 - 2.1 Verification test and its technical evaluation (for proposal(s) for ensuring the function of the intake)
 - 2.2 Preliminary design of facility(s)
 - 2.3 Operation and Maintenance plan of facility(s)
 - 2.4 Project cost estimation and financial analysis
 - 2.5 Project implementation plan / schedule
 - 2.6 Project Evaluation
 - 2.6.1 Financial Evaluation
 - 2.6.2 Economic Evaluation
 - 2.6.3 Technical Evaluation
 - 2.6.4 Environmental and social Evaluation (Environmental Impact Assessment Level)
- 3 Technology Transfer

V. SCHEDULE OF THE STUDY

The Study will be carried out in accordance with the tentative schedule as attached in ANNEX I. The schedule is tentative and subject to be modified when both JICA and Indonesian side agree upon any necessity that will arise during the course of the Study.

VI. REPORTS

JICA will prepare and submit the following reports in English to Indonesian side.

1. Inception Report:

Twenty (20) English copies will be submitted at the commencement of the Study in Indonesia.

2. Progress Report (1), (2), (3):

Twenty (20) English copies of each progress report will be submitted during the master plan study period.

3. Interim Report:

Twenty (20) English copies will be submitted when a master plan is formulated.

4. Draft Final Report:

Twenty (20) English copies will be submitted just after the end of feasibility study. Indonesian side shall submit its comments within one (1) month after the receipt of the Draft Final Report.

5. Final Report (Summary, Main Report, Supporting Report, and/or Data Book):

Twenty (20) English copies will be submitted within one (1) month after the receipt of the comments on the Draft Final Report.

VII. UNDERTAKINGS OF THE GOVERNMENT OF INDONESIA

- 1 To facilitate the smooth conduct of the Study, the Government of Indonesia shall take following necessary measures:
 - 1.1 To permit the members of the Japanese study team (hereinafter referred to as "the Team") to enter, leave and sojourn in Indonesia for the duration of their assignments therein and exempt them from foreign registration requirements and consular fees;
 - 1.2 To exempt the members of the Team from taxes, duties, and any other charges on equipment, machinery and other materials brought into and out of Indonesia for the implementation of the Study;
 - 1.3 To exempt the members of the Team from income tax and charges of any kind imposed on or in connection with any emoluments or allowances paid to the members of the Team for their services in connection with the implementation of the Study; and
 - 1.4 To provide necessary facilities to the Team for remittance as well as utilization of the funds introduced into Indonesia from Japan in connection with the implementation of the Study.
- 2 The Government of Indonesia shall bear claims, if any arises, against a member(s) of the Team resulting from, occurring in the course of, or otherwise connected with, the discharge of their duties in the implementation of the Study, except when such claims arise from gross negligence or willful misconduct on the part of the member of the Team.
- 3 Directorate General of Water Resources (hereinafter referred to as "DGWR"), Ministry of Settlement and Regional Infrastructure shall act as a counterpart agency to the Team and also as a coordinating body in relation to other governmental and non-governmental organizations for the smooth implementation of the Study.
- 4 DGWR shall, at its own expense, provide the Team with the following, in cooperation with other organizations concerned:
 - 4.1 Security-related information as well as measures to ensure the safety of the Team;
 - 4.2 Information on as well as support in obtaining medical service;
 - 4.3 Available data and information related to the Study;
 - 4.4 Counterpart personnel;
 - 4.5 Suitable office space with necessary office equipment; and
 - 4.6 Credentials or identification cards.

VIII. CONSULTATION

JICA and DGWR shall consult with each other in respect of any matter that may arise from or in connection with the Study.

Annex I

Tentative Schedule

Month	1	2	3	4	5	6	7	8	9	10	11	12	13	14	15	16	17	18	19	20	21	22	23	24	
Work																									
Phase																									
Report	IC/R				P/R(1)					P/R(2)						P/R(3)							IT/R		
Seminar / Workshop	▲				▲					▲						▲							▲		

Month	25	26	27	28	29	30	31	32	33	34	35	36
Work												
Phase												
Report									DF/R		F/R	
Seminar / Workshop									▲			▲

IC/R: Inception Report, P/R: Progress Report, IT/R: Interim Report,
 DF/R: Draft Final Report, F/R: Final Report

Lampiran 2
Minutes of Meeting on Scope of Work

Minutes of Meetings on
Scope of Work
For the Study
on
Countermeasures for Sedimentation
in the Wonogiri Multipurpose Dam Reservoir

AGREED UPON BETWEEN

Ministry of Settlement and Regional Infrastructure
AND
Japan International Cooperation Agency

Jakarta, March 9, 2003



Dr. Ir. Moch. BASUKI H, M.Sc
Director General,
Directorate General of Water Resources,
Ministry of Settlement and Regional
Infrastructure

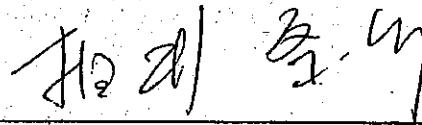

Mr. Josuke KASHIWAI
Leader of Preparatory Study Team,
Japan International Cooperation Agency

Introduction

Japan International Cooperation Agency (hereinafter referred to as "JICA"), in response to the official request of the government of the Republic of Indonesia (hereinafter referred to as "Government of Indonesia"), dispatched a Preparatory Study Team led by Mr. Josuke KASHIWAI, from February 29th to March 9th, 2004 to discuss and determine the Scope of Work for the Study on Countermeasures for Sedimentation in the Wonogiri Multipurpose Dam Reservoir (hereinafter referred to as "the Study").

The Preparatory Study Team carried out a field survey in the Study area, and held a series of discussions with the Directorate General of Water Resources, Ministry of Settlement and Regional Infrastructure (hereinafter referred to as "DGWR"), Central Java Province, Wonogiri Regency, Bengawan Solo River Basin Development Project, Perum Jasa Tirta I (hereinafter referred to as "PJT-I") and other authorities concerned.

The Minutes of Meeting summarize the results of discussions between the Preparatory Study Team and the related agencies of the Government of Indonesia (hereinafter referred to as "Indonesian side"). The list of attendees is attached in Appendix 1. Main items discussed are as follows.

1. Steering Committee

The Preparatory Study Team and Indonesian side (hereinafter referred to as "both sides") agreed that the Indonesian side would set up a Steering Committee under the initiative of DGWR. The Committee will comprise the following organizations, and the other organizations could be included if DGWR and the team of the Study (hereinafter referred to as "the Study Team") recognize its necessity.

- a. Ministry of Settlement and Regional Infrastructure (as chairman)
- b. BAPPENAS (National Planning Board)
- c. Ministry of Forestry
- d. Ministry of Home Affairs
- e. State Ministry of Environment
- f. Ministry of Agriculture

The Steering Committee shall monitor progress of the Study and provide guidance related to National policies, regulations, principle and procedure, while coordinating. The Committee shall also provide necessary resources for the Study Team in order to improve and supporting their activities.

2. Technical Working Groups

Both sides agreed that the Indonesian side would organize some Technical Working Groups, which would handle the technical and scientific aspects or activities in relation to the Study. They should ensure that all related accurate data and information obtained in the course of the Study. The Technical Working Groups will be composed of the following organizations.

Watershed Conservation

- a. Ministry of Settlement and Regional Infrastructure
- b. Ministry of Forestry
- c. Ministry of Home Affairs
- d. State Ministry of Environment
- e. Central Java Province
- f. Wonogiri District

Sediment removal system near the intake, and structural and operational countermeasures for sediment in Wonogiri dam:

- a. Ministry of Settlement and Regional Infrastructure
- b. State Ministry of Environment
- c. Bengawan Solo River Basin Development Project
- d. PJT-I
- e. Central Java Province
- f. Balai PSDA Bengawan Solo

3. Collaboration with Universities and/or Institutions in Indonesia

Both sides agreed that universities and/or institutions in Indonesia should be involved in the Study, in order to support activities of the study (for example experiments and/or simulations) and to follow up or monitor proposed project(s) after completion of the Study.

Both sides also agreed that those universities and/or institutions would be determined under consultation between Indonesian side and JICA Indonesia Office by the commencement of the Study.

4. Environment and Social Consideration Based on JICA's New Guidelines

The Preparatory Study Team explained that the background and the present situation on the revision of JICA's "Guidelines for Environmental and Social Considerations" and that the new basic approaches set forth in the Guideline accordingly should be applied to the Study.

The Indonesian side understood the new guidelines and promised to have responsibilities for explanation to stakeholders and reply to their comments from the early stage of the Study. The Indonesian side, however, requested technical and financial support. The Preparatory Study Team promised to convey the requests to JICA Headquarters.

5. Information Disclosure

Both sides agreed that Indonesian side and JICA should dispose information. The Preparatory Study Team explained that information disclosure was necessary to ensure the participation of and dialogues with various stakeholders for taking accountability in order to achieve appropriate environmental and social considerations.

Both side agreed that all reports prepared during the study should be opened to the public.

6. Basic Studies

Both sides agreed that basic studies (such as topographic survey in the reservoir and taking water samples) should be carried out in the Study.

7. Study Schedule

Both sides agreed following three items.

- 1) Countermeasure(s) for sedimentation problem near the intake should be finalized in two years as requested by Government of Indonesia had requested, because intake would be closed near future and the problem had to be solved urgently.
- 2) Watershed Conservation Plan should be formulated in two years as Government of Indonesia had requested, because it could be possible.
- 3) Countermeasure(s) for sedimentation problem of whole the Wonogiri dam reservoir should be finalized in three years.

8. Verification test(s)

Both sides agreed that verification test(s) should be conducted if necessary after the selection of countermeasure(s) from conceivable alternatives.

9. Report of Indonesian version

Both sides agreed that each main and/or summary report should be prepared in Indonesian as well as English in order for Indonesian side to understand easily and utilize effectively a result of the Study.

Both side also agreed that English version should be formal if any discrepancy were found between two version.

10. Undertakings of the Government of Indonesia

The Indonesian side promised to provide adequate office space (at least for twenty (20) people) with desks, chairs, and telephone lines. The Indonesian side, however, explained that it was difficult to provide some office equipment (for example personal computer, copy machine and facsimile machine), and requested that JICA should prepare them. The Preparatory Study Team promised to convey the requests to JICA Headquarters.

11. Seminars / Workshops for Technology Transfer

Both sides agreed that seminars and workshops would be essential to provide necessary information and knowledge for the central, the provincial, and the regional government staff.

12. Counterpart Training

The Indonesian side requested that JICA conduct counterpart training in Japan for the personnel of the agencies concerned in order to transfer technology smoothly during the Study.

The Preparatory Study Team promised to convey the requests to JICA Headquarters.

13. Counterpart Personnel

The Indonesian side promised following two items.

- 1) Indonesian side would assign one part-time counterpart personnel for each expert of the Study Team and two or three full time counterpart personnel for the Study Team.
- 2) List of counterpart personnel would be submitted to JICA by the commencement of the Study.

Both sides agreed that counterpart personnel should be Indonesian government officials.

14. Indonesian Consultants to Support Indonesian Counterpart Personnel

Both sides agreed following two items.

- 1) Indonesian side would assign Indonesian consultants at its own expense in order to support Indonesian counterparts.
 - 2) The Study Team would transfer their knowledge in relation to the Study to Indonesian consultants, who would be assigned by Indonesian side, as well as Indonesian counterpart.
- 

ANNEX: List of Attendees

Indonesian side

KINPRASWIL: Mr. Djoko Subarkah

(Director, Directorate of Water Resources for Central Region)

Mr. Prasidananto Nungroho

(Directorate of Water resources for Central Region)

Mr. Djoko Sundjotmiko (Dit. PSDA, Conservation Section)

Mr. Beckey. S (Dit. PSDA, Institution Section)

Mr. Soekistiarso (Dit. Bintek, River, Dams)

PSDA Bengawan Solo:

Mr. Eko Subekti (Manager of Implementation)

Mr. Sunder Sono (Project manager)

Mr. Sudi Horsono, Mr. Tri Rohadi, Mr. Erwin B, Mr. Sudarsono,

Mr. Risuantorg, Mr. Bambang Nurhadi, Mr. Widihardjo

PJT1: Mr. Rismantro, Mr. Stioso Budirahadjo

BAPPEDA Wonogiri:

Mr. Suprpto, Mr. Haryono

PRINDAG KOP: Mr. Sri Jarwadi

WANPERTA: Mr. Heru Stutopo, Mr. Mardjito

DINKESOS: Mr. Endang Sri Rejek, Mr. Eni Purwanti

PDAM: Mr. Djuwarso

DPAR: Mr. Gatot Hariadi

DPPSB: Mr. Ananto

DISNAKER: Mr. C. Suharnng

PERTANIAN: Mr. Guduh Santoso

PERHUBUNGAH:

Mr. Wanyuti

JICA Expert Mr. Shunichi Maeda (KINPRASWIL)

Japanese side

JICA Preparatory Study Team

Mr. Josuke Kashiwai (Team Leader, Public Works Research Institute)

Mr. Masayuki Shiraishi (Tokyo Electric Power Services Co., Ltd.)

Mr. Ichiro Tanaka (OYO International Corporation)

Mr. Hideaki Matsumoto (JICA)

JICA Indonesia Representative Office

Mr. Shiro Nakasone

Lampiran 3
Minutes of Meeting on Inception Report

Minutes of Meeting
on
Inception Report
on
the Study on Countermeasures for Sedimentation
in the Wonogiri Multipurpose Dam Reservoir
agreed upon between
Ministry of Settlement and Regional Infrastructure
and
Japan International Cooperation Agency

Jakarta, September 8, 2004



Dr. Ir. Moch. BASUKI H, M.Sc
Director General,
Directorate General of Water Resources,
Ministry of Settlement and Regional
Infrastructure

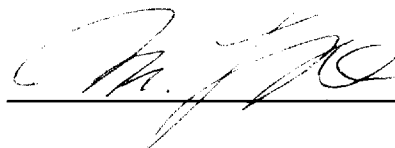

Mr. Minoru OUCHI
Leader of Study Team
Japan International Cooperation Agency

Introduction

The Government of Japan, in response to the official request of the Government of the Republic of Indonesia (hereafter referred to as "Indonesia"), decided to conduct the Study on Countermeasures for Sedimentation in the Wonogiri Multipurpose Dam Reservoir (hereafter referred to as "the Study") and the Japan International Cooperation Agency (hereafter referred to as "JICA") dispatched the Preparatory Study Team to Indonesia from February 29 to March 9, 2004.

The Directorate General of Water Resources, Ministry of Settlement and Regional Infrastructure (hereafter referred to as "DGWR") and the Preparatory Study Team signed on and exchanged agreement on the Scope of Work (hereafter referred to as "S/W") and Minutes of Meetings (hereafter referred to as "M/M") for the Study.

JICA has prepared the Study according to the S/W and M/M, and dispatched the Study Team, headed by Mr. Minoru OUCHI of Nippon Koei Co., Ltd., to Indonesia from August 29, 2004.

At the commencement of the Study, the Study Team explained the contents of the Inception Report to Indonesian organizations concerned (hereafter referred to as "Indonesian side") and Indonesian side and the Study Team (hereafter referred to as "Both sides") had a series of discussion on the Inception Report. The list of attendance is attached in Attachment.

Result of the Discussion

Indonesian side basically accepted the contents of the Inception Report and mentioned some comments, requests, and agreements in those discussions as follows:

- 1) Consideration of the Study
- 2) Collaboration with related Organizations and Universities in Indonesia
- 3) Information Disclosure
- 4) Technology Transfer
- 5) Counterpart Personnel
- 6) Undertaking of the Government of Indonesia

1. Consideration of the Study

- Indonesian side emphasized that asset management of the existing dams is an increasing concern and of great importance. The Study shall be a model case of countermeasure formulation for sedimentation problems in reservoirs in Indonesia.
- Regarding watershed management, Indonesian side requested the Study Team to study how to improve cultivation practices of local people especially in relation to activities of non-structural measures for land conservation.
- Indonesian side requested the Study Team to consider sustainability of the management of

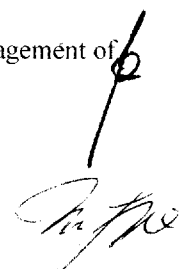

dam facilities and land use in the dam catchment area.

- Indonesian side advised the Study Team to collect useful data and information including the study on watershed management project by the World Bank.
- Indonesian side advised that master plan should be formulated based on the field data and information. Many study results are also available at agencies concerned.
- Indonesian side advised that learning-by-doing approach and socialization to local people would be important for non-structural measures for watershed management.

2. Collaboration with related Organizations and Universities in Indonesia

- Both sides agreed importance of collaboration with related organizations and universities in Indonesia for study of watershed conservation.

3. Information Disclosure

- Both sides agreed that all the data and information as well as planning process under the Study shall be open to all the stakeholders.

4. Technology Transfer

- Both sides agreed that technology transfer should be made through on-the-job training in the course of the Study.
- Both sides agreed that seminars and workshops would be essential to exchange views with stakeholders and the public, and precious opportunity of technology transfer for sustainable management of dam reservoir and watershed.
- JICA informed two counterparts would be invited for training in Japan for about one month around in February 2005 in order to facilitate technology transfer.
- Indonesian side requested some more counterparts for training in Japan are preferable in view of importance of countermeasures for reservoir sedimentation problems.
- JICA promised to convey the request to the JICA headquarters.

5. Counterpart Personnel

- Both sides agreed that counterpart organizations are DGWR in Jakarta and Proyek Bengawan Solo (hereafter referred to as "PBS") and Perum Jasa Tirta I Bengawan Solo Branch (hereafter referred to as "PJT I Solo") at the site level.
- Both sides agreed that appointment of counterparts would be coordinated by PBS. PBS would request the related agencies to provide appropriate counterparts for the Study. The Study Team will soon provide the required counterpart assignment schedule.

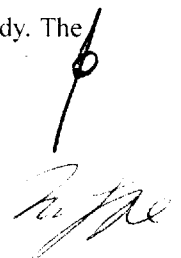

6. Undertaking of the Government of Indonesia

- PBS agreed to provide two rooms as office space in the PBS headquarters in Solo and PBS Wonogiri Dam office, respectively.
- The Study Team requested to provide more rooms in Solo (PJT I Solo Office) when the office space becomes not enough for accommodating experts of the Study Team and counterparts to be assigned from agencies concerned.

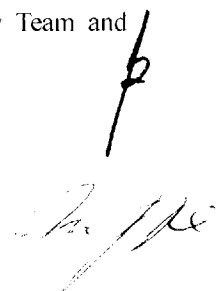
A handwritten signature in black ink, appearing to be 'M. P. P.', located to the right of the second list item.

Attachment: List of Attendants

(1) Meeting in Jakarta on August 31, 2004

Indonesian side

Directorate General of Water Resources, Ministry of Settlement and Regional Infrastructure (KIMPRASWIL):

Mr. Prasadanto Nugroho (Directorate of Water Resources for Central Region)

Mr. Eko Subekti (Directorate of Technical Guidance – Water Resource)

Mr. Bistok S. (Directorate of Technical Guidance)

Mr. M. Murni (Directorate of Technical Guidance)

Mr. A. Azis (Directorate of Technical Guidance)

Mr. Teguh Ungsiadi (Dam Safety Unit)

Bengawan Solo River Basin Development Project Office (PBS):

Mr. Hetomo

National Development Planning Agency (BAPENAS):

Mr. Donny Azdan

Ministry of Forestry (DEPHUT) Mr. Saeful Rachman

State Ministry of Environment (KLH) Ms. Gossy Suzanna

JICA Expert for Directorate General of Water Resources, Ministry of Settlement and Regional Infrastructure:

Mr. Shunichi Maeda (Water Resource Policy)

Mr. Masato Jogasaki (Sabo Planning)

Japanese side

JICA Study Team:

Mr. Minoru Ouchi

Mr. Naoki Yamashita

Ms. Hikaru Sugimoto

JICA Tokyo:

Mr. Hideaki Matsumoto

JICA Indonesia Representative Office:

Mr. Shiro Nakasone

(2) Meeting in Surakarta on September 3, 2004

Indonesian side

Directorate General of Water Resources, Ministry of Settlement and Regional Infrastructure:

Mr. Eko Subekti (Technical Guidance)

Mr. Teguh Ungsiadi (Dam Safety Unit)

Water Resource Management Service in Central Java Province:

Mr. Ketut Arsa

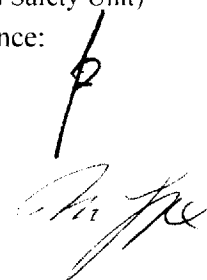

Perum Jasa Tirta I Bengawan Solo Branch:

Mr. S. Budi Raharjo

Regional Planning Agency in Wonogiri District:

Mr. Drs. Sutomo S

1st Assistant of Regional Secretary in Wonogiri District:

Mr. Sru Huduyo

Agriculture Service in Wonogiri District:

Mr. Tri Luwarso

Environment, Forestry and Mining Service in Woonogiri District:

Mr. Gembong MH

Public Works Service in Wonogiri District:

Mr. Edi Djoko D

Regional Office of Watershed Management in Bengawan Solo:

Mr. Anton Supriyanto

Watershed Management Technology Center in Solo:

Mr. Uero Hari Murtiono

Water Resource Management Service in Bengawan Solo:

Mr. Sri Purwanto

Head of Implementation, Bengawan Solo River Basin Development Project:

Mr. Hetomo

Head of Planning, Bengawan Solo River Basin Development Project:

Mr. Tri Rohadi

Water Resource Management, Bengawan Solo River Basin Development Project:

Mr. Darsono

Sub Project, Bengawan Solo River Basin Development Project:

Mr. Sutaryono

Perum Jasa Tirta I Bengawan Solo Branch:

Mr. Muljana

Mr. Widihardjo

Mr. SB Ekoyanto

Perum Jasa Tirta I Bengawan Solo Branch:

Mr. Erwin S

Mr. Sudiro Hw

Bengawan Solo River Basin Development Project:

Mr. Sudi Harsono

Japanese side

JICA Study Team:

Mr. Minoru Ouchi

Mr. Naoki Yamashita

Ms. Hikaru Sugimoto

JICA Tokyo:

Mr. Hideaki Matsumoto



Lampiran 4
Minutes of Meeting on Progress Report (1)

Minutes of Meeting on
Progress Report (1)
For the Study
on
Countermeasures for Sedimentation
in the Wonogiri Multipurpose Dam Reservoir

AGREED UPON BETWEEN

Ministry of Public Works

AND

Japan International Cooperation Agency

Jakarta, January 20, 2005

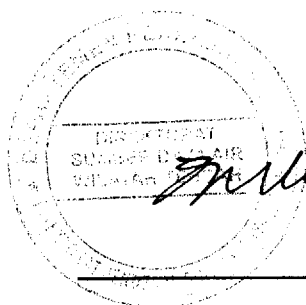

Mr. Ir. Djoko Subarkah, Dipl.HE

Director of Water Resources 
for Central Region
Directorate General of Water Resources
Ministry of Public Works

Mr. Minoru OUCHI

Leader of the Study Team
Japan International Cooperation Agency

Minutes of Meeting on the Progress Report (1)

Subject: Progress Report (1)

Date: 19 January 2005, 9:30-13:30

Place: Meeting room of PU

The JICA Study Team submitted 20 copies of the Progress Report (1) during the first field works in Indonesia in accordance with the Scope of Works of the Study. The meeting was chaired by Ir. Djoko Subarkah, Dipl.HE, Director of Water Resources for Central Region. In the meeting, the JICA Study Team explained the contents of the Progress Report (1). Thereafter, a series of discussion was made between both sides. As a result of discussions, the contents of the Progress Report (1) were in principle agreed by both sides. The list of participants is attached hereto.

Main points of discussion are as follows:

1. The study seems to focus on technical aspect more than environment, social, economic, financial, and institutional aspects. The Study Team explained the starting points of the Study were the clarification of current conditions of the Wonogiri reservoir and the watershed. Thus, the first field works were focused on the technical aspects. Environmental, social, economic and institutional aspects will be studied in detail in the next stage, although basic study results are described in the Progress Report (1).
2. SWOT analysis is needed in the next stage to solve the problem statements identified in this study properly.
3. The riverbed movement analysis and the verification test of sediment removal system will be carried out in the next stage.
4. The trash boom (floating net) in front of intake looks light, so it can not stop the garbage to enter into the intake. The modified trash boom shall be considered in view of easy operation and maintenance.
5. The farmers are very poor. This study should find out some alternatives to solve it. It is suggested that farmers participation approach should be adopted. And possibility of agro forestry by planting of crops like Jati Emas, mango, jambu mete, etc for reforestation should be assessed with provision of credit services from bank.
6. Some of reforestation programs were not successfully implemented because of poor guidance.

7. There are three kinds of forest classification on the State Forestry Enterprise; limited production, production, and protection forests. In the regulation, farmers are not allowed to cultivate all the forests, but Ministry of Forestry can not guard all forests from the farmer's activities. So, promotion of joint program is expected.
8. Population pressure is one of the factors of soil erosion in the Wonogiri watershed. A transmigration program is one of countermeasures.
9. The Government considers that farmer's participation approach is an effective methodology for soil conservation programs. This approach was not always sustainable in the implementation of past soil conservation projects.
10. Downstream people benefited from the Wonogiri reservoir should financially assist the Wonogiri watershed conservation. This principle (raising of people's awareness) shall be studied in the next stage.

Attachment: List of Participants

Indonesian side

Institution	Name	Position
Directorate of Water Resources for Central Region	Mr. Djoko Subarkah	Director
Directorate of Technical Guidance	Mr. Prasidananto	Chief of Sub Directorate
	Mr. Bistok S	Chief of Section
	Mr. Sri Hartono	Chief of Section
	Mr. Gunto Nababan	Staff
Directorate of Water Resources for Eastern Region	Mr. Kusbandoro	Chief of Sub Directorate
Directorate of Water Resources Management	Mr. Imam Anshori	Chief of Sub Directorate
Directorate of Water Resources for Central Region	Mr. Thomson Panggabean	Chief of Section
Dam Safety Unit	Mr. Teguh Ungsiadi	Chief of Section
Ministry of Forestry	Mr. Saeful Rachman	Chief of Sub Directorate
PJT-1, Bengawan Solo	Mr. Sutioso Budirahardjo	Director
	Mr. Erwin Budoyo	Chief of Technical Division
PIPWS BS	Mr. Tri Rohadi	Manager of Planning
	Mr. Widihardjo	Assistant
	Ms. Lilik Retno C	Staff
Directorate General of Water Resources	Mr. Shunichi MAEDA	JICA Expert

Japanese side

Institution	Name	Position
JICA Study Team	Mr. Minoru OUCHI	Team Leader
	Mr. Kenjiro ONAKA	Co-Team Leader
	Mr. Tamotsu SHINGU	Civil Engineer/ Dam & Related Facility
	Mr. Tadahiro FUKUDA	Sediment Hydraulic Expert
	Ms. Hikaru SUGIMOTO	Coordinator/ Water Quality Expert

Lampiran 5
Minutes of Meeting on Progress Report (2)

Minutes of Meeting on Steering Committee

Progress Report (2)

For the Study

on

Countermeasures for Sedimentation

in the Wonogiri Multipurpose Dam Reservoir

AGREED UPON BETWEEN

Ministry of Public Works

AND

Japan International Cooperation Agency

Jakarta, August 22, 2005

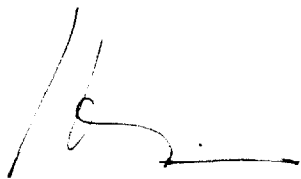

Mrs. Ir. Dyah Rahayu Pangesti, Dipl.HE, APU

Director of Rivers, Lakes and Reservoirs
Directorate General of Water Resources
Ministry of Public Works

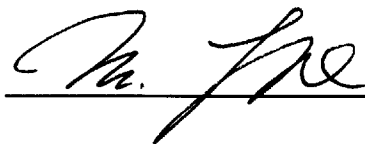

Mr. Minoru OUCHI

Leader of the Study Team
Japan International Cooperation Agency

Minutes of Meeting on Steering Committee

Subject: Progress Report (2)

Date: 22 August 2005, 14:00-18:00

Place: Meeting room of PU

The JICA Study Team submitted 25 copies of the Progress Report (2) during the second field works in Indonesia in accordance with the Scope of Works of the Study. The meeting was chaired by Ir. Dyah Rahayu Pangesti, Dipl.HE, APU Director of Rivers, Lakes and Reservoirs. In the meeting, Ir. Siswoko, Dipl.HE., Director General of Water Resources also attended. The JICA Study Team explained the main contents of the Progress Report (2) with the focus on the current condition and issues on both the Wonogiri dam reservoir sedimentation and its watershed. Thereafter, a series of discussion was made between both sides. As a result of discussions, the contents of the Progress Report (2) were agreed by both sides. The list of participant is attached hereto.

Main points of discussion are as follows:

1. The Study results seem to focus on structural measures (civil works) in reservoir. The main issue of Wonogiri reservoir sedimentation is much soil erosion in the watershed. At present, PU worries about a dilemma between increasing water demand and decreasing reservoir capacity. To solve the problem, PU considers erosion control involving poor farmers is key factor. In this respect, only PU can not solve this issue. Therefore PU considers to invite and involve relating agencies to solve the watershed management problems together.
2. Sediment bypass from the Keduang River will cause relatively high concentrated sediment flow to downstream reaches together with the water. The Keduang bypass will cause another sedimentation problems to the Colo weir. As a result, it will be only transfer of sedimentation problems from the Wonogiri watershed to the Colo weir.
3. The idea of heightening the dam elevation to increase water volume is not recommendable as it will cause a very wide impacts such as stability of dam body, acquisition of reservoir area, social problems, etc.
4. To deal with the accumulated sedimentation in the Wonogiri Dam, routine clearing of garbage and sediment in front of the intake is recommended.
5. Sedimentation problems are happening in other reservoirs in Indonesia. Thus this Study is very important. The approach of the Study shall be applicable to other reservoirs suffering from sedimentation.



6. Handling of sedimentation problems of the Wonogiri Dam is suggested to integrate structural and non-structural measures with involvement of the local community and stakeholders.
7. Farmers upstream of Wonogiri Dam especially in steep areas are very poor. Increasing their income (poverty alleviation) is very crucial.
8. Advantage and disadvantage of the sediment management options shall be explained. Although it is omitted in this meeting, it has already explained in the Progress Report (2). The sedimentation issues are mainly from social problems. Good pattern (method) to solve social problems shall be established. Of great importance is to implement the method. The Study results shall be implemented in a sustainable way from social, economical and environmental aspects.
9. Since the water is flowing natural resources with no administrative boundary, it is necessary to establish the role sharing between upstream and downstream stakeholders from the aspects of both financing and benefit.

Ta. Pro

Attachment: List of Participants

Indonesian Side:

Institution	Name	Position
Directorate General of Water Resources	Mr. Siswoko	Director General
Directorate of Rivers, Lakes, and Reservoirs	Mrs. Dyah Rahayu Pangesti	Director
	Mr. Bambang Warsito	Sub Director of Water Resources Conservation
	Mr. Slamet Budi Santoso	Sub Directorate of Rivers, Lakes, and Reservoirs Technical Planning
	Mr. Mr. Prasidananto Nugroho	Sub Director of Implementation for West Region
	Mr. Bambang Hargono	Sub Director of Implementation for East Region
Directorate of Planning and Programming	Mrs. Deliana	Staff of Sub Directorate of River Basin Planning
Directorate of Water Resources Management	Mr. Prabowo	Staff of Sub Directorate of O&M of Rivers, Lakes and Reservoirs
BAPPENAS	Mr. Candra R	Staff of Directorate of Water Resources and Irrigation
Ministry of Home Affairs	Mr. Suharyanto	Staff of Directorate of Spatial Planning and Environment Facilitation
	Mr. Suyanto	Staff of Directorate of Spatial Planning and Environment Facilitation
Ministry of Forestry	Mr. Iyus Sutisna	Chief of Section for Watershed Management and Social Economic Evaluation
Ministry of Agriculture	Mr. Ali Boser	Chief of Sub Directorate of Irrigation Water Usage
Ministry of Environment	Mrs. Yossy Suzanna	Chief of Sub Directorate of Lakes
	Mr. Harjono	Chief of Sub Directorate of Reservoirs
PJT-1, Bengawan Solo	Mr. Sutioso Budirahardjo	Director
	Mr. Erwin Budoyo	Chief of Technical Division
	Mr. Hartono	Chief of Water Services Division
PIPWS BS	Mr. Tri Rohadi	Manager of Planning
	Mr. Widihardjo	Assistant
	Ms. Lilik Retno C	Staff

Japanese Side:

Institution	Name	Position
JICA Study Team	Mr. Minoru OUCHI	Team Leader
	Mr. Kenjiro ONAKA	Co-Team Leader
	Mr. Tamotsu SHINGU	Civil Engineer/ Dam & Related Facility
	Mr. Tadahiro FUKUDA	Sediment Hydraulic Expert
Directorate General of Water Resources	Mr. Yasuyuki HIRAI	JICA Expert on Water Resources Policy

D-110

Lampiran 6
Minutes of Meeting on Progress Report (3)

Minutes of Meeting on Steering Committee

*Progress Report (3)
for the Study
on
Countermeasures for Sedimentation
in the Wonogiri Multipurpose Dam Reservoir*

AGREED UPON BETWEEN

Ministry of Public Works

AND

Japan International Cooperation Agency

Jakarta, March 2, 2006



Ir. Widagdo Dipl. HE

Director of Rivers, Lakes and Reservoirs
Directorate General of Water Resources
Ministry of Public Works

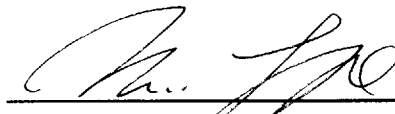

Mr. Minoru OUCHI

Leader of the Study Team
Japan International Cooperation Agency

Minutes of Meeting on Steering Committee

Subject: Progress Report (3)

Date: March 2, 2006, 9:50-13:00

Place: Jatiluhur Meeting room of Directorate of Water Resources

The JICA Study Team submitted 20 copies of the Progress Report (3) during the second field works in Indonesia in accordance with the Scope of Works of the Study. The meeting was chaired by Ir. Widagdo Dipl. HE, Director of Rivers, Lakes and Reservoirs. The JICA Study Team explained the main contents of the Progress Report (3) on the progress to date, direction, and strategy of master planning, urgent countermeasures for sedimentation at the intake issues and watershed conservation as a mid / long term measures for Wonogiri reservoir sedimentation problems. Thereafter, a series of discussion was made between both sides. As a result of discussions, the contents of the Progress Report (3) were agreed by both sides. The list of participant is attached hereto.

Main points of discussion are as follows:

1. The Wonogiri reservoir must be sustained as it is an important facility for storing water. Combination of structural and non-structural countermeasures would be the best solution for handling for sedimentation problems in the Wonogiri reservoir.
2. The result of the Study on wonogiri reservoir sedimentation countermeasures should be a model of reservoir sedimentation countermeasures as a guidance for other reservoirs which are suffering for sedimentation problems.
3. The main issues are sediment deposits at the intake and the continuing sediment inflow into the Wonogiri reservoir. The short term solution that must be highlighted is how to overcome the blockage of the intake by sediment and garbage. Since dredging of sediment is a temporary measure, the structural measures to be proposed should be based on the application detail and operation rules. In addition, the alternative structural measure of the sediment bypass tunnel of the Keduang River needs to be of further consideration from the aspects of impacts that may affect the Colo weir downstream.
4. In the future, the sediment entering the Wonogiri reservoir must be reduced significantly. From the aspect of watershed conservation, changing of lifestyle of local people would be very much required because the problem of erosion / sedimentation comes from human activities.
5. The current operation method of Wonogiri reservoir is risky because of almost no observance of the existing operation rule. This might come from strong demand of downstream stakeholders

for more water supply. Under the Study, re-allocation of the current remaining reservoir capacity will be recommended to secure the current water supply. However, this will require some safety devices from dam safety point of view.

6. The Study should highlight empowerment of community such as how to support people's activities, to increase people's income and to improve people's environment (refer activities of pilot project in Grindulu watershed, Kabupaten Pacitan). In addition, a matrix of role sharing and action plan covering all agencies concerned should be prepared.
7. In view of how to motivate the local people on watershed management and conservation, sharing of benefits between the upstream and downstream stakeholders shall be an important factor. This concept for benefit sharing comes from the Integrated Water Resources Management (IWRM).
8. Conservation of the Wonogiri watershed should involve all the stakeholders concerned. The GNKPA (Gerakan Nasional Kemitraan Penyelamatan Air: National Movement on Partnership of Water Conservation) shall be recommended to implement the Wonogiri watershed conservation master plan to be proposed by the study

Attachment: List of Participants

Indonesian Side:

Institution	Name	Position
Directorate of Rivers, Lakes, and Reservoirs	Mr. Widagdo	Director
	Mr. Bambang Warsiro	Chief of Sub Directorate of Conservation
Directorate of Planning and Programming	Mr. Hariyanto	Chief of Sub Directorate of Water Resources Development for West Region
Directorate of Water Resources Management	Mr. Sulad Sriharto	Chief of Sub Directorate of O&M of Rivers, Lakes and Reservoirs
	Mr. Suko Rahardjo	Chief of Sub Directorate of Community Empowerment
Directorate of Irrigation	Mr. Hastina Zulkarinain	Sub Directorate of Irrigation for West Region
BAPPENAS	Mr. Donny Azdan	Director of Water Resources and Irrigation
	Mr. Amor Rio S	Staff of Directorate of Forestry and Conservation of Water Resources
Dam Safety Unit	Mr. A. Hanan Akhmad	Chief of Dam Safety Unit
	Mr. Teguh Ungsiadi	Chief of Section for Program and Evaluation
Ministry of Agriculture	Mr. Iwan Patma	Directorate of Land and Water Management
Ministry of Forestry	Mr. Saeful Rachman	Chief of Sub Directorate of Watershed Management
Ministry of Environment	Mr. Harjono	Chief of Sub Directorate of Reservoirs
PJT I Bengawan Solo	Mr. Sutioso Budirahardjo	Director
	Mr. Erwin Budoyo	Chief of Technical Division
	Mr. Hartono	Chief of Water Services Division
PIPWS Bengawan Solo	Mr. Sugiyanto	General Manager
	Mr. Tri Rohadi	Manager for Planning
	Mr. Widihardjo	Assistant for Design
SNVT PPSA Bengawan Solo	Mr. Agus Rudyanto	Chief of Sub Unit of Planning Guidance

Japanese Side:

Institution	Name	Position
JICA Indonesia	Mr. Katsuhiko OHARA	Assistant Resident Representative
	Ms. Sulisty Wardani	Program Officer
Directorate General of Water Resources	Mr. Yasuyuki HIRAI	JICA Expert on Water Resources Policy
WREFR&CIP	Mr. Masaki ITO	Team Leader
JICA Study Team	Mr. Minoru OUCHI	Team Leader
	Mr. Kenjiro ONAKA	Co-Team Leader
	Mr. Tadahiro FUKUDA	Sediment Hydraulic Expert
	Mr. Tamotsu SHINGU	Civil Engineer/ Dam & Related Facility
	Ms. Hikaru SUGIMOTO	Coordinator/ Water Quality Expert
Sebelas Maret University	Ms. Siti Qomariyah	Interpreter/Translator

Lampiran 7
Minutes of Meeting on Interim Report

Minutes of Meeting on Steering Committee
Interim Report
for the Study
on
Countermeasures for Sedimentation
in the Wonogiri Multipurpose Dam Reservoir

AGREED UPON BETWEEN

Ministry of Public Works

AND

Japan International Cooperation Agency

Jakarta, July 19, 2006

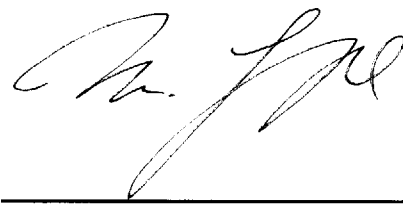

Ir. Widagdo, Dipl.HE

Director of River, Lake and Reservoir
Directorate General of Water Resources
Ministry of Public Works

Mr. Minoru OUCHI

Leader of the Study Team
Japan International Cooperation Agency

Minutes of Meeting on Steering Committee

Subject: Interim Report

Date: July 19, 2006, 13:00-16:30

Place: Jatiluhur Meeting room of Directorate of Water Resources

The JICA Study Team submitted 20 copies of the Interim Report to Directorate of River, Lake and Reservoir at the Steering Committee on July 4, 2006 in accordance with the Scope of Works of the Study. The meeting was chaired by Ir. Widagdo Dipl. HE, Director of River, Lake and Reservoir. The JICA Study Team explained main content of the Interim Report and exchanged discussions with the Committee members. However, conclusion of the Steering Committee was postponed until the next Steering Committee two weeks later for review of the Interim Report by the Committee members, because the Interim Report presents the Master Plan of countermeasures for sedimentation problems in the Wonogiri reservoir, and hence it was of great importance to decide the direction of comprehensive sediment management of the Wonogiri watershed as well as the sedimentation in the Wonogiri reservoir.

The next Steering Committee was held on July 19, 2006 chaired by Ir. Widagdo Dipl. HE, Director of River, Lake and Reservoir. The JICA Study Team explained with the main focus on selecting process of the sediment storage reservoir with gate among alternative structural countermeasures and major activities of watershed management and conservation. Thereafter, a series of discussion was made between both sides. As a result of discussions, the contents of Interim Report were agreed by both sides. The list of participant is attached hereto.

Main points and conclusions of discussions are as follows:

1. Participants understood with no objections the concept of Master Plan by means of combination approach of structural and non-structural countermeasures for the sedimentation problems in the Wonogiri reservoir. Structural and non-structural countermeasures should be done simultaneously.
2. The proposed Master Plan was approved and the urgent measures for coping with the sediment and garbage inflows from the Keduang River were approved for proceeding to the feasibility study in the Phase 2 of the Study. The urgent measures subject to feasibility study are the sediment storage reservoir with new gates, periodic maintenance dredging at intake and watershed management and conservation in the Keduang catchment.
3. As for technical comments and suggestions from PJT-I Bengawan Solo on the operational method of the proposed sediment storage reservoir as well as other comments from PBS and

agencies concerned, they should be studied for clear understanding during the stage of feasibility study, because they are to be examined and studied in detail through the feasibility study.

4. Community-based watershed conservation and management plan should be formulated based on the participatory approach (bottom-up method) with the main focus on how to empower the local farmers and how to support them to increase agricultural production and their income.
5. Valuable experiences of watershed conservation projects already conducted in several areas should be considered for reference. During the feasibility study, close coordination with not only DGWR but also local government as well as concerned agencies should be made concerning the implementation plans.
6. The estimated construction cost of all the countermeasures proposed master plan is high. The cost should be reviewed during the feasibility study stage.
7. It is expected that AMDAL should be carried out for the proposed urgent countermeasures. Environmental Impact Analysis (EIA) will be carried out for the proposed urgent countermeasures during the feasibility study stage.

Attachment: List of Participants

Indonesian Side:

Institution	Name	Position
Director General of Water Resources, Ministry of Public Works	Mr. Siswoko	Director General
Directorate of River, Lake, and Reservoir	Mr. Widagdo	Director
	Mr. Bambang Warsito	Chief of Sub Directorate of Water Resources Conservation
	Mr. Budisantoso	Staff of Sub Directorate of Technical Planning
	Mr. Adritra S.	Staff of Directorate of River, Lake, and Reservoir
Directorate of Water Resources Management	Mr. Imam Anshori	Director
	Mr. Arifin	Staff of O&M for River, Lake and Reservoir
	Mr. Adha Fuad	Staff of O&M for River, Lake and Reservoir
	Mr. Agus Praptomo	Staff of O&M for River, Lake and Reservoir
Directorate of Programming	Mr. Abdul Rais	Staff of Directorate of Programming
	Mr. A. H. Subarda	Staff of Directorate of Programming
Directorate General of Spatial Planning	Mr. Andi Renald	Staff of Directorate General of Spatial Planning
Directorate of Irrigation	Mr. Hastina Zulkarnain	Staff of Directorate of Irrigation
Dam Safety Unit	Mr. A. Hanan Akhmad	Chief of Dam Safety Unit
	Mr. Achmad Zubaidi	Dam Engineer
WREFR&CIP	Mr. Masaki Ito	Team Leader
Ministry of Environment	Mr. Harmin M.	Chief of Sub Directorate of Reservoirs
Ministry of Energy and Mineral Resources	Mr. Satrio Hadipurwo	
Ministry of Agriculture	Mr. Surawan	Chief of Sub Directorate of Land Rehabilitation and Conservation
Ministry of Forestry	Mr. Sentot Subagyo	Chief of Sub Directorate of Watershed Management
	Mr. Suwindo	Staff of Sub Directorate of Watershed Management

PJT I Bengawan Solo	Mr. Sutioso Budirahardjo	Director
	Mr. Erwin Budoyo	Chief of Technical Division
	Mr. Hartono	Chief of Water Services Division
PIPWS Bengawan Solo	Mr. Sugiyanto	General Manager
	Mr. Rochadi M.	Project Manager for Flood Control of Bengawan Solo River
	Mr. Widihardjo	Technical Assistant of Planning Division
	Mr. Agus R.	Chief of Conservation and Development of Water Resources
Wonogiri District	Drs. Edi Sutopo	Chief of Industry and Trade
	Sudaryanto	Chief of Public Works Services

Japanese Side:

Institution	Name	Position
JICA Study Team	Mr. Minoru Ouchi	Team Leader
	Mr. Kenjiro Onaka	Co-Team Leader
	Mr. Haisheng Jin	Hydraulic Numerical Analyst
	Mr. Tadahiro Fukuda	Sediment Hydraulic Expert
	Mr. Tamotsu Shingu	Civil Engineer/ Dam & Related Facility
	Mr. Saksono Hadi	Interpreter/Translator

Lampiran 8
Minutes of Meeting on Draft Final Report

Minutes of Meeting on Steering Committee

Draft Final Report

for the Study

on

Countermeasures for Sedimentation

in the Wonogiri Multipurpose Dam Reservoir

AGREED UPON BETWEEN

Ministry of Public Works

AND

Japan International Cooperation Agency

Jakarta, February 27, 2007



Ir. Widagdo, Dipl.HE

Director of Rivers, Lakes and Reservoirs
Directorate General of Water Resources
Ministry of Public Works



Mr. Minoru OUCHI

Leader of the Study Team
Japan International Cooperation Agency

Minutes of Meeting on Steering Committee

Subject: Draft Final Report

Date: February 27, 2007, 10:00-13:30

Place: Jatiluhur Meeting room of Directorate of Water Resources

The JICA Study Team submitted 25 copies of the Draft Final Report to Directorate of Rivers, Lakes and Reservoirs, Directorate of General of Water Resources in accordance with the Scope of Works of the Study. The meeting was chaired by Ir. Widagdo Dipl. HE, Director of Rivers, Lakes and Reservoirs. The JICA Study Team explained the main content of the Draft Final Report focusing on the results of feasibility study on the urgent countermeasures, and discussed with the Steering Committee members. Thereafter, exchange of opinions was made between both sides. The list of participant is attached hereto.

Main points of discussion are as follows:

1. The Study has formulated several applicable proposals of countermeasures and has analyzed in detail. Although the Study presented the urgent, middle and long term countermeasures, the most important alternative measure needs to be determined to cope with the current sedimentation problems. In addition, real actions are required to be taken up and hopefully applicable to other reservoirs of similar sedimentation problems as a model for solution, so that real actions should be recommended in this Study.
2. From the technical aspect, the proposed countermeasures are acceptable. More clarifications of impacts accrued from the proposed urgent countermeasures are required for; i) flood control function of the Wonogiri reservoir to the downstream reaches, ii) irrigation water supply due to decrease of storage capacity, and iii) river maintenance due to sediment release. The Study Team explained that the impacts have been clarified and evaluated in the course of the Study and already described in the Draft Final Report.
3. It is important to include the required O&M cost for maintaining the Wonogiri dam besides the investment cost as recommended in the feasibility study.
4. Watershed management should involve many sectors and other departments for successful and effective implementation. What sectors and departments are recommended to be participated in the watershed conservation activities. The Study Team explained the recommendable agencies to be involved at the national level, district level and community level as proposed in the Draft Final Report.

5. Required actions to be taken up by Balai Besar Bengawan Solo before implementation of urgent countermeasures should be recommended, because the construction of urgent countermeasures is planned to commence from 2010 in the Draft Final Report.
6. The Study Team will discuss the content of Draft Final Report with the JICA Advisory Committee in Tokyo. The Study Team will explain the Draft Final Report referring the comments from JICA Advisory Committee at the next Steering Committee meeting in May 2007. Then the Final Report will be submitted to the Indonesian Government in July after the Steering Committee meeting reflecting all the comments from the Indonesian Government.
7. Considering that the next Steering Committee meeting is planned to be held in May, the comments as well as recommendations are to be sent to the Study Team by e-mail or letter via PBS.

Attachment: List of Participants

Indonesian Side:

Institution	Name	Position
Directorate of Rivers Lakes and Reservoirs	Mr. Widagdo	Director
	Mr. Bambang Warsito	Chief of Sub Directorate of Water Resources Conservation
	Mr. Harjono	Chief of Sub Directorate of Reservoir Management
	Mr. Mahar Himawan	Staff of Sub Directorate of Water Resources Conservation
Directorate of Water Resources Management	Mr. Imam Anshori	Director
	Mr. Bambang Subyandono	Chief of Division on River Basin Development, Directorate of Bina Program
BAPPENAS	Mr. Bambang Prihartono	
WREFR&CIP	Mr. Masaki Ito	Team Leader
Ministry of Agriculture	Mr. Rahmanto	Directorate General PLA – Department of Agriculture
Ministry of Forestry	Mr. Suhardijono	Department of Forestry
BBWS Bengawan Solo	Mr. Imam Agus Nugroho	General Manager
	Mr. Trirohadi.	Manager for Programming and Evaluation
	Mrs. Susan	Section of Program

Japanese Side:

Institution	Name	Position
JICA Indonesia Office	Mr. Katsuhiko OHARA	Assistant Resident Representative
Directorate General of Water Resources	Mr. Yasuyuki HIRAI	JICA Expert on Water Resources Policy
JICA Study Team	Mr. Minoru Ouchi	Team Leader
	Mr. Kenjiro Onaka	Co-Team Leader
	Mr. Tadahiro Fukuda	Sediment Hydraulic Expert
	Mr. Tamotsu Shingu	Dam & Related Facility
	Mr. Saksono Hadi	Interpreter/Translator
Sebelas Maret University	Mrs. Siti Qumariyah	Interpreter/Translator

Lampiran 9
Minutes of Meeting on Draft Final Report

Minutes of Meeting on Steering Committee

Draft Final Report

for the Study

on

Countermeasures for Sedimentation

in the Wonogiri Multipurpose Dam Reservoir

Agreed upon between

Ministry of Public Works

and

Japan International Cooperation Agency

Jakarta, June 4, 2007



Ir. Siswoko, Dipl. HE

Director General of Water Resources
Ministry of Public Works

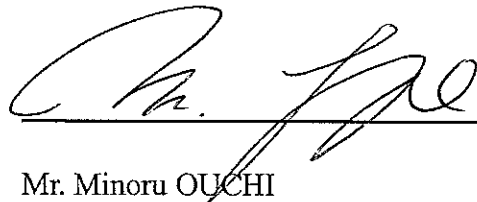

Mr. Minoru OUCHI

Leader of the Study Team
Japan International Cooperation Agency

Minutes of Meeting on Steering Committee

Subject: Draft Final Report

Date: May 30, 2007, 14:00-17:00

Place: Jatiluhur Meeting Room of Directorate of Water Resources, Ministry of Public Works

Attendant: Attached list of participants

The Draft Final Report was already submitted to DGWR and discussed at the Steering Committee Meeting on February 27, 2007. This Steering Committee Meeting was held to discuss again the content of the Draft Final Report as well as the comment at the JICA Advisory Committee Meeting held on May 24, 2007 in Tokyo.

The meeting was chaired by Ir. Siswoko Dipl. HE, Director General of Water Resources. In the opening remarks, Ir. Siswoko gave an overview of the Draft Final Report recommending the combination of two solutions, i.e. the structural and nonstructural measures. He hoped that this meeting could achieve approval among related agencies and these two solutions could proceed to detailed design and implementation stage.

After the opening remarks, Mr. Shokichi SAKATA, Group Director, Global Environmental Department of JICA headquarters in Tokyo, expressed his sincere thanks to DGWR and the members of the Steering Committee for cooperation to the JICA Study.

The JICA Study Team explained the content of the Draft Final Report and the comment of JICA Advisory Committee, and then discussion was made. The contents of Draft Final Report were mutually agreed by both sides.

Main comments and suggestions in the Meeting are as follows:

1. The operation of the proposed sediment storage reservoir looks like complicated. The operation rule as well as the maintenance manual should be studied in detail and established in the latter stage.
2. Support programs for watershed conservation are very important for sustainable management of soil erosion. An approach to poverty alleviation and socialization to local farmers should be also necessary for the increase of farm income.
3. For the implementation of the watershed conservation project as proposed by JICA Study, coordination and integration with the ongoing community-based programs in the Wonogiri dam catchment under GNKPA (i.e. coordination programs among Ministry of Public Works, Ministry of Forestry and Ministry of Agriculture in accordance with the MOU) would be very important. To avoid duplication of watershed conservation and management programs, demarcation of programs in locations and project activities should be carefully made clear in view of budget allocation by APBN and Loan.
4. Flood control is the main function of the Wonogiri reservoir. Because the storage capacity of

sediment storage reservoir is small for coping with the flood inflow from Keduang River, the operation rule of sediment storage reservoir should be carefully established. In view of mitigation of flood and sediment inflow, watershed conservation and management for the Keduang River basin would be top priority. The Study Team explained that the flood inflow from the Keduang River would be handled by both the sediment storage reservoir and the main Wonogiri reservoir connected by the overflow dike and the length of overflow dike was determined based on flood routing calculation against PMF from the dam safety viewpoint.

5. The sediment storage reservoir would become check dam or sand pocket in future without proper operation. If the sediment storage reservoir is filled with sediment deposits, almost all of the sediment inflow from the Keduang River would overflow into the main Wonogiri reservoir. To avoid this critical situation, proper operation of sediment storage reservoir and watershed conservation in the Keduang River basin would be very important.
6. Monitoring of reservoir sedimentation including the sediment storage reservoir is very important in view of sustainable use of the Wonogiri reservoir. It was suggested by the Study Team that periodic reservoir survey should be continued preferably every 3 years to monitor reservoir sedimentation rate and the topographic contour mapping of reservoir bed should be prepared to obtain reliable sedimentation volume.
7. Sediment releasing from the Wonogiri reservoir might cause sedimentation problem to the Colo weir and irrigation canals. The Colo weir is suffering from sediment inflow from the Walikan River (a tributary between the Wonogiri dam and the Colo weir). The Study Team explained that the Colo intake gates shall be closed in a few days during sediment releasing operation. Disposal of sediment deposits in the reservoir might be very difficult because of almost no availability of disposal area. Sediment release by use of river power to the river mouth would be practical solution. The integrated operation of the sediment storage reservoir and the Colo weir should be established.
8. It is expected that the project solving the sedimentation issues in the Wonogiri reservoir might create another issues. The inundation area in the proposed sediment storage reservoir might be encroached illegally by local people for crop cultivation. To prohibit such activities, boundary setting such as a green belt should be necessary.
9. Since the new spillway location of sediment storage reservoir is close to the existing main dam, the new spillway should be carefully designed based on the geotechnical investigation in the succeeding detailed design stage. The Study Team explained that the proposed new spillway is located independently from the main dam and its foundation rock is hard enough from the drilling survey results that were conducted in the JICA Study.

Attachment: List of Participants

Indonesian Side:

Institution	Name	Position
Directorate General of Water Resources, Ministry of Public Works	Mr. Siswoko	Director General
Directorate of Rivers, Lakes and Reservoirs	Ms. Dyah R.P.	Secretariat General
	Mr. Widagdo	Director
	Mr. Prasidananto Nugroho	Chief of Sub Directorate of West Regional Implementation
	Mr. Bambang Warsito	Chief of Sub Directorate of Water Resources Conservation
	Mr. Budi Santosa	Chief of Sub Directorate of Technical Planning
	Mr. Hanan Ahmad	Manager of Dam Safety Unit
	Mr. A. Zubaidi	Chief of Dam Safety Unit
	Mr. Bambang Pinudji	Staff of Dam Safety Unit
	Mr. Sigit D.	Staff
	Mr. Nugroho	Staff
Directorate of Water Resources Management		
Directorate of Bina Program	Mr. Agus SK	Chief of Sub Directorate of Data and Information
BBWS Bengawan Solo	Mr. Imam Agus Nugroho	General Manager
	Mr. Trirohadi	Manager for Programming and Evaluation
PJT I Bengawan Solo River	Ms. Lilik	Chief of Evaluation Section
	Mr. Erwin Budoyo	Chief of Technical Division
	Mr. Hartono	Chief of Water Services Division
BAPPENAS	Mr. Anwar Rio	Staff of Rehabilitation & Conservation of Water Resources
	Mr. Tirta S.	Staff of Land Development
Ministry of Agriculture	Ms. Andi Halu	Staff of Directorate of Land & Water Development
Ministry of Forestry	Mr. Joko Budi	Staff of Directorate of Watershed Management
Ministry of Energy & Mineral Resources	Mr. Agus Sayekti	Staff of Center for Geologic Environment
Ministry of Environment	Ms. Zussy Suzanna	Manager of Lake and Reservoir

Japanese Side:

Institution	Name	Position
Global Environmental Department, JICA Headquarters	Mr. Shokichi Sakata	Group Director
JICA Indonesia Office	Mr. Katsuhiko Ohara	Assistant Resident Representative
	Ms. Sulisty Wardani	Program Officer
Directorate General of Water Resources	Mr. Yasuyuki Hirai	JICA Expert on Water Resources Policy
JICA Study Team	Mr. Minoru Ouchi	Team Leader
	Mr. Kenjiro Onaka	Co-Team Leader
	Mr. Tadahiro Fukuda	Sediment Hydraulic Expert
	Mr. Hidetoshi Kanamura	Civil Engineer/Sediment Removal System
	Mr. Maulana	Interpreter/Translator
Sebelas Maret University	Ms. Siti Qumariyah	Interpreter/Translator

