

Annex 4 Workshop documents

Technical Transfer Program Curriculum Sheet			Curriculum No. 1 -01	
Lecture name	Incident or Accident?			
Target of course	※ To survey deference of mind of engineer before & after of earthquake for seismic resistant building. ※ Level investigation of engineer's quakeproof engineering.			
Form of Lecture	<input checked="" type="checkbox"/> Brainstorming	<input type="checkbox"/> Lecture	<input type="checkbox"/> Seminar	<input checked="" type="checkbox"/>
Content : 1. Showing many photograph of destroyed Building element by the Earthquake. 2. Ask to the participant as follows: What's happen? Is this an incident or accident? Could you prevent this mutter? How do you prevent this muter? 3. From the answer, engineer's technical level and deference of mind of engineer before & after of earthquake for seismic resistant building can be judged. 4. Above information will be reflected to the following curriculums. 5. While discussion assistant shall make a record.				
Teaching material: 1. Power Point "Curriculum 1" 2.			Equipment: 1. Computer 2. Projector 3. Pointer 4. Screen(wall)	
Results	Date : 2006/07/18	Number of Attendance	Lecturer:	
	Time: 11:00-12:30		Made by: Fuluichi	
Place	Muzaffarabad office			
Person for attending a lecture: 6				
Evaluation for Lecturer:	Skill:	Knowledge:	Concern:	
Evaluation for Attendance:	Volition:	Understanding:	Attitude:	
Comments:				

Evaluation ⇒ Fill in the mean value.

Technical Transfer Program Curriculum Sheet			Curriculum No. 1 -02	
Lecture name	Incident or Accident?			
Target of course	※ To survey deference of mind of engineer before & after of earthquake for seismic resistant building. ※ Level investigation of engineer's quakeproof engineering.			
Form of Lecture	<input checked="" type="checkbox"/> Brainstorming	<input type="checkbox"/> Lecture	<input type="checkbox"/> Seminar	<input checked="" type="checkbox"/>
Content :				
1. Showing many photograph of destroyed Building element by the Earthquake. 2. Ask to the participant as follows: What's happen? Is this an incident or accident? Could you prevent this mutter? How do you prevent this muter? 3. From the answer, engineer's technical level and deference of mind of engineer before & after of earthquake for seismic resistant building can be judged. 4. Above information will be reflected to the following curriculums. 5. While discussion assistant shall make a record.				
Teaching material:			Equipment:	
1. Power Point "Curriculum 1" 2.			1. Computer 2. Projector 3. Pointer 4. Screen(wall)	
Results	Date : 2006/07/25		Number of Attendance 5	Lecturer: Fuluichi
	Time: 11:00-12:00			Made by: Fuluichi
Place	Mansehra office			
Evaluation for Lecturer:	Skill:	4.75	Knowledge:	5
Evaluation for Attendance:	Volition:		Understanding:	
Comments:				

Evaluation ⇒ Fill in the mean value.

Technical Transfer Program Curriculum Sheet			Curriculum No. 1 -03	
Lecture name	Incident or Accident?			
Target of course	※ To survey deference of mind of engineer before & after of earthquake for seismic resistant building. ※ Level investigation of engineer's quakeproof engineering.			
Form of Lecture	<input checked="" type="checkbox"/> Brainstorming	<input type="checkbox"/> Lecture	<input type="checkbox"/> Seminar	<input checked="" type="checkbox"/>
Content : 1. Showing many photograph of destroyed Building element by the Earthquake. 2. Ask to the participant as follows: What's happen? Is this an incident or accident? Could you prevent this mutter? How do you prevent this muter? 3. From the answer, engineer's technical level and deference of mind of engineer before & after of earthquake for seismic resistant building can be judged. 4. Above information will be reflected to the following curriculums. 5. While discussion assistant shall make a record.				
Teaching material: 1. Power Point "Curriculum 1" 2.			Equipment: 1. Computer 2. Projector 3. Pointer 4. Screen(wall)	
Results	Date : 2006/07/31	Number of Attendance 6		Lecturer: Fuluichi
	Time: 14:00-16:00			Made by: Fuluichi
Place	Mansehra office			
Evaluation for Lecturer:	Skill: 4	Knowledge: 4.5	Concern: 4.5	
Evaluation for Attendance:	Volition:	Understanding:	Attitude:	
Comments: For other group of W&S				

Evaluation ⇒ Fill in the mean value.

JICA

The Technical Cooperation Project
for
Designing Prototype Seismic
Resistant and Barrier-free BHUs
at Langapur in AJK
and
at Attarshisha in NWFP

Curriculum 1

(Brainstorming)

Incident or Accident?

Could you prevent this matter?



Could you prevent this
matter?

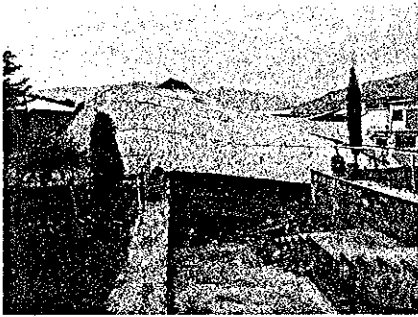

Land selection

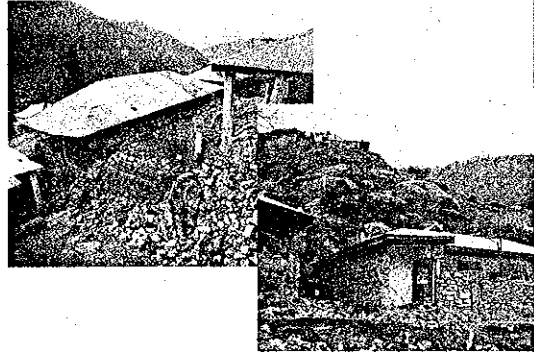

Land selection 2

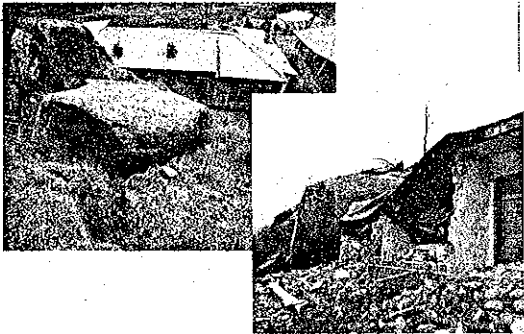

Why was this wall collapsed?

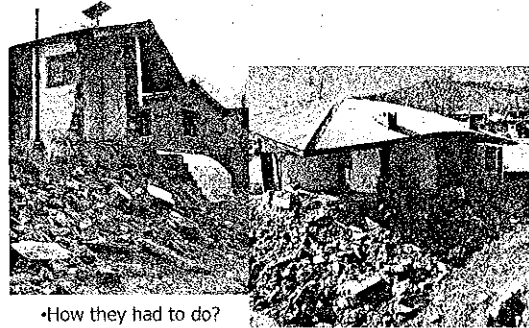

•How they had to do?

Veranda Collapse

What kind Structure



New Construction

◆ New structure Veranda

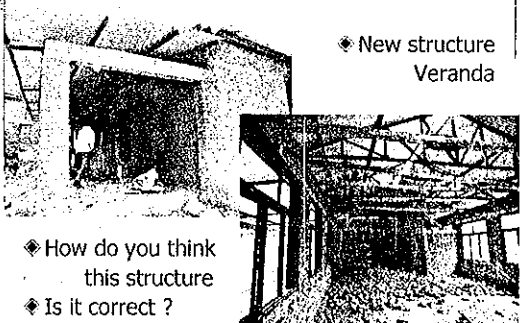

◆ How do you think this structure
◆ Is it correct ?

Remaining Roof

◆ Why roof remains?

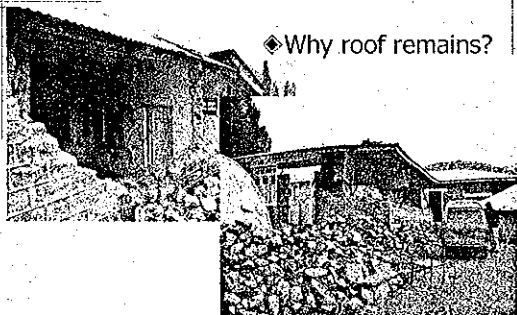

Remaining Roof 2

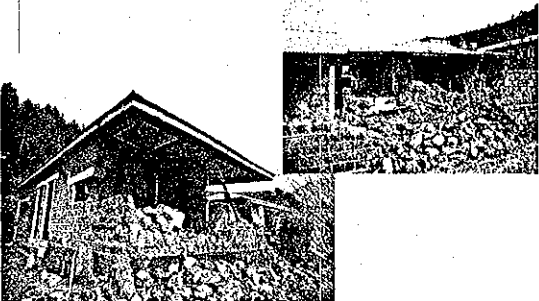

Column & Beam



Column & Beam 2



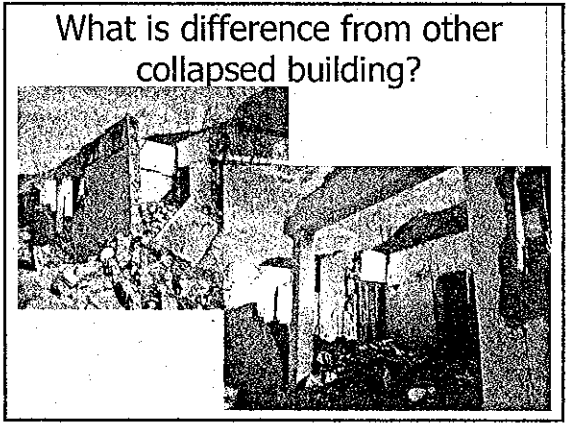
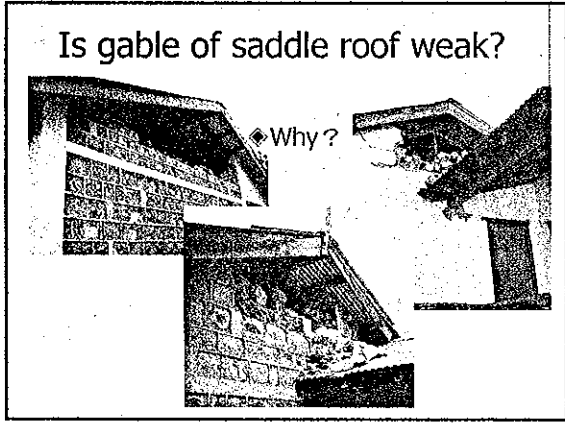
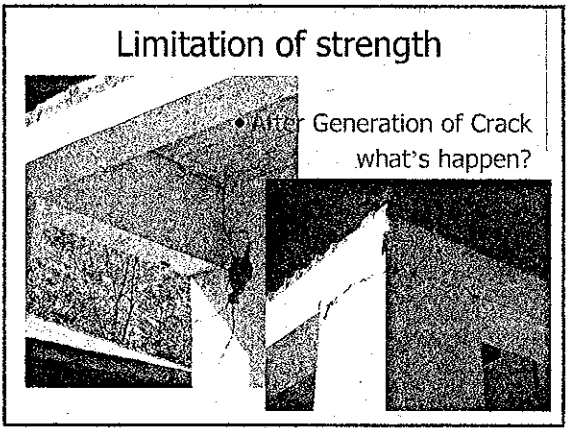
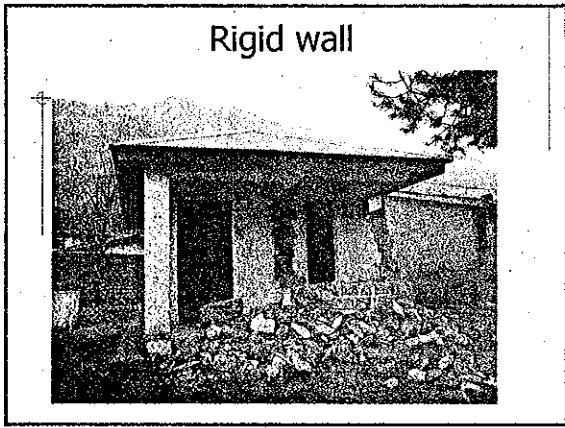
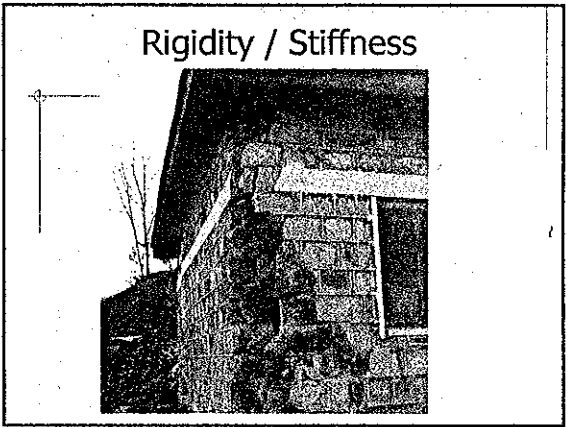
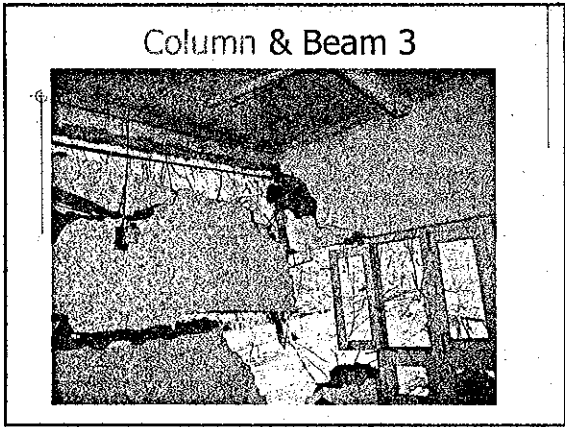

What is difference from other collapsed building?

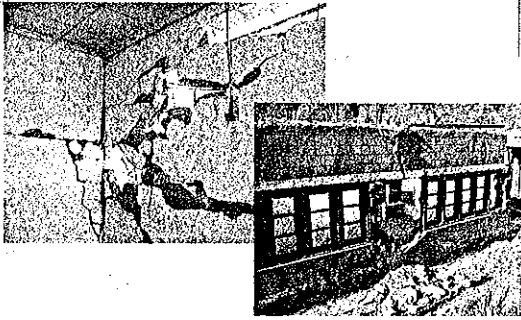

What is wrong?

And why it's happened?

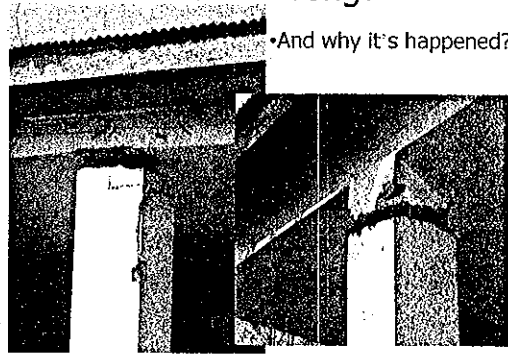

What is wrong?



What is wrong?



Pakistan nice technology
Hydro-Dynamo

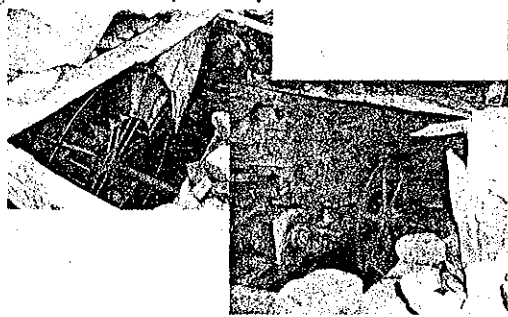

END

THANK YOU for your attention

Technical Transfer Program Curriculum Sheet		Curriculum No.02		- 1
Lecture name	Engineer's role in Stability of Land			
Target of course	1. Site engineer's job at the commencement of the site work 2. Many way of soil test			
Form of Lecture	<input type="checkbox"/> Brainstorming	<input checked="" type="checkbox"/> Lecture	<input type="checkbox"/> Seminar	
Content : 1. At the commencement of the site work what's kind of attention should be paid for the land? 2. How to check the land stability 3. Soil test 4.				
Teaching material : 1. Power Point [Curriculum 2] 2. [Sheet 1] 3.		Equipment : 1. 1 Computer 2. Projector 3. Pointer 4. Screen(wall) 5.		
Results	Date : 29 July 2006	Number of Attendance	Lecturer: Fuluichi	
	Time: 14:00		Made by: Fuluichi	
Place	Muzaffarabad			
Person for attending a lecture: 4				
Evaluation for Curriculum:	Skill: 4	Knowledge: 4.25	Management: 3.75	
Evaluation for Attendance:	Volition:	Understanding:	Attitude:	
Comments:				

Evaluation ⇒ Fill in the mean value.

Technical Transfer Program Curriculum Sheet		Curriculum No.02		-2
Lecture name	Engineer's role in Stability of Land			
Target of course	1. Site engineer's job at the commencement of the site work 2. Many way of soil test			
Form of Lecture	<input type="checkbox"/> Brainstorming	<input checked="" type="checkbox"/> Lecture	<input type="checkbox"/> Seminar	
Content : 1. At the commencement of the site work what's kind of attention should be paid for the land? 2. How to check the land stability 3. Soil test 4.				
Teaching material : 1. Power Point [Curriculum 2] 2. [Sheet 1] 3.		Equipment : 1. 1 Computer 2. Projector 3. Pointer 4. Screen(wall) 5.		
Results	Date : 29 July 2006	Number of Attendance	Lecturer: Fuluichi	
	Time: 14:00-16:00		Made by: Fuluichi	
Place	Mansehra office			
Person for attending a lecture: 6				
Evaluation for Curriculum:	Skill: 4	Knowledge: 4.5	Management: 4.5	
Evaluation for Attendance:	Volition:	Understanding:	Attitude:	
Comments:				

Evaluation ⇒ Fill in the mean value.

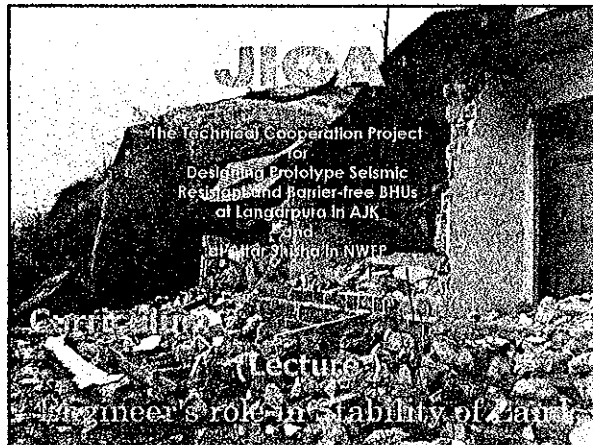

Engineer's work at the commencement

- ◆ Grasp of designer design intention
- ◆ Grasp of process
- ◆ Grasp of construction condition
 - Grasp of situation around the vicinity of site
 - Grasp situation of site
 - Soil test, Topographic Survey
- ◆ Establishment of system for Surveillance
 - Organization
 - Quality control
 - System of Meeting, Report, etc.
- ◆ Etc.

Grasp of situation around the vicinity of site

Observation Item

- ◆ Adjoining cliff or mountain
- ◆ Peripheral nature of soil
- ◆ Retaining wall
- ◆ Water flow
 - River (Record of flood, The highest water level)
 - Flow of water at torrential rains
 - Amount of spring water
- ◆ Slope stability
- ◆ Trees

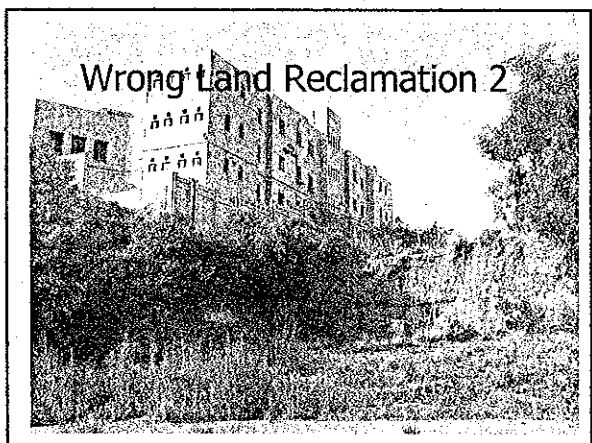
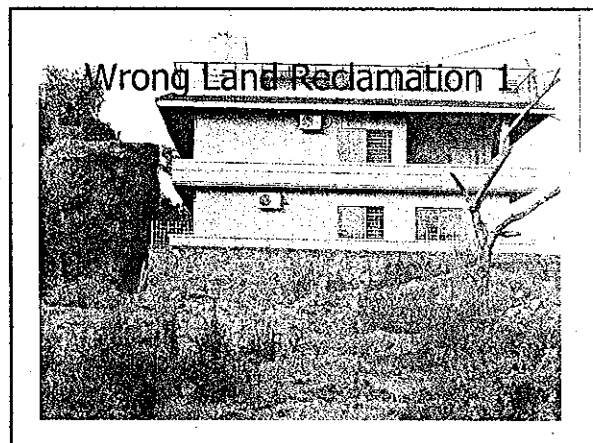
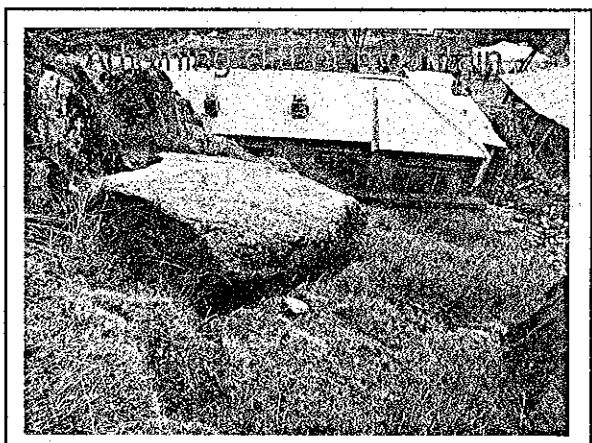

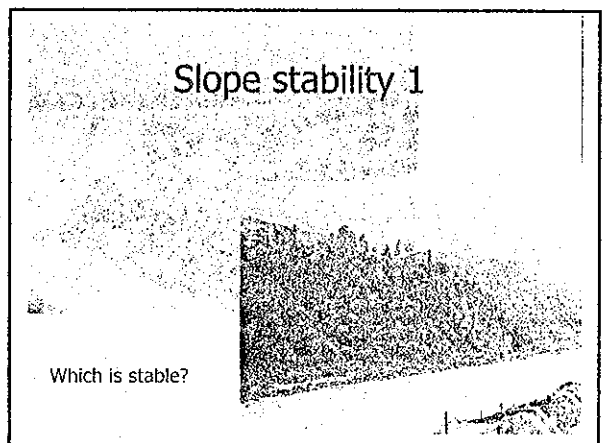
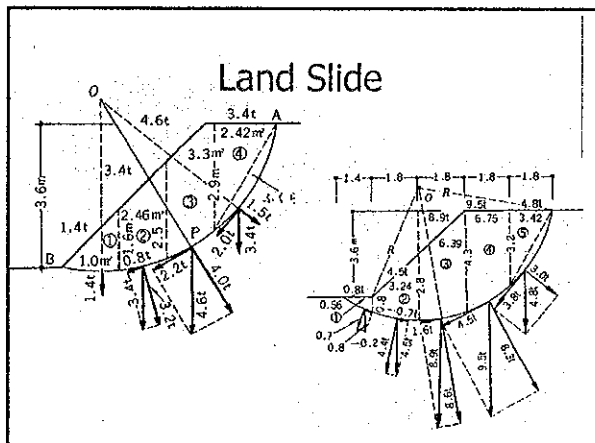
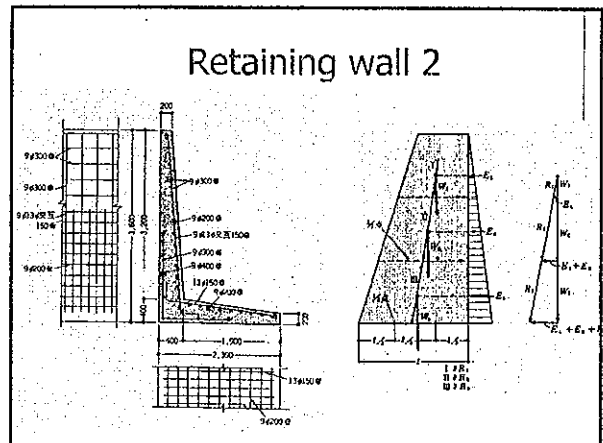
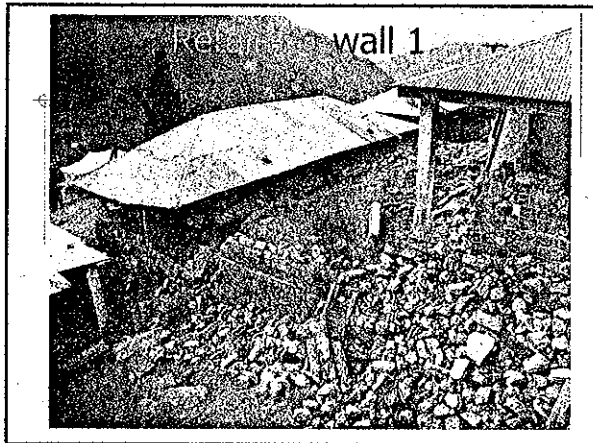
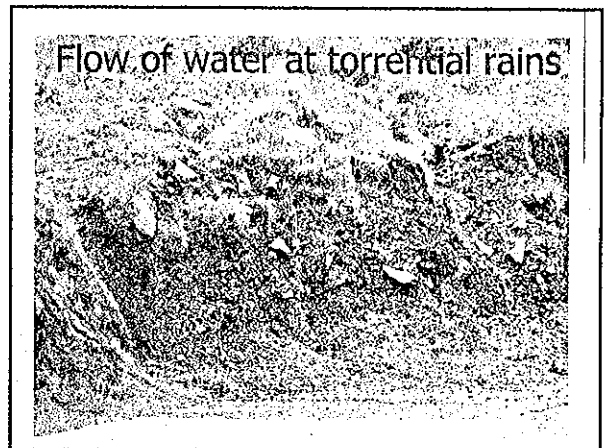
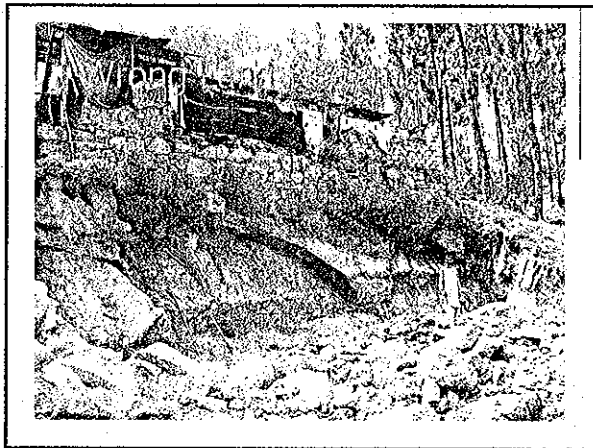

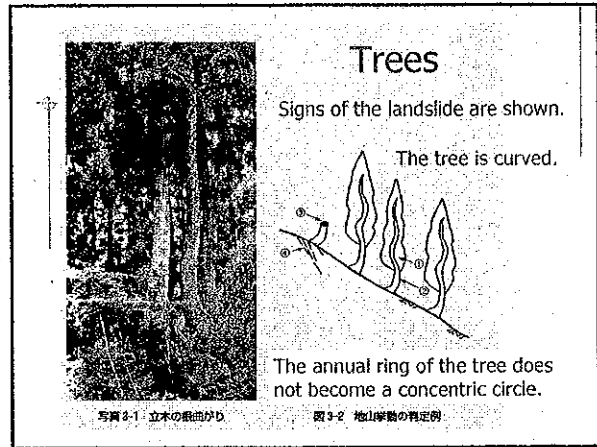
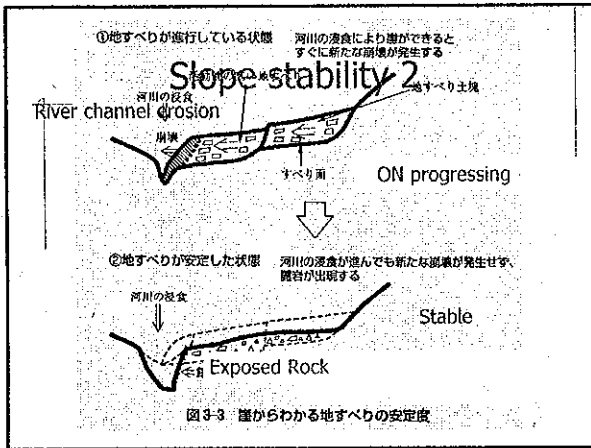

- ### Grasp situation of site
- ◆ Soil test
 - Standard penetration test
 - Plate bearing test
 - Swedish weight sounding test
 - Etc.
 - ◆ Topographic Survey

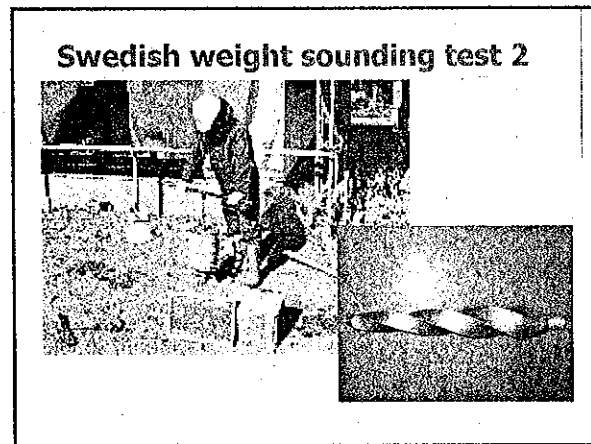
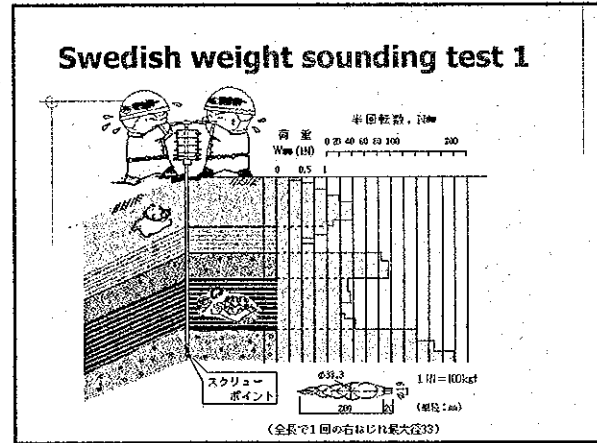

- ### Correlation of Standard penetration test N value and Swedish weight sounding test
- ◆ Gravel, stone, and sandiness
 - $N = 0.002W_{sw} + 0.067N_{sw}$
 - ◆ Gravel clay, Clay
 - $N = 0.003W_{sw} + 0.050N_{sw}$
 - Or
 - ◆ Sand deposit
 - $N = 1/12 \cdot N_{sw}$
 - ◆ Tuff loam
 - $N = 1/9 \cdot N_{sw}$

General method of surveying ground and satisfaction rating

Requirements test method	Standard Penetration test	Swedish weight Sounding test	Dense Penetrometer test	Plate bearing test	Hard Auger
Search cost cheap	X	⊙	⊙	X	⊙
Investigation period short	X	⊙	⊙	X	⊙
firm depth Possible	⊙	⊙	△	X	X
Soil nature can be judged	⊙	△	X	X	⊙
Light and small	X	⊙	⊙	X	⊙
Handling easy	X	⊙	⊙	X	⊙

END

THANK YOU
for your attention

Technical Transfer Program Curriculum Sheet		Curriculum No.03 -01	
Lecture name	Engineer's role and New material		
Target of course	Engineer's role on Quality control and Management Item		
Form of Lecture	<input type="checkbox"/> Brainstorming	<input checked="" type="checkbox"/> Lecture	<input type="checkbox"/> Seminar
Content : 1. Importance of preparing sufficient design document and drawings. 2. Structural Calculation. 3. Structural Drawings			
Teaching material : 1. Building project of Works and Service 2. Documents and Drawings of this project. 3.		Equipment : 1. Computer 2. Projector 3. Pointer 4. Screen	
Results	Date : 16 October 2006	Number of Attendance 5	Lecturer: Furuichi
	Time: 11:00		Made by: Furuichi
Place	Muzzafarabad		
Evaluation for Lecturer:	Skill: 3.4	Knowledge: 3.8	Management: 4.0
Evaluation for Attendance:	Volition:	Understanding:	Attitude:
Comments: 			

Evaluation ⇒ Fill in the mean value.

Technical Transfer Program Curriculum Sheet		Curriculum No.03		-02
Lecture name	Engineer's role and New material			
Target of course	Engineer's role on Quality control and Management Item			
Form of Lecture	<input type="checkbox"/> Brainstorming	<input checked="" type="checkbox"/> Lecture	<input type="checkbox"/> Seminar	
Content : 1. Importance of preparing sufficient design document and drawings. 2. Structural Calculation. 3. Structural Drawings				
Teaching material : 1. Building project of Works and Service 2. Documents and Drawings of this project. 3.			Equipment : 1. Computer 2. Projector 3. Pointer 4. Screen	
Results	Date : 16 October 2006	Number of Attendance 4	Lecturer: Furuichi	
	Time: 15:00		Made by: Furuichi	
Place	Mansehra			
Evaluation for Lecturer:	Skill: 4.75	Knowledge: 4.75	Management: 4.75	
Evaluation for Attendance:	Volition:	Understanding:	Attitude:	
Comments: 				

Evaluation ⇒ Fill in the mean value.

Management Control Item & New Material

For seismic resistant Building
Material of a less management
control item

Role of Surveillance Engineer

- Elements of Site Management
 - Time and Quality
- Role of Site Surveillance Engineer
 - Control of Time and Quality
 - Final Responsible Person for Quality

Management control item

- Concrete Work
- Reinforcement
- Hollow Brick work
- Finishing work
- Steel Structure Work
- ETC.

The management
item decreases by
going below

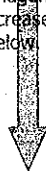

Management control items of Reinforcement

- Number, Size, Type, Strength (of each part)
- Splice (Position, Length, Hook of each part)
- Shape of Hook (180° , 135° , 90°)
- Compression Splice & Tension Splice
- Anchorage (Dowel)
- Thickness of Protection cover concrete
- Spacer, Bolster, Chair
- Etc.

Many Mistake on Reinforcement

What is wrong?

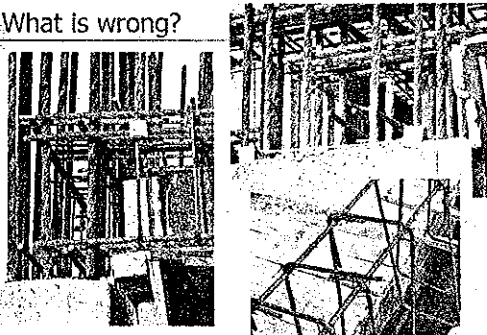

Many Mistake on Reinforcement

- Why such mistakes were happened?

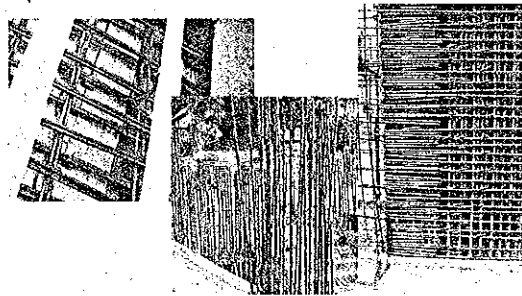

Can you control all Management Items?

- You can not control all Management Items.

How to manage?

Two Solutions

- To find your colleague to support you
 - NO!
 - You have to make collaboration with Contractor's Engineer of Site
 - How to? → Next Lecture!
- To find Material of a Less Management Control Items

Material of a Less Management Control Items

- Which is a Less Management Control Item's Material

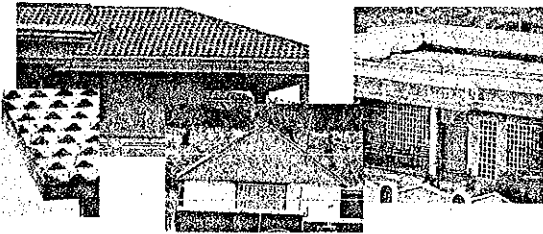

Material of a Less Management Control Items

- Industrial Material
 - half-finished goods, partially fabricated item
 - semi manufactured goods
- Hollow Block
- Steel Structure
- Prefabrication's building
- Panel Wall
 - Pre-cast concrete Panel
 - C-Panel Wall

Hollow Block

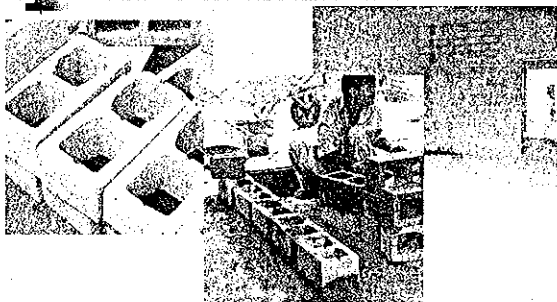

Other Standard's Hollow Block

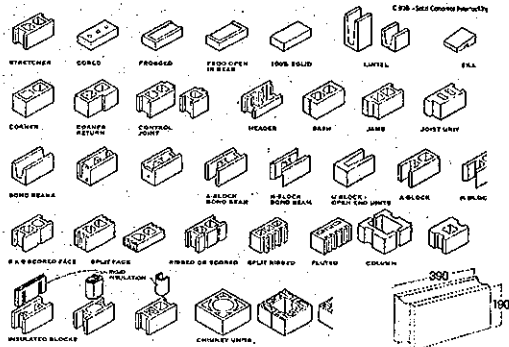

C-Panel Wall

4cm~7cm styrene board
+ cement mortar

C-Panel Wall construction process 1

C-Panel Wall construction process 2

C-Panel Wall performance assessment

Weight of panel: 4.8kg/m²
 Shear strength: 2.5t/m
 Thermal insulation performance:
 0.62kcal/m²·h·°C
 Fire resistance class:
 Mortar Th. 2 x 37.5 2 hour fireproof
 Classification of sound insulation
 More than D-40

C-Panel Wall Example of construction

END

THANK YOU for your attention

Technical Transfer Program Curriculum Sheet			Curriculum No.07	
Lecture name	Make a drawing of reinforcing bar assembling			
Target of course	Upgrade of standard building technology			
Form of Lecture	<input checked="" type="checkbox"/> Work shop	Lecture	<input type="checkbox"/> Seminar	
Content : 1. Presentation of drawing of reinforcing bar assembling 2. 3.				
Teaching material : 1.drawings 2. 3.			Equipment : 1. Computer 2. Printer 3. 4,	
Results	Date : August 31,2006		Number of Attendance 5	Lecturer: Koizumi
	Time: 11:30			Made by: Koizumi
Place	PP band office, Muzaffarabad			
Person for attending a lecture:				
Evaluation for Lecturer:	Skill:	Knowledge:	Concern:	
Evaluation for Attendance:	Volition:	Understanding:	Attitude:	
Comments:				

Evaluation ⇒ Fill in the mean value.

Technical Transfer Program Curriculum Sheet			Curriculum No.07 -2	
Lecture name	Make a drawing of reinforcing bar assembling			
Target of course	Upgrade of standard building technology			
Form of Lecture	<input checked="" type="checkbox"/> Work shop	Lecture	<input type="checkbox"/> Seminar	
Content : 1. Presentation of drawing of reinforcing bar assembling 2. 3.				
Teaching material : 1. drawings 2. 3.			Equipment : 1. Computer 2. Printer 3. 4,	
Results	Date : September 16,2006	Number of Attendance 4	Lecturer: Koizumi	
	Time: 15:00		Made by: Koizumi	
Place	PP band office, Muzaffarabad			
Person for attending a lecture:				
Evaluation for Lecturer:	Skill:	Knowledge:	Concern:	
Evaluation for Attendance:	Volition:	Understanding:	Attitude:	
Comments:				

Evaluation ⇒ Fill in the mean value.

Make a drawing of reinforcing bar assembling

No	Attendance		Curriculum Evaluation		
	Name	Title	Useful	Not useful	Other comment
1	Laja Saeed	SDO PWD	✓		
2	SOHAIL RUKESHKI	SDO PWP	✓		
3	MATID IQBAL	SDO PWD	✓		
4	ARSHAD AHMED Khan	SIE PWP			
5	ZARA ULLAH	SITE ENGINEER (PARTHONAN)	✓		
6					
7					
8					
9					

Opinion for today's Curriculum:

Clear Cover Size of Beam must increase the clear cover of the Col with same dimension.
 I am agree at above noted. we should change the clear cover items you want to know
 to adjust the bind the bars (ZARA ULLAH)
 If you please let us know what ideas you have for future workshops.
 The ACI specification of min & max clear cover of Col & Beam.

Curriculum Result: Date 2006 ^{September} 31/16 August Curriculum No. _____ Lecturer: NOBUYASU KOIZUMI

Make a drawing of reinforcing bar assembling

No	Attendance		Curriculum Evaluation		
	Name	Title	Useful	Not useful	Other comment
1	FIDA MUHAMMAD	SUB-ENGINEER WAS Member	✓		very very useful for us
2	ISRAR AHMAD	do	do		do
3	TARIQ YOUSAF	do	do		do
4	Mohammad Saqib	Contractor			
5					
6					
7					
8					
9					

Opinion for today's Curriculum:

I received very good informations about the steel/reinforcing design and applying future projects.

Items you want to know

About make a drawings of reinforcing bar assembling design.

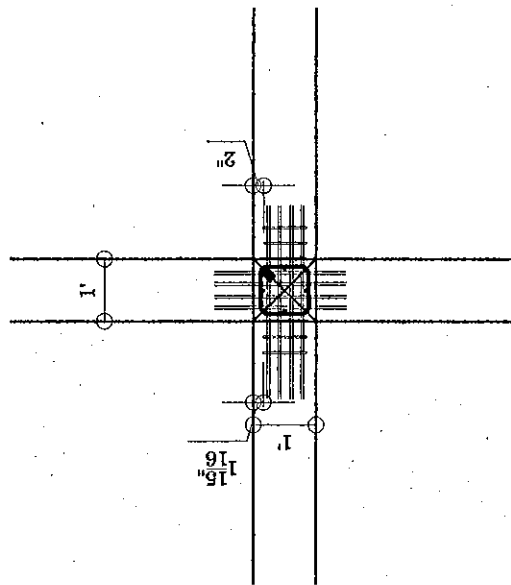
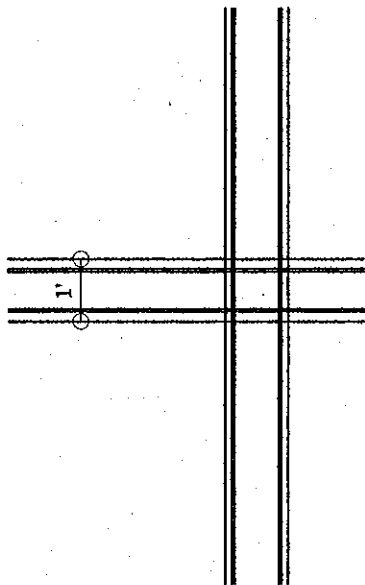
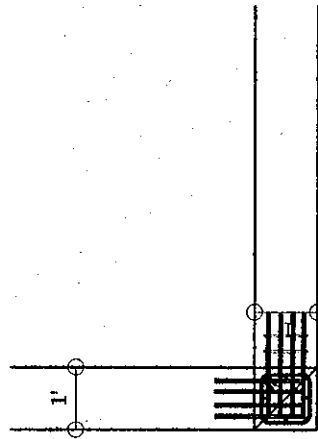
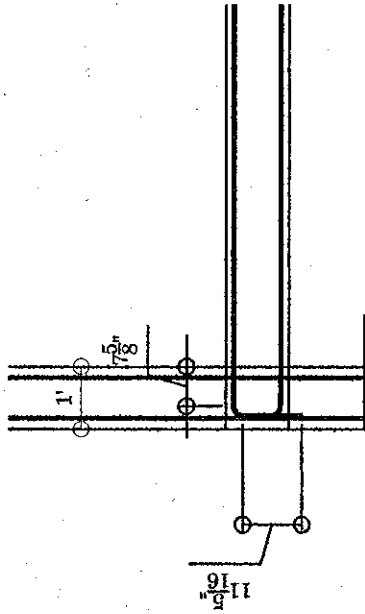

Public Works Department	Works and Services	PROJECT:	Designing Prototype Basic Health Unit		DATE:	DRAWING NO:
		DRAWING TITLE:	Make a drawing of reinforcing bar assembling		DESIGNED BY:	SIGNATURE:
				SCALE:		S01

Designing Prototype Seismic Resistant and Barrier-free BHU in AJK and NWFP

Islamabad
4th November, 2006

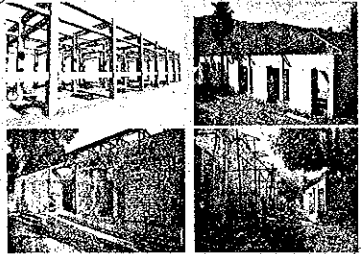

ICA
Asian Technical Cooperation Agency

Designing Prototype Seismic Resistant and Barrier-free BHU in AJK and NWFP

Contents

- ◆ Perspective for the Standard Design of BHU
- ◆ Concept of Designing BHU
 - ◇ Seismic design
 - ◇ Barrier-free
 - ◇ Grid system
- ◆ Standard Plan
- ◆ Model Construction in AJK & NWFP

Background of the project

The primary health care facilities as BHU and RHC was damaged heavily by the earthquake on 8th October, 2005.

And the need for safeguarding primary health care facilities by earthquake, becomes more evident and pertinent after the last earthquake.

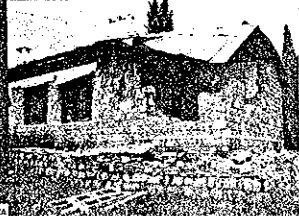

Designing Prototype Seismic Resistant And Barrier-free BHU in AJK and NWFP

Perspective for the Standard design of BHU

It is not only one building, Standard design should be disseminated to the this Area.

We have to consider about

- Local condition
 - material availability
 - material accessibility
 - skill of workmanship
- Local situation
 - climate
 - land situation
 - (hilly area, soil condition)



Land situation

The standard design should be have a Adaptability for many kinds of lands.

It should be adapt to Hilly area for example Narrow and step site.



Cause of Damage in affected area

In many case, the buildings in the earthquake has been appeared to cause of damage

Vulnerability of buildings

Most damaged/destroyed houses were constructed Masonry method by stone, brick or C.B. and

No Earthquake Resistance Sources

Such buildings destroyed on account of,

Weakness of wall against horizontal force

- Weak connection on the corner
- Weak connection between roof to wall.
- Weak joint mortal



CONCEPT of Designing BHU

1, Seismic design
The health care facilities should be remain safe and functioning after earthquake.

2, Barrier-free as Universal design
All public facilities should be easy access and user friendly for the all people.

Standardization for the Public building

Seismic design

Structure method of BHU:
RC Frame + Masonry Wall

We consider about design and detailing for the quality of construction.
/ Dr. Hanazato



After the earthquake, Existing RC Frame structure also exposed
Improper construction,
Substandard material.

- Quality control / Mr. Furuichi
- Knowledge of construction / Mr. Kobumi

Ideal Earthquake Resistant building

- *Small mass
- *Low Height-to-base ratio
- *Balanced Elevation
- *Symmetrical Plan
- *Short spans

Grid system

Repetition of one module.

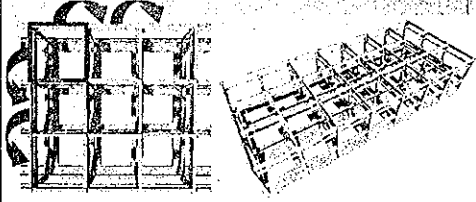

Characteristic of Grids system

- 1. Flexibility:**
Grids plan as module to provide flexibility for the needs.
We can choose the number of module Grid Box depend on necessary facility.
- 2. Adaptability:**
Grids plan as module to provide adaptability. The standard design should be adapt to location.
The number of module Grid Box can adapt to the site situation.
- 3. Uniformity:**
Grids plan as module to provide uniformity. The size of all column and beam should be standardized.
- 4. Simplify:**
About human(workman) resource friendly, the construction should be about work simplification.

Barrier-free as Universal design

Apart from damage to infrastructure the last earthquake also left a large number of people with physical disabilities.

Therefore, it is equally important to ensure that the new health facility designing are not only earthquake seismic design but also barrier-free as universal design.

All public facilities should be easy access and user friendly for the all people.

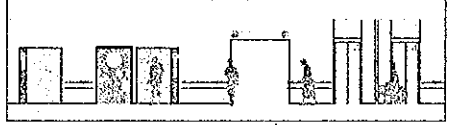

Point of view of Universal design
It is not only disabled people, it is for the all people.

Design point of building

- Planning of Zoning
People's Circulation Line
Planning of level of elevation
Planning of Signage

Points of view

- Simple for the all
- Comfortable for the all
- Safety for the all
- Flexible for the all

■ Perspective of the Universal design

Experiences machine of disabled

Step1: Everybody can access to the building

- No difference in level → Provide slope
- Easy access → Consider about entrance

Step2: Everybody can use safely and comfortably

- No difference in level → Flat slab (Between corridor to room)
- Easy access → Consider about door size etc.
- Waiting space → Enough space, People's Circulation line
- Toilet → Clean, Enough number and size.

Step3: Everybody will feel friendly to the building

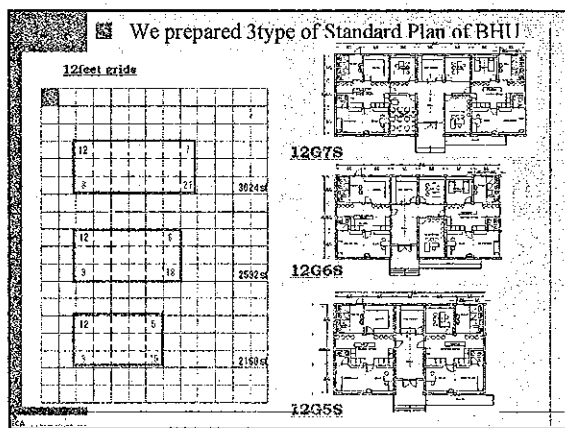
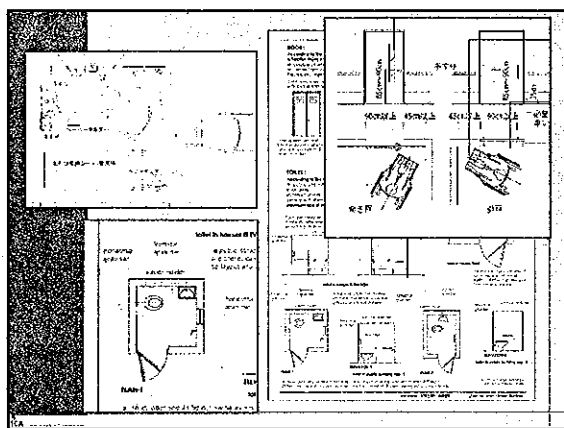
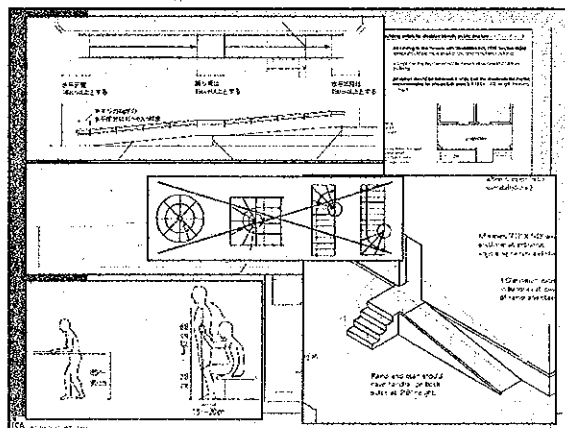
■ Why we choose 12feet Grids for the module,

- 1. Flexibility**
12feet grids can be planed 2span or 3span depth based on site situation.
-----2span depth is 24ft, 3span depth is 36ft.
(Existing BHU was depth 27ft - 30ft)
- 2. Economical**
According to structural analyses,
Columns is 1ft x 1ft
Plinth beam is 1ft x 1ft
Roof beam is 1ft x 9inch
-----These are standard size.
- 3. Earthquake Safer design structure**
Short span, small mass.
Easy Quality control

■ 12ft Grids is the most suitable design in the present and future situation.

■ New BHU facilities

As request from health department, New BHU should be integrated facilities,

■ Necessary facilities,

- Procedure
- Exam
- Dispensary
- E.P.I
- Ward
- Family planning (NWFP)
- Training room (NWFP)
- T.B center (AJK)
- Laboratory (AJK)

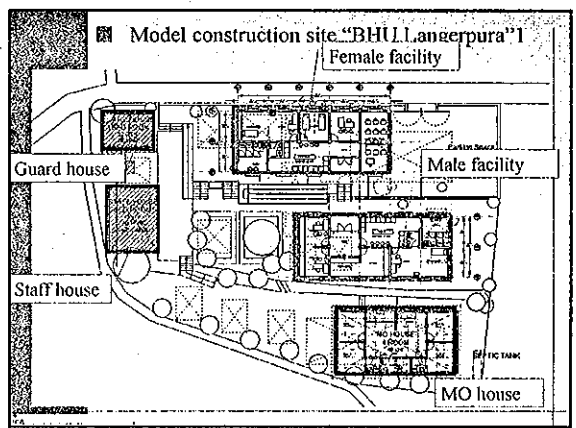
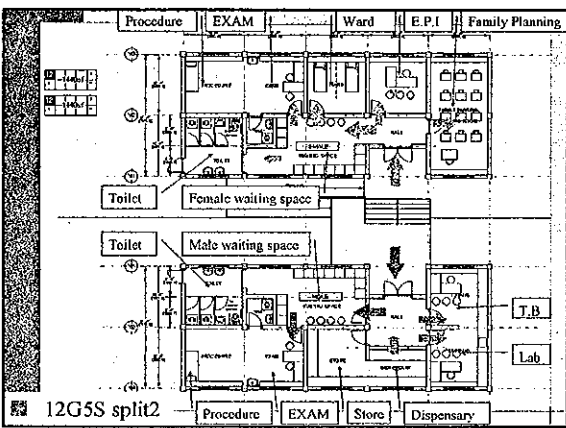
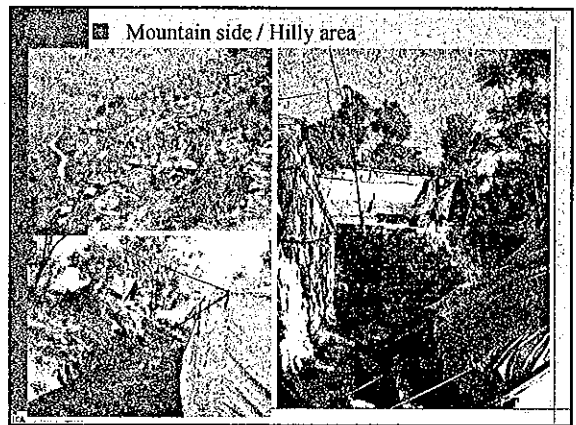
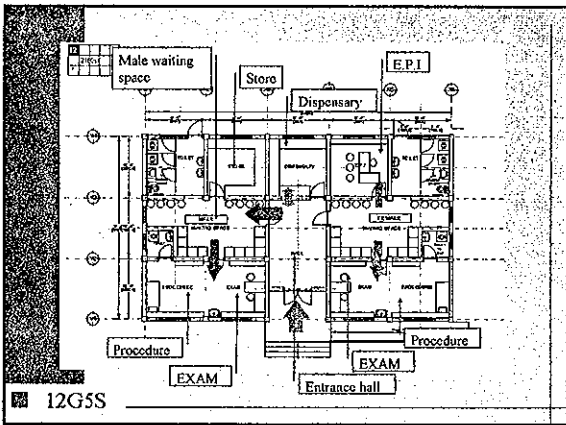
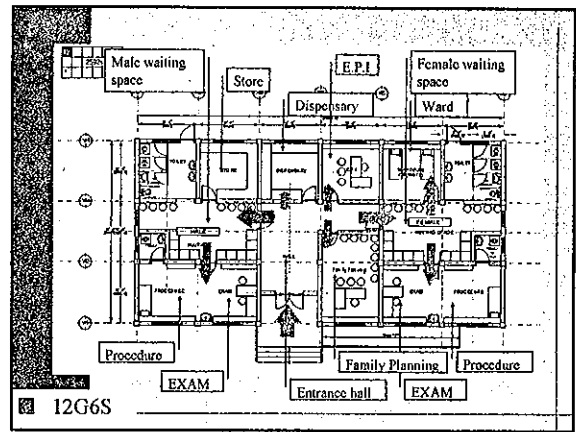
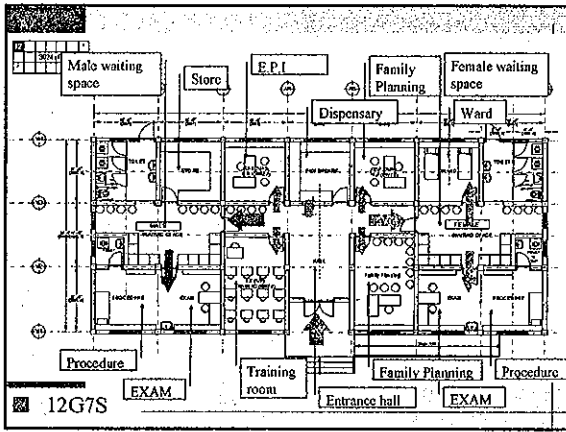

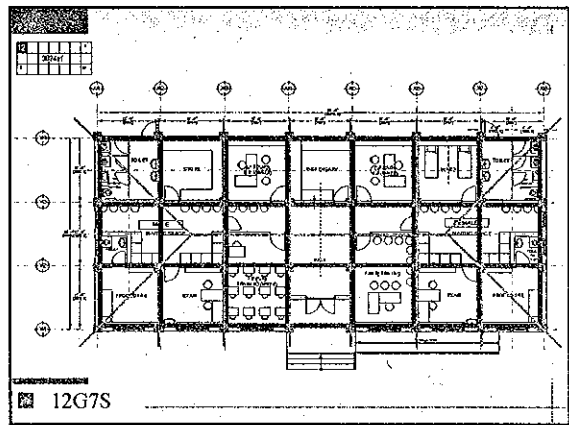
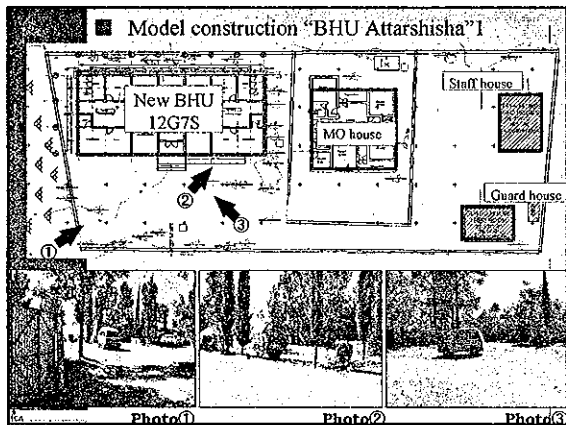
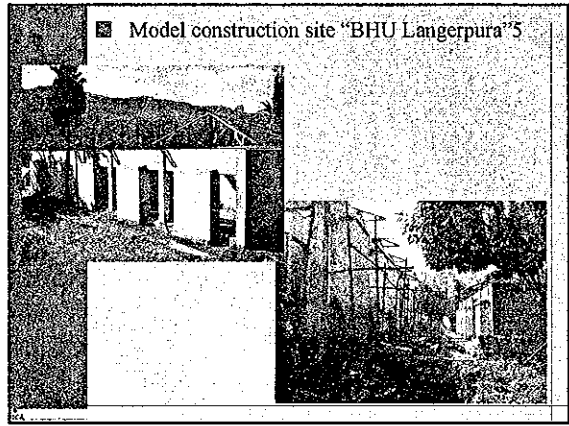
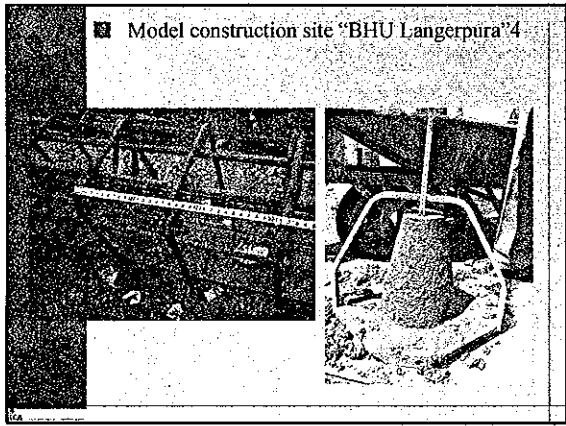
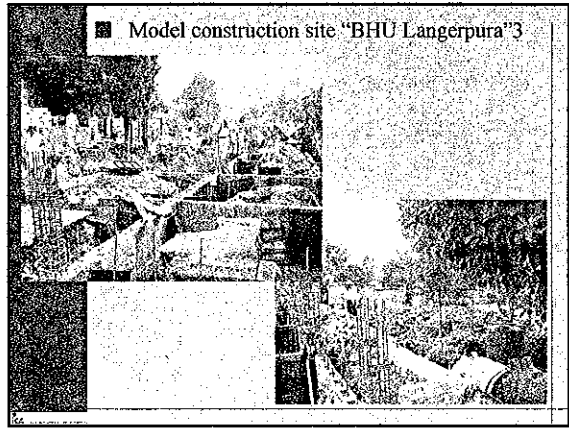
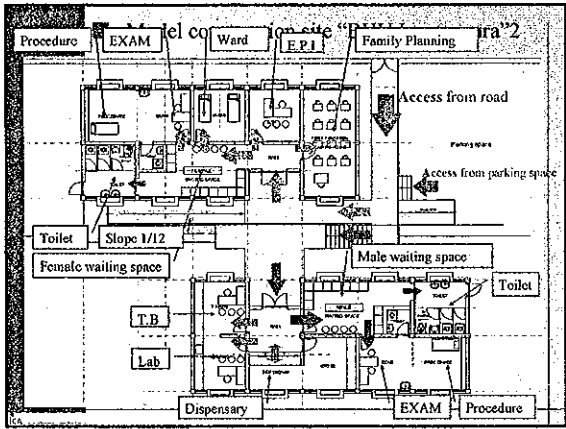

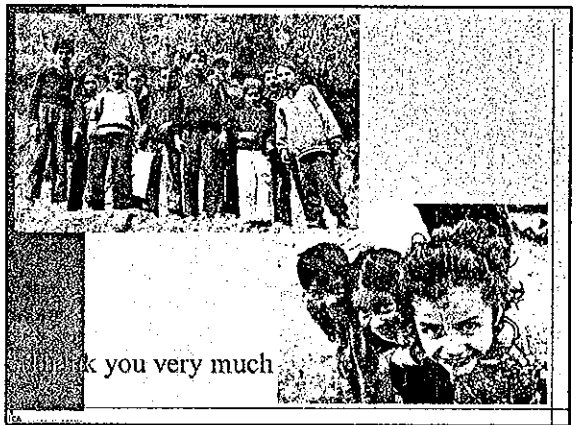
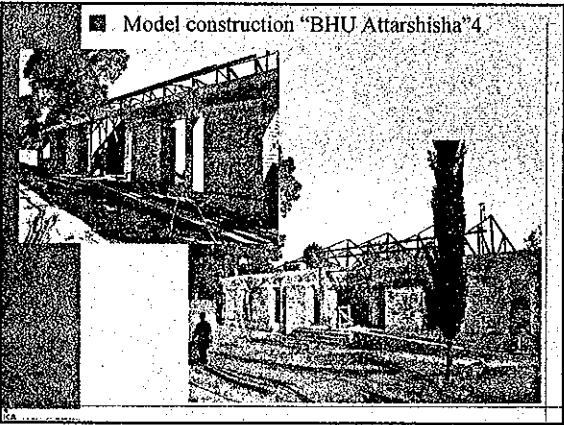
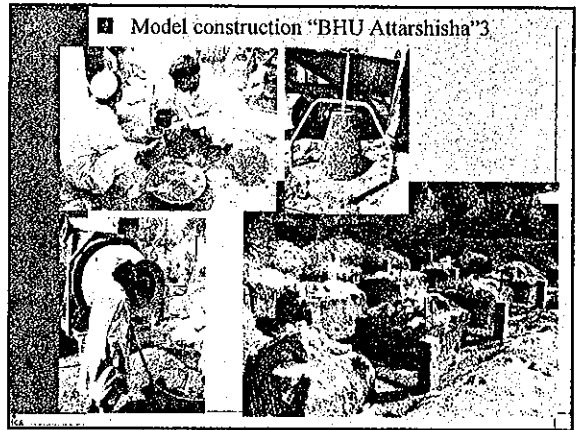
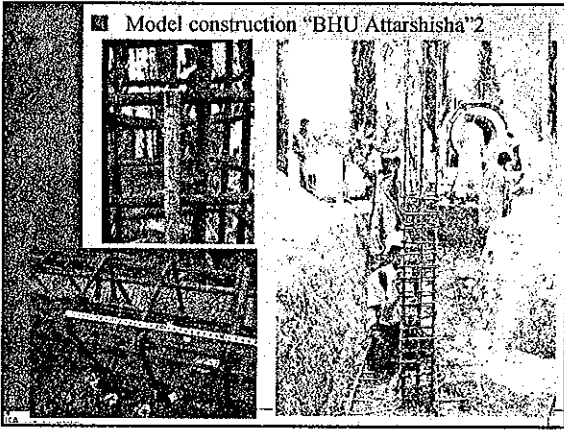

DESIGNING PROTOTYPE SISMIC RESISTANT AND BARRIER FREE BASIC HEALTH UNITS

Structural Seismic Designing



STRUCTURAL SEISMIC DESIGN

- Lessons from earthquake damage
- Concept for seismic construction
- Outlines of structural design
- Recommendations

Irregularities and weak joints

Bagh

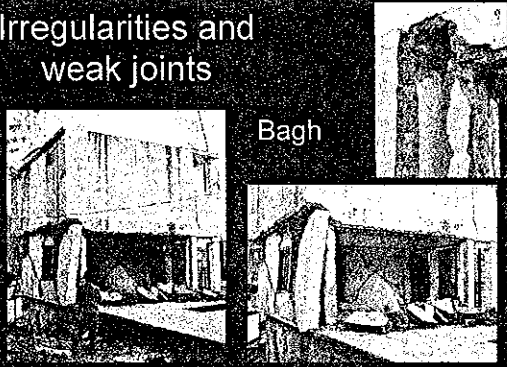

Lessons from earthquake damage

Shear Failure of Brick Masonry Wall

RHC Muzafarabad



Lessons from earthquake damage

Insufficient connection

BHU Shawal

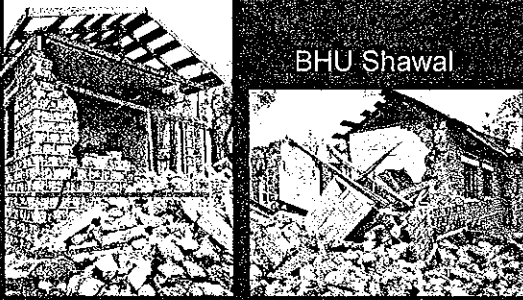

Lessons from earthquake damage

Unreinforced masonry wall with poor mortar joints

Out of plane collapse

Dadar Balakot

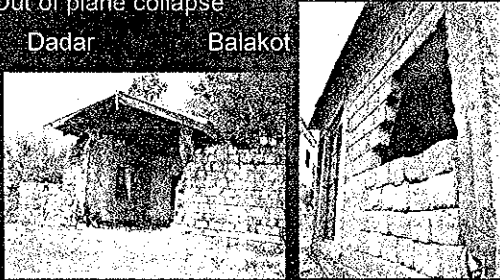

Lessons from earthquake damage

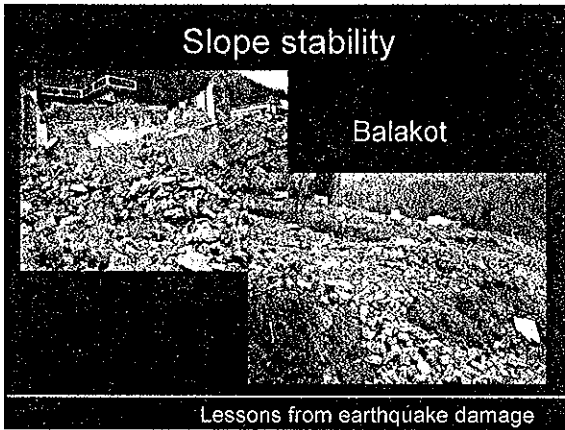

CONCEPTS of SEISMIC DESIGN

Dual Mode Design

- Moderate earthquake ground motions will not cause structural damage to the building
- Extremely strong ground motions will not cause damage to human lives
 - Prevent collapse of not only framed structure but also masonry walls

STRUCTURAL DESIGN

Reinforced Concrete Frame & Masonry Wall

- Seismic resistant design of framed structure of reinforced concrete and of masonry walls
- Wind and snow resistant design of roof trusses

Regulations for Design

- Based on concepts of Japanese Building Code.
- To strengthen masonry walls, the guidelines published by Architectural Institute of Japan & proposal by Dr. Qaisar Ali, UET Peshawar
- Referring to Uniform Building Code, as well as, to the original structural design by UET, Peshawar

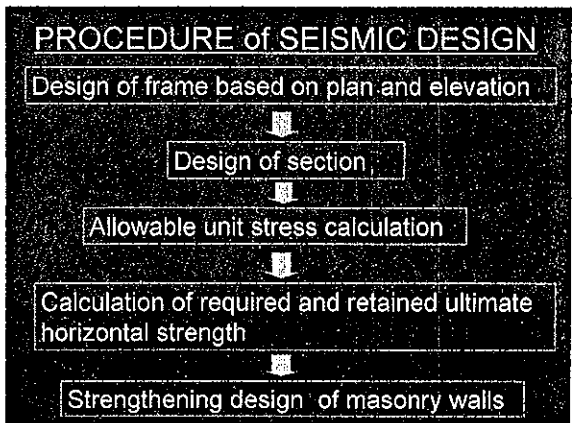
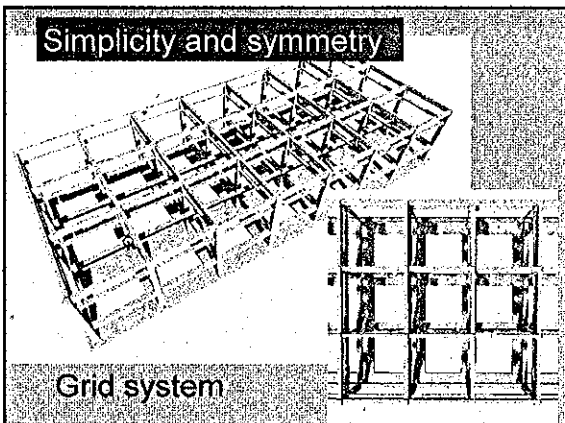

Comparison of Seismic Design Loads

Base shear coefficient

	Pakistan	Present design	Japanese Code
Allowable unit stress	0.07 for Zone 2 (before	0.15	0.20
Ultimate lateral strength	0.22 UET, Pesh (UBC-9	Response Acceleration = 0.75G	
			0.30 (S=0.30)

Ds : Reduction factor due to damping and ductility

Ultimate Lateral Strength

To protect human lives during extremely large earthquakes ,

- 1) Framed structure will not collapse
Deformation and failure mechanism
Limit state of structure
- 2) Masonry walls will not collapse
Deformation of structure <
Safety limit of masonry walls

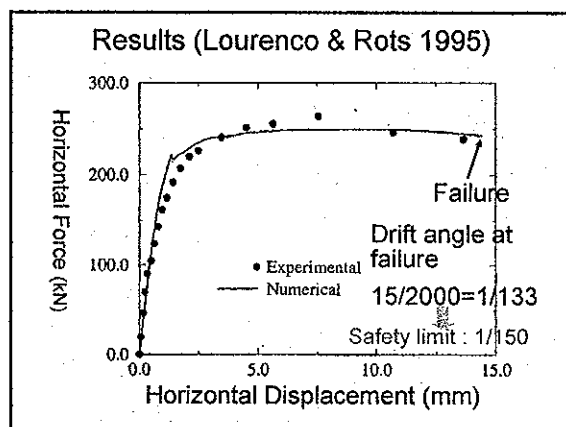
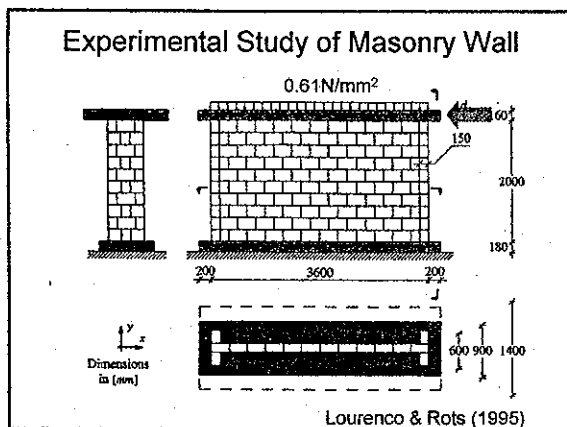

As results, our structural design drawing : similar to original design conducted by Dr. Qaisar Ali, UET Peshawar

Assumption of Structural Analysis

- Reinforced concrete frame resists earthquake loads
- Masonry walls are non-structural elements (Safety side evaluation)
- Boundary condition of analysis model is based on actual condition of structure

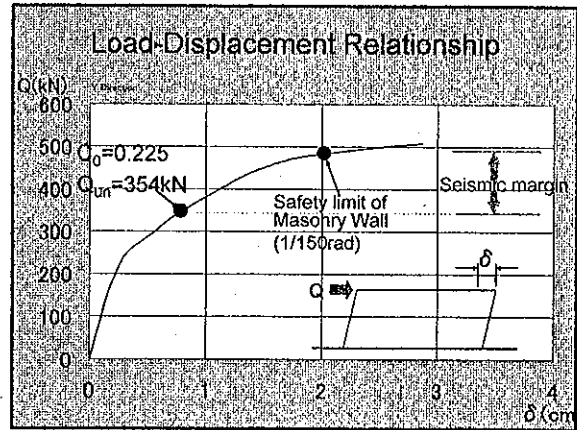
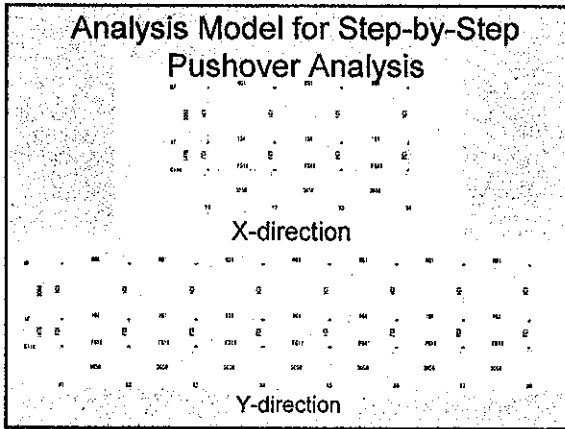

Concrete Strength

Design compressive strength = 2550psi (180kgf/cm²)

	Test results	Ave.
Laboratory compressive tests of cylindrical specimen	2970psi	2943psi (207kgf/cm ²)
	3071psi	
	2788psi	

Sample : Langarpura site, 4 weeks

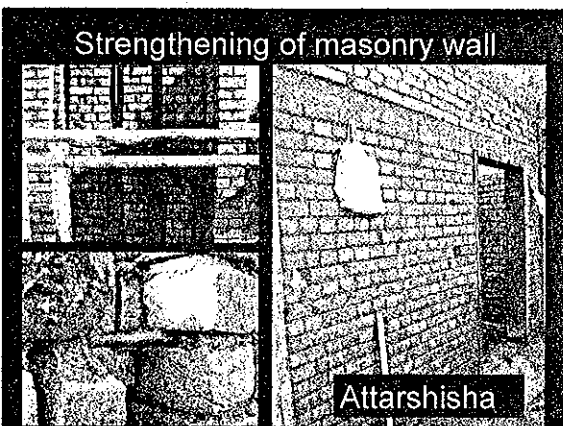
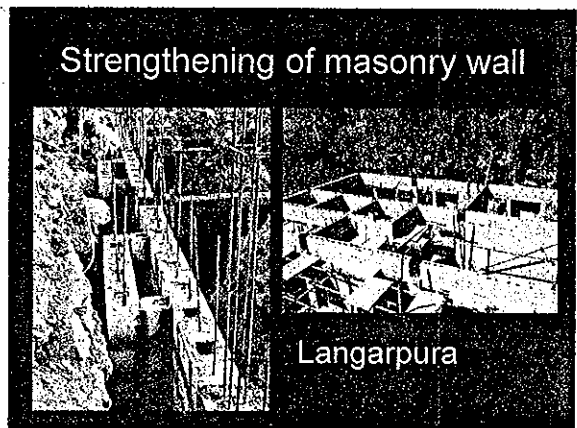

- ### Recommendations
- Ductility, deformability and damageability should be taken into account for seismic construction
 - Construction works should be conducted to satisfy structural condition of analysis as engineered structure
 - Quality control of concrete should be done by periodical check of strength
 - Further study would be needed for strengthening masonry wall in consideration of local availability of materials

DESIGNING PROTOTYPE
SISMIC RESISTANT
AND BARRIER FREE
BASIC HEALTH UNITS

Thank you

