

7.6 基本設計図面集

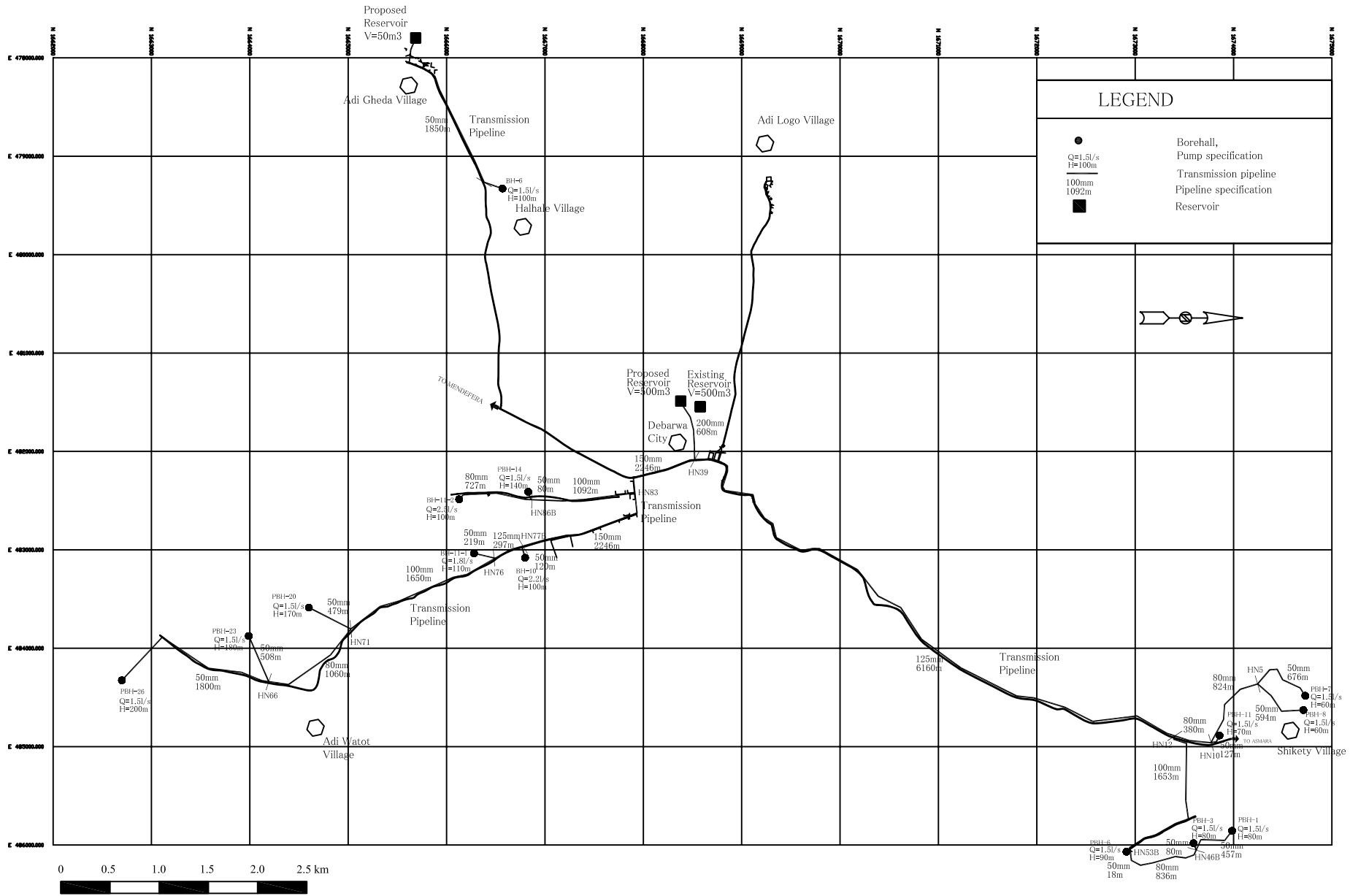

JAPAN INTERNATIONAL COOPERATION AGENCY

 **NIPPON KOEI CO.,LTD.**

DRAWING TITLE

デバルワ市における給水施設配置概要-(1) 送水管

SCALE

DATE

MAY 2006

DRAWING NO.

BD-001

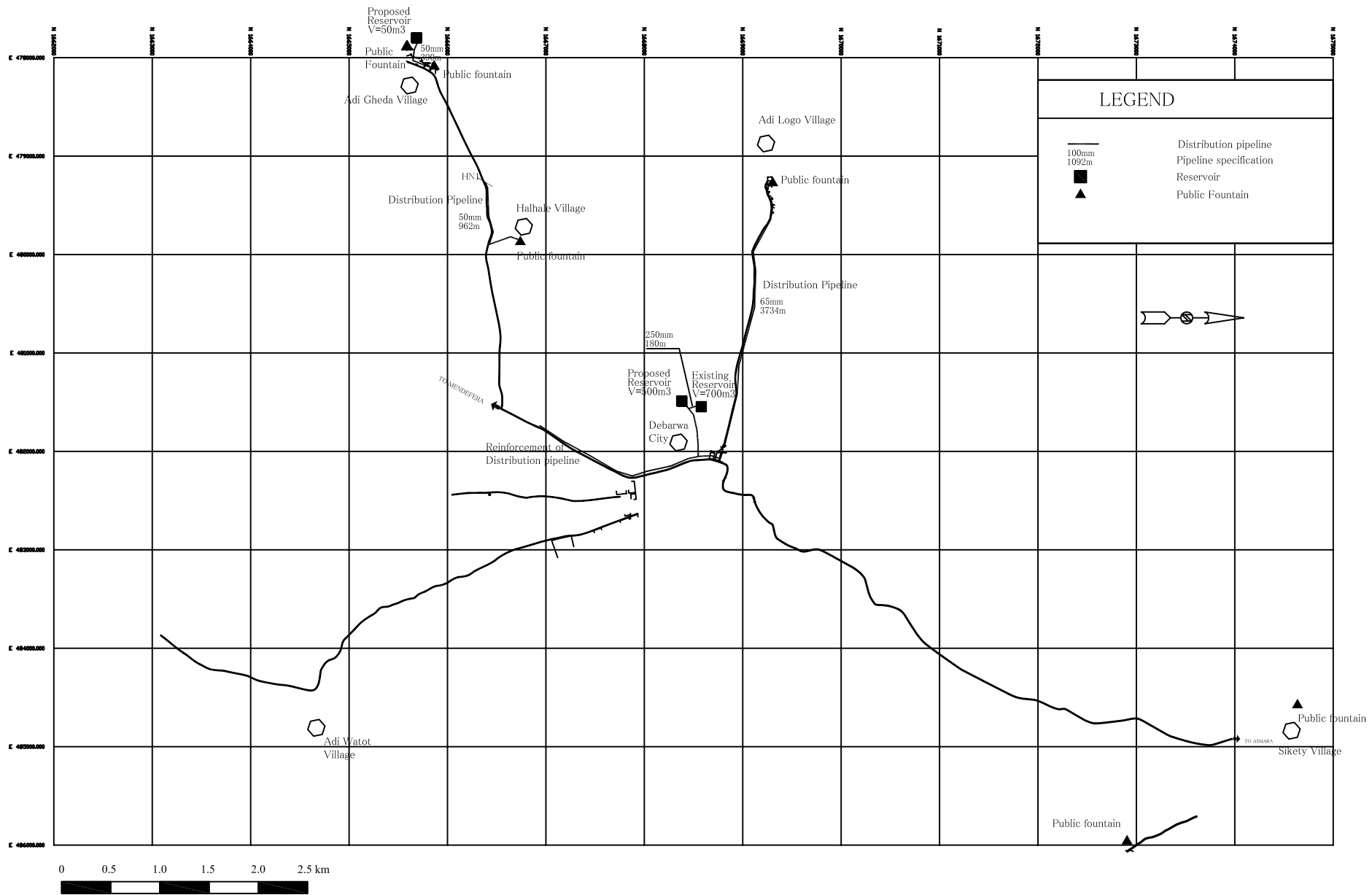

THE BASIC DESIGN STUDY ON THE PROJECT
FOR URBAN WATER SUPPLY IN DEBUB REGION
IN THE STATE OF ERITREA

JAPAN INTERNATIONAL COOPERATION AGENCY

 NIPPON KOEI CO.,LTD.

DRAWING TITLE

デバルワ市における給水施設概要-(2) 配水管

SCALE

DATE

MAY 2006

DRAWING NO.

BD-002

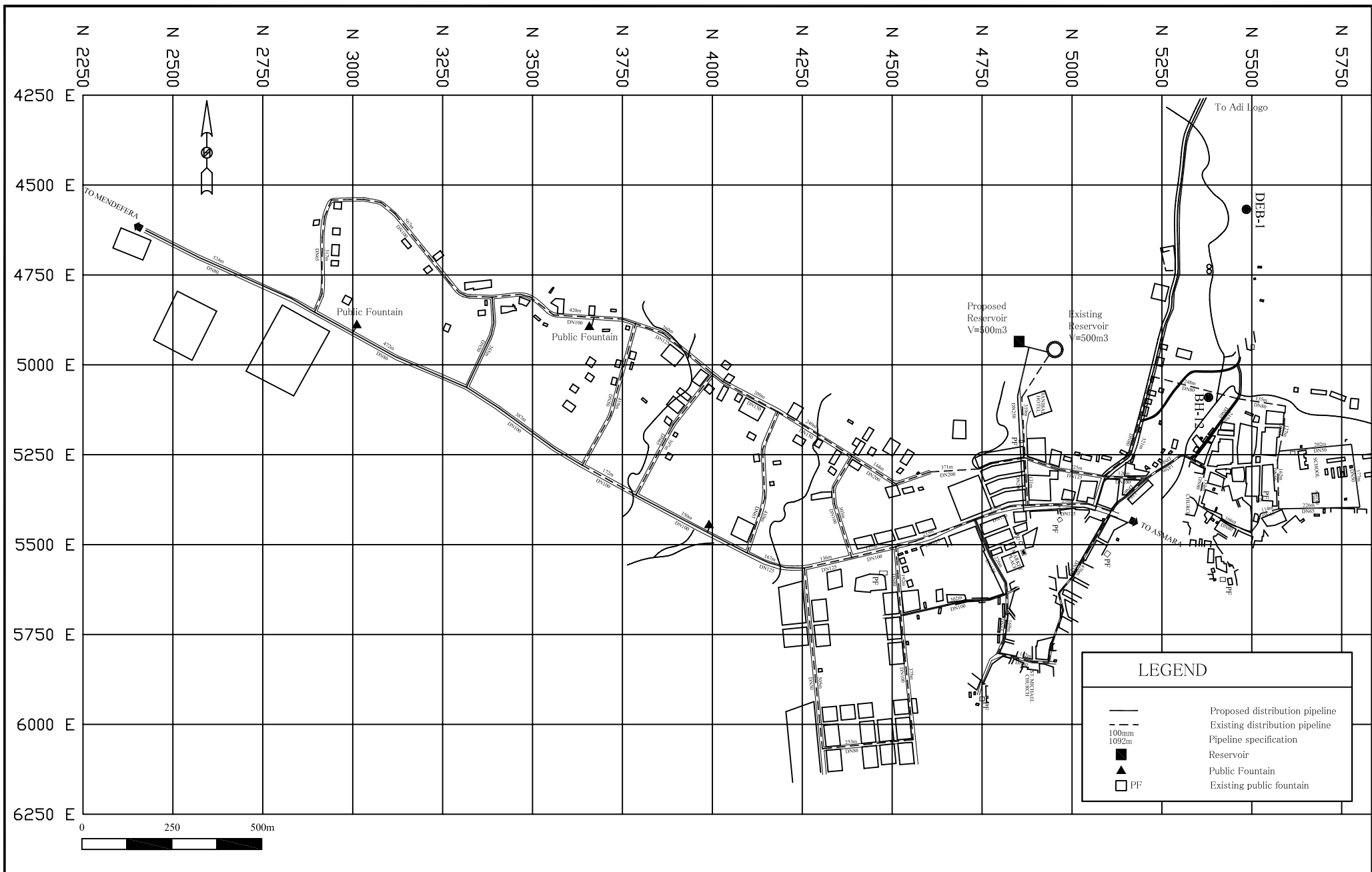

THE BASIC DESIGN STUDY ON THE PROJECT
FOR URBAN WATER SUPPLY IN DEBUB REGION
IN THE STATE OF ERITREA

JAPAN INTERNATIONAL COOPERATION AGENCY

 **NIPPON KOEI CO.,LTD.**

DRAWING TITLE デバルワ市における給水施設概要-(3) 市内配水管網		
SCALE	DATE MAY 2006	DRAWING NO. BD-003

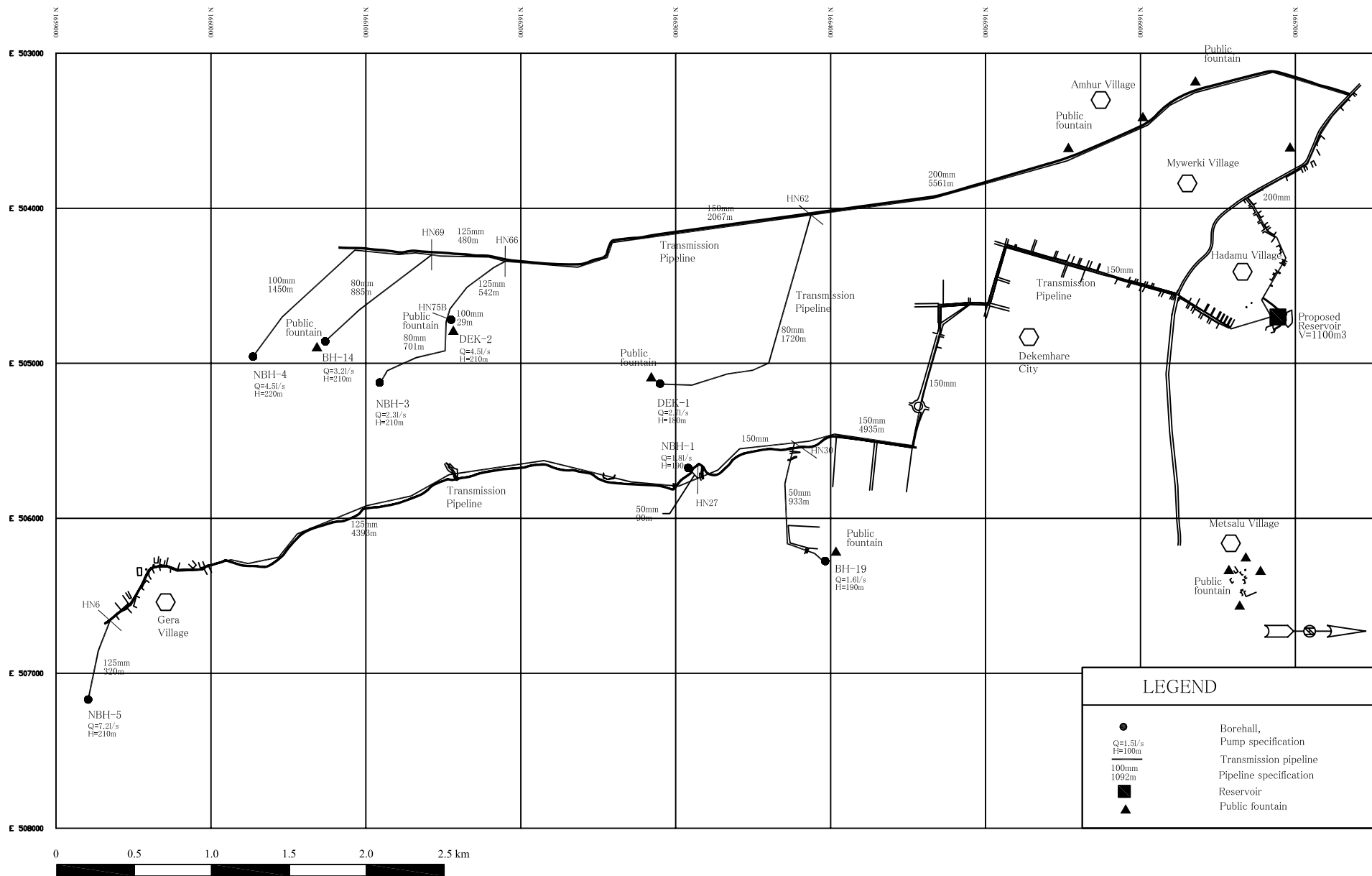

THE BASIC DESIGN STUDY ON THE PROJECT
FOR URBAN WATER SUPPLY IN DEBUB REGION
IN THE STATE OF ERITREA

JAPAN INTERNATIONAL COOPERATION AGENCY

 NIPPON KOEI CO.,LTD.

DRAWING TITLE

デケムハレ市における給水施設配置概要-(1) 送水管

SCALE

DATE

MAY 2006

DRAWING NO.

BD-004



THE BASIC DESIGN STUDY ON THE PROJECT
FOR URBAN WATER SUPPLY IN DEBUB REGION
IN THE STATE OF ERITREA

JAPAN INTERNATIONAL COOPERATION AGENCY

 NIPPON KOEI CO.,LTD.

DRAWING TITLE デケムハレ市における給水施設配置概要-(2) 配水管		
SCALE	DATE MAY 2006	DRAWING NO. BD-005

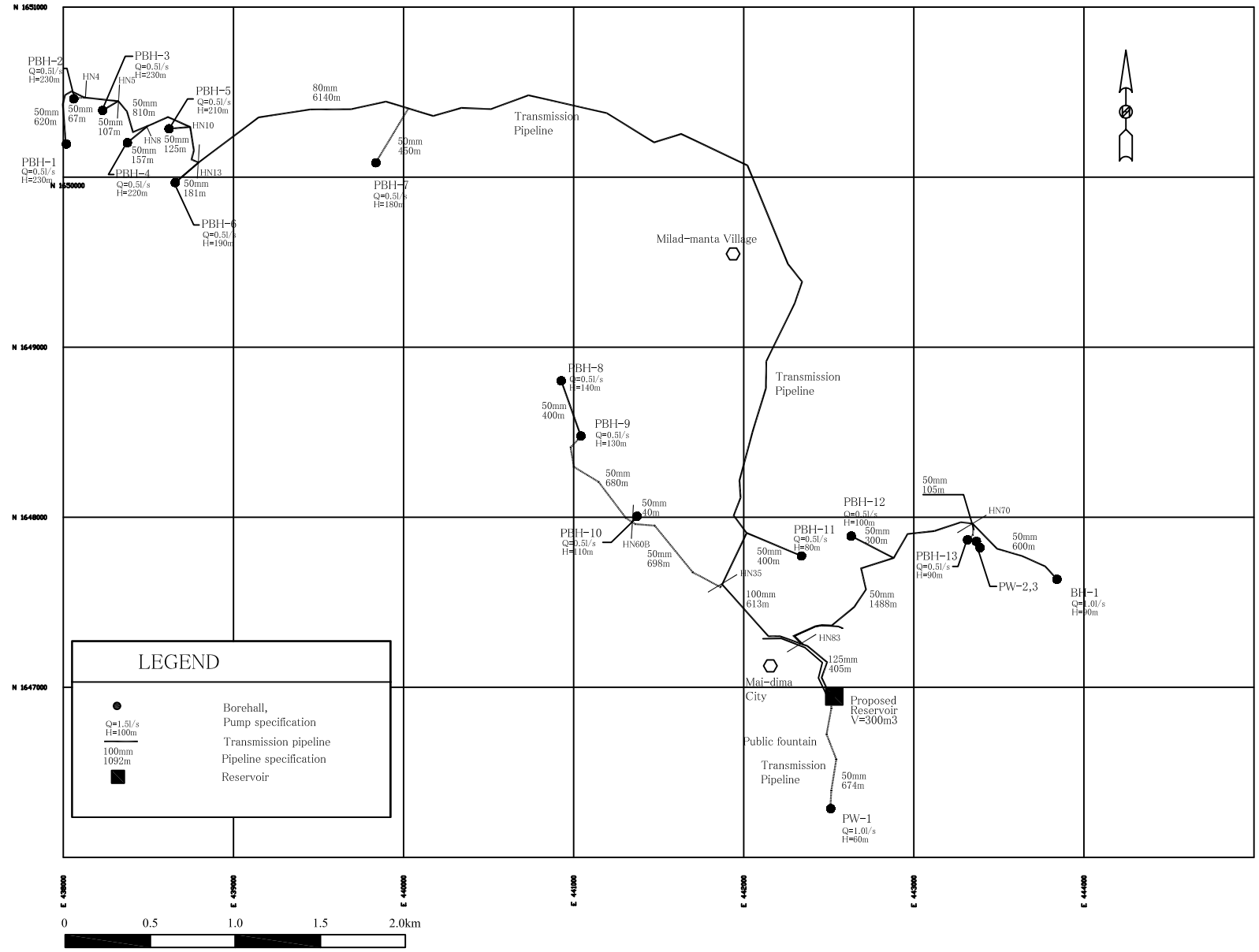

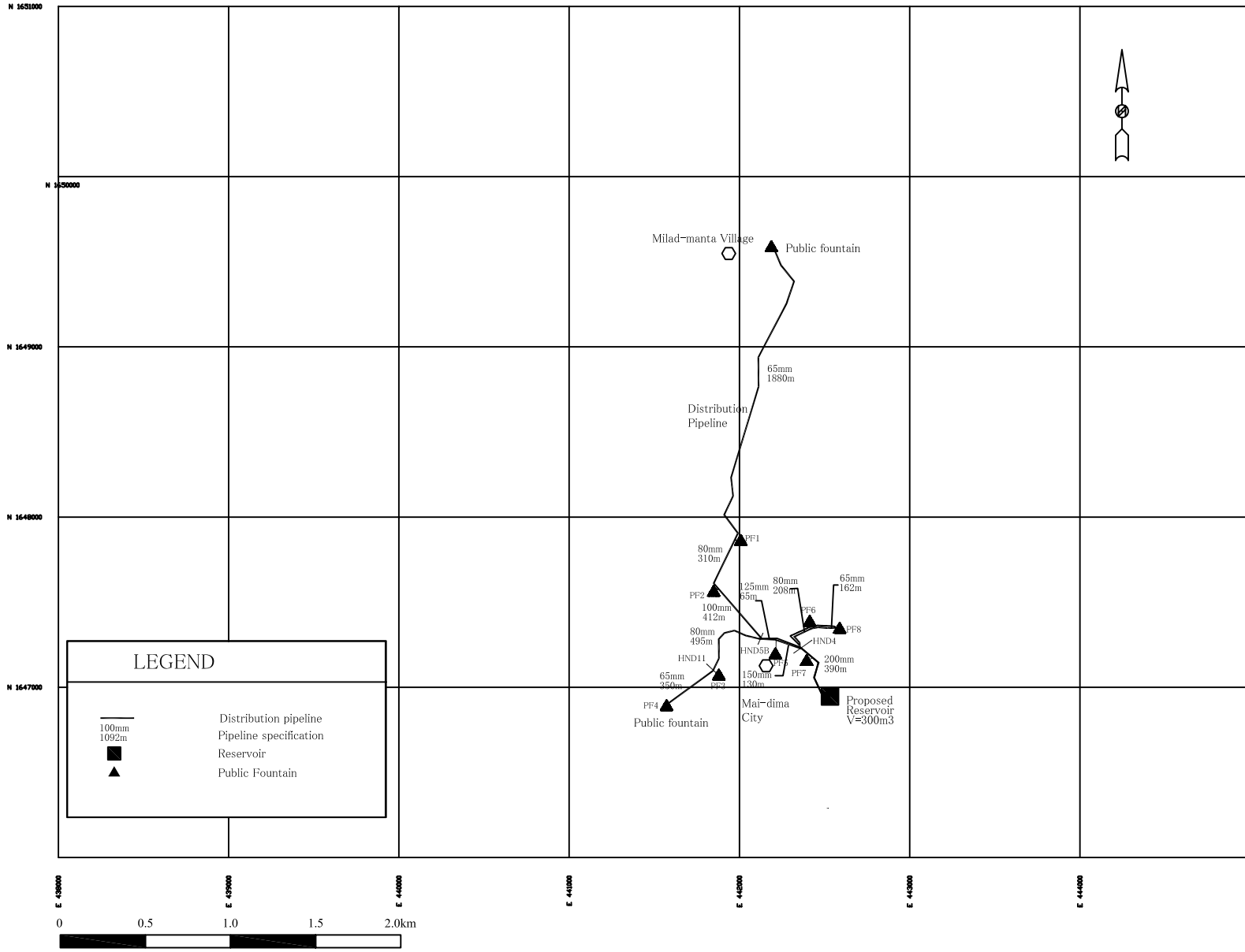

THE BASIC DESIGN STUDY ON THE PROJECT
FOR URBAN WATER SUPPLY IN DEBUB REGION
IN THE STATE OF ERITREA

JAPAN INTERNATIONAL COOPERATION AGENCY

 NIPPON KOEI CO.,LTD.

DRAWING TITLE

マイディマ市における給水施設配置概要-(2) 配水管

SCALE

DATE

MAY 2006

DRAWING NO.

BD-007

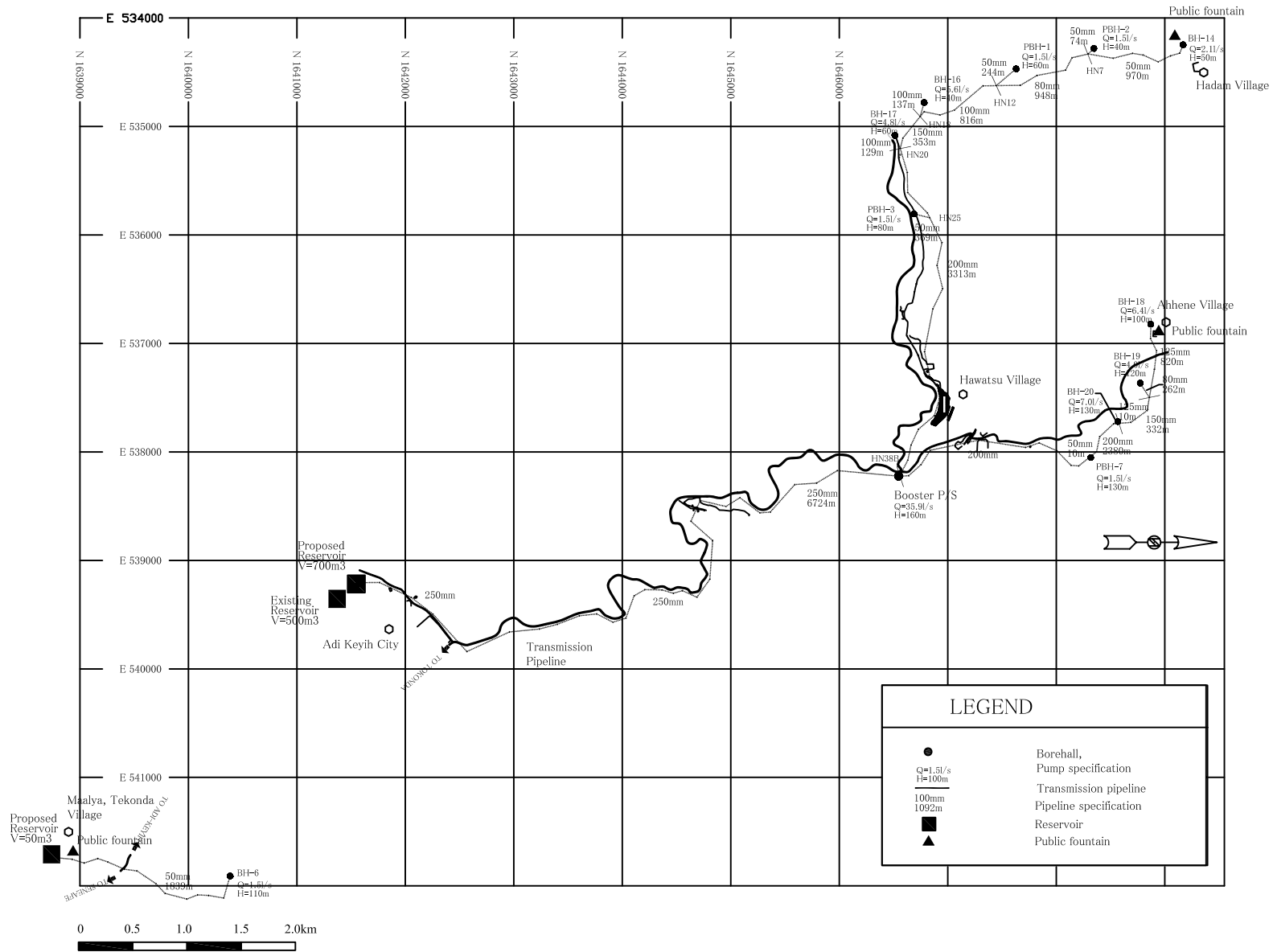

THE BASIC DESIGN STUDY ON THE PROJECT
FOR URBAN WATER SUPPLY IN DEBUB REGION
IN THE STATE OF ERITREA

JAPAN INTERNATIONAL COOPERATION AGENCY

NIPPON KOEI CO.,LTD.

DRAWING TITLE

アディケイ市における給水施設配置概要(1) 送水管

SCALE

DATE

MAY 2006

DRAWING NO.

BD-008

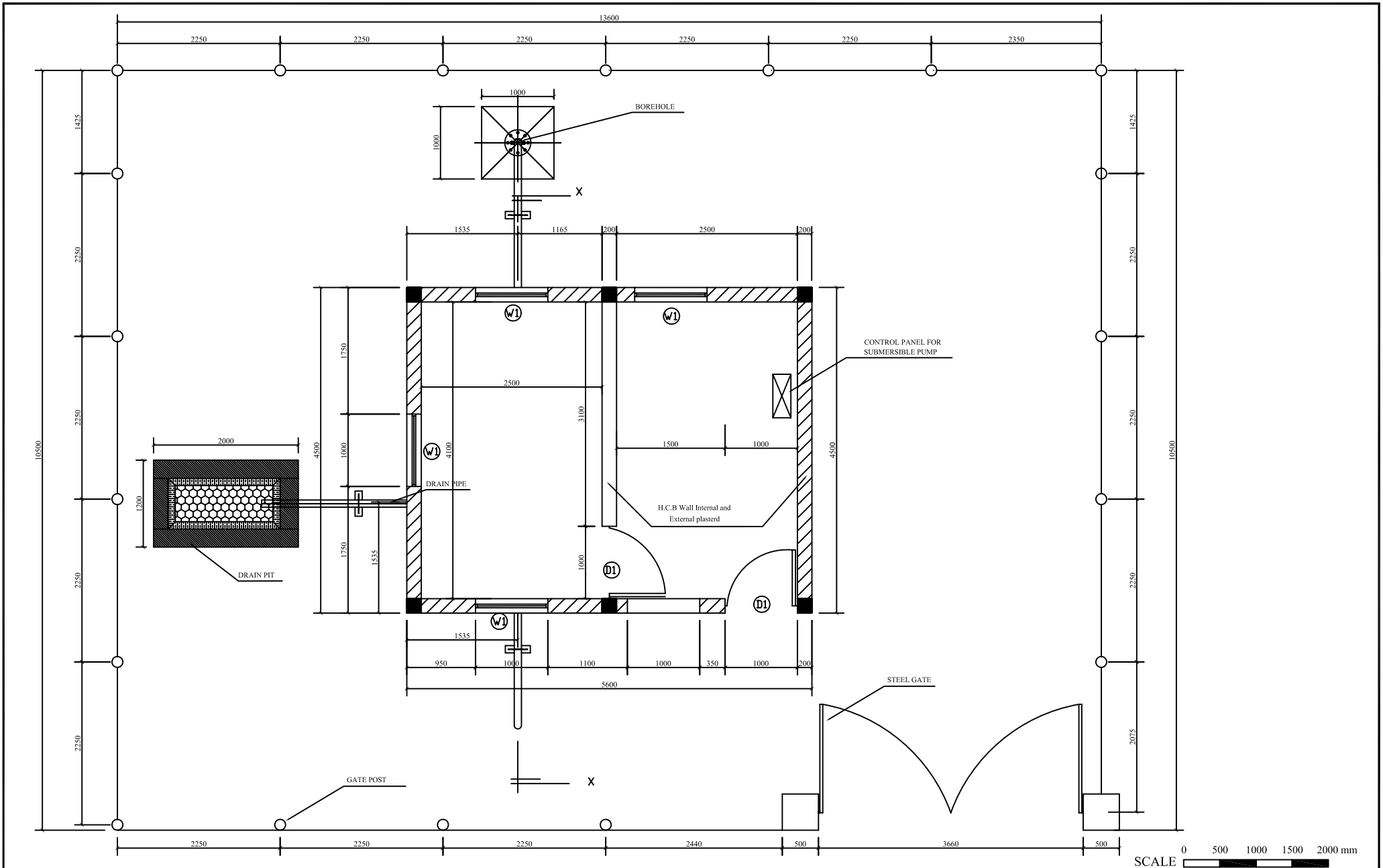

SCALE 0 500 1000 1500 2000 mm

THE BASIC DESIGN STUDY ON THE PROJECT
FOR URBAN WATER SUPPLY IN DEBUB REGION
IN THE STATE OF ERITREA

JAPAN INTERNATIONAL COOPERATION AGENCY

 NIPPON KOEI CO.,LTD.

DRAWING TITLE 取水施設概要図		
SCALE	DATE MAY 2006	DRAWING NO. BD-009

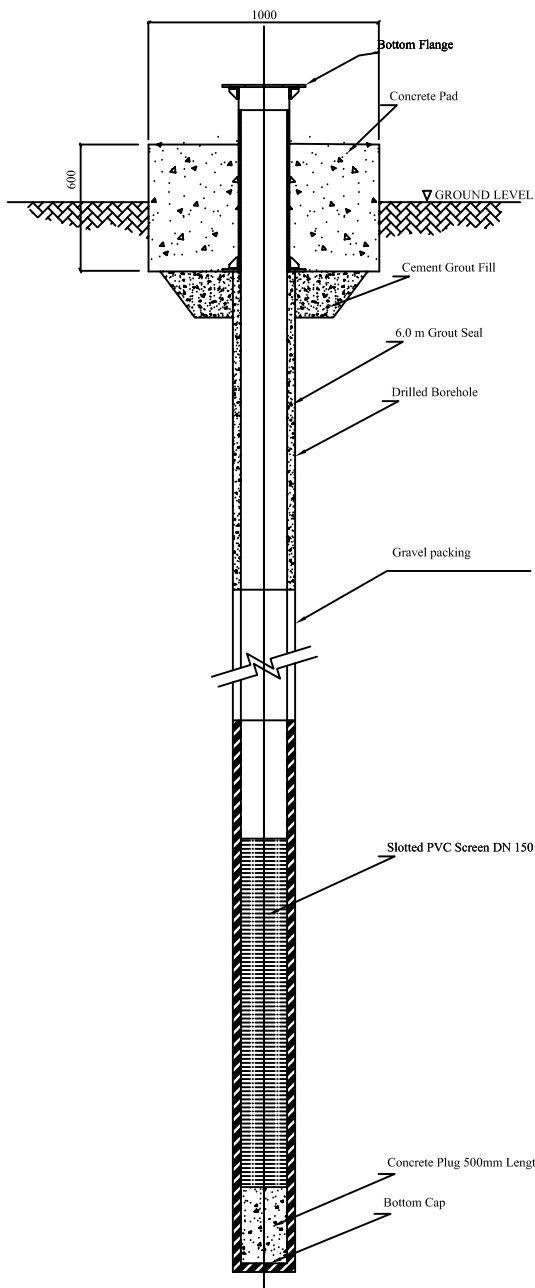

DRILLED BOREHOLE AND CASING

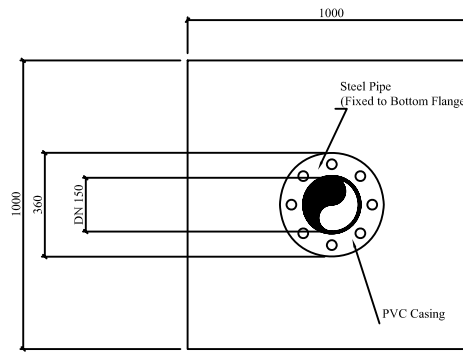

BOREHOLE PLAN VIEW

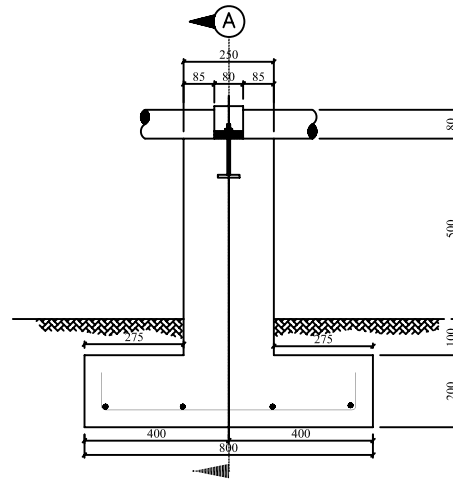

PIPE SUPPORT

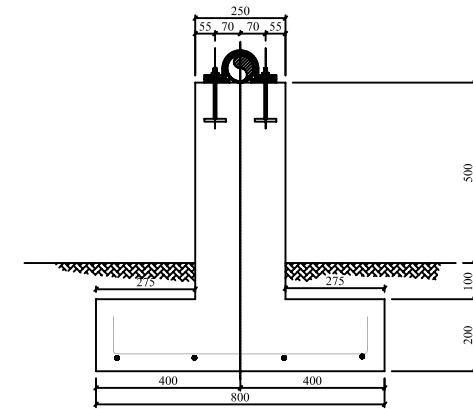

(Section A-A)

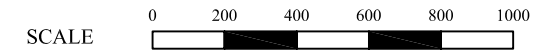

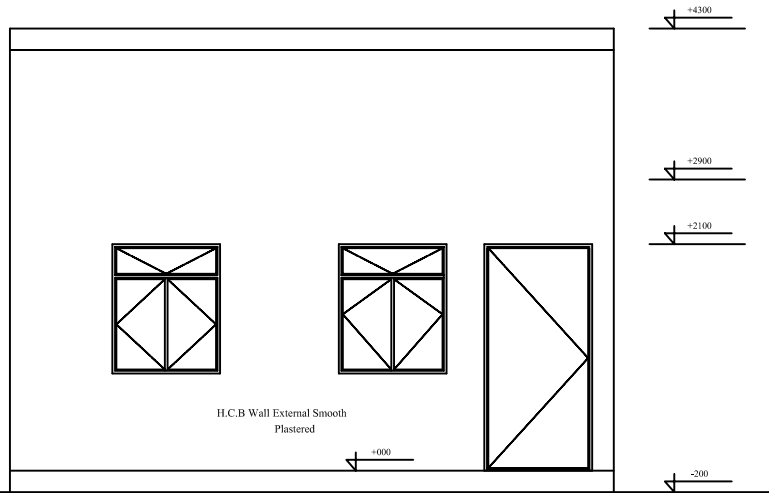

FRONT ELEVATION

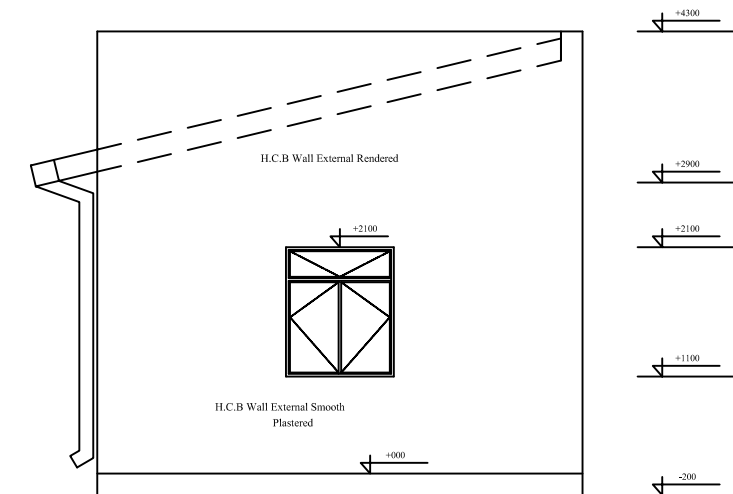

SIDE ELEVATION

SCALE 0 500 1000 1500 2000 mm

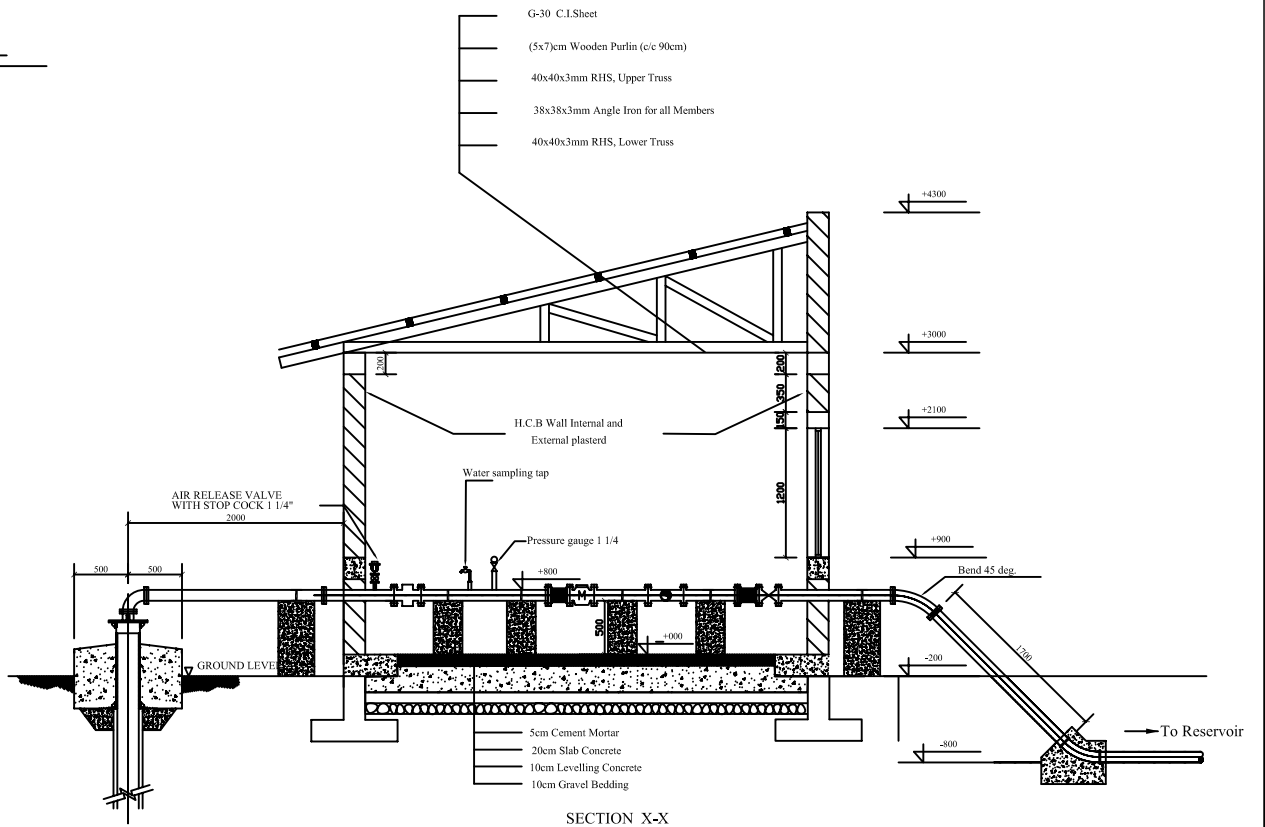

SECTION X-X

THE BASIC DESIGN STUDY ON THE PROJECT
FOR URBAN WATER SUPPLY IN DEBUB REGION
IN THE STATE OF ERITREA

JAPAN INTERNATIONAL COOPERATION AGENCY

 NIPPON KOEI CO.,LTD.

DRAWING TITLE

ポンプ小屋

SCALE

DATE

MAY 2006

DRAWING NO.

BD-011

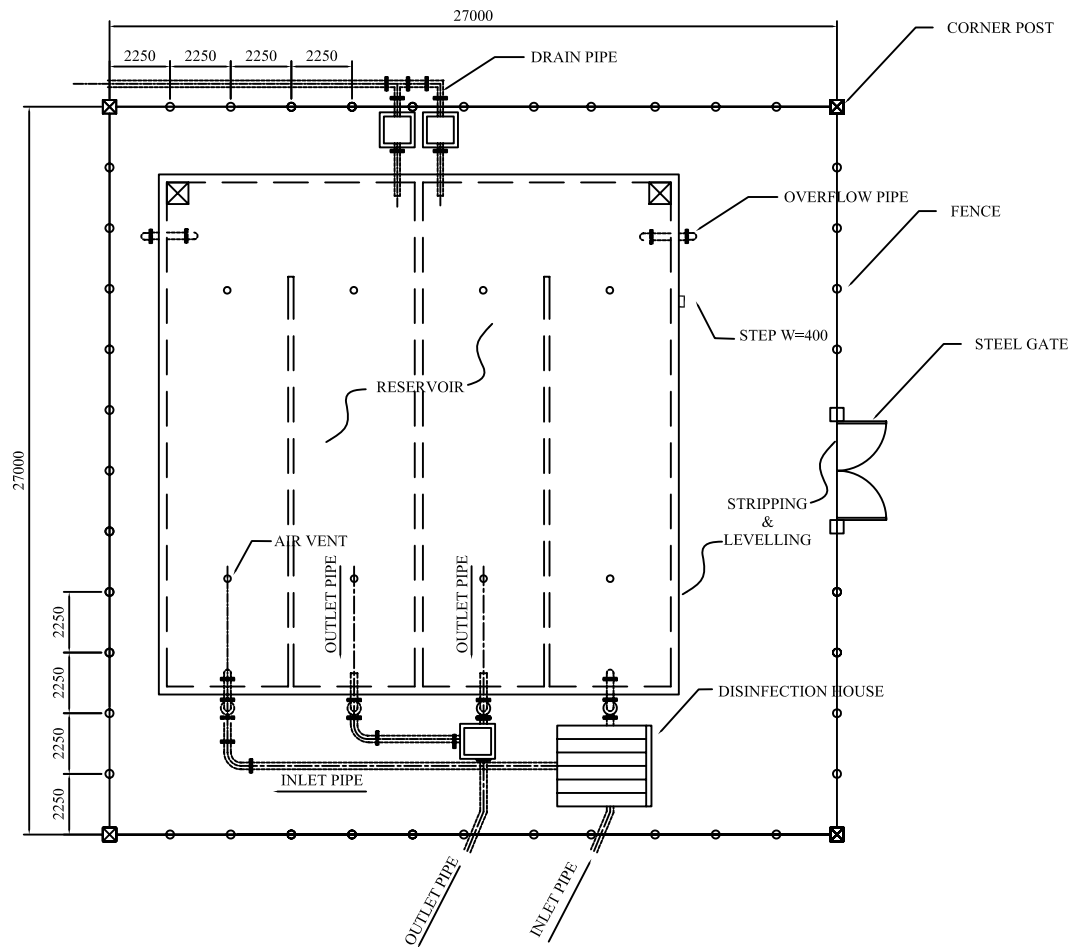

LAYOUT PLAN



THE BASIC DESIGN STUDY ON THE PROJECT
FOR URBAN WATER SUPPLY IN DEBUB REGION
IN THE STATE OF ERITREA

JAPAN INTERNATIONAL COOPERATION AGENCY

 NIPPON KOEI CO.,LTD.

DRAWING TITLE
配水池施設概要図

SCALE

DATE
MAY 2006

DRAWING NO.
BD-012

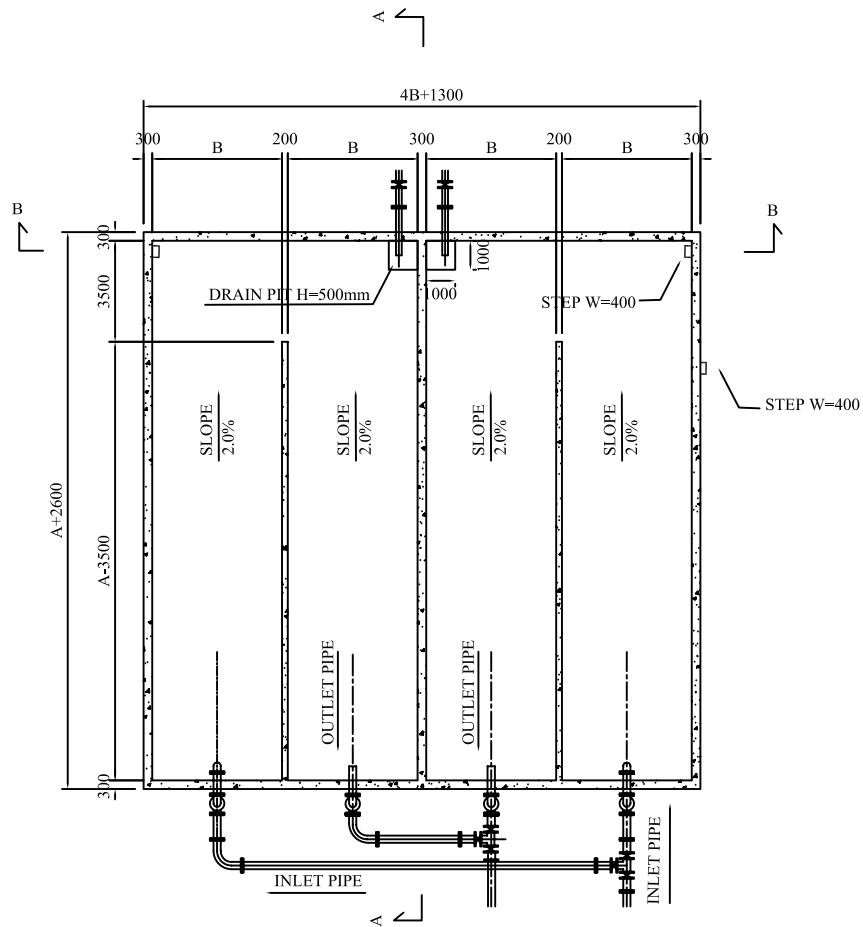

RESERVOIR PLAN

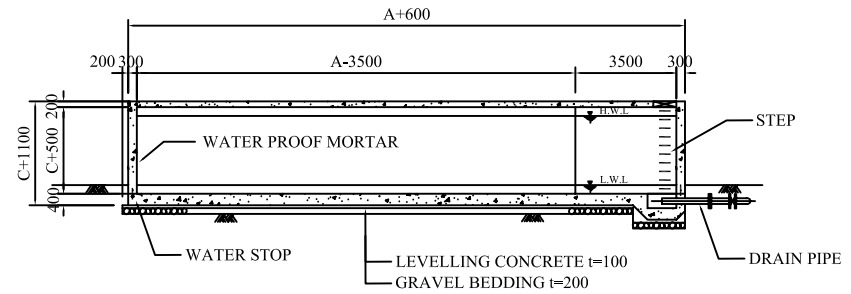

SECTION A-A

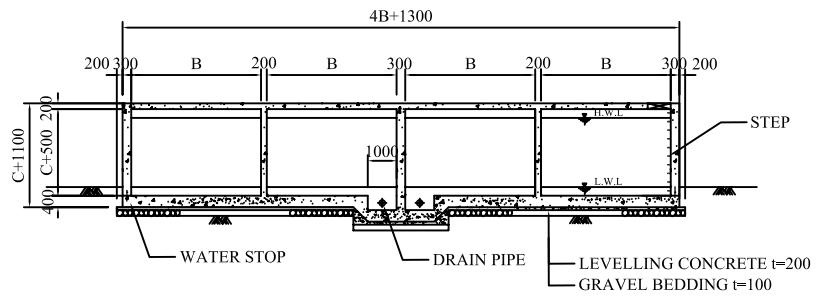

SECTION B-B

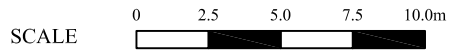

CITY	VOLUME	LENGTH		
		A	B	C
DEBARWA	500m ³	12.0m	3.5m	3.0m
	50m ³	5.0m	1.25m	2.0m
DEKEMHARE	1100m ³	18.0m	4.5m	3.0m
MAI-DIMA	300m ³	10.0m	2.5m	3.0m
ADIKEYH	700m ³	15.0m	4.0m	3.0m
	50m ³	5.0m	1.25m	2.0m

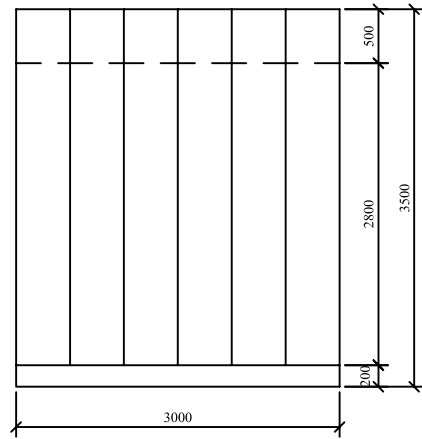

ROOF PLAN

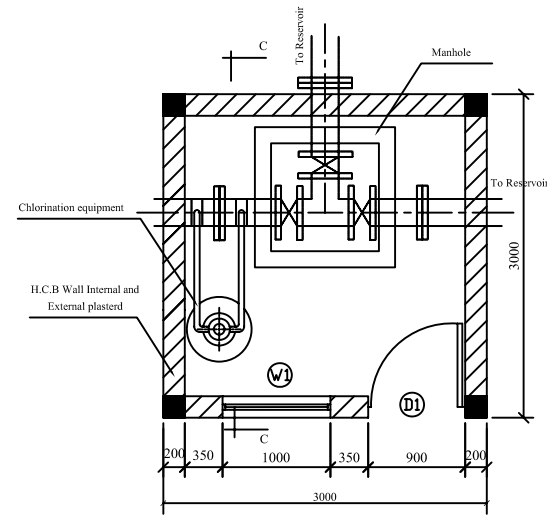

PLAN

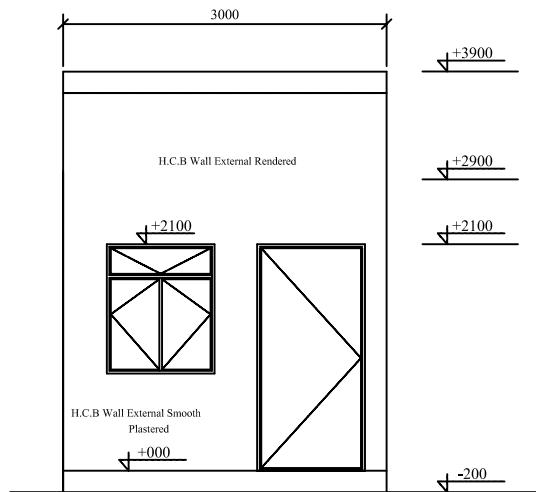

FRONT ELEVATION OF THE HOUSE

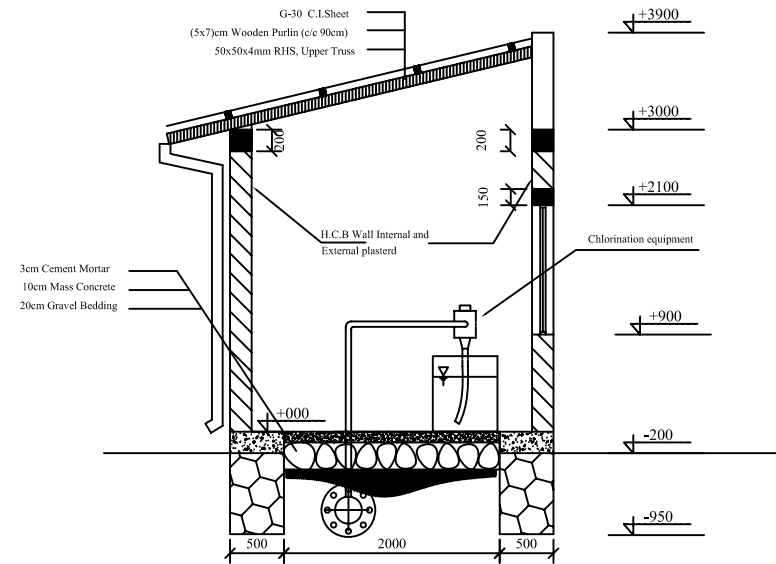

SECTION C-C



THE BASIC DESIGN STUDY ON THE PROJECT
FOR URBAN WATER SUPPLY IN DEBUB REGION
IN THE STATE OF ERITREA

JAPAN INTERNATIONAL COOPERATION AGENCY

 NIPPON KOEI CO.,LTD.

DRAWING TITLE
塩素消毒施設

SCALE

DATE
MAY 2006

DRAWING NO.
BD-014

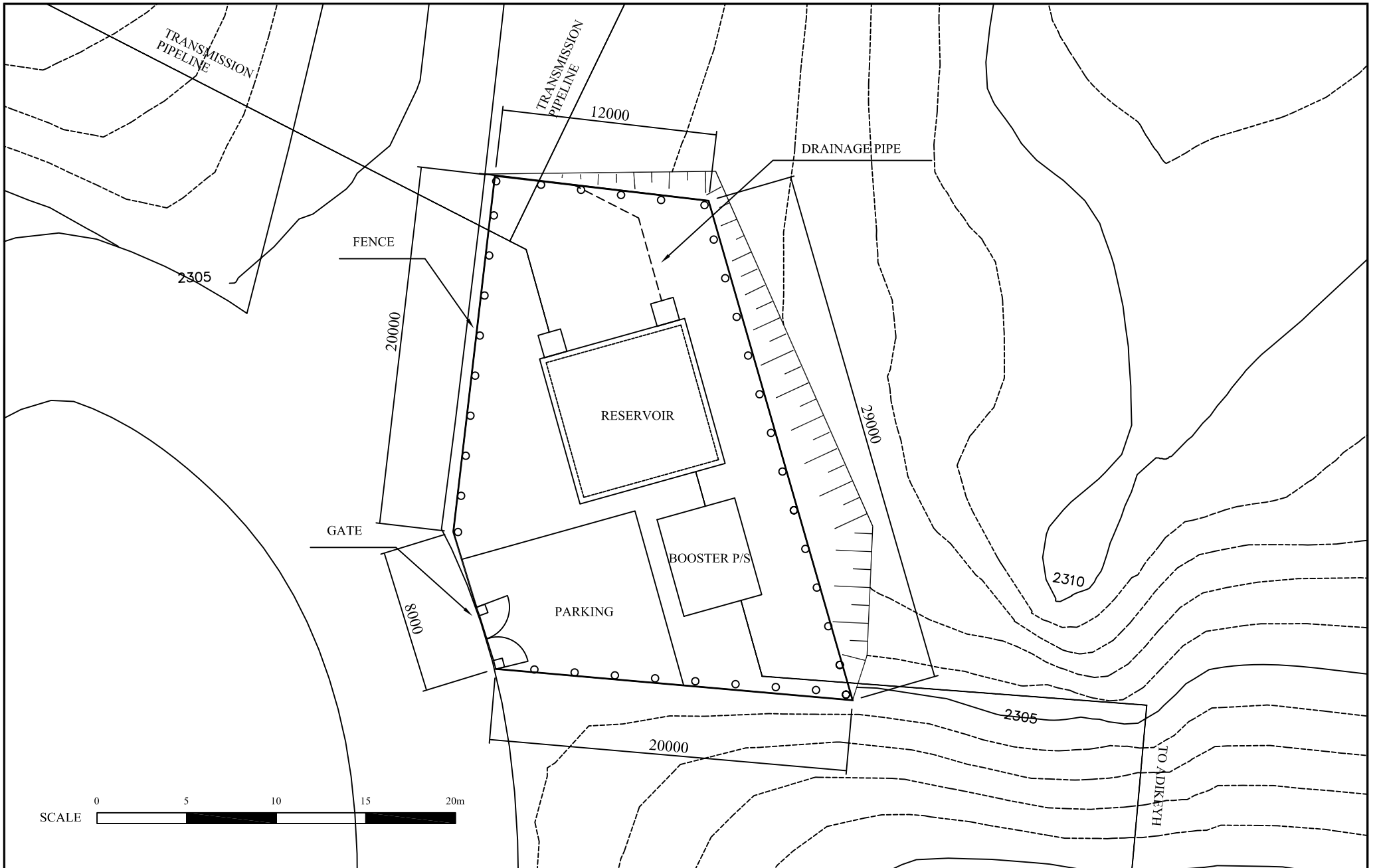

THE BASIC DESIGN STUDY ON THE PROJECT
FOR URBAN WATER SUPPLY IN DEBUB REGION
IN THE STATE OF ERITREA

JAPAN INTERNATIONAL COOPERATION AGENCY

 NIPPON KOEI CO.,LTD.

DRAWING TITLE

中継ポンプ場施設概要図

SCALE

DATE

MAY 2006

DRAWING NO.

BD-015

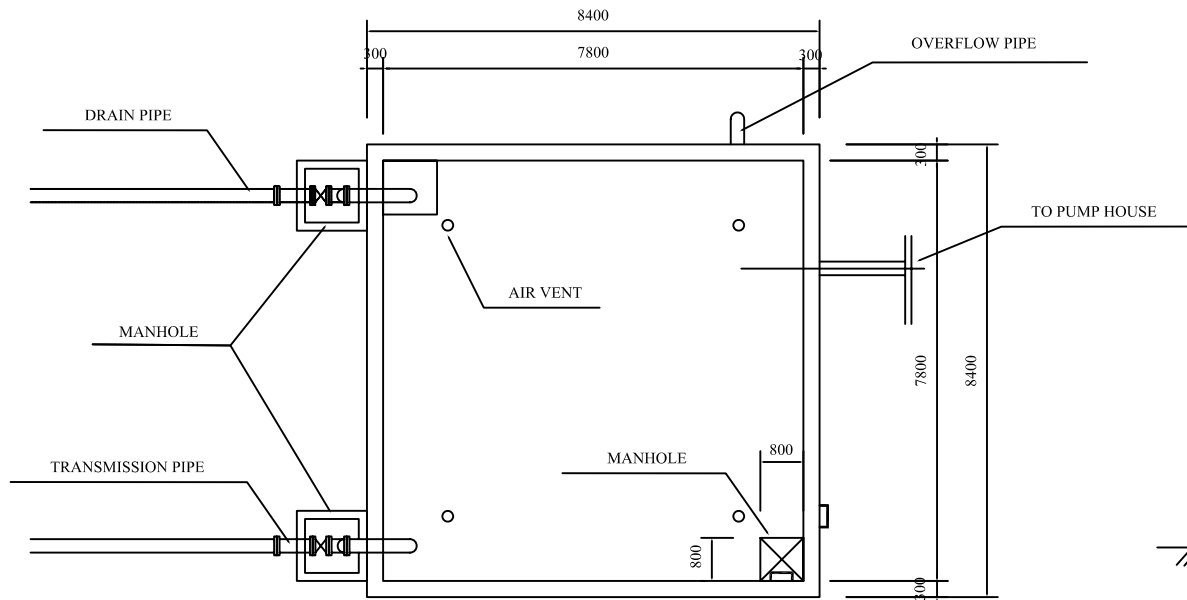

RESERVOIR PLAN

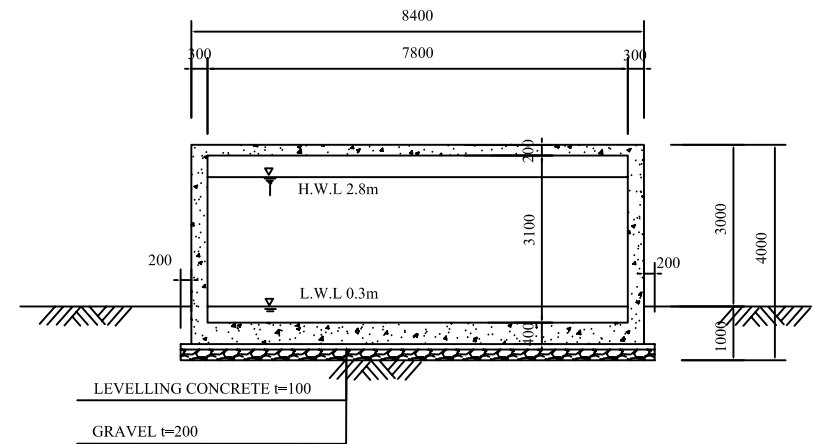

SECTION



THE BASIC DESIGN STUDY ON THE PROJECT
FOR URBAN WATER SUPPLY IN DEBUB REGION
IN THE STATE OF ERITREA

JAPAN INTERNATIONAL COOPERATION AGENCY

 NIPPON KOEI CO.,LTD.

DRAWING TITLE

貯水池

SCALE

DATE

MAY 2006

DRAWING NO.

BD-016

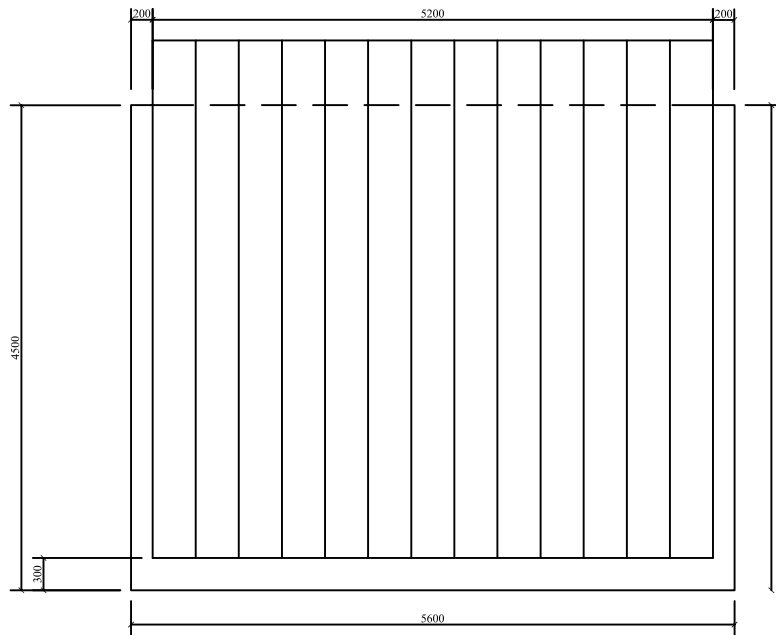

ROOF PLAN

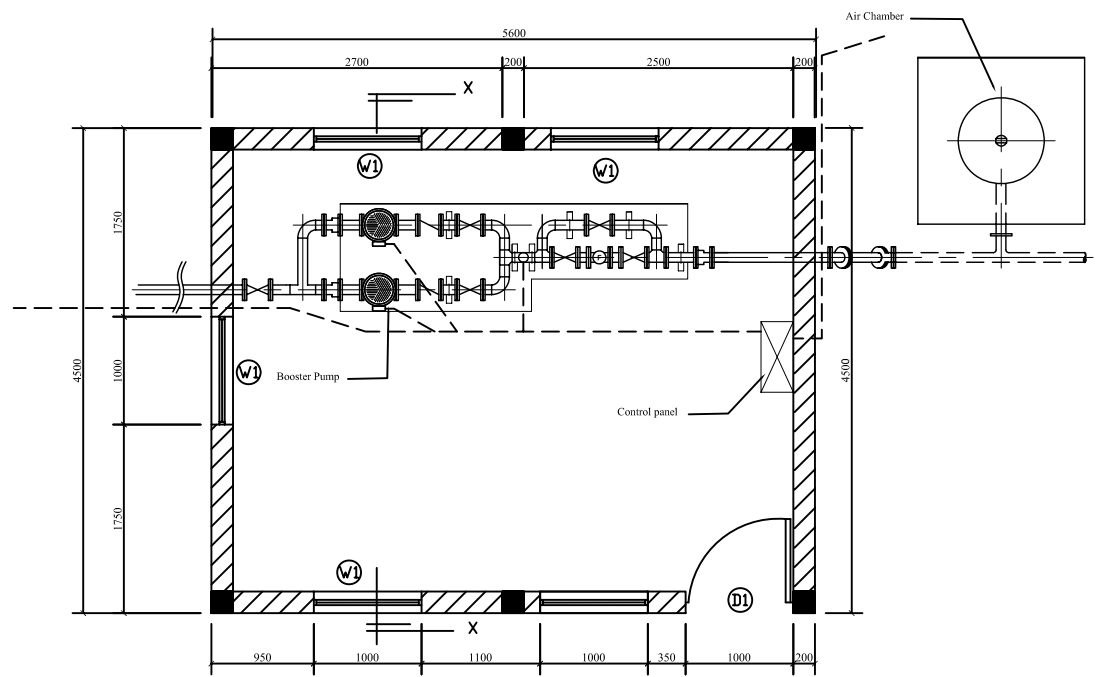

FLOOR PLAN

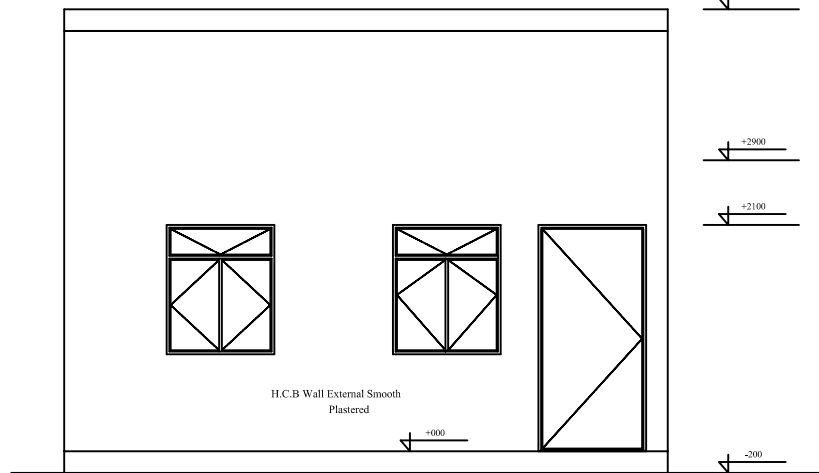

FRONT ELEVATION

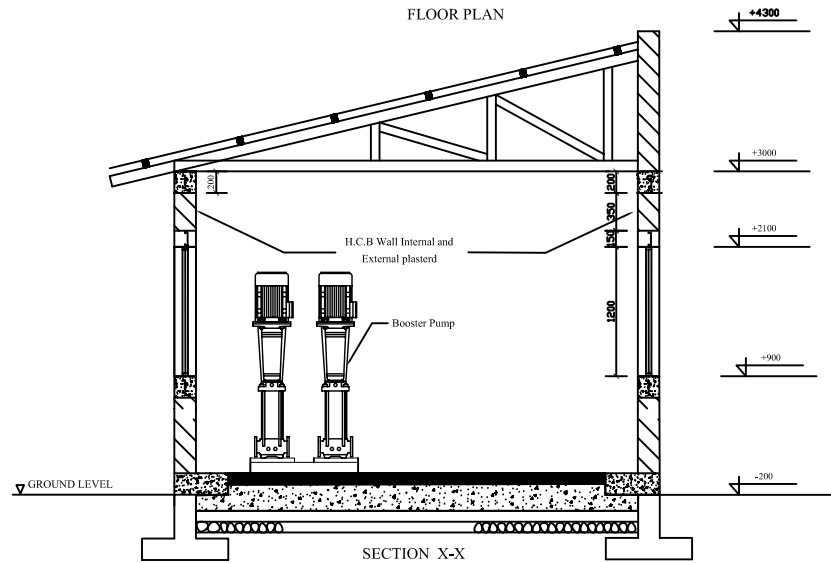

SECTION X-X



THE BASIC DESIGN STUDY ON THE PROJECT
FOR URBAN WATER SUPPLY IN DEBUB REGION
IN THE STATE OF ERITREA

JAPAN INTERNATIONAL COOPERATION AGENCY

 NIPPON KOEI CO.,LTD.

DRAWING TITLE

中継ポンプ場

SCALE

DATE

MAY 2006

DRAWING NO.

BD-017

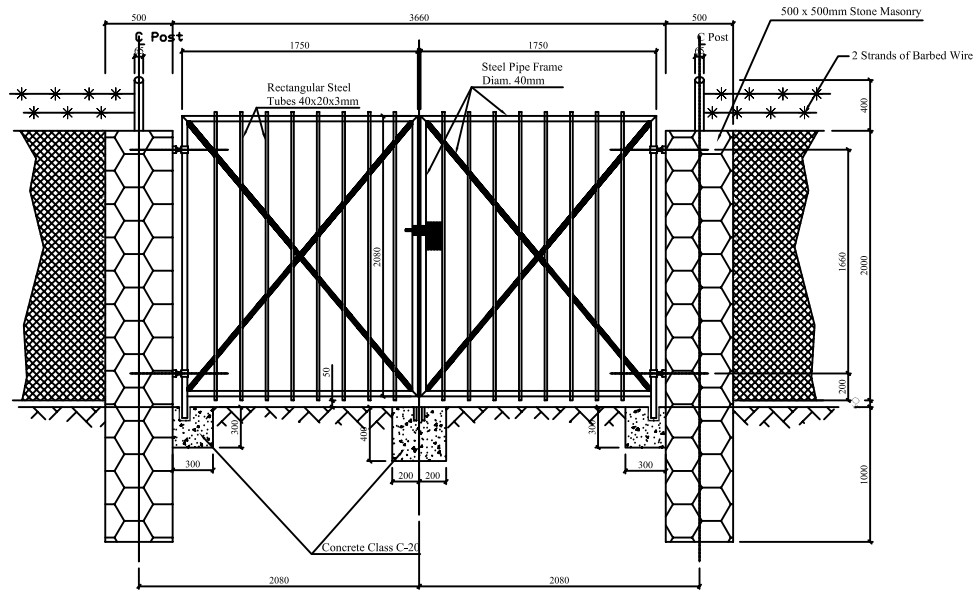

REAR ELEVATION OF GATE

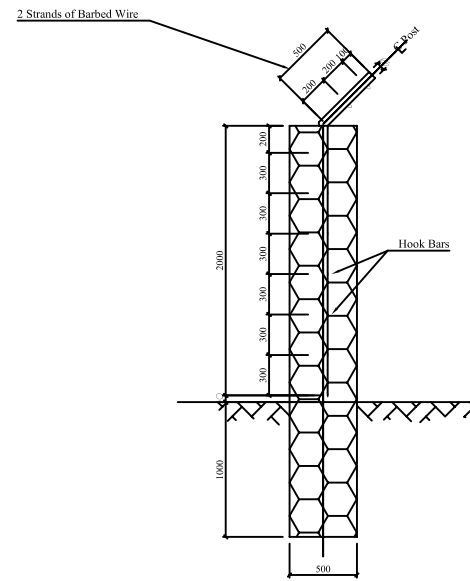

SIDE VIEW OF GATE POST

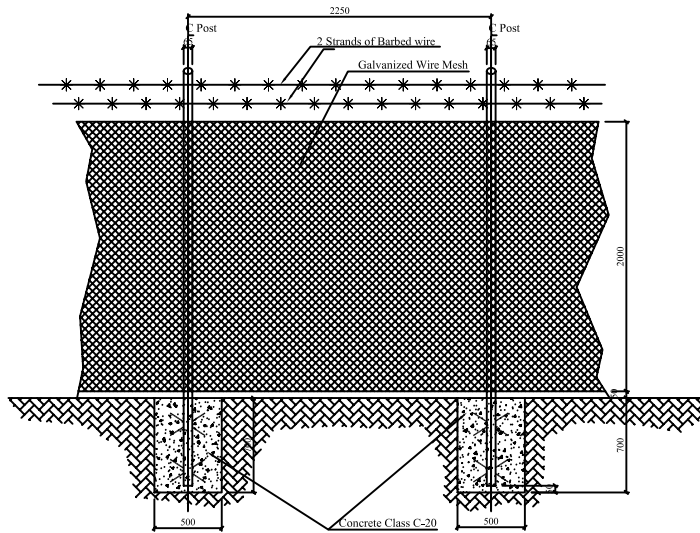

ELEVATION VIEW OF FENCE

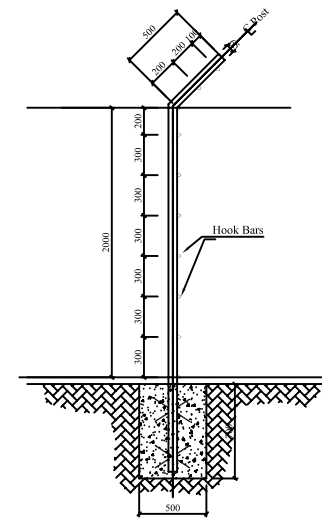

SIDE VIEW OF FENCE

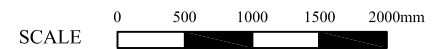

THE BASIC DESIGN STUDY ON THE PROJECT
FOR URBAN WATER SUPPLY IN DEBUB REGION
IN THE STATE OF ERITREA

JAPAN INTERNATIONAL COOPERATION AGENCY

 NIPPON KOEI CO.,LTD.

DRAWING TITLE

フェンス及びゲート

SCALE

DATE

MAY 2006

DRAWING NO.

BD-018

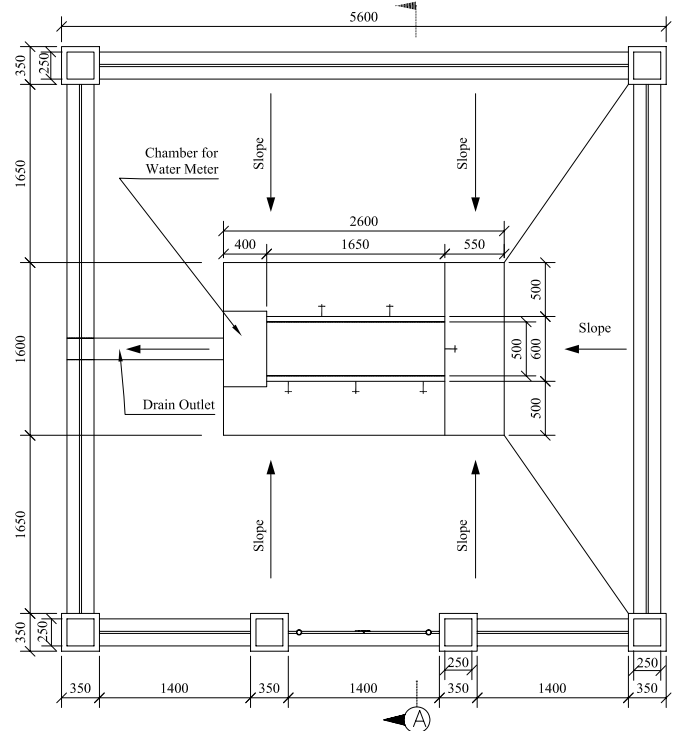

PLAN OF PUBLIC FOUNTAIN

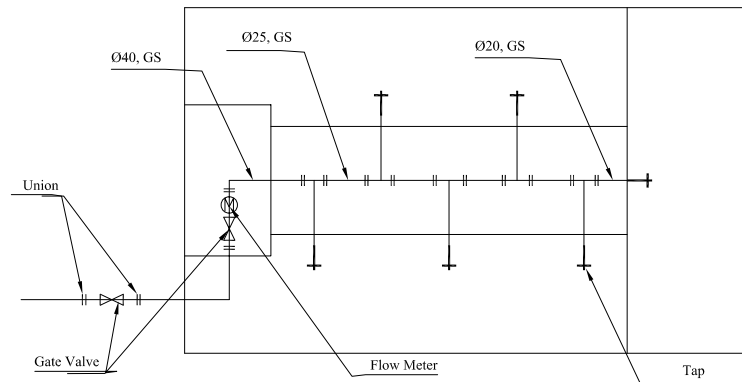

PLUMBING WORKS

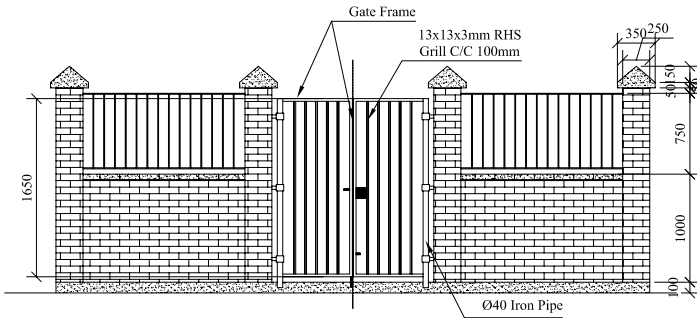

FRONT ELEVATION

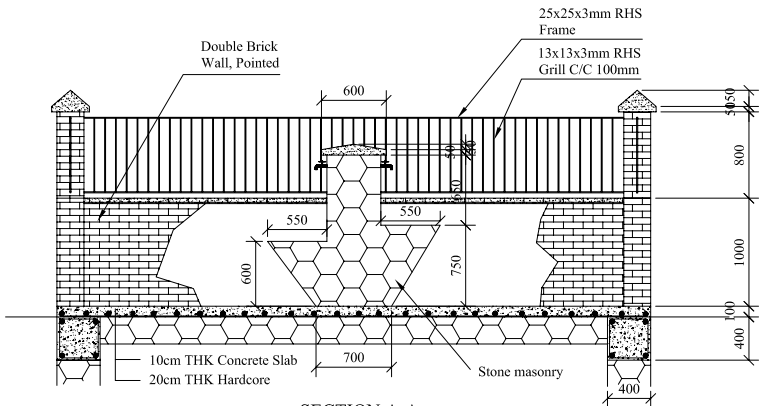

SECTION A-A



THE BASIC DESIGN STUDY ON THE PROJECT FOR URBAN WATER SUPPLY IN DEBUB REGION IN THE STATE OF ERITREA

JAPAN INTERNATIONAL COOPERATION AGENCY

 NIPPON KOEI CO.,LTD.

DRAWING TITLE 公共水栓		
SCALE	DATE MAY 2006	DRAWING NO. BD-019

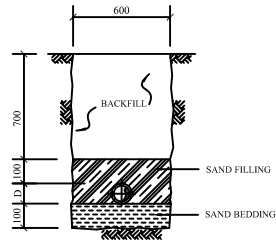

STANDARD CROSS SECTION
D 50 ~ 150mm

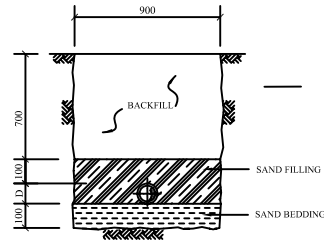

STANDARD CROSS SECTION
D 200 mm ~

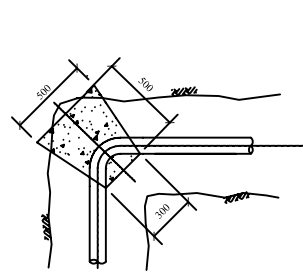

TRUST BLOCK PIPE LESS THAN D150

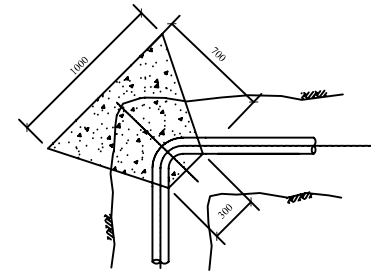

TRUST BLOCK PIPE MORE THAN D200

* Note : Excavated material is applied to normal section and selected material is used for rock section.

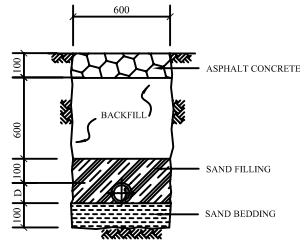

ASPHALT ROAD REPAIRING SECTION
D 50 ~ 150mm

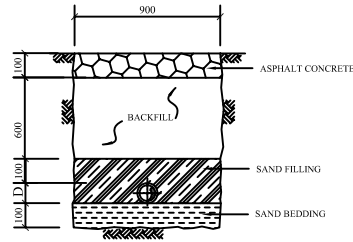

ASPHALT ROAD REPAIRING SECTION
D 200 mm ~

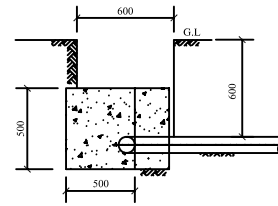

TYPICAL SECTION

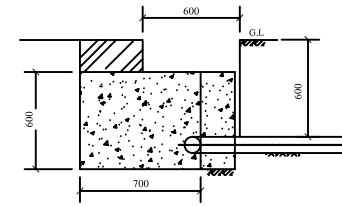

TYPICAL SECTION

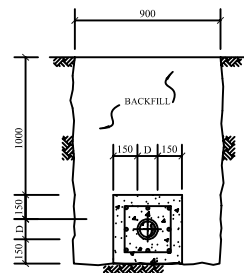

RIVER CROSS SECTION
D 40 ~ 150mm

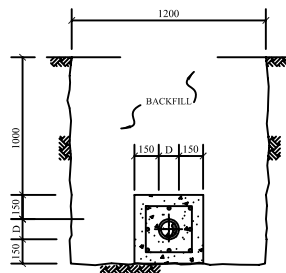

RIVER CROSS SECTION
D 200mm ~

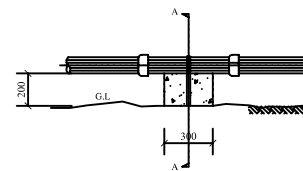

THRUST BLOCK

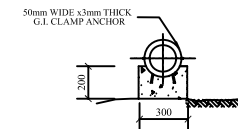

SECTION A-A



THE BASIC DESIGN STUDY ON THE PROJECT
FOR URBAN WATER SUPPLY IN DEBUB REGION
IN THE STATE OF ERITREA

JAPAN INTERNATIONAL COOPERATION AGENCY

NIPPON KOEI CO.,LTD.

DRAWING TITLE
パイプ敷設標準断面図

SCALE

DATE

MAY 2006

DRAWING NO.

BD-020

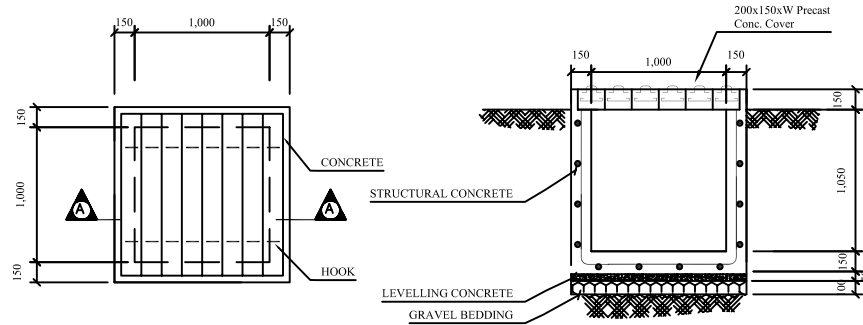

MANHOLE PLAN

SECTION A-A

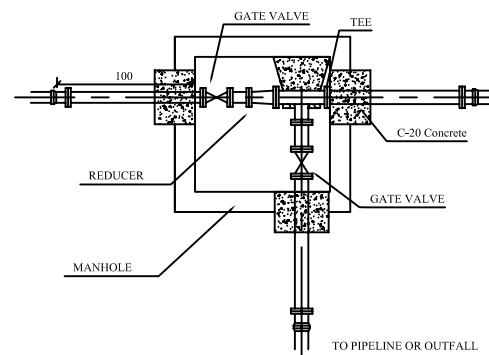

GATE VALVE & FITTINGS PLAN

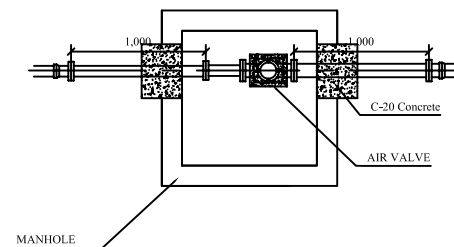

AIR VALVE PLAN

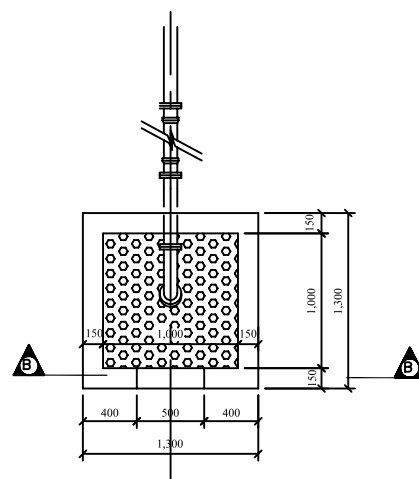

OUTFALL PLAN

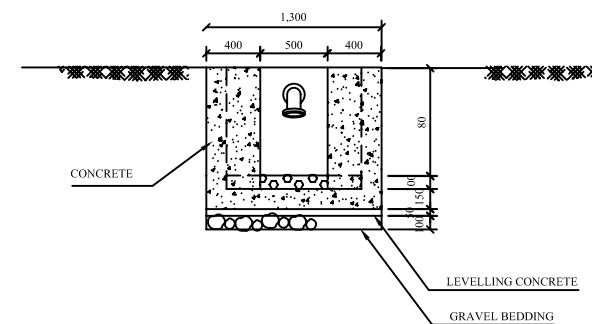

SECTION B-B

SCALE 0 500 1000 1500 2000mm

THE BASIC DESIGN STUDY ON THE PROJECT FOR URBAN WATER SUPPLY IN DEBUB REGION IN THE STATE OF ERITREA

JAPAN INTERNATIONAL COOPERATION AGENCY

 NIPPON KOEI CO.,LTD.

DRAWING TITLE

マンホール及びバルブ標準図

SCALE

DATE

MAY 2006

DRAWING NO.

BD-021