

BASIC DESIGN STUDY ON THE PROJECT FOR PROVISION OF POTABLE STEEL BRIDGES
ON UPAZILA AND UNION ROADS
IN
BANGLADESH

GENERAL PLAN, ELEVATION AND TYPICAL CROSS SECTION
PHASE-II

LOCAL GOVERNMENT ENGINEERING DEPARTMENT
THE GOVERNMENT OF THE PEOPLE'S REPUBLIC
OF BANGLADESH

 **K&E**
KATAHIRA & ENGINEERS INTERNATIONAL
TOKYO, JAPAN

INDEX OF BRIDGE'S GENERAL VIEW FOR PHASE-II

PREFECTURE	NO.OF BRIDGE	PAGE	PREFECTURE	NO.OF BRIDGE	PAGE
DAHKA	NO. 01-03-02	II-1	NATORE	NO. 52-04-02	II-21
DAHKA	NO. 01-06-N1	II-2	SIRAJGANJ	NO. 55-06-01	II-22
NARAYANANJ	NO. 03-04-01	II-3	SIRAJGANJ	NO.55-06-02	II-23
MUNSHIGANJ	NO. 04-02-03	II-4	SIRAJGANJ	NO. 55-07-07	II-24
MUNSHIGANJ	NO. 04-02-N5	II-5	SIRAJGANJ	NO. 55-07-08	II-25
MUNSHIGANJ	NO. 04-05-04	II-6	SIRAJGANJ	NO. 55-07-12	II-26
MANIKGANJ	NO. 05-01-01	II-7	PABNA	NO. 56-01-02	II-27
MANIKGANJ	NO. 05-04-04	II-8	BOGRA	NO. 57-02-N3	II-28
MANIKGANJ	NO. 05-04-05	II-9	BOGRA	NO. 57-02-N5	II-29
MANIKGANJ	NO. 05-05-N2	II-10	BOGRA	NO. 57-09-02	II-30
MANIKGANJ	NO. 05-06-02	II-11			
RAJBARI	NO. 11-03-01	II-12			
GOPALGONJ	NO. 12-02-N2	II-13			
GOPALGONJ	NO. 12-03-03	II-14			
GOPALGONJ	NO. 12-03-06	II-15			
FARIDPUR	NO. 16-01-N2	II-16			
COMILLA	NO. 19-10-N1	II-17			
CHANDPUR	NO. 21-01-N1	II-18			
CHANDPUR	NO. 21-01-N2	II-19			
FENI	NO. 22-02-04	II-20			

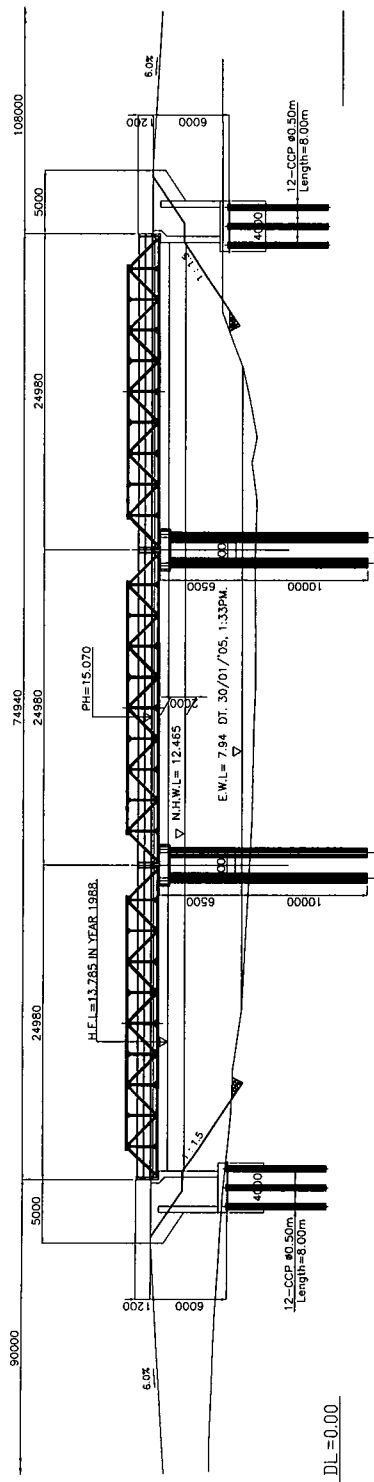

ELEVATION
SCALE 1:400

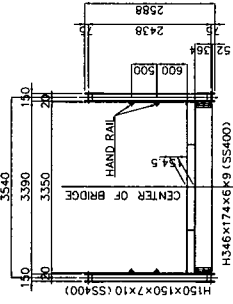

TYPICAL CROSS SECTION
SCALE 1:100

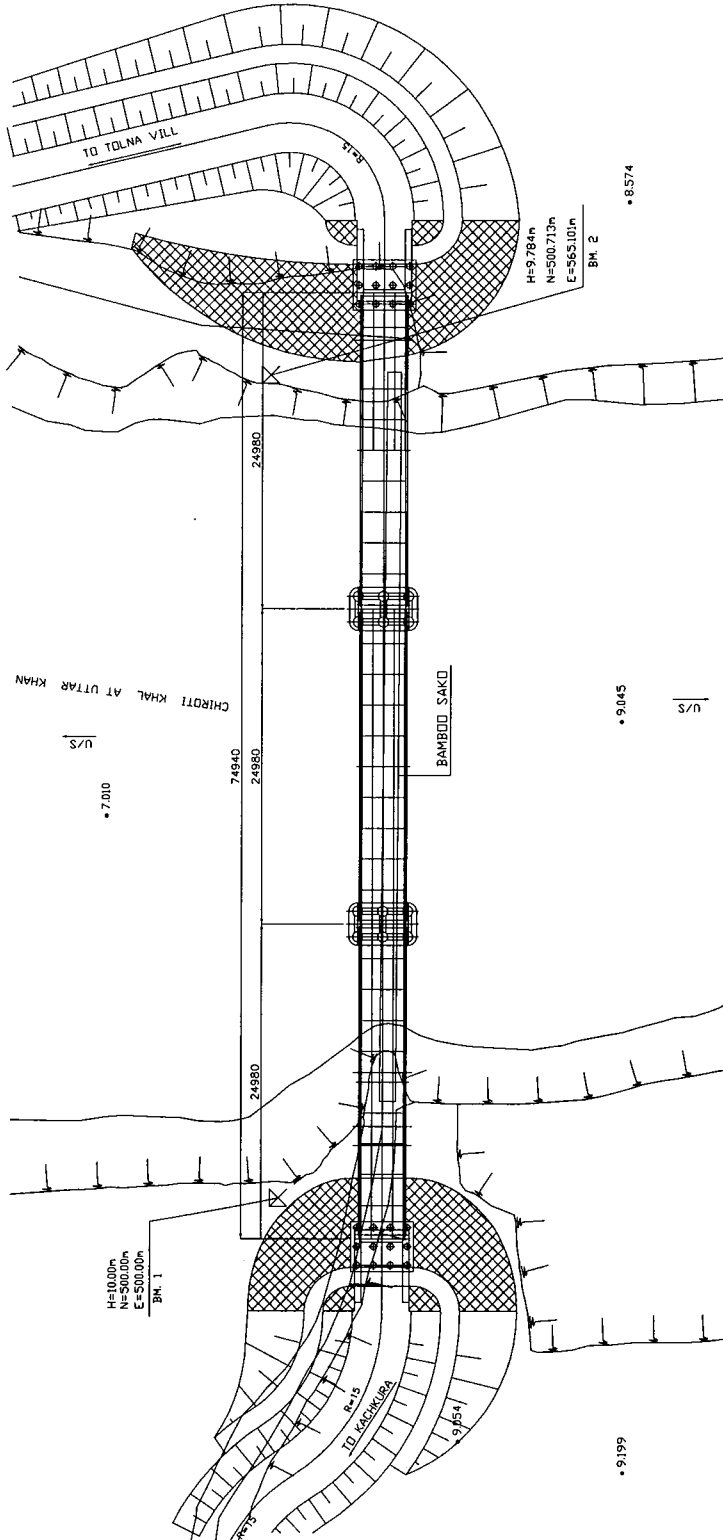

PLAN
SCALE 1:400

LOCAL GOVERNMENT ENGINEERING DEPARTMENT PEOPLE'S REPUBLIC OF BANGLADESH	BASIC DESIGN STUDY ON THE PROJECT FOR PROVISION OF PORTABLE STEEL BRIDGES ON UPAZILA AND UNION ROADS	JAPAN INTERNATIONAL COOPERATION AGENCY KATAHIRA & ENGINEERS INTERNATIONAL	SCALE As Shown	DRAWING NO. II-1/30
--	--	--	-------------------	------------------------

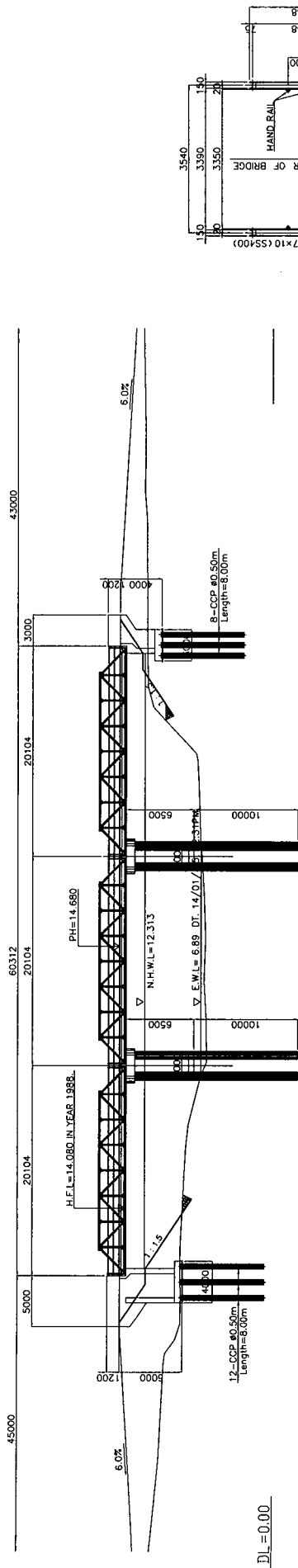

ELEVATION
SCALE 1:400

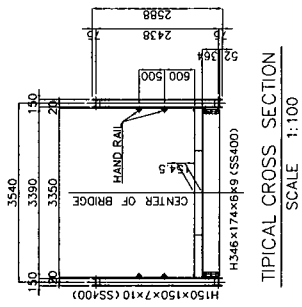

TYPICAL CROSS SECTION
SCALE 1:100

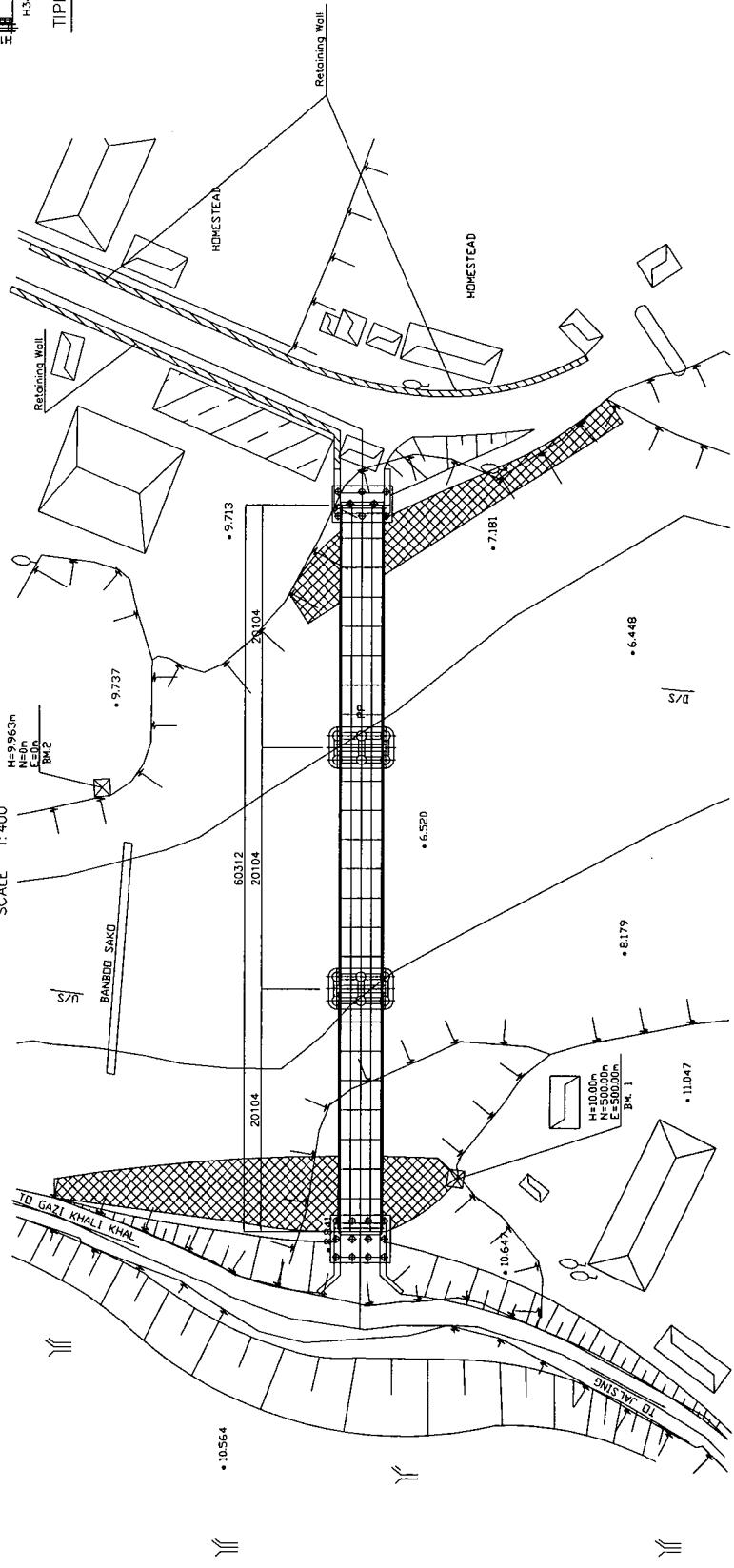

PLAN
SCALE 1:400

LOCAL GOVERNMENT ENGINEERING DEPARTMENT PEOPLE'S REPUBLIC OF BANGLADESH	BASIC DESIGN STUDY ON THE PROJECT FOR PROVISION OF PORTABLE STEEL BRIDGES ON UPAZILA AND UNION ROADS	JAPAN INTERNATIONAL COOPERATION AGENCY KATAHIRA & ENGINEERS INTERNATIONAL	GENERAL PLAN, ELEVATION & TYPICAL CROSS SECTION DHAKA BRIDGE NO. 01-06-N1	DRAWING NO. II-2/30
--	--	--	---	------------------------

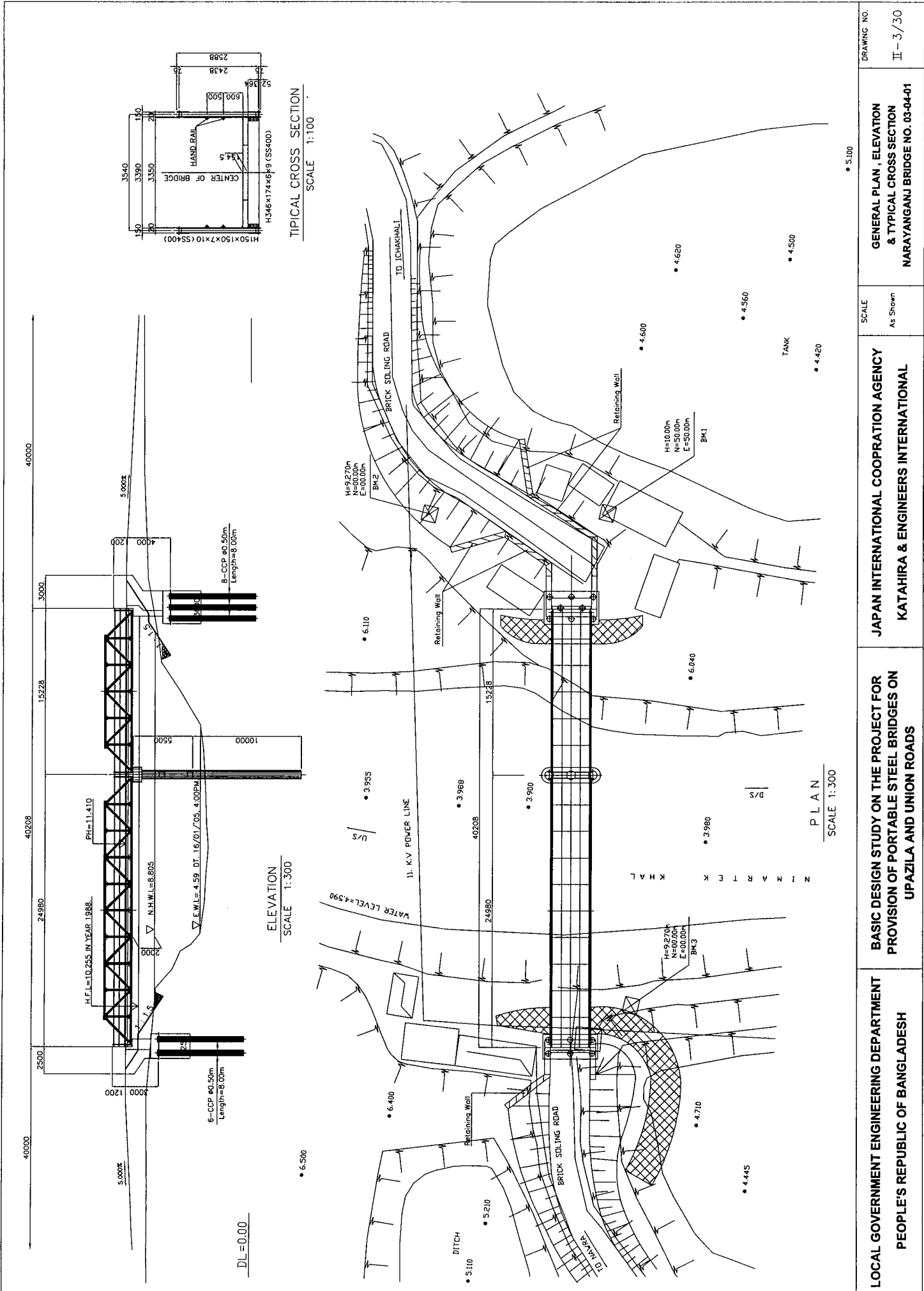

DRAWING NO. II-3/30	SCALE As Shown	JAPAN INTERNATIONAL COOPERATION AGENCY KATAHIRA & ENGINEERS INTERNATIONAL	LOCAL GOVERNMENT ENGINEERING DEPARTMENT PEOPLE'S REPUBLIC OF BANGLADESH
------------------------	-------------------	--	--

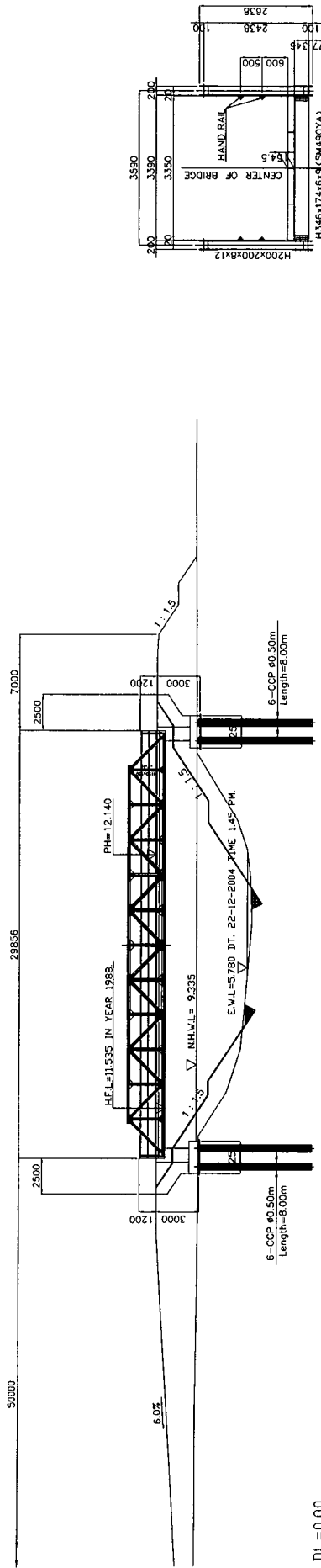

ELEVATION
SCALE 1:300

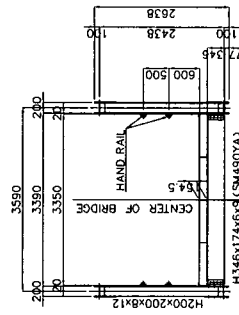

TYPICAL CROSS SECTION
SCALE 1:100

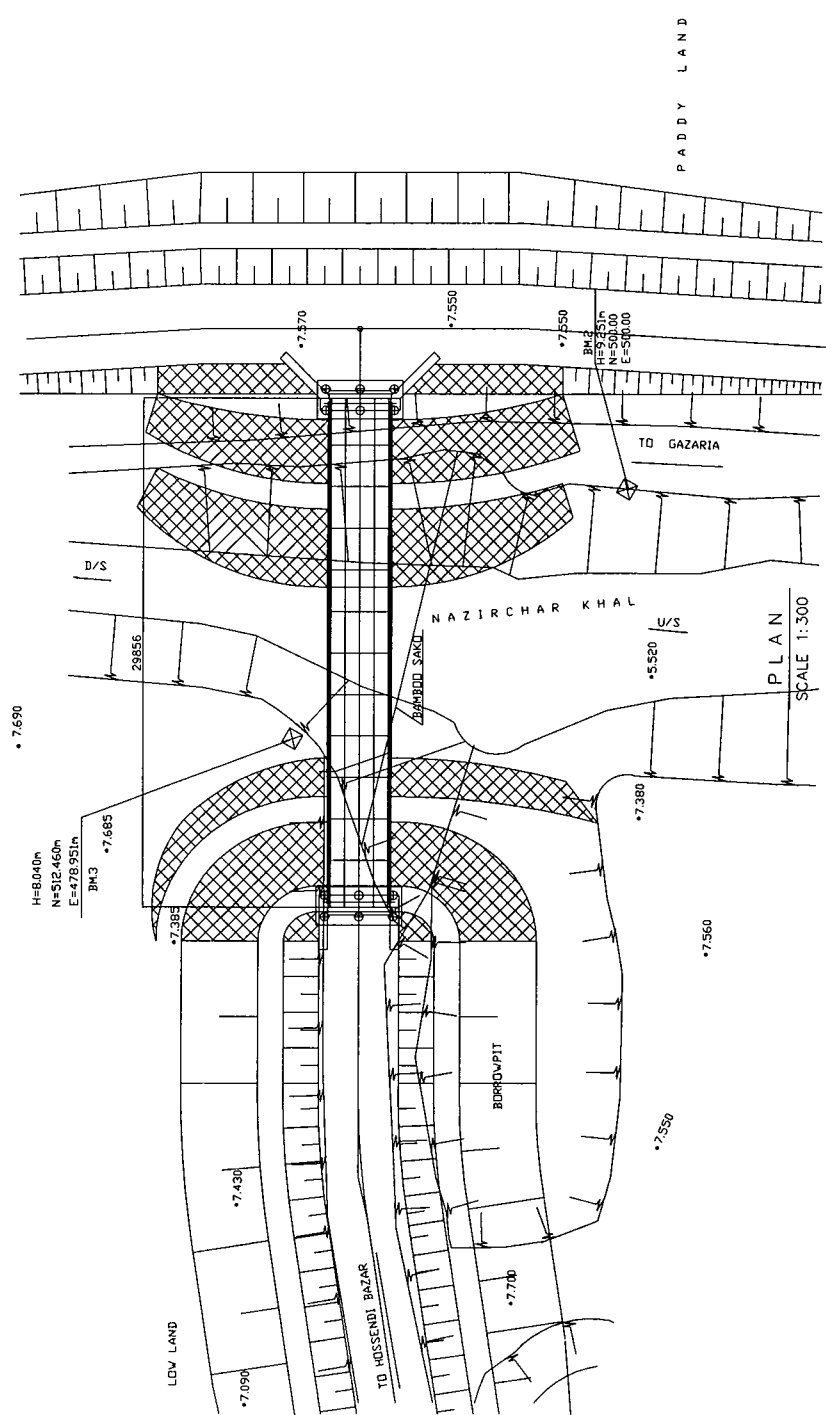

<p>LOCAL GOVERNMENT ENGINEERING DEPARTMENT PEOPLE'S REPUBLIC OF BANGLADESH</p>	<p>BASIC DESIGN STUDY ON THE PROJECT FOR PROVISION OF PORTABLE STEEL BRIDGES ON UPAZILA AND UNION ROADS</p>	<p>JAPAN INTERNATIONAL COOPERATION AGENCY KATAHIRA & ENGINEERS INTERNATIONAL</p>	<p>SCALE As Shown</p>	<p>GENERAL PLAN, ELEVATION & TYPICAL CROSS SECTION MUNSHIGANJ BRIDGE NO. 04-02-03</p>	<p>DRAWING NO. II-4/30</p>
--	---	--	---------------------------	---	--------------------------------

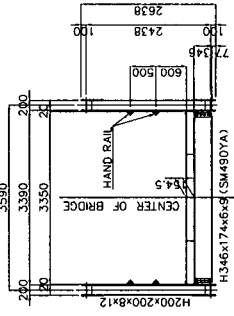
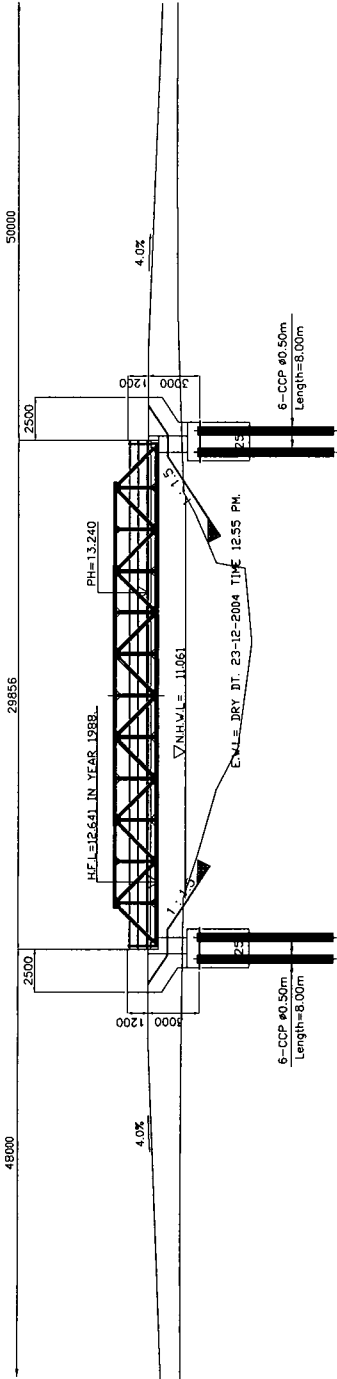

TYPICAL CROSS SECTION
SCALE 1:100

ELEVATION
SCALE 1:300

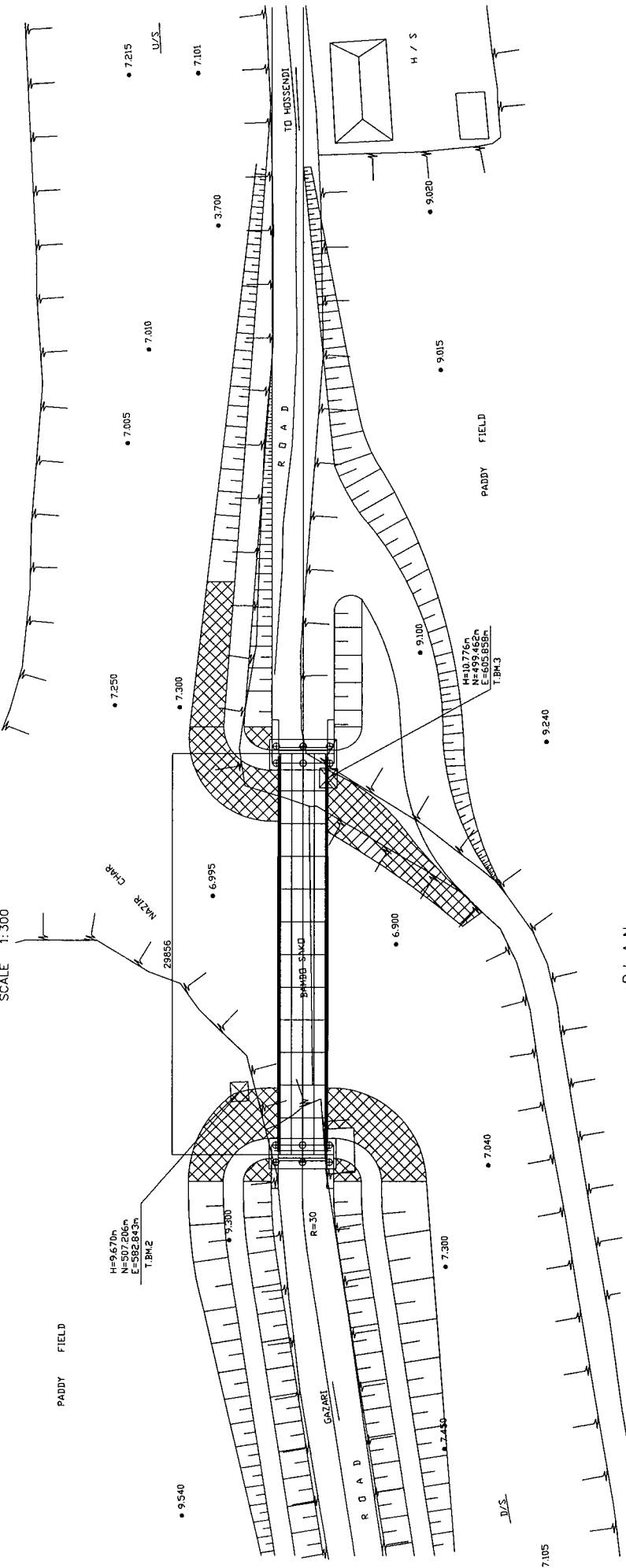

PLAN
SCALE 1:300

<p>LOCAL GOVERNMENT ENGINEERING DEPARTMENT PEOPLE'S REPUBLIC OF BANGLADESH</p>	<p>BASIC DESIGN STUDY ON THE PROJECT FOR PROVISION OF PORTABLE STEEL BRIDGES ON UPAZILA AND UNION ROADS</p>	<p>JAPAN INTERNATIONAL COOPERATION AGENCY KATAHIRA & ENGINEERS INTERNATIONAL</p>	<p>SCALE As Shown</p>	<p>GENERAL PLAN, ELEVATION & TYPICAL CROSS SECTION MUNSHIGANJ BRIDGE NO. 04-02-N5</p>	<p>DRAWING NO. II-5/30</p>
--	---	--	---------------------------	---	--------------------------------

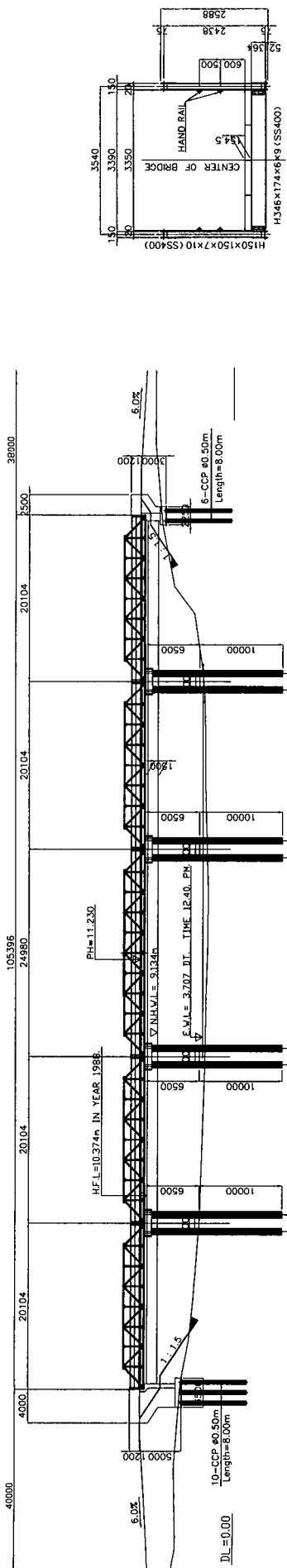

ELEVATION
SCALE 1:500

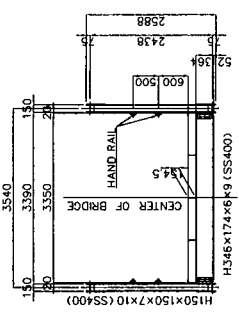

TYPICAL CROSS SECTION
SCALE 1:100

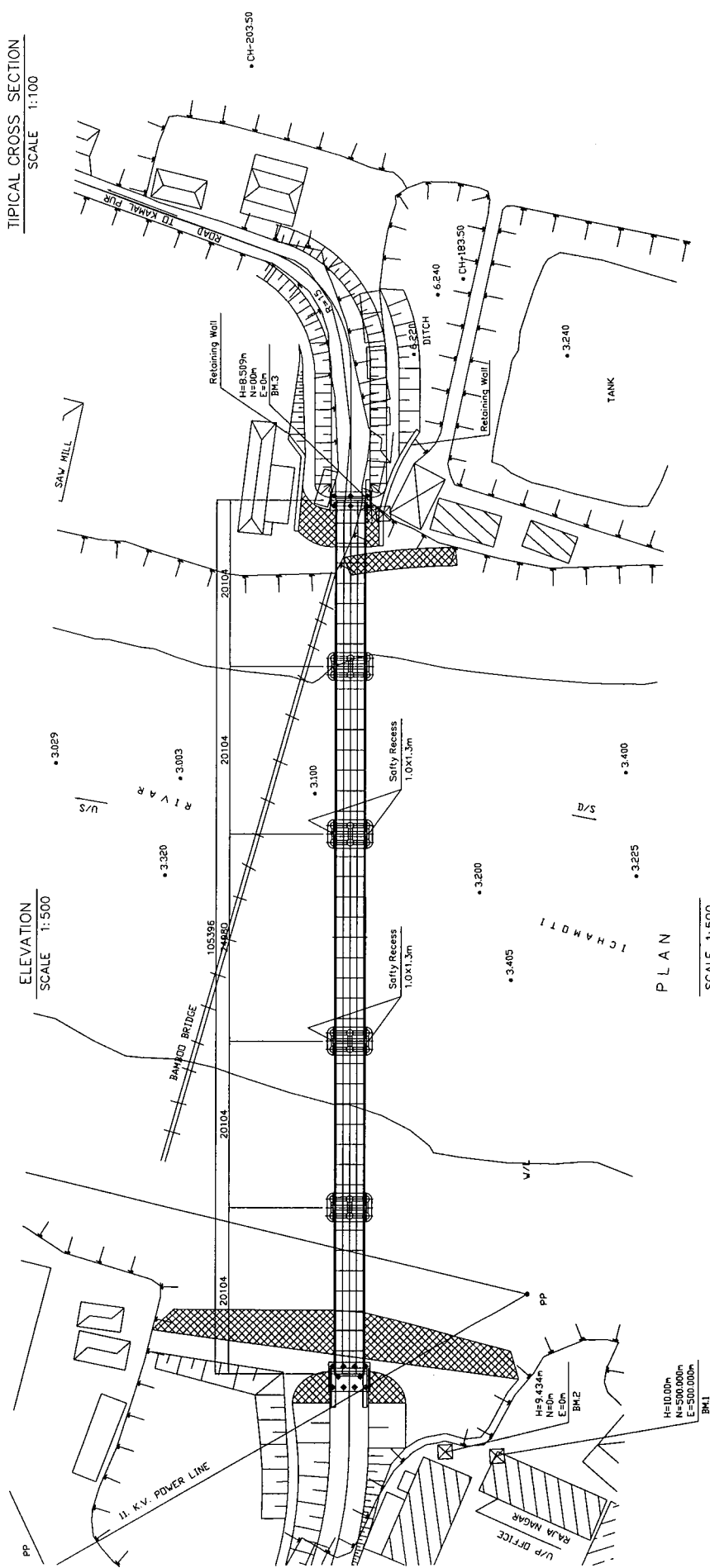

PLAN
SCALE 1:500

LOCAL GOVERNMENT ENGINEERING DEPARTMENT PEOPLE'S REPUBLIC OF BANGLADESH	BASIC DESIGN STUDY ON THE PROJECT FOR PROVISION OF PORTABLE STEEL BRIDGES ON UPAZILA AND UNION ROADS	JAPAN INTERNATIONAL COOPERATION AGENCY KATAHIRA & ENGINEERS INTERNATIONAL	SCALE AS SHOWN	GENERAL PLAN, ELEVATION & TYPICAL CROSS SECTION MUNSHIGANJ BRIDGE NO. 04-05-04	DRAWING NO. II - 6/30
--	--	--	-------------------	--	--------------------------

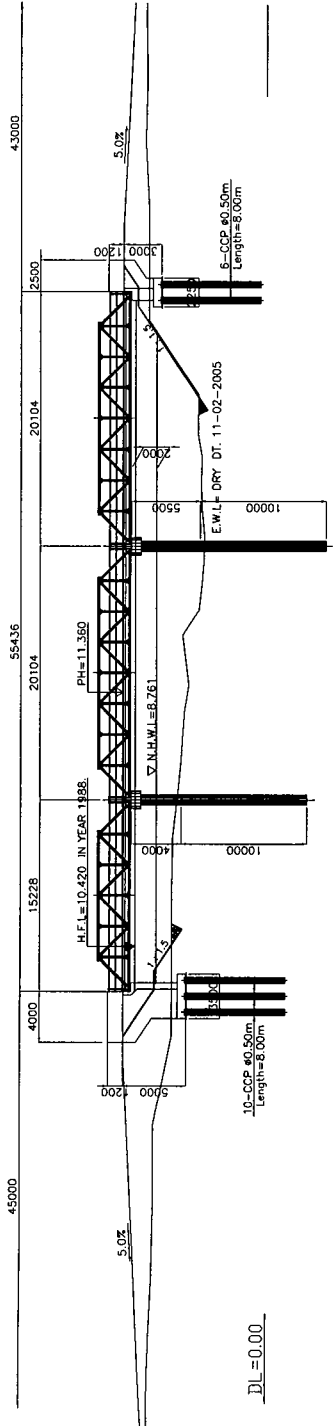

ELEVATION
SCALE 1:400

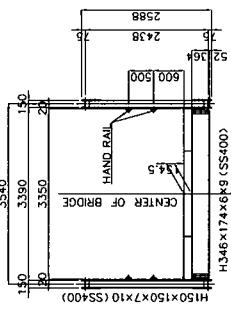

TYPICAL CROSS SECTION
SCALE 1:100

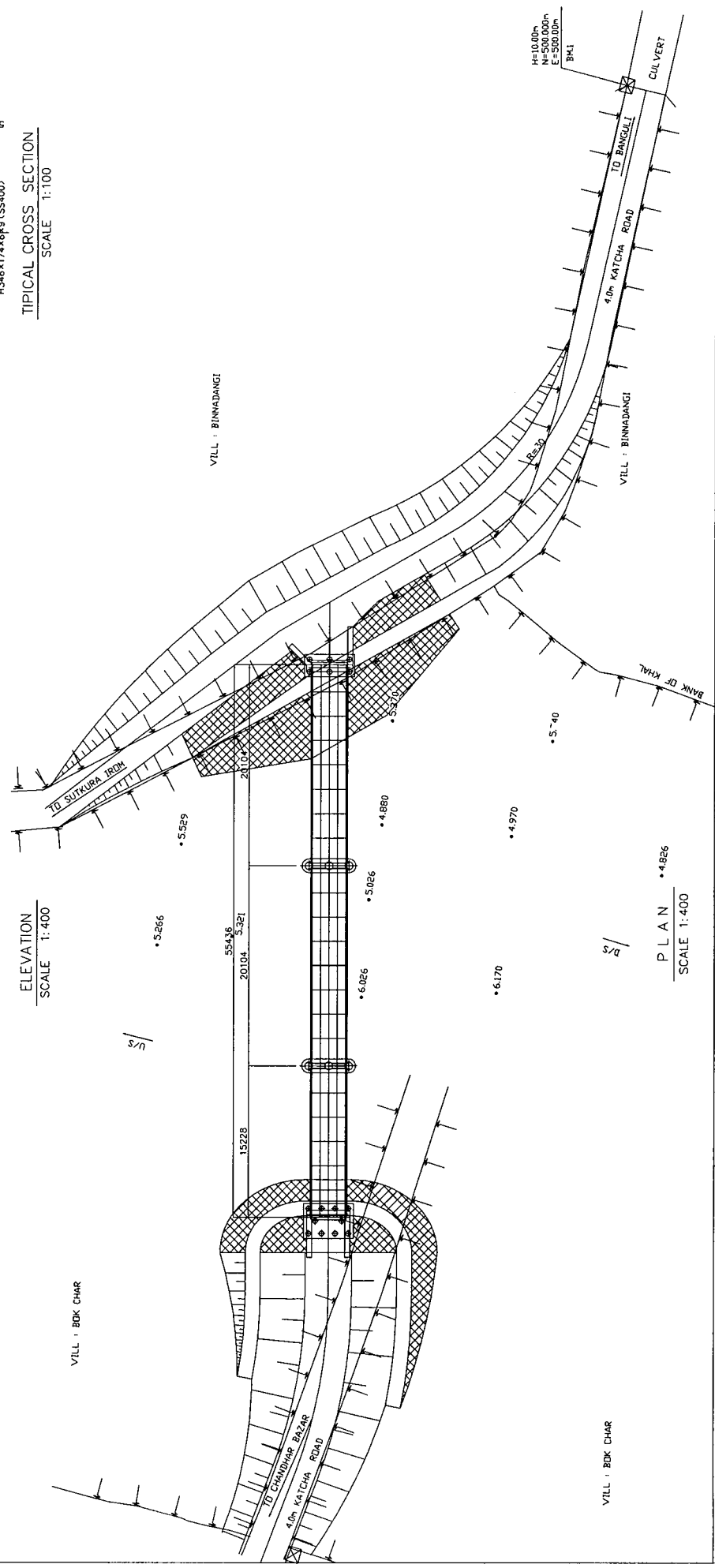

<p>LOCAL GOVERNMENT ENGINEERING DEPARTMENT PEOPLE'S REPUBLIC OF BANGLADESH</p>	<p>BASIC DESIGN STUDY ON THE PROJECT FOR PROVISION OF PORTABLE STEEL BRIDGES ON UPAZILA AND UNION ROADS</p>	<p>JAPAN INTERNATIONAL COOPERATION AGENCY KATAHIRA & ENGINEERS INTERNATIONAL</p>	<p>SCALE As Shown</p>	<p>DRAWING NO. II - 7/30</p>
<p>GENERAL PLAN, ELEVATION & TYPICAL CROSS SECTION MANIKGANJ BRIDGE NO. 05-01-01</p>				

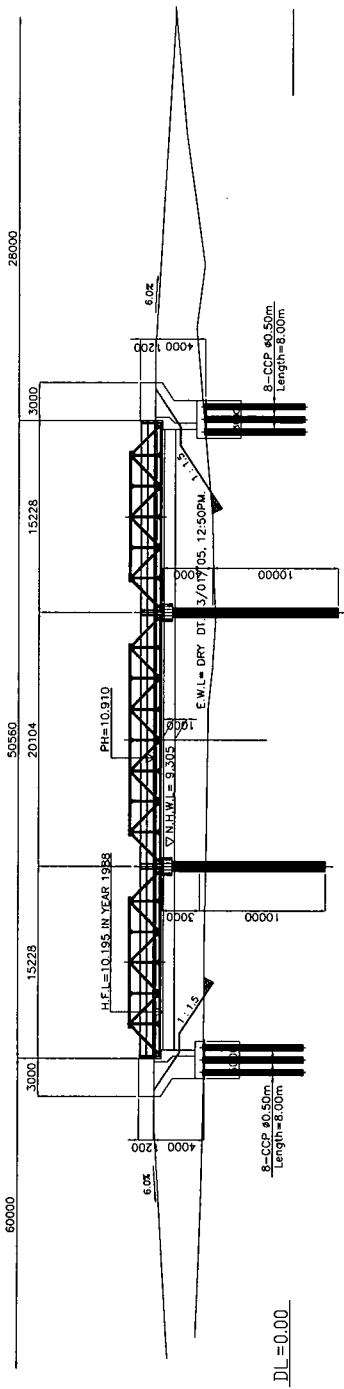

ELEVATION
SCALE 1:400

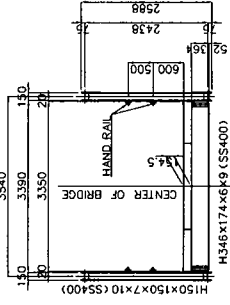

TYPICAL CROSS SECTION
SCALE 1:100

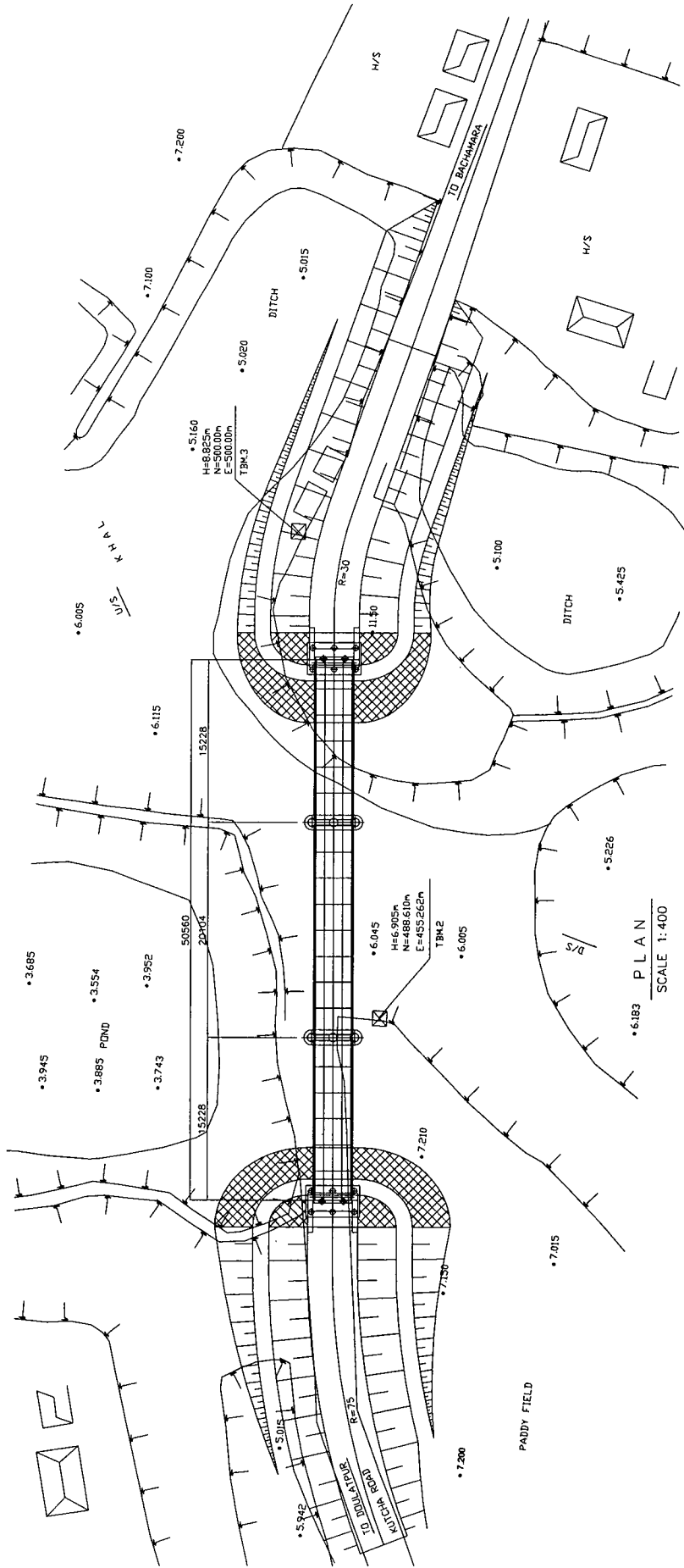

PLAN
SCALE 1:400

LOCAL GOVERNMENT ENGINEERING DEPARTMENT
PEOPLE'S REPUBLIC OF BANGLADESH

BASIC DESIGN STUDY ON THE PROJECT FOR
PROVISION OF PORTABLE STEEL BRIDGES ON
UPAZILA AND UNION ROADS

JAPAN INTERNATIONAL COOPERATION AGENCY
KATAHIRA & ENGINEERS INTERNATIONAL

SCALE
As Shown

GENERAL PLAN, ELEVATION
& TYPICAL CROSS SECTION
MANIKGANJ BRIDGE NO. 05-04-04

DRAWING NO.

II - 8/30

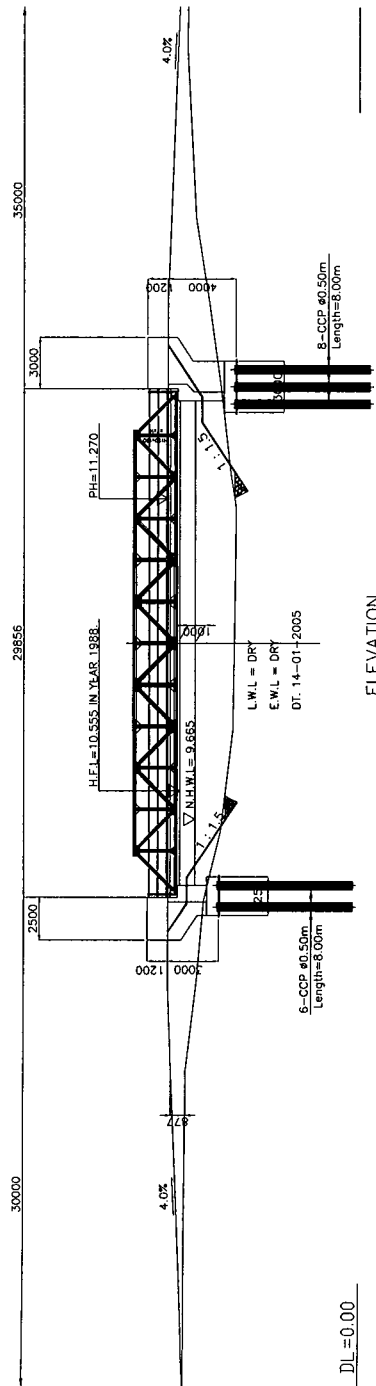

DL=0.00

ELEVATION SCALE 1:300

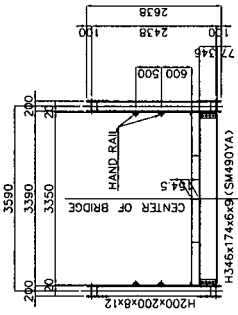

TYPICAL CROSS SECTION SCALE 1:100

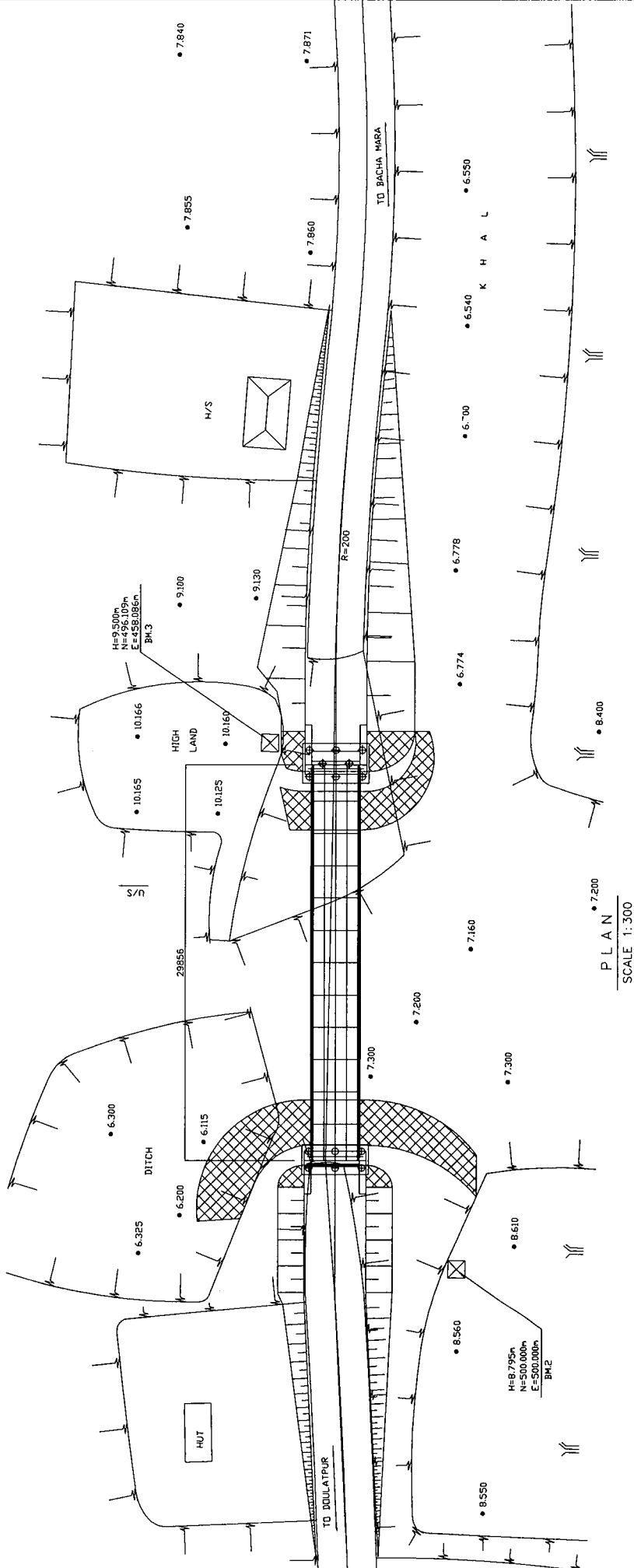

PLAN SCALE 1:300

LOCAL GOVERNMENT ENGINEERING DEPARTMENT
PEOPLE'S REPUBLIC OF BANGLADESH

BASIC DESIGN STUDY ON THE PROJECT FOR
PROVISION OF PORTABLE STEEL BRIDGES ON
UPAZILA AND UNION ROADS

JAPAN INTERNATIONAL COOPERATION AGENCY
KATAHIRA & ENGINEERS INTERNATIONAL

SCALE
As Shown

GENERAL PLAN, ELEVATION
& TYPICAL CROSS SECTION
MANIKGANJ BRIDGE NO. 05-04-05

DRAWING NO.
II-9/30

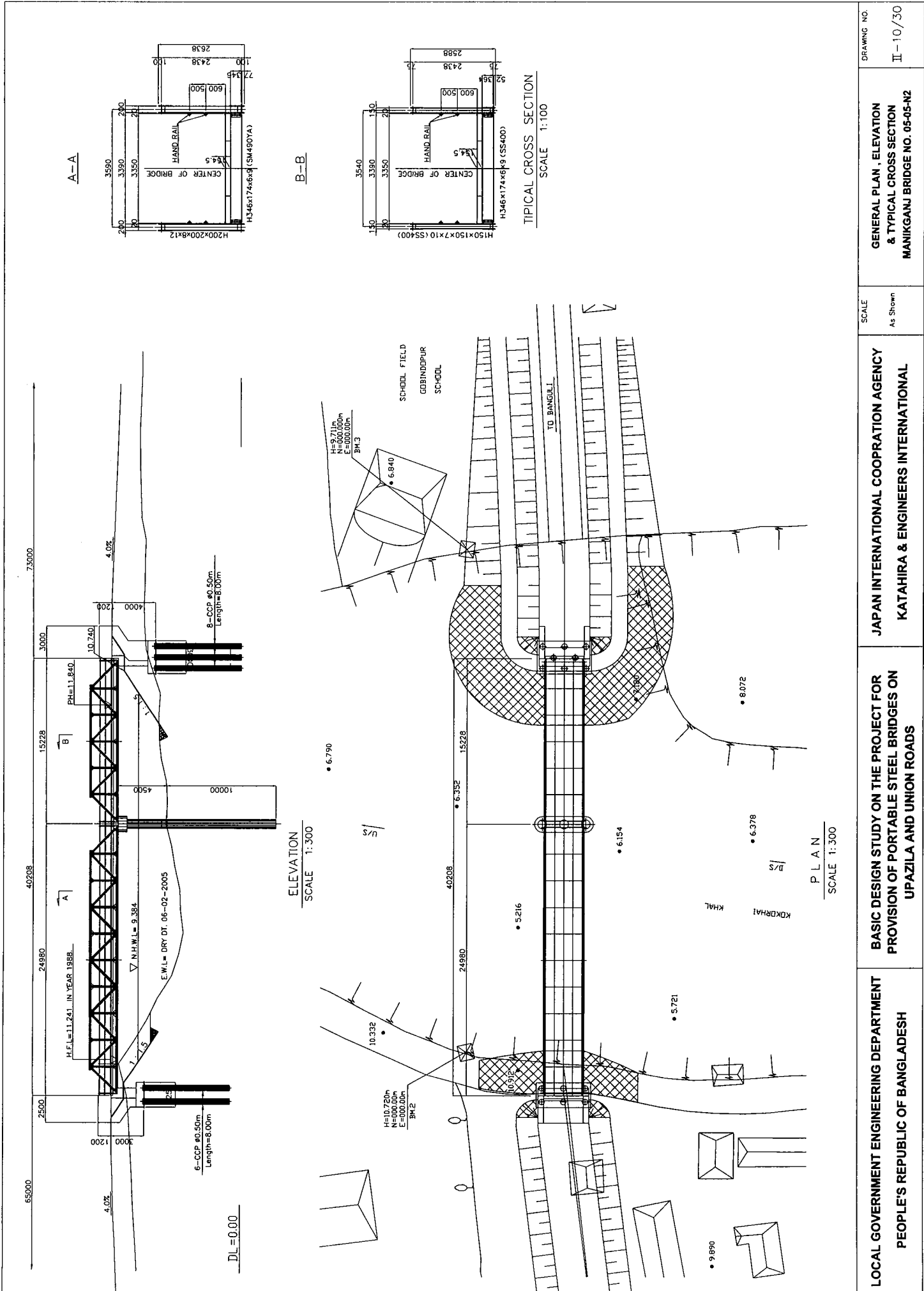

A-A

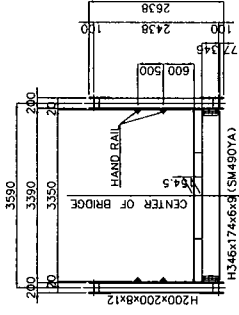

B-B

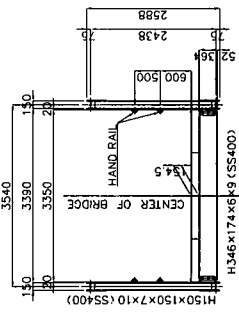

TYPICAL CROSS SECTION
SCALE 1:100

ELEVATION
SCALE 1:300

PLAN
SCALE 1:300

<p>LOCAL GOVERNMENT ENGINEERING DEPARTMENT PEOPLE'S REPUBLIC OF BANGLADESH</p>	<p>BASIC DESIGN STUDY ON THE PROJECT FOR PROVISION OF PORTABLE STEEL BRIDGES ON UPAZILA AND UNION ROADS</p>	<p>JAPAN INTERNATIONAL COOPERATION AGENCY KATAHIRA & ENGINEERS INTERNATIONAL</p>	<p>SCALE As Shown</p>	<p>GENERAL PLAN, ELEVATION & TYPICAL CROSS SECTION MANIKGANJ BRIDGE NO. 05-05-N2</p>	<p>DRAWING NO. II-10/30</p>
--	---	--	---------------------------	--	---------------------------------

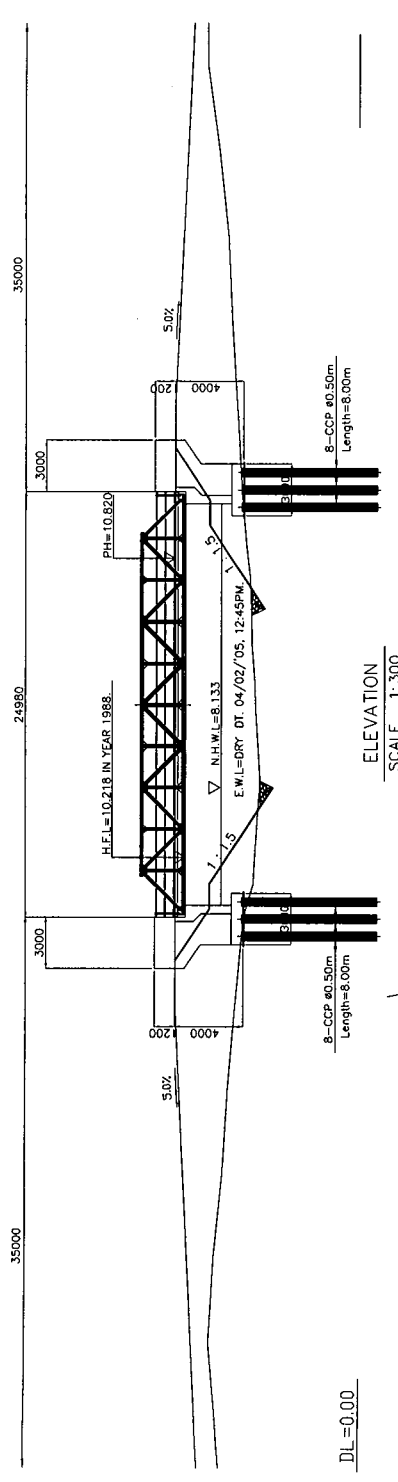

ELEVATION
SCALE 1:300

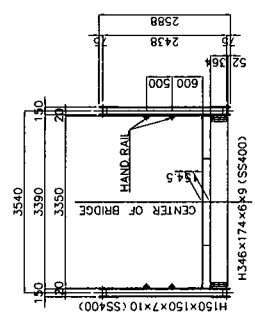

TYPICAL CROSS SECTION
SCALE 1:100

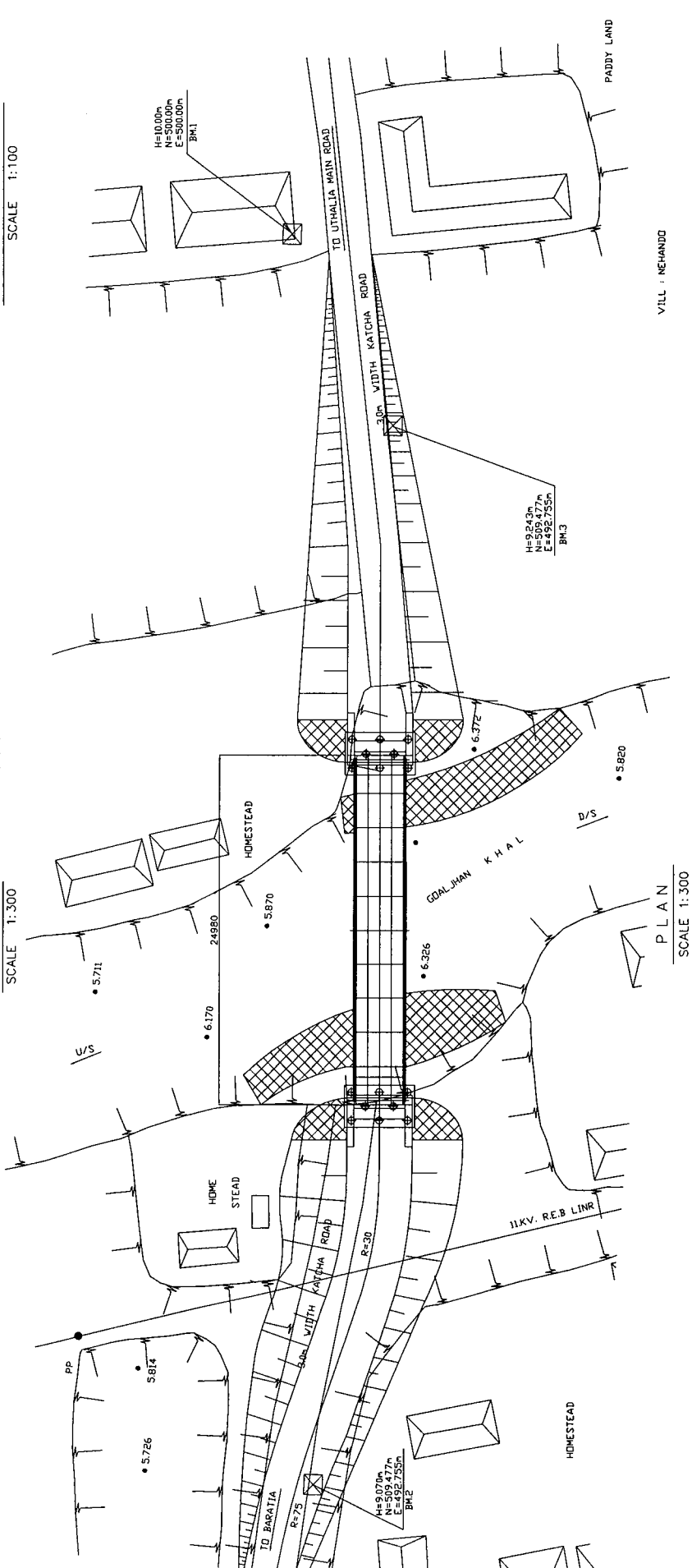

VILL : NEHANDO

PLAN
SCALE 1:300

<p>LOCAL GOVERNMENT ENGINEERING DEPARTMENT PEOPLE'S REPUBLIC OF BANGLADESH</p>	<p>BASIC DESIGN STUDY ON THE PROJECT FOR PROVISION OF PORTABLE STEEL BRIDGES ON UPAZILA AND UNION ROADS</p>	<p>JAPAN INTERNATIONAL COOPERATION AGENCY KATAHIRA & ENGINEERS INTERNATIONAL</p>	<p>GENERAL PLAN, ELEVATION & TYPICAL CROSS SECTION MANIKGANJ BRIDGE NO. 05-06-02</p>	<p>DRAWING NO. II-11/30</p>
--	---	--	--	---------------------------------

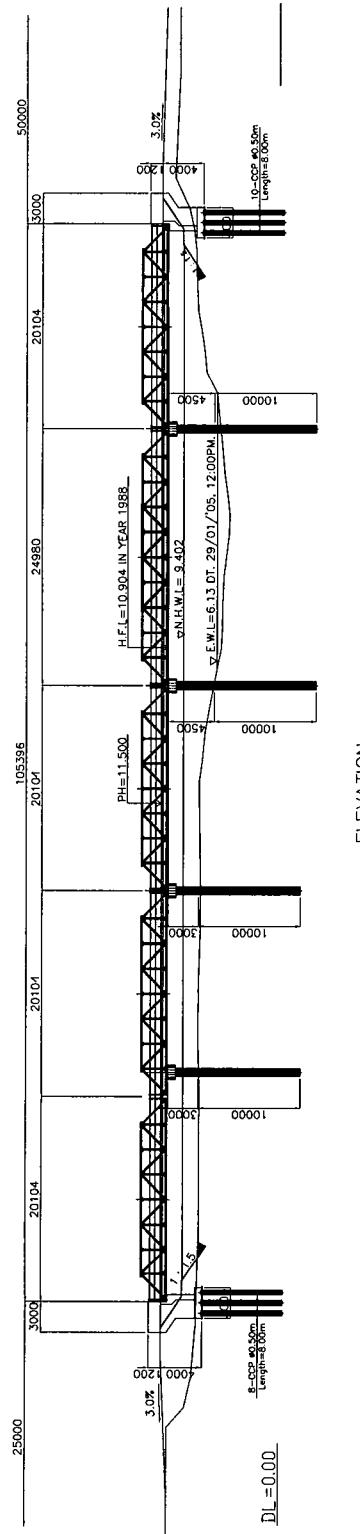

ELEVATION
SCALE 1:1:500

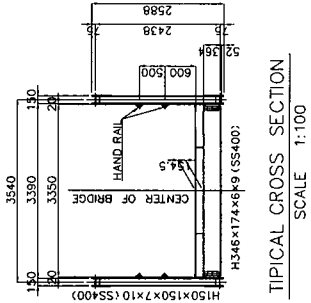

TYPICAL CROSS SECTION
SCALE 1:1:100

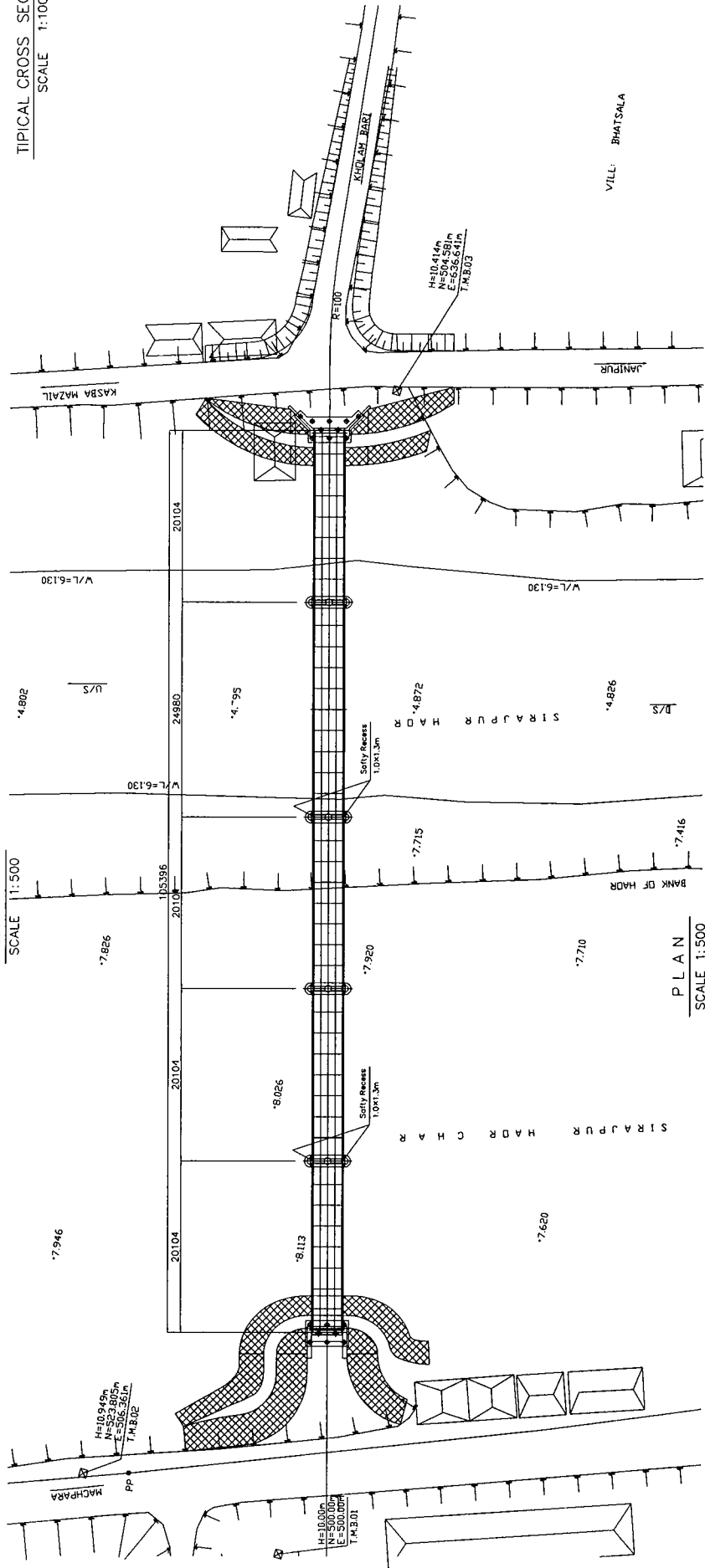

PLAN
SCALE 1:1:500

<p>LOCAL GOVERNMENT ENGINEERING DEPARTMENT PEOPLE'S REPUBLIC OF BANGLADESH</p>	<p>BASIC DESIGN STUDY ON THE PROJECT FOR PROVISION OF PORTABLE STEEL BRIDGES ON UPAZILA AND UNION ROADS</p>	<p>JAPAN INTERNATIONAL COOPERATION AGENCY KATAHIRA & ENGINEERS INTERNATIONAL</p>	<p>SCALE As Shown</p>	<p>GENERAL PLAN, ELEVATION & TYPICAL CROSS SECTION RAJBARI BRIDGE NO. 11-03-01 DRAWING NO. II-12/30</p>
--	---	--	---------------------------	---

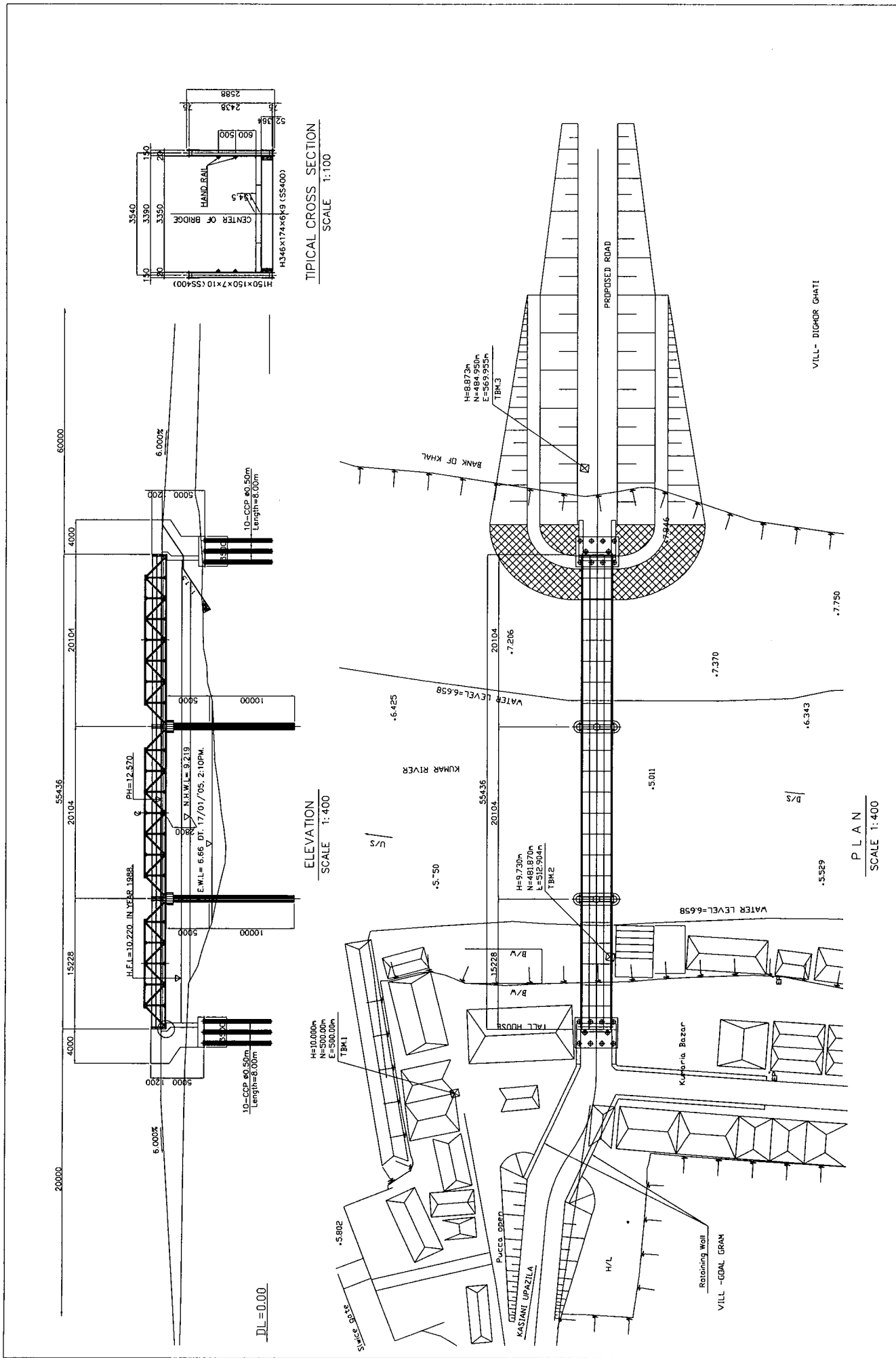

DRAWING NO. II - 13/30	GENERAL PLAN, ELEVATION & TYPICAL CROSS SECTION GOPALGONJ BRIDGE NO. 12-02-N2	SCALE As Shown	JAPAN INTERNATIONAL COOPERATION AGENCY KATAHIRA & ENGINEERS INTERNATIONAL	BASIC DESIGN STUDY ON THE PROJECT FOR PROVISION OF PORTABLE STEEL BRIDGES ON UPAZILA AND UNION ROADS	LOCAL GOVERNMENT ENGINEERING DEPARTMENT PEOPLE'S REPUBLIC OF BANGLADESH
---------------------------	---	-------------------	--	--	--

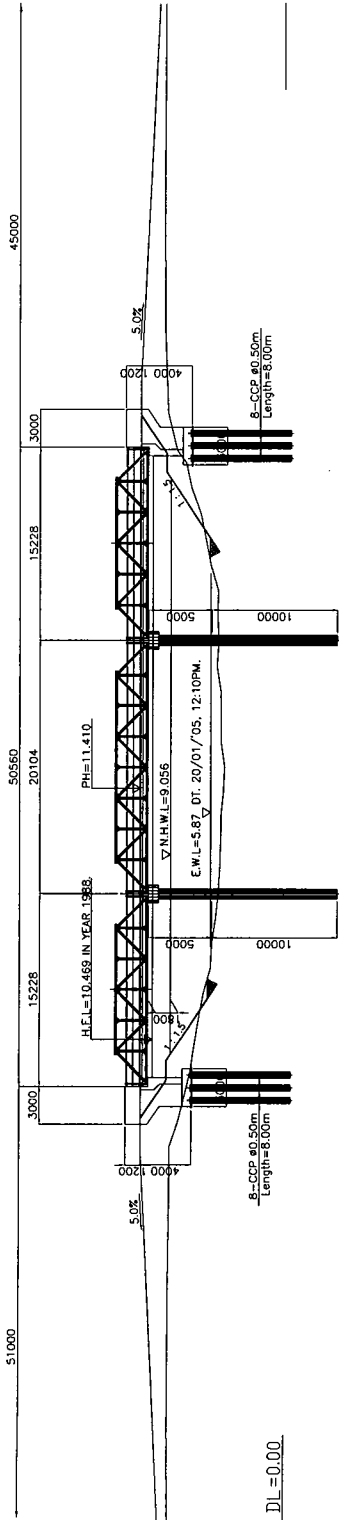

ELEVATION
SCALE 1:400

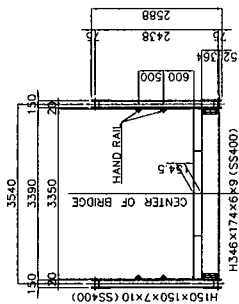

TYPICAL CROSS SECTION
SCALE 1:100

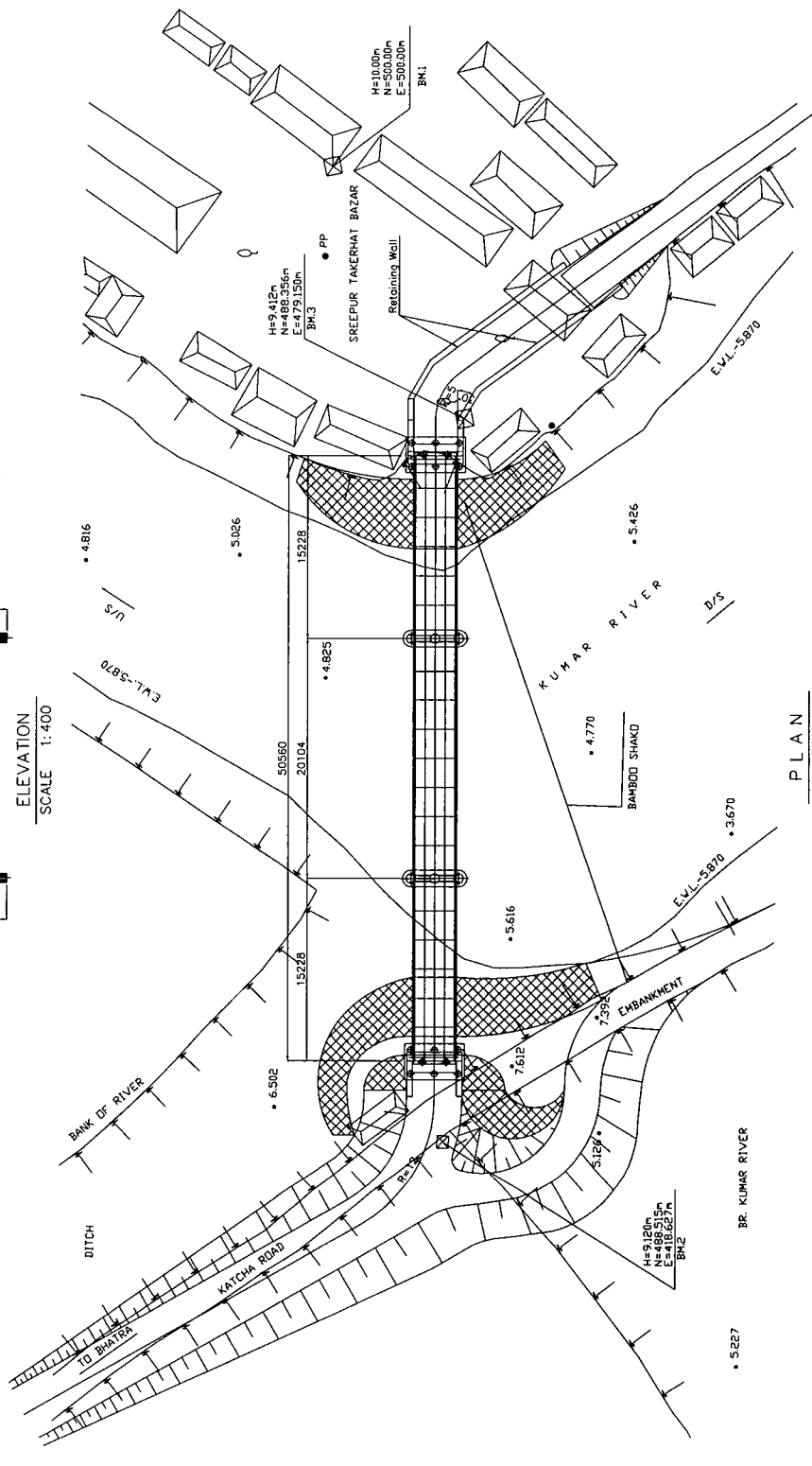

PLAN
SCALE 1:400

<p>LOCAL GOVERNMENT ENGINEERING DEPARTMENT PEOPLE'S REPUBLIC OF BANGLADESH</p>	<p>BASIC DESIGN STUDY ON THE PROJECT FOR PROVISION OF PORTABLE STEEL BRIDGES ON UPAZILA AND UNION ROADS</p>	<p>JAPAN INTERNATIONAL COOPERATION AGENCY KATAHIRA & ENGINEERS INTERNATIONAL</p>	<p>SCALE As Shown</p>	<p>DRAWING NO II - 14 / 30</p>
--	---	--	---------------------------	------------------------------------

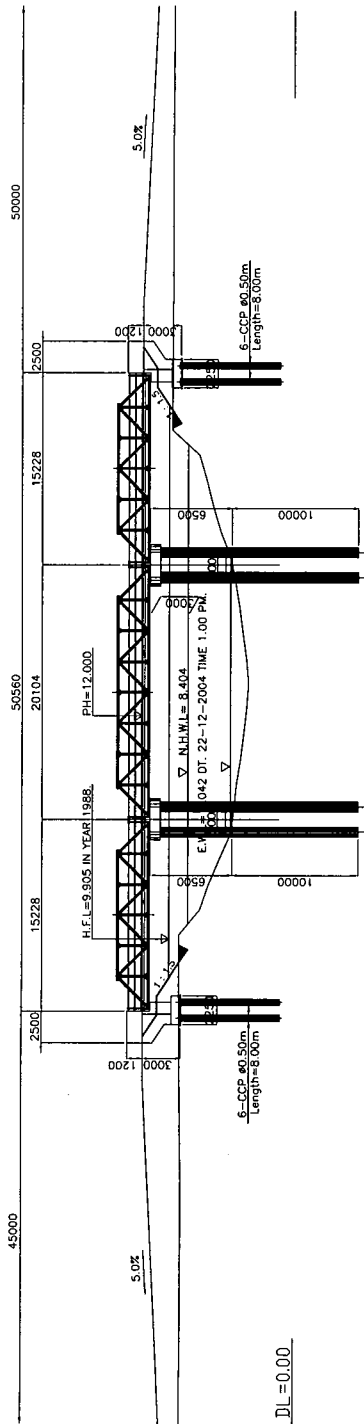

ELEVATION
SCALE 1:400

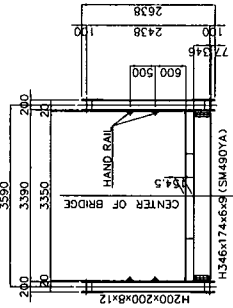

TYPICAL CROSS SECTION
SCALE 1:100

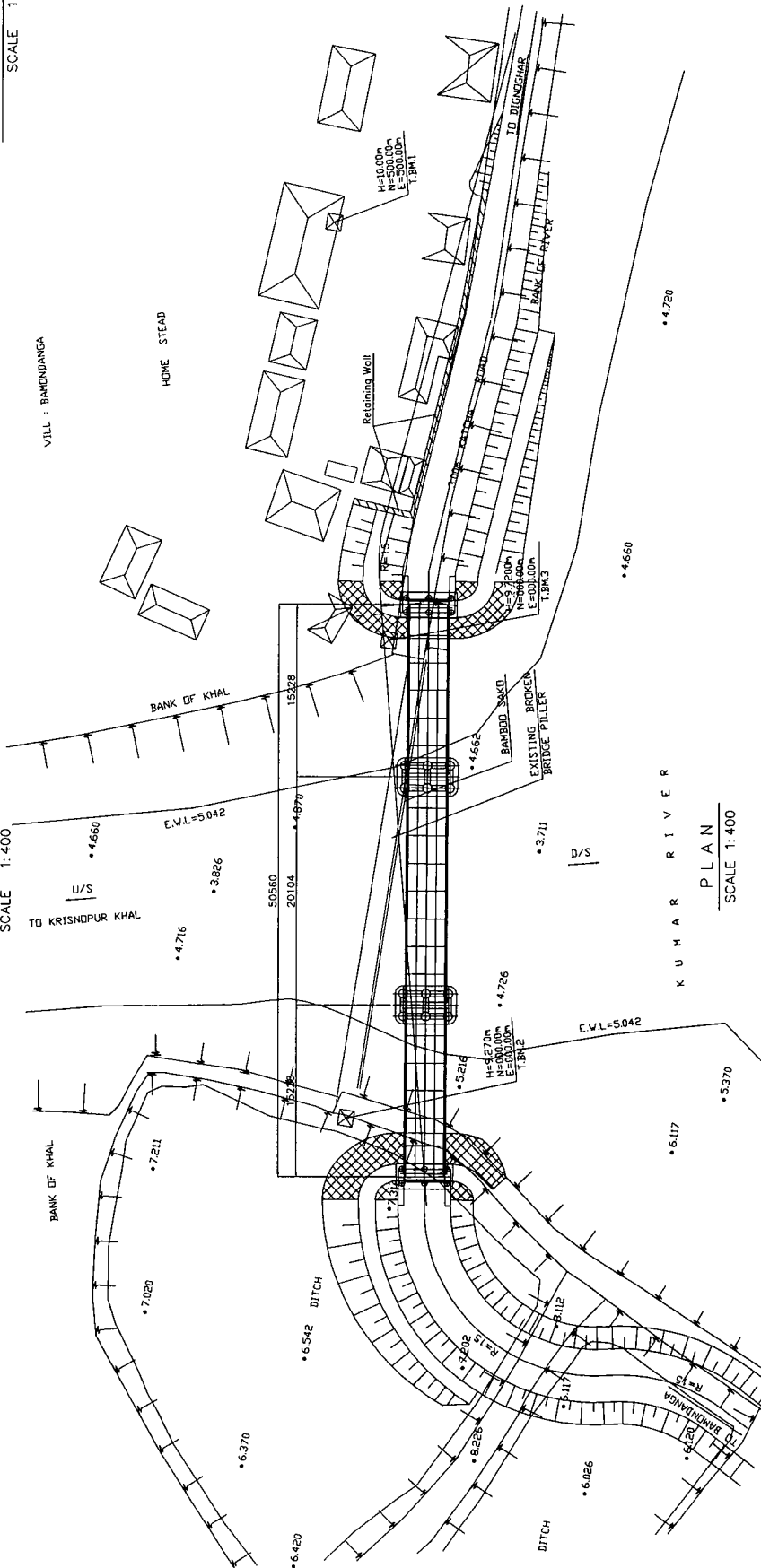

PLAN
SCALE 1:400

LOCAL GOVERNMENT ENGINEERING DEPARTMENT PEOPLE'S REPUBLIC OF BANGLADESH	BASIC DESIGN STUDY ON THE PROJECT FOR PROVISION OF PORTABLE STEEL BRIDGES ON UPAZILA AND UNION ROADS	JAPAN INTERNATIONAL COOPERATION AGENCY KATAHIRA & ENGINEERS INTERNATIONAL	SCALE As Shown	DRAWING NO. II-15/30
--	--	--	-------------------	-------------------------

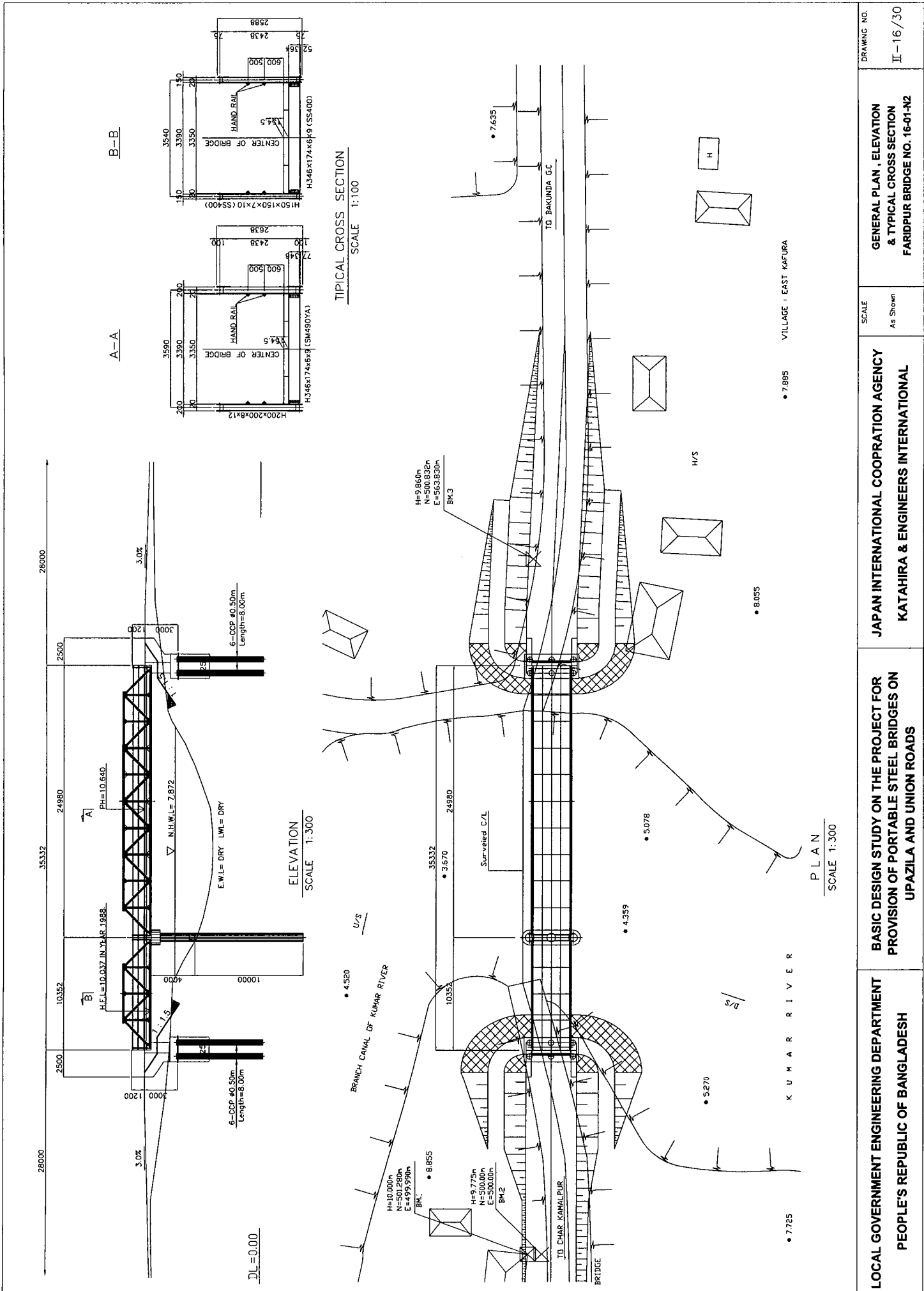

A-A

B-B

TYPICAL CROSS SECTION
SCALE 1:100

ELEVATION
SCALE 1:300

PLAN
SCALE 1:300

DRAWING NO. II-16/30	GENERAL PLAN, ELEVATION & TYPICAL CROSS SECTION FARIDPUR BRIDGE NO. 16-01-N2	JAPAN INTERNATIONAL COOPERATION AGENCY KATAHIRA & ENGINEERS INTERNATIONAL	BASIC DESIGN STUDY ON THE PROJECT FOR PROVISION OF PORTABLE STEEL BRIDGES ON UPAZILA AND UNION ROADS
SCALE As Shown		LOCAL GOVERNMENT ENGINEERING DEPARTMENT PEOPLE'S REPUBLIC OF BANGLADESH	

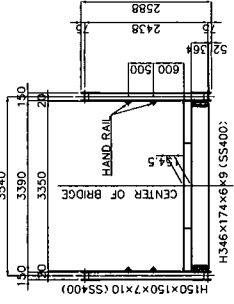
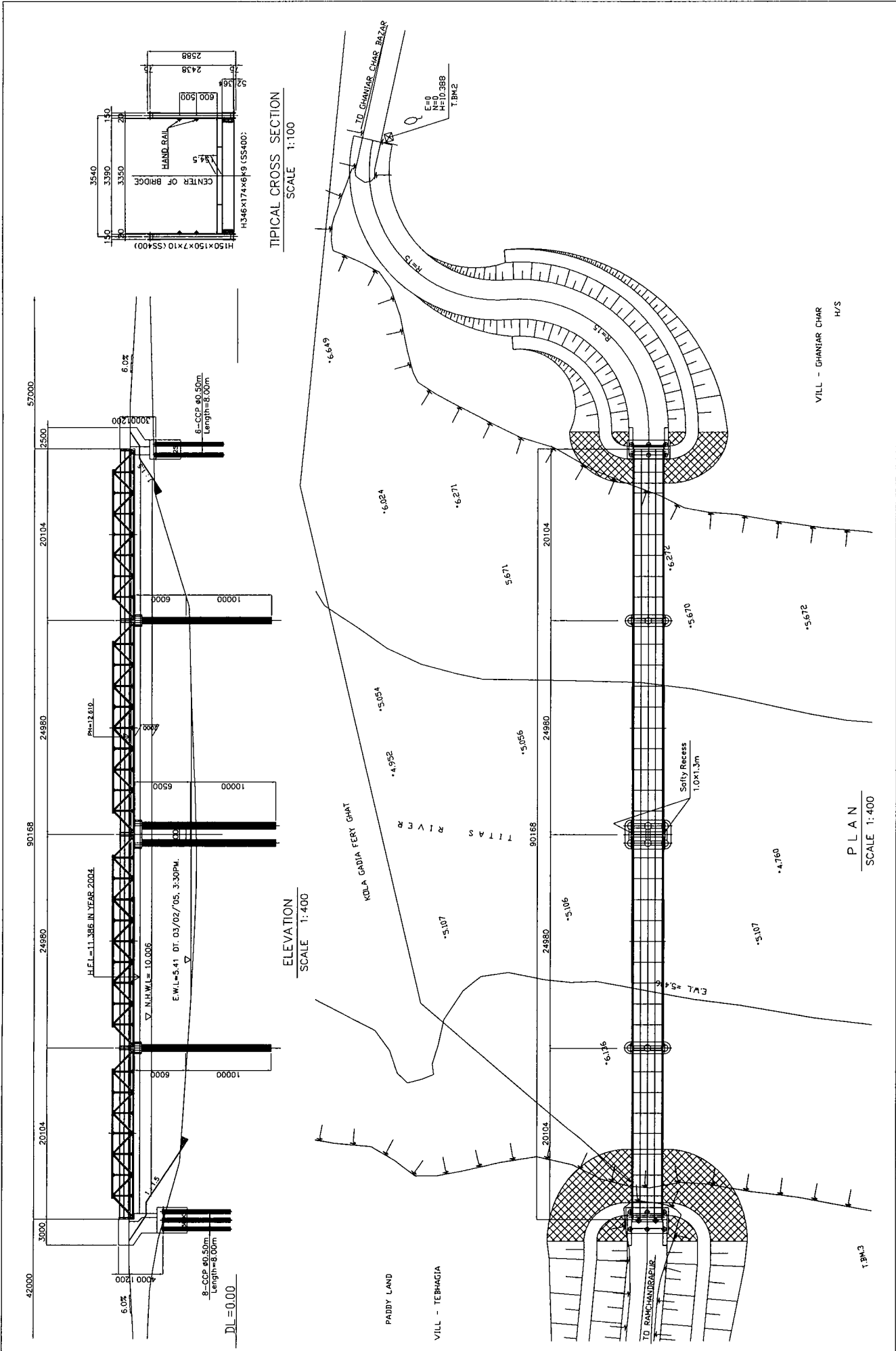

TYPICAL CROSS SECTION
SCALE 1:100

ELEVATION
SCALE 1:400

PLAN
SCALE 1:400

DRAWING NO. II - 17/30	GENERAL PLAN, ELEVATION & TYPICAL CROSS SECTION COMILLA BRIDGE NO. 19-10-41	SCALE As Shown	JAPAN INTERNATIONAL COOPERATION AGENCY KATAHIRA & ENGINEERS INTERNATIONAL	LOCAL GOVERNMENT ENGINEERING DEPARTMENT PEOPLE'S REPUBLIC OF BANGLADESH
---------------------------	---	-------------------	--	--

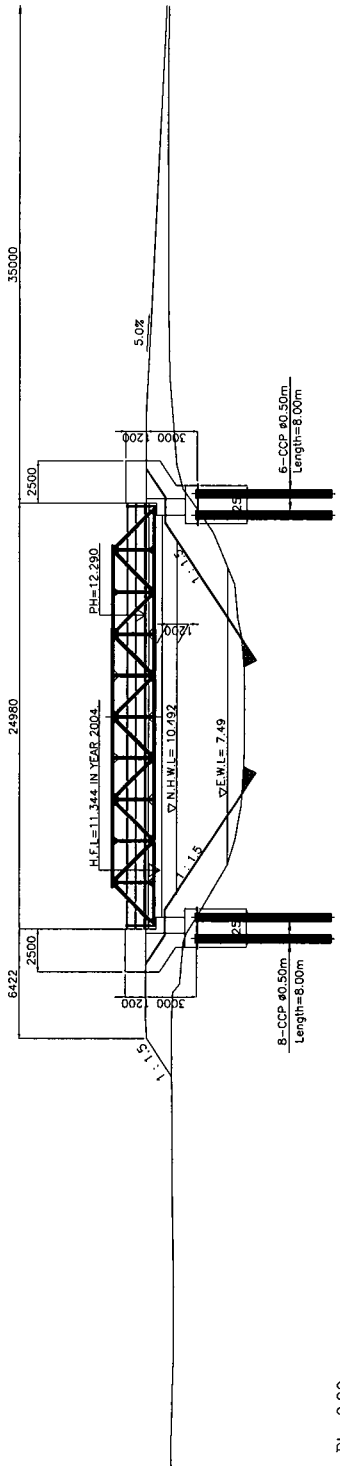

ELEVATION
SCALE 1:300

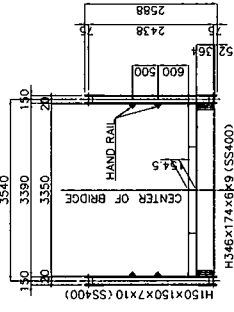

TYPICAL CROSS SECTION
SCALE 1:100

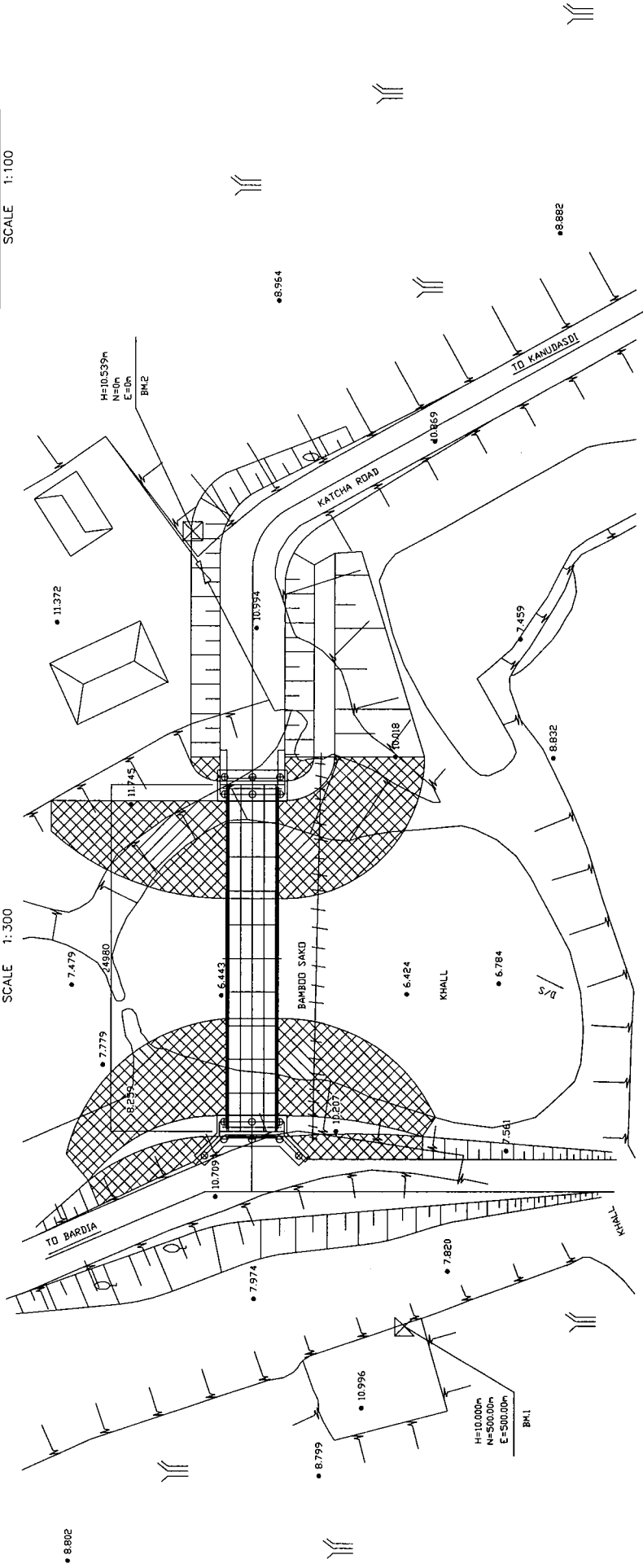

PLAN
SCALE 1:300

LOCAL GOVERNMENT ENGINEERING DEPARTMENT
PEOPLE'S REPUBLIC OF BANGLADESH

BASIC DESIGN STUDY ON THE PROJECT FOR
PROVISION OF PORTABLE STEEL BRIDGES ON
UPAZILA AND UNION ROADS

JAPAN INTERNATIONAL COOPERATION AGENCY
KATAHIRA & ENGINEERS INTERNATIONAL

SCALE
As Shown

GENERAL PLAN, ELEVATION
& TYPICAL CROSS SECTION
CHANDPUR BRIDGE NO. 21-01-N1

DRAWING NO.
II - 18 / 30

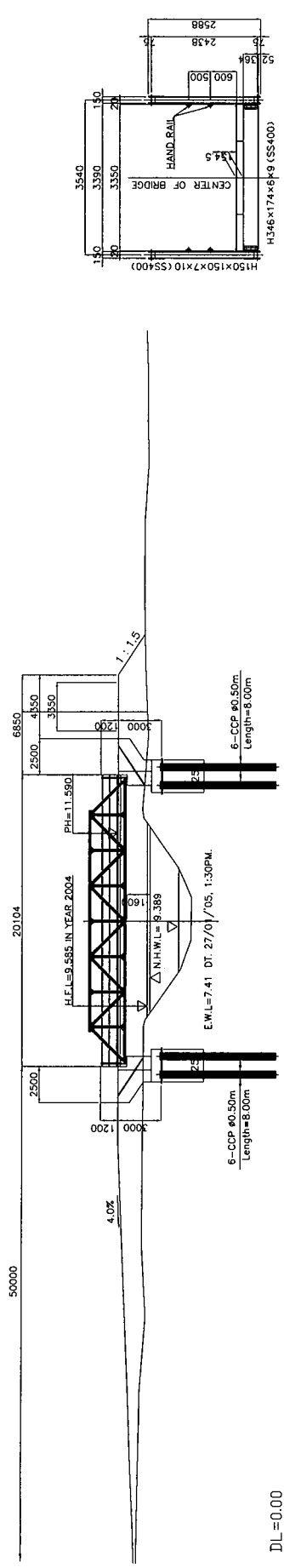

ELEVATION
SCALE 1:300

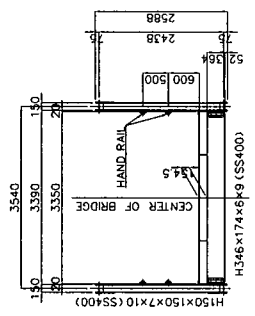

TYPICAL CROSS SECTION
SCALE 1:100

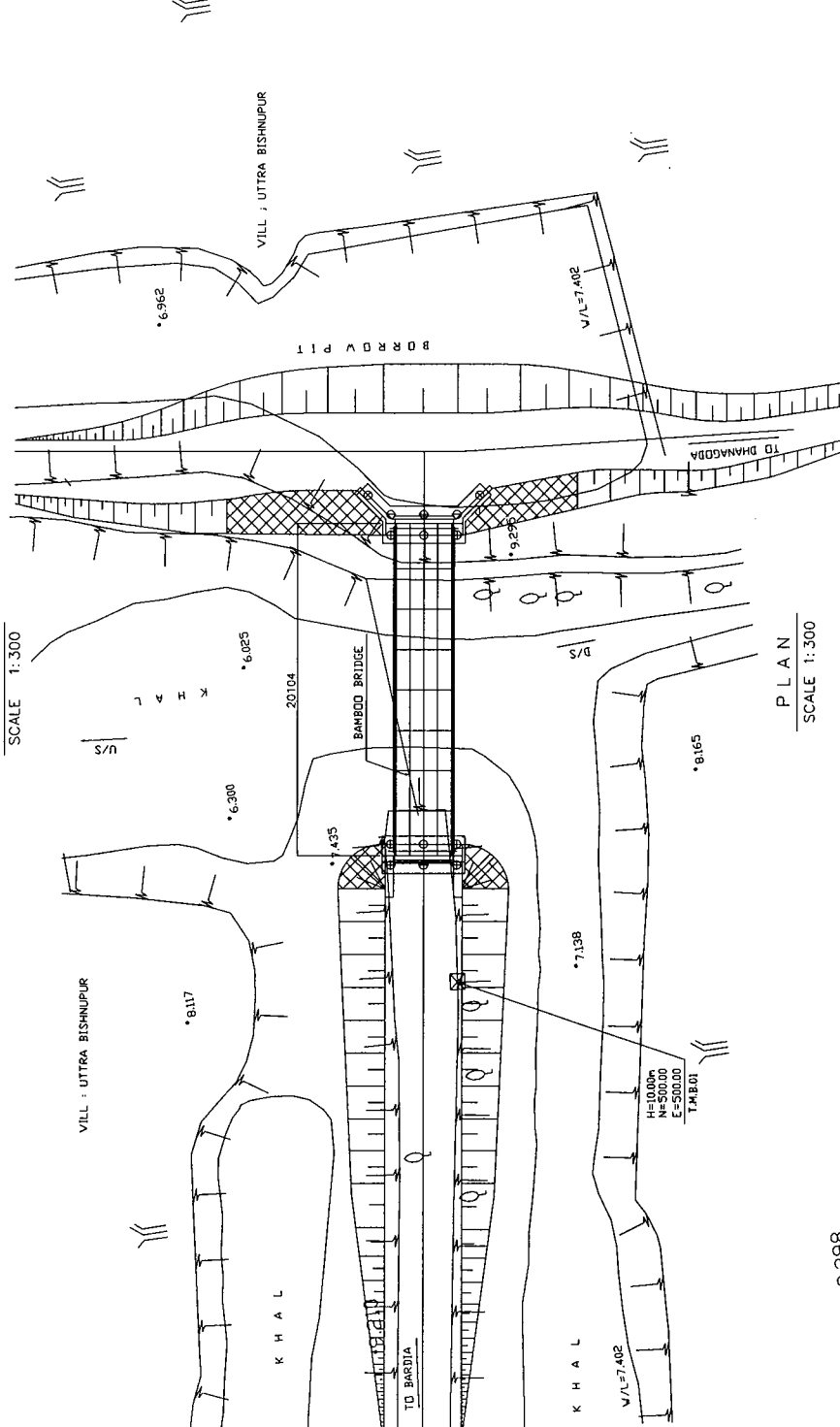

PLAN
SCALE 1:300

*8.298

<p>LOCAL GOVERNMENT ENGINEERING DEPARTMENT PEOPLE'S REPUBLIC OF BANGLADESH</p>	<p>BASIC DESIGN STUDY ON THE PROJECT FOR PROVISION OF PORTABLE STEEL BRIDGES ON UPAZILA AND UNION ROADS</p>	<p>JAPAN INTERNATIONAL COOPERATION AGENCY KATAHIRA & ENGINEERS INTERNATIONAL</p>	<p>SCALE As Shown</p>	<p>GENERAL PLAN, ELEVATION & TYPICAL CROSS SECTION CHANDPUR BRIDGE NO. 21-01-N2</p>	<p>DRAWING NO. II-19/30</p>
--	---	--	---------------------------	---	---------------------------------

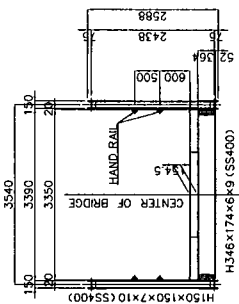
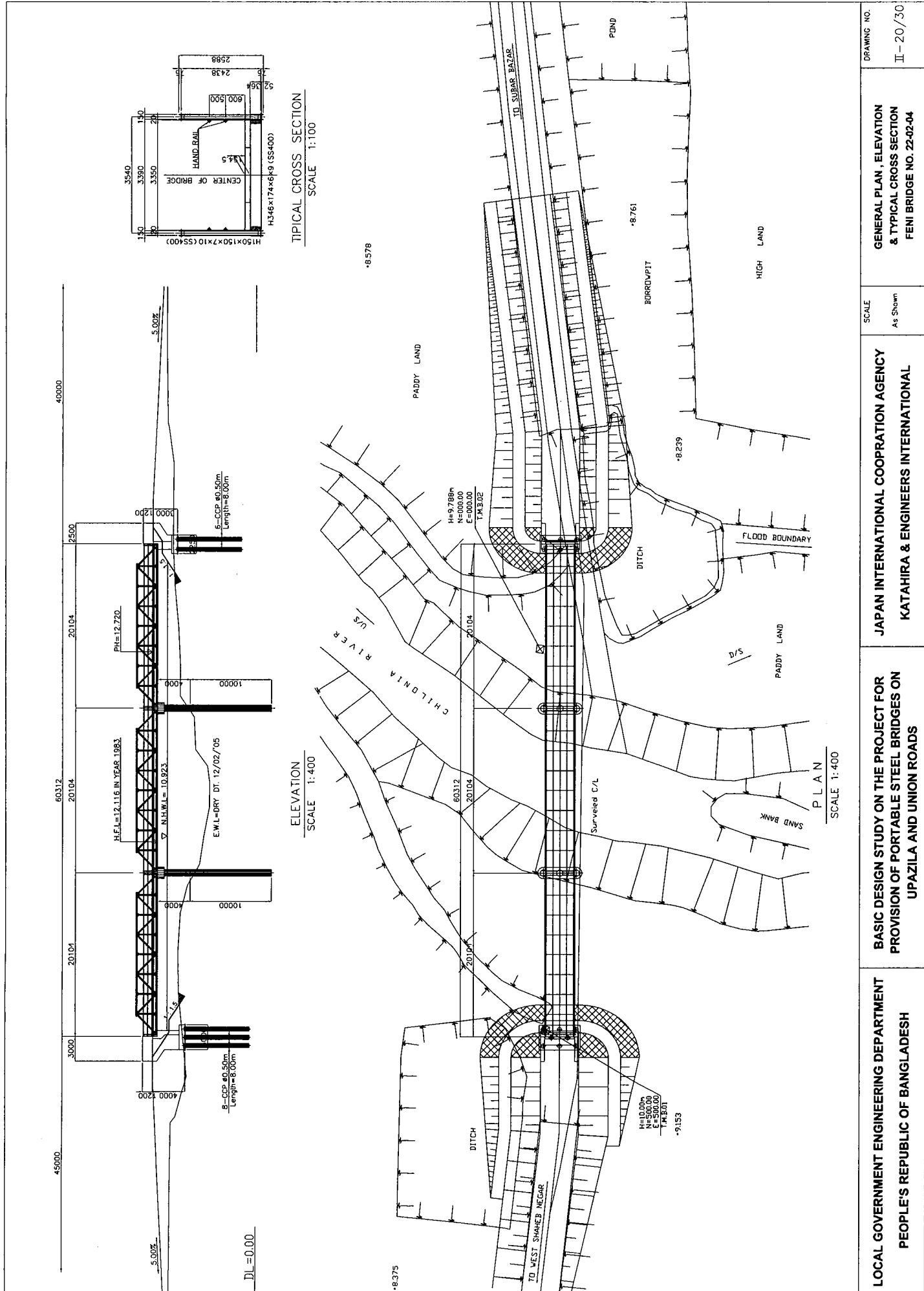

TYPICAL CROSS SECTION
SCALE 1:100

ELEVATION
SCALE 1:400

PLAN
SCALE 1:400

<p>LOCAL GOVERNMENT ENGINEERING DEPARTMENT PEOPLE'S REPUBLIC OF BANGLADESH</p>	<p>BASIC DESIGN STUDY ON THE PROJECT FOR PROVISION OF PORTABLE STEEL BRIDGES ON UPAZILA AND UNION ROADS</p>	<p>JAPAN INTERNATIONAL COOPERATION AGENCY KATAHIRA & ENGINEERS INTERNATIONAL</p>	<p>SCALE As Shown</p>	<p>GENERAL PLAN, ELEVATION & TYPICAL CROSS SECTION FENI BRIDGE NO. 22-02-04</p>
				<p>DRAWING NO. II - 20/30</p>

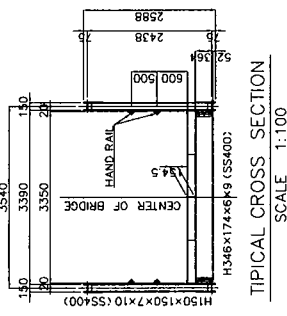
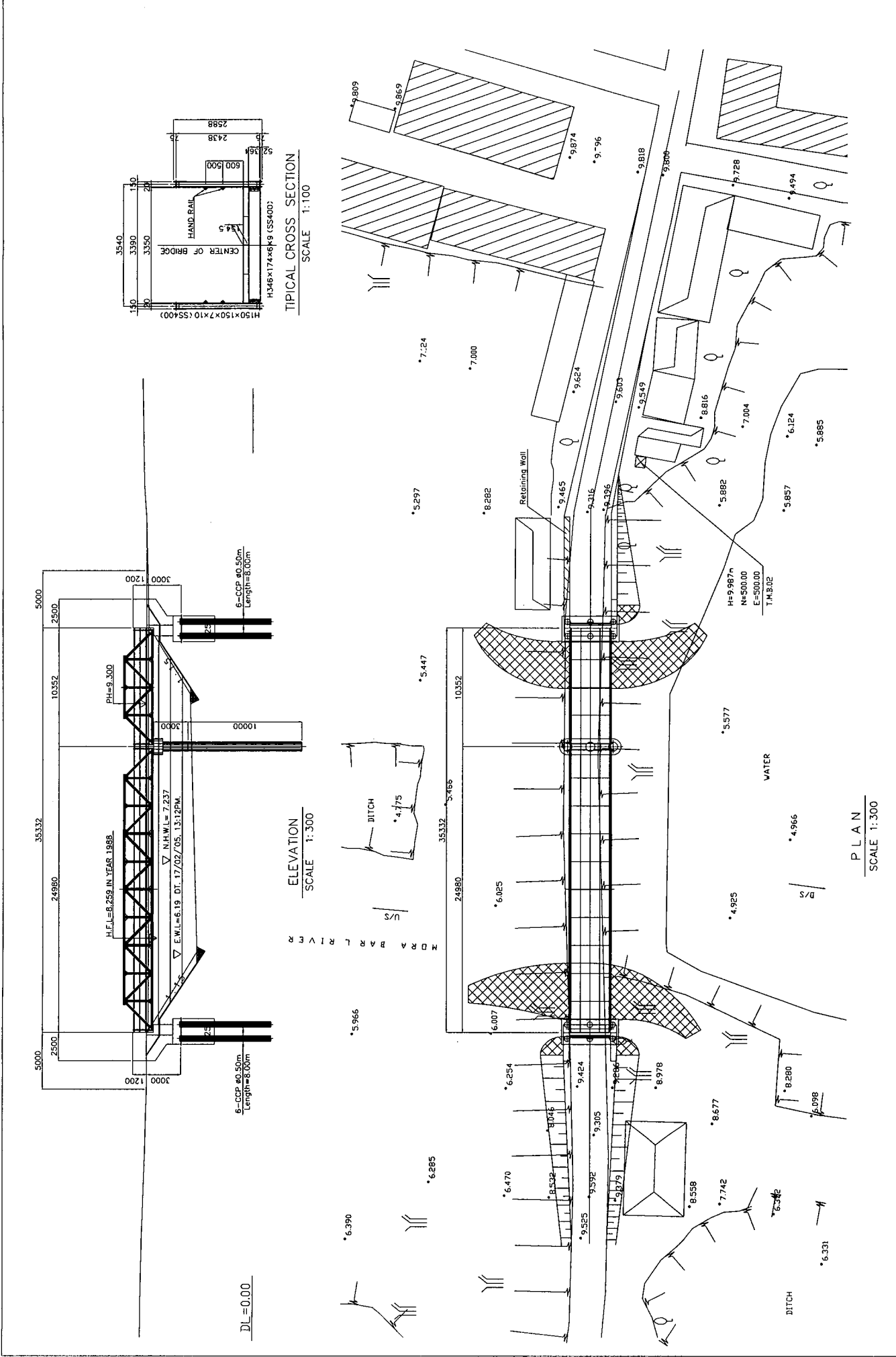

ELEVATION
SCALE 1:300

PLAN
SCALE 1:300

<p>LOCAL GOVERNMENT ENGINEERING DEPARTMENT PEOPLE'S REPUBLIC OF BANGLADESH</p>	<p>BASIC DESIGN STUDY ON THE PROJECT FOR PROVISION OF PORTABLE STEEL BRIDGES ON UPAZILA AND UNION ROADS</p>	<p>JAPAN INTERNATIONAL COOPERATION AGENCY KATAHIRA & ENGINEERS INTERNATIONAL</p>	<p>SCALE As Shown</p>	<p>GENERAL PLAN, ELEVATION & TYPICAL CROSS SECTION NATORE BRIDGE NO. 52-04-02</p>	<p>DRAWING NO. II - 21 / 30</p>
--	---	--	---------------------------	---	-------------------------------------

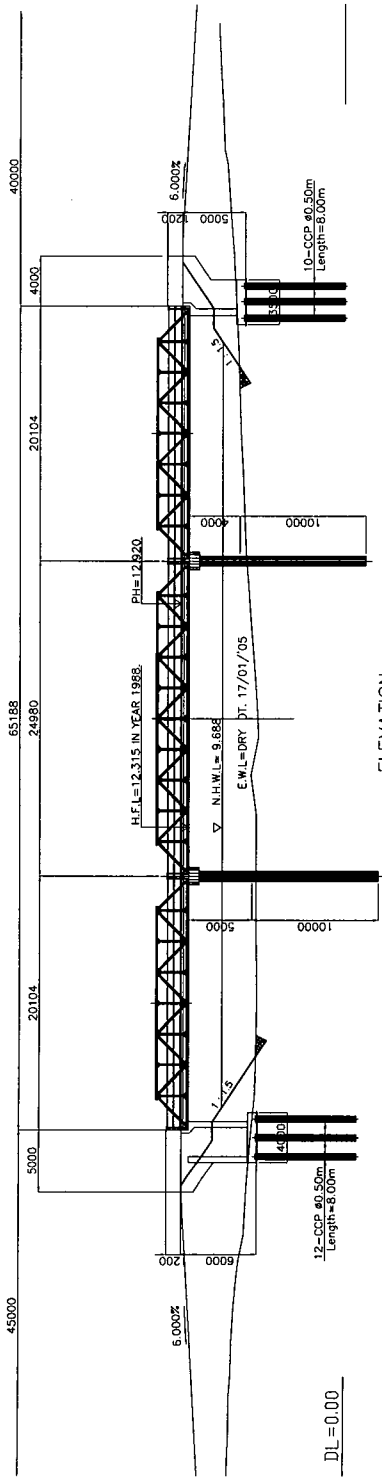

ELEVATION
SCALE 1:400

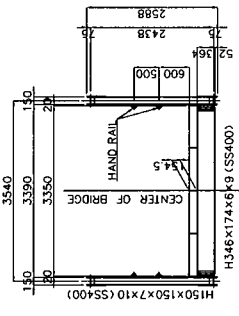

TYPICAL CROSS SECTION
SCALE 1:100

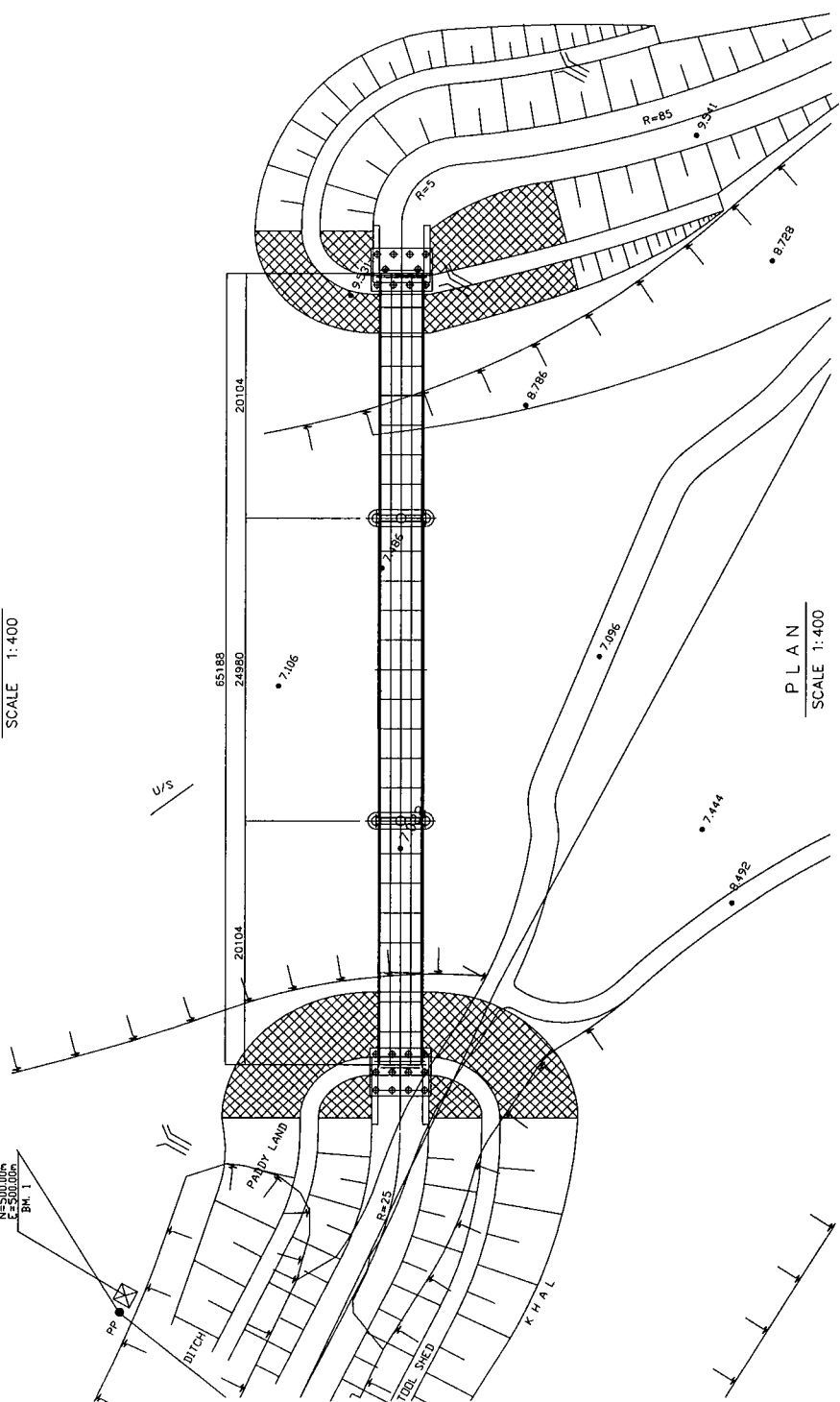

PLAN
SCALE 1:400

<p>LOCAL GOVERNMENT ENGINEERING DEPARTMENT PEOPLE'S REPUBLIC OF BANGLADESH</p>	<p>BASIC DESIGN STUDY ON THE PROJECT FOR PROVISION OF PORTABLE STEEL BRIDGES ON UPAZILA AND UNION ROADS</p>	<p>JAPAN INTERNATIONAL COOPERATION AGENCY KATAHIRA & ENGINEERS INTERNATIONAL</p>	<p>SCALE As Shown</p>	<p>DRAWING NO. II - 22 / 30</p>
--	---	--	---------------------------	-------------------------------------

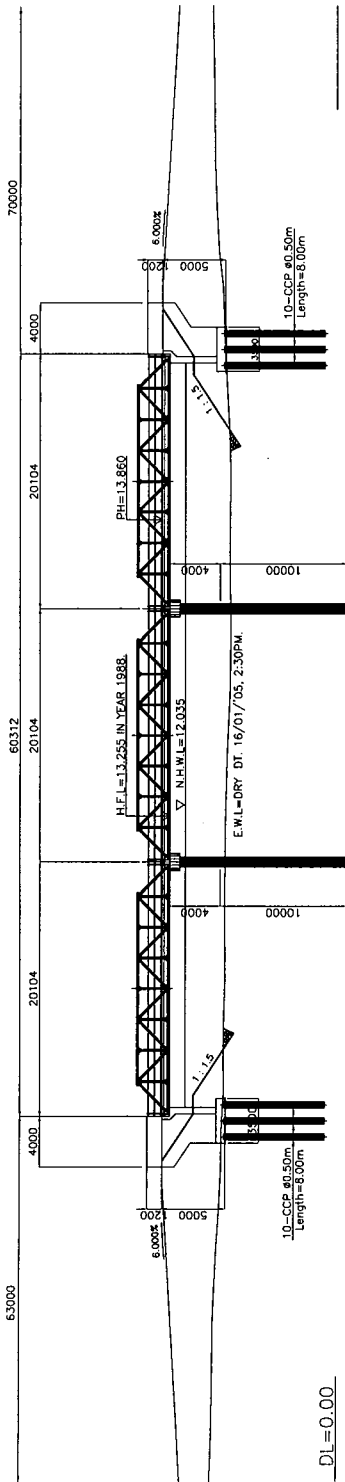

DL=0.00

ELEVATION
SCALE 1:400

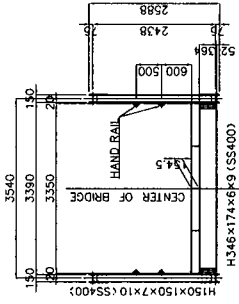

TYPICAL CROSS SECTION
SCALE 1:100

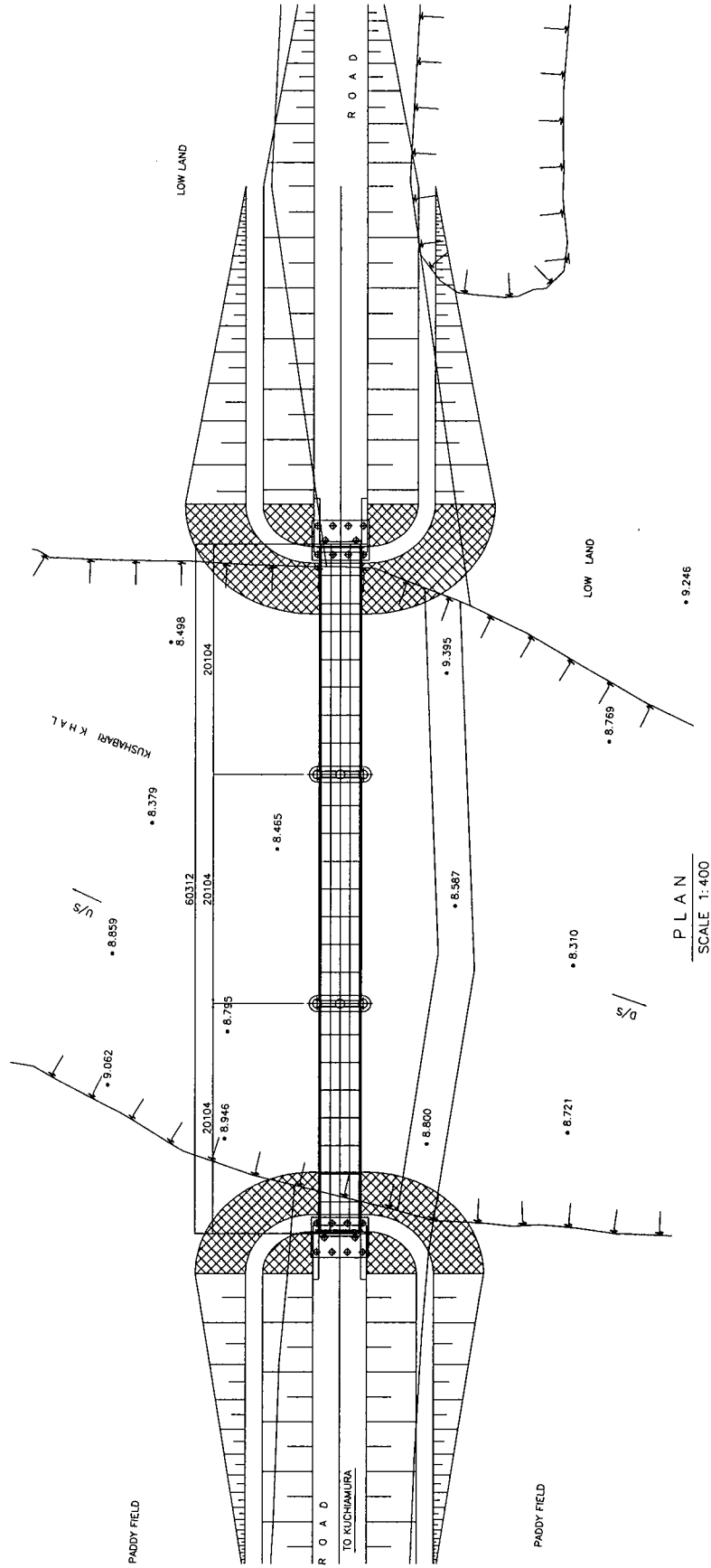

PLAN
SCALE 1:400

<p>LOCAL GOVERNMENT ENGINEERING DEPARTMENT PEOPLE'S REPUBLIC OF BANGLADESH</p>	<p>BASIC DESIGN STUDY ON THE PROJECT FOR PROVISION OF PORTABLE STEEL BRIDGES ON UPAZILA AND UNION ROADS</p>	<p>JAPAN INTERNATIONAL COOPERATION AGENCY KATAHIRA & ENGINEERS INTERNATIONAL</p>	<p>SCALE As Shown</p>	<p>DRAWING NO. II-23/30</p>
--	---	--	---------------------------	---------------------------------

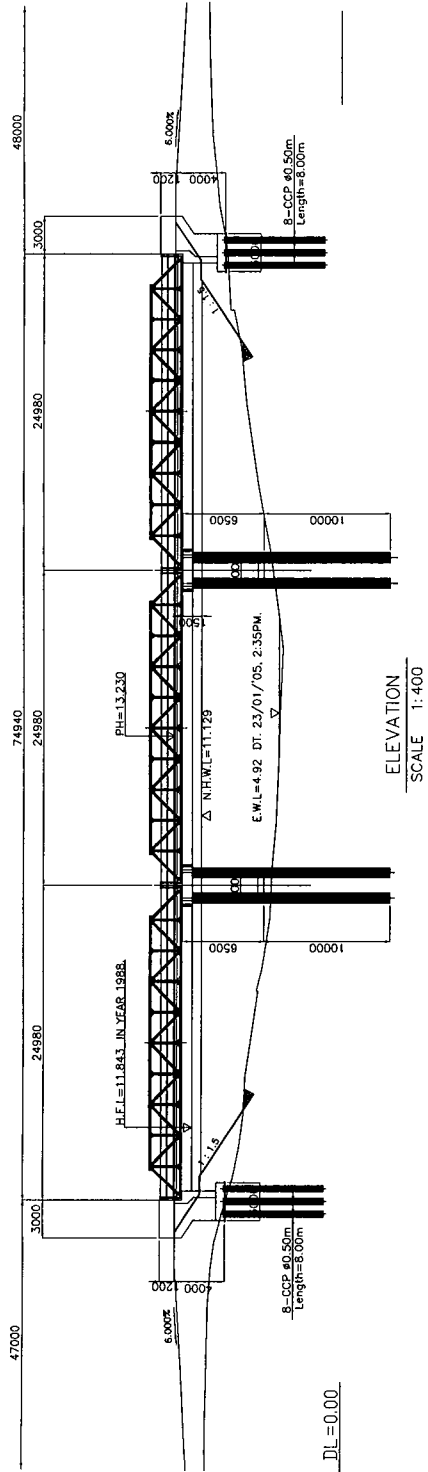

TYPICAL CROSS SECTION
SCALE 1:100

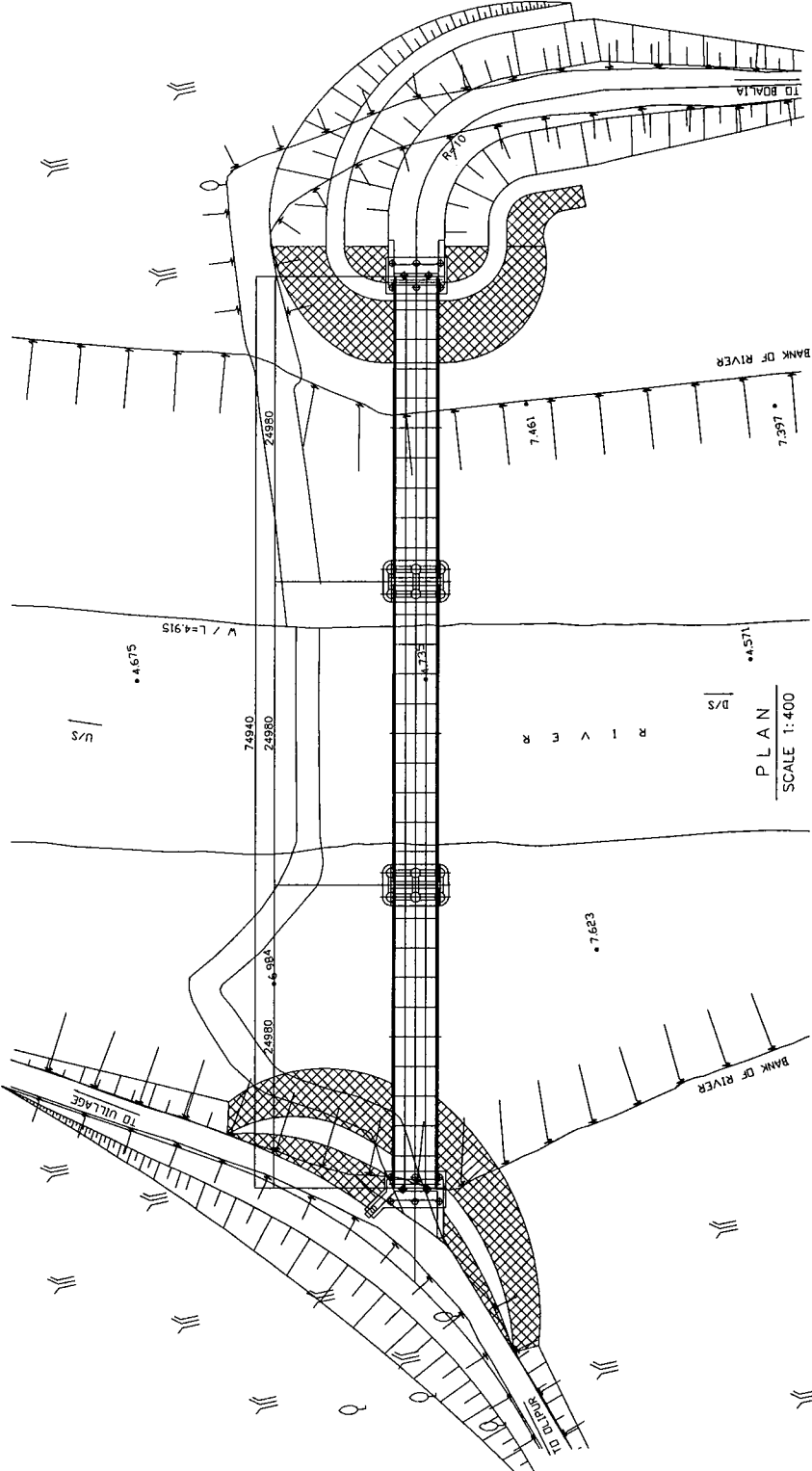
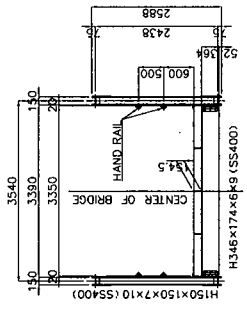

DRAWING NO. II - 24 / 30	GENERAL PLAN, ELEVATION & TYPICAL CROSS SECTION SIRAJG ANJ BRIDGE NO. 55-07-07	SCALE As Shown	JAPAN INTERNATIONAL COOPERATION AGENCY KATAHIRA & ENGINEERS INTERNATIONAL
BASIC DESIGN STUDY ON THE PROJECT FOR PROVISION OF PORTABLE STEEL BRIDGES ON UPAZILA AND UNION ROADS		LOCAL GOVERNMENT ENGINEERING DEPARTMENT PEOPLE'S REPUBLIC OF BANGLADESH	

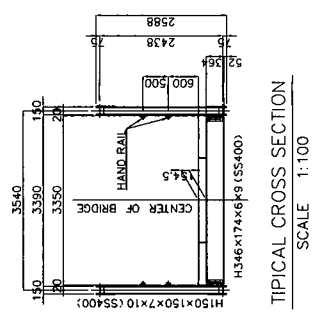
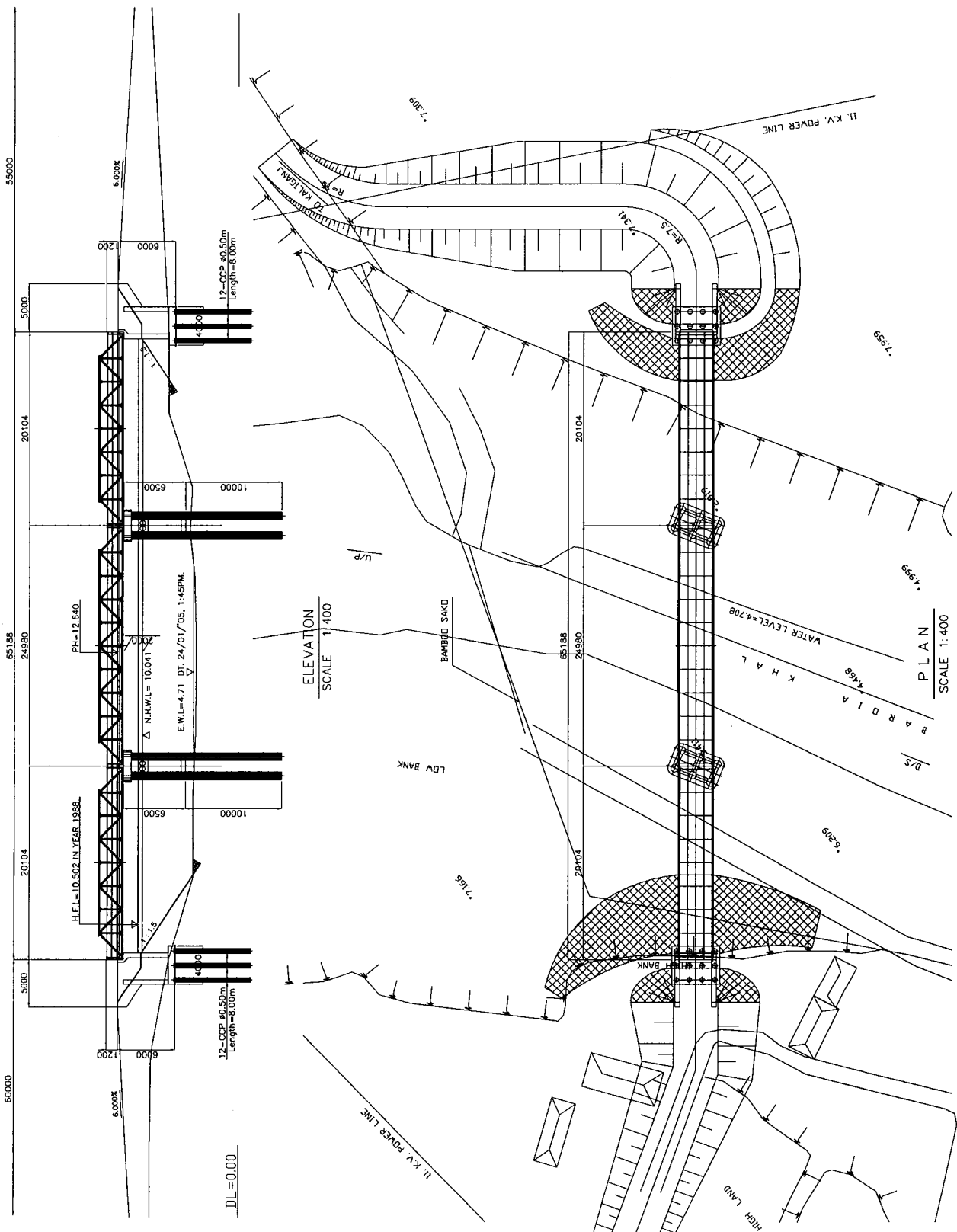

DRAWING NO. II - 25/30	GENERAL PLAN, ELEVATION & TYPICAL CROSS SECTION SIRAJGANJ BRIDGE NO. 55-07-08	SCALE As Shown	JAPAN INTERNATIONAL COOPERATION AGENCY KATAHIRA & ENGINEERS INTERNATIONAL
BASIC DESIGN STUDY ON THE PROJECT FOR PROVISION OF PORTABLE STEEL BRIDGES ON UPAZILA AND UNION ROADS		LOCAL GOVERNMENT ENGINEERING DEPARTMENT PEOPLE'S REPUBLIC OF BANGLADESH	

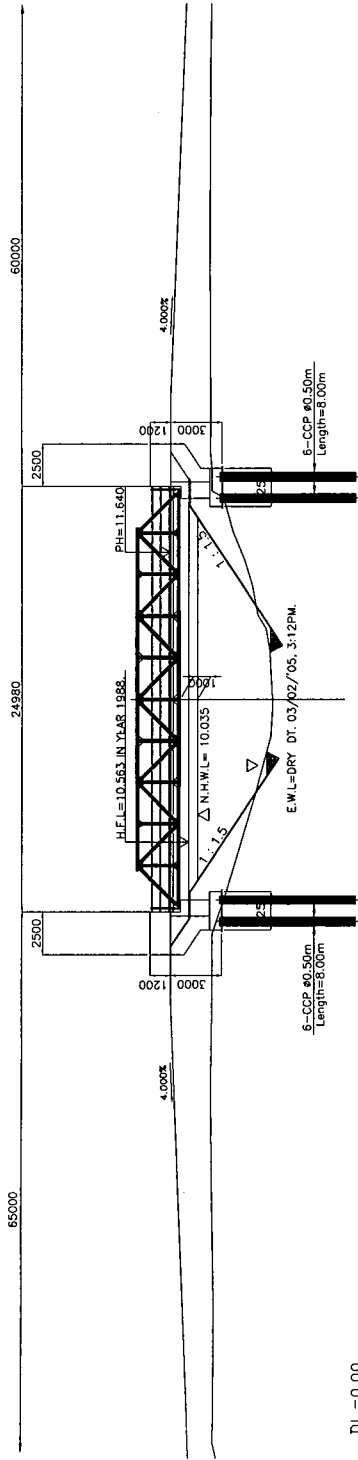

ELEVATION
SCALE 1:300

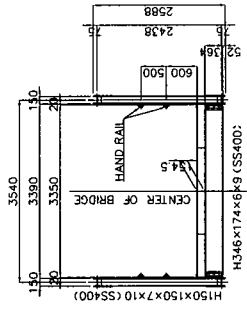

TYPICAL CROSS SECTION
SCALE 1:100

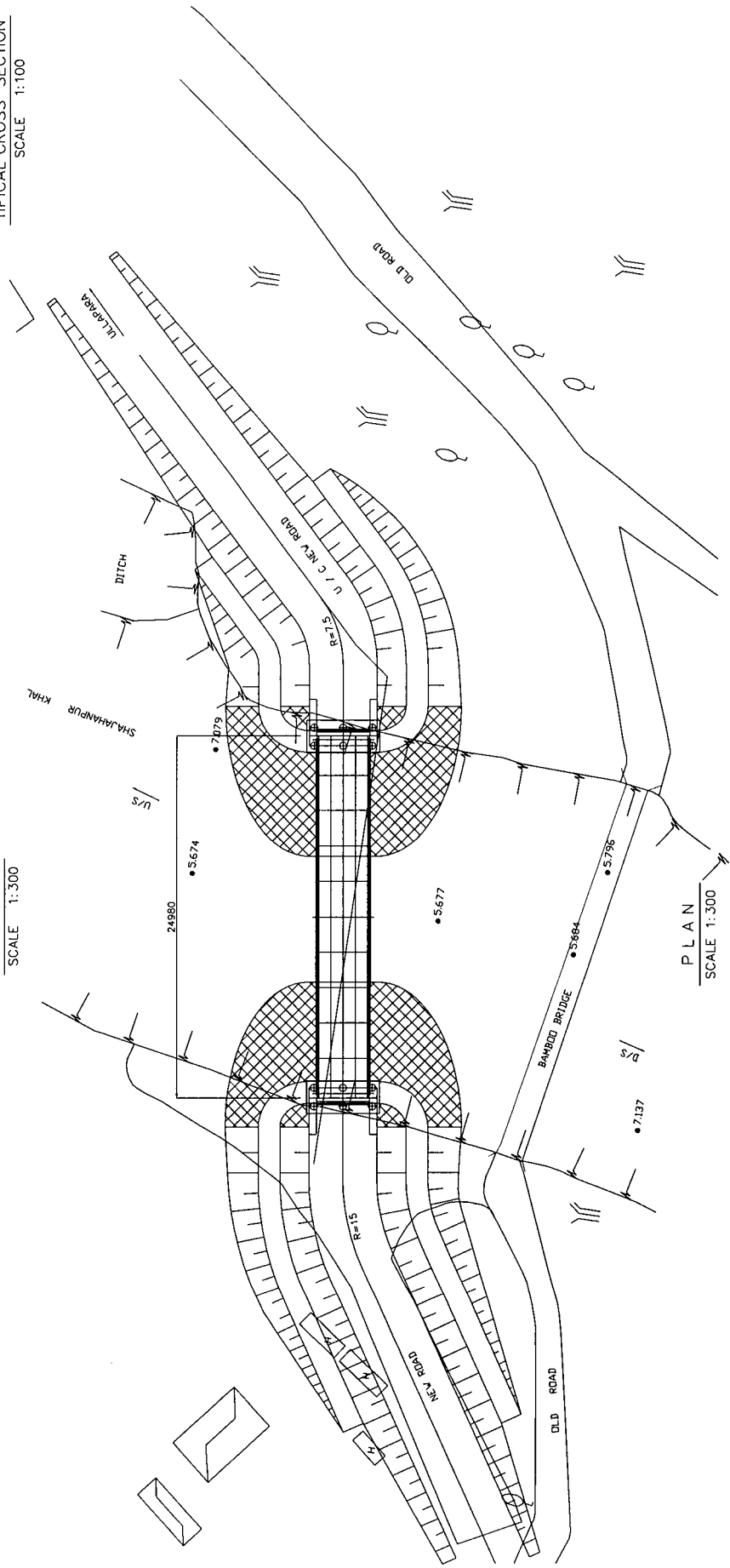

PLAN
SCALE 1:300

<p>LOCAL GOVERNMENT ENGINEERING DEPARTMENT PEOPLE'S REPUBLIC OF BANGLADESH</p>	<p>BASIC DESIGN STUDY ON THE PROJECT FOR PROVISION OF PORTABLE STEEL BRIDGES ON UPAZILA AND UNION ROADS</p>	<p>JAPAN INTERNATIONAL COOPERATION AGENCY KATAHIRA & ENGINEERS INTERNATIONAL</p>	<p>GENERAL PLAN, ELEVATION & TYPICAL CROSS SECTION SIRAJGANJ BRIDGE NO. 55-07-12</p>	<p>DRAWING NO. II - 26 / 30</p>
--	---	--	--	-------------------------------------

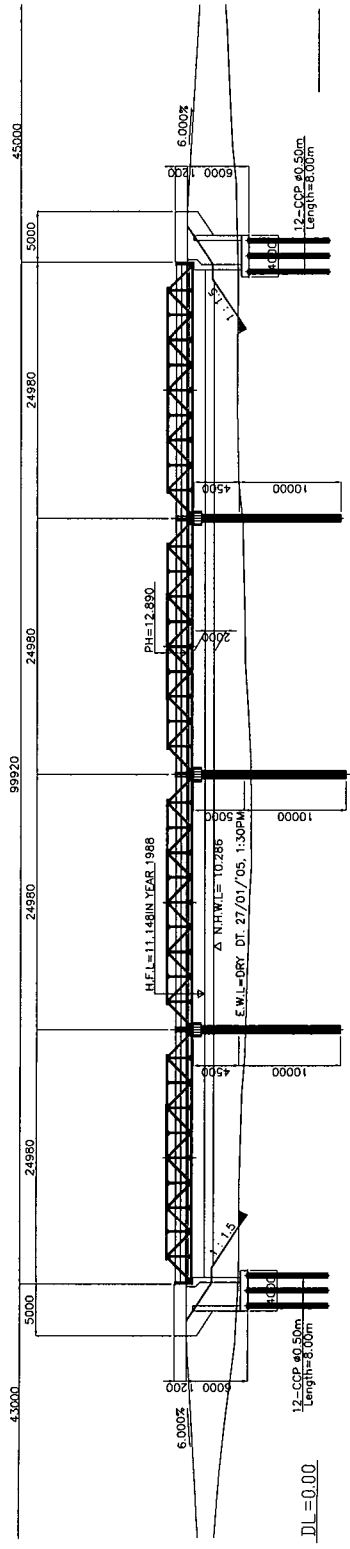

ELEVATION
SCALE 1:500

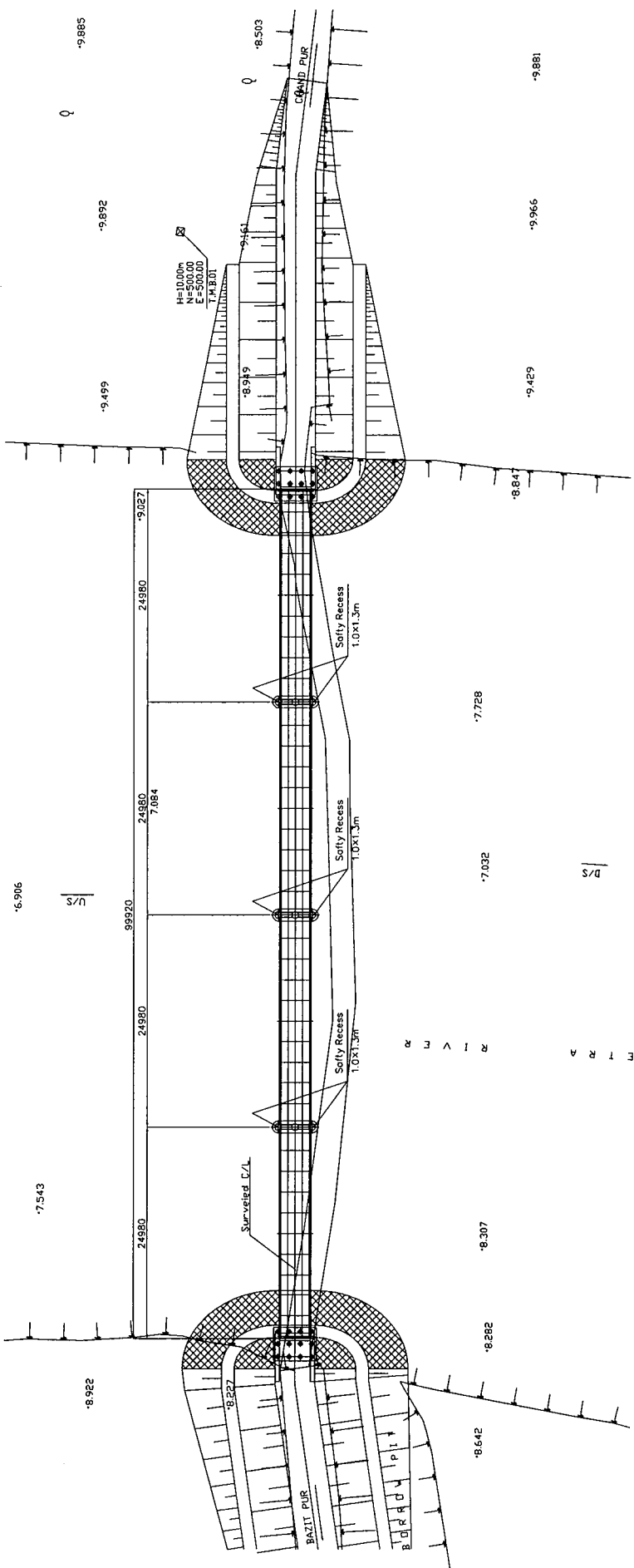

PLAN
SCALE 1:500

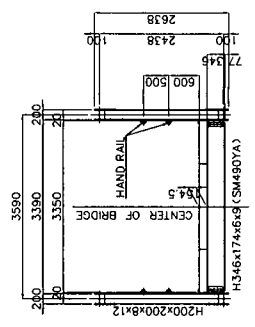

TYPICAL CROSS SECTION
SCALE 1:100

LOCAL GOVERNMENT ENGINEERING DEPARTMENT PEOPLE'S REPUBLIC OF BANGLADESH	BASIC DESIGN STUDY ON THE PROJECT FOR PROVISION OF PORTABLE STEEL BRIDGES ON UPAZILA AND UNION ROADS	JAPAN INTERNATIONAL COOPERATION AGENCY KATAHIRA & ENGINEERS INTERNATIONAL	SCALE As Shown	GENERAL PLAN, ELEVATION & TYPICAL CROSS SECTION PABNA BRIDGE NO. 56-01-02 DRAWING NO. II-27/30
--	--	--	-------------------	--

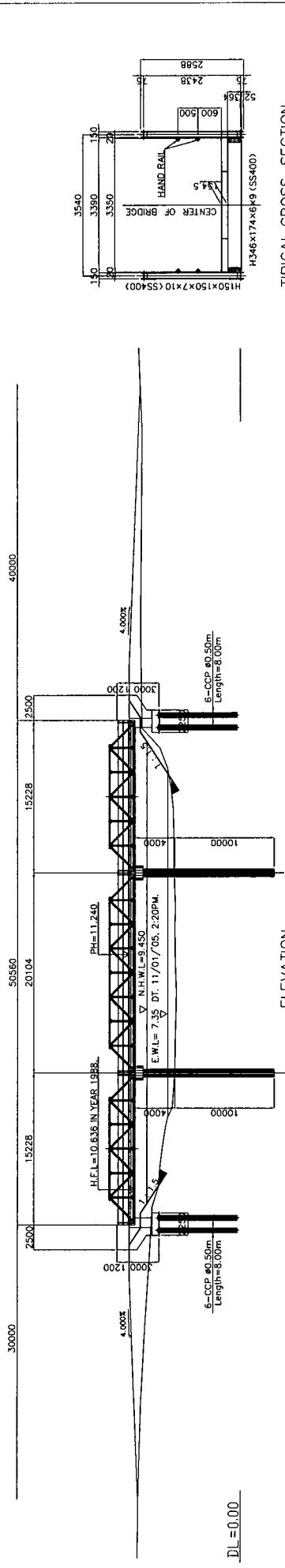

TYPICAL CROSS SECTION
SCALE 1:100

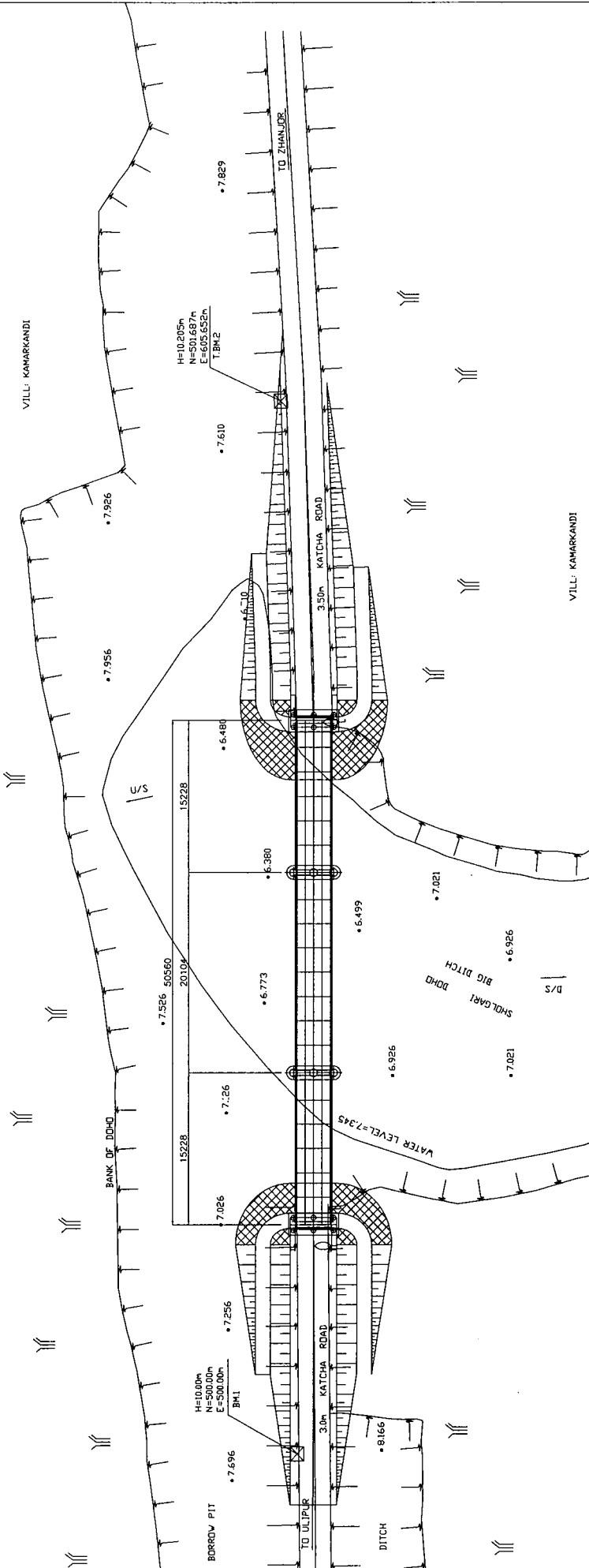
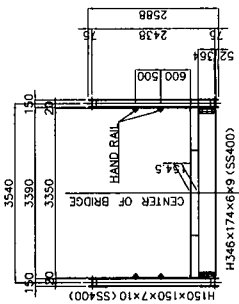

<p>LOCAL GOVERNMENT ENGINEERING DEPARTMENT PEOPLE'S REPUBLIC OF BANGLADESH</p>	<p>BASIC DESIGN STUDY ON THE PROJECT FOR PROVISION OF PORTABLE STEEL BRIDGES ON UPAZILA AND UNION ROADS</p>	<p>JAPAN INTERNATIONAL COOPERATION AGENCY KATAHIRA & ENGINEERS INTERNATIONAL</p>	<p>GENERAL PLAN, ELEVATION & TYPICAL CROSS SECTION BOGRA BRIDGE NO. 57-02-N3</p>
<p>SCALE As Shown</p>		<p>DRAWING NO. II - 28/30</p>	

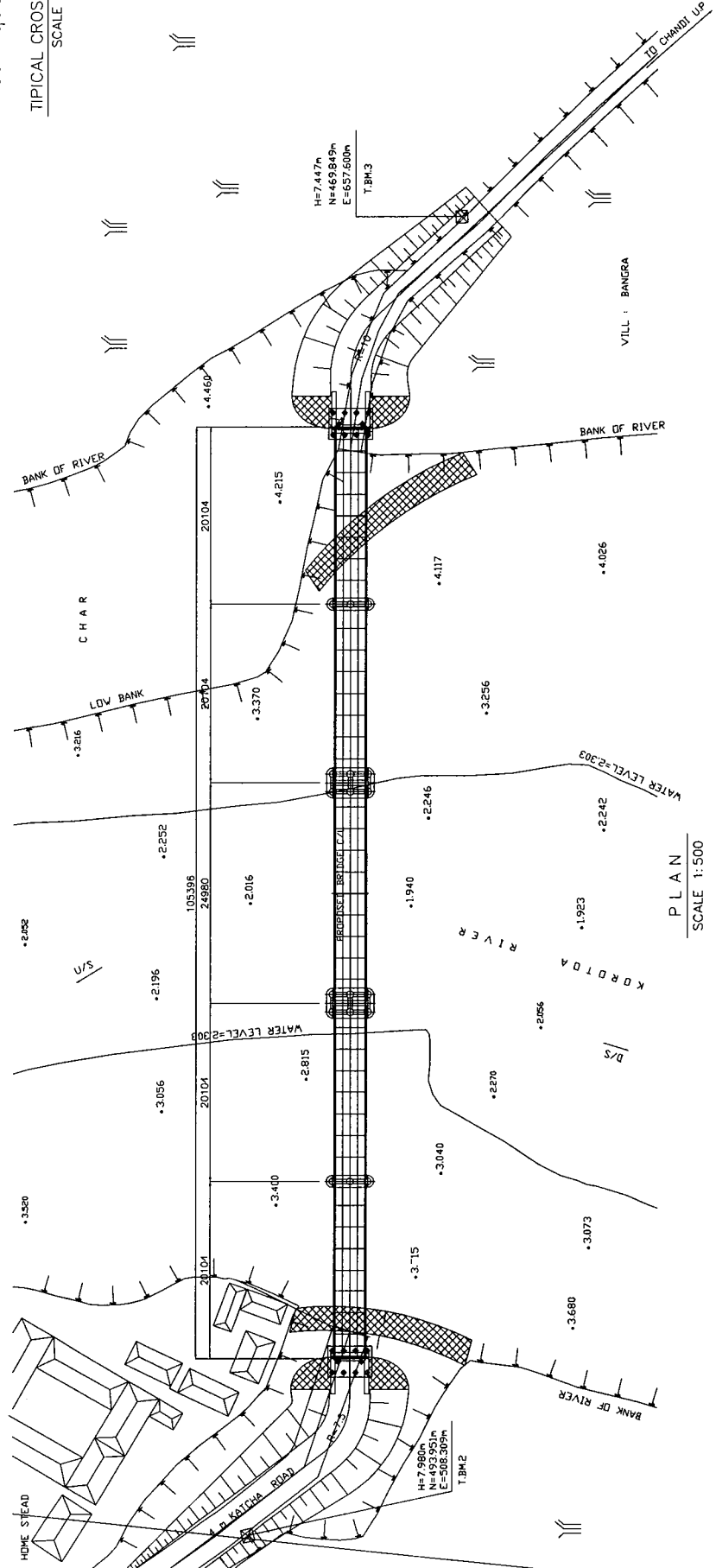
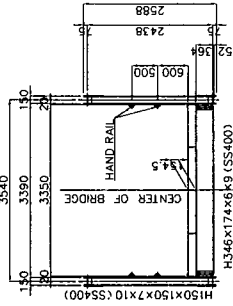
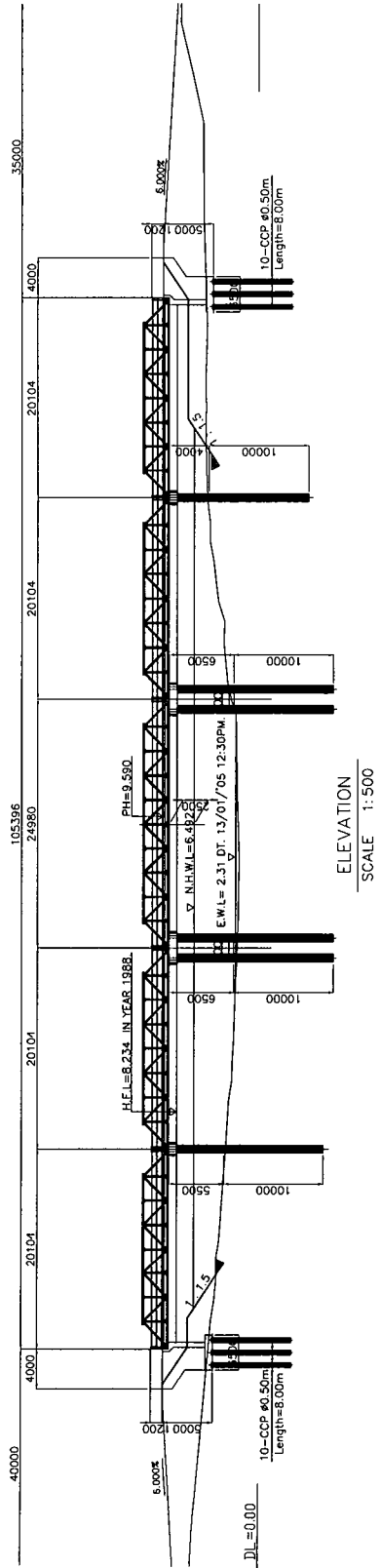

<p>LOCAL GOVERNMENT ENGINEERING DEPARTMENT PEOPLE'S REPUBLIC OF BANGLADESH</p>	<p>BASIC DESIGN STUDY ON THE PROJECT FOR PROVISION OF PORTABLE STEEL BRIDGES ON UPAZILA AND UNION ROADS</p>	<p>JAPAN INTERNATIONAL COOPERATION AGENCY KATAHIRA & ENGINEERS INTERNATIONAL</p>	<p>SCALE As Shown</p>	<p>GENERAL PLAN, ELEVATION & TYPICAL CROSS SECTION BOGRA BRIDGE NO. 57-02-N5 DRAWING NO. II - 29 / 30</p>
--	---	--	---------------------------	---

A-A

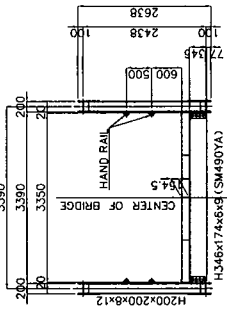

B-B

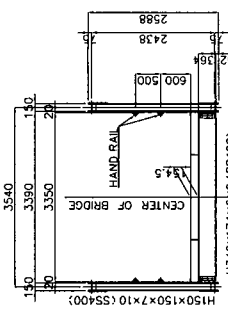

TYPICAL CROSS SECTION
SCALE 1:100

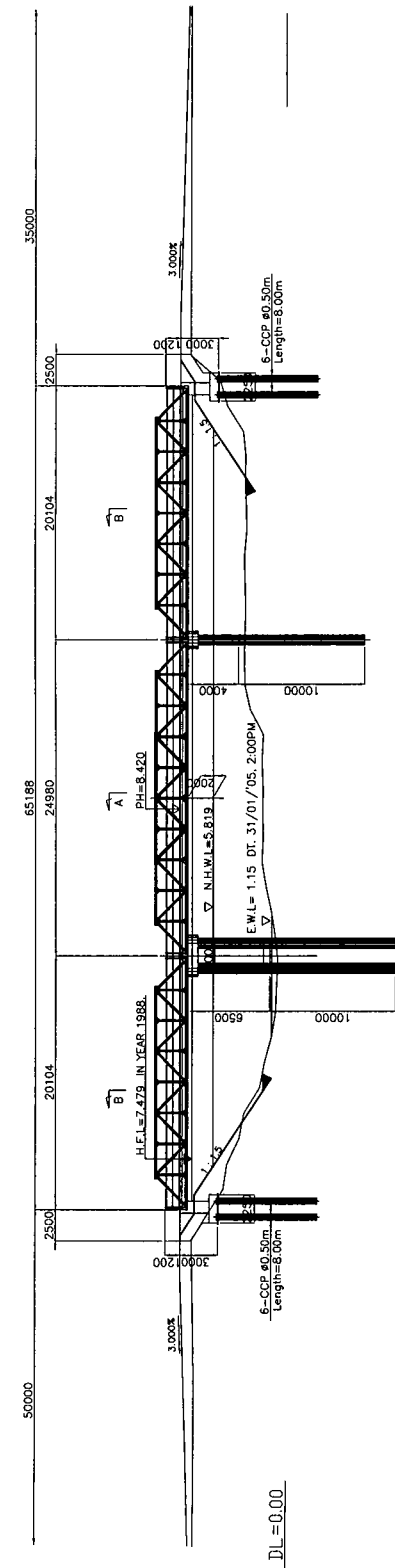

ELEVATION
SCALE 1:400

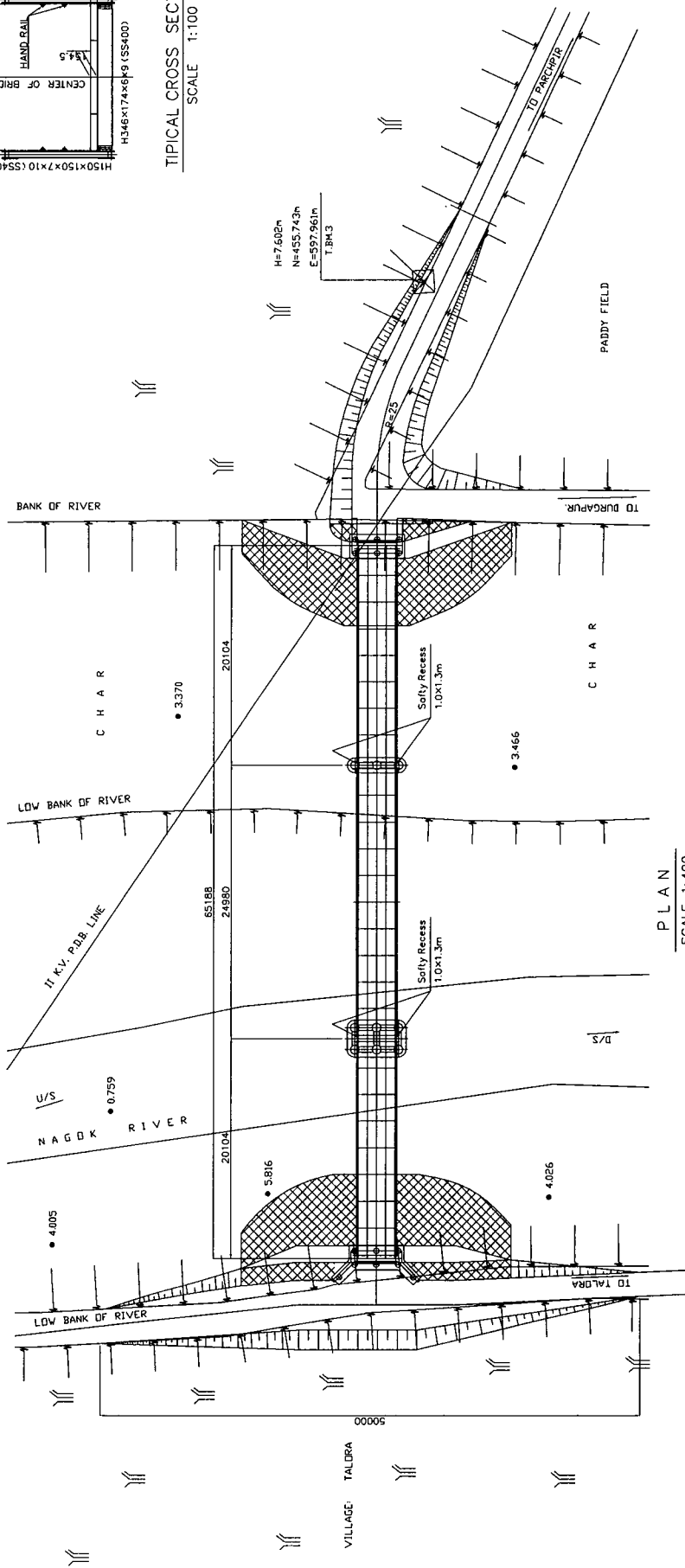

PLAN
SCALE 1:400

DRAWING NO.

GENERAL PLAN, ELEVATION
& TYPICAL CROSS SECTION
BOGRA BRIDGE NO. 57-09-02

SCALE

As Shown

JAPAN INTERNATIONAL COOPERATION AGENCY
KATAHIRA & ENGINEERS INTERNATIONAL

BASIC DESIGN STUDY ON THE PROJECT FOR
PROVISION OF PORTABLE STEEL BRIDGES ON
UPAZILA AND UNION ROADS

LOCAL GOVERNMENT ENGINEERING DEPARTMENT
PEOPLE'S REPUBLIC OF BANGLADESH

BASIC DESIGN STUDY ON THE PROJECT FOR PROVISION OF POTABLE STEEL BRIDGES
ON UPAZILA AND UNION ROADS
IN
BANGLADESH

GENERAL PLAN, ELEVATION AND TYPICAL CROSS SECTION

PHASE-III

LOCAL GOVERNMENT ENGINEERING DEPARTMENT
THE GOVERNMENT OF THE PEOPLE'S REPUBLIC
OF BANGLADESH

 **KEI**
KATAHIRA & ENGINEERS INTERNATIONAL
TOKYO, JAPAN

INDEX OF BRIDGE'S GENERAL VIEW FOR PHASE-III

PREFECTURE	NO .OF BRIDGE	PAGE	PREFECTURE	NO OF BRIDGE	PAGE
DAHKA	NO. 01-02-01	III- 1	NATORE	NO. 52-02-01	III- 16
DAHKA	NO. 01-05-01	III- 2	NATORE	NO. 52-03-01	III- 17
MUNSHIGANJ	NO. 04-01-N5	III- 3	S IRAJGANJ	NO. 55-01-02	III- 18
MUNSHIGANJ	NO. 04-02-02	III- 4	S IRAJGANJ	NO. 55-01-03	III- 19
MANIKGANJ	NO. 05-04-02	III- 5	S IRAJGANJ	NO. 55-07-10	III- 20
MANIKGANJ	NO. 05-04-06	III- 6	S IRAJGANJ	NO. 55-07-N2	III- 21
MANIKGANJ	NO. 05-04-07	III- 7	S IRAJGANJ	NO. 55-07-N3	III- 22
MANIKGANJ	NO. 05-05-01	III- 8	P ABNA	NO. 56-03-05	III- 23
MANIKGANJ	NO. 05-06-N6	III- 9	P ABNA	NO. 56-06-01	III- 24
RAJBARI	NO. 11-02-02	III- 10	BOGRA	NO. 57-07-N4	III- 25
GOPALGONJ	NO. 12-03-02	III- 11	BOGRA	NO. 57-07-N6	III- 26
GOPALGONJ	NO. 12-03-N2	III- 12			
F ARIDPUR	NO. 16-01-N3	III- 13			
CHANDPUR	NO. 21-01-N3	III- 14			
CHANDPUR	NO. 21-01-N4	III- 15			

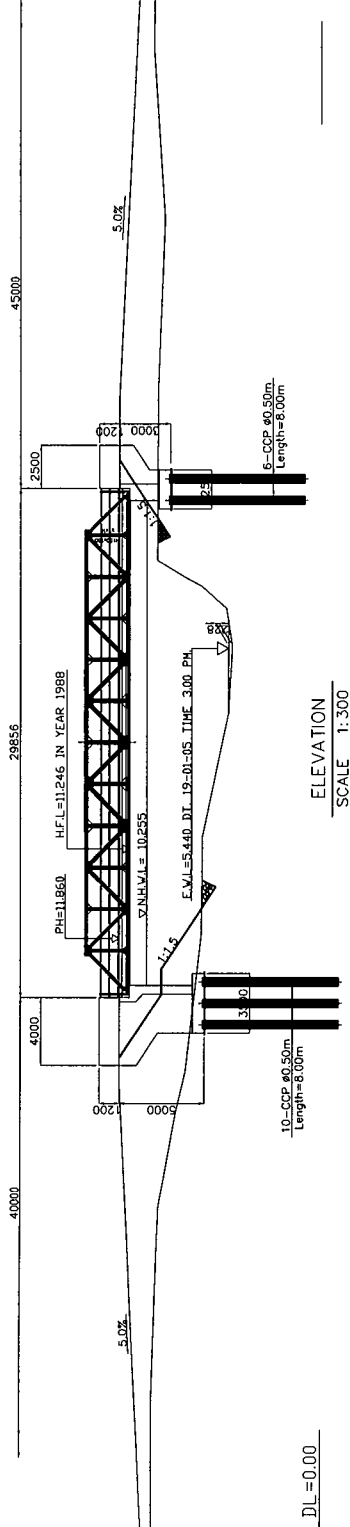

ELEVATION
SCALE 1:300

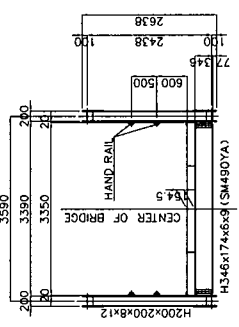

TYPICAL CROSS SECTION
SCALE 1:100

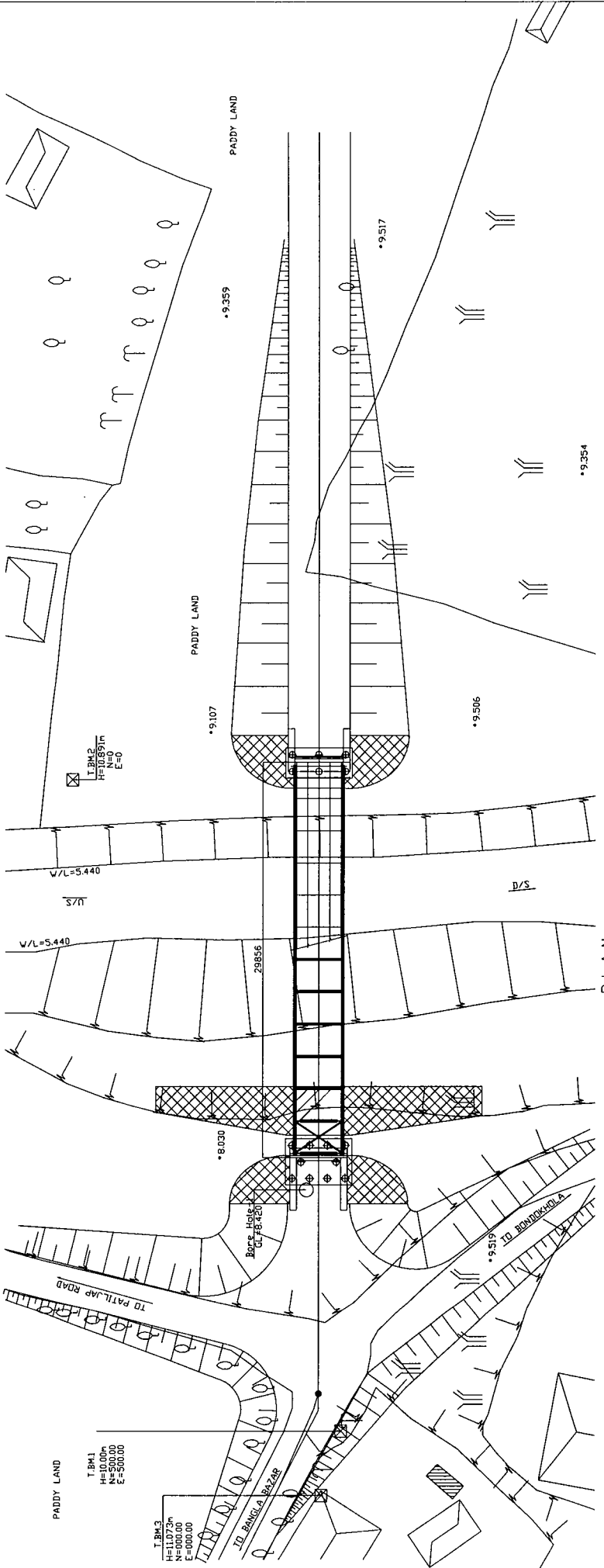

PLAN
SCALE 1:300

LOCAL GOVERNMENT ENGINEERING DEPARTMENT
PEOPLE'S REPUBLIC OF BANGLADESH

BASIC DESIGN STUDY ON THE PROJECT FOR
PROVISION OF PORTABLE STEEL BRIDGES ON
UPAZILA AND UNION ROADS

JAPAN INTERNATIONAL COOPERATION AGENCY
KATAHIRA & ENGINEERS INTERNATIONAL

GENERAL PLAN, ELEVATION
& TYPICAL CROSS SECTION
DHAKA BRIDGE NO. 01-02-01

DRAWING NO.
III - 1/26

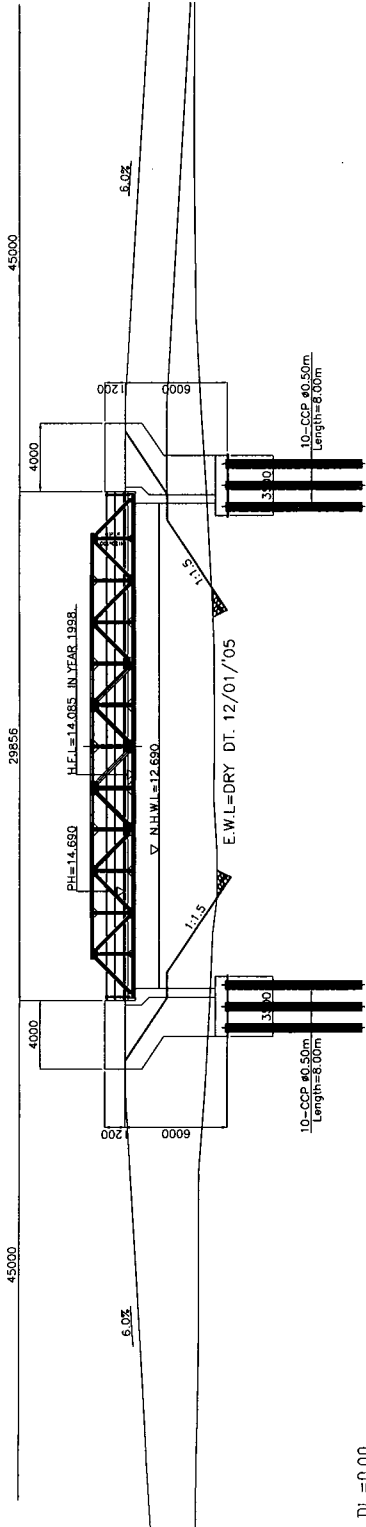

ELEVATION
SCALE 1:300

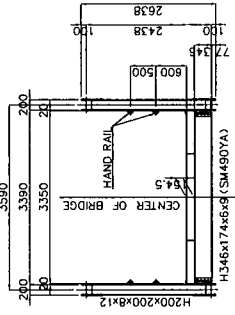

TYPICAL CROSS SECTION
SCALE 1:100

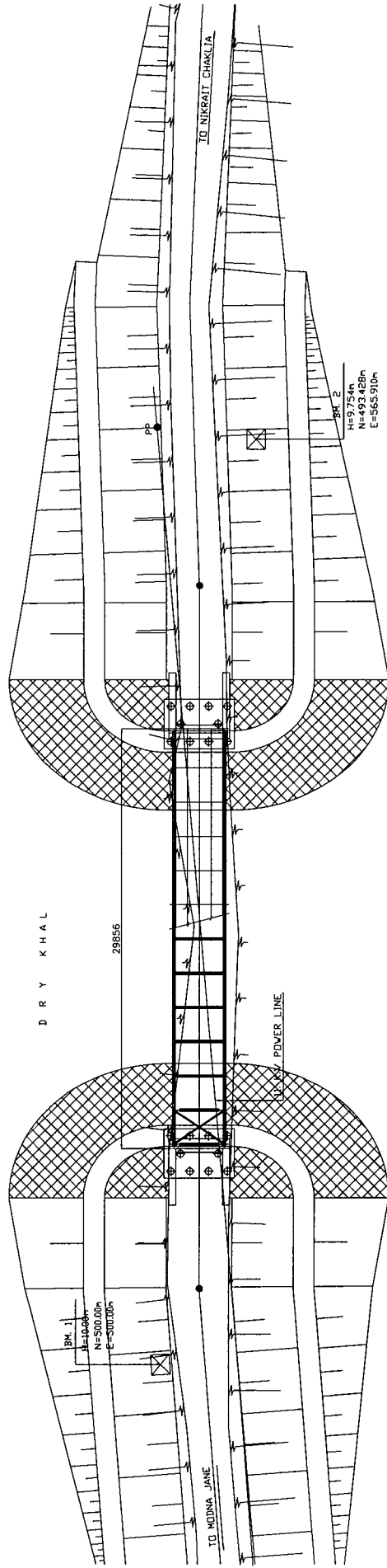

P L A N
SCALE 1:300

LOCAL GOVERNMENT ENGINEERING DEPARTMENT
PEOPLE'S REPUBLIC OF BANGLADESH

BASIC DESIGN STUDY ON THE PROJECT FOR
PROVISION OF PORTABLE STEEL BRIDGES ON
UPAZILA AND UNION ROADS

JAPAN INTERNATIONAL COOPERATION AGENCY
KATAHIRA & ENGINEERS INTERNATIONAL

SCALE
As Shown

GENERAL PLAN, ELEVATION
& TYPICAL CROSS SECTION
DHAKA BRIDGE NO. 01-05-01

DRAWING NO.
III - 2/26

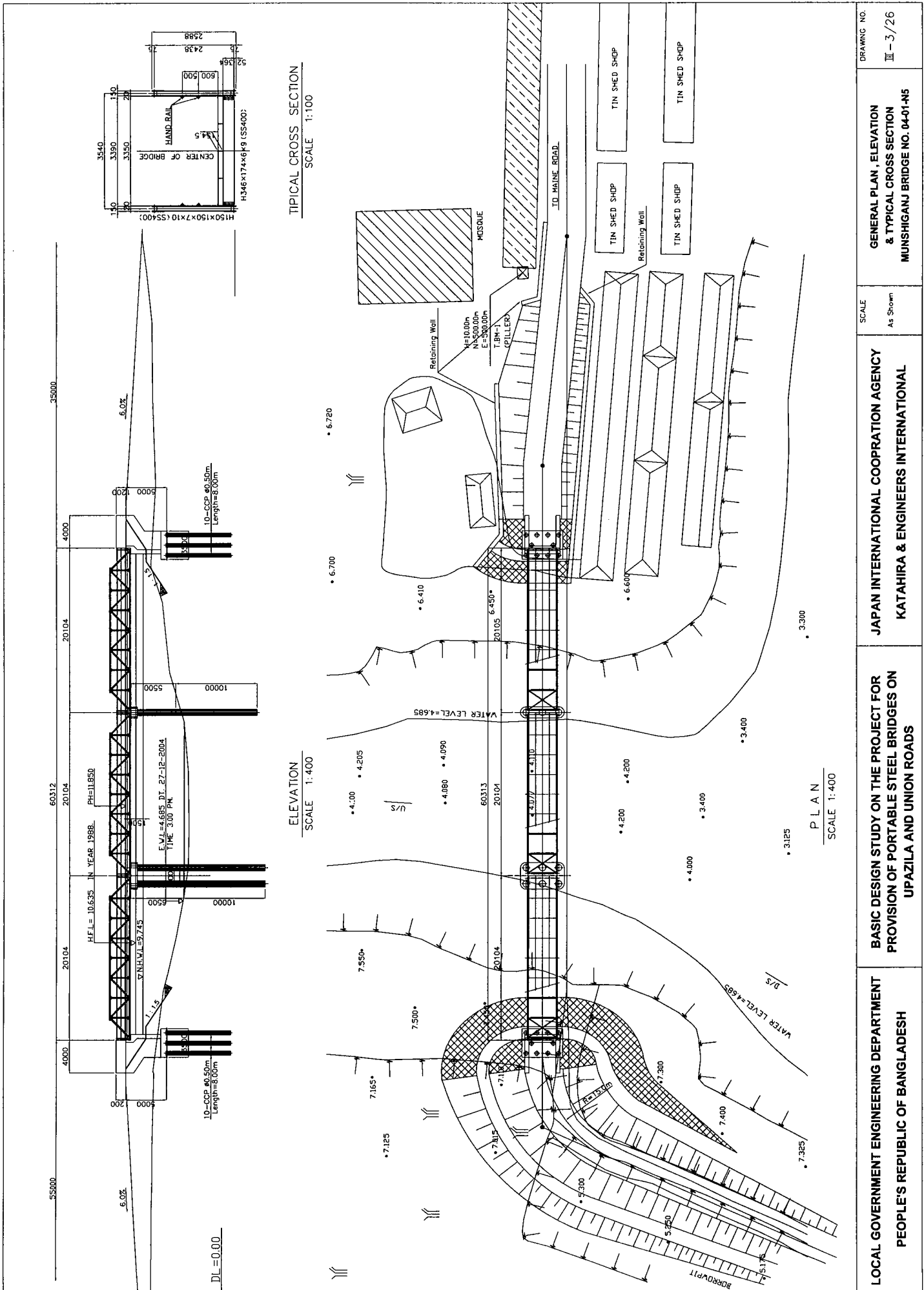

<p>LOCAL GOVERNMENT ENGINEERING DEPARTMENT PEOPLE'S REPUBLIC OF BANGLADESH</p>	<p>BASIC DESIGN STUDY ON THE PROJECT FOR PROVISION OF PORTABLE STEEL BRIDGES ON UPAZILA AND UNION ROADS</p>	<p>JAPAN INTERNATIONAL COOPERATION AGENCY KATAHIRA & ENGINEERS INTERNATIONAL</p>	<p>GENERAL PLAN, ELEVATION & TYPICAL CROSS SECTION MUNSHIGANJ BRIDGE NO. 04-01-N5</p>
<p>SCALE: 1:400</p>		<p>SCALE: As Shown</p>	<p>DRAWING NO. III - 3/26</p>

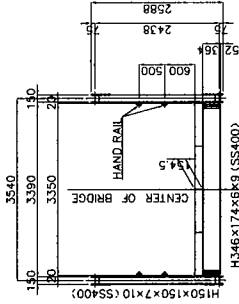
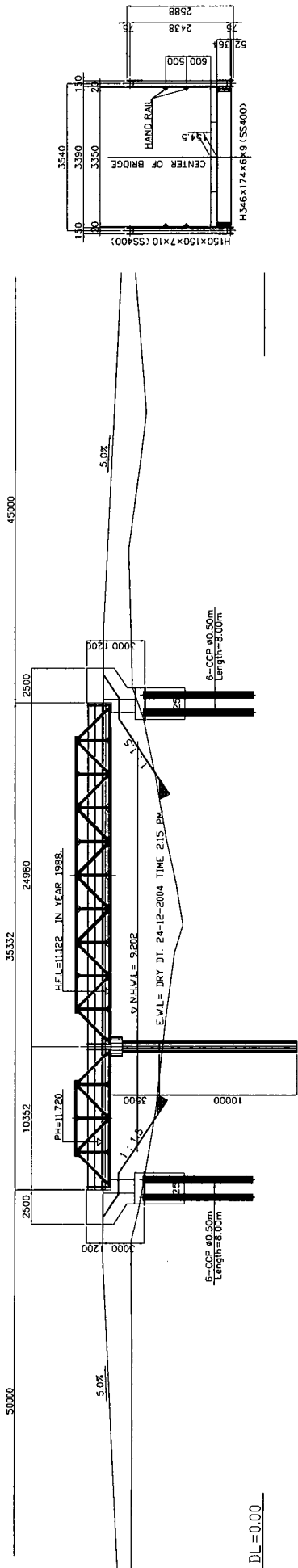

TYPICAL CROSS SECTION
SCALE 1:100

ELEVATION
SCALE 1:300

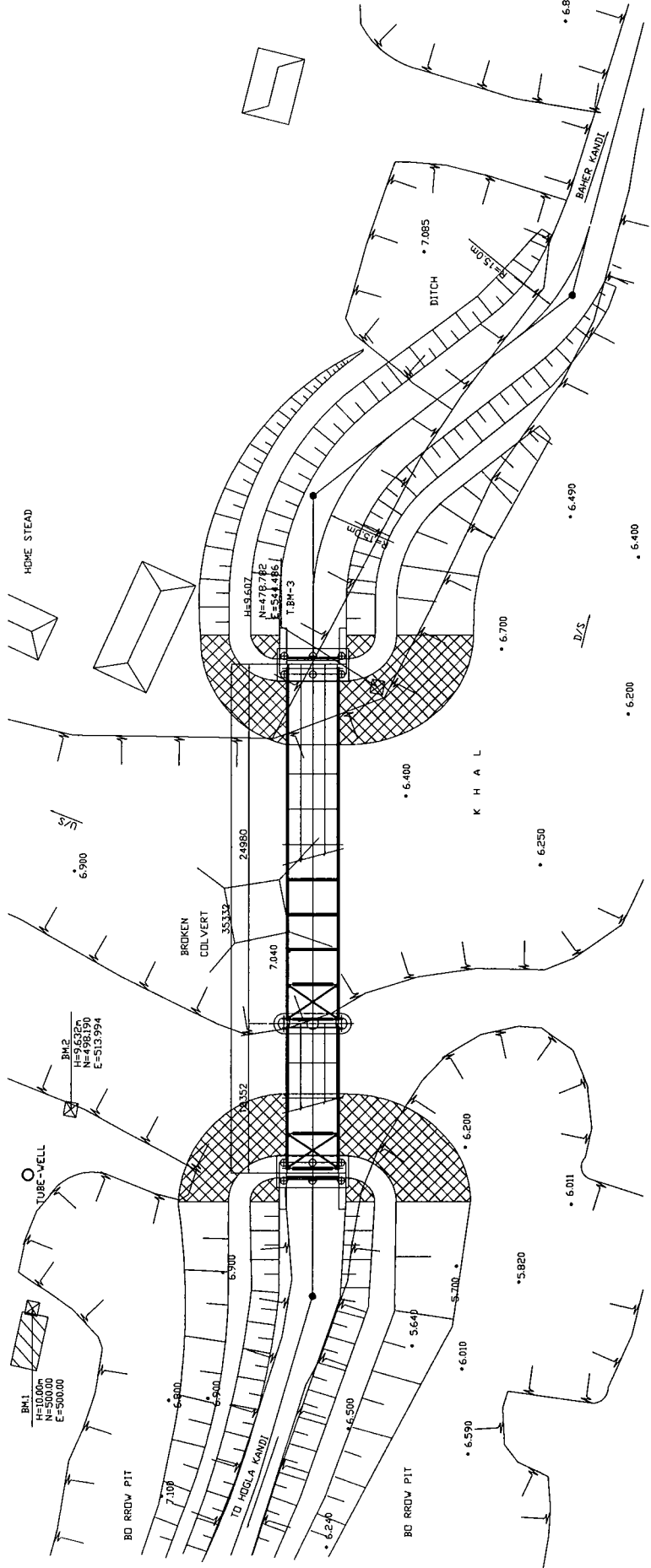

PLAN
SCALE 1:300

<p>LOCAL GOVERNMENT ENGINEERING DEPARTMENT PEOPLE'S REPUBLIC OF BANGLADESH</p>	<p>BASIC DESIGN STUDY ON THE PROJECT FOR PROVISION OF PORTABLE STEEL BRIDGES ON UPAZILA AND UNION ROADS</p>	<p>JAPAN INTERNATIONAL COOPERATION AGENCY KATAHIRA & ENGINEERS INTERNATIONAL</p>	<p>GENERAL PLAN, ELEVATION & TYPICAL CROSS SECTION MUNSHIGANJ BRIDGE NO. 04-02-02</p>	<p>DRAWING NO. III - 4 / 26</p>
--	---	--	---	-------------------------------------

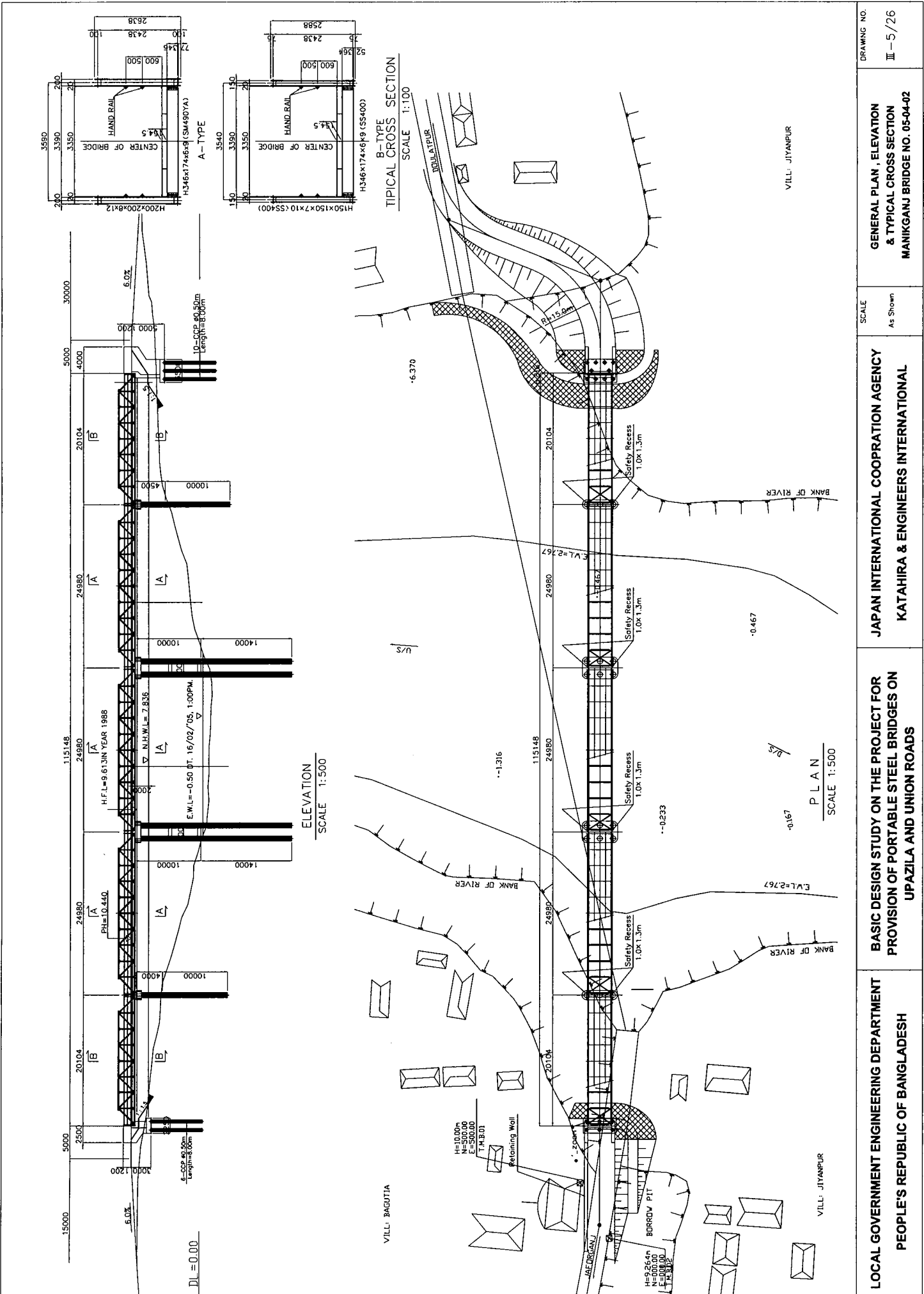

<p>LOCAL GOVERNMENT ENGINEERING DEPARTMENT PEOPLE'S REPUBLIC OF BANGLADESH</p>	<p>BASIC DESIGN STUDY ON THE PROJECT FOR PROVISION OF PORTABLE STEEL BRIDGES ON UPAZILA AND UNION ROADS</p>	<p>JAPAN INTERNATIONAL COOPERATION AGENCY KATAHIRA & ENGINEERS INTERNATIONAL</p>	<p>SCALE As Shown</p>	<p>GENERAL PLAN, ELEVATION & TYPICAL CROSS SECTION MANIKGANJ BRIDGE NO. 05-04-02</p>	<p>DRAWING NO. III-5/26</p>
--	---	--	---------------------------	--	---------------------------------

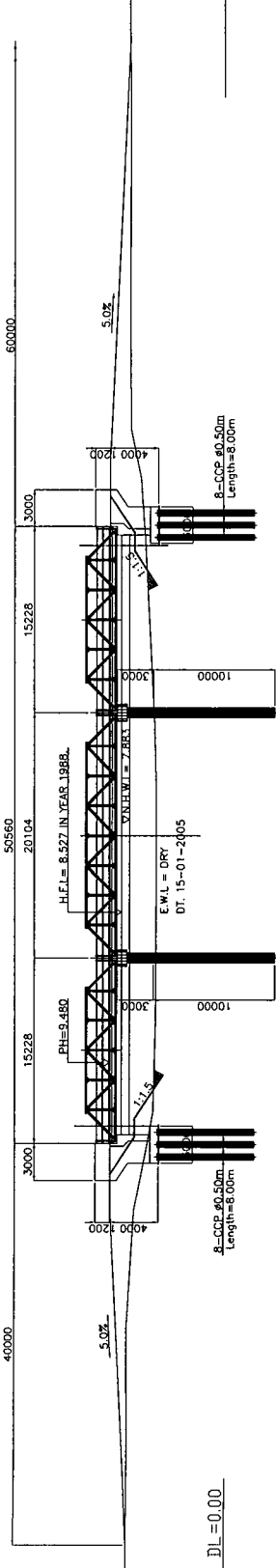

ELEVATION
SCALE 1:400

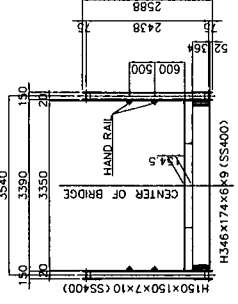

TYPICAL CROSS SECTION
SCALE 1:100

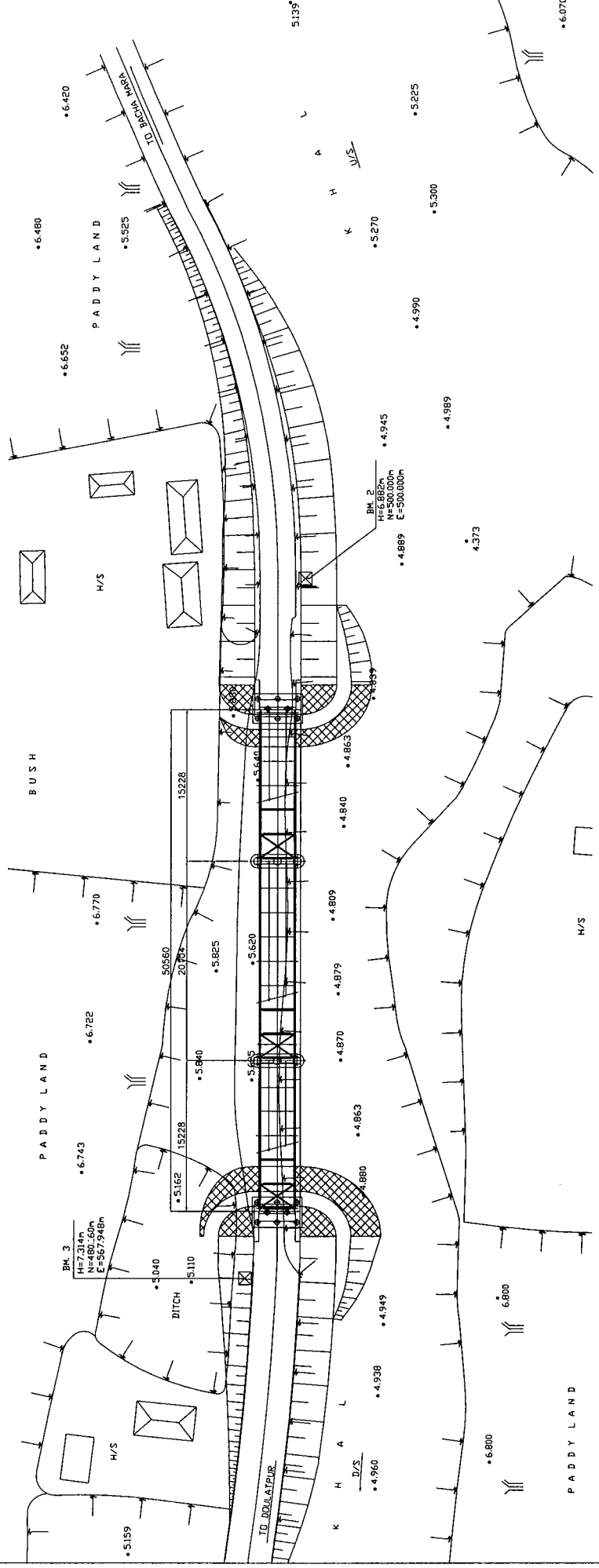

PLAN
SCALE 1:400

<p>LOCAL GOVERNMENT ENGINEERING DEPARTMENT PEOPLE'S REPUBLIC OF BANGLADESH</p>	<p>BASIC DESIGN STUDY ON THE PROJECT FOR PROVISION OF PORTABLE STEEL BRIDGES ON UPAZILA AND UNION ROADS</p>	<p>JAPAN INTERNATIONAL COOPERATION AGENCY KATAHIRA & ENGINEERS INTERNATIONAL</p>	<p>SCALE As Shown</p> <p>GENERAL PLAN, ELEVATION & TYPICAL CROSS SECTION MANIKGANJ BRIDGE NO. 05-04-06</p> <p>DRAWING NO. III - 6 / 26</p>
--	---	--	--

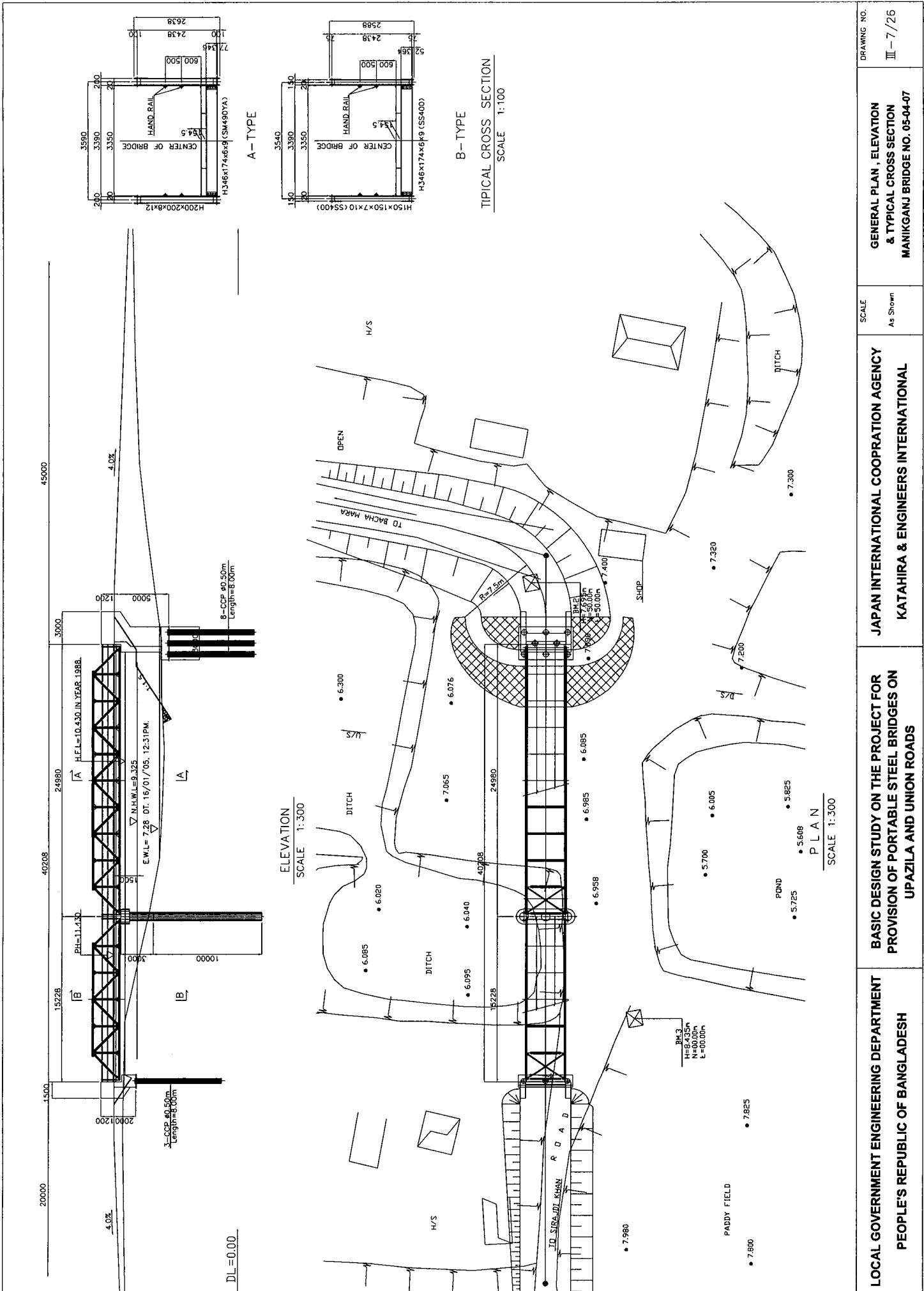

DRAWING NO. III - 7/26	GENERAL PLAN, ELEVATION & TYPICAL CROSS SECTION MANIKGANJ BRIDGE NO. 05-04-07	SCALE As Shown	JAPAN INTERNATIONAL COOPERATION AGENCY KATAHIRA & ENGINEERS INTERNATIONAL	BASIC DESIGN STUDY ON THE PROJECT FOR PROVISION OF PORTABLE STEEL BRIDGES ON UPAZILA AND UNION ROADS	LOCAL GOVERNMENT ENGINEERING DEPARTMENT PEOPLE'S REPUBLIC OF BANGLADESH
----------------------------------	---	-------------------	---	--	--

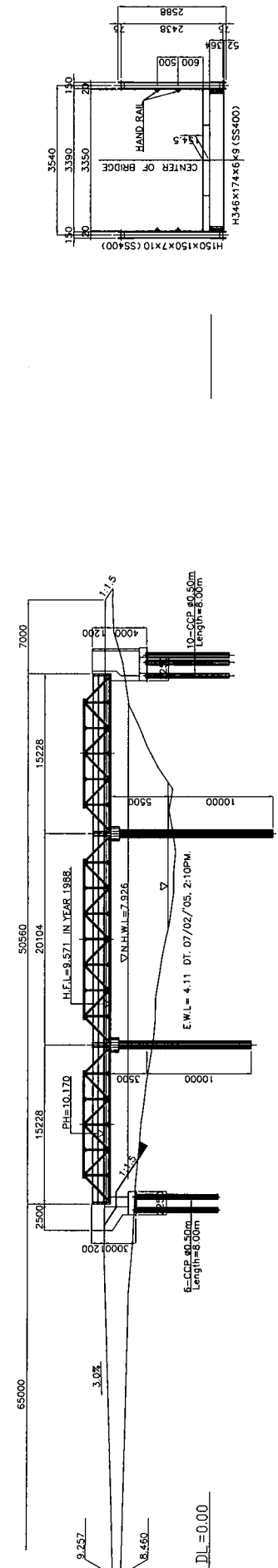

ELEVATION
SCALE 1:400

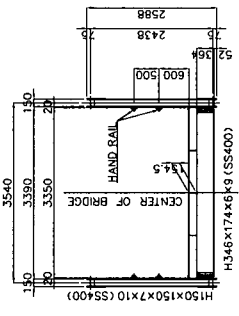

TYPICAL CROSS SECTION
SCALE 1:100

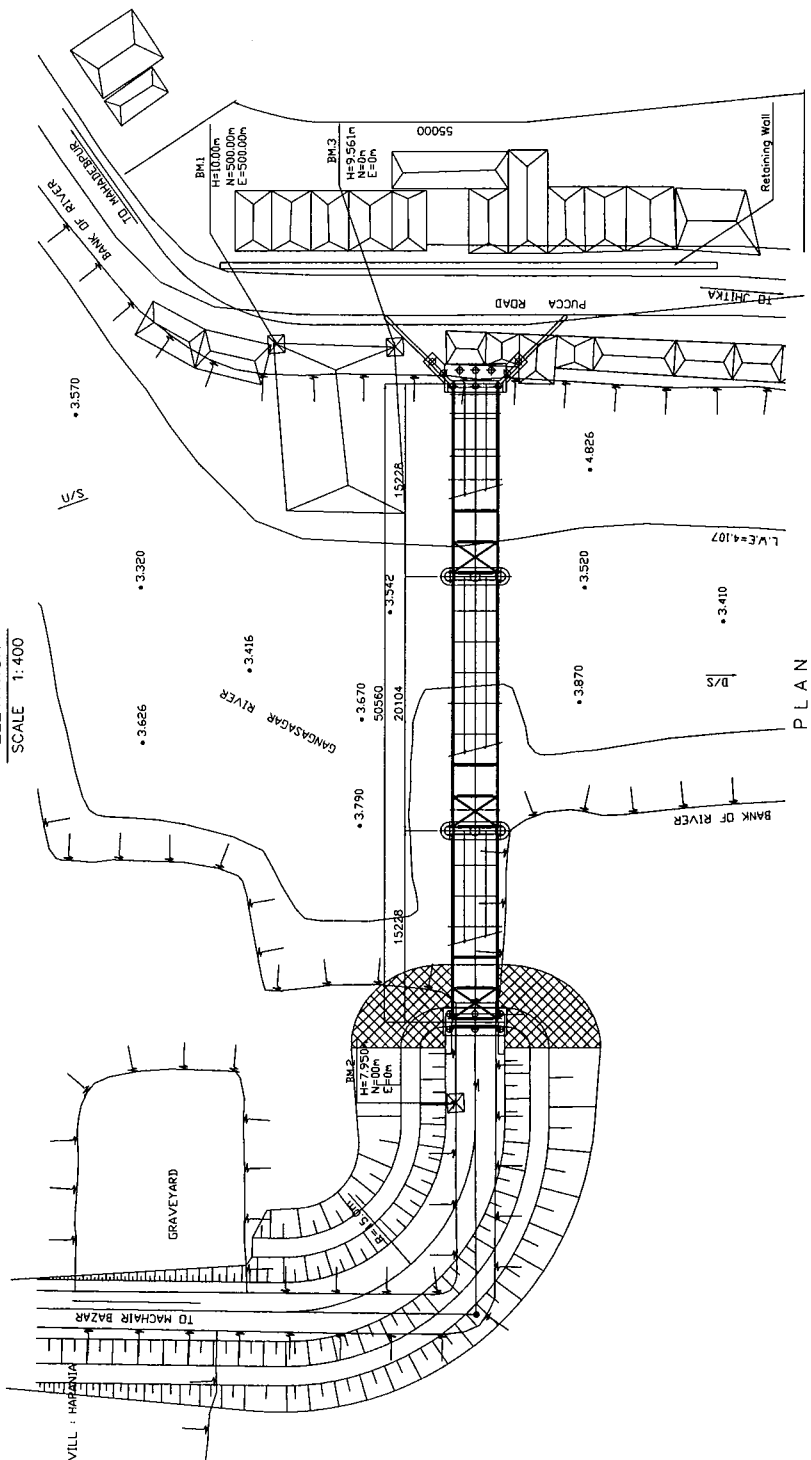

PLAN
SCALE 1:400

<p>LOCAL GOVERNMENT ENGINEERING DEPARTMENT PEOPLE'S REPUBLIC OF BANGLADESH</p>	<p>BASIC DESIGN STUDY ON THE PROJECT FOR PROVISION OF PORTABLE STEEL BRIDGES ON UPAZILA AND UNION ROADS</p>	<p>JAPAN INTERNATIONAL COOPERATION AGENCY KATAHIRA & ENGINEERS INTERNATIONAL</p>	<p>SCALE As Shown</p>	<p>DRAWING NO. III - 8/26 GENERAL PLAN, ELEVATION & TYPICAL CROSS SECTION MANIKGANJ BRIDGE NO. 05-05-01</p>
--	---	--	---------------------------	---

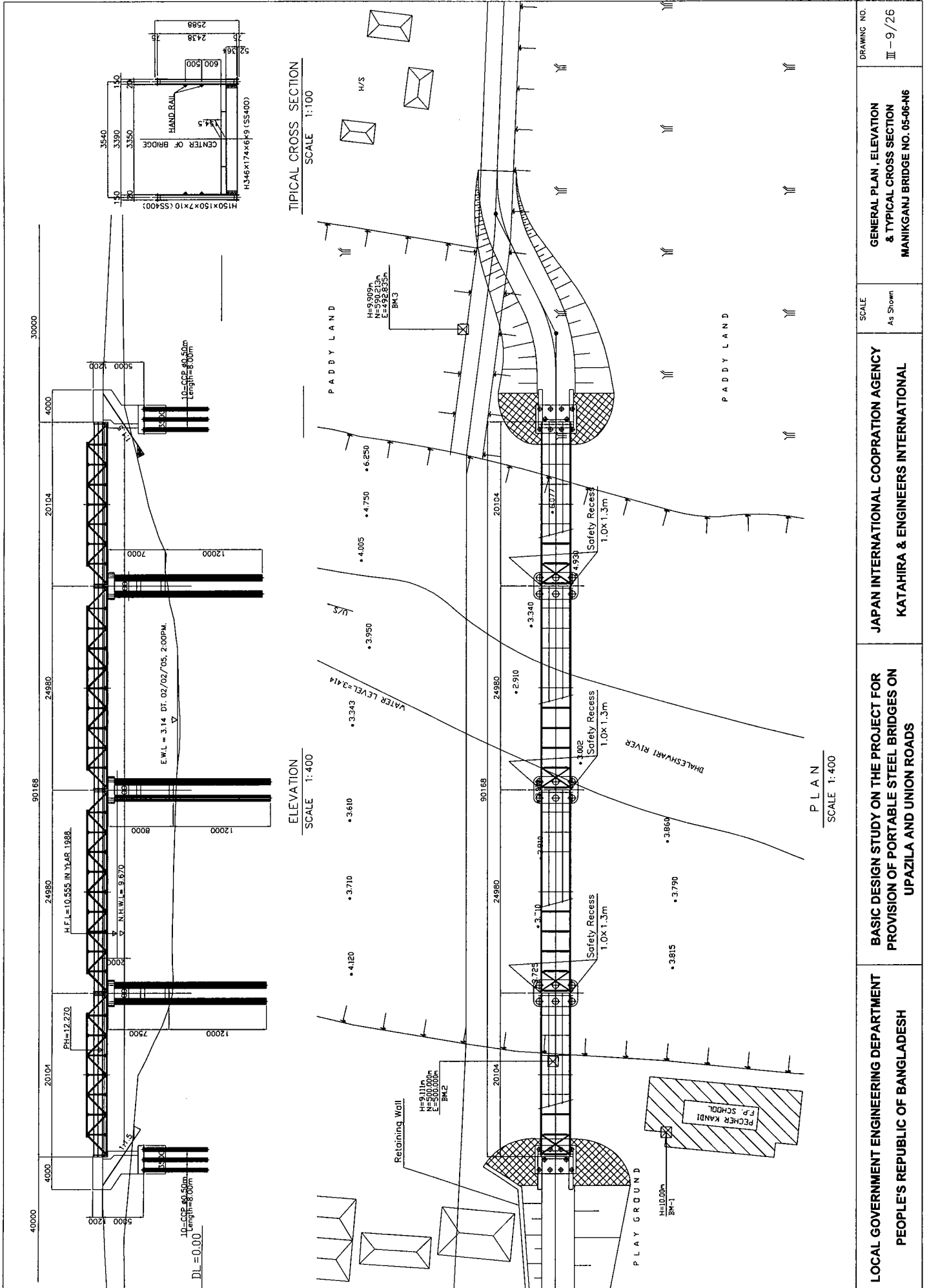

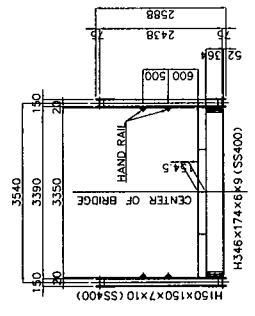

TYPICAL CROSS SECTION
SCALE 1:100

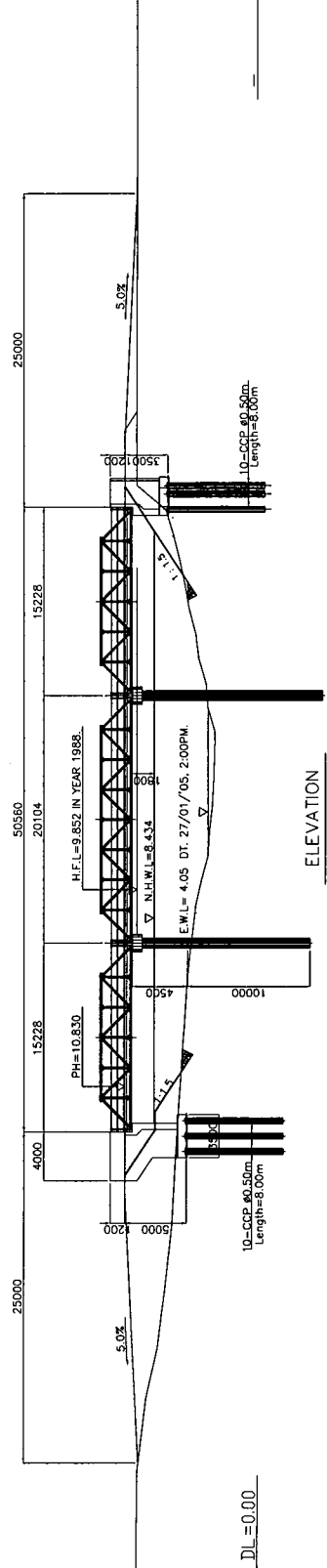

ELEVATION
SCALE 1:400

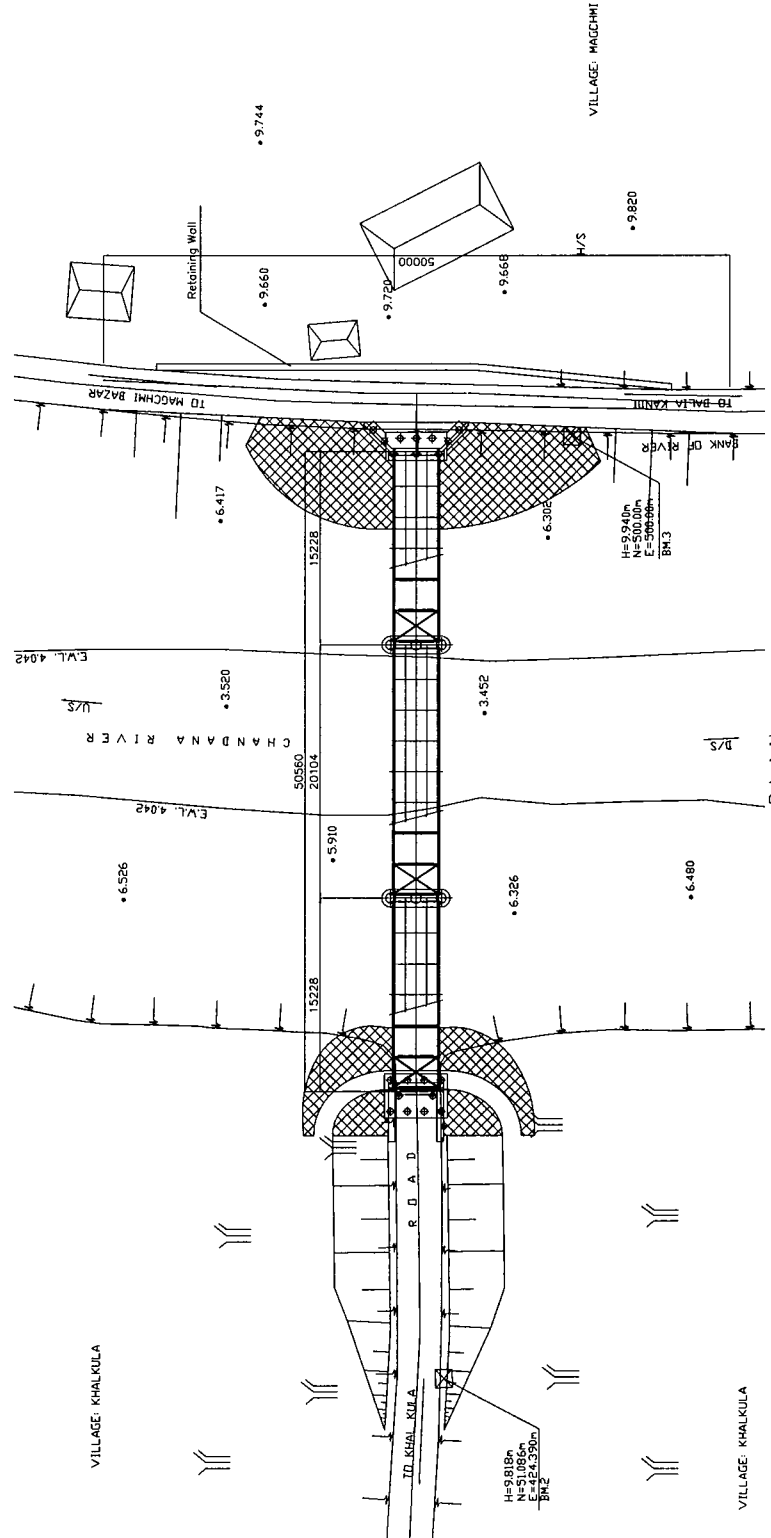

PLAN
SCALE 1:400

<p>LOCAL GOVERNMENT ENGINEERING DEPARTMENT PEOPLE'S REPUBLIC OF BANGLADESH</p>	<p>BASIC DESIGN STUDY ON THE PROJECT FOR PROVISION OF PORTABLE STEEL BRIDGES ON UPAZILA AND UNION ROADS</p>	<p>JAPAN INTERNATIONAL COOPERATION AGENCY KATAHIRA & ENGINEERS INTERNATIONAL</p>	<p>GENERAL PLAN, ELEVATION & TYPICAL CROSS SECTION RAJBARI BRIDGE NO. 11-02-02</p>	<p>DRAWING NO. III-10/26</p>
--	---	--	--	----------------------------------

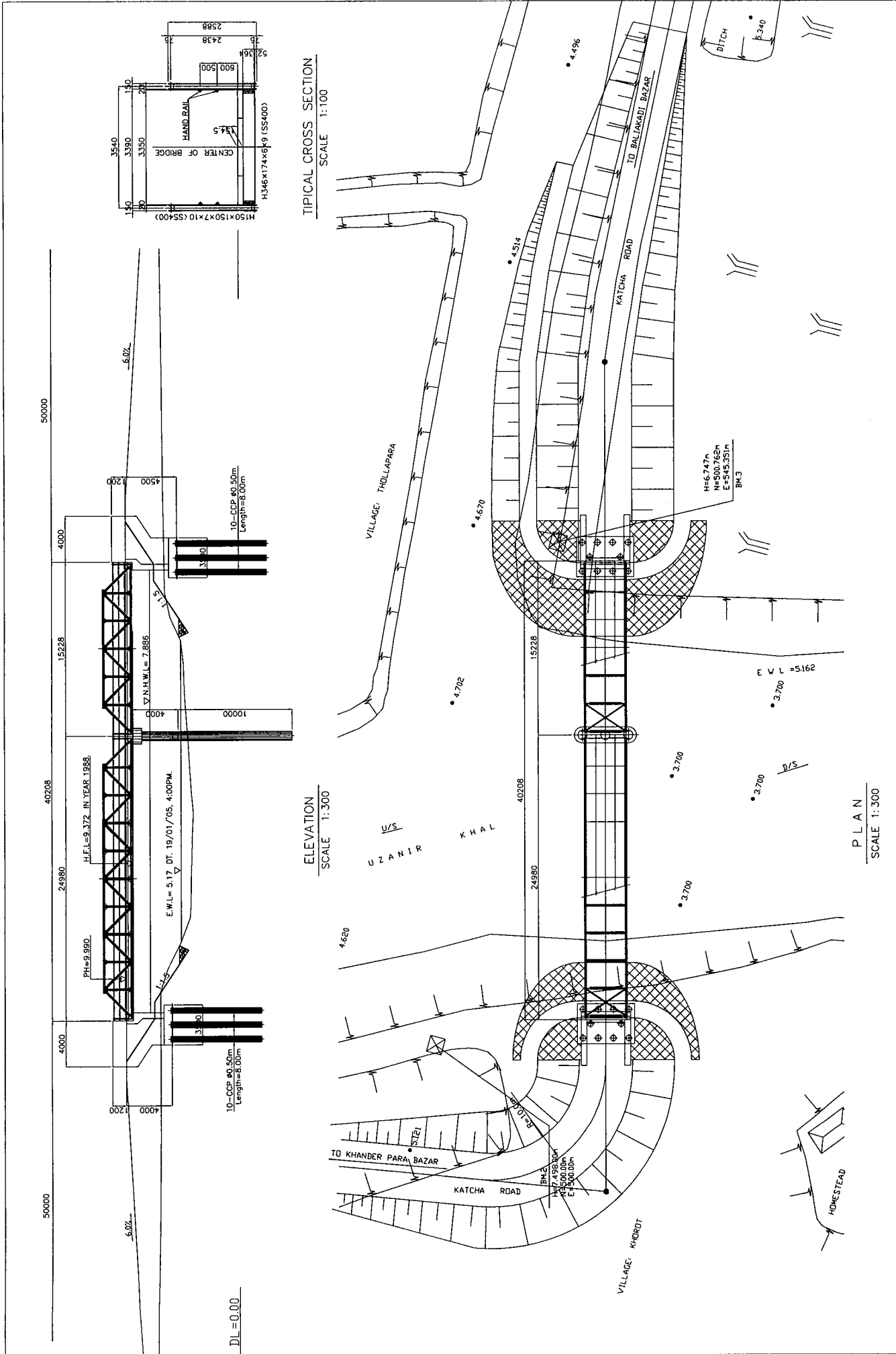

ELEVATION
SCALE 1:300

PLAN
SCALE 1:300

TYPICAL CROSS SECTION
SCALE 1:100

<p>LOCAL GOVERNMENT ENGINEERING DEPARTMENT PEOPLE'S REPUBLIC OF BANGLADESH</p>	<p>BASIC DESIGN STUDY ON THE PROJECT FOR PROVISION OF PORTABLE STEEL BRIDGES ON UPAZILA AND UNION ROADS</p>	<p>JAPAN INTERNATIONAL COOPERATION AGENCY KATAHIRA & ENGINEERS INTERNATIONAL</p>	<p>SCALE As Shown</p>	<p>GENERAL PLAN, ELEVATION & TYPICAL CROSS SECTION GOPALGONJ BRIDGE NO. 12-03-N2 DRAWING NO. III-12/26</p>
--	---	--	---------------------------	--

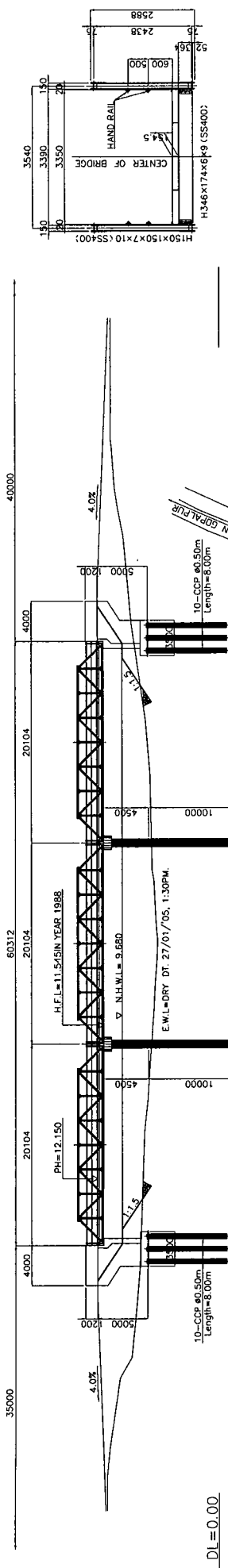

ELEVATION
SCALE 1:400

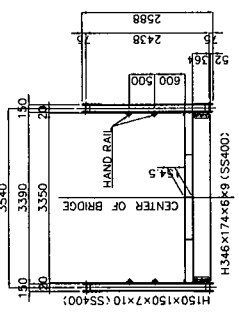

TYPICAL CROSS SECTION
SCALE 1:100

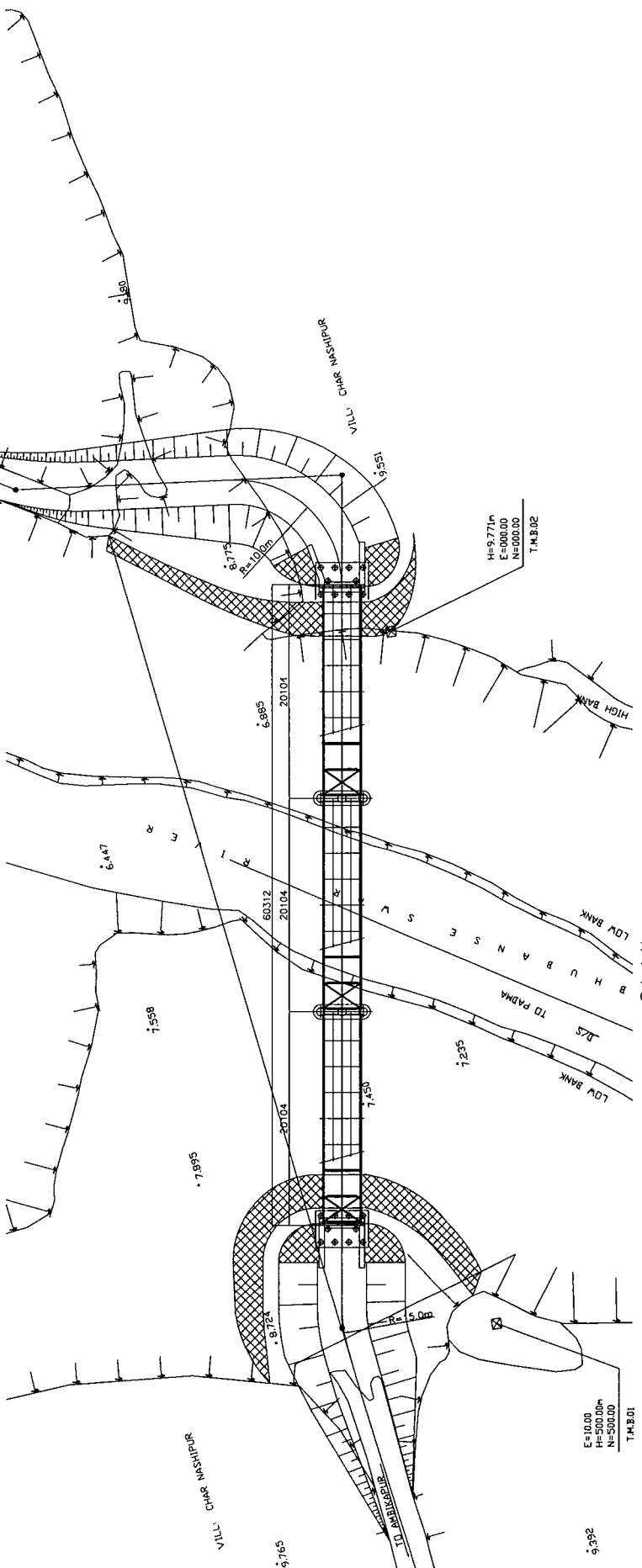

PLAN
SCALE 1:400

DRAWING NO. III-13/26	SCALE As Shown	GENERAL PLAN, ELEVATION & TYPICAL CROSS SECTION FARIDPUR BRIDGE NO. 16-01-N3	LOCAL GOVERNMENT ENGINEERING DEPARTMENT PEOPLE'S REPUBLIC OF BANGLADESH
JAPAN INTERNATIONAL COOPERATION AGENCY KATAHIRA & ENGINEERS INTERNATIONAL		BASIC DESIGN STUDY ON THE PROJECT FOR PROVISION OF PORTABLE STEEL BRIDGES ON UPAZILA AND UNION ROADS	

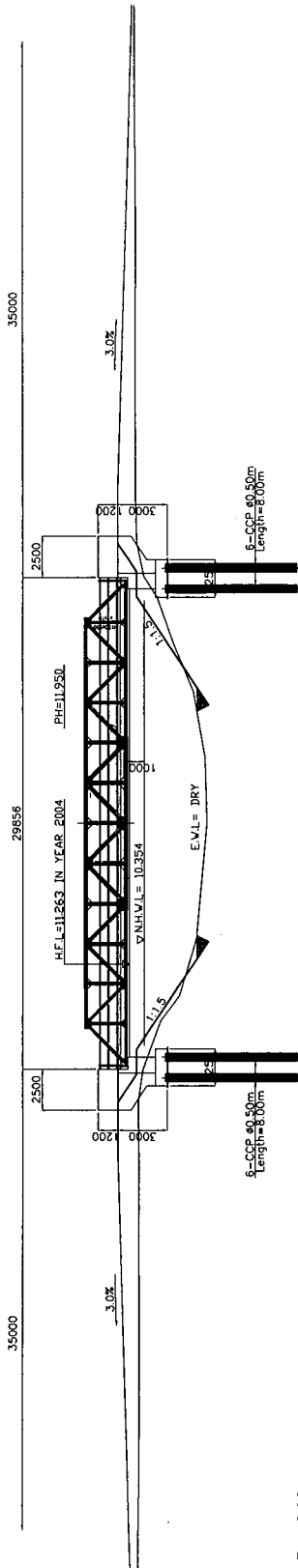

DL = 0.00

ELEVATION
SCALE 1:300

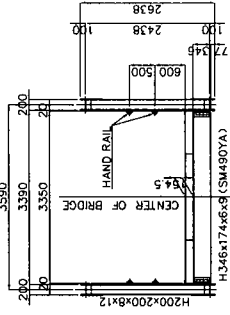

TYPICAL CROSS SECTION
SCALE 1:100

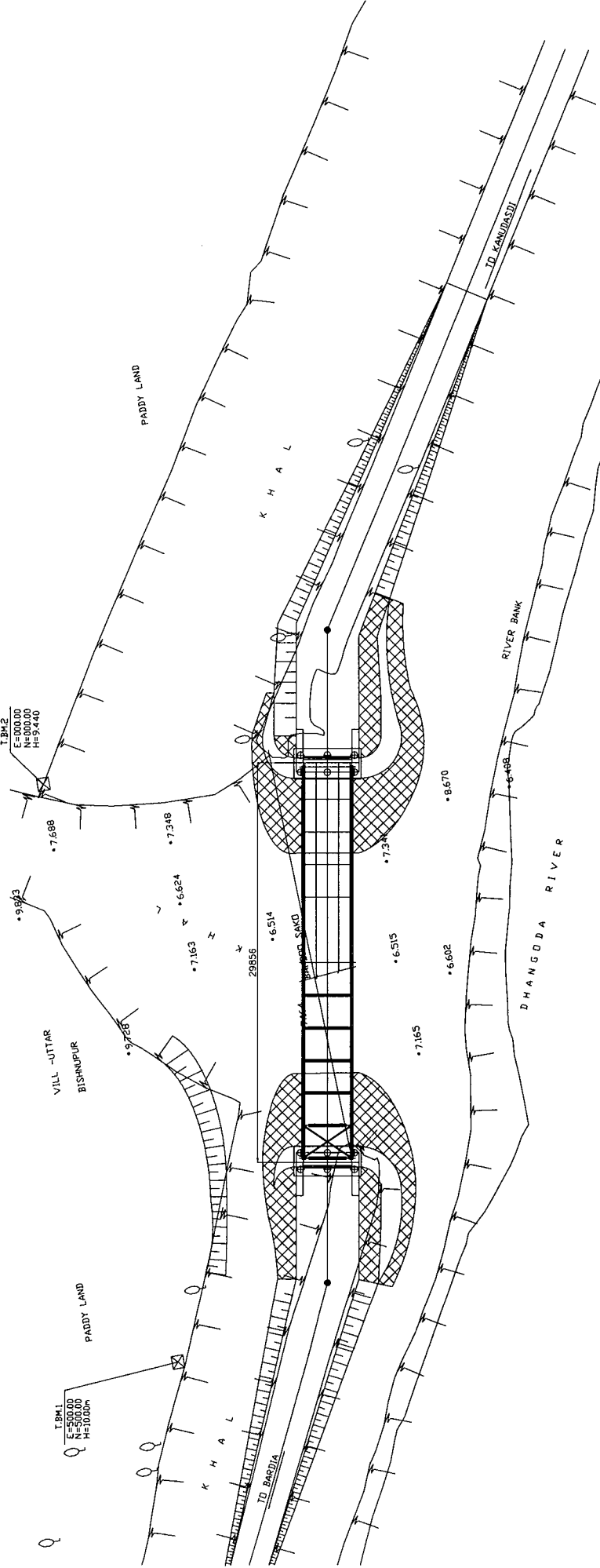

PLAN
SCALE 1:300

<p>LOCAL GOVERNMENT ENGINEERING DEPARTMENT PEOPLE'S REPUBLIC OF BANGLADESH</p>	<p>BASIC DESIGN STUDY ON THE PROJECT FOR PROVISION OF PORTABLE STEEL BRIDGES ON UPAZILA AND UNION ROADS</p>	<p>JAPAN INTERNATIONAL COOPERATION AGENCY KATAHIRA & ENGINEERS INTERNATIONAL</p>	<p>SCALE As Shown</p>	<p>GENERAL PLAN, ELEVATION & TYPICAL CROSS SECTION CHANDPUR BRIDGE NO. 21-01-N3 DRAWING NO. III - 14 / 26</p>
--	---	--	---------------------------	---

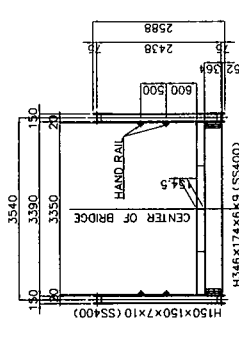
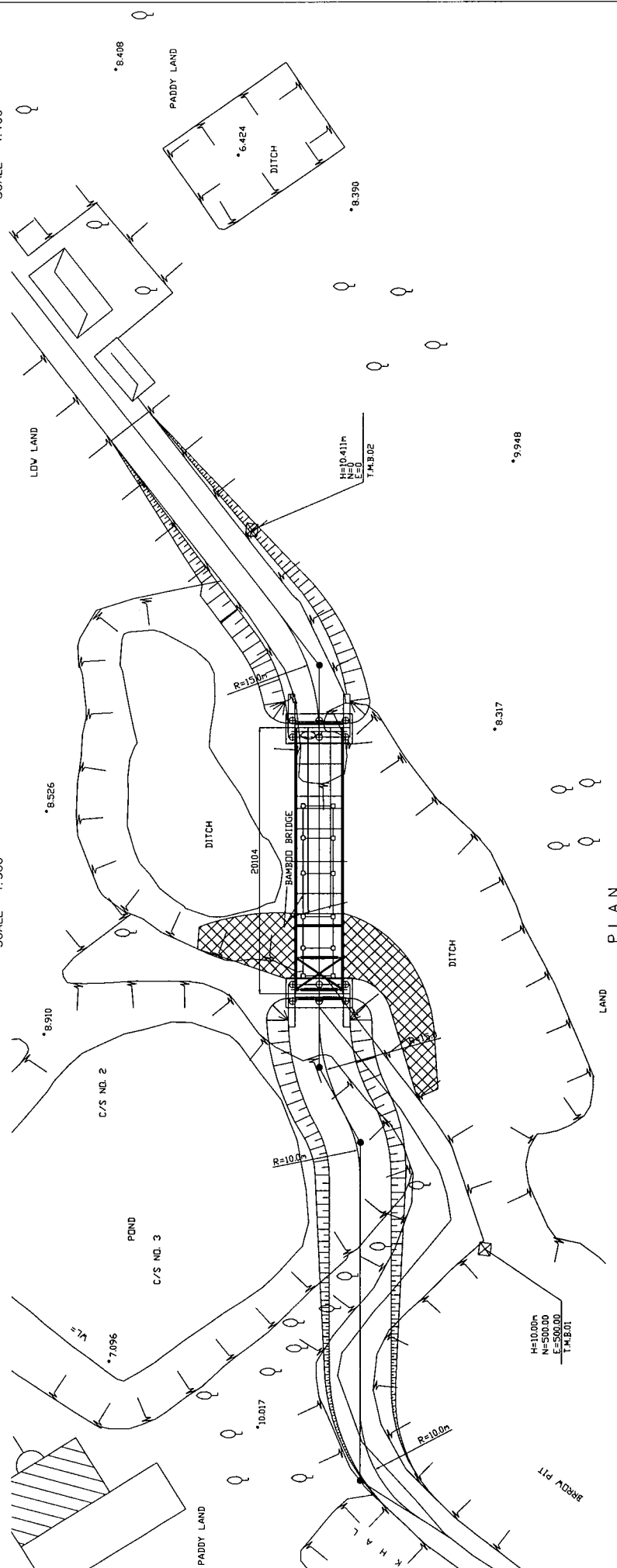
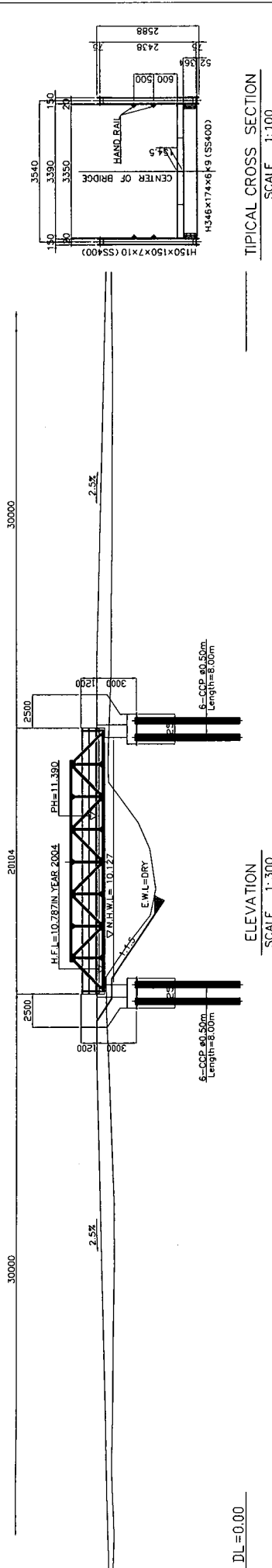

<p>LOCAL GOVERNMENT ENGINEERING DEPARTMENT PEOPLE'S REPUBLIC OF BANGLADESH</p>	<p>BASIC DESIGN STUDY ON THE PROJECT FOR PROVISION OF PORTABLE STEEL BRIDGES ON UPAZILA AND UNION ROADS</p>	<p>JAPAN INTERNATIONAL COOPERATION AGENCY KATAHIRA & ENGINEERS INTERNATIONAL</p>	<p>GENERAL PLAN, ELEVATION & TYPICAL CROSS SECTION CHANDPUR BRIDGE NO. 21-01-N4</p>
		SCALE As Shown	DRAWING NO. III-15/26

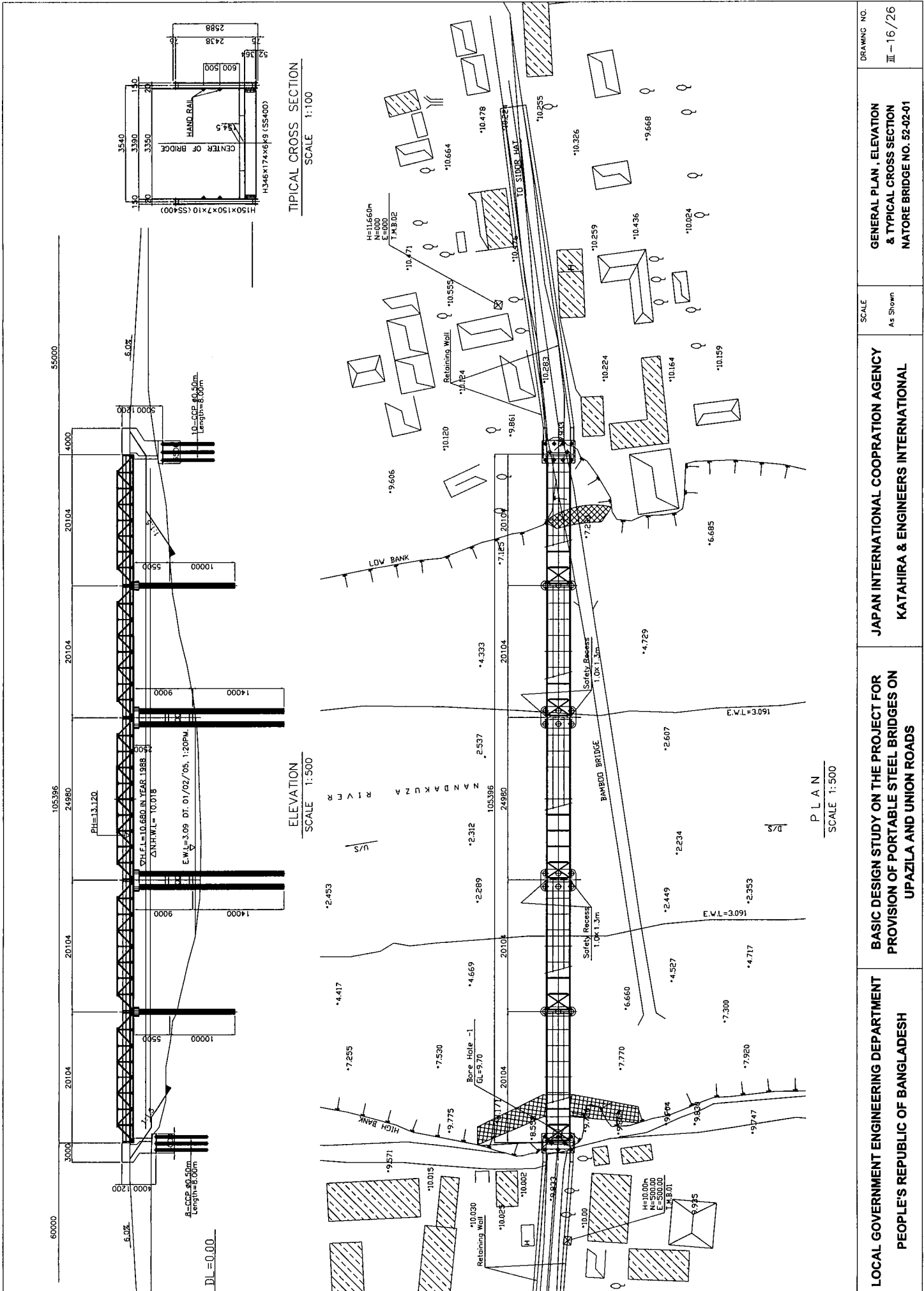

TYPICAL CROSS SECTION
SCALE 1:100

ELEVATION
SCALE 1:500

PLAN
SCALE 1:500

<p>LOCAL GOVERNMENT ENGINEERING DEPARTMENT PEOPLE'S REPUBLIC OF BANGLADESH</p>	<p>BASIC DESIGN STUDY ON THE PROJECT FOR PROVISION OF PORTABLE STEEL BRIDGES ON UPAZILA AND UNION ROADS</p>	<p>JAPAN INTERNATIONAL COOPERATION AGENCY KATAHIRA & ENGINEERS INTERNATIONAL</p>	<p>SCALE As Shown</p>	<p>GENERAL PLAN, ELEVATION & TYPICAL CROSS SECTION NATORE BRIDGE NO. 52-02-01</p>	<p>DRAWING NO. III-16/26</p>
--	---	--	---------------------------	---	----------------------------------

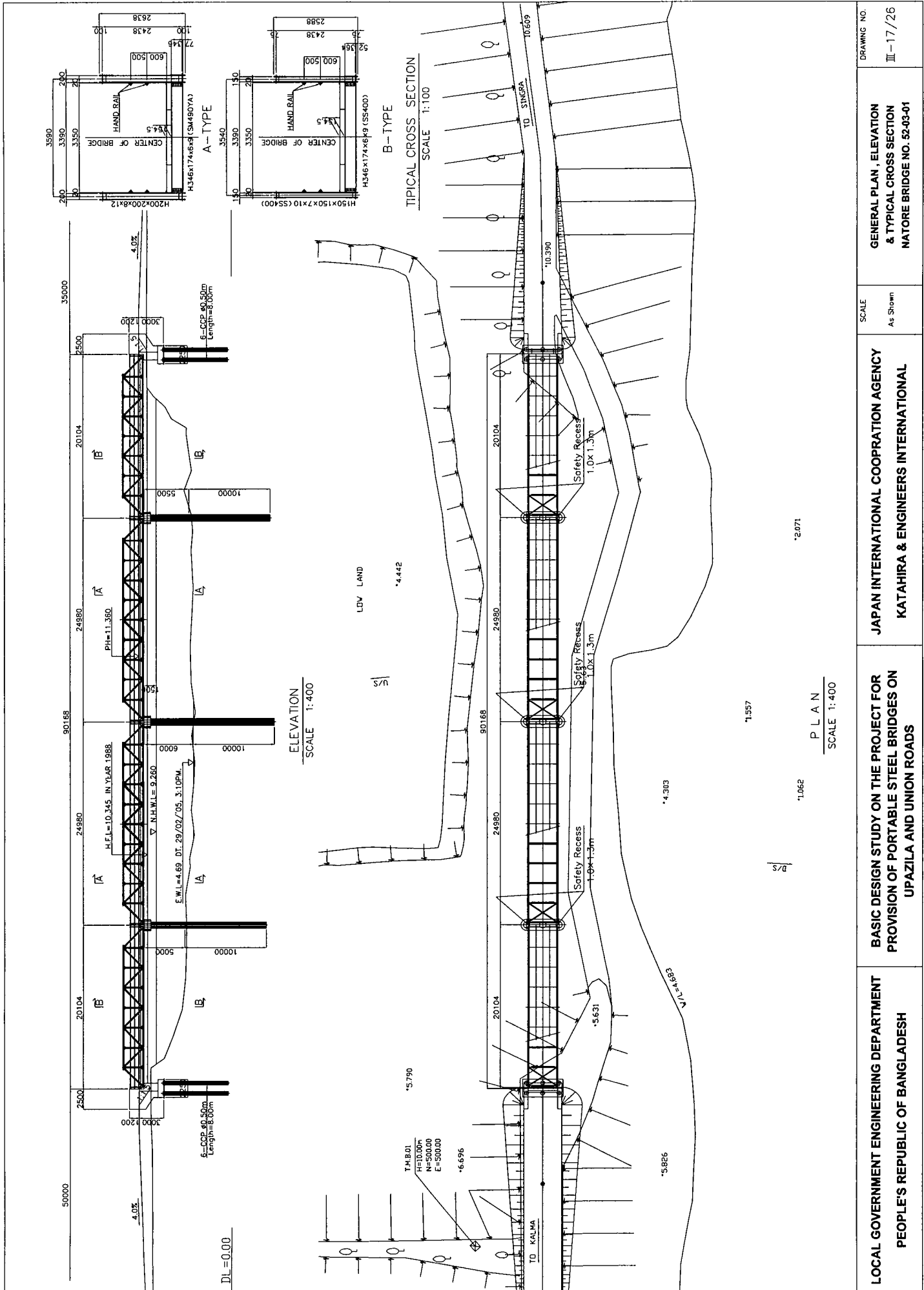

DRAWING NO. III-17/26	GENERAL PLAN, ELEVATION & TYPICAL CROSS SECTION NATORE BRIDGE NO. 52-03-01	SCALE As Shown	JAPAN INTERNATIONAL COOPERATION AGENCY KATAHIRA & ENGINEERS INTERNATIONAL
BASIC DESIGN STUDY ON THE PROJECT FOR PROVISION OF PORTABLE STEEL BRIDGES ON UPAZILA AND UNION ROADS		SCALE 1:400	LOCAL GOVERNMENT ENGINEERING DEPARTMENT PEOPLE'S REPUBLIC OF BANGLADESH

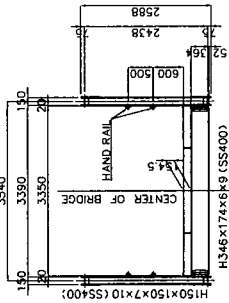
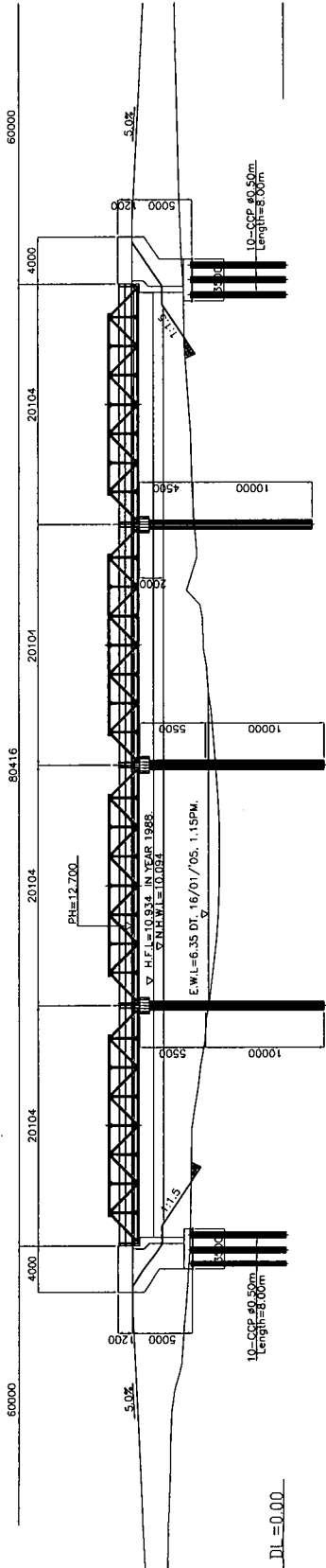

TYPICAL CROSS SECTION
SCALE 1:100

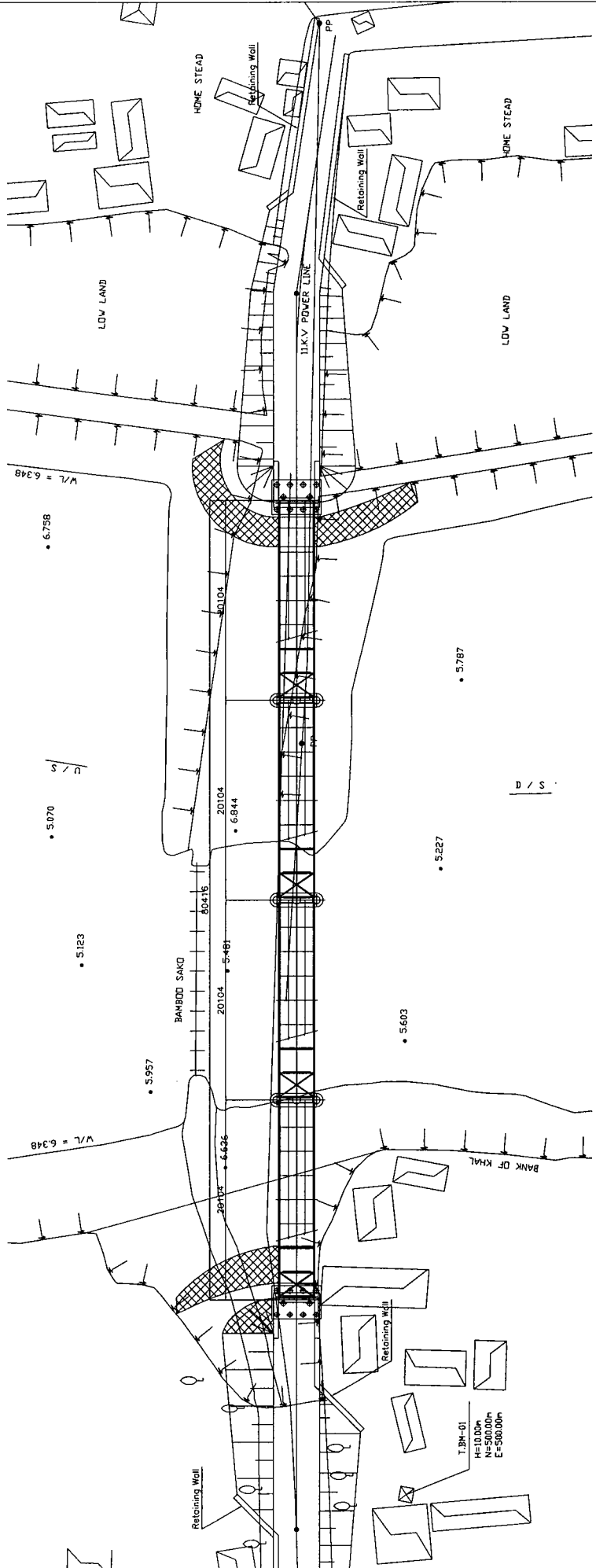

PLAN
SCALE 1:400

<p>LOCAL GOVERNMENT ENGINEERING DEPARTMENT PEOPLE'S REPUBLIC OF BANGLADESH</p>	<p>BASIC DESIGN STUDY ON THE PROJECT FOR PROVISION OF PORTABLE STEEL BRIDGES ON UPAZILA AND UNION ROADS</p>	<p>JAPAN INTERNATIONAL COOPERATION AGENCY KATAHIRA & ENGINEERS INTERNATIONAL</p>	<p>GENERAL PLAN, ELEVATION & TYPICAL CROSS SECTION SIRAJGANJ BRIDGE NO. 55-01-02</p>	<p>DRAWING NO. III-18/26</p>
--	---	--	--	----------------------------------

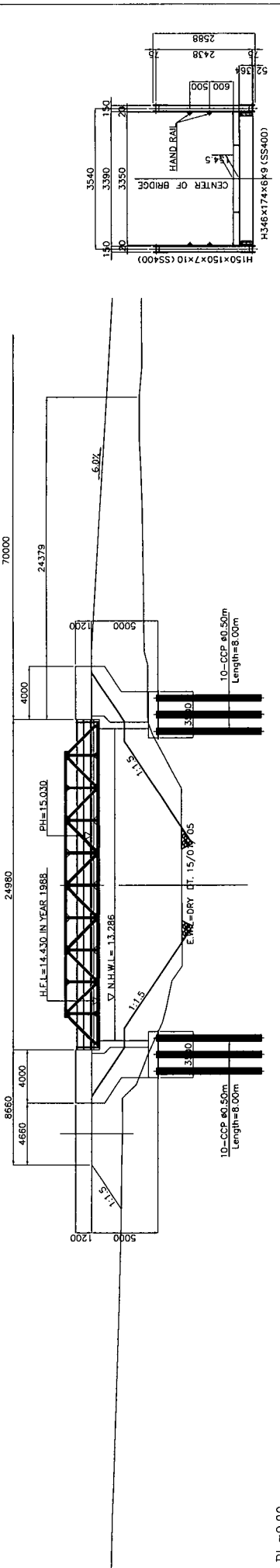

ELEVATION
SCALE 1:300

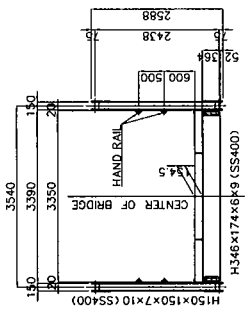

TYPICAL CROSS SECTION
SCALE 1:100

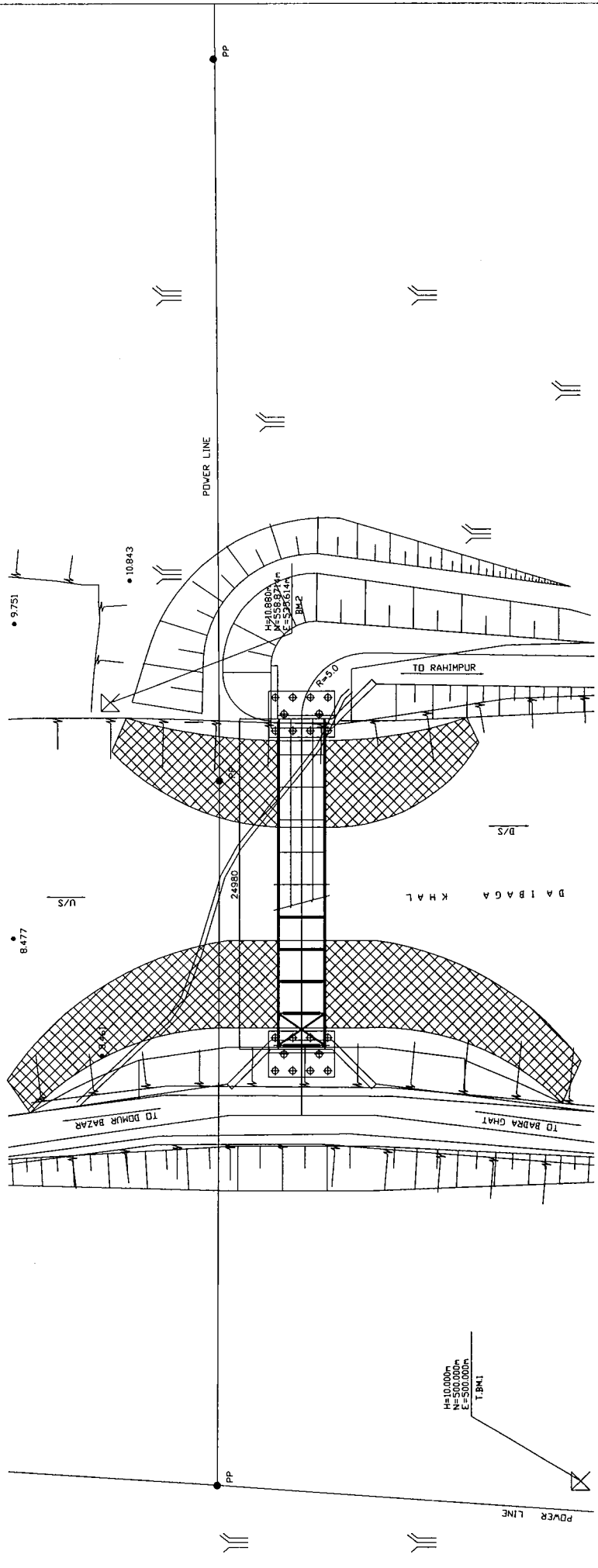

P L A N
SCALE 1:300

<p>LOCAL GOVERNMENT ENGINEERING DEPARTMENT PEOPLE'S REPUBLIC OF BANGLADESH</p>	<p>BASIC DESIGN STUDY ON THE PROJECT FOR PROVISION OF PORTABLE STEEL BRIDGES ON UPAZILA AND UNION ROADS</p>	<p>JAPAN INTERNATIONAL COOPERATION AGENCY KATAHIRA & ENGINEERS INTERNATIONAL</p>	<p>SCALE As Shown</p>	<p>GENERAL PLAN , ELEVATION & TYPICAL CROSS SECTION SIRAJGANJ BRIDGE NO. 55-01-03</p>	<p>DRAWING NO. III-19/26</p>
--	---	--	---------------------------	---	----------------------------------

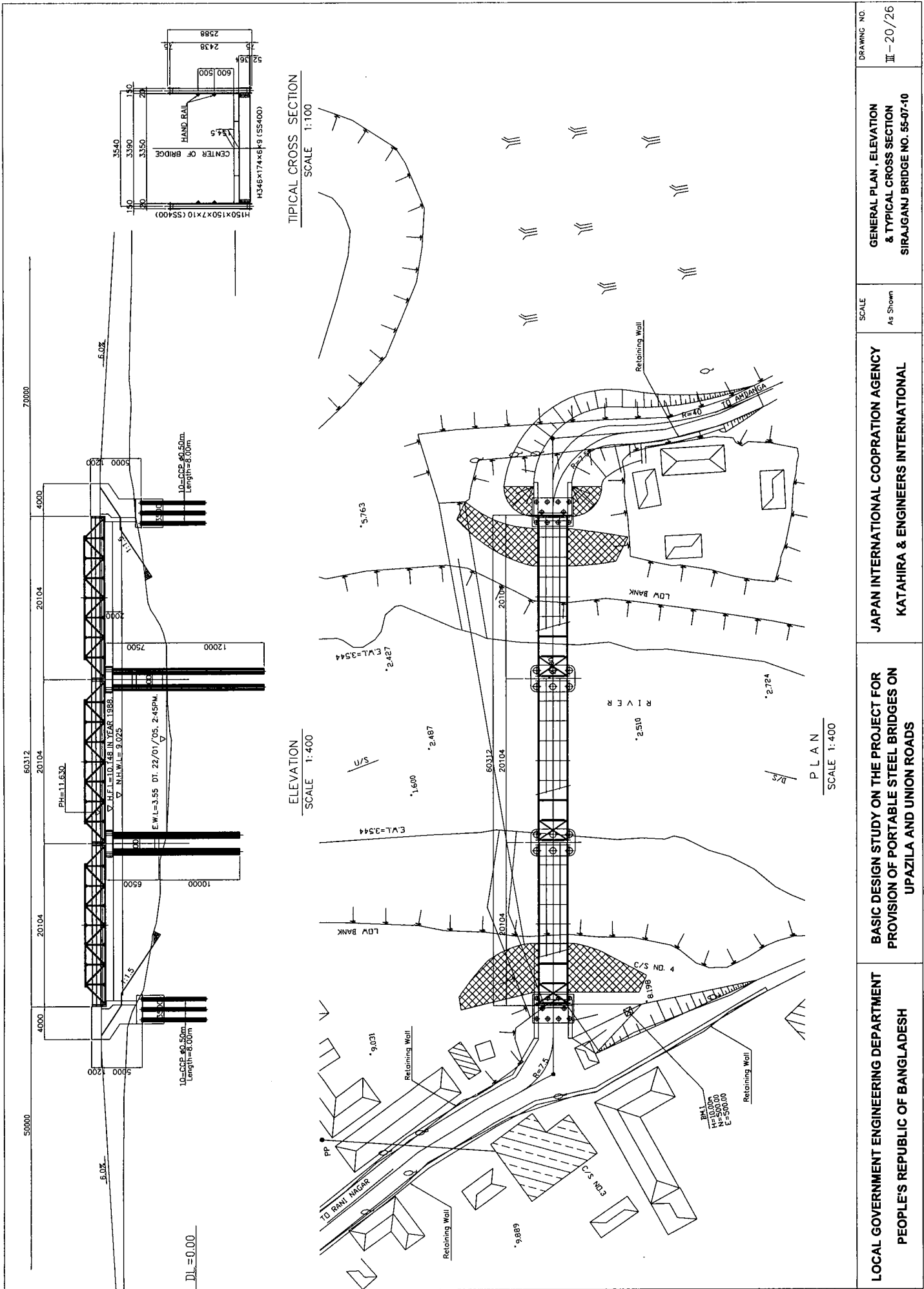

DRAWING NO. III-20/26	GENERAL PLAN, ELEVATION & TYPICAL CROSS SECTION SIRAJGANJ BRIDGE NO. 55-07-10	SCALE As Shown	JAPAN INTERNATIONAL COOPERATION AGENCY KATAHIRA & ENGINEERS INTERNATIONAL	BASIC DESIGN STUDY ON THE PROJECT FOR PROVISION OF PORTABLE STEEL BRIDGES ON UPAZILA AND UNION ROADS	LOCAL GOVERNMENT ENGINEERING DEPARTMENT PEOPLE'S REPUBLIC OF BANGLADESH
--------------------------	---	-------------------	--	--	--

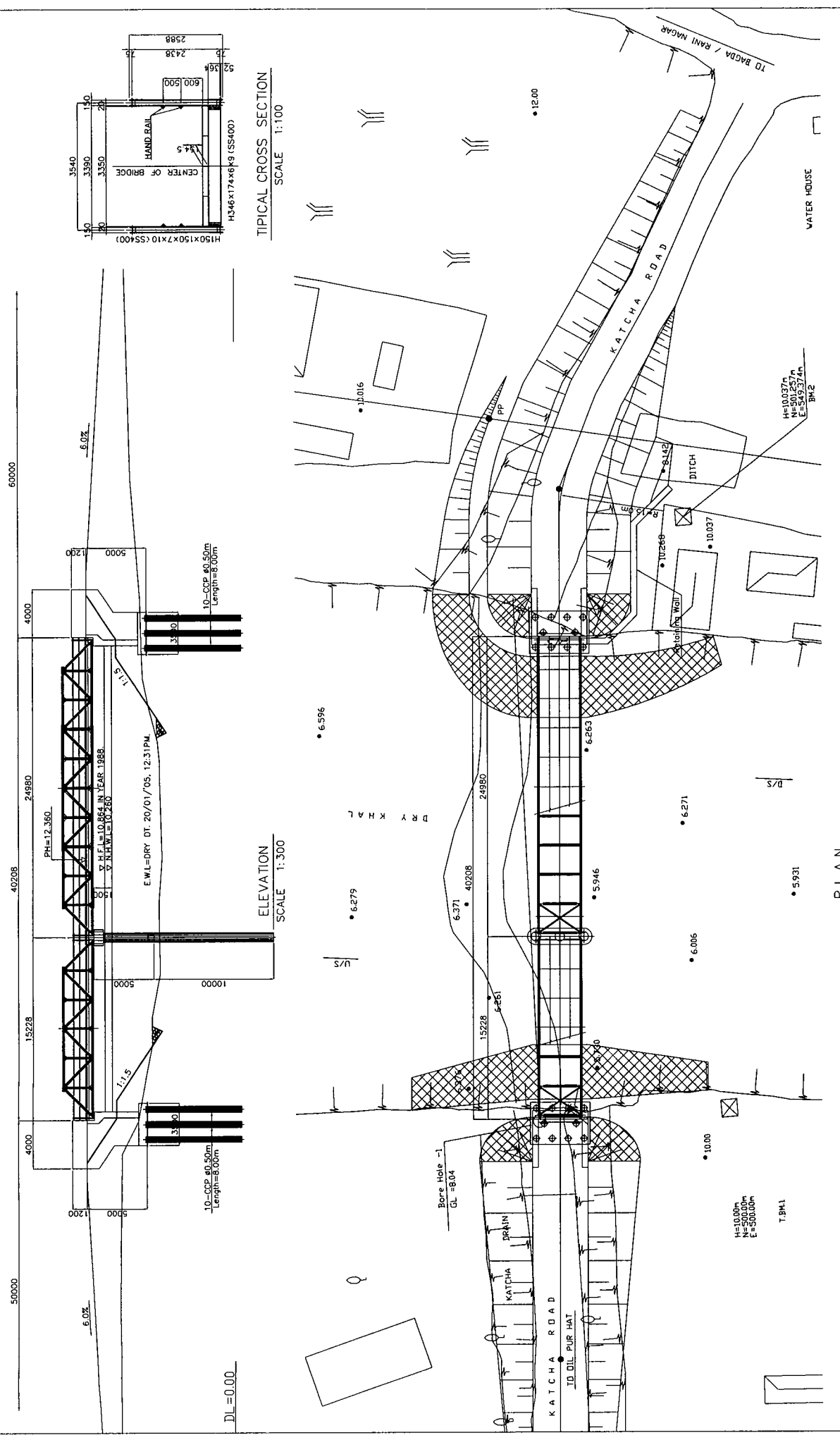

TYPICAL CROSS SECTION
SCALE 1:100

ELEVATION
SCALE 1:300

PLAN
SCALE 1:300

<p>DRAWING NO. III-21/26</p>	<p>GENERAL PLAN, ELEVATION & TYPICAL CROSS SECTION SIRAJGANJ BRIDGE NO. 55-07-N2</p>	<p>JAPAN INTERNATIONAL COOPERATION AGENCY KATAHIRA & ENGINEERS INTERNATIONAL</p>	<p>LOCAL GOVERNMENT ENGINEERING DEPARTMENT PEOPLE'S REPUBLIC OF BANGLADESH</p>
<p>SCALE As Shown</p>		<p>BASIC DESIGN STUDY ON THE PROJECT FOR PROVISION OF PORTABLE STEEL BRIDGES ON UPAZILA AND UNION ROADS</p>	

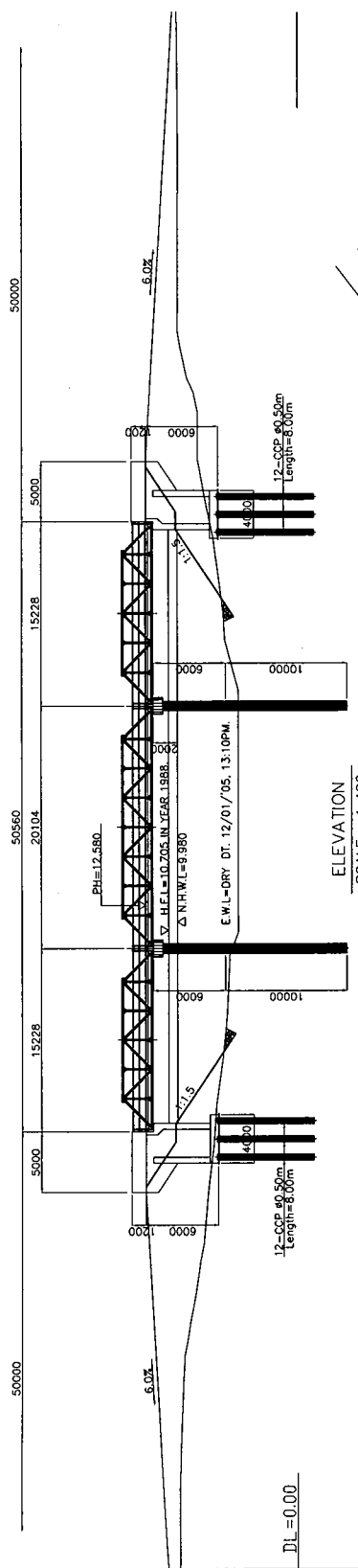

ELEVATION
 SCALE 1:400

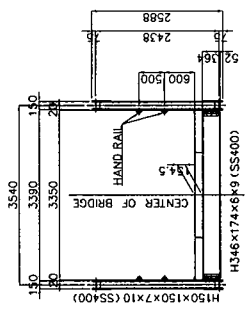

TYPICAL CROSS SECTION
 SCALE 1:100

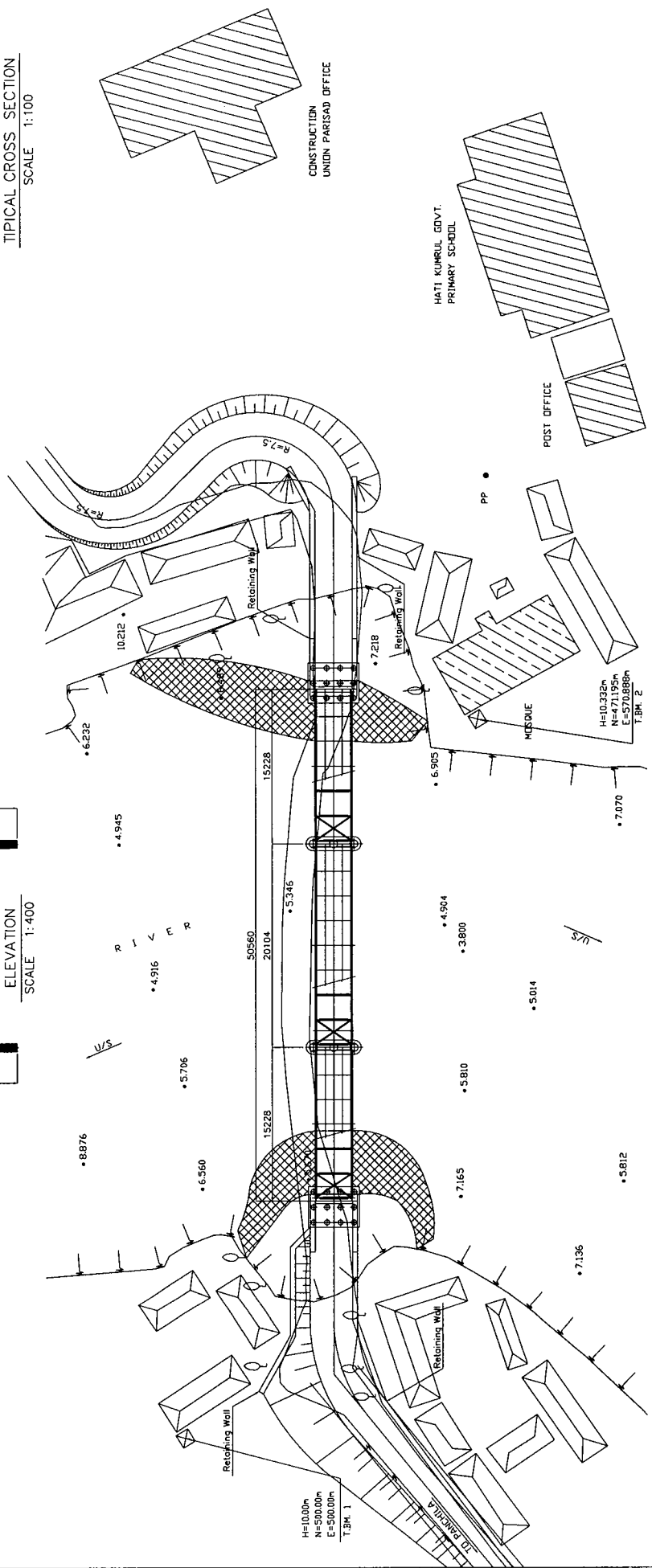

PLAN
 SCALE 1:400

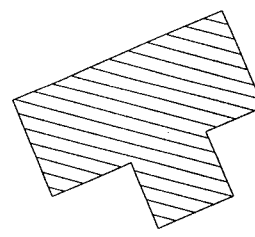

LOCAL GOVERNMENT ENGINEERING DEPARTMENT PEOPLE'S REPUBLIC OF BANGLADESH	BASIC DESIGN STUDY ON THE PROJECT FOR PROVISION OF PORTABLE STEEL BRIDGES ON UPAZILA AND UNION ROADS	JAPAN INTERNATIONAL COOPERATION AGENCY KATAHIRA & ENGINEERS INTERNATIONAL	SCALE As Shown	GENERAL PLAN, ELEVATION & TYPICAL CROSS SECTION SIRAJGANJ BRIDGE NO. 55-07-N3 DRAWING NO. III - 22 / 26
--	--	--	-------------------	---

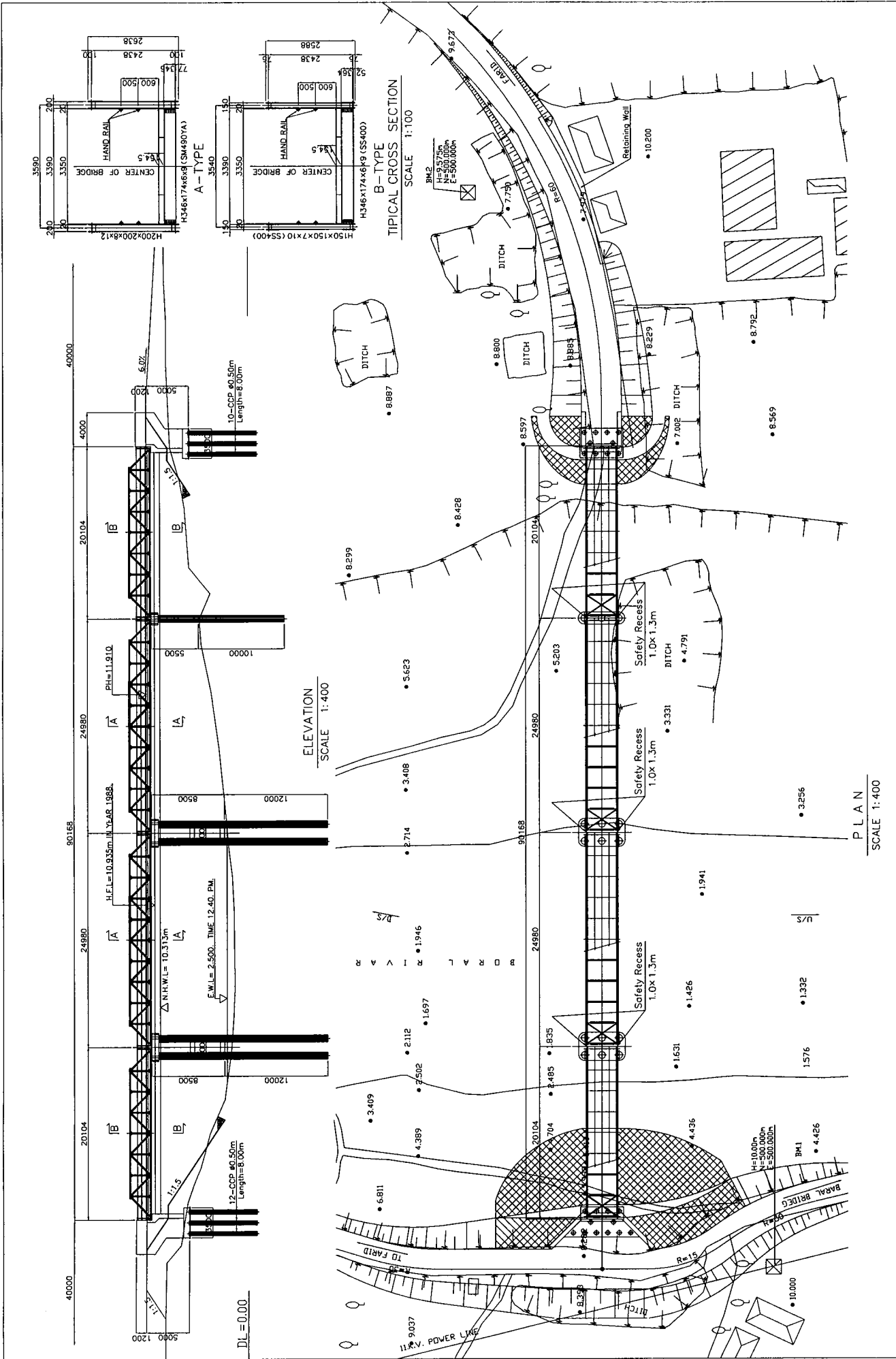

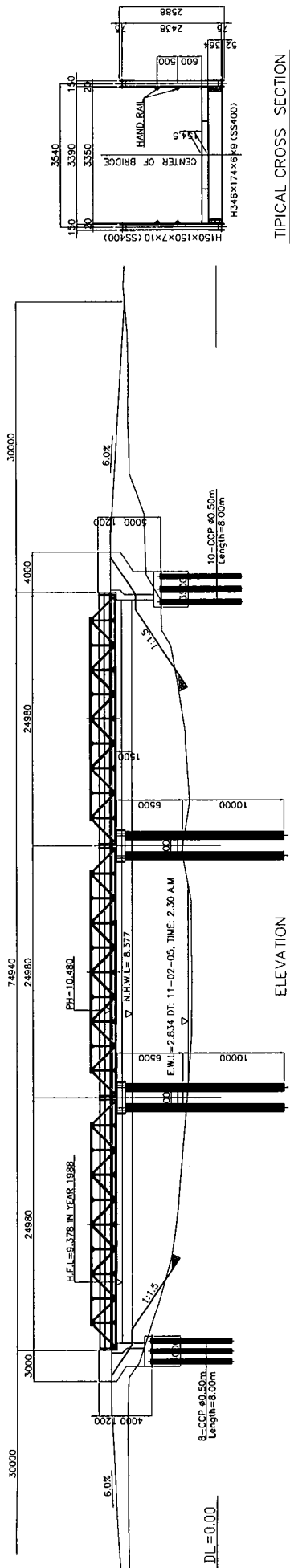

ELEVATION
SCALE 1:400

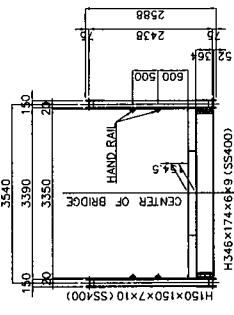

TYPICAL CROSS SECTION
SCALE 1:100

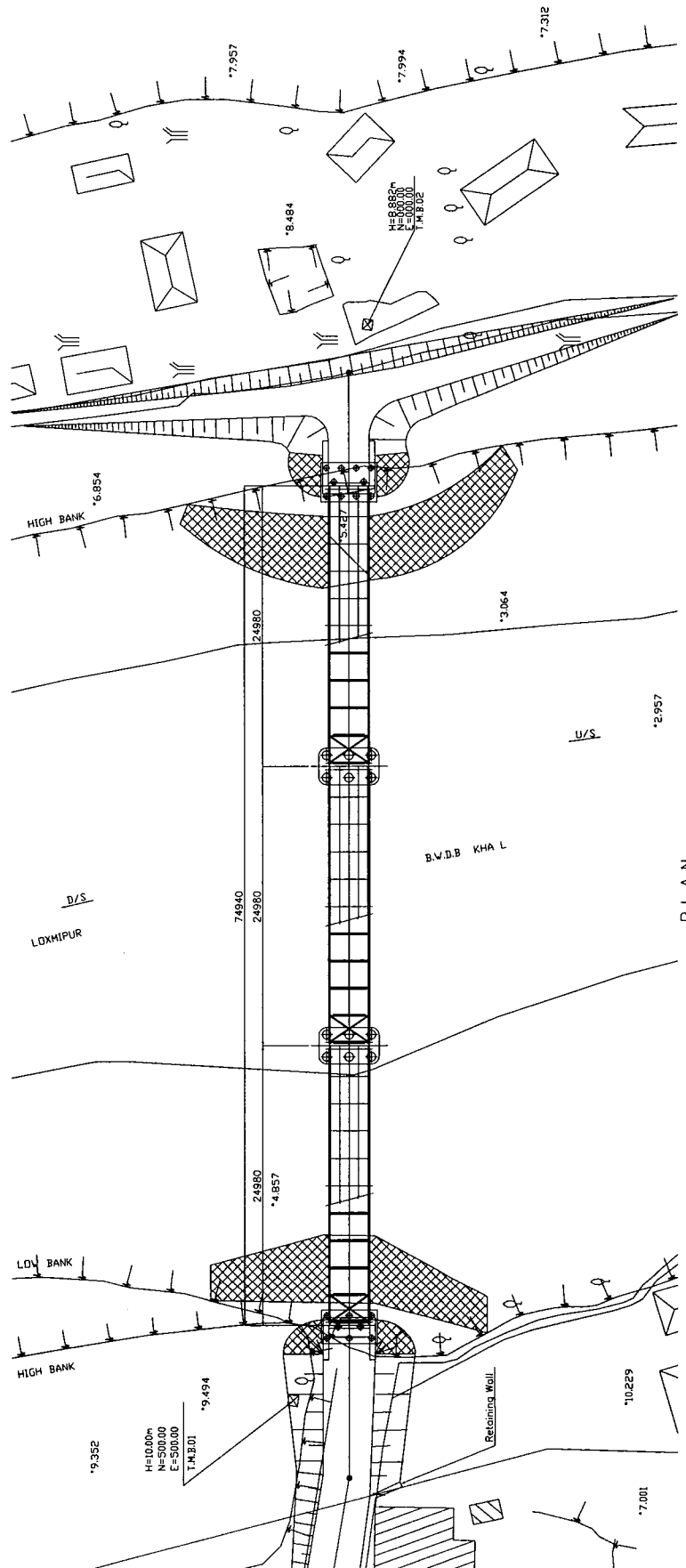

PLAN
SCALE 1:400

<p>LOCAL GOVERNMENT ENGINEERING DEPARTMENT PEOPLE'S REPUBLIC OF BANGLADESH</p>	<p>BASIC DESIGN STUDY ON THE PROJECT FOR PROVISION OF PORTABLE STEEL BRIDGES ON UPAZILA AND UNION ROADS</p>	<p>JAPAN INTERNATIONAL COOPERATION AGENCY KATAHIRA & ENGINEERS INTERNATIONAL</p>	<p>SCALE As Shown</p>	<p>GENERAL PLAN, ELEVATION & TYPICAL CROSS SECTION PABNA BRIDGE NO. 56-06-01</p>	<p>DRAWING NO. III - 24/26</p>
--	---	--	---------------------------	--	------------------------------------

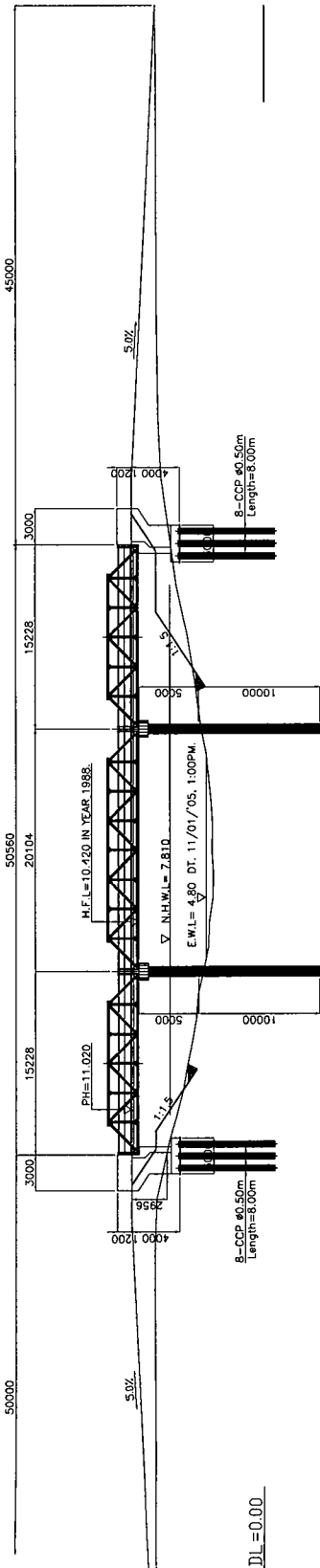

ELEVATION
SCALE 1:400

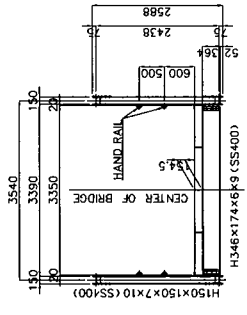

TYPICAL CROSS SECTION
SCALE 1:100

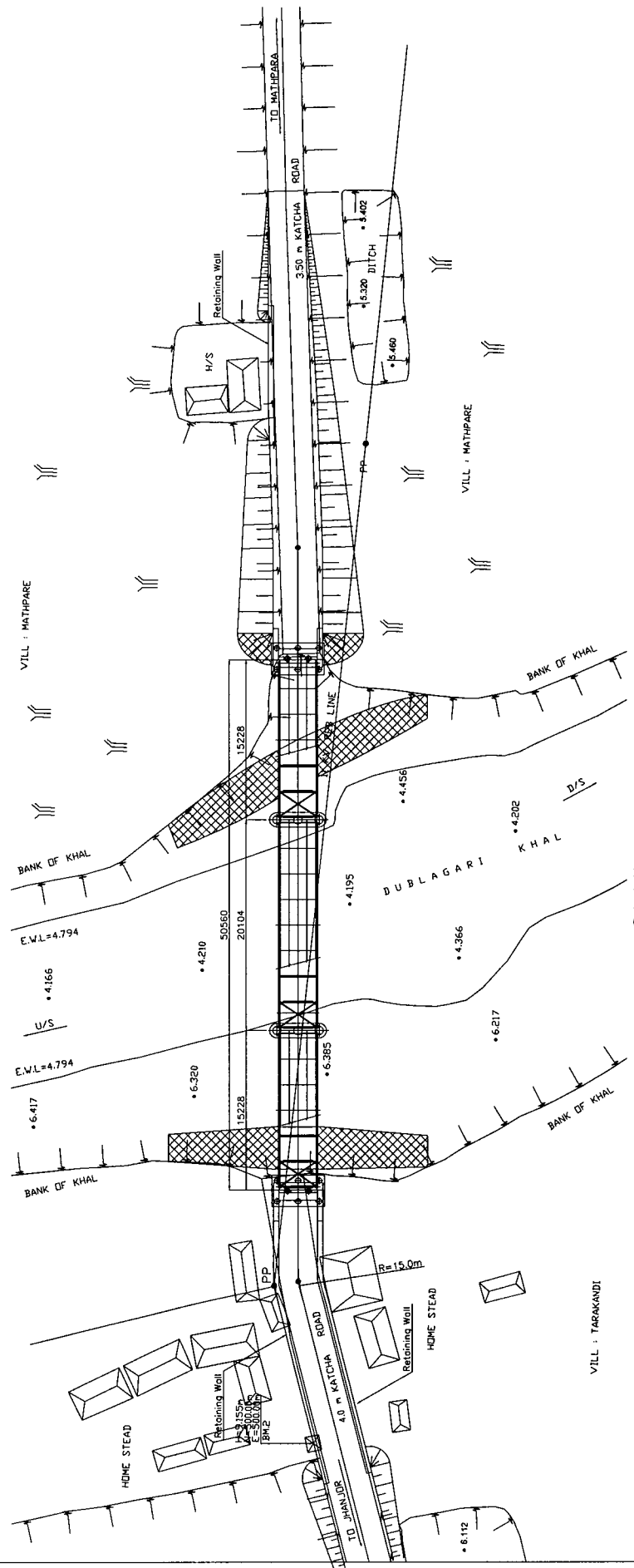

PLAN
SCALE 1:400

<p>DRAWING NO. III - 25 / 26</p>	<p>SCALE As Shown</p>	<p>GENERAL PLAN, ELEVATION & TYPICAL CROSS SECTION BOGRA BRIDGE NO. 57-07-44</p>	<p>JAPAN INTERNATIONAL COOPERATION AGENCY KATAHIRA & ENGINEERS INTERNATIONAL</p>
<p>BASIC DESIGN STUDY ON THE PROJECT FOR PROVISION OF PORTABLE STEEL BRIDGES ON UPAZILA AND UNION ROADS</p>		<p>LOCAL GOVERNMENT ENGINEERING DEPARTMENT PEOPLE'S REPUBLIC OF BANGLADESH</p>	

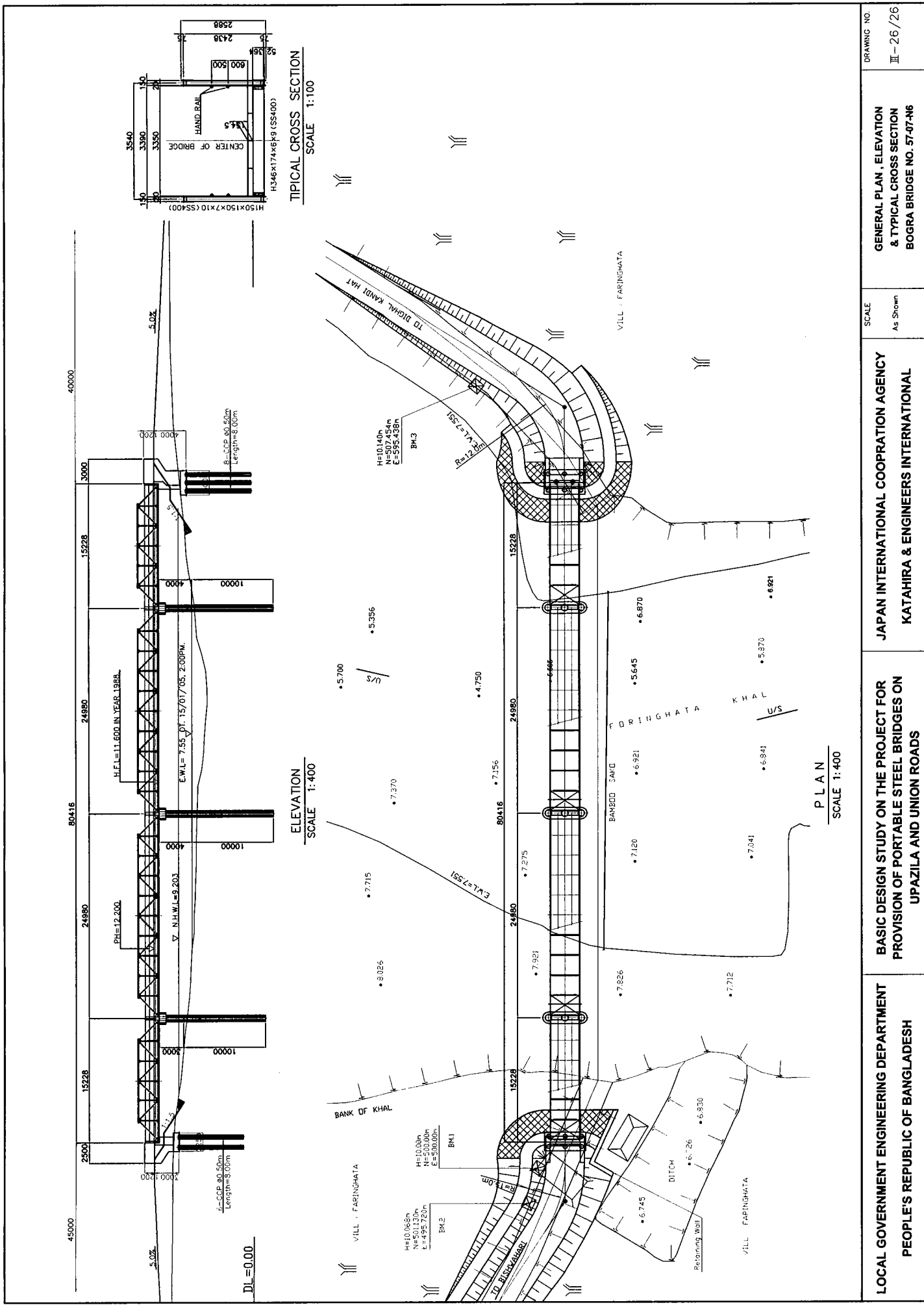

LOCAL GOVERNMENT ENGINEERING DEPARTMENT PEOPLE'S REPUBLIC OF BANGLADESH	BASIC DESIGN STUDY ON THE PROJECT FOR PROVISION OF PORTABLE STEEL BRIDGES ON UPAZILA AND UNION ROADS	JAPAN INTERNATIONAL COOPERATION AGENCY KATAHIRA & ENGINEERS INTERNATIONAL	GENERAL PLAN, ELEVATION & TYPICAL CROSS SECTION BOGRA BRIDGE NO. 57-07-46
		SCALE As Shown	DRAWING NO. III-26/26