

2-2-3 Basic Design Drawing

	Page
• Structure of a Deep Well	2-30
• Water Transmission Pipeline	
(No.1 Ereimentau)	2-32
(No.2 Turbaisky)	2-34
(No.3 Minskoye, No.4 Iskra)	2-35
(No.5 Zholymbet)	2-36
(No.6 Valikhanove)	2-37
(No.7 Korneevka, No.8 Aksu, No.9 Novopokrovka)	2-38
(No.10 Ostagan, No.11 Ulgy)	2-39
(No.12 Kladbinka, No.13 Maibalyk)	2-40
(No.14 Kirovka, No.15 Novoishimsky)	2-41
• Fitting Plan (Ereimentau)	2-42
(Nigini Turgaisky, Turgaisky, Minskoye, Iskra)	2-43
(Zholymbet, Valikhanove)	2-44
(Korneevka, Aksu)	2-45
(Novopokrovka, Ostagan)	2-46
(Ulgy, Kladbinka)	2-47
(Maibalyk, Kirovka)	2-48
(Novoishimsky)	2-49

Structure of a Deep Well

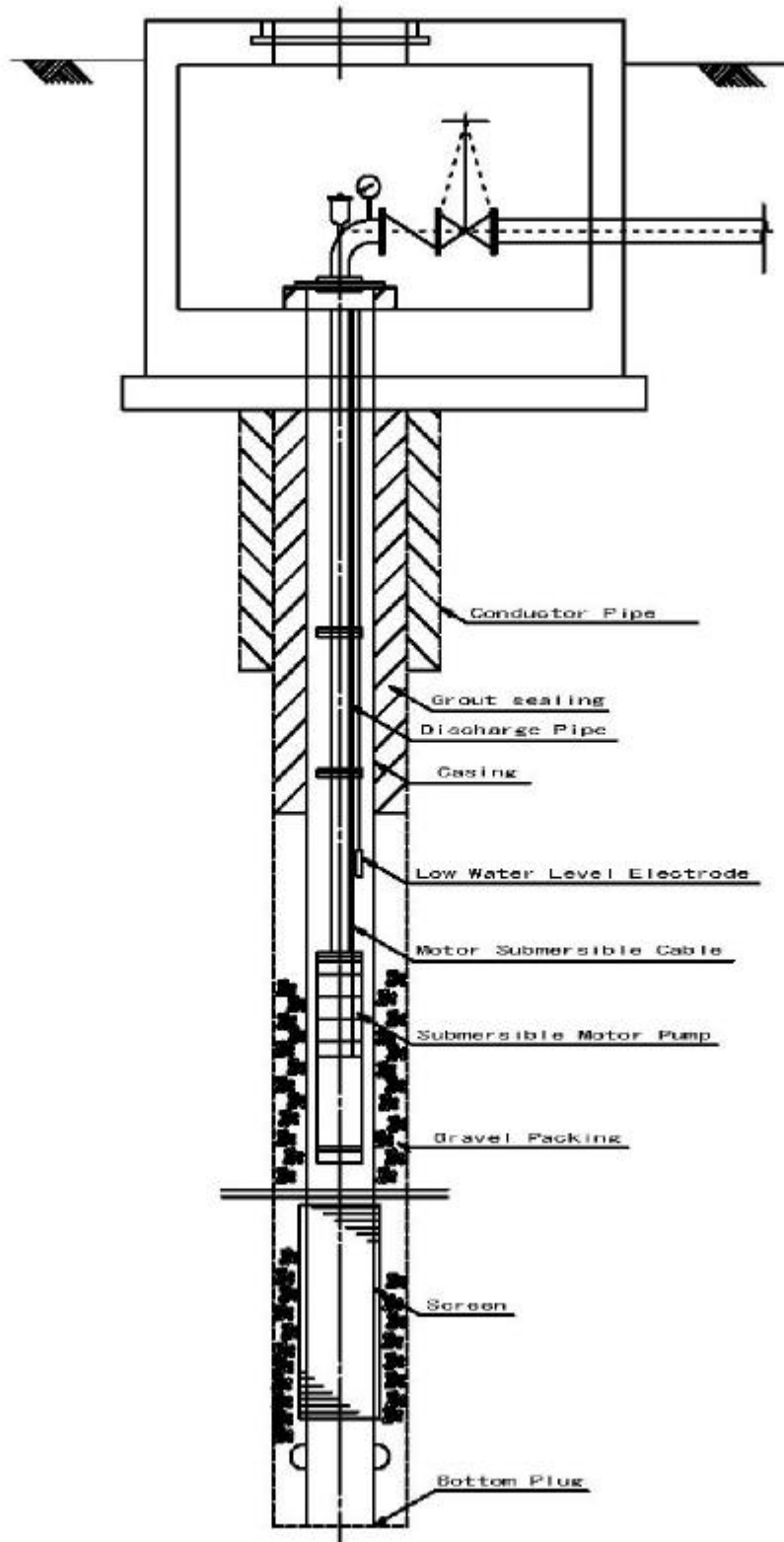

Sluice Valve

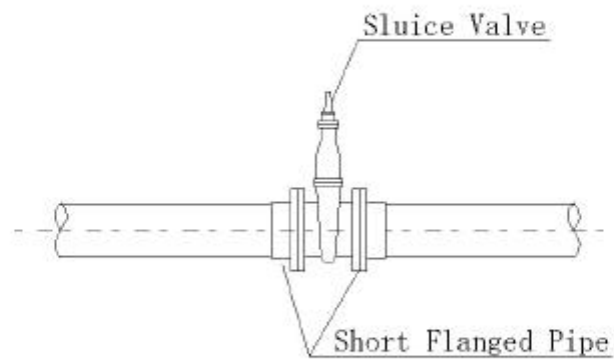

Air Release Valve

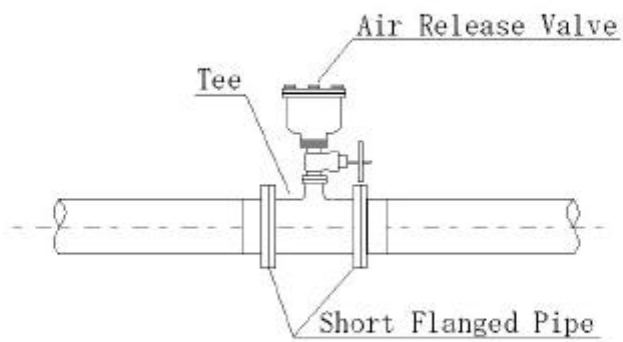

Blow-off Valve

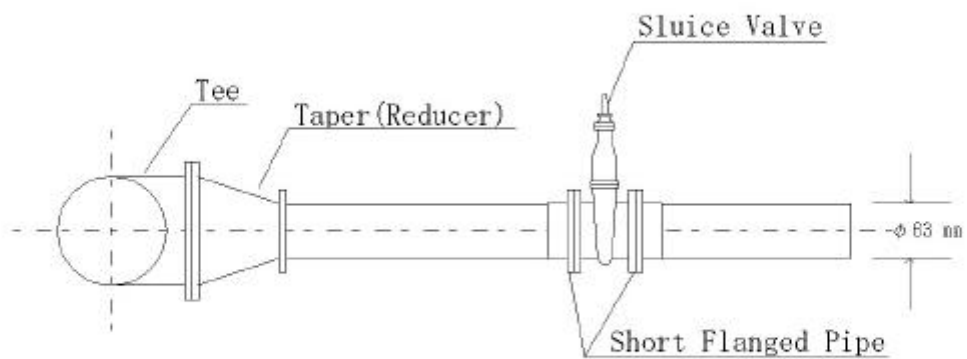

Key Map

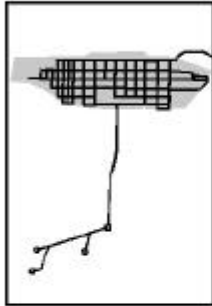

LEGEND

- New Facilities (planned by Kazakhstan)
- New Facilities (procured by Japan)
- Well No.
- Pumping Volume
- ⊙ Air Release Valve
- ⊖ Blow-off Valve

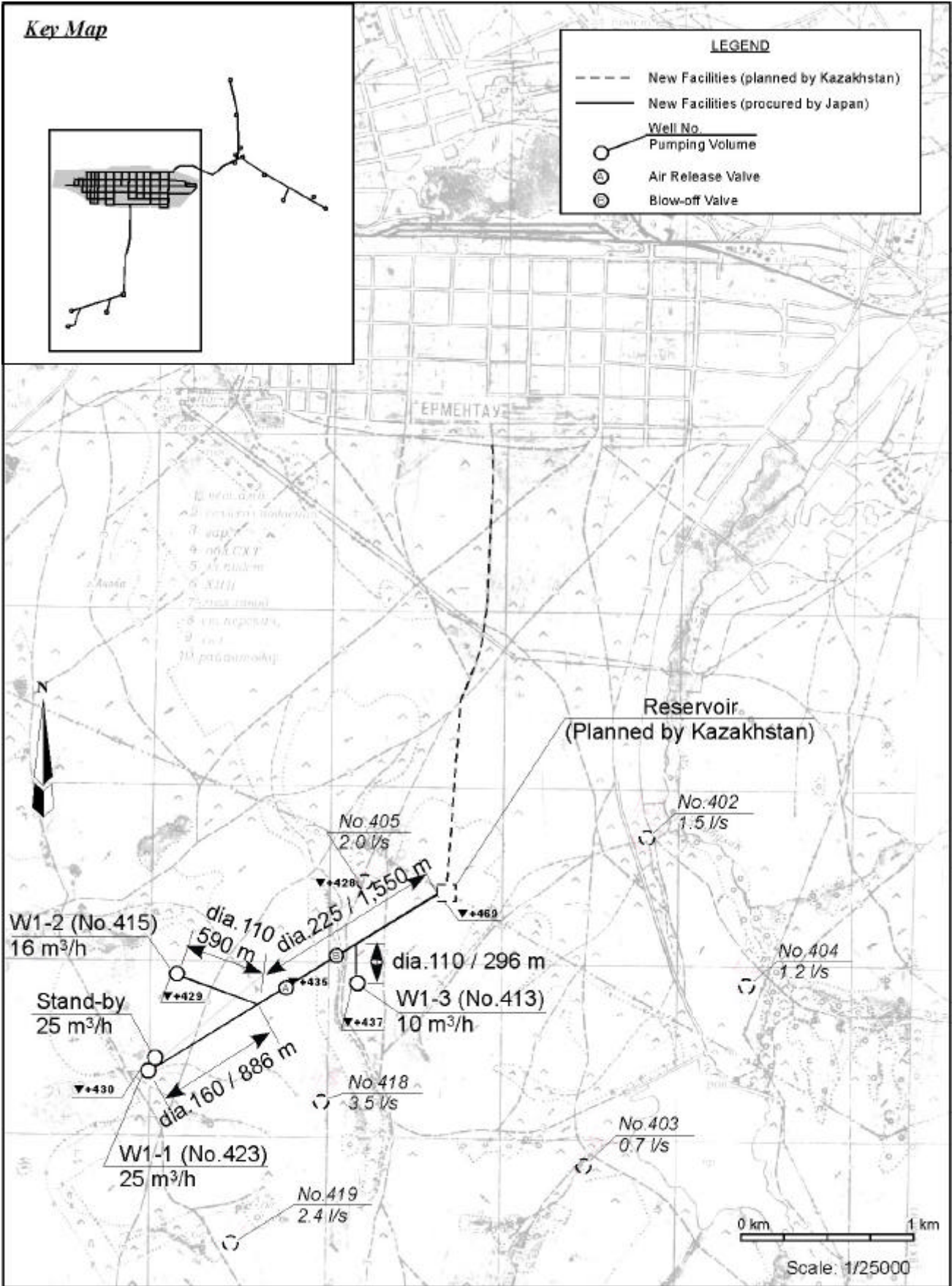

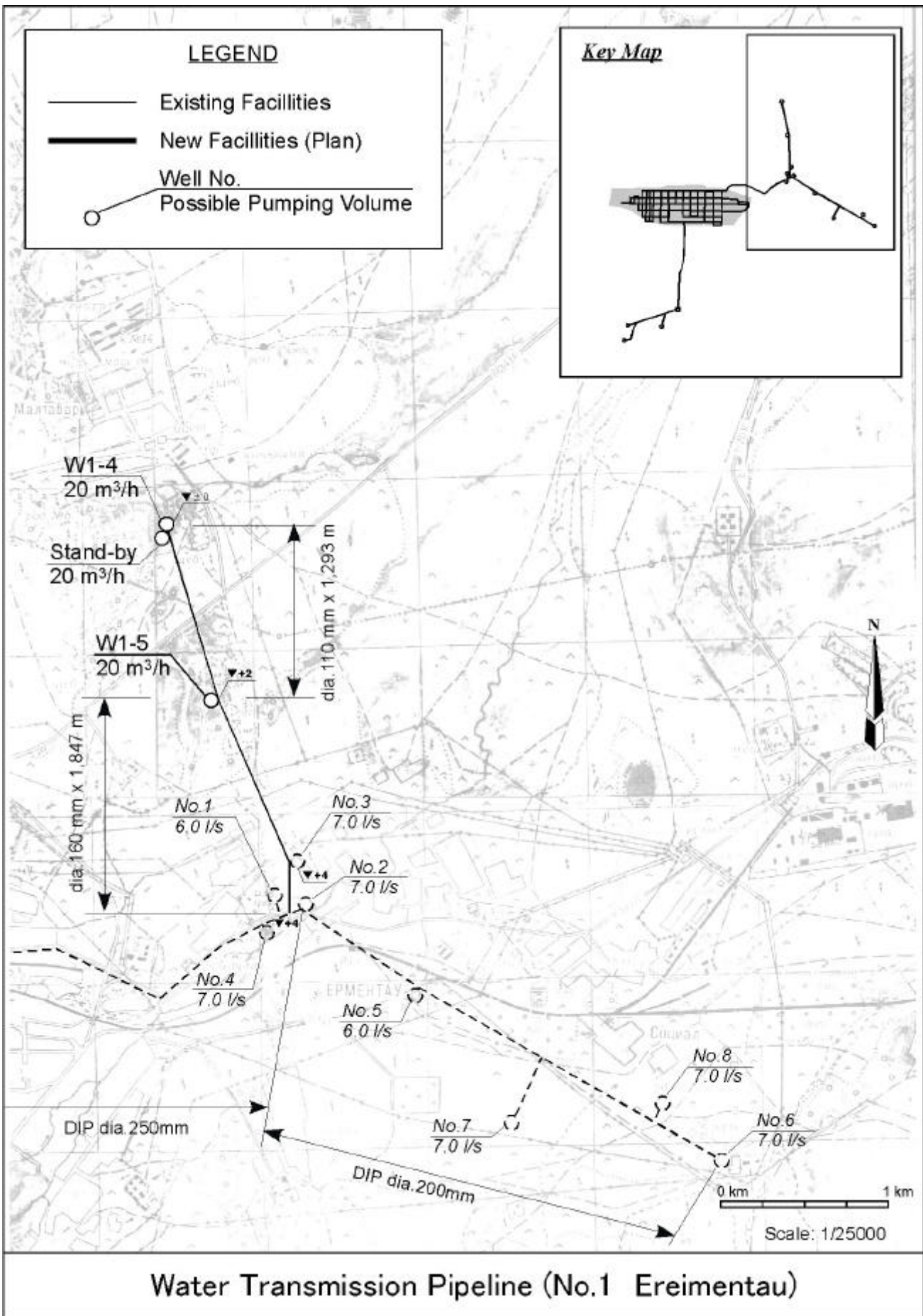

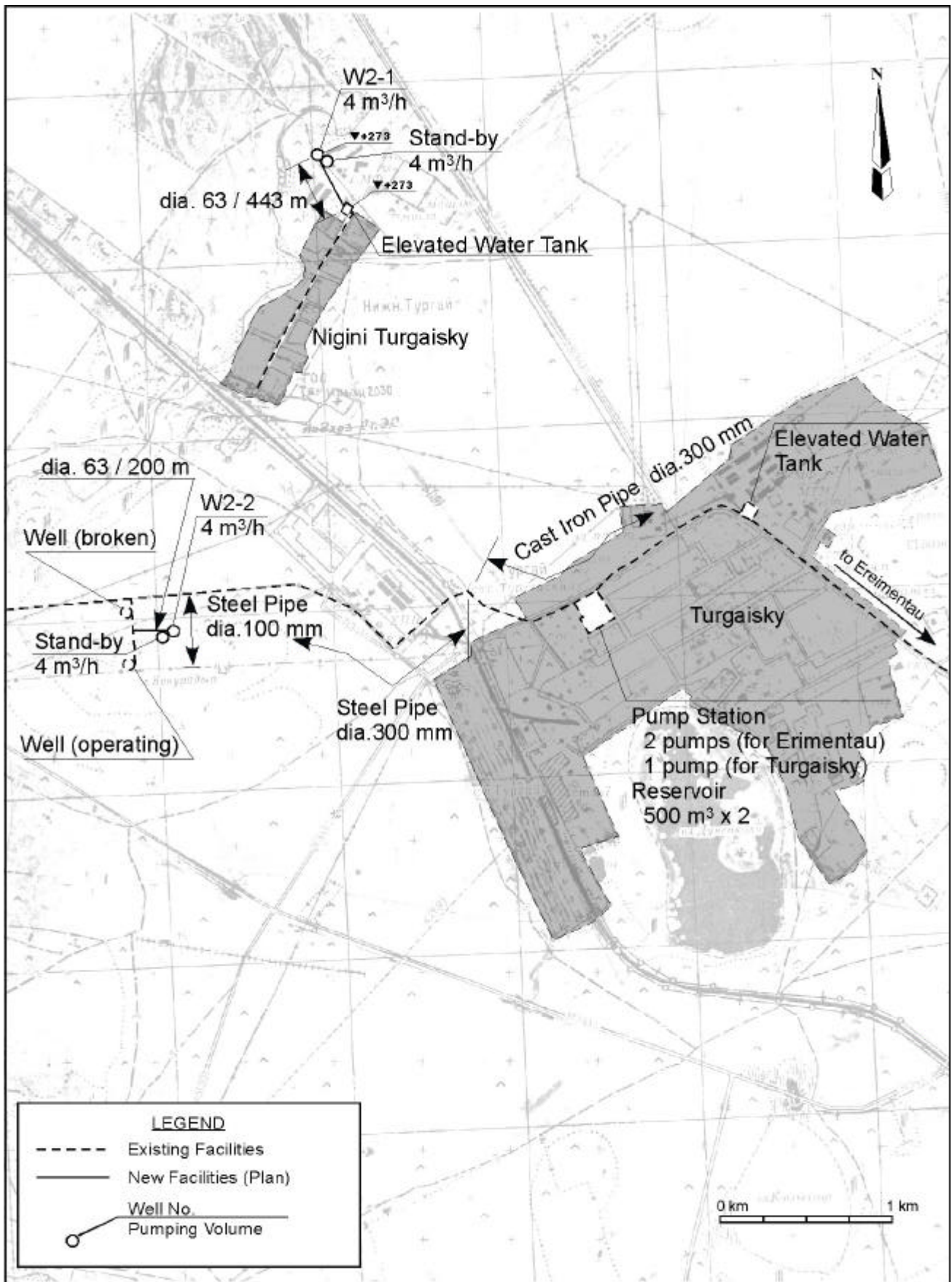

Water Transmission Pipeline (No.2 Turgaisky)