

教員サポートリソースセンター棟

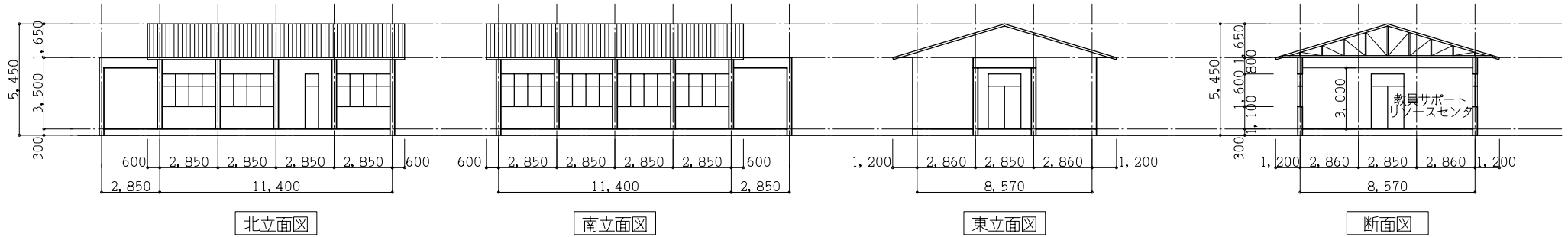

便所棟

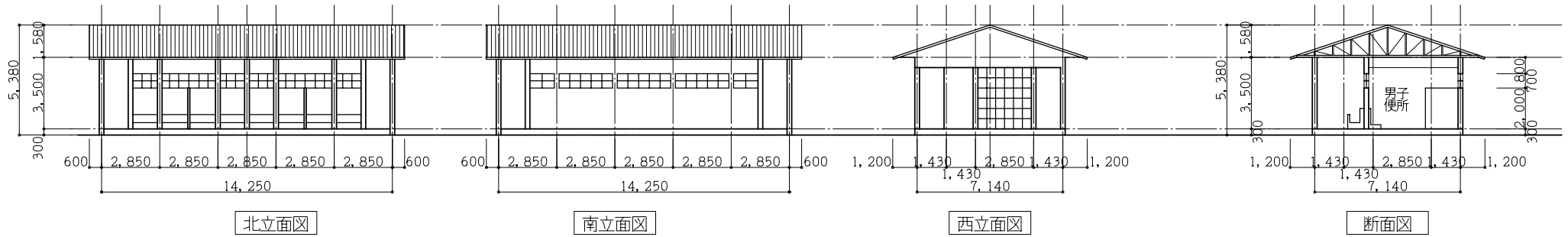

特別教室棟

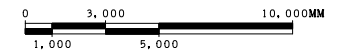
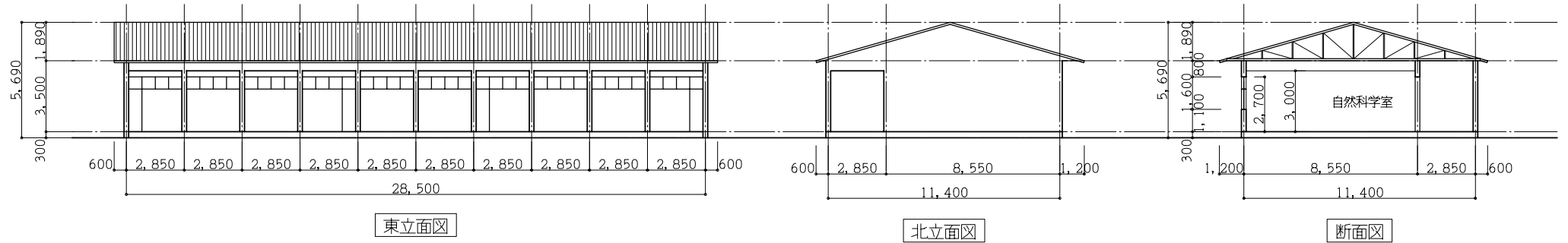

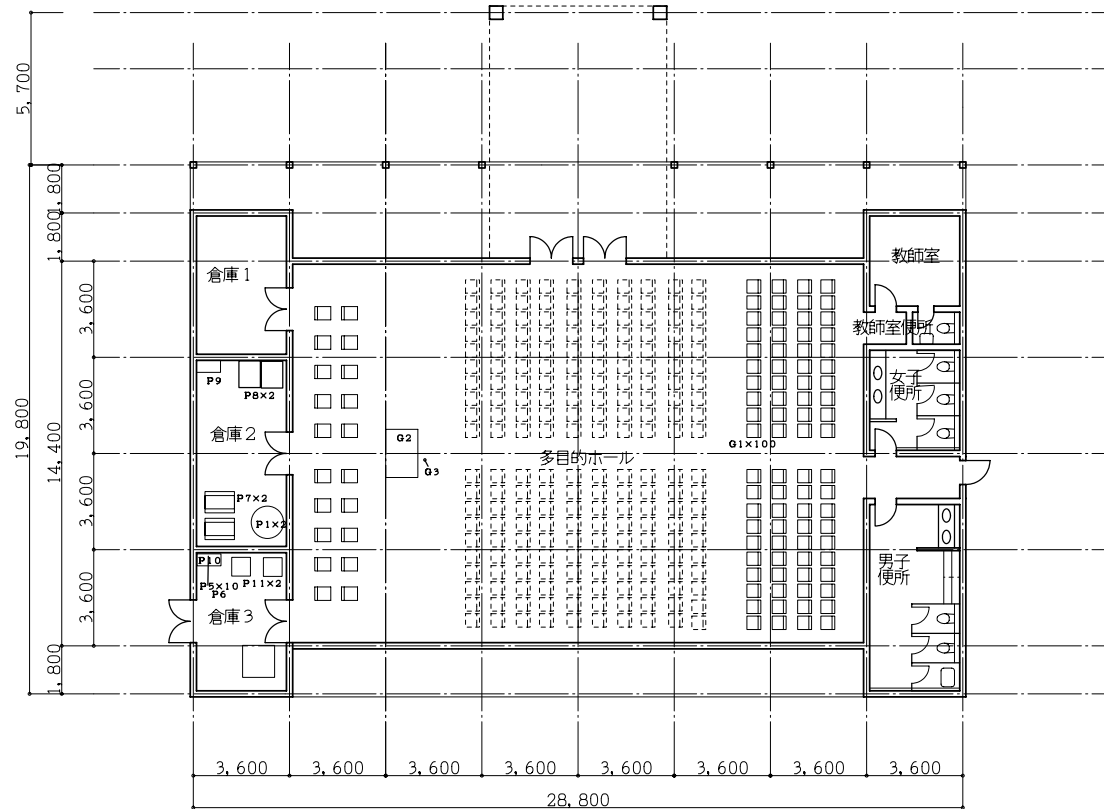

新築

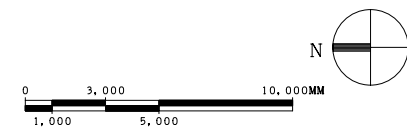



東立面図

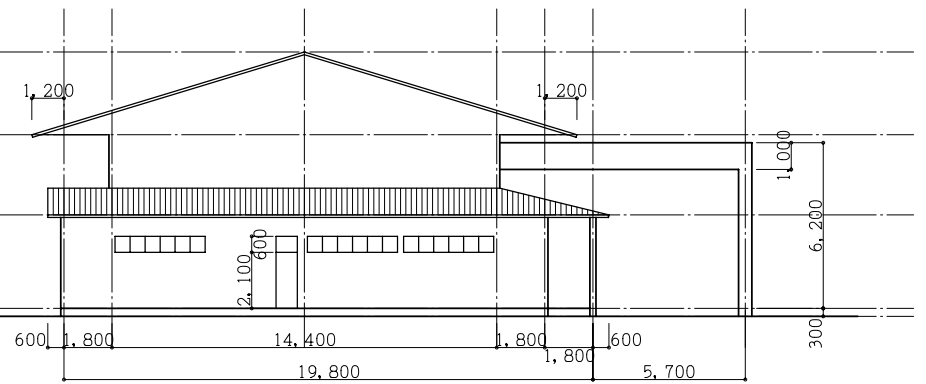

南立面図

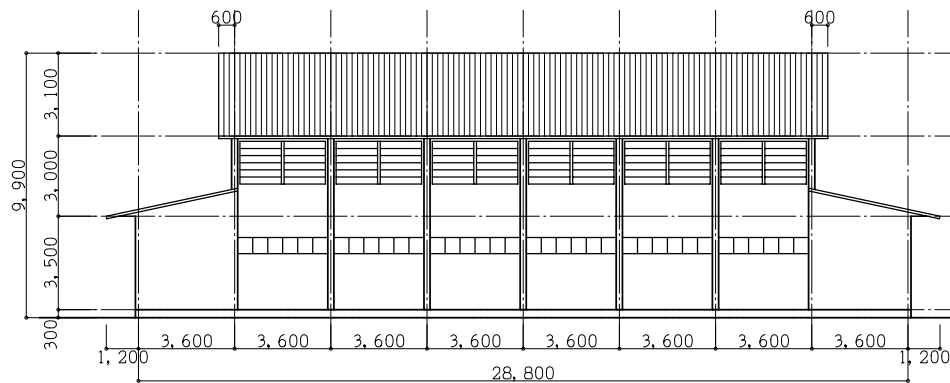

西立面図

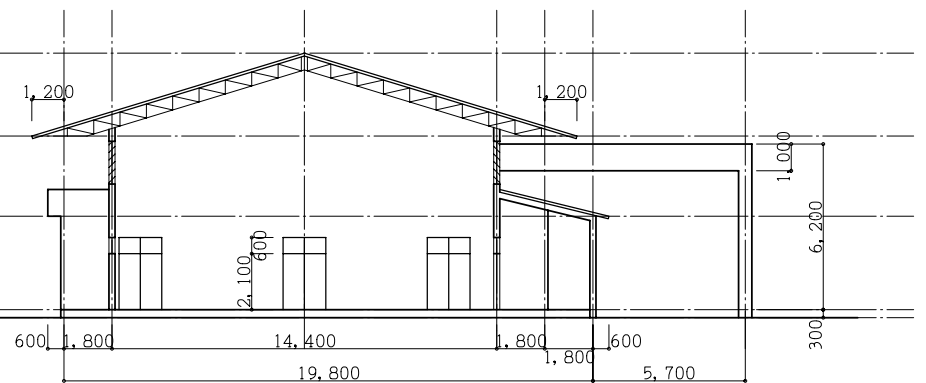

断面図

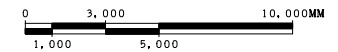

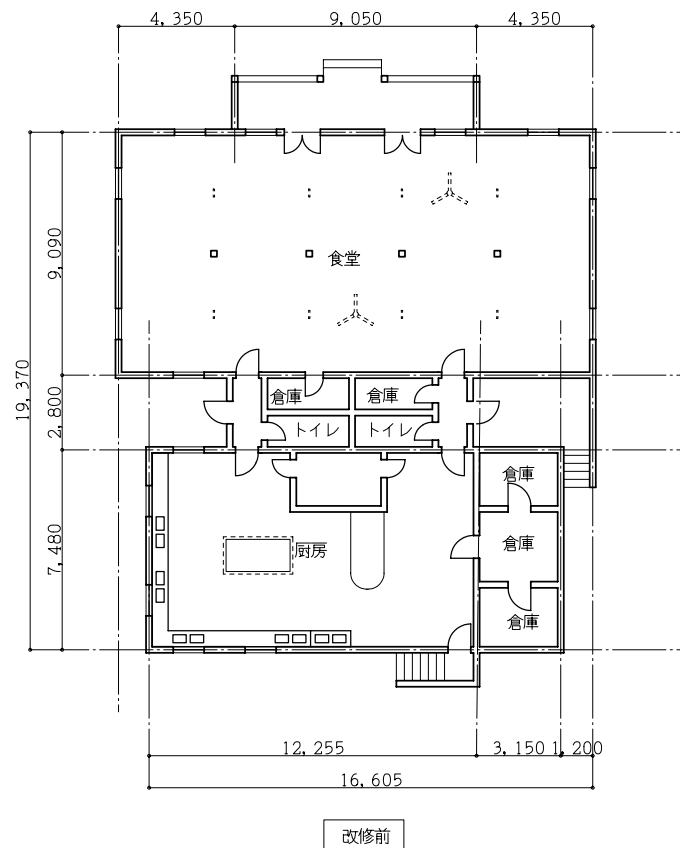

改修前

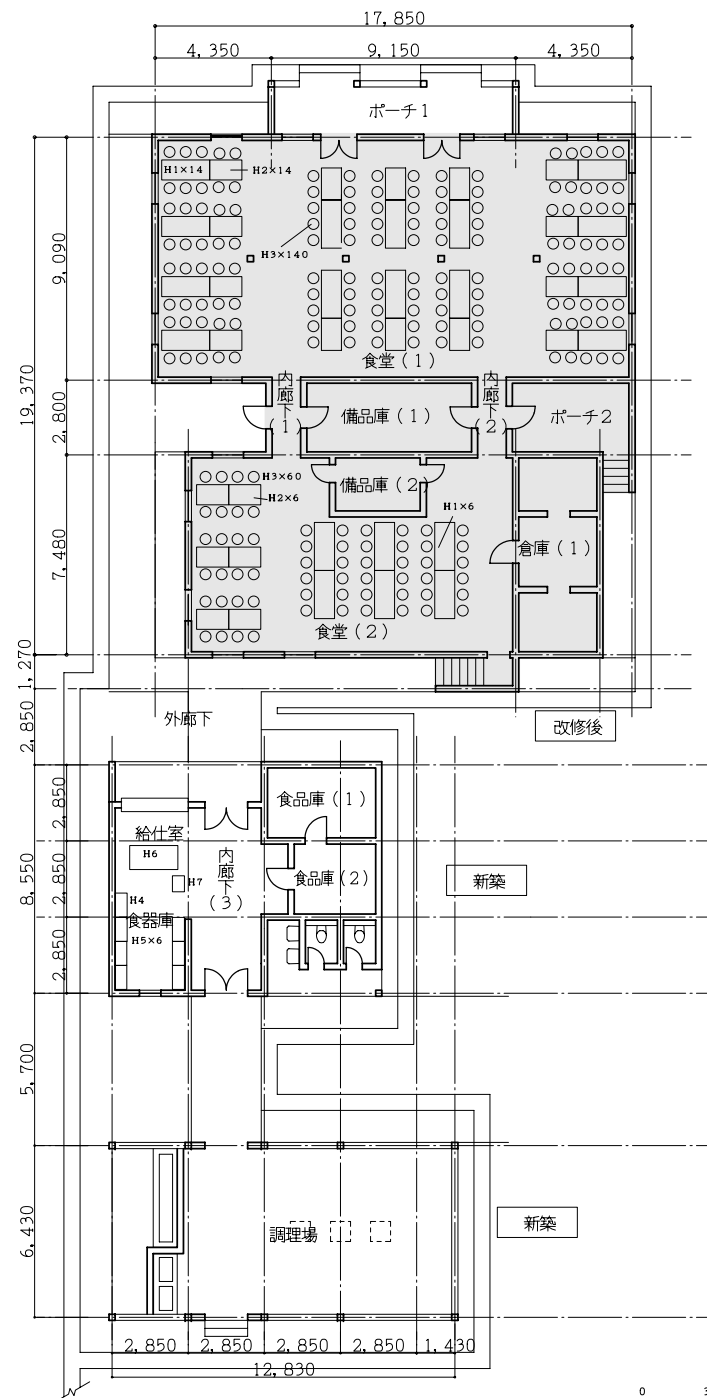

改修後

新築

新築

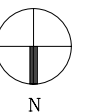
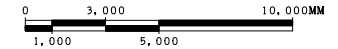

食堂

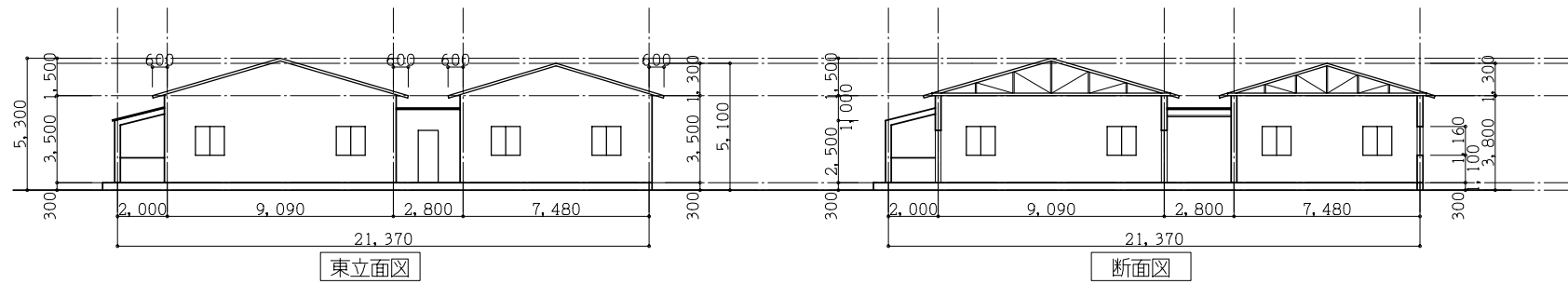

給仕室

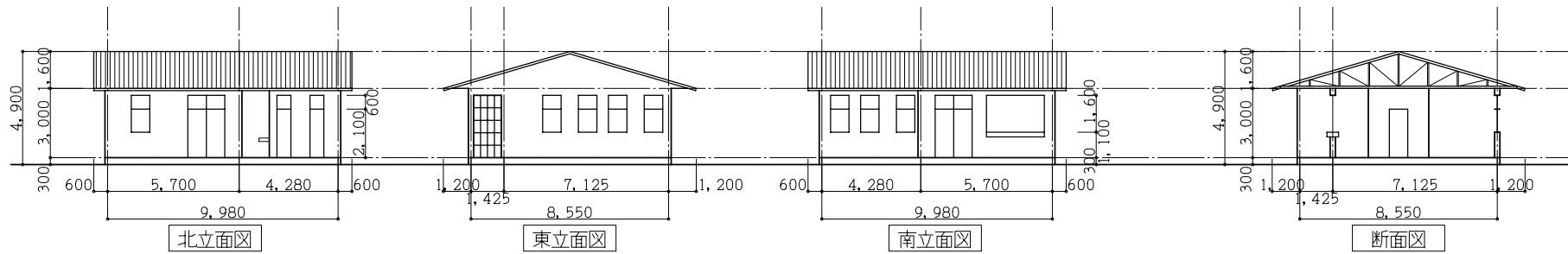

調理場

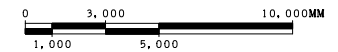
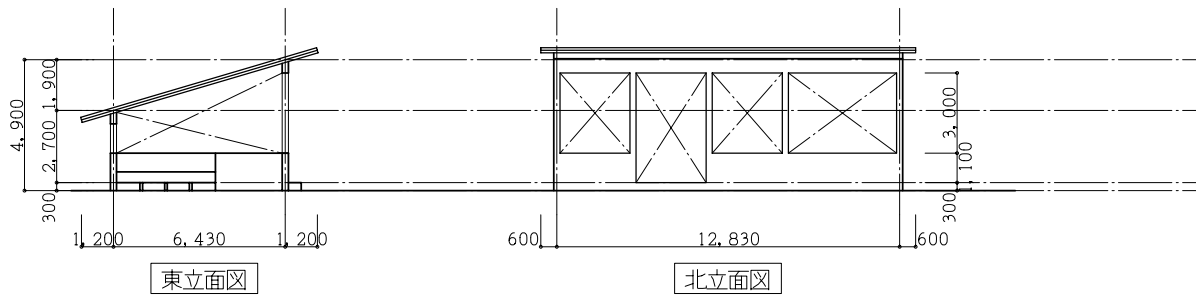

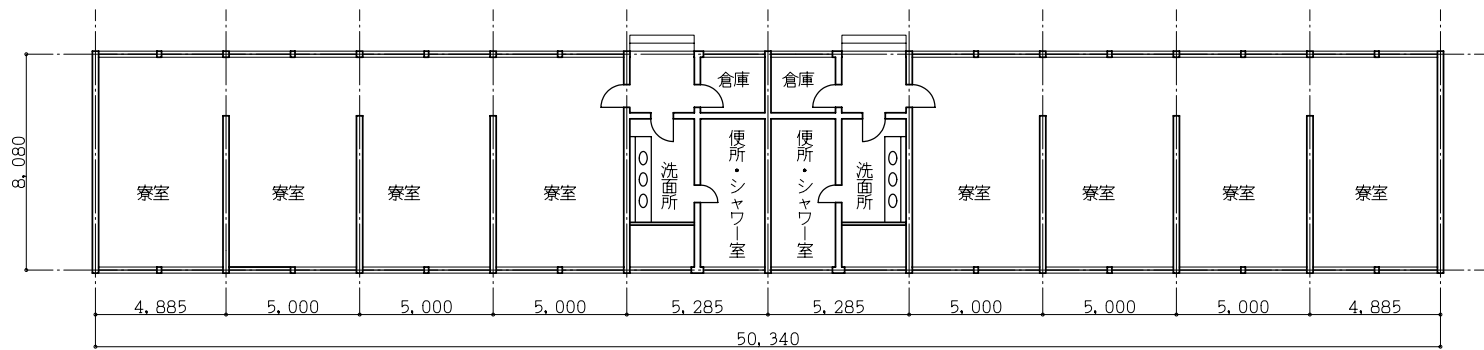

改修前

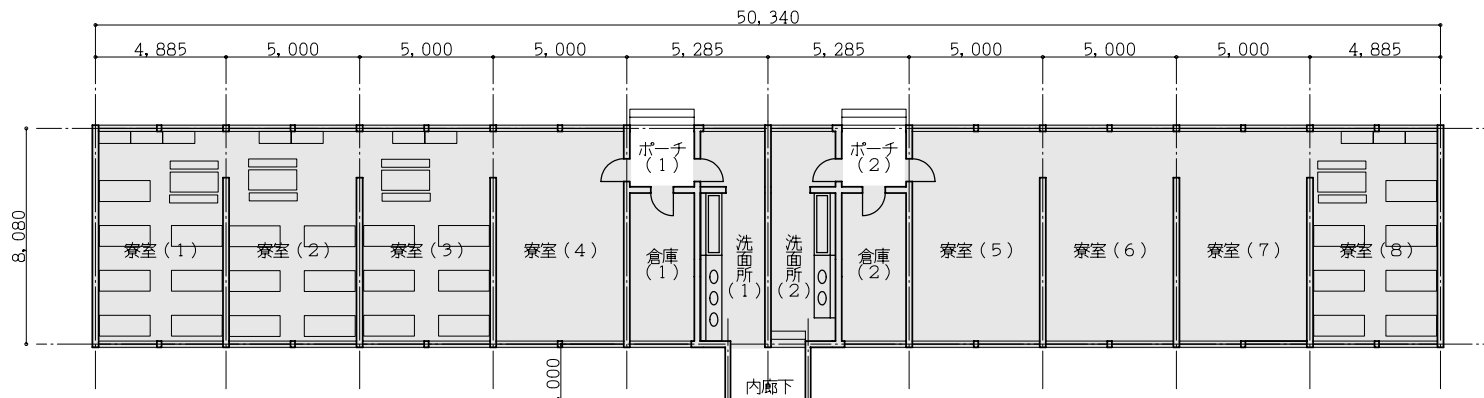

改修後

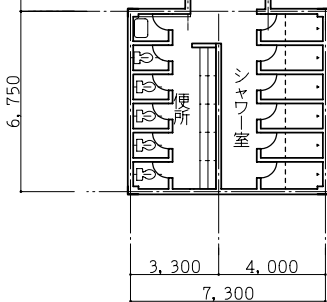

新築

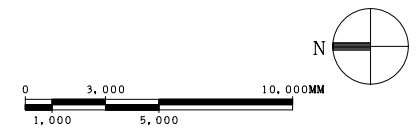

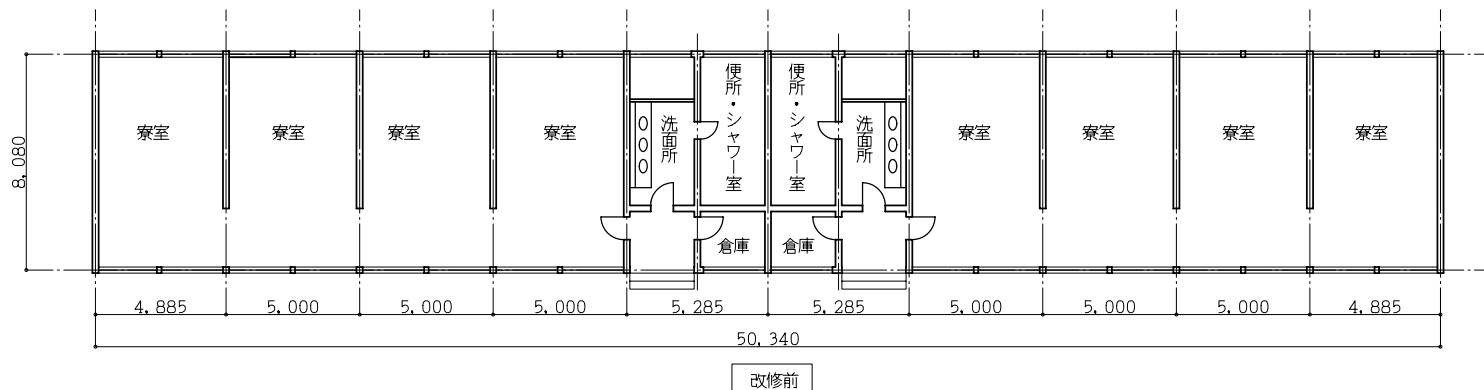

改修前

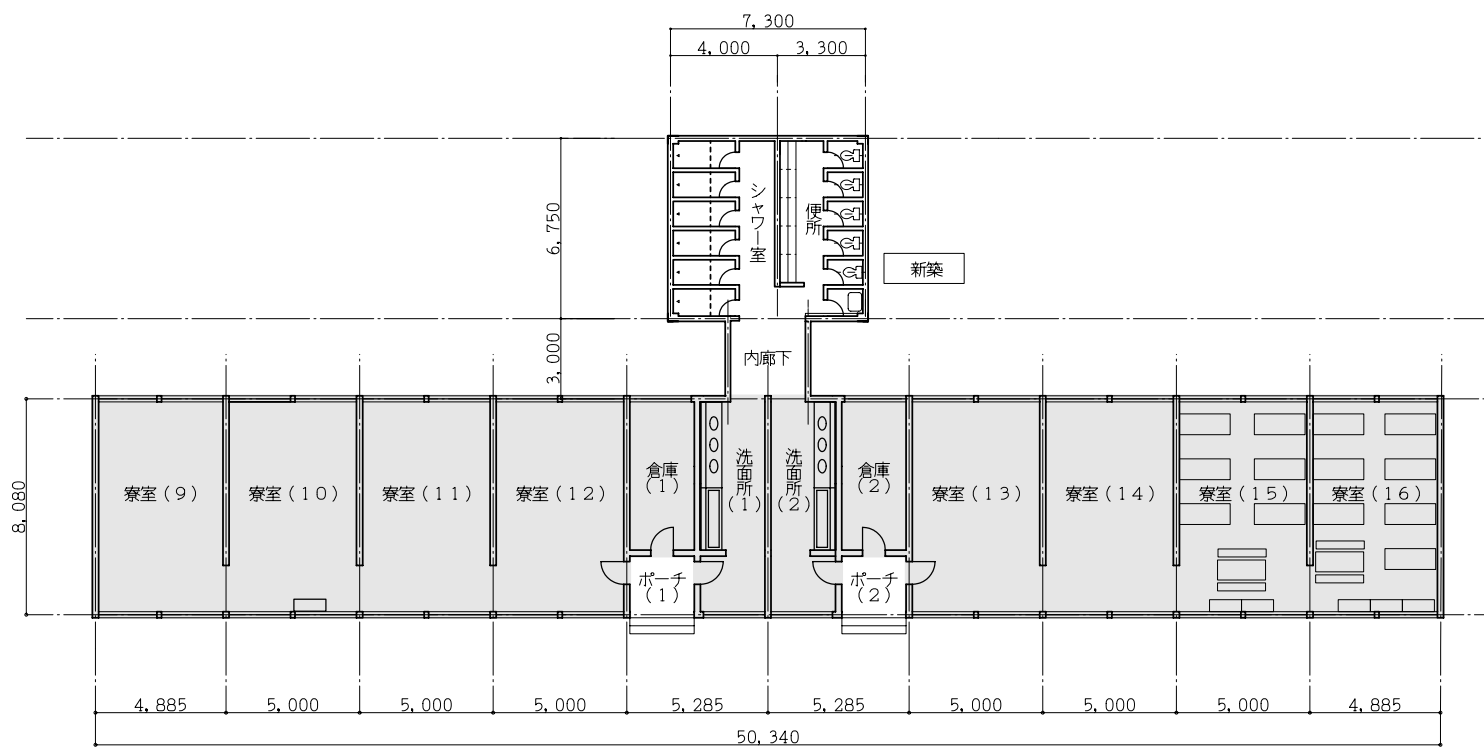
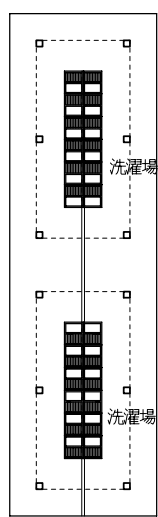

改修後

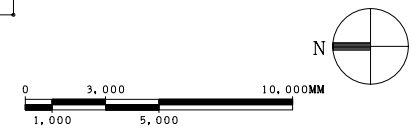

男子寮棟 (1)

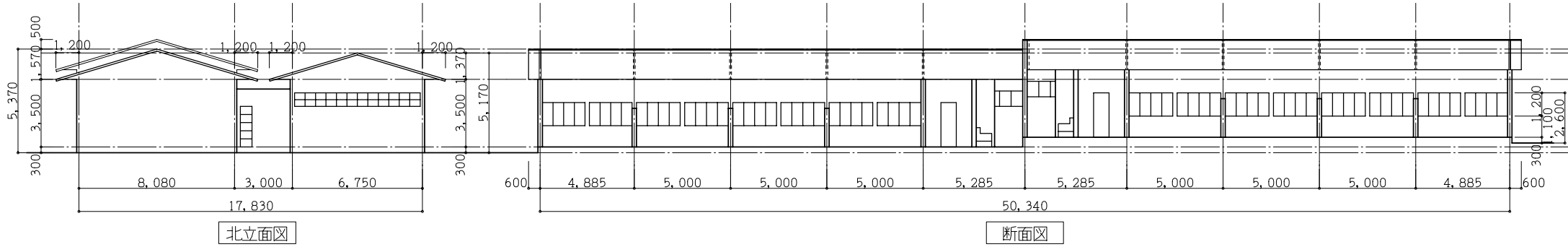

男子寮棟 (2)

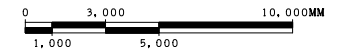
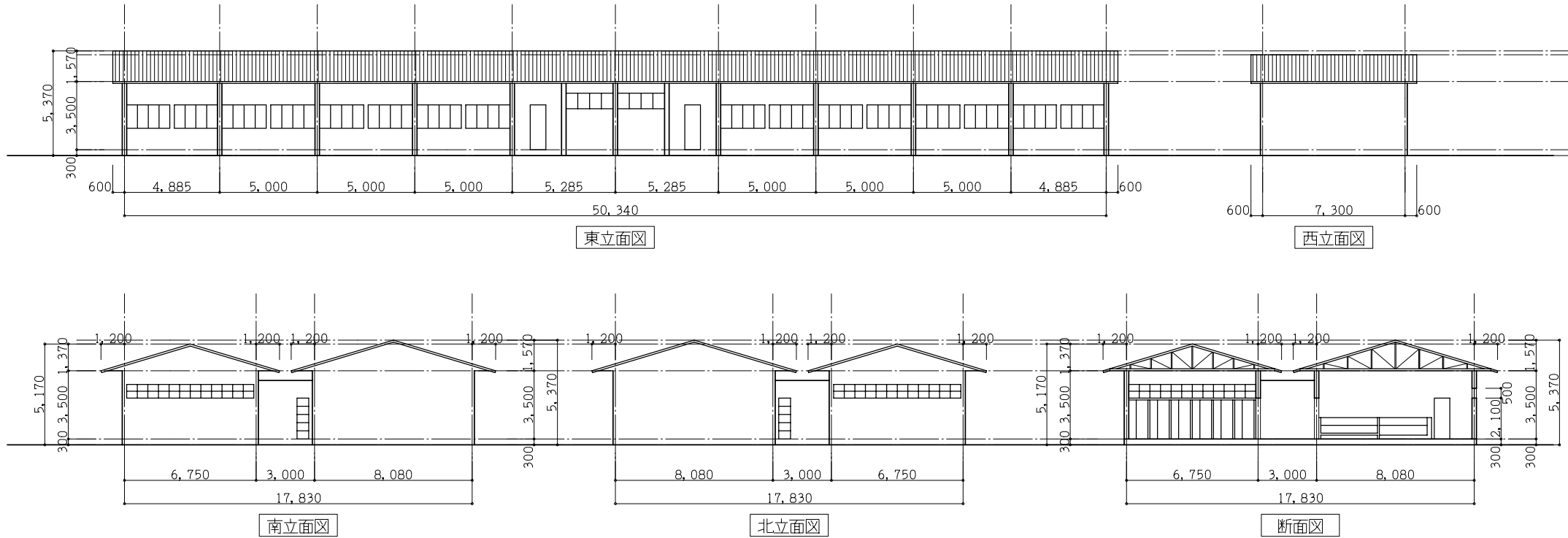



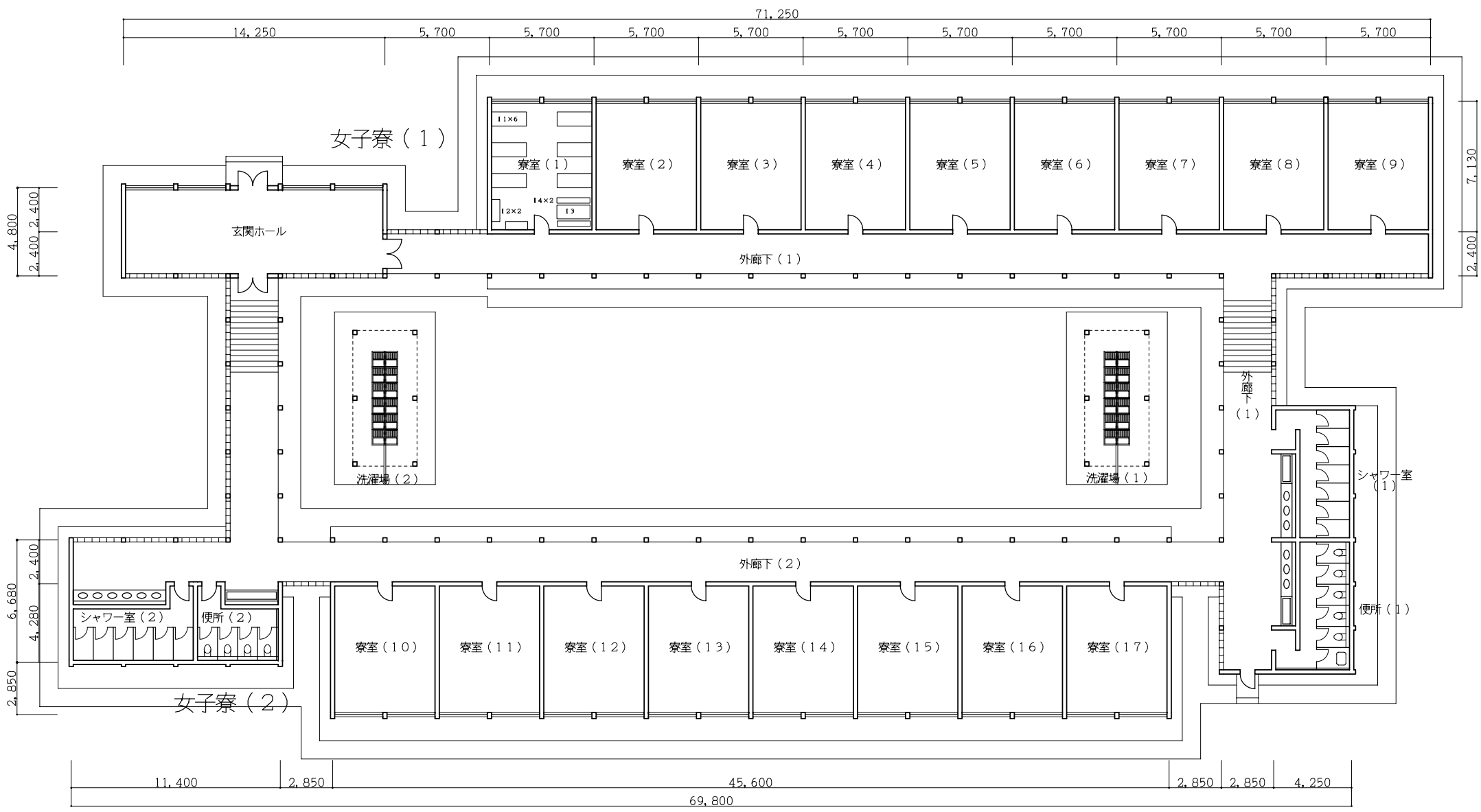

新築

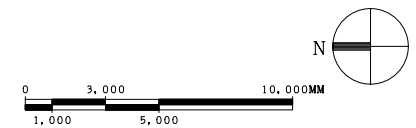

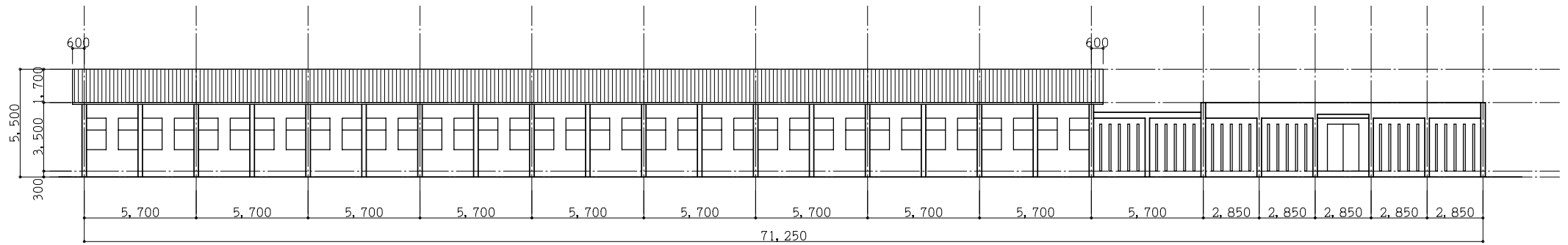

東立面図

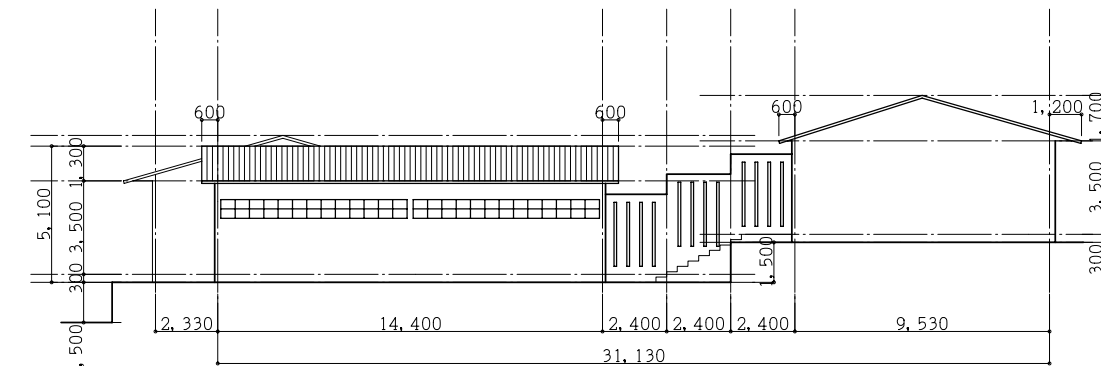

南立面図

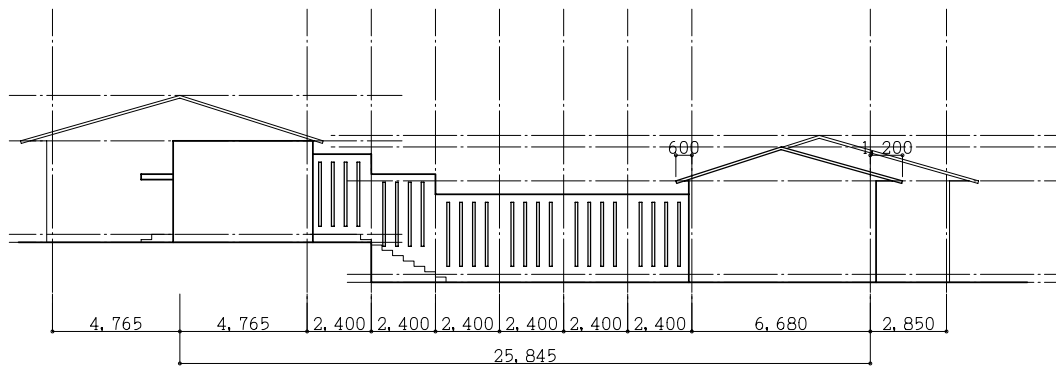

北立面図

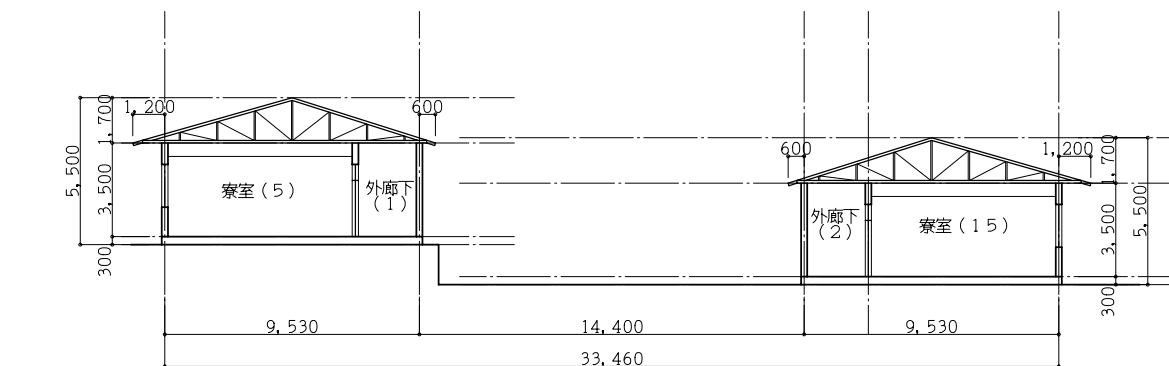

断面図1

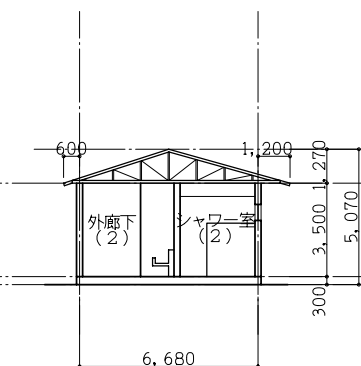

断面図2

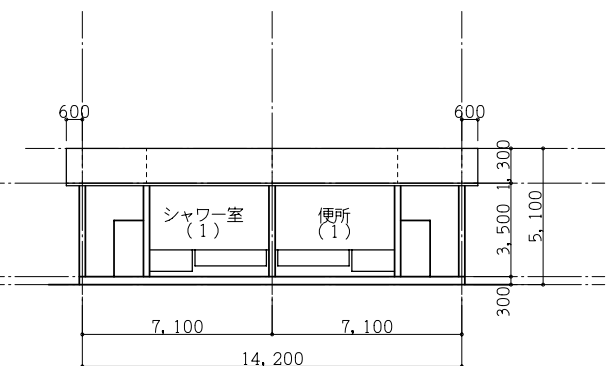

断面図3

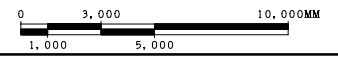

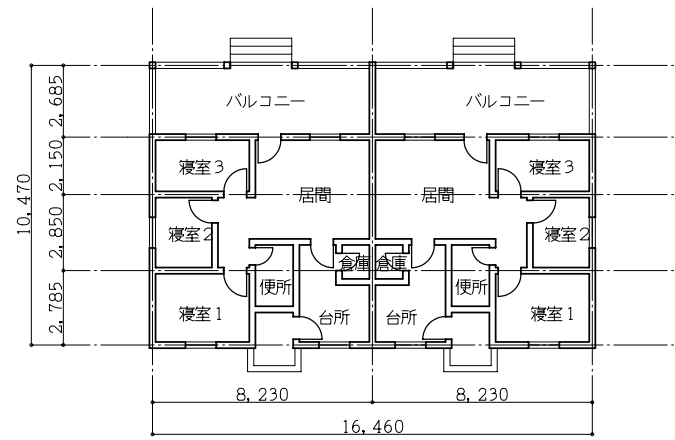

(1A)

(1B)

改修前

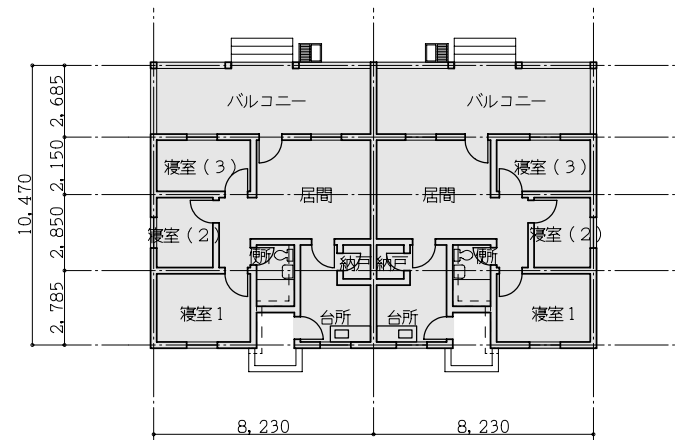

(1A)

(1B)

改修後

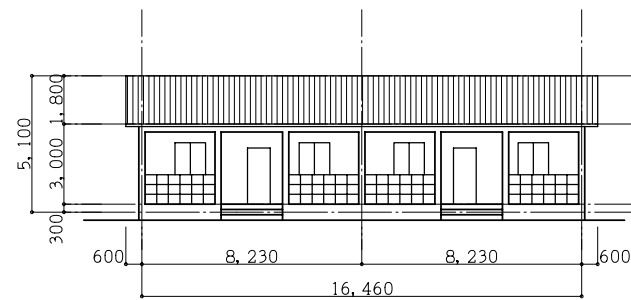

東立面図

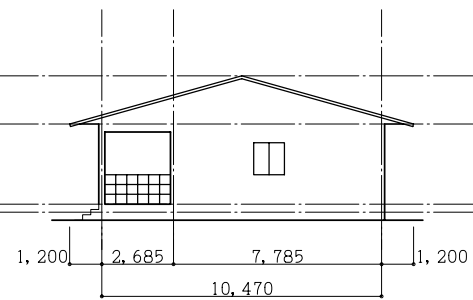

北立面図

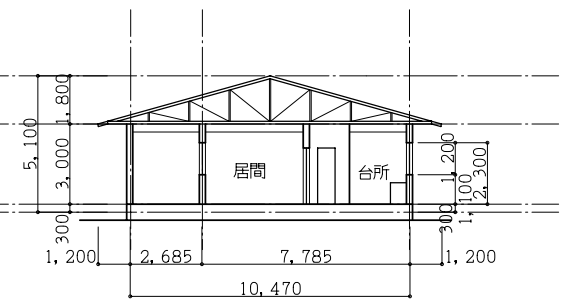

断面図

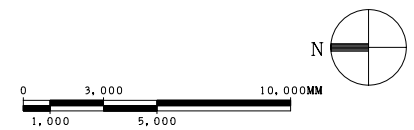

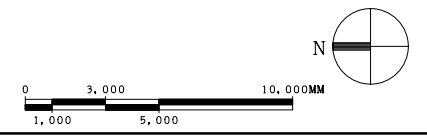
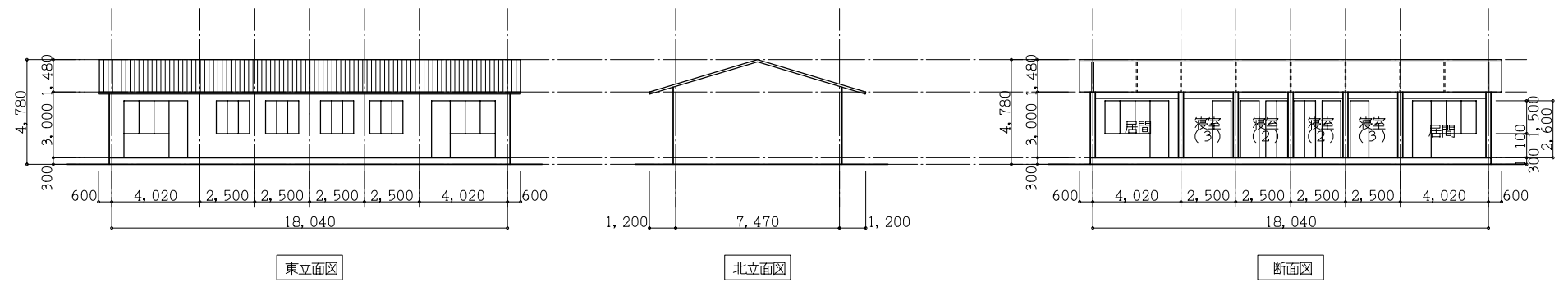
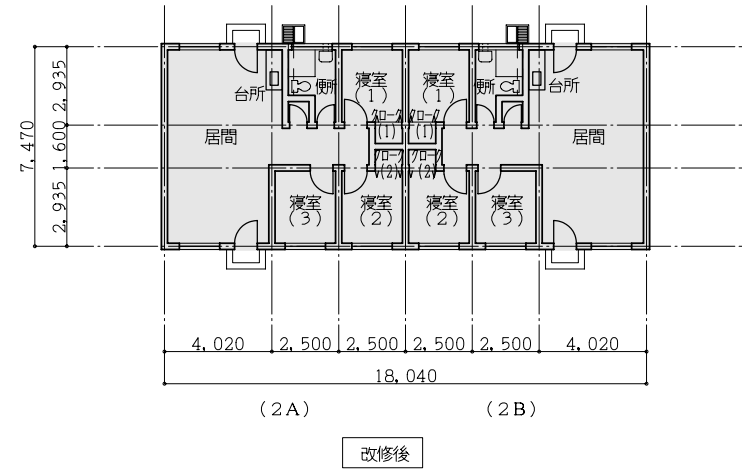
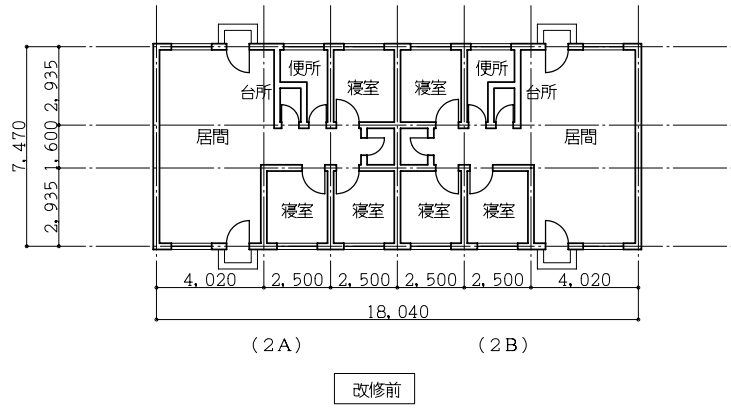

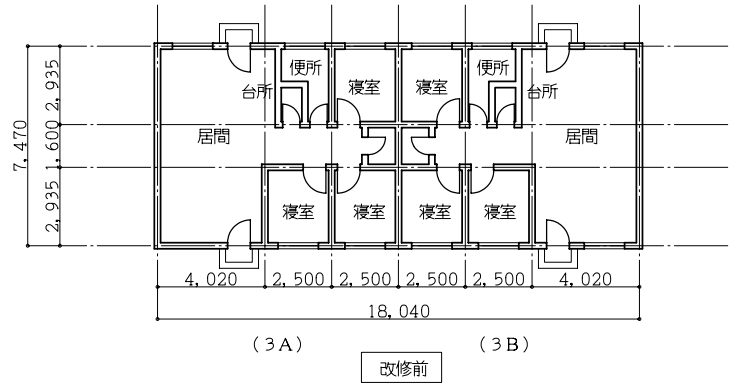

(3A) (3B)

改修前

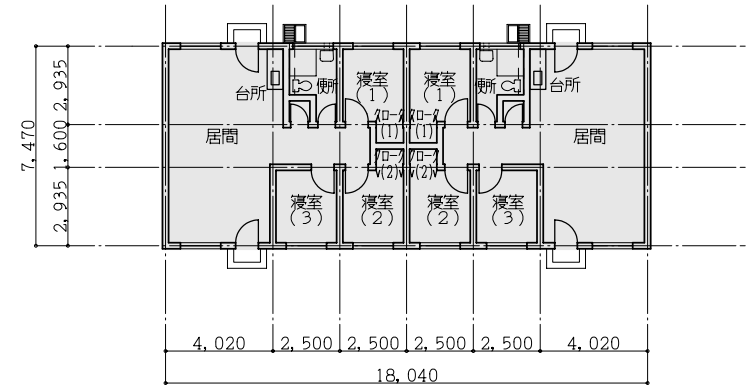

(3A) (3B)

改修後

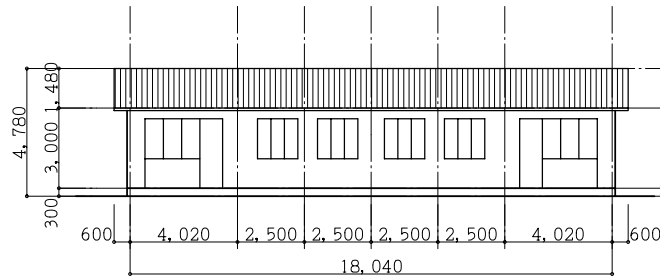

東立面図

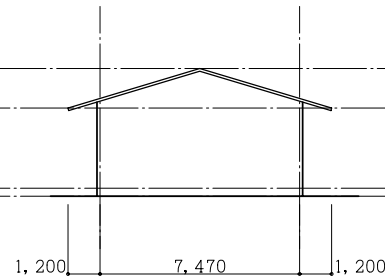

北立面図

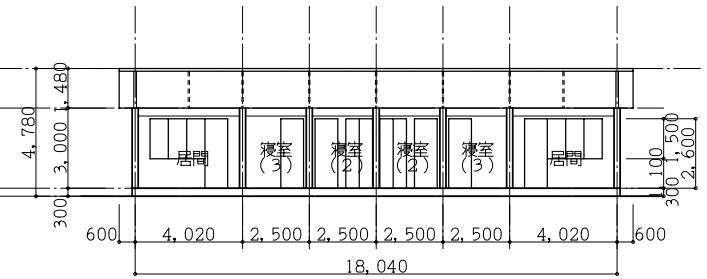

断面図

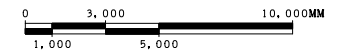
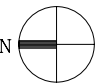

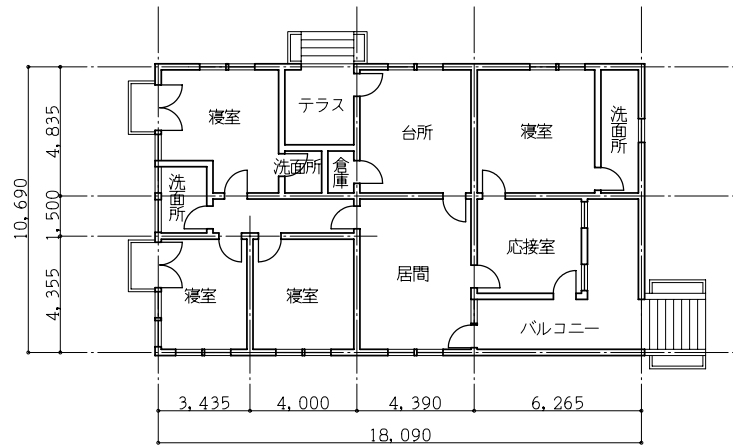

改修前

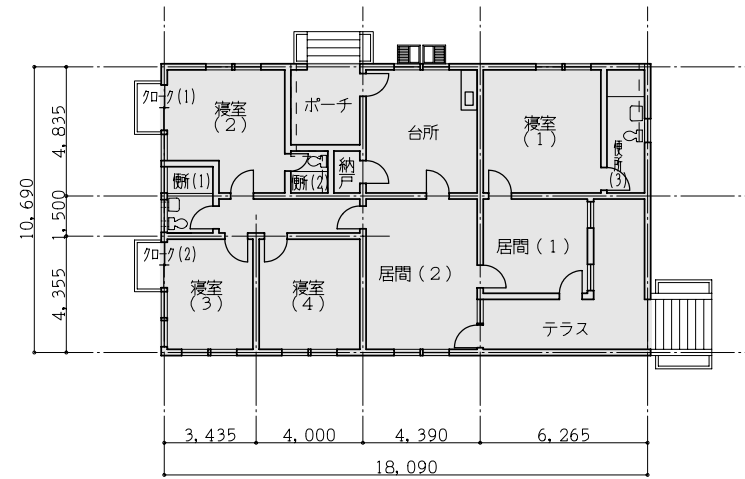

改修後

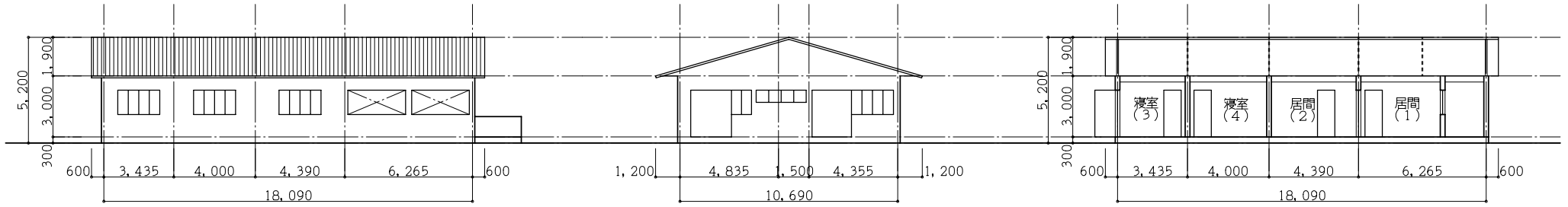

北立面図

東立面図

断面図

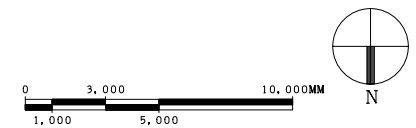

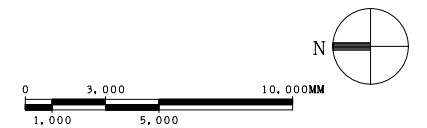
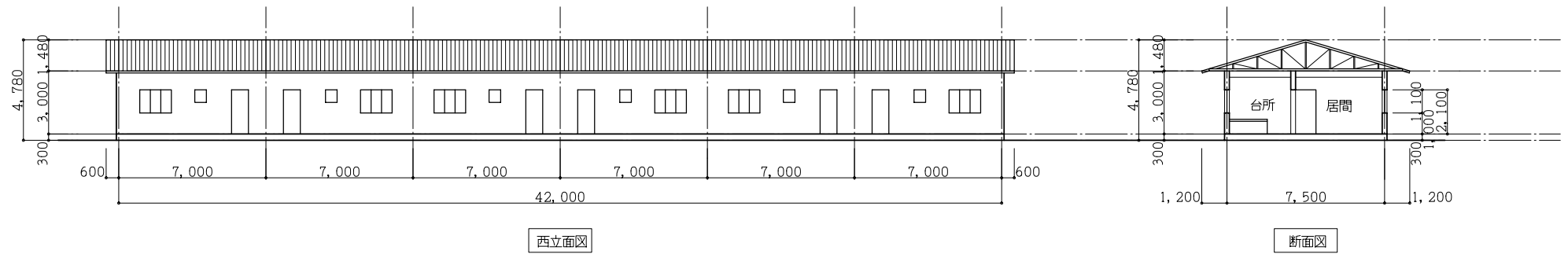
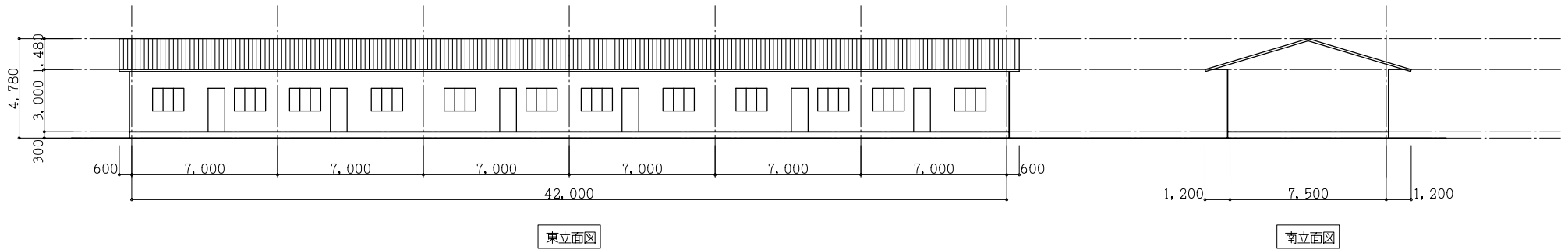
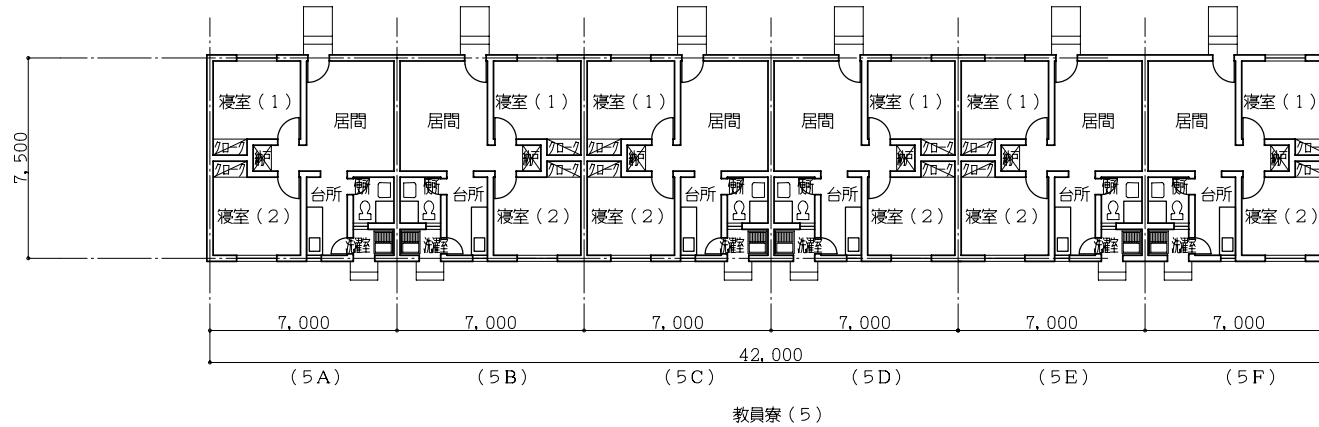

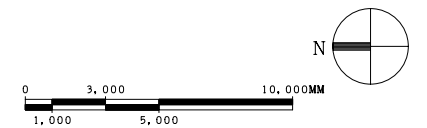
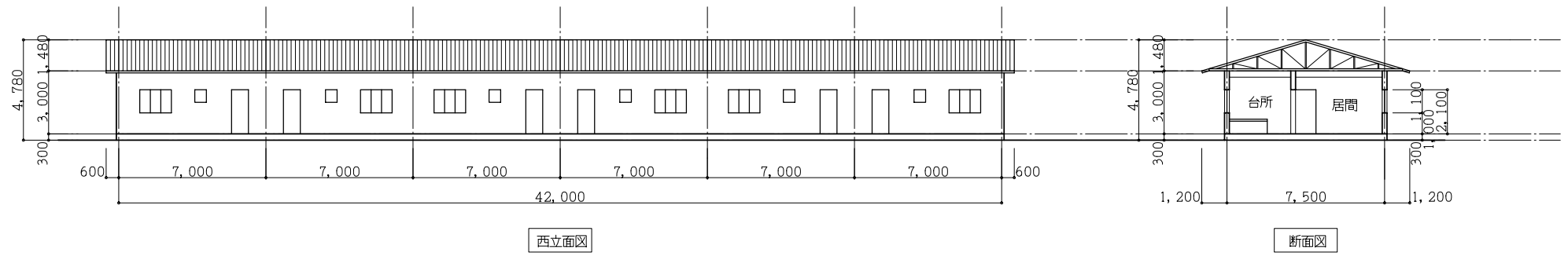
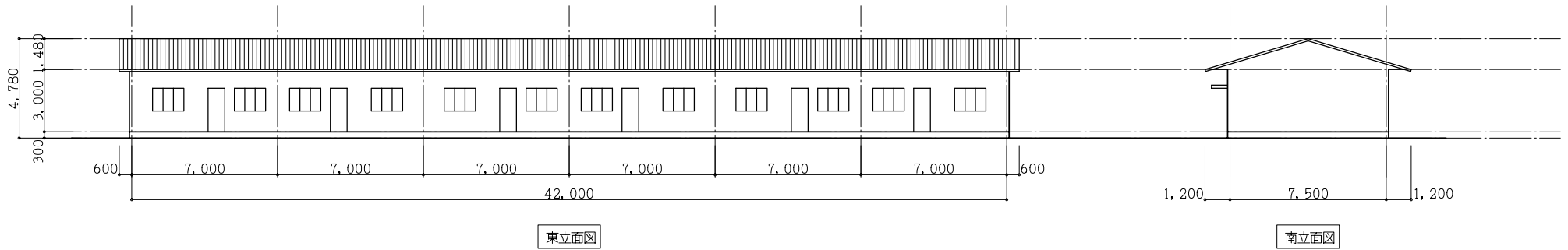
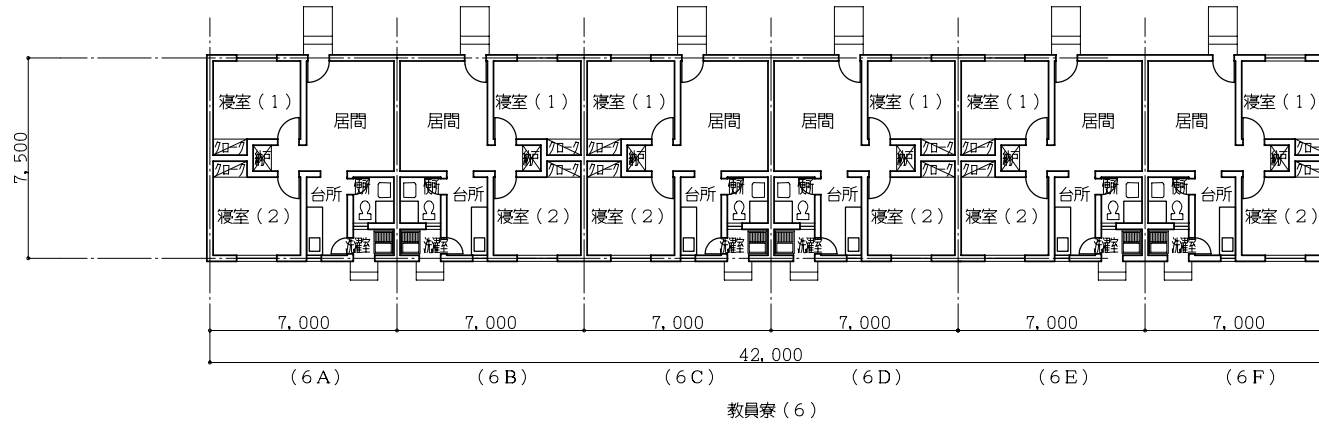



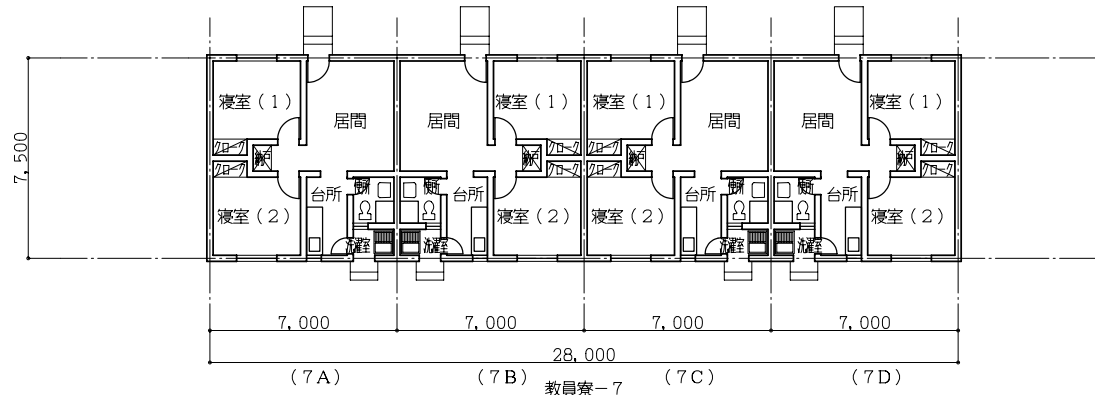

新築

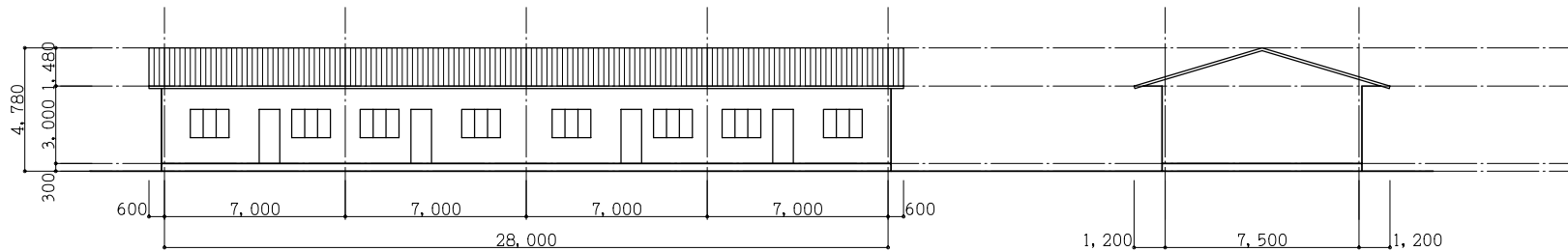

東立面図

南立面図

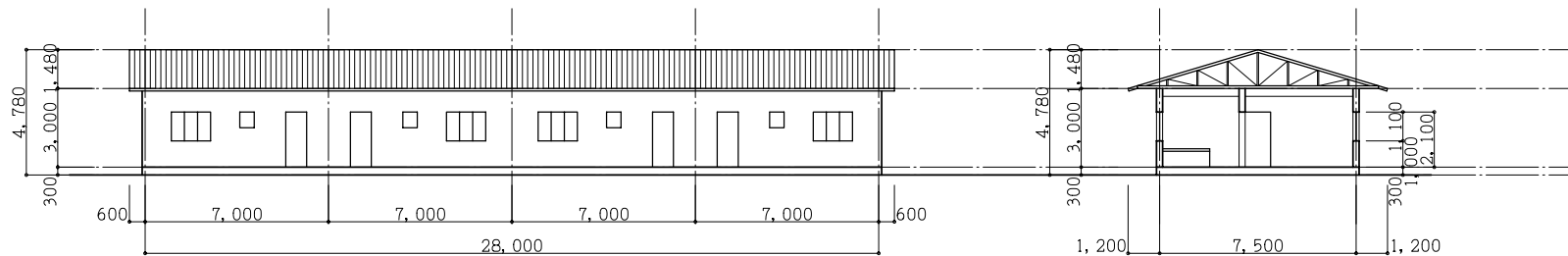

西立面図

断面図

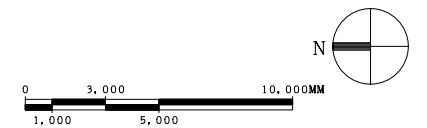

車庫 (1)

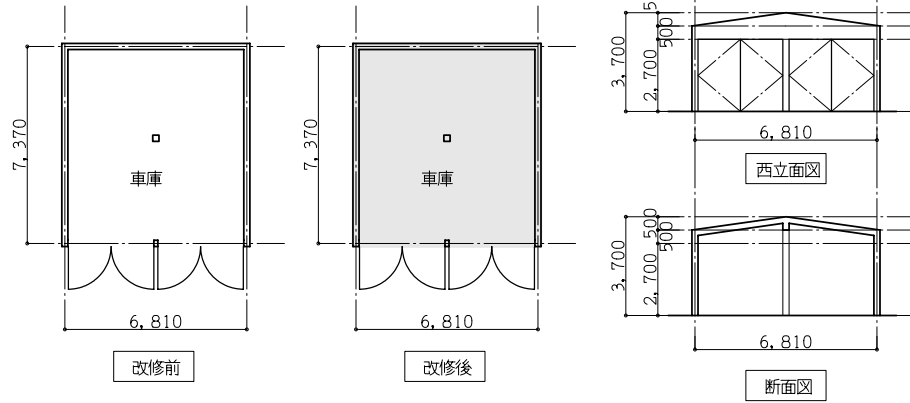

車庫 (2)

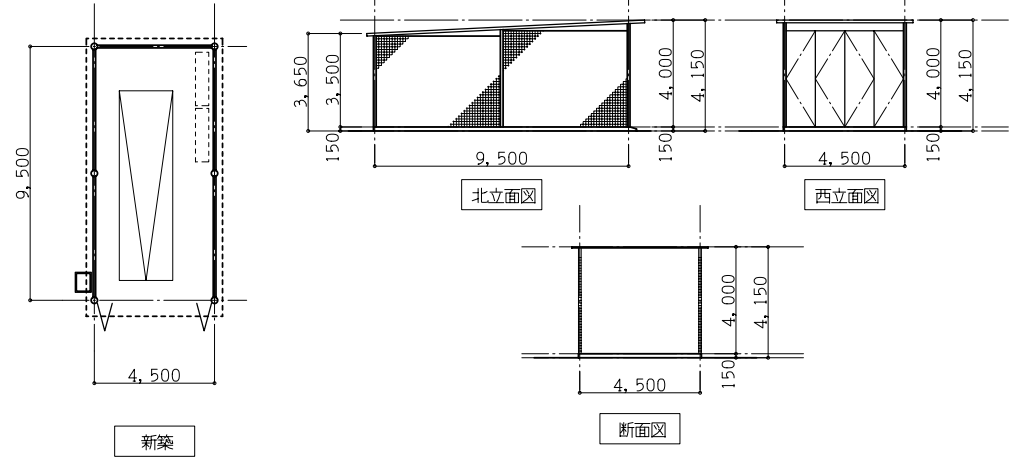

電気室棟 (1)

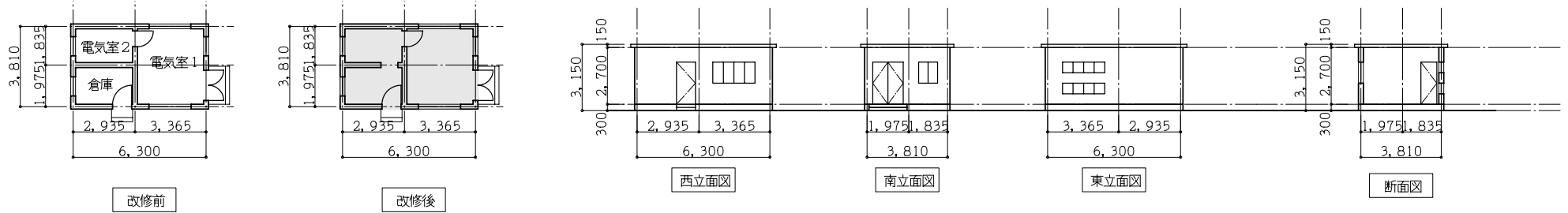

電気室棟 (2)

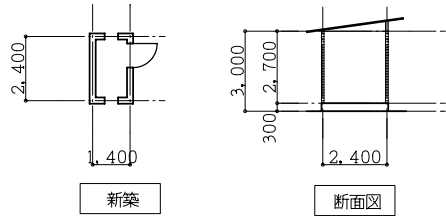

守衛室棟

