

*The Study on Water Resources Development for  
Metro Manila in the Republic of the Philippines  
Final Report  
Data Book*

***Geological  
Investigation  
Data***

# ***G1 Borehole Log***

G1-1

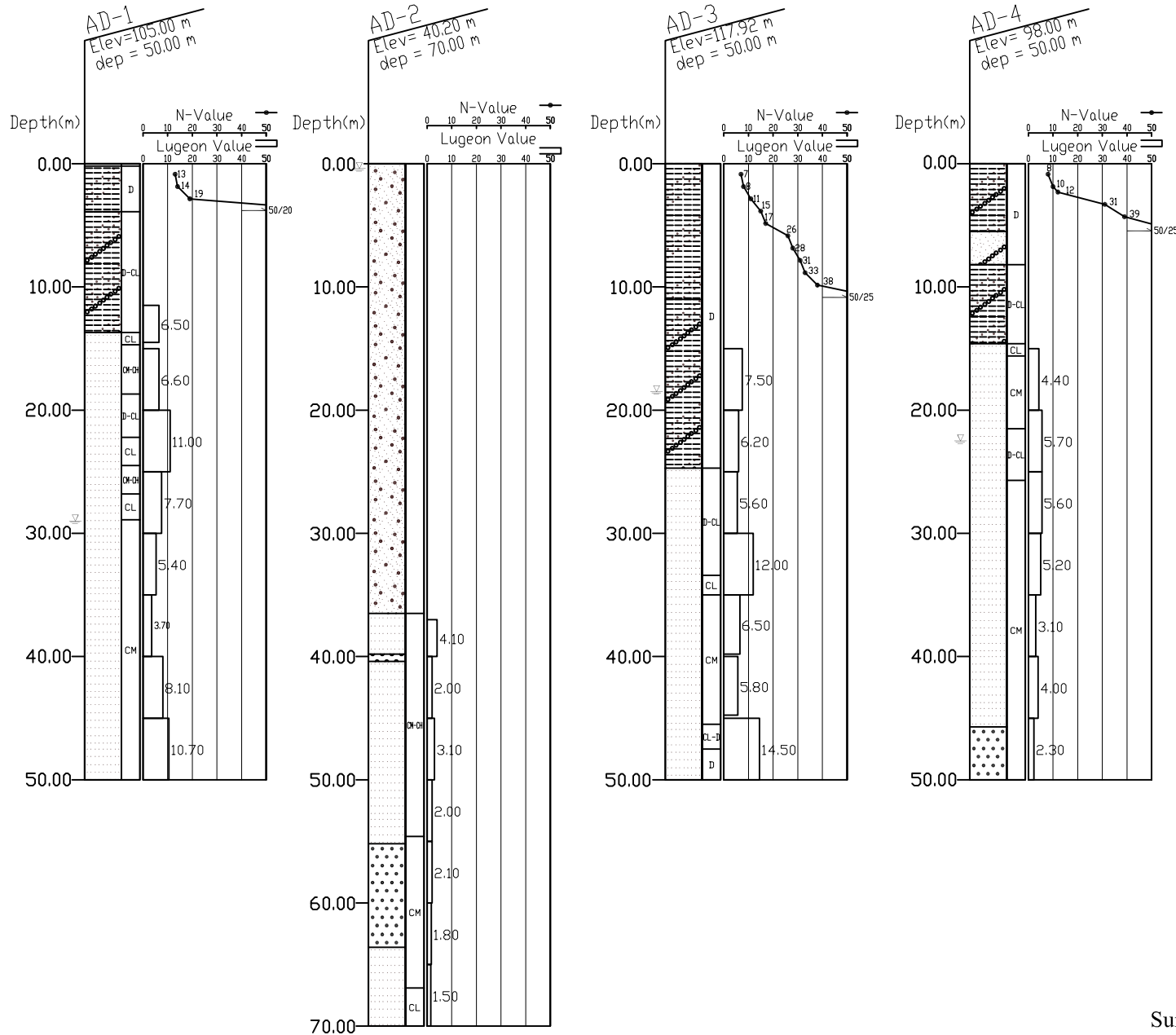

- LEGEND**
- Sandstone
  - Conglomerate
  - Shale
  - Mudstone
  - Alternation of Conglomerate and Sandstone
  - Alternation of Sandstone and Shale
  - Alternation of Conglomerate and Shale
  - Limestone
  - Tuff Breccia
  - Basalt
  - Fault
  - Sand and Gravel
  - Gravelly Sand
  - Sand with Gravel
  - Sand
  - Silty Sand with Gravel
  - Silty Sand
  - Sandy Silt with Gravel
  - Gravelly Silt
  - Sandy Silt
  - Silt
  - Clayey Silt
  - Sandy Clay
  - Silty Clay
  - Clay
  - Humic Soil

Summarized Borehold Log (Agos Damsite 1/2)

G1-2

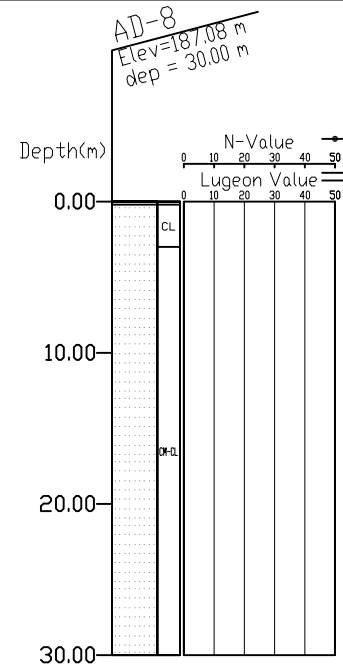
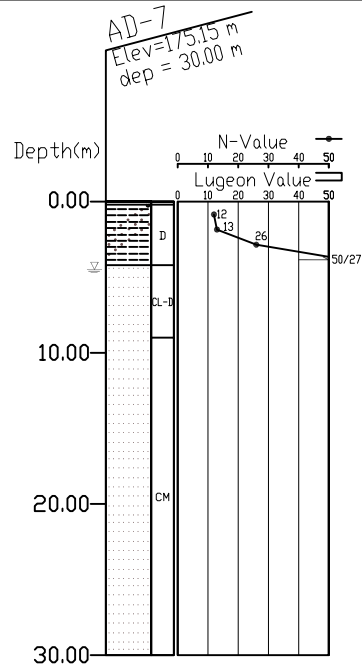
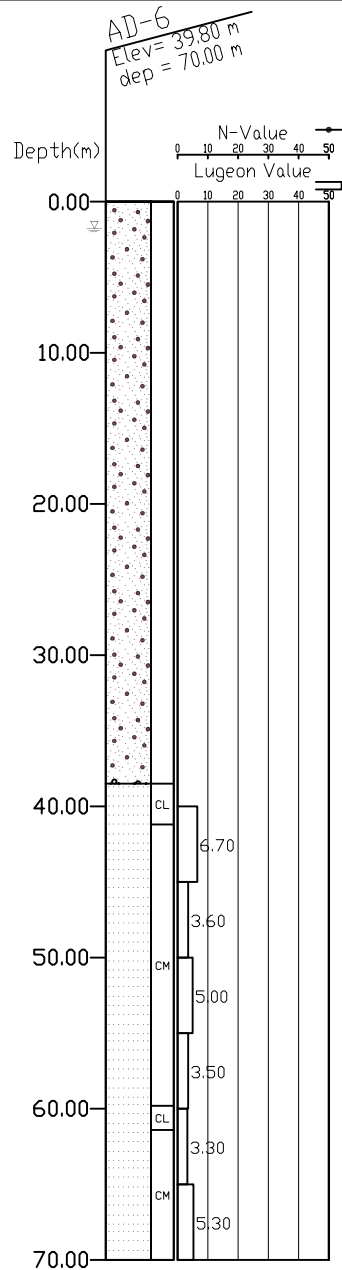
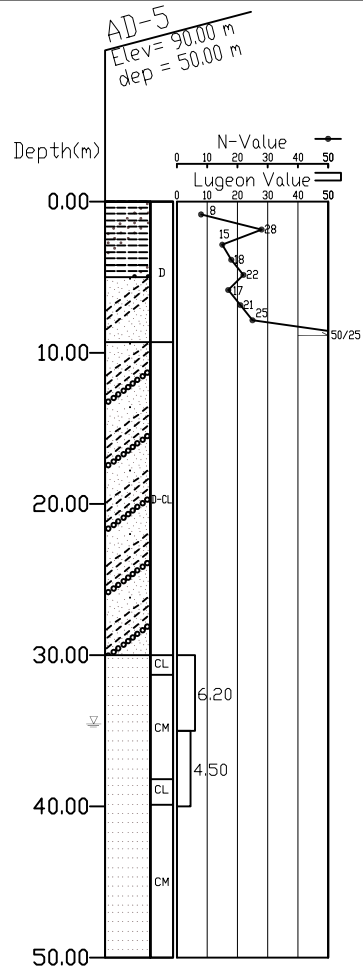

**LEGEND**

- Sandstone
- Conglomerate
- Shale
- Mudstone
- Alternation of Conglomerate and Sandstone
- Alternation of Sandstone and Shale
- Alternation of Conglomerate and Shale
- Limestone
- Tuff Breccia
- Basalt
- Fault
- Sand and Gravel
- Gravelly Sand
- Sand with Gravel
- Sand
- Silty Sand with Gravel
- Silty Sand
- Sandy Silt with Gravel
- Gravelly Silt
- Sandy Silt
- Silt
- Clayey Silt
- Sandy Clay
- Silty Clay
- Clay
- Humic Soil

Summarized Borehold Log (Agos Damsite 2/2)

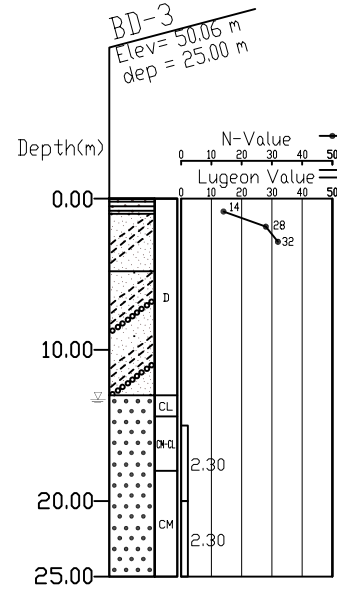
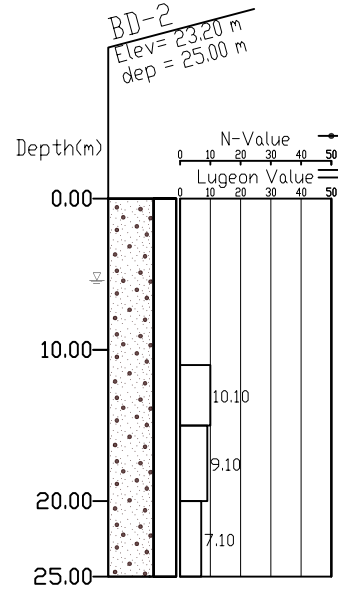
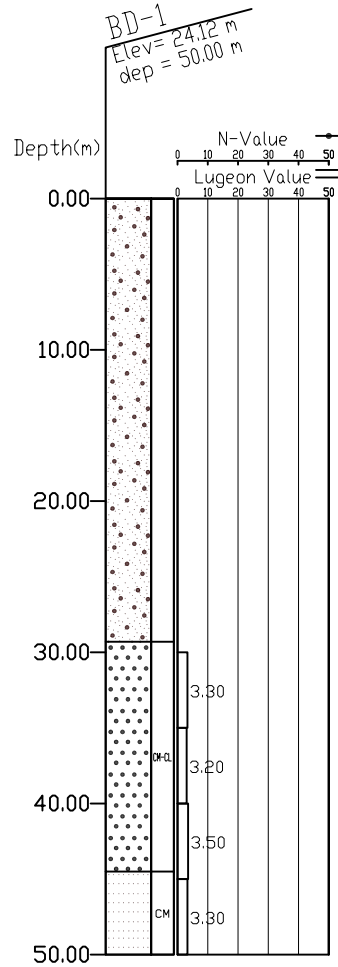







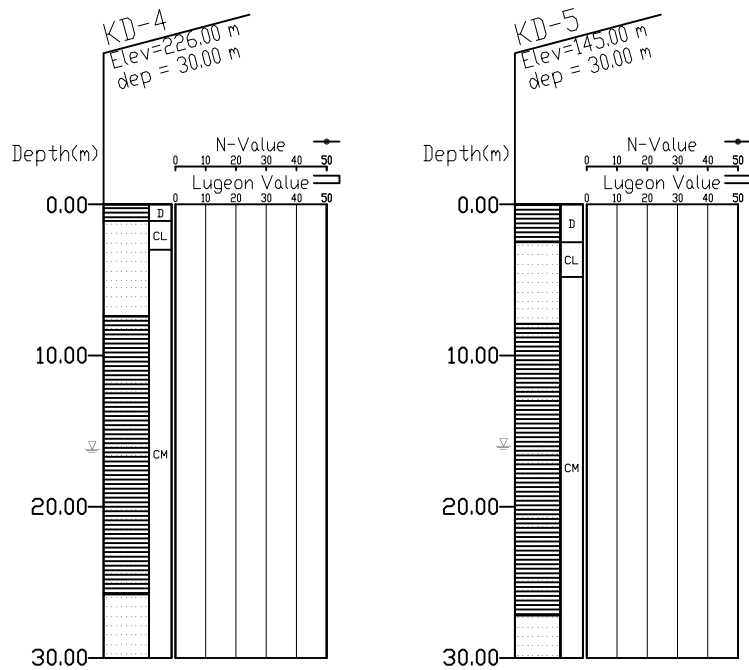
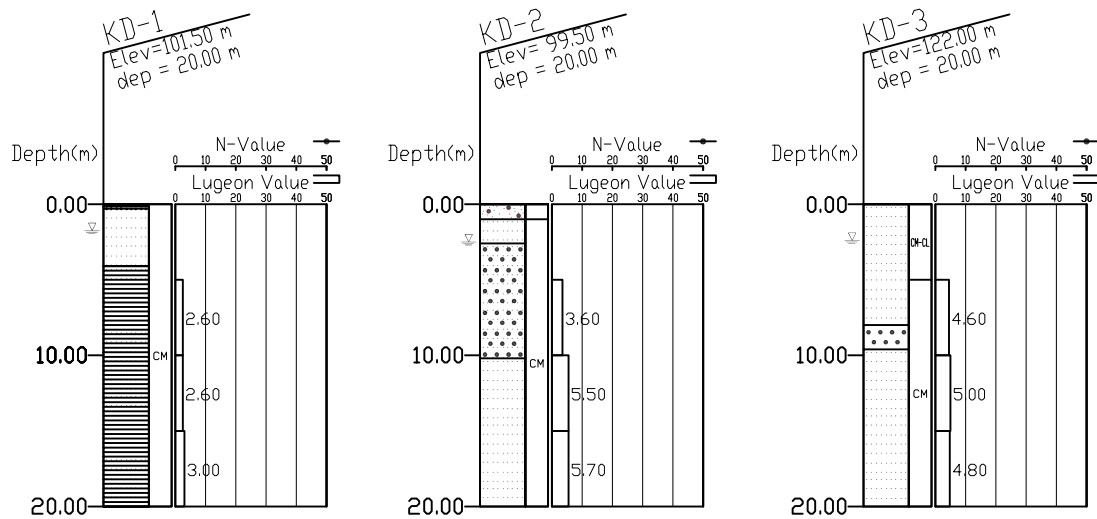



















**LEGEND**

- Sandstone
- Conglomerate
- Shale
- Mudstone
- Alternation of Conglomerate and Sandstone
- Alternation of Sandstone and Shale
- Alternation of Conglomerate and Shale
- Limestone
- Tuff Breccia
- Basalt
- Fault
- Sand and Gravel
- Gravelly Sand
- Sand with Gravel
- Sand
- Silty Sand with Gravel
- Silty Sand
- Sandy Silt with Gravel
- Gravelly Silt
- Sandy Silt
- Silt
- Clayey Silt
- Sandy Clay
- Silty Clay
- Clay
- Humic Soil

Summarized Borehold Log (Agos Afterbay Weir Site)



**LEGEND**

-  Sandstone
-  Conglomerate
-  Shale
-  Mudstone
-  Alternation of Conglomerate and Sandstone
-  Alternation of Sandstone and Shale
-  Alternation of Conglomerate and Shale
-  Limestone
-  Tuff Breccia
-  Basalt
-  Fault
-  Sand and Gravel
-  Gravelly Sand
-  Sand with Gravel
-  Sand
-  Silty Sand with Gravel
-  Silty Sand
-  Sandy Silt with Gravel
-  Gravelly Silt
-  Sandy Silt
-  Silt
-  Clayey Silt
-  Sandy Clay
-  Silty Clay
-  Clay
-  Humic Soil

Summarized Borehold Log (Kaliwa Low Damsite)