

CHELDIN PROJECT AREA

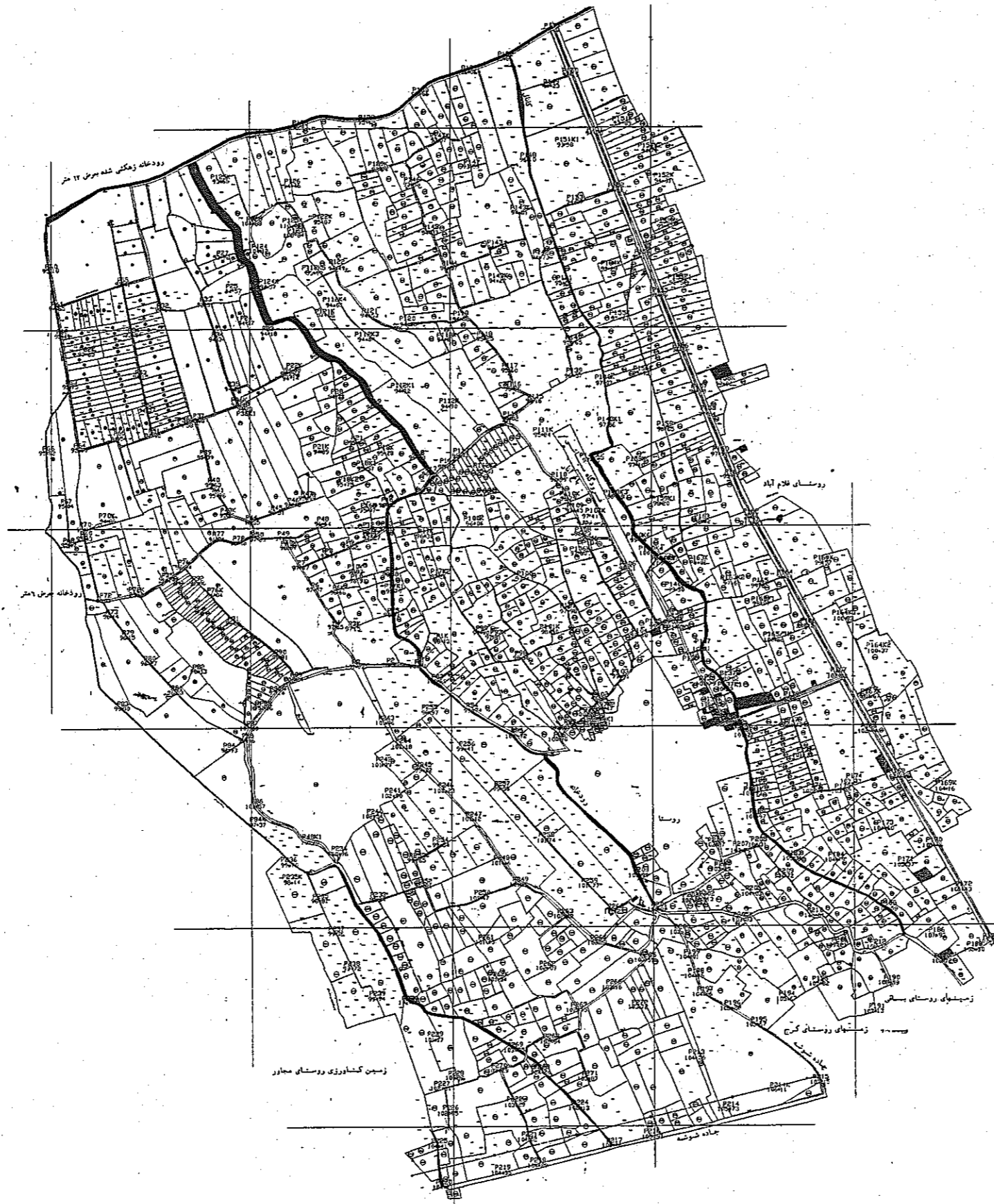

LEGEND **علامت**

BUILDING		ساختمان
RELIGIOUS BUILDING		ادبی عمارت
FOUND		فونداسیون
BUILDING BLOCK		مسکونی
WALL		دیوار
CEMETERY		گورستان
LIGHT		نور
DIAM		رادیوس خطی
DIAM		رادیوس خطی
ASPHALTED		راه آسفالت
4 WHEEL ROAD		راه چهار چرخ
UNSPAVED ROAD		راه خاکی
FOOTPATH		راه پیاده
IRRIG		سیلاب
WIRE FENCE		سیم خاردار
FENCE		نرده
HEDGE		حصار
POWER LINE		خط انتقال نیرو
PYLON		دکولن
TELEPHONE OR TELEGRAPH LINE		تلفون یا تلگراف - روی
PIPE LINE		خط لوله
GARDEN TREES		درختکاری
CULTIVATED LAND		زمین کشت
PASTURE-LAWN		میدان چمن
TREE LINE		ردیف درخت
BUSHES		بوشه زار
RIVER		رودخانه
CANAL		کانال
CANAL		کانال
WATER CHANNEL		آبچرخ
FLOOD WAY		مسیر سیلاب
LAGOON		بسترآب
CONTROLS		مختصات
DAM-WELL		دره شاد - چاه
CUTTING		برهه گوی - شرفه
SPOT HEIGHT		نقطه ارتفاع
TUG POINT		نقطه تکیه
54 PLYTON STATION		پایه پلکان - روی پلکان
54 SURVEY STATION		پایگاه فرس
VINEYARD		باغستان
POOL		استخر
ROCK		سنگ
TANK/WATER TOWER		مخزن (یا منقش آب)
GATE		دریچه
FAUCET		شیرآب
PUMP STATION		پمپخانه
Reservoir		آب انبار

JICA Japan International Cooperation Agency (JICA)
 The Study on Improvement of Irrigation & Drainage and Agricultural Development for Geozma Plain, Geozma Province in The Islamic Republic of Iran

Islamic Republic of Iran جمهوری اسلامی ایران
 Ministry of Jihad - Agriculture وزارت جهاد کشاورزی
 Organization of Jihad - Agriculture Geozma Province سازمان جهاد کشاورزی استان گوزما
 Title: General layout plan of Irrigation & Drainage system of Geozma Plain نقشه کلی سیستمهای آبیاری و زهکشی نواره آبیاری

Date: 2002-June	تاریخ: ۱۳۸۱ تیر	Designed: Fezhad Zaimy	طراح: فزحد زایمی
Drawn: Fezhad Zaimy	ترسیم: فزحد زایمی	Checked: Fezhad Zaimy	کنترل: فزحد زایمی
Scale: 1:20000	مقیاس: ۱/۲۰۰۰۰	Approved: Fezhad Zaimy	تصویب: فزحد زایمی

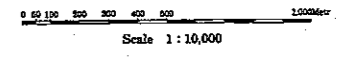

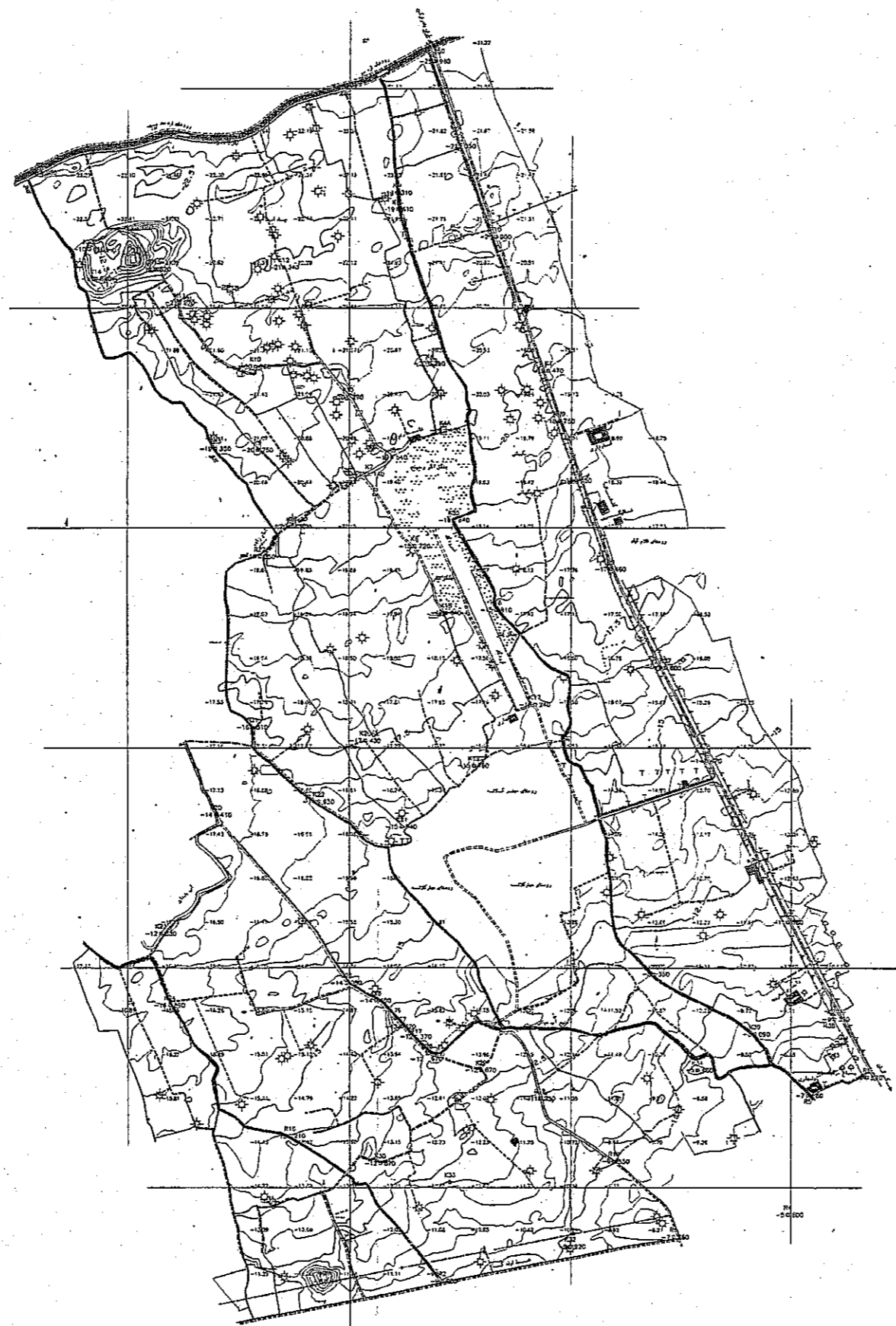

LEGEND **نشانها**

- BUILDING ساختمان
- REGGIOUS BUILDING اماکن مذهبی
- RIVER رودخانه
- BUILDING BLOCK محله
- WALL دیوار
- CEMETERY گورستان
- LIMIT حد
- DIAM قطر
- GAZE نگاه
- ASPHALTED راه آسفالت
- 4 WHEEL ROAD راه چهار چرخ
- UNASPHALTED ROAD راه خاکی
- FOOTPATH راه پیاده
- BRIDGE پل
- WIRE FENCE سیم خاردار
- FENCE دیوار
- HEDGE چمن
- POWER LINE خط انتقال نیرو
- PTON دکل
- TELEPHONE OR TELEGRAPH LINE ت ت - تلفن - تلگراف
- PIPE LINE خط لوله
- BANDED TREES بوخ درختکاری
- CULTIVATED LAND زمین کشت
- PLANT-LAWN بوخ - چمن
- TREE LINE ردیف درخت
- BUSHES بوخچه
- RIVER رودخانه
- CANAL کانال
- CANAL کانال
- WATER COURSE آبدره
- FLOOD WAY سیلاب
- LAGOON بستر آب
- CONTOURS منحنی ارتفاع
- CAHAT-WELL رشته
- CUTTING بریده
- SPOT HEIGHT نشانه ارتفاع
- TRIP POINT نقطه توقف
- 5M POLLUTION STATION ایستگاه آلودگی
- 5M SURVEY STATION ایستگاه نقشه
- VINEYARD باغستان
- POOL استخر
- DOCK بندر
- INDUSTRIAL PLANT کارخانه
- WELL چاه
- FACTORY کارخانه
- PUMP STATION ایستگاه پمپ
- Reservoir آب انبار

JICA Japan International Cooperation Agency (JICA)
 The Study on Improvement of Irrigation & Drainage and Agricultural
 Development for Gorgan Plain, Guilan Province in The Islamic Republic of Iran

جمهوری اسلامی ایران
 وزارت جهاد کشاورزی
 سازمان جهاد کشاورزی استان گلستان
 وزارت جهاد کشاورزی - c- Agriculture
 Organization of Jihad - Agriculture Guilan Province
 Title: General layout plan
 طرح کلی سیستم آبیاری و
 Irrigation & Drainage system of
 زمین کشاورزی نازم آباد

Date:	تاریخ:	Design:	طراحی:
2002-June	تیر ۱۳۸۱		
Drawn:	ترسیم:	Checked:	کنترل:
Farhad Zainy	فرهاد زینی		
Scale:	مقیاس:	Approved:	تصویب:
1:20000	۱:۲۰۰۰۰		

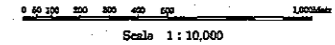

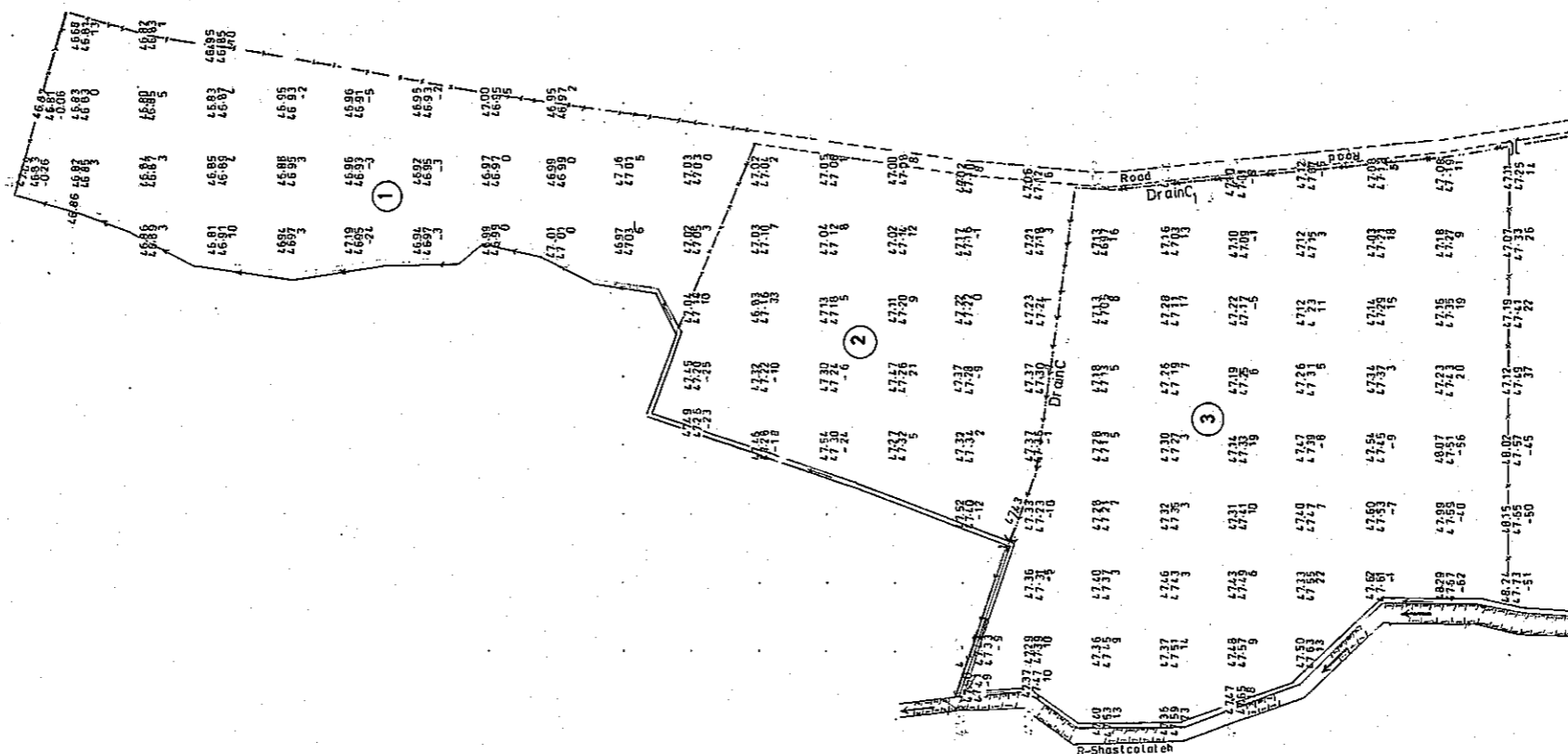

BYE DRAIN		ساخته
RELIGIOUS BUILDING		ساکنان مذهبی
ROADWAY		جاده
BUILDING BLOCK		مدرسه
WALL		دیوار
CEMETERY		گورستان
LIMIT		حد
Main DRAIN		ریگ اصلی
SE DRAIN		ریگ جنوبی
TILLY/PALE		ریگ شمالی
ASPHALTED		راه آسفالت
WHEEL ROAD		راه چرخه
UNSURFACED ROAD		راه خاکی
FOOTPATH		راه پیاده
GRASS		چمن
WIRE FENCE		سیم خاردار
FENCE		سورخ
HEDGE		پشمه
POWER LINE		خط انتقال نیرو
WELL		کند
TELEPHONE OR TELEGRAPH LINE		تیرکلی - مخابرات
PIPE LINE		خط لوله
GARDEN TREES		میان - درختان
CULTIVATED LAND		زارعت
PASTURE-LAND		چمن
TREE LINE		درخت
BUSHES		بوشه دار
RIVER		رودخانه
CANAL		کانال
CANAL		کانال
WATER COURSE		آبدره
FLOODWAY		سیلاب
LAGOON		برج
CONTOURS		مختصات
CANAL-Well		درخت خشک شده
CUTTING		بروزگی
SPOT HEIGHT		ارتفاع
TRIP POINT		نقطه اندازه گیری
BM POLYTON STATION		بنای سنگی
SUB SURVEY STATION		ایستگاه
VINEYARD		باغستان
POOL		استخر
ROCK		سنگ
DANGER (WATER)		خطر (آب)
Direction		جهت
MARKET		بازار
PUMP STATION		پمپخانه
RESERVOIR		آب انبار

2 1

JICA Japan International Cooperation Agency (JICA)
 The Study on Improvement of Irrigation & Drainage and Agricultural Development for Gorgan Plain, Gilan Province in The Islamic Republic of Iran

Islamic Republic of Iran
 Ministry of Jihad - e Agriculture
 Organization of Jihad - e Agriculture Gilan Province
 Title: Land leveling, solum drainage and in case study of Maklar-Ishk

Date:	تاریخ:	2002- June	1381
Drawn:	ترسیم:	Farhad Zainy	فرهاد زین
Scale:	مقیاس:		

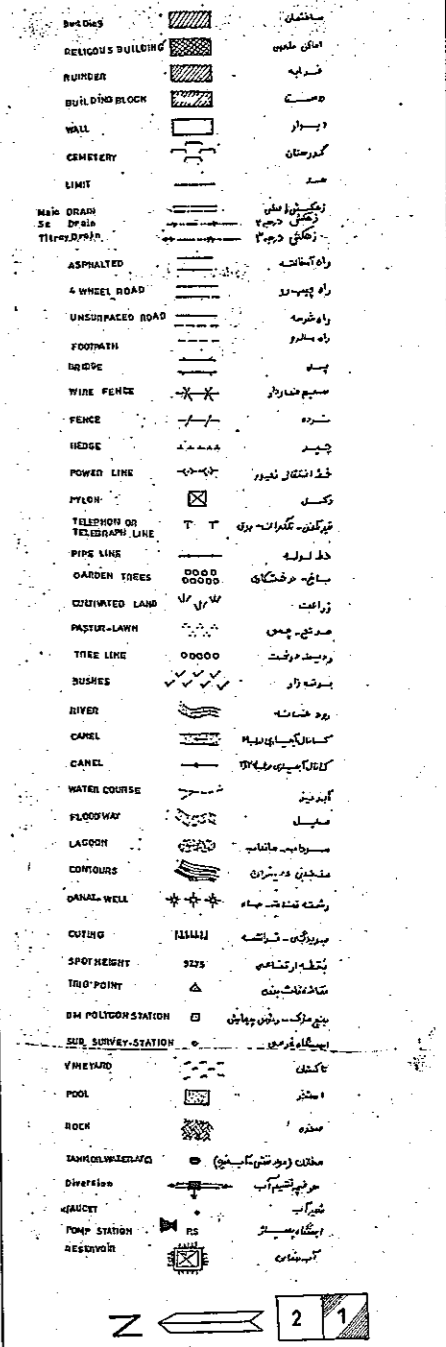
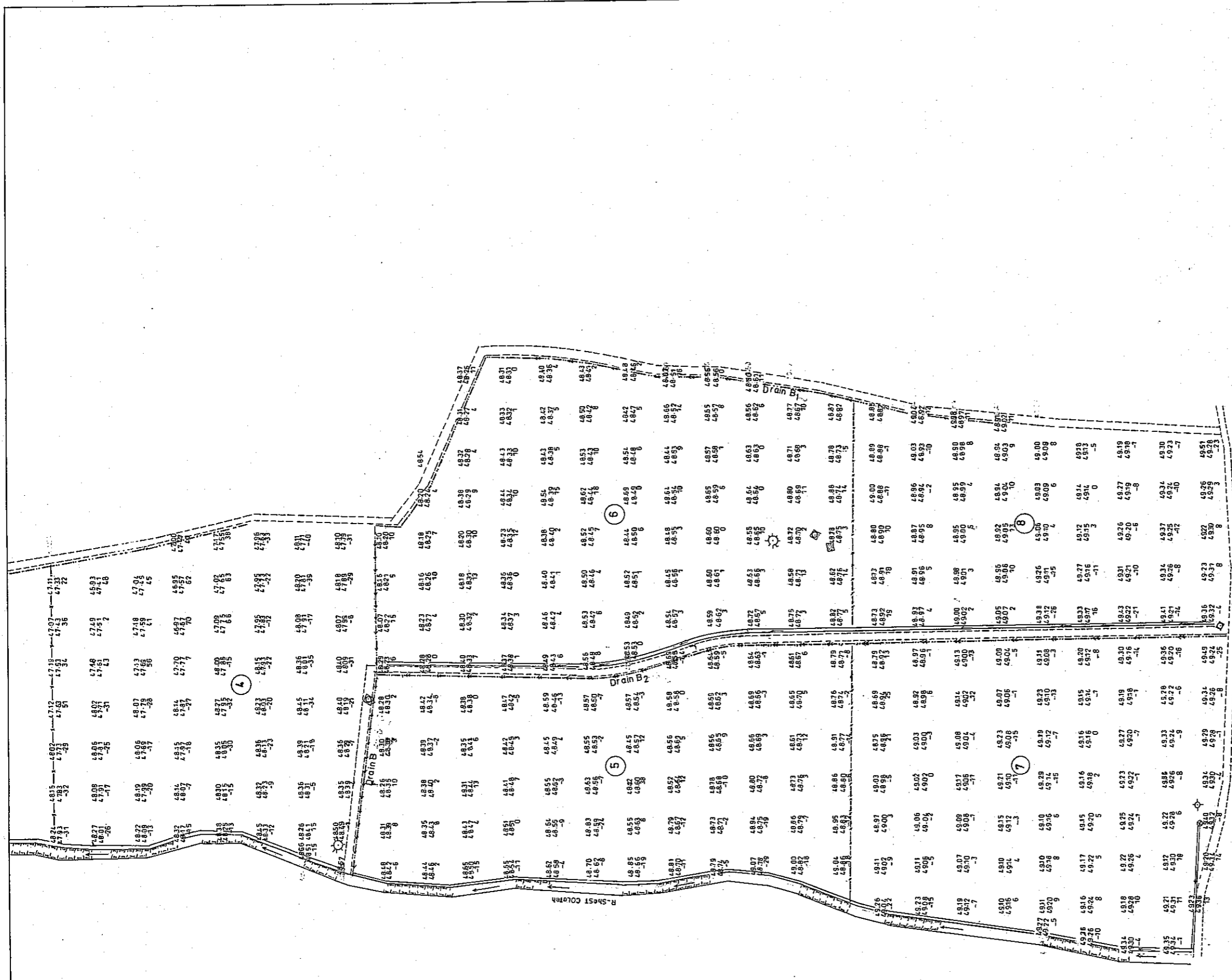

Japan International Cooperation Agency (JICA) The Study on Improvement of Irrigation & Drainage and Agricultural Development for Gorgan Plain, Golestan Province in The Islamic Republic of Iran			
Islamic Republic of Iran Ministry of Jihad-e-Agriculture Organization of Jihad-e-Agriculture Golestan Province سازمان جهاد کشاورزی استان گولستان		وزارت جهاد کشاورزی سازمان جهاد کشاورزی استان گولستان	
Title: Land leveling system drawings and its construction study of Mahan-kola موضوع:			
Date: 2002-June	تاریخ: ۱۳۸۱	Designed:	طراح:
Drawn:	ترسیم:	Checked:	کنترل:
Fielded Zolay:	فرهنگ زایی:	Approved:	تصویب:
Scale:	مقیاس:	Approved:	تصویب:

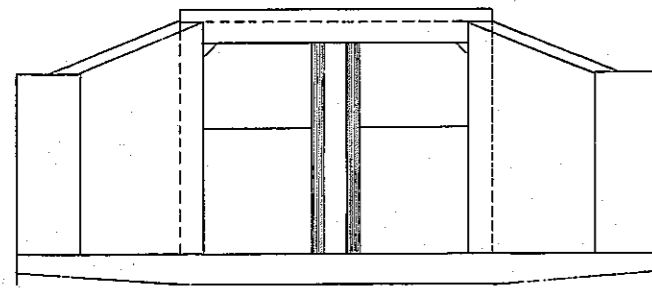

Section B-B
Scale 1:50

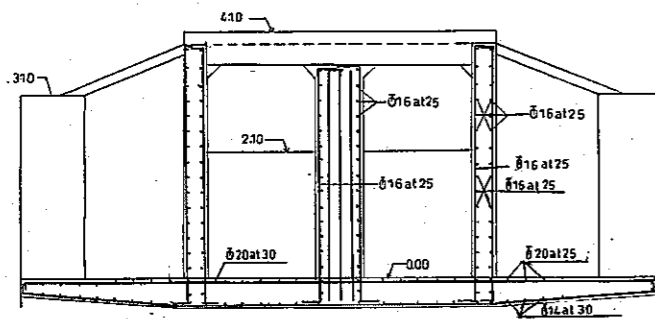

Section C-C
Scale 1:50

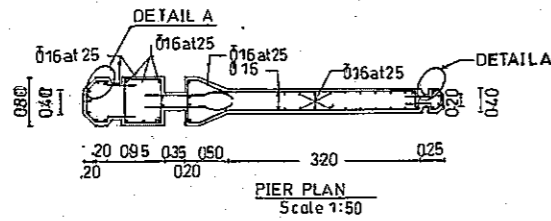

PIER PLAN
Scale 1:50

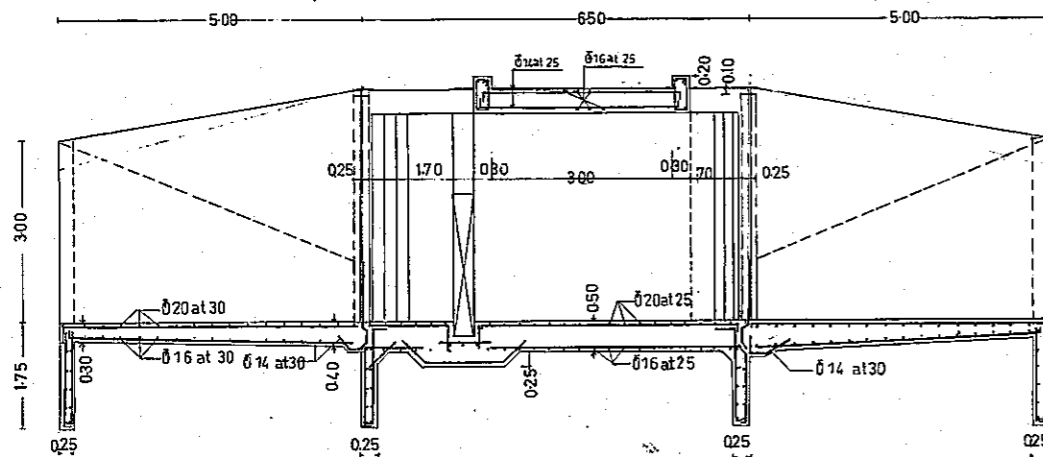

Section A-A
Scale 1:50

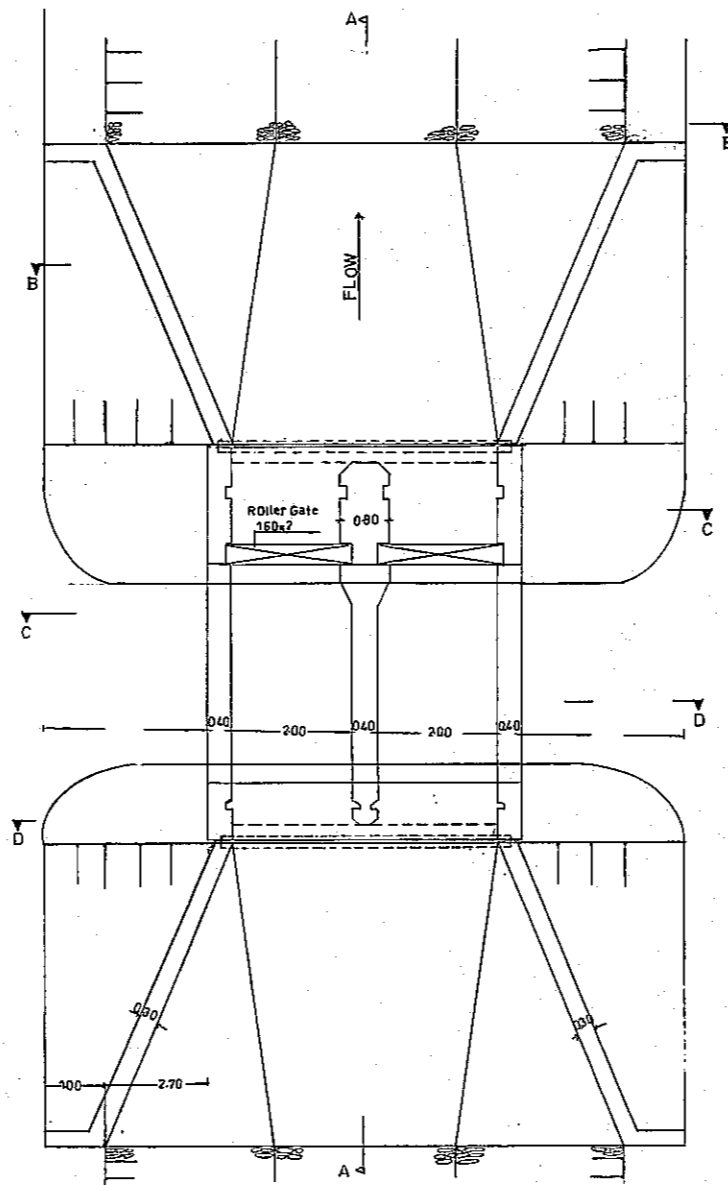

PLAN
Scale 1:50

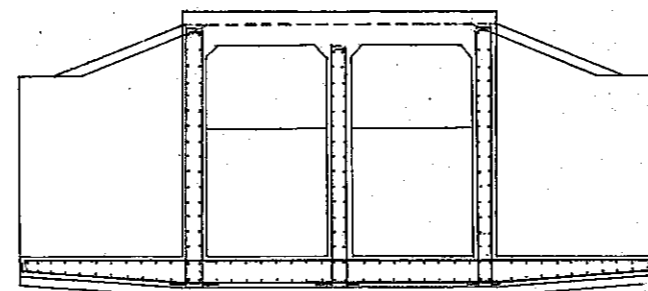

Section D-D
Scale 1:50

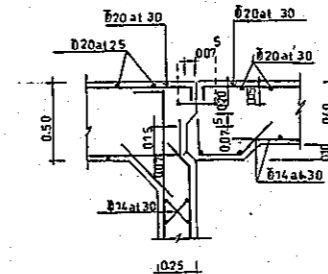

DETAIL B
Scale 1:20

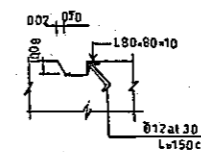

DETAIL A
Scale 1:20

LEGEND

REINFORCED CONCRETE	ساخته بتن مسلح
REINFORCED BUILDING	ساکنه بتن مسلح
REINFORCED	ساخته بتن مسلح
BUILDING BLOCK	ساخته بتن مسلح
WALL	دیوار
CEMENTERY	گورستان
LINE	خط
Main DRAIN	زیرزمین اصلی
Sub DRAIN	زیرزمین فرعی
FLYOVER	پل
ASPHALTED	راه آسفالتی
4 WHEEL ROAD	راه چرخه 4
UNSURFACED ROAD	راه نرسیده
FOOTPATH	راه پیاده
GRASS	چمن
WINE FENCE	سیم خاردار
FENCE	سنگریز
HEDGE	چمن
POWER LINE	خط انتقال نیرو
PIEON	کاسه
TELEPHONE OR TELEGRAPH LINE	تله گراف یا تله فون
PIPE LINE	خط لوله
GARDEN TREES	درختچه
CULTIVATED LAND	زراعت
PASTURE-LAWN	مرداب چمن
TREE LINE	درختچه
BUSHES	بوسه دار
RIVER	رودخانه
CANAL	کانال
CANAL	کانال
HATCH COURSE	گهریز
FLOODWAY	سیلاب
LAGOON	مرداب
CONTOURS	مختصات
CANAL-WELL	رشته نشاء چشمه
CUTTING	بروزگه
SPOT HEIGHT	نقطه ارتفاع
TIDY POINT	نقطه مرتب
B.M. POLYDOR STATION	بندی درگاه پلیدور
SUB SURVEY STATION	ایستگاه زیرزمینی
VINEYARD	باغچه
POOL	استخر
DECK	سقف
TANK/WATER TOWER	مخزن (در تانک آب)
Direction	جهت جریان آب
MANCET	شیر آب
PUMP STATION	پمپخانه
RESERVOIR	مخزن

JICA Japan International Cooperation Agency (JICA)
The Study on Improvement of Irrigation & Drainage and Agricultural Development for Golestan Plain, Golestan Province in The Islamic Republic of Iran

جمهوری اسلامی ایران
وزارت جهاد کشاورزی
سازمان جهاد کشاورزی استان گولستان
موضوع: نقشه کلی طرح کنترل آب رودخانه
شهرت: گولستان

Date: 2002-June تاریخ: 1381 خرداد
Design: طراحی: فرهاد زینی
Drawn: فرهاد زینی Checked: کنترل: فرهاد زینی
Scale: 1:50 Approved: تصویب: فرهاد زینی

PAGE NO. 16 CROSS-SECTION . A

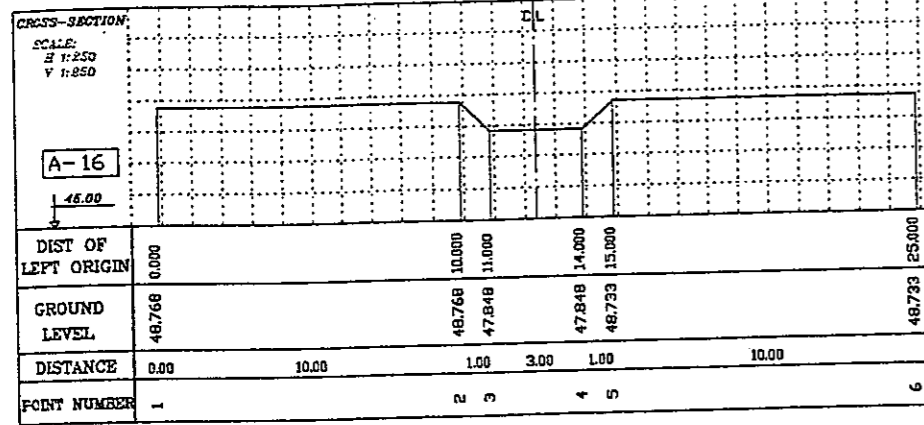

PAGE NO. 15 CROSS-SECTION . A

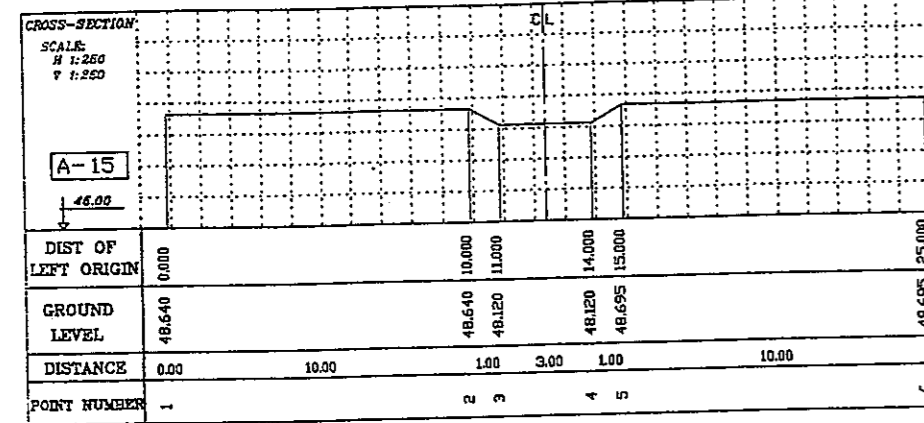

PAGE NO. 14 CROSS-SECTION . A

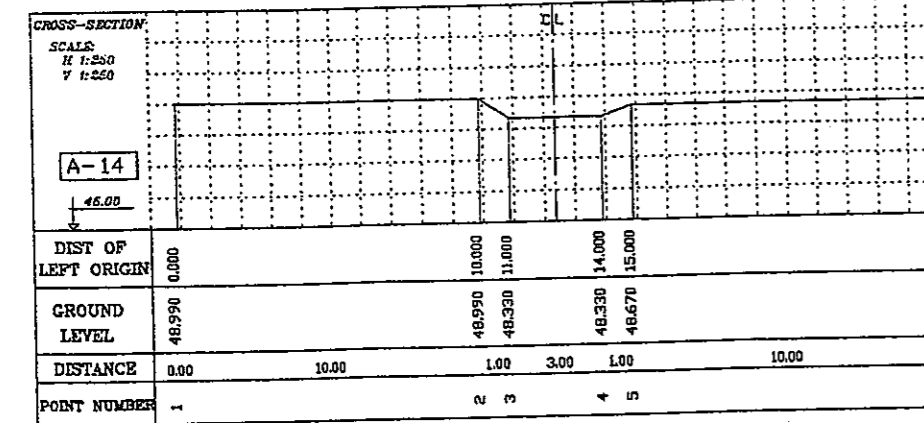

PAGE NO. 13 CROSS-SECTION . A

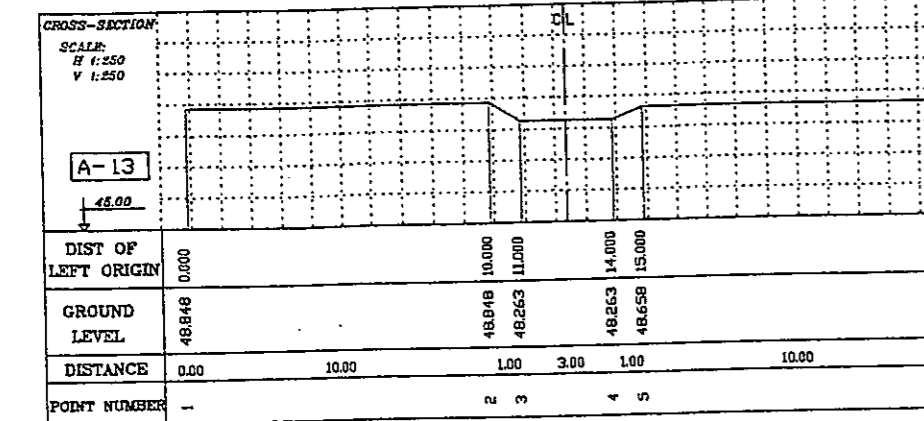

PAGE NO. 20 CROSS-SECTION . A

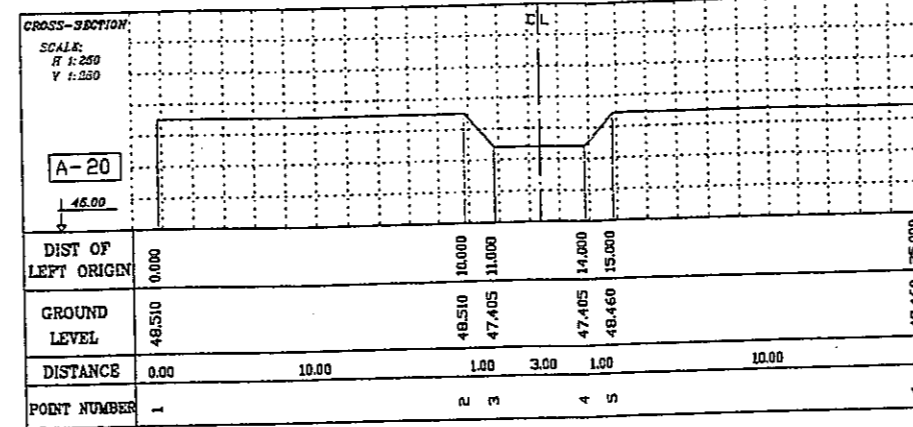

PAGE NO. 19 CROSS-SECTION . A

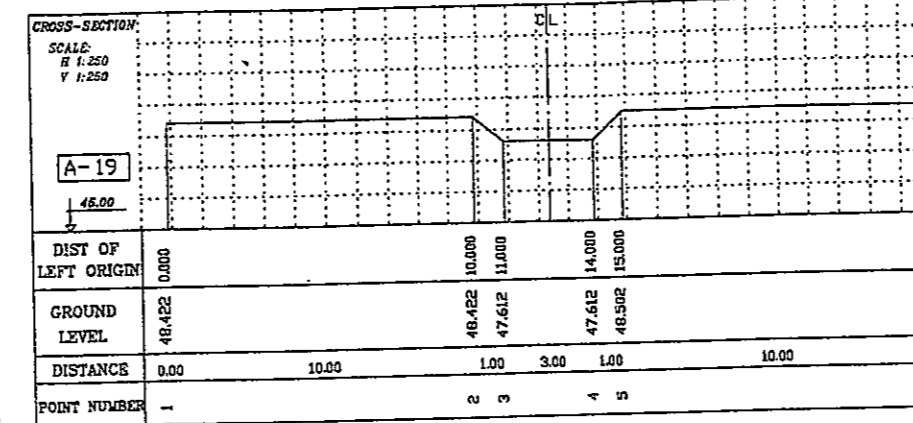

PAGE NO. 18 CROSS-SECTION . A

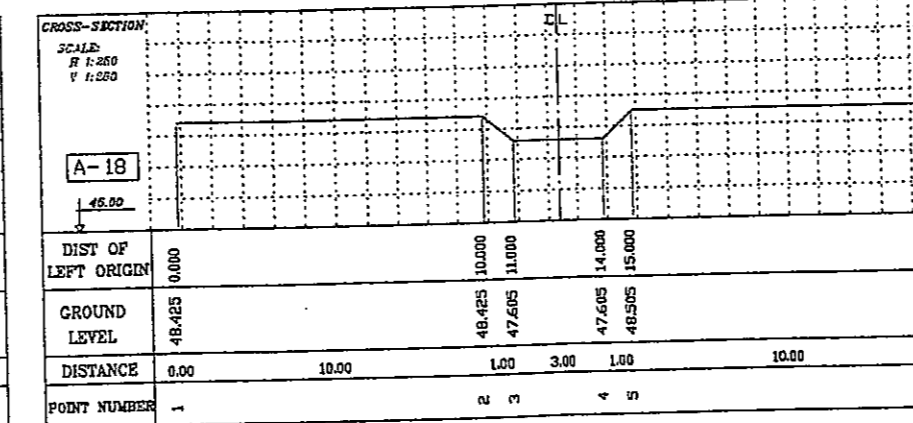

PAGE NO. 17 CROSS-SECTION . A

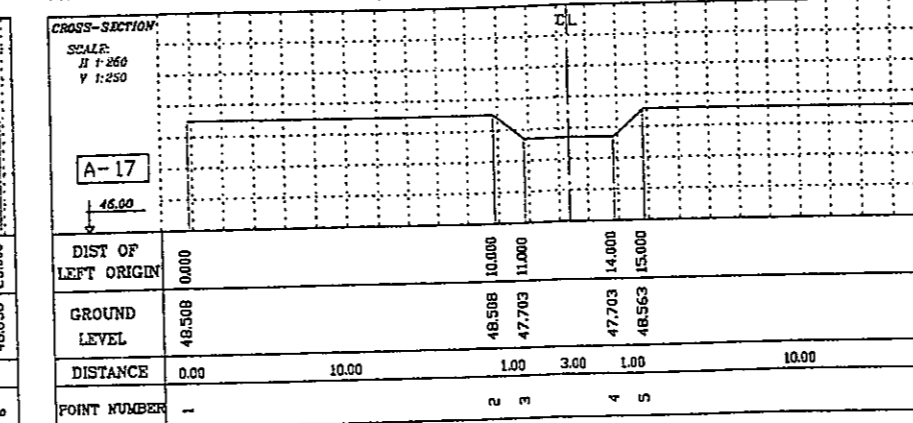

PAGE NO. 24 CROSS-SECTION . A

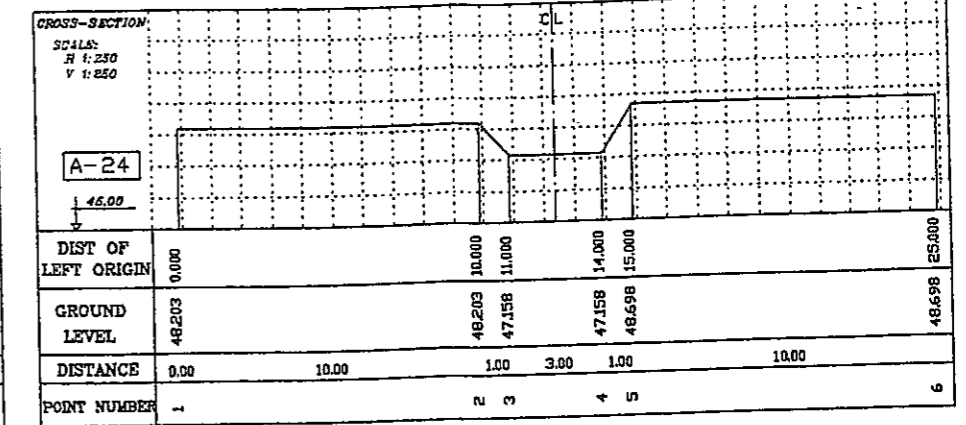

PAGE NO. 23 CROSS-SECTION . A

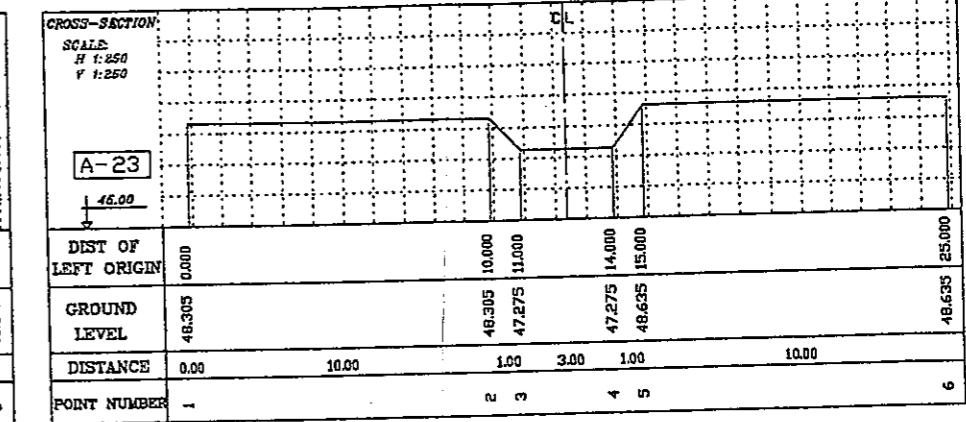

PAGE NO. 22 CROSS-SECTION . A

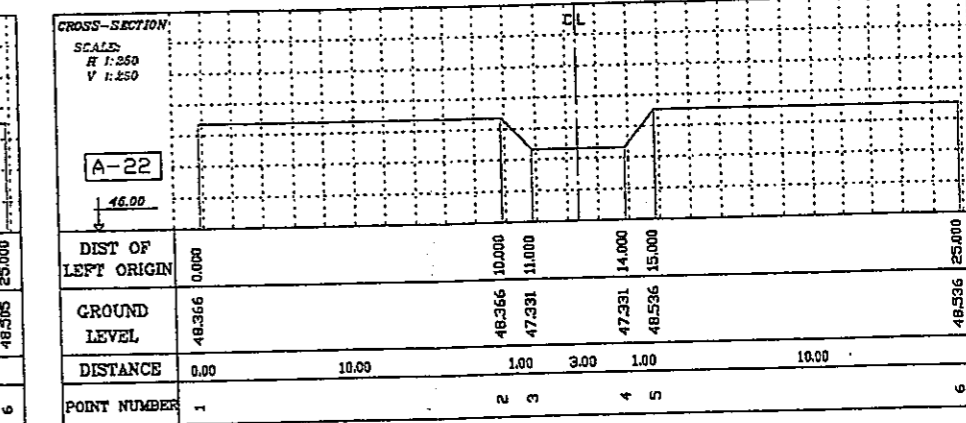

PAGE NO. 21 CROSS-SECTION . A

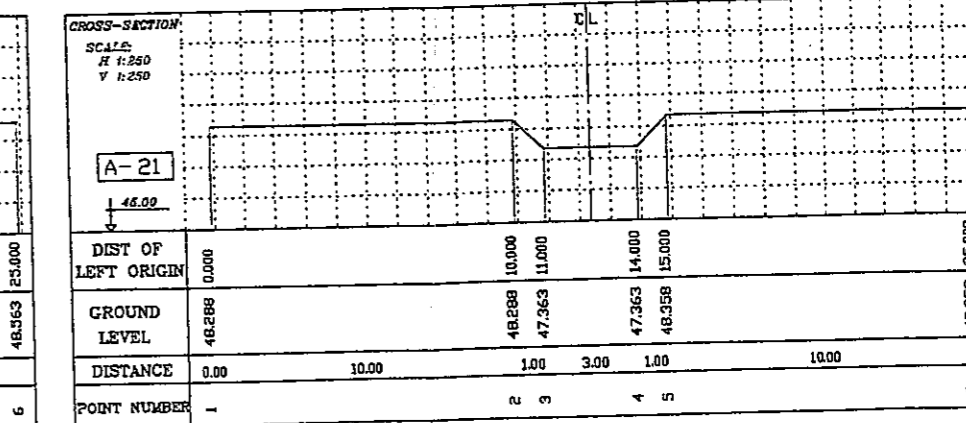

PAGE NO. 4 CROSS-SECTION . A

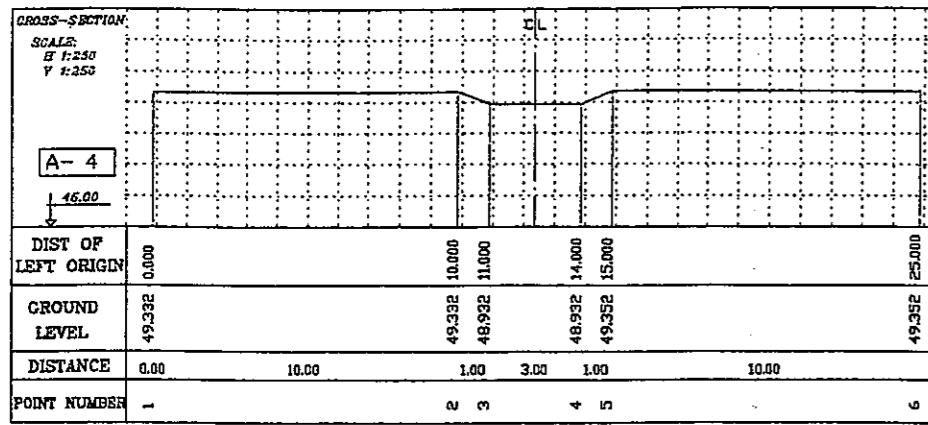

PAGE NO. 8 CROSS-SECTION . A

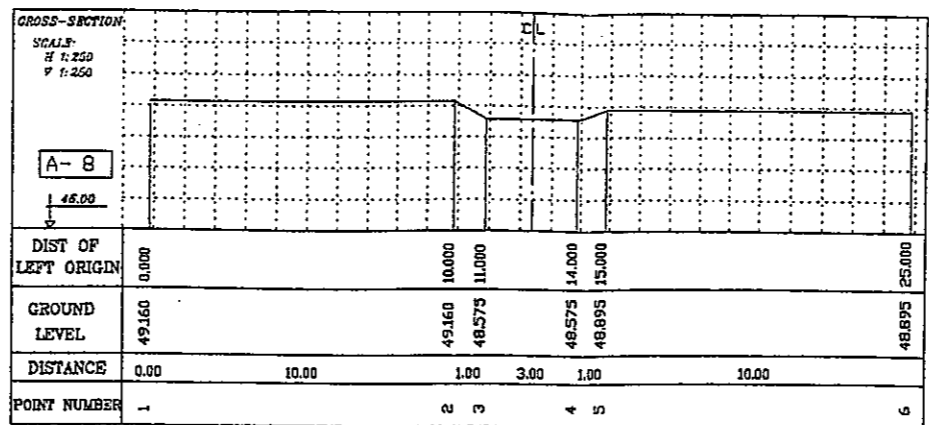

PAGE NO. 12 CROSS-SECTION . A

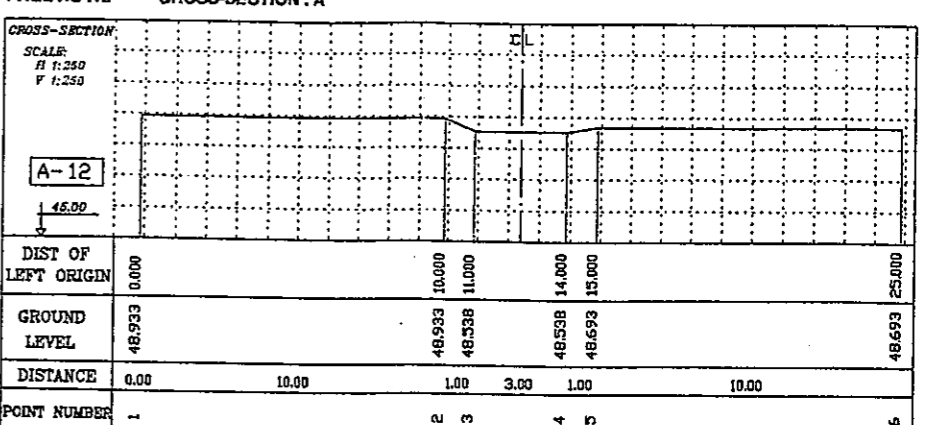

PAGE NO. 3 CROSS-SECTION . A

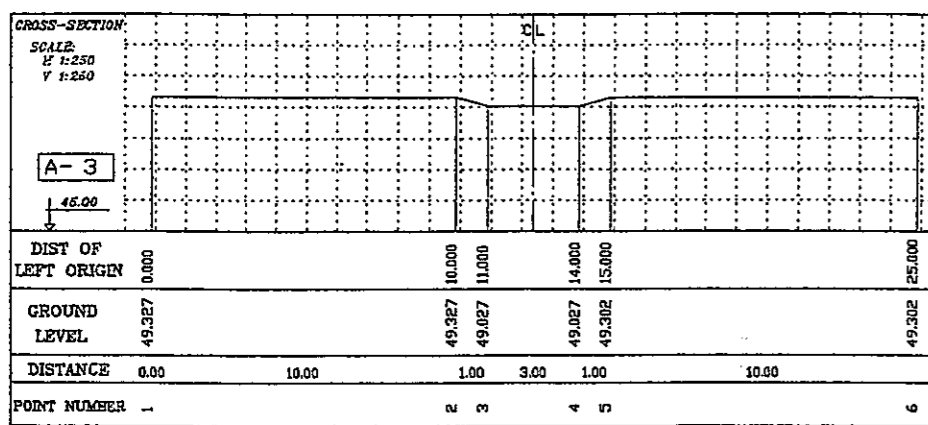

PAGE NO. 7 CROSS-SECTION . A

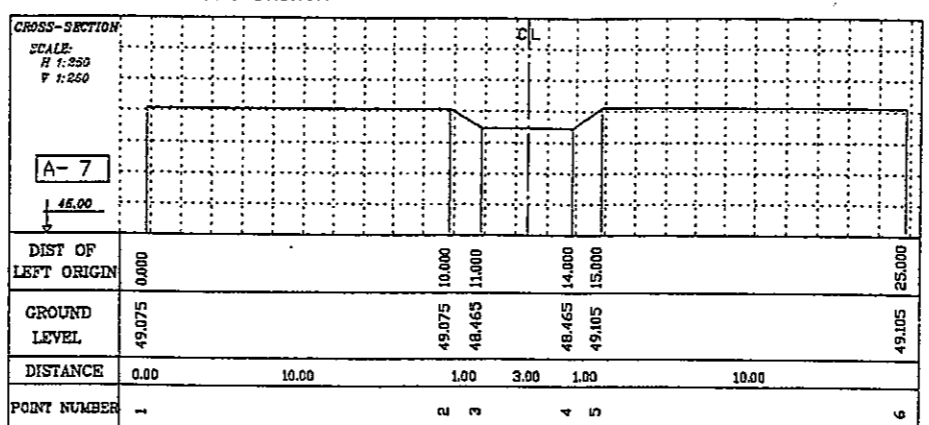

PAGE NO. 11 CROSS-SECTION . A

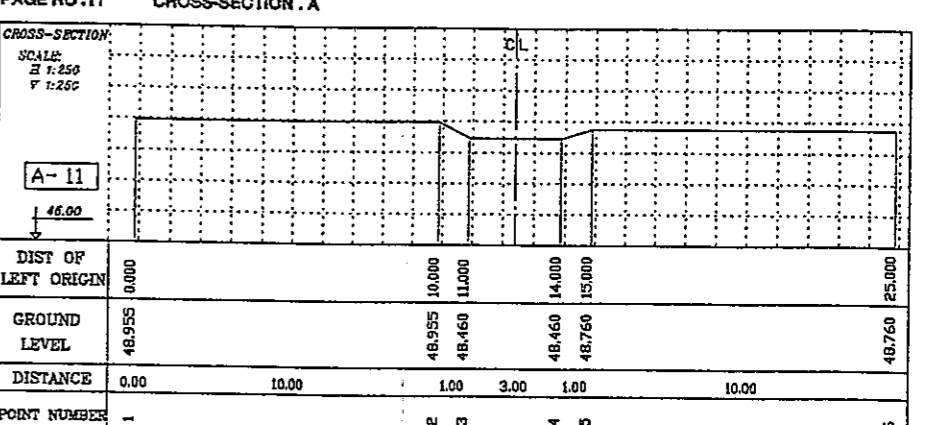

PAGE NO. 2 CROSS-SECTION . A

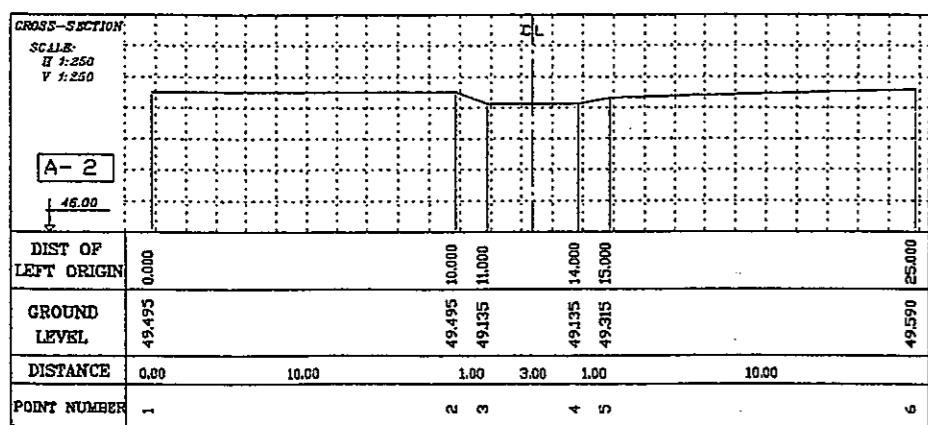

PAGE NO. 6 CROSS-SECTION . A

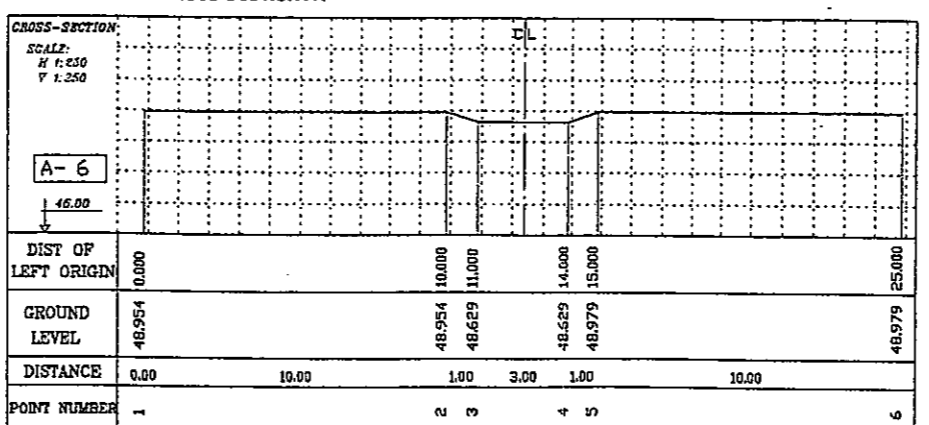

PAGE NO. 10 CROSS-SECTION . A

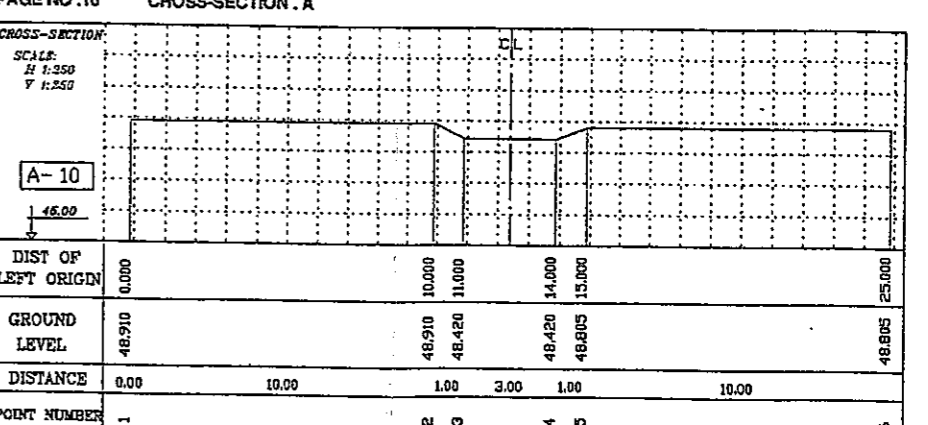

PAGE NO. 1 CROSS-SECTION . A

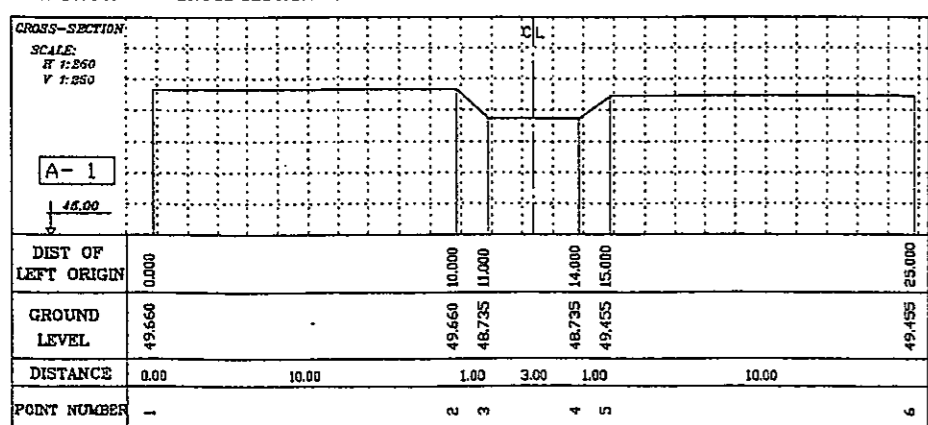

PAGE NO. 5 CROSS-SECTION . A

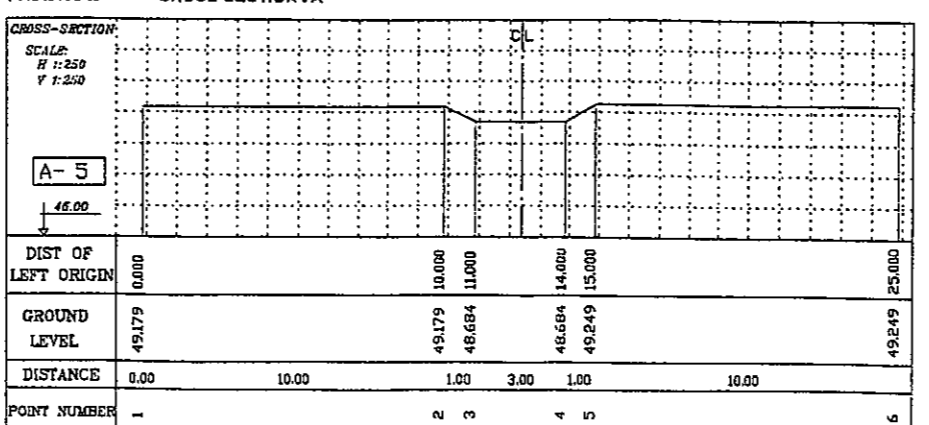

PAGE NO. 9 CROSS-SECTION . A

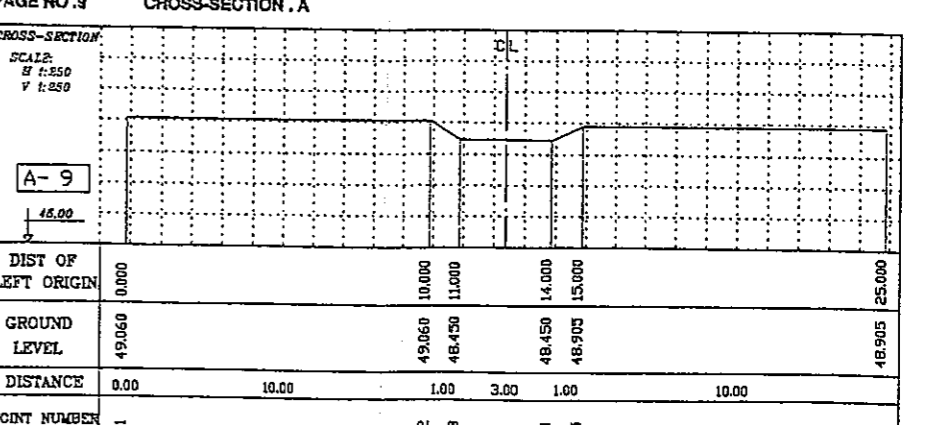

PAGE NO 28 CROSS-SECTION . A

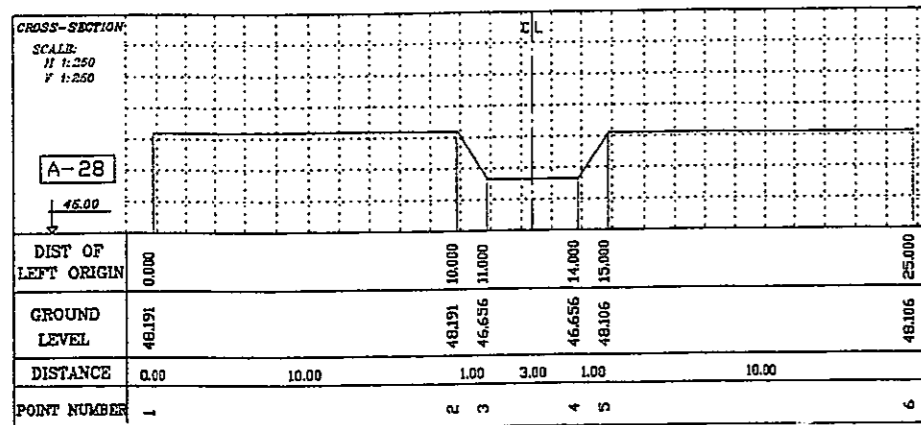

PAGE NO 32 CROSS-SECTION . A

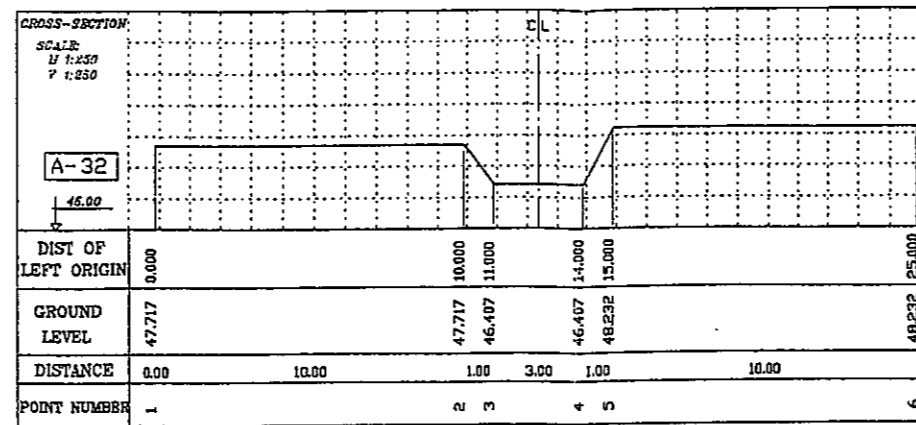

PAGE NO 36 CROSS-SECTION . A

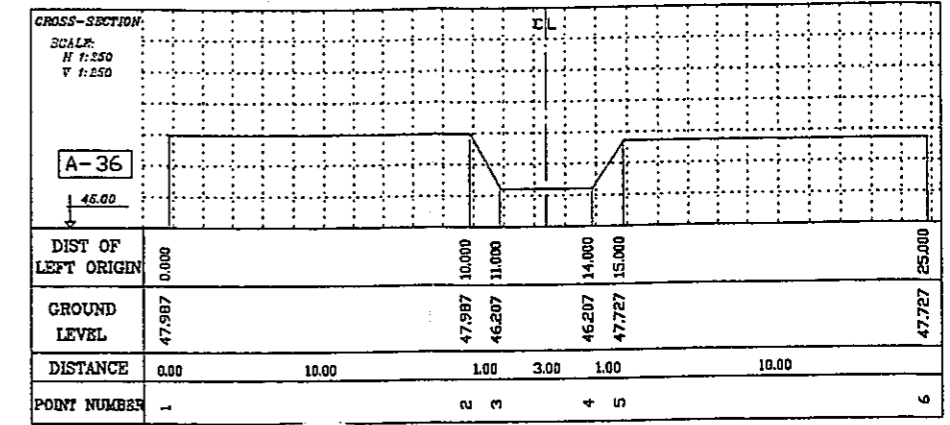

PAGE NO 27 CROSS-SECTION . A

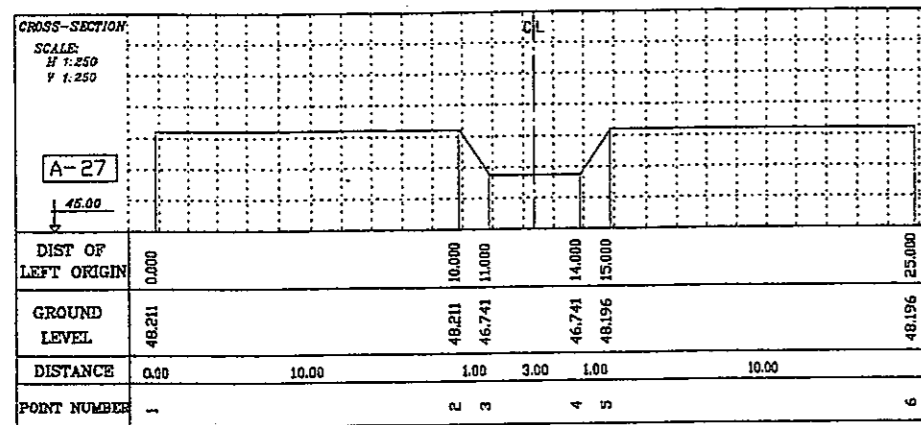

PAGE NO 31 CROSS-SECTION . A

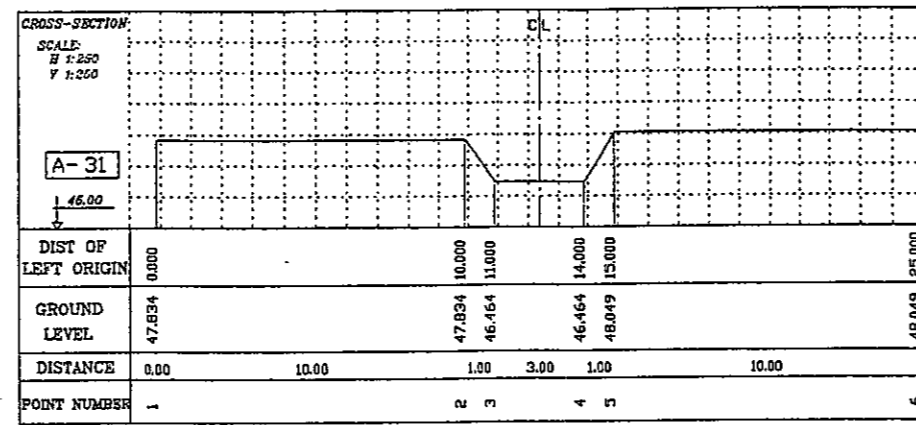

PAGE NO 35 CROSS-SECTION . A

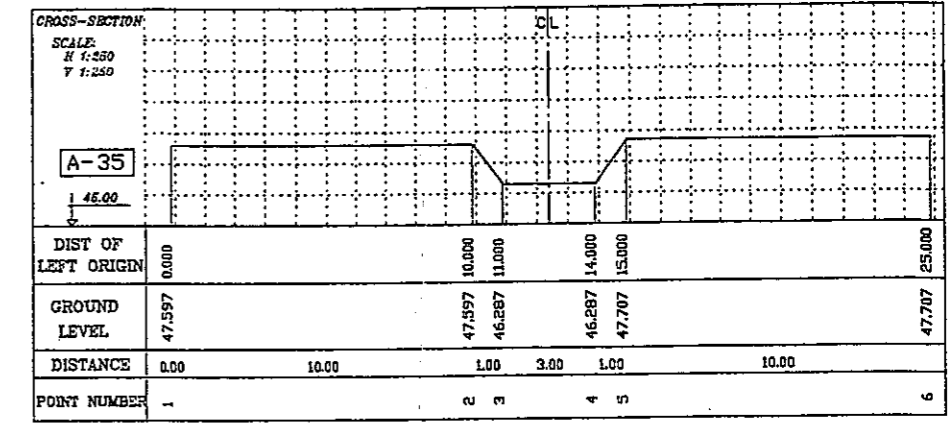

PAGE NO 26 CROSS-SECTION . A

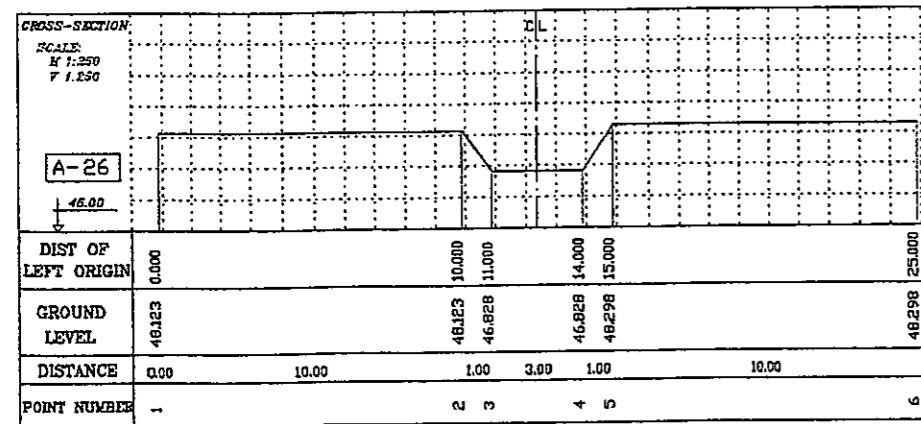

PAGE NO 30 CROSS-SECTION . A

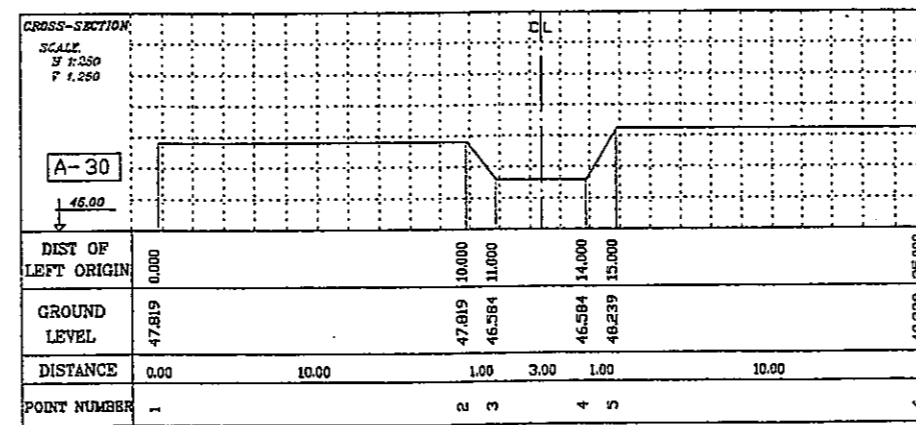

PAGE NO 34 CROSS-SECTION . A

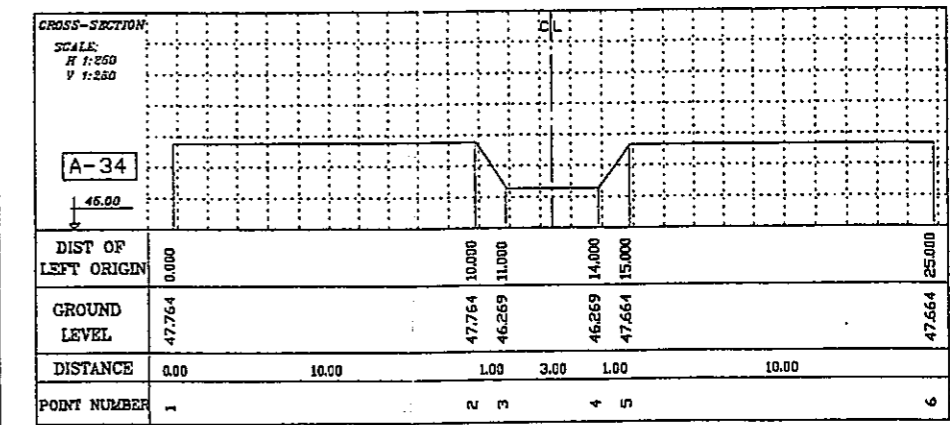

PAGE NO 25 CROSS-SECTION . A

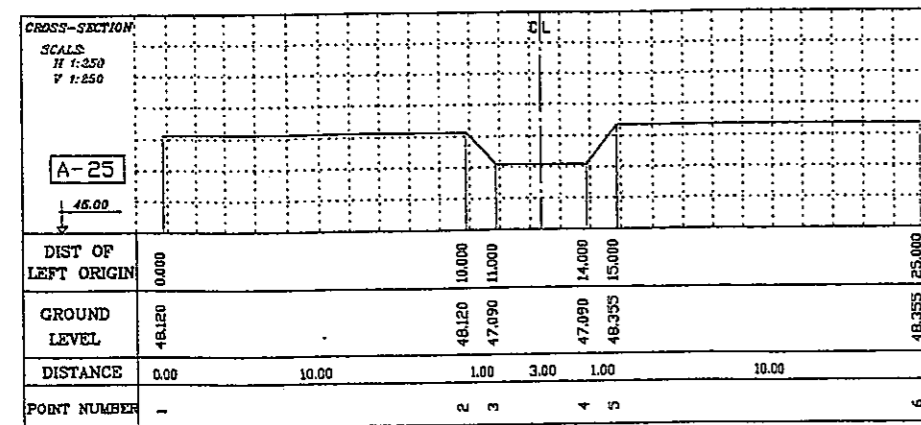

PAGE NO 29 CROSS-SECTION . A

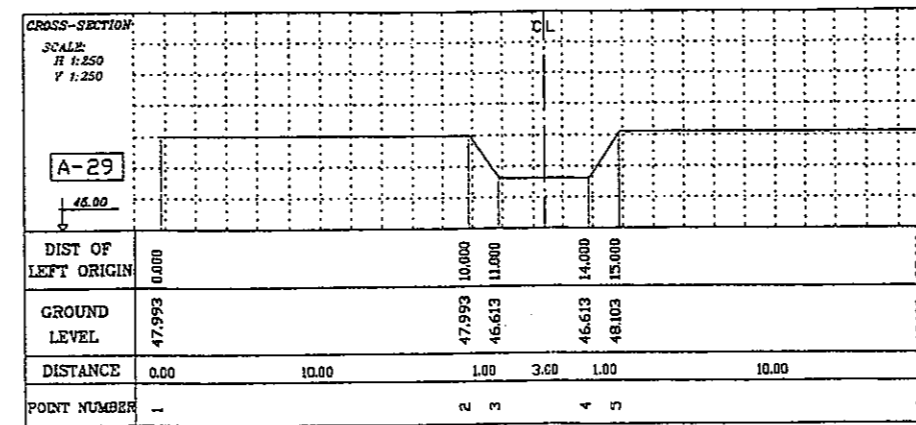

PAGE NO 33 CROSS-SECTION . A

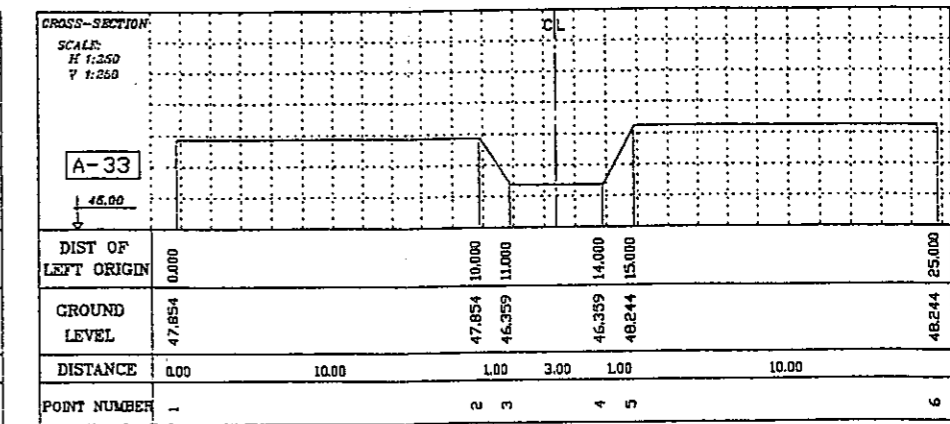

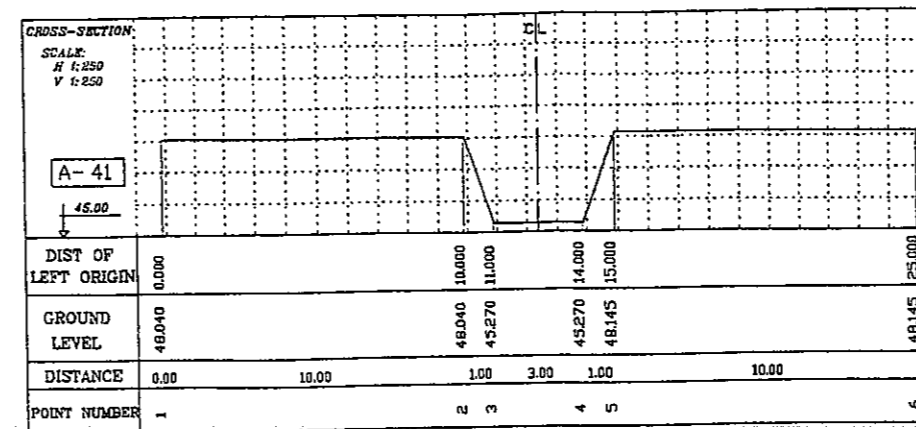
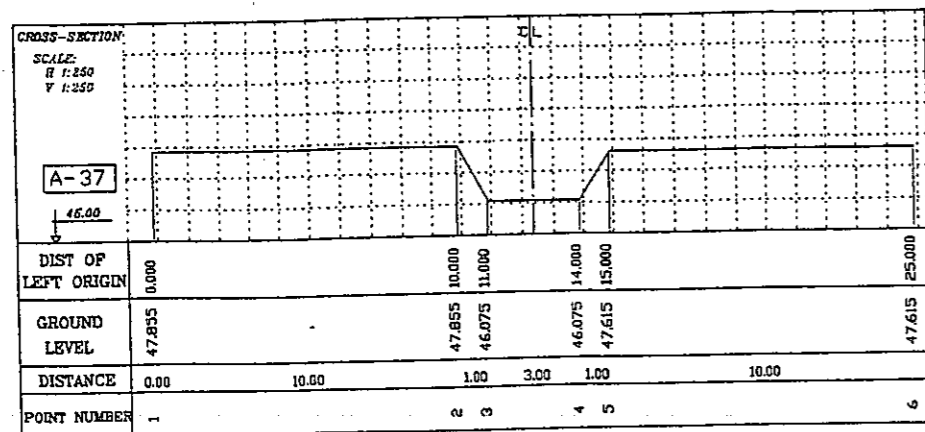
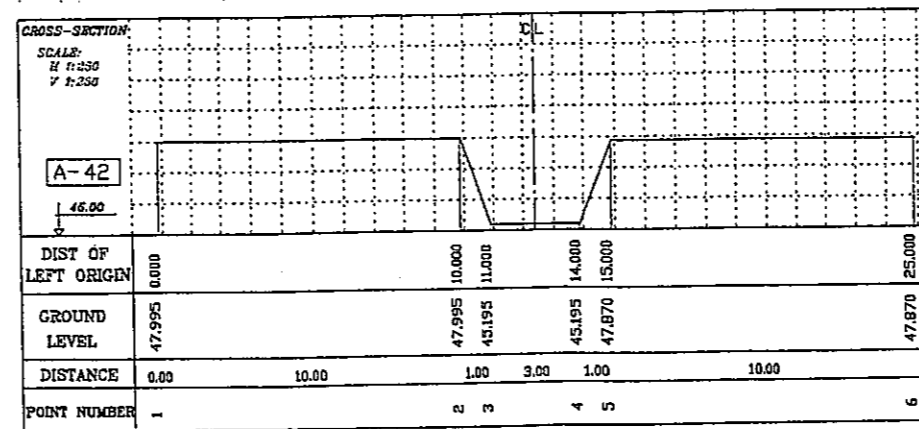
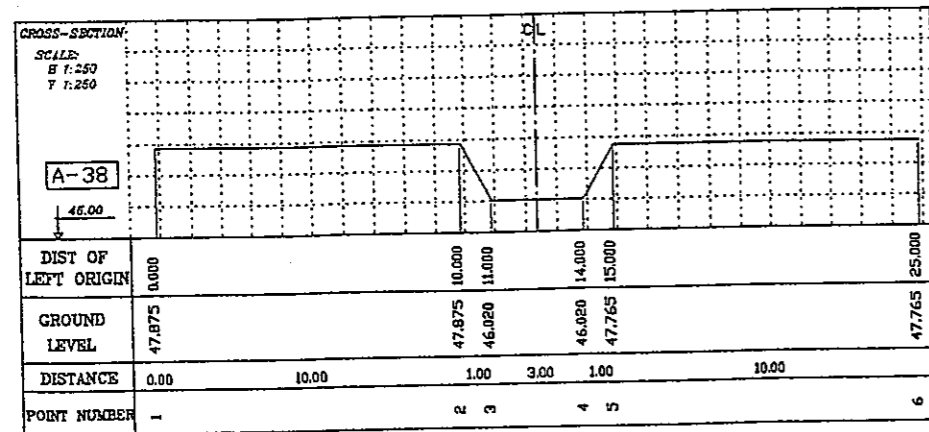
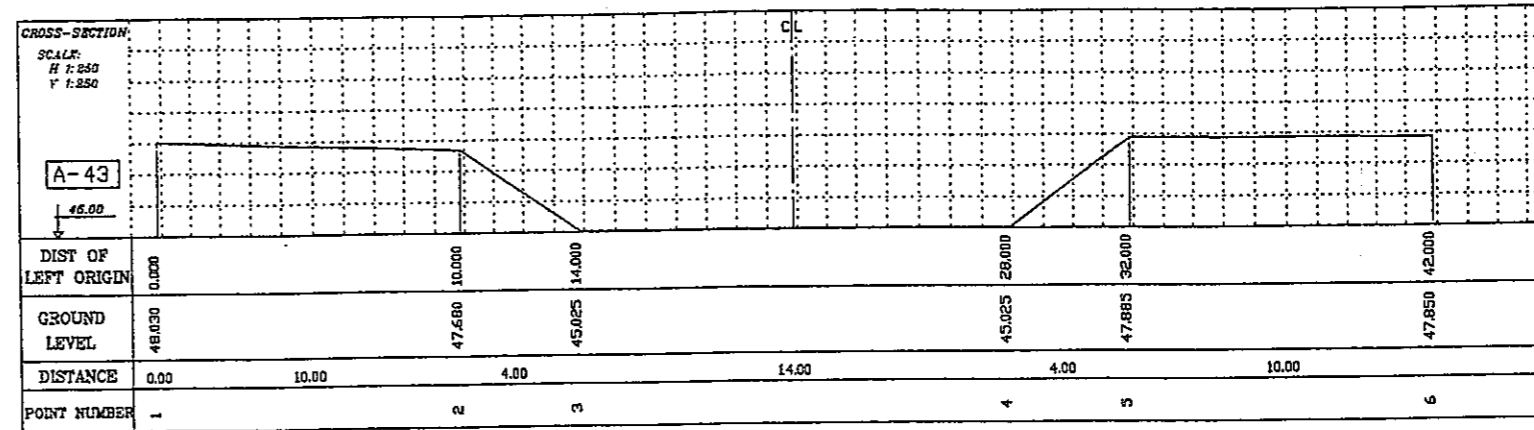
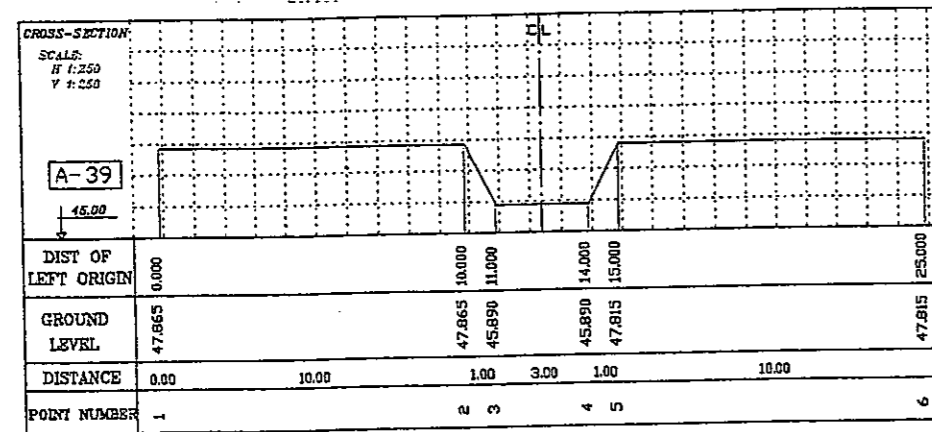
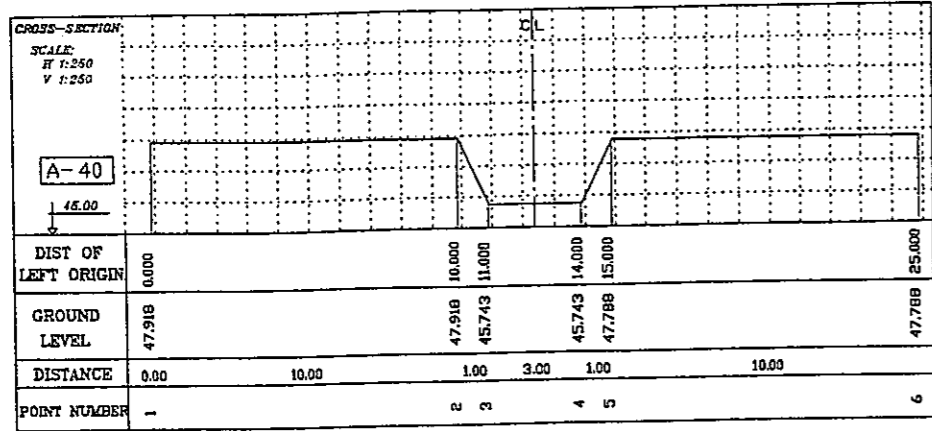

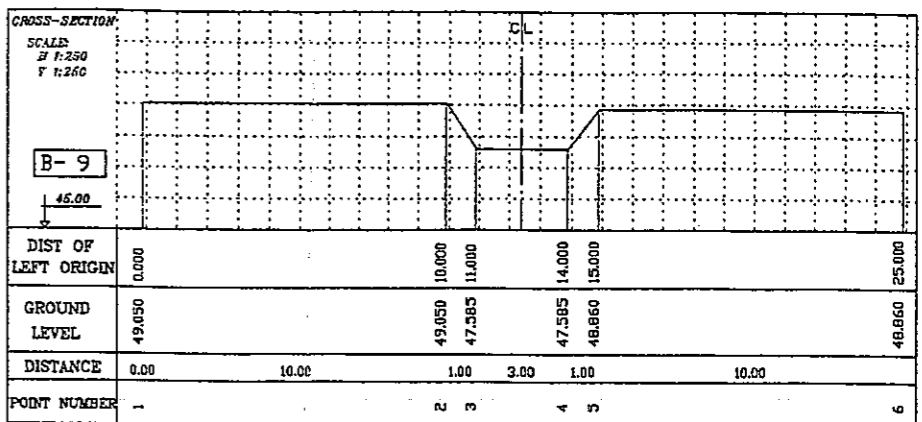
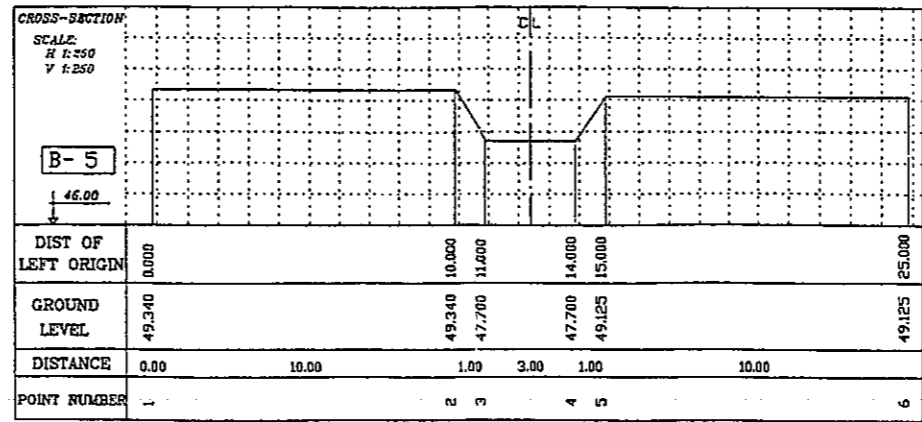
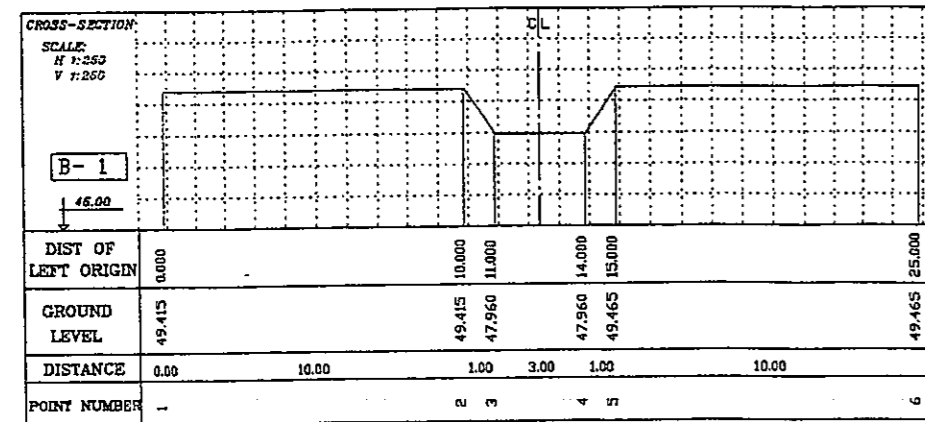
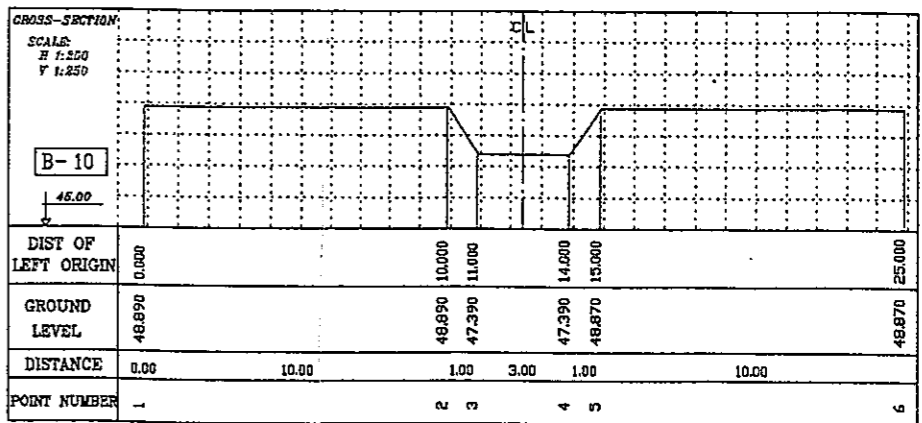
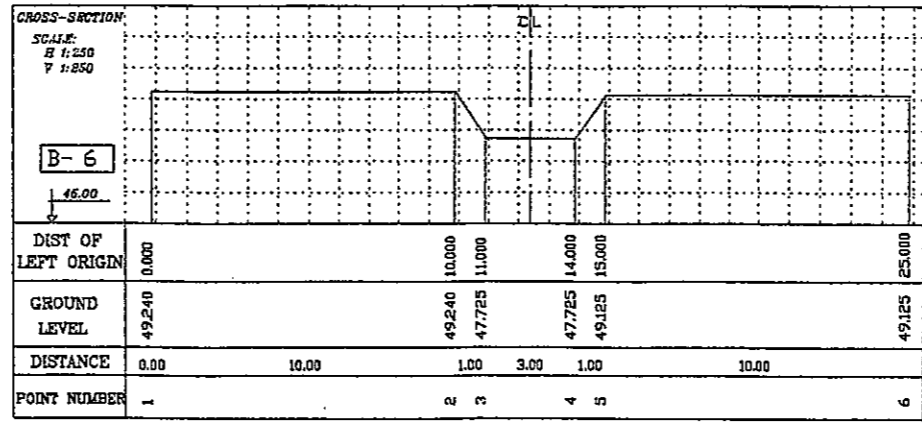
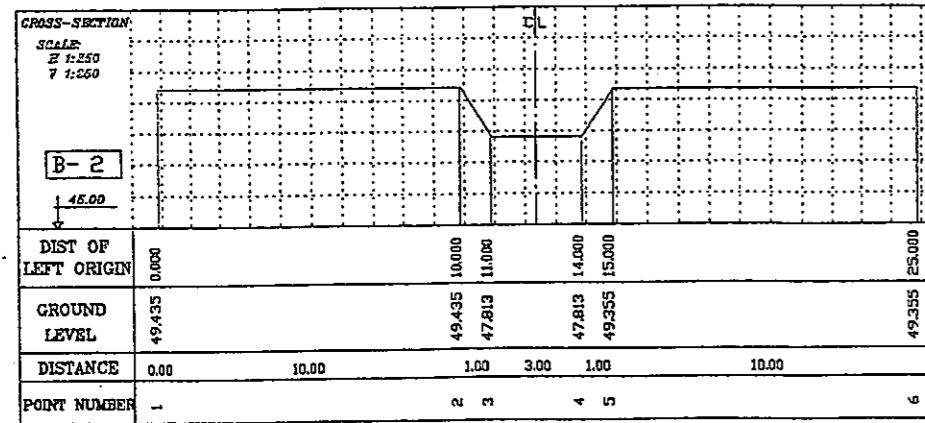
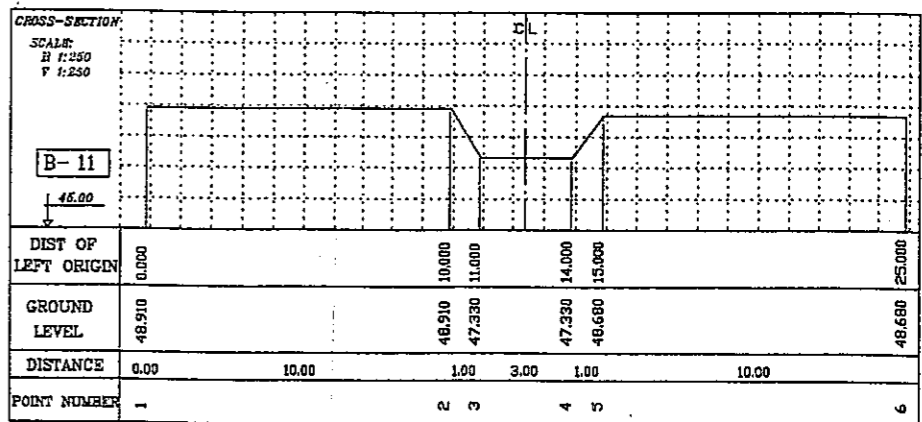
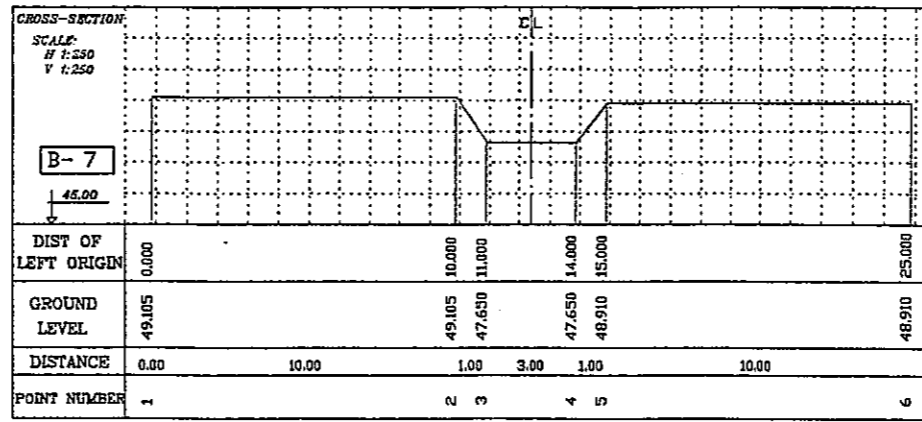
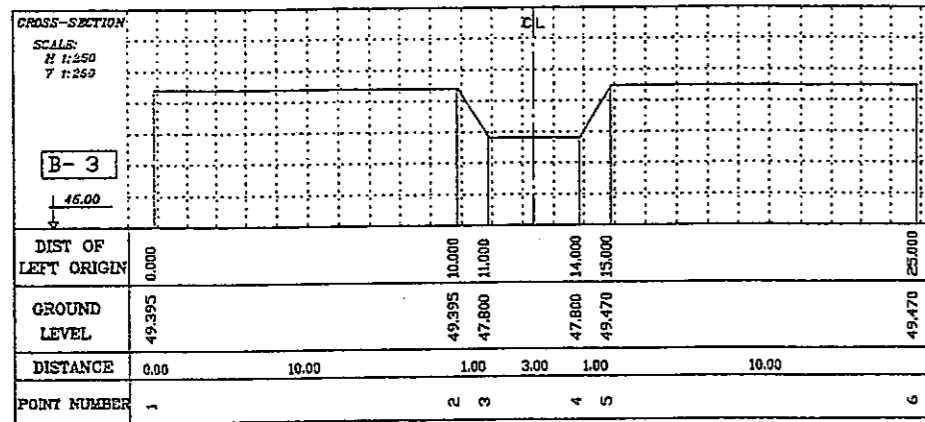
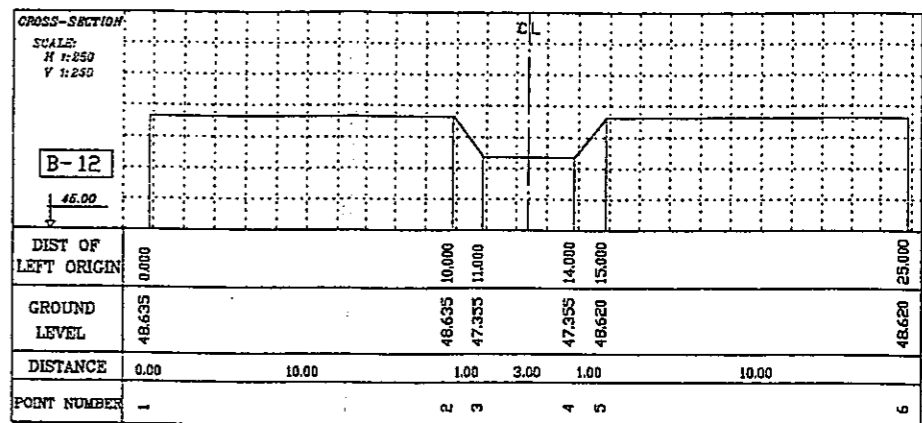
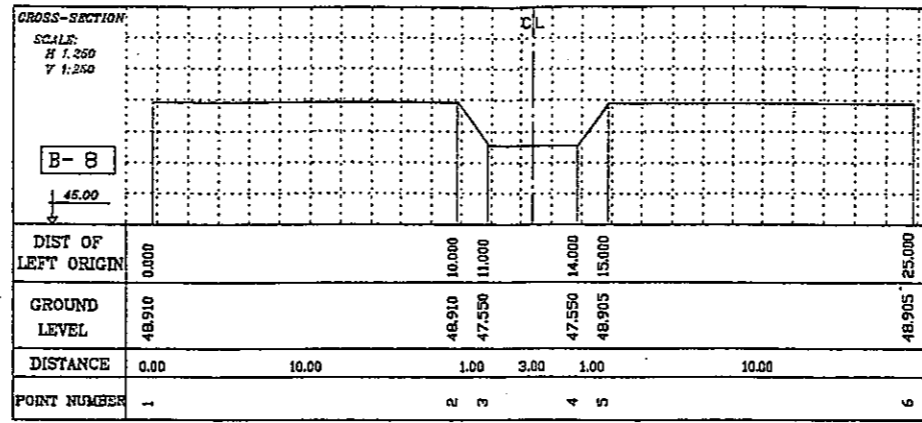
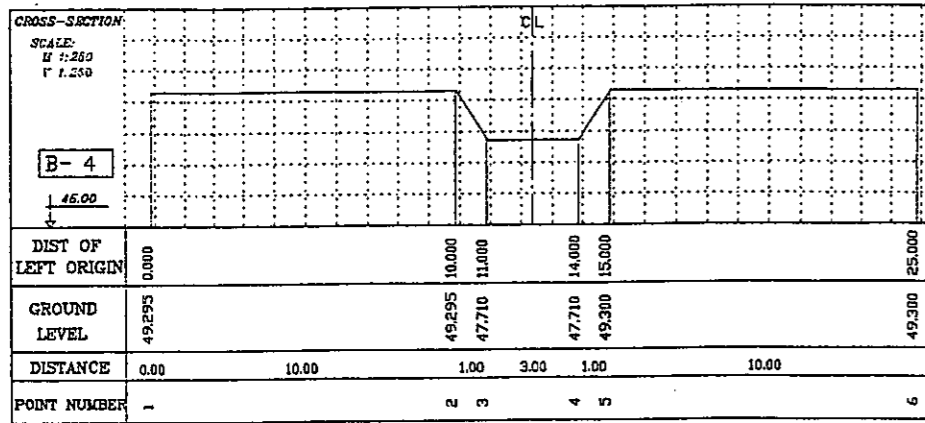

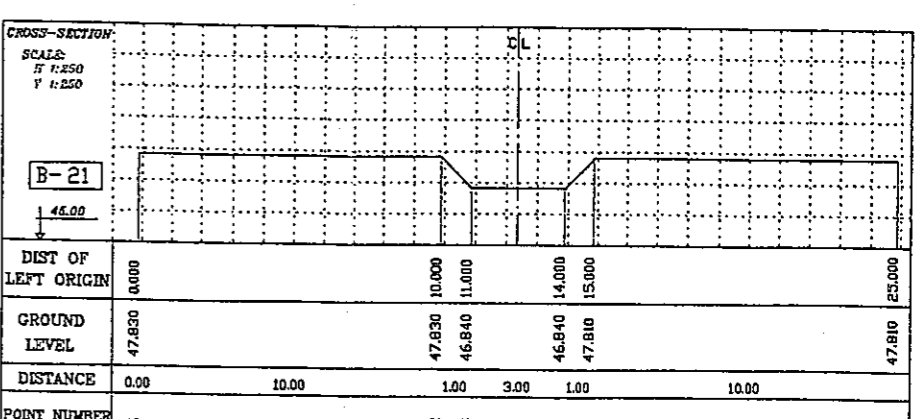
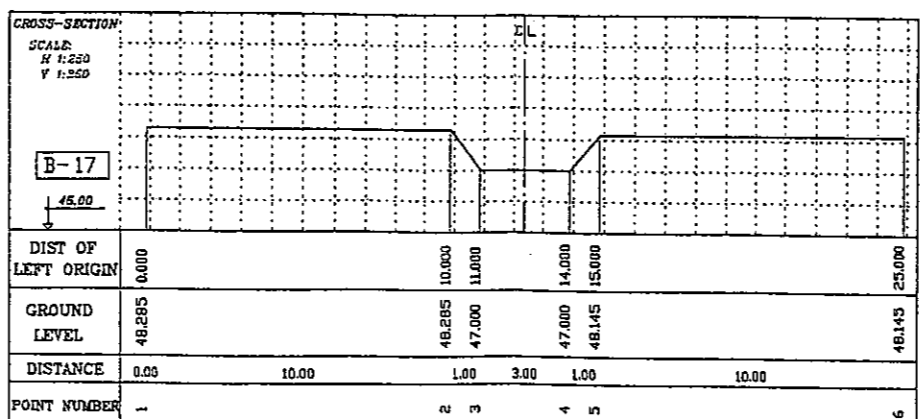
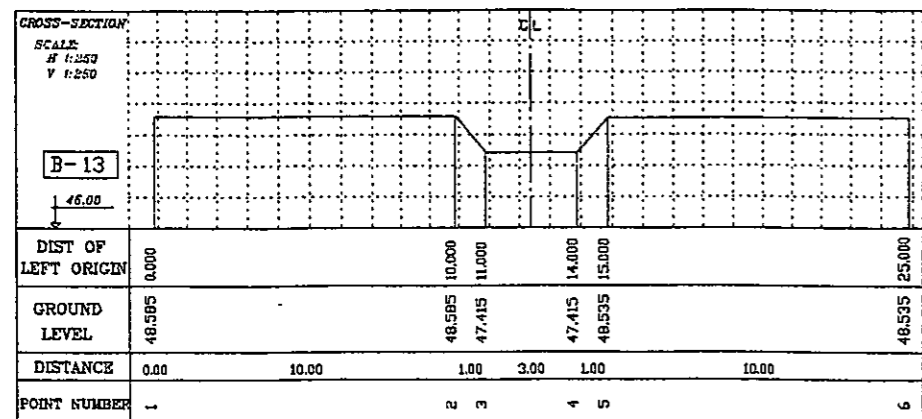
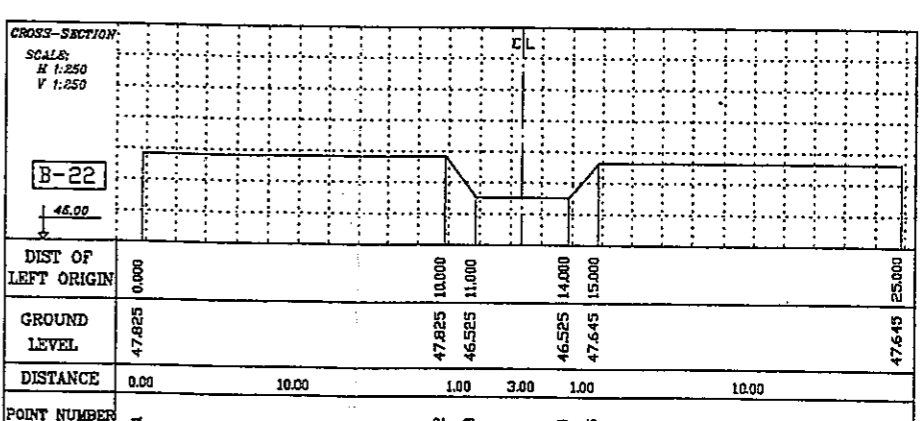
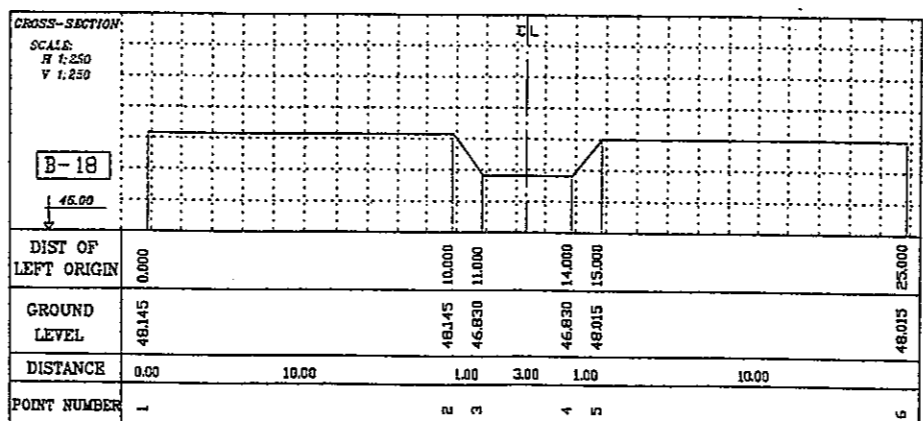
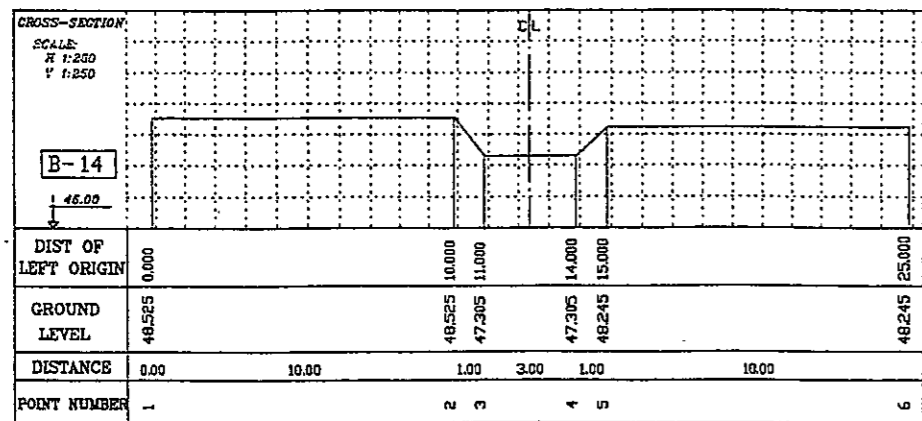
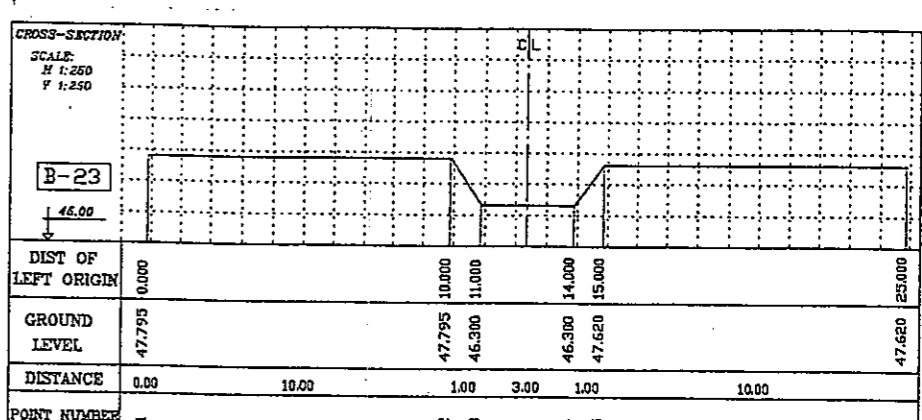
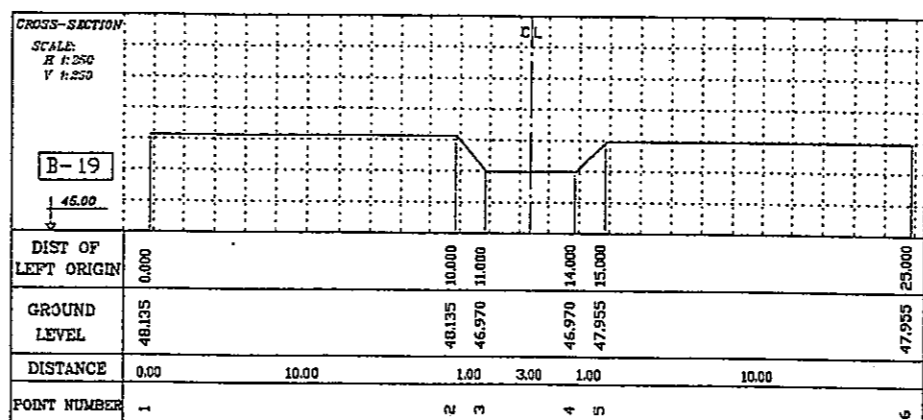
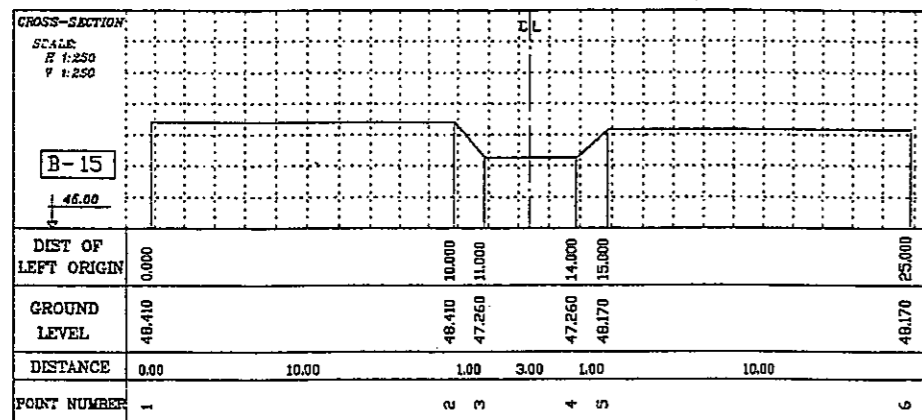
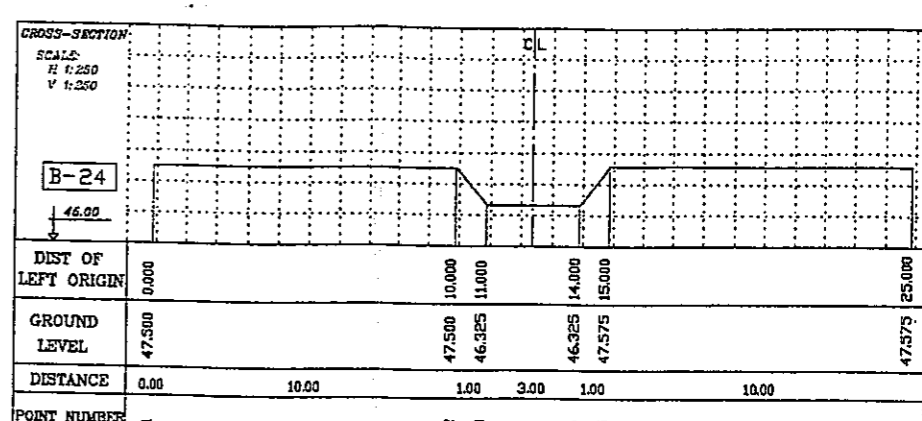
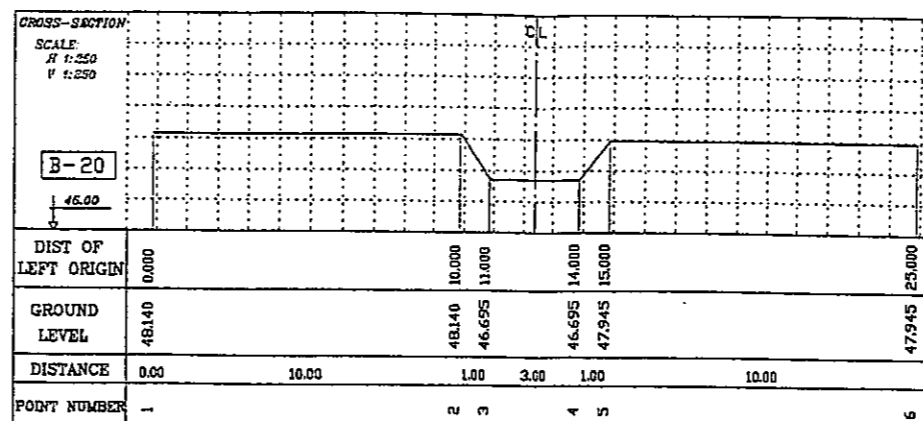
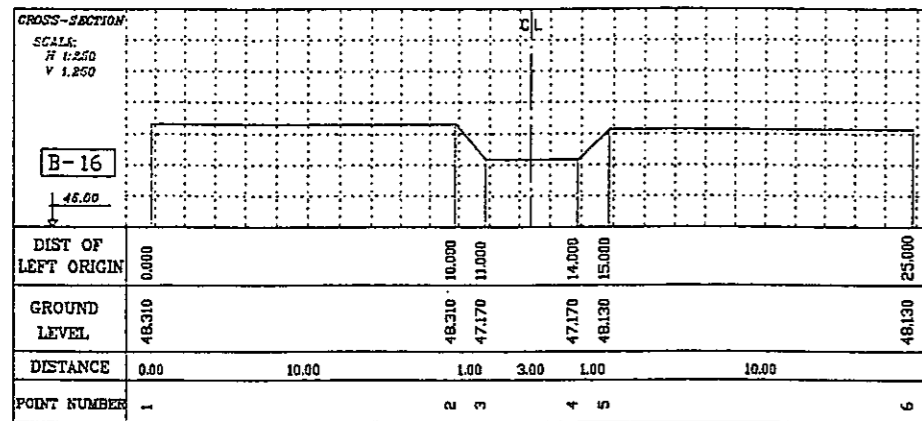

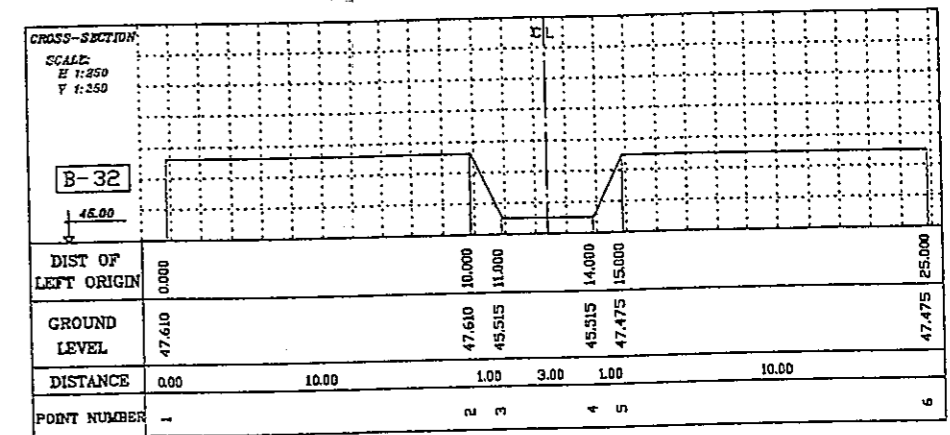
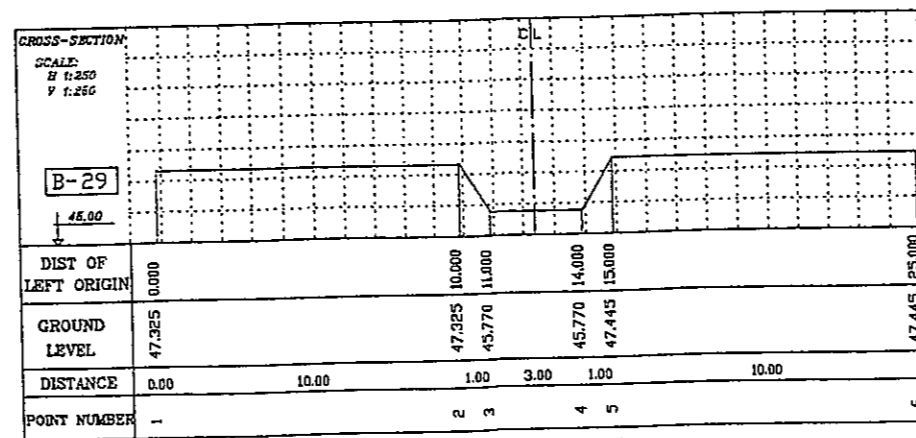
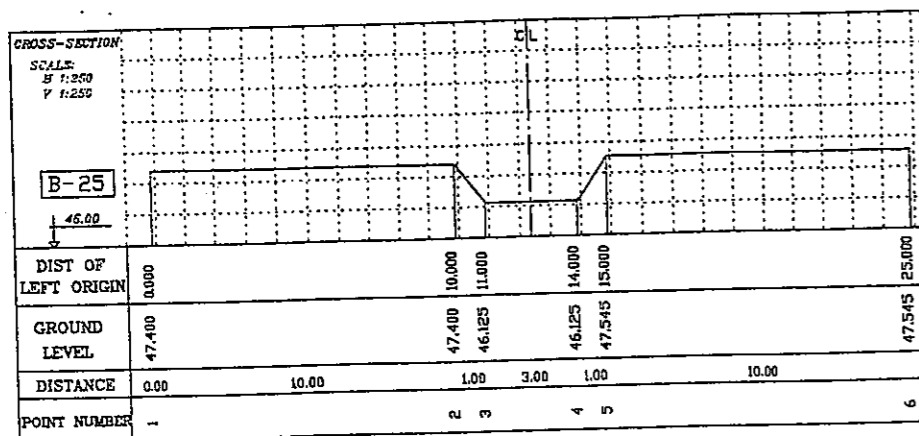
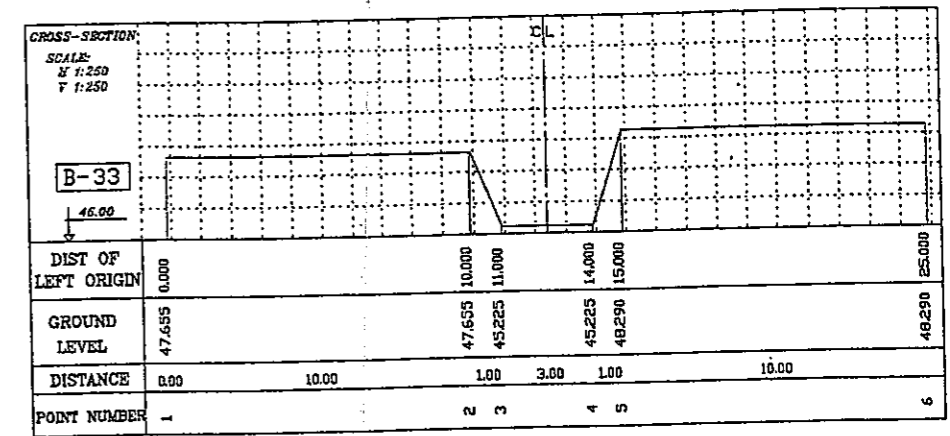
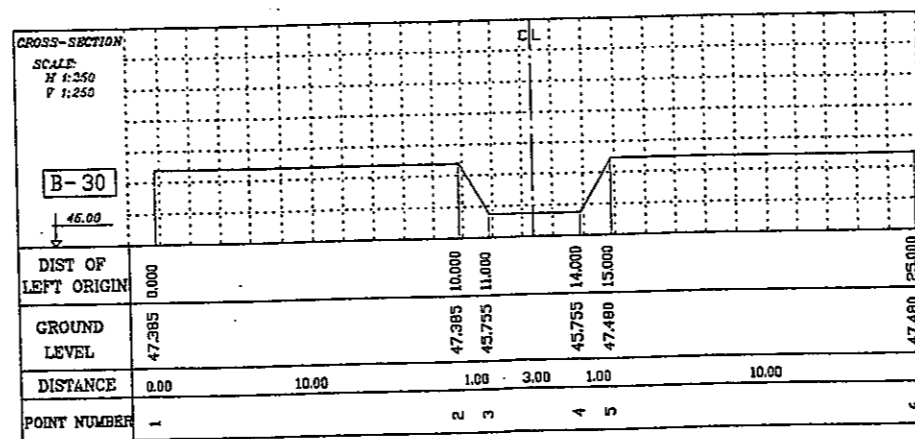
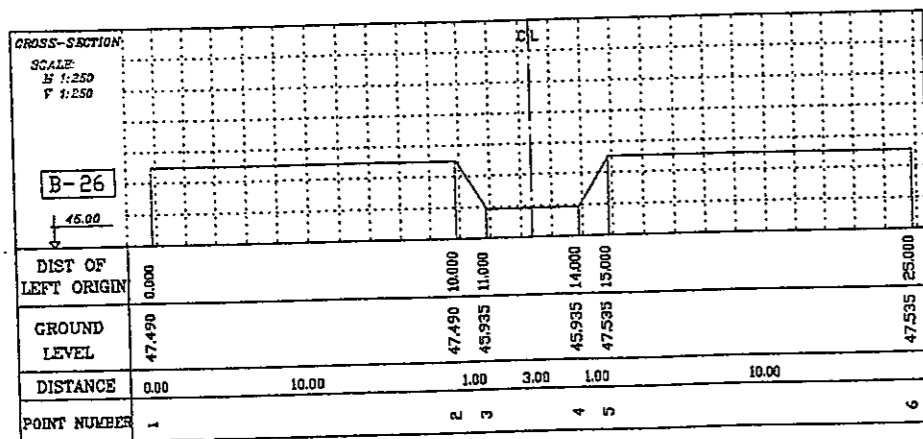
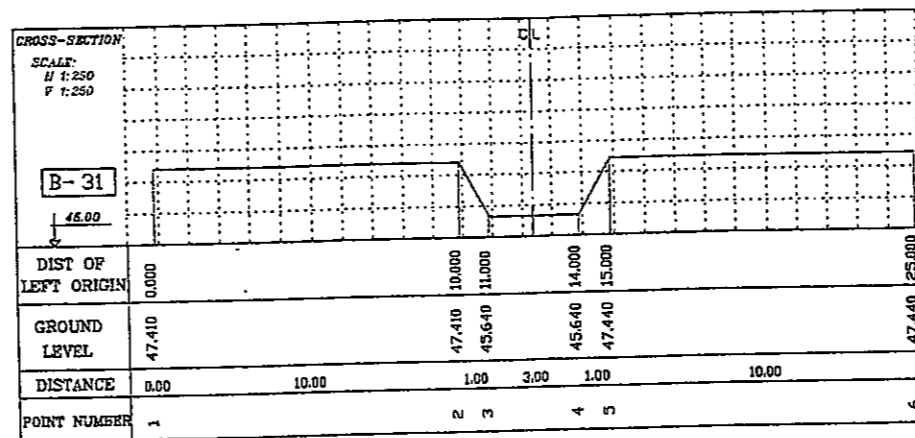
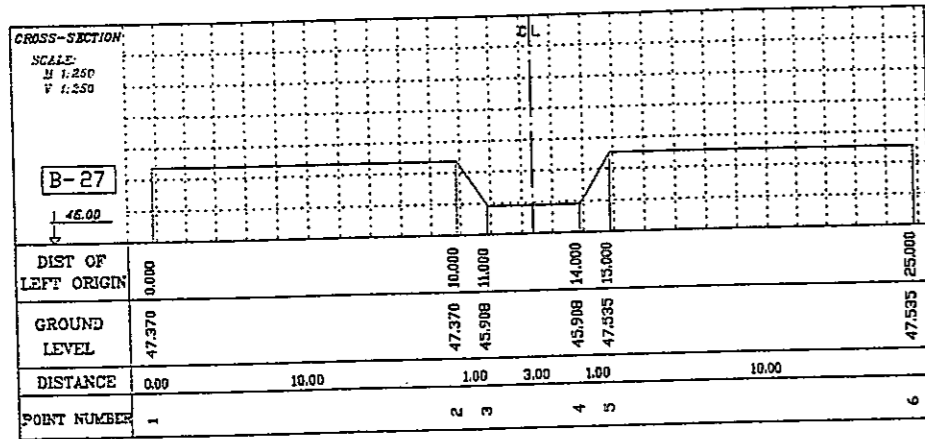
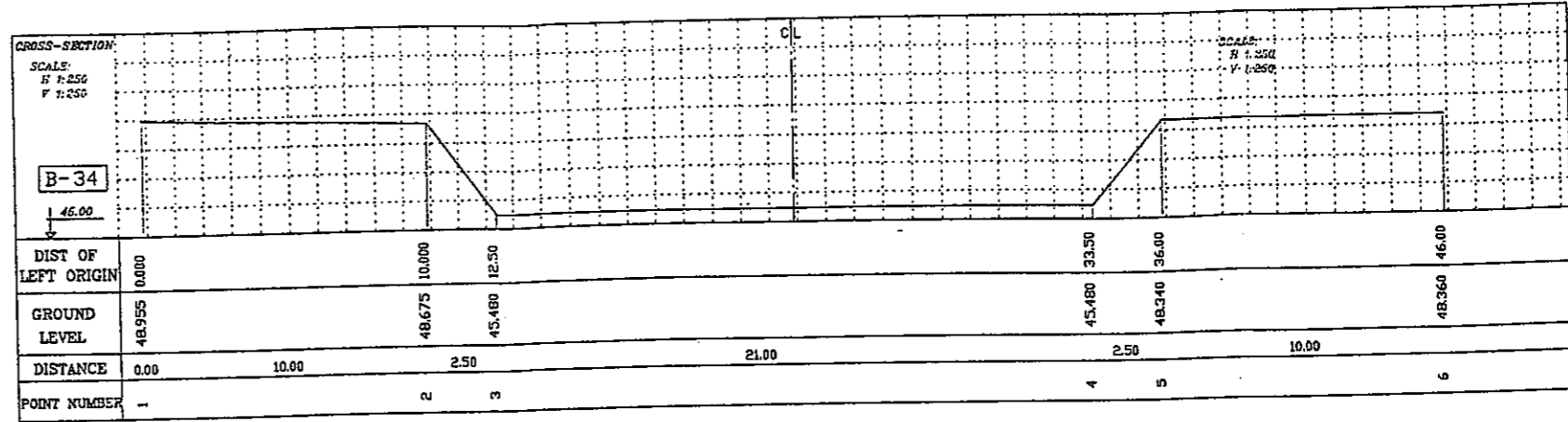
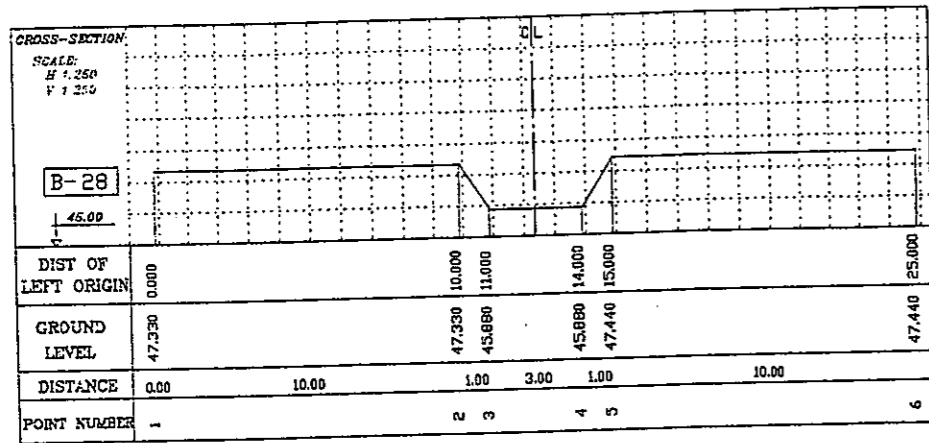

LONG-SECTION . A

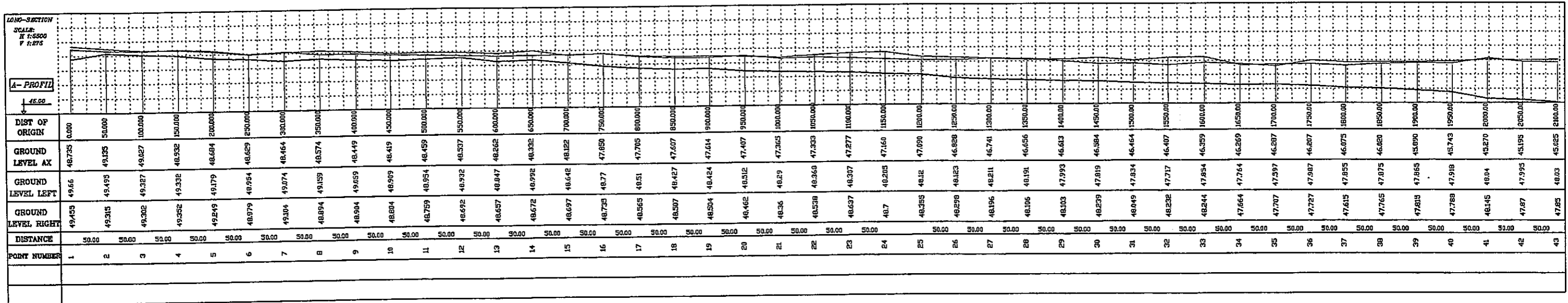

APPROVED	تصویب	CHECKED	کنترل	DESCRIPTION:	REV.
				عنوان نقشه : برو فیل طولی	SCALE:
CLIENT	تاریخ	امضا	تاریخ	امضا	تاریخ
	DATE	SIGNATURE	DATE	SIGNATURE	DATE
		MIRAEZ			
		نقشه بردار			
		SURVEYED BY			
		ترسیم			
		DRAWN BY			
		کنترل			
		CHECKED BY			
		تصویب			
		APPROVED			
				LONG-SECTION A	
				DWG. TITLE	
				DWG. No	

LONG-SECTION . B

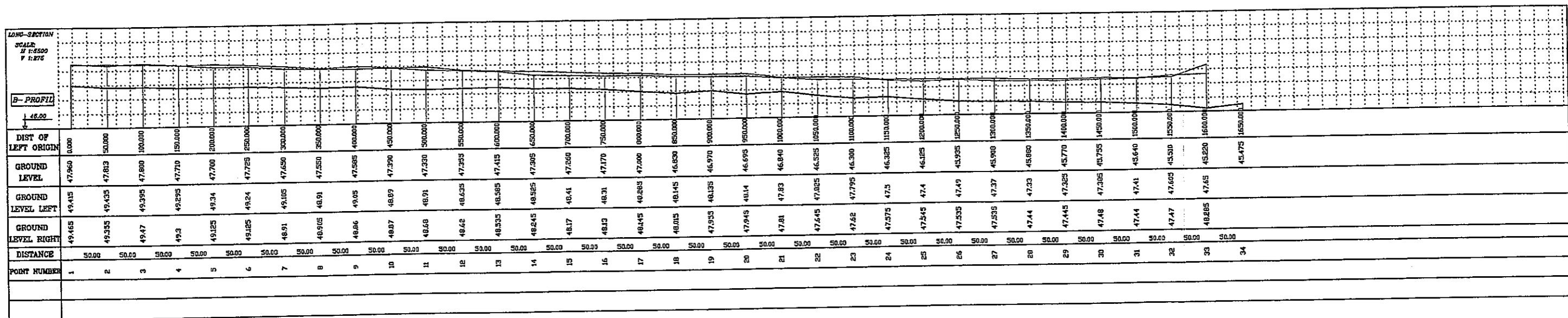

امضا APPROVED	تاریخ DATE	امضا CHECKED	تاریخ DATE	REV.
DESCRIPTION:				ار فرما:
CLIENT				
تاریخ DATE	امضا SIGNATURE	نقشه بردار SURVEYD BY		
	MIRAEZ	ترسیم DRAWN BY		
		کنترل CHECKED BY		
		تصویب APPROVED		
		عنوان نقشه : پروفیل طولی LONG-SECTION B		
		DWG. TITLE		
		شماره نقشه : UNIT:		
		DWG. No.		